

MARKS PUBLISHED FOR OPPOSITION

The following marks are published in compliance with section 12(a) of the Trademark Act of 1946. Applications for the registration of marks in more than one class have been filed as provided in section 30 of said act as amended by Public Law 772, 87th Congress, approved Oct. 9, 1962, 76 Stat. 769. Opposition under section 13 may be filed within thirty days of the date of this publication. See rules 2.101 to 2.105.

A separate fee of two hundred dollars for opposing each mark in each class must accompany the opposition.

SECTION 1.— INTERNATIONAL CLASSIFICATION

The short titles associated below with the international class numbers are terms designed merely for quick identification and are not an official part of the international classification. The full names of international classes are given in section 6.1 of the trademark rules of practice.

The designation "U.S. Cl." appearing in this section refers to the U.S. class in effect prior to Sep. 1, 1973 rather than the international class which applies to applications filed on or after that date. For adoption of international classification see notice in the OFFICIAL GAZETTE of Jun. 26, 1973 (911 O.G. TM 210).

Application in more than one class

SN 75-233,858. GLOBAL VISION COMMUNICATIONS, INC.,
KATONAH, NY. FILED 1-30-1997.

SN 75-375,295. PPL ELECTRIC UTILITIES CORPORATION,
ALLENTOWN, PA. FILED 10-17-1997.

PPL ENERGYPLUS

CLASS 35—ADVERTISING AND BUSINESS

FOR PROMOTING THE GOODS AND SERVICES OF OTHERS BY TELEVISION, RADIO AND PRINT ADVERTISING; BUSINESS MANAGEMENT, NAMELY OPERATION OF COGENERATION AND OTHER-NON-REGULATED ELECTRIC GENERATION FACILITIES FOR OTHERS; BUSINESS MANAGEMENT, NAMELY, OPERATION OF POWER GENERATION FACILITIES FOR OTHERS; ENERGY MARKETING SERVICES, NAMELY, PROVIDING TELEVISION, RADIO, AND PRINT ADVERTISING, DIRECT MAIL ADVERTISING, AND PUBLIC RELATIONS FOR OTHERS IN THE FIELD OF GENERATION AND TRANSPORTATION OF OIL, GAS, ELECTRICITY AND RELATED ENERGY COMMODITIES AND CONSULTATION PROVIDED TOGETHER THEREWITH; BILLING SERVICES; RETAIL STORE SERVICES IN THE FIELD OF SOFTWARE FOR UTILITY SYSTEMS; DISTRIBUTORSHIPS FEATURING POWER AND ITS BY-PRODUCTS GENERATED FROM COGENERATION, DIESEL FUEL, NATURAL GAS, OIL, NATURAL GAS LIQUIDS, LIQUEFIED PETROLEUM GAS, COAL AND RELATED ENERGY SOURCES; DISTRIBUTORSHIPS IN THE FIELD OF NATURAL GAS, OIL, NATURAL GAS LIQUIDS, LIQUEFIED PETROLEUM GAS AND PETROCHEMICALS; PROCUREMENT SERVICES, NAMELY, BUYING NATURAL GAS, OIL, NATURAL GAS LIQUIDS, LIQUEFIED PETROLEUM GAS, AND PETROCHEMICALS FOR OTHERS; AND PROVIDING AND ARRANGING LONG-TERM SUPPLY CONTRACTS FOR THE DELIVERY OR TRANSMISSION OF NATURAL GAS, OIL, NATURAL GAS LIQUIDS, LIQUEFIED PETROLEUM GAS, PETROCHEMICALS AND/OR REFINED PETROLEUM PRODUCTS (U.S. CLS. 100, 101 AND 102).



NO CLAIM IS MADE TO THE EXCLUSIVE RIGHT TO USE "COMMUNICATIONS INC.", APART FROM THE MARK AS SHOWN.

THE LINING INDICATES THE COLOR BLUE AND IS NOT A FEATURE OF THE MARK.

CLASS 35—ADVERTISING AND BUSINESS

FOR BUSINESS MANAGEMENT CONSULTING (U.S. CLS. 100, 101 AND 102).

FIRST USE 7-16-1993; IN COMMERCE 7-20-1993.

CLASS 42—SCIENTIFIC, COMPUTER AND LEGAL SERVICES

FOR GRAPHIC ART DESIGN SERVICES AND CUSTOM WRITING OF MARKETING BROCHURES, NEWSLETTERS, INTERACTIVE PROGRAMS AND GLOBAL COMPUTER NETWORK WEBSITES (U.S. CLS. 100 AND 101).

FIRST USE 7-16-1993; IN COMMERCE 7-20-1993.
DAVID ELTON, EXAMINING ATTORNEY

CLASS 36—INSURANCE AND FINANCIAL

FOR PROVIDING ENERGY EFFICIENCY LOANS; PROVIDING EXTENDED WARRANTIES ON APPLIANCES; AND PROVIDING BROKERAGE SERVICES WITH RESPECT TO OIL, GAS, ELECTRICITY AND RELATED ENERGY COMMODITIES (U.S. CLS. 100, 101 AND 102).

CLASS 42—SCIENTIFIC, COMPUTER AND LEGAL SERVICES

FOR ENGINEERING AND CONSULTING SERVICES IN THE AREAS OF ELECTRIC TECHNOLOGY, PRODUCT DESIGN, AND THE ENVIRONMENT; TESTING SERVICES, NAMELY, NUCLEAR DOSIMETRY TESTS, COAL ANALYSIS, ENVIRONMENTAL TESTS, RUBBER GLOVE TESTS, AND EQUIPMENT TESTS; WASTEWATER MANAGEMENT; AND ENGINEERING SERVICES IN THE FIELD OF OIL AND NATURAL GAS EXTRACTION (U.S. CLS. 100 AND 101).

CATHERINE FAINT, EXAMINING ATTORNEY

SN 75-390,923. YALETOWN TECHNOLOGY GROUP INC, VANCOUVER, BRITISH COLUMBIA V6B 2W9, CANADA, FILED 11-17-1997.

YALETOWN TECHNOLOGY

PRIORITY CLAIMED UNDER SEC. 44(D) ON CANADA APPLICATION NO. 854,393, FILED 8-25-1997, REG. NO. TMA530942, DATED 8-9-2000, EXPIRES 8-9-2015.

NO CLAIM IS MADE TO THE EXCLUSIVE RIGHT TO USE "TECHNOLOGY", APART FROM THE MARK AS SHOWN.

CLASS 9—ELECTRICAL AND SCIENTIFIC APPARATUS

FOR COMPUTER SOFTWARE FOR USE IN INPUTTING, EDITING, MAINTAINING, INDEXING, SEARCHING, RETRIEVING, EXTRACTING, TRANSFORMING AND TRANSMITTING DATABASE INFORMATION, AND PRINTED MATERIALS RELATED TO THE USE OF SOFTWARE, ALL SOLD AS A UNIT (U.S. CLS. 21, 23, 26, 36 AND 38).

CLASS 35—ADVERTISING AND BUSINESS

FOR ON-LINE RETAIL STORE SERVICES FEATURING COMPUTER SOFTWARE FOR USE IN DATABASE MANAGEMENT, DECISION SUPPORT SYSTEMS AND DOCUMENT MANAGEMENT (U.S. CLS. 100, 101 AND 102).

CLASS 42—SCIENTIFIC, COMPUTER AND LEGAL SERVICES

FOR CONSULTATION SERVICES IN THE FIELDS OF DECISION SUPPORT SYSTEM DESIGN, IMPLEMENTATION AND DEVELOPMENT, CUSTOM SOFTWARE DEVELOPMENT AND DOCUMENT MANAGEMENT SYSTEMS (U.S. CLS. 100 AND 101).

KATHERINE STOIDES, EXAMINING ATTORNEY

SN 75-481,668. SAGA LEISURE LIMITED, FOLKESTONE, KENT, ENGLAND, FILED 5-8-1998.

SAGA

OWNER OF UNITED KINGDOM REG. NO. 1431874, DATED 7-24-1992, EXPIRES 6-20-2007.

OWNER OF UNITED KINGDOM REG. NO. 1443793, DATED 2-10-1995, EXPIRES 10-10-2007.

OWNER OF U.S. REG. NO. 1,278,341 AND OTHERS.

CLASS 5—PHARMACEUTICALS

FOR VITAMIN AND DIETARY SUPPLEMENTS; MEDICATED CONFECTIONERY, NAMELY COUGH DROPS AND LOZENGES; DIETARY FOOD PREPARATIONS, NAMELY DAIRY AND NON-DAIRY MEAL REPLACEMENT DRINKS (U.S. CLS. 6, 18, 44, 46, 51 AND 52).

CLASS 9—ELECTRICAL AND SCIENTIFIC APPARATUS

FOR FIRE ALARMS; BURGLAR ALARMS AND PERSONAL SECURITY ALARMS; PRE-RECORDED VIDEO TAPES, AND RECORDS, ALL FEATURING SUBJECT MATTER IN THE NATURE OF MUSIC, HEALTH AND FITNESS OF INTEREST TO INDIVIDUALS OVER THE AGE OF 50; BUT NOT INCLUDING THE AFORESAID GOODS RELATING TO AMUSEMENT APPARATUS (U.S. CLS. 21, 23, 26, 36 AND 38).

CLASS 29—MEATS AND PROCESSED FOODS

FOR PREPARED MEALS CONSISTING OF MEAT, POULTRY, DRIED AND COOKED FRUITS AND VEGETABLES; JELLIES, JAMS; FRUIT PRESERVES (U.S. CL. 46).

CLASS 30—STAPLE FOODS

FOR COFFEE, TEA, COCOA; BREAKFAST CEREALS AND PREPARED MEALS MADE FROM CEREALS; BREAD; PASTRIES; CONFECTIONERY PRODUCTS, NAMELY CANDY AND GUM (U.S. CL. 46).

CLASS 35—ADVERTISING AND BUSINESS

FOR ADVERTISING SERVICES, NAMELY, PROVIDING ADVERTISING SPACE IN A PERIODICAL; MARKET RESEARCH; CONDUCTING MARKETING STUDIES; DIRECT MAIL ADVERTISING; COMPILATION OF MAILING LISTS; BUSINESS MANAGEMENT CONSULTATION; EMPLOYMENT AGENCY SERVICES; PERSONNEL MANAGEMENT CONSULTATION; PROVIDING RADIO AND TELEVISION ADVERTISING FOR OTHERS; ORGANIZING OF BUSINESS CONFERENCES, CONVENTIONS, AND EXHIBITIONS OF INTEREST FOR INDIVIDUALS OVER THE AGE OF 50; ORGANIZING TRADE SHOWS (U.S. CLS. 100, 101 AND 102).

CLASS 36—INSURANCE AND FINANCIAL

FOR FINANCIAL SERVICES, NAMELY INSURANCE UNDERWRITING IN THE FIELD OF LIFE, HEALTH, ACCIDENT AND FIRE INSURANCE, INSURANCE BROKERAGE SERVICES, BANKING SERVICES, MUTUAL FUND INVESTMENT SERVICES, PENSION MANAGEMENT AND ADVISORY SERVICES, CREDIT AND DEBIT CARD SERVICES, DISCOUNT CARD SERVICES, INVESTMENT ADVISORY AND SECURITIES BROKERAGE SERVICES, MORTGAGE BROKERAGE AND LOAN SERVICES, AND CURRENCY EXCHANGE SERVICES (U.S. CLS. 100, 101 AND 102).

WANDA KAY PRICE, EXAMINING ATTORNEY

SN 75-522,623. HONDA GIKEN KOGYO KABUSHIKI KAISHA (HONDA MOTOR CO., LTD.), MINATO-KU, TOKYO 107, JAPAN, FILED 7-21-1998.

HONDALINE

OWNER OF U.S. REG. NO. 826,779.

CLASS 16—PAPER GOODS AND PRINTED MATTER

FOR PRINTED MATERIALS, NAMELY, CATALOGS, PAMPHLETS AND BROCHURES FEATURING PRODUCTS ASSOCIATED WITH MOTORCYCLES, NAMELY, HELMETS, APPAREL, CAPS, GLOVES, MOTORCYCLE PARTS, RADIOS, ENGINE OIL, COOLANTS, ENGINE FLUIDS, CLEANERS, FINISHERS, POLISHERS, TIRE SEALANT AND BATTERIES (U.S. CLS. 2, 5, 22, 23, 29, 37, 38 AND 50).

FIRST USE 0-0-1973; IN COMMERCE 0-0-1973.

CLASS 35—ADVERTISING AND BUSINESS

FOR DISTRIBUTION OF PUBLICITY MATERIALS IN THE NATURE OF CATALOGS, PAMPHLETS AND BROCHURES DISTRIBUTED THROUGH THE MAIL AND THROUGH DEALERS FEATURING PRODUCTS ASSOCIATED WITH MOTORCYCLES, NAMELY, HELMETS, APPAREL, CAPS, GLOVES, MOTORCYCLE PARTS, RADIOS, ENGINE OIL, COOLANTS, ENGINE FLUIDS, CLEANERS, FINISHERS, POLISHERS, TIRE SEALANT AND BATTERIES (U.S. CLS. 100, 101 AND 102).

FIRST USE 0-0-1973; IN COMMERCE 0-0-1973.
VIVIAN MICZNIK FIRST, EXAMINING ATTORNEY

CLASS 44—MEDICAL, BEAUTY AND AGRICULTURAL SERVICES

FOR HEALTH SPA SERVICES FOR HEALTH AND WELLNESS OF THE BODY AND SPIRIT OFFERED AT A HEALTH RESORT, AND HEALTH SPA SERVICES, NAMELY, COSMETIC BODY CARE SERVICES (U.S. CLS. 100 AND 101).

FIRST USE 8-0-1996; IN COMMERCE 8-0-1996.
KATHERINE STOIDES, EXAMINING ATTORNEY

SN 75-545,601. TELLURIDE RESORT & SPA, L.P., DALLAS, TX. FILED 8-31-1998.

SN 75-545,605. TELLURIDE RESORT & SPA, L.P., DALLAS, TX. FILED 8-31-1998.

THE PEAKS

OWNER OF U.S. REG. NOS. 1,910,574 AND 1,915,720.

CLASS 35—ADVERTISING AND BUSINESS

FOR HOTEL AND RESORT MANAGEMENT SERVICES FOR OTHERS (U.S. CLS. 100, 101 AND 102).

FIRST USE 9-30-1993; IN COMMERCE 9-30-1993.

CLASS 36—INSURANCE AND FINANCIAL

FOR REAL ESTATE BROKERAGE SERVICES INVOLVING RESORT PROPERTIES; REAL ESTATE MANAGEMENT; REAL ESTATE BROKERAGE SERVICES INVOLVING REAL ESTATE TIME SHARING PROPERTIES (U.S. CLS. 100, 101 AND 102).

FIRST USE 9-30-1993; IN COMMERCE 9-30-1993.

CLASS 41—EDUCATION AND ENTERTAINMENT

FOR HEALTH AND FITNESS CLUB SERVICES; PHYSICAL FITNESS INSTRUCTION (U.S. CLS. 100, 101 AND 107).

FIRST USE 9-30-1993; IN COMMERCE 9-30-1993.

CLASS 43—HOTEL AND RESTAURANT SERVICES

FOR RESORT HOTELS; RESTAURANT SERVICES (U.S. CLS. 100 AND 101).

FIRST USE 9-30-1993; IN COMMERCE 9-30-1993.

CLASS 44—MEDICAL, BEAUTY AND AGRICULTURAL SERVICES

FOR HEALTH SPA SERVICES FOR HEALTH AND WELLNESS OF THE BODY AND SPIRIT OFFERED AT A HEALTH RESORT AND HEALTH SPA SERVICES, NAMELY, COSMETIC BODY CARE SERVICES (U.S. CLS. 100 AND 101).

FIRST USE 9-30-1993; IN COMMERCE 9-30-1993.
KATHERINE STOIDES, EXAMINING ATTORNEY

CLASS 35—ADVERTISING AND BUSINESS

FOR HOTEL AND RESORT MANAGEMENT SERVICES FOR OTHERS (U.S. CLS. 100, 101 AND 102).

FIRST USE 8-0-1996; IN COMMERCE 8-0-1996.

CLASS 41—EDUCATION AND ENTERTAINMENT

FOR HEALTH AND FITNESS CLUB SERVICES; PHYSICAL FITNESS INSTRUCTION (U.S. CLS. 100, 101 AND 107).

FIRST USE 8-0-1996; IN COMMERCE 8-0-1996.

CLASS 43—HOTEL AND RESTAURANT SERVICES

FOR RESORT HOTELS; RESTAURANT SERVICES (U.S. CLS. 100 AND 101).

FIRST USE 8-0-1996; IN COMMERCE 8-0-1996.



OWNER OF U.S. REG. NOS. 1,910,574 AND 1,915,720.
NO CLAIM IS MADE TO THE EXCLUSIVE RIGHT TO USE "RESORT & SPA", APART FROM THE MARK AS SHOWN.

SN 75-626,578. NICKRIS WORLD MOVIE CORPORATION, BEVERLY HILLS, CA. FILED 1-23-1999.

**"PRINCESS CHRISTINA, A
PORTRAIT OF GRACE &
DIGNITY & ART OF
COMMUNICATION, WITH
EXUBERANT ELEGANCE.**

THE NAME "PRINCESS CHRISTINA" IDENTIFIES A LIVING INDIVIDUAL WHOSE CONSENT IS OF RECORD.

CLASS 9—ELECTRICAL AND SCIENTIFIC APPARATUS

FOR AUDIO CASSETTES ON BEAUTY SECRETS, VIDEO CASSETTES ON BEAUTY SECRETS (U.S. CLS. 21, 23, 26, 36 AND 38).

FIRST USE 0-0-1967; IN COMMERCE 0-0-1988.

CLASS 14—JEWELRY

FOR WALL CLOCKS DEPICTING BEAUTY (U.S. CLS. 2, 27, 28 AND 50).

FIRST USE 0-0-1988; IN COMMERCE 0-0-1988.

CLASS 16—PAPER GOODS AND PRINTED MATTER

FOR MAGAZINES FOR BEAUTY SECRETS; NEWSLETTERS FOR BEAUTY SECRETS; PORTRAITS FOR BEAUTY; CALENDARS FOR BEAUTY (U.S. CLS. 2, 5, 22, 23, 29, 37, 38 AND 50).

FIRST USE 0-0-1988; IN COMMERCE 0-0-1988.

CLASS 21—HOUSEWARES AND GLASS

FOR COFFEE MUGS DEPICTING BEAUTY (U.S. CLS. 2, 13, 23, 29, 30, 33, 40 AND 50).

FIRST USE 0-0-1988; IN COMMERCE 0-0-1988.

CLASS 25—CLOTHING

FOR T-SHIRTS, AND JEANS, MEANING PANTS (U.S. CLS. 22 AND 39).

FIRST USE 0-0-1967; IN COMMERCE 0-0-1988.

CLASS 41—EDUCATION AND ENTERTAINMENT

FOR ENTERTAINMENT IN THE NATURE OF ONGOING RADIO PROGRAMS IN THE FIELD OF PROPER DEMEANOR, SPEAKING SKILLS, ATTIRE, AND BEAUTY SECRETS (U.S. CLS. 100, 101 AND 107).

FIRST USE 0-0-1988; IN COMMERCE 0-0-1988.

DAN VAVONESE, EXAMINING ATTORNEY

SN 75-682,770. CONDAT, COURBEVOIE, FRANCE, FILED 4-14-1999.

CONDAT

PRIORITY CLAIMED UNDER SEC. 44(D) ON FRANCE APPLICATION NO. 98/755694, FILED 10-22-1998, REG. NO. 98/755694, DATED 10-22-1998, EXPIRES 10-22-2008.

OWNER OF U.S. REG. NOS. 1,391,559 AND 1,394,838.

CLASS 16—PAPER GOODS AND PRINTED MATTER

FOR PAPER, NAMELY DRAWING PAPER, PAPER RIBBONS, PAPER SHEETS, PAPER FOR RECORDING MACHINES, PAPER FOR PHOTOGRAPHS, FILTER PAPER, TRACING PAPER FOR WRITING AND DRAWING; PRINTING SCRIPT, NAMELY NUMERALS AND LETTERS FOR PRINTING; PRINTING PRODUCTS, NAMELY PRINTING BLOCKS, PRINTING TYPES; ARTICLES FOR BOOK BINDING, NAMELY BOOKBINDING STRIPS, BOOKBINDING CLOTHS, BOOKBINDING CORDS; UNMOUNTED AND MOUNTED PHOTOGRAPHS; STATIONERY ITEMS, NAMELY WRITING AND DRAWING BOOKS, NOTE BOOKS, STATIONERY PADS, BLOTTERS, FILES, INKS, INDIA INK, PENCIL LEADS, PENCIL SHARPENERS, PENCILS, FOUNTAIN PENS, GLUE FOR STATIONERY, RUBBER ERASERS, ENVELOPES; CARDBOARD ARTICLES, NAMELY CARDS, COVERS, CARDBOARD TUBES, HAT BOXES MADE OF CARDBOARD, ENVELOPES MADE OF CARDBOARD; ARTIST'S MATERIALS, NAMELY DRAWING PADS, DRAWING SETS, DRAWING RULERS, DRAWING SQUARES, STENCIL PLATES, CANVAS FOR PAINTING, PAINT BOXES, CHARCOAL PENCILS, AQUARELLES, PASTELS, PAINTBRUSHES, PAINTERS' EASELS, ARTISTS' WATERCOLOR SAUCERS; OFFICE EQUIPMENT, NAMELY INKING PADS, ADHESIVE BANDS FOR STATIONERY, ADHESIVE TAPE DISPENSERS, TYPEWRITER RIBBONS, FILES, FOLDERS, THUMBSTACKS, CLIPS FOR OFFICES, ELASTIC BANDS FOR OFFICES, PERFORATORS, PAPER KNIVES; TEACHING AND INSTRUCTION EQUIPMENT, NAMELY SCHOOL SUPPLIES NAMELY, STATIONERY, BLACKBOARDS, PLACARDS OF PAPER AND CARDBOARD, ATLASES GEOGRAPHICAL MAPS; NEGATIVES, NAMELY PLATES AND FILMS WHICH CARRY A PICTURE; PUBLICATIONS, NAMELY MAGAZINES, PERIODICALS, PAMPHLETS, BOOKLETS AND PROSPECTUSES IN THE FIELDS OF PRODUCTION AND DISTRIBUTION OF PAPER AND STATIONERY; AND BOOKS, CATALOGUES AND NEWSPAPERS IN THE FIELDS OF PRODUCTION AND DISTRIBUTION OF PAPER AND STATIONERY (U.S. CLS. 2, 5, 22, 23, 29, 37, 38 AND 50).

CLASS 38—COMMUNICATION

FOR PROVIDING TELECOMMUNICATION CONNECTIONS TO A GLOBAL COMPUTER NETWORK; TELECOMMUNICATION SERVICES, NAMELY TRANSMISSION OF INFORMATION, DATA, MESSAGES AND PICTURES BY TELEPHONE, FAX, COMPUTER, ELECTRONIC MAIL, COMMUTER MAIL, MOBILE TELEPHONES AND A GLOBAL COMPUTER NETWORK; AND TELECOMMUNICATIONS GATEWAY SERVICES (U.S. CLS. 100, 101 AND 104).

CLASS 41—EDUCATION AND ENTERTAINMENT

FOR PUBLICATION OF BOOKS, REVIEWS, NEWSPAPERS AND BROCHURES; BOOK LENDING SERVICES; ORGANIZING AND CONDUCTING SYMPOSIUMS, CONFERENCES AND CONGRESSES IN THE FIELDS OF PRODUCTION AND DISTRIBUTION OF PAPER AND STATIONERY; ORGANIZING AND CONDUCTING CULTURAL AND EDUCATIONAL EXHIBITIONS (U.S. CLS. 100, 101 AND 107).

CLASS 42—SCIENTIFIC, COMPUTER AND LEGAL SERVICES

FOR PROVIDING SCIENTIFIC AND INDUSTRIAL RESEARCH IN THE FIELDS OF PRODUCTION AND DISTRIBUTION OF PAPER AND STATIONERY; GRAPHIC ART DESIGN SERVICES; INDUSTRIAL DRAWING SERVICES; OFFSET PRINTING SERVICES; LITHOGRAPHIC PRINTING SERVICES; PRINTING SERVICES; COMPUTER PROGRAMMING FOR OTHERS; DESIGNING COMPUTER SOFTWARE FOR OTHERS; ENGINEERING SERVICES (U.S. CLS. 100 AND 101).

DOMINICK J. SALEMI, EXAMINING ATTORNEY

SN 75-687,092. FOSTER POULTRY FARMS, DBA FOSTER FARMS, LIVINGSTON, CA. FILED 4-20-1999.

SN 75-790,720. QUEST INTERNATIONAL B.V., 1411 GP NAARDEN, NETHERLANDS, FILED 9-1-1999.

FRESH & EASY

NO CLAIM IS MADE TO THE EXCLUSIVE RIGHT TO USE "FRESH", APART FROM THE MARK AS SHOWN.

CLASS 29—MEATS AND PROCESSED FOODS

FOR PACKAGED REFRIGERATED MEALS CONSISTING OF POULTRY AND A SEPARATE SAUCE SOLD AS A UNIT (U.S. CL. 46).
FIRST USE 10-1-1995; IN COMMERCE 11-1-1995.

CLASS 30—STAPLE FOODS

FOR SAUCE, PACKAGED AND SOLD AS A UNIT WITH POULTRY (U.S. CL. 46).
FIRST USE 10-1-1995; IN COMMERCE 11-1-1995.
SCOTT OSLICK, EXAMINING ATTORNEY



OWNER OF BENELUX REG. NO. 438802, DATED 11-19-1987, EXPIRES 11-19-2007.

OWNER OF U.S. REG. NOS. 2,689,644, 2,733,625 AND OTHERS.

NO CLAIM IS MADE TO THE EXCLUSIVE RIGHT TO USE "INTERNATIONAL", APART FROM THE MARK AS SHOWN.

SN 75-787,071. CITIZEN TOKEI KABUSHIKI KAISHA, TA CITIZEN WATCH CO, LTD., TOKYO, JAPAN, FILED 8-27-1999.

CITIZEN

OWNER OF U.S. REG. NOS. 803,079 AND 1,309,811.

CLASS 9—ELECTRICAL AND SCIENTIFIC APPARATUS

FOR COMPUTER SOFTWARE FOR USE IN THE MAINTENANCE, DIAGNOSIS, AND REPAIR OF MACHINE TOOLS AND NUMERICALLY CONTROLLED MACHINE TOOLS (U.S. CLS. 21, 23, 26, 36 AND 38).

CLASS 42—SCIENTIFIC, COMPUTER AND LEGAL SERVICES

FOR COMPUTER DIAGNOSTIC SERVICES, LEASING ACCESS TIME TO A COMPUTER DATABASE, UPDATING OF COMPUTER SOFTWARE, COMPUTER SOFTWARE DESIGN FOR OTHERS, REMOTE MONITORING OF COMPUTER SYSTEMS, REMOTE DIAGNOSIS OF COMPUTER SYSTEMS, ALL RELATING TO MACHINING OPERATIONS OF NUMERICALLY CONTROLLED MACHINE TOOLS; RENTAL OF COMPUTER SOFTWARE CONCERNING MACHINING OPERATIONS; COMPUTER SERVICES, NAMELY, PROVIDING TEMPORARY USE OF ON-LINE NON-DOWNLOADABLE SOFTWARE FOR USE IN THE MAINTENANCE, DIAGNOSIS AND REPAIR OF MACHINE TOOLS AND NUMERICALLY CONTROLLED MACHINES; COMPUTER SERVICES, NAMELY PROVIDING REMOTE ACCESS TO A DATABASE OF INFORMATION ON THE MACHINING OPERATIONS OF MACHINE TOOLS AND NUMERICALLY CONTROLLED MACHINE TOOLS (U.S. CLS. 100 AND 101).

CHARLES JOYNER, EXAMINING ATTORNEY

CLASS 1—CHEMICALS

FOR CHEMICALS FOR USE IN THE MANUFACTURE AND PRESERVATION OF FOODS; CHEMICAL PREPARATIONS ALL BEING ARTIFICIAL SWEETENERS; EMULSIFIERS FOR FOODS; CHEMICALS FOR USE IN THE FERMENTING OF ALCOHOLIC AND NON-ALCOHOLIC BEVERAGES; SACCHARIN; DISPERSING, STABILIZING, BLEACHING AND WETTING AGENTS FOR INDUSTRIAL USE, NAMELY, FOR USE IN THE MANUFACTURE OF COSMETICS; CHEMICAL PREPARATIONS FOR USE IN THE MANUFACTURE OF PERFUMES; CHEMICAL PROTEINS AND CULTURES FOR USE IN THE MANUFACTURE OF FOODS, CHEMICAL ENZYMES FOR USE IN THE MANUFACTURE OF FOODS AND CHEMICALS FOR USE IN THE FORMULATION OF FRAGRANCES, PERFUMES AND ESSENTIAL OILS; OILS FOR USE IN THE PRESERVATION OF FOODS; GELATINE FOR INDUSTRIAL PURPOSES (U.S. CLS. 1, 5, 6, 10, 26 AND 46).

CLASS 2—PAINTS

FOR FOOD COLORINGS FOR DOMESTIC USE AND FOR USE IN THE MANUFACTURE OF FOODS (U.S. CLS. 6, 11 AND 16).

CLASS 3—COSMETICS AND CLEANING PREPARATIONS

FOR DETERGENTS FOR INDUSTRIAL USE; ETHEREAL ESSENCES AND OILS FOR USE IN THE MANUFACTURE OF PERFUME; FLAVORINGS FOR BEVERAGES ALL BEING ESSENTIAL OILS; COSMETIC AND TOILET PREPARATIONS, NAMELY, SHAMPOOS, CONDITIONERS AND SKIN TONER; PERFUMES ESSENTIAL OILS FOR USE IN THE MANUFACTURE OF COSMETICS; PERFUMES AND ESSENTIAL OILS FOR PERSONAL USE; ETHEREAL ESSENCES FOR USE IN IMPARTING FLAVORING TO FOODS (U.S. CLS. 1, 4, 6, 50, 51 AND 52).

CLASS 29—MEATS AND PROCESSED FOODS

FOR ENZYMES FOR INDUSTRIAL PURPOSES, NAMELY, FOR USE AS A FOOD FILLER; FATTY ACIDS FOR USE AS A FOOD FILLER; UNFLAVORED AND UNSWEETENED GELATINS FOR INDUSTRIAL PURPOSES; NAMELY FOR USE IN THE MANUFACTURE OF FOODS (U.S. CL. 46).

CLASS 30—STAPLE FOODS

FOR FLAVORINGS FOR FOODS; FLAVORED AND SWEETENED GELATIN FOR INDUSTRIAL PURPOSES, NAMELY, FOR USE IN THE MANUFACTURE OF FOOD; FLAVORINGS FOR FOODS AND BEVERAGES OTHER THAN ESSENTIAL OILS; GLUCOSE AND GLUTEN FOR FOODS; MALT EXTRACT FOR FOOD; STARCH FOR FOOD (U.S. CL. 46).

CLASS 32—LIGHT BEVERAGES

FOR PREPARATIONS FOR MAKING BEVERAGES, NAMELY, SYRUPS FOR MAKING BEVERAGES; POWDERS AND PASTILLES FOR MAKING EFFERVESCENT BEVERAGES (U.S. CLS. 45, 46 AND 48).
BRIAN BROWN, EXAMINING ATTORNEY

SN 75-867,075. HONDA GIKEN KOGYO KABUSHIKI KAISHA (HONDA MOTOR CO., LTD.), MINATO-KU, TOKYO 107, JAPAN, FILED 12-8-1999.

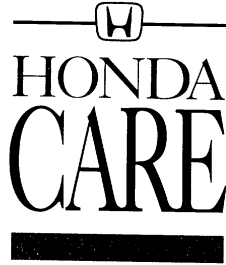

OWNER OF U.S. REG. NOS. 2,184,359, 2,229,290 AND OTHERS.

NO CLAIM IS MADE TO THE EXCLUSIVE RIGHT TO USE "CARE", APART FROM THE MARK AS SHOWN.

THE MARK CONSISTS, IN PART, OF A STYLIZED DRAWING OF THE LETTER H.

CLASS 16—PAPER GOODS AND PRINTED MATTER

FOR PRINTED FORMS, NAMELY VEHICLE SERVICE CONTRACTS, VEHICLE SERVICE PROGRAM APPLICATION FORMS, PAYMENT PLAN INSTRUCTION FORMS, CUSTOMER INFORMATION FORMS, TRANSFER OF CONTRACT REQUEST FORMS, CANCELLATION REQUEST FORMS, MATERIAL ORDER FORMS; STICKERS; BROCHURES, NAMELY, VEHICLE COMPREHENSIVE COVERAGE AND 24 HOUR ROADSIDE ASSISTANCE; REFERENCE GUIDES, NAMELY, VEHICLE SERVICE ADVISOR QUICK REFERENCE GUIDES, POSTCARDS, DESKTOP MATS; INFORMATION CARDS, NAMELY ROADSIDE ASSISTANCE CUSTOMER PERSPECTIVE CARDS; CAR DOOR HANG SIGNS (U.S. CLS. 2, 5, 22, 23, 29, 37, 38 AND 50).
FIRST USE 4-0-1994; IN COMMERCE 4-0-1994.

CLASS 36—INSURANCE AND FINANCIAL

FOR PROVIDING EXTENDED WARRANTY CONTRACTS FOR VEHICLE SERVICE PROGRAMS (U.S. CLS. 100, 101 AND 102).

FIRST USE 4-0-1994; IN COMMERCE 4-0-1994.

CLASS 37—CONSTRUCTION AND REPAIR

FOR REPAIR AND MAINTENANCE SERVICES FOR VEHICLES; EMERGENCY ROADSIDE ASSISTANCE SERVICES (U.S. CLS. 100, 103 AND 106).

FIRST USE 4-0-1994; IN COMMERCE 4-0-1994.

CLASS 38—COMMUNICATION

FOR MESSAGING SERVICES, NAMELY, URGENT MESSAGE RELAY BY TELEPHONE (U.S. CLS. 100, 101 AND 104).

FIRST USE 4-0-1994; IN COMMERCE 4-0-1994.

CLASS 39—TRANSPORTATION AND STORAGE

FOR MOTOR VEHICLE CUSTOMER SERVICES, NAMELY COMPUTERIZED TOURING PACKAGES; EMERGENCY TOWING SERVICES FOR VEHICLES, TRAVEL PLANNING SERVICES (U.S. CLS. 100 AND 105).

FIRST USE 4-0-1994; IN COMMERCE 4-0-1994.

CLASS 42—SCIENTIFIC, COMPUTER AND LEGAL SERVICES

FOR CONSULTATION SERVICES IN THE AREA OF VEHICLE SERVICE PROGRAMS; MOTOR VEHICLE CUSTOMER SERVICES, NAMELY PROVIDING 24-HOUR WEATHER INFORMATION (U.S. CLS. 100 AND 101).

FIRST USE 4-0-1994; IN COMMERCE 4-0-1994.

JULIE WATSON, EXAMINING ATTORNEY

SN 75-874,874. HONDA GIKEN KOGYO KABUSHIKI KAISHA (HONDA MOTOR CO., LTD.), MINATO-KU, TOKYO 107, JAPAN, FILED 12-17-1999.

HONDA CARE

OWNER OF U.S. REG. NOS. 2,184,359, 2,229,290 AND OTHERS.

NO CLAIM IS MADE TO THE EXCLUSIVE RIGHT TO USE "CARE", APART FROM THE MARK AS SHOWN.

CLASS 16—PAPER GOODS AND PRINTED MATTER

FOR PRINTED FORMS, NAMELY VEHICLE SERVICE CONTRACTS, VEHICLE SERVICE PROGRAM APPLICATION FORMS, PAYMENT PLAN INSTRUCTION FORMS, CUSTOMER INFORMATION FORMS, TRANSFER OF CONTRACT REQUEST FORMS, CANCELLATION REQUEST FORMS, MATERIAL ORDER FORMS; STICKERS; BROCHURES, NAMELY, VEHICLE COMPREHENSIVE COVERAGE AND 24 HOUR ROADSIDE ASSISTANCE; REFERENCE GUIDES, NAMELY, VEHICLE SERVICE ADVISOR QUICK REFERENCE GUIDES, POSTCARDS, DESKTOP MATS; INFORMATION CARDS, NAMELY ROADSIDE ASSISTANCE CUSTOMER PERSPECTIVE CARDS; CAR DOOR HANG SIGNS (U.S. CLS. 2, 5, 22, 23, 29, 37, 38 AND 50).
FIRST USE 4-0-1994; IN COMMERCE 4-0-1994.

CLASS 36—INSURANCE AND FINANCIAL

FOR PROVIDING EXTENDED WARRANTY CONTRACTS FOR VEHICLE SERVICE PROGRAMS (U.S. CLS. 100, 101 AND 102).

FIRST USE 4-0-1994; IN COMMERCE 4-0-1994.

CLASS 37—CONSTRUCTION AND REPAIR

FOR REPAIR AND MAINTENANCE SERVICES FOR VEHICLE; EMERGENCY ROADSIDE ASSISTANCE SERVICES (U.S. CLS. 100, 103 AND 106).

FIRST USE 4-0-1994; IN COMMERCE 4-0-1994.

CLASS 38—COMMUNICATION

FOR MESSAGING SERVICES, NAMELY, URGENT MESSAGE RELAY BY TELEPHONE (U.S. CLS. 100, 101 AND 104).

FIRST USE 4-0-1994; IN COMMERCE 4-0-1994.

CLASS 39—TRANSPORTATION AND STORAGE

FOR MOTOR VEHICLE CUSTOMER SERVICES, NAMELY COMPUTERIZED TOURING PACKAGES; EMERGENCY TOWING SERVICES FOR VEHICLES; TRAVEL PLANNING SERVICES (U.S. CLS. 100 AND 105).

FIRST USE 4-0-1994; IN COMMERCE 4-0-1994.

CLASS 42—SCIENTIFIC, COMPUTER AND LEGAL SERVICES

FOR CONSULTATION SERVICES IN THE AREA OF VEHICLE SERVICE PROGRAMS; MOTOR VEHICLE CUSTOMER SERVICES, NAMELY PROVIDING 24-HOUR WEATHER INFORMATION (U.S. CLS. 100 AND 101).

FIRST USE 4-0-1994; IN COMMERCE 4-0-1994.
JULIE WATSON, EXAMINING ATTORNEY

SN 75-877,882. ROSETTA INPHARMATICS LLC, KIRKLAND, WA. FILED 12-21-1999.

ROSETTA
INPHARMATICS

CLASS 9—ELECTRICAL AND SCIENTIFIC APPARATUS

FOR COMPUTER SOFTWARE CONTAINING AN ARCHITECTURE TO ACCESS A DATABASE FOR USE IN RESEARCH AND DRUG DISCOVERY; COMPUTER SOFTWARE FOR STORING, RETRIEVING AND ANALYZING GENE EXPRESSION DATA FOR USE IN RESEARCH AND DRUG DISCOVERY (U.S. CLS. 21, 23, 26, 36 AND 38).

FIRST USE 11-15-1999; IN COMMERCE 11-15-1999.

CLASS 16—PAPER GOODS AND PRINTED MATTER

FOR MANUALS FOR USE WITH RESEARCH, DATABASE, AND DRUG DISCOVERY SOFTWARE (U.S. CLS. 2, 5, 22, 23, 29, 37, 38 AND 50).

FIRST USE 11-15-1999; IN COMMERCE 11-15-1999.

CLASS 42—SCIENTIFIC, COMPUTER AND LEGAL SERVICES

FOR RESEARCH AND SCIENTIFIC ANALYSIS RELATING TO DRUG DISCOVERY AND DEVELOPMENT FOR OTHERS (U.S. CLS. 100 AND 101).

FIRST USE 11-15-1999; IN COMMERCE 11-15-1999.
KATHLEEN M. VANSTON, EXAMINING ATTORNEY

SN 75-924,852. KABUSHIKI KAISHA HITACHI SEISAKUSHO, DBA HITACHI, LTD., CHIYODA-KU, TOKYO, JAPAN, FILED 2-22-2000.

INSPIRE THE NEXT**CLASS 1—CHEMICALS**

FOR MANURES; FIRE EXTINGUISHING COMPOSITION; TEMPERING AND SOLDERING CHEMICALS FOR USE IN METALWORKING AND FOR USE IN THE MANUFACTURE OF SEMICONDUCTORS, ELECTRICAL PARTS, AND CONSUMER APPLIANCES; CHEMICAL SUBSTANCES FOR PRESERVING FOODSTUFFS; TANNING SUBSTANCES, NAMELY, TANNING CHEMICALS FOR USE IN THE MANUFACTURE OF LEATHER; ADHESIVES FOR USE IN THE MANUFACTURE OF SEMICONDUCTORS, ELECTRICAL PARTS, AND CONSUMER APPLIANCES; ABSORBING CARBONS FOR GENERAL INDUSTRIAL USE, CARBON DISULFIDE, CARBON FLUOROCHLORIDE, CARBON TETRACHLORIDE; CHEMICALS FOR USE IN THE MANUFACTURE OF SEMICONDUCTORS, ELECTRICAL PARTS, CONSUMER APPLIANCES, AND PHARMACEUTICALS; CHEMICALS FOR USE IN SCIENTIFIC RESEARCH, NAMELY, POLYAMIDES, CARBIDES, CERAMICS, ALUMINUM, AND MONOMERS; CHEMICALS FOR USE IN THE PHOTOGRAPHY INDUSTRY, NAMELY, SILANES, SILOXANES AND ORGANOSILICON COPOLYMERS; ACID ANHYDRIDE FOR USE IN THE MANUFACTURE OF EPOXY RESIN, POLYESTER RESIN AND ALKYD RESIN; DICYCLOPENTADIENE FOR USE IN THE MANUFACTURE OF UNSATURATED POLYESTER RESINS, PETROLEUM HYDROCARBON RESINS, ETHYLENE-PROPYLENE TERPOLYMERS, SYNTHETIC RESINS, PLASTICIZERS, ACCELERATORS, STABILIZERS AND FLAME RETARDANTS, ALL FOR USE IN MANUFACTURING PESTICIDES, HARDENERS AND DRYERS IN LINSEED AND SOYBEAN OIL, PAINTS, VARNISHES, METAL DERIVATIVES, ELASTOMERS, METALLOCENES, EPOXY RESINS, NORBORNENE, ADAMANTANE, GLUTARALDEHYDE, PERFUMES, HIGH QUALITY OPTICAL LENSES, FLAME RETARDANTS, MEDICINES, AND POLYCYCLOPENTADIENE; PACKED COLUMNS FOR USE IN THE MANUFACTURE OF ELECTRONICS, SEMICONDUCTORS, PHARMACEUTICALS, AND SCIENTIFIC RESEARCH; CERAMIC SEALS, AND CERAMIC BONDINGS FOR USE IN THE MANUFACTURE OF ELECTRONICS AND IN SCIENTIFIC RESEARCH; POLYSTYRENE BEADS FOR USE AS ASSAYS IN BIOLOGY AND GENETIC RESEARCH; POLYSTYRENE BEADS COATED WITH REAGENTS FOR USE IN BIOLOGY AND GENETICS RESEARCH (U.S. CLS. 1, 5, 6, 10, 26 AND 46).

CLASS 6—METAL GOODS

FOR COMMON METALS AND THEIR ALLOYS SOLD IN BULK; METAL BUILDING MATERIALS, NAMELY, GIRDERS, DOORS, AND WINDOW FRAMES; TRANSPORTABLE BUILDINGS OF METAL; METAL MATERIALS FOR RAILWAY TRACKS, NAMELY, RAILS AND BOLTS; NON-ELECTRIC CABLES AND WIRES OF COMMON METAL; IRONMONGERY AND SMALL ITEMS OF METAL HARDWARE, NAMELY, TACKS, NAILS, WINDOW CASEMENT BOLTS, WINDOW FASTENERS OF METAL, FURNITURE CASTERS OF METAL, NUTS OF METAL, AND SHIMS; PIPES AND TUBES OF METAL FOR USE IN THE MANUFACTURE OF SEMICONDUCTORS, ELECTRICAL PARTS, AND CONSUMER APPLIANCES; METAL SAFES; GOODS OF COMMON METAL, NAMELY, METAL ROPES; ORES, NAMELY, ZINC ORES, ANTIMONY ORES, URANIUM ORES, GOLD ORES, SILVER ORES, CHROME ORES, COBALT ORES, MERCURY ORES, TIN ORES, BISMUTH ORES, TUNGSTEN ORES, IRON ORES, COPPER ORES, THORIUM ORES, LEAD ORES, NICKEL ORES, MANGANESE ORES, MOLYBDENUM ORES, AND IRON PYRITES, SOLD IN BULK; SOFT FERRITE, UNWROUGHT COMMON METAL, AND SEMI-WROUGHT COMMON METAL, ALL FOR USE IN OPTICAL NETWORK COMMUNICATION HARDWARE, ANTENNAE, PORTABLE PHONES, MAGNET COMPASS SENSORS, INFORMATION TECHNOLOGY SENSORS, NOISE REDUCTION HARDWARE, POWER SUPPLIES, MAGNETS,

MOTORS, MOBILE TELEPHONES, PERSONAL DIGITAL ASSISTANTS, PAGERS, FLAT PANEL DISPLAYS, SEMI-CONDUCTORS, INTEGRATED CIRCUITS, AUTOMOBILES, FILTERS, PIPES, METAL MANUFACTURING ROLLS, PLASTIC MANUFACTURING ROLLS, MOLDS FOR PLASTIC AND METAL MANUFACTURING, AND STEEL BLADES; IRON, NICKEL, COBALT, CHROMIUM, MOLYBDENUM, ALUMINUM, SILVER, COPPER, TITANIUM, NIOBIUM, AND ZIRCONIUM ALLOYS; ALUMINUM ALLOY CASTING; ALUMINUM WIRE AND CABLE; BUS DUCTS AND TROLLEY BUS DUCTS; MAGNESIUM ALLOY CASTINGS, CHAINS, ROLLING BARS, PIPE FITTINGS; MALLEABLE CAST IRON FOR USE IN ELECTRONICS MANUFACTURING, CAR MANUFACTURING, AUTOMOTIVE COMPONENTS AND MATERIALS, PIPING AND INFRASTRUCTURE PRODUCTS, BUILDING CONSTRUCTION AND INDUSTRIAL BUILDING PLANT COMPONENT AND MATERIALS, ELECTRICAL POWER SUPPLY AND ELECTRICAL POWER SUPPLY COMPONENTS, AND AEROSPACE DEVICES; FORGING AND CAST STEEL FOR USE IN ELECTRONICS MANUFACTURING, CAR MANUFACTURING, AUTOMOTIVE COMPONENTS AND MATERIALS, PIPING AND INFRASTRUCTURE PRODUCTS, BUILDING CONSTRUCTION AND INDUSTRIAL BUILDING PLANT COMPONENT AND MATERIALS, ELECTRICAL POWER SUPPLY AND ELECTRICAL POWER SUPPLY COMPONENTS, AND AEROSPACE DEVICES; VALVES OF METAL, OTHER THAN PARTS OF MACHINES; TOOL STEEL; COPPER AND OXYGEN-FREE COPPER PRODUCTS, NAMELY, BIMETAL, COPPER TUBES, COPPER STRIPS, COPPER TAPE, AND COPPER BARS; ROPEWAYS OF METAL; METAL CLAD LAMINATE; COPPER CLAD LAMINATED SHEETS; MOLDING COMPOUNDS OF METAL FOR USE IN ELECTRONICS MANUFACTURING; METAL MOLDS FOR USE IN ELECTRONICS MANUFACTURING; METAL DIES FOR USE IN ELECTRONICS MANUFACTURING; METAL MOLDS AND DIES FOR USE IN CAR MANUFACTURING, AUTOMOTIVE COMPONENTS AND MATERIALS, PIPING AND INFRASTRUCTURE PRODUCTS, CONSTRUCTION AND PLANT MATERIALS, POWER SUPPLY AND POWER SUPPLY COMPONENTS, AND AEROSPACE DEVICES; SINTERED METAL PARTS FOR USE IN ELECTRONICS MANUFACTURING, CAR MANUFACTURING, AUTOMOTIVE COMPONENTS AND MATERIALS, PIPING AND INFRASTRUCTURE PRODUCTS, CONSTRUCTION AND PLANT MATERIALS, POWER SUPPLY AND POWER SUPPLY COMPONENTS, AND AEROSPACE DEVICES; POWDER METALLURGY METALS FOR USE IN ELECTRONICS MANUFACTURING, CAR MANUFACTURING, AUTOMOTIVE COMPONENTS AND MATERIALS, PIPING AND INFRASTRUCTURE PRODUCTS, CONSTRUCTION AND PLANT MATERIALS, POWER SUPPLY AND POWER SUPPLY COMPONENTS, AND AEROSPACE DEVICES; BRASS, SOLD IN BULK (U.S. CLS. 2, 12, 13, 14, 23, 25 AND 50).

CLASS 7—MACHINERY

FOR INCUBATORS FOR EGGS; MOTORS AND ENGINES, NAMELY, AIRCRAFT MOTORS AND ENGINES, BOAT MOTORS AND ENGINES, DIESEL ENGINES FOR MACHINES, ELECTRIC MOTORS FOR MACHINES; ELECTRIC GENERATORS; STARTERS FOR MOTORS AND ENGINES; CAPACITOR PRODUCTION MACHINES; STARTER ALTERNATORS; ALTERNATORS FOR LAND VEHICLES; INDUSTRIAL ROBOTS; ELEVATORS; ESCALATORS; MOVING STAIRWAYS; MOVING WALKWAYS; MINING MACHINES; CIVIL ENGINEERING MACHINES, NAMELY, CONCRETE MIXERS, ASPHALT SPREADERS, CRUSHING MACHINES, CENTRIFUGAL MACHINES, COMPRESSORS FOR MACHINES, GRINDING MACHINES, PAY LOADERS, HOPPERS, BULLDOZERS, GRADERS, DRAINAGE MACHINES, DIGGING MACHINES, CRUSHING ROLLERS, EXTRACTING MACHINES, DRILLING MACHINES FOR APPLYING ASPHALT, MIXING MACHINES, AND AERIAL PLATFORMS; CARGO WORKING MACHINES, NAMELY, DERRICKS, UNLOADERS, BUCKET ELEVATORS, WINCHES, WINDLASSES, CAPSTANS, CHAIN BLOCKS, AND UNLOADING HOPPERS; CRANES; HOISTS; WINCHES; CONVEYORS; DRAG SCRAPERS; LOADERS; SHEET PILERS; SHEET FEEDERS; LIFTS, NAMELY, CAR LIFTS, HYDRAULIC LIFTS, POWER-OPERATED LIFTS USED TO TRANSPORT AND PLACE PORTABLE STORAGE CONTAIN-

ERS, AND POWER-OPERATED LIFTS FOR MOVING, PARKING, AND STORING LAND VEHICLES; CAR DUMPERS; PNEUMATIC UNLOADERS; RECLAIMERS; MAGNETIC SEPARATORS; LOADING SHOVELS; TUNNELING MACHINES; PILE DRIVERS; EXCAVATORS; WHEEL LOADERS; EARTH DRILLS; ROTARY CASING DRIVERS; REVERSE CIRCULATION DRILLS; FOUNDATION MACHINES; CARRIERS; GAS PIPE TUNNELERS; AMPHIBIOUS SOFT TERRAIN BACKHOES; LOAD SENSORS; STEAM TURBINES; WATER TURBINES; GAS TURBINES; DIESEL ENGINES; INTERNAL COMBUSTION ENGINES; SPEED CHANGERS, NAMELY, GEARS, GEAR BOXES, AND TRANSMISSIONS; WATER WHEELS AND TURBINES; PUMPS, NAMELY, FUEL PUMPS, WATER PUMPS FOR IRRIGATION AND SEWAGE, FEED PUMPS, VACUUM PUMPS, HIGH VISCOSITY FLUID PUMPS, AND LIQUID METAL PUMPS; OIL-WELL PUMPING MACHINES; CENTRIFUGES; AIR COMPRESSORS; ELECTRIC COMPRESSORS; POWER-OPERATED BLOWERS AND FANS FOR MACHINE ENGINES; HYSINC HAMMERS, HYDRAULIC TRUCK CRANES, SHIELD MACHINES, AND MACHINE TOOLS, NAMELY, MECHANICAL AND COMPUTER-CONTROLLED METAL CUTTING, REMOVING AND FORMING MACHINE TOOLS; POWER DRIVEN HAND/STATIONERY TOOLS, NAMELY, CIRCULAR SAWS, CUTTERS, DRILLS, GRASS CUTTERS, GRINDERS, HAMMERS, MITER SAWS, PLANER JOINERS, PNEUMATIC NAILERS, POLISHERS, ROTARY BANDSAWS, ROUTERS, SANDERS, TRIMMERS, AND THICKNESS PLANERS; ROLLING MILLS; STRIP MILLS; MILLING MACHINES; INDUSTRIAL MACHINE PRESSES; OFFSET PRESSES; PRINTING PRESSES; MECHANICAL MILLING PRESSES AND CRUSHERS; PAPER MAKING MACHINES; MACHINES AND EQUIPMENT FOR CHEMICAL INDUSTRY, NAMELY, MIXERS, AGITATORS, PROCESSORS, DRYING MACHINES AND CHEMICAL FILTERING MACHINES TO REMOVE IMPURITIES, AND THEIR FITTINGS; ELECTRIC DUST COLLECTORS; PRINTING MACHINES, NAMELY, FLEXOGRAPHIC PRINTING MACHINES; CNC DRILLING MACHINES; CNC ROUTING MACHINES; ELECTRICAL DISCHARGE MACHINES, NAMELY, ELECTRIC DISCHARGE MACHINE FOR PRECISION DIE PRODUCTION AND PARTS MACHINING; DIGITIZERS, NAMELY, ANALOG-DIGITAL CONVERTERS; METAL WORKING MACHINES, NAMELY, MACHINING CENTERS; WELDING MACHINES, NAMELY, ELECTRIC WELDING MACHINES AND GAS WELDING MACHINES; WATER SUPPLY APPARATUS, NAMELY, WATER PUMPS FOR USE IN LAND VEHICLE MOTORS AND LAND VEHICLE ENGINES; MECHANICAL SCREENS; STRAINERS; CENTRIFUGAL SEPARATORS; AUTOMATIC CONVEYING EQUIPMENT; EQUIPMENT AND APPLIANCES FOR AUTOMOBILES, NAMELY, CHARGING GENERATORS, DISTRIBUTORS, IGNITION COILS, SPARK PLUGS, CARBURETORS, ALTERNATORS, AIR PUMPS, AND THROTTLE BODIES; HOUSEHOLD ELECTRIC APPLIANCES, NAMELY, CLOTHES WASHING MACHINES, BLENDERS, JUICERS, CAN OPENERS, DISHWASHERS, VACUUM CLEANERS, DISPOSERS, AND PUMPS; SEWING MACHINES; ROLL FOR ROLLING MILLS AND PRINTING MACHINES; CARBON PRODUCTS, NAMELY, BEARINGS, MECHANICAL SEALS, GASKETS, SILICON CARBIDE FOR BATTERIES, GRAPHITE COMPOUND MATERIAL FOR BATTERIES, NEGATIVE ELECTRODE MATERIALS FOR LITHIUM ION BATTERIES, GRAPHITE FOR BATTERIES, POLES MADE FROM CARBON, ANODE MATERIALS FOR LITHIUM ION BATTERIES, AND BRUSHES MADE OF CARBON FOR USE IN AUTOMOBILE MOTORS, APPLIANCE MOTORS, AND POWER TOOL MOTORS; CERAMIC PRODUCTS FOR MACHINE PARTS, NAMELY, CERAMIC MECHANICAL SEALS FOR AUTOMOBILES, LIQUID CRYSTAL DISPLAY MANUFACTURING EQUIPMENT MADE OF CERAMIC AND SEMICONDUCTOR MANUFACTURING EQUIPMENT MADE OF CERAMIC; WINDING MACHINES FOR COILS AND CAPACITORS; FRICTION PRODUCTS, NAMELY, DRUM BRAKE LININGS AND DISC BRAKE PADS; PLASTIC MACHINE COMPONENTS, NAMELY, GEARS AND BEARINGS; ELECTRIC FOOD PROCESSORS; ELECTRIC KNIFE SHARPENERS; POWER-OPERATED FLOOR POLISHERS (U.S. CLS. 13, 19, 21, 23, 31, 34 AND 35).

CLASS 8—HAND TOOLS

FOR CUTLERY, NAMELY, FORKS, SPOONS, AND KNIVES; RAZORS; HOUSEHOLD ELECTRIC APPLIANCES, NAMELY, ELECTRIC SHAVERS AND RAZORS; CUTTING TOOLS; NAMELY, METAL CUTTING SAWS (U.S. CLS. 23, 28 AND 44).

CLASS 9—ELECTRICAL AND SCIENTIFIC APPARATUS

FOR AUTOMATIC VENDING MACHINES AND MECHANISMS FOR COIN-OPERATED APPARATUS, NAMELY, COIN AND BILL ACCEPTORS; CASH REGISTERS; CALCULATING MACHINES; DATA PROCESSING EQUIPMENT AND COMPUTERS; FIRE-EXTINGUISHING APPARATUS; CONTROLLING APPARATUS FOR ELECTRIC MOTORS AND GENERATORS, NAMELY, CONTROLLERS, RESISTORS, CONTACTORS, RELAYS, AUTOMATIC VOLTAGE REGULATORS, REMOTE CONTROLLING APPARATUS; MACHINES AND EQUIPMENT FOR ELECTRIC POWER DISTRIBUTION, NAMELY, TRANSFORMERS, ELECTRIC CURRENT LIMITING REACTORS, ARC-SUPPRESSION COILS, MERCURY RECTIFIERS, SEMICONDUCTOR RECTIFIERS, ROTARY CONVERTERS, MAGNETIC AMPLIFIERS, CIRCUIT BREAKERS, SWITCHES, SWITCH GEARS, SWITCH BOARDS AND BOXES, RELAYS, FREQUENCY CHARGERS, LIGHTNING ARRESTERS, LOAD DISPATCHERS; CHARGERS; BATTERIES; BATTERY CHARGERS; RECHARGEABLE BATTERIES; NICKEL CADMIUM BATTERIES; DRY BATTERIES; BATTERY BOXES; BATTERY JARS; POWER CABLE; TELECOMMUNICATION CABLE; INSULATED ELECTRICAL CABLES, SUBMARINE ELECTRICAL CABLES, ELECTRICAL FIBER-OPTIC LAN CABLES, AND ELECTRICAL FIBER-OPTIC CABLES; ELECTRONIC WIRES AND CABLES; MAGNETIC CORE; MAGNETS; ELECTRIC AND MAGNETIC METERS, NAMELY, POWER METERS, AMPERE METERS, VOLT METERS, WATT METERS, WATT-HOUR METERS, INSULATION RESISTANCE METERS; INDUSTRIAL MEASURING INSTRUMENTS, NAMELY, THERMOMETERS, PRESSURE METERS, FLOW METERS, DYNAMOMETERS, WAVE SWEEP OSCILLATORS, OSCILLOGRAPHS, WAVE FORM MONITORS; ULTRASONIC INSPECTION AND IMAGING INSTRUMENTS, NAMELY, ULTRASONIC DEPTH SOUNDERS, ULTRASONIC SCANNERS AND PROBES USED TO DETECT FLAWS, AND ULTRASONIC SENSORS/SONARS; ULTRASONIC FLAW DETECTORS; ULTRASONIC MICROSCOPES; ELECTRON TUBES, NAMELY, PICTURE TUBES, RECEIVING TUBES, TRANSMISSION TUBES, PICKUP TUBES, CATHODE RAY TUBES, IMAGE PICKUP TUBES, STORAGE TUBES, POWER TUBES, X-RAY TUBES, MAGNETRONS, RECTIFIER TUBES, VIDICONS, LIQUID CRYSTAL DISPLAY DEVICES, CORE MEMORY, BUBBLE MEMORY; ELECTRIC CIRCUIT PARTS USING SEMICONDUCTIVE MATERIAL, NAMELY, TRANSISTORS, DIODES, PHOTO CELLS, PHOTOCONDUCTIVE DEVICES, NAMELY, PHOTO CONDUCTIVE DRUMS; THERMISTORY, VARISTERS, ELECTRIC CONDENSERS, INTEGRATED CIRCUITS, LARGE SCALE INTEGRATED CIRCUITS, LIGHT EMITTING DIODES, RANDOM ACCESS MEMORY, READ ONLY MEMORY, STEPPERS, MICROPROCESSORS, AND THYRISTERS; TELEPHONE SETS; ATTENDANT CONSOLES OF TELEPHONE SETS; TELEPHONE SWITCHBOARDS; SEMICONDUCTOR MANUFACTURING APPARATUS, NAMELY, DRY ETCHING EQUIPMENT, INSPECTION EQUIPMENT FOR DUST PARTICLES, THROUGH-PUT INTEGRATED CIRCUIT MEMORY TEST EQUIPMENT, WAFER/MASK BLANKS SURFACE INSPECTION EQUIPMENT; CLEAN BENCHES COMPRISED OF BENCHES WITH FILTERS TO PREVENT DUST FROM ENTERING THE BENCH, USED FOR MANUFACTURING, INSPECTION, RESEARCH, AND EXPERIMENTS IN THE FIELDS OF CHEMISTRY, AGRICULTURE, BIOTECHNOLOGY, PRECISION MACHINERY, AND OPTICAL INSTRUMENTS; ELECTRONIC BEAM LITHOGRAPHY SYSTEMS FOR USE IN THE PRODUCTION OF SEMICONDUCTORS AND COMPUTER CHIPS, CONSISTING OF A THERMOSTATIC CONTROL CHAMBER, LASERS, ELECTRON GUNS, ELECTRON OPTICAL COLUMNS, ELECTRON BEAM LENSES, ELECTRON BEAM DEFLECTORS, SAMPLE CHAMBERS, SUBSTRATE STAGES, WAFER TRANSPORTERS AND LOADERS, VACUUM PUMP AND CONTROLLERS,

CONTROL AND DATA STORAGE COMPUTERS, OPERATING SOFTWARE FOR SAME, OPERATOR CONSOLES, POWER SUPPLIES, AND PARTS THEREFOR; ELECTRONIC APPLIED APPARATUS, NAMELY, ELECTRONIC COMPUTERS, DATA PROCESSORS, DATATYPEWRITERS, LINE PRINTERS, CASSETTE DATA READERS, CARD READER PUNCH, COLOR COPYING MACHINES, CATHODE RAY TUBE DISPLAY COPIERS, MICRO FICHE RETRIEVERS, INVENTORY CONTROL MACHINES, ELECTRONIC CASH REGISTERS, MARK SHEET READERS, COPYING MACHINES, ELECTRIC PLOTTERS, OPTICAL CHARACTER READERS, MAGNETIC DISCS, DRUM MEMORY, MAGNETIC TAPE UNITS, AUTOMATIC ELECTRICAL CONTROLLING APPARATUS, ELECTRON MICROSCOPES, PARTICLE ACCELERATORS, RADAR APPARATUS, ELECTRONIC CALCULATORS, WORD PROCESSORS; COMPUTER PROGRAMS FOR USE IN THE FIELDS OF ACCOUNTING, HUMAN RESOURCES, NAMELY, FOR MANAGEMENT AND OPERATION OF ENTERPRISE HUMAN RESOURCE DEPARTMENTS AND MANAGEMENT OF HUMAN RESOURCES DATA AND INFORMATION, AND INDUSTRY, NAMELY, COMPUTER PROGRAMS FOR CONTROLLING AND ANALYZING DEVICES FOR PLANTS, TRANSPORTATION, POWER GENERATION, AND MEDICAL TREATMENT; COMPUTER PROGRAMS FOR USE IN THE MANUFACTURE OF SEMICONDUCTORS AND CONSUMER APPLIANCES; ENTERPRISE APPLICATION INTEGRATION SOFTWARE AND ENTERPRISE SYSTEM MANAGEMENT SOFTWARE; PROJECTOR MANAGEMENT AND CONTROL SOFTWARE; DATA STORAGE SOFTWARE; SOFTWARE FOR COMPUTER NETWORK MANAGEMENT AND MAINTENANCE; COMPUTER PROGRAMS FOR USE IN THE FIELD OF GENERAL PURPOSE MAINFRAME COMPUTER OPERATING SYSTEMS, DIAGNOSTICS AND MAINTENANCE; PRINTERS, NAMELY, COMPUTER PRINTERS, LASER PRINTERS, AND INK JET PRINTERS; RADIO TELEPHONE EQUIPMENT AND ACCESSORIES, NAMELY, CALL BOXES AND SYSTEMS, DIALING ASSEMBLIES, TELEPHONE UNITS, AUDIO OPERATED RELAYS, SIGNALING DEVICES, RECEIVING DEVICES, TERMINATION EQUIPMENT, FILTERS, PROTECTORS AND AUTOMATIC SIGNALING AND CONTROL EQUIPMENT; TELEPHONE EXCHANGERS; ASYNCHRONOUS TRANSFER MODES, NAMELY, NETWORK HUBS, NETWORK CARDS, ROUTERS, SWITCHES, CONNECTORS AND SOFTWARE USED TO TRANSMIT VIDEO, AUDIO, AND COMPUTER DATA OVER THE SAME NETWORK IN PACKET OF FIXED SIZE; ATTENDANT CONSOLES OF TELEPHONES AND TELEGRAPHS; CARRIER TELEPHONES; TELEVISION CONFERENCE EQUIPMENT, NAMELY, TELEVISIONS, VIDEO CAMERAS, NETWORK HUBS, NETWORK ROUTERS, SOFTWARE FOR TELEVISION CONFERENCING, AND VIDEO VIEWERS; PRIVATE TELEPHONE BRANCH EXCHANGES; FACSIMILES; VOICE RESPONSE SYSTEMS, NAMELY, INTERACTIVE VOICE RESPONSE UNITS AND TELEPHONES; TELEVISION, ANALOG, AND DIGITAL SIGNAL FIELD PICK-UP FOR BROADCASTING, NAMELY, INTERPHONES, WAVEGUIDES, ANTENNAE; WIRELESS COMMUNICATIONS APPARATUS, NAMELY, WIRELESS AND CELLULAR TELEPHONES, PAGERS, PAGING EQUIPMENT, WIRELESS PORTABLE COMPUTER DEVICES, NAMELY, MOBILE DATA RECEIVERS, INTERNET PROTOCOL AND TELECOMMUNICATIONS NETWORK TRANSMITTERS, MODEMS, RECEIVERS, CONVERTERS, AND ROUTERS; WIRELESS FACSIMILE TRANSMITTERS AND RECEIVERS, WIRELESS FAX MACHINES, WIRELESS PERSONAL COMMUNICATIONS EQUIPMENT, NAMELY, PERSONAL DIGITAL ASSISTANTS; ELECTRONIC CONTROLLING EQUIPMENT FOR ROLLING STOCK, NAMELY, CHOPPER CONTROLLERS, RECTIFIERS, TRANSFORMERS, INVERTERS; SCIENTIFIC MEASURING INSTRUMENTS, NAMELY, MASS SPECTROMETERS, MICRO ANALYZERS, MICROSCOPES, MAGNETIC RESONANCE SPECTROPHOTOMETERS, SPECTROMETERS, PHOTOMETERS, P;H; METERS, TOSELIUS ELECTROPHORESIS APPARATUS, GEIGER COUNTERS, GAS CHROMATOGRAPHS, NUCLEAR MAGNETIC RESONANCE, AMINO ACID ANALYZERS, FLUORESCENCE SPECTROPHOTOMETERS, ATOMIC ABSORPTION SPECTROMETERS, LIQUID CHROMATOGRAPHS; CARGO MACHINES, NAMELY, LIFTING MAGNETS; STEAM CONDENSERS; MAGNETIC APPLIANCES, NAMELY, MAGNETIC SEPARATORS AND MAGNETIC STRAINERS; ELECTROSTATIC EMISSION CONTROL DE-

VICES, NAMELY, ELECTROSTATIC PRECIPITATORS FOR REDUCING PARTICULATE EMISSIONS IN INDUSTRIAL APPLICATIONS; EQUIPMENT AND APPLIANCES FOR AUTOMOBILES, NAMELY, BATTERIES AND RELAYS; TRANSMITTING AND RECEIVING APPARATUS FOR RADIO AND TELEVISION BROADCASTING AND FOR LONG-DISTANCE TRANSMISSION; RADIO RECEIVING SETS; FREEZE-PICTURE TRANSMISSION SYSTEMS COMPRISED OF VIDEO TRANSMITTERS, RECEIVERS, COMPUTER CHIPS, AND SOFTWARE; TELEVISION RECEIVING SETS; TELEVISION TRANSLATORS; TELEVISION CAMERAS; VIDEO CAMERAS; INDUSTRIAL TELEVISION EQUIPMENT; ELECTRIC GRAMOPHONES; RECORD PLAYERS; AUTOMATIC SYNC SOUND FILMSTRIP PROJECTORS; STEREO EQUIPMENT, NAMELY, RECEIVERS, AMPLIFIERS, TUNERS, SPEAKER SYSTEMS, SPEAKER UNITS, DISC CARTRIDGES, TAPE DECKS, HEADPHONES, ELECTRIC CLEANERS FOR RECORD DISCS, MAGNETIC TAPE RECORDERS; STEREO MODULAR COMBINATION WITH 8-TRACK PLAYER, CASSETTE TAPE RECORDERS, RECORD AUTO CHANGERS, CASSETTE TAPE DECKS, VIDEO PROJECTORS, VIDEO MONITORS; BLANK MAGNETIC RECORDING TAPES; BLANK VIDEO TAPES; BLANK MAGNETIC FLOPPY DISCS; LIQUID CRYSTAL DISPLAYS AND THEIR PARTS; BLANK CARTRIDGE TAPES; BLANK VIDEO DISCS, BLANK AUDIO DISCS; BLANK CASSETTE TAPES; VIDEO TAPE RECORDERS; VIDEO DISC PLAYERS; AUDIO DISC PLAYERS; OPTICAL DISC PLAYERS; CASSETTE PLAYERS; CASSETTE RECORDERS; CAR RADIOS; TRANSCEIVERS; HOUSEHOLD ELECTRIC APPLIANCES, NAMELY, HAIR SETTERS, ELECTRIC IRONS, TIMER SWITCHES; ELECTRONIC THERMOMETERS; FERRITE MAGNETS; COPPER AND COPPER ALLOY, NAMELY, BUS BARS AND INDUCTION COILS; GRAPHITE PRODUCTS, NAMELY, GRAPHITE ELECTRODES; CERAMIC PRODUCTS FOR ELECTRIC AND ELECTRONIC PARTS, NAMELY, CERAMIC SCINTILLATORS, CERAMICS FOR USE IN SEMICONDUCTORS AND INTEGRATED CIRCUITS, AND CERAMICS FOR ELECTRO-MAGNETIC HEADS; MEASURING INSTRUMENTS, NAMELY, ELECTRIC INDICATORS, INDICATING CONTROLLERS, SEQUENTIAL CONTROLLERS, RECORDERS, INSULATION TESTERS, ELECTRONIC PRESSURE TRANSMITTERS, PNEUMATIC PRESSURE TRANSMITTERS, LEVEL GAUGES, THICKNESS GAUGES, MOISTURE GAUGES, DENSITY GAUGES, OXYGEN METERS, RECORDING CONTROLLERS; ELECTRIC AND ELECTRONIC PARTS, NAMELY, PRINTED WIRING BOARDS, CAPACITORS, COILS, RESISTORS, PRINTED CIRCUIT BOARDS, PRINTED CIRCUIT BOARD MATERIALS, SEMICONDUCTOR MATERIALS; ANISOTROPIC CONDUCTIVE FILM; WIRING DEVICES, NAMELY, ELECTRICAL SWITCHES, ELECTRICAL RECEPTACLES, ELECTRICAL PLUGS AND PLUG CAPS, ELECTRICAL CONNECTORS, ELECTRICAL AND ELECTRONIC WIRING DEVICE COVER PLATES AND WALL PLATES, AND ELECTRICAL GROUNDING, SOCKET AND OUTLET ADAPTERS; LOCAL AREA NETWORK AND INTEGRATED SERVICE DIGITAL NETWORK APPARATUS, NAMELY, HUBS, SWITCHES, AND ROUTERS, NETWORK CARDS, AND NETWORK ACCESS SERVER HARDWARE AND SOFTWARE; ELECTRIC DOOR BELLS, ALARM BUZZERS, ELECTRIC DUST COLLECTORS; ELECTRIC HAIR BRUSHES; ELECTRIC CONTROL EQUIPMENT FOR ROLLING MILLS; ELECTRIC ARC WELDERS; NUCLEAR MEDICAL DATA PROCESSING SYSTEMS COMPRISED OF PERSONAL COMPUTERS, WORK STATION COMPUTERS, NUCLEAR MEDICAL DATA ANALYSIS PROCESSING SOFTWARE, AND GAMMA CAMERAS; POLYSTYRENE BEADS FOR USE AS LABORATORY EQUIPMENT IN BIOLOGY AND GENETICS RESEARCH (U.S. CLS. 21, 23, 26, 36 AND 38).

CLASS 10—MEDICAL APPARATUS

FOR ARTIFICIAL LIMBS, EYES AND TEETH; ORTHOPEDIC ARTICLES, NAMELY, DERMATOLOGIC ORTHOPEDIC INSTRUMENTS, NAMELY, SCALPELS AND FORCEPS, ORTHOPEDIC SUPPORT BANDAGES AND ARTIFICIAL LIMBS; SUTURE MATERIALS, NAMELY, SUTURES, THREAD, AND NEEDLES, FOR MEDICAL USE; ELECTRONIC THERMOMETERS FOR MEDICAL PURPOSES; MEDICAL EQUIPMENT, NAMELY, TOMOGRAPHS, TOMOGRAPHY UNITS, X-RAY UNITS, X-RAY GENERATORS, ULTRASONIC BLOOD FLOW MONITORS, ULTRASOUND CARDIOGRAM UNITS; RADIO THERAPEUTIC MICROTROP SYSTEMS; SCINTILLATION CAMERAS FOR MEDICAL USE USED TO DETECT GAMMA RAYS EMITTED FROM RADIOACTIVE MEDICAL AGENTS AND TO IMAGE THE DISTRIBUTION OF RADIOACTIVE MEDICAL AGENTS INJECTED INTO A PATIENT; BIO-CLEAN UNITS FOR HOSPITAL OPERATING ROOMS COMPRISED OF SANITIZED AND STERILE AIR CONDITIONING, SANITARY AND ELECTRICAL APPARATUS TO BLOCK ENTRY OF BACTERIA, TO PREVENT COLLECTION OF BACTERIA, TO PREVENT GENERATION OF BACTERIA, AND TO ELIMINATE BACTERIA; CT SCANNERS, SPHYGMOMANOMETERS, MAGNETIC RESONANCE IMAGING EQUIPMENT, MASSAGERS, ULTRASOUND SCANNERS (U.S. CLS. 26, 39 AND 44).

CLASS 11—ENVIRONMENTAL CONTROL APPARATUS

FOR NUCLEAR POWER PLANTS, NAMELY, NUCLEAR REACTORS; BOILERS, FEED WATER PURIFIER FOR BOILERS; HEAT EXCHANGERS; REFRIGERATING MACHINES; WATER COOLERS; CHILLERS; REFRIGERATING DISPLAY CASES; AIR CONDITIONING EQUIPMENT; ELECTRIC PORTABLE WATER COOLERS; ELECTRIC DEHUMIDIFIERS; ELECTRIC FURNACES; AIR POLLUTION CONTROL APPARATUS; WATER SUPPLY APPARATUS; WATER POLLUTION CONTROL APPARATUS; SLUDGE COLLECTOR APPARATUS; GRIT COLLECTOR APPARATUS; OIL AND GAS RANGES; OIL AND GAS STOVES; KEROSENE HEATERS; LIGHTING EQUIPMENT, NAMELY, MERCURY LAMPS, INFRARED LAMPS, FLUORESCENT LAMPS, INCANDESCENT LAMPS, LAMP FIXTURES, FLASHLIGHTS, ELECTRIC TORCHES, ELECTRIC LANTERNS, UNDERWATER LIGHTS; ATOMIC FURNACES; HOUSEHOLD ELECTRIC APPLIANCES, NAMELY, OIL HEATERS, SPACE HEATERS, FOOD WARMERS, TOWEL WARMERS; TOASTERS, ELECTRIC RICE COOKERS, EGG COOKERS, ELECTRIC POTS, ROASTERS, MICROWAVE OVENS, REFRIGERATORS, ICE MAKERS, COFFEE MAKERS, FOUNTAINS, WATER CLEANERS, HAIR DRYERS, CLOTHES DRYERS, DEHUMIDIFIERS, HUMIDIFIERS, DESK FANS, FLOOR FANS, CEILING FANS, VENTILATING FANS, ROOM AIR CONDITIONERS, FLOOR HEATING PANELS; HOUSEHOLD APPLIANCES, NAMELY, HOME BATHS AND BATH UNITS, KITCHEN SINKS, DISPOSAL TANKS, SEWAGE TANKS, HOME BOILERS, SOLAR WATER HEATERS; CLEAN ROOMS (U.S. CLS. 13, 21, 23, 31 AND 34).

CLASS 12—VEHICLES

FOR VEHICLES, NAMELY, AUTOMOBILES AND SUBMERSIBLE REMOTELY OPERATED VEHICLES; RAILWAY ROLLING STOCK; ELECTRIC LOCOMOTIVES; DIESEL LOCOMOTIVES; DIESEL ELECTRIC LOCOMOTIVES; DIESEL ENGINES FOR LAND VEHICLES; PASSENGER COACHES; ELECTRIC CARS; DIESEL CARS; MONO-RAIL CARS; CABLE CARS; ROPEWAYS, NAMELY, CONVEYANCES TO TRANSPORT PASSENGERS OR FREIGHT IN CARRIERS SUSPENDED FROM CABLES AND SUPPORTED BY A SERIES OF TOWERS; FREIGHT CARS; WAGONS; VANS; TANK CARS; INDUSTRIAL ROLLING STOCK; INDUSTRIAL TRAILERS; DUMP-TRUCKS; TRAILERS; HYDRO RAILWAY AND TRAILER COUPLING; HYDRO TORQUE CONVERTERS FOR LAND VEHICLES; AUTOMATIC CONVEYING VEHICLES; LEISURE APPLIANCES, NAMELY, BOATS, GOLF CARTS; CLUTCH FACING (U.S. CLS. 19, 21, 23, 31, 35 AND 44).

CLASS 14—JEWELRY

FOR PRECIOUS METALS AND THEIR ALLOYS AND GOODS IN PRECIOUS METALS OR COATED THEREWITH, NAMELY, GOLD, SILVER, AND PLATINUM; JEWELRY, PRECIOUS STONES; HOROLOGICAL, AND CHRONOMETRIC INSTRUMENTS, NAMELY, STOPWATCHES, WATCHES, CHRONOGRAPHS FOR USE AS WATCHES, POCKET WATCHES, WRISTWATCHES, CLOCKS; CHRONOMETERS; ELECTRIC/ELECTRONIC CLOCKS AND WATCHES (U.S. CLS. 2, 27, 28 AND 50).

CLASS 16—PAPER GOODS AND PRINTED MATTER

FOR PRINTED MATTER, NAMELY, NEWSLETTERS, MANUALS, PAMPHLETS, BROCHURES, ANNUAL REPORTS, AND JOURNALS IN THE FIELDS OF SEMICONDUCTOR MANUFACTURING, COMPUTER SOFTWARE AND HARDWARE, POWER SYSTEMS, METALS, CHEMICALS, POWER TOOLS, ENGINEERING, TELECOMMUNICATIONS, MEDICAL DEVICES, AUDIO-VISUAL COMMUNICATIONS, MULTIMEDIA PRESENTATIONS, CHARITABLE FOUNDATIONS, DIGITAL MEDIA, HOME ELECTRONICS, CONSUMER APPLIANCES, ENGINEERING, AND INFORMATION TECHNOLOGY; BOOKBINDING MATERIALS, NAMELY, BINDINGS, BOOKBINDING TAPE, BOOKBINDING GLUE, BOOKBINDING WIRE, AND CLOTH FOR BOOKBINDING; STATIONERY; ADHESIVES FOR STATIONERY OR HOUSEHOLD PURPOSES; ARTISTS' MATERIALS, NAMELY, PAINTS, PENCILS, MARKERS, AND STENCILS; PAINT BRUSHES; TYPEWRITERS; OFFICE SUPPLIES, NAMELY, PUNCHES, RUBBER BANDS, STAPLERS, PAPER EMBOSSERS, AND PAPER CUTTERS; PRINTED INSTRUCTIONAL AND TEACHING MATERIALS IN THE FIELDS OF SEMICONDUCTOR MANUFACTURING, COMPUTER SOFTWARE AND HARDWARE, POWER SYSTEMS, METALS, CHEMICALS, POWER TOOLS, TELECOMMUNICATIONS, MEDICAL DEVICES, AUDIO-VISUAL COMMUNICATIONS, MULTIMEDIA PRESENTATIONS, CHARITABLE FOUNDATIONS, DIGITAL MEDIA, HOME ELECTRONICS, CONSUMER APPLIANCES, ENGINEERING, AND INFORMATION TECHNOLOGY; PLASTIC MATERIALS FOR PACKAGING, NAMELY, PLASTIC ENVELOPES AND PLASTIC BUBBLE PACKS FOR WRAPPING OR PACKAGING; PLAYING CARDS; PRINTERS' TYPE; PRINTING BLOCKS; CATALOGS IN THE FIELDS OF SEMICONDUCTOR MANUFACTURING, COMPUTER SOFTWARE AND HARDWARE, POWER SYSTEMS, METALS, CHEMICALS, POWER TOOLS, TELECOMMUNICATIONS, MEDICAL DEVICES, AUDIO-VISUAL COMMUNICATIONS, MULTIMEDIA PRESENTATIONS, CHARITABLE FOUNDATIONS, DIGITAL MEDIA, HOME ELECTRONICS, CONSUMER APPLIANCES, ENGINEERING, AND INFORMATION TECHNOLOGY; PVC STRETCH FILM FOR FOOD; PENCIL SHARPENERS; ELECTRIC LETTER OPENERS; ELECTRIC PENCIL SHARPENERS (U.S. CLS. 2, 5, 22, 23, 29, 37, 38 AND 50).

CLASS 17—RUBBER GOODS

FOR PLASTICS IN EXTRUDED FORM FOR USE IN MANUFACTURE; PACKING, STOPPING, AND INSULATING MATERIALS, NAMELY, PLASTIC AND POLYSTYRENE PACKING AND INSULATION FOR USE IN THE FIELDS OF SEMICONDUCTOR MANUFACTURING, COMPUTER SOFTWARE AND HARDWARE, POWER SYSTEMS, POWER TOOLS, ENGINEERING, TELECOMMUNICATIONS, MEDICAL DEVICES, AUDIO-VISUAL COMMUNICATIONS, HOME ELECTRONICS, CONSUMER APPLIANCES, AND ENGINEERING; BUILDING INSULATION; FLEXIBLE PIPES, NOT OF METAL, FOR USE IN THE FIELDS OF SEMICONDUCTOR MANUFACTURING, COMPUTER SOFTWARE AND HARDWARE, POWER SYSTEMS, METALS, CHEMICALS, POWER TOOLS, ENGINEERING, TELECOMMUNICATIONS, MEDICAL DEVICES, AUDIO-VISUAL COMMUNICATIONS, HOME ELECTRONICS, AND CONSUMER APPLIANCES; FLEXIBLE PLASTIC PLUMBING PIPES; INDUSTRIAL RUBBER, NAMELY, CONTAINER BAGS AND HIGH PRESSURE HOSES; ELECTRIC INSULATING MATERIALS, NAMELY, LAMINATES, VARNISHES, VARNISHED CLOTH, TAPES, MICA, CERAMICS, PAINTS, FILM, PIPES, RODS,

TUBES, BARS; PLASTICS IN THE FORM OF POWDERS, LIQUID OR PASTE, FOR INDUSTRIAL USE, NAMELY, MOLDING COMPOUND FOR ELECTRICAL INSULATING MATERIALS; SEMI-FINISHED PLASTIC MOLDED SUBSTANCES FOR USE IN ELECTRONICS, ELECTRONICS MANUFACTURING, AND SEMICONDUCTOR MANUFACTURING; PARTLY-PROCESSED FRICTION MATERIAL FOR CLUTCH FACING; PLASTICS IN THE FORM OF SHEET, BLOCK, RODS, PIPES, TUBE, TAPE FOR USE IN MANUFACTURING; WEATHERABLE THERMOPLASTICS FOR USE IN MANUFACTURING IN A WIDE VARIETY OF INDUSTRIES; EXPANDABLE POLYSTYRENE BEADS FOR USE IN PACKING MATERIALS; RUBBER, NAMELY, CRUDE RUBBER, RUBBER CUSHIONING FOR STUFFING, ELECTRICAL INSULATING RUBBER AND FOAM RUBBER; INDUSTRIAL RUBBER, NAMELY, RUBBER FOR ESCALATOR HANDRAILS AND RUBBER BELTS; WATERPROOF RUBBER SHEETS; RUBBER HOSES; RUBBER HOSES FOR AUTOMOBILES (U.S. CLS. 1, 5, 12, 13, 35 AND 50).

CLASS 35—ADVERTISING AND BUSINESS

FOR BUSINESS MANAGEMENT; BUSINESS ADMINISTRATION; OFFICE FUNCTIONS, NAMELY, BOOKKEEPING, SECRETARIAL SERVICES, CLERICAL SERVICES, TELEPHONE ANSWERING SERVICES, DOCUMENT REPRODUCTION SERVICES, TYPING AND WORD PROCESSING SERVICES, DATA PROCESSING OF COMPUTER DATA, AND ACCOUNTING SERVICES; BUSINESS ORGANIZATION AND BUSINESS CONSULTING, MARKETING RESEARCH AND MARKETING ANALYSES, BUSINESS MARKETING AND MANAGEMENT CONSULTING, PROCUREMENT OF CONTRACTS FOR OTHERS FOR THE PURCHASE AND SALE OF GOODS, BUSINESS ADMINISTRATION; CONSULTATION, DESIGN OF BUSINESS STRATEGIES, RESEARCH AND DEVELOPMENT IN THE FIELDS OF ADVERTISEMENT, BUSINESS MANAGEMENT, ELECTRONIC COMMERCE, SUPPLY CHAIN MANAGEMENT, CUSTOMER RELATIONSHIP MANAGEMENT; PROVIDING ON-LINE EXCHANGE SERVICES OF GOODS AND SERVICES FOR USERS THROUGH A NETWORK OF COMPUTERS, SERVERS, DATABASES, AND SOLUTION APPLICATIONS; LEASING OF OFFICE MACHINES AND EQUIPMENT; BUSINESS CONSULTING SERVICES RELATING TO LOGISTICS; RESEARCH OF STRATEGIES FOR BUSINESS MANAGEMENT INNOVATIONS AND FOR HUMAN RESOURCES MANAGEMENT; PROVIDING DATABASES IN THE FIELDS OF SENDING AND RECEIVING PRODUCT ORDERS, MANUFACTURING ESTIMATES, INVENTORY CONTROL, PRODUCTS DISTRIBUTION AND CIRCULATION, MANAGEMENT OF CUSTOMER INFORMATION, EMPLOYEE PERSONNEL INFORMATION MANAGEMENT, STUDENT PERSONAL INFORMATION MANAGEMENT FOR USE BY POTENTIAL EMPLOYERS AND EDUCATIONAL INSTITUTIONS, LIBRARY MANAGEMENT, DOCUMENT MANAGEMENT, OFFICE EQUIPMENT SUPPLY MANAGEMENT, PERSONAL MEDICAL HISTORY RECORD MANAGEMENT (U.S. CLS. 100, 101 AND 102).

CLASS 36—INSURANCE AND FINANCIAL

FOR FINANCIAL PLANNING SERVICES; MONETARY SERVICES, NAMELY, BILL PAYMENT SERVICES, REAL ESTATE LEASING SERVICES, AND LOAN SERVICES, CREDIT CARD SERVICES, ISSUING OF CREDIT CARDS, CREDIT CONSULTING AND AGENCIES; REAL ESTATE BROKERAGE SERVICES; REAL ESTATE AGENCY; REAL ESTATE MANAGEMENT; ELECTRONIC COMMERCE SERVICES, NAMELY, ELECTRONIC CREDIT CARD AND DEBIT TRANSACTIONS, FUNDS TRANSFERS AND PAYMENT PROCESSING; FINANCIAL ANALYSIS AND CONSULTATION; FINANCIAL INFORMATION PROVIDED BY ELECTRONIC MEANS; FINANCIAL INFORMATION PROCESSING; FINANCIAL CONSULTATION SERVICES, NAMELY, ASSISTING OTHERS WITH THE COMPLETION OF FINANCIAL TRANSACTIONS FOR STOCKS, BONDS, SECURITIES, AND EQUITIES; FINANCIAL MANAGEMENT; FINANCIAL TRANSACTION SERVICES, NAMELY, INVESTMENT FUND AND INVESTMENT SECURITIES TRANSACTION SERVICES; REAL ESTATE INVESTMENT SERVICES, INVESTMENT BROKERAGE SERVICES, AND ALL UTILIZING THE

GLOBAL INFORMATION NETWORK OR PROVIDED BY ELECTRONIC MEANS; LEASING OF COMMERCIAL REAL ESTATE; LOAN SERVICES FOR THE ACQUISITION OF OFFICES, APARTMENTS, FLATS, BUILDINGS, CONSTRUCTION FACILITIES, AND COMMERCIAL REAL ESTATE; PACKAGE LEASING COMBINED WITH LOANS OR INSTALLMENT PLANS MAKING LAND, BUILDINGS, FACILITIES AND EQUIPMENT ALL AVAILABLE IN ONE PACKAGE, FOR HOTELS, HOSPITALS, PLANTS OR STORES, LEASE-PURCHASE LOANS; PROVIDING DATABASES IN THE FIELD OF MAKING FINANCIAL TRANSACTIONS (U.S. CLS. 100, 101 AND 102).

CLASS 37—CONSTRUCTION AND REPAIR

FOR COMMERCIAL AND RESIDENTIAL BUILDING CONSTRUCTION; BUILDING AND CONSTRUCTION BY ENGINEERS; RENTAL OF CONSTRUCTION MACHINES; INSTALLATION AND REPAIR OF INDUSTRIAL PLANTS; INSTALLATION AND REPAIR OF MACHINERY, NAMELY, AIR-CONDITIONING, WATER SUPPLY, SEWERS, SANITATION EQUIPMENT, ELECTRICAL EQUIPMENT, CLEAN ROOMS, ENVIRONMENTAL CONTROL SYSTEMS; MATERIALS HANDLING SYSTEMS, AND AIR POLLUTION CONTROL SYSTEMS; CONSTRUCTION, INSTALLATION, MAINTENANCE AND REPAIR OF COMPUTER NETWORK SYSTEMS UTILIZING THE GLOBAL INFORMATION NETWORK; MAINTENANCE OF OFFICE MACHINES AND EQUIPMENT; TECHNICAL SERVICES IN THE MAINTENANCE OF NETWORKED COMPUTER SYSTEMS BY MAINTAINING COMPUTER SOFTWARE; MAINTAINING COMPUTER HARDWARE AND SOFTWARE FOR TELECOMMUNICATIONS NETWORKS (U.S. CLS. 100, 103 AND 106).

CLASS 38—COMMUNICATION

FOR TELECOMMUNICATIONS SERVICES, NAMELY, THE ELECTRONIC TRANSMISSION OF VOICE, FACSIMILE, DATA, VIDEO AND INFORMATION; PROVIDING TELECOMMUNICATIONS CONNECTIONS TO WORLD-WIDE GLOBAL COMPUTER NETWORKS, OTHER COMPUTING NETWORKS, ON-LINE SERVICES AND BULLETIN BOARDS; COMMUNICATIONS BY COMPUTER TERMINALS AND ON COMPUTER NETWORK; ELECTRONIC DATA TRANSMISSION AND INTERCHANGE SERVICES; PROVIDING MULTIPLE-USER ACCESS TO A GLOBAL COMMUNICATION INFORMATION NETWORK; LEASING AND RENTAL OF COMMUNICATION EQUIPMENT; PROVIDING ON-LINE CHAT ROOMS AND ELECTRONIC BULLETIN BOARDS FOR TRANSMISSION OF MESSAGES AMONG USERS IN THE FIELD OF GENERAL INTEREST (U.S. CLS. 100, 101 AND 104).

CLASS 39—TRANSPORTATION AND STORAGE

FOR LOGISTICS AND REVERSE LOGISTICS SERVICES, NAMELY, STORAGE, TRANSPORTATION AND DELIVERY OF DOCUMENTS, PACKAGES, RAW MATERIALS, AND OTHER FREIGHT FOR OTHERS BY AIR, RAIL, SHIP OR TRUCK; VEHICLE RENTALS; RENTAL OF WAREHOUSES; PROVIDING TRAVEL INFORMATION SERVICES THROUGH A GLOBAL COMPUTER NETWORK; PROVIDING DATABASES IN THE FIELDS OF TRANSPORTATION AND DELIVERY OF PRODUCTS, AND PRODUCT TRANSPORTATION CONTROL (U.S. CLS. 100 AND 105).

CLASS 40—MATERIAL TREATMENT

FOR MATERIAL TREATMENT SERVICES, NAMELY, DRYING, DYEING, FIREPROOFING, WATERPROOFING OF CLOTH, CLOTHING, FUR, AND LEATHER; ELECTROPLATING, METAL AND GLASS ANNEALING; METAL TEMPERING; GALVANIZING; THERMALLY-SPRAYED METAL COATING SERVICES TO PROTECT AND RECLAIM METAL SURFACES FROM ABRASION, CORROSION, CAVITATION, EROSION, AND FATIGUE; SEMICONDUCTOR AND INTEGRATED CIRCUIT FOUNDRY SERVICES, NAMELY, THE CUSTOM MANUFACTURE AND ASSEMBLY OF ELECTRICAL AND ELECTRONIC PRODUCTS, COMPUTER COMPONENTS, INTEGRATED CIRCUITS, AND SEMICONDUCTORS TO THE ORDER AND SPECIFICATION OF OTHERS; SEMICONDUCTOR AND INTEGRATED CIRCUIT FOUNDRY SERVICES, NAMELY, PROTOTYPE MANUFACTURING OF SEMICONDUCTORS TO THE ORDER AND SPECIFICATION OF OTHERS; RENTAL OF INDUSTRIAL MACHINERY, NAMELY, INDUSTRIAL ROBOTS, MACHINE TOOLS, PRINTING AND BOOKBINDING MACHINES, PHOTOENGRAVING MACHINES, CHEMICAL MACHINES FOR MOLDING AND PROCESSING PLASTIC, AND FOR MANUFACTURING MEDICINES AND CHEMICALS, CASTING APPARATUSES IN THE NATURE OF APPARATUSES FOR SAND CONTROL, MOLDING MACHINES, SMELTERS, INDUSTRIAL FURNACES, BOILERS, TURBINES, GENERATORS, CO-GENERATORS, AND SWITCHBOARDS (U.S. CLS. 100, 103 AND 106).

CLASS 41—EDUCATION AND ENTERTAINMENT

FOR PUBLICATION AND ISSUING OF BOOKS, JOURNALS, MAGAZINES AND OTHER PUBLICATIONS; PROVIDING EDUCATIONAL AND TRAINING INFORMATION IN THE FIELDS OF COMPUTERS, MANUFACTURING, CONSTRUCTION, INDUSTRIAL MACHINERY, ENGINEERING, MATHEMATICS, PHYSICS, CHEMISTRY, TELECOMMUNICATIONS, TRANSPORTATION, LOGISTICS, EMPLOYMENT, BUSINESS MANAGEMENT, AND SOFTWARE, VIA A GLOBAL COMPUTER COMMUNICATION NETWORK; PROVIDING INFORMATION IN THE FIELDS OF SPORTS, NAMELY, GOLF, BASEBALL, TENNIS, FOOTBALL, HOCKEY, BASKETBALL, AND VOLLEYBALL, AND CULTURAL ACTIVITIES, NAMELY, OPERAS, PLAYS, MUSICAL CONCERTS AND FESTIVALS, VIA A GLOBAL COMPUTER COMMUNICATIONS NETWORK; PROVIDING ENTERTAINMENT SERVICES, NAMELY, PROVIDING ONLINE COMPUTER GAMES AND PROVIDING PRE-RECORDED MUSIC, VIA A GLOBAL COMPUTER COMMUNICATIONS NETWORK; RENTAL OF PHOTOGRAPHIC, CINEMATOGRAPHIC, AUDIO AND VIDEO, AND LIGHTING EQUIPMENT AND APPARATUS (U.S. CLS. 100, 101 AND 107).

CLASS 42—SCIENTIFIC, COMPUTER AND LEGAL SERVICES

FOR DEVELOPMENT, DESIGNING, AND UPDATING COMPUTER HARDWARE AND SOFTWARE FOR TELECOMMUNICATIONS NETWORKS; DEVELOPMENT AND DESIGN OF MONITORING SYSTEMS AND NETWORKS; DEVELOPMENT AND DESIGN OF PRODUCTS IN THE AREA OF ELECTRONIC INFORMATION COMMUNICATION SYSTEMS; DESIGNING AND PLANNING OF TELECOMMUNICATIONS EQUIPMENT; PROVIDING COMPUTER NETWORK SYSTEMS INTEGRATION SERVICES; DATABASE DEVELOPMENT SERVICES; PROVIDING DATABASES IN THE FIELD OF PRODUCT QUALITY AND PROCESS CONTROL; TECHNICAL SUPPORT SERVICES, NAMELY, TROUBLESHOOTING OF COMPUTER HARDWARE AND SOFTWARE PROBLEMS; TECHNICAL SUPPORT, NAMELY, MONITORING OF NETWORK SYSTEMS; TECHNICAL SUPPORT, NAMELY, PROVIDING BACK-UP COMPUTER PROGRAMS AND FACILITIES; RESEARCH FOR OTHERS IN THE FIELDS OF ELECTRONIC MONEY, NETWORK PAYMENT SYSTEMS AND NETWORK SECURITY; RESEARCH FOR OTHERS IN THE FIELDS OF TELECOMMUNICATION AND INFORMATION TECHNOLOGY NETWORKS AND SYSTEMS; CONSULTATION FOR OTHERS IN THE DESIGN OF COMPUTER NETWORK SITES; TECHNICAL SERVICES

IN THE OPERATION OF NETWORKED COMPUTER SYSTEMS, NAMELY, PROVIDING COMPUTER PROGRAMMING FOR OTHERS, AND PROTECTING THE SECURITY OF DATA TRANSMITTED OVER COMPUTER NETWORKS BY MEANS OF AN AUTHENTICATION OF USER IDENTITY AND MESSAGE CONTENT, VERIFICATION OF NON-REPUDIATION OF TRANSMISSIONS AND ACCESS CONTROL; CONSULTING FOR A VARIETY OF BUSINESS ENTERPRISES RELATED TO PROVIDING COMPUTER NETWORK SYSTEMS AND PROVIDING COMPUTER NETWORK SERVICES FOR SENDING AND RECEIVING PRODUCT ORDERS, PRODUCT AND MANUFACTURING ESTIMATES, DRAWINGS, DOCUMENTS AND INVENTORY LISTS; PROVIDING PRODUCT QUALITY CONTROL AND PROCESS CONTROL FOR OTHERS BY MEANS OF COMPUTER NETWORKS, COMPUTER HARDWARE, AND COMPUTER SOFTWARE; LOADING, REVISING, AND UPDATING COMPUTER SOFTWARE FOR ELECTRONIC DATA INTERCHANGE AND TELECOMMUNICATIONS NETWORKS FOR OTHERS; COMPUTER NETWORK SUPPORT SERVICES, NAMELY, PROTECTING THE SECURITY OF DATA TRANSMITTED OVER COMPUTER NETWORKS BY MEANS OF ENCRYPTION AND CRYPTOGRAPHY; ARCHITECTURAL CONSULTATION AND CONSTRUCTION DRAFTING; SERVICES OF ENGINEERS; DESIGN AND ENGINEERING OF POWER PLANTS; DEVELOPMENT OF INTRANET/INTRANET/EXTRANET SYSTEMS AND FIREWALL SYSTEMS; SERVICES OF CHEMISTS, OF ENGINEERS AND OF PHYSICISTS; TECHNICAL CONSULTATION IN A WIDE VARIETY OF SCIENTIFIC AND ENGINEERING FIELDS, NAMELY, LOGISTICS, CHEMISTRY, NUCLEAR SCIENCE, ENVIRONMENTAL SCIENCE, BIOLOGY, SOFTWARE ENGINEERING, ELECTRICAL ENGINEERING, MECHANICAL ENGINEERING, INDUSTRIAL ENGINEERING, CHEMICAL ENGINEERING, CIVIL ENGINEERING, BIOMEDICAL ENGINEERING, ENVIRONMENTAL ENGINEERING, AEROSPACE ENGINEERING; LAND SURVEYING, FARM SURVEYING, GEOLOGICAL SURVEYING, OIL FIELD SURVEYING, AND SURVEYING OF HISTORIC BUILDINGS; SCIENTIFIC AND INDUSTRIAL RESEARCH IN THE FIELDS OF ELECTRONICS AND SEMICONDUCTOR MANUFACTURING; DEVELOPMENT OF TECHNOLOGIES FOR THE PURIFICATION OF SOIL AND UNDERGROUND WATER RESOURCES; RESEARCH WITHIN THE FIELDS OF ECONOMIC AND POLITICAL STABILITY; LEASING OF COMPUTER SOFTWARE; RENTAL OF MEASURING APPARATUS AND INSTRUMENTS; COMPUTER SERVICES, NAMELY, PROVIDING A NETWORK OF COMPUTERS, SERVERS, DATABASE AND SOLUTION APPLICATIONS FOR THE ON-LINE EXCHANGE OF GOODS AND SERVICES; RENTAL OF NETWORKING HARDWARE AND SOFTWARE THAT PROVIDE INFORMATION TECHNOLOGY INFRASTRUCTURE AND ENVIRONMENT FOR ELECTRONIC COMMUNICATION; LEASING AND RENTAL OF COMMUNICATION COMPUTERS; LEASING AND RENTAL OF EQUIPMENT FOR EDUCATIONAL, TRAINING, ENTERTAINING, SPORTING AND CULTURAL PURPOSES, NAMELY, COMPUTER HARDWARE, COMPUTERS, AND COMPUTER SOFTWARE (U.S. CLS. 100 AND 101).

CLASS 44—MEDICAL, BEAUTY AND AGRICULTURAL SERVICES

FOR RENTAL OF MEDICAL APPLIANCES, NAMELY, X-RAY DIAGNOSTIC EQUIPMENT, X-RAY CT EQUIPMENT, MRI EQUIPMENT, AND ULTRASOUND EQUIPMENT, ALL FOR MEDICAL USE; PROVIDING DATABASES IN THE FIELD OF ACCUMULATION OF GENETIC INFORMATION (U.S. CLS. 100 AND 101).

JEAN IM, EXAMINING ATTORNEY

SN 75-938,272. KABUSHIKI KAISHA SONY COMPUTER ENTERTAINMENT, TA SONY COMPUTER ENTERTAINMENT INC., TOKYO 107-0052, JAPAN, FILED 3-8-2000.



OWNER OF JAPAN REG. NO. 4599973, DATED 8-30-2002, EXPIRES 8-30-2012.

OWNER OF U.S. REG. NOS. 1,903,261, 2,343,853 AND OTHERS.

NO CLAIM IS MADE TO THE EXCLUSIVE RIGHT TO USE "COM", APART FROM THE MARK AS SHOWN.

CLASS 9—ELECTRICAL AND SCIENTIFIC APPARATUS

FOR AIR TANKS FOR USE IN SCUBA DIVING; BULLET-PROOF VESTS AND CLOTHING; COMPUTER GAME CARTRIDGES; COMPUTER GAME CASSETTES; COMPUTER GAME DISCS; COMPUTER GAME EQUIPMENT CONTAINING MEMORY DEVICES, NAMELY, DISCS; COMPUTER GAME JOYSTICKS; COMPUTER GAME PROGRAMS; COMPUTER GAME SOFTWARE; COMPUTER GAME TAPES; GLASS TUBES FOR SCIENTIFIC PURPOSES; GRADUATED GLASSWARE; LABORATORY GLASSWARE; HIGHWAY SAFETY CONES; LIFE BELTS; LIFE JACKETS; LIFE NETS; LIFE PRESERVERS; LIFE-BUOYS; LIFE-SAVING RAFTS; MACHINES FOR PLAYING GAMES OF CHANCE; INTERACTIVE MULTIMEDIA COMPUTER GAME PROGRAM; INTERACTIVE VIDEO GAME PROGRAMS; INTERACTIVE VIDEO GAMES OF VIRTUAL REALITY COMPRISED OF COMPUTER HARDWARE AND SOFTWARE; JOYSTICKS FOR VIDEO GAMES; PROTECTIVE CLOTHING; PROTECTIVE GLOVES FOR INDUSTRIAL USE; PROTECTIVE OR SAFETY HELMETS; RADON DETECTORS; REGULATORS FOR USE IN SCUBA DIVING; RESPIRATORS OTHER THAN FOR ARTIFICIAL RESPIRATION; RESPIRATORY MASK FILTERS; RHEOSTATS; RING BUOYS FOR USE IN WATER RESCUE; SAFETY GOGGLES; SAFETY HARNESSES OTHER THAN FOR VEHICLES OR SPORTS PURPOSES; SAFETY MARKERS; SAFETY OR PROTECTIVE HELMETS; SAFETY PRODUCTS, NAMELY, REFLECTIVE HELMET SKIRTS; SAFETY PRODUCTS, NAMELY, REFLECTIVE SAFETY BANDS TO BE WORN ON THE BODY; SMOKE DETECTORS; SUPPORT BELTS FOR WORKERS; VENDING MACHINES; VIDEO GAME CARTRIDGES; VIDEO GAME DISCS; VIDEO GAME INTERACTIVE CONTROL FLOOR PADS OR MATS; VIDEO GAME INTERACTIVE REMOTE CONTROL UNITS; VIDEO GAME JOYSTICKS; VIDEO GAME MACHINES FOR USE WITH TELEVISIONS; VIDEO GAME SOFTWARE; VIDEO GAME TAPE CASSETTES; VIRTUAL REALITY GAME SOFTWARE; WARNING TRIANGLES TO INDICATE VEHICLE BREAKDOWNS; WATER SKI SAFETY VESTS (U.S. CLS. 21, 23, 26, 36 AND 38).

CLASS 14—JEWELRY

FOR ALARM CLOCKS; ANKLE BRACELETS; ASHTRAYS OF PRECIOUS METAL; BADGES OF PRECIOUS METAL; BRACELETS OF PRECIOUS METAL; BROOCHES; BUSTS OF PRECIOUS METAL; CANDLE HOLDERS OF PRECIOUS METAL; CANDLE RINGS OF PRECIOUS METAL; CANDLE SNUFFERS OF PRECIOUS METAL; CANDLSTICKS OF PRECIOUS METAL; CHARMS; CHRONOGRAPHS FOR USE AS WATCHES; CHRONOMETERS; CIGARETTE CASES MADE OF PRECIOUS METAL; CIGARETTE HOLDERS OF PRECIOUS METAL; CIGARETTE LIGHTERS OF PRECIOUS METAL; CLOCKS INCORPORATING RADIOS; CLOCKS; COFFEE POTS OF PRECIOUS METAL; COFFEE SERVICES OF PRECIOUS METAL; COSTUME JEWELRY; CRUET STANDS FOR OIL OR VINEGAR OF PRECIOUS METAL; CRUETS OF PRECIOUS METAL; CUFF-LINKS; DECORATIVE BOXES MADE OF PRECIOUS METAL; DIAMONDS; EAR CLIPS; EARRINGS; EMERALDS; FIG-

URES OF PRECIOUS METAL; FIGURINES OF PRECIOUS METAL; GRAVE MARKERS OF PRECIOUS METAL; HAT ORNAMENTS OF PRECIOUS METAL; HAT PINS OF PRECIOUS METAL; INGOTS OF PRECIOUS METAL; JEWELRY BOXES OF PRECIOUS METAL; JEWELRY CASES OF PRECIOUS METAL; JEWELRY FINDINGS; JEWELRY PINS FOR USE ON HATS; JEWELRY; MATCH BOXES OF PRECIOUS METAL; MATCH HOLDERS OF PRECIOUS METAL; MEDALLIONS; NAPKIN RINGS OF PRECIOUS METAL; NECKLACES; NECKTIE FASTENERS; NUT CRACKERS OF PRECIOUS METAL; ORNAMENTAL LAPEL PINS; ORNAMENTAL PINS; PEARLS; PENDANTS; PIGGY BANKS MADE OF PRECIOUS METAL; PINS BEING JEWELRY; POCKET WATCHES; PRECIOUS GEMSTONES; PRECIOUS METALS AND THEIR ALLOYS SOLD IN BULK; RINGS BEING JEWELRY; SCULPTURES MADE OF PRECIOUS METAL; SEMI-PRECIOUS GEMSTONES; SERVIETTE RINGS OF PRECIOUS METAL; SERVING PLATTERS OF PRECIOUS METAL; SHOE ORNAMENTS OF PRECIOUS METAL; SNUFF BOXES OF PRECIOUS METAL; STATUES OF PRECIOUS METAL; STATUETTES OF PRECIOUS METAL; STOP WATCHES; SUN DIALS; TANKARDS OF PRECIOUS METAL; TEA BALLS OF PRECIOUS METAL; TEA INFUSERS OF PRECIOUS METAL; TEA POTS OF PRECIOUS METAL; TEA SERVICES OF PRECIOUS METAL; TIE CLIPS; TIE FASTENERS; TIE PINS; TIE TACKS; TOMBSTONES OF PRECIOUS METAL; WALL CLOCKS; WATCH BANDS; WATCH CASES; WATCH CHAINS; WATCH FOBS; WATCH MOVEMENTS; WATCH STRAPS; WATCHES CONTAINING A GAME FUNCTION; WATCHES; WEDDING BANDS; WRISTWATCHES (U.S. CLS. 2, 27, 28 AND 50).

CLASS 16—PAPER GOODS AND PRINTED MATTER

FOR GARBAGE BAGS OF PLASTIC FOR HOUSEHOLD USE; PAPER BANNERS; PAPER GARBAGE BAGS FOR HOUSEHOLD USE; PAPER BLINDS; PAPER FLAGS; PAPER AND KERCHIEFS; PLAYING CARDS; TABLE CLOTHS OF PAPER; TABLE NAPKINS OF PAPER (U.S. CLS. 2, 5, 22, 23, 29, 37, 38 AND 50).

CLASS 18—LEATHER GOODS

FOR ANIMAL GAME BAGS; ATHLETIC BAGS; BARREL BAGS; BEACH BAGS; BEACH UMBRELLAS; BOOK BAGS; BOSTON BAGS; BRIEFBAGS; CANE HANDLES; CANES; CARRY-ON BAGS; CLUTCH BAGS; DIAPER BAGS; DOG CLOTHING; DOG COLLARS; DRAWSTRING POUCHES; DUFFEL BAGS; FEEDBAGS FOR ANIMALS; FELT POUCHES; GARMENT BAGS FOR TRAVEL; GOLF UMBRELLAS; GYM BAGS; HANDBAGS; HUNTERS' GAME BAGS; KNAPSACKS; OVERNIGHT BAGS; PARASOLS; PATIO UMBRELLAS; ROLL BAGS; SCHOOL BAGS; SCHOOL BOOK BAGS; SHAVING BAGS SOLD EMPTY; SHOE BAGS FOR TRAVEL; SHOPPING BAGS WITH WHEELS ATTACHED; SHOULDER BAGS; SPORTSMAN'S HUNTING BAGS; SUIT BAGS; TOOL BAGS SOLD EMPTY; TOTE BAGS; TRAVEL BAGS; TRAVELING BAGS; UMBRELLAS; VANITY CASES SOLD EMPTY; WALKING STICKS; WRIST MOUNTED CARRYALL BAGS; WRIST MOUNTED PURSES (U.S. CLS. 1, 2, 3, 22 AND 41).

CLASS 21—HOUSEWARES AND GLASS

FOR BOOT JACKS; BOTTLE OPENERS; CANDLE STICKS NOT OF PRECIOUS METAL; CHAMBER POTS; CINDER SIFTERS, FOR HOUSEHOLD USE; CLOTHES BRUSHES; COAL SCUTTLES; COCKTAIL SHAKERS; DENTAL FLOSS; DRINKING FLASKS; DUSTING GLOVES; EGG CUPS; FLOWER POTS; FLY SWATTERS; ICE PAILS; LEMON SQUEEZERS; MOUSE TRAPS; NAPKIN HOLDERS NOT OF PRECIOUS METAL; PEPPER MILLS; ROLLING PINS; SALT SHAKERS; SHOE BRUSHES; SHOE HORNS; SHOE TREES; SOAP DISPENSERS; TOILET TISSUE HOLDERS; TOOTHPICK HOLDERS; TOOTHPICKS; TRAYS FOR USE IN FINGERNAIL POLISHING; TRIVETS; VACUUM BOTTLES; WATERING CANS; WHISKS; WIND CHIMES (U.S. CLS. 2, 13, 23, 29, 30, 33, 40 AND 50).

CLASS 24—FABRICS

FOR BED SHEETS; CURTAINS; DISH CLOTHS; DRAPERIES; MOSQUITO NETS; PILLOW CASES; TABLE CLOTHS NOT OF PAPER; WINDOW CURTAINS (U.S. CLS. 42 AND 50).

CLASS 25—CLOTHING

FOR AFTER SKI BOOTS; ALBS; APRONS; ASCOTS; ATHLETIC FOOTWEAR, ATHLETIC SHOES; ATHLETIC UNIFORMS; BABUSHKAS; BABY BUNTING; BALLOON PANTS; BANDANAS; BANDEAUX; BASEBALL CAPS; BATHING CAPS; BATHING SUITS; BATHING TRUNKS; BATHROBES; BEACH COVERUPS; BEACHWEAR; BED JACKETS; BERETS; BERMUDA SHORTS; BIKINIS; BLAZERS; BLOOMERS; BLOUSES; BLOUSONS; BOAS; BODY SHAPERS; BODY SUITS; BOLEROS; BONNETS; BOOTIES; BOOTS; BOTTOMS; BOW TIES; BOXER SHORTS; BRAS; BRASSIERES; BREECHES; BUSTIERS; CAFTANS; CAMISOLES; CAPES; CARDIGANS; CASOCKS; CHAPS; CHASUBLES; CHEMISES; CHEMISSETTES; CLOGS; CLOTH BIBS; CLOTH DIAPERS; COATS; COLLARS; COMBINATIONS; COMPETITORS' NUMBERS OF TEXTILE; CORSELETS; COVERALLS; COVERUPS; CRAVATS; CREEPERS; CUFFS; CULOTTES; CUMMERBUNDS; DICKIES; DRESS SHIELDS; DRESSES; DRESSING GOWNS; DRY SUITS; DUNGAREES; EAR MUFFS; ESPADRILLES; EVENING GOWNS; FISHING VESTS; FISHING WADERS; FLIGHT SUITS; FOOTWEAR; FOUL WEATHER GEAR; FOUNDATION GARMENTS; FROCKS; FUR CLOAKS; FUR COATS; FUR JACKETS; FUR STOLE; GABERDINES; GAITERS; GALOSHES; GARTER BELTS; GAUCHOS; GLOVES; GOLF SHIRTS; GOLF SHOES; GOWNS; GREATCOATS; GYM SHORTS; GYM SUITS; HALLOWEEN COSTUMES; HALTER TOPS; HATS; HEAD BANDS; HEAD WEAR; HEEL INSERTS; HEELS; HOSE; HOSE; HOUSECOATS; INFANTWEAR; INNER SOLES; INSOLES; JACKETS; JEANS; JERKINS; JODHPURS; JOGGING SUITS; JUMPERS; JUMPSUITS; KERCHIEFS; KILTS; KIMONS; KNEE HIGHS; KNICKERS; KNIT SHIRTS; LAB COATS; LAYETTES; LEATHER COATS; LEATHER JACKETS; LEG WARMERS; LEGGINGS; LEOTARDS; LIGHT-REFLECTING COATS; LIGHT-REFLECTING JACKETS; LINGERIE; LOUNGEWEAR; MAILLOTS; MANTILLAS; MASQUERADE COSTUMES AND MASKS SOLD IN CONNECTION THEREWITH; MASQUERADE COSTUMES; MINISKIRTS; MITTENS; MOCCASINS; MONEY BELTS; MUFFS; MUKLUKS; MUU MUU; NECK BANDS; NECKERCHIEFS; NECKTIES; NECKWEAR; NEGLIGENCE; NIGHT GOWNS; NIGHT SHIRTS; OVERALLS; OVERCOATS; OVERSHOES; PAJAMAS; PANTALOONS; PANTIES; PANTS; PANTSUITS; PANTYHOSE; PARAMENTS; PAREU; PARKAS; PEDAL PUSHERS; PEIGNOIRS; PELERINES; PELISSES; PETTICOATS; PINAFORES; PLAY SUITS; PLUS FOURS; POCKET SQUARES; POLO SHIRTS; PONCHOS; PULLOVERS; QUILTED VESTS; RAIN COATS; RAIN SUITS; RAINWEAR ROBES; ROMPERS; RUBBERS; SANDALS; SARIS; SARONGS; SASHES; SCARVES; SHAWLS; SHIRTS; SHOES; SHORTALLS; SHORTS; SHOULDER PADS FOR CLOTHING; SHOWER CAPS; SINGLETS; SKI BIBS; SKI BOOT BAGS; SKI BOOTS; SKI GLOVES; SKI MASKS; SKI PANTS; SKI SUITS; SKI WEAR; SKIRTS; SKORTS; SLACKS; SLEEP MASKS; SLEEPWEAR; SLIPPERS; SLIPS; SMOCKS; SNEAKERS; SNOW PANTS; SNOW SUITS; SNOWBOARD BOOTS; SNOWBOARD GLOVES; SOCKS; SPORT COATS; SPORT SHIRTS; STOCKINGS; STOLE; SUIT COATS; SUITS; SUN VISORS; SUNSUITS; SUSPENDERS; SWADDLING CLOTHES; SWEAT BANDS; SWEAT PANTS; SWEAT SHIRTS; SWEAT SHORTS; SWEAT SUITS; SWEATERS; SWEATSOCKS; SWIM TRUNKS; SWIM WEAR; SWIMSUITS; T-SHIRTS; TAILLEURS; TANGAS; TANK TOPS; TAP PANTS; TEDDIES; TENNIS WEAR; THERMAL SOCKS; THERMAL UNDERWEAR; TIGHTS; TOE BOXES; TOGAS; TOPCOATS; TOQUES; TRACKSUITS; TROUSERS; TUNICS; TURBANS; TURTLENECK SWEATERS; TURTLENECKS; TUXEDOS; UNDERCLOTHES; UNDERGARMENTS; UNDERPANTS; UNDERSHIRTS; UNDERWEAR; UNIFORMS; UNITARDS; V-NECK SWEATERS; VEILS; VESTED SUITS; VESTS; VISORS; WAISTCOATS; WARM UP SUITS; WEDDING GOWNS; WET SUITS; WIND RESISTANT JACKETS; WINDSHIRTS; WRIST BANDS; ZOOT SUITS; ZORI (U.S. CLS. 22 AND 39).

CLASS 26—FANCY GOODS

FOR BUTTONS FOR CLOTHING; CAMPAIGN BUTTONS; CLOTHING BUCKLES; ELASTIC RIBBONS; ELASTIC TAPE; EMBROIDERED EMBLEMS; HAIR ORNAMENTS; HAIR ORNAMENTS IN THE NATURE OF HAIR WRAPS; HAIR RIBBONS; HOOK AND LOOP FASTENING TAPE; HOOK AND PILE FASTENING TAPES; ORNAMENTAL NOVELTY BUTTONS; ORNAMENTAL RIBBONS MADE OF TEXTILES; PRESS BUTTONS; PRIZE RIBBONS; RIBBONS FOR GIFT WRAPPING; RIBBONS; RIVET BUTTONS; SHIRT BUTTONS; SHOE LACES; SHOE ORNAMENTS NOT OF PRECIOUS METAL; SLIDE FASTENERS; SNAP FASTENERS; TAPE FOR FIXING WIGS (U.S. CLS. 37, 39, 40, 42 AND 50).

CLASS 28—TOYS AND SPORTING GOODS

FOR ACTION FIGURES AND ACCESSORIES THEREFOR; ACTION FIGURES; ACTION SKILL GAMES; ACTION-TYPE TARGET GAMES; ADULTS' AND CHILDREN'S PARTY GAMES; AERO-DYNAMIC DISK FOR USE IN PLAYING CATCHING GAMES; AIR MATTRESSES FOR RECREATIONAL USE; AMUSEMENT PARK RIDES; ANIMAL ATTRACTANT SCENTS; ANKLE AND WRIST WEIGHTS FOR EXERCISE; ARCADE GAMES; ARM GUARDS FOR ATHLETIC USE; ATHLETIC SPORTING GOODS, NAMELY, ATHLETIC WRIST AND JOINT SUPPORTS; ATHLETIC SUPPORTERS; ATHLETIC TAPE; BABY MULTIPLE ACTIVITY TOYS; BABY RATTLES; BACKBOARDS FOR BASKETBALL; BACKGAMMON GAME SETS; BADMINTON FLOOR PLATES; BADMINTON GAME PLAYING EQUIPMENT; BADMINTON RACKET STRINGS; BADMINTON RACKETS; BADMINTON SETS; BADMINTON SHUTTLECOCKS; BADMINTON UPRIGHTS; BALL BEARINGS FOR IN-LINE SKATES; BALL BEARINGS FOR ROLLER SKATES; BALL CAGES; BALL PITCHING MACHINES; BALLOONS; BARBELLS; BASEBALL BASES; BASEBALL BATS; BASEBALL BATting GLOVES; BASEBALL BATting TEES; BASEBALL GLOVES; BASEBALL MITTS; BASEBALLS; BASKETBALL GOAL SETS; BASKETBALL GOALS; BASKETBALL NETS; BASKETBALLS; BATH TOYS; BATHTUB TOYS; BATting GLOVES; BEACH BALLS; BEAN BAGS; BENDABLE TOYS; BICYCLING GLOVES; BILLIARD BALLS; BILLIARD BRIDGES; BILLIARD BUMPER; BILLIARD CHALK; BILLIARD CUE RACKS; BILLIARD CUES; BILLIARD CUSHIONS; BILLIARD GAME PLAYING EQUIPMENT; BILLIARD NETS; BILLIARD TABLES; BILLIARD TALLY BALLS; BILLIARD TIPS; BILLIARD TRIANGLES; BINGO CARDS; BINGO GAME PLAYING EQUIPMENT; BIRD CALLS; BLOCKING DUMMIES; BOARD GAMES; BOBSLEDS; BOCCI BALLS; BODY BOARDS; BOOMERANGS; BOWLING BAGS; BOWLING BALL COVERS; BOWLING BALL RETURNS; BOWLING BALLS; BOWLING DEFLECTORS; BOWLING PINS; BOWLING PINSETTERS AND PARTS THEREFOR; BOWLING PIT MATS; BOXING BAG SWIVEL MECHANISMS; BOXING BAGS; BOXING GLOVES; BUBBLE MAKING WAND AND SOLUTION SETS; CAPS FOR TOY PISTOLS; CARD GAMES; CASES FOR ACTION FIGURES; CASES FOR PLAY ACCESSORIES; CASES FOR TOY STRUCTURES; CASES FOR TOY VEHICLES; CAT TOYS; CATCHERS' MASKS; CHECKER SETS; CHERLEADING POM-POMS; CHESS SETS; CHEST PROTECTORS FOR SPORTS; CHILDREN'S ACTIVITY TABLES CONTAINING MANIPULATIVE TOYS WHICH CONVERT TO EASELS; CHRISTMAS GARLANDS; CHRISTMAS STOCKINGS; CHRISTMAS TREE SKIRTS; CHRISTMAS TREE STAND COVERS; CHRISTMAS TREE STANDS; CLIMBERS' HARNESSSES; COIN-OPERATED VIDEO GAMES; COLLECTABLE TOY FIGURES; CONSTRUCTION TOYS; COSTUME MASKS; CRAFT SETS FOR DECORATING BALLOONS; CRIB MOBILES; CRIB TOYS; CRICKET BALLS; CRICKET BATS; CROSSBOWS; CURLING STONES; DART BOARD CASES; DART BOARDS; DART CARRYING CASES; DART FLIGHTS; DART POINT SHARPENERS; DART POINTS; DART SHAFTS; DART STEMS; DARTS; DICE; DISC TOSS TOYS; DISCUS; DIVOT REPAIR TOOL FOR GOLFERS; DOG TOYS; DOLL ACCESSORIES; DOLL CASES; DOLL CLOTHING; DOLL COSTUMES; DOLL FURNITURE; DOLL HOUSE FURNISHINGS; DOLL HOUSES; DOLLS AND ACCESSORIES THEREFOR; DOLLS AND PLAYSETS THEREFOR; DOLLS; DOMINOES; DRAWING TOYS; DUCK BLINDS; DUMBBELL SETS; DUMB-

BELLS; EASTER EGG COLORING KITS; EGG DECORATING KITS; ELBOW GUARDS FOR ATHLETIC USE; ELBOW PAD FOR ATHLETIC USE; ELECTRIC ACTION TOYS; ELECTRIC TOY TRAIN TRANSFORMERS; ELECTRONIC DART GAMES; ELECTRONIC EDUCATIONAL GAME MACHINES FOR CHILDREN; ELECTRONIC GAME EQUIPMENT WITH A WATCH FUNCTION; EQUIPMENT SOLD AS A UNIT FOR PLAYING A MEMORY GAME; EXERCISE BARS; EXERCISE BENCHES; EXERCISE DOORWAY GYM BARS; EXERCISE EQUIPMENT FOR LATERAL MOVEMENT IN A SKATING MOTION; EXERCISE EQUIPMENT, NAMELY, STAIR-STEPPING MACHINES; EXERCISE MACHINES; EXERCISE PLATFORMS; EXERCISE TABLES; EXERCISE TRAMPOLINES; EXERCISE TREADMILLS; EXERCISE WEIGHT CUFFS; EXERCISE WEIGHTS; EXERCISING EQUIPMENT, NAMELY MANUALLY OPERATED JOGGING MACHINES; EXERCISING EQUIPMENT, NAMELY POWERED TREADMILLS FOR RUNNING; EXERCISING EQUIPMENT, NAMELY PULLEYS; EXERCISING EQUIPMENT, NAMELY ROWING MACHINES; EXERCISING EQUIPMENT, NAMELY WEIGHT LIFTING MACHINES; EXERCISING PULLEYS; FANTASY CHARACTER TOYS; FIELD HOCKEY BALLS; FIELD HOCKEY GOALIE PADS; FIELD HOCKEY STICKS; FINS FOR BODY BOARDS; FIREARM TARGETS; FIRST BASEMAN'S MITTS; FISH ATTRACTANTS; FISHING BUOYS; FISHING CREELS; FISHING EQUIPMENT, NAMELY WINGING MATERIAL FOR FISHING JIGS AND STREAMERS; FISHING FLIES; FISHING FLOATS; FISHING FLY BOXES; FISHING HOOKS; FISHING LEADERS; FISHING LINES; FISHING LURE BOXES; FISHING LURE PARTS; FISHING LURES; FISHING PLUGS; FISHING POLE HOLDERS WORN ON THE BODY; FISHING REELS; FISHING ROD BLANKS; FISHING ROD HANDLES; FISHING ROD HOLDERS; FISHING RODS; FISHING SAFETY HARNESS; FISHING SPINNERS; FISHING TACKLE BOXES; FISHING TACKLE CONTAINERS; FISHING TACKLE; FLIES FOR USE IN FISHING; FLIPPERS FOR USE IN SCUBA DIVING; FLOATING RECREATIONAL LOUNGE CHAIRS; FLYING DISCS; FOOTBALL BODY PROTECTORS; FOOTBALL GIRDLES; FOOTBALL SHOULDER PADS; FOOTBALLS; GAME EQUIPMENT NAMELY, CHIPS; GAME TABLES; GAMING TABLES; GOALKEEPERS' GLOVES; GOLF ACCESSORY POUCHES; GOLF BAG COVERS; GOLF BAG TAGS; GOLF BAGS; GOLF BALL MARKERS; GOLF BALL RETRIEVERS; GOLF BALLS; GOLF CLUB HEADS; GOLF CLUB INSERTS; GOLF CLUB SHAFTS; GOLF CLUBS; GOLF FLAGS; GOLF GLOVES; GOLF IRONS; GOLF PUTTER COVERS; GOLF PUTTERS; GOLF TEE MARKERS; GOLF TEES; GRIP TAPES FOR BASEBALL BATS; GRIP TAPES FOR GOLF CLUBS; GRIP TAPES FOR RACKETS; GYMNAS TIC APPARATUS; GYMNAS TIC HORIZONTAL BARS; GYMNAS TIC PARALLEL BARS; GYMNAS TIC TRAINING STOOLS; GYMNAS TIC VAULTING HORSES; HAND PADS FOR ATHLETIC USE; HANDBALL GLOVES; HANDBALLS; HAND HELD UNIT FOR PLAYING ELECTRONIC GAME; HANDLE GRIPS FOR SPORTING EQUIPMENT; HANG GLIDERS; HEAD COVERS FOR GOLF CLUBS; HOCKEY GLOVES; HOCKEY PUCKS; HOCKEY STICKS; HOME PLATES; HORSESHOES FOR RECREATIONAL PURPOSES; HUNTERS' SCENT CAMOUFLAGE; HUNTERS' SCENT LURE; HUNTING ARROW POINTS; HUNTING BLINDS; HUNTING BOWS; HUNTING CAMOUFLAGE USED AS HUNTING BLINDS; HUNTING GAME CALLS; HUNTING STANDS; ICE FISHING STRIKE INDICATOR; ICE HOCKEY GOALIE PADS; ICE HOCKEY STICKS; ICE SKATES; IN-LINE SKATES; INFANT ACTION CRIB TOYS; INFANT TOYS; INFLATABLE BOP BAGS; INFLATABLE INNER TUBES FOR AQUATIC RECREATIONAL USE; INFLATABLE TOYS SHOWING DECORATIVE PICTURES; INFLATABLE TOYS; JIGSAW PUZZLES; JUMP ROPES; KARATE GLOVES; KARATE HEAD GUARDS; KARATE KICK PADS; KARATE SHIN PADS; KTRATE TARGET PADS; KENO CARDS; KICK BOARD FLOTATION DEVICES FOR RECREATIONAL USE; KICKING TEES; KITE HANDLES; KITE LINES; KITE PARTS; KITE REELS; KITE STRING; KITE TAILS; KITES; KITS FOR BUILDING OUTDOOR PLAY EQUIPMENT; KNEE GUARDS FOR ATHLETIC USE; KNEE PADS FOR ATHLETIC USE; LCD GAME MACHINES; LACROSSE BALL BAGS; LACROSSE BALLS; LACROSSE STICKS; LEASHES USED IN CONJUNCTION WITH SURFING; LEG GUARDS FOR ATHLETIC USE; LEG WEIGHTS FOR ATHLETIC USE; LEG WEIGHTS FOR EXERCISING; LOTTERY

CARDS; LOTTERY TICKETS; LURES FOR HUNTING; MAGIC TRICKS; MAH JONG GAMES; MANIPULATIVE GAMES; MANIPULATIVE PUZZLES; MARBLES; MARIONETTE PUPPETS; MECHANICAL ACTION TOYS; MECHANICAL TOYS; MOBILES FOR CHILDREN; MOUNTAINEERING EQUIPMENT, NAMELY, BINDING STRAPS; MOUNTAINEERING EQUIPMENT, NAMELY, CARABINERS; MOUNTAINEERING EQUIPMENT NAMELY, HOOK AND RING COMBINATIONS; MOUNTAINEERING EQUIPMENT, NAMELY, HOOKS; MOUTH GUARDS FOR ATHLETIC USE; MUSIC BOX TOYS; MUSICAL TOYS; NEEDLES FOR PUMPS FOR INFLATING SPORTS EQUIPMENT; NETBALLS; PADDLE BALL GAMES; PADDLE BALLS; PADDLES FOR USE IN PADDLE BALL GAMES; PAPER AIRPLANES; PAPER DOLLS; PAPER FACE MASKS; PARAGLIDERS; PARLOR GAMES; PARTY FAVORS IN THE NATURE OF SMALL TOYS; PET TOYS; PINBALL-TYPE GAMES; PINTAS; PITCHERS' PLATES; PLATFORM TENNIS BALLS; PLATFORM TENNIS NETS; PLATFORM TENNIS PADDLES; PLAY HOUSES; PLAY MATS CONTAINING INFANT TOYS; PLAY MATS FOR USE WITH TOY VEHICLES; PLAY TENTS; PLAYGROUND BALLS; PLAY SET BUILDINGS; PLAYSETS FOR DOLLS; PLUSH TOYS; POOL BRIDGES; POOL BUMPER; POOL CHALK HOLDERS; POOL CUE CASES; POOL CUE CEMENT; POOL CUE CHALK; POOL CUE CLAMPS; POOL CUE RACKS; POOL CUE REPAIR KITS; POOL CUE TIPS; POOL CUES; POOL CUSHIONS; POOL TALLY BALLS; POP UP TOYS; PORCELAIN DOLLS; PORTABLE SUPPORT STRUCTURES FOR DANCE AND OTHER EXERCISES; POSITIONABLE TOY FIGURES; PRINTING TOYS; PROMOTIONAL GAME CARDS; PROMOTIONAL GAME MATERIALS; PULL TOYS; PUMPS FOR INFLATING SPORTS EQUIPMENT, SUCH AS BASKETBALLS, FOOTBALLS; PUNCHING BAGS; PUNCHING TOYS; PUPPETS; PUSH TOYS; RACKET GRIP TAPE; RACQUET BALL GLOVES; RACQUET BALL NETS; RACQUET BALL RACKET COVERS; RACQUET BALL RACKET STRINGS; RACQUET BALL RACKETS; RACQUET BALLS; RADIO CONTROLLED MODEL VEHICLES; RADIO CONTROLLED TOY VEHICLES; RAG DOLLS; RIDE-ON TOYS; RING BUOYS FOR RECREATIONAL USE; ROCKING HORSES; ROLE PLAYING GAME EQUIPMENT IN THE NATURE OF GAME BOOK MANUALS; ROLE PLAYING GAMES; ROLLER SKATES; RUBBER ACTION BALLS; RUGBY BALLS; SAFETY PADDING FOR VOLLEYBALL AND TENNIS UPRIGHTS; SAIL BOARD FOOT RESTRAINTS; SAIL BOARD FOOT STRAPS; SAIL BOARD LEASHES; SAIL BOARD MASTS; SAIL BOARDS; SAND TOYS; SANDBOX TOYS; SCUBA DIVING MASKS; SCUBA EQUIPMENT, NAMELY SPRING ACTIVATED SPEARGUNS; SCUBA FINS; SCUBA FLIPPERS; SCUBA GOGGLES; SCUBA MASKS; SCUBA SNORKELS; SHIN GUARDS FOR ATHLETIC USE; SHIN PADS FOR ATHLETIC USE; SHOULDER PAD ELASTIC FOR ATHLETIC USE; SHOULDER PAD LACELOCKS FOR ATHLETIC USE; SHOULDER PAD LACES FOR ATHLETIC USE; SKATEBOARDS; SKETCHING TOYS; SKI BINDINGS AND PARTS THEREFOR; SKI BRAKES; SKI EDGES; SKI POLES; SKI ROPES; SKI SCRAPERS; SKI WAX; SKIM BOARDS; SKIN DIVING MASKS; SKIPPING ROPE; SKIS; TITTLES; SLEDS FOR USE IN DOWNHILL AMUSEMENT RIDES; SLING SHOTS; SNORKELS; SNOW BOARDS; SNOW SAUCERS; SNOW SHOES; SNOW SKIS; SNOW SLEDS FOR RECREATIONAL USE; SOCCER BALLS; SOFT SCULPTURE DOLLS; SOFT SCULPTURE PLUSH TOYS; SOFTBALL BATS; SOFTBALL GLOVES; SOFTBALL MITTS; SPINNING; SPORT BALLS; SPORTSMAN'S FISHING BAGS; SPRING BAR TENSION SETS FOR USE IN EXERCISING; SPRING BARS FOR EXERCISING; SQUASH BALLS; SQUASH RACKET COVERS; SQUASH RACKET STRINGS; SQUASH RACKETS; SQUEEZE TOYS; STAND ALONE VIDEO GAME MACHINES; STATIONARY EXERCISE BICYCLES; STUFFED TOY ANIMALS; STUFFED TOYS; SURF FINS; SURFBOARD FINS; SURFBOARD LEASHES; SURFBOARD WAX; SURFBOARDS; SWIM BOARDS FOR RECREATIONAL USE; SWIM FINS; SWIM FLOATS FOR RECREATIONAL USE; SWIM GOGGLES; SWIM MASKS; SE SWIMMING EQUIPMENT, NAMELY, RACING LANES; SWIMMING EQUIPMENT, NAMELY, STARTING BLOCKS; SWIMMING GLOVES; SWING SETS; TABLE TENNIS BALLS; TABLE TENNIS NETS; TABLE TENNIS PADDLES; TABLE TENNIS POST SETS; TABLE TENNIS RACKETS; TABLE TENNIS TABLES; TALKING TOYS; TARGET GAMES; TARGETS; TEACHING MATERIALS IN THE FORM OF

CARD GAMES; TEDDY BEARS; TENNIS BALL RETRIEVERS; TENNIS BALLS; TENNIS NETS; TENNIS RACKET COVERS; TENNIS RACKET PRESSES; TENNIS RACKET STRINGS; TENNIS RACKETS; TENNIS UPRIGHTS; TETHER BALLS; THROAT PROTECTORS FOR ATHLETIC USE; TOSSING DISC TOYS; TOY ACTION FIGURES AND ACCESSORIES THEREFOR; TOY ACTION FIGURES; TOY ARMOR; TOY ARTIFICIAL FINGERNAILS; TOY BOWS AND ARROWS; TOY BOXES; TOY FIGURES; TOY GLIDERS; TOY GUNS; TOY HOLSTERS; TOY HOOP SETS; TOY MOBILES; TOY MODEL HOBBY CRAFT KITS; TOY MODELING DOUGH; TOY PISTOLS; TOY PUTTY; TOY ROCKETS; TOY SNOW GLOBES; TOY STAMPS; TOY SWORDS; TOY VEHICLES; TOY VEHICLES WITH TRANSFORMING PARTS; TOY WATCHES; TOY WEAPONS; TOYS, NAMELY, A DISK TO TOSS IN PLAYING A GAME WHEREIN OTHER DISKS ARE FLIPPED AND COLLECTED; TRACTORS AND SLEDS FOR USE IN DOWN-HILL AMUSEMENT RIDES; TRAIN SET ACCESSORIES, NAMELY, ARTIFICIAL TREES, TURF, FOLIAGE, BALLAST, LICHEN AND GRASS; TRANSFORMING ROBOTIC TOY VEHICLES; TRANSFORMING ROBOTIC TOYS; UMPIRE PROTECTION EQUIPMENT; VENTRILOQUIST'S DUMMIES; VIDEO OUTPUT GAMES; VOLLEYBALL FLOOR PLATES; VOLLEYBALL GAME PLAYING EQUIPMENT; VOLLEYBALL NET ANTENNAS; VOLLEYBALL NETS; VOLLEYBALL UPRIGHTS; VOLLEYBALLS; WAKE BOARDS; WATER PISTOLS; WATER SKI ROPE BRIDGES; WATER SQUIRTING TOYS; WATER WING SWIM AIDS FOR RECREATIONAL USE; WATER SKI BINDINGS; WATERSKI BRIDLES; WATER SKI CARRYING CASES; WATERSKI GLOVES; WATERSKI HANDLES; WATERSKI ROPE BRIDLES; WATERSKI ROPE HANDLES; WATERSKI ROPES; WATERSKI TOW HARNESSES; WATERSKI TOW ROPES; WATERSKIS; WEIGHT LIFTING BELTS; WEIGHT LIFTING BENCHES AND BENCH ACCESSORIES; WEIGHT LIFTING GLOVES; WIND-UP TOYS; WIND-UP WALKING TOYS; WRIST AND ANKLE WEIGHTS FOR EXERCISE; YOS (U.S. CLS. 22, 23, 38 AND 50).

PRISCILLA MILTON, EXAMINING ATTORNEY

SN 76-018,644. VISCOCHECK AB, 102 14 STOCKHOLM, SWEDEN, FILED 4-5-2000.

VISCOCHECK

PRIORITY CLAIMED UNDER SEC. 44(D) ON SWEDEN APPLICATION NO. 1999-07099, FILED 10-6-1999, REG. NO. 370739, DATED 2-25-2005, EXPIRES 2-25-2015.

CLASS 9—ELECTRICAL AND SCIENTIFIC APPARATUS

FOR SCIENTIFIC INSTRUMENTS, NAMELY, WHOLE BLOOD VISCOSITY MONITORS, FOR MEASURING THE VISCOELASTICITY IN BIOLOGICAL LIQUIDS (U.S. CLS. 21, 23, 26, 36 AND 38).

CLASS 10—MEDICAL APPARATUS

FOR DIAGNOSTIC INSTRUMENTS, NAMELY, WHOLE BLOOD VISCOSITY MONITORS, FOR THE DIAGNOSIS OF HEART DISEASES AND CONDITIONS (U.S. CLS. 26, 39 AND 44).

CLASS 16—PAPER GOODS AND PRINTED MATTER

FOR PRINTING TEACHING AND INSTRUCTION MANUALS IN THE FIELD OF THE OPERATION AND MAINTENANCE OF A DIAGNOSTIC INSTRUMENT FOR DIAGNOSIS OF HEART DISEASES (U.S. CLS. 2, 5, 22, 23, 29, 37, 38 AND 50).

CLASS 42—SCIENTIFIC, COMPUTER AND LEGAL SERVICES

FOR HEALTH TEST SERVICES IN THE FIELD OF HEART DISEASE AND CONDITIONS (U.S. CLS. 100 AND 101).

SUE LAWRENCE, EXAMINING ATTORNEY

SN 76-051,995. OMNIMEDIA SYSTEMS, INC., GREAT BARRINGTON, MA. FILED 5-10-2000.

TAILORED MEDIA. ON DEMAND.**CLASS 9—ELECTRICAL AND SCIENTIFIC APPARATUS**

FOR COMPUTER HARDWARE AND SOFTWARE FOR CREATING CUSTOM AUDIO-VISUAL WORKS AND DELIVERING THE SAME OVER THE INTERNET OR VIA VIDEOTAPES OR CD-ROM'S OR DVD'S (U.S. CLS. 21, 23, 26, 36 AND 38).

CLASS 41—EDUCATION AND ENTERTAINMENT

FOR PRODUCTION AND DISTRIBUTION OF AUDIO-VISUAL WORKS (U.S. CLS. 100, 101 AND 107).

STEPHANIE DAVIS, EXAMINING ATTORNEY

SN 76-034,928. VICTOR HUGO ARTEFATOS DE COURO, LTDA., RIO DE JANEIRO, RJ, BRAZIL, FILED 4-26-2000.

VICTOR HUGO

OWNER OF BRAZIL REG. NO. 812337794, DATED 12-15-1992, EXPIRES 12-15-2012.

OWNER OF BRAZIL REG. NO. 200059483, DATED 12-15-1992, EXPIRES 12-12-2012.

THE NAME VICTOR HUGO IDENTIFIES A LIVING INDIVIDUAL WHOSE CONSENT IS OF RECORD.

CLASS 18—LEATHER GOODS

FOR HANDBAGS; BRIEFCASES; WALLETS AND SUITCASES (U.S. CLS. 1, 2, 3, 22 AND 41).

CLASS 25—CLOTHING

FOR ARTICLES OF CLOTHING FOR MEN AND WOMEN, NAMELY, TUXEDOS, COATS, SPORT COATS, TOPCOATS, RAINCOATS, RAINWEAR, GOWNS, DRESSES, SKIRTS, CULOTTES, JACKETS, SUITS, VESTS, SHIRTS, OVERALLS, COVERALLS, JUMPSUITS, PANTSUITS, PANTS, SLACKS, TROUSERS, SWEAT-PANTS, SHORTS, JEANS, DENIM JACKETS, SPORT SHIRTS, POLO SHIRTS, KNIT SHIRTS, T-SHIRTS, TANK TOPS, TURTLENECKS, BODYSUITS, BODYWEAR, NAMELY LEGGINGS, TIGHTS, BRIEFS, BOXER SHORTS, SPORT TANK TOPS, SHORTS, BOTTOMS, SPORT KNIT TOPS, TANK TOPS, BODY TANK TOPS, CAMISOLES, SWEAT SHIRTS, LINGERIE, BODY STOCKINGS, BUSTIERS, LEOTARDS AND UNITARDS, CULOTTES, CHEMISES, TEDDIES, TAP PANTS, PETTIPANTS, BLOOMERS, VESTS, SOCKS AND HOSIERY, SOCKS AND STOCKINGS, HEAD SCARVES, NECK SCARVES, SHOULDER SCARVES, POCKET KERCHIEFS, SHOES, FASHION BOOTS, HEADWEAR, BELTS, EXERCISE SUITS; GLOVES AND MITTENS NORMALLY WORN AS CLOTHING, INCLUDING FASHION, CASUAL AND DRESS GLOVES, EXCLUDING WORK GLOVES, INDUSTRIAL AND PROTECTIVE GLOVES, GARDENING GLOVES, RUBBER PROTECTIVE GLOVES AND GLOVES DESIGNED FOR SPECIFIC SPORTS AND HAVING A SPECIFIC PROTECTIVE OR OTHER PERFORMANCE RELATED FUNCTION FOR SAID SPORTS; SWEATERS, CARDIGANS, PULLOVERS, CHEMISES, BLOUSONS, JOGGING SUITS, SWEATSHIRTS, LOUNGEWEAR, SUSPENDERS, BATHING SUITS, BATHING CAPS, SWIMWEAR, BEACHWEAR, ROBES, SLEEPWEAR, AND UNDERWEAR (U.S. CLS. 22 AND 39).

ANGELA M. MICHELI, EXAMINING ATTORNEY

SN 76-065,423. E4E, INC., SANTA CLARA, CA. FILED 6-6-2000.

E4E**CLASS 35—ADVERTISING AND BUSINESS**

FOR BUSINESS CONSULTING SERVICES, NAMELY, CUSTOMER RELATIONSHIP MANAGEMENT SERVICES; BUSINESS ACQUISITION OF TECHNOLOGY COMPANIES, ELECTRONIC COMMERCE COMPANIES, GLOBAL COMPUTER NETWORK-BASED COMPANIES AND EXCHANGES AND INFRASTRUCTURE SERVICE PROVIDERS (U.S. CLS. 100, 101 AND 102).

CLASS 36—INSURANCE AND FINANCIAL

FOR FINANCIAL INVESTMENT IN THE FIELD OF TECHNOLOGY COMPANIES, ELECTRONIC COMMERCE COMPANIES, GLOBAL COMPUTER NETWORK-BASED COMPANIES AND EXCHANGES AND INFRASTRUCTURE SERVICE PROVIDERS; FINANCIAL CONSULTATION SERVICES FOR TECHNOLOGY COMPANIES, ELECTRONIC COMMERCE COMPANIES, GLOBAL COMPUTER NETWORK-BASED COMPANIES AND EXCHANGES AND INFRASTRUCTURE SERVICE PROVIDERS (U.S. CLS. 100, 101 AND 102).

ALICE BENMAMAN, EXAMINING ATTORNEY

SN 76-178,478. ARDANA BIOSCIENCE LIMITED, LONDON, ENGLAND, UNITED KINGDOM, FILED 12-11-2000.

ARDANA BIOSCIENCE

PRIORITY CLAIMED UNDER SEC. 44(D) ON UNITED KINGDOM APPLICATION NO. 2235463, FILED 6-9-2000, REG. NO. 2235463, DATED 3-8-2002, EXPIRES 6-9-2010.

NO CLAIM IS MADE TO THE EXCLUSIVE RIGHT TO USE "BIOSCIENCE", APART FROM THE MARK AS SHOWN.

CLASS 5—PHARMACEUTICALS

FOR PHARMACEUTICAL PREPARATIONS FOR MEDICAL DIAGNOSIS, NAMELY, FOR THE DIAGNOSIS OF PREGNANCY; SANITARY PREPARATIONS, NAMELY, TAMPONS USED FOR DELIVERING PHARMACEUTICAL PREPARATIONS TO THE FEMALE REPRODUCTIVE TRACT AND TAMPONS DESIGNED TO REDUCE THE CHANCE OF INFECTION OF THE FEMALE REPRODUCTIVE TRACT; SANITARY PADS; SANITARY NAPKINS; DIETETIC PRODUCTS FOR MEDICAL USE, NAMELY, DIETARY SUPPLEMENTS AND FOOD FOR MEDICAL RESTRICTED DIETS; DIAGNOSTIC KITS CONSISTING PRIMARILY OF MEDICAL DIAGNOSTIC REAGENTS AND PREPARATIONS FOR REPRODUCTIVE HEALTH USES, SEMEN ANALYSIS, TESTING SPERM FERTILIZATION CAPABILITY, HORMONE LEVEL ANALYSIS FOR TESTING THE PRESENCE AND LEVEL OF LUTENEISING HORMONE (LH), FOLLICLE STIMULATING HORMONE (FSH), BETA-OESTRADIOL, PROLACTIN, PROGESTERONE, HUMAN CHORIONIC GONADOTROPHIN (HCG) AND TESTOSTERONE, TO DETECT GENITAL INFECTIONS, TO TEST FOR ANTIBODIES TO VARIOUS ORGANISMS, TO DETECT MARKERS OF PRE-TERM LABOR, PREGNANCY COMPLICATIONS, MISCARRIAGE AND IMPLANTATION FAILURE, TO DETECT ANTIPHOSPHOLIPIDS, PROTEIN S DEFICIENCY, LUPUS ANTI-COAGULANT AND FACTOR V LEIDEN MUTATION, TO DETECT MARKERS OF FEMALE FERTILITY, TO DETECT DAZL HETEROZYGOUS MUTATION AND ASSOCIATED BIOCHEMICAL MARKERS SUCH AS TESTOSTERONE FOR THE ANALYSIS OF DNA, RNA FOR THE DETECTION OF DISEASE OR REDISPOSITION ASSOCIATED WITH REPRODUCTION, FOR THE ANALYSIS OF PROTEIN OR OTHER BIOCHEMICAL MARKERS OF DISEASE OR PREDISPOSITION OF DISEASE, TO DETECT BIOCHEMICAL MARKERS WHICH INDICATE DISEASE OR PREDISPOSITION TO DISEASE; ORAL CONTRACEPTIVES; CONTRACEPTIVE FOAMS (U.S. CLS. 6, 18, 44, 46, 51 AND 52).

CLASS 10—MEDICAL APPARATUS

FOR DIAGNOSTIC KITS CONSISTING PRIMARILY OF DIPSTICKS, LITMUS PAPER, TEST-TUBES, PIPETTES, STYLETS FOR DRAWING BLOOD SAMPLES, PLASTIC CONTAINERS, SLIDES, SYRINGES, NEEDLES, SPATULAS AND NON-INVASIVE DEVICES, AND MEDICAL DIAGNOSTIC REAGENTS AND PREPARATIONS FOR OBTAINING AND TESTING BIOLOGICAL SAMPLES FOR REPRODUCTIVE HEALTH USES, SEMEN ANALYSIS, TESTING SPERM FERTILIZATION CAPABILITY, HORMONE LEVEL ANALYSIS FOR TESTING THE PRESENCE AND LEVEL OF LUTENEISING HORMONE (LH), FOLLICLE STIMULATING HORMONE (FSH), BETA-OESTRADIOL, PROLACTIN, PROGESTERONE, HUMAN CHORIONIC GONADOTROPHIN (HCG) AND TESTOSTERONE, TO DETECT GENITAL INFECTIONS, TO TEST FOR ANTIBODIES TO VARIOUS ORGANISMS, TO DETECT MARKERS OF PRE-TERM LABOR, PREGNANCY COMPLICATIONS, MISCARRIAGE AND IMPLANTATION FAILURE, TO DETECT ANTIPHOSPHOLIPIDS, PROTEIN S DEFICIENCY, LUPUS ANTI-COAGULANT AND FACTOR V LEIDEN MUTATION, TO DETECT MARKERS OF FEMALE FERTILITY, TO DETECT DAZL HETEROZYGOUS MUTATION AND ASSOCIATED BIOCHEMICAL MARKERS SUCH AS TESTOSTERONE FOR THE ANALYSIS OF DNA, RNA FOR THE DETECTION OF DISEASE OR PREDISPOSITION ASSOCIATED WITH REPRODUCTION, FOR THE ANALYSIS OF PROTEIN OR OTHER BIOCHEMICAL MARKERS OF DISEASE OR PREDISPOSITION OF DISEASE, TO DETECT BIOCHEMICAL MARKERS WHICH INDICATE DISEASE OR PREDISPOSITION TO DISEASE; SURGICAL AND MEDICAL APPARATUS, NAMELY, DIPSTICKS, LITMUS PAPER, TEST-TUBES, PIPETTES, STYLETS FOR DRAWING BLOOD SAMPLES, PLASTIC CONTAINERS, SLIDES, SYRINGES, NEEDLES, SPATULAS AND NON-INVASIVE DEVICES FOR OBTAINING AND TESTING BIOLOGICAL SAMPLES; DIAPHRAGMS FOR CONTRACEPTION; COILS FOR CONTRACEPTION; PROTECTIVE SHEATHS FOR CONTRACEPTION (U.S. CLS. 26, 39 AND 44).

CLASS 35—ADVERTISING AND BUSINESS

FOR MEDICAL ASSISTANCE, NAMELY THE PROVISION OF MEDICAL SUPPORT STAFF TO CLINICS AND MEDICAL PRACTICES FOR THE SCREENING OF PATIENTS, AUDITING AND MAINTENANCE OF RECORDS, AND CONSULTATION REGARDING DIAGNOSES AND TREATMENT OPTIONS; NURSING SERVICES, NAMELY PROVIDING NURSING STAFF TO DOCTORS, CLINICS, HOSPITALS AND MEDICAL PRACTICES (U.S. CLS. 100, 101 AND 102).

CLASS 42—SCIENTIFIC, COMPUTER AND LEGAL SERVICES

FOR SCIENTIFIC RESEARCH AND DEVELOPMENT OF NEW PRODUCTS FOR OTHERS; TECHNICAL CONSULTATION AND RESEARCH IN THE FIELDS OF HEALTH, WELLBEING, NURSING, MEDICINE AND HEALTHCARE (U.S. CLS. 100 AND 101).

CLASS 44—MEDICAL, BEAUTY AND AGRICULTURAL SERVICES

FOR HEALTHCARE SERVICES; MEDICAL CLINICS; MIDWIFE SERVICES; PROVISION OF INFORMATION RELATING TO HEALTH, WELLBEING, NURSING, MEDICINE AND HEALTHCARE VIA THE INTERNET (U.S. CLS. 100 AND 101).

MICHAEL SOUDERS, EXAMINING ATTORNEY

SN 76-179,588. INTERSECTIONS INC., CHANTILLY, VA. FILED 12-12-2000.

CREDIT OBSERVER

NO CLAIM IS MADE TO THE EXCLUSIVE RIGHT TO USE "CREDIT", APART FROM THE MARK AS SHOWN.

CLASS 35—ADVERTISING AND BUSINESS

FOR CREDIT CARD REGISTRATION; MONITORING INDIVIDUAL AND BUSINESS CREDIT STATUS THROUGH A CREDIT BUREAU SERVICE (U.S. CLS. 100, 101 AND 102).

CLASS 36—INSURANCE AND FINANCIAL

FOR CREDIT CARD INFORMATION SERVICES; CREDIT BUREAU INFORMATION SERVICES; CREDIT CARD CANCELLATION SERVICES FOR LOST OR STOLEN CARDS; MONITORING CREDIT PROFILES OF INDIVIDUALS FOR USE IN DETERMINING WHEN A CREDIT CARD HAS BEEN STOLEN; AND PROVIDING INDIVIDUALS WITH THEIR CREDIT PROFILES (U.S. CLS. 100, 101 AND 102).

KAREN K. BUSH, EXAMINING ATTORNEY

SN 76-189,428. LUFTHANSA TECHNIK AG, 22335 HAMBURG, FED REP GERMANY, FILED 1-3-2001.

ARC

PRIORITY CLAIMED UNDER SEC. 44(D) ON FED REP GERMANY APPLICATION NO. 30068797.4, FILED 11-13-2000, REG. NO. 30068797, DATED 11-13-2000, EXPIRES 11-30-2010.

CLASS 12—VEHICLES

FOR CUSTOM-MADE AIRPLANES (U.S. CLS. 19, 21, 23, 31, 35 AND 44).

CLASS 37—CONSTRUCTION AND REPAIR

FOR AIRCRAFT REPAIR AND MAINTENANCE NAMELY PERFORMED BY AIRCRAFT ENGINEERS, FLIGHT ENGINEERS, FLIGHT MECHANICS AND INTERIOR DESIGNERS; REPAIR AND MAINTENANCE, FOR THIRD PARTIES, OF AIRCRAFT POWER PLANTS, AIRCRAFT ENGINES, AIRCRAFT ELECTRONIC AND OPTICAL EQUIPMENT AND AIRCRAFT MOTOR DRIVE MECHANISMS, RENOVATION OF AIRCRAFT AND PARTS THEREOF; MODERNIZATION OF AIRCRAFT AND PARTS THEREOF; IMPROVEMENT AND RENOVATION OF AIRCRAFT CABIN FURNISHING (U.S. CLS. 100, 103 AND 106).

CLASS 39—TRANSPORTATION AND STORAGE

FOR STORAGE AND FREIGHT TRANSPORTATION BY TRUCK OF TOOLS NECESSARY FOR MAINTENANCE, REPAIR AND REBUILDING OF AIRCRAFT; LEASING OF AIRCRAFT COMPONENTS, NAMELY DRIVING UNITS AND COMPONENTS THEREOF (U.S. CLS. 100 AND 105).

CLASS 40—MATERIAL TREATMENT

FOR CUSTOM MANUFACTURE OF AIRPLANES (U.S. CLS. 100, 103 AND 106).

CLASS 42—SCIENTIFIC, COMPUTER AND LEGAL SERVICES

FOR PROVIDING INFORMATION IN THE FIELD OF TECHNICAL INNOVATION REGARDING AIRCRAFT AND THEIR COMPONENTS; TECHNICAL CONSULTATION IN THE FIELD OF AVIATION; TECHNICAL EXPERT OPINION IN THE FIELD OF AVIATION FOR OTHERS; DEVELOPMENT OF NON-EDP DEPENDENT INSPECTION PROGRAMS FOR AIRCRAFT AND PARTS THEREOF (U.S. CLS. 100 AND 101).

WON TEAK OH, EXAMINING ATTORNEY

CLASS 35—ADVERTISING AND BUSINESS

FOR BUSINESS MANAGEMENT CONSULTING SERVICES, NAMELY, ASSISTING COMPANIES IN DEVELOPING ORGANIZATION STRATEGIES FOR THEIR BUSINESS, NAMELY, THE CREATION OF VISION PLANS, STRATEGIC PLANNING, INNOVATIVE ORGANIZATION DESIGN, CREATIVE PROBLEM SOLVING, PROCESS REENGINEERING, CHANGE MANAGEMENT, SUCCESSION PLANNING, COMMUNICATION AND MENTORING SKILLS, AND BUSINESS TEAM DEVELOPMENT ASSISTING COMPANIES IN THE SELECTION AND ASSESSMENT OF PERSONNEL, NAMELY, MANAGEMENT ASSESSMENT AND AUDIT SERVICES, BUSINESS CULTURE AUDIT SERVICES, JOB ANALYSIS SERVICES, CAREER AND COMPETENCY ASSESSMENT SERVICES, ORGANIZATION SURVEY SERVICES AND INTERVIEWING SERVICES, ASSISTING COMPANIES IN THE CREATION OF LEADERSHIP CRITERIA, DEVELOPMENT, ASSESSMENT AND TRAINING INITIATIVES (U.S. CLS. 100, 101 AND 102).

FIRST USE 11-0-1996; IN COMMERCE 11-0-1996.

CLASS 41—EDUCATION AND ENTERTAINMENT

FOR EDUCATIONAL SERVICES, NAMELY PROVIDING TRAINING EDUCATION FOR PERSONNEL AND INDUSTRIES AND GOVERNMENTS BY MEANS OF TRAINING PROGRAMS, SEMINARS AND PERSONNEL INSTRUCTION CONCERNING BUSINESS DEVELOPMENT AND MANAGEMENT SKILLS, LEADERSHIP DEVELOPMENT SKILLS, COMMUNICATION SKILLS, CUSTOMER RELATIONS, NEGOTIATION AND PRESENTATION SKILLS, ORGANIZATION AND TIME MANAGEMENT SKILLS, BUSINESS WRITING SKILLS AND PERSONNEL RECRUITMENT, DEVELOPMENT AND ASSESSMENT SKILLS (U.S. CLS. 100, 101 AND 107).

FIRST USE 11-0-1996; IN COMMERCE 11-0-1996.

CLASS 42—SCIENTIFIC, COMPUTER AND LEGAL SERVICES

FOR CAREER COUNSELING, NAMELY, PROVIDING COUNSELING, CONSULTING AND ASSESSMENT CONCERNING CAREER RENEWAL (U.S. CLS. 100 AND 101).

FIRST USE 11-0-1996; IN COMMERCE 11-0-1996.

MARK SPARACINO, EXAMINING ATTORNEY

SN 76-225,523. PRESSOL SCHMIERGERÄTE GMBH, 90427 NÜRNBERG, FED REP GERMANY, FILED 3-16-2001.

PRESSOL

SN 76-214,532. MICA INTERNATIONAL INC., TORONTO, ONTARIO, CANADA, FILED 2-22-2001.

OWNER OF FED REP GERMANY REG. NO. 981361, DATED 1-31-1979, EXPIRES 11-30-2008.

OWNER OF FED REP GERMANY REG. NO. 679872, DATED 8-2-1955, RENEWED AS REG. NO. 679872, DATED 6-30-2004, EXPIRES 6-30-2014.

OWNER OF FED REP GERMANY REG. NO. 1061547, DATED 3-28-1984, RENEWED AS REG. NO. 1061547, DATED 8-31-2003, EXPIRES 8-31-2013.

OWNER OF U.S. REG. NOS. 1,533,950, 1,624,845 AND OTHERS.

RESULTS YOU CAN SEE**CLASS 6—METAL GOODS**

FOR METAL LUBRICATION CANS, NAMELY, CANS FOR STORING OIL SOLD EMPTY; METAL OIL SQUIRT CANS SOLD EMPTY; INJECTION CANS, NAMELY, METAL CANS FOR INJECTING GREASE SOLD EMPTY (U.S. CLS. 2, 12, 13, 14, 23, 25 AND 50).

PRIORITY CLAIMED UNDER SEC. 44(D) ON CANADA APPLICATION NO. 1072489, FILED 8-24-2000, REG. NO. TMA571628, DATED 12-3-2002, EXPIRES 12-3-2017.

CLASS 7—MACHINERY

FOR PNEUMATIC GREASE GUNS; SUCTION PUMPS FOR LIQUID INJECTION PUMPS; GREASE FILLING PUMPS; GREASE PUMPS; POWER-OPERATED TOOL FOR LUBRICATING, NAMELY, PISTOLS; COMPRESSED AIR GREASE GUNS; INDUSTRIAL ATOMIZERS FOR SPRAYING LIQUIDS; POWER-OPERATED HAND PUMPS FOR USE IN HEATING OIL; POWER-OPERATED HAND PUMPS FOR PUMPING LIQUIDS (U.S. CLS. 13, 19, 21, 23, 31, 34 AND 35).

CLASS 8—HAND TOOLS

FOR MANUALLY OPERATED GREASE GUNS; MANUALLY OPERATED HAND TOOLS FOR LUBRICATING, NAMELY, PISTOLS; MANUALLY OPERATED HAND PUMPS FOR USE IN HEATING OIL; MANUALLY OPERATED HAND PUMPS FOR PUMPING LIQUIDS (U.S. CLS. 23, 28 AND 44).

CLASS 20—FURNITURE AND ARTICLES NOT OTHERWISE CLASSIFIED

FOR NON-METAL LUBRICATION CANS, NAMELY, CANS FOR STORING OIL SOLD EMPTY; NON-METAL OIL SUPPLY CANS SOLD EMPTY (U.S. CLS. 2, 13, 22, 25, 32 AND 50).

CLASS 21—HOUSEWARES AND GLASS

FOR FUNNELS; HOUSEHOLD ATOMIZERS FOR LIQUIDS SOLD EMPTY (U.S. CLS. 2, 13, 23, 29, 30, 33, 40 AND 50).

TRICIA THOMPSON, EXAMINING ATTORNEY

SN 76-288,268. LEFEBVRE, KELLY, SEATTLE, WA. FILED 7-23-2001.



NO CLAIM IS MADE TO THE EXCLUSIVE RIGHT TO USE "YOGA CO.", APART FROM THE MARK AS SHOWN.

CLASS 5—PHARMACEUTICALS

FOR SILK EYE PILLOWS CONTAINING AROMATIC AND NON-AROMATIC SUBSTANCES FOR RELIEF FROM HEADACHES, INSOMNIA AND SINUS DISCOMFORT (U.S. CLS. 6, 18, 44, 46, 51 AND 52).

FIRST USE 2-0-1998; IN COMMERCE 2-0-1998.

CLASS 18—LEATHER GOODS

FOR YOGA MAT BAGS, NAMELY, SPORTS BAGS FOR CARRYING YOGA MATS OR EXERCISE MATS (U.S. CLS. 1, 2, 3, 22 AND 41).

FIRST USE 2-0-1998; IN COMMERCE 2-0-1998.

CLASS 28—TOYS AND SPORTING GOODS

FOR YOGA ACCESSORIES, YOGA PRODUCTS AND YOGA PROPS, NAMELY, PERSONAL YOGA EXERCISE MATS, PERSONAL YOGA EXERCISE RUGS, PERSONAL YOGA EXERCISE BLANKETS, PERSONAL YOGA EXERCISE STRAPS, AND PERSONAL YOGA EXERCISE BLOCKS (U.S. CLS. 22, 23, 38 AND 50).

FIRST USE 2-0-1998; IN COMMERCE 2-0-1998.
SONYA STEPHENS, EXAMINING ATTORNEY

SN 76-297,774. THE DEAK GROUP, INC., FT. LAUDERDALE, FL. FILED 8-13-2001.

PRIDE FACTORY**CLASS 35—ADVERTISING AND BUSINESS**

FOR RETAIL STORE SERVICES AND ON-LINE RETAIL STORE SERVICES FEATURING ADULT VIDEOS, ADULT BOOKS, ADULT MAGAZINES, CLOTHING, NAMELY, SWIM SUITS, TANK TOPS, T-SHIRTS, FITNESS WEAR, GIFTS, PERSONAL LUBRICANTS, VIDEO HEAD CLEANERS (U.S. CLS. 100, 101 AND 102).

FIRST USE 5-16-1996; IN COMMERCE 2-26-2001.

CLASS 41—EDUCATION AND ENTERTAINMENT

FOR ADULT VIDEOTAPE RENTAL (U.S. CLS. 100, 101 AND 107).

FIRST USE 5-16-1996; IN COMMERCE 2-26-2001.

CLASS 43—HOTEL AND RESTAURANT SERVICES

FOR RESTAURANT AND CAFE SERVICES (U.S. CLS. 100 AND 101).

FIRST USE 5-16-1996; IN COMMERCE 2-26-2001.
JASON TURNER, EXAMINING ATTORNEY

SN 76-320,269. JULIEN INC., QUEBEC (QUEBEC) G1P 2H3, CANADA, FILED 10-2-2001.

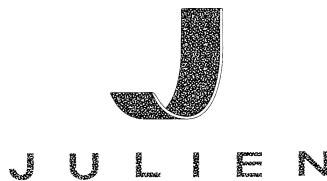

PRIORITY CLAIMED UNDER SEC. 44(D) ON CANADA APPLICATION NO. 1113228, FILED 8-21-2001, REG. NO. TMA591911, DATED 10-8-2003, EXPIRES 10-8-2018.

OWNER OF U.S. REG. NO. 2,831,228.

THE STIPLING IS A FEATURE OF THE MARK AND DOES NOT INDICATE COLOR.

CLASS 6—METAL GOODS

FOR (BASED ON USE IN COMMERCE AND 44(D) PRIORITY APPLICATION) PREFABRICATED METAL PLATFORMS; METAL DOORS FOR CUPBOARDS (U.S. CLS. 2, 12, 13, 14, 23, 25 AND 50).

FIRST USE 6-6-2001; IN COMMERCE 7-3-2001.

CLASS 11—ENVIRONMENTAL CONTROL APPARATUS

FOR (BASED ON USE IN COMMERCE AND 44(D) PRIORITY APPLICATION) CAFETERIA STEAM TABLES; CAFETERIA STEAM TABLES WITH INDIVIDUAL OPENINGS; REFRIGERATING PRODUCTS, NAMELY, REFRIGERATED DISPLAY CASES, REFRIGERATED WORK COUNTERS, REFRIGERATED SANDWICH COUNTERS, REFRIGERATED PIZZA COUNTERS, BAR REFRIGERATORS, REFRIGERATED GARNISH COUNTERS; SINKS, NAMELY, POT SINKS, MOBILE SINKS, BAR SINKS, HAND SINKS; COCKTAIL UNITS COMPRISED OF BOWLS, PROPANE OR BUTANE; SHOWER DOORS; SHOWER BASES; ELECTRIC HOT PLATES; PLUMBING UNITS COMPRISED OF BATHROOM FAUCETS, SINKS AND ACCESSORIES; WARM PLATE DISPENSERS, VENTILATION HOODS FOR STOVES; REFRIGERATED PASTRY TABLES (U.S. CLS. 13, 21, 23, 31 AND 34).

FIRST USE 11-23-2001; IN COMMERCE 3-19-2002.

CLASS 12—VEHICLES

FOR (BASED ON USE IN COMMERCE AND 44(D) PRIORITY APPLICATION) NON-MOTORIZED CARTS, NAMELY, CORNER CARTS, UTILITY CARTS, BASKET CARTS, PLATFORM CARTS, PLATTER CARTS, CUTLERY CARTS, DISH CARTS, SERVING PLATTER CARTS, FIXED LEVEL CARTS, SERVING CARTS (U.S. CLS. 19, 21, 23, 31, 35 AND 44).

FIRST USE 11-23-2001; IN COMMERCE 3-19-2002.

CLASS 19—NON-METALLIC BUILDING MATERIALS

FOR (BASED ON 44(D) PRIORITY APPLICATION) NON METAL DOORS FOR CUPBOARDS (U.S. CLS. 1, 12, 33 AND 50).

CLASS 20—FURNITURE AND ARTICLES NOT OTHERWISE CLASSIFIED

FOR (BASED ON USE IN COMMERCE AND 44(D) PRIORITY APPLICATION) FIXED SHELVING; MOBILE SHELVING; SHOWER SHELVES; SHELVES; DRAWERS; INDUSTRIAL WORK TABLES MADE OF STAINLESS STEEL AND WOOD; MEDICINE CABINETS; MODULAR CABINETS; HUTCHES (U.S. CLS. 2, 13, 22, 25, 32 AND 50).

FIRST USE 11-23-2001; IN COMMERCE 3-19-2002.

CLASS 21—HOUSEWARES AND GLASS

FOR (BASED ON 44(D) PRIORITY APPLICATION) CREAMER PITCHERS; URNS; SPICE RACKS; SAUCEPAN SUPPORTS; BASINS, NAMELY BOWLS; FUNNELS (U.S. CLS. 2, 13, 23, 29, 30, 33, 40 AND 50).

CLASS 37—CONSTRUCTION AND REPAIR

FOR (BASED ON USE IN COMMERCE AND 44(D) PRIORITY APPLICATION) CONSTRUCTION SERVICES, NAMELY CONSTRUCTION OF KITCHENS AND BATHROOMS FOR INDUSTRIAL, INSTITUTIONAL AND COMMERCIAL BUILDINGS (U.S. CLS. 100, 103 AND 106).

FIRST USE 11-23-2001; IN COMMERCE 3-19-2002.

CLASS 42—SCIENTIFIC, COMPUTER AND LEGAL SERVICES

FOR (BASED ON USE IN COMMERCE AND 44(D) PRIORITY APPLICATION) DESIGN SERVICES, NAMELY, DESIGN OF KITCHENS AND BATHROOMS FOR OTHERS (U.S. CLS. 100 AND 101).

FIRST USE 6-19-2002; IN COMMERCE 6-21-2002.

DAVID MURRAY, EXAMINING ATTORNEY

SN 76-320,558. EDSMART, INC., NEW BRITAIN, CT. FILED 10-2-2001.

EDEXPLORE**CLASS 9—ELECTRICAL AND SCIENTIFIC APPARATUS**

FOR ELECTRONIC DATABASES RECORDED ON COMPUTER MEDIA FOR STORING ACADEMIC-RELATED DATA, NAMELY, STUDENT RELATED RECORDS INCLUDING STUDENT DEMOGRAPHIC INFORMATION, COURSES TAKEN, TEACHERS, GRADES, GPA, ATTENDANCE, DISCIPLINE, SPECIAL OR REMEDIAL INSTRUCTIONAL PROGRAMS, NATIONAL, STATE, AND LOCAL ASSESSMENTS, AWARDS AND STAFF RELATED RECORDS, INCLUDING TEACHER AND ADMINISTRATOR INFORMATION, AND ANALYSIS TOOLS THEREFOR, NAMELY, DATA MINING, REPORTING AND ANALYTICAL TOOLS FOR REPORTING AND ANALYZING THE STORED DATA (U.S. CLS. 21, 23, 26, 36 AND 38).

FIRST USE 10-0-2000; IN COMMERCE 10-0-2000.

CLASS 16—PAPER GOODS AND PRINTED MATTER

FOR PRINTED INSTRUCTIONAL AND TEACHING MATERIALS RELATED TO ELECTRONIC DATABASES IN THE FIELD OF ACADEMIC-RELATED RECORDS STORAGE AND ANALYTICAL TOOLS FOR REPORTING AND ANALYZING THE STORED DATA, NAMELY, INSTRUCTION MANUALS, SET-UP AND HELP GUIDES, AND SAMPLE REPORTS (U.S. CLS. 2, 5, 22, 23, 29, 37, 38 AND 50).

FIRST USE 10-0-2000; IN COMMERCE 10-0-2000.

CLASS 38—COMMUNICATION

FOR REMOTE ACCESS SERVICES IN THE FIELD OF ACADEMIC-RELATED RECORDS STORAGE SERVICES, NAMELY, PROVIDING REMOTE ACCESS TO COMPUTER NETWORKS FOR THE TRANSMISSION AND RECEPTION OF ELECTRONIC DATA (U.S. CLS. 100, 101 AND 104).

FIRST USE 10-0-2000; IN COMMERCE 10-0-2000.

CLASS 41—EDUCATION AND ENTERTAINMENT

FOR EDUCATIONAL TRAINING IN THE UTILIZATION OF DATABASE DEVELOPMENT, ANALYSIS AND REMOTE ACCESS SERVICES, NAMELY, COMPUTER AND DATA PROCESSING TRAINING IN THE FIELD OF ACADEMIC-RELATED RECORDS STORAGE SERVICES; AND ON-LINE DATABASE SERVICES IN THE FIELD OF ACADEMIC-RELATED RECORDS AND ACADEMIC RELATED DATA, NAMELY, PROVIDING AND MAINTAINING SUCH ON-LINE DATABASES (U.S. CLS. 100, 101 AND 107).

FIRST USE 10-0-2000; IN COMMERCE 10-0-2000.

CHRISTOPHER BUONGIORNO, EXAMINING ATTORNEY

SN 76-322,505. TERANET ENTERPRISES LTD., TORONTO, ONTARIO, CANADA, FILED 10-5-2001.

BAR-EXPRESS

PRIORITY CLAIMED UNDER SEC. 44(D) ON CANADA APPLICATION NO. 1098836, FILED 4-6-2001, REG. NO. TMA609670, DATED 5-7-2004, EXPIRES 5-7-2019.

CLASS 9—ELECTRICAL AND SCIENTIFIC APPARATUS

FOR COMPUTER COMMUNICATIONS SOFTWARE TO ENABLE USERS TO ACCESS AND VIEW DOCUMENTS, DATA, PRODUCTS, AND SERVICES ON THE INTERNET AND INTRANET WEBSITES (U.S. CLS. 21, 23, 26, 36 AND 38).

CLASS 42—SCIENTIFIC, COMPUTER AND LEGAL SERVICES

FOR PROVIDING TEMPORARY USE OF ON-LINE NON-DOWNLOADABLE SOFTWARE ENABLING USERS TO TRANSMIT DOCUMENTS AND DATA TO A WEB SITE AND TO VIEW AND ACCESS DOCUMENTS AND DATA PREVIOUSLY TRANSMITTED (U.S. CLS. 100 AND 101).

TRACY CROSS, EXAMINING ATTORNEY

CLASS 5—PHARMACEUTICALS

FOR MEDICAL AND SURGICAL WOUND AND BURN DRESSINGS UTILIZING ANTIMICROBIAL COATINGS (U.S. CLS. 6, 18, 44, 46, 51 AND 52).

FIRST USE 3-12-2004; IN COMMERCE 3-12-2004.

KAREN K. BUSH, EXAMINING ATTORNEY

SN 76-328,696. INTERVET INTERNATIONAL B.V., 5831 AN BOXMEER, NETHERLANDS, FILED 10-19-2001.

VETSTREAM

OWNER OF BENELUX REG. NO. 682219, DATED 3-30-2001, EXPIRES 3-30-2011.

CLASS 16—PAPER GOODS AND PRINTED MATTER

FOR PRINTED MATTER, NAMELY, NEWSPAPERS, PERIODICALS, MAGAZINES, BOOKS; ALL RELATING TO THE PRACTICE AND PROCEDURES OF VETERINARY MEDICINE OR TO ANIMAL HEALTH DATA AND INFORMATION (U.S. CLS. 2, 5, 22, 23, 29, 37, 38 AND 50).

CLASS 41—EDUCATION AND ENTERTAINMENT

FOR EDUCATIONAL SERVICES, NAMELY CONDUCTING CLASSES, SEMINARS, CONFERENCES AND WORKSHOPS AND PROVIDING TRAINING, ALL IN THE FIELD OF ANIMAL HEALTH AND ANIMAL CARE (U.S. CLS. 100, 101 AND 107).

CLASS 44—MEDICAL, BEAUTY AND AGRICULTURAL SERVICES

FOR PROVIDING VETERINARIAN AND ANIMAL HEALTH INFORMATION AND DATA TO THE VETERINARIAN MARKET (U.S. CLS. 100 AND 101).

MARTHA FROMM, EXAMINING ATTORNEY

SN 76-329,012. NUCRYST PHARMACEUTICALS CORP., FT. SASKATCHEWAN, ALBERTA T8L 3W4, CANADA, FILED 10-24-2001.

SILCRYST

OWNER OF CANADA REG. NO. TMA621,912, DATED 10-6-2004, EXPIRES 10-6-2019.

CLASS 2—PAINTS

FOR [SECTION 44 ONLY] METAL COATINGS AND METAL POWDERS USED TO PREVENT THE GROWTH OF MICROBES FOR USE IN THE FIELD OF MEDICINE (U.S. CLS. 6, 11 AND 16).

SN 76-330,778. VODOO CREATIVE COMPUTER SOLUTIONS LTD., CALGARY, ALBERTA, CANADA, FILED 10-29-2001.



PRIORITY CLAIMED UNDER SEC. 44(D) ON CANADA APPLICATION NO. 1,100,959, FILED 4-27-2001, REG. NO. TMA576769, DATED 3-3-2003, EXPIRES 3-3-2018.

THE MARK CONSISTS, IN PART, OF A STYLIZED DESIGN OF A PICTURE OF A MASK EMBEDDED IN A DIAMOND SHAPE.

CLASS 9—ELECTRICAL AND SCIENTIFIC APPARATUS

FOR (BASED ON USE IN COMMERCE) (BASED ON 44(D) PRIORITY APPLICATION) COMPUTER SYSTEMS, NAMELY, PERSONAL AND GAMING COMPUTERS (U.S. CLS. 21, 23, 26, 36 AND 38).

FIRST USE 0-0-1991; IN COMMERCE 1-0-1994.

CLASS 40—MATERIAL TREATMENT

FOR (BASED ON 44(D) PRIORITY APPLICATION) CUSTOM MANUFACTURE OF COMPUTERS FOR OTHERS (U.S. CLS. 100, 103 AND 106).

CLASS 42—SCIENTIFIC, COMPUTER AND LEGAL SERVICES

FOR (BASED ON 44(D) PRIORITY APPLICATION) CUSTOM DESIGN OF COMPUTERS FOR OTHERS; TECHNICAL SUPPORT SERVICES, NAMELY, PROVIDING INFORMATION AND ASSISTANCE CONCERNING THE USE AND FUNCTION OF COMPUTER HARDWARE AND SOFTWARE; AND, INFORMATION SERVICES, NAMELY, PROVIDING INFORMATION ON COMPUTER SYSTEMS, COMPUTER DESIGN, TECHNOLOGY AND THE INDUSTRY TO THE PUBLIC VIA CONNECTION TO THE GLOBAL COMPUTER NETWORK (U.S. CLS. 100 AND 101).

TINA L. SNAPP, EXAMINING ATTORNEY

SN 76-346,275. MATTHIAS, PAUL, 10709 BERLIN, FED REP GERMANY, FILED 12-10-2001.

SN 76-352,865. UMA INFORMATION TECHNOLOGY AG, A-1220 VIENNA, AUSTRIA, FILED 12-19-2001.



THE MARK CONSISTS OF THE LETTERS "P", "V", "D" PRESENTED IN AN OVERLAPPED DESIGN AND CENTERED INSIDE OF AN OVAL SHAPED RING SET AT AN ANGLE.

CLASS 9—ELECTRICAL AND SCIENTIFIC APPARATUS

FOR SERIES OF MUSICAL SOUND RECORDINGS, PRE-RECORDED COMPACT DISCS, AUDIO CASSETTES, DIGITAL VIDEO DISCS, PHONOGRAPH RECORDS AND DIGITAL AUDIO FILES FEATURING MUSIC (U.S. CLS. 21, 23, 26, 36 AND 38).

FIRST USE 1-0-1994; IN COMMERCE 1-0-1994.

CLASS 25—CLOTHING

FOR CLOTHING, NAMELY SHIRTS, JACKETS, SWEATSHIRTS, SWEATERS, T-SHIRTS, HATS; FOOTWEAR AND HEADWEAR (U.S. CLS. 22 AND 39).

FIRST USE 1-0-1996; IN COMMERCE 1-0-1996.

CLASS 41—EDUCATION AND ENTERTAINMENT

FOR ENTERTAINMENT SERVICES, NAMELY LIVE PERFORMANCES BY A MUSICAL PERFORMER AND NAMELY, DISC JOCKEY SERVICES (U.S. CLS. 100, 101 AND 107).

FIRST USE 11-0-1991; IN COMMERCE 11-0-1991.
BRENDAN REGAN, EXAMINING ATTORNEY

SN 76-349,523. SOFTPRO SOFTWARE PROFESSIONAL GMBH & CO. KG, 71034 BOEBLINGEN, FED REP GERMANY, FILED 12-14-2001.

SIGNINFO

OWNER OF FED REP GERMANY REG. NO. 30170025, DATED 4-29-2002, EXPIRES 12-31-2011.

CLASS 9—ELECTRICAL AND SCIENTIFIC APPARATUS

FOR COMPUTER SOFTWARE FOR STORING, DISPLAYING, ADMINISTERING AND SEARCHING A DATABASE OF CUSTOMER AND ACCOUNT INFORMATION, USING IMAGES, PHOTOGRAPHS, SIGNATURES, FINGERPRINTS AND OTHER MEANS OF AUTHENTICATING TRANSACTIONS (U.S. CLS. 21, 23, 26, 36 AND 38).

CLASS 42—SCIENTIFIC, COMPUTER AND LEGAL SERVICES

FOR DEVELOPMENT OF SOFTWARE FOR OTHERS (U.S. CLS. 100 AND 101).
CAROLYN CATALDO, EXAMINING ATTORNEY



OWNER OF AUSTRIA REG. NO. 192362, DATED 11-24-2000, EXPIRES 11-24-2010.

CLASS 9—ELECTRICAL AND SCIENTIFIC APPARATUS

FOR COMPUTER TERMINAL FOR RECORDING, TRANSMISSION OR REPRODUCTION OF SOUND OR IMAGES; PRE-RECORDED MAGNETIC DATA CARRIERS, RECORDING DISCS, COMPUTERS, SOFTWARE FOR USE IN ORGANIZING, SURVEYING AND EVALUATING INFORMATION AND DATA (U.S. CLS. 21, 23, 26, 36 AND 38).

CLASS 35—ADVERTISING AND BUSINESS

FOR BUSINESS MANAGEMENT SERVICES; REAL ESTATE MARKETING SERVICES, NAMELY ON-LINE SERVICES FEATURING REAL OR VIRTUAL TOURS OF RESIDENTIAL AND COMMERCIAL REAL ESTATE AND REAL ESTATE INFORMATION TECHNOLOGY SERVICES, NAMELY, CUSTOMER RELATIONSHIP REAL ESTATE MANAGEMENT SERVICES (U.S. CLS. 100, 101 AND 102).

CLASS 36—INSURANCE AND FINANCIAL

FOR REAL ESTATE LISTING; REAL ESTATE MANAGEMENT (U.S. CLS. 100, 101 AND 102).

CLASS 42—SCIENTIFIC, COMPUTER AND LEGAL SERVICES

FOR SCIENTIFIC RESEARCH IN THE FIELD OF INFORMATION TECHNOLOGY AND KNOWLEDGE TRANSFER; COMPUTER PROGRAMMING IN THE FIELD OF INFORMATION TECHNOLOGY AND KNOWLEDGE TRANSFER (U.S. CLS. 100 AND 101).
SOPHIA S. KIM, EXAMINING ATTORNEY

SN 76-361,135. DEZAC GROUP LIMITED, THE, GLOUCESTERSHIRE GL53 7HJ, ENGLAND, FILED 1-22-2002.



PRIORITY CLAIMED UNDER SEC. 44(D) ON ERPN CMNTY TM OFC APPLICATION NO. 002307387, FILED 7-19-2001, REG. NO. 2307387, DATED 4-15-2004, EXPIRES 7-19-2011.

THE ENGLISH TRANSLATION OF THE SPANISH WORD "RIO" IS "RIVER".

CLASS 3—COSMETICS AND CLEANING PREPARATIONS

FOR AROMATHERAPY OILS AND ESSENTIAL OILS FOR PERSONAL USE; AROMATHERAPY FRAGRANCES, NAMELY PERFUME, EAU DE COLOGNE, EAU DE TOILETTE AND ROOM FRESHENERS; NON-MEDICATED BATH OILS; ESSENTIAL OILS FOR PERSONAL USE; NON-MEDICATED BATH SALTS; NON-MEDICATED COSMETIC PREPARATIONS FOR SLIMMING PURPOSES; SKIN MOISTURIZERS; SKIN CONDITIONERS; NON-MEDICATED HAIR CARE PREPARATIONS; DEPILATORY CREAMS; SKIN TONERS; SKIN FRESHENERS, NAMELY LIQUID, SPRAY, CREAM, FOAM, TONERS OR FRESHENERS; MASSAGE CREAMS AND OILS FOR PERSONAL USE (U.S. CLS. 1, 4, 6, 50, 51 AND 52).

CLASS 7—MACHINERY

FOR DUST EXTRACTING INSTALLATIONS, NAMELY DUST SEPARATORS TO REMOVE AIR CONTAMINANTS, DUST OR PARTICULATES FROM AIR AND SURFACES TO REDUCE ALLERGIES; DUST SEPARATORS; AERATORS, NAMELY OXYGEN GENERATORS FOR INCREASING OXYGEN CONTENT IN WATER (U.S. CLS. 13, 19, 21, 23, 31, 34 AND 35).

CLASS 8—HAND TOOLS

FOR ELECTRIC AND NON-ELECTRIC DEPILATION APPLIANCES; ELECTRIC AND NON-ELECTRIC TWEEZERS; HAIR CLIPPERS; NAIL CLIPPERS; HAND OPERATED ATOMIZERS, SPRAYERS, VAPORIZERS, ALL BEING FOR INSECTICIDES (U.S. CLS. 23, 28 AND 44).

CLASS 10—MEDICAL APPARATUS

FOR ABDOMINAL BELTS; MASSAGING DEVICES, NAMELY MASSAGING APPARATUS FOR PERSONAL USE; VIBRO MASSAGE APPARATUS, NAMELY ELECTRONIC APPARATUS FOR PERSONAL USE; LIGHT THERAPY DEVICES, NAMELY SENSORY LIGHT THERAPY UNITS, FULL SPECTRUM LIGHT BULBS; LAMPS USED FOR THE TREATMENT OF SEASONAL AFFECTIVE DISORDER AND FOR SIMULATING NATURAL SUNLIGHT AND LIGHT-BASED COMBS FOR COSMETIC USE; AIR CUSHIONS; MATTRESSES AND BEDS, ALL BEING FOR MEDICAL PURPOSES; HEATING PADS FOR MEDICAL PURPOSES, BEING EITHER CHEMICALLY OR ELECTRONICALLY ACTIVATED; COOLING PADS FOR MEDICAL PURPOSES, BEING EITHER CHEMICALLY OR ELECTRONICALLY ACTIVATED; MEDICAL DEVICES FOR SLIMMING TREATMENTS, NAMELY ABDOMINAL PADS AND PADS FOR PLACING ON THE LIMBS OR TORSO; EXERCISE MACHINES FOR REHABILITATION AND THERAPY PURPOSES; MEDICAL PILLOWS FOR THE TREATMENT OF INSOMNIA; SKIN TREATMENT APPARATUS PARTICULARLY FOR THE TREATMENT OF ACNE, NAMELY ANAESTHETIC MASKS AND LASERS FOR MEDICAL USE (U.S. CLS. 26, 39 AND 44).

CLASS 11—ENVIRONMENTAL CONTROL APPARATUS

FOR WATER AND LIQUID IONIZERS FOR HOUSEHOLD PURPOSES; ELECTRIC AIR DEODORIZERS; FACIAL SAUNAS; STEAM GENERATORS; STERILIZERS NOT FOR MEDICAL PURPOSES; WATER FILTERS; ELECTRIC VAPORIZERS; AIR FILTERS FOR AIR CONDITIONING UNITS; HOUSEHOLD AIR CLEANERS; AIR FILTERS FOR DOMESTIC USE TO REMOVE PARTICULATES FROM AIR TO REDUCE ALLERGIES; SPAS IN THE NATURE OF BATHS FOR THE FEET AND HEATED POOLS; WHIRLPOOL JETS, NAMELY JET NOZZLES FOR GENERATING MASSAGE CURRENTS IN BATHS (U.S. CLS. 13, 21, 23, 31 AND 34).

CLASS 28—TOYS AND SPORTING GOODS

FOR EXERCISE APPARATUS, NAMELY EXERCISE MACHINES FOR THERAPEUTIC USE, MANUALLY OPERATED EXERCISE MACHINES, STATIONARY EXERCISE BICYCLES, TREADMILLS, JOGGING MACHINES, AEROBIC AND STAIR STEPPING MACHINES, ROWING MACHINES, APPARATUS USED IN PILATES EXERCISES, WEIGHTS, ABDOMINAL BOARDS, CHEST EXPANDERS AND CHEST PULLS; SPORTS EQUIPMENT, NAMELY SPORTS BALLS, WEIGHT LIFTING BELTS, PUNCH BAGS, BOXING GLOVES, FACE MASKS AND CHEST PROTECTORS FOR SPORTS; EXERCISE BODY REHABILITATION EQUIPMENT, NAMELY STATIONARY EXERCISE BICYCLES, TREADMILLS, JOGGING MACHINES, AEROBIC AND STAIR STEPPING MACHINES AND ROWING MACHINES (U.S. CLS. 22, 23, 38 AND 50).

LOURDES AYALA, EXAMINING ATTORNEY

SN 76-372,129. L P AERO PLASTICS, INC., JEANNETTE, PA, FILED 2-20-2002.



NO CLAIM IS MADE TO THE EXCLUSIVE RIGHT TO USE "AERO PLASTICS INC.", APART FROM THE MARK AS SHOWN.

CLASS 3—COSMETICS AND CLEANING PREPARATIONS

FOR WINDSHIELD AND WINDOW POLISH AND SEALANT (U.S. CLS. 1, 4, 6, 50, 51 AND 52).
FIRST USE 12-30-1991; IN COMMERCE 12-30-1991.

CLASS 12—VEHICLES

FOR AIRCRAFT WINDSHIELDS AND WINDOWS, LATCHES AND HINGES FOR AIRCRAFT WINDOWS, TAXI LIGHT LENSES, LANDING LIGHT LENSES, NAVIGATION LIGHT LENSES AND FUEL GAUGE INDICATOR COVERS (U.S. CLS. 19, 21, 23, 31, 35 AND 44).

FIRST USE 12-30-1991; IN COMMERCE 12-30-1991.
KAREN K. BUSH, EXAMINING ATTORNEY

SN 76-379,718. WEIDER PUBLICATIONS, LLC, BOCA RATON, FL. FILED 2-22-2002.

OWNER OF U.S. REG. NOS. 1,240,271, 2,692,744 AND OTHERS.
SEC. 2(F) AS TO "MUSCLE & FITNESS".

CLASS 9—ELECTRICAL AND SCIENTIFIC APPARATUS

FOR PRE-RECORDED CD-ROMS, PRERECORDED AUDIO AND VIDEO CASSETTES AND COMPUTER SOFTWARE, ALL FEATURING INFORMATION ABOUT HEALTH AND FITNESS; COMPUTER HARDWARE; ELECTRONIC DEVICES, NAMELY, ELECTRONIC PERSONAL ORGANIZERS, CD PLAYERS, RADIOS, TELEVISIONS, TELEPHONES, PERSONAL STEREOS, AUDIO TAPE PLAYERS AND RECORDERS, VIDEO TAPE PLAYERS AND RECORDERS, MP3 PLAYERS, DIGITAL VIDEO DISC PLAYERS AND RECORDERS, DIGITAL AUDIO PLAYERS AND RECORDERS; SUNGLASSES, DECORATIVE MAGNETS, TAPE MEASURES, CALCULATORS, BINOCULARS, AND CAMERAS (U.S. CLS. 21, 23, 26, 36 AND 38).

CLASS 16—PAPER GOODS AND PRINTED MATTER

FOR PRINTED MATTER, NAMELY A SET OF UPDATABLE BINDERS CONTAINING INFORMATION RELATED TO HEALTH AND FITNESS AND TO THE CONTENT OF APPLICANT'S MAGAZINES; POSTERS, CALENDARS, PENS, PENCILS, GREETING CARDS, POSTER BOOKS, PHOTOGRAPH ALBUMS, ADDRESS BOOKS, APPOINTMENT BOOKS, PAPER PLACE MATS, DECALS, STICKERS, NOTEBOOKS, LITHOGRAPHS, NOTE PADS, DESKTOP BUSINESS CARD HOLDERS, PRINTS AND POSTCARDS, SCRATCH PADS, FOLDERS AND TRADING CARDS (U.S. CLS. 2, 5, 22, 23, 29, 37, 38 AND 50).

LESLEY LAMOTHE, EXAMINING ATTORNEY

SN 76-395,166. MIOFRIO CORPORATION, TORONTO, ONTARIO M5T 2Y9, CANADA, FILED 4-12-2002.

MIOFRIO

PRIORITY CLAIMED UNDER SEC. 44(D) ON CANADA APPLICATION NO. 1136598, FILED 4-5-2002, REG. NO. TMA607037, DATED 4-5-2004, EXPIRES 4-5-2019.

CLASS 20—FURNITURE AND ARTICLES NOT OTHERWISE CLASSIFIED

FOR FURNITURE, NAMELY, TABLES, CHAIRS, AND SOFAS (U.S. CLS. 2, 13, 22, 25, 32 AND 50).

CLASS 21—HOUSEWARES AND GLASS

FOR CHINA AND BEVERAGE GLASSWARE; KITCHEN CONTAINERS NOT OF PRECIOUS METAL; GIFTWARE MADE OF CERAMIC MATERIAL, GLASS, METAL OR WOOD; NAMELY, DRINKING GLASSES, MUGS AND CUPS (U.S. CLS. 2, 13, 23, 29, 30, 33, 40 AND 50).

CLASS 30—STAPLE FOODS

FOR CEREAL BASED SNACK FOOD; FROZEN CONFECTIONS; BAKERY DESSERTS, PASTRIES; CAKES, COOKIES AND BISCUITS (U.S. CL. 46).

CLASS 32—LIGHT BEVERAGES

FOR MINERAL AND AERATED WATER, NON-ALCOHOLIC CARBONATED BEVERAGES; NON-ALCOHOLIC CARBONATED BEVERAGES; NON-ALCOHOLIC FRUIT DRINKS AND FRUIT JUICES, SYRUPS AND OTHER PREPARATIONS FOR MAKING FRUIT JUICES; NON-ALCOHOLIC, FLAVORED AND AERATED COLD BEVERAGES AND HOT BEVERAGES, NAMELY, COFFEE, CAPPUCCINO, CAFÉ LATTE, TEA, ESPRESSO AND HOT CHOCOLATE (U.S. CLS. 45, 46 AND 48).

CLASS 43—HOTEL AND RESTAURANT SERVICES

FOR RESTAURANT SERVICES (U.S. CLS. 100 AND 101).
LESLEY LAMOTHE, EXAMINING ATTORNEY

SN 76-398,432. THOMSON CANADA LIMITED, TORONTO, ONTARIO, CANADA, FILED 4-22-2002.

CLASS 9—ELECTRICAL AND SCIENTIFIC APPARATUS

FOR COMPUTER SOFTWARE CONTAINING REFERENCE INFORMATION ON A VARIETY OF INFORMATION IN THE FIELDS OF FINANCE, INVESTMENTS, BANKING REGULATIONS, CORPORATE OWNERSHIP, BUSINESSES, STATE AND FEDERAL TAXES, MEDICINE, PHARMACEUTICALS, LAW, HEALTHCARE AND INSURANCE; PRE-RECORDED COMPACT DISCS AND MAGNETIC DISCS AND TAPES, FEATURING INFORMATION ON FINANCE, INVESTMENTS, BANKING REGULATIONS, CORPORATE OWNERSHIP, BUSINESSES, STATE AND FEDERAL TAXES, MEDICINE, PHARMACEUTICALS, LAW, HEALTHCARE, AND INSURANCE FOR USE IN RESEARCH, EDUCATION, AND

INFORMATION GATHERING, AND SOFTWARE PROGRAMS FOR DATA STORAGE, TRANSMISSION AND DISTRIBUTION ON SITE, DOWNLOADABLE ON-LINE AND VIA TELEPHONE; PRE-RECORDED COMPUTER PROGRAMS FOR RESEARCH AND EDUCATION PURPOSES AND INFORMATION GATHERING AND INSTRUCTION MANUALS SOLD AS A UNIT RELATING TO COLLEGE SELECTION AND EDUCATIONAL FINANCIAL AID PROGRAMS; PRE-RECORDED AUDIO AND VIDEO CASSETTES AND PHOTOGRAPHIC SLIDE TRANSPARENCIES USED TO TRAIN PARTICIPANTS IN EFFECTIVE CAREER CONSULTATION, PERSONNEL MANAGEMENT AND JOB SEARCHING TECHNIQUES AND SKILLS AND FEATURING INFORMATION REGARDING SAME; PHOTOGRAPHIC SLIDE TRANSPARENCIES FOR PROJECTING IMAGES THERETO; COMPUTER SOFTWARE RECORDED ON CD-ROM THAT PROVIDES ACCESS TO BIBLIOGRAPHIC CITATIONS AND ABSTRACTS OF RESEARCH MATERIAL AND UPDATES OF JOURNAL LITERATURE IN THE FIELD OF SCIENCE; PRE-RECORDED AUDIO AND VIDEO TAPES FEATURING INSTRUCTIONAL MATERIALS FOR DISTANCE LEARNING COURSES VIA A GLOBAL COMPUTER NETWORK AND DISTANCE LEARNING COURSES BY CORRESPONDENCE AT THE SECONDARY, UNDERGRADUATE AND GRADUATE LEVELS, CONTINUING EDUCATION, PROFESSIONAL AND OCCUPATIONAL TRAINING COURSES FOR ADULTS AND CERTIFICATE PROGRAMS FOR NONTRADITIONAL STUDENTS IN THE FIELDS OF FINANCE, INVESTMENTS, BANKING REGULATIONS, CORPORATE OWNERSHIP, BUSINESSES, STATE AND FEDERAL TAXES, MEDICINE, PHARMACEUTICALS, LAW, HEALTHCARE AND INSURANCE; COMPUTER SOFTWARE, NAMELY, CD-ROMS DISCS AND DISKETTES FEATURING INFORMATION ON FINANCE, INVESTMENTS, BANKING REGULATIONS, CORPORATE OWNERSHIP, BUSINESSES, STATE AND FEDERAL TAXES, MEDICINE, PHARMACEUTICALS, LAW, HEALTHCARE, AND INSURANCE FOR USE IN RESEARCH, EDUCATION, AND INFORMATION GATHERING; PRERECORDED CD-ROMS PROVIDING RESEARCH AND PRACTICAL ENGAGEMENT GUIDANCE FOR USE BY ACCOUNTING PROFESSIONALS IN PROVIDING CONSULTING SERVICES, NAMELY, BUSINESS VALUATION, LITIGATION SUPPORT AND FRAUD INVESTIGATIONS FOR THEIR CLIENT; COMPUTER PROGRAMS FOR ACCESSING A VARIETY OF DATABASES IN A VARIETY OF FIELDS SUCH AS BUSINESS, LAW, SCIENCE AND TECHNOLOGY, HUMANITIES AND SOCIAL SCIENCE; PRE-RECORDED VIDEOTAPE CASSETTES FEATURING FINANCIAL AND ECONOMIC ISSUES PERTAINING TO THE MEDICAL, PHARMACEUTICAL AND ALLIED HEALTH CARE INDUSTRIES; COMPUTER SOFTWARE AND INSTRUCTION MANUALS FOR RESEARCH AND EDUCATIONAL PURPOSES AND INFORMATION GATHERING, ALL SOLD AS A UNIT FOR USE IN THE FIELD OF LEGAL RESEARCH; COMPUTER REFERENCE SOFTWARE CONTAINING REFERENCE MATERIALS AND EDUCATIONAL INFORMATION IN THE FIELDS OF BUSINESS, CHEMISTRY, COMPUTER SCIENCE, ECONOMICS, LAW, ENGINEERING, MATHEMATICS AND NURSING DIRECTED TO THE PRIMARY, SECONDARY, COLLEGE AND CORPORATE EDUCATIONAL MARKETS; COMPUTER SOFTWARE FOR RESEARCH AND EDUCATION PURPOSES AND INFORMATION GATHERING FOR USE IN THE FIELDS OF LAW, SECONDARY, COLLEGE AND POST-SECONDARY EDUCATION, AND INSTRUCTION MANUALS SOLD THEREWITH AS A UNIT; COMPUTER PROGRAMS, NAMELY, COMMUNICATIONS SOFTWARE TO FACILITATE THE TRANSFER OF ELECTRONIC DATA BY PROVIDING ACCESS TO DATABASES WHICH PROVIDE INFORMATION ON BUSINESS, SCIENCE AND TECHNOLOGY, HUMANITIES AND THE SOCIAL SCIENCES (U.S. CLS. 21, 23, 26, 36 AND 38).

CLASS 16—PAPER GOODS AND PRINTED MATTER

FOR PRINTED PUBLICATIONS, NAMELY, BOOKS, MAGAZINES, NEWSLETTERS, JOURNALS, DIRECTORIES, LOOSE LEAF BINDERS, PAMPHLETS AND BROCHURES CONTAINING REFERENCE INFORMATION ON A VARIETY OF TOPICS IN THE FIELDS OF FINANCE, INVESTMENTS, BANKING REGULATIONS, CORPORATE OWNERSHIP, BUSINESSES, STATE AND FEDERAL TAXES, MEDICINE, PHARMACEUTICALS, LAW, HEALTHCARE AND INSURANCE; PRACTICE MANAGEMENT MAGAZINE FOR THE ANIMAL HEALTH CARE PROFESSIONAL; GENERAL INTEREST NON-FICTION SELF-HELP REFERENCE BOOKS, DIRECTORIES, PAMPHLETS AND DATA REPORTS PROVIDING INFORMATION ABOUT INSTITUTIONS AND ORGANIZATIONS OFFERING ELEMENTARY, SECONDARY AND HIGHER EDUCATION; AND INFORMATION ABOUT CORPORATIONS, HEALTH FACILITIES AND OTHER ORGANIZATIONS IN THE PUBLIC AND PRIVATE SECTORS; INFORMATION ON FINANCIAL AID, COLLEGE GUIDANCE AND PLANNING, GRADUATE AND PROFESSIONAL SCHOOL, ENTRY TEST PREPARATION, CAREER GUIDANCE AND PLANNING, SUMMER JOBS, WORKING ABROAD, INTERNSHIPS; AND EDUCATION ADMINISTRATION; AND HUMAN RESOURCES ADMINISTRATION AND EXECUTIVE TRAINING; AND INFORMATION ON CHILDREN'S AND TEENS' SUMMER PROGRAMS; MAGAZINES ABOUT CAREER AND JOB SEARCH INFORMATION AND COLLEGE INFORMATION; GUIDE BOOKS, DIRECTORIES, AND CATALOGS ABOUT EDUCATIONAL PROGRAMS AND SERVICES, AND EDUCATIONAL BOOKS FOR USE IN HIGH SCHOOL AND SECONDARY EDUCATIONAL INSTITUTIONS AND MARKETS IN THE EDUCATIONAL FIELDS OF MARKETING, REAL ESTATE, AUTOMOTIVE AND TECHNICAL TRAINING, SCIENCE, BUILDING TRADE, COSMETOLOGY, COLLEGE AND CAREER SUCCESS, ELECTRONICS, TRANSPORTATION, HUMANITIES, GRAPHIC COMMUNICATIONS, FIRE RESCUE AND EMERGENCY, STATISTICS AND LANGUAGES, ACCOUNTING, AUDITING, TAXATION, BUSINESS MANAGEMENT, BUSINESS, CHEMISTRY, COMPUTER SCIENCE, ECONOMICS, ENGINEERING, MATHEMATICS, NURSING, FINANCE, INVESTMENTS, BANKING REGULATIONS, CORPORATE OWNERSHIP, LAW, BUSINESSES, STATE AND FEDERAL TAXES, AND HEALTHCARE; TEXTBOOKS, INSTRUCTIONAL MANUALS AND WORKBOOKS FOR USE IN HIGH SCHOOL AND SECONDARY EDUCATIONAL INSTITUTIONS AND MARKETS IN CONJUNCTION WITH TRAINING PROGRAMS IN THE CAREER MANAGEMENT AND PERSONNEL HIRING FIELDS; EDUCATIONAL PRINTED MATERIALS, NAMELY, BOOKS, WORKBOOKS AND STUDY GUIDES FOR USE IN HIGH SCHOOL AND SECONDARY EDUCATIONAL INSTITUTIONS AND MARKETS IN THE EDUCATIONAL FIELDS OF MARKETING, REAL ESTATE, AUTOMOTIVE AND TECHNICAL TRAINING, SCIENCE, BUILDING TRADE, COSMETOLOGY, COLLEGE AND CAREER SUCCESS, ELECTRONICS, TRANSPORTATION, HUMANITIES, GRAPHIC COMMUNICATIONS, FIRE RESCUE AND EMERGENCY, STATISTICS AND LANGUAGES, ACCOUNTING, AUDITING, TAXATION, BUSINESS MANAGEMENT, BUSINESS, CHEMISTRY, COMPUTER SCIENCE, ECONOMICS, ENGINEERING, MATHEMATICS, NURSING, FINANCE, INVESTMENTS, BANKING REGULATIONS, CORPORATE OWNERSHIP, LAW, BUSINESSES, STATE AND FEDERAL TAXES, AND HEALTHCARE; PRINTED WORKSHEETS AND TEST FORMS FOR DISTANCE LEARNING COURSES VIA A GLOBAL COMPUTER NETWORK AND DISTANCE LEARNING COURSES BY CORRESPONDENCE AT THE SECONDARY, UNDERGRADUATE AND GRADUATE LEVELS, CONTINUING EDUCATION, PROFESSIONAL AND OCCUPATIONAL TRAINING COURSES FOR ADULTS AND CERTIFICATE PROGRAMS FOR NONTRADITIONAL STUDENTS; PUBLICATIONS, NAMELY, PRINTED BOOKS, CARDS, INDEXES, ABSTRACTS AND DIAGRAMS WHICH PROVIDE SCIENTIFIC AND PATENT INFORMATION TO THE TECHNOLOGY INDUSTRY, SPECIFICALLY, THE CHEMICAL AND ENGINEERING INDUSTRIES; TECHNICAL REFERENCE MANUALS, NEWSLETTERS AND CATALOGS FOR USE IN THE AREAS OF ACCOUNTING, AUDITING, TAXATION AND BUSINESS MANAGEMENT; PAMPHLETS, NON-ADVERTISING

BROCHURES AND NEWSLETTERS CONTAINING CLINICAL MEDICAL AND SCIENTIFIC INFORMATION AND COMPUTER PROGRAM MANUALS; PRINTED PUBLICATIONS, NAMELY, BOOKS, TEXTBOOKS, INSTRUCTORS' MANUALS AND DIRECTORIES CONTAINING REFERENCE MATERIALS AND EDUCATIONAL INFORMATION IN THE FIELDS OF BUSINESS, CHEMISTRY, COMPUTER SCIENCE, ECONOMICS, ENGINEERING, MATHEMATICS, NURSING, MARKETING, REAL ESTATE, AUTOMOTIVE AND TECHNICAL TRAINING, SCIENCE, BUILDING TRADE, COSMETOLOGY, COLLEGE AND CAREER SUCCESS, ELECTRONICS, TRANSPORTATION, HUMANITIES, GRAPHIC COMMUNICATIONS, FIRE RESCUE AND EMERGENCY, STATISTICS AND LANGUAGES, ACCOUNTING, AUDITING, TAXATION, BUSINESS MANAGEMENT, FINANCE, INVESTMENTS, BANKING REGULATIONS, CORPORATE OWNERSHIP, LAW, BUSINESSES, STATE AND FEDERAL TAXES, AND HEALTHCARE DIRECTED TO THE PRIMARY, SECONDARY, COLLEGE AND CORPORATE EDUCATIONAL MARKETS; PRINTED PUBLICATIONS, NAMELY, BOOKS AND PAMPHLETS AND NEWSLETTERS FEATURING INFORMATION ON FINANCE, INVESTMENTS, BANKING REGULATIONS, CORPORATE OWNERSHIP, BUSINESSES, STATE AND FEDERAL TAXES, MEDICINE, PHARMACEUTICALS, HEALTHCARE, AND INSURANCE FOR USE IN RESEARCH, EDUCATION, AND INFORMATION GATHERING; PUBLICATIONS, NAMELY, BOOKS, JOURNALS, MAGAZINES, PAMPHLETS AND NEWSLETTERS ABOUT CONDUCTING LEGAL RESEARCH (U.S. CLS. 2, 5, 22, 23, 29, 37, 38 AND 50).

CLASS 35—ADVERTISING AND BUSINESS

FOR EMPLOYMENT RECRUITMENT SERVICES, PROVIDING INFORMATION ABOUT POTENTIAL JOB CANDIDATES TO PROSPECTIVE EMPLOYERS, PROVIDING INFORMATION ABOUT EMPLOYERS TO JOB SEEKERS, AND PROVIDING MARKET RESEARCH SERVICES FOR CORPORATE MARKETING AND SALES SUPPORT; PROVIDING PROFESSIONAL CAREER MANAGEMENT AND CAREER CONSULTATION SERVICES VIA ONLINE GLOBAL COMPUTER NETWORKS AND PROVIDING AN ONLINE COMPUTER DATABASE FOR JOB MATCHING FOR EMPLOYERS AND INDIVIDUALS FOR USE BY FORMER CLIENTS; HEALTH CARE COST REVIEW AND DATA PROCESSING SERVICES FOR HEALTH CARE AND HEALTH CLAIMS AND INSURANCE INFORMATION AND INFORMATION FOR CONTROLLING MEDICAL COSTS, MEASURING HEALTH CARE MARKETS AND RESEARCH PURPOSES; PROVIDING ONLINE EMPLOYMENT SERVICES, NAMELY, DATABASES FEATURING INFORMATION ENABLING THE SELECTION, EDUCATION, ASSESSMENT AND PERFORMANCE MANAGEMENT OF CORPORATE AND GOVERNMENT EMPLOYEES PERTAINING TO A WIDE VARIETY OF TOPICS VIA A GLOBAL COMPUTER NETWORK; COMPUTER SERVICES, NAMELY, PROVIDING A DATABASE FEATURING BUSINESS NEWS AND INFORMATION, BUSINESS CORPORATE FILINGS, AND BUSINESS REPORTS FOR LEGAL RESEARCH; LICENSING OF COMPUTER SOFTWARE AND CUSTOMIZED DATABASES, TABLES AND DATA SUMMARIES FOR THE PROCESSING OF HEALTH CARE AND HEALTH CLAIMS INFORMATION AND INFORMATION FOR CONTROLLING MEDICAL COSTS, MEASURING HEALTH CARE MARKETS AND HEALTH CARE RESEARCH PURPOSES; PROVIDE CUSTOMIZED STATISTICAL REPORTS CONCERNING DEMOGRAPHIC DATA (U.S. CLS. 100, 101 AND 102).

CLASS 36—INSURANCE AND FINANCIAL

FOR PROVISION OF INFORMATION ON THE TOPICS OF ACCOUNTING AND AUDITING, FINANCIAL ADVISORY SERVICES, TAX PLANNING AND COMPLIANCE; PROVIDING RESEARCH GUIDANCE ON THE TOPICS OF ACCOUNTING AND AUDITING, FINANCIAL ADVISORY SERVICES, TAX PLANNING AND COMPLIANCE; A HOUSE MARK FOR PROVIDING A FULL RANGE OF FINANCIAL SERVICES, NAMELY, INFORMATION, ANALYSIS AND REPORTS ON MUNICIPAL MARKETS AND TREASURY CASH, MERGERS AND ACQUISITIONS, OWNERSHIP OF CORPORATIONS, INFORMATION REGARDING CORPORATE AND FINANCIAL EXECUTIVES, POST TRADE OPERATIONS IN THE GLOBAL SECURITIES MARKETS; PROVIDE CUSTOMIZED STATISTICAL REPORTS CONCERNING FINANCIAL DATA (U.S. CLS. 100, 101 AND 102).

CLASS 38—COMMUNICATION

FOR ELECTRONIC MAIL AND FACSIMILE TRANSMISSION OF REFERENCE INFORMATION AND UPDATES ON JOURNAL LITERATURE IN THE FIELD OF SCIENCE; PROVIDING TELECOMMUNICATIONS GATEWAY SERVICES TO LEGAL PUBLICATIONS AND GENERAL INFORMATION; PROVIDING TELECOMMUNICATIONS ACCESS TO BIBLIOGRAPHIC CITATIONS AND ABSTRACTS OF RESEARCH MATERIAL AND UPDATES ON JOURNAL LITERATURE IN THE FIELD OF SCIENCE VIA A GLOBAL COMPUTER NETWORK (U.S. CLS. 100, 101 AND 104).

CLASS 39—TRANSPORTATION AND STORAGE

FOR COMPUTERIZED INFORMATION STORAGE OF FILES AND DOCUMENTS IN THE AREA OF LEGAL RESEARCH (U.S. CLS. 100 AND 105).

CLASS 41—EDUCATION AND ENTERTAINMENT

FOR EDUCATIONAL SERVICES, NAMELY, PROVIDING TECHNOLOGY BASED TRAINING PROGRAMS IN COMPUTER USE AND MANAGEMENT AND PROFESSIONAL DEVELOPMENT TO BUSINESS AND GOVERNMENT ORGANIZATIONS AND INDIVIDUALS; BOOK PUBLISHING SERVICES; SERVICES FOR ACADEMIC INSTITUTIONS AND SUMMER CAMPS, NAMELY PROVIDING BIOGRAPHICAL DATABASES LINKING SUMMER PROGRAMS, SCHOOLS, COLLEGES, UNIVERSITIES AND GRADUATE SCHOOLS WITH QUALIFIED APPLICANTS, PROVIDING SPECIALIZED ADMISSIONS SERVICES INCLUDING DISTRIBUTION OF PUBLICATIONS AND OTHER INSTITUTIONAL LITERATURE TO PROSPECTIVE STUDENTS HERE AND ABROAD, PROVIDING INFORMATION TO THE PUBLIC ON EDUCATIONAL INSTITUTIONS AND PROGRAMS, PROVIDING EDUCATIONAL RESEARCH SUPPORT FOR ADMISSIONS AND ENROLLMENT PLANNING AND FOR INSTITUTIONAL MANAGEMENT VIA ELECTRONIC AND PRINT MEDIA; PROVIDING CONFERENCE, SEMINAR AND WORKSHOP SERVICES IN THE MEDICAL, HEALTHCARE, FINANCIAL, BANKING, TAX, ACCOUNTING AND LEGAL FIELDS FOR PROFESSIONALS IN THOSE FIELDS TO IMPROVE THE PROFESSIONAL SKILLS OF INDIVIDUALS IN ACADEMIC ADMISSIONS; EDUCATIONAL SERVICES, NAMELY, CONDUCTING TRAINING PROGRAMS IN THE CAREER MANAGEMENT AND PERSONNEL HIRING FIELDS; EDUCATIONAL SERVICES, NAMELY, PROVIDING DISTANCE LEARNING COURSES VIA A GLOBAL COMPUTER NETWORK AND DISTANCE LEARNING COURSES BY CORRESPONDENCE AT THE SECONDARY, UNDERGRADUATE AND GRADUATE LEVELS, CONTINUING EDUCATION, PROFESSIONAL AND OCCUPATIONAL TRAINING COURSES FOR ADULTS AND CERTIFICATE PROGRAMS FOR NONTRADITIONAL STUDENTS; EDUCATIONAL SERVICES, NAMELY, PROVISION OF CONTINUING PROFESSIONAL EDUCATIONAL (CPE) COURSES TO SMALL TO MID-SIZED ACCOUNTING FIRM MARKET VIA A GLOBAL COMPUTER NETWORK; PREPARING, ADMINISTERING

AND SCORING A FULL RANGE OF ASSESSMENTS, EXAMINATIONS AND STANDARDIZED TESTS FOR EDUCATIONAL USE; PREPARING, ADMINISTERING AND SCORING A FULL RANGE OF ASSESSMENTS, EXAMINATIONS AND STANDARDIZED TESTS FOR EMPLOYMENT, COMMERCIAL AND GOVERNMENTAL USE; PROVIDING ON-LINE SERVICES, NAMELY, DATABASES FEATURING EDUCATIONAL INFORMATION PERTAINING TO A WIDE VARIETY OF TOPICS VIA A GLOBAL COMPUTER NETWORK DIRECTED TO THE PRIMARY, SECONDARY, COLLEGE AND CORPORATE EDUCATIONAL MARKETS; ON-LINE EDUCATION SERVICES IN THE NATURE OF CLASSES, SEMINARS, CONFERENCES AND WORKSHOPS IN THE MEDICAL, BANKING, TAX, ACCOUNTING, COMPUTER TRAINING, BUSINESS AND LEGAL FIELDS VIA A GLOBAL COMPUTER INFORMATION NETWORK FEATURING ELECTRONIC CONFERENCING AND FORUMS AND COURSE MATERIALS, NAMELY, BOOKS, WORKBOOKS, MAGAZINES, LEAFLETS AND CD-ROMS; ON-LINE SUBSCRIPTION BASED EDUCATIONAL SERVICES IN THE NATURE OF CLASSES, SEMINARS, CONFERENCES AND WORKSHOPS IN THE MEDICAL, BANKING, TAX, ACCOUNTING, COMPUTER TRAINING, BUSINESS AND LEGAL FIELDS FEATURING ELECTRONIC CONFERENCING AND FORUMS, AND PUBLISHING OF COURSE MATERIALS, NAMELY, BOOKS, WORKBOOKS, MAGAZINES, LEAFLETS AND CD-ROMS; TRAINING SERVICES IN ON-LINE SEARCHING OF COMPUTER DATABASES, COMPUTER SERVICES, NAMELY, PROVIDING A DATABASE FEATURING DIRECTORIES AND REFERENCE MATERIAL FEATURING INFORMATION ON SOCIAL SCIENCE AND THE HUMANITIES, GOVERNMENT AND POLITICS, LIBRARY SCIENCE AND BIOGRAPHICAL DATA FOR LEGAL RESEARCH (U.S. CLS. 100, 101 AND 107).

CLASS 42—SCIENTIFIC, COMPUTER AND LEGAL SERVICES

FOR CUSTOMIZED COMPUTER RESEARCH IN THE FIELD OF SCIENCE; INFORMATION SERVICES, NAMELY, PROVIDING SCIENTIFIC AND PATENT INFORMATION TO THE TECHNOLOGY INDUSTRY, SPECIFICALLY THE CHEMICAL AND ENGINEERING INDUSTRIES; ONLINE DATABASES WHICH PROVIDE SCIENTIFIC AND PATENT INFORMATION TO THE TECHNOLOGY INDUSTRY, SPECIFICALLY, THE CHEMICAL AND ENGINEERING INDUSTRIES PROVIDING AN ON-LINE COMPUTER DATABASE OF TRADEMARK INFORMATION FOR USE BY OTHERS; PAYER DOCUMENT RETRIEVAL SYSTEM DIRECTED TOWARD THE LEGAL COMMUNITY IN THE FIELD OF LEGAL RESEARCH, PROVIDING LINKS TO LEGAL PUBLICATIONS AND INFORMATION WEB SITES OF OTHERS FEATURING LEGAL MATTERS, BUSINESS NEWS AND INFORMATION, BUSINESS AND CORPORATE FILINGS, BUSINESS REPORTS, DIRECTORIES AND REFERENCE MATERIAL FEATURING INFORMATION ON SOCIAL SCIENCE AND THE HUMANITIES, GOVERNMENT AND POLITICS, LIBRARY SCIENCE, MEDICAL AND BIOGRAPHICAL DATA FOR LEGAL RESEARCH; COMPUTER SERVICES, NAMELY, PROVIDING DATABASE FEATURING LEGAL MATTERS, BUSINESS NEWS AND INFORMATION, BUSINESS AND CORPORATE FILINGS, BUSINESS REPORTS, DIRECTORIES AND REFERENCE MATERIAL FEATURING INFORMATION ON SOCIAL SCIENCE AND THE HUMANITIES, GOVERNMENT AND POLITICS, LIBRARY SCIENCE, MEDICAL AND BIOGRAPHICAL DATA FOR LEGAL RESEARCH; TRADEMARK RESEARCH SERVICES, NAMELY, PROVIDING COMPREHENSIVE INFORMATION AS TO THE USE, STATUS, HISTORY AND OWNERSHIP OF TRADEMARKS AND COMPANY NAMES, TO BE USED AS AN AID TO TRADEMARK AND COMPANY NAME, SELECTION, REVIEW AND PROTECTION; CUSTOMIZED ELECTRONIC AND COMPUTERIZED INFORMATION RETRIEVAL SERVICES IN THE AREA OF LEGAL RESEARCH, NAMELY, PROVIDING INFORMATION AT THE SPECIFIC REQUEST OF END-USERS BY MEANS OF A GLOBAL COMPUTER NETWORK; AND COMPUTER SERVICES, NAMELY, PROVIDING A DATABASE FEATURING INFORMATION FOR LEGAL RESEARCH (U.S. CLS. 100 AND 101).

CLASS 44—MEDICAL, BEAUTY AND AGRICULTURAL SERVICES

FOR PROVIDING MEDICAL AND CLINICAL HEALTH CARE INFORMATION VIA THE INTERNET; AND PROVIDING HEALTH CARE INFORMATION; HEALTH CARE CONSULTING SERVICES THAT PROVIDE CUSTOMIZED STATISTICAL REPORTS CONCERNING PATIENT, PROVIDER, CLINICAL AND HEALTH CLAIMS (U.S. CLS. 100 AND 101).
KARANENDRA S. CHHINA, EXAMINING ATTORNEY

SN 76-400,230. STOWELL ASSOCIATES SELECTSTAFF INC., MILWAUKEE, WI. FILED 4-22-2002.

SELECTSTAFF

CLASS 44—MEDICAL, BEAUTY AND AGRICULTURAL SERVICES

FOR HOME CARE AND SUPPORT SERVICES, NAMELY PROVIDING HYGIENIC CARE ASSISTANCE TO THE ELDERLY AND MENTALLY OR PHYSICALLY CHALLENGED PEOPLE, SPECIFICALLY NOT INCLUDING EMPLOYEE RECRUITMENT OR EMPLOYEE PLACEMENT SERVICES IN THE MEDICAL FIELD OR ANY OTHER FIELD (U.S. CLS. 100 AND 101).
FIRST USE 1-2-1996; IN COMMERCE 1-2-1996.

CLASS 45—PERSONAL SERVICES

FOR HOME CARE AND SUPPORT SERVICES, NAMELY PROVIDING NON-HYGIENIC COMPANIONSHIP AND PERSONAL CARE ASSISTANCE OF ACTIVITIES OF DAILY LIVING, SUCH AS BATHING, GROOMING AND PERSONAL MOBILITY FOR THE ELDERLY AND MENTALLY OR PHYSICALLY CHALLENGED PEOPLE, SPECIFICALLY NOT INCLUDING EMPLOYEE RECRUITMENT OR EMPLOYEE PLACEMENT SERVICES IN THE MEDICAL FIELD OR ANY OTHER FIELD (U.S. CLS. 100 AND 101).
FIRST USE 1-2-1996; IN COMMERCE 1-2-1996.

MARTHA FROMM, EXAMINING ATTORNEY

SN 76-411,028. PRIORITY ONE INTERNATIONAL, INC., PLANO, TX. FILED 5-23-2002.

BLUEFISH TV

CLASS 9—ELECTRICAL AND SCIENTIFIC APPARATUS

FOR PRE-RECORDED VIDEO CASSETTES AND DVDS IN THE FIELD OF BIBLE STUDY, CHRISTIAN MISSIONARY SERVICE AND CHRISTIAN EDUCATION, FEATURING RELIGIOUS, SPIRITUAL AND PERSONAL GROWTH TOPICS AND INFORMATION (U.S. CLS. 21, 23, 26, 36 AND 38).

CLASS 16—PAPER GOODS AND PRINTED MATTER

FOR PRINTED MATERIALS, NAMELY, DISCUSSION GUIDES FOR BIBLE STUDY, BIBLE STUDY CURRICULUM GUIDES AND CHRISTIAN EDUCATION BROCHURES AND BOOKLETS (U.S. CLS. 2, 5, 22, 23, 29, 37, 38 AND 50).

CLASS 41—EDUCATION AND ENTERTAINMENT

FOR EDUCATIONAL AND ENTERTAINMENT SERVICES CONCERNING RELIGIOUS TOPICS, NAMELY, PROVIDING A WEB SITE CONTAINING AUDIO, VISUAL AND TEXTUAL MATERIALS DESIGNED TO INFORM AND MOBILIZE CHRISTIANS FOR MISSIONARY SERVICE THROUGH RELIGIOUS INSTRUCTION, INSTRUCTION ON PERSONAL AND SPIRITUAL GROWTH AND BIBLE STUDY VIA A GLOBAL COMPUTER INFORMATION NETWORK, AND PROVIDING RELIGIOUS INSTRUCTION, CLASSES, CONFERENCES AND CONVENTIONS DESIGNED TO INFORM AND MOBILIZE CHRISTIANS FOR MISSIONARY SERVICE (U.S. CLS. 100, 101 AND 107).

CLASS 45—PERSONAL SERVICES

FOR PROVIDING EVANGELISTIC AND MINISTERIAL SERVICES, NAMELY, PROVIDING INFORMATION CONCERNING RELIGIOUS TOPICS, PERSONAL AND SPIRITUAL GROWTH AND MISSIONARY OPPORTUNITIES VIA A GLOBAL COMPUTER INFORMATION NETWORK AND PROVIDING A MINISTERIAL WEBSITE CONTAINING ON-LINE BIBLE STUDY MATERIALS, INFORMATION REGARDING MISSIONARY SERVICE AND OPPORTUNITIES, AND ON-LINE INTERVIEW TRANSCRIPTS, JOURNALS AND NEWSLETTERS IN THE FIELD OF MISSIONARY SERVICE (U.S. CLS. 100 AND 101).

CAROLINE WEIMER, EXAMINING ATTORNEY

SN 76-416,063. HAROLD IMPORT CO., INC., LAKEWOOD, NJ. FILED 6-6-2002.

MRS. ANDERSON'S BAKING

NO CLAIM IS MADE TO THE EXCLUSIVE RIGHT TO USE "BAKING", APART FROM THE MARK AS SHOWN. "MRS. ANDERSON" DOES NOT IDENTIFY A LIVING INDIVIDUAL.

CLASS 9—ELECTRICAL AND SCIENTIFIC APPARATUS

FOR MEASURING SPOONS (U.S. CLS. 21, 23, 26, 36 AND 38).

FIRST USE 5-1-1993; IN COMMERCE 5-1-1993.

CLASS 16—PAPER GOODS AND PRINTED MATTER

FOR PARCHMENT PAPER; PAPER BAKING CUPS; PAPER BAKING MUFFIN CUPS; PAPER BAKING CUP-CAKE CUPS (U.S. CLS. 2, 5, 22, 23, 29, 37, 38 AND 50).

FIRST USE 5-1-1993; IN COMMERCE 5-1-1993.

CLASS 21—HOUSEWARES AND GLASS

FOR FLOUR SHIFTERS, COOKING SPATULAS, PIE TOP CUTTERS, WHISKS, MIXING BOWLS AND COOKIE CUTTER SETS, COOKIE DOUGH SCOOPER, PIE CRUST MOLD SHIELDS AND WEIGHTS AND A MOLD WITH A FUNCTION TO CREATE SHAPES FOR COOKIES OUT OF COOKIE DOUGH (U.S. CLS. 2, 13, 23, 29, 30, 33, 40 AND 50).

FIRST USE 5-1-1993; IN COMMERCE 5-1-1993.

BARBARA A. LOUGHRAN, EXAMINING ATTORNEY

SN 76-417,102. KER, INCORPORATED, LONGMONT, CO. FILED 6-3-2002.

**CLASS 9—ELECTRICAL AND SCIENTIFIC APPARATUS**

FOR COMPUTER PROGRAMS, NAMELY, SECURITY SOFTWARE USED FOR DETERMINATION OF AND PROTECTION AGAINST UNAUTHORIZED USE OF FILES, AND FOR VIRUS PROTECTION (U.S. CLS. 21, 23, 26, 36 AND 38).

CLASS 42—SCIENTIFIC, COMPUTER AND LEGAL SERVICES

FOR PROVIDING TEMPORARY USE OF ON-LINE NON-DOWNLOADABLE COMPUTER PROGRAMS, NAMELY, SECURITY SOFTWARE USED FOR DETERMINATION OF AND PROTECTION AGAINST UNAUTHORIZED USE OF FILES, AND FOR VIRUS PROTECTION (U.S. CLS. 100 AND 101).

BRIAN PINO, EXAMINING ATTORNEY

SN 76-421,802. THE SANSIN CORPORATION, STRATHROY, ONTARIO, CANADA. FILED 6-17-2002.

**THERE IS ONLY ONE
BETTER NATURAL WOOD
PROTECTOR ... IT'S CALLED
BARK**

PRIORITY CLAIMED UNDER SEC. 44(D) ON CANADA APPLICATION NO. 1141721, FILED 5-24-2002, REG. NO. TMA619,918, DATED 9-17-2004, EXPIRES 9-17-2019.

CLASS 2—PAINTS

FOR WOOD STAINS, SEALER COATINGS FOR USE ON WOOD; WOOD PRESERVATIVE (U.S. CLS. 6, 11 AND 16).

CLASS 35—ADVERTISING AND BUSINESS

FOR WHOLESALE DISTRIBUTORSHIP AND ORDERING SERVICES FEATURING WOOD STAINS, SEALER COATINGS FOR USE ON WOOD AND WOOD PRESERVATIVES (U.S. CLS. 100, 101 AND 102).

TONI HICKEY, EXAMINING ATTORNEY

SN 76-433,220. ARDEN CORPORATION, SOUTHFIELD, MI.
FILED 7-23-2002.

SN 76-452,210. INTERNATIONAL TREX LIMITED, DUN-
DEE, DD2 4TG, UNITED KINGDOM, FILED 9-19-2002.

CHEF'S LINE

OWNER OF U.S. REG. NO. 1,985,287.
SEC. 2(F).

CLASS 24—FABRICS

FOR POTHOLDERS, TOWELS, AND OVEN MITTS
(U.S. CLS. 42 AND 50).
FIRST USE 7-12-1993; IN COMMERCE 7-12-1993.

CLASS 25—CLOTHING

FOR APRONS AND CHEF'S HATS (U.S. CLS. 22 AND
39).
FIRST USE 7-12-1993; IN COMMERCE 7-12-1993.
KIM SAITO, EXAMINING ATTORNEY

SN 76-437,728. IDEA AG, 80807 MUNICH, FED REP GER-
MANY, FILED 8-2-2002.

TRANSFERSOME

PRIORITY CLAIMED UNDER SEC. 44(D) ON ERP
CMNTY TM OFC APPLICATION NO. 002771657, FILED 7-
10-2002, REG. NO. 002771657, DATED 2-4-2004, EXPIRES 7-10-
2012.

CLASS 1—CHEMICALS

FOR INTERMEDIATE AND FINISHED CHEMICAL
PREPARATIONS FOR USE IN THE MANUFACTURE OF
LIPOSOMAL CARRIERS (U.S. CLS. 1, 5, 6, 10, 26 AND
46).

CLASS 3—COSMETICS AND CLEANING PRE- PARATIONS

FOR LIPOSOMAL CARRIERS SOLD AS AN INTEL-
GURAL COMPONENT OF PERFUMES, BODY LOTIONS,
ETHERIC OILS AND COSMETICS (U.S. CLS. 1, 4, 6, 50,
51 AND 52).

CLASS 5—PHARMACEUTICALS

FOR LIPOSOMAL CARRIERS, NAMELY, CHEMICAL
PREPARATIONS USED TO HELP THE TRANSPORT OF
PHARMACEUTICAL AND VETERINARY PREPARA-
TIONS THROUGH THE SKIN, SOLD AS AN INTEGRAL
INGREDIENT OF PHARMACEUTICAL AND VETERIN-
ARY PREPARATIONS FOR USE IN THE TREATMENT
OF A WIDE VARIETY OF ILLNESSES; AND MEDICAL
PLASTERS AND BANDAGES FOR SKIN WOUNDS (U.S.
CLS. 6, 18, 44, 46, 51 AND 52).
CURTIS FRENCH, EXAMINING ATTORNEY



PRIORITY CLAIMED UNDER SEC. 44(D) ON ERP
CMNTY TM OFC APPLICATION NO. 002704799, FILED 5-
16-2002, REG. NO. 002704799, DATED 4-7-2004, EXPIRES 5-16-
2012.

NO CLAIM IS MADE TO THE EXCLUSIVE RIGHT TO
USE "STEAM", APART FROM THE MARK AS SHOWN.
THE MARK CONSISTS IN PART OF THE WORDS "EASY
STEAM", THE LETTERS "T" AND "E" AND THE DESIGN
OF A DIAMOND, AND DESIGN.

CLASS 16—PAPER GOODS AND PRINTED MATTER

FOR PLASTIC BAGS FOR PACKAGING; PAPER FOR
WRAPPING AND PACKAGING; PLASTIC WRAP AND
PLASTIC GIFT WRAP; ALL PURPOSE PLASTIC BAGS;
PLASTIC SHEETS FOR WRITING, PRINTING AND
MARKING; PLASTIC FILMS USED AS PACKAGING
FOR FOOD; PLASTIC FILM NOT FOR COMMERCIAL
OR INDUSTRIAL PURPOSES; MICROWAVE COOKING
BAGS FOR PRESSURE COOKING AND STEAM COOK-
ING (U.S. CLS. 2, 5, 22, 23, 29, 37, 38 AND 50).

CLASS 17—RUBBER GOODS

FOR PLASTIC FILM FOR INDUSTRIAL AND COM-
MERCIAL PACKING USE; EXTRUDED PLASTICS IN
THE FORM OF FILMS, FOILS, SHEETS, RODS, SLABS
OR TUBES; PLASTICS COMPOSITE MATERIALS IN
THE FORM OF MOLDINGS AND EXTRUSIONS FOR
USE IN MANUFACTURE; PLASTIC IN AN EXTRUDED
FORM FOR GENERAL INDUSTRIAL USE (U.S. CLS. 1,
5, 12, 13, 35 AND 50).
BARBARA A. GOLD, EXAMINING ATTORNEY

SN 76-457,446. LAR ANALYTIK & UMWELTMESSTECHNIK
GMBH, 10179 BERLIN, FED REP GERMANY, FILED 10-
10-2002.

QuickTON

PRIORITY CLAIMED UNDER SEC. 44(D) ON ERP
CMNTY TM OFC APPLICATION NO. 002829968, FILED 8-
28-2002, REG. NO. 002829968, DATED 1-18-2005, EXPIRES 8-
28-2012.

CLASS 9—ELECTRICAL AND SCIENTIFIC APPARATUS

FOR MEASURING DEVICES, NAMELY, CARBON
AND NITROGEN CONTENT MEASURING APPARATUS
FOR THE ENVIRONMENTAL TECHNOLOGY; CHEMI-
CAL ANALYSIS DEVICES, NAMELY, CARBON AND
NITROGEN CONTENT MEASURING APPARATUS;
DEVICES, NAMELY, CARBON AND NITROGEN CON-
TENT MEASURING APPARATUS FOR WATER MEA-
SURING AND WATER ANALYSIS TECHNOLOGY AND
PARTS THEREOF (U.S. CLS. 21, 23, 26, 36 AND 38).

CLASS 42—SCIENTIFIC, COMPUTER AND LEGAL SERVICES

FOR LEASING OF MEASURING DEVICES FOR ENVIRONMENTAL TECHNOLOGY, OF CHEMICAL ANALYSIS DEVICES AND DEVICES FOR WATER MEASURING AND WATER ANALYSIS TECHNOLOGY AND PARTS THEREOF; DEVELOPMENT AND OPERATION OF MEASURING DEVICES FOR ENVIRONMENTAL TECHNOLOGY, OF CHEMICAL ANALYSIS DEVICES AND DEVICES FOR WATER MEASURING AND WATER ANALYSIS TECHNOLOGY AND PARTS THEREOF, ENGINEERING SERVICES, NAMELY, PLANNING THE UTILIZATION OF SUCH DEVICES AND PERFORMING OF MEASUREMENTS AND ANALYSIS IN THE FIELDS OF ENVIRONMENTAL TECHNOLOGY, PERFORMING OF MEASUREMENTS AND ANALYSIS IN THE FIELDS OF CHEMISTRY AND PERFORMING OF WATER MEASUREMENTS AND WATER ANALYSIS (U.S. CLS. 100 AND 101).

KEVON CHISOLM, EXAMINING ATTORNEY

CLASS 9—ELECTRICAL AND SCIENTIFIC APPARATUS

FOR ELECTRONIC PUBLICATIONS, NAMELY, NEWSLETTERS, BROCHURES, CATALOGUES, INSTRUCTIONAL, TEACHING AND EDUCATIONAL MATERIAL, FEATURING INFORMATION, IMAGES, ILLUSTRATIONS, AND ARTWORK RELATING TO PLAYING CARDS AND CARD GAMES AND INFORMATION RELATING TO THE PROPRIETOR, RECORDED ON COMPUTER MEDIA; COMPUTER SOFTWARE USED FOR PLAYING CARDS AND CARD GAMES; COMPUTER PROGRAMS USED FOR PLAYING CARDS AND CARD GAMES; CD'S, CD-ROM'S, DVD'S, DVD-ROM'S, VIDEOTAPES, AND COMPUTER DISCS FEATURING INFORMATION, IMAGES, ILLUSTRATIONS, AND ARTWORK RELATING TO PLAYING CARDS AND CARD GAMES; PRE-RECORDED DISCS AND TAPES, NAMELY, CD'S, CD-ROM'S, DVD'S, DVD-ROM'S, VIDEOTAPES, CASSETTES, AND COMPUTER DISCS FEATURING INFORMATION, IMAGES, ILLUSTRATIONS, AND ARTWORK RELATING TO PLAYING CARDS AND CARD GAMES; RECORDINGS, NAMELY, CD'S, CD-ROM'S, DVD'S, DVD-ROM'S, VIDEOTAPES, CASSETTES AND COMPUTER DISCS OF TEXT, IMAGES, INFORMATION AND DATA IN THE FIELD OF PLAYING CARDS AND CARD GAMES, AND OF AUDIO, VIDEO, AND/OR AUDIO VISUAL MATERIAL, NAMELY, INFORMATION, IMAGES, ILLUSTRATIONS, ARTWORK, SOUNDS AND MUSIC RELATING TO PLAYING CARDS AND CARD GAMES AND ILLUSTRATIONS FEATURED ON PLAYING CARDS AND CARD GAMES (U.S. CLS. 21, 23, 26, 36 AND 38).

CLASS 28—TOYS AND SPORTING GOODS

FOR PLAYING CARDS; CARD GAMES; PLAYTHINGS, NAMELY, PLAYING CARDS AND CARD GAMES; PUZZLES (U.S. CLS. 22, 23, 38 AND 50).

KEVON CHISOLM, EXAMINING ATTORNEY

SN 76-461,050. HERITAGE PLAYING CARD COMPANY LIMITED, ILKESTON, DERBYSHIRE, ENGLAND, FILED 10-21-2002.

SN 76-463,505. MINNEAPOLIS HEART INSTITUTE, INC., MINNEAPOLIS, MN. FILED 10-28-2002.



MHI

OWNER OF U.S. REG. NO. 2,411,564.

CLASS 41—EDUCATION AND ENTERTAINMENT

FOR EDUCATIONAL SERVICES, NAMELY, CONDUCTING CLASSES, SEMINARS AND LECTURES IN THE FIELD OF MEDICAL CARE (U.S. CLS. 100, 101 AND 107).

CLASS 44—MEDICAL, BEAUTY AND AGRICULTURAL SERVICES

FOR INTEGRATED HEALTH SERVICES, NAMELY, DIETARY THERAPY, GUIDED IMAGERY, MASSAGE THERAPY, MUSIC THERAPY, RELAXATION AND STRESS MANAGEMENT TRAINING AND SPIRITUAL CARE; MEDICAL CLINICS; MEDICAL CONSULTATION; MEDICAL COUNSELING; MEDICAL LABORATORIES; MEDICAL SERVICES; MEDICAL TESTING; NUTRITION COUNSELING; PROVIDING MEDICAL INFORMATION; AND SURGICAL SERVICES, NAMELY, CARDIOVASCULAR, THORACIC, TRANSPLANTATION AND VASCULAR (U.S. CLS. 100 AND 101).

INGA ERVIN, EXAMINING ATTORNEY

PRIORITY CLAIMED UNDER SEC. 44(D) ON ERPN CMNTY TM OFC APPLICATION NO. 2673457, FILED 4-22-2002, REG. NO. 002673457, DATED 12-17-2003, EXPIRES 4-22-2012.

THE STIPPLING IN THE MARK INDICATES SHADING AND IS NOT INTENDED TO INDICATE COLOR.

THE MARK CONSISTS OF THE LETTER "H" ABOVE THE TERM "HERITAGE" ON A YELLOW BACKGROUND.

SN 76-465,687. IQ AUTOMATION GMBH, 85386 ECHING, GERMANY DEM REP, FILED 11-8-2002.

EASYSO NIC

PRIORITY CLAIMED UNDER SEC. 44(D) ON FED REP GERMANY APPLICATION NO. 30223626.0/0, FILED 5-12-2002, REG. NO. 30223626, DATED 7-18-2002, EXPIRES 5-31-2012.

CLASS 9—ELECTRICAL AND SCIENTIFIC APPARATUS

FOR COMPUTER HARDWARE; PARTS AND PERIPHERAL DEVICES FOR COMPUTERS, NAMELY, CIRCUIT BOARDS AND PRINTED CIRCUIT BOARDS; COMPUTER MONITORS, VIDEO SCREENS AND LIQUID CRYSTAL DISPLAYS; COMPUTER TERMINALS; WALL COMPUTER TERMINALS, STAND-ALONE COMPUTER TERMINALS AND TABLE COMPUTER TERMINALS; LUMINESCENT DISPLAY PANELS; ELECTRONIC DISPLAY PANELS; DISTANCE METERS; PROXIMITY SENSORS; PROXIMITY DETECTORS; MOTION DETECTORS; COMPUTER TERMINAL REMOTE CONTROL UNITS; PROJECTION DEVICES, NAMELY LIQUID CRYSTAL DISPLAY (LCD) PROJECTORS, AND PROJECTION SCREENS; COMPUTER SOFTWARE FOR USE IN CONTROLLING THE OPERATION OF A COMPUTER TERMINAL; COMPUTER SCREEN SAVER SOFTWARE; AND COMPUTER MONITOR CONTROL SOFTWARE (U.S. CLS. 21, 23, 26, 36 AND 38).

CLASS 16—PAPER GOODS AND PRINTED MATTER

FOR PRINTED TEACHING AND INSTRUCTIONAL MATERIAL IN THE FIELDS OF COMPUTER HARDWARE AND COMPUTER TERMINALS; BOOKS, MAGAZINES AND MANUALS CONCERNING THE FIELDS OF COMPUTER HARDWARE AND COMPUTER TERMINALS (U.S. CLS. 2, 5, 22, 23, 29, 37, 38 AND 50).

CLASS 37—CONSTRUCTION AND REPAIR

FOR INSTALLATION, MAINTENANCE AND REPAIR OF— COMPUTER HARDWARE; PARTS AND PERIPHERAL DEVICES FOR COMPUTERS, NAMELY, CIRCUIT BOARDS AND PRINTED CIRCUIT BOARDS; COMPUTER MONITORS, VIDEO SCREENS AND LIQUID CRYSTAL DISPLAYS; COMPUTER TERMINALS; WALL COMPUTER TERMINALS, STAND-ALONE COMPUTER TERMINALS AND TABLE COMPUTER TERMINALS; LUMINESCENT DISPLAY PANELS; ELECTRONIC DISPLAY PANELS; DISTANCE METERS; PROXIMITY SENSORS; PROXIMITY DETECTORS; MOTION DETECTORS; COMPUTER TERMINAL REMOTE CONTROL UNITS; PROJECTION DEVICES, NAMELY LIQUID CRYSTAL DISPLAY (LCD) PROJECTORS, AND PROJECTION SCREENS (U.S. CLS. 100, 103 AND 106).

TRACY CROSS, EXAMINING ATTORNEY

SN 76-465,759. ROSENGRENS SAFEPAY AB, S-402 42 GÖTEBORG, SWEDEN, FILED 11-12-2002.



PRIORITY CLAIMED UNDER SEC. 44(D) ON SWEDEN APPLICATION NO. 2002/06523, FILED 10-9-2002, REG. NO. 367390, DATED 6-11-2004, EXPIRES 6-11-2014.

CLASS 6—METAL GOODS

FOR METAL SAFES, CASH BOXES OF METAL, SAFE DEPOSIT BOXES, METAL CASSETTES FOR SAFE DEPOSIT BOXES, NON-ELECTRIC METAL LOCKS AND LOCK GOODS OF METAL, NAMELY, METAL LOCK CYLINDERS AND METAL KEYS FOR LOCKS (U.S. CLS. 2, 12, 13, 14, 23, 25 AND 50).

CLASS 9—ELECTRICAL AND SCIENTIFIC APPARATUS

FOR CASH REGISTERS, AUTOMATED MACHINES FOR VALIDATING AND VERIFYING COINS BANK NOTES, AUTOMATED COIN, BANK NOTE AND CURRENCY SORTING AND COUNTING MACHINES, AUTOMATIC CASH DISPENSERS, ELECTRONIC BANK NOTE DISPENSING MACHINES WITH IN-BUILT SECURITY DEVICES TO PREVENT THEFT OR SIMILAR ACTIONS, ELECTRIC LOCKS (U.S. CLS. 21, 23, 26, 36 AND 38).

CLASS 37—CONSTRUCTION AND REPAIR

FOR INSTALLATION, SERVICE AND REPAIR SERVICES OF SAFES AND THEFT ALARMS AND OTHER SECURITY CONSTRUCTIONS (U.S. CLS. 100, 103 AND 106).

MARCIE MILONE, EXAMINING ATTORNEY

SN 76-468,598. GEZE GMBH, 71229 LEONBERG, FED REP GERMANY, FILED 11-8-2002.

GEZE

OWNER OF FED REP GERMANY REG. NO. 39915143, DATED 7-6-1999, EXPIRES 3-31-2009.

OWNER OF U.S. REG. NOS. 786,673 AND 960,725.

CLASS 6—METAL GOODS

FOR DOORS, GATES AND WINDOWS OF METAL, CONSTRUCTION FITTINGS OF IRON AND METAL, DOOR, GATE AND IRONWORK FOR WINDOWS, OF METAL, IN PARTICULAR DOOR BANDS, DOOR STATED, DOOR LEAL, DOOR PANELS, DOOR HANDLES, DOOR FRAME AND DOOR STICKS, DOOR BOLTS, METAL RUNNERS FOR SLIDING DOORS, ALWAYS OF IRON, METAL, ALUMINUM AND STEEL; NON-ELECTRIC DOOR SPRINGS OF METAL, WINDOW BANDS, WINDOW FASTENERS, WINDOW FRAMES OF ALUMINUM, METAL AND STEEL; WINDOW CASEMENT BOLTS, WINDOW PULLEYS; SHUTTERS OF METAL; CASEMENT WINDOWS OF METAL, ALUMINUM AND STEEL; DRIFT BARS OF METAL FOR USE WITH DOORS, WINDOWS AND GATES AND COMPONENT PARTS THEREFOR; NON-ELECTRIC METAL FANLIGHT OPENER; NON-ELECTRIC FANLIGHT CONTACT OF METAL; BOLTS OF METAL; HINGES OF METAL; NON-ELECTRIC LOCKS OF METAL; METAL VEHICLE LOCKS; PANEL HARDWARE OF METAL, IN PARTICULAR PANEL HARDWARE FOR DOORS, GATES, AND WINDOWS, NAMELY, DOOR SUSPENSION UNITS, HANGER BOLTS AND NUTS, ROLLERS, RAILS, CARRIER PLATES, STOPS, BUFFERS, CLAMPING PLATES, COUPLERS, CAGES, ATTACHMENT ANGLES, LIMIT STOPS, TRACKS, GUIDES, SLIDES, BRACKETS, SCREWS, SPACERS AND RUNNERS; LOCKERS HARDWARE OF METAL, IN PARTICULAR CARRIER RAILS, BALL BEARINGS, SCREWS, BRACKETS, SPACERS; FAÇADE ELEMENTS OF ALUMINUM, METAL AND STEEL, NAMELY TRIM FOR DOORS, WINDOWS AND DRAWERS; FIXED FIELD SHUTTERS OF ALUMINUM, METAL AND STEEL; METAL CABLES; METAL AUTOMATIC DOORS, AUTOMATIC DOORS AND WINDOWS OF METAL; METAL DOOR PANELS EXCEPT FOR LAND VEHICLES; METAL SHOP WINDOWS AND WINDOW FRAMES; APPLIANCES FOR FIRE PREVENTION, NAMELY FITTINGS AND HARDWARE FOR FIRE

DOORS AND FIRE WINDOWS MADE OF METAL, IN PARTICULAR, DOOR SUSPENSION UNITS, HANGER BOLTS AND NUTS, ROLLERS, RAILS, GUIDES, CARRIER PLATES, STOPS, BUFFERS, CLAMPING PLATES, COUPLERS, CAGES, ATTACHMENT ANGLES, LIMIT STOPS, TRACKS, SLIDES, BRACKETS, SCREWS, SPACERS AND RUNNERS (U.S. CLS. 2, 12, 13, 14, 23, 25 AND 50).

CLASS 7—MACHINERY

FOR BALL BEARINGS FOR USE WITH DOORS, WINDOWS, MOTORS AND APPLIANCES FOR FIRE PREVENTION FOR DOORS, GATES AND WINDOWS; ENGINES, EXCEPT FOR LAND VEHICLES; ELECTRICAL MOTORS, EXCEPT FOR LAND VEHICLES; HYDRAULIC MOTORS FOR MACHINES; COMPRESSED AIR ENGINES FOR MACHINES; HYDRAULIC AND PNEUMATIC DRIVE FOR MACHINES AND ENGINES; AUTOMATIC DRIVE UNITS FOR DOORS AND WINDOWS, NAMELY ELECTRIC AND PNEUMATIC ENGINES NOT FOR LAND VEHICLES AND COMPONENT ELECTRONIC CONTROLLERS; AUTOMATIC OPERATED DOORS AND WINDOWS AND NON-METAL AND GLASS; GUIDES FOR MACHINES, COMPRISED OF A CARRIER RAIL, TRACK, CAGE AND BALL BEARINGS; CASING MACHINES AND ENGINES; TRANSMISSION BELTS FOR ENGINES OTHER THAN FOR LAND VEHICLES; DRIVING CHAINS EXCEPT FOR LAND VEHICLES; COMPRESSED AIR MACHINES; TRANSMISSION BELT BRACKETS AND TRANSMISSION BELT TIGHTENERS OF METAL FOR MACHINES; MECHANICAL, HYDRAULIC AND PNEUMATIC DOOR, WINDOW AND FANLIGHT OPENERS AND CLOSERS MADE OF METAL AND PLASTIC (U.S. CLS. 13, 19, 21, 23, 31, 34 AND 35).

CLASS 9—ELECTRICAL AND SCIENTIFIC APPARATUS

FOR MAGNETS; ELECTRIC AND ELECTRONIC DOOR OPENERS AND DOOR CLOSERS; ELECTRIC WINDOWS OPENER AND WINDOWS MAKE CONTACT; ELECTRIC FANLIGHT OPENER AND FANLIGHT MAKE CONTACT; FIRE ALARMS; SMOKE AND HEAT DETECTORS; HEAT REGULATORS; ELECTRIC SWITCHES; TELERUPTORS; ELECTRIC SWITCHGEAR; ELECTRIC LOCKS; ELECTRIC REGULATORS; ELECTRONIC CONTROLLERS FOR DOOR, GATE, WINDOWS AND FANLIGHT DRIVE; DIAGNOSIS APPARATUS, NOT FOR MEDICAL PURPOSES, NAMELY ADJUSTERS FOR DOORS, WINDOWS AND DRAWERS; REMOTE CONTROLS FOR LOCKING MECHANISMS, ACTUATION AND ESCAPE ROUTE CONTROL; ELECTRODYNAMIC AND SIGNALING REMOTE CONTROL SIGNALERS; PRESSURE MEASURING APPARATUS; ELECTRIC WIRES AND MAGNETIC WIRES USED FOR ELECTRICAL LOCKS, AUTOMATIC DRIVE UNITS FOR DOORS AND WINDOWS, NAMELY, ELECTRONIC CONTROLLERS; MACHINE PARTS, NAMELY PRESSURE REGULATORS; APPLIANCES FOR FIRE PREVENTION, IN PARTICULAR FIRE AND SMOKE PROTECTION DEGREES, STATE EQUIPMENT FOR DOORS AND LIDS, CLOSING BLOCK REGULATORS, AND SMOKE AND HEAT REDUCTION EQUIPMENT, ALL FOR OPERATION AND CONTROL OF SMOKE AND HEAT VENTILATION ELEMENTS (U.S. CLS. 21, 23, 26, 36 AND 38).

CLASS 12—VEHICLES

FOR VEHICLE DOORS AND WINDOWS (U.S. CLS. 19, 21, 23, 31, 35 AND 44).

CLASS 19—NON-METALLIC BUILDING MATERIALS

FOR DOORS, GATES, WINDOWS, NOT OF METAL; FOLDING DOORS, NOT OF METAL; DOOR LEAL, NOT OF METAL, IN PARTICULAR GLASS; NON-METAL DOOR PANELS EXCEPT FOR LAND VEHICLES, DOOR FRAME AND DOOR STICKS, NOT OF METAL, IN PARTICULAR OF PLASTIC; NON-METAL SHOP WINDOWS AND WINDOW FRAMES; WINDOW GLASS EXCEPT FOR LAND VEHICLES; GLASS, EXCEPT GLASS FOR VEHICLE DISCS; WINDOW GLASS FOR BUILDING; INSULATING GLASS; FAÇADE ELEMENTS NOT OF METAL, NAMELY FRAMELESS GLASS FOR MOVING ELEMENTS, NAMELY DOORS, WINDOWS AND FIXED PANELS, MADE IN PARTICULAR OF GLASS AND PLASTIC; FIXED FIELD SHUTTER NOT OF METAL, IN PARTICULAR GLASS AND PLASTIC; NON-METAL AUTOMATIC DOORS OF PLASTIC, NON-METAL AUTOMATIC DOORS AND WINDOWS OF PLASTIC AND GLASS (U.S. CLS. 1, 12, 33 AND 50).

CLASS 20—FURNITURE AND ARTICLES NOT OTHERWISE CLASSIFIED

FOR CONSTRUCTION FITTINGS, NOT OF METAL, NAMELY ACCESSORIES/MOUNTING PARTS MADE OF PLASTIC FOR DOORS, GATES, WINDOWS AND FANLIGHTS, NAMELY DOOR SUSPENSION UNITS, HANGER BOLTS AND NUTS, ROLLERS, RAILS, GUIDES, CARRIER PLATES, STOPS, BUFFERS, CLAMPING PLATES, COUPLERS, CAGES, ATTACHMENT ANGLES, LIMIT STOPS, TRACKS, GUIDES, SLIDES, BRACKETS, SCREWS, SPACERS AND RUNNERS; DOOR BANDS, DOOR STATED, DOOR BOLTS NOT OF METAL, IN PARTICULAR OF PLASTIC; WINDOW BANDS, WINDOW MAKE CONTACT NOT OF METAL, IN PARTICULAR OF PLASTIC; FANLIGHT MAKE CONTACT NOT OF METAL, IN PARTICULAR OF PLASTIC; PANEL HARDWARE, IN PARTICULAR PANEL HARDWARE FOR DOORS, GATES AND WINDOWS, NOT OF METAL, IN PARTICULAR OF PLASTIC, NAMELY DOOR SUSPENSION UNITS, HANGER BOLTS AND NUTS, ROLLERS, RAILS, GUIDES, CARRIER PLATES, STOPS, BUFFERS, CLAMPING PLATES, COUPLERS, CAGES, ATTACHMENT ANGLES, LIMIT STOPS, TRACKS, GUIDES, SLIDES, BRACKETS, SCREWS, SPACERS AND RUNNERS; FURNITURE PARTS NOT OF METAL, IN PARTICULAR OF PLASTIC; LOCKERS HARDWARE NOT OF METAL, IN PARTICULAR OF PLASTIC FOR USE WITH DOORS, WINDOWS AND GATES, IN PARTICULAR, DOOR SUSPENSION UNITS, HANGER BOLTS AND NUTS, ROLLERS, RAILS, GUIDES, CARRIER PLATES, STOPS, BUFFERS, CLAMPING PLATES, COUPLERS, CAGES, ATTACHMENT ANGLES, LIMIT STOPS, TRACKS, GUIDES, SLIDES, BRACKETS, SCREWS, SPACERS AND RUNNERS; DOORS FOR FURNITURE; BOLTS NOT OF METAL; HINGES NOT OF METAL; NON-ELECTRIC, NON-METAL LOCKS; VEHICLE LOCKS NOT OF METAL; METAL FURNITURE PARTS; APPLIANCES FOR FIRE PREVENTION, NAMELY FITTINGS AND HARDWARE FOR FIRE DOORS AND FIRE WINDOWS MADE OF PLASTIC, IN PARTICULAR, DOOR SUSPENSION UNITS, HANGER BOLTS AND NUTS, ROLLERS, RAILS, GUIDES, CARRIER PLATES, STOPS, BUFFERS, CLAMPING PLATES, COUPLERS, CAGES, ATTACHMENT ANGLES, LIMIT STOPS, TRACKS, SLIDES, BRACKETS, SCREWS, SPACERS AND RUNNERS (U.S. CLS. 2, 13, 22, 25, 32 AND 50).

CLASS 37—CONSTRUCTION AND REPAIR

FOR SERVICES, IN PARTICULAR ASSEMBLY, MAINTENANCE AND REPAIR OF AUTOMATIC DRIVEN DOORS, GATES, WINDOWS AND FANLIGHTS AND AUTOMATIC DOORS AND GATE IN FLIGHT AND RESCUE AS WELL AS ASSEMBLE AND PUTTING INTO SERVICE AND MAINTENANCE OF APPLIANCES FOR PREVENTING FIRES, NAMELY OF FIRE AND SMOKE DEGREES, STATE EQUIPMENT FOR DOORS AND LIDS, FIRE, SMOKE AND HEAT DETECTORS, CLOSING BLOCK REGULATORS, SMOKE AND HEAT DISCOUNT EQUIPMENT FOR OPERATION AND CONTROL SYSTEM OF VENTILATION ELEMENTS ASSEMBLY OF DOOR CLOSERS (U.S. CLS. 100, 103 AND 106).

TRICIA THOMPSON, EXAMINING ATTORNEY

SN 76-472.432. ARNOLDO MONDADORI EDITORE S.P.A.,
20122 MILAN (MI), ITALY, FILED 12-3-2002.

FLAIR ITALY

PRIORITY CLAIMED UNDER SEC. 44(D) ON ITALY
APPLICATION NO. RM2002C00569, FILED 10-21-2002, REG.
NO. 00879896, DATED 12-6-2002, EXPIRES 10-21-2012.

NO CLAIM IS MADE TO THE EXCLUSIVE RIGHT TO
USE "ITALY", APART FROM THE MARK AS SHOWN.

CLASS 9—ELECTRICAL AND SCIENTIFIC APPARATUS

FOR ELECTRIC AND ELECTRONIC APPARATUSES,
NAMELY, RADIO SETS; CAMERAS, NAMELY, MOTION
PICTURE CAMERAS AND VIDEO CAMERAS; TEACH-
ING AIDES, NAMELY, MOTION PICTURES FILMS
FEATURING EDUCATIONAL TOPICS OF GENERAL
INTEREST, NAMELY, HISTORY, SCIENCE AND AS-
TRONOMY, AND FEATURING ACTION, COMEDY
AND DRAMA; SCIENTIFIC INSTRUMENTS, NAMELY,
OPTICAL CHARACTER READERS, OPTICAL SCAN-
NERS AND OPTICAL INSPECTION APPARATUS, SIG-
NAL PROCESSORS; BLANK AND PRERECORDED
AUDIO AND VIDEO TAPES, CD-ROMS, DVD'S AND
FLOPPY DISCS FEATURING EDUCATIONAL TOPICS
OF GENERAL INTEREST TO THE PUBLIC AND AC-
TION, COMEDY, DRAMA AND MUSIC; COMPUTER
SOFTWARE FOR USE IN DATABASE MANAGEMENT,
FOR USE AS A SPREADSHEET, FOR WORD PROCES-
SING AND FOR CONTROL, DIAGNOSTIC AND ANA-
LYSIS OF ELECTRONIC COMPUTERS AND DATA
PROCESSING NETWORKS; BLANK AND PRERE-
CORDED FLOPPY DISCS, OPTICAL DISCS, CD-ROM'S,
DVD'S, AUDIO CASSETTES AND VIDEOCASSETTES
FEATURING EDUCATIONAL TOPICS OF GENERAL
INTEREST TO THE PUBLIC AND COMEDY, MUSIC,
GAMES AND DRAMA; COMPUTER PERIPHERALS,
NAMELY, MODEMS, COMPUTER MONITORS, COMPU-
TER MOUSE, COMPUTER MOUSE PADS AND COMPU-
TER KEYBOARDS; APPARATUS FOR RECORDING,
TRANSMISSION AND REPRODUCTION OF SOUNDS
AND IMAGES, NAMELY, AUDIO CASSETTE, VIDEO
CASSETTE, CD AND DVD RECORDERS AND
PLAYERS; SOFTWARE FOR OPERATING THE AUDIO
CASSETTE, VIDEO CASSETTE, CD AND DVD REC-
ORDERS AND PLAYERS; APPARATUS FOR PLAYING
COMPUTER GAMES, NAMELY, EQUIPMENT CON-
TAINING MEMORY DEVICES, NAMELY, DISCS, COM-
PUTER GAME CARTRIDGES, COMPUTER GAME
CASSETTES, COMPUTER GAME DISCS, COMPUTER
GAME JOYSTICKS, COMPUTER GAME CONTROLLERS
AND VIDEO MONITORS; EYEGASSES AND EYE-
GLASS ACCESSORIES, NAMELY, EYEGASS FRAMES
AND EYEGASS CASES (U.S. CLS. 21, 23, 26, 36 AND 38).

CLASS 16—PAPER GOODS AND PRINTED MATTER

FOR PAPER, PAPERBOARD ARTICLES AND
PRINTED MATTER, NAMELY, NEWSPAPERS, JOUR-
NALS, MAGAZINES, PAMPHLETS, BOOKS, INSTRU-
CTION HANDBOOKS, REFERENCE GUIDES AND
CATALOGUES, ALL FEATURING EDUCATIONAL, LIT-
ERARY, ARTISTIC, POLITICAL, SCIENTIFIC, HISTOR-
ICAL AND ENTERTAINMENT SUBJECT MATTER;
GREETING CARDS, OFFICE ARTICLES, NAMELY,
STATIONERY, CALENDARS, DATE BOOKS, DIARIES,
NOTEBOOKS, NOTE CARDS, NOTE PADS AND NOTE
PAPER; ARTISTS MATERIALS, NAMELY, ARTIST AND
DRAWING BRUSHES, PASTELS AND ARTS AND
CRAFT PAINT KITS; PHOTOGRAPHS, PHOTOGRAPHIC
PRINTS, PRINTED PAPER LABELS, PRINTED ART
REPRODUCTIONS, ENGRAVINGS AND POSTERS;
AND PRINTED INSTRUCTIONAL AND TEACHING
MATERIALS IN THE LITERARY, ARTISTIC, POLITI-
CAL, SCIENTIFIC, HISTORICAL AND ENTERTAIN-
MENT FIELDS (U.S. CLS. 2, 5, 22, 23, 29, 37, 38 AND 50).

CLASS 38—COMMUNICATION

FOR TELECOMMUNICATION SERVICES, NAMELY,
RADIO AND TELEVISION PROGRAM BROADCAST-
ING; SATELLITE BROADCASTING AND REBROAD-
CASTING VIA TELEVISION ANTENNAS, CABLE AND
TERTIARY RADIO-TELEVISION EMITTERS, COMPU-
TER ONLINE NETWORKS, FIXED AND MOBILE
RADIOTELEPHONY TRANSMITTERS, AND TELE-
METRIC AND DATA PROCESSING NETWORKS; LO-
CAL AND LONG DISTANCE TRANSMISSION OF
VOICE, DATA, DOCUMENTS, INFORMATION, IMAGES
AND GRAPHICS BY MEANS OF TELEPHONE, CABLE
AND SATELLITE TRANSMISSION AND BY MEANS OF
COMPUTERS AND COMPUTER TERMINALS; ELEC-
TRONIC MAIL SERVICES; ELECTRIC, ELECTRONIC
AND DIGITAL TRANSMISSION OF DATA, IMAGES,
VOICE, SIGNALS AND MESSAGES VIA A GLOBAL
COMPUTER NETWORK; PROVIDING ONLINE ELEC-
TRONIC BULLETIN BOARDS FOR TRANSMISSION OF
MESSAGES AMONG COMPUTER USERS CONCERNING
NEWS, LITERARY, ARTISTIC, POLITICAL, SCIENTI-
FIC, HISTORICAL AND ENTERTAINMENT TOPICS;
STREAMING OF AUDIO AND VIDEO MATERIAL ON
THE INTERNET (U.S. CLS. 100, 101 AND 104).

ELIZABETH J. WINTER, EXAMINING ATTORNEY

SN 76-472.433. ARNOLDO MONDADORI EDITORE S.P.A.,
20122 MILAN (MI), ITALY, FILED 12-3-2002.

FLAIR

PRIORITY CLAIMED UNDER SEC. 44(D) ON ITALY
APPLICATION NO. RM2002C00441, FILED 8-2-2002, REG.
NO. 00879905, DATED 12-6-2002, EXPIRES 8-2-2012.

CLASS 9—ELECTRICAL AND SCIENTIFIC APPARATUS

FOR ELECTRIC AND ELECTRONIC APPARATUSES,
NAMELY, RADIO SETS; CAMERAS, NAMELY, MOTION
PICTURE CAMERAS AND VIDEO CAMERAS; TEACH-
ING AIDES, NAMELY, MOTION PICTURES FILMS
FEATURING EDUCATIONAL TOPICS OF GENERAL
INTEREST, NAMELY, HISTORY, SCIENCE AND AS-
TRONOMY, AND FEATURING ACTION, COMEDY
AND DRAMA; SCIENTIFIC INSTRUMENTS, NAMELY,
OPTICAL CHARACTER READERS, OPTICAL SCAN-
NERS AND OPTICAL INSPECTION APPARATUS, SIG-
NAL PROCESSORS; BLANK AND PRERECORDED
AUDIO AND VIDEO TAPES, CD-ROMS, DVD'S AND
FLOPPY DISCS FEATURING EDUCATIONAL TOPICS
OF GENERAL INTEREST TO THE PUBLIC AND AC-
TION, COMEDY, DRAMA AND MUSIC; COMPUTER
SOFTWARE FOR USE IN DATABASE MANAGEMENT,
FOR USE AS A SPREADSHEET, FOR WORD PROCES-
SING AND FOR CONTROL, DIAGNOSTIC AND ANA-
LYSIS OF ELECTRONIC COMPUTERS AND DATA
PROCESSING NETWORKS; BLANK AND PRERE-
CORDED FLOPPY DISCS, OPTICAL DISCS, CD-ROM'S,
DVD'S, AUDIO CASSETTES AND VIDEOCASSETTES
FEATURING EDUCATIONAL TOPICS OF GENERAL
INTEREST TO THE PUBLIC AND COMEDY, MUSIC,
GAMES AND DRAMA; COMPUTER PERIPHERALS,
NAMELY, MODEMS, COMPUTER MONITORS, COMPU-
TER MOUSE, COMPUTER MOUSE PADS AND COMPU-
TER KEYBOARDS; APPARATUS FOR RECORDING,
TRANSMISSION AND REPRODUCTION OF SOUNDS
AND IMAGES, NAMELY, AUDIO CASSETTE, VIDEO
CASSETTE, CD AND DVD RECORDERS AND
PLAYERS; SOFTWARE FOR OPERATING THE AUDIO
CASSETTE, VIDEO CASSETTE, CD AND DVD REC-
ORDERS AND PLAYERS; APPARATUS FOR PLAYING
COMPUTER GAMES, NAMELY, EQUIPMENT CON-
TAINING MEMORY DEVICES, NAMELY, DISCS, COM-
PUTER GAME CARTRIDGES, COMPUTER GAME
CASSETTES, COMPUTER GAME DISCS, COMPUTER
GAME JOYSTICKS, COMPUTER GAME CONTROLLERS
AND VIDEO MONITORS; EYEGASSES AND EYE-
GLASS ACCESSORIES, NAMELY, EYEGASS FRAMES
AND EYEGASS CASES (U.S. CLS. 21, 23, 26, 36 AND 38).

CLASS 16—PAPER GOODS AND PRINTED MATTER

FOR PAPER, PAPERBOARD ARTICLES AND PRINTED MATTER, NAMELY, NEWSPAPERS, JOURNALS, MAGAZINES, PAMPHLETS, BOOKS, INSTRUCTION HANDBOOKS, REFERENCE GUIDES AND CATALOGUES, ALL FEATURING EDUCATIONAL, LITERARY, ARTISTIC, POLITICAL, SCIENTIFIC, HISTORICAL AND ENTERTAINMENT SUBJECT MATTER; GREETING CARDS, OFFICE ARTICLES, NAMELY, STATIONERY, CALENDARS, DATE BOOKS, DIARIES, NOTEBOOKS, NOTE CARDS, NOTE PADS AND NOTE PAPER; ARTISTS MATERIALS, NAMELY, ARTIST AND DRAWING BRUSHES, PASTELS AND ARTS AND CRAFT PAINT KITS; PHOTOGRAPHS, PHOTOGRAPHIC PRINTS, PRINTED PAPER LABELS, PRINTED ART REPRODUCTIONS, ENGRAVINGS AND POSTERS; AND PRINTED INSTRUCTIONAL AND TEACHING MATERIALS IN THE LITERARY ARTISTIC, POLITICAL, SCIENTIFIC, HISTORICAL AND ENTERTAINMENT FIELDS (U.S. CLS. 2, 5, 22, 23, 29, 37, 38 AND 50).

CLASS 38—COMMUNICATION

FOR TELECOMMUNICATION SERVICES, NAMELY, RADIO AND TELEVISION PROGRAM BROADCASTING; SATELLITE BROADCASTING AND REBROADCASTING VIA TELEVISION ANTENNAS, CABLE AND TERTIARY RADIO-TELEVISION EMITTERS, COMPUTER ONLINE NETWORKS, FIXED AND MOBILE RADIOTELEPHONY TRANSMITTERS, AND TELEMETRIC AND DATA PROCESSING NETWORKS; LOCAL AND LONG DISTANCE TRANSMISSION OF VOICE, DATA, DOCUMENTS, INFORMATION, IMAGES AND GRAPHICS BY MEANS OF TELEPHONE, CABLE AND SATELLITE TRANSMISSION AND BY MEANS OF COMPUTERS AND COMPUTER TERMINALS; ELECTRONIC MAIL SERVICES; ELECTRIC, ELECTRONIC AND DIGITAL TRANSMISSION OF DATA, IMAGES, VOICE, SIGNALS AND MESSAGES VIA A GLOBAL COMPUTER NETWORK; PROVIDING ONLINE ELECTRONIC BULLETIN BOARDS FOR TRANSMISSION OF MESSAGES AMONG COMPUTER USERS CONCERNING NEWS, LITERARY, ARTISTIC, POLITICAL, SCIENTIFIC, HISTORICAL AND ENTERTAINMENT TOPICS; STREAMING OF AUDIO AND VIDEO MATERIAL ON THE INTERNET (U.S. CLS. 100, 101 AND 104).

ELIZABETH J. WINTER, EXAMINING ATTORNEY

SN 76-472,629, INTERCEDE LTD, LUTTERWORTH, UNITED KINGDOM, FILED 12-4-2002.



PRIORITY CLAIMED UNDER SEC. 44(D) ON ERPN CMNTY TM OFC APPLICATION NO. 2750750, FILED 6-26-2002, REG. NO. 2750750, DATED 3-2-2004, EXPIRES 6-26-2012.
OWNER OF U.S. REG. NO. 2,859,269.
THE STIPPLING IN APPLICANT'S DRAWING IS FOR SHADING PURPOSES ONLY.

CLASS 9—ELECTRICAL AND SCIENTIFIC APPARATUS

FOR SCIENTIFIC APPARATUS AND INSTRUMENTS, NAMELY, ENCODED SMART CARDS CONTAINING PROGRAMMING USED TO SEND AND RECEIVE DATA, CARDS FOR SECURITY PURPOSES WITH MAGNETIC STRIPS, ENCODED CARDS FOR SECURITY PURPOSES CONTAINING PROGRAMMING USED FOR SECURE ACCESS, CARD READERS, CARDS BEARING STORED DATA, ENCODED OR MAGNETIC CARDS ALL FOR SENDING AND RECEIVING DATA, AND ENCODED OR MAGNETIC CARDS FEATURING PROGRAMMING THAT ALLOWS SECURE ACCESS TO COMPUTER NETWORKS INCLUDING GLOBAL COMMUNICATIONS NETWORKS, NAMELY, THE INTERNET; COMPUTER HARDWARE AND COMPUTER SOFTWARE FOR SECURITY MANAGEMENT OF COMPUTER NETWORKS AND APPLICATIONS; COMPUTER HARDWARE AND COMPUTER SOFTWARE DESIGNED TO CREATE AND MANAGE A SECURE COMPUTING ENVIRONMENT; COMPUTER HARDWARE AND COMPUTER SOFTWARE FOR CONNECTION TO AND ACCESS TO GLOBAL COMMUNICATIONS NETWORKS AND ONLINE SERVICES, NAMELY, THE INTERNET; COMPUTER HARDWARE AND SOFTWARE FOR DATABASE ACCESS AND SEARCHING; COMPUTER HARDWARE AND COMPUTER SOFTWARE FOR ACCESS CONTROL OF GLOBAL COMMUNICATIONS NETWORKS, NAMELY, THE INTERNET; COMPUTER HARDWARE AND COMPUTER SOFTWARE FOR CRYPTOGRAPHY; DOWNLOADABLE ELECTRONIC PUBLICATIONS, NAMELY, CATALOGS, BOOKS, BOOKLETS, MAGAZINES, INSTRUCTION MANUALS, NEWSLETTERS AND BROCHURES ON COMPUTER SOFTWARE PRODUCTS, UPGRADES FOR COMPUTER SOFTWARE PRODUCTS AND COMPUTER ACCESSORIES FOR OTHERS AND COMPUTER SOFTWARE FOR NETWORK SECURITY, NETWORK MANAGEMENT AND NETWORK COMMUNICATIONS AVAILABLE ON CD-ROM AND AVAILABLE AS DOWNLOADABLE ELECTRONIC PUBLICATIONS; COMPUTER HARDWARE AND COMPUTER SOFTWARE FOR DATABASE MANAGEMENT; APPARATUS FOR SEARCHING ELECTRONIC INFORMATION FROM A GLOBAL COMPUTER NETWORK OR THE INTERNET, NAMELY, COMPUTERS AND PERSONAL DIGITAL HAND-HELD COMPUTERS; BLANK DATA CARRIERS, NAMELY, MAGNETIC AND ELECTRONIC DATA CARRIERS; PRE-RECORDED DATA CARRIERS, NAMELY MAGNETIC AND ELECTRONIC DATA CARRIERS FEATURING INFORMATION FOR ACCESS CONTROL, AUTHENTICATION OF IDENTITY, ACCESS TO DATABASE, SECURITY NETWORKS AND SECURITY MANAGEMENT; DATA PROCESSING EQUIPMENT, NAMELY DATA PROCESSORS; APPARATUS, EQUIPMENT AND HARDWARE, NAMELY, INTERNET REMOTE ACCESS SERVERS AND INTERNET CENTRAL SECURITY SERVERS, APPARATUS AND EQUIPMENT FOR CONNECTION TO COMPUTER NETWORKS AND THE INTERNET, NAMELY, FIBER-OPTICS, COMPUTERS AND CABLES; INTEGRATED COMPUTER HARDWARE FOR COMPUTER SECURITY USING CRYPTOGRAPHY; INTEGRATED COMPUTER SOFTWARE FOR COMPUTER SECURITY USING CRYPTOGRAPHY, DIGITAL SIGNATURES, SMART CARDS AND BIOMETRICS (U.S. CLS. 21, 23, 26, 36 AND 38).

CLASS 37—CONSTRUCTION AND REPAIR

FOR REPAIR OF COMPUTER NETWORKS, COMPUTER PARTS, DEVICES AND EQUIPMENT; MAINTENANCE OF COMPUTER NETWORKS, COMPUTER PARTS, DEVICES AND EQUIPMENT; INSTALLATION OF COMPUTER NETWORKS, COMPUTER PARTS, DEVICES AND EQUIPMENT (U.S. CLS. 100, 103 AND 106).

CLASS 42—SCIENTIFIC, COMPUTER AND LEGAL SERVICES

FOR COMPUTER SERVICES, NAMELY, COMPUTER PROGRAMMING FOR OTHERS; DESIGNING AND DEVELOPING COMPUTERS, COMPUTER PARTS, COMPUTER ACCESSORIES AND EQUIPMENT; INTEGRATING COMPUTER SYSTEMS; COMPUTER SOFTWARE SERVICES, NAMELY, DEVELOPING SOFTWARE; INTEGRATING COMPUTER SOFTWARE; REPAIR, INSTALLATION AND MAINTENANCE OF COMPUTER SOFTWARE; UPGRADING COMPUTER SOFTWARE (U.S. CLS. 100 AND 101).

JAMES A. RAUEN, EXAMINING ATTORNEY

SN 76-472,718. ARISTOCRAT TECHNOLOGIES AUSTRALIA PTY LTD, LANE COVE, 2066, NSW, AUSTRALIA, FILED 12-6-2002.

THEMED BANKING

PRIORITY CLAIMED UNDER SEC. 44(D) ON AUSTRALIA APPLICATION NO. 917643, FILED 6-24-2002, REG. NO. 917643, DATED 2-3-2003, EXPIRES 2-3-2013.

CLASS 9—ELECTRICAL AND SCIENTIFIC APPARATUS

FOR GAMING DEVICES, NAMELY, GAMING MACHINES AND ASSOCIATED SOFTWARE FOR USE THEREWITH (U.S. CLS. 21, 23, 26, 36 AND 38).

CLASS 41—EDUCATION AND ENTERTAINMENT

FOR ENTERTAINMENT SERVICES, NAMELY, PROVIDING GAMING SERVICES THROUGH A SERIES OF ELECTRONIC GAMING MACHINES COMPRISING A MINIMUM NUMBER THAT FEATURE THE SAME GAMES AND ELECTRONIC DISPLAY SIGNS (U.S. CLS. 100, 101 AND 107).

PAULA MAHONEY, EXAMINING ATTORNEY

SN 76-472,754. HYPERTRUST, 3001 HEVERLEE, BELGIUM, FILED 12-9-2002.

Send2Store

PRIORITY CLAIMED UNDER SEC. 44(D) ON ERPN CMNTY TM OFC APPLICATION NO. 2873909, FILED 10-2-2002, REG. NO. 2873909, DATED 3-23-2004, EXPIRES 10-2-2012.

CLASS 38—COMMUNICATION

FOR PROVIDING MULTIPLE USER ACCESS TO A GLOBAL COMPUTER NETWORK; PROVIDING TELECOMMUNICATIONS CONNECTIONS TO A GLOBAL COMPUTER NETWORK (U.S. CLS. 100, 101 AND 104).

CLASS 42—SCIENTIFIC, COMPUTER AND LEGAL SERVICES

FOR RENTAL OF COMPUTER PROGRAMS THAT ALLOW ONLINE STORAGE, SHARING, SENDING, BUILDING AND MANAGEMENT OF FILES AND COLLECTIONS OF FILES (U.S. CLS. 100 AND 101).

TARAH HARDY, EXAMINING ATTORNEY

SN 76-478,653. VEKASY, RACINDA LEEANN, SAN ANTONIO, TX. FILED 12-27-2002.

**CLASS 5—PHARMACEUTICALS**

FOR PHARMACEUTICAL AND SANITARY PREPARATIONS, NAMELY, TO TREAT WOUNDS, SORES, ABRASIONS, NON-SURGICAL CUTS, SURGICAL INCISIONS, AND ARTICLES FOR INCONTINENCE PADS; DIETETIC SUBSTANCES ADAPTED FOR MEDICAL USE, NAMELY, NUTRITIONAL SUPPLEMENTS IN THE FORM OF LIQUIDS, POWDERS, SHAKES AND FORMULAS; MEDICAL PLASTERS, MATERIALS FOR DRESSINGS, NAMELY, GAUZE, ADHESIVE BANDAGES, AND MEDICAL ADHESIVE TAPES; MATERIALS FOR STOPPING TEETH, DENTAL WAX; ALL-PURPOSE DISINFECTANTS; FUNGICIDES AND HERBICIDES FOR DOMESTIC USE ONLY (U.S. CLS. 6, 18, 44, 46, 51 AND 52).

FIRST USE 4-20-1995; IN COMMERCE 4-20-1995.

CLASS 10—MEDICAL APPARATUS

FOR SURGICAL, MEDICAL, DENTAL AND INSTRUMENTS, NAMELY, PATIENT TRANSFER SYSTEMS IN THE NATURE OF STRETCHERS; SEATING SYSTEMS IN THE NATURE OF PATIENT TREATMENT CHAIRS; FEEDING SYSTEMS IN THE NATURE OF ENTERAL NUTRITION AND FOOD PUMPS; BLOOD PRESSURE MONITORS; STETHOSCOPES; THERMOMETERS FOR MEDICAL PURPOSES; NEBULIZERS FOR RESPIRATION THERAPY; SPIROMETERS; MEDICAL SYRINGES; MATERIALS FOR IVS IN THE NATURE OF DISPOSABLE TUBING; ASSORTED TUBING IN THE NATURE OF MEDICAL EQUIPMENT TUBING USED WITH NEBULIZERS, PEAK FLOW METERS, AERO-CHAMBERS AND IV UNITS; MEDICAL BRACES FOR LIMBS, JOINTS, SPLINTS; MEDICAL PATIENT TREATMENT CHAIRS; INVALID WALKERS; HOSPITAL BEDS FOR USE BY BURN PATIENTS, IN-HOME HEALTH CARE PATIENTS, NURSING HOME PATIENTS AND SKILLED NURSING CARE PATIENTS; ASSOCIATED GRAB BARS; TRANSFER HANDLES AND RAMPS ADAPTED FOR MEDICAL USE; ARTIFICIAL LIMBS, EYES AND TEETH, ORTHOPEDIC ARTICLES IN THE NATURE OF SPLINTS AND BRACES; PEAK FLOW METERS USED IN RESPIRATION THERAPY; AERO-CHAMBERS FOR USE IN RESPIRATION THERAPY; BEDDING SYSTEMS IN THE NATURE OF LOW AIR AND ALTERNATE PRESSURE BEDS FOR MEDICAL USE; AND SUTURES (U.S. CLS. 26, 39 AND 44).

FIRST USE 4-20-1995; IN COMMERCE 4-20-1995.

CLASS 12—VEHICLES

FOR WHEELCHAIRS, WHEELCHAIR PARTS, WHEELCHAIR LIFTS AND TRANSPORTATION SYSTEMS IN THE NATURE OF SCOOTERS AND POWER WHEELCHAIRS (U.S. CLS. 19, 21, 23, 31, 35 AND 44).

FIRST USE 4-20-1995; IN COMMERCE 4-20-1995.
BARNEY CHARLON, EXAMINING ATTORNEY

SN 76-482,818. TEXAS-NEW MEXICO NEWSPAPERS PARTNERSHIP, EL PASO, TX. FILED 1-16-2003.

ALAMOGORDO DAILY NEWS

OWNER OF U.S. REG. NO. 2,718,848.
NO CLAIM IS MADE TO THE EXCLUSIVE RIGHT TO USE "DAILY NEWS", APART FROM THE MARK AS SHOWN.
SEC. 2(F).

CLASS 35—ADVERTISING AND BUSINESS

FOR ADVERTISING SERVICES, NAMELY PROVIDING AND DISSEMINATING ADVERTISING FOR OTHERS VIA NEWSPAPERS AND THE INTERNET (U.S. CLS. 100, 101 AND 102).
FIRST USE 1-0-2000; IN COMMERCE 1-0-2000.

CLASS 41—EDUCATION AND ENTERTAINMENT

FOR PROVIDING LINKS TO THE WEB SITES OF OTHERS FEATURING NEWSPAPERS OF GENERAL CIRCULATION (U.S. CLS. 100, 101 AND 107).
FIRST USE 1-0-2000; IN COMMERCE 1-0-2000.
WANDA KAY PRICE, EXAMINING ATTORNEY

SN 76-482,836. BIOSSENTIENT CORPORATION, HOUSTON, TX. FILED 1-16-2003.



biosentient

THE MARK CONSISTS OF ALL LOWERCASE LETTERS WITH THE "SENTIENT" PART BOLDED. FILLED DOTS, IN INCREASING SIZE, START FROM THE SECOND LETTER "I" AND END AT THE EIGHTH LETTER "I". THESE FILLED DOTS TRACE AN ARC. THE LETTERS AND DOTS CAN BE IN VARIOUS COLORS.

CLASS 9—ELECTRICAL AND SCIENTIFIC APPARATUS

FOR PHYSIOLOGICAL DATA RECORDER FOR SCIENTIFIC RESEARCH AND TEACHING IN THE FIELDS OF ATHLETIC CONDITIONING AND PHYSICAL FITNESS; COMPUTER SOFTWARE FOR USE IN MOBILE PHYSIOLOGIC DATA GATHERING AND ANALYSIS EQUIPMENT FOR ENHANCING HEALTH AND HUMAN PERFORMANCE; COMPUTER HARDWARE USED FOR MOBILE PHYSIOLOGIC DATA GATHERING AND ANALYSIS EQUIPMENT FOR ENHANCING HEALTH AND HUMAN PERFORMANCE; ELECTRONIC APPARATUS, NAMELY, SENSORS, WEARABLE COMPUTER, WEARER INTERFACE, POWER PACK AND TRANSMITTER FOR MEASURING, RECORDING, ANALYZING (U.S. CLS. 21, 23, 26, 36 AND 38).
FIRST USE 12-31-2002; IN COMMERCE 12-31-2002.

CLASS 10—MEDICAL APPARATUS

FOR MEDICAL MONITORING SYSTEM, NAMELY, A WEARABLE GARMENT THAT COLLECTS, ANALYZES AND STORES PHYSIOLOGICAL DATA AND SENDS THE DATA OVER A GLOBAL COMPUTER NETWORK; MEDICAL APPARATUS, NAMELY SENSORS AND MONITORS FOR MEASURING, RECORDING AND ANALYZING PHYSIOLOGIC DATA FOR ENHANCING HEALTH AND HUMAN PERFORMANCE; PATIENT MONITORS FOR MEASURING, RECORDING, STORING AND REPRODUCING PHYSIOLOGICAL DATA (U.S. CLS. 26, 39 AND 44).
FIRST USE 12-31-2002; IN COMMERCE 12-31-2002.

CLASS 25—CLOTHING

FOR CLOTHING, NAMELY, SHIRTS, TOPS, PANTS, BELTS, SHOES, SOCKS, AND UNDERGARMENTS FOR USE WITH PHYSIOLOGIC DATA GATHERING AND ANALYSIS EQUIPMENT FOR ENHANCING HEALTH AND HUMAN PERFORMANCE (U.S. CLS. 22 AND 39).
FIRST USE 12-31-2002; IN COMMERCE 12-31-2002.

CLASS 41—EDUCATION AND ENTERTAINMENT

FOR TRAINING SERVICES IN THE FIELD OF CONTROLLING PHYSIOLOGICAL RESPONSES USING DATA GATHERING AND ANALYSIS EQUIPMENT AND REGULATION TECHNIQUES FOR ENHANCING HEALTH AND HUMAN PERFORMANCE; TESTING, ANALYSIS, AND EVALUATION OF TRAINEES IN THE FIELD OF CONTROLLING PHYSIOLOGICAL RESPONSES USING DATA GATHERING AND ANALYSIS EQUIPMENT AND REGULATION TECHNIQUES FOR ENHANCING HEALTH AND HUMAN PERFORMANCE; TESTING, ANALYSIS, AND EVALUATION OF TRAINEES IN THE FIELD OF COMPUTER HARDWARE AND SOFTWARE USED FOR ENHANCING HEALTH AND HUMAN PERFORMANCE (U.S. CLS. 100, 101 AND 107).

CLASS 42—SCIENTIFIC, COMPUTER AND LEGAL SERVICES

FOR SCIENTIFIC AND TECHNOLOGICAL SERVICES IN THE FIELD OF SCIENTIFIC RESEARCH SERVICES FOR MEDICAL PURPOSES; DESIGN AND DEVELOPMENT OF COMPUTER HARDWARE AND SOFTWARE USED FOR ENHANCING HEALTH AND HUMAN PERFORMANCE (U.S. CLS. 100 AND 101).

CLASS 44—MEDICAL, BEAUTY AND AGRICULTURAL SERVICES

FOR MEDICAL SERVICES IN THE FIELD OF MEDICAL TESTING AND CLINICAL ANALYSIS SERVICES RELATING TO THE TREATMENT OF PERSONS FOR ENHANCING HEALTH AND HUMAN PERFORMANCE (U.S. CLS. 100 AND 101).
BRIAN BROWN, EXAMINING ATTORNEY

SN 76-483,741. I-MED PHARMA INC., MONTREAL (DDO) QUEBEC H9B 3H7, CANADA, FILED 1-21-2003.

BIOCIA

OWNER OF CANADA REG. NO. TMA629,951, DATED 1-11-2005, EXPIRES 1-11-2020.

CLASS 5—PHARMACEUTICALS

FOR SURGICAL AND THERAPEUTIC MEDICAL PRODUCTS, NAMELY VISCOPROTECTANT NASAL MIST, ELASTOVISCOUS EYE DROPS, VISCOELASTICS FOR THE TREATMENT OF DRY NOSE, DRY EYE, DRY MOUTH CONDITIONS AND AS A SURGICAL AID TO FACILITATE EYE, EAR, NOSE AND OTHER FACIAL SURGERIES; OTC PROPRIETARY DRUGS FOR THE TREATMENT OF DRY NOSE, DRY EYE, DRY MOUTH CONDITIONS AND AS A SURGICAL AID TO FACILITATE EYE, EAR, NOSE AND OTHER FACIAL SURGERIES; PROPRIETARY DRUGS FOR THE TREATMENT OF DRY NOSE, DRY EYE, DRY MOUTH CONDITIONS AND AS A SURGICAL AID TO FACILITATE EYE, EAR, NOSE AND OTHER FACIAL SURGERIES (U.S. CLS. 6, 18, 44, 46, 51 AND 52).

CLASS 35—ADVERTISING AND BUSINESS

FOR WHOLESALE AND RETAIL SERVICES PROVIDED ON-LINE TO PATIENTS AND DIRECTLY TO PHARMACIES, DISTRIBUTORS AND PHYSICIANS FEATURING MEDICAL PRODUCTS, INSTRUMENTS AND DEVICES (U.S. CLS. 100, 101 AND 102).

CLASS 40—MATERIAL TREATMENT

FOR CUSTOM MANUFACTURE OF MEDICAL PRODUCTS, INSTRUMENTS AND DEVICES (U.S. CLS. 100, 103 AND 106).

LEIGH CAROLINE CASE, EXAMINING ATTORNEY

SN 76-485,414. SHPIESEL, JULIE, OAKLAND, CA. FILED 1-27-2003.

NOTOX**CLASS 41—EDUCATION AND ENTERTAINMENT**

FOR EDUCATIONAL SERVICES, NAMELY, PROVIDING COURSES OF INSTRUCTION IN THE FIELD OF ACUPUNCTURE, AND DISTRIBUTING COURSE MATERIAL IN CONNECTION THEREWITH (U.S. CLS. 100, 101 AND 107).

FIRST USE 8-25-2002; IN COMMERCE 8-25-2002.

CLASS 44—MEDICAL, BEAUTY AND AGRICULTURAL SERVICES

FOR PROVIDING ACUPUNCTURE SERVICES (U.S. CLS. 100 AND 101).

FIRST USE 8-25-2002; IN COMMERCE 8-25-2002.
MITCHELL FRONT, EXAMINING ATTORNEY

SN 76-488,622. INCONT, LTD., 602 00 BRNO, CZECH REPUBLIC, FILED 2-10-2003.



PRIORITY CLAIMED UNDER SEC. 44(D) ON CZECH REPUBLIC APPLICATION NO. 184862, FILED 10-22-2002, REG. NO. 255285, DATED 6-25-2003, EXPIRES 10-22-2012.

CLASS 17—RUBBER GOODS

FOR PRODUCTS AND SEMIFINISHED PRODUCTS FROM CAOUTCHOUC, GUTTA-PERCHA, RUBBER, ASBESTOS, MICA, AND PLASTICS IN THE FORM OF BLOCKS, BOARDS, CYLINDERS, PELLETS, RODS, SHEETS, AND TUBES FOR USE IN MANUFACTURING; GASKETS, CAULKING, RINGS, CYLINDER JOINTS, AND SEALS FOR THERMAL, ELECTRICAL, AND ACOUSTICAL INSULATION; FLEXIBLE PIPES, NOT OF METAL; PLASTIC HOSES FOR CONVEYING LIQUIDS OR GASES FOR AGRICULTURAL, INDUSTRIAL, RESIDENTIAL, OR TRANSPORTATION USE; RUBBER HOSES FOR CONVEYING LIQUIDS OR GASES FOR AGRICULTURAL, INDUSTRIAL, RESIDENTIAL, OR TRANSPORTATION USE; PACKING PADDING OF PLASTIC FOR SHIPPING CONTAINERS; PACKING PADDING OF RUBBER FOR SHIPPING CONTAINERS; SHOCK ABSORBING RUBBER BUFFERS FOR INDUSTRIAL MACHINERY; AND PADDING OF RUBBER OR PLASTIC FOR IMPACT PROTECTION USED FOR SHIPPING ITEMS (U.S. CLS. 1, 5, 12, 13, 35 AND 50).

CLASS 28—TOYS AND SPORTING GOODS

FOR EQUIPMENT FOR ARCHERY, BADMINTON, BASEBALL, BASKETBALL, BOXING, FIELD HOCKEY, FOOTBALL, GOLF, GYMNASTICS, HANDBALL, ICE HOCKEY, KARATE, MARTIAL ARTS, RACQUET BALL, SKIING, SOCCER, TENNIS, VOLLEYBALL, AND WATERSKIING; FISHING EQUIPMENT, NAMELY, LURES, FLIES, FLOATS, SINKS, CREELS, LINE, TACKLE, RODS, AND REELS; TOY SCOOTERS; PLAYING CARDS; CHRISTMAS TREE DECORATIONS; GOODS FOR BEACH AND SWIMMING ACTIVITIES, NAMELY, BEACH BALLS, BODY BOARDS, ARM FLOATS, FOAM FLOATS, SWIM FLOATS, POOL RINGS, WATER WINGS, FLOATING RECREATIONAL LOUNGE CHAIRS, INFLATABLE FLOAT MATTRESSES AND PADS FOR RECREATIONAL USE, INFLATABLE INNER TUBES FOR RECREATIONAL USE, INFLATABLE SWIMMING POOLS, PLAY SWIMMING POOLS, KICK BOARD FLOTATION DEVICES FOR RECREATIONAL USE, SCUBA FINS AND FLIPPERS, RING BUOYS FOR RECREATIONAL USE, SKIM BOARDS, SWIM BOARDS FOR RECREATIONAL USE, AND WAKE BOARDS; AND PROTECTIVE EQUIPMENT FOR ATHLETIC USE, NAMELY, KNEE PROTECTORS AND PADS, HEAD PROTECTORS, FOREHEAD PROTECTORS, TEMPLE PROTECTORS, FACE MASKS, SHIN GUARDS AND PROTECTORS, SHOULDER PADS AND PROTECTORS, FINGER PROTECTORS, MOUTH GUARDS, WRIST GUARDS AND PROTECTORS, ELBOWS PADS AND PROTECTORS, AND ANKLE GUARDS AND PROTECTORS (U.S. CLS. 22, 23, 38 AND 50).

ALLISON HOLTZ, EXAMINING ATTORNEY

SN 76-489,869. FAYETTEVILLE STATE UNIVERSITY, FAYETTEVILLE, NC. FILED 2-13-2003.

FAYETTEVILLE STATE UNIVERSITY

NO CLAIM IS MADE TO THE EXCLUSIVE RIGHT TO USE "FAYETTEVILLE", APART FROM THE MARK AS SHOWN.

CLASS 16—PAPER GOODS AND PRINTED MATTER

FOR DECALS, NOTEBOOKS, NOTEPADS, WRITING PAPER AND ENVELOPES, BINDERS, NOTEPAD HOLDERS, NOTEBOOK FILLER PAPER, PAPER NAPKINS AND PAPER PLACEMATS (U.S. CLS. 2, 5, 22, 23, 29, 37, 38 AND 50).

CLASS 21—HOUSEWARES AND GLASS

FOR DRINKING GLASSES, MUGS, PITCHERS, VASES AND WASTE PAPER BASKETS (U.S. CLS. 2, 13, 23, 29, 30, 33, 40 AND 50).

CLASS 25—CLOTHING

FOR CLOTHING, NAMELY, SKIRTS, SLACKS, JEANS, JACKETS, SWEATERS, CAPS, PARKAS, SHORTS, JOGGING SUITS, SWEAT SUITS, VESTS, NECKTIES, LEISURE SUITS, RAINWEAR, SPORTS COATS, CHEERLEADING OUTFITS, COMPRISING, SHORTS, SKIRTS, TOPS AND SWEATERS; SLEEPWEAR, SOCKS, AND ATHLETIC JERSEYS (U.S. CLS. 22 AND 39).

CLASS 28—TOYS AND SPORTING GOODS

FOR TOYS AND SPORTING GOODS, NAMELY, FOOTBALLS, BASKETBALLS, GOLF BALLS AND FLYING DISCS (U.S. CLS. 22, 23, 38 AND 50).
BARBARA A. GOLD, EXAMINING ATTORNEY

SN 76-494,482. SLIWA, CYNTHIA A., HERMOSA BEACH, CA. FILED 3-4-2003.

APPRECIA**CLASS 35—ADVERTISING AND BUSINESS**

FOR ON-LINE RETAIL STORE SERVICES FEATURING FINE JEWELRY; ON-LINE ORDERING SERVICES FEATURING FINE JEWELRY; RETAIL STORE SERVICES, AVAILABLE THROUGH COMPUTER COMMUNICATIONS AND INTERACTIVE TELEVISION, FEATURING FINE JEWELRY; TELEPHONE SHOP-AT-HOME SERVICES IN THE FIELD OF FINE JEWELRY; AND RETAIL STORE SERVICES FEATURING FINE JEWELRY (U.S. CLS. 100, 101 AND 102).

CLASS 40—MATERIAL TREATMENT

FOR CUSTOM MANUFACTURE OF FINE JEWELRY (U.S. CLS. 100, 103 AND 106).
ALICE BENMAMAN, EXAMINING ATTORNEY

SN 76-495,496. CLAUS, CATHERINE, ST. JOB IN 'T GOOR, BELGIUM, FILED 3-5-2003.

PROFESSIONAILS

SN 76-494,271. VIPER MOTORCYCLE COMPANY, GOLDEN VALLEY, MN. FILED 3-3-2003.

VIPER MOTORCYCLES

NO CLAIM IS MADE TO THE EXCLUSIVE RIGHT TO USE MOTORCYCLES, APART FROM THE MARK AS SHOWN.

CLASS 12—VEHICLES

FOR MOTORCYCLES AND STRUCTURAL PARTS FOR MOTORCYCLES; MOTORCYCLE PARTS, NAMELY, BRAKE CABLES, CLUTCH CABLE, FORK BEARING AND RACES, FORK DUST BOOTS, FORK SEALS, HANDLE BARS, HANDLE BAR CONTROL LEVERS, HANDLE BAR DAMPERS, HANDLE BAR GRIPS, BRAKE CALIPERS, BRAKE PEDALS, BRAKE ROTORS, FRONT SPACERS, FRONT DASH PANELS, SHIFT LEVERS AND HEADLIGHT MOUNTS; AND MOTORCYCLE ACCESSORIES, NAMELY, MOTORCYCLE KICKSTANDS, MOTORCYCLE SADDLEBAGS AND MOTORCYCLE SIDECARS (U.S. CLS. 19, 21, 23, 31, 35 AND 44).
FIRST USE 2-24-2003; IN COMMERCE 2-24-2003.

CLASS 25—CLOTHING

FOR (BASED ON INTENT TO USE) APPAREL, NAMELY, SWEATSHIRTS, RUGGED SHIRTS, T-SHIRTS, JACKETS, HATS, SWEATERS, VESTS, JERSEYS, PULLOVERS, SHIRTS, BANDANAS, COATS, SHELLS (U.S. CLS. 22 AND 39).
BARBARA A. LOUGHRAN, EXAMINING ATTORNEY

PRIORITY CLAIMED UNDER SEC. 44(D) ON BENELUX APPLICATION NO. 1,025,629, FILED 1-22-2003, REG. NO. 728968, DATED 1-22-2003, EXPIRES 1-22-2013.

OWNER OF U.S. REG. NO. 1,322,873.
THE MARK CONSISTS OF THE WORD "PROFESSIONAILS" IN WHICH THE LETTERS ARE WRITTEN IN GREY AND THE "O'S" ARE IN THE SHAPE OF RED FINGERNAILS WITH WHITE SHADING.

CLASS 3—COSMETICS AND CLEANING PREPARATIONS

FOR HANDCARE AND NAILCARE PRODUCTS, NAMELY, NAIL TIPS, NAIL POLISHES, NAIL POLISH REMOVERS, NAIL TIP REMOVERS, NAIL OVERLAY ENAMEL GELS, ACRYL LIQUIDS USED AS NAIL HARDENERS, PRIMERS FOR ADHESION OF ACRYL LIQUIDS AND GELS ONTO NAILS, NAIL POLISH THINNERS AND PUMICE STONES FOR PERSONAL USE (U.S. CLS. 1, 4, 6, 50, 51 AND 52).

CLASS 8—HAND TOOLS

FOR MANICURE AND PEDICURE IMPLEMENTS, NAMELY, NAIL FILES, NAIL SCISSORS, NAIL CLIPPERS, CUTICLE SCISSORS, CUTICLE PUSHERS, NAIL CUTTERS, BLADES, NAIL BUFFING BLOCKS AND TWEEZERS; ELECTRIC MANICURE AND PEDICURE SETS CONTAINING AN ELECTRIC MOTOR GRINDER WITH BUILT-IN ASPIRATION USED FOR MANICURE AND PEDICURE (U.S. CLS. 23, 28 AND 44).

CLASS 11—ENVIRONMENTAL CONTROL APPARATUS

FOR ULTRAVIOLET LAMPS NOT FOR MEDICAL USE, NAMELY, ULTRAVIOLET LAMPS FOR CURING NAILS (U.S. CLS. 13, 21, 23, 31 AND 34).

CLASS 21—HOUSEWARES AND GLASS

FOR NAILBRUSHES (U.S. CLS. 2, 13, 23, 29, 30, 33, 40 AND 50).

CLASS 41—EDUCATION AND ENTERTAINMENT

FOR EDUCATIONAL SERVICES, NAMELY, CONDUCTING CLASSES, SEMINARS, CONFERENCES AND WORKSHOPS IN THE FIELDS OF HAND CARE AND NAIL CARE; TRAINING SERVICES IN THE FIELDS OF HAND CARE AND NAIL CARE; TRAINING SERVICES IN APPLYING, MANICURING AND REMOVING NAIL TIPS (U.S. CLS. 100, 101 AND 107).

FRED MANDIR, EXAMINING ATTORNEY

SN 76-497,127. TAO GROUP LTD., EARLEY READING, UNITED KINGDOM, FILED 3-13-2003.



PRIORITY CLAIMED UNDER SEC. 44(D) ON UNITED KINGDOM APPLICATION NO. 2316684, FILED 11-26-2002, REG. NO. 2316684, DATED 6-13-2003, EXPIRES 11-26-2012.

THE STIPPLING SHOWN IN THE DRAWING IS A FEATURE OF THE MARK.

CLASS 9—ELECTRICAL AND SCIENTIFIC APPARATUS

FOR COMPUTERS; COMPUTER HARDWARE; MICROPROCESSORS; CIRCUIT BOARDS; COMPUTER MONITORS; BLANK MAGNETIC DATA CARRIERS; BLANK MAGNETIC COMPUTER TAPES; COMPUTER SOFTWARE FOR USE AS AN OPERATING SYSTEM, IN DATABASE MANAGEMENT, AS MULTIMEDIA, NAMELY GRAPHICS AND AUDIO SOFTWARE, FOR COMPUTER GAMES, AS A SOFTWARE PLATFORM FOR RUNNING OTHER SOFTWARE PROGRAMS, FOR MUSIC APPLICATIONS, FOR ENTERTAINMENT, AND FOR A JAVA VIRTUAL MACHINE, ALL THAT MAY BE DOWNLOADED FROM A GLOBAL COMPUTER NETWORK; COMPUTER FIRMWARE FOR USE AS AN OPERATING SYSTEM, IN DATABASE MANAGEMENT, AS MULTIMEDIA, NAMELY GRAPHICS AND AUDIO SOFTWARE, FOR COMPUTER GAMES, AS A SOFTWARE PLATFORM FOR RUNNING OTHER SOFTWARE PROGRAMS, FOR MUSIC APPLICATIONS, FOR ENTERTAINMENT, AND FOR A JAVA VIRTUAL MACHINE, ALL THAT MAY BE DOWNLOADED FROM A GLOBAL COMPUTER NETWORK; COMPUTER FILES IN THE FORM OF IMAGES AND AUDIO FILES THAT MAY BE USED IN A MIDI SYSTEM OR TO PERSONALIZE A CELL PHONE; ELECTRONIC AND ELECTROMECHANICAL COMPUTER PERIPHERALS; COMPUTER NETWORK SYSTEMS, NAMELY, COMPUTERS, COMPUTER NETWORKING HARDWARE, COMMUNICATIONS SOFTWARE FOR CONNECTING COMPUTER NETWORK USERS, COMPUTER NETWORK ADAPTERS AND COMPUTER NETWORK HUBS, SWITCHES AND ROUTERS; COMPUTER PROGRAMS FOR USE AS AN OPERATING SYSTEM, IN DATABASE MANAGEMENT, AS MULTIMEDIA, NAMELY GRAPHICS AND AUDIO SOFTWARE FOR COMPUTER GAMES, AS A SOFTWARE PLATFORM FOR RUNNING OTHER SOFTWARE PROGRAMS, FOR MUSIC APPLICATIONS, FOR ENTERTAINMENT, AND FOR A JAVA VIRTUAL MACHINE; COMPUTER SOFTWARE PROGRAMS WHICH ENABLE USERS TO ACCESS AND USE VARIOUS COMPUTER PROGRAMMING CODE LANGUAGES FOR USE IN FACILITATING COMPUTER

PROGRAMMING; COMPUTER PERIPHERALS; MAGNETICALLY AND ELECTRONICALLY RECORDED EDUCATIONAL SOFTWARE FEATURING INSTRUCTION IN COMPUTER USE AND RELATED COMPUTER SOFTWARE USE; DOWNLOADABLE ELECTRONIC VIDEO RECORDINGS FEATURING INSTRUCTION ON COMPUTER USE AND RELATED COMPUTER SOFTWARE USE AN INTERNATIONAL CLASS NETWORK (U.S. CLS. 21, 23, 26, 36 AND 38).

CLASS 42—SCIENTIFIC, COMPUTER AND LEGAL SERVICES

FOR COMPUTER PROGRAMMING FOR OTHERS; COMPUTER CONSULTATION; COMPUTER SOFTWARE CONSULTATION; COMPUTER NETWORK DESIGN FOR OTHERS; COMPUTER SITE DESIGN; CONSULTING SERVICES IN THE FIELD OF DESIGN, SELECTION, IMPLEMENTATION AND USE OF COMPUTER HARDWARE AND SOFTWARE SYSTEMS FOR OTHERS; TECHNICAL SUPPORT SERVICES, NAMELY, TROUBLESHOOTING OF COMPUTER HARDWARE AND SOFTWARE PROBLEMS; WEB SITE DESIGN; HOSTING THE WEB SITES OF OTHERS ON A COMPUTER SERVER FOR A GLOBAL COMPUTER NETWORK; COMPUTER SERVICES, NAMELY CREATING INDEXES OF INFORMATION, SITES AND OTHER RESOURCES AVAILABLE ON COMPUTER NETWORKS; COMPUTER SERVICE, NAMELY, ACTING AS AN APPLICATION SERVICE PROVIDER IN THE FIELD AT KNOWLEDGE MANAGEMENT TO HOST COMPUTER APPLICATION SOFTWARE FOR THE COLLECTION, EDITING, ORGANIZING, MODIFYING, BOOK MARKING, TRANSMISSION, STORAGE AND SHARING OF DATA AND INFORMATION; COMPUTER SERVICES, NAMELY, PROVIDING SEARCH ENGINES FOR OBTAINING DATA ON A GLOBAL COMPUTER NETWORK; COMPUTER SOFTWARE AND HARDWARE DESIGN SERVICES FOR OTHERS; COMPUTER SYSTEM AND NETWORK DESIGN SERVICES FOR OTHERS (U.S. CLS. 100 AND 101).

CHRISTOPHER ADKINS, EXAMINING ATTORNEY

SN 76-497,294. CUNDIFF STEEL ERECTORS, INC., LOUISVILLE, KY. FILED 3-14-2003.

WE RISE HIGH ABOVE THE REST**CLASS 37—CONSTRUCTION AND REPAIR**

FOR ERECTION OF STRUCTURAL STEEL AND IRON, NAMELY ANCHORS, ANGLES, CHANNELS, PLATFORMS, STEEL BEAMS, STEEL JOISTS, STRUCTURAL MISCELLANEOUS STEEL, TUBE STEEL AND RAILINGS (U.S. CLS. 100, 103 AND 106).

FIRST USE 10-11-1994; IN COMMERCE 10-11-1994.

CLASS 40—MATERIAL TREATMENT

FOR CUSTOM STEEL FABRICATION OF STRUCTURAL STEEL AND MISCELLANEOUS IRON PIECES, NAMELY, ANGLES, CHANNELS, STEEL BEAMS, TUBE STEEL AND RAILINGS; AND THE MANUFACTURE OF STRUCTURAL STEEL AND MISCELLANEOUS IRON PIECES, NAMELY, ANGLES, CHANNELS, STEEL BEAMS, TUBE STEEL AND RAILINGS TO THE ORDER AND SPECIFICATIONS OF OTHERS (U.S. CLS. 100, 103 AND 106).

FIRST USE 10-11-1994; IN COMMERCE 10-11-1994.

JOHN DALIER, EXAMINING ATTORNEY

SN 76-499,033. BACKROADS, BERKELEY, CA. FILED 3-3-2003.

SN 76-506,694. SINGAPORE TELECOMMUNICATIONS LIMITED, COMCENTRE, SINGAPORE, FILED 4-3-2003.

EPIC JOURNEYS

NO CLAIM IS MADE TO THE EXCLUSIVE RIGHT TO USE "JOURNEYS", APART FROM THE MARK AS SHOWN.

CLASS 39—TRANSPORTATION AND STORAGE

FOR ORGANIZING AND ARRANGING TRAVEL TOURS; ORGANIZING AND ARRANGING VACATIONS, NAMELY, MAKING RESERVATIONS AND BOOKINGS FOR TRANSPORTATION (U.S. CLS. 100 AND 105).

FIRST USE 8-15-2002; IN COMMERCE 9-15-2002.

CLASS 43—HOTEL AND RESTAURANT SERVICES

FOR ORGANIZING AND ARRANGING VACATIONS, NAMELY, MAKING RESERVATIONS AND BOOKING FOR TEMPORARY LODGING (U.S. CLS. 100 AND 101).

FIRST USE 8-15-2002; IN COMMERCE 9-15-2002.

SUSAN STIGLITZ, EXAMINING ATTORNEY

SN 76-501,721. SB&T, INC., DBA RED ROCK WEST SALOON, NEW YORK, NY. FILED 3-28-2003.

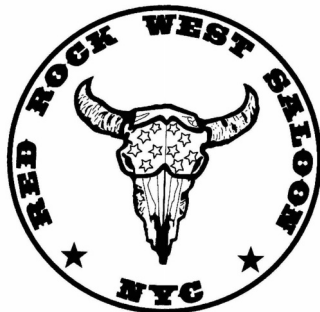

NO CLAIM IS MADE TO THE EXCLUSIVE RIGHT TO USE "SALOON" AND "NYC", APART FROM THE MARK AS SHOWN.

CLASS 25—CLOTHING

FOR CLOTHING, NAMELY, SHIRTS, HATS, BANDANAS AND JACKETS (U.S. CLS. 22 AND 39).

FIRST USE 9-0-1995; IN COMMERCE 9-0-1995.

CLASS 43—HOTEL AND RESTAURANT SERVICES

FOR RESTAURANT AND BAR SERVICES (U.S. CLS. 100 AND 101).

FIRST USE 9-0-1995; IN COMMERCE 9-0-1995.

ALICE BENMAMAN, EXAMINING ATTORNEY

SINGTEL

CLASS 9—ELECTRICAL AND SCIENTIFIC APPARATUS

FOR CONDUCTIVE FIBERS FOR CONDUCTING ELECTRICAL CHARGES, ELECTRIC SWITCHES, ELECTRICAL TRANSFORMERS, ELECTRIC ACCUMULATORS, VOLTAGE REGULATORS FOR ELECTRIC POWER, ELECTRICAL CONTROLLERS; APPARATUS FOR RECORDING, TRANSMISSION OR REPRODUCTION OF SOUND OR IMAGES, NAMELY, VIDEO AND DIGITAL CAMERAS, BLANK MAGNETIC DATA CARRIERS; PRE-RECORDED MAGNETIC DATA CARRIERS FEATURING GRAPHICS, SOUND AND IMAGES; DATA PROCESSORS; AERIALS; AMPLIFIERS; TELEPHONE ANSWERING MACHINES; COAXIAL CABLES; COMPUTER PERIPHERALS; COMPUTER SOFTWARE FOR TRANSMISSION OR REPRODUCTION OF SOUND OR IMAGES; COMPUTERS; FACSIMILE MACHINES; FIBER OPTIC CABLE; INTERCOMMUNICATION TELEPHONE APPARATUS, NAMELY, INTERCOMS; COMPUTER INTERFACE BOARDS; MODEMS; PORTABLE TELEPHONES; RADAR; RADIO PAGERS; RADIO TELEGRAPHS; RADIO TELEPHONES; SATELLITE NAVIGATIONAL SYSTEM, NAMELY, A GLOBAL POSITIONING SYSTEM; TELEGRAPH ELECTRICAL WIRES; TELEGRAPHS; TELEMETERS; TELEPHONE APPARATUS IN THE NATURE OF CELLULAR AND WIRELESS TELEPHONE ACCESSORIES, NAMELY, PHONE HOUSINGS AND CASINGS, TELEPHONE MOUNTING RACKS, TELEPHONE HOLSTERS, BELT CLIPS AND CARRYING CASES FOR CELLULAR TELEPHONES, LEATHER CASES FOR CELLULAR TELEPHONES, CELLULAR TELEPHONE CONNECTORS AND CORDS, TELEPHONE POWER CORDS AND ANTENNAS, TELEPHONE SPEAKERS, TELEPHONE MICROPHONES, TELEPHONE HANDS-FREE ADAPTERS, TELEPHONE TRANSCIEVERS, TELEPHONE BATTERIES, TELEPHONE CIGARETTE LIGHTER POWER ADAPTERS, TELEPHONE BATTERY CHARGERS, TELEPHONE POWER ADAPTERS, TELEPHONE ELECTRIC CONNECTORS, TELEPHONE SIGNAL BOOSTERS, CELLULAR TELEPHONE MODEMS AND MODEM CABLES; TELEPHONE FAX/MODEM CARDS, WIRELESS TELEPHONE CONNECTION CABLES, COMPUTER OPERATING SYSTEM SOFTWARE FOR CELLULAR AND WIRELESS TELEPHONES AND INSTRUCTIONAL MANUALS FOR USE THEREWITH, PERSONAL COMMUNICATIONS SERVICE HANDSETS, TELEPHONE RECEIVERS, TELEPHONE TRANSMITTERS, TELEPHONE ELECTRICAL WIRES, TELEPHONE SATELLITE TRANSMITTERS AND RECEIVERS, TELEPHONE SATELLITE DISHES, TELEPHONE SATELLITE ANTENNAE, TELEPHONE ANTENNAE PEDESTAL, VERY SMALL APERTURE TERMINAL TELEPHONE SATELLITE SYSTEM COMPRISED OF ANTENNA AND TRANSCIEVER AND MODEM AND MULTIPLEXER/ROUTER, INDOOR TELEPHONE ANTENNAS, TELEPHONE ANTENNA POLES, TELEPHONE SUPPORTS, RADIO FREQUENCY FEEDER CABLES FOR TELEPHONES, LEAKY COAXIAL CABLES FOR TELEPHONES, RADIO FREQUENCY POWER SPLITTERS FOR TELEPHONES, COUPLERS FOR TELEPHONES, DIPLEXERS, TRIPLEXERS, TELEPHONE BASE STATION TRANSCIEVERS, OFF-AIR REPEATERS, PERSONAL REPEATERS, IN-LINE BOOSTERS, TOWER-MOUNT AMPLIFIERS, RADIO FREQUENCY COMBINERS FOR TELEPHONES; MOBILE TELECOMMUNICATION SWITCHES AND TELECOMMUNICATIONS AND DATA NETWORKING HARDWARE, NAMELY, DEVICES FOR TRANSPORTING AND AGGREGATING VOICE, DATA, AND VIDEO COMMUNICATIONS ACROSS MULTIPLE NETWORK INFRASTRUCTURES AND COMMUNICATIONS PROTOCOLS FOR TELEPHONES, MOBILE SATELLITE TRANSMITTERS AND RECEIVERS FOR TELEPHONES (U.S. CLS. 21, 23, 26, 36 AND 38).

CLASS 35—ADVERTISING AND BUSINESS

FOR ADVERTISING SERVICES, NAMELY, DISSEMINATION OF ADVERTISING MATTER; BUSINESS MANAGEMENT; COMPILATION OF INFORMATION INTO COMPUTER DATABASE, NAMELY, COMPUTERIZED DATABASE MANAGEMENT; ORGANIZATION OF EXHIBITIONS FOR ADVERTISING AND THE PROMOTION OF TELECOMMUNICATIONS APPARATUS AND SERVICES, AND THE TRADE IN GENERAL; OFFICE MACHINES AND EQUIPMENT RENTAL; TELEPHONE ANSWERING SERVICES (U.S. CLS. 100, 101 AND 102).

CLASS 37—CONSTRUCTION AND REPAIR

FOR INSTALLATION, MAINTENANCE AND REPAIR OF TELECOMMUNICATIONS APPARATUS, NAMELY, INTERCOMS, COMPUTER INTERFACE BOARDS, MODEMS, PORTABLE TELEPHONES, RADAR, RADIO PAGES, RADIO TELEGRAPHS, RADIO TELEPHONES, SATELLITE NAVIGATIONAL SYSTEM, NAMELY, A GLOBAL POSITIONING SYSTEM, TELEGRAPH ELECTRICAL WIRES, TELEGRAPHS; BUILDING CONSTRUCTION AND REPAIR OF TELEMETERS; UNDERWATER CONSTRUCTION; UNDERWATER REPAIR (U.S. CLS. 100, 103 AND 106).

CLASS 38—COMMUNICATION

FOR TELECOMMUNICATIONS, NAMELY, LOCAL AND LONG DISTANCE TRANSMISSION OF VOICE, DATA, AND GRAPHICS BY MEANS OF TELEPHONE, TELEGRAPHIC, CABLE AND SATELLITE TRANSMISSIONS; CABLE TELEVISION BROADCASTING; CELLULAR TELEPHONE COMMUNICATION SERVICES; COMMUNICATIONS BY COMPUTER TERMINALS, NAMELY, ELECTRONIC TRANSMISSION OF DATA AND DOCUMENTS VIA COMPUTER TERMINALS; COMMUNICATIONS BY FIBER OPTIC NETWORKS, NAMELY, PROVIDING FIBER OPTIC NETWORK SERVICES; ELECTRONIC BULLETIN BOARD SERVICES, NAMELY, PROVIDING ON-LINE ELECTRONIC BULLETIN BOARDS FOR THE TRANSMISSION OF MESSAGES AMONG COMPUTER USERS CONCERNING SUBJECTS OF GENERAL INTEREST; FACSIMILE TRANSMISSION; PROVIDING INFORMATION IN THE FIELD OF TELECOMMUNICATION; ELECTRONIC TRANSMISSION OF MESSAGES; PROVIDING TELECOMMUNICATIONS CONNECTIONS TO A GLOBAL COMPUTER NETWORK; PROVIDING MULTIPLE-USER ACCESS TO A GLOBAL COMPUTER NETWORK; RENTAL OF TELECOMMUNICATION EQUIPMENT; SATELLITE TRANSMISSION SERVICES; TELEGRAM TRANSMISSION; TELECOMMUNICATIONS ROUTING AND JUNCTION SERVICES; AUDIO AND VIDEO TELECONFERENCING SERVICES; TELEGRAPH SERVICES; TELEPHONE SERVICES, NAMELY, LOCAL AND LONG DISTANCE TELEPHONE SERVICES; TRANSMISSION OF TELEGRAMS; LOCAL AND LONG DISTANCE TRANSMISSION OF VOICE, DATA, VIDEO AND GRAPHICS BY MEANS OF MICROWAVE TRANSMISSIONS; TELECOMMUNICATIONS FOR INTEGRATED SERVICES, NAMELY, VOICE, DATA AND VIDEO TRANSMISSION; TELECOMMUNICATIONS BY ACCESS NETWORK VIA MULTIPLEXES, FIBRE CABLES, CROSS CONNECT SWITCHES, NAMELY, VOICE, DATA, VIDEO AND GRAPHICS TRANSMISSION (U.S. CLS. 100, 101 AND 104).

CLASS 40—MATERIAL TREATMENT

FOR DIGITAL IMAGING SERVICES; CONVERSION OF DATA OR DOCUMENTS FROM PHYSICAL MEDIA TO ELECTRONIC MEDIA; DUPLICATION OF COMPUTER PROGRAMS (U.S. CLS. 100, 103 AND 106).

CLASS 41—EDUCATION AND ENTERTAINMENT

FOR PROVIDING OF TRAINING SERVICES IN THE FIELD OF TELECOMMUNICATIONS; ORGANIZING COMMUNITY SPORTING AND CULTURAL EVENTS; ARRANGING AND CONDUCTING EDUCATIONAL CONFERENCES AND COMPETITIONS; ARRANGING AND CONDUCTING OF SEMINARS IN THE FIELD OF TELECOMMUNICATIONS; ARRANGING AND CONDUCTING OF SYMPOSIUMS IN THE FIELD OF TELECOMMUNICATIONS; ARRANGING AND CONDUCTING OF TRAINING WORKSHOPS IN THE FIELD OF TELECOMMUNICATIONS; ENTERTAINMENT SERVICES, NAMELY, PROVIDING AN ON-LINE COMPUTER GAME; ORGANIZATION OF ENTERTAINMENT COMPETITIONS, NAMELY, ARRANGING AND CONDUCTING ATHLETIC COMPETITIONS; RECORDING STUDIO SERVICES; RENTAL OF SOUND RECORDINGS (U.S. CLS. 100, 101 AND 107).

CLASS 42—SCIENTIFIC, COMPUTER AND LEGAL SERVICES

FOR SCIENTIFIC RESEARCH; TECHNICAL RESEARCH IN THE FIELD OF TELECOMMUNICATIONS; DESIGN FOR OTHERS IN THE FIELD OF TELECOMMUNICATIONS; DESIGN AND DEVELOPMENT OF COMPUTER HARDWARE AND SOFTWARE FOR OTHERS; COMPUTER PROGRAMMING FOR OTHERS; RENTAL OF COMPUTERS; COMPUTER SOFTWARE DESIGN FOR OTHERS; INSTALLATION OF COMPUTER SOFTWARE; MAINTENANCE OF COMPUTER SOFTWARE; UPDATING OF COMPUTER SOFTWARE FOR OTHERS; COMPUTER SYSTEMS ANALYSIS; CONSULTANCY IN THE FIELD OF COMPUTER HARDWARE; INTELLECTUAL PROPERTY CONSULTANCY; CREATING AND MAINTAINING WEB SITES FOR OTHERS; DATA CONVERSION OF COMPUTER PROGRAM DATA OR INFORMATION; HOSTING THE COMPUTER WEB SITES OF OTHERS ON A COMPUTER SERVER FOR A GLOBAL COMPUTER NETWORK; RECOVERY OF COMPUTER DATA; RENTAL OF COMPUTER SOFTWARE; COMPILATION OF INFORMATION INTO COMPUTER DATABASE, NAMELY, DATABASE DEVELOPMENT SERVICES (U.S. CLS. 100 AND 101).

JOHN DWYER, EXAMINING ATTORNEY

SN 76-506,695. SINGAPORE TELECOMMUNICATIONS LIMITED, COMCENTRE, SINGAPORE, FILED 4-3-2003.

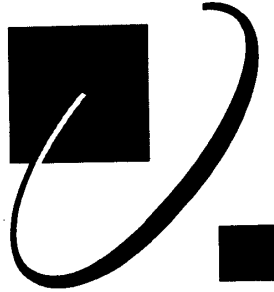

CLASS 9—ELECTRICAL AND SCIENTIFIC APPARATUS

FOR CONDUCTIVE FIBERS FOR CONDUCTING ELECTRICAL CHARGES, ELECTRIC SWITCHES, ELECTRICAL TRANSFORMERS, ELECTRIC ACCUMULATORS, VOLTAGE REGULATORS FOR ELECTRIC POWER, ELECTRICAL CONTROLLERS; APPARATUS FOR RECORDING, TRANSMISSION OR REPRODUCTION OF SOUND OR IMAGES, NAMELY, VIDEO AND DIGITAL CAMERAS, BLANK MAGNETIC DATA CARRIERS; PRE-RECORDED MAGNETIC DATA CARRIERS FEATURING GRAPHICS, SOUND AND IMAGES; DATA PROCESSORS; AERIALS; AMPLIFIERS; TELEPHONE ANSWERING MACHINES; COAXIAL CABLES; COMPUTER PERIPHERALS; COMPUTER SOFTWARE FOR TRANSMISSION OR REPRODUCTION OF SOUND OR IMAGES; COMPUTERS; FACSIMILE MACHINES; FIBER OPTIC CABLE; INTERCOMMUNICATION TELEPHONE APPARATUS, NAMELY, INTERCOMS; COMPUTER INTERFACE BOARDS; MODEMS; PORTABLE TELEPHONES; RADAR; RADIO PAGERS; RADIO TELEGRAPHS; RADIO TELEPHONES; SATELLITE NAVIGATIONAL SYSTEM, NAMELY, A GLOBAL POSITIONING SYSTEM; TELEGRAPH ELECTRICAL WIRES; TELEGRAPHS; TELEMETERS; TELEPHONE APPARATUS IN THE NATURE OF CELLULAR AND WIRELESS TELEPHONE ACCESSORIES, NAMELY, PHONE HOUSINGS AND CASINGS, TELEPHONE MOUNTING RACKS, TELEPHONE HOLSTERS, BELT CLIPS AND CARRYING CASES FOR CELLULAR TELEPHONES, LEATHER CASES FOR CELLULAR TELEPHONES, CELLULAR TELEPHONE CONNECTORS AND CORDS, TELEPHONE POWER CORDS AND ANTENNAS, TELEPHONE SPEAKERS, TELEPHONE MICROPHONES, TELEPHONE HANDS-FREE ADAPTERS, TELEPHONE TRANSCIVERS, TELEPHONE BATTERIES, TELEPHONE CIGARETTE LIGHTER POWER ADAPTERS, TELEPHONE BATTERY CHARGERS, TELEPHONE POWER ADAPTERS, TELEPHONE ELECTRIC CONNECTORS, TELEPHONE SIGNAL BOOSTERS, CELLULAR TELEPHONE MODEMS AND MODEM CABLES; TELEPHONE FAX/MODEM CARDS, WIRELESS TELEPHONE CONNECTION CABLES, COMPUTER OPERATING SYSTEM SOFTWARE FOR CELLULAR AND WIRELESS TELEPHONES AND INSTRUCTIONAL MANUALS FOR USE THEREWITH, PERSONAL COMMUNICATIONS SERVICE HANDSETS, TELEPHONE RECEIVERS, TELEPHONE TRANSMITTERS, TELEPHONE ELECTRICAL WIRES, TELEPHONE SATELLITE TRANSMITTERS AND RECEIVERS, TELEPHONE SATELLITE DISHES, TELEPHONE SATELLITE ANTENNAE, TELEPHONE ANTENNAE PEDESTAL, VERY SMALL APERTURE TERMINAL TELEPHONE SATELLITE SYSTEM COMPRISED OF ANTENNA AND TRANSCIVER AND MODEM AND MULTIPLEXER/ROUTER, INDOOR TELEPHONE ANTENNAS, TELEPHONE ANTENNA POLES, TELEPHONE SUPPORTS, RADIO FREQUENCY FEEDER CABLES FOR TELEPHONES, LEAKY COAXIAL CABLES FOR TELEPHONES, RADIO FREQUENCY POWER SPLITTERS FOR TELEPHONES, COUPLERS FOR TELEPHONES, DIPLEXERS, TRIPLEXERS, TELEPHONE BASE STATION TRANSCIVERS, OFF-AIR REPEATERS, PERSONAL REPEATERS, IN-LINE BOOSTERS, TOWER-MOUNT AMPLIFIERS, RADIO FRE-

QUENCY COMBINERS FOR TELEPHONES; MOBILE TELECOMMUNICATION SWITCHES AND TELECOMMUNICATIONS AND DATA NETWORKING HARDWARE, NAMELY DEVICES FOR TRANSPORTING AND AGGREGATING VOICE, DATA, AND VIDEO COMMUNICATIONS ACROSS MULTIPLE NETWORK INFRASTRUCTURES AND COMMUNICATIONS PROTOCOLS FOR TELEPHONES, MOBILE SATELLITE TRANSMITTERS AND RECEIVERS FOR TELEPHONES (U.S. CLS. 21, 23, 26, 36 AND 38).

CLASS 35—ADVERTISING AND BUSINESS

FOR ADVERTISING SERVICES, NAMELY, DISSEMINATION OF ADVERTISING MATTER; BUSINESS MANAGEMENT; COMPILATION OF INFORMATION INTO COMPUTER DATABASE, NAMELY, COMPUTERIZED DATABASE MANAGEMENT; ORGANIZATION OF EXHIBITIONS FOR ADVERTISING AND THE PROMOTION OF TELECOMMUNICATIONS APPARATUS AND SERVICES, AND THE TRADE IN GENERAL; OFFICE MACHINES AND EQUIPMENT RENTAL; TELEPHONE ANSWERING SERVICES (U.S. CLS. 100, 101 AND 102).

CLASS 37—CONSTRUCTION AND REPAIR

FOR INSTALLATION, MAINTENANCE AND REPAIR OF TELECOMMUNICATIONS APPARATUS, NAMELY, INTERCOMS, COMPUTER INTERFACE BOARDS, MODEMS, PORTABLE TELEPHONES, RADAR, RADIO PAGERS, RADIO TELEGRAPHS, RADIO TELEPHONES, SATELLITE NAVIGATIONAL SYSTEM, NAMELY, A GLOBAL POSITIONING SYSTEM, TELEGRAPH ELECTRICAL WIRES, TELEGRAPHS; BUILDING CONSTRUCTION AND REPAIR OF TELEMETERS; UNDERWATER CONSTRUCTION; UNDERWATER REPAIR (U.S. CLS. 100, 103 AND 106).

CLASS 38—COMMUNICATION

FOR TELECOMMUNICATIONS, NAMELY, LOCAL AND LONG DISTANCE TRANSMISSION OF VOICE, DATA, AND GRAPHICS BY MEANS OF TELEPHONE, TELEGRAPHIC, CABLE AND SATELLITE TRANSMISSIONS; CABLE TELEVISION BROADCASTING; CELLULAR TELEPHONE COMMUNICATION SERVICES; COMMUNICATIONS BY COMPUTER TERMINALS, NAMELY, ELECTRONIC TRANSMISSION OF DATA AND DOCUMENTS VIA COMPUTER TERMINALS; COMMUNICATIONS BY FIBER OPTIC NETWORKS, NAMELY, PROVIDING FIBER OPTIC NETWORK SERVICES; ELECTRONIC BULLETIN BOARD SERVICES, NAMELY, PROVIDING ON-LINE ELECTRONIC BULLETIN BOARDS FOR THE TRANSMISSION OF MESSAGES AMONG COMPUTER USERS CONCERNING SUBJECTS OF GENERAL INTEREST; FACSIMILE TRANSMISSION; PROVIDING INFORMATION IN THE FIELD OF TELECOMMUNICATION; ELECTRONIC TRANSMISSION OF MESSAGES; PROVIDING TELECOMMUNICATIONS CONNECTIONS TO A GLOBAL COMPUTER NETWORK; PROVIDING MULTIPLE-USER ACCESS TO A GLOBAL COMPUTER NETWORK; RENTAL OF TELECOMMUNICATION EQUIPMENT; SATELLITE TRANSMISSION SERVICES; TELEGRAM TRANSMISSION; TELECOMMUNICATIONS ROUTING AND JUNCTION SERVICES; AUDIO AND VIDEO TELECONFERENCING SERVICES; TELEGRAPH SERVICES; TELEPHONE SERVICES, NAMELY, LOCAL AND LONG DISTANCE TELEPHONE SERVICES; TRANSMISSION OF TELEGRAMS; LOCAL AND LONG DISTANCE TRANSMISSION OF VOICE, DATA, VIDEO AND GRAPHICS BY MEANS OF MICROWAVE TRANSMISSIONS; TELECOMMUNICATIONS FOR INTEGRATED SERVICES, NAMELY, VOICE, DATA AND VIDEO TRANSMISSION; TELECOMMUNICATIONS BY ACCESS NETWORK VIA MULTIPLEXES, FIBRE CABLES, CROSS CONNECT SWITCHES, NAMELY, VOICE, DATA, VIDEO AND GRAPHICS TRANSMISSION (U.S. CLS. 100, 101 AND 104).

CLASS 40—MATERIAL TREATMENT

FOR DIGITAL IMAGING SERVICES; CONVERSION OF DATA OR DOCUMENTS FROM PHYSICAL MEDIA TO ELECTRONIC MEDIA; DUPLICATION OF COMPUTER PROGRAMS (U.S. CLS. 100, 103 AND 106).

CLASS 41—EDUCATION AND ENTERTAINMENT

FOR PROVIDING OF TRAINING SERVICES IN THE FIELD OF TELECOMMUNICATIONS; ORGANIZING COMMUNITY SPORTING AND CULTURAL EVENTS; ARRANGING AND CONDUCTING EDUCATIONAL CONFERENCES AND COMPETITIONS; ARRANGING AND CONDUCTING OF SEMINARS IN THE FIELD OF TELECOMMUNICATIONS; ARRANGING AND CONDUCTING OF SYMPOSIUMS IN THE FIELD OF TELECOMMUNICATIONS; ARRANGING AND CONDUCTING OF TRAINING WORKSHOPS IN THE FIELD OF TELECOMMUNICATIONS; ENTERTAINMENT SERVICES, NAMELY, PROVIDING AN ON-LINE COMPUTER GAME; ORGANIZATION OF ENTERTAINMENT COMPETITIONS, NAMELY, ARRANGING AND CONDUCTING ATHLETIC COMPETITIONS; RECORDING STUDIO SERVICES; RENTAL OF SOUND RECORDINGS (U.S. CLS. 100, 101 AND 107).

CLASS 42—SCIENTIFIC, COMPUTER AND LEGAL SERVICES

FOR SCIENTIFIC RESEARCH; TECHNICAL RESEARCH IN THE FIELD OF TELECOMMUNICATIONS; DESIGN FOR OTHERS IN THE FIELD OF TELECOMMUNICATIONS; DESIGN AND DEVELOPMENT OF COMPUTER HARDWARE AND SOFTWARE FOR OTHERS; COMPUTER PROGRAMMING FOR OTHERS; RENTAL OF COMPUTERS; COMPUTER SOFTWARE DESIGN FOR OTHERS; INSTALLATION OF COMPUTER SOFTWARE; MAINTENANCE OF COMPUTER SOFTWARE; UPDATING OF COMPUTER SOFTWARE FOR OTHERS; COMPUTER SYSTEMS ANALYSIS; CONSULTANCY IN THE FIELD OF COMPUTER HARDWARE; INTELLECTUAL PROPERTY CONSULTANCY; CREATING AND MAINTAINING WEB SITES FOR OTHERS; DATA CONVERSION OF COMPUTER PROGRAM DATA OR INFORMATION; HOSTING THE COMPUTER WEB SITES OF OTHERS ON COMPUTER SERVER FOR A GLOBAL COMPUTER NETWORK; RECOVERY OF COMPUTER DATA; RENTAL OF COMPUTER SOFTWARE; COMPILATION OF INFORMATION INTO COMPUTER DATABASE, NAMELY, DATABASE DEVELOPMENT SERVICES (U.S. CLS. 100 AND 101).

JOHN DWYER, EXAMINING ATTORNEY

SN 76-511,423. FUENTE MARKETING, LTD., ROAD TOWN, TORTOLA, BR. VIRGIN ISLANDS, FILED 5-1-2003.

TAKING IT TO THE NEXT LEVEL**CLASS 21—HOUSEWARES AND GLASS**

FOR COFFEE MUGS (U.S. CLS. 2, 13, 23, 29, 30, 33, 40 AND 50).

CLASS 25—CLOTHING

FOR CLOTHING, NAMELY, BASEBALL CAPS, SWEATERS, SWEATSHIRTS, SHIRTS, T-SHIRTS, CLOTHING TIES, SUSPENDERS, BELTS, JACKETS, COATS, BLAZERS, AND HATS (U.S. CLS. 22 AND 39).

KARANENDRA S. CHHINA, EXAMINING ATTORNEY

SN 76-512,487. ATLANTIC PACIFIC DEVELOPMENT GROUP LIMITED, CENTRAL, HONG KONG, CHINA, FILED 5-1-2003.

SUNSATIION**CLASS 21—HOUSEWARES AND GLASS**

FOR PATIO ACCESSORIES, NAMELY, BARBECUE TOOLS, NAMELY, TONGS AND FORKS (U.S. CLS. 2, 13, 23, 29, 30, 33, 40 AND 50).

CLASS 22—CORDAGE AND FIBERS

FOR OUTDOOR AND GARDEN ACCESSORIES, NAMELY, CANVAS AND CLOTH BAGS FOR STORAGE (U.S. CLS. 1, 2, 7, 19, 22, 42 AND 50).

KARLA PERKINS, EXAMINING ATTORNEY

SN 76-512,815. MASTER CUTLERY CORPORATION, CHIBA 273-0865, JAPAN, FILED 5-8-2003.

MINOGEAR

PRIORITY CLAIMED UNDER SEC. 44(D) ON JAPAN APPLICATION NO. 2002-107298, FILED 12-19-2002, REG. NO. 4685846, DATED 6-27-2003, EXPIRES 6-27-2013.

CLASS 8—HAND TOOLS

FOR MANUALLY-OPERATED HAND TOOLS AND IMPLEMENTS, NAMELY, TWEEZERS, KITCHEN KNIVES, EGG SLICERS, CHEESE SLICERS, NON-ELECTRIC CAN OPENERS, NUT CRACKERS NOT OF PRECIOUS METAL, FORKS, SPOONS, PIZZA CUTTERS, MANICURE SETS, DIVERS' KNIVES, AND PALETTE KNIVES, TABLEWARE, NAMELY, KNIVES, FORKS, AND SPOONS (U.S. CLS. 23, 28 AND 44).

CLASS 21—HOUSEWARES AND GLASS

FOR HOUSEHOLD AND KITCHEN UTENSILS AND CONTAINERS, NAMELY, SKEWERS, POTS AND PANS, CAST IRON POTS, ICE BUCKETS, ICE TONGS, WHISKS, SIEVES, COLANDERS, SALT SHAKERS NOT OF PRECIOUS METAL, LADLES, MANUAL COFFEE OR PEPPER MILLS, BOTTLE OPENERS, GRATERS, TRIVETS, CUTTING BOARDS, AND LEMON SQUEEZERS, CHOPSTICKS (U.S. CLS. 2, 13, 23, 29, 30, 33, 40 AND 50).

STEVEN JACKSON, EXAMINING ATTORNEY

SN 76-513,798. VIDISOLUTIONS, INC., NEW YORK, NY, FILED 5-13-2003.

VIDIGRAM**CLASS 9—ELECTRICAL AND SCIENTIFIC APPARATUS**

FOR NETWORK COMMUNICATIONS SOFTWARE FOR GENERATING AND TRANSMITTING ELECTRONIC VIDEO MESSAGES (U.S. CLS. 21, 23, 26, 36 AND 38).

CLASS 38—COMMUNICATION

FOR ELECTRONIC MESSAGING SERVICES, NAMELY, THE RECORDING, STORAGE AND SUBSEQUENT TRANSMISSION OF VIDEO MESSAGES; VIDEO CONFERENCING SERVICES (U.S. CLS. 100, 101 AND 104).

PAULA MAHONEY, EXAMINING ATTORNEY

SN 76-517,752. 6WIND S.A., 75008 PARIS, FRANCE, FILED 5-5-2003.



OWNER OF FRANCE REG. NO. 99775338, DATED 2-11-1999, EXPIRES 2-11-2009.

NO CLAIM IS MADE TO THE EXCLUSIVE RIGHT TO USE "INTERNET", APART FROM THE MARK AS SHOWN.

CLASS 9—ELECTRICAL AND SCIENTIFIC APPARATUS

FOR APPARATUS FOR RECORDING, TRANSMISSION OR REPRODUCTION OF SOUND OR IMAGES, NAMELY, AUDIO TAPE RECORDERS, VIDEO CASSETTE RECORDERS, VCR'S; ELECTRONIC APPARATUS AND INSTRUMENTS, NAMELY, CALCULATORS AND COMPUTER INTERFACES; DATA PROCESSING APPARATUS, NAMELY, MODEMS; COMPUTERS AND COMPUTER PERIPHERAL DEVICES, NAMELY, MICROPROCESSORS; TELECOMMUNICATION ACCESS EQUIPMENT AND INSTRUMENTS, NAMELY, MODEMS; COMPUTER ROUTERS; COMPUTER DATABASE SOFTWARE FOR USE IN PROTOCOL TREATMENT, FOR DATA CONVERSION AND FOR DATA COMPRESSION AND FOR TREATMENT OF VIDEO AND TELECOMMUNICATION FLOWS; COMPUTER DATA BASE SOFTWARE RECORDED ON ELECTRONIC MEDIA FOR DATA CONVERSION AND FOR DATA COMPRESSION AND FOR DATA ENCRYPTION IN THE FIELDS OF TELECOMMUNICATION SERVICES MEETING INTERNET STANDARDS AND FOR PROCESSING INTERNET PROTOCOL INFRASTRUCTURE OF FIXED OR MOBILE TELECOMMUNICATIONS, TELEGRAPHIC COMMUNICATION, AND OF LOCAL NETWORK AND WIRELESS COMMUNICATION (U.S. CLS. 21, 23, 26, 36 AND 38).

CLASS 35—ADVERTISING AND BUSINESS

FOR BUSINESS CONSULTATION; CONDUCTING MARKETING STUDIES; MANAGEMENT OF COMPUTER FILES FOR OTHERS (U.S. CLS. 100, 101 AND 102).

CLASS 38—COMMUNICATION

FOR PROVIDING ACCESS TO TELECOMMUNICATION DATA VIA A GLOBAL COMMUNICATION NETWORK; COMPUTER AIDED TRANSMISSION OF MESSAGES, IMAGES AND DATA; CONSULTING IN THE FIELD OF TELECOMMUNICATION; PROVIDING ACCESS TO INTERNET AND EXTRANET, PROVIDING INFORMATION ABOUT TELECOMMUNICATION (U.S. CLS. 100, 101 AND 104).

CLASS 42—SCIENTIFIC, COMPUTER AND LEGAL SERVICES

FOR COMPUTER PROGRAMMING FOR OTHERS; ENGINEERING AND DESIGN OF ROUTERS IN THE FIELD OF COMPUTER SAFETY; COMPUTER NETWORK ENGINEERING AND DESIGN FOR OTHERS; MAINTENANCE OF COMPUTER SOFTWARE, SCIENTIFIC AND INDUSTRIAL RESEARCH AND DEVELOPMENT OF NEW PRODUCTS AND SERVICES FOR OTHERS (U.S. CLS. 100 AND 101).

JERI J. FICKES, EXAMINING ATTORNEY

SN 76-519,043. SUSHI MACHINES INTERNATIONAL LIMITED, CAMBRIDGE CB2 5LZ, GREAT BRITAIN, FILED 5-13-2003.



OWNER OF UNITED KINGDOM REG. NO. 2294524, DATED 9-6-2002, EXPIRES 3-6-2012.

NO CLAIM IS MADE TO THE EXCLUSIVE RIGHT TO USE "SUSHI", APART FROM THE MARK AS SHOWN.

THE TRADEMARK IS A DESIGN FOR "SUSHI@HOME" WITH A RED CIRCULAR BACKGROUND.

CLASS 8—HAND TOOLS

FOR CUTLERY; HAND OPERATED TOOLS AND IMPLEMENTS, NAMELY FORMING BLOCKS, ROLLERS AND PRESSES FOR FORMING SHAPED PORTIONS OF COOKED RICE (U.S. CLS. 23, 28 AND 44).

CLASS 29—MEATS AND PROCESSED FOODS

FOR FRESH FISH; PREPARED FISH; FROZEN FISH; FISH FOR FOOD PURPOSES (U.S. CL. 46).

CLASS 30—STAPLE FOODS

FOR RICE AND RICE PREPARATIONS, NAMELY, SUSHI RICE (U.S. CL. 46).

MICHELE SWAIN, EXAMINING ATTORNEY

SN 76-524,243. BERKSHIRE FASHIONS, INC., EDISON, NJ, FILED 3-10-2003.

CUTTING EDGE**CLASS 9—ELECTRICAL AND SCIENTIFIC APPARATUS**

FOR COMPACT DISC CARRYING CASES; CARRYING CASES FOR CELLULAR PHONES; AND MOUSEPADS (U.S. CLS. 21, 23, 26, 36 AND 38).

CLASS 16—PAPER GOODS AND PRINTED MATTER

FOR STATIONERY, PENS, PENCILS AND NOTEBOOKS (U.S. CLS. 2, 5, 22, 23, 29, 37, 38 AND 50).

CLASS 25—CLOTHING

FOR NON-SPORTS TYPE CLOTHING, NAMELY, HATS, SCARVES, GLOVES, HOSIERY AND SLIPPERS (U.S. CLS. 22 AND 39).

STEPHANIE DAVIS, EXAMINING ATTORNEY

SN 76-526,186. DOSS, GREGORY, CHICAGO, IL. FILED 6-26-2003.

WILLIAM D. FIELDS

THE NAME IN THE MARK DOES NOT IDENTIFY A LIVING INDIVIDUAL.

CLASS 42—SCIENTIFIC, COMPUTER AND LEGAL SERVICES

FOR DESIGN SERVICES IN THE FIELD OF CLOTHING (U.S. CLS. 100 AND 101).

CLASS 45—PERSONAL SERVICES

FOR FASHION CONSULTING SERVICES (U.S. CLS. 100 AND 101).

G. MAYERSCHOFF, EXAMINING ATTORNEY

SN 76-527,493. PROSPECTIVE CONCEPTS AG, CH-8152 GLATTBRUGG, SWITZERLAND, FILED 7-3-2003.



OWNER OF SWITZERLAND REG. NO. 512443, DATED 7-15-2003, EXPIRES 5-23-2013.

CLASS 9—ELECTRICAL AND SCIENTIFIC APPARATUS

FOR ELECTRIC OR ELECTRONIC SENSORS FOR PHYSICAL, CHEMICAL AND MEDICAL DATA IN THE NATURE OF ACCELERATION, AIR AND LIQUID PRESSURE, SPEED, TEMPERATURE, HUMIDITY, ELECTRIC CURRENT AND VOLTAGE; MEASURING MODULES, NAMELY, SENSORS FOR DETECTING AND MEASURING PHYSICAL, CHEMICAL AND MEDICAL DATA IN THE NATURE OF ACCELERATION, AIR AND LIQUID PRESSURE, SPEED, TEMPERATURE, HUMIDITY, ELECTRIC CURRENT AND VOLTAGE; DATA STORAGE DEVICES AND DISPLAYS FOR PHYSICAL, CHEMICAL AND MEDICAL DATA, NAMELY, BLANK COMPUTER DISKS AND OTHER ELECTRONIC STORAGE DEVICES NAMELY, FLASH MEMORY, EEPROM, NVRAM; INTEGRATED CIRCUITS; PRINTED CIRCUIT BOARDS; COMPUTER PROGRAMS, BOTH DOWNLOADABLE AND STORED ON CDROM AND DVD, FOR USE IN CONFIGURING, UPDATING AND RUNNING MEASURING MODULES; DOWNLOADABLE ELECTRONIC PUBLICATIONS IN THE NATURE OF NEWSLETTERS, FEATURING THE EXCHANGE OF EXPERIENCE AND SUGGESTIONS FOR MEASURING APPARATUS IN THE FIELD OF SCIENTIFIC, MEDICAL, AND CHEMICAL DATA MEASURING; ELECTRONIC DATA PROCESSING DEVICES, NAMELY, DATA PROCESSORS; DATA STORAGE MEANS, NAMELY, COMPUTER SOFTWARE FOR THE STORAGE OF DATA; DETECTORS FOR PHYSICAL, CHEMICAL AND MEDICAL PARAMETERS, NAMELY, ACCELERATION, AIR AND LIQUID PRESSURE, SPEED, TEMPERATURE, HUMIDITY, AND ELECTRIC CURRENT AND VOLTAGE; GPS NAVIGATION SYSTEMS (U.S. CLS. 21, 23, 26, 36 AND 38).

CLASS 10—MEDICAL APPARATUS

FOR MEDICAL RESPIRATION AND HEART MONITORS (U.S. CLS. 26, 39 AND 44).

CLASS 16—PAPER GOODS AND PRINTED MATTER

FOR FOLDERS, DOCUMENT COVERS IN THE NATURE OF PAPER REPORT COVERS, PAPER BAGS AND PAPER ENVELOPES FOR PACKAGING; PLASTIC BAGS FOR PACKAGING; PRINTED MATTER, NAMELY DATA SHEETS, HANDBOOKS, OPERATING MANUALS, BUSINESS FORMS, BROCHURES, AND CATALOGS IN THE FIELD OF DATA MEASURING, ADHESIVE STICKERS MADE OF PAPER OR PLASTIC MATERIAL FOR USE IN APPLYING TO OD-ROMS AND DVDS (U.S. CLS. 2, 5, 22, 23, 29, 37, 38 AND 50).

MARC LEIPZIG, EXAMINING ATTORNEY

SN 76-528,450. THE LAMSON & SESSIONS CO., CLEVELAND, OH. FILED 7-9-2003.

CARLON

OWNER OF U.S. REG. NOS. 532,098, 995,761 AND 2,036,498.
SEC. 2(F).

CLASS 9—ELECTRICAL AND SCIENTIFIC APPARATUS

FOR NON-METALLIC ELECTRICAL SWITCH AND OUTLET BOXES; NON-METALLIC HOUSINGS, FITTINGS, INNERDUCTS AND CONDUIT FOR PROTECTING FIBER OPTIC CABLES; ELECTRONIC APPARATUSES, NAMELY RADIO FREQUENCY TRANSMITTERS AND RECEIVERS FOR ALLOWING CONTROL OF FANS, LIGHTS, DOOR BELLS AND CHIMES, TELEPHONE RINGING AND ALARMS FOR DOOR AND WINDOW MOVEMENT; SECURITY SYSTEMS COMPRISING ELECTRICAL DETECTORS FOR SENSING DOORS AND WINDOWS OPENING AND ALARMS FOR PRODUCING A SIGNAL IN RESPONSE TO THE DETECTORS, AND PERSONAL SECURITY ALARMS; RADIO FREQUENCY TRANSMITTERS AND RECEIVERS FOR DETECTING ACTUATION OF A DOOR BELL SWITCH AND FOR TRANSMITTING INFORMATION TO A REMOTE LOCATION TO PROVIDE AUDIO INDICATION OF THE ACTUATION; OLD AND NEW WORK STYLE ELECTRICAL WIRING BOXES WITH MULTIPLE GANG CAPACITY; CORRUGATED CONDUIT FOR USE IN PROTECTING FIBER OPTIC CABLE; THERMOPLASTIC NON-METALLIC ENCLOSURES FOR ELECTRICAL WIRING AND ELECTRICAL SERVICE DEVICES; ELECTRICAL CIRCUITS, NAMELY DISCONNECTS, MOTOR STARTERS, AND PUSH BUTTONS PRE-ASSEMBLED INTO NON-METALLIC ENCLOSURES; WIRELESS ELECTRICAL DOORBELLS AND CHIMES AND TRANSMITTER BUTTONS; NON-METALLIC WEATHERPROOF ELECTRICAL OUTLET COVERS; NON-METALLIC, NON-CONDUCTIVE WEATHERPROOF OUTDOOR LIGHTING SYSTEMS; NON-METALLIC WEATHERPROOF ENCLOSURES FOR ELECTRICAL WIRING AND ELECTRICAL SERVICE DEVICES; MOLDED NON-METALLIC ELECTRIC JUNCTION BOXES; NON-METALLIC ELECTRICAL OUTLET BOXES FOR USE WITH CABLE TELEVISION, DATA COMMUNICATION OR TELEPHONE JACKS; ADJUSTABLE ELECTRICAL OUTLET BOXES; NON-METALLIC RACEWAY FOR ENCLOSING ELECTRICAL CABLING AND WIRING; BRASS AND NON-METALLIC FLOOR BOX COVERS FOR ELECTRICAL OUTLETS; NON-METALLIC CABLE BOXES AND BRACKETS, FLEXIBLE RACEWAY, FLOOR BOXES, CABLE CLIPS AND CONDUIT CLAMPS, ALL FOR INSTALLATION OF ELECTRICAL CABLES AND WIRING; PLASTIC CONDUIT FOR USE IN ELECTRICAL INSTALLATIONS; PLASTIC CONDUIT FOR ELECTRICAL USE; ELECTRICAL SHIELDING SPACERS, NAMELY, PLASTIC SPACERS FOR SPACING ELONGATED SECTIONS OF PLASTIC PIPE CONTAINING ELECTRICAL POWER AND COMMUNICATIONS WIRING FROM EACH OTHER IN VERTICAL AND HORIZONTAL SPACING PATTERNS; NON-METALLIC CORRUGATED FLEXIBLE CONDUIT AND PIPE FOR USE IN PROTECTING FIBER OPTIC AND TELECOMMUNICATIONS CABLES; PLASTIC CONDUIT FOR ELECTRICAL POWER AND COMMUNICATION TRANSMISSIONS INSTALLATIONS; PVC NON-METALLIC PLASTIC TUBING FOR USE IN PLENUM AND RISER FIBER OPTICS CABLES AND FLEXIBLE RACEWAY FOR USE IN HOUSING FIBER OPTICS CABLES IN WALLS, FLOORS AND NON-PLENUM CEILING; PLASTIC LINING FOR THE INTERIOR OF TELECOMMUNICATIONS CABLE, FIBER OPTIC CABLE, PIPE AND CONDUIT; HALOGEN FREE NON-METALLIC CORRUGATED FLEXIBLE CONDUIT FOR USE IN FIBER OPTICS RISER APPLICATIONS (U.S. CLS. 21, 23, 26, 36 AND 38).

FIRST USE 1-0-1968; IN COMMERCE 1-0-1968.

CLASS 11—ENVIRONMENTAL CONTROL APPARATUS

FOR NON-METALLIC, NON-CONDUCTIVE WEATHERPROOF OUTDOOR LIGHTING SYSTEMS, COMPRISED OF ELECTRIC LIGHTING FIXTURES, LAMP HOLDERS, RECEPTACLE COVERS, AND LIGHTING GLOBES (U.S. CLS. 13, 21, 23, 31 AND 34).

FIRST USE 3-0-1989; IN COMMERCE 3-0-1989.

CLASS 19—NON-METALLIC BUILDING MATERIALS

FOR PLASTIC CONSTRUCTION PIPES, NAMELY, NON-METALLIC UTILITY PIPES AND SUPPORTS THEREFOR, NAMELY, RISERS (U.S. CLS. 1, 12, 33 AND 50).

FIRST USE 4-0-1984; IN COMMERCE 4-0-1984.
LEIGH LOWRY, EXAMINING ATTORNEY

SN 76-528,562. AMERICAN IRONHORSE MOTORCYCLE COMPANY, INC., FORT WORTH, TX. FILED 7-9-2003.

GUNSLINGER**CLASS 9—ELECTRICAL AND SCIENTIFIC APPARATUS**

FOR SUNGLASSES; MOTORCYCLE HELMETS (U.S. CLS. 21, 23, 26, 36 AND 38).

CLASS 12—VEHICLES

FOR CUSTOM AND SPECIALTY MOTORCYCLES AND STRUCTURAL PARTS THEREFOR; MOTORCYCLES AND PARTS, PIECES AND ACCESSORIES FOR MOTORCYCLES, NAMELY, WINDSHIELDS AND REAR LUGGAGE RACKS, BACK RESTS, ENGINE CASE PROTECTORS, SHIFT LEVERS, BRAKE LEVERS, AND HANDLEBAR LEVERS, MOTORCYCLE HANDLEBAR GRIPS; MOTORCYCLE HANDLEBAR GRIP CAPS; MOTORCYCLE HANDLEBAR GRIP DECORATIVE RINGS; BRAKE AND CLUTCH CONTROL DRESS-UP KIT FOR A MOTORCYCLE COMPRISING SWITCH HOUSINGS, MASTER CYLINDER COVERS, CLUTCH PERCHES, CLAMPS AND HARDWARE ACCENTS; FRAME KITS FOR MOTORCYCLES COMPRISING CHASSIS, FRAMES AND SWING ARMS, FORKS AND SUSPENSIONS SYSTEMS; DRIVE TRAIN COMPONENTS FOR MOTORCYCLES NAMELY MOTORCYCLE DRIVE CHAINS AND DRIVE CHAIN TENSION GUIDES; COVERS, NAMELY CALIPER COVERS, ROTOR COVERS, MASTER CYLINDER COVERS, HORN COVERS, TANK COVERS, CLUTCH COVERS, BRAKE COVERS, LEVER COVERS, SEAT COVERS, HANDLE POLE COVERS, AND FITTED AND SEMI-FITTED MOTORCYCLE COVERS; WHEELS AND BRAKES FOR MOTORCYCLES (U.S. CLS. 19, 21, 23, 31, 35 AND 44).

KELLY BOULTON, EXAMINING ATTORNEY

SN 76-530,498. TOURETTE SYNDROME ASSOCIATION, INC., BAYSIDE, NY. FILED 7-7-2003.

TSA**CLASS 16—PAPER GOODS AND PRINTED MATTER**

FOR PAMPHLETS AND NEWSLETTERS IN THE FIELD OF ISSUES RELATING TO TOURETTE SYNDROME AND PERSONS AFFLICTED BY TOURETTE SYNDROME (U.S. CLS. 2, 5, 22, 23, 29, 37, 38 AND 50).

FIRST USE 10-0-1971; IN COMMERCE 10-0-1971.

CLASS 35—ADVERTISING AND BUSINESS

FOR EDUCATIONAL SERVICES, NAMELY, PROVIDING A WEB SITE AND CONDUCTING PROGRAMS DESIGNED TO PROMOTE PUBLIC AWARENESS OF THE TOURETTE SYNDROME (U.S. CLS. 100, 101 AND 102).

FIRST USE 10-0-1971; IN COMMERCE 10-0-1971.
RICHARD WHITE, EXAMINING ATTORNEY

SN 76-530,523. GANZCORP INVESTMENTS INC., TWINSBURG, OH. FILED 7-16-2003.

MUSTANG DYNAMOMETER

NO CLAIM IS MADE TO THE EXCLUSIVE RIGHT TO USE "DYNAMOMETER", APART FROM THE MARK AS SHOWN.

CLASS 9—ELECTRICAL AND SCIENTIFIC APPARATUS

FOR TESTING DYNAMOMETERS, AND COMPONENTS OF TESTING DYNAMOMETERS, NAMELY DYNAMOMETER CONTROL SOFTWARE WITH DATA BASE AND DATA ACQUISITION CAPABILITIES, OXYGEN SENSORS, PRESSURE SENSORS, GAS ANALYZERS, TEMPERATURE, HUMIDITY AND BAROMETRIC PRESSURE SENSORS, DIESEL SMOKE OPACITY METERS (U.S. CLS. 21, 23, 26, 36 AND 38).
FIRST USE 12-31-1980; IN COMMERCE 12-31-1980.

CLASS 37—CONSTRUCTION AND REPAIR

FOR SERVICES RELATED TO DYNAMOMETERS IN THE NATURE OF DYNAMOMETER INSTALLATION, DYNAMOMETER REPAIR, AND DYNAMOMETER MAINTENANCE (U.S. CLS. 100, 103 AND 106).
FIRST USE 12-31-1980; IN COMMERCE 12-31-1980.

CLASS 41—EDUCATION AND ENTERTAINMENT

FOR SERVICES RELATED TO DYNAMOMETERS IN THE NATURE OF DYNAMOMETER TRAINING (U.S. CLS. 100, 101 AND 107).
FIRST USE 12-31-1980; IN COMMERCE 12-31-1980.

CLASS 42—SCIENTIFIC, COMPUTER AND LEGAL SERVICES

FOR SERVICES RELATED TO DYNAMOMETERS IN THE NATURE OF PERFORMING VEHICLE DYNAMOMETER TESTING, PERFORMING ENGINE DYNAMOMETER TESTING, SOFTWARE PROGRAMMING FOR OTHERS, TROUBLE SHOOTING COMPUTER SOFTWARE PROBLEMS FOR VEHICLE DYNAMOMETER TESTING, ENGINE DYNAMOMETER TESTING AND EMISSIONS TESTING (U.S. CLS. 100 AND 101).
FIRST USE 12-31-1980; IN COMMERCE 12-31-1980.
JERI J. FICKES, EXAMINING ATTORNEY

SN 76-532,766. HKO MEDIA, INC., ANN ARBOR, MI. FILED 7-15-2003.

PENDRAGON PARK

CLASS 16—PAPER GOODS AND PRINTED MATTER

FOR PRINT PUBLICATIONS, NAMELY, EDUCATIONAL BOOKS AND MAGAZINES FOR USE BY CHILDREN, PARENTS AND EDUCATORS ON THE SUBJECT OF TEACHING METHODS AND LEARNING IN THE FIELD OF LANGUAGE, VISUAL, FINE AND PERFORMING ARTS (U.S. CLS. 2, 5, 22, 23, 29, 37, 38 AND 50).

CLASS 41—EDUCATION AND ENTERTAINMENT

FOR ENTERTAINMENT SERVICES, NAMELY PRODUCTION OF CHILDREN'S TELEVISION PROGRAMMING; EDUCATIONAL SERVICES, NAMELY DEVELOPMENT AND PRODUCTION OF CHILDREN'S EDUCATIONAL PROGRAMS IN VARIOUS MEDIA PLATFORMS, NAMELY TELEVISION, PRE-RECORDED CD, DVD, VIDEOTAPE, AUDIOTAPE FORMAT, AND VIA THE INTERNET; PROVIDING AN EDUCATIONAL WEBSITE FEATURING INFORMATION RELATING TO METHODS OF TEACHING AND LEARNING (U.S. CLS. 100, 101 AND 107).

DEZMONA MIZELLE, EXAMINING ATTORNEY

SN 76-535,341. HOME SAFETY COUNCIL, WILKESBORO, NC. FILED 7-24-2003.

HOME SAFETY COUNCIL

NO CLAIM IS MADE TO THE EXCLUSIVE RIGHT TO USE "HOME SAFETY", APART FROM THE MARK AS SHOWN.

SEC. 2(F) COUNCIL.

CLASS 9—ELECTRICAL AND SCIENTIFIC APPARATUS

FOR PRERECORDED VIDEOTAPES PROMOTING HOME SAFETY AWARENESS AND INJURY PREVENTION (U.S. CLS. 21, 23, 26, 36 AND 38).
FIRST USE 9-0-2002; IN COMMERCE 9-0-2002.

CLASS 16—PAPER GOODS AND PRINTED MATTER

FOR PRINTED PUBLICATIONS, NAMELY, BROCHURES, PAMPHLETS, NEWSLETTERS AND POSTERS IN THE AREA OF HOME SAFETY AWARENESS AND INJURY PREVENTION (U.S. CLS. 2, 5, 22, 23, 29, 37, 38 AND 50).
FIRST USE 9-0-2002; IN COMMERCE 9-0-2002.

CLASS 36—INSURANCE AND FINANCIAL

FOR CHARITABLE FUND RAISING (U.S. CLS. 100, 101 AND 102).
FIRST USE 9-0-2002; IN COMMERCE 9-0-2002.

CLASS 41—EDUCATION AND ENTERTAINMENT

FOR EDUCATIONAL SERVICES, NAMELY, CONDUCTING WORKSHOPS, SEMINARS AND CLASSES TO PROMOTE HOME SAFETY AWARENESS AND INJURY PREVENTION (U.S. CLS. 100, 101 AND 107).
FIRST USE 9-0-2002; IN COMMERCE 9-0-2002.
RONALD AIKENS, EXAMINING ATTORNEY

SN 76-536,213. MORGAN CREEK PRODUCTIONS, INC.,
BURBANK, CA. FILED 8-11-2003.

EXORCIST: THE BEGINNING

CLASS 9—ELECTRICAL AND SCIENTIFIC APPARATUS

FOR PRERECORDED MOTION PICTURE FILMS, VIDEO CASSETTES AND VIDEO DISCS ALL FEATURING DRAMA AND A DRAMATIC TELEVISION PROGRAM SERIES; PRERECORDED AUDIO TAPES, AUDIO CASSETTES AND COMPACT DISCS ALL FEATURING MUSIC AND/OR EDITED SOUND AND DIALOGUE BITES FROM DRAMATIC MOVIES BITES FROM DRAMATIC MOVIES; COMPUTER GAME PROGRAMS IN THE FIELD OF THRILLERS (U.S. CLS. 21, 23, 26, 36 AND 38).

CLASS 41—EDUCATION AND ENTERTAINMENT

FOR ENTERTAINMENT IN THE NATURE OF AN ONGOING DRAMATIC TELEVISION PROGRAM SERIES (U.S. CLS. 100, 101 AND 107).
DAVID TAYLOR, EXAMINING ATTORNEY

SN 76-539,151. THE DEVLIN GROUP, INC., JACKSONVILLE
BEACH, FL. FILED 8-21-2003.

DG THE DEVLIN GROUP

NO CLAIM IS MADE TO THE EXCLUSIVE RIGHT TO USE "GROUP", APART FROM THE MARK AS SHOWN.

CLASS 36—INSURANCE AND FINANCIAL

FOR REAL ESTATE BROKERAGE, REAL ESTATE MANAGEMENT, AND REAL ESTATE ACQUISITION SERVICES (U.S. CLS. 100, 101 AND 102).
FIRST USE 10-0-2001; IN COMMERCE 10-0-2001.

CLASS 37—CONSTRUCTION AND REPAIR

FOR REAL ESTATE DEVELOPMENT SERVICES (U.S. CLS. 100, 103 AND 106).
FIRST USE 10-0-2001; IN COMMERCE 10-0-2001.
KHANH LE, EXAMINING ATTORNEY

SN 76-539,208. DEUTSCHE MESSE AG, D-30521 HANN-
OVER, FED REP GERMANY, FILED 8-20-2003.

LIGNA⁺

PRIORITY CLAIMED UNDER SEC. 44(D) ON FED REP GERMANY APPLICATION NO. 30315970.735, FILED 3-26-2003, REG. NO. 30315970, DATED 5-26-2003, EXPIRES 5-31-2013.

OWNER OF U.S. REG. NO. 1,969,514.

CLASS 16—PAPER GOODS AND PRINTED MATTER

FOR PRINTED MATTER, NAMELY, MAGAZINES IN THE FIELD OF WOODWORKING AND WOOD PROCESSING AND IN THE FIELD OF TRADE FAIRS AND EXHIBITIONS RELATING TO WOODWORKING AND WOOD PROCESSING FOR THE FORESTRY AND WOOD INDUSTRY, CATALOGUES IN THE FIELD OF WOODWORKING AND WOOD PROCESSING AND IN THE FIELD OF TRADE FAIRS AND EXHIBITIONS RELATING TO WOODWORKING AND WOOD PROCESSING, PROSPECTUSES IN THE FIELD OF WOODWORKING AND WOOD PROCESSING AND IN THE FIELD OF TRADE FAIRS AND EXHIBITIONS RELATING TO WOODWORKING AND WOOD PROCESSING FOR THE FORESTRY AND WOOD INDUSTRY, POSTERS AND PHOTOGRAPHS; PRINTED INSTRUCTIONAL, EDUCATIONAL AND TEACHING MATERIALS IN THE FIELD OF WOODWORKING AND WOOD PROCESSING AND IN THE FIELD OF TRADE FAIRS AND EXHIBITIONS RELATING TO WOODWORKING AND WOOD PROCESSING (U.S. CLS. 2, 5, 22, 23, 29, 37, 38 AND 50).

CLASS 35—ADVERTISING AND BUSINESS

FOR ARRANGING AND CONDUCTING OF TRADE FAIRS AND EXHIBITIONS FOR COMMERCIAL OR ADVERTISING PURPOSES IN THE FIELD OF WOODWORKING AND WOOD PROCESSING FOR THE FORESTRY AND WOOD INDUSTRY; CONSULTANCY IN THE CONDUCTING AND ORGANIZATION OF COMMERCIAL EXHIBITIONS AND TRADE FAIRS; CONDUCTING AN ON-LINE TRADE SHOW EXHIBITION, IN THE FIELD OF WOODWORKING AND WOOD PROCESSING FOR THE FORESTRY AND WOOD INDUSTRY; ARRANGING AND CONDUCTING BUSINESS CONFERENCES; RENTAL OF ADVERTISING SPACE AND EXHIBITION STANDS FOR ADVERTISING PURPOSES; PUBLIC RELATIONS; DIRECT MARKETING ADVERTISING FOR OTHERS; CONDUCTING MARKET RESEARCH AND MARKET ANALYSIS; PRODUCT DEMONSTRATION FOR CULTURAL, TEACHING AND EDUCATIONAL PURPOSES (U.S. CLS. 100, 101 AND 102).

CLASS 41—EDUCATION AND ENTERTAINMENT

FOR ARRANGING AND CONDUCTING OF CONFERENCES AND SPECIAL SHOWS FOR CULTURAL, TEACHING AND EDUCATIONAL PURPOSES; CONGRESSES, SYMPOSIUMS AND COMPETITIONS FOR CULTURAL, TEACHING AND EDUCATIONAL PURPOSES; PUBLICATION OF JOURNALS, CATALOGUES, BROCHURES; ORGANIZATION, ARRANGING AND CONDUCTING OF SEMINARS, WORKSHOPS AND EXHIBITIONS FOR CULTURAL OR EDUCATIONAL PURPOSES (U.S. CLS. 100, 101 AND 107).

CLASS 43—HOTEL AND RESTAURANT SERVICES

FOR RENTAL OF EQUIPMENT FOR FLOOR SPACE AND EXHIBITION STANDS, NAMELY PARTITION WALLS, CARPETS, TABLES, CHAIRS, COAT RACKS AND RUBBISH BINS (U.S. CLS. 100 AND 101).
DAVID ELTON, EXAMINING ATTORNEY

SN 76-539,905. THYSSENKRUPP AG, 40211, DUSSELDORF, FED REP GERMANY, FILED 8-12-2003.

THYSSENKRUPP

PRIORITY CLAIMED UNDER SEC. 44(D) ON FED REP GERMANY APPLICATION NO. 30313878.507, FILED 3-14-2003, REG. NO. 30313878, DATED 7-3-2003, EXPIRES 3-31-2013.

OWNER OF U.S. REG. NOS. 907,794, 2,731,269 AND OTHERS.

CLASS 1—CHEMICALS

FOR CHEMICALS FOR USE IN THE PRODUCTION OF METALS AND THEIR ALLOYS; FOUNDRY SANDS, FOUNDRY MouldING PREPARATIONS, FOUNDRY BINDING SUBSTANCES; ADHESIVES USED IN INDUSTRY FOR GENERAL INDUSTRIAL USE (U.S. CLS. 1, 5, 6, 10, 26 AND 46).

CLASS 4—LUBRICANTS AND FUELS

FOR COAL AND COKE FUELS (U.S. CLS. 1, 6 AND 15).

CLASS 6—METAL GOODS

FOR METAL ORES; COMMON METALS AND THEIR ALLOYS AS WELL AS PRODUCTS MADE OF THE AFOREMENTIONED METALS AND ALLOYS, NAMELY OF UNMACHINED OR MACHINED BANDS, BARS, BEAMS, BILLETS, BRUSHES AND ANCHORING FILAMENTS, CABLE, CHAINS, CIRCLES, COATED WIRES, COIL FORMERS, CASTINGS, COILS, COIN BLANKS, COMPOSITE WIRES, CORD WIRES, FITTINGS AND FLANGES, FLEXIBLE PLATES, FOILS, FORGINGS, INGOTS, JOISTS, PLATES, PROFILES, RAILS, RINGS, RODS, ROPES, SANDWICH PANELS, SECTIONS, SHEETS, SLABS, SPRINGS, STRANDS, STRIPS, WELDING FILLER, WELDING WIRES, AND WIRES; CAST METAL PARTS; METAL SOLDER MATERIAL, NAMELY FILLER WIRE, FILLER RODS MADE OUT OF METAL; GOODS OF COMMON METAL NAMELY FITTINGS, CONTAINERS, ARMATURES, SPRINGS, WINDOWS, WINDOW SILLS, WINDOW FRAMES, FORGING DIES, WIRE CLOTH, GRIDS, HOOKS, CRAMPS, BEARINGS, RUNNING RAILS, NAILS, PROFILES, SPATIAL TRUSSED STRUCTURES, RINGS, LOOPS, LOCKS, SCREWS, SILOS, PINS, FRAMES FOR DOORS AND GATES, DOORS AND GATES, SUPPORTING FRAMEWORK, STAIRS, DRUMS, DOOR PANELS, DOOR HANDLES, PARTS FOR SCREW FITTINGS, ANGLES, FENCES AND PARTS THEREOF, DOOR HARDWARE; IRONMONGERY AND SMALL ITEMS OF METAL HARDWARE; PIPES AND TUBES OF METAL; NON-ELECTRIC CABLE AND WIRES OF COMMON METAL; TRANSPORTABLE BUILDINGS OF METAL; SCAFFOLDINGS AND CONSTRUCTION FORMS AND PARTS THEREOF MADE OF METAL; RAILROAD TRACKS AND POINTS MADE OF METAL; RAILWAY MATERIALS OF METAL; METAL DERAILER AND CHECK RAILS FOR RAIL BORN VEHICLES; METAL ANGLES, CRAMPS, HOOKS, NAILS, NUTS, PINS, PROFILES, SCREWS, SCREW NAILS, BRACES AND WIRE (U.S. CLS. 2, 12, 13, 14, 23, 25 AND 50).

CLASS 7—MACHINERY

FOR DRIVES FOR MACHINES; PRIMARY SHAFTS, NOT FOR VEHICLES; MOTOR DRIVEN APPARATUS AND MOTOR DRIVEN INSTALLATIONS FOR THE PRODUCTION OF FABRICATED MATERIALS OR PRODUCTS FOR THE PHARMACEUTICS INDUSTRY AND FOOD INDUSTRY, CHEMICAL INDUSTRY, FERTILIZER INDUSTRY, MAN-MADE AND SYNTHETIC FIBERS INDUSTRY, COSMETIC INDUSTRY; MECHANICAL SYNTHESIS GAS PRODUCERS EXCEPT GAS PRODUCERS FOR VEHICLES; MACHINES FOR STEAM GENERATING; MACHINES FOR PROCESSING OF ELASTOMER, GUM AND RUBBER; MACHINES FOR THE FOODSTUFF INDUSTRY; INSTALLATIONS FOR THE MANUFACTURE OF CHEMICAL PRODUCTS

CONSISTING OF STEAM REFORMING MACHINES FOR THE CHEMICAL INDUSTRY; INSTALLATIONS FOR THE MANUFACTURE OF CHEMICAL PRODUCTS, NAMELY FERTILIZERS; CONSISTING OF MACHINES FOR THE CHEMICAL INDUSTRY; APPARATUS FOR THE TREATMENT OF GASES; COMPRESSORS; PRESSURE INTENSIFIER; MACHINES FOR TREATING OF FLUIDS; MACHINES FOR THE TEXTILE INDUSTRY; ELEVATORS, ESCALATORS, MOVING SIDEWALKS, PASSENGER BRIDGES, MOVING STAIRWAYS, STAIRWAY LIFTS; PARTS OF ELEVATORS, ESCALATORS, MOVING SIDEWALKS, PASSENGER BRIDGES, MOVING STAIRWAYS, STAIRWAY LIFTS; FLUIDIZER, NAMELY APPARATUS FOR FLUIDIZING OF BULK MATERIAL BY GAS STREAMS TO SUPPORT THE FLOW PROPERTIES; ELECTRIC GENERATORS FOR DRIVING MACHINES; MACHINES FOR WINNING OF ENERGY, NAMELY POWER STATIONS; WIND, WATER, GAS OR STEAM POWERED GENERATORS FOR ELECTRICITY; INDUSTRIAL ROBOTS; METAL, WOOD AND PLASTICS WORKING MACHINES; MACHINE TOOLS FOR THE CUTTING AND FORMING OF MATERIALS; DRILLING MACHINES AND PARTS THEREOF; MACHINES FOR POSITIONING, ADJUSTING AND HOLDING OF WORK PIECES; MACHINE DRIVEN LIFTING DEVICES AND LIFTING APPARATUS; MACHINES FOR SECURING, WINNING, PREPARING AND DEMOLISHING OF MINERALS, EARTH, ROCK, EXCAVATED MATERIAL, USED MATERIALS, ORES, BOULDERS AND BRICKWORK; MACHINES FOR LOADING BULK AND UNIT MATERIAL; MACHINES FOR THE PRODUCTION OF MORTAR AND CONCRETE AND FOR THE PRODUCTION OF ASSEMBLY UNITS MADE OF THESE MATERIALS; EARTH MOVING MACHINES, NAMELY EXCAVATORS; CONVEYORS; MACHINES FOR THE TREATMENT OF METAL MELT; MACHINES FOR THE PRODUCTION OF COKE; FLAME CHIPPING INSTALLATIONS; GAS CUTTING INSTALLATIONS; MIXING MACHINES; INDUSTRIAL MACHINE MILLS; INDUSTRIAL MACHINE PRESSES; PUMPS, NAMELY, BURSTING TESTS AND PRESSURE TEST PUMPS, DOSING PUMPS, GROUND WATER PUMPS, INJECTION PUMPS, POSITIVE DISPLACEMENT PUMPS, PRESSURE GENERATORS FOR WATER-JET CUTTING PLANTS AND PRESSING PLANTS, PUMPS FOR PRESSING RAM PROFILES, RAM PILES, RAM TUBES AND SHEET PILES; INDUSTRIAL STIRRING MACHINES; MOTORS AND PARTS THEREOF, BUT NOT FOR LAND VEHICLES; TURBINES, BUT NOT FOR LAND VEHICLES, AND PARTS THEREOF; GEAR BOXES OTHER THAN FOR LAND VEHICLES AND PARTS THEREOF; DRIVES FOR DOORS; MACHINE PARTS, NAMELY, DIES AND OTHER TOOLS TO OBTAIN DEEP-DRAWN PIECES AND PARTS OF AUTOMOTIVE VEHICLES, REAMERS, JIGS AND FIXTURES; PISTON RODS AS PARTS OF MACHINES; MACHINE PARTS, NAMELY BEARINGS; CENTRIFUGES; BEARINGS FOR SUPPORTING SHIPS; RAILWAY TRACK MACHINERY (U.S. CLS. 13, 19, 21, 23, 31, 34 AND 35).

CLASS 8—HAND TOOLS

FOR HAND OPERATED LIFTING DEVICES AND LIFTING APPARATUS, NAMELY HYDRAULIC AND MECHANICAL DRIVEN JACKS, FOLDING LIFT TABLES, ELEVATING WORK PLATFORMS (U.S. CLS. 23, 28 AND 44).

CLASS 9—ELECTRICAL AND SCIENTIFIC APPARATUS

FOR APPARATUS AND INSTRUMENTS FOR CONDUCTING, SWITCHING, TRANSFORMING, ACCUMULATING, REGULATING AND CONTROLLING OF ELECTRICITY; APPARATUS FOR RECORDING, TRANSMITTING, PROCESSING AND REPRODUCING OF SOUND, IMAGES AND DATA IN ANALOG, DIGITAL, AUDIO AND VIDEO FORMATS; BLANK DATA CARRIERS; DATA PROCESSING APPARATUS AND COMPUTERS; COMPUTER SOFTWARE FOR CONTROLLING AND SIMULATING INDUSTRIAL PROCESSES; ELECTRICAL STARTERS FOR ENGINES; ELECTRICAL COLD WEATHER STARTING DEVICES; ELECTRIC WELDING APPARATUS; WELDING ELECTRODES; ELECTRICAL CABLES; FIRE EXTINGUISHING APPARATUS; CHECKING APPARATUS AND

INSTRUMENTS, NAMELY ELECTRICAL APPARATUS FOR MONITORING ELEVATORS, ESCALATORS, PASSENGER CONVEYORS, MOVING WALKS, INCLINED PLATFORMS, VERTICAL PLATFORMS, STAIRWAY LIFTS, BOARDING BRIDGES; MAGNETS; MEASURING APPARATUS AND INSTRUMENTS, NAMELY LEAK TESTERS, MEASURING APPARATUS FOR DETECTING THE POLARIZATION OF MAGNETS, DIAGNOSTIC APPARATUS FOR EVALUATING / DETERMINING ERRORS DURING OPERATION OF ELEVATORS, ESCALATORS, PASSENGER CONVEYORS, MOVING WALKS, INCLINED PLATFORMS, VERTICAL PLATFORMS, STAIRWAY LIFTS, BOARDING BRIDGES; APPARATUS FOR CONVERTING LIGHT RADIATION TO ELECTRICAL ENERGY, NAMELY PHOTO VOLTAIC SOLAR MODULES (U.S. CLS. 21, 23, 26, 36 AND 38).

CLASS 11—ENVIRONMENTAL CONTROL APPARATUS

FOR APPARATUS FOR STEAM GENERATING, NAMELY ACCUMULATORS AND GENERATORS; DISTILLING APPARATUS UNITS; HEATING AND COOLING INSTALLATIONS, APPARATUS AND MACHINES, NAMELY AIR CONDITIONERS, AIR CONDITIONING UNITS, AIR FILTERS, AIR PURIFIERS, BATTERY WARMERS, CAR INTERIOR WARMERS, COOLERS, ENGINE HEATERS, ENGINE WARMING UNITS, FUEL WARMERS, HEAT EXCHANGERS, HEATERS FOR ENGINE OIL, RADIATOR HOSE HEATERS, VEHICLE OIL PAN HEATERS, VEHICLE TANK HEATERS, VENTILATORS, ALL FOR COMMERCIAL, DOMESTIC AND INDUSTRIAL USE; DRYING INSTALLATIONS AND MACHINES, NAMELY INDUSTRIAL DRYERS FOR DEHUMIDIFYING; MACHINES FOR THE THERMAL TREATMENT OF WASTE MATERIALS; FURNACES FOR INDUSTRIAL USE; SOLAR COLLECTORS (U.S. CLS. 13, 21, 23, 31 AND 34).

CLASS 12—VEHICLES

FOR VEHICLES AND APPARATUS FOR LOCOMOTION BY LAND, WATER OR AIR; PARTS OF VEHICLES AND APPARATUS FOR LOCOMOTION BY LAND, WATER OR AIR; CAR BODIES MADE OF METAL; DRIVES FOR VEHICLES; PARTS OF DRIVES FOR VEHICLES; PLASTIC PREFORMED PARTS FOR THE CONSTRUCTION OF CARS (U.S. CLS. 19, 21, 23, 31, 35 AND 44).

CLASS 16—PAPER GOODS AND PRINTED MATTER

FOR OFFICE SUPPLIES, WITH THE EXCEPTION OF OFFICE FURNITURE, NAMELY, STATIONERY, STATIONERY PAPER, CARDBOARD AND GOODS MADE FROM THESE, NAMELY, CARDBOARD BOXES, CARDBOARD MAILING TUBES, CARDBOARD CARTONS; ADHESIVES FOR PAPER PRODUCTS AND STATIONERY AND/OR FOR HOUSEHOLD PURPOSES; PHOTOGRAPHS; PRINTERS TYPE, PRINTING BLOCKS; PRINTED MATTER NAMELY BOOKS, MANUALS, JOURNALS AND NEWSLETTERS IN THE FIELDS OF ADVERTISEMENT, ELECTRONIC COMMUNICATION, DATA STORAGE AND RETRIEVAL, OFFICE, BUSINESS MANAGEMENT, ADVERTISING, INDUSTRY, MATERIALS AND EDUCATION; PLASTIC MATERIALS FOR PACKAGING, NAMELY PACKAGING ARTICLES TO THE ORDER AND SPECIFICATION OF OTHERS (U.S. CLS. 2, 5, 22, 23, 29, 37, 38 AND 50).

CLASS 17—RUBBER GOODS

FOR PLASTIC PRODUCTS, NAMELY NON-METAL TUBING, TUBING COUPLINGS FOR JOINING AND TERMINATING PIPES; PLASTIC SEMI-FINISHED PRODUCTS, NAMELY BARS, BEAMS, BILLETS, BLOCKS, CASTINGS, CHAINS, CIRCLES, EXTRUDED PARTS, FITTINGS AND FLANGES, FOILS, JOISTS, LIGHT CUP GLASS, PANELS, PELLETS, PLATES, PROFILES, RAILS, RINGS, RODS, ROPES, SANDWICH PANELS, SECTIONS, SHEETS, SHIELDS, SLABS, SPRINGS, STRANDS, STRIPS, TUBES, TUBULARS, WAINSCOTS, ALL AFOREMENTIONED GOODS FOR USE IN MANUFACTURING, BUILDING AND GARDENING; STOPPING, PACKING AND INSULATING MATERIALS, NAMELY NON METAL MATERIALS FOR PACKING, NON METAL STOPPING AND INSULATING WALL-, CEILING- AND ROOF-CONSTRUCTION-ELEMENTS, NON METAL GASKETS FOR USE IN DOORS, WINDOWS, COOLING AND AIR CONDITIONING ROOMS; PLASTIC FOILS OTHER THAN FOR PACKAGING; ADHESIVE BANDS, NAMELY ADHESIVE PACKING TAPE FOR INDUSTRIAL OR COMMERCIAL USE; FILLERS FOR WELDING OF PLASTICS IN THE FORM OF WIRE, POWDER OR GRANULATE (U.S. CLS. 1, 5, 12, 13, 35 AND 50).

CLASS 19—NON-METALLIC BUILDING MATERIALS

FOR ASPHALT, PITCH AND BITUMEN; BUILDING MATERIALS, NAMELY WALL, HARDWOOD, DECKING, WOOD, PARTICLE BOARDS AND OTHER NON-METAL BUILDING MATERIAL, NAMELY, ANGLES, BLOCKS, BOLTS, CEILING- AND ROOF-CONSTRUCTION-ELEMENTS, CRAMP, DOORS, FASTENERS FOR FASTENING RAILS, FITTINGS, FRAMEWORKS, GATES, HOOKS, LIGHT CUP GLASS, NAILS, PANELS, PINS, PLATES, PLUMBING NAILS, PROFILES, RAIL CLIPS, RODS, SCREW NAILS, SCREWS, SHAPED PINS, SHIELDS, SPRING WASHERS, TRUSSED STRUCTURES, TUBES, WAINSCOTS, WALL-, CEILING- AND ROOF-PANELS, WALLS FOR BUILDING, WINDOWS, WIRE; SCAFFOLDINGS AND CONSTRUCTION FORMS AND PARTS THEREOF NOT MADE OF METAL; NON-METAL WINDOWS; SEALS FOR WINDOWS; WINDOW SILLS NOT MADE OF METAL; DOOR AND GATE FRAMINGS, NOT MADE OF METAL; NON-METAL PROFILES FOR WINDOWS, DOORS, SHUTTERS AND FAÇADES; DOOR PANELS NOT OF METAL; DOOR HANDLE NOT OF METAL; LIGHT WELLS NOT MADE OF METAL; NON METAL DRAINAGE BOXES; REFRACTORY RAW MATERIALS, NAMELY, REFRACTORY BLOCKS, REFRACTORY BRICKS, REFRACTORY CAST ABLE MIXES, REFRACTORY FURNACE LININGS, REFRACTORY MORTARS; REFRACTORY RAW MATERIALS FOR THE PRODUCTION OF BLOCKS AND REFRACTORY SHAPES; RAILROAD TIES NOT MADE OF METAL; DOORS AND GATES NOT OF METAL; TRANSPORTABLE BUILDINGS NOT OF METAL; STAIRS NOT MADE OF METAL; PREFABRICATED SIDE RAILS FOR BALCONIES NOT MADE OF METAL; FENCES AND PARTS THEREOF NOT MADE OF METAL; TANKS MADE OUT OF BRICK WORK; PLASTIC PREFORMED PARTS FOR THE CONSTRUCTION OF BUILDINGS (U.S. CLS. 1, 12, 33 AND 50).

CLASS 20—FURNITURE AND ARTICLES NOT OTHERWISE CLASSIFIED

FOR PACKAGING CONTAINERS NOT MADE OF METAL; TANKS NOT MADE OF METAL AND NOT MADE OF BRICK WORK; SIGNBOARDS OF PLASTICS; ANGLES, CRAMPS, HOOKS, NAILS, NUTS, PINS, SCREWS, SCREW NAILS, BRACES AND WIRE NOT MADE OF METAL (U.S. CLS. 2, 13, 22, 25, 32 AND 50).

CLASS 35—ADVERTISING AND BUSINESS

FOR PERSONNEL MANAGEMENT AND RECRUITING CONSULTATION SERVICES; TEMPORARY EMPLOYEE ASSIGNMENT; BUSINESS MANAGEMENT CONSULTANCY AND ORGANIZATION CONSULTANCY; BUSINESS MANAGEMENT ANALYSIS OF BUSINESS PROCESSES; BUSINESS MANAGEMENT; BUSINESS ADMINISTRATION; INVESTIGATIONS INTO BUSINESS MATTERS; BOOKKEEPING; OFFICE FUNCTIONS, NAMELY PHOTOCOPYING AND TELEPHONE ANSWERING SERVICES; COLLECTION, PROVISION AND TRANSMISSION OF INFORMATION, TEXTS, DRAWINGS AND IMAGES, NEWS AND DATA RELATED TO BUSINESS AFFAIRS; PROVIDING STATISTICAL INFORMATION FOR BUSINESS AND COMMERCIAL PURPOSES; NEGOTIATING AND CONCLUDING BUSINESS FOR OTHERS; BUSINESS MARKETING CONSULTATION, BUSINESS MARKETING CONSULTING SERVICES, CONDUCTING MARKETING STUDIES; ADVERTISING, NAMELY AGENCY SERVICES, DIRECT MAIL ADVERTISING, DISTRIBUTION OF GOODS FOR ADVERTISING PURPOSES; MARKET RESEARCH AND ANALYSIS; OPINION POLLING; ORGANIZATION OF FAIRS AND EXHIBITIONS FOR COMMERCIAL OR ADVERTISING PURPOSES IN THE AUTOMOBILE BUSINESS, FASHION BUSINESS, THE STEEL BUSINESS AND THE MACHINERY BUSINESS; RENTAL OF OFFICE MACHINES AND EQUIPMENT; MANAGEMENT OF PERFORMING ARTISTS; RELOCATION SERVICES; ARTISTS' AGENCY; WHOLESALE DISTRIBUTORSHIP FEATURING PRE-RECORDED VIDEOS (U.S. CLS. 100, 101 AND 102).

CLASS 36—INSURANCE AND FINANCIAL

FOR FINANCIAL AFFAIRS, NAMELY FINANCIAL ANALYSIS AND CONSULTATION, FINANCIAL MANAGEMENT, FINANCIAL PLANNING; FINANCING SERVICES; FINANCIAL SPONSORING, NAMELY FINANCIAL SPONSORSHIP OF SPORTS ACTIVITIES, SPORTSMAN AND -WOMEN; REAL ESTATE AFFAIRS, NAMELY, FACILITY MANAGEMENT, REAL ESTATE AGENCIES, REAL ESTATE APPRAISAL, REAL ESTATE ACQUISITION SERVICES, REAL ESTATE BROKERAGE, REAL ESTATE INVESTMENT, REAL ESTATE MANAGEMENT, REAL ESTATE PROCUREMENT FOR OTHERS, REAL ESTATE SYNDICATION, REAL ESTATE TRUSTEE SERVICES; LEASING SERVICES; INSURANCE, NAMELY, INSURANCE ADMINISTRATION, SERVICES OF AN INSURANCE AGENCY; BROKERAGE OF AIRTIMES IN RADIO, TELEVISION, VIDEO AND FILM PROGRAMS (U.S. CLS. 100, 101 AND 102).

CLASS 37—CONSTRUCTION AND REPAIR

FOR BUILDING CONSTRUCTION; RENTAL OF SCAFFOLDS, CONSTRUCTION FORMS, STAGES AND CONSTRUCTION MACHINES; SCAFFOLDING ERECTION AND REPAIR; PAINTING SERVICES; RENTAL OF BUILDING MACHINES; TECHNOLOGY, NAMELY PLANNING AND CONSTRUCTION OF INDUSTRIAL PLANTS TO THE ORDER OF OTHERS; RENTAL OF INDUSTRIAL MACHINES; REPAIR AND MAINTENANCE OF BUILDINGS AND CONNECTED SUPPLY INSTALLATIONS; CLEANING OF BUILDINGS; INSTALLATION, MAINTENANCE AND REPAIR OF ELEVATORS, ESCALATORS, MOVING SIDEWALKS, PASSENGER BRIDGES, MOVING STAIRWAYS, STAIRWAY LIFTS; INSTALLATION, MAINTENANCE AND REPAIR OF EQUIPMENT AND APPARATUS FOR USE IN MINING, OPEN PIT MINING, QUARRYING, WORKING ON ORES AND COAL, DESTRUCTION AND ROAD BUILDING; INSTALLATION, MAINTENANCE AND REPAIR OF BUILDINGS; INSTALLATION, MAINTENANCE AND REPAIR OF CHASSIS-PARTS AND BODIES FOR VEHICLES; INSTALLATION, MAINTENANCE AND REPAIR OF INDUSTRIAL MACHINERY AND MANUFACTURING PLANTS; INSTALLATION, MAINTENANCE AND REPAIR OF TELECOMMUNICATIONS EQUIPMENT; INSTALLATION, MAINTENANCE AND REPAIR OF MODULES AND SYSTEMS FOR DRIVING AND RUNNING OF VEHICLES; INSTALLATION, MAINTENANCE AND REPAIR OF VEHICLES; INSTALLATION, MAINTENANCE AND REPAIR OF THE TECHNICAL EQUIPMENT INSTALLED IN BUILDINGS; INSTALLATION, MAINTENANCE AND REPAIR

OF TRANSPORTABLE BUILDINGS, SPACE CABINS, COOLING AND AIR CONDITION ROOMS AND THEIR PARTS; INSTALLATION, MAINTENANCE AND REPAIR OF FENCE AND DOOR INSTALLATIONS; INSTALLATION, MAINTENANCE AND REPAIR OF TRACKS; INSTALLATION, MAINTENANCE AND REPAIR OF VEHICLES; CONSTRUCTION OF PROTOTYPES; COLLECTION, PROVISION AND TRANSMISSION OF INFORMATION, TEXTS, DRAWINGS AND IMAGES, NEWS AND DATA RELATED TO REPAIR SERVICES AND INSTALLATION SERVICES OF GOODS (U.S. CLS. 100, 103 AND 106).

CLASS 38—COMMUNICATION

FOR BROADCASTING SERVICES, NAMELY AUDIO, VIDEO, CABLE AND WIRELESS BROADCASTING; COORDINATION AND PROVISION OF INTERNET AND INTRANET SERVICES, NAMELY, PROVIDING MULTIPLE USER ACCESS TO A GLOBAL OR INTERNAL COMPUTER NETWORK; ELECTRONIC MAIL SERVICES, PROVIDING TELECOMMUNICATIONS CONNECTIONS TO A GLOBAL COMPUTER NETWORK; PROVIDING MULTIPLE USER ACCESS TO A GLOBAL COMPUTER INFORMATION DATA NETWORK; TELECOMMUNICATION, NAMELY, OPERATION OF TELECOMMUNICATION NETWORKS; RENTAL OF TELECOMMUNICATIONS EQUIPMENT (U.S. CLS. 100, 101 AND 104).

CLASS 39—TRANSPORTATION AND STORAGE

FOR TRANSPORTATION SERVICES, NAMELY TRANSPORT OF PERSONS AND PEOPLE BY RAIL, BOAT, AUTOMOBILES, TRUCKS AND AIRPLANE; PACKAGING, STORAGE AND LOGISTIC SERVICES, NAMELY PACKAGING, STORAGE AND LOGISTICS MANAGEMENT IN THE FIELD OF INDUSTRIAL PARTS AND MATERIALS FOR USE IN INDUSTRY, METAL AND NON METAL PRODUCTS, MACHINES AND MACHINE PARTS, VEHICLES AND VEHICLES PARTS; TRANSPORTATION LOGISTICS AND REVERSE LOGISTICS SERVICES, NAMELY ARRANGING THE TRANSPORTATION OF GOODS FOR OTHERS; STORAGE, TRANSPORTATION AND DELIVERY OF DOCUMENTS, PACKAGES, RAW MATERIALS AND OTHER FREIGHT FOR OTHERS BY RAIL, BOAT, AUTOMOBILES, TRUCKS AND AIRPLANE; PUBLIC UTILITY SERVICES IN THE NATURE OF WATER DISTRIBUTION (U.S. CLS. 100 AND 105).

CLASS 40—MATERIAL TREATMENT

FOR PROTOTYPE FABRICATION OF NEW PRODUCTS FOR OTHERS; TREATMENT OF MATERIALS, NAMELY MANUFACTURE OF METAL PRODUCTS TO THE ORDER AND / OR CONSTRUCTION OF OTHERS IN INDUSTRY, METAL FABRICATION AND MACHINING SERVICES, NAMELY FORMING OF METAL SHEETS, LASER WELDING AND CUTTING FOR OTHERS IN INDUSTRY, TREATMENT AND MACHINING OF METAL AND PLASTICS FOR OTHERS, TREATMENT OF SURFACES OF WORK PIECES TO THE ORDER OF OTHERS, HEAT TREATING OF METAL OR PLASTIC MATERIAL FOR OTHERS; MANUFACTURE OF CAR BODIES TO THE ORDER OF OTHERS; MANUFACTURE OF MACHINE TOOLS TO THE ORDER OF OTHERS; TREATMENT OF WASTE AND HARMFUL SUBSTANCES, RECYCLING OF WASTE AND TRASH; HAZARDOUS WASTE MANAGEMENT SERVICES, NAMELY ASSESSMENT AND ANALYTICAL SERVICES RELATED TO REMEDIATION AND HAZARDOUS WASTE TREATMENT; HAZARDOUS WASTE MANAGEMENT SERVICES, NAMELY, REMEDIATION, DESIGN, CLEANING UP AND MANAGEMENT OF HAZARDOUS WASTE SITES, ENVIRONMENTAL REMEDIATION SITES, HAZARDOUS WASTE STORAGE SITES AND HAZARDOUS WASTE AND CHEMICAL DISPOSAL SITES; PRINTING SERVICES (U.S. CLS. 100, 103 AND 106).

CLASS 41—EDUCATION AND ENTERTAINMENT

FOR ORGANIZING SPORTING AND CULTURAL EVENTS; PRODUCTION OF RADIO AND TELEVISION PROGRAMS; PRODUCTION AND DISTRIBUTION OF MOTION PICTURE FILMS; PUBLICATION OF BOOKS, MAGAZINES, NEWSPAPERS AND JOURNALS; RENTAL OF BOOKS, MAGAZINES, NEWSPAPERS; RENTAL OF RADIOS, TELEVISIONS, VIDEO RECORDERS, FILMING EQUIPMENT, CD, TAPE AND DVD PLAYERS AND RECORDERS; RENTAL OF PHOTOGRAPHIC EQUIPMENT, NAMELY, CAMERAS; COLLECTION, PROVIDING INFORMATION, TEXTS, DRAWINGS AND IMAGES, NEWS AND DATA RELATED TO ENTERTAINMENT AND EDUCATION; TRANSLATION SERVICES; PHOTOGRAPHIC COMPOSITION SERVICES FOR OTHERS (U.S. CLS. 100, 101 AND 107).

CLASS 42—SCIENTIFIC, COMPUTER AND LEGAL SERVICES

FOR ARCHITECT SERVICES; TOWN AND CITY PLANNING SERVICES; CIVIL ENGINEER SERVICES; SERVICES OF A MINING ENGINEER; ENGINEERING SERVICES; INTERIOR DECORATING SERVICES; SERVICES OF A MEDIA CONSULTANT, NAMELY CONSULTATION IN THE FIELD OF ELECTRONIC MEDIA; SERVICES OF A PHYSICIST; SERVICES OF A SOFTWARE PROGRAMMER; SERVICES OF AN ENGINEER ENGAGED IN STATISTICAL CALCULATIONS; SERVICES OF A TECHNICAL DRAFTSMAN; SERVICES OF A SURVEYOR; MATERIAL TESTING; RECULTIVATION OF INDUSTRIAL WASTELANDS, NAMELY AGRICULTURAL, HORTICULTURAL AND FORESTRY SERVICES RELATING TO THE RECULTIVATION OF INDUSTRIAL WASTELANDS; TECHNICAL ADVICE SERVICES IN THE FIELD OF COMPUTERS; INSTALLATION AND MAINTENANCE OF COMPUTER SOFTWARE; RENTAL OF DATA PROCESSING EQUIPMENT AND COMPUTERS; RENTAL OF COMPUTERS; HORTICULTURAL AND FORESTRY CONSULTING SERVICES; TECHNICAL CONSULTATION AND RESEARCH IN THE FIELD OF IT INFRASTRUCTURE AND PROJECTING AND PLANNING OF INSTALLATION AND APPARATUS FOR TELECOMMUNICATIONS (U.S. CLS. 100 AND 101).

CLASS 43—HOTEL AND RESTAURANT SERVICES

FOR RESTAURANT SERVICES FOR PROVIDING FOOD AND DRINK; TEMPORARY ACCOMMODATIONS, NAMELY HOTELS, MOTELS, LONG TERM TEMPORARY RESIDENCES (U.S. CLS. 100 AND 101).

CLASS 44—MEDICAL, BEAUTY AND AGRICULTURAL SERVICES

FOR LANDSCAPE GARDENING SERVICES; LANDSCAPE GARDENING PLANNING AND DESIGN FOR OTHERS (U.S. CLS. 100 AND 101).

CLASS 45—PERSONAL SERVICES

FOR SECURITY GUARD SERVICES FOR THE PROTECTION OF PROPERTY AND INDIVIDUALS (U.S. CLS. 100 AND 101).
PAULA MAHONEY, EXAMINING ATTORNEY

SN 76-540,860. AMERICAN HEART ASSOCIATION, INC., DALLAS, TX. FILED 8-27-2003.

HEARTSAVER CPR IN SCHOOLS

OWNER OF U.S. REG. NO. 1,495,740.
NO CLAIM IS MADE TO THE EXCLUSIVE RIGHT TO USE "CPR IN SCHOOLS", APART FROM THE MARK AS SHOWN.

CLASS 9—ELECTRICAL AND SCIENTIFIC APPARATUS

FOR EDUCATIONAL MATERIALS, NAMELY, PRE-RECORDED VIDEOTAPES FOR USE IN TEACHING STEPS FOR PERFORMING CARDIOPULMONARY RESUSCITATION (CPR) AND EMERGENCY ACTIONS FOR CHOKING, AS WELL AS CHILD SAFETY AND INJURY PREVENTION, SIGNS AND SIGNALS OF CARDIAC ARREST AND STROKE, AND AUTOMATED EXTERNAL DEFIBRILLATION (U.S. CLS. 21, 23, 26, 36 AND 38).
FIRST USE 4-0-2001; IN COMMERCE 4-0-2001.

CLASS 16—PAPER GOODS AND PRINTED MATTER

FOR EDUCATIONAL MATERIALS, NAMELY, BOOKS FOR USE IN TEACHING STEPS FOR PERFORMING CARDIOPULMONARY RESUSCITATION (CPR) AND EMERGENCY ACTIONS FOR CHOKING, AS WELL AS CHILD SAFETY AND INJURY PREVENTION, SIGNS AND SIGNALS OF CARDIAC ARREST AND STROKE, AND AUTOMATED EXTERNAL DEFIBRILLATION (U.S. CLS. 2, 5, 22, 23, 29, 37, 38 AND 50).
FIRST USE 4-0-2001; IN COMMERCE 4-0-2001.

CLASS 35—ADVERTISING AND BUSINESS

FOR PROMOTING PUBLIC AWARENESS OF THE NEED FOR CARDIOPULMONARY RESUSCITATION (CPR) EDUCATION IN SCHOOLS AND THE DISTRIBUTION OF INFORMATION AND MATERIALS RELATED THERETO (U.S. CLS. 100, 101 AND 102).
FIRST USE 4-0-2001; IN COMMERCE 4-0-2001.
NANCY CLARKE, EXAMINING ATTORNEY

SN 76-542,368. RELLEK PUBLISHING PARTNERS, LLC, AUSTIN, TX. FILED 9-3-2003.

MILLIONAIRE REAL ESTATE AGENT

NO CLAIM IS MADE TO THE EXCLUSIVE RIGHT TO USE REAL ESTATE AGENT, APART FROM THE MARK AS SHOWN.

CLASS 35—ADVERTISING AND BUSINESS

FOR ON-LINE RETAIL STORE SERVICES FEATURING BOOKS (U.S. CLS. 100, 101 AND 102).
FIRST USE 2-15-2003; IN COMMERCE 2-15-2003.

CLASS 41—EDUCATION AND ENTERTAINMENT

FOR CONDUCTING WORKSHOPS AND SEMINARS IN THE FIELD OF REAL ESTATE (U.S. CLS. 100, 101 AND 107).
FIRST USE 2-28-2003; IN COMMERCE 2-28-2003.
STEVEN R. FINE, EXAMINING ATTORNEY

SN 76-543,894. ASPECTS SOFTWARE LIMITED, BROADSTONE, DORSET, BH18 8AT, UNITED KINGDOM, FILED 9-10-2003.



PRIORITY CLAIMED UNDER SEC. 44(D) ON UNITED KINGDOM APPLICATION NO. 3110442, FILED 3-15-2003, REG. NO. 003110442, DATED 4-11-2005, EXPIRES 3-15-2013. THE STIPPLING IS INTENDED TO INDICATE SHADING.

CLASS 9—ELECTRICAL AND SCIENTIFIC APPARATUS

FOR TELECOMMUNICATION SMART CARDS CONTAINING PROGRAMMING USED IN THE OPERATION OF MOBILE PHONES; CARDS WITH EMBEDDED AND INTEGRATED CIRCUITS, NAMELY, ENCODED SMART CARDS PROGRAMMED FOR RECORDING, TRANSMITTING, AND REPRODUCING SOUND AND IMAGES AND FOR PROVIDING SECURITY IN MOBILE TELEPHONE SERVICES; DATA PROCESSING EQUIPMENT, ELECTRONIC DATA PROCESSING EQUIPMENT, NAMELY A CENTRAL PROCESSING UNIT, A SMART CARD READER AND A SMART CARD WRITER, ALL FOR USE IN TESTING AND/OR OPERATING SMART CARDS AND THEIR INTERFACE WITH MOBILE PHONES; MOBILE TELEPHONES; COMPUTER PROGRAMS AND SOFTWARE FOR USE IN CONJUNCTION WITH SMART CARDS FOR FACILITATING COMMUNICATIONS AND TRANSACTIONS ON TELECOMMUNICATIONS NETWORKS, NAMELY, COMPUTER SOFTWARE FOR MOBILE TELEPHONE SECURITY APPLICATIONS; MOBILE PHONE SECURITY PRODUCTS AND SOFTWARE, NAMELY, ENCODED SMART CARDS PROGRAMMED WITH SOFTWARE FOR MOBILE TELEPHONE SECURITY APPLICATIONS AND SMART CARD OPERATING SOFTWARE; COMPUTER SOFTWARE AND TELECOMMUNICATIONS APPARATUS TO ENABLE CONNECTION TO DATABASES AND THE INTERNET, NAMELY, SMART CARDS AND OPERATING SOFTWARE THEREFOR; ALL FOR APPLICATION DEVELOPMENT AND TEST TOOLS AND OPERATING SYSTEMS FOR SMART CARDS; DOWNLOADABLE ELECTRONIC PUBLICATIONS NAMELY, MANUALS FEATURING INFORMATION ON APPLICATION DEVELOPMENT AND TEST TOOLS AND OPERATING SYSTEMS FOR SMART CARDS (U.S. CLS. 21, 23, 26, 36 AND 38).

CLASS 38—COMMUNICATION

FOR TELECOMMUNICATION OF INFORMATION IN THE FORM OF WEB PAGES, NAMELY, TRANSFER OF WEB-PAGE DATA BY TELECOMMUNICATIONS (U.S. CLS. 100, 101 AND 104).

CLASS 42—SCIENTIFIC, COMPUTER AND LEGAL SERVICES

FOR APPLICATION AND DEVELOPMENT AND TEST TOOLS AND OPERATING SYSTEMS FOR SMART CARDS, NAMELY, DESIGN, RENTAL, MAINTENANCE AND PROGRAMMING OF COMPUTER SOFTWARE AND COMPUTER PROGRAMS; COMPUTER PROGRAMMING SERVICES FOR FACILITATING COMMUNICATIONS AND TRANSACTIONS OVER TELECOMMUNICATION NETWORKS AND THE INTERNET AND ON ON-LINE SERVICES (U.S. CLS. 100 AND 101).

CLASS 45—PERSONAL SERVICES

FOR IDENTIFICATION VERIFICATION SERVICES, NAMELY, ELECTRONIC IDENTIFICATION OF CALLERS TO MOBILE PHONES (U.S. CLS. 100 AND 101).
MICHAEL WEBSTER, EXAMINING ATTORNEY

SN 76-546,169. PIAA CORPORATION, TOKYO, JAPAN, FILED 9-22-2003.

PIAA

OWNER OF U.S. REG. NOS. 1,422,723, 1,447,345 AND 1,467,189.

CLASS 11—ENVIRONMENTAL CONTROL APPARATUS

FOR AUTOMOBILE, BUS, TRUCK, MOTORCYCLE AND TRACTOR LIGHTS, NAMELY HEADLIGHTS, TAIL LIGHTS, TURN SIGNAL INDICATOR LIGHTS, SIDE OR WIDTH LIGHTS, FRONT DASHBOARD LIGHTS, REAR DASHBOARD LIGHTS, FOG LIGHTS; AND ELECTRIC DECORATIVE LIGHTS FOR AUTOMOBILES, BUSES, TRUCKS, MOTORCYCLES, AND TRACTORS, NAMELY, DECORATIVE COLORED HEADLIGHTS, TAIL LIGHTS, TURN SIGNAL INDICATOR LIGHTS, SIDE OR WIDTH LIGHTS, FRONT DASHBOARD LIGHTS, REAR DASHBOARD LIGHTS, FOG LIGHTS; AND ELECTRIC LIGHT DECORATIVE STRINGS FOR ATTACHMENT TO AUTOMOBILES, BUSES, TRUCKS, MOTORCYCLES, AND TRACTORS (U.S. CLS. 13, 21, 23, 31 AND 34).

FIRST USE 9-5-2001; IN COMMERCE 9-5-2001.

CLASS 12—VEHICLES

FOR AUTOMOBILE, BUS, TRUCK, TRACTOR, AND MOTORCYCLE WINDSHIELD WIPER BLADES AND REPLACEMENT WINDSHIELD WIPER BLADES; CARGO CARRIERS FOR VEHICLES FOR MOUNTING ON THE ROOFS OF AUTOMOBILES, BUSES, TRUCKS, AND TRACTORS; PARTS AND ACCESSORIES FOR AUTOMOBILES, TRUCKS, TRACTORS, BUSES AND MOTORCYCLES, NAMELY WHEEL COVERS, STEERING WHEELS, AND TIRE SNOW CHAINS (U.S. CLS. 19, 21, 23, 31, 35 AND 44).

FIRST USE 9-5-2001; IN COMMERCE 9-5-2001.

TONI HICKEY, EXAMINING ATTORNEY

SN 76-546,648. OKUN, LORRAINE, LEDGEWOOD, NJ, FILED 9-24-2003.

JOKER POKER LADY

THE MARK CONSISTS OF STANDARD CHARACTERS WITHOUT CLAIM TO ANY PARTICULAR FONT, STYLE, SIZE, OR COLOR.

NO CLAIM IS MADE TO THE EXCLUSIVE RIGHT TO USE "JOKER POKER", APART FROM THE MARK AS SHOWN.

CLASS 16—PAPER GOODS AND PRINTED MATTER

FOR MERCHANDISE RELATED TO THE CASINO INDUSTRY, NAMELY, STICKERS, STATIONARY, PENS, PENCILS, GREETING CARDS AND GIFT CARDS (U.S. CLS. 2, 5, 22, 23, 29, 37, 38 AND 50).

CLASS 35—ADVERTISING AND BUSINESS

FOR SERVICES RELATED TO THE CASINO INDUSTRY, NAMELY, BUSINESS MARKETING CONSULTING SERVICES, PROMOTING THE GOODS AND SERVICES OF OTHERS THROUGH ON-LINE ORDERING AND CATALOGING OF THOSE GOODS AND SERVICES, AND RETAIL SHOPS FEATURING CASINO-RELATED MERCHANDISE (U.S. CLS. 100, 101 AND 102).

JIM RINGLE, EXAMINING ATTORNEY

SN 76-547,802. ALI S.P.A., ANZOLA EMILIA (PROVINCE OF BOLOGNA), ITALY, FILED 9-25-2003.



PRIORITY CLAIMED UNDER SEC. 44(D) ON ERPN CMNTY TM OFC APPLICATION NO. 003177763, FILED 4-25-2003, REG. NO. 003177763, DATED 11-11-2004, EXPIRES 4-25-2013.

OWNER OF U.S. REG. NO. 2,468,627.

CLASS 7—MACHINERY

FOR NON-REFRIGERATED MACHINES FOR MAKING AND DISPENSING ICE CREAM, WHIPPED CREAM, SOFT ICE CREAM AND BEVERAGES, FOR HOUSEHOLD, INDUSTRIAL OR COMMERCIAL USE (U.S. CLS. 13, 19, 21, 23, 31, 34 AND 35).

CLASS 9—ELECTRICAL AND SCIENTIFIC APPARATUS

FOR BEVERAGE VENDING MACHINES (U.S. CLS. 21, 23, 26, 36 AND 38).

CLASS 11—ENVIRONMENTAL CONTROL APPARATUS

FOR REFRIGERATED MACHINES FOR MAKING AND DISPENSING ICE CREAM, WHIPPED CREAM, SOFT ICE CREAM AND BEVERAGES FOR DOMESTIC, COMMERCIAL AND INDUSTRIAL USE (U.S. CLS. 13, 21, 23, 31 AND 34).

MARIA-VICTORIA SUAREZ, EXAMINING ATTORNEY

SN 76-547,806. ALI S.P.A., ANZOLA EMILIA (PROVINCE OF BOLOGNA), ITALY, FILED 9-25-2003.



OWNER OF ERPN CMNTY TM OFC REG. NO. 003269891, DATED 1-17-2005, EXPIRES 7-14-2013.

OWNER OF U.S. REG. NOS. 796,337, 2,361,256 AND 2,608,379.

NO CLAIM IS MADE TO THE EXCLUSIVE RIGHT TO USE GELATO - ICE CREAM & FROZEN DESSERT, APART FROM THE MARK AS SHOWN.

CLASS 7—MACHINERY

FOR NON-REFRIGERATED MACHINES FOR MAKING AND DISPENSING ICE CREAM, WHIPPED CREAM, SOFT ICE CREAM AND BEVERAGES, FOR HOUSEHOLD, INDUSTRIAL OR COMMERCIAL USE (U.S. CLS. 13, 19, 21, 23, 31, 34 AND 35).

CLASS 11—ENVIRONMENTAL CONTROL APPARATUS

FOR REFRIGERATED MACHINES FOR MAKING AND DISPENSING ICE CREAM, WHIPPED CREAM, SOFT ICE CREAM AND BEVERAGES FOR DOMESTIC, COMMERCIAL AND INDUSTRIAL USE; PASTEURIZERS AND REFRIGERATORS FOR DOMESTIC, COMMERCIAL AND INDUSTRIAL USE (U.S. CLS. 13, 21, 23, 31 AND 34).

MARIA-VICTORIA SUAREZ, EXAMINING ATTORNEY

SN 76-547,924. VERBAND HANNOVERSCHER WARMBLUTZUCHTER E.V., VERDEN, FED REP GERMANY, FILED 9-29-2003.

HANNOVERANER

OWNER OF U.S. REG. NO. 1,192,878.
SEC. 2(F).

CLASS 16—PAPER GOODS AND PRINTED MATTER

FOR PERIODICALS, NAMELY AUCTION CATALOGS (U.S. CLS. 2, 5, 22, 23, 29, 37, 38 AND 50).

FIRST USE 1-1-1928; IN COMMERCE 1-1-1946.

CLASS 31—NATURAL AGRICULTURAL PRODUCTS

FOR LIVESTOCK, NAMELY HORSES (U.S. CLS. 1 AND 46).

FIRST USE 1-1-1928; IN COMMERCE 1-1-1946.

CLASS 35—ADVERTISING AND BUSINESS

FOR AUCTION SERVICES NAMELY THE AUCTIONING OF HORSES AND RELATED EQUIPMENT VIA TELEPHONE AND LIVE (U.S. CLS. 100, 101 AND 102).

FIRST USE 1-1-1928; IN COMMERCE 1-1-1946.

CLASS 39—TRANSPORTATION AND STORAGE

FOR ARRANGING FOR TRAVEL VISAS, PASSPORTS, AND TRAVEL DOCUMENTS FOR ANIMALS, NAMELY HORSES, TRAVELING ABROAD (U.S. CLS. 100 AND 105).

FIRST USE 1-1-1928; IN COMMERCE 1-1-1946.

CLASS 42—SCIENTIFIC, COMPUTER AND LEGAL SERVICES

FOR AUTHENTICATION IN THE FIELD OF HORSES (U.S. CLS. 100 AND 101).

FIRST USE 1-1-1928; IN COMMERCE 1-1-1946.

CLASS 44—MEDICAL, BEAUTY AND AGRICULTURAL SERVICES

FOR HORSE BREEDING AND STUD SERVICES (U.S. CLS. 100 AND 101).

FIRST USE 1-1-1928; IN COMMERCE 1-1-1946.

PAULA MAYS, EXAMINING ATTORNEY

SN 76-550,038. HIGH LINER FOODS INCORPORATED, LUNEBURG, NOVA SCOTIA BOJ 2CO, CANADA, FILED 9-22-2003.

IT'S A GOOD NIGHT FOR FISH

PRIORITY CLAIMED UNDER SEC. 44(D) ON CANADA APPLICATION NO. 1184100, FILED 7-24-2003, REG. NO. TMA641733, DATED 6-9-2005, EXPIRES 6-9-2020.

CLASS 29—MEATS AND PROCESSED FOODS

FOR FISH AND SEAFOOD (U.S. CL. 46).

CLASS 35—ADVERTISING AND BUSINESS

FOR PROMOTING THE CONSUMPTION OF FISH AND SEAFOOD (U.S. CLS. 100, 101 AND 102). DANIEL CAPSHAW, EXAMINING ATTORNEY

SN 76-550,623. REVISION EYEWEAR INC., MONTREAL, QUEBEC, CANADA, FILED 10-9-2003.

REVISION

CLASS 9—ELECTRICAL AND SCIENTIFIC APPARATUS

FOR PROTECTIVE EYEWEAR AND PROTECTIVE GLASSES FOR MILITARY AND SECURITY PERSONNEL, NOT SOLD THROUGH VISION CENTERS (U.S. CLS. 21, 23, 26, 36 AND 38). FIRST USE 2-0-2002; IN COMMERCE 2-0-2002.

CLASS 28—TOYS AND SPORTING GOODS

FOR PAINT BALL MASKS (U.S. CLS. 22, 23, 38 AND 50). FIRST USE 2-0-2002; IN COMMERCE 2-0-2002. TRICIA SONNEBORN, EXAMINING ATTORNEY

SN 76-550,953. MCK HOLDINGS, LLC, DBA FOODLINE.-COM, BOSTON, MA. FILED 9-22-2003.

FOODLINE

SN 76-550,613. SEALING AGENTS WATERPROOFING, INC., DBA THE AGENTS, INDIAN TRAIL, NC. FILED 10-9-2003.



CLASS 39—TRANSPORTATION AND STORAGE

FOR INTENT TO USE-1(B) FOOD DELIVERY SERVICES (U.S. CLS. 100 AND 105).

CLASS 43—HOTEL AND RESTAURANT SERVICES

FOR PROVIDING A WEBSITE WHEREBY CONSUMERS CAN OBTAIN INFORMATION ON RESTAURANTS; ON-LINE RESTAURANT RESERVATION SERVICES FOR DINERS (U.S. CLS. 100 AND 101). FIRST USE 1-16-1999; IN COMMERCE 1-16-1999. DARRYL SPRUILL, EXAMINING ATTORNEY

SN 76-552,724. NATIONAL LEISURE GROUP, INC., WOBURN, MA. FILED 10-20-2003.

NATIONAL LEISURE GROUP

NO CLAIM IS MADE TO THE EXCLUSIVE RIGHT TO USE "NATIONAL" AND "GROUP", APART FROM THE MARK AS SHOWN.

CLASS 37—CONSTRUCTION AND REPAIR

FOR BASEMENT WATERPROOFING; FOUNDATION CONTRACTOR SERVICES; WATERPROOFING OF BUILDINGS (U.S. CLS. 100, 103 AND 106). FIRST USE 4-15-1996; IN COMMERCE 4-15-1996.

CLASS 39—TRANSPORTATION AND STORAGE

FOR DELIVERY OF STONE, SAND AND LANDSCAPE MATERIAL BY TRUCK; TRUCK HAULING, NAMELY, HAULING OF STONE, SAND AND LANDSCAPE MATERIAL BY TRUCK (U.S. CLS. 100 AND 105). FIRST USE 4-15-1996; IN COMMERCE 4-15-1996. JENNIFER MARTIN, EXAMINING ATTORNEY

CLASS 39—TRANSPORTATION AND STORAGE

FOR TRAVEL AGENCY SERVICES, NAMELY, MAKING RESERVATIONS AND BOOKINGS FOR TRANSPORTATION AND CRUISES; MAKING RESERVATIONS AND BOOKINGS FOR TRANSPORTATION AND CRUISES VIA THE INTERNET; TRAVEL INFORMATION SERVICES; ARRANGING TRAVEL TOURS AND CONDUCTING SIGHT SEEING TOURS FOR OTHERS; ARRANGING TRAVEL TOURS AND CONDUCTING SIGHT SEEING TOURS FOR OTHERS VIA THE INTERNET (U.S. CLS. 100 AND 105). FIRST USE 10-16-1989; IN COMMERCE 10-16-1989.

CLASS 43—HOTEL AND RESTAURANT SERVICES

FOR TRAVEL AGENCY SERVICES, NAMELY, PROVIDING INFORMATION ABOUT TEMPORARY LODGING, RESTAURANTS AND MEALS; PROVIDING INFORMATION ABOUT TEMPORARY LODGING, RESTAURANTS AND MEALS VIA THE INTERNET; MAKING RESERVATIONS AND BOOKINGS FOR TEMPORARY LODGING, RESTAURANTS AND MEALS; AND MAKING RESERVATIONS AND BOOKINGS FOR TEMPORARY LODGING, RESTAURANTS AND MEALS VIA THE INTERNET (U.S. CLS. 100 AND 101).

FIRST USE 10-16-1989; IN COMMERCE 10-16-1989.
WON TEAK OH, EXAMINING ATTORNEY

SN 76-554,829. WEN TECHNOLOGY CORPORATION, YONKERS, NY. FILED 10-14-2003.

WEN

SEC. 2(F).

CLASS 37—CONSTRUCTION AND REPAIR

FOR INSTALLATION, REPAIR OR MAINTENANCE OF SECURITY SYSTEMS (U.S. CLS. 100, 103 AND 106).
FIRST USE 11-0-2001; IN COMMERCE 11-0-2001.

CLASS 38—COMMUNICATION

FOR COMMUNICATIONS SERVICES, NAMELY ELECTRONIC TRANSMISSION OF DATA AND DOCUMENTS AMONG USERS OF COMPUTERS; COMMUNICATIONS SERVICES, NAMELY TRANSMITTING STREAMED SOUND AND AUDIO-VISUAL RECORDINGS VIA THE INTERNET; ELECTRONIC TRANSMISSION OF FACSIMILE COMMUNICATIONS (U.S. CLS. 100, 101 AND 104).

FIRST USE 11-0-1991; IN COMMERCE 11-0-1991.

CLASS 42—SCIENTIFIC, COMPUTER AND LEGAL SERVICES

FOR COMPUTER SERVICES, NAMELY ACTING AS AN APPLICATION SERVICE PROVIDER IN THE FIELD OF KNOWLEDGE MANAGEMENT TO HOST COMPUTER APPLICATION SOFTWARE FOR SEARCHING AND RETRIEVING NETWORKS; COMPUTER SERVICES NAMELY, ACTING AS AN APPLICATION SERVICE PROVIDER IN THE FIELD OF KNOWLEDGE MANAGEMENT TO HOST COMPUTER APPLICATION SOFTWARE FOR THE COLLECTION, EDITING, ORGANIZING, MODIFYING, BOOK MARKING; TRANSMISSION, STORAGE AND SHARING OF DATA AND INFORMATION; COMPUTER NETWORK DESIGN FOR OTHERS; COMPUTER SERVICES, NAMELY, DESIGNING AND IMPLEMENTING NETWORK WEB PAGES FOR OTHERS; CONSULTING SERVICES IN THE FIELD OF DESIGN, SELECTION, IMPLEMENTATION AND USE OF COMPUTER HARDWARE AND SOFTWARE SYSTEMS FOR OTHERS; INSTALLATION OF COMPUTER SOFTWARE; INTEGRATION OF COMPUTER SYSTEMS AND NETWORKS; MAINTENANCE OF COMPUTER SOFTWARE; UPDATING OF COMPUTER SOFTWARE FOR OTHERS; COMPUTER HARDWARE DEVELOPMENT; DESIGN FOR OTHERS IN THE FIELD OF SECURITY SYSTEMS; DEVELOPMENT OF NEW TECHNOLOGY FOR OTHERS IN THE FIELD OF SECURITY SYSTEMS; DESIGN AND DEVELOPMENT OF SECURITY SYSTEMS (U.S. CLS. 100 AND 101).

FIRST USE 11-0-1991; IN COMMERCE 11-0-1991.

CLASS 45—PERSONAL SERVICES

FOR MONITORING OF COMPUTER SYSTEMS FOR SECURITY PURPOSES (U.S. CLS. 100 AND 101).
FIRST USE 11-0-1991; IN COMMERCE 11-0-1991.
ANGELA M. MICHELI, EXAMINING ATTORNEY

SN 76-554,936. VASOGEN IRELAND LIMITED, SHANNON, COUNTY CLARE, IRELAND, FILED 10-24-2003.

VASOGEN

PRIORITY CLAIMED UNDER SEC. 44(D) ON IRELAND APPLICATION NO. 228063, FILED 10-21-2003, REG. NO. 228063, DATED 10-21-2003, EXPIRES 10-21-2010.

CLASS 9—ELECTRICAL AND SCIENTIFIC APPARATUS

FOR ELECTRONIC PATIENT AND APPARATUS IDENTIFICATION BAND AND LABEL READERS AND RECORDERS (U.S. CLS. 21, 23, 26, 36 AND 38).

CLASS 10—MEDICAL APPARATUS

FOR MEDICAL APPARATUS AND INSTRUMENTS FOR EXTRACTING BLOOD FROM A PATIENT, TREATING IT, AND RETURNING IT TO THE PATIENT BY INJECTION, FOR IMMUNE MODULATION THERAPY; MEDICAL APPARATUS AND INSTRUMENTS FOR EXTRACTING BLOOD FROM A PATIENT, TREATING IT, AND RETURNING IT TO THE PATIENT BY INJECTION, FOR IMMUNE MODULATION THERAPY FOR TREATMENT OF CARDIOVASCULAR DISEASES AND CONDITIONS; MEDICAL UNITS WHICH TREAT BLOOD BY EXPOSING IT TO OXIDATIVE STRESS AND ULTRAVIOLET LIGHT; ACCESSORIES FOR USE WITH SUCH MEDICAL UNITS, NAMELY, BLOOD EXTRACTING NEEDLES AND SYRINGES, BLOOD RETURN NEEDLES AND SYRINGES, CONTAINERS IN WHICH THE BLOOD IS STORED AND TREATED UNDER SEALED CONDITIONS, PATIENT IDENTIFYING BANDS AND IDENTIFYING BANDS AND LABELS FOR MEDICAL APPARATUS; BLOOD SAMPLE MANAGEMENT KITS COMPRISING OR CONSISTING OF BLOOD EXTRACTING NEEDLES AND SYRINGES, BLOOD RETURN NEEDLES AND SYRINGES, SYRINGE HOLDERS AND TRANSPORTERS, BLOOD TREATMENT CONTAINERS, COLLAPSIBLE BLOOD BAGS, COMBINED AND INTERCONNECTED SYRINGE HOLDERS AND TRANSPORTERS, COLLAPSIBLE BLOOD TREATMENT BAGS, SYRINGE CAPS, PATIENT IDENTIFICATION BANDS, IDENTIFICATION BANDS AND LABELS FOR MEDICAL APPARATUS, BLOOD SAMPLE CONTROLS, MEDICAL APPARATUS CONTROLS AND PATIENT AND MEDICAL APPARATUS IDENTIFICATION READERS (U.S. CLS. 26, 39 AND 44).

CLASS 42—SCIENTIFIC, COMPUTER AND LEGAL SERVICES

FOR MEDICAL LABORATORY SERVICES; SCIENTIFIC RESEARCH AND DEVELOPMENT FOR MEDICAL PURPOSES; LABORATORY TESTING AND ANALYSIS OF BLOOD (U.S. CLS. 100 AND 101).

CLASS 44—MEDICAL, BEAUTY AND AGRICULTURAL SERVICES

FOR MEDICAL SERVICES, NAMELY, THE PROVISION OF IMMUNE MODULATION THERAPY BY MEANS OF EXTRACTING BLOOD FROM PATIENTS, TREATING IT, AND RETURNING IT TO THE PATIENT BY INJECTION; MEDICAL SERVICES, NAMELY, THE PROVISION OF IMMUNE MODULATION THERAPY BY MEANS OF EXTRACTING BLOOD FROM PATIENTS, TREATING IT, AND RETURNING IT TO THE PATIENT BY INJECTION, FOR TREATMENT OF CARDIOVASCULAR DISEASES AND CONDITIONS; BLOOD DIALYSIS AND TRANSFUSION (U.S. CLS. 100 AND 101).
STEVEN R. FINE, EXAMINING ATTORNEY

SN 76-555,249. DRUGTECH CORPORATION, WILMINGTON, DE. FILED 10-30-2003.

SN 76-556,598. THE OHIO ROUNDTABLE, STRONGSVILLE, OH. FILED 11-4-2003.

CHRONOMETRIC SYSTEM

NO CLAIM IS MADE TO THE EXCLUSIVE RIGHT TO USE "SYSTEM", APART FROM THE MARK AS SHOWN.

CLASS 1—CHEMICALS

FOR IMMEDIATE AND TIME RELEASED CHEMICAL COMPOSITIONS SOLD IN BULK QUANTITIES FOR THE USE IN THE MANUFACTURE OF PHARMACEUTICALS, CHEMICALS AND NUTRITIONAL SUPPLEMENTS (U.S. CLS. 1, 5, 6, 10, 26 AND 46).

CLASS 5—PHARMACEUTICALS

FOR NUTRITIONAL SUPPLEMENTS; VITAMINS AND PHARMACEUTICAL AND THERAPEUTIC SUBSTANCES FOR THE TREATMENT OF A WIDE VARIETY OF ILLNESSES, DISEASES AND MEDICAL CONDITIONS, NAMELY, HORMONES, ANALGESICS, ELECTROLYTES, ANTI-INFECTIVES, CARDIOVASCULAR AGENTS, FERTILITY AGENTS, BIRTH CONTROL AGENTS, NEONATAL AGENTS, OSTEOPORETIC, ANTI-AGING AGENT, ANTI-SENILITY AGENTS, AND ANTI-NAUSEA AGENTS. ALL FOR USE IN THE TREATMENT OF MORNING SICKNESS, HORMONE REPLACEMENT, INFLAMMATION, MUSCLE PAIN, ARTHRITIS, MIGRAINES, HYPOKALEMIA, DEHYDRATION, FUNGAL AND MICROBIAL INFECTIONS, VIRALOGICAL INFECTIONS, HYPERTENSION, CIRCULATION DISEASES, INFERTILITY, CONCEPTION, OSTEOPOROSIS, ALZHEIMERS, AND DEMENTIA, SCHIZOPHRENIA, PANIC DISORDERS, CENTRAL NERVOUS SYSTEM DISEASES, AND TREMORS (U.S. CLS. 6, 18, 44, 46, 51 AND 52).

SOPHIA S. KIM, EXAMINING ATTORNEY

SN 76-556,545. THE ALDO GROUP INC., VILLE ST. LAURENT, QUEBEC H4N 2B3, CANADA, FILED 11-4-2003.

WALK A MILE IN OUR SHOES!

THE MARK CONSISTS OF STANDARD CHARACTERS WITHOUT CLAIM TO ANY PARTICULAR FONT, STYLE, SIZE, OR COLOR.

OWNER OF CANADA REG. NO. TMA461,542, DATED 8-23-1996, EXPIRES 8-23-2011.

OWNER OF U.S. REG. NO. 2,056,590.

CLASS 25—CLOTHING

FOR MEN'S, WOMEN'S AND CHILDREN'S FOOTWEAR; NAMELY, SHOES, SANDALS, SLIPPERS, BOOTS, HIKING BOOTS, MOCCASINS, SNEAKERS, LOAFERS, JOGGING SHOES, WALKING SHOES, WALKING BOOTS (U.S. CLS. 22 AND 39).

CLASS 35—ADVERTISING AND BUSINESS

FOR OPERATION OF RETAIL STORES FEATURING FOOTWEAR, CLOTHING, LEATHER APPAREL, HANDBAGS, LUGGAGE, WALLETS AND FASHION ACCESSORIES (U.S. CLS. 100, 101 AND 102).

SHARI SHEFFIELD, EXAMINING ATTORNEY

OHIO ROUNDTABLE

THE MARK CONSISTS OF STANDARD CHARACTERS WITHOUT CLAIM TO ANY PARTICULAR FONT, STYLE, SIZE, OR COLOR.

NO CLAIM IS MADE TO THE EXCLUSIVE RIGHT TO USE "ROUNDTABLE", APART FROM THE MARK AS SHOWN.

SEC. 2(F).

CLASS 41—EDUCATION AND ENTERTAINMENT

FOR EDUCATIONAL SERVICES, NAMELY CONDUCTING EDUCATIONAL MEETINGS, SEMINARS AND FORUMS IN THE FIELD OF LOCAL, STATE AND FEDERAL PUBLIC POLICY ISSUES (U.S. CLS. 100, 101 AND 107).

FIRST USE 0-0-1980; IN COMMERCE 0-0-1980.

CLASS 42—SCIENTIFIC, COMPUTER AND LEGAL SERVICES

FOR PROVIDING INFORMATION AND RESEARCH IN THE FIELD OF LOCAL, STATE AND FEDERAL PUBLIC POLICY ISSUES (U.S. CLS. 100 AND 101).

FIRST USE 0-0-1980; IN COMMERCE 0-0-1980.

DANIEL CAPSHAW, EXAMINING ATTORNEY

SN 76-556,858. SCHOTT AG, MAINZ, FED REP GERMANY, FILED 10-21-2003.

RIVULETTA

PRIORITY CLAIMED UNDER SEC. 44(D) ON ERPNCMNTY TM OFC APPLICATION NO. 003200466, FILED 7-9-2003, REG. NO. 003200466, DATED 7-9-2003, EXPIRES 7-9-2013.

CLASS 11—ENVIRONMENTAL CONTROL APPARATUS

FOR GLASS COMPONENTS FOR SANITARY INSTALLATIONS, NAMELY SHOWER WALLS AND DOORS; GLASS COMPONENTS FOR LIGHTS, NAMELY GLASS SHADES FOR LIGHTS (U.S. CLS. 13, 21, 23, 31 AND 34).

CLASS 19—NON-METALLIC BUILDING MATERIALS

FOR GLASS COMPONENTS FOR ARCHITECTURAL AND DECORATIVE PURPOSES, NAMELY FOR WINDOWS AND DOORS, PARTITION WALLS, AND ARTISTIC GLAZING (U.S. CLS. 1, 12, 33 AND 50).

CLASS 21—HOUSEWARES AND GLASS

FOR UNWORKED AND SEMI-WORKED GLASS (EXCEPT GLASS USED IN BUILDING); GLASS COMPONENTS FOR FURNITURE NAMELY GLASS FOR CABINETS AND BOOKCASES (U.S. CLS. 2, 13, 23, 29, 30, 33, 40 AND 50).

ALICE BENMAMAN, EXAMINING ATTORNEY

SN 76-558,502. ETIENNE, ROUSSAN JR, COLLEGE PARK, MD. FILED 11-10-2003.

SN 76-558,542. CUSTOM MANUFACTURING AND ENGINEERING, INC., ST. PETERSBURG, FL. FILED 11-10-2003.

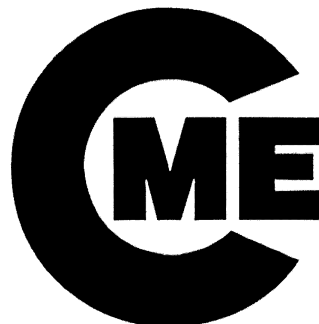

CLASS 40—MATERIAL TREATMENT

FOR PROTOTYPING, FABRICATION AND ASSEMBLY OF MECHANICAL, ELECTRICAL, AND ELECTROMECHANICAL DEVICES FOR OTHERS (U.S. CLS. 100, 103 AND 106).

FIRST USE 1-31-1997; IN COMMERCE 1-31-1997.

CLASS 42—SCIENTIFIC, COMPUTER AND LEGAL SERVICES

FOR ENGINEERING RESEARCH AND DEVELOPMENT OF MECHANICAL, ELECTRICAL, AND ELECTROMECHANICAL DEVICES FOR OTHERS (U.S. CLS. 100 AND 101).

FIRST USE 1-31-1997; IN COMMERCE 1-31-1997.

FRED MANDIR, EXAMINING ATTORNEY

SN 76-559,891. PR NEWSWIRE ASSOCIATION LLC, NEW YORK, NY. FILED 11-14-2003.

NO CLAIM IS MADE TO THE EXCLUSIVE RIGHT TO USE "MARKETING INTERNATIONAL", APART FROM THE MARK AS SHOWN.

CLASS 35—ADVERTISING AND BUSINESS

FOR PROVIDING BUSINESS MARKETING INFORMATION, BUSINESS MARKETING CONSULTING SERVICES, DIRECT MARKETING ADVERTISING SERVICES FOR OTHERS, PROMOTING THE CONCERTS OF OTHERS; PROMOTING THE GOODS AND SERVICES OF OTHERS BY ARRANGING FOR SPONSORS TO AFFILIATE THEIR GOODS AND SERVICES WITH CONCERTS, PLAYS, AWARD SHOWS, TRADE SHOWS, AND VARIETY SHOWS; BUSINESS MANAGEMENT SERVICES, MANAGEMENT OF PERFORMING ARTISTS, PUBLICITY AGENTS, PUBLICATION OF PUBLICITY TEXTS, HANDBILL DISTRIBUTION, SAMPLE DISTRIBUTION (U.S. CLS. 100, 101 AND 102).

FIRST USE 1-1-1997; IN COMMERCE 4-1-1997.

CLASS 41—EDUCATION AND ENTERTAINMENT

FOR ENTERTAINMENT SERVICES IN THE NATURE OF LIVE CONCERTS, AWARD SHOWS, AND SPORTING EVENTS, LIVE MUSICAL PERFORMANCES BY INDIVIDUALS AND BANDS, LIVE COMEDY PERFORMANCES, AND LIVE PERSONAL APPEARANCES BY CELEBRITIES, ENTERTAINERS AND SPEAKERS (U.S. CLS. 100, 101 AND 107).

FIRST USE 1-1-1997; IN COMMERCE 4-1-1997.

PAUL F. GAST, EXAMINING ATTORNEY

eWatch

THE MARK CONSISTS OF STANDARD CHARACTERS WITHOUT CLAIM TO ANY PARTICULAR FONT, STYLE, SIZE, OR COLOR.

OWNER OF U.S. REG. NO. 2,572,985.

CLASS 35—ADVERTISING AND BUSINESS

FOR ELECTRONIC NEWS CLIPPING SERVICES (U.S. CLS. 100, 101 AND 102).

FIRST USE 1-20-1995; IN COMMERCE 1-20-1995.

CLASS 42—SCIENTIFIC, COMPUTER AND LEGAL SERVICES

FOR INTERNET MONITORING SERVICES, INCLUDING MONITORING OF ONLINE NEWS SOURCES, INVESTOR MESSAGE BOARDS, PUBLIC DISCUSSION AREAS, AND WEB SITES; AND REPORTING SERVICE CONCERNING RESULTS OF SUCH MONITORING (U.S. CLS. 100 AND 101).

FIRST USE 1-20-1995; IN COMMERCE 1-20-1995.

TOMAS V. VLCEK, EXAMINING ATTORNEY

SN 76-560,905. A. RICHARD, G.P., BERTHIERVILLE, QUEBEC, CANADA, FILED 11-18-2003.

SN 76-562,404. FAST TRACK SYSTEMS, INC, SAN MATEO, CA. FILED 11-17-2003.

RICHARD



NO CLAIM IS MADE TO THE EXCLUSIVE RIGHT TO USE SYSTEMS INC., APART FROM THE MARK AS SHOWN.

THE MARK CONSISTS OF STANDARD CHARACTERS WITHOUT CLAIM TO ANY PARTICULAR FONT, STYLE, SIZE, OR COLOR.

CLASS 7—MACHINERY

FOR CERAMIC TOOL MACHINES, NAMELY, HOLE BORERS AND CIRCLE CUTTERS (U.S. CLS. 13, 19, 21, 23, 31, 34 AND 35).

FIRST USE 6-30-2002; IN COMMERCE 6-30-2002.

CLASS 8—HAND TOOLS

FOR HAND TOOLS, NAMELY, HOPPER GUNS FOR SPRAYING TEXTURE COATING; PAINT ACCESSORIES, NAMELY, PAINT SHIELDS; INDUSTRIAL AND COMMERCIAL KNIVES, NAMELY, TAPING KNIFE, PUTTY KNIFE, FLOORING KNIFE, ROOFING KNIFE, UTILITY KNIFE, KITCHEN KNIFE, HOBBY KNIFE, GLASS CUTTER AND CARPET KNIFE, AND REPLACEMENT BLADES THEREFOR; HAND TOOLS, NAMELY, JOINT FILLING TOOLS, LAWN EDGERS, DRYWALL SAWS, MANUAL TILE CUTTERS, PAINT SCRAPERS, PAINT TRIM GUIDES, PAINT SCRAPER REPLACEMENT BLADES, PAINT CAN OPENER, HAND SANDER, SANDING BLOCKS, ADHESIVE SPREADERS FOR FLOOR COVERINGS, TROWELS, SANDING BLOCS, SANDING SPONGES, TILE CUTTERS, CERAMIC HAND TOOLS, NAMELY, HOLE BORER AND CIRCLE CUTTERS; DRYWALL TOOLS, NAMELY, HAWKS; WALLPAPER HANGING TOOLS, NAMELY, CHALK LINES; 9 IN 1 PAINT TOOL, NAMELY, A TOOL WHICH OPENS AND CLOSES PAINT CANS AND HAS A FUNCTION OF A HAMMER, SCRAPER AND ROLLER CLEANER (U.S. CLS. 23, 28 AND 44).

FIRST USE 12-31-1890; IN COMMERCE 12-31-1975.

CLASS 16—PAPER GOODS AND PRINTED MATTER

FOR PAINT STIRRERS; WALLPAPER ROLLER, WALLPAPER BRUSHES, WALLPAPER WETTING TRAY AND SMOOTHER, WALLPAPER TRIM GUIDE; T-SQUARES (U.S. CLS. 2, 5, 22, 23, 29, 37, 38 AND 50).

FIRST USE 12-31-1890; IN COMMERCE 12-31-1975.

CLASS 21—HOUSEWARES AND GLASS

FOR DRYWALL TEXTURE BRUSHES, SCRAPING BRUSHES (U.S. CLS. 2, 13, 23, 29, 30, 33, 40 AND 50).

FIRST USE 12-31-1890; IN COMMERCE 12-31-1975.
KIM SAITO, EXAMINING ATTORNEY

CLASS 35—ADVERTISING AND BUSINESS

FOR PROVIDING DATABASES OF INDUSTRY DATA FOR PHARMACEUTICAL AND BIOTECHNOLOGY COMPANIES THAT ENABLE THE ANALYSIS OF CAPABILITIES, PERFORMANCE, AND COST STRUCTURES FOR CLINICAL TRIALS (U.S. CLS. 100, 101 AND 102).

FIRST USE 5-21-1999; IN COMMERCE 5-21-1999.

CLASS 42—SCIENTIFIC, COMPUTER AND LEGAL SERVICES

FOR PROVIDING DATABASES OF INDUSTRY DATA FOR PHARMACEUTICAL AND BIOTECHNOLOGY COMPANIES THAT ENABLE THE COLLABORATIVE PLANNING OF CLINICAL TRIALS (U.S. CLS. 100 AND 101).

FIRST USE 5-21-1999; IN COMMERCE 5-21-1999.

JOHN HWANG, EXAMINING ATTORNEY

SN 76-562,484. BELLARTISAN INC., TORONTO, ONTARIO, CANADA, FILED 11-17-2003.

BELLARTISAN

PRIORITY CLAIMED UNDER SEC. 44(D) ON CANADA APPLICATION NO. 1,186,117, FILED 8-11-2003, REG. NO. TMA644,403, DATED 7-14-2005, EXPIRES 7-14-2020.

CLASS 9—ELECTRICAL AND SCIENTIFIC APPARATUS

FOR ELECTRONIC PUBLICATIONS, NAMELY, BOOKS FEATURING COMEDY, DRAMA, ACTION AND/OR ADVENTURE AND THEIR CHARACTERS RECORDED ON CD-ROM, PRE-RECORDED VIDEOTAPES, CD-ROMS AND DVDS FEATURING ANIMATED FILMS (U.S. CLS. 21, 23, 26, 36 AND 38).

CLASS 16—PAPER GOODS AND PRINTED MATTER

FOR GREETING CARDS, NOTEPADS, POSTCARDS, CALENDARS, POSTERS, COLOURING BOOKS, BOOKS FEATURING COMEDY, DRAMA, ACTION AND/OR ADVENTURE AND THEIR CHARACTERS (U.S. CLS. 2, 5, 22, 23, 29, 37, 38 AND 50).

CLASS 45—PERSONAL SERVICES

FOR PROVIDING ON-LINE ELECTRONIC GREETING CARDS (U.S. CLS. 100 AND 101).
JOANNA DUKOVIC, EXAMINING ATTORNEY

SN 76-562,555. MITSUI CHEMICALS, INC., AKA MITSUI KAGAKU KABUSHIKI KAISHA, TOKYO, JAPAN, FILED 12-2-2003.

**CLASS 1—CHEMICALS**

FOR CHEMICALS USED IN INDUSTRY, SCIENCE AND PHOTOGRAPHY, AS WELL AS IN AGRICULTURE, HORTICULTURE AND FORESTRY; UNPROCESSED SYNTHETIC RESINS FOR USE IN A WIDE VARIETY OF FIELDS, UNPROCESSED PLASTIC MATERIALS IN POWDER, LIQUID OR PASTE FORM FOR USE IN A WIDE VARIETY OF FIELDS; MANURES; COMPOST; FIRE EXTINGUISHING COMPOSITIONS; TEMPERING AND SOLDERING PREPARATIONS, CHEMICAL SUBSTANCES FOR PRESERVING FOODSTUFFS, TANNING SUBSTANCES, NAMELY, TANNING AGENTS FOR USE IN THE MANUFACTURE OF LEATHER; ADHESIVES FOR GENERAL INDUSTRIAL USE (U.S. CLS. 1, 5, 6, 10, 26 AND 46).

CLASS 5—PHARMACEUTICALS

FOR PHARMACEUTICAL ANTITUSSIVE-COLD PREPARATIONS, PHARMACEUTICAL ANTI-ALLERGIC PREPARATIONS AND SUBSTANCES; PHARMACEUTICAL FOR THE TREATMENT OF ERECTILE DYSFUNCTION, PHARMACEUTICAL PREPARATIONS NAMELY, ANTICOAGULANTS, PHARMACEUTICAL PREPARATIONS NAMELY, ANTIDEPRESSANTS; PHARMACEUTICAL PREPARATIONS NAMELY, APPETITE SUPPRESSANTS; PHARMACEUTICAL PREPARATIONS FOR USE IN CHEMOTHERAPY, PHARMACEUTICAL PREPARATION FOR THE TREATMENT OF GOUT; PHARMACEUTICAL PREPARATIONS FOR THE TREATMENT OF HEART RHYTHM DISORDERS; PHARMACEUTICAL PREPARATIONS FOR THE TREATMENT OF INFECTIOUS DISEASES; PHARMACEUTICAL PREPARATIONS, NAMELY, A DRUG DELIVERY SYSTEM COMPRISING POLYMER-BASED ORAL TABLETS FOR THE CONTINUOUS RELEASE OF A WIDE VARIETY OF THERAPEUTIC AGENTS; PHARMACEUTICAL PREPARATIONS ACTING ON THE CENTRAL NERVOUS SYSTEM; PHARMACEUTICAL PREPARATIONS AND SUBSTANCES FOR THE TREATMENT OF GASTRO-INTESTINAL DISEASES; PHARMACEUTICAL PREPARATIONS FOR ANIMAL SKINCARE; PHARMACEUTICAL PREPARATIONS FOR INHALATION FOR THE TREATMENT OF PULMONARY HYPERTENSION; PHARMACEUTICAL PREPARATIONS FOR OCULAR OR INTRAOCULAR SURGERY; PHARMACEUTICAL PREPARATIONS FOR THE TREATMENT OF HORMONAL DISORDERS AND THE PREVENTION OF OSTEOPOROSIS; PHARMACEUTICAL PREPARA-

TIONS FOR TREATING ALLERGIC RHINITIS AND ASTHMA; PHARMACEUTICAL PREPARATIONS FOR TREATING DIABETES; PHARMACEUTICAL PREPARATIONS FOR TREATING SKIN DISORDERS; PHARMACEUTICAL PREPARATIONS FOR USE IN DERMATOLOGY, PHARMACEUTICAL PREPARATIONS FOR WOUNDS; PHARMACEUTICAL PRODUCTS AND PREPARATIONS AGAINST DRY SKIN CAUSED BY PREGNANCY; PHARMACEUTICAL PRODUCTS AND PREPARATIONS FOR CHLOASMA; PHARMACEUTICAL PRODUCTS AND PREPARATIONS FOR HYDRATING THE SKIN DURING PREGNANCY; PHARMACEUTICAL PRODUCTS AND PREPARATIONS FOR PREGNANCY BLEMISHES; PHARMACEUTICAL PRODUCTS AND PREPARATIONS FOR PREVENTING SKIN BLEMISHES DURING PREGNANCY; PHARMACEUTICAL PRODUCTS AND PREPARATIONS TO PREVENT STRETCH MARKS; PHARMACEUTICAL PRODUCTS AND PREPARATIONS TO PREVENT SWELLING IN THE LEGS; PHARMACEUTICAL PRODUCTS FOR OPHTHALMOLOGICAL USE; PHARMACEUTICAL PRODUCTS FOR SKIN CARE FOR ANIMALS; PHARMACEUTICAL PRODUCTS FOR THE TREATMENT OF BONE DISEASES; PHARMACEUTICAL PRODUCTS FOR THE TREATMENT OF VIRAL AND INFECTIOUS DISEASES AND FOR THE TREATMENT OF CANCER; PHARMACEUTICAL PRODUCTS FOR TREATING RESPIRATORY DISEASES AND ASTHMA; PHARMACEUTICAL SKIN LOTIONS; PHARMACEUTICAL SOLUTIONS USED IN DIALYSIS; VETERINARY PREPARATIONS, NAMELY, PAIN RELIEF MEDICATION; VETERINARY PREPARATIONS FOR TREATMENT OF INTESTINAL BACTERIA; VETERINARY VACCINE FOR HORSES; VETERINARY VACCINES; VETERINARY VACCINES FOR BOVINE, SHEEP, HORSE, CAT, DOG, CHICKEN; YEAST OR YEAST EXTRACTS FOR MEDICAL, VETERINARY OR PHARMACEUTICAL PURPOSES; SANITARY PREPARATIONS FOR MEDICAL PURPOSES, NAMELY, SANITIZERS FOR HOSPITAL AND HOUSEHOLD USE AND FOR USE IN INSTITUTIONAL AND INDUSTRIAL AREAS; DEODORANTS OTHER THAN FOR PERSONAL USE, NAMELY, AIR DEODORANT, CAR DEODORANT, AND HOUSEHOLD DEODORANT; DIETETIC SUBSTANCES ADAPTED FOR MEDICAL USE, NAMELY, BEE POLLEN FOR USE AS A DIETARY FOOD SUPPLEMENT, DIETARY DRINK MIX FOR USE AS A MEAL REPLACEMENT, DIETARY FOOD SUPPLEMENTS, DIETARY SUPPLEMENTAL DRINKS, DIETARY SUPPLEMENTS, LECITHIN FOR USE AS A DIETARY SUPPLEMENT, MEAL REPLACEMENT AND DIETARY SUPPLEMENT DRINK MIXES, NUTRACEUTICALS FOR USE AS A DIETARY SUPPLEMENT, AND WHEAT FOR USE AS A DIETARY SUPPLEMENT; FOOD FOR BABIES; MEDICAL PLASTERS; WOUND, BURN, AND SURGICAL DRESSING MATERIALS; MATERIAL FOR STOPPING TEETH; DENTAL WAX; ALL-PURPOSE DISINFECTANTS; PREPARATIONS FOR DESTROYING VERMIN; FUNGICIDES FOR DOMESTIC AND AGRICULTURAL USE, HERBICIDES FOR DOMESTIC AND AGRICULTURAL USE (U.S. CLS. 6, 18, 44, 46, 51 AND 52).

CLASS 17—RUBBER GOODS

FOR RUBBER, GUTTA-PERCHA, GUM, ASBESTOS, MICA AND GOODS MADE FROM THESE MATERIALS AND NOT INCLUDED IN OTHER CLASSES, NAMELY, NATURAL RUBBER, NITRILE RUBBER, PACKING PADDING OF RUBBER FOR SHIPPING CONTAINERS, POLYSULFIDE RUBBER, RECLAIMED RUBBER, RINGS OF RUBBER FOR USE AS PIPE CONNECTION SEALS, RAW OR SEMI-WORKED RUBBER, RUBBER BAGS FOR MERCHANDISE PACKAGING IN THE NATURE OF ENVELOPES OR POUCHES, RUBBER BANDS FOR COMMERCIAL AND INDUSTRIAL USES, RUBBER BARS AND RODS, RUBBER BOTTLE STOPPERS, RUBBER BUMPERS FOR LOADING DOCKS, RUBBER CHIPS OR GRANULES FOR USE AS A PLAYGROUND GROUND COVER, RUBBER CLACK VALVES FOR INDUSTRIAL USE, RUBBER CORDS AND LACES, RUBBER DERIVATIVES, RUBBER FOR USE IN THE MANUFACTURE OF TIRES, CABLE, PAPER, RUBBER HOSE FOR USE IN CONNECTION WITH WELDING, RUBBER LIDS AND CAPS FOR INDUSTRIAL PACKAGING CONTAINERS, RUBBER PACKING FOR SHIPPING CONTAINERS, RUBBER PADDING FOR SHIPPING CONTAINERS, RUBBER SEALANT FOR CAULKING AND ADHESIVE PURPOSES, RUBBER

SHEETS, RUBBER SHOCK ABSORBERS FOR INDUSTRIAL MACHINERY, RUBBER SLEEVES FOR PROTECTING PARTS OF MACHINERY, RUBBER STOPPERS FOR INDUSTRIAL PACKAGING CONTAINERS, RUBBER THREAD NOT FOR TEXTILE USE, RUBBER THREAD AND COVERED RUBBER YARN NOT FOR TEXTILE USE, RUBBER TUBES AND PIPES, SHOCK ABSORBING RUBBER BUFFERS FOR INDUSTRIAL MACHINERY, SHOCK BUFFERS OF RUBBER FOR INDUSTRIAL MACHINERY, SILICONE RUBBER, SLEEVES OF RUBBER FOR PROTECTING PARTS OF MACHINERY, STUFFING OF RUBBER, STYRENE-BUTADIENE RUBBER, SYNTHETIC RUBBER, SYNTHETIC RUBBER FOR USE IN THE MANUFACTURE OF TIRES, CABLE, PAPER, VALVES OF RUBBER OR VULCANIZED FIBER NOT INCLUDING MACHINE ELEMENTS, AND WASHERS OF RUBBER OR VULCANIZED FIBER; AND PLASTICS IN THE FORM OF POWDERS, PASTES, LIQUIDS, FIBRES, CAPILLARITIES, EMULSIONS, PELLETS, GRANULES, FILMS, SHEETS, PLATES, BLOCKS, RODS AND PIPES INCLUDING FLEXIBLE PIPES NOT OF METAL, ALL FOR FURTHER INDUSTRIAL AND AGRICULTURAL USE OR MANUFACTURE; ELECTRICAL, THERMAL AND ACOUSTIC INSULATING MATERIALS FOR BUILDINGS AND CONSTRUCTION; PADDING MATERIALS OF RUBBER AND PLASTICS FOR PACKING USE AND/OR FOR TIGHTLY FIXING PURPOSES; FLOATING ANTI-POLLUTION BARRIERS, NAMELY, BARRIER CURTAINS IN THE NATURE OF FLOATING BAFFLES OR BOOMS FOR THE CONTAINMENT OF POLLUTANTS (U.S. CLS. 1, 5, 12, 13, 35 AND 50).

DARRYL SPRUILL, EXAMINING ATTORNEY

SN 76-563,374. THE METHODIST HOMES FOR THE AGING OF THE WYOMING CONFERENCE IN THE STATE OF NEW YORK, ENDWELL, NY. FILED 12-4-2003.

WE CARE ABOUT THE PEOPLE WE CARE FOR

THE MARK CONSISTS OF STANDARD CHARACTERS WITHOUT CLAIM TO ANY PARTICULAR FONT, STYLE, SIZE, OR COLOR.

CLASS 43—HOTEL AND RESTAURANT SERVICES

FOR HOUSING AND HOUSING SERVICES FOR THE AGING, NAMELY, RETIREMENT HOMES; ADULT CARE LIVING FACILITIES AND ASSISTED LIVING CARE FACILITIES (U.S. CLS. 100 AND 101).

FIRST USE 0-0-1978; IN COMMERCE 0-0-1978.

CLASS 44—MEDICAL, BEAUTY AND AGRICULTURAL SERVICES

FOR PHYSICAL THERAPY, OCCUPATIONAL THERAPY, SPEECH LANGUAGE PATHOLOGY SERVICES; MASSAGE THERAPY; RESPITE AND PALLIATIVE CARE SERVICES, NAMELY SHORT TERM CARE FOR CHRONICALLY ILL PERSONS, SUPPORTIVE CARE FOR TERMINAL PATIENTS; SKILLED NURSING FACILITIES, NAMELY, NURSING HOMES; CASE MANAGEMENT SERVICES, NAMELY, ASSISTING PERSONS IN APPROPRIATE UTILIZATION OF HEALTHCARE SERVICES (U.S. CLS. 100 AND 101).

FIRST USE 0-0-1978; IN COMMERCE 0-0-1978.

STACY WAHLBERG, EXAMINING ATTORNEY

SN 76-563,074. VERLAND, SEWICKLEY, PA. FILED 12-3-2003.

STATE OF THE HEART

THE MARK CONSISTS OF STANDARD CHARACTERS WITHOUT CLAIM TO ANY PARTICULAR FONT, STYLE, SIZE, OR COLOR.

CLASS 41—EDUCATION AND ENTERTAINMENT

FOR VOCATIONAL GUIDANCE AND EDUCATIONAL SERVICES IN THE NATURE OF CLASSES AND PROGRAMS FOR MENTALLY RETARDED AND DEVELOPMENTALLY DISABLED CHILDREN AND ADULTS (U.S. CLS. 100, 101 AND 107).

FIRST USE 6-1-2000; IN COMMERCE 6-1-2000.

CLASS 43—HOTEL AND RESTAURANT SERVICES

FOR PROVIDING ASSISTED LIVING ACCOMMODATIONS, NAMELY, RESIDENCES FOR MENTALLY RETARDED AND DEVELOPMENTALLY DISABLED CHILDREN AND ADULTS (U.S. CLS. 100 AND 101).

FIRST USE 6-1-2000; IN COMMERCE 6-1-2000.

CLASS 44—MEDICAL, BEAUTY AND AGRICULTURAL SERVICES

FOR HEALTH CARE SERVICES, NAMELY, PSYCHIATRIC, MEDICAL, AND MENTAL HEALTH SERVICES; PSYCHOLOGICAL CONSULTATION AND COUNSELING (U.S. CLS. 100 AND 101).

FIRST USE 6-1-2000; IN COMMERCE 6-1-2000.

RICHARD WHITE, EXAMINING ATTORNEY

SN 76-563,765. GORDON BROTHERS GROUP, LLC, BOSTON, MA. FILED 12-8-2003.

GB ASSET ADVISORS

THE MARK CONSISTS OF STANDARD CHARACTERS WITHOUT CLAIM TO ANY PARTICULAR FONT, STYLE, SIZE, OR COLOR.

NO CLAIM IS MADE TO THE EXCLUSIVE RIGHT TO USE ASSET ADVISORS, APART FROM THE MARK AS SHOWN.

CLASS 35—ADVERTISING AND BUSINESS

FOR BUSINESS APPRAISAL SERVICES FOR THE CONSUMER PRODUCTS AND RETAILING INDUSTRIES NAMELY INVENTORY, ASSET AND OPERATIONS (U.S. CLS. 100, 101 AND 102).

FIRST USE 4-0-1998; IN COMMERCE 4-0-1998.

CLASS 36—INSURANCE AND FINANCIAL

FOR REAL ESTATE VALUATION (U.S. CLS. 100, 101 AND 102).

FIRST USE 4-0-1998; IN COMMERCE 4-0-1998.

MICHAEL ENGEL, EXAMINING ATTORNEY

SN 76-563,766. GORDON BROTHERS GROUP, LLC, BOSTON, MA. FILED 12-8-2003.

SN 76-565,065. SUPERIOR WIND ENERGY INC., HAMILTON, ON, CANADA, FILED 12-1-2003.

DJM

THE MARK CONSISTS OF STANDARD CHARACTERS WITHOUT CLAIM TO ANY PARTICULAR FONT, STYLE, SIZE, OR COLOR.

CLASS 35—ADVERTISING AND BUSINESS

FOR REAL ESTATE AUCTION SERVICES FOR THE CONSUMER PRODUCTS AND RETAILING INDUSTRIES (U.S. CLS. 100, 101 AND 102).
FIRST USE 5-0-1992; IN COMMERCE 5-0-1992.

CLASS 36—INSURANCE AND FINANCIAL

FOR REAL ESTATE CONSULTING, LEASE NEGOTIATION, LEASE MANAGEMENT AND RESTRUCTURING AND DISPOSITION SERVICES FOR THE CONSUMER PRODUCTS AND RETAILING INDUSTRIES (U.S. CLS. 100, 101 AND 102).
FIRST USE 5-0-1992; IN COMMERCE 5-0-1992.

CLASS 37—CONSTRUCTION AND REPAIR

FOR REAL ESTATE SITE SELECTION (U.S. CLS. 100, 103 AND 106).
FIRST USE 5-0-1992; IN COMMERCE 5-0-1992.
MICHAEL ENGEL, EXAMINING ATTORNEY

SN 76-564,858. SAFESHRED CO., INC., LOS ANGELES, CA. FILED 12-12-2003.

SAFESHRED

THE MARK CONSISTS OF STANDARD CHARACTERS WITHOUT CLAIM TO ANY PARTICULAR FONT, STYLE, SIZE, OR COLOR.

CLASS 37—CONSTRUCTION AND REPAIR

FOR PAPER COLLECTION FOR RECYCLING, NAMELY, THE COLLECTION OF WASTE PAPER FOR PULPING (U.S. CLS. 100, 103 AND 106).

CLASS 40—MATERIAL TREATMENT

FOR DESTRUCTION OF DOCUMENTS, DATA STORAGE MEDIA, TRASH AND WASTE, WHETHER CONTAINING PERSONAL, BUSINESS, LEGAL, TECHNICAL, MEDICAL, FINANCIAL, CONFIDENTIAL, OR SECURITY INFORMATION; SHREDDING OF DOCUMENTS, DATA STORAGE MEDIA, AND RELATED TRASH AND WASTE; RECYCLING OF WASTE PAPER FOR PULPING (U.S. CLS. 100, 103 AND 106).
TINA L. SNAPP, EXAMINING ATTORNEY

WIND WIZARD

PRIORITY CLAIMED UNDER SEC. 44(D) ON CANADA APPLICATION NO. 1180996, FILED 6-10-2003, REG. NO. TMA635100, DATED 3-14-2005, EXPIRES 3-14-2020.

NO CLAIM IS MADE TO THE EXCLUSIVE RIGHT TO USE WIND, APART FROM THE MARK AS SHOWN.

CLASS 35—ADVERTISING AND BUSINESS

FOR RETAIL STORE SERVICES FEATURING MOBILE PHONIC DETECTION AND RANGING DOPPLER SYSTEMS FOR THE PURPOSE OF EVALUATING POTENTIAL WIND GENERATION SITES, CONDUCTING POLLUTION PLUME, AND WAKE TURBULENCE STUDIES (U.S. CLS. 100, 101 AND 102).

CLASS 42—SCIENTIFIC, COMPUTER AND LEGAL SERVICES

FOR SONAR AND RADAR DETECTION FOR THE PURPOSE OF EVALUATING POTENTIAL WIND GENERATION SITES, CONDUCTING POLLUTION PLUME, AND WAKE TURBULENCE STUDIES (U.S. CLS. 100 AND 101).

ALICE BENMAMAN, EXAMINING ATTORNEY

SN 76-565,092. SAGEDYNAMICS, LLC, PALO ALTO, CA. FILED 12-4-2003.

SAGEERA

THE MARK CONSISTS OF STANDARD CHARACTERS WITHOUT CLAIM TO ANY PARTICULAR FONT, STYLE, SIZE, OR COLOR.

SAGEERA DOES NOT IDENTIFY A PARTICULAR LIVING INDIVIDUAL.

CLASS 9—ELECTRICAL AND SCIENTIFIC APPARATUS

FOR PRE-RECORDED AUDIO CASSETTES, AUDIO TAPES, COMPACT DISCS, VIDEO RECORDINGS, CD-ROMS, DVDS, AND VIDEO CASSETTES, AND DOWNLOADABLE ELECTRONIC PUBLICATIONS, NAMELY NEWSLETTERS, ARTICLES AND BOOKS, ALL ON THE TOPICS OF SELF-IMPROVEMENT, SELF-HELP, WELL-BEING, PERSONAL AND PROFESSIONAL SUCCESS, SELF-AWARENESS, ENLIGHTENMENT, MEDITATION, METAPHYSICAL AND SPIRITUAL DISCOVERY, RELAXATION, HEALING TECHNIQUES, FITNESS, NUTRITION, AND PHYSICAL, EMOTIONAL AND MENTAL HEALTH; DOWNLOADABLE SOFTWARE TO CALCULATE AND VISUALIZE ANTHROPOMORPHIC DATA, E.G; BODY MASS INDEX OR AEROBIC FITNESS LEVEL; AND TO SURVEY AND ASSESS HEALTH AND DIET RELATED INFORMATION (U.S. CLS. 21, 23, 26, 36 AND 38).

CLASS 16—PAPER GOODS AND PRINTED MATTER

FOR PRINTED MATERIALS, NAMELY MAGAZINES, NEWSLETTERS, FICTION AND NON-FICTION BOOKS, ALL ON THE TOPICS OF SELF-IMPROVEMENT, SELF-HELP, WELLBEING, PERSONAL AND PROFESSIONAL SUCCESS, SELF-AWARENESS, ENLIGHTENMENT, MEDITATION, METAPHYSICAL AND SPIRITUAL DISCOVERY, RELAXATION, HEALING TECHNIQUES, FITNESS, NUTRITION, AND PHYSICAL, EMOTIONAL AND MENTAL HEALTH; COOKBOOKS AND NON-ELECTRONIC PERSONAL DAILY PLANNERS AND PERSONAL ORGANIZERS (U.S. CLS. 2, 5, 22, 23, 29, 37, 38 AND 50).

CLASS 38—COMMUNICATION

FOR PROVIDING INTERACTIVE DISCUSSION BOARDS, CHAT ROOMS, ELECTRONIC MESSAGING AND E-MAIL SERVICES, ALL ON THE TOPICS OF SELF-IMPROVEMENT, SELF-HELP, WELLBEING, PERSONAL AND PROFESSIONAL SUCCESS, SELF-AWARENESS, ENLIGHTENMENT, MEDITATION, METAPHYSICAL AND SPIRITUAL DISCOVERY, RELAXATION, HEALING TECHNIQUES, FITNESS, NUTRITION, AND PHYSICAL, EMOTIONAL AND MENTAL HEALTH (U.S. CLS. 100, 101 AND 104).

CLASS 41—EDUCATION AND ENTERTAINMENT

FOR CONDUCTING OR SPONSORING WORKSHOPS, SEMINARS AND CLASSES ON THE TOPICS OF SELF-IMPROVEMENT, SELF-HELP, WELL-BEING, PERSONAL AND PROFESSIONAL SUCCESS, SELF-AWARENESS, ENLIGHTENMENT, MEDITATION, METAPHYSICAL AND SPIRITUAL DISCOVERY, RELAXATION, HEALING TECHNIQUES, FITNESS, NUTRITION, AND PHYSICAL, EMOTIONAL AND MENTAL HEALTH, HEALING TECHNIQUES AND PHYSICAL FITNESS, NUTRITION, PHYSICAL, EMOTIONAL AND MENTAL HEALTH AND PSYCHOLOGICAL TESTS; PREPARING, ADMINISTERING AND SCORING PERSONALITY TESTS, PSYCHOLOGICAL TESTS AND LEADERSHIP DEVELOPMENT TESTS; PROVIDING INFORMATION AND INTERACTIVE DATABASES ON THE INTERNET IN THE FIELD OF PHYSICAL FITNESS (U.S. CLS. 100, 101 AND 107).

CLASS 44—MEDICAL, BEAUTY AND AGRICULTURAL SERVICES

FOR PROVIDING INFORMATION AND INTERACTIVE DATABASES ON THE INTERNET, ALL ON THE TOPICS OF NUTRITION; PHYSICAL, EMOTIONAL AND MENTAL HEALTH; HEALING TECHNIQUES AND PSYCHOLOGICAL TESTS (U.S. CLS. 100 AND 101).

CLASS 45—PERSONAL SERVICES

FOR PROVIDING INFORMATION AND INTERACTIVE DATABASES ON THE INTERNET, ALL ON THE TOPICS OF SELF-IMPROVEMENT, SELF-HELP, WELL-BEING, PERSONAL AND PROFESSIONAL SUCCESS, SELF-AWARENESS, ENLIGHTENMENT, MEDITATION, METAPHYSICAL AND SPIRITUAL DISCOVERY, AND RELAXATION (U.S. CLS. 100 AND 101).

ANDREW BENZMILLER, EXAMINING ATTORNEY

SN 76-565,396. MICRO ESSENTIAL LABORATORY, INC., BROOKLYN, NY. FILED 12-3-2003.

INSTA-CHEK

THE MARK CONSISTS OF STANDARD CHARACTERS WITHOUT CLAIM TO ANY PARTICULAR FONT, STYLE, SIZE, OR COLOR.

CLASS 1—CHEMICALS

FOR CHEMICAL TEST PRODUCTS AND SETS COMPRISING CHEMICAL TEST PAPERS, CHEMICAL INDICATORS, PH INDICATOR PENCILS, AND COLOR CHARTS, FOR TESTING, DETECTING, IDENTIFYING, MEASURING, AND INDICATING LEVELS OF PH, AND DISPENSERS THEREFOR, NONE OF THE FOREGOING USED FOR DETECTING ILLEGAL DRUG SUBSTANCES OR ILLEGAL DRUG SUBSTANCE USE (U.S. CLS. 1, 5, 6, 10, 26 AND 46).

FIRST USE 0-0-1975; IN COMMERCE 0-0-1975.

CLASS 5—PHARMACEUTICALS

FOR CHEMICAL TEST PRODUCTS AND SETS COMPRISING CHEMICAL TEST PAPERS, AND COLOR CHARTS, FOR TESTING, DETECTING, IDENTIFYING, MEASURING, AND INDICATING LEVELS OF PH, AND DISPENSERS THEREFOR, FOR CLINICAL AND MEDICAL USE, NONE OF THE FOREGOING USED FOR DETECTING ILLEGAL DRUG SUBSTANCES OR ILLEGAL DRUG SUBSTANCE USE (U.S. CLS. 6, 18, 44, 46, 51 AND 52).

FIRST USE 12-31-1980; IN COMMERCE 12-31-1980.
STEVEN JACKSON, EXAMINING ATTORNEY

SN 76-566,807. DEGUSSA AG, 40474 DUESSELDORF, FED REP GERMANY, FILED 12-11-2003.

INDISPRON

OWNER OF FED REP GERMANY REG. NO. 30332398, DATED 11-3-2003, EXPIRES 6-30-2013.

CLASS 1—CHEMICALS

FOR CHEMICALS USED IN INDUSTRY, SCIENCE AND PHOTOGRAPHY, AS WELL AS IN AGRICULTURE, HORTICULTURE AND FORESTRY; MANURES; FIRE EXTINGUISHING COMPOSITIONS; CHEMICAL SUBSTANCES FOR PRESERVING FOODSTUFFS; ADHESIVES USED IN INDUSTRY (U.S. CLS. 1, 5, 6, 10, 26 AND 46).

CLASS 5—PHARMACEUTICALS

FOR DISINFECTANTS; PREPARATIONS FOR DESTROYING VERMIN; FUNGICIDES, HERBICIDES FOR AGRICULTURAL USE AND DOMESTIC USE (U.S. CLS. 6, 18, 44, 46, 51 AND 52).

CLASS 42—SCIENTIFIC, COMPUTER AND LEGAL SERVICES

FOR PROVIDING OF INFORMATION ABOUT CHEMICALS IN THE INTERNET (U.S. CLS. 100 AND 101).
CAROLYN GRAY, EXAMINING ATTORNEY

SN 76-567,022. WORLD OF JEANS & TOPS, INC., IRVINE, CA. FILED 12-15-2003.

COREBLUE

THE MARK CONSISTS OF STANDARD CHARACTERS WITHOUT CLAIM TO ANY PARTICULAR FONT, STYLE, SIZE, OR COLOR.

THE MARK CONSISTS OF THE WORD "COREBLUE" AS SHOWN IN THE DRAWING.

CLASS 25—CLOTHING

FOR MENS' AND BOY'S WEARING APPAREL, NAMELY, T-SHIRTS, SWEATSHIRTS, TANK TOPS, WOMEN SHIRTS, SWEATERS, CARDIGANS, VESTS, JACKETS, PANTS, SWEATPANTS, JEANS, SHORTS, HATS, CAPS, COATS, PAJAMAS, SOCKS, UNDERWEAR, SWIM WEAR, AND TRUNKS; AND WOMEN'S AND GIRL'S WEARING APPAREL, NAMELY, T-SHIRTS, CARDIGANS, VESTS, JACKETS, PANTS, SWEATPANTS, JEANS, SHORTS, HATS, CAPS, COATS, PAJAMAS, SOCKS, UNDERWEAR, PANTYHOSE, TEDDIES, BRAS, SKIRTS, DRESSES, BLOUSES, SWIM WEAR, AND BIKINIS (U.S. CLS. 22 AND 39).

CLASS 35—ADVERTISING AND BUSINESS

FOR RETAIL STORE SERVICES FEATURING MEN'S, BOY'S, WOMEN'S, AND GIRL'S WEARING APPAREL (U.S. CLS. 100, 101 AND 102).

JERI J. FICKES, EXAMINING ATTORNEY

SN 76-567,693. MUNOZ DE LA ESPADA (UK) LTD., LONDON SW3 3DD, ENGLAND, FILED 12-10-2003.

 **DE LA ESPADA**

OWNER OF ERPN CMNTY TM OFC REG. NO. 2238947, DATED 4-22-2003, EXPIRES 5-30-2011.

THE MARK CONSISTS OF THE WORDS DE LA ESPADA IN PLAIN BLOCK LETTERS WITH AN ACCOMPANYING SQUARE-SHAPED DESIGN ELEMENT AND THE TWO LETTERS "E" FACING EACH OTHER.

THE ENGLISH TRANSLATION OF THE WORDS DE LA ESPADA IN THE MARK IS: OF THE SWORD.

CLASS 11—ENVIRONMENTAL CONTROL APPARATUS

FOR LIGHTS, NAMELY, ELECTRIC LIGHT BULBS; LAMPS; LAMP SHADES; LAMP SHADE HOLDERS; ELECTRIC LIGHT FITTINGS, NAMELY, SOCKETS, WIRES, ELECTRICAL FITTINGS FOR HOLDING LIGHT BULBS AND FILAMENTS, ELECTRIC LIGHTING FIXTURES; AND PARTS FOR ALL OF THE AFORESAID GOODS (U.S. CLS. 13, 21, 23, 31 AND 34).

FIRST USE 0-0-1996; IN COMMERCE 0-0-1998.

CLASS 20—FURNITURE AND ARTICLES NOT OTHERWISE CLASSIFIED

FOR FURNITURE; MIRRORS; PICTURE FRAMES; CHAIRS; TABLES; SHELVES; CABINETS; DESKS; BEDROOM FURNITURE; CUSHIONS, MATTRESSES; KITCHEN FURNITURE; LIVING ROOM FURNITURE; OFFICE FURNITURE; BEDS; CHESTS OF DRAWERS; MAGAZINE STANDS; NON-METAL MAGAZINE STORAGE BOXES; FOOTSTOOLS; UMBRELLA STANDS; AND FOREGOING GOODS OF WOOD, CORK, REED, CANE, WICKER, HORN, BONE, IVORY, WHALEBONE, SHELL, AMBER, MOTHER-OF-PEARL, MEERSCHAUM AND SUBSTITUTES FOR ALL THESE MATERIALS OR OF PLASTICS (U.S. CLS. 2, 13, 22, 25, 32 AND 50).

FIRST USE 0-0-1996; IN COMMERCE 0-0-1998.

CLASS 24—FABRICS

FOR TEXTILES AND TEXTILE GOODS, NAMELY, BED LINENS, BED COVERS, BED CLOTHS, BLANKETS, CURTAINS, BLINDS, HANDKERCHIEFS, NAPKINS, PILLOWCASES, QUILTS, TABLE RUNNERS, SHEETS, TABLE CLOTHS, TABLE LINENS, TABLE MATS AND TOWELS (U.S. CLS. 42 AND 50).

FIRST USE 0-0-1996; IN COMMERCE 0-0-1998.

CLASS 27—FLOOR COVERINGS

FOR CARPETS, RUGS, DOORMATS, BATHMATS, FLOOR RUNNERS AND MATTING FOR COVERING EXISTING FLOORS (U.S. CLS. 19, 20, 37, 42 AND 50).

FIRST USE 0-0-1996; IN COMMERCE 0-0-1998.

CLASS 35—ADVERTISING AND BUSINESS

FOR RETAIL STORE AND ONLINE RETAIL STORE SERVICES FEATURING FURNITURE, LIGHTS AND LIGHTING, HOME FURNISHINGS, TEXTILES AND TEXTILE GOODS, FLOOR COVERINGS, AND HOME AND DECORATIVE FIXTURES AND ACCESSORIES (U.S. CLS. 100, 101 AND 102).

FIRST USE 0-0-1996; IN COMMERCE 0-0-1998.

CLASS 42—SCIENTIFIC, COMPUTER AND LEGAL SERVICES

FOR INTERIOR DESIGN SERVICES (U.S. CLS. 100 AND 101).

FIRST USE 0-0-1996; IN COMMERCE 0-0-1998.

JOSETTE BEVERLY, EXAMINING ATTORNEY

SN 76-568,673. AVPC RENTALS CORPORATION, NASHVILLE, TN. FILED 12-24-2003.

SN 76-569,068. OVERHAUL COMPANY, INC., HUDSON, MA. FILED 1-9-2004.

RITM

CLASS 7—MACHINERY

FOR BICYCLE DYNAMOS; FUEL INJECTORS FOR ENGINES; POWER-OPERATED GENERATORS FOR ELECTRICITY; ENGINES FOR BOATS, LUBRICATING PUMPS, NAMELY, OIL PUMPS FOR LAND VEHICLES; VACUUM PUMPS FOR MACHINES; AIR CONDENSERS; AXLES FOR MACHINES; MECHANICALLY OPERATED HAND-HELD TOOLS, NAMELY, MECHANICALLY OPERATED HAND-HELD CRIMPERS; POWER-OPERATED TOOLS, NAMELY, GRINDERS AND CRUSHERS FOR ICES; ELECTRIC FOOD GRINDERS FOR DOMESTIC USE; ELECTRIC FOOD BLENDERS FOR HOUSEHOLD PURPOSES; ELECTRIC HAND-HELD DRILLS; ELECTRIC GLUE GUNS; ELECTRIC FOOD PROCESSORS; VACUUM CLEANERS; CLOTHES WASHING MACHINES; EMBOSsing MACHINES; GLASS WORKING MACHINES; ELECTROMECHANICAL MACHINES FOR USE IN THE CHEMICAL INDUSTRY; CLOTHES RINSING MACHINES; DRILLING MACHINES; POWER HAMMERS; PNEUMATIC HAMMERS; CATALYTIC MOLDING MACHINES; MACHINE PARTS, NAMELY, CONVERTERS FOR USE IN THE STEEL INDUSTRY; STANDS FOR MACHINES; MILLING MACHINES; MACHINE PARTS, NAMELY, KNIVES; BLADE SHARPENING MACHINES; PUNCHING MACHINES, NAMELY, PUNCHING PRESSES FOR METALWORKING; PAINT SPRAY GUNS; PAINTING MACHINES; OIL REFINING MACHINES; MACHINE, NAMELY ROAD ROLLERS; WOOD BEATING MACHINES; ESCALATORS; AGRICULTURAL MACHINES AND PARTS THEREOF, NAMELY, SEEDERS; ELECTRIC KNIVES; DRAINAGE MACHINES FOR HOUSEHOLD PURPOSE; WEEDING MACHINES; AERATING PUMPS FOR AQUARIA; NET HAULING MACHINES FOR USE IN FISHING; MILKING MACHINES; SHEARING MACHINES FOR ANIMALS; POWER SAW BLADES BEING MACHINE PARTS; MACHINE, NAMELY, POWER SAWS; PAPER MAKING MACHINES; PRINTING PLATES; MACHINE PARTS, NAMELY, POWER-OPERATED REELS FOR WEAVING LOOMS; LACE MAKING MACHINES; MACHINE PARTS, NAMELY, POWER-OPERATED REELS SPINNING WHEELS; KNITTING MACHINES; DYEING MACHINES; BREWING MACHINES; TOBACCO PROCESSING MACHINES; LEATHER PARING MACHINES; HONING MACHINES FOR USE IN CLOTHING INDUSTRY; POWER-OPERATED POTTERS' WHEELS; ENGRAVING MACHINES; BATTERY-MAKING MACHINES; PACKING MACHINES; CIVIL COAL PROCESSING MACHINES; STEAM ENGINES NOT FOR LAND VEHICLES; HYDRAULIC ENGINES AND MOTORS FOR MACHINES; BUTTONS AND ZIPPERS MAKING MACHINES; GAS SEPARATING APPARATUS, NAMELY, GAS SEPARATORS; OIL SEPARATORS; MACHINE PARTS, NAMELY, ANTI-FRICTION BEARINGS; ELECTRIC WELDING MACHINES; WASHING APPARATUS, NAMELY, DISH WASHING MACHINES; FOOD WASTE DISPOSAL MACHINES (U.S. CLS. 13, 19, 21, 23, 31, 34 AND 35).

FIRST USE 10-20-2003; IN COMMERCE 10-20-2003.

CLASS 8—HAND TOOLS

FOR HAND TOOLS, NAMELY, BLADES FOR PLANES; HAND-OPERATED GOUGES; HAND-OPERATED CLAMPS USE BY CARPENTERS OR COOPERS; HAND-OPERATED CHISELS; HAND-OPERATED SCREWDRIVERS; HAND-OPERATED PLIERS; HAND-OPERATED NIPPERS; HAND-OPERATED CUTTING TOOLS; HAND-OPERATED LIFTING JACKS; HAND-OPERATED NAIL PUNCHES; HAND-OPERATED BORERS; HAND-OPERATED DRILLS; HAND-OPERATED POLISHING IRONS FOR USE IN GLAZING; HAND-OPERATED MOLDING IRONS; HAND-OPERATED GUNS, NAMELY, CAULKING GUNS; HAND PUMPS; HAND-OPERATED TWEET-



CLASS 41—EDUCATION AND ENTERTAINMENT

FOR RENTAL OF AUDIO-VISUAL EQUIPMENT FOR USE IN COMPUTER TRAINING ROOMS, AT MEETINGS, CONFERENCES, SEMINARS, TRADESHOWS AND OTHER SUCH EVENTS (U.S. CLS. 100, 101 AND 107).

FIRST USE 7-2-2003; IN COMMERCE 7-2-2003.

CLASS 42—SCIENTIFIC, COMPUTER AND LEGAL SERVICES

FOR RENTAL OF COMPUTERS (U.S. CLS. 100 AND 101).

FIRST USE 7-2-2003; IN COMMERCE 7-2-2003.

CIMMERIAN COLEMAN, EXAMINING ATTORNEY

ZERS; HAND-OPERATED SPATULAS FOR SPREADING; HAND-OPERATED KNIFE SHARPENING STEELS; CUTTERS, NAMELY, WIRE CUTTERS; HAND-OPERATED SAW BLADES FOR HAND SAWS; HAND-OPERATED ABRADING TOOLS; HAND-OPERATED SHARPENING TOOLS AND INSTRUMENTS; SHARPENING WHEELS; EMERY MANUALLY-OPERATED GRINDING WHEELS; HAND-OPERATED BUSH HAMMERS; HAND-OPERATED PICK HAMMERS; HAND-OPERATED SHOVELS; HAND HELD NEEDLE FILES; HAND-OPERATED BAR CUTTERS; HAND-OPERATED REAMERS; BITS FOR HAND DRILLS; HAND-OPERATED SQUARES; HAND-OPERATED CUTTING BARS; HAND DRILLS; HAND-OPERATED MORTISE AXES; HAND-OPERATED SAWS; HAND-OPERATED WRENCHES; HAND-OPERATED SPANNERS PLANES; HAND-OPERATED AGRICULTURAL IMPLEMENTS, NAMELY, FORKS; HAND-OPERATED GARDEN TOOLS, NAMELY, TOOLS, NAMELY, BRANDING IRONS; HAND-OPERATED MINCING KNIVES; HAND-OPERATED SWORD SCABARDS AND TABLE CUTLERY, NAMELY, KNIVES, FORKS AND SPOONS (U.S. CLS. 23, 28 AND 44).

FIRST USE 10-20-2003; IN COMMERCE 10-20-2003.
ZACHARY BELLO, EXAMINING ATTORNEY

SN 76-571,512. TELETRONICS INTERNATIONAL INC., ROCKVILLE, MD. FILED 1-21-2004.

The logo for EZHOTSPOT features the word "EZHOTSPOT" in a bold, black, sans-serif font. The letter "O" is replaced by a stylized graphic of a hot air balloon or a similar circular shape with a vertical line extending downwards from its center.

CLASS 16—PAPER GOODS AND PRINTED MATTER

FOR PRINTED WIRELESS COMMUNICATION SYSTEMS ACCESS CARDS, NOT MAGNETICALLY ENCODED (U.S. CLS. 2, 5, 22, 23, 29, 37, 38 AND 50).
FIRST USE 5-31-2003; IN COMMERCE 12-1-2003.

CLASS 38—COMMUNICATION

FOR COMMUNICATION SERVICES, NAMELY, ELECTRONIC, WIRELESS, ELECTRIC, AND DIGITAL TRANSMISSION OF VOICE, DATA, IMAGES, SIGNALS AND MESSAGES; PROVIDING AND CONTROLLING USER ACCESS TO ELECTRONIC NETWORK COMMUNICATIONS, AND PROVIDING ONLINE USER ACCESS INFORMATION, USED IN CONNECTION THEREWITH (U.S. CLS. 100, 101 AND 104).

FIRST USE 5-31-2003; IN COMMERCE 12-1-2003.
STEVEN JACKSON, EXAMINING ATTORNEY

SN 76-571,095. PLUS ONE HOLDINGS, INC., NEW YORK, NY. FILED 12-8-2003.

+1

SN 76-571,821. PRC PROPERTIES, LLC, DBA THE ROCKS AT PINNACLE PEAK, SCOTTSDALE, AZ. FILED 1-26-2004.

THE ROCKS AT PINNACLE PEAK

THE MARK CONSISTS OF STANDARD CHARACTERS WITHOUT CLAIM TO ANY PARTICULAR FONT, STYLE, SIZE, OR COLOR.

CLASS 41—EDUCATION AND ENTERTAINMENT

FOR PHYSICAL FITNESS INSTRUCTION; AND PERSONAL TRAINING SERVICES, NAMELY, STRENGTH AND CONDITIONING TRAINING (U.S. CLS. 100, 101 AND 107).

FIRST USE 3-31-2001; IN COMMERCE 3-31-2001.

CLASS 44—MEDICAL, BEAUTY AND AGRICULTURAL SERVICES

FOR FOOD NUTRITION CONSULTING; PHYSICAL THERAPY SERVICES; AND HEALTH SPA SERVICES, NAMELY, BODY CARE SERVICES (U.S. CLS. 100 AND 101).

FIRST USE 3-31-2001; IN COMMERCE 3-31-2001.
BARBARA GAYNOR, EXAMINING ATTORNEY

THE MARK CONSISTS OF STANDARD CHARACTERS WITHOUT CLAIM TO ANY PARTICULAR FONT, STYLE, SIZE, OR COLOR.

NO CLAIM IS MADE TO THE EXCLUSIVE RIGHT TO USE "PINNACLE PEAK", APART FROM THE MARK AS SHOWN.

CLASS 36—INSURANCE AND FINANCIAL

FOR REAL ESTATE MANAGEMENT; REAL ESTATE BROKERAGE SERVICES (U.S. CLS. 100, 101 AND 102).
FIRST USE 6-1-2003; IN COMMERCE 6-15-2003.

CLASS 37—CONSTRUCTION AND REPAIR

FOR REAL ESTATE DEVELOPMENT (U.S. CLS. 100, 103 AND 106).

FIRST USE 6-1-2003; IN COMMERCE 6-15-2003.
DANIEL CAPSHAW, EXAMINING ATTORNEY

SN 76-571,825. INTERNATIONAL FUEL TECHNOLOGY, INC., ST. LOUIS, MO. FILED 1-26-2004.

GASOLIFT

THE MARK CONSISTS OF STANDARD CHARACTERS WITHOUT CLAIM TO ANY PARTICULAR FONT, STYLE, SIZE, OR COLOR.

PRIORITY CLAIMED UNDER SEC. 44(D) ON ERPN CMNTY TM OFC APPLICATION NO. 003288305, FILED 7-28-2003, REG. NO. 003288305, DATED 2-4-2005, EXPIRES 7-28-2013.

CLASS 1—CHEMICALS

FOR CHEMICAL ADDITIVES FOR MOTOR FUEL (U.S. CLS. 1, 5, 6, 10, 26 AND 46).

CLASS 4—LUBRICANTS AND FUELS

FOR MOTOR FUEL FOR ENGINES UTILIZING DISTILLATE HYDRO-CARBON FUELS NAMELY, DIESEL, KEROSENE, GASOLINE; MOTOR FUEL FOR ENGINES NAMELY BIO-DIESEL, ETHANOL; MOTOR FUEL FOR ENGINES NAMELY FUEL BLENDS CONTAINING COMBINATIONS OF DIESEL, KEROSENE, GASOLINE WITH ETHANOL AND/OR BIO-DIESEL; MOTOR FUEL FOR ENGINES NAMELY LIQUID PETROLEUM GAS AND COMPRESSED NATURAL GAS (U.S. CLS. 1, 6 AND 15).

CLASS 39—TRANSPORTATION AND STORAGE

FOR TRANSPORTATION OF FUEL BY ROAD, SEA, RAIL AND PIPELINE; DISTRIBUTION IN THE NATURE OF FUEL SUPPLYING SERVICES; STORING OF FUEL SERVICES (U.S. CLS. 100 AND 105).

CLASS 40—MATERIAL TREATMENT

FOR FUEL TREATMENT SERVICES FOR OTHERS, NAMELY SERVICES OF ADDING ADDITIVES TO MOTOR FUEL AND SERVICES OF BLENDING MOTOR FUEL (U.S. CLS. 100, 103 AND 106).

ALICE BENMAMAN, EXAMINING ATTORNEY

SN 76-572,961. TCC COMMUNICATIONS, LLC, DBA SOFTWARE SECURITY SOLUTIONS, LAKEWOOD, CO. FILED 1-29-2004.

IF YOUR DATA ISN'T SECURE, IT ISN'T YOUR DATA

THE MARK CONSISTS OF STANDARD CHARACTERS WITHOUT CLAIM TO ANY PARTICULAR FONT, STYLE, SIZE, OR COLOR.

CLASS 35—ADVERTISING AND BUSINESS

FOR ON-LINE RETAIL STORE SERVICES FEATURING COMPUTER AND NETWORK SOFTWARE PROGRAMS IN THE FIELDS OF SECURITY SOFTWARE, NAMELY, ANTI-HACKING SOFTWARE, ANTI-VIRUS SOFTWARE, FIREWALL SOFTWARE, CONTENT FILTERING SOFTWARE, E-MAIL FILTERING SOFTWARE, DATA ENCRYPTION SOFTWARE; COMPUTER UTILITIES SOFTWARE; COMPUTER SOFTWARE AND PATCHES USED TO ENHANCE THE PERFORMANCE, ADJUST, OR DEBUG EXISTING APPLICATIONS AND OTHER SOFTWARE PROGRAMS; RETAIL SERVICES IN THE FIELDS OF COMPUTERS, NAMELY, CLIENT, SERVER, AND STAND-ALONE COMPUTER SYSTEMS; COMPUTER AND NETWORK PERIPHERALS, NAMELY MONITORS, KEYBOARDS, PRINTERS, MICE, CO-PROCESSORS, MODEMS, STORAGE DEVICES NAMELY, HARD AND FLOPPY DISK DRIVES, TAPE DRIVES, OPTICAL MEDIA DRIVES, ENCODABLE MEMORY CARDS AND MEMORY ADD-ONS, MEMORY BOARDS AND CHIPS, CABLES AND CONNECTORS; AND COMPUTER AND NETWORK DEVICES NAMELY COMMUNICATIONS SERVERS, FIREWALL DEVICES, NETWORK SWITCHES, AND NETWORK CONCENTRATORS; ACCESSORIES AND COMPONENTS THEREFORE (U.S. CLS. 100, 101 AND 102).

FIRST USE 8-23-2002; IN COMMERCE 8-23-2002.

CLASS 42—SCIENTIFIC, COMPUTER AND LEGAL SERVICES

FOR TECHNICAL CONSULTING SERVICES IN THE FIELD OF DESIGN, SELECTION, IMPLEMENTATION, AND USE OF COMPUTER HARDWARE AND SOFTWARE SYSTEMS; TECHNICAL CONSULTING SERVICES IN THE FIELDS OF COMPUTER SECURITY, NETWORK SECURITY, SECURITY INTEGRATION, AND ENCRYPTION/DECRYPTION TECHNOLOGY FOR NETWORKED AND STAND-ALONE COMPUTER SYSTEMS (U.S. CLS. 100 AND 101).

FIRST USE 8-23-2002; IN COMMERCE 8-23-2002.
EDWARD NELSON, EXAMINING ATTORNEY

SN 76-573,946. CLAAS KGAA MBH, D-33428 HARSEWINKEL, FED REP GERMANY, FILED 2-4-2004.

Cougar

THE MARK CONSISTS OF STANDARD CHARACTERS WITHOUT CLAIM TO ANY PARTICULAR FONT, STYLE, SIZE, OR COLOR.

OWNER OF FED REP GERMANY REG. NO. 30347778, DATED 11-20-2003, EXPIRES 9-30-2013.
OWNER OF U.S. REG. NOS. 1,962,291 AND 2,242,783.

CLASS 7—MACHINERY

FOR MACHINES FOR AGRICULTURAL PURPOSES AND MACHINE TOOLS, NAMELY COMBINE-HARVESTERS, FORAGE HARVESTERS, BAILING PRESSES, TRACTORS, AGRICULTURAL TRANSPORTERS, LOAD CARRYING VEHICLES, CUTTER BARS, TILTERS, AND SWATHERS, SOIL WORKING MACHINES AND DEVICES, NAMELY, SOWERS, DEVICES FOR APPLYING FERTILIZERS AND AGRICULTURAL CONTROL CHEMICALS AND THEIR PARTS AND COMPONENTS (U.S. CLS. 13, 19, 21, 23, 31, 34 AND 35).

CLASS 9—ELECTRICAL AND SCIENTIFIC APPARATUS

FOR SCIENTIFIC, SURVEYING, ELECTRIC, PHOTOGRAPHIC, OPTICAL, WEIGHING, MEASURING, SIGNALING, CONTROL APPARATUSES AND INSTRUMENTS, NAMELY, LASERS, SENSORS, AND CAMERAS; APPARATUS FOR RECORDING, TRANSMISSION AND REPRODUCTION OF SOUND AND IMAGES, NAMELY, SPEAKERS, RADIOS, RECEIVERS, AND TRANSCEIVERS; CABLES, NAMELY, COAXIAL CABLES AND ELECTRICAL CABLES; SWITCHES, NAMELY, ELECTRIC SWITCHES AND ANTENNAS; MAGNETIC DATA CARRIERS, NAMELY, BLANK MAGNETIC DATA CARRIERS AND PRE-RECORDED MAGNETIC DATA CARRIERS FEATURING MAPS, AGRICULTURAL DATA, AND AGRICULTURAL MACHINES INFORMATION; COMPUTING MACHINES AND DATA PROCESSING DEVICES, NAMELY, COMPUTERS AND COMPUTER PROGRAMS FOR GLOBAL POSITIONING, FOR USE IN HARVESTING, FOR USE IN MACHINE SERVICING MANAGEMENT; LINKS, NAMELY, FUSIBLE LINKS, ELECTRICAL FUSES; AND TAPE MEASURES, NONE OF THE AFORESAID GOODS FOR VEHICLES, WITH THE EXCEPTION OF AGRICULTURAL VEHICLES, INCLUDING TRACTORS (U.S. CLS. 21, 23, 26, 36 AND 38).

CLASS 12—VEHICLES

FOR TRACTORS AND PARTS AND COMPONENTS THEREFORE (U.S. CLS. 19, 21, 23, 31, 35 AND 44).
GRETTA YAO, EXAMINING ATTORNEY

SN 76-574,103. FABBRICA D'ARMI P. BERETTA, S.P.A., BRESCIA, ITALY, FILED 2-4-2004.

WORLD OF BERETTA

THE MARK CONSISTS OF STANDARD CHARACTERS WITHOUT CLAIM TO ANY PARTICULAR FONT, STYLE, SIZE, OR COLOR.

OWNER OF U.S. REG. NOS. 587,716, 2,786,096 AND OTHERS.

CLASS 13—FIREARMS

FOR FIREARMS (U.S. CLS. 2 AND 9).
FIRST USE 1-0-2000; IN COMMERCE 1-0-2000.

CLASS 25—CLOTHING

FOR WEARING APPAREL, NAMELY, MEN'S AND WOMEN'S SPORTSWEAR AND ACTIVE WEAR, NAMELY SHIRTS, VESTS, COATS, JACKETS, PANTS, CAPS, SWEATERS, SHORTS, GLOVES, SWEATSHIRTS, AND T-SHIRTS (U.S. CLS. 22 AND 39).
FIRST USE 1-0-2000; IN COMMERCE 1-0-2000.

ELIZABETH PIGNATELLO, EXAMINING ATTORNEY

SN 76-575,688. FOOTBALL AMERICA, INC., COLUMBIA, MD. FILED 2-3-2004.



NO CLAIM IS MADE TO THE EXCLUSIVE RIGHT TO USE FOOTBALL AMERICA AMERICA'S FOOTBALL EQUIPMENT SUPPLIER, APART FROM THE MARK AS SHOWN.

THE COLOR(S) RED, BLUE AND BROWN IS/ARE CLAIMED AS A FEATURE OF THE MARK.

THE COLOR RED APPEARS IN THE STRIPES. THE COLOR BLUE APPEARS IN THE WORDS-FOOTBALL AMERICA AMERICA'S FOOTBALL EQUIPMENT SUPPLIER. THE COLOR BROWN APPEARS IN THE FOOTBALL.

CLASS 9—ELECTRICAL AND SCIENTIFIC APPARATUS

FOR FOOTBALL HELMETS, CHINSTRAPS FOR HELMETS (U.S. CLS. 21, 23, 26, 36 AND 38).

FIRST USE 9-0-1999; IN COMMERCE 9-0-1999.

CLASS 25—CLOTHING

FOR FOOTBALL SHOES, JERSEYS, SHIRTS, JACKETS, SHOES, SOCKS PANTS, SHORTS, GLOVES (U.S. CLS. 22 AND 39).

FIRST USE 9-0-1999; IN COMMERCE 9-0-1999.

CLASS 28—TOYS AND SPORTING GOODS

FOR FOOTBALLS, BODY PROTECTORS, CHEST PADS, FOOTBALL ELBOW PADS, GIRDLES KNEE PADS, LEG PADS, SHOULDER PADS, FACEMASKS FOR FOOTBALL, ATHLETIC SUPPORTERS (U.S. CLS. 22, 23, 38 AND 50).

FIRST USE 9-0-1999; IN COMMERCE 9-0-1999.

ANNE MADDEN, EXAMINING ATTORNEY

SN 76-575,962. FORTIFIBER CORPORATION, INCLINE VILLAGE, NV. FILED 2-18-2004.

FORTIFIBER BUILDING SYSTEMS GROUP

THE MARK CONSISTS OF STANDARD CHARACTERS WITHOUT CLAIM TO ANY PARTICULAR FONT, STYLE, SIZE, OR COLOR.

OWNER OF U.S. REG. NOS. 571,230, 573,179 AND 2,839,612.

NO CLAIM IS MADE TO THE EXCLUSIVE RIGHT TO USE "BUILDING SYSTEMS GROUP", APART FROM THE MARK AS SHOWN.

CLASS 16—PAPER GOODS AND PRINTED MATTER

FOR PAPER BAGS AND LAMINATED PAPER IN ROLL AND SHEET FORM (U.S. CLS. 2, 5, 22, 23, 29, 37, 38 AND 50).

FIRST USE 7-1-2003; IN COMMERCE 7-1-2003.

CLASS 17—RUBBER GOODS

FOR BUILDING MATERIALS, NAMELY, NON-METAL WATER VAPOR BARRIERS (U.S. CLS. 1, 5, 12, 13, 35 AND 50).

FIRST USE 7-1-2003; IN COMMERCE 7-1-2003.

CLASS 19—NON-METALLIC BUILDING MATERIALS

FOR NON-METAL WINDOW FLASHING AND DOOR FLASHING; NON-METAL CONCRETE CURING PAPERS, NON-METAL FINISHING FLOORING AND TILE UNDERLAYMENT (U.S. CLS. 1, 12, 33 AND 50).

FIRST USE 7-1-2003; IN COMMERCE 7-1-2003.

BRIAN PINO, EXAMINING ATTORNEY

SN 76-576,162. CUDD PRESSURE CONTROLS, INC., HOUSTON, TX. FILED 2-19-2004.

RACK JACK

THE MARK CONSISTS OF STANDARD CHARACTERS WITHOUT CLAIM TO ANY PARTICULAR FONT, STYLE, SIZE, OR COLOR.

NO CLAIM IS MADE TO THE EXCLUSIVE RIGHT TO USE JACK, APART FROM THE MARK AS SHOWN.

CLASS 37—CONSTRUCTION AND REPAIR

FOR OIL AND GAS WELL DRILLING, WORKOVER AND WELL REPAIR SERVICES (U.S. CLS. 100, 103 AND 106).

FIRST USE 4-1-2001; IN COMMERCE 4-1-2001.

CLASS 40—MATERIAL TREATMENT

FOR OIL AND GAS PRODUCTION SERVICES (U.S. CLS. 100, 103 AND 106).

FIRST USE 4-1-2001; IN COMMERCE 4-1-2001.

KAREN K. BUSH, EXAMINING ATTORNEY

SN 76-576,170. HUMANA INC., LOUISVILLE, KY. FILED 2-19-2004.

RxImpact

THE MARK CONSISTS OF STANDARD CHARACTERS WITHOUT CLAIM TO ANY PARTICULAR FONT, STYLE, SIZE, OR COLOR.

CLASS 35—ADVERTISING AND BUSINESS

FOR SUPPLYING PRESCRIPTION DRUGS TO HEALTH PLAN PARTICIPANTS FOR THE FUNDING ORGANIZATION (U.S. CLS. 100, 101 AND 102).

CLASS 36—INSURANCE AND FINANCIAL

FOR UNDERWRITING, ORGANIZING AND ADMINISTRATION OF PRE-PAID HEALTH CARE AND PRESCRIPTION DRUG SERVICES AND PLANS (U.S. CLS. 100, 101 AND 102).

CLASS 44—MEDICAL, BEAUTY AND AGRICULTURAL SERVICES

FOR HEALTH CARE SERVICES IN THE NATURE OF HEALTH MAINTENANCE AND PREFERRED PROVIDER ORGANIZATIONS (U.S. CLS. 100 AND 101).

MATTHEW KLINE, EXAMINING ATTORNEY

SN 76-578,390. S.A.S., JEAN CASSEGRAIN, 75001 PARIS, FRANCE, FILED 3-1-2004.

LE PLIAGE

THE MARK CONSISTS OF STANDARD CHARACTERS WITHOUT CLAIM TO ANY PARTICULAR FONT, STYLE, SIZE, OR COLOR.

OWNER OF FRANCE REG. NO. 809037, DATED 6-11-2003, EXPIRES 6-11-2013.

OWNER OF U.S. REG. NO. 2,844,358.

THE ENGLISH TRANSLATION OF LE PLIAGE IS THE FOLDING.

SEC. 2(F).

CLASS 18—LEATHER GOODS

FOR HANDBAGS AND TRAVEL BAGS (U.S. CLS. 1, 2, 3, 22 AND 41).

FIRST USE 7-23-2003; IN COMMERCE .

CLASS 25—CLOTHING

FOR CLOTHING, NAMELY RAINCOATS AND HATS (U.S. CLS. 22 AND 39).

CLASS 35—ADVERTISING AND BUSINESS

FOR COMPUTERIZED ON-LINE RETAIL SERVICES IN THE FIELD OF HANDBAGS AND TRAVEL BAGS (U.S. CLS. 100, 101 AND 102).

FIRST USE 10-0-2003; IN COMMERCE 10-0-2003.

DORITT L. CARROLL, EXAMINING ATTORNEY

SN 76-579,545. NATIONAL AUTOMOBILE DEALERS ASSOCIATION, MCLEAN, VA. FILED 3-3-2004.

NADA**CLASS 35—ADVERTISING AND BUSINESS**

FOR MANAGEMENT CONSULTING SERVICES RENDERED TO AUTOMOBILE DEALERS (U.S. CLS. 100, 101 AND 102).

FIRST USE 8-0-1917; IN COMMERCE 8-0-1917.

CLASS 42—SCIENTIFIC, COMPUTER AND LEGAL SERVICES

FOR ASSOCIATION SERVICES; NAMELY, PROMOTING THE INTERESTS OF AUTOMOBILE DEALERS (U.S. CLS. 100 AND 101).

FIRST USE 8-0-1917; IN COMMERCE 8-0-1917.

CHERYL STEPLIGHT, EXAMINING ATTORNEY

SN 76-580,601. LOMBARDINI S.R.L. A SOCIO UNICO, 42100 REGGIO EMILIA, ITALY, FILED 3-11-2004.

ECOLIFE

PRIORITY CLAIMED UNDER SEC. 44(D) ON ITALY APPLICATION NO. TO2004C241, FILED 1-28-2004, REG. NO. 0000927670, DATED 1-28-2004, EXPIRES 1-28-2014.

CLASS 7—MACHINERY

FOR HYBRID PROPULSION UNITS COMPRISED OF AN INTERNAL COMBUSTION AND ELECTRICAL ENGINES FOR MACHINES AND MACHINE TOOLS FOR USE IN THE HIGH TECHNOLOGY FIELD (U.S. CLS. 13, 19, 21, 23, 31, 34 AND 35).

CLASS 11—ENVIRONMENTAL CONTROL APPARATUS

FOR MICRO COGENERATION UNITS FOR SIMULTANEOUS GENERATION OF HEAT AND ELECTRIC POWER FOR USE IN THE HIGH TECHNOLOGY FIELD (U.S. CLS. 13, 21, 23, 31 AND 34).

BARBARA RUTLAND, EXAMINING ATTORNEY

SN 76-580,956. ROCKLINE INDUSTRIES, INC., SHEBOYGAN, WI. FILED 3-15-2004.

ROCKLINE INDUSTRIES

THE MARK CONSISTS OF STANDARD CHARACTERS WITHOUT CLAIM TO ANY PARTICULAR FONT, STYLE, SIZE, OR COLOR.

NO CLAIM IS MADE TO THE EXCLUSIVE RIGHT TO USE "INDUSTRIES", APART FROM THE MARK AS SHOWN.

CLASS 3—COSMETICS AND CLEANING PREPARATIONS

FOR CLEANING CLOTHS AND WIPES IMPREGNATED WITH CLEANING CHEMICALS; HOUSEHOLD CLEANING WIPES; BABY WIPES; PRE-MOISTENED BABY WIPES; DISPOSABLE WIPES AND TOWELETTES IMPREGNATED WITH CHEMICALS OR COMPOUNDS FOR PERSONAL HYGIENE USE; PRE-MOISTENED WIPES FOR PERSONAL HYGIENE, NAMELY, WET WIPES, MAKE-UP REMOVER WIPES AND MOIST TOILET WIPES AND TISSUE; DRY-WATER ACTIVATED WIPES FOR PERSONAL HYGIENE; PRE-MOISTENED COSMETIC TOWELETTES; PREMOISTENED COSMETIC WIPES AND TOWELETTES; COFFEEMAKER CLEANING SOLUTION (U.S. CLS. 1, 4, 6, 50, 51 AND 52).

FIRST USE 11-11-1983; IN COMMERCE 11-11-1983.

CLASS 5—PHARMACEUTICALS

FOR PRE-MOISTENED ANTI-BACTERIAL HAND AND FACE WIPES (U.S. CLS. 6, 18, 44, 46, 51 AND 52).

FIRST USE 1-0-1999; IN COMMERCE 1-0-1999.

CLASS 16—PAPER GOODS AND PRINTED MATTER

FOR DIAPER DISPOSAL BAG; DISPOSABLE DIAPERS AND TRAINING PANTS; COFFEE FILTERS (U.S. CLS. 2, 5, 22, 23, 29, 37, 38 AND 50).

FIRST USE 7-7-1983; IN COMMERCE 7-7-1983.

CLASS 21—HOUSEWARES AND GLASS

FOR GLASS CARAFES FOR COFFEEMAKERS; PERMANENT FILTERS FOR COFFEEMAKERS AND COFFEE STIR STICKS; WATER FILTRATION PITCHERS AND REPLACEMENT CARTRIDGES FOR SAME (U.S. CLS. 2, 13, 23, 29, 30, 33, 40 AND 50).

FIRST USE 10-0-1994; IN COMMERCE 10-0-1994.

RON FAIRBANKS, EXAMINING ATTORNEY

SN 76-583,253. KUMON INSTITUTE OF EDUCATION CO., LTD., KITA-KU, OSAKA, JAPAN, FILED 3-26-2004.

KUMON

OWNER OF JAPAN REG. NO. 4644488, DATED 2-14-2003, EXPIRES 2-14-2013.

CLASS 14—JEWELRY

FOR PRECIOUS METALS; TABLEWARE OF PRECIOUS METAL NAMELY, PLATES, SERVICE PLATTERS, CUPS, MUGS; NUTCRACKERS, PEPPER POTS, SUGAR BOWLS, SALT SHAKERS, EGG CUPS, NAPKIN HOLDERS, NAPKIN RINGS, TRAYS AND TOOTHPICK HOLDERS OF PRECIOUS METAL; FLOWER VASES AND BOWLS OF PRECIOUS METAL; BOXES OF PRECIOUS METAL FOR NEEDLES; JEWEL CASES OF PRECIOUS METAL; CANDLE EXTINGUISHERS AND CANDLESTICKS OF PRECIOUS METAL; PURSES OF PRECIOUS METAL; SHOE ORNAMENTS OF PRECIOUS METAL; POWDER COMPACTS OF PRECIOUS METAL; WALLETS OF PRECIOUS METAL; PERSONAL ORNAMENTS OF PRECIOUS METAL, UNWROUGHT AND SEMI-WROUGHT PRECIOUS STONES AND THEIR IMITATIONS; CLOCKS AND WATCHES; PRECIOUS METAL TROPHIES; COMMEMORATIVE SHIELDS OF PRECIOUS METAL; KEY RINGS OF PRECIOUS METAL; CHARMS FOR KEY RINGS, CHARMS AND FOBS FOR WATCH CHAINS (U.S. CLS. 2, 27, 28 AND 50).

CLASS 18—LEATHER GOODS

FOR UNWORKED OR SEMI-WORKED LEATHER; BAGS, NAMELY, HANDBAGS, BRIEFCASES, SHOULDER BAGS, CARRY-ON BAGS, SUITCASES, TRAVEL BAGS, VALISES, ATHLETIC BAGS, SHOE BAGS FOR TRAVEL TO SCHOOL, MAKEUP BAGS SOLD EMPTY, AND BOOK BAGS; WATCH POUCHES FOR SCHOOL CHILDREN, FANNY PACKS, BACKPACKS, WALLETS, COIN PURSES; VANITY CASES SOLD EMPTY; HANDBAG FRAMES; PURSE FRAMES; UMBRELLAS AND PARTS THEREFOR; CANES AND WALKING STICKS; HANDLES OF CANES AND WALKING STICKS; SADDLERY; CLOTHING FOR DOMESTIC PETS (U.S. CLS. 1, 2, 3, 22 AND 41).

CLASS 20—FURNITURE AND ARTICLES NOT OTHERWISE CLASSIFIED

FOR TROPHIES MADE OF WOOD; COMMEMORATIVE SHIELDS MADE OF WOOD; TROPHIES MADE OF PLASTIC; COMMEMORATIVE SHIELDS MADE OF PLASTIC (U.S. CLS. 2, 13, 22, 25, 32 AND 50).

TRICIA SONNEBORN, EXAMINING ATTORNEY

SN 76-584,440. COLLEGE OF SAINT ROSE, ALBANY, NY.
FILED 4-2-2004.



NO CLAIM IS MADE TO THE EXCLUSIVE RIGHT TO USE "THE COLLEGE OF", APART FROM THE MARK AS SHOWN.

CLASS 25—CLOTHING

FOR CLOTHING, NAMELY SHIRTS, T-SHIRTS, JACKETS, SHORTS, PANTS, CAPS, HATS, BASEBALL HATS, SWEATSHIRTS, AND GOLF SHIRTS (U.S. CLS. 22 AND 39).

FIRST USE 1-1-2002; IN COMMERCE 1-1-2002.

CLASS 26—FANCY GOODS

FOR DECORATIVE METAL ORNAMENTAL NOVELTY PINS (U.S. CLS. 37, 39, 40, 42 AND 50).

FIRST USE 1-1-2002; IN COMMERCE 1-1-2002.

CLASS 41—EDUCATION AND ENTERTAINMENT

FOR EDUCATIONAL SERVICES, NAMELY PROVIDING COURSES OF INSTRUCTION AT THE COLLEGE LEVEL; ENTERTAINMENT SERVICES IN THE FORM OF INTERCOLLEGIATE SPORTS EXHIBITIONS (U.S. CLS. 100, 101 AND 107).

FIRST USE 1-1-2002; IN COMMERCE 1-1-2002.
WILLIAM VERHOSEK, EXAMINING ATTORNEY

SN 76-584,798. PUNK ZIEGEL & COMPANY, NEW YORK, NY. FILED 4-5-2004.

PUNK ZIEGEL & COMPANY

THE MARK CONSISTS OF STANDARD CHARACTERS WITHOUT CLAIM TO ANY PARTICULAR FONT, STYLE, SIZE, OR COLOR.

NO CLAIM IS MADE TO THE EXCLUSIVE RIGHT TO USE & COMPANY, APART FROM THE MARK AS SHOWN.

CLASS 35—ADVERTISING AND BUSINESS

FOR BUSINESS ACQUISITIONS AND MERGER CONSULTATIONS; MERGERS AND ACQUISITION SERVICES, NAMELY, EXCLUSIVE SALE ASSIGNMENTS, ACQUISITIONS, DIVESTITURES, CORPORATE PARTNERING AND RESTRUCTURING, LEVERAGED AND MANAGEMENT BUYOUTS, TENDER OFFERS, FINANCIAL ADVISORY ASSIGNMENTS, TAKEOVER DEFENSES, EXCLUSIVE SALE ASSIGNMENTS, ACQUISITIONS, DIVESTITURES AND FAIRNESS OPINIONS IN RELATIONSHIP THERETO (U.S. CLS. 100, 101 AND 102).

FIRST USE 7-2-1990; IN COMMERCE 7-2-1990.

CLASS 36—INSURANCE AND FINANCIAL

FOR FINANCIAL SERVICES, NAMELY, INVESTMENT MANAGEMENT, INVESTMENT ADVICE, MUTUAL FUND INVESTMENT, FINANCIAL ADVISORY SERVICES, CAPITAL MANAGEMENT SERVICES, INITIAL AND SECONDARY PUBLIC OFFERINGS, INVESTMENT OF FUNDS FOR OTHERS; PORTFOLIO MANAGEMENT SERVICES; INVESTMENT BANKING, CORPORATE FINANCIAL SERVICES, NAMELY, INITIAL PUBLIC OFFERINGS, SECONDARY OFFERINGS, CONVERTIBLE DEBT AND PREFERRED OFFERINGS, UNDERWRITTEN CALLS, PRIVATE PLACEMENTS AND STOCK REPURCHASES; INITIAL PUBLIC OFFERING SERVICES, NAMELY, FOLLOW ON EQUITY AND EQUITY EQUIVALENT OFFERINGS, PRIVATE PLACEMENTS OF EQUITY, PRIVATE PLACEMENTS OF DEBT, FAIRNESS OPINIONS, NAMELY, FINANCIAL VALUATIONS OF BUSINESS ASSETS; FINANCIAL ADVISORY SERVICES; FINANCIAL, INVESTMENT, MANAGEMENT SERVICES RELATED TO THE OPERATION OF PRIVATE EQUITY AND VENTURE CAPITAL FUNDS; ADVISORY SERVICES IN CONNECTION WITH THE FORMATION AND OPERATION OF INVESTMENT FUNDS AND OFFSHORE FUNDS (U.S. CLS. 100, 101 AND 102).

FIRST USE 7-2-1990; IN COMMERCE 7-2-1990.
ESTHER A. BORSUK, EXAMINING ATTORNEY

SN 76-585,114. ETHNIC EDIBLES, LLC, BRONX, NY. FILED 4-5-2004.

ETHNIC EDIBLES

THE MARK CONSISTS OF STANDARD CHARACTERS WITHOUT CLAIM TO ANY PARTICULAR FONT, STYLE, SIZE, OR COLOR.
SEC. 2(F).

CLASS 21—HOUSEWARES AND GLASS

FOR COOKIE CUTTERS (U.S. CLS. 2, 13, 23, 29, 30, 33, 40 AND 50).

FIRST USE 0-0-1999; IN COMMERCE 0-0-1999.

CLASS 30—STAPLE FOODS

FOR COOKIES (U.S. CL. 46).
FIRST USE 0-0-2000; IN COMMERCE 0-0-2000.
STEVEN JACKSON, EXAMINING ATTORNEY

SN 76-585,115. ETHNIC EDIBLES, LLC, BRONX, NY. FILED 4-5-2004.

SN 76-585,920. THE BANK OF EAST ASIA, LIMITED, CENTRAL HONG KONG, HONG KONG, FILED 4-9-2004.



BEA

CLASS 21—HOUSEWARES AND GLASS

FOR COOKIE CUTTERS (U.S. CLS. 2, 13, 23, 29, 30, 33, 40 AND 50).
FIRST USE 0-0-1999; IN COMMERCE 0-0-1999.

CLASS 30—STAPLE FOODS

FOR COOKIES (U.S. CL. 46).
FIRST USE 0-0-2000; IN COMMERCE 0-0-2000.
STEVEN JACKSON, EXAMINING ATTORNEY

THE MARK CONSISTS OF STANDARD CHARACTERS WITHOUT CLAIM TO ANY PARTICULAR FONT, STYLE, SIZE, OR COLOR.

OWNER OF U.S. REG. NOS. 1,439,475, 2,823,844 AND 2,835,084.

SN 76-585,888. DIGITAL INFORMATION NETWORK, L.L.C., OKLAHOMA CITY, OK. FILED 4-9-2004.

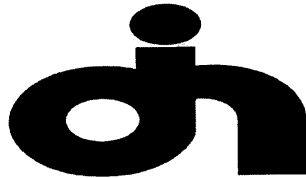

THE MARK CONSISTS OF A STYLIZED REPRESENTATION OF "DIN".

CLASS 9—ELECTRICAL AND SCIENTIFIC APPARATUS

FOR COMMUNICATION SOFTWARE, NAMELY, SOFTWARE FOR DISSEMINATING AND CONVEYING NEWS, WEATHER, BUSINESS COMMUNICATIONS, ALERTS AND A WIDE VARIETY OF INFORMATION (U.S. CLS. 21, 23, 26, 36 AND 38).

FIRST USE 1-9-2002; IN COMMERCE 1-9-2002.

CLASS 35—ADVERTISING AND BUSINESS

FOR ADVERTISING SERVICES, NAMELY, PROVIDING ADVERTISING SPACE BY ELECTRONIC MEANS AND PLACING ADVERTISEMENTS FOR OTHERS IN DESK TOP SOFTWARE APPLICATION (U.S. CLS. 100, 101 AND 102).

FIRST USE 1-9-2002; IN COMMERCE 1-9-2002.

CLASS 38—COMMUNICATION

FOR INFORMATION SERVICES, NAMELY, INFORMATION TRANSMISSION TO DESKTOP SOFTWARE APPLICATION VIA ELECTRONIC COMMUNICATION NETWORKS (U.S. CLS. 100, 101 AND 104).

FIRST USE 1-9-2002; IN COMMERCE 1-9-2002.

VIVIAN MICZNIK FIRST, EXAMINING ATTORNEY

CLASS 16—PAPER GOODS AND PRINTED MATTER

FOR PRINTED MATTER AND PRINTED PUBLICATIONS, NAMELY, BOOKS, MAGAZINES, PAMPHLETS, BROCHURE, NEWSLETTERS AND MANUALS ALL RELATING TO BANKING AND FINANCIAL SERVICES; PRINTED BANK CHECKS, SAVINGS PASSBOOK (U.S. CLS. 2, 5, 22, 23, 29, 37, 38 AND 50).

FIRST USE 2-5-2002; IN COMMERCE 8-1-2002.

CLASS 36—INSURANCE AND FINANCIAL

FOR BANKING; FINANCIAL SERVICES, NAMELY, COMMERCIAL AND CONSUMER LENDING; MORTGAGE LENDING; LOAN FINANCING; CREDIT CARD SERVICES; DEBIT CARD SERVICES; BANK DEPOSITORY SERVICES, NAMELY, CHECKING ACCOUNT SERVICES, SAVINGS ACCOUNT SERVICES, CERTIFICATE OF DEPOSIT ACCOUNT SERVICES AND MONEY MARKET ACCOUNT SERVICES; DEBT-COLLECTION SERVICES; INVESTMENT SERVICES, NAMELY, PROVIDING INVESTMENT ANALYSIS, INVESTMENT CONSULTATION, INVESTMENT PLANNING, INVESTMENT MANAGEMENT, INVESTMENT ADVISORY, INVESTMENT BROKERAGE, INVESTMENT BANKING AND INVESTMENT RESEARCH SERVICES ALL OF THE FOREGOING INVESTMENT SERVICES RELATING TO STOCKS, MUTUAL FUNDS, PROVIDENT FUNDS, PENSION FUNDS, SECURITIES, BONDS, COMMODITIES, AND REAL ESTATE; INSURANCE SERVICES, NAMELY PROVIDING INSURANCE ADMINISTRATION SERVICES, INSURANCE CONSULTATION SERVICES, AND INSURANCE UNDERWRITING SERVICES FOR ALL TYPES OF INSURANCE; PROVIDING FINANCIAL PLANNING AND BANKING INFORMATION ALL VIA GLOBAL COMPUTER NETWORKS AND VIA TELECOMMUNICATION NETWORKS; FOREIGN CURRENCY EXCHANGE AND ADVISORY SERVICES; TRUSTESHIP REPRESENTATIVE SERVICES; FIDUCIARY REPRESENTATIVE SERVICES; NOMINEE SERVICES; FINANCIAL VALUATION OF PERSONAL PROPERTY AND REAL ESTATE; REAL ESTATE ACQUISITION SERVICES; REAL ESTATE LEASING SERVICES; REAL ESTATE BROKERAGE SERVICES; REAL ESTATE APPRAISAL; REAL ESTATE MANAGEMENT (U.S. CLS. 100, 101 AND 102).

FIRST USE 2-5-2002; IN COMMERCE 8-1-2002.

BERYL GARDNER, EXAMINING ATTORNEY

SN 76-586,187. AMERICAN SHEEP INDUSTRY ASSOCIATION, INC., CENTENNIAL, CO. FILED 4-12-2004.



THE MARK CONSISTS OF IN PART OF THE REPRESENTATION OF THE HEAD OF A SHEEP.

CLASS 35—ADVERTISING AND BUSINESS

FOR ASSOCIATION SERVICES, NAMELY PROMOTING THE HEALTH AND WELFARE OF SHEEP AND GOATS AND THE QUALITY OF CONSUMER PRODUCTS FROM SHEEP AND GOATS IN THE UNITED STATES (U.S. CLS. 100, 101 AND 102).
FIRST USE 3-31-1990; IN COMMERCE 3-31-1990.

CLASS 41—EDUCATION AND ENTERTAINMENT

FOR EDUCATIONAL SERVICES, NAMELY CONDUCTING PROGRAMS ASSOCIATED WITH PROMOTING THE HEALTH AND WELFARE OF SHEEP AND GOATS AND THE QUALITY OF CONSUMER PRODUCTS FROM SHEEP AND GOATS IN THE UNITED STATES AND DISTRIBUTING PROGRAM MATERIALS IN CONNECTION THEREWITH (U.S. CLS. 100, 101 AND 107).
FIRST USE 3-31-1990; IN COMMERCE 3-31-1990.
PRISCILLA MILTON, EXAMINING ATTORNEY

CLASS 16—PAPER GOODS AND PRINTED MATTER

FOR PRINTED AND STAMPED PLASTIC AND CARDBOARD GREETING, BLANK, NOTE, AND INDEX CARDS; NOTE PAPER AND ENVELOPES; NAMETAGS AND LABELS MADE FROM PAPER OR CARDBOARD; NOTEBOOKS; NOTE PADS; STATIONERY; PAPER, NAMELY, BOND PAPER AND ART PAPER; GIFT-WRAP PAPER; DIARIES; ADDRESS BOOKS; STUDENT CALENDARS; STAMP ALBUMS AND PHOTO-ALBUMS; FOLDERS FOR LETTERS AND LOOSE PAPERS; STATIONERY CLEAR HOLE REINFORCEMENTS FOR PAPER; RUBBER STAMPS AND IMPRESSION STAMPS; PAPER WEIGHTS; LETTER OPENERS; DRAWING AND UNGRADUATED RULERS; ERASERS; STAPLERS; PAPER CLIPS; BLOTTING PADS; DESK FILE TRAYS; DESK STANDS AND HOLDERS FOR HOLDING STATIONERY AND OFFICE IMPLEMENTS; BOOKMARKERS; STENCILS; SCRATCH PICTURES; POLYVINYL CHLORIDE STICKERS; BLACKBOARDS; CHALK STICKS; ADHESIVES FOR STATIONERY OR HOUSEHOLD PURPOSES; DRAWING AND PAINTING MATERIALS, NAMELY, PENCILS, DRAWING PENCILS, PENS, DRAWING PENS, PAINT TRAYS, PAINTING SETS FOR ARTISTS, PAINTING SETS FOR CHILDREN, CRAFT PAINT KITS, AND PENCIL CASES; BUMPER STICKERS (U.S. CLS. 2, 5, 22, 23, 29, 37, 38 AND 50).

CLASS 21—HOUSEWARES AND GLASS

FOR BEVERAGE GLASSWARE AND MUGS (U.S. CLS. 2, 13, 23, 29, 30, 33, 40 AND 50).

CLASS 28—TOYS AND SPORTING GOODS

FOR TOYS, NAMELY, BOARD GAMES, PARLOR GAMES, CARD GAMES, TOY ACTION FIGURES, WIND-UP TOYS, STUFFED TOYS, ELECTRICAL AND MECHANICAL ACTION TOYS, BASEBALL EQUIPMENT AND ACCESSORIES, NAMELY BASEBALLS, BASEBALL BATS, BASEBALL BASES, BASEBALL MITTS, BASEBALL GLOVES (U.S. CLS. 22, 23, 38 AND 50).
SUELLEN HICKEY, EXAMINING ATTORNEY

SN 76-586,220. D. ALLAN SUCH & ASSOCIATES, INC., GREAT FALLS, MT. FILED 4-12-2004.

SN 76-586,202. BRYAN, HARRELL, CHICAGO, IL. FILED 4-12-2004.

NEXT YEAR IS HERE AT LAST

THE MARK CONSISTS OF STANDARD CHARACTERS WITHOUT CLAIM TO ANY PARTICULAR FONT, STYLE, SIZE, OR COLOR.

CLASS 9—ELECTRICAL AND SCIENTIFIC APPARATUS

FOR PRE-RECORDED COMPACT DISCS FEATURING MUSICAL COMPOSITION (U.S. CLS. 21, 23, 26, 36 AND 38).

MERCHANDISE AND MORE

THE MARK CONSISTS OF STANDARD CHARACTERS WITHOUT CLAIM TO ANY PARTICULAR FONT, STYLE, SIZE, OR COLOR.

OWNER OF U.S. REG. NO. 2,632,763.
NO CLAIM IS MADE TO THE EXCLUSIVE RIGHT TO USE "MERCHANDISE", APART FROM THE MARK AS SHOWN.

CLASS 16—PAPER GOODS AND PRINTED MATTER

FOR PRINTED MATERIALS, NAMELY CATALOGS FOR LISTING OF GOODS AND SERVICES FOR SALE BY OTHERS, COUPONS FOR MERCHANDISE AND SERVICES (U.S. CLS. 2, 5, 22, 23, 29, 37, 38 AND 50).

CLASS 28—TOYS AND SPORTING GOODS

FOR DISPOSABLE TICKETS AND TICKET SETS FOR PLAYING GAMES OF CHANCE (U.S. CLS. 22, 23, 38 AND 50).

CLASS 35—ADVERTISING AND BUSINESS

FOR ADVERTISING SERVICES, NAMELY— DISSEMINATION OF ADVERTISING MATERIALS FOR OTHERS, DISSEMINATION OF ADVERTISING MATERIALS FOR OTHERS ON GAMING TICKETS, DISSEMINATION OF ADVERTISING FOR OTHERS VIA GLOBAL INFORMATION NETWORKS, DISSEMINATION OF ADVERTISING FOR OTHERS IN PRINTED PUBLICATIONS, DISSEMINATION OF ADVERTISING FOR OTHERS VIA TELEPHONE; RETAILING SERVICES, NAMELY— ON-LINE RETAIL STORE SERVICES, PRINTED CATALOG SALES SERVICES, TELEPHONE SALES SERVICES, PHYSICAL RETAIL STORE SERVICES, ON-LINE AUCTIONEERING SERVICES; ALL FEATURING A WIDE VARIETY OF CONSUMER GOODS AND SERVICES FOR OTHERS; PROMOTING THE SALE OF GOODS AND SERVICES OF OTHERS BY KEEPING RECORDS WHICH MAY BE ACCESSED BY TELEPHONE OR VIA GLOBAL INFORMATION NETWORKS OF COUPON CREDITS ACCRUED BY CONSUMERS AND WHICH ARE USED IN THE PURCHASE OF GOODS AND SERVICES PROVIDED BY OTHERS FOR WHICH ADVERTISING SERVICES ARE PROVIDED (U.S. CLS. 100, 101 AND 102).

CLASS 41—EDUCATION AND ENTERTAINMENT

FOR ENTERTAINMENT SERVICES IN THE NATURE OF INTERACTIVE GAMES PROVIDED VIA GLOBAL INFORMATION NETWORKS; EDUCATION SERVICES IN THE NATURE OF PROVIDING EDUCATIONAL MATERIALS AND INTERACTIVE EDUCATIONAL GAMES PROVIDED VIA GLOBAL INFORMATION NETWORKS, NAMELY, INTERACTIVE GAMES FOR CHILDREN OR OTHER PEOPLE TO COLOR PICTURES ONLINE THAT AWARD COUPONS TO SOME OR ALL PARTICIPANTS AND GAMES THAT TEACH BIBLE LESSONS (U.S. CLS. 100, 101 AND 107).
ERNEST SHOSHO, EXAMINING ATTORNEY

SN 76-586,366. SOLIFLEX CORPORATION INC., OTTAWA, ONTARIO, CANADA, FILED 4-6-2004.

BUNGEE BANNER.

THE MARK CONSISTS OF STANDARD CHARACTERS WITHOUT CLAIM TO ANY PARTICULAR FONT, STYLE, SIZE, OR COLOR.

OWNER OF CANADA REG. NO. 438142, DATED 1-20-1995, EXPIRES 1-20-2010.

OWNER OF U.S. REG. NO. 2,157,340.

NO CLAIM IS MADE TO THE EXCLUSIVE RIGHT TO USE "BANNER", APART FROM THE MARK AS SHOWN.

CLASS 35—ADVERTISING AND BUSINESS

FOR (BASED ON FIRST USE) LICENSING OF BUSINESS MODEL IN THE SIGN AND BANNER INDUSTRY (U.S. CLS. 100, 101 AND 102).
FIRST USE 1-1-2000; IN COMMERCE 1-1-2000.

CLASS 37—CONSTRUCTION AND REPAIR

FOR (BASED ON USE IN COMMERCE) INSTALLATION, MAINTENANCE AND REPAIR OF SIGNS AND BANNERS; (BASED ON 44(E)) MAINTENANCE OF SIGNS AND BANNERS OF OTHERS (U.S. CLS. 100, 103 AND 106).
FIRST USE 1-1-2000; IN COMMERCE 1-1-2000.

CLASS 42—SCIENTIFIC, COMPUTER AND LEGAL SERVICES

FOR (BASED ON 44(E)) DESIGNING SIGNS AND BANNERS (U.S. CLS. 100 AND 101).
RAUL CORDOVA, EXAMINING ATTORNEY

SN 76-587,649. ALL NATURE LLC., MIAMI, FL. FILED 4-19-2004.

FAVELLI

THE MARK CONSISTS OF STANDARD CHARACTERS WITHOUT CLAIM TO ANY PARTICULAR FONT, STYLE, SIZE, OR COLOR.

THE ENGLISH TRANSLATION OF "FAVELLI" IS "YOU SPEAK OR YOU DISCOURSE".

CLASS 29—MEATS AND PROCESSED FOODS

FOR OLIVE OIL, VEGETABLE OIL, SOYBEAN OIL (U.S. CL. 46).
FIRST USE 1-0-2004; IN COMMERCE 1-0-2004.

CLASS 30—STAPLE FOODS

FOR BREAKFAST CEREALS (U.S. CL. 46).
FIRST USE 12-0-2001; IN COMMERCE 12-0-2001.
ANNE FARRELL, EXAMINING ATTORNEY

SN 76-588,698. IVENUE.COM CORPORATION, LAS VEGAS, NV. FILED 4-26-2004.

DOLLARS BY DESIGN**CLASS 36—INSURANCE AND FINANCIAL**

FOR MERCHANT ACCOUNTS, NAMELY, PROVISION OF MONTHLY STATEMENTS ON LINE, PROVISION OF MERCHANT ACCOUNT INTERCHANGE QUALIFICATION REPORTING, CHARGEBACK AND RETRIEVAL INFORMATION, PROVISION OF DAILY DEPOSIT SUMMARIES FOR REVIEW, RETRIEVAL OF REQUESTS FOR SALES AND CREDIT SLIPS AND CREDIT MATCH VERIFICATION; PROCESSING SERVICES, NAMELY, PROCESSING ALL TYPES OF CREDIT CARDS AND DEBIT CARDS (U.S. CLS. 100, 101 AND 102).
FIRST USE 11-8-2001; IN COMMERCE 11-8-2001.

CLASS 42—SCIENTIFIC, COMPUTER AND LEGAL SERVICES

FOR CREATION, DESIGNING, MAINTENANCE AND HOSTING OF WEBSITES FOR OTHERS; REGISTRATION OF DOMAIN NAMES FOR IDENTIFICATION OF USERS ON A GLOBAL COMPUTER NETWORK (U.S. CLS. 100 AND 101).
FIRST USE 11-8-2001; IN COMMERCE 11-8-2001.

CLASS 45—PERSONAL SERVICES

FOR PROVIDING USER AUTHENTICATION SERVICES IN E-COMMERCE TRANSACTIONS (U.S. CLS. 100 AND 101).
FIRST USE 11-8-2001; IN COMMERCE 11-8-2001.
LESLEY LAMOTHE, EXAMINING ATTORNEY

SN 76-589,047. ORANGE BANG, INC., SYLMAR, CA. FILED 4-26-2004.



NO CLAIM IS MADE TO THE EXCLUSIVE RIGHT TO USE "HORCHATA", APART FROM THE MARK AS SHOWN.

CLASS 29—MEATS AND PROCESSED FOODS

FOR NON-ALCOHOLIC, NON-CARBONATED MILK-BASED BEVERAGES (U.S. CL. 46).
FIRST USE 10-0-1985; IN COMMERCE 10-0-1985.

CLASS 30—STAPLE FOODS

FOR NON-ALCOHOLIC, NON-CARBONATED FRUIT JUICE BEVERAGES AND RICE-BASED BEVERAGES (U.S. CL. 46).
FIRST USE 10-0-1985; IN COMMERCE 10-0-1985.
SKYE YOUNG, EXAMINING ATTORNEY

SN 76-589,057. SPIEGEL, KAREN S., LOS ANGELES, CA. FILED 4-28-2004.



NO CLAIM IS MADE TO THE EXCLUSIVE RIGHT TO USE PRODUCTIONS, APART FROM THE MARK AS SHOWN.

CLASS 9—ELECTRICAL AND SCIENTIFIC APPARATUS

FOR PRE-RECORDED VIDEO AND AUDIO TAPES FEATURING ART, EDUCATION AND ENTERTAINMENT; MULTIMEDIA SOFTWARE IN THE NATURE OF COMPACT DISCS AND CD-ROMS FEATURING ART, EDUCATION AND ENTERTAINMENT (U.S. CLS. 21, 23, 26, 36 AND 38).

CLASS 16—PAPER GOODS AND PRINTED MATTER

FOR SERIES OF FICTION AND NON-FICTION BOOKS IN THE FIELD OF ART, ENTERTAINMENT, AND EDUCATION (U.S. CLS. 2, 5, 22, 23, 29, 37, 38 AND 50).

CLASS 28—TOYS AND SPORTING GOODS

FOR AMUSEMENT PARK RIDES; TOYS, NAMELY ACTION FIGURES, STUFFED TOY ANIMALS, RUBBER ACTION BALLS, DISC TOSS TOYS, YO-YOS, SPORT BALLS AND BOARD GAMES (U.S. CLS. 22, 23, 38 AND 50).

CLASS 41—EDUCATION AND ENTERTAINMENT

FOR PRODUCTION OF MULTIMEDIA SOFTWARE, IN THE NATURE OF COMPACT DISCS, CD-ROMS FEATURING ART, EDUCATION AND ENTERTAINMENT (U.S. CLS. 100, 101 AND 107).

ROBERT C. CLARK JR., EXAMINING ATTORNEY

SN 76-589,062. CONAGRA FOODS, INC., OMAHA, NE. FILED 4-28-2004.

DINNER CREATIONS

THE MARK CONSISTS OF STANDARD CHARACTERS WITHOUT CLAIM TO ANY PARTICULAR FONT, STYLE, SIZE, OR COLOR.

NO CLAIM IS MADE TO THE EXCLUSIVE RIGHT TO USE "DINNER", APART FROM THE MARK AS SHOWN.

CLASS 29—MEATS AND PROCESSED FOODS

FOR FROZEN PREPARED MEALS AND ENTREES CONSISTING PRIMARILY OF BEEF; PORK, SEAFOOD, POULTRY OR VEGETABLES (U.S. CL. 46).

CLASS 30—STAPLE FOODS

FOR FROZEN PREPARED MEALS AND ENTREES CONSISTING PRIMARILY OF PASTA OR RICE (U.S. CL. 46).

ROBERT C. CLARK JR., EXAMINING ATTORNEY

SN 76-589,203. INTEGRIGUARD, LLC, SAN FRANCISCO, CA. FILED 4-28-2004.

GETTING RESULTS. MAKING A DIFFERENCE.

THE MARK CONSISTS OF STANDARD CHARACTERS WITHOUT CLAIM TO ANY PARTICULAR FONT, STYLE, SIZE, OR COLOR.

CLASS 35—ADVERTISING AND BUSINESS

FOR AUDITING SERVICES, NAMELY, BUSINESS, ACCOUNT, AND COST REPORT AUDITING FOR OTHERS; AUDITING OF THE OPERATIONS AND MANAGEMENT OF HEALTH CARE PROVIDERS AND MANAGED CARE HEALTH PLANS; AUDITING OF MEDICAL CLAIMS AUDIT; ASSET AUDITING; BUSINESS AUDITING; INSURANCE CLAIMS AUDITING SERVICES; INVESTIGATION SERVICES, NAMELY, BUSINESS INVESTIGATION; PROVIDING STATISTICAL INFORMATION FOR THE STATISTICAL ANALYSIS OF ENROLLMENT, SPECIAL HEALTH STATUS CATEGORIES, AND DEMOGRAPHIC INFORMATION IN MANAGED CARE PLANS TO DETERMINE INCONSISTENCIES, TRENDS AND VULNERABILITIES; AUDITING AND MONITORING OF HEALTH CARE PLANS FOR COMPLIANCE WITH REGULATIONS; AUDITING OF ADJUSTED COMMUNITY RATING USED BY MANAGED HEALTH CARE PLANS; CONDUCTING MARKETING STUDIES IN THE NATURE OF PROBE STUDIES OF ENROLLMENT AND ELIGIBILITY DATA FOR MANAGED CARE HEALTH PLANS; HEALTH CARE COST REVIEW IN THE NATURE OF COST, UTILIZATION AND REVIEW SERVICES TO THE HEALTH CARE INDUSTRY; REVIEW AND AUDIT MANAGED CARE ENROLLMENT AND ELIGIBILITY INFORMATION TO ENSURE THAT INDIVIDUALS ARE PROPERLY AND TIMELY ENROLLED; MARKETING CONSULTING IN THE NATURE OF REVIEW OF MARKETING MATERIALS AND QUALITY OF CARE FOR MANAGED CARE HEALTH PLANS (U.S. CLS. 100, 101 AND 102).

CLASS 36—INSURANCE AND FINANCIAL

FOR INSURANCE CONSULTATION SERVICES IN THE NATURE OF CLAIMS APPEALS SERVICES, PROVIDING REVIEWS AND EXPEDITED REVIEWS OF DENIED HEALTH CARE CLAIMS FOR HEALTH CARE PROGRAMS, PROVIDING REVIEW AND ANALYSIS OF DENIED CLAIMS TO DETERMINE INCONSISTENCIES, TRENDS, AND VULNERABILITIES AND COORDINATION OF SUBSEQUENT APPEALS; FINANCIAL SERVICES, NAMELY, FINANCIAL RESEARCH (U.S. CLS. 100, 101 AND 102).

CLASS 42—SCIENTIFIC, COMPUTER AND LEGAL SERVICES

FOR REVIEW OF STANDARDS AND PRACTICES TO ASSURE COMPLIANCE WITH IMPLEMENTATION OF CHANGES IN MANAGED CARE ENROLLMENT, SPECIAL HEALTH STATUS CATEGORIES, AND DEMOGRAPHIC INFORMATION FOR STATE AND COUNTY CODES; REVIEW OF STANDARDS AND PRACTICES OF OTHERS TO ASSURE COMPLIANCE WITH FEDERAL LAWS AND REGULATIONS IN THE HEALTH CARE INDUSTRY (U.S. CLS. 100 AND 101).

CLASS 44—MEDICAL, BEAUTY AND AGRICULTURAL SERVICES

FOR HEALTH CARE CONSULTING SERVICES IN THE NATURE OF REVIEW OF MEDICAL RECORDS (U.S. CLS. 100 AND 101).

CLASS 45—PERSONAL SERVICES

FOR INVESTIGATION SERVICES RELATED TO INSURANCE CLAIMS; INVESTIGATION SERVICES TO DETECT, PREVENT, AND AID IN THE PROSECUTION OF FRAUD AND ABUSE IN BOTH THE PUBLIC AND PRIVATE SECTOR OF THE HEALTH CARE INDUSTRY; FRAUD DETECTION SERVICES IN THE NATURE OF UTILIZATION REVIEW SERVICES, AND PROGRAMS AND SERVICES TO DETECT, PREVENT AND AID IN THE PROSECUTION OF FRAUD AND ABUSE IN THE PUBLIC AND PRIVATE SECTOR OF THE HEALTH CARE INDUSTRY (U.S. CLS. 100 AND 101).

ALLISON HOLTZ, EXAMINING ATTORNEY

SN 76-589,330. CONAGRA FOODS, INC., OMAHA, NE. FILED 4-28-2004.

DINNER CLASSICS

THE MARK CONSISTS OF STANDARD CHARACTERS WITHOUT CLAIM TO ANY PARTICULAR FONT, STYLE, SIZE, OR COLOR.

NO CLAIM IS MADE TO THE EXCLUSIVE RIGHT TO USE "DINNER", APART FROM THE MARK AS SHOWN.

CLASS 29—MEATS AND PROCESSED FOODS

FOR FROZEN PREPARED MEALS AND ENTREES CONSISTING PRIMARILY OF BEEF, PORK, SEAFOOD, POULTRY OR VEGETABLES (U.S. CL. 46).

CLASS 30—STAPLE FOODS

FOR FROZEN PREPARED MEALS AND ENTREES CONSISTING PRIMARILY OF PASTA OR RICE (U.S. CL. 46).

ALLISON HOLTZ, EXAMINING ATTORNEY

SN 76-589,788. EVERBEE NETWORKS S.A., 75002 PARIS, NO. SIREN: 432 809 663, FRANCE, FILED 4-30-2004.

SECURING INTERNET ACCESS - ANYONE, ANYTIME, ANYWHERE

THE MARK CONSISTS OF STANDARD CHARACTERS WITHOUT CLAIM TO ANY PARTICULAR FONT, STYLE, SIZE, OR COLOR.

PRIORITY CLAIMED UNDER SEC. 44(D) ON FRANCE APPLICATION NO. 033254761, FILED 11-3-2003, REG. NO. 033254761, DATED 11-3-2003, EXPIRES 11-2-2013.

CLASS 9—ELECTRICAL AND SCIENTIFIC APPARATUS

FOR ELECTRONIC COMPONENTS, NAMELY, SWITCHES, CAPACITORS, RESISTORS, TRANSFORMERS, ELECTRONIC TESTING EQUIPMENT, FUSES, INDICATOR LIGHTS, PICKUPS, SIGNAL BAND SEPARATORS, CABLES, EXCHANGERS, AND TRANSMITTERS FOR COMPUTER AND TELECOMMUNICATIONS SECURITY AND FOR MANAGEMENT OF COMPUTER AND TELECOMMUNICATIONS NETWORKS; INTEGRATED CIRCUITS, ELECTRONIC CARDS, NAMELY, BLANK ELECTRONIC CHIP CARDS, BLANK SMART CARDS, ELECTRONIC AND MAGNETIC ID CARDS FOR USE IN CONNECTION WITH SECURITY AND FOR MANAGEMENT OF COMPUTER AND TELECOMMUNICATIONS NETWORKS, ELECTRONIC CARD READERS, ENCODED ELECTRONIC CHIP CARDS FOR USE IN CONNECTION WITH COMPUTER AND TELECOMMUNICATIONS SECURITY AND FOR MANAGEMENT OF COMPUTER AND TELECOMMUNICATIONS NETWORKS; SOFTWARE, MORE PARTICULARLY FOR COMPUTER AND TELECOMMUNICATION SECURITY AND FOR THE MANAGEMENT OF COMPUTER AND TELECOMMUNICATION NETWORKS (U.S. CLS. 21, 23, 26, 36 AND 38).

CLASS 38—COMMUNICATION

FOR INFORMATION TRANSMISSION VIA AN AUTHENTICATION MANAGEMENT SERVER, TRANSMISSION OF INFORMATION VIA THE INTERNET (U.S. CLS. 100, 101 AND 104).

CLASS 42—SCIENTIFIC, COMPUTER AND LEGAL SERVICES

FOR DESIGN, CREATION AND DEVELOPMENT OF COMPUTER SOFTWARES, ALGORITHMS, MORE PARTICULARLY FOR COMPUTER AND TELECOMMUNICATION SECURITY AND FOR THE MANAGEMENT OF COMPUTER AND TELECOMMUNICATION NETWORKS (U.S. CLS. 100 AND 101).

DARRYL SPRUILL, EXAMINING ATTORNEY

SN 76-590,057. LEVIN, JOHN G., TOPEKA, KS. FILED 4-30-2004.

LINDYSPRING

THE MARK CONSISTS OF STANDARD CHARACTERS WITHOUT CLAIM TO ANY PARTICULAR FONT, STYLE, SIZE, OR COLOR.

CLASS 30—STAPLE FOODS

FOR ICE; ICE CUBES (U.S. CL. 46).
FIRST USE 3-1-1987; IN COMMERCE 6-1-1988.

CLASS 32—LIGHT BEVERAGES

FOR BOTTLED DRINKING WATER (U.S. CLS. 45, 46 AND 48).
 FIRST USE 3-1-1987; IN COMMERCE 6-1-1988.

SN 76-590,126. WEIGEL BROADCASTING COMPANY, CHICAGO, IL. FILED 5-3-2004.

CLASS 40—MATERIAL TREATMENT

FOR WATER TREATMENT SERVICES, NAMELY, WATER FILTRATION, PURIFICATION AND DEIONIZATION TREATMENT SERVICES; RENTAL OF WATER TREATMENT EQUIPMENT, NAMELY, WATER SOFTENER UNITS, WATER CONDITIONING UNITS, WATER DEIONIZATION UNITS, WATER PURIFICATION UNITS AND WATER FILTRATION UNITS FOR INDUSTRIAL, COMMERCIAL AND RESIDENTIAL USE (U.S. CLS. 100, 103 AND 106).
 FIRST USE 3-1-1987; IN COMMERCE 6-1-1988.



CLASS 43—HOTEL AND RESTAURANT SERVICES

FOR RENTAL OF DRINKING WATER EQUIPMENT, NAMELY COOLERS AND HOT AND COLD DISPENSING CONSOLES (U.S. CLS. 100 AND 101).
 FIRST USE 3-1-1987; IN COMMERCE 6-1-1988.
 RAMONA ORTIGA, EXAMINING ATTORNEY

SN 76-590,106. THE COOKING CLUB INC., OMAHA, NE. FILED 5-3-2004.

NO CLAIM IS MADE TO THE EXCLUSIVE RIGHT TO USE "CHANNEL 26", APART FROM THE MARK AS SHOWN.

CLASS 38—COMMUNICATION

FOR TELEVISION BROADCASTING (U.S. CLS. 100, 101 AND 104).
 FIRST USE 1-1-1995; IN COMMERCE 1-1-1995.



CLASS 41—EDUCATION AND ENTERTAINMENT

FOR TELEVISION PROGRAMMING AND PRODUCTION (U.S. CLS. 100, 101 AND 107).
 FIRST USE 1-1-1995; IN COMMERCE 1-1-1995.
 LINDA E. BLOHM, EXAMINING ATTORNEY

NO CLAIM IS MADE TO THE EXCLUSIVE RIGHT TO USE "THE COOKING CLUB INC." FOR CLASS 41, AND COOKING AND INC FOR CLASS 30, APART FROM THE MARK AS SHOWN.

SN 76-590,573. BLUE TULIP, LLC, PRINCETON, NJ. FILED 5-5-2004.

CLASS 30—STAPLE FOODS

FOR FOOD PRODUCTS, NAMELY, SAUCES, SALAD DRESSINGS, SPICES, MEAT RUBS, FLAVORING MIXTURES FOR ADDITION TO DAIRY PRODUCTS AND MARINADES (U.S. CL. 46).
 FIRST USE 9-19-2003; IN COMMERCE 9-19-2003.

MANY OCCASIONS.... ONE STORE

CLASS 41—EDUCATION AND ENTERTAINMENT

FOR EDUCATIONAL SERVICES, NAMELY CONDUCTING CLASSES, SEMINARS AND WORKSHOPS IN THE FIELD OF COOKING AND NUTRITION (U.S. CLS. 100, 101 AND 107).
 FIRST USE 9-19-2003; IN COMMERCE 9-19-2003.
 DANIEL CAPSHAW, EXAMINING ATTORNEY

THE MARK CONSISTS OF STANDARD CHARACTERS WITHOUT CLAIM TO ANY PARTICULAR FONT, STYLE, SIZE, OR COLOR.

CLASS 35—ADVERTISING AND BUSINESS

FOR RETAIL VARIETY STORES FEATURING GIFTS FOR ALL OCCASIONS INCLUDING FOR ETHNIC, RELIGIOUS AND NATIONAL HOLIDAYS AND NATIONAL OCCASIONS, STATIONERY, ENVELOPES, GREETING CARDS, INVITATIONS, BLANK JOURNALS, PHOTO ALBUMS, SCRAPBOOK ALBUMS AND SUPPLIES, ART AND CRAFT KITS, BOOKBINDING ART AND CRAFT KITS, BOOK CLOTH, TEXT BLOCKS, TOOLS, GLUES, BOOK BOARD AND BOOKS RELATING TO THE ART OF BOOKBINDING, ART PAPER, CRAFT PAPER, HANDMADE PAPERS, DECORATIVE PAPERS, ORIGAMI, DECOUPAGE, CARDBOARD BOXES, PAPER BOXES, STATIONERY BOXES, PAPER GIFT WRAPPING RIBBONS, STICKERS, RUBBER STAMPS, PENS, INKS, PAINTS, CORRUGATED BOXES, WATERCOLOR PAPERS, PRINTMAKING PAPERS, PAPER RIBBONS, CLOTH TAPE FOR ADHERING TO PAPER, ADHESIVE TAPE FOR STATIONERY OR HOUSEHOLD USE, GLUE FOR STATIONERY OR HOUSEHOLD USE, GLUE STICKS FOR STATIONERY OR HOUSEHOLD USE, ART BRUSHES, PAINT BRUSHES, DRAWING BRUSHES, GLUE BRUSHES, PHOTOGRAPH MOUNTS, ART MOUNTS, PHOTOGRAPH MOUNTING CORNERS, PAPER CUTTERS AND PAPER HOLE PUNCHES (U.S. CLS. 100, 101 AND 102).

FIRST USE 11-30-2003; IN COMMERCE 11-30-2003.

CLASS 41—EDUCATION AND ENTERTAINMENT

FOR EDUCATIONAL SERVICES, NAMELY, CONDUCTING WORKSHOPS AND SEMINARS IN THE FIELDS OF ARTS AND CRAFTS, PHOTO AND SCRAPBOOK ALBUM PREPARATION, BOOKBINDING, PAPER ARTS, BOOK ARTS, CARD MAKING, PRINT MAKING, MAKING LUMINARIES AND LANTERNS, CALLIGRAPHY INSTRUCTION, GIFT WRAPPING INSTRUCTION, MAKING WEDDING INVITATIONS AND ANNOUNCEMENTS AND INSTRUCTION IN DECOUPAGE AND RELATED DECORATIVE ARTS (U.S. CLS. 100, 101 AND 107).

FIRST USE 11-30-2003; IN COMMERCE 11-30-2003.
DANIEL CAPSHAW, EXAMINING ATTORNEY

SN 76-590,612. TREVI MANUFACTURING, INC., LAS VEGAS, NV. FILED 5-5-2004.

TREVI

THE MARK CONSISTS OF STANDARD CHARACTERS WITHOUT CLAIM TO ANY PARTICULAR FONT, STYLE, SIZE, OR COLOR.

CLASS 11—ENVIRONMENTAL CONTROL APPARATUS

FOR FOUNTAINS, NAMELY DECORATIVE WATER FOUNTAINS (U.S. CLS. 13, 21, 23, 31 AND 34).
FIRST USE 10-0-2001; IN COMMERCE 10-0-2001.

CLASS 19—NON-METALLIC BUILDING MATERIALS

FOR STATUARY, NAMELY DECORATIVE STATUES MADE OF CONCRETE, INCLUDING GLASS FIBER REINFORCED CONCRETE (U.S. CLS. 1, 12, 33 AND 50).
FIRST USE 10-0-2001; IN COMMERCE 10-0-2001.

CLASS 21—HOUSEWARES AND GLASS

FOR PLANTERS, NAMELY DECORATIVE PLANTERS FOR FLOWERS AND PLANTS MADE OF CONCRETE, INCLUDING GLASS FIBER REINFORCED CONCRETE (U.S. CLS. 2, 13, 23, 29, 30, 33, 40 AND 50).
FIRST USE 10-0-2001; IN COMMERCE 10-0-2001.
BARBARA RUTLAND, EXAMINING ATTORNEY

SN 76-590,796. HP HOOD LLC, CHELSEA, MA. FILED 5-4-2004.

OWNER OF U.S. REG. NOS. 1,222,752 AND 1,224,429.
THE MARK CONSISTS OF THE WORD CROWLEY WITH AN INWARD FACING LEAF DESIGN ATTACHED TO THE UPPER POINT OF THE LETTER "C".
SEC. 2(F).

CLASS 29—MEATS AND PROCESSED FOODS

FOR DAIRY PRODUCTS, NAMELY, CHOCOLATE MILK, CREAM, CREAM PACKAGED UNDER PRESSURE TO BE DISPENSED AS AEROSOL CREAM TOPPING, HALF AND HALF, COTTAGE CHEESE, SOUR CREAM, EGGNOG, BUTTER, YOGURT, YOGURT-BASED DIPS, ITALIAN CHEESES, CREAM CHEESE; MILK, EXCLUDING CANNED, SWEETENED EVAPORATED OR CONDENSED MILK, BUTTERMILK; PACKAGED PREPARED FOODS, NAMELY, CABBAGE SALAD AND POTATO SALAD (U.S. CL. 46).
FIRST USE 2-24-1969; IN COMMERCE 2-24-1969.

CLASS 30—STAPLE FOODS

FOR CHEESE-BASED SALAD DRESSING, PUDDING, ICE CREAM, ICE CREAM MIXES, ICE TEAS, HORSE-RADISH; PACKAGED PREPARED FOODS, NAMELY, MACARONI SALAD; FROZEN YOGURT, FROZEN YOGURT TO BE SHIPPED TO RESTAURANTS; FROZEN YOGURT MIX, NONFAT FROZEN DESSERT MIX, ICE CREAM MIX, SHERBERT MIX, MILKSHAKE MIX, ICE MILK MIX, COMBINATION OF FROZEN YOGURT AND SORBET (U.S. CL. 46).
FIRST USE 2-24-1969; IN COMMERCE 2-24-1969.

CLASS 32—LIGHT BEVERAGES

FOR FRUIT JUICES AND FRUIT FLAVORED SOFT DRINKS AND NON-ALCOHOLIC SWEET APPLE CIDER (U.S. CLS. 45, 46 AND 48).
FIRST USE 2-24-1969; IN COMMERCE 2-24-1969.
SAMUEL E. SHARPER JR., EXAMINING ATTORNEY

SN 76-591,084. BOARD OF REGENTS OF THE UNIVERSITY SYSTEM OF GEORGIA, ATLANTA, GA. FILED 5-7-2004.



NO CLAIM IS MADE TO THE EXCLUSIVE RIGHT TO USE "STATE UNIVERSITY", APART FROM THE MARK AS SHOWN.

CLASS 16—PAPER GOODS AND PRINTED MATTER

FOR EXAMINATION BOOK (U.S. CLS. 2, 5, 22, 23, 29, 37, 38 AND 50).
FIRST USE 7-0-1996; IN COMMERCE 7-0-1996.

CLASS 25—CLOTHING

FOR T-SHIRTS AND VESTS (U.S. CLS. 22 AND 39).
FIRST USE 7-0-1996; IN COMMERCE 7-0-1996.

CLASS 41—EDUCATION AND ENTERTAINMENT

FOR EDUCATION SERVICES, NAMELY CONDUCTING COURSES OF STUDY AT THE UNIVERSITY LEVEL (U.S. CLS. 100, 101 AND 107).
FIRST USE 7-0-1996; IN COMMERCE 7-0-1996.
BARBARA BROWN, EXAMINING ATTORNEY

SN 76-591,407. COPPER RIVER COUNTRY CLUB, FRESNO, CA. FILED 5-11-2004.

COPPER RIVER

THE MARK CONSISTS OF STANDARD CHARACTERS WITHOUT CLAIM TO ANY PARTICULAR FONT, STYLE, SIZE, OR COLOR.

CLASS 35—ADVERTISING AND BUSINESS

FOR RETAIL GOLF PRO SHOP SERVICES FEATURING GOLF, TENNIS, AND FITNESS EQUIPMENT AND APPAREL (U.S. CLS. 100, 101 AND 102).
FIRST USE 1-31-1994; IN COMMERCE 1-31-1994.

CLASS 41—EDUCATION AND ENTERTAINMENT

FOR COUNTRY CLUB SERVICES; ENTERTAINMENT IN THE NATURE OF TENNIS AND GOLF TOURNAMENTS; TENNIS INSTRUCTION; GOLF INSTRUCTION; GOLF COURSES; AND PHYSICAL FITNESS INSTRUCTION (U.S. CLS. 100, 101 AND 107).
FIRST USE 1-31-1994; IN COMMERCE 1-31-1994.

CLASS 42—SCIENTIFIC, COMPUTER AND LEGAL SERVICES

FOR RESTAURANT SERVICES; PROVIDING BANQUET AND SOCIAL FUNCTION FACILITIES FOR SPECIAL OCCASIONS (U.S. CLS. 100 AND 101).
FIRST USE 1-31-1994; IN COMMERCE 1-31-1994.
LINDA M. KING, EXAMINING ATTORNEY

SN 76-591,544. PUBLIC ABSTRACT CORPORATION, ROCHESTER, NY. FILED 5-4-2004.

PUBLIC ABSTRACT

THE MARK CONSISTS OF STANDARD CHARACTERS WITHOUT CLAIM TO ANY PARTICULAR FONT, STYLE, SIZE, OR COLOR.

NO CLAIM IS MADE TO THE EXCLUSIVE RIGHT TO USE "ABSTRACT", APART FROM THE MARK AS SHOWN.

CLASS 35—ADVERTISING AND BUSINESS

FOR VENDOR MANAGEMENT SERVICES FOR REAL ESTATE (U.S. CLS. 100, 101 AND 102).
FIRST USE 5-1-2000; IN COMMERCE 5-1-2000.

CLASS 36—INSURANCE AND FINANCIAL

FOR TITLE INSURANCE AGENCY SERVICES; REAL ESTATE LEASING SERVICES AND REAL ESTATE FINANCING SERVICES; ESCROW SERVICES FOR REAL ESTATE (U.S. CLS. 100, 101 AND 102).
FIRST USE 4-1-1969; IN COMMERCE 4-1-1979.

CLASS 41—EDUCATION AND ENTERTAINMENT

FOR CONDUCTING TRAINING AND EDUCATIONAL SEMINARS RELATING TO REAL ESTATE, REAL ESTATE LEASING AND REAL ESTATE FINANCING TRANSACTIONS (U.S. CLS. 100, 101 AND 107).
FIRST USE 6-15-1999; IN COMMERCE 6-15-1999.

CLASS 42—SCIENTIFIC, COMPUTER AND LEGAL SERVICES

FOR ISSUANCE OF LEGAL TITLE OPINIONS AND LEGAL TITLE CERTIFICATIONS FOR REAL ESTATE, LEGAL SERVICES IN THE FIELD OF REAL ESTATE, REAL ESTATE CLOSING AND REAL ESTATE FINANCING; PREPARATION OF ABSTRACTS OF TITLE AND REPORTS OF TITLE FOR REAL ESTATE, PROVIDING ASSISTANCE WITH COMPLETION OF CLOSING DOCUMENTATION FOR REAL ESTATE, REAL ESTATE TAX, TITLE AND LIEN SEARCHES AND REPORTS; LEGAL WITNESS AND NOTARY SERVICES FOR REAL ESTATE, PREPARATION AND FILING OF LEGAL DOCUMENTS FOR RECORDATION IN OFFICIAL OFFICES AND REGISTRIES; SETTLEMENT SERVICES FOR REAL ESTATE (U.S. CLS. 100 AND 101).
FIRST USE 4-1-1969; IN COMMERCE 4-1-1979.
DAVID H. STINE, EXAMINING ATTORNEY

SN 76-591,623. SCHOOL OF VISUAL ARTS, INC., NEW YORK, NY. FILED 5-11-2004.



THE MARK CONSISTS OF A HAND WITH A HEAD.

CLASS 9—ELECTRICAL AND SCIENTIFIC APPARATUS

FOR COMPUTER SOFTWARE, NAMELY, COMPUTER SOFTWARE PROGRAM TO FACILITATE NAVIGATION OF, AND USER INTERACTION WITH, WEB SITES (U.S. CLS. 21, 23, 26, 36 AND 38).

CLASS 42—SCIENTIFIC, COMPUTER AND LEGAL SERVICES

FOR PROVIDING TEMPORARY USE OF ON-LINE NON-DOWNLOADABLE SOFTWARE IN THE NATURE OF NAVIGATIONAL AIDS TO FACILITATE USER INTERACTION WITH WEB SITES (U.S. CLS. 100 AND 101).

ALICE BENMAMAN, EXAMINING ATTORNEY

SN 76-591,676. ARES TRADING S.A., CH-1170, AUBONNE, SWITZERLAND, FILED 5-12-2004.

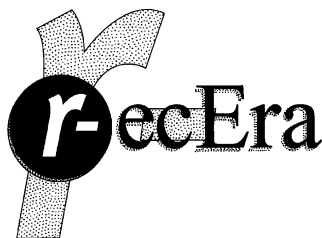

"THE MARK CONSISTS OF A LARGE SHADED STYLIZED 'R' AND HYPHEN DISPLAYED BENEATH A SMALLER STYLIZED 'R' AND HYPHEN, SHOWN WITHIN A CIRCLE, AND PICTURED NEXT TO THE WORDING 'ECERA'."

CLASS 9—ELECTRICAL AND SCIENTIFIC APPARATUS

FOR PRERECORDED CD-ROMS FEATURING MEDICAL INFORMATION (U.S. CLS. 21, 23, 26, 36 AND 38).

CLASS 16—PAPER GOODS AND PRINTED MATTER

FOR PRINTED MATERIALS, NAMELY, LEAFLETS AND BROCHURES ABOUT INFERTILITY; PRINTED INSTRUCTIONAL, EDUCATIONAL AND TEACHING MATERIALS IN THE AREAS OF MEDICINE AND DRUGS (U.S. CLS. 2, 5, 22, 23, 29, 37, 38 AND 50).

CLASS 44—MEDICAL, BEAUTY AND AGRICULTURAL SERVICES

FOR HOUSE MARK FOR MEDICAL SERVICES; PROVIDING MEDICAL INFORMATION SERVICES, NAMELY, PROVIDING MEDICAL INFORMATION RELATED TO THE TREATMENT OF INFERTILITY; MEDICAL COUNSELING (U.S. CLS. 100 AND 101).

DARRYL SPRUILL, EXAMINING ATTORNEY

SN 76-591,830. LORDI CONSULTING ASSOCIATES, LTD., GLEN MILLS, PA. FILED 5-12-2004.

LORDI CONSULTING

THE MARK CONSISTS OF STANDARD CHARACTERS WITHOUT CLAIM TO ANY PARTICULAR FONT, STYLE, SIZE, OR COLOR.

NO CLAIM IS MADE TO THE EXCLUSIVE RIGHT TO USE CONSULTING, APART FROM THE MARK AS SHOWN.

SEC. 2(F).

CLASS 35—ADVERTISING AND BUSINESS

FOR ACCOUNTING SERVICES (U.S. CLS. 100, 101 AND 102).

FIRST USE 2-0-1999; IN COMMERCE 2-0-1999.

CLASS 36—INSURANCE AND FINANCIAL

FOR PROVIDING FINANCIAL INFORMATION AND ANALYSIS, NAMELY USE OF DATA GATHERING SOFTWARE AND PROCESSES TO SUMMARIZE FINANCIAL INFORMATION; FINANCIAL CONSULTING AND STRATEGIC PLANNING FOR COMPANIES RELATED TO MERGERS, ACQUISITIONS, CAPITAL STRUCTURE CHANGES, FUNDRAISING AND DIVESTITURES (U.S. CLS. 100, 101 AND 102).

FIRST USE 2-0-1999; IN COMMERCE 2-0-1999.

CLASS 42—SCIENTIFIC, COMPUTER AND LEGAL SERVICES

FOR CONSULTING SERVICES IN THE FIELD OF SELECTION, IMPLEMENTATION AND USE OF COMPUTER HARDWARE AND SOFTWARE SYSTEMS FOR OTHERS (U.S. CLS. 100 AND 101).

FIRST USE 2-0-1999; IN COMMERCE 2-0-1999.

TARAH HARDY, EXAMINING ATTORNEY

SN 76-591,906. FRANCE/SCOTT FETZER COMPANY, FAIRVIEW, TN. FILED 5-12-2004.

TOTALIGHT SYSTEMS

THE MARK CONSISTS OF STANDARD CHARACTERS WITHOUT CLAIM TO ANY PARTICULAR FONT, STYLE, SIZE, OR COLOR.

NO CLAIM IS MADE TO THE EXCLUSIVE RIGHT TO USE SYSTEMS, APART FROM THE MARK AS SHOWN.

CLASS 9—ELECTRICAL AND SCIENTIFIC APPARATUS

FOR SIGNS, NAMELY ELECTRIC SIGNS, AND PARTS THEREFOR (U.S. CLS. 21, 23, 26, 36 AND 38).
FIRST USE 6-0-2004; IN COMMERCE 6-0-2004.

CLASS 40—MATERIAL TREATMENT

FOR CUSTOM MANUFACTURE OF SIGNS FOR OTHERS (U.S. CLS. 100, 103 AND 106).
FIRST USE 3-0-2005; IN COMMERCE 3-0-2005.
NICHOLAS ALTREE, EXAMINING ATTORNEY

SN 76-592,192. USA SYNTHETICS, LLC, BENTONVILLE, AR.
FILED 5-14-2004.

USA GOLD

THE MARK CONSISTS OF STANDARD CHARACTERS WITHOUT CLAIM TO ANY PARTICULAR FONT, STYLE, SIZE, OR COLOR.

OWNER OF U.S. REG. NO. 2,134,693.
NO CLAIM IS MADE TO THE EXCLUSIVE RIGHT TO USE "USA", APART FROM THE MARK AS SHOWN.

CLASS 1—CHEMICALS

FOR AUTOMATIC TRANSMISSION FLUIDS (U.S. CLS. 1, 5, 6, 10, 26 AND 46).
FIRST USE 5-14-2004; IN COMMERCE 5-14-2004.

CLASS 4—LUBRICANTS AND FUELS

FOR MOTOR OIL, INDUSTRIAL OIL, AND AUTOMOTIVE GREASES (U.S. CLS. 1, 6 AND 15).
FIRST USE 1-2-1996; IN COMMERCE 1-2-1996.
MAUREEN DALL, EXAMINING ATTORNEY

SN 76-592,433. F.A.S. SEAFOOD PRODUCERS LTD., VICTORIA, BRITISH COLUMBIA, CANADA, FILED 5-17-2004.



PRIORITY CLAIMED UNDER SEC. 44(D) ON CANADA APPLICATION NO. 1,214,324, FILED 4-22-2004, REG. NO. TMA634,501, DATED 3-7-2005, EXPIRES 3-7-2020.

THE STIPPLING IS FOR SHADING PURPOSES ONLY.
THE MARK CONSISTS OF THE LETTERS FAS STYLISED SHOWN IN AN OVAL WITH A BOAT IN THE UPPER PORTION OF THE OVAL. THE MARK IS NOT IN COLOR.

CLASS 29—MEATS AND PROCESSED FOODS

FOR (BASED ON USE IN COMMERCE AND 44) FISH AND SEAFOOD (U.S. CL. 46).
FIRST USE 2-0-2002; IN COMMERCE 2-0-2002.

CLASS 35—ADVERTISING AND BUSINESS

FOR (BASED ON INTENT TO USE AND 44) WHOLESALE STORES AND RETAIL STORES FEATURING FISH AND SEAFOOD (U.S. CLS. 100, 101 AND 102).

CLASS 40—MATERIAL TREATMENT

FOR (BASED ON INTENT TO USE AND 44) PROVIDING FOR OTHERS THE SERVICE OF PROCESSING OF FISH AND SEAFOOD NAMELY SMOKING, FILLETING AND FREEZING (U.S. CLS. 100, 103 AND 106).
BRENDAN REGAN, EXAMINING ATTORNEY

SN 76-592,546. SPENCER GIFTS LLC, EGG HARBOR TOWNSHIP, NJ. FILED 5-17-2004.

MIDNIGHT REALMS

THE MARK CONSISTS OF STANDARD CHARACTERS WITHOUT CLAIM TO ANY PARTICULAR FONT, STYLE, SIZE, OR COLOR.

CLASS 9—ELECTRICAL AND SCIENTIFIC APPARATUS

FOR CLOCKS (U.S. CLS. 21, 23, 26, 36 AND 38).
FIRST USE 6-14-2004; IN COMMERCE 6-14-2004.

CLASS 11—ENVIRONMENTAL CONTROL APPARATUS

FOR LAMPS (U.S. CLS. 13, 21, 23, 31 AND 34).
FIRST USE 6-14-2004; IN COMMERCE 6-14-2004.

CLASS 20—FURNITURE AND ARTICLES NOT OTHERWISE CLASSIFIED

FOR HOME DECOR ITEMS, NAMELY, MIRRORS (U.S. CLS. 2, 13, 22, 25, 32 AND 50).
FIRST USE 6-14-2004; IN COMMERCE 6-14-2004.

CLASS 21—HOUSEWARES AND GLASS

FOR NON-ELECTRIC CANDELABRAS, NOT MADE OF PRECIOUS METAL; URNS, NOT MADE OF PRECIOUS METAL (U.S. CLS. 2, 13, 23, 29, 30, 33, 40 AND 50).
FIRST USE 6-14-2004; IN COMMERCE 6-14-2004.
SKYE YOUNG, EXAMINING ATTORNEY

SN 76-592,906. BABSON COLLEGE, WELLESLEY, MA. AND LONDON BUSINESS SCHOOL, LONDON, UNITED KINGDOM, FILED 5-19-2004.



CLASS 16—PAPER GOODS AND PRINTED MATTER

FOR PRINTED REPORTS AND PUBLICATIONS RELATING TO ENTREPRENEURIAL AND BUSINESS ACTIVITY (U.S. CLS. 2, 5, 22, 23, 29, 37, 38 AND 50).
FIRST USE 11-1-1999; IN COMMERCE 11-1-1999.

CLASS 35—ADVERTISING AND BUSINESS

FOR COMPILATION, ANALYSIS AND EXPLOITATION OF STATISTICAL AND RESEARCH DATA RELATING TO ENTREPRENEURIAL AND BUSINESS ACTIVITY; RESEARCH, CONSULTING AND FORECASTING SERVICES IN THE FIELDS OF ENTREPRENEURIAL ACTIVITY (U.S. CLS. 100, 101 AND 102).
FIRST USE 11-1-1999; IN COMMERCE 11-1-1999.

CLASS 41—EDUCATION AND ENTERTAINMENT

FOR ARRANGING AND CONDUCTING OF SEMINARS, CONFERENCES AND WORKSHOPS RELATING TO ENTREPRENEURIAL AND BUSINESS ACTIVITY; PROVIDING NON-DOWNLOADABLE ELECTRONIC PUBLICATIONS RELATING TO ENTREPRENEURIAL AND BUSINESS ACTIVITY; PUBLISHING ON-LINE REPORTS AND JOURNALS RELATING TO ENTREPRENEURIAL AND BUSINESS ACTIVITY; TEACHING, TRAINING AND TUITION SERVICES RELATING TO ENTREPRENEURIAL AND BUSINESS ACTIVITY (U.S. CLS. 100, 101 AND 107).

FIRST USE 11-1-1999; IN COMMERCE 11-1-1999.
BRIAN NEVILLE, EXAMINING ATTORNEY

SN 76-592,907. BABSON COLLEGE, WELLESLEY, MA. AND LONDON BUSINESS SCHOOL, LONDON, UNITED KINGDOM, FILED 5-19-2004.

GEM

THE MARK CONSISTS OF STANDARD CHARACTERS WITHOUT CLAIM TO ANY PARTICULAR FONT, STYLE, SIZE, OR COLOR.

CLASS 16—PAPER GOODS AND PRINTED MATTER

FOR PRINTED REPORTS AND PUBLICATIONS RELATING TO ENTREPRENEURIAL AND BUSINESS ACTIVITY (U.S. CLS. 2, 5, 22, 23, 29, 37, 38 AND 50).
FIRST USE 11-1-1999; IN COMMERCE 11-1-1999.

CLASS 35—ADVERTISING AND BUSINESS

FOR COMPILATION, ANALYSIS AND EXPLOITATION OF STATISTICAL AND RESEARCH DATA RELATING TO ENTREPRENEURIAL AND BUSINESS ACTIVITY; RESEARCH, CONSULTING AND FORECASTING SERVICES IN THE FIELDS OF ENTREPRENEURIAL ACTIVITY (U.S. CLS. 100, 101 AND 102).
FIRST USE 6-1-1998; IN COMMERCE 6-1-1998.

CLASS 41—EDUCATION AND ENTERTAINMENT

FOR ARRANGING AND CONDUCTING OF SEMINARS, CONFERENCES AND WORKSHOPS RELATING TO ENTREPRENEURIAL AND BUSINESS ACTIVITY; PROVIDING NON-DOWNLOADABLE ELECTRONIC PUBLICATIONS RELATING TO ENTREPRENEURIAL AND BUSINESS ACTIVITY; PUBLISHING ON-LINE REPORTS AND JOURNALS RELATING TO ENTREPRENEURIAL AND BUSINESS ACTIVITY; TEACHING, TRAINING AND TUITION SERVICES RELATING TO ENTREPRENEURIAL AND BUSINESS ACTIVITY (U.S. CLS. 100, 101 AND 107).

FIRST USE 11-1-1999; IN COMMERCE 11-1-1999.
BRIAN NEVILLE, EXAMINING ATTORNEY

SN 76-592,908. BABSON COLLEGE, WELLESLEY, MA. AND LONDON BUSINESS SCHOOL, LONDON NW1 4SA, UNITED KINGDOM, FILED 5-19-2004.

**GLOBAL
ENTREPRENEURSHIP
MONITOR**

THE MARK CONSISTS OF STANDARD CHARACTERS WITHOUT CLAIM TO ANY PARTICULAR FONT, STYLE, SIZE, OR COLOR.
SEC. 2(F).

CLASS 16—PAPER GOODS AND PRINTED MATTER

FOR PRINTED REPORTS AND PUBLICATIONS RELATING TO ENTREPRENEURIAL AND BUSINESS ACTIVITY (U.S. CLS. 2, 5, 22, 23, 29, 37, 38 AND 50).
FIRST USE 11-1-1999; IN COMMERCE 11-1-1999.

CLASS 35—ADVERTISING AND BUSINESS

FOR COMPILATION, ANALYSIS AND EXPLOITATION OF STATISTICAL AND RESEARCH DATA RELATING TO ENTREPRENEURIAL AND BUSINESS ACTIVITY; RESEARCH, CONSULTING AND FORECASTING SERVICES IN THE FIELDS OF ENTREPRENEURIAL ACTIVITY (U.S. CLS. 100, 101 AND 102).
FIRST USE 6-1-1998; IN COMMERCE 6-1-1998.

CLASS 41—EDUCATION AND ENTERTAINMENT

FOR ARRANGING AND CONDUCTING OF SEMINARS, CONFERENCES AND WORKSHOPS RELATING TO ENTREPRENEURIAL AND BUSINESS ACTIVITY; PROVIDING NON-DOWNLOADABLE ELECTRONIC PUBLICATIONS RELATING TO ENTREPRENEURIAL AND BUSINESS ACTIVITY; PUBLISHING ON-LINE REPORTS AND JOURNALS RELATING TO ENTREPRENEURIAL AND BUSINESS ACTIVITY; TEACHING, TRAINING AND TUITION SERVICES RELATING TO ENTREPRENEURIAL AND BUSINESS ACTIVITY (U.S. CLS. 100, 101 AND 107).

FIRST USE 11-1-1999; IN COMMERCE 11-1-1999.
BRIAN NEVILLE, EXAMINING ATTORNEY

SN 76-593,804. THE AFFILIATED GROUP, INC., ROCHESTER, MN. FILED 5-24-2004.

SN 76-594,361. DAIMLERCHRYSLER AG, 70567 STUTTGART, FED REP GERMANY, FILED 5-27-2004.

WE KEEP CASH FLOWING

CLS 65

CLASS 35—ADVERTISING AND BUSINESS

FOR ACCOUNTS RECEIVABLE SERVICES (U.S. CLS. 100, 101 AND 102).
FIRST USE 3-1-2004; IN COMMERCE 3-1-2004.

CLASS 36—INSURANCE AND FINANCIAL

FOR DEBT RECOVERY AND COLLECTION AGENCIES (U.S. CLS. 100, 101 AND 102).
FIRST USE 3-1-2004; IN COMMERCE 3-1-2004.
DAVID C. REIHNER, EXAMINING ATTORNEY

THE MARK CONSISTS OF STANDARD CHARACTERS WITHOUT CLAIM TO ANY PARTICULAR FONT, STYLE, SIZE, OR COLOR.

PRIORITY CLAIMED UNDER SEC. 44(D) ON FED REP GERMANY APPLICATION NO. 30367469.512, FILED 12-22-2003, REG. NO. 30367469, DATED 2-9-2004, EXPIRES 12-22-2013.

OWNER OF U.S. REG. NOS. 2,651,874, 2,763,464 AND OTHERS.

NO CLAIM IS MADE TO THE EXCLUSIVE RIGHT TO USE "65", APART FROM THE MARK AS SHOWN.

CLASS 12—VEHICLES

FOR MOTOR VEHICLES, NAMELY, AUTOMOBILES AND SPORT UTILITY VEHICLES AND THEIR STRUCTURAL PARTS (U.S. CLS. 19, 21, 23, 31, 35 AND 44).

CLASS 28—TOYS AND SPORTING GOODS

FOR TOY MODEL VEHICLES (U.S. CLS. 22, 23, 38 AND 50).
SALLY SHIH, EXAMINING ATTORNEY

SN 76-594,360. DAIMLERCHRYSLER AG, 70567 STUTTGART, FED REP GERMANY, FILED 5-27-2004.

SN 76-594,709. CYBER MEDICAL IMAGING, INC., STUDIO CITY, CA. FILED 5-21-2004.

CLS 63

XDR

THE MARK CONSISTS OF STANDARD CHARACTERS WITHOUT CLAIM TO ANY PARTICULAR FONT, STYLE, SIZE, OR COLOR.

PRIORITY CLAIMED UNDER SEC. 44(D) ON FED REP GERMANY APPLICATION NO. 30367468.7/1, FILED 12-22-2003, REG. NO. 30367468, DATED 2-9-2004, EXPIRES 12-22-2013.

OWNER OF U.S. REG. NOS. 2,529,332, 2,561,223 AND OTHERS.

NO CLAIM IS MADE TO THE EXCLUSIVE RIGHT TO USE "63", APART FROM THE MARK AS SHOWN.

CLASS 12—VEHICLES

FOR MOTOR VEHICLES, NAMELY, AUTOMOBILES AND SPORT UTILITY VEHICLES AND THEIR STRUCTURAL PARTS (U.S. CLS. 19, 21, 23, 31, 35 AND 44).

CLASS 28—TOYS AND SPORTING GOODS

FOR TOY MODEL VEHICLES (U.S. CLS. 22, 23, 38 AND 50).
WINSTON FOLMAR, EXAMINING ATTORNEY

CLASS 9—ELECTRICAL AND SCIENTIFIC APPARATUS

FOR COMPUTER SOFTWARE USED WITH DENTAL RADIOGRAPHIC IMAGING SYSTEMS (U.S. CLS. 21, 23, 26, 36 AND 38).

FIRST USE 11-26-2002; IN COMMERCE 5-0-2003.

CLASS 10—MEDICAL APPARATUS

FOR DENTAL IMAGING EQUIPMENT; DENTAL RADIOGRAPHIC IMAGING SENSORS, NAMELY, FILM, STORAGE PHOSPHOR DEVICES, COMMONLY COMMERCIALY KNOWN AS COMPUTED RADIOGRAPHY (CR) SENSORS, AND SOLID-STATE DIRECT CAPTURE DEVICES, COMMONLY COMMERCIALY KNOWN AS DIRECT DIGITAL RADIOGRAPHY (DR) DETECTORS, USED WITH DENTAL RADIOGRAPHIC IMAGING SYSTEMS TO PRODUCE DENTAL RADIOGRAPHIC IMAGES; DENTAL RADIOGRAPHIC IMAGING SYSTEMS, NAMELY COMPUTERS AND VIDEO MONITORS FOR DISPLAYING RADIOGRAPHS (U.S. CLS. 26, 39 AND 44).

FIRST USE 11-26-2002; IN COMMERCE 5-0-2003.
PAULA MAHONEY, EXAMINING ATTORNEY

SN 76-594,714. BIG TWELVE CONFERENCE, INC., THE, DALLAS, TX. FILED 5-28-2004.

XII BIG 12 CONFERENCE

THE MARK CONSISTS OF STANDARD CHARACTERS WITHOUT CLAIM TO ANY PARTICULAR FONT, STYLE, SIZE, OR COLOR.

OWNER OF U.S. REG. NOS. 1,883,152, 2,688,419 AND OTHERS.

NO CLAIM IS MADE TO THE EXCLUSIVE RIGHT TO USE "CONFERENCE", APART FROM THE MARK AS SHOWN.

CLASS 35—ADVERTISING AND BUSINESS

FOR ASSOCIATION SERVICES, NAMELY, SUPPORTING AND PROMOTING THE INTERESTS OF COLLEGES PARTICIPATING IN INTERCOLLEGIATE ATHLETIC PROGRAMS; PROMOTING THE STANDARDS OF SCHOLARSHIP, SPORTSMANSHIP AND EQUITY INTERESTS OF COLLEGES; PROMOTING THE GOODS AND SERVICES OF OTHERS BY ARRANGING FOR SPONSORS TO AFFILIATE THEIR GOODS AND SERVICES WITH COLLEGE ATHLETIC COMPETITIONS AND CONTESTS (U.S. CLS. 100, 101 AND 102).
FIRST USE 6-0-1996; IN COMMERCE 6-0-1996.

CLASS 41—EDUCATION AND ENTERTAINMENT

FOR ENTERTAINMENT SERVICES, NAMELY ORGANIZING, PRESENTING, PROMOTING AND COORDINATING ATHLETIC COMPETITIONS AND CONTESTS; ONLINE COMPUTER SERVICES, NAMELY, PROVIDING NEWS, SCORES AND INFORMATION FEATURING SPORTING EVENTS VIA THE GLOBAL COMPUTER NETWORK (U.S. CLS. 100, 101 AND 107).
FIRST USE 6-0-1996; IN COMMERCE 6-0-1996.

LA TONIA FISHER, EXAMINING ATTORNEY

SN 76-594,734. FOURTEEN CO., LTD., MUSASHINO-CITY, TOKYO, 180-0003, JAPAN, FILED 5-28-2004.



PRIORITY CLAIMED UNDER SEC. 44(D) ON JAPAN APPLICATION NO. 2003-115928, FILED 12-26-2003, REG. NO. 4792754, DATED 8-6-2004, EXPIRES 8-6-2014.

CLASS 18—LEATHER GOODS

FOR (BASED ON INTENT TO USE) AND (BASED ON 44(E)) GOLF UMBRELLAS (U.S. CLS. 1, 2, 3, 22 AND 41).

CLASS 25—CLOTHING

FOR (BASED ON INTENT TO USE) AND (BASED ON 44(E)) GOLF JACKETS, GOLF SKIRTS, GOLF TROUSERS, GOLF RAIN COATS, GOLF CARDIGANS, GOLF SWEATERS, GOLF SHIRTS, GOLF SOCKS, SUN VISORS FOR GOLF, GOLF CAPS, GOLF SHOES, GOLF SPIKES (U.S. CLS. 22 AND 39).

CLASS 28—TOYS AND SPORTING GOODS

FOR (BASED ON USE) AND (BASED ON 44(E)) GOLF CLUBS; (BASED ON INTENT TO USE) AND (BASED ON 44(E)) GOLF ACCESSORY POUCHES, GOLF BAGS, GOLF CLUB BAGS, GOLF BALLS (U.S. CLS. 22, 23, 38 AND 50).

FIRST USE 6-30-2002; IN COMMERCE 6-30-2002.
WANDA KAY PRICE, EXAMINING ATTORNEY

SN 76-595,052. SIEDMAN, DAVA, SAMMAMISH, WA. FILED 6-2-2004.

UN-AVERAGE FEMALE

THE MARK CONSISTS OF STANDARD CHARACTERS WITHOUT CLAIM TO ANY PARTICULAR FONT, STYLE, SIZE, OR COLOR.

NO CLAIM IS MADE TO THE EXCLUSIVE RIGHT TO USE "FEMALE", APART FROM THE MARK AS SHOWN.

CLASS 14—JEWELRY

FOR JEWELRY, NAMELY, NECKLACES, CHAIN NECKLACES, AND BALL CHAIN NECKLACES (U.S. CLS. 2, 27, 28 AND 50).

CLASS 25—CLOTHING

FOR WOMEN'S APPAREL, NAMELY SWEATSHIRTS, HOODED SWEATSHIRTS, T-SHIRTS, T-SHIRTS WITH POCKETS AND/OR RAGLAN SLEEVES, TANK TOPS AND RIB TANK TOPS, PANTS AND JEANS; HEADWEAR, NAMELY SKULL CAPS; AND ACCESSORIES, NAMELY BELTS AND WRIST CUFFS (U.S. CLS. 22 AND 39).

MELISSA SHELLA, EXAMINING ATTORNEY

SN 76-595,246. AVUE TECHNOLOGIES CORPORATION, TACOMA, WA. FILED 6-2-2004.

AVUE ENTERPRISE DIRECT

THE MARK CONSISTS OF STANDARD CHARACTERS WITHOUT CLAIM TO ANY PARTICULAR FONT, STYLE, SIZE, OR COLOR.

NO CLAIM IS MADE TO THE EXCLUSIVE RIGHT TO USE DIRECT, APART FROM THE MARK AS SHOWN.

CLASS 35—ADVERTISING AND BUSINESS

FOR BUSINESS CONSULTING SERVICES IN THE FIELDS OF WORKFORCE MANAGEMENT AND HUMAN RESOURCES, FEATURING WORKFORCE MANAGEMENT AND HUMAN RESOURCES INFORMATION IN THE FIELDS OF TRANSACTION PROCESSING, DECISION SUPPORT, AND WORKFLOW ENABLING, ALL IN THE AREAS OF PERSONNEL FORECASTING, POSITION DESIGN, STAFFING, RECRUITMENT, HIRING, TRAINING, EVALUATION, DEVELOPMENT, COMPENSATION, COMPLIANCE, ANALYSIS, ORGANIZATIONAL ARCHITECTURE ANALYSIS, MANAGEMENT AND SUCCESSION PLANNING, ALL VIA E-MAIL, FACSIMILE AND TELEPHONE (U.S. CLS. 100, 101 AND 102).

FIRST USE 2-4-2004; IN COMMERCE 2-4-2004.

CLASS 42—SCIENTIFIC, COMPUTER AND LEGAL SERVICES

FOR PROVIDING ON-LINE NON-DOWNLOADABLE SOFTWARE FOR HUMAN RESOURCES MANAGEMENT, INCLUDING PERSONNEL FORECASTING, POSITION DESIGN, STAFFING, RECRUITMENT, HIRING, TRAINING, EVALUATION, DEVELOPMENT, COMPENSATION, COMPLIANCE, ANALYSIS, ORGANIZATIONAL ARCHITECTURE ANALYSIS, MANAGEMENT AND SUCCESSION PLANNING (U.S. CLS. 100 AND 101).

FIRST USE 2-4-2004; IN COMMERCE 2-4-2004.

KATHERINE STOIDES, EXAMINING ATTORNEY

CLASS 41—EDUCATION AND ENTERTAINMENT

FOR PROVIDING AMUSEMENT ARCADE SERVICES; AMUSEMENT PARKS; PROVIDING CASINO FACILITIES; PROVIDING GAMES FOR ARCADE VIDEO GAME MACHINES OR VIDEO GAME MACHINES FOR HOME USE THROUGH THE INTERNET OR COMPUTER NETWORKS; PROVIDING GAMES FOR ARCADE VIDEO GAME MACHINES OR VIDEO GAME MACHINES FOR HOME USE THROUGH TELECOMMUNICATIONS LINES; PROVIDING INFORMATION REGARDING GAMES FOR ARCADE VIDEO GAME MACHINES OR VIDEO GAME MACHINES FOR HOME USE THROUGH THE INTERNET OR COMPUTER NETWORKS (U.S. CLS. 100, 101 AND 107).

ALICE SUE CARRUTHERS, EXAMINING ATTORNEY

SN 76-595,264. SAMMY CORPORATION, TOSHIMA-KU, TOKYO, JAPAN, FILED 6-3-2004.

PRIZEPARTY

THE MARK CONSISTS OF STANDARD CHARACTERS WITHOUT CLAIM TO ANY PARTICULAR FONT, STYLE, SIZE, OR COLOR.

PRIORITY CLAIMED UNDER SEC. 44(D) ON JAPAN APPLICATION NO. 2004-10368, FILED 2-6-2004.

CLASS 9—ELECTRICAL AND SCIENTIFIC APPARATUS

FOR RECORDING MEDIA HAVING COMPUTER GAME PROGRAMS STORED THEREON, NAMELY, ELECTRONIC CIRCUITS, MAGNETIC DISCS, OPTICAL DISCS, CD-ROMS, DVD-ROMS AND MAGNETIC TAPES; RECORDING MEDIA HAVING ARCADE VIDEO GAME PROGRAMS STORED THEREON, NAMELY, ELECTRONIC CIRCUITS, MAGNETIC DISCS, OPTICAL DISCS, CD-ROMS, DVD-ROMS AND MAGNETIC TAPES; RECORDING MEDIA HAVING VIDEO GAME PROGRAMS FOR HOME USE STORED THEREON, NAMELY, ELECTRONIC CIRCUITS, MAGNETIC DISCS, OPTICAL DISCS, CD-ROMS, DVD-ROMS AND MAGNETIC TAPES; ELECTRONIC GAME MACHINES ADAPTED FOR USE WITH TELEVISION RECEIVERS ONLY FOR HOME USE; RECORDING MEDIA HAVING GAME PROGRAMS FOR PORTABLE GAME MACHINES WITH LIQUID CRYSTAL DISPLAY STORED THEREON, NAMELY, ELECTRONIC CIRCUITS, MAGNETIC DISCS, OPTICAL DISCS, CD-ROMS, DVD-ROMS AND MAGNETIC TAPES; VIDEO GAME PROGRAMS FOR PORTABLE GAME MACHINES WITH LIQUID CRYSTAL DISPLAY; ELECTRONIC CIRCUITS AND CD-ROMS HAVING AUTOMATIC PLAYING PROGRAMS FOR ELECTRONIC MUSICAL INSTRUMENTS STORED THEREON; VENDING MACHINES; SLOT MACHINES (U.S. CLS. 21, 23, 26, 36 AND 38).

CLASS 28—TOYS AND SPORTING GOODS

FOR BALLS FOR GAMES; AUTOMATIC GAMES OTHER THAN THOSE ADAPTED FOR USE WITH TELEVISION RECEIVERS ONLY, NAMELY, PRIZE-DISPENSING GAMES; TOY MOBILES; SCALE-MODEL TOY VEHICLES; PARLOR GAMES; PLAYGROUND BALLS; PLAYING CARDS; RADIO-CONTROLLED TOY VEHICLES; ARCADE VIDEO GAME MACHINES; COIN-OPERATED ARCADE VIDEO GAME MACHINES; MAGNETIC-CARD-OPERATED ARCADE VIDEO GAME MACHINES; ELECTRONIC GAME MACHINES FOR OFFERING GIFTS; PORTABLE GAME MACHINES WITH LIQUID CRYSTAL DISPLAY; ARCADE TOY SELLING MACHINES; AUTOMATIC AND COIN-OPERATED STAND-ALONE VIDEO GAME MACHINES (U.S. CLS. 22, 23, 38 AND 50).

SN 76-595,280. SHELBY WILLIAMS INDUSTRIES, INC., MORRISTOWN, TN. FILED 6-3-2004.



OWNER OF U.S. REG. NO. 1,278,979.

CLASS 18—LEATHER GOODS

FOR LEATHER OR SYNTHETIC LEATHER SOLD IN BULK FOR USE IN UPHOLSTERY COVERINGS FOR FURNITURE (U.S. CLS. 1, 2, 3, 22 AND 41).

FIRST USE 5-0-2001; IN COMMERCE 5-0-2001.

CLASS 20—FURNITURE AND ARTICLES NOT OTHERWISE CLASSIFIED

FOR FURNITURE, NAMELY, CHAIRS, SOFAS, SETTEES, LOVE SEATS, OTTOMANS, BENCHES, TABLES, STOOLS, BOOTH-STYLE SEATING, MIRRORS, CONVERTIBLE SLEEP-SOFAS, BEDS, BED FRAMES, MODULAR SEATING UNITS, STACK CHAIR CARRIERS IN THE NATURE OF A SET OF STACK CHAIRS, SHOE FITTING STOOLS, DESKS, CREDENZAS AND FILE CABINETS (U.S. CLS. 2, 13, 22, 25, 32 AND 50).

FIRST USE 5-0-2001; IN COMMERCE 5-0-2001.

CLASS 24—FABRICS

FOR TEXTILE MATERIAL FOR UPHOLSTERING FURNITURE (U.S. CLS. 42 AND 50).

FIRST USE 5-0-2001; IN COMMERCE 5-0-2001.

WILLIAM VERHOSEK, EXAMINING ATTORNEY

SN 76-595,289. MURAD, HOWARD, EL SEGUNDO, CA.
FILED 6-3-2004.

THE RESULTS ARE CLEAR

THE MARK CONSISTS OF STANDARD CHARACTERS WITHOUT CLAIM TO ANY PARTICULAR FONT, STYLE, SIZE, OR COLOR.

CLASS 3—COSMETICS AND CLEANING PREPARATIONS

FOR SKIN CARE PRODUCTS, NAMELY EXFOLIATING CREAMS, SKIN CLEANSER, FACIAL SCRUB, NON-MEDICATED SKIN ASTRINGENT, SKIN MOISTURIZER AND NIGHT CREAM; HAND AND BODY MOISTURIZER, BATH AND SHOWER GELS, HAIR SHAMPOO AND HAIR CONDITIONER, SUN BLOCK PREPARATIONS, BATH OIL, ANTI-WRINKLE CREAM, MOISTURE CREAM AND UNDER EYE COVER (U.S. CLS. 1, 4, 6, 50, 51 AND 52).

CLASS 5—PHARMACEUTICALS

FOR VITAMINS AND DIETARY FOOD SUPPLEMENTS (U.S. CLS. 6, 18, 44, 46, 51 AND 52).
ALEXANDER L. POWERS, EXAMINING ATTORNEY

SN 76-596,018. KABBALAH CENTRE INTERNATIONAL, INC., LOS ANGELES, CA. FILED 6-7-2004.

KABBALISTIC NANOTECHNOLOGY

THE MARK CONSISTS OF STANDARD CHARACTERS WITHOUT CLAIM TO ANY PARTICULAR FONT, STYLE, SIZE, OR COLOR.

CLASS 3—COSMETICS AND CLEANING PREPARATIONS

FOR TOILET SOAP, BATH SALTS, BUBBLE BATH, PERFUME, TOILET WATER, COLOGNE, LIPSTICKS, NAIL POLISHES, MAKE-UP CREAMS, CLEANSING MILK, BODY AND FACE POWDERS, SKIN CLEANSING LOTIONS AND CREAMS, EYE-LINER, AFTER SHAVE LOTION, SHAVING SOAP, PERSONAL DEODORANTS, HAIR LOTIONS AND TALCUM POWDER (U.S. CLS. 1, 4, 6, 50, 51 AND 52).

CLASS 9—ELECTRICAL AND SCIENTIFIC APPARATUS

FOR CDS, DVDS, AUDIO CASSETTES AND VIDEOTAPES FEATURING RELIGION AND SPIRITUALITY; CD AND TAPE COVERS (U.S. CLS. 21, 23, 26, 36 AND 38).

CLASS 16—PAPER GOODS AND PRINTED MATTER

FOR SERIES OF BOOKS, MAGAZINES AND NEWSLETTERS FEATURING RELIGION AND SPIRITUALITY; COLORING BOOKS, MOUNTED AND UNMOUNTED PHOTOGRAPHS, POSTERS, POSTCARDS, CALENDARS AND GREETING CARDS (U.S. CLS. 2, 5, 22, 23, 29, 37, 38 AND 50).

CLASS 25—CLOTHING

FOR CLOTHING, NAMELY, SHIRTS, VESTS, SWEATERS, SHOES, CAPS, BANDANNAS, SHORTS, SWEAT SHIRTS, PANTS, BELTS FOR CLOTHING, SOCKS, SWIM WEAR, JACKETS, RAIN WEAR, BLOUSES, DRESSES, FOOTWEAR, HOSE, SCARVES, HATS, HEAD BANDS, PAJAMAS AND SLEEP WEAR (U.S. CLS. 22 AND 39).

CLASS 32—LIGHT BEVERAGES

FOR BOTTLED DRINKING WATER (U.S. CLS. 45, 46 AND 48).

CLASS 41—EDUCATION AND ENTERTAINMENT

FOR EDUCATIONAL SERVICES, NAMELY, PROVIDING SEMINARS AND COURSES ON RELIGION AND SPIRITUALITY (U.S. CLS. 100, 101 AND 107).
HEATHER THOMPSON, EXAMINING ATTORNEY

SN 76-596,197. LEDERMA, INC., BEVERLY HILLS, CA.
FILED 6-7-2004.

HEALTHY SKIN FOR LIFE

THE MARK CONSISTS OF STANDARD CHARACTERS WITHOUT CLAIM TO ANY PARTICULAR FONT, STYLE, SIZE, OR COLOR.

NO CLAIM IS MADE TO THE EXCLUSIVE RIGHT TO USE "HEALTHY SKIN", APART FROM THE MARK AS SHOWN.

CLASS 3—COSMETICS AND CLEANING PREPARATIONS

FOR COSMETICS, NAMELY, NAIL POLISH, LIPSTICK, EYE SHADOW, FOUNDATION, FACE POWDER AND PERFUME (U.S. CLS. 1, 4, 6, 50, 51 AND 52).

CLASS 5—PHARMACEUTICALS

FOR MEDICATED TRANSDERMAL AND EPIDERMAL ANTIOXIDANTS, OILS, LOTIONS, CREAMS, GELS, SOLUTIONS AND SPRAYS CONTAINING MEDICATIONS TO REDUCE SKIN ERYTHEMA AND DERMATITIS AND FOR MOISTURIZING, ANTI-AGING, BLEACHING, TANNING, SKIN DAMAGE REPAIR, SUN BLOCKING AND WRINKLE REDUCING; TOPICAL ACNE, ECZEMA AND PSORIASIS TREATMENT PREPARATIONS; AND SHAMPOO WITH ADDED DANDRUFF CONTROL TREATMENT (U.S. CLS. 6, 18, 44, 46, 51 AND 52).

NAKWAMA ANKRAH, EXAMINING ATTORNEY

SN 76-596,482. L.J.C., INC., HOFFMAN ESTATES, IL. FILED 6-10-2004.

WHITE VELOCITY

THE MARK CONSISTS OF STANDARD CHARACTERS WITHOUT CLAIM TO ANY PARTICULAR FONT, STYLE, SIZE, OR COLOR.

CLASS 3—COSMETICS AND CLEANING PREPARATIONS

FOR DENTAL KIT COMPRISING DENTAL WHITENING GEL AND DENTAL TRAY FOR USE IN CONNECTION WITH TOOTH WHITENING SOLD AS A UNIT; DENTAL WHITENING GEL AND TOOTHPASTE (U.S. CLS. 1, 4, 6, 50, 51 AND 52).

CLASS 10—MEDICAL APPARATUS

FOR DENTAL WHITENING TRAYS (U.S. CLS. 26, 39 AND 44).
SALLY SHIH, EXAMINING ATTORNEY

SN 76-596,947. SPRINGFIELD PRO HOCKEY, LLC, SPRINGFIELD, MA. FILED 6-14-2004.



SN 76-596,593. FRIARS NATIONAL ASSOCIATION, INC., THE, NEW YORK, NY. FILED 6-10-2004.

FRIARS OF BEVERLY HILLS

THE MARK CONSISTS OF STANDARD CHARACTERS WITHOUT CLAIM TO ANY PARTICULAR FONT, STYLE, SIZE, OR COLOR.

OWNER OF U.S. REG. NO. 2,387,620.

NO CLAIM IS MADE TO THE EXCLUSIVE RIGHT TO USE "BEVERLY HILLS", APART FROM THE MARK AS SHOWN.

NO CLAIM IS MADE TO THE EXCLUSIVE RIGHT TO USE "SPRINGFIELD", APART FROM THE MARK AS SHOWN.

THE MARK CONSISTS OF THE WORDS SPRINGFIELD FALCONS, WITH A FALCON HOLDING A HOCKEY STICK AGAINST A SHIELD.

CLASS 43—HOTEL AND RESTAURANT SERVICES

FOR RESTAURANT SERVICES (U.S. CLS. 100 AND 101).

CLASS 45—PERSONAL SERVICES

FOR PRIVATE SOCIAL CLUB SERVICES (U.S. CLS. 100 AND 101).
LOURDES AYALA, EXAMINING ATTORNEY

CLASS 25—CLOTHING

FOR CLOTHING, NAMELY, SHORT AND LONG SLEEVED T-SHIRTS, HATS; BABY CLOTHES, NAMELY, INFANT ROMPERS; TODDLER APPAREL, NAMELY, SHORT SETS, SWEAT SHIRTS AND T-SHIRTS; SWEAT SHIRTS, SWEAT PANTS, JACKETS, OVERALLS, NYLON WIND SUITS, SHORT AND LONG SLEEVED GOLF SHIRTS, GAME JERSEYS, GAME PANTS, SOCKS, SWEATERS AND MITTENS (U.S. CLS. 22 AND 39).

FIRST USE 9-24-2003; IN COMMERCE 9-24-2003.

CLASS 41—EDUCATION AND ENTERTAINMENT

FOR ENTERTAINMENT IN THE NATURE OF PROFESSIONAL ICE HOCKEY EXHIBITIONS (U.S. CLS. 100, 101 AND 107).

FIRST USE 9-24-2003; IN COMMERCE 9-24-2003.

LEIGH CAROLINE CASE, EXAMINING ATTORNEY

SN 76-596,594. FRIARS NATIONAL ASSOCIATION, INC., THE, NEW YORK, NY. FILED 6-10-2004.

FRIARS CLUB OF CALIFORNIA

THE MARK CONSISTS OF STANDARD CHARACTERS WITHOUT CLAIM TO ANY PARTICULAR FONT, STYLE, SIZE, OR COLOR.

OWNER OF U.S. REG. NO. 2,387,620.

NO CLAIM IS MADE TO THE EXCLUSIVE RIGHT TO USE "CLUB OF CALIFORNIA", APART FROM THE MARK AS SHOWN.

SN 76-597,926. INVENTEC CORPORATION, SHIH LIN DISTRICT, TAIPEI, TAIWAN, FILED 6-18-2004.

**CLASS 43—HOTEL AND RESTAURANT SERVICES**

FOR RESTAURANT SERVICES (U.S. CLS. 100 AND 101).

CLASS 45—PERSONAL SERVICES

FOR PRIVATE SOCIAL CLUB SERVICES (U.S. CLS. 100 AND 101).
LOURDES AYALA, EXAMINING ATTORNEY

NO CLAIM IS MADE TO THE EXCLUSIVE RIGHT TO USE HOME AND DIGITAL HOME, APART FROM THE MARK AS SHOWN.

CLASS 7—MACHINERY

FOR ELECTRIC COFFEE GRINDERS FOR COMMERCIAL AND DOMESTIC USE; ELECTRIC FRUIT AND VEGETABLE JUICE EXTRACTORS FOR DOMESTIC USE; WASHING MACHINES FOR CLOTHES (U.S. CLS. 13, 19, 21, 23, 31, 34 AND 35).

CLASS 9—ELECTRICAL AND SCIENTIFIC APPARATUS

FOR COMPUTER LIGHT PENS; BLANK MAGNETIC DISCS; COMPUTER KEYBOARDS; COMPUTER PRINTERS; INTEGRATED CIRCUIT CARDS; COMPUTER INTERFACE CARDS; PERSONAL DIGITAL ASSISTANTS (PDA); PLOTTERS; ELECTRONIC POCKET TRANSLATORS; COMPUTER DISC DRIVES; RECORDERS FOR RECORDING BOOKS IN ELECTRONIC FORM; COMPUTERS; ELECTRONIC BOOKS FEATURING NEWS, WEATHER, SPORTS, CURRENT EVENTS, AND REFERENCE MATERIALS RECORDED ON FLOPPY DISKS, COMPACT DISKS, DIGITAL VIDEO DISCS, DOWNLOADABLE FROM COMPUTER NETWORKS; COMPUTER MEMORIES; COMPUTER MICE; LAN (LOCAL AREA NETWORK) COMPUTER CARDS FOR CONNECTING PORTABLE COMPUTER DEVICES TO COMPUTER NETWORKS; MEMORY CARDS; MODEMS; COMPUTER MONITORS; EARPHONES; STEREO PHONIC SOUND APPARATUS, NAMELY, TUNERS, RECEIVERS, AMPLIFIERS, CD PLAYERS, AUDIO TAPE RECORDERS; COMPUTER LOUDSPEAKERS; TAPE RECORDERS; FAX MACHINES; CALCULATORS; TELEPHONES; CELLULAR TELEPHONES; RADIO PAGERS; TELEPHONE ANSWERING MACHINES; IMAGE DISPLAYING TELEPHONES; DIGITAL TELEPHONE DIALERS; DIGITAL CAMERAS; MAGNETIC TELEPHONE WIRES; AUDIO MIXERS; ELECTRONIC DICTIONARIES, NOTEBOOK COMPUTERS; BLANK OPTICAL DISCS; OPTICAL DISCS PRE-RECORDED WITH COMPUTER PROGRAMS FOR TEACHING AND LEARNING FOREIGN LANGUAGES, PRACTICE AND TESTING OF CONVERSATION AND TRANSLATION SKILLS; CASH REGISTERS; IMAGE SCANNERS; WORD PROCESSORS; SOUND CARDS; ANTENNAS; COMPUTER DATA INTEGRATORS; DVD PLAYERS; VIDEO TAPE PLAYERS AND RECORDERS; COMMUNICATIONS SERVERS; COMPUTER WORKSTATIONS, COMPRISING COMPUTERS, MONITORS; DIGITAL VIDEO CAMERAS; BATTERIES; BATTERY CHARGERS; COMPUTER PROGRAMS TO CONTROL AND IMPROVE COMPUTER AND AUDIO-VISUAL EQUIPMENT SOUND AND IMAGES QUALITY; COMPUTER NETWORK STORAGE DEVICES COMPRISING NETWORK ATTACHED STORAGE, HARD-DISCS, MAINBOARDS, BACK PLANES, BASIC INPUT/OUTPUT SYSTEMS OF MAINBOARDS, REMOTE CONTROLLING INTERFACE CARDS FOR NETWORK SERVERS; INTERNAL COOLING FANS FOR COMPUTERS; COMPUTER SOFTWARE FOR DATA BASE MANAGEMENT, WORD PROCESSING, AND SPREAD SHEETS; TELEVISION SETS; VIDEO GAME MACHINES FOR USE WITH TELEVISIONS; ENTERTAINMENT MACHINES FOR USE WITH TELEVISIONS, NAMELY GAME MACHINES; ENCODED MAGNETIC VIDEO GAME CARDS; NETWORK GATEWAY; SET-TOP BOXES (U.S. CLS. 21, 23, 26, 36 AND 38).

CLASS 11—ENVIRONMENTAL CONTROL APPARATUS

FOR AIR PURIFYING UNITS FOR COMMERCIAL, DOMESTIC AND INDUSTRIAL USE; ELECTRIC SPACE HEATERS; VENTILATING FANS FOR COMMERCIAL, DOMESTIC AND INDUSTRIAL USE; AIR CONDITIONING UNITS; AIR FILTERS FOR DOMESTIC AND INDUSTRIAL USE; ELECTRIC CLOTHES DRYERS FOR DOMESTIC USE; VENTILATORS FOR COMMERCIAL, DOMESTIC AND INDUSTRIAL USE; DRINKING FOUNTAINS (U.S. CLS. 13, 21, 23, 31 AND 34).

CLASS 16—PAPER GOODS AND PRINTED MATTER

FOR BOOKS ABOUT COMPUTERS, GLOBAL COMMUNICATIONS NETWORK RESOURCES, TRAVEL, ENTERTAINMENT, NEWS, AND LITERATURE; STORY BOOKS; GENERAL FEATURE MAGAZINES; COMIC BOOKS; ENVELOPES; LETTER PAPERS; GREETING CARDS; BOOKMARKS; NOTEPAPERS; GENERAL FEATURE PERIODICALS; COMPUTER PROGRAM INSTRUCTIONAL MANUALS FOR LEARNING FOREIGN LANGUAGES; NOVELS; EXERCISE BOOKS; NOTE BOOKS; DIARIES; DATE BOOKS (U.S. CLS. 2, 5, 22, 23, 29, 37, 38 AND 50).

CLASS 35—ADVERTISING AND BUSINESS

FOR ADVERTISEMENT PLANNING; DISSEMINATION OF ADVERTISING MATTER; ADVERTISING AGENCIES; MAIL ORDER SERVICES FEATURING ELECTRIC APPLIANCES, ELECTRONIC AND TELECOMMUNICATION GOODS; COMPUTERIZED ON-LINE ORDERING SERVICES FEATURING ELECTRIC APPLIANCES, ELECTRONIC AND TELECOMMUNICATION GOODS; COMPILATION OF COMPUTER DATABASE; MANAGEMENT OF COMPUTERIZED FILES; MANAGEMENT OF COMPUTER DATABASE; RENTAL OF ADVERTISING SPACE ON WEB SITES AND ON THE INTERNET; PROVIDING TELEVISION ADVERTISING FOR OTHERS (U.S. CLS. 100, 101 AND 102).

CLASS 41—EDUCATION AND ENTERTAINMENT

FOR RENTAL OF BOOKS AND MAGAZINES; TEACHING IN THE FIELD OF MECHANICS, COMPUTERS AND SCIENCES; CONDUCTING EDUCATIONAL LECTURES IN THE FIELD OF SCIENCES, LANGUAGES, AND COMPUTERS; TEACHING IN THE FIELD OF FOREIGN LANGUAGES VIA A GLOBAL COMPUTER NETWORK; EDUCATIONAL SERVICES, NAMELY, CONDUCTING DISTANCE LEARNING INSTRUCTION AT THE SECONDARY, COLLEGE AND GRADUATE LEVELS; PROVIDING COMPUTER GAMES VIA A GLOBAL COMPUTER NETWORK; PROVIDING INSTRUCTION IN THE FIELD OF COMPUTERS, SCIENCES AND FOREIGN LANGUAGES VIA A GLOBAL COMPUTER NETWORK; PROVIDING ENTERTAINMENT INFORMATION IN THE FIELD OF MUSIC, MOTION PICTURE FILMS, COMPUTER GAMES, TELEVISION AND MOVIE FILMS VIA A GLOBAL COMPUTER NETWORK; PRODUCTION OF RADIO AND TELEVISION PROGRAMS; ENTERTAINMENT IN THE NATURE OF ON-GOING TELEVISION PROGRAMS IN THE FIELD OF NEWS, COMEDY, DRAMA (U.S. CLS. 100, 101 AND 107).

CLASS 42—SCIENTIFIC, COMPUTER AND LEGAL SERVICES

FOR ANALYSIS OF COMPUTER SOFTWARE SYSTEMS; COMPUTER SOFTWARE DESIGN FOR OTHERS; REVISING OF COMPUTER SOFTWARE FOR OTHERS; MAINTENANCE OF COMPUTER SOFTWARE; COMPUTER CONSULTATION; CREATING AND MAINTAINING WEB SITES FOR OTHERS; INDUSTRIAL PRODUCTS DESIGN FOR OTHERS; COMPUTER HARDWARE DESIGN FOR OTHERS; CUSTOM SEARCHING SERVICES IN RESPECT OF COMPUTERIZED DATA FILES, NAMELY BUSINESS, TRAVELING, FOODS, HEALTH AND MEDICINES, SCIENCES (U.S. CLS. 100 AND 101).

BARBARA GAYNOR, EXAMINING ATTORNEY

SN 76-598,175. FIRM, INC., THE, BEVERLY HILLS, CA.
FILED 6-18-2004.

BACKSTAGE ACCESS

NO CLAIM IS MADE TO THE EXCLUSIVE RIGHT TO USE "BACKSTAGE", APART FROM THE MARK AS SHOWN.

CLASS 38—COMMUNICATION

FOR TELEVISION BROADCASTING SERVICES (U.S. CLS. 100, 101 AND 104).

CLASS 41—EDUCATION AND ENTERTAINMENT

FOR PRODUCTION OF A SERIES OF TELEVISION PROGRAMS; TELEVISION ENTERTAINMENT SERVICES, NAMELY, PROVIDING A SERIES OF TELEVISION PROGRAMS FEATURING ENTERTAINMENT NEWS, MUSIC, LIVE CONCERTS, AND EXCERPTS OF MOTION PICTURES AND PREVIOUSLY RECORDED TELEVISION PROGRAMS (U.S. CLS. 100, 101 AND 107).
WILLIAM BRECKENFELD, EXAMINING ATTORNEY

SN 76-598,282. GOULD, ELMER LEROY, FORT WORTH, TX.
FILED 6-21-2004.

R.T.P.D.

THE MARK CONSISTS OF STANDARD CHARACTERS WITHOUT CLAIM TO ANY PARTICULAR FONT, STYLE, SIZE, OR COLOR.

CLASS 25—CLOTHING

FOR CLOTHING, NAMELY SHIRTS, JACKETS, HATS, SHOES, SWEATERS, DRESSES, ROBES, APRONS, SWEAT BANDS, VESTS, SOCKS, SUITS AND UNIFORMS (U.S. CLS. 22 AND 39).

CLASS 26—FANCY GOODS

FOR SETS OF BEADS FOR USE IN HANDICRAFT WORK (U.S. CLS. 37, 39, 40, 42 AND 50).
STEVEN R. FOSTER, EXAMINING ATTORNEY

SN 76-598,447. ANACONDA SPORTS, INC., LAKE KATRINE, NY. FILED 6-21-2004.



OWNER OF U.S. REG. NOS. 1,534,487, 2,804,533 AND OTHERS.

CLASS 9—ELECTRICAL AND SCIENTIFIC APPARATUS

FOR SPORT WHISTLES (U.S. CLS. 21, 23, 26, 36 AND 38).
FIRST USE 3-15-2002; IN COMMERCE 3-15-2002.

CLASS 16—PAPER GOODS AND PRINTED MATTER

FOR STATIONERY-TYPE PORTFOLIOS, SCORING BOOKS, AND CLIPBOARDS (U.S. CLS. 2, 5, 22, 23, 29, 37, 38 AND 50).
FIRST USE 3-15-2002; IN COMMERCE 3-15-2002.

CLASS 18—LEATHER GOODS

FOR BAGS, NAMELY, TRAVEL BAGS, ATTACHE BAGS, DUFFEL BAGS, TOTE BAGS, CARRY-ALL BAGS, AND ATHLETIC BAGS (U.S. CLS. 1, 2, 3, 22 AND 41).
FIRST USE 3-15-2002; IN COMMERCE 3-15-2002.

CLASS 22—CORDAGE AND FIBERS

FOR LANYARDS FOR HOLDING KEYS AND WHISTLES (U.S. CLS. 1, 2, 7, 19, 22, 42 AND 50).
FIRST USE 3-15-2002; IN COMMERCE 3-15-2002.

CLASS 25—CLOTHING

FOR CLOTHING, NAMELY, JACKETS, SWEATERS, SHIRTS, T-SHIRTS, SWEATSHIRTS, SPORT SHIRTS, SHORTS, SWEAT SHORTS, SPORT SHORTS, PANTS, SWEAT PANTS, SPORT PANTS, HATS, CAPS, SWEATERS, AND ATHLETIC UNIFORMS (U.S. CLS. 22 AND 39).
FIRST USE 3-15-2002; IN COMMERCE 3-15-2002.

CLASS 28—TOYS AND SPORTING GOODS

FOR ATHLETIC EQUIPMENT, NAMELY, BALL RACKS, BASKETBALLS, BASKETBALL RIMS, AND BAGS FOR CARRYING SPORT BALLS (U.S. CLS. 22, 23, 38 AND 50).
FIRST USE 3-15-2002; IN COMMERCE 3-15-2002.
ALICE SUE CARRUTHERS, EXAMINING ATTORNEY

SN 76-598,456. VICTORIA PRINCIPAL PRODUCTIONS, INC., LOS ANGELES, CA. FILED 6-22-2004.

HONEY YOU'RE A BABE

THE MARK CONSISTS OF STANDARD CHARACTERS WITHOUT CLAIM TO ANY PARTICULAR FONT, STYLE, SIZE, OR COLOR.

CLASS 16—PAPER GOODS AND PRINTED MATTER

FOR PRINTED MATTER, NAMELY, BOOKS, NEWSLETTERS, MAGAZINES AND GUIDES PROVIDING INFORMATION ON HEALTH, BEAUTY, COSMETICS, HAIR CARE, SKIN CARE, NUTRITION AND EXERCISE (U.S. CLS. 2, 5, 22, 23, 29, 37, 38 AND 50).

CLASS 44—MEDICAL, BEAUTY AND AGRICULTURAL SERVICES

FOR COMPUTER SERVICES, NAMELY PROVIDING ONLINE INFORMATION AND CONSULTATION SERVICES ON HEALTH, BEAUTY, COSMETICS, HAIR CARE, SKIN CARE AND NUTRITION (U.S. CLS. 100 AND 101).
MARK T. MULLEN, EXAMINING ATTORNEY

SN 76-598,517. FLORIDA NURSERYMEN AND GROWERS ASSOCIATION, INC., ORLANDO, FL. FILED 6-18-2004.



CLASS 35—ADVERTISING AND BUSINESS

FOR ASSOCIATION SERVICES, NAMELY, PROMOTING THE INTERESTS OF INDIVIDUALS AND ORGANIZATIONS IN THE FIELDS OF AGRICULTURE, NURSERY AND LANDSCAPE; PROTECTING THE BUSINESS INTERESTS OF INDIVIDUALS AND ORGANIZATIONS IN THE FIELDS OF AGRICULTURE, NURSERY AND LANDSCAPE; PROMOTING AND CONDUCTING TRADESHOWS IN THE FIELDS OF AGRICULTURE, NURSERY AND LANDSCAPE (U.S. CLS. 100, 101 AND 102).

FIRST USE 6-1-2004; IN COMMERCE 6-1-2004.

CLASS 41—EDUCATION AND ENTERTAINMENT

FOR EDUCATIONAL SERVICES, NAMELY, ARRANGING AND CONDUCTING EXHIBITIONS, CONVENTIONS, PROGRAMS AND WORKSHOPS AND CONFERENCES AND SEMINARS IN THE FIELDS OF AGRICULTURE, NURSERY AND LANDSCAPE (U.S. CLS. 100, 101 AND 107).

FIRST USE 6-1-2004; IN COMMERCE 6-1-2004.

JACQUELINE A. LAVINE, EXAMINING ATTORNEY

SN 76-598,659. TOPCODER, INC., GLASTONBURY, CT. FILED 6-18-2004.

[TOPCODER]

THE MARK CONSISTS OF STANDARD CHARACTERS WITHOUT CLAIM TO ANY PARTICULAR FONT, STYLE, SIZE, OR COLOR.

OWNER OF U.S. REG. NOS. 2,764,034, 2,764,035 AND 2,813,438.

CLASS 35—ADVERTISING AND BUSINESS

FOR LICENSING OF COMPUTER SOFTWARE; ON-LINE COMPUTER SOFTWARE ORDERING SERVICES FEATURING DOWNLOADABLE COMPUTER SOFTWARE; SUBSCRIPTION TO A COMPUTER SERVICE, NAMELY PROVISION OF DOWNLOADABLE COMPUTER SOFTWARE ON A SUBSCRIPTION BASIS (U.S. CLS. 100, 101 AND 102).

FIRST USE 10-14-2002; IN COMMERCE 10-14-2002.

CLASS 42—SCIENTIFIC, COMPUTER AND LEGAL SERVICES

FOR COMPUTER SOFTWARE SERVICES FOR OTHERS, NAMELY COORDINATING AND FACILITATING THE DESIGN, DEVELOPMENT AND CUSTOMIZATION OF COMPUTER SOFTWARE COMPONENTS AND APPLICATIONS; DESIGNING, DEVELOPING, AND CUSTOMIZING COMPUTER SOFTWARE COMPONENTS AND APPLICATIONS FOR OTHERS (U.S. CLS. 100 AND 101).

FIRST USE 4-9-2002; IN COMMERCE 4-9-2002.

WINSTON FOLMAR, EXAMINING ATTORNEY

SN 76-598,660. TOPCODER, INC., GLASTONBURY, CT. FILED 6-18-2004.

[TOPCODER] SOFTWARE

THE MARK CONSISTS OF STANDARD CHARACTERS WITHOUT CLAIM TO ANY PARTICULAR FONT, STYLE, SIZE, OR COLOR.

OWNER OF U.S. REG. NOS. 2,764,034, 2,764,035 AND 2,813,438.

NO CLAIM IS MADE TO THE EXCLUSIVE RIGHT TO USE "SOFTWARE", APART FROM THE MARK AS SHOWN.

CLASS 35—ADVERTISING AND BUSINESS

FOR LICENSING OF COMPUTER SOFTWARE; ON-LINE COMPUTER SOFTWARE ORDERING SERVICES FEATURING DOWNLOADABLE COMPUTER SOFTWARE; SUBSCRIPTION TO A COMPUTER SERVICE, NAMELY PROVISION OF DOWNLOADABLE COMPUTER SOFTWARE ON A SUBSCRIPTION BASIS (U.S. CLS. 100, 101 AND 102).

FIRST USE 10-14-2002; IN COMMERCE 10-14-2002.

CLASS 42—SCIENTIFIC, COMPUTER AND LEGAL SERVICES

FOR COMPUTER SOFTWARE SERVICES FOR OTHERS, NAMELY COORDINATING AND FACILITATING THE DESIGN, DEVELOPMENT AND CUSTOMIZATION OF COMPUTER SOFTWARE COMPONENTS AND APPLICATIONS; DESIGNING, DEVELOPING, AND CUSTOMIZING COMPUTER SOFTWARE COMPONENTS AND APPLICATIONS FOR OTHERS (U.S. CLS. 100 AND 101).

FIRST USE 4-9-2002; IN COMMERCE 4-9-2002.

WINSTON FOLMAR, EXAMINING ATTORNEY

SN 76-598,787. NATREON, INC., NEW BRUNSWICK, NJ. FILED 6-21-2004.

NATREON

THE MARK CONSISTS OF STANDARD CHARACTERS WITHOUT CLAIM TO ANY PARTICULAR FONT, STYLE, SIZE, OR COLOR.

CLASS 1—CHEMICALS

FOR PROCESSED HERBS, NAMELY INGREDIENTS USED IN THE MANUFACTURE OF HERBAL SUPPLEMENTS, NUTRITIONAL SUPPLEMENTS, HERBAL PRODUCTS, NUTRITIONAL PRODUCTS, FOOD AND DRINK PRODUCTS (U.S. CLS. 1, 5, 6, 10, 26 AND 46).

CLASS 5—PHARMACEUTICALS

FOR HERBAL SUPPLEMENTS; NUTRITIONAL SUPPLEMENTS; DIETARY SUPPLEMENTS (U.S. CLS. 6, 18, 44, 46, 51 AND 52).
TIMOTHY FINNEGAN, EXAMINING ATTORNEY

SN 76-598,953. SIMPLIFIED BUSINESS SOLUTIONS, INC., PHOENIX, AZ. FILED 6-22-2004.

AMCHECK

THE MARK CONSISTS OF STANDARD CHARACTERS WITHOUT CLAIM TO ANY PARTICULAR FONT, STYLE, SIZE, OR COLOR.

CLASS 35—ADVERTISING AND BUSINESS

FOR EMPLOYEE LEASING SERVICES; EMPLOYEE STAFFING SERVICES; PAYROLL PREPARATION SERVICES; ONLINE PAYROLL PREPARATION SERVICES; WAGE PAYROLL PREPARATION SERVICES, NAMELY, PAYROLL WORKERS COMPENSATION SERVICES, PAYROLL DIRECT DEPOSIT SERVICES, PAYROLL WITHHOLDING SERVICES, PAYROLL DEDUCTION SERVICES, AND PAYROLL INFORMATION TRACKING SERVICES; PAYROLL TAX SERVICES, NAMELY, PAYROLL TAX COMPUTATION AND COMPLIANCE SERVICES, PAYROLL TAX CREDIT COMPUTATION AND COMPLIANCE SERVICES, PAYROLL TAX REQUIREMENTS TRACKING SERVICES, AND EMPLOYER PAYROLL TAX REPORTING SERVICES; EMPLOYEE ONLINE TIMESHEET SERVICES; HUMAN RESOURCES SERVICES; EMPLOYEE RECRUITING, PLACEMENT, REFERENCES, HIRING, ORIENTATION AND TERMINATION SERVICES; AND EMPLOYEE CHILD SUPPORT AND WAGE GARNISHMENT SERVICES (U.S. CLS. 100, 101 AND 102).

FIRST USE 6-4-2004; IN COMMERCE 6-4-2004.

CLASS 36—INSURANCE AND FINANCIAL

FOR EMPLOYEE BENEFITS SERVICES, NAMELY, ADMINISTRATION OF EMPLOYEE BENEFIT PLANS; EMPLOYEE WORKERS COMPENSATION RISK MANAGEMENT SERVICES; INSURANCE BROKERAGE IN THE FIELDS OF EMPLOYEE MEDICAL, DENTAL, VISION, LIFE, DISABILITY, PET HEALTH CARE, AND OTHER PAYROLL DEDUCTION AND PAYMENT REMITTANCE INSURANCE SERVICES; EMPLOYEE WORKERS COMPENSATION CLAIMS ADMINISTRATION SERVICES; ADMINISTRATION OF EMPLOYEE PENSION, RETIREMENT PLAN, FLEX PLAN, DEPENDANT CARE PLAN, LEGAL SERVICES PLAN, AND DISCOUNT CLUB MEMBERSHIP PLAN SERVICES; EMPLOYEE UNEMPLOYMENT PLAN CLAIMS ADMINISTRATION SERVICES; AND EMPLOYEE BENEFIT PLAN PROCESSING SERVICES (U.S. CLS. 100, 101 AND 102).

FIRST USE 6-4-2004; IN COMMERCE 6-4-2004.

CLASS 45—PERSONAL SERVICES

FOR PRE-EMPLOYMENT BACKGROUND SCREENING SERVICES; AND WORKPLACE SAFETY ASSESSMENT SERVICES (U.S. CLS. 100 AND 101).

FIRST USE 6-21-2004; IN COMMERCE 6-21-2004.
MICHAEL KEATING, EXAMINING ATTORNEY

SN 76-599,210. SHOPKO STORES, INC., GREEN BAY, WI. FILED 6-21-2004.

NORTHCREST HOME

OWNER OF U.S. REG. NOS. 1,820,673, 2,602,031 AND OTHERS.

NO CLAIM IS MADE TO THE EXCLUSIVE RIGHT TO USE "HOME", APART FROM THE MARK AS SHOWN.

CLASS 20—FURNITURE AND ARTICLES NOT OTHERWISE CLASSIFIED

FOR PICTURE FRAMES, MIRRORS, FURNITURE, NAMELY, BEDROOM FURNITURE, BOOKSHELVES, TABLES, CHAIRS, TELEVISION STANDS, ENTERTAINMENT CENTERS, BUFFETS, HUTCHES AND KITCHEN CARTS; BED PILLOWS; DECORATIVE PILLOWS (U.S. CLS. 2, 13, 22, 25, 32 AND 50).

CLASS 21—HOUSEWARES AND GLASS

FOR COOKWARE, NAMELY POTS AND PANS; BAKEWARE, NAMELY GLASS AND METAL CASSEROLE PANS, CAKE PANS, LOAF PANS, COOKIE SHEETS, MUFFIN TINS; HOUSEHOLD UTENSILS, NAMELY GRATERS, SIEVES, SPATULAS, STRAINERS, TURNERS, WHISKS, ROLLING PINS, AND PAN SCRAPERS; GLASS AND PLASTIC BEVERAGeware, GLASS AND PLASTIC MIXING BOWLS, GLASS AND PLASTIC SERVING BOWLS; CANDLE HOLDERS; BATHROOM ACCESSORIES, NAMELY, SOAP DISHES, TOOTHBRUSH HOLDERS, DRINKING CUPS, LOTION AND SOAP DISPENSERS; VASES; BARWARE, NAMELY, CORK SCREWS, BOTTLE TOPPERS, SWIZZLE STICKS, COCKTAIL PICKS, COCKTAIL SHAKERS AND ICE BUCKETS; PLASTIC STORAGE CONTAINERS FOR HOUSEHOLD AND KITCHEN USE; BASKETS, NOT OF METAL, FOR HOUSEHOLD AND KITCHEN USE; PLATES, CUPS, SOUP BOWLS, SALAD BOWLS, AND MUGS (U.S. CLS. 2, 13, 23, 29, 30, 33, 40 AND 50).

CAROLYN CATALDO, EXAMINING ATTORNEY

SN 76-599,266. E.C. S.P.A., MILAN, ITALY, FILED 6-25-2004.

C'N'C CoSTUME NATIONAL

PRIORITY CLAIMED UNDER SEC. 44(D) ON ITALY APPLICATION NO. MI2004C00057, FILED 1-23-2004, REG. NO. 0000928094, DATED 1-23-2004, EXPIRES 1-23-2014.

OWNER OF U.S. REG. NOS. 2,011,553, 2,261,978 AND OTHERS.

NO CLAIM IS MADE TO THE EXCLUSIVE RIGHT TO USE "COSTUME", APART FROM THE MARK AS SHOWN.

CLASS 18—LEATHER GOODS

FOR LEATHER AND LEATHER ARTICLES, NAMELY TRAVELING BAGS, BAGS, RUCKSACKS, HANDBAGS, BRIEFCASES, WALLETS, PURSES, BRIEFCASE-TYPE PORTFOLIOS AND UMBRELLAS (U.S. CLS. 1, 2, 3, 22 AND 41).

CLASS 25—CLOTHING

FOR CLOTHING ARTICLES FOR MEN, WOMEN AND CHILDREN, NAMELY SUITS, DRESSES, TAILLEURS, JACKETS, HEAVY JACKETS, RAINCOATS, COATS, TROUSERS, SKIRTS, SHIRTS, TIES, NECKTIES, T-SHIRTS, SWEATERS, PULLOVERS, BLOUSES, BATHING SUITS, BELTS, FOOTWEAR, HEAD WEAR, AND UNDERWEAR (U.S. CLS. 22 AND 39).

VERNA BETH RIRIE, EXAMINING ATTORNEY

SN 76-599,524. NETWORK COURIER SERVICES, LOS ANGELES, CA. FILED 6-28-2004.

NETWORK COURIER/LOGISTICS SERVICES

THE MARK CONSISTS OF STANDARD CHARACTERS WITHOUT CLAIM TO ANY PARTICULAR FONT, STYLE, SIZE, OR COLOR.

OWNER OF U.S. REG. NO. 1,280,152.

NO CLAIM IS MADE TO THE EXCLUSIVE RIGHT TO USE "LOGISTICS SERVICES", APART FROM THE MARK AS SHOWN.

SEC. 2(F) AS TO NETWORK COURIER.

CLASS 35—ADVERTISING AND BUSINESS

FOR TRANSPORTATION LOGISTICS SERVICES, NAMELY, ARRANGING THE TRANSPORTATION OF GOODS FOR OTHERS; INVENTORY MANAGEMENT IN THE FIELDS OF MEDICAL, SURGICAL AND ELECTRONIC PRODUCTS; AND LOGISTICS MANAGEMENT IN THE FIELDS OF MEDICAL, SURGICAL AND ELECTRONIC PRODUCTS (U.S. CLS. 100, 101 AND 102).

FIRST USE 7-1-2002; IN COMMERCE 7-1-2002.

CLASS 39—TRANSPORTATION AND STORAGE

FOR COURIER SERVICES; DELIVERY SERVICES BY MESSENGER; TRANSPORTATION AND SHIPPING OF PACKAGES BY MESSENGER, LAND VEHICLES, NAMELY, TRUCKS, CARS AND AIRCRAFT; CENTRALIZED WAREHOUSE SERVICES NAMELY, WAREHOUSE STORAGE; SUPPLY CHAIN AND LOGISTICS SERVICES NAMELY, STORAGE, TRANSPORTATION AND DELIVERY OF DOCUMENTS, PACKAGES, RAW MATERIALS, AND OTHER FREIGHT FOR OTHERS BY AIR, RAIL, SHIP OR TRUCK; AND STORAGE OF MEDICAL, SURGICAL AND ELECTRONICS PRODUCTS FOR OTHERS (U.S. CLS. 100 AND 105).

FIRST USE 7-1-2002; IN COMMERCE 7-1-2002.

LOURDES AYALA, EXAMINING ATTORNEY

SN 76-599,637. WINGS RESEARCH & DEVELOPMENT S.R.L., 40065 PIANORO (BO), ITALY, FILED 6-29-2004.



PRIORITY CLAIMED UNDER SEC. 44(D) ON ITALY APPLICATION NO. IT-BO2004C00, FILED 4-6-2004, REG. NO. 0000930009, DATED 4-6-2004, EXPIRES 4-6-2014.

OWNER OF U.S. REG. NO. 2,221,077.

CLASS 18—LEATHER GOODS

FOR BACK PACKS, TRAVEL BAGS, SURF BAGS, BEACH BAGS, SPORT BAGS, HANDBAGS, KEY CASES, LUGGAGE, POCKET WALLETS, PURSES, SCHOOL BAGS, SHOPPING BAGS MADE OF LEATHER, MESH AND TEXTILES, SUITCASES, UMBRELLAS AND VALISES (U.S. CLS. 1, 2, 3, 22 AND 41).

CLASS 25—CLOTHING

FOR BATH ROBES, BATHING SUITS, BEACH CLOTHES, NAMELY, BEACH COVER-UPS AND BEACH SHOES; BELTS FOR CLOTHING; HEADWEAR NAMELY, BERETS, CAPS, CAP PEAKS AND VISORS; LINGERIE; GYMNASTIC CLOTHING, NAMELY, SHOES, SHORTS, AND LEOTARDS; CLOTHING MADE OF LEATHER, NAMELY, COATS, FOOTWEAR, GLOVES, JACKETS, JUMPERS, AND OVERCOATS; COATS, FOOTWEAR, GLOVES, AND JACKETS; HEADBANDS; JERSEYS, JUMPERS, OVERCOATS, PAJAMAS, PANTS, PARKAS, POLO SHIRTS, PULLOVERS, SANDALS, SCARVES, SHAWLS, SHIRTS, SLIPPERS, SOCKS, TIES, T-SHIRTS, TROUSERS, UNDERWEAR, VESTS, MANTLES, JOGGING AND RUNNING SUITS, ANTI-WIND JACKETS, PERFORMANCE JACKETS, PERFORMANCE PANTS, PERFORMANCE CLOTH BIBS; AND BRACES, NAMELY SUSPENDERS (U.S. CLS. 22 AND 39).

CLASS 28—TOYS AND SPORTING GOODS

FOR GYMNASTIC APPARATUS, GOLF BAGS, GOLF CLUBS, GOLF GLOVES, SKATEBOARDS, SKIS, SNOW BOARDS, SURFBOARDS, SURF SKIS AND WATER SKIS (U.S. CLS. 22, 23, 38 AND 50).

DARRYL SPRUILL, EXAMINING ATTORNEY

SN 76-599,836. WORRY FREE INVENTIONS, INC., DEERFIELD BEACH, FL. FILED 6-28-2004.

THE VOICE BOX

CLASS 25—CLOTHING

FOR CLOTHING, NAMELY, T-SHIRTS, SHORTS, PANTS, SOCKS, SNEAKERS, SANDALS AND HATS (U.S. CLS. 22 AND 39).

CLASS 28—TOYS AND SPORTING GOODS

FOR TOYS AND GAMES, NAMELY, STUFFED TOYS, PLUSH TOYS, PLASTIC CHARACTER AND ACTION FIGURES, BOARD GAMES, CARD GAMES AND ACTION SKILL GAMES (U.S. CLS. 22, 23, 38 AND 50).

SAMUEL E. SHARPER JR., EXAMINING ATTORNEY

SN 76-599,919. FOREST HEALTH SERVICES, LLC, YPSILANTI, MI. FILED 6-30-2004.



OWNER OF U.S. REG. NOS. 1,809,788 AND 2,889,915.
NO CLAIM IS MADE TO THE EXCLUSIVE RIGHT TO USE "CLINICS" AND "AMERICA'S LEADER IN BARIATRIC SURGERY", APART FROM THE MARK AS SHOWN.

CLASS 41—EDUCATION AND ENTERTAINMENT

FOR EDUCATIONAL SERVICES, NAMELY, CONDUCTING WORKSHOPS, SEMINARS AND LECTURES IN THE FIELD OF NUTRITION (U.S. CLS. 100, 101 AND 107).

FIRST USE 5-0-2004; IN COMMERCE 5-0-2004.

CLASS 44—MEDICAL, BEAUTY AND AGRICULTURAL SERVICES

FOR MEDICAL SERVICES; MEDICAL AND SURGICAL SERVICES IN THE FIELD OF WEIGHT REDUCTION AND MAINTENANCE, ORTHOPEDICS, DIAGNOSTICS, AND DISEASE TREATMENT; MEDICAL SERVICES IN THE FIELD OF NUTRITIONAL COUNSELING (U.S. CLS. 100 AND 101).

FIRST USE 5-0-2004; IN COMMERCE 5-0-2004.

MICHAEL KAZAZIAN, EXAMINING ATTORNEY

SN 76-600,889. BALAILA, ZUKI, MONTRÉAL, QUÉBEC, CANADA, FILED 7-7-2004.

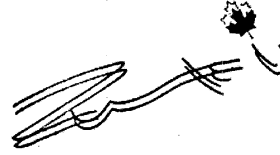

PRIORITY CLAIMED UNDER SEC. 44(D) ON CANADA APPLICATION NO. 1221818, FILED 6-21-2004, REG. NO. TMA640992, DATED 6-1-2005, EXPIRES 6-1-2020.
OWNER OF U.S. REG. NO. 1,468,428.

SN 76-600,193. INT & EXT, INC., LOS ANGELES, CA. FILED 7-1-2004.

MAAHVELOUS: PRINCESS PUUT AND DALI

"PRINCESS PUUT" AND "DALI" DO NOT IDENTIFY LIVING INDIVIDUALS.

CLASS 16—PAPER GOODS AND PRINTED MATTER

FOR BOOKS, MAGAZINES, PAMPHLETS, BROCHURES, NEWSPAPERS, NEWSLETTERS, BOOKLETS, PERIODICALS, PRIMERS, COLUMNS, AND HANDBOOKS ABOUT THE ADVENTURES OF FICTIONAL CHARACTERS PRINCESS PUUT AND DALI, CIRCULARS ABOUT THE ADVENTURES OF FICTIONAL CHARACTERS PRINCESS PUUT AND DALI, TEXTBOOKS AND TEXTS, NAMELY EDUCATIONAL BOOKS FEATURING THE FICTIONAL CHARACTERS PRINCESS PUUT AND DALI, TREATISES, NAMELY A SERIES OF PRINTED DOCUMENTS ON THE SUBJECT OF THE ADVENTURES OF FICTIONAL CHARACTERS PRINCESS PUUT AND DALI, ARTICLES, NAMELY SYNDICATED COMIC STRIPS DEALING WITH FICTIONAL CHARACTERS PRINCESS PUUT AND DALI; COMIC BOOKS, GRAPHIC NOVELS (U.S. CLS. 2, 5, 22, 23, 29, 37, 38 AND 50).

CLASS 41—EDUCATION AND ENTERTAINMENT

FOR RENTAL OF VIDEOS, VIDEOCASSETTES, DVDS, CDS, AUDIO RECORDINGS, VIDEO RECORDINGS, AND AUDIOCASSETTES; VIDEOTAPE PRODUCTION; ENTERTAINMENT IN THE NATURE OF ONGOING TELEVISION PROGRAMS IN THE FIELD OF COMEDY AND VARIETY; ENTERTAINMENT SERVICES, NAMELY, PROVIDING A WEB SITE FEATURING ANIMATION, VIDEOS, RELATED FILM CLIPS, PHOTOGRAPHS AND OTHER MULTIMEDIA MATERIALS; PRODUCTION OF FEATURE FILMS AND DOCUMENTARY FILMS; PRESENTATION OF LIVE PERFORMANCES AND SPEECHES; PUBLISHING, NAMELY, PUBLICATION OF BOOKS AND MAGAZINES REGARDING THE FICTIONAL CHARACTERS PRINCESS PUUT AND DALI (U.S. CLS. 100, 101 AND 107).

ELIZABETH J. WINTER, EXAMINING ATTORNEY

CLASS 3—COSMETICS AND CLEANING PREPARATIONS

FOR PERSONAL CARE PRODUCTS AND TOILETRIES, NAMELY FRAGRANCES, PERFUMES AND COSMETICS, EYELINER PENCILS, LIPLINER PENCILS, EYEBROW PENCILS, LIPLINER PENCILS AND EYEBROW PENCILS, AUTOMATIC EYELINER PENCILS, AUTOMATIC LIPLINER PENCILS, AUTOMATIC EYEBROW PENCILS, EYE SHADOWS, FOUNDATION, POWDER BLUSH, CREAM BLUSH, LIPSTICKS, CONCEALERS, LIQUID EYELINERS, NATURAL AND SYNTHETIC NAIL POLISH, NAIL POLISH REMOVER; COTTON PUFFS FOR COSMETIC PURPOSES; BATH AND SHOWER LIQUID PREPARATIONS, NAMELY SHOWER GELS, BATH GELS, BUBBLE BATH; GLYCERINE SOAPS, LIQUID SOAPS, HARD MILLED SOAPS, TOILET SOAPS, TALCUM POWDERS, BEARD SOFTENERS, SKIN LOTIONS AND CREAMS AND OILS, SKIN CLEANSERS, SKIN CARE PREPARATIONS, HAIR GELS, AND HAIR CARE PREPARATIONS (U.S. CLS. 1, 4, 6, 50, 51 AND 52).

CLASS 9—ELECTRICAL AND SCIENTIFIC APPARATUS

FOR EYEWEAR, NAMELY EYEGLASSES, SUNGLASSES, FRAMES FOR EYEGLASSES AND SUNGLASSES; AND GOGGLES, NAMELY GOGGLES FOR SPORTS AND SNOW GOGGLES (U.S. CLS. 21, 23, 26, 36 AND 38).

CLASS 18—LEATHER GOODS

FOR FUR PURSES; MEN'S, WOMEN'S, LADIES', TEENS', BOYS', GIRLS' AND CHILDREN'S GOODS MADE OF LEATHER AND/OR IMITATION OR SYNTHETIC LEATHER, NAMELY, HANDBAGS, PURSES, TOTE BAGS, BACKPACKS, DAYPACKS, WAISTPACKS, FANNY PACKS, SCHOOL BAGS, KNAPSACKS, RUCKSACKS, SHOULDER BAGS, SPORTSMAN'S HUNTING BAGS, ALL PURPOSE SPORTS BAGS, ATHLETIC BAGS, TEAM BAGS, TOOL BAGS SOLD EMPTY; DUFFEL BAGS, SLING BAGS FOR CARRYING INFANTS, DIAPER BAGS, SHOPPING BAGS OF LEATHER OR TEXTILE, CLUTCH BAGS, CLUTCH PURSES, WALLETS, POCKET BOOKS, BILLFOLDS; DOCUMENT CASES, TICKET POUCHES, CREDIT CARD CASES, CHANGE AND COIN PURSES, COSMETIC BAGS SOLD EMPTY, COSMETIC CASES, VANITY CASES SOLD EMPTY, KEY CASES; UMBRELLAS, PARASOLS, WALKING STICKS; ATTACHE CASES, BRIEFCASES, BUSINESS CARD CASES, TRAVEL BAGS, CARRY ON TRAVEL BAGS, SATCHELS, SUITCASES; VALISES, TRUNKS, LUGGAGE, LEATHER STRAPS FOR USE TO CARRY HANDBAGS, PURSES, LUGGAGE, SUITCASES, OVERNIGHT BAGS, TRAVEL GARMENT BAGS, GARMENT BAGS FOR HOME STORAGE OF GARMENTS, LUGGAGE TAGS, LEASHES, CARRYING BAGS AND CARRYING PACKS FOR ATTACHMENT TO BICYCLES (U.S. CLS. 1, 2, 3, 22 AND 41).

CLASS 25—CLOTHING

FOR FUR GARMENTS, NAMELY, MEN'S, WOMEN'S, LADIES', TEENS', BOYS', GIRLS AND CHILDREN'S FUR COATS, FUR-JACKETS, FUR HATS, FUR STOLEES, FUR CAPES, FUR MUFFS, FUR EAR MUFFS, FUR MUFFLERS, AND FUR SCARVES AND SCARVES TRIMMED WITH FUR, MEN'S, WOMEN'S, LADIES', TEENS', BOYS', GIRLS AND CHILDREN'S WEARING APPAREL MADE OF LEATHER AND/OR IMITATION OR SYNTHETIC LEATHER, NAMELY, SUITS, JACKETS, SLACKS, PANTS, TROUSERS, COATS, OVERCOATS, JACKETS, BOMBER JACKETS, SHIRTS, VESTS, BELTS, COLLARS, SLIPPERS, TIES, HATS, CAPS AND SKULLCAPS; MEN'S, WOMEN'S LADIES', TEENS, BOYS', GIRLS' AND CHILDREN'S CLOTHING, NAMELY, SUITS, JACKETS, PANTS, COATS, SHIRTS, SPORT SHIRTS, CASUAL SHIRTS, T-SHIRTS, KNITTED POLO T-SHIRTS, KNITTED SHIRTS, SWEATERS, PULL-OVERS, CARDIGANS, TURTLENECKS, DRESSES, SKIRTS, BUSTIERS, SWEATSUITS, SWEATSHIRTS, SWEATPANTS, TRACK SUITS, SHORTS, BLOUSES, BLOUSONS, VESTS, ROBES, TIES, BIBS, NAMELY, CLOTH BIBS; WRISTBANDS, HEADBANDS, PAJAMAS, ROBES, KIMONOS, CAFTANS, SWIMWEAR AND BATHING SUITS, THONGS, COVER-UPS, SARONGS AND SUN VISORS; OUTERWEAR, NAMELY, COATS, RAINCOATS, PONCHOS, JACKETS, SKI JACKETS, MITTENS AND GLOVES; FORMAL WEAR, NAMELY, TUXEDOS, COAT TAILS, MORNING PANTS AND SUITS, VESTS, CUMMERBUNDS, SHIRTS, TIES AND GOWNS; EXERCISE CLOTHING, NAMELY, TIGHTS, SHORTS, TOPS, BODY SUITS, ATHLETIC UNIFORMS AND LEOTARDS, SWEATSHIRTS, SWEATPANTS, SWEATSUITS AND TRACK SUITS; LEGWEAR, NAMELY, HOSE, SOCKS, KNEE-HIGHS, LEGGINGS, TIGHTS, PANTY-HOSE, STOCKINGS AND HALF-HOSE; HEADWEAR, NAMELY, HATS, CAPS, SPORT CAPS, SKULLCAPS, MUFFLERS, SCARVES, EAR MUFFS AND BANDANAS; UNDERWEAR, NAMELY, BRIEFS, BOXERS, SHORTS, THONGS, LINGERIE AND INTIMATE APPAREL FOR WOMEN, NAMELY, UNDERGARMENTS, FOUNDATION GARMENTS, CHEMISES, CAMISOLES, TEDDIES, BODYSHAPER SUITS, BUSTIERS, TANK TOPS, GARTER BELTS, UNDERWEAR, NAMELY, PANTIES, BRIEFS, STEP-INS, BIKINIS, THONGS, BOY-LEG BRIEFS, GIRDLES, AND PANTY GIRDLES; BRAS; FOOTWEAR, NAMELY, SHOES, SLIPPERS, BOOTS, SANDALS, RUNNING SHOES, TENNIS SHOES, WALKING SHOES, SPORT SHOES, DECK SHOES, SNEAKERS AND ATHLETIC SHOES; BELTS, SUSPENDERS, POKET SQUARES (U.S. CLS. 22 AND 39).

RICHARD WHITE, EXAMINING ATTORNEY

SN 76-600,891. BALAILA, ZUKI, MONTRÉAL, QUÉBEC, CANADA, FILED 7-7-2004.

ZUKI

THE MARK CONSISTS OF STANDARD CHARACTERS WITHOUT CLAIM TO ANY PARTICULAR FONT, STYLE, SIZE, OR COLOR.

PRIORITY CLAIMED UNDER SEC. 44(D) ON CANADA APPLICATION NO. 1221819, FILED 6-21-2004, REG. NO. TMA641128, DATED 6-2-2005, EXPIRES 6-2-2020.

OWNER OF U.S. REG. NO. 1,468,428.

CLASS 3—COSMETICS AND CLEANING PREPARATIONS

FOR PERSONAL CARE PRODUCTS AND TOILETRIES, NAMELY FRAGRANCES, PERFUMES AND COSMETICS, EYELINER PENCILS, LIP LINER PENCILS, EYEBROW PENCILS, LIP LINER PENCILS AND EYEBROW PENCILS, AUTOMATIC EYELINER PENCILS, AUTOMATIC LIP LINER PENCILS, AUTOMATIC EYEBROW PENCILS, EYE SHADOWS, FOUNDATION, POWDER BLUSH, CREAM BLUSH, LIPSTICKS, CONCEALERS, LIQUID EYELINERS, NATURAL AND SYNTHETIC NAIL POLISH, NAIL POLISH REMOVER; COTTON PUFFS FOR COSMETIC PURPOSES; BATH AND SHOWER LIQUID PREPARATIONS, NAMELY SHOWER GELS, BATH GELS, BUBBLE BATH; GLYCERINE SOAPS, LIQUID SOAPS, HARD MILLED SOAPS, TOILET SOAPS, TALCUM POWDERS, BEARD SOFTENERS, SKIN LOTIONS AND CREAMS AND OILS, SKIN CLEANSERS, SKIN CARE PREPARATIONS, HAIR GELS, AND HAIR CARE PREPARATIONS (U.S. CLS. 1, 4, 6, 50, 51 AND 52).

CLASS 9—ELECTRICAL AND SCIENTIFIC APPARATUS

FOR EYEWEAR, NAMELY EYEGLASSES, SUNGLASSES, FRAMES FOR EYEGLASSES AND SUNGLASSES; AND GOGGLES, NAMELY GOGGLES FOR SPORTS AND SNOW GOGGLES (U.S. CLS. 21, 23, 26, 36 AND 38).

CLASS 18—LEATHER GOODS

FOR FUR PURSES; MEN'S, WOMEN'S, LADIES', TEENS', BOYS', GIRLS' AND CHILDREN'S GOODS MADE OF LEATHER AND/OR IMITATION OR SYNTHETIC LEATHER, NAMELY, HANDBAGS, PURSES, TOTE BAGS, BACKPACKS, DAYPACKS, WAISTPACKS, FANNY PACKS, SCHOOL BAGS, KNAPSACKS, RUCKSACKS, SHOULDER BAGS, SPORTSMAN'S HUNTING BAGS, ALL PURPOSE SPORTS BAGS, ATHLETIC BAGS, TEAM BAGS, TOOL BAGS SOLD EMPTY; DUFFEL BAGS, SLING BAGS FOR CARRYING INFANTS, DIAPER BAGS, SHOPPING BAGS OF LEATHER OR TEXTILE, CLUTCH BAGS, CLUTCH PURSES, WALLET, POCKET BOOKS, BILLFOLDS; DOCUMENT CASES, TICKET POUCHES, CREDIT CARD CASES, CHANGE AND COIN PURSES, COSMETIC BAGS SOLD EMPTY, COSMETIC CASES, VANITY CASES SOLD EMPTY, KEY CASES; UMBRELLAS, PARASOLS, WALKING STICKS; ATTACHE CASES, BRIEFCASES, BUSINESS CARD CASES, TRAVEL BAGS, CARRY ON TRAVEL BAGS, SATCHELS, SUITCASES; VALISES, TRUNKS, LUGGAGE, LEATHER STRAPS FOR USE TO CARRY HANDBAGS, PURSES, LUGGAGE, SUITCASES, OVERNIGHT BAGS, TRAVEL GARMENT BAGS, GARMENT BAGS FOR HOME STORAGE OF GARMENTS, LUGGAGE TAGS, LEASHES, CARRYING BAGS AND CARRYING PACKS FOR ATTACHMENT TO BICYCLES (U.S. CLS. 1, 2, 3, 22 AND 41).

CLASS 25—CLOTHING

FOR FUR GARMENTS, NAMELY, MEN'S, WOMEN'S, LADIES', TEENS', BOYS', GIRLS AND CHILDREN'S FUR COATS, FUR-JACKETS, FUR HATS, FUR STOLEES, FUR CAPES, FUR MUFFS, FUR EAR MUFFS, FUR MUFFLERS, AND FUR SCARVES AND SCARVES TRIMMED WITH FUR, MEN'S, WOMEN'S, LADIES', TEENS', BOYS', GIRLS AND CHILDREN'S WEARING APPAREL MADE OF LEATHER AND/OR IMITATION OR SYNTHETIC LEATHER, NAMELY, SUITS, JACKETS, SLACKS, PANTS, TROUSERS, COATS, OVERCOATS, JACKETS, BOMBER JACKETS, SHIRTS, VESTS, BELTS, COLLARS, SLIPPERS, TIES, HATS, CAPS AND SKULLCAPS; MEN'S, WOMEN'S LADIES', TEENS, BOYS', GIRLS' AND CHILDREN'S CLOTHING, NAMELY, SUITS, JACKETS, PANTS, COATS, SHIRTS, SPORT SHIRTS, CASUAL SHIRTS, T-SHIRTS, KNITTED POLO T-SHIRTS, KNITTED SHIRTS, SWEATERS, PULL-OVERS, CARDIGANS, TURTLENECKS, DRESSES, SKIRTS, BUSTIERS, SWEATSUITS, SWEATSHIRTS, SWEATPANTS, TRACK SUITS, SHORTS, BLOUSES, BLOUSONS, VESTS, ROBES, TIES, BIBS, NAMELY, CLOTH BIBS; WRISTBANDS, HEADBANDS, PAJAMAS,

ROBES, KIMONOS, CAFTANS, SWIMWEAR AND BATHING SUITS, THONGS, COVER-UPS, SARONGS AND SUN VISORS; OUTERWEAR, NAMELY, COATS, RAINCOATS, PONCHOS, JACKETS, SKI JACKETS, MITTENS AND GLOVES; FORMAL WEAR, NAMELY, TUXEDOS, COAT TAILS, MORNING PANTS AND SUITS, VESTS, CUMMERBUNDS, SHIRTS, TIES AND GOWNS; EXERCISE CLOTHING, NAMELY, TIGHTS, SHORTS, TOPS, BODY SUITS, ATHLETIC UNIFORMS AND LEOTARDS, SWEATSHIRTS, SWEATPANTS, SWEATSUITS AND TRACK SUITS; LEGWEAR, NAMELY, HOSE, SOCKS, KNEE-HIGHS, LEGGINGS, TIGHTS, PANTY-HOSE, STOCKINGS AND HALF-HOSE; HEADWEAR, NAMELY, HATS, CAPS, SPORT CAPS, SKULLCAPS, MUFFLERS, SCARVES, EAR MUFFS AND BANDANAS; UNDERWEAR, NAMELY, BRIEFS, BOXERS, SHORTS, THONGS, LINGERIE AND INTIMATE APPAREL FOR WOMEN, NAMELY, UNDERGARMENTS, FOUNDATION GARMENTS, CHEMISES, CAMISOLES, TEDDIES, BODYSHAPER SUITS, BUSTIERS, TANK TOPS, GARTER BELTS, UNDERWEAR, NAMELY, PANTIES, BRIEFS, STEP-INS, BIKINIS, THONGS, BOY-LEG BRIEFS, GIRDLES, AND PANTY GIRDLES; BRAS; FOOTWEAR, NAMELY, SHOES, SLIPPERS, BOOTS, SANDALS, RUNNING SHOES, TENNIS SHOES, WALKING SHOES, SPORT SHOES, DECK SHOES, SNEAKERS AND ATHLETIC SHOES; BELTS, SUSPENDERS, POCKET SQUARES (U.S. CLS. 22 AND 39).

RICHARD WHITE, EXAMINING ATTORNEY

SN 76-600,917. HARD CANDY LLC, COSTA MESA, CA. FILED 7-2-2004.

HARD CANDY IS YUMMY

THE MARK CONSISTS OF STANDARD CHARACTERS WITHOUT CLAIM TO ANY PARTICULAR FONT, STYLE, SIZE, OR COLOR.

OWNER OF U.S. REG. NOS. 1,987,262, 2,666,793 AND OTHERS.

CLASS 3—COSMETICS AND CLEANING PREPARATIONS

FOR COSMETICS (U.S. CLS. 1, 4, 6, 50, 51 AND 52).

CLASS 25—CLOTHING

FOR CLOTHING, NAMELY, T-SHIRTS (U.S. CLS. 22 AND 39).

CLASS 35—ADVERTISING AND BUSINESS

FOR ONLINE RETAIL STORE SERVICES FEATURING CLOTHING AND COSMETICS (U.S. CLS. 100, 101 AND 102).

HEATHER THOMPSON, EXAMINING ATTORNEY

SN 76-600,989. ICF CONSULTING GROUP, INC., FAIRFAX, VA. FILED 7-6-2004.

PERSPECTIVES

THE MARK CONSISTS OF STANDARD CHARACTERS WITHOUT CLAIM TO ANY PARTICULAR FONT, STYLE, SIZE, OR COLOR.

OWNER OF U.S. REG. NOS. 2,593,580 AND 2,827,304.

CLASS 9—ELECTRICAL AND SCIENTIFIC APPARATUS

FOR DOWNLOADABLE ONLINE PERIODICAL NEWSLETTER PERTAINING TO CONSULTING SERVICES IN THE FIELDS OF CHANGE MANAGEMENT OF AN ORGANIZATION INCLUDING MISSION, ORGANIZATIONAL CULTURE, AND E-LEARNING; FINANCIAL AND REGULATORY ISSUES IN THE ENERGY INDUSTRY RETAIL AND WHOLESALE MARKETS, INCLUDING ASSET MANAGEMENT, RISK MANAGEMENT, EMISSIONS STRATEGY, AND OIL AND GAS; ECONOMIC AND COMMUNITY DEVELOPMENT; TRANSPORTATION DEVELOPMENT INVOLVING ENERGY CONSUMPTION, ECONOMIC DEVELOPMENT, FREIGHT, AIR QUALITY, HAZARDOUS MATERIALS TRANSPORT, AND LAND USE; INFORMATION TECHNOLOGY AND INFORMATION MANAGEMENT FOR THE PUBLIC SECTOR, INCLUDING ENTERPRISE SOLUTIONS, ENTERPRISE ARCHITECTURE, E-GOVERNMENT, CUSTOMER RELATIONSHIP MANAGEMENT, AND GRANTS MANAGEMENT; STRATEGIC COMMUNICATIONS, INCLUDING GOVERNMENT AND PUBLIC RELATIONS CAMPAIGN COMMUNICATIONS, AND SOCIAL MARKETING; HOMELAND SECURITY, INCLUDING ANTI-TERRORISM, CRITICAL INFRASTRUCTURE DEFENSE, HOMELAND DEFENSE, EMERGENCY MANAGEMENT, AND RISK MANAGEMENT; AND TECHNOLOGY PLANNING AND MANAGEMENT; AND IMPROVEMENT OF THE ENVIRONMENT INCLUDING STRATEGIC ENVIRONMENTAL MANAGEMENT, ENVIRONMENTAL RISK MANAGEMENT, HEALTH AND SAFETY MANAGEMENT, ENVIRONMENTALLY SUSTAINABLE BUSINESS PRACTICES, REGULATORY ADHERENCE AND ENVIRONMENTAL REMEDIATION (U.S. CLS. 21, 23, 26, 36 AND 38).

FIRST USE 6-18-2002; IN COMMERCE 6-18-2002.

CLASS 16—PAPER GOODS AND PRINTED MATTER

FOR PERIODICAL NEWSLETTER PERTAINING TO CONSULTING SERVICES IN THE FIELDS OF CHANGE MANAGEMENT OF AN ORGANIZATION INCLUDING MISSION, ORGANIZATIONAL CULTURE, AND E-LEARNING; FINANCIAL AND REGULATORY ISSUES IN THE ENERGY INDUSTRY RETAIL AND WHOLESALE MARKETS, INCLUDING ASSET MANAGEMENT, RISK MANAGEMENT, EMISSIONS STRATEGY, AND OIL AND GAS; ECONOMIC AND COMMUNITY DEVELOPMENT; TRANSPORTATION DEVELOPMENT INVOLVING ENERGY CONSUMPTION, ECONOMIC DEVELOPMENT, FREIGHT, AIR QUALITY, HAZARDOUS MATERIALS TRANSPORT, AND LAND USE; INFORMATION TECHNOLOGY AND INFORMATION MANAGEMENT FOR THE PUBLIC SECTOR, INCLUDING ENTERPRISE SOLUTIONS, ENTERPRISE ARCHITECTURE, E-GOVERNMENT, CUSTOMER RELATIONSHIP MANAGEMENT, AND GRANTS MANAGEMENT; STRATEGIC COMMUNICATIONS, INCLUDING GOVERNMENT AND PUBLIC RELATIONS CAMPAIGN COMMUNICATIONS, AND SOCIAL MARKETING; HOMELAND SECURITY, INCLUDING ANTI-TERRORISM, CRITICAL INFRASTRUCTURE DEFENSE, HOMELAND DEFENSE, EMERGENCY MANAGEMENT, AND RISK MANAGEMENT; AND TECHNOLOGY PLANNING AND MANAGEMENT; AND IMPROVEMENT OF THE ENVIRONMENT INCLUDING STRATEGIC ENVIRONMENTAL MANAGEMENT, ENVIRONMENTAL RISK MANAGEMENT, HEALTH AND SAFETY MANAGEMENT, ENVIRONMENTALLY SUSTAINABLE BUSINESS PRACTICES, REGULATORY ADHERENCE AND ENVIRONMENTAL REMEDIATION (U.S. CLS. 2, 5, 22, 23, 29, 37, 38 AND 50).

FIRST USE 6-18-2002; IN COMMERCE 6-18-2002.
KAREN K. BUSH, EXAMINING ATTORNEY

SN 76-601.400. POWER PRODUCTS, INC., KANSAS CITY, MO. FILED 7-8-2004.

SLEEPRIGHT

THE MARK CONSISTS OF STANDARD CHARACTERS WITHOUT CLAIM TO ANY PARTICULAR FONT, STYLE, SIZE, OR COLOR.

OWNER OF U.S. REG. NO. 2,289,753.

CLASS 9—ELECTRICAL AND SCIENTIFIC APPARATUS

FOR (BASED ON INTENT TO USE) PRE-RECORDED CDS AND DVDS FEATURING MOOD ALTERING MUSIC AND HABIT RELIEF MESSAGES (U.S. CLS. 21, 23, 26, 36 AND 38).

CLASS 10—MEDICAL APPARATUS

FOR (BASED ON USE IN COMMERCE) MEDICAL APPARATUSES, NAMELY, DRUG DELIVERY SYSTEMS FOR DELIVERING DRUGS TO THE LUNGS THROUGH THE NASAL PASSAGES; MEDICAL APPARATUSES, NAMELY, NASAL DILATORS, FOAM PILLOWS FOR MEDICAL USE, AND ORTHOPEDIC CUSHIONS AND SUPPORTS (U.S. CLS. 26, 39 AND 44).

FIRST USE 8-15-2000; IN COMMERCE 8-15-2000.
REBECCA SMITH, EXAMINING ATTORNEY

SN 76-601.608. FIAT AUTO S.P.A., TORINO, ITALY, FILED 7-9-2004.

ALFA ROMEO CONNECT

THE MARK CONSISTS OF STANDARD CHARACTERS WITHOUT CLAIM TO ANY PARTICULAR FONT, STYLE, SIZE, OR COLOR.

OWNER OF U.S. REG. NOS. 1,150,430, 2,870,813 AND OTHERS.

CLASS 9—ELECTRICAL AND SCIENTIFIC APPARATUS

FOR COMMUNICATIONS APPARATUS AND CONTROL UNITS, NAMELY GLOBAL POSITIONING SYSTEM (GPS) CONSISTING OF COMPUTERS, COMPUTER SOFTWARE, TRANSMITTERS, RECEIVERS, AND NETWORK INTERFACE DEVICES FOR USE IN MOTOR VEHICLES FOR ENABLING TRANSMISSION OF INFORMATION TO FIELD REQUESTS FOR INTERVENTION IN AN EMERGENCY INCLUDING MEDICAL, MECHANICAL AND ROAD ASSISTANCE IN GENERAL, OR WITH REFERENCE TO POSITIONING IN DRIVING, TO TRAFFIC INFORMATION, TO METEOROLOGICAL INFORMATION, TO INFORMATION ON PUBLIC FACILITIES (U.S. CLS. 21, 23, 26, 36 AND 38).

CLASS 12—VEHICLES

FOR MOTOR VEHICLES, NAMELY AUTOMOBILES AND STRUCTURAL PARTS THEREOF (U.S. CLS. 19, 21, 23, 31, 35 AND 44).

CLASS 35—ADVERTISING AND BUSINESS

FOR COMPUTERIZED DATABASE MANAGEMENT SERVICES IN THE FIELDS OF TOPOGRAPHY AND ROAD MAPS, TRAFFIC INFORMATION, INFORMATION ABOUT SHOPPING AND AVAILABLE MEDICAL, MECHANICAL, HOTEL ACCOMMODATION AND OTHER PUBLIC SERVICES (U.S. CLS. 100, 101 AND 102).

CLASS 37—CONSTRUCTION AND REPAIR

FOR PROVIDING ROADSIDE EMERGENCY SERVICES FOR VEHICLES AND FOR TRAVELERS, NAMELY ROADSIDE RECOVERY AND TRANSPORTATION OF TRAVELERS, TOWING OF VEHICLES (U.S. CLS. 100, 103 AND 106).

CLASS 38—COMMUNICATION

FOR TELECOMMUNICATIONS SERVICES, NAMELY TRANSMISSION OF DATA IN THE FIELDS OF INFORMATION ON EMERGENCY ROAD AND MEDICAL CARE ASSISTANCE, LEGAL, INSURANCE AND FINANCIAL MATTERS AND IN THE FIELDS OF TOURISM AND EVENT INFORMATION, AND ASSISTANCE IN LOCATING PUBLIC PREMISES; BROADCASTING OVER TELECOMMUNICATIONS NETWORKS OF INFORMATION ON NAUTICAL LOCATION AND DIRECTION, TRAFFIC AND WEATHER FORECASTS (U.S. CLS. 100, 101 AND 104).

CLASS 39—TRANSPORTATION AND STORAGE

FOR TRAVEL INFORMATION SERVICES, NAMELY PROVIDING INFORMATION IN THE FIELD OF TOURISM (U.S. CLS. 100 AND 105).

CLASS 42—SCIENTIFIC, COMPUTER AND LEGAL SERVICES

FOR DESIGNING OF DATABASES AND COMPUTER SOFTWARE SYSTEMS; LEGAL ADVICE SERVICES; WEATHER FORECAST SERVICES (U.S. CLS. 100 AND 101).

JOHN KELLY, EXAMINING ATTORNEY

SN 76-601.950. ARCSIGHT, INC., CUPERTINO, CA. FILED 6-25-2004.

ARCSIGHT

THE MARK CONSISTS OF STANDARD CHARACTERS WITHOUT CLAIM TO ANY PARTICULAR FONT, STYLE, SIZE, OR COLOR.

CLASS 9—ELECTRICAL AND SCIENTIFIC APPARATUS

FOR COMPUTER HARDWARE; COMPUTER SOFTWARE USED FOR COLLECTING AND ANALYZING DATA, TO DISCOVER RISKS, CORRELATE SECURITY INFORMATION, ASSESS VULNERABILITIES, AND MANAGING AND COMMUNICATING COMPLIANCE, ALL IN THE AREA OF ENTERPRISE SECURITY; SECURITY INFORMATION MANAGEMENT SOFTWARE USED TO PROVIDE SECURITY ORGANIZATIONS WITH COMPREHENSIVE, REAL TIME, EXPERT SECURITY INFORMATION ANALYSIS AND REMEDIATION CAPABILITIES; COMPUTER SOFTWARE FOR USE IN EVALUATING AND REPORTING RISKS TO AN ENTERPRISE'S COMPUTER NETWORK; INTRUSION DETECTION HARDWARE AND SOFTWARE, NAMELY COMPUTER HARDWARE AND SOFTWARE FOR USE IN DETECTING, EVALUATING AND RESPONDING TO ATTACKS TO A COMPUTER NETWORK; NETWORK MANAGEMENT SOFTWARE; DATA MINING SOFTWARE, DATA STORAGE SOFTWARE; COMPUTER SOFTWARE FOR USE IN ANALYZING COMPUTER NETWORKS; SOFTWARE FOR COMPUTER SECURITY TESTING (U.S. CLS. 21, 23, 26, 36 AND 38).

FIRST USE 6-28-2002; IN COMMERCE 11-18-2002.

CLASS 42—SCIENTIFIC, COMPUTER AND LEGAL SERVICES

FOR COMPUTER PROGRAMMING SERVICES; TECHNICAL AND STRATEGIC CONSULTATION IN THE FIELD OF COMPUTER SOFTWARE, NETWORK MANAGEMENT AND NETWORK SECURITY; COMPUTER SUPPORT SERVICES, NAMELY, INSTALLATION, MAINTENANCE, REPAIR AND UPDATING OF COMPUTER SOFTWARE, COMPUTER SYSTEMS ANALYSIS; TECHNICAL SUPPORT SERVICES, NAMELY, TROUBLESHOOTING OF COMPUTER HARDWARE AND SOFTWARE PROBLEMS; COMPUTER SOFTWARE DESIGN FOR OTHERS; APPLICATION SERVICE PROVIDER (ASP) FEATURING SOFTWARE IN THE FIELD OF SECURITY MANAGEMENT USED FOR ENTERPRISES' COMPUTER NETWORKS; TECHNICAL SUPPORT SERVICES, NAMELY, MONITORING OF NETWORK SYSTEMS (U.S. CLS. 100 AND 101).

FIRST USE 6-28-2002; IN COMMERCE 11-18-2002.

KEVON CHISOLM, EXAMINING ATTORNEY

CLASS 9—ELECTRICAL AND SCIENTIFIC APPARATUS

FOR TELECOMMUNICATIONS EQUIPMENT FOR TELECONFERENCING, VIDEO AND DATA CONFERENCING, OR FOR INTERACTIVE VOICE RESPONSE, NAMELY, TELEPHONES, AUDIO SPEAKERS, MICROPHONES, HEADSETS, SERVERS, SWITCHES, POWER SUPPLIES, MODEMS, OPERATOR CONSOLES, NETWORK INTERFACE CARDS, ROUTERS, BRIDGES, BRIDGE SERVERS, SIGNAL GENERATORS, RECEIVERS, MULTIPLEXERS, MONITORS, T1 TELECOMMUNICATION LINES, SERVERS WITH TELEPHONE AND INTERNET PROTOCOL TELEPHONY LINES, ETHERNET SWITCHES, ETHERNET PC CARDS, AND SYSTEM MANAGEMENT COMPUTERS; COMPUTER HARDWARE AND SOFTWARE FOR TELECONFERENCING ROUTING VIA INTERNAL COMPUTER NETWORKS AND GLOBAL COMPUTER NETWORK AND FOR INTERACTIVE VOICE RESPONSE; AUDIO TELECONFERENCING EQUIPMENT, NAMELY, ANALOG TELEPHONE INTERFACES, DIGITAL TELEPHONE INTERFACES, AND INTERNET PROTOCOL TELEPHONY SOFTWARE AND HARDWARE; COMPUTER SOFTWARE FOR USE IN THE INTEGRATED MANAGEMENT OF TELECONFERENCE CALLS AND TELECOMMUNICATIONS EQUIPMENT (U.S. CLS. 21, 23, 26, 36 AND 38).

FIRST USE 5-20-2004; IN COMMERCE 5-20-2004.

CLASS 35—ADVERTISING AND BUSINESS

FOR BUSINESS CONSULTING SERVICES IN THE FIELDS OF ONLINE CONFERENCES, MEETINGS, DEMONSTRATIONS, TOURS, PRESENTATIONS, AND DISCUSSIONS; ARRANGING AND CONDUCTING ONLINE AND IN-PERSON BUSINESS MEETINGS, BUSINESS CONFERENCES, BUSINESS DEMONSTRATIONS AND BUSINESS PRESENTATIONS (U.S. CLS. 100, 101 AND 102).

FIRST USE 5-20-2004; IN COMMERCE 5-20-2004.

SN 76-602,053. ADIGO, INC., EL SEGUNDO, CA. FILED 7-13-2004.



THE COLORS BURNT ORANGE AND BLACK ARE CLAIMED AS A FEATURE OF THE MARK.

THE COLOR BURNT ORANGE APPEARS IN THE SWIRL PORTION OF THE MARK; THE COLOR BLACK APPEARS IN THE WORD "ADIGO."

CLASS 38—COMMUNICATION

FOR TELECOMMUNICATIONS SERVICES, NAMELY VOICE, VIDEO, AND DATA CONFERENCING BY TELEPHONE, GLOBAL INTERACTIVE COMPUTER NETWORK, OR INTERNAL COMPUTER NETWORK; ELECTRONIC TRANSMISSION OF AUDIO, VIDEO, OR DATA VIA COMPUTER HARDWARE DEVICES OR WIRELESS MEDIA, NAMELY BROADCASTING IMAGES, SOUND, VIDEO, AND DATA VIA TELEPHONE, GLOBAL COMPUTER NETWORK, OR INTERNAL COMPUTER NETWORK; WEB-BASED MULTIMEDIA TELECONFERENCING SERVICES, AND WEB-BASED REAL-TIME MULTIMEDIA COMMUNICATIONS SERVICES, WHICH ALLOW USERS TO SIMULTANEOUSLY VIEW ELECTRONIC DATA, DOCUMENTS, AND APPLICATIONS USING A STANDARD WEB BROWSER OR OTHER SOFTWARE APPLICATION, AND WHICH ALLOW ANY USER THE ABILITY TO EDIT SUCH DATA OR DOCUMENTS AND CONTROL SUCH APPLICATIONS (U.S. CLS. 100, 101 AND 104).

FIRST USE 5-20-2004; IN COMMERCE 5-20-2004.

MITCHELL FRONT, EXAMINING ATTORNEY

SN 76-602,055. ADIGO, INC., EL SEGUNDO, CA. FILED 7-13-2004.

SN 76-602,577. MOBIAPPS, INC., ARLINGTON, VA. FILED 7-15-2004.

ADIGO



THE MARK CONSISTS OF STANDARD CHARACTERS WITHOUT CLAIM TO ANY PARTICULAR FONT, STYLE, SIZE, OR COLOR.

CLASS 9—ELECTRICAL AND SCIENTIFIC APPARATUS

FOR TELECOMMUNICATIONS EQUIPMENT FOR TELECONFERENCING, VIDEO AND DATA CONFERENCING, OR FOR INTERACTIVE VOICE RESPONSE, NAMELY, TELEPHONES, AUDIO SPEAKERS, MICROPHONES, HEADSETS, SERVERS, SWITCHES, POWER SUPPLIES, MODEMS, OPERATOR CONSOLES, NETWORK INTERFACE CARDS, ROUTERS, BRIDGES, BRIDGE SERVERS, SIGNAL GENERATORS, RECEIVERS, MULTIPLEXERS, MONITORS, T1 TELECOMMUNICATION LINES, SERVERS WITH TELEPHONE AND INTERNET PROTOCOL TELEPHONY LINES, ETHERNET SWITCHES, ETHERNET PC CARDS, AND SYSTEM MANAGEMENT COMPUTERS; COMPUTER HARDWARE AND SOFTWARE FOR TELECONFERENCING ROUTING VIA INTERNAL COMPUTER NETWORKS AND GLOBAL COMPUTER NETWORK AND FOR INTERACTIVE VOICE RESPONSE; AUDIO TELECONFERENCING EQUIPMENT, NAMELY, ANALOG TELEPHONE INTERFACES, DIGITAL TELEPHONE INTERFACES, AND INTERNET PROTOCOL TELEPHONY SOFTWARE AND HARDWARE; COMPUTER SOFTWARE FOR USE IN THE INTEGRATED MANAGEMENT OF TELECONFERENCE CALLS AND TELECOMMUNICATIONS EQUIPMENT (U.S. CLS. 21, 23, 26, 36 AND 38).

FIRST USE 5-20-2004; IN COMMERCE 5-20-2004.

CLASS 35—ADVERTISING AND BUSINESS

FOR BUSINESS CONSULTING SERVICES IN THE FIELDS OF ONLINE CONFERENCES, MEETINGS, DEMONSTRATIONS, TOURS, PRESENTATIONS, AND DISCUSSIONS; ARRANGING AND CONDUCTING ONLINE AND IN-PERSON BUSINESS MEETINGS, BUSINESS CONFERENCES, BUSINESS DEMONSTRATIONS AND BUSINESS PRESENTATIONS (U.S. CLS. 100, 101 AND 102).

FIRST USE 5-20-2004; IN COMMERCE 5-20-2004.

CLASS 38—COMMUNICATION

FOR TELECOMMUNICATIONS SERVICES, NAMELY VOICE, VIDEO, AND DATA CONFERENCING BY TELEPHONE, GLOBAL INTERACTIVE COMPUTER NETWORK, OR INTERNAL COMPUTER NETWORK; ELECTRONIC TRANSMISSION OF AUDIO, VIDEO, OR DATA VIA COMPUTER HARDWARE DEVICES OR WIRELESS MEDIA, NAMELY BROADCASTING IMAGES, SOUND, VIDEO, AND DATA VIA TELEPHONE, GLOBAL COMPUTER NETWORK, OR INTERNAL COMPUTER NETWORK; WEB-BASED MULTIMEDIA TELECONFERENCING SERVICES, AND WEB-BASED REAL-TIME MULTIMEDIA COMMUNICATIONS SERVICES, WHICH ALLOW USERS TO SIMULTANEOUSLY VIEW ELECTRONIC DATA, DOCUMENTS, AND APPLICATIONS USING A STANDARD WEB BROWSER OR OTHER SOFTWARE APPLICATION, AND WHICH ALLOW ANY USER THE ABILITY TO EDIT SUCH DATA OR DOCUMENTS AND CONTROL SUCH APPLICATIONS (U.S. CLS. 100, 101 AND 104).

FIRST USE 5-20-2004; IN COMMERCE 5-20-2004. MITCHELL FRONT, EXAMINING ATTORNEY

CLASS 9—ELECTRICAL AND SCIENTIFIC APPARATUS

FOR TRANSCEIVERS; TRANSCEIVERS FOR VEHICLE AND ASSET TRACKING; TRANSCEIVERS FOR WIRELESS TRACKING AND MESSAGING; COMPUTER SOFTWARE, NAMELY, SOFTWARE FOR VEHICLE AND ASSET TRACKING AND FOR WIRELESS TRACKING AND MESSAGING (U.S. CLS. 21, 23, 26, 36 AND 38).

FIRST USE 4-0-2000; IN COMMERCE 4-0-2000.

CLASS 35—ADVERTISING AND BUSINESS

FOR TRACKING, LOCATING AND MONITORING OF VEHICLES. (U.S. CLS. 100, 101 AND 102).

FIRST USE 4-0-2000; IN COMMERCE 4-0-2000.

CLASS 38—COMMUNICATION

FOR ELECTRONIC AND SATELLITE TRANSMISSION OF MESSAGES AND DATA (U.S. CLS. 100, 101 AND 104).

FIRST USE 4-0-2000; IN COMMERCE 4-0-2000. BRIDGETT SMITH, EXAMINING ATTORNEY

SN 76-602,591. AARP, WASHINGTON, DC. FILED 7-15-2004.

ON THE ROAD TO RETIREMENT SECURITY: BUILDING OUR RETIREMENT FUTURE

THE MARK CONSISTS OF STANDARD CHARACTERS WITHOUT CLAIM TO ANY PARTICULAR FONT, STYLE, SIZE, OR COLOR.

CLASS 16—PAPER GOODS AND PRINTED MATTER

FOR PRINTED PUBLICATIONS, NAMELY, BOOKS, NEWSLETTERS, BULLETINS, BROCHURES, PAMPHLETS, GUIDES AND MAGAZINES IN THE FIELD OF VOTER EDUCATION (U.S. CLS. 2, 5, 22, 23, 29, 37, 38 AND 50).

CLASS 41—EDUCATION AND ENTERTAINMENT

FOR ONLINE PUBLICATIONS, NAMELY, ONLINE NEWSLETTERS, BULLETINS, BROCHURES, PAMPHLETS, GUIDES AND MAGAZINES IN THE FIELD OF VOTER EDUCATION; PROVIDING INFORMATION AND ONLINE DATABASES IN THE FIELD OF VOTER EDUCATION; ARRANGING AND CONDUCTING CLASSES, SEMINARS, CONFERENCES AND WORKSHOPS IN THE FIELD OF VOTER EDUCATION; AND DISTRIBUTION OF COURSE MATERIALS IN CONNECTION THEREWITH (U.S. CLS. 100, 101 AND 107).

BRIDGETT SMITH, EXAMINING ATTORNEY

SN 76-602,857. MARTIN, ALFRED MICHAEL, BROOKLYN, NY. FILED 7-19-2004.



THE BLACKNESS IN MANHOOD, INC.

NO CLAIM IS MADE TO THE EXCLUSIVE RIGHT TO USE "INC", APART FROM THE MARK AS SHOWN.

CLASS 16—PAPER GOODS AND PRINTED MATTER

FOR PENS AND PENCILS (U.S. CLS. 2, 5, 22, 23, 29, 37, 38 AND 50).
FIRST USE 1-31-1987; IN COMMERCE 1-31-1987.

CLASS 25—CLOTHING

FOR T-SHIRTS (U.S. CLS. 22 AND 39).
FIRST USE 1-31-1987; IN COMMERCE 1-31-1987.
ARETHA SOMERVILLE, EXAMINING ATTORNEY

SN 76-602,934. CUNNINGHAM, WILLIAM, JR., BIRMINGHAM, AL. FILED 7-16-2004.

DOCUMENT DISCIPLINE

THE MARK CONSISTS OF STANDARD CHARACTERS WITHOUT CLAIM TO ANY PARTICULAR FONT, STYLE, SIZE, OR COLOR.

NO CLAIM IS MADE TO THE EXCLUSIVE RIGHT TO USE "DOCUMENT", APART FROM THE MARK AS SHOWN.

CLASS 35—ADVERTISING AND BUSINESS

FOR DOCUMENT MANAGEMENT SERVICES, NAMELY, DOCUMENT INDEXING FOR OTHERS IN THE FIELD OF BUSINESS RECORDS, VITAL RECORDS, MEDICAL RECORDS, MICROFILM, MICROFICHE, COMPUTER DISK DOCUMENTS, COMPUTER TAPE DOCUMENTS, FILM, BLUEPRINTS, PLANS, DRAWINGS AND INFORMATION IN OTHER FORMATS (U.S. CLS. 100, 101 AND 102).

CLASS 36—INSURANCE AND FINANCIAL

FOR TITLE INSURANCE BROKERAGE AND UNDERWRITING SERVICES; REAL ESTATE TITLE INSURANCE BROKERAGE AND UNDERWRITING SERVICES; COMMERCIAL REAL ESTATE CLOSING SERVICES; REAL ESTATE ESCROW AND CLOSING SERVICES; COMMERCIAL REAL ESTATE LENDING; REAL ESTATE LEASING SERVICES (U.S. CLS. 100, 101 AND 102).

MELISSA SHELLA, EXAMINING ATTORNEY

SN 76-603,641. BARNARD COLLEGE, NEW YORK, NY. FILED 7-22-2004.

REACTING TO THE PAST

THE MARK CONSISTS OF STANDARD CHARACTERS WITHOUT CLAIM TO ANY PARTICULAR FONT, STYLE, SIZE, OR COLOR.

CLASS 16—PAPER GOODS AND PRINTED MATTER

FOR PRINTED PUBLICATIONS, NAMELY, A SERIES OF INSTRUCTIONAL, EDUCATIONAL, TEACHING MATERIALS, PERTAINING TO COURSES IN THE FIELDS OF HISTORY, RELIGION, PHILOSOPHY, GOVERNMENT AND SCIENCE (U.S. CLS. 2, 5, 22, 23, 29, 37, 38 AND 50).

FIRST USE 9-0-1996; IN COMMERCE 9-0-1996.

CLASS 41—EDUCATION AND ENTERTAINMENT

FOR EDUCATIONAL SERVICES, NAMELY, PROVIDING COURSES AT THE COLLEGE LEVEL AND POST-GRADUATE LEVEL FOR TRAINING TEACHERS AND STUDENTS IN GAME-BASED EDUCATIONAL METHODS IN THE FIELDS OF HISTORY, RELIGION, PHILOSOPHY, GOVERNMENT AND SCIENCE; AND PROVIDING NON-DOWNLOADABLE ON-LINE BOOKS, NEWSLETTERS AND WORKBOOKS ABOUT GAME-BASED EDUCATIONAL METHODS FOR TEACHERS AND STUDENTS AT THE COLLEGE LEVEL AND POST GRADUATE LEVEL IN THE FIELDS OF HISTORY, RELIGION, PHILOSOPHY, GOVERNMENT AND SCIENCE (U.S. CLS. 100, 101 AND 107).

FIRST USE 9-0-1996; IN COMMERCE 9-0-1996.
GLENN CLARK, EXAMINING ATTORNEY

SN 76-603,770. WURLD MEDIA, INC., SARATOGA SPRINGS, NY. FILED 7-23-2004.



THE MARK CONSISTS, IN PART, OF A STYLIZED LETTER "W".

CLASS 35—ADVERTISING AND BUSINESS

FOR SERVICES IN THE FIELDS OF FACILITATING DIGITAL FILE AND DATA TRANSFER AND NOTIFICATION, NAMELY, COMPUTERIZED INTEGRATED TRACKING AND MANAGEMENT OF COMMERCIAL TRANSACTIONS REGARDING AUDIO AND VIDEO FILES VIA THE INTERNET AND OTHER COMPUTER NETWORKS; ADMINISTRATION, BILLING, ACCOUNT AUDITING AND RECONCILIATION OF FILE AND DATA TRANSFER USER ACCOUNTS REGARDING AUDIO AND VIDEO FILE TRANSFERS ON BEHALF OF OTHERS (U.S. CLS. 100, 101 AND 102).

CLASS 38—COMMUNICATION

FOR SERVICES IN THE FIELDS OF FACILITATING DIGITAL FILE AND DATA TRANSFER, NAMELY, TRANSFER OF AUDIO AND VIDEO FILES AND DATA BY TELECOMMUNICATION VIA THE INTERNET AND OTHER COMPUTER NETWORKS (U.S. CLS. 100, 101 AND 104).

STEVEN R. FINE, EXAMINING ATTORNEY

SN 76-603,775. WURLD MEDIA, INC., SARATOGA SPRINGS, NY. FILED 7-23-2004.

PEER IMPACT-It Pays To Shop

THE MARK CONSISTS OF STANDARD CHARACTERS WITHOUT CLAIM TO ANY PARTICULAR FONT, STYLE, SIZE, OR COLOR.

CLASS 35—ADVERTISING AND BUSINESS

FOR SERVICES IN THE FIELDS OF FACILITATING DIGITAL FILE AND DATA TRANSFER AND NOTIFICATION, NAMELY, COMPUTERIZED INTEGRATED TRACKING AND MANAGEMENT OF COMMERCIAL TRANSACTIONS REGARDING AUDIO AND VIDEO FILES VIA THE INTERNET AND OTHER COMPUTER NETWORKS; ADMINISTRATION, BILLING, ACCOUNT AUDITING AND RECONCILIATION OF FILE AND DATA TRANSFER USER ACCOUNTS REGARDING AUDIO AND VIDEO FILE TRANSFERS ON BEHALF OF OTHERS (U.S. CLS. 100, 101 AND 102).

CLASS 38—COMMUNICATION

FOR SERVICES IN THE FIELDS OF FACILITATING DIGITAL FILE AND DATA TRANSFER, NAMELY, TRANSFER OF AUDIO AND VIDEO FILES AND DATA BY TELECOMMUNICATION VIA THE INTERNET AND OTHER COMPUTER NETWORKS (U.S. CLS. 100, 101 AND 104).

STEVEN R. FINE, EXAMINING ATTORNEY

SN 76-604,044. 8X8, INC., SANTA CLARA, CA. FILED 7-22-2004.

PacketS

OWNER OF U.S. REG. NO. 2,896,720.

CLASS 9—ELECTRICAL AND SCIENTIFIC APPARATUS

FOR COMPUTER HARDWARE THAT ENABLES VIDEO COMMUNICATIONS, VOICE COMMUNICATIONS, VOICE-OVER INTERNET PROTOCOL COMMUNICATIONS, VIDEO-OVER INTERNET PROTOCOL COMMUNICATIONS, ONLINE COMMUNICATIONS, VOICE-OVER-DIGITAL-SUBSCRIBER LINE COMMUNICATIONS, VIDEO-OVER-DIGITAL-SUBSCRIBER LINE COMMUNICATIONS, VOICE MAIL, VIDEO MAIL, CALL FORWARDING, CALLER ID, CONFERENCING, CUSTOMIZED PHONE NUMBER DIRECTORIES, CALL ROUTING SERVICES AND VOICE-OVER DIGITAL LINE COMMUNICATIONS; COMPUTER SOFTWARE THAT ENABLES VIDEO COMMUNICATIONS, VOICE COMMUNICATIONS, VOICE-OVER INTERNET PROTOCOL COMMUNICATIONS, VIDEO-COMMUNICATIONS, VOICE COMMUNICATIONS, VOICE-OVER INTERNET PROTOCOL COMMUNICATIONS, VIDEO-OVER INTERNET PROTOCOL COMMUNICATIONS, VIDEO-OVER INTERNET PROTOCOL COMMUNICATIONS, ONLINE COMMUNICATIONS, VOICE-OVER-DIGITAL-SUBSCRIBER LINE COMMUNICATIONS, VIDEO-OVER-DIGITAL-SUBSCRIBER LINE COMMUNICATIONS, VOICE MAIL, VIDEO MAIL, CALL FORWARDING, CALLER ID, CONFERENCING, CUSTOMIZED PHONE NUMBER DIRECTORIES, CALL ROUTING SERVICES AND VOICE-OVER DIGITAL LINE COMMUNICATIONS (U.S. CLS. 21, 23, 26, 36 AND 38).

FIRST USE 6-0-2004; IN COMMERCE 6-0-2004.

CLASS 38—COMMUNICATION

FOR INTERNET TELEPHONY SERVICES; STREAMING OF AUDIO AND VIDEO MATERIAL ON THE INTERNET; LOCAL AND LONG DISTANCE TELEPHONE SERVICES; VOICE MAIL SERVICES; VIDEO MAIL SERVICES, NAMELY TRANSMISSION OF VIDEO MESSAGES OVER ELECTRONIC MEDIA; CALL FORWARDING SERVICES; CALLER ID SERVICES; TELEPHONE CONFERENCING SERVICES AND TELEPHONY CALL ROUTING SERVICES (U.S. CLS. 100, 101 AND 104).

FIRST USE 6-0-2004; IN COMMERCE 6-0-2004.

CLASS 42—SCIENTIFIC, COMPUTER AND LEGAL SERVICES

FOR TECHNICAL SUPPORT SERVICES, NAMELY, IMPLEMENTING AND TROUBLESHOOTING OF COMPUTER HARDWARE AND SOFTWARE PROBLEMS FOR WEB-BASED CUSTOMERS (U.S. CLS. 100 AND 101).

FIRST USE 6-0-2004; IN COMMERCE 6-0-2004.

DANIEL BRODY, EXAMINING ATTORNEY

SN 76-604,178. ASIAN VENTURES, INC., AUGUSTA, GA. FILED 7-26-2004.

MONTANA CLASSIC TOYS

THE MARK CONSISTS OF STANDARD CHARACTERS WITHOUT CLAIM TO ANY PARTICULAR FONT, STYLE, SIZE, OR COLOR.

NO CLAIM IS MADE TO THE EXCLUSIVE RIGHT TO USE "CLASSIC TOYS", APART FROM THE MARK AS SHOWN.

CLASS 12—VEHICLES

FOR BICYCLES, TRICYCLES, WAGONS, PULL-BEHIND WAGONS (U.S. CLS. 19, 21, 23, 31, 35 AND 44).

CLASS 28—TOYS AND SPORTING GOODS

FOR TOY DUMP TRUCKS; RIDE-ON TOYS, NAMELY, FOOT-TO-FLOOR CARS, PEDAL CARS, TOY SCOOTERS, RIDE-ON DUMP TRUCK TOYS (U.S. CLS. 22, 23, 38 AND 50).

JOHN DALIER, EXAMINING ATTORNEY

SN 76-604,439. THE CHRISTIAN NETWORK, INC., CLEARWATER, FL. FILED 7-28-2004.

WORSHIP.NET

THE MARK CONSISTS OF STANDARD CHARACTERS WITHOUT CLAIM TO ANY PARTICULAR FONT, STYLE, SIZE, OR COLOR.

OWNER OF U.S. REG. NOS. 1,763,818, 2,011,971 AND OTHERS.

CLASS 38—COMMUNICATION

FOR PROVIDING TELEVISION, VIDEO AND CABLE TELEVISION BROADCASTING SERVICES; AND PROVIDING ON-LINE MESSAGE BOARDS AND CHAT ROOMS FOR TRANSMISSION OF MESSAGES AMONG COMPUTER USERS ON THE SUBJECT OF RELIGION AND PRAYER (U.S. CLS. 100, 101 AND 104).

FIRST USE 10-31-2003; IN COMMERCE 10-31-2003.

CLASS 45—PERSONAL SERVICES

FOR PROVIDING NEWS, INFORMATION AND COMMENTARY VIA THE INTERNET IN THE FIELD OF RELIGION (U.S. CLS. 100 AND 101).

FIRST USE 4-0-1996; IN COMMERCE 4-0-1996.
KATRINA EDGE, EXAMINING ATTORNEY

SN 76-604,849. THE SHERATON CORPORATION, WHITE PLAINS, NY. FILED 7-30-2004.

ST. REGIS

THE MARK CONSISTS OF STANDARD CHARACTERS WITHOUT CLAIM TO ANY PARTICULAR FONT, STYLE, SIZE, OR COLOR.

OWNER OF U.S. REG. NOS. 1,897,870, 2,757,310 AND 2,893,705.

CLASS 41—EDUCATION AND ENTERTAINMENT

FOR HEALTH CLUB SERVICES, NAMELY PROVIDING INSTRUCTION AND EQUIPMENT IN THE FIELD OF PHYSICAL EXERCISE; HEALTH CLUBS PROVIDING PHYSICAL FITNESS FACILITIES FOR RECREATIONAL PURPOSES (U.S. CLS. 100, 101 AND 107).

FIRST USE 10-0-2001; IN COMMERCE 10-0-2001.

CLASS 43—HOTEL AND RESTAURANT SERVICES

FOR HEALTH RESORT SERVICES, NAMELY, PROVIDING FOOD AND LODGING THAT SPECIALIZE IN PROMOTING PATRONS' GENERAL HEALTH AND WELL-BEING (U.S. CLS. 100 AND 101).

FIRST USE 10-0-2001; IN COMMERCE 10-0-2001.

CLASS 44—MEDICAL, BEAUTY AND AGRICULTURAL SERVICES

FOR HEALTH AND DAY SPA SERVICES FOR HEALTH AND WELLNESS OF THE BODY AND SPIRIT OFFERED AT A HEALTH RESORT; HEALTH SPA SERVICES, NAMELY, FACIALS, BODY MASSAGES, MINERAL BATHS, COSMETIC BODY CARE SERVICES OFFERED AT A HEALTH RESORT (U.S. CLS. 100 AND 101).

FIRST USE 10-0-2001; IN COMMERCE 10-0-2001.
JASON TURNER, EXAMINING ATTORNEY

SN 76-605,071. THE CLIFFS COMMUNITIES, INC., TRAVELERS REST, SC. FILED 7-30-2004.

THE CLIFFS AT KEOWEE FALLS

THE MARK CONSISTS OF STANDARD CHARACTERS WITHOUT CLAIM TO ANY PARTICULAR FONT, STYLE, SIZE, OR COLOR.

OWNER OF U.S. REG. NO. 2,689,951.

CLASS 36—INSURANCE AND FINANCIAL

FOR REAL ESTATE BROKERAGE (U.S. CLS. 100, 101 AND 102).

FIRST USE 0-0-2002; IN COMMERCE 0-0-2002.

CLASS 37—CONSTRUCTION AND REPAIR

FOR REAL ESTATE DEVELOPMENT, CONSTRUCTION SERVICES IN THE FIELD OF RESIDENTIAL BUILDING, AND PLANNING AND LAYING OUT OF RESIDENTIAL COMMUNITIES (U.S. CLS. 100, 103 AND 106).

FIRST USE 0-0-2002; IN COMMERCE 0-0-2002.
BRIDGETT SMITH, EXAMINING ATTORNEY

SN 76-605,367. BAUR, THOMAS, DENVER, CO. FILED 8-3-2004.

KASNAT

THE MARK CONSISTS OF STANDARD CHARACTERS WITHOUT CLAIM TO ANY PARTICULAR FONT, STYLE, SIZE, OR COLOR.

CLASS 12—VEHICLES

FOR ACCESSORIES AND STRUCTURAL PARTS FOR AUTOMOBILES, NAMELY, AUTOMOTIVE WINDSHIELD SHADE SCREENS (U.S. CLS. 19, 21, 23, 31, 35 AND 44).

FIRST USE 7-30-2004; IN COMMERCE 7-30-2004.

CLASS 35—ADVERTISING AND BUSINESS

FOR ADVERTISING AND BUSINESS CONSULTATION SERVICES; MAIL ORDER, RETAIL STORE, WHOLESALE DISTRIBUTORSHIPS, CATALOG AND ONLINE RETAIL STORE SERVICES FEATURING ACCESSORIES AND PARTS FOR VEHICLES (U.S. CLS. 100, 101 AND 102).

FIRST USE 7-30-2004; IN COMMERCE 7-30-2004.
ROBERT LORENZO, EXAMINING ATTORNEY

SN 76-606,302. HOSTEING, ETIENNE, 16130 SEGONZAC, FRANCE, FILED 8-10-2004.

GENSAC SPRINGS

THE MARK CONSISTS OF STANDARD CHARACTERS WITHOUT CLAIM TO ANY PARTICULAR FONT, STYLE, SIZE, OR COLOR.

NO CLAIM IS MADE TO THE EXCLUSIVE RIGHT TO USE "SPRINGS", APART FROM THE MARK AS SHOWN.

CLASS 32—LIGHT BEVERAGES

FOR BEERS; MINERAL AND AERATED WATERS; NON-ALCOHOLIC DRINKS, NAMELY, CARBONATED BEVERAGES; FRUIT DRINKS AND FRUIT JUICES; SYRUPS FOR BEVERAGES; PREPARATIONS FOR MAKING BEVERAGES, NAMELY, NON-ALCOHOLIC COCKTAIL MIXES, JUICE BASE CONCENTRATES, AND POWDERS (U.S. CLS. 45, 46 AND 48).

CLASS 33—WINES AND SPIRITS

FOR ALCOHOLIC BEVERAGES, NAMELY, ALCOHOLIC PUNCH, BRANDY, LIQUEURS, VODKA, WHISKEY, GIN, TEQUILA, COGNAC, WINES, AND HARD CIDER (U.S. CLS. 47 AND 49).
DAWN HAN, EXAMINING ATTORNEY

CLASS 43—HOTEL AND RESTAURANT SERVICES

FOR PROVIDING OF FOOD AND DRINK (U.S. CLS. 100 AND 101).
FIRST USE 3-3-2002; IN COMMERCE 3-30-2002.
JOHN LINCOSKI, EXAMINING ATTORNEY

SN 76-606,617. KARL KNAUZ MOTORS, INC., LAKE BLUFF, IL. FILED 8-9-2004.

SN 76-607,698. CELEBRITY KITCHENS, WILMINGTON, DE. FILED 8-16-2004.

KNAUZ

THE MARK CONSISTS OF STANDARD CHARACTERS WITHOUT CLAIM TO ANY PARTICULAR FONT, STYLE, SIZE, OR COLOR.
SEC. 2(F).

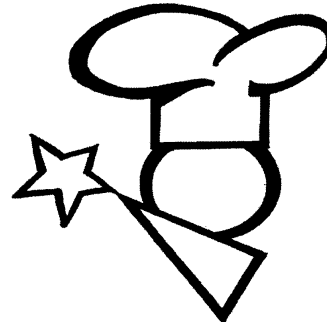

CLASS 12—VEHICLES

FOR AUTOMOBILES (U.S. CLS. 19, 21, 23, 31, 35 AND 44).
FIRST USE 0-0-1934; IN COMMERCE 0-0-1934.

CLASS 41—EDUCATION AND ENTERTAINMENT

FOR EDUCATIONAL SERVICES, NAMELY CLASSES, WORKSHOPS, SEMINARS AND TRAINING, INCLUDING PRINTED MATERIAL PROVIDED THEREIN, ALL IN THE FIELD OF FOOD PREPARATION AND PRESENTATION (U.S. CLS. 100, 101 AND 107).
FIRST USE 3-3-2002; IN COMMERCE 3-30-2002.

CLASS 35—ADVERTISING AND BUSINESS

FOR AUTOMOBILE DEALERSHIPS (U.S. CLS. 100, 101 AND 102).
FIRST USE 0-0-1934; IN COMMERCE 0-0-1934.

CLASS 37—CONSTRUCTION AND REPAIR

FOR REPAIR AND MAINTENANCE OF AUTOMOBILE PARTS (U.S. CLS. 100, 103 AND 106).
FIRST USE 0-0-1934; IN COMMERCE 0-0-1934.
JOANNA DUKOVIC, EXAMINING ATTORNEY

CLASS 43—HOTEL AND RESTAURANT SERVICES

FOR PROVIDING OF FOOD AND DRINK (U.S. CLS. 100 AND 101).
FIRST USE 3-3-2002; IN COMMERCE 3-30-2002.
JOHN LINCOSKI, EXAMINING ATTORNEY

SN 76-607,697. CELEBRITY KITCHENS, WILMINGTON, DE. FILED 8-16-2004.

SN 76-607,699. CELEBRITY KITCHENS, WILMINGTON, DE. FILED 8-16-2004.



CLASS 41—EDUCATION AND ENTERTAINMENT

FOR EDUCATIONAL SERVICES, NAMELY CLASSES, WORKSHOPS, SEMINARS AND TRAINING, INCLUDING PRINTED MATERIAL PROVIDED THEREIN, ALL IN THE FIELD OF FOOD PREPARATION AND PRESENTATION (U.S. CLS. 100, 101 AND 107).
FIRST USE 3-3-2002; IN COMMERCE 3-30-2002.

CLASS 41—EDUCATION AND ENTERTAINMENT

FOR EDUCATIONAL SERVICES, NAMELY CLASSES, WORKSHOPS, SEMINARS AND TRAINING, INCLUDING PRINTED MATERIAL PROVIDED THEREIN, ALL IN THE FIELD OF FOOD PREPARATION AND PRESENTATION (U.S. CLS. 100, 101 AND 107).
FIRST USE 3-3-2002; IN COMMERCE 3-30-2002.

CLASS 43—HOTEL AND RESTAURANT SERVICES

FOR PROVIDING OF FOOD AND DRINK (U.S. CLS. 100 AND 101).
FIRST USE 3-3-2002; IN COMMERCE 3-30-2002.
JOHN LINCOSKI, EXAMINING ATTORNEY

SN 76-607,968. BOARD OF REGENTS, THE UNIVERSITY OF TEXAS SYSTEM, AUSTIN, TX. FILED 8-20-2004.

PETEX

THE MARK CONSISTS OF STANDARD CHARACTERS WITHOUT CLAIM TO ANY PARTICULAR FONT, STYLE, SIZE, OR COLOR.

SN 76-607,718. PLAYHUT, INC., CITY OF INDUSTRY, CA. FILED 8-16-2004.

KATZZ

THE MARK CONSISTS OF STANDARD CHARACTERS WITHOUT CLAIM TO ANY PARTICULAR FONT, STYLE, SIZE, OR COLOR.

CLASS 9—ELECTRICAL AND SCIENTIFIC APPARATUS

FOR VIDEO GAME CARTRIDGES, BLANK COMPUTER DISKS AND DVDS; PRE-RECORDED DVDS FEATURING CARTOON CHARACTERS (U.S. CLS. 21, 23, 26, 36 AND 38).

CLASS 16—PAPER GOODS AND PRINTED MATTER

FOR SCHOOL SUPPLIES, NAMELY PENCILS, PENS, WRITING PAPER, SPIRAL NOTEBOOKS, AND ERASERS; COLORING BOOKS; AND CHILDREN'S ACTIVITY BOOKS (U.S. CLS. 2, 5, 22, 23, 29, 37, 38 AND 50).

CLASS 21—HOUSEWARES AND GLASS

FOR LUNCH BOXES; DRINKING GLASSES AND DRINKING VESSELS (U.S. CLS. 2, 13, 23, 29, 30, 33, 40 AND 50).

CLASS 28—TOYS AND SPORTING GOODS

FOR MECHANICAL AND ELECTRICAL ACTION TOYS; GAMES; PLAYTHINGS, NAMELY, ACTION FIGURES, DOLLS, AND BOARD GAMES (U.S. CLS. 22, 23, 38 AND 50).

CLASS 32—LIGHT BEVERAGES

FOR BOTTLED WATER AND FRUIT JUICES (U.S. CLS. 45, 46 AND 48).
YSA DEJESUS, EXAMINING ATTORNEY

CLASS 9—ELECTRICAL AND SCIENTIFIC APPARATUS

FOR COMPUTER SOFTWARE FOR EDUCATION IN THE FIELD OF PETROLEUM SERVICES; MOTION PICTURE FILMS, SLIDE FILMS, VIDEOTAPES, AND AUDIOTAPES FOR EDUCATION IN THE FIELD OF PETROLEUM SERVICES (U.S. CLS. 21, 23, 26, 36 AND 38).
FIRST USE 12-0-1944; IN COMMERCE 12-0-1944.

CLASS 16—PAPER GOODS AND PRINTED MATTER

FOR EDUCATIONAL PUBLICATIONS, NAMELY, TRAINING MANUALS, SCRIPTS, WORKBOOKS, AND INSTRUCTOR GUIDES IN THE FIELD OF PETROLEUM SERVICES (U.S. CLS. 2, 5, 22, 23, 29, 37, 38 AND 50).
FIRST USE 12-0-1944; IN COMMERCE 12-0-1944.

CLASS 41—EDUCATION AND ENTERTAINMENT

FOR DEVELOPING EDUCATIONAL PUBLICATIONS, NAMELY, TRAINING MANUALS, SCRIPTS, WORKBOOKS, AND INSTRUCTOR GUIDES, FOR OTHERS IN THE FIELD OF PETROLEUM SERVICES; PRODUCTION OF MOTION PICTURE FILMS, SLIDE FILMS, VIDEOTAPES, AND AUDIOTAPES; MULTIMEDIA EDUCATIONAL SOFTWARE PRODUCTION SERVICES (U.S. CLS. 100, 101 AND 107).
FIRST USE 12-0-1944; IN COMMERCE 12-0-1944.
JENNIFER KRISP, EXAMINING ATTORNEY

SN 76-609,382. DOLLAR TREE STORES, INC., CHESAPEAKE, VA. FILED 8-30-2004.

WINDHAM HEIGHTS

THE MARK CONSISTS OF STANDARD CHARACTERS WITHOUT CLAIM TO ANY PARTICULAR FONT, STYLE, SIZE, OR COLOR.

CLASS 20—FURNITURE AND ARTICLES NOT OTHERWISE CLASSIFIED

FOR POLYRESIN MINIATURE FIGURINES (U.S. CLS. 2, 13, 22, 25, 32 AND 50).
FIRST USE 7-21-2004; IN COMMERCE 7-21-2004.

CLASS 21—HOUSEWARES AND GLASS

FOR PORCELAIN MINIATURE FIGURINES (U.S. CLS. 2, 13, 23, 29, 30, 33, 40 AND 50).
FIRST USE 7-21-2004; IN COMMERCE 7-21-2004.
DAWN FELDMAN, EXAMINING ATTORNEY

SN 76-610,439. KABUSHIKI KAISHA SONY COMPUTER ENTERTAINMENT, TA SONY COMPUTER ENTERTAINMENT INC., TOKYO 107-0062, JAPAN, FILED 9-8-2004.

SN 76-610,639. MILLENNIUM THOROUGHBREDS, INC., AUSTIN, TX. FILED 9-2-2004.

PlayStation Portable

THE MARK CONSISTS OF STANDARD CHARACTERS WITHOUT CLAIM TO ANY PARTICULAR FONT, STYLE, SIZE, OR COLOR.

OWNER OF U.S. REG. NO. 2,713,919.

NO CLAIM IS MADE TO THE EXCLUSIVE RIGHT TO USE "PORTABLE", APART FROM THE MARK AS SHOWN.

CLASS 9—ELECTRICAL AND SCIENTIFIC APPARATUS

FOR CD PLAYERS; AUDIO RECORDED COMPACT DISCS FEATURING MUSIC; VIDEO RECORDED COMPACT DISCS FEATURING MAGAZINES, BOOKS, NEWSPAPERS, MAPS, PICTURES; CONSUMER VIDEO GAME MACHINES ADAPTED FOR USE WITH TELEVISION RECEIVERS ONLY; CONTROLLERS, JOYSTICKS, MEMORY CARDS, VOLUME CONTROLLERS AND MOUSE FOR CONSUMER VIDEO GAME MACHINES ADAPTED FOR USE WITH TELEVISION RECEIVERS ONLY; DVD PLAYER; DOWNLOADABLE DIGITAL IMAGE RECORDING, NAMELY, PICTURE, PHOTOGRAPHS, SCANNED IMAGE DATA; DOWNLOADABLE MUSIC RECORDINGS; DOWNLOADABLE SOUND RECORDINGS FEATURING MUSIC; DOWNLOADABLE VIDEO RECORDINGS FEATURING COMEDY, DRAMA, ACTION, ADVENTURE AND/OR ANIMATION; ELECTRONIC CIRCUITS, CD-ROMS, OPTICAL DISCS AND OTHER MEMORY MEDIA RECORDED PROGRAMS FOR HAND-HELD GAMES WITH LIQUID CRYSTAL DISPLAYS; DOWNLOADABLE ELECTRONIC PUBLICATIONS FEATURING MAGAZINES, BOOKS, NEWSPAPERS, MAPS, PICTURES; PROGRAMS FOR ARCADE VIDEO GAME MACHINES; PROGRAMS FOR ARCADE VIDEO GAME MACHINES; COMPUTER GAME PROGRAMS; COMPUTER OPERATING PROGRAMS; COMPUTER PROGRAMS FOR EDITING IMAGES, SOUND AND VIDEO; ELECTRONIC GAME PROGRAMS; COMPUTER PROGRAMS FOR USE IN NAVIGATING, BROWSING, TRANSFERRING INFORMATION, AND DISTRIBUTING AND VIEWING OTHER COMPUTER PROGRAMS ON COMPUTERS, COMPUTER NETWORKS AND GLOBAL COMMUNICATIONS NETWORKS; RECORDED DISCS BEARING IMAGES; RECORDED DVD-ROMS FEATURING MUSIC, COMEDY, DRAMA, ACTION, ADVENTURE AND/OR ANIMATION; RECORDED VIDEO DISCS AND TAPES FEATURING COMEDY, DRAMA, ACTION, ADVENTURE AND/OR ANIMATION; SOUND RECORDED MAGNETIC CARDS AND TAPES FEATURING MUSIC; SOUND RECORDED OPTICAL DISCS FEATURING COMEDY, DRAMA, ACTION, ADVENTURE AND/OR ANIMATION; GAMES ADAPTED FOR USE WITH DOT MATRIX LIQUID CRYSTAL DISPLAYS IN THE NATURE OF VIDEO GAME CONSOLE (U.S. CLS. 21, 23, 26, 36 AND 38).

CLASS 28—TOYS AND SPORTING GOODS

FOR HAND-HELD GAMES WITH LIQUID CRYSTAL DISPLAYS; POCKET-SIZED ELECTRONIC GAMES; VIDEO GAME AMUSEMENT APPARATUS NOT ADAPTED FOR USE WITH TELEVISION RECEIVERS, IN THE NATURE OF STAND-ALONE VIDEO GAME MACHINES (U.S. CLS. 22, 23, 38 AND 50).

RAUL CORDOVA, EXAMINING ATTORNEY

MILLENNIUM THOROUGHBREDS

OWNER OF U.S. REG. NO. 2,933,882.

NO CLAIM IS MADE TO THE EXCLUSIVE RIGHT TO USE "THOROUGHBREDS", APART FROM THE MARK AS SHOWN.

CLASS 41—EDUCATION AND ENTERTAINMENT

FOR ENTERTAINMENT SERVICES, NAMELY, CONDUCTING HORSE RACES; RACING OF HORSES FOR OTHERS (U.S. CLS. 100, 101 AND 107).

CLASS 44—MEDICAL, BEAUTY AND AGRICULTURAL SERVICES

FOR HORSE FARMS, NAMELY, BOARDING AND CARING FOR HORSES; HORSE BREEDING AND STUD SERVICES (U.S. CLS. 100 AND 101).

DARRYL SPRUILL, EXAMINING ATTORNEY

SN 76-610,811. FOOT LOCKER, INC., NEW YORK, NY. FILED 9-10-2004.

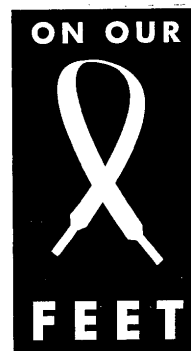

THE MARK CONSISTS IN PART OF A STYLIZED SHOELACE.

CLASS 25—CLOTHING

FOR HEADGEAR, NAMELY HATS AND CAPS, ATHLETIC APPAREL, NAMELY, SHIRTS, T-SHIRTS, SHORTS (U.S. CLS. 22 AND 39).

FIRST USE 12-0-2002; IN COMMERCE 12-0-2002.

CLASS 36—INSURANCE AND FINANCIAL

FOR CHARITABLE FUNDRAISING (U.S. CLS. 100, 101 AND 102).

FIRST USE 12-0-2001; IN COMMERCE 12-0-2001.
GLENN CLARK, EXAMINING ATTORNEY

SN 76-611,248. HU-FRIEDY MFG. CO., INC., CHICAGO, IL.
FILED 9-9-2004.

HOW PRACTICES MAKE PERFECT

CLASS 37—CONSTRUCTION AND REPAIR

FOR SANITATION CONSULTATION SERVICES IN THE FIELD OF WORK FLOW IN CLEANING AND WORK FLOW PROCESSES FOR DENTAL PRACTITIONERS (U.S. CLS. 100, 103 AND 106).

CLASS 41—EDUCATION AND ENTERTAINMENT

FOR EDUCATIONAL SERVICES, NAMELY, CONDUCTING SEMINARS RELATING TO INFECTION CONTROL GUIDELINES IN THE FIELD OF DENTISTRY FOR DENTAL PRACTITIONERS (U.S. CLS. 100, 101 AND 107).

TRACY FLETCHER, EXAMINING ATTORNEY

CLASS 9—ELECTRICAL AND SCIENTIFIC APPARATUS

FOR COMPUTER SOFTWARE AND COMPUTER FIRMWARE FOR USE IN FACILITATING AND TRACKING DIGITAL AUDIO AND VIDEO FILE TRANSFERS VIA THE INTERNET, COMPUTER-FACILITATED NETWORK TRANSACTIONS, AND FOR RELATED DATA TRANSFER FACILITATION, NAMELY, TRANSACTION REPORTING, NOTIFICATION AND SECURITY (U.S. CLS. 21, 23, 26, 36 AND 38).

CLASS 42—SCIENTIFIC, COMPUTER AND LEGAL SERVICES

FOR COMPUTER SERVICES IN THE FIELDS OF FACILITATING DIGITAL FILE AND DATA TRANSFER AND NOTIFICATION, NAMELY, TRANSACTION TRACKING AND DATA TRANSFER SERVICES, FILE AND DATA TRANSFER ACCOUNTING MANAGEMENT AND NOTIFICATION SERVICES; ACCOUNT REPORTING AND NOTIFICATION SERVICES, ALL PROVIDED WITH RESPECT TO AUDIO AND VIDEO FILE TRANSFERS ON BEHALF OF OTHERS (U.S. CLS. 100 AND 101).

ANNE E. GUSTASON, EXAMINING ATTORNEY

SN 76-611,335. GARY ROSENTHAL COLLECTION, INC.,
KENSINGTON, MD. FILED 9-14-2004.

ART AS A CATALYST

THE MARK CONSISTS OF STANDARD CHARACTERS WITHOUT CLAIM TO ANY PARTICULAR FONT, STYLE, SIZE, OR COLOR.

NO CLAIM IS MADE TO THE EXCLUSIVE RIGHT TO USE "ART", APART FROM THE MARK AS SHOWN.

CLASS 35—ADVERTISING AND BUSINESS

FOR PHILANTHROPIC SERVICES AND EMPOWERMENT PROGRAMS, NAMELY, PROVIDING EMPLOYMENT OPPORTUNITIES IN THE FIELD OF MANUFACTURING OF ART AND SCULPTURES; ART BROKERAGE SERVICES IN THE FIELD OF ART AND SCULPTURES FOR PHILANTHROPIC PURPOSES AND PROMOTING THE SALE OF GOODS OF OTHERS THROUGH THE DISTRIBUTION OF PRINTED MATERIALS AND BUSINESS TO BUSINESS NETWORKING (U.S. CLS. 100, 101 AND 102).

CLASS 36—INSURANCE AND FINANCIAL

FOR CHARITABLE FUNDRAISING AND PHILANTHROPIC SERVICES CONCERNING MONETARY DONATIONS (U.S. CLS. 100, 101 AND 102).

RAUL CORDOVA, EXAMINING ATTORNEY

SN 76-611,844. TAILGATOR GEAR, LTD., LUBBOCK, TX.
FILED 9-17-2004.

TAILGATOR GEAR

THE MARK CONSISTS OF STANDARD CHARACTERS WITHOUT CLAIM TO ANY PARTICULAR FONT, STYLE, SIZE, OR COLOR.

CLASS 12—VEHICLES

FOR THERMALLY INSULATIVE, MAGNETICALLY ATTACHABLE, BEVERAGE HOLDERS MADE PRIMARILY OF PLASTIC FOR USE IN AND ON CARS (U.S. CLS. 19, 21, 23, 31, 35 AND 44).

CLASS 21—HOUSEWARES AND GLASS

FOR THERMALLY INSULATIVE, MAGNETICALLY ATTACHABLE, BEVERAGE HOLDERS MADE PRIMARILY OF PLASTIC (U.S. CLS. 2, 13, 23, 29, 30, 33, 40 AND 50).

KELLEY WELLS, EXAMINING ATTORNEY

SN 76-611,340. WURLD MEDIA, INC., SARATOGA
SPRINGS, NY. FILED 9-14-2004.

GET INTO THE GRID

THE MARK CONSISTS OF STANDARD CHARACTERS WITHOUT CLAIM TO ANY PARTICULAR FONT, STYLE, SIZE, OR COLOR.

SN 76-612,599. SIMON PROPERTY GROUP, LP, INDIANAPOLIS, IN. FILED 9-23-2004.

CELLAR SELECTIONS

CLASS 16—PAPER GOODS AND PRINTED MATTER

FOR NEWSLETTERS FEATURING INFORMATION ABOUT WINE (U.S. CLS. 2, 5, 22, 23, 29, 37, 38 AND 50).

FIRST USE 8-12-2004; IN COMMERCE 8-12-2004.

CLASS 35—ADVERTISING AND BUSINESS

FOR ADMINISTRATION OF A DISCOUNT PROGRAM FOR ENABLING PARTICIPANTS TO OBTAIN DISCOUNTS ON GOODS AND SERVICES THROUGH USE OF A DISCOUNT MEMBERSHIP CARD; WINE CLUB SERVICES, NAMELY PROVIDING MONTHLY CATALOG AND ON-LINE ORDERING OF WINE AND WINE RELATED PRODUCTS AND PROMOTING THE WINES AND WINE RELATED PRODUCTS OF OTHERS BY MEANS OF A PREFERRED CUSTOMER PROGRAM THAT PERIODICALLY FEATURES SELECTED WINES AT DISCOUNTED PRICES (U.S. CLS. 100, 101 AND 102).
FIRST USE 8-12-2004; IN COMMERCE 8-12-2004.

CLASS 41—EDUCATION AND ENTERTAINMENT

FOR PROVIDING WINE TASTING EVENTS FOR WINE CLUB MEMBERS; CONDUCTING ENTERTAINMENT EXHIBITIONS IN THE NATURE OF WINE ORIENTED SPECIAL EVENTS IN SHOPPING MALLS, AND PROVIDING EDUCATION SERVICES IN THE NATURE OF WINE SEMINARS (U.S. CLS. 100, 101 AND 107).

FIRST USE 8-15-2004; IN COMMERCE 8-15-2004.
KELLEY WELLS, EXAMINING ATTORNEY

SN 76-612,672. THE CLIFFS COMMUNITIES, INC., TRAVELERS REST, SC. FILED 9-23-2004.

THE CLIFFS AT KEOWEE FALLS SOUTH

THE MARK CONSISTS OF STANDARD CHARACTERS WITHOUT CLAIM TO ANY PARTICULAR FONT, STYLE, SIZE, OR COLOR.

OWNER OF U.S. REG. NO. 2,689,951.
NO CLAIM IS MADE TO THE EXCLUSIVE RIGHT TO USE "KEOWEE", APART FROM THE MARK AS SHOWN.

CLASS 36—INSURANCE AND FINANCIAL

FOR REAL ESTATE BROKERAGE (U.S. CLS. 100, 101 AND 102).

FIRST USE 6-0-2003; IN COMMERCE 6-0-2003.

CLASS 37—CONSTRUCTION AND REPAIR

FOR REAL ESTATE DEVELOPMENT, CONSTRUCTION SERVICES IN THE FIELD OF RESIDENTIAL BUILDING, AND PLANNING AND LAYING OUT OF RESIDENTIAL COMMUNITIES (U.S. CLS. 100, 103 AND 106).

FIRST USE 6-0-2003; IN COMMERCE 6-0-2003.
BRIDGETT SMITH, EXAMINING ATTORNEY

SN 76-612,710. SIRIUS PRODUCTS, INC., LONGMONT, CO. FILED 9-23-2004.

THE GREAT IDEA NETWORK

THE MARK CONSISTS OF STANDARD CHARACTERS WITHOUT CLAIM TO ANY PARTICULAR FONT, STYLE, SIZE, OR COLOR.

CLASS 35—ADVERTISING AND BUSINESS

FOR BUSINESS MARKETING CONSULTATION; PROVIDING ONLINE BUSINESS INFORMATION RELATED TO ORGANIZING AND OPERATING A NEW BUSINESS; PROVIDING ENTREPRENEURIAL BUSINESS ASSISTANCE TO STARTUP AND EMERGING COMPANIES, NAMELY, MARKETING CONCEPT DEVELOPMENT, BUSINESS PROJECT MANAGEMENT FOR OTHERS, PRODUCT MARKETING, ORGANIZATIONAL STRATEGY, BUSINESS MANAGEMENT AND FACILITATING FINANCING IN THE NATURE OF MATCHING INVESTORS WITH STARTUP COMPANIES; BUSINESS CONSULTATION AND MANAGEMENT REGARDING MARKETING ACTIVITIES AND LAUNCHING OF NEW PRODUCTS; ADVERTISING, NAMELY, CREATING CORPORATE AND BRAND IDENTITY FOR OTHERS; CONSULTING IN THE FIELD OF BUSINESS PARTNER RELATIONSHIP MANAGEMENT; BUSINESS ADVISORY SERVICES IN THE NATURE OF NEW VENTURE DEVELOPMENT AND FORMATION CONSULTING SERVICES, NAMELY ADVISING OTHERS WITH STARTUP INITIATIVES IN ALL BUSINESS FIELDS ON INDUSTRY AND MARKET ANALYSIS, PRODUCT DEVELOPMENT, VALUE PROPOSITION, BUSINESS PLANNING, MARKETING, RECOURSE ACQUISITION, VALUATION, MERGER AND ACQUISITION, ALLIANCE AND JOINT VENTURE OPPORTUNITIES; BUSINESS MANAGEMENT SERVICES NAMELY, ASSISTING OTHERS IN ENTERING INTO JOINT VENTURE PARTNERSHIP PROJECTS WITH ENTREPRENEURS. (U.S. CLS. 100, 101 AND 102).

CLASS 36—INSURANCE AND FINANCIAL

FOR FINANCIAL SERVICES, NAMELY, INVESTMENT ANALYSIS AND CONSULTATION IN THE NATURE OF ASSISTING OTHERS WITH EVALUATION OF MATTERS FOR INVESTMENT AND STRATEGIC INITIATIVES, NAMELY, INVESTMENT, CAPITAL FORMATION, FINANCIAL STRUCTURING, RESEARCH MANAGEMENT, MERGER, ACQUISITION, ALLIANCE AND JOINT VENTURE CONSULTATION; JOINT VENTURE INVESTMENT SERVICES; VENTURE CAPITAL SERVICES, PROVIDING FUNDING TO EMERGING, START-UP AND EARLY STAGE COMPANIES (U.S. CLS. 100, 101 AND 102).

CLASS 42—SCIENTIFIC, COMPUTER AND LEGAL SERVICES

FOR PRODUCT DEVELOPMENT; DESIGN AND TESTING OF NEW PRODUCT DEVELOPMENT AND PRODUCT RESEARCH. (U.S. CLS. 100 AND 101).

KAREN BRACEY, EXAMINING ATTORNEY

SN 76-612,918. SRAMEK, JITKA, LARCHMONT, NY. FILED 9-27-2004.



BLACK, RED, YELLOW, WHITE, ORANGE, BLUE, GRAY AND PURPLE

THE MARK CONSISTS OF 1. (YO) IN RED, BLACK BORDER 2. (TAXI) IN YELLOW, BLACK BORDER 3. (FACE) IN BLACK/WHITE/PURPLE/BLUE/YELLOW/GRAY 4. (FLAME) YELLOW/ORANGE/RED 5. (CHECK) BLACK/WHITE

CLASS 25—CLOTHING

FOR T-SHIRTS (U.S. CLS. 22 AND 39).

CLASS 28—TOYS AND SPORTING GOODS

FOR PLUSH TOYS (U.S. CLS. 22, 23, 38 AND 50).
RON FAIRBANKS, EXAMINING ATTORNEY

SN 76-613,045. ATX GROUP, INC., IRVING, TX. FILED 9-20-2004.

ATX

THE MARK CONSISTS OF STANDARD CHARACTERS WITHOUT CLAIM TO ANY PARTICULAR FONT, STYLE, SIZE, OR COLOR.

OWNER OF U.S. REG. NO. 2,189,864.

CLASS 37—CONSTRUCTION AND REPAIR

FOR PROVIDING ROADSIDE SERVICES THROUGH TWO-WAY WIRELESS COMMUNICATIONS WITH A REMOTE RESPONSE CENTER, NAMELY, REMOTE DOOR UNLOCKING, VOICE-ROUTING, AND LOCATION ASSISTANCE (U.S. CLS. 100, 103 AND 106).
FIRST USE 3-27-2003; IN COMMERCE 3-27-2003.

CLASS 38—COMMUNICATION

FOR COMMUNICATIONS SERVICES VIA IN-VEHICLE WIRELESS TWO-WAY COMMUNICATION WITH A REMOTE RESPONSE CENTER WHICH TRACKS VEHICLE LOCATIONS AND PUTS A DRIVER IN VOICE CONTACT FOR COLLISION RESPONSE; SATELLITE POSITIONING SERVICES, NAMELY, PROVIDING PRECISION VEHICLE POSITIONING AND VEHICLE NAVIGATION SERVICES (U.S. CLS. 100, 101 AND 104).
FIRST USE 3-27-2003; IN COMMERCE 3-27-2003.

JIM RINGLE, EXAMINING ATTORNEY

SN 76-615,079. IIC-INTERSPORT INTERNATIONAL CORPORATION GMBH, OSTERMUNDIGEN, SWITZERLAND, FILED 10-8-2004.

NORTHBROOK

THE MARK CONSISTS OF STANDARD CHARACTERS WITHOUT CLAIM TO ANY PARTICULAR FONT, STYLE, SIZE, OR COLOR.

PRIORITY CLAIMED UNDER SEC. 44(D) ON SWITZERLAND APPLICATION NO. 01513/2004, FILED 4-27-2004, REG. NO. 523657, DATED 7-13-2004, EXPIRES 7-13-2014.

CLASS 9—ELECTRICAL AND SCIENTIFIC APPARATUS

FOR GLASSES, NAMELY, SPORTING GLASSES AND SUNGLASSES; PROTECTIVE HELMETS FOR SPORT (U.S. CLS. 21, 23, 26, 36 AND 38).

CLASS 14—JEWELRY

FOR WATCHES, WRISTWATCHES, STOP WATCHES, SPORT AND DIVING WATCHES, MULTIFUNCTION WATCHES ALSO DISPLAYING OR INDICATING OTHER INFORMATION THAN THE DATE AND TIME (U.S. CLS. 2, 27, 28 AND 50).

CLASS 18—LEATHER GOODS

FOR ALL-PURPOSE SPORTING BAGS, RUCKSACKS AND HIKING BAGS (U.S. CLS. 1, 2, 3, 22 AND 41).

CLASS 25—CLOTHING

FOR CLOTHING, NAMELY, SKI WEAR, SNOWBOARD WEAR, TENNIS WEAR, SWIM WEAR, SWEATSUITS, SWEAT SHIRTS, SHIRTS, JOGGING AND TRAINING SUITS, POLO SHIRTS, TOPS, SHORTS, UNDERWEAR, ANORAKS, OVERALLS, OVERCOATS, PANTS, TROUSERS, JEANS, JACKETS, COATS, RAINCOATS, PULLOVERS, TEESHIRTS, SCARVES, SOCKS, LEGGINGS, STOCKINGS, GLOVES, WRISTBANDS; HEADGEAR, NAMELY, CAPS, HATS, HEADBANDS; FOOTWEAR, NAMELY, MOUNTAINEERING BOOTS AND SHOES, SKI AND SNOWBOARD BOOTS, CROSS-COUNTRY SKI BOOTS, TENNIS SHOES, SQUASH SHOES, BASKETBALL SHOES, HANDBALL SHOES, VOLLEYBALL SHOES, SOCCER SHOES, AEROBIC SHOES, GYMNASTIC SHOES, SPORT SANDALS, SLIPPERS, AFTER-SKI BOOTS, SOFT WINTERSPORT BOOTS, RUNNING SHOES, JOGGING SHOES (U.S. CLS. 22 AND 39).

CLASS 28—TOYS AND SPORTING GOODS

FOR GAMES AND PLAYTHINGS, SPORTING AND GYMNASTIC ARTICLES, NAMELY, ROLLER SKATES, INLINE ROLLER SKATES, SKATEBOARDS, SNOWBOARDS, ICE SKATES, SLEDS, SKIS, SKI BINDINGS, SKI POLES; PROTECTION DEVICES FOR ATHLETIC USE, NAMELY ELBOW PADS, WRIST PADS, ANKLE PADS, SHIN PADS, SHOULDER PADS, KNEE PADS; BALLS, GLOVES AND BATS FOR BASEBALL, AMERICAN FOOTBALL BALLS, BASKETBALLS, HOCKEY STICKS, FLYING DISCS, BOOMERANGS, DARTS; INDOOR GYMNASTIC AND SPORTING ARTICLES, NAMELY, SPORT BALLS FOR FITNESS EXERCISES, STRETCH BANDS FOR PHYSICAL EXERCISES, JUMP ROPES, MANUALLY OPERATED BODY-BUILDING EQUIPMENT, MANUALLY OPERATED MACHINES FOR PHYSICAL EXERCISES; RACKETS FOR TENNIS, SQUASH, BADMINTON, TABLE TENNIS AND RACQUETBALL, RACKET COVERS AND STRINGS FOR TENNIS, SQUASH, BADMINTON AND RACQUETBALL RACKETS; COVERS AND BAGS FOR THE AFORESAID RACKETS; RACKET GRIPS; TABLES FOR TABLE TENNIS; BALLS AND BADMINTON SHUTTLECOCKS; SKATES, STICKS AND GLOVES FOR ICE-HOCKEY; SNOW SLEDS FOR RECREATIONAL USE; BAGS MADE OF LEATHER AND FABRIC ADAPTED FOR THE TRANSPORT OF SPORTING ARTICLES (U.S. CLS. 22, 23, 38 AND 50).

SUSAN STIGLITZ, EXAMINING ATTORNEY

SN 76-615,132. E. I. DU PONT DE NEMOURS AND COMPANY, WILMINGTON, DE. FILED 10-8-2004.

STANDOFLEX

THE MARK CONSISTS OF STANDARD CHARACTERS WITHOUT CLAIM TO ANY PARTICULAR FONT, STYLE, SIZE, OR COLOR.

OWNER OF U.S. REG. NOS. 1,457,086, 2,396,700 AND OTHERS.

CLASS 1—CHEMICALS

FOR FILLER COMPOUNDS, NAMELY, AUTOMOBILE BODY FILLERS (U.S. CLS. 1, 5, 6, 10, 26 AND 46).
FIRST USE 2-1-1988; IN COMMERCE 2-1-1988.

CLASS 2—PAINTS

FOR PAINT AND PRIMERS FOR PREPARING SURFACES TO BE PAINTED, ALL FOR USE IN THE AUTOMOBILE INDUSTRY (U.S. CLS. 6, 11 AND 16).
FIRST USE 2-1-1988; IN COMMERCE 2-1-1988.
EVELYN BRADLEY, EXAMINING ATTORNEY

SN 76-615,489. EQUIANT FINANCIAL SERVICES INC., PEMBROKE, MA. FILED 10-7-2004.

SN 76-615,420. SONY KABUSHIKI KAISHA, TA SONY CORPORATION, TOKYO, JAPAN, FILED 10-5-2004.

**CLASS 9—ELECTRICAL AND SCIENTIFIC APPARATUS**

FOR DIGITAL AUDIO PLAYERS AND/OR RECORDERS WHICH USE INTEGRATED CIRCUITS AS RECORDING MEDIA; AUDIO TAPE PLAYERS AND/OR RECORDERS; AUDIO DISC PLAYERS AND/OR RECORDERS; VIDEO TAPE PLAYERS AND/OR RECORDERS; VIDEO DISC PLAYERS AND/OR RECORDERS; VIDEO CAMERAS; VIDEO CAMERAS COMBINED WITH VIDEO RECORDERS AND/OR PLAYERS; SET TOP BOXES; TELEVISION SETS; LIQUID CRYSTAL DISPLAYS; PLASMA DISPLAYS; ELECTRONIC STILL CAMERAS; TELEPHONE APPARATUS; COMPUTERS; COMPUTER PERIPHERALS, NAMELY, DISC DRIVES, MONITORS, KEYBOARDS, MICE AND TABLET DEVICES, NAMELY, COMPUTER GRAPHIC TABLET AND DIGITIZER; PERSONAL DIGITAL ASSISTANTS; COMPUTER SOFTWARE FOR PLAYING, RECORDING, EDITING AND PROCESSING AUDIO, VIDEO AND/OR COMPUTING DATA; PR-RECORDED COMPUTER DATA RECORDING MEDIA, NAMELY, TAPES, OPTICAL DISCS, MAGNETIC DISCS, MAGNETO-OPTICAL DISCS, INTEGRATED CIRCUITS FEATURING MUSIC, MOVIES, PICTURES, ANIMATIONS AND WRITING; VIDEO GAME MACHINES FOR USE WITH TELEVISIONS; ROBOTS FOR ENTERTAINMENT USE (U.S. CLS. 21, 23, 26, 36 AND 38).

CLASS 20—FURNITURE AND ARTICLES NOT OTHERWISE CLASSIFIED

FOR FURNITURE; CUSHIONS; PILLOWS (U.S. CLS. 2, 13, 22, 25, 32 AND 50).

CLASS 24—FABRICS

FOR GOODS MADE FROM FABRICS, NAMELY, TABLE CLOTHS, SOFA COVERS, CUSHION COVERS AND PILLOWCASES (U.S. CLS. 42 AND 50).

CLASS 25—CLOTHING

FOR CLOTHING, NAMELY, JACKETS (U.S. CLS. 22 AND 39).

CLASS 28—TOYS AND SPORTING GOODS

FOR HAND-HELD GAMES WITH LIQUID CRYSTAL DISPLAYS (U.S. CLS. 22, 23, 38 AND 50).
MARLENE BELL, EXAMINING ATTORNEY

EQUIANT

THE MARK CONSISTS OF STANDARD CHARACTERS WITHOUT CLAIM TO ANY PARTICULAR FONT, STYLE, SIZE, OR COLOR.

CLASS 36—INSURANCE AND FINANCIAL

FOR ADMINISTRATION, MANAGEMENT AND SERVICING FOR OTHERS OF THEIR PORTFOLIOS OF REAL ESTATE LOAN AND RELATED PROPERTY MAINTENANCE FEE RECEIVABLES, PERIODIC NOTIFICATION OF DEBTORS OF THEIR REAL ESTATE LOAN AND RELATED PROPERTY MAINTENANCE FEES DUE FOR PAYMENT, POSTING DEBTORS' LOAN AND RELATED PROPERTY MAINTENANCE FEE PAYMENTS TO THEIR RESPECTIVE ACCOUNTS, DEPOSITING DEBTORS' PAYMENTS IN FINANCIAL INSTITUTIONS, REPORTING DEBTORS' PAYMENTS TO THEIR RESPECTIVE CREDITORS, SUCH AS LENDERS, REAL ESTATE DEVELOPERS AND/OR PROPERTY OWNERS' ASSOCIATIONS, AND REMITTING DEBTORS' PAYMENTS TO THEIR RESPECTIVE CREDITORS; DEBTOR-SPECIFIC REAL ESTATE LOAN AND PROPERTY MAINTENANCE FEE INFORMATION COLLECTION AND REPORTING TO OWNERS OF PORTFOLIOS OF REAL ESTATE LOAN AND RELATED PROPERTY MAINTENANCE FEE RECEIVABLES; RECEIVABLES PORTFOLIO SECURITIZATION SERVICES; DEBT RECOVERY AND COLLECTION SERVICES FOR OTHERS; CUSTOMER SERVICE FOR OTHERS IN THE FIELD OF REAL ESTATE LOAN AND RELATED PROPERTY MAINTENANCE FEE PAYMENT COLLECTION; AND DEBTOR LOCATING SERVICES (U.S. CLS. 100, 101 AND 102).

FIRST USE 3-15-2004; IN COMMERCE 3-15-2004.

CLASS 39—TRANSPORTATION AND STORAGE

FOR FINANCIAL DOCUMENT CUSTODIAL SERVICES FOR OTHERS IN THE NATURE OF ELECTRONIC AND/OR PHYSICAL DOCUMENT STORAGE; BACK-UP SERVICING FOR CREDITORS OF THEIR PORTFOLIOS OF REAL ESTATE LOAN AND RELATED PROPERTY MAINTENANCE FEE RECEIVABLES BEING SERVICED BY OTHERS IN THE NATURE OF STORAGE OF A DUPLICATE OF THE RECORDS MAINTAINED BY THE PERSONS PRIMARILY RESPONSIBLE FOR SERVICING THE AFORESAID PORTFOLIO SO AS TO BE ABLE TO TAKE OVER SAID SERVICING IN THE EVENT IT BECOMES NECESSARY TO REPLACE THE PERSONS WHO WERE PRIMARILY RESPONSIBLE FOR SERVICING THE AFORESAID PORTFOLIO (U.S. CLS. 100 AND 105).

FIRST USE 3-15-2004; IN COMMERCE 3-15-2004.

CLASS 40—MATERIAL TREATMENT

FOR BACK-UP SERVICING FOR CREDITORS OF THEIR PORTFOLIOS OF REAL ESTATE LOAN AND RELATED PROPERTY MAINTENANCE FEE RECEIVABLES BEING SERVICED BY OTHERS IN THE NATURE OF MEDIA DUPLICATION OF DATA AND DIGITAL INFORMATION OF THE RECORDS MAINTAINED BY THE PERSONS PRIMARILY RESPONSIBLE FOR SERVICING THE AFORESAID PORTFOLIO SO AS TO BE ABLE TO TAKE OVER SAID SERVICING IN THE EVENT IT BECOMES NECESSARY TO REPLACE THE PERSONS WHO WERE PRIMARILY RESPONSIBLE FOR SERVICING THE AFORESAID PORTFOLIO (U.S. CLS. 100, 103 AND 106).

FIRST USE 3-15-2004; IN COMMERCE 3-15-2004.
LEIGH CAROLINE CASE, EXAMINING ATTORNEY

SN 76-616,658. MEYER JABARA HOTELS, LLC, WEST PALM BEACH, FL. FILED 10-15-2004.

EXPERIENCE SPECIALIST

THE MARK CONSISTS OF STANDARD CHARACTERS WITHOUT CLAIM TO ANY PARTICULAR FONT, STYLE, SIZE, OR COLOR.

NO CLAIM IS MADE TO THE EXCLUSIVE RIGHT TO USE "SPECIALIST", APART FROM THE MARK AS SHOWN.

CLASS 39—TRANSPORTATION AND STORAGE

FOR BOOKING OF EXCURSIONS FOR TRAVELERS INCLUDING ON-LINE EXCURSION RESERVATION SERVICES (U.S. CLS. 100 AND 105).

FIRST USE 0-0-2003; IN COMMERCE 0-0-2003.

CLASS 43—HOTEL AND RESTAURANT SERVICES

FOR HOTEL SERVICES AND MAKING HOTEL RESERVATIONS FOR TRAVELERS INCLUDING ON-LINE HOTEL RESERVATION SERVICES (U.S. CLS. 100 AND 101).

FIRST USE 0-0-2003; IN COMMERCE 0-0-2003.
TARAH HARDY, EXAMINING ATTORNEY

SN 76-616,782. DOJO WEST 42ND REALTY, LLC, NEW YORK, NY. FILED 10-20-2004.

SANCTUARY FOR THE MODERN SAMURAI

THE MARK CONSISTS OF STANDARD CHARACTERS WITHOUT CLAIM TO ANY PARTICULAR FONT, STYLE, SIZE, OR COLOR.

CLASS 41—EDUCATION AND ENTERTAINMENT

FOR KARATE INSTRUCTION; HEALTH CLUB SERVICES, NAMELY PROVIDING INSTRUCTION AND EQUIPMENT IN THE FIELD OF PHYSICAL EXERCISE (U.S. CLS. 100, 101 AND 107).

CLASS 44—MEDICAL, BEAUTY AND AGRICULTURAL SERVICES

FOR MASSAGE AND THERAPEUTIC SHIATSU MASSAGE (U.S. CLS. 100 AND 101).

MICHAEL TANNER, EXAMINING ATTORNEY

SN 76-617,013. W.W.M. DRIESSEN BEHEER B.V., PURMEREND, NETHERLANDS, FILED 10-20-2004.

QSERVE

THE MARK CONSISTS OF STANDARD CHARACTERS WITHOUT CLAIM TO ANY PARTICULAR FONT, STYLE, SIZE, OR COLOR.

CLASS 35—ADVERTISING AND BUSINESS

FOR BUSINESS CONSULTING, NAMELY RELATING TO REGULATORY COMPLIANCE IN THE MEDICAL FIELD; BUSINESS AUDITING; SUPPLIER AND DISTRIBUTOR AUDITING; BUSINESS CONSULTING REGARDING IMPLEMENTATION OF QUALITY MANAGEMENT SYSTEMS IN THE MEDICAL FIELD (U.S. CLS. 100, 101 AND 102).

FIRST USE 0-0-1998; IN COMMERCE 2-0-2002.

CLASS 41—EDUCATION AND ENTERTAINMENT

FOR PROVIDING EDUCATIONAL TRAINING AND COURSES IN THE FIELD OF AUDITING; PROVIDING EDUCATIONAL TRAINING AND COURSES RELATING TO REGULATORY COMPLIANCE IN THE MEDICAL FIELD; PROVIDING EDUCATIONAL TRAINING AND COURSES RELATING TO THE IMPLEMENTATION OF QUALITY MANAGEMENT SYSTEMS AND RISK MANAGEMENT SYSTEMS IN THE MEDICAL FIELD (U.S. CLS. 100, 101 AND 107).

FIRST USE 0-0-1998; IN COMMERCE 2-0-2002.

CLASS 42—SCIENTIFIC, COMPUTER AND LEGAL SERVICES

FOR PROVIDING QUALITY ASSURANCE SERVICES IN THE MEDICAL FIELD; QUALITY CONTROL FOR OTHERS; VALIDATION SERVICES RELATING TO MEDICAL DEVICE PRODUCTS, MEDICAL DEVICE DESIGN AND MEDICAL DEVICE QUALITY CONTROL PROCESSES (U.S. CLS. 100 AND 101).

FIRST USE 0-0-1998; IN COMMERCE 2-0-2002.

JENNIFER KRISP, EXAMINING ATTORNEY

SN 76-617,089. FLORIDA POOL PRODUCTS, INC., CLEARWATER, FL. FILED 10-18-2004.

SOLUS SPA COLLECTION

THE MARK CONSISTS OF STANDARD CHARACTERS WITHOUT CLAIM TO ANY PARTICULAR FONT, STYLE, SIZE, OR COLOR.

NO CLAIM IS MADE TO THE EXCLUSIVE RIGHT TO USE "SPA COLLECTION", APART FROM THE MARK AS SHOWN.

THE FOREIGN WORDING IN THE MARK TRANSLATES INTO ENGLISH AS ALONE.

CLASS 1—CHEMICALS

FOR WATER TREATMENT CHEMICALS FOR USE IN SPAS AND HOT TUBS (U.S. CLS. 1, 5, 6, 10, 26 AND 46).

CLASS 3—COSMETICS AND CLEANING PREPARATIONS

FOR FRAGRANCES AND SKIN MOISTURIZERS FOR USE IN SPAS AND HOT TUBS; CHEMICALS FOR CLEANING THE SURFACES OF SPAS AND HOT TUBS (U.S. CLS. 1, 4, 6, 50, 51 AND 52).

JASON LOTT, EXAMINING ATTORNEY

CLASS 18—LEATHER GOODS

FOR LEATHER BAGS, NAMELY, DUFFLE BAGS, PURSES BRIEFCASES AND SMALL LEATHER GOODS, NAMELY, WALLETS (U.S. CLS. 1, 2, 3, 22 AND 41).
FIRST USE 6-1-2003; IN COMMERCE 6-1-2003.

CLASS 25—CLOTHING

FOR CLOTHING, NAMELY, FOOTWEAR, JACKETS (U.S. CLS. 22 AND 39).
FIRST USE 0-0-1978; IN COMMERCE 0-0-1978.
BILL DAWE, EXAMINING ATTORNEY

SN 76-617,495. PARADISE PEN COMPANY, DENVER, CO.
FILED 10-25-2004.

SN 76-618,960. GIDDY UP, L.L.C., ANN ARBOR, MI. FILED
11-2-2004.

PADRINO

THE MARK CONSISTS OF STANDARD CHARACTERS WITHOUT CLAIM TO ANY PARTICULAR FONT, STYLE, SIZE, OR COLOR.

THE ENGLISH TRANSLATION OF THE WORD PADRINO IN THE MARK IS GODFATHER.

CLASS 14—JEWELRY

FOR CLOCKS (U.S. CLS. 2, 27, 28 AND 50).
FIRST USE 1-31-2003; IN COMMERCE 1-31-2003.

CLASS 16—PAPER GOODS AND PRINTED MATTER

FOR WRITING INSTRUMENTS, NAMELY, PENS (U.S. CLS. 2, 5, 22, 23, 29, 37, 38 AND 50).
FIRST USE 1-31-2003; IN COMMERCE 1-31-2003.
JILL C. ALT, EXAMINING ATTORNEY

WOW SCRATCHERS

THE MARK CONSISTS OF STANDARD CHARACTERS WITHOUT CLAIM TO ANY PARTICULAR FONT, STYLE, SIZE, OR COLOR.

NO CLAIM IS MADE TO THE EXCLUSIVE RIGHT TO USE "SCRATCHERS", APART FROM THE MARK AS SHOWN.

CLASS 16—PAPER GOODS AND PRINTED MATTER

FOR CHILDREN'S ACTIVITY BOOKS FEATURING PAGES WITH HIDDEN CHARACTERS AND PATTERNS, FOR CHILDREN AGES 4 THROUGH 12 YEARS OF AGE (U.S. CLS. 2, 5, 22, 23, 29, 37, 38 AND 50).

CLASS 28—TOYS AND SPORTING GOODS

FOR NON-ELECTRONIC DRAWING TOYS WHICH UTILIZE SCRATCH TOOLS TO REVEAL HIDDEN IMAGES ON PRE-PRINTED PAPERS AND CARDS-STOCKS, FOR CHILDREN AGES 4 THROUGH 12 YEARS OF AGE (U.S. CLS. 22, 23, 38 AND 50).
JOHN GARTNER, EXAMINING ATTORNEY

SN 76-618,758. JIMLAR CORPORATION, GREAT NECK, NY.
FILED 11-1-2004.

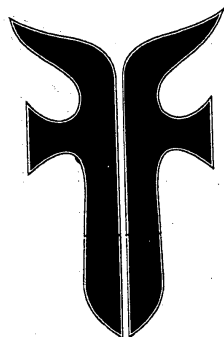

OWNER OF U.S. REG. NO. 1,244,640.

SN 76-619,011. WINTOP FENSTERWERK GMBH, 19057 SCHWERIN, FED REP GERMANY, FILED 11-1-2004.

MATRIX

WINDOW AND DOOR SYSTEMS

THE MARK CONSISTS OF STANDARD CHARACTERS WITHOUT CLAIM TO ANY PARTICULAR FONT, STYLE, SIZE, OR COLOR.

NO CLAIM IS MADE TO THE EXCLUSIVE RIGHT TO USE "WINDOW AND DOOR SYSTEMS", APART FROM THE MARK AS SHOWN.

CLASS 6—METAL GOODS

FOR METAL WINDOWS AND DOORS, EXCLUDING VEHICLE WINDOWS AND DOORS (U.S. CLS. 2, 12, 13, 14, 23, 25 AND 50).

CLASS 19—NON-METALLIC BUILDING MATERIALS

FOR NON-METAL WINDOWS AND DOORS, EXCLUDING VEHICLE WINDOWS AND DOORS (U.S. CLS. 1, 12, 33 AND 50).
DAVID ELTON, EXAMINING ATTORNEY

SN 76-619,163. HELEN OF TROY LIMITED, BRIDGETOWN, BARBADOS, FILED 11-3-2004.

SN 76-619,291. PELICAN PRODUCTS, INC., TORRANCE, CA. FILED 11-4-2004.

Idelle

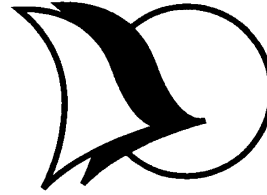

CLASS 3—COSMETICS AND CLEANING PREPARATIONS

FOR HAIR SPRAY; HAIR CONDITIONER; SHAMPOO; HAIR TONIC; HAIR STYLING PREPARATIONS; AFTER-SHAVE LOTIONS, CREAMS AND GELS; ANTI-PERSPIRANT; SHAVING CREAM; SHAVING GEL; COLOGNE; BODY LOTION FOR USE IN THE SHOWER; DEODORANT FOR PERSONAL USE; SKIN ASTRINGENTS FOR COSMETIC PURPOSE; FACIAL CLEANSING CREAM; SKIN MOISTURIZER; PREPARATIONS FOR APPLICATIONS TO THE HAIR TO EMBELLISH, CLEAN, CONDITION, STYLE, SHINE AND HOLD THE HAIR; DEPILATORY LOTIONS AND CREAMS; HAIR REMOVAL FOAMS AND CREAMS; FACIAL AND BODY MASKS; SKIN LOTIONS; ANTI-WRINKLE CREAMS AND GELS; ANTI-AGING CREAMS AND GELS; NIGHT CREAM; BODY CREAM; BUBBLE BATH; NON-MEDICATED BATH SALTS; LIQUID SOAPS FOR THE HANDS, FACE AND BODY; AND SKIN SOAPS. (U.S. CLS. 1, 4, 6, 50, 51 AND 52).

CLASS 5—PHARMACEUTICALS

FOR MEDICATED FOOT POWDERS, MEDICATED BABY POWDERS, AND ANTISEPTICS, NAMELY ANTI-SEPTIC FOOT POWDERS AND ANTISEPTICS FOR THE SKIN (U.S. CLS. 6, 18, 44, 46, 51 AND 52).
ROBERT LAVACHE, EXAMINING ATTORNEY

SN 76-619,193. COAST TO COAST SERVICES, LLC, YUKON, OK. FILED 11-3-2004.

BE YOUR OWN BOSS

THE MARK CONSISTS OF STANDARD CHARACTERS WITHOUT CLAIM TO ANY PARTICULAR FONT, STYLE, SIZE, OR COLOR.

CLASS 35—ADVERTISING AND BUSINESS

FOR CONSULTING AND MANAGEMENT SERVICES FOR INTRASTATE AND INTERSTATE CARRIERS, NAMELY, PROVIDING INFORMATION REGARDING COMPLIANCE WITH INTERSTATE AND INTRASTATE VEHICULAR PERMITS, TAGS REGISTRATION AND TAXES (U.S. CLS. 100, 101 AND 102).
FIRST USE 3-0-2002; IN COMMERCE 3-0-2002.

CLASS 42—SCIENTIFIC, COMPUTER AND LEGAL SERVICES

FOR CONSULTING AND MANAGEMENT SERVICES FOR INTRASTATE AND INTERSTATE CARRIERS, NAMELY, PROVIDING INFORMATION REGARDING COMPLIANCE WITH INTERSTATE AND INTRASTATE CARRIER LAWS AND REGULATIONS (U.S. CLS. 100 AND 101).
FIRST USE 11-12-2004; IN COMMERCE 11-12-2004.
ROBERT LORENZO, EXAMINING ATTORNEY

CLASS 9—ELECTRICAL AND SCIENTIFIC APPARATUS

FOR SOFT-SIDED AND HARD-SIDED CASES FOR CARRYING AND STORING A VARIETY OF TYPES OF GOODS, NAMELY, CASES FOR CARRYING AND STORING PHOTOGRAPHIC AND ELECTRONIC EQUIPMENT AND OTHER SENSITIVE EQUIPMENT, NAMELY, CELL PHONES, PDAS, HAND-HELD ELECTRONIC GAME MACHINES, GAME CARTRIDGES, GAME CASSETTES, AUDIO AND VIDEO CASSETTES, SMALL RADIOS, AUDIO AND VIDEO CASSETTE PLAYERS, AND CD PLAYERS; COMPUTER CARRYING CASES; CASES FOR CARRYING AND STORING SPECIALTY ELECTRONIC INSTRUMENTS (U.S. CLS. 21, 23, 26, 36 AND 38).
FIRST USE 1-0-2004; IN COMMERCE 1-0-2004.

CLASS 11—ENVIRONMENTAL CONTROL APPARATUS

FOR FLASHLIGHTS AND RECHARGEABLE FLASHLIGHTS (U.S. CLS. 13, 21, 23, 31 AND 34).
FIRST USE 1-0-2004; IN COMMERCE 1-0-2004.
JASON LOTT, EXAMINING ATTORNEY

SN 76-619,613. SIMPSON, GRAHAM D., RENO, NV. FILED 11-8-2004.

THE AGELESS-ZONE

THE MARK CONSISTS OF STANDARD CHARACTERS WITHOUT CLAIM TO ANY PARTICULAR FONT, STYLE, SIZE, OR COLOR.

CLASS 41—EDUCATION AND ENTERTAINMENT

FOR EXERCISE CONSULTING SERVICES (U.S. CLS. 100, 101 AND 107).

CLASS 44—MEDICAL, BEAUTY AND AGRICULTURAL SERVICES

FOR SPA SERVICES, NAMELY, MASSAGE, MESOTHERAPY, DETOXIFICATION THERAPY, BODY WRAPS, BODY SCRUBS, EXFOLIATING SCRUBS; SALON SERVICES, NAMELY, PEDICURES, MANICURES, FACIALS, HAIR STYLING AND CUTTING, SKIN TREATMENT, AND SKIN TANNING; MEDICAL SERVICES, NAMELY LASER COSMETIC SURGERY AND INJECTING TISSUE AUGMENTING GELS, FACIAL FILLERS, AND PHARMACEUTICAL PREPARATIONS FOR TREATING WRINKLES, MUSCLE DYSTONIAS, HEADACHES, AND SPASMS; NUTRITION COUNSELING (U.S. CLS. 100 AND 101).
MARY ROSSMAN, EXAMINING ATTORNEY

SN 76-619,696. SEPIALINE, SAN FRANCISCO, CA. FILED 11-8-2004.



CLASS 9—ELECTRICAL AND SCIENTIFIC APPARATUS

FOR COMPUTER SOFTWARE, THAT IS DOWNLOADABLE OR PROVIDED ON COMPUTER MEDIA, FOR PURPOSES OF TRACKING, BILLING AND RECOVERING OFFICE EXPENSES; COMPUTER TERMINALS; COMPUTER HARDWARE, NAMELY, DEVICES TO ENABLE COMPUTER TERMINALS TO INTERFACE WITH PHOTOCOPIERS AND FAX MACHINES; COMPUTER CABLES (U.S. CLS. 21, 23, 26, 36 AND 38).

FIRST USE 0-0-2001; IN COMMERCE 0-0-2001.

CLASS 42—SCIENTIFIC, COMPUTER AND LEGAL SERVICES

FOR CONSULTING SERVICES IN THE FIELD OF DESIGN, SELECTION, IMPLEMENTATION AND USE OF COMPUTER SOFTWARE AND HARDWARE FOR TRACKING, BILLING AND RECOVERING OFFICE EXPENSES; COMPUTER SERVICES, NAMELY, INSTALLATION OF COMPUTER SOFTWARE; TECHNICAL SUPPORT SERVICES, NAMELY, TROUBLESHOOTING OF COMPUTER HARDWARE AND SOFTWARE PROBLEMS VIA E-MAIL, INSTANT MESSAGING, TELEPHONE, REMOTE DESKTOP CONTROL AND IN PERSON (U.S. CLS. 100 AND 101).

FIRST USE 0-0-2001; IN COMMERCE 0-0-2001.

ROBIN CHOSID, EXAMINING ATTORNEY

SN 76-619,971. NEW YORK KITCHEN & BATHROOM CORP., NEW YORK, NY. FILED 11-9-2004.

CLASS 35—ADVERTISING AND BUSINESS

FOR RETAIL STORE SERVICES IN THE FIELD OF KITCHEN AND BATHROOM ITEMS (U.S. CLS. 100, 101 AND 102).

FIRST USE 6-30-2003; IN COMMERCE 6-30-2003.

CLASS 37—CONSTRUCTION AND REPAIR

FOR INSTALLATION OF KITCHEN AND BATHROOM CABINETS AND APPLIANCES AND REMODELLING OF KITCHENS AND BATHROOMS (U.S. CLS. 100, 103 AND 106).

FIRST USE 6-30-2003; IN COMMERCE 6-30-2003.

JACQUELINE A. LAVINE, EXAMINING ATTORNEY

SN 76-620,307. DACO MANUFACTURING, LTD., CONCORD, ONTARIO, CANADA, FILED 11-12-2004.

THE MARK CONSISTS OF STANDARD CHARACTERS WITHOUT CLAIM TO ANY PARTICULAR FONT, STYLE, SIZE, OR COLOR.

THE MARK DOES NOT IDENTIFY ANY PARTICULAR LIVING INDIVIDUAL.

CLASS 9—ELECTRICAL AND SCIENTIFIC APPARATUS

FOR ELECTRIC HAIR STRAIGHTNERS (U.S. CLS. 21, 23, 26, 36 AND 38).

CLASS 11—ENVIRONMENTAL CONTROL APPARATUS

FOR HAND-HELD ELECTRIC HAIR DRYERS (U.S. CLS. 13, 21, 23, 31 AND 34).

CLASS 14—JEWELRY

FOR JEWELRY (U.S. CLS. 2, 27, 28 AND 50).
GENE MACIOL, EXAMINING ATTORNEY

SN 76-620,462. HONEYWELL INTERNATIONAL INC., MORRISTOWN, NJ. AND SILENT KNIGHT SECURITY SYSTEMS OF MINNESOTA, INC., BLOOMINGTON, MN. FILED 11-15-2004.



CLASS 37—CONSTRUCTION AND REPAIR

FOR INSTALLATION AND MAINTENANCE OF SECURITY, ACCESS CONTROL, VIDEO SURVEILLANCE, FIRE, AND LIFE SAFETY SYSTEMS FOR RESIDENTIAL AND COMMERCIAL CUSTOMERS (U.S. CLS. 100, 103 AND 106).

FIRST USE 1-1-1970; IN COMMERCE 1-1-1970.

CLASS 42—SCIENTIFIC, COMPUTER AND LEGAL SERVICES

FOR DESIGN OF SECURITY, ACCESS CONTROL, VIDEO SURVEILLANCE, FIRE, AND LIFE SAFETY SYSTEMS FOR RESIDENTIAL AND COMMERCIAL CUSTOMERS (U.S. CLS. 100 AND 101).

FIRST USE 1-1-1970; IN COMMERCE 1-1-1970.

CLASS 45—PERSONAL SERVICES

FOR PROVIDING ELECTRONIC SECURITY SERVICES, NAMELY, THE MONITORING OF SECURITY, ACCESS CONTROL, VIDEO SURVEILLANCE, FIRE, AND LIFE SAFETY SYSTEMS FOR RESIDENTIAL AND COMMERCIAL CUSTOMERS (U.S. CLS. 100 AND 101).

FIRST USE 1-1-1970; IN COMMERCE 1-1-1970.
STEVEN JACKSON, EXAMINING ATTORNEY

SN 76-620,861. SEARS, BARRY D., DANVERS, MA. FILED 11-15-2004.

SN 76-620,472. ARES TRADING S.A., CH-1170 AUBONNE, SWITZERLAND, FILED 11-15-2004.

FERTILITY LIFELINES

THE MARK CONSISTS OF STANDARD CHARACTERS WITHOUT CLAIM TO ANY PARTICULAR FONT, STYLE, SIZE, OR COLOR.

NO CLAIM IS MADE TO THE EXCLUSIVE RIGHT TO USE "FERTILITY", APART FROM THE MARK AS SHOWN.

CLASS 44—MEDICAL, BEAUTY AND AGRICULTURAL SERVICES

FOR MEDICAL INFORMATION (U.S. CLS. 100 AND 101).

FIRST USE 4-26-2004; IN COMMERCE 4-26-2004.

CLASS 45—PERSONAL SERVICES

FOR PROVIDING PERSONAL SUPPORT SERVICES FOR FAMILIES OF PATIENTS WITH LIFE THREATENING DISORDERS, NAMELY, COMPANIONSHIP, HELP WITH MEDICAL FORMS, COUNSELING AND EMOTIONAL SUPPORT (U.S. CLS. 100 AND 101).

FIRST USE 4-26-2004; IN COMMERCE 4-26-2004.
LINDA E. BLOHM, EXAMINING ATTORNEY

SN 76-620,829. RUBEN, MARSHALL S., HARTFORD, CT. FILED 11-16-2004.

BLUE STATE COFFEE

THE MARK CONSISTS OF STANDARD CHARACTERS WITHOUT CLAIM TO ANY PARTICULAR FONT, STYLE, SIZE, OR COLOR.

NO CLAIM IS MADE TO THE EXCLUSIVE RIGHT TO USE "COFFEE", APART FROM THE MARK AS SHOWN.

CLASS 30—STAPLE FOODS

FOR FOOD AND BEVERAGE ITEMS; NAMELY, COFFEE, TEA AND OTHER BEVERAGES BASED ON COFFEE AND TEA (U.S. CL. 46).

CLASS 43—HOTEL AND RESTAURANT SERVICES

FOR RETAIL RESTAURANT SERVICES; NAMELY, RESTAURANT SERVICES SPECIALIZING IN COFFEE AND TEA DRINKS AND LIGHT FOOD (U.S. CLS. 100 AND 101).

DAWN HAN, EXAMINING ATTORNEY



THE COLORS YELLOW AND RED ARE CLAIMED AS FEATURES OF THE MARK.

THE COLOR YELLOW APPEARS IN THE LETTER "O" AND THE COLOR RED APPEARS ON THE LETTERS "Z," "N," AND "E".

CLASS 3—COSMETICS AND CLEANING PREPARATIONS

FOR NON-MEDICATED SKIN CARE PREPARATIONS AND COSMETICS; NON-MEDICATED SKIN CARE PREPARATIONS FOR ANIMALS, NAMELY, SHAMPOOS, LOTIONS, OILS, OINTMENTS, CREAMS, SOAPS, AND CONDITIONERS (U.S. CLS. 1, 4, 6, 50, 51 AND 52).

CLASS 5—PHARMACEUTICALS

FOR VITAMINS; NUTRITIONAL SUPPLEMENTS; PROTEIN BASED NUTRIENT DENSE MEAL REPLACEMENT BARS; MEDICATED SKIN CARE PREPARATIONS IN THE NATURE OF MEDICATED COSMETICS; FEED SUPPLEMENTS FOR PETS; MEAL REPLACEMENT DRINK MIX (U.S. CLS. 6, 18, 44, 46, 51 AND 52).

CLASS 9—ELECTRICAL AND SCIENTIFIC APPARATUS

FOR ELECTRONIC PUBLICATIONS, NAMELY, MAGAZINES, A SERIES OF BOOKS, NEWSLETTERS, AND BULLETINS, ALL RECORDED ON COMPUTER MEDIA, IN THE FIELDS OF DIET, HEALTH AND NUTRITION (U.S. CLS. 21, 23, 26, 36 AND 38).

CLASS 16—PAPER GOODS AND PRINTED MATTER

FOR PRINTED MATERIALS, NAMELY NEWSLETTERS, MAGAZINES, AND A SERIES OF BOOKS, ALL IN THE FIELD OF DIET, HEALTH AND NUTRITION (U.S. CLS. 2, 5, 22, 23, 29, 37, 38 AND 50).

CLASS 29—MEATS AND PROCESSED FOODS

FOR PREPARED ENTREES CONSISTING PRIMARILY OF MEAT, FISH POULTRY, OR VEGETABLE; EDIBLE OILS AND FATS; NUTRITIONAL FOOD BARS, NAMELY, PROTEIN BASED NUTRIENT DENSE SNACK BARS (U.S. CL. 46).

CLASS 30—STAPLE FOODS

FOR ICE CREAM; BAKERY GOODS, NAMELY, BROWNIES, SNACK CAKES, COOKIES, BISCUITS (U.S. CL. 46).

CLASS 31—NATURAL AGRICULTURAL PRODUCTS

FOR ANIMAL FEED AND ANIMAL FOODSTUFFS; DOG FOOD AND EDIBLE DOG TREATS; CAT FOOD AND EDIBLE CAT TREATS (U.S. CLS. 1 AND 46).

CLASS 41—EDUCATION AND ENTERTAINMENT

FOR EDUCATIONAL SERVICES, NAMELY, CONDUCTING WORKSHOPS, SEMINARS, AND CLASSES IN THE FIELDS OF HEALTH AND NUTRITION; PROVIDING ON-LINE MAGAZINES, NEWSLETTERS AND BULLETINS IN THE FIELD OF DIET, HEALTH AND NUTRITION VIA E-MAIL; INFORMATION ABOUT EDUCATION IN THE FIELDS OF DIET, HEALTH AND NUTRITION VIA THE INTERNET (U.S. CLS. 100, 101 AND 107).

CLASS 43—HOTEL AND RESTAURANT SERVICES

FOR CATERING SERVICES; RESTAURANT, CAFE AND SNACK BAR SERVICES (U.S. CLS. 100 AND 101).

CLASS 44—MEDICAL, BEAUTY AND AGRICULTURAL SERVICES

FOR PROVIDING COUNSELING AND INFORMATION IN THE FIELDS OF HEALTH AND NUTRITION VIA THE INTERNET; COUNSELING SERVICES IN THE FIELD OF DIET, HEALTH AND NUTRITION; PROVIDING INFORMATION IN THE FIELDS OF DIET, HEALTH AND NUTRITION (U.S. CLS. 100 AND 101).
DAWN HAN, EXAMINING ATTORNEY

CLASS 9—ELECTRICAL AND SCIENTIFIC APPARATUS

FOR ELECTRONIC PUBLICATIONS, NAMELY, MAGAZINES, A SERIES OF BOOKS, NEWSLETTERS, AND BULLETINS, ALL RECORDED ON COMPUTER MEDIA, IN THE FIELDS OF DIET, HEALTH AND NUTRITION (U.S. CLS. 21, 23, 26, 36 AND 38).

CLASS 16—PAPER GOODS AND PRINTED MATTER

FOR PRINTED MATERIALS, NAMELY NEWSLETTERS, MAGAZINES, AND A SERIES OF BOOKS, ALL IN THE FIELD OF DIET, HEALTH AND NUTRITION (U.S. CLS. 2, 5, 22, 23, 29, 37, 38 AND 50).

CLASS 29—MEATS AND PROCESSED FOODS

FOR PREPARED ENTREES CONSISTING PRIMARILY OF MEAT, FISH POULTRY, OR VEGETABLE; EDIBLE OILS AND FATS; NUTRITIONAL FOOD BARS, NAMELY, PROTEIN BASED NUTRIENT DENSE SNACK BARS (U.S. CL. 46).

CLASS 30—STAPLE FOODS

FOR ICE CREAM; BAKERY GOODS, NAMELY, BROWNIES, SNACK CAKES, COOKIES, BISCUITS (U.S. CL. 46).

CLASS 31—NATURAL AGRICULTURAL PRODUCTS

FOR ANIMAL FEED AND ANIMAL FOODSTUFFS; DOG FOOD AND EDIBLE DOG TREATS; CAT FOOD AND EDIBLE CAT TREATS (U.S. CLS. 1 AND 46).

CLASS 41—EDUCATION AND ENTERTAINMENT

FOR EDUCATIONAL SERVICES, NAMELY, CONDUCTING WORKSHOPS, SEMINARS, AND CLASSES IN THE FIELDS OF HEALTH AND NUTRITION; PROVIDING ON-LINE MAGAZINES, NEWSLETTERS AND BULLETINS IN THE FIELD OF DIET, HEALTH AND NUTRITION VIA E-MAIL; INFORMATION ABOUT EDUCATION IN THE FIELDS OF DIET, HEALTH AND NUTRITION VIA THE INTERNET (U.S. CLS. 100, 101 AND 107).

CLASS 43—HOTEL AND RESTAURANT SERVICES

FOR CATERING SERVICES; RESTAURANT, CAFE AND SNACK BAR SERVICES (U.S. CLS. 100 AND 101).

CLASS 44—MEDICAL, BEAUTY AND AGRICULTURAL SERVICES

FOR PROVIDING COUNSELING AND INFORMATION IN THE FIELDS OF HEALTH AND NUTRITION VIA THE INTERNET; COUNSELING SERVICES IN THE FIELD OF DIET, HEALTH AND NUTRITION; PROVIDING INFORMATION IN THE FIELDS OF DIET, HEALTH AND NUTRITION (U.S. CLS. 100 AND 101).
DAWN HAN, EXAMINING ATTORNEY

SN 76-620,899. SEARS, BARRY D., DANVERS, MA. FILED 11-15-2004.

**CLASS 3—COSMETICS AND CLEANING PREPARATIONS**

FOR NON-MEDICATED SKIN CARE PREPARATIONS AND COSMETICS; NON-MEDICATED SKIN CARE PREPARATIONS FOR ANIMALS, NAMELY, SHAMPOOS, LOTIONS, OILS, OINTMENTS, CREAMS, SOAPS, AND CONDITIONERS (U.S. CLS. 1, 4, 6, 50, 51 AND 52).

CLASS 5—PHARMACEUTICALS

FOR VITAMINS; NUTRITIONAL SUPPLEMENTS; PROTEIN BASED NUTRIENT DENSE MEAL REPLACEMENT BARS; MEDICATED SKIN CARE PREPARATIONS IN THE NATURE OF MEDICATED COSMETICS; FEED SUPPLEMENTS FOR PETS; MEAL REPLACEMENT DRINK MIX (U.S. CLS. 6, 18, 44, 46, 51 AND 52).

SN 76-621,012. ALLTECH, INC., NICHOLASVILLE, KY.
FILED 11-18-2004.

SN 76-621,568. ASBURY AUTOMOTIVE GROUP, INC., NEW
YORK, NY. FILED 11-22-2004.

FEB-200

MISS. GAS

THE MARK CONSISTS OF STANDARD CHARACTERS
WITHOUT CLAIM TO ANY PARTICULAR FONT, STYLE,
SIZE, OR COLOR.

CLASS 5—PHARMACEUTICALS

FOR VETERINARY PREPARATIONS CONTAINING
BREWER'S DRIED YEAST AND ANTI-CAKING
AGENTS FOR USE IN ANIMAL FEED; NUTRITIONAL
SUPPLEMENTS AND ADDITIVES FOR USE IN ANIMAL
FEEDS (U.S. CLS. 6, 18, 44, 46, 51 AND 52).
FIRST USE 1-1-2004; IN COMMERCE 1-1-2004.

CLASS 31—NATURAL AGRICULTURAL PRO- DUCTS

FOR FOODSTUFFS FOR ANIMALS CONTAINING
BREWER'S DRIED YEAST AND ANTI-CAKING
AGENTS (U.S. CLS. 1 AND 46).
FIRST USE 1-1-2004; IN COMMERCE 1-1-2004.
ANDREA SAUNDERS, EXAMINING ATTORNEY

SN 76-621,327. NORFOLK SOUTHERN CORPORATION,
NORFOLK, VA. FILED 11-15-2004.

MACH-ONE MACHINERY SERVICES

THE MARK CONSISTS OF STANDARD CHARACTERS
WITHOUT CLAIM TO ANY PARTICULAR FONT, STYLE,
SIZE, OR COLOR.

NO CLAIM IS MADE TO THE EXCLUSIVE RIGHT TO
USE MACHINERY SERVICES, APART FROM THE MARK
AS SHOWN.

CLASS 35—ADVERTISING AND BUSINESS

FOR INVENTORY MANAGEMENT AND TRACKING
SERVICES IN THE FIELD OF CARGO HANDLING OF
MACHINERY AND MACHINE PARTS TRANSPORTED
FOR OTHERS (U.S. CLS. 100, 101 AND 102).
FIRST USE 1-31-2004; IN COMMERCE 1-31-2004.

CLASS 39—TRANSPORTATION AND STO- RAGE

FOR TRANSPORTATION SERVICES, NAMELY RAIL
TRANSPORT, STORAGE, AND TRANSLOAD CARGO
HANDLING OF MACHINERY AND MACHINE PARTS
FOR OTHERS (U.S. CLS. 100 AND 105).
FIRST USE 1-31-2004; IN COMMERCE 1-31-2004.
LINDA POWELL, EXAMINING ATTORNEY

THE MARK CONSISTS OF STANDARD CHARACTERS
WITHOUT CLAIM TO ANY PARTICULAR FONT, STYLE,
SIZE, OR COLOR.

CLASS 3—COSMETICS AND CLEANING PRE- PARATIONS

FOR HEALTH AND BEAUTY AIDS, NAMELY, SOAP,
SHAMPOO, COSMETICS AND FRAGRANCES FOR PER-
SONAL USE (U.S. CLS. 1, 4, 6, 50, 51 AND 52).

CLASS 6—METAL GOODS

FOR METAL KEY CHAINS; JEWELRY BOXES OF
METAL (U.S. CLS. 2, 12, 13, 14, 23, 25 AND 50).

CLASS 9—ELECTRICAL AND SCIENTIFIC APPARATUS

FOR EYEWEAR, NAMELY, SUNGLASSES AND
SPORTS EYEWEAR; MOUSE PADS (U.S. CLS. 21, 23, 26,
36 AND 38).

CLASS 12—VEHICLES

FOR BICYCLES, TRICYCLES AND NON-MOTORIZED
SCOOTERS (U.S. CLS. 19, 21, 23, 31, 35 AND 44).

CLASS 14—JEWELRY

FOR JEWELRY, NAMELY, WATCHES, PINS, BRACE-
LETS, CHARMS AND CUFF LINKS (U.S. CLS. 2, 27, 28
AND 50).

CLASS 16—PAPER GOODS AND PRINTED MATTER

FOR PAPER PARTY DECORATIONS; STATIONERY
AND PAPER GOODS, NAMELY, NOTE PADS, GREET-
ING CARDS AND WRAPPING PAPER; PENS (U.S. CLS.
2, 5, 22, 23, 29, 37, 38 AND 50).

CLASS 18—LEATHER GOODS

FOR SMALL LEATHER GOODS, NAMELY, WALLETS
AND KEY CASES; HANDBAGS; LUGGAGE; TOTE
BAGS; UMBRELLAS (U.S. CLS. 1, 2, 3, 22 AND 41).

CLASS 20—FURNITURE AND ARTICLES NOT OTHERWISE CLASSIFIED

FOR PICTURE FRAMES; JEWELRY BOXES NOT OF
METAL (U.S. CLS. 2, 13, 22, 25, 32 AND 50).

CLASS 21—HOUSEWARES AND GLASS

FOR COMBS; HAIR BRUSHES; DINNERWARE, BEV-
ERAGE GLASSWARE AND MUGS (U.S. CLS. 2, 13, 23,
29, 30, 33, 40 AND 50).

CLASS 24—FABRICS

FOR TOWELS; BED SHEETS; TEXTILE PLACE MATS;
VINYL PLACE MATS; PLASTIC PLACE MATS (U.S. CLS.
42 AND 50).

CLASS 25—CLOTHING

FOR APPAREL, NAMELY, SCARVES, HATS, GLOVES, SHIRTS AND JACKETS; KNITWEAR, NAMELY, KNIT SHIRTS; SPORTSWEAR AND ATHLETIC WEAR, NAMELY, SHIRTS, PANTS, SHORTS, SWEAT SHIRTS, SWEAT PANTS, SWEAT SHORTS AND SWEAT SUITS; FLEECE TOPS; T-SHIRTS; TIES (U.S. CLS. 22 AND 39).

CLASS 28—TOYS AND SPORTING GOODS

FOR TOYS AND GAMES, NAMELY, DOLLS, STUFFED ANIMALS, PLUSH FIGURES, TRUCKS, RACE CARS AND MODEL GAS STATIONS (U.S. CLS. 22, 23, 38 AND 50).

CLASS 35—ADVERTISING AND BUSINESS

FOR RETAIL STORE SERVICES FEATURING CONVENIENCE STORE ITEMS AND GASOLINE (U.S. CLS. 100, 101 AND 102).

CLASS 43—HOTEL AND RESTAURANT SERVICES

FOR RESTAURANTS (U.S. CLS. 100 AND 101).
YONG KIM, EXAMINING ATTORNEY

CLASS 1—CHEMICALS

FOR WATER BINDING AGENTS FOR PROCESSED MEATS AND SEAFOODS; CHEMICAL ADDITIVES FOR USE IN THE MANUFACTURE OF FOODS AND BEVERAGES; FOOD ADDITIVES FOR NON-NUTRITIONAL PURPOSES FOR USE AS BINDING AGENTS, THICKENING AGENTS, EMULSIFIERS, STABILIZERS, GELATION AGENTS AND HEAT STABILIZERS (U.S. CLS. 1, 5, 6, 10, 26 AND 46).

CLASS 29—MEATS AND PROCESSED FOODS

FOR PROTEIN FOR USE AS FOOD ADDITIVES; PROTEIN FOR USE IN THE MANUFACTURE OF FOODS AND BEVERAGES; PROTEIN PREPARATION FOR USE AS FOOD ADDITIVES; PROTEIN PREPARATION FOR USE IN THE MANUFACTURE OF FOODS AND BEVERAGES (U.S. CL. 46).

CLASS 30—STAPLE FOODS

FOR FOOD ADDITIVES FOR NON-NUTRITIONAL PURPOSES FOR USE AS FLAVORING, INGREDIENT OR FILLER (U.S. CL. 46).
JEAN IM, EXAMINING ATTORNEY

SN 76-621,569. KOHL'S ILLINOIS, INC., AURORA, IL. FILED 11-22-2004.

SO...SO REAL. SO RIGHT

THE MARK CONSISTS OF STANDARD CHARACTERS WITHOUT CLAIM TO ANY PARTICULAR FONT, STYLE, SIZE, OR COLOR.

CLASS 20—FURNITURE AND ARTICLES NOT OTHERWISE CLASSIFIED

FOR DECORATIVE PILLOWS (U.S. CLS. 2, 13, 22, 25, 32 AND 50).

CLASS 24—FABRICS

FOR THROW BLANKETS (U.S. CLS. 42 AND 50).
YONG KIM, EXAMINING ATTORNEY

SN 76-621,616. TAIYO KAGAKU CO., LTD., MIE-KEN, JAPAN, FILED 11-22-2004.

PROFIX

THE MARK CONSISTS OF STANDARD CHARACTERS WITHOUT CLAIM TO ANY PARTICULAR FONT, STYLE, SIZE, OR COLOR.

SN 76-621,682. HORPHAG RESEARCH LIMITED, GUERNSEY, CHANNEL ISLANDS, FILED 11-23-2004.

PYCNO

THE MARK CONSISTS OF STANDARD CHARACTERS WITHOUT CLAIM TO ANY PARTICULAR FONT, STYLE, SIZE, OR COLOR.

OWNER OF U.S. REG. NOS. 1,769,633, 2,461,921 AND 2,796,485.

CLASS 3—COSMETICS AND CLEANING PREPARATIONS

FOR SKIN CARE CREAMS; NON-MEDICATED TOPICAL ANTIOXIDANT COSMETICS, NAMELY, FACIAL LOTIONS AND SKIN LOTIONS (U.S. CLS. 1, 4, 6, 50, 51 AND 52).

CLASS 5—PHARMACEUTICALS

FOR DIETARY SUPPLEMENTS (U.S. CLS. 6, 18, 44, 46, 51 AND 52).
JULIE WATSON, EXAMINING ATTORNEY

SN 76-621,973. INTERNATIONAL SUZUKI ASSOCIATION,
RICHARDSON, TX. FILED 11-23-2004.

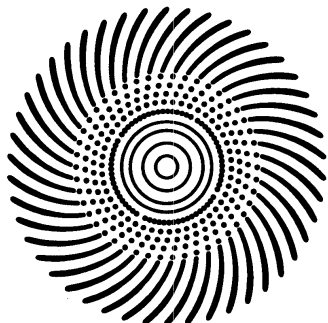

OWNER OF U.S. REG. NOS. 1,356,347 AND 1,800,673.

CLASS 9—ELECTRICAL AND SCIENTIFIC APPARATUS

FOR PRERECORDED AUDIO TAPES AND COMPACT DISCS PERTAINING TO MUSIC FOR USE IN MUSIC INSTRUCTIONS (U.S. CLS. 21, 23, 26, 36 AND 38).
FIRST USE 1-0-2004; IN COMMERCE 1-0-2004.

CLASS 16—PAPER GOODS AND PRINTED MATTER

FOR PRINTED MUSIC BOOKS (U.S. CLS. 2, 5, 22, 23, 29, 37, 38 AND 50).
FIRST USE 1-0-2004; IN COMMERCE 1-0-2004.
WILLIAM VERHOSEK, EXAMINING ATTORNEY

SN 76-621,986. NEW FASHIONS INTERNATIONAL, LLC,
THE WOODLANDS, TX. FILED 11-24-2004.

EOS

THE MARK CONSISTS OF STANDARD CHARACTERS WITHOUT CLAIM TO ANY PARTICULAR FONT, STYLE, SIZE, OR COLOR.

CLASS 25—CLOTHING

FOR CLOTHING, NAMELY DRESSES, SKIRTS, BLOUSES, SUITS, PANTS, JACKETS, COATS, SHOES, SOCKS, BELTS AND SCARVES (U.S. CLS. 22 AND 39).

CLASS 35—ADVERTISING AND BUSINESS

FOR RETAIL CLOTHING STORES (U.S. CLS. 100, 101 AND 102).
KARLA PERKINS, EXAMINING ATTORNEY

SN 76-622,099. PRODUCT PARTNERS, LLC, BEVERLY HILLS, CA. FILED 11-24-2004.



BEACHBODY

CLASS 18—LEATHER GOODS

FOR BACKPACKS (U.S. CLS. 1, 2, 3, 22 AND 41).
FIRST USE 8-30-2004; IN COMMERCE 8-30-2004.

CLASS 25—CLOTHING

FOR CLOTHING, NAMELY SHIRTS AND TOPS (U.S. CLS. 22 AND 39).
FIRST USE 8-30-2004; IN COMMERCE 8-30-2004.
ANDREA SAUNDERS, EXAMINING ATTORNEY

SN 76-622,305. RANSOMED HEART MINISTRIES, COLORADO SPRINGS, CO. FILED 11-26-2004.

RANSOMED HEART

THE MARK CONSISTS OF STANDARD CHARACTERS WITHOUT CLAIM TO ANY PARTICULAR FONT, STYLE, SIZE, OR COLOR.

CLASS 9—ELECTRICAL AND SCIENTIFIC APPARATUS

FOR SERIES OF PRERECORDED COMPACT DISCS, AUDIO TAPES, VIDEO TAPES AND DVDS FEATURING DISCUSSIONS, SERMONS, LECTURES, AND MUSIC RELATED TO CHRISTIAN TOPICS (U.S. CLS. 21, 23, 26, 36 AND 38).
FIRST USE 1-1-2000; IN COMMERCE 10-1-2000.

CLASS 16—PAPER GOODS AND PRINTED MATTER

FOR PUBLICATIONS, NAMELY, PAMPHLETS, BROCHURES, CHURCH INSERTS, BULLETINS AND SERIES OF BOOKS AND WORKBOOKS RELATED TO CHRISTIAN TOPICS (U.S. CLS. 2, 5, 22, 23, 29, 37, 38 AND 50).
FIRST USE 1-1-2000; IN COMMERCE 10-1-2000.

CLASS 41—EDUCATION AND ENTERTAINMENT

FOR EDUCATIONAL SERVICES, NAMELY, ARRANGING AND CONDUCTING CONFERENCES, SEMINARS, WORKSHOPS AND RETREATS, FEATURING TEACHING, DISCUSSIONS, SERMONS, AND LECTURES ON CHRISTIAN TOPICS (U.S. CLS. 100, 101 AND 107).
FIRST USE 1-1-2000; IN COMMERCE 10-1-2000.
NICHOLAS ALTREE, EXAMINING ATTORNEY

SN 76-622,717. GENTIVA HEALTH SERVICES HOLDING CORP., MELVILLE, NY. FILED 12-1-2004.

SN 76-622,887. NHS SCHOLARS' BOWL, RESTON, VA. FILED 12-1-2004.

CASEMATCH

THE MARK CONSISTS OF STANDARD CHARACTERS WITHOUT CLAIM TO ANY PARTICULAR FONT, STYLE, SIZE, OR COLOR.

CLASS 9—ELECTRICAL AND SCIENTIFIC APPARATUS

FOR COMPUTER SOFTWARE USED TO SCHEDULE AND MANAGE STAFFING, PERSONNEL AND HUMAN RESOURCES IN THE MEDICAL AND HEALTHCARE FIELDS, AND MANUALS SOLD THEREWITH AS A UNIT; COMPUTER SOFTWARE USED TO SCHEDULE AND MANAGE STAFFING, PERSONNEL AND HUMAN RESOURCES IN THE MEDICAL AND HEALTHCARE FIELDS, THAT MAY BE DOWNLOADED FROM A GLOBAL COMPUTER NETWORK (U.S. CLS. 21, 23, 26, 36 AND 38).

CLASS 35—ADVERTISING AND BUSINESS

FOR PERSONNEL MANAGEMENT, PERSONNEL MANAGEMENT CONSULTATION AND PERSONNEL PLACEMENT AND RECRUITMENT SERVICES IN THE MEDICAL AND HEALTHCARE FIELDS USING PROPRIETARY SOFTWARE; SERVING AS A HUMAN RESOURCES DEPARTMENT FOR OTHERS IN THE MEDICAL AND HEALTHCARE FIELDS USING PROPRIETARY SOFTWARE; CAREER AND JOB PLACEMENT SERVICES IN THE MEDICAL AND HEALTHCARE FIELDS USING PROPRIETARY SOFTWARE; EMPLOYMENT HIRING, RECRUITING, PLACEMENT, STAFFING AND CAREER NETWORKING SERVICES IN THE MEDICAL AND HEALTHCARE FIELDS USING PROPRIETARY SOFTWARE; SCHEDULING AND MANAGING STAFFING, PERSONNEL AND HUMAN RESOURCES IN THE MEDICAL AND HEALTHCARE FIELDS USING PROPRIETARY SOFTWARE (U.S. CLS. 100, 101 AND 102).

CLASS 42—SCIENTIFIC, COMPUTER AND LEGAL SERVICES

FOR APPLICATION SERVICE PROVIDER (ASP) FEATURING SOFTWARE USED TO SCHEDULE AND MANAGE STAFFING, PERSONNEL AND HUMAN RESOURCES IN THE MEDICAL AND HEALTHCARE FIELDS; PROVIDING TEMPORARY USE OF ON-LINE NON-DOWNLOADABLE SOFTWARE USED TO SCHEDULE AND MANAGE STAFFING, PERSONNEL AND HUMAN RESOURCES IN THE MEDICAL AND HEALTHCARE FIELDS; DATA AUTOMATION AND COLLECTION SERVICE USING PROPRIETARY SOFTWARE TO EVALUATE, ANALYZE AND COLLECT SERVICE DATA, NAMELY, DATA REGARDING THE SCHEDULING AND MANAGEMENT OF STAFFING, PERSONNEL AND HUMAN RESOURCES IN THE MEDICAL AND HEALTHCARE FIELDS (U.S. CLS. 100 AND 101).

DOMINICK J. SALEMI, EXAMINING ATTORNEY

NHS SCHOLARS' BOWL

OWNER OF U.S. REG. NOS. 2,193,248 AND 2,575,782.

CLASS 14—JEWELRY

FOR JEWELRY; ORNAMENTAL LAPEL PINS; GUARDS FOR ORNAMENTAL LAPEL PINS; TIE TACKS; CHARMS; NECKLACES; AND WATCHES (U.S. CLS. 2, 27, 28 AND 50).

CLASS 25—CLOTHING

FOR CLOTHING, NAMELY, CAPS, SHIRTS, T-SHIRTS, SWEAT SHIRTS, DENIM SHIRTS, POLO SHIRTS, STOLE, AND ARM BANDS (U.S. CLS. 22 AND 39).

TRACY FLETCHER, EXAMINING ATTORNEY

SN 76-622,912. HILEX POLY CO., LLC, HARTSVILLE, DARLINGTON COUNTY, SC. FILED 12-2-2004.

BAG-2-BAG

THE MARK CONSISTS OF STANDARD CHARACTERS WITHOUT CLAIM TO ANY PARTICULAR FONT, STYLE, SIZE, OR COLOR.

CLASS 40—MATERIAL TREATMENT

FOR RECYCLING SERVICES; NAMELY, RECYCLING OF PLASTIC BAGS (U.S. CLS. 100, 103 AND 106).

CLASS 41—EDUCATION AND ENTERTAINMENT

FOR EDUCATIONAL SERVICES; NAMELY, CONDUCTING EDUCATIONAL PROGRAMS PROMOTING THE BENEFITS OF PLASTIC BAG RECYCLING; DEVELOPING AND DISSEMINATING EDUCATIONAL MATERIALS AND INFORMATION PROMOTING THE BENEFITS OF PLASTIC BAG RECYCLING; TRAINING OTHERS IN THE FIELD OF PLASTIC BAG RECYCLING (U.S. CLS. 100, 101 AND 107).

MIDGE BUTLER, EXAMINING ATTORNEY

SN 76-623,161. PHONAK HOLDING AG, CH-8712 STAEFA, SWITZERLAND, FILED 12-3-2004.

SoundNavigation

PRIORITY CLAIMED UNDER SEC. 44(D) ON SWITZERLAND APPLICATION NO. 525608, FILED 9-1-2004, REG. NO. 525608, DATED 9-1-2004, EXPIRES 9-1-2014.

CLASS 9—ELECTRICAL AND SCIENTIFIC APPARATUS

FOR SOFTWARE FOR THE CONTROL OF BIOMEDICAL APPARATUS (U.S. CLS. 21, 23, 26, 36 AND 38).

CLASS 10—MEDICAL APPARATUS

FOR BIOMEDICAL APPARATUS, NAMELY HEARING AIDS AND PARTS THEREOF (U.S. CLS. 26, 39 AND 44).
DAVID ELTON, EXAMINING ATTORNEY

SN 76-623,336. ACCLIVUS CORPORATION, DALLAS, TX.
FILED 12-6-2004.

V3 IMPACT

THE MARK CONSISTS OF STANDARD CHARACTERS WITHOUT CLAIM TO ANY PARTICULAR FONT, STYLE, SIZE, OR COLOR.

CLASS 16—PAPER GOODS AND PRINTED MATTER

FOR PRINTED MATERIALS, NAMELY, WORKBOOKS, WALL CHARTS AND SKILL GUIDES FOR USE IN WORKSHOPS, LECTURES, COURSE SYMPOSIA AND CONFERENCES IN THE FIELD OF BUSINESS MANAGEMENT, SALES COMMUNICATION AND BUILDING RELATIONSHIPS WITH CUSTOMERS (U.S. CLS. 2, 5, 22, 23, 29, 37, 38 AND 50).

CLASS 41—EDUCATION AND ENTERTAINMENT

FOR EDUCATION SERVICES, NAMELY, CONDUCTING WORKSHOPS, LECTURES, COURSE SYMPOSIA AND CONFERENCES IN THE FIELD OF BUSINESS MANAGEMENT, SALES COMMUNICATION AND BUILDING RELATIONSHIPS WITH CUSTOMERS AND DISTRIBUTING COURSE MATERIALS IN CONNECTION THEREWITH (U.S. CLS. 100, 101 AND 107).
BRIDGETT SMITH, EXAMINING ATTORNEY

SN 76-623,512. MURTAUGH, JEANNE L., GREENSBORO, NC. FILED 12-7-2004.

ATHLETES THAT CARE

THE MARK CONSISTS OF STANDARD CHARACTERS WITHOUT CLAIM TO ANY PARTICULAR FONT, STYLE, SIZE, OR COLOR.

CLASS 14—JEWELRY

FOR WATCHES; JEWELRY, NAMELY LAPEL PINS, CHARMS, PENDANTS, BROACHES, BRACELETS, NECKLACES, EARRINGS, TIE FASTENERS, TIE CLASPS AND WATCH BANDS (U.S. CLS. 2, 27, 28 AND 50).

CLASS 25—CLOTHING

FOR SCARVES AND NECKTIES; KERCHIEFS; SWEATSHIRTS, T-SHIRTS, SOCKS, HOSIERY AND SHIRTS; HATS AND CAPS (U.S. CLS. 22 AND 39).
LAURIE MAYES, EXAMINING ATTORNEY

SN 76-623,514. MURTAUGH, JEANNE L., GREENSBORO, NC. FILED 12-7-2004.

CARS THAT CARE

THE MARK CONSISTS OF STANDARD CHARACTERS WITHOUT CLAIM TO ANY PARTICULAR FONT, STYLE, SIZE, OR COLOR.

CLASS 14—JEWELRY

FOR WATCHES; JEWELRY, NAMELY LAPEL PINS, CHARMS, PENDANTS, BROACHES, BRACELETS, NECKLACES, EARRINGS, TIE FASTENERS, TIE CLASPS AND WATCH BANDS (U.S. CLS. 2, 27, 28 AND 50).

CLASS 25—CLOTHING

FOR SCARVES AND NECKTIES; KERCHIEFS; SWEATSHIRTS, T-SHIRTS, SOCKS, HOSIERY AND SHIRTS; HATS AND CAPS (U.S. CLS. 22 AND 39).
LAURIE MAYES, EXAMINING ATTORNEY

SN 76-623,580. DOSKOCIL MANUFACTURING COMPANY, INC., ARLINGTON, TX. FILED 12-7-2004.

PETMATE POP-UP

THE MARK CONSISTS OF STANDARD CHARACTERS WITHOUT CLAIM TO ANY PARTICULAR FONT, STYLE, SIZE, OR COLOR.

OWNER OF U.S. REG. NOS. 1,371,337, 2,042,829 AND 2,368,076.

NO CLAIM IS MADE TO THE EXCLUSIVE RIGHT TO USE "POP UP", APART FROM THE MARK AS SHOWN.

CLASS 18—LEATHER GOODS

FOR PET CARRIERS (U.S. CLS. 1, 2, 3, 22 AND 41).

CLASS 19—NON-METALLIC BUILDING MATERIALS

FOR PET SHELTERS, NAMELY PREFABRICATED DOG HOUSES (U.S. CLS. 1, 12, 33 AND 50).

CLASS 20—FURNITURE AND ARTICLES NOT OTHERWISE CLASSIFIED

FOR PET KENNELS WITH CARRIERS AND DOG KENNELS (U.S. CLS. 2, 13, 22, 25, 32 AND 50).
BILL DAWE, EXAMINING ATTORNEY

SN 76-624,140. THE NATIONAL RESTAURANT ASSOCIATION EDUCATIONAL FOUNDATION, CHICAGO, IL. FILED 12-13-2004.



OWNER OF U.S. REG. NOS. 1,640,839, 2,208,910 AND OTHERS.

NO CLAIM IS MADE TO THE EXCLUSIVE RIGHT TO USE "ALCOHOL", APART FROM THE MARK AS SHOWN.

CLASS 9—ELECTRICAL AND SCIENTIFIC APPARATUS

FOR PRE-RECORDED MEDIA, NAMELY PRE-RECORDED VIDEOS, CD-ROM'S AND DVD'S FOR THE PURPOSE OF EDUCATION AND TESTING IN THE FIELD OF FOOD AND BEVERAGE SERVICE MANAGEMENT, FOOD AND BEVERAGE HANDLING, AND FOOD AND BEVERAGE SERVICES (U.S. CLS. 21, 23, 26, 36 AND 38).

CLASS 16—PAPER GOODS AND PRINTED MATTER

FOR BOOKLETS, MANUALS, BOOKS AND MAGAZINES FOR THE PURPOSE OF EDUCATION AND TESTING IN THE FIELD OF FOOD AND BEVERAGE SERVICE MANAGEMENT, FOOD AND BEVERAGE HANDLING, AND FOOD AND BEVERAGE SERVICE (U.S. CLS. 2, 5, 22, 23, 29, 37, 38 AND 50).

CLASS 41—EDUCATION AND ENTERTAINMENT

FOR EDUCATIONAL AND TESTING SERVICES, NAMELY CERTIFICATION SEMINARS AND COURSES AND PROVIDING RELATED STUDENT EVALUATIONS IN THE FIELD OF FOOD AND BEVERAGE SERVICE MANAGEMENT, FOOD AND BEVERAGE HANDLING, AND FOOD AND BEVERAGE SERVICE (U.S. CLS. 100, 101 AND 107).

GEORGIA CARTY, EXAMINING ATTORNEY

SN 76-624,155. MILLENNIUM THOROUGHBREDS, INC., AUSTIN, TX. FILED 12-13-2004.

MILLENNIUM STALLIONS

THE MARK CONSISTS OF STANDARD CHARACTERS WITHOUT CLAIM TO ANY PARTICULAR FONT, STYLE, SIZE, OR COLOR.

OWNER OF U.S. REG. NO. 2,933,882.

NO CLAIM IS MADE TO THE EXCLUSIVE RIGHT TO USE "STALLIONS", APART FROM THE MARK AS SHOWN.

CLASS 41—EDUCATION AND ENTERTAINMENT

FOR ENTERTAINMENT SERVICES, NAMELY, CONDUCTING HORSE RACES; RACING OF HORSES FOR OTHERS (U.S. CLS. 100, 101 AND 107).

CLASS 44—MEDICAL, BEAUTY AND AGRICULTURAL SERVICES

FOR HORSE FARMS, NAMELY, BOARDING AND CARING FOR HORSES; HORSE BREEDING AND STUD SERVICES (U.S. CLS. 100 AND 101).

DARRYL SPRUILL, EXAMINING ATTORNEY

SN 76-625,358. ROSALIND FRANKLIN UNIVERSITY OF MEDICINE AND SCIENCE, NORTH CHICAGO, IL. FILED 12-21-2004.



NO CLAIM IS MADE TO THE EXCLUSIVE RIGHT TO USE "UNIVERSITY OF MEDICINE AND SCIENCE, EST 1912", APART FROM THE MARK AS SHOWN.

THE NAME ROSALIND FRANKLIN DOES NOT IDENTIFY A LIVING INDIVIDUAL.

THE COLORS, RED, ORANGE, BLUE, GREEN, AND BLACK, ARE CLAIMED AS FEATURES OF THE MARK.

THE COLORS, RED, ORANGE, BLUE, AND GREEN, APPEAR IN THE CENTRAL PORTION OF THE MARK. THE BALANCE OF THE MARK APPEARS IN BLACK.

THE WORDING "VITA IN INVENTIONE" TRANSLATES INTO ENGLISH AS "LIFE IN DISCOVERY".

CLASS 41—EDUCATION AND ENTERTAINMENT

FOR EDUCATIONAL SERVICES, NAMELY, CONDUCTING UNDERGRADUATE, GRADUATE, POST-GRADUATE, AND PATIENT EDUCATION CLASSES, SEMINARS, AND WORKSHOPS IN THE FIELDS OF MEDICINE, NUTRITION, PATHOLOGY, PHYSICAL THERAPY, PODIATRY, PHYSICIAN ASSISTANCE, CLINICAL LABORATORY SCIENCES, AND BASIC BIO-MEDICAL SCIENCES (U.S. CLS. 100, 101 AND 107).

FIRST USE 3-1-2004; IN COMMERCE 3-1-2004.

CLASS 42—SCIENTIFIC, COMPUTER AND LEGAL SERVICES

FOR RESEARCH SERVICES IN THE FIELDS OF MEDICINE, NUTRITION, PATHOLOGY, PHYSICAL THERAPY, PODIATRY, PHYSICIAN ASSISTANCE, CLINICAL LABORATORY SCIENCES, AND BASIC BIO-MEDICAL SCIENCES (U.S. CLS. 100 AND 101).

FIRST USE 3-1-2004; IN COMMERCE 3-1-2004.

CLASS 44—MEDICAL, BEAUTY AND AGRICULTURAL SERVICES

FOR DIETARY AND NUTRITIONAL GUIDANCE; FOOD NUTRITION CONSULTATION; HEALTH CARE; MAINTAINING FILES AND RECORDS CONCERNING THE MEDICAL CONDITION OF INDIVIDUALS; MEDICAL CLINICS; MEDICAL CONSULTATIONS; MEDICAL EVALUATION SERVICES; MEDICAL IMAGING SERVICES; MEDICAL SERVICES; MEDICAL TESTING; NURSING CARE; NUTRITION COUNSELING; PHYSICAL THERAPY; PHYSICIAN'S SERVICES; PROVIDING HEALTH INFORMATION; PROVIDING MEDICAL INFORMATION; SURGERY; AND X-RAY TECHNICIAN SERVICES (U.S. CLS. 100 AND 101).

FIRST USE 3-1-2004; IN COMMERCE 3-1-2004.
RICHARD A. STRASER, EXAMINING ATTORNEY

SN 76-625,837. MACLAREN, DAVID S., CLEVELAND, OH. FILED 12-27-2004.



OWNER OF U.S. REG. NO. 1,982,792.

CLASS 1—CHEMICALS

FOR SUBMERGED ATTACHED GROWTH MEDIA FOR PROCESSING ORGANIC WASTE WATER, GASES, SLURRIES OR OTHER LIQUIDS (U.S. CLS. 1, 5, 6, 10, 26 AND 46).

FIRST USE 4-20-1993; IN COMMERCE 4-20-1993.

CLASS 11—ENVIRONMENTAL CONTROL APPARATUS

FOR SEWAGE TREATMENT AND DISPOSAL PLANTS (U.S. CLS. 13, 21, 23, 31 AND 34).

FIRST USE 4-20-1993; IN COMMERCE 4-20-1993.
RICHARD A. STRASER, EXAMINING ATTORNEY

SN 76-626,106. CONROW COMPANY L.L.C., ADDISON, TX. FILED 12-29-2004.



NO CLAIM IS MADE TO THE EXCLUSIVE RIGHT TO USE "COMPANY" AND "REAL ESTATE & FINANCIAL SERVICES", APART FROM THE MARK AS SHOWN.

CLASS 36—INSURANCE AND FINANCIAL

FOR REAL ESTATE SERVICES, NAMELY, LEASING OF REAL ESTATE, REAL ESTATE BROKERAGE SERVICES, REAL ESTATE FINANCING SERVICES, REAL ESTATE CONSULTATION SERVICES, REAL ESTATE INVESTMENT SERVICES, REAL ESTATE MANAGEMENT SERVICES, REAL ESTATE ACQUISITION SERVICES (U.S. CLS. 100, 101 AND 102).

FIRST USE 8-20-2004; IN COMMERCE 8-20-2004.

CLASS 37—CONSTRUCTION AND REPAIR

FOR REAL ESTATE SITE SELECTION SERVICES AND REAL ESTATE DEVELOPMENT SERVICES (U.S. CLS. 100, 103 AND 106).

FIRST USE 8-20-2004; IN COMMERCE 8-20-2004.
BRENDAN MCCAULEY, EXAMINING ATTORNEY

SN 76-626,107. CONROW COMPANY L.L.C., ADDISON, TX. FILED 12-29-2004.



NO CLAIM IS MADE TO THE EXCLUSIVE RIGHT TO USE "COMPANY" AND "REAL ESTATE & FINANCIAL SERVICES", APART FROM THE MARK AS SHOWN.

CLASS 36—INSURANCE AND FINANCIAL

FOR REAL ESTATE SERVICES, NAMELY, LEASING OF REAL ESTATE, REAL ESTATE BROKERAGE SERVICES, REAL ESTATE FINANCING SERVICES, REAL ESTATE CONSULTATION SERVICES, REAL ESTATE INVESTMENT SERVICES, REAL ESTATE MANAGEMENT SERVICES, REAL ESTATE ACQUISITION SERVICES (U.S. CLS. 100, 101 AND 102).

FIRST USE 8-20-2004; IN COMMERCE 8-20-2004.

CLASS 37—CONSTRUCTION AND REPAIR

FOR REAL ESTATE SITE SELECTION SERVICES AND REAL ESTATE DEVELOPMENT SERVICES (U.S. CLS. 100, 103 AND 106).

FIRST USE 8-20-2004; IN COMMERCE 8-20-2004.
BRENDAN MCCAULEY, EXAMINING ATTORNEY

SN 76-626,229. MUNSON, RANDALL D., ROCHESTER, MN. FILED 12-27-2004.

BUSINESS MAGIC

THE MARK CONSISTS OF STANDARD CHARACTERS WITHOUT CLAIM TO ANY PARTICULAR FONT, STYLE, SIZE, OR COLOR.

NO CLAIM IS MADE TO THE EXCLUSIVE RIGHT TO USE "BUSINESS", APART FROM THE MARK AS SHOWN.

CLASS 9—ELECTRICAL AND SCIENTIFIC APPARATUS

FOR VIDEO AND AUDIO RECORDINGS ON THE SUBJECTS OF HUMOR, CREATIVITY, CHANGE MANAGEMENT, SALES, MARKETING, PROFESSIONAL DEVELOPMENT AND COMPUTER TECHNOLOGY (U.S. CLS. 21, 23, 26, 36 AND 38).

CLASS 16—PAPER GOODS AND PRINTED MATTER

FOR PRINTED MATERIALS, NAMELY, NEWSLETTERS, BOOKS, MAGAZINES, BROCHURES, AND BOOKLETS, IN THE FIELDS OF HUMOR, CREATIVITY, CHANGE MANAGEMENT, SALES, MARKETING, PROFESSIONAL DEVELOPMENT AND COMPUTER TECHNOLOGY (U.S. CLS. 2, 5, 22, 23, 29, 37, 38 AND 50).

CLASS 35—ADVERTISING AND BUSINESS

FOR BUSINESS CONSULTING IN THE FIELDS OF HUMOR, CREATIVITY, CHANGE MANAGEMENT, SALES, MARKETING, PROFESSIONAL DEVELOPMENT AND COMPUTER TECHNOLOGY (U.S. CLS. 100, 101 AND 102).

CLASS 41—EDUCATION AND ENTERTAINMENT

FOR EDUCATIONAL TRAINING AND EDUCATIONAL SERVICES IN THE NATURE OF SEMINARS AND WORKSHOPS, AND ENTERTAINMENT IN THE NATURE OF LIVE PERFORMANCES BY TEACHERS, INSTRUCTORS, MAGICIANS, COMEDIANS, MIMES, CLOWNS, AND VENTRILOQUISTS, ON THE SUBJECTS OF HUMOR, CREATIVITY, CHANGE MANAGEMENT, SALES, MARKETING, PROFESSIONAL DEVELOPMENT AND COMPUTER TECHNOLOGY (U.S. CLS. 100, 101 AND 107).

BARBARA A. GOLD, EXAMINING ATTORNEY

SN 76-626,393. PONZIO, FRANK J. JR., MANTOLOKING, NJ.
FILED 12-28-2004.

WHO KNOWS THE DATA

THE MARK CONSISTS OF STANDARD CHARACTERS WITHOUT CLAIM TO ANY PARTICULAR FONT, STYLE, SIZE, OR COLOR.

CLASS 41—EDUCATION AND ENTERTAINMENT

FOR EDUCATION TRAINING SERVICES IN THE FIELD OF COMMUNICATION AND COMPUTER TECHNOLOGIES (U.S. CLS. 100, 101 AND 107).

FIRST USE 12-21-2004; IN COMMERCE 12-21-2004.

CLASS 42—SCIENTIFIC, COMPUTER AND LEGAL SERVICES

FOR CONSULTING SERVICES IN THE FIELD OF DESIGN, SELECTION, IMPLEMENTATION AND USE OF COMPUTER HARDWARE AND SOFTWARE SYSTEMS FOR OTHERS (U.S. CLS. 100 AND 101).

FIRST USE 12-21-2004; IN COMMERCE 12-21-2004.
NICHOLAS ALTREE, EXAMINING ATTORNEY

SN 76-627,858. HYDROTECH, INC., CINCINNATI, OH.
FILED 1-13-2005.

ULTRA-LINK

THE MARK CONSISTS OF STANDARD CHARACTERS WITHOUT CLAIM TO ANY PARTICULAR FONT, STYLE, SIZE, OR COLOR.

CLASS 7—MACHINERY

FOR PROGRAMMABLE LUBRICATION SYSTEM COMPRISED OF RESERVOIR, PUMPS, DISTRIBUTION LINES, VALVES, PRESSURE REGULATORS, HOSES, SENSORS, DISPENSING NOZZLES AND NECESSARY BRACKETS FOR METERING LUBRICANTS TO COMPONENTS OF INDUSTRIAL MACHINERY (U.S. CLS. 13, 19, 21, 23, 31, 34 AND 35).

CLASS 9—ELECTRICAL AND SCIENTIFIC APPARATUS

FOR COMPUTER HARDWARE USED IN A PROGRAMMABLE LUBRICATION SYSTEM; COMPUTER HARDWARE FOR CONTROL, SUPERVISION AND REMOTE MANAGEMENT OF EQUIPMENT USED IN A PROGRAMMABLE LUBRICATION SYSTEM; SOFTWARE FOR USE IN MANAGING AND MONITORING A PROGRAMMABLE LUBRICATION SYSTEM (U.S. CLS. 21, 23, 26, 36 AND 38).

SALLY SHIH, EXAMINING ATTORNEY

SN 76-631,536. MURTAUGH, JEANNE L., GREENSBORO, NC. FILED 2-18-2005.

DRIVERS THAT CARE

THE MARK CONSISTS OF STANDARD CHARACTERS WITHOUT CLAIM TO ANY PARTICULAR FONT, STYLE, SIZE, OR COLOR.

CLASS 14—JEWELRY

FOR WATCHES; JEWELRY, NAMELY LAPEL PINS, CHARMS, PENDANTS, BROACHES, BRACELETS, NECKLACES, EARRINGS, TIE FASTENERS, TIE CLASPS AND WATCH BANDS (U.S. CLS. 2, 27, 28 AND 50).

CLASS 25—CLOTHING

FOR SCARVES AND NECKTIES; KERCHIEFS; SWEATSHIRTS, T-SHIRTS, SOCKS, HOSIERY AND SHIRTS; HATS AND CAPS (U.S. CLS. 22 AND 39).

LAURIE MAYES, EXAMINING ATTORNEY

SN 76-639,057. ADVANCE MAGAZINE PUBLISHERS INC.,
NEW YORK, NY. FILED 5-17-2005.

GOLF DIGEST

THE MARK CONSISTS OF STANDARD CHARACTERS WITHOUT CLAIM TO ANY PARTICULAR FONT, STYLE, SIZE, OR COLOR.

OWNER OF U.S. REG. NOS. 781,433, 2,897,773 AND OTHERS.

NO CLAIM IS MADE TO THE EXCLUSIVE RIGHT TO USE "GOLF", APART FROM THE MARK AS SHOWN.

CLASS 35—ADVERTISING AND BUSINESS

FOR RETAIL STORE SERVICES FEATURING ITEMS OF INTEREST TO GOLFERS, APPAREL AND SPORTING GOODS; ONLINE RETAIL STORE SERVICES FEATURING ITEMS OF INTEREST TO GOLFERS, APPAREL AND SPORTING GOODS (U.S. CLS. 100, 101 AND 102).

CLASS 43—HOTEL AND RESTAURANT SERVICES

FOR CATERING FOR PROVISION OF FOOD AND DRINK, RESTAURANT AND CATERING SERVICES, BAR, AND CAFÉ SERVICES (U.S. CLS. 100 AND 101).
ANNE FARRELL, EXAMINING ATTORNEY

SN 76-976,257. DEUTSCHE TELEKOM AG, 53113 BONN,
FED REP GERMANY, FILED 8-2-2000.

T · · Gate ·

PRIORITY CLAIMED UNDER SEC. 44(D) ON FED REP GERMANY APPLICATION NO. 30007443.3/3, FILED 2-2-2000, REG. NO. 30007443, DATED 3-23-2000, EXPIRES 2-28-2010.

THE LETTER T ON THE DRAWING IS THE COLOR MAGENTA. THE DESIGN PORTION CONSISTING OF FIVE BOXES AND THE WORD GATE ON THE DRAWING ARE THE COLOR GRAY.

THE COLOR(S) GRAY AND MAGENTA IS/ARE CLAIMED AS A FEATURE OF THE MARK.

CLASS 9—ELECTRICAL AND SCIENTIFIC APPARATUS

FOR ELECTRIC, ELECTRONIC, OPTICAL, MEASURING, SIGNALING, CONTROLLING OR TEACHING APPARATUS AND INSTRUMENTS, ALL FOR USE WITH TELECOMMUNICATIONS, NAMELY, APPARATUS FOR PRODUCING SOUND, IMAGES OR DATA, MAGNETIC AND OPTICAL DATA CARRIERS, DATA PROCESSORS AND COMPUTERS, NAMELY, MICROCOMPUTERS, MINICOMPUTERS, COMPUTER CENTRAL PROCESSORS, COMPUTER MONITORS, COMPUTER KEYBOARDS, COMPUTER TERMINALS, COMPUTER INTERFACE BOARDS, COMPUTER MEMORIES, COMPUTER LASER PRINTERS, COMPUTER IMPACT PRINTERS, COMPUTER DOT MATRIX PRINTERS, COMPUTER OPERATING SYSTEMS, COMPUTERS AND INSTRUCTIONAL MANUALS SOLD AS A UNIT, COMPUTER INTERFACE APPARATUS, NAMELY, COMPUTER MODEMS, COMPUTER MOUSE AND MOUSE PAD, COMPUTER PERIPHERALS AND PARTS THEREOF COMPUTER PROGRAMS AND DATA

BASES FOR USE IN OPERATING TELECOMMUNICATIONS AND BUSINESS MANAGEMENT SYSTEMS AND RELATED INSTRUCTION MANUALS SOLD AS A UNIT; OPTICAL CABLES, OPTIC FILTERS, OPTICAL SCANNERS, OPTICAL CHARACTER READERS, OPTICAL DISCS, OPTICAL FIBERS, OPTICAL GLASS FOR SIGNAL TRANSMISSION, OPTIC TRANSMITTERS, OPTIC RECEIVERS, OPTICAL SIGNAL PROCESSING APPARATUS, OPTIC SWITCHES, OPTICAL NETWORKS COMPRISING COMMUNICATION TRANSMISSION SWITCHING AND RECEPTION APPARATUS, OPTICAL ATTENUATORS, OPTICAL AMPLIFIERS, OPTICAL CHARACTER RECOGNITION APPARATUS, AND PARTS THEREOF; AUDIO, VIDEO AND DATA COMMUNICATIONS SYSTEMS, NAMELY, DIGITAL AND ANALOGUE SIGNAL TRANSMITTERS, RECEIVERS AND CONVERTERS, RADIO AND TELEPHONE TRANSMITTERS, RECEIVERS AND SERVERS, STATIONARY, WIRELESS AND CELLULAR TELEPHONE SYSTEMS AND ANSWERING MACHINES, TELECOMMUNICATION TRANSMISSION, RECEIVING AND STORAGE APPARATUS, TELECOMMUNICATIONS TRANSMITTING SETS, DATA TRANSMITTERS, FACSIMILE MACHINES, ELECTRONIC MAIL APPARATUS FOR ELECTRONIC EXCHANGE OF DATA IMAGES AND MESSAGES, REMOTE CONTROLS AND SET-TOP UNITS, CINEMATOGRAPHIC TELEVISION AND AMUSEMENT EQUIPMENT, NAMELY, SIGNAL DECODERS AND INTERACTIVE AUDIO AND VIDEO EQUIPMENT TO FACILITATE INTERACTION BETWEEN CONSUMERS AND PROVIDERS OF GOODS AND SERVICES, ELECTRICAL WIRE, ELECTRICAL WIRE CONNECTORS, INTEGRATED CIRCUITS, PRINTED CIRCUITS, ELECTRIC CIRCUITS, CIRCUIT BREAKERS, PRINTED CIRCUIT BOARDS, ELECTRIC CIRCUIT BOARDS, CIRCUIT CONNECTORS, ELECTRICAL CONTROLLERS, ELECTRICAL CONVERTERS, ELECTRICAL FUSES, ELECTRIC LUMINESCENT DISPLAY PANELS, ELECTRICAL SWITCH PLATES, ELECTRIC PLUGS, ANTENNAS, ELECTRICAL CABLES, COMPUTER CABLES, COMPUTER CHIPS, SILICON CHIPS, CHRONOGRAPHS FOR USE AS SPECIALIZED TIME RECORDING APPARATUS, ELECTRIC COILS, COMPUTER BUFFERS, BLANK COMPUTER DISCS, BLANK COMPUTER FLOPPY DISKS, COMPUTER HARD DISCS, ELECTRICAL CONDUCTORS, ACOUSTIC CONDUITS, ELECTRICAL CONDUITS, FIBER OPTIC CONDUITS AND PARTS THEREOF; COMPACT DISC PLAYERS, AUDIO AND VIDEO TAPE RECORDERS, AUDIO AND VIDEO TAPE PLAYERS, AUDIO AND VIDEO CASSETTE RECORDERS, AUDIO AND VIDEO CASSETTE PLAYERS, BLANK AUDIO AND VIDEO TAPES, CASSETTES, DISCS AND MICROFICHE; AUDIO AND VIDEO TAPES, CASSETTES, DISCS AND MICROFICHE FEATURING INFORMATION CONCERNING TELECOMMUNICATIONS, PERSONAL AND BUSINESS MANAGEMENT SYSTEMS; VIDEO MONITORS, AUTOMATIC VENDING MACHINES AND TIMING MECHANISMS THEREFOR, AND PARTS THEREOF; DATA PROCESSORS AND READERS, WORD PROCESSORS, MAGNETIC CODED CARD READERS, MAGNETIC CARDS, ELECTRONIC ENCRYPTION UNITS, LASERS, LIGHT EMITTING DIODES, LIGHT EMITTING DIODE DISPLAYS, MICROPROCESSORS, BLANK MAGNETIC DATA CARRIERS, DEMAGNETIZERS FOR MAGNETIC TAPES, AND PARTS THEREOF; COMMUNICATIONS AND VIDEO TRANSMISSION SWITCHING AND RECEPTION APPARATUS; COMPUTER, DATA AND VIDEO NETWORKING AND CONFERENCING EQUIPMENT, NAMELY, TELECONFERENCING EQUIPMENT, AUDIOVISUAL TEACHING EQUIPMENT, OVERHEAD FILM, PHOTOGRAPHIC AND SLIDE PROJECTORS, PROJECTION SCREENS, COMPUTER BASED INFORMATION DISPLAY EQUIPMENT, NAMELY, COMPUTERS WHICH DISPLAY INFORMATION ON AN OVERHEAD SCREEN, INTERCOMS, TELEPHONES, TELEPHONE ANSWERING MACHINES, TELEPHONE TRANSMITTERS, TELEPHONE NETWORKS, TELEPHONE WIRES, TELEPRINTERS, TELETYPEWRITERS, AND PARTS THEREOF, NAMELY, CALLER IDENTIFICATION BOXES, RADIO TELEPHONE EQUIPMENT AND ACCESSORIES, NAMELY, CALL BOXES AND SYSTEMS, DIALING ASSEMBLIES, TELEPHONE UNITS, AUDIO OPERATED RELAYS, SIGNALING DEVICES, RECEIVING DEVICES, TERMINATION EQUIPMENT, FILTERS, PROTECTORS AND AUTOMATIC SIGNALLING AND CONTROL EQUIPMENT, TELEMETERS, WIRELESS AND CELLULAR TELEPHONES, PAGERS, PAGING EQUIPMENT, PORTABLE COMPUTER DEVICES, FAC-

SIMILE TRANSMITTERS AND RECEIVERS, WIRELESS FAX MACHINES, PERSONAL COMMUNICATIONS EQUIPMENT, NAMELY, PERSONAL DIGITAL ASSISTANTS (PDA), CALCULATORS AND RELATED PERIPHERALS; SATELLITE PROCESSORS, SATELLITES AND SATELLITE COMMUNICATION EARTH STATIONS BOTH STATIONARY AND MOVEABLE; BASEBALL BATTING HELMETS; PRERECORDED COMPACT DISCS, AUDIO CASSETTE TAPES, VIDEO CASSETTE TAPES, DIGITAL AUDIO TAPES AND DIGITAL VIDEO DISCS FEATURING MUSICAL, VARIETY, NEWS AND COMEDY SHOWS; AND COMPUTER GAME PROGRAMS FOR CHILDREN AND ADULTS BUT NOT INCLUDING MULTIMEDIA COMPUTER SOFTWARE FOR USE IN COMMUNICATING ON COMPUTER NETWORKS, INCLUDING GLOBAL COMPUTER NETWORKS (U.S. CLS. 21, 23, 26, 36 AND 38).

SN 76-977,598. FIENE, GREGG, MANHATTAN BEACH, CA. FILED 4-5-2004.

YANK

THE MARK CONSISTS OF STANDARD CHARACTERS WITHOUT CLAIM TO ANY PARTICULAR FONT, STYLE, SIZE, OR COLOR.

CLASS 38—COMMUNICATION

FOR PROVIDING MULTIPLE USER ACCESS TO THE INTERNET; PROVIDING INFORMATION VIA THE INTERNET IN THE FIELD OF TELECOMMUNICATIONS; TELECOMMUNICATION SERVICES, NAMELY, ELECTRIC, DIGITAL, CELLULAR AND WIRELESS TRANSMISSION OF VOICE, DATA, INFORMATION, IMAGES, SIGNALS AND MESSAGES; PROVIDING TELECOMMUNICATIONS CONNECTIONS OVER A GLOBAL COMMUNICATIONS NETWORK, ELECTRONIC MAIL, VOICE MAIL AND MESSAGING SERVICES, AUDIO AND VIDEO TELECONFERENCING, RENTAL OF TELECOMMUNICATIONS EQUIPMENT, NAMELY, EQUIPMENT FOR ELECTRONIC ACCESS TO GLOBAL TELECOMMUNICATIONS NETWORK, EQUIPMENT FOR TRANSMITTING, RECEIVING, RECORDING AND MONITORING VOICE, DATA, INFORMATION, IMAGES, SIGNALS, MESSAGES, COMPRISED OF DATA AND WORD PROCESSORS, AND TELECOMMUNICATIONS HARDWARE AND SOFTWARE INCLUDING COMPONENTS AND PERIPHERALS THEREOF FOR USE IN THE TELECOMMUNICATIONS INDUSTRY, AND FOR TRANSMITTING, RECEIVING, RECORDING AND MONITORING COMPUTER PROGRAMS FOR USE IN OPERATING AND ACCESSING TELECOMMUNICATIONS SYSTEMS; AUDIO AND VIDEO BROADCASTING FEATURING ENTERTAINMENT IN THE NATURE OF LIVE VISUAL AND AUDIO PERFORMANCES, AND MUSICAL, VARIETY, NEWS AND COMEDY SHOWS; AND PROVIDING ACCESS TO COMPUTER INFORMATION NETWORKS BUT NOT INCLUDING INSTALLATION OF TELEPHONE AND COMPUTER NETWORKING EQUIPMENT WITH AN ASSOCIATED OPERATING HARDWARE AND SOFTWARE (U.S. CLS. 100, 101 AND 104).

CLASS 3—COSMETICS AND CLEANING PREPARATIONS

FOR COSMETICS AND ALL PURPOSE CLEANING PREPARATIONS (U.S. CLS. 1, 4, 6, 50, 51 AND 52).

CLASS 14—JEWELRY

FOR JEWELRY, NAMELY WATCHES, BRACELETS, EARRINGS, RINGS, NECKLACES, AND PINS (U.S. CLS. 2, 27, 28 AND 50).

CLASS 18—LEATHER GOODS

FOR LEATHER GOODS, NAMELY, PURSES, AND LEATHER ACCESSORIES, NAMELY, WALLETS, BUSINESS, CALLING AND CREDIT CARD CASES AND LUGGAGE (U.S. CLS. 1, 2, 3, 22 AND 41).
PAUL F. GAST, EXAMINING ATTORNEY

SN 76-977,656. FOREST LABORATORIES, INC., NEW YORK, NY. FILED 10-25-2002.



CLASS 42—SCIENTIFIC, COMPUTER AND LEGAL SERVICES

FOR COMPUTER PROGRAMMING FOR OTHERS; RENTAL OF DATA PROCESSING EQUIPMENT; RENTAL OF COMPUTER HARDWARE AND SOFTWARE; DESIGN FOR OTHERS IN THE FIELD OF TELECOMMUNICATIONS EQUIPMENT; CONSULTING IN THE FIELD OF TELECOMMUNICATION, RENTAL OF SOFTWARE; AND HARDWARE FOR ONLINE ACCESS; SERVICES OF AN INTERNET TRUST CENTER, NAMELY ASSURANCE AND ADMINISTRATION OF DIGITAL KEYS AND/OR DIGITAL CERTIFICATES; RENTAL OF DATA PROCESSING EQUIPMENT (U.S. CLS. 100 AND 101).

HOWARD B. LEVINE, EXAMINING ATTORNEY

CLASS 5—PHARMACEUTICALS

FOR PHARMACEUTICAL PREPARATIONS FOR THE TREATMENT OF DEPRESSION, CARDIOVASCULAR DISEASES, HIGH BLOOD PRESSURE, CONGESTIVE HEART FAILURE, DIABETIC NEPHROPATHY, ARTERIOSCLEROSIS, STROKE, POTASSIUM LOSS FROM THE BODY, RESPIRATORY DISORDERS, LUNG FUNCTION AND ASTHMA, THYROID DISORDERS, COUGHS, ARTHRITIS AND MINOR MUSCULAR ACHES AND PAINS; LIQUID BRONCHODILATOR WITH EXPECTORANT ACTION; AEROSOL DELIVERY DEVICES, NAMELY, HOLDING CHAMBERS FOR USE WITH AEROSOL DISPENSING DEVICES (U.S. CLS. 6, 18, 44, 46, 51 AND 52).

FIRST USE 8-10-1994; IN COMMERCE 8-10-1994.

CLASS 16—PAPER GOODS AND PRINTED MATTER

FOR PRINTED MATTER, NAMELY BROCHURES AND PAMPHLETS CONCERNING A WIDE VARIETY OF DISEASES AND DISORDERS AND TREATMENT THEREOF (U.S. CLS. 2, 5, 22, 23, 29, 37, 38 AND 50).

FIRST USE 8-10-1994; IN COMMERCE 8-10-1994.
CURTIS FRENCH, EXAMINING ATTORNEY

SN 78-012,804. CORNFIELD, RANDALL R., COTE SAINT LUC, QUEBEC, CANADA, FILED 6-15-2000.



PRIORITY CLAIMED UNDER SEC. 44(D) ON CANADA APPLICATION NO. 1039626, FILED 12-15-1999, REG. NO. TMA561.994, DATED 5-14-2002, EXPIRES 5-14-2017.

NO CLAIM IS MADE TO THE EXCLUSIVE RIGHT TO USE "CONDIMENTS", APART FROM THE MARK AS SHOWN.

CLASS 29—MEATS AND PROCESSED FOODS

FOR FROZEN PRE-PREPARED MEALS AND FRESH PRE-PREPARED ENTREES CONSISTING PRIMARILY OF MEAT, FISH, POULTRY OR VEGETABLES; CHEESE, SOUPS, JAMS, JELLIES, SOUP MIXES, FRUIT SAUCES, COOKING OILS, POTATO CHIPS AND RAISINS, FROZEN VEGETABLES; CANDIED NUTS; PROCESSED EDIBLE SEEDS; CANDIED FRUIT SNACKS (U.S. CL. 46).

FIRST USE 1-1-2000; IN COMMERCE 1-1-2000.

CLASS 30—STAPLE FOODS

FOR FROZEN PRE-PREPARED MEALS AND FRESH PRE-PREPARED ENTREES CONSISTING PRIMARILY OF PASTA OR RICE; SPICES, MEAT SAUCES, TOMATO SAUCES, MAYONNAISE, MUSTARD AND BARBECUE SAUCE, PACKAGED MIXES NAMELY, CAKE MIX, COOKIE MIX, MUFFIN MIX, PANCAKE MIX, CONDENSED SAUCES NAMELY SPAGHETTI SAUCE, TOMATO SAUCE, CHOCOLATE SAUCE, POPPED POPCORN, CHOCOLATE-COVERED NUTS, PACKAGED FLOUR, PACKAGED COOKIES, TORTILLA CHIPS, PRETZELS, CHOCOLATE BARS, HARD CANDIES, BAGELS, TARTS, AND PACKAGED RICE; GRANOLA-BASED SNACK BARS (U.S. CL. 46).

FLORENTINA BLANDU, EXAMINING ATTORNEY

SN 78-031,291. MCMURTRY, ANDREA S., KANSAS CITY, MO. FILED 10-18-2000.



NO CLAIM IS MADE TO THE EXCLUSIVE RIGHT TO USE "RESOURCE GROUP L.L.C.", APART FROM THE MARK AS SHOWN.

CLASS 41—EDUCATION AND ENTERTAINMENT

FOR COMPUTER EDUCATION TRAINING FOR COMPUTER SOFTWARE BOTH ONSITE AND TO THE PUBLIC; EDUCATIONAL SERVICES, NAMELY CONDUCTING SEMINARS AND WORKSHOPS IN THE FIELD OF COMPUTER EDUCATION FOR TEACHING INSTRUCTORS SO THE INSTRUCTORS MAY TEACH EACH OTHER (U.S. CLS. 100, 101 AND 107).

FIRST USE 4-24-1998; IN COMMERCE 4-24-1998.

CLASS 42—SCIENTIFIC, COMPUTER AND LEGAL SERVICES

FOR COMPUTER PROGRAMMING FOR OTHERS AND COMPUTER SOFTWARE DESIGN FOR OTHERS USING VARIOUS SOFTWARE APPLICATIONS (U.S. CLS. 100 AND 101).

FIRST USE 4-24-1998; IN COMMERCE 4-24-1998.
MICHAEL ENGEL, EXAMINING ATTORNEY

SN 78-040,400. SNECMA MOTEURS SOCIETE ANONYME, PARIS, FRANCE, FILED 12-22-2000.

PPS

PRIORITY CLAIMED UNDER SEC. 44(D) ON FRANCE APPLICATION NO. 3040419, FILED 7-12-2000, REG. NO. 3040419, DATED 7-12-2000, EXPIRES 7-12-2010.

CLASS 7—MACHINERY

FOR POWER TOOLS FOR SURFACE TREATMENT, NAMELY, FLAME SPRAYING MACHINES, PLASMA SPRAYING MACHINES, THERMAL SPRAY COATING MACHINES, AND PLASMA ELECTRIC ARC SPRAYING MACHINES; MOTORS NOT FOR LAND VEHICLES, NAMELY, MOTORS FOR SPACE VEHICLES AND SATELLITES, NAMELY, PLASMA MOTORS, IONIC MOTORS, MAGNETO PLASMA DYNAMIC MOTORS, ARC JETS; AND STRUCTURAL AND REPLACEMENT PARTS FOR THE AFORESAID GOODS (U.S. CLS. 13, 19, 21, 23, 31, 34 AND 35).

CLASS 9—ELECTRICAL AND SCIENTIFIC APPARATUS

FOR SATELLITES (U.S. CLS. 21, 23, 26, 36 AND 38).

CLASS 12—VEHICLES

FOR PLASMA PROPULSION SYSTEMS COMPOSED OF IONIC THRUSTERS, ELECTRIC THRUSTERS AND PLASMA ROCKET THRUSTERS FOR PROPULSION AND ORBIT CONTROL OF GEOSTATIONARY AND CONSTELLATION SATELLITES AND SPACE VEHICLES, AND STRUCTURAL AND REPLACEMENT PARTS THEREFOR (U.S. CLS. 19, 21, 23, 31, 35 AND 44).

CLASS 40—MATERIAL TREATMENT

FOR TREATMENT OF MATERIALS, NAMELY, THERMAL TREATMENTS OF METALS AND METALLIC ALLOYS (U.S. CLS. 100, 103 AND 106).

LEIGH LOWRY, EXAMINING ATTORNEY

SN 78-119,879. ROYAL APPLIANCE MFG. CO., GLENWILLOW, OH. FILED 4-5-2002.

CARPET CPR

NO CLAIM IS MADE TO THE EXCLUSIVE RIGHT TO USE "CARPET", APART FROM THE MARK AS SHOWN.

CLASS 3—COSMETICS AND CLEANING PREPARATIONS

FOR CARPET CLEANING PREPARATIONS (U.S. CLS. 1, 4, 6, 50, 51 AND 52).

CLASS 7—MACHINERY

FOR BATTERY POWERED SPRAYERS FOR DISPENSING CARPET CLEANING PREPARATIONS (U.S. CLS. 13, 19, 21, 23, 31, 34 AND 35).

FLORENTINA BLANDU, EXAMINING ATTORNEY

SN 78-128,987. DIRECT ENERGY MARKETING LIMITED, NORTH YORK ONTARIO, CANADA, FILED 5-15-2002.

DIRECT ENERGY ESSENTIAL HOME SERVICES

PRIORITY CLAIMED UNDER SEC. 44(D) ON CANADA APPLICATION NO. 1135867, FILED 3-28-2002, REG. NO. TMA625697, DATED 11-17-2004, EXPIRES 11-17-2019.

NO CLAIM IS MADE TO THE EXCLUSIVE RIGHT TO USE "ENERGY" AND "HOME SERVICES", APART FROM THE MARK AS SHOWN.

CLASS 35—ADVERTISING AND BUSINESS

FOR RETAIL STORE SERVICES FEATURING HOUSEHOLD APPLIANCES, NAMELY, OVENS, RANGES, REFRIGERATORS, FREEZERS, MICROWAVE OVENS, DISHWASHERS, CLOTHES WASHERS, CLOTHES DRYERS, FIREPLACES, HEATERS, GAS LAMPS, AIR CONDITIONERS, HUMIDIFIERS, DEHUMIDIFIERS, FURNACES, WATER HEATERS, BARBEQUES, AIR CLEANERS AND FIREPLACES (U.S. CLS. 100, 101 AND 102).

CLASS 36—INSURANCE AND FINANCIAL

FOR FINANCING OF HOME AND COMMERCIAL APPLIANCES AND EQUIPMENT (U.S. CLS. 100, 101 AND 102).

CLASS 37—CONSTRUCTION AND REPAIR

FOR HOME MAINTENANCE AND REPAIR SERVICES; INSTALLATION, REPAIR AND MAINTENANCE OF ALL AIR HEATING, AIR CONDITIONING AND VENTILATION SYSTEMS AND ALL COMPONENTS THEREOF; INSTALLATION, MAINTENANCE OF HOME AND BUSINESS SECURITY SYSTEMS; INSTALLATION AND REPAIR OF HOME AND COMMERCIAL APPLIANCES; PLUMBING SERVICES, NAMELY, PROVIDING REPAIR AND SUPPORT SERVICES FOR PLUMBING AND DRAINS; INSTALLATION OF WIRING AND CABLING IN RESIDENTIAL AND COMMERCIAL PREMISES; RENTAL AND LEASING OF CLOTHES WASHING MACHINES, CLOTHES DRYERS, AND DISHWASHERS (U.S. CLS. 100, 103 AND 106).

CLASS 38—COMMUNICATION

FOR TELECOMMUNICATION, COMMUNICATION AND INTERNET SERVICES, NAMELY, TELEPHONE VOICE MESSAGING SERVICES, LONG DISTANCE TELEPHONE COMMUNICATION SERVICES, FACSIMILE TRANSMISSION AND RETRIEVAL; PROVIDING INTERNET ACCESS; PROVIDING MULTIPLE USER DIAL-UP AND DEDICATED ACCESS TO THE INTERNET (U.S. CLS. 100, 101 AND 104).

CLASS 39—TRANSPORTATION AND STORAGE

FOR PUBLIC UTILITY SERVICES IN THE NATURE OF ELECTRICITY AND NATURAL GAS; RENTAL OF REFRIGERATOR AND FREEZERS FOR HOUSEHOLD PURPOSES (U.S. CLS. 100 AND 105).

CLASS 40—MATERIAL TREATMENT

FOR RENTAL AND LEASING OF FIREPLACES, ELECTRIC AND GAS HEATERS, GAS LAMPS, AIR CONDITIONERS, HUMIDIFIERS, DEHUMIDIFIERS, FURNACES, HOT WATER HEATERS, HOUSEHOLD AND COMMERCIAL AIR CLEANERS; RENTAL AND LEASING SERVICES, NAMELY, THE RENTAL AND LEASING OF HOME AND COMMERCIAL APPLIANCES, NAMELY, DOMESTIC COOKING AND CONVECTION OVENS, GAS AND ELECTRIC RANGES, BARBEQUES, AND MICROWAVE OVENS FOR COOKING (U.S. CLS. 100, 103 AND 106).

CLASS 42—SCIENTIFIC, COMPUTER AND LEGAL SERVICES

FOR ARCHITECTURAL, ENGINEERING AND CONSTRUCTION DESIGN SERVICES FOR RESIDENTIAL AND COMMERCIAL PREMISES TO OPTIMIZE ENERGY CONSERVATION IN THE USE OF HEATING, AIR CONDITIONING, LIGHTING, INSULATION AND APPLIANCES (U.S. CLS. 100 AND 101).

CLASS 45—PERSONAL SERVICES

FOR AUTOMATION SERVICES, NAMELY, MONITORING HOME AND BUSINESS SECURITY SYSTEMS BY UTILIZING WIRELESS, TELEPHONIC, ELECTRIC AND WEB MONITORING TECHNOLOGIES THAT ALLOW REMOTE OR AUTOMATED CONTROL OF APPLIANCES, LIGHTING, SECURITY EQUIPMENT, HEATING AND COOLING SYSTEMS (U.S. CLS. 100 AND 101).

CHERYL CLAYTON, EXAMINING ATTORNEY

SN 78-138,806. AUTOBYTEL INC., IRVINE, CA. FILED 6-25-2002.



THE COLOR(S) RED, GRAY, RED/PINK AND RED/ORANGE IS/ARE CLAIMED AS A FEATURE OF THE MARK.

THE MARK CONSISTS OF A GRAPHIC ILLUSTRATION OF A STYLIZED VEHICLE DRIVING THROUGH A RESIDENTIAL NEIGHBORHOOD, ALL IN BLACK AND WHITE EXCEPT THE CAR, THE WAGON AND SKATEBOARD, THE STREET SIGN AND ONE ROOFTOP ARE RED, THE DOORS ARE LIGHT RED/PINK, THE SHRUBS ARE GREY, AND THE 2ND ROOFTOP IS RED/ORANGE.

CLASS 35—ADVERTISING AND BUSINESS

FOR PUBLIC RELATION SERVICES RELATING TO TRAFFIC SAFETY, DRIVING HABITS AND NEIGHBORHOOD SAFETY CONCERNS, AND PROMOTING PUBLIC AWARENESS OF THE NEED FOR TRAFFIC SAFETY, DRIVING HABITS AND NEIGHBORHOOD SAFETY CONCERNS, AND PRINTED MATERIALS, DECALS, STICKERS, VIDEO TAPES AND SIGNAGE DISTRIBUTED IN CONNECTION THEREWITH (U.S. CLS. 100, 101 AND 102).

FIRST USE 4-29-2000; IN COMMERCE 4-29-2000.

CLASS 41—EDUCATION AND ENTERTAINMENT

FOR EDUCATIONAL SERVICES, NAMELY CONDUCTING PROGRAMS IN THE FIELD OF TRAFFIC SAFETY, DRIVING HABITS AND NEIGHBORHOOD SAFETY CONCERNS, AND PRINTED MATERIALS, DECALS, STICKERS, VIDEO TAPES AND SIGNAGE DISTRIBUTED IN CONNECTION THEREWITH (U.S. CLS. 100, 101 AND 107).

FIRST USE 4-29-2002; IN COMMERCE 4-29-2002.

HOWARD SMIGA, EXAMINING ATTORNEY

SN 78-153,742. DEUTSCHE TELEKOM AG, BONN, FED REP GERMANY, FILED 8-13-2002.

T-FINANCE

THE MARK CONSISTS OF STANDARD CHARACTERS WITHOUT CLAIM TO ANY PARTICULAR FONT, STYLE, SIZE, OR COLOR.

PRIORITY CLAIMED UNDER SEC. 44(D) ON FED REP GERMANY APPLICATION NO. 30207456.2, FILED 2-14-2002, REG. NO. 30207456, DATED 4-12-2002, EXPIRES 2-29-2012. OWNER OF U.S. REG. NOS. 2,156,145, 2,694,550 AND OTHERS.

NO CLAIM IS MADE TO THE EXCLUSIVE RIGHT TO USE "FINANCE", APART FROM THE MARK AS SHOWN.

CLASS 9—ELECTRICAL AND SCIENTIFIC APPARATUS

FOR ELECTRIC, ELECTRONIC, OPTICAL, MEASURING, SIGNALING, CONTROLLING AND TEACHING APPARATUS AND INSTRUMENTS, ALL FOR USE WITH TELECOMMUNICATIONS, NAMELY, APPARATUS FOR PRODUCING SOUND, IMAGES AND DATA; BLANK MAGNETIC DATA CARRIERS; DATA PROCESSORS; COMPUTER PROGRAMS FOR USE IN OPERATING TELECOMMUNICATIONS AND BUSINESS MANAGEMENT SYSTEMS AND RELATED INSTRUCTION MANUALS SOLD AS A UNIT; COMPUTER PROGRAMS, NAMELY, FINANCIAL ACCOUNTING SYSTEM SOFTWARE, SOFTWARE USED FOR THE PROVISION OF ONLINE INFORMATION SERVICES, NETWORK MANAGEMENT SOFTWARE, COMPUTER PROXY SOFTWARE FOR USE WITH OTHER SOFTWARE PROGRAMS, ALARM MONITORING SOFTWARE, BILLING ANALYSIS SOFTWARE, SOFTWARE FOR NETWORK ACCESS CONTROL AND SOFTWARE FOR CREATING AND MAINTAINING FIREWALLS; COMPUTER PROGRAMS FOR ACCESSING A GLOBAL COMPUTER NETWORK AND INTERACTIVE COMPUTER COMMUNICATIONS NETWORK; FIBER OPTICS, NAMELY, OPTICAL CABLES, OPTIC FILTERS, OPTICAL SCANNERS, OPTICAL CHARACTER READERS, BLANK OPTICAL DISCS, OPTICAL FIBERS, OPTICAL GLASS FOR SIGNAL TRANSMISSION, OPTIC TRANSMITTERS, OPTICAL SIGNAL PROCESSING APPARATUS, OPTIC SWITCHES, OPTICAL ATTENUATORS, OPTICAL AMPLIFIERS, OPTICAL CHARACTER RECOGNITION APPARATUS; ELECTRONIC AND OPTICAL COMMUNICATIONS INSTRUMENTS AND COMPONENTS, NAMELY, OPTICAL RECEIVERS; AUDIO, VIDEO AND DATA COMMUNICATIONS SYSTEMS, NAMELY, DIGITAL AND ANALOGUE SIGNAL TRANSMITTERS, RECEIVERS, FREQUENCY CONVERTERS, AND TV AND VIDEO CONVERTERS, RADIO AND TELEPHONE TRANSMITTERS, RECEIVERS, RECEIVERS AND COMMUNICATIONS SERVERS, ANSWERING MACHINES, TELECOMMUNICATION TRANSMISSION; RECEIVING AND STORAGE APPARATUS, NAMELY, TELEPHONE SETS, DATA TRANSMITTERS, FACSIMILE MACHINES, ELECTRONIC MAIL APPARATUS FOR ELECTRONIC EXCHANGE OF DATA IMAGES AND MESSAGES, REMOTE CONTROLS AND SET-TOP UNITS FOR TELEVISION, CINEMATOGRAPHIC TELEVISION AND AMUSEMENT EQUIPMENT, NAMELY, SIGNAL DECODERS, ELECTRICAL WIRE, ELECTRICAL WIRE CONNECTORS, INTEGRATED CIRCUITS, PRINTED CIRCUITS, ELECTRIC CIRCUITS, CIRCUIT BREAKERS, PRINTED CIRCUIT BOARDS, ELECTRIC CIRCUIT BOARDS, CIRCUIT CONNECTORS, ELECTRICAL CONTROLLERS, ELECTRICAL CONVERTERS, ELECTRICAL FUSES, ELECTRIC LUMINESCENT DISPLAY PANELS, ELECTRICAL SWITCH PLATES, ELECTRIC PLUGS, ANTENNAS, ELECTRICAL CABLES, COMPUTER CABLES, COMPUTER CHIPS, SILICON CHIPS, CHRONOGRAPHS FOR USE AS SPECIALIZED TIME RECORDING APPARATUS, ELECTRIC COILS, COMPUTER BUFFERS, BLANK COMPUTER DISCS, BLANK COMPUTER FLOPPY DISKS AND COMPUTER HARD DISCS, ELECTRICAL CONDUCTORS, ACOUSTIC CONDUITS, ELECTRICAL CONDUITS, FIBER OPTIC CONDUITS; COMPACT DISC PLAYERS, AUDIO AND VIDEO TAPE RECORDERS, AUDIO AND VIDEO TAPE PLAYERS, AUDIO AND VIDEO CASSETTE RECORDERS, AUDIO AND VIDEO CASSETTE PLAYERS, BLANK AUDIO AND VIDEO TAPES, CASSETTES, DISCS AND MICROFICHE; AUDIO AND VIDEO TAPES, CASSETTES, DISCS AND MICROFICHE FEATURING INFORMATION CONCERNING TELECOMMUNICATIONS AND CONCERNING PERSONAL AND BUSINESS MANAGEMENT SYSTEMS; AUDIO AND VIDEO RECORDINGS IN THE FIELD OF TELECOMMUNICATIONS, INFORMATION TECHNOLOGY; TELEVISION AND TELEVISION PERIPHERAL EQUIPMENT, NAMELY CAMERAS, SET BOXES, REMOTE CONTROL UNITS FOR INTERACTIVE AND NON-INTERACTIVE USE; COMPUTER MEMORY, COMPUTER PERIPHERALS AND MODEMS; VIDEO MONITORS, AUTOMATIC VENDING MACHINES AND TIMING MECHANISMS THEREFOR; MACHINE READABLE, MAGNETICALLY ENCODED CARDS, NAMELY, PREPAID TELEPHONE CALLING CARDS, CREDIT CARDS AND SMART CARDS; DATA PROCESSORS AND READERS, WORD PROCESSORS, MAGNETIC CODED CARD READERS, MAGNETIC CODED CARDS,

ELECTRONIC ENCRYPTION UNITS, LASERS NOT FOR MEDICAL USE, LIGHT EMITTING DIODES, LIGHT EMITTING DIODE DISPLAYS, MICROPROCESSORS, BLANK DATA CARRIERS, DEMAGNETIZERS FOR MAGNETIC TAPES; TELECONFERENCING EQUIPMENT AND AUDIOVISUAL TEACHING EQUIPMENT IN THE NATURE OF OVERHEAD FILM, PHOTOGRAPHIC AND SLIDE PROJECTORS, PROJECTION SCREENS, COMPUTER BASED INFORMATION DISPLAY EQUIPMENT, NAMELY, COMPUTERS WHICH DISPLAY INFORMATION ON AN OVERHEAD SCREEN, INTERCOMS; TELEPHONES, TELEPHONE ANSWERING MACHINES, TELEPHONE TRANSMITTERS, TELEPHONE NETWORKS, TELEPHONE WIRES, TELEPRINTERS, TELETYPEWRITERS, NAMELY, CALLER IDENTIFICATION BOXES, DIALING ASSEMBLIES, TELEPHONE UNITS, AUDIO OPERATED RELAYS; AUDIO/VIDEO SIGNAL AND OPTICAL FILTERS AND PROTECTORS, TELEMETERS, WIRELESS AND CELLULAR TELEPHONES, RADIO PAGERS; PORTABLE COMPUTER DEVICES, NAMELY LAPTOPS, HANDHELD AND POCKET COMPUTERS, FACSIMILE TRANSMITTERS AND RECEIVERS, WIRELESS FAX MACHINES, PERSONAL COMMUNICATIONS EQUIPMENT, NAMELY, PERSONAL DIGITAL ASSISTANTS, CALCULATORS AND RELATED PERIPHERALS; SATELLITE PROCESSORS, SATELLITES AND SATELLITE COMMUNICATION EARTH STATIONS BOTH STATIONARY AND MOVEABLE; AUDIO AND VIDEO RECORDINGS IN THE FIELD OF NEWS, SPORTS, MUSIC, CULTURE, BUSINESS AND FINANCE, WEATHER AND TRAVEL; PRERECORDED COMPACT DISCS, AUDIO CASSETTE TAPES, VIDEO CASSETTE TAPES, DIGITAL AUDIO TAPES AND DIGITAL VIDEO DISCS FEATURING MUSICAL, VARIETY, NEWS AND COMEDY SHOWS; COMPUTER GAME PROGRAMS FOR CHILDREN AND ADULTS; VIDEO AND COMPUTER GAME CARTRIDGES (U.S. CLS. 21, 23, 26, 36 AND 38).

CLASS 16—PAPER GOODS AND PRINTED MATTER

FOR PRINTED MATTER, NAMELY, TELEPHONE DIRECTORIES, BOOKS, NEWSLETTERS, PAMPHLETS, BROCHURES, MAGAZINES AND PAPERBACKS ALL IN THE FIELD OF TELECOMMUNICATIONS; STAMPED AND PRINTED CARDS OF CARDBOARD OR PLASTIC, NAMELY, BASEBALL CARDS, GREETING CARDS, TRADING CARDS, TRIVIA CARDS; NOTE PAPER AND ENVELOPES, RUBBER STAMPS, BLANK NAME TAGS AND LABELS MADE FROM PAPER OR CARDBOARD, NOTEBOOKS, DIARIES, NOTE PAPERS, NOTE PADS, ADDRESS BOOKS, FOLDERS FOR LETTERS, FILES OR LOOSE PAPER, CLEAR HOLE REINFORCEMENTS, STUDENT CALENDARS, STAMP ALBUMS AND PHOTO-ALBUMS; PAPER WEIGHTS, LETTER OPENERS, BLOTTER PADS; DESK TRAYS, DESK STANDS AND HOLDERS FOR HOLDING STATIONERY AND OFFICE IMPLEMENTS; PRINTED INSTRUCTIONAL AND TEACHING MATERIALS ALL IN THE FIELDS OF TELECOMMUNICATIONS, INFORMATION TECHNOLOGY, NEWS, SPORTS, MUSIC, CULTURE, BUSINESS AND FINANCE, WEATHER AND TRAVEL; STATIONERY, DRAFTING, DRAWING AND UNGRADUATED RULERS, ERASERS, STAPLERS, STAPLES, PAPER CLIPS, BOOK MARKERS, CUTOUT STENCILS; SCRATCH PICTURES, PAPER, NAMELY, BOND PAPER AND ART PAPER, PVC STICKERS, GIFT WRAP PAPER; BLACKBOARDS, CHALK STICKS, ADHESIVES FOR STATIONERY OR HOUSEHOLD PURPOSES; DRAWING AND PAINTING MATERIALS, NAMELY, PENCILS, DRAWING PENCILS, PENS, DRAWING PENS, PAINT TRAYS, PAINTING SETS FOR ARTISTS, PAINTING SETS FOR CHILDREN, ARTS AND CRAFT PAINT KITS, AND PENCIL CASES; NON-MAGNETICALLY ENCODED, PREPAID TELEPHONE CALLING CARDS (U.S. CLS. 2, 5, 22, 23, 29, 37, 38 AND 50).

CLASS 35—ADVERTISING AND BUSINESS

FOR ADVERTISING SERVICES, NAMELY, PREPARING AND PLACING ADVERTISEMENTS FOR OTHERS PROMOTING THE GOODS AND SERVICES OF OTHERS THROUGH PRINTED ADVERTISING, PRINTED DIRECTORIES, THROUGH ENCODED MEDIA, THROUGH THE DISSEMINATION OF PROMOTIONAL MATERIALS, THROUGH DIRECT MAIL ADVERTISING, THROUGH ELECTRONIC BILLBOARD ADVERTISING, AND PREPARING AUDIO-VISUAL PRESENTATIONS FOR USE IN ADVERTISING; BUSINESS SERVICES, NAMELY, BUSINESS APPRAISALS, BUSINESS AUDITING, PROVIDING BUSINESS INFORMATION, NAMELY, PREPARING BUSINESS REPORTS AND CONDUCTING BUSINESS RESEARCH, ANALYSIS AND SURVEYS, BUSINESS MANAGEMENT PLANNING, BUSINESS MANAGEMENT CONSULTATION, BUSINESS MANAGEMENT SUPERVISION, CONDUCTING BUSINESS NETWORKING FOR OTHERS; BUSINESS MANAGEMENT AND CONSULTING SERVICES EXCLUDING AGRICULTURAL BUSINESS MANAGEMENT AND CONSULTING SERVICES; BUSINESS INFORMATION SERVICES IN THE FIELD OF TELECOMMUNICATIONS, ADVERTISING, INFORMATION TECHNOLOGY; RENTAL OF AUTOMATIC VENDING MACHINES AND ORGANIZING JOB FAIRS; PROFESSIONAL CONSULTANCY IN THE FIELD OF DATA PROCESSING; RENTAL OF DATA PROCESSING EQUIPMENT (U.S. CLS. 100, 101 AND 102).

CLASS 36—INSURANCE AND FINANCIAL

FOR CLEARING OF SECURE FINANCIAL TRANSACTIONS THROUGH ONLINE SERVICES; FINANCIAL AND MONETARY SERVICES, NAMELY FINANCIAL ANALYSIS AND CONSULTATION, PROVIDING FINANCIAL INFORMATION, ISSUANCE OF SECURITIES, COMMERCIAL LENDING SERVICES, FINANCIAL PORTFOLIO MANAGEMENT, DISCOUNT BROKERAGE SERVICES, BROKERAGE OF SHARES, OF SETS AND BUSINESS VENTURES, BROKERAGE OF FUND SHARES, SECURITIES CONSULTING AND SAFE KEEPING, BROKERAGE OF PRODUCTIVE INVESTMENTS AND FUNDS; FINANCIAL SPONSORSHIP OF SPORTS, EDUCATIONAL AND ENTERTAINMENT PROGRAMS AND EVENTS; MONETARY EXCHANGE; CREDIT CARD SERVICES; TELEPHONE CALLING CARD SERVICE; ELECTRONIC COMMERCE SERVICES, NAMELY, ELECTRONIC DEBIT AND CREDIT CARD PROCESSING SERVICES, FUNDS TRANSFER AND PAYMENT PROCESSING SERVICES; PROVIDING INFORMATION VIA THE TELEPHONE AND THE GLOBAL COMMUNICATION NETWORKS IN THE FIELD OF FINANCE (U.S. CLS. 100, 101 AND 102).

CLASS 38—COMMUNICATION

FOR TELECOMMUNICATIONS SERVICES, NAMELY ELECTRIC, DIGITAL, CELLULAR AND WIRELESS TRANSMISSION OF VOICE, DATA, INFORMATION, IMAGES, SIGNALS AND MESSAGES AND TRANSMISSION OF VOICE, DATA, IMAGES, AUDIO, VIDEO AND INFORMATION VIA TELEPHONE, TELEVISION AND GLOBAL COMMUNICATION NETWORKS; PROVIDING TELECOMMUNICATIONS CONNECTIONS OVER A GLOBAL COMMUNICATIONS NETWORK, ELECTRONIC MAIL, VOICE MAIL AND MESSAGING SERVICES, NAMELY, THE RECORDING AND STORAGE AND SUBSEQUENT TRANSMISSION OF VOICE MESSAGES BY TELEPHONE; AUDIO AND VIDEO TELECONFERENCING, RENTAL OF TELECOMMUNICATIONS EQUIPMENT, NAMELY, EQUIPMENT FOR ELECTRONIC ACCESS TO GLOBAL TELECOMMUNICATIONS NETWORK, EQUIPMENT FOR TRANSMITTING, RECEIVING, RECORDING AND MONITORING VOICE, DATA, INFORMATION, IMAGES, SIGNALS, MESSAGES, COMPRISED OF DATA AND WORD PROCESSORS, AND TELECOMMUNICATIONS HARDWARE AND SOFTWARE, NAMELY, COMPONENTS AND PERIPHERALS THEREOF FOR USE IN THE TELECOMMUNICATIONS INDUSTRY, AND RENTAL OF EQUIPMENT FOR TRANSMITTING, RECEIVING, RECORDING AND MONITORING COMPUTER PROGRAMS FOR USE IN OPERATING AND ACCESSING TELECOMMUNICATIONS SYSTEMS; AUDIO AND VIDEO BROADCASTING FEATURING ENTERTAINMENT IN THE NATURE OF LIVE VISUAL AND AUDIO

PERFORMANCES, AND MUSICAL, VARIETY, NEWS AND COMEDY SHOWS; PROVIDING MULTIPLE USER DIAL-UP AND DEDICATED ACCESS TO THE INTERNET; PERSONAL COMMUNICATIONS SERVICES; PAGER SERVICES; ELECTRONIC MAIL SERVICES; TRANSMISSION AND BROADCAST OF AUDIO AND VIDEO PROGRAMMING, NAMELY, TRANSMISSION OF SOUND, PICTURE AND DATA SIGNALS; PROVIDING MULTIPLE-USER ACCESS TO A GLOBAL COMMUNICATION NETWORK; LEASING TELECOMMUNICATIONS EQUIPMENT, COMPONENTS, SYSTEMS AND SUPPLIES; CONSULTING IN THE FIELD OF TELECOMMUNICATIONS (U.S. CLS. 100, 101 AND 104).

CLASS 39—TRANSPORTATION AND STORAGE

FOR WAREHOUSE STORAGE OF GOODS, NAMELY, STORAGE OF GOODS RELATING TO TELECOMMUNICATIONS, COMPUTERS AND OTHER INFORMATION TECHNOLOGY DEVICES; TRANSPORTATION OF GOODS BY TRUCK, SHIP, RAILWAY AND PLANE; ELECTRONIC STORAGE OF INFORMATION IN THE NATURE OF FILES AND DOCUMENTS; TRAFFIC INFORMATION SERVICES, NAMELY, MANAGEMENT OF TRAFFIC FLOW THROUGH ADVANCED COMMUNICATIONS NETWORKS AND TECHNOLOGY; AIRPORT SERVICES, NAMELY, AIR TRAFFIC CONTROL SERVICES; TRAFFIC INFORMATION SERVICES, NAMELY, TRAFFIC INFORMATION SERVICES PROVIDED BY TELEPHONE, CELLULAR TELEPHONE, RADIO, COMPUTER OVER A GLOBAL COMPUTER NETWORK; TRAVEL AGENCY SERVICES, NAMELY MAKING RESERVATIONS AND BOOKINGS FOR TRANSPORTATION; ARRANGING TRAVEL TOURS AND CRUISES (U.S. CLS. 100 AND 105).

CLASS 41—EDUCATION AND ENTERTAINMENT

FOR EDUCATION AND INSTRUCTION, NAMELY, EDUCATIONAL SERVICES IN THE NATURE OF CLASSES AND SEMINARS IN THE FIELDS OF BUSINESS, TELECOMMUNICATIONS AND COMPUTERS, AND THE DISTRIBUTION OF COURSE MATERIALS THEREWITH; ENTERTAINMENT IN THE NATURE OF VISUAL AND AUDIO PERFORMANCES, NAMELY, MUSICAL BAND, ROCK GROUP, GYMNASTIC, DANCE, AND BALLET PERFORMANCES; ENTERTAINMENT SERVICES, NAMELY, PROVIDING MUSICAL, VARIETY, NEWS AND COMEDY SHOWS VIA A GLOBAL COMPUTER INFORMATION NETWORK; ENTERTAINMENT SERVICES, NAMELY, PROVIDING ONLINE COMPUTER GAMES FOR CHILDREN AND ADULTS; ORGANIZING COMMUNITY SPORTING AND CULTURAL EVENTS; PUBLICATION OF BOOKS, MAGAZINES, JOURNALS, MANUALS, BROCHURES AND LEAFLETS ON THE SUBJECT OF TELECOMMUNICATIONS; ELECTRONIC PUBLISHING SERVICES, NAMELY, PUBLICATION OF TEXT AND GRAPHIC WORKS OF OTHERS ON TELECOMMUNICATIONS RECORDED ON ELECTRONIC MEDIA; CONDUCTING ENTERTAINMENT EXHIBITIONS IN THE NATURE OF VISUAL AND AUDIO PERFORMANCES, NAMELY, ROCK GROUP, GYMNASTIC, DANCE, AND BALLET PERFORMANCES (U.S. CLS. 100, 101 AND 107).

CLASS 42—SCIENTIFIC, COMPUTER AND LEGAL SERVICES

FOR COMPUTER PROGRAMMING SERVICES FOR OTHERS; DEVELOPMENT OF DATA PROCESSING PROGRAMS BY ORDER OF THIRD PARTIES; CONSULTING IN THE FIELD OF RENTAL OF SOFTWARE AND HARDWARE FOR ONLINE ACCESS; SERVICES OF AN INTERNET TRUST CENTER, NAMELY, ASSURANCE AND ADMINISTRATION OF DIGITAL KEYS AND DIGITAL CERTIFICATES; DEVELOPMENT OF DATA PROCESSING PROGRAMS FOR OTHERS; WEB PAGE HOSTING SERVICES FOR OTHERS; CONSULTING AND DESIGN SERVICES IN THE FIELD OF INFORMATION TECHNOLOGY, COMPUTER PROGRAMMING, AND GLOBAL COMMUNICATION NETWORKS; DESIGN OF TELECOMMUNICATIONS SYSTEMS AND NETWORKS; INSTALLATION, MAINTENANCE AND REPAIR OF COMPUTER SOFTWARE; DATABASE DEVELOPMENT SERVICES FOR OPERATING TELECOMMUNICATIONS AND BUSINESS MANAGEMENT SYSTEMS (U.S. CLS. 100 AND 101).
LOURDES AYALA, EXAMINING ATTORNEY

SN 78-178,695. CROSSASSET SOFTWARE LLC, NEW YORK, NY. FILED 10-25-2002.



The logo for Cross Asset features the word "cross" in a lowercase, sans-serif font, followed by a large, stylized "X" that is formed by two intersecting diagonal lines. To the right of the "X" is the word "asset" in a lowercase, sans-serif font. The entire logo is rendered in black.

NO CLAIM IS MADE TO THE EXCLUSIVE RIGHT TO USE CROSS ASSET, APART FROM THE MARK AS SHOWN.

CLASS 9—ELECTRICAL AND SCIENTIFIC APPARATUS

FOR DOWNLOADABLE COMPUTER SOFTWARE FOR PERFORMING FINANCIAL ANALYSIS AND MODELING; DOWNLOADABLE COMPUTER SOFTWARE FOR PERFORMING PRICING, VALUING, AND EVALUATING AND MANAGING RISK OF FINANCIAL INSTRUMENTS, DERIVATIVES, INVESTMENT SECURITIES, AND PORTFOLIOS THEREFOR, AND INSTRUCTIONAL MANUALS SOLD AS A UNIT THEREWITH (U.S. CLS. 21, 23, 26, 36 AND 38).

FIRST USE 6-27-2002; IN COMMERCE 9-9-2002.

CLASS 36—INSURANCE AND FINANCIAL

FOR FINANCIAL ANALYSIS CONSULTING SERVICES; INVESTMENT INFORMATION SERVICES NAMELY THE PROVIDING OF PRICING, VALUATION, AND RISK ANALYSIS INFORMATION FOR FINANCIAL INSTRUMENTS, DERIVATIVES, INVESTMENT SECURITIES, AND PORTFOLIOS THEREOF (U.S. CLS. 100, 101 AND 102).

FIRST USE 6-27-2002; IN COMMERCE 9-9-2002.

ELISSA GARBER KON, EXAMINING ATTORNEY

SN 78-180,500. SOUTHERN CALIFORNIA GAS COMPANY, LOS ANGELES, CA. FILED 10-31-2002.

SOCALGAS ENVOY

SEC. 2(F) AS TO "SOCALGAS".

CLASS 35—ADVERTISING AND BUSINESS

FOR PROVIDING INTERNET-BASED ONLINE ORDERING SERVICES IN THE FIELD OF NATURAL GAS (U.S. CLS. 100, 101 AND 102).

CLASS 42—SCIENTIFIC, COMPUTER AND LEGAL SERVICES

FOR PROVIDING INTERNET-BASED NATURAL GAS SERVICES, NAMELY, ONLINE METER MANAGEMENT AND ANALYSIS (U.S. CLS. 100 AND 101).

RONALD MCMORROW, EXAMINING ATTORNEY

CLASS 35—ADVERTISING AND BUSINESS

FOR ADVERTISING, NAMELY, THE DISSEMINATION OF ADVERTISING MATTER; INTERACTIVE ADVERTISING, NAMELY THE DISSEMINATION OF INTERACTIVE ADVERTISING FOR OTHERS VIA THE INTERNET; DISSEMINATION AND UPDATING OF ADVERTISING MATTER; DIFFUSION/DISTRIBUTION OF PUBLICITY MATERIAL, SUCH AS LEAFLETS, SAMPLES, CATALOGUES AND PROSPECTUS; RENTAL OF ADVERTISING SPACE ON COMPUTER NETWORKS; DOCUMENT REPRODUCTION; ORGANIZATION OF EXHIBITIONS FOR COMMERCIAL OR ADVERTISING PURPOSES IN THE FIELDS OF TELEVISION AND MULTIMEDIA (U.S. CLS. 100, 101 AND 102).

CLASS 38—COMMUNICATION

FOR COMMUNICATIONS SERVICES, NAMELY, CABLE RADIO TRANSMISSION, CABLE TELEVISION TRANSMISSION, DIGITAL DIFFUSION AND TRANSMISSION OF SOUND, DATA, IMAGES, SIGNALS, AND MESSAGES VIA SATELLITE, CABLE, AND ANTENNA; ELECTRONIC TRANSMISSION OF INFORMATION IN THE FIELD OF TELEVISION, RADIO AND CINEMA (U.S. CLS. 100, 101 AND 104).

CLASS 41—EDUCATION AND ENTERTAINMENT

FOR EDUCATION SERVICES, NAMELY, PROVIDING OF TRAINING IN THE FIELDS OF TELEVISION AND ELECTRONICS; PUBLICATION OF BOOKS, MAGAZINES, AUDIO AND VIDEO CASSETTES, CD ROMS, AND OPTICAL AND COMPACT DISCS; ELECTRONIC AND DIGITAL PUBLICATION OF MAGAZINES AND NEWSPAPERS IN THE FIELDS OF TELEVISION AND TELEVISION BROADCASTING; ARRANGING AND CONDUCTING SEMINARS, CONFERENCES, AND CONGRESSES IN THE FIELDS OF TELEVISION, TELEVISION BROADCASTING, AND MULTIMEDIA; RENTAL OF TELEVISIONS AND OTHER ELECTRONIC GOODS, NAMELY, MULTIMEDIA VIDEO SCREENS, VIDEO TAPE RECORDERS, AUDIO AND VIDEO CASSETTE PLAYERS AND RECORDERS, DIGITAL COMPACT DISC PLAYERS AND RECORDERS, DIGITAL AUDIO AND VIDEO DISC PLAYERS AND RECORDERS, PORTABLE COMPACT DISC PLAYERS, CAMCORDERS, PROJECTION TELEVISIONS, AND CAMERAS (U.S. CLS. 100, 101 AND 107).

CLASS 42—SCIENTIFIC, COMPUTER AND LEGAL SERVICES

FOR RESEARCH AND INDUSTRIAL DESIGN SERVICES FOR NEW PRODUCT DEVELOPMENT IN THE FIELDS OF TELEVISION, TELEVISION BROADCASTING, AND MULTIMEDIA; ENGINEERING; PROFESSIONAL CONSULTANCY IN THE DESIGN AND DEVELOPMENT OF TELEVISION AND OTHER ELECTRONIC GOODS, NAMELY, MULTIMEDIA VIDEO SCREENS, VIDEO TAPE RECORDERS, AUDIO AND VIDEO CASSETTE PLAYERS AND RECORDERS, DIGITAL COMPACT DISC PLAYERS AND RECORDERS, DIGITAL AUDIO AND VIDEO DISC PLAYERS AND RECORDERS, PORTABLE COMPACT DISC PLAYERS, CAMCORDERS, PROJECTION TELEVISIONS, AND CAMERAS; COMPUTER SERVICES, NAMELY COMPUTER SOFTWARE AND WEBSITE DESIGN FOR OTHERS; INTELLECTUAL PROPERTY CONSULTANCY, LEGAL REPRESENTATION SERVICES IN ORDER TO OBTAIN AND TO MAINTAIN THE EXPLOITATION AND DEFENSE OF INTELLECTUAL PROPERTY (U.S. CLS. 100 AND 101).

ESTHER A. BORSUK, EXAMINING ATTORNEY

SN 78-185,507. THOMSON MULTIMEDIA, BOULOGNE-BILLANCOURT, FRANCE, FILED 11-15-2002.

EXPERIENCE HOME CINEMA LIKE NEVER BEFORE

OWNER OF FRANCE REG. NO. 023165659, DATED 5-2-2002, EXPIRES 5-2-2012.

CLASS 9—ELECTRICAL AND SCIENTIFIC APPARATUS

FOR TELEVISIONS; INTERACTIVE TELEVISIONS; TELEVISION SETS WITH DIGITAL AUDIO-VIDEO DISC PLAYER INTEGRATED; TELEVISIONS WITH VIDEO RECORDER INTEGRATED; TELEVISION SCREENS, MULTIMEDIA VIDEO SCREENS; VIDEO TAPE RECORDERS; AUDIO CASSETTE PLAYERS/RECORDERS; DIGITAL COMPACT DISC PLAYERS/RECORDERS; DIGITAL AUDIO AND VIDEO DISC PLAYERS/RECORDERS; PROJECTION TELEVISIONS; DIGITAL AUDIO AND VIDEO DISC WRITERS/RECORDERS; HIGH FIDELITY MICRO/MINI SYSTEMS COMPRISED OF STEREO TUNERS, STEREO RECEIVERS, STEREO SPEAKERS, COMPACT DISC PLAYERS AND RECORDERS, CASSETTE PLAYERS AND RECORDERS; RADIO SETS; VIDEO TRANSMITTERS; AUDIO-VIDEO RECEIVERS; REMOTE CONTROLS FOR ALL THE AFORESAID GOODS; BLANK MAGNETIC DATA CARRIERS; BLANK ACOUSTIC RECORDING DISCS; BLANK AUDIO-VIDEO COMPACT DISCS; DATA PROCESSING EQUIPMENT, NAMELY BLANK COMPUTER HARD DISKS, AND COMPUTERS; PORTABLE COMPACT DISC PLAYERS; CAMCORDERS; AMPLIFIERS; COMPUTER PERIPHERAL DEVICES; PHOTOGRAPHIC CAMERAS; RADIO CASSETTE PLAYERS; CLOCK RADIOS; DICTATING MACHINES; HEADPHONES; WIRELESS HEADPHONES; MICROPHONES; TELEPHONES; PHONE EXTENSION OUTLETS; MODEMS; LOUD SPEAKERS; ANTENNAS; PARABOLAS FOR TELEVISIONS (U.S. CLS. 21, 23, 26, 36 AND 38).

CLASS 16—PAPER GOODS AND PRINTED MATTER

FOR PAPER, CARDBOARD, AND PRINTED MATTER, NAMELY, NEWSPAPERS, MAGAZINES, BOOKS, PAMPHLETS, AND INSTRUCTIONAL AND TEACHING MANUALS, ALL IN THE FIELDS OF TELEVISION, MULTIMEDIA, AND CONSUMER ELECTRONICS; BAGS OF PAPER OR PLASTIC FOR PACKAGING; SIGNBOARDS OF PAPER OR CARDBOARD; POSTERS; PRINTING BLOCKS (U.S. CLS. 2, 5, 22, 23, 29, 37, 38 AND 50).

SN 78-186,152. CEMENT ASSOCIATION OF CANADA, OTTAWA, ONTARIO, CANADA, FILED 11-18-2002.

SN 78-189,863. INTERNATIONAL TRADE DIFFUSION, MARSEILLE, FRANCE, FILED 11-29-2002.

CONCRETE THINKING

PRIORITY CLAIMED UNDER SEC. 44(D) ON CANADA APPLICATION NO. 1141150, FILED 5-17-2002, REG. NO. TMA605074, DATED 5-17-2002, EXPIRES 5-17-2017.

CLASS 9—ELECTRICAL AND SCIENTIFIC APPARATUS

FOR PRE-RECORDED COMPUTER SOFTWARE CONTAINING TRAINING MATERIALS RELATING TO CONCRETE AND CEMENT MANUFACTURING (U.S. CLS. 21, 23, 26, 36 AND 38).

CLASS 16—PAPER GOODS AND PRINTED MATTER

FOR PRINTED MATERIALS, NAMELY, BROCHURES ABOUT THE CONCRETE INDUSTRY; PRINTED TRAINING MATERIALS IN THE FIELD OF PREPARATION OF CONCRETE FOR USE IN CONSTRUCTIONS (U.S. CLS. 2, 5, 22, 23, 29, 37, 38 AND 50).

CLASS 35—ADVERTISING AND BUSINESS

FOR PROMOTING THE SERVICES OF THE CONCRETE AND CEMENT INDUSTRY THROUGH THE DISTRIBUTION OF PRINTED, VIDEO AND AUDIO PROMOTIONAL MATERIALS, ALL OF THE FOREGOING IN THE FIELD OF CONCRETE AND CEMENT MANUFACTURING; PUBLIC RELATIONS SERVICES, NAMELY, PROVIDING MEDIA RELATIONS AND ADVERTISING SERVICES IN THE NATURE OF DIRECT MAIL ADVERTISING AND ADVERTISING FLYER DISTRIBUTION FOR OTHERS TO THE CONCRETE AND CEMENT INDUSTRY; ADVERTISING SERVICES, NAMELY, ADVERTISING AGENCIES, DIRECT MAIL ADVERTISING, DISSEMINATION OF ADVERTISING VIA THE INTERNET FOR OTHERS TO THE CONCRETE AND CEMENT INDUSTRY; PROMOTING CONSTRUCTION PROGRAMS NAMELY, DIRECT MAIL ADVERTISING; PROVIDING TELEVISION ADVERTISING FOR OTHERS TO THE CONCRETE AND CEMENT INDUSTRY; PROVIDING RADIO ADVERTISING FOR OTHERS TO THE CONCRETE AND CEMENT INDUSTRY; PROVIDING TELEPHONE ADVERTISING FOR OTHERS TO THE CONCRETE AND CEMENT INDUSTRY IN THE NATURE OF PRERECORDED TELEPHONE ADVERTISING MESSAGES (U.S. CLS. 100, 101 AND 102).

CLASS 37—CONSTRUCTION AND REPAIR

FOR PROVIDING A WEB SITE ABOUT CONSTRUCTION PROJECTS TO OTHERS IN THE CONCRETE AND CEMENT INDUSTRY (U.S. CLS. 100, 103 AND 106).

CLASS 40—MATERIAL TREATMENT

FOR PROVIDING A WEB SITE IN THE FIELD OF CONCRETE AND CEMENT MANUFACTURING (U.S. CLS. 100, 103 AND 106).

CLASS 41—EDUCATION AND ENTERTAINMENT

FOR PROMOTING AWARD PROGRAMS AND SPONSORSHIP EVENT PROGRAMS IN THE FIELD OF CEMENT AND CONCRETE MANUFACTURERS, NAMELY, PROVIDING RECOGNITION AND INCENTIVES BY THE WAY OF AWARDS TO DEMONSTRATE EXCELLENCE IN THE FIELD OF CEMENT AND CONCRETE MANUFACTURING; CONDUCTING CLASSES, SEMINARS AND WORKSHOPS IN THE FIELD OF CONCRETE AND CEMENT TECHNOLOGY AND MANUFACTURING IN GENERAL AND AS THEY RELATE TO CONSTRUCTION (U.S. CLS. 100, 101 AND 107).

NANCY CLARKE, EXAMINING ATTORNEY



CLASS 22—CORDAGE AND FIBERS

FOR NATURAL HAIR, NAMELY, ANIMAL HAIR (U.S. CLS. 1, 2, 7, 19, 22, 42 AND 50).

CLASS 26—FANCY GOODS

FOR NATURAL AND SYNTHETIC HAIR PIECES AND EXTENSIONS, NAMELY, FALSE MUSTACHES, PLATED HAIR, TRESSES OF HAIR, FALSE HAIR SET ON HAIR BANDS, NATURAL HAIR FOR EXTENSION OF HAIR LENGTH AND WAFTED HAIR; HAIR ACCESSORIES, NAMELY, HAIR BANDS, HAIR SLIDES, ELASTIC BANDS, CLIPS, FASTENINGS, NETS, BOWS AND PINS; HAIR ORNAMENTS, NAMELY, PEARLS AND FEATHERS (U.S. CLS. 37, 39, 40, 42 AND 50).

BARBARA BROWN, EXAMINING ATTORNEY

SN 78-191,034. HARBISON-WALKER REFRACTORIES COMPANY, MOON TOWNSHIP, PA. FILED 12-4-2002.



OWNER OF U.S. REG. NOS. 321,533, 1,022,674 AND OTHERS.

NO CLAIM IS MADE TO THE EXCLUSIVE RIGHT TO USE "REFRACTORIES COMPANY", APART FROM THE MARK AS SHOWN.

THE DRAWING IS LINED FOR THE COLOR(S) RED BUT COLOR IS NOT A FEATURE OF THE MARK.

THE MARK CONSISTS OF A FLAME THAT IS YELLOW WITH A BACKGROUND THAT IS RED. THE HYPHEN AND DOTS BETWEEN THE WORDS "HARBISON WALKER REFRACTORIES COMPANY" ARE RED, BUT NO CLAIM IS MADE TO COLOR.

CLASS 11—ENVIRONMENTAL CONTROL APPARATUS

FOR METAL RECLAIMER, NAMELY, A FOUNDRY CRUCIBLE FOR RECLAIMING METAL FROM DROSS DURING PROCESSING (U.S. CLS. 13, 21, 23, 31 AND 34).

FIRST USE 10-28-2002; IN COMMERCE 10-28-2002.

CLASS 19—NON-METALLIC BUILDING MATERIALS

FOR REFRACTORY PRODUCTS OF ALL KINDS, INCLUDING REFRACTORY BRICK, REFRACTORY CEMENT, REFRACTORY MORTAR, REFRACTORY CASTABLES, REFRACTORY GUNNING MIX, REFRACTORY SHAPES, REFRACTORY POROUS PLUGS, PLASTIC REFRACTORY MATERIAL AND RAMMING REFRACTORY (U.S. CLS. 1, 12, 33 AND 50).

FIRST USE 2-1-1992; IN COMMERCE 2-1-1992.

DORITT L. CARROLL, EXAMINING ATTORNEY

CLASS 20—FURNITURE AND ARTICLES NOT OTHERWISE CLASSIFIED

FOR PLASTIC PACKING AND STORAGE CONTAINERS, NAMELY, PLASTIC CASES AND MOLDED PLASTIC CASES WITH HANDLES AND WHEELS FOR INDUSTRIAL, COMMERCIAL AND/OR PERSONAL USE IN PACKAGING, SHIPPING, TRANSPORTATION, PROTECTION OF CONTENTS AND STORAGE (U.S. CLS. 2, 13, 22, 25, 32 AND 50).

FRED MANDIR, EXAMINING ATTORNEY

SN 78-197,125. FRANKLIN, DANIEL YATES, VAN BUREN, AR. FILED 12-21-2002.



NO CLAIM IS MADE TO THE EXCLUSIVE RIGHT TO USE "BEST" "CHEMICALS" AND "EQUIPMENT", APART FROM THE MARK AS SHOWN.
SEC. 2(F).

CLASS 35—ADVERTISING AND BUSINESS

FOR RETAIL STORE SERVICES FEATURING CHEMICALS AND EQUIPMENT FOR SANITATION (U.S. CLS. 100, 101 AND 102).

FIRST USE 1-1-2000; IN COMMERCE 1-1-2000.

CLASS 37—CONSTRUCTION AND REPAIR

FOR SANITATION CONSULTATION (U.S. CLS. 100, 103 AND 106).

FIRST USE 1-3-2000; IN COMMERCE 1-3-2000.

NAAKWAMA ANKRAH, EXAMINING ATTORNEY

SN 78-199,256. AMERIPACK, INC. CRANBURY, NJ. FILED 1-1-2003.

WARRIOR

Tough containers and cases

NO CLAIM IS MADE TO THE EXCLUSIVE RIGHT TO USE "TOUGH CONTAINERS AND CASES", APART FROM THE MARK AS SHOWN.

CLASS 15—MUSICAL INSTRUMENTS

FOR MOLDED PLASTIC CARRYING CASES FOR MUSICAL INSTRUMENTS (U.S. CLS. 2, 21 AND 36).

SN 78-202,232. MILARD GROUP, LTD., GOLETA, CA. FILED 1-10-2003.

COBALT

CLASS 7—MACHINERY

FOR ENGINE COOLING SYSTEM COMPONENTS, NAMELY, HOSES AND PUMPS; RADIATORS FOR MOTORS AND ENGINES; ENGINE BELTS; FUEL SYSTEM COMPONENTS, NAMELY CARBURETORS, FLAME ARRESTORS, FUEL REGULATORS, FUEL FLOW CONTROLS, FUEL PUMPS, FUEL VALVES, OIL FILTERS FOR MOTORS AND ENGINES; OIL PUMPS; FUEL FILTERS; VEHICLE ENGINE PARTS, NAMELY, OIL TANK PLUGS AND CAPS; AUTOMOTIVE ENGINE COMPONENTS, NAMELY, FUEL PUMPS (U.S. CLS. 13, 19, 21, 23, 31, 34 AND 35).

CLASS 9—ELECTRICAL AND SCIENTIFIC APPARATUS

FOR ELECTRICAL SYSTEM COMPONENTS, NAMELY BATTERIES, CABLES, AND VOLTAGE REGULATORS FOR AUTOMOTIVE USE; GAUGES FOR AUTOMOTIVE USE, NAMELY FOR MEASURING OIL PRESSURE, WATER TEMPERATURE, OIL TEMPERATURE, VOLT, AMP, BOOST PRESSURE, FUEL PRESSURE, FUEL LEVEL, HOUR METER, TRANSMISSION TEMPERATURE, ENGINE VACUUM, NITROUS PRESSURE, TIRE PRESSURE, PYROMETERS, SPEEDOMETERS, AND TACHOMETERS (U.S. CLS. 21, 23, 26, 36 AND 38).

CLASS 11—ENVIRONMENTAL CONTROL APPARATUS

FOR EXTERIOR LIGHTING FOR AUTOMOTIVE USE, NAMELY BACKUP LIGHTS FOR LAND VEHICLES; LIGHT BARS FOR LAND VEHICLES; REAR LIGHTS FOR VEHICLES; VEHICLE TURN-SIGNAL LIGHT BULBS; RUNNING LIGHTS FOR LAND VEHICLES; TAIL LIGHTS FOR LAND VEHICLES; TRAILER LIGHTS FOR LAND VEHICLES, VEHICLE TURN-SIGNAL LIGHT BULBS, VEHICLE HEADLIGHTS, AND DECORATIVE LIGHTS (U.S. CLS. 13, 21, 23, 31 AND 34).

CLASS 12—VEHICLES

FOR AUTOMOTIVE STRUCTURAL AND REPLACEMENT PARTS, NAMELY, BODY PANELS; BUMPERS; LAND VEHICLE PARTS, NAMELY, FENDERS AND FENDER FLARES; DOOR PANELS FOR LAND VEHICLES, ROOF PANELS FOR LAND VEHICLES; SPOILERS FOR LAND VEHICLES; PLASTIC PARTS FOR LAND VEHICLES, NAMELY, AUTOMOTIVE EXTERIOR AND INTERIOR PLASTIC EXTRUDED DECORATIVE AND PROTECTIVE TRIM; AUTOMOTIVE SIDE VIEW AND REAR VIEW MIRRORS; WINDSHIELD SUNSHADES, WINDSHIELD VISORS, WINDSHIELD WIPER BLADES BRAKE SYSTEMS AND COMPONENTS THEREFOR, NAMELY, BRAKE PADS AND SHOES, MASTER CYLINDERS, BRAKE HOSES, DISC BRAKES, CALIPERS, AND WHEEL CYLINDERS; AUTOMOBILE CHASSIS; CLUTCH SYSTEM COMPONENTS, NAMELY, HYDRAULICS, LINES HOSES PRESSURE PLATES; DASHBOARD ACCESSORIES, NAMELY, INSTRUMENT PANELS AND GAUGES; WINDOW WIPERS AND WASHERS; AUTOMOTIVE ENGINE COMPONENTS, NAMELY, FUEL PUMPS; FUEL LINES FOR VEHICLES; GAS TANKS FOR LAND VEHICLES PETROL TANK CAPS FOR MOTOR CARS; TIRE ACCESSORIES AND WHEEL ACCESSORIES, NAMELY WHEEL CAPS; SEMI-FITTED COVERS FOR VEHICLES; LUGGAGE RACKS; BICYCLE RACKS; HARD TOPS FOR AUTOMOBILES; STEERING WHEELS AND FITTINGS THEREFOR; FRONT AND REAR SUSPENSION COMPONENTS FOR MOTOR CARS, NAMELY SHOCK ABSORBERS; LEAF SPRINGS, COIL SPRINGS, SHOCK ABSORBING SPRINGS, SUSPENSION SPRINGS; POWER STEERING COMPONENTS, NAMELY POWER STEERING GEARS; STEERING UNITS FOR LAND VEHICLES AND PARTS THEREOF; TIRES AND WHEELS AND FITTINGS THEREFOR (U.S. CLS. 19, 21, 23, 31, 35 AND 44).

CIMMERIAN COLEMAN, EXAMINING ATTORNEY

SN 78-202,927. FALWELL, JERRY L., LYNCHBURG, VA. FILED 1-14-2003.

JERRY FALWELL

OWNER OF U.S. REG. NO. 2,382,656. THE NAME(S), PORTRAIT(S), AND/OR SIGNATURE(S) SHOWN IN THE MARK IDENTIFIES JERRY FALWELL, WHOSE CONSENT(S) TO REGISTER IS SUBMITTED.

CLASS 16—PAPER GOODS AND PRINTED MATTER

FOR NEWSLETTERS IN THE FIELD OF MORAL AND RELIGIOUS ISSUES AND EVENTS (U.S. CLS. 2, 5, 22, 23, 29, 37, 38 AND 50).

FIRST USE 6-30-1995; IN COMMERCE 6-30-1995.

CLASS 35—ADVERTISING AND BUSINESS

FOR RETAILING SERVICES VIA COMPUTER AND DIRECT RESPONSE RETAIL SERVICES BY MEANS OF COMMERCIALS FEATURING RELIGIOUS ITEMS (U.S. CLS. 100, 101 AND 102).

FIRST USE 12-31-1956; IN COMMERCE 12-31-1971.

CLASS 41—EDUCATION AND ENTERTAINMENT

FOR EDUCATIONAL LECTURING AND TEACHING SERVICES, NAMELY, RELIGIOUS INSTRUCTION AND TEACHING IN THE FIELD OF RELIGIOUS STUDIES (U.S. CLS. 100, 101 AND 107).

FIRST USE 4-13-1998; IN COMMERCE 4-14-1998.

CLASS 45—PERSONAL SERVICES

FOR PREACHING AND COUNSELING, NAMELY, MINISTERIAL SERVICES (U.S. CLS. 100 AND 101). FIRST USE 1-31-1971; IN COMMERCE 1-31-1971. JOHN DWYER, EXAMINING ATTORNEY

SN 78-206,798. BLUE MARLIN CORP., SAN FRANCISCO, CA. FILED 1-24-2003.

BROOKLYN SURPLUS CORP.

NO CLAIM IS MADE TO THE EXCLUSIVE RIGHT TO USE "CORP.", APART FROM THE MARK AS SHOWN.

CLASS 18—LEATHER GOODS

FOR ACCESSORIES, NAMELY LEATHER KEY FOBS, LEATHER BACKPACKS AND SACHELS, HANDBAGS, COIN PURSES, TOTE BAGS, PURSES, BILLFOLDS, WALLETS, BACKPACKS, DAYPACKS, WAIST BAGS, ALL PURPOSE SPORTS BAGS, BEACH BAGS, BOOK BAGS, CARRY-ON BAGS, CLUTCH BAGS, DUFFEL BAGS, SHOULDER BAGS, AND TRAVEL BAGS (U.S. CLS. 1, 2, 3, 22 AND 41).

CLASS 25—CLOTHING

FOR VINTAGE STYLE APPAREL, NAMELY HATS, CAPS, DRESSES, JACKETS, JEANS, JOGGING SUITS, WARM-UP SUITS, LOUNGE WEAR, NIGHTSHIRTS, SWEATERS, VESTS, HALTER TOPS, UNDERSHIRTS, T-SHIRTS, SWEATSHIRTS, SHORTS, GYM SHORTS, SWEAT SHORTS, TROUSERS, KHAKIS, AND WOVEN SHIRTS (U.S. CLS. 22 AND 39).

JOHN DALIER, EXAMINING ATTORNEY

SN 78-208,206. CHAIN DRUG CONSORTIUM, LLC, BOCA RATON, FL. FILED 1-29-2003.

PREMIER VALUE**CLASS 3—COSMETICS AND CLEANING PREPARATIONS**

FOR AFTERSHAVE LOTION, ALL-PURPOSE CLEANERS, ALOE VERA SKIN MOISTURIZER, BABY OIL, BABY POWDER, BABY SHAMPOO, BATH POWDER, BATH OILS, NON-MEDICATED BATH SALTS, CARPET DEODORIZER, COTTON SQUARES FOR COSMETIC PURPOSES, ALL PURPOSE COTTON SWABS FOR PERSONAL USE, DENTURE CLEANSER, PERSONAL DEODORANT AND ANTIPERSPIRANT, FABRIC SOFTENER, FACIAL CLEANSING SPONGES, GLASS CLEANER, HAIR GEL, HAIR SHAMPOO, HAIR SPRAY, LAUNDRY DETERGENT, LIP BALM WITH SUNSCREEN, NAIL POLISH REMOVER, SCOURING POWDER, SHAVING CREAMS AND LOTIONS, SKIN CREME, SKIN LOTIONS, SKIN MOISTURIZERS, LAUNDRY STARCH, SUNTAN LOTION, AND TOOTHPASTE (U.S. CLS. 1, 4, 6, 50, 51 AND 52).

CLASS 5—PHARMACEUTICALS

FOR ACNE MEDICATIONS, ALLERGY MEDICINE, ANTISEPTICS AND GENERAL PURPOSE GERMICIDES, ANTACIDS, ANTIBIOTIC CREAM, ANTIFUNGAL POWDER, ANTIHISTAMINE, ANTI-PLAQUE RINSE ANTI-SEPTIC, ATHLETE'S FOOT PREPARATIONS, NAMELY, POWDER, SPRAY AND CREAM FOR ANTISEPTIC PURPOSES, POWDER, BORIC ACID POWDER FOR USE AS AN ANTISEPTIC, CAMPHOR SPIRIT FOR ANTISEPTIC PURPOSES, COLD CAPSULES, COUGH DROPS, CREAM PAIN RELIEVER, DANDRUFF SHAMPOO, DAY AND NIGHT COLD MEDICINE, DECONGESTANT TABLETS, DENTAL FLOSS, DIARRHEA MEDICATION, DISINFECTANT SPRAY, DOUCHES, ENEMA PREPARATIONS, EYE DROPS, FEMININE SANITARY PADS, NAPKINS, TAMPONS AND PANTILINERS, FLU MEDICINE, GLYCERIN SUPPOSITORIES, HEMORRHOID SUPPOSITORIES, HYDROCORTISONE CREAM, HYDROGEN PEROXIDE FOR MEDICAL USE, INSECT REPELLENTS AND INSECTICIDES FOR DOMESTIC USE, IODINE, IPECAC SYRUP TO INDUCE VOMITING AND AID IN THE TREATMENT OF POISONING, LAXATIVES, MEDICATED LIP BALM WITH SUNSCREEN, LUBRICATING JELLY FOR MEDICAL PURPOSES, MAGNESIUM CITRATE AND MINERAL OIL FOR USE AS LAXATIVES, MOUTHWASH, MULTI-ANTIBIOTIC CREAM, NASAL SPRAY PREPARATIONS, ORAL ANTISEPTIC, PAIN RELIEVERS, NAMELY, ASPIRIN AND NON ASPIRIN, PEDIATRIC ELECTROLYTE, RUBBING ALCOHOL, SALINE SOLUTION, SINUS TABLETS, SORE THROAT LOZENGES, TINCTURE IODINE, VAGINAL CREAM, VITAMIN A AND D OINTMENT, VITAMIN SUPPLEMENTS, WITCHHAZEL AND ZINC OXIDE OINTMENT FOR THE TREATMENT OF ACNE (U.S. CLS. 6, 18, 44, 46, 51 AND 52).

CLASS 8—HAND TOOLS

FOR RAZOR BLADES, NON-ELECTRIC RAZORS, AND TABLEWARE, NAMELY PLASTIC KNIVES, FORKS, AND SPOONS (U.S. CLS. 23, 28 AND 44).

CLASS 9—ELECTRICAL AND SCIENTIFIC APPARATUS

FOR BATTERIES FOR HOUSEHOLD USE (U.S. CLS. 21, 23, 26, 36 AND 38).

CLASS 10—MEDICAL APPARATUS

FOR DROPPERS FOR ADMINISTERING MEDICATIONS SOLD EMPTY, ENEMA APPARATUS, HEATING PADS FOR MEDICAL PURPOSES, MEDICAL ICE PACKS AND THERMOMETERS FOR MEDICAL PURPOSES (U.S. CLS. 26, 39 AND 44).

CLASS 11—ENVIRONMENTAL CONTROL APPARATUS

FOR AIR FRESHENER DISPENSING UNITS FOR ROOMS, HOT WATER BOTTLES, AND ELECTRIC LIGHT BULBS (U.S. CLS. 13, 21, 23, 31 AND 34).

CLASS 16—PAPER GOODS AND PRINTED MATTER

FOR PAPER FILTERS FOR COFFEE MAKERS, DISPOSABLE DIAPERS, FACIAL TISSUE, PHOTO ALBUMS, PLASTIC SANDWICH BAGS; PLASTIC FOOD STORAGE BAGS FOR HOUSEHOLD USE, AND PLASTIC TRASH BAGS AND SANITARY TOILET SEAT COVER PAPER (U.S. CLS. 2, 5, 22, 23, 29, 37, 38 AND 50).

CLASS 21—HOUSEWARES AND GLASS

FOR COTTON BALLS, COTTON SQUARES, RUBBER HOUSEHOLD GLOVES, PAPER PLATES, PLASTIC CUPS, PRE-MOISTENED TOWELETTES FOR CLEANING AND NON-ELECTRIC TOOTHBRUSHES (U.S. CLS. 2, 13, 23, 29, 30, 33, 40 AND 50).

CLASS 25—CLOTHING

FOR CAPS, INNER SOLES, HOSIERY, SWEATSHIRTS, AND T-SHIRTS (U.S. CLS. 22 AND 39).

CLASS 29—MEATS AND PROCESSED FOODS

FOR ROASTED PEANUTS, UNSALTED PEANUTS, HONEY ROASTED PEANUTS AND CASHEWS (U.S. CL. 46).

CLASS 30—STAPLE FOODS

FOR ICE CREAM (U.S. CL. 46).

CLASS 35—ADVERTISING AND BUSINESS

FOR RETAIL DRUG STORE SERVICES AND RETAIL PHARMACY SERVICES (U.S. CLS. 100, 101 AND 102).
JOHN KELLY, EXAMINING ATTORNEY

SN 78-213,995. CIE AUTOMOTIVE, S.A., 20720 AZKOITIA, (GUIPUZCOA), SPAIN, FILED 2-12-2003.



CIE Automotive

OWNER OF SPAIN REG. NO. 0002501515, DATED 8-14-2002, EXPIRES 8-14-2012.

OWNER OF U.S. REG. NO. 2,718,577.

NO CLAIM IS MADE TO THE EXCLUSIVE RIGHT TO USE "AUTOMOTIVE", APART FROM THE MARK AS SHOWN.

CLASS 6—METAL GOODS

FOR SPECIAL STEELS, NAMELY, CARBON STEELS AND ALLOYS FOR RESISTANCE, CEMENTING AND IMPROVED MACHINABILITY, BORON STEEL, MICRO ALLOY STEELS, STEEL FOR SPRINGS, STEEL FOR BEARINGS, NITRIDING STEEL, RESISTANCE STEELS FOR TRACTION AND PLATING, STEEL FOR TOOLS, MARTENSITIC STAINLESS STEEL; METALLIC TUBES; METAL MOULDS FOR METALLIC FOUNDRY WORK; METALLIC PARTS FOR FREE-MACHINING AND STAMPING FOR INDUSTRY IN GENERAL AND THE AUTOMOBILE INDUSTRY IN PARTICULAR (U.S. CLS. 2, 12, 13, 14, 23, 25 AND 50).

CLASS 7—MACHINERY

FOR PUMPS FOR MACHINES AND PARTS THEREOF, NAMELY, OIL PUMPS FOR LAND VEHICLES, OIL PUMPS FOR USE IN MOTORS AND ENGINES, WATER PUMPS FOR LAND VEHICLES, WATER PUMPS FOR USE IN MOTOR AND ENGINES, FUEL PUMPS FOR LAND VEHICLES, OIL PUMP CASINGS AND COVERS, WATER PUMP CASINGS AND COVERS, VACUUM PUMP CASINGS AND COVERS; AUTOMOBILE COMPONENTS FOR APPLICATION IN OR IN CONNECTION WITH MOTORS OF VEHICLES, NAMELY, CRANKSHAFT COVERS, MOTOR BASES, MOTOR CASINGS, ALL OF ALUMINUM, CRANKSHAFTS, EXHAUST SPIGOTS, COMPONENTS FOR STARTERS, NAMELY, STARTER CASINGS, ALL OF FORGED STEEL, OIL FILTER CASINGS FOR ENGINES, EXHAUST SYSTEMS, NAMELY, EXHAUST PIPES, MUFFLERS, HEADERS AND CLAMPS, ALL OF METAL; COMMON RAILS FOR FUEL INJECTORS (U.S. CLS. 13, 19, 21, 23, 31, 34 AND 35).

CLASS 11—ENVIRONMENTAL CONTROL APPARATUS

FOR PARTS FOR AUTOMOBILE AIR CONDITIONING UNITS, NAMELY, AIR DEPOSIT RECEPTACLES, HELIX FLANGES AND HELIX CHASSIS, WATER DEPOSIT RECEPTACLES, ALL OF PLASTIC (U.S. CLS. 13, 21, 23, 31 AND 34).

CLASS 12—VEHICLES

FOR AUTOMOBILE COMPONENTS FOR APPLICATION IN OR IN CONNECTION WITH GEARBOXES, COUPLINGS, TRANSMISSIONS AND BODYWORK OF VEHICLES, NAMELY, OIL PANS AND GEARBOX BASES, ALL OF ALUMINUM, AXLE SHAFTS, CROWNS, TRANSMISSION GEARS, BRAKE PISTONS, WHEEL HUBS, ATTACK GEARS AND STUB-AXLES, ALL OF FORGED STEEL, CLUTCH COVERS, BRAKE PLATES, POWER BREAK BOOSTER SHELLS, SUSPENSION COMPONENTS, NAMELY, SUSPENSION RACKS, STEERING SYSTEM SUBSETS, NAMELY, STEERING TUBES, VEHICLE STRUCTURE SUBSETS, NAMELY, ENGINE RACKS, CROSSBEAMS, COVER DOOR PANELS, AIRBAG BRACKETS, STRUCTURAL PARTS FOR AUTOMOBILES, PARTIALLY ASSEMBLED SEAT FRAMES, DASHBOARD SUPPORT FRAMES, LUGGAGE RACK BARS, CONDUITS AND FRAMES FOR WINDOWS, THERMAL PROTECTORS, BUMPER BARS, ALL OF METAL, STEERING DEPOSIT PUMPS, STEERING SYSTEM ASSEMBLIES, NAMELY, STEERING TANKS, STEERING OIL TANK CAPS, STEERING BUSH LINERS AND RINGS, AIRBAG CASINGS, INTERNAL STRUCTURAL PILLARS, INTERNAL STRUCTURAL TRAYS, EXTERNAL HUBCAPS, ALL OF PLASTIC (U.S. CLS. 19, 21, 23, 31, 35 AND 44).

CLASS 40—MATERIAL TREATMENT

FOR TREATMENT OF MATERIALS IN THE MANUFACTURE OF PRODUCTS, PARTS AND COMPONENTS FOR THE AUTOMOBILE INDUSTRY, NAMELY, LAMINATION OF STEEL, THERMAL TREATMENTS, NAMELY, ANNEALING AND TEMPERING OF STEEL, STRAIGHTENING OF STEEL, TURNING OF STEEL ON A LATHE, CUTTING, BEVELING, POLISHING, INLAYING, STAMPING, WELDING AND RIVETING OF STEEL, HEATED PRESSURE FORGING OF METAL, COLD PRESSURE FORGING OF METAL, ALUMINUM INJECTION MOLDING; CUSTOM MANUFACTURE OF ALUMINUM PARTS, INLAYING AND STAMPING OF METALLIC PARTS, WELDING AND RIVETING OF PLASTIC PARTS, TUBE MOLDING, PLASTIC INJECTION MOLDING, ALL FOR THE AUTOMOBILE INDUSTRY (U.S. CLS. 100, 103 AND 106).

CLASS 42—SCIENTIFIC, COMPUTER AND LEGAL SERVICES

FOR INDUSTRIAL DESIGN, RESEARCH AND DEVELOPMENT FOR THE MANUFACTURE OF STEEL, ALUMINUM AND PLASTIC PARTS AND COMPONENTS FOR THE AUTOMOBILE INDUSTRY (U.S. CLS. 100 AND 101).

MATTHEW PAPPAS, EXAMINING ATTORNEY

SN 78-218,402. NOVICK, KENDRA JM, EVERGREEN, CO. FILED 2-24-2003.

WICKING J. SLEEPWEAR

NO CLAIM IS MADE TO THE EXCLUSIVE RIGHT TO USE "WICKING" AND "SLEEPWEAR", APART FROM THE MARK AS SHOWN.

CLASS 35—ADVERTISING AND BUSINESS

FOR RETAIL STORE SERVICES FEATURING WICKING SLEEPWEAR (U.S. CLS. 100, 101 AND 102). FIRST USE 7-15-2003; IN COMMERCE 7-15-2003.

CLASS 40—MATERIAL TREATMENT

FOR CUSTOM MANUFACTURE OF WICKING SLEEPWEAR (U.S. CLS. 100, 103 AND 106). FIRST USE 7-15-2003; IN COMMERCE 7-15-2003. TRICIA THOMPSON, EXAMINING ATTORNEY

SN 78-218,669. AQUADA CORPORATION LTD., ISLE OF MAN, UNITED KINGDOM, FILED 2-25-2003.

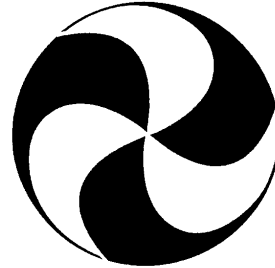

PRIORITY CLAIMED UNDER SEC. 44(D) ON UNITED KINGDOM APPLICATION NO. 003062338, FILED 2-21-2003, REG. NO. 003062338, DATED 9-13-2004, EXPIRES 2-21-2013.

CLASS 12—VEHICLES

FOR LAND AND MARINE VEHICLES; NAMELY, MOTORIZED WHEELED VEHICLES FOR USE ON LAND WHICH ARE ALSO CAPABLE OF TRAVEL ON WATER; SAFETY CAR SEATS FOR CHILDREN; FITTED OR SEMI-FITTED VEHICLE COVERS; VEHICLE REPLACEMENT PARTS, FITTINGS AND ACCESSORIES, NAMELY, LOOSE SEAT COVERS SHAPED FOR VEHICLE SEATS AND ANTI-THEFT ALARMS FOR VEHICLES (U.S. CLS. 19, 21, 23, 31, 35 AND 44).

CLASS 14—JEWELRY

FOR ALARM CLOCKS; JEWELRY, NAMELY, AMULETS, BRACELETS, BROOCHES, CHARMS, TIE CLIPS, TIE PINS, MEDALLIONS, NECKLACES, CUFFLINKS, EARRINGS, AND RINGS; ASHTRAYS OF PRECIOUS METAL FOR SMOKERS; ATOMIC CLOCKS; BADGES OF PRECIOUS METAL; CASES FOR WATCHES; CHRONOGRAPHS, NAMELY, WATCHES; CHRONOMETERS; CHRONOSCOPES; CLOCKS; CLOCK DIALS; TRINKETS AND FOBS, NAMELY, KEY RINGS OF PRECIOUS METAL; ORNAMENTAL PINS; PRECIOUS METAL-PLATED ARTICLES, NAMELY, PENDANTS; SILVER AND GOLD WARE, OTHER THAN CUTLERY, FORKS, AND SPOONS, NAMELY, ANKLE BANDS; STOP WATCHES; STRAPS FOR WRISTWATCHES; TOOTHPICK HOLDERS OF PRECIOUS METAL; WATCH BANDS; WATCH CASES; WATCH STRAPS; WATCHES; WRISTWATCHES (U.S. CLS. 2, 27, 28 AND 50).

CLASS 25—CLOTHING

FOR FOOTWEAR; HEADGEAR, NAMELY, HATS AND CAPS; BELTS; WATERPROOF CLOTHING, NAMELY, JACKETS AND TROUSERS; JACKETS; FLEECE, NAMELY COATS, JACKETS, SKIRTS, AND PULL-OVERS; SWIM WEAR; BEACH WEAR; SWEATSHIRTS; TEE SHIRTS; WET SUITS FOR WATER SKIING; BODY WARMERS, NAMELY, SLEEVELESS VEST JACKETS AND WAIST COATS; GILETS; GLOVES; SOCKS; UNDERWEAR; TIES; CLOTHING ACCESSORIES THEREFOR, NAMELY, ARM BANDS, BANDANAS, SARONGS, SUN VISORS, SWEAT BANDS, AND DETACHABLE HOODS (U.S. CLS. 22 AND 39).

CLASS 28—TOYS AND SPORTING GOODS

FOR TOYS, NAMELY, MODEL HOBBY CRAFT KITS, MODEL VEHICLES, HOBBY CRAFT KITS COMPRISING PARTS FOR CONSTRUCTING MODELS, PLASTIC TOY MODEL VEHICLES, SCALE MODEL VEHICLES; TOY VEHICLES; SCUBA FLIPPERS; BEACH BALLS; AND FLYING DISKS (U.S. CLS. 22, 23, 38 AND 50).
JOHN GARTNER, EXAMINING ATTORNEY

CLASS 44—MEDICAL, BEAUTY AND AGRICULTURAL SERVICES

FOR PROVIDING INFORMATION IN THE FIELDS OF HEALTH AND MEDICINE VIA THE INTERNET; FOOD NUTRITION CONSULTATION; PROVIDING AN ON-LINE COMPUTER DATABASE IN THE FIELDS OF HEALTH AND MEDICINE; PROVIDING INFORMATION IN THE FIELDS OF HEALTH AND MEDICINE (U.S. CLS. 100 AND 101).

CLASS 45—PERSONAL SERVICES

FOR PROVIDING INFORMATION IN THE FIELDS OF SAFETY, PERSONAL SECURITY, AND DISASTER PREPAREDNESS VIA THE INTERNET; PROVIDING AN ON-LINE COMPUTER DATABASE IN THE FIELDS OF SAFETY, PERSONAL SECURITY, AND DISASTER PREPAREDNESS; PROVIDING INFORMATION IN THE FIELDS OF SAFETY, PERSONAL SECURITY, AND DISASTER PREPAREDNESS (U.S. CLS. 100 AND 101).
JANICE L. MCMORROW, EXAMINING ATTORNEY

SN 78-220,435. IFDA, INC., FALLS CHURCH, VA. FILED 2-28-2003.

SN 78-219,767. PREPAREFIRST, INC., ATLANTA, GA. FILED 2-27-2003.

PREPAREWARE**CLASS 35—ADVERTISING AND BUSINESS**

FOR BUSINESS SERVICES, NAMELY, PROVIDING COMPUTER DATABASES REGARDING THE PURCHASE AND SALE OF A WIDE VARIETY OF PRODUCTS AND SERVICES OF OTHERS; ELECTRONIC RETAILING SERVICES VIA COMPUTER FEATURING GOODS AND SERVICES IN THE FIELDS OF HEALTH, SAFETY, SECURITY, DISASTER PREPAREDNESS AND MEDICINE; PROVIDING INFORMATION ABOUT THE GOODS AND SERVICES OF OTHERS VIA THE GLOBAL COMPUTER NETWORK IN THE FIELDS OF HEALTH, SAFETY, SECURITY, DISASTER PREPAREDNESS AND MEDICINE; COMPUTERIZED ON-LINE RETAIL SERVICES IN THE FIELDS OF HEALTH, SAFETY, SECURITY, DISASTER PREPAREDNESS AND MEDICINE; ON-LINE RETAIL STORE SERVICES FEATURING HEALTH, SAFETY, SECURITY, DISASTER PREPAREDNESS AND MEDICAL PRODUCTS (U.S. CLS. 100, 101 AND 102).

CLASS 42—SCIENTIFIC, COMPUTER AND LEGAL SERVICES

FOR PROVIDING INFORMATION AT THE SPECIFIC REQUEST OF END-USERS AND CUSTOMERS BY MEANS OF GLOBAL COMPUTER NETWORKS; PROVIDING TEMPORARY USE OF ON-LINE NON-DOWNLOADABLE SOFTWARE FOR INPUTTING AND ACCESSING INFORMATION AND DATA, MANAGING DATA, TRACKING THE EXPIRATION DATES OF MEDICATIONS AND OTHER PRODUCTS AND FOR ANALYSING, EVALUATING AND ASSESSING RISKS, PROBLEMS AND REMEDIAL MEASURES, ALL IN THE FIELDS OF HEALTH, SAFETY, SECURITY, DISASTER PREPAREDNESS AND MEDICINE; PROVIDING TEMPORARY USE OF ON-LINE NON-DOWNLOADABLE EDUCATIONAL SOFTWARE FEATURING INSTRUCTION IN THE FIELDS OF HEALTH, SAFETY, SECURITY, DISASTER PREPAREDNESS AND MEDICINE (U.S. CLS. 100 AND 101).



NO CLAIM IS MADE TO THE EXCLUSIVE RIGHT TO USE "INTERNATIONAL FOODSERVICE DISTRIBUTORS ASSOCIATION", APART FROM THE MARK AS SHOWN.

THE MARK CONSISTS OF THE LETTERS AND WORDS IFDA INTERNATIONAL FOODSERVICE DISTRIBUTORS ASSOCIATION, AND THE DESIGN OF A STYLIZED FORK ON A GENERALLY CIRCULAR BACKGROUND BENEATH AN ARC.

CLASS 16—PAPER GOODS AND PRINTED MATTER

FOR PUBLICATIONS, NAMELY, NEWSLETTERS, MAGAZINES, REPORTS, BOOKS, GUIDELINES, HANDBOOKS, MANUALS, SURVEYS, GUIDES, AND POSTERS, ALL IN THE FIELD OF LOGISTICS AND DISTRIBUTION FOR FOODSERVICE AND FOOD DISTRIBUTION BUSINESSES (U.S. CLS. 2, 5, 22, 23, 29, 37, 38 AND 50).

FIRST USE 1-1-2003; IN COMMERCE 1-1-2003.

CLASS 35—ADVERTISING AND BUSINESS

FOR PUBLIC RELATIONS; LOBBYING SERVICES FOR MEMBERS OF THE FOOD SERVICE AND FOOD DISTRIBUTION BUSINESSES; AND GOVERNMENT AFFAIRS SERVICES FOR MEMBERS OF THE FOOD SERVICE AND FOOD DISTRIBUTION BUSINESSES; ARRANGING AND CONDUCTING TRADE SHOW EXHIBITIONS IN THE FIELD OF LOGISTICS AND DISTRIBUTION FOR FOODSERVICE AND FOOD DISTRIBUTION BUSINESSES; ASSOCIATION SERVICES, NAMELY, THE PROMOTION OF THE INTERESTS OF FOODSERVICE AND FOOD DISTRIBUTION BUSINESSES (U.S. CLS. 100, 101 AND 102).

FIRST USE 1-1-2003; IN COMMERCE 1-1-2003.

CLASS 41—EDUCATION AND ENTERTAINMENT

FOR EDUCATIONAL SERVICES, NAMELY, THE ARRANGING AND CONDUCTING OF EDUCATIONAL CONFERENCES IN THE FIELD OF LOGISTICS AND DISTRIBUTION FOR FOODSERVICE AND FOOD DISTRIBUTION BUSINESSES (U.S. CLS. 100, 101 AND 107).
FIRST USE 1-1-2003; IN COMMERCE 1-1-2003.
ZACHARY BELLO, EXAMINING ATTORNEY

CLASS 13—FIREARMS

FOR FIREARMS; AMMUNITIONS AND PROJECTILES; FIREWORKS; DETONATORS (U.S. CLS. 2 AND 9).
DOMINICK J. SALEMI, EXAMINING ATTORNEY

SN 78-222,829. CARETEL INNS OF AMERICA, ROYAL OAK, MI. FILED 3-7-2003.

"SEND-EM-HOME"**CLASS 21—HOUSEWARES AND GLASS**

FOR MUGS (U.S. CLS. 2, 13, 23, 29, 30, 33, 40 AND 50).

CLASS 25—CLOTHING

FOR T-SHIRTS (U.S. CLS. 22 AND 39).
AISHA CLARKE, EXAMINING ATTORNEY

SN 78-231,558. AMERICAN COVERS, INC., DRAPER, UT. FILED 3-28-2003.

SN 78-225,593. DETNET SOLUTIONS (PROPRIETARY) LIMITED, GAUTENG, SOUTH AFRICA, FILED 3-14-2003.

BLASTWEB**CLASS 9—ELECTRICAL AND SCIENTIFIC APPARATUS**

FOR ELECTRONIC DETONATORS AND ELECTRONIC DELAY DETONATORS FOR USE IN BLASTING OPERATIONS IN THE MINING INDUSTRY; REMOTE CONTROLS; COMPUTER SOFTWARE PROGRAMS, AND COMPUTER PERIPHERALS FOR CONTROLLING BLASTING OPERATIONS IN THE MINING INDUSTRY (U.S. CLS. 21, 23, 26, 36 AND 38).

CLASS 13—FIREARMS

FOR FIREARMS; AMMUNITIONS AND PROJECTILES; FIREWORKS; DETONATORS (U.S. CLS. 2 AND 9).
DOMINICK J. SALEMI, EXAMINING ATTORNEY



NO CLAIM IS MADE TO THE EXCLUSIVE RIGHT TO USE NO ADHESIVE & NON-MAGNETIC & WASHABLE & REUSABLE & TECHNOLOGY, APART FROM THE MARK AS SHOWN.

SN 78-225,600. DETNET SOLUTIONS (PROPRIETARY) LIMITED, GAUTENG, SOUTH AFRICA, FILED 3-14-2003.

CHANGING THE WAY THE WORLD MINES**CLASS 9—ELECTRICAL AND SCIENTIFIC APPARATUS**

FOR ELECTRONIC DETONATORS AND ELECTRONIC DELAY DETONATORS FOR USE IN BLASTING OPERATIONS IN THE MINING INDUSTRY; REMOTE CONTROLS; COMPUTER SOFTWARE PROGRAMS, AND COMPUTER PERIPHERALS FOR CONTROLLING BLASTING OPERATIONS IN THE MINING INDUSTRY (U.S. CLS. 21, 23, 26, 36 AND 38).

CLASS 9—ELECTRICAL AND SCIENTIFIC APPARATUS

FOR COMPUTER MOUSE PADS; WRIST SUPPORTS FOR COMPUTER MOUSE USERS, WRIST SUPPORTS FOR COMPUTER KEYBOARD USERS, TELEPHONE HEADSET SUPPORT PADS (U.S. CLS. 21, 23, 26, 36 AND 38).

CLASS 12—VEHICLES

FOR SCREEN FOR ATTACHMENT TO CAR WINDOW FOR SHIELDING PASSENGER FROM SUNLIGHT (U.S. CLS. 19, 21, 23, 31, 35 AND 44).

CLASS 20—FURNITURE AND ARTICLES NOT OTHERWISE CLASSIFIED

FOR REMOVABLE NON-SLIP PADS FOR USE IN VEHICLES TO HOLD OBJECTS ON DASHBOARD AND OTHER INTERIOR SURFACES (U.S. CLS. 2, 13, 22, 25, 32 AND 50).
CHERYL CLAYTON, EXAMINING ATTORNEY

SN 78-241,320. ALLPAX PRODUCTS, INC., COVINGTON, LA. FILED 4-23-2003.

ALLPAX

CLASS 7—MACHINERY

FOR INDUSTRIAL AUTOMATED ROBOTICS FOR CONTROL, LOADING, AND UNLOADING RETORTS, STERILIZERS AND AUTOCLAVES, AND BASKETS, SHUTTLES AND CONVEYORS THEREFORE; AUTOMATED CONTAINER AND PACKAGING LOADING AND UNLOADING MACHINES; AUTOMATED HANDLING AND LOADING SYSTEMS, EQUIPMENT AND CONTROLS, NAMELY, INDUSTRIAL ROBOTS FOR USE IN LOADING AND UNLOADING STERILIZERS AND AUTOCLAVES NOT FOR MEDICAL USE; CONTAINER AND PACKAGE LOADING AND UNLOADING MACHINES COMPRISED OF INDEXERS, TRANSPORT AND LOADING SHUTTLES, BASKET TIPPERS, AND CONVEYORS THEREFORE; LOADING MACHINERY FOR STERILIZERS, AUTOCLAVES AND BASKETS; AUTOMATED CAN, POUCH AND CONTAINER LOADING AND UNLOADING MACHINERY AND INDUSTRIAL DRONES FOR LOADING AND UNLOADING MATERIALS, MATERIAL HANDLING SHUTTLES, CARTS, PALLETS, AND BASKETS THEREFORE, AUTOMATED CASE PACKING MACHINERY FOR BOTTLES, JARS, CANS, POUCHES, VIALS, BOXES AND OTHER TYPES OF CONTAINERS CONTAINING PHARMACEUTICALS, FOODSTUFFS, AND PERISHABLES (U.S. CLS. 13, 19, 21, 23, 31, 34 AND 35).

FIRST USE 5-15-1992; IN COMMERCE 5-15-1992.

CLASS 9—ELECTRICAL AND SCIENTIFIC APPARATUS

FOR SOFTWARE FOR USE IN OPERATING AUTOCLAVES, STERILIZERS AND RETORTS FOR USE IN THE TREATMENT OF CONTAINERIZED FOODSTUFFS AND/OR PHARMACEUTICALS (U.S. CLS. 21, 23, 26, 36 AND 38).

FIRST USE 5-15-1992; IN COMMERCE 5-15-1992.

CLASS 11—ENVIRONMENTAL CONTROL APPARATUS

FOR NON-MEDICAL AUTOCLAVES, RETORTS AND STERILIZERS; PHARMACEUTICAL, LABORATORY, AND SCIENTIFIC STERILIZERS, RETORTS AND AUTOCLAVES AND SOFTWARE SOLD AS A UNIT WITH AUTOCLAVES, RETORTS AND STERILIZERS FOR USE IN THE TREATMENT OF CONTAINERIZED FOODSTUFFS AND/OR PHARMACEUTICALS (U.S. CLS. 13, 21, 23, 31 AND 34).

FIRST USE 1-15-1990; IN COMMERCE 1-15-1990.

CLASS 35—ADVERTISING AND BUSINESS

FOR RETAIL SERVICES, NAMELY, ON-LINE RETAIL STORE SERVICES AND RETAIL SERVICES BY DIRECT SOLICITATION BY SALES AGENTS, ALL FEATURING INDUSTRIAL EQUIPMENT, NAMELY AUTOCLAVES, RETORTS, AND STERILIZERS, INDUSTRIAL AUTOMATED ROBOTICS FOR CONTROL, LOADING AND UNLOADING RETORTS, STERILIZERS AND AUTOCLAVE SYSTEMS, AND BASKETS, SHUTTLES AND CONVEYORS THEREFORE, AUTOMATED CONTAINER AND PACKAGING LOADING AND UNLOADING MACHINES, INDEXERS, TRANSPORT AND LOADING SHUTTLES, STERILIZERS, AUTOCLAVES, AND BASKET LOADERS, CARTS, PALLETS AND CONVEYORS THEREFORE, AND CASE PACKING MACHINERY FOR BOTTLES, JARS, CANS, POUCHES, VIALS, AND OTHER TYPES OF CONTAINERS, ROBOTICS, AUTOMATED CONTAINER AND PACKAGING LOADING AND UNLOADING SYSTEMS, CONTROLS, HARDWARE AND SOFTWARE THEREFORE, AND SOFTWARE AND COMPUTERS FOR MONITORING, CONTROLLING, AND MANAGING RETORT, AUTOCLAVE, AND STERILIZER SYSTEMS (U.S. CLS. 100, 101 AND 102).

FIRST USE 1-15-1990; IN COMMERCE 1-15-1990.

CLASS 40—MATERIAL TREATMENT

FOR CUSTOMIZED FABRICATION AND CONSULTATION IN CONNECTION THEREWITH OF INDUSTRIAL AUTOMATION MACHINERY, RETORTS, STERILIZERS, AUTOCLAVES, AND EQUIPMENT THEREFORE (U.S. CLS. 100, 103 AND 106).

FIRST USE 5-15-1992; IN COMMERCE 5-15-1992.
MARY CRAWFORD, EXAMINING ATTORNEY

SN 78-244,652. METRO NATIONAL CORPORATION, HOUSTON, TX. FILED 5-1-2003.

METRONATIONAL INVESTMENT/DEVELOPMENT/ MANAGEMENT/ MANAGEMENT

NO CLAIM IS MADE TO THE EXCLUSIVE RIGHT TO USE "INVESTMENT, DEVELOPMENT, MANAGEMENT", APART FROM THE MARK AS SHOWN.

CLASS 36—INSURANCE AND FINANCIAL

FOR REAL ESTATE INVESTMENT AND BROKERAGE SERVICES; LEASING OF REAL ESTATE; REAL ESTATE MANAGEMENT SERVICES; REAL ESTATE MANAGEMENT SERVICES FEATURING MANAGEMENT AND OPERATION OF MASTER PLANNED RESIDENTIAL COMMUNITIES AND COMMERCIAL DISTRICTS; MANAGEMENT OF COMMERCIAL, INDUSTRIAL, RETAIL, HEALTHCARE, HOSPITALITY AND PROFESSIONAL BUILDING FACILITIES; FINANCIAL INVESTMENT IN THE FIELD OF CAPITAL INVESTMENTS AND REAL ESTATE INVESTMENTS; FINANCING SERVICES IN THE FIELDS OF RESIDENTIAL HOUSING CONSTRUCTION, COMMERCIAL, INDUSTRIAL, RETAIL, AND HEALTHCARE FACILITIES CONSTRUCTION, AND PROFESSIONAL-BUILDING CONSTRUCTION (U.S. CLS. 100, 101 AND 102).

FIRST USE 0-0-1998; IN COMMERCE 0-0-1998.

CLASS 37—CONSTRUCTION AND REPAIR

FOR REAL ESTATE DEVELOPMENT SERVICES; BUILDING CONSTRUCTION SERVICES, NAMELY, PLANNING, LAYING OUT AND CONSTRUCTION OF RESIDENTIAL COMMUNITIES AND COMMERCIAL DISTRICTS; CONSTRUCTION OF SINGLE FAMILY AND MULTIPLE FAMILY DWELLINGS (U.S. CLS. 100, 103 AND 106).

FIRST USE 0-0-1998; IN COMMERCE 0-0-1998.
CHARLES JOYNER, EXAMINING ATTORNEY

SN 78-246,736. KABUSHIKI KAISHA ROCK FIELD, DBA ROCK FIELD CO., LTD., KOBE, JAPAN, FILED 5-7-2003.

SN 78-249,309. GULF AGENCY COMPANY LIMITED, 9495 TRIESEN, LIECHTENSTEIN, FILED 5-13-2003.



OWNER OF JAPAN REG. NO. 4061420, DATED 10-3-1997, EXPIRES 10-3-2007.

OWNER OF JAPAN REG. NO. 4087593, DATED 12-5-1997, EXPIRES 12-5-2007.

NO CLAIM IS MADE TO THE EXCLUSIVE RIGHT TO USE SOZAI, APART FROM THE MARK AS SHOWN.

THE JAPANESE WORD "SOZAI" TRANSLATES INTO "DELICATESSEN" IN THE ENGLISH LANGUAGE.

CLASS 29—MEATS AND PROCESSED FOODS

FOR PREPARED AND PACKAGED ENTREES AND SIDE DISHES CONSISTING PRIMARILY OF MEAT, SEAFOOD, FRUIT, VEGETABLES, OR TOFU; CROQUETTES CONSISTING PRIMARILY OF MEAT, SEAFOOD, POTATOES, OR VEGETABLES; MEAT; SEAFOOD; MEAT PRODUCTS, NAMELY, ROAST BEEF, HAMBURGER MEAT, BEEF STEW; PROCESSED MARINE PRODUCTS, NAMELY, FISH FRIES, OYSTER FRIES, SHRIMP FRIES; SALADS EXCEPT MACARONI, RICE AND PASTA SALADS; PROCESSED VEGETABLES; PROCESSED FRUITS; SOUP PREPARATIONS, STEW PREPARATIONS, CURRY PREPARATIONS; EGGS; MILK PRODUCTS, NAMELY, CHEESE FOR TOPPING; COOKING FATS AND OILS; FRIED TOFU PIECES; FROZEN TOFU; KONNYAKU (GELATINOUS FOOD PRODUCT MADE FROM SEAWEED); SOY MILK; TOFU; NATTO (FERMENTED SOY BEANS); VEGETABLE MOUSSE (U.S. CL. 46).

CLASS 30—STAPLE FOODS

FOR COFFEE; COCOA; MISO (SOY PASTE); WORCESTERSHIRE SAUCE, SOY SAUCE, SOBA (BUCKWHEAT NOODLE) SAUCE, YAKINIKU (GRILLED MEAT) SAUCE, WHITE SAUCE; VINEGAR; SALAD DRESSINGS; MAYONNAISE; DEXTROSE; GRANULATED SUGAR, FRUCTOSE, GLUCOSE FOR FOOD, ROCK SUGAR, MALT SUGAR, HONEY, POWDERED CANDY, LIQUID CANDY; SESAME SALT, TABLE SALT, CELERY SALT; GROUND SESAME SEEDS; SPICES; RICE, RICE-BASED FOODSTUFFS, NAMELY, RICE GRATIN AND ONIGIRI (READY-TO-EAT RICE BALLS); THRESHED BARLEY, STARCH, PREPARATIONS MADE FROM CEREALS, NAMELY, READY-TO-EAT PASTA, READY-TO-EAT NOODLES; SANDWICHES; SUSHI; PIZZA; RICE-BASED BENTO (BOXED READY-TO-EAT LUNCH); MEAT PIES; RAVIOLI; BREAD; PREPARED AND PACKAGED ENTREES AND SIDE DISHES CONSISTING PRIMARILY OF RICE, MACARONI AND PASTA; CROQUETTES CONSISTING PRIMARILY OF RICE, MACARONI AND PASTA; STARCH FOR MAKING OCHAZUKE (SIDE DISH CONSISTING OF RICE IN GREEN TEA) (U.S. CL. 46).

ANNE MADDEN, EXAMINING ATTORNEY



THE MARK CONSISTS OF THE WORD GAC WITH AN ARBITRARY DESIGN.

CLASS 35—ADVERTISING AND BUSINESS

FOR CUSTOMS CLEARANCE SERVICES FOR VESSELS, PASSENGERS AND FREIGHT; AGENCY FOR CREW RECRUITING SERVICES FOR SHIPS; SERVICES OF A SHIPPING AGENT, NAMELY, ACQUISITION AND CONCLUSION OF SEA FREIGHT DEALS ON BEHALF OF SHIPPING COMPANIES; NEGOTIATION AND CONCLUSION OF FREIGHT AND SHIP INSURANCES ON BEHALF OF SHIPPING COMPANIES (U.S. CLS. 100, 101 AND 102).

FIRST USE 1-31-1996; IN COMMERCE 1-31-1996.

CLASS 36—INSURANCE AND FINANCIAL

FOR CUSTOMS BROKERAGE SERVICES; INSURANCE, NAMELY, INCIDENT AND CLAIMS ADMINISTRATION SERVICES (U.S. CLS. 100, 101 AND 102).

FIRST USE 1-31-1996; IN COMMERCE 1-31-1996.

CLASS 39—TRANSPORTATION AND STORAGE

FOR TRANSPORT, PACKAGING AND STORAGE OF GOODS AND PASSENGERS BY ROAD, RAIL, MARINE AND AIR; LOADING AND UNLOADING OF SHIPS, UNLOADING CARGO; STORAGE AND DELIVERY OF RAW MATERIALS AND FINISHED PRODUCTS; RENTAL AND CHARTERING OF SHIPS, ARRANGING OF CRUISES, TRANSPORT RESERVATION; SHIPPING OF FREIGHT, FREIGHT FORWARDING, FREIGHT BROKERAGE AND LIGHTERAGE; WAREHOUSING SERVICES, RENTAL OF WAREHOUSES; TOWING AND RESCUING SERVICES FOR BOATS; WRECK REMOVAL AND FIELD DECOMMISSIONING; MAIL DELIVERY SERVICES AND INFORMATION ON BOAT LOCATIONS; PORTERAGE, PILOTING, REFLOATING OF SHIPS (U.S. CLS. 100 AND 105).

FIRST USE 1-31-1996; IN COMMERCE 1-31-1996.
SCOTT OSLICK, EXAMINING ATTORNEY

SN 78-250,489. THE SOCIETY OF DYERS AND COLOURISTS, WEST YORKSHIRE, UNITED KINGDOM, FILED 5-15-2003.

SN 78-264,702. CLYNE, ROGER MEADE, TEMPE, AZ. FILED 6-19-2003.



PRIORITY CLAIMED UNDER SEC. 44(D) ON UNITED KINGDOM APPLICATION NO. 2326059, FILED 3-10-2003, REG. NO. 2326059, DATED 8-8-2003, EXPIRES 3-10-2013.

CLASS 1—CHEMICALS

FOR CHEMICALS FOR USE IN TESTING THE APPLICATION OF COLORS AND DYES TO MATERIALS (U.S. CLS. 1, 5, 6, 10, 26 AND 46).

CLASS 16—PAPER GOODS AND PRINTED MATTER

FOR PRINTED MATTER AND PUBLICATIONS, NAMELY, PERIODICAL PUBLICATIONS AND JOURNALS, BOOKS, MANUALS, BROCHURES, AND INSTRUCTIONAL AND TEACHING MATERIALS RELATING TO COLORS, DYES, THE APPLICATION OF COLORS AND DYES TO MATERIALS; STATIONERY (U.S. CLS. 2, 5, 22, 23, 29, 37, 38 AND 50).

CLASS 24—FABRICS

FOR TEXTILES FOR USE IN TESTING, NAMELY, FLAX, COTTON FABRIC, MATERIALS, NAMELY, FABRICS MADE FROM NATURAL FIBERS, SYNTHETIC FIBERS AND A MIXTURE THEREOF (U.S. CLS. 42 AND 50).

RICHARD WHITE, EXAMINING ATTORNEY



SN 78-259,007. INTUIT INC., MOUNTAIN VIEW, CA. FILED 6-5-2003.

INTUIT

OWNER OF U.S. REG. NOS. 1,821,148, 1,840,504 AND 1,944,875.

CLASS 35—ADVERTISING AND BUSINESS

FOR CHARITABLE SERVICES, NAMELY PROVIDING VOLUNTEER SERVICES TO NON-PROFIT ORGANIZATIONS IN A WIDE VARIETY OF FIELDS; PROVIDING COMPUTER SOFTWARE, BUSINESS MANAGEMENT AND FINANCIAL SERVICES, TAX PREPARATION AND FILING SERVICES, AND TRAINING AND TECHNICAL SUPPORT TO NON-PROFIT ORGANIZATIONS, INDIVIDUALS AND SMALL BUSINESSES (U.S. CLS. 100, 101 AND 102).

FIRST USE 10-0-1995; IN COMMERCE 10-0-1995.

CLASS 36—INSURANCE AND FINANCIAL

FOR PHILANTHROPIC SERVICES CONCERNING MONETARY DONATIONS (U.S. CLS. 100, 101 AND 102).

FIRST USE 10-0-1995; IN COMMERCE 10-0-1995.
CAROLYN GRAY, EXAMINING ATTORNEY

A STAR WITH FIVE APPENDAGES ROUGHLY EQUIDISTANT FROM EACH OTHER. EACH APPENDAGE CURLS TO A WAVE-LIKE FORM AT ITS TERMINUS. THE TERMINUS OF EACH WAVE-LIKE APPENDAGE "BREAKS" IN A CLOCKWISE DIRECTION. FROM THE CENTER OF THE SYMBOL A SPIRAL EMANATES OUTWARD TWO REVOLUTIONS OR ROUGHLY 720 DEGREES AND IS WHOLLY CONTAINED WITHIN THE BODY OF THE SYMBOL.

CLASS 25—CLOTHING

FOR T-SHIRTS, SWEATSHIRTS AND HATS (U.S. CLS. 22 AND 39).

FIRST USE 2-1-2001; IN COMMERCE 4-1-2001.

CLASS 41—EDUCATION AND ENTERTAINMENT

FOR ENTERTAINMENT, NAMELY, LIVE PERFORMANCES BY A MUSICIAN (U.S. CLS. 100, 101 AND 107).

FIRST USE 2-1-2001; IN COMMERCE 4-1-2001.
HOWARD SMIGA, EXAMINING ATTORNEY

SN 78-265,175. INGENIO, INC., SAN FRANCISCO, CA.
FILED 6-20-2003.

KNOWLEDGE ON CALL

CLASS 35—ADVERTISING AND BUSINESS

FOR PROVIDING REFERRALS TO ADVISORS IN THE FIELDS OF ART, ARCHITECTURE, BUSINESS, RETAIL, BANKING, FINANCE, SECURITIES, INSURANCE, TAX, ACCOUNTING, ECONOMICS, BUSINESS AUDITING, REAL ESTATE, MOTOR VEHICLES, EDUCATION, CAREER PLANNING, COMPUTERS, THE INTERNET, TECHNOLOGY, INFORMATION TECHNOLOGY, FILM, MUSIC, THEATER, LAW, MEDICINE, HEALTH AND FITNESS, HOME, INTERIOR DESIGN, LANDSCAPING, PARENTING, TRAVEL, CONSTRUCTION, GOVERNMENTAL AFFAIRS, COMMUNITY AFFAIRS, COUNSELING, AND PSYCHOLOGY; COMMERCIAL INFORMATION AND DIRECTORY AGENCY; PROVIDING REFERRALS TO INDEPENDENT CONTRACTORS IN THE FIELDS OF ART, ARCHITECTURE, BUSINESS, RETAIL, BANKING, FINANCE, SECURITIES, INSURANCE, TAX, ACCOUNTING, ECONOMICS, BUSINESS AUDITING, REAL ESTATE, MOTOR VEHICLES, EDUCATION, CAREER PLANNING, COMPUTERS, THE INTERNET, TECHNOLOGY, INFORMATION TECHNOLOGY, FILM, MUSIC, THEATER, LAW, MEDICINE, HEALTH AND FITNESS, HOME, INTERIOR DESIGN, LANDSCAPING, PARENTING, TRAVEL, CONSTRUCTION, GOVERNMENTAL AFFAIRS, COMMUNITY AFFAIRS, COUNSELING, AND PSYCHOLOGY; TELEPHONE DIRECTORY INFORMATION; PROVIDING INFORMATION SERVICES IN THE FIELD OF TAX, ACCOUNTING AND ECONOMICS; TELEPHONE INFORMATION SERVICE FEATURING INFORMATION IN THE FIELDS OF BUSINESS, RETAIL, TAX, BUSINESS AUDITING, CAREER PLACEMENT, ACCOUNTING, ECONOMICS AND GOVERNMENTAL AFFAIRS (U.S. CLS. 100, 101 AND 102).

CLASS 36—INSURANCE AND FINANCIAL

FOR PROVIDING INFORMATION SERVICES IN THE FIELD OF REAL ESTATE, BANKING, FINANCE, SECURITIES, AND INSURANCE; TELEPHONE INFORMATION SERVICE FEATURING INFORMATION IN THE FIELDS OF BANKING, FINANCE, SECURITIES, INSURANCE AND REAL ESTATE (U.S. CLS. 100, 101 AND 102).

CLASS 42—SCIENTIFIC, COMPUTER AND LEGAL SERVICES

FOR PROVIDING TEMPORARY USE OF A NON-DOWNLOADABLE SOFTWARE PLATFORM THAT ALLOWS USERS TO COMMUNICATE AND TRANSMIT INFORMATION VIA COMPUTER NETWORKS; TELEPHONE INFORMATION SERVICE FEATURING INFORMATION IN THE FIELDS OF ARCHITECTURAL DESIGN, COMPUTERS, TECHNOLOGY, INFORMATION TECHNOLOGY, LAW, HOME, AND INTERIOR DESIGN; PROVIDING TEMPORARY USE OF A NON-DOWNLOADABLE SOFTWARE PLATFORM FOR ENABLING TELEPHONE CONVERSATIONS AMONG USERS; PROVIDING METEOROLOGICAL INFORMATION; COMPUTER SERVICES, NAMELY CREATING INDEXES OF INFORMATION, SITES AND OTHER RESOURCES AVAILABLE ON COMPUTER NETWORKS; COMPUTER SERVICES, NAMELY PROVIDING CUSTOMIZED ONLINE WEB PAGES FEATURING USER-DEFINED INFORMATION, WHICH INCLUDES SEARCH ENGINES AND ONLINE WEB LINKS TO OTHER SITES; PROVIDING INFORMATION AT THE SPECIFIC REQUEST OF END USERS BY MEANS OF TELEPHONE OR GLOBAL COMPUTER NETWORKS; PROVIDING SPECIFIC INFORMATION AS REQUESTED BY CUSTO-

MERS VIA THE INTERNET; E-COMMERCE SERVICES, NAMELY, PROVIDING TEMPORARY USE OF A NON-DOWNLOADABLE E-COMMERCE SOFTWARE PLATFORM; PROVIDING TEMPORARY USE OF A NON-DOWNLOADABLE E-COMMERCE SOFTWARE PLATFORM THAT ALLOWS BUSINESSES TO PERFORM VARIOUS BUSINESS, ADVERTISING AND E-COMMERCE FUNCTIONS; PROVIDING TEMPORARY USE OF A NON-DOWNLOADABLE SECURE SOFTWARE PLATFORM FOR ENABLING COMMERCE-BASED INFORMATION EXCHANGE AMONG USERS (U.S. CLS. 100 AND 101).

JAMES A. RAUEN, EXAMINING ATTORNEY

SN 78-276,270. CAMERON MACKINTOSH (OVERSEAS) LIMITED, LONDON, UNITED KINGDOM, FILED 7-18-2003.

LES MISÉRABLES SCHOOL EDITION

OWNER OF ERPN CMNTY TM OFC REG. NO. 003017126, DATED 1-17-2005, EXPIRES 1-20-2013.

OWNER OF U.S. REG. NOS. 1,550,093 AND 1,817,769.

NO CLAIM IS MADE TO THE EXCLUSIVE RIGHT TO USE "SCHOOL EDITION", APART FROM THE MARK AS SHOWN.

THE ENGLISH TRANSLATION OF THE FOREIGN WORDING IN THE MARK IS "THE WRETCHED".

CLASS 9—ELECTRICAL AND SCIENTIFIC APPARATUS

FOR (SECTION 44) PHONOGRAPH RECORDS FEATURING MUSIC AND THEATRICAL PRODUCTIONS AND PERFORMANCES, AUDIO AND AUDIO-VIDEO RECORDINGS FEATURING MUSIC AND THEATRICAL PRODUCTIONS AND PERFORMANCES, VIDEO TAPES FEATURING MUSIC AND THEATRICAL PRODUCTIONS AND PERFORMANCES, COMPACT DISCS FEATURING MUSIC AND THEATRICAL PRODUCTIONS AND PERFORMANCES, AND PRE-RECORDED AUDIO TAPES FEATURING MUSIC AND THEATRICAL PRODUCTIONS AND PERFORMANCES (U.S. CLS. 21, 23, 26, 36 AND 38).

CLASS 16—PAPER GOODS AND PRINTED MATTER

FOR (SECTION 44) PRINTED MATTER, NAMELY, BOOKS FEATURING MUSIC, THEATRICAL PRODUCTIONS AND PERFORMANCES, POSTERS, PHOTOGRAPHS, STATIONERY AND SCRIPTS FEATURING MUSIC, THEATRICAL PRODUCTIONS AND PERFORMANCES, STUDY GUIDES, SHEET MUSIC BOOKS, CONDUCTORS MUSICAL SCORES, LYRIC BOOKS, SOUVENIR PROGRAMS FEATURING MUSIC, THEATRICAL PRODUCTIONS AND PERFORMANCES AND BROCHURES FEATURING MUSIC, THEATRICAL PRODUCTIONS AND PERFORMANCES; PACKAGING MATERIALS NAMELY, CARDBOARD BOXES, PAPER BAGS, PLASTIC BAGS, WRAPPING PAPER AND PLASTIC WRAP; COASTERS MADE OF PAPER, SHEET MUSIC AND TISSUE PAPER (U.S. CLS. 2, 5, 22, 23, 29, 37, 38 AND 50).

CLASS 25—CLOTHING

FOR (SECTION 44) ARTICLES OF OUTER CLOTHING, NAMELY, SWEATSHIRTS, T-SHIRTS, COATS, JACKETS, WIND-RESISTANT JACKETS, MITTENS, GLOVES, SCARVES AND HATS (U.S. CLS. 22 AND 39).

CLASS 41—EDUCATION AND ENTERTAINMENT

FOR (SECTIONS 44 AND USE IN COMMERCE) ENTERTAINMENT/SHOW BUSINESS SERVICES IN THE NATURE OF LIVE THEATRICAL PRODUCTIONS AND PERFORMANCES (U.S. CLS. 100, 101 AND 107).

FIRST USE 5-10-2001; IN COMMERCE 5-10-2001.
MATTHEW PAPPAS, EXAMINING ATTORNEY

SN 78-280,435. DR. TORO'S MIXING COMPANY, INC., MIAMI BEACH, CA. FILED 7-29-2003.



SN 78-276,949. EVANS CONSOLES CORPORATION, CALGARY, ALBERTA, CANADA, FILED 7-21-2003.

CONTROL CENTER SOLUTIONS

PRIORITY CLAIMED UNDER SEC. 44(D) ON CANADA APPLICATION NO. 1185334, FILED 7-16-2003, REG. NO. TMA640918, DATED 5-31-2005, EXPIRES 5-31-2020.

NO CLAIM IS MADE TO THE EXCLUSIVE RIGHT TO USE "CONTROL CENTER", APART FROM THE MARK AS SHOWN.

CLASS 37—CONSTRUCTION AND REPAIR

FOR INSTALLATION OF EQUIPMENT CONSOLES, WORKSTATIONS, LARGE SCREEN DISPLAYS WALLS AND UNITS, OFFICE FURNITURE, CABINETRY, DESKS, WORK SURFACES, STRUCTURAL ENCLOSURES, HOUSING AND KIOSKS, SHELVING AND TASK LIGHTS; MAINTENANCE AND REPAIR OF EQUIPMENT CONSOLES, WORKSTATIONS, LARGE SCREEN DISPLAY WALLS AND UNITS, OFFICE FURNITURE, CABINETRY, DESKS, WORK SURFACES, STRUCTURAL ENCLOSURES, HOUSING AND KIOSKS, SHELVING AND TASK LIGHTS, PROJECT MANAGEMENT SERVICES, NAMELY, CONSTRUCTION MANAGEMENT SERVICES (U.S. CLS. 100, 103 AND 106).

CLASS 40—MATERIAL TREATMENT

FOR CUSTOM MANUFACTURE OF EQUIPMENT CONSOLES, WORKSTATIONS, LARGE SCREEN DISPLAY WALLS AND UNITS, OFFICE FURNITURE, CABINETRY, DESKS, WORK SURFACES, STRUCTURAL ENCLOSURES, HOUSING AND KIOSKS, SHELVING AND TASK LIGHTS BUILT TO THE SPECIFICATIONS OF OTHERS (U.S. CLS. 100, 103 AND 106).

CLASS 41—EDUCATION AND ENTERTAINMENT

FOR EDUCATIONAL SERVICES, NAMELY, PROVIDING SEMINARS AND WORKSHOPS IN THE INSTALLATION, MAINTENANCE AND REPAIR OF EQUIPMENT CONSOLES AND WORKSHOPS (U.S. CLS. 100, 101 AND 107).

CLASS 42—SCIENTIFIC, COMPUTER AND LEGAL SERVICES

FOR ARCHITECTURAL, INTERIOR DESIGN, DESIGN CONSULTANCY AND CUSTOM DESIGN SERVICES RELATING TO PLANNING AND DESIGNING OF COMMAND AND CONTROL CENTERS AND THE INTERIOR OF COMMAND AND CONTROL CENTER BUILDINGS (U.S. CLS. 100 AND 101).

EDWARD NELSON, EXAMINING ATTORNEY

NO CLAIM IS MADE TO THE EXCLUSIVE RIGHT TO USE "COMPANY", APART FROM THE MARK AS SHOWN. THE NAME IN THE MARK DOES NOT REFER TO A PARTICULAR LIVING INDIVIDUAL.

THE MARK CONSISTS OF A HUMANIZED SNORTING BULL FIGURE WITH ITS LEFT ARM EXTENDED AND HOLDING A BOTTLE AND GLASS ON A SERVING TRAY AND ITS RIGHT ARM FLEXED WITH A CLINCHED FIST, ALL FRAMED WITHIN A CROSS BRACKETED BY THE STYLIZED TEXT "DR. TORO'S", PRINTED ON A CURVE ABOVE THE CROSS, AND THE STYLIZED TEXT "MIXING COMPANY" PRINTED AT AN ASCENDING ANGLE BELOW THE CROSS.

THE FOREIGN WORDING IN THE MARK TRANSLATES INTO ENGLISH AS BULL.

CLASS 25—CLOTHING

FOR CLOTHING, NAMELY SWEATSHIRTS, SWEATPANTS, PANTS, T-SHIRTS, JACKETS, SHORTS, FLEECE TOPS, JERSEYS, HATS AND FOOTWEAR (U.S. CLS. 22 AND 39).

FIRST USE 3-1-2003; IN COMMERCE 3-1-2003.

CLASS 32—LIGHT BEVERAGES

FOR NON-ALCOHOLIC COCKTAIL MIXES (U.S. CLS. 45, 46 AND 48).

FIRST USE 3-1-2003; IN COMMERCE 3-1-2003.

PAUL F. GAST, EXAMINING ATTORNEY

SN 78-285,284. IMERG, INC., BEVERLY HILLS, CA. FILED 8-8-2003.

AT LAST**CLASS 9—ELECTRICAL AND SCIENTIFIC APPARATUS**

FOR MUSICAL SOUND RECORDINGS (U.S. CLS. 21, 23, 26, 36 AND 38).

FIRST USE 2-1-2000; IN COMMERCE 5-1-2000.

CLASS 41—EDUCATION AND ENTERTAINMENT

FOR LIVE PERFORMANCES BY A MUSICAL GROUP (U.S. CLS. 100, 101 AND 107).

FIRST USE 2-1-2000; IN COMMERCE 5-1-2000.

CAROLYN GRAY, EXAMINING ATTORNEY

SN 78-288,200. TIDE MARK ENTERPRISE LIMITED, SHANTIN, N.T., HONG KONG, FILED 8-15-2003.



THE NAME JACKIE SHOWN IN THE MARK IDENTIFIES A LIVING INDIVIDUAL.

THE MARK COMPRISES JACKIE IN STYLIZED LETTERS SURROUNDED BY DOVE AND DRAGON DESIGNS WITH CHINESE CHARACTERS IN A RING OF FIRE.

THE CHINESE CHARACTERS IN THE MARK TRANSLITERATE TO "LONG" AND MEAN "DRAGON" IN ENGLISH".

CLASS 3—COSMETICS AND CLEANING PREPARATIONS

FOR COSMETICS; SHAMPOOS; HAIR CONDITIONERS; SKIN CLEANSING MILK; PERFUMERY; SOAP; CREAM FOR WHITENING SKIN AND TEETH (U.S. CLS. 1, 4, 6, 50, 51 AND 52).

CLASS 11—ENVIRONMENTAL CONTROL APPARATUS

FOR ELECTRIC COOKING POTS; ARC LAMPS; ELECTRIC LAMPS; ELECTRIC FANS; LAMPS; VEHICLE HEADLIGHTS; VEHICLE REFLECTORS; LIGHTS FOR VEHICLES (U.S. CLS. 13, 21, 23, 31 AND 34).

CLASS 12—VEHICLES

FOR BICYCLES; AUTOMOBILES; AIR BALLOONS; AEROPLANES; AIRCRAFTS; CABLE CARS; CARS; TRAIN DINING CARS; ELECTRIC AUTOMOBILE; ENGINES FOR LAND VEHICLES; SPORTS CARS; WINDSCREENS FOR VEHICLES; FINISHED WINDSHIELDS FOR VEHICLES (U.S. CLS. 19, 21, 23, 31, 35 AND 44).

CLASS 21—HOUSEWARES AND GLASS

FOR POLISHED AND SMOOTH PLATE GLASS; BAKING DISHES; PLATES; GLASS BOWLS; KITCHEN CONTAINERS, NOT OF PRECIOUS METAL; BOXES OF GLASS; UTENSILS FOR BARBECUES, NAMELY FORKS, TONGS; NON-ELECTRIC DEEP FRYERS; FLASKS; CRYSTAL OR EARTHENWARE STATUES (U.S. CLS. 2, 13, 23, 29, 30, 33, 40 AND 50).

CLASS 24—FABRICS

FOR TOWELS; FACE TOWELS OF TEXTILE; BED LINENS; COTTON FABRICS; UNFITTED FURNITURE COVERS OF TEXTILE; CURTAINS OF TEXTILE; PILLOW CASES; QUILTS; SILK FABRICS (U.S. CLS. 42 AND 50).

CLASS 27—FLOOR COVERINGS

FOR CARPETS; VINYL FLOOR COVERINGS; GYMNASIUM EXERCISE MATS; WALLPAPER; BATH MATS; AUTOMATIC CARPETS (U.S. CLS. 19, 20, 37, 42 AND 50).

CLASS 28—TOYS AND SPORTING GOODS

FOR TOY WATCHES; TOY WEAPONS; TOY, NAMELY, BATTERY-POWERED COMPUTER GAME WITH AN LCD FEATURING ANIMATION AND SOUND EFFECTS; PLAYING CARDS; TOY VEHICLES; SCALE MODEL VEHICLES; TREADMILLS FOR BODY TRAINING; BUILDING GAMES, NAMELY, TOY BUILDING BLOCKS; GOLF BAGS, WITH OR WITHOUT WHEELS; GOLF GLOVES; MOBILES OF TOYS; TOY AIRPLANES; TOY FIGURES; TOY GUNS (U.S. CLS. 22, 23, 38 AND 50).
WILLIAM BRECKENFELD, EXAMINING ATTORNEY

SN 78-291,929. ENHANCED TELECOMMUNICATIONS, INC., NORCROSS, GA. FILED 8-25-2003.

TVTICKET

CLASS 9—ELECTRICAL AND SCIENTIFIC APPARATUS

FOR PREPAID CABLE AND SATELLITE TELEVISION PROGRAMMING ACCESS CARDS, ALL BEING MAGNETIC OR ENCODED FOR ACCESSING CABLE AND SATELLITE TELEVISION PROGRAMMING (U.S. CLS. 21, 23, 26, 36 AND 38).

CLASS 16—PAPER GOODS AND PRINTED MATTER

FOR PREPAID NON-MAGNETICALLY ENCODED CABLE AND SATELLITE TELEVISION PROGRAMMING ACCESS CARDS FOR ACCESSING CABLE AND SATELLITE TELEVISION PROGRAMMING (U.S. CLS. 2, 5, 22, 23, 29, 37, 38 AND 50).

CLASS 35—ADVERTISING AND BUSINESS

FOR RETAIL STORE SERVICES OFFERED AT HOTELS AND EXTENDED STAY LOCATIONS FEATURING PREPAID AND COMPLEMENTARY PRODUCTS, NAMELY, PREPAID CABLE AND SATELLITE TELEVISION PROGRAMMING ACCESS CARDS; ONLINE RETAIL STORE SERVICES, FEATURING PREPAID PRODUCTS, NAMELY, PREPAID CABLE AND SATELLITE TELEVISION PROGRAMMING ACCESS CARDS; TELEPHONE AND ON-LINE ORDERING SERVICES FEATURING PAY PER VIEW MOVIES AND EVENTS, PREMIUM CHANNELS AND SATELLITE NETWORKS ALL PAID FOR BY PREPAID PROGRAMMING ACCESS CARDS; RETAIL STORE SERVICES, FEATURING PREPAID CABLE AND SATELLITE PROGRAMMING ACCESS CARDS (U.S. CLS. 100, 101 AND 102).

CLASS 36—INSURANCE AND FINANCIAL

FOR PREPAID PURCHASE CARD SERVICES, NAMELY, PROCESSING ELECTRONIC PAYMENTS MADE THROUGH PREPAID CARDS, PROVIDING SERVICES FOR ORDERING BY TELEPHONE OR ON-LINE OR OTHER ELECTRONIC MEANS PAY-PER-VIEW MOVIES AND EVENTS, PREMIUM CHANNELS AND SATELLITE NETWORKS PAID FOR BY A PREPAID PROGRAMMING ACCESS CARD, PROCESSING ELECTRONIC PAYMENTS MADE THROUGH PREPAID CARDS (U.S. CLS. 100, 101 AND 102).

CLASS 38—COMMUNICATION

FOR PREPAID SATELLITE TELEVISION TRANSMISSION SERVICES; PREPAID CABLE TELEVISION BROADCASTING SERVICES; SATELLITE TELEVISION TRANSMISSION SERVICES; CABLE TELEVISION BROADCASTING SERVICES; TELEVISION BROADCASTING SERVICES, NAMELY CABLE AND SATELLITE TELEVISION TRANSMISSION BROADCASTING SERVICES (U.S. CLS. 100, 101 AND 104).

NAKWAMA ANKRAH, EXAMINING ATTORNEY

SN 78-293,427. RESTAT, LLC, GERMANTOWN, WI. FILED 8-28-2003.



OWNER OF U.S. REG. NO. 1,908,726.

CLASS 35—ADVERTISING AND BUSINESS

FOR PROVIDING A SECURE WEBSITE ALLOWING PRESCRIPTION DRUG USERS TO REVIEW PRESCRIPTION INFORMATION ON INCENTIVES TO PROMOTE GENERIC AND FORMULARY DRUG UTILIZATION (U.S. CLS. 100, 101 AND 102).

FIRST USE 1-1-1992; IN COMMERCE 7-1-1992.

CLASS 36—INSURANCE AND FINANCIAL

FOR PROVIDING A SECURE WEBSITE ALLOWING PRESCRIPTION DRUG USERS TO REVIEW PRESCRIPTION INFORMATION ON-LINE, NAMELY, INFORMATION REGARDING PAYMENT COORDINATION WITH PRIMARY OR SECONDARY CARRIERS (U.S. CLS. 100, 101 AND 102).

FIRST USE 1-1-1992; IN COMMERCE 7-1-1992.

CLASS 44—MEDICAL, BEAUTY AND AGRICULTURAL SERVICES

FOR PROVIDING A SECURE WEBSITE ALLOWING PRESCRIPTION DRUG USERS TO REVIEW PRESCRIPTION INFORMATION ON-LINE INCLUDING, DRUG SELECTION AND UTILIZATION; AUTHORIZATION FOR DRUG UTILIZATION, AND FORMULARY OVER-RIDES (U.S. CLS. 100 AND 101).

FIRST USE 1-1-1992; IN COMMERCE 7-1-1992.
CHRISTOPHER BUONGIORNO, EXAMINING ATTORNEY

SN 78-294,816. STUDENT LOAN XPRESS, INC., SAN DIEGO, CA. FILED 9-2-2003.

EVERYSTUDENT BENEFITS

NO CLAIM IS MADE TO THE EXCLUSIVE RIGHT TO USE "BENEFITS", APART FROM THE MARK AS SHOWN.

CLASS 36—INSURANCE AND FINANCIAL

FOR PROVIDING ONLINE INFORMATION TO STUDENTS AND RECENT GRADUATES REGARDING LOANS, NAMELY, CONSOLIDATION LOANS, GRADUATE SCHOOL LOANS, AUTO LOANS, INSURANCE AND OTHER FINANCIAL PRODUCTS; PROVIDING ONLINE FINANCIAL SERVICES TO STUDENTS AND RECENT GRADUATES IN THE FIELD OF FINANCIAL PLANNING AND BUDGETING ADVICE; PROVIDING ONLINE INFORMATION CONCERNING THE PURCHASE OR LEASING OF HOUSES (U.S. CLS. 100, 101 AND 102).

CLASS 41—EDUCATION AND ENTERTAINMENT

FOR PROVIDING ONLINE INFORMATION TO STUDENTS AND RECENT GRADUATES IN THE FIELD OF GRADUATE AND ADVANCED EDUCATIONAL PROGRAMS (U.S. CLS. 100, 101 AND 107).

KAREN BRACEY, EXAMINING ATTORNEY

SN 78-295,122. GUANGDONG STRONG GROUP CO. LTD., GUANGDONG PROVINCE, CHINA, FILED 9-2-2003.

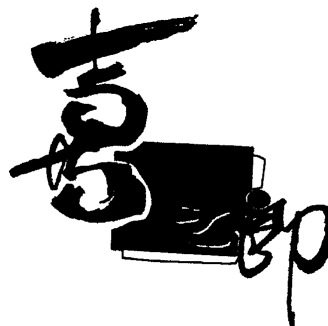

OWNER OF CHINA REG. NO. 1387544, DATED 4-21-2000, EXPIRES 4-20-2010.

OWNER OF CHINA REG. NO. 1341604, DATED 12-7-1999, EXPIRES 12-6-2009.

THE MARK CONSISTS OF CHINESE CHARACTERS WHICH MEAN MAN OF HAPPINESS AND AN ARBITRARY DESIGN.

THE NON-LATIN CHARACTERS IN THE MARK TRANSLITERATE TO XI ZHI LANG.

CLASS 29—MEATS AND PROCESSED FOODS

FOR JELLIES (U.S. CL. 46).

CLASS 30—STAPLE FOODS

FOR FRUIT JELLIES IN THE NATURE OF CONFECTIONERY; PUDDINGS (U.S. CL. 46).

ROBERT C. CLARK JR., EXAMINING ATTORNEY

SN 78-298,160. THE WANDSWORTH GROUP LTD, SURREY, UNITED KINGDOM, FILED 9-9-2003.



THE MARK CONSISTS OF THE WORD TELE-CALL WITH A DESIGN ELEMENT OVER THE LAST TWO L'S. THE TERM TELE- IS IN THE COLOR YELLOW AND THE TERM CALL IS IN THE COLOR PURPLE. THE DESIGN ELEMENT CONSISTS OF THREE PARTS: THE BOTTOM PORTION OF THE DESIGN IS DARK RED, THE CENTER PORTION IS ORANGE AND THE TOP PORTION IS YELLOW.

CLASS 35—ADVERTISING AND BUSINESS

FOR COMPUTERIZED ON-LINE ORDERING SERVICES IN THE FIELD OF MEALS FOR HOSPITAL PATIENTS (U.S. CLS. 100, 101 AND 102).

CLASS 38—COMMUNICATION

FOR PROVIDING TELECOMMUNICATIONS SERVICES TO HEALTHCARE PATIENTS BY MEANS OF HOSPITAL BEDSIDE CONSOLES, NAMELY, PROVIDING PATIENT ACCESS TO A GLOBAL COMPUTER NETWORK, PROVIDING ELECTRONIC MAIL SERVICES, AND PROVIDING LOCAL AND LONG DISTANCE TELEPHONE SERVICES TO PATIENTS; PROVIDING TO PATIENTS ACCESS TO RADIO AND TELEVISION BROADCASTS BY MEANS OF SATELLITE, CABLE AND WIRELESS TRANSMISSION; BROADCASTING SERVICES, NAMELY, VIDEO BROADCASTING, TELEVISION BROADCASTING, CABLE TELEVISION BROADCASTING, AUDIO BROADCASTING, BROADCASTING PROGRAMS VIA SATELLITE, CABLE, WIRELESS AND GLOBAL COMPUTER NETWORKS; RENTAL OF COMMUNICATIONS APPARATUS AND INSTRUMENTS; PROVIDING TO PATIENTS, FOR EDUCATIONAL AND ENTERTAINMENT PURPOSES, ACCESS TO TELEVISION CHANNELS, MOVIE CHANNELS, TELETEXT INFORMATION, E-MAIL, THE WORLD WIDE WEB AND RADIO, ALL BEING PROVIDED BY MEANS OF ELECTRONIC, ELECTRIC, AND DIGITAL TRANSMISSION (U.S. CLS. 100, 101 AND 104).

CLASS 41—EDUCATION AND ENTERTAINMENT

FOR ENTERTAINMENT SERVICES, NAMELY, ON-GOING TELEVISION PROGRAMS FOR USE BY HOSPITALS AND HEALTHCARE FACILITIES THAT PROVIDE INFORMATION TO PATIENTS ON NEWS AND CURRENT EVENTS, MEDICAL CARE, HOSPITAL SERVICES AND POLICIES, AND MEDICAL RESEARCH; ENTERTAINMENT SERVICES, NAMELY, ON-GOING TELEVISION PROGRAMS FOR USE BY HOSPITALS AND HEALTHCARE FACILITIES FEATURING VISUAL AND AUDIO-VISUAL PERFORMANCES, AND MUSICAL, VARIETY, NEWS AND COMEDY SHOWS (U.S. CLS. 100, 101 AND 107).

CLASS 44—MEDICAL, BEAUTY AND AGRICULTURAL SERVICES

FOR PROVIDING MEDICAL REHABILITATION, PSYCHOLOGICAL AND GRIEF COUNSELING SERVICES TO PATIENTS (U.S. CLS. 100 AND 101).

CLASS 45—PERSONAL SERVICES

FOR PROVIDING RELIGIOUS AND PERSONAL COUNSELING SERVICES TO PATIENTS (U.S. CLS. 100 AND 101).

ELIZABETH J. WINTER, EXAMINING ATTORNEY

SN 78-301.111. PAPPAS TELECASTING COMPANIES, VISALIA, CA. FILED 9-16-2003.

GREAT DAY**CLASS 38—COMMUNICATION**

FOR TELEVISION BROADCASTING (U.S. CLS. 100, 101 AND 104).

FIRST USE 10-6-2003; IN COMMERCE 10-6-2003.

CLASS 41—EDUCATION AND ENTERTAINMENT

FOR TELEVISION PROGRAMMING (U.S. CLS. 100, 101 AND 107).

FIRST USE 10-6-2003; IN COMMERCE 10-6-2003.
MARC LEIPZIG, EXAMINING ATTORNEY

SN 78-302.013. KÜBEL, JOHANN, A-3072 KASTEN, AUSTRIA, FILED 9-18-2003.

TOP HAT

PRIORITY CLAIMED UNDER SEC. 44(D) ON AUSTRIA APPLICATION NO. AM18832003, FILED 3-18-2003, REG. NO. 212510, DATED 9-17-2003, EXPIRES 9-30-2013.

OWNER OF U.S. REG. NO. 2,721,748.

CLASS 6—METAL GOODS

FOR GOODS PREDOMINANTLY MADE FROM METAL, NAMELY, PIPES, HOSES, PIPE END CAPS, HOSE END CAPS, PIPE CONNECTORS, HOSE CONNECTORS, SLEEVES, PIPE COLLARS, CRIMPED COLLARS, BAFFLES, DEFLECTORS AND LAMELLAE (U.S. CLS. 2, 12, 13, 14, 23, 25 AND 50).

CLASS 7—MACHINERY

FOR SEWAGE PIPE ROBOTS; MACHINES FOR REHABILITATING SEWAGE SYSTEMS; MACHINES FOR LAYING CABLES (U.S. CLS. 13, 19, 21, 23, 31, 34 AND 35).

CLASS 16—PAPER GOODS AND PRINTED MATTER

FOR BROCHURES, PAMPHLETS, DATA SHEETS, AND USER MANUALS IN THE FIELDS OF SEWER MAINTENANCE AND REPAIR AND PIPES AND PIPELINE INSTALLATION AND REPAIR (U.S. CLS. 2, 5, 22, 23, 29, 37, 38 AND 50).

CLASS 17—RUBBER GOODS

FOR GOODS PREDOMINANTLY MADE FROM GLASS-FIBER REINFORCED PLASTIC, NAMELY, PIPES, HOSES, PIPE END CAPS, HOSE END CAPS, PIPE CONNECTORS, HOSE CONNECTORS, SLEEVES, PIPE COLLARS, CRIMPED COLLARS, BAFFLES, DEFLECTORS AND LAMELLAE (U.S. CLS. 1, 5, 12, 13, 35 AND 50).

CLASS 37—CONSTRUCTION AND REPAIR

FOR REPAIR OF SEWAGE SYSTEMS; SEWAGE REPAIR SERVICES, NAMELY, CONNECTING AND SEALING OF WATER PIPES AND SEWER PIPES SERVICES (U.S. CLS. 100, 103 AND 106).

KEVON CHISOLM, EXAMINING ATTORNEY

SN 78-303,632. I.T. WORX, INC., GREENSBORO, NC. FILED 9-22-2003.



CLASS 37—CONSTRUCTION AND REPAIR

FOR COMPUTER INSTALLATION AND REPAIR; INSTALLATION OF COMPUTER SYSTEMS, MAINTENANCE AND REPAIR OF COMPUTER HARDWARE; INSTALLATION, MAINTENANCE AND REPAIR OF COMPUTER NETWORK (U.S. CLS. 100, 103 AND 106).
FIRST USE 6-15-2002; IN COMMERCE 6-15-2002.

CLASS 42—SCIENTIFIC, COMPUTER AND LEGAL SERVICES

FOR CONSULTING SERVICES IN THE FIELD OF DESIGN, SELECTION, IMPLEMENTATION AND USE OF COMPUTERS, COMPUTER HARDWARE AND SOFTWARE SYSTEMS FOR OTHERS; COMPUTER PROJECT MANAGEMENT SERVICES; MONITORING THE COMPUTER SYSTEMS OF OTHERS FOR TECHNICAL PURPOSES AND PROVIDING BACK-UP COMPUTER PROGRAMS AND FACILITIES; REMOTE MONITORING SERVICES OF COMPUTER SYSTEMS OF OTHERS FOR TECHNICAL PURPOSES AND PROVIDING BACK-UP COMPUTER PROGRAMS AND FACILITIES; TECHNICAL SUPPORT SERVICES, NAMELY, TROUBLESHOOTING OF COMPUTER HARDWARE AND SOFTWARE PROBLEMS, COMPUTER CONSULTATION SERVICES, NAMELY TREND ANALYSIS REGARDING THE PERFORMANCE OF NETWORKED COMPUTER SYSTEMS; UPGRADING OF COMPUTER HARDWARE AND COMPUTER SOFTWARE (U.S. CLS. 100 AND 101).
FIRST USE 6-15-2002; IN COMMERCE 6-15-2002.
GEORGIA CARTY, EXAMINING ATTORNEY

SN 78-305,219. FIBA FÉDÉRATION INTERNATIONALE DE BASKETBALL, CH 1214 VERNIER/GENEVA, SWITZERLAND, FILED 9-25-2003.

FIBA

PRIORITY CLAIMED UNDER SEC. 44(D) ON SWITZERLAND APPLICATION NO. 511171, FILED 3-26-2003, REG. NO. 511171, DATED 6-5-2003, EXPIRES 3-26-2013.

CLASS 25—CLOTHING

FOR CLOTHING, FOOTWEAR AND HEADGEAR, NAMELY, TENNIS SHOES, BASKETBALL SHOES, LEATHER SHOES, BEACH SHOES, SANDALS, GYMNASIATIC SHOES, CLOGS, GOLF SHOES, BOOTS, TRACK SHOES, SLIPPERS, FLIP-FLOPS, LOW SHOES, INNER-SOLES; HATS, CAPS, BERETS, HEADBANDS, BANDANNAS, SHAWLS, VISORS; KNIT SHIRTS, JERSEY AND TANK TOPS, T-SHIRTS, PULLOVERS, SHORT SLEEVED SHIRTS, SPORT SHIRTS, POLO SHIRTS; SKIRTS, DRESSES, UNDERWEAR, SWIMWEAR, SHORTS, SPORTS PANTS, SWEATERS, SCARVES, WARM-UP SUITS, SPORTS UNIFORMS; NECKTIES, WRISTBANDS, GLOVES FOR PROTECTION AGAINST COLD, MITTENS, APRONS, CLOTH BIBS; PAJAMAS, TODDLER AND INFANT PLAYWEAR, NAMELY, PANTS, SHIRTS, CAPS; SOCKS AND HOSIERY, SUSPENDERS FOR CLOTHING; TEXTILE BABY DIAPERS, WATER RESISTANT JACKETS, SPORTING ANORAKS, LEATHER BELTS, JEANS, BATH ROBES; LEOTARDS, TRACK SUITS; BASEBALL JERSEYS, BOW TIES, DIAPER COVERS, EAR MUFFS, MUFFLERS, KIMONOS, TROUSERS, NIGHT GOWNS, LEATHER JACKETS (U.S. CLS. 22 AND 39).

CLASS 38—COMMUNICATION

FOR TELECOMMUNICATION SERVICES, NAMELY, PROVIDING TELECOMMUNICATIONS CONNECTIONS TO A GLOBAL COMPUTER NETWORK, TRANSMISSION OF RADIO AND TELEVISION BROADCAST, TELEPHONE TRANSMISSION SERVICES, NAMELY, LOCAL AND LONG DISTANCE TRANSMISSION OF VOICE, DATA, GRAPHICS BY MEANS OF TELEPHONE, TELEGRAM AND FACSIMILE TRANSMISSION SERVICES; CELLULAR TELEPHONE COMMUNICATION SERVICES; TELEVISION BROADCASTING SERVICES, RADIO BROADCASTING SERVICES; ELECTRONIC MAIL SERVICES, MESSAGES AND IMAGES TRANSMISSION SERVICES USING COMPUTERS, NAMELY WEBCASTING SERVICES IN THE NATURE OF PROVIDING ON-LINE CHAT ROOMS AND ON-LINE INTERACTIVE CHAT ROOMS WITH GUESTS FOR TRANSMISSION OF MESSAGES AMONG COMPUTER USERS CONCERNING THE FIELD OF BASKETBALL; PROVIDING ON-LINE ELECTRONIC BULLETIN BOARDS FOR TRANSMISSION OF MESSAGES AMONG COMPUTER USERS CONCERNING THE FIELD OF BASKETBALL; PROVIDING MULTIPLE USER DIAL-UP AND DEDICATED ACCESS TO THE INTERNET; ELECTRONIC DELIVERY OF IMAGES, PHOTOGRAPHS AND SOUNDS VIA A GLOBAL COMPUTER NETWORK, MOBILE PHONES, SATELLITE, CABLE OR WIRELESS (U.S. CLS. 100, 101 AND 104).

CLASS 41—EDUCATION AND ENTERTAINMENT

FOR EDUCATION TRAINING AND ENTERTAINMENT SERVICES, NAMELY, ORGANIZATION OF LOTTERIES; ORGANIZING OF SPORTING AND CULTURAL EVENTS AND ACTIVITIES; RENTAL SERVICES FOR AUDIO EQUIPMENT, RENTAL SERVICES FOR VIDEO EQUIPMENT, RADIO SET RENTAL SERVICES, TELEVISION SET RENTAL SERVICES, RADIO PROGRAM PRODUCTION SERVICES, TELEVISION PROGRAM PRODUCTION SERVICES, PRODUCTION OF ANIMATION TV PROGRAMS, LIVE PERFORMANCES OF BASKETBALL GAMES, VIDEOTAPE FILM PRODUCTION SERVICES, VIDEOTAPE EDITING SERVICES, TELEVISION SHOW PRODUCTION SERVICES, SEAT BOOKING SERVICES FOR BASKETBALL GAMES, ORGANIZATION OF CULTURAL AND SPORTING EVENTS AND ACTIVITIES, MOTION PICTURE FILM PRODUCTION SERVICES, MOTION PICTURE RENTAL SERVICES, TELEVISION ENTERTAINMENT SERVICES, NAMELY, PRODUCTION AND DISTRIBUTION OF RADIO AND TELEVISION BROADCASTS OF BASKETBALL GAMES, BASKETBALL EVENTS AND PROGRAMS IN THE FIELD OF BASKETBALL; ENTERTAINMENT SERVICES, NAMELY PROVIDING A WEBSITE FEATURING TELEVISION HIGHLIGHTS, INTERACTIVE TELEVISION HIGHLIGHTS, VIDEO RECORDINGS, VIDEO STREAM RECORDINGS, INTERACTIVE VIDEO HIGHLIGHT SELECTIONS, RADIO PROGRAMS, RADIO HIGHLIGHTS AND AUDIO RE-

CORDINGS IN THE FIELD OF BASKETBALL; PUBLICATIONS OF TEXTS, PUBLICATIONS OF BOOKS, PROVIDING INFORMATION IN THE FIELD OF EDUCATION, EXHIBITION OPENING AND MANAGEMENT SERVICES, NAMELY, ORGANIZING EXHIBITIONS FOR CULTURAL AND SPORTING PURPOSES, STADIUM FACILITY RENTAL SERVICES, COMPETITION ORGANIZATION SERVICES, NAMELY, ARRANGING AND CONDUCTING ATHLETIC COMPETITIONS, FAN CLUB SERVICES, PUBLICATION OF ATHLETIC RECORDS AND STATISTICAL INFORMATION, SPORTS EQUIPMENT RENTAL SERVICES EXCLUDING VEHICLES, BEAUTY CONTEST ARRANGEMENT SERVICES, MUSICAL EVENT ARRANGEMENT SERVICES, SPORTS EVENT TIME MEASUREMENT SERVICES, NAMELY, TIMING OF SPORTS EVENTS, PUBLICATION OF INFORMATION ON GAMES BY MAGAZINES AND/OR BY NEWSPAPERS; PRODUCTION OF ANIMATION MOVIES; ENTERTAINMENT SERVICES IN THE NATURE OF ONGOING TELEVISION AND RADIO PROGRAMS IN THE FIELD OF BASKETBALL AND WITH LIVE BASKETBALL GAMES AND BASKETBALL EXHIBITIONS (U.S. CLS. 100, 101 AND 107).

ANN LINNEHAN, EXAMINING ATTORNEY

SN 78-305,521. PHARMACHEM LABORATORIES, INC., KEARNY, NJ. FILED 9-25-2003.

FRUITCEUTICAL

CLASS 1—CHEMICALS

FOR CHEMICALS FOR USE IN THE MANUFACTURE OF PHARMACEUTICAL PREPARATIONS AND DIETARY NUTRITIONAL SUPPLEMENTS (U.S. CLS. 1, 5, 6, 10, 26 AND 46).

CLASS 5—PHARMACEUTICALS

FOR PHARMACEUTICAL PREPARATIONS AND DIETARY NUTRITIONAL SUPPLEMENTS (U.S. CLS. 6, 18, 44, 46, 51 AND 52).

CURTIS FRENCH, EXAMINING ATTORNEY

SN 78-305,598. REED PUBLISHING (NZ) LIMITED, AUCKLAND, NEW ZEALAND, FILED 9-25-2003.

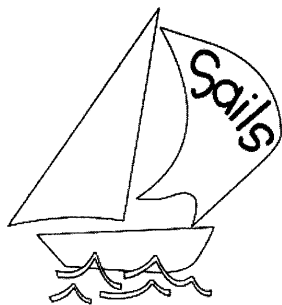

PRIORITY CLAIMED UNDER SEC. 44(D) ON NEW ZEALAND APPLICATION NO. 677428, FILED 4-15-2003, REG. NO. 677428, DATED 10-16-2003, EXPIRES 4-15-2010.

PRIORITY CLAIMED UNDER SEC. 44(D) ON NEW ZEALAND APPLICATION NO. 677427, FILED 4-15-2003, REG. NO. 677427, DATED 10-16-2003, EXPIRES 4-15-2010.

PRIORITY CLAIMED UNDER SEC. 44(D) ON NEW ZEALAND APPLICATION NO. 677426, FILED 4-15-2003, REG. NO. 677426, DATED 10-16-2003, EXPIRES 4-15-2010.

CLASS 9—ELECTRICAL AND SCIENTIFIC APPARATUS

FOR AUDIO RECORDINGS, VIDEO RECORDINGS AND AUDIO VISUAL RECORDINGS IN THE FIELD OF LITERACY, NAMELY, CASSETTE TAPES, COMPACT DISCS, PHONOGRAPH RECORDS, AUDIO AND VIDEO TAPES AND CD-ROM (U.S. CLS. 21, 23, 26, 36 AND 38).

CLASS 16—PAPER GOODS AND PRINTED MATTER

FOR PRINTED MATTER IN THE FIELD OF LITERACY, NAMELY, BOOKS AND BOOKLETS; USER MANUALS AND PRINTED INSTRUCTION MANUALS FOR UTILIZING AND IMPLEMENTING A LITERACY PROGRAM (U.S. CLS. 2, 5, 22, 23, 29, 37, 38 AND 50).

CLASS 36—INSURANCE AND FINANCIAL

FOR TUITION SERVICES, NAMELY, PROVIDING TUITION GRANTS TO LITERACY TRAINING COURSE ATTENDEES (U.S. CLS. 100, 101 AND 102).

CLASS 41—EDUCATION AND ENTERTAINMENT

FOR EDUCATION SERVICES, NAMELY, CONDUCTING LITERACY PROGRAMMES; TRAINING, COACHING AND INSTRUCTION SERVICES FOR LITERACY PROGRAMMES; INFORMATION, ADVISORY AND CONSULTANCY SERVICES RELATING TO ALL OF THE AFORESAID; PROVIDING ON LINE BOOKS AND AUDIO RECORDINGS IN THE FIELD OF LITERACY (U.S. CLS. 100, 101 AND 107).

PRISCILLA MILTON, EXAMINING ATTORNEY

SN 78-306,264. HOMESTORE, INC., WESTLAKE VILLAGE, CA. FILED 9-26-2003.

HOMEBUILDER.COM

SEC. 2(F).

CLASS 35—ADVERTISING AND BUSINESS

FOR ADVERTISING SERVICES, NAMELY, PREPARING ADVERTISEMENTS FOR OTHERS, PLACING ADVERTISEMENTS FOR OTHERS, DISPLAYING ADVERTISEMENTS FOR OTHERS, AND DISSEMINATION OF ADVERTISING FOR OTHERS VIA A GLOBAL COMPUTER NETWORK; PROVIDING AN ON-LINE COMPUTER DATABASE FEATURING ECONOMIC AND DEMOGRAPHIC DATA (U.S. CLS. 100, 101 AND 102).

FIRST USE 10-7-1998; IN COMMERCE 10-7-1998.

CLASS 36—INSURANCE AND FINANCIAL

FOR PROVIDING SERVICES FOR NEW HOME BUILDERS AND NEW HOME BUYERS, NAMELY, REAL ESTATE BROKERAGE SERVICES AND INFORMATION REGARDING MORTGAGE LENDING AND REMODEL FINANCING; AND PROVIDING AN ON-LINE COMPUTER DATABASE IN THE FIELD OF MORTGAGE LENDING (U.S. CLS. 100, 101 AND 102).

FIRST USE 10-7-1998; IN COMMERCE 10-7-1998.

CLASS 37—CONSTRUCTION AND REPAIR

FOR PROVIDING AN ON-LINE COMPUTER DATABASE IN THE FIELDS OF NEW HOME CONSTRUCTION, CONTRACT BUILDERS, SUBDIVISION DEVELOPMENT, HOUSE MODELS, FLOOR PLANS, CUSTOM CONSTRUCTION OF RESIDENTIAL AND COMMERCIAL COMMUNITIES; AND PROVIDING LINKS TO WEB SITES OF OTHERS FEATURING INFORMATION ON BUILDING OF CUSTOM HOMES (U.S. CLS. 100, 103 AND 106).

FIRST USE 10-7-1998; IN COMMERCE 10-7-1998.

CLASS 41—EDUCATION AND ENTERTAINMENT

FOR PROVIDING NON-DOWNLOADABLE, ON-LINE GUIDES IN WHICH BUILDERS OF NEW HOMES PROMOTE THOSE PROPERTIES; PROVIDING AN ON-LINE COMPUTER DATABASE FEATURING MAPS AND INFORMATION ON AREA SCHOOLS, COMMUNITY EVENTS AND ACTIVITIES; ON-LINE LIBRARY SERVICES, NAMELY, PROVIDING ELECTRONIC LIBRARY SERVICES WHICH FEATURE PHOTOGRAPHS VIA AN ON-LINE COMPUTER NETWORK (U.S. CLS. 100, 101 AND 107).

FIRST USE 10-7-1998; IN COMMERCE 10-7-1998.
KATHERINE STOIDES, EXAMINING ATTORNEY

SN 78-307,691. ELBIT SYSTEMS LTD., HAIFA, ISRAEL,
FILED 9-30-2003.

SKYLARK

PRIORITY CLAIMED UNDER SEC. 44(D) ON ISRAEL APPLICATION NO. 166457, FILED 8-26-2003, REG. NO. 166457, DATED 10-19-2004, EXPIRES 8-26-2010.

PRIORITY CLAIMED UNDER SEC. 44(D) ON ISRAEL APPLICATION NO. 166456, FILED 8-26-2003, REG. NO. 166456, DATED 6-30-2004, EXPIRES 8-26-2010.

CLASS 9—ELECTRICAL AND SCIENTIFIC APPARATUS

FOR (BASED ON 44(E) ISRAEL FOREIGN REGISTRATION NUMBER 166456) ELECTRICAL AND SCIENTIFIC APPARATUS, NAMELY, AIRBORNE, LAND AND SHIPBOARD SURVEILLANCE AND RECONNAISSANCE SYSTEMS COMPRISING SURVEYING CAMERAS AND MONITORS, AUDIO AND VIDEO RECEIVERS, TELEMETERS, ELECTRONIC SIGNAL TRANSMITTERS AND ELECTRONIC MONITORING DEVICES (U.S. CLS. 21, 23, 26, 36 AND 38).

CLASS 12—VEHICLES

FOR (BASED ON 44(E) ISRAEL FOREIGN REGISTRATION NUMBER 166457) UNMANNED AIRCRAFT VEHICLES; UNMANNED LAND VEHICLES AND UNMANNED WATER VEHICLES (U.S. CLS. 19, 21, 23, 31, 35 AND 44).

MARY I. SPARROW, EXAMINING ATTORNEY

SN 78-309,250. IRVINE SCIENTIFIC SALES COMPANY,
INC., SANTA ANA, CA. FILED 10-3-2003.

MULTIBLAST MEDIUM

NO CLAIM IS MADE TO THE EXCLUSIVE RIGHT TO USE "MEDIUM", APART FROM THE MARK AS SHOWN.

CLASS 1—CHEMICALS

FOR TISSUE CULTURE MEDIA AND SERA FOR RESEARCH AND LAB USE; DIAGNOSTIC REAGENTS FOR RESEARCH AND LAB USE; MEDICAL TEST KITS COMPRISING TISSUE CULTURE MEDIA AND SERA AND DIAGNOSTIC REAGENTS FOR RESEARCH AND LAB USE (U.S. CLS. 1, 5, 6, 10, 26 AND 46).

CLASS 5—PHARMACEUTICALS

FOR TISSUE CULTURE MEDIA AND SERA CLINICAL AND MEDICAL LABORATORY USE, DIAGNOSTIC REAGENTS FOR CLINICAL AND MEDICAL LABORATORY USE, AND MEDICAL TEST KITS FOR COMPRISING TISSUE CULTURE MEDIA AND SERA AND DIAGNOSTIC REAGENTS FOR CLINICAL AND MEDICAL LABORATORY USE (U.S. CLS. 6, 18, 44, 46, 51 AND 52).

FLORENTINA BLANDU, EXAMINING ATTORNEY

SN 78-309,850. VALEO SYLVANIA, L.L.C., SEYMOUR, IN.
FILED 10-6-2003.

X SIGHTING LIGHTING

OWNER OF U.S. REG. NO. 2,780,124.
NO CLAIM IS MADE TO THE EXCLUSIVE RIGHT TO USE "LIGHTING", APART FROM THE MARK AS SHOWN.

CLASS 11—ENVIRONMENTAL CONTROL APPARATUS

FOR ELECTRIC LAMPS; AUTOMOTIVE HEADLAMPS, NAMELY, HID HEADLAMPS; LIGHTING SYSTEMS FOR AUTOMOBILES, MOTORCYCLES, ALL TERRAIN VEHICLES, AND TRUCKS, NAMELY, ELECTRIC HEADLAMPS AND TAIL LAMPS; ELECTRIC LAMPS FOR EXTERIOR LIGHTING OF AUTOMOBILES, MOTORCYCLES, ALL TERRAIN VEHICLES, AND TRUCKS; ELECTRIC WORK LAMPS FOR COMMERCIAL, FARM/AGRICULTURAL, AND CONSTRUCTION EQUIPMENT VEHICLES (U.S. CLS. 13, 21, 23, 31 AND 34).

CLASS 35—ADVERTISING AND BUSINESS

FOR WEBSITE PROVIDING CONSUMER INFORMATION REGARDING THE FEATURES OF AUTOMOTIVE LIGHTING PRODUCTS, SUCH AS HEADLAMPS AND TAIL LAMPS, HOW AUTOMOTIVE LIGHTING PRODUCTS OPERATE AND HOW THESE PRODUCTS CAN IMPROVE SAFETY AND VISIBILITY (U.S. CLS. 100, 101 AND 102).

KHANH LE, EXAMINING ATTORNEY

SN 78-310,173. THE LEAGUE OF AMERICAN THEATRES
AND PRODUCERS, INC., NEW YORK, NY. FILED 10-7-
2003.

**KIDS' NIGHT ON
BROADWAY**

OWNER OF U.S. REG. NO. 2,136,891.
SEC. 2(F).

CLASS 35—ADVERTISING AND BUSINESS

FOR PROMOTING TO YOUNG PEOPLE THE LIVE THEATRICAL PERFORMANCES OF OTHERS AND ENCOURAGING THEIR ATTENDANCE BY OFFERING DISCOUNTS OR FREE ADMISSIONS AT THEATERS, PARKING GARAGES AND RESTAURANTS AND DISTRIBUTING MATERIALS IN CONNECTION THEREWITH (U.S. CLS. 100, 101 AND 102).

FIRST USE 10-27-1996; IN COMMERCE 10-27-1996.

CLASS 41—EDUCATION AND ENTERTAINMENT

FOR EDUCATIONAL AND ENTERTAINMENT SERVICES TO INTRODUCE YOUNG PEOPLE TO THE LIVE THEATRICAL PERFORMANCES OF OTHERS AND TO ENCOURAGE THEIR ATTENDANCE AT SUCH PERFORMANCES BY OFFERING VIA THE INTERNET INTERACTIVE ACTIVITIES AND EVENTS ON THE SUBJECT OF THEATERS (U.S. CLS. 100, 101 AND 107).

FIRST USE 10-27-1996; IN COMMERCE 10-27-1996.

TANYA AMOS, EXAMINING ATTORNEY

SN 78-310,174. THE LEAGUE OF AMERICAN THEATRES AND PRODUCERS, INC., NEW YORK, NY. FILED 10-7-2003.



NO CLAIM IS MADE TO THE EXCLUSIVE RIGHT TO USE "KIDS' NIGHT ON BROADWAY", APART FROM THE MARK AS SHOWN.

CLASS 35—ADVERTISING AND BUSINESS

FOR PROMOTING TO YOUNG PEOPLE THE LIVE THEATRICAL PERFORMANCES OF OTHERS AND ENCOURAGING THEIR ATTENDANCE BY OFFERING DISCOUNTS OR FREE ADMISSIONS AT THEATERS, PARKING GARAGES AND RESTAURANTS AND DISTRIBUTING MATERIALS IN CONNECTION THEREWITH (U.S. CLS. 100, 101 AND 102).

FIRST USE 3-0-2002; IN COMMERCE 3-0-2002.

CLASS 41—EDUCATION AND ENTERTAINMENT

FOR EDUCATIONAL AND ENTERTAINMENT SERVICES TO INTRODUCE YOUNG PEOPLE TO THE LIVE THEATRICAL PERFORMANCES OF OTHERS AND TO ENCOURAGE THEIR ATTENDANCE AT SUCH PERFORMANCES BY OFFERING VIA THE INTERNET INTERACTIVE ACTIVITIES AND EVENTS ON THE SUBJECT OF THEATERS (U.S. CLS. 100, 101 AND 107).

FIRST USE 3-0-2002; IN COMMERCE 3-0-2002.

TANYA AMOS, EXAMINING ATTORNEY

SN 78-310,552. ABBISS, ROGER OWEN, DUNDAS, ONTARIO, CANADA, FILED 10-7-2003.

RED PAGES

OWNER OF CANADA REG. NO. TMA587811, DATED 8-21-2003, EXPIRES 8-20-2018.

NO CLAIM IS MADE TO THE EXCLUSIVE RIGHT TO USE "RED", APART FROM THE MARK AS SHOWN.

CLASS 16—PAPER GOODS AND PRINTED MATTER

FOR PRINTED DIRECTORY OF LOCAL BUSINESSES WITH EMPHASIS ON LISTING OF WEBSITES AND EMAIL ADDRESSES; AND INCLUDING WORD AND DISPLAY ADVERTISING (U.S. CLS. 2, 5, 22, 23, 29, 37, 38 AND 50).

CLASS 35—ADVERTISING AND BUSINESS

FOR ON-LINE DIRECTORY OF LOCAL BUSINESSES WITH EMPHASIS ON LISTING OF WEBSITES AND EMAIL ADDRESSES; AND INCLUDING WORD AND DISPLAY ADVERTISING, ACCESSIBLE VIA GLOBAL COMPUTER NETWORK (U.S. CLS. 100, 101 AND 102).

PAULA MAYS, EXAMINING ATTORNEY

SN 78-311,524. SIGMOID BIOTECHNOLOGIES LTD., RANELAGH, DUBLIN 6, IRELAND, FILED 10-9-2003.

LEDDS

PRIORITY CLAIMED UNDER SEC. 44(D) ON IRELAND APPLICATION NO. 3134939, FILED 4-16-2003, REG. NO. 3134939, DATED 4-16-2003, EXPIRES 4-16-2013.

CLASS 5—PHARMACEUTICALS

FOR PHARMACEUTICAL AND VETERINARY PREPARATIONS AND SUBSTANCES FOR THE TREATMENT OF CARDIOVASCULAR DISORDERS, CENTRAL NERVOUS SYSTEM DISORDERS, ACUTE AND CHRONIC PAIN, EPILEPSY, INSOMNIA, LEARNING DISORDERS, INFECTIOUS DISEASES, GASTROINTESTINAL DISEASES, DIABETES, IMPOTENCE, OBESITY, SKIN DISORDERS, HOST-GRAFT REJECTIONS, ARTHRITIS AND AUTOIMMUNE DISORDERS; PHARMACEUTICAL AND VETERINARY PREPARATIONS AND SUBSTANCES ALLOWING FOR CONTROLLED ABSORPTION AND/OR CONTROLLED RELEASE OF AN ACTIVE INGREDIENT FOLLOWING ADMINISTRATION TO HUMAN AND NON-HUMAN ANIMALS FOR THE TREATMENT OF CARDIOVASCULAR DISORDERS, CENTRAL NERVOUS SYSTEM DISORDERS, ACUTE AND CHRONIC PAIN EPILEPSY, INSOMNIA, LEARNING DISORDERS, INFECTIOUS DISEASES, GASTROINTESTINAL DISEASES, DIABETES, IMPOTENCE, OBESITY, SKIN DISORDERS, HOST-GRAFT REJECTIONS, ARTHRITIS AND AUTOIMMUNE DISORDERS (U.S. CLS. 6, 18, 44, 46, 51 AND 52).

CLASS 42—SCIENTIFIC, COMPUTER AND LEGAL SERVICES

FOR SCIENTIFIC AND BIOLOGICAL RESEARCH RELATING TO THE RESEARCH AND DEVELOPMENT OF PHARMACEUTICAL AND VETERINARY PREPARATIONS AND SUBSTANCES; MEDICAL RESEARCH RELATING TO THE DIAGNOSIS AND TREATMENT OF DISEASE; MEDICAL RESEARCH ON THE EFFICACY OF PHARMACEUTICAL AND VETERINARY PREPARATIONS AND SUBSTANCES; MEDICAL AND SCIENTIFIC RESEARCH, NAMELY, CONDUCTING CLINICAL TRIALS INVOLVING PHARMACEUTICAL AND VETERINARY PREPARATIONS AND SUBSTANCES (U.S. CLS. 100 AND 101).

TINA L. SNAPP, EXAMINING ATTORNEY

SN 78-311,533. SIGMOID BIOTECHNOLOGIES LTD., RANELAGH, DUBLIN 6, IRELAND, FILED 10-9-2003.

NANOFORM

PRIORITY CLAIMED UNDER SEC. 44(D) ON ERPN CMNTY TM OFC APPLICATION NO. 3137023, FILED 4-16-2003, REG. NO. 3137023, DATED 4-16-2003, EXPIRES 4-16-2013.

CLASS 5—PHARMACEUTICALS

FOR PHARMACEUTICAL AND VETERINARY PREPARATIONS AND SUBSTANCES FOR THE TREATMENT OF CARDIOVASCULAR DISORDERS, CENTRAL NERVOUS SYSTEM DISORDERS, ACUTE AND CHRONIC PAIN, EPILEPSY, INSOMNIA, LEARNING DISORDERS, INFECTIOUS DISEASES, GASTROINTESTINAL DISEASES, DIABETES, IMPOTENCE, OBESITY, SKIN DISORDERS, HOST-GRAFT REJECTIONS, ARTHRITIS AND AUTOIMMUNE DISORDERS; PHARMACEUTICAL AND VETERINARY PREPARATIONS AND SUBSTANCES ALLOWING FOR CONTROLLED ABSORPTION AND/OR CONTROLLED RELEASE OF AN ACTIVE INGREDIENT FOLLOWING ADMINISTRATION TO HUMAN AND NON-HUMAN ANIMALS FOR THE TREATMENT OF CARDIOVASCULAR DISORDERS, CENTRAL NERVOUS SYSTEM DISORDERS, ACUTE AND CHRONIC PAIN, EPILEPSY, INSOMNIA, LEARNING DISORDERS, INFECTIOUS DISEASES, GASTROINTESTINAL DISEASES, DIABETES, IMPOTENCE, OBESITY, SKIN DISORDERS, HOST-GRAFT REJECTIONS, ARTHRITIS AND AUTOIMMUNE DISORDERS (U.S. CLS. 6, 18, 44, 46, 51 AND 52).

CLASS 42—SCIENTIFIC, COMPUTER AND LEGAL SERVICES

FOR SCIENTIFIC AND BIOLOGICAL RESEARCH RELATING TO THE RESEARCH AND DEVELOPMENT OF PHARMACEUTICAL AND VETERINARY PREPARATIONS AND SUBSTANCES; MEDICAL RESEARCH RELATING TO THE DIAGNOSIS AND TREATMENT OF DISEASE; MEDICAL RESEARCH ON THE EFFICACY OF PHARMACEUTICAL AND VETERINARY PREPARATIONS AND SUBSTANCES; MEDICAL AND SCIENTIFIC RESEARCH, NAMELY, CONDUCTING CLINICAL TRIALS INVOLVING PHARMACEUTICAL AND VETERINARY PREPARATIONS AND SUBSTANCES (U.S. CLS. 100 AND 101).

TINA L. SNAPP, EXAMINING ATTORNEY

SN 78-312,536. BURNELL, DAVID A., BOUNTIFUL, UT. FILED 10-12-2003.

WHERE THE ELITE MEET**CLASS 9—ELECTRICAL AND SCIENTIFIC APPARATUS**

FOR PROTECTIVE BODY ARMOR, NAMELY BALLISTIC, BULLET, SLASH AND STAB RESISTANT BODY ARMOR AND PROTECTIVE CLOTHING; PROTECTIVE HELMETS FOR USE IN PLAYING PAINTBALL GAMES; AND SPORTS GOGGLES FOR PLAYING PAINTBALL GAMES (U.S. CLS. 21, 23, 26, 36 AND 38).

FIRST USE 7-15-2001; IN COMMERCE 7-15-2001.

CLASS 28—TOYS AND SPORTING GOODS

FOR PAINTBALL PRODUCTS, NAMELY, PADS FOR USE IN PLAYING PAINTBALL GAMES, NAMELY CHEST PADS, HAND PADS, NECK PADS, KNEE PADS, ELBOW PADS, LEG PADS, FOOT PADS, BODY PADS, AND ARM PADS, BAGS FOR USE IN CARRYING PAINTBALL GEAR, GLOVES FOR USE IN PLAYING PAINTBALL GAMES, HOLSTERS FOR PAINTBALL MARKERS, ACTION FIGURES (U.S. CLS. 22, 23, 38 AND 50).

FIRST USE 7-15-2001; IN COMMERCE 7-15-2001.

MARTHA FROMM, EXAMINING ATTORNEY

SN 78-312,777. HELIOVOLT CORPORATION, AUSTIN, TX. FILED 10-13-2003.

FASST**CLASS 7—MACHINERY**

FOR MACHINES USED TO MANUFACTURE COATINGS APPLIED TO METAL, GLASS, PLASTICS, AND CERAMICS FOR USE AS SEMICONDUCTORS (U.S. CLS. 13, 19, 21, 23, 31, 34 AND 35).

CLASS 9—ELECTRICAL AND SCIENTIFIC APPARATUS

FOR APPARATUS FOR CONVERTING ELECTRONIC RADIATION TO ELECTRICAL ENERGY, NAMELY PHOTOVOLTAIC SOLAR MODULES (U.S. CLS. 21, 23, 26, 36 AND 38).

KATHERINE STOIDES, EXAMINING ATTORNEY

SN 78-314,658. SHORELINE MEDIA, INC., NEW YORK, NY. FILED 10-16-2003.

FESTIVAL OF THE OLYMPIANS

NO CLAIM IS MADE TO THE EXCLUSIVE RIGHT TO USE FESTIVAL, APART FROM THE MARK AS SHOWN.

CLASS 9—ELECTRICAL AND SCIENTIFIC APPARATUS

FOR COMPACT DISCS, AUDIO TAPES, VIDEOTAPES, AND DVD'S FEATURING MUSIC, PRE-RECORDED CONCERTS AND PRE-RECORDED MUSICAL PERFORMANCES (U.S. CLS. 21, 23, 26, 36 AND 38).

CLASS 41—EDUCATION AND ENTERTAINMENT

FOR ENTERTAINMENT IN THE NATURE OF LIVE MUSIC CONCERTS AND PERFORMANCES BY AN INDIVIDUAL OR GROUP (U.S. CLS. 100, 101 AND 107).
BARBARA BROWN, EXAMINING ATTORNEY

SN 78-317,289. NORDSTROM, INC., SEATTLE, WA. FILED 10-22-2003.

NORDSTROM EBAR

OWNER OF U.S. REG. NO. 2,802,958.

CLASS 35—ADVERTISING AND BUSINESS

FOR RETAIL STORE SERVICES FEATURING BAKED GOODS, SALADS, SANDWICHES, CANDY, NAMELY, CHOCOLATES, MINTS AND OTHER SMALL CONFECTIONS, COFFEE BREWING AND DRINKING ITEMS, COFFEE MUGS, COFFEE PRESSES, COFFEE GRINDERS, SERVEWARE, DRINKWARE, TEA BREWING AND DRINKING ITEMS, TEA CUPS, TEA POTS, TEA STRAINERS, TEA BAG TONGS, CHILD DRINKING CUPS, DECORATIVE SERVING PLATTERS, PLATES AND CONTAINERS (U.S. CLS. 100, 101 AND 102).
FIRST USE 3-16-2001; IN COMMERCE 3-16-2001.

CLASS 43—HOTEL AND RESTAURANT SERVICES

FOR ESPRESSO BAR AND CAFE SERVICES (U.S. CLS. 100 AND 101).
FIRST USE 3-16-2001; IN COMMERCE 3-16-2001.
MATTHEW KLINE, EXAMINING ATTORNEY

SN 78-319,078. PRODUITS BERGER, PARIS, FRANCE, FILED 10-27-2003.

AIR BERGER

OWNER OF FRANCE REG. NO. 1587125, DATED 4-18-1990, EXPIRES 4-18-2010.
OWNER OF U.S. REG. NOS. 1,279,538 AND 1,898,481.

CLASS 3—COSMETICS AND CLEANING PREPARATIONS

FOR PRODUCTS FOR DEODORIZING, DISINFECTING AND CLEANSING OF AIR, NAMELY PERFUMED AIR SPRAYS, POTPOURRIS AND PERFUMED STICKS, AIR FRESHENING SPRAYS, AND ESSENTIAL OILS. (U.S. CLS. 1, 4, 6, 50, 51 AND 52).

CLASS 4—LUBRICANTS AND FUELS

FOR PRODUCTS FOR DEODORIZING, DISINFECTING AND CLEANSING OF AIR, NAMELY PERFUMED CANDLES. (U.S. CLS. 1, 6 AND 15).

CLASS 5—PHARMACEUTICALS

FOR PHARMACEUTICAL, VETERINARY AND HYGIENIC PREPARATIONS FOR USE IN APPARATUS OR LAMPS FOR DISINFECTING, CLEANSING AND PURIFYING THE ATMOSPHERE AND FOR ABSORPTION OF ODORS AND SMOKES; INSECTICIDES FOR DOMESTIC USE, AND ANTIBACTERIAL PHARMACEUTICALS. (U.S. CLS. 6, 18, 44, 46, 51 AND 52).

CLASS 11—ENVIRONMENTAL CONTROL APPARATUS

FOR APPARATUS, NAMELY ELECTRIC APPARATUS FOR DEODORIZING, DISINFECTING AND CLEARING THE AIR; APPARATUS, NAMELY ELECTRIC APPARATUS FOR THE DIFFUSION OF MAKING UP OR CLEANSING RAW MATERIALS NOTABLY ESSENTIAL OILS AND DISINFECTANT RAW MATERIAL, BACTERICIDES, ACARICIDES, INSECTICIDE; APPARATUS NAMELY ELECTRIC APPARATUS FOR THE DESTRUCTION OF ODORS AND SMOKES IN PARTICULAR TOBACCO (U.S. CLS. 13, 21, 23, 31 AND 34).
RON FAIRBANKS, EXAMINING ATTORNEY

SN 78-319,911. KOCKELMAN, STEVEN, J, HONOLULU, HI. FILED 10-28-2003.



NO CLAIM IS MADE TO THE EXCLUSIVE RIGHT TO USE "FITNESS", APART FROM THE MARK AS SHOWN.

CLASS 25—CLOTHING

FOR CLOTHING NAMELY, SHORTS, PANTS, T-SHIRTS, HATS, WRISTBANDS, HEADBANDS, POLO SHIRTS, LONG SLEEVE SHIRTS, ATHLETIC PANTS, SWEAT PANTS, MESH-SHIRTS, GLOVES, SOCKS, SHOES, SANDALS, BELTS, TANK-TOPS, ATHLETIC SHIRTS, JERSEYS, JACKETS, COATS, SWIM-WEAR (U.S. CLS. 22 AND 39).

CLASS 41—EDUCATION AND ENTERTAINMENT

FOR CONDUCTING, CLASSES, SEMINARS, AND WORKSHOPS IN THE FIELD OF PHYSICAL FITNESS, HEALTH AND WELLNESS AND NUTRITION; ALSO CONDUCTING ENTERTAINMENT IN THE NATURE OF PHYSICAL FITNESS COMPETITIONS, PHYSICAL FITNESS EXPOS, AND PHYSICAL FITNESS INSTRUCTION (U.S. CLS. 100, 101 AND 107).
LESLEY LAMOTHE, EXAMINING ATTORNEY

SN 78-320,680. 4170695 CANADA INC., BOUCHERVILLE, QUEBEC J4B 6H5, CANADA, FILED 10-30-2003.

SN 78-323,846. THE PNC FINANCIAL SERVICES GROUP, INC., PITTSBURGH, PA. FILED 11-6-2003.

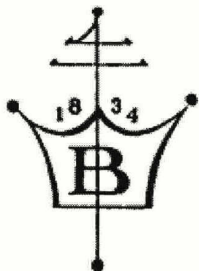

OWNER OF U.S. REG. NO. 737,159.
NO CLAIM IS MADE TO THE EXCLUSIVE RIGHT TO USE "1834", APART FROM THE MARK AS SHOWN.

CLASS 16—PAPER GOODS AND PRINTED MATTER

FOR SAMPLE BOOKS OF WALLPAPER AND VINYL WALL COVERINGS (U.S. CLS. 2, 5, 22, 23, 29, 37, 38 AND 50).
FIRST USE 5-19-1961; IN COMMERCE 5-19-1961.

CLASS 27—FLOOR COVERINGS

FOR VINYL AND PAPER WALL COVERINGS AND BORDERS (U.S. CLS. 19, 20, 37, 42 AND 50).
FIRST USE 5-19-1961; IN COMMERCE 5-19-1961.
TRACY WHITAKER-BOWN, EXAMINING ATTORNEY

SN 78-322,986. LINDSAY, JAMES, PHILADELPHIA, PA. FILED 11-4-2003.

RAPPER'S DELIGHT

THE MARK CONSISTS OF STANDARD CHARACTERS WITHOUT CLAIM TO ANY PARTICULAR FONT, STYLE, SIZE, OR COLOR.

CLASS 30—STAPLE FOODS

FOR BREADS AND PASTRIES, NAMELY DOUGHNUTS (U.S. CL. 46).

CLASS 32—LIGHT BEVERAGES

FOR SOFT DRINKS AND FRUIT FLAVORED DRINKS (U.S. CLS. 45, 46 AND 48).
ALICIA COLLINS, EXAMINING ATTORNEY

ADVISORport

THE MARK CONSISTS OF STANDARD CHARACTERS WITHOUT CLAIM TO ANY PARTICULAR FONT, STYLE, SIZE, OR COLOR.

OWNER OF U.S. REG. NO. 2,456,332.

CLASS 35—ADVERTISING AND BUSINESS

FOR BACK-OFFICE SUPPORT SERVICES, NAMELY, BOOKKEEPING AND OPERATIONAL SUPPORT SERVICES FOR FINANCIAL INVESTMENT VEHICLES; INVESTMENT FUND ACCOUNTING (U.S. CLS. 100, 101 AND 102).
FIRST USE 1-10-2000; IN COMMERCE 4-26-2000.

CLASS 36—INSURANCE AND FINANCIAL

FOR FINANCIAL INVESTMENT ACCOUNT SERVICES FOR REGISTERED INVESTMENT ADVISORS, PROGRAM SPONSORS AND INVESTMENT MANAGERS, NAMELY, ADMINISTRATION OF INVESTMENT ACCOUNTS, INVESTMENT ACCOUNT MANAGEMENT, RESEARCH AND ANALYSIS IN THE FIELD OF INVESTMENT MANAGEMENT; FINANCIAL INVESTMENT ACCOUNT SERVICES IN THE NATURE OF DETERMINING PORTFOLIO ALLOCATIONS BASED ON CLIENT PROFILES; ASSET ALLOCATION ANALYSIS IN CONNECTION WITH INVESTMENTS; INVESTMENT ACCOUNT PERFORMANCE MONITORING; AND CUSTOMIZED REPORT GENERATION PERTAINING TO INVESTMENT ACCOUNT PERFORMANCE; WEB-BASED CLIENT PROFILE ANALYSIS FOR DETERMINING CLIENT FINANCIAL ASSET ALLOCATION (U.S. CLS. 100, 101 AND 102).
FIRST USE 1-10-2000; IN COMMERCE 4-26-2000.

CLASS 41—EDUCATION AND ENTERTAINMENT

FOR PROVIDING WEB-BASED TRAINING FOR FINANCIAL INVESTMENT ACCOUNT SERVICES PROVIDERS IN THE FIELD OF INVESTMENT ACCOUNT ADMINISTRATION (U.S. CLS. 100, 101 AND 107).
FIRST USE 1-10-2000; IN COMMERCE 4-26-2000.

CLASS 42—SCIENTIFIC, COMPUTER AND LEGAL SERVICES

FOR TECHNOLOGY SUPPORT SERVICES, NAMELY, TROUBLESHOOTING OF COMPUTER HARDWARE AND SOFTWARE PROBLEMS ON A WEB-BASED PLATFORM FOR FINANCIAL INVESTMENT ACCOUNT SERVICES PROVIDERS (U.S. CLS. 100 AND 101).
FIRST USE 1-10-2000; IN COMMERCE 4-26-2000.

CLASS 45—PERSONAL SERVICES

FOR PRE-EMPLOYMENT BACKGROUND INVESTIGATIONS OF INVESTMENT MANAGERS (U.S. CLS. 100 AND 101).
FIRST USE 1-10-2000; IN COMMERCE 4-26-2000.
JOHN LINCOSKI, EXAMINING ATTORNEY

SN 78-324,044. J.M. SPECIALTIES, INC., A NEW JERSEY CORPORATION, FAIRFIELD, NJ. FILED 11-6-2003.



NO CLAIM IS MADE TO THE EXCLUSIVE RIGHT TO USE 'CHEESECAKE COMPANY, INC.', APART FROM THE MARK AS SHOWN.
SEC. 2(F).

CLASS 30—STAPLE FOODS

FOR CHEESECAKES, CAKES, PIES, MUFFINS, TARTS, TART SHELLS AND PASTRIES (U.S. CL. 46).
FIRST USE 7-5-2000; IN COMMERCE 7-5-2000.

CLASS 35—ADVERTISING AND BUSINESS

FOR RETAIL OUTLETS FEATURING CHEESECAKES AND OTHER BAKED GOODS (U.S. CLS. 100, 101 AND 102).
FIRST USE 7-5-2000; IN COMMERCE 7-5-2000.
CURTIS FRENCH, EXAMINING ATTORNEY

SN 78-324,738. LEASE PLAN U.S.A., INC., ALPHARETTA, GA. FILED 11-7-2003.

SAFEPLAN

THE MARK CONSISTS OF STANDARD CHARACTERS WITHOUT CLAIM TO ANY PARTICULAR FONT, STYLE, SIZE, OR COLOR.

CLASS 35—ADVERTISING AND BUSINESS

FOR CONDUCTING EMPLOYEE INCENTIVE AWARD PROGRAM TO PROMOTE ON THE JOB DRIVER SAFETY (U.S. CLS. 100, 101 AND 102).

CLASS 36—INSURANCE AND FINANCIAL

FOR RISK MANAGEMENT SERVICES AND RELATED CONSULTING SERVICES FOR THE FLEET-LEASED VEHICLE INDUSTRY (U.S. CLS. 100, 101 AND 102).

CLASS 45—PERSONAL SERVICES

FOR CONSULTING SERVICES IN THE FIELD OF DRIVER SAFETY FOR THE VEHICLE LEASING AND FLEET MANAGEMENT INDUSTRY (U.S. CLS. 100 AND 101).

RENEE MCCRAY, EXAMINING ATTORNEY

SN 78-324,812. POLIMERWELT GMBH, POSTFACH 4657, SWITZERLAND, FILED 11-7-2003.

AZZINTEC

THE MARK CONSISTS OF STANDARD CHARACTERS WITHOUT CLAIM TO ANY PARTICULAR FONT, STYLE, SIZE, OR COLOR.

PRIORITY CLAIMED UNDER SEC. 44(D) ON UNITED KINGDOM APPLICATION NO. 2331484, FILED 5-9-2003.

CLASS 1—CHEMICALS

FOR CHEMICALS USED IN INDUSTRY; CHEMICALS AND COMBINATIONS OF CHEMICALS FOR USE IN METAL PLATING, IN THE ELECTRONICS INDUSTRY, AND IN THE MANUFACTURE OF ELECTRONIC COMPONENTS, PRINTED CIRCUIT BOARDS AND COMPONENTS OF PRINTED CIRCUIT BOARDS; CHEMICALS AND COMBINATIONS OF CHEMICALS FOR USE IN TIN PLATING AND IN IMMERSION TIN PROCESSES; IMMERSION TIN PLATING COMPOSITIONS FOR THE MANUFACTURE OF PRINTED CIRCUIT BOARDS AND THEIR COMPONENTS; SOLDERING COMPOSITIONS AND SOLDERING CHEMICALS (U.S. CLS. 1, 5, 6, 10, 26 AND 46).

CLASS 7—MACHINERY

FOR MACHINES AND MACHINE TOOLS FOR USE IN METAL PLATING, INCLUDING TIN PLATING, IN IMMERSION TIN PROCESS, IN THE MANUFACTURE OF ELECTRONIC COMPONENTS, AND IN THE MANUFACTURE OF PRINTED CIRCUIT BOARDS AND THEIR COMPONENTS; MACHINES FOR TIN PLATING ONTO PRINTED CIRCUIT BOARDS AND THEIR COMPONENTS; MACHINE COUPLING AND TRANSMISSION COMPONENTS, NAMELY, TRANSMISSION GEARS FOR MACHINES (U.S. CLS. 13, 19, 21, 23, 31, 34 AND 35).

CLASS 40—MATERIAL TREATMENT

FOR PLATING SERVICES, NAMELY, TIN PLATING SERVICES FOR OTHERS ONTO PRINTED CIRCUIT BOARDS, CIRCUIT BOARD COMPONENTS AND PRODUCTS IN CONTACT WITH CIRCUIT BOARDS (U.S. CLS. 100, 103 AND 106).

AMY GEARIN, EXAMINING ATTORNEY

SN 78-327,374. DIOSYNTH B.V., OSS, NETHERLANDS, FILED 11-13-2003.

**EXPERIENCE FULLY
EXPRESSED**

SN 78-325,767. THE REDBUSH TEA COMPANY LIMITED, LONDON, UNITED KINGDOM, FILED 11-10-2003.

TAKE IT AS RED

THE MARK CONSISTS OF STANDARD CHARACTERS WITHOUT CLAIM TO ANY PARTICULAR FONT, STYLE, SIZE, OR COLOR.

CLASS 3—COSMETICS AND CLEANING PREPARATIONS

FOR BLEACHING PREPARATIONS FOR LAUNDRY USE; GENERAL PURPOSE CLEANING, POLISHING, SCOURING AND ABRASIVE LIQUIDS AND POWDERS; SOAPS; PERFUMERY; ESSENTIAL OILS FOR PERSONAL USE; COSMETICS; HAIR LOTIONS; DENTIFRICES (U.S. CLS. 1, 4, 6, 50, 51 AND 52).

CLASS 16—PAPER GOODS AND PRINTED MATTER

FOR PRINTED MATTER, NAMELY, FLYERS, NEWSLETTERS, PRODUCT GUIDES FEATURING INFORMATION CONCERNING DIET, HEALTH, NUTRITION, AND TEA. (U.S. CLS. 2, 5, 22, 23, 29, 37, 38 AND 50).

CLASS 30—STAPLE FOODS

FOR COFFEE, TEA, COCOA, SUGAR, RICE, TAPIOCA, SAGO, ARTIFICIAL COFFEE; FLOUR AND SNACK FOODS MADE FROM CEREALS, BREAD, AND PASTRY; FROZEN CONFECTIONS, CANDIES, FLAVORED ICES; HONEY, TREACLE; YEAST, BAKING POWDER, SALT, MUSTARD; VINEGAR, SAUCES; SPICES; ICE; ICED TEA AND TEA-BASED BEVERAGES (U.S. CL. 46).

CLASS 32—LIGHT BEVERAGES

FOR BEERS, MINERAL AND AERATED WATERS AND OTHER NON-ALCOHOLIC DRINKS, NAMELY, SOFT DRINKS (U.S. CLS. 45, 46 AND 48).

CLASS 43—HOTEL AND RESTAURANT SERVICES

FOR SERVICES FOR PROVIDING FOOD AND DRINK, NAMELY, PROVIDING INFORMATION RELATING TO THE PROVISION OF FOOD AND DRINK, NAMELY, PROVIDING RECIPES RELATING TO THE USE OF TEA. (U.S. CLS. 100 AND 101).

KIMBERLY FRYE, EXAMINING ATTORNEY

THE MARK CONSISTS OF STANDARD CHARACTERS WITHOUT CLAIM TO ANY PARTICULAR FONT, STYLE, SIZE, OR COLOR.

PRIORITY CLAIMED UNDER SEC. 44(D) ON BENELUX APPLICATION NO. 1042134, FILED 10-17-2003, REG. NO. 0739063, DATED 1-5-2005, EXPIRES 10-17-2013.

CLASS 1—CHEMICALS

FOR CHEMICALS FOR USE IN THE MAKING OF PHARMACEUTICAL AND VETERINARY PREPARATIONS (U.S. CLS. 1, 5, 6, 10, 26 AND 46).

CLASS 16—PAPER GOODS AND PRINTED MATTER

FOR MAGAZINES AND BROCHURES IN THE FIELD OF VETERINARY AND PHARMACEUTICALS (U.S. CLS. 2, 5, 22, 23, 29, 37, 38 AND 50).

CLASS 35—ADVERTISING AND BUSINESS

FOR ONLINE ADVERTISING VIA THE INTERNET IN THE FIELD OF VETERINARY AND PHARMACEUTICALS (U.S. CLS. 100, 101 AND 102).

LOURDES AYALA, EXAMINING ATTORNEY

SN 78-327,682. SPYKE, INC., GRIMES, IA. FILED 11-13-2003.

PROWLER

THE MARK CONSISTS OF STANDARD CHARACTERS WITHOUT CLAIM TO ANY PARTICULAR FONT, STYLE, SIZE, OR COLOR.

CLASS 7—MACHINERY

FOR PARTS FOR ENGINES AND MOTORS OF MOTORCYCLES, NAMELY, ENGINE CASES, ENGINE HEADS, AIR CLEANER SUPPORT BRACKET KITS CONSISTING PRIMARILY OF AIR CLEANER SUPPORT BRACKETS AND MOUNTING HARDWARE, AIR CLEANERS, AIR CLEANER COVERS, AIR FILTERS, IGNITIONS, IGNITION SWITCHES, KICK STARTERS, OIL FILTER MOUNTS, OIL TANK MOUNTS, PLUG WIRES, POINTS COVERS, SPARK PLUGS, STARTER BOOTS, STARTERS, STARTER BUTTONS, STARTER RELAY PLUGS, THROTTLE CABLES, THROTTLE GRIP SETS, THROTTLE HOUSING CARBURETORS, DISTRIBUTOR KITS CONSISTING PRIMARILY OF IGNITIONS, IGNITION ROTORS, PLUG IGNITION COILS, PLUG WIRES, AND HOLD DOWN CLAMPS, EXHAUST BRACKETS, EXHAUST FLANGE KITS CONSISTING PRIMARILY OF EXHAUST FLANGES, RETAINING RINGS, GASKETS, AND MOUNTING HARDWARE, EXHAUST PIPES, PULLEYS, SPROCKET PULLEYS, AND FUEL VALVES (U.S. CLS. 13, 19, 21, 23, 31, 34 AND 35).

FIRST USE 1-1-2004; IN COMMERCE 1-1-2004.

SN 78-328,277. HANSGROHE AG, D-77761 SCHILTACH, FED REP GERMANY, FILED 11-14-2003.

AQUADEMIE

THE MARK CONSISTS OF STANDARD CHARACTERS WITHOUT CLAIM TO ANY PARTICULAR FONT, STYLE, SIZE, OR COLOR.

OWNER OF FED REP GERMANY REG. NO. 2906952, DATED 5-26-1995, EXPIRES 9-30-2014.

CLASS 12—VEHICLES

FOR MOTORCYCLES, MOTORCYCLE ENGINES, MOTORCYCLE MOTORS, AND MOTORCYCLE STRUCTURAL PARTS, NAMELY, COUPLINGS, AXLE COVERS, AXLE SPACERS, BATTERY CUSHIONS, BATTERY STRAPS, BELT GUARDS, BRAKE CALIPERS, BRAKE HANGERS, BRAKE LINES, BRAKE PADS, BRAKE ROTORS, CABLE COVERS, CHARGING SYSTEMS, CLUTCHES, CLUTCH CABLES, CLUTCH CABLE COVERS, CLUTCH PUSHRODS, CLUTCH SHELLS, DISC ROTOR VENTS, DRIVE BELTS, FENDER PAINT SAVERS, FORK STOPS, FORK TUBES, FORK TUBE LUGS, FUEL TANKS, HANDLE BAR CONTROLS, HANDLE BAR DAMPENERS, HANDLE BAR RISERS, HANDLE BARS, HANDLE GRIPS, HEADLIGHT MOUNTING BLOCKS, HORN WITH COVERS, IDLE CABLES, INVERTED FRONT ENDS, JUMPER HARNESSSES, KEY SWITCH COVERS, KICK STANDS, KICKER ARMS, LICENSE PLATE FRAMES, MINI HORNS, MIRRORS, MOTOR MOUNT SPACERS, PRIMARY DRIVE SYSTEMS, NAMELY, PRIMARY CHAIN DRIVES, PRIMARY BELT DRIVES, PRIMARY SPACERS, INNER PRIMARY COVERS, AND OUTER PRIMARY COVERS, ROTOR SPACERS, RUBBER ISOLATORS, SHIFTER RODS, SHOCK ABSORBER KITS CONSISTING PRIMARILY OF SHOCK ABSORBERS AND MOUNTING HARDWARE, SHOCKS, SWING-ARM BUMPERS, TRIPLE TREES, TURN SIGNAL MOUNTS, UPPER LEG BUSHINGS, VAPOR VALVES, VOLTAGE REGULATOR MOUNT, TRANSMISSIONS, TRANSMISSION CASES, AND TRANSMISSION COMPONENTS, NAMELY, HYDRAULIC ACTUATORS FOR MOTORCYCLES (U.S. CLS. 19, 21, 23, 31, 35 AND 44).

FIRST USE 1-1-2004; IN COMMERCE 1-1-2004.
MARCIE MILONE, EXAMINING ATTORNEY

CLASS 16—PAPER GOODS AND PRINTED MATTER

FOR PRINTED MATTER, NAMELY TEACHING MATERIALS IN THE FIELD OF WATER SUPPLY AND SANITARY INSTALLATIONS, NAMELY, MIXING VALVES, PLUMBING FITTINGS, VALVES AND TRAPS, MANUALLY AND AUTOMATICALLY OPERATED VALVES, MIXER TAPS FOR WASH STANDS, BIDETS, WASHING TABLES, BATHTUBS AND SHOWERS, SHOWER CABINS, SHOWER COMBINATIONS, OVERHEAD SHOWERS, LATERAL SHOWERS AND HAND HELD SHOWERS, NOZZLES FOR SHOWERS AND TAPS, COMPLETE SHOWER UNITS, PRE-ASSEMBLED SHOWER UNITS COMBINING OVERHEAD SHOWERS, LATERAL SHOWERS AND HAND HELD SHOWERS; COMPLETE SHOWER UNITS, HAND HELD SHOWERS, WALL BARS FOR HAND SHOWERS AND SHOWER HOSES, SHOWER ENCLOSURES AND PARTS OF SHOWER ENCLOSURES (U.S. CLS. 2, 5, 22, 23, 29, 37, 38 AND 50).

CLASS 41—EDUCATION AND ENTERTAINMENT

FOR EDUCATIONAL SERVICES, NAMELY, TRAINING IN THE FIELD OF WATER SUPPLY AND SANITARY INSTALLATIONS, NAMELY, MIXING VALVES, PLUMBING FITTINGS, VALVES AND TRAPS, MANUALLY AND AUTOMATICALLY OPERATED VALVES, MIXER TAPS FOR WASH STANDS, BIDETS, WASHING TABLES, BATHTUBS AND SHOWERS, SHOWER CABINS, SHOWER COMBINATIONS, OVERHEAD SHOWERS, LATERAL SHOWERS AND HAND HELD SHOWERS, NOZZLES FOR SHOWERS AND TAPS, COMPLETE SHOWER UNITS, PRE-ASSEMBLED SHOWER UNITS COMBINING OVERHEAD SHOWERS, LATERAL SHOWERS AND HAND HELD SHOWERS; COMPLETE SHOWER UNITS, HAND HELD SHOWERS, WALL BARS FOR HAND SHOWERS AND SHOWER HOSES, SHOWER ENCLOSURES AND PARTS OF SHOWER ENCLOSURES (U.S. CLS. 100, 101 AND 107).

CLASS 42—SCIENTIFIC, COMPUTER AND LEGAL SERVICES

FOR TECHNICAL CONSULTATION SERVICES IN THE FIELD OF WATER SUPPLY AND SANITARY INSTALLATIONS, NAMELY, MIXING VALVES, PLUMBING FITTINGS, VALVES AND TRAPS, MANUALLY AND AUTOMATICALLY OPERATED VALVES, MIXER TAPS FOR WASH STANDS, BIDETS, WASHING TABLES, BATHTUBS AND SHOWERS, SHOWER CABINS, SHOWER COMBINATIONS, OVERHEAD SHOWERS, LATERAL SHOWERS AND HAND HELD SHOWERS, NOZZLES FOR SHOWERS AND TAPS, COMPLETE SHOWER UNITS, PRE-ASSEMBLED SHOWER UNITS COMBINING OVERHEAD SHOWERS, LATERAL SHOWERS AND HAND HELD SHOWERS; COMPLETE SHOWER UNITS, HAND HELD SHOWERS, WALL BARS FOR HAND SHOWERS AND SHOWER HOSES, SHOWER ENCLOSURES AND PARTS OF SHOWER ENCLOSURES (U.S. CLS. 100 AND 101).

TARAH HARDY, EXAMINING ATTORNEY

CLASS 42—SCIENTIFIC, COMPUTER AND LEGAL SERVICES

FOR COMPUTER SERVICES, NAMELY, DEVELOPING SOFTWARE FOR OTHERS DESIGNED TO PERMIT SECURE ONLINE ELECTRONIC TRANSACTIONS; COMPUTER CONSULTATION IN THE FIELD OF SECURE ONLINE ELECTRONIC TRANSACTIONS; MAINTENANCE AND SERVICING OF SOFTWARE DESIGNED TO PERMIT SECURE ONLINE ELECTRONIC TRANSACTIONS; PROVIDING A SERVICE WHICH ALLOWS OTHERS TO CONDUCT SECURE ONLINE ELECTRONIC TRANSACTIONS BY PROVIDING TEMPORARY USE OF ON-LINE NON-DOWNLOADABLE E-COMMERCE SOFTWARE WHICH ALLOWS USERS TO PERFORM ELECTRONIC BUSINESS AND FINANCIAL TRANSACTIONS VIA THE INTERNET (U.S. CLS. 100 AND 101).

FIRST USE 2-14-2000; IN COMMERCE 2-14-2000.
JEFF DEFORD, EXAMINING ATTORNEY

SN 78-329,653. PUREEDGE SOLUTIONS, INC., VICTORIA, BRITISH COLUMBIA, CANADA, FILED 11-18-2003.

SN 78-329,694. GOLF FUSION, LLC, HALF MOON BAY, CA, FILED 11-18-2003.

PUREEDGE

GOLF FUSION

THE MARK CONSISTS OF STANDARD CHARACTERS WITHOUT CLAIM TO ANY PARTICULAR FONT, STYLE, SIZE, OR COLOR.

NO CLAIM IS MADE TO THE EXCLUSIVE RIGHT TO USE "GOLF", APART FROM THE MARK AS SHOWN.

THE MARK CONSISTS OF STANDARD CHARACTERS WITHOUT CLAIM TO ANY PARTICULAR FONT, STYLE, SIZE, OR COLOR.

PRIORITY CLAIMED UNDER SEC. 44(D) ON CANADA APPLICATION NO. 1187027, FILED 8-12-2003, REG. NO. TMA629012, DATED 12-22-2004, EXPIRES 12-22-2019.

CLASS 9—ELECTRICAL AND SCIENTIFIC APPARATUS

FOR COMPUTER HARDWARE, NAMELY, COMPUTER SERVERS AND VARIOUS STORAGE DEVICES; COMPUTER SOFTWARE DESIGNED TO PERMIT SECURE ONLINE ELECTRONIC TRANSACTIONS PRIMARILY FOR USE IN THE FINANCIAL SERVICES, GOVERNMENT AND HEALTHCARE SECTORS (U.S. CLS. 21, 23, 26, 36 AND 38).

FIRST USE 2-14-2000; IN COMMERCE 2-14-2000.

CLASS 41—EDUCATION AND ENTERTAINMENT

FOR PROVIDING TRAINING IN THE USE OF SOFTWARE PRODUCTS DESIGNED TO PERMIT SECURE ONLINE ELECTRONIC TRANSACTIONS (U.S. CLS. 100, 101 AND 107).

FIRST USE 2-14-2000; IN COMMERCE 2-14-2000.

CLASS 35—ADVERTISING AND BUSINESS

FOR PROVIDING ON-LINE REGISTRATION SERVICES FOR GOLF CLUB MEMBERSHIP; PROVIDING ON-LINE GOLF TOURNAMENT REGISTRATION SERVICES (U.S. CLS. 100, 101 AND 102).

FIRST USE 5-1-2003; IN COMMERCE 8-1-2003.

CLASS 38—COMMUNICATION

FOR ELECTRONIC MESSAGING SERVICES, NAMELY, SENDING MESSAGES VIA ELECTRONIC MAIL (U.S. CLS. 100, 101 AND 104).

FIRST USE 5-1-2003; IN COMMERCE 8-1-2003.

CLASS 41—EDUCATION AND ENTERTAINMENT

FOR PROVISION OF ONLINE NEWSLETTERS IN THE FIELD OF GOLF; PROVISION OF GOLF CLUB BYLAWS TO GOLF CLUB MEMBERS VIA THE INTERNET; PROVISION OF ON-LINE GOLF PLAYER PROFILES; PROVIDING ONLINE GOLF HANDICAP SERVICES TO MEMBERS; PROVIDING ONLINE GOLF CLUB SERVICES, NAMELY, PLAYER PAIRINGS, TEE TIMES, AND GOLF TOURNAMENT SCORES AND AWARDS (U.S. CLS. 100, 101 AND 107).

FIRST USE 5-1-2003; IN COMMERCE 8-1-2003.

CLASS 42—SCIENTIFIC, COMPUTER AND LEGAL SERVICES

FOR PROVIDING TEMPORARY USE OF NON-DOWNLOADABLE COMPUTER SOFTWARE FOR GOLF CLUB MEMBERSHIP APPLICATIONS; PROVIDING TEMPORARY USE OF NON-DOWNLOADABLE SOFTWARE FOR GOLF CLUBS FOR USE IN MEMBERSHIP MANAGEMENT, FOR USE IN DISSEMINATION OF INFORMATION, FOR USE IN PROVIDING BULLETIN BOARD SERVICES, AND FOR USE IN FACILITATING ELECTRONIC COMMERCE; APPLICATION SERVICE PROVIDER (ASP) SERVICES, NAMELY, HOSTING COMPUTER SOFTWARE APPLICATIONS OF OTHERS; DESIGN, CREATION, HOSTING, MAINTENANCE OF WEBSITES FOR OTHERS; HOSTING OF DIGITAL CONTENT ON THE INTERNET (U.S. CLS. 100 AND 101).

FIRST USE 5-1-2003; IN COMMERCE 8-1-2003.
BILL DAWE, EXAMINING ATTORNEY

SN 78-330,959. ANNO 2003 AG, ZUG, SWITZERLAND,
FILED 11-20-2003.

PAYSHARE

THE MARK CONSISTS OF STANDARD CHARACTERS WITHOUT CLAIM TO ANY PARTICULAR FONT, STYLE, SIZE, OR COLOR.

PRIORITY CLAIMED UNDER SEC. 44(D) ON FED REP GERMANY APPLICATION NO. 30325716.4, FILED 5-20-2003, REG. NO. 30325716.4, DATED 11-3-2003, EXPIRES 5-20-2013.

SN 78-330,669. INTELILINKS, L.L.C., DEARBORN, MI.
FILED 11-20-2003.

GLINFO

THE MARK CONSISTS OF STANDARD CHARACTERS WITHOUT CLAIM TO ANY PARTICULAR FONT, STYLE, SIZE, OR COLOR.

CLASS 9—ELECTRICAL AND SCIENTIFIC APPARATUS

FOR ELECTRONIC DATABASES IN THE FIELDS OF BUSINESS, ECONOMICS, MEDIA, LAW, CONSUMER RESEARCH, AND SURVEYS, RECORDED ON COMPUTER MEDIA (U.S. CLS. 21, 23, 26, 36 AND 38).

CLASS 42—SCIENTIFIC, COMPUTER AND LEGAL SERVICES

FOR COMPUTER SERVICES, NAMELY, PROVIDING SEARCH ENGINES FOR OBTAINING DATA ON A GLOBAL COMPUTER NETWORK IN THE FIELDS OF BUSINESS, ECONOMICS, MEDIA, LAW, CONSUMER RESEARCH, AND SURVEYS (U.S. CLS. 100 AND 101).
ESTHER BELENKER, EXAMINING ATTORNEY

CLASS 9—ELECTRICAL AND SCIENTIFIC APPARATUS

FOR COMPUTERS; COMPUTERS THAT CAN BE USED TO STORE AND RETRANSMIT/PROVIDE MUSIC AND VIDEOS; SOFTWARE FOR RECORDING MUSIC; SOFTWARE FOR PROCESSING AUDIO FILES; SOFTWARE FOR PLAYING BACK AUDIO FILES; SOFTWARE FOR MANAGING AUDIO FILES; SOFTWARE FOR PROCESSING VIDEO FILES; SOFTWARE FOR PLAYING BACK VIDEO FILES; SOFTWARE FOR MANAGING VIDEO FILES; SOFTWARE FOR PROCESSING MULTIMEDIA FILES; SOFTWARE FOR PLAYING BACK MULTIMEDIA FILES; SOFTWARE FOR MANAGING MULTIMEDIA FILES; SOFTWARE FOR PROCESSING E-BOOKS; SOFTWARE FOR MANAGING E-BOOKS; SOFTWARE FOR PROCESSING DOCUMENTS; SOFTWARE FOR MANAGING DOCUMENTS; SOFTWARE FOR MANAGING AUTHOR LICENSE FEES. (U.S. CLS. 21, 23, 26, 36 AND 38).

CLASS 36—INSURANCE AND FINANCIAL

FOR FINANCIAL SERVICES, NAMELY, COLLECTION OF COPYRIGHT AND ROYALTIES AND ADMINISTRATION OF COPYRIGHT ROYALTIES (U.S. CLS. 100, 101 AND 102).

CLASS 38—COMMUNICATION

FOR COMMUNICATION OF AUDIO AND/OR VIDEO DATA FILES VIA TELECOMMUNICATION NETWORKS (U.S. CLS. 100, 101 AND 104).

VIVIAN MICZNIK FIRST, EXAMINING ATTORNEY

SN 78-331,071. HIDDEN DREAMS ENTERTAINMENT LLC,
LOS ANGELES, CA. FILED 11-20-2003.

HIDDEN DREAMS

THE MARK CONSISTS OF STANDARD CHARACTERS WITHOUT CLAIM TO ANY PARTICULAR FONT, STYLE, SIZE, OR COLOR.

CLASS 16—PAPER GOODS AND PRINTED MATTER

FOR PAPER GOODS AND PRINTED MATTER, NAMELY, PUBLICATIONS, NAMELY, MAGAZINES AND BOOKS ON THE TOPIC OF MUSICAL ARTISTS; SERIES OF ILLUSTRATED CHILDREN'S BOOKS; COMIC BOOKS; COLORING BOOKS; CHILDREN'S PLAY-ACTIVITY BOOKS; STICKER BOOKS; POSTER BOOKS; POSTCARD BOOKS; WORD PUZZLE BOOKS; POSTCARDS; FLASHCARDS; TRADING/TRIVIA CARDS; GREETING CARDS; CALENDARS; STATIONARY; DIARIES; SOUVENIR PROGRAMS CONCERNING TELEVISION SHOWS, TELEVISION FILMS AND MOTION PICTURE FILMS; ARTS AND CRAFT PAINT KITS; SCRAPBOOKS; ADDRESS AND SCHEDULE BOOKS; NOTEBOOKS; BOOK COVERS; PHOTOGRAPH ALBUMS; PAPER SUPPLIES AND DECORATIONS, NAMELY, PAPER HATS, PAPER NAPKINS, PAPER GIFT BAGS, PAPER PLACEMATS, PRINTED INVITATIONS, NOTE CARDS, PAPER DOOR SIGNS, PAPER PLACE CARDS, PAPER TABLE COVERS, PAPER BAGS, PAPER PENNANTS, PAPER BANNERS, GENERAL PURPOSE PLASTIC BAGS, PAPER IDENTIFICATION NAME TAGS, DECORATIVE PAPER CENTERPIECES; PAPER PARTY FAVORS, NAMELY, PAPER PARTY HATS, PAPER DOILIES, PAPER PARTY DECORATIONS, AND PAPER PARTY BAGS; GIFT WRAPPING PAPER; RUBBER STAMPS, STAMP PADS, LOOSE-LEAF BINDERS; PAPER BOXES; CHILDREN'S BOOKS COMBINED WITH PRE-RECORDED AUDIO TAPE CASSETTES FEATURING STORIES AND MUSIC, SOLD AS UNITS; CHILDREN'S BOOKS COMBINED WITH ELECTRONIC SOUND-EMITTING DEVICES, SOLD AS UNITS; CHILDREN'S BOOKS COMBINED WITH DOLLS, SOLD AS UNITS; CRAYONS; PENS; PENCILS; PENCIL CASES; PENCIL SHARPENERS, MECHANICAL PENCILS; NON-ELECTRIC ERASERS; INK MARKERS AND CASES AND HOLDERS THEREFOR; BUMPER STICKERS; CHILDREN'S PAINTING KITS AND ACCESSORIES THEREFOR, NAMELY, FINGER PAINTS, POSTER PAINTS, WATERCOLOR PAINTS, ARTIST PAINT BRUSHES, EASELS, POSTER BOARD, ART PAPER, SKETCHBOOKS; WALL POSTERS; STICK-ON STICKERS; CROSS-WORD PUZZLES; NOTE PAPER; NOTE PADS; PAPER MEMO PAD CUBES; MEMO PADS; BOOKMARKS; CHALK; CHALK ERASERS; CREPE PAPER; MODELING CLAY; PAPER BIBS; DECORATIVE PEN- AND PENCIL-TOP ORNAMENTS; PAPER DECALS AND STENCILS; CONSTRUCTION PAPER; TRACING PAPER; BOND PAPER; PICTURES; LITHOGRAPHS; PHOTOGRAPHS; PRINTS; PICTORIAL PRINTS; STICKERS; TELEPHONE CALLING CARDS NOT MAGNETICALLY CODED; BLACKBOARDS; CORK BOARDS; BULLETIN BOARDS; MEMORANDUM BOARDS; SLATE BOARDS FOR WRITING; BOOK HOLDERS; BOOKENDS; PAPER COASTERS; ENVELOPE (U.S. CLS. 2, 5, 22, 23, 29, 37, 38 AND 50).

SN 78-332,186. LONDON SOLE, LLC, SANTA MONICA, CA. FILED 11-24-2003.

London Sole

THE MARK CONSISTS OF STANDARD CHARACTERS WITHOUT CLAIM TO ANY PARTICULAR FONT, STYLE, SIZE, OR COLOR.

CLASS 25—CLOTHING

FOR FOOTWEAR DESIGNED IN LONDON (U.S. CLS. 22 AND 39).
FIRST USE 12-1-2003; IN COMMERCE 12-1-2003.

CLASS 35—ADVERTISING AND BUSINESS

FOR RETAIL STORE SERVICES FEATURING FOOTWEAR DESIGNED IN LONDON (U.S. CLS. 100, 101 AND 102).
FIRST USE 12-1-2003; IN COMMERCE 12-1-2003.
DAVID H. STINE, EXAMINING ATTORNEY

SN 78-333,224. HIDDEN DREAMS ENTERTAINMENT, LLC, LOS ANGELES, CA. FILED 11-25-2003.

CLASS 25—CLOTHING

FOR CLOTHING FOR WOMEN, MEN, AND CHILDREN, NAMELY, T-SHIRTS, SHIRTS, SWEATSHIRTS, SWEATPANTS, CAPS, HATS, SUN VISORS, HEADBANDS, HEADWEAR, JACKETS, COATS, SWEATERS, RAINWEAR, SCARVES, TIES, SLEEPWEAR, ROBES, BEACHWEAR, UNDERWEAR, LINGERIE, HOSIERY, SOCKS, JEANS, VESTS, BLOUSES, SKIRTS, DRESSES, JUMPERS, PANTS, SHORTS, TROUSERS, OVERALLS, GLOVES, MITTENS, LEOTARDS, JUMPSUITS, BELTS, SUSPENDERS, FOOTWEAR, TOPS, BOTTOMS, APRONS, AND CHILDREN'S CLOTH EATING BIBS; MASQUERADE COSTUMES AND MASKS SOLD IN CONNECTION THEREWITH (U.S. CLS. 22 AND 39).
STEVEN R. FINE, EXAMINING ATTORNEY

THE GORDY COLLECTION

THE MARK CONSISTS OF STANDARD CHARACTERS WITHOUT CLAIM TO ANY PARTICULAR FONT, STYLE, SIZE, OR COLOR.

NO CLAIM IS MADE TO THE EXCLUSIVE RIGHT TO USE "COLLECTION", APART FROM THE MARK AS SHOWN.

CLASS 16—PAPER GOODS AND PRINTED MATTER

FOR PAPER GOODS AND PRINTED MATTER, NAMELY, PUBLICATIONS, NAMELY, MAGAZINES, BOOKS AND NOVELIZATIONS IN THE FIELD OF SCIENCE FICTION; SERIES OF ILLUSTRATED CHILDREN'S BOOKS; COMIC BOOKS; COLORING BOOKS; CHILDREN'S PLAY-ACTIVITY BOOKS; STICKER BOOKS; POSTER BOOKS; POSTCARD BOOKS; WORD PUZZLE BOOKS; POSTCARDS; FLASHCARDS; TRADING/TRIVIA CARDS; GREETING CARDS; CALENDARS; STATIONERY; DIARIES; PRINTED SOUVENIR PROGRAMS CONCERNING TELEVISION SHOWS, TELEVISION FILMS AND MOTION PICTURE FILMS; ARTS AND CRAFT PAINT KITS; SCRAPBOOKS; ADDRESS AND SCHEDULE BOOKS; NOTEBOOKS; BOOK COVERS; PHOTOGRAPH ALBUMS; PAPER SUPPLIES AND DECORATIONS, NAMELY, PAPER NAPKINS, PAPER GIFT BAGS, PAPER PLACEMATS, PRINTED INVITATIONS, NOTE CARDS, PAPER DOOR SIGNS, PAPER PLACE CARDS, PAPER TABLE COVERS, PAPER BAGS, PAPER PENNANTS, PAPER BANNERS, GENERAL PURPOSE PLASTIC BAGS, PAPER IDENTIFICATION NAME TAGS, DECORATIVE PAPER CENTERPIECES; PAPER PARTY FAVORS, NAMELY, PAPER PARTY HATS, PAPER DOLLIES, PAPER PARTY DECORATIONS, AND PAPER PARTY BAGS; GIFT WRAPPING PAPER; RUBBER STAMPS, STAMP PADS; LOOSE-LEAF BINDERS; PAPER BOXES; CHILDREN'S BOOKS COMBINED WITH PRE-RECORDED AUDIO TAPE CASSETTES FEATURING STORIES AND MUSIC, SOLD AS UNITS; CHILDREN'S BOOKS COMBINED WITH ELECTRONIC SOUND-EMITTING DEVICES, SOLD AS UNITS; CHILDREN'S BOOKS COMBINED WITH DOLLS, SOLD AS UNITS; CRAYONS; PENS; PENCILS; PENCIL CASES; PENCIL SHARPENERS, MECHANICAL PENCILS; NON-ELECTRIC ERASERS; INK MARKERS AND CASES AND HOLDERS THEREFOR; BUMPER STICKERS; CHILDREN'S PAINTING KITS AND ACCESSORIES THEREFOR, NAMELY, FINGER PAINTS, POSTER PAINTS, WATERCOLOR PAINTS, ARTIST PAINT BRUSHES, EASELS, POSTER BOARD, ART PAPER, SKETCHBOOKS; WALL POSTERS; STICK-ON STICKERS; CROSS-WORD PUZZLES; NOTE PAPER; NOTE PADS; PAPER MEMO PAD CUBES; MEMO PADS; BOOKMARKS; CHALK; CHALK ERASERS; CREPE PAPER; MODELING CLAY; PAPER BABY BIBS; DECORATIVE PEN- AND PENCIL-TOP ORNAMENTS; PAPER DECALS AND STENCILS; CONSTRUCTION PAPER; TRACING PAPER; BOND PAPER; PRINTS; PICTURES; LITHOGRAPHS; PICTORIAL PRINTS; STICKERS; TELEPHONE CALLING CARDS NOT MAGNETICALLY CODED; BLACKBOARDS; CORK BOARDS; BULLETIN BOARDS; MEMORANDUM BOARDS; SLATE BOARDS FOR WRITING; BOOK HOLDERS; BOOKENDS; PAPER COASTERS; ENVELOPES (U.S. CLS. 2, 5, 22, 23, 29, 37, 38 AND 50).

CLASS 25—CLOTHING

FOR CLOTHING FOR WOMEN, MEN, AND CHILDREN, NAMELY, T-SHIRTS, SHIRTS, SWEATSHIRTS, SWEATPANTS, CAPS, HATS, SUN VISORS, HEADBANDS, HEADWEAR, JACKETS, COATS, SWEATERS, RAINWEAR, SCARVES, TIES, SLEEPWEAR, ROBES, BEACHWEAR, UNDERWEAR, LINGERIE, HOSIERY, SOCKS, JEANS, VESTS, BLOUSES, SKIRTS, DRESSES, JUMPERS, PANTS, SHORTS, TROUSERS, OVERALLS, GLOVES, MITTENS, LEOTARDS, JUMPSUITS, BELTS, SUSPENDERS, FOOTWEAR, TOPS, BOTTOMS, APRONS, AND CHILDREN'S CLOTH EATING BIBS; MASQUERADE COSTUMES AND MASKS SOLD IN CONNECTION THEREWITH (U.S. CLS. 22 AND 39).

CLASS 28—TOYS AND SPORTING GOODS

FOR TOYS, GAMES AND PLAYTHINGS, NAMELY, MECHANICAL AND ELECTRIC ACTION TOYS, BABY MULTIPLE-ACTIVITY TOYS, CONSTRUCTION TOYS, MODELED PLASTIC TOY FIGURINES, TOY ACTION FIGURES; ACTION SKILLS GAMES, BOARD GAMES, CARD GAMES, HAND-HELD UNITS FOR PLAYING VIDEO GAMES; PLAY FIGURES, PLAY HOUSES; PLUSH TOYS, STUFFED TOYS; PUPPETS; INFLATABLE VINYL TOY FIGURES; DOLLS, DOLL CLOTHING, AND ACCESSORIES THEREFOR; PAPER DOLLS, PRINTED PAPER DOLL CLOTHING, AND ACCESSORIES THEREFOR; TOY PLASTIC DISHES; COSTUME MASKS; TOY JEWELRY; COIN-OPERATED PINBALL MACHINES; TOY MODEL HOBBYCRAFT KITS; EQUIPMENT SOLD AS UNITS FOR PURPOSES OF PLAYING BOARD, PARLOR AND SKILL AND ACTION-TYPE GAMES; BOXED JIGSAW PUZZLES; JIGSAW PUZZLES SOLD AS UNITS IN THEIR ASSEMBLED FORM; HAND-HELD MANIPULATIVE PUZZLES; SELF-ERASING TOY WRITING AND DRAWING BOARD DEVICE INTENDED FOR TEMPORARILY RECEIVING WRITTEN AND/OR DRAWN IMPRESSIONS; MARBLES; YO-YO'S; TOY GLIDERS AND TOY GUNS WHICH PROJECT SAID GLIDERS; SEWING/LACING PLAY ACTIVITY CARDS; TOY BANKS; TOY BUILDING BLOCKS; BATH TUB TOYS; KITES; FLYING DISKS; BALLOONS; RIDE-ON TOYS; TOY VEHICLES; SKATEBOARDS; ROLLER SKATES; CASES FOR PLAY ACCESSORIES; BATTERY-POWERED COMPUTER GAMES WITH LCD SCREENS THAT FEATURE ANIMATION AND SOUND EFFECTS, SOLD AS A UNIT, FOR PLAYING A PARLOR-TYPE GAME; PLAYING CARDS AND PLAYING CARD CASES (U.S. CLS. 22, 23, 38 AND 50).

CLASS 35—ADVERTISING AND BUSINESS

FOR ONLINE ORDERING SERVICES FEATURING PRERECORDED SOUND RECORDINGS, VIDEO RECORDINGS, AND MOTION PICTURES IN THE FIELDS OF MUSICAL ENTERTAINMENT, COMEDY, DRAMA, ACTION, ADVENTURE, AND ANIMATION; VIDEO AND COMPUTER GAMES AND EQUIPMENT; BOOKS, PAPER GOODS, AND STATIONERY SUPPLIES; MASQUERADE COSTUMES AND MASKS; CLOTHING FOR MEN, WOMEN AND CHILDREN; AND TOYS, GAMES, AND PLAYTHINGS (U.S. CLS. 100, 101 AND 102).

CLASS 41—EDUCATION AND ENTERTAINMENT

FOR ENTERTAINMENT SERVICES, NAMELY, PRODUCTION AND DISTRIBUTION OF MOTION PICTURE FILMS; SOUND RECORDING PRODUCTION; SOUND RECORDING PUBLISHING SERVICES; AUDIOVISUAL RECORDING AND PRODUCTION SERVICES; PRODUCTION OF COMPUTER GAME TAPES, COMPUTER GAME SOFTWARE, MULTIMEDIA GAME SOFTWARE RECORDED ON CD-ROM, COMPUTER GAME TAPE CARTRIDGES, COMPUTER GAME CASSETTES AND VIDEO GAME CARTRIDGES; PROVIDING INFORMATION IN THE FIELD OF ENTERTAINMENT BY MEANS OF A GLOBAL COMPUTER NETWORK AND OTHER COMPUTER NETWORKS; ENTERTAINMENT SERVICES IN THE NATURE OF LIVE-ACTION, COMEDY, DRAMA AND/OR ANIMATED ON-GOING TELEVISION PROGRAMS; PRODUCTION OF LIVE-ACTION, COMEDY, DRAMA AND/OR ANIMATED TELEVISION PROGRAMS; ENTERTAINMENT SERVICES IN THE NATURE OF LIVE-ACTION, COMEDY, DRAMA AND/OR ANIMATED MOTION PICTURE THEATRICAL FILMS; PRODUCTION OF LIVE-ACTION, COMEDY, DRAMA AND/OR ANIMATED MOTION PICTURE THEATRICAL FILMS; ENTERTAINMENT SERVICES IN THE NATURE OF LIVE THEATRICAL PERFORMANCES; AND PROVIDING, VIA A GLOBAL COMPUTER NETWORK, AN ON-LINE COMPUTER DATABASE FEATURING INFORMATION REGARDING LIVE-ACTION, COMEDY, DRAMA AND/OR ANIMATED TELEVISION PROGRAMS AND INFORMATION REGARDING THE PRODUCTION OF LIVE-ACTION, COMEDY, DRAMA AND/OR ANIMATED MOTION PICTURE FILMS FOR TELEVISION (U.S. CLS. 100, 101 AND 107).

LINDA E. BLOHM, EXAMINING ATTORNEY

SN 78-333,558. RATE, LLC, OLATHE, KS. FILED 11-26-2003.

RATE

THE MARK CONSISTS OF STANDARD CHARACTERS WITHOUT CLAIM TO ANY PARTICULAR FONT, STYLE, SIZE, OR COLOR.

CLASS 31—NATURAL AGRICULTURAL PRODUCTS

FOR ELECTROLYTE FOOD AND DRINK SUPPLEMENTS FOR ANIMALS (U.S. CLS. 1 AND 46).
FIRST USE 7-15-2002; IN COMMERCE 7-15-2002.

CLASS 32—LIGHT BEVERAGES

FOR ELECTROLYTE DRINK SUPPLEMENTS FOR HUMANS SOLD AS AN INTEGRAL PART OF SPORTS DRINKS (U.S. CLS. 45, 46 AND 48).
FIRST USE 7-15-2002; IN COMMERCE 7-15-2002.
AMY HELLA, EXAMINING ATTORNEY

SN 78-333,675. CZUCHRY, ANDREW J., JR., AUBURN, GA. FILED 11-26-2003.

ENNOVIX

THE MARK CONSISTS OF STANDARD CHARACTERS WITHOUT CLAIM TO ANY PARTICULAR FONT, STYLE, SIZE, OR COLOR.

CLASS 37—CONSTRUCTION AND REPAIR

FOR INSTALLATION OF COMPUTER SYSTEMS AND NETWORKS FOR BUSINESSES, ACADEMIC INSTITUTIONS, AND GOVERNMENT AGENCIES AND ENTITIES (U.S. CLS. 100, 103 AND 106).

CLASS 41—EDUCATION AND ENTERTAINMENT

FOR MULTIMEDIA ENTERTAINMENT SOFTWARE PRODUCTION SERVICES, NAMELY, MULTIMEDIA PRODUCTION OF ENTERTAINMENT SOFTWARE FEATURING INTERACTIVE MEDIA, GRAPHICS, AUDIO, VIDEO AND DIGITAL CONTENT (U.S. CLS. 100, 101 AND 107).

CLASS 42—SCIENTIFIC, COMPUTER AND LEGAL SERVICES

FOR COMPUTER SERVICES, NAMELY, PROVIDING COMPUTER SOFTWARE APPLICATION DEVELOPMENT AND CUSTOMIZATION, NAMELY, CUSTOMIZING COMPUTER SOFTWARE APPLICATIONS FOR BUSINESSES, ACADEMIC INSTITUTIONS AND GOVERNMENT AGENCIES AND ENTITIES; UPDATING SOFTWARE, NAMELY, UPDATING SOFTWARE APPLICATIONS FOR BUSINESSES, ACADEMIC INSTITUTIONS AND GOVERNMENT AGENCIES AND ENTITIES; DESIGNING COMPUTER NETWORKS AND DISTRIBUTED ARCHITECTURES, NAMELY, COMPUTER SYSTEMS, FOR BUSINESSES, ACADEMIC INSTITUTIONS AND GOVERNMENT AGENCIES AND ENTITIES; COMPUTER SERVICES, NAMELY, APPLICATION SERVICE PROVIDER TO HOST COMPUTER SOFTWARE APPLICATIONS FOR OTHERS (U.S. CLS. 100 AND 101).

LANA PHAM, EXAMINING ATTORNEY

SN 78-333,919. CHARLES SCHWAB & CO., INC., SAN FRANCISCO, CA. FILED 11-26-2003.

SCHWAB TRADER CT

THE MARK CONSISTS OF STANDARD CHARACTERS WITHOUT CLAIM TO ANY PARTICULAR FONT, STYLE, SIZE, OR COLOR.

OWNER OF U.S. REG. NOS. 2,574,925, 2,706,554 AND OTHERS.

NO CLAIM IS MADE TO THE EXCLUSIVE RIGHT TO USE TRADER, APART FROM THE MARK AS SHOWN.

CLASS 9—ELECTRICAL AND SCIENTIFIC APPARATUS

FOR DOWNLOADABLE SOFTWARE FOR USE BY INVESTORS IN THE TRADING AND ANALYSIS OF INVESTMENTS, FINANCES AND FINANCIAL PLANNING, VIA A GLOBAL COMPUTER NETWORK, NAMELY, SOFTWARE FOR ELECTRONIC TRADING IN ALL FORMS OF SECURITIES, NAMELY, STOCKS, BONDS, MUTUAL FUNDS, MONEY MARKET FUNDS, CURRENCIES, COMMODITIES, FUTURES, OPTIONS, INDICES OF ANY OF THEM, AND ANY OTHER INVESTMENT VEHICLES; DOWNLOADABLE SOFTWARE FOR PROVIDING FINANCIAL AND INVESTMENT INFORMATION, FINANCIAL AND INVESTMENT NEWS, STREAMING QUOTES, AND FINANCIAL AND INVESTMENT RESEARCH; DOWNLOADABLE SOFTWARE FOR USE IN MAINTAINING FINANCIAL AND INVESTMENT DATABASES (U.S. CLS. 21, 23, 26, 36 AND 38).

CLASS 35—ADVERTISING AND BUSINESS

FOR PROVIDING INFORMATION AND ANALYSIS IN THE FIELDS OF ECONOMICS AND BUSINESS, NAMELY, INDUSTRY AND SECTOR REPORTS AND FORECASTS, ECONOMIC REPORTS AND FORECASTS (U.S. CLS. 100, 101 AND 102).

CLASS 36—INSURANCE AND FINANCIAL

FOR INVESTMENT BROKERAGE SERVICES AND SECURITIES INVESTMENT SERVICES PROVIDED ELECTRONICALLY AND VIA THE INTERNET, NAMELY, ELECTRONIC TRADING FOR OTHERS IN SECURITIES, STOCKS, BONDS, MUTUAL FUNDS, MONEY MARKET FUNDS, COMMODITIES, FUTURES, OPTIONS, CURRENCIES, INDICES OF ANY OF THEM, AND ANY OTHER INVESTMENT VEHICLES; INVESTMENT BROKERAGE SERVICES AND INVESTMENT SERVICES, NAMELY, TRADING IN SECURITIES, STOCKS, BONDS, MUTUAL FUNDS, MONEY MARKET FUNDS, COMMODITIES, FUTURES, OPTIONS, CURRENCIES, INDICES OF ANY OF THEM, AND ANY OTHER INVESTMENT VEHICLES; PROVIDING AND INVESTMENT INFORMATION, FINANCIAL AND INVESTMENT NEWS, FINANCIAL AND INVESTMENT RESEARCH SERVICES, FINANCIAL AND INVESTMENT INFORMATION, NAMELY, PROVIDING REAL-TIME, STREAMING NASDAQ LEVEL II QUOTES, ADVANCED TECHNICAL CHARTING MARKET CHARTS, WATCH LISTS AND ALERTS, STOCK SCREENERS, AND TRADE EXECUTION INFORMATION, PROVIDING AN ON-LINE COMPUTER DATABASE IN THE FIELD OF FINANCE AND FINANCIAL INVESTMENTS ALL FOR USE BY INVESTORS IN THE TRADING AND ANALYSIS OF INVESTMENTS, FINANCES, AND FINANCIAL PLANNING VIA THE INTERNET OR VIA MEANS; FINANCIAL PORTFOLIO MANAGEMENT SERVICES PROVIDED VIA ELECTRONIC COMMUNICATION NETWORKS; SECURITIES BROKERAGE ACCOUNT SERVICES INCLUDING AN INTEREST BEARING FEATURE FOR CASH BETWEEN INVESTMENTS, ACCESS TO CASH, AND MARGIN LOANS; CREDIT CARD AND DEBIT CARD SERVICES; CASH MANAGEMENT ACCOUNT SERVICES; BILL PAYMENT SERVICES AND ELECTRONIC FUND TRANSFER SERVICES; FINANCIAL ANALYSIS IN THE FIELDS OF INVESTING, FINANCE, STOCK SCREENING, AND MARKET TRENDS; FINANCIAL PLANNING AND FINANCIAL DECISION MAKING SERVICES; FINANCIAL ANALYSIS, NAMELY, MONITORING INVESTMENT VALUE AND PERFORMANCE OF INVESTMENT, ANALYZING INVESTMENT PERFORMANCE, EVALUATING ASSET ALLOCATION, RISK TOLERANCE, FINANCIAL ALTERNATIVE PLANS AND INVESTMENT TIME FRAMES; PROVIDING INFORMATION AND ANALYSIS IN THE FIELDS OF FINANCE, FINANCIAL INVESTMENT, FINANCIAL PLANNING, AND FINANCIAL INVESTMENT STRATEGY; PROVIDING INVESTMENT RESEARCH; PROVIDING AN INTERACTIVE ONLINE COMPUTER DATABASE IN THE FIELD OF FINANCIAL PORTFOLIO MANAGEMENT, FINANCIAL INVESTING, FINANCE, FINANCIAL PLANNING, FINANCIAL NEWS, AND FINANCIAL INFORMATION; PROVIDING INFORMATION IN THE FIELDS OF FINANCIAL INVESTMENT ACCOUNT INFORMATION AND FINANCIAL RESEARCH VIA ONLINE AND ELECTRONIC MEANS; PROVISION OF NEWS, INFORMATION, RESEARCH, AND ANALYSIS IN THE FIELDS OF FINANCIAL INVESTING, FINANCE, AND FINANCIAL PLANNING VIA ELECTRONIC COMMUNICATION NETWORKS (U.S. CLS. 100, 101 AND 102).

CLASS 38—COMMUNICATION

FOR PROVIDING ON-LINE CHAT ROOMS FOR TRANSMISSION OF MESSAGES, INCLUDING VOICE, TEXT, AND IMAGES, AMONG COMPUTER USERS CONCERNING THE TRADING AND ANALYSIS OF INVESTMENTS, FINANCES AND FINANCIAL PLANNING, SECURITIES, NAMELY, STOCKS, BONDS, MUTUAL FUNDS, MONEY MARKET FUNDS, CURRENCIES, COMMODITIES, FUTURES, OPTIONS, INDICES OF ANY OF THEM, AND ANY OTHER INVESTMENT VEHICLES; PROVIDING ON-LINE CHAT ROOMS FOR TRANSMISSION OF MESSAGES, INCLUDING VOICE, TEXT, AND IMAGES, AMONG COMPUTER USERS CONCERNING FINANCIAL AND INVESTMENT INFORMATION, FINANCIAL AND INVESTMENT NEWS, AND FINANCIAL AND INVESTMENT RESEARCH, THE FINANCIAL SECURITIES MARKET, REAL-TIME MARKET ANALYSIS, AND TECHNICAL AND FUNDAMENTAL ANALYSIS (U.S. CLS. 100, 101 AND 104).

CLASS 41—EDUCATION AND ENTERTAINMENT

FOR EDUCATION SERVICES, NAMELY, PROVIDING IN PERSON AND ON-LINE INTERACTIVE TRAINING SESSIONS FOR INVESTORS IN THE FIELD OF TRADING IN ALL FORMS OF SECURITIES, NAMELY, STOCKS, BONDS, MUTUAL FUNDS, MONEY MARKET FUNDS, CURRENCIES, COMMODITIES, FUTURES, OPTIONS, INDICES OF ANY OF THEM, AND ANY OTHER INVESTMENT VEHICLES; EDUCATION SERVICES, NAMELY, PROVIDING IN PERSON AND ON-LINE INTERACTIVE TRAINING SESSIONS FOR INVESTORS IN THE FIELD OF FINANCIAL AND INVESTMENT INFORMATION, FINANCIAL AND INVESTMENT NEWS, FINANCIAL AND INVESTMENT RESEARCH, THE FINANCIAL SECURITIES MARKET, REAL-TIME MARKET ANALYSIS, TECHNICAL AND FUNDAMENTAL ANALYSIS; EDUCATION SERVICES, NAMELY, PROVIDING IN PERSON AND ON-LINE INTERACTIVE TRAINING SESSIONS FOR INVESTORS IN THE FIELD OF THE TRADING AND ANALYSIS OF INVESTMENTS, FINANCES AND FINANCIAL PLANNING (U.S. CLS. 100, 101 AND 107).

CLASS 42—SCIENTIFIC, COMPUTER AND LEGAL SERVICES

FOR PROVIDING TEMPORARY USE OF NON-DOWNLOADABLE SOFTWARE FOR USE BY INVESTORS IN THE TRADING AND ANALYSIS OF INVESTMENTS, FINANCES AND FINANCIAL PLANNING, VIA A GLOBAL COMPUTER NETWORK, NAMELY, SOFTWARE FOR ELECTRONIC TRADING IN ALL FORMS OF SECURITIES, NAMELY, STOCKS, BONDS, MUTUAL FUNDS, MONEY MARKET FUNDS, CURRENCIES, COMMODITIES, FUTURES, OPTIONS, INDICES OF ANY OF THEM, AND ANY OTHER INVESTMENT VEHICLES; PROVIDING TEMPORARY USE OF NON-DOWNLOADABLE SOFTWARE FOR USE IN OBTAINING FINANCIAL AND INVESTMENT INFORMATION, FINANCIAL AND INVESTMENT NEWS, AND FINANCIAL AND INVESTMENT RESEARCH; PROVIDING TEMPORARY USE OF NON-DOWNLOADABLE SOFTWARE FOR USE IN MAINTAINING FINANCIAL AND INVESTMENT DATABASES (U.S. CLS. 100 AND 101).
EVELYN BRADLEY, EXAMINING ATTORNEY

SN 78-334,337, RAPAPORT MARTIN, LAS VEGAS, NV.
FILED 12-1-2003.

INDEX - INTERNET DIAMOND EXCHANGE

THE MARK CONSISTS OF STANDARD CHARACTERS WITHOUT CLAIM TO ANY PARTICULAR FONT, STYLE, SIZE, OR COLOR.

OWNER OF U.S. REG. NO. 2,189,627.

NO CLAIM IS MADE TO THE EXCLUSIVE RIGHT TO USE "INTERNET DIAMOND EXCHANGE", APART FROM THE MARK AS SHOWN.

CLASS 35—ADVERTISING AND BUSINESS

FOR PROVIDING TRADE INFORMATION SERVICES AND COMPUTERIZED ONLINE ORDERING, PRICING, AND PURCHASING SERVICES FOR OTHERS FEATURING JEWELRY, DIAMONDS, PRECIOUS GEMSTONES, SEMI-PRECIOUS GEMSTONES, PRECIOUS GEMSTONES, PRECIOUS GEMS, SEMI-PRECIOUS GEMS, WATCHES, PRE-OWNED, USED, SECOND-HAND AND ESTATE JEWELRY; PROVIDING INFORMATION CONCERNING BUYING AND SELLING AND TRADING IN THE FIELD OF JEWELRY, DIAMONDS, PRECIOUS GEMSTONES, SEMI-PRECIOUS GEMSTONES, PRECIOUS GEMS, SEMI-PRECIOUS GEMS, WATCHES, PRE-OWNED, USED, SECOND-HAND AND ESTATE JEWELRY; ARRANGING AND CONDUCTING OF ONLINE AND NON-ONLINE AUCTION SALES IN THE FIELD OF JEWELRY, DIAMONDS, PRECIOUS GEMSTONES, SEMI-PRECIOUS GEMSTONES, PRECIOUS GEMS, SEMI-PRECIOUS GEMS AND WATCHES; AUCTIONEERING SERVICES RELATED TO PRE-OWNED, USED, SECOND-HAND AND ESTATE JEWELRY; DIRECT MARKETING ADVERTISING FOR OTHERS IN THE FIELD OF JEWELRY, DIAMONDS, PRECIOUS GEMSTONES, SEMI-PRECIOUS GEMSTONES, PRECIOUS GEMSTONES, PRECIOUS GEMS, SEMI-PRECIOUS GEMS, WATCHES, PRE-OWNED, USED, SECOND-HAND AND ESTATE JEWELRY; ON-LINE TRADING SERVICES IN WHICH SELLER POSTS PRODUCTS TO BE AUCTIONED OR SOLD, AND BIDDING OR OFFERS ARE RECEIVED VIA THE INTERNET IN THE FIELD OF JEWELRY, DIAMONDS, PRECIOUS GEMSTONES, SEMI-PRECIOUS GEMSTONES, PRECIOUS GEMS, SEMI-PRECIOUS GEMS, WATCHES, PRE-OWNED, USED, SECOND-HAND AND ESTATE JEWELRY; NON ON-LINE TRADING SERVICES IN WHICH SELLER SUBMITS PRODUCTS TO BE AUCTIONED OR SOLD IN THE FIELD OF JEWELRY, DIAMONDS, PRECIOUS GEMSTONES, SEMI-PRECIOUS GEMSTONES, PRECIOUS GEMS, SEMI-PRECIOUS GEMS, WATCHES; PRE-OWNED, USED, SECOND-HAND AND ESTATE JEWELRY; PROVIDING A DATABASE OF CONSUMER INFORMATION IN THE NATURE OF MARKET, PRICE AND TRANSACTION INFORMATION IN THE FIELDS OF JEWELRY, DIAMONDS, PRECIOUS GEMSTONES, SEMI-PRECIOUS GEMSTONES, PRECIOUS GEMS, SEMI-PRECIOUS GEMS, WATCHES; PRE-OWNED, USED, SECOND-HAND AND ESTATE JEWELRY; FACILITATING TRANSACTIONS BETWEEN BUYERS AND SELLERS THROUGH PROVIDING BUYERS WITH CONSUMER INFORMATION IN THE FIELDS OF JEWELRY, DIAMONDS, PRECIOUS GEMSTONES, SEMI-PRECIOUS GEMSTONES, PRECIOUS GEMS, SEMI-PRECIOUS GEMS, WATCHES; PRE-OWNED, USED, SECOND-HAND AND ESTATE JEWELRY (U.S. CLS. 100, 101 AND 102).

FIRST USE 1-4-2002; IN COMMERCE 1-4-2002.

CLASS 36—INSURANCE AND FINANCIAL

FOR PROVIDING FINANCIAL INFORMATION IN THE FIELD OF JEWELRY, DIAMONDS, PRECIOUS GEMSTONES, SEMI-PRECIOUS GEMSTONES; PRECIOUS GEMS, SEMI-PRECIOUS GEMS; WATCHES; PRE-OWNED, USED, SECOND-HAND AND ESTATE JEWELRY; ONLINE AND NON-ONLINE BROKERAGE AND FINANCIAL CLEARING HOUSE SERVICES IN THE FIELD OF JEWELRY, DIAMONDS, PRECIOUS GEMSTONES, SEMI-PRECIOUS GEMSTONES, PRECIOUS GEMS, SEMI-PRECIOUS GEMS, WATCHES, PRE-OWNED, USED, SECOND-HAND AND ESTATE JEWELRY; PROVIDING A DATABASE OF APPRAISAL INFORMATION IN THE FIELD OF JEWELRY, DIAMONDS, PRECIOUS GEMSTONES, SEMI-PRECIOUS GEMSTONES, PRECIOUS GEMS, SEMI-PRECIOUS GEMS, WATCHES, PRE-OWNED, USED, SECOND-HAND AND ESTATE JEWELRY; FACTORING SERVICES, NAMELY THE PURCHASE AND SALE OF DEBTS IN THE FIELDS OF JEWELRY, DIAMONDS, PRECIOUS GEMSTONES, SEMI-PRECIOUS GEMSTONES, PRECIOUS GEMS, SEMI-PRECIOUS GEMS; WATCHES; PRE-OWNED, USED, SECOND-HAND AND ESTATE JEWELRY (U.S. CLS. 100, 101 AND 102).

FIRST USE 5-30-2003; IN COMMERCE 5-30-2003.

CLASS 42—SCIENTIFIC, COMPUTER AND LEGAL SERVICES

FOR COMPUTER SOFTWARE PROGRAMMING SERVICES RELATED TO JEWELRY, DIAMONDS, PRECIOUS GEMSTONES, SEMI-PRECIOUS GEMSTONES, PRECIOUS GEMSTONES, PRECIOUS GEMS, SEMI-PRECIOUS GEMS; WATCHES, PRE-OWNED; USED, SECOND-HAND AND ESTATE JEWELRY (U.S. CLS. 100 AND 101).

FIRST USE 5-30-2003; IN COMMERCE 5-30-2003.

CAROLINE WOOD, EXAMINING ATTORNEY

SN 78-337,710. CZUCHRY, ANDREW J., JR., AUBURN, GA.
FILED 12-8-2003.



The logo for Ennovix Systems features the word "Ennovix" in a large, stylized, cursive script font. Below it, the word "SYSTEMS" is written in a smaller, all-caps, sans-serif font, with wide letter spacing.

NO CLAIM IS MADE TO THE EXCLUSIVE RIGHT TO USE "SYSTEMS", APART FROM THE MARK AS SHOWN.

CLASS 37—CONSTRUCTION AND REPAIR

FOR INSTALLATION OF COMPUTER SYSTEMS AND NETWORKS FOR BUSINESSES, ACADEMIC INSTITUTIONS, AND GOVERNMENT AGENCIES AND ENTITIES (U.S. CLS. 100, 103 AND 106).

CLASS 41—EDUCATION AND ENTERTAINMENT

FOR MULTIMEDIA ENTERTAINMENT SOFTWARE PRODUCTION SERVICES, NAMELY, MULTIMEDIA PRODUCTION OF ENTERTAINMENT SOFTWARE FEATURING INTERACTIVE MEDIA, GRAPHICS, AUDIO, VIDEO AND DIGITAL CONTENT (U.S. CLS. 100, 101 AND 107).

CLASS 42—SCIENTIFIC, COMPUTER AND LEGAL SERVICES

FOR COMPUTER SERVICES, NAMELY, PROVIDING COMPUTER SOFTWARE APPLICATION DEVELOPMENT AND CUSTOMIZATION, NAMELY, CUSTOMIZING COMPUTER SOFTWARE APPLICATIONS FOR BUSINESSES, ACADEMIC INSTITUTIONS AND GOVERNMENT AGENCIES AND ENTITIES; UPDATING SOFTWARE, NAMELY, UPDATING SOFTWARE APPLICATIONS FOR BUSINESSES, ACADEMIC INSTITUTIONS AND GOVERNMENT AGENCIES AND ENTITIES; DESIGNING COMPUTER NETWORKS AND DISTRIBUTED ARCHITECTURES, NAMELY, COMPUTER SYSTEMS, FOR BUSINESSES, ACADEMIC INSTITUTIONS AND GOVERNMENT AGENCIES AND ENTITIES; COMPUTER SERVICES, NAMELY, APPLICATION SERVICE PROVIDER TO HOST COMPUTER SOFTWARE APPLICATIONS FOR OTHERS (U.S. CLS. 100 AND 101).

LANA PHAM, EXAMINING ATTORNEY

SN 78-338,787. PEAK BODY SYSTEMS, INC., BOULDER, CO.
FILED 12-10-2003.

SN 78-339,473. THE DANNON COMPANY, INC., TARRY-
TOWN, NY. FILED 12-11-2003.

MAKE EVERY CARB COUNT

PEAK PILATESYSTEM

THE MARK CONSISTS OF STANDARD CHARACTERS
WITHOUT CLAIM TO ANY PARTICULAR FONT, STYLE,
SIZE, OR COLOR.

NO CLAIM IS MADE TO THE EXCLUSIVE RIGHT TO
USE PILATES SYSTEM, APART FROM THE MARK AS
SHOWN.

CLASS 9—ELECTRICAL AND SCIENTIFIC APPARATUS

FOR PRERECORDED VIDEO TAPES RELATING TO
TRAINING AND INSTRUCTIONAL TECHNIQUES RE-
LATING TO EXERCISING, PHYSICAL THERAPY, GEN-
ERAL BODY CONDITIONING AND FLEXIBILITY
TRAINING (U.S. CLS. 21, 23, 26, 36 AND 38).

FIRST USE 2-1-2003; IN COMMERCE 2-1-2003.

CLASS 10—MEDICAL APPARATUS

FOR PILATES EXERCISE MACHINES FOR USE IN
PHYSICAL THERAPY (U.S. CLS. 26, 39 AND 44).

FIRST USE 2-1-2003; IN COMMERCE 2-1-2003.

CLASS 28—TOYS AND SPORTING GOODS

FOR PILATES EXERCISE MACHINES, NAMELY EX-
ERCISE MACHINES FOR GENERAL BODY CONDI-
TIONING (U.S. CLS. 22, 23, 38 AND 50).

FIRST USE 2-1-2003; IN COMMERCE 2-1-2003.

CLASS 41—EDUCATION AND ENTERTAIN- MENT

FOR EDUCATIONAL SERVICES, NAMELY, TRAIN-
ING SEMINARS AND INSTRUCTION THROUGH
COURSES, PROGRAMS AND WORKSHOPS RELATING
TO EXERCISING, PHYSICAL THERAPY, GENERAL
BODY CONDITIONING AND FLEXIBILITY TRAINING
(U.S. CLS. 100, 101 AND 107).

FIRST USE 2-1-2003; IN COMMERCE 2-1-2003.

CLASS 42—SCIENTIFIC, COMPUTER AND LEGAL SERVICES

FOR DESIGN, ENGINEERING AND DEVELOPMENT
OF NEW PRODUCTS RELATING TO EXERCISE EQUIP-
MENT FOR OTHERS (U.S. CLS. 100 AND 101).

FIRST USE 2-1-2003; IN COMMERCE 2-1-2003.
TONI HICKEY, EXAMINING ATTORNEY

THE MARK CONSISTS OF STANDARD CHARACTERS
WITHOUT CLAIM TO ANY PARTICULAR FONT, STYLE,
SIZE, OR COLOR.

CLASS 29—MEATS AND PROCESSED FOODS

FOR DAIRY PRODUCTS, EXCLUDING ICE CREAM,
ICE MILK AND FROZEN YOGURT; DAIRY-BASED
BEVERAGES (U.S. CL. 46).

CLASS 30—STAPLE FOODS

FOR DAIRY PRODUCTS, NAMELY ICE CREAM, ICE
MILK AND FROZEN YOGURT (U.S. CL. 46).

MELVIN AXILBUND, EXAMINING ATTORNEY

SN 78-340,321. INGEENI STUDIOS, INC., CAMBRIDGE, MA.
FILED 12-12-2003.

INGEENI

THE MARK CONSISTS OF STANDARD CHARACTERS
WITHOUT CLAIM TO ANY PARTICULAR FONT, STYLE,
SIZE, OR COLOR.

CLASS 9—ELECTRICAL AND SCIENTIFIC APPARATUS

FOR COMPUTER SOFTWARE, NAMELY, ARTIFI-
CIAL INTELLIGENCE COMPUTER GAME SOFTWARE;
COMPUTER SOFTWARE FOR USE IN WEBSITE CON-
TENT DEVELOPMENT (U.S. CLS. 21, 23, 26, 36 AND 38).

CLASS 35—ADVERTISING AND BUSINESS

FOR MARKETING AND ADVERTISING SERVICES,
NAMELY, PROVIDING ON-LINE ADVERTISING ON
COMPUTER COMMUNICATION NETWORKS FOR USE
IN BRANDING AND PROMOTING PRODUCTS (U.S.
CLS. 100, 101 AND 102).

RENEE MCCRAY, EXAMINING ATTORNEY

SN 78-340,851. AMOREPACIFIC CORPORATION, SEOUL, REPUBLIC OF KOREA, FILED 12-15-2003.

SN 78-342,001. FLORIDA CREDIT UNION LEAGUE, TALLAHASSEE, FL. FILED 12-17-2003.

No more searching...No more guessing...
KNOWMORE

WHITE ENERGY COMPLEX

CLASS 35—ADVERTISING AND BUSINESS

FOR CONSULTING SERVICES IN THE FIELD OF CREDIT UNION OPERATION (U.S. CLS. 100, 101 AND 102).

CLASS 41—EDUCATION AND ENTERTAINMENT

FOR TRAINING IN THE FIELD OF CREDIT UNION OPERATION (U.S. CLS. 100, 101 AND 107).
 VIVIAN MICZNIK FIRST, EXAMINING ATTORNEY

THE MARK CONSISTS OF STANDARD CHARACTERS WITHOUT CLAIM TO ANY PARTICULAR FONT, STYLE, SIZE, OR COLOR.

PRIORITY CLAIMED UNDER SEC. 44(D) ON REPUBLIC OF KOREA APPLICATION NO. 4020030044, FILED 10-9-2003, REG. NO. 0600133, DATED 11-24-2004, EXPIRES 11-24-2014.

CLASS 1—CHEMICALS

FOR (BASED ON 44(E)) ENZYMES FOR USE IN THE MANUFACTURE OF COSMETICS; ARTIFICIAL SWEETENERS; CHEMICAL ADDITIVES CONTAINING LICORICE EXTRACT FOR USE IN THE MANUFACTURE OF COSMETICS; CHEMICAL ADDITIVES CONTAINING RED GINSENG FOR USE IN THE MANUFACTURE OF COSMETICS; VEGETABLE HORMONES TO BE USED IN THE MANUFACTURING OF COSMETICS; MICROORGANISMS TO BE USED IN THE MANUFACTURING OF COSMETICS; CHEMICAL ADDITIVES FOR USE IN THE MANUFACTURE OF COSMETICS; CHEMICAL REAGENTS OTHER THAN FOR MEDICAL PURPOSES; EMULSIFIERS FOR USE IN THE MANUFACTURE OF COSMETICS; ORGANIC ACID SALTS FOR USE IN THE MANUFACTURE OF COSMETICS, INDUSTRIAL SALTS FOR USE IN THE MANUFACTURE OF COSMETICS; AGRICULTURAL MIXED FERTILIZERS (U.S. CLS. 1, 5, 6, 10, 26 AND 46).

CLASS 3—COSMETICS AND CLEANING PREPARATIONS

FOR (BASED ON INTENT TO USE) SKIN NOURISHING CREAMS, EYEBROW PENCILS, LIPSTICKS, LIP GLOSS, MASCARA, FACIAL MASKS, MASSAGE CREAMS, MASSAGE OILS, SKIN CLEANSING CREAMS, SKIN CLEANSING FOAMS, SKIN CLEANSING AND SKIN MASSAGE CREAMS, EYELINERS, SKIN MILKS, SKIN FRESHENERS, PERFUMES, EYE MAKE-UP REMOVERS, EYE SHADOWS, NON-MEDICATED NUTRITIONAL MOISTURIZING SERUMS, PERMANENT WAVING PREPARATIONS, FOUNDATION CREAMS, HAND CREAMS, HAIR LOTIONS, HAIR CREAMS, FACE POWDERS SOLD IN COMPACT, FACE POWDERS, SUN CREAMS, SUN OILS, SUN MILKS, COSMETIC SOAPS, HAIR SHAMPOOS, HAIR RINSES, BODY CLEANSERS, SKIN WHITENING CREAMS, COSMETIC PREPARATIONS HAVING A BODY SLIMMING EFFECT, EAU DE COLOGNES, TISSUES IMPREGNATED WITH COSMETIC LOTIONS, COTTON WOOL FOR COSMETIC PURPOSES (U.S. CLS. 1, 4, 6, 50, 51 AND 52).

MARIA-VICTORIA SUAREZ, EXAMINING ATTORNEY

SN 78-342,258. GENEART GMBH, REGENSBURG, FED REP GERMANY, FILED 12-17-2003.

XXL Genes

THE MARK CONSISTS OF STANDARD CHARACTERS WITHOUT CLAIM TO ANY PARTICULAR FONT, STYLE, SIZE, OR COLOR.

PRIORITY CLAIMED UNDER SEC. 44(D) ON FED REP GERMANY APPLICATION NO. 30331518.0/0, FILED 6-24-2003, REG. NO. 30331518, DATED 8-13-2003, EXPIRES 6-30-2013.

NO CLAIM IS MADE TO THE EXCLUSIVE RIGHT TO USE "GENES", APART FROM THE MARK AS SHOWN.

CLASS 1—CHEMICALS

FOR BACTERIA FOR USE IN FOOD MANUFACTURE, WASTE WATER TREATMENT, FERMENTATION, PHARMACEUTICAL RESEARCH, MANUFACTURE OF COSMETICS, MANUFACTURE OF SCIENTIFIC COMPOUNDS, AND MANUFACTURE OF PHARMACEUTICAL COMPOUNDS; BACTERIOLOGICAL PREPARATIONS FOR USE IN FOOD MANUFACTURE, WASTE WATER TREATMENT, FERMENTATION, PHARMACEUTICAL RESEARCH, MANUFACTURE OF COSMETICS, MANUFACTURE OF SCIENTIFIC COMPOUNDS, AND MANUFACTURE OF PHARMACEUTICAL COMPOUNDS; MICRO-ORGANISM CULTURES FOR USE IN FOOD MANUFACTURE, WASTE WATER TREATMENT, FERMENTATION, PHARMACEUTICAL RESEARCH, MANUFACTURE OF COSMETICS, MANUFACTURE OF SCIENTIFIC COMPOUNDS, AND MANUFACTURE OF PHARMACEUTICAL COMPOUNDS; BIOCHEMICAL CATALYSTS FOR USE IN FOOD MANUFACTURE, WASTE WATER TREATMENT, FERMENTATION, PHARMACEUTICAL RESEARCH, MANUFACTURE OF COSMETICS, MANUFACTURE OF SCIENTIFIC COMPOUNDS, AND MANUFACTURE OF PHARMACEUTICAL COMPOUNDS; BIOLOGICAL PREPARATIONS FOR CLINICAL, RESEARCH AND MEDICAL LABORATORY USE, NAMELY PROTEINS, DNA, RNA AND MODIFICATIONS THEREOF; DIAGNOSTIC PREPARATIONS FOR CLINICAL, RESEARCH AND MEDICAL LABORATORY USE, NAMELY PROTEINS, DNA, RNA AND MODIFICATIONS THEREOF; AND ENZYMES AND ENZYME PREPARATIONS FOR USE IN THE FIELD OF FOOD MANUFACTURE, WASTE WATER TREATMENT, FERMENTATION, PHARMACEUTICAL RESEARCH, MANUFACTURE OF COSMETICS, MANUFACTURE OF SCIENTIFIC COMPOUNDS, AND MANUFACTURE OF PHARMACEUTICAL COMPOUNDS (U.S. CLS. 1, 5, 6, 10, 26 AND 46).

CLASS 5—PHARMACEUTICALS

FOR MEDICINES FOR HUMAN MEDICAL PURPOSES, NAMELY, ANTIBIOTICS, ANTIBODIES, DNA, RNA, VACCINES, BLOOD-PRODUCING PREPARATIONS, HORMONES AND ENZYMES, FOR USE IN THE TREATMENT OF CANCER, DIABETES, ALZHEIMER'S DISEASE AND INFECTIOUS DISEASES; MEDICINES FOR DENTAL PURPOSES, NAMELY, ANTIBIOTICS, ANTIBODIES, DNA, RNA, VACCINES, BLOOD-PRODUCING PREPARATIONS, HORMONES AND ENZYMES, FOR USE IN THE TREATMENT OF CANCER, DIABETES, ALZHEIMER'S DISEASE AND INFECTIOUS DISEASES; MEDICINES FOR VETERINARY PURPOSES, NAMELY, ANTIBIOTICS, ANTIBODIES, DNA, RNA, VACCINES, BLOOD-PRODUCING PREPARATIONS, HORMONES AND ENZYMES, FOR USE IN THE TREATMENT OF CANCER, DIABETES, ALZHEIMER'S DISEASE AND INFECTIOUS DISEASES; BACTERIOLOGICAL PREPARATIONS FOR MEDICAL AND VETERINARY PURPOSES, FOR USE IN THE TREATMENT OF CANCER, HIGH BLOOD PRESSURE, DIARRHEA, SKIN IRRITATIONS, INFECTIONS, DIABETES, AUTOIMMUNE DISEASES AND ARTHRITIS, AS WELL AS FOR USE IN GENE THERAPY; BIOLOGICAL PREPARATIONS FOR MEDICAL PURPOSES, NAMELY, ANTIBIOTICS, ANTIBODIES, DNA, RNA, VACCINES, BLOOD-PRODUCING PREPARATIONS, HORMONES AND ENZYMES, FOR USE IN THE TREATMENT OF CANCER, DIABETES, ALZHEIMER'S DISEASE AND INFECTIOUS DISEASES; BIOLOGICAL PREPARATIONS FOR VETERINARY PURPOSES, NAMELY, ANTIBIOTICS, ANTIBODIES, DNA, RNA, VACCINES, BLOOD-PRODUCING PREPARATIONS, HORMONES AND ENZYMES FOR USE IN THE TREATMENT OF CANCER, DIABETES, ALZHEIMER'S DISEASE AND INFECTIOUS DISEASES; GERMICIDES FOR MEDICAL AND INSTITUTIONAL USE, AND DOMESTIC USES; VERMICIDES FOR MEDICAL AND INSTITUTIONAL USE, DOMESTIC USE, AND RESIDENTIAL USES, FUNGICIDES FOR MEDICAL AND INSTITUTIONAL USE, AND DOMESTIC USES; BIOLOGICAL PREPARATIONS FOR MEDICAL DIAGNOSTIC LABORATORY USE, NAMELY, PROTEINS, DNA, RNA AND MODIFICATIONS THEREOF; AND DIAGNOSTIC MATERIALS FOR CLINICAL AND MEDICAL LABORATORY PURPOSES, NAMELY, PROTEINS, DNA, RNA AND MODIFICATIONS THEREOF (U.S. CLS. 6, 18, 44, 46, 51 AND 52).

CLASS 9—ELECTRICAL AND SCIENTIFIC APPARATUS

FOR AUTOMATIC MACHINES FOR THE SYNTHESIS OF DEOXYRIBONUCLEIC ACIDS; ROBOTIC MACHINES FOR LABORATORY PURPOSES, NAMELY, PIPPETTING ROBOTS, LIQUID HANDLING ROBOTS, DNA SYNTHESIZER ROBOTS; COMPUTER TERMINALS; COMPUTER PROGRAMS FOR USE AS TOOLS IN THE FIELD OF BIOTECHNOLOGY AND MOLECULAR BIOLOGY; COMPUTER SOFTWARE TO INCREASE POTENCY OF ENZYMES AND ENZYME PREPARATIONS, BACTERIA PREPARATIONS, BACTERIOLOGICAL PREPARATIONS, MICRO-ORGANISM CULTURES, BIOLOGICAL PREPARATIONS, DIAGNOSTIC PREPARATIONS; COMPUTER OPERATING PROGRAMS; COMPUTER PERIPHERALS; COMPUTER KEYBOARDS; BLANK MAGNETIC DATA CARRIERS; BLANK OPTICAL DISKS; DATA PROCESSORS; COMPUTER MEMORIES; BLANK FLOPPY DISKS; HARD DRIVES FOR COMPUTERS; PRINTERS FOR USE WITH COMPUTERS; COMPUTER INTERFACE BOARDS; LAPTOP COMPUTERS; DATA PROCESSORS, NAMELY, READERS AND SCANNERS; COMPUTER MOUSE; SEMICONDUCTORS; COMPUTER MODEMS; COMPUTER MONITORS; COMPUTER HARDWARE; AND NOTEBOOK COMPUTERS (U.S. CLS. 21, 23, 26, 36 AND 38).

CLASS 42—SCIENTIFIC, COMPUTER AND LEGAL SERVICES

FOR COMPUTER SERVICES, NAMELY, UPDATING OF COMPUTER SOFTWARE FOR OTHERS, CONSULTATION IN THE FIELDS OF BIOTECHNOLOGY, DESIGNING COMPUTER SOFTWARE FOR OTHERS, MAINTENANCE OF COMPUTER SOFTWARE FOR OTHERS, LEASING OF COMPUTER SOFTWARE, PROVIDING AN ONLINE COMPUTER DATABASE IN THE FIELDS OF MEDICINES, PHARMACEUTICALS, AND GENOMICS, COMPUTER PROGRAMMING FOR OTHERS, LEASING OF COMPUTERS, AND RECOVERY OF COMPUTER DATA FOR OTHERS; CHEMICAL ANALYSIS FOR OTHERS; RESEARCH FOR OTHERS IN THE FIELDS OF BACTERIOLOGY, BIOLOGY, CHEMISTRY, PHYSICS, GENEALOGY, COSMETICS, ENGINEERING, AND MACHINE ENGINEERING; LABORATORY RESEARCH SERVICES FOR OTHERS IN THE FIELDS OF BACTERIOLOGY AND CHEMISTRY; CONSULTATION IN THE FIELDS OF BACTERIOLOGY, BIOLOGY, CHEMISTRY, PHYSICS, GENEALOGY, COSMETICS, ENGINEERING AND MACHINE ENGINEERING; PHARMACEUTICAL CONSULTATION; MEASURING CALIBRATION FOR OTHERS; DEVELOPMENT AND RESEARCH OF NEW PRODUCTS FOR OTHERS; TECHNICAL CONSULTATION IN THE FIELD OF ENVIRONMENTAL PROTECTION; TECHNICAL PROJECT PLANNING AND CONSULTING SERVICES IN THE FIELDS OF BACTERIOLOGY, BIOLOGY, CHEMISTRY, PHYSICS, GENEALOGY, COSMETICS, ENGINEERING, AND MACHINE ENGINEERING; AND QUALITY CONTROL FOR OTHERS (U.S. CLS. 100 AND 101).

BILL DAWE, EXAMINING ATTORNEY

SN 78-343,532. BEST SHOT PET PRODUCTS INTERNATIONAL, LLC, MOGADORE, OH. FILED 12-19-2003.

SN 78-344,390. ROX PUBLISHING, ATLANTA, GA. FILED 12-22-2003.



CLASS 3—COSMETICS AND CLEANING PREPARATIONS

FOR NON-VETERINARY, NON-MEDICAL GROOMING AND CLEANING PREPARATIONS FOR PETS COMPRISING: SHAMPOO; CONDITIONER; VITALIZING MIST; CONDITIONING SHAMPOO AND RINSE; COLOGNE; HOOF POLISH (U.S. CLS. 1, 4, 6, 50, 51 AND 52).

CLASS 5—PHARMACEUTICALS

FOR VETERINARY AND MEDICAL PREPARATIONS FOR PETS COMPRISING: FLEA AND TICK SHAMPOO; ANTI-BUG SPRAY; DISINFECTANT; HORSE LINIMENT; SORE MUSCLE AND JOINT RELIEF RUB (U.S. CLS. 6, 18, 44, 46, 51 AND 52).

JOHN HWANG, EXAMINING ATTORNEY

SN 78-344,008. STAMP ON THIS! LLC, EVERGREEN, CO. FILED 12-21-2003.



THE COLOR(S) HOT PINK AND GREEN IS/ARE CLAIMED AS A FEATURE OF THE MARK.

THE MARK CONSISTS OF HOT PINK FLOWER (ROSE), GREEN STEM AND LEAVES.

CLASS 16—PAPER GOODS AND PRINTED MATTER

FOR PAPER LUNCH BAGS, PAPER CANDY BAGS, PAPER WINE BAGS, PAPERBOARD CARD BOXES, DIE-CUT CARDBOARD BOXES, PLASTIC BAGS FOR PACKAGING, PAPER RIBBON, FABRIC BOOK COVERS, FABRIC CHECKBOOK COVERS (U.S. CLS. 2, 5, 22, 23, 29, 37, 38 AND 50).

FIRST USE 6-1-2003; IN COMMERCE 9-25-2003.

CLASS 24—FABRICS

FOR FABRIC PILLOW COVERS (U.S. CLS. 42 AND 50). FIRST USE 6-1-2003; IN COMMERCE 9-25-2003. WILLIAM BRECKENFELD, EXAMINING ATTORNEY

Rox Publishing

THE MARK CONSISTS OF STANDARD CHARACTERS WITHOUT CLAIM TO ANY PARTICULAR FONT, STYLE, SIZE, OR COLOR.

NO CLAIM IS MADE TO THE EXCLUSIVE RIGHT TO USE "PUBLISHING", APART FROM THE MARK AS SHOWN.

CLASS 41—EDUCATION AND ENTERTAINMENT

FOR PUBLICATION OF NEWSLETTERS, MAGAZINES AND SPECIALTY PROMOTIONAL ADVERTISEMENTS (U.S. CLS. 100, 101 AND 107).

FIRST USE 2-5-1992; IN COMMERCE 2-5-1992.

CLASS 42—SCIENTIFIC, COMPUTER AND LEGAL SERVICES

FOR GRAPHIC ART DESIGN OF NEWSLETTERS, MAGAZINES AND SPECIALTY PROMOTIONAL ITEMS FOR USE IN PRINT AND ELECTRONIC FORMATS (U.S. CLS. 100 AND 101).

FIRST USE 2-5-1992; IN COMMERCE 2-5-1992.

TARAH HARDY, EXAMINING ATTORNEY

SN 78-346,217. ORBYX ELECTRONICS, A DIVISION OF INTERTAN CANADA LTD., BARRIE, ONTARIO, CANADA, FILED 12-29-2003.

NEXXTECH

THE MARK CONSISTS OF STANDARD CHARACTERS WITHOUT CLAIM TO ANY PARTICULAR FONT, STYLE, SIZE, OR COLOR.

CLASS 8—HAND TOOLS

FOR ELECTRIC SHAVERS (U.S. CLS. 23, 28 AND 44).

CLASS 9—ELECTRICAL AND SCIENTIFIC APPARATUS

FOR POCKET AM AND AM/FM RADIOS, PORTABLE AM AND AM/FM HEADSET RADIOS, STEREOMATES, WATER-RESISTANT AM/FM RADIO, PORTABLE AND MULTI-BAND RADIOS, NOVELTY RADIOS, CLOCK AND TABLE RADIOS, AM/FM AND CD CLOCK RADIOS, WEATHER RADIOS, FRS (FAMILY RADIO SERVICES) 2-WAY HAND-HELD RADIOS, FRS ACCESSORIES, NAMELY CHARGERS, ELECTRICAL AND POWER CABLES, CARRYING CASES, FOR RADIOS AND RADIO CHARGERS, RADIO BELT-CLIPS, ELECTRICAL AND POWER CABLES, WALKIE-TALKIE RADIOS; PORTABLE AUDIO UNITS NAMELY MP3 (MINI-DISC) PLAYERS, DIGITAL RECORDERS, TAPE CASSETTE RECORDERS AND PLAYERS, MICRO-CASSETTE RECORDERS AND PLAYERS, MINI-DISC PLAYERS AND RECORDERS, AM/FM TAPE PLAYERS, AM AND AM/FM/CASSETTE/CD PORTABLE PLAYERS, CASSETTE TAPE DECKS, CD PLAYERS; DIGITAL STORAGE CONTAINERS IN THE NATURE OF CD ORGANIZERS THAT CLIP TO CAR VISORS, NYLON WALLET CD HOLDERS WITH ZIPPERS FOR CD MEDIA, CD-R/CD-RW MEDIA, DVD-R/DVD+R MEDIA, CD/CD ROM CLEANING KITS COMPRISED OF HEAD CLEANING FLUIDS, CHAMOIS CLOTHS AND SWABS; AUTOMOTIVE AUDIO SYSTEMS COMPRISED OF AM/FM/CASSETTE PLAYERS, AUTOMOTIVE CD UNITS, BOOSTERS/EQUALIZERS/CASSETTE PLAYERS, AUTOMOTIVE SPEAKERS, AUTOMOTIVE ANTENNAS, ELECTRICAL AND POWER CABLES; MICRO AUDIO SYSTEMS COMPRISED OF AUTOMOTIVE RAW SPEAKERS AND REPLACEMENT PARTS FOR SPEAKERS; FULL SIZE AUDIO COMPONENT STEREO SYSTEMS; STEREO SYSTEMS, HOME THEATRE SPEAKER SYSTEMS, AUDIO RECEIVERS, DVD PLAYERS, AM/FM STEREO, PORTABLE DVD PLAYERS, AM/FM RECEIVERS, EQUALIZERS, PUBLIC ADDRESS SYSTEMS, KARAOKE MACHINES, ELECTRICAL AND POWER CABLES AND CONNECTORS, SOUND MIXERS AND REVERBATORS, AMPLIFIERS, DIGITAL VIDEO RECORDERS, COMBINATION TV/VCR'S, COMBINATION DVD/VCR'S, HOME TELEVISIONS, PORTABLE TELEVISIONS, LCD (LIQUID CRYSTAL DISPLAY) TELEVISIONS, VCR PLAYERS, HOME THEATRE SYSTEMS IN A BOX, NAMELY, SPEAKERS, RECEIVERS, RADIOS, HOME THEATRE SYSTEMS, NAMELY, SPEAKERS, RECEIVERS, DVD PLAYERS, RADIOS, COMPACT DISC PLAYER HOME SYSTEMS EQUIPMENT, NAMELY INTERCOM SYSTEM WITH THE ADDITION OF A AM/FM RADIO, MUSIC MEDIA TURNTABLES, AM/FM INTERCOM SYSTEMS EQUIPMENT, NAMELY, SPEAKERS, RECEIVERS, RADIOS, AUDIO AND VIDEO AND VIDEO ACCESSORIES NAMELY, VIDEO, ELECTRICAL AND POWER CABLES AND CONNECTORS, VIDEO AMPLIFIERS, SPLITTERS AND SWITCHES, A/V S-VIDEO SELECTORS, REMOTE CONTROL UNITS FOR ALL AUDIO AND AUDIO/VIDEO EQUIPMENT, UNIVERSAL REMOTE CONTROLLERS, RF MODULATORS, AUDIO AND VIDEO ELECTRICAL AND POWER CABLES AND CONNECTORS, ELECTRICAL AND POWER ANALOG AND DIGITAL MULTI-TESTERS, ELECTRICAL AND POWER CABLES, BLANK VIDEO TAPES, VIDEO STORAGE CABINETS, SPEAKERS NAMELY, BOOK SHELF SPEAKERS, FLOOR STANDING SPEAKERS, WIRELESS SPEAKERS, SUBWOOFERS, RAW SPEAKERS AND REPLACEMENT PARTS NAMELY, POWER CABLES AND WIRING, FOR HOME SPEAKERS MULTI-MEDIA SPEAKERS; CAMERAS, NAMELY, DIGITAL CAMERAS, COMPACT DIGITAL CAMERAS, CAMCORDERS, 35MM CAMERAS, CAMERA TRIPODS, WEB AND INTERNET CAMERAS; CAMERA ACCESSORIES, NAMELY, BATTERY CHECKERS, POWER SUPPLIES, CAMCORDER TAPES, DIGITAL FILM, AUDIO TAPES, DIGITAL AND VIDEO CAMERA CARRYING CASES, CAMERA BAGS, USB CARD READERS, ELECTRICAL AND POWER CABLES, CONNECTORS, OPTICAL COMPONENT ELECTRICAL AND POWER CABLES, ADAPTER PLUGS; PDA'S (PERSONAL DIGITAL ASSISTANTS), PDA SOFTWARE, PDA ACCESSORIES NAMELY, PROTECTIVE CASE COVERS, UPGRADE MEMORY CARDS, CRADLE RECHARGING UNITS, PLASTIC AND METAL STYLUS, ADAPTERS; AUDIO ACCESSORIES, NAMELY, WIRELESS MICROPHONES, WIRELESS HEADPHONES, FULL SIZE HEADPHONES, MICROPHONES, COMPACT HEADPHONES, EARBUD HEADPHONES, HEADSETS, PERSONAL COMPUTER MICROPHONES; PERSONAL COMPUTER, LAP-

TOP COMPUTERS, LCD (LIQUID CRYSTAL DISPLAY) MONITORS, COMPUTER MONITORS, COMPUTER KEYBOARDS BOTH WIRED AND WIRELESS, COMPUTER GAME PADS, COMPUTER JOYSTICKS, COMPUTER CONTROLLERS, NAMELY, STEERING WHEELS, FLIGHT YOKES, COMPUTER MICE BOTH WIRED AND WIRELESS, COMPUTER COMPONENTS, NAMELY, OPTICAL DRIVES, ROMS, ADAPTERS, NETWORK CABLES, COMPUTER WRIST-RESTS, COMPUTER SPEAKERS, COMPUTER RAMS, OPTICAL DRIVES, COMPUTER CONNECTION CABLES AND ADAPTERS, NETWORKING CABLES, CONNECTORS, INKJET PRINTERS, INKJET PHOTO PRINTERS, LASER PRINTERS, LASER PHOTO PRINTERS, INKJET ALL-IN-ONE PRINT CENTER COMPRISED OF PRINTER, PAGE SCANNER AND COPIER COMBINATION UNIT; COMPUTER DOCUMENT SCANNERS, DIGITAL MEMORY STORAGE DEVICES, PORTABLE USB DRIVES, DIGITAL USB STORAGE DEVICES IN THE NATURE OF DIGITAL MEDIA CARD READERS, DIGITAL MEDIA CARDS, COMPUTER UPGRADE CARDS, MEDIA STORAGE NAMELY, CD HOLDERS, DVD HOLDERS, CASSETTE HOLDERS; TELEPHONES, NAMELY, STANDARD TELEPHONES, MULTI-LINE TELEPHONES, FEATURE TELEPHONES, WIRELESS TELEPHONES, FASHION TELEPHONES, CORDLESS TELEPHONES, MAGNETICALLY ENCODED CALLING CARDS, MAGNETICALLY ENCODED LONG DISTANCE CALLING CARDS, MICRO TAPE TELEPHONE ANSWERING DEVICES, TELEPHONE AUTO DIALER/AMPLIFIER, DIGITAL TELEPHONE ANSWERING MACHINES, DIGITAL TELEPHONE ANSWERING MACHINES WITH TELEPHONE, TELEPHONE ANSWERING DEVICE WITH CORDLESS TELEPHONE, TELEPHONE ACCESSORIES, NAMELY ELECTRICAL CORDS, EXTENSION CORDS, ADAPTORS, PLUGS, SPEAKERPHONES, OVER-THE-EAR TELEPHONE HEADSETS, HANDS FREE MINI TELEPHONES, WIRELESS MODEM/TELEPHONE JACKS, TELEPHONE ID ELECTRONIC MODULE; ELECTRONIC DOOR CHIMES, WIRELESS ELECTRONIC DOOR CHIMES, ELECTRONIC VOICE MEMO PADS, ELECTRONIC DIGITAL RECORDING PENS; AUTOMOBILE ACCESSORIES, NAMELY, TIRE PRESSURE GAUGES, CAR COMPASSES, ELECTRONIC LOCK DE-ICERS, ELECTRONIC KEY FINDERS, COMPASSES; METAL DETECTORS, PRO-METAL DETECTORS, PORTABLE METAL DETECTORS, THERMOMETERS, INDOOR/OUTDOOR THERMOMETERS, WIRELESS THERMOMETERS, TALKING THERMOMETERS, MAGNIFYING GLASSES, FOLDING MAGNIFIERS, DUAL LENS MAGNIFIERS, BINOCULARS, OPTICAL BINOCULARS, FOLDING BINOCULARS, NIGHT VISION SCOPE, MICROCOPES, LASER POINTERS, LASER POINTER PENS; GOLF TELESCOPES, ELECTRONIC DIGITAL GOLF CADDIES, BATTERY CHECKERS; HAND-HELD AND DESK TYPE ELECTRONIC CALCULATORS, PRINTING CALCULATORS, SCIENTIFIC CALCULATORS, ELECTRONIC LANGUAGE TRANSLATORS, ELECTRONIC SPELL CHECKERS, ELECTRONIC POCKET INTERPRETERS, ELECTRONIC FRENCH TRANSLATORS, ELECTRONIC DICTIONARIES, ELECTRONIC THESAURUS, ELECTRONIC DIARIES, ELECTRONIC CROSSWORDS GAMES, ELECTRONIC ORGANIZERS (U.S. CLS. 21, 23, 26, 36 AND 38).

CLASS 10—MEDICAL APPARATUS

FOR HEALTH CARE DEVICES, NAMELY, EAR THERMOMETERS, IN-EAR THERMOMETERS; BLOOD PRESSURE METERS, WRIST BLOOD PRESSURE METERS, HI-SPEED BLOOD PRESSURE METERS, HEART RATE MONITORS, MUSCLE MASSAGERS, FOOT MASSAGERS, ELECTRIC MASSAGERS, HAND-HELD MASSAGERS, CALORIE MONITORS, BODY FAT ANALYZERS (U.S. CLS. 26, 39 AND 44).

CLASS 11—ENVIRONMENTAL CONTROL APPARATUS

FOR LIGHTED KEY-CHAINS; LIGHTS NAMELY FLASHLIGHTS, BOOK LIGHTS, MOTION DETECTOR LIGHTS, PARTY LIGHTS (U.S. CLS. 13, 21, 23, 31 AND 34).

CLASS 14—JEWELRY

FOR TIME KEEPING DEVICES NAMELY, LCD (LIQUID CRYSTAL DISPLAY) CLOCKS, KEYCHAIN CLOCKS, WALL CLOCKS, ANALOG ALARM CLOCKS, TRAVEL ALARM CLOCKS, ALARM CLOCKS WITH THERMOMETERS, DIGITAL WALL CLOCKS, ATOMIC CLOCKS, ROTATING CLOCKS, DESK CLOCKS, FOLDING ALARM CLOCKS, REMOTE CONTROL ALARM CLOCKS, PROJECTING CLOCKS, REMOTE CONTROL PROJECTION CLOCKS, ANALOG/DIGITAL REMOTE CONTROL ALARM CLOCKS, STOPWATCHES, WATCHES, ALARM WATCHES, ATOMIC WATCHES, TALKING WATCHES, CAMERA WATCHES, COMPASS WATCHES, REMOTE CONTROL WATCHES, CALCULATOR WATCHES, ALTIMETER WATCHES (U.S. CLS. 2, 27, 28 AND 50).

CLASS 15—MUSICAL INSTRUMENTS

FOR MUSICAL INSTRUMENTS, PIANO KEYBOARDS (U.S. CLS. 2, 21 AND 36).

CLASS 16—PAPER GOODS AND PRINTED MATTER

FOR CALENDARS (U.S. CLS. 2, 5, 22, 23, 29, 37, 38 AND 50).

CLASS 20—FURNITURE AND ARTICLES NOT OTHERWISE CLASSIFIED

FOR PICTURE FRAMES WITH MESSAGE RECORDERS (U.S. CLS. 2, 13, 22, 25, 32 AND 50).

CLASS 28—TOYS AND SPORTING GOODS

FOR ELECTRONIC CHESS SETS, CHESS SETS, EDUCATIONAL TOYS, NAMELY, ANATOMY KITS WITH MULTI-COLORED DISSECTIBLE PIECES, MICROSCOPES WITH BLANK SLIDES TO TEST SPECIMENS, ELECTRONIC LAB KITS COMPRISED OF MANUALS TO BUILD RADIOS, TIMERS AND OTHER PROJECTS; PRESCHOOL GAMES, NAMELY, REMOTE CONTROL SCHOOL BUS, RESCUE FIRE ENGINE, BOULDER DUMP TRUCK, REMOTE CONTROL CARS; ADULT GAMES, NAMELY, HAND-HELD ELECTRONIC GAMES, NAMELY, BASEBALL, BASKETBALL, CAR RACING, POKER, FOOTBALL, HOCKEY, CASINO; MUSICAL TOYS, AIR-POWERED TOYS, NAMELY, AIRPLANES; TOY RACING SETS, SIMPLE FUNCTION REMOTE-CONTROLLED TOY VEHICLES, AND MULTI-FUNCTION REMOTE-CONTROLLED TOY VEHICLES (U.S. CLS. 22, 23, 38 AND 50).

BRIDGETT SMITH, EXAMINING ATTORNEY

CLASS 35—ADVERTISING AND BUSINESS

FOR PROVIDING BUSINESS MANAGEMENT AND DATA COLLECTION SERVICES FOR THE AGRICULTURE AND TURF INDUSTRIES (U.S. CLS. 100, 101 AND 102).

FIRST USE 10-10-2001; IN COMMERCE 10-10-2001.

CLASS 42—SCIENTIFIC, COMPUTER AND LEGAL SERVICES

FOR PROVIDING DATA ANALYSIS SERVICES FOR THE AGRICULTURE AND TURF INDUSTRIES (U.S. CLS. 100 AND 101).

FIRST USE 10-10-2001; IN COMMERCE 10-10-2001.

TRICIA THOMPSON, EXAMINING ATTORNEY

SN 78-349,171. GENIVAR CONSULTING GROUP, INC., QUEBEC, CANADA, FILED 1-8-2004.

XEOS

THE MARK CONSISTS OF STANDARD CHARACTERS WITHOUT CLAIM TO ANY PARTICULAR FONT, STYLE, SIZE, OR COLOR.

CLASS 40—MATERIAL TREATMENT

FOR REMOTE ELECTRONIC IMAGING SERVICES, NAMELY, INTEGRATION OF AERIAL DIGITAL PHOTOGRAPHIC IMAGERY INTO GEOGRAPHIC INFORMATION SYSTEMS, CREATION OF DIGITAL PHOTOGRAPHIC IMAGE MOSAICS, AND INTEGRATION OF DIGITAL PHOTOGRAPHIC IMAGE MOSAICS INTO GEOGRAPHIC INFORMATION SYSTEM (U.S. CLS. 100, 103 AND 106).

FIRST USE 11-14-2002; IN COMMERCE 11-14-2002.

CLASS 41—EDUCATION AND ENTERTAINMENT

FOR PROVISION OF REMOTE IMAGING SERVICES, NAMELY, AERIAL PHOTOGRAPHY; AERIAL DIGITAL PHOTOGRAPHIC IMAGE CAPTURE (U.S. CLS. 100, 101 AND 107).

FIRST USE 11-14-2002; IN COMMERCE 11-14-2002.

LANA PHAM, EXAMINING ATTORNEY

SN 78-348,883. UNITED AGRI PRODUCTS, INC., GREELEY, CO. FILED 1-7-2004.

Geo Ag
solutions

NO CLAIM IS MADE TO THE EXCLUSIVE RIGHT TO USE "AG SOLUTIONS", APART FROM THE MARK AS SHOWN.

THE MARK CONSISTS OF THE STYLIZED WORDS GEO AG SOLUTIONS WITH THE DESIGN OF A GLOBE ON THE "O" OF GEO.

SN 78-349,572. CALIFORNIA DEPARTMENT OF TRANSPORTATION, SACRAMENTO, CA. FILED 1-8-2004.

SN 78-349,576. CALIFORNIA DEPARTMENT OF TRANSPORTATION, SACRAMENTO, CA. FILED 1-8-2004.



CALTRANS

CLASS 35—ADVERTISING AND BUSINESS

FOR TRANSPORTATION FACILITIES SERVICES, NAMELY, BUSINESS MANAGEMENT AND BUSINESS PLANNING FOR ALL FORMS OF TRANSPORTATION ON BEHALF OF THE STATE OF CALIFORNIA (U.S. CLS. 100, 101 AND 102).
FIRST USE 9-4-1973; IN COMMERCE 9-4-1973.

CLASS 37—CONSTRUCTION AND REPAIR

FOR MAINTENANCE OF TRANSPORTATION FACILITIES TO ENSURE SAFETY, RELIABILITY, PERFORMANCE, FLEXIBILITY AND PRODUCTIVITY FOR ALL FORMS OF TRANSPORTATION ON BEHALF OF THE STATE OF CALIFORNIA (U.S. CLS. 100, 103 AND 106).
FIRST USE 9-4-1973; IN COMMERCE 9-4-1973.

CLASS 42—SCIENTIFIC, COMPUTER AND LEGAL SERVICES

FOR DESIGN OF TRANSPORTATION FACILITIES FOR ALL FORMS OF TRANSPORTATION ON BEHALF OF THE STATE OF CALIFORNIA (U.S. CLS. 100 AND 101).
FIRST USE 9-4-1973; IN COMMERCE 9-4-1973.
GRETTA YAO, EXAMINING ATTORNEY

THE MARK CONSISTS OF STANDARD CHARACTERS WITHOUT CLAIM TO ANY PARTICULAR FONT, STYLE, SIZE, OR COLOR.

SN 78-350,052. TUMBLEBUS INCORPORATED, NEW ALBANY, IN. FILED 1-9-2004.

CLASS 35—ADVERTISING AND BUSINESS

FOR TRANSPORTATION FACILITIES SERVICES, NAMELY, BUSINESS MANAGEMENT AND BUSINESS PLANNING FOR ALL FORMS OF TRANSPORTATION ON BEHALF OF THE STATE OF CALIFORNIA (U.S. CLS. 100, 101 AND 102).
FIRST USE 9-4-1973; IN COMMERCE 9-4-1973.

CLASS 37—CONSTRUCTION AND REPAIR

FOR MAINTENANCE OF TRANSPORTATION FACILITIES TO ENSURE SAFETY, RELIABILITY, PERFORMANCE, FLEXIBILITY AND PRODUCTIVITY FOR ALL FORMS OF TRANSPORTATION ON BEHALF OF THE STATE OF CALIFORNIA (U.S. CLS. 100, 103 AND 106).
FIRST USE 9-4-1973; IN COMMERCE 9-4-1973.

CLASS 42—SCIENTIFIC, COMPUTER AND LEGAL SERVICES

FOR DESIGN OF TRANSPORTATION FACILITIES FOR ALL FORMS OF TRANSPORTATION ON BEHALF OF THE STATE OF CALIFORNIA (U.S. CLS. 100 AND 101).
FIRST USE 9-4-1973; IN COMMERCE 9-4-1973.
GRETTA YAO, EXAMINING ATTORNEY

TUMBLEBUS

THE MARK CONSISTS OF STANDARD CHARACTERS WITHOUT CLAIM TO ANY PARTICULAR FONT, STYLE, SIZE, OR COLOR.

CLASS 35—ADVERTISING AND BUSINESS

FOR RETAIL STORE SERVICES FEATURING RETROFITTED BUSES CONTAINING GYMNASIUM AND PHYSICAL EDUCATION EQUIPMENT (U.S. CLS. 100, 101 AND 102).
FIRST USE 12-31-1989; IN COMMERCE 12-31-1989.

CLASS 41—EDUCATION AND ENTERTAINMENT

FOR PROVIDING INSTRUCTIONAL GYMNASIUM AND PHYSICAL EDUCATION SERVICES TO CHILDREN VIA A MOBILE GYMNASIUM (U.S. CLS. 100, 101 AND 107).

FIRST USE 12-31-1989; IN COMMERCE 12-31-1989.
CURTIS FRENCH, EXAMINING ATTORNEY

SN 78-351,098. PHILIP MORRIS USA INC., RICHMOND, VA. FILED 1-13-2004.

CLASS 37—CONSTRUCTION AND REPAIR

FOR INSTALLATION, REPAIR, AND MAINTENANCE SERVICES FOR AUTOMOTIVE LIFTS (U.S. CLS. 100, 103 AND 106).

CLASS 41—EDUCATION AND ENTERTAINMENT

FOR TRAINING IN THE INSTALLATION, REPAIR AND MAINTENANCE OF AUTOMOTIVE LIFTS AND TRAINING IN THE USE AND OPERATION OF AUTOMOTIVE LIFTS (U.S. CLS. 100, 101 AND 107).

AMY GEARIN, EXAMINING ATTORNEY

SN 78-351,928. CRIF DECISION SOLUTIONS S.P.A., BOLOGNA, ITALY, FILED 1-14-2004.

QUITASSIST

THE MARK CONSISTS OF STANDARD CHARACTERS WITHOUT CLAIM TO ANY PARTICULAR FONT, STYLE, SIZE, OR COLOR.

CLASS 41—EDUCATION AND ENTERTAINMENT

FOR EDUCATIONAL SERVICES, NAMELY, CONDUCTING PROGRAMS, CLASSES, SEMINARS, CONFERENCES, WORKSHOPS ON SMOKING CESSATION AND DISTRIBUTING MATERIALS IN CONNECTION THEREWITH (U.S. CLS. 100, 101 AND 107).

CLASS 44—MEDICAL, BEAUTY AND AGRICULTURAL SERVICES

FOR PROVIDING INFORMATION RELATING TO SMOKING CESSATION BOTH ON-LINE AND OFF-LINE (U.S. CLS. 100 AND 101).

YONG KIM, EXAMINING ATTORNEY

SN 78-351,694. DELAWARE CAPITAL FORMATION, INC., WILMINGTON, DE. FILED 1-14-2004.

CREDITFLOW

THE MARK CONSISTS OF STANDARD CHARACTERS WITHOUT CLAIM TO ANY PARTICULAR FONT, STYLE, SIZE, OR COLOR.

CLASS 9—ELECTRICAL AND SCIENTIFIC APPARATUS

FOR COMPUTER SOFTWARE AND FIRMWARE FOR USE IN SEARCHING AND RETRIEVING INFORMATION ON BUSINESS ACTIVITY CLASSIFICATIONS, AND FOR USE IN COLLECTING AND MANAGING FINANCIAL AND CREDIT INFORMATION; COMPUTER SOFTWARE AND FIRMWARE FOR USE IN GENERATING FINANCIAL, MARKETING AND CREDIT RATING REPORTS, AND FOR USE IN ECONOMIC AND FINANCIAL RESEARCH; BUSINESS STATISTICAL INFORMATION COMPUTER SOFTWARE FOR USE IN EVALUATING BUSINESS CREDENTIALS; COMPUTER SOFTWARE FOR USE IN GENERATING BUSINESS LISTS AND MARKETING LISTS; COMPUTER SOFTWARE AND FIRMWARE FOR USE IN DEBT COLLECTION AND FINANCIAL, BUSINESS, CUSTOMER, SALES, CREDIT AND MARKETING ANALYSIS; WORKFLOW COMPUTER SOFTWARE FOR USE IN CUSTOMER ACQUISITION ACCREDIT AND CUSTOMER MANAGEMENT; ALL FOR USE IN THE FIELDS OF BANKING, FINANCE, INSURANCE, MARKETING, REAL ESTATE, ECONOMICS AND BUSINESS; ELECTRIC AND ELECTRONIC APPARATUS AND INSTRUMENTS IN THE NATURE OF SOUND AND VIDEO RECORDING AND REPRODUCING APPARATUS AND INSTRUMENTS, NAMELY, BLANK MAGNETIC DISCS, BLANK MAGNETIC COMPUTER TAPES, BLANK AUDIO AND VIDEO CASSETTES, BLANK COMPACT DISCS, BLANK CD-ROMS FOR SOUND OR VIDEO RECORDING, PUNCHED ENCODED TAPES, ENCODED SMART CARDS CONTAINING PROGRAMMING FOR SECURE STORAGE OF FINANCIAL AND BUSINESS INFORMATION (U.S. CLS. 21, 23, 26, 36 AND 38).

RAI

THE MARK CONSISTS OF STANDARD CHARACTERS WITHOUT CLAIM TO ANY PARTICULAR FONT, STYLE, SIZE, OR COLOR.

CLASS 36—INSURANCE AND FINANCIAL

FOR ONLINE FINANCIAL SERVICES, NAMELY, PREPARING FINANCIAL REPORTS FOR OTHERS; PROVIDING FINANCIAL INFORMATION; FINANCIAL RESEARCH; PROVIDING INVESTMENT ANALYSIS; AND ONLINE INSURANCE SERVICES, NAMELY, PROVIDING INFORMATION IN INSURANCE MATTERS (U.S. CLS. 100, 101 AND 102).

RENEE MCCRAY, EXAMINING ATTORNEY

SN 78-352,208. CHESTER BARRIE LIMITED, BOREHAMWOOD, UNITED KINGDOM, FILED 1-15-2004.

CHESTER BY CHESTER BARRIE

THE MARK CONSISTS OF STANDARD CHARACTERS WITHOUT CLAIM TO ANY PARTICULAR FONT, STYLE, SIZE, OR COLOR.

PRIORITY CLAIMED UNDER SEC. 44(D) ON UNITED KINGDOM APPLICATION NO. 2339002, FILED 7-28-2003, REG. NO. 2339002, DATED 7-28-2003, EXPIRES 7-28-2013.

OWNER OF U.S. REG. NOS. 342,491 AND 653,455.

THE NAME CHESTER BARRIE DOES NOT IDENTIFY A LIVING INDIVIDUAL.

CLASS 14—JEWELRY

FOR JEWELRY; HOROLOGICAL AND CHRONOMETRIC INSTRUMENTS, NAMELY, WATCHES AND CLOCKS; CUFFLINKS; TIE CLIPS; PARTS AND FITTINGS FOR ALL THE AFORESAID GOODS. (U.S. CLS. 2, 27, 28 AND 50).

CLASS 18—LEATHER GOODS

FOR ALL GOODS MADE OF LEATHER AND IMITATIONS OF LEATHER, NAMELY BAGS, CASES, BRIEF-CASE TYPE PORTFOLIOS, DUFFLE AND TOTE BAGS, SPORTS BAGS, BRIEF CASES, ATTACHE CASES, HAT BOXES FOR TRAVEL, ANIMAL SKINS AND HIDES; TRUNKS AND TRAVELING BAGS; UMBRELLAS, PARASOLS AND WALKING STICKS; WHIPS, HARNESSES AND SADDLERY; LEATHER ACCESSORIES NAMELY, WALLETS, KEY CASES, PURSES, TOILETRY CASES SOLD EMPTY, BILLFOLDS, LUGGAGE TAGS; LUGGAGE STRAPS, CREDIT CARD CASES, BUSINESS CARD CASES; PARTS AND FITTINGS FOR ALL THE AFORESAID GOODS. (U.S. CLS. 1, 2, 3, 22 AND 41).

CLASS 25—CLOTHING

FOR CLOTHING, NAMELY, SUITS, TROUSERS, JACKETS, SKIRTS, KILTS, SHORTS, SHIRTS, BLOUSES, T-SHIRTS, SWEATERS, PULLOVERS, SWEAT SHIRTS, JEANS, CARDIGANS, PAJAMAS, NIGHTWEAR, LINGERIE, VESTS, BRIEFS, UNDER WEAR, CAMISOLES, CORSETS, PETTICOATS, SUSPENDER BELTS, GARTERS, SOCKS, TIGHTS, STOCKINGS, WAISTCOATS, COATS, TRACK SUITS, GLOVES, SCARVES, CRAVATS, CUMMERBUNDS, SUSPENDERS, TIES, SHAWLS, STOLEES, PASHMINAS, BOAS, VEILS, SWIMWEAR; FOOTWEAR; HEADGEAR, NAMELY, HATS, CAPS, SCARVES, BERETS, BOBBLE HATS, BEANIE HATS, KNITTED HATS; ATHLETIC FOOTWEAR; ATHLETIC SHOES; BELTS. (U.S. CLS. 22 AND 39).

CLASS 35—ADVERTISING AND BUSINESS

FOR ADVERTISING SERVICES FOR OTHERS; BUSINESS ADMINISTRATION AND MANAGEMENT; ADVERTISING, MARKETING AND PROMOTION SERVICES; RETAIL STORE SERVICES, ON-LINE RETAIL STORE SERVICES, AND MAIL ORDER CATALOG SERVICES ALL FEATURING GENERAL MERCHANDISE, CLOTHING, FOOTWEAR, AND HEADWEAR OF OTHERS; PROVISION OF SHOPPERS GUIDE INFORMATION, NAMELY, PROVIDING INFORMATION, ADVICE, AND ASSISTANCE IN THE SELECTION OF GOODS AND THE SELECTION OF SERVICE PROVIDERS; PROVIDING A WEBSITE WHICH FEATURES ADVERTISEMENTS FOR THE GOODS AND SERVICES OF OTHERS ON A GLOBAL COMPUTER NETWORK (U.S. CLS. 100, 101 AND 102).

JASON TURNER, EXAMINING ATTORNEY

SN 78-354,204. KAISER, ANDREW BRIAN, GRAND RAPIDS, MI. FILED 1-20-2004.

Digital Bits

THE MARK CONSISTS OF STANDARD CHARACTERS WITHOUT CLAIM TO ANY PARTICULAR FONT, STYLE, SIZE, OR COLOR.

CLASS 16—PAPER GOODS AND PRINTED MATTER

FOR SYNDICATED NEWSPAPER COLUMNS DEALING WITH COMPUTERS AND TECHNOLOGY (U.S. CLS. 2, 5, 22, 23, 29, 37, 38 AND 50).

FIRST USE 11-13-2002; IN COMMERCE 11-13-2002.

CLASS 41—EDUCATION AND ENTERTAINMENT

FOR PROVIDING ON-LINE SYNDICATED NEWSPAPER COLUMNS DEALING WITH COMPUTERS AND TECHNOLOGY (U.S. CLS. 100, 101 AND 107).

FIRST USE 11-13-2002; IN COMMERCE 11-13-2002.

STEVEN JACKSON, EXAMINING ATTORNEY

SN 78-354,607. MOTAMED, KATAYOON, NY, NY. FILED 1-20-2004.

JUST CHOOSE AGAIN

THE MARK CONSISTS OF STANDARD CHARACTERS WITHOUT CLAIM TO ANY PARTICULAR FONT, STYLE, SIZE, OR COLOR.

CLASS 25—CLOTHING

FOR (BASED ON INTENT TO USE) CLOTHING NAMELY - T-SHIRTS, BASE BALL CAPS, TANK TOPS, SHORTS (U.S. CLS. 22 AND 39).

CLASS 41—EDUCATION AND ENTERTAINMENT

FOR EDUCATION- NAMELY PERSONAL DEVELOPMENT SEMINARS (U.S. CLS. 100, 101 AND 107).
FIRST USE 1-11-2003; IN COMMERCE 1-11-2003.
PAUL F. GAST, EXAMINING ATTORNEY

SN 78-354,608. ARGENBRIGHT, INC., ROGERS, MN. FILED 1-20-2004.

ARCHWAY

THE MARK CONSISTS OF STANDARD CHARACTERS WITHOUT CLAIM TO ANY PARTICULAR FONT, STYLE, SIZE, OR COLOR.
OWNER OF U.S. REG. NO. 2,777,854.

CLASS 35—ADVERTISING AND BUSINESS

FOR MARKETING AND MERCHANDISING SERVICES, NAMELY ORDER FULFILLMENT SERVICES; CUSTOMER RELATIONSHIP MANAGEMENT; INVENTORY CONTROL; TELEPHONE ORDER-TAKING SERVICES FOR OTHERS; OUTSOURCED MAILING OF REFUNDS, REBATES, PREMIUMS, WARRANTIES, PRODUCT SAMPLES, SWEEPSTAKES, GAME AND CONTEST MATERIALS, NAMELY, MAIL SORTING, HANDLING AND RECEIVING; PREPARING PROMOTIONAL AND MERCHANDISING MATERIAL FOR OTHERS; PRODUCT AND SERVICE MERCHANDISING; MARKETING MATERIALS DISTRIBUTION, NAMELY DISTRIBUTION OF SALES COLLATERAL, MERCHANDISE AND POINT OF SALE MATERIALS; PROCESSING MANUFACTURER'S REBATES; ISSUING GIFT CERTIFICATES WHICH MAY THEN BE REDEEMED FOR GOODS OR SERVICES; SCHEDULED, DIRECTED, SYNDICATED, AND ROUTED CALLS, NAMELY, OPERATION OF TELEPHONE CALL CENTERS FOR OTHERS; IN-STORE MERCHANDISING SERVICES, NAMELY, PRODUCT MERCHANDISING, PRODUCT ASSEMBLY AND IN-STORE DEMONSTRATIONS OF PRODUCT; REPLENISHMENT, REORDERING, AND STOCKING, NAMELY, INVENTORY CONTROL; PLANOGRAM MAINTENANCE, CUT-INS, DISCONTINUED PRODUCT REMOVAL, NEW ITEM INTRODUCTIONS, ITEM DELETIONS SET TO PLANOGRAMS, MONITORING AND REPORTING AND PLANOGRAM COMPLIANCE; SHELF RESETS AND UPDATES; UNIT INTEGRITY CHECKS AND CORRECTIONS; INVENTORY CYCLE COUNTS, NAMELY, INVENTORY CONTROL; RETAIL AUDITS, NAMELY, AUDITING AND REPORTING ON RETAIL STORE CONDITIONS, COMPLIANCE AND PRICE CHECKS; AND MYSTERY SHOPPING, NAMELY, SHOPPING BY RESEARCHERS WHO POSE AS CUSTOMERS TO EVALUATE THE QUALITY OF SERVICE DELIVERED (U.S. CLS. 100, 101 AND 102).

FIRST USE 12-19-2002; IN COMMERCE 12-19-2002.

CLASS 37—CONSTRUCTION AND REPAIR

FOR INSTALLATION OF TEMPORARY AND PERMANENT DISPLAY ASSEMBLIES; INSTALLATION AND REMOVAL OF SIGNAGE AND POINT OF PURCHASE DISPLAYS AND ASSEMBLIES; FRONT-END CHECK-OUT RESETS (U.S. CLS. 100, 103 AND 106).

FIRST USE 12-19-2002; IN COMMERCE 12-19-2002.

CLASS 42—SCIENTIFIC, COMPUTER AND LEGAL SERVICES

FOR DATA AUTOMATION, COLLECTION SERVICES USING PROPRIETARY SOFTWARE TO EVALUATE, ANALYZE AND COLLECT SERVICE DATA; DATA WAREHOUSING AND DATA MINING SERVICES; ALL IN THE FIELD OF MARKETING AND MERCHANDISING (U.S. CLS. 100 AND 101).

FIRST USE 12-19-2002; IN COMMERCE 12-19-2002.

INGRID C. EULIN, EXAMINING ATTORNEY

SN 78-357,953. RIVERDEEP INTERACTIVE LEARNING LIMITED, DUBLIN, IRELAND, FILED 1-27-2004.



OWNER OF U.S. REG. NOS. 2,400,552, 2,605,772 AND OTHERS.

NO CLAIM IS MADE TO THE EXCLUSIVE RIGHT TO USE LEARNING, APART FROM THE MARK AS SHOWN.

CLASS 41—EDUCATION AND ENTERTAINMENT

FOR EDUCATIONAL SERVICES, NAMELY PROVIDING ONLINE EDUCATIONAL PROGRAMS AND INSTRUCTION IN THE FIELD OF STANDARD K-12 CURRICULUM SUBJECT MATTER VIA A GLOBAL COMPUTER NETWORK; EDUCATIONAL SERVICES, NAMELY CREATION AND DEVELOPMENT OF STANDARD K-12 CURRICULUM THAT HELPS SCHOOLS MEET FEDERAL AND STATE STANDARDS (U.S. CLS. 100, 101 AND 107).

CLASS 42—SCIENTIFIC, COMPUTER AND LEGAL SERVICES

FOR COMPUTER SERVICES, NAMELY INSTALLATION, MAINTENANCE AND TROUBLESHOOTING OF COMPUTER SOFTWARE APPLICATIONS; PROVIDING TEMPORARY USE OF ON-LINE NON-DOWNLOADABLE SOFTWARE FOR CREATING AND DEVELOPING STANDARD K-12 CURRICULUM TO HELP SCHOOLS MEET FEDERAL AND STATED STANDARDS (U.S. CLS. 100 AND 101).

ELLEN PERKINS, EXAMINING ATTORNEY

SN 78-358,408. VIGNETTE CORPORATION, AUSTIN, TX.
FILED 1-27-2004.



OWNER OF U.S. REG. NO. 2,295,970.
THE MARK CONSISTS OF V IN CIRCLE AND DOTS.

CLASS 9—ELECTRICAL AND SCIENTIFIC APPARATUS

FOR COMPUTER SOFTWARE FOR USE IN CREATING, MODIFYING, CONFIGURING, MAINTAINING, MANAGING, AND DEPLOYING WEB APPLICATIONS, ONLINE CONTENT AND AN ONLINE BUSINESS PRESENCE BY BUSINESS, PUBLIC SECTOR, EDUCATIONAL AND NONPROFIT ENTITIES; COMPUTER SOFTWARE FOR USE IN CREATING, MODIFYING, CONFIGURING, MODELING, ADAPTING, MAINTAINING, MANAGING, AND DEPLOYING WORK FLOWS FOR BUSINESS PROCESSES BY BUSINESS, PUBLIC SECTOR, EDUCATIONAL AND NONPROFIT ENTITIES; COMPUTER SOFTWARE FOR USE IN CREATING, MODIFYING, CONFIGURING, MODELING, ADAPTING, MAINTAINING, MANAGING, AND DEPLOYING WORK FLOWS FOR BUSINESS PROCESSES BY BUSINESS, PUBLIC SECTOR, EDUCATIONAL AND NONPROFIT ENTITIES; COMPUTER SOFTWARE FOR ONLINE COLLABORATION AND FOR USE IN CREATING, MODIFYING, CONFIGURING, MAINTAINING, MANAGING, AND DEPLOYING APPLICATIONS THAT INTEGRATE APPLICATIONS AND CONTENT ACROSS COMPUTER SYSTEMS AND NETWORKS BY BUSINESS, PUBLIC SECTOR, EDUCATIONAL AND NONPROFIT ENTITIES; COMPUTER SOFTWARE FOR CREATING, MODIFYING, CONFIGURING, MAINTAINING, MANAGING, AND DEPLOYING APPLICATIONS THAT MEASURE THE USAGE AND EFFECTIVENESS OF WEB APPLICATIONS AND CONTENT BY BUSINESS, PUBLIC SECTOR, EDUCATIONAL AND NONPROFIT ENTITIES; COMPUTER SOFTWARE FOR CREATING, MODIFYING, CONFIGURING, MAINTAINING, MANAGING, AND DEPLOYING APPLICATIONS THAT MANAGE CUSTOMER CONTACTS, INTERACTIONS, AND RELATIONSHIPS BY BUSINESS, PUBLIC SECTOR, EDUCATIONAL AND NONPROFIT ENTITIES; COMPUTER SOFTWARE FOR USE IN DOCUMENT AND RECORDS MANAGEMENT, COMPLIANCE AND RISK MANAGEMENT, WORKFLOW, AND RECORDS DISTRIBUTION, AND FOR USE IN INPUTTING, CAPTURING, IMAGING, MANAGING, STORING AND COLLABORATING ON DOCUMENTS OVER COMPUTER NETWORKS AND THE INTERNET BY BUSINESS, PUBLIC SECTOR, EDUCATIONAL AND NONPROFIT ENTITIES; AND COMPUTER SOFTWARE FOR ENTERPRISE CONTENT MANAGEMENT AND TO MANAGE ONLINE DISTRIBUTION OF GOODS AND SERVICES; INSTRUCTIONAL MANUALS PROVIDED AS A UNIT (U.S. CLS. 21, 23, 26, 36 AND 38).

FIRST USE 2-1-1996; IN COMMERCE 2-1-1996.

CLASS 41—EDUCATION AND ENTERTAINMENT

FOR EDUCATIONAL SERVICES, NAMELY, PROVIDING TRAINING, WORKSHOPS AND SEMINARS IN THE FIELD OF ENTERPRISE COMPUTER SOFTWARE (U.S. CLS. 100, 101 AND 107).

FIRST USE 11-15-1996; IN COMMERCE 11-15-1996.

CLASS 42—SCIENTIFIC, COMPUTER AND LEGAL SERVICES

FOR INSTALLATION AND MAINTENANCE OF ENTERPRISE COMPUTER SOFTWARE; CONSULTING SERVICES IN THE FIELD OF COMPUTER SOFTWARE; COMPUTER TECHNICAL SUPPORT SERVICES, NAMELY, TROUBLESHOOTING OF COMPUTERS AND COMPUTER SOFTWARE VIA EMAIL, OVER A COMPUTER NETWORK AND BY TELEPHONE (U.S. CLS. 100 AND 101).

FIRST USE 11-4-1996; IN COMMERCE 11-4-1996.
INGA ERVIN, EXAMINING ATTORNEY

SN 78-361,719. DWI HOLDINGS, INC., ATLANTA, GA.
FILED 2-3-2004.

PALLADIUM

THE MARK CONSISTS OF STANDARD CHARACTERS WITHOUT CLAIM TO ANY PARTICULAR FONT, STYLE, SIZE, OR COLOR.

CLASS 20—FURNITURE AND ARTICLES NOT OTHERWISE CLASSIFIED

FOR DECORATIVE PILLOWS, PILLOWS (U.S. CLS. 2, 13, 22, 25, 32 AND 50).

CLASS 24—FABRICS

FOR MATTRESS PADS, BED SHEETS, PILLOW CASES, COMFORTERS, DUVETS, DUVET COVERS, COMFORTER COVERS, PILLOW SHAMS, BEDSKIRTS, DRAPERIES, CURTAINS, QUILTS, BEDSPREADS, TROWLS, BED BLANKETS, TOWELS, SHOWER CURTAINS AND TABLE LINENS (U.S. CLS. 42 AND 50).
MITCHELL FRONT, EXAMINING ATTORNEY

SN 78-363,008. HECHT, CLAUDIA, JALISCO, MEXICO,
FILED 2-5-2004.

CLAUDIA HECHT

THE MARK CONSISTS OF STANDARD CHARACTERS WITHOUT CLAIM TO ANY PARTICULAR FONT, STYLE, SIZE, OR COLOR.

THE NAME(S), PORTRAIT(S), AND/OR SIGNATURE(S) SHOWN IN THE MARK IDENTIFIES CLAUDIA HECHT, WHOSE CONSENT(S) TO REGISTER IS SUBMITTED.

CLASS 14—JEWELRY

FOR JEWELRY (U.S. CLS. 2, 27, 28 AND 50).

SN 78-364,964. AMATO'S SANDWICH SHOPS, INC., PORTLAND, ME. FILED 2-9-2004.

CLASS 16—PAPER GOODS AND PRINTED MATTER

FOR ART PRINTS, PICTURES AND POST CARDS (U.S. CLS. 2, 5, 22, 23, 29, 37, 38 AND 50).
FIRST USE 5-6-1991; IN COMMERCE 10-24-1997.
LOURDES AYALA, EXAMINING ATTORNEY

AMATO'S

SN 78-363,519. SPRYANCE, INC., MAYNARD, MA. FILED 2-5-2004.

THE MARK CONSISTS OF STANDARD CHARACTERS WITHOUT CLAIM TO ANY PARTICULAR FONT, STYLE, SIZE, OR COLOR.

CLASS 29—MEATS AND PROCESSED FOODS

FOR SALAD OILS AND SANDWICH OILS (U.S. CL. 46).
FIRST USE 11-3-2003; IN COMMERCE 11-3-2003.

CLASS 30—STAPLE FOODS

FOR PIZZA SAUCES AND PASTA SAUCES (U.S. CL. 46).
FIRST USE 11-3-2003; IN COMMERCE 11-3-2003.
STEPHANIE DAVIS, EXAMINING ATTORNEY

SPRYFORCE

SN 78-365,546. BOEHRINGER INGELHEIM INTERNATIONAL GMBH, INGELHEIM AM RHEIN, FED REP GERMANY, FILED 2-10-2004.

LIVING WELL WITH COPD

THE MARK CONSISTS OF STANDARD CHARACTERS WITHOUT CLAIM TO ANY PARTICULAR FONT, STYLE, SIZE, OR COLOR.

CLASS 9—ELECTRICAL AND SCIENTIFIC APPARATUS

FOR SOFTWARE FOR USE IN MEDICAL TRANSCRIPTION, MESSAGE TRANSCRIPTION AND REMOTE TRANSCRIPTION; WEB-BASED SOFTWARE FOR WORKFLOW MANAGEMENT APPLICATIONS (U.S. CLS. 21, 23, 26, 36 AND 38).

THE MARK CONSISTS OF STANDARD CHARACTERS WITHOUT CLAIM TO ANY PARTICULAR FONT, STYLE, SIZE, OR COLOR.

NO CLAIM IS MADE TO THE EXCLUSIVE RIGHT TO USE COPD, APART FROM THE MARK AS SHOWN.

CLASS 9—ELECTRICAL AND SCIENTIFIC APPARATUS

FOR PRE-RECORDED VIDEO TAPES FEATURING EDUCATIONAL INFORMATION ABOUT PHARMACEUTICALS AND PRE-RECORDED COMPACT DISCS CONTAINING EDUCATIONAL SOFTWARE FEATURING INSTRUCTION IN THERAPEUTIC PULMONARY TREATMENTS (U.S. CLS. 21, 23, 26, 36 AND 38).

CLASS 35—ADVERTISING AND BUSINESS

FOR MEDICAL TRANSCRIPTION SERVICES, MESSAGE TRANSCRIPTION AND REMOTE MESSAGE TRANSCRIPTION SERVICES (U.S. CLS. 100, 101 AND 102).
LANA PHAM, EXAMINING ATTORNEY

CLASS 16—PAPER GOODS AND PRINTED MATTER

FOR PRINTED MATTER RELATED TO THE MEDICAL AND PHARMACEUTICAL FIELD, NAMELY NEWSPAPERS, MAGAZINES, NEWSLETTERS, BROCHURES, PAMPHLETS, BOOKS AND JOURNALS, DICTIONARIES AND INSTRUCTIONAL AND TEACHING MATERIALS IN THE FIELD OF RESPIRATORY DISEASES (U.S. CLS. 2, 5, 22, 23, 29, 37, 38 AND 50).

SN 78-368,793. MINESTRELLA, PAUL A, REDONDO BEACH, CA. AND THOMAS, PURDOM C III, CARLSBAD, CA. AND THOMAS, ERIC B, CARLSBAD, CA. FILED 2-16-2004.

CLASS 42—SCIENTIFIC, COMPUTER AND LEGAL SERVICES

FOR RESEARCH SERVICES IN THE MEDICAL AND PHARMACEUTICAL FIELD (U.S. CLS. 100 AND 101).



CLASS 44—MEDICAL, BEAUTY AND AGRICULTURAL SERVICES

FOR MEDICAL SERVICES, NAMELY PROVIDING MEDICAL AND PHARMACEUTICAL INFORMATION (U.S. CLS. 100 AND 101).
JENNIFER CHICOSKI, EXAMINING ATTORNEY

THE MARK CONSISTS OF A THICK LINE WITH AN OFF CENTER OVAL WITH THE LETTER "K" IN IT.

CLASS 14—JEWELRY

FOR (BASED ON INTENT TO USE) WATCHES (U.S. CLS. 2, 27, 28 AND 50).

SN 78-367,272. WORLDWOOD INDUSTRIES, INC., OKLAHOMA CITY, OK. FILED 2-12-2004.

CLASS 25—CLOTHING

FOR (BASED ON USE IN COMMERCE) MEN'S AND WOMEN'S APPAREL, NAMELY, JEANS, PANTS, BLOUSES, T-SHIRTS, KNIT TOPS, WOVEN TOPS, SWEATPANTS, SWEATSHIRTS, AND JACKETS (U.S. CLS. 22 AND 39).
FIRST USE 1-6-2004; IN COMMERCE 2-1-2004.
TINA L. SNAPP, EXAMINING ATTORNEY

**SOMETHING FABULOUS
SOAP CREATIONS**

THE MARK CONSISTS OF STANDARD CHARACTERS WITHOUT CLAIM TO ANY PARTICULAR FONT, STYLE, SIZE, OR COLOR.
NO CLAIM IS MADE TO THE EXCLUSIVE RIGHT TO USE "SOAP CREATIONS", APART FROM THE MARK AS SHOWN.

SN 78-368,830. BRIGHTPOINT, INC., PLAINFIELD, IN. FILED 2-17-2004.

CLASS 1—CHEMICALS

FOR FRAGRANCES AND BOTANICAL EXTRACTS FOR USE IN MANUFACTURING SOAP. (U.S. CLS. 1, 5, 6, 10, 26 AND 46).

**BRIGHTPOINT
CREATIVE WIRELESS
DISTRIBUTION
CUSTOMER
COMMITMENT
CUSTOMIZED
SERVICES**

CLASS 2—PAINTS

FOR DYES FOR MAKING SOAP. (U.S. CLS. 6, 11 AND 16).

CLASS 3—COSMETICS AND CLEANING PREPARATIONS

FOR DO-IT-YOURSELF SOAP MAKING PRODUCTS, NAMELY GLYCERIN SOAP, GELS AND LOTIONS (U.S. CLS. 1, 4, 6, 50, 51 AND 52).
DEZMONA MIZELLE, EXAMINING ATTORNEY

THE MARK CONSISTS OF STANDARD CHARACTERS WITHOUT CLAIM TO ANY PARTICULAR FONT, STYLE, SIZE, OR COLOR.
NO CLAIM IS MADE TO THE EXCLUSIVE RIGHT TO USE "CUSTOMER COMMITMENT" AND "CUSTOMIZED SERVICES", APART FROM THE MARK AS SHOWN.

CLASS 35—ADVERTISING AND BUSINESS

FOR DISTRIBUTORSHIPS IN THE FIELD OF WIRELESS COMMUNICATIONS EQUIPMENT, NAMELY, DISTRIBUTORSHIPS FOR WIRELESS COMMUNICATIONS DEVICES, INCLUDING TELEPHONE HANDSETS, PAGERS, AND PERSONAL DATA ASSISTANTS, WIRELESS TELEPHONE BATTERY CHARGERS, BATTERY ELIMINATORS, REPLACEMENT BATTERIES, WATTAGE BOOSTERS, HANDS-FREE HEADSETS AND KITS, HOLDERS AND CRADLES, CARRYING CASES AND BAGS, EAR PHONES, MICROPHONES, CIGARETTE LIGHTER ADAPTERS, ANTENNAE, HANG-UP CUPS, HANDSET EXTENSION CABLES, POWER CABLES AND DATA CABLES TO ORDER AND SPECIFICATION, REPAIR PARTS FOR WIRELESS COMMUNICATIONS EQUIPMENT, GAMES FOR WIRELESS COMMUNICATIONS EQUIPMENT, DOWNLOADABLE AND CONTAINED ON CD-ROM, 2 POINT 45 GIGAHERTZ-COMPATIBLE WIRELESS COMMUNICATIONS DEVICES, WIRELESS COMPUTING DEVICES, FACE PLATES FOR WIRELESS COMMUNICATIONS DEVICES, GRAPHICS FOR WIRELESS COMMUNICATIONS DEVICES, AUDIO AND VIDEO FOR WIRELESS COMMUNICATIONS DEVICES, DIGITAL CAMERAS FOR WIRELESS COMMUNICATIONS DEVICES, DATA STORAGE DEVICES FOR WIRELESS COMMUNICATIONS EQUIPMENT TO ORDER AND SPECIFICATION; INVENTORY MANAGEMENT FOR OTHERS OF WIRELESS COMMUNICATION EQUIPMENT; ACCOUNTS RECEIVABLE MANAGEMENT SERVICES IN THE FIELD OF WIRELESS COMMUNICATION EQUIPMENT (U.S. CLS. 100, 101 AND 102).

SN 78-369,454. PLATFORM COMPUTING CORPORATION, MARKHAM ONTARIO L3R 3T7, CANADA, FILED 2-17-2004.

ACCELERATE INTELLIGENCE

THE MARK CONSISTS OF STANDARD CHARACTERS WITHOUT CLAIM TO ANY PARTICULAR FONT, STYLE, SIZE, OR COLOR.

PRIORITY CLAIMED UNDER SEC. 44(D) ON CANADA APPLICATION NO. 1200402, FILED 12-24-2003, REG. NO. TMA626793, DATED 11-26-2004, EXPIRES 11-26-2019.

CLASS 36—INSURANCE AND FINANCIAL

FOR FINANCIAL SERVICES RELATING TO WIRELESS COMMUNICATION EQUIPMENT, NAMELY, CREDIT AND DEBT RECOVERY COLLECTION PROCESSING, AND CREDIT RISK MANAGEMENT SERVICES (U.S. CLS. 100, 101 AND 102).

CLASS 9—ELECTRICAL AND SCIENTIFIC APPARATUS

FOR SOFTWARE THAT ALLOWS USERS TO CONSOLIDATE AND OPTIMIZE INFORMATION TECHNOLOGY RESOURCES ACROSS A NETWORK BY ENABLING APPLICATIONS RUNNING ON THE NETWORK TO SHARE THOSE RESOURCES THROUGH SELF-MANAGEMENT, GUARANTEED SERVICE, RESOURCE PROVISIONING AND WORKLOAD MANAGEMENT ACROSS MULTIPLE DOMAINS AND GEOGRAPHIC LOCATIONS (U.S. CLS. 21, 23, 26, 36 AND 38).

CLASS 37—CONSTRUCTION AND REPAIR

FOR REPAIR AND REFURBISHING OF WIRELESS COMMUNICATION EQUIPMENT (U.S. CLS. 100, 103 AND 106).

CLASS 42—SCIENTIFIC, COMPUTER AND LEGAL SERVICES

FOR CONSULTING SERVICES FOR OTHERS IN THE FIELD OF INSTALLATION OF COMPUTER SOFTWARE, CONFIGURATION OF COMPUTER SOFTWARE FOR INDIVIDUAL USERS' SYSTEMS, AND INTEGRATION OF COMPUTER SOFTWARE INTO INDIVIDUAL USERS' SYSTEMS, ALL RELATING TO SOFTWARE THAT ALLOWS USERS TO CONSOLIDATE AND OPTIMIZE INFORMATION TECHNOLOGY RESOURCES ACROSS A NETWORK BY ENABLING APPLICATIONS RUNNING ON THE NETWORK TO SHARE THOSE RESOURCES THROUGH SELF-MANAGEMENT, GUARANTEED SERVICE, RESOURCE PROVISIONING AND WORKLOAD MANAGEMENT ACROSS MULTIPLE DOMAINS AND GEOGRAPHIC LOCATIONS; MAINTENANCE AND SUPPORT SERVICES RELATED TO SOFTWARE THAT ALLOWS USERS TO CONSOLIDATE AND OPTIMIZE INFORMATION TECHNOLOGY RESOURCES ACROSS A NETWORK BY ENABLING APPLICATIONS RUNNING ON THE NETWORK TO SHARE THOSE RESOURCES THROUGH SELF-MANAGEMENT, GUARANTEED SERVICE, RESOURCE PROVISIONING AND WORKLOAD MANAGEMENT ACROSS MULTIPLE DOMAINS AND GEOGRAPHIC LOCATIONS, NAMELY, PROVIDING TELEPHONE AND ELECTRONIC MAIL SUPPORT SERVICES AND UPDATES FOR RESPONDING TO TECHNICAL QUESTIONS FROM END USERS OF THE FOREGOING SOFTWARE, TROUBLESHOOTING SOFTWARE PROBLEMS AND UPGRADING SOFTWARE (U.S. CLS. 100 AND 101).

CLASS 39—TRANSPORTATION AND STORAGE

FOR INVENTORY STORAGE SERVICES, NAMELY, STORAGE OF WIRELESS COMMUNICATION EQUIPMENT FOR OTHERS (U.S. CLS. 100 AND 105).

CLASS 42—SCIENTIFIC, COMPUTER AND LEGAL SERVICES

FOR PACKAGING DESIGN FOR WIRELESS COMMUNICATIONS EQUIPMENT FOR OTHERS (U.S. CLS. 100 AND 101).

DAVID ELTON, EXAMINING ATTORNEY

HENRY S. ZAK, EXAMINING ATTORNEY

SN 78-369,471. PLATFORM COMPUTING CORPORATION, MARKHAM, ONTARIO, CANADA, FILED 2-17-2004.

SN 78-372,942. TEMPO CARPENTRY & DESIGN, INC., SAN JUAN CAPISTRANO, CA. FILED 2-24-2004.

ACCELERATING INTELLIGENCE

THE MARK CONSISTS OF STANDARD CHARACTERS WITHOUT CLAIM TO ANY PARTICULAR FONT, STYLE, SIZE, OR COLOR.

PRIORITY CLAIMED UNDER SEC. 44(D) ON CANADA APPLICATION NO. 1200403, FILED 12-24-2003, REG. NO. TMA626847, DATED 11-26-2004, EXPIRES 11-26-2019.

CLASS 9—ELECTRICAL AND SCIENTIFIC APPARATUS

FOR SOFTWARE THAT ALLOWS USERS TO CONSOLIDATE AND OPTIMIZE INFORMATION TECHNOLOGY RESOURCES ACROSS A NETWORK BY ENABLING APPLICATIONS RUNNING ON THE NETWORK TO SHARE THOSE RESOURCES THROUGH SELF-MANAGEMENT, GUARANTEED SERVICE, RESOURCE PROVISIONING AND WORKLOAD MANAGEMENT ACROSS MULTIPLE DOMAINS AND GEOGRAPHIC LOCATIONS (U.S. CLS. 21, 23, 26, 36 AND 38).

FIRST USE 6-13-2003; IN COMMERCE 6-13-2003.

CLASS 42—SCIENTIFIC, COMPUTER AND LEGAL SERVICES

FOR CONSULTING SERVICES FOR OTHERS IN THE FIELD OF INSTALLATION OF COMPUTER SOFTWARE, CONFIGURATION OF COMPUTER SOFTWARE FOR INDIVIDUAL USERS' SYSTEMS, AND INTEGRATION OF COMPUTER SOFTWARE INTO INDIVIDUAL USERS' SYSTEMS, ALL RELATING TO SOFTWARE THAT ALLOWS USERS TO CONSOLIDATE AND OPTIMIZE INFORMATION TECHNOLOGY RESOURCES ACROSS A NETWORK BY ENABLING APPLICATIONS RUNNING ON THE NETWORK TO SHARE THOSE RESOURCES THROUGH SELF-MANAGEMENT, GUARANTEED SERVICE, RESOURCE PROVISIONING AND WORKLOAD MANAGEMENT ACROSS MULTIPLE DOMAINS AND GEOGRAPHIC LOCATIONS; MAINTENANCE AND SUPPORT SERVICES RELATED TO SOFTWARE THAT ALLOWS USERS TO CONSOLIDATE AND OPTIMIZE INFORMATION TECHNOLOGY RESOURCES ACROSS A NETWORK BY ENABLING APPLICATIONS RUNNING ON THE NETWORK TO SHARE THOSE RESOURCES THROUGH SELF-MANAGEMENT, GUARANTEED SERVICE, RESOURCE PROVISIONING AND WORKLOAD MANAGEMENT ACROSS MULTIPLE DOMAINS AND GEOGRAPHIC LOCATIONS, NAMELY, PROVIDING TELEPHONE AND ELECTRONIC MAIL SUPPORT SERVICES AND UPDATES FOR RESPONDING TO TECHNICAL QUESTIONS FROM END USERS OF THE FOREGOING SOFTWARE, TROUBLESHOOTING SOFTWARE PROBLEMS AND UPGRADING SOFTWARE (U.S. CLS. 100 AND 101).

FIRST USE 6-13-2003; IN COMMERCE 6-13-2003.
HENRY S. ZAK, EXAMINING ATTORNEY

THINKING OUTSIDE THE CABINET

THE MARK CONSISTS OF STANDARD CHARACTERS WITHOUT CLAIM TO ANY PARTICULAR FONT, STYLE, SIZE, OR COLOR.

CLASS 40—MATERIAL TREATMENT

FOR CUSTOM MANUFACTURING OF FINISHED HARDWOOD CABINETS AND FURNITURE (U.S. CLS. 100, 103 AND 106).

FIRST USE 2-16-2004; IN COMMERCE 2-16-2004.

CLASS 42—SCIENTIFIC, COMPUTER AND LEGAL SERVICES

FOR CUSTOM DESIGN OF HARDWOOD CABINETS AND FURNITURE (U.S. CLS. 100 AND 101).

FIRST USE 2-16-2004; IN COMMERCE 2-16-2004.

DEZMONA MIZELLE, EXAMINING ATTORNEY

SN 78-374,123. MATTEL, INC., EL SEGUNDO, CA. FILED 2-25-2004.

SUGAR

THE MARK CONSISTS OF STANDARD CHARACTERS WITHOUT CLAIM TO ANY PARTICULAR FONT, STYLE, SIZE, OR COLOR.

CLASS 28—TOYS AND SPORTING GOODS

FOR TOYS, GAMES AND PLAYTHINGS, NAMELY, PLUSH TOYS, TOY FIGURES AND ACCESSORIES THEREFOR (U.S. CLS. 22, 23, 38 AND 50).

CLASS 41—EDUCATION AND ENTERTAINMENT

FOR ENTERTAINMENT SERVICES, NAMELY, PROVIDING ONLINE GAMES, ONLINE CONTESTS AND ONLINE PRODUCT TRIVIA ABOUT GAMES AND TOYS, INTENDED FOR CONSUMERS OF ALL AGES (U.S. CLS. 100, 101 AND 107).

KATHY DE JONGE, EXAMINING ATTORNEY

SN 78-375,734. WASHINGTON STATE UNIVERSITY, PULLMAN, WA. FILED 2-27-2004.

PEOPLE-PET PARTNERSHIP

THE MARK CONSISTS OF STANDARD CHARACTERS WITHOUT CLAIM TO ANY PARTICULAR FONT, STYLE, SIZE, OR COLOR.

CLASS 41—EDUCATION AND ENTERTAINMENT

FOR EDUCATION IN THE FIELD OF EDUCATING THE PUBLIC ON THE PROPER TREATMENT OF COMPANION ANIMALS AND THE HUMAN-ANIMAL BOND AND ITS APPLICATION RENDERED THROUGH IN-PERSON AND INTERNET ONLINE COURSES; EDUCATIONAL SERVICES, NAMELY PROVIDING IN-PERSON AND INTERPRET ONLINE EDUCATIONAL COURSES AT THE POST-GRADUATE VETERINARY SCHOOL LEVEL FOR VETERINARY STUDENTS DIRECTED TO IMPROVING UNDERSTANDING AND USE OF PET LOSS AND GRIEF, SELF CARE, SITUATIONS INVOLVING IMPAIRED PROFESSIONALS, LEADERSHIP SKILLS, ETHICAL DECISION MAKING, LEGAL ISSUES, ANIMAL RIGHTS, ANIMAL WELFARE AND THE HUMAN-ANIMAL BOND INVOLVING COMPANION ANIMALS; RECREATIONAL SERVICES IN THE NATURE OF HORSEBACK RIDING SERVICES AND FACILITIES AND SERVICES FOR OTHER COMPANION ANIMAL INTERACTION TO INDIVIDUALS HAVING EMOTIONAL, PHYSICAL AND/OR MENTAL CHALLENGES, OR DISABILITIES IN THE NATURE OF PROVIDING SUPERVISED HORSEBACK RIDING, AND THE SUBSEQUENT TRAINING IN THE CARE OF HORSES (U.S. CLS. 100, 101 AND 107).

FIRST USE 5-1-1979; IN COMMERCE 5-1-1979.

CLASS 42—SCIENTIFIC, COMPUTER AND LEGAL SERVICES

FOR SCIENTIFIC AND MEDICAL RESEARCH SERVICES DIRECTED TO THE PROPER TREATMENT OF COMPANION ANIMALS AND THE HUMAN-ANIMAL BOND AND ITS APPLICATION (U.S. CLS. 100 AND 101).

FIRST USE 5-1-1979; IN COMMERCE 5-1-1979.

CHRISTOPHER ADKINS, EXAMINING ATTORNEY

SN 78-376,683. ALIMENTATION COUCHE-TARD INC., LAVAL, QUEBEC, CANADA, FILED 3-2-2004.

FROSTER

PRIORITY CLAIMED UNDER SEC. 44(D) ON CANADA APPLICATION NO. 1203681, FILED 1-20-2004, REG. NO. TMA635584, DATED 3-17-2005, EXPIRES 3-17-2019.

THE MARK CONSISTS OF THE WORD FROSTER IN STYLIZED LETTERS.

CLASS 20—FURNITURE AND ARTICLES NOT OTHERWISE CLASSIFIED

FOR STRAWS, NAMELY, DRINKING STRAWS (U.S. CLS. 2, 13, 22, 25, 32 AND 50).

CLASS 21—HOUSEWARES AND GLASS

FOR DISPOSABLE BEVERAGE CUPS; REFILLABLE/REUSABLE BEVERAGE CUPS; REFILLABLE/REUSABLE BEVERAGE BOTTLES SOLD EMPTY (U.S. CLS. 2, 13, 23, 29, 30, 33, 40 AND 50).

CLASS 32—LIGHT BEVERAGES

FOR NON-CARBONATED, NON-ALCOHOLIC FROZEN FLAVORED BEVERAGES (U.S. CLS. 45, 46 AND 48).
ALLISON SCHRODY, EXAMINING ATTORNEY

SN 78-376,684. ALIMENTATION COUCHE-TARD INC., LAVAL, QUEBEC, CANADA, FILED 3-2-2004.



PRIORITY CLAIMED UNDER SEC. 44(D) ON CANADA APPLICATION NO. 1203683, FILED 1-20-2004, REG. NO. TMA635537, DATED 3-17-2005, EXPIRES 3-17-2019.

CLASS 20—FURNITURE AND ARTICLES NOT OTHERWISE CLASSIFIED

FOR STRAWS, NAMELY, DRINKING STRAWS (U.S. CLS. 2, 13, 22, 25, 32 AND 50).

CLASS 21—HOUSEWARES AND GLASS

FOR DISPOSABLE BEVERAGE CUPS; REFILLABLE/REUSABLE BEVERAGE CUPS; REFILLABLE/REUSABLE BEVERAGE BOTTLES SOLD EMPTY (U.S. CLS. 2, 13, 23, 29, 30, 33, 40 AND 50).

CLASS 32—LIGHT BEVERAGES

FOR NON-CARBONATED, NON-ALCOHOLIC FROZEN FLAVORED BEVERAGES (U.S. CLS. 45, 46 AND 48).
ALLISON SCHRODY, EXAMINING ATTORNEY

SN 78-376,686. ALIMENTATION COUCHE-TARD INC., LAVAL, QUEBEC, CANADA, FILED 3-2-2004.



PRIORITY CLAIMED UNDER SEC. 44(D) ON CANADA APPLICATION NO. 1203676, FILED 1-20-2004, REG. NO. TMA635448, DATED 3-16-2005, EXPIRES 3-16-2019.

CLASS 20—FURNITURE AND ARTICLES NOT OTHERWISE CLASSIFIED

FOR STRAWS, NAMELY, DRINKING STRAWS (U.S. CLS. 2, 13, 22, 25, 32 AND 50).

CLASS 21—HOUSEWARES AND GLASS

FOR DISPOSABLE BEVERAGE CUPS; REFILLABLE/REUSABLE BEVERAGE CUPS; REFILLABLE/REUSABLE BEVERAGE BOTTLES SOLD EMPTY (U.S. CLS. 2, 13, 23, 29, 30, 33, 40 AND 50).

CLASS 32—LIGHT BEVERAGES

FOR NON-CARBONATED, NON-ALCOHOLIC FROZEN FLAVORED BEVERAGES (U.S. CLS. 45, 46 AND 48). ALLISON SCHRODY, EXAMINING ATTORNEY

SN 78-376,818. LIFECYCLE PHARMA A/S, HORSHOLM, DENMARK, FILED 3-2-2004.

MELTDOSE CR

THE MARK CONSISTS OF STANDARD CHARACTERS WITHOUT CLAIM TO ANY PARTICULAR FONT, STYLE, SIZE, OR COLOR.

PRIORITY CLAIMED UNDER SEC. 44(D) ON DENMARK APPLICATION NO. VA200303378, FILED 9-18-2003, REG. NO. VA200303378, DATED 9-18-2003, EXPIRES 9-18-2013.

NO CLAIM IS MADE TO THE EXCLUSIVE RIGHT TO USE "CR", APART FROM THE MARK AS SHOWN.

CLASS 5—PHARMACEUTICALS

FOR PHARMACEUTICAL PREPARATIONS; MEDICAL PREPARATIONS; AND DRUG DELIVERY SYSTEMS, PHARMACEUTICAL MODIFIED RELEASE SYSTEMS, AND CONTROLLED RELEASE SYSTEMS, COMPRISED OF TABLETS, GRANULES, PILLS, SACHETS, POWDERS, AND CAPSULES; ALL OF THE ABOVE FOR USE IN THE TREATMENT OF MENTAL AND PHYSICAL DISORDERS, TRAUMAS AND EMERGENCIES, ADDICTIONS, AGING, ALLERGY/IMMUNOLOGY, BURNS, DISEASES OF THE HEART AND BLOOD VESSELS, DENTAL AND GUM DISEASES, SKIN DISEASES, NUTRITIONAL AND DIETARY DISEASES, DISEASES OF THE ENDOCRINOLOGICAL SYSTEM AND PANCREATIC DISEASES, DIABETES, EPIDEMICAL DISEASES, DISEASES AND AFFLICTIONS OF THE GASTROENTEROLOGICAL SYSTEM, DISEASES OF THE BLOOD, INFECTIOUS DISEASES, NEUROLOGICAL DISEASES, NEPHROLOGICAL DISEASES, DISEASES IN THE OBSTETRICAL- AND GYNECOLOGICAL FIELD, CANCER, OPHTHALMOLOGICAL DISEASES, DISEASES AND AFFLICTIONS AFFECTING THE BONES, JOINTS, CARTILAGE MATERIAL AND MUSCLES, DISEASES AND AFFLICTIONS OF THE EAR, NOSE AND THROAT, DISEASES AND AFFLICTIONS IN THE PSYCHIATRIC FIELD, PULMONOLOGICAL DISEASES AND AFFLICTIONS, RHEUMATISM, UROLOGICAL DISEASES AND AFFLICTIONS AND GENERALISED PAIN (U.S. CLS. 6, 18, 44, 46, 51 AND 52).

CLASS 40—MATERIAL TREATMENT

FOR TREATMENT OF MATERIALS, NAMELY MILLING, GRINDING, MIXING, COMPRESSING, AND MELTING OF PHARMACEUTICAL OR MEDICAL PREPARATIONS, COMPOUNDS OR SUBSTANCES FOR USE IN THE PHARMACEUTICAL AND MEDICAL INDUSTRIES (U.S. CLS. 100, 103 AND 106).

CLASS 41—EDUCATION AND ENTERTAINMENT

FOR EDUCATIONAL TRAINING SERVICES, NAMELY, ARRANGING AND CONDUCTING OF SEMINARS, WORKSHOPS, CONFERENCES, LECTURES AND CONGRESSES, ALL IN THE MEDICAL, CHEMICAL, AND PHARMACEUTICAL FIELDS (U.S. CLS. 100, 101 AND 107).

CLASS 42—SCIENTIFIC, COMPUTER AND LEGAL SERVICES

FOR SCIENTIFIC RESEARCH, NAMELY, BACTERIOLOGICAL RESEARCH, BIOLOGICAL RESEARCH, BIOTECHNOLOGICAL RESEARCH, SCIENTIFIC RESEARCH SERVICES FOR MEDICAL PURPOSES AND SCIENTIFIC RESEARCH CONSULTATION; RESEARCH AND DEVELOPMENT FOR NEW PRODUCTS FOR OTHERS; DESIGNING AND DEVELOPMENT OF MEDICAL EQUIPMENT; INDUSTRIAL DESIGN SERVICES; PHARMACEUTICAL AND MEDICAL CONSULTATION REGARDING PHARMACEUTICAL DRUG DEVELOPMENT SERVICES; COSMETIC RESEARCH FOR OTHERS; DESIGN SERVICES FOR OTHERS IN THE FIELD OF MEDICAL PACKAGING AND EQUIPMENT; MEDICAL RESEARCH; MEDICAL AND SCIENTIFIC RESEARCH, NAMELY, CONDUCTING CLINICAL TRIALS, NAMELY, TESTING OF MEDICAL SUBSTANCES AND TESTING OF MEDICAL APPLICATIONS; PHARMACEUTICAL DRUG DEVELOPMENT SERVICES, NAMELY, DEVELOPMENT OF MEDICAL APPLICATIONS, DRUG DESIGN, DRUG FORMULATION, PHARMACEUTICAL FORMULATION, AND DEVELOPMENT OF PHARMACEUTICAL FORMULATIONS AND CONSULTATION REGARDING PHARMACEUTICAL FORMULATION; DEVELOPMENT OF DRUG DELIVERY SYSTEMS FOR OTHERS, NAMELY, DEVELOPMENT OF SOLID DOSAGE FORMS, PHARMACEUTICAL CONTROLLED RELEASE SYSTEMS, MODIFIED RELEASE SYSTEMS AND PHARMA-

CEUTICAL MODIFIED RELEASE SYSTEMS AND CONSULTATION RELATED THERETO; PHARMACEUTICAL DRUG DEVELOPMENT SERVICES, NAMELY, DEVELOPMENT OF MIXING TECHNOLOGY, DEVELOPMENT OF PARTICULATE MATERIAL, DEVELOPMENT OF PARTICULATE MATERIAL MIXING TECHNOLOGY, DEVELOPMENT OF GRANULATE TECHNOLOGY, DEVELOPMENT OF TABLETING TECHNOLOGY, AND CONSULTATION RELATED THERETO; MATERIALS TESTING FOR THE PHARMACEUTICAL AND MEDICAL INDUSTRIES (U.S. CLS. 100 AND 101).
ALICIA COLLINS, EXAMINING ATTORNEY

CLASS 37—CONSTRUCTION AND REPAIR

FOR CONSTRUCTION SERVICES, NAMELY, CONSTRUCTION OF CONCRETE STRUCTURES IN THE NATURE OF ROADS AND HIGHWAYS, AIRFIELDS, UTILITY INSTALLATIONS, UNDERWATER CONSTRUCTION, BRIDGES, RESIDENTIAL DRIVEWAYS AND SIDEWALKS AND ASPHALT ROAD PAVING; CUSTOM CONSTRUCTION OF STAMPED CONCRETE SIDEWALKS, DRIVEWAYS, ABUTMENTS, AND RETAINING WALLS (U.S. CLS. 100, 103 AND 106).
FIRST USE 1-1-1984; IN COMMERCE 1-1-1984.

CLASS 40—MATERIAL TREATMENT

FOR CUSTOM MANUFACTURE OF STAMPED CONCRETE BLOCKS FOR USE IN RETAINING WALLS, SIDEWALKS AND DRIVEWAYS (U.S. CLS. 100, 103 AND 106).
FIRST USE 1-1-1984; IN COMMERCE 1-1-1984.
VIVIAN MICZNIK FIRST, EXAMINING ATTORNEY

SN 78-377,484. PANGAIR LLC, GREENWOOD, IN. FILED 3-3-2004.

PangeAir

THE MARK CONSISTS OF STANDARD CHARACTERS WITHOUT CLAIM TO ANY PARTICULAR FONT, STYLE, SIZE, OR COLOR.

CLASS 35—ADVERTISING AND BUSINESS

FOR OPERATION OF TELECOMMUNICATION SYSTEMS FOR OTHERS, NAMELY, VIDEO, VOICE AND DATA COMMUNICATION SYSTEMS (U.S. CLS. 100, 101 AND 102).
FIRST USE 8-15-2003; IN COMMERCE 4-1-2004.

SN 78-378,722. SANCHEZ, ANTONIO N., OAKLAND, CA. FILED 3-4-2004.

CLASS 37—CONSTRUCTION AND REPAIR

FOR INSTALLATION OF VIDEO, VOICE AND DATA COMMUNICATION SYSTEMS (U.S. CLS. 100, 103 AND 106).
FIRST USE 8-15-2003; IN COMMERCE 4-1-2004.
TONJA GASKINS, EXAMINING ATTORNEY

AMERICAN SUPER

SN 78-378,391. GLENN O. HAWBAKER, INC., STATE COLLEGE, PA. FILED 3-4-2004.



THE LITERAL ELEMENT OF THE MARK CONSISTS OF "GOH".

CLASS 19—NON-METALLIC BUILDING MATERIALS

FOR NON-METALLIC CONSTRUCTION MATERIALS, NAMELY, CONCRETE, ASPHALT, LIMESTONE, SANDSTONE, AND AGGREGATE COMPOSED OF STONE, SAND AND GRAVEL FOR CONCRETE AND ASPHALT (U.S. CLS. 1, 12, 33 AND 50).
FIRST USE 1-1-1984; IN COMMERCE 1-1-1984.

THE MARK CONSISTS OF STANDARD CHARACTERS WITHOUT CLAIM TO ANY PARTICULAR FONT, STYLE, SIZE, OR COLOR.
NO CLAIM IS MADE TO THE EXCLUSIVE RIGHT TO USE "AMERICAN", APART FROM THE MARK AS SHOWN.

CLASS 9—ELECTRICAL AND SCIENTIFIC APPARATUS

FOR MUSICAL SOUND RECORDINGS (U.S. CLS. 21, 23, 26, 36 AND 38).

CLASS 16—PAPER GOODS AND PRINTED MATTER

FOR PUBLICATIONS, NAMELY COMIC MAGAZINES AND STORIES IN ILLUSTRATED FORM; STORYBOOKS (U.S. CLS. 2, 5, 22, 23, 29, 37, 38 AND 50).
DAVID TAYLOR, EXAMINING ATTORNEY

SN 78-378,856. EXEGY INCORPORATED, ST. LOUIS, MO.
FILED 3-4-2004.

SN 78-380,207. RIGIE, MITCHELL, NEW YORK, NY. FILED
3-8-2004.

iFlow

EXEGY

THE MARK CONSISTS OF STANDARD CHARACTERS WITHOUT CLAIM TO ANY PARTICULAR FONT, STYLE, SIZE, OR COLOR.

CLASS 16—PAPER GOODS AND PRINTED MATTER

FOR PRINTED PUBLICATIONS AND FORMS, NAMELY, ASSESSMENTS, INSTRUCTION MANUALS, WORKBOOKS, DIRECTORIES, LOGS, AND FORMS FOR USE IN THE TEACHING AND PRACTICE OF TECHNIQUES FOR HELPING INDIVIDUALS OR GROUPS OF INDIVIDUALS ACHIEVE STATES OF PERFORMANCE CREATIVE FLOW (U.S. CLS. 2, 5, 22, 23, 29, 37, 38 AND 50).

CLASS 41—EDUCATION AND ENTERTAINMENT

FOR EDUCATIONAL SERVICES, NAMELY, CONDUCTING CLASSES AND WORKSHOPS IN THE FIELDS OF EDUCATIONAL AND HUMAN DEVELOPMENT TRAINING PROGRAM BASED ON THE CONCEPT OF ENHANCING STATES OF PEAK PERFORMANCE FLOW; THE PROGRAM IS DESIGNED TO HELP INDIVIDUALS OR GROUPS OF INDIVIDUALS ASSESS THEIR CREATIVE THOUGHT PROCESSES, WORK HABITS, AND PERSONAL PRODUCTIVITY AND IDENTIFY AREAS OF STRENGTHS AND WEAKNESSES AND CREATE ACTION PLANS TO IMPROVE THEIR PERFORMANCES VIA FLOW ALIGNMENT (U.S. CLS. 100, 101 AND 107).

GEORGIA CARTY, EXAMINING ATTORNEY

THE MARK CONSISTS OF STANDARD CHARACTERS WITHOUT CLAIM TO ANY PARTICULAR FONT, STYLE, SIZE, OR COLOR.

CLASS 9—ELECTRICAL AND SCIENTIFIC APPARATUS

FOR COMPUTER HARDWARE; COMPUTER SOFTWARE AND FIRMWARE FOR SEARCHING AND RETRIEVING DATA FROM COMPUTER HARDWARE; COMPUTER OPERATING SYSTEMS, AND DATABASES; COMPUTER SOFTWARE AND FIRMWARE FOR USE IN DATABASE MANAGEMENT; COMPUTER SOFTWARE AND FIRMWARE FOR DATA ENCRYPTION AND DECRYPTION, DATA MINING, DATA COMPRESSION AND DECOMPRESSION, AND DATA FILTERING (U.S. CLS. 21, 23, 26, 36 AND 38).

CLASS 40—MATERIAL TREATMENT

FOR DIGITAL COMPRESSION AND DECOMPRESSION OF COMPUTER DATA (U.S. CLS. 100, 103 AND 106).

CLASS 42—SCIENTIFIC, COMPUTER AND LEGAL SERVICES

FOR DATA MINING; ENCRYPTING DATA AND DECRYPTING DATA (U.S. CLS. 100 AND 101).
TONI HICKEY, EXAMINING ATTORNEY

SN 78-380,580. STORYMANAGER, INC., OAKLAND, CA.
FILED 3-8-2004.

THE STORY CLUB

THE MARK CONSISTS OF STANDARD CHARACTERS WITHOUT CLAIM TO ANY PARTICULAR FONT, STYLE, SIZE, OR COLOR.

CLASS 9—ELECTRICAL AND SCIENTIFIC APPARATUS

FOR COMPUTER SOFTWARE FOR DATABASE MANAGEMENT AND COMPILATION AND MANAGEMENT OF INFORMATION FOR USE BY ENTERPRISES, NON-PROFITS, AND INDIVIDUALS TO FACILITATE THE IDENTIFICATION, EVALUATION, EXPLOITATION, AND MANAGEMENT OF HUMAN RESOURCES, INVENTIONS, BRANDS, CREATIVE EXPRESSION, AND NOVEL IDEAS, AS WELL AS IMPROVE PROFESSIONAL AND PERSONAL COMMUNICATIONS SKILLS. (U.S. CLS. 21, 23, 26, 36 AND 38).

SN 78-383,317. C&P ADVISORS, LLC, CLEVELAND, OH. FILED 3-12-2004.



THE MARK CONSISTS OF A STYLIZED CP FORMED BY AN OFFSET SPLIT OVAL CONSISTING OF INVERTED CRESCENTS.

CLASS 35—ADVERTISING AND BUSINESS

FOR BUSINESS DEVELOPMENT AND SALES PRESENTATION SERVICES, NAMELY, PROVIDING SUPPORT FOR BUSINESSES OF OTHERS OVER A GLOBAL COMPUTER NETWORK TO FACILITATE THE IDENTIFICATION, EVALUATION, EXPLOITATION, EXPANSION, AND MANAGEMENT OF HUMAN RESOURCES, INVENTIONS, CREATIVE EXPRESSION, BRANDS, AND NOVEL IDEAS, AS WELL AS IMPROVE PROFESSIONAL AND PERSONAL COMMUNICATIONS SKILLS, FOR NON-PROFITS, BUSINESSES AND INDIVIDUALS (U.S. CLS. 100, 101 AND 102).

GRETTA YAO, EXAMINING ATTORNEY

CLASS 35—ADVERTISING AND BUSINESS

FOR ACCOUNTING AND ACCOUNT AUDITING, TAX PLANNING AND COMPLIANCE CONSULTATION, BUSINESS MANAGEMENT ADVISORY, STRATEGIC BUSINESS PLANNING, BUSINESS SUCCESSION PLANNING, HUMAN RESOURCES CONSULTING, AND INTERIM BUSINESS MANAGEMENT SERVICES (U.S. CLS. 100, 101 AND 102).

SN 78-382,860. ROWLEY'S SOUTH RIDGE FARMS, INC., SANTAQUIN, UT. FILED 3-11-2004.

CLASS 36—INSURANCE AND FINANCIAL

FOR PERSONAL FINANCIAL PLANNING SERVICES (U.S. CLS. 100, 101 AND 102).

TONJA GASKINS, EXAMINING ATTORNEY

SOUTH RIDGE FARMS

SN 78-383,439. AVI ARAD & ASSOCIATES, LLC, WESTPORT, CT. FILED 3-12-2004.

THE MARK CONSISTS OF STANDARD CHARACTERS WITHOUT CLAIM TO ANY PARTICULAR FONT, STYLE, SIZE, OR COLOR.

OWNER OF U.S. REG. NO. 1,818,056.

NO CLAIM IS MADE TO THE EXCLUSIVE RIGHT TO USE "FARMS", APART FROM THE MARK AS SHOWN.

RESCUE PUPPY**CLASS 29—MEATS AND PROCESSED FOODS**

FOR YOGURT COVERED PRODUCTS, NAMELY YOGURT COVERED CHERRIES AND CRANBERRIES AND OTHER FRUITS AND NUTS (U.S. CL. 46).

FIRST USE 9-3-2003; IN COMMERCE 9-3-2003.

THE MARK CONSISTS OF STANDARD CHARACTERS WITHOUT CLAIM TO ANY PARTICULAR FONT, STYLE, SIZE, OR COLOR.

NO CLAIM IS MADE TO THE EXCLUSIVE RIGHT TO USE "PUPPY", APART FROM THE MARK AS SHOWN.

CLASS 30—STAPLE FOODS

FOR CHOCOLATE COVERED PRODUCTS AND CHOCOLATE COVERED FRUIT, NAMELY, CHOCOLATE COVERED CRANBERRIES, BLUEBERRIES, ALMONDS AND CHERRIES, OTHER FRUITS AND NUTS (U.S. CL. 46).

FIRST USE 9-3-2003; IN COMMERCE 9-3-2003.

CLASS 9—ELECTRICAL AND SCIENTIFIC APPARATUS

FOR CHILDREN'S ENTERTAINMENT PRODUCTS, NAMELY, PRE-RECORDED VIDEO CASSETTES AND DVDS FEATURING CHILDREN'S EDUCATIONAL ENTERTAINMENT CONTENT; PRE-RECORDED MUSIC CDS AND AUDIO CASSETTES FEATURING CHILDREN'S EDUCATIONAL ENTERTAINMENT CONTENT; COMPUTER GAME SOFTWARE AND PROGRAMS; VIDEO GAME SOFTWARE, PROGRAMS, DISCS, AND CARTRIDGES; COMPUTER GAME EQUIPMENT CONTAINING MEMORY DEVICES, NAMELY, DISCS; MOUSE PADS; REFRIGERATOR MAGNETS AND SUNGLASSES (U.S. CLS. 21, 23, 26, 36 AND 38).

CLASS 32—LIGHT BEVERAGES

FOR FRUIT JUICE CONCENTRATES AND FRUIT JUICES (U.S. CLS. 45, 46 AND 48).

FIRST USE 9-3-2003; IN COMMERCE 9-3-2003.

HENRY S. ZAK, EXAMINING ATTORNEY

CLASS 41—EDUCATION AND ENTERTAINMENT

FOR TELEVISION PROGRAMMING IN THE FIELD OF CHILDREN'S ENTERTAINMENT; AND MOTION PICTURE PROGRAMMING VIA TELEVISION AND CABLE TELEVISION IN THE FIELD OF CHILDREN'S ENTERTAINMENT (U.S. CLS. 100, 101 AND 107).

TONI HICKEY, EXAMINING ATTORNEY

SN 78-385,088. CONCERTED INNOVATIONS, INC., BLACK-LICK, OH. FILED 3-16-2004.

SN 78-383,717. KAPTURENET LLC., ATLANTIS, FL. FILED 3-12-2004.

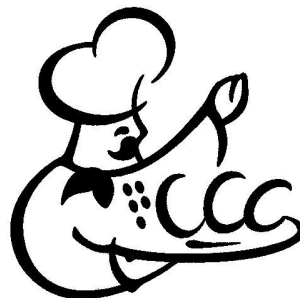

KaptureNet

THE MARK CONSISTS OF STANDARD CHARACTERS WITHOUT CLAIM TO ANY PARTICULAR FONT, STYLE, SIZE, OR COLOR.

CLASS 9—ELECTRICAL AND SCIENTIFIC APPARATUS

FOR DIGITAL VIDEO IMAGING SYSTEMS CONSISTING OF VIDEO CAMERAS CONNECTED TO A COMPUTER NETWORK FEATURING DATA TRANSMISSION AND ELECTRONIC STORAGE DEVICES, NAMELY, COMPUTER HARD DRIVES, DVD/CD ROMS DRIVES AND TAPE BACKUP DRIVES FOR COMPUTERS (U.S. CLS. 21, 23, 26, 36 AND 38).

CLASS 40—MATERIAL TREATMENT

FOR MANUFACTURE OF VIDEO IMAGING, VOICE DATA TRANSMISSION AND STORAGE DEVICES TO THE ORDER AND SPECIFICATION OF OTHERS (U.S. CLS. 100, 103 AND 106).

MARLENE BELL, EXAMINING ATTORNEY

THE MARK CONSISTS OF A CHEF WITH MOUSTACHE, NECK TIE AND CHEF'S HAT WITH A TRAY OF FOOD ARTICLES AND ONE ARM EXTENDED.

CLASS 11—ENVIRONMENTAL CONTROL APPARATUS

FOR FOOD PROCESSING EQUIPMENT, NAMELY, EQUIPMENT FOR COOKING AGRICULTURAL PRODUCTS, SUCH AS VEGETABLES (U.S. CLS. 13, 21, 23, 31 AND 34).

CLASS 29—MEATS AND PROCESSED FOODS

FOR PREPARED FOODS, NAMELY, REFRIGERATED SIDE DISHES CONSISTING PRIMARILY OF VEGETABLES AND PRE-COOKED VEGETABLES (U.S. CL. 46).

CLASS 39—TRANSPORTATION AND STORAGE

FOR TRANSPORTATION OF FOODSTUFFS OF OTHERS BY TRUCK (U.S. CLS. 100 AND 105).

CLASS 40—MATERIAL TREATMENT

FOR FOOD PROCESSING (U.S. CLS. 100, 103 AND 106).

CLASS 42—SCIENTIFIC, COMPUTER AND LEGAL SERVICES

FOR RESEARCH AND DEVELOPMENT OF PREPARED FOODS FOR OTHERS; LICENSING OF INTELLECTUAL PROPERTY (U.S. CLS. 100 AND 101).

WANDA KAY PRICE, EXAMINING ATTORNEY

SN 78-385,779. B.G. ARNOLD SERVICES LTD., MISSISSAUGA, ONTARIO, CANADA, FILED 3-17-2004.

PIPE SHIELD

THE MARK CONSISTS OF STANDARD CHARACTERS WITHOUT CLAIM TO ANY PARTICULAR FONT, STYLE, SIZE, OR COLOR.

NO CLAIM IS MADE TO THE EXCLUSIVE RIGHT TO USE PIPE, APART FROM THE MARK AS SHOWN.

CLASS 37—CONSTRUCTION AND REPAIR

FOR BUILDING CONSTRUCTION, REPAIR, CLEANING, RENOVATION AND RESTORATION SERVICES, NAMELY CLEANING PIPES, TUBES AND OTHER SIMILAR PIPE INSTALLATIONS, AND PROVIDING INFORMATION ABOUT REPAIR, RESTORATION AND PRESERVATION OF PIPES, TUBES AND OTHER SIMILAR PIPE INSTALLATIONS (U.S. CLS. 100, 103 AND 106).

FIRST USE 6-12-2002; IN COMMERCE 12-18-2002.

CLASS 40—MATERIAL TREATMENT

FOR BUILDING TREATMENT AND RELINING SERVICES, NAMELY, RE-LINING AND TREATING PIPES, TUBES AND OTHER SIMILAR PIPE INSTALLATIONS, AND PROVIDING INFORMATION AND RELINING AND TREATING PIPES, TUBES AND OTHER SIMILAR PIPE INSTALLATIONS (U.S. CLS. 100, 103 AND 106).

FIRST USE 6-12-2002; IN COMMERCE 12-18-2002.
MARY ROSSMAN, EXAMINING ATTORNEY

SN 78-386,000. DS WATERS, LP, ATLANTA, GA. FILED 3-17-2004.

DS WATERS

THE MARK CONSISTS OF STANDARD CHARACTERS WITHOUT CLAIM TO ANY PARTICULAR FONT, STYLE, SIZE, OR COLOR.

NO CLAIM IS MADE TO THE EXCLUSIVE RIGHT TO USE WATERS, APART FROM THE MARK AS SHOWN.

CLASS 11—ENVIRONMENTAL CONTROL APPARATUS

FOR DRINKING WATER DISPENSERS (U.S. CLS. 13, 21, 23, 31 AND 34).

CLASS 32—LIGHT BEVERAGES

FOR DRINKING WATER (U.S. CLS. 45, 46 AND 48).

CLASS 39—TRANSPORTATION AND STORAGE

FOR DELIVERY SERVICES FOR BOTTLED DRINKING WATER (U.S. CLS. 100 AND 105).

JEFF DEFORD, EXAMINING ATTORNEY

SN 78-386,246. BMM INTERNATIONAL PTY LTD, BOX HILL VIC, AUSTRALIA, FILED 3-17-2004.

THE REFRESHING CHOICE IN TESTLABS

THE MARK CONSISTS OF STANDARD CHARACTERS WITHOUT CLAIM TO ANY PARTICULAR FONT, STYLE, SIZE, OR COLOR.

PRIORITY CLAIMED UNDER SEC. 44(D) ON AUSTRALIA APPLICATION NO. 970762, FILED 9-18-2003, REG. NO. 970762, DATED 12-21-2004, EXPIRES 9-18-2013.

CLASS 41—EDUCATION AND ENTERTAINMENT

FOR PROVIDING CASINO FACILITIES; ENTERTAINMENT SERVICES, NAMELY, GAMING SERVICES; PROVIDING ON-LINE COMPUTER GAMING; PROVIDING ON-LINE CASINO SERVICES; CASINO SERVICES (U.S. CLS. 100, 101 AND 107).

CLASS 42—SCIENTIFIC, COMPUTER AND LEGAL SERVICES

FOR CONSULTING SERVICES IN THE FIELD OF DESIGN, SELECTION, IMPLEMENTATION AND USE OF COMPUTER HARDWARE AND SOFTWARE SYSTEMS FOR OTHERS, COMPUTER PROGRAMMING FOR OTHERS, COMPUTER SYSTEMS ANALYSIS; DATA CONVERSION OF COMPUTER PROGRAMS AND DATA MATERIAL TESTING (U.S. CLS. 100 AND 101).

KARLA PERKINS, EXAMINING ATTORNEY

SN 78-386,872. AMERICASDOCTOR, INC., GURNEE, IL.
FILED 3-18-2004.

**CLASS 42—SCIENTIFIC, COMPUTER AND
LEGAL SERVICES**

FOR PRODUCT DEVELOPMENT AND CONTRACT RESEARCH SERVICES RELATING TO PUBLIC OR PRIVATE CLINICAL TRIALS OR MEDICAL STUDIES OF PHARMACEUTICAL, PHARMACOGENOMIC, NUTRITIONAL, BIOTECHNICAL OR MEDICAL PRODUCTS OR DEVICES; LABORATORY RESEARCH TESTING IN THE FIELDS OF PHARMACOLOGY, NUTRITION, BIOTECHNOLOGY AND MEDICINE; CONDUCTING MEDICAL, SCIENTIFIC AND DATA ANALYSIS RESEARCH SERVICES FOR CLINICAL TRIALS OR STUDIES; DEVELOPMENT OR CLINICAL TRIAL METHODOLOGIES, PROTOCOL AND PROJECT DESIGN, DATA RETRIEVAL METHODS, CLINICAL DATA MANAGEMENT AND PREPARING STATISTICAL REPORTS RESULTING FROM SUCH CLINICAL TRIALS OR STUDIES; ADVISORY SERVICES IN THE FIELD OF PRODUCT DEVELOPMENT AND RESEARCH PROVIDED TO PHYSICIANS INVOLVED IN THE PLANNING AND PREPARATION OF LIFECYCLE MANAGEMENT ACTIVITIES FOR PHARMACEUTICAL, PHARMACOGENOMIC, BIOTECHNICAL, NUTRITIONAL, OR MEDICAL PRODUCTS OR DEVICES; AND TECHNICAL CONSULTING SERVICES IN THE NATURE OF PREPARING AND FILING DOCUMENTS TO COMPLY WITH US FOOD AND DRUG ADMINISTRATION REQUIREMENTS CONCERNING CLINICAL TRIALS (U.S. CLS. 100 AND 101).

TONI HICKEY, EXAMINING ATTORNEY

ESSENTIAL

THE MARK CONSISTS OF STANDARD CHARACTERS WITHOUT CLAIM TO ANY PARTICULAR FONT, STYLE, SIZE, OR COLOR.

CLASS 35—ADVERTISING AND BUSINESS

FOR PROVIDING GENERAL BUSINESS ADMINISTRATION AND MANAGEMENT SERVICES ON BEHALF OF ENTITIES PROVIDING PUBLIC OR PRIVATE CLINICAL TRIALS, MEDICAL STUDIES OR MARKET RESEARCH STUDIES OF PHARMACEUTICAL, PHARMACOGENOMIC, BIOTECHNICAL, NUTRITIONAL OR MEDICAL PRODUCTS OR DEVICES IN TERMS OF EVALUATING THIRD PARTY CLINICAL RESEARCH SITES FOR THEIR ABILITY TO PROVIDE CONTRACTUAL RESEARCH TRADE SERVICES; ARRANGING OF CONTRACTUAL TRADE SERVICES WITH SELECTED THIRD PARTIES TO PERFORM SUCH TRIALS AND STUDIES; ARRANGING OF CONTRACTUAL TRADE SERVICES WITH THIRD PARTIES TO COLLECT AND TEST LABORATORY SPECIMENS FROM CLINICAL TRIAL AND STUDY SITES; AND ADVERTISING AND BUSINESS MANAGEMENT CONSULTANCY REGARDING CLINICAL TRIALS AND STUDIES AND THE RECRUITMENT OF PATIENTS AND CONSUMERS FOR SUCH TRIALS AND STUDIES (U.S. CLS. 100, 101 AND 102).

SN 78-387,272. POYZER, MICHAEL JAMES, CARLTON, NOTTINGHAM, UNITED KINGDOM, AND POYZER, SUSAN MARY, CARLTON, NOTTINGHAM, UNITED KINGDOM, FILED 3-19-2004.

TENSILE

CLASS 41—EDUCATION AND ENTERTAINMENT

FOR EDUCATIONAL SERVICES IN THE NATURE OF PROVIDING COURSES, TRAINING, TESTING AND WORKSHOPS IN THE FIELD OF CLINICAL RESEARCH, PRODUCT LIFECYCLE MANAGEMENT, MEDICAL EDUCATION, AND DISTRIBUTING COURSE MATERIALS IN CONNECTION THEREWITH; TRAINING CLINICAL TRIAL SITE AND STUDY SITE PERSONNEL IN THE USE OF TESTS AND RATING SYSTEMS FOR PROTOCOL REQUIREMENTS; TRAINING CLINICAL TRIAL SITE PERSONNEL IN THE USE OF MEDICAL AND RESEARCH EQUIPMENT REQUIRED BY TRIAL AND STUDY PROTOCOLS; AND EDUCATIONAL SERVICES IN THE NATURE OF ARRANGING FOR CONFERENCE AND SEMINAR SPEAKERS THROUGH A SPEAKERS' BUREAU (U.S. CLS. 100, 101 AND 107).

THE MARK CONSISTS OF STANDARD CHARACTERS WITHOUT CLAIM TO ANY PARTICULAR FONT, STYLE, SIZE, OR COLOR.

OWNER OF UNITED KINGDOM REG. NO. 2324407, DATED 2-21-2003, EXPIRES 2-20-2013.

CLASS 12—VEHICLES

FOR BICYCLES, TRICYCLES, TANDEM BICYCLES AND UNICYCLES; BICYCLE, TRICYCLE, TANDEM BICYCLE AND UNICYCLE PARTS, NAMELY, FRAMES BOTH RIGID AND SUSPENSION, FORKS BOTH RIGID AND SUSPENSION, WHEELS, RIMS, SPOKES, HUBS, TIRES, INNER TUBES, RIM TAPES, CHAINS AND CHAINRINGS, BASH GUARDS AND BASH RINGS, BOTTOM BRACKETS, CRANKS, REAR SPROCKETS AND SPACERS FITTED ON FREEHUB CASSETTE BODIES, FREEWHEELS BOTH SINGLE AND MULTIPLE, FREEHUBS AND FREEHUB BODIES, PEDALS BOTH STANDARD AND CLIPLESS, NAMELY THOSE ATTACHING TO SHOES WITH CLEATS, TOECLIPS AND STRAPS, DERAILLEUR GEARS BOTH FRONT AND REAR, REAR HUBS WITH FULLY ENCLOSED MULTIPLE GEARS, GEAR CHANGE LEVERS WHICH CONNECT MECHANICALLY, HYDRAULICALLY, PNEUMATICALLY OR ELECTRONICALLY WITH GEARS CONNECTED TO THE REAR WHEEL, TWIST GRIP GEAR CHANGERS WHICH FIT ON THE HANDLEBARS AND OPERATE GEARS MECHANICALLY OR HYDRAULICALLY, HANDLEBARS, HANDLEBAR STEMS, SEAT POSTS AND SEAT CLAMPS, SEATS AND SADDLES, CALIPER BRAKES, CANTILEVER BRAKES, LINEAR PULL BRAKES, HUB AND DISC BRAKES BOTH MECHANICALLY AND HYDRAULICALLY OPERATED, BRAKE LEVERS BOTH MECHANICAL AND HYDRAULIC, BRAKE AND GEAR CONTROL CABLES AND HYDRAULIC PIPING CONTROL ASSEMBLIES, REAR FRAME SHOCK ABSORBER UNITS, CHAIN GUARDS AND DEVICES MOUNTED AROUND THE FRONT CHAINWHEEL TO KEEP THE CHAIN IN CONTACT WITH THE CHAINWHEEL TEETH DURING EXTREME CYCLE SPORTS; BICYCLE, TRICYCLE, TANDEM BICYCLE AND UNICYCLE ACCESSORIES NAMELY, WATER BOTTLE HOLDERS, SADDLE COVERS WITH PADDING, KICKSTANDS, FENDERS, LUGGAGE CARRYING RACKS FITTED ANYWHERE ON THE CYCLE, TRIATHLON STYLE HANDLEBAR EXTENSIONS AND ATTACHMENTS, CHILD CARRYING SEATS FITTED ANYWHERE ON THE CYCLE, TRAILERS FOR BOTH LUGGAGE, CHILDREN AND PETS, BAGS AND CASES FOR CARRYING CYCLES AND WHEELS IN TRANSIT, RACKS AND TRAILERS FITTED TO AUTOMOBILES, CARAVANS AND MOTOR HOMES WHICH CARRY CYCLES, CYCLE REPAIR WORKSTANDS AND CYCLE TOOLKITS ADAPTED TO FIT ANYWHERE ON THE CYCLE (U.S. CLS. 19, 21, 23, 31, 35 AND 44).

CLASS 25—CLOTHING

FOR CLOTHING NAMELY SHIRTS AND T SHIRTS, BLOUSES, SKIRTS AND DRESSES, VESTS, SWEATSHIRTS AND HOODED TOPS, SWEATERS, CARDIGANS, UNDERWEAR, TROUSERS AND JEANS, GLOVES AND MITTENS, JACKETS, OVERCOATS AND RAINWEAR; FOOTWEAR, NAMELY BOOTS AND SHOES, INCLUDING THOSE DESIGNED FOR ATTACHING TO BICYCLE PEDALS PLUS THE CLEATS AND ANY OTHER REQUIRED HARD WEAR, SOCKS, OVERSHOES AND SHOE LINERS ALL FOR EVERYDAY USE OR SPECIFICALLY DESIGNED FOR SPORTING ACTIVITIES; HEADGEAR, NAMELY HATS, CAPS, BANDANAS, BALACLAVAS, SWEATBANDS, EARWARMERS. (U.S. CLS. 22 AND 39).

GINA FINK, EXAMINING ATTORNEY

SN 78-387,743. GRAND DAME, INC., OCEANSIDE, NY. FILED 3-19-2004.

GRAND DAME

THE MARK CONSISTS OF STANDARD CHARACTERS WITHOUT CLAIM TO ANY PARTICULAR FONT, STYLE, SIZE, OR COLOR.

CLASS 6—METAL GOODS

FOR CURRENCY AND CREDIT CARD HOLDERS CONSISTING PRIMARILY OF NON-PRECIOUS METAL WITH AN ELASTIC BAND (U.S. CLS. 2, 12, 13, 14, 23, 25 AND 50).

CLASS 14—JEWELRY

FOR CURRENCY AND CREDIT CARD HOLDERS CONSISTING PRIMARILY OF PRECIOUS METAL WITH AN ELASTIC BAND (U.S. CLS. 2, 27, 28 AND 50).
TRACY FLETCHER, EXAMINING ATTORNEY

SN 78-388,252. FISK UNIVERSITY, NASHVILLE, TN. FILED 3-22-2004.

FISK JUBILEE SINGERS

THE MARK CONSISTS OF STANDARD CHARACTERS WITHOUT CLAIM TO ANY PARTICULAR FONT, STYLE, SIZE, OR COLOR.

NO CLAIM IS MADE TO THE EXCLUSIVE RIGHT TO USE "JUBILEE SINGERS" AS TO CLASSES 9, 16, AND 41, APART FROM THE MARK AS SHOWN.

SEC. 2(F).

CLASS 9—ELECTRICAL AND SCIENTIFIC APPARATUS

FOR SERIES OF MUSICAL SOUND RECORDINGS INCLUDING PRE-RECORDED COMPACT DISCS AND CASSETTE TAPES, ALL FEATURING PERFORMANCES BY A MUSICAL GROUP AND PRE-RECORDED VIDEOTAPES AND DVDS, ALL FEATURING PERFORMANCES BY A MUSICAL GROUP (U.S. CLS. 21, 23, 26, 36 AND 38).

FIRST USE 10-6-1871; IN COMMERCE 10-6-1871.

CLASS 16—PAPER GOODS AND PRINTED MATTER

SN 78-389,309. LAZ/KARP ASSOCIATES, INC., HARTFORD, CT. FILED 3-23-2004.

FOR PAPER GOODS, NAMELY BOOKS ABOUT A MUSICAL GROUP, BOOKS ABOUT THE SONGS OF MUSICAL GROUP, BROCHURES ABOUT A MUSICAL GROUP, PAMPHLETS ABOUT A MUSICAL GROUP, SOUVENIR PROGRAMS CONCERNING A MUSICAL GROUP OR THE PERFORMANCES OF A MUSICAL GROUP, PRESENTATION FOLDERS, POSTERS, EVENT PROGRAMS, SONG SHEETS IN THE NATURE OF MUSIC SHEETS, STATIONERY FOLDERS, AND STATIONERY (U.S. CLS. 2, 5, 22, 23, 29, 37, 38 AND 50).

FIRST USE 10-6-1871; IN COMMERCE 10-6-1871.

CLASS 25—CLOTHING

FOR CLOTHING, NAMELY CAPS, HATS, JERSEYS, TIES, TOPS, WRAPS, SHIRTS, T-SHIRTS, SWEAT-SHIRTS, SWEATERS, JACKETS, COATS, SCARVES, AND PANTS (U.S. CLS. 22 AND 39).

FIRST USE 10-6-1871; IN COMMERCE 10-6-1871.

CLASS 41—EDUCATION AND ENTERTAINMENT

FOR ENTERTAINMENT IN THE NATURE OF LIVE PERFORMANCES BY A MUSICAL GROUP AND PRESENTATION OF MUSICAL PERFORMANCES (U.S. CLS. 100, 101 AND 107).

FIRST USE 10-6-1871; IN COMMERCE 10-6-1871.
SONYA STEPHENS, EXAMINING ATTORNEY

THE MARK CONSISTS OF STANDARD CHARACTERS WITHOUT CLAIM TO ANY PARTICULAR FONT, STYLE, SIZE, OR COLOR.

CLASS 35—ADVERTISING AND BUSINESS

FOR BUSINESS MANAGEMENT AND CONSULTING SERVICES FOR THE PARKING LOT AND PARKING GARAGE INDUSTRIES; PARKING LOT/GARAGE SERVICES, NAMELY, THE OPERATION AND MANAGEMENT OF PARKING FACILITIES (U.S. CLS. 100, 101 AND 102).

SN 78-389,284. MYTELESCOPE.COM INC., ST. JOHNS, NF, CANADA, FILED 3-23-2004.

CLASS 39—TRANSPORTATION AND STORAGE

FOR LEASING OF PARKING AND GARAGE SPACES (U.S. CLS. 100 AND 105).
KAREN K. BUSH, EXAMINING ATTORNEY

MYTELESCOPE.COM

SN 78-389,690. COMIC RELIEF LIMITED, LONDON, UNITED KINGDOM, FILED 3-24-2004.

THE MARK CONSISTS OF STANDARD CHARACTERS WITHOUT CLAIM TO ANY PARTICULAR FONT, STYLE, SIZE, OR COLOR.

CLASS 9—ELECTRICAL AND SCIENTIFIC APPARATUS

FOR DOWNLOADABLE COMPUTER SOFTWARE NAMELY, SOFTWARE FOR ACCESSING TELESCOPES AND A WORLDWIDE NETWORK OF TELESCOPES VIA A GLOBAL COMPUTER NETWORK (U.S. CLS. 21, 23, 26, 36 AND 38).

FIRST USE 4-5-2000; IN COMMERCE 4-5-2000.

CLASS 42—SCIENTIFIC, COMPUTER AND LEGAL SERVICES

FOR PROVIDING A WEBSITE FEATURING INFORMATION IN THE FIELD OF ASTRONOMY AND ACCESS TO TELESCOPES (U.S. CLS. 100 AND 101).

FIRST USE 4-5-2000; IN COMMERCE 4-5-2000.
SHARON MEIER, EXAMINING ATTORNEY

THE MARK CONSISTS OF STANDARD CHARACTERS WITHOUT CLAIM TO ANY PARTICULAR FONT, STYLE, SIZE, OR COLOR.

NO CLAIM IS MADE TO THE EXCLUSIVE RIGHT TO USE "FUND", APART FROM THE MARK AS SHOWN.

CLASS 36—INSURANCE AND FINANCIAL

FOR CHARITABLE FUND RAISING SERVICES; ADVISORY AND CONSULTING IN THE FIELD OF CHARITABLE FUND RAISING (U.S. CLS. 100, 101 AND 102).

888-WEPARKU

RED NOSE FUND

CLASS 41—EDUCATION AND ENTERTAINMENT

FOR ENTERTAINMENT SERVICES, NAMELY, ORGANIZING INFORMATIVE EXHIBITIONS FOR CHARITABLE PURPOSES TO HIGHLIGHT WORTHY CAUSES; PROVIDING AN ON-GOING TELEVISION VARIETY SHOW DURING WHICH VIEWERS CAN TELEPHONE IN TO PLEDGE DONATIONS TO CHARITY; PRODUCTION AND DISTRIBUTION OF TELEVISION PROGRAMS; PROVISION OF AND CONDUCTING SPORTING EVENTS, NAMELY, ATHLETIC EVENTS, NAMELY, RACES AND EXHIBITIONS OF FOOTBALL, SOCCER, SWIMMING, CRICKET AND MOTOR RACING; ARRANGING AND CONDUCTING ATHLETIC COMPETITIONS; PRODUCTION OF LIVE MUSICAL CONCERTS; MUSIC PRODUCTION SERVICES; ENTERTAINMENT IN THE NATURE OF LIVE MUSICAL CONCERTS; THEATRE PRODUCTIONS; PERSONAL APPEARANCES BY FILM, SPORTS AND MUSIC CELEBRITIES; ORGANIZING COMMUNITY EVENTS AND FESTIVALS FEATURING A VARIETY OF ACTIVITIES, NAMELY, SPORTING EVENTS, EXHIBITIONS, THEATRE PRODUCTIONS, LIVE MUSICAL CONCERTS, FLEA MARKETS, ETHNIC DANCES AND THE LIKE; PRODUCTION OF RADIO AND TELEVISION PROGRAMS; EDUCATIONAL SERVICES IN THE NATURE OF SEMINARS, COURSES, LECTURES AND CONFERENCES AND THE DISSEMINATION OF EDUCATIONAL MATERIALS OF OTHERS, ALL RELATING TO CHARITIES AND CHARITABLE FUNDRAISING AVAILABLE ON OR OFF LINE VIA A COMPUTER NETWORK OR THE INTERNET; ARRANGING AND CONDUCTING EDUCATIONAL CONFERENCES AND SEMINARS ALL RELATING TO CHARITIES AND CHARITABLE FUNDRAISING AVAILABLE ON OR OFF LINE VIA A COMPUTER NETWORK OR THE INTERNET; EDUCATIONAL RESEARCH, NAMELY, COMPILATION OF LESSON PLANS, COURSE MATERIALS, AND CURRICULUM DEVELOPMENT FOR OTHERS, TRAINING TECHNIQUES FOR ELEMENTARY AND SECONDARY SCHOOL TEACHERS AND ADMINISTRATORS ALL RELATING TO CHARITIES AND CHARITABLE FUNDRAISING AVAILABLE ON OR OFF LINE VIA A COMPUTER NETWORK OR THE INTERNET; DEVELOPMENT OF EDUCATIONAL LESSON PLANS FOR OTHERS TEACHING A VARIETY OF SUBJECTS ALL RELATING TO CHARITIES AND CHARITABLE FUNDRAISING AVAILABLE ON OR OFF LINE VIA A COMPUTER NETWORK OR THE INTERNET (U.S. CLS. 100, 101 AND 107).

LOURDES AYALA, EXAMINING ATTORNEY

CLASS 35—ADVERTISING AND BUSINESS

FOR ADVERTISING AND MARKETING SERVICES, NAMELY, DISTRIBUTION AND DISSEMINATION OF ADVERTISING MATERIALS IN THE FORM OF BROCHURES, MARKETING LITERATURE, CATALOGS, AND PRINTED MATTER; DISSEMINATION OF ADVERTISING FOR OTHERS VIA ELECTRONIC PUBLICATIONS OVER THE INTERNET; DATABASE MANAGEMENT OF CUSTOMER INFORMATION FOR USE IN MARKETING (U.S. CLS. 100, 101 AND 102).

FIRST USE 6-1-2002; IN COMMERCE 6-1-2002.

CLASS 40—MATERIAL TREATMENT

FOR ON DEMAND PRINTING SERVICES (U.S. CLS. 100, 103 AND 106).

FIRST USE 6-1-2002; IN COMMERCE 6-1-2002.

ANDREW RHIM, EXAMINING ATTORNEY

SN 78-390,490. GEORGIA-PACIFIC CORPORATION, ATLANTA, GA. FILED 3-25-2004.

Green Guard

SN 78-390,003. SUPERIOR BUSINESS FORMS, INC., KALAMAZOO, MI. FILED 3-24-2004.

SCOPE 1 MARKETING TECHNOLOGIES

THE MARK CONSISTS OF STANDARD CHARACTERS WITHOUT CLAIM TO ANY PARTICULAR FONT, STYLE, SIZE, OR COLOR.

NO CLAIM IS MADE TO THE EXCLUSIVE RIGHT TO USE "MARKETING TECHNOLOGIES", APART FROM THE MARK AS SHOWN.

THE MARK CONSISTS OF STANDARD CHARACTERS WITHOUT CLAIM TO ANY PARTICULAR FONT, STYLE, SIZE, OR COLOR.

OWNER OF U.S. REG. NOS. 1,101,497, 1,275,782 AND OTHERS.

CLASS 16—PAPER GOODS AND PRINTED MATTER

FOR CORRUGATED PAPERBOARD CONTAINERS (U.S. CLS. 2, 5, 22, 23, 29, 37, 38 AND 50).

CLASS 42—SCIENTIFIC, COMPUTER AND LEGAL SERVICES

FOR CONSULTATION SERVICES IN THE FIELD OF CUSTOM PACKAGING DESIGN (U.S. CLS. 100 AND 101).

JOHN DALIER, EXAMINING ATTORNEY

SN 78-392,853. SIGNATURE FRUIT COMPANY, LLC, MODOSTO, CA. FILED 3-29-2004.

SIGNATURE

THE MARK CONSISTS OF STANDARD CHARACTERS WITHOUT CLAIM TO ANY PARTICULAR FONT, STYLE, SIZE, OR COLOR.

CLASS 35—ADVERTISING AND BUSINESS

FOR MERCHANDISE PACKAGING, NAMELY, PACKAGING FRUIT FOR TRANSPORTATION; WHOLESALE DISTRIBUTORSHIPS FEATURING FRUIT (U.S. CLS. 100, 101 AND 102).

FIRST USE 4-3-2001; IN COMMERCE 4-3-2001.

CLASS 40—MATERIAL TREATMENT

FOR FRUIT PROCESSING AND CANNING (U.S. CLS. 100, 103 AND 106).

FIRST USE 4-3-2001; IN COMMERCE 4-3-2001.
BRIAN PINO, EXAMINING ATTORNEY

SN 78-393,794. IROBOT CORPORATION, BURLINGTON, MA. FILED 3-31-2004.

AWARE

THE MARK CONSISTS OF STANDARD CHARACTERS WITHOUT CLAIM TO ANY PARTICULAR FONT, STYLE, SIZE, OR COLOR.

CLASS 7—MACHINERY

FOR INDUSTRIAL ROBOTS FOR USE IN THE FIELDS OF INTERIOR MAINTENANCE OF HOUSEHOLDS AND COMMERCIAL BUILDINGS, AGRICULTURE, MILITARY OPERATIONS, SCIENTIFIC RESEARCH AND EXPLORATION, UNDERWATER EXPLORATION, WASTE DISPOSAL, MINING, TELECOMMUNICATIONS, AEROSPACE, AND SEARCH AND RESCUE (U.S. CLS. 13, 19, 21, 23, 31, 34 AND 35).

CLASS 9—ELECTRICAL AND SCIENTIFIC APPARATUS

FOR REMOTE CONTROLS FOR ROBOTIC MACHINES; INTELLIGENT CHEMICAL, BIOLOGICAL, LASER, ACOUSTIC, AND VISUAL SENSORS; COMPUTER HARDWARE AND SOFTWARE FOR THE CONTROL AND DEVELOPMENT OF ROBOTIC DEVICES (U.S. CLS. 21, 23, 26, 36 AND 38).

CLASS 12—VEHICLES

FOR AUTOMATIC MACHINES FOR USE IN THE FIELDS OF INTERIOR MAINTENANCE OF HOUSEHOLDS AND COMMERCIAL BUILDINGS, AGRICULTURE, MILITARY OPERATIONS, SCIENTIFIC RESEARCH AND EXPLORATION, UNDERWATER EXPLORATION, WASTE DISPOSAL, MINING, TELECOMMUNICATIONS, AEROSPACE, AND SEARCH AND RESCUE, NAMELY, AUTOMATIC GUIDED VEHICLES, ROBOTIC TRANSPORT VEHICLES, AMPHIBIOUS VEHICLES, ALL-TERRAIN VEHICLES, ARMORED VEHICLES, AND REMOTELY CONTROLLED LAND VEHICLES FOR AGRICULTURE, MILITARY OPERATIONS, SCIENTIFIC RESEARCH AND EXPLORATION, WASTE DISPOSAL, MINING, TELECOMMUNICATIONS, AND SEARCH AND RESCUE (U.S. CLS. 19, 21, 23, 31, 35 AND 44).

BRIAN PINO, EXAMINING ATTORNEY

SN 78-395,242. NOGUEIRA, GILBERTO F., PORTO ALEGRE, BRAZIL, FILED 4-2-2004.



CLASS 25—CLOTHING

FOR SURF WEAR, SHIRTS, SWEAT SHIRTS, POLO SHIRTS, SPORT SHIRTS, WIND SHIRTS, T-SHIRTS, PANTS, SWEAT PANTS, SHORTS, BERMUDA SHORTS, GYM SHORTS, WALKING SHORTS, SWEATERS, PULL-OVERS, BEANIES, HATS, CAPS (U.S. CLS. 22 AND 39).

FIRST USE 4-15-1987; IN COMMERCE 8-12-2002.

CLASS 28—TOYS AND SPORTING GOODS

FOR WAKE BOARDS, SURFBOARDS, SURFBOARD LEASHES, SURFBOARD WAX, SURFBOARD COVERS, WAKE BOARD COVERS, SURFBOARD LEASHES, SURFBOARD TAIL PROTECTORS, SURFBOARD NOSE PROTECTORS, WAKE BOARD GRIPS, SURFBOARD GRIPS (U.S. CLS. 22, 23, 38 AND 50).

FIRST USE 4-15-1987; IN COMMERCE 8-12-2002.
KAREN K. BUSH, EXAMINING ATTORNEY

SN 78-397,064. LELAS, TIHOMIR, 10040 ZAGREB, CROATIA, AND LJUBICIC, MIJO, 10585 BERLIN, FED REP GERMANY, FILED 4-6-2004.

NANOPRIME

THE MARK CONSISTS OF STANDARD CHARACTERS WITHOUT CLAIM TO ANY PARTICULAR FONT, STYLE, SIZE, OR COLOR.

CLASS 1—CHEMICALS

FOR CHEMICALS USED IN INDUSTRY, SCIENCE AND PHOTOGRAPHY, AS WELL AS IN AGRICULTURE, HORTICULTURE AND FORESTRY; FERTILIZERS (U.S. CLS. 1, 5, 6, 10, 26 AND 46).

CLASS 3—COSMETICS AND CLEANING PREPARATIONS

FOR BLEACHING PREPARATIONS AND OTHER SUBSTANCES NAMELY DETERGENTS FOR LAUNDRY USE; CLEANING, POLISHING, SCOURING AND ABRASIVE PREPARATIONS; SOAPS, PERFUMERY, ESSENTIAL OILS FOR USE IN PERFUMERY PRODUCTS, COSMETICS, HAIR LOTIONS, DENTIFRICES (U.S. CLS. 1, 4, 6, 50, 51 AND 52).

CLASS 5—PHARMACEUTICALS

FOR MEDICATION FOR THE TREATMENT OF METABOLIC SYNDROME; PHARMACEUTICAL PREPARATIONS FOR THE TREATMENT OF METABOLIC SYNDROME; HEALTH AIDS, NAMELY, VITAMINS FOR METABOLIC SYNDROME; DIETETIC FOODS ADAPTED FOR MEDICAL PURPOSES; FOOD SUPPLEMENTS FOR MEDICAL PURPOSES; DIETETIC FOODS AND FOOD PREPARATIONS, NAMELY, MEAL SUPPLEMENTS; DIETETIC HEALTH AIDS NAMELY, VITAMINS, MINERALS, AND ANABOLIC FOOD SUPPLEMENTS; PLASTERS, MATERIAL FOR DRESSING NAMELY BANDAGES, GAUZES AND BURN AND WOUND DRESSINGS; VITAMIN ENRICHED AND NUTRITIONALLY FORTIFIED FOOD SUPPLEMENTS FOR NON-MEDICAL USE SUBSTANTIALLY OF VITAMINS, AMINO ACIDS, MINERALS, AND TRACE ELEMENTS; VITAMIN-MINERAL AND TRACE-ELEMENT-BASED PREPARATIONS FOR DIETETIC PURPOSES AND AS FOOD SUPPLEMENTS; MINERAL SALTS FOR MEDICAL PURPOSES; BABY FOOD; MATERIAL FOR STOPPING TEETH; DENTAL WAX; ALL PURPOSE DISINFECTANTS FOR MEDICAL USE; PREPARATIONS FOR DESTROYING VERMIN, FUNGICIDES FOR MEDICAL USE (U.S. CLS. 6, 18, 44, 46, 51 AND 52).

CLASS 24—FABRICS

FOR TEXTILES AND TEXTILE GOODS, NAMELY, BED LINEN, BED SHEETS, PILLOW CASES, DUVETS, BLANKETS (U.S. CLS. 42 AND 50).

CLASS 25—CLOTHING

FOR CLOTHING FOR WOMEN, MEN AND CHILDREN NAMELY, SOCKS, UNDERPANTS, UNDERSHIRTS, SHIRTS, T-SHIRTS, POLO SHIRTS, BLOUSES, PANTS, COATS, PAJAMA, HATS, HEAD WEAR, TIES, SHAWLS, SHOES NAMELY, DRESS SHOES, BOOTS, BOOTLETS, HOUSE SHOES, SANDALS, LEISURE CLOTHES NAMELY, SWEAT SUITS, SWEAT SHIRTS, SWEAT PANTS, JOGGING SUITS, SPORTS- JOGGING AND ATHLETIC SHOES (U.S. CLS. 22 AND 39).

CLASS 34—SMOKERS' ARTICLES

FOR TOBACCO, TOBACCO GOODS NAMELY, CIGARS, CIGARETTES, SMOKING TOBACCO, CHEWING TOBACCO, SNUFF, CIGARETTE PAPER, CIGARETTE HOLDERS WITH AND WITHOUT FILTER NOT OF PRECIOUS METAL, CIGARETTE FILTERS (U.S. CLS. 2, 8, 9 AND 17).

GRETTA YAO, EXAMINING ATTORNEY

SN 78-397,240. DELTA STATE UNIVERSITY, CLEVELAND, MS. FILED 4-6-2004.

DSU

THE MARK CONSISTS OF STANDARD CHARACTERS WITHOUT CLAIM TO ANY PARTICULAR FONT, STYLE, SIZE, OR COLOR.

CLASS 16—PAPER GOODS AND PRINTED MATTER

FOR PAPER GOODS AND PRINTED MATTER, NAMELY, WIRE BOUND NOTEBOOKS, BUMPER STICKERS, BINDERS, WINDOW STICKERS, STATIONERY (U.S. CLS. 2, 5, 22, 23, 29, 37, 38 AND 50).

FIRST USE 12-31-1980; IN COMMERCE 12-31-1980.

CLASS 25—CLOTHING

FOR CLOTHING, NAMELY, T-SHIRTS, SWEATSHIRTS, SWEAT PANTS, JOGGING SUITS, SHORTS, HATS, CLOTH BIBS, HOODED SWEATSHIRTS, RUGBY SHIRTS, POLO SHIRTS (U.S. CLS. 22 AND 39).

FIRST USE 12-31-1980; IN COMMERCE 12-31-1980.

CLASS 41—EDUCATION AND ENTERTAINMENT

FOR EDUCATIONAL SERVICES, NAMELY, PROVIDING COURSES OF STUDY AT UNIVERSITY UNDERGRADUATE AND GRADUATE LEVELS, CONDUCTING COMMUNITY AND DISTANCE LEARNING INSTRUCTION AT THE SECONDARY COLLEGE AND GRADUATE LEVELS AND CONTINUING EDUCATION COURSES; ARRANGING INDEPENDENT STUDY PROGRAMS, PUBLIC LECTURES, WORKSHOPS, FINE ARTS EVENTS, REMEDIAL ASSISTANCE PROGRAMS, SEMINARS, CONFERENCES, AND CHILDREN AND TEENAGE SUMMER ACADEMIC CAMPS; AND ENTERTAINMENT SERVICES, NAMELY, INTERCOLLEGIATE SPORTS CONTESTS AND EXHIBITIONS IN THE NATURE OF FOOTBALL, SOFTBALL, SWIMMING AND GOLF (U.S. CLS. 100, 101 AND 107).

FIRST USE 12-31-1980; IN COMMERCE 12-31-1980.
BRIDGETT SMITH, EXAMINING ATTORNEY

SN 78-397,539. AQUA-LEISURE INDUSTRIES, INC., AVON, MA. FILED 4-7-2004.

WATER GET INTO IT!

SN 78-397,246. DELTA STATE UNIVERSITY, CLEVELAND, MS. FILED 4-6-2004.

**DELTA STATE
UNIVERSITY**

THE MARK CONSISTS OF STANDARD CHARACTERS WITHOUT CLAIM TO ANY PARTICULAR FONT, STYLE, SIZE, OR COLOR.

NO CLAIM IS MADE TO THE EXCLUSIVE RIGHT TO USE "STATE UNIVERSITY", APART FROM THE MARK AS SHOWN.

CLASS 16—PAPER GOODS AND PRINTED MATTER

FOR PAPERGOODS AND PRINTED MATTER, NAMELY, WIRE BOUND NOTEBOOKS, BUMPER STICKERS, BINDERS, WINDOW STICKERS, STATIONERY (U.S. CLS. 2, 5, 22, 23, 29, 37, 38 AND 50).

FIRST USE 12-31-1980; IN COMMERCE 12-31-1980.

CLASS 25—CLOTHING

FOR CLOTHING, NAMELY, T-SHIRTS, SWEATSHIRTS, SWEAT PANTS, JOGGING SUITS, SHORTS, HATS, CLOTH BIBS, HOODED SWEATSHIRTS, RUGBY SHIRTS, POLO SHIRTS (U.S. CLS. 22 AND 39).

FIRST USE 12-31-1980; IN COMMERCE 12-31-1980.

CLASS 41—EDUCATION AND ENTERTAINMENT

FOR EDUCATIONAL SERVICES, NAMELY, EDUCATING AT UNIVERSITY UNDERGRADUATE, GRADUATE, EXTENSION, CONTINUING AND COMMUNITY EDUCATION, ARRANGING OF INDEPENDENT STUDY PROGRAMS, PUBLIC LECTURES, WORKSHOPS, FINE ARTS EVENTS, REMEDIAL ASSISTANCE PROGRAMS, SEMINARS, CONFERENCES, AND CHILDREN AND TEENAGE SUMMER ACADEMIC CAMPS AND ENTERTAINMENT SERVICES, NAMELY, INTERCOLLEGIATE SPORTS CONTESTS AND EXHIBITIONS IN THE NATURE OF FOOTBALL, SOFTBALL, SWIMMING AND GOLF (U.S. CLS. 100, 101 AND 107).

FIRST USE 12-31-1980; IN COMMERCE 12-31-1980.
STEVEN JACKSON, EXAMINING ATTORNEY

THE MARK CONSISTS OF STANDARD CHARACTERS WITHOUT CLAIM TO ANY PARTICULAR FONT, STYLE, SIZE, OR COLOR.

CLASS 9—ELECTRICAL AND SCIENTIFIC APPARATUS

FOR SWIMMING PRODUCTS, NAMELY, MASKS, GOGGLES, FINS, SNORKELS, EYE AND NOSE GUARDS, AND EAR PLUGS FOR RECREATIONAL USE; RECREATIONAL SNOW PRODUCTS, NAMELY, GOGGLES AND SAFETY VESTS; SUN PROTECTIVE ACCESSORIES, NAMELY, ULTRA-VIOLET DETECTORS; SWIMMING POOL THERMOMETERS (U.S. CLS. 21, 23, 26, 36 AND 38).

FIRST USE 7-1-2001; IN COMMERCE 7-1-2001.

CLASS 28—TOYS AND SPORTING GOODS

FOR RECREATIONAL PRODUCTS, NAMELY, INFLATABLE SWIMMING POOLS FOR RECREATIONAL USE; BEACH AND SWIMMING POOL GAMES FOR RECREATIONAL USE, NAMELY, INFLATABLE FLOATING WATER BOARD, RING TOSS, HOCKEY, VOLLEYBALL, BASEBALL, POLO, AND BASKETBALL GAMES; BEACH AND SWIMMING TOYS FOR RECREATIONAL USE OUTSIDE OF THE WATER, WITHIN AND ABOVE THE WATER, AND WITHIN AND BELOW THE WATER, NAMELY, RING TOSS, UNDERWATER GLIDERS, SKIMMERS, AND DISKS; INFLATABLE FLOATATION DEVICES FOR RECREATIONAL USE IN A WATER ENVIRONMENT SUCH AS BEACHES AND SWIMMING POOLS; INFLATABLE AND NON-INFLATABLE BEACH AND POOL TOYS FOR RECREATIONAL USE, NAMELY; SOFT FOAM WATER ANIMALS IN VARIOUS SHAPES FOR USE BY CHILDREN, WATER SOAKING TOYS; SWIMMING AIDS, NAMELY, INFLATABLE ARM FLOATS AND VESTS TO AID IN TEACHING SWIMMING; BABY PLAY MATS; PLAY SWIMMING POOLS HAVING A CANOPY TOP; EXERCISE EQUIPMENT FOR USE IN WATER TO PROMOTE TONING, STRENGTH AND AEROBIC CONDITIONING, NAMELY, KICK BOARDS, ATTACHABLE HAND AND LEG RESISTANCE SPHERES, AND ATTACHABLE HAND AND LEG RESISTANCE PADDLES; INFLATABLE PLAY AREAS; RECREATIONAL SNOW PRODUCTS, NAMELY, INFLATABLE SNOW TUBES AND SLEDS, INFLATABLE CLUB HOUSES; INDOOR AND OUTDOOR GOLF PITCHING GAME FOR RECREATIONAL USE (U.S. CLS. 22, 23, 38 AND 50).

FIRST USE 7-1-2001; IN COMMERCE 7-1-2001.

DOMINIC J. FERRAIUOLO, EXAMINING ATTORNEY

SN 78-398,646. DALISA, ANTHONY E., DEER PARK, NY.
FILED 4-8-2004.

SN 78-400,042. FERRARI S.P.A., 41100 MODENA, ITALY,
FILED 4-12-2004.

BOOTYFUL

F430

THE MARK CONSISTS OF STANDARD CHARACTERS WITHOUT CLAIM TO ANY PARTICULAR FONT, STYLE, SIZE, OR COLOR.

PRIORITY CLAIMED UNDER SEC. 44(D) ON ITALY APPLICATION NO. TO2004C00087, FILED 3-22-2004, REG. NO. 00930032, DATED 5-21-2004, EXPIRES 3-22-2014.

CLASS 3—COSMETICS AND CLEANING PREPARATIONS

FOR FRAGRANCES (U.S. CLS. 1, 4, 6, 50, 51 AND 52).

CLASS 12—VEHICLES

FOR LAND MOTOR VEHICLES, NAMELY, AUTOMOBILES AND SPORT CARS, STRUCTURAL AND REPLACEMENT PARTS THEREOF; BRAKES, ENGINES AND TIRES FOR LAND MOTOR VEHICLES; BICYCLES, MOTORCYCLES, VANS, TRUCKS (U.S. CLS. 19, 21, 23, 31, 35 AND 44).

CLASS 16—PAPER GOODS AND PRINTED MATTER

FOR MAGAZINES IN THE FIELD OF FEMALE MODELS, POSING (U.S. CLS. 2, 5, 22, 23, 29, 37, 38 AND 50).

SHARI SHEFFIELD, EXAMINING ATTORNEY

CLASS 28—TOYS AND SPORTING GOODS

FOR TOYS AND PLAYTHINGS, NAMELY MODEL CARS FOR SALE IN AN ASSEMBLY KIT FORM, TOY MODEL VEHICLES, TOY COLLECTION MODELS REPRESENTING AUTOMOBILES AND OTHER VEHICLES, MODULAR STRUCTURES CONSTRUCTION TOYS AND CONNECTING LINKS THEREFOR, TOY CONSTRUCTION BLOCKS KITS, DOLLS, DOLLS' CLOTHING, ACCESSORIES FOR DOLLS, SOFT FELT TOYS, TOY VEHICLE TRACKS, TOY REAL-SIZE NON OPERATING REPLICAS OF AUTOMOBILES FOR ORNAMENT, ENTERTAINMENT AND EXHIBITION PURPOSES, GAME PUZZLES, HAND HELD VIDEO GAMES, TENNIS BAGS, GOLF BAGS, GOLF POUCHES, GOLF CLUBS, PLAYING CARDS (U.S. CLS. 22, 23, 38 AND 50).

MARK RADEMACHER, EXAMINING ATTORNEY

SN 78-399,350. NO FEAR, INC., CARLSBAD, CA. FILED 4-9-2004.

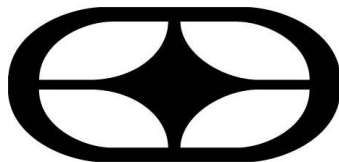

OWNER OF U.S. REG. NO. 2,446,306.

SN 78-400,239. T. GRAND INTERNATIONAL CO. LTD., SAN CHUNG CITY, TAIPEI HSIEN, TAIWAN, FILED 4-12-2004.

CLASS 9—ELECTRICAL AND SCIENTIFIC APPARATUS

FOR SPORTING GOODS AND SPORTING EQUIPMENT, NAMELY, PROTECTIVE GEAR FOR BMX, MOTOCROSS AND BICYCLING, NAMELY, PROTECTIVE RIDING GLOVES, PROTECTIVE RIDING PANTS, PROTECTIVE RIDING JERSEYS, PROTECTIVE RIDING JACKETS, GOGGLES AND HELMETS (U.S. CLS. 21, 23, 26, 36 AND 38).

FIRST USE 10-1-1997; IN COMMERCE 10-1-1997.

ROSA

CLASS 28—TOYS AND SPORTING GOODS

FOR SPORTING GOODS AND SPORTING EQUIPMENT, NAMELY, CHEST PROTECTORS, KNEE GUARDS, KIDNEY BELTS AND SUPPORT BELTS, BAGS SPECIALLY ADAPTED FOR SPORTS EQUIPMENT FOR RIDING GEAR FOR BMX, MOTOCROSS AND BICYCLES; FACE MASKS, AND SAFETY PADDING FOR BMX, MOTOCROSS AND BICYCLE RIDERS (U.S. CLS. 22, 23, 38 AND 50).

FIRST USE 10-1-1997; IN COMMERCE 10-1-1997.
TARAH HARDY, EXAMINING ATTORNEY

THE MARK CONSISTS OF STANDARD CHARACTERS WITHOUT CLAIM TO ANY PARTICULAR FONT, STYLE, SIZE, OR COLOR.

CLASS 30—STAPLE FOODS

FOR BEVERAGES, NAMELY, TEA AND COFFEE (U.S. CL. 46).
FIRST USE 3-1-1987; IN COMMERCE 3-1-1987.

CLASS 32—LIGHT BEVERAGES

FOR BEVERAGES, NAMELY FRUIT DRINKS AND JUICES, ENERGY DRINKS, SPORTS DRINKS, FLAVORED WATERS, MINERAL AND AERATED WATERS, SOFT DRINKS; SYRUPS, CONCENTRATES AND POWDERS USED IN THE PREPARATION OF FLAVORED WATERS, MINERAL AND AERATED WATERS, SOFT DRINKS, ENERGY DRINKS, AND SPORTS DRINKS (U.S. CLS. 45, 46 AND 48).

FIRST USE 3-1-1987; IN COMMERCE 3-1-1987.
WINSTON FOLMAR, EXAMINING ATTORNEY

SN 78-401,096. CLIENTS FIRST BUSINESS SOLUTIONS, LLC, SHORT HILLS, NJ. FILED 4-13-2004.



NO CLAIM IS MADE TO THE EXCLUSIVE RIGHT TO USE "BUSINESS SOLUTIONS", APART FROM THE MARK AS SHOWN.

THE MARK CONSISTS OF OF THE WORDS CLIENTS FIRST WHICH THE WORDS BUSINESS SOLUTIONS UNDERNEATH. ON THE LEFT SIDE OF THE WORDING ARE TWO LINES WITH A DOT OVER THE LINES IN A STYLIZED FORM.

CLASS 37—CONSTRUCTION AND REPAIR

FOR INSTALLATION OF COMPUTER HARDWARE, NAMELY, SERVERS, NETWORKS, WORKSTATIONS, PRINTERS, SCANNERS, OPERATING SYSTEMS, BRIDGES AND ROUTERS (U.S. CLS. 100, 103 AND 106).
FIRST USE 3-3-2004; IN COMMERCE 3-3-2004.

SN 78-400,785. LOVE ME OR LEAVE ME, LLC, WINTER GARDEN, FL. FILED 4-13-2004.

CLASS 41—EDUCATION AND ENTERTAINMENT

FOR EDUCATIONAL SERVICES NAMELY, TRAINING IN THE FIELD OF COMPUTER SOFTWARE (U.S. CLS. 100, 101 AND 107).
FIRST USE 3-3-2004; IN COMMERCE 3-3-2004.

CLASS 42—SCIENTIFIC, COMPUTER AND LEGAL SERVICES

FOR COMPUTER SOFTWARE CONSULTATION; INSTALLATION OF COMPUTER SOFTWARE; TECHNICAL SUPPORT SERVICES, NAMELY TROUBLESHOOTING OF COMPUTER HARDWARE AND SOFTWARE PROBLEMS (U.S. CLS. 100 AND 101).
FIRST USE 3-3-2004; IN COMMERCE 3-3-2004.
REBECCA SMITH, EXAMINING ATTORNEY

Tierney Allen

SN 78-401,691. NEXTEST SYSTEMS CORPORATION, SAN JOSE, CA. FILED 4-14-2004.

THE MARK CONSISTS OF STANDARD CHARACTERS WITHOUT CLAIM TO ANY PARTICULAR FONT, STYLE, SIZE, OR COLOR.

"TIERNEY ALLEN" IDENTIFIES A LIVING INDIVIDUAL WHOSE CONSENT IS OF RECORD.

CLASS 9—ELECTRICAL AND SCIENTIFIC APPARATUS

FOR PRE-RECORDED COMPACT DISCS, AUDIO CASSETTES AND VIDEO CASSETTES FEATURING MUSIC (U.S. CLS. 21, 23, 26, 36 AND 38).
FIRST USE 1-1-1997; IN COMMERCE 1-1-1997.

NEXTEST

CLASS 41—EDUCATION AND ENTERTAINMENT

FOR ENTERTAINMENT SERVICES IN THE NATURE OF LIVE PERFORMANCES BY AN INDIVIDUAL AND/OR MUSICAL GROUP (U.S. CLS. 100, 101 AND 107).
FIRST USE 1-1-1997; IN COMMERCE 1-1-1997.
RICHARD WHITE, EXAMINING ATTORNEY

THE MARK CONSISTS OF STANDARD CHARACTERS WITHOUT CLAIM TO ANY PARTICULAR FONT, STYLE, SIZE, OR COLOR.

CLASS 41—EDUCATION AND ENTERTAINMENT

FOR TRAINING SERVICES IN THE FIELDS OF CIRCUIT BOARD CABLES, BASE BOARDS, SOCKET CARDS AND AUTOMATIC TEST EQUIPMENT FOR SEMICONDUCTORS (U.S. CLS. 100, 101 AND 107).

FIRST USE 11-0-1997; IN COMMERCE 11-0-1997.

CLASS 42—SCIENTIFIC, COMPUTER AND LEGAL SERVICES

FOR ENGINEERING SERVICES, CONSULTING SERVICES, AND TECHNICAL SUPPORT SERVICES IN THE FIELDS OF CIRCUIT BOARD CABLES, BASE BOARDS, SOCKET CARDS AND AUTOMATIC TEST EQUIPMENT FOR SEMICONDUCTORS (U.S. CLS. 100 AND 101).

FIRST USE 11-0-1997; IN COMMERCE 11-0-1997.

MICHAEL HALL, EXAMINING ATTORNEY

SN 78-402,234. THE FIRST MARBLEHEAD CORPORATION, BOSTON, MA. FILED 4-15-2004.



THE MARK CONSISTS OF A SERIES OF SQUARES OF VARYING SIZES ARRANGED TO FORM THE SHAPE OF A DIAMOND AND THE TERM FIRSTMARBLEHEAD. SEC. 2(F).

CLASS 35—ADVERTISING AND BUSINESS

FOR ADVERTISING, MARKETING, AND COORDINATION OF STUDENT LOAN PROGRAMS FOR SCHOOLS, COLLEGES AND UNIVERSITIES (U.S. CLS. 100, 101 AND 102).

FIRST USE 0-0-1997; IN COMMERCE 0-0-1997.

CLASS 36—INSURANCE AND FINANCIAL

FOR STUDENT LOAN FINANCING SERVICES (U.S. CLS. 100, 101 AND 102).

FIRST USE 0-0-1997; IN COMMERCE 0-0-1997.

KATHRYN COWARD, EXAMINING ATTORNEY

SN 78-402,896. HERITAGE PRESERVATION CORPORATION, SPARTANBURG, SC. FILED 4-16-2004.



OWNER OF U.S. REG. NOS. 1,315,738 AND 1,337,313. THE MARK CONSISTS OF INDIAN HEAD DESIGN.

CLASS 7—MACHINERY

FOR DOCUMENT HANDLING EQUIPMENT, NAMELY, DECOLLATORS, FOLDERS, DETACHERS, BURSTERS, FORM SIGNERS AND FORM IMPRINTERS (U.S. CLS. 13, 19, 21, 23, 31, 34 AND 35).

CLASS 9—ELECTRICAL AND SCIENTIFIC APPARATUS

FOR COMPUTER SOFTWARE FOR USE IN BAR CODING AND BAR CODE DATA COLLECTION; COMPUTER HARDWARE, NAMELY, PRINT HEADS AND SCANNERS; MAGNETICALLY ENCODED DEBIT AND IDENTIFICATION CARDS, AND ENCODED ELECTRONIC CHIP CARDS CONTAINING PROGRAMMING USED FOR DEBIT AND CREDIT CARD FINANCIAL TRANSACTIONS, DEBIT AND CREDIT CARD ACCESS SECURITY, FACILITY ACCESS SECURITY, INFORMATION SYSTEMS ACCESS SECURITY; AND DATABASE MANAGEMENT COMPUTER SOFTWARE (U.S. CLS. 21, 23, 26, 36 AND 38).

CLASS 16—PAPER GOODS AND PRINTED MATTER

FOR LABEL PRINTING MACHINES, BUSINESS FORMS AND PAPER LABELS; COMPUTER SUPPLIES, NAMELY, PAPER LABELS, PAPER TAGS AND COMPUTER PRINTER RIBBONS (U.S. CLS. 2, 5, 22, 23, 29, 37, 38 AND 50).

CLASS 35—ADVERTISING AND BUSINESS

FOR DIRECT MAIL CONSULTING SERVICES; MAILING SERVICES, NAMELY, MAIL PLANNING, SORTING AND ADVERTISING MAIL DISTRIBUTION SERVICES; COMMERCIAL AND SPECIALTY PRINTING PROJECT MANAGEMENT SERVICES ON OR OFF-SITE FOR OTHERS; BUSINESS INFORMATION MANAGEMENT; COMPUTERIZED DATABASE MANAGEMENT SERVICES INCLUDING DIRECT MAIL; BUSINESS MAILING LIST MANAGEMENT; BUSINESS SERVICES, NAMELY, FACILITIES MANAGEMENT OF TECHNICAL OPERATIONS; PACKAGING PRINTED MATERIALS TO THE ORDER AND SPECIFICATION OF OTHERS; MANAGEMENT SERVICES RELATED TO CUSTOMER RETURNS OF MERCHANDISE; BUSINESS CONSULTATION IN THE FIELD OF DIGITAL ASSET MANAGEMENT AND MANAGEMENT OF PRINTED AND ELECTRONIC MATERIALS; PREPARING AUDIO-VISUAL PRESENTATIONS FOR USE IN ADVERTISING; ON-LINE BUSINESS MARKETING CONSULTING SERVICES, NAMELY, DEVELOPING ON-LINE MARKETING STRATEGY FOR OTHERS; PLANNING AND SCHEDULING OF SHIPMENT OF ORDERS FOR OTHERS; TELEMARKETING SERVICES; CONSULTING AND MANAGEMENT SERVICES IN THE FIELD OF INVENTORY CONTROL; LOGISTICS MANAGEMENT AND FULFILLMENT SERVICES IN THE FIELD OF PRINTING AND ELECTRONIC PRINTING; RETAIL SERVICES BY DIRECT SOLICITATION BY SALES AGENTS, ONLINE ORDERING, AND ELECTRONIC RETAILING IN THE FIELD OF ANTI-THEFT AND SOURCE IDENTIFICATION TAGS AND LABELS, INVENTORY CONTROL COMPUTER SOFTWARE, AND COMPUTER HARDWARE AND SUPPLIES (U.S. CLS. 100, 101 AND 102).

CLASS 36—INSURANCE AND FINANCIAL

FOR BUSINESS INFORMATION BROKERAGE SERVICES (U.S. CLS. 100, 101 AND 102).

CLASS 37—CONSTRUCTION AND REPAIR

FOR INSTALLATION AND MAINTENANCE SERVICES, NAMELY, BAR CODING AND DOCUMENT HANDLING EQUIPMENT IN THE FIELD OF INVENTORY CONTROL AND WAREHOUSING (U.S. CLS. 100, 103 AND 106).

CLASS 38—COMMUNICATION

FOR BUSINESS COMMUNICATION SERVICES, NAMELY, TRANSMISSION OF INFORMATION BY DATA COMMUNICATIONS FOR PUBLISHING SERVICES; AND ELECTRONIC TRANSMISSION OF TEXT, PHOTOS, ILLUSTRATIONS AND SCHEMATICS (U.S. CLS. 100, 101 AND 104).

CLASS 39—TRANSPORTATION AND STORAGE

FOR PLANNING, MAILING AND SHIPPING SERVICES, NAMELY, THE DELIVERY OF GOODS BY TRUCK, SHIP, AIRPLANE AND RAIL; AND CONSULTING AND MANAGEMENT SERVICES IN THE FIELD OF WAREHOUSING (U.S. CLS. 100 AND 105).

CLASS 40—MATERIAL TREATMENT

FOR DOCUMENT DATA TRANSFER AND PHYSICAL CONVERSION SERVICES FROM ONE MEDIA TO ANOTHER; BINDING OF PRINTED PUBLICATIONS; DIE CUTTING AND SPECIALTY FINISHING OF PRINTED MATERIALS; PHYSICAL CONVERSION OF PRINTED TEXT, PHOTOS, ILLUSTRATIONS, AND SCHEMATICS INTO DIGITAL FORM; CUSTOM MANUFACTURE OF PRINTED AND ELECTRONIC PUBLICATIONS; ASSEMBLY OF PRINTED AND ELECTRONIC MATERIALS FOR OTHERS; PHYSICAL DOCUMENT CONVERSION FROM ELECTRONIC TO PRINTED FORMAT FOR OTHERS; PHYSICAL INFORMATION CONVERSION TO DIGITAL ON-LINE DATABASES FOR OTHERS; PHOTOENGRAVING, ROTOGRAVURE AND PHOTOGRAVURE WORK SERVICES; PHOTOCOMPOSITION SERVICES; PRINTING SERVICES; DIGITAL IMAGING SERVICES; PRINTING OF CATALOGS, BROCHURES, BOOKS, MAGAZINES, FINANCIAL SERVICES DOCUMENTATION, NEWSPAPER INSERTS, RETAIL INSERTS, AD CIRCULARS, DIRECTORIES, BUYERS' GUIDES, AND PROMOTIONS; LITHOGRAPHIC PRINTING AND TYPESETTING; AND CUSTOM MANUFACTURE OF PRINTED AND PARTIALLY PRINTED DEBIT AND TRANSACTION CARDS, AND PRINTED AND PARTIALLY PRINTED CARDS FOR IDENTIFYING INDIVIDUALS WITH AND WITHOUT ELECTRONIC DATA BAR CODE LABEL PRINTING SERVICES (U.S. CLS. 100, 103 AND 106).

CLASS 41—EDUCATION AND ENTERTAINMENT

FOR DIGITAL AND FILM PHOTOGRAPHY SERVICES; PUBLICATION OF PRINTED AND ELECTRONIC MATERIALS, NAMELY, CATALOGS, BROCHURES, BOOKS, MAGAZINES, FINANCIAL SERVICES DOCUMENTATION, NEWSPAPER INSERTS, RETAIL INSERTS, AD CIRCULARS, DIRECTORIES, BUYERS' GUIDES AND PROMOTIONS; LANGUAGE TRANSLATIONS OF TECHNICAL AND CONSUMER INFORMATION; EDITORIAL CONSULTATION; ADVERTISING COPY WRITING SERVICES; TRAINING SERVICES IN THE FIELD OF INVENTORY CONTROL AND WAREHOUSING; AND WRITTEN TEXT EDITING (U.S. CLS. 100, 101 AND 107).

CLASS 42—SCIENTIFIC, COMPUTER AND LEGAL SERVICES

FOR GRAPHIC ART, LAYOUT AND PRINT DESIGN SERVICES; DATABASE DEVELOPMENT SERVICES; COMPUTER SERVICES, NAMELY, DESIGNING AND IMPLEMENTING WEB SITES FOR OTHERS; CUSTOM DESIGN OF PRINTED AND ELECTRONIC BUSINESS FORMS; TESTING IN THE FIELD OF INVENTORY CONTROL AND WAREHOUSING; PROTOTYPE DEVELOPMENT AND PROTOTYPE DESIGN OF PRODUCT PACKAGING FOR OTHERS; AND ELECTRONIC FILING OF PUBLIC SECURITIES DOCUMENTS FOR OTHERS (U.S. CLS. 100 AND 101).

VIVIAN MICZNIK FIRST, EXAMINING ATTORNEY

SN 78-403,059. THOUSAND TRAILS, L.P., FRISCO, TX.
FILED 4-16-2004.

GETAWAY CLUB

THE MARK CONSISTS OF STANDARD CHARACTERS WITHOUT CLAIM TO ANY PARTICULAR FONT, STYLE, SIZE, OR COLOR.

NO CLAIM IS MADE TO THE EXCLUSIVE RIGHT TO USE GETAWAY, APART FROM THE MARK AS SHOWN.

CLASS 41—EDUCATION AND ENTERTAINMENT

FOR PROVIDING FACILITIES FOR RECREATION ACTIVITIES; RECREATIONAL SERVICES IN THE NATURE OF HORSEBACK RIDING, GAMES, TENNIS, BOATING, FISHING, HIKING; RECREATIONAL CAMPS (U.S. CLS. 100, 101 AND 107).

CLASS 43—HOTEL AND RESTAURANT SERVICES

FOR PROVIDING CAMPGROUND FACILITIES; PROVIDING LODGING WITH POOLS; TRAVEL AGENCY SERVICES, NAMELY, MAKING RESERVATIONS AND BOOKING FOR TEMPORARY LODGING (U.S. CLS. 100 AND 101).

DEZMONA MIZELLE, EXAMINING ATTORNEY

SN 78-403,064. THOUSAND TRAILS, L.P., FRISCO, TX.
FILED 4-16-2004.

VIP GETAWAY CLUB

THE MARK CONSISTS OF STANDARD CHARACTERS WITHOUT CLAIM TO ANY PARTICULAR FONT, STYLE, SIZE, OR COLOR.

NO CLAIM IS MADE TO THE EXCLUSIVE RIGHT TO USE VIP GETAWAY, APART FROM THE MARK AS SHOWN.

CLASS 41—EDUCATION AND ENTERTAINMENT

FOR PROVIDING FACILITIES FOR RECREATION ACTIVITIES; RECREATIONAL SERVICES IN THE NATURE OF HORSEBACK RIDING, GAMES, TENNIS, BOATING, FISHING, HIKING; RECREATIONAL CAMPS (U.S. CLS. 100, 101 AND 107).

CLASS 43—HOTEL AND RESTAURANT SERVICES

FOR PROVIDING CAMPGROUND FACILITIES; PROVIDING LODGING WITH POOLS, TRAVEL AGENCY SERVICES, NAMELY, MAKING RESERVATIONS AND BOOKING FOR TEMPORARY LODGING (U.S. CLS. 100 AND 101).

DEZMONA MIZELLE, EXAMINING ATTORNEY

SN 78-403,084. AMERICAN COLLEGE OF NURSE-MIDWIVES INC., SILVER SPRING, MD. FILED 4-16-2004.

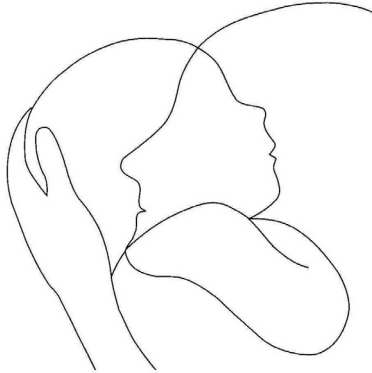

OWNER OF U.S. REG. NO. 2,216,973.
THE MARK CONSISTS OF AN IMAGE OF A WOMAN HOLDING A CHILD.

CLASS 14—JEWELRY

FOR JEWELRY; PINS BEING JEWELRY; LAPEL PINS; ORNAMENTAL PINS FOR USE ON CLOTHING; NECKLACES; PENDANTS; EARRINGS; AND TIARAS (U.S. CLS. 2, 27, 28 AND 50).
FIRST USE 0-0-1990; IN COMMERCE 0-0-1990.

CLASS 16—PAPER GOODS AND PRINTED MATTER

FOR PRINTED MATTER, NAMELY BROCHURES, PUBLICATIONS IN THE NATURE OF JOURNALS, TRAINING MANUALS, HANDBOOKS, INSTRUCTIONAL MANUALS, GUIDES, BOOKS, MANUALS, AND INSTRUCTIONAL AND EDUCATIONAL MATERIALS IN THE FIELDS OF BUSINESS MANAGEMENT, HEALTH CARE, MIDWIFERY SERVICES, AND SUBJECT MATTER OF INTEREST TO WOMEN'S HEALTH CARE PROVIDERS OR THEIR CLIENTELE, NAMELY, SUBJECT MATTER INVOLVING WOMEN'S HEALTH, MEDICAL CARE, CHILD BIRTH AND CHILD CARE (U.S. CLS. 2, 5, 22, 23, 29, 37, 38 AND 50).
FIRST USE 0-0-1979; IN COMMERCE 0-0-1979.

CLASS 35—ADVERTISING AND BUSINESS

FOR ASSOCIATION SERVICES, NAMELY, PROMOTING THE INTERESTS OF NURSE-MIDWIVES AND WOMEN'S HEALTH CARE PROVIDERS (U.S. CLS. 100, 101 AND 102).
FIRST USE 2-0-1983; IN COMMERCE 2-0-1983.

CLASS 41—EDUCATION AND ENTERTAINMENT

FOR EDUCATIONAL SERVICES, NAMELY, PROVIDING SEMINARS AND TRAINING COURSES FEATURING SUBJECT MATTER OF INTEREST TO WOMEN'S HEALTH CARE PROVIDERS, NAMELY, CHILD BIRTH, PRENATAL CARE, WOMEN'S HEALTH, MEDICAL CARE, AND MANAGEMENT AND OPERATIONS OF A MIDWIFERY PRACTICE AND RELATED MEDICAL PRACTICE IN THE FIELD OF WOMEN'S HEALTH CARE; PROVIDING EDUCATIONAL SEMINARS, COURSES OF INSTRUCTION AT THE POST-GRADUATE LEVEL, AND EDUCATIONAL TESTING IN THE FIELD OF NURSE-MIDWIFERY AND RELATED MEDICAL PRACTICE IN THE FIELD OF WOMEN'S HEALTH CARE, AND DISTRIBUTING COURSE MATERIALS IN CONNECTION THEREWITH (U.S. CLS. 100, 101 AND 107).
FIRST USE 2-0-1983; IN COMMERCE 2-0-1983.
LANA PHAM, EXAMINING ATTORNEY

SN 78-403,093. GENERAL ELECTRIC CAPITAL CORPORATION, STAMFORD, CT. FILED 4-16-2004.

TOTAL IMAGE MANAGEMENT

THE MARK CONSISTS OF STANDARD CHARACTERS WITHOUT CLAIM TO ANY PARTICULAR FONT, STYLE, SIZE, OR COLOR.

OWNER OF U.S. REG. NO. 1,933,894.
NO CLAIM IS MADE TO THE EXCLUSIVE RIGHT TO USE "MANAGEMENT", APART FROM THE MARK AS SHOWN.

CLASS 35—ADVERTISING AND BUSINESS

FOR LEASING OF OFFICE EQUIPMENT, NAMELY, PHOTOCOPIERS, SCANNERS, PRINTERS AND FACSIMILE MACHINES (U.S. CLS. 100, 101 AND 102).

CLASS 36—INSURANCE AND FINANCIAL

FOR FINANCING OF OFFICE EQUIPMENT, NAMELY, PHOTOCOPIERS, SCANNERS, PRINTERS AND FACSIMILE MACHINES (U.S. CLS. 100, 101 AND 102).
BRIDGETT SMITH, EXAMINING ATTORNEY

SN 78-403,220. BENCHMARK PERFORMANCE GROUP, INC., HOUSTON, TX. FILED 4-16-2004.

SlurryService

THE MARK CONSISTS OF STANDARD CHARACTERS WITHOUT CLAIM TO ANY PARTICULAR FONT, STYLE, SIZE, OR COLOR.

CLASS 37—CONSTRUCTION AND REPAIR

FOR INSTALLATION SERVICES, NAMELY, THE TURN-KEY FABRICATION AND INSTALLATION OF TANKS, CONTAINMENT SYSTEMS, PUMPS, MIXERS AND OTHER EQUIPMENT NECESSARY FOR THE ON-SITE STORAGE OF POLYMER SLURRIES AT OILFIELD SERVICES AND PRESSURE PUMPING COMPANIES (U.S. CLS. 100, 103 AND 106).
FIRST USE 2-0-1998; IN COMMERCE 2-0-1998.

CLASS 39—TRANSPORTATION AND STORAGE

FOR DELIVERY AND RE-SUPPLY OF POLYMER SLURRIES TO OILFIELD SERVICES AND PRESSURE PUMPING COMPANIES (U.S. CLS. 100 AND 105).

FIRST USE 2-0-1998; IN COMMERCE 2-0-1998.
DAVID MURRAY, EXAMINING ATTORNEY

CLASS 38—COMMUNICATION

FOR RADIO BROADCASTING SERVICES; TERRESTRIAL RADIO BROADCASTING; WEBCASTING; WEBCASTING TRANSMISSIONS TO WIRELESS COMMUNICATIONS DEVICES (U.S. CLS. 100, 101 AND 104).

FIRST USE 4-1-2004; IN COMMERCE 4-1-2004.

CLASS 41—EDUCATION AND ENTERTAINMENT

FOR PRODUCTION OF RADIO PROGRAMS (U.S. CLS. 100, 101 AND 107).

FIRST USE 4-1-2004; IN COMMERCE 4-1-2004.
LA TONIA FISHER, EXAMINING ATTORNEY

SN 78-403,239. BENCHMARK PERFORMANCE GROUP, INC., HOUSTON, TX. FILED 4-16-2004.

**CHEMICAL SERVICES
- CHEMICAL
SOLUTIONS**

SN 78-404,012. LYDIAN, LLC, JOHNSTON, IA. FILED 4-19-2004.

THE MARK CONSISTS OF STANDARD CHARACTERS WITHOUT CLAIM TO ANY PARTICULAR FONT, STYLE, SIZE, OR COLOR.

CLASS 35—ADVERTISING AND BUSINESS

FOR DISTRIBUTORSHIP SERVICES FEATURING COMMODITY AND SPECIALTY CHEMICALS AND COMPOUNDS FOR OILFIELD AND INDUSTRIAL USES AND APPLICATIONS (U.S. CLS. 100, 101 AND 102).

FIRST USE 7-0-1996; IN COMMERCE 7-0-1996.

**LEADING WITH
INSIGHT**

CLASS 40—MATERIAL TREATMENT

FOR MANUFACTURE OF COMMODITY AND SPECIALTY CHEMICALS AND COMPOUNDS FOR OILFIELD AND INDUSTRIAL USES AND APPLICATIONS TO THE ORDER OR SPECIFICATION OF OTHERS (U.S. CLS. 100, 103 AND 106).

FIRST USE 7-0-1996; IN COMMERCE 7-0-1996.
CATHERINE CAIN, EXAMINING ATTORNEY

THE MARK CONSISTS OF STANDARD CHARACTERS WITHOUT CLAIM TO ANY PARTICULAR FONT, STYLE, SIZE, OR COLOR.

SN 78-403,513. FIRST BROADCASTING INVESTMENT PARTNERS, LLC, DALLAS, TX. FILED 4-16-2004.

CLASS 16—PAPER GOODS AND PRINTED MATTER

FOR PRINTED MATERIAL, NAMELY, BOOKS, PAMPHLETS AND BROCHURES IN THE FIELD OF LEADERSHIP TRAINING (U.S. CLS. 2, 5, 22, 23, 29, 37, 38 AND 50).

FLASHRADIO

CLASS 35—ADVERTISING AND BUSINESS

FOR BUSINESS CONSULTATION IN THE FIELD OF LEADERSHIP; BUSINESS APPRAISALS AND ASSESSMENTS IN BUSINESS LEADERSHIP MATTERS (U.S. CLS. 100, 101 AND 102).

CLASS 41—EDUCATION AND ENTERTAINMENT

FOR EDUCATIONAL SERVICES, NAMELY, CONDUCTING WORKSHOPS IN THE FIELD OF LEADERSHIP TRAINING (U.S. CLS. 100, 101 AND 107).

JOHN GARTNER, EXAMINING ATTORNEY

THE MARK CONSISTS OF STANDARD CHARACTERS WITHOUT CLAIM TO ANY PARTICULAR FONT, STYLE, SIZE, OR COLOR.

SN 78-404,983. ODWALLA, INC., HALF MOON BAY, CA.
FILED 4-20-2004.

SN 78-408,536. SOUTHWEST AG, INC., BAYFIELD, CO.
FILED 4-27-2004.

BERRIES GOMEGA



THE MARK CONSISTS OF STANDARD CHARACTERS WITHOUT CLAIM TO ANY PARTICULAR FONT, STYLE, SIZE, OR COLOR.

NO CLAIM IS MADE TO THE EXCLUSIVE RIGHT TO USE "BERRIES", APART FROM THE MARK AS SHOWN.

CLASS 29—MEATS AND PROCESSED FOODS

FOR READY TO EAT FOOD BARS MADE PRIMARILY OF FRUITS AND CONTAINING GROUND FLAX AND OATS (U.S. CL. 46).

CLASS 30—STAPLE FOODS

FOR READY TO EAT FOOD BARS MADE PRIMARILY OF OATS AND GROUND FLAX AND CONTAINING FRUIT (U.S. CL. 46).

TONJA GASKINS, EXAMINING ATTORNEY

NO CLAIM IS MADE TO THE EXCLUSIVE RIGHT TO USE ESTABLISHED 1982 AND INC., APART FROM THE MARK AS SHOWN.

CLASS 35—ADVERTISING AND BUSINESS

FOR RETAIL STORE SERVICES IN THE FIELD OF TRACTORS, AGRICULTURAL AND EXCAVATION EQUIPMENT, IMPLEMENTS AND PARTS (U.S. CLS. 100, 101 AND 102).

FIRST USE 8-15-2003; IN COMMERCE 8-15-2003.

CLASS 37—CONSTRUCTION AND REPAIR

FOR REPAIR SERVICES AND RENTAL SERVICES IN THE FIELD OF TRACTORS, AGRICULTURAL AND EXCAVATION EQUIPMENT AND IMPLEMENTS (U.S. CLS. 100, 103 AND 106).

FIRST USE 8-15-2003; IN COMMERCE 8-15-2003.

CHRISTOPHER ADKINS, EXAMINING ATTORNEY

SN 78-405,635. MSC CORPORATION, NASHUA, NH. FILED
4-21-2004.

SN 78-408,843. DAIMLERCHRYSLER CORPORATION, AUBURN HILLS, MI. FILED 4-27-2004.



THE MARK CONSISTS OF THE WORD ONE WHERE THE O IS A GOLF BALL WITH FLAMES COMING FROM THE LEFT HAND SIDE, FOLLOWED BY THE PHRASE THAT'S ALL

CLASS 25—CLOTHING

FOR FOOTWEAR; CLOTHING, NAMELY CAPS, GLOVES, HATS, JACKETS, PANTS, RAINWEAR, SHIRTS, SHORTS, SOCKS, SWEATERS, SWEATSHIRTS, T-SHIRTS, VESTS, VISORS (U.S. CLS. 22 AND 39).

CLASS 28—TOYS AND SPORTING GOODS

FOR GOLF BALLS, GOLF CLUBS, GOLF TEES, GOLF BALL MARKERS, GOLF DIVOT REPAIR TOOLS, GOLF CLUB HEAD COVERS, GOLF BAG TAGS (U.S. CLS. 22, 23, 38 AND 50).

JASON TURNER, EXAMINING ATTORNEY



NO CLAIM IS MADE TO THE EXCLUSIVE RIGHT TO USE "TIRE" AND "TIRE INSTALLATION & REPAIR EXCELLENCE", APART FROM THE MARK AS SHOWN.

CLASS 35—ADVERTISING AND BUSINESS

FOR RETAIL STORE SERVICES IN THE FIELD OF MOTOR VEHICLE TIRES (U.S. CLS. 100, 101 AND 102).

FIRST USE 2-21-2003; IN COMMERCE 2-21-2003.

CLASS 37—CONSTRUCTION AND REPAIR

FOR MOTOR VEHICLE TIRE REPAIR AND INSTALLATION OF TIRES FOR MOTOR VEHICLES (U.S. CLS. 100, 103 AND 106).

FIRST USE 2-21-2003; IN COMMERCE 2-21-2003.

RAMONA ORTIGA, EXAMINING ATTORNEY

SN 78-409,326. CARR, DANIEL B., CHESTNUT HILL, MA.
FILED 4-28-2004.

**CLOSING ANALGESIC
GAPS**

THE MARK CONSISTS OF STANDARD CHARACTERS WITHOUT CLAIM TO ANY PARTICULAR FONT, STYLE, SIZE, OR COLOR.

NO CLAIM IS MADE TO THE EXCLUSIVE RIGHT TO USE "ANALGESIC", APART FROM THE MARK AS SHOWN.

CLASS 5—PHARMACEUTICALS

FOR ANALGESICS (U.S. CLS. 6, 18, 44, 46, 51 AND 52).

CLASS 10—MEDICAL APPARATUS

FOR DRUG DELIVERY DEVICES, NAMELY TRANS-DERMAL APPLICATORS, INTRAVENOUS APPLICATORS, SUBCUTANEOUS APPLICATORS, ORAL APPLICATORS, INHALERS, TRANSMUCOSAL, AND RECTAL APPLICATORS (U.S. CLS. 26, 39 AND 44).
RON FAIRBANKS, EXAMINING ATTORNEY

SN 78-409,749. THOUSAND TRAILS, L.P., FRISCO, TX.
FILED 4-28-2004.



NO CLAIM IS MADE TO THE EXCLUSIVE RIGHT TO USE VIP GETAWAY, APART FROM THE MARK AS SHOWN.

THE MARK CONSISTS OF A CROWN AND RIBBON DESIGN AND VIP GETAWAY CLUB.

CLASS 41—EDUCATION AND ENTERTAINMENT

FOR PROVIDING FACILITIES FOR RECREATION ACTIVITIES; RECREATIONAL SERVICES IN THE NATURE OF HORSEBACK RIDING, GAMES, TENNIS, BOATING, FISHING, HIKING; RECREATIONAL CAMPS (U.S. CLS. 100, 101 AND 107).

CLASS 43—HOTEL AND RESTAURANT SERVICES

FOR PROVIDING CAMPGROUND FACILITIES; PROVIDING LODGING WITH POOLS; TRAVEL AGENCY SERVICES, NAMELY, MAKING RESERVATIONS AND BOOKING FOR TEMPORARY LODGING (U.S. CLS. 100 AND 101).

DEZMONA MIZELLE, EXAMINING ATTORNEY

SN 78-409,755. THOUSAND TRAILS, L.P., FRISCO, TX.
FILED 4-28-2004.



NO CLAIM IS MADE TO THE EXCLUSIVE RIGHT TO USE GETAWAY, APART FROM THE MARK AS SHOWN. THE MARK CONSISTS OF AN EAGLE HEAD AND WINGS ABOVE THE WORDS GETAWAY CLUB.

CLASS 41—EDUCATION AND ENTERTAINMENT

FOR PROVIDING FACILITIES FOR RECREATION ACTIVITIES; RECREATIONAL SERVICES IN THE NATURE OF HORSEBACK RIDING, GAMES, TENNIS, BOATING, FISHING, HIKING; RECREATIONAL CAMPS (U.S. CLS. 100, 101 AND 107).

CLASS 43—HOTEL AND RESTAURANT SERVICES

FOR PROVIDING CAMPGROUND FACILITIES; PROVIDING LODGING WITH POOLS; TRAVEL AGENCY SERVICES, NAMELY, MAKING RESERVATIONS AND BOOKING FOR TEMPORARY LODGING (U.S. CLS. 100 AND 101).

DEZMONA MIZELLE, EXAMINING ATTORNEY

SN 78-409,879. ALEXANDRIA REAL ESTATE EQUITIES, INC., PASADENA, CA. FILED 4-28-2004.

**ALEXANDRIA =
LABSPACE**

THE MARK CONSISTS OF STANDARD CHARACTERS WITHOUT CLAIM TO ANY PARTICULAR FONT, STYLE, SIZE, OR COLOR.

OWNER OF U.S. REG. NOS. 2,300,322, 2,865,403 AND OTHERS.

CLASS 35—ADVERTISING AND BUSINESS

FOR BUSINESS ADMINISTRATION SERVICES; BUSINESS CONSULTING SERVICES; BUSINESS INCUBATOR SERVICES, NAMELY BUSINESS MARKETING, BUSINESS MANAGEMENT, AND BUSINESS DEVELOPMENT SERVICES IN THE FORM OF START-UP SUPPORT FOR BUSINESSES OF OTHERS; PROPERTY MANAGEMENT, NAMELY RENTAL AND LEASING OF OFFICE MACHINERY AND EQUIPMENT (U.S. CLS. 100, 101 AND 102).

CLASS 36—INSURANCE AND FINANCIAL

FOR REAL ESTATE SERVICES, NAMELY REAL ESTATE BROKERAGE, ACQUISITION, RENTAL, LEASING AND MANAGEMENT SERVICES; ASSET MANAGEMENT SERVICES; FINANCIAL SERVICES, NAMELY FINANCIAL CONSULTATION, FINANCIAL ANALYSIS, FINANCIAL PLANNING, FINANCIAL MANAGEMENT, FINANCING SERVICES, PROVIDING DEBT AND EQUITY CAPITAL, TANGIBLE AND INTANGIBLE ASSET FINANCING, AND FINANCIAL PORTFOLIO MANAGEMENT; BUSINESS INCUBATOR SERVICES, NAMELY PROVIDING DEBT AND EQUITY FINANCING TO EMERGING AND START-UP COMPANIES (U.S. CLS. 100, 101 AND 102).

CLASS 37—CONSTRUCTION AND REPAIR

FOR REAL ESTATE DEVELOPMENT SERVICES, NAMELY DEVELOPMENT, MAINTENANCE AND REPAIR OF RESEARCH AND LABORATORY PROPERTIES; BUILDING CONSTRUCTION AND REPAIR SERVICES; REAL ESTATE MAINTENANCE (U.S. CLS. 100, 103 AND 106).

CLASS 39—TRANSPORTATION AND STORAGE

FOR RENTAL OF WAREHOUSE SPACE (U.S. CLS. 100 AND 105).

CLASS 42—SCIENTIFIC, COMPUTER AND LEGAL SERVICES

FOR ARCHITECTURAL AND ARCHITECTURAL DESIGN SERVICES; ENGINEERING SERVICES; PROPERTY MANAGEMENT, NAMELY RENTAL AND LEASING OF COMPUTERS (U.S. CLS. 100 AND 101).
MICHAEL HALL, EXAMINING ATTORNEY

SN 78-410,577. NCO HOLDINGS, INC., HORSHAM, PA.
FILED 4-29-2004.



THE MARK CONSISTS OF A FOUR POINTED GEOMETRIC SHAPE WITH THE WORDS NCOEFORWARDEASE TO THE RIGHT.

CLASS 9—ELECTRICAL AND SCIENTIFIC APPARATUS

FOR COMPUTER SOFTWARE FOR USE IN DATABASE MANAGEMENT AND SHARING AND PROCESSING OF DATA AND INFORMATION IN CONNECTION WITH DEBT RECOVERY AND COLLECTION AGENCY SERVICES, DEBT RECOVERY AND COLLECTION AGENCY SERVICES PROVIDED VIA A WEB SITE, ACCOUNTS RECEIVABLE COLLECTION SERVICES RENDERED TO THE LEGAL PROFESSION (U.S. CLS. 21, 23, 26, 36 AND 38).

CLASS 35—ADVERTISING AND BUSINESS

FOR ACCOUNTS RECEIVABLE COLLECTION SERVICES RENDERED TO THE LEGAL PROFESSION (U.S. CLS. 100, 101 AND 102).

CLASS 36—INSURANCE AND FINANCIAL

FOR DEBT RECOVERY AND COLLECTION AGENCY SERVICES; DEBT RECOVERY AND COLLECTION AGENCY SERVICES PROVIDED VIA A WEB SITE (U.S. CLS. 100, 101 AND 102).
LEIGH CAROLINE CASE, EXAMINING ATTORNEY

SN 78-410,663. VOLUME SERVICES AMERICA, INC., SPARTANBURG, SC. FILED 4-29-2004.

TORTILLA JUNCTION

THE MARK CONSISTS OF STANDARD CHARACTERS WITHOUT CLAIM TO ANY PARTICULAR FONT, STYLE, SIZE, OR COLOR.

NO CLAIM IS MADE TO THE EXCLUSIVE RIGHT TO USE TORTILLA, APART FROM THE MARK AS SHOWN.

CLASS 35—ADVERTISING AND BUSINESS

FOR CONCESSION STANDS, RETAIL KIOSKS AND ROVING VENDOR SERVICES FEATURING FOODS, BEVERAGES, SOUVENIRS, NOVELTIES AND/OR SUNDRIES (U.S. CLS. 100, 101 AND 102).

FIRST USE 8-1-2004; IN COMMERCE 8-1-2004.

CLASS 43—HOTEL AND RESTAURANT SERVICES

FOR CATERING, FOOD PREPARATION, CONTRACT FOOD SERVICES AND PROVIDING FOODS AND BEVERAGES IN CAFETERIAS, SPORTS STADIUMS, ARENAS, CONVENTION CENTERS, CARRY OUT RESTAURANTS, RESTAURANTS, BARS AND LOUNGES (U.S. CLS. 100 AND 101).

FIRST USE 8-1-2004; IN COMMERCE 8-1-2004.
JOHN E. MICHOS, EXAMINING ATTORNEY

SN 78-411,117. MINTEL INTERNATIONAL GROUP LIMITED, LONDON, UNITED KINGDOM, FILED 4-30-2004.

MINTEL

THE MARK CONSISTS OF STANDARD CHARACTERS WITHOUT CLAIM TO ANY PARTICULAR FONT, STYLE, SIZE, OR COLOR.

OWNER OF UNITED KINGDOM REG. NO. 2158663, DATED 12-18-1998, EXPIRES 2-19-2008.

OWNER OF UNITED KINGDOM REG. NO. 1405167, DATED 4-18-1997, EXPIRES 10-27-2006.

OWNER OF UNITED KINGDOM REG. NO. 1405166, DATED 5-23-1997, EXPIRES 10-27-2006.

OWNER OF UNITED KINGDOM REG. NO. 2111165, DATED 12-17-1999, EXPIRES 9-25-2006.

OWNER OF U.S. REG. NO. 1,421,039.

CLASS 9—ELECTRICAL AND SCIENTIFIC APPARATUS

FOR DOWNLOADABLE ELECTRONIC PUBLICATIONS, NAMELY RESEARCH REPORTS IN THE FIELDS OF BUSINESS NEWS, MARKET RESEARCH AND THE MARKETING AND ADVERTISING CAMPAIGNS OF OTHERS; AND CD-ROMS FEATURING INSURANCE AND PENSION RESEARCH INFORMATION IN THE NATURE OF REPORTING, EVALUATION AND ANALYSIS OF THE INSURANCE AND PENSION MARKETS IN VARIED SECTORS, INCLUDING REPORTING, EVALUATION AND ANALYSIS OF NEW AND EXISTING INSURANCE AND PENSION FINANCIAL PRODUCTS (U.S. CLS. 21, 23, 26, 36 AND 38).

CLASS 35—ADVERTISING AND BUSINESS

FOR PROVIDING ON-LINE MARKET RESEARCH AND INFORMATION, NAMELY PROVIDING CONSUMER AND BUSINESS SECTOR PRINT ADVERTISING AND DIRECT MAIL CAMPAIGN INFORMATION AT OR BEFORE THE TIME OF DISTRIBUTION OF SUCH ADVERTISING AND CAMPAIGN MATERIAL, IN A SEARCHABLE DATABASE ON A GLOBAL COMPUTER NETWORK, PROVIDING MARKETING RESEARCH AND ANALYSIS SERVICES, AND PROVIDING AN ON-LINE SEARCHABLE DATABASE FOR THE PURPOSE OF MONITORING COMPETITORS' ADVERTISING AND MARKETING CAMPAIGNS IN A VARIETY OF MEDIA AND TO AID IN THE DESIGNING OF EFFECTIVE ADVERTISING AND MARKETING PROMOTION CAMPAIGNS (U.S. CLS. 100, 101 AND 102).

CLASS 36—INSURANCE AND FINANCIAL

FOR FINANCIAL INFORMATION SERVICES PROVIDED BY ELECTRONIC MEANS; AND FINANCIAL RESEARCH; INSURANCE AND PENSION INFORMATION SERVICES, NAMELY REPORTING, EVALUATION AND ANALYSIS OF THE INSURANCE AND PENSION MARKETS IN VARIED SECTORS, INCLUDING REPORTING, EVALUATION AND ANALYSIS OF NEW AND EXISTING INSURANCE AND PENSION FINANCIAL PRODUCTS; PROVIDING ON-LINE INSURANCE AND PENSION RESEARCH, NAMELY REPORTING, EVALUATION AND ANALYSIS OF THE INSURANCE AND PENSION MARKETS IN VARIED SECTORS, INCLUDING REPORTING, EVALUATION AND ANALYSIS OF NEW AND EXISTING INSURANCE AND PENSION FINANCIAL PRODUCTS; AND PROVIDING A WEB SITE FEATURING INSURANCE AND PENSION RESEARCH (U.S. CLS. 100, 101 AND 102).

ALICE BENMAMAN, EXAMINING ATTORNEY

SN 78-411,372. POLYSCIENCES, INC., WARRINGTON, PA, FILED 4-30-2004.

**CHEMISTRY BEYOND
THE ORDINARY**

THE MARK CONSISTS OF STANDARD CHARACTERS WITHOUT CLAIM TO ANY PARTICULAR FONT, STYLE, SIZE, OR COLOR.

CLASS 1—CHEMICALS

FOR CHEMICALS FOR USE IN INDUSTRY AND SCIENCE, NAMELY, BUFFER AND STANDARD SOLUTIONS USED IN ANALYTICAL CHEMISTRY; DIAGNOSTIC PREPARATIONS AND REAGENTS FOR SCIENTIFIC OR RESEARCH USE AND REAGENTS FOR CHEMICAL OR BIOLOGICAL ANALYSIS; REAGENTS FOR TESTING OF CONCENTRATION OR PRESENCE OF PHARMACEUTICALS; COPOLYMER AND POLYMER BEADS FOR USE IN RESEARCH AND THE MANUFACTURE OF COMMERCIAL AND INDUSTRIAL GOODS; MONOMERS FOR USE IN THE SYNTHESIS AND MANUFACTURE OF POLYMERS, OPTICAL LENSES, DIAGNOSTIC ASSAYS, COATINGS, ADHESIVES, AND FABRICATION OF ELECTRONIC DEVICES; POLYMERS FOR THE MANUFACTURE OF COATINGS FOR CIRCUITRY PROTECTION AND CIRCUITRY DURABILITY, ADHESIVES AND ELECTRONIC DEVICES; BIOCHEMICALS, NAMELY, MONOCLONAL ANTIBODIES FOR IN VITRO SCIENTIFIC OR RESEARCH USE; CHEMICAL SOURCE MATERIAL FOR THE DEPOSITION OF THIN FILMS UPON SEMICONDUCTOR WAFERS FOR THE MANUFACTURE OF SEMICONDUCTORS; SOLVENT TYPE PROCESSING CHEMICALS FOR USE IN THE ELECTRONICS INDUSTRY (U.S. CLS. 1, 5, 6, 10, 26 AND 46).

FIRST USE 4-19-2004; IN COMMERCE 4-19-2004.

CLASS 2—PAINTS

FOR SYNTHETIC DYES FOR HISTOLOGY, SCIENTIFIC OR RESEARCH USE (U.S. CLS. 6, 11 AND 16).

FIRST USE 4-19-2004; IN COMMERCE 4-19-2004.
BILL DAWE, EXAMINING ATTORNEY

SN 78-412,306. UNIVERSITY OF GEORGIA ATHLETIC ASSOCIATION, INC., ATHENS, GA. FILED 5-3-2004.



THE MARK CONSISTS OF A FROWNING BULLDOG HEAD WITH A STUDDED COLLAR .

CLASS 14—JEWELRY

FOR JEWELRY, WATCHES, PRECIOUS METALS, AND PRECIOUS STONES (U.S. CLS. 2, 27, 28 AND 50).
FIRST USE 1-31-1999; IN COMMERCE 1-31-1999.

CLASS 16—PAPER GOODS AND PRINTED MATTER

FOR PRINTED BOOKLETS, NEWSLETTERS, CATALOGS, AND BROCHURES FEATURING INFORMATION OF INTEREST TO STUDENTS, FACULTY, AND ALUMNI OF THE UNIVERSITY OF GEORGIA; DECALS; TEMPORARY TATTOOS; NOTE PAPER; NOTEBOOKS; DECORATIVE PAPER FLAGS; PAPER BANNERS; AND PAPER FOLDERS (U.S. CLS. 2, 5, 22, 23, 29, 37, 38 AND 50).
FIRST USE 1-31-1999; IN COMMERCE 1-31-1999.

CLASS 25—CLOTHING

FOR CLOTHING, NAMELY BOXER SHORTS, CAPS, COATS, FOOTWEAR, HATS, JACKETS, JERSEYS, PANTS, RAINWEAR, SHIRTS, SHOES, SOCKS, SHORTS, SWEATPANTS, SWEATSHIRTS, SWEAT SUITS, SWEATERS, T-SHIRTS, TIES, VISORS, AND INFANT WEAR IN THE NATURE OF SHIRTS, PANTS, SHORTS, CLOTH BIBS, SOCKS, AND PAJAMAS (U.S. CLS. 22 AND 39).
FIRST USE 1-31-1999; IN COMMERCE 1-31-1999.

CLASS 28—TOYS AND SPORTING GOODS

FOR TOYS, GAMES, AND SPORTING GOODS, NAMELY BOARD GAMES, STUFFED TOY ANIMALS, FOOTBALLS, BASKETBALLS, SOCCER BALLS, BASEBALLS, GOLF BALLS, GOLF BAGS, AND GOLF ACCESSORIES, NAMELY GOLF CLUB COVERS, GOLF CLUB HEAD COVERS, DIVOT REPAIR TOOLS, GOLF ACCESSORY POUCHES, GOLF BAG COVERS, GOLF BAG TAGS, GOLF BALL MARKERS, GOLF BALL RETRIEVERS, GOLF BALL SLEEVES, GOLF CLUB GRIPS, GOLF CLUB HEADS, GOLF CLUB INSERTS, GOLF CLUB SHAFTS, GOLF GLOVES, GOLF PUTTER COVERS, GOLF PUTTERS, GOLF TEE MARKERS, GOLF TEES, AND GOLF TOWEL CLIPS FOR ATTACHMENT TO GOLF BAGS; AND CHRISTMAS TREE ORNAMENTS (U.S. CLS. 22, 23, 38 AND 50).
FIRST USE 1-31-1999; IN COMMERCE 1-31-1999.

CLASS 41—EDUCATION AND ENTERTAINMENT

FOR EDUCATION SERVICES, NAMELY PROVIDING COURSES OF INSTRUCTION AT THE COLLEGE LEVEL, AND ENTERTAINMENT SERVICES, NAMELY ORGANIZING AND CONDUCTING COLLEGIATE SPORTING EVENTS (U.S. CLS. 100, 101 AND 107).
FIRST USE 1-31-1999; IN COMMERCE 1-31-1999.
WON TEAK OH, EXAMINING ATTORNEY

SN 78-412,478. OREGON NATURAL RESOURCES COUNCIL FUND, DBA OREGON NATURAL RESOURCES COUNCIL, AND DBA ONRC, PORTLAND, OR. FILED 5-3-2004.

OREGON WILD

THE MARK CONSISTS OF STANDARD CHARACTERS WITHOUT CLAIM TO ANY PARTICULAR FONT, STYLE, SIZE, OR COLOR.

NO CLAIM IS MADE TO THE EXCLUSIVE RIGHT TO USE "OREGON", APART FROM THE MARK AS SHOWN.

CLASS 35—ADVERTISING AND BUSINESS

FOR LOBBYING SERVICES, CONDUCTING LETTER-WRITING CAMPAIGNS, EMAIL CAMPAIGNS AND ORGANIZING POLITICAL DEMONSTRATIONS AND COALITIONS AMONG OTHER ORGANIZATIONS ALL IN THE FIELD OF ENVIRONMENTAL PROTECTION, NATURAL RESOURCES, WATER SOURCES, RIVERS, FORESTS, AND CONSERVATION (U.S. CLS. 100, 101 AND 102).
FIRST USE 12-0-1997; IN COMMERCE 12-0-1997.

CLASS 41—EDUCATION AND ENTERTAINMENT

FOR EDUCATIONAL SERVICES, NAMELY CONDUCTING CONFERENCES, PROGRAMS, SEMINARS AND TRAININGS IN THE FIELDS OF THE ENVIRONMENTAL PROTECTION, NATURAL RESOURCES, WATER SOURCES, RIVERS, FORESTS, AND CONSERVATION; ORGANIZING EXHIBITIONS, PHOTO CONTESTS; PUBLICATION OF BOOKS, TEXTS, AND MAPS IN ANY MEDIUM, INCLUDING IN PRINTED MEDIA, IN ELECTRONIC FORM, AND FOR DISTRIBUTION ON THE INTERNET; ALL IN THE FIELDS OF THE ENVIRONMENTAL PROTECTION, NATURAL RESOURCES, WATER SOURCES, RIVERS, FORESTS, AND CONSERVATION (U.S. CLS. 100, 101 AND 107).
FIRST USE 12-0-1997; IN COMMERCE 12-0-1997.
JOHN HWANG, EXAMINING ATTORNEY

SN 78-412,483. MINDERCE.COM, AURORA, CO. FILED 5-3-2004.

MINDERCE

THE MARK CONSISTS OF STANDARD CHARACTERS WITHOUT CLAIM TO ANY PARTICULAR FONT, STYLE, SIZE, OR COLOR.

CLASS 9—ELECTRICAL AND SCIENTIFIC APPARATUS

FOR VIDEO AND SOUND RECORDINGS FEATURING SELF-HELP, SELF IMPROVEMENT SEMINAR PRESENTATIONS ON MENTAL HEALTH TOPICS SUCH AS MEMORY IMPROVEMENT, PROCRASTINATION, DEPRESSION, WEIGHT LOSS, RETIREMENT (U.S. CLS. 21, 23, 26, 36 AND 38).

FIRST USE 5-6-1988; IN COMMERCE 5-6-1988.

CLASS 16—PAPER GOODS AND PRINTED MATTER

FOR BOOKS IN THE FIELD OF MENTAL HEALTH TOPICS SUCH AS MEMORY IMPROVEMENT, PROCRASTINATION, DEPRESSION, WEIGHT LOSS, RETIREMENT (U.S. CLS. 2, 5, 22, 23, 29, 37, 38 AND 50).

FIRST USE 5-6-1988; IN COMMERCE 5-6-1988.

CLASS 41—EDUCATION AND ENTERTAINMENT

FOR EDUCATIONAL SERVICES NAMELY CONDUCTING SELF-HELP/SELF IMPROVEMENT MENTAL HEALTH SEMINARS ON MEMORY IMPROVEMENT, PROCRASTINATION, WEIGHT LOSS, RETIREMENT, DEPRESSION (U.S. CLS. 100, 101 AND 107).

FIRST USE 5-6-1988; IN COMMERCE 5-6-1988.

JOHN HWANG, EXAMINING ATTORNEY

SN 78-412,701. TAESOO CREATIVE STUDIO, INC., FOUNTAIN VALLEY, CA. FILED 5-4-2004.

Teri Tori

THE MARK CONSISTS OF STANDARD CHARACTERS WITHOUT CLAIM TO ANY PARTICULAR FONT, STYLE, SIZE, OR COLOR.

CLASS 16—PAPER GOODS AND PRINTED MATTER

FOR PAPER GOODS AND PRINTED MATERIALS, NAMELY STATIONERY, STICKERS (U.S. CLS. 2, 5, 22, 23, 29, 37, 38 AND 50).

CLASS 28—TOYS AND SPORTING GOODS

FOR TOYS AND SPORTING GOODS, NAMELY FABRIC AND PLASTIC DOLLS, STUFFED ANIMAL (U.S. CLS. 22, 23, 38 AND 50).

TANYA AMOS, EXAMINING ATTORNEY

SN 78-412,723. BIOCEPT, INC., SAN DIEGO, CA. FILED 5-4-2004.

BIOCEPT LABORATORIES

THE MARK CONSISTS OF STANDARD CHARACTERS WITHOUT CLAIM TO ANY PARTICULAR FONT, STYLE, SIZE, OR COLOR.

OWNER OF U.S. REG. NO. 2,880,222.

NO CLAIM IS MADE TO THE EXCLUSIVE RIGHT TO USE LABORATORIES, APART FROM THE MARK AS SHOWN.

CLASS 9—ELECTRICAL AND SCIENTIFIC APPARATUS

FOR SCIENTIFIC EQUIPMENT, NAMELY, MICROTITERS, MULTI-WELL PLATES, BIOSENSORS, MICROARRAYS, BIOCHIPS, AND APPARATUS FOR BIOASSAY ANALYSIS, OPTICAL READERS, SCANNERS AND DETECTORS USED IN THE SCREENING AND ANALYSIS OF BIOLOGICAL SAMPLES FOR SCIENTIFIC, MEDICAL AND CLINICAL RESEARCH USE (U.S. CLS. 21, 23, 26, 36 AND 38).

CLASS 42—SCIENTIFIC, COMPUTER AND LEGAL SERVICES

FOR CLINICAL AND MEDICAL DIAGNOSTIC SCIENCE SERVICES IN THE FIELD OF SCIENTIFIC EQUIPMENT, NAMELY, MICROTITERS, MULTI-WELL PLATES, BIOSENSORS, MICROARRAYS, BIOCHIPS, AND APPARATUS FOR BIOASSAY ANALYSIS, OPTICAL READERS, SCANNERS AND DETECTORS USED IN THE SCREENING AND ANALYSIS OF BIOLOGICAL SAMPLES; AND DIAGNOSTIC SCREENING IN THE FIELD OF DRUG RESEARCH AND DEVELOPMENT (U.S. CLS. 100 AND 101).

STEVEN JACKSON, EXAMINING ATTORNEY

SN 78-412,935. DUQUESNE UNIVERSITY OF THE HOLY GHOST, PITTSBURGH, PA. FILED 5-4-2004.



THE MARK CONSISTS OF A REPRESENTATION OF A MASCOT GENERALLY IN THE FORM OF A MAN WEARING A HAT AND A UNIQUELY CONFIGURED SUIT.

CLASS 25—CLOTHING

FOR CLOTHING; NAMELY; SWEATSHIRTS; CREW SHIRTS; T-SHIRTS AND HATS (U.S. CLS. 22 AND 39).
FIRST USE 1-18-2003; IN COMMERCE 4-21-2004.

CLASS 41—EDUCATION AND ENTERTAINMENT

FOR ENTERTAINMENT SERVICES IN THE NATURE OF PRESENTATIONS AND PERFORMANCES BY A UNIVERSITY MASCOT WEARING A COSTUME (U.S. CLS. 100, 101 AND 107).

FIRST USE 1-18-2003; IN COMMERCE 4-21-2004.
ELIZABETH PIGNATELLO, EXAMINING ATTORNEY

SN 78-413,002. SOCIETY FOR THE PRESERVATION OF NEW ENGLAND ANTIQUITIES, BOSTON, MA. FILED 5-4-2004.



CLASS 37—CONSTRUCTION AND REPAIR

FOR CONSULTING AND ADVISING IN THE FIELD OF HISTORIC PRESERVATION AND RESTORATION OF HISTORICAL PROPERTIES, ART AND ANTIQUES (U.S. CLS. 100, 103 AND 106).

FIRST USE 6-30-1996; IN COMMERCE 6-30-1996.

CLASS 41—EDUCATION AND ENTERTAINMENT

FOR MUSEUM SERVICES; PROVIDING GUIDED TOURS OF HISTORIC PROPERTIES; EDUCATIONAL SERVICES, NAMELY CONDUCTING LECTURES, SEMINARS, WORKSHOPS AND FAIRS IN THE FIELDS OF NEW ENGLAND LIFE, HISTORIC PRESERVATION AND RESTORATION OF HISTORICAL PROPERTIES, ART AND ANTIQUES; PROVIDING AFTER SCHOOL INSTRUCTION IN THE FIELDS OF NEW ENGLAND LIFE, HISTORIC PRESERVATION AND RESTORATION OF HISTORICAL PROPERTIES, ART AND ANTIQUES (U.S. CLS. 100, 101 AND 107).

FIRST USE 6-0-1996; IN COMMERCE 6-0-1996.
MARY CRAWFORD, EXAMINING ATTORNEY

SN 78-413,338. OMP, INC., LONG BEACH, CA. FILED 5-5-2004.

PHOTOLUMINES

THE MARK CONSISTS OF STANDARD CHARACTERS WITHOUT CLAIM TO ANY PARTICULAR FONT, STYLE, SIZE, OR COLOR.

CLASS 3—COSMETICS AND CLEANING PREPARATIONS

FOR NON-MEDICATED SKIN CARE PREPARATIONS (U.S. CLS. 1, 4, 6, 50, 51 AND 52).
FIRST USE 4-26-2004; IN COMMERCE 4-26-2004.

CLASS 5—PHARMACEUTICALS

FOR MEDICATED SKIN CARE PREPARATIONS (U.S. CLS. 6, 18, 44, 46, 51 AND 52).
FIRST USE 4-26-2004; IN COMMERCE 4-26-2004.
PRISCILLA MILTON, EXAMINING ATTORNEY

SN 78-413,476. CLARK CONSULTING, INC., NORTH BARRINGTON, IL. FILED 5-5-2004.

PEARL MEYER & PARTNERS

THE MARK CONSISTS OF STANDARD CHARACTERS WITHOUT CLAIM TO ANY PARTICULAR FONT, STYLE, SIZE, OR COLOR.

NO CLAIM IS MADE TO THE EXCLUSIVE RIGHT TO USE "PARTNERS", APART FROM THE MARK AS SHOWN. THE NAME PEARL MEYER IDENTIFIES A LIVING INDIVIDUAL WHOSE CONSENT IS OF RECORD.

CLASS 35—ADVERTISING AND BUSINESS

FOR HUMAN RESOURCE SERVICES FOR OTEHRS
(U.S. CLS. 100, 101 AND 102).
FIRST USE 0-0-1989; IN COMMERCE 0-0-1989.

SN 78-413,647. VANGARD, INC., WEST MELBOURNE, FL.
FILED 5-5-2004.

CLASS 36—INSURANCE AND FINANCIAL

FOR FINANCIAL ADVISORY SERVICES AND THE
DESIGN, IMPLEMENTATION AND ADMINISTRATION
OF EXECUTIVE BENEFIT AND COMPENSATION
PLANS (U.S. CLS. 100, 101 AND 102).
FIRST USE 0-0-1989; IN COMMERCE 0-0-1989.
DOMINICK J. SALEMI, EXAMINING ATTORNEY

COOK-GARD

THE MARK CONSISTS OF STANDARD CHARACTERS
WITHOUT CLAIM TO ANY PARTICULAR FONT, STYLE,
SIZE, OR COLOR.

SN 78-413,632. CERTIFIED TRANSMISSION REBUILDERS,
INC., OMAHA, NE. FILED 5-5-2004.

CLASS 16—PAPER GOODS AND PRINTED MATTER

FOR PLASTIC BAGS FOR PACKAGING OF FOOD
PRODUCTS (U.S. CLS. 2, 5, 22, 23, 29, 37, 38 AND 50).

CLASS 17—RUBBER GOODS

FOR ARTIFICIAL PLASTIC CASINGS USED FOR
INDUSTRIAL AND COMMERCIAL PACKAGING OF
PROCESSED MEAT AND CHEESE PRODUCTS; AND
PLASTIC FILMS USED IN THE MEAT AND CHEESE
PROCESSING INDUSTRIES FOR PACKAGING (U.S.
CLS. 1, 5, 12, 13, 35 AND 50).

DANIEL BRODY, EXAMINING ATTORNEY

**Certified
Transmission**

SN 78-413,691. KENTON BROTHERS LOCKSMITHS, INC.,
KANSAS CITY, MO. FILED 5-5-2004.

**KENTON BROTHERS
INC.**

THE MARK CONSISTS OF STANDARD CHARACTERS
WITHOUT CLAIM TO ANY PARTICULAR FONT, STYLE,
SIZE, OR COLOR.

NO CLAIM IS MADE TO THE EXCLUSIVE RIGHT TO
USE "TRANSMISSION", APART FROM THE MARK AS
SHOWN.

SEC. 2(F).

CLASS 12—VEHICLES

FOR TRANSMISSIONS AND TRANSAXLES FOR
LAND VEHICLES (U.S. CLS. 19, 21, 23, 31, 35 AND 44).
FIRST USE 6-17-1985; IN COMMERCE 6-17-1985.

THE MARK CONSISTS OF STANDARD CHARACTERS
WITHOUT CLAIM TO ANY PARTICULAR FONT, STYLE,
SIZE, OR COLOR.

NO CLAIM IS MADE TO THE EXCLUSIVE RIGHT TO
USE "BROTHERS INC.", APART FROM THE MARK AS
SHOWN.

SEC. 2(F).

CLASS 25—CLOTHING

FOR HEADGEAR AND CLOTHING, NAMELY, BALL
CAPS, VISORS, BUTTON DOWN SHIRTS, T-SHIRTS,
SWEAT SHIRTS, POLO SHIRTS, AND VESTS; OUTER-
WEAR, NAMELY, JACKETS (U.S. CLS. 22 AND 39).
FIRST USE 5-1-1981; IN COMMERCE 5-1-1981.

CLASS 35—ADVERTISING AND BUSINESS

FOR RETAIL AND WHOLESALE STORES AND SALES
THROUGH DIRECT SOLICITATION IN THE FIELD OF
MECHANICAL AND ELECTRICAL LOCKING HARD-
WARE AND ACCESS CONTROL DEVICES, NAMELY
ACCESS CONTROL SYSTEMS CARDS, READERS AND
KEYPADS; CUSTOM ALARMS; REMOTE RELEASE
OPENING SYSTEMS, CLOSED CIRCUIT TELEVISION
SYSTEMS, REMOTE RELEASE OPENING SYSTEMS,
TURNSTILES, BIOMETRIC READERS, MAGNETIC
LOCKS, ELECTRIC STRIKES, POWER ACCESS DOOR
OPENERS, LOCKS, KEYS, HIGH SECURITY KEYING
SYSTEMS, EXIT DEVICES, PUSH BUTTON LOCKS,
DOOR CLOSERS, PADLOCKS, KEY CONTROL SOFT-
WARE AND STORAGE CABINETS, MASTERKEY SYS-
TEMS, AND SAFES (U.S. CLS. 100, 101 AND 102).

FIRST USE 0-0-1992; IN COMMERCE 0-0-1992.

CLASS 37—CONSTRUCTION AND REPAIR

FOR REPAIR AND MAINTENANCE FOR VEHICLE
TRANSMISSIONS AND TRANSAXLES; NAMELY, RE-
MOVAL, SERVICE, REBUILDING, INSTALLATION OF
VEHICLE TRANSMISSIONS (U.S. CLS. 100, 103 AND
106).

FIRST USE 11-1-1979; IN COMMERCE 11-1-1979.
TONI HICKEY, EXAMINING ATTORNEY

CLASS 37—CONSTRUCTION AND REPAIR

FOR INSTALLATION AND MAINTENANCE OF MECHANICAL AND ELECTRICAL LOCKING HARDWARE AND ACCESS CONTROL DEVICES, NAMELY ACCESS CONTROL SYSTEMS CARDS, READERS AND KEY-PADS; CUSTOM ALARMS; REMOTE RELEASE OPENING SYSTEMS, CLOSED CIRCUIT TELEVISION SYSTEMS, REMOTE RELEASE OPENING SYSTEMS, TURNSTILES, BIOMETRIC READERS, MAGNETIC LOCKS, ELECTRIC STRIKES, POWER ACCESS DOOR OPENERS, LOCKS, KEYS, HIGH SECURITY KEYING SYSTEMS, EXIT DEVICES, PUSH BUTTON LOCKS, DOOR CLOSERS, PADLOCKS, AND STORAGE CABINETS, MASTERKEY SYSTEMS, AND SAFES (U.S. CLS. 100, 103 AND 106).

FIRST USE 0-0-1992; IN COMMERCE 0-0-1992.
KHANH LE, EXAMINING ATTORNEY

SN 78-414,151. CONNORS, DAMESHEK, FONG AND MANCUSO, INC., LISBON, NH. FILED 5-6-2004.

RIALTO

THE MARK CONSISTS OF STANDARD CHARACTERS WITHOUT CLAIM TO ANY PARTICULAR FONT, STYLE, SIZE, OR COLOR.

CLASS 18—LEATHER GOODS

FOR HANDBAGS (U.S. CLS. 1, 2, 3, 22 AND 41).

CLASS 25—CLOTHING

FOR FOOTWEAR; CLOTHING, NAMELY, TOPS, SHIRTS, BLOUSES, TEE-SHIRTS, TANK TOPS, HALTER TOPS; PANTS, TROUSERS, SHORTS, CAPRI PANTS, CULOTTES; SKIRTS; COATS, JACKETS, JERSEYS, RAINCOATS, PARKAS; VESTS; SWEATERS; SUITS; DRESSES, SUN DRESSES AND EVENING GOWNS; SPORTS CLOTHING, NAMELY, WARM-UP SUITS, SWEAT SUITS, LEOTARDS, TIGHTS, LEG WARMERS, SWIM SUITS, BIKING SHORTS; UNDERWEAR, LINGERIE, PAJAMAS, NIGHT GOWNS, BOXER SHORTS, ROBES, SLIPS, SOCKS (U.S. CLS. 22 AND 39).

JANICE L. MCMORROW, EXAMINING ATTORNEY

SN 78-413,965. S31T, INC., SAN FRANCISCO, CA. FILED 5-6-2004.

Bassy

SN 78-414,277. DISCOVERY COMMUNICATIONS, INC., SILVER SPRING, MD. FILED 5-6-2004.

THE MARK CONSISTS OF STANDARD CHARACTERS WITHOUT CLAIM TO ANY PARTICULAR FONT, STYLE, SIZE, OR COLOR.

GO BEHIND THE LINES

CLASS 25—CLOTHING

FOR CLOTHING, NAMELY, SHIRTS, T-SHIRTS, JACKETS, PANTS, SHORTS, UNDERWEAR AND UNDERGARMENTS, FOOTWEAR, ATHLETIC SHOES, SOCKS, WRISTBANDS, AND HEADGEAR, NAMELY, HATS AND CAPS (U.S. CLS. 22 AND 39).

THE MARK CONSISTS OF STANDARD CHARACTERS WITHOUT CLAIM TO ANY PARTICULAR FONT, STYLE, SIZE, OR COLOR.

CLASS 28—TOYS AND SPORTING GOODS

FOR SPORTING GOODS, NAMELY, BASKETBALLS, BASKETBALL HOOPS, AND BASKETBALL BACKBOARDS (U.S. CLS. 22, 23, 38 AND 50).
MARC LEIPZIG, EXAMINING ATTORNEY

CLASS 38—COMMUNICATION

FOR TELEVISION BROADCASTING SERVICES (U.S. CLS. 100, 101 AND 104).

CLASS 41—EDUCATION AND ENTERTAINMENT

FOR ENTERTAINMENT SERVICES IN THE NATURE OF A NONFICTION TELEVISION PROGRAM SERIES FEATURING MILITARY TOPICS; PROVIDING INFORMATION ABOUT THE APPLICANT'S TELEVISION PROGRAM OF THE SAME NAME VIA A GLOBAL COMPUTER NETWORK (U.S. CLS. 100, 101 AND 107).
MICHELE SWAIN, EXAMINING ATTORNEY

CLASS 41—EDUCATION AND ENTERTAINMENT

FOR COUNTRY CLUB SERVICES AND GOLF CLUB SERVICES, SERVICES IN THE NATURE OF CONDUCTING GOLF TOURNAMENTS, AND GOLF INSTRUCTION SERVICES (U.S. CLS. 100, 101 AND 107).
FIRST USE 12-0-1981; IN COMMERCE 12-0-1981.
REBECCA SMITH, EXAMINING ATTORNEY

SN 78-414,281. DUE PROCESS GOLF & HORSE STABLES, LLC, DBA DUE PROCESS STABLE, COLTS NECK, NJ. FILED 5-6-2004.



NO CLAIM IS MADE TO THE EXCLUSIVE RIGHT TO USE "STABLE", APART FROM THE MARK AS SHOWN. THE COLOR(S) ORANGE, GREEN, BLACK AND WHITE IS/ARE CLAIMED AS A FEATURE OF THE MARK.

THE MARK CONSISTS OF THE WORDS DUE PROCESS STABLE ENCIRCLING A DESIGN CONSISTING OF A CIRCLE HAVING THEREIN A FOLIAGE ELEMENT AND THE BUST PORTION OF AN ANIMAL FIGURE INTERPOSED THEREON; THE CIRCLE OF THE DESIGN IS ORANGE IN COLOR; THE FOLIAGE OF THE DESIGN IS GREEN IN COLOR; THE ANIMAL BUST OF THE DESIGN IS BLACK IN COLOR; AND THE BACKGROUND OF THE DESIGN WITHIN THE CIRCLE IS WHITE IN COLOR.

CLASS 21—HOUSEWARES AND GLASS

FOR GLASS BEVERAGeware, GIFTWARE, NAMELY, BOWLS, DISHES, FIGURINES AND SCULPTURES MADE OF GLASS, CRYSTAL AND CHINA, AND BARWARE, NAMELY DRINKING GLASSES, MUGS AND COASTERS (U.S. CLS. 2, 13, 23, 29, 30, 33, 40 AND 50).

FIRST USE 4-1-1998; IN COMMERCE 4-1-1998.

CLASS 25—CLOTHING

FOR CLOTHING, OUTERWEAR, AND ACCESSORIES FOR MEN, WOMEN AND CHILDREN, NAMELY, SHIRTS, SWEATSHIRTS, SWEATERS, VESTS, WIND SHIRTS, COATS, JACKETS, RAIN SUITS, PANTS, SHORTS, TIES, BELTS, SCARVES AND SOCKS HEAD WEAR, NAMELY HATS, CAPS AND VISORS (U.S. CLS. 22 AND 39).

FIRST USE 4-1-1995; IN COMMERCE 4-1-1995.

CLASS 28—TOYS AND SPORTING GOODS

FOR SPORTING GOODS AND GOLF EQUIPMENT USED IN CONNECTION WITH THE GAME OF GOLF, NAMELY, GOLF BAGS, GOLF BAG COVERS, GOLF CLUBS, GOLF CLUB COVERS, GOLF GLOVES, GOLF BALLS, GOLF BAG TAGS, GOLF FLAGS, GOLF BALL MARKERS, AND DIVOT REPAIR TOOLS (U.S. CLS. 22, 23, 38 AND 50).

FIRST USE 4-1-1995; IN COMMERCE 4-1-1995.

SN 78-414,480. STOLLER ENTERPRISES, INC., HOUSTON, TX. FILED 5-6-2004.



THE MARK CONSISTS OF A PINWHEEL DESIGN.

CLASS 1—CHEMICALS

FOR CHEMICALS USED IN AGRICULTURAL AND HORTICULTURAL APPLICATIONS, NAMELY, FERTILIZERS, FERTILIZER ADDITIVES AND SUPPLEMENTS, MINERAL SUPPLEMENTS FOR PLANTS, PLANT GROWTH REGULATORS, MICRONUTRIENTS AND FLOWABLE SULFUR FOR USE AS A FERTILIZER, ALL USED TO IMPROVE PLANT GROWTH AND PROVIDED AS LIQUIDS OR LIQUID SOLUTIONS READY TO APPLY, AS CONCENTRATES, OR AS DRY PARTICLES OR FLOWABLE SOLIDS; AGRICULTURAL AND HORTICULTURAL PLANT HORMONES USED TO IMPROVE PLANT RESISTANCE TO AND INHIBIT ATTACK BY DISEASE AND PESTS AND PROVIDED AS LIQUIDS OR LIQUID SOLUTIONS READY TO APPLY OR AS CONCENTRATES (U.S. CLS. 1, 5, 6, 10, 26 AND 46).

FIRST USE 0-0-1970; IN COMMERCE 0-0-1970.

CLASS 5—PHARMACEUTICALS

FOR AGRICULTURAL AND HORTICULTURAL FUNGICIDES, PESTICIDES AND OTHER CHEMICAL AGENTS, NAMELY, INSECTICIDES, ALL USED TO IMPROVE RESISTANCE TO AND INHIBIT ATTACK BY DISEASE AND PESTS AND PROVIDED AS LIQUIDS OR LIQUID SOLUTIONS READY TO APPLY OR AS CONCENTRATES (U.S. CLS. 6, 18, 44, 46, 51 AND 52).

FIRST USE 0-0-1970; IN COMMERCE 0-0-1970.

LEIGH LOWRY, EXAMINING ATTORNEY

SN 78-414,498. STOLLER ENTERPRISES, INC., HOUSTON, TX. FILED 5-6-2004.



CLASS 1—CHEMICALS

FOR CHEMICALS USED IN AGRICULTURAL AND HORTICULTURAL APPLICATIONS, NAMELY, FERTILIZERS, FERTILIZER ADDITIVES AND SUPPLEMENTS, MINERAL SUPPLEMENTS FOR PLANTS, PLANT GROWTH REGULATORS, MICRONUTRIENTS AND FLOWABLE SULFUR FOR USE AS A FERTILIZER, ALL USED TO IMPROVE PLANT GROWTH AND PROVIDED AS LIQUIDS OR LIQUID SOLUTIONS READY TO APPLY, AS CONCENTRATES, OR AS DRY PARTICLES OR FLOWABLE SOLIDS; AGRICULTURAL AND HORTICULTURAL PLANT HORMONES USED TO IMPROVE PLANT RESISTANCE TO AND INHIBIT ATTACK BY DISEASE AND PESTS AND PROVIDED AS LIQUIDS OR LIQUID SOLUTIONS READY TO APPLY OR AS CONCENTRATES (U.S. CLS. 1, 5, 6, 10, 26 AND 46).

FIRST USE 0-0-1978; IN COMMERCE 0-0-1978.

CLASS 5—PHARMACEUTICALS

FOR AGRICULTURAL AND HORTICULTURAL FUNGICIDES, PESTICIDES AND OTHER CHEMICAL AGENTS, NAMELY, INSECTICIDES, ALL USED TO IMPROVE RESISTANCE TO AND INHIBIT ATTACK BY DISEASE AND PESTS AND PROVIDED AS LIQUIDS OR LIQUID SOLUTIONS READY TO APPLY OR AS CONCENTRATES (U.S. CLS. 6, 18, 44, 46, 51 AND 52).

FIRST USE 0-0-1978; IN COMMERCE 0-0-1978.

LEIGH LOWRY, EXAMINING ATTORNEY

SN 78-414,679. HAUZER TECHNO COATING BV, VENLO, NETHERLANDS, FILED 5-7-2004.

HAUZER

THE MARK CONSISTS OF STANDARD CHARACTERS WITHOUT CLAIM TO ANY PARTICULAR FONT, STYLE, SIZE, OR COLOR.

CLASS 6—METAL GOODS

FOR MAGNETRON SPUTTERING SOURCES AND TARGETS OF METAL AND CERAMIC FOR MAGNETRON SPUTTERING SOURCES; ARC SOURCES AND TARGETS OF METAL AND CERAMIC FOR ARC SOURCES (U.S. CLS. 2, 12, 13, 14, 23, 25 AND 50).

FIRST USE 12-31-1983; IN COMMERCE 12-31-1985.

CLASS 7—MACHINERY

FOR MACHINES AND APPARATUS FOR THE APPLICATION OF COATINGS TO A WIDE VARIETY OF METAL ARTICLES APPLIED UNDER VACUUM USING PHYSICAL VAPOR DEPOSITION (PVD) AND/OR PLASMA ASSISTED CHEMICAL VAPOR DEPOSITION PROCESSES (PACVD); SPUTTERING MACHINES AND SPUTTERING APPARATUS, MAGNETRON SPUTTERING MACHINES AND MAGNETRON SPUTTERING APPARATUS FOR COATING METALS; ARC COATING MACHINES AND ARC COATING APPARATUS FOR USE ON METAL SURFACES; MACHINERY, NAMELY, TREATMENT CHAMBERS FOR PHYSICAL COATING APPARATUS AND CHEMICAL COATING APPARATUS FOR USE ON METAL SURFACES; VACUUM PUMPS (U.S. CLS. 13, 19, 21, 23, 31, 34 AND 35).

FIRST USE 12-31-1983; IN COMMERCE 12-31-1985.

ALEXANDER L. POWERS, EXAMINING ATTORNEY

SN 78-414,934. COTTON INCORPORATED, NEW YORK, NY. FILED 5-7-2004.

YOU CAN NEVER HAVE ENOUGH

THE MARK CONSISTS OF STANDARD CHARACTERS WITHOUT CLAIM TO ANY PARTICULAR FONT, STYLE, SIZE, OR COLOR.

CLASS 25—CLOTHING

FOR CLOTHING, NAMELY, GARMENTS FOR MEN, WOMEN AND CHILDREN, NAMELY, HOSIERY, UNDERWEAR, KNIT SHIRTS, DRESS SHIRTS, SPORT SHIRTS, SLACKS, PANTS, JEANS, SWEATERS, UNIFORMS, SHORTS, THERMAL UNDERWEAR, TIES, PAJAMAS, LOUNGEWEAR, ROBES, TURTLENECK SWEATERS, KNIT HATS, WOMEN'S DRESSES, SKIRTS, WOMEN'S BLOUSES, LINGERIE, BRAS, PANTIES, SWEATPANTS, SWEATSHIRTS, SWEATSUITS, INFANT CLOTH DIAPERS, FOOTWEAR AND HEADWEAR (U.S. CLS. 22 AND 39).

CLASS 35—ADVERTISING AND BUSINESS

FOR PROMOTING THE CONSUMPTION OF COTTON AND PRODUCTS MADE FROM COTTON AND THE INTERESTS OF THE UNITED STATES COTTON PRODUCERS AND IMPORTERS BY MEANS OF PRINTED MATERIAL, RADIO AND TELEVISION (U.S. CLS. 100, 101 AND 102).

ALICE SUE CARRUTHERS, EXAMINING ATTORNEY

SN 78-415,000. SCA HYGIENE PRODUCTS AB, GOTEORG, SWEDEN, FILED 5-7-2004.

NIGHT & DAY

THE MARK CONSISTS OF STANDARD CHARACTERS WITHOUT CLAIM TO ANY PARTICULAR FONT, STYLE, SIZE, OR COLOR.

CLASS 5—PHARMACEUTICALS

FOR INCONTINENCE DIAPERS FOR SANITARY PURPOSES AND FOR USE BY PERSONS SUFFERING FROM INCONTINENCE (U.S. CLS. 6, 18, 44, 46, 51 AND 52).

CLASS 10—MEDICAL APPARATUS

FOR INCONTINENCE SHEETS FOR USE BY PERSONS SUFFERING FROM INCONTINENCE (U.S. CLS. 26, 39 AND 44).

CLASS 16—PAPER GOODS AND PRINTED MATTER

FOR HAND TOWELS OF PAPER, PAPER TOWELS, DISPOSABLE PANTS MADE OF PAPER, ALL FOR USE WITHIN THE FIELD OF INCONTINENCE AND GERIATRIC CARE (U.S. CLS. 2, 5, 22, 23, 29, 37, 38 AND 50). ANNE E. GUSTASON, EXAMINING ATTORNEY

SN 78-415,055. IMRA AMERICA, INC., ANN ARBOR, MI. FILED 5-7-2004.

μJEWEL

NO CLAIM IS MADE TO THE EXCLUSIVE RIGHT TO USE MICROJOULE, APART FROM THE MARK AS SHOWN.

THE MARK CONSISTS OF THE WORD JEWEL WITH THE GREEK LETTER MU IMMEDIATELY PRECEDING JEWEL.

CLASS 9—ELECTRICAL AND SCIENTIFIC APPARATUS

FOR LASERS NOT FOR MEDICAL USE, LASER OSCILLATORS, PARTS AND ACCESSORIES FOR ALL OF THE FOREGOING (U.S. CLS. 21, 23, 26, 36 AND 38).

CLASS 10—MEDICAL APPARATUS

FOR LASERS AND LASER OSCILLATORS THEREFOR FOR MEDICAL USE AND PARTS AND ACCESSORIES FOR ALL OF THE FOREGOING (U.S. CLS. 26, 39 AND 44).

DANIEL CAPSHAW, EXAMINING ATTORNEY

SN 78-415,215. GIRLS & SPORTS, LLC, LOS ANGELES, CA. FILED 5-7-2004.

ONE NIGHT STAND GIRL

THE MARK CONSISTS OF STANDARD CHARACTERS WITHOUT CLAIM TO ANY PARTICULAR FONT, STYLE, SIZE, OR COLOR.

NO CLAIM IS MADE TO THE EXCLUSIVE RIGHT TO USE "GIRL", APART FROM THE MARK AS SHOWN.

CLASS 16—PAPER GOODS AND PRINTED MATTER

FOR CARTOONS, NAMELY, CARTOON PRINTS, CARTOON STRIPS, NEWSPAPER CARTOONS, NEWS-PAPER COMIC STRIPS, COMIC BOOKS, ADDRESS BOOKS, ANIMATION CELLS, ANNOUNCEMENT CARDS, AUTOGRAPH BOOKS, APPOINTMENT BOOKS, GUEST BOOKS, PICTURE BOOKS, TELEPHONE NUMBER BOOKS, CALENDARS, TRADING CARDS, GREETING CARDS, DAILY PLANNERS, DECALS, DESK CALENDARS, ENVELOPES, GIFT CARDS, ADDRESS LABELS, NOTEBOOKS, PAPER NAPKINS, PRINTED PAPER SIGNS, PICTURE POSTCARDS, POSTCARDS, POSTERS, ART PRINTS, COLOR PRINTS, LITHOGRAPH PRINTS, PHOTOGRAPHIC PRINTS, RUBBER STAMPS (U.S. CLS. 2, 5, 22, 23, 29, 37, 38 AND 50). FIRST USE 5-5-2004; IN COMMERCE 5-5-2004.

CLASS 25—CLOTHING

FOR CLOTHING, NAMELY, ATHLETIC UNIFORMS, BASEBALL CAPS, BATHING TRUNKS, BEACHWEAR, BOXER SHORTS, GYM SHORTS, HATS, JACKETS, SHIRTS, SHORTS, SWEAT PANTS, SWEAT SHIRTS, SWEAT SHORTS, SWEAT SUITS, SWEATERS, SWIM TRUNKS, TEE SHIRTS, TANK TOPS, AND UNIFORMS (U.S. CLS. 22 AND 39).

FIRST USE 5-5-2004; IN COMMERCE 5-5-2004. ANN LINNEHAN, EXAMINING ATTORNEY

SN 78-415,220. GIRLS & SPORTS, LLC, LOS ANGELES, CA. FILED 5-7-2004.

SWEET & INNOCENT GIRL

THE MARK CONSISTS OF STANDARD CHARACTERS WITHOUT CLAIM TO ANY PARTICULAR FONT, STYLE, SIZE, OR COLOR.

CLASS 16—PAPER GOODS AND PRINTED MATTER

FOR CARTOON PRINTS, CARTOON STRIPS, NEWS-PAPER CARTOONS, NEWSPAPER COMIC STRIPS, COMIC BOOKS, ADDRESS BOOKS, ANIMATION CELLS, ANNOUNCEMENT CARDS, AUTOGRAPH BOOKS, APPOINTMENT BOOKS, GUEST BOOKS, PICTURE BOOKS, TELEPHONE NUMBER BOOKS, CALENDARS, TRADING CARDS, GREETING CARDS, DAILY PLANNERS, DECALS, DESK CALENDARS, ENVELOPES, GIFT CARDS, ADDRESS LABELS, NOTEBOOKS, PAPER NAPKINS, PRINTED PAPER SIGNS, PICTURE POSTCARDS, POSTCARDS, POSTERS, ART PRINTS, COLOR PRINTS, LITHOGRAPH PRINTS, PHOTOGRAPHIC PRINTS, RUBBER STAMPS (U.S. CLS. 2, 5, 22, 23, 29, 37, 38 AND 50).

FIRST USE 5-5-2004; IN COMMERCE 5-5-2004.

CLASS 25—CLOTHING

FOR CLOTHING, NAMELY, ATHLETIC UNIFORMS, BASEBALL CAPS, BATHING TRUNKS, BEACHWEAR, BOXER SHORTS, GYM SHORTS, HATS, JACKETS, SHIRTS, SHORTS, SWEAT PANTS, SWEAT SHIRTS, SWEAT SHORTS, SWEAT SUITS, SWEATERS, SWIM TRUNKS, TEE SHIRTS, TANK TOPS, AND UNIFORMS (U.S. CLS. 22 AND 39).

FIRST USE 5-5-2004; IN COMMERCE 5-5-2004.

SAMUEL E. SHARPER JR., EXAMINING ATTORNEY

SN 78-415,864. KONDOH INDUSTRIES, LTD., TOKYO, JAPAN, FILED 5-10-2004.

V-PAC

THE MARK CONSISTS OF STANDARD CHARACTERS WITHOUT CLAIM TO ANY PARTICULAR FONT, STYLE, SIZE, OR COLOR.

CLASS 7—MACHINERY

FOR AIR FILTERS FOR MECHANICAL PURPOSES (U.S. CLS. 13, 19, 21, 23, 31, 34 AND 35).

CLASS 11—ENVIRONMENTAL CONTROL APPARATUS

FOR AIR FILTERS FOR AIR CONDITIONING UNITS; AIR FILTERS FOR INDUSTRIAL INSTALLATIONS (U.S. CLS. 13, 21, 23, 31 AND 34).

SALLY SHIH, EXAMINING ATTORNEY

SN 78-415,937. MEDIANEWS GROUP INTERACTIVE, INC., DENVER, CO. FILED 5-10-2004.

THE DAILY FLASH

THE MARK CONSISTS OF STANDARD CHARACTERS WITHOUT CLAIM TO ANY PARTICULAR FONT, STYLE, SIZE, OR COLOR.

NO CLAIM IS MADE TO THE EXCLUSIVE RIGHT TO USE DAILY, APART FROM THE MARK AS SHOWN.

CLASS 16—PAPER GOODS AND PRINTED MATTER

FOR PRINTED NEWSPAPERS (U.S. CLS. 2, 5, 22, 23, 29, 37, 38 AND 50).

CLASS 41—EDUCATION AND ENTERTAINMENT

FOR PROVIDING NON-DOWNLOADABLE ON-LINE NEWSPAPERS (U.S. CLS. 100, 101 AND 107).

BRIDGETT SMITH, EXAMINING ATTORNEY

SN 78-416,131. JOHN BOOS & CO., EFFINGHAM, IL. FILED 5-10-2004.

JOHN BOOS

THE MARK CONSISTS OF STANDARD CHARACTERS WITHOUT CLAIM TO ANY PARTICULAR FONT, STYLE, SIZE, OR COLOR.

THE NAME(S), PORTRAIT(S), AND/OR SIGNATURE(S) SHOWN IN THE MARK DOES NOT IDENTIFY A PARTICULAR LIVING INDIVIDUAL".

CLASS 20—FURNITURE AND ARTICLES NOT OTHERWISE CLASSIFIED

FOR FURNITURE, NAMELY, TABLES, KITCHEN ISLANDS, SERVICE AND FOOD PREPARATION CARTS, BENCHES, SHELVES, STOOLS, POT RACKS, AND PARTS THEREOF (U.S. CLS. 2, 13, 22, 25, 32 AND 50).

FIRST USE 12-0-1900; IN COMMERCE 12-0-1900.

CLASS 21—HOUSEWARES AND GLASS

FOR CUTTING BOARDS; BUTCHER BLOCKS; AND KNIFE BLOCKS (U.S. CLS. 2, 13, 23, 29, 30, 33, 40 AND 50).

FIRST USE 12-0-1900; IN COMMERCE 12-0-1900.
ALICE BENMAMAN, EXAMINING ATTORNEY

SN 78-416,541. CLEARSNAP, INC., ANACORTES, WA.
FILED 5-11-2004.

MICA MAGIC

THE MARK CONSISTS OF STANDARD CHARACTERS WITHOUT CLAIM TO ANY PARTICULAR FONT, STYLE, SIZE, OR COLOR.

NO CLAIM IS MADE TO THE EXCLUSIVE RIGHT TO USE "MICA", APART FROM THE MARK AS SHOWN.

CLASS 2—PAINTS

FOR THERMOGRAPHIC PRINTING POWDERS (U.S. CLS. 6, 11 AND 16).

CLASS 16—PAPER GOODS AND PRINTED MATTER

FOR INK PADS; INKS FOR RUBBER STAMPS; EMBOSSING POWDERS. (U.S. CLS. 2, 5, 22, 23, 29, 37, 38 AND 50).

FRED MANDIR, EXAMINING ATTORNEY

SN 78-417,095. HUNTER DOUGLAS INC., UPPER SADDLE RIVER, NJ. FILED 5-12-2004.

ENLINEA

THE MARK CONSISTS OF STANDARD CHARACTERS WITHOUT CLAIM TO ANY PARTICULAR FONT, STYLE, SIZE, OR COLOR.

THE FOREIGN WORDING IN THE MARK TRANSLATES INTO ENGLISH AS IN LINE.

CLASS 20—FURNITURE AND ARTICLES NOT OTHERWISE CLASSIFIED

FOR WINDOW BLINDS AND WINDOW SHADES. (U.S. CLS. 2, 13, 22, 25, 32 AND 50).

CLASS 24—FABRICS

FOR FABRIC FOR USE IN WINDOW COVERINGS, WINDOW BLINDS AND WINDOW SHADES; FABRIC FOR USE AS WALL COVERINGS; FABRIC FOR USE IN UPHOLSTERY; FABRIC COMPRISED OF NON-WOVEN BONDED FIBERS. (U.S. CLS. 42 AND 50).

MARIA-VICTORIA SUAREZ, EXAMINING ATTORNEY

SN 78-417,140. IN THE SWIM, WEST CHICAGO, IL. FILED 5-12-2004.

ORDER TODAY...CHEMICALS TOMORROW!

THE MARK CONSISTS OF STANDARD CHARACTERS WITHOUT CLAIM TO ANY PARTICULAR FONT, STYLE, SIZE, OR COLOR.

CLASS 1—CHEMICALS

FOR WATER TREATMENT CHEMICALS FOR USE IN SWIMMING POOLS AND SPAS (U.S. CLS. 1, 5, 6, 10, 26 AND 46).

FIRST USE 3-1-2002; IN COMMERCE 3-1-2002.

CLASS 35—ADVERTISING AND BUSINESS

FOR MAIL ORDER CATALOG SERVICES FEATURING SWIMMING POOL CHEMICALS AND SUPPLIES (U.S. CLS. 100, 101 AND 102).

FIRST USE 3-1-2002; IN COMMERCE 3-1-2002.

NANCY CLARKE, EXAMINING ATTORNEY

SN 78-417,322. PRORHYTHM, INC., RONKONKOMA, NY.
FILED 5-12-2004.

PRORHYTHM

THE MARK CONSISTS OF STANDARD CHARACTERS WITHOUT CLAIM TO ANY PARTICULAR FONT, STYLE, SIZE, OR COLOR.

CLASS 10—MEDICAL APPARATUS

FOR MEDICAL APPARATUS FOR CARDIAC ABLATION; MEDICAL APPARATUS FOR CARDIAC MAPPING; MEDICAL APPARATUS FOR CARDIOVASCULAR DIAGNOSTICS; CATHETERS; MEDICAL SHEATHS; MEDICAL GUIDEWIRES; ULTRASONIC GENERATORS FOR MEDICAL USE (U.S. CLS. 26, 39 AND 44).

CLASS 37—CONSTRUCTION AND REPAIR

FOR MAINTENANCE AND REPAIR OF MEDICAL APPARATUS (U.S. CLS. 100, 103 AND 106).

JOHN KELLY, EXAMINING ATTORNEY

SN 78-417,352. GOTHAM LICENSING GROUP, LLC, NEW YORK, NY. FILED 5-12-2004.



THE MARK CONSISTS OF THE DESIGN OF GIGI'S HEAD.

CLASS 14—JEWELRY

FOR JEWELRY (U.S. CLS. 2, 27, 28 AND 50).
FIRST USE 11-26-1994; IN COMMERCE 11-26-1994.

CLASS 25—CLOTHING

FOR CLOTHING, NAMELY, PANTS, JEANS, SHORTS, SKIRTS, DRESSES, ROMPERS, TOPS, SHIRTS, SWEAT PANTS, SWEAT SHIRTS, T-SHIRTS, SWEATERS, JACKETS, UNDERWEAR, ROBES, SLEEPWEAR, BRIEFS, CAMISOLES, BRAS, PANTIES, SOCKS, TIGHTS, PANTYHOSE, SLIPPER SOCKS, SWIMSUITS, SCARVES, GLOVES, HATS; AND FOOTWEAR, NAMELY, SHOES (U.S. CLS. 22 AND 39).
FIRST USE 11-26-1994; IN COMMERCE 11-26-1994.
CIMMERIAN COLEMAN, EXAMINING ATTORNEY

SN 78-417,522. UNIVERSITY OF GEORGIA ATHLETIC ASSOCIATION, ATHENS, GA. FILED 5-12-2004.



THE COLORS RED AND BLACK ARE CLAIMED AS A FEATURE OF THE MARK.
THE COLOR RED APPEARS ON THE FOOTBALL HELMET AND THE COLOR BLACK APPEARS IN THE LETTER "G" AND IN THE MIDDLE STRIPE ON THE HELMET.
THE MARK CONSISTS OF UNIVERSITY OF GEORGIA FOOTBALL HELMET DESIGN WITH AN OVAL "G" ON HELMET.

CLASS 16—PAPER GOODS AND PRINTED MATTER

FOR PRINTED BOOKLETS, NEWSLETTERS, CATALOGS, AND BROCHURES FEATURING INFORMATION OF INTEREST TO STUDENTS, FACULTY, AND ALUMNI OF THE UNIVERSITY OF GEORGIA; DECALS; TEMPORARY TATTOOS; NOTE PAPER; NOTEBOOKS; DECORATIVE PAPER FLAGS; PAPER BANNERS; AND PAPER FOLDERS (U.S. CLS. 2, 5, 22, 23, 29, 37, 38 AND 50).
FIRST USE 12-31-1994; IN COMMERCE 12-31-1994.

CLASS 25—CLOTHING

FOR CLOTHING, NAMELY BOXER SHORTS, CAPS, COATS, FOOTWEAR, HATS, JACKETS, JERSEYS, PANTS, RAINWEAR, SHIRTS, SHOES, SOCKS, SHORTS, SWEATPANTS, SWEATSHIRTS, SWEAT SUITS, SWEATERS, T-SHIRTS, TIES, VISORS, AND INFANT WEAR IN THE NATURE OF SHIRTS, PANTS, SHORTS, CLOTH BIBS, SOCKS, AND PAJAMAS (U.S. CLS. 22 AND 39).
FIRST USE 12-31-1994; IN COMMERCE 12-31-1994.

CLASS 28—TOYS AND SPORTING GOODS

FOR TOYS, GAMES, AND SPORTING GOODS, NAMELY BOARD GAMES, STUFFED TOY ANIMALS, FOOTBALLS, BASKETBALLS, SOCCER BALLS, BASEBALLS, GOLF BALLS, GOLF BAGS, AND GOLF ACCESSORIES, NAMELY GOLF CLUB COVERS, GOLF CLUB HEAD COVERS, DIVOT REPAIR TOOLS, GOLF ACCESSORY POUCHES, GOLF BAG COVERS, GOLF BAG TAGS, GOLF BALL MARKERS, GOLF BALL RETRIEVERS, GOLF BALL SLEEVES, GOLF CLUB GRIPS, GOLF CLUB HEADS, GOLF CLUB INSERTS, GOLF CLUB SHAFTS, GOLF GLOVES, GOLF PUTTER COVERS, GOLF PUTTERS, GOLF TEE MARKERS, GOLF TEES, AND GOLF TOWEL CLIPS FOR ATTACHMENT TO GOLF BAGS; AND CHRISTMAS TREE ORNAMENTS (U.S. CLS. 22, 23, 38 AND 50).
FIRST USE 12-31-1994; IN COMMERCE 12-31-1994.

CLASS 41—EDUCATION AND ENTERTAINMENT

FOR EDUCATION SERVICES, NAMELY PROVIDING INSTRUCTION AT THE COLLEGE LEVEL, AND ENTERTAINMENT SERVICES, NAMELY ORGANIZING AND CONDUCTING COLLEGIATE SPORTING EVENTS (U.S. CLS. 100, 101 AND 107).
FIRST USE 12-31-1994; IN COMMERCE 12-31-1994.
WON TEAK OH, EXAMINING ATTORNEY

SN 78-417,622. UNIVERSITY OF GEORGIA ATHLETIC ASSOCIATION, INC., ATHENS, GA. FILED 5-12-2004.



OWNER OF U.S. REG. NO. 1,286,482.
THE COLOR RED IS CLAIMED AS A FEATURE OF THE MARK.
THE COLOR RED APPEARS ON THE BORDER CIRCLE SURROUNDING THE LETTER G
THE MARK CONSISTS OF "G" IN OVAL DESIGN.

CLASS 14—JEWELRY

FOR JEWELRY, WATCHES, PRECIOUS METALS, AND PRECIOUS STONES (U.S. CLS. 2, 27, 28 AND 50).
FIRST USE 9-30-1964; IN COMMERCE 9-30-1964.

SN 78-417,670. UNIVERSITY OF GEORGIA ATHLETIC ASSOCIATION, INC., ATHENS, GA. FILED 5-12-2004.



THE MARK CONSISTS OF CARTOON FROWNING BULLDOG WITH STUDED COLLAR DESIGN.

CLASS 16—PAPER GOODS AND PRINTED MATTER

FOR PRINTED BOOKLETS, NEWSLETTERS, CATALOGS, AND BROCHURES FEATURING INFORMATION OF INTEREST TO STUDENTS, FACULTY, AND ALUMNI OF THE UNIVERSITY OF GEORGIA; DECALS; TEMPORARY TATTOOS; NOTE PAPER; NOTEBOOKS; DECORATIVE PAPER FLAGS; PAPER BANNERS; AND PAPER FOLDERS (U.S. CLS. 2, 5, 22, 23, 29, 37, 38 AND 50).

FIRST USE 9-30-1964; IN COMMERCE 9-30-1964.

CLASS 14—JEWELRY

FOR JEWELRY, WATCHES, PRECIOUS METALS, AND PRECIOUS STONES (U.S. CLS. 2, 27, 28 AND 50).
FIRST USE 1-31-1999; IN COMMERCE 1-31-1999.

CLASS 21—HOUSEWARES AND GLASS

FOR BEVERAGE GLASSWARE, EARTHENWARE, AND PLASTICWARE, NAMELY DRINKING GLASSES, MUGS, COFFEE CUPS AND SHOT GLASSES AND COASTERS; INSULATED PORTABLE BEVERAGE COOLERS (U.S. CLS. 2, 13, 23, 29, 30, 33, 40 AND 50).

FIRST USE 9-30-1964; IN COMMERCE 9-30-1964.

CLASS 16—PAPER GOODS AND PRINTED MATTER

FOR PRINTED BOOKLETS, NEWSLETTERS, CATALOGS, AND BROCHURES FEATURING INFORMATION OF INTEREST TO STUDENTS, FACULTY, AND ALUMNI OF THE UNIVERSITY OF GEORGIA; DECALS; TEMPORARY TATTOOS; NOTE PAPER; NOTEBOOKS; DECORATIVE PAPER FLAGS; PAPER BANNERS; AND PAPER FOLDERS (U.S. CLS. 2, 5, 22, 23, 29, 37, 38 AND 50).

FIRST USE 1-31-1999; IN COMMERCE 1-31-1999.

CLASS 25—CLOTHING

FOR CLOTHING, NAMELY BOXER SHORTS, CAPS, COATS, FOOTWEAR, HATS, JACKETS, JERSEYS, PANTS, RAINWEAR, SHIRTS, SHOES, SOCKS, SHORTS, SWEATPANTS, SWEATSHIRTS, SWEAT SUITS, SWEATERS, T-SHIRTS, TIES, VISORS, AND INFANT WEAR IN THE NATURE OF SHIRTS, PANTS, SHORTS, CLOTH BIBS, SOCKS, AND PAJAMAS (U.S. CLS. 22 AND 39).

FIRST USE 9-30-1964; IN COMMERCE 9-30-1964.

CLASS 21—HOUSEWARES AND GLASS

FOR BEVERAGE GLASSWARE, EARTHENWARE, AND PLASTICWARE, NAMELY DRINKING GLASSES, MUGS, COFFEE CUPS AND SHOT GLASSES AND COASTERS; INSULATED PORTABLE BEVERAGE COOLERS (U.S. CLS. 2, 13, 23, 29, 30, 33, 40 AND 50).

FIRST USE 1-31-1999; IN COMMERCE 1-31-1999.

CLASS 25—CLOTHING

FOR CLOTHING, NAMELY BOXER SHORTS, CAPS, COATS, FOOTWEAR, HATS, JACKETS, JERSEYS, PANTS, RAINWEAR, SHIRTS, SHOES, SOCKS, SHORTS, SWEATPANTS, SWEATSHIRTS, SWEAT SUITS, SWEATERS, T-SHIRTS, TIES, VISORS, AND INFANT WEAR IN THE NATURE OF SHIRTS, PANTS, SHORTS, CLOTH BIBS, SOCKS, AND PAJAMAS (U.S. CLS. 22 AND 39).

FIRST USE 1-31-1999; IN COMMERCE 1-31-1999.

CLASS 28—TOYS AND SPORTING GOODS

FOR TOYS, GAMES, AND SPORTING GOODS, NAMELY BOARD GAMES, STUFFED TOY ANIMALS, FOOTBALLS, BASKETBALLS, SOCCER BALLS, BASEBALLS, GOLF BALLS, GOLF BAGS, AND GOLF ACCESSORIES, NAMELY GOLF CLUB COVERS, GOLF CLUB HEAD COVERS, DIVOT REPAIR TOOLS, GOLF ACCESSORY POUCHES, GOLF BAG COVERS, GOLF BAG TAGS, GOLF BALL MARKERS, GOLF BALL RETRIEVERS, GOLF BALL SLEEVES, GOLF CLUB GRIPS, GOLF CLUB HEADS, GOLF CLUB INSERTS, GOLF CLUB SHAFTS, GOLF GLOVES, GOLF PUTTER COVERS, GOLF PUTTERS, GOLF TEE MARKERS, GOLF TEES, AND GOLF TOWEL CLIPS FOR ATTACHMENT TO GOLF BAGS; AND CHRISTMAS TREE ORNAMENTS (U.S. CLS. 22, 23, 38 AND 50).

FIRST USE 9-30-1964; IN COMMERCE 9-30-1964.

WON TEAK OH, EXAMINING ATTORNEY

CLASS 28—TOYS AND SPORTING GOODS

FOR TOYS, GAMES, AND SPORTING GOODS, NAMELY BOARD GAMES, STUFFED TOY ANIMALS, FOOTBALLS, BASKETBALLS, SOCCER BALLS, BASEBALLS, GOLF BALLS, GOLF BAGS, AND GOLF ACCESSORIES, NAMELY GOLF CLUB COVERS, GOLF CLUB HEAD COVERS, DIVOT REPAIR TOOLS, GOLF ACCESSORY POUCHES, GOLF BAG COVERS, GOLF BAG TAGS, GOLF BALL MARKERS, GOLF BALL RETRIEVERS, GOLF BALL SLEEVES, GOLF CLUB GRIPS, GOLF CLUB HEADS, GOLF CLUB INSERTS, GOLF CLUB SHAFTS, GOLF GLOVES, GOLF PUTTER COVERS, GOLF PUTTERS, GOLF TEE MARKERS, GOLF TEES, AND GOLF TOWEL CLIPS FOR ATTACHMENT TO GOLF BAGS; AND CHRISTMAS TREE ORNAMENTS (U.S. CLS. 22, 23, 38 AND 50).

FIRST USE 1-31-1999; IN COMMERCE 1-31-1999.

CLASS 41—EDUCATION AND ENTERTAINMENT

FOR EDUCATION SERVICES, NAMELY PROVIDING COURSES OF INSTRUCTION AT THE COLLEGE LEVEL, AND ENTERTAINMENT SERVICES, NAMELY ORGANIZING AND CONDUCTING COLLEGIATE SPORTING EVENTS (U.S. CLS. 100, 101 AND 107).

FIRST USE 1-31-1999; IN COMMERCE 1-31-1999.
WON TEAK OH, EXAMINING ATTORNEY

SN 78-417,863. MICRO INNOVATIONS, INC., NIXA, MO.
FILED 5-13-2004.

HEALTHPORT

SN 78-417,858. MICRO INNOVATIONS INC., NIXA, MO.
FILED 5-13-2004.

THE MARK CONSISTS OF STANDARD CHARACTERS WITHOUT CLAIM TO ANY PARTICULAR FONT, STYLE, SIZE, OR COLOR.

CLASS 9—ELECTRICAL AND SCIENTIFIC APPARATUS

FOR DATABASE MANAGEMENT SOFTWARE WHICH ALLOWS HOSPITALS TO SCAN MEDICAL RECORDS IN ELECTRONIC FORM AND THE CAPTURE OF ELECTRONIC INFORMATION IN REAL TIME TO CREATE A VIRTUAL MEDICAL RECORD AND THAT PROVIDES DATABASE MANAGEMENT AND DOCUMENT RETENTION (U.S. CLS. 21, 23, 26, 36 AND 38).

FIRST USE 1-31-2004; IN COMMERCE 1-31-2004.

**NAUVALIS
HEALTHCARE
SOLUTIONS**

THE MARK CONSISTS OF STANDARD CHARACTERS WITHOUT CLAIM TO ANY PARTICULAR FONT, STYLE, SIZE, OR COLOR.

NO CLAIM IS MADE TO THE EXCLUSIVE RIGHT TO USE HEALTHCARE SOLUTIONS, APART FROM THE MARK AS SHOWN.

CLASS 9—ELECTRICAL AND SCIENTIFIC APPARATUS

FOR COMPUTER SOFTWARE FOR USE FOR DATABASE MANAGEMENT IN THE HEALTH CARE INDUSTRY (U.S. CLS. 21, 23, 26, 36 AND 38).

FIRST USE 2-20-2004; IN COMMERCE 2-20-2004.

CLASS 42—SCIENTIFIC, COMPUTER AND LEGAL SERVICES

FOR PROVIDING TEMPORARY USE OF NON-DOWNLOADABLE SOFTWARE WHICH ALLOWS HOSPITALS TO SCAN MEDICAL RECORDS INTO AN ELECTRONIC FORM AND THE CAPTURE OF ELECTRONIC INFORMATION IN REAL TIME TO CREATE A VIRTUAL MEDICAL RECORD AND THAT PROVIDES DATABASE MANAGEMENT AND DOCUMENT RETENTION (U.S. CLS. 100 AND 101).

FIRST USE 1-31-2004; IN COMMERCE 1-31-2004.
PAULA MAHONEY, EXAMINING ATTORNEY

CLASS 39—TRANSPORTATION AND STORAGE

FOR PHYSICAL STORAGE SERVICES FOR ARCHIVING ELECTRONIC DATA FOR THE HEALTH CARE INDUSTRY; ELECTRONIC STORAGE OF FILES AND DOCUMENTS; CONSULTING SERVICES REGARDING DOCUMENT RETENTION IN THE HEALTH CARE INDUSTRY (U.S. CLS. 100 AND 105).

FIRST USE 2-20-2004; IN COMMERCE 2-20-2004.

CLASS 40—MATERIAL TREATMENT

FOR DIGITAL IMAGING SERVICES, NAMELY, CONVERTING PAPER MEDIA TO DIGITAL IMAGES (U.S. CLS. 100, 103 AND 106).

FIRST USE 2-20-2004; IN COMMERCE 2-20-2004.

CLASS 42—SCIENTIFIC, COMPUTER AND LEGAL SERVICES

FOR APPLICATION SERVICE PROVIDER, NAMELY HOSTING COMPUTER SOFTWARE APPLICATIONS OF OTHERS FOR THE HEALTH CARE INDUSTRY (U.S. CLS. 100 AND 101).

FIRST USE 2-20-2004; IN COMMERCE 2-20-2004.
PAULA MAHONEY, EXAMINING ATTORNEY

SN 78-417,986. JASON STEEL MAPLES, NAPERVILLE, IL.
FILED 5-13-2004.

TINY TOWN PRODUCTS

THE MARK CONSISTS OF STANDARD CHARACTERS WITHOUT CLAIM TO ANY PARTICULAR FONT, STYLE, SIZE, OR COLOR.

NO CLAIM IS MADE TO THE EXCLUSIVE RIGHT TO USE "PRODUCTS", APART FROM THE MARK AS SHOWN.

CLASS 16—PAPER GOODS AND PRINTED MATTER

FOR COOK BOOKS (U.S. CLS. 2, 5, 22, 23, 29, 37, 38 AND 50).

CLASS 28—TOYS AND SPORTING GOODS

FOR SPORTING GOODS, NAMELY, FISHING POLES, LURES, REELS, FISHING LINE (U.S. CLS. 22, 23, 38 AND 50).

CLASS 29—MEATS AND PROCESSED FOODS

FOR SOUPS, CHILI (U.S. CL. 46).

CLASS 30—STAPLE FOODS

FOR FOOD SEASONINGS, SPICES, MARINADES, FOOD FLAVORINGS, DIPPING SAUCES, BREADING MIXES; SEASONING COATINGS FOR FOOD, NAMELY, BATTERS AND BATTER MIXES; SALAD DRESSING, SAUCES, BEVERAGE MADE OF TEA AND COFFEE; HONEY MUSTARD, DELI STYLE MUSTARD, THREE PEPPER MUSTARD, CHIPOLTE SAUCE, CHILI SAUCE, ROASTED PEPPER MARINADE, GARLIC AND HERB MARINADE, SWEET AND TANGY MARINADE, TERIYAKI MARINADE, SOUTHERN DIJON MARINADE, BOURBON PEPPERCORN MARINADE, TEQUILA LIME MARINADE, HOT WING SAUCE, STEAK SAUCE, SWEET ONION STEAK SAUCE, BBQ SAUCE, SMOKED BBQ SAUCE, SWEET ONION BBQ SAUCE, THREE PEPPER RANCH FOOD DRESSING, SWEET ONION RANCH FOOD DRESSING, BACON RANCH FOOD DRESSING, ORIGINAL RANCH FOOD DRESSING, THOUSAND ISLAND FOOD DRESSING, BLUE CHEESE FOOD DRESSING, ITALIAN FOOD DRESSING, TARTAR SAUCE, COCKTAIL SAUCE; SEASONING COATINGS FOR FOOD, NAMELY, GARLIC BATTER, HOT PEPPER BATTER; GARLIC BREADING MIXES, HOT PEPPER BREADING MIXES, CAJUN SEASONING, STEAK SEASONING, LEMON PEPPER SEASONING, POTATO SEASONING, ALL PURPOSE SEASONING, MESQUITE SEASONING, GARLIC PEPPER SEASONING (U.S. CL. 46).

CLASS 32—LIGHT BEVERAGES

FOR BEVERAGES, NAMELY, DRINKING WATER; SPRING WATER (U.S. CLS. 45, 46 AND 48).
CHARLES JOYNER, EXAMINING ATTORNEY

SN 78-418,105. CHEMCENTRIC, L.P., HOUSTON, TX. FILED 5-13-2004.

CLASS 40—MATERIAL TREATMENT

FOR WATER TREATMENT SERVICES AND WATER TREATMENT CONSULTATION SERVICES (U.S. CLS. 100, 103 AND 106).
FIRST USE 8-1-2001; IN COMMERCE 8-1-2001.

CLASS 42—SCIENTIFIC, COMPUTER AND LEGAL SERVICES

FOR COMPUTER SERVICES, NAMELY, PROVIDING TEMPORARY USE OF ON-LINE NON-DOWNLOADABLE SOFTWARE FOR MANAGING THE LOGGING, EDITING, ARCHIVAL, AND RETRIEVAL OF LABORATORY TEST RESULTS, ANALYZER AND CONTROL DATA FROM FIELD ELEMENTS, AND ELECTRONIC FILES RELATED TO SERVICING A WATER TREATMENT CUSTOMER, AND PROVIDING INFORMATION FROM MATERIAL SAFETY DATA SHEETS, EQUIPMENT INSPECTION REPORTS, AND OTHER VERBAL AND WRITTEN COMMUNICATIONS BETWEEN THE CUSTOMER AND THE SERVICE PROVIDER (U.S. CLS. 100 AND 101).

FIRST USE 8-1-2001; IN COMMERCE 8-1-2001.
DARRYL SPRULL, EXAMINING ATTORNEY

SN 78-418,454. MAPLES, JASON STEEL, NAPERVILLE, IL. FILED 5-13-2004.

Chemmunication

THE MARK CONSISTS OF STANDARD CHARACTERS WITHOUT CLAIM TO ANY PARTICULAR FONT, STYLE, SIZE, OR COLOR.

CLASS 35—ADVERTISING AND BUSINESS

FOR WATER TREATMENT MANAGEMENT SERVICES, NAMELY, INTERNET-BASED SERVICE FOR MANAGING THE LOGGING, EDITING, ARCHIVAL, AND RETRIEVAL OF LABORATORY TEST RESULTS, ANALYZER AND CONTROL DATA FROM FIELD ELEMENTS, AND ELECTRONIC FILES RELATED TO SERVICING A WATER TREATMENT CUSTOMER, AND PROVIDING INFORMATION FROM MATERIAL SAFETY DATA SHEETS, EQUIPMENT INSPECTION REPORTS, AND OTHER VERBAL AND WRITTEN COMMUNICATIONS BETWEEN THE CUSTOMER AND THE SERVICE PROVIDER (U.S. CLS. 100, 101 AND 102).
FIRST USE 8-1-2001; IN COMMERCE 8-1-2001.

**CLASS 28—TOYS AND SPORTING GOODS**

FOR SPORTING GOODS, NAMELY, FISHING POLES, LURES, REELS, FISHING LINE. (U.S. CLS. 22, 23, 38 AND 50).

CLASS 29—MEATS AND PROCESSED FOODS

FOR SOUPS, CHILI. (U.S. CL. 46).

CLASS 30—STAPLE FOODS

FOR FOOD SEASONINGS, SPICES, MARINADES, FOOD FLAVORINGS, DIPPING SAUCES, BREADING MIXES, BATTER MIXES, SALAD DRESSING, SAUCES, BEVERAGE MADE OF TEA AND COFFEE; BATTERS, HONEY MUSTARD, DELI STYLE MUSTARD, THREE PEPPER MUSTARD, CHIPOLTE SAUCE, CHILI SAUCE, ROASTED PEPPER MARINADE, GARLIC AND HERB MARINADE, SWEET AND TANGY MARINADE, TERIYAKI MARINADE, SOUTHERN DIJON MARINADE, BOURBON PEPPERCORN MARINADE, TEQUILA LIME MARINADE, HOT WING SAUCE, ORIGINAL STEAK SAUCE, SWEET ONION STEAK SAUCE, ORIGINAL BBQ SAUCE, SMOKED BBQ SAUCE, SWEET ONION BBQ SAUCE, THREE PEPPER RANCH DRESSING, SWEET ONION RANCH DRESSING, BACON RANCH DRESSING, ORIGINAL RANCH DRESSING, THOUSAND ISLAND DRESSING, BLUE CHEESE DRESSING, ITALIAN DRESSING, TARTAR SAUCE, COCKTAIL SAUCE, GARLIC BATTER, HOT PEPPER BATTER, ORIGINAL BATTER, GARLIC BREADING, HOT PEPPER BREADING, ORIGINAL BREADING, CAJUN SEASONING, STEAK SEASONING, LEMON PEPPER SEASONING, POTATO SEASONING, ALL PURPOSE SEASONING, MESQUITE SEASONING, GARLIC PEPPER SEASONING. (U.S. CL. 46).

TRACY CROSS, EXAMINING ATTORNEY

SN 78-419,849. AMERICAN DIESEL & GAS, INC., BOCA RATON, FL. FILED 5-17-2004.

Q-SHIELD

SN 78-419,307. CLAUD, DAVID W., PORTLAND, OR. FILED 5-14-2004.

CLONE-A-WILLY

THE MARK CONSISTS OF STANDARD CHARACTERS WITHOUT CLAIM TO ANY PARTICULAR FONT, STYLE, SIZE, OR COLOR.

CLASS 10—MEDICAL APPARATUS

FOR ADULT SEXUAL AIDS, NAMELY, KIT CONSISTING PRIMARILY OF A MOLDING TUBE, MOLDING POWDER TO BE MIXED WITH WATER IN ORDER TO FORM A MOLD, A POURABLE, SOLIDIFYING MATERIAL TO POUR INTO THE MOLD TO FORM A CAST, AND A COMPLETE SET OF DIRECTIONS DETAILING HOW TO USE SAID MATERIALS TO FORM AN ARTIFICIAL PENIS (U.S. CLS. 26, 39 AND 44).

FIRST USE 10-15-2003; IN COMMERCE 1-15-2004.

CLASS 28—TOYS AND SPORTING GOODS

FOR HOBBY-CRAFT IN HOME PENIS CASTING KIT CONSISTING PRIMARILY OF A MOLDING TUBE, MOLDING POWDER TO BE MIXED WITH WATER IN ORDER TO FORM A MOLD, A POURABLE, SOLIDIFYING MATERIAL TO POUR INTO THE MOLD TO FORM A CAST, AND A COMPLETE SET OF DIRECTIONS DETAILING HOW TO USE SAID MATERIALS TO FORM AN ARTIFICIAL PENIS (U.S. CLS. 22, 23, 38 AND 50).

FIRST USE 10-15-2003; IN COMMERCE 1-15-2004.
ANNE MADDEN, EXAMINING ATTORNEY

THE MARK CONSISTS OF STANDARD CHARACTERS WITHOUT CLAIM TO ANY PARTICULAR FONT, STYLE, SIZE, OR COLOR.

CLASS 6—METAL GOODS

FOR METAL FASTENERS FOR INSULATING MATERIALS AND WRAPS, NAMELY, WIRES, SAFETY STRAPS AND CLAMPS (U.S. CLS. 2, 12, 13, 14, 23, 25 AND 50).

CLASS 17—RUBBER GOODS

FOR MULTILAYERED HEAT REFLECTIVE AND HEAT INSULATING MATERIALS, NAMELY, WRAPS, COVERS AND BLANKETS, IN THE FORM OF PRE-CUT PIECES, PRE-CUT AND ASSEMBLED PIECES OR IN SHEET FORM, ADHESIVE COATED OR NON-ADHESIVE COATED, FOR USE ON ENGINE COMPONENTS, ENGINE COMPARTMENT WALLS AND ACCESS HOODS; METAL FOIL ADHESIVE TAPES FOR HEAT REFLECTIVE AND INSULATING MATERIALS (U.S. CLS. 1, 5, 12, 13, 35 AND 50).

CLASS 37—CONSTRUCTION AND REPAIR

FOR INSTALLATION OF HEAT REFLECTIVE AND INSULATING MATERIALS, NAMELY, WRAPS, COVERS AND BLANKETS, IN THE FORM OF PRE-CUT PIECES, PRE-CUT AND ASSEMBLED PIECES OR IN SHEET METAL FORM, FOR USE ON ENGINE COMPONENTS, ENGINE COMPARTMENT WALLS AND ACCESS HOODS (U.S. CLS. 100, 103 AND 106).

CLASS 42—SCIENTIFIC, COMPUTER AND LEGAL SERVICES

FOR DESIGN AND DEVELOPMENT FOR OTHERS OF INSULATING MATERIALS FOR ENGINES, ENGINE COMPONENTS AND ENGINE COMPARTMENTS (U.S. CLS. 100 AND 101).

ASMAT KHAN, EXAMINING ATTORNEY

SN 78-419,977. CLASSMATES ONLINE, INC., RENTON, WA.
FILED 5-17-2004.



THE MARK CONSISTS OF SQUARE-SHAPED BOX WITH SMILE INSIDE.

CLASS 9—ELECTRICAL AND SCIENTIFIC APPARATUS

FOR AUDIO RECORDINGS, NAMELY, PRE-RECORDED AUDIO CASSETTES, AUDIO TAPES, AND COMPACT DISCS FEATURING MUSIC AND SPOKEN WORD; AUDIOVISUAL RECORDINGS, NAMELY PRE-RECORDED VIDEOTAPES, LASER DISCS, AND DVD RECORDINGS FEATURING COMEDY, VARIETY, DRAMA AND DOCUMENTARY TELEVISION PROGRAMS AND MOTION PICTURES (U.S. CLS. 21, 23, 26, 36 AND 38).

CLASS 35—ADVERTISING AND BUSINESS

FOR PROVIDING DATABASES OF CONTACT AND BIOGRAPHICAL INFORMATION FOR FACILITATING PROFESSIONAL RELATIONSHIPS AND NETWORKING, NAMELY, INFORMATION PERTAINING TO WORKPLACE, MILITARY RECORD AND HISTORY, AND EDUCATIONAL RECORD AND HISTORY, ALL VIA COMMUNICATIONS NETWORKS; DISSEMINATION OF ADVERTISING FOR OTHERS; REFERRAL SERVICES IN THE FIELD OF CONSUMER GOODS AND SERVICES; PROMOTING THE SALE OF GOODS AND SERVICES OF OTHERS BY MEANS OF A PREFERRED CUSTOMER PROGRAM FEATURING REBATES, DISCOUNTS AND INCENTIVES (U.S. CLS. 100, 101 AND 102).

CLASS 38—COMMUNICATION

FOR COMMUNICATION SERVICES, NAMELY, PROVIDING ELECTRONIC TRANSMISSION OF INFORMATION, DATA, SOUND, IMAGES, VIDEO AND DOCUMENTS; PROVIDING ELECTRONIC MESSAGING SERVICES VIA COMMUNICATIONS NETWORKS; PROVIDING ELECTRONIC BULLETIN BOARDS AND CHAT ROOMS FOR TRANSMISSION OF MESSAGES, VIA COMMUNICATIONS NETWORKS, PERTAINING TO PERSONAL AND PROFESSIONAL RELATIONSHIPS, PERSONAL NETWORKING, ROMANCE, FAMILY, WORKPLACE, MILITARY, EDUCATIONAL INSTITUTIONS, AFFINITY GROUPS, REUNIONS, AND ESTABLISHING AND MAINTAINING FRIENDSHIPS AND ACQUAINTANCES; PROVIDING MULTIPLE-USER ACCESS TO COMMUNICATIONS NETWORKS; PROVIDING MULTIPLE-USER ACCESS TO AUDIO AND VIDEO WEBCASTS VIA COMMUNICATIONS NETWORKS (U.S. CLS. 100, 101 AND 104).

CLASS 41—EDUCATION AND ENTERTAINMENT

FOR SPECIAL EVENT PLANNING; ENTERTAINMENT SERVICES IN THE NATURE OF A SERIES OF COMEDY, VARIETY, DRAMA AND DOCUMENTARY TELEVISION PROGRAMS AND MOTION PICTURES; ENTERTAINMENT SERVICES IN THE NATURE OF A SERIES OF COMEDY, VARIETY, DRAMA AND DOCUMENTARY PROGRAMS AND MOTION PICTURES, ALL DISTRIBUTED VIA AN ELECTRONIC COMMUNICATION NETWORK; TELEVISION PROGRAM PRODUCTION; MOTION PICTURE PRODUCTION; PRODUCTION OF WEBCAST PROGRAMS; ENTERTAINMENT SERVICES IN THE NATURE OF A SERIES OF WEBCAST PROGRAMS IN THE FIELDS OF RELATIONSHIPS, PERSONAL INTRODUCTIONS, FAMILY, MILITARY, WORKPLACE, EDUCATIONAL INSTITUTIONS, AFFINITY GROUPS, ROMANCE, FRIENDSHIPS, AND REUNIONS (U.S. CLS. 100, 101 AND 107).

CLASS 45—PERSONAL SERVICES

FOR SOCIAL INTRODUCTION SERVICES IN THE NATURE OF PROVIDING INFORMATION PERTAINING TO RELATIONSHIPS, PERSONAL INTRODUCTIONS, FAMILY, MILITARY SERVICE, WORKPLACE, EDUCATIONAL INSTITUTIONS, AFFINITY GROUPS, ROMANCE, FRIENDSHIPS, AND REUNIONS, ALL FOR SOCIAL NETWORKING PURPOSES (U.S. CLS. 100 AND 101).

NICHOLAS ALTREE, EXAMINING ATTORNEY

SN 78-420,776. JOHNSON & JOHNSON, NEW BRUNSWICK, NJ. FILED 5-18-2004.

PROTIENT AGELESS

THE MARK CONSISTS OF STANDARD CHARACTERS WITHOUT CLAIM TO ANY PARTICULAR FONT, STYLE, SIZE, OR COLOR.

OWNER OF U.S. REG. NOS. 2,623,738, 2,748,722 AND 2,776,302.

CLASS 3—COSMETICS AND CLEANING PREPARATIONS

FOR NON-MEDICATED SKIN CARE PREPARATIONS, NAMELY, SKIN FIRING MOISTURIZERS, CREAMS AND LOTIONS, EYE GELS, LIP BALMS AND SKIN CLEANSERS (U.S. CLS. 1, 4, 6, 50, 51 AND 52).

CLASS 5—PHARMACEUTICALS

FOR MEDICATED SKIN CARE PREPARATIONS, NAMELY, SKIN FIRING MOISTURIZERS, CREAMS AND LOTIONS, EYE GELS, LIP BALMS AND SKIN CLEANSERS (U.S. CLS. 6, 18, 44, 46, 51 AND 52).

MARIA-VICTORIA SUAREZ, EXAMINING ATTORNEY

SN 78-421,292. ICBA MORTGAGE CORPORATION, ARLINGTON, VA. FILED 5-19-2004.

SMARTLENDER ADVANTAGE

THE MARK CONSISTS OF STANDARD CHARACTERS WITHOUT CLAIM TO ANY PARTICULAR FONT, STYLE, SIZE, OR COLOR.

CLASS 9—ELECTRICAL AND SCIENTIFIC APPARATUS

FOR DOWNLOADABLE MORTGAGE AND INSURANCE DOCUMENTS PROVIDED FOR MEMBER BANKS (U.S. CLS. 21, 23, 26, 36 AND 38).

CLASS 36—INSURANCE AND FINANCIAL

FOR MORTGAGE BROKERAGE AND INSURANCE BROKERAGE SERVICES, NAMELY PROVIDING MORTGAGE AND INSURANCE SERVICES TO MEMBER BANKS (U.S. CLS. 100, 101 AND 102).
SKYE YOUNG, EXAMINING ATTORNEY

SN 78-421,975. EMPLOYER CONSULTANCY, INC., FLEMINGTON, NJ. FILED 5-20-2004.

ECI

THE MARK CONSISTS OF STANDARD CHARACTERS WITHOUT CLAIM TO ANY PARTICULAR FONT, STYLE, SIZE, OR COLOR.

CLASS 35—ADVERTISING AND BUSINESS

FOR CONSULTING SERVICES FOR HIRING, MANAGING AND MOTIVATING PRODUCTIVITY OF PERSONNEL; ADMINISTRATION OF TESTING AND ANALYSIS OF TEST RESULTS FOR SELECTION AND DEVELOPMENT OF PERSONNEL; CONDUCTING COMPARATIVE STUDIES TO IDENTIFY BEHAVIORAL FACTORS RELATED TO TOP PERFORMING PERSONNEL (U.S. CLS. 100, 101 AND 102).
FIRST USE 4-1-1996; IN COMMERCE 4-1-1996.

CLASS 41—EDUCATION AND ENTERTAINMENT

FOR CONSULTING SERVICES FOR TRAINING OF PERSONNEL (U.S. CLS. 100, 101 AND 107).
FIRST USE 4-1-1996; IN COMMERCE 4-1-1996.

CLASS 42—SCIENTIFIC, COMPUTER AND LEGAL SERVICES

FOR PROVIDING TEMPORARY NON-DOWNLOADABLE SOFTWARE VIA THE INTERNET FOR PSYCHOLOGICAL AND JOB COMPETENCY TESTING, GENERATION OF ANALYSIS AND REPORTS OF TEST RESULTS, ALL FOR SELECTION AND DEVELOPMENT OF PERSONNEL (U.S. CLS. 100 AND 101).
FIRST USE 4-1-1996; IN COMMERCE 4-1-1996.
MATTHEW PAPPAS, EXAMINING ATTORNEY

SN 78-422,143. KIDS II, INC., ALPHARETTA, GA. FILED 5-20-2004.

BRIGHT INSPIRATIONS

THE MARK CONSISTS OF STANDARD CHARACTERS WITHOUT CLAIM TO ANY PARTICULAR FONT, STYLE, SIZE, OR COLOR.
OWNER OF U.S. REG. NOS. 2,613,509 AND 2,854,316.

CLASS 20—FURNITURE AND ARTICLES NOT OTHERWISE CLASSIFIED

FOR DECORATIVE PILLOWS (U.S. CLS. 2, 13, 22, 25, 32 AND 50).
FIRST USE 7-9-2004; IN COMMERCE 7-9-2004.

CLASS 24—FABRICS

FOR INFANT AND CHILDREN'S BEDDING AND ACCESSORIES, NAMELY, QUILTS, CRIB BLANKETS, RECEIVING BLANKETS, BLANKET THROWS, TOWELS, NAMELY, BATH TOWELS, HOODED TOWELS, WASH-CLOTHS AND WASHING MITTS (U.S. CLS. 42 AND 50).
FIRST USE 7-9-2004; IN COMMERCE 7-9-2004.

CLASS 25—CLOTHING

FOR INFANT AND CHILDREN'S CLOTHING, NAMELY, CLOTH BIBS, SLIPPERS, SOCKS, HATS AND MITTENS (U.S. CLS. 22 AND 39).
FIRST USE 8-3-2004; IN COMMERCE 8-3-2004.

CLASS 28—TOYS AND SPORTING GOODS

FOR INFANT AND CHILDREN'S TOYS, NAMELY, SOFT TOY PICTURE BOOKS, PLUSH BABY RATTLES, PLUSH TOY ANIMALS; PLUSH TOY ANIMALS ATTACHED TO BLANKETS (U.S. CLS. 22, 23, 38 AND 50).
FIRST USE 4-10-2001; IN COMMERCE 4-10-2001.
ROBERT LORENZO, EXAMINING ATTORNEY

SN 78-422,182. CLASSIFIED VENTURES, LLC, CHICAGO, IL. FILED 5-20-2004.

WHYPAYSTICKER.COM

THE MARK CONSISTS OF STANDARD CHARACTERS WITHOUT CLAIM TO ANY PARTICULAR FONT, STYLE, SIZE, OR COLOR.

CLASS 35—ADVERTISING AND BUSINESS

FOR PROMOTING THE GOODS SERVICES OF OTHERS BY PROVIDING A WEB SITE AT WHICH USERS CAN LINK TO AUTOMOTIVE INDUSTRY LINKS REGARDING NEW AND PRE-OWNED VEHICLE PRICE QUOTES, USED CARS FOR SALE; PROMOTING THE GOODS AND SERVICES OF OTHERS BY PROVIDING HYPERTEXT LINKS TO THE WEB SITES OF OTHERS IN THE AUTOMOTIVE INDUSTRY; PROVIDING INFORMATION PERTAINING TO NEW AND PRE-OWNED VEHICLE PRICE QUOTES AND USED CARS FOR SALE VIA THE INTERNET (U.S. CLS. 100, 101 AND 102).

FIRST USE 2-27-2004; IN COMMERCE 2-27-2004.

CLASS 36—INSURANCE AND FINANCIAL

FOR PROVIDING INFORMATION REGARDING EXTENDED VEHICLE SERVICE PLANS AND INSURANCE, AND FINANCING THE PURCHASE OF VEHICLES VIA THE INTERNET (U.S. CLS. 100, 101 AND 102).

FIRST USE 2-27-2004; IN COMMERCE 2-27-2004.
GEOFFREY FOSDICK, EXAMINING ATTORNEY

SN 78-422,209. 260 DEGREES ENTERTAINMENT, INC., WOODLAND HILLS, CA. FILED 5-20-2004.

**SOUL THEATER
SERIES**

THE MARK CONSISTS OF STANDARD CHARACTERS WITHOUT CLAIM TO ANY PARTICULAR FONT, STYLE, SIZE, OR COLOR.

NO CLAIM IS MADE TO THE EXCLUSIVE RIGHT TO USE "THEATER SERIES", APART FROM THE MARK AS SHOWN.

CLASS 9—ELECTRICAL AND SCIENTIFIC APPARATUS

FOR PRERECORDED CDS, VIDEO TAPES, LASER DISKS, DVDS AND VIDEO CASSETTES FEATURING COMEDIC, DRAMATIC, RELIGIOUS AND MUSICAL PERFORMANCES (U.S. CLS. 21, 23, 26, 36 AND 38).

CLASS 25—CLOTHING

FOR CLOTHING, NAMELY, T-SHIRTS, SWEATSHIRTS, SHORTS, PANTS, JACKETS AND HEADWEAR (U.S. CLS. 22 AND 39).

CLASS 41—EDUCATION AND ENTERTAINMENT

FOR PRODUCTION OF RADIO AND TELEVISION SHOWS; AUDIO RECORDING AND PRODUCTION; PRODUCTION AND DISTRIBUTION OF MOTION PICTURES; ENTERTAINMENT IN THE NATURE OF THEATER PRODUCTIONS (U.S. CLS. 100, 101 AND 107).

IRA J. GOODSaid, EXAMINING ATTORNEY

SN 78-422,247. MORGAN, ROLAND, SEATTLE, WA. FILED 5-20-2004.

.AIR

THE MARK CONSISTS OF STANDARD CHARACTERS WITHOUT CLAIM TO ANY PARTICULAR FONT, STYLE, SIZE, OR COLOR.

CLASS 41—EDUCATION AND ENTERTAINMENT

FOR COMPUTER SERVICES, NAMELY, PROVIDING ONLINE BOOKS, MANUALS, GUIDES, FORMS, ILLUSTRATIONS AND TECHNICAL DATA PACKAGES IN THE FIELD OF AIRCRAFT, AIRCRAFT PARTS AND AVIONICS; TRAINING IN THE USE AND OPERATION OF AIRCRAFT AND AEROSPACE PRODUCTS, PARTS AND SUPPORT EQUIPMENT (U.S. CLS. 100, 101 AND 107).

CLASS 42—SCIENTIFIC, COMPUTER AND LEGAL SERVICES

FOR TECHNICAL CONSULTATION AND RESEARCH, DESIGN, AND TESTING OF NEW PRODUCTS FOR OTHERS; TECHNICAL CONSULTATION AND ASSISTANCE RELATED TO THE DESIGN, MANUFACTURE, CERTIFICATION, OPERATION, MAINTENANCE, REPAIR, OVERHAUL, OR MODIFICATION OF AIRCRAFT AND AIRCRAFT PARTS (U.S. CLS. 100 AND 101).

MICHAEL KEATING, EXAMINING ATTORNEY

SN 78-422,404. I-DOT, INC., LAKE GENEVA, WI. FILED 5-20-2004.

I-DOT

THE MARK CONSISTS OF STANDARD CHARACTERS WITHOUT CLAIM TO ANY PARTICULAR FONT, STYLE, SIZE, OR COLOR.

CLASS 7—MACHINERY

FOR DIGITAL FINISHING MACHINES FOR PRINTING GRAPHICS IN THE GRAPHIC ARTS INDUSTRY (U.S. CLS. 13, 19, 21, 23, 31, 34 AND 35).

CLASS 42—SCIENTIFIC, COMPUTER AND LEGAL SERVICES

FOR TECHNICAL CONSULTING SERVICES ABOUT PRODUCING GRAPHIC ARTS (U.S. CLS. 100 AND 101).
G. MAYERSCHOFF, EXAMINING ATTORNEY

SN 78-423,228. MACROPORE BIOSURGERY, INC., SAN DIEGO, CA. FILED 5-21-2004.

ADVACEL

THE MARK CONSISTS OF STANDARD CHARACTERS WITHOUT CLAIM TO ANY PARTICULAR FONT, STYLE, SIZE, OR COLOR.

CLASS 1—CHEMICALS

FOR THERAPEUTIC CELL AND STEM CELL COMPOSITIONS FOR SCIENTIFIC OR MEDICAL OR LABORATORY RESEARCH (U.S. CLS. 1, 5, 6, 10, 26 AND 46).

CLASS 5—PHARMACEUTICALS

FOR THERAPEUTIC CELLULAR AND STEM CELL COMPOSITIONS FOR CLINICAL OR MEDICAL USE; CELLS AND STEM CELLS COMPOSITIONS FOR THE TREATMENT OF HUMANS DISEASES (U.S. CLS. 6, 18, 44, 46, 51 AND 52).

CLASS 10—MEDICAL APPARATUS

FOR REGENERATIVE MEDICAL PRODUCTS, NAMELY, CELL, CELLULAR COMPONENT, AND STEM CELL EXTRACTION, PROCESSING AND APPLICATION MEDICAL DEVICES FOR MEDICAL APPLICATIONS; MEDICAL APPARATUSES FOR IMPLEMENTING TREATMENT METHODS USING CELLS, CELLULAR COMPONENTS AND STEM CELLS; CELL PURIFICATION DEVICES FOR MEDICAL APPLICATIONS, NAMELY, MEDICAL DEVICES USED FOR THE ISOLATION OF CELLS AND CELLULAR COMPONENTS WITHIN ADIPOSE TISSUE; TISSUE PROCESSING MEDICAL DEVICES, NAMELY, MEDICAL DEVICES USED FOR THE COLLECTION AND PROCESSING OF ADIPOSE TISSUE (U.S. CLS. 26, 39 AND 44).

CLASS 39—TRANSPORTATION AND STORAGE

FOR STORAGE OF HUMAN CELLS AND CELLULAR COMPONENTS; STORAGE OF HUMAN CELLS AND CELLULAR COMPONENTS FOR USE IN CELL AND CELLULAR COMPONENT TRANSPLANTATIONS AND TREATMENTS (U.S. CLS. 100 AND 105).
HEATHER THOMPSON, EXAMINING ATTORNEY

SN 78-423,417. PHAIR, ROBERT E., DOVER, NJ. FILED 5-22-2004.

COTANGENT

THE MARK CONSISTS OF STANDARD CHARACTERS WITHOUT CLAIM TO ANY PARTICULAR FONT, STYLE, SIZE, OR COLOR.

CLASS 35—ADVERTISING AND BUSINESS

FOR DIRECT MARKETING ADVERTISING FOR OTHERS; DEVELOPMENT OF MARKETING STRATEGIES AND CONCEPTS; COOPERATIVE ADVERTISING AND MARKETING SERVICES BY WAY OF SOLICITATION, CUSTOMER SERVICE AND PROVIDING MARKETING INFORMATION VIA WEBSITES ON A GLOBAL COMPUTER NETWORK; MARKETING CONSULTING (U.S. CLS. 100, 101 AND 102).

FIRST USE 5-7-2004; IN COMMERCE 5-22-2004.

CLASS 41—EDUCATION AND ENTERTAINMENT

SN 78-423,921. BILL YOUNG PRODUCTIONS, INC., SUGAR LAND, TX. FILED 5-24-2004.

FOR EDUCATIONAL SERVICES, NAMELY, CONDUCTING ON-LINE EXHIBITIONS AND DISPLAYS AND INTERACTIVE EXHIBITS IN THE FIELD OF MARKETING DESIGN, FORMS AND METHODS OF DIRECT MARKETING, DESIGN AND IMPLEMENTATION OF COMPUTER SERVICES FOR BUSINESSES, AND BUSINESS DEVELOPMENT (U.S. CLS. 100, 101 AND 107).

FIRST USE 5-7-2004; IN COMMERCE 5-22-2004.

CLASS 42—SCIENTIFIC, COMPUTER AND LEGAL SERVICES

FOR DESIGN, CREATION, HOSTING, MAINTENANCE OF WEBSITES FOR OTHERS; CONSULTING SERVICES IN THE FIELD OF DESIGN, SELECTION, IMPLEMENTATION AND USE OF COMPUTER HARDWARE AND SOFTWARE SYSTEMS FOR OTHERS; TECHNICAL CONSULTING SERVICES FOR COMPUTER PROGRAMMING, DATABASE DESIGN, GRAPHIC ART DESIGN, TECHNICAL WRITING FOR OTHERS (U.S. CLS. 100 AND 101).

FIRST USE 5-7-2004; IN COMMERCE 5-22-2004.
SALLY SHIH, EXAMINING ATTORNEY

THE POWER OF IMAGINATION

THE MARK CONSISTS OF A STYLIZED LETTER O IN THE WORD POWER IN THE MARK "THE POWER OF IMAGINATION".

CLASS 35—ADVERTISING AND BUSINESS

FOR ADVERTISING SERVICES, NAMELY, RADIO COMMERCIAL PRODUCTION, VIDEO COMMERCIAL PRODUCTION, PROMOTING THE CONCERTS AND SPECIAL EVENT OF OTHERS, AND BUSINESS CONSULTATION IN THE FIELD OF CORPORATE COMMUNICATIONS (U.S. CLS. 100, 101 AND 102).

FIRST USE 0-0-2002; IN COMMERCE 0-0-2002.

CLASS 41—EDUCATION AND ENTERTAINMENT

FOR ANIMATION PRODUCTION, TELEVISION PROGRAM PRODUCTION, INTERACTIVE MEDIA PROGRAM PRODUCTION, AND SPECIAL EVENT PLANNING AND CONSULTATION (U.S. CLS. 100, 101 AND 107).

FIRST USE 0-0-2002; IN COMMERCE 0-0-2002.

CLASS 42—SCIENTIFIC, COMPUTER AND LEGAL SERVICES

FOR GRAPHIC DESIGN AND WEBSITE DESIGN (U.S. CLS. 100 AND 101).

FIRST USE 0-0-2002; IN COMMERCE 0-0-2002.

WENDY GOODMAN, EXAMINING ATTORNEY

SN 78-423,573. WORLD NOTES, LLC, WELLESLEY, MA. FILED 5-24-2004.

BAKU THE TRAVEL
BUG

SN 78-424,501. THARANGNI, INC., GAINESVILLE, FL. FILED 5-25-2004.

THE MARK CONSISTS OF STANDARD CHARACTERS WITHOUT CLAIM TO ANY PARTICULAR FONT, STYLE, SIZE, OR COLOR.

CLASS 9—ELECTRICAL AND SCIENTIFIC APPARATUS

FOR PRE-RECORDED VIDEO CASSETTES AND DIGITAL VERSATILE DISCS FEATURING CHILDREN'S MOVIES, STORIES AND MUSIC (U.S. CLS. 21, 23, 26, 36 AND 38).

CLASS 16—PAPER GOODS AND PRINTED MATTER

FOR CHILDREN'S STORY BOOKS AND CHILDREN'S ACTIVITY BOOKS (U.S. CLS. 2, 5, 22, 23, 29, 37, 38 AND 50).

LINDA POWELL, EXAMINING ATTORNEY

AYAAN

THE MARK CONSISTS OF STANDARD CHARACTERS WITHOUT CLAIM TO ANY PARTICULAR FONT, STYLE, SIZE, OR COLOR.

THE ENGLISH TRANSLATION OF AYAAN IS "CLEAR" AND "NOBLE".

CLASS 9—ELECTRICAL AND SCIENTIFIC APPARATUS

FOR PRE-RECORDED ENTERTAINMENT MEDIA, NAMELY, CD'S, AUDIO CASSETTES, DVD'S AND VIDEO CASSETTES ALL FEATURING MUSIC (U.S. CLS. 21, 23, 26, 36 AND 38).

CLASS 16—PAPER GOODS AND PRINTED MATTER

FOR SHEET MUSIC, POSTERS AND POSTCARDS (U.S. CLS. 2, 5, 22, 23, 29, 37, 38 AND 50).

CLASS 25—CLOTHING

FOR CLOTHING, NAMELY T-SHIRTS, CAPS AND SWEATSHIRTS (U.S. CLS. 22 AND 39).

CLASS 35—ADVERTISING AND BUSINESS

FOR MANAGEMENT OF PERFORMING ARTISTS (U.S. CLS. 100, 101 AND 102).

CLASS 36—INSURANCE AND FINANCIAL

FOR PROVIDING FINANCIAL SPONSORSHIP OF THE MUSICAL CONCERTS, PERSONAL APPEARANCES, DRAMATIC PRESENTATIONS, COMEDIC PRESENTATIONS AND PLAYS OF OTHERS; FINANCIAL PLANNING AND FINANCIAL MANAGEMENT (U.S. CLS. 100, 101 AND 102).

CLASS 41—EDUCATION AND ENTERTAINMENT

FOR ENTERTAINMENT SERVICES, NAMELY PRODUCING ENTERTAINMENT EVENTS, NAMELY PRODUCING MUSICAL CONCERTS, PRESENTATIONS OF DRAMATIC AND COMEDIC PERFORMANCES, AND PLAYS; ENTERTAINMENT SERVICES, NAMELY PERSONAL APPEARANCES BY MUSICAL PERFORMERS, AND MOVIE STARS (U.S. CLS. 100, 101 AND 107).
NORA BUCHANAN WILL, EXAMINING ATTORNEY

CLASS 16—PAPER GOODS AND PRINTED MATTER

FOR SHEET MUSIC, POSTERS AND POSTCARDS (U.S. CLS. 2, 5, 22, 23, 29, 37, 38 AND 50).

CLASS 25—CLOTHING

FOR CLOTHING, NAMELY T-SHIRTS, CAPS AND SWEATSHIRTS (U.S. CLS. 22 AND 39).

CLASS 35—ADVERTISING AND BUSINESS

FOR MANAGEMENT OF PERFORMING ARTISTS; PROMOTING THE ENTERTAINMENT EVENTS OF OTHERS, NAMELY PROMOTING MUSICAL CONCERTS, PERSONAL APPEARANCES BY MUSICAL PERFORMERS, PRESENTATIONS OF DRAMATIC AND COMEDIC PERFORMANCES, AND PLAYS (U.S. CLS. 100, 101 AND 102).

CLASS 36—INSURANCE AND FINANCIAL

FOR PROVIDING FINANCIAL SPONSORSHIP OF THE MUSICAL CONCERTS, PERSONAL APPEARANCES, DRAMATIC PRESENTATIONS, COMEDIC PRESENTATIONS AND PLAYS OF OTHERS; FINANCIAL PLANNING AND FINANCIAL MANAGEMENT (U.S. CLS. 100, 101 AND 102).

CLASS 41—EDUCATION AND ENTERTAINMENT

FOR ENTERTAINMENT SERVICES, NAMELY PRODUCING ENTERTAINMENT EVENTS, NAMELY PRODUCING MUSICAL CONCERTS, PRESENTATIONS OF DRAMATIC AND COMEDIC PERFORMANCES, AND PLAYS; ENTERTAINMENT SERVICES, NAMELY PERSONAL APPEARANCES BY MUSICAL PERFORMERS, AND MOVIE STARS (U.S. CLS. 100, 101 AND 107).
FIRST USE 9-30-1999; IN COMMERCE 9-30-1999.
JOHN DWYER, EXAMINING ATTORNEY

SN 78-424,652. THARANGNI, INC., GAINESVILLE, FL.
FILED 5-25-2004.

**CLASS 9—ELECTRICAL AND SCIENTIFIC APPARATUS**

FOR PRE-RECORDED ENTERTAINMENT MEDIA, NAMELY CD'S, AUDIO CASSETTES, DVD'S AND VIDEO CASSETTES ALL FEATURING MUSIC AND PERFORMANCES, NAMELY, APPEARANCES BY MUSICAL PERFORMERS, PRESENTATIONS OF DRAMATIC AND COMEDIC PERFORMANCES, AND PLAYS (U.S. CLS. 21, 23, 26, 36 AND 38).
FIRST USE 9-30-1999; IN COMMERCE 9-30-1999.

SN 78-425,124. PII LIMITED, CRAMLINGTON, NORTH-UMBERLAND, UNITED KINGDOM, FILED 5-26-2004.

ULTRASCAN

THE MARK CONSISTS OF STANDARD CHARACTERS WITHOUT CLAIM TO ANY PARTICULAR FONT, STYLE, SIZE, OR COLOR.

CLASS 9—ELECTRICAL AND SCIENTIFIC APPARATUS

FOR ULTRASONIC PIPELINE INSPECTION TOOLS, NAMELY, ULTRASONIC LEAKAGE SENSORS (U.S. CLS. 21, 23, 26, 36 AND 38).

CLASS 42—SCIENTIFIC, COMPUTER AND LEGAL SERVICES

FOR PIPELINE INSPECTION SERVICES (U.S. CLS. 100 AND 101).
MELISSA SHELLA, EXAMINING ATTORNEY

SN 78-425,394. NINAPHARM, ANNECY, FRANCE, FILED 5-26-2004.

NANOFORCE

THE MARK CONSISTS OF STANDARD CHARACTERS WITHOUT CLAIM TO ANY PARTICULAR FONT, STYLE, SIZE, OR COLOR.

CLASS 3—COSMETICS AND CLEANING PREPARATIONS

FOR COSMETICS, PERFUMERY PRODUCTS, NAMELY EAU DE COLOGNE, HAIR LOTIONS, COSMETIC CREAMS, ESSENTIAL OILS FOR PERSONAL USE, BEAUTY LOTIONS, SOAPS, FRAGRANCES FOR PERSONAL USE, PERFUMES, DEPILATORY PREPARATIONS, DENTIFRICES, LIPSTICKS, BEAUTY MASKS, SHAVING PREPARATIONS (U.S. CLS. 1, 4, 6, 50, 51 AND 52).

CLASS 5—PHARMACEUTICALS

FOR PHARMACEUTICAL PREPARATIONS, NAMELY ANTIOXIDANTS; SANITARY PREPARATIONS FOR MEDICAL PURPOSES; DIETETIC FOODS ADAPTED FOR MEDICAL USE; FOODS SUPPLEMENTS, NAMELY ANTI-OXIDANTS; DIET PILLS, DIET CAPSULES; DIETARY NUTRITIONAL SUPPLEMENTS FOR WOMEN EXPERIENCING MENOPAUSE; CHOLESTEROL REDUCERS; ANTI-DIABETIC PREPARATIONS; MEDICINAL HERBS IN DRIED OR PRESERVED FORM; HERB TEAS FOR MEDICINAL PURPOSES (U.S. CLS. 6, 18, 44, 46, 51 AND 52).

MARK SPARACINO, EXAMINING ATTORNEY

SN 78-425,435. BALL, GEOFF, LOS ALTOS, CA. FILED 5-26-2004.

SMARTGROUPS

THE MARK CONSISTS OF STANDARD CHARACTERS WITHOUT CLAIM TO ANY PARTICULAR FONT, STYLE, SIZE, OR COLOR.

CLASS 16—PAPER GOODS AND PRINTED MATTER

FOR PRINTED INSTRUCTIONAL, EDUCATIONAL AND TEACHING MATERIALS IN THE FIELDS OF HUMAN RESOURCES, PERSONNEL DEVELOPMENT, AND BUSINESS MANAGEMENT (U.S. CLS. 2, 5, 22, 23, 29, 37, 38 AND 50).

FIRST USE 2-20-2004; IN COMMERCE 2-20-2004.

CLASS 35—ADVERTISING AND BUSINESS

FOR CONSULTING SERVICES IN THE FIELDS OF HUMAN RESOURCES, PERSONNEL DEVELOPMENT, AND BUSINESS MANAGEMENT (U.S. CLS. 100, 101 AND 102).

FIRST USE 2-20-2004; IN COMMERCE 2-20-2004.

STEVEN JACKSON, EXAMINING ATTORNEY

SN 78-425,920. LABORATOIRES QUINTON INTERNATIONAL S.L., E-03160 ALMORADI, SPAIN, FILED 5-27-2004.

QUINTON

THE MARK CONSISTS OF STANDARD CHARACTERS WITHOUT CLAIM TO ANY PARTICULAR FONT, STYLE, SIZE, OR COLOR.

CLASS 5—PHARMACEUTICALS

FOR COLD MICROFILTERED SEAWATER FOR PHARMACEUTICAL AND VETERINARY USE; SANITARY PREPARATIONS FOR MEDICAL USE AND DIETETIC FOODS ADAPTED FOR MEDICAL USE; BABY FOOD, MEDICAL PLASTERS, MATERIALS FOR DRESSINGS, NAMELY GAUZE FOR DRESSING, SURGICAL DRESSING AND WOUND DRESSING; MATERIAL FOR STOPPING TEETH; DENTAL WAX; DISINFECTANTS, NAMELY ALL PURPOSE DISINFECTANTS, DISINFECTANTS FOR CONTACT LENSES, AND DISINFECTANTS FOR SANITARY PURPOSES, AND PREPARATIONS FOR DESTROYING VERMIN. (U.S. CLS. 6, 18, 44, 46, 51 AND 52).

CLASS 32—LIGHT BEVERAGES

FOR COLD MICROFILTERED SEAWATER FOR USE AS MINERAL AND AERATED WATERS, AND COLD MICRO-FILTERED SEAWATER FOR USE IN MAKING OTHER NON-ALCOHOLIC DRINKS, NAMELY AERATED FRUIT JUICES AND FRUIT FLAVORED BEVERAGES; FRUIT DRINKS AND FRUIT JUICES; SYRUPS FOR BEVERAGES; AND PREPARATIONS FOR MAKING BEVERAGES, NAMELY JUICE CONCENTRATES AND POWDERS FOR MAKING FRUIT JUICE DRINKS. (U.S. CLS. 45, 46 AND 48).

CLASS 42—SCIENTIFIC, COMPUTER AND LEGAL SERVICES

FOR SCIENTIFIC AND TECHNOLOGICAL RESEARCH SERVICES RELATING TO THE USE OF COLD MICROFILTERED SEAWATER; INDUSTRIAL ANALYSIS AND RESEARCH SERVICES RELATING TO THE USE OF COLD MICROFILTERED SEAWATER, DESIGN AND DEVELOPMENT OF COMPUTER HARDWARE AND SOFTWARE FOR OTHERS RELATING TO COLD MICROFILTERED SEAWATER; AND LEGAL SERVICES. (U.S. CLS. 100 AND 101).

ELLEN PERKINS, EXAMINING ATTORNEY

SN 78-426,357. ALLINA HEALTH SYSTEM, MINNEAPOLIS, MN. FILED 5-27-2004.

EXCELLIAN

SN 78-426,279. UNIGROUP, INC., FENTON, MO. FILED 5-27-2004.

CITYPOINTE

THE MARK CONSISTS OF STANDARD CHARACTERS WITHOUT CLAIM TO ANY PARTICULAR FONT, STYLE, SIZE, OR COLOR.

CLASS 35—ADVERTISING AND BUSINESS

FOR PERSONAL RELOCATION SERVICES, BUSINESS RELOCATION SERVICES, AND PROVIDING INFORMATION ON DESTINATION COMMUNITIES (U.S. CLS. 100, 101 AND 102).

CLASS 36—INSURANCE AND FINANCIAL

FOR PROVIDING INFORMATION REGARDING REAL ESTATE AGENTS AND PROVIDING ASSISTANCE IN OBTAINING A MORTGAGE LOAN (U.S. CLS. 100, 101 AND 102).

CLASS 39—TRANSPORTATION AND STORAGE

FOR TRANSPORTATION OF GOODS OF OTHERS BY TRUCK AND VAN, FURNITURE MOVING, MOVING VAN SERVICES, AND STORAGE OF GOODS OF OTHERS (U.S. CLS. 100 AND 105).

ALICE SUE CARRUTHERS, EXAMINING ATTORNEY

THE MARK CONSISTS OF STANDARD CHARACTERS WITHOUT CLAIM TO ANY PARTICULAR FONT, STYLE, SIZE, OR COLOR.

CLASS 9—ELECTRICAL AND SCIENTIFIC APPARATUS

FOR COMPUTER SOFTWARE FOR ACCESSING ELECTRONIC PATIENT RECORDS CONTAINING CURRENT AND HISTORICAL MEDICAL INFORMATION, HEALTH INSURANCE INFORMATION, PAYMENT AND BILLING INFORMATION; COMPUTER SOFTWARE FOR APPOINTMENT SCHEDULING AND REGISTRATION; COMPUTER SOFTWARE FOR MANAGING BILLING, INVOICING, AND COLLECTIONS (U.S. CLS. 21, 23, 26, 36 AND 38).

CLASS 35—ADVERTISING AND BUSINESS

FOR PROVIDING ONLINE MEDICAL APPOINTMENT SCHEDULING AND REGISTRATION SERVICES VIA A GLOBAL OR LOCAL COMPUTER NETWORK (U.S. CLS. 100, 101 AND 102).

CLASS 36—INSURANCE AND FINANCIAL

FOR PROVIDING ONLINE SERVICES TO PATIENTS AND CAREGIVERS, NAMELY, MAINTAINING PATIENT RECORDS CONTAINING HEALTH INSURANCE INFORMATION AND PAYMENT AND BILLING INFORMATION ON A GLOBAL OR LOCAL COMPUTER NETWORK (U.S. CLS. 100, 101 AND 102).

CLASS 38—COMMUNICATION

FOR PROVIDING SECURE ONLINE MESSAGING SERVICES TO PATIENTS AND CAREGIVERS (U.S. CLS. 100, 101 AND 104).

CLASS 41—EDUCATION AND ENTERTAINMENT

FOR EDUCATIONAL SERVICES, NAMELY PROVIDING TRAINING IN THE FIELD OF COMPUTER ACCESS TO AN AUTOMATED PATIENT RECORD AND BILLING SYSTEM (U.S. CLS. 100, 101 AND 107).

CLASS 42—SCIENTIFIC, COMPUTER AND LEGAL SERVICES

FOR PROVIDING TECHNICAL SUPPORT SERVICES, NAMELY, TROUBLESHOOTING OF COMPUTER HARDWARE AND SOFTWARE PROBLEMS (U.S. CLS. 100 AND 101).

CLASS 44—MEDICAL, BEAUTY AND AGRICULTURAL SERVICES

FOR PROVIDING ONLINE SERVICES TO PATIENTS AND CAREGIVERS, NAMELY, MAINTAINING PATIENT RECORDS CONTAINING CURRENT AND HISTORICAL MEDICAL INFORMATION AND PROVIDING PORTIONS OF PATIENT MEDICAL RECORDS INFORMATION ON A GLOBAL OR LOCAL COMPUTER NETWORK (U.S. CLS. 100 AND 101).

SOPHIA S. KIM, EXAMINING ATTORNEY

SN 78-427,285. MORRISSEY HOSPITALITY COMPANIES, INC., ST. PAUL, MN. FILED 5-28-2004.



NO CLAIM IS MADE TO THE EXCLUSIVE RIGHT TO USE "HOSPITALITY COMPANIES INC.", APART FROM THE MARK AS SHOWN.

THE NAME(S), PORTRAIT(S), AND/OR SIGNATURE(S) SHOWN IN THE MARK IDENTIFIES WILLIAM MORRISSEY, WHOSE CONSENT(S) TO REGISTER IS SUBMITTED.

THE COLOR GRAY IS/ARE CLAIMED AS A FEATURE OF THE MARK.

THE MARK CONSISTS OF THE LETTERS MHC APPEAR IN GRAY TYPE BEHIND THE WORD "MORRISSEY".

THE MARK CONSISTS OF THE LETTERS MHC APPEAR IN GRAY TYPE BEHIND THE WORD "MORRISSEY". IN THE LINE BELOW THE WORD "MORRISSEY" APPEAR THE WORDS "HOSPITALITY COMPANIES INC." WHICH LINE BEGINS BELOW AND TO THE RIGHT OF THE WORD "MORRISSEY" BUT WHICH THEN ENDS WITH THE PERIOD AFTER INC. DIRECTLY BELOW THE END OF THE WORD "MORRISSEY" SUCH THAT THE LINES OF THE LOGO ARE FLUSH WITH THE RIGHT HAND MARGIN OF THE LOGO. THE WORDS "MORRISSEY HOSPITALITY COMPANIES INC." APPEAR IN DARKER PRINT THAN THE LETTERS "MHC".

SN 78-426,616. NEEDHAM, BRAD, CARLSBAD, CA. FILED 5-27-2004.

UTAP

CLASS 35—ADVERTISING AND BUSINESS

FOR HOTEL MANAGEMENT FOR OTHERS AND RESTAURANT MANAGEMENT FOR OTHERS (U.S. CLS. 100, 101 AND 102).

FIRST USE 3-0-1995; IN COMMERCE 3-0-1995.

CLASS 43—HOTEL AND RESTAURANT SERVICES

FOR CATERING AND CONSULTING SERVICES IN THE FIELD OF HOSPITALITY (U.S. CLS. 100 AND 101).

FIRST USE 3-0-1995; IN COMMERCE 3-0-1995.

BRIAN NEVILLE, EXAMINING ATTORNEY

THE MARK CONSISTS OF STANDARD CHARACTERS WITHOUT CLAIM TO ANY PARTICULAR FONT, STYLE, SIZE, OR COLOR.

CLASS 35—ADVERTISING AND BUSINESS

FOR PROMOTING COMPETITIONS AND DEMONSTRATIONS IN THE FIELD OF MARTIAL ARTS, MIXED MARTIAL ARTS AND NO HOLDS BARRED FIGHTING; BUSINESS MANAGEMENT OF COMPETITIONS AND DEMONSTRATIONS IN THE FIELD OF MARTIAL ARTS, MIXED MARTIAL ARTS AND NO HOLDS BARRED FIGHTING (U.S. CLS. 100, 101 AND 102).

CLASS 41—EDUCATION AND ENTERTAINMENT

FOR ENTERTAINMENT IN THE NATURE OF MARTIAL ARTS COMPETITIONS; ORGANIZING AND CONDUCTING COMPETITIONS AND DEMONSTRATIONS IN THE FIELD OF MARTIAL ARTS, MIXED MARTIAL ARTS AND NO HOLDS BARRED FIGHTING (U.S. CLS. 100, 101 AND 107).

ANDREA SAUNDERS, EXAMINING ATTORNEY

SN 78-428,095. CONCENTRA OPERATING CORPORATION, ADDISON, TX. FILED 6-1-2004.



OWNER OF U.S. REG. NOS. 2,091,581 AND 2,236,716.

CLASS 42—SCIENTIFIC, COMPUTER AND LEGAL SERVICES

FOR MEDICAL, CHEMICAL AND OPTICAL LABORATORY SERVICES (U.S. CLS. 100 AND 101).

CLASS 44—MEDICAL, BEAUTY AND AGRICULTURAL SERVICES

FOR HEALTH CARE SERVICES, NAMELY, OCCUPATIONAL THERAPY SERVICES AND CONSULTING IN THE FIELD OF PHYSICAL REHABILITATION; MINOR MEDICAL EMERGENCY SERVICES, DISPENSING OF PHARMACEUTICALS, OCCUPATIONAL AND PHYSICAL THERAPY AND REHABILITATION SERVICES, DRUG SCREENING, PHYSICAL EXAMS FOR INSURANCE PURPOSES, NURSING CARE SERVICES; OUTPATIENT MEDICAL SERVICES, MANAGED MEDICAL CARE SERVICES AND GENERAL MEDICINE AND SURGERY SERVICES (U.S. CLS. 100 AND 101).

KELLY CHOE, EXAMINING ATTORNEY

SN 78-429,252. METAMORPHIX INC., SAVAGE, MD. FILED 6-3-2004.

Genius Whole Genome Systems

THE MARK CONSISTS OF STANDARD CHARACTERS WITHOUT CLAIM TO ANY PARTICULAR FONT, STYLE, SIZE, OR COLOR.

NO CLAIM IS MADE TO THE EXCLUSIVE RIGHT TO USE "WHOLE GENOME SYSTEMS", APART FROM THE MARK AS SHOWN.

SN 78-428,579. CONCENTRA OPERATING CORPORATION, ADDISON, TX. FILED 6-2-2004.

**CLASS 5—PHARMACEUTICALS**

FOR PHARMACEUTICAL PREPARATION FOR USE IN THE IDENTIFICATION OF DOMINANT GENES IN LIVESTOCK, DOMESTIC AND COMPANION ANIMALS, INCLUDING BUT NOT LIMITED TO CATTLE, SWINE, CHICKEN, TURKEY, FISH AND OTHER MARINE ANIMALS, HORSES, DOGS, CATS, AND OTHER ANIMALS, FOR BREEDING SELECTION, HEALTH AND LIFESTYLE MANAGEMENT, LIVESTOCK MANAGEMENT, DEVELOPMENT OF THERAPEUTIC SOLUTIONS, AND RELATED USES (U.S. CLS. 6, 18, 44, 46, 51 AND 52).

CLASS 42—SCIENTIFIC, COMPUTER AND LEGAL SERVICES

FOR RESEARCH SERVICES FOR IDENTIFYING DOMINANT GENES IN ANIMALS INCLUDING BUT NOT LIMITED TO CATTLE, SWINE, CHICKEN, TURKEY, FISH AND OTHER MARINE ANIMALS, HORSES, DOGS, CATS, AND OTHER ANIMALS, FOR BREEDING SELECTION, HEALTH AND LIFESTYLE MANAGEMENT, LIVESTOCK MANAGEMENT, DEVELOPMENT OF THERAPEUTIC SOLUTIONS, AND RELATED USES (U.S. CLS. 100 AND 101).

PAM WILLIS, EXAMINING ATTORNEY

OWNER OF U.S. REG. NOS. 1,917,433, 2,236,716 AND OTHERS.

CLASS 42—SCIENTIFIC, COMPUTER AND LEGAL SERVICES

FOR MEDICAL, CHEMICAL AND OPTICAL LABORATORY SERVICES (U.S. CLS. 100 AND 101).

CLASS 44—MEDICAL, BEAUTY AND AGRICULTURAL SERVICES

FOR HEALTH CARE SERVICES, NAMELY, OCCUPATIONAL THERAPY SERVICES AND CONSULTING IN THE FIELD OF PHYSICAL REHABILITATION; MINOR MEDICAL EMERGENCY SERVICES, DISPENSING OF PHARMACEUTICALS, OCCUPATIONAL AND PHYSICAL THERAPY AND REHABILITATION SERVICES, DRUG SCREENING, PHYSICAL EXAMS FOR INSURANCE PURPOSES, NURSING CARE SERVICES; OUTPATIENT MEDICAL SERVICES, MANAGED MEDICAL CARE SERVICES AND GENERAL MEDICINE AND SURGERY SERVICES (U.S. CLS. 100 AND 101).

KELLY CHOE, EXAMINING ATTORNEY

SN 78-429,300. NBC UNIVERSAL, INC., NEW YORK, NY. FILED 6-3-2004.

NBC WEATHER PLUS

THE MARK CONSISTS OF STANDARD CHARACTERS WITHOUT CLAIM TO ANY PARTICULAR FONT, STYLE, SIZE, OR COLOR.

NO CLAIM IS MADE TO THE EXCLUSIVE RIGHT TO USE "WEATHER", APART FROM THE MARK AS SHOWN.

CLASS 41—EDUCATION AND ENTERTAINMENT

FOR ENTERTAINMENT IN THE NATURE OF ONGOING TELEVISION PROGRAMS IN THE FIELD OF WEATHER AND WEATHER RELATED SUBJECTS (U.S. CLS. 100, 101 AND 107).

CLASS 42—SCIENTIFIC, COMPUTER AND LEGAL SERVICES

FOR METEOROLOGICAL SERVICES, NAMELY, METEOROLOGICAL FORECASTING AND PROVIDING METEOROLOGICAL INFORMATION (U.S. CLS. 100 AND 101).

BARBARA BROWN, EXAMINING ATTORNEY

SN 78-429,574. EXELIXIS, INC., SOUTH SAN FRANCISCO, CA. FILED 6-3-2004.

**SPECTRUM SELECTIVE
KINASE INHIBITOR**

SN 78-429,355. UNITEDHEALTH GROUP INCORPORATED, MINNETONKA, MN. FILED 6-3-2004.

THE MARK CONSISTS OF STANDARD CHARACTERS WITHOUT CLAIM TO ANY PARTICULAR FONT, STYLE, SIZE, OR COLOR.

NO CLAIM IS MADE TO THE EXCLUSIVE RIGHT TO USE "SELECTIVE KINASE INHIBITOR", APART FROM THE MARK AS SHOWN.

CLASS 5—PHARMACEUTICALS

FOR PHARMACEUTICAL PREPARATIONS FOR THE TREATMENT OF CANCER AND DISEASES RELATED TO CANCER (U.S. CLS. 6, 18, 44, 46, 51 AND 52).

CLASS 42—SCIENTIFIC, COMPUTER AND LEGAL SERVICES

FOR MEDICAL AND SCIENTIFIC RESEARCH; DISCOVERY, DEVELOPMENT AND DESIGN OF PHARMACEUTICAL AND THERAPEUTIC PREPARATIONS (U.S. CLS. 100 AND 101).

ESTHER A. BORSUK, EXAMINING ATTORNEY

**UNITEDHEALTH
BASICS**

SN 78-429,785. ISOTEC, INC., HUNTINGTON BEACH, CA. FILED 6-3-2004.

THE MARK CONSISTS OF STANDARD CHARACTERS WITHOUT CLAIM TO ANY PARTICULAR FONT, STYLE, SIZE, OR COLOR.

OWNER OF U.S. REG. NOS. 1,967,622, 2,635,728 AND OTHERS.

NO CLAIM IS MADE TO THE EXCLUSIVE RIGHT TO USE "BASICS", APART FROM THE MARK AS SHOWN.

CLASS 36—INSURANCE AND FINANCIAL

FOR ORGANIZING AND ADMINISTERING EMPLOYEE BENEFIT PLANS; ORGANIZING AND ADMINISTERING EMPLOYEE HEALTH CARE PLANS; ORGANIZING AND ADMINISTERING HEALTH CARE BENEFIT PLANS; INSURANCE UNDERWRITING IN THE FIELD OF HEALTH FOR HEALTH CARE INSURANCE; INSURANCE UNDERWRITING IN THE FIELD OF HEALTH FOR PREPAID HEALTH CARE INSURANCE; PROVIDING MANAGED HEALTH CARE INSURANCE; PROVIDING ON-LINE HEALTH INSURANCE INFORMATION (U.S. CLS. 100, 101 AND 102).

FIRST USE 5-14-2004; IN COMMERCE 5-14-2004.

CLASS 44—MEDICAL, BEAUTY AND AGRICULTURAL SERVICES

FOR PROVIDING ON-LINE HEALTH AND MEDICAL INFORMATION (U.S. CLS. 100 AND 101).

FIRST USE 5-14-2004; IN COMMERCE 5-14-2004.
TRACY CROSS, EXAMINING ATTORNEY

SUNSCAPE

THE MARK CONSISTS OF STANDARD CHARACTERS WITHOUT CLAIM TO ANY PARTICULAR FONT, STYLE, SIZE, OR COLOR.

CLASS 11—ENVIRONMENTAL CONTROL APPARATUS

FOR LANDSCAPE LIGHTING FIXTURES (U.S. CLS. 13, 21, 23, 31 AND 34).

CLASS 20—FURNITURE AND ARTICLES NOT OTHERWISE CLASSIFIED

FOR OUTDOOR FURNITURE (U.S. CLS. 2, 13, 22, 25, 32 AND 50).

MELISSA SHELLA, EXAMINING ATTORNEY

SN 78-430,193. INTERHEART LLC, TUCSON, AZ. FILED 6-4-2004.

INTERHEART

THE MARK CONSISTS OF STANDARD CHARACTERS WITHOUT CLAIM TO ANY PARTICULAR FONT, STYLE, SIZE, OR COLOR.

CLASS 9—ELECTRICAL AND SCIENTIFIC APPARATUS

FOR PRERECORDED CDS, DVDS AND AUDIO AND VIDEO TAPES IN THE FIELD OF PERSONAL RELATIONSHIPS AND PERSONAL WELL BEING; MOUSE PADS, DECORATIVE MAGNETS (U.S. CLS. 21, 23, 26, 36 AND 38).

CLASS 14—JEWELRY

FOR JEWELRY, NAMELY, ORNAMENTAL LAPEL PINS, ORNAMENTAL PINS, PENDANTS, BRACELETS, INSIGNIAS OF PRECIOUS METALS, MEDALS AND RINGS; WATCHES AND CLOCKS (U.S. CLS. 2, 27, 28 AND 50).

CLASS 16—PAPER GOODS AND PRINTED MATTER

FOR PRINTED MATTER, NAMELY BOOKS, NEWSLETTERS AND MAGAZINES ALL IN THE FIELD OF PERSONAL RELATIONSHIPS AND PERSONAL WELL BEING; POSTERS, PHOTOGRAPHS, STICKERS, DECALS, BUMPER STICKERS, CALENDARS; WRITING STATIONERY, WIRE-BOUND NOTEBOOKS; MAPS; PENS AND PENCILS; GREETING CARDS; PRINTED PAPER SIGNS (U.S. CLS. 2, 5, 22, 23, 29, 37, 38 AND 50).

CLASS 25—CLOTHING

FOR T-SHIRTS, SWEATSHIRTS, POLO SHIRTS, SWEATERS, VESTS, TANK TOPS, PULLOVERS, BASEBALL CAPS, CLOTHING CAPS, HATS, WIND RESISTANT JACKETS, JACKETS, COATS, SUN VISORS, SHIRTS (U.S. CLS. 22 AND 39).

CLASS 35—ADVERTISING AND BUSINESS

FOR BUSINESS SERVICES, NAMELY, RETAIL, ON-LINE, AND MAIL ORDER CATALOGS OF AUDIO AND VIDEO RECORDINGS, PRINTED MATTER, POSTERS, PHOTOGRAPHS, JEWELRY, CLOCKS AND WATCHES, EDUCATIONAL MATERIALS, CLOTHING, TOWELS, LUGGAGE, TOTE BAGS AND BEACH BAGS, MUGS, AND DRINKING GLASSES, PORTABLE INSULATED CONTAINERS (U.S. CLS. 100, 101 AND 102).

CLASS 38—COMMUNICATION

FOR PROVIDING ON-LINE CHAT ROOMS, AND BULLETIN BOARDS FOR TRANSMISSION OF MESSAGES CONCERNING TOPICS IN THE FIELD OF PERSONAL RELATIONSHIPS AND PERSONAL WELL BEING; PROVIDING MULTIPLE USER ACCESS TO A GLOBAL COMPUTER INFORMATION NETWORK IN THE FIELD OF PERSONAL RELATIONSHIPS AND PERSONAL WELL BEING (U.S. CLS. 100, 101 AND 104).

CLASS 41—EDUCATION AND ENTERTAINMENT

FOR EDUCATIONAL SERVICES, NAMELY CONDUCTING CONFERENCES, SEMINARS, CLASSES, WORKSHOPS AND LECTURES IN THE FIELD OF PERSONAL RELATIONSHIPS AND PERSONAL WELL BEING (U.S. CLS. 100, 101 AND 107).

CLASS 45—PERSONAL SERVICES

FOR PROVIDING INFORMATION VIA A WEBSITE AND LINKS IN THE FIELD OF PERSONAL RELATIONSHIPS AND PERSONAL WELL BEING (U.S. CLS. 100 AND 101).

SALLY SHIH, EXAMINING ATTORNEY

SN 78-431,118. IRIS MEDIA, INC., EUGENE, OR. FILED 6-7-2004.



NO CLAIM IS MADE TO THE EXCLUSIVE RIGHT TO USE "MEDIA INC", APART FROM THE MARK AS SHOWN. THE MARK CONSISTS OF A STYLIZED LOWER-CASE "I" RESTING ON ITS RIGHT SIDE, WITH THE WORD "IRIS" IN THE STEM AND A CAMERA IRIS AS THE DOT.

CLASS 9—ELECTRICAL AND SCIENTIFIC APPARATUS

FOR PRERECORDED VIDEOTAPES AND DVDS ON THE TOPICS OF PARENTING, HUMAN DEVELOPMENT, PERSONAL ACHIEVEMENT, PROFESSIONAL DEVELOPMENT AND EDUCATION (U.S. CLS. 21, 23, 26, 36 AND 38).

FIRST USE 11-22-2002; IN COMMERCE 11-22-2002.

CLASS 16—PAPER GOODS AND PRINTED MATTER

FOR EDUCATIONAL BOOKS, BOOKLETS AND PAMPHLETS ON THE TOPICS OF PARENTING, HUMAN DEVELOPMENT, PERSONAL ACHIEVEMENT, PROFESSIONAL DEVELOPMENT AND EDUCATION (U.S. CLS. 2, 5, 22, 23, 29, 37, 38 AND 50).

FIRST USE 11-22-2002; IN COMMERCE 11-22-2002.

CLASS 41—EDUCATION AND ENTERTAINMENT

FOR ONLINE TRAINING ON THE TOPICS OF PARENTING, HUMAN DEVELOPMENT, PERSONAL ACHIEVEMENT, PROFESSIONAL DEVELOPMENT AND EDUCATION (U.S. CLS. 100, 101 AND 107).

YONG KIM, EXAMINING ATTORNEY

SN 78-431,470. ASTRAZENECA AB, SODERTALJE SE151 85, SWEDEN, FILED 6-8-2004.

SUITE SUCCESS

THE MARK CONSISTS OF STANDARD CHARACTERS WITHOUT CLAIM TO ANY PARTICULAR FONT, STYLE, SIZE, OR COLOR.

PRIORITY CLAIMED UNDER SEC. 44(D) ON SWEDEN APPLICATION NO. 2004/03777, FILED 5-26-2004, REG. NO. 371265, DATED 3-24-2005, EXPIRES 3-24-2015.

CLASS 5—PHARMACEUTICALS

FOR PHARMACEUTICAL PREPARATIONS FOR THE TREATMENT OF CARDIOVASCULAR DISEASES FOR HUMANS ONLY (U.S. CLS. 6, 18, 44, 46, 51 AND 52).

CLASS 16—PAPER GOODS AND PRINTED MATTER

FOR PRINTED MATTERS, NAMELY NEWSLETTERS, STATIONERY TEMPLATES, BOOKLETS, POSTERS, SIGNBOARDS OF PAPER OR CARDBOARD, PAMPHLETS, PRINTED PUBLICATIONS, ALL IN RELATION TO SCIENTIFIC RESEARCH WITHIN THE CARDIOVASCULAR AREA (U.S. CLS. 2, 5, 22, 23, 29, 37, 38 AND 50).

CLASS 44—MEDICAL, BEAUTY AND AGRICULTURAL SERVICES

FOR MEDICAL SERVICES SUCH AS PROVIDING INFORMATION OF PHARMACEUTICAL PREPARATIONS FOR THE TREATMENT OF CARDIOVASCULAR DISEASES FOR HUMANS ONLY (U.S. CLS. 100 AND 101).

ARETHA SOMERVILLE, EXAMINING ATTORNEY

SN 78-431,876. ONVOY, INC., MINNEAPOLIS, MN. FILED 6-8-2004.

VOICE BUILT ON HIGH-SPEED

THE MARK CONSISTS OF STANDARD CHARACTERS WITHOUT CLAIM TO ANY PARTICULAR FONT, STYLE, SIZE, OR COLOR.

NO CLAIM IS MADE TO THE EXCLUSIVE RIGHT TO USE "VOICE AND HIGH-SPEED", APART FROM THE MARK AS SHOWN.

CLASS 9—ELECTRICAL AND SCIENTIFIC APPARATUS

FOR COMPUTER SOFTWARE FOR VOICE AND DATA COMMUNICATIONS AND FOR TRANSMISSION OVER NETWORKS, NAMELY, SOFTWARE FOR WIRELESS BROADBAND COMMUNICATION; SOFTWARE FOR LONG DISTANCE TELEPHONE COMMUNICATION; SOFTWARE FOR VOICE OVER INTERNET PROTOCOL; ELECTRONIC MAIL SOFTWARE FOR SENDING, RECEIVING AND MANAGING ELECTRONIC MAIL MESSAGES, SOFTWARE FOR VIDEO CONFERENCING AND BROADCASTING VIDEO, SOFTWARE FOR MANAGING NETWORKS, SOFTWARE FOR INTERNET ACCESS, AND COMPUTER HARDWARE FOR VOICE AND DATA COMMUNICATIONS AND FOR TRANSMISSION OVER NETWORKS AND THE INTERNET (U.S. CLS. 21, 23, 26, 36 AND 38).

CLASS 35—ADVERTISING AND BUSINESS

FOR BUSINESS DEVELOPMENT SERVICES, NAMELY, PROVIDING START-UP SUPPORT FOR RESELLERS IN THE TELECOMMUNICATION FIELD FOR TRANSMISSION OF VOICE, DATA AND IMAGES THROUGH WIDE AREA NETWORKS, LOCAL AREA NETWORKS, FIBER OPTIC NETWORKS AND THE INTERNET; BUSINESS MARKETING CONSULTATION SERVICES FOR RESELLERS IN THE TELECOMMUNICATION FIELD FOR THE TRANSMISSION OF VOICE, DATA AND IMAGES THROUGH WIDE AREA NETWORKS, LOCAL AREA NETWORKS, FIBER OPTIC NETWORKS AND THE INTERNET; TELEPHONE ANSWERING AND TELEPHONE DIRECTORY INFORMATION SERVICES; BUSINESS MANAGEMENT CONSULTATION FOR E-BUSINESSES (U.S. CLS. 100, 101 AND 102).

CLASS 38—COMMUNICATION

FOR TELECOMMUNICATIONS SERVICES, NAMELY, TELEPHONE COMMUNICATION SERVICES, ELECTRONIC TRANSMISSION OF MESSAGES, DATA, AND VOICE; VIDEO TELECONFERENCING; PROVIDING TELECOMMUNICATIONS CONNECTIONS TO A GLOBAL COMPUTER NETWORK; LONG DISTANCE TELEPHONE COMMUNICATION SERVICES FEATURING CENTRALIZED EQUAL ACCESS TO LOCAL EXCHANGE COMPANIES; VOICE OVER INTERNET PROTOCOL SERVICES; PROVIDING MULTI-USER ACCESS TO A GLOBAL COMPUTER INFORMATION NETWORK (U.S. CLS. 100, 101 AND 104).

CLASS 42—SCIENTIFIC, COMPUTER AND LEGAL SERVICES

FOR CONSULTING SERVICES IN THE FIELD OF DESIGN, SELECTION, IMPLEMENTATION AND USE OF COMPUTER HARDWARE AND SOFTWARE SYSTEMS FOR OTHERS; COMPUTER CONSULTING SERVICES; PROVIDING INFORMATION IN THE FIELD OF COMPUTER NETWORKS AND ASSOCIATED TECHNOLOGIES; HOSTING, DESIGN, CREATION, MAINTENANCE OF WEB SITES FOR OTHERS (U.S. CLS. 100 AND 101).

RAMONA ORTIGA, EXAMINING ATTORNEY

SN 78-432,161. MAGER, SCOTT, FORT LAUDERDALE, FL.
FILED 6-9-2004.

SN 78-434,118. FELLOWSHIP CHURCH, GRAPEVINE, TX.
FILED 6-11-2004.

WHERE EVERY CASE IS A PRIORITY

THE MARK CONSISTS OF STANDARD CHARACTERS WITHOUT CLAIM TO ANY PARTICULAR FONT, STYLE, SIZE, OR COLOR.

CLASS 9—ELECTRICAL AND SCIENTIFIC APPARATUS

FOR COMPUTER SOFTWARE FOR USE IN THE LEGAL FIELD FEATURING LITIGATION MANAGEMENT, INSURANCE CLAIM MANAGEMENT AND INSURANCE CLAIM PROCESSING (U.S. CLS. 21, 23, 26, 36 AND 38).

FIRST USE 8-1-2003; IN COMMERCE 8-1-2003.

CLASS 42—SCIENTIFIC, COMPUTER AND LEGAL SERVICES

FOR PROVIDING TEMPORARY USE OF NON-DOWNLOADABLE WEB-BASED COMPUTER SOFTWARE FOR USE IN THE LEGAL FIELD FEATURING LITIGATION MANAGEMENT, INSURANCE CLAIM MANAGEMENT AND INSURANCE CLAIM PROCESSING (U.S. CLS. 100 AND 101).

FIRST USE 8-1-2003; IN COMMERCE 8-1-2003.

MARIA-VICTORIA SUAREZ, EXAMINING ATTORNEY

SN 78-434,019. GAMELOGIC INC., CAMBRIDGE, MA.
FILED 6-11-2004.



CLASS 16—PAPER GOODS AND PRINTED MATTER

FOR STUDY GUIDES, NEWSLETTERS, PRAYER JOURNALS, RELIGIOUS BOOKLETS, DEVOTIONALS, CALENDARS, POSTERS, AND PHOTOGRAPHS, ALL IN THE FIELD OF RELIGION (U.S. CLS. 2, 5, 22, 23, 29, 37, 38 AND 50).

FIRST USE 1-1-1996; IN COMMERCE 1-1-1996.

CLASS 41—EDUCATION AND ENTERTAINMENT

FOR EDUCATIONAL AND ENTERTAINMENT SERVICES IN THE NATURE OF CLASSES, CONFERENCES, SEMINARS AND WORKSHOPS IN THE FIELD OF RELIGION AND THE DISTRIBUTION OF COURSE MATERIAL IN CONNECTION THEREWITH (U.S. CLS. 100, 101 AND 107).

FIRST USE 1-1-1996; IN COMMERCE 1-1-1996.

MELVIN AXILBUND, EXAMINING ATTORNEY

SN 78-434,513. FISHER, MARA, MIAMI, FL. FILED 6-14-2004.

CASH SPIN OUT

THE MARK CONSISTS OF STANDARD CHARACTERS WITHOUT CLAIM TO ANY PARTICULAR FONT, STYLE, SIZE, OR COLOR.

CLASS 9—ELECTRICAL AND SCIENTIFIC APPARATUS

FOR COMPUTER GAME SOFTWARE; COMPUTER SOFTWARE FOR USE IN GAMING MACHINES; ELECTRONIC GAMING MACHINES; COMPUTER SOFTWARE FOR ONLINE PAYMENT AND TRANSACTION PROCESSING; VIDEO GAME MACHINES FOR USE WITH TELEVISIONS (U.S. CLS. 21, 23, 26, 36 AND 38).

CLASS 28—TOYS AND SPORTING GOODS

FOR CARDS, NAMELY BINGO CARDS, LOTTERY CARDS AND KENO CARDS AND TICKETS, NAMELY LOTTERY TICKETS, FOR PLAYING GAMES OF CHANCE; COMPUTER GAME MACHINES, NAMELY STAND ALONE VIDEO GAME MACHINES (U.S. CLS. 22, 23, 38 AND 50).

KATHLEEN M. VANSTON, EXAMINING ATTORNEY

BRIDGE OF LIFE

THE MARK CONSISTS OF STANDARD CHARACTERS WITHOUT CLAIM TO ANY PARTICULAR FONT, STYLE, SIZE, OR COLOR.

CLASS 41—EDUCATION AND ENTERTAINMENT

FOR PERSONAL COACHING SERVICES IN THE FIELD OF LEARNING HOW TO UNDERSTAND OTHERS FOR MORE EFFECTIVE COMMUNICATION, TEACHING HOW TO USE A RELATIONSHIP TO GROW INTELLECTUALLY AND EMOTIONALLY, ASSISTING PEOPLE IN PRIORITIZING THEIR NEEDS, ASSISTING PEOPLE IN LEARNING HOW TO CHALLENGE SELF DEFEATING BEHAVIOR, HELPING PEOPLE TO CREATE THE LIFE THEY WANT, TEACHING PEOPLE INTERPERSONAL RELATIONSHIP SKILLS, HELPING PEOPLE WORK THROUGH GRIEF (U.S. CLS. 100, 101 AND 107).

FIRST USE 0-0-1992; IN COMMERCE 0-0-1994.

CLASS 44—MEDICAL, BEAUTY AND AGRICULTURAL SERVICES

FOR PSYCHOLOGICAL COUNSELING AND PSYCHOTHERAPY SERVICES, NAMELY, TO LEARN HOW TO UNDERSTAND OTHERS FOR MORE EFFECTIVE COMMUNICATION, TEACHING HOW TO USE A RELATIONSHIP TO GROW INTELLECTUALLY AND EMOTIONALLY, ASSISTING PEOPLE IN PRIORITIZING THEIR NEEDS, ASSISTING PEOPLE IN LEARNING HOW TO CHALLENGE SELF DEFEATING BEHAVIOR, HELPING PEOPLE TO CREATE THE LIFE THEY WANT, TEACHING PEOPLE INTERPERSONAL RELATIONSHIP SKILLS, HELPING PEOPLE WORK THROUGH GRIEF (U.S. CLS. 100 AND 101).

FIRST USE 0-0-1992; IN COMMERCE 0-0-1994.
KIMBERLY PERRY, EXAMINING ATTORNEY

SN 78-435,043. RONALD REAGAN PRESIDENTIAL LIBRARY FOUNDATION, THE, SIMI VALLEY, CA. FILED 6-14-2004.

MOURNING IN AMERICA

THE MARK CONSISTS OF STANDARD CHARACTERS WITHOUT CLAIM TO ANY PARTICULAR FONT, STYLE, SIZE, OR COLOR.

CLASS 9—ELECTRICAL AND SCIENTIFIC APPARATUS

FOR VIDEO AND AUDIO RECORDINGS, COMPACT DISC, DVDS AND VIDEO TAPES FEATURING THE EVENTS SURROUNDING AND INCLUDING THE MEMORIAL SERVICES OF RONALD REAGAN (U.S. CLS. 21, 23, 26, 36 AND 38).

CLASS 16—PAPER GOODS AND PRINTED MATTER

FOR PRINTED MATERIALS, NAMELY, BOOKS FEATURING THE EVENTS SURROUNDING AND INCLUDING THE MEMORIAL SERVICES OF RONALD REAGAN (U.S. CLS. 2, 5, 22, 23, 29, 37, 38 AND 50).
BARBARA A. GOLD, EXAMINING ATTORNEY

SN 78-435,035. SPICE HUT CORPORATION, BELLINGHAM, WA. FILED 6-14-2004.



NO CLAIM IS MADE TO THE EXCLUSIVE RIGHT TO USE "SPICE", APART FROM THE MARK AS SHOWN.

THE COLORS GREEN AND RED ARE CLAIMED AS A FEATURE OF THE MARK.

THE STEM PORTION OF THE VINE IS GREEN AND THE PEPPER IS A REDDISH COLOR.

THE MARK CONSISTS OF A VINE ON THE LOWER PORTION OF THE MARK. THE VINE LOOPS VERTICALLY IN THE LEFT HAND PORTION AND ONE END OF THE VINE HAS A PEPPER ATTACHED THERETO. THE PEPPER HANGS DOWNWARDLY AND FORMS THE LETTER "I" IN THE WORDING "SPICE HUT".

CLASS 30—STAPLE FOODS

FOR SPICES, TEAS, LOOSE-LEAF TEAS, RICE, FLOUR, HONEY AND SAUCES (U.S. CL. 46).
FIRST USE 6-7-2004; IN COMMERCE 6-7-2004.

CLASS 35—ADVERTISING AND BUSINESS

FOR RETAIL STORE SERVICES FEATURING PRE-PACKAGED AND CUSTOM-MIXED SPICES, TEAS, LOOSE-LEAF TEAS, LENTILS, RICE, FLOUR, HONEY, SAUCES, TEA ACCESSORIES, TEA POTS, TEA STRAINERS, TEA DIFFUSERS (U.S. CLS. 100, 101 AND 102).

FIRST USE 6-7-2004; IN COMMERCE 6-7-2004.
MELVIN AXILBUND, EXAMINING ATTORNEY

SN 78-435,172. 4IMPRINT, INC., OSHKOSH, WI. FILED 6-15-2004.

BLUE BOX

THE MARK CONSISTS OF STANDARD CHARACTERS WITHOUT CLAIM TO ANY PARTICULAR FONT, STYLE, SIZE, OR COLOR.

CLASS 35—ADVERTISING AND BUSINESS

FOR MAIL ORDER AND COMPUTERIZED ONLINE ORDERING SERVICES FEATURING CUSTOMIZED IMPRINTING OF APPAREL, PERSONAL AND OFFICE ACCESSORIES, SPORTING GOODS, GLASSWARE, LUGGAGE AND CARRYING BAGS, STATIONERY, AND JEWELRY (U.S. CLS. 100, 101 AND 102).

FIRST USE 12-29-2003; IN COMMERCE 12-29-2003.

CLASS 40—MATERIAL TREATMENT

FOR CUSTOM IMPRINTING OF APPAREL, PERSONAL AND OFFICE ACCESSORIES, SPORTING GOODS, GLASSWARE, LUGGAGE AND CARRYING BAGS, STATIONERY, AND JEWELRY WITH CUSTOMERS' TRADEMARKS, SERVICE MARKS, TRADE NAMES AND RELATED CUSTOMER INFORMATION (U.S. CLS. 100, 103 AND 106).

FIRST USE 12-29-2003; IN COMMERCE 12-29-2003.
CATHERINE FAINT, EXAMINING ATTORNEY

SN 78-435,342. PIXELWORKS, INC., TUALATIN, OR. FILED 6-15-2004.

DIGITAL NATURAL EXPRESSION

THE MARK CONSISTS OF STANDARD CHARACTERS WITHOUT CLAIM TO ANY PARTICULAR FONT, STYLE, SIZE, OR COLOR.

NO CLAIM IS MADE TO THE EXCLUSIVE RIGHT TO USE "DIGITAL", APART FROM THE MARK AS SHOWN.

CLASS 9—ELECTRICAL AND SCIENTIFIC APPARATUS

FOR TELEVISIONS; PROJECTORS USED FOR A WIDE VARIETY OF USER-SPECIFIED CONTENT AND FORMATS UTILIZING LCD, NAMELY LIQUID CRYSTAL DISPLAY, DISPLAY TECHNOLOGY; PROJECTORS USED FOR A WIDE VARIETY OF USER-SPECIFIED CONTENT AND FORMATS UTILIZING LCOS, NAMELY LIQUID CRYSTAL ON SILICON, DISPLAY TECHNOLOGY; PROJECTORS USED FOR A WIDE VARIETY OF USER-SPECIFIED CONTENT AND FORMATS UTILIZING POLYSILICON DISPLAY TECHNOLOGY; PROJECTORS USED FOR A WIDE VARIETY OF USER-SPECIFIED CONTENT AND FORMATS UTILIZING PLASMA DISPLAY TECHNOLOGY; PROJECTORS USED FOR A WIDE VARIETY OF USER-SPECIFIED CONTENT AND FORMATS UTILIZING CRT, NAMELY, CATHODE RAY TUBE, DISPLAY TECHNOLOGY; PROJECTORS USED FOR A WIDE VARIETY OF USER-SPECIFIED CONTENT AND FORMATS UTILIZING DLP, NAMELY DIGITAL LIGHT PROCESSING, DISPLAY TECHNOLOGY; LCD, NAMELY LIQUID CRYSTAL DISPLAY, DISPLAYS; LCOS, NAMELY LIQUID CRYSTAL ON SILICON, DISPLAYS; POLYSILICON DISPLAYS; PLASMA DISPLAYS; CRT, NAMELY CATHODE RAY TUBE, DISPLAYS; DLP, NAMELY DIGITAL LIGHT PROCESSING, DISPLAYS; HDTV, NAMELY HIGH DEFINITION TELEVISION, DISPLAYS; STANDARD DEFINITION TELEVISION DISPLAYS; DIGITAL RGB, NAMELY RED-GREEN-BLUE, DISPLAYS; ANALOG RGB, NAMELY RED-GREEN-BLUE, DISPLAYS; COMPUTER MONITORS; PRINTED CIRCUIT BOARDS; COMPUTER SOFTWARE FOR TESTING DISPLAYS AND ASSOCIATED CONTROLLERS; FIRMWARE FOR TESTING DISPLAYS AND ASSOCIATED CONTROLLERS; HARDWARE FOR TESTING DISPLAYS AND ASSOCIATED CONTROLLERS; COMPUTER SOFTWARE FOR MANIPULATING, STORING, RECEIVING, TRANSFERRING, PROCESSING, AND DIGITIZING IMAGES; COMPUTER FIRMWARE FOR MANIPULATING, STORING, RECEIVING, TRANSFERRING, PROCESSING, AND DIGITIZING IMAGES; COMPUTER SOFTWARE FOR DRIVING, SUPPORTING, AND ENHANCING DISPLAYS AND PROJECTED IMAGES FOR MULTIMEDIA PROJECTORS; COMPUTER SOFTWARE FOR DRIVING, SUPPORTING, AND ENHANCING DISPLAYS AND PROJECTED IMAGES FOR MULTIMEDIA PROJECTORS; INTEGRATED CIRCUITS; INTEGRATED CIRCUIT MODULES; AND DOWNLOADABLE ELECTRONIC PUBLICATIONS, NAMELY, BOOKS, BRO-

CHURES, WHITE PAPERS, CATALOGS, AND PAMPHLETS IN THE FIELD OF IMAGE PROCESSING TECHNOLOGY. (U.S. CLS. 21, 23, 26, 36 AND 38).

CLASS 42—SCIENTIFIC, COMPUTER AND LEGAL SERVICES

FOR TECHNICAL SUPPORT SERVICES, NAMELY, TROUBLESHOOTING OF DISPLAY DESIGN AND DISPLAY APPLICATION PROBLEMS; TECHNICAL SUPPORT SERVICES NAMELY, SUPPORT AND CONSULTING SERVICES FOR DRIVING, SUPPORTING, AND ENHANCING DISPLAYS; PROVIDING INFORMATION IN THE FIELD OF IMAGE PROCESSING TECHNOLOGY VIA THE INTERNET; DESIGN FOR OTHERS IN THE FIELD OF INTEGRATED CIRCUITS FOR DRIVING, SUPPORTING, AND ENHANCING DISPLAYS; DESIGNING AND DEVELOPING EXAMPLE CIRCUIT REFERENCE STANDARDS TO ASSIST OTHERS IN THE IMPLEMENTATION OF INTEGRATED CIRCUITS IN DISPLAY SYSTEMS FOR DRIVING, SUPPORTING, AND ENHANCING DISPLAYS; DESIGNING AND DEVELOPING EXAMPLE SOFTWARE REFERENCE STANDARDS TO ASSIST OTHERS IN THE IMPLEMENTATION OF INTEGRATED CIRCUITS IN DISPLAY SYSTEMS FOR DRIVING, SUPPORTING, AND ENHANCING DISPLAYS. (U.S. CLS. 100 AND 101).
TIMOTHY FINNEGAN, EXAMINING ATTORNEY

SN 78-435,745. NEXXAR GROUP, INC., SADDLE RIVER, NJ. FILED 6-15-2004.

SENDIT

THE MARK CONSISTS OF STANDARD CHARACTERS WITHOUT CLAIM TO ANY PARTICULAR FONT, STYLE, SIZE, OR COLOR.

CLASS 36—INSURANCE AND FINANCIAL

FOR FINANCIAL SERVICES, NAMELY, CHECK CASHING, BILL PAYMENT, ELECTRONIC FUNDS TRANSFER AND ELECTRONIC TRANSFER OF MONEY; TELEPHONE CALLING CARD SERVICES (U.S. CLS. 100, 101 AND 102).

CLASS 38—COMMUNICATION

FOR TELEPHONE TELECOMMUNICATIONS SERVICES PROVIDED VIA PREPAID TELEPHONE CALLING CARDS USING ENCODED CARDS, PIN CODES AND WIRELESS ACCESS (U.S. CLS. 100, 101 AND 104).
JAMES A. RAUEN, EXAMINING ATTORNEY

SN 78-435,829. UNITED PARCEL SERVICE OF AMERICA, INC., ATLANTA, GA. FILED 6-15-2004.

SN 78-436,051. RIZZA FOODS, INC., NEW YORK, NY. FILED 6-16-2004.

TERRITORY

PLANNER

OWNER OF U.S. REG. NO. 2,312,808.
 THE MARK CONSISTS OF THE WORDS TERRITORY PLANNER. IN BETWEEN THE WORDS TERRITORY AND PLANNER, THERE IS A CURVED LINED WITH A FILLED IN CIRCLE AT THE END OF IT.
 SEC. 2(F) AS TO TERRITORY PLANNER.

CLASS 9—ELECTRICAL AND SCIENTIFIC APPARATUS

FOR COMPUTER PROGRAMS, COMPUTER HARDWARE, COMPUTER SOFTWARE AND COMPUTER PERIPHERALS FOR ROUTING AND SCHEDULING OF VEHICLES FOR THE DELIVERY OF PERSONAL PROPERTY (U.S. CLS. 21, 23, 26, 36 AND 38).

CLASS 35—ADVERTISING AND BUSINESS

FOR BUSINESS CONSULTANCY SERVICES IN THE FIELD OF VEHICLE ROUTING AND SCHEDULING (U.S. CLS. 100, 101 AND 102).
 BRIAN NEVILLE, EXAMINING ATTORNEY

SN 78-435,997. RIZZA FOODS, INC., NEW YORK, NY. FILED 6-16-2004.

MOMMA DEE LISHUS

THE MARK CONSISTS OF STANDARD CHARACTERS WITHOUT CLAIM TO ANY PARTICULAR FONT, STYLE, SIZE, OR COLOR.

CLASS 29—MEATS AND PROCESSED FOODS

FOR FROZEN, PREPARED AND PACKAGED ENTREES CONSISTING PRIMARILY OF MEATS WITH CHEESE, VEGETABLES, PASTA AND SAUCES (U.S. CL. 46).

CLASS 30—STAPLE FOODS

FOR FROZEN, PREPARED AND PACKAGED ENTREES CONSISTING PRIMARILY OF PASTA, WITH SAUCES, MEAT, CHEESE AND VEGETABLES; PASTA; SAUCES (U.S. CL. 46).

CLASS 43—HOTEL AND RESTAURANT SERVICES

FOR RESTAURANT SERVICES (U.S. CLS. 100 AND 101).
 STEVEN R. FINE, EXAMINING ATTORNEY

RIZZA PIZZA

THE MARK CONSISTS OF STANDARD CHARACTERS WITHOUT CLAIM TO ANY PARTICULAR FONT, STYLE, SIZE, OR COLOR.

NO CLAIM IS MADE TO THE EXCLUSIVE RIGHT TO USE "PIZZA", APART FROM THE MARK AS SHOWN.

CLASS 29—MEATS AND PROCESSED FOODS

FOR FROZEN, PREPARED AND PACKAGED MEALS CONSISTING PRIMARILY OF MEATS, CHEESE AND SAUCE (U.S. CL. 46).

CLASS 30—STAPLE FOODS

FOR FROZEN, PREPARED AND PACKAGED MEALS CONSISTING PRIMARILY OF PASTA, CHEESE AND SAUCE; PASTA; PIZZA; PIZZA DOUGH; PIZZA CRUST (U.S. CL. 46).

CLASS 43—HOTEL AND RESTAURANT SERVICES

FOR RESTAURANT SERVICES (U.S. CLS. 100 AND 101).
 KATHERINE STOIDES, EXAMINING ATTORNEY

SN 78-436,141. RIVERTREE PRODUCTIONS, INC., BRADFORD, NH. FILED 6-16-2004.

ODDS BODKIN

THE MARK CONSISTS OF STANDARD CHARACTERS WITHOUT CLAIM TO ANY PARTICULAR FONT, STYLE, SIZE, OR COLOR.

THE NAME(S), PORTRAIT(S), AND/OR SIGNATURE(S) SHOWN IN THE MARK IDENTIFIES ODDS BODKIN, A LIVING INDIVIDUAL, WHOSE CONSENT(S) TO REGISTER IS SUBMITTED.

CLASS 9—ELECTRICAL AND SCIENTIFIC APPARATUS

FOR PRE-RECORDED AUDIO TAPES AND COMPACT DISCS, FEATURING MUSIC AND STORIES (U.S. CLS. 21, 23, 26, 36 AND 38).
 FIRST USE 12-31-1983; IN COMMERCE 12-31-1983.

CLASS 16—PAPER GOODS AND PRINTED MATTER

FOR BOOKS AND PRINTED MATERIAL, NAMELY BROCHURES AND POSTERS FEATURING CHILDREN'S-THEMED STORIES, PICTURES AND MUSIC (U.S. CLS. 2, 5, 22, 23, 29, 37, 38 AND 50).
FIRST USE 12-31-1995; IN COMMERCE 12-31-1995.

CLASS 41—EDUCATION AND ENTERTAINMENT

FOR EDUCATION AND ENTERTAINMENT SERVICES, NAMELY PROVIDING KEYNOTE ADDRESSES, PERFORMANCES AND WORKSHOPS IN THE FIELDS OF MUSIC AND STORYTELLING (U.S. CLS. 100, 101 AND 107).
FIRST USE 12-31-1982; IN COMMERCE 12-31-1982.
AISHA CLARKE, EXAMINING ATTORNEY

CLASS 9—ELECTRICAL AND SCIENTIFIC APPARATUS

FOR PRE-RECORDED DVDS, CDS, AND VIDEO TAPES FEATURING EDUCATIONAL SUBJECT MATTER IN THE FIELDS OF GRADES K - 12 SUBJECTS (U.S. CLS. 21, 23, 26, 36 AND 38).

CLASS 35—ADVERTISING AND BUSINESS

FOR ON-LINE RETAIL STORE SERVICES FEATURING DOWNLOADABLE VIDEO SEGMENTS FEATURING EDUCATIONAL SUBJECT MATTER (U.S. CLS. 100, 101 AND 102).
JENNIFER KRISP, EXAMINING ATTORNEY

SN 78-437,656. GUTHY-RENKER CORPORATION, PALM DESERT, CA. FILED 6-18-2004.

SN 78-438,721. COLART AMERICAS, INC., PISCATAWAY, NJ. FILED 6-21-2004.

TANK TOP SEXY

THE MARK CONSISTS OF STANDARD CHARACTERS WITHOUT CLAIM TO ANY PARTICULAR FONT, STYLE, SIZE, OR COLOR.

CLASS 9—ELECTRICAL AND SCIENTIFIC APPARATUS

FOR SERIES OF AUDIO AND VIDEO RECORDINGS FEATURING EXERCISE INSTRUCTION (U.S. CLS. 21, 23, 26, 36 AND 38).

CLASS 28—TOYS AND SPORTING GOODS

FOR MANUALLY OPERATED EXERCISE EQUIPMENT (U.S. CLS. 22, 23, 38 AND 50).
PAULA MAYS, EXAMINING ATTORNEY

SN 78-437,910. SCHOOL SPECIALTY, INC., APPLETON, WI. FILED 6-18-2004.

CURRICULUM CLIPS

THE MARK CONSISTS OF STANDARD CHARACTERS WITHOUT CLAIM TO ANY PARTICULAR FONT, STYLE, SIZE, OR COLOR.

PIXEL2PAINT

THE MARK CONSISTS OF STANDARD CHARACTERS WITHOUT CLAIM TO ANY PARTICULAR FONT, STYLE, SIZE, OR COLOR.

CLASS 2—PAINTS

FOR ARTISTS' MATERIALS, NAMELY, ARTISTS' PAINTS, ACRYLIC PAINTS, ACRYLIC PAINT COLORS AND WATERCOLOR PAINTS, COLOR PIGMENTS, COLORS, VARNISH, PIGMENTED PAINTING EXTENDERS USED TO EXTEND ARTISTS' PAINTS AND PAINT GELS AND PAINT IN THE FORM OF PIGMENTED PASTE USED FOR MODELING AND TEXTURING ARTIST PAINTS, SCULPTURE AND FRAME DECORATION (U.S. CLS. 6, 11 AND 16).

CLASS 9—ELECTRICAL AND SCIENTIFIC APPARATUS

FOR SOFTWARE PACKAGE, WHICH TEACHES COLOR MIXING (U.S. CLS. 21, 23, 26, 36 AND 38).
KIMBERLY FRYE, EXAMINING ATTORNEY

SN 78-438,778. MARKEN PROPERTIES, INC., RIVERHEAD, NY. FILED 6-21-2004.

SN 78-439,136. ORGANIZATION FOR THE ADVANCEMENT OF ABORIGINAL PEOPLES' HEALTH, OTTAWA, ONTARIO, CANADA, FILED 6-22-2004.

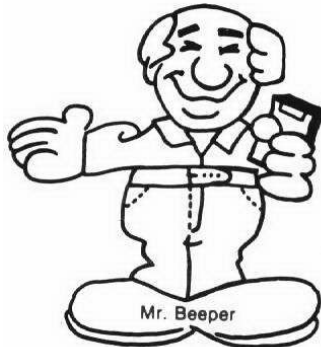

OWNER OF U.S. REG. NO. 1,503,202.
THE DRAWING CONSISTS OF A CARTOON MAN WITH ONE ARM EXTENDED, HOLDING A RADIO PAGER IN THE OTHER HAND AND THE WORDS MR. BEEPER ON THE SHOES.

CLASS 35—ADVERTISING AND BUSINESS

FOR TELEPHONE ANSWERING SERVICES, ORDER FULFILLMENT SERVICES (U.S. CLS. 100, 101 AND 102).
FIRST USE 4-3-1983; IN COMMERCE 4-3-1983.

CLASS 38—COMMUNICATION

FOR RADIO PAGING SERVICES, TELEPHONE VOICE MESSAGING SERVICES, AND FACSIMILE TRANSMISSION AND RETRIEVAL SERVICES (U.S. CLS. 100, 101 AND 104).
FIRST USE 4-3-1983; IN COMMERCE 4-3-1983.
AMY HELLA, EXAMINING ATTORNEY

SN 78-438,818. ZAKARIYYA ABDUR-RAHMAN, PHILADELPHIA, PA. FILED 6-21-2004.



NO CLAIM IS MADE TO THE EXCLUSIVE RIGHT TO USE FOODS, APART FROM THE MARK AS SHOWN.

CLASS 29—MEATS AND PROCESSED FOODS

FOR POTATO CHIPS (U.S. CL. 46).

CLASS 30—STAPLE FOODS

FOR TORTILLA CHIPS, CORN CHIPS, CHEESE PUFFS, POPCORN (U.S. CL. 46).
ALICE BENMAMAN, EXAMINING ATTORNEY

NAHO

THE MARK CONSISTS OF STANDARD CHARACTERS WITHOUT CLAIM TO ANY PARTICULAR FONT, STYLE, SIZE, OR COLOR.

PRIORITY CLAIMED UNDER SEC. 44(D) ON CANADA APPLICATION NO. 1213594, FILED 4-16-2004, REG. NO. TMA642201, DATED 6-16-2005, EXPIRES 6-16-2020.

CLASS 35—ADVERTISING AND BUSINESS

FOR ASSOCIATION SERVICES, NAMELY, PROMOTING THE INTERESTS AND STATUS OF ABORIGINAL PEOPLES IN COMMUNITIES (U.S. CLS. 100, 101 AND 102).

CLASS 44—MEDICAL, BEAUTY AND AGRICULTURAL SERVICES

FOR IMPROVING THE HEALTH STATUS OF ABORIGINAL PEOPLES IN COMMUNITIES BY DISSEMINATING KNOWLEDGE OF ABORIGINAL HEALTH ISSUES (U.S. CLS. 100 AND 101).
SUSAN LESLIE DUBOIS, EXAMINING ATTORNEY

SN 78-439,972. RIVERA, EDWIN, SANTA ANA, CA. FILED 6-23-2004.

GENETIC THREAT

THE MARK CONSISTS OF STANDARD CHARACTERS WITHOUT CLAIM TO ANY PARTICULAR FONT, STYLE, SIZE, OR COLOR.

CLASS 16—PAPER GOODS AND PRINTED MATTER

FOR PAPER, CARDBOARD AND PRINTED MATERIAL, NAMELY, ART PRINT, POSTCARDS, PHOTOGRAPHS, STATIONERY, POSTERS, PAPER BANNERS, TATTOOS, ADHESIVES FOR STATIONERY OR HOUSEHOLD PURPOSES, STICKERS, AND CARDBOARD FLOOR DISPLAY UNITS FOR MERCHANDISING PRODUCTS (U.S. CLS. 2, 5, 22, 23, 29, 37, 38 AND 50).

FIRST USE 12-1-2004; IN COMMERCE 12-1-2004.

CLASS 25—CLOTHING

FOR CLOTHING, NAMELY MEN'S, WOMEN'S, AND CHILDREN'S PANTS, SLACKS, TROUSERS, JEANS, SHORTS, BOXERS, OVERALLS, SHIRTS, T-SHIRTS, BLOUSES, VESTS, APRONS, SKIRTS, JACKETS, COATS, GOLF SHIRTS, HALTER TOPS, DANCE PANTS, SPORT COATS, SWEATERS, SWEATSHIRTS, SWEATPANTS, TIES, BELTS, SOCKS, SWIMWEAR, BATHING SUITS, BIKINIS, COVER-UPS, TANK TOPS, DRESSES, JUMPERS, CAPRIS, LEGGINGS, PAJAMAS, ROBES, JERSEYS, UNDERWEAR, AND GLOVES; HEADWEAR, NAMELY, SWEATBANDS, BEANIES, HATS, CAPS, BANDANAS, AND VISORS; AND FOOTWEAR, NAMELY, SANDALS, SLIPPERS, BOOTS, SHOES, AND ATHLETIC SHOES (U.S. CLS. 22 AND 39).

FIRST USE 12-1-2003; IN COMMERCE 12-1-2003.
PATRICIA EVANKO, EXAMINING ATTORNEY

SN 78-439,990. DS WATERS OF AMERICA, LP, ATLANTA, GA. FILED 6-23-2004.

CLASS 9—ELECTRICAL AND SCIENTIFIC APPARATUS

FOR COMPUTER SOFTWARE FOR THE SECURE COLLECTION, EDITING, ORGANIZING, MODIFYING, TRANSMISSION, STORAGE, AND SHARING OF DATA AND INFORMATION (U.S. CLS. 21, 23, 26, 36 AND 38).
FIRST USE 6-1-2000; IN COMMERCE 6-1-2000.

CLASS 42—SCIENTIFIC, COMPUTER AND LEGAL SERVICES

FOR COMPUTER SERVICES, NAMELY, ACTING AS AN APPLICATION SERVICES PROVIDER TO HOST COMPUTER SOFTWARE FOR AUTOMATED CUSTOMER COMMUNICATIONS MANAGEMENT, CUSTOMER RETENTION PROGRAMS, AND OPERATIONAL EFFICIENCY REPORTING (U.S. CLS. 100 AND 101).
FIRST USE 6-1-2000; IN COMMERCE 6-1-2000.
TARAH HARDY, EXAMINING ATTORNEY

SN 78-440,868. VENERABLE PARTNERS, LLC, PARK RIDGE, IL. FILED 6-24-2004.

CULLYSPRING WATER

THE MARK CONSISTS OF STANDARD CHARACTERS WITHOUT CLAIM TO ANY PARTICULAR FONT, STYLE, SIZE, OR COLOR.

NO CLAIM IS MADE TO THE EXCLUSIVE RIGHT TO USE "WATER", APART FROM THE MARK AS SHOWN.

CLASS 32—LIGHT BEVERAGES

FOR BOTTLED DRINKING WATER (U.S. CLS. 45, 46 AND 48).

CLASS 39—TRANSPORTATION AND STORAGE

FOR HOME AND OFFICE DELIVERY OF BOTTLED WATER PRODUCTS (U.S. CLS. 100 AND 105).
JENNIFER KRISP, EXAMINING ATTORNEY

SN 78-440,138. MECHANICNET GROUP, INC, PLEASANTON, CA. FILED 6-23-2004.

VENERABLE REGISTRY

THE MARK CONSISTS OF STANDARD CHARACTERS WITHOUT CLAIM TO ANY PARTICULAR FONT, STYLE, SIZE, OR COLOR.

NO CLAIM IS MADE TO THE EXCLUSIVE RIGHT TO USE "REGISTRY", APART FROM THE MARK AS SHOWN.

CLASS 16—PAPER GOODS AND PRINTED MATTER

FOR PRINTED REPORTS FEATURING INFORMATION IN THE FIELDS OF EXECUTIVE SEARCH, BOARD OF DIRECTOR RECRUITING, AND EXECUTIVE BENCHMARKING ASSESSMENTS (U.S. CLS. 2, 5, 22, 23, 29, 37, 38 AND 50).

CLASS 35—ADVERTISING AND BUSINESS

FOR PROVIDING ON-LINE INFORMATION IN THE FIELDS OF EXECUTIVE SEARCH, BOARD OF DIRECTOR RECRUITING, AND EXECUTIVE BENCHMARKING ASSESSMENTS (U.S. CLS. 100, 101 AND 102).
JANICE L. MCMORROW, EXAMINING ATTORNEY

SN 78-441,063. BAKER, MARIANNA, IRVINE, CA. FILED 6-24-2004.

LinkUp

THE MARK CONSISTS OF STANDARD CHARACTERS WITHOUT CLAIM TO ANY PARTICULAR FONT, STYLE, SIZE, OR COLOR.
SEC. 2(F).

BUBBLECHICK

THE MARK CONSISTS OF STANDARD CHARACTERS WITHOUT CLAIM TO ANY PARTICULAR FONT, STYLE, SIZE, OR COLOR.

CLASS 25—CLOTHING

FOR MEN'S, WOMEN'S, AND CHILDREN'S CLOTHING, NAMELY, T-SHIRTS, PAJAMAS, NIGHTGOWNS, UNDERWEAR, PANTS, SHORTS, SHIRTS AND HATS (U.S. CLS. 22 AND 39).

SN 78-442,570. STATE WARS HOCKEY, INC., LAKEWOOD, CA. FILED 6-28-2004.

CLASS 41—EDUCATION AND ENTERTAINMENT

FOR ENTERTAINMENT IN THE NATURE OF AN ANIMATED TELEVISION SERIES (U.S. CLS. 100, 101 AND 107).

BARBARA GAYNOR, EXAMINING ATTORNEY

STATE WARS

THE MARK CONSISTS OF STANDARD CHARACTERS WITHOUT CLAIM TO ANY PARTICULAR FONT, STYLE, SIZE, OR COLOR.

NO CLAIM IS MADE TO THE EXCLUSIVE RIGHT TO USE "STATE", APART FROM THE MARK AS SHOWN.

SN 78-441,655. UNITED PARCEL SERVICE OF AMERICA, INC., ATLANTA, GA. FILED 6-25-2004.

CLASS 25—CLOTHING

FOR MEN'S, WOMEN'S AND CHILDREN'S CLOTHING, NAMELY T-SHIRTS, POLO SHIRTS, GOLF SHIRTS, WOVEN SHIRTS, KNIT SHIRTS, JERSEYS, FLEECE TOPS AND BOTTOMS, TANK TOPS, SWEATSHIRTS, SWEATERS, JACKETS, TURTLENECKS, WARM-UP SUITS, SWEAT PANTS, SHORTS, PANTS, HATS, CAPS AND HEADWEAR (U.S. CLS. 22 AND 39).

CLASS 41—EDUCATION AND ENTERTAINMENT

FOR ENTERTAINMENT SERVICES IN THE NATURE OF ORGANIZING, SCHEDULING, AND CONDUCTING AMATEUR IN-LINE ROLLER HOCKEY GAMES, CONTESTS, TOURNAMENTS AND COMPETITIONS; ENTERTAINMENT SERVICES IN THE NATURE OF ORGANIZING AND CONDUCTING ROLLER HOCKEY CLINICS; ENTERTAINMENT IN THE NATURE OF ONGOING TELEVISION PROGRAMS IN THE FIELD OF SPORTS; ENTERTAINMENT SERVICES, NAMELY SPORTS AND SPORTS-RELATED PROGRAMS PROVIDED VIA TELEVISION BROADCASTING, CABLE TRANSMISSION, SATELLITE TRANSMISSION, RADIO AND/OR VIA A GLOBAL COMPUTER NETWORK; AND PROVIDING A WEBSITE ON GLOBAL COMPUTER NETWORKS FEATURING NEWS AND ENTERTAINMENT IN THE FIELD OF SPORTS (U.S. CLS. 100, 101 AND 107).

VERNA BETH RIRIE, EXAMINING ATTORNEY



SN 78-442,821. MONEYGRAM INTERNATIONAL, INC., MINNEAPOLIS, MN. FILED 6-29-2004.

OWNER OF U.S. REG. NOS. 735,064 AND 2,868,000.

CLASS 24—FABRICS

FOR SPORT TOWELS (U.S. CLS. 42 AND 50).

CLASS 28—TOYS AND SPORTING GOODS

FOR TOYS, NAMELY BOARD GAMES, PLUSH TOYS, ACTION TOYS; STUFFED TOY ANIMALS, SOFTBALL BATS, SOFTBALLS, FOOTBALLS, SOCCER BALLS, TENNIS BALLS, TOY CARS AND TRUCKS, BALLOONS AND FLYING DISCS; CHRISTMAS TREE ORNAMENTS; TOY TRUCKS, TOY TRAINS, TOY AIRPLANES AND MODELS OF TRUCKS TRAINS, AND AIRPLANES (U.S. CLS. 22, 23, 38 AND 50).

ANNE MADDEN, EXAMINING ATTORNEY



OWNER OF U.S. REG. NOS. 2,127,954, 2,450,906 AND OTHERS.

NO CLAIM IS MADE TO THE EXCLUSIVE RIGHT TO USE "INTERNATIONAL", APART FROM THE MARK AS SHOWN.

SEC. 2(F) AS TO MONEYGRAM.

CLASS 9—ELECTRICAL AND SCIENTIFIC APPARATUS

FOR MAGNETIC CODED CARDS FOR BANKING AND DEBIT CARD SERVICES FINANCIAL SERVICES NETWORK DATA TERMINALS, NAMELY, ELECTRONIC PAYMENT TERMINALS; AUTOMATED REPORT PRINTERS; COMPUTER PROGRAMS FOR TRANSMISSION, PROCESSING AND RECEIPT OF DATA FOR USE IN THE FINANCIAL SERVICES FIELD (U.S. CLS. 21, 23, 26, 36 AND 38).

CLASS 16—PAPER GOODS AND PRINTED MATTER

FOR PRINTED FINANCIAL FORMS; PRINTED MATTER AND PUBLICATIONS, NAMELY, MANUALS AND PRINTED INSTRUCTION MATERIAL IN THE FIELDS OF FINANCE AND FUNDS TRANSFER; BANK CHECKS, MONEY ORDER FORMS AND NEGOTIABLE INSTRUMENT FORMS (U.S. CLS. 2, 5, 22, 23, 29, 37, 38 AND 50).

CLASS 36—INSURANCE AND FINANCIAL

FOR FINANCIAL SERVICES, NAMELY, CLEARING HOUSE SERVICES, BANKING, CREDIT INQUIRY AND CONSULTATION, CREDIT RECOVERY AND COLLECTION, CURRENCY EXCHANGE AND ADVICE, ELECTRONIC FUNDS TRANSFER; ELECTRONIC PAYMENT, NAMELY, ELECTRONIC PROCESSING AND TRANSMISSION OF BILL PAYMENT DATA, ELECTRONIC CREDIT AND DEBIT TRANSACTION PROCESSING, PROCESSING PAYMENTS TO THIRD PARTIES, MONEY ORDER SERVICES, CHECK PROCESSING, ELECTRONIC CHECK RE-PRESENTMENT SERVICES, ISSUANCE OF TRAVELERS' CHECKS, CHECK VERIFICATION, BILL PAYMENT SERVICES; FINANCIAL AGENCY SERVICES FOR ALL OF THE FOREGOING (U.S. CLS. 100, 101 AND 102).

DAVID ELTON, EXAMINING ATTORNEY

SN 78-443,151. CHERLE COMMUNICATIONS, INC., OAK BROOK, IL. FILED 6-29-2004.

NO CLAIM IS MADE TO THE EXCLUSIVE RIGHT TO USE "NY", APART FROM THE MARK AS SHOWN.

CLASS 6—METAL GOODS

FOR METAL KEYCHAINS (U.S. CLS. 2, 12, 13, 14, 23, 25 AND 50).

CLASS 9—ELECTRICAL AND SCIENTIFIC APPARATUS

FOR PERSONAL DIGITAL ASSISTANT CASES AND COVERS, CELL PHONE CASES, CD AND DIGITAL VIDEO DISC WALLETS AND CASES, CAMERAS, MOUSE PADS, CALCULATORS, SUNGLASSES, SUNGLASS HOLDERS (U.S. CLS. 21, 23, 26, 36 AND 38).

JOHN E. MICHOS, EXAMINING ATTORNEY

SN 78-442,961. TRI-STATE WINDOW & DOOR FACTORY, INC., WOOD RIDGE, NJ. FILED 6-29-2004.

SN 78-443,337. TRUELIGHT TECHNOLOGIES, LLC, WESTFORD, MA. FILED 6-29-2004.

ULTRAWALL SYSTEM

THE MARK CONSISTS OF STANDARD CHARACTERS WITHOUT CLAIM TO ANY PARTICULAR FONT, STYLE, SIZE, OR COLOR.

CLASS 35—ADVERTISING AND BUSINESS

FOR ON-LINE RETAIL STORE SERVICES FEATURING SIDING INCORPORATING CONTOURED POLYSTYRENE INSULATION THAT FITS BEHIND THE SIDING; AND RETAIL SERVICES BY DIRECT SOLICITATION BY SALES AGENTS IN THE FIELD OF SIDING INCORPORATING CONTOURED POLYSTYRENE INSULATION THAT FITS BEHIND THE SIDING (U.S. CLS. 100, 101 AND 102).

FIRST USE 5-13-2004; IN COMMERCE 5-13-2004.

CLASS 37—CONSTRUCTION AND REPAIR

FOR INSTALLATION, REPAIR AND MAINTENANCE OF SIDING INCORPORATING CONTOURED POLYSTYRENE INSULATION THAT FITS BEHIND THE SIDING (U.S. CLS. 100, 103 AND 106).

FIRST USE 5-13-2004; IN COMMERCE 5-13-2004.
MICHAEL HALL, EXAMINING ATTORNEY

THE MARK CONSISTS OF STANDARD CHARACTERS WITHOUT CLAIM TO ANY PARTICULAR FONT, STYLE, SIZE, OR COLOR.

NO CLAIM IS MADE TO THE EXCLUSIVE RIGHT TO USE "TECHNOLOGIES", APART FROM THE MARK AS SHOWN.

CLASS 9—ELECTRICAL AND SCIENTIFIC APPARATUS

FOR COMPUTER HARDWARE AND COMPUTER SOFTWARE FOR CONTENT DELIVERY, DECODING, ENCRYPTION, AND FOR APPLICATION AND DATABASE INTEGRATION OF MULTIMEDIA DATA OVER A PUBLIC NETWORK, A PRIVATE NETWORK, A COMMUNICATIONS NETWORK, A DATA TRANSMISSION NETWORK, A SATELLITE NETWORK, ELECTRICAL POWER SYSTEMS, A MULTI-USER NETWORK, OR THE INTERNET (U.S. CLS. 21, 23, 26, 36 AND 38).

CLASS 42—SCIENTIFIC, COMPUTER AND LEGAL SERVICES

FOR COMPUTER SERVICES, NAMELY, DESIGN AND DEVELOPMENT OF COMPUTER HARDWARE AND COMPUTER SOFTWARE FOR MULTIMEDIA APPLICATIONS FOR USE IN THE FIELDS OF ENTERTAINMENT, EDUCATION, MEDICINE, SECURITY, BROADCASTING, VIDEO CONFERENCING AND COMMUNICATIONS; AND TECHNICAL SUPPORT SERVICES, NAMELY, TROUBLESHOOTING OF COMPUTER HARDWARE AND SOFTWARE PROBLEMS (U.S. CLS. 100 AND 101).

STEVEN R. FOSTER, EXAMINING ATTORNEY

CLASS 45—PERSONAL SERVICES

FOR CONSULTING SERVICES IN THE FIELD OF HOMELAND SECURITY AS APPLIED TO BODIES OF WATER (U.S. CLS. 100 AND 101).

BARBARA GAYNOR, EXAMINING ATTORNEY

SN 78-443,428. RAMOS, LESLIE P., SAN LORENZO, CA. FILED 6-29-2004.

SN 78-443,593. RCD CORPORATION, EUSTIS, FL. FILED 6-30-2004.

**LIFE SO POWERFUL
IT'S FELT**

THE MARK CONSISTS OF STANDARD CHARACTERS WITHOUT CLAIM TO ANY PARTICULAR FONT, STYLE, SIZE, OR COLOR.

CLASS 25—CLOTHING

FOR CLOTHING, NAMELY, HEADWEAR, BOTTOMS AND TOPS (U.S. CLS. 22 AND 39).

CLASS 45—PERSONAL SERVICES

FOR COMPUTER SERVICES, NAMELY, ONLINE DATING, INTRODUCTION AND SOCIAL NETWORKING SERVICES (U.S. CLS. 100 AND 101).

JAMES A. RAUEN, EXAMINING ATTORNEY

SN 78-443,440. RILEY, PATRICK G., SAN FRANCISCO, CA. FILED 6-29-2004.

ELECTRIC RIVER

THE MARK CONSISTS OF STANDARD CHARACTERS WITHOUT CLAIM TO ANY PARTICULAR FONT, STYLE, SIZE, OR COLOR.

CLASS 40—MATERIAL TREATMENT

FOR CONSULTING SERVICES IN THE FIELDS OF SOLAR POWER GENERATION AND HYDROGEN POWER GENERATION (U.S. CLS. 100, 103 AND 106).

CLASS 42—SCIENTIFIC, COMPUTER AND LEGAL SERVICES

FOR CONSULTING SERVICES IN THE FIELD OF WATER CONSERVATION (U.S. CLS. 100 AND 101).

#7 MASTIC

THE MARK CONSISTS OF STANDARD CHARACTERS WITHOUT CLAIM TO ANY PARTICULAR FONT, STYLE, SIZE, OR COLOR.

NO CLAIM IS MADE TO THE EXCLUSIVE RIGHT TO USE "MASTIC", APART FROM THE MARK AS SHOWN.

CLASS 1—CHEMICALS

FOR ADHESIVES FOR USE IN CONSTRUCTION (U.S. CLS. 1, 5, 6, 10, 26 AND 46).

FIRST USE 10-0-1986; IN COMMERCE 10-0-1986.

CLASS 17—RUBBER GOODS

FOR ADHESIVE-SEALANT USED FOR PERMANENTLY SEALING THE FABRICATED JOINTS AND SEAMS OF SHEET METAL AIR DUCTS, RIGID FIBERGLASS AIR DUCTS, FLEXIBLE AIR DUCTS, AND THERMAL INSULATION, AS WELL AS FOR REPAIRING DAMAGED AND LEAKING AIR DUCTS AND SEALING CONDITIONED SPACES FROM AIR FILTRATION (U.S. CLS. 1, 5, 12, 13, 35 AND 50).

FIRST USE 10-0-1986; IN COMMERCE 10-0-1986.

ALICE SUE CARRUTHERS, EXAMINING ATTORNEY

SN 78-443,756. RCD CORPORATION, EUSTIS, FL. FILED 6-30-2004.

SN 78-444,651. MWH GLOBAL, INC., BROOMFIELD, CO. FILED 7-1-2004.

#10 MASTIC

THE MARK CONSISTS OF STANDARD CHARACTERS WITHOUT CLAIM TO ANY PARTICULAR FONT, STYLE, SIZE, OR COLOR.

NO CLAIM IS MADE TO THE EXCLUSIVE RIGHT TO USE "MASTIC", APART FROM THE MARK AS SHOWN.

CLASS 1—CHEMICALS

FOR ADHESIVES FOR USE IN AIR DUCTS AND THERMAL INSULATION; ADHESIVES FOR USE BY THE HEATING AND COOLING INDUSTRY (U.S. CLS. 1, 5, 6, 10, 26 AND 46).

CLASS 17—RUBBER GOODS

FOR SEALANTS AND ADHESIVE SEALANT FOR USE IN AIR DUCTS AND THERMAL INSULATION; AIR DUCT SEALANTS AND ADHESIVE SEALANTS FOR INDUSTRIAL AND COMMERCIAL USE BY THE HEATING AND COOLING INDUSTRIES (U.S. CLS. 1, 5, 12, 13, 35 AND 50).

TRACY CROSS, EXAMINING ATTORNEY

SN 78-443,900. POLARIS REALTY (CANADA) LIMITED, MISSISSAUGA, ONTARIO, CANADA, FILED 6-30-2004.



POLARIS REALTY

PRIORITY CLAIMED UNDER SEC. 44(D) ON CANADA APPLICATION NO. 1217936, FILED 5-25-2004, REG. NO. 638036, DATED 4-21-2005, EXPIRES 4-21-2020.

NO CLAIM IS MADE TO THE EXCLUSIVE RIGHT TO USE "REALTY", APART FROM THE MARK AS SHOWN.

CLASS 36—INSURANCE AND FINANCIAL

FOR MANAGEMENT OF COMMERCIAL REAL ESTATE FOR OTHERS (U.S. CLS. 100, 101 AND 102).

CLASS 37—CONSTRUCTION AND REPAIR

FOR DEVELOPMENT OF COMMERCIAL REAL ESTATE FOR OTHERS (U.S. CLS. 100, 103 AND 106).
NAAKWAMA ANKRAH, EXAMINING ATTORNEY

WISH WANT WALK

THE MARK CONSISTS OF STANDARD CHARACTERS WITHOUT CLAIM TO ANY PARTICULAR FONT, STYLE, SIZE, OR COLOR.

CLASS 35—ADVERTISING AND BUSINESS

FOR PROVIDING BUSINESS CONSULTATION SERVICES IN THE FIELD OF CORPORATE STRATEGY CONCERNING NEGOTIATION OF CONTRACTS AND BUSINESS RELATIONSHIPS (U.S. CLS. 100, 101 AND 102).

CLASS 41—EDUCATION AND ENTERTAINMENT

FOR TEACHING IN THE FIELD OF NEGOTIATION SKILLS (U.S. CLS. 100, 101 AND 107).

NELSON SNYDER, EXAMINING ATTORNEY

SN 78-444,969. SNAK KING CORP, CITY OF INDUSTRY, CA. FILED 7-1-2004.

TWISTITOS

THE MARK CONSISTS OF STANDARD CHARACTERS WITHOUT CLAIM TO ANY PARTICULAR FONT, STYLE, SIZE, OR COLOR.

CLASS 29—MEATS AND PROCESSED FOODS

FOR POTATO CHIPS (U.S. CL. 46).

CLASS 30—STAPLE FOODS

FOR RICE PUFFS, CORN PUFFS, CORN CURLS, CORN CHIPS, GRAIN-BASED CHIPS, TACO CHIPS, TORTILLA CHIPS (U.S. CL. 46).

JASON LOTT, EXAMINING ATTORNEY

SN 78-445,096. BAYER BUILT WOODWORKS, INC., BELGRADE, MN. FILED 7-2-2004.

ACCLIMATED ENTRY SYSTEMS

THE MARK CONSISTS OF STANDARD CHARACTERS WITHOUT CLAIM TO ANY PARTICULAR FONT, STYLE, SIZE, OR COLOR.

NO CLAIM IS MADE TO THE EXCLUSIVE RIGHT TO USE "ENTRY SYSTEMS", APART FROM THE MARK AS SHOWN.

CLASS 6—METAL GOODS

FOR ENTRY DOOR SYSTEMS COMPRISED OF METAL DOORS, FRAMES, SIDELIGHTS, AND HARDWARE COMPONENTS (U.S. CLS. 2, 12, 13, 14, 23, AND 50).

FIRST USE 5-14-2004; IN COMMERCE 5-14-2004.

CLASS 19—NON-METALLIC BUILDING MATERIALS

FOR ENTRY DOOR SYSTEMS COMPRISED OF NON-METAL DOORS, FRAMES, SIDELIGHTS, AND HARDWARE COMPONENTS (U.S. CLS. 1, 12, 33 AND 50).

FIRST USE 5-14-2004; IN COMMERCE 5-14-2004.

MARK SPARACINO, EXAMINING ATTORNEY

SN 78-445,159. NAVIO SYSTEMS, INC., CUPERTINO, CA. FILED 7-2-2004.

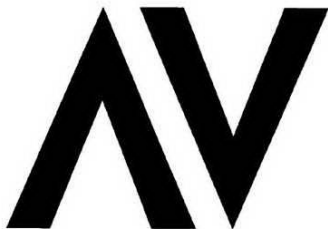

CLASS 9—ELECTRICAL AND SCIENTIFIC APPARATUS

FOR SOFTWARE TO ALLOW BUSINESSES AND CONSUMERS TO SEND AND RECEIVE ELECTRONIC MESSAGES VIA FIXED LINE AND WIRELESS NETWORKS; E-COMMERCE SOFTWARE TO ALLOW BUSINESSES AND CONSUMERS TO PERFORM BUSINESS TRANSACTIONS VIA A GLOBAL COMPUTER NETWORK; SOFTWARE TO SECURE ELECTRONIC COMMUNICATIONS, BUSINESS TRANSACTIONS, AND DIGITAL CONTENT ON COMPUTERS AND MOBILE DEVICES INCLUDING PERSONAL DIGITAL ASSISTANTS AND MOBILE PHONES (U.S. CLS. 21, 23, 26, 36 AND 38).

CLASS 35—ADVERTISING AND BUSINESS

FOR COMPUTERIZED ON-LINE ORDERING SERVICES IN THE FIELD OF DIGITAL CONTENT, NAMELY, COMPUTER FILES, DIGITAL MUSIC, AND DIGITAL PHOTOS AND VIDEO; PROVIDING ON-LINE DIRECTORY INFORMATION SERVICES TO HELP LOCATE PEOPLE, PLACES, ORGANIZATIONS, PRODUCTS, PHONE NUMBERS, HOME PAGES AND ELECTRONIC MAIL ADDRESSES; SHOPPERS GUIDE INFORMATION; TELEPHONE DIRECTORY INFORMATION; DISSEMINATION OF ADVERTISING FOR OTHERS VIA AN ONLINE ELECTRONIC OR WIRELESS COMMUNICATIONS NETWORK; BUSINESS SERVICES, NAMELY PROVIDING COMPUTER DATABASES REGARDING THE PURCHASE AND SALE OF A WIDE VARIETY OF PRODUCTS AND SERVICES FOR OTHERS (U.S. CLS. 100, 101 AND 102).

CLASS 38—COMMUNICATION

FOR FIXED LINE AND WIRELESS COMMUNICATION SERVICES THAT ALLOW THE ELECTRONIC TRANSMISSION, ELECTRONIC STORE-AND-FORWARD, AND TWO-WAY MESSAGING OF REFERENCES AND DESCRIPTIONS TO ELECTRONIC CONTENT, NAMELY COMPUTER FILES, DIGITAL MUSIC, VIDEO, DIGITAL PHOTOS, IDENTITIES, ELECTRONIC TOKENS AND COMPUTER FILES, TO ALLOW SUCH CONTENT TO BE SENT UPON REQUEST (U.S. CLS. 100, 101 AND 104).

CLASS 42—SCIENTIFIC, COMPUTER AND LEGAL SERVICES

FOR PROVIDING CONSULTANCY SERVICES TO BUSINESSES IN THE AREAS OF DIGITAL SECURITY, DIGITAL CONTENT DISTRIBUTION, DIGITAL CONTENT MANAGEMENT AND ELECTRONIC PAYMENT AND TRADING SYSTEMS; SOFTWARE DEVELOPMENT FOR OTHERS, INTEGRATION OF SOFTWARE SYSTEMS, INSTALLATION OF COMPLEX SOFTWARE SYSTEMS, CONSULTANCY ON DIGITAL SECURITY TECHNOLOGY AND DIGITAL CONTENT SYSTEMS (U.S. CLS. 100 AND 101).

DAWN FELDMAN, EXAMINING ATTORNEY

SN 78-445,441. GAMELOGIC INC., CAMBRIDGE, MA. FILED 7-2-2004.

QUICKPICK BINGO

THE MARK CONSISTS OF STANDARD CHARACTERS WITHOUT CLAIM TO ANY PARTICULAR FONT, STYLE, SIZE, OR COLOR.

NO CLAIM IS MADE TO THE EXCLUSIVE RIGHT TO USE "BINGO", APART FROM THE MARK AS SHOWN.

CLASS 9—ELECTRICAL AND SCIENTIFIC APPARATUS

FOR COMPUTER GAME SOFTWARE; COMPUTER SOFTWARE FOR USE IN GAMING MACHINES; ELECTRONIC GAMING MACHINES; COMPUTER SOFTWARE FOR ONLINE PAYMENT AND TRANSACTION PROCESSING; VIDEO GAME MACHINES FOR USE WITH TELEVISIONS (U.S. CLS. 21, 23, 26, 36 AND 38).

CLASS 28—TOYS AND SPORTING GOODS

FOR CARDS, NAMELY BINGO CARDS, LOTTERY CARDS AND KENO CARDS AND TICKETS, NAMELY LOTTERY TICKETS, FOR PLAYING GAMES OF CHANCE; COMPUTER GAME MACHINES, NAMELY STAND ALONE VIDEO GAME MACHINES (U.S. CLS. 22, 23, 38 AND 50).

STEPHANIE DAVIS, EXAMINING ATTORNEY

CLASS 29—MEATS AND PROCESSED FOODS

FOR POTATO CHIPS (U.S. CL. 46).

CLASS 30—STAPLE FOODS

FOR RICE PUFFS, CORN PUFFS, CORN CURLS, CORN CHIPS, GRAIN-BASED CHIPS, TACO CHIPS, TORTILLA CHIPS (U.S. CL. 46).

JASON LOTT, EXAMINING ATTORNEY

SN 78-446,136. GEORGIA-PACIFIC CORPORATION, ATLANTA, GA. FILED 7-6-2004.



NO CLAIM IS MADE TO THE EXCLUSIVE RIGHT TO USE "PERFECT SIZE", APART FROM THE MARK AS SHOWN.

CLASS 16—PAPER GOODS AND PRINTED MATTER

FOR BATH TISSUE, PAPER TOWELS, PAPER NAPKINS, FACIAL TISSUE AND PAPER SEAT COVERS (U.S. CLS. 2, 5, 22, 23, 29, 37, 38 AND 50).

CLASS 21—HOUSEWARES AND GLASS

FOR DISPENSERS FOR BATH TISSUE, PAPER TOWELS, PAPER NAPKINS, FACIAL TISSUE AND PAPER SEAT COVERS (U.S. CLS. 2, 13, 23, 29, 30, 33, 40 AND 50).

TARAH HARDY, EXAMINING ATTORNEY

SN 78-446,535. SNAK KING CORP, CITY OF INDUSTRY, CA. FILED 7-6-2004.

TWISTITAS

THE MARK CONSISTS OF STANDARD CHARACTERS WITHOUT CLAIM TO ANY PARTICULAR FONT, STYLE, SIZE, OR COLOR.

SN 78-446,977. FOUR SEASONS SOLAR PRODUCTS, LLC, HOLBROOK, NY. FILED 7-7-2004.

ULTRA LIVING

THE MARK CONSISTS OF STANDARD CHARACTERS WITHOUT CLAIM TO ANY PARTICULAR FONT, STYLE, SIZE, OR COLOR.

CLASS 6—METAL GOODS

FOR PREFABRICATED AND MODULAR METAL BUILDINGS, NAMELY, GREENHOUSES, SUNROOMS, SOLARIUM ENCLOSURES, CONSERVATORIES, AND ATRIUMS; METAL SKYLIGHTS (U.S. CLS. 2, 12, 13, 14, 23, 25 AND 50).

CLASS 19—NON-METALLIC BUILDING MATERIALS

FOR PREFABRICATED AND MODULAR NON-METAL BUILDINGS, NAMELY GREENHOUSES, SUNROOMS, SOLARIUM ENCLOSURES, CONSERVATORIES, AND ATRIUMS; NON-METAL SKYLIGHTS, GLASS PANELS, GLASS PANES, INSULATED GLASS, AND WINDOW GLASS (U.S. CLS. 1, 12, 33 AND 50).

CLASS 37—CONSTRUCTION AND REPAIR

FOR INSTALLATION OF PREFABRICATED AND MODULAR GREENHOUSES, PREFABRICATED SUNROOMS, SOLARIUM ENCLOSURES, CONSERVATORIES, ATRIUMS AND SKYLIGHTS IN HOMES AND COMMERCIAL PROPERTY (U.S. CLS. 100, 103 AND 106).

RONALD MCMORROW, EXAMINING ATTORNEY

SN 78-447,406. HDS COSMETICS LAB, INC., YONKERS, NY.
FILED 7-8-2004.

DDFPRO

THE MARK CONSISTS OF STANDARD CHARACTERS WITHOUT CLAIM TO ANY PARTICULAR FONT, STYLE, SIZE, OR COLOR.

OWNER OF U.S. REG. NOS. 1,957,741 AND 2,856,386.

CLASS 3—COSMETICS AND CLEANING PREPARATIONS

FOR NON-MEDICATED SKIN CARE PREPARATIONS (U.S. CLS. 1, 4, 6, 50, 51 AND 52).

CLASS 5—PHARMACEUTICALS

FOR DERMATOLOGICAL PHARMACEUTICALS AND MEDICATED SKIN CARE PREPARATIONS (U.S. CLS. 6, 18, 44, 46, 51 AND 52).

CHRISTOPHER ADKINS, EXAMINING ATTORNEY

SN 78-448,427. HJM ENTERPRISES, LLC, AUBURN HILLS, MI. FILED 7-9-2004.

TROPICAL SQUEEZE

THE MARK CONSISTS OF STANDARD CHARACTERS WITHOUT CLAIM TO ANY PARTICULAR FONT, STYLE, SIZE, OR COLOR.

OWNER OF U.S. REG. NO. 2,574,052.

NO CLAIM IS MADE TO THE EXCLUSIVE RIGHT TO USE "TROPICAL", APART FROM THE MARK AS SHOWN.

CLASS 29—MEATS AND PROCESSED FOODS

FOR CREAM, WHIPPING CREAM, HALF AND HALF, MILK, CHOCOLATE MILK, DAIRY AND NON-DAIRY BASED WHIPPED TOPPING, NON-DAIRY COFFEE CREAMER, MILK-BASED BEVERAGES CONTAINING COFFEE, SOY-BASED FOOD BEVERAGE USED AS A MILK SUBSTITUTE, FRUIT SALADS, VEGETABLE SALADS, SOUPS, AND PREPARED MEALS CONSISTING PRIMARILY OF MEAT, FISH, POULTRY OR VEGETABLES (U.S. CL. 46).

CLASS 30—STAPLE FOODS

FOR COFFEE, TEA, COCOA, CAPPUCINO, ESPRESSO, BAKERY GOODS, CHOCOLATES, CANDY, ICE CREAM, ICE MILK, MILKSHAKES, MALTED SHAKES, FROZEN CONFECTIONS, SHERBET, SORBET, WHOLE BEAN COFFEE, GROUND COFFEE, SANDWICHES, PASTA SALADS, PREPARED MEALS CONSISTING PRIMARILY OF PASTA OR RICE, AND EXTRACTS USED AS FLAVORING FOR BEVERAGES, MILK AND MILK PRODUCTS. (U.S. CL. 46).

CLASS 32—LIGHT BEVERAGES

FOR SMOOTHIES, FROZEN SMOOTHIES, FRUIT JUICES, FROZEN FRUIT JUICES, SPARKLING FRUIT JUICES, SOFT DRINKS, CARBONATED SOFT DRINKS, FLAVORED SYRUPS FOR BEVERAGES, MILK, AND MILK BASED BEVERAGES, NON-ALCOHOLIC FRUIT EXTRACTS USED IN THE PREPARATION OF BEVERAGES, LIQUID AND POWDERED NON-ALCOHOLIC COCKTAIL BEVERAGE MIXES, BOTTLED WATER AND MINERAL WATER (U.S. CLS. 45, 46 AND 48).

CLASS 35—ADVERTISING AND BUSINESS

FOR RETAIL BAKERY STORE SERVICES; RETAIL STORE, ON-LINE RETAIL STORE AND MAIL ORDER SERVICES FEATURING COFFEE PRODUCTS, TEA PRODUCTS, SMOOTHIE PRODUCTS, JUICE PRODUCTS, DAIRY PRODUCTS, BEVERAGE PRODUCTS, BAKERY PRODUCTS, CANDY, CHOCOLATES, FROZEN CONFECTIONS, CLOTHING, COFFEE GRINDERS, COFFEE MAKERS, ESPRESSO MACHINES, COFFEE PRODUCT GIFT SETS, AND NOVELTY ITEMS (U.S. CLS. 100, 101 AND 102).

CLASS 43—HOTEL AND RESTAURANT SERVICES

FOR COFFEE SHOP SERVICES AND RESTAURANT SERVICES (U.S. CLS. 100 AND 101).

LANA PHAM, EXAMINING ATTORNEY

SN 78-449,198. SIMDESK TECHNOLOGIES, INC., HOUSTON, TX. FILED 7-12-2004.

Community Access Network for Digital Outreach

THE MARK CONSISTS OF STANDARD CHARACTERS WITHOUT CLAIM TO ANY PARTICULAR FONT, STYLE, SIZE, OR COLOR.

NO CLAIM IS MADE TO THE EXCLUSIVE RIGHT TO USE "COMMUNITY ACCESS NETWORK" AND "DIGITAL", APART FROM THE MARK AS SHOWN.

CLASS 9—ELECTRICAL AND SCIENTIFIC APPARATUS

FOR COMMUNICATIONS SOFTWARE ALLOWING USERS IN A COMMUNITY DIGITAL INCLUSION PROGRAM ACCESS FROM ANY INTERNET CAPABLE DEVICE TO A GLOBAL COMPUTER NETWORK ALLOWING DISTRIBUTION AND USE OF ON-LINE SOFTWARE APPLICATIONS, NAMELY, WORD PROCESSING; SPREADSHEET; FILE MANAGEMENT; PERSONAL INFORMATION MANAGEMENT; E-MAIL; INSTANT MESSAGING; REMOTE PRINTING; DATA ARCHIVING, RETRIEVAL, SHARING AND COLLABORATION; AND MULTIMEDIA PRESENTATION DEVELOPMENT (U.S. CLS. 21, 23, 26, 36 AND 38).

CLASS 42—SCIENTIFIC, COMPUTER AND LEGAL SERVICES

FOR APPLICATION SERVICE PROVIDER SERVICES ALLOWING USERS IN A COMMUNITY DIGITAL INCLUSION PROGRAM ACCESS FROM ANY INTERNET CAPABLE DEVICE TO A GLOBAL COMPUTER NETWORK ALLOWING DISTRIBUTION AND USE OF ON-LINE SOFTWARE APPLICATIONS FOR WORD PROCESSING; SPREADSHEET DEVELOPMENT; FILE MANAGEMENT; PERSONAL INFORMATION MANAGEMENT; E-MAIL; INSTANT MESSAGING; REMOTE PRINTING; DATA ARCHIVING, RETRIEVAL, SHARING AND COLLABORATION; AND MULTIMEDIA PRESENTATION DEVELOPMENT (U.S. CLS. 100 AND 101).

ARETHA SOMERVILLE, EXAMINING ATTORNEY

SN 78-450,128. PIZZICATO FRANCHISE, INC., PORTLAND, OR. FILED 7-13-2004.

PIZZICATO

THE MARK CONSISTS OF STANDARD CHARACTERS WITHOUT CLAIM TO ANY PARTICULAR FONT, STYLE, SIZE, OR COLOR.

CLASS 16—PAPER GOODS AND PRINTED MATTER

FOR MENUS, MENU BOARDS, PIZZA BOXES, NEWSLETTERS FEATURING INFORMATION ABOUT COMPANY POLICIES, CUSTOMER SERVICE INITIATIVES AND ACCOMPLISHMENTS, HEALTH AND SAFETY STANDARDS, EMPLOYEE BENEFITS, VENDOR INFORMATION, AND ACHIEVEMENTS BY INDIVIDUAL RESTAURANTS AND EMPLOYEES, AND OTHER PAPER GOODS, NAMELY, PAPER BAGS AND STICKERS (U.S. CLS. 2, 5, 22, 23, 29, 37, 38 AND 50).

FIRST USE 12-1-1989; IN COMMERCE 8-26-1994.

CLASS 30—STAPLE FOODS

FOR PIZZA, PIZZA CRUST, PIZZA DOUGH, PIZZA SAUCE (U.S. CL. 46).

FIRST USE 12-1-1989; IN COMMERCE 8-26-1994.

CLASS 43—HOTEL AND RESTAURANT SERVICES

FOR RESTAURANT, TAKE-OUT AND CATERING SERVICES (U.S. CLS. 100 AND 101).

FIRST USE 12-1-1989; IN COMMERCE 8-26-1994.
MICHAEL KEATING, EXAMINING ATTORNEY

SN 78-450,710. THE BENEVOLINK CORPORATION, ATLANTA, GA. FILED 7-14-2004.

FUNDRAISING MADE SIMPLE

THE MARK CONSISTS OF STANDARD CHARACTERS WITHOUT CLAIM TO ANY PARTICULAR FONT, STYLE, SIZE, OR COLOR.

NO CLAIM IS MADE TO THE EXCLUSIVE RIGHT TO USE "FUNDRAISING", APART FROM THE MARK AS SHOWN.

CLASS 35—ADVERTISING AND BUSINESS

FOR PROMOTING THE SALE OF GOODS AND SERVICES OF OTHERS THROUGH THE ADMINISTRATION OF LOYALTY MARKETING PROGRAMS; BUSINESS MARKETING CONSULTING SERVICES (U.S. CLS. 100, 101 AND 102).

CLASS 36—INSURANCE AND FINANCIAL

FOR PHILANTHROPIC CHARITABLE FUNDRAISING SERVICES (U.S. CLS. 100, 101 AND 102).

MARGERY A. TIERNEY, EXAMINING ATTORNEY

SN 78-451,947. K2C, INC., ALPHARETTA, GA. FILED 7-16-2004.

WHERE BUILDERS GET DOWN TO BUSINESS

THE MARK CONSISTS OF STANDARD CHARACTERS WITHOUT CLAIM TO ANY PARTICULAR FONT, STYLE, SIZE, OR COLOR.

CLASS 35—ADVERTISING AND BUSINESS

FOR BUSINESS MANAGEMENT SERVICES, NAMELY, ESTIMATING CONTRACTING WORK, TASK APPOINTMENT SCHEDULING, AND CUSTOMER AND CONTACT DATABASE MANAGEMENT; ADVERTISING SERVICES, NAMELY, PROMOTING THE GOODS AND SERVICES OF OTHERS BY PROVIDING HYPERTEXT LINKS TO THE WEBSITES OF OTHER BUILDERS, MANUFACTURERS, CONTRACTORS, AND SUBCONTRACTORS; ONLINE PRODUCT INFORMATION, NAMELY, PROVIDING CONSUMER PRODUCT INFORMATION VIA THE INTERNET (U.S. CLS. 100, 101 AND 102).

CLASS 42—SCIENTIFIC, COMPUTER AND LEGAL SERVICES

FOR DATABASE DEVELOPMENT SERVICES, NAMELY, CREATING DATABASES FOR BUILDERS AND CONSUMERS TO LOCATE SUBCONTRACTORS, FOR BUILDERS AND MANUFACTURERS TO BUY AND SELL SURPLUS BUILDING MATERIALS, FOR BUILDERS, MANUFACTURERS, AND SUBCONTRACTORS TO FILL EMPLOYMENT POSITIONS (U.S. CLS. 100 AND 101).

JOHN DWYER, EXAMINING ATTORNEY

SN 78-455,724. HONDA MOTOR CO., LTD., TOKYO 107-8556, JAPAN, FILED 7-23-2004.

ACURA KEYLESS ACCESS SYSTEM

THE MARK CONSISTS OF STANDARD CHARACTERS WITHOUT CLAIM TO ANY PARTICULAR FONT, STYLE, SIZE, OR COLOR.

OWNER OF U.S. REG. NOS. 1,407,602, 2,365,656 AND OTHERS.

NO CLAIM IS MADE TO THE EXCLUSIVE RIGHT TO USE "KEYLESS ACCESS SYSTEM", APART FROM THE MARK AS SHOWN.

CLASS 9—ELECTRICAL AND SCIENTIFIC APPARATUS

FOR ELECTRONIC CONTROLLERS FOR OPENING AND CLOSING DOORS AND FOR STARTING ENGINES FOR MOTOR CARS (U.S. CLS. 21, 23, 26, 36 AND 38).

CLASS 12—VEHICLES

FOR MOTOR CARS AND STRUCTURAL PARTS FOR MOTOR CARS (U.S. CLS. 19, 21, 23, 31, 35 AND 44).

RON FAIRBANKS, EXAMINING ATTORNEY

SN 78-452,563. JAMISON, STEVEN B., KANSAS CITY, MO. FILED 7-19-2004.

SN 78-456,047. FINANCENTER, INC., TUCSON, AZ. FILED 7-23-2004.

Thizzel

THE MARK CONSISTS OF STANDARD CHARACTERS WITHOUT CLAIM TO ANY PARTICULAR FONT, STYLE, SIZE, OR COLOR.

CLASS 9—ELECTRICAL AND SCIENTIFIC APPARATUS

FOR EYE GLASSES, SUN GLASSES (U.S. CLS. 21, 23, 26, 36 AND 38).

CLASS 25—CLOTHING

FOR T-SHIRTS, SHORTS, SWEAT SHIRTS, PANTS, SHOES, HATS, G-STRINGS, HEAD BANDS, UNDERWEAR, SOCKS, JEANS (U.S. CLS. 22 AND 39).

DORITT L. CARROLL, EXAMINING ATTORNEY

CLASS 9—ELECTRICAL AND SCIENTIFIC APPARATUS

FOR COMPUTER SOFTWARE PLATFORM THAT ENABLES GENERATION, MANAGEMENT, AND CONVERSION OPTIMIZATION OF LEADS (U.S. CLS. 21, 23, 26, 36 AND 38).

FIRST USE 3-10-2004; IN COMMERCE 3-10-2004.

CLASS 35—ADVERTISING AND BUSINESS

FOR MARKETING SERVICES, NAMELY, ONLINE MARKETING PLATFORM SERVICES THAT ENABLE GENERATION, MANAGEMENT, AND CONVERSION OPTIMIZATION OF LEADS (U.S. CLS. 100, 101 AND 102).

FIRST USE 3-10-2004; IN COMMERCE 3-10-2004.

ANGELA M. MICHELI, EXAMINING ATTORNEY

SN 78-456,110. REEFMATTERS LLC, JACKSON HOLE, WY.
FILED 7-23-2004.

REEFMATTERS

THE MARK CONSISTS OF STANDARD CHARACTERS WITHOUT CLAIM TO ANY PARTICULAR FONT, STYLE, SIZE, OR COLOR.

CLASS 7—MACHINERY

FOR AQUATIC AERATION EQUIPMENT, NAMELY AIR PUMPS AND DIFFUSERS (U.S. CLS. 13, 19, 21, 23, 31, 34 AND 35).

CLASS 37—CONSTRUCTION AND REPAIR

FOR INSTALLATION OF ARTIFICIAL REEF STRUCTURES (U.S. CLS. 100, 103 AND 106).
BARBARA A. GOLD, EXAMINING ATTORNEY

SN 78-456,817. GTSI CORP., CHANTILLY, VA. FILED 7-26-2004.

InteGuard Alliance

THE MARK CONSISTS OF STANDARD CHARACTERS WITHOUT CLAIM TO ANY PARTICULAR FONT, STYLE, SIZE, OR COLOR.

NO CLAIM IS MADE TO THE EXCLUSIVE RIGHT TO USE "ALLIANCE", APART FROM THE MARK AS SHOWN.

CLASS 40—MATERIAL TREATMENT

FOR INSERTING SOFTWARE PROTECTION PROGRAMS AND SECURITY PROGRAMS ONTO MAGNETIC MEDIA. (U.S. CLS. 100, 103 AND 106).

CLASS 42—SCIENTIFIC, COMPUTER AND LEGAL SERVICES

FOR PROVIDING ELECTRONIC VERIFICATION OF ON-LINE ORDERS OF DIGITAL CONTENT AND GENERATING ELECTRONIC PERMISSION CODES WHICH THEN ALLOW USERS TO ACCESS SAID DIGITAL CONTENT; COMPUTER-VIRUS PROTECTION SERVICES (U.S. CLS. 100 AND 101).

CLASS 45—PERSONAL SERVICES

FOR IDENTIFICATION VERIFICATION SERVICES AND SOLUTIONS, NAMELY, PROVIDING AUTHENTICATION OF PERSONAL IDENTIFICATION INFORMATION; CONSULTING SERVICES IN THE FIELD OF MAINTAINING THE SECURITY AND INTEGRITY OF DATABASES; MONITORING OF SECURITY SYSTEMS FOR SECURITY PURPOSES; ELECTRONIC MONITORING SERVICES FOR SECURITY PURPOSES IN THE FIELD OF PHYSICAL AND INFORMATION TECHNOLOGY SECURITY PROTECTION; INVESTIGATION OR SURVEILLANCE ON BACKGROUND PROFILES; CONTROL OF BUILDING ENVIRONMENTAL ACCESS AND SECURITY SYSTEMS; SECURITY SERVICES, NAMELY, RISK AND VULNERABILITY ASSESSMENT IN THE FIELD OF PHYSICAL AND INFORMATION TECHNOLOGY SECURITY PROTECTION (U.S. CLS. 100 AND 101).
ANGELA M. MICHELI, EXAMINING ATTORNEY

SN 78-456,914. DIGITAL MEDIA BROADCASTING CORPORATION, RESTON, VA. FILED 7-26-2004.

catch the vision

THE MARK CONSISTS OF STANDARD CHARACTERS WITHOUT CLAIM TO ANY PARTICULAR FONT, STYLE, SIZE, OR COLOR.

CLASS 9—ELECTRICAL AND SCIENTIFIC APPARATUS

FOR PRE-RECORDED CDS, VIDEO TAPES, AND DVDS FEATURING EDUCATIONAL AND ENTERTAINMENT TOPICS IN THE AREAS OF MEDICINE, SPORTS, AND GOVERNMENT (U.S. CLS. 21, 23, 26, 36 AND 38).

CLASS 35—ADVERTISING AND BUSINESS

FOR INFORMATION IN THE FIELD OF GOVERNMENT AFFAIRS (U.S. CLS. 100, 101 AND 102).

CLASS 38—COMMUNICATION

FOR BROADCASTING PROGRAMS VIA A GLOBAL COMPUTER NETWORK (U.S. CLS. 100, 101 AND 104).

CLASS 41—EDUCATION AND ENTERTAINMENT

FOR EDUCATIONAL SERVICES, NAMELY, CONDUCTING COURSES, SEMINARS, EXHIBITIONS AND DISPLAYS, ON-LINE, IN THE FIELDS OF MEDICINE AND GOVERNMENT; EDUCATIONAL SERVICES, NAMELY, CONDUCTING COURSES, SEMINARS, EXHIBITIONS AND DISPLAYS, ON-LINE, REGARDING HOW TO PLAY SOCCER, FOOTBALL, TENNIS, BASKETBALL, GOLF, WRESTLING, BASEBALL, AND LACROSSE; ENTERTAINMENT SERVICES IN THE NATURE OF SOCCER, FOOTBALL, TENNIS, BASKETBALL, GOLF, WRESTLING, BASEBALL, AND LACROSSE GAMES (U.S. CLS. 100, 101 AND 107).
LINDA E. BLOHM, EXAMINING ATTORNEY

SN 78-456,924. DIGITAL MEDIA BROADCASTING CORPORATION, RESTON, VA. FILED 7-26-2004.

SN 78-457,082. VALSPAR SOURCING, INC., MINNEAPOLIS, MN. FILED 7-27-2004.

ZENITH

the next
generation of
broadcasting

THE MARK CONSISTS OF STANDARD CHARACTERS WITHOUT CLAIM TO ANY PARTICULAR FONT, STYLE, SIZE, OR COLOR.

CLASS 1—CHEMICALS

FOR ADDITIVES IN THE NATURE OF ISOCYANATES FOR USE IN THE MANUFACTURE OF PAINTS AND COATINGS FOR VEHICLES AND POWERED EQUIPMENT (U.S. CLS. 1, 5, 6, 10, 26 AND 46).

CLASS 2—PAINTS

FOR ADDITIVES IN THE NATURE OF COLORANTS FOR USE IN PAINTS AND COATINGS USED ON VEHICLES AND POWERED EQUIPMENT; COATINGS IN THE NATURE OF PRIMERS AND TOP COATS FOR PAINTS USED ON VEHICLES AND POWERED EQUIPMENT; AND PAINTS AND FINISHING COATINGS FOR USE ON VEHICLES AND POWERED EQUIPMENT (U.S. CLS. 6, 11 AND 16).

MARTHA FROMM, EXAMINING ATTORNEY

THE MARK CONSISTS OF STANDARD CHARACTERS WITHOUT CLAIM TO ANY PARTICULAR FONT, STYLE, SIZE, OR COLOR.

NO CLAIM IS MADE TO THE EXCLUSIVE RIGHT TO USE BROADCASTING, APART FROM THE MARK AS SHOWN.

CLASS 9—ELECTRICAL AND SCIENTIFIC APPARATUS

FOR PRE-RECORDED CDS, VIDEO TAPES, AND DVDS FEATURING EDUCATIONAL AND ENTERTAINMENT TOPICS IN THE AREAS OF MEDICINE, SPORTS, AND GOVERNMENT (U.S. CLS. 21, 23, 26, 36 AND 38).

CLASS 35—ADVERTISING AND BUSINESS

FOR INFORMATION IN THE FIELD OF GOVERNMENT AFFAIRS (U.S. CLS. 100, 101 AND 102).

CLASS 38—COMMUNICATION

FOR BROADCASTING PROGRAMS VIA A GLOBAL COMPUTER NETWORK (U.S. CLS. 100, 101 AND 104).

CLASS 41—EDUCATION AND ENTERTAINMENT

FOR EDUCATIONAL SERVICES, NAMELY, CONDUCTING COURSES, SEMINARS, EXHIBITIONS, AND DISPLAYS, ON-LINE, IN THE FIELDS OF MEDICINE AND GOVERNMENT; EDUCATIONAL SERVICES, NAMELY CONDUCTING COURSES, SEMINARS, EXHIBITIONS, AND DISPLAYS, ON-LINE, REGARDING HOW TO PLAY SOCCER, FOOTBALL, TENNIS, BASKETBALL, ICE HOCKEY, GOLF, WRESTLING, BASEBALL, AND LACROSSE; ENTERTAINMENT SERVICES IN THE NATURE OF SOCCER, FOOTBALL, TENNIS, BASKETBALL, ICE HOCKEY, GOLF, WRESTLING, BASEBALL, AND LACROSSE GAMES (U.S. CLS. 100, 101 AND 107).

LINDA E. BLOHM, EXAMINING ATTORNEY

SN 78-457,144. THE SPRING AIR COMPANY, ELK GROVE VILLAGE, IL. FILED 7-27-2004.

SPRING AIR SLEEP CENTER

THE MARK CONSISTS OF STANDARD CHARACTERS WITHOUT CLAIM TO ANY PARTICULAR FONT, STYLE, SIZE, OR COLOR.

OWNER OF U.S. REG. NOS. 1,059,300, 1,955,913 AND OTHERS.

NO CLAIM IS MADE TO THE EXCLUSIVE RIGHT TO USE "SLEEP CENTER", APART FROM THE MARK AS SHOWN.

CLASS 16—PAPER GOODS AND PRINTED MATTER

FOR INSTRUCTIONAL, EDUCATIONAL AND TEACHING MATERIAL IN THE FIELD OF SALES TRAINING (U.S. CLS. 2, 5, 22, 23, 29, 37, 38 AND 50).

CLASS 20—FURNITURE AND ARTICLES NOT OTHERWISE CLASSIFIED

FOR MATTRESSES AND BOX SPRINGS (U.S. CLS. 2, 13, 22, 25, 32 AND 50).
JOHN DWYER, EXAMINING ATTORNEY

SN 78-457,465. IPC INTERNATIONAL, INC., BANNOCKBURN, IL. FILED 7-27-2004.

IPC

THE MARK CONSISTS OF STANDARD CHARACTERS WITHOUT CLAIM TO ANY PARTICULAR FONT, STYLE, SIZE, OR COLOR.

OWNER OF U.S. REG. NOS. 2,324,147, 2,361,451 AND 2,397,058.

CLASS 9—ELECTRICAL AND SCIENTIFIC APPARATUS

FOR EDUCATIONAL AND INFORMATIONAL SOFTWARE FEATURING TECHNICAL DATA AND SAFETY INFORMATION FOR THE PRINTED CIRCUIT BOARD MANUFACTURING AND DESIGN INDUSTRY AND THE ELECTRONICS MANUFACTURING INDUSTRY; PRE-RECORDED DVDS, VIDEO CASSETTE TAPES, AND CD-ROMS FEATURING TECHNICAL DATA AND SAFETY INFORMATION FOR THE PRINTED CIRCUIT BOARD MANUFACTURING AND DESIGN INDUSTRY AND THE ELECTRONICS MANUFACTURING INDUSTRY; ELECTRONIC DATABASE RECORDED ON COMPUTER MEDIA FEATURING TECHNICAL DATA AND SAFETY INFORMATION FOR THE PRINTED CIRCUIT BOARD MANUFACTURING AND DESIGN INDUSTRY AND THE ELECTRONICS MANUFACTURING INDUSTRY (U.S. CLS. 21, 23, 26, 36 AND 38).

FIRST USE 0-0-1980; IN COMMERCE 0-0-1980.

CLASS 16—PAPER GOODS AND PRINTED MATTER

FOR EDUCATIONAL AND INFORMATIONAL BOOKS, MANUALS, POSTERS, MAGAZINES, NEWSLETTERS, AND PICTURES FEATURING TECHNICAL DATA, SAFETY INFORMATION AND MARKET AND BUSINESS DATA FOR THE PRINTED CIRCUIT BOARD MANUFACTURING AND DESIGN INDUSTRY AND THE ELECTRONICS MANUFACTURING INDUSTRY (U.S. CLS. 2, 5, 22, 23, 29, 37, 38 AND 50).

FIRST USE 0-0-1959; IN COMMERCE 0-0-1959.

CLASS 35—ADVERTISING AND BUSINESS

FOR ASSOCIATION SERVICES, NAMELY, PROMOTING THE INTERESTS OF THE PRINTED CIRCUIT BOARD MANUFACTURING AND DESIGN INDUSTRY AND THE ELECTRONICS MANUFACTURING INDUSTRY; ARRANGING BUSINESS MEETINGS, SYMPOSIA, AND CONFERENCES FOR THE PRINTED CIRCUIT BOARD MANUFACTURING AND DESIGN INDUSTRY AND THE ELECTRONICS MANUFACTURING INDUSTRY; CONDUCTING TRADE SHOWS FOR THE PRINTED CIRCUIT BOARD MANUFACTURING AND DESIGN INDUSTRY AND THE ELECTRONICS MANUFACTURING INDUSTRY; CONDUCTING MARKET RESEARCH FOR THE PRINTED CIRCUIT BOARD MANUFACTURING AND DESIGN INDUSTRY AND THE ELECTRONICS INDUSTRY (U.S. CLS. 100, 101 AND 102).

FIRST USE 0-0-1959; IN COMMERCE 0-0-1959.

CLASS 41—EDUCATION AND ENTERTAINMENT

FOR EDUCATIONAL SERVICES FOR THE PRINTED CIRCUIT BOARD MANUFACTURING AND DESIGN INDUSTRY AND THE ELECTRONICS MANUFACTURING INDUSTRY, NAMELY, CONDUCTING SEMINARS AND CONFERENCES FEATURING TECHNICAL DATA AND SAFETY INFORMATION; EDUCATIONAL RESEARCH FOR THE PRINTED CIRCUIT BOARD MANUFACTURING AND DESIGN INDUSTRY AND THE ELECTRONICS MANUFACTURING INDUSTRY (U.S. CLS. 100, 101 AND 107).

FIRST USE 0-0-1959; IN COMMERCE 0-0-1959.

JASON LOTT, EXAMINING ATTORNEY

SN 78-457,687. SEROLOGICALS ROYALTY COMPANY, FREEPORT, GRAND BAHAMA, BAHAMAS, FILED 7-27-2004.

BUILDING VALUE,
ENHANCING LIVES

THE MARK CONSISTS OF STANDARD CHARACTERS WITHOUT CLAIM TO ANY PARTICULAR FONT, STYLE, SIZE, OR COLOR.

CLASS 1—CHEMICALS

FOR REAGENTS FOR MEDICAL OR SCIENTIFIC RESEARCH USE; KITS FOR THE EXPRESSION, AMPLIFICATION, PURIFICATION AND ANALYSIS OF BIOLOGICAL SAMPLES, SAID KITS CONSISTING PRIMARILY OF ONE OR MORE OF THE FOLLOWING: PROTEINS, NUCLEIC ACIDS, CELLS, GELS, PROBES, BUFFERS, STAINS AND ASSOCIATED REAGENTS AND DEVICES FOR CARRYING OUT SAID PURPOSES; BIOCHEMICAL REAGENTS, NAMELY, CELL CULTURE MEDIA COMPONENTS, SUPPLEMENTS, AND ADDITIVES; BIOCHEMICALS FOR SCIENTIFIC AND RESEARCH USE, NAMELY, MONOCLONAL ANTIBODIES, POLYCLONAL ANTIBODIES, PURIFIED RECOMBINANT PROTEINS, PURIFIED NATURAL PROTEINS, FETAL BOVINE SERUM, CELL GROWTH SUPPLEMENTS, NAMELY, BIOCHEMICALS FOR AFFINITY PURIFICATION, BIOCHEMICALS FOR WESTERN IMMUNO BLOTTING, BIOCHEMICALS FOR IMMUNOCYTO CHEMISTRY (U.S. CLS. 1, 5, 6, 10, 26 AND 46).

CLASS 5—PHARMACEUTICALS

FOR BLOOD PLASMA PRODUCTS, NAMELY, BLOOD-TYPING REAGENTS AND DIAGNOSTIC TEST KIT CONTROL MATERIALS AND IMMUNE GLOBULINS (U.S. CLS. 6, 18, 44, 46, 51 AND 52).

CLASS 9—ELECTRICAL AND SCIENTIFIC APPARATUS

FOR LABORATORY EQUIPMENT, NAMELY, TISSUE ARRAYERS (U.S. CLS. 21, 23, 26, 36 AND 38).

CLASS 42—SCIENTIFIC, COMPUTER AND LEGAL SERVICES

FOR PHARMACEUTICAL AND BIOLOGICAL RESEARCH SERVICES, NAMELY, ANTISERA STUDIES, IMMUNOGEN PREPARATION, IMMUNIZATION AND PRODUCTION, ANTIBODY CHARACTERIZATION, ANTIBODY PURIFICATION, ANTIBODY PACKAGING, HYBRIDOMA DEVELOPMENT AND SELECTION, PREPARATION OF CUSTOM TISSUE CULTURES, IMMUNOASSAY DEVELOPMENT AND TESTING, IMMUNOGENICITY TESTING, AND VIVARIUM SERVICES IN THE NATURE OF PHARMACOLOGICAL, SAFETY AND TOXICITY RESEARCH, IN-VIVO MODELING, ANTIBODY GENERATION AND CELL LINE DEVELOPMENT, AND CUSTOM ANTIBODY PRODUCTION; CUSTOM PRODUCTION OF CELL CULTURES AND BIOLOGICAL PRODUCTS IN THE NATURE OF ANTIBODIES AND PROTEINS AND RELATED REAGENTS (U.S. CLS. 100 AND 101).
CATHERINE CAIN, EXAMINING ATTORNEY

CLASS 42—SCIENTIFIC, COMPUTER AND LEGAL SERVICES

FOR PROVIDING A WEBSITE USED FOR DISPLAYING THE DIGITAL IMAGES OF OTHERS ON THE INTERNET; COMPUTER SERVICES, NAMELY PROVIDING WEB PAGES USED TO CREATE PERSONALIZED WEBSITES FEATURING THE DIGITAL IMAGES OF OTHERS (U.S. CLS. 100 AND 101).
FIRST USE 5-18-2002; IN COMMERCE 5-18-2002.
KEVON CHISOLM, EXAMINING ATTORNEY

SN 78-460,348. SCREENLIFE, LLC, SEATTLE, WA. FILED 8-2-2004.

SCREENLIFE STUDIOS

SN 78-458,202. FOTOLOG, INC., NEW YORK, NY. FILED 7-28-2004.

FOTOLOG

THE MARK CONSISTS OF STANDARD CHARACTERS WITHOUT CLAIM TO ANY PARTICULAR FONT, STYLE, SIZE, OR COLOR.

CLASS 38—COMMUNICATION

FOR PROVIDING ELECTRONIC BULLETIN BOARDS AND MESSAGE BOARDS FOR TRANSMISSION OF MESSAGES AMONG COMPUTER USERS CONCERNING TOPICS OF GENERAL INTEREST; PROVIDING ONLINE ACCESS TO PROCESSED DIGITAL IMAGES VIA A GLOBAL COMPUTER NETWORK (U.S. CLS. 100, 101 AND 104).
FIRST USE 5-18-2002; IN COMMERCE 5-18-2002.

THE MARK CONSISTS OF STANDARD CHARACTERS WITHOUT CLAIM TO ANY PARTICULAR FONT, STYLE, SIZE, OR COLOR.

NO CLAIM IS MADE TO THE EXCLUSIVE RIGHT TO USE "STUDIOS", APART FROM THE MARK AS SHOWN.

CLASS 9—ELECTRICAL AND SCIENTIFIC APPARATUS

FOR COMPUTER GAME PROGRAMS, COMPUTER GAME SOFTWARE, VIDEO GAME PROGRAMS, VIDEO GAME SOFTWARE, PRE-RECORDED DIGITAL VIDEO DISCS FEATURING VIDEO CLIPS ON A WIDE VARIETY OF SUBJECTS; GAME EQUIPMENT, NAMELY, PRE-RECORDED DIGITAL VIDEO DISCS FEATURING VIDEO CLIPS ON A WIDE VARIETY OF SUBJECTS (U.S. CLS. 21, 23, 26, 36 AND 38).

CLASS 28—TOYS AND SPORTING GOODS

FOR EQUIPMENT SOLD AS A UNIT FOR PLAYING A BOARD OR PARLOR GAME (U.S. CLS. 22, 23, 38 AND 50).

CLASS 41—EDUCATION AND ENTERTAINMENT

FOR PRODUCTION OF TELEVISION SHOWS, PROVIDING AN ONLINE COMPUTER GAME, AND ENTERTAINMENT IN THE NATURE OF TELEVISION GAME SHOW SERIES (U.S. CLS. 100, 101 AND 107).

CLASS 42—SCIENTIFIC, COMPUTER AND LEGAL SERVICES

FOR PRODUCT DEVELOPMENT, AND PRODUCT DEVELOPMENT CONSULTATION SERVICES (U.S. CLS. 100 AND 101).
DARRYL SPRUILL, EXAMINING ATTORNEY

SN 78-460,944. GTSI CORP., CHANTILLY, VA. FILED 8-3-2004.

I Rely on GTSI

THE MARK CONSISTS OF STANDARD CHARACTERS WITHOUT CLAIM TO ANY PARTICULAR FONT, STYLE, SIZE, OR COLOR.

OWNER OF U.S. REG. NOS. 1,511,242, 2,927,921 AND OTHERS.

CLASS 35—ADVERTISING AND BUSINESS

FOR PROCUREMENT SERVICES, NAMELY, PURCHASING COMPUTER HARDWARE, COMPUTER SOFTWARE, COMPUTER NETWORKING SYSTEM COMPONENTS, AND TELECOMMUNICATION SYSTEM COMPONENTS FOR OTHERS; PROMOTING THE GOODS AND SERVICES OF OTHERS VIA A GLOBAL COMPUTER NETWORK, TELEPHONE, AND LIVE CONFERENCES, AND BY DISTRIBUTING ADVERTISING MATERIALS THROUGH MAIL ORDER CATALOGS AND PRINTED MATERIALS; CUSTOMER SERVICES IN THE FIELD OF COMPUTERS AND COMPUTER NETWORKING (U.S. CLS. 100, 101 AND 102).

CLASS 37—CONSTRUCTION AND REPAIR

FOR INSTALLATION OF COMPUTER NETWORKS, COMPUTER SYSTEMS, AND TELECOMMUNICATION SYSTEMS (U.S. CLS. 100, 103 AND 106).

CLASS 38—COMMUNICATION

FOR TELECOMMUNICATIONS CONSULTATION; CONSULTING IN THE FIELD OF THE USE OF TELECOMMUNICATIONS SYSTEMS. (U.S. CLS. 100, 101 AND 104).

CLASS 39—TRANSPORTATION AND STORAGE

FOR WAREHOUSING SERVICES, NAMELY, STORAGE, DISTRIBUTION AND PACKING OF COMPUTER HARDWARE, COMPUTER SOFTWARE, COMPUTER NETWORKING EQUIPMENT AND TELECOMMUNICATION SYSTEM COMPONENTS FOR OTHERS; STORAGE SERVICES FOR ARCHIVING DATABASES, IMAGES AND OTHER ELECTRONIC DATA IN THE FIELDS OF COMPUTERS AND COMPUTER NETWORKING; CONSULTING SERVICES IN THE FIELD OF THE ELECTRONIC STORAGE OF DATA (U.S. CLS. 100 AND 105).

CLASS 41—EDUCATION AND ENTERTAINMENT

FOR TRAINING SERVICES IN THE FIELD OF INFORMATION TECHNOLOGY (IT) DEVELOPMENT AND IT SOLUTION INTEGRATION; TRAINING SERVICES IN THE FIELD OF COMPUTER NETWORKING. (U.S. CLS. 100, 101 AND 107).

CLASS 42—SCIENTIFIC, COMPUTER AND LEGAL SERVICES

FOR TECHNICAL SUPPORT SERVICES, NAMELY, TROUBLESHOOTING OF COMPUTER HARDWARE AND SOFTWARE PROGRAMS; COMPUTER SERVICES, NAMELY, DATA RECOVERY SERVICES IN THE FIELDS OF COMPUTER AND COMPUTER NETWORKING; CONSULTING SERVICES IN THE FIELD OF DESIGN, SELECTION, IMPLEMENTATION AND USE OF COMPUTER HARDWARE, COMPUTER SOFTWARE AND COMPUTER NETWORKS FOR OTHERS; COMPUTER CONSULTATION IN THE FIELDS OF IT DEVELOPMENT, IT SOLUTION INTEGRATION, COMPUTER HARDWARE, COMPUTER SOFTWARE, COMPUTER NETWORKING, TELECOMMUNICATIONS, EMERGING TECHNOLOGIES, AND COMPUTER SECURITY; INTEGRATION OF COMPUTER SYSTEMS AND NETWORKS (U.S. CLS. 100 AND 101).

CLASS 45—PERSONAL SERVICES

FOR ASSET TAGGING IN THE NATURE OF SECURITY PRINTING, NAMELY, ENCODING IDENTIFICATION INFORMATION ON VALUABLE DOCUMENTS AND PRODUCTS; CONSULTING SERVICES IN THE FIELD OF MONITORING OF COMPUTER SYSTEMS FOR SECURITY PURPOSES (U.S. CLS. 100 AND 101).

JOHN GARTNER, EXAMINING ATTORNEY

SN 78-460,984. GTSI CORP., CHANTILLY, VA. FILED 8-3-2004.



OWNER OF U.S. REG. NOS. 1,511,242, 2,927,921 AND OTHERS.

THE COLOR(S) WHITE AND RED IS/ARE CLAIMED AS A FEATURE OF THE MARK.

THE MARK CONSISTS OF THE LITERAL ELEMENT IN WHITE ON A RED BUTTON.

CLASS 35—ADVERTISING AND BUSINESS

FOR PROCUREMENT SERVICES, NAMELY, PURCHASING COMPUTER HARDWARE, COMPUTER SOFTWARE, COMPUTER NETWORKING SYSTEM COMPONENTS, AND TELECOMMUNICATION SYSTEM COMPONENTS FOR OTHERS; PROMOTING THE GOODS AND SERVICES OF OTHERS VIA A GLOBAL COMPUTER NETWORK, TELEPHONE, AND LIVE CONFERENCES, AND BY DISTRIBUTING ADVERTISING MATERIALS THROUGH MAIL ORDER CATALOGS AND PRINTED MATERIALS; CUSTOMER SERVICES IN THE FIELD OF COMPUTERS AND COMPUTER NETWORKING (U.S. CLS. 100, 101 AND 102).

CLASS 37—CONSTRUCTION AND REPAIR

FOR INSTALLATION OF COMPUTER NETWORKS, COMPUTER SYSTEMS, AND TELECOMMUNICATION SYSTEMS (U.S. CLS. 100, 103 AND 106).

CLASS 38—COMMUNICATION

FOR TELECOMMUNICATIONS CONSULTATION; CONSULTING IN THE FIELD OF THE USE OF TELECOMMUNICATIONS SYSTEMS (U.S. CLS. 100, 101 AND 104).

CLASS 39—TRANSPORTATION AND STORAGE

FOR WAREHOUSING SERVICES, NAMELY, STORAGE, DISTRIBUTION, AND PACKING OF COMPUTER HARDWARE, COMPUTER SOFTWARE, COMPUTER NETWORKING EQUIPMENT, AND TELECOMMUNICATION SYSTEM COMPONENTS FOR OTHERS; STORAGE SERVICES FOR ARCHIVING DATABASES, IMAGES AND OTHER ELECTRONIC DATA IN THE FIELDS OF COMPUTERS AND COMPUTER NETWORKING; CONSULTING SERVICES IN THE FIELD OF THE ELECTRONIC STORAGE OF DATA (U.S. CLS. 100 AND 105).

CLASS 41—EDUCATION AND ENTERTAINMENT

FOR TRAINING SERVICES IN THE FIELD OF INFORMATION TECHNOLOGY (IT) DEVELOPMENT AND IT SOLUTION INTEGRATION; TRAINING SERVICES IN THE FIELD OF COMPUTER NETWORKING (U.S. CLS. 100, 101 AND 107).

CLASS 42—SCIENTIFIC, COMPUTER AND LEGAL SERVICES

FOR TECHNICAL SUPPORT SERVICES, NAMELY, TROUBLESHOOTING OF COMPUTER HARDWARE AND SOFTWARE PROGRAMS; COMPUTER SERVICES, NAMELY, DATA RECOVERY SERVICES IN THE FIELDS OF COMPUTERS AND COMPUTER NETWORKING; CONSULTING SERVICES IN THE FIELD OF DESIGN, SELECTION, IMPLEMENTATION AND USE OF COMPUTER HARDWARE, COMPUTER SOFTWARE AND COMPUTER NETWORKS FOR OTHERS; COMPUTER CONSULTATION IN THE FIELDS OF IT DEVELOPMENT, IT SOLUTION INTEGRATION, COMPUTER HARDWARE, COMPUTER SOFTWARE, COMPUTER NETWORKING, EMERGING TECHNOLOGIES AND COMPUTER SECURITY; INTEGRATION OF COMPUTER SYSTEMS AND NETWORKS (U.S. CLS. 100 AND 101).

CLASS 45—PERSONAL SERVICES

FOR ASSET TAGGING IN THE NATURE OF SECURITY PRINTING, NAMELY, ENCODING IDENTIFICATION INFORMATION ON VALUABLE DOCUMENTS AND PRODUCTS; CONSULTING SERVICES IN THE FIELD OF MONITORING OF COMPUTER SYSTEMS FOR SECURITY PURPOSES (U.S. CLS. 100 AND 101).
JOHN GARTNER, EXAMINING ATTORNEY

SN 78-461,092. MUSICGREMLIN, INC., NEW YORK, NY. FILED 8-3-2004.

RECORD STORE IN YOUR POCKET

THE MARK CONSISTS OF STANDARD CHARACTERS WITHOUT CLAIM TO ANY PARTICULAR FONT, STYLE, SIZE, OR COLOR.

CLASS 9—ELECTRICAL AND SCIENTIFIC APPARATUS

FOR DIGITAL AUDIO PLAYERS, DIGITAL VIDEO PLAYERS (U.S. CLS. 21, 23, 26, 36 AND 38).

CLASS 41—EDUCATION AND ENTERTAINMENT

FOR ENTERTAINMENT SERVICES NAMELY PROVIDING PRERECORDED MUSIC, INFORMATION ABOUT MUSIC AND COMMENTARY ABOUT MUSIC ALL VIA A WIRELESS NETWORK (U.S. CLS. 100, 101 AND 107).

YSA DEJESUS, EXAMINING ATTORNEY

SN 78-461,602. CARNAL, BARBARA J., HILTON HEAD ISLAND, SC. FILED 8-4-2004.

PATCHWORK FAMILY

THE MARK CONSISTS OF STANDARD CHARACTERS WITHOUT CLAIM TO ANY PARTICULAR FONT, STYLE, SIZE, OR COLOR.

OWNER OF U.S. REG. NO. 2,414,820.
SEC. 2(F).

CLASS 16—PAPER GOODS AND PRINTED MATTER

FOR COLUMNS DEALING WITH ADVICE IN NEWSPAPERS AND MAGAZINES; BOOKS; AND POSTERS; ALL CONCERNING PARENT-CHILD-FAMILY RELATIONSHIPS (U.S. CLS. 2, 5, 22, 23, 29, 37, 38 AND 50).

FIRST USE 9-18-1998; IN COMMERCE 9-18-1998.

CLASS 45—PERSONAL SERVICES

FOR MARRIAGE AND FAMILY COUNSELING (U.S. CLS. 100 AND 101).

FIRST USE 12-10-1997; IN COMMERCE 12-10-1997.
STEVEN JACKSON, EXAMINING ATTORNEY

SN 78-461,902. GULSAN SEKERLEME SANAYI VE TICARET ANONIM SIRKETI, KAYSERI, TURKEY, FILED 8-4-2004.



meysu

CLASS 29—MEATS AND PROCESSED FOODS

FOR PROCESSED, CANNED, FROZEN AND FRESH MEATS, POULTRY AND GAME; PROCESSED, CANNED, FROZEN AND FRESH SEAFOOD; PROCESSED FRUITS AND VEGETABLES; PROCESSED AND FRESH DAIRY PRODUCTS, NAMELY, MILK, CHEESE, YOGURT, AND SOUR CREAM; EGGS; PICKLES; PROCESSED NUTS AND PROCESSED EDIBLE SEEDS; PROCESSED BEANS, PEAS, AND LEGUMES; EDIBLE OILS AND FATS; JAMS, JELLIES, MARMALADE AND FRUIT PRESERVES; PREPARED ENTREES CONSISTING PRIMARILY OF MEAT, POULTRY, FISH OR VEGETABLES (U.S. CL. 46).

CLASS 30—STAPLE FOODS

FOR COFFEE AND COFFEE SUBSTITUTES, TEA, COCOA, SUGAR, RICE, TAPIOCA, SAGO; FLOUR, PROCESSED CEREAL AND PREPARATIONS MADE FROM CEREALS, NAMELY, BREAKFAST CEREALS; BREAD, BISCUITS, CAKES, BAKERY GOODS, PASTRY AND CONFECTIONERY, NAMELY, CANDY, CHEWING GUM; PASTA; FLAVORED ICES; PROCESSED POP-CORN; HONEY, TREACLE; YEAST, BAKING POWDER; SALT, PEPPER; KETCHUP, MUSTARD, MAYONNAISE; VINEGAR, SAUCES, FLAVORING SYRUP; SPICES; ICE, EXTRUDED CORN AND WHEAT SNACKS (U.S. CL. 46).

CLASS 32—LIGHT BEVERAGES

FOR BEER, ALE, AND MALT LIQUOR, NON-ALCOHOLIC BEER, DE-ALCOHOLIZED WINES; MINERAL, SPRING, AERATED, AND FLAVORED WATER; SOFT DRINKS, ENERGY DRINKS, SPORTS DRINKS; FRUIT AND VEGETABLE DRINKS, FRUIT AND VEGETABLE JUICES, FRUIT SMOOTHIES; SYRUPS FOR MAKING SOFT DRINKS AND FRUIT AND VEGETABLE DRINKS (U.S. CLS. 45, 46 AND 48).

KIMBERLY FRYE, EXAMINING ATTORNEY

CLASS 16—PAPER GOODS AND PRINTED MATTER

FOR BOOKS, BOOKS OF POETRY, GIFT CARDS, NEWSLETTERS, PERIODICALS, JOURNALS, CHILDREN'S BOOKS, AND MAGAZINES ALL FEATURING SUBJECT MATTER RELATED TO ENCOURAGING INTROSPECTION, PERSONAL DEVELOPMENT AND PERSONAL GROWTH (U.S. CLS. 2, 5, 22, 23, 29, 37, 38 AND 50).

CLASS 20—FURNITURE AND ARTICLES NOT OTHERWISE CLASSIFIED

FOR NOVELTY GIFTS IN THE NATURE OF SEEDS NOT INTENDED FOR PLANTING OR CONSUMPTION ENCLOSED IN DECORATIVE GLASS, METAL, PAPER, OR OTHER TYPES OF CONTAINERS FOR USE AS A METAPHOR FOR ENCOURAGING INTROSPECTION AND PERSONAL GROWTH (U.S. CLS. 2, 13, 22, 25, 32 AND 50).

MONTIA G. PRESSEY, EXAMINING ATTORNEY

SN 78-462,775. HAVEY, BRIDGET, BURR RIDGE, IL. FILED 8-5-2004.



THE MARK CONSISTS OF STYLIZED WRITTEN WORDING "MESSENGER" WITH FLOWING LINES OUTLINING TO THE LEFT AND TOP OF WRITING.

CLASS 18—LEATHER GOODS

FOR HANDBAGS (U.S. CLS. 1, 2, 3, 22 AND 41).
FIRST USE 8-1-2004; IN COMMERCE 8-1-2004.

CLASS 25—CLOTHING

FOR SCARVES (U.S. CLS. 22 AND 39).
FIRST USE 8-1-2004; IN COMMERCE 8-1-2004.
LESLEY LAMOTHE, EXAMINING ATTORNEY

SN 78-463,968. OLIVEIRA, TRACY L, WINCHESTER BAY, OR. FILED 8-9-2004.



THE COLOR(S) GREEN, BROWN AND BLACK IS/ARE CLAIMED AS A FEATURE OF THE MARK.

THE LETTERS IN THE MARK APPEAR IN THE COLOR GREEN; THE SEEDS APPEAR IN THE COLOR BROWN; AND THE SEEDS AND LETTERS ARE OUTLINED IN THE COLOR BLACK.

SN 78-464,128. HENRYHANNAH, INC., WILLIAMSTOWN, MA. FILED 8-9-2004.

SPA SAVVY

THE MARK CONSISTS OF STANDARD CHARACTERS WITHOUT CLAIM TO ANY PARTICULAR FONT, STYLE, SIZE, OR COLOR.

NO CLAIM IS MADE TO THE EXCLUSIVE RIGHT TO USE "SPA", APART FROM THE MARK AS SHOWN.

CLASS 3—COSMETICS AND CLEANING PREPARATIONS

FOR BEAUTY CARE COSMETIC AND SKIN CARE PRODUCTS, NAMELY, FACIAL AND BODY CLEANSERS, TONERS, MOISTURIZERS, CREAMS, GELS, MASKS, SERUMS, PEELS, SKIN LIGHTENERS AND BRIGHTENERS, ANTI-AGING CREAMS, OILS, SCRUBS, EXFOLIANTS, SHAVING CREAMS, SHAVING OILS, SHAVING TONICS, NON-MEDICATED SKIN TREATMENTS, SUN TANNING PREPARATIONS, SUN-BLOCK PREPARATIONS, SELF-TANNING PRODUCTS, NAMELY, TANNING CREAMS, SHOWER AND BATH OILS AND GELS, BODY SPRITZES, MASSAGE OILS, AROMATHERAPY CREAMS, AROMATHERAPY OILS, AROMATHERAPY LOTIONS, FRAGRANCE FOR PERSONAL USE, SKIN AND BODY SOAPS, SHAMPOOS, CONDITIONERS, NON-MEDICATED HAIR CARE PREPARATIONS, AND FACIAL AND BODY HAIR REMOVAL PREPARATIONS (U.S. CLS. 1, 4, 6, 50, 51 AND 52).

CLASS 35—ADVERTISING AND BUSINESS

FOR RETAIL STORE AND MAIL ORDER CATALOG SERVICES, ON-LINE RETAIL STORE SERVICES, PRODUCT DEMONSTRATIONS AND SHOP-AT-HOME PARTIES, ALL FEATURING BEAUTY CARE COSMETIC AND SKIN CARE PRODUCTS, NAMELY, FACIAL AND BODY CLEANSERS, TONERS, MOISTURIZERS, CREAMS, GELS, MASKS, SERUMS, PEELS, SKIN LIGHTENERS AND BRIGHTENERS, ANTI-AGING CREAMS, OILS, SCRUBS, EXFOLIANTS, SHAVING CREAMS, SHAVING OILS, SHAVING TONICS, TOOTH-PASTES, SKIN TREATMENTS, SUN TANNING PREPARATIONS, SUN-BLOCK PREPARATIONS, SELF-TANNING PRODUCTS, SHOWER AND BATH OILS AND GELS, BODY SPRITZES, AROMATHERAPY CREAMS, AROMATHERAPY OILS, AROMATHERAPY LOTIONS, FRAGRANCE FOR PERSONAL USE, SKIN AND BODY SOAPS, SHAMPOOS, CONDITIONERS, HAIR CARE PREPARATIONS, FACIAL AND BODY HAIR REMOVAL PREPARATIONS, HAIR BRUSHES, COMBS, COSMETIC BRUSHES, CALLUS REMOVERS, MASSAGING TOOLS, EYE GEL MASKS, TWEEZERS, EYELASH CURLERS, MASCARA, NAIL BRUSHES, NAIL FILES, NAIL CLIPPERS, CUTICLE PUSHERS, NAIL AND CUTICLE SCISSORS, PEDICURE SANDALS AND SLIPPERS, EYE PILLOWS, CANDLES, SUN PROTECTIVE AND SPA CLOTHING, TEE SHIRTS, TOTES, BAGS, MAKE-UP KITS, SCARVES, JEWELRY, AND RELAXATION MUSIC (U.S. CLS. 100, 101 AND 102).

SN 78-464,848. SEVEN SEAS LIMITED, EAST YORKSHIRE, UNITED KINGDOM, FILED 8-10-2004.

SPORTFLEX

THE MARK CONSISTS OF STANDARD CHARACTERS WITHOUT CLAIM TO ANY PARTICULAR FONT, STYLE, SIZE, OR COLOR.

OWNER OF UNITED KINGDOM REG. NO. 2293069, DATED 9-27-2002, EXPIRES 2-16-2012.

CLASS 5—PHARMACEUTICALS

FOR NUTRITIONAL SUPPLEMENTS FOR HUMANS; VITAMINS; MINERALS AND MINERAL SALTS; COD LIVER OIL FOR PHARMACEUTICAL PURPOSES (U.S. CLS. 6, 18, 44, 46, 51 AND 52).

CLASS 29—MEATS AND PROCESSED FOODS

FOR PROCESSED FISH AND PROCESSED SEAFOOD; OILS AND FATS FOR FOOD (U.S. CL. 46).
DAWN FELDMAN, EXAMINING ATTORNEY

CLASS 41—EDUCATION AND ENTERTAINMENT

FOR ENTERTAINMENT SERVICES, NAMELY, CONDUCTING AND PLANNING THEME PARTIES (U.S. CLS. 100, 101 AND 107).

SN 78-467,124. IRONPORT SYSTEMS, INC., SAN BRUNO, CA. FILED 8-13-2004.

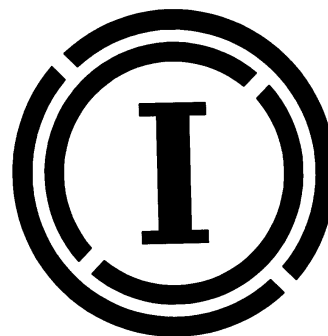
**CLASS 44—MEDICAL, BEAUTY AND AGRICULTURAL SERVICES**

FOR HEALTH SPA SERVICES, NAMELY, COSMETIC BODY CARE SERVICES, FACIALS, SKIN ENHANCEMENT TREATMENTS, MASSAGE, CELLULITE MASSAGE, BODY EXFOLIATING TREATMENTS, HERBAL WRAPS, MANICURES, PEDICURES, HAIR REMOVAL; AROMATHERAPY SERVICES; TANNING SERVICES; SELF-TANNING APPLICATIONS; HYDROTHERAPY SERVICES; AND MEDICALLY SUPERVISED SERVICES, NAMELY, MICRODERMABRASION, CHEMICAL PEELS, LASER ASSISTED HAIR REMOVAL, SCLEROTHERAPY, LASER ASSISTED VEIN-REDUCTION, INTENSE PULSE LIGHT TREATMENTS, ULTRASOUND THERAPY, ELECTROSTIMULATION, INJECTION THERAPIES FOR WRINKLE REDUCTION, AND PERMANENT MAKE-UP (U.S. CLS. 100 AND 101).
KIMBERLY PERRY, EXAMINING ATTORNEY

CLASS 9—ELECTRICAL AND SCIENTIFIC APPARATUS

FOR DIGITAL DATA PROCESSORS FOR USE AS MAIL TRANSFER AGENTS; COMPUTER SOFTWARE IN THE FIELD OF ELECTRONIC MESSAGE DELIVERY AND MESSAGE MANAGEMENT; COMPUTER SOFTWARE IN THE FIELD OF VIRUS SCANNING, CONTENT FILTERING, MESSAGE ENCRYPTION AND DECRYPTION, POLICY ENFORCEMENT, AND INSTANT MESSAGING (U.S. CLS. 21, 23, 26, 36 AND 38).
FIRST USE 12-15-2001; IN COMMERCE 12-15-2001.

CLASS 38—COMMUNICATION

SN 78-467,497. HUNT ELP, LTD., EL PASO, TX. FILED 8-13-2004.

FOR ONLINE INFORMATION SERVICES IN THE FIELD OF ELECTRONIC MESSAGE MANAGEMENT, THE COLLECTION OF ELECTRONIC MAIL, VOICE AND FAX MESSAGES FROM OTHER SYSTEMS, AND THE GUARANTEED DELIVERY OF LEGITIMATE ELECTRONIC MAIL (U.S. CLS. 100, 101 AND 104).
JOHN LINCOSKI, EXAMINING ATTORNEY



SN 78-467,138. TAHITIAN NONI INTERNATIONAL, INC., PROVO, UT. FILED 8-13-2004.

THE MARK CONSISTS IN PART OF THE STYLIZED DESIGN OF A CAPITAL LETTER H.

CLASS 36—INSURANCE AND FINANCIAL

FOR REAL PROPERTY MANAGEMENT SERVICES; AND INVESTMENT OF FUNDS FOR OTHERS FOR THE USE AND DEVELOPMENT OF LAND AND THE NATURAL RESOURCES ASSOCIATED WITH THAT LAND (U.S. CLS. 100, 101 AND 102).

Tahiti Trim

CLASS 37—CONSTRUCTION AND REPAIR

FOR REAL ESTATE DEVELOPMENT SERVICES (U.S. CLS. 100, 103 AND 106).

CLASS 39—TRANSPORTATION AND STORAGE

FOR AIR TRANSPORTATION SERVICES (U.S. CLS. 100 AND 105).
STEVEN R. FOSTER, EXAMINING ATTORNEY

THE MARK CONSISTS OF STANDARD CHARACTERS WITHOUT CLAIM TO ANY PARTICULAR FONT, STYLE, SIZE, OR COLOR.

OWNER OF U.S. REG. NO. 2,448,136.
NO CLAIM IS MADE TO THE EXCLUSIVE RIGHT TO USE "TAHITI", APART FROM THE MARK AS SHOWN.

SN 78-469,078. TCB IMPORTS, INC., VERNON, CA. FILED 8-17-2004.

CLASS 3—COSMETICS AND CLEANING PREPARATIONS

FOR BEAUTY CREAMS, BEAUTY SERUMS, BODY AND BEAUTY CARE PREPARATIONS (U.S. CLS. 1, 4, 6, 50, 51 AND 52).
FIRST USE 8-1-1998; IN COMMERCE 8-1-1998.

TRUESTYLE

CLASS 5—PHARMACEUTICALS

FOR APPETITE SUPPRESSANT, CALCIUM SUPPLEMENTS, DIETARY FOOD SUPPLEMENTS, MEAL REPLACEMENT BARS, MEAL REPLACEMENT DRINKS, NUTRITIONAL DRINK MIX FOR USE AS A MEAL REPLACEMENT, VITAMIN AND MINERAL SUPPLEMENTS (U.S. CLS. 6, 18, 44, 46, 51 AND 52).
FIRST USE 8-1-1998; IN COMMERCE 8-1-1998.

THE MARK CONSISTS OF STANDARD CHARACTERS WITHOUT CLAIM TO ANY PARTICULAR FONT, STYLE, SIZE, OR COLOR.

CLASS 9—ELECTRICAL AND SCIENTIFIC APPARATUS

FOR BLANK AUDIO CASSETTES; BLANK AUDIO TAPES; BLANK CD-ROMS FOR SOUND OR VIDEO RECORDING; BLANK COMPUTER DISCS; BLANK DIGITAL AUDIO TAPES; CD PLAYERS; CD STORAGE RACKS; CD STORAGE WALLETS; COMPACT DISC CASES; EARPHONES; HEAD CLEANING TAPES FOR AUDIO AND VIDEO RECORDERS; HEADSETS FOR TELEPHONES; HEADSETS FOR USE WITH COMPUTERS; JACKETS FOR COMPUTER DISKS; MICROPHONES; JACKETS FOR VIDEO CASSETTES; MP3 PLAYERS; HEADPHONES (U.S. CLS. 21, 23, 26, 36 AND 38).
FIRST USE 11-10-2003; IN COMMERCE 11-10-2003.

CLASS 29—MEATS AND PROCESSED FOODS

FOR PROTEIN BASED, NUTRIENT-DENSE SNACK BARS, SOY BASED SNACK FOODS (U.S. CL. 46).
FIRST USE 8-1-1998; IN COMMERCE 8-1-1998.

CLASS 32—LIGHT BEVERAGES

FOR FRUIT JUICES (U.S. CLS. 45, 46 AND 48).
FIRST USE 8-1-1998; IN COMMERCE 8-1-1998.
MIDGE BUTLER, EXAMINING ATTORNEY

CLASS 11—ENVIRONMENTAL CONTROL APPARATUS

FOR CEILING FANS; CHANDELIERS; DECORATIVE WATER FOUNTAIN; TABLE TOP WATER FOUNTAIN; ELECTRIC COOKWARE, NAMELY, ELECTRIC COOK TOPS, ELECTRIC RANGE, ELECTRIC STOVE, AND ELECTRIC TOASTER; ELECTRIC FAN; ELECTRIC HOLIDAY LIGHT; ELECTRIC NIGHT LIGHT; FRAGRANCE DISPENSING NIGHT LIGHT; LAMP SHADES; LAMPS; TOILET SEATS; WALL LIGHT; WATER FOUNTAIN; BROILERS; ELECTRIC AIR DEODORIZERS; FLUORESCENT LAMPS; HAIR DRYERS (U.S. CLS. 13, 21, 23, 31 AND 34).

FIRST USE 3-4-2004; IN COMMERCE 3-4-2004.
KIMBERLY FRYE, EXAMINING ATTORNEY

SN 78-473,267. EE PUBLISHING & PRODUCTIONS, INC., CLIFTON, VA. FILED 8-25-2004.

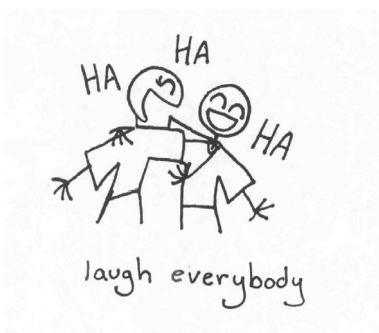
**CLASS 18—LEATHER GOODS**

FOR BACKPACKS, ALL PURPOSE SPORTS BAGS, TRAVEL BAGS, TOTE BAGS, KNAPSACKS (U.S. CLS. 1, 2, 3, 22 AND 41).

CLASS 21—HOUSEWARES AND GLASS

FOR CUPS, MUGS (U.S. CLS. 2, 13, 23, 29, 30, 33, 40 AND 50).

CLASS 25—CLOTHING

FOR HATS, T-SHIRTS, KNIT SHIRTS, SWEATSHIRTS (U.S. CLS. 22 AND 39).
STEPHANIE DAVIS, EXAMINING ATTORNEY

SN 78-474,990. AVENTIS PHARMACEUTICALS HOLDINGS INC., GREENVILLE, DE. FILED 8-27-2004.



THE MARK CONSISTS OF CAPITAL M WITH IMAGE TO THE RIGHT OF THE M OF SIDE VIEW OF HUMAN FACE.

CLASS 3—COSMETICS AND CLEANING PREPARATIONS

FOR COSMETIC PREPARATIONS FOR SKIN CARE, NAMELY PEEL SOLUTION (U.S. CLS. 1, 4, 6, 50, 51 AND 52).

CLASS 5—PHARMACEUTICALS

FOR PHARMACEUTICAL PREPARATIONS FOR SKIN CARE (U.S. CLS. 6, 18, 44, 46, 51 AND 52).
MATTHEW PAPPAS, EXAMINING ATTORNEY

SN 78-475,538. CMW, LLC, MONTROSE, CO. FILED 8-30-2004.

VANISH

THE MARK CONSISTS OF STANDARD CHARACTERS WITHOUT CLAIM TO ANY PARTICULAR FONT, STYLE, SIZE, OR COLOR.

CLASS 16—PAPER GOODS AND PRINTED MATTER

FOR PRINTED CAMOUFLAGE PATTERNS FOR HARD OR SOFT SURFACES AND FOR VARIOUS OTHER CAMOUFLAGE-DECORATED PRODUCTS (U.S. CLS. 2, 5, 22, 23, 29, 37, 38 AND 50).

CLASS 18—LEATHER GOODS

FOR DAY PACKS, FANNY PACKS AND TOTE BAGS (U.S. CLS. 1, 2, 3, 22 AND 41).

CLASS 20—FURNITURE AND ARTICLES NOT OTHERWISE CLASSIFIED

FOR CAMPING EQUIPMENT, NAMELY, SLEEPING BAGS, COTS, FOLDING OUTDOOR CHAIRS; FURNITURE, BEDS AND PILLOWS (U.S. CLS. 2, 13, 22, 25, 32 AND 50).

CLASS 22—CORDAGE AND FIBERS

FOR TENTS (U.S. CLS. 1, 2, 7, 19, 22, 42 AND 50).

CLASS 25—CLOTHING

FOR CLOTHING, NAMELY, SPORTS SHIRTS, SPORTS RAINWEAR AND SPORTS FOOTWEAR, INCLUDING, CAPS AND HEADWEAR CONSISTING OF HATS AND FACE MASKS, GLOVES, SHIRTS, JACKETS, COATS, HUNTING VESTS, PANTS, BIB OVERALLS, BOOTS, SHOES, AND BOOT COVERS, CONSISTING OF BOOT PROTECTIVE COVERINGS AND WADERS (U.S. CLS. 22 AND 39).

CLASS 28—TOYS AND SPORTING GOODS

FOR ARCHERY EQUIPMENT, NAMELY, ARM GUARDS, ARROW POINTS, BOW CASES, NON-TELESCOPIC BOW SITES, BOW STRINGS, FINGER TABS, QUIVERS AND TARGETS; HUNTING GAME CALLS, HUNTING STANDS (U.S. CLS. 22, 23, 38 AND 50).

CARRIE ACHEN, EXAMINING ATTORNEY

SN 78-476,000. KABUSHIKI KAISHA SQUARE ENIX, TA SQUARE ENIX CO., LTD., TOKYO, JAPAN, FILED 8-30-2004.

CODE AGE BRAWLS

SN 78-475,742. IFDA, INC., FALLS CHURCH, VA. FILED 8-30-2004.



NO CLAIM IS MADE TO THE EXCLUSIVE RIGHT TO USE "INTERNATIONAL FOODSERVICE DISTRIBUTORS ASSOCIATION", APART FROM THE MARK AS SHOWN.

THE COLORS BLACK AND RED ARE CLAIMED AS A FEATURE OF THE MARK

THE COLOR BLACK APPEARS IN THE LETTERS IFDA AND WORDING INTERNATIONAL FOODSERVICE DISTRIBUTORS ASSOCIATION, AND THE COLOR RED APPEARS IN THE DESIGN ELEMENT.

THE MARK CONSISTS OF A STYLIZED FORK ON A GENERALLY CIRCULAR BACKGROUND BENEATH AN ARC.

CLASS 16—PAPER GOODS AND PRINTED MATTER

FOR PUBLICATIONS, NAMELY, NEWSLETTERS AND MAGAZINES IN THE FIELD OF LOGISTICS AND DISTRIBUTION FOR FOODSERVICE AND FOOD DISTRIBUTION BUSINESSES (U.S. CLS. 2, 5, 22, 23, 29, 37, 38 AND 50).

FIRST USE 1-1-2003; IN COMMERCE 1-1-2003.

CLASS 35—ADVERTISING AND BUSINESS

FOR PUBLIC RELATIONS; LOBBYING SERVICES FOR MEMBERS OF THE FOOD SERVICE AND FOOD DISTRIBUTION BUSINESSES; AND GOVERNMENT AFFAIRS SERVICES FOR MEMBERS OF THE FOOD SERVICE AND FOOD DISTRIBUTION BUSINESSES; ARRANGING AND CONDUCTING TRADE SHOW EXHIBITIONS IN THE FIELD OF LOGISTICS AND DISTRIBUTION FOR FOODSERVICE AND FOOD DISTRIBUTION BUSINESSES; ASSOCIATION SERVICES, NAMELY, THE PROMOTION OF THE INTERESTS OF FOODSERVICE AND FOOD DISTRIBUTION BUSINESSES (U.S. CLS. 100, 101 AND 102).

FIRST USE 1-1-2003; IN COMMERCE 1-1-2003.

CLASS 41—EDUCATION AND ENTERTAINMENT

FOR EDUCATIONAL SERVICES, NAMELY, THE ARRANGING AND CONDUCTING OF EDUCATIONAL CONFERENCES IN THE FIELD OF LOGISTICS AND DISTRIBUTION FOR FOODSERVICE AND FOOD DISTRIBUTION BUSINESSES (U.S. CLS. 100, 101 AND 107).

FIRST USE 1-1-2003; IN COMMERCE 1-1-2003.

PRISCILLA MILTON, EXAMINING ATTORNEY

THE MARK CONSISTS OF STANDARD CHARACTERS WITHOUT CLAIM TO ANY PARTICULAR FONT, STYLE, SIZE, OR COLOR.

CLASS 9—ELECTRICAL AND SCIENTIFIC APPARATUS

FOR COMPUTER GAME SOFTWARE; VIDEO GAME SOFTWARE; SOUND RECORDINGS IN THE FORM OF OPTICAL DISCS, MAGNETIC DISCS AND TAPES, SEMICONDUCTOR ROMS FEATURING MUSIC OR FICTIONAL STORIES; AUDIO VISUAL RECORDINGS IN THE FORM OF OPTICAL DISCS, MAGNETIC DISCS AND TAPES, SEMICONDUCTOR ROMS FEATURING MUSIC AND/OR ANIMATED FICTIONAL STORIES; PRERECORDED COMPACT DISCS FEATURING MUSIC; PRERECORDED DIGITAL VIDEO DISCS FEATURING MUSIC AND/OR ANIMATED FICTIONAL STORIES; PRERECORDED VIDEO CASSETTES FEATURING MUSIC AND/OR ANIMATED FICTIONAL STORIES; DECORATIVE MAGNETS; MOUSE PADS; STRAPS FOR CELLULAR PHONES; SUNGLASSES; BLANK MEMORY CARDS; MEMORY CARD CASES; CD CASES; COMPUTER KEYBOARDS; JOYSTICKS; VIDEO GAME CONTROLLERS; DOWNLOADABLE COMPUTER GRAPHICS SOFTWARE, NAMELY DOWNLOADABLE WALLPAPERS OR DOWNLOADABLE SCREENSAVERS FOR THE SCREENS OF COMPUTER DISPLAYS OR MOBILE PHONE DISPLAYS; DOWNLOADABLE COMPUTER GRAPHIC SOFTWARE CONTAINING DOWNLOADABLE ANIMATED ACTIVE WALLPAPERS OR DOWNLOADABLE ANIMATED SCREENSAVERS FOR THE SCREENS OF COMPUTER DISPLAYS OR MOBILE PHONE DISPLAYS; DOWNLOADABLE VIDEO RECORDINGS FEATURING CARTOON CHARACTERS AND/OR VIDEO GAME CHARACTERS; DOWNLOADABLE MUSICAL AND SOUND RECORDINGS; DOWNLOADABLE GAME PROGRAMS; DOWNLOADABLE ELECTRONIC PUBLICATIONS IN THE NATURE OF MAGAZINES, JOURNALS AND NEWSLETTERS IN THE FIELD OF COMPUTER GAMES, VIDEO GAMES AND GENERAL ENTERTAINMENT (U.S. CLS. 21, 23, 26, 36 AND 38).

CLASS 16—PAPER GOODS AND PRINTED MATTER

FOR COMPUTER GAME STRATEGY GUIDEBOOKS; VIDEO GAME STRATEGY GUIDEBOOKS; A SERIES OF BOOKS FEATURING FICTIONAL AND/OR FANTASY STORIES; SONG BOOKS; MUSICAL SCORE BOOKS; COMIC BOOKS; MAGAZINES FEATURING VIDEO GAMES; POSTERS; STICKERS; PAPER BANNERS; CALENDARS; POSTCARDS; PENS; PENCILS; PENCIL CAPS; PEN CASES; DRAWING RULERS; RUBBER STAMPS; NOTEBOOKS; COLLECTORS' CARDS; TRADING CARDS; PHOTOGRAPHS (U.S. CLS. 2, 5, 22, 23, 29, 37, 38 AND 50).

CLASS 28—TOYS AND SPORTING GOODS

FOR DOLLS; TOY FIGURES; STUFFED TOYS; INFLATABLE TOYS; TOY VEHICLES; TOY GUNS; TOY SWORDS; PLAYING CARDS; CARD GAMES; BOARD GAMES; JIGSAW PUZZLES; HAND-HELD VIDEO GAME UNITS (U.S. CLS. 22, 23, 38 AND 50).

CLASS 41—EDUCATION AND ENTERTAINMENT

FOR PROVIDING ON-LINE COMPUTER GAMES AND/OR ON-LINE VIDEO GAMES; PROVIDING INFORMATION ON COMPUTER GAME STRATEGIES AND VIDEO GAME STRATEGIES VIA COMPUTER NETWORKS AND/OR GLOBAL COMMUNICATION NETWORKS; PROVIDING INFORMATION ON ENTERTAINMENT IN THE FIELD OF COMPUTER GAMES, VIDEO GAMES, CARD GAMES, ANIMATED CARTOONS, COMICS, NOVELS AND MAGAZINES; PROVIDING ON-LINE NON-DOWNLOADABLE COMICS; PROVIDING ON-LINE NON-DOWNLOADABLE MAGAZINES IN THE FIELD OF COMPUTER GAMES, VIDEO GAMES, CARTOONS AND GENERAL ENTERTAINMENT (U.S. CLS. 100, 101 AND 107).

SUELLEN HICKEY, EXAMINING ATTORNEY

CLASS 38—COMMUNICATION

FOR COMMUNICATIONS SERVICES AS PART OF A VIRTUAL WORLD COMPUTER PROGRAM FEATURING SIMULATIONS AND COMMUNICATIONS, NAMELY, ELECTRONIC MESSAGING, ON-LINE CHAT ROOMS, VOICE-BASED CHAT, AND AVATAR-BASED COMMUNICATIONS FOR TRANSMISSION OF MESSAGES AMONG COMPUTER USERS REGARDING THE SUBJECT OF THE VIRTUAL WORLD FOR USE IN COMPUTER GAMES AND ACTIVITIES AND FOR USE BY GOVERNMENT, BUSINESS ENTERPRISES AND EDUCATIONAL INSTITUTIONS. (U.S. CLS. 100, 101 AND 104).

CLASS 42—SCIENTIFIC, COMPUTER AND LEGAL SERVICES

FOR PROVIDING TEMPORARY USE OF ONLINE NON-DOWNLOADABLE COMPUTER SOFTWARE FOR OPERATING AND MAINTAINING A VIRTUAL WORLD FOR USE IN SIMULATIONS AND COMMUNICATIONS FOR USE BY GOVERNMENT, BUSINESS ENTERPRISES AND EDUCATIONAL INSTITUTIONS. (U.S. CLS. 100 AND 101).

ROBIN CHOSID, EXAMINING ATTORNEY

SN 78-476,479. THERE, INC., MENLO PARK, CA. FILED 8-31-2004.

SN 78-476,860. APTIUM ONCOLOGY, INC., LOS ANGELES, CA. FILED 8-31-2004.

FORTERRA

APTIUM

THE MARK CONSISTS OF STANDARD CHARACTERS WITHOUT CLAIM TO ANY PARTICULAR FONT, STYLE, SIZE, OR COLOR.

CLASS 9—ELECTRICAL AND SCIENTIFIC APPARATUS

FOR COMPUTER SOFTWARE FOR OPERATING AND MAINTAINING A VIRTUAL WORLD FEATURING SIMULATIONS AND COMMUNICATIONS, NAMELY, ELECTRONIC MESSAGING, ON-LINE CHAT ROOMS, VOICE-BASED COMMUNICATIONS, AVATAR-BASED COMMUNICATIONS FOR TRANSMISSION OF MESSAGES AMONG COMPUTER USERS FOR USE IN COMPUTER GAMES AND ACTIVITIES AND FOR USE BY GOVERNMENT, BUSINESS ENTERPRISES AND EDUCATIONAL INSTITUTIONS (U.S. CLS. 21, 23, 26, 36 AND 38).

CLASS 35—ADVERTISING AND BUSINESS

FOR LICENSING OF COMPUTER SOFTWARE FOR OPERATING, MAINTAINING, SUPPORTING AND EXPANDING A VIRTUAL WORLD PROGRAM. (U.S. CLS. 100, 101 AND 102).

THE MARK CONSISTS OF STANDARD CHARACTERS WITHOUT CLAIM TO ANY PARTICULAR FONT, STYLE, SIZE, OR COLOR.

CLASS 35—ADVERTISING AND BUSINESS

FOR BUSINESS MANAGEMENT SERVICES, ADMINISTRATIVE OFFICE SERVICES, NAMELY, BUSINESS ADMINISTRATION AND OFFICE WORK, BILLING, ACCOUNTING SERVICES, AND BUSINESS CONSULTATION SERVICES FOR HOSPITALS, INDIVIDUALS AND ORGANIZATIONS THAT PROVIDE CANCER SCREENING, DETECTION, DIAGNOSIS, AND/OR TREATMENT (U.S. CLS. 100, 101 AND 102).

FIRST USE 2-11-2005; IN COMMERCE 2-11-2005.

CLASS 36—INSURANCE AND FINANCIAL

FOR COLLECTION OF PAYMENTS (U.S. CLS. 100, 101 AND 102).

FIRST USE 2-11-2005; IN COMMERCE 2-11-2005.

CLASS 42—SCIENTIFIC, COMPUTER AND LEGAL SERVICES

FOR CONDUCTING CLINICAL RESEARCH IN THE FIELD OF CANCER SCREENING, DETECTION, DIAGNOSIS, AND/OR TREATMENT (U.S. CLS. 100 AND 101).

FIRST USE 2-11-2005; IN COMMERCE 2-11-2005.

CLASS 44—MEDICAL, BEAUTY AND AGRICULTURAL SERVICES

FOR HEALTH CARE SERVICES, NAMELY, CANCER SCREENING, DETECTION, DIAGNOSIS, AND/OR TREATMENT (U.S. CLS. 100 AND 101).

FIRST USE 2-11-2005; IN COMMERCE 2-11-2005.
ANN LINNEHAN, EXAMINING ATTORNEY

SN 78-477,244. REVLON CONSUMER PRODUCTS CORPORATION, NEW YORK, NY. FILED 9-1-2004.

**REVLON NAIL
ENHANCERS**

THE MARK CONSISTS OF STANDARD CHARACTERS WITHOUT CLAIM TO ANY PARTICULAR FONT, STYLE, SIZE, OR COLOR.

OWNER OF U.S. REG. NOS. 2,886,630 AND 2,891,420.
NO CLAIM IS MADE TO THE EXCLUSIVE RIGHT TO USE "NAIL ENHANCERS", APART FROM THE MARK AS SHOWN.

CLASS 3—COSMETICS AND CLEANING PREPARATIONS

FOR ARTIFICIAL FINGERNAILS, ARTIFICIAL FINGERNAIL TIPS AND ARTIFICIAL NAIL ART SOLD EXCLUSIVELY FOR ARTIFICIAL FINGERNAILS (U.S. CLS. 1, 4, 6, 50, 51 AND 52).

CLASS 8—HAND TOOLS

FOR MANICURE IMPLEMENTS FOR USE ON ARTIFICIAL NAILS, NAMELY, NAIL CLIPPERS, NAIL FILES AND NON-ELECTRIC NAIL BUFFERS. (U.S. CLS. 23, 28 AND 44).

VERNA BETH RIRIE, EXAMINING ATTORNEY

SN 78-477,246. LAUREL KATHLEEN MILLER, BERKELEY, CA. FILED 9-1-2004.

**The Sustainable
Kitchen**

THE MARK CONSISTS OF STANDARD CHARACTERS WITHOUT CLAIM TO ANY PARTICULAR FONT, STYLE, SIZE, OR COLOR.

NO CLAIM IS MADE TO THE EXCLUSIVE RIGHT TO USE "SUSTAINABLE", APART FROM THE MARK AS SHOWN.

CLASS 16—PAPER GOODS AND PRINTED MATTER

FOR PRINTED MATTER, NAMELY NEWSLETTERS, MAGAZINES, AND BOOKS IN THE FIELD OF CULINARY ARTS, ORGANIC AND SUSTAINABLE FARMING, ORGANIC AND SUSTAINABLE GARDENING, ORGANIC AND SUSTAINABLE COOKING, WITH EMPHASIS ON ECOLOGICALLY SOUND METHODS; PRINTED INSTRUCTIONAL AND TEACHING MATERIAL IN THE FIELD OF CULINARY ARTS, ORGANIC AND SUSTAINABLE FARMING, ORGANIC AND SUSTAINABLE GARDENING, ORGANIC AND SUSTAINABLE COOKING, WITH EMPHASIS ON ECOLOGICALLY SOUND METHODS (U.S. CLS. 2, 5, 22, 23, 29, 37, 38 AND 50).

FIRST USE 9-24-1999; IN COMMERCE 7-12-2000.

CLASS 39—TRANSPORTATION AND STORAGE

FOR ARRANGING TRAVEL TOURS (U.S. CLS. 100 AND 105).

FIRST USE 9-24-1999; IN COMMERCE 7-12-2000.

CLASS 41—EDUCATION AND ENTERTAINMENT

FOR CUSTOM WRITING SERVICES; TEACHING AND CLASSES IN THE FIELD OF CULINARY ARTS, ORGANIC AND SUSTAINABLE FARMING, ORGANIC AND SUSTAINABLE GARDENING, ORGANIC AND SUSTAINABLE COOKING, WITH EMPHASIS ON ECOLOGICALLY SOUND METHODS; GUIDED TOURS OF ORGANIC AND SUSTAINABLE FARMS, ORGANIC AND SUSTAINABLE GARDENS, FARMERS' MARKETS, ORGANIC AND SUSTAINABLE RESTAURANTS, ORGANIC AND SUSTAINABLE FOOD HARVESTS, ORGANIC AND SUSTAINABLE ARTISANAL FOOD PRODUCTION FACILITIES, AND ORGANIC AND SUSTAINABLE FOOD COMPANIES (U.S. CLS. 100, 101 AND 107).

FIRST USE 9-24-1999; IN COMMERCE 7-12-1999.

KEVON CHISOLM, EXAMINING ATTORNEY

SN 78-477,592. ASIAINSPECTION, SHUENG WAN, HONG KONG, FILED 9-2-2004.

**YOUR EYES IN THE
FACTORY !**

THE MARK CONSISTS OF STANDARD CHARACTERS WITHOUT CLAIM TO ANY PARTICULAR FONT, STYLE, SIZE, OR COLOR.

CLASS 35—ADVERTISING AND BUSINESS

FOR ADVERTISEMENT SERVICES; FRANCHISING, NAMELY CONSULTATION AND ASSISTANCE IN BUSINESS MANAGEMENT, ORGANIZATION AND PROMOTION; COMMERCIAL INFORMATION IN THE FIELD OF PRODUCT ORDERS PROCESSING, MANUFACTURING PLACES, MANUFACTURING MEANS AND CONSEQUENCES OF THE PRODUCTS MANUFACTURING ON ECOLOGY; DATA PROCESSING SERVICES, NAMELY, DATA INPUT, FORMATTING, COMPILATION AND PROCESSING OF DATA RELATING TO PRODUCT ORDERS PROCESSING, MANUFACTURING PLACES, MANUFACTURING MEANS AND CONSEQUENCES OF THE PRODUCTS MANUFACTURING ON ECOLOGY; SUBSCRIPTION TO COMPUTER SERVICE, NAMELY, SUBSCRIPTION TO GLOBAL COMPUTER NETWORKS; CONDUCTING PUBLIC OPINION POLLS; BUSINESS INVESTIGATIONS; PERSONNEL RECRUITMENT, NAMELY ONLINE RECRUITMENT OF STAFF AND INVESTIGATORS (U.S. CLS. 100, 101 AND 102).

CLASS 42—SCIENTIFIC, COMPUTER AND LEGAL SERVICES

FOR HOSTING OF DIGITAL CONTENT ON THE INTERNET; LICENSING OF INTELLECTUAL PROPERTY; COPYRIGHT MANAGEMENT; DATABASE DEVELOPMENT SERVICES, NAMELY, CONSTRUCTION, DESIGN AND OPERATION OF TECHNICAL DATA BANKS AND DATABASES; PREPARING ENVIRONMENTAL COMPLIANCE REPORTS AND REVIEWING STANDARDS AND PRACTICES TO ASSURE COMPLIANCE WITH ENVIRONMENTAL LAWS AND REGULATIONS; PROVIDING QUALITY ASSURANCE SERVICES IN THE FIELD OF MANUFACTURING VIA PHOTOGRAPHS, CALIBRATION, MATCHING, COUNT AND BENCHMARKING (U.S. CLS. 100 AND 101).

ROBERT LAVACHE, EXAMINING ATTORNEY

SN 78-478,280. SORTPRICE INC, BROOKLYN, NY. FILED 9-2-2004.

SORTPRICE

THE MARK CONSISTS OF STANDARD CHARACTERS WITHOUT CLAIM TO ANY PARTICULAR FONT, STYLE, SIZE, OR COLOR.

CLASS 35—ADVERTISING AND BUSINESS

FOR PROVIDING INFORMATION ABOUT THE GOODS AND SERVICES OF OTHERS VIA THE GLOBAL COMPUTER NETWORK; AND ADVERTISING AND ADVERTISEMENT SERVICES, NAMELY, PROMOTING THE SALE OF GOODS AND SERVICES OF OTHERS VIA A GLOBAL COMPUTER NETWORK (U.S. CLS. 100, 101 AND 102).

FIRST USE 2-1-2004; IN COMMERCE 2-1-2004.

CLASS 42—SCIENTIFIC, COMPUTER AND LEGAL SERVICES

FOR COMPUTER SERVICES, NAMELY, ACTING AS AN APPLICATION SERVICE PROVIDER IN THE FIELD OF KNOWLEDGE MANAGEMENT TO HOST COMPUTER APPLICATION SOFTWARE FOR CREATING SEARCHABLE DATABASES OF INFORMATION AND DATA AND FOR SEARCHING AND RETRIEVING INFORMATION FROM DATABASES AND GLOBAL COMPUTER NETWORKS; COMPUTER SERVICES, NAMELY, PROVIDING SEARCH ENGINES FOR OBTAINING DATA ON A GLOBAL COMPUTER NETWORK; DATA MINING; COMPUTER SERVICES, NAMELY, CREATING INDEXES OF OTHER INFORMATION SOURCES WHICH INCLUDE ONLINE WEB LINKS TO OTHER WEB SITES (U.S. CLS. 100 AND 101).

FIRST USE 2-1-2004; IN COMMERCE 2-1-2004.

KATHERINE STOIDES, EXAMINING ATTORNEY

SN 78-478,644. H. MIZRACHI, INC., CHATSWORTH, CA. FILED 9-3-2004.

Nature Creation

THE MARK CONSISTS OF STANDARD CHARACTERS WITHOUT CLAIM TO ANY PARTICULAR FONT, STYLE, SIZE, OR COLOR.

CLASS 10—MEDICAL APPARATUS

FOR MICROWAVABLE AND FREEZABLE HEATING AND COOLING PADS FILLED WITH NATURAL MATERIAL, INCLUDING HERBS, FOR THERAPEUTIC PERSONAL USE (U.S. CLS. 26, 39 AND 44).

FIRST USE 5-13-2002; IN COMMERCE 5-13-2002.

CLASS 11—ENVIRONMENTAL CONTROL APPARATUS

FOR MICROWAVABLE AND FREEZABLE HEATING AND COOLING PADS FILLED WITH NATURAL MATERIAL, INCLUDING THERAPEUTIC HERBS, FOR NON-MEDICAL PERSONAL USE (U.S. CLS. 13, 21, 23, 31 AND 34).

FIRST USE 5-13-2002; IN COMMERCE 5-13-2002.

ZHALEH DELANEY, EXAMINING ATTORNEY

SN 78-478,948. SCOZZAFAVA, RALPH, BURR RIDGE, IL.
FILED 9-3-2004.

WOW: WIN THE
STORE, OWN THE
CUSTOMER, WORK
TOGETHER

THE MARK CONSISTS OF STANDARD CHARACTERS WITHOUT CLAIM TO ANY PARTICULAR FONT, STYLE, SIZE, OR COLOR.

CLASS 35—ADVERTISING AND BUSINESS

FOR CONSULTING IN THE FIELDS OF SALES, SALES MANAGEMENT AND SALES ORGANIZATIONS (U.S. CLS. 100, 101 AND 102).

FIRST USE 12-20-2000; IN COMMERCE 4-5-2001.

CLASS 41—EDUCATION AND ENTERTAINMENT

FOR EDUCATIONAL SERVICES, NAMELY, PRESENTATIONS, SEMINARS AND TRAINING IN THE AREAS OF SALES, SALES MANAGEMENT AND SALES ORGANIZATIONS (U.S. CLS. 100, 101 AND 107).

FIRST USE 12-20-2000; IN COMMERCE 4-5-2001.
CAROLYN GRAY, EXAMINING ATTORNEY

SN 78-480,464. DREAMWORKS ANIMATION L.L.C., GLENDALE, CA. FILED 9-8-2004.

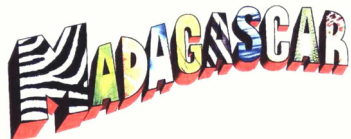

THE COLOR(S) BLACK, GREEN, YELLOW, BLUE, AND RED IS/ARE CLAIMED AS A FEATURE OF THE MARK.

THE MARK CONSISTS OF THE LETTER "M" APPEARS IN BLACK, WHITE, AND RED; THE LETTER "A" APPEARS IN GREEN, RED, AND BLACK; THE LETTER "D" APPEARS IN YELLOW, RED, AND BLACK; THE LETTER "A" APPEARS IN BLUE, RED, AND BLACK; THE LETTER "G" APPEARS IN YELLOW, RED, AND BLACK; THE LETTER "A" APPEARS IN BLACK, WHITE, AND RED; THE LETTER "S" APPEARS IN BLUE, BLACK, AND RED; THE LETTER "C" APPEARS IN YELLOW, BLACK, AND RED; THE LETTER "A" APPEARS IN GREEN, BLACK, AND RED; AND THE LETTER "R" APPEARS IN YELLOW, RED, AND BLACK.

CLASS 9—ELECTRICAL AND SCIENTIFIC APPARATUS

FOR COMPUTER PERIPHERAL, NAMELY MOUSE PADS, HOLDERS FOR COMPACT DISCS, COMPUTER GAME CARTRIDGES, COMPUTER GAME CASSETTES, AND COMPUTER GAME TAPES; VIDEO GAME CARTRIDGES, VIDEO GAME CASSETTES; PRERECORDED AUDIO CASSETTES, PRERECORDED VIDEO CASSETTES, PRERECORDED AUDIO TAPES, PRERECORDED VIDEO TAPES, PRERECORDED DISCS FEATURING MUSIC AND MOTION PICTURE SOUND TRACKS; CD ROM AND DVD PROGRAMS FEATURING MUSIC AND MOTION PICTURE SOUND TRACKS; COMPUTER OPERATING SYSTEM SOFTWARE; PRERECORDED COMPUTER SOFTWARE PROGRAMS FEATURING MUSIC AND MOTION PICTURE SOUND TRACKS; INTERACTIVE MULTIMEDIA SOFTWARE PROGRAMS CONTAINING MOTION PICTURES FOR ENTERTAINMENT; INTERACTIVE MULTI-MEDIA SOFTWARE FOR PLAYING GAMES; MAGNETS AND SUNGLASSES (U.S. CLS. 21, 23, 26, 36 AND 38).

CLASS 16—PAPER GOODS AND PRINTED MATTER

FOR PAPER PARTY DECORATIONS; PAPER PARTY SUPPLIES; NAMELY, PAPER PARTY HATS, PAPER NAPKINS, PAPER PLACE MATS, GIFTWRAPPING PAPER AND GIFT WRAPPING RIBBONS, PAPER GIFT WRAP BOWS, PAPER TABLE CLOTHS AND PAPER PARTY BAGS; CHILDREN'S ACTIVITY BOOKS, CHILDREN'S STORYBOOKS, COMIC BOOKS, COLORING BOOKS, BOOK MARKS, LOOSE LEAF BINDERS, STATIONERY-TYPE PORTFOLIOS, SPIRAL BOUND NOTEBOOKS, NOTE PADS OR WRITING PADS, DIARIES, DAILY PLANNERS, CALENDARS, SCRAPBOOK ALBUMS, SKETCHBOOK ALBUMS, PHOTOGRAPH ALBUMS, STICKER ALBUMS, STICKERS, DECALS, STAMP PADS OR INKING PADS, RUBBER STAMPS, HEAT APPLIED APPLIQUES MADE OF PAPER, TEMPORARY TATTOOS, SLATEBOARDS FOR WRITING, PENCILS, PENS, PENCIL ERASERS, DECORATIVE PENCIL-TOP ORNAMENTS, PEN CASES AND PENCIL CASES, PEN BOXES AND PENCIL BOXES, PENCIL SHARPENERS, CHALK, MARKERS, POSTERS, POSTCARDS, TRADING CARDS, GREETING CARDS, PENNANTS MADE OF PAPER, PAINTING SETS FOR CHILDREN; ARTS AND CRAFTS PAINT KITS; STUDY KITS, CONSISTING OF PENCIL ERASERS, DRAWING RULERS, PENCIL SHARPENERS AND PENCIL CASE; STATIONERY PACKS CONSISTING OF WRITING PAPER, ENVELOPES, MARKERS, AND STENCILS; AND ACTIVITY KITS CONSISTING OF STICKERS AND STAMPS (U.S. CLS. 2, 5, 22, 23, 29, 37, 38 AND 50).

CLASS 25—CLOTHING

FOR SHIRTS AND TOPS, DRESSES, SKIRTS, PANTS, TROUSERS, JEANS, SHORTS, ROMPERS, OVERALLS, SWEATSHIRTS AND SWEAT PANTS, SWEATSUITS, CAPS AND HATS, GLOVES, SUSPENDERS, TIES, COATS AND JACKETS, HOSIERY, SHOES, BOOTS, SLIPPERS, PAJAMAS, ROBES, SLEEPSHIRTS, SLEEPWEAR, UNDERWEAR, HALLOWEEN COSTUMES, AND CLOTH BABY BIBS (U.S. CLS. 22 AND 39).

CLASS 28—TOYS AND SPORTING GOODS

FOR ACTION FIGURES AND ACCESSORIES THEREFOR, BATHTUB TOYS, KITES, TOY BUILDING BLOCKS, BOARD GAMES, COSTUME MASKS, HANDHELD UNIT FOR PLAYING ELECTRONIC GAMES, DIE CAST MINIATURE TOY VEHICLES, DOLLS, DOLL ACCESSORIES, DOLL CLOTHING, BEAN BAG DOLLS, BENDABLE PLAY FIGURES, FLYING DISCS, INFLATABLE VINYL PLAY FIGURES, JIGSAW PUZZLES, MARBLES, PLUSH TOYS, PUPPETS, RIDE-ON TOYS, SKATEBOARDS, BALLOONS, ROLLERSKATES, TOY BANKS, WATER SQUIRTING TOYS, STUFFED TOYS, TOY VEHICLES, CHRISTMAS TREE ORNAMENTS; PINBALL MACHINES AND MODEL CRAFT KITS OF TOY FIGURES; AND PLAYING CARDS (U.S. CLS. 22, 23, 38 AND 50).

RUSS HERMAN, EXAMINING ATTORNEY

SN 78-480,772. CRANE PROCESS FLOW TECHNOLOGIES LTD, GWENT, UNITED KINGDOM, AND ALFA LAVAL BOKINETICS INC, PHILADELPHIA, PA. FILED 9-9-2004.

SN 78-482,011. WINECONSUMER INC, FAIRFIELD, CA. FILED 9-10-2004.



SIMFLEX

NO CLAIM IS MADE TO THE EXCLUSIVE RIGHT TO USE "WINECONSUMER", APART FROM THE MARK AS SHOWN.

THE COLOR(S) RED, BURGUNDY, TAN, GOLD, YELLOW, YELLOW-GREEN, GREEN IS/ARE CLAIMED AS A FEATURE OF THE MARK.

THE MARK CONSISTS OF DRAWING OF A TAN STICK-MAN HOLDING A GLASS OF RED WINE ABOVE HIS HEAD AND POURING THE CONTENTS INTO HIS OTHER OUTSTRETCHED HAND. THE LITERAL ELEMENT WINECONSUMER IS BURGUNDY. THE LITERAL ELEMENT "YOUR WINE. YOUR VOICE" IS YELLOW GREEN.

CLASS 16—PAPER GOODS AND PRINTED MATTER

FOR (BASED ON INTENT TO USE) MAGAZINES AND BOOKS FEATURING THE SUBJECT OF WINE (U.S. CLS. 2, 5, 22, 23, 29, 37, 38 AND 50).

CLASS 41—EDUCATION AND ENTERTAINMENT

FOR (BASED ON USE IN COMMERCE) PROVIDING AN ONLINE MAGAZINE IN THE FIELD OF WINES (U.S. CLS. 100, 101 AND 107).

FIRST USE 6-30-2001; IN COMMERCE 6-30-2001.
NAAKWAMA ANKRAH, EXAMINING ATTORNEY

THE MARK CONSISTS OF STANDARD CHARACTERS WITHOUT CLAIM TO ANY PARTICULAR FONT, STYLE, SIZE, OR COLOR.

PRIORITY CLAIMED UNDER SEC. 44(D) ON UNITED KINGDOM APPLICATION NO. 2358376, FILED 3-16-2004, REG. NO. 2358376, DATED 3-16-2004, EXPIRES 3-16-2014.

CLASS 6—METAL GOODS

FOR MANUALLY OPERATED VALVES MADE WHOLLY OR PRINCIPALLY OF METAL; MANUALLY OPERATED VALVES MADE WHOLLY OR PRINCIPALLY OF METAL AND PLASTIC MATERIAL; AND PARTS AND FITTINGS FOR THE AFORESAID GOODS (U.S. CLS. 2, 12, 13, 14, 23, 25 AND 50).

CLASS 7—MACHINERY

FOR VALVES BEING PARTS OF PHARMACEUTICAL PRODUCTION PROCESSING EQUIPMENT, FOR REGULATING FLUID FLOW, AND PARTS AND FITTINGS THEREFOR (U.S. CLS. 13, 19, 21, 23, 31, 34 AND 35).

CLASS 20—FURNITURE AND ARTICLES NOT OTHERWISE CLASSIFIED

FOR VALVES MADE WHOLLY OR PRINCIPALLY OF PLASTICS, NOT BEING MACHINE PARTS, AND PARTS AND FITTINGS THEREFOR (U.S. CLS. 2, 13, 22, 25, 32 AND 50).

SUSAN HAYASH, EXAMINING ATTORNEY

SN 78-482,423. TRACTORBEAM LP, DALLAS, TX. FILED 9-13-2004.

TRACTORBEAM

THE MARK CONSISTS OF STANDARD CHARACTERS WITHOUT CLAIM TO ANY PARTICULAR FONT, STYLE, SIZE, OR COLOR.

OWNER OF U.S. REG. NO. 2,513,721.

CLASS 25—CLOTHING

FOR (BASED ON INTENT TO USE) CLOTHING, NAMELY HATS, SHIRTS, T-SHIRTS, JEANS, SWEATERS, AND SOCKS (U.S. CLS. 22 AND 39).

CLASS 35—ADVERTISING AND BUSINESS

FOR (BASED ON USE IN COMMERCE) ADVERTISING AGENCY SERVICES, NAMELY PROMOTING THE SERVICES OF OTHERS THROUGH THE DISTRIBUTION OF PRINTED AND AUDIO PROMOTIONAL MATERIALS AND BY RENDERING SALES PROMOTION ADVICE; BUSINESS MARKETING CONSULTING SERVICES; COOPERATIVE ADVERTISING AND MARKETING SERVICES (U.S. CLS. 100, 101 AND 102).

FIRST USE 12-31-1997; IN COMMERCE 12-31-1997.
LANA PHAM, EXAMINING ATTORNEY

SN 78-483,029. CARRIER CORPORATION, FARMINGTON, CT. FILED 9-14-2004.

MT ALLIANCE

SN 78-482,971. JAPAN AIRLINES INTERNATIONAL CO., LTD., TOKYO, JAPAN, FILED 9-14-2004.

THE MARK CONSISTS OF STANDARD CHARACTERS WITHOUT CLAIM TO ANY PARTICULAR FONT, STYLE, SIZE, OR COLOR.

SAKE TOURISM

THE MARK CONSISTS OF STANDARD CHARACTERS WITHOUT CLAIM TO ANY PARTICULAR FONT, STYLE, SIZE, OR COLOR.

PRIORITY CLAIMED UNDER SEC. 44(D) ON JAPAN APPLICATION NO. 2004-24683, FILED 3-17-2004, REG. NO. 4814484, DATED 3-17-2004, EXPIRES 3-17-2014.

NO CLAIM IS MADE TO THE EXCLUSIVE RIGHT TO USE "TOURISM", APART FROM THE MARK AS SHOWN.

CLASS 39—TRANSPORTATION AND STORAGE

FOR TRANSPORTATION OF PASSENGERS AND CARGO BY AIR; PROVIDING FLIGHT ARRIVAL AND DEPARTURE INFORMATION, FURNITURE TRANSPORTATION FOR OTHERS BY AIR; PORTERAGE; CARGO LOADING AND UNLOADING; CARGO PACKAGING BEFORE TRANSPORTATION; WAREHOUSING, FROZEN FOOD LOCKER RENTAL, RENTAL OF STORAGE CONTAINERS; ARRANGING TRAVEL TOURS; TRAVEL AGENCY SERVICES, NAMELY, MAKING RESERVATIONS AND BOOKINGS FOR TRANSPORTATION; TRAVEL INFORMATION SERVICES; BOOKING SEATS FOR TRAVEL, ESCORTING OF TRAVELERS, FREIGHT BROKERAGE; TRANSPORT BROKERAGE; DELIVERY OF GOODS, DELIVERY OF NEWSPAPERS; DELIVERY OF MAIL; GUARDED TRANSPORT OF VALUABLES; RENTAL OF AUTOMOBILES, LEASING OF PLANES; LEASING OF FREIGHT CONTAINERS (U.S. CLS. 100 AND 105).

CLASS 43—HOTEL AND RESTAURANT SERVICES

FOR RESTAURANT SERVICES; HOTELS; CAFES; BAR SERVICES, CAFETERIAS, CANTEENS, FOOD AND DRINK CATERING, SNACK BARS; ARRANGING TEMPORARY HOUSING ACCOMMODATIONS, RENTAL OF TEMPORARY ACCOMMODATIONS; PROVIDING FACILITIES FOR CONVENTIONS AND EXHIBITIONS; TRAVEL AGENCY SERVICES, NAMELY MAKING RESERVATIONS AND BOOKINGS FOR TEMPORARY LODGING; MAKING HOTEL RESERVATIONS FOR OTHERS; RENTAL OF MEETING ROOMS; IN-FLIGHT CATERING SERVICES (U.S. CLS. 100 AND 101).

IRENE D. WILLIAMS, EXAMINING ATTORNEY

CLASS 9—ELECTRICAL AND SCIENTIFIC APPARATUS

FOR SENSORS, NAMELY TEMPERATURE AND HUMIDITY SENSORS, MEASURING EQUIPMENT, NAMELY MEASURING DEVICES FOR AIR CONDITIONING TECHNOLOGY, COMPUTER EQUIPMENT, NAMELY COMPUTER HARDWARE; VPN, NAMELY, VIRTUAL PRIVATE NETWORK OPERATING SOFTWARE AND COMPUTER OPERATING SYSTEMS, ALL FOR THE CONTROL AND MANAGEMENT OF ENERGY, ENVIRONMENT, AND CLIMATE CONDITIONS FOR SUPERMARKETS AND COMMERCIAL BUILDINGS (U.S. CLS. 21, 23, 26, 36 AND 38).

FIRST USE 1-1-1997; IN COMMERCE 1-1-1997.

CLASS 41—EDUCATION AND ENTERTAINMENT

FOR TRAINING IN THE USE AND OPERATING OF SENSORS, MEASURING EQUIPMENT, COMPUTER EQUIPMENT, SOFTWARE AND COMPUTER SYSTEMS FOR THE CONTROL AND MANAGEMENT OF ENERGY, ENVIRONMENT, AND CLIMATE CONDITIONS IN SUPERMARKETS AND COMMERCIAL BUILDINGS (U.S. CLS. 100, 101 AND 107).

FIRST USE 8-9-2004; IN COMMERCE 8-9-2004.

ANDREA K. NADELMAN, EXAMINING ATTORNEY

SN 78-483,755. CYBERLUX CORPORATION, DURHAM, NC. FILED 9-15-2004.

SENSORBRIGHT

THE MARK CONSISTS OF STANDARD CHARACTERS WITHOUT CLAIM TO ANY PARTICULAR FONT, STYLE, SIZE, OR COLOR.

CLASS 9—ELECTRICAL AND SCIENTIFIC APPARATUS

FOR LIGHTING, NAMELY, EMERGENCY LIGHTING USING DIODAL LIGHTING ELEMENTS (U.S. CLS. 21, 23, 26, 36 AND 38).

CLASS 11—ENVIRONMENTAL CONTROL APPARATUS

FOR LIGHTING, NAMELY, LIGHTING FIXTURES (U.S. CLS. 13, 21, 23, 31 AND 34).
 GEORGIA CARTY, EXAMINING ATTORNEY

SN 78-483,935. SUPERVALU INC., EDEN PRAIRIE, MN.
 FILED 9-15-2004.



NO CLAIM IS MADE TO THE EXCLUSIVE RIGHT TO USE "SUPER CRUNCH", APART FROM THE MARK AS SHOWN.

CLASS 29—MEATS AND PROCESSED FOODS

FOR POTATO CHIPS, PROCESSED SNACK NUTS, NAMELY, SHELLED AND ROASTED NUTS; SNACK DIPS; POTATO-BASED SNACK FOODS; PORK RINDS (U.S. CL. 46).

CLASS 30—STAPLE FOODS

FOR SNACK MIX CONSISTING PRIMARILY OF CRACKERS AND PRETZELS; POPCORN; SALTY SNACKS, NAMELY, CORN CHIPS, TORTILLA CHIPS, PRETZELS; SNACK CRACKERS; CHEESE FLAVORED SNACKS, NAMELY CHEESE CURLS AND CHEESE FLAVORED PUFFED CORN SNACKS (U.S. CL. 46).
 KIMBERLY FRYE, EXAMINING ATTORNEY

SN 78-484,790. M-D BUILDING PRODUCTS, INC., OKLAHOMA CITY, OK. FILED 9-16-2004.

QUIETCHOICE

THE MARK CONSISTS OF STANDARD CHARACTERS WITHOUT CLAIM TO ANY PARTICULAR FONT, STYLE, SIZE, OR COLOR.

CLASS 17—RUBBER GOODS

FOR SOUND ABSORBING FLOORING UNDERLAYMENT, NAMELY, UNDERLAYMENT USED WITH LAMINATE AND WOOD FLOORING PRODUCTS (U.S. CLS. 1, 5, 12, 13, 35 AND 50).
 FIRST USE 9-7-2004; IN COMMERCE 9-7-2004.

CLASS 19—NON-METALLIC BUILDING MATERIALS

FOR FLOORING UNDERLAYMENTS, NAMELY, UNDERLAYMENT USED WITH LAMINATE AND WOOD FLOORING PRODUCTS (U.S. CLS. 1, 12, 33 AND 50).
 FIRST USE 9-7-2004; IN COMMERCE 9-7-2004.
 GEORGE LORENZO, EXAMINING ATTORNEY

SN 78-484,812. MCCAR DEVELOPMENT CORP., ALPHARETTA, GA. FILED 9-16-2004.



NO CLAIM IS MADE TO THE EXCLUSIVE RIGHT TO USE "HOMES", APART FROM THE MARK AS SHOWN.

CLASS 36—INSURANCE AND FINANCIAL

FOR MORTGAGE BROKERAGE; MORTGAGE LENDING; REAL ESTATE BROKERAGE (U.S. CLS. 100, 101 AND 102).

CLASS 37—CONSTRUCTION AND REPAIR

FOR REAL ESTATE DEVELOPMENT; PLANNING AND LAYING OUT OF RESIDENTIAL COMMUNITIES; BUILDING AND CONSTRUCTION OF RESIDENTIAL HOMES AND RESIDENTIAL COMMUNITIES (U.S. CLS. 100, 103 AND 106).
 CAROLYN GRAY, EXAMINING ATTORNEY

SN 78-484,897. KONG KEE FOOD CORP., NEW YORK, NY.
 FILED 9-16-2004.



THE MARK CONSISTS OF TWO CHINESE CHARACTERS WHICH ARE PRONOUNCED "KONG KEE" IN CANTONESE AND TRANSLATES INTO ENGLISH TO MEAN "KONG'S" OR "PRODUCTS OF KONG".

CLASS 29—MEATS AND PROCESSED FOODS

FOR SOYA MILK; FIRM TOFU; SILKEN TOFU; SOFT TOFU; FRIED TOFU, SHREDDED BEAN CURD; EGG TOFU; SALTED TOFU; SMOKED TOFU; FIRM TOFU, NAMELY, DRIED TOFU; MEAT SUBSTITUTES; CHICKEN SUBSTITUTES; VEGETABLE-BASED FOOD BEVERAGES; PRESERVED MUSTARD GREENS (U.S. CL. 46).

FIRST USE 12-13-1994; IN COMMERCE 2-1-1995.

CLASS 30—STAPLE FOODS

FOR FLOUR, RICE NOODLES, RICE CAKES, RICE CREPES, SWEET RICE CAKES KNOWN AS LIN KOA AND TANG KOA; TOFU CUSTARD; EGG NOODLES, HERBAL TEA FOR FOOD PURPOSES, CHRYSANTHEMUM TEA, TURNIP CAKES, TARO CAKES, TOFU PUDDING (U.S. CL. 46).

FIRST USE 12-13-1994; IN COMMERCE 2-1-1995.

CLASS 32—LIGHT BEVERAGES

FOR SOY-BASED BEVERAGES NOT BEING MILK SUBSTITUTES; VEGETABLE JUICE BEVERAGES, NAMELY, GRASS JELLY BEVERAGES; FLAVORED SOY-BASED BEVERAGES NOT BEING MILK SUBSTITUTES; SUGAR CANE DRINK; VEGETABLE JUICE BEVERAGES; FRUIT DRINKS (U.S. CLS. 45, 46 AND 48).

FIRST USE 12-13-1994; IN COMMERCE 2-1-1995.

ALEXANDER L. POWERS, EXAMINING ATTORNEY

SN 78-486,293. CITY OF LOS ANGELES, LOS ANGELES, CA. FILED 9-20-2004.



SN 78-484,919. STONYFIELD FARM, INC., LONDONDERY, NH. FILED 9-16-2004.

STONYFIELD FARM

THE MARK CONSISTS OF STANDARD CHARACTERS WITHOUT CLAIM TO ANY PARTICULAR FONT, STYLE, SIZE, OR COLOR.

OWNER OF U.S. REG. NOS. 1,541,732, 2,292,896 AND 2,436,224.

NO CLAIM IS MADE TO THE EXCLUSIVE RIGHT TO USE "FARM", APART FROM THE MARK AS SHOWN.

CLASS 29—MEATS AND PROCESSED FOODS

FOR DAIRY PRODUCTS EXCLUDING ICE CREAM, ICE MILK, AND FROZEN YOGURT (U.S. CL. 46).

FIRST USE 4-1-1983; IN COMMERCE 4-1-1983.

CLASS 30—STAPLE FOODS

FOR ICE CREAM AND FROZEN YOGURT (U.S. CL. 46).

FIRST USE 6-30-1992; IN COMMERCE 6-30-1992.
ERNEST SHOSHO, EXAMINING ATTORNEY

NO CLAIM IS MADE TO THE EXCLUSIVE RIGHT TO USE "CITY OF LOS ANGELES", APART FROM THE MARK AS SHOWN.

THE STIPPLING IS FOR SHADING PURPOSES ONLY.

THE MARK CONSISTS OF THE DESIGN OF A BADGE WITH AN EAGLE, A HERALDIC DESIGN CONSISTING OF STARS AND BARS IN UPPER LEFT, A BEAR WITH A STAR AT UPPER RIGHT, AN EAGLE HOLDING A SERPENT AT LOWER LEFT, A CASTLE TURRET AT BOTTOM CENTER, AND A LION AT BOTTOM RIGHT, ALL LOCATED BETWEEN THE LETTERS LAFD AND THE WORDS CITY OF LOS ANGELES.

CLASS 9—ELECTRICAL AND SCIENTIFIC APPARATUS

FOR COMPUTER GAME SOFTWARE, AND PRERECORDED DVDS AND CD-ROMS FEATURING GAMES AND MOVIES (U.S. CLS. 21, 23, 26, 36 AND 38).

CLASS 16—PAPER GOODS AND PRINTED MATTER

FOR PRINTED MATERIALS, NAMELY, POSTERS, CALENDARS AND POSTCARDS (U.S. CLS. 2, 5, 22, 23, 29, 37, 38 AND 50).

CLASS 18—LEATHER GOODS

FOR BACKPACKS (U.S. CLS. 1, 2, 3, 22 AND 41).

CLASS 25—CLOTHING

FOR CLOTHING, NAMELY, HATS, SHIRTS AND JACKETS (U.S. CLS. 22 AND 39).

IRENE D. WILLIAMS, EXAMINING ATTORNEY

SN 78-487,132. SILICON IMAGE, INC., SUNNYVALE, CA.
FILED 9-21-2004.

STEELVINE

THE MARK CONSISTS OF STANDARD CHARACTERS WITHOUT CLAIM TO ANY PARTICULAR FONT, STYLE, SIZE, OR COLOR.

CLASS 9—ELECTRICAL AND SCIENTIFIC APPARATUS

FOR COMPUTER HARDWARE; COMPUTER PERIPHERALS; COMMUNICATIONS SERVERS; INTEGRATED CIRCUITS; MICROPROCESSORS; COMPUTER SERVER OPERATING SOFTWARE; COMPUTER SOFTWARE FOR THE MANAGEMENT, TRANSMISSION AND STORAGE OF DATA AND INFORMATION; FIRMWARE FOR THE MANAGEMENT, TRANSMISSION AND STORAGE OF DATA AND INFORMATION; CABLE, SATELLITE AND TERRESTRIAL DIGITAL SET-TOP BOXES; DVD PLAYERS AND RECORDERS; DIGITAL VHS PLAYERS AND RECORDERS; CABLE BOXES; TELEVISION MONITORS; AUDIO CASSETTE RECORDERS; AUDIO CASSETTE PLAYERS; COMPACT DISC PLAYERS; COMPACT DISC RECORDERS; DIGITAL CAMERAS; DIGITAL VIDEO RECORDERS; FACSIMILE MACHINES; GLOBAL POSITIONING SYSTEM TRANSMITTERS AND RECEIVERS; INTERNET TELEVISION HARDWARE, NAMELY COMPUTER HARDWARE FOR USE IN ACCESSING TELEVISION PROGRAMMING THROUGH THE INTERNET; MOTION PICTURE CAMERAS; OPTICAL SCANNERS; PHOTOCOPYING MACHINES; PERSONAL DIGITAL ASSISTANTS; PHOTOGRAPHIC CAMERAS; PHOTOGRAPHIC PROJECTORS; SLIDE PROJECTORS; RADIO PAGERS; RADIOS; SCANNERS; TELEPHONE ANSWERING MACHINES; TELEVISION SET-TOP BOXES; VIDEO CAMERAS; VIDEO CASSETTE RECORDERS; VIDEO MONITORS; VIDEO TAPE RECORDERS; VOICE MESSAGING SYSTEMS; RADIO, ANALOG, DIGITAL AND ELECTRONIC PAGERS; TELEVISIONS; AUDIO AND VIDEO RECORDERS AND PLAYERS; LASER DISC RECORDERS AND PLAYERS; MP3 RECORDERS AND PLAYERS; DVD RECORDERS AND PLAYERS; STEREO; VIDEO GAME PLAYERS; HAND-HELD ELECTRONIC DEVICES, NAMELY, PORTABLE DIGITAL AUDIO, VIDEO, MULTIMEDIA AND DIGITAL PLAYERS AND RECEIVERS; ELECTRONIC INPUT DEVICES, NAMELY, ELECTRONIC TOUCH PADS; STEREO TUNERS; HYBRID SET-TOP BOXES; GAMING IN SET-TOP BOXES, NAMELY SET-TOP BOXES FOR USE IN PLAYING COMPUTER GAMES; GAME CONSOLES, NAMELY VIDEO GAME MACHINES FOR USE WITH TELEVISIONS AND COMPUTER MONITORS; DOWNLOADABLE ELECTRONIC PUBLICATIONS IN THE NATURE OF USER MANUALS, WHITE PAPERS, AND TECHNICAL DOCUMENTATION, IN THE FIELD OF COMPUTER HARDWARE AND SOFTWARE FOR USE IN THE MANAGEMENT, TRANSMISSION AND STORAGE OF DATA AND INFORMATION (U.S. CLS. 21, 23, 26, 36 AND 38).

CLASS 39—TRANSPORTATION AND STORAGE

FOR DATA STORAGE CONSULTING SERVICES (U.S. CLS. 100 AND 105).

CLASS 42—SCIENTIFIC, COMPUTER AND LEGAL SERVICES

FOR COMPUTER HARDWARE CONSULTING SERVICES RELATING TO THE DESIGN AND DEVELOPMENT OF COMPUTER HARDWARE; COMPUTER NETWORK CONSULTING SERVICES RELATING TO THE DESIGN AND DEVELOPMENT OF COMPUTER NETWORKS; CONSULTING SERVICES IN THE FIELD OF DESIGN AND DEVELOPMENT OF CONSUMER ELECTRONICS; COMPUTER DEVELOPMENT SERVICES; SOFTWARE DEVELOPMENT SERVICES; COMPUTER HARDWARE DEVELOPMENT SERVICES; COMPUTER NETWORK DEVELOPMENT SERVICES; DATA STORAGE SYSTEMS DEVELOPMENT SERVICES; MICROPROCESSOR DESIGN SERVICES (U.S. CLS. 100 AND 101).

DAVID C. REIHNER, EXAMINING ATTORNEY

SN 78-487,480. SONY COMPUTER ENTERTAINMENT EUROPE LIMITED, LONDON W1F 9LD, UNITED KINGDOM, FILED 9-22-2004.

MELTDOWN

THE MARK CONSISTS OF STANDARD CHARACTERS WITHOUT CLAIM TO ANY PARTICULAR FONT, STYLE, SIZE, OR COLOR.

CLASS 9—ELECTRICAL AND SCIENTIFIC APPARATUS

FOR COMPUTER AND VIDEO GAME CARTRIDGES, DISCS AND SOFTWARE, ALL RELATING TO VEHICLES AND VEHICLE RACING; PRE-RECORDED AUDIO AND VIDEO TAPES FEATURING COMPUTER AND VIDEO GAME MATERIAL ALL RELATING TO VEHICLES AND VEHICLE RACING; PRE-RECORDED, MAGNETIC DATA CARRIERS AND COMPACT DISCS, PRE-RECORDED VIDEO DISCS, AND PRE-RECORDED DVD'S FEATURING COMPUTER AND GAME MATERIAL RELATING TO VEHICLES AND VEHICLE RACING; FEATURE FILMS AND ANIMATIONS (U.S. CLS. 21, 23, 26, 36 AND 38).

CLASS 16—PAPER GOODS AND PRINTED MATTER

FOR BOOKS, MANUALS, PRINTED MATTER, PUBLICATIONS, ALL FEATURING INFORMATION IN THE FIELD OF COMPUTER AND VIDEO GAMES RELATING TO VEHICLES AND VEHICLE RACING; STATIONERY (U.S. CLS. 2, 5, 22, 23, 29, 37, 38 AND 50).

CLASS 28—TOYS AND SPORTING GOODS

FOR TOYS, GAMES AND PLAYTHINGS, NAMELY HANDHELD UNITS FOR PLAYING A VEHICLE RACING BASED VIDEO GAME (U.S. CLS. 22, 23, 38 AND 50).

CLASS 41—EDUCATION AND ENTERTAINMENT

FOR ENTERTAINMENT SERVICES, NAMELY, PROVIDING ONLINE COMPUTER GAMES RELATING TO VEHICLES AND VEHICLE RACING (U.S. CLS. 100, 101 AND 107).

RONALD AIKENS, EXAMINING ATTORNEY

SN 78-487,510. ASTRAZENECA AB, SODERTALJE, SWEDEN, FILED 9-22-2004.

HEALTH IN HAND

THE MARK CONSISTS OF STANDARD CHARACTERS WITHOUT CLAIM TO ANY PARTICULAR FONT, STYLE, SIZE, OR COLOR.

CLASS 16—PAPER GOODS AND PRINTED MATTER

FOR PRINTED MATTERS, NAMELY NEWSLETTERS, STATIONERY TEMPLATES, BOOKLETS, POSTERS, SIGNS OF PAPER OR CARDBOARD, PAMPHLETS, PRINTED PUBLICATIONS, NAMELY, BROCHURES, BOOKS, JOURNALS AND NEWSLETTERS, ALL IN THE FIELD OF SCIENTIFIC RESEARCH WITHIN THE CARDIOVASCULAR AREA (U.S. CLS. 2, 5, 22, 23, 29, 37, 38 AND 50).

CLASS 42—SCIENTIFIC, COMPUTER AND LEGAL SERVICES

FOR SCIENTIFIC RESEARCH; MEDICAL RESEARCH AND MEDICAL LABORATORIES WITHIN THE CARDIOVASCULAR AREA (U.S. CLS. 100 AND 101).

CLASS 44—MEDICAL, BEAUTY AND AGRICULTURAL SERVICES

FOR MEDICAL INFORMATION SERVICES, NAMELY, PROVIDING INFORMATION OF PHARMACEUTICAL PREPARATIONS FOR THE TREATMENT OF CARDIOVASCULAR DISEASES, FOR HUMAN USE ONLY (U.S. CLS. 100 AND 101).

ANDREA K. NADELMAN, EXAMINING ATTORNEY

SN 78-489,851. JEFF GORDON, INC., CHARLOTTE, NC. FILED 9-27-2004.



OWNER OF U.S. REG. NOS. 1,964,012, 2,579,120 AND 2,611,105.

THE NAME(S), PORTRAIT(S), AND/OR SIGNATURE(S) SHOWN IN THE MARK IDENTIFIES JEFFREY M. GORDON, WHOSE CONSENT(S) TO REGISTER IS SUBMITTED.

THE MARK CONSISTS OF STYLIZED SIGNATURE OF THE NAME JEFF GORDON.

CLASS 6—METAL GOODS

FOR METAL GOODS, NAMELY METAL KEY RINGS AND METAL LICENSE PLATES (U.S. CLS. 2, 12, 13, 14, 23, 25 AND 50).

FIRST USE 3-31-1991; IN COMMERCE 3-31-1991.

CLASS 9—ELECTRICAL AND SCIENTIFIC APPARATUS

FOR SUNGLASSES (U.S. CLS. 21, 23, 26, 36 AND 38).

FIRST USE 3-31-1991; IN COMMERCE 3-31-1991.

CLASS 14—JEWELRY

FOR JEWELRY (U.S. CLS. 2, 27, 28 AND 50).

FIRST USE 3-31-1991; IN COMMERCE 3-31-1991.

CLASS 16—PAPER GOODS AND PRINTED MATTER

FOR PAPER GOODS AND PRINTED MATTER, NAMELY POSTERS, STICKERS, DECALS, CALENDARS, AND BROCHURES DIRECTED TO AUTOMOBILE RACING; CARDS, NAMELY TRADING CARDS DIRECTED TO AUTOMOBILE RACING (U.S. CLS. 2, 5, 22, 23, 29, 37, 38 AND 50).

FIRST USE 3-31-1991; IN COMMERCE 3-31-1991.

CLASS 21—HOUSEWARES AND GLASS

FOR HOUSEWARES AND GLASS PRODUCTS, NAMELY DRINKING GLASSES, CUPS, AND MUGS; RUBBER, PLASTIC, OR FOAM INSULATED BEVERAGE HOLDERS; PLASTIC WATER BOTTLES SOLD EMPTY (U.S. CLS. 2, 13, 23, 29, 30, 33, 40 AND 50).

FIRST USE 3-31-1991; IN COMMERCE 3-31-1991.

CLASS 25—CLOTHING

FOR CLOTHING, NAMELY SWEATSHIRTS, T-SHIRTS, SWEATSUITS, SHORTS, PANTS, JACKETS, SWEATERS, SOCKS, AND CAPS (U.S. CLS. 22 AND 39).

FIRST USE 3-31-1991; IN COMMERCE 3-31-1991.

CLASS 28—TOYS AND SPORTING GOODS

FOR TOYS AND SPORTING GOODS, NAMELY MINIATURE CARS AND TRUCKS (U.S. CLS. 22, 23, 38 AND 50).

FIRST USE 3-31-1991; IN COMMERCE 3-31-1991.

CLASS 41—EDUCATION AND ENTERTAINMENT

FOR ENTERTAINMENT SERVICES IN THE NATURE OF PARTICIPATING IN PROFESSIONAL AUTOMOBILE RACES AND RELATED EXHIBITIONS (U.S. CLS. 100, 101 AND 107).

FIRST USE 3-31-1991; IN COMMERCE 3-31-1991.
GEORGE LORENZO, EXAMINING ATTORNEY

SN 78-490,263. HEARTS ON FIRE COMPANY LLC, BOSTON, MA. FILED 9-27-2004.

HEARTS ON FIRE

THE MARK CONSISTS OF STANDARD CHARACTERS WITHOUT CLAIM TO ANY PARTICULAR FONT, STYLE, SIZE, OR COLOR.

OWNER OF U.S. REG. NOS. 2,119,886 AND 2,686,511.

CLASS 35—ADVERTISING AND BUSINESS

FOR PROVIDING INCENTIVES TO INDIVIDUALS AND ORGANIZATIONS TO DEMONSTRATE EXCELLENCE IN THE FIELD OF RETAIL SALES OF DIAMONDS AND JEWELRY (U.S. CLS. 100, 101 AND 102).

CLASS 41—EDUCATION AND ENTERTAINMENT

FOR ARRANGING AND CONDUCTING EDUCATIONAL CONFERENCES, SEMINARS, WORKSHOPS AND CLASSED IN THE FIELD OF DIAMONDS AND JEWELRY AND THE RETAIL THEREOF AND DISTRIBUTING COURSE MATERIALS IN CONNECTION THEREWITH (U.S. CLS. 100, 101 AND 107).

DAVID H. STINE, EXAMINING ATTORNEY

SN 78-490,704. BATH & BODY WORKS, INC., REYNOLDSBURG, OH. FILED 9-28-2004.

VANILLA SCENTED CANDLES & ONLY VANILLA SCENTED CANDLES

THE MARK CONSISTS OF STANDARD CHARACTERS WITHOUT CLAIM TO ANY PARTICULAR FONT, STYLE, SIZE, OR COLOR.

NO CLAIM IS MADE TO THE EXCLUSIVE RIGHT TO USE "VANILLA SCENTED CANDLES", APART FROM THE MARK AS SHOWN.

CLASS 3—COSMETICS AND CLEANING PREPARATIONS

FOR FRAGRANT ROOM SPRAYS, POTPOURRI, REFILLS FOR ELECTRIC FRAGRANCE DISPENSERS, AND PERSONAL CARE PRODUCTS, NAMELY, BODY CREAM, BODY LOTION, BODY SCRUB, BODY WASH, BUBBLE BATH, EAU DE TOILETTE, ESSENTIAL OILS, FRAGRANT BODY SPLASH, SHOWER GELS, AND SOAPS (U.S. CLS. 1, 4, 6, 50, 51 AND 52).

CLASS 4—LUBRICANTS AND FUELS

FOR CANDLES (U.S. CLS. 1, 6 AND 15).

CLASS 11—ENVIRONMENTAL CONTROL APPARATUS

FOR ELECTRIC FRAGRANCE DISPENSERS (U.S. CLS. 13, 21, 23, 31 AND 34).

CLASS 35—ADVERTISING AND BUSINESS

FOR RETAIL STORE SERVICES IN THE FIELD OF PERSONAL CARE PRODUCTS AND HOME FRAGRANCE PRODUCTS AND ACCESSORIES (U.S. CLS. 100, 101 AND 102).

GRETTA YAO, EXAMINING ATTORNEY

SN 78-491,194. FUEL MANAGERS, INCORPORATED, TULSA, OK. FILED 9-29-2004.

CUSTOMIZE, OPTIMIZE, MAXIMIZE

THE MARK CONSISTS OF STANDARD CHARACTERS WITHOUT CLAIM TO ANY PARTICULAR FONT, STYLE, SIZE, OR COLOR.

CLASS 4—LUBRICANTS AND FUELS

FOR MOTOR FUEL PRODUCTS, NAMELY, GASOLINE, ON AND OFF ROAD DIESEL FUEL, JET FUEL AND AVIATION GAS (U.S. CLS. 1, 6 AND 15).

CLASS 35—ADVERTISING AND BUSINESS

FOR FUEL MANAGEMENT SERVICES FOR OTHERS, NAMELY, INVENTORY MANAGEMENT, PROVIDING DATA FOR COMPLIANCE WITH ENVIRONMENTAL LAWS AND REGULATIONS, AND FUEL TRANSPORTATION LOGISTICS MANAGEMENT SERVICES IN THE NATURE OF DELIVERY SCHEDULING, PURCHASE TIMING OPTIMIZATION AND FUEL REPORTING (U.S. CLS. 100, 101 AND 102).

BRENDAN REGAN, EXAMINING ATTORNEY

SN 78-491,208. THE COMMUNITY FOUNDATION OF NORTHWEST GEORGIA, DALTON, GA. FILED 9-29-2004.



The
COMMUNITY FOUNDATION
of Northwest Georgia

NO CLAIM IS MADE TO THE EXCLUSIVE RIGHT TO USE "THE COMMUNITY FOUNDATION OF NORTHWEST GEORGIA", APART FROM THE MARK AS SHOWN.

CLASS 35—ADVERTISING AND BUSINESS

FOR CHARITABLE SERVICES, NAMELY, ORGANIZING, DEVELOPING AND CONDUCTING PROJECTS FOR CIVIC ORGANIZATIONS; MANAGEMENT OF CHARITABLE FOUNDATION (U.S. CLS. 100, 101 AND 102).

FIRST USE 12-0-2003; IN COMMERCE 3-0-2004.

CLASS 36—INSURANCE AND FINANCIAL

FOR CHARITABLE FUND MANAGEMENT, NAMELY, ACCEPTING AND ADMINISTERING MONETARY CHARITABLE CONTRIBUTIONS (U.S. CLS. 100, 101 AND 102).

FIRST USE 12-0-2003; IN COMMERCE 3-0-2004.

ELIZABETH J. WINTER, EXAMINING ATTORNEY

SN 78-491,625. J. KANE & SONS, INC., DBA SOFTER LITE WINDOW COMPANY, CHICAGO, IL. FILED 9-29-2004.

SHINE THROUGH

SN 78-491,369. COOPER'S INC., DBA WESTERN WAREHOUSE, ALBUQUERQUE, NM. FILED 9-29-2004.



THE MARK CONSISTS OF A DRAWING OF A BOOT WITH SMALL WINGS AT THE LOWER BACK PART OF THE BOOT.

CLASS 3—COSMETICS AND CLEANING PREPARATIONS

FOR CLEANING PREPARATIONS FOR USE IN THE BATH, NAMELY, BATH SALTS, BATH MILKS, AND BUBBLE BATH; SOAPS, PERFUMERY, COSMETICS, SKIN SPRAYS FOR COSMETIC PURPOSES, BODY SPRAYS, MEN'S AND WOMEN'S DEODORANT SPRAYS, SKIN LOTIONS, FACIAL LOTIONS, BODY LOTIONS, HAIR CARE PRODUCTS, NAMELY, HAIR LOTIONS, CONDITIONERS AND SHAMPOOS, HAIR COLORS, HAIR COLOR REMOVERS, DENTRIFICES (U.S. CLS. 1, 4, 6, 50, 51 AND 52).

CLASS 18—LEATHER GOODS

FOR HANDBAGS, WALLETS, TRAVELING BAGS, LUGGAGE, TOILETRY CASES SOLD EMPTY (U.S. CLS. 1, 2, 3, 22 AND 41).

CLASS 25—CLOTHING

FOR WOMEN'S AND CHILDREN'S CLOTHING, HEADGEAR, OUTERWEAR AND ACCESSORIES, NAMELY, FOOTWEAR, SHIRTS, TEE-SHIRTS, SKIRTS, JEANS, SWEATERS, PANTS, SHORTS, SOCKS, UNDERWEAR, UNDERGARMENTS, JACKETS, VESTS, COATS, RAINWEAR, HATS, CAPS, VISORS, COWBOY HATS, DRESSES, SUITS, SPORT COATS, BELTS, CHAPS, SCARVES, GLOVES, EARMUFFS, SWEATSHIRTS, SWEATPANTS (U.S. CLS. 22 AND 39).

CLASS 28—TOYS AND SPORTING GOODS

FOR BABY MULTIPLE ACTIVITY TOYS, BATH TOYS, CHILDREN'S MULTIPLE ACTIVITY TOYS, PLASTIC CHARACTER TOYS, STUFFED TOYS, PLUSH TOYS (U.S. CLS. 22, 23, 38 AND 50).

SHARON MEIER, EXAMINING ATTORNEY

THE MARK CONSISTS OF STANDARD CHARACTERS WITHOUT CLAIM TO ANY PARTICULAR FONT, STYLE, SIZE, OR COLOR.

CLASS 35—ADVERTISING AND BUSINESS

FOR ADVERTISING, MARKETING; AND RETAIL SERVICES BY DIRECT SOLICITATION BY SALES AGENTS IN THE FIELD OF WINDOWS, SLIDING GLASS DOORS, AND GLASS TERRACE DOORS. (U.S. CLS. 100, 101 AND 102).

CLASS 37—CONSTRUCTION AND REPAIR

FOR WINDOW INSTALLATION SERVICES (U.S. CLS. 100, 103 AND 106).

PAULA MAYS, EXAMINING ATTORNEY

SN 78-491,691. JARRITOS, INC., SAN ANTONIO, TX. FILED 9-29-2004.



NO CLAIM IS MADE TO THE EXCLUSIVE RIGHT TO USE "MEXICO" AND "REPRESENTATION OF THE SOCCER BALL", APART FROM THE MARK AS SHOWN.

THE FOREIGN WORDING IN THE MARK TRANSLATES INTO ENGLISH AS CUP OF REFRESHMENTS FROM MEXICO.

CLASS 35—ADVERTISING AND BUSINESS

FOR PROMOTING THE PUBLIC AWARENESS OF CORE VALUES SUCH AS DISCIPLINE, TEAMWORK, SELF-ESTEEM AND SPORTSMANSHIP THROUGH THE SPONSORSHIP OF SOCCER TEAMS AND PLAYERS (U.S. CLS. 100, 101 AND 102).

CLASS 41—EDUCATION AND ENTERTAINMENT

SN 78-492,319. SYNGENTA PARTICIPATIONS AG, BASEL, SWITZERLAND, FILED 9-30-2004.

FOR DEVELOPING, ORGANIZING, AND MAINTAINING SOCCER OUTREACH PROGRAMS FOR YOUTH IN THE HISPANIC COMMUNITY IN CONJUNCTION WITH LEADERS IN THE HISPANIC COMMUNITY IN CONJUNCTION WITH LEADERS IN THE HISPANIC COMMUNITY THROUGH EDUCATIONAL SERVICES, NAMELY, SEMINARS, WORKSHOPS AND LECTURES IN THE FIELD OF LEADERSHIP TRAINING FOR ADULTS IN A YOUTH SOCCER ORGANIZATION; CONDUCTING YOUTH CLASSES, SEMINARS, CONFERENCES, AND WORKSHOPS IN THE FIELD OF THE PRINCIPALS OF SOCCER (U.S. CLS. 100, 101 AND 107).

CHARLES L. JENKINS, EXAMINING ATTORNEY

SHAPE

THE MARK CONSISTS OF STANDARD CHARACTERS WITHOUT CLAIM TO ANY PARTICULAR FONT, STYLE, SIZE, OR COLOR.

SN 78-492,269. TOFOODS INTERNATIONAL, LLC, PORTLAND, OR. FILED 9-30-2004.

CLASS 1—CHEMICALS

FOR CHEMICAL PREPARATIONS FOR USE IN AGRICULTURE, HORTICULTURE AND FORESTRY, NAMELY, CHEMICAL PREPARATIONS FOR THE TREATMENT OF SEEDS (U.S. CLS. 1, 5, 6, 10, 26 AND 46).

CLASS 5—PHARMACEUTICALS

FOR PREPARATIONS FOR DESTROYING VERMIN; FUNGICIDES, HERBICIDES, INSECTICIDES, PESTICIDES FOR AGRICULTURAL USE (U.S. CLS. 6, 18, 44, 46, 51 AND 52).

STEVEN JACKSON, EXAMINING ATTORNEY

PROTONS

SN 78-493,219. GILDED AGE RENOVATION, L.L.C., SAINT LOUIS, MO. FILED 10-1-2004.

Gilded Age

THE MARK CONSISTS OF STANDARD CHARACTERS WITHOUT CLAIM TO ANY PARTICULAR FONT, STYLE, SIZE, OR COLOR.

CLASS 29—MEATS AND PROCESSED FOODS

FOR SOY-BASED SNACK FOODS (U.S. CL. 46).

CLASS 30—STAPLE FOODS

FOR CROUTONS; COOKIES; CRACKERS (U.S. CL. 46).
DAWN HAN, EXAMINING ATTORNEY

THE MARK CONSISTS OF STANDARD CHARACTERS WITHOUT CLAIM TO ANY PARTICULAR FONT, STYLE, SIZE, OR COLOR.

CLASS 36—INSURANCE AND FINANCIAL

FOR REAL ESTATE MANAGEMENT FEATURING THE MANAGEMENT AND LEASING OF RESIDENTIAL, COMMERCIAL AND MIXED USE PROJECTS IN THE HISTORIC NEIGHBORHOODS OF THE CITY OF SAINT LOUIS, MISSOURI, AND OTHER COMMUNITIES IN EASTERN MISSOURI; REAL ESTATE ACQUISITION SERVICES OF RESIDENTIAL, COMMERCIAL, AND MIXED USE PROJECTS IN THE HISTORIC NEIGHBORHOODS OF THE CITY OF SAINT LOUIS, MISSOURI, AND OTHER COMMUNITIES IN EASTERN MISSOURI; REAL ESTATE BROKERAGE SERVICES OF RESIDENTIAL, COMMERCIAL AND MIXED USE PROJECTS IN THE HISTORIC NEIGHBORHOODS OF THE CITY OF SAINT LOUIS, MISSOURI, AND OTHER COMMUNITIES IN EASTERN MISSOURI (U.S. CLS. 100, 101 AND 102).

FIRST USE 1-1-1998; IN COMMERCE 1-1-1998.

CLASS 37—CONSTRUCTION AND REPAIR

FOR REAL ESTATE DEVELOPMENT FEATURING RESIDENTIAL, COMMERCIAL AND MIXED USE CONSTRUCTION AND LAND DEVELOPMENT SERVICES, NAMELY, PLANNING AND LAYING OUT OF RESIDENTIAL, COMMERCIAL AND MIXED USE DEVELOPMENTS IN THE HISTORIC NEIGHBORHOODS OF THE CITY OF SAINT LOUIS, MISSOURI, AND OTHER COMMUNITIES IN EASTERN MISSOURI (U.S. CLS. 100, 103 AND 106).

FIRST USE 1-1-1998; IN COMMERCE 1-1-1998.
SUSAN HAYASH, EXAMINING ATTORNEY

SN 78-494,400. HUNT, BARBARA, REDWOOD SHORES, CA. FILED 10-4-2004.



The logo for AI_TechServ features the letters "AI" in a stylized, red, italicized font, followed by the word "TechServ" in a black, cursive script font.

THE COLORS RED AND BLACK ARE CLAIMED AS FEATURES OF THE MARK.

THE COLOR RED APPEARS IN THE TERM "AI", AND THE COLOR BLACK APPEARS IN THE TERM "TECH-SERV".

CLASS 35—ADVERTISING AND BUSINESS

FOR BUSINESS CONSULTING IN THE FIELDS OF BUSINESS MANAGEMENT AND PROJECT MANAGEMENT. (U.S. CLS. 100, 101 AND 102).

CLASS 40—MATERIAL TREATMENT

FOR DESKTOP PUBLISHING FOR OTHERS. (U.S. CLS. 100, 103 AND 106).

CLASS 42—SCIENTIFIC, COMPUTER AND LEGAL SERVICES

FOR INSTRUCTIONAL DESIGN FOR OTHERS IN THE FIELDS OF INFORMATION TECHNOLOGY AND GENERAL BUSINESS. (U.S. CLS. 100 AND 101).
LINDA M. KING, EXAMINING ATTORNEY

SN 78-494,908. KROGER CO. OF MICHIGAN, THE, LIVONIA, MI. FILED 10-5-2004.

FIRST CHOICE

THE MARK CONSISTS OF STANDARD CHARACTERS WITHOUT CLAIM TO ANY PARTICULAR FONT, STYLE, SIZE, OR COLOR.

OWNER OF U.S. REG. NOS. 1,522,302, 2,708,627 AND OTHERS.

CLASS 29—MEATS AND PROCESSED FOODS

FOR PREPARED SALADS, NAMELY FRUIT SALADS, DESSERT SALADS, VEGETABLE SALADS, BEAN SALADS, TUNA SALADS, SEAFOOD SALADS, AND COLE SLAW SALADS; DIPS; PREPARED ENTREES AND SIDE DISHES, CONSISTING PRIMARILY OF POULTRY OR SEAFOOD; CHEESE (U.S. CL. 46).

CLASS 30—STAPLE FOODS

FOR PUDDINGS; PASTA SALADS; PREPARED ENTREES AND SIDE DISHES, CONSISTING PRIMARILY OF PASTA (U.S. CL. 46).

TEJBIR SINGH, EXAMINING ATTORNEY

SN 78-494,973. IIR COMMUNISPOND, INC., NEW YORK, NY. FILED 10-5-2004.

WRITE UP FRONT

THE MARK CONSISTS OF STANDARD CHARACTERS WITHOUT CLAIM TO ANY PARTICULAR FONT, STYLE, SIZE, OR COLOR.

CLASS 16—PAPER GOODS AND PRINTED MATTER

FOR WRITTEN PUBLICATIONS IN THE FIELD OF BUSINESS WRITING SKILLS DEVELOPMENT, NAMELY, TRAINING AND QUESTIONNAIRE BOOKLETS, WORKBOOKS AND MANUALS ALL IN THE FIELD OF BUSINESS WRITING SKILLS DEVELOPMENT (U.S. CLS. 2, 5, 22, 23, 29, 37, 38 AND 50).

FIRST USE 7-0-1982; IN COMMERCE 7-0-1982.

CLASS 41—EDUCATION AND ENTERTAINMENT

FOR EDUCATIONAL SERVICES, NAMELY, PROVIDING TRAINING PROGRAMS AND SEMINARS IN THE FIELD OF BUSINESS WRITING SKILLS DEVELOPMENT (U.S. CLS. 100, 101 AND 107).

FIRST USE 7-0-1982; IN COMMERCE 7-0-1982.

KATHRYN COWARD, EXAMINING ATTORNEY

SN 78-495,318. HOMEGOODS, INC., FRAMINGHAM, MA.
FILED 10-6-2004.

SN 78-496,498. MOMENTIVE CONSUMER CREDIT COUN-
SELING SERVICE, INC., INDIANAPOLIS, IN. FILED 10-7-
2004.

MOMENTIVE

THE CHARMED PATIO

THE MARK CONSISTS OF STANDARD CHARACTERS
WITHOUT CLAIM TO ANY PARTICULAR FONT, STYLE,
SIZE, OR COLOR.

NO CLAIM IS MADE TO THE EXCLUSIVE RIGHT TO
USE "PATIO", APART FROM THE MARK AS SHOWN.

CLASS 4—LUBRICANTS AND FUELS

FOR CITRONELLA CANDLES AND PATIO TORCHES
(U.S. CLS. 1, 6 AND 15).

CLASS 6—METAL GOODS

FOR METAL HOSE GUIDES; METAL DECORATIVE
SIGNS, NAMELY, NON-LUMINOUS, NON-MECHANICAL
SIGNS MADE OF METAL (U.S. CLS. 2, 12, 13, 14, 23,
25 AND 50).

CLASS 8—HAND TOOLS

FOR HAND-OPERATED GARDEN TOOLS, NAMELY,
TROWELS, SHOVELS AND TRANSPLANTERS (U.S.
CLS. 23, 28 AND 44).

CLASS 11—ENVIRONMENTAL CONTROL AP- PARATUS

FOR ELECTRICAL, BATTERY-OPERATED AND CAN-
DLE LANTERNS FOR OUTDOOR USE (U.S. CLS. 13, 21,
23, 31 AND 34).

CLASS 19—NON-METALLIC BUILDING MA- TERIALS

FOR DECORATIVE SIGNS, NAMELY, NON-LUMI-
NOUS, NON-MECHANICAL SIGNS NOT MADE OF
METAL (U.S. CLS. 1, 12, 33 AND 50).

CLASS 20—FURNITURE AND ARTICLES NOT OTHERWISE CLASSIFIED

FOR OUTDOOR FURNITURE; NON-METAL HOSE
GUIDES (U.S. CLS. 2, 13, 22, 25, 32 AND 50).

CLASS 21—HOUSEWARES AND GLASS

FOR PLANTERS FOR FLOWERS AND PLANTS,
NAMELY, PLANTER POTS MADE OF TERRA COTTA,
PLASTIC, FIBERGLASS, CERAMIC AND METAL; AND
BIRD BATHS (U.S. CLS. 2, 13, 23, 29, 30, 33, 40 AND 50).
CHRISTOPHER BUONGIORNO, EXAMINING ATTOR-
NEY

THE MARK CONSISTS OF STANDARD CHARACTERS
WITHOUT CLAIM TO ANY PARTICULAR FONT, STYLE,
SIZE, OR COLOR.

CLASS 36—INSURANCE AND FINANCIAL

FOR DEBT AND CREDIT COUNSELING; HOUSING
COUNSELING, NAMELY, HOUSE PURCHASING AND
LOSS MITIGATION FINANCIAL COUNSELING; PRO-
VIDING INFORMATION IN THE FIELD OF CONSU-
MER CREDIT AND MONEY AND DEBT
MANAGEMENT (U.S. CLS. 100, 101 AND 102).

FIRST USE 9-0-2003; IN COMMERCE 9-0-2003.

CLASS 41—EDUCATION AND ENTERTAIN- MENT

FOR EDUCATIONAL SERVICES, NAMELY, CON-
DUCTING PROGRAMS IN THE FIELD OF PERSONAL
CREDIT, DEBT MANAGEMENT, AND HOME PUR-
CHASING (U.S. CLS. 100, 101 AND 107).

FIRST USE 9-0-2003; IN COMMERCE 9-0-2003.

TIMOTHY FINNEGAN, EXAMINING ATTORNEY

SN 78-496,896. ANDEVICES, INC., FREMONT, CA. FILED 10-
8-2004.

ANDeVices

THE MARK CONSISTS OF STANDARD CHARACTERS
WITHOUT CLAIM TO ANY PARTICULAR FONT, STYLE,
SIZE, OR COLOR.

CLASS 40—MATERIAL TREATMENT

FOR MANUFACTURE OF SILICA-BASED PLANAR
LIGHTWAVE CIRCUITS FOR COMBINING OR SPLIT-
TING COMMUNICATION CHANNELS BASED UPON
OPTICAL ENERGY OR WAVELENGTHS TO ORDER
AND/OR THE SPECIFICATIONS OF OTHERS (U.S.
CLS. 100, 103 AND 106).

FIRST USE 4-1-2004; IN COMMERCE 4-1-2004.

CLASS 42—SCIENTIFIC, COMPUTER AND LEGAL SERVICES

FOR DEVELOPMENT OF SILICA-BASED PLANAR LIGHT WAVE CIRCUITS FOR COMBINING OR SPLITTING COMMUNICATION CHANNELS BASED UPON OPTICAL ENERGY OR WAVELENGTHS FOR OTHERS (U.S. CLS. 100 AND 101).

FIRST USE 4-1-2004; IN COMMERCE 4-1-2004.
DEBRA LEE, EXAMINING ATTORNEY

SN 78-498,111. THE WEINBERG GROUP, INC., WASHINGTON, DC. FILED 10-12-2004.

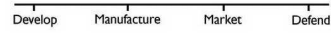

SN 78-497,081. REINPRECHT, SARAH HUMPHREY, DENVER, CO. FILED 10-8-2004.

SARAH LANSDALE

THE MARK CONSISTS OF STANDARD CHARACTERS WITHOUT CLAIM TO ANY PARTICULAR FONT, STYLE, SIZE, OR COLOR.

THE NAME SARAH LANSDALE IDENTIFIES A LIVING INDIVIDUAL WHOSE CONSENT IS OF RECORD.

CLASS 18—LEATHER GOODS

FOR WEDDING HANDBAGS FOR USE BY BRIDES AND BRIDESMAIDS (U.S. CLS. 1, 2, 3, 22 AND 41).

CLASS 20—FURNITURE AND ARTICLES NOT OTHERWISE CLASSIFIED

FOR RING-BEARER PILLOWS FOR USE IN WEDDINGS; BABY PILLOWS (U.S. CLS. 2, 13, 22, 25, 32 AND 50).

CLASS 21—HOUSEWARES AND GLASS

FOR FLOWERS BASKETS FOR USE BY FLOWER GIRLS IN WEDDINGS (U.S. CLS. 2, 13, 23, 29, 30, 33, 40 AND 50).

CLASS 25—CLOTHING

FOR GARTERS (U.S. CLS. 22 AND 39).
MATTHEW PAPPAS, EXAMINING ATTORNEY

CLASS 35—ADVERTISING AND BUSINESS

FOR LEGISLATIVE SUPPORT CONSULTING SERVICES, NAMELY CRITICAL ANALYSIS OF THE SCIENTIFIC, ECONOMIC, BUSINESS, MARKET, AND SOCIO-POLITICAL ASPECTS OF ISSUES RAISED IN LEGISLATION, FOR COMPANIES IN THE FIELDS OF PHARMACEUTICALS, MEDICAL, BIOTECH, CONSUMER PRODUCTS, COSMETICS AND TOILETRIES, DIETARY SUPPLEMENTS, FOODS, ELECTRONICS, CHEMICALS, EMISSIONS AND WASTE PRODUCTS, PESTICIDES, AGRICULTURE AND UTILITIES (U.S. CLS. 100, 101 AND 102).
FIRST USE 10-11-2004; IN COMMERCE 10-11-2004.

CLASS 42—SCIENTIFIC, COMPUTER AND LEGAL SERVICES

FOR SCIENTIFIC ANALYSIS, GOVERNMENT REGULATORY COMPLIANCE, AND LITIGATION SUPPORT CONSULTING SERVICES; RISK ASSESSMENT, NAMELY RESEARCH, ANALYSIS AND EVALUATION OF POTENTIAL RISKS OF PRODUCTS, SUBSTANCES, AND MANUFACTURING PROCESSES TO HEALTH, SAFETY AND THE ENVIRONMENT, ALL FOR COMPANIES IN THE FIELDS OF PHARMACEUTICALS, MEDICAL, BIOTECH, CONSUMER PRODUCTS, COSMETICS AND TOILETRIES, DIETARY SUPPLEMENTS, FOODS, ELECTRONICS, CHEMICALS, EMISSIONS AND WASTE PRODUCTS, PESTICIDES, AGRICULTURE AND UTILITIES (U.S. CLS. 100 AND 101).

FIRST USE 10-11-2004; IN COMMERCE 10-11-2004.
JACQUELINE A. LAVINE, EXAMINING ATTORNEY

SN 78-498,566. I DEMAND SYSTEMS LLC, HULL, MA. FILED 10-12-2004.

I Demand Music

THE MARK CONSISTS OF STANDARD CHARACTERS WITHOUT CLAIM TO ANY PARTICULAR FONT, STYLE, SIZE, OR COLOR.

NO CLAIM IS MADE TO THE EXCLUSIVE RIGHT TO USE "MUSIC", APART FROM THE MARK AS SHOWN.

CLASS 35—ADVERTISING AND BUSINESS

FOR ONLINE CONSIGNMENT STORE SERVICES FEATURING DIGITAL MUSIC FILES ACCESSED BY MEANS OF USER-DEFINED INFORMATION (U.S. CLS. 100, 101 AND 102).

CLASS 42—SCIENTIFIC, COMPUTER AND LEGAL SERVICES

FOR HOSTING OF DIGITAL CONTENT, NAMELY MUSIC, ON THE INTERNET (U.S. CLS. 100 AND 101).
KIMBERLY FRYE, EXAMINING ATTORNEY

SN 78-498,901. SALESONE, LLC, STAMFORD, CT. FILED 10-13-2004.

WILD TRIBE

THE MARK CONSISTS OF STANDARD CHARACTERS WITHOUT CLAIM TO ANY PARTICULAR FONT, STYLE, SIZE, OR COLOR.

CLASS 14—JEWELRY

FOR LEATHER CHOKERS; LEATHER WATCH-STRAPS (U.S. CLS. 2, 27, 28 AND 50).

CLASS 18—LEATHER GOODS

FOR LEATHER GOODS, NAMELY, WALLETS, KEY CHAINS, KEY CASES, HANDBAGS, MESSENGER BAGS, TOTE BAGS, PURSES, BACKPACKS (U.S. CLS. 1, 2, 3, 22 AND 41).

CLASS 25—CLOTHING

FOR LEATHER WRISTBANDS, LEATHER GLOVES, LEATHER BELTS (U.S. CLS. 22 AND 39).
CAROLINE WOOD, EXAMINING ATTORNEY

SN 78-499,993. GUERIN, JANET JOHNSON, GLEN RIDGE, NJ. FILED 10-14-2004.

PhACIS

THE MARK CONSISTS OF STANDARD CHARACTERS WITHOUT CLAIM TO ANY PARTICULAR FONT, STYLE, SIZE, OR COLOR.

CLASS 16—PAPER GOODS AND PRINTED MATTER

FOR PRINTED TEACHING MATERIALS, NAMELY BOOKS, PAMPHLETS, BROCHURES, INFORMATION CARDS AND PRE-PRINTED TESTS IN THE FIELD OF HEALTH AND SELF-CARE (U.S. CLS. 2, 5, 22, 23, 29, 37, 38 AND 50).

CLASS 41—EDUCATION AND ENTERTAINMENT

FOR EDUCATION AND TRAINING SERVICES, NAMELY PROVIDING SEMINARS, PROGRAMS, LECTURES, CLASSES, IN THE FIELD OF HEALTH, SELF-CARE, SELF-LEARNING CLASSES AND SELF-TESTING WITH FEEDBACK AND ANALYSIS TO PATIENTS, DOCTORS AND HEALTH INSURERS (U.S. CLS. 100, 101 AND 107).
ADA HAN, EXAMINING ATTORNEY

SN 78-500,745. BT PARTNERS, LTD., DALLAS, TX. FILED 10-15-2004.

studio.one.ten

THE MARK CONSISTS OF STANDARD CHARACTERS WITHOUT CLAIM TO ANY PARTICULAR FONT, STYLE, SIZE, OR COLOR.

NO CLAIM IS MADE TO THE EXCLUSIVE RIGHT TO USE "STUDIO", APART FROM THE MARK AS SHOWN.

CLASS 3—COSMETICS AND CLEANING PREPARATIONS

FOR HAIR CARE PREPARATIONS, NAMELY, SHAMPOO, CONDITIONER, SPRAY, MOUSSE, GEL, STRAIGHTENER, DETANGLER, SHINES AND TEXTURIZERS (U.S. CLS. 1, 4, 6, 50, 51 AND 52).
FIRST USE 9-1-2000; IN COMMERCE 9-1-2000.

CLASS 44—MEDICAL, BEAUTY AND AGRICULTURAL SERVICES

FOR BEAUTY SALON SERVICES, NAMELY, HAIR CUTTING, HAIR DRESSING, HAIR STYLING AND BEAUTY MAKEOVERS (U.S. CLS. 100 AND 101).
FIRST USE 9-1-2000; IN COMMERCE 9-1-2000.
DAWN FELDMAN, EXAMINING ATTORNEY

SN 78-500,867. INFOSPACE, INC., BELLEVUE, WA. FILED 10-15-2004.

SN 78-501,545. TARGETED CONVERGENCE CORPORATION, COPPELL, TX. FILED 10-18-2004.

PRIZE-21 FOR PRIZES

TARGETED CONVERGENCE: CONVERGENT DESIGN

THE MARK CONSISTS OF STANDARD CHARACTERS WITHOUT CLAIM TO ANY PARTICULAR FONT, STYLE, SIZE, OR COLOR.

NO CLAIM IS MADE TO THE EXCLUSIVE RIGHT TO USE "FOR PRIZES", APART FROM THE MARK AS SHOWN.

THE MARK CONSISTS OF STANDARD CHARACTERS WITHOUT CLAIM TO ANY PARTICULAR FONT, STYLE, SIZE, OR COLOR.

NO CLAIM IS MADE TO THE EXCLUSIVE RIGHT TO USE "CONVERGENT DESIGN", APART FROM THE MARK AS SHOWN.

CLASS 9—ELECTRICAL AND SCIENTIFIC APPARATUS

FOR DOWNLOADABLE INTERACTIVE COMPUTER GAME SOFTWARE (U.S. CLS. 21, 23, 26, 36 AND 38). FIRST USE 11-29-2003; IN COMMERCE 11-29-2003.

CLASS 9—ELECTRICAL AND SCIENTIFIC APPARATUS

FOR COMPUTER SOFTWARE FOR MAKING PRODUCT DESIGN AND DEVELOPMENT DECISIONS IN THE PROCESS IMPROVEMENT, PRODUCT DEVELOPMENT, PROJECT PLANNING, KNOWLEDGE MANAGEMENT AND CORPORATE LEARNING FIELDS (U.S. CLS. 21, 23, 26, 36 AND 38).

CLASS 41—EDUCATION AND ENTERTAINMENT

FOR ENTERTAINMENT SERVICES, NAMELY, CONDUCTING INTERACTIVE GAMES VIA MOBILE PHONES (U.S. CLS. 100, 101 AND 107).

FIRST USE 11-29-2003; IN COMMERCE 11-29-2003. JOHN LINCOSKI, EXAMINING ATTORNEY

CLASS 42—SCIENTIFIC, COMPUTER AND LEGAL SERVICES

FOR COMPUTER SOFTWARE DESIGN AND DEVELOPMENT SERVICES FOR USE IN THE PROCESS IMPROVEMENT, PRODUCT DEVELOPMENT, PROJECT PLANNING, KNOWLEDGE MANAGEMENT AND CORPORATE LEARNING FIELDS (U.S. CLS. 100 AND 101). MICHAEL TANNER, EXAMINING ATTORNEY

SN 78-501,462. SANDY FRANK ENTERTAINMENT, NEW YORK, NY. FILED 10-18-2004.

SN 78-501,559. TARGETED CONVERGENCE CORPORATION, COPPELL, TX. FILED 10-18-2004.

GLUCOLO

TARGETED CONVERGENCE: CONVERGENT PLANNING

THE MARK CONSISTS OF STANDARD CHARACTERS WITHOUT CLAIM TO ANY PARTICULAR FONT, STYLE, SIZE, OR COLOR.

CLASS 5—PHARMACEUTICALS

FOR FOODS FOR MEDICALLY RESTRICTED DIETS (U.S. CLS. 6, 18, 44, 46, 51 AND 52).

THE MARK CONSISTS OF STANDARD CHARACTERS WITHOUT CLAIM TO ANY PARTICULAR FONT, STYLE, SIZE, OR COLOR.

CLASS 30—STAPLE FOODS

FOR COOKIES AND EDIBLE WAFERS (U.S. CL. 46). TANYA AMOS, EXAMINING ATTORNEY

NO CLAIM IS MADE TO THE EXCLUSIVE RIGHT TO USE "CONVERGENT PLANNING", APART FROM THE MARK AS SHOWN.

CLASS 9—ELECTRICAL AND SCIENTIFIC APPARATUS

FOR COMPUTER SOFTWARE FOR THE PLANNING AND MANAGEMENT OF PRODUCT DEVELOPMENT, NAMELY, SOFTWARE FOR USE IN TRACKING AND EDITING PRODUCT DESIGN AND DEVELOPMENT DECISIONS FOR THE PROCESS IMPROVEMENT, PRODUCT DEVELOPMENT, PROJECT PLANNING, KNOWLEDGE MANAGEMENT AND CORPORATE LEARNING FIELDS (U.S. CLS. 21, 23, 26, 36 AND 38).

CLASS 42—SCIENTIFIC, COMPUTER AND LEGAL SERVICES

FOR COMPUTER SOFTWARE DESIGN AND DEVELOPMENT SERVICES FOR USE IN THE PROCESS IMPROVEMENT, PRODUCT DEVELOPMENT, PROJECT PLANNING, KNOWLEDGE MANAGEMENT AND CORPORATE LEARNING FIELDS (U.S. CLS. 100 AND 101).
MICHAEL TANNER, EXAMINING ATTORNEY

SN 78-502,271. POLYMER GROUP, INC., NORTH CHARLESTON, SC. FILED 10-19-2004.

Pick it up

THE MARK CONSISTS OF STANDARD CHARACTERS WITHOUT CLAIM TO ANY PARTICULAR FONT, STYLE, SIZE, OR COLOR.

CLASS 16—PAPER GOODS AND PRINTED MATTER

FOR DISPOSABLE WIPES NOT IMPREGNATED WITH CHEMICALS OR COMPOUNDS (U.S. CLS. 2, 5, 22, 23, 29, 37, 38 AND 50).

FIRST USE 10-0-2001; IN COMMERCE 10-0-2001.

CLASS 24—FABRICS

FOR KITCHEN AND BATH CLOTHS (U.S. CLS. 42 AND 50).

FIRST USE 10-0-2001; IN COMMERCE 10-0-2001.

TEJBIR SINGH, EXAMINING ATTORNEY

SN 78-501,719. ADEARA, INC., SUNNYVALE, CA, CA. FILED 10-18-2004.

Adeara

SN 78-502,279. WATKINS MANUFACTURING CORPORATION, VISTA, CA. FILED 10-19-2004.



OWNER OF U.S. REG. NOS. 1,614,761, 2,862,661 AND OTHERS.

THE MARK CONSISTS OF STANDARD CHARACTERS WITHOUT CLAIM TO ANY PARTICULAR FONT, STYLE, SIZE, OR COLOR.

CLASS 37—CONSTRUCTION AND REPAIR

FOR INSTALLATION AND REPAIR OF COMPUTER AND NETWORK SYSTEMS (U.S. CLS. 100, 103 AND 106).
FIRST USE 3-12-2004; IN COMMERCE 3-12-2004.

CLASS 42—SCIENTIFIC, COMPUTER AND LEGAL SERVICES

FOR COMPUTER CONSULTATION RELATED TO COMPUTER AND NETWORK SYSTEMS (U.S. CLS. 100 AND 101).

FIRST USE 3-12-2004; IN COMMERCE 3-12-2004.
CHRISIE B. KING, EXAMINING ATTORNEY

CLASS 35—ADVERTISING AND BUSINESS

FOR RETAIL STORE SERVICES FEATURING HOT TUBS AND SPAS IN THE NATURE OF HEATED WHIRLPOOLS, BACKYARD WATER FOUNTAINS AND GAZEBOS; RETAIL STORE SERVICES FEATURING PARTS, ACCESSORIES, FILTERS, CARTRIDGES, HEATING EQUIPMENT, LIGHTING FIXTURES, COVERS AND FLOATING BLANKETS, COVER RETRACTORS, COVER STANDS, STEPS, HANDRAILS, SOUND SYSTEMS, JETS, FACEPLATES, CUSHIONED HEADRESTS, UMBRELLAS, STOOLS, BENCHES, VINYL DECKING, PRIVACY PANELS AND ENCLOSURES, BACKYARD ROOMS AND BARS, WATER CARE SYSTEMS, WATER TREATMENT CHEMICALS, OZONE GENERATORS, WOOD STAINS, CLEANERS AND BRIGHTENERS, FILTER CLEANING PREPARATIONS, POLYMER SEALANTS FOR CONDITIONING AND PROTECTING VINYL SPA COVERS AND SPA SHELLS, AND VACUUMS, ALL FOR USE WITH HOT TUBS AND SPAS IN THE NATURE OF HEATED WHIRLPOOLS (U.S. CLS. 100, 101 AND 102).

CLASS 37—CONSTRUCTION AND REPAIR

FOR INSTALLATION, MAINTENANCE AND REPAIR OF HOT TUBS AND SPAS IN THE NATURE OF HEATED WHIRLPOOLS (U.S. CLS. 100, 103 AND 106).
REBECCA GAN, EXAMINING ATTORNEY

SN 78-502,763. SECUREWATCH24 LLC, NEW YORK, NY.
FILED 10-20-2004.

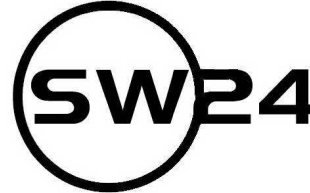

SN 78-502,290. WATKINS MANUFACTURING CORPORATION, VISTA, CA. FILED 10-19-2004.

HOTSPRING

THE MARK CONSISTS OF STANDARD CHARACTERS WITHOUT CLAIM TO ANY PARTICULAR FONT, STYLE, SIZE, OR COLOR.
OWNER OF U.S. REG. NOS. 1,614,761, 2,862,661 AND OTHERS.

CLASS 37—CONSTRUCTION AND REPAIR

FOR INSTALLATION AND MAINTENANCE OF SECURITY SYSTEMS COMPRISING VIDEO SURVEILLANCE CAMERAS (U.S. CLS. 100, 103 AND 106).
FIRST USE 5-1-2004; IN COMMERCE 5-1-2004.

CLASS 45—PERSONAL SERVICES

FOR ONLINE MONITORING FOR SECURITY PURPOSES, NAMELY, VIDEO MONITORING OF FACILITIES, VIEWABLE THROUGH A GLOBAL COMPUTER NETWORK; SECURITY CONSULTATION THAT PROVIDES ANALYSIS, MANAGEMENT AND INVESTIGATION OF EVENTS IN THE NATURE OF CRIMINAL, FRAUDULENT AND SUSPICIOUS EVENTS DISCLOSED BY VIDEO MONITORING (U.S. CLS. 100 AND 101).
FIRST USE 5-1-2004; IN COMMERCE 5-1-2004.
MARGERY A. TIERNEY, EXAMINING ATTORNEY

SN 78-503,043. KUTNER, RICHARD B., BROOMAL, PA.
FILED 10-20-2004.

CLASS 35—ADVERTISING AND BUSINESS

FOR RETAIL STORE SERVICES FEATURING HOT TUBS AND SPAS IN THE NATURE OF HEATED WHIRLPOOLS, BACKYARD WATER FOUNTAINS AND GAZEBOS; RETAIL STORE SERVICES FEATURING PARTS, ACCESSORIES, FILTERS, CARTRIDGES, HEATING EQUIPMENT, LIGHTING FIXTURES, COVERS AND FLOATING BLANKETS, COVER RETRACTORS, COVER STANDS, STEPS, HANDRAILS, SOUND SYSTEMS, JETS, FACEPLATES, CUSHIONED HEADRESTS, UMBRELLAS, STOOLS, BENCHES, VINYL DECKING, PRIVACY PANELS AND ENCLOSURES, BACKYARD ROOMS AND BARS, WATER CARE SYSTEMS, WATER TREATMENT CHEMICALS, OZONE GENERATORS, WOOD STAINS, CLEANERS AND BRIGHTENERS, FILTER CLEANING PREPARATIONS, POLYMER SEALANTS FOR CONDITIONING AND PROTECTING VINYL SPA COVERS AND SPA SHELLS, AND VACUUMS, ALL FOR USE WITH HOT TUBS AND SPAS IN THE NATURE OF HEATED WHIRLPOOLS (U.S. CLS. 100, 101 AND 102).

BEBE BONHEUR

THE MARK CONSISTS OF STANDARD CHARACTERS WITHOUT CLAIM TO ANY PARTICULAR FONT, STYLE, SIZE, OR COLOR.

NO CLAIM IS MADE TO THE EXCLUSIVE RIGHT TO USE "BEBE", APART FROM THE MARK AS SHOWN.

THE FOREIGN WORDING IN THE MARK TRANSLATES INTO ENGLISH AS HAPPY BABY.

CLASS 37—CONSTRUCTION AND REPAIR

FOR INSTALLATION, MAINTENANCE AND REPAIR OF HOT TUBS AND SPAS IN THE NATURE OF HEATED WHIRLPOOLS (U.S. CLS. 100, 103 AND 106).
REBECCA GAN, EXAMINING ATTORNEY

CLASS 24—FABRICS

FOR CHILDREN'S BLANKETS (U.S. CLS. 42 AND 50).

CLASS 25—CLOTHING

FOR CHILDREN'S APPAREL, NAMELY UNDERWEAR, COVERALLS, CHEMISE, TUNICS, LONG SLEEVE T-SHIRTS, SHORT SLEEVE T-SHIRTS, OVERALLS, SWIMMING SUITS, VESTS, KNITTED VESTS, PAREO, KNITTED SUITS, BABY BUNTING, PULL-OVERS, KNITTED CARDIGANS, ROMPERS, SWEATSHIRTS, CARDIGANS, TWO AND THREE PIECE SUITS, LEGGINGS, PANTS, SHORTS, DUNGAREE SHORTS, DUNGAREE LONG PANTS, BLOOMERS, SKIRTS, ENSEMBLE SUITS, DRESSES, SUN DRESSES, JUMPERS, BLOUSES, JACKETS, PARKAS, CAPES, RAINCOATS, WINDBREAKER, SNOWSUIT, SOCKS, TIGHTS, BONNETS, BERETS, SCARVES, GLOVES, MITTENS, HATS, CULOTTES, SHOES, BELTS, CLOTH BIBS, BOOTIES AND HEADBANDS (U.S. CLS. 22 AND 39).

RENEE MCCRAY, EXAMINING ATTORNEY

SN 78-504,784. CIRCLE OF REASON, THE, MINNEAPOLIS, MN. FILED 10-22-2004.

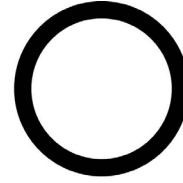

THE CIRCLE OF REASON

CLASS 35—ADVERTISING AND BUSINESS

FOR CHARITABLE SERVICES, NAMELY ORGANIZING AND CONDUCTING VOLUNTEER PROGRAMS AND COMMUNITY SERVICE PROJECTS (U.S. CLS. 100, 101 AND 102).

CLASS 41—EDUCATION AND ENTERTAINMENT

FOR RELIGIOUS INSTRUCTION SERVICES (U.S. CLS. 100, 101 AND 107).

KATRINA EDGE, EXAMINING ATTORNEY

SN 78-503,357. MACROSERVE PTE LTD, SINGAPORE, SINGAPORE, FILED 10-21-2004.

SN 78-504,847. EXTRACT MEDIA LLC, CAMBRIDGE, MA. FILED 10-23-2004.

HDI

NO NAG

THE MARK CONSISTS OF STANDARD CHARACTERS WITHOUT CLAIM TO ANY PARTICULAR FONT, STYLE, SIZE, OR COLOR.

CLASS 3—COSMETICS AND CLEANING PREPARATIONS

FOR BODY CARE PRODUCTS NAMELY LOTIONS, SHAMPOO, CREAMS AND OILS (U.S. CLS. 1, 4, 6, 50, 51 AND 52).

FIRST USE 0-0-1998; IN COMMERCE 0-0-1998.

CLASS 5—PHARMACEUTICALS

FOR DIETARY SUPPLEMENTS IN TABLET, CAPSULE OR LIQUID NAMELY HEALTH FOOD SUPPLEMENTS; SPORTS NUTRITION SUPPLEMENTS (U.S. CLS. 6, 18, 44, 46, 51 AND 52).

FIRST USE 0-0-1998; IN COMMERCE 0-0-1998.

AMY HELLA, EXAMINING ATTORNEY

THE MARK CONSISTS OF STANDARD CHARACTERS WITHOUT CLAIM TO ANY PARTICULAR FONT, STYLE, SIZE, OR COLOR.

CLASS 9—ELECTRICAL AND SCIENTIFIC APPARATUS

FOR REFRIGERATOR MAGNETS (U.S. CLS. 21, 23, 26, 36 AND 38).

CLASS 16—PAPER GOODS AND PRINTED MATTER

FOR DRY ERASE WRITING BOARDS AND WRITING SURFACES (U.S. CLS. 2, 5, 22, 23, 29, 37, 38 AND 50).

CARRIE ACHEN, EXAMINING ATTORNEY

SN 78-505,027. RUE21, INC., WARRENDALE, PA. FILED 10-25-2004.

CLASS 45—PERSONAL SERVICES

FOR CONSULTATION SERVICES IN THE FIELD OF ACCIDENT RECONSTRUCTION (U.S. CLS. 100 AND 101).

FIRST USE 3-1-2000; IN COMMERCE 3-1-2000.
MARGERY A. TIERNEY, EXAMINING ATTORNEY

CARBON

THE MARK CONSISTS OF STANDARD CHARACTERS WITHOUT CLAIM TO ANY PARTICULAR FONT, STYLE, SIZE, OR COLOR.

OWNER OF U.S. REG. NO. 2,445,086.

CLASS 3—COSMETICS AND CLEANING PREPARATIONS

FOR FRAGRANCES, FOR PERSONAL USE; COSMETICS (U.S. CLS. 1, 4, 6, 50, 51 AND 52).

CLASS 25—CLOTHING

FOR MEN'S CLOTHING, NAMELY, AND ACCESSORIES, NAMELY, KNIT TOPS, T-SHIRTS, WOVEN SHIRTS, FLEECE TOPS, SWEATERS, FLEECE VESTS, FLEECE JACKETS, NYLON VESTS, NYLON JACKETS, SHORTS, PANTS, SWIMWEAR, DENIM JEANS, DENIM SHORTS, HATS, BELTS, OUTERWEAR, JEWELRY AND SOCKS (U.S. CLS. 22 AND 39).

ROBERT LORENZO, EXAMINING ATTORNEY

SN 78-505,755. THE PROCTER & GAMBLE COMPANY, CINCINNATI, OH. FILED 10-26-2004.



SN 78-505,650. MICHAEL W. DOBBS, SANTA MONICA, CA. FILED 10-25-2004.

Consistent Formulations

THE MARK CONSISTS OF STANDARD CHARACTERS WITHOUT CLAIM TO ANY PARTICULAR FONT, STYLE, SIZE, OR COLOR.

CLASS 44—MEDICAL, BEAUTY AND AGRICULTURAL SERVICES

FOR CONSULTATION SERVICES IN THE FIELD OF STRESS ANALYSIS (U.S. CLS. 100 AND 101).
FIRST USE 8-4-1980; IN COMMERCE 3-1-2000.

THE MARK CONSISTS OF A MADONNA FACE IN AN OVAL DESIGN.

CLASS 3—COSMETICS AND CLEANING PREPARATIONS

FOR SKIN CARE PRODUCTS, NAMELY LOTION, SKIN CREAM, TOILET SOAP, BATH SOAP, MOISTURIZING BODY WASH, FOUNDATION, FACIAL POWDER, EYESHADOW, MASCARA, BLUSH, CONCEALER, EYE LINER, NAIL ENAMEL, LIPSTICK; NON-MEDICATED TOWELETTES IMPREGNATED WITH SKIN CLEANSER (U.S. CLS. 1, 4, 6, 50, 51 AND 52).

FIRST USE 1-31-2001; IN COMMERCE 1-31-2001.

CLASS 5—PHARMACEUTICALS

FOR VITAMINS AND NUTRITIONAL SUPPLEMENTS (U.S. CLS. 6, 18, 44, 46, 51 AND 52).

FIRST USE 1-31-2001; IN COMMERCE 1-31-2001.
DAWN HAN, EXAMINING ATTORNEY

SN 78-505,766. THE PROCTER & GAMBLE COMPANY,
CINCINNATI, OH. FILED 10-26-2004.



THE MARK CONSISTS OF A MADONNA FACE IN AN
OVAL DESIGN WITH A FOUR-SIDED DOUBLE OUTLINE.

CLASS 3—COSMETICS AND CLEANING PREPARATIONS

FOR SKIN CARE PRODUCTS, NAMELY LOTION, SKIN CREAM, TOILET SOAP, BATH SOAP, MOISTURIZING BODY WASH, FOUNDATION, FACIAL POWDER, EYESHADOW, MASCARA, BLUSH, CONCEALER, EYE LINER, NAIL ENAMEL, LIPSTICK; NON-MEDICATED TOWELETTES IMPREGNATED WITH SKIN CLEANSER (U.S. CLS. 1, 4, 6, 50, 51 AND 52).

FIRST USE 1-31-2001; IN COMMERCE 1-31-2001.

CLASS 5—PHARMACEUTICALS

FOR VITAMINS AND NUTRITIONAL SUPPLEMENTS (U.S. CLS. 6, 18, 44, 46, 51 AND 52).

FIRST USE 1-31-2001; IN COMMERCE 1-31-2001.

DAWN HAN, EXAMINING ATTORNEY

SN 78-505,786. UNIFORMS UNLIMITED, INC., VERNON HILLS, IL. FILED 10-26-2004.

JASCO

THE MARK CONSISTS OF STANDARD CHARACTERS WITHOUT CLAIM TO ANY PARTICULAR FONT, STYLE, SIZE, OR COLOR.

OWNER OF U.S. REG. NO. 1,605,678.

CLASS 25—CLOTHING

FOR UNIFORMS AND SCRUBS (U.S. CLS. 22 AND 39).
FIRST USE 2-10-1989; IN COMMERCE 2-10-1989.

CLASS 35—ADVERTISING AND BUSINESS

FOR MAIL ORDER AND ON-LINE ORDER SERVICES OF UNIFORMS, SCRUBS AND OTHER NURSING EQUIPMENT (U.S. CLS. 100, 101 AND 102).

FIRST USE 2-10-1989; IN COMMERCE 2-10-1989.

HENRY S. ZAK, EXAMINING ATTORNEY

SN 78-506,306. HOFFSTAETTER, MICHEL, DBA LISTEN SKATEBOARDS, NEWPORT BEACH, CA. FILED 10-26-2004.

LISTEN

THE MARK CONSISTS OF STANDARD CHARACTERS WITHOUT CLAIM TO ANY PARTICULAR FONT, STYLE, SIZE, OR COLOR.

CLASS 9—ELECTRICAL AND SCIENTIFIC APPARATUS

FOR SKATEBOARDING HELMETS (U.S. CLS. 21, 23, 26, 36 AND 38).

CLASS 14—JEWELRY

FOR JEWELRY, NAMELY LEATHER BRACELETS (U.S. CLS. 2, 27, 28 AND 50).

CLASS 25—CLOTHING

FOR HEADWEAR, NAMELY, HATS; CLOTHING, NAMELY, SHIRTS, PANTS, SWEATSHIRTS, SWEAT-PANTS, JACKETS, JEANS, SLACKS, TOPS, SHORTS, AND CLOTHING BELTS; AND SKATEBOARDING GLOVES (U.S. CLS. 22 AND 39).

CLASS 26—FANCY GOODS

FOR ACCESSORIES, NAMELY, CLOTH PATCHES FOR CLOTHING (U.S. CLS. 37, 39, 40, 42 AND 50).

CLASS 28—TOYS AND SPORTING GOODS

FOR SPORTING GOODS, NAMELY, SKATEBOARDS AND RELATED PARTS, NAMELY WHEELS, DECKS, TRUCKS, BALL BEARINGS, AND ATHLETIC PROTECTIVE PADS FOR ELBOWS AND KNEES, AND WRIST GUARDS (U.S. CLS. 22, 23, 38 AND 50).

MATTHEW PAPPAS, EXAMINING ATTORNEY

SN 78-506,527. HARRIS, CLIFFORD J./NAME, ATLANTA, GA. AND GETER, JASON/NAME, ATLANTA, GA. FILED 10-27-2004.

SN 78-507,534. ESTEFAN ENTERPRISES, INC., MIAMI BEACH, FL. FILED 10-28-2004.

GRAND HUSTLE

THE MARK CONSISTS OF STANDARD CHARACTERS WITHOUT CLAIM TO ANY PARTICULAR FONT, STYLE, SIZE, OR COLOR.

CLASS 9—ELECTRICAL AND SCIENTIFIC APPARATUS

FOR MUSICAL SOUND RECORDINGS AND AUDIO-VISUAL RECORDINGS, NAMELY, COMPACT DISCS, TAPE CASSETTES, RECORDS, CD-ROMS, VIDEO TAPES, DVDS AND LASER DISCS FEATURING MUSIC (U.S. CLS. 21, 23, 26, 36 AND 38).

FIRST USE 10-9-2001; IN COMMERCE 8-19-2003.

CLASS 41—EDUCATION AND ENTERTAINMENT

FOR ENTERTAINMENT SERVICES, NAMELY, PRODUCING MUSICAL AUDIO AND VIDEO RECORDINGS; ORGANIZING CONCERTS FEATURING LIVE MUSICAL PERFORMANCES (U.S. CLS. 100, 101 AND 107).

FIRST USE 10-9-2001; IN COMMERCE 8-19-2003.
MIDGE BUTLER, EXAMINING ATTORNEY

SN 78-507,324. WHITMORE MANUFACTURING COMPANY, THE, ROCKWALL, TX. FILED 10-28-2004.



OWNER OF U.S. REG. NOS. 1,448,066, 2,254,848 AND 2,707,758.

NO CLAIM IS MADE TO THE EXCLUSIVE RIGHT TO USE "COATINGS", APART FROM THE MARK AS SHOWN. THE MARK CONSISTS OF THE WORDS KATS COATINGS AND THE PROFILE OF A CAT HEAD.

CLASS 2—PAINTS

FOR COATINGS FOR PROTECTING METAL AND PAINTED METAL SURFACES FROM CORROSION AND ENVIRONMENTAL DAMAGE (U.S. CLS. 6, 11 AND 16).

FIRST USE 4-10-2001; IN COMMERCE 4-10-2001.

CLASS 3—COSMETICS AND CLEANING PREPARATIONS

FOR PROTECTIVE COATING REMOVERS (U.S. CLS. 1, 4, 6, 50, 51 AND 52).

FIRST USE 4-10-2001; IN COMMERCE 4-10-2001.
G. MAYERSCHOFF, EXAMINING ATTORNEY

PRESS POLICE

THE MARK CONSISTS OF STANDARD CHARACTERS WITHOUT CLAIM TO ANY PARTICULAR FONT, STYLE, SIZE, OR COLOR.

NO CLAIM IS MADE TO THE EXCLUSIVE RIGHT TO USE "PRESS", APART FROM THE MARK AS SHOWN.

CLASS 16—PAPER GOODS AND PRINTED MATTER

FOR POSTERS, CALENDARS, NOTEBOOKS, BINDERS, DAILY ORGANIZERS, MEMOPADS, STICKERS, COMIC BOOKS, WRITING PAPER, ENVELOPES, GREETING CARDS, PAPER COASTERS, PAPER MATS, NEWSPAPERS FOR GENERAL CIRCULATION, BOOKS AND MAGAZINES IN THE FIELD OF INVESTIGATIVE TELEVISION SHOWS, PHOTOGRAPHS, POSTCARDS, TRADING CARDS, CARDBOARD STAND-UP CUTOUTS FEATURING PHOTOGRAPHS OR ARTWORK, PREPAID PHONE CALLING DEBIT CARDS WITHOUT MAGNETIC CODING, TRADING CARD MILK BOTTLE CAPS, BUMPER STICKERS, PENCILS, BALL POINT PENS, AND PERSONAL CHECK BOOKS (U.S. CLS. 2, 5, 22, 23, 29, 37, 38 AND 50).

CLASS 20—FURNITURE AND ARTICLES NOT OTHERWISE CLASSIFIED

FOR NONMETAL AND NON-LEATHER KEYCHAINS (U.S. CLS. 2, 13, 22, 25, 32 AND 50).

CLASS 21—HOUSEWARES AND GLASS

FOR COFFEE MUGS, BEER MUGS, LUNCH BOXES, DRINKING GLASSES, HAIR BRUSHES, AND HAIR COMBS (U.S. CLS. 2, 13, 23, 29, 30, 33, 40 AND 50).

CLASS 25—CLOTHING

FOR CLOTHING, NAMELY, RAINWEAR, T-SHIRTS, SWEAT SHIRTS, JERSEYS, SHORTS, SWEAT PANTS, JACKETS, SCARVES, GLOVES, HOSIERY, NECKTIES, PAJAMAS, ROBES, NIGHT SHIRTS, NIGHT GOWNS, UNDERWEAR, BOXER SHORTS, HEAD BANDS, WRIST BANDS, SWIM SUITS, SKIRTS, SHIRTS, TANK TOPS, PANTS, COATS, SWEATERS, LEOTARDS, LEG WARMERS, STOCKINGS, SOCKS, PANTY HOSE, TIGHTS, BELTS; FOOTWEAR, NAMELY, SHOES, ATHLETIC SHOES, SLIPPERS, BOOTS, SANDALS; AND HEADWEAR, NAMELY, HATS AND CAPS (U.S. CLS. 22 AND 39).

CLASS 41—EDUCATION AND ENTERTAINMENT

FOR ENTERTAINMENT SERVICES, NAMELY, A TELEVISION SERIES FEATURING INVESTIGATIVE REPORTING (U.S. CLS. 100, 101 AND 107).

KELLY BOULTON, EXAMINING ATTORNEY

SN 78-508,238. STEWART ENGINEERS & ASSOCIATES,
FLAT ROCK, MI. FILED 10-29-2004.

StewartFloat

THE MARK CONSISTS OF STANDARD CHARACTERS WITHOUT CLAIM TO ANY PARTICULAR FONT, STYLE, SIZE, OR COLOR.

CLASS 35—ADVERTISING AND BUSINESS

FOR BUSINESS SERVICES, NAMELY, CONSULTING OTHERS IN THE OPERATION OF GLASS MAKING SYSTEMS (U.S. CLS. 100, 101 AND 102).

CLASS 40—MATERIAL TREATMENT

FOR CUSTOM FABRICATION OF GLASS MAKING SYSTEMS FOR OTHERS (U.S. CLS. 100, 103 AND 106).

CLASS 42—SCIENTIFIC, COMPUTER AND LEGAL SERVICES

FOR DESIGN OF GLASS MAKING SYSTEMS FOR OTHERS (U.S. CLS. 100 AND 101).
PAULA MAHONEY, EXAMINING ATTORNEY

SN 78-508,281. MANPOWER INC., MILWAUKEE, WI. FILED
10-29-2004.

@irect source

THE MARK CONSISTS OF THE WORD "DIRECT" STYLIZED AND IN BOLD PRINT, FOLLOWED BY THE WORD "SOURCE" IN BLOCK PRINT.

CLASS 35—ADVERTISING AND BUSINESS

FOR EMPLOYMENT AGENCY SERVICES IN THE FIELD OF TEMPORARY AND PERMANENT PLACEMENT; EMPLOYMENT AGENCY SERVICES PROVIDED VIA A GLOBAL COMPUTER NETWORK; EMPLOYMENT HIRING, RECRUITING, PLACEMENT, STAFFING AND CAREER NETWORKING SERVICES; PROVIDING CAREER INFORMATION VIA GLOBAL COMPUTER NETWORK; AND PROVIDING TEMPORARY EMPLOYMENT AGENCY SERVICES VIA A GLOBAL COMPUTER NETWORK; PRE-EMPLOYMENT EVALUATION SERVICES, NAMELY, TESTING TO DETERMINE EMPLOYMENT SKILLS (U.S. CLS. 100, 101 AND 102).

CLASS 41—EDUCATION AND ENTERTAINMENT

FOR PROVIDING ON-LINE INFORMATION AND NEWS IN THE FIELD OF EMPLOYMENT TRAINING VIA A GLOBAL COMPUTER NETWORK; EDUCATION AND TRAINING SERVICES, NAMELY, PROVIDING ON-LINE COURSES, CLASSES AND SEMINARS IN THE FIELDS OF COMPUTER SKILLS, COMPUTER PROGRAMMING, BUSINESS MANAGEMENT, PERSONAL COMMUNICATION, TECHNICAL SUPPORT, CUSTOMER SERVICE AND INTERACTION, TELECOMMUNICATIONS AND BUSINESS SKILLS, MARKETING, AND JOB SEARCH AND INTERVIEWING SKILLS (U.S. CLS. 100, 101 AND 107).

CLASS 42—SCIENTIFIC, COMPUTER AND LEGAL SERVICES

FOR PROVIDING TEMPORARY USE OF ON-LINE NON-DOWNLOADABLE SOFTWARE THAT IS USED FOR EMPLOYMENT AND STAFFING PLANNING BY EMPLOYERS, ORDERING OF TEMPORARY EMPLOYEE SERVICES, HIRING OF PERMANENT EMPLOYEES FROM AN EMPLOYMENT AGENCY, AND TRACKING AND ANALYZING LABOR AND STAFFING ALLOCATIONS (U.S. CLS. 100 AND 101).

CLASS 45—PERSONAL SERVICES

FOR PRE-EMPLOYMENT BACKGROUND SCREENING AND INVESTIGATION (U.S. CLS. 100 AND 101).
YONG KIM, EXAMINING ATTORNEY

SN 78-508,600. BROWN, JOSHUA, FRANKLIN, TN. FILED
10-29-2004.

DAY OF FIRE

THE MARK CONSISTS OF STANDARD CHARACTERS WITHOUT CLAIM TO ANY PARTICULAR FONT, STYLE, SIZE, OR COLOR.

CLASS 9—ELECTRICAL AND SCIENTIFIC APPARATUS

FOR MUSICAL SOUND RECORDINGS AND AUDIOVISUAL RECORDINGS FEATURING MUSIC; DOWNLOADABLE MUSICAL SOUND RECORDINGS AND AUDIOVISUAL RECORDINGS FEATURING MUSIC AND MUSICAL-BASED ENTERTAINMENT (U.S. CLS. 21, 23, 26, 36 AND 38).

CLASS 16—PAPER GOODS AND PRINTED MATTER

FOR SOUVENIR PROGRAMS CONCERNING MUSICAL PERFORMING TOURS OF MUSICAL GROUPS; POSTERS; PHOTOGRAPHS; AND PRINTED MATERIALS IN THE NATURE OF STICKERS AND BUMPER STICKERS (U.S. CLS. 2, 5, 22, 23, 29, 37, 38 AND 50).

CLASS 25—CLOTHING

FOR MERCHANDISE, NAMELY, CLOTHING, NAMELY, SHIRTS, T-SHIRTS, JACKETS AND HEADWEAR (U.S. CLS. 22 AND 39).

CLASS 35—ADVERTISING AND BUSINESS

FOR ONLINE RETAIL STORE SERVICES FEATURING SOUND RECORDINGS, AUDIOVISUAL RECORDINGS, SOUVENIR PROGRAMS, POSTERS, PHOTOGRAPHS, STICKERS, BUMPER STICKERS, SHIRTS, T-SHIRTS, JACKETS AND HEADWEAR (U.S. CLS. 100, 101 AND 102).

CLASS 38—COMMUNICATION

FOR STREAMING OF SOUND AND AUDIOVISUAL RECORDINGS FEATURING MUSIC AND MUSICAL BASED ENTERTAINMENT, TRANSMISSION OF LIVE WEB CASTS OF MUSICAL PERFORMANCES AND TRANSMISSION OF LIVE WEB CASTS OF MUSICAL TOURS VIA THE INTERNET (U.S. CLS. 100, 101 AND 104).

CLASS 41—EDUCATION AND ENTERTAINMENT

FOR ENTERTAINMENT SERVICES, NAMELY, LIVE MUSICAL PERFORMANCES BY A MUSICAL BAND; PROVIDING ENTERTAINMENT INFORMATION REGARDING A MUSICAL GROUP, NAMELY, PERFORMANCES, RECORDINGS, APPEARANCES, BIOGRAPHIES, TOURS, AND PHOTOGRAPHS VIA A WEBSITE ON A GLOBAL COMPUTER NETWORK; PROVIDING MUSIC SELECTABLE BY INDIVIDUAL USERS BY MEANS OF A GLOBAL COMPUTER NETWORK, NAMELY, PROVIDING ONLINE MUSIC AND MUSICAL VIDEO ENTERTAINMENT BY SUBSCRIPTION (U.S. CLS. 100, 101 AND 107).
DEZMONA MIZELLE, EXAMINING ATTORNEY

SN 78-508,627. HOMETEK INTERNATIONAL GROUP CORPORATION, NAPERVILLE, IL. FILED 10-29-2004.

Hometek Pacific

THE MARK CONSISTS OF STANDARD CHARACTERS WITHOUT CLAIM TO ANY PARTICULAR FONT, STYLE, SIZE, OR COLOR.
OWNER OF U.S. REG. NOS. 1,886,070, 2,287,326 AND 2,297,399.

CLASS 11—ENVIRONMENTAL CONTROL APPARATUS

FOR PLUMBING FIXTURES, NAMELY, FAUCETS, BIDETS, SINK SPRAYERS, SHOWER SPRAYERS, FAUCET SPRAYERS, SHOWER HEAD SPRAYERS, VALVES, DIVERTERS, SPOUTS, LAVATORY TRAPS, SINK TRAPS, BIBBS, COCKS, FAUCET AERATORS, DRAIN ASSEMBLY, SHOWERHEADS, SHOWER ARMS, SHOWER PANELS, HAND-HELD SHOWERS AND HOSES FOR HAND-HELD SHOWERS HEADS SOLD TOGETHER AS A UNIT; SINKS, SINK STRAINERS, BATH TUBS, TUB PARTS, NAMELY, TUB FEET, TUB WASTES AND OVERFLOWS; WASH BASINS, WASH BASIN PEDESTAL; TOILET TANKS, TOILET BOWLS, TOILET SEATS; REPLACEMENT PARTS AND COMPONENTS FOR THE AFOREMENTIONED GOODS (U.S. CLS. 13, 21, 23, 31 AND 34).
FIRST USE 9-1-2004; IN COMMERCE 9-23-2004.

CLASS 21—HOUSEWARES AND GLASS

FOR BATHROOM ACCESSORIES NOT OF PRECIOUS METAL, NAMELY, SOAP DISHES, SOAP HOLDERS, SOAP BASKETS, SOAP DISPENSERS, TOOTHBRUSH AND TUMBLER HOLDERS, TOWEL BARS, TOWEL HOLDERS, TOWEL RACKS, TOWEL HOOKS, TOWEL RINGS, TOWEL BASKETS, TOILET PAPER HOLDERS, TOILET BRUSH AND TOILET BRUSH HOLDER, PAPER TOWEL HOLDERS, CORNER CADDIES (U.S. CLS. 2, 13, 23, 29, 30, 33, 40 AND 50).
FIRST USE 9-15-2004; IN COMMERCE 9-23-2004.
PRISCILLA MILTON, EXAMINING ATTORNEY

SN 78-509,596. BFS RETAIL AND COMMERCIAL OPERATIONS, LLC, BLOOMINGDALE, IL. FILED 11-2-2004.

THE EXPERIENCE YOU WANT

THE MARK CONSISTS OF STANDARD CHARACTERS WITHOUT CLAIM TO ANY PARTICULAR FONT, STYLE, SIZE, OR COLOR.

CLASS 35—ADVERTISING AND BUSINESS

FOR RETAIL STORES FEATURING AUTOMOBILE TIRES AND PARTS (U.S. CLS. 100, 101 AND 102).

CLASS 37—CONSTRUCTION AND REPAIR

FOR AUTOMOTIVE SERVICES, NAMELY, AUTOMOBILE MAINTENANCE AND REPAIR (U.S. CLS. 100, 103 AND 106).

CLASS 42—SCIENTIFIC, COMPUTER AND LEGAL SERVICES

FOR AUTOMOTIVE DIAGNOSTIC SERVICES; AUTOMOBILE INSPECTION SERVICES (U.S. CLS. 100 AND 101).
JASON LOTT, EXAMINING ATTORNEY

SN 78-509,951. BAUSCH & LOMB INCORPORATED, RO-CHESTER, NY. FILED 11-2-2004.

SN 78-510,459. TEMPUR WORLD, LLC, LEXINGTON, KY. FILED 11-3-2004.

**BAUSCH & LOMB
FOGSHIELD XP**

THE MARK CONSISTS OF STANDARD CHARACTERS WITHOUT CLAIM TO ANY PARTICULAR FONT, STYLE, SIZE, OR COLOR.

CLASS 3—COSMETICS AND CLEANING PREPARATIONS

FOR OPTICAL LENS CLEANING PRODUCTS, NAMELY, LENS CLEANING SOLUTIONS (U.S. CLS. 1, 4, 6, 50, 51 AND 52).
FIRST USE 4-5-2002; IN COMMERCE 4-5-2002.

CLASS 9—ELECTRICAL AND SCIENTIFIC APPARATUS

FOR OPTICAL LENS CLEANING PRODUCTS, NAMELY, CLEANING CLOTHS AND TISSUES FOR OPTICAL AND SPECTACLE LENSES AND SAFETY GOGGLES (U.S. CLS. 21, 23, 26, 36 AND 38).
FIRST USE 4-5-2002; IN COMMERCE 4-5-2002.
JULIE GUTTADAURO, EXAMINING ATTORNEY

SN 78-510,451. TEMPUR WORLD, LLC, LEXINGTON, KY. FILED 11-3-2004.

**THE BACK BED BY
TEMPUR-PEDIC**

THE MARK CONSISTS OF STANDARD CHARACTERS WITHOUT CLAIM TO ANY PARTICULAR FONT, STYLE, SIZE, OR COLOR.

OWNER OF U.S. REG. NOS. 2,823,185, 2,840,686 AND 2,840,687.

NO CLAIM IS MADE TO THE EXCLUSIVE RIGHT TO USE "BACK BED", APART FROM THE MARK AS SHOWN.

CLASS 10—MEDICAL APPARATUS

FOR SEATING AND COUCHING MATS IN THE NATURE OF A PILLOW OR SEAT LINER, PILLOWS, CUSHIONS, MATTRESSES, TOP MATTRESSES, BOLSTERS AND CHAIR PADS FOR ORTHOPEDIC, MEDICAL AND MEDICAL NURSING HOME AND HOSPITAL USE (U.S. CLS. 26, 39 AND 44).

CLASS 20—FURNITURE AND ARTICLES NOT OTHERWISE CLASSIFIED

FOR SEATING AND COUCHING MATS IN THE NATURE OF A PILLOW OR SEAT LINER, PILLOWS, CUSHIONS, MATTRESSES, TOP MATTRESSES, BOLSTERS AND CHAIR PADS (U.S. CLS. 2, 13, 22, 25, 32 AND 50).
JOHN GARTNER, EXAMINING ATTORNEY

**THE BACK MATTRESS
BY TEMPUR-PEDIC**

THE MARK CONSISTS OF STANDARD CHARACTERS WITHOUT CLAIM TO ANY PARTICULAR FONT, STYLE, SIZE, OR COLOR.

OWNER OF U.S. REG. NOS. 2,823,185, 2,840,686 AND 2,840,687.

NO CLAIM IS MADE TO THE EXCLUSIVE RIGHT TO USE "BACK MATTRESS", APART FROM THE MARK AS SHOWN.

CLASS 10—MEDICAL APPARATUS

FOR SEATING AND COUCHING MATS IN THE NATURE OF A PILLOW OR SEAT LINER, PILLOWS, CUSHIONS, MATTRESSES, TOP MATTRESSES, BOLSTERS AND CHAIR PADS FOR ORTHOPEDIC, MEDICAL AND MEDICAL NURSING HOME AND HOSPITAL USE (U.S. CLS. 26, 39 AND 44).

CLASS 20—FURNITURE AND ARTICLES NOT OTHERWISE CLASSIFIED

FOR SEATING AND COUCHING MATS IN THE NATURE OF A PILLOW OR SEAT LINER, PILLOWS, CUSHIONS, MATTRESSES, TOP MATTRESSES, BOLSTERS AND CHAIR PADS (U.S. CLS. 2, 13, 22, 25, 32 AND 50).

JOHN GARTNER, EXAMINING ATTORNEY

SN 78-510,502. PRESSTEK, INC., HUDSON, NH. FILED 11-3-2004.

**A SMARTER WAY TO
PRINT**

THE MARK CONSISTS OF STANDARD CHARACTERS WITHOUT CLAIM TO ANY PARTICULAR FONT, STYLE, SIZE, OR COLOR.

CLASS 7—MACHINERY

FOR PRINTING PLATES AND PRINTING PRESSES (U.S. CLS. 13, 19, 21, 23, 31, 34 AND 35).
FIRST USE 2-1-2004; IN COMMERCE 2-1-2004.

CLASS 9—ELECTRICAL AND SCIENTIFIC APPARATUS

FOR PRINTING EQUIPMENT, NAMELY, PLATESSETTERS (U.S. CLS. 21, 23, 26, 36 AND 38).
FIRST USE 2-1-2004; IN COMMERCE 2-1-2004.
ALICIA COLLINS, EXAMINING ATTORNEY

SN 78-510,541. I.M. GOOD, CANTON, OH. FILED 11-3-2004.

CLASS 20—FURNITURE AND ARTICLES NOT OTHERWISE CLASSIFIED

FOR SEATING AND COUCHING MATS IN THE NATURE OF A PILLOW OR SEAT LINER, PILLOWS, CUSHIONS, MATTRESSES, TOP MATTRESSES, BOLSTERS AND CHAIR PADS (U.S. CLS. 2, 13, 22, 25, 32 AND 50).

JOHN GARTNER, EXAMINING ATTORNEY

I.M.GOOD

SN 78-510,584. TEMPUR WORLD, LLC, LEXINGTON, KY. FILED 11-3-2004.

THE MARK CONSISTS OF STANDARD CHARACTERS WITHOUT CLAIM TO ANY PARTICULAR FONT, STYLE, SIZE, OR COLOR.

CLASS 29—MEATS AND PROCESSED FOODS

FOR PROCESSED NUTS; FRUIT SAUCES, NAMELY, CRANBERRY SAUCE AND APPLESAUCE; MEATS AND MEAT SNACKS, NAMELY, BEEF JERKY AND DRIED MEAT STICKS (U.S. CL. 46).

FIRST USE 3-1-1997; IN COMMERCE 3-1-1997.

CLASS 30—STAPLE FOODS

FOR PRETZELS, LICORICE, CANDY AND FLAVORED SAUCES, NAMELY, HOT CHILI SAUCES AND TOMATO BASED SEASONING SAUCES USED IN COOKING (U.S. CL. 46).

FIRST USE 3-1-1997; IN COMMERCE 3-1-1997.

SAMUEL E. SHARPER JR., EXAMINING ATTORNEY

**THE SUPPORT
MATTRESS BY
TEMPUR-PEDIC**

SN 78-510,554. TEMPUR WORLD, LLC, LEXINGTON, KY. FILED 11-3-2004.

**THE SUPPORT BED BY
TEMPUR-PEDIC**

THE MARK CONSISTS OF STANDARD CHARACTERS WITHOUT CLAIM TO ANY PARTICULAR FONT, STYLE, SIZE, OR COLOR.

OWNER OF U.S. REG. NOS. 2,823,185, 2,840,686 AND 2,840,687.

NO CLAIM IS MADE TO THE EXCLUSIVE RIGHT TO USE "SUPPORT MATTRESS", APART FROM THE MARK AS SHOWN.

CLASS 10—MEDICAL APPARATUS

FOR SEATING AND COUCHING MATS IN THE NATURE OF A PILLOW OR SEAT LINER, PILLOWS, CUSHIONS, MATTRESSES, TOP MATTRESSES, BOLSTERS AND CHAIR PADS FOR ORTHOPEDIC, MEDICAL AND MEDICAL NURSING HOME AND HOSPITAL USE (U.S. CLS. 26, 39 AND 44).

THE MARK CONSISTS OF STANDARD CHARACTERS WITHOUT CLAIM TO ANY PARTICULAR FONT, STYLE, SIZE, OR COLOR.

OWNER OF U.S. REG. NOS. 2,823,185, 2,840,686 AND 2,840,687.

NO CLAIM IS MADE TO THE EXCLUSIVE RIGHT TO USE "SUPPORT BED", APART FROM THE MARK AS SHOWN.

CLASS 10—MEDICAL APPARATUS

FOR SEATING AND COUCHING MATS IN THE NATURE OF A PILLOW OR SEAT LINER, PILLOWS, CUSHIONS, MATTRESSES, TOP MATTRESSES, BOLSTERS AND CHAIR PADS FOR ORTHOPEDIC, MEDICAL AND MEDICAL NURSING HOME AND HOSPITAL USE (U.S. CLS. 26, 39 AND 44).

CLASS 20—FURNITURE AND ARTICLES NOT OTHERWISE CLASSIFIED

FOR SEATING AND COUCHING MATS IN THE NATURE OF A PILLOW OR SEAT LINER, PILLOWS, CUSHIONS, MATTRESSES, TOP MATTRESSES, BOLSTERS AND CHAIR PADS (U.S. CLS. 2, 13, 22, 25, 32 AND 50).

JOHN GARTNER, EXAMINING ATTORNEY

SN 78-511,133. AMERIGROUP CORPORATION, VIRGINIA BEACH, VA. FILED 11-4-2004.

AMERINET

THE MARK CONSISTS OF STANDARD CHARACTERS WITHOUT CLAIM TO ANY PARTICULAR FONT, STYLE, SIZE, OR COLOR.

OWNER OF U.S. REG. NOS. 2,145,108, 2,215,444 AND OTHERS.

CLASS 36—INSURANCE AND FINANCIAL

FOR ADMINISTRATION OF PRE-PAID HEALTH CARE PLANS (U.S. CLS. 100, 101 AND 102).

CLASS 44—MEDICAL, BEAUTY AND AGRICULTURAL SERVICES

FOR HEALTH CARE IN THE NATURE OF HEALTH MAINTENANCE ORGANIZATIONS (U.S. CLS. 100 AND 101).

MATTHEW PAPPAS, EXAMINING ATTORNEY

SN 78-511,215. INDEVUS PHARMACEUTICALS, INC., LEXINGTON, MA. FILED 11-4-2004.



OWNER OF U.S. REG. NO. 2,875,279.

NO CLAIM IS MADE TO THE EXCLUSIVE RIGHT TO USE "PHARMACEUTICALS, INC.", APART FROM THE MARK AS SHOWN.

THE MARK CONSISTS OF STYLIZED DESIGN OF THE LETTER 'I' CENTERED ON AN ELLIPSOID WHICH IS ANGLED AT 45 DEGREES.

CLASS 35—ADVERTISING AND BUSINESS

FOR LICENSING AND BUSINESS MARKETING CONSULTING IN THE FIELD OF PRODUCTS IN THE BIOMEDICAL AND PHARMACEUTICAL FIELDS (U.S. CLS. 100, 101 AND 102).

FIRST USE 4-2-2002; IN COMMERCE 4-2-2002.

CLASS 42—SCIENTIFIC, COMPUTER AND LEGAL SERVICES

FOR PRODUCT DEVELOPMENT FOR OTHERS, PRODUCT DEVELOPMENT CONSULTATION AND RESEARCH, VALIDATION OF PRODUCT RESEARCH, TESTING FOR OTHERS OF NEW PRODUCTS IN THE BIOMEDICAL AND PHARMACEUTICAL FIELDS (U.S. CLS. 100 AND 101).

FIRST USE 4-2-2002; IN COMMERCE 4-2-2002.
TANYA AMOS, EXAMINING ATTORNEY

SN 78-511,345. IDEAL FOR YOU, LLC, MADISON, WI. FILED 11-4-2004.

IDEAL FOR YOU

THE MARK CONSISTS OF STANDARD CHARACTERS WITHOUT CLAIM TO ANY PARTICULAR FONT, STYLE, SIZE, OR COLOR.

CLASS 25—CLOTHING

FOR CLOTHING, NAMELY SHIRTS, PANTS AND PAJAMAS (U.S. CLS. 22 AND 39).

FIRST USE 3-3-2003; IN COMMERCE 5-15-2003.

CLASS 35—ADVERTISING AND BUSINESS

FOR RETAIL STORES AND ON-LINE RETAIL STORE SERVICES FEATURING HOUSEHOLD GOODS, HOME DECORATION GOODS, CLOTHING, FASHION ACCESSORIES, ARTWORK, JEWELRY, GIFTS, AND TOYS (U.S. CLS. 100, 101 AND 102).

FIRST USE 3-3-2003; IN COMMERCE 5-15-2003.
HENRY S. ZAK, EXAMINING ATTORNEY

SN 78-511,567. HARDEE'S FOOD SYSTEMS, INC., ST. LOUIS, MO. FILED 11-4-2004.



NO CLAIM IS MADE TO THE EXCLUSIVE RIGHT TO USE HAND-SCOOPED ICE CREAM SHAKES & MALTS, APART FROM THE MARK AS SHOWN.

THE MARK CONSISTS OF IMAGE OF ICE CREAM SHAKE IN GLASS WITH SURROUNDING SUNBURST WITH STYLIZED WORDS HAND-SCOOPED ABOVE AND ICE CREAM SHAKES & MALTS BELOW.

CLASS 30—STAPLE FOODS

FOR ICE CREAM, ICE CREAM SHAKES AND ICE CREAM DRINKS INCLUDING MALT POWDER (U.S. CL. 46).

FIRST USE 12-0-2004; IN COMMERCE 4-11-2005.

CLASS 43—HOTEL AND RESTAURANT SERVICES

FOR RESTAURANT SERVICES (U.S. CLS. 100 AND 101).
FIRST USE 12-0-2004; IN COMMERCE 4-11-2005.
CHRISTOPHER ADKINS, EXAMINING ATTORNEY

SN 78-512,126. WOODWARD AVENUE ACTION ASSOCIATION, ROYAL OAK, MI. FILED 11-5-2004.



THE MARK CONSISTS OF A STYLIZED VERSION OF THE TERMS WOODWARD AVENUE.

CLASS 35—ADVERTISING AND BUSINESS

FOR CHAMBER OF COMMERCE SERVICES, NAMELY, PROMOTING BUSINESS AND TOURISM IN SOUTHEASTERN MICHIGAN; PROMOTING PUBLIC AWARENESS ABOUT SOUTHEASTERN MICHIGAN; PROMOTING ECONOMIC DEVELOPMENT IN SOUTHEASTERN MICHIGAN; PLANNING AND CONDUCTING OF TRADE FAIRS, EXHIBITIONS AND PRESENTATIONS FOR ECONOMIC OR ADVERTISING PURPOSES (U.S. CLS. 100, 101 AND 102).
FIRST USE 8-20-2003; IN COMMERCE 8-20-2003.

CLASS 37—CONSTRUCTION AND REPAIR

FOR CONSERVATION AND PRESERVATION OF LANDMARKS, HISTORICAL RESOURCES AND ATTRACTIONS (U.S. CLS. 100, 103 AND 106).
FIRST USE 8-20-2003; IN COMMERCE 8-20-2003.
INGA ERVIN, EXAMINING ATTORNEY

SN 78-512,375. 3M COMPANY, ST. PAUL, MN. FILED 11-5-2004.

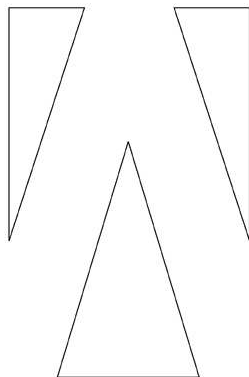

THE MARK CONSISTS OF A DESIGN CONSISTING OF THREE TRIANGLES.

CLASS 9—ELECTRICAL AND SCIENTIFIC APPARATUS

FOR SAFETY PRODUCTS, NAMELY, REFLECTIVE MATERIAL SOLD AS AN INTEGRAL COMPONENT OF SAFETY BANDS TO BE WORN ON THE BODY (U.S. CLS. 21, 23, 26, 36 AND 38).
FIRST USE 1-0-1996; IN COMMERCE 1-0-1996.

CLASS 17—RUBBER GOODS

FOR LIGHT REFLECTIVE MATERIAL IN THE FORM OF TAPES, STRIPS, AND SHEETING FOR USE ON CLOTHING, HIGHWAY TRAFFIC SIGNS, EMERGENCY AND WARNING SIGNS, AND FOR OTHER SAFETY PURPOSES (U.S. CLS. 1, 5, 12, 13, 35 AND 50).
FIRST USE 1-0-1996; IN COMMERCE 1-0-1996.
AMY HELLA, EXAMINING ATTORNEY

SN 78-512,947. CGB ENTERPRISES, INC., COVINGTON, LA. FILED 11-8-2004.



THE MARK CONSISTS OF STANDARD CHARACTERS WITHOUT CLAIM TO ANY PARTICULAR FONT, STYLE, SIZE, OR COLOR.

CLASS 35—ADVERTISING AND BUSINESS

FOR GRAIN DISTRIBUTORSHIP SERVICES (U.S. CLS. 100, 101 AND 102).
FIRST USE 4-22-1993; IN COMMERCE 4-22-1993.

CLASS 36—INSURANCE AND FINANCIAL

FOR INSURANCE SERVICES, NAMELY, INSURANCE UNDERWRITING IN THE FIELD OF COMMODITIES, AND FINANCIAL SERVICES, NAMELY, LOAN SERVICING IN THE FIELDS OF REAL ESTATE LOANS, FARM OPERATIONAL LOANS, AND FARM EQUIPMENT PURCHASING LOANS (U.S. CLS. 100, 101 AND 102).
FIRST USE 12-10-1997; IN COMMERCE 12-10-1997.

CLASS 39—TRANSPORTATION AND STORAGE

FOR TRANSPORTATION AND STORAGE OF DRY BULK COMMODITIES, BY TRUCK, TRAIN AND AIR (U.S. CLS. 100 AND 105).
FIRST USE 4-22-1993; IN COMMERCE 4-22-1993.
ALEX KEAM, EXAMINING ATTORNEY

SN 78-512,951. CGB ENTERPRISES, INC., COVINGTON, LA. FILED 11-8-2004.

CGB Enterprises

THE MARK CONSISTS OF STANDARD CHARACTERS WITHOUT CLAIM TO ANY PARTICULAR FONT, STYLE, SIZE, OR COLOR.

NO CLAIM IS MADE TO THE EXCLUSIVE RIGHT TO USE "ENTERPRISES", APART FROM THE MARK AS SHOWN.

CLASS 35—ADVERTISING AND BUSINESS

FOR GRAIN DISTRIBUTORSHIP SERVICES (U.S. CLS. 100, 101 AND 102).
FIRST USE 4-22-1993; IN COMMERCE 4-22-1993.

CLASS 36—INSURANCE AND FINANCIAL

FOR INSURANCE AND FINANCIAL SERVICES, NAMELY LOAN FINANCING (U.S. CLS. 100, 101 AND 102).
FIRST USE 12-10-1997; IN COMMERCE 12-10-1997.

CLASS 39—TRANSPORTATION AND STORAGE

FOR TRANSPORTATION AND STORAGE OF DRY BULK COMMODITIES BY TRUCK, TRAIN AND AIR (U.S. CLS. 100 AND 105).
FIRST USE 4-22-1993; IN COMMERCE 4-22-1993.
JOANNA DUKOVIC, EXAMINING ATTORNEY

SN 78-513,568. CENDANT TRAVEL DISTRIBUTION SERVICES GROUP, INC., PARSIPPANY, NJ. FILED 11-9-2004.

JUMPSTART

THE MARK CONSISTS OF STANDARD CHARACTERS WITHOUT CLAIM TO ANY PARTICULAR FONT, STYLE, SIZE, OR COLOR.

CLASS 38—COMMUNICATION

FOR TELECOMMUNICATIONS AND DATA COMMUNICATIONS SERVICES, NAMELY, PROVIDING ACCESS TO ON-LINE COMPUTER DATABASES IN THE FIELD OF TRANSPORTATION AND TRAVEL RESERVATIONS AND INFORMATION; ELECTRONIC DATA TRANSMISSION SERVICES; PROVIDING ACCESS TO GLOBAL TELECOMMUNICATIONS NETWORK FOR THE TRANSFER AND DISSEMINATION OF TRANSPORTATION AND TRAVEL INFORMATION (U.S. CLS. 100, 101 AND 104).
FIRST USE 3-31-2003; IN COMMERCE 3-31-2003.

CLASS 39—TRANSPORTATION AND STORAGE

FOR PROVIDING INFORMATION IN THE FIELD OF TRANSPORTATION RESERVATIONS AND PROVIDING TRANSPORTATION RESERVATION SERVICES BY MEANS OF GLOBAL COMPUTER NETWORKS AND GLOBAL TELECOMMUNICATIONS NETWORKS, PROVIDING ON-LINE DATABASES IN THE FIELD OF TRAVEL TRANSPORTATION (U.S. CLS. 100 AND 105).
FIRST USE 3-31-2003; IN COMMERCE 3-31-2003.

CLASS 43—HOTEL AND RESTAURANT SERVICES

FOR PROVIDING INFORMATION IN THE FIELD OF LODGING RESERVATIONS AND PROVIDING LODGING SERVICES BY MEANS OF GLOBAL COMPUTER NETWORKS AND GLOBAL TELECOMMUNICATIONS NETWORKS; PROVIDING ON-LINE DATABASES IN THE FIELD OF TRAVEL ACCOMMODATIONS (U.S. CLS. 100 AND 101).
FIRST USE 3-31-2003; IN COMMERCE 3-31-2003.
JEAN IM, EXAMINING ATTORNEY

SN 78-513,693. GSI COMMERCE SOLUTIONS, INC., KING OF PRUSSIA, PA. FILED 11-9-2004.

GSI COMMERCE

THE MARK CONSISTS OF STANDARD CHARACTERS WITHOUT CLAIM TO ANY PARTICULAR FONT, STYLE, SIZE, OR COLOR.

OWNER OF U.S. REG. NO. 2,900,595.
NO CLAIM IS MADE TO THE EXCLUSIVE RIGHT TO USE COMMERCE, APART FROM THE MARK AS SHOWN.

CLASS 35—ADVERTISING AND BUSINESS

FOR PRODUCT MERCHANDISING, NAMELY, PURCHASING AND MAINTAINING INVENTORY OF PRODUCTS FOR OTHERS; ORDER FULFILLMENT SERVICES; BUSINESS MARKETING CONSULTING SERVICES, NAMELY, PROVIDING BUSINESS ADVICE TO OTHERS IN DEVELOPING ONLINE RETAIL SITES AND DIRECT MARKETING RESPONSE BUSINESSES; CUSTOMER SERVICES IN THE FIELD OF RETAIL STORE SERVICES (U.S. CLS. 100, 101 AND 102).
FIRST USE 6-0-2002; IN COMMERCE 6-0-2002.

CLASS 42—SCIENTIFIC, COMPUTER AND LEGAL SERVICES

FOR DEVELOPMENT OF NEW TECHNOLOGY FOR OTHERS IN THE FIELD OF RETAIL STORE SERVICES (U.S. CLS. 100 AND 101).

FIRST USE 6-0-2002; IN COMMERCE 6-0-2002.
ANGELA M. MICHELI, EXAMINING ATTORNEY

CLASS 45—PERSONAL SERVICES

FOR ALARM RESPONSE AND VERIFICATION SERVICES (U.S. CLS. 100 AND 101).

FIRST USE 12-31-2000; IN COMMERCE 12-31-2000.
STACY WAHLBERG, EXAMINING ATTORNEY

SN 78-513,855. HOPE RIVER VENTURES, INC., GRAND RAPIDS, MI. FILED 11-9-2004.

**HOPE RIVER
VENTURES**

SN 78-514,667. CROWN EQUIPMENT CORPORATION, NEW BREMEN, OH. FILED 11-10-2004.

THE MARK CONSISTS OF STANDARD CHARACTERS WITHOUT CLAIM TO ANY PARTICULAR FONT, STYLE, SIZE, OR COLOR.

NO CLAIM IS MADE TO THE EXCLUSIVE RIGHT TO USE VENTURES, APART FROM THE MARK AS SHOWN.

CLASS 35—ADVERTISING AND BUSINESS

FOR BUSINESS CONSULTING SERVICES IN THE FIELD OF HEALTH SCIENCES SERVICES AND HEALTH SCIENCES PRODUCTS (U.S. CLS. 100, 101 AND 102).

CLASS 36—INSURANCE AND FINANCIAL

FOR VENTURE CAPITAL FUNDING SERVICES IN THE FIELD OF HEALTH SCIENCES SERVICES AND HEALTH SCIENCES PRODUCTS (U.S. CLS. 100, 101 AND 102).

JEFF DEFORD, EXAMINING ATTORNEY

**INTEGRITY PARTS
AND SERVICE
SYSTEM**

SN 78-514,362. INTEGRATED ALARM SERVICES GROUP, INC., ALBANY, NY. FILED 11-10-2004.

**WE KEEP BAD THINGS
FROM HAPPENING TO
GOOD PEOPLE**

THE MARK CONSISTS OF STANDARD CHARACTERS WITHOUT CLAIM TO ANY PARTICULAR FONT, STYLE, SIZE, OR COLOR.

NO CLAIM IS MADE TO THE EXCLUSIVE RIGHT TO USE "PARTS AND SERVICE SYSTEM", APART FROM THE MARK AS SHOWN.

CLASS 37—CONSTRUCTION AND REPAIR

FOR MAINTENANCE AND REPAIR OF MATERIAL LIFTING, TRANSPORTING, AND HANDLING EQUIPMENT (U.S. CLS. 100, 103 AND 106).

CLASS 42—SCIENTIFIC, COMPUTER AND LEGAL SERVICES

FOR INSPECTION SERVICES IN THE FIELD OF MATERIAL LIFTING, TRANSPORTING, AND HANDLING EQUIPMENT (U.S. CLS. 100 AND 101).

DAVID H. STINE, EXAMINING ATTORNEY

THE MARK CONSISTS OF STANDARD CHARACTERS WITHOUT CLAIM TO ANY PARTICULAR FONT, STYLE, SIZE, OR COLOR.

CLASS 37—CONSTRUCTION AND REPAIR

FOR FIRE AND/OR BURGLAR ALARM INSTALLATION AND/OR REPAIR (U.S. CLS. 100, 103 AND 106).

FIRST USE 12-31-2000; IN COMMERCE 12-31-2000.

SN 78-514,942. HURLEY INTERNATIONAL LLC, COSTA MESA, CA. FILED 11-10-2004.

SN 78-514,943. HURLEY INTERNATIONAL LLC, COSTA MESA, CA. FILED 11-10-2004.

HURLEY

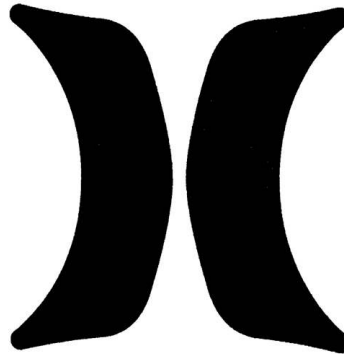

CLASS 9—ELECTRICAL AND SCIENTIFIC APPARATUS

FOR EYEWEAR, NAMELY, SPORTS EYEWEAR, EYEGLASSES, PRESCRIPTION EYEWEAR AND THEIR COMPONENT PARTS AND ACCESSORIES, NAMELY, FRAMES, EAR STEMS, NOSE PIECES, STRAPS, NECK CORDS AND HEAD STRAPS WHICH RESTRAIN EYEWEAR FROM MOVEMENT ON A WEARER; EYEWEAR CASES; EYEWEAR CHAINS; SUNGLASSES; PHONOGRAPH RECORDS AND COMPACT DISCS FEATURING MUSIC AND SPOKEN WORD; VIDEO TAPES AND DVDS FEATURING MUSIC, SPORTING EVENTS AND ENTERTAINMENT IN THE NATURE OF MUSIC PERFORMANCES, SPORTING ACTIVITIES AND DRAMATIC PERFORMANCES; CD CARRYING CASES; COMPUTER CARRYING CASES; COMPUTER GAME CARTRIDGES, DISCS AND PROGRAMS (U.S. CLS. 21, 23, 26, 36 AND 38).

CLASS 14—JEWELRY

FOR JEWELRY, ORNAMENTAL PINS, BROOCHES, CHARMS, WATCHES, WATCH CASES, WATCH STRAPS AND CLOCKS (U.S. CLS. 2, 27, 28 AND 50).

CLASS 35—ADVERTISING AND BUSINESS

FOR RETAIL AND ONLINE STORES FEATURING CLOTHING, HEADWEAR, FOOTWEAR, WETSUITS, LUGGAGE, BAGS, WATCHES, JEWELRY, COSMETICS, EYEWEAR, BEDDING AND BEDROOM ACCESSORIES, BOOKS, PRINTED MATTER, HOUSEHOLD ITEMS AND SPORTING GOODS (U.S. CLS. 100, 101 AND 102).
JEAN IM, EXAMINING ATTORNEY

THE MARK CONSISTS OF STANDARD CHARACTERS WITHOUT CLAIM TO ANY PARTICULAR FONT, STYLE, SIZE, OR COLOR.

OWNER OF U.S. REG. NOS. 2,334,509, 2,484,181 AND 2,780,274.
SEC. 2(F).

CLASS 14—JEWELRY

FOR JEWELRY, ORNAMENTAL PINS, BROOCHES, CHARMS, WATCHES, WATCH CASES, WATCH STRAPS AND CLOCKS (U.S. CLS. 2, 27, 28 AND 50).

CLASS 35—ADVERTISING AND BUSINESS

FOR RETAIL AND ONLINE STORES FEATURING CLOTHING, HEADWEAR, FOOTWEAR, WETSUITS, LUGGAGE, BAGS, WATCHES, JEWELRY, COSMETICS, EYEWEAR, BEDDING AND BEDROOM ACCESSORIES, BOOKS, PRINTED MATTER, HOUSEHOLD ITEMS AND SPORTING GOODS (U.S. CLS. 100, 101 AND 102).
JEAN IM, EXAMINING ATTORNEY

SN 78-515,049. NAME RITE, L.L.C., TEMECULA, CA. FILED 11-11-2004.

BEAUTY EXTRAS

THE MARK CONSISTS OF STANDARD CHARACTERS WITHOUT CLAIM TO ANY PARTICULAR FONT, STYLE, SIZE, OR COLOR.

NO CLAIM IS MADE TO THE EXCLUSIVE RIGHT TO USE "BEAUTY", APART FROM THE MARK AS SHOWN.

CLASS 16—PAPER GOODS AND PRINTED MATTER

FOR COUPONS FOR RETAIL COSMETICS AND BEAUTY PRODUCTS (U.S. CLS. 2, 5, 22, 23, 29, 37, 38 AND 50).

CLASS 35—ADVERTISING AND BUSINESS

FOR PROMOTING THE SALE OF COSMETICS AND BEAUTY PRODUCTS THROUGH SPECIAL PRICING DISCOUNTS, THE DISTRIBUTION OF COUPONS AND/OR MEMBERSHIP DISCOUNT CARDS, AND/OR THE ADMINISTRATION OF AN INCENTIVE AWARDS PROGRAM (U.S. CLS. 100, 101 AND 102).

CLASS 36—INSURANCE AND FINANCIAL

FOR PROVIDING REBATES ON THE PURCHASE OF COSMETICS AND BEAUTY PRODUCTS THROUGH THE USE OF A MEMBERSHIP CARD, SPECIAL PRICING REWARDS AND DISCOUNTS FEATURING COMBINATIONS OF SPECIFICALLY IDENTIFIED COMPLEMENTARY PRODUCTS (U.S. CLS. 100, 101 AND 102).

JENNIFER KRISP, EXAMINING ATTORNEY

SN 78-516,280. TURTLE WAX, INC., CHICAGO, IL. FILED 11-12-2004.

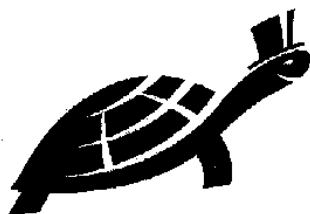

OWNER OF U.S. REG. NOS. 1,373,806, 2,859,973 AND OTHERS.

CLASS 3—COSMETICS AND CLEANING PREPARATIONS

FOR PREPARATIONS FOR CLEANING, SHINING AND PROTECTING LEATHER, RUBBER AND VINYL; PREPARATIONS FOR CLEANING, SHINING, PROTECTING, AND SEALING THE FINISHED SURFACES OF AUTOMOBILES; DEGREASING AND ALL-PURPOSE CLEANING PREPARATIONS; GLASS CLEANERS; PREPARATIONS FOR CLEANING, DEODORIZING AND PROTECTING CARPET, UPHOLSTERY AND OTHER CLOTH SURFACES; PREPARATIONS FOR CLEANING, SHINING AND PROTECTING VEHICLE WHEEL SURFACES (U.S. CLS. 1, 4, 6, 50, 51 AND 52).

CLASS 5—PHARMACEUTICALS

FOR PREPARATIONS FOR REMOVING ODORS FROM CARPET, UPHOLSTERY AND OTHER FABRIC; AIR FRESHENERS, AIR DEODORIZERS (U.S. CLS. 6, 18, 44, 46, 51 AND 52).

CLASS 18—LEATHER GOODS

FOR UMBRELLAS AND ALL-PURPOSE SPORTS BAGS (U.S. CLS. 1, 2, 3, 22 AND 41).

CLASS 21—HOUSEWARES AND GLASS

FOR VINYL AND LATEX GLOVES FOR CLEANING; CHAMOIS AND SYNTHETIC CHAMOIS FOR CLEANING; WOVEN, NON-WOVEN AND KNITTED CLEANING, WASHING AND POLISHING CLOTHS, TOWELS AND WIPES; AND ACRYLIC COTTON AND LAMB'S WOOL WASHING MITTS (U.S. CLS. 2, 13, 23, 29, 30, 33, 40 AND 50).

KAREN K. BUSH, EXAMINING ATTORNEY

SN 78-516,331. BYRNE, ROBERT W., HERMOSA BEACH, CA. FILED 11-12-2004.

ART TO BE SEEN

THE MARK CONSISTS OF STANDARD CHARACTERS WITHOUT CLAIM TO ANY PARTICULAR FONT, STYLE, SIZE, OR COLOR.

CLASS 25—CLOTHING

FOR CLOTHING, NAMELY MEN'S, WOMEN'S, AND CHILDREN'S T-SHIRTS, BASEBALL CAPS, SWEAT SHIRTS AND CASUAL OUTERWEAR, NAMELY, JACKETS AND COATS (U.S. CLS. 22 AND 39).

FIRST USE 8-20-2004; IN COMMERCE 8-20-2004.

CLASS 41—EDUCATION AND ENTERTAINMENT

FOR A WEBSITE FOR THE PRESENTATION OF WORKS OF VISUAL ART AND LITERATURE TO THE PUBLIC FOR CULTURAL, EDUCATIONAL AND ENTERTAINMENT PURPOSES (U.S. CLS. 100, 101 AND 107).

FIRST USE 5-1-2004; IN COMMERCE 5-1-2004.

HOWARD SMIGA, EXAMINING ATTORNEY

SN 78-516,502. ANTHONY, TOMAS C., BROOKLYN, NY. FILED 11-13-2004.

Everyday Athlete

THE MARK CONSISTS OF STANDARD CHARACTERS WITHOUT CLAIM TO ANY PARTICULAR FONT, STYLE, SIZE, OR COLOR.

NO CLAIM IS MADE TO THE EXCLUSIVE RIGHT TO USE ATHLETE, APART FROM THE MARK AS SHOWN.

CLASS 9—ELECTRICAL AND SCIENTIFIC APPARATUS

FOR BASED ON INTENT TO USE— PRE-RECORDED VIDEO DISKS, VIDEOTAPES, VIDEO CASSETTES, CDS AND DVDS PROVIDING INSTRUCTION ON PERSONAL TRAINING, ATHLETIC COACHING AND EXERCISE TECHNIQUES AND METHODOLOGY (U.S. CLS. 21, 23, 26, 36 AND 38).

SN 78-517,038. GRIEBAHN, LYNN, DAVENPORT, IA. FILED 11-15-2004.

CLASS 25—CLOTHING

FOR BASED ON INTENT TO USE— T-SHIRTS (U.S. CLS. 22 AND 39).

CLASS 41—EDUCATION AND ENTERTAINMENT

FOR BASED ON USE—PERSONAL TRAINING SERVICES, NAMELY, WEIGHT AND RESISTANCE, FLEXIBILITY, BALANCE AND STRENGTHENING MUSCULATURE (U.S. CLS. 100, 101 AND 107).

FIRST USE 1-1-1999; IN COMMERCE 1-1-2001.
H. M. FISHER, EXAMINING ATTORNEY

**THE FRIENDLY
DENTIST**

SN 78-516,908. COMPUTER SCIENCES CORPORATION, EL SEGUNDO, CA. FILED 11-15-2004.

RISK GRADIENT

THE MARK CONSISTS OF STANDARD CHARACTERS WITHOUT CLAIM TO ANY PARTICULAR FONT, STYLE, SIZE, OR COLOR.

NO CLAIM IS MADE TO THE EXCLUSIVE RIGHT TO USE "RISK", APART FROM THE MARK AS SHOWN.

CLASS 42—SCIENTIFIC, COMPUTER AND LEGAL SERVICES

FOR COMPUTER CONSULTATION IN THE FIELD OF COMPUTER SECURITY. (U.S. CLS. 100 AND 101).

CLASS 45—PERSONAL SERVICES

FOR MONITORING OF COMPUTER SYSTEMS FOR SECURITY PURPOSES. (U.S. CLS. 100 AND 101).
TINA L. SNAPP, EXAMINING ATTORNEY

THE MARK CONSISTS OF STANDARD CHARACTERS WITHOUT CLAIM TO ANY PARTICULAR FONT, STYLE, SIZE, OR COLOR.

NO CLAIM IS MADE TO THE EXCLUSIVE RIGHT TO USE "DENTIST", APART FROM THE MARK AS SHOWN.

CLASS 9—ELECTRICAL AND SCIENTIFIC APPARATUS

FOR VIDEO DISKS AND VIDEO TAPES WITH RECORDED ANIMATED CARTOONS (U.S. CLS. 21, 23, 26, 36 AND 38).

CLASS 16—PAPER GOODS AND PRINTED MATTER

FOR BOOKS, NAMELY, COLORING BOOKS AND CHILDREN'S BOOKS (U.S. CLS. 2, 5, 22, 23, 29, 37, 38 AND 50).

CLASS 25—CLOTHING

FOR WEARING APPAREL, NAMELY, T-SHIRTS (U.S. CLS. 22 AND 39).

CLASS 28—TOYS AND SPORTING GOODS

FOR TOYS, NAMELY, BALLOONS (U.S. CLS. 22, 23, 38 AND 50).

CLASS 35—ADVERTISING AND BUSINESS

FOR DIRECT MARKETING SERVICES IN THE FIELD OF DENTISTRY (U.S. CLS. 100, 101 AND 102).
YONG KIM, EXAMINING ATTORNEY

SN 78-517,191. FEITIAN TECHNOLOGIES CO., LTD., BEIJING, CHINA, FILED 11-15-2004.

SN 78-517,308. VISIONMOS INTERNATIONAL, INC., TEMPE, AZ. FILED 11-15-2004.



FEITIAN

CLASS 9—ELECTRICAL AND SCIENTIFIC APPARATUS

FOR COMPUTERS, COMPUTER HARDWARE; SEMICONDUCTORS; MICROPROCESSORS AND SEMICONDUCTOR DEVICES; INTEGRATED CIRCUITS; INTEGRATED CIRCUIT CHIPS; SEMICONDUCTOR PROCESSORS; SEMICONDUCTOR PROCESSOR CHIPS; MICROPROCESSOR CORES; MACRO CELLS; MICROCONTROLLERS BUS INTERFACES; PRINTED CIRCUIT BOARDS; ELECTRONIC CIRCUIT BOARDS; COMPUTER MEMORY DEVICES, NAMELY, COMPUTER MEMORY HARDWARE, COMPUTER MEMORY DRIVES, COMPUTER MEMORIES, MEMORY BOARDS, MEMORY CARDS, SOLID STATE MEMORY CARDS; SEMICONDUCTOR MEMORIES; COMPUTER CHIPSETS, NAMELY, FOR USE IN TRANSMITTING DATA TO AND FROM A CENTRAL PROCESSING UNIT, MULTIMEDIA DEVICES, AND DIGITAL CAMERAS; COMPUTER MOTHERBOARDS AND DAUGHTERBOARDS; MICROCOMPUTERS; SOFTWARE PROGRAMMABLE MICROPROCESSORS; COMPUTER PERIPHERALS; COMPUTER FIRMWARE, NAMELY, COMPUTER UTILITY SOFTWARE AND OTHER COMPUTER SOFTWARE USED TO MAINTAIN AND OPERATE COMPUTER SYSTEMS ALL STORED IN A COMPUTER'S READ-ONLY MEMORY (ROM) OR ELSEWHERE IN THE COMPUTER'S CIRCUITRY, AND OPERATING SYSTEM SOFTWARE; COMPUTER FIRMWARE FOR OPERATING AND MAINTAINING COMPUTER SYSTEMS, DIGITAL CAMERAS, DIGITAL VIDEO CAMERAS, PERSONAL MEDIA PLAYERS, PERSONAL RECORDING DEVICES, CELLULAR TELEPHONES, PDAS, AND COMPUTER PERIPHERAL DEVICES; ALL THE FOREGOING SOLD WITH OR WITHOUT USER MANUALS FOR USE THEREWITH AND PARTS THEREOF (U.S. CLS. 21, 23, 26, 36 AND 38).

THE MARK CONSISTS OF STANDARD CHARACTERS WITHOUT CLAIM TO ANY PARTICULAR FONT, STYLE, SIZE, OR COLOR.

CHINESE, "FEI" LITERALLY MEANS "FLY" AND "TIAN" MEANS "DAY" OR "SKY. BUT, "FEITIAN" ALSO IS THE NAME OF AN ANCIENT FLYING GODDESS EMBODYING TRUST IN CHINESE MYTHOLOGY.

CLASS 9—ELECTRICAL AND SCIENTIFIC APPARATUS

FOR SECURITY DEVICES USED FOR SOFTWARE PROTECTION, AUTHENTICATION, NAMELY, COMPUTER HARDWARE; SECURE APPLICATIONS, NAMELY, COMPUTER SOFTWARE FOR PROVIDING SECURITY AND PROTECTION FROM UNAUTHORIZED ACCESS (U.S. CLS. 21, 23, 26, 36 AND 38).

FIRST USE 8-31-2001; IN COMMERCE 8-31-2001.

CLASS 35—ADVERTISING AND BUSINESS

FOR RETAIL AND WHOLESALE DISTRIBUTORSHIPS FEATURING SECURITY DEVICES USED FOR SOFTWARE PROTECTION, AUTHENTICATION AND SECURE APPLICATIONS, AND SOFTWARE FOR USE WITH SUCH DEVICES (U.S. CLS. 100, 101 AND 102).

FIRST USE 8-31-2001; IN COMMERCE 8-31-2001.
THEODORE MCBRIDE, EXAMINING ATTORNEY

CLASS 42—SCIENTIFIC, COMPUTER AND LEGAL SERVICES

FOR TECHNICAL CONSULTATION IN THE FIELDS OF COMPUTERS AND SEMICONDUCTORS, CIRCUITS, CHIPSETS, CIRCUIT BOARD, PROCESSORS, COMPUTER FIRMWARE AND COMPUTER UTILITY SOFTWARE AND OTHER COMPUTER SOFTWARE USED TO MAINTAIN AND OPERATE COMPUTER SYSTEM; DESIGN OF COMPUTERS AND SEMICONDUCTORS, CIRCUITS, CHIPSETS, CIRCUIT BOARD, PROCESSOR, COMPUTER FIRMWARE AND COMPUTER UTILITY SOFTWARE AND OTHER COMPUTER SOFTWARE USED TO MAINTAIN AND OPERATE COMPUTER SYSTEM FOR OTHERS; COMPUTER SOFTWARE AND FIRMWARE DEVELOPMENT FOR OTHERS; SEMICONDUCTOR, CIRCUIT, CHIPSET, PROCESSOR, AND CIRCUIT BOARD DEVELOPMENT FOR OTHERS; COMPUTER SOFTWARE, COMPUTER FIRMWARE, COMPUTER HARDWARE AND COMPUTER COMPONENT DESIGN SERVICES; PRODUCT RESEARCH AND DEVELOPMENT, DESIGN FOR OTHERS, AND CONSULTATION IN THE AREAS OF COMPUTER HARDWARE AND COMPUTER COMPONENTS; TECHNICAL SUPPORT SERVICES IN THE FIELD OF COMPUTERS AND COMPUTER COMPONENTS, NAMELY, TROUBLESHOOTING OF COMPUTER HARDWARE, COMPUTER PERIPHERAL DEVICES, COMPUTER COMPONENTS, AND COMPUTER SOFTWARE PROBLEMS (U.S. CLS. 100 AND 101).

JEAN IM, EXAMINING ATTORNEY

SN 78-517,314. UPSELLUSA, INC., SEATTLE, WA. FILED 11-15-2004.



NO CLAIM IS MADE TO THE EXCLUSIVE RIGHT TO USE "UPSELL" AND "USA", APART FROM THE MARK AS SHOWN.

CLASS 35—ADVERTISING AND BUSINESS

FOR CONDUCTING INCENTIVE AWARD PROGRAMS TO PROMOTE EMPLOYEE LEARNING AND IMPROVE THE SALE OF PRODUCTS AND SERVICES OF OTHERS (U.S. CLS. 100, 101 AND 102).

FIRST USE 1-0-2002; IN COMMERCE 1-0-2002.

CLASS 42—SCIENTIFIC, COMPUTER AND LEGAL SERVICES

FOR PROVIDING TEMPORARY USE OF NON-DOWNLOADABLE SOFTWARE FOR USE IN CONDUCTING EMPLOYEE LEARNING PROGRAMS AND INCENTIVE AWARD PROGRAMS, FOR USE IN PROVIDING TRAINING AND EDUCATION IN THEIR USE, AND FOR USE OF INSTRUCTION MATERIALS THEREWITH (U.S. CLS. 100 AND 101).

FIRST USE 1-0-2002; IN COMMERCE 1-0-2002.

PAUL F. GAST, EXAMINING ATTORNEY

SN 78-517,373. VISTAR CORPORATION, CENTENNIAL, CO. FILED 11-16-2004.

LISA

THE MARK CONSISTS OF STANDARD CHARACTERS WITHOUT CLAIM TO ANY PARTICULAR FONT, STYLE, SIZE, OR COLOR.

THE NAME LISA DOES NOT IDENTIFY A LIVING INDIVIDUAL.

CLASS 3—COSMETICS AND CLEANING PREPARATIONS

FOR LIQUID SOAP (U.S. CLS. 1, 4, 6, 50, 51 AND 52).
FIRST USE 1-1-1970; IN COMMERCE 1-1-1970.

CLASS 29—MEATS AND PROCESSED FOODS

FOR PROCESSED CLAMS, PROCESSED ANCHOVIES, PROCESSED TOMATOES, CHEESE, GROUND BEEF, PROCESSED MEATS, PROCESSED PIGNOLI NUTS, OLIVE OIL, PROCESSED OLIVES, PROCESSED PEPPERS, PROCESSED EGGPLANT, PROCESSED MUSHROOMS, TOMATO PASTE, PROCESSED ARTICHOKE, GIARDINIERA, CANNED CHICK PEAS, CANNED KIDNEY BEANS, SAUSAGE, BACON, SHAVED STEAK AND FRESH AND FROZEN VEAL (U.S. CL. 46).

FIRST USE 1-1-1970; IN COMMERCE 1-1-1970.

CLASS 30—STAPLE FOODS

FOR SEASONINGS, BREAD CRUMBS, FLOUR, PASTA, SPICES, CAPERS, SPAGHETTI SAUCE, PIZZA SAUCE, VINEGAR, GNOCCHI, STUFFED SHELLS, LASAGNA AND MEATBALLS (U.S. CL. 46).

FIRST USE 1-1-1970; IN COMMERCE 1-1-1970.

MARGERY A. TIERNEY, EXAMINING ATTORNEY

SN 78-517,388. WBS HOCKEY LP, WILKES-BARRE, PA. FILED 11-16-2004.



NO CLAIM IS MADE TO THE EXCLUSIVE RIGHT TO USE "WILKES-BARRE SCRANTON", APART FROM THE MARK AS SHOWN.

THE STIPPLING IS FOR SHADING PURPOSES ONLY.

THE MARK CONSISTS OF A SKATING PENGUIN WITH A HOCKEY STICK IN A CIRCLE.

CLASS 18—LEATHER GOODS

FOR GYM BAGS; BACKPACKS (U.S. CLS. 1, 2, 3, 22 AND 41).

FIRST USE 1-0-1998; IN COMMERCE 1-0-1998.

CLASS 21—HOUSEWARES AND GLASS

FOR BEVERAGE GLASSWARE; TRAVEL MUGS (U.S. CLS. 2, 13, 23, 29, 30, 33, 40 AND 50).

FIRST USE 1-0-1998; IN COMMERCE 1-0-1998.

CLASS 25—CLOTHING

FOR CLOTHING, NAMELY, INFANT, MEN'S, WOMEN'S AND CHILDREN'S SWEATSHIRTS, T-SHIRTS, JACKETS AND COATS, SWEATERS, SWEATPANTS, HEADWEAR, NIGHTSHIRTS, SHORTS, PANTS, JERSEYS, SLEEPWEAR, SHIRTS, FOOTWEAR, SOCKS, TIES AND CLOTH BIBS (U.S. CLS. 22 AND 39).

FIRST USE 1-0-1998; IN COMMERCE 1-0-1998.

CLASS 28—TOYS AND SPORTING GOODS

FOR SPORTING EQUIPMENT, NAMELY GOLF BALLS, GOLF CLUBS, FLYING DISCS; HOCKEY EQUIPMENT, NAMELY HOCKEY STICKS, HOCKEY PUCKS, HOCKEY MASKS (U.S. CLS. 22, 23, 38 AND 50).
FIRST USE 1-0-1998; IN COMMERCE 1-0-1998.

CLASS 41—EDUCATION AND ENTERTAINMENT

FOR ENTERTAINMENT SERVICES IN THE NATURE OF PROFESSIONAL ICE HOCKEY EXHIBITIONS, GAMES, AND CONTESTS (U.S. CLS. 100, 101 AND 107).
FIRST USE 1-0-1998; IN COMMERCE 1-0-1998.
CHERYL CLAYTON, EXAMINING ATTORNEY

SN 78-517,409. WBS HOCKEY LP, WILKES-BARRE, PA.
FILED 11-16-2004.



NO CLAIM IS MADE TO THE EXCLUSIVE RIGHT TO USE "WILKES-BARRE SCRANTON", APART FROM THE MARK AS SHOWN.

THE STIPPLING IS FOR SHADING PURPOSES ONLY.
THE MARK CONSISTS OF A STYLIZED WILKES-BARRE SCRANTON PENGUINS.

CLASS 25—CLOTHING

FOR CLOTHING, NAMELY, INFANT, MEN'S, WOMEN'S AND CHILDREN'S SWEATSHIRTS, T-SHIRTS, JACKETS AND COATS, SWEATERS, SWEATPANTS, HEADWEAR, NIGHTSHIRTS, SHORTS, PANTS, JERSEYS, SLEEPWEAR, SHIRTS, FOOTWEAR, SOCKS, TIES AND CLOTH BIBS (U.S. CLS. 22 AND 39).
FIRST USE 1-0-1998; IN COMMERCE 1-0-1998.

SN 78-517,394. SURF LINE HAWAII, LTD., HONOLULU, HI.
FILED 11-16-2004.

CLASS 41—EDUCATION AND ENTERTAINMENT

FOR ENTERTAINMENT SERVICES IN THE NATURE OF PROFESSIONAL ICE HOCKEY EXHIBITIONS, GAMES, AND CONTESTS (U.S. CLS. 100, 101 AND 107).
FIRST USE 1-0-1998; IN COMMERCE 1-0-1998.
CHERYL CLAYTON, EXAMINING ATTORNEY

BUTT-CUTS

THE MARK CONSISTS OF STANDARD CHARACTERS WITHOUT CLAIM TO ANY PARTICULAR FONT, STYLE, SIZE, OR COLOR.
OWNER OF U.S. REG. NO. 987,415.

CLASS 18—LEATHER GOODS

FOR HANDBAGS (U.S. CLS. 1, 2, 3, 22 AND 41).
FIRST USE 1-0-2004; IN COMMERCE 1-0-2004.

CLASS 24—FABRICS

FOR TOWELS (U.S. CLS. 42 AND 50).
FIRST USE 1-0-2004; IN COMMERCE 1-0-2004.

CLASS 25—CLOTHING

FOR SHORTS, PANTS, SWIMWEAR, SHIRTS, JACKETS, T-SHIRTS, KNIT TOPS, DRESSES, HEADWEAR, HATS AND SLIPPERS (U.S. CLS. 22 AND 39).
FIRST USE 1-0-2004; IN COMMERCE 1-0-2004.
CHERYL CLAYTON, EXAMINING ATTORNEY

SN 78-517,416. PHANGUYEN, THINH, SANTA ANA, CA.
FILED 11-16-2004.

THE GAME FLOOR

THE MARK CONSISTS OF STANDARD CHARACTERS WITHOUT CLAIM TO ANY PARTICULAR FONT, STYLE, SIZE, OR COLOR.

NO CLAIM IS MADE TO THE EXCLUSIVE RIGHT TO USE "GAME", APART FROM THE MARK AS SHOWN.

CLASS 35—ADVERTISING AND BUSINESS

FOR RETAIL AND ONLINE RETAIL STORE SERVICES FEATURING VIDEO GAMES, VIDEO GAMES AND TRADES, NAMELY A TRADE IN PROGRAM IN WHICH CUSTOMERS CAN EXCHANGE OLD GAMES FOR NEW ONES (U.S. CLS. 100, 101 AND 102).
FIRST USE 9-23-2004; IN COMMERCE 4-9-2005.

CLASS 37—CONSTRUCTION AND REPAIR

FOR REPAIR SERVICES FOR VIDEO GAMES (U.S. CLS. 100, 103 AND 106).
FIRST USE 9-23-2004; IN COMMERCE 4-9-2005.
EUGENIA MARTIN, EXAMINING ATTORNEY

SN 78-517,860. THE KANALY COMPANY, HOUSTON, TX.
FILED 11-16-2004.

THE KANALY WAY

THE MARK CONSISTS OF STANDARD CHARACTERS WITHOUT CLAIM TO ANY PARTICULAR FONT, STYLE, SIZE, OR COLOR.

OWNER OF U.S. REG. NOS. 1,298,025 AND 1,299,919.

CLASS 36—INSURANCE AND FINANCIAL

FOR FINANCIAL SERVICES, NAMELY, PERSONAL FINANCIAL COUNSELING, INVESTMENT MANAGEMENT, TRUST AND ESTATE PLANNING AND ADMINISTRATION, GENERAL CASH FLOW MANAGEMENT AND INSURANCE ANALYSIS AND PLANNING SERVICES (U.S. CLS. 100, 101 AND 102).

FIRST USE 1-22-2003; IN COMMERCE 1-22-2003.

CLASS 41—EDUCATION AND ENTERTAINMENT

FOR EDUCATIONAL SERVICES, NAMELY, CONDUCTING SEMINARS IN THE FIELDS OF INVESTMENT PLANNING, TRUST AND ESTATE PLANNING, GENERAL CASH FLOW MANAGEMENT AND INSURANCE ANALYSIS AND PLANNING (U.S. CLS. 100, 101 AND 107).

FIRST USE 4-1-2003; IN COMMERCE 4-1-2003.

CHERYL CLAYTON, EXAMINING ATTORNEY

SN 78-518,189. POPULAR, INC., SAN JUAN, PUERTO RICO,
FILED 11-17-2004.



CLASS 35—ADVERTISING AND BUSINESS

FOR DATA MANAGEMENT AND PROCESSING SERVICES; BUSINESS MANAGEMENT SERVICES; BUSINESS RESEARCH AND EVALUATION SERVICES; OUTSOURCING SERVICES IN THE FIELD OF TECHNICAL OPERATIONS AND DATA; BUSINESS SERVICES, NAMELY FACILITIES MANAGEMENT OF TECHNICAL OPERATIONS; POINT OF SALE PROCESSING OF COMMERCIAL TRANSACTIONS; DATABASE PROCESSING FOR FINANCIAL INSTITUTIONS; TRANSACTION PROCESSING, NAMELY MEDICAL RECORD REPRODUCTION (U.S. CLS. 100, 101 AND 102).

FIRST USE 4-1-2004; IN COMMERCE 4-1-2004.

CLASS 36—INSURANCE AND FINANCIAL

FOR TRANSACTION PROCESSING, NAMELY, CREDIT CARDS, DEBIT CARDS, ATM, CHECK PROCESSING, MONEY TRANSFERS, INSURANCE BENEFIT PROCESSING, PAYMENT PROCESSING; PROCESSING AND AUTHORIZATION OF ELECTRONIC TRANSACTIONS FOR FINANCIAL INSTITUTIONS (U.S. CLS. 100, 101 AND 102).

FIRST USE 4-1-2004; IN COMMERCE 4-1-2004.

CLASS 38—COMMUNICATION

FOR PROVIDING ACCESS TO CUSTOMER INTERNAL TELECOMMUNICATIONS NETWORKS FROM REMOTE PROCESSING FACILITIES; TRANSACTION PROCESSING, NAMELY ELECTRONIC TRANSMISSION OF MEDICAL RECORDS VIA COMPUTER TERMINALS (U.S. CLS. 100, 101 AND 104).

FIRST USE 4-1-2004; IN COMMERCE 4-1-2004.

CLASS 42—SCIENTIFIC, COMPUTER AND LEGAL SERVICES

FOR INTEGRATION OF COMPUTER SYSTEMS AND NETWORKS; COMPUTER NETWORK MANAGEMENT AND TECHNICAL SUPPORT SERVICES, NAMELY DESIGN AND MAINTENANCE OF SOFTWARE; COMPUTER DISASTER RECOVERY PLANNING; TECHNICAL SUPPORT SERVICES FOR COMPUTER SYSTEMS AND NETWORKS, NAMELY TROUBLESHOOTING COMPUTER SYSTEMS AND NETWORKS AND PROVIDING BACK-UP COMPUTER FACILITIES; DATA CONVERSION OF COMPUTER PROGRAM DATA OR INFORMATION; COMPUTER SYSTEMS DESIGN AND ANALYSIS; IMPLEMENTATION OF COMPUTER SYSTEMS FOR BUSINESS APPLICATIONS; DESIGN OF VOICE SYSTEMS; CONSULTING SERVICES IN THE FIELD OF INFORMATION TECHNOLOGY (U.S. CLS. 100 AND 101).

FIRST USE 4-1-2004; IN COMMERCE 4-1-2004.

THEODORE MCBRIDE, EXAMINING ATTORNEY

SN 78-518,311. RC HOUSE, LLC., NEW YORK, NY. FILED 11-17-2004.

CENTRIA

THE MARK CONSISTS OF STANDARD CHARACTERS WITHOUT CLAIM TO ANY PARTICULAR FONT, STYLE, SIZE, OR COLOR.

CLASS 36—INSURANCE AND FINANCIAL

FOR REAL ESTATE SERVICES, NAMELY, LISTING RESIDENTIAL PROPERTY (U.S. CLS. 100, 101 AND 102).

CLASS 37—CONSTRUCTION AND REPAIR

FOR REAL ESTATE DEVELOPMENT AND CONSTRUCTION OF RESIDENTIAL PROPERTY (U.S. CLS. 100, 103 AND 106).

GEORGE LORENZO, EXAMINING ATTORNEY

SN 78-518,346. THE DANNON COMPANY, INC., WHITE PLAINS, NY. FILED 11-17-2004.

2XCALD

THE MARK CONSISTS OF STANDARD CHARACTERS WITHOUT CLAIM TO ANY PARTICULAR FONT, STYLE, SIZE, OR COLOR.

CLASS 29—MEATS AND PROCESSED FOODS

FOR YOGURT AND YOGURT-BASED BEVERAGES (U.S. CL. 46).

CLASS 32—LIGHT BEVERAGES

FOR FRUIT JUICES AND FRUIT DRINKS; FRUIT-BASED BEVERAGES WITH YOGURT; SMOOTHIES (U.S. CLS. 45, 46 AND 48).

SUNG IN, EXAMINING ATTORNEY

SN 78-518,579. DREAMWORKS ANIMATION L.L.C., GLENDALE, CA. FILED 11-17-2004.

CROOD AWAKENING

THE MARK CONSISTS OF STANDARD CHARACTERS WITHOUT CLAIM TO ANY PARTICULAR FONT, STYLE, SIZE, OR COLOR.

CLASS 9—ELECTRICAL AND SCIENTIFIC APPARATUS

FOR COMPUTER PERIPHERAL, NAMELY MOUSE PADS, HOLDERS FOR COMPACT DISCS, COMPUTER GAME CARTRIDGES, COMPUTER GAME CASSETTES, AND COMPUTER GAME TAPES; VIDEO GAME CARTRIDGES, VIDEO GAME CASSETTES; PRERECORDED AUDIO CASSETTES, PRERECORDED VIDEO CASSETTES, PRERECORDED AUDIO TAPES, PRERECORDED VIDEO TAPES, PRERECORDED DISCS FEATURING MUSIC AND MOTION PICTURE SOUND TRACKS; CD ROM AND DVD PROGRAMS FEATURING MUSIC AND MOTION PICTURE SOUND TRACKS; COMPUTER OPERATING SYSTEM SOFTWARE; PRERECORDED COMPUTER SOFTWARE PROGRAMS FEATURING MUSIC AND MOTION PICTURE SOUND TRACKS; INTERACTIVE MULTIMEDIA SOFTWARE PROGRAMS CONTAINING MOTION PICTURES FOR ENTERTAINMENT; INTERACTIVE MULTI-MEDIA SOFTWARE FOR PLAYING GAMES; MAGNETS AND SUNGLASSES (U.S. CLS. 21, 23, 26, 36 AND 38).

CLASS 16—PAPER GOODS AND PRINTED MATTER

FOR PAPER PARTY DECORATIONS; PAPER PARTY SUPPLIES; NAMELY, PAPER PARTY HATS, PAPER NAPKINS, PAPER PLACE MATS, GIFT WRAPPING PAPER AND GIFT WRAPPING RIBBONS, PAPER GIFT WRAP BOWS, PAPER TABLE CLOTHS AND PAPER PARTY BAGS; CHILDREN'S ACTIVITY BOOKS, CHILDREN'S STORYBOOKS, COMIC BOOKS, COLORING BOOKS, BOOK MARKS, LOOSE LEAF BINDERS, STATIONERY-TYPE PORTFOLIOS, SPIRAL BOUND NOTEBOOKS, NOTE PADS OR WRITING PADS, DIARIES, DAILY PLANNERS, CALENDARS, SCRAPBOOK ALBUMS, SKETCHBOOK ALBUMS, PHOTOGRAPH ALBUMS, STICKER ALBUMS, STICKERS, DECALS, STAMP PADS OR INKING PADS, RUBBER STAMPS, HEAT APPLIED APPLIQUES MADE OF PAPER, TEMPORARY TATTOOS, SLATE BOARDS FOR WRITING, PENCILS, PENS, PENCIL ERASERS, DECORATIVE PENCIL-TOP ORNAMENTS, PEN CASES AND PENCIL CASES, PEN BOXES AND PENCIL BOXES, PENCIL SHARPENERS, CHALK, MARKERS, POSTERS, POSTCARDS, TRADING CARDS, GREETING CARDS, PENNANTS MADE OF PAPER, PAINTING SETS FOR CHILDREN; ARTS AND CRAFTS PAINT KITS; STUDY KITS, CONSISTING OF PENCIL ERASERS, DRAWING RULERS, PENCIL SHARPENERS AND PENCIL CASE; STATIONERY PACKS CONSISTING OF WRITING PAPER, ENVELOPES, MARKERS, AND STENCILS; AND ACTIVITY KITS CONSISTING OF STICKERS AND RUBBER STAMPS (U.S. CLS. 2, 5, 22, 23, 29, 37, 38 AND 50).

CLASS 25—CLOTHING

FOR SHIRTS AND TOPS, DRESSES, SKIRTS, PANTS, TROUSERS, JEANS, SHORTS, ROMPERS, OVERALLS, SWEATSHIRTS AND SWEAT PANTS, SWEATSUITS, CAPS AND HATS, GLOVES, SUSPENDERS, TIES, COATS AND JACKETS, HOSIERY, SHOES, BOOTS, SLIPPERS, PAJAMAS, ROBES, SLEEPSHIRTS, SLEEPWEAR, UNDERWEAR, HALLOWEEN COSTUMES, AND CLOTH BABY BIBS (U.S. CLS. 22 AND 39).

CLASS 28—TOYS AND SPORTING GOODS

FOR ACTION FIGURES AND ACCESSORIES THEREFOR, BATHTUB TOYS, KITES, TOY BUILDING BLOCKS, BOARD GAMES, COSTUME MASKS, HANDHELD UNIT FOR PLAYING ELECTRONIC GAMES, DIE CAST MINIATURE TOY VEHICLES, DOLLS, DOLL ACCESSORIES, DOLL CLOTHING, BEAN BAG DOLLS, BENDABLE PLAY FIGURES, FLYING DISCS, INFLATABLE VINYL PLAY FIGURES, JIGSAW PUZZLES, MARBLES, PLUSH TOYS, PUPPETS, RIDE-ON TOYS, SKATEBOARDS, BALLOONS, ROLLERSKATES, TOY BANKS, WATER SQUIRTING TOYS, STUFFED TOYS, TOY VEHICLES, CHRISTMAS TREE ORNAMENTS; PINBALL MACHINES AND MODEL CRAFT KITS OF TOY FIGURES; AND PLAYING CARDS (U.S. CLS. 22, 23, 38 AND 50).

KELLY CHOE, EXAMINING ATTORNEY

SN 78-518,671. BECKSON MANUFACTURING, INC.,
BRIDGEPORT, CT. FILED 11-17-2004.

SN 78-518,822. RICHMONT CORPORATION, PLANO, TX.
FILED 11-17-2004.

BECKSON

RICHMONT

THE MARK CONSISTS OF STANDARD CHARACTERS
WITHOUT CLAIM TO ANY PARTICULAR FONT, STYLE,
SIZE, OR COLOR.

OWNER OF U.S. REG. NO. 2,482,841.

CLASS 35—ADVERTISING AND BUSINESS

FOR PROFESSIONAL BUSINESS CONSULTING; BUSI-
NESS MANAGEMENT AND CONSULTATION RELATED
THERE TO (U.S. CLS. 100, 101 AND 102).

FIRST USE 7-1-1989; IN COMMERCE 7-1-1989.

CLASS 36—INSURANCE AND FINANCIAL

FOR FINANCIAL CONSULTATIONS (U.S. CLS. 100,
101 AND 102).

FIRST USE 7-1-1989; IN COMMERCE 7-1-1989.
INGRID C. EULIN, EXAMINING ATTORNEY

THE MARK CONSISTS OF STANDARD CHARACTERS
WITHOUT CLAIM TO ANY PARTICULAR FONT, STYLE,
SIZE, OR COLOR.

OWNER OF U.S. REG. NO. 2,195,309.

SN 78-518,840. SHEPLEY WOOD PRODUCTS, INC., HYAN-
NIS, MA. FILED 11-17-2004.

CLASS 6—METAL GOODS

FOR ALUMINUM CUP HOLDERS (U.S. CLS. 2, 12, 13,
14, 23, 25 AND 50).

FIRST USE 7-0-2004; IN COMMERCE 7-0-2004.

CLASS 12—VEHICLES

FOR CUP HOLDERS FOR USE IN VEHICLES AND
RECREATIONAL BOATS; PLASTIC DECK PLATES,
DRAIN PORTS AND HATCHES FOR CONCEALING
HOLES IN VEHICLES AND RECREATIONAL BOATS
(U.S. CLS. 19, 21, 23, 31, 35 AND 44).

FIRST USE 10-0-1968; IN COMMERCE 10-0-1968.

**IF YOUR BUILDER
ISN'T USING
SHEPLEY, PLEASE
ASK WHY!**

CLASS 19—NON-METALLIC BUILDING MA- TERIALS

FOR NON-METAL WINDOWS, NON-METAL WIN-
DOW FRAMES, NON-METAL WINDOW SCREENS,
AND NON-METAL EXTERIOR WINDOW SHADES (U.S.
CLS. 1, 12, 33 AND 50).

FIRST USE 10-0-1972; IN COMMERCE 10-0-1972.

THE MARK CONSISTS OF STANDARD CHARACTERS
WITHOUT CLAIM TO ANY PARTICULAR FONT, STYLE,
SIZE, OR COLOR.

CLASS 20—FURNITURE AND ARTICLES NOT OTHERWISE CLASSIFIED

FOR NON-METAL LACING HOOKS AND NON-ME-
TAL EYE STRAPS FOR USE IN FASTENING (U.S. CLS.
2, 13, 22, 25, 32 AND 50).

FIRST USE 7-0-2004; IN COMMERCE 7-0-2004.
LINDA M. KING, EXAMINING ATTORNEY

CLASS 35—ADVERTISING AND BUSINESS

FOR WHOLESALE AND RETAIL STORE SERVICES
FEATURING BUILDING MATERIALS, CONSTRU-
TION MATERIALS AND LUMBER (U.S. CLS. 100, 101
AND 102).

FIRST USE 4-3-1997; IN COMMERCE 4-3-1997.

CLASS 37—CONSTRUCTION AND REPAIR

FOR INSTALLATION, MAINTENANCE AND REPAIR OF WINDOWS AND DOORS (U.S. CLS. 100, 103 AND 106).

FIRST USE 4-3-1997; IN COMMERCE 4-3-1997.
BARBARA BROWN, EXAMINING ATTORNEY

SN 78-518,981. QUILES, RANDY, BROOKLYN, NY. FILED 11-18-2004.

REBELUTION DESIGNS

THE MARK CONSISTS OF STANDARD CHARACTERS WITHOUT CLAIM TO ANY PARTICULAR FONT, STYLE, SIZE, OR COLOR.

NO CLAIM IS MADE TO THE EXCLUSIVE RIGHT TO USE "DESIGNS", APART FROM THE MARK AS SHOWN.

CLASS 25—CLOTHING

FOR MEN'S, WOMEN'S AND CHILDREN'S CLOTHING, NAMELY, SHIRTS, SWEAT SHIRTS, T-SHIRTS, HALTERS, BLOUSES, CAMISOLES, SWEATERS, BLOUSES, VESTS, JEANS, SWEATPANTS, SLACKS, SHORTS, SKIRTS, DRESSES, SUITS, COATS, PARKAS, JACKETS, BLAZERS, SPORTS JACKETS, BATHING TRUNKS, BATHING SUITS, LINGERIE, SLEEPWEAR, HOSIERY, BELTS, NECKTIES, SCARVES, HEADBANDS, HATS, VISORS, CAPS, WRISTBANDS, SOCKS, SHOES, ATHLETIC SHOES, BOOTS AND SANDALS; UNDERGARMENTS, NAMELY, PANTIES, BRAS, BRIEFS (U.S. CLS. 22 AND 39).

FIRST USE 5-1-2002; IN COMMERCE 8-30-2002.

CLASS 35—ADVERTISING AND BUSINESS

FOR PROMOTIONAL, ADVERTISING AND MARKETING SERVICES, NAMELY PROMOTING THE SALE OF THE GOODS AND SERVICES OF OTHERS THROUGH THE DISTRIBUTION OF PRINTED AND BRANDED ADVERTISING MATERIALS, VIA THE INTERNET, DISTRIBUTION OF PRODUCT SAMPLES AND COUPONS, CONDUCTING PROMOTIONAL EVENTS AND CONTESTS, PLACEMENT OF ADVERTISING ON BEHALF OF OTHERS (U.S. CLS. 100, 101 AND 102).

PATRICIA EVANKO, EXAMINING ATTORNEY

SN 78-519,000. ROCUS, INC., ALTADENA, CA. FILED 11-18-2004.

MOJO ENERGY DRINK

THE MARK CONSISTS OF STANDARD CHARACTERS WITHOUT CLAIM TO ANY PARTICULAR FONT, STYLE, SIZE, OR COLOR.

NO CLAIM IS MADE TO THE EXCLUSIVE RIGHT TO USE "ENERGY DRINK", APART FROM THE MARK AS SHOWN.

CLASS 25—CLOTHING

FOR CLOTHING, NAMELY PULLOVERS, CARDIGANS, SWEATERS, TROUSERS, SKIRTS, JACKETS, BLOUSES, SHIRTS, JEANS, SWEATPANTS, SHORTS, SWEATSHIRTS, SUITS, DRESSES, OVERCOATS, COATS, RAINCOATS, BELTS, JERSEYS, NECKWEAR, SOCKS AND STOCKINGS, TIGHTS, VESTS, WAISTCOATS, JUMPERS, TRACKSUITS, OVERALLS, BLOUSONS, GYM SUITS, KNICKERS, T-SHIRTS, ANORAKS, SUSPENDERS, LOUNGEWEAR, UNDERWEAR, BEACHWEAR, SLEEPWEAR, HEADWEAR, HATS, CAPS, SCARVES, GLOVES, SHOES, SANDALS, BOOTS AND SLIPPERS (U.S. CLS. 22 AND 39).

CLASS 32—LIGHT BEVERAGES

FOR MINERAL AND AERATED WATERS AND OTHER NON-ALCOHOLIC DRINKS, NAMELY, CARBONATED BEVERAGES; FRUIT DRINKS AND FRUIT JUICES; SYRUPS FOR BEVERAGES (U.S. CLS. 45, 46 AND 48).

CHERYL CLAYTON, EXAMINING ATTORNEY

SN 78-519,043. DIAGEO NORTH AMERICA, INC., NORWALK, CT. FILED 11-18-2004.

**SMIRNOFF SELECT
NO. 64**

THE MARK CONSISTS OF STANDARD CHARACTERS WITHOUT CLAIM TO ANY PARTICULAR FONT, STYLE, SIZE, OR COLOR.

OWNER OF U.S. REG. NOS. 513,428, 2,869,402 AND OTHERS.

CLASS 32—LIGHT BEVERAGES

FOR BREWED MALT-BASED ALCOHOLIC BEVERAGE IN THE NATURE OF A BEER (U.S. CLS. 45, 46 AND 48).

CLASS 33—WINES AND SPIRITS

FOR FLAVORED BREWED MALT BEVERAGE (U.S. CLS. 47 AND 49).

WON TEAK OH, EXAMINING ATTORNEY

SN 78-519,045. DIAGEO NORTH AMERICA, INC., NORWALK, CT. FILED 11-18-2004.

SMIRNOFF SELECT

THE MARK CONSISTS OF STANDARD CHARACTERS WITHOUT CLAIM TO ANY PARTICULAR FONT, STYLE, SIZE, OR COLOR.

OWNER OF U.S. REG. NOS. 513,428, 2,869,402 AND OTHERS.

CLASS 32—LIGHT BEVERAGES

FOR BREWED MALT-BASED ALCOHOLIC BEVERAGE IN THE NATURE OF A BEER (U.S. CLS. 45, 46 AND 48).

CLASS 33—WINES AND SPIRITS

FOR FLAVORED BREWED MALT BEVERAGE (U.S. CLS. 47 AND 49).
WON TEAK OH, EXAMINING ATTORNEY

SN 78-519,046. DIAGEO NORTH AMERICA, INC., NORWALK, CT. FILED 11-18-2004.

CLASS 35—ADVERTISING AND BUSINESS

FOR WHOLESALE DISTRIBUTORSHIP SERVICES IN THE FIELDS OF BUILDING PRODUCTS, CHEMICALS, CONSUMER PRODUCTS, COMMERCIAL PRODUCTS, FOOD SERVICE PRODUCTS, PAPER PRODUCTS, PACKAGING AND PAPERBOARD (U.S. CLS. 100, 101 AND 102).

CLASS 40—MATERIAL TREATMENT

FOR CUSTOM MANUFACTURE OF BUILDING PRODUCTS, CHEMICALS, CONSUMER PRODUCTS, COMMERCIAL PRODUCTS, FOOD SERVICE PRODUCTS, PAPER PRODUCTS, PACKAGING AND PAPERBOARD TO THE ORDER AND/OR SPECIFICATION OF OTHERS (U.S. CLS. 100, 103 AND 106).

CHRISTOPHER ADKINS, EXAMINING ATTORNEY

NO. 64

SN 78-519,133. GANNETT FLEMING, INC., CAMP HILL, PA. FILED 11-18-2004.

THE MARK CONSISTS OF STANDARD CHARACTERS WITHOUT CLAIM TO ANY PARTICULAR FONT, STYLE, SIZE, OR COLOR.

CLASS 32—LIGHT BEVERAGES

FOR BREWED MALT-BASED ALCOHOLIC BEVERAGE IN THE NATURE OF A BEER (U.S. CLS. 45, 46 AND 48).

CLASS 33—WINES AND SPIRITS

FOR FLAVORED BREWED MALT BEVERAGE (U.S. CLS. 47 AND 49).
WON TEAK OH, EXAMINING ATTORNEY

SN 78-519,078. GEORGIA-PACIFIC CORPORATION, ATLANTA, GA. FILED 11-18-2004.

RESOURCEFUL BY NATURE

THE MARK CONSISTS OF STANDARD CHARACTERS WITHOUT CLAIM TO ANY PARTICULAR FONT, STYLE, SIZE, OR COLOR.

**CLASS 9—ELECTRICAL AND SCIENTIFIC APPARATUS**

FOR COMPUTER SOFTWARE FOR USE IN THE FIELD OF CRIME ANALYSIS AND MAPPING (U.S. CLS. 21, 23, 26, 36 AND 38).

FIRST USE 7-19-2004; IN COMMERCE 8-9-2004.

CLASS 42—SCIENTIFIC, COMPUTER AND LEGAL SERVICES

FOR PROVIDING TEMPORARY ACCESS TO NON-DOWNLOADABLE SOFTWARE FOR PURPOSES OF CRIME ANALYSIS AND MAPPING (U.S. CLS. 100 AND 101).

FIRST USE 7-19-2004; IN COMMERCE 8-9-2004.
SUNG IN, EXAMINING ATTORNEY

SN 78-519,158. SYMRISE GMBH & CO. KG, HOLZMINDEN,
FED REP GERMANY, FILED 11-18-2004.

SYMCAP

THE MARK CONSISTS OF STANDARD CHARACTERS
WITHOUT CLAIM TO ANY PARTICULAR FONT, STYLE,
SIZE, OR COLOR.

OWNER OF U.S. REG. NO. 2,921,802.

CLASS 2—PAINTS

FOR PROCESSED NATURAL RESINS FOR USE AS A
FRAGRANCE (U.S. CLS. 6, 11 AND 16).

CLASS 3—COSMETICS AND CLEANING PRE- PARATIONS

FOR PERFUMERY; ESSENTIAL OILS FOR PERSONAL
AND HOUSEHOLD USE; ESSENTIAL OILS FOR
USE IN THE MANUFACTURE OF SCENTED PRODUCTS;
SCENTS AND PERFUME SUBSTANCES FOR
LAUNDRY USE, NAMELY, DETERGENTS, BLEACHES
AND FABRIC SOFTENERS; BODY SOAPS; COSMETICS;
HAIR LOTIONS; DENTIFRICES; NON-MEDICATED
MOUTH CARE PRODUCTS, NAMELY, TOOTHPASTE
AND MOUTHWASH (U.S. CLS. 1, 4, 6, 50, 51 AND 52).

MARCIE MILONE, EXAMINING ATTORNEY

SN 78-519,202. DYNAL BIOTECH LLC, BROWN DEER, WI,
FILED 11-18-2004.

DYNAPLEX

THE MARK CONSISTS OF STANDARD CHARACTERS
WITHOUT CLAIM TO ANY PARTICULAR FONT, STYLE,
SIZE, OR COLOR.

CLASS 1—CHEMICALS

FOR DIAGNOSTIC PREPARATIONS FOR SCIENTIFIC
OR RESEARCH USE (U.S. CLS. 1, 5, 6, 10, 26 AND 46).
FIRST USE 8-31-2004; IN COMMERCE 8-31-2004.

CLASS 5—PHARMACEUTICALS

FOR DIAGNOSTIC PREPARATIONS FOR CLINICAL
OR MEDICAL LABORATORY USE (U.S. CLS. 6, 18, 44,
46, 51 AND 52).

FIRST USE 8-31-2004; IN COMMERCE 8-31-2004.

ANNE MADDEN, EXAMINING ATTORNEY

SN 78-519,553. ADKISON, TONY LEE, MANSFIELD, TX,
AND TAYLOR, RICKY LEE, MANSFIELD, TX. FILED 11-
18-2004.

DEER PANTS

THE MARK CONSISTS OF STANDARD CHARACTERS
WITHOUT CLAIM TO ANY PARTICULAR FONT, STYLE,
SIZE, OR COLOR.

NO CLAIM IS MADE TO THE EXCLUSIVE RIGHT TO
USE "PANTS", APART FROM THE MARK AS SHOWN.

CLASS 16—PAPER GOODS AND PRINTED MATTER

FOR PRINTED MATTER, NAMELY, EDUCATIONAL
BROCHURES, PAMPHLETS, BOOKS AND TRAINING
MANUALS FOR USE IN HOMES, CHURCHES AND
CONFERENCES FOCUSING ON SPIRITUAL TOPICS
(U.S. CLS. 2, 5, 22, 23, 29, 37, 38 AND 50).

CLASS 25—CLOTHING

FOR CLOTHING, NAMELY JACKETS, SWEATSHIRTS
AND SWEAT PANTS, SWEATERS, TEE-SHIRTS, GOLF
SHIRTS, POLO SHIRTS AND CAPS (U.S. CLS. 22 AND
39).

MIDGE BUTLER, EXAMINING ATTORNEY

SN 78-519,579. LISA SEVERINO BEAUTY ELEMENTS, LLC,
CHERRY HILL, NJ. FILED 11-18-2004.

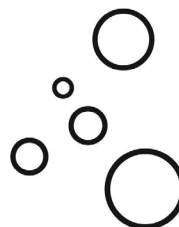

color elements

NO CLAIM IS MADE TO THE EXCLUSIVE RIGHT TO
USE "COLOR", APART FROM THE MARK AS SHOWN.

THE MARK CONSISTS OF THE LITERAL ELEMENT
AND A GROUP OF CIRCLES.

CLASS 3—COSMETICS AND CLEANING PREPARATIONS

FOR MAKEUP, NAMELY, EYE MAKEUP, LIP MAKEUP, AND SKIN MAKEUP (U.S. CLS. 1, 4, 6, 50, 51 AND 52).

CLASS 44—MEDICAL, BEAUTY AND AGRICULTURAL SERVICES

FOR BEAUTY SERVICES, NAMELY, MAKEUP APPLICATION FOR OTHERS AND PROVIDING INFORMATION ABOUT MAKEUP APPLICATION (U.S. CLS. 100 AND 101).

ELLEN BURNS, EXAMINING ATTORNEY

SN 78-519,603. DOWN NARA CO., LTD, SEOUL, REPUBLIC OF KOREA, FILED 11-18-2004.

GELPIA

SN 78-519,598. CDW CORPORATION, VERNON HILLS, IL. FILED 11-18-2004.

CDW SOLUTIONEDGE

THE MARK CONSISTS OF STANDARD CHARACTERS WITHOUT CLAIM TO ANY PARTICULAR FONT, STYLE, SIZE, OR COLOR.

OWNER OF U.S. REG. NOS. 1,649,113, 1,741,908 AND OTHERS.

CLASS 35—ADVERTISING AND BUSINESS

FOR MARKETING AND PROMOTING THE CONSULTING SERVICES OF OTHERS IN THE FIELD OF DESIGN, SELECTION, IMPLEMENTATION, AND USE OF ELECTRONIC EQUIPMENT, COMPUTER HARDWARE, AND RELATED PERIPHERAL DEVICES THROUGH SALES AGENTS; INVENTORY MANAGEMENT SERVICES IN THE FIELD OF ELECTRONIC EQUIPMENT, COMPUTER HARDWARE, AND RELATED PERIPHERAL DEVICES; RETAIL AND WHOLESALE STORE SERVICES, AND MAIL ORDER SERVICES FEATURING ELECTRONIC EQUIPMENT AND COMPUTER SOFTWARE, AND RETAIL SERVICES BY DIRECT SOLICITATION THROUGH SALES AGENTS AND THROUGH THE INTERNET FOR ELECTRONIC EQUIPMENT, COMPUTER SOFTWARE, COMPUTER HARDWARE, AND RELATED PERIPHERAL DEVICES (U.S. CLS. 100, 101 AND 102).

FIRST USE 10-12-2004; IN COMMERCE 10-12-2004.

CLASS 37—CONSTRUCTION AND REPAIR

FOR INSTALLATION, MAINTENANCE, REPAIR, AND UPGRADE OF ELECTRONIC EQUIPMENT, COMPUTER HARDWARE, AND RELATED PERIPHERAL DEVICES (U.S. CLS. 100, 103 AND 106).

FIRST USE 10-12-2004; IN COMMERCE 10-12-2004.

CLASS 42—SCIENTIFIC, COMPUTER AND LEGAL SERVICES

FOR CUSTOMIZATION OF COMPUTER HARDWARE AND SOFTWARE; INSTALLATION OF COMPUTER SOFTWARE; TECHNICAL SUPPORT SERVICES, NAMELY, TROUBLESHOOTING OF COMPUTER HARDWARE AND OPERATING SYSTEM PROBLEMS (U.S. CLS. 100 AND 101).

FIRST USE 10-12-2004; IN COMMERCE 10-12-2004.
MICHAEL KEATING, EXAMINING ATTORNEY

THE MARK CONSISTS OF STANDARD CHARACTERS WITHOUT CLAIM TO ANY PARTICULAR FONT, STYLE, SIZE, OR COLOR.

CLASS 24—FABRICS

FOR STITCHED COMFORTERS, DUVETS, MATTRESS COVERS, BED SHEETS, BED BLANKETS, PILLOW CASES, UNDER QUILTS, QUILT COVERS, COMFORTERS, COMFORTER COVERS, BED COVERS AND CUSHION COVERS (U.S. CLS. 42 AND 50).

CLASS 25—CLOTHING

FOR CLOTHING, NAMELY, SHIRTS, PANTS, SHORTS, SKIRTS, JACKETS, T-SHIRTS, COATS, SWEATSHIRTS, SWEATPANTS, UNDERSHIRTS, UNDERPANTS AND SUITS; HATS AND CAPS; AND SOCKS (U.S. CLS. 22 AND 39).

WILLIAM BRECKENFELD, EXAMINING ATTORNEY

SN 78-519,645. BRIDON CORDAGE LLC, ALBERT LEA, MN. FILED 11-18-2004.

ANYTHING LESS WILL COST YOU MORE

THE MARK CONSISTS OF STANDARD CHARACTERS WITHOUT CLAIM TO ANY PARTICULAR FONT, STYLE, SIZE, OR COLOR.

CLASS 17—RUBBER GOODS

FOR PLASTIC FILM, PLASTIC SHEETING AND PLASTIC WRAP FOR AGRICULTURAL, HORTICULTURAL, INDUSTRIAL AND COMMERCIAL USES, NAMELY, FOR SECURING, WRAPPING, BALING, AND BINDING AGRICULTURAL MATERIALS SUCH AS HAY, GRASSES, FORAGE, STRAW, OTHER AGRICULTURAL CROPS, OTHER PLANTS, FRUITS, VEGETABLES AND OTHER FIBROUS MATERIALS, FOR PROVIDING SHADE, WIND PROTECTION, BIRD AND RODENT PROTECTION, SHELTER AND COVERING FOR AGRICULTURAL MATERIALS SUCH AS HAY, GRASSES, FORAGE, STRAW, OTHER AGRICULTURAL CROPS, OTHER PLANTS, FRUITS, VEGETABLES AND OTHER FIBROUS MATERIALS, FOR PREVENTING WEED GROWTH, FOR USE IN LANDSCAPING, LAWN CARE AND GARDENING, AND FOR USE IN DRAINAGE OF FLUIDS AND SOIL STABILIZATION; PLASTIC FILM, PLASTIC SHEETING AND PLASTIC WRAP FOR PROVIDING SHADE, WIND PROTECTION, BIRD AND RODENT PROTECTION, SHELTER AND COVERING FOR AGRICULTURAL MATERIALS SUCH AS HAY, GRASSES, FORAGE, STRAW, OTHER AGRICULTURAL CROPS, OTHER PLANTS, FRUITS, VEGETABLES AND OTHER FIBROUS MATERIALS (U.S. CLS. 1, 5, 12, 13, 35 AND 50).

CLASS 22—CORDAGE AND FIBERS

FOR ROPES, CORDAGE, TWINE, BALING TWINE, TYING TWINE, POLYPROPYLENE BALER TWINE, SISAL TWINE, BALER AND BINDER TWINE, TEXTILE FIBERS AND STRING; PLASTIC AND ELASTIC NETTING USED FOR AGRICULTURAL, HORTICULTURAL, INDUSTRIAL AND COMMERCIAL USE, NAMELY, FOR SECURING, WRAPPING, BALING, AND BINDING AGRICULTURAL MATERIALS SUCH AS HAY, GRASSES, FORAGE, STRAW, OTHER AGRICULTURAL CROPS, OTHER PLANTS, FRUITS, VEGETABLES AND OTHER FIBROUS MATERIALS, FOR PROVIDING SHADE, WIND PROTECTION, BIRD AND RODENT PROTECTION, SHELTER AND COVERING FOR AGRICULTURAL MATERIALS SUCH AS HAY, GRASSES, FORAGE, STRAW, OTHER AGRICULTURAL CROPS, OTHER PLANTS, FRUITS, VEGETABLES AND OTHER FIBROUS MATERIALS, FOR PREVENTING WEED GROWTH, FOR USE IN LANDSCAPING, LAWN CARE AND GARDENING, AND FOR USE IN DRAINAGE OF FLUIDS AND SOIL STABILIZATION; PROTECTIVE NETTING AND MESH, NAMELY, PROTECTIVE NETTING AND MESH MADE OF PLASTIC FOR PROVIDING SHADE, WIND PROTECTION, BIRD AND RODENT PROTECTION, SHELTER AND COVERING FOR AGRICULTURAL MATERIALS SUCH AS HAY, GRASSES, FORAGE, STRAW, OTHER AGRICULTURAL CROPS, OTHER PLANTS, FRUITS, VEGETABLES AND OTHER FIBROUS MATERIALS; PALLET NETTING, NAMELY, PALLET NETTING MADE OF PLASTIC USED TO SECURE CARGO ONTO PALLETS; PLASTIC BAGS USED FOR STORING AGRICULTURAL MATERIALS SUCH AS HAY, GRASSES, FORAGE, STRAW, OTHER AGRICULTURAL CROPS, OTHER PLANTS, FRUITS, VEGETABLES AND OTHER FIBROUS MATERIALS (U.S. CLS. 1, 2, 7, 19, 22, 42 AND 50).

ROBERT LAVACHE, EXAMINING ATTORNEY

SN 78-519,749. SHAREBUILDER CORPORATION, BELLEVUE, WA. FILED 11-18-2004.

SHAREBUILDER INVESTOR STARTER KIT

THE MARK CONSISTS OF STANDARD CHARACTERS WITHOUT CLAIM TO ANY PARTICULAR FONT, STYLE, SIZE, OR COLOR.

OWNER OF U.S. REG. NO. 2,488,646.

NO CLAIM IS MADE TO THE EXCLUSIVE RIGHT TO USE "INVESTOR STARTER KIT", APART FROM THE MARK AS SHOWN.

CLASS 16—PAPER GOODS AND PRINTED MATTER

FOR INVESTOR STARTER KIT CONSISTING OF A COUPON REDEEMABLE FOR OPENING INVESTMENT ACCOUNTS, AN INVESTOR GUIDE BOOKS PUBLISHED BY OTHERS, AND PRE-PAID SUBSCRIPTIONS TO INVESTMENT PUBLICATIONS OF OTHERS, DISTRIBUTED AS A UNIT IN A SINGLE GIFT BOX, TO FACILITATE THE OPENING OF INVESTMENT ACCOUNTS (U.S. CLS. 2, 5, 22, 23, 29, 37, 38 AND 50).

FIRST USE 10-0-2003; IN COMMERCE 10-0-2003.

CLASS 35—ADVERTISING AND BUSINESS

FOR ISSUING GIFT CERTIFICATES THAT MAY BE REDEEMED FOR OPENING INVESTMENT ACCOUNTS, AND ARRANGING OF SUBSCRIPTIONS TO INVESTMENT PUBLICATIONS OF OTHERS (U.S. CLS. 100, 101 AND 102).

FIRST USE 10-0-2003; IN COMMERCE 10-0-2003.

CHERYL CLAYTON, EXAMINING ATTORNEY

SN 78-519,890. ASCOT, LLC, BALTIMORE, MD. FILED 11-19-2004.

Whitney & Rhodes

THE MARK CONSISTS OF STANDARD CHARACTERS WITHOUT CLAIM TO ANY PARTICULAR FONT, STYLE, SIZE, OR COLOR.

CLASS 14—JEWELRY

FOR JEWELRY, NAMELY CUFF-LINKS, SHIRT STUDS AND COLLAR BUTTONS (U.S. CLS. 2, 27, 28 AND 50).

FIRST USE 8-0-2002; IN COMMERCE 8-0-2002.

CLASS 25—CLOTHING

FOR CLOTHING, NAMELY MEN'S FORMAL WEAR AND ACCESSORIES, NAMELY, TUXEDOS, SUITS, DINNER JACKETS, TROUSERS, SHIRTS, VESTS, WAIST COATS, TIES, CUMMERBUNDS, SHOES, ASCOTS AND GLOVES (U.S. CLS. 22 AND 39).

FIRST USE 8-0-2002; IN COMMERCE 8-0-2002.
JOHN DALIER, EXAMINING ATTORNEY

SN 78-519,934. ASCOT, LLC, BALTIMORE, MD. FILED 11-19-2004.



THE MARK CONSISTS OF A MAN DRESSED IN A TUXEDO, WEARING A TOP HAT AND CARRYING A CANE.

CLASS 14—JEWELRY

FOR JEWELRY, NAMELY CUFF-LINKS, SHIRT STUDS AND COLLAR BUTTONS (U.S. CLS. 2, 27, 28 AND 50).

FIRST USE 8-0-2002; IN COMMERCE 8-0-2002.

CLASS 25—CLOTHING

FOR CLOTHING, NAMELY MEN'S FORMAL WEAR AND ACCESSORIES, NAMELY TUXEDOS, SUITS, DINNER JACKETS, TROUSERS, SHIRTS, VESTS, WAIST COATS, TIES, CUMMERBUNDS, SHOES, ASCOTS AND GLOVES (U.S. CLS. 22 AND 39).

FIRST USE 8-0-2002; IN COMMERCE 8-0-2002.
JOHN HWANG, EXAMINING ATTORNEY

SN 78-519,987. SECURE COM SECURITY INTERNATIONAL, INC., TAMPA, FL. FILED 11-19-2004.

SECURESTIK

THE MARK CONSISTS OF STANDARD CHARACTERS WITHOUT CLAIM TO ANY PARTICULAR FONT, STYLE, SIZE, OR COLOR.

CLASS 1—CHEMICALS

FOR ADHESIVE FOR APPLYING SECURITY FILM TO GLASS (U.S. CLS. 1, 5, 6, 10, 26 AND 46).

FIRST USE 11-28-2003; IN COMMERCE 11-28-2003.

CLASS 40—MATERIAL TREATMENT

FOR APPLYING PROTECTIVE COATINGS TO GLASS (U.S. CLS. 100, 103 AND 106).

FIRST USE 11-28-2003; IN COMMERCE 11-28-2003.
WINSTON FOLMAR, EXAMINING ATTORNEY

SN 78-520,181. ATC HEALTHCARE SERVICES, INC., LAKE SUCCESS, NY. FILED 11-19-2004.

ATC ALPHASOURCE

THE MARK CONSISTS OF STANDARD CHARACTERS WITHOUT CLAIM TO ANY PARTICULAR FONT, STYLE, SIZE, OR COLOR.

OWNER OF U.S. REG. NO. 1,577,053.

CLASS 9—ELECTRICAL AND SCIENTIFIC APPARATUS

FOR COMPUTER SOFTWARE FOR USE IN AUTOMATING BUSINESS PROCESSES, NAMELY, VENDOR MANAGEMENT, STAFFING ADMINISTRATION, PROFESSIONAL CREDENTIALING, AND BILLING (U.S. CLS. 21, 23, 26, 36 AND 38).

CLASS 35—ADVERTISING AND BUSINESS

FOR MEDICAL EMPLOYMENT PLACEMENT AND STAFFING SERVICES (U.S. CLS. 100, 101 AND 102).

RENEE MCCRAY, EXAMINING ATTORNEY

SN 78-520,192. PRODUCERS ENVIRONMENTAL PRODUCTS, DBA ENVIRONMENTAL SOLUTIONS INTERNATIONAL, BATAVIA, IL. FILED 11-19-2004.

TETRAFLEX

THE MARK CONSISTS OF STANDARD CHARACTERS WITHOUT CLAIM TO ANY PARTICULAR FONT, STYLE, SIZE, OR COLOR.

CLASS 1—CHEMICALS

FOR STAIN REPELLENTS AND FABRIC PROTECTANTS FOR CARPETS (U.S. CLS. 1, 5, 6, 10, 26 AND 46).

FIRST USE 6-15-2004; IN COMMERCE 6-15-2004.

CLASS 3—COSMETICS AND CLEANING PREPARATIONS

FOR CLEANING PREPARATIONS FOR CARPETS (U.S. CLS. 1, 4, 6, 50, 51 AND 52).
FIRST USE 6-15-2004; IN COMMERCE 6-15-2004.
SUNG IN, EXAMINING ATTORNEY

SN 78-520,353. BEST BUY ENTERPRISE SERVICES, INC.,
RICHFIELD, MN. FILED 11-19-2004.

DYNEX

THE MARK CONSISTS OF STANDARD CHARACTERS WITHOUT CLAIM TO ANY PARTICULAR FONT, STYLE, SIZE, OR COLOR.

CLASS 2—PAINTS

FOR PRINTER INK CARTRIDGES, INKJET PRINTER CARTRIDGES FOR COMPUTER PRINTERS AND WORD PROCESSORS (U.S. CLS. 6, 11 AND 16).

CLASS 16—PAPER GOODS AND PRINTED MATTER

FOR PRINTING PAPER, COMPUTER PRINTER PAPER, AND PAPER SHREDDERS FOR OFFICE USE (U.S. CLS. 2, 5, 22, 23, 29, 37, 38 AND 50).
SANJEEV VOHRA, EXAMINING ATTORNEY

SN 78-520,445. UNDERHILL, DEREK, GRANTS, NM. FILED
11-19-2004.

Sound Souvenirs

THE MARK CONSISTS OF STANDARD CHARACTERS WITHOUT CLAIM TO ANY PARTICULAR FONT, STYLE, SIZE, OR COLOR.
NO CLAIM IS MADE TO THE EXCLUSIVE RIGHT TO USE "SOUND", APART FROM THE MARK AS SHOWN.

CLASS 38—COMMUNICATION

FOR RADIO, CABLE TELEVISION AND INTERNET PROGRAM BROADCASTING FEATURING POPULAR MUSIC FROM PREVIOUS DECADES; STREAMING OF AUDIO MATERIAL ON THE INTERNET FEATURING POPULAR MUSIC FROM PREVIOUS DECADES (U.S. CLS. 100, 101 AND 104).
FIRST USE 7-0-1983; IN COMMERCE 7-0-1983.

CLASS 41—EDUCATION AND ENTERTAINMENT

FOR ENTERTAINMENT SERVICES, NAMELY RADIO, CABLE TELEVISION AND INTERNET PROGRAMS AND PROGRAMMING FEATURING POPULAR MUSIC FROM PREVIOUS DECADES; PRODUCTION OF PROGRAMS FEATURING POPULAR MUSIC FROM PREVIOUS DECADES FOR BROADCAST OVER THE RADIO, CABLE TELEVISION AND THE INTERNET (U.S. CLS. 100, 101 AND 107).
FIRST USE 7-0-1983; IN COMMERCE 7-0-1983.
VIVIAN MICZNIK FIRST, EXAMINING ATTORNEY

SN 78-520,536. YOUNG, DEON K., CLERMONT, FL. FILED
11-20-2004.

THRILLTECH

THE MARK CONSISTS OF STANDARD CHARACTERS WITHOUT CLAIM TO ANY PARTICULAR FONT, STYLE, SIZE, OR COLOR.

CLASS 25—CLOTHING

FOR CLOTHING, NAMELY, PANTS, SHIRTS, TEE-SHIRTS (U.S. CLS. 22 AND 39).

CLASS 41—EDUCATION AND ENTERTAINMENT

FOR AMUSEMENT AND THEME PARK SERVICES (U.S. CLS. 100, 101 AND 107).
GINA FINK, EXAMINING ATTORNEY

SN 78-520,574. SUEBA USA CORPORATION, HOUSTON, TX.
FILED 11-20-2004.



OWNER OF U.S. REG. NO. 2,251,115.
NO CLAIM IS MADE TO THE EXCLUSIVE RIGHT TO
USE "USA", APART FROM THE MARK AS SHOWN.

CLASS 36—INSURANCE AND FINANCIAL

FOR REAL ESTATE SERVICES, NAMELY, LEASING
OF REAL ESTATE, REAL ESTATE BROKERAGE, REAL
ESTATE TRADING, AND REAL ESTATE MANAGE-
MENT (U.S. CLS. 100, 101 AND 102).

CLASS 37—CONSTRUCTION AND REPAIR

FOR REAL ESTATE DEVELOPMENT AND CON-
STRUCTION SERVICES, NAMELY, RESIDENTIAL
AND COMMERCIAL BUILDING CONSTRUCTION,
BUILDING CONSTRUCTION AND REPAIR, CON-
STRUCTION MANAGEMENT, CONSTRUCTION OF
HOMES, AND CONSTRUCTION PLANNING; CON-
STRUCTION SERVICES, NAMELY, PLANNING, LAY-
ING OUT, AND CUSTOM CONSTRUCTION OF
RESIDENTIAL AND COMMERCIAL COMMUNITIES;
AND CONSTRUCTION SUPERVISION (U.S. CLS. 100,
103 AND 106).

CLASS 42—SCIENTIFIC, COMPUTER AND LEGAL SERVICES

FOR ARCHITECTURAL DESIGN SERVICES (U.S. CLS.
100 AND 101).
AMY GEARIN, EXAMINING ATTORNEY

SN 78-520,599. SEALLS, ALAN, R., MOBILE, AL. FILED 11-
20-2004.

Weatherthings

THE MARK CONSISTS OF STANDARD CHARACTERS
WITHOUT CLAIM TO ANY PARTICULAR FONT, STYLE,
SIZE, OR COLOR.

CLASS 9—ELECTRICAL AND SCIENTIFIC APPARATUS

FOR EDUCATIONAL WEATHER VIDEOS (U.S. CLS.
21, 23, 26, 36 AND 38).

CLASS 16—PAPER GOODS AND PRINTED MATTER

FOR WEATHER POSTERS AND WEATHER PICTURES
(U.S. CLS. 2, 5, 22, 23, 29, 37, 38 AND 50).
PAULA MAHONEY, EXAMINING ATTORNEY

SN 78-520,737. THE TRUSTEES OF PRINCETON UNIVER-
SITY, PRINCETON, NJ. FILED 11-22-2004.



THE MARK CONSISTS OF A STALKING TIGER.

CLASS 16—PAPER GOODS AND PRINTED MATTER

FOR PRINTED MATERIALS, NAMELY, WRITING
PAPER, STATIONERY, FILE FOLDERS, LOOSE LEAF
BINDERS, NOTEBOOKS, YEARBOOKS AND SCHOOL
DIRECTORIES (U.S. CLS. 2, 5, 22, 23, 29, 37, 38 AND 50).

CLASS 25—CLOTHING

FOR CLOTHING, NAMELY, T-SHIRTS, SWEATERS,
JACKETS, SWEATSHIRTS, SWEATPANTS, SHORTS,
TIES, CAPS, HATS AND SOCKS (U.S. CLS. 22 AND 39).

CLASS 41—EDUCATION AND ENTERTAIN- MENT

FOR EDUCATIONAL SERVICES, NAMELY, PROVID-
ING INSTRUCTION AND TRAINING AT THE UNDER-
GRADUATE, GRADUATE, AND POSTGRADUATE
LEVELS; ENTERTAINMENT SERVICES IN THE NATURE
OF PRESENTATION OF A VARIETY OF INTER-
COLLEGIATE SPORTING EVENTS (U.S. CLS. 100, 101
AND 107).
KIMBERLY PERRY, EXAMINING ATTORNEY

SN 78-520,738. THE TRUSTEES OF PRINCETON UNIVERSITY, PRINCETON, NJ. FILED 11-22-2004.



THE MARK CONSISTS OF A SITTING TIGER.

CLASS 16—PAPER GOODS AND PRINTED MATTER

FOR PRINTED MATERIALS, NAMELY, WRITING PAPER, STATIONERY, FILE FOLDERS, LOOSE LEAF BINDERS, NOTEBOOKS, YEARBOOKS AND SCHOOL DIRECTORIES (U.S. CLS. 2, 5, 22, 23, 29, 37, 38 AND 50).

CLASS 25—CLOTHING

FOR CLOTHING, NAMELY, T-SHIRTS, SWEATERS, JACKETS, SWEATSHIRTS, SWEATPANTS, SHORTS, TIES, CAPS, HATS AND SOCKS (U.S. CLS. 22 AND 39).

CLASS 41—EDUCATION AND ENTERTAINMENT

FOR EDUCATIONAL SERVICES, NAMELY, PROVIDING INSTRUCTION AND TRAINING AT THE UNDERGRADUATE, GRADUATE AND POSTGRADUATE LEVELS; ENTERTAINMENT SERVICES IN THE NATURE OF PRESENTATION OF A VARIETY OF INTERCOLLEGIATE SPORTING EVENTS (U.S. CLS. 100, 101 AND 107).

MONTIA G. PRESSEY, EXAMINING ATTORNEY

SN 78-520,743. OLD RELIABLE WHOLESALE CO., INC., BARBERTON, OH. FILED 11-22-2004.

C.C. SUPPLY

THE MARK CONSISTS OF STANDARD CHARACTERS WITHOUT CLAIM TO ANY PARTICULAR FONT, STYLE, SIZE, OR COLOR.

NO CLAIM IS MADE TO THE EXCLUSIVE RIGHT TO USE "SUPPLY", APART FROM THE MARK AS SHOWN.

CLASS 35—ADVERTISING AND BUSINESS

FOR RETAIL AND WHOLESALE STORE SERVICES FEATURING A VARIETY OF BUILDING MATERIALS, ROOFING MATERIALS, SIDING, WINDOWS, CABINETRY, DOORS, SHUTTERS AND SKYLIGHTS (U.S. CLS. 100, 101 AND 102).

FIRST USE 12-31-1974; IN COMMERCE 11-1-1992.

CLASS 39—TRANSPORTATION AND STORAGE

FOR DELIVERY AND TRANSPORTATION OF HOME IMPROVEMENT PRODUCTS BY TRUCK AND MOTOR VEHICLE (U.S. CLS. 100 AND 105).

FIRST USE 12-31-1974; IN COMMERCE 11-1-1992.

MARK T. MULLEN, EXAMINING ATTORNEY

SN 78-520,771. ABBOTT LABORATORIES, ABBOTT PARK, IL. FILED 11-22-2004.

CELL-DYN CORAL

THE MARK CONSISTS OF STANDARD CHARACTERS WITHOUT CLAIM TO ANY PARTICULAR FONT, STYLE, SIZE, OR COLOR.

OWNER OF U.S. REG. NO. 1,298,458.

CLASS 5—PHARMACEUTICALS

FOR DIAGNOSTIC PREPARATIONS FOR CLINICAL OR MEDICAL LABORATORY USE (U.S. CLS. 6, 18, 44, 46, 51 AND 52).

CLASS 10—MEDICAL APPARATUS

FOR AUTOMATED HEMATOLOGICAL INSTRUMENTS WHICH USE ELECTRONICS AND OPTICAL FLUORESCENCE FLOW CYTOMETRY TO ANALYZE BLOOD (U.S. CLS. 26, 39 AND 44).

APRIL L. RADEMACHER, EXAMINING ATTORNEY

SN 78-520,775. ABBOTT LABORATORIES, ABBOTT PARK, IL. FILED 11-22-2004.

CELL-DYN DIAMOND

THE MARK CONSISTS OF STANDARD CHARACTERS WITHOUT CLAIM TO ANY PARTICULAR FONT, STYLE, SIZE, OR COLOR.

OWNER OF U.S. REG. NO. 1,298,458.

CLASS 5—PHARMACEUTICALS

FOR DIAGNOSTIC PREPARATIONS FOR CLINICAL OR MEDICAL LABORATORY USE (U.S. CLS. 6, 18, 44, 46, 51 AND 52).

CLASS 10—MEDICAL APPARATUS

FOR AUTOMATED HEMATOLOGICAL INSTRUMENTS WHICH USE ELECTRONICS AND OPTICAL FLUORESCENCE FLOW CYTOMETRY TO ANALYZE BLOOD (U.S. CLS. 26, 39 AND 44).
APRIL L. RADEMACHER, EXAMINING ATTORNEY

SN 78-520,792. ABBOTT LABORATORIES, ABBOTT PARK, IL. FILED 11-22-2004.

SN 78-520,779. ABBOTT LABORATORIES, ABBOTT PARK, IL. FILED 11-22-2004.

CELL-DYN EMERALD

THE MARK CONSISTS OF STANDARD CHARACTERS WITHOUT CLAIM TO ANY PARTICULAR FONT, STYLE, SIZE, OR COLOR.
OWNER OF U.S. REG. NO. 1,298,458.

THE MARK CONSISTS OF STANDARD CHARACTERS WITHOUT CLAIM TO ANY PARTICULAR FONT, STYLE, SIZE, OR COLOR.
OWNER OF U.S. REG. NO. 1,298,458.

CLASS 5—PHARMACEUTICALS

FOR DIAGNOSTIC PREPARATIONS FOR CLINICAL OR MEDICAL LABORATORY USE (U.S. CLS. 6, 18, 44, 46, 51 AND 52).

CLASS 5—PHARMACEUTICALS

FOR DIAGNOSTIC PREPARATIONS FOR CLINICAL OR MEDICAL LABORATORY USE (U.S. CLS. 6, 18, 44, 46, 51 AND 52).

CLASS 10—MEDICAL APPARATUS

FOR AUTOMATED HEMATOLOGICAL INSTRUMENTS WHICH USE ELECTRONICS AND OPTICAL FLUORESCENCE FLOW CYTOMETRY TO ANALYZE BLOOD (U.S. CLS. 26, 39 AND 44).
APRIL L. RADEMACHER, EXAMINING ATTORNEY

CLASS 10—MEDICAL APPARATUS

FOR AUTOMATED HEMATOLOGICAL INSTRUMENTS WHICH USE ELECTRONICS AND OPTICAL FLUORESCENCE FLOW CYTOMETRY TO ANALYZE BLOOD (U.S. CLS. 26, 39 AND 44).
APRIL L. RADEMACHER, EXAMINING ATTORNEY

SN 78-520,784. ABBOTT LABORATORIES, ABBOTT PARK, IL. FILED 11-22-2004.

SN 78-520,797. ABBOTT LABORATORIES, ABBOTT PARK, IL. FILED 11-22-2004.

CELL-DYN GARNET

THE MARK CONSISTS OF STANDARD CHARACTERS WITHOUT CLAIM TO ANY PARTICULAR FONT, STYLE, SIZE, OR COLOR.
OWNER OF U.S. REG. NO. 1,298,458.

CELL-DYN PEARL

THE MARK CONSISTS OF STANDARD CHARACTERS WITHOUT CLAIM TO ANY PARTICULAR FONT, STYLE, SIZE, OR COLOR.
OWNER OF U.S. REG. NO. 1,298,458.

CLASS 5—PHARMACEUTICALS

FOR DIAGNOSTIC PREPARATIONS FOR CLINICAL OR MEDICAL LABORATORY USE (U.S. CLS. 6, 18, 44, 46, 51 AND 52).

CLASS 5—PHARMACEUTICALS

FOR DIAGNOSTIC PREPARATIONS FOR CLINICAL OR MEDICAL LABORATORY USE (U.S. CLS. 6, 18, 44, 46, 51 AND 52).

CLASS 10—MEDICAL APPARATUS

FOR AUTOMATED HEMATOLOGICAL INSTRUMENTS WHICH USE ELECTRONICS AND OPTICAL FLUORESCENCE FLOW CYTOMETRY TO ANALYZE BLOOD (U.S. CLS. 26, 39 AND 44).
APRIL L. RADEMACHER, EXAMINING ATTORNEY

CLASS 10—MEDICAL APPARATUS

FOR AUTOMATED HEMATOLOGICAL INSTRUMENTS WHICH USE ELECTRONICS AND OPTICAL FLUORESCENCE FLOW CYTOMETRY TO ANALYZE BLOOD (U.S. CLS. 26, 39 AND 44).
APRIL L. RADEMACHER, EXAMINING ATTORNEY

SN 78-520,804. ABBOTT LABORATORIES, ABBOTT PARK, IL. FILED 11-22-2004.

CELL-DYN RUBY

THE MARK CONSISTS OF STANDARD CHARACTERS WITHOUT CLAIM TO ANY PARTICULAR FONT, STYLE, SIZE, OR COLOR.

OWNER OF U.S. REG. NO. 1,298,458.

CLASS 5—PHARMACEUTICALS

FOR DIAGNOSTIC PREPARATIONS FOR CLINICAL OR MEDICAL LABORATORY USE (U.S. CLS. 6, 18, 44, 46, 51 AND 52).

CLASS 10—MEDICAL APPARATUS

FOR AUTOMATED HEMATOLOGICAL INSTRUMENTS WHICH USE ELECTRONICS AND OPTICAL FLUORESCENCE FLOW CYTOMETRY TO ANALYZE BLOOD (U.S. CLS. 26, 39 AND 44).

APRIL L. RADEMACHER, EXAMINING ATTORNEY

SN 78-520,852. NEXUS DISTRIBUTION CORPORATION, ITASCA, IL. FILED 11-22-2004.



NO CLAIM IS MADE TO THE EXCLUSIVE RIGHT TO USE "DISTRIBUTION CORPORATION", APART FROM THE MARK AS SHOWN.

THE COLOR(S) BLUE AND RED IS/ARE CLAIMED AS A FEATURE OF THE MARK.

THE COLOR BLUE APPEARS IN THE WORDS NEXUS DISTRIBUTION CORPORATION AND THE CENTER DESIGN ELEMENT, AND THE COLOR RED APPEARS IN THE HORIZONTAL DESIGN ELEMENTS.

THE MARK CONSISTS OF THE WORDS NEXUS DISTRIBUTION CORPORATION ARE IN BLUE.

CLASS 35—ADVERTISING AND BUSINESS

FOR ARRANGING FOR PICKUP, DELIVERY, STORAGE AND TRANSPORTATION OF DOCUMENTS, PACKAGES, FREIGHT AND PARCELS VIA GROUND AND AIR CARRIERS; BUSINESS CONSULTING SERVICES RELATING TO PRODUCT DISTRIBUTION, OPERATIONS MANAGEMENT SERVICES, LOGISTICS, REVERSE LOGISTICS, SUPPLY CHAIN, AND PRODUCTION SYSTEMS AND DISTRIBUTION SOLUTIONS; BUSINESS MANAGEMENT SERVICES, NAMELY, MANAGING LOGISTICS, REVERSE LOGISTICS, SUPPLY CHAIN SERVICES, SUPPLY CHAIN VISIBILITY AND SYNCHRONIZATION, SUPPLY AND DEMAND FORECASTING AND PRODUCT DISTRIBUTION PROCESSES FOR OTHERS; INFORMATION MANAGEMENT SERVICES, NAMELY, SHIPMENT PROCESSING, PREPARING SHIPPING DOCUMENTS AND INVOICES, TRACKING DOCUMENTS, PACKAGES AND FREIGHT OVER COMPUTER NETWORKS, INTRANETS AND INTERNETS; LOGISTICS MANAGEMENT IN THE FIELD OF TRANSPORTED GOODS; INVENTORY MANAGEMENT IN THE FIELD OF OF TRANSPORTED GOODS; PROVIDING ELECTRONIC TRACKING OF FREIGHT INFORMATION TO OTHERS; TRANSPORTATION LOGISTICS SERVICES, NAMELY, ARRANGING THE TRANSPORTATION OF GOODS FOR OTHERS; TRANSPORTATION LOGISTICS SERVICES, NAMELY, PLANNING AND SCHEDULING SHIPMENTS FOR USERS OF TRANSPORTATION SERVICES (U.S. CLS. 100, 101 AND 102).

FIRST USE 12-31-1981; IN COMMERCE 12-31-1981.

CLASS 39—TRANSPORTATION AND STORAGE

FOR FREIGHT BROKERAGE; FREIGHT FORWARDING; FREIGHT TRANSPORTATION BY TRUCK; GOODS WAREHOUSING; PACKING ARTICLES FOR TRANSPORTATION; SUPPLY CHAIN, LOGISTICS AND REVERSE LOGISTICS SERVICES, NAMELY, STORAGE, TRANSPORTATION AND DELIVERY OF DOCUMENTS, PACKAGES, RAW MATERIALS, AND OTHER FREIGHT FOR OTHERS BY AIR, RAIL, SHIP OR TRUCK; TRANSPORT BROKERAGE; TRANSPORTATION AND DELIVERY SERVICES, NAMELY, SAME DAY SHIPMENT SERVICES; TRUCK TRANSPORT; WAREHOUSE STORAGE; WAREHOUSING SERVICES, NAMELY, STORAGE, DISTRIBUTION, PICK-UP, AND PACKING FOR SHIPMENT OF DOCUMENTS, PACKAGES, RAW MATERIALS, AND OTHER FREIGHT FOR OTHERS; WAREHOUSING SERVICES (U.S. CLS. 100 AND 105).

FIRST USE 12-31-1981; IN COMMERCE 12-31-1981.

CLASS 42—SCIENTIFIC, COMPUTER AND LEGAL SERVICES

FOR PROVIDING USE OF ONLINE NON-DOWNLOADABLE COMPUTER SOFTWARE FOR PREPARING SHIPPING DOCUMENTS OVER COMPUTER NETWORKS, INTRANETS AND THE INTERNET; PROVIDING USE OF ONLINE NON-DOWNLOADABLE COMPUTER SOFTWARE FOR TRACKING FREIGHT OVER COMPUTER NETWORKS, INTRANETS AND THE INTERNET (U.S. CLS. 100 AND 101).

FIRST USE 12-31-1999; IN COMMERCE 12-31-1999.
VIVIAN MICZNIK FIRST, EXAMINING ATTORNEY

SN 78-520,853. PRODUCT PARTNERS, LLC, BEVERLY HILLS, CA. FILED 11-22-2004.

SN 78-521,075. GUARDIAN LIFE INSURANCE COMPANY OF AMERICA, THE, NEW YORK, NY. FILED 11-22-2004.

BEACHBODY

THE MARK CONSISTS OF STANDARD CHARACTERS WITHOUT CLAIM TO ANY PARTICULAR FONT, STYLE, SIZE, OR COLOR.

CLASS 18—LEATHER GOODS

FOR BACKPACKS (U.S. CLS. 1, 2, 3, 22 AND 41).
FIRST USE 8-23-2004; IN COMMERCE 8-23-2004.

CLASS 25—CLOTHING

FOR CLOTHING, NAMELY SHIRTS AND TOPS (U.S. CLS. 22 AND 39).
FIRST USE 8-23-2004; IN COMMERCE 8-23-2004.
ANDREA SAUNDERS, EXAMINING ATTORNEY

SN 78-520,924. CANON COMMUNICATIONS, LLC, LOS ANGELES, CA. FILED 11-22-2004.

CMDM

THE MARK CONSISTS OF STANDARD CHARACTERS WITHOUT CLAIM TO ANY PARTICULAR FONT, STYLE, SIZE, OR COLOR.

CLASS 16—PAPER GOODS AND PRINTED MATTER

FOR MAGAZINES AND TRADE JOURNALS RELATED TO MEDICAL EQUIPMENT (U.S. CLS. 2, 5, 22, 23, 29, 37, 38 AND 50).

CLASS 35—ADVERTISING AND BUSINESS

FOR ARRANGING AND CONDUCTING TRADE SHOWS IN THE FIELD OF MEDICAL EQUIPMENT (U.S. CLS. 100, 101 AND 102).
MICHAEL SOUDERS, EXAMINING ATTORNEY

REAL FACTS ABOUT MONEY FOR WOMEN

THE MARK CONSISTS OF STANDARD CHARACTERS WITHOUT CLAIM TO ANY PARTICULAR FONT, STYLE, SIZE, OR COLOR.

CLASS 16—PAPER GOODS AND PRINTED MATTER

FOR EDUCATIONAL PUBLICATIONS, NAMELY, INFORMATIONAL BROCHURES REGARDING MONEY MANAGEMENT, BUDGETING AND FINANCIAL PLANNING FOR WOMEN AND FAMILIES (U.S. CLS. 2, 5, 22, 23, 29, 37, 38 AND 50).

CLASS 41—EDUCATION AND ENTERTAINMENT

FOR EDUCATIONAL SERVICES, NAMELY, SEMINARS, MEETINGS, CONFERENCES, WORKSHOPS IN THE FIELD OF MONEY MANAGEMENT, BUDGETING, AND FINANCIAL PLANNING FOR WOMEN AND FAMILIES; ONLINE NEWSLETTERS IN THE FIELD OF MONEY MANAGEMENT, BUDGETING, AND FINANCIAL PLANNING FOR WOMEN AND FAMILIES (U.S. CLS. 100, 101 AND 107).
CAROLYN CATALDO, EXAMINING ATTORNEY

SN 78-521,174. RFE/RL, INC., WASHINGTON, DC. FILED 11-22-2004.



THE COLOR(S) ORANGE IS/ARE CLAIMED AS A FEATURE OF THE MARK.

THE MARK IS COMPRISED OF AN ORANGE TORCH WITH AN ORANGE FLAME.

CLASS 38—COMMUNICATION

FOR INTERNATIONAL RADIO BROADCASTING SERVICES (U.S. CLS. 100, 101 AND 104).

CLASS 41—EDUCATION AND ENTERTAINMENT

FOR PRODUCTION OF INTERNATIONAL RADIO BROADCASTING NEWS, PUBLIC AFFAIRS AND ENTERTAINMENT PROGRAMS (U.S. CLS. 100, 101 AND 107).

ELISSA GARBER KON, EXAMINING ATTORNEY

SN 78-521,188. W.C. BRADLEY COMPANY, COLUMBUS, GA. FILED 11-22-2004.

**IT'S WHAT'S UNDER
THE HOOD**

THE MARK CONSISTS OF STANDARD CHARACTERS WITHOUT CLAIM TO ANY PARTICULAR FONT, STYLE, SIZE, OR COLOR.

CLASS 11—ENVIRONMENTAL CONTROL APPARATUS

FOR GAS, ELECTRIC AND CHARCOAL BARBECUE GRILLS; SMOKER GRILLS; BARBECUE GRILL BURNERS; OUTDOOR FIREPLACES AND REPAIR AND REPLACEMENT PARTS THEREFOR (U.S. CLS. 13, 21, 23, 31 AND 34).

CLASS 21—HOUSEWARES AND GLASS

FOR UTENSILS FOR BARBECUES, NAMELY, SPATULAS, FORKS, TONGS AND BRUSHES; BARBECUE GRILL BURNER COVERS (U.S. CLS. 2, 13, 23, 29, 30, 33, 40 AND 50).

KEVIN DINALLO, EXAMINING ATTORNEY

SN 78-521,223. FARMER, BRYAN PIERCE, SMYRNA, GA. FILED 11-22-2004.



NO CLAIM IS MADE TO THE EXCLUSIVE RIGHT TO USE "CAMO", APART FROM THE MARK AS SHOWN.

CLASS 16—PAPER GOODS AND PRINTED MATTER

FOR PATTERNS FOR USE IN THE MANUFACTURE OF CLOTHING, TENTS, SLEEPING BAGS AND OUTDOOR APPAREL AND ACCESSORIES (U.S. CLS. 2, 5, 22, 23, 29, 37, 38 AND 50).

CLASS 24—FABRICS

FOR MIXED FIBER FABRIC AND TEXTILE FABRIC FOR THE MANUFACTURE OF OUTDOOR APPAREL AND ACCESSORIES AND HUNTING WEAR (U.S. CLS. 42 AND 50).

CLASS 25—CLOTHING

FOR HUNTING APPAREL, NAMELY, SHORTS, PANTS, SHIRTS, TANK TOPS, VESTS, JACKETS, HATS, HOODS, GLOVES, BOOTS AND SHOES; CLOTHING NAMELY, SHORTS, PANTS, SHIRTS, TANK TOPS, VESTS, JACKETS, HATS, HOODS, GLOVES, BOOTS AND SHOES (U.S. CLS. 22 AND 39).

ELIZABETH PIGNATELLO, EXAMINING ATTORNEY

SN 78-521,231. EURO-PRO OPERATING LLC, WEST NEWTON, MA. FILED 11-22-2004.

SWEEPERELLA

THE MARK CONSISTS OF STANDARD CHARACTERS WITHOUT CLAIM TO ANY PARTICULAR FONT, STYLE, SIZE, OR COLOR.

CLASS 7—MACHINERY

FOR ELECTRIC CARPET AND FLOOR SWEEPERS (U.S. CLS. 13, 19, 21, 23, 31, 34 AND 35).

CLASS 21—HOUSEWARES AND GLASS

FOR NON-ELECTRIC CARPET SWEEPERS (U.S. CLS. 2, 13, 23, 29, 30, 33, 40 AND 50).

STEVEN R. FOSTER, EXAMINING ATTORNEY

SN 78-521,629. PEPSICO, INC., PURCHASE, NY. FILED 11-23-2004.

STAY COOL

THE MARK CONSISTS OF STANDARD CHARACTERS WITHOUT CLAIM TO ANY PARTICULAR FONT, STYLE, SIZE, OR COLOR.

CLASS 30—STAPLE FOODS

FOR ICED TEA (U.S. CL. 46).

CLASS 32—LIGHT BEVERAGES

FOR SOFT DRINKS, FRUIT DRINKS, FRUIT JUICE DRINKS (U.S. CLS. 45, 46 AND 48).
MARY CRAWFORD, EXAMINING ATTORNEY

SN 78-521,648. ENTERTAINMENT PUBLICATIONS, INC.,
TROY, MI. FILED 11-23-2004.

CLASS 16—PAPER GOODS AND PRINTED MATTER

FOR PAINT COLOR SAMPLE KITS COMPRISED PRIMARILY OF PAINT SAMPLE COLOR CARDS, PAINT ROLLERS, PAINT ROLLER HANDLES, PAINT TRAYS, A PRINTED PAINT COLOR DESIGN GUIDE, AND PAINT SAMPLES, SOLD AS A UNIT (U.S. CLS. 2, 5, 22, 23, 29, 37, 38 AND 50).

JASON LOTT, EXAMINING ATTORNEY

RSR RELAX SOOTHE REFRESH

SN 78-521,954. CANALES, ORIBE, NEW YORK, NY. FILED
11-23-2004.

THE MARK CONSISTS OF STANDARD CHARACTERS WITHOUT CLAIM TO ANY PARTICULAR FONT, STYLE, SIZE, OR COLOR.

CLASS 3—COSMETICS AND CLEANING PREPARATIONS

FOR BATH AND BODY PRODUCTS, NAMELY, BATH OILS, BATH BEADS, BATH FOAM, BATH LOTION, SOAPS, SHAMPOOS, SHOWER AND BATH GEL, AND BODY AND BEAUTY CARE COSMETICS (U.S. CLS. 1, 4, 6, 50, 51 AND 52).

CLASS 21—HOUSEWARES AND GLASS

FOR BATH ACCESSORIES, NAMELY, SPONGES, BRUSHES, SOAP HOLDERS, CUP HOLDERS AND TOOTHBRUSH HOLDERS (U.S. CLS. 2, 13, 23, 29, 30, 33, 40 AND 50).

DAVID ELTON, EXAMINING ATTORNEY

SN 78-521,825. BEHR PROCESS CORPORATION, SANTA ANA, CA. FILED 11-23-2004.

METRO EDGE

THE MARK CONSISTS OF STANDARD CHARACTERS WITHOUT CLAIM TO ANY PARTICULAR FONT, STYLE, SIZE, OR COLOR.

CLASS 2—PAINTS

FOR INTERIOR AND EXTERIOR PAINT; PAINT COLOR SAMPLE KITS COMPRISED PRIMARILY OF PAINT SAMPLES, PAINT ROLLERS, PAINT ROLLER HANDLES, PAINT TRAYS, A PRINTED PAINT COLOR DESIGN GUIDE, AND PAINT SAMPLE COLOR CARDS, SOLD AS A UNIT (U.S. CLS. 6, 11 AND 16).

ORIBE

THE MARK CONSISTS OF STANDARD CHARACTERS WITHOUT CLAIM TO ANY PARTICULAR FONT, STYLE, SIZE, OR COLOR.

OWNER OF U.S. REG. NO. 2,166,871.

CLASS 3—COSMETICS AND CLEANING PREPARATIONS

FOR STYLING GELS, HAIR SPRAY, STYLING BALM, HAIR MOISTURIZING CREAM, HAIR MOUSSE, RELAXERS, PERMANENT WAVE PREPARATIONS AND HAIR COLOR (U.S. CLS. 1, 4, 6, 50, 51 AND 52).

CLASS 26—FANCY GOODS

FOR WIGS AND HAIR EXTENSIONS (U.S. CLS. 37, 39, 40, 42 AND 50).

CLASS 44—MEDICAL, BEAUTY AND AGRICULTURAL SERVICES

FOR HAIR SALON SERVICES, MAKE-UP APPLICATION SERVICES, MANICURE SERVICES (U.S. CLS. 100 AND 101).

CHRISTOPHER BUONGIORNO, EXAMINING ATTORNEY

SN 78-522,240. HERSHEY CHOCOLATE & CONFECTIONERY CORPORATION, WHEAT RIDGE, CO. FILED 11-23-2004.

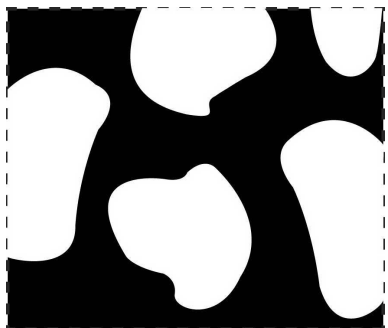

THE MARK IS A TWO-DIMENSIONAL STYLIZED DESIGN REPRESENTING COW SPOTS, CONSISTING OF IRREGULAR SHAPES ON A CONTRASTING BACKGROUND. THE MARK COVERS A PORTION OF THE BACKGROUND OF THE PACKAGING FOR THE GOODS. THE BROKEN LINES INDICATE THE POSITION OF THE MARK AND DO NOT FORM PART OF THE MARK. NO CLAIM IS MADE AS TO COLOR.

CLASS 29—MEATS AND PROCESSED FOODS

FOR STRAWBERRY TOPPING; DAIRY-BASED CHOCOLATE FOOD BEVERAGE; YOGURT; YOGURT BASED BEVERAGES (U.S. CL. 46).

CLASS 30—STAPLE FOODS

FOR CANDY; CHOCOLATE TOPPING; CARAMEL TOPPING; PUDDING; ICING; NON-DAIRY BASED CHOCOLATE BEVERAGE DRINK; FROZEN CONFECTIONS, NAMELY, FROZEN YOGURT, FROZEN YOGURT CONFECTIONS, ICE CREAM, ICE CREAM CONFECTIONS, ICE MILK, SORBETS, MILK SHAKES, FREEZE POPS (U.S. CL. 46).

BRENDAN REGAN, EXAMINING ATTORNEY

SN 78-522,402. RFE/RL, INC., WASHINGTON, DC. FILED 11-24-2004.



THE MARK CONSISTS OF A TORCH WITH A FLAME.

CLASS 38—COMMUNICATION

FOR INTERNATIONAL RADIO BROADCASTING SERVICES (U.S. CLS. 100, 101 AND 104).

CLASS 41—EDUCATION AND ENTERTAINMENT

FOR PRODUCTION OF INTERNATIONAL RADIO BROADCASTING NEWS, PUBLIC AFFAIRS AND ENTERTAINMENT PROGRAMS (U.S. CLS. 100, 101 AND 107).

ELISSA GARBER KON, EXAMINING ATTORNEY

SN 78-522,607. MARRIOTT INTERNATIONAL, INC., BETHESDA, MD. FILED 11-24-2004.

**GREAT HEALTH FIT
FOR YOU**

THE MARK CONSISTS OF STANDARD CHARACTERS WITHOUT CLAIM TO ANY PARTICULAR FONT, STYLE, SIZE, OR COLOR.

CLASS 41—EDUCATION AND ENTERTAINMENT

FOR PROVIDING EXERCISE INFORMATION AND EQUIPMENT TO HOTEL GUESTS (U.S. CLS. 100, 101 AND 107).

CLASS 43—HOTEL AND RESTAURANT SERVICES

FOR HOTEL SERVICES; RESORT AND LODGING SERVICES; RESERVATION SERVICES FOR HOTEL ACCOMMODATIONS FOR OTHERS (U.S. CLS. 100 AND 101).

ROBIN CHOSID, EXAMINING ATTORNEY

SN 78-522,692. CLK MANAGEMENT, LLC, OVERLAND PARK, KS. FILED 11-24-2004.

PARTNERWEEKLY

THE MARK CONSISTS OF STANDARD CHARACTERS WITHOUT CLAIM TO ANY PARTICULAR FONT, STYLE, SIZE, OR COLOR.

CLASS 35—ADVERTISING AND BUSINESS

FOR ADVERTISING AND PROMOTION OF THE GOODS AND SERVICES OF OTHERS VIA THE INTERNET; INTERNET ADVERTISING AGENCY SERVICES NAMELY PROVIDING A LIST OF POTENTIAL ADVERTISERS TO POTENTIAL INTERNET AFFILIATES, ASSISTING THE INTERNET AFFILIATES WITH PLACEMENT OF THE ADVERTISEMENTS ON THEIR WEBSITES, AND MANAGING AND TRACKING THE USE OF AND COMPENSATION FOR THE ADVERTISEMENTS (U.S. CLS. 100, 101 AND 102).

FIRST USE 2-0-2003; IN COMMERCE 2-0-2003.

CLASS 42—SCIENTIFIC, COMPUTER AND LEGAL SERVICES

FOR COMPUTER SERVICES, NAMELY, COMPUTER WEBSITE DESIGN AND DEVELOPMENT FOR OTHERS (U.S. CLS. 100 AND 101).

FIRST USE 2-0-2003; IN COMMERCE 2-0-2003.
JOHN HWANG, EXAMINING ATTORNEY

SN 78-522,882. VELASCO & ASSOCIATES, PROFESSIONAL LAW CORPORATION, ANAHEIM, CA. FILED 11-24-2004.

CLASS 39—TRANSPORTATION AND STORAGE

FOR CORRESPONDENCE DELIVERY BY POST AND/OR MESSENGER; DELIVERY OF GIFT BASKETS WITH SELECTED ITEMS REGARDING A PARTICULAR OCCASION OR THEME; DELIVERY OF GOODS AND MESSAGES ACCOMPANIED BY BALLOONS AND/OR NOVELTY PRESENTATIONS; DOCUMENT, PARCEL AND MESSAGE DELIVERY; EXPRESS DOCUMENT, PARCEL AND MESSAGE DELIVERY; POSTAL SERVICES, NAMELY, PARCEL DELIVERY, PACKAGING ARTICLES FOR TRANSPORTATION (U.S. CLS. 100 AND 105).

GINA HAYES, EXAMINING ATTORNEY

HABLANDO DE NEGOCIOS

THE MARK CONSISTS OF STANDARD CHARACTERS WITHOUT CLAIM TO ANY PARTICULAR FONT, STYLE, SIZE, OR COLOR.

THE FOREIGN WORDING IN THE MARK TRANSLATES INTO ENGLISH AS TALKING ABOUT BUSINESS.

CLASS 41—EDUCATION AND ENTERTAINMENT

FOR EDUCATIONAL SERVICES, NAMELY, PROVIDING CLASSES, SEMINARS, AND WORKSHOPS IN THE FIELD OF LAW AND BUSINESS FOR THE LATINO COMMUNITY (U.S. CLS. 100, 101 AND 107).

FIRST USE 2-0-2003; IN COMMERCE 2-0-2003.

CLASS 42—SCIENTIFIC, COMPUTER AND LEGAL SERVICES

FOR LEGAL SERVICES (U.S. CLS. 100 AND 101).
FIRST USE 2-0-2003; IN COMMERCE 2-0-2003.
DEBRA LEE, EXAMINING ATTORNEY

SN 78-523,234. MOETTELI, JOHN, ST. GALLEN, SWITZERLAND, FILED 11-27-2004.

HEAVEN'S MAIL - IT'S ETERNAL

THE MARK CONSISTS OF STANDARD CHARACTERS WITHOUT CLAIM TO ANY PARTICULAR FONT, STYLE, SIZE, OR COLOR.

CLASS 38—COMMUNICATION

FOR DELIVERY OF MESSAGES BY ELECTRONIC TRANSMISSION; DELIVERY OF PERSONALIZED GREETING CARDS TO OTHERS VIA ELECTRONIC MAIL; ELECTRONIC DELIVERY OF IMAGES AND PHOTOGRAPHS VIA A GLOBAL COMPUTER NETWORK; ON-LINE DOCUMENT DELIVERY VIA A GLOBAL COMPUTER NETWORK (U.S. CLS. 100, 101 AND 104).

SN 78-523,681. MCCARNEY, KEVIN T., DBA POQUITO MAS, NO. HOLLYWOOD, CA. FILED 11-29-2004.

CHEF-MEX

THE MARK CONSISTS OF STANDARD CHARACTERS WITHOUT CLAIM TO ANY PARTICULAR FONT, STYLE, SIZE, OR COLOR.

OWNER OF U.S. REG. NO. 2,057,149.

CLASS 8—HAND TOOLS

FOR HAND-OPERATED FOOD PROCESSORS (U.S. CLS. 23, 28 AND 44).

CLASS 16—PAPER GOODS AND PRINTED MATTER

FOR COOK BOOKS (U.S. CLS. 2, 5, 22, 23, 29, 37, 38 AND 50).

CLASS 29—MEATS AND PROCESSED FOODS

FOR FOOD PRODUCTS, NAMELY FROZEN MEALS AND ENTREES CONSISTING PRIMARILY OF MEAT (U.S. CL. 46).

CLASS 30—STAPLE FOODS

FOR TORTILLAS; SPICES (U.S. CL. 46).
ADA HAN, EXAMINING ATTORNEY

SN 78-523,860. GENERAL CABLE TECHNOLOGIES CORPORATION, HIGHLAND HEIGHTS, KY. FILED 11-29-2004.

PANGEN

THE MARK CONSISTS OF STANDARD CHARACTERS WITHOUT CLAIM TO ANY PARTICULAR FONT, STYLE, SIZE, OR COLOR.

CLASS 9—ELECTRICAL AND SCIENTIFIC APPARATUS

FOR DATA COMMUNICATION CABLES AND CONNECTORS; FIBER OPTIC CABLES AND CONNECTORS (U.S. CLS. 21, 23, 26, 36 AND 38).

CLASS 38—COMMUNICATION

FOR COMMUNICATION SERVICES, NAMELY, A DATA COMMUNICATION SYSTEM PROVIDED VIA CABLE AND RELATED CONNECTIVITY HARDWARE (U.S. CLS. 100, 101 AND 104).

JOHN WILKE, EXAMINING ATTORNEY

SN 78-524,233. IENTERPRISES, INC., MURRAY HILL, NJ. FILED 11-30-2004.

CRM ON THE GO

THE MARK CONSISTS OF STANDARD CHARACTERS WITHOUT CLAIM TO ANY PARTICULAR FONT, STYLE, SIZE, OR COLOR.

NO CLAIM IS MADE TO THE EXCLUSIVE RIGHT TO USE "CRM", APART FROM THE MARK AS SHOWN.

CLASS 9—ELECTRICAL AND SCIENTIFIC APPARATUS

FOR COMPUTER SOFTWARE, NAMELY, CUSTOMER RELATIONSHIP MANAGEMENT SOFTWARE FOR USE WITH WIRELESS DEVICES (U.S. CLS. 21, 23, 26, 36 AND 38).

CLASS 42—SCIENTIFIC, COMPUTER AND LEGAL SERVICES

FOR INTEGRATION AND IMPLEMENTATION OF COMPUTER SYSTEMS AND NETWORKS FOR USE IN CUSTOMER RELATIONSHIP MANAGEMENT (U.S. CLS. 100 AND 101).

LOURDES AYALA, EXAMINING ATTORNEY

SN 78-524,281. SYNGENTA PARTICIPATIONS AG, BASEL, SWITZERLAND, FILED 11-30-2004.

VIGOR TRIGGER

THE MARK CONSISTS OF STANDARD CHARACTERS WITHOUT CLAIM TO ANY PARTICULAR FONT, STYLE, SIZE, OR COLOR.

CLASS 5—PHARMACEUTICALS

FOR BIOLOGICAL INSECTICIDES FOR AGRICULTURAL USE (U.S. CLS. 6, 18, 44, 46, 51 AND 52).

CLASS 44—MEDICAL, BEAUTY AND AGRICULTURAL SERVICES

FOR COMPUTER SERVICES, NAMELY, PROVIDING AN ON-LINE INTERACTIVE COMPUTER DATABASE IN THE FIELD OF AGRICULTURE (U.S. CLS. 100 AND 101).

BRENDAN REGAN, EXAMINING ATTORNEY

SN 78-524,428. CALGON CARBON CORPORATION, PITTSBURGH, PA. FILED 11-30-2004.



CLASS 1—CHEMICALS

FOR ACTIVATED CARBON FOR USE IN AIR PURIFICATION (U.S. CLS. 1, 5, 6, 10, 26 AND 46).

CLASS 5—PHARMACEUTICALS

FOR AIR DEODORIZER (U.S. CLS. 6, 18, 44, 46, 51 AND 52).

CLASS 11—ENVIRONMENTAL CONTROL APPARATUS

FOR AIR CLEANING UNITS (U.S. CLS. 13, 21, 23, 31 AND 34).
KEVIN DINALLO, EXAMINING ATTORNEY

CLASS 39—TRANSPORTATION AND STORAGE

FOR SOLID WASTE HAULING SERVICES (U.S. CLS. 100 AND 105).
FIRST USE 12-31-1996; IN COMMERCE 8-31-1998.

SN 78-524,440. CALGON CARBON CORPORATION, PITTSBURGH, PA. FILED 11-30-2004.

**CLASS 40—MATERIAL TREATMENT**

FOR RECYCLING SERVICES FOR CORRUGATED CARDBOARD (U.S. CLS. 100, 103 AND 106).
FIRST USE 12-31-1996; IN COMMERCE 8-31-1998.
ANNE FARRELL, EXAMINING ATTORNEY

SN 78-524,642. GROGAN & COMPANY, INC., CUMMING, GA. FILED 11-30-2004.

CLASS 1—CHEMICALS

FOR ACTIVATED CARBON FOR USE IN AIR PURIFICATION (U.S. CLS. 1, 5, 6, 10, 26 AND 46).

CLASS 5—PHARMACEUTICALS

FOR AIR DEODORIZER (U.S. CLS. 6, 18, 44, 46, 51 AND 52).

CLASS 11—ENVIRONMENTAL CONTROL APPARATUS

FOR AIR CLEANING UNITS (U.S. CLS. 13, 21, 23, 31 AND 34).
KEVIN DINALLO, EXAMINING ATTORNEY



SN 78-524,563. GROGAN & COMPANY, INC., CUMMING, GA. FILED 11-30-2004.

Grogan & Co.

NO CLAIM IS MADE TO THE EXCLUSIVE RIGHT TO USE "CO., INC." OR "SANITATION SYSTEMS", APART FROM THE MARK AS SHOWN.

THE COLOR(S) RED, GREEN AND YELLOW IS/ARE CLAIMED AS A FEATURE OF THE MARK.

THE MARK CONSISTS OF A YELLOW INNER OVAL WITH "G&G" IN RED CENTERED ON A GREEN RECYCLING SYMBOL, ALL SURROUNDED BY A RED OUTER OVAL WITH YELLOW "GROGAN & CO., INC." ALONG THE TOP AND YELLOW "SANITATION SYSTEMS" ALONG THE BOTTOM.

CLASS 39—TRANSPORTATION AND STORAGE

FOR SOLID WASTE HAULING SERVICES (U.S. CLS. 100 AND 105).
FIRST USE 12-31-1996; IN COMMERCE 8-31-1998.

CLASS 40—MATERIAL TREATMENT

FOR RECYCLING SERVICES FOR CORRUGATED CARDBOARD (U.S. CLS. 100, 103 AND 106).
FIRST USE 12-31-1996; IN COMMERCE 8-31-1998.
TINA L. SNAPP, EXAMINING ATTORNEY

THE MARK CONSISTS OF STANDARD CHARACTERS WITHOUT CLAIM TO ANY PARTICULAR FONT, STYLE, SIZE, OR COLOR.

NO CLAIM IS MADE TO THE EXCLUSIVE RIGHT TO USE "CO.", APART FROM THE MARK AS SHOWN.
SEC. 2(F).

SN 78-524,714. STORYPARADE, INC., LA MIRADA, CA.
FILED 11-30-2004.

STORYPARADE

THE MARK CONSISTS OF STANDARD CHARACTERS WITHOUT CLAIM TO ANY PARTICULAR FONT, STYLE, SIZE, OR COLOR.

CLASS 9—ELECTRICAL AND SCIENTIFIC APPARATUS

FOR PRERECORDED EDUCATIONAL COMPACT DISCS, LASER DISCS, CD ROMS, DVDS, COMPUTER SOFTWARE, VIDEO TAPES, CASSETTES ALL DIRECTED TO THE SUBJECT MATTER OF STORIES, STORYTELLING, READING, LITERATURE, SPELLING, ENGLISH AND LANGUAGE ARTS (U.S. CLS. 21, 23, 26, 36 AND 38).

CLASS 16—PAPER GOODS AND PRINTED MATTER

FOR SERIES OF NON-FICTION EDUCATIONAL BOOKS, EDUCATIONAL MAGAZINES, EDUCATIONAL NEWSLETTERS, EDUCATIONAL PAMPHLETS AND EDUCATIONAL BROCHURES IN THE FIELDS OF STORIES, STORYTELLING, READING, LITERATURE, SPELLING, ENGLISH AND LANGUAGE ARTS; PRINTED CARDS, NAMELY STUDY CARDS AND FLASH CARDS CONTAINING INFORMATION ON PHONICS AND LANGUAGE ARTS (U.S. CLS. 2, 5, 22, 23, 29, 37, 38 AND 50).

DAWN FELDMAN, EXAMINING ATTORNEY

SN 78-524,779. RUBIN, TINA, OAKLAND, CA. FILED 11-30-2004.



NO CLAIM IS MADE TO THE EXCLUSIVE RIGHT TO USE "KIDS.COM", APART FROM THE MARK AS SHOWN.

CLASS 25—CLOTHING

FOR T-SHIRTS AND HATS (U.S. CLS. 22 AND 39).

CLASS 35—ADVERTISING AND BUSINESS

FOR ONLINE RETAIL STORE SERVICES FEATURING A FAMILY GIFT SHOP SPECIALIZING IN ADOPTION LIFE BOOKS (U.S. CLS. 100, 101 AND 102).
KATHLEEN M. VANSTON, EXAMINING ATTORNEY

SN 78-524,860. THE FERRARI GROUP, LLC, LEXINGTON, KY. FILED 11-30-2004.

ETTA MAY

THE MARK CONSISTS OF STANDARD CHARACTERS WITHOUT CLAIM TO ANY PARTICULAR FONT, STYLE, SIZE, OR COLOR.

THE NAME ETTA MAY SHOWN IN THE MARK IDENTIFIES THE STAGE NAME FOR BRENDA FERRARI, WHOSE CONSENT TO REGISTER IS SUBMITTED.

CLASS 9—ELECTRICAL AND SCIENTIFIC APPARATUS

FOR PRERECORDED VIDEO CASSETTES, CDS, AND DVDS FEATURING COMEDY PRESENTATIONS (U.S. CLS. 21, 23, 26, 36 AND 38).

FIRST USE 8-11-1993; IN COMMERCE 8-11-1993.

CLASS 25—CLOTHING

FOR CLOTHING, NAMELY, T-SHIRTS (U.S. CLS. 22 AND 39).

FIRST USE 8-4-1992; IN COMMERCE 8-4-1992.

TANYA AMOS, EXAMINING ATTORNEY

SN 78-524,978. LERNELL CO, LLC, DBA LERNELL/MASS, LLC, BROOKLYN, NY. AND MASS MARKET IDEAS, LLC, DBA LERNELL/MASS, LLC, BROOKLYN, NY. FILED 12-1-2004.

FUSION FORCE

THE MARK CONSISTS OF STANDARD CHARACTERS WITHOUT CLAIM TO ANY PARTICULAR FONT, STYLE, SIZE, OR COLOR.

CLASS 28—TOYS AND SPORTING GOODS

FOR TOYS AND GAMES, NAMELY, HAND HELD UNIT FOR PLAYING ELECTRONIC GAMES, PLAYSETS FOR ACTION FIGURES, TOY VEHICLES AND TOY ACTION FIGURES (U.S. CLS. 22, 23, 38 AND 50).

SN 78-525,906. HEALTH RESEARCH, INC., ROSWELL PARK CANCER INSTITUTE, BUFFALO, NY. FILED 12-2-2004.

CLASS 41—EDUCATION AND ENTERTAINMENT

FOR ENTERTAINMENT SERVICES, NAMELY, PRODUCTION OF CHILDREN'S TELEVISION SHOWS, ANIMATED CARTOONS AND MOTION PICTURES (U.S. CLS. 100, 101 AND 107).

ZACHARY BELLO, EXAMINING ATTORNEY

RPCI

SN 78-524,985. LERNELL CO. LLC, DBA LERNELL/MASS, LLC, BROOKLYN, NY. AND MASS MARKET IDEAS, LLC, DBA LERNELL/MASS, LLC, BROOKLYN, NY. FILED 12-1-2004.

THE MARK CONSISTS OF STANDARD CHARACTERS WITHOUT CLAIM TO ANY PARTICULAR FONT, STYLE, SIZE, OR COLOR.

OWNER OF U.S. REG. NO. 2,840,189.

CLASS 1—CHEMICALS

FOR IMMUNOLOGICAL REAGENTS, NAMELY, ANTIBODIES AND FRAGMENTS THEREOF, FOR OTHER THAN MEDICAL AND VETERINARY PURPOSES (U.S. CLS. 1, 5, 6, 10, 26 AND 46).

CLASS 5—PHARMACEUTICALS

FOR IMMUNOLOGICAL REAGENTS, NAMELY, ANTIBODIES AND FRAGMENTS THEREOF, FOR MEDICAL AND VETERINARY PURPOSES (U.S. CLS. 6, 18, 44, 46, 51 AND 52).

NELSON SNYDER, EXAMINING ATTORNEY

UNITORZ

SN 78-527,452. BALTIC LINEN COMPANY, INC., VALLEY STREAM, NY. FILED 12-6-2004.

THE MARK CONSISTS OF STANDARD CHARACTERS WITHOUT CLAIM TO ANY PARTICULAR FONT, STYLE, SIZE, OR COLOR.

CLASS 28—TOYS AND SPORTING GOODS

FOR TOYS AND GAMES, NAMELY, HAND HELD UNIT FOR PLAYING ELECTRONIC GAMES, PLAYSETS FOR ACTION FIGURES, TOY VEHICLES AND TOY ACTION FIGURES (U.S. CLS. 22, 23, 38 AND 50).

THE MARK CONSISTS OF STANDARD CHARACTERS WITHOUT CLAIM TO ANY PARTICULAR FONT, STYLE, SIZE, OR COLOR.

CLASS 6—METAL GOODS

FOR METAL CURTAIN RINGS AND METAL SHOWER CURTAIN RINGS (U.S. CLS. 2, 12, 13, 14, 23, 25 AND 50).

CLASS 41—EDUCATION AND ENTERTAINMENT

FOR ENTERTAINMENT SERVICES, NAMELY, PRODUCTION OF CHILDREN'S TELEVISION SHOWS, ANIMATED CARTOONS AND MOTION PICTURES (U.S. CLS. 100, 101 AND 107).

ZACHARY BELLO, EXAMINING ATTORNEY

CLASS 20—FURNITURE AND ARTICLES NOT OTHERWISE CLASSIFIED

FOR DECORATIVE PILLOWS, NON-METAL SHOWER CURTAIN RINGS AND NON-METAL HOOKS (U.S. CLS. 2, 13, 22, 25, 32 AND 50).

BAMBOOTOO

CLASS 21—HOUSEWARES AND GLASS

FOR SOAP DISHES, TUMBLERS, TOOTHBRUSH HOLDERS, TISSUE HOLDERS, TOILET PAPER HOLDERS, LOTION DISPENSERS, SOAP DISPENSERS, CANISTERS, AND WASTEPAPER BASKETS (U.S. CLS. 2, 13, 23, 29, 30, 33, 40 AND 50).

SN 78-527,878. MAXFIELD INC., SAN MATEO, CA. FILED 12-6-2004.

CLASS 24—FABRICS

FOR COMFORTERS, DUVET COVERS, COVERLETS, BLANKETS, THROWS, BED SHEETS, BED SHEET SETS, BEDSKIRTS, PILLOWS CASES, SHAMS, BATH TOWELS, HAND TOWELS, WASHCLOTHS, SHOWER CURTAINS, SHOWER CURTAIN LINERS, CURTAINS AND FABRIC VALANCES (U.S. CLS. 42 AND 50).
KATRINA EDGE, EXAMINING ATTORNEY

TERIS

THE MARK CONSISTS OF STANDARD CHARACTERS WITHOUT CLAIM TO ANY PARTICULAR FONT, STYLE, SIZE, OR COLOR.

CLASS 35—ADVERTISING AND BUSINESS

FOR FRANCHISING, NAMELY, OFFERING TECHNICAL ASSISTANCE IN THE ESTABLISHMENT AND/OR OPERATION OF RESTAURANTS (U.S. CLS. 100, 101 AND 102).

SN 78-527,656. GOLDFARB, REBECCA, SAN FRANCISCO, CA. FILED 12-6-2004.

CLASS 43—HOTEL AND RESTAURANT SERVICES

FOR RESTAURANTS (U.S. CLS. 100 AND 101).
MONTIA G. PRESSEY, EXAMINING ATTORNEY

LINGER PROJECTS

SN 78-529,341. WORKINGBUILDINGS, LLC, ATLANTA, GA. FILED 12-8-2004.

**DELIVERING
BUILDINGS THAT
WORK**

THE MARK CONSISTS OF STANDARD CHARACTERS WITHOUT CLAIM TO ANY PARTICULAR FONT, STYLE, SIZE, OR COLOR.

THE MARK CONSISTS OF STANDARD CHARACTERS WITHOUT CLAIM TO ANY PARTICULAR FONT, STYLE, SIZE, OR COLOR.

CLASS 16—PAPER GOODS AND PRINTED MATTER

FOR NOTE BOOKS, SKETCH BOOKS, DRAWING PADS AND PAPER, STATIONERY, NOTE CARDS AND WRITING PADS AND PAPER (U.S. CLS. 2, 5, 22, 23, 29, 37, 38 AND 50).

CLASS 37—CONSTRUCTION AND REPAIR

FOR BUILDING INSPECTION SERVICES; CONSTRUCTION MANAGEMENT SUPERVISION SERVICES; BUILDING CONSTRUCTION OBSERVATION, NAMELY, STATIC INSPECTION, FUNCTIONAL VERIFICATION INSPECTION, PERFORMANCE VERIFICATION INSPECTION; CONSTRUCTION SUPERVISION SERVICES; CONSTRUCTION PLANNING SERVICES; TECHNICAL CONSULTATION IN THE FIELD OF BUILDING CONSTRUCTION; CONSULTATION SERVICES, NAMELY, REVIEW OF AND REMEDIAL RECOMMENDATIONS FOR BUILDING MECHANICAL, PLUMBING, ELECTRICAL SYSTEMS, COMPUTER NETWORKS AND TELECOMMUNICATIONS NETWORKS (U.S. CLS. 100, 103 AND 106).
FIRST USE 1-0-2002; IN COMMERCE 1-0-2002.

CLASS 21—HOUSEWARES AND GLASS

FOR VASES, CUPS, BOWLS, DISHES AND CONTAINERS FOR HOUSEHOLD OR KITCHEN USE, NOT OF PRECIOUS METAL (U.S. CLS. 2, 13, 23, 29, 30, 33, 40 AND 50).
REBECCA GILBERT, EXAMINING ATTORNEY

CLASS 42—SCIENTIFIC, COMPUTER AND LEGAL SERVICES

SN 78-529,353. WORKINGBUILDINGS, LLC, ATLANTA, GA. FILED 12-8-2004.

FOR BUILDING ARCHITECTURAL DESIGN REVIEW; TECHNICAL CONSULTATION IN THE FIELD OF BUILDING ARCHITECTURAL DESIGN; QUALITY CONTROL SERVICES FOR OTHERS RELATING TO THE DESIGN, CONSTRUCTION, AND OPERATION OF BUILDINGS; PROVIDING QUALITY ASSURANCE SERVICES RELATING TO THE DESIGN, CONSTRUCTION, AND OPERATION OF BUILDINGS; CONSULTING ENGINEERING SERVICES; BUILDING ENGINEERING SURVEYS OF BUILDING DESIGN AND CONSTRUCTION FLAWS, BUILDING OPERATIONAL ISSUES, AND INDOOR ENVIRONMENTAL QUALITY ISSUES; CONSULTATION SERVICES, NAMELY, REVIEW OF AND REMEDIAL RECOMMENDATIONS FOR INDOOR ENVIRONMENTAL QUALITY ISSUES (U.S. CLS. 100 AND 101).

FIRST USE 1-0-2002; IN COMMERCE 1-0-2002.
CYNTHIA SLOAN, EXAMINING ATTORNEY



SN 78-529,345. WORKINGBUILDINGS, LLC, ATLANTA, GA. FILED 12-8-2004.

WORKINGBUILDINGS

THE MARK CONSISTS OF STANDARD CHARACTERS WITHOUT CLAIM TO ANY PARTICULAR FONT, STYLE, SIZE, OR COLOR.

CLASS 37—CONSTRUCTION AND REPAIR**CLASS 37—CONSTRUCTION AND REPAIR**

FOR BUILDING INSPECTION SERVICES; CONSTRUCTION MANAGEMENT SUPERVISION SERVICES; BUILDING CONSTRUCTION OBSERVATION, NAMELY, STATIC INSPECTION, FUNCTIONAL VERIFICATION INSPECTION, PERFORMANCE VERIFICATION INSPECTION; CONSTRUCTION SUPERVISION SERVICES; CONSTRUCTION PLANNING SERVICES; TECHNICAL CONSULTATION IN THE FIELD OF BUILDING CONSTRUCTION; CONSULTATION SERVICES, NAMELY, REVIEW OF AND REMEDIAL RECOMMENDATIONS FOR BUILDING MECHANICAL, PLUMBING, ELECTRICAL SYSTEMS, COMPUTER NETWORKS AND TELECOMMUNICATIONS NETWORKS (U.S. CLS. 100, 103 AND 106).

FOR BUILDING INSPECTION SERVICES; CONSTRUCTION MANAGEMENT SUPERVISION SERVICES; BUILDING CONSTRUCTION OBSERVATION, NAMELY, STATIC INSPECTION, FUNCTIONAL VERIFICATION INSPECTION, PERFORMANCE VERIFICATION INSPECTION; CONSTRUCTION SUPERVISION SERVICES; CONSTRUCTION PLANNING SERVICES; TECHNICAL CONSULTATION IN THE FIELD OF BUILDING CONSTRUCTION; CONSULTATION SERVICES, NAMELY, REVIEW OF AND REMEDIAL RECOMMENDATIONS FOR BUILDING MECHANICAL, PLUMBING, ELECTRICAL SYSTEMS, COMPUTER NETWORKS AND TELECOMMUNICATIONS NETWORKS (U.S. CLS. 100, 103 AND 106).

FIRST USE 8-23-1999; IN COMMERCE 8-23-1999.

FIRST USE 9-30-1999; IN COMMERCE 9-30-1999.

CLASS 42—SCIENTIFIC, COMPUTER AND LEGAL SERVICES**CLASS 42—SCIENTIFIC, COMPUTER AND LEGAL SERVICES**

FOR BUILDING ARCHITECTURAL DESIGN REVIEW; TECHNICAL CONSULTATION IN THE FIELD OF BUILDING ARCHITECTURAL DESIGN; QUALITY CONTROL SERVICES FOR OTHERS RELATING TO THE DESIGN, CONSTRUCTION, AND OPERATION OF BUILDINGS; PROVIDING QUALITY ASSURANCE SERVICES RELATING TO THE DESIGN, CONSTRUCTION, AND OPERATION OF BUILDINGS; CONSULTING ENGINEERING SERVICES; BUILDING ENGINEERING SURVEYS OF BUILDING DESIGN AND CONSTRUCTION FLAWS, BUILDING OPERATIONAL ISSUES, AND INDOOR ENVIRONMENTAL QUALITY ISSUES; CONSULTATION SERVICES, NAMELY, REVIEW OF AND REMEDIAL RECOMMENDATIONS FOR INDOOR ENVIRONMENTAL QUALITY ISSUES (U.S. CLS. 100 AND 101).

FOR BUILDING ARCHITECTURAL DESIGN REVIEW; TECHNICAL CONSULTATION IN THE FIELD OF BUILDING ARCHITECTURAL DESIGN; QUALITY CONTROL SERVICES FOR OTHERS RELATING TO THE DESIGN, CONSTRUCTION, AND OPERATION OF BUILDINGS; PROVIDING QUALITY ASSURANCE SERVICES RELATING TO THE DESIGN, CONSTRUCTION, AND OPERATION OF BUILDINGS; CONSULTING ENGINEERING SERVICES; BUILDING ENGINEERING SURVEYS OF BUILDING DESIGN AND CONSTRUCTION FLAWS, BUILDING OPERATIONAL ISSUES, AND INDOOR ENVIRONMENTAL QUALITY ISSUES; CONSULTATION SERVICES, NAMELY, REVIEW OF AND REMEDIAL RECOMMENDATIONS FOR INDOOR ENVIRONMENTAL QUALITY ISSUES (U.S. CLS. 100 AND 101).

FIRST USE 8-23-1999; IN COMMERCE 8-23-1999.
CYNTHIA SLOAN, EXAMINING ATTORNEY

FIRST USE 9-30-1999; IN COMMERCE 9-30-1999.
CYNTHIA SLOAN, EXAMINING ATTORNEY

SN 78-529,358. WORKINGBUILDINGS, LLC, ATLANTA, GA.
FILED 12-8-2004.



CLASS 37—CONSTRUCTION AND REPAIR

FOR BUILDING INSPECTION SERVICES; CONSTRUCTION MANAGEMENT SUPERVISION SERVICES; BUILDING CONSTRUCTION OBSERVATION, NAMELY, STATIC INSPECTION, FUNCTIONAL VERIFICATION INSPECTION, PERFORMANCE VERIFICATION INSPECTION; CONSTRUCTION SUPERVISION SERVICES; CONSTRUCTION PLANNING SERVICES; TECHNICAL CONSULTATION IN THE FIELD OF BUILDING CONSTRUCTION; CONSULTATION SERVICES, NAMELY, REVIEW OF AND REMEDIAL RECOMMENDATIONS FOR BUILDING MECHANICAL, PLUMBING, ELECTRICAL SYSTEMS, COMPUTER NETWORKS AND TELECOMMUNICATIONS NETWORKS (U.S. CLS. 100, 103 AND 106).

FIRST USE 9-30-1999; IN COMMERCE 9-30-1999.

CLASS 42—SCIENTIFIC, COMPUTER AND LEGAL SERVICES

FOR BUILDING ARCHITECTURAL DESIGN REVIEW; TECHNICAL CONSULTATION IN THE FIELD OF BUILDING ARCHITECTURAL DESIGN; QUALITY CONTROL SERVICES FOR OTHERS RELATING TO THE DESIGN, CONSTRUCTION, AND OPERATION OF BUILDINGS; PROVIDING QUALITY ASSURANCE SERVICES RELATING TO THE DESIGN, CONSTRUCTION, AND OPERATION OF BUILDINGS; CONSULTING ENGINEERING SERVICES; BUILDING ENGINEERING SURVEYS OF BUILDING DESIGN AND CONSTRUCTION FLAWS, BUILDING OPERATIONAL ISSUES, AND INDOOR ENVIRONMENTAL QUALITY ISSUES; CONSULTATION SERVICES, NAMELY, REVIEW OF AND REMEDIAL RECOMMENDATIONS FOR INDOOR ENVIRONMENTAL QUALITY ISSUES (U.S. CLS. 100 AND 101).

FIRST USE 9-30-1999; IN COMMERCE 9-30-1999.
CYNTHIA SLOAN, EXAMINING ATTORNEY

SN 78-529,981. LANCER, HAROLD A., BEVERLY HILLS, CA.
FILED 12-9-2004.



OWNER OF U.S. REG. NO. 2,559,742.

CLASS 3—COSMETICS AND CLEANING PREPARATIONS

FOR COSMETICS; NON-MEDICATED SKIN CARE PREPARATIONS; SUNSCREENS; SKIN, NAIL AND CUTICLE MOISTURIZERS; SKIN AND NAIL CLEANSERS; SKIN POLISHERS; NON-MEDICATED PREPARATIONS TO PROTECT THE SKIN FROM WIND, COLD, HEAT AND ENVIRONMENTAL POLLUTION (U.S. CLS. 1, 4, 6, 50, 51 AND 52).

CLASS 10—MEDICAL APPARATUS

FOR MULTI-PURPOSE, ELECTRICALLY OPERATED, FOOT CONDITIONER, NAMELY AN ORTHOEPI-CALLY-ENGINEERED APPLIANCE THAT CLEANSSES, SOOTHES, HYDRATES AND PROPERLY DRIES THE FEET (U.S. CLS. 26, 39 AND 44).

INGRID C. EULIN, EXAMINING ATTORNEY

SN 78-530,000. EASTMAN CHEMICAL COMPANY, KINGSPORT, TN. FILED 12-9-2004.

MICROBIOLOGY AT THE SPEED OF LIGHT

THE MARK CONSISTS OF STANDARD CHARACTERS WITHOUT CLAIM TO ANY PARTICULAR FONT, STYLE, SIZE, OR COLOR.

NO CLAIM IS MADE TO THE EXCLUSIVE RIGHT TO USE "MICROBIOLOGY", APART FROM THE MARK AS SHOWN.

CLASS 1—CHEMICALS

FOR DIAGNOSTIC TEST KITS COMPOSED OF REAGENTS FOR SCIENTIFIC OR RESEARCH USE, NAMELY, FOR FOOD SAFETY TESTING (U.S. CLS. 1, 5, 6, 10, 26 AND 46).

CLASS 42—SCIENTIFIC, COMPUTER AND LEGAL SERVICES

FOR CONSULTING AND TESTING SERVICES IN THE FIELD OF FOOD SAFETY AND FOOD COMPOSITION (U.S. CLS. 100 AND 101).

JENNIFER DIXON, EXAMINING ATTORNEY

SN 78-530,193. MILLS GIFTS INTERNATIONAL, INC., NEWBURY PARK, CA. FILED 12-9-2004.

LAND OF THE FREE BECAUSE OF THE BRAVE

THE MARK CONSISTS OF STANDARD CHARACTERS WITHOUT CLAIM TO ANY PARTICULAR FONT, STYLE, SIZE, OR COLOR.

CLASS 14—JEWELRY

FOR JEWELRY, NAMELY NON-METALLIC BRACELETS (U.S. CLS. 2, 27, 28 AND 50).

CLASS 28—TOYS AND SPORTING GOODS

FOR TOYS, NAMELY ANIMATED TALKING TOY FIGURES AND PLUSH TOYS (U.S. CLS. 22, 23, 38 AND 50).

ROBERT LORENZO, EXAMINING ATTORNEY

SN 78-531,186. GEORGE MASON UNIVERSITY, FAIRFAX, VA. FILED 12-13-2004.



SN 78-530,371. GEORGE MASON UNIVERSITY, FAIRFAX, VA. FILED 12-10-2004.



OWNER OF U.S. REG. NOS. 1,589,393, 2,085,820 AND OTHERS.

THE MARK CONSISTS OF A SHOOTING STAR TRAILED BY A BOLT ABOVE THE STYLIZED WORD "MASON".

CLASS 25—CLOTHING

FOR CLOTHING AND HEADGEAR, NAMELY T-SHIRTS, RUGBY SHIRTS, BASEBALL CAPS, SWEAT PANTS, SHORTS, SWEAT SHIRTS (U.S. CLS. 22 AND 39).

CLASS 28—TOYS AND SPORTING GOODS

FOR SPORTING ARTICLES, NAMELY, BASKETBALLS, BASEBALLS AND GOLF BALLS; DECORATIONS FOR CHRISTMAS TREES (U.S. CLS. 22, 23, 38 AND 50).

CLASS 41—EDUCATION AND ENTERTAINMENT

FOR ENTERTAINMENT SERVICES IN THE NATURE OF COLLEGIATE SPORTING EVENTS AND COMPETITIONS (U.S. CLS. 100, 101 AND 107).

PAULA MAHONEY, EXAMINING ATTORNEY

OWNER OF U.S. REG. NOS. 1,589,393, 2,085,820 AND OTHERS.

THE MARK CONSISTS OF A SHOOTING STAR TRAILED BY A BOLT ABOVE THE STYLIZED WORDS "MASON PATRIOTS".

CLASS 25—CLOTHING

FOR CLOTHING AND HEADGEAR, NAMELY T-SHIRTS, RUGBY SHIRTS, BASEBALL CAPS, SWEAT PANTS, SHORTS, SWEAT SHIRTS (U.S. CLS. 22 AND 39).

CLASS 28—TOYS AND SPORTING GOODS

FOR SPORTING ARTICLES, NAMELY, BASKETBALLS, BASEBALLS AND GOLF BALLS; DECORATIONS FOR CHRISTMAS TREES (U.S. CLS. 22, 23, 38 AND 50).

CLASS 41—EDUCATION AND ENTERTAINMENT

FOR ENTERTAINMENT SERVICES IN THE NATURE OF COLLEGIATE SPORTING EVENTS AND COMPETITIONS (U.S. CLS. 100, 101 AND 107).

PAULA MAHONEY, EXAMINING ATTORNEY

SN 78-531,257. GEORGE MASON UNIVERSITY, FAIRFAX, VA. FILED 12-13-2004.



OWNER OF U.S. REG. NOS. 1,589,393, 2,085,820 AND OTHERS.

THE MARK CONSISTS OF THE WORD "MASON" ABOVE THE WORD "PATRIOTS", BOTH IN STYLIZED SCRIPT.

CLASS 25—CLOTHING

FOR CLOTHING AND HEADGEAR, NAMELY T-SHIRTS, RUGBY SHIRTS, BASEBALL CAPS, SWEAT PANTS, SHORTS, SWEAT SHIRTS (U.S. CLS. 22 AND 39).

CLASS 28—TOYS AND SPORTING GOODS

FOR SPORTING ARTICLES, NAMELY, BASKETBALLS, BASEBALLS AND GOLF BALLS; DECORATIONS FOR CHRISTMAS TREES (U.S. CLS. 22, 23, 38 AND 50).

CLASS 41—EDUCATION AND ENTERTAINMENT

FOR ENTERTAINMENT SERVICES IN THE NATURE OF COLLEGIATE SPORTING EVENTS AND COMPETITIONS (U.S. CLS. 100, 101 AND 107).

PAULA MAHONEY, EXAMINING ATTORNEY

CLASS 42—SCIENTIFIC, COMPUTER AND LEGAL SERVICES

FOR PROVIDING NON-DOWNLOADABLE COMPUTER SOFTWARE FOR VIEWING, SEARCHING AND EDITING DIGITAL INFORMATION FROM A COMPUTER DATABASE IN RELATION TO ITS POSITION ON A DIGITAL MAP, DIGITAL DIAGRAM OR DIGITAL IMAGE (U.S. CLS. 100 AND 101).

ZACHARY BELLO, EXAMINING ATTORNEY

SN 78-532,489. JUNIPER NETWORKS, INC., SUNNYVALE, CA. FILED 12-14-2004.

SN 78-531,927. SCHMAP LIMITED, HONG KONG, HONG KONG, FILED 12-14-2004.

Schmap

THE MARK CONSISTS OF STANDARD CHARACTERS WITHOUT CLAIM TO ANY PARTICULAR FONT, STYLE, SIZE, OR COLOR.

CLASS 9—ELECTRICAL AND SCIENTIFIC APPARATUS

FOR COMPUTER SOFTWARE FOR VIEWING, SEARCHING AND EDITING DIGITAL INFORMATION FROM A COMPUTER DATABASE IN RELATION TO ITS POSITION ON A DIGITAL MAP, DIGITAL DIAGRAM OR DIGITAL IMAGE (U.S. CLS. 21, 23, 26, 36 AND 38).

CLASS 35—ADVERTISING AND BUSINESS

FOR PROVIDING GEOGRAPHIC INFORMATION AND MAP IMAGES IN THE FIELD OF CONSUMER-ORIENTED BUSINESS VIA GLOBAL INFORMATION NETWORKS (U.S. CLS. 100, 101 AND 102).

CLASS 39—TRANSPORTATION AND STORAGE

FOR PROVISION OF INFORMATION RELATING TO TRAVEL AND TRAVEL MAPS VIA GLOBAL INFORMATION NETWORKS (U.S. CLS. 100 AND 105).



OWNER OF U.S. REG. NOS. 2,255,921 AND 2,761,776.

NO CLAIM IS MADE TO THE EXCLUSIVE RIGHT TO USE "N ETWORKS", APART FROM THE MARK AS SHOWN.

THE MARK CONSISTS OF A LEAF LIKE PLANT IN A CIRCLE WITHIN A SQUARE. THE WORDS JUNIPER NETWORKS ARE ON THE RIGHT SIDE OF THE SQUARE.

CLASS 9—ELECTRICAL AND SCIENTIFIC APPARATUS

FOR COMPUTER HARDWARE AND SOFTWARE, USED ALONE OR IN COMBINATION, FOR INTERCONNECTING, ESTABLISHING, MANAGING, SECURING, MONITORING, CONTROLLING, OPERATING, AND ACCESSING LOCAL, WIDE, AND GLOBAL AREA NETWORKS; COMPUTER HARDWARE AND SOFTWARE, USED ALONE OR IN COMBINATION, FOR ROUTING, SWITCHING, TRANSMITTING, PROCESSING, FILTERING, ANALYZING, SECURING, AND STORING DATA, VIDEO OR VOICE TRAFFIC, PACKETS, OR OTHER FORMS OF COMMUNICATIONS; COMPUTER HARDWARE AND SOFTWARE, USED ALONE OR IN COMBINATION, FOR PROVIDING SECURITY FUNCTIONALITY FOR NETWORKS OR ELECTRONIC DEVICES, SUCH AS PROVIDING FIREWALL FILTERS, VIRTUAL PRIVATE NETWORKS, AND PROTECTION AGAINST NETWORK INTRUSION AND VIRUSES; COMPUTER HARDWARE AND SOFTWARE, USED ALONE OR IN COMBINATION, FOR USE IN OR WITH A NETWORK; DOWNLOADABLE INSTRUCTIONAL MATERIALS, NAMELY, MANUALS AND GUIDES IN THE FIELDS OF NETWORKING, TELECOMMUNICATIONS, AND NETWORK SECURITY, AND ESTABLISHING, MANAGING, AND OPERATING LOCAL AND WIDE AREA NETWORK (U.S. CLS. 21, 23, 26, 36 AND 38).

FIRST USE 8-5-1998; IN COMMERCE 8-5-1998.

CLASS 37—CONSTRUCTION AND REPAIR

FOR INSTALLATION, MAINTENANCE, AND REPAIR SERVICES IN THE FIELDS OF COMPUTERS, TELECOMMUNICATIONS, NETWORKING, COMMUNICATIONS, AND NETWORK SECURITY (U.S. CLS. 100, 103 AND 106).

FIRST USE 8-5-1998; IN COMMERCE 8-5-1998.

CLASS 42—SCIENTIFIC, COMPUTER AND LEGAL SERVICES

FOR CONSULTING IN THE FIELDS OF COMPUTERS, NETWORKING, COMMUNICATIONS, AND NETWORK SECURITY; SECURITY SERVICES FOR COMPUTER AND TELEPHONY SYSTEMS; COMPUTER SUPPORT SERVICES IN CONNECTION WITH HARDWARE AND SOFTWARE FOR INTERCONNECTING, MANAGING, SECURING, MONITORING, CONTROLLING, OPERATING, AND ACCESSING LOCAL AND WIDE AREA NETWORKS AND TELEPHONY SYSTEMS; DESIGN, TESTING, ENGINEERING, RESEARCH AND ADVISORY SERVICES RELATING TO COMPUTERS, TELECOMMUNICATIONS, NETWORKS, COMPUTER SOFTWARE, COMPUTER PROGRAMMING, AND NETWORK SECURITY (U.S. CLS. 100 AND 101).

FIRST USE 8-5-1998; IN COMMERCE 8-5-1998.

NAAKWAMA ANKRAH, EXAMINING ATTORNEY

CLASS 42—SCIENTIFIC, COMPUTER AND LEGAL SERVICES

FOR CONSULTING IN THE FIELDS OF COMPUTERS, NETWORKING, COMMUNICATIONS, AND NETWORK SECURITY; SECURITY SERVICES FOR COMPUTER AND TELEPHONY SYSTEMS; COMPUTER SUPPORT SERVICES IN CONNECTION WITH HARDWARE AND SOFTWARE FOR INTERCONNECTING, MANAGING, SECURING, MONITORING, CONTROLLING, OPERATING, AND ACCESSING LOCAL AND WIDE AREA NETWORKS AND TELEPHONY SYSTEMS; DESIGN, TESTING, ENGINEERING, RESEARCH AND ADVISORY SERVICES RELATING TO COMPUTERS, TELECOMMUNICATIONS, NETWORKS, COMPUTER SOFTWARE, COMPUTER PROGRAMMING, AND NETWORK SECURITY (U.S. CLS. 100 AND 101).

FIRST USE 8-5-1998; IN COMMERCE 8-5-1998.

NAAKWAMA ANKRAH, EXAMINING ATTORNEY

SN 78-532,494. JUNIPER NETWORKS, INC., SUNNYVALE, CA. FILED 12-14-2004.

SN 78-532,529. SWABPLUS INC., RANCHO CUCAMONGA, CA. FILED 12-14-2004.

JUNIPER NETWORKS

THE MARK CONSISTS OF STANDARD CHARACTERS WITHOUT CLAIM TO ANY PARTICULAR FONT, STYLE, SIZE, OR COLOR.

OWNER OF U.S. REG. NOS. 2,255,921 AND 2,761,776.

NO CLAIM IS MADE TO THE EXCLUSIVE RIGHT TO USE "NETWORKS", APART FROM THE MARK AS SHOWN.

CLASS 9—ELECTRICAL AND SCIENTIFIC APPARATUS

FOR COMPUTER HARDWARE AND SOFTWARE, USED ALONE OR IN COMBINATION, FOR INTERCONNECTING, ESTABLISHING, MANAGING, SECURING, MONITORING, CONTROLLING, OPERATING, AND ACCESSING LOCAL, WIDE, AND GLOBAL AREA NETWORKS; COMPUTER HARDWARE AND SOFTWARE, USED ALONE OR IN COMBINATION, FOR ROUTING, SWITCHING, TRANSMITTING, PROCESSING, FILTERING, ANALYZING, SECURING, AND STORING DATA, VIDEO OR VOICE TRAFFIC, PACKETS, OR OTHER FORMS OF COMMUNICATIONS; COMPUTER HARDWARE AND SOFTWARE, USED ALONE OR IN COMBINATION, FOR PROVIDING SECURITY FUNCTIONALITY FOR NETWORKS OR ELECTRONIC DEVICES, SUCH AS PROVIDING FIREWALL FILTERS, VIRTUAL PRIVATE NETWORKS, AND PROTECTION AGAINST NETWORK INTRUSION AND VIRUSES; COMPUTER HARDWARE AND SOFTWARE, USED ALONE OR IN COMBINATION, FOR USE IN OR WITH A NETWORK; DOWNLOADABLE INSTRUCTIONAL MATERIALS, NAMELY, MANUALS AND GUIDES IN THE FIELDS OF NETWORKING, TELECOMMUNICATIONS, AND NETWORK SECURITY, AND ESTABLISHING, MANAGING, AND OPERATING LOCAL AND WIDE AREA NETWORKS (U.S. CLS. 21, 23, 26, 36 AND 38).

FIRST USE 8-5-1998; IN COMMERCE 8-5-1998.

CLASS 37—CONSTRUCTION AND REPAIR

FOR INSTALLATION, MAINTENANCE, AND REPAIR SERVICES IN THE FIELDS OF COMPUTERS, TELECOMMUNICATIONS, NETWORKING, COMMUNICATIONS, AND NETWORK SECURITY (U.S. CLS. 100, 103 AND 106).

FIRST USE 8-5-1998; IN COMMERCE 8-5-1998.

SNAP TIPS

THE MARK CONSISTS OF STANDARD CHARACTERS WITHOUT CLAIM TO ANY PARTICULAR FONT, STYLE, SIZE, OR COLOR.

NO CLAIM IS MADE TO THE EXCLUSIVE RIGHT TO USE "TIPS", APART FROM THE MARK AS SHOWN.

CLASS 3—COSMETICS AND CLEANING PREPARATIONS

FOR COTTON SWAB WITH A HOLLOW TUBE APPLICATOR WHICH CONTAINS ONE OR MORE OF THE FOLLOWING, NAMELY COSMETICS, COSMETIC CLEANSING CREAMS, WATER FOR PERSONAL AND COSMETIC USE, PERFUMES, TOOTH WHITENERS, BREATH FRESHENERS, NAIL POLISH REMOVERS, EYE LINERS AND EYE LINER REMOVERS, AND LIPSTICK ALL FOR PERSONAL AND COSMETIC USE (U.S. CLS. 1, 4, 6, 50, 51 AND 52).

CLASS 5—PHARMACEUTICALS

FOR COTTON SWAB WITH A HOLLOW APPLICATOR TUBE WHICH CONTAINS ONE OR MORE OF THE FOLLOWING, NAMELY CLEANSING SOLUTIONS FOR MEDICAL USE, ALL PURPOSE DISINFECTANTS, DISINFECTANTS FOR CONTACT LENSES, DISINFECTANTS FOR MEDICAL INSTRUMENTS, MEDICINES NAMELY ASPIRIN, ANALGESICS, AND ANTIBIOTIC OINTMENTS, IODINE, VITAMIN DROPS, VITAMIN ENRICHED WATER, TOOTH ACHE PAIN RELIEVERS, ACNE TREATMENT PREPARATIONS, HERBAL ANTI-ITCH AND SORE SKIN OINTMENTS FOR PETS, AND FUNGUS TREATMENT PREPARATIONS (U.S. CLS. 6, 18, 44, 46, 51 AND 52).

CLASS 10—MEDICAL APPARATUS

FOR MEDICAL INSTRUMENT, NAMELY HOLLOW APPLICATOR TUBE WITH A COTTON TIP FOR PRECISE APPLICATION OF TOPICAL LIQUIDS, DENTAL MATERIALS, AND ANTISEPTIC PREPARATIONS (U.S. CLS. 26, 39 AND 44).

KIMBERLY FRYE, EXAMINING ATTORNEY

SN 78-533,519. DIAGIO DIAMONDS, INC., LAKE SUCCESS, NY. FILED 12-16-2004.

DIAGIO

THE MARK CONSISTS OF STANDARD CHARACTERS WITHOUT CLAIM TO ANY PARTICULAR FONT, STYLE, SIZE, OR COLOR.

CLASS 14—JEWELRY

FOR JEWELRY, INCLUDING DIAMOND JEWELRY (U.S. CLS. 2, 27, 28 AND 50).

CLASS 35—ADVERTISING AND BUSINESS

FOR COMPUTERIZED ON-LINE RETAIL STORE SERVICES FEATURING JEWELRY INCLUDING DIAMOND JEWELRY (U.S. CLS. 100, 101 AND 102).

CAROLINE WOOD, EXAMINING ATTORNEY

SN 78-534,940. MARLOTH, GILLIAN, LOS ANGELES, CA. FILED 12-17-2004.

YOGA BOOTY BALLET LIVE!

THE MARK CONSISTS OF STANDARD CHARACTERS WITHOUT CLAIM TO ANY PARTICULAR FONT, STYLE, SIZE, OR COLOR.

OWNER OF U.S. REG. NOS. 2,752,330 AND 2,951,238.

NO CLAIM IS MADE TO THE EXCLUSIVE RIGHT TO USE "YOGA AND BALLET", APART FROM THE MARK AS SHOWN.

CLASS 9—ELECTRICAL AND SCIENTIFIC APPARATUS

FOR PRE-RECORDED VIDEO CASSETTES AND DVD'S FEATURING EXERCISE, FITNESS AND DIETARY INFORMATION AND INSTRUCTION (U.S. CLS. 21, 23, 26, 36 AND 38).

CLASS 28—TOYS AND SPORTING GOODS

FOR EXERCISE EQUIPMENT, NAMELY, MACHINES, EXERCISE BALLS, ELASTIC BANDS FOR EXERCISE, BENCHES, TABLES, TRAMPOLINES, AND WEIGHTS (U.S. CLS. 22, 23, 38 AND 50).

CLASS 41—EDUCATION AND ENTERTAINMENT

FOR EXERCISE CLASSES, INCORPORATING TRADITIONAL TECHNIQUES FROM HATHA AND KUNDALINI YOGA, CLASSICAL DANCE BARRE-WORK, AND BODY SCULPTING EXERCISES (U.S. CLS. 100, 101 AND 107).

INGRID C. EULIN, EXAMINING ATTORNEY

SN 78-535,850. DILLON COMPANIES, INC., HUTCHISON, KS. FILED 12-20-2004.

TURKEY HILL

THE MARK CONSISTS OF STANDARD CHARACTERS WITHOUT CLAIM TO ANY PARTICULAR FONT, STYLE, SIZE, OR COLOR.

OWNER OF U.S. REG. NOS. 1,328,771 AND 1,668,705.

CLASS 30—STAPLE FOODS

FOR FROZEN CONFECTIONS, NAMELY ICE CREAM CONES AND ICE CREAM SANDWICHES (U.S. CL. 46).
FIRST USE 3-0-1997; IN COMMERCE 3-0-1997.

CLASS 32—LIGHT BEVERAGES

FOR BOTTLED DRINKING WATER (U.S. CLS. 45, 46 AND 48).

FIRST USE 7-0-2001; IN COMMERCE 7-0-2001.

GEORGE LORENZO, EXAMINING ATTORNEY

SN 78-535,963. OSHKOSH B'GOSH, INC., OSHKOSH, WI. FILED 12-21-2004.

OSHKOSH BABY

THE MARK CONSISTS OF STANDARD CHARACTERS WITHOUT CLAIM TO ANY PARTICULAR FONT, STYLE, SIZE, OR COLOR.

OWNER OF U.S. REG. NOS. 511,479, 1,559,976 AND OTHERS.

NO CLAIM IS MADE TO THE EXCLUSIVE RIGHT TO USE "BABY", APART FROM THE MARK AS SHOWN.

SEC. 2(F) AS TO OSHKOSH.

CLASS 24—FABRICS

FOR BED LINENS, BED SHEETS, PILLOW CASES, PILLOW SHAMS, DUST RUFFLES, COMFORTERS, QUILTS, BLANKETS, CRIB BUMPER PADS, TOWELS, WASHCLOTHS, RECEIVING BLANKETS (U.S. CLS. 42 AND 50).

FIRST USE 7-31-2003; IN COMMERCE 7-31-2003.

CLASS 25—CLOTHING

FOR SLEEPWEAR, BODYSUITS, COVERALLS, CREEPERS, ROMPERS, T-SHIRTS, FABRIC DIAPER COVERS, BOOTIES, CLOTH BABY BIBS, BIB OVERALLS, BIB SHORTALLS, JUMPERS, DRESSES, SKIRTS, PANTS, SHORTS, SHIRTS, JUMPSUITS, SWEATERS, JACKETS, COATS, SNOWSUITS, PRAMSUITS, UNDERWEAR, SOCKS, GLOVES, MITTENS, SCARVES, CAPS, HATS, AND SHOES (U.S. CLS. 22 AND 39).

FIRST USE 7-31-2003; IN COMMERCE 7-31-2003.

CLASS 28—TOYS AND SPORTING GOODS

FOR PLUSH TOYS, DOLLS, SOFT STACKABLE ANIMAL TOYS, ACCORDION MUSICAL PULL TOYS, TOY SHAPE SORTERS, TOY BUILDING BLOCKS, BABY RATTLES, CRIB MOBILES, BABY MULTIPLE ACTIVITY TOYS, JIGSAW PUZZLES, AND MANIPULATIVE PUZZLES (U.S. CLS. 22, 23, 38 AND 50).

FIRST USE 7-31-2003; IN COMMERCE 7-31-2003.
ZHALEH DELANEY, EXAMINING ATTORNEY

SN 78-536,027. PRODUCT PARTNERS, LLC, BEVERLY HILLS, CA. FILED 12-21-2004.

KEEP PUSHING PLAY

THE MARK CONSISTS OF STANDARD CHARACTERS WITHOUT CLAIM TO ANY PARTICULAR FONT, STYLE, SIZE, OR COLOR.

CLASS 9—ELECTRICAL AND SCIENTIFIC APPARATUS

FOR PRE-RECORDED VIDEO TAPES AND CASSETTES, DVDS, CDS, FEATURING EXERCISE, FITNESS AND DIETARY INFORMATION AND INSTRUCTION (U.S. CLS. 21, 23, 26, 36 AND 38).

CLASS 41—EDUCATION AND ENTERTAINMENT

FOR EDUCATIONAL SERVICES, NAMELY PHYSICAL FITNESS INSTRUCTION AND INSTRUCTION IN THE FIELDS OF DIET AND EXERCISE AND PRINTED MATERIALS USED IN CONNECTION THEREWITH (U.S. CLS. 100, 101 AND 107).

PAM WILLIS, EXAMINING ATTORNEY

SN 78-537,117. JOHNS MANVILLE AB, HELSINGBORG, SWEDEN, FILED 12-22-2004.

apt. 101

PRIORITY CLAIMED UNDER SEC. 44(D) ON SWEDEN APPLICATION NO. 2004/04472, FILED 6-28-2004, REG. NO. 371728, DATED 4-22-2005, EXPIRES 4-22-2015.

CLASS 24—FABRICS

FOR FIBERGLASS FABRICS FOR USE IN TEXTILE WALLCOVERINGS (U.S. CLS. 42 AND 50).

CLASS 27—FLOOR COVERINGS

FOR WALLCOVERINGS AND CEILING COVERINGS COMPOSED OF FIBERGLASS FABRICS (U.S. CLS. 19, 20, 37, 42 AND 50).

JOHN WILKE, EXAMINING ATTORNEY

SN 78-537,734. VITASOY INTERNATIONAL HOLDINGS LIMITED, NEW TERRITORIES, HONG KONG, FILED 12-23-2004.

Vitasoy

OWNER OF U.S. REG. NOS. 1,868,942, 2,765,529 AND OTHERS.

CLASS 5—PHARMACEUTICALS

FOR DIETARY SUPPLEMENTS AND NUTRITIONAL SUPPLEMENTS FOR WEIGHT MANAGEMENT; MEAL REPLACEMENT BARS; MEAL REPLACEMENT DRINKS; MEAL REPLACEMENT SHAKES; MEAL REPLACEMENT POWDERS; NUTRITIONAL DRINK FOR USE AS A MEAL REPLACEMENT; NUTRITIONAL SHAKE FOR USE AS A MEAL REPLACEMENT; NUTRITIONAL POWDER FOR USE AS A MEAL REPLACEMENT; NUTRITIONAL BAR FOR USE AS A MEAL REPLACEMENT (U.S. CLS. 6, 18, 44, 46, 51 AND 52).

CLASS 29—MEATS AND PROCESSED FOODS

FOR SOY-BASED FOOD, NAMELY, TOFU, FRUIT AND SOY BASED SNACK FOOD, SOY-BASED FOOD BARS, SOY-BASED SNACK FOODS, FROZEN AND PREPARED MEALS CONSISTING PRIMARILY OF SOY-BASED FOOD BEVERAGE, FROZEN AND PREPARED MEALS CONSISTING OF A BEVERAGE CONSISTING PRIMARILY OF SOYMILK, FRUIT JUICE AND TEA, MEALS PRIMARILY CONSISTING OF A FRUIT AND SOY-BASED FOOD BAR AND SOY-BASED POWDER FOR NUTRITIONAL PURPOSES (U.S. CL. 46).

CLASS 30—STAPLE FOODS

FOR SOY-BASED ICE CREAM SUBSTITUTE; SOY-BASED PUDDING; SOY -BASED CUSTARDS; SOY-BASED NOODLES AND PASTA (U.S. CL. 46).

CLASS 32—LIGHT BEVERAGES

FOR SOY-BASED BEVERAGES NOT BEING MILK SUBSTITUTES; SOY-BASED BEVERAGES CONTAINING FRUIT JUICES; SOY-BASED BEVERAGES CONTAINING TEA OR TEA FLAVOR; SOY-BASED BEVERAGES CONTAINING VEGETABLE JUICES; FRUIT JUICES AND FRUIT DRINKS MADE WITH SOY; FRUIT AND VEGETABLE BASED NON-CARBONATED NON-ALCOHOLIC DRINKS AND BEVERAGES (U.S. CLS. 45, 46 AND 48).

ANGELA M. MICHELI, EXAMINING ATTORNEY

CLASS 42—SCIENTIFIC, COMPUTER AND LEGAL SERVICES

FOR COMPUTER SERVICES, NAMELY, PROVIDING COMPUTERIZED ANALYTICAL PROCESSING AND DATA ANALYSIS SERVICES THAT USE PREDICTIVE MODELING TO FACILITATE MANAGEMENT OF INFORMATION; PROVIDING AN INTERACTIVE WEBSITE FEATURING COMPUTERIZED ANALYTICAL PROCESSING AND DATA ANALYSIS (U.S. CLS. 100 AND 101).

FIRST USE 7-0-2004; IN COMMERCE 7-0-2004.
BRENDAN MCCAULEY, EXAMINING ATTORNEY

SN 78-539,228. KROGER CO. OF MICHIGAN, THE, LIVONIA, MI. FILED 12-28-2004.

SN 78-538,001. FIRST LOOK NETWORKS, LLC, CHICAGO, IL. FILED 12-23-2004.

**REFLECT BY HD
DESIGNS**

FIRST LOOK EDGE

THE MARK CONSISTS OF STANDARD CHARACTERS WITHOUT CLAIM TO ANY PARTICULAR FONT, STYLE, SIZE, OR COLOR.

CLASS 35—ADVERTISING AND BUSINESS

FOR BUSINESS SERVICES, NAMELY, PROVIDING BUSINESS INFORMATION AND MARKETING DATA TO OTHERS; DATA PROCESSING SERVICES; COMPUTERIZED REAL-TIME AND DELAYED TRANSACTIONAL DATA MANAGEMENT SERVICES, NAMELY, SEARCHING, GATHERING, PROCESSING, ORGANIZING AND DISSEMINATING INFORMATION FOR OTHERS VIA A GLOBAL COMPUTER NETWORK; PROVIDING AN INTERACTIVE WEBSITE FEATURING INFORMATION PERTAINING TO COMPUTERIZED REAL-TIME AND DELAYED TRANSACTIONAL DATA MANAGEMENT SERVICES, NAMELY, INFORMATION OBTAINED BY SEARCHING, GATHERING, PROCESSING, ORGANIZING AND DISSEMINATING INFORMATION FOR OTHERS (U.S. CLS. 100, 101 AND 102).

FIRST USE 7-0-2004; IN COMMERCE 7-0-2004.

THE MARK CONSISTS OF STANDARD CHARACTERS WITHOUT CLAIM TO ANY PARTICULAR FONT, STYLE, SIZE, OR COLOR.

OWNER OF U.S. REG. NOS. 2,670,144, 2,726,559 AND OTHERS.

NO CLAIM IS MADE TO THE EXCLUSIVE RIGHT TO USE "DESIGNS", APART FROM THE MARK AS SHOWN.

CLASS 4—LUBRICANTS AND FUELS

FOR CANDLES (U.S. CLS. 1, 6 AND 15).

CLASS 20—FURNITURE AND ARTICLES NOT OTHERWISE CLASSIFIED

FOR PILLOWS (U.S. CLS. 2, 13, 22, 25, 32 AND 50).

CLASS 24—FABRICS

FOR COMFORTERS, BED SHEETS, PILLOWCASES, PILLOW SHAMS, DUVETS, BED SKIRTS, MATTRESS PADS, BLANKETS, BATH TOWELS, SHOWER CURTAINS (U.S. CLS. 42 AND 50).

CLASS 27—FLOOR COVERINGS

FOR FABRIC BATH MATS (U.S. CLS. 19, 20, 37, 42 AND 50).

WILLIAM P. SHANAHAN, EXAMINING ATTORNEY

SN 78-539,501. INDEPENDENT FILM CHANNEL LLC, THE, JERICHO, NY. FILED 12-29-2004.

SN 78-540,088. GLOBAL WATER, LLC, LAKE OSWEGO, OR. FILED 12-30-2004.

IFC TV, UNCUT

THE MARK CONSISTS OF STANDARD CHARACTERS WITHOUT CLAIM TO ANY PARTICULAR FONT, STYLE, SIZE, OR COLOR.

OWNER OF U.S. REG. NOS. 2,923,508 AND 2,956,449.

NO CLAIM IS MADE TO THE EXCLUSIVE RIGHT TO USE TV, APART FROM THE MARK AS SHOWN.

CLASS 38—COMMUNICATION

FOR TELEVISION AND CABLE TELEVISION BROADCASTING SERVICES (U.S. CLS. 100, 101 AND 104).

CLASS 41—EDUCATION AND ENTERTAINMENT

FOR PRODUCTION OF TELEVISION AND CABLE TELEVISION PROGRAMS AND SCHEDULING OF TELEVISION AND CABLE TELEVISION PROGRAMMING SERVICES (U.S. CLS. 100, 101 AND 107).
HOWARD SMIGA, EXAMINING ATTORNEY

SN 78-539,626. VANGARD, INC., W MELBOURNE, FL. FILED 12-29-2004.

CRISTAL-GARD

THE MARK CONSISTS OF STANDARD CHARACTERS WITHOUT CLAIM TO ANY PARTICULAR FONT, STYLE, SIZE, OR COLOR.

CLASS 16—PAPER GOODS AND PRINTED MATTER

FOR PLASTIC BAGS USED IN THE MEAT AND CHEESE PROCESSING INDUSTRIES FOR PACKAGING (U.S. CLS. 2, 5, 22, 23, 29, 37, 38 AND 50).

CLASS 17—RUBBER GOODS

FOR ARTIFICIAL PLASTIC CASINGS USED FOR INDUSTRIAL AND COMMERCIAL PACKAGING OF PROCESSED MEAT AND CHEESE PRODUCTS; AND PLASTIC FILMS USED IN THE MEAT AND CHEESE PROCESSING INDUSTRIES FOR PACKAGING (U.S. CLS. 1, 5, 12, 13, 35 AND 50).

TINA L. SNAPP, EXAMINING ATTORNEY

FREEWATER

THE MARK CONSISTS OF STANDARD CHARACTERS WITHOUT CLAIM TO ANY PARTICULAR FONT, STYLE, SIZE, OR COLOR.

CLASS 11—ENVIRONMENTAL CONTROL APPARATUS

FOR WATER FILTRATION UNITS FOR DOMESTIC USE AND WATER PURIFICATION UNITS, AND REPLACEMENT CARTRIDGES AND FILTERS THEREFOR; WATER FILTERS (U.S. CLS. 13, 21, 23, 31 AND 34).

CLASS 21—HOUSEWARES AND GLASS

FOR PORTABLE WATER DISPENSERS AND WATER CONTAINERS FOR HOUSEHOLD USE; PORTABLE BOTTLES, SOLD EMPTY (U.S. CLS. 2, 13, 23, 29, 30, 33, 40 AND 50).

JEAN IM, EXAMINING ATTORNEY

SN 78-540,527. HEARTT PLEASURES LLC, HILLSIDE, NJ. FILED 12-31-2004.

Heart Pleasures

THE MARK CONSISTS OF STANDARD CHARACTERS WITHOUT CLAIM TO ANY PARTICULAR FONT, STYLE, SIZE, OR COLOR.

CLASS 29—MEATS AND PROCESSED FOODS

FOR PROTEIN BASED OR NUTRIENT-DENSE SNACK BARS, CANDIED FRUIT, CANDIED FRUIT SNACKS, CANDIED NUTS, CRANBERRY SAUCE, PACKAGED PREPARED ENTREES DESIGNED FOR A HEALTHY LIFE STYLE (U.S. CL. 46).

CLASS 30—STAPLE FOODS

FOR CANDIES, CHOCOLATES, HEALTH FOODS, NAMELY, GRANOLA-BASED SNACK BARS, CAKES AND DESSERTS IN THE NATURE OF BAKERY DESSERTS, DESSERT MOUSSE AND COOKIES THAT HAVE AN ESPECIALLY PLEASING TASTE AND EATING SENSATION AND ARE FORMULATED TO ENHANCE FITNESS AND WELLNESS (U.S. CL. 46).

DAVID YONTEF, EXAMINING ATTORNEY

SN 78-540,960. ELMER'S INVESTMENTS LLC, COLUMBUS, OH. FILED 1-3-2005.

SN 78-541,417. ISODIAGNOSTIKA, INC., SCOTTSDALE, AZ. FILED 1-3-2005.

CREATE 'N LEARN

THE MARK CONSISTS OF STANDARD CHARACTERS WITHOUT CLAIM TO ANY PARTICULAR FONT, STYLE, SIZE, OR COLOR.

CLASS 8—HAND TOOLS

FOR SCISSORS (U.S. CLS. 23, 28 AND 44).

CLASS 16—PAPER GOODS AND PRINTED MATTER

FOR ADHESIVE TAPE, GLUE, AND PASTE FOR STATIONERY AND HOUSEHOLD USE; ARTS AND CRAFT PAINT KITS; PAINT BRUSHES; CRAYONS; BOND PAPER; CRAFT PAPER; POSTER BOARD; PENS; PENCILS; FELT-TIP MARKERS; EASELS; ORGANIZERS FOR STATIONERY USE (U.S. CLS. 2, 5, 22, 23, 29, 37, 38 AND 50).

CLASS 28—TOYS AND SPORTING GOODS

FOR HOBBY CRAFT SETS FOR CREATING PAPER CRAFTS (U.S. CLS. 22, 23, 38 AND 50).
EVELYN BRADLEY, EXAMINING ATTORNEY

SN 78-541,384. STERLING, JAMES A., EL PASO, TX. FILED 1-3-2005.

Challenge Your Limits Fitness

THE MARK CONSISTS OF STANDARD CHARACTERS WITHOUT CLAIM TO ANY PARTICULAR FONT, STYLE, SIZE, OR COLOR.

CLASS 28—TOYS AND SPORTING GOODS

FOR PERSONAL FITNESS EQUIPMENT, NAMELY EXERCISE WEIGHTS (U.S. CLS. 22, 23, 38 AND 50).

CLASS 41—EDUCATION AND ENTERTAINMENT

FOR PERSONAL FITNESS EDUCATIONAL SERVICES (U.S. CLS. 100, 101 AND 107).
DAVID YONTEF, EXAMINING ATTORNEY

DIATEST

THE MARK CONSISTS OF STANDARD CHARACTERS WITHOUT CLAIM TO ANY PARTICULAR FONT, STYLE, SIZE, OR COLOR.

OWNER OF U.S. REG. NO. 2,923,626.

CLASS 5—PHARMACEUTICALS

FOR CLINICAL MEDICAL DIAGNOSTIC KITS COMPOSED OF REAGENTS AND CONTAINERS FOR USE IN ANALYZING BREATH SAMPLES (U.S. CLS. 6, 18, 44, 46, 51 AND 52).

FIRST USE 1-20-2000; IN COMMERCE 7-27-2000.

CLASS 10—MEDICAL APPARATUS

FOR CLINICAL MEDICAL DIAGNOSTIC KITS COMPOSED OF CONTAINERS AND REAGENTS FOR USE IN ANALYZING BREATH SAMPLES (U.S. CLS. 26, 39 AND 44).

FIRST USE 1-20-2000; IN COMMERCE 7-27-2000.
BARNEY CHARLON, EXAMINING ATTORNEY

SN 78-541,914. NATIONAL RAILWAY EQUIPMENT CO., DIXMOOR, IL. FILED 1-4-2005.



CLASS 35—ADVERTISING AND BUSINESS

FOR WHOLESALE DISTRIBUTORSHIPS IN THE FIELD OF LOCOMOTIVES AND LOCOMOTIVE SUB-ASSEMBLIES AND WHOLESALE STORES FEATURING LOCOMOTIVES AND LOCOMOTIVE SUB-ASSEMBLIES (U.S. CLS. 100, 101 AND 102).

FIRST USE 6-0-1985; IN COMMERCE 6-0-1985.

CLASS 37—CONSTRUCTION AND REPAIR

FOR REBUILDING, PAINTING, MAINTENANCE AND REPAIR SERVICES OF LOCOMOTIVES AND LOCOMOTIVE SUB-ASSEMBLIES; DIESEL ENGINE REMANUFACTURE; AND REPAIR AND PAINTING SERVICES FOR MARINE, POWER GENERATION AND CO-GENERATION DRILLING APPLICATIONS (U.S. CLS. 100, 103 AND 106).

FIRST USE 6-0-1985; IN COMMERCE 6-0-1985.

CLASS 39—TRANSPORTATION AND STORAGE

FOR LEASING OF LOCOMOTIVES AND LOCOMOTIVE SUB-ASSEMBLIES (U.S. CLS. 100 AND 105).

FIRST USE 6-0-1985; IN COMMERCE 6-0-1985.

MATTHEW MCDOWELL, EXAMINING ATTORNEY

CLASS 41—EDUCATION AND ENTERTAINMENT

FOR ENTERTAINMENT SERVICES, NAMELY, PROVIDING A WEB SITE FEATURING MUSICAL RECORDINGS, TEXT, PHOTOGRAPHS AND OTHER MULTIMEDIA CONTENT AND AN INTERACTIVE MESSAGING AND RATING SYSTEM ENABLING WEB SITE USERS TO COMMUNICATE REVIEWS OF ARTISTS' CONTENT; PROVIDING INFORMATION ABOUT ARTISTS, MUSICAL GROUPS AND ENTERTAINMENT-RELATED EVENTS (U.S. CLS. 100, 101 AND 107).

FIRST USE 11-11-2004; IN COMMERCE 11-11-2004.

CAROLYN CATALDO, EXAMINING ATTORNEY

SN 78-542,595. NASSAU CANDY DISTRIBUTORS, INC., HICKSVILLE, NY. FILED 1-5-2005.

SN 78-543,115. J. WILKINS ARTSCAPE, INC., PASO ROBLES, CA. FILED 1-6-2005.

CULVER RIDGE

THE MARK CONSISTS OF STANDARD CHARACTERS WITHOUT CLAIM TO ANY PARTICULAR FONT, STYLE, SIZE, OR COLOR.

CLASS 29—MEATS AND PROCESSED FOODS

FOR YOGURT-COVERED PRETZELS, YOGURT-COVERED RAISINS, ROASTED NUTS, DRIED FRUIT MIXES, DRIED FRUIT AND NUT MIX, SOY NUTS, NAMELY, DRIED ROASTED SOYBEANS (U.S. CL. 46).

FIRST USE 5-15-2005; IN COMMERCE 5-15-2005.

CLASS 30—STAPLE FOODS

FOR CHOCOLATE-COVERED NUTS, CHOCOLATE-COVERED PEANUTS, CHOCOLATE-COVERED DRIED FRUIT, CHOCOLATE-COVERED SOY NUTS, SESAME STICKS, NAMELY, CANDY COMPRISED OF GROUND SESAME SEEDS, GRANOLA, NAMELY, DRIED FRUIT GRANOLA, CHOCOLATE CHIP GRANOLA, PEANUT BUTTER CHIP GRANOLA (U.S. CL. 46).

FIRST USE 5-15-2005; IN COMMERCE 5-15-2005.

JEFFERY COWARD, EXAMINING ATTORNEY

SN 78-542,976. INTERTECH MEDIA, LLC, OLD GREENWICH, CT. FILED 1-6-2005.



ListenerStation

CLASS 38—COMMUNICATION

FOR TELECOMMUNICATIONS SERVICES, NAMELY, ELECTRONIC TRANSMISSION OF AUDIO FILES VIA A COMPUTER NETWORK (U.S. CLS. 100, 101 AND 104).

FIRST USE 11-11-2004; IN COMMERCE 11-11-2004.

Age Old Stone

THE MARK CONSISTS OF STANDARD CHARACTERS WITHOUT CLAIM TO ANY PARTICULAR FONT, STYLE, SIZE, OR COLOR.

NO CLAIM IS MADE TO THE EXCLUSIVE RIGHT TO USE "STONE", APART FROM THE MARK AS SHOWN.

CLASS 19—NON-METALLIC BUILDING MATERIALS

FOR CONCRETE BUILDING MATERIALS, NAMELY, DECK PIER BLOCKS, WALL VENEERS, WALL CAPS, POOL COVER SLABS, POOL COPING, CAPS NAMELY, POST CAPS, PILASTER CAPS, AND COLUMN CAPS, WINDOW SILLS, WINDOW LINTELS, TRIMS AND SURROUNDS, WAINSCOT SILLS, STAIR TREADS AND RISERS, BIRD BATHS, COBBLES AND BOULDERS, PAVING STONES, CAST STONE GARDEN AND HOUSEHOLD ORNAMENTS, CONCRETE FIGURES AND FIGURINES, CONCRETE STATUES AND STATUETTES, CONCRETE SCULPTURES, CONCRETE DESKTOP STATUARY, AND CONCRETE MANTELS FOR FIREPLACES (U.S. CLS. 1, 12, 33 AND 50).

FIRST USE 1-2-1996; IN COMMERCE 5-5-1996.

CLASS 20—FURNITURE AND ARTICLES NOT OTHERWISE CLASSIFIED

FOR BENCHES, CAST STONE HOUSEHOLD AND GARDEN FURNITURE, AND PEDESTALS (U.S. CLS. 2, 13, 22, 25, 32 AND 50).

FIRST USE 1-2-1996; IN COMMERCE 5-5-1996.

RICHARD WHITE, EXAMINING ATTORNEY

SN 78-543,292. AMERICAN YOUTH HOSTELS, INC, SILVER SPRING, MD. FILED 1-6-2005.

CLASS 16—PAPER GOODS AND PRINTED MATTER

FOR MAGAZINE PUBLICATIONS RELATING TO DIABETIC MICROVASCULAR COMPLICATIONS, EDUCATIONAL PROGRAMS, THERAPIES, AND PROCEDURES (U.S. CLS. 2, 5, 22, 23, 29, 37, 38 AND 50).
FIRST USE 10-1-2004; IN COMMERCE 10-1-2004.
HEATHER THOMPSON, EXAMINING ATTORNEY

HI

SN 78-544,924. MOUNTAIN TOWER, LTD., INC., DEMOREST, GA. FILED 1-10-2005.

THE MARK CONSISTS OF STANDARD CHARACTERS WITHOUT CLAIM TO ANY PARTICULAR FONT, STYLE, SIZE, OR COLOR.

RadioBytes

CLASS 39—TRANSPORTATION AND STORAGE

FOR ARRANGING TRAVEL TOURS; TRAVEL GUIDE SERVICES (U.S. CLS. 100 AND 105).
FIRST USE 1-1-1996; IN COMMERCE 1-1-1996.

CLASS 41—EDUCATION AND ENTERTAINMENT

FOR EDUCATIONAL SERVICES, NAMELY, CONDUCTING EDUCATIONAL PROGRAMS IN THE FIELDS OF TRAVEL, INTERCULTURAL COMMUNICATION AND EXCHANGE, AND COMMUNITY SERVICE EFFORTS (U.S. CLS. 100, 101 AND 107).
FIRST USE 1-1-1996; IN COMMERCE 1-1-1996.

THE MARK CONSISTS OF STANDARD CHARACTERS WITHOUT CLAIM TO ANY PARTICULAR FONT, STYLE, SIZE, OR COLOR.

CLASS 16—PAPER GOODS AND PRINTED MATTER

FOR NEWSLETTERS IN THE FIELD OF THE COMMUNICATION INDUSTRY (U.S. CLS. 2, 5, 22, 23, 29, 37, 38 AND 50).

CLASS 43—HOTEL AND RESTAURANT SERVICES

FOR PROVIDING TEMPORARY LODGING ACCOMMODATIONS, NAMELY, HOSTELS (U.S. CLS. 100 AND 101).
FIRST USE 1-1-1996; IN COMMERCE 1-1-1996.
DORITT L. CARROLL, EXAMINING ATTORNEY

CLASS 41—EDUCATION AND ENTERTAINMENT

FOR PROVIDING NEWSLETTERS IN THE FIELD OF THE COMMUNICATION INDUSTRY VIA ELECTRONIC MAIL (U.S. CLS. 100, 101 AND 107).
ZACHARY BELLO, EXAMINING ATTORNEY

SN 78-544,498. BRYN MAWR COMMUNICATIONS III, LLC, WAYNE, PA. FILED 1-9-2005.

SN 78-545,299. NOVA 53 RECORDS, INC., CAMDEN, NJ. FILED 1-11-2005.

DIABETIC
Microvascular Complications
TODAY

NO CLAIM IS MADE TO THE EXCLUSIVE RIGHT TO USE "DIABETIC MICROVASCULAR COMPLICATIONS", APART FROM THE MARK AS SHOWN.

NOVA 53 RECORDS

CLASS 9—ELECTRICAL AND SCIENTIFIC APPARATUS

FOR DOWNLOADABLE ELECTRONIC PUBLICATION, NAMELY MAGAZINES RELATING TO DIABETIC MICROVASCULAR COMPLICATIONS, EDUCATIONAL PROGRAMS, THERAPIES AND PROCEDURES (U.S. CLS. 21, 23, 26, 36 AND 38).
FIRST USE 10-1-2004; IN COMMERCE 10-1-2004.

THE MARK CONSISTS OF STANDARD CHARACTERS WITHOUT CLAIM TO ANY PARTICULAR FONT, STYLE, SIZE, OR COLOR.
NO CLAIM IS MADE TO THE EXCLUSIVE RIGHT TO USE RECORDS, APART FROM THE MARK AS SHOWN.

CLASS 9—ELECTRICAL AND SCIENTIFIC APPARATUS

FOR MUSICAL SOUND RECORDINGS (U.S. CLS. 21, 23, 26, 36 AND 38).

CLASS 41—EDUCATION AND ENTERTAINMENT

FOR ENTERTAINMENT SERVICES, NAMELY, PRODUCTION OF MUSICAL SOUND RECORDINGS (U.S. CLS. 100, 101 AND 107).

Laurie Mayes, Examining Attorney

CLASS 16—PAPER GOODS AND PRINTED MATTER

FOR MAPS, NAMELY, MAPS FOR THE LIFE SCIENCE INDUSTRY DEPICTING THE GEOGRAPHIC LOCATION OF LIFE SCIENCE COMPANIES (U.S. CLS. 2, 5, 22, 23, 29, 37, 38 AND 50).

FIRST USE 9-26-2002; IN COMMERCE 9-26-2002.

CLASS 42—SCIENTIFIC, COMPUTER AND LEGAL SERVICES

FOR LIFE SCIENCE NEWS AND INFORMATION (U.S. CLS. 100 AND 101).

FIRST USE 9-26-2002; IN COMMERCE 9-26-2002.

Margery A. Tierney, Examining Attorney

SN 78-545,350. ONVISOURCE, INC., ATLANTA, GA. FILED 1-11-2005.

ONVISOURCE

SN 78-545,876. DALLAS CITY LIMITS, LLC, HOUSTON, TX. FILED 1-11-2005.

THE MARK CONSISTS OF STANDARD CHARACTERS WITHOUT CLAIM TO ANY PARTICULAR FONT, STYLE, SIZE, OR COLOR.

CLASS 9—ELECTRICAL AND SCIENTIFIC APPARATUS

FOR COMPUTER SOFTWARE, NAMELY, TELECOMMUNICATIONS SOFTWARE APPLICATIONS FOR TRANSPORTING AND AGGREGATING VOICE, DATA, AND VIDEO COMMUNICATIONS ACROSS MULTIPLE NETWORK INFRASTRUCTURES AND COMMUNICATIONS PROTOCOLS (U.S. CLS. 21, 23, 26, 36 AND 38).

CLASS 38—COMMUNICATION

FOR TELECOMMUNICATION ACCESS SERVICES; TELECOMMUNICATIONS RESELLER SERVICES, NAMELY, PROVIDING LONG DISTANCE TELECOMMUNICATION SERVICES (U.S. CLS. 100, 101 AND 104).

Kristina Kloiber, Examining Attorney

DALLAS CITY LIMITS

THE MARK CONSISTS OF STANDARD CHARACTERS WITHOUT CLAIM TO ANY PARTICULAR FONT, STYLE, SIZE, OR COLOR.

NO CLAIM IS MADE TO THE EXCLUSIVE RIGHT TO USE DALLAS, APART FROM THE MARK AS SHOWN.

SN 78-545,516. CI VENTURES, LLC, DBA BIOSPACE, POINT PLEASANT, NJ. FILED 1-11-2005.

CLASS 36—INSURANCE AND FINANCIAL

FOR SHOPPING CENTER SERVICES, NAMELY, LEASING SHOPPING MALL SPACE (U.S. CLS. 100, 101 AND 102).

BIOCORRIDOR**CLASS 41—EDUCATION AND ENTERTAINMENT**

FOR ENTERTAINMENT SERVICES, NAMELY, OPERATING A NIGHTCLUB (U.S. CLS. 100, 101 AND 107).

CLASS 43—HOTEL AND RESTAURANT SERVICES

FOR RESTAURANT AND BAR SERVICES (U.S. CLS. 100 AND 101).

William Verhosek, Examining Attorney

THE MARK CONSISTS OF STANDARD CHARACTERS WITHOUT CLAIM TO ANY PARTICULAR FONT, STYLE, SIZE, OR COLOR.

SN 78-546,379. BOTANICUS INC., GAITHERSBURG, MD.
FILED 1-12-2005.

BLUE BAMBOO

THE MARK CONSISTS OF STANDARD CHARACTERS WITHOUT CLAIM TO ANY PARTICULAR FONT, STYLE, SIZE, OR COLOR.

NO CLAIM IS MADE TO THE EXCLUSIVE RIGHT TO USE "BAMBOO", APART FROM THE MARK AS SHOWN.

CLASS 3—COSMETICS AND CLEANING PREPARATIONS

FOR PERFUMES (U.S. CLS. 1, 4, 6, 50, 51 AND 52).
FIRST USE 12-27-2004; IN COMMERCE 12-27-2004.

CLASS 4—LUBRICANTS AND FUELS

FOR CANDLES (U.S. CLS. 1, 6 AND 15).
FIRST USE 12-27-2004; IN COMMERCE 12-27-2004.
DEBRA LEE, EXAMINING ATTORNEY

SN 78-546,699. SWABPLUS INC., RANCHO CUCAMONGA,
CA. FILED 1-12-2005.

BEAUTYFILLS

THE MARK CONSISTS OF STANDARD CHARACTERS WITHOUT CLAIM TO ANY PARTICULAR FONT, STYLE, SIZE, OR COLOR.

CLASS 3—COSMETICS AND CLEANING PREPARATIONS

FOR COTTON SWAB WITH A HOLLOW TUBE APPLICATOR WHICH CONTAINS ONE OR MORE OF THE FOLLOWING, NAMELY COSMETICS, COSMETIC CLEANSING CREAMS, WATER FOR PERSONAL AND COSMETIC USE, PERFUMES, TOOTH WHITENERS, BREATH FRESHENERS, NAIL POLISH REMOVERS, EYE LINERS AND EYE LINER REMOVERS, AND LIPSTICK ALL FOR PERSONAL AND COSMETIC USE (U.S. CLS. 1, 4, 6, 50, 51 AND 52).

CLASS 5—PHARMACEUTICALS

FOR COTTON SWAB WITH A HOLLOW APPLICATOR TUBE WHICH CONTAINS ONE OR MORE OF THE FOLLOWING, NAMELY CLEANSING SOLUTIONS FOR MEDICAL USE, ALL PURPOSE DISINFECTANTS, DISINFECTANTS FOR CONTACT LENSES, DISINFECTANTS FOR MEDICAL INSTRUMENTS, MEDICINES NAMELY ASPIRIN, ANALGESICS, AND ANTIBIOTIC OINTMENTS, IODINE, VITAMIN DROPS, VITAMIN ENRICHED WATER, TOOTH ACHE PAIN RELIEVERS, ACNE TREATMENT PREPARATIONS, HERBAL ANTI-ITCH AND SORE SKIN OINTMENTS FOR PETS, AND FUNGUS TREATMENT PREPARATIONS (U.S. CLS. 6, 18, 44, 46, 51 AND 52).

CLASS 10—MEDICAL APPARATUS

FOR MEDICAL INSTRUMENT, NAMELY HOLLOW APPLICATOR TUBE WITH A COTTON TIP FOR PRECISE APPLICATION OF TOPICAL LIQUIDS, DENTAL MATERIALS, AND ANTISEPTIC PREPARATIONS (U.S. CLS. 26, 39 AND 44).

KATRINA EDGE, EXAMINING ATTORNEY

SN 78-547,233. LONDON FOG INDUSTRIES, INC., SEATTLE,
WA. FILED 1-13-2005.

SASHA THARP

THE MARK CONSISTS OF STANDARD CHARACTERS WITHOUT CLAIM TO ANY PARTICULAR FONT, STYLE, SIZE, OR COLOR.

THE LIKENESS (OR, "PORTRAIT") IN THE MARK DOES NOT IDENTIFY A LIVING INDIVIDUAL.

CLASS 20—FURNITURE AND ARTICLES NOT OTHERWISE CLASSIFIED

FOR DECORATIVE PILLOWS (U.S. CLS. 2, 13, 22, 25, 32 AND 50).

CLASS 24—FABRICS

FOR BED LINENS, COMFORTERS, DUVET COVERS, SHAMS, BEDSKIRTS, SHEETS; DECORATIVE WINDOW TREATMENTS, WINDOW CURTAIN PANELS; DECORATIVE THROWS (U.S. CLS. 42 AND 50).

JENNIFER KRISP, EXAMINING ATTORNEY

SN 78-547,546. 949, INC., LAKE FOREST, CA. FILED 1-14-2005.

SN 78-547,748. DORFMAN, LOUIS B., COSTA MESA, CA. FILED 1-14-2005.

DRAVEN

949

THE MARK CONSISTS OF STANDARD CHARACTERS WITHOUT CLAIM TO ANY PARTICULAR FONT, STYLE, SIZE, OR COLOR.

CLASS 25—CLOTHING

FOR CLOTHING, NAMELY TEE SHIRTS, SHIRTS, PANTS, SWEAT PANTS, SHORTS, SWIM WEAR, SOCKS, FOOTWEAR, SANDALS, TANK TOPS, SWEATERS, JACKETS, HATS, CAPS, BLOUSES, DRESSES, LEGGINGS, HOSIERY, ATHLETIC FOOTWEAR, BANDANAS, BEACHWEAR, BELTS, BOXER SHORTS, BOXER BRIEFS, COATS, COVERALLS, FLEECE PULLOVERS, FLEECE SHORTS, JEANS, PAJAMAS, SKI GLOVES, SKI PANTS, SKI JACKETS, SKI MASKS, SLEEPWEAR, SNOWBOARDING SUITS, SNOWBOARD BOOTS, SNOWBOARD GLOVES AND SPORTS JACKETS (U.S. CLS. 22 AND 39).

CLASS 28—TOYS AND SPORTING GOODS

FOR SPORTING GOODS, NAMELY, SNOWBOARDS, SNOWBOARD BINDINGS, SKATEBOARDS, SKATEBOARD WHEELS, SKATEBOARD AXLES, BAGS FOR SKATEBOARDS, BALL BEARINGS FOR SKATEBOARDS, SKATEBOARD TRUCKS, SNOWBOARD LEASHES, BODY BOARDS, FINS FOR BODY BOARDS, SURF BOARDS AND IN LINE SKATES (U.S. CLS. 22, 23, 38 AND 50).

JENNIFER KRISP, EXAMINING ATTORNEY

THE MARK CONSISTS OF STANDARD CHARACTERS WITHOUT CLAIM TO ANY PARTICULAR FONT, STYLE, SIZE, OR COLOR.

CLASS 35—ADVERTISING AND BUSINESS

FOR BUSINESS CONSULTATION AND MANAGEMENT REGARDING MARKETING ACTIVITIES AND LAUNCHING OF NEW PRODUCTS; DEVELOPMENT OF MARKETING STRATEGIES AND CONCEPTS; COOPERATIVE ADVERTISING AND MARKETING SERVICES BY WAY OF SOLICITATION, CUSTOMER SERVICE AND PROVIDING MARKETING INFORMATION VIA WEBSITES ON A GLOBAL COMPUTER NETWORK; AND CREATION OF MARKETING TOOLS DESIGNED TO INCREASE A CLIENT COMPANY'S KNOWLEDGE OF CUSTOMER NEEDS, AND ITS COMPETITORS' PRODUCTS AND SERVICES, PRICING, ADVERTISING STRATEGY AND SALES STRATEGY (U.S. CLS. 100, 101 AND 102).

FIRST USE 9-24-2004; IN COMMERCE 9-24-2004.

CLASS 42—SCIENTIFIC, COMPUTER AND LEGAL SERVICES

FOR COMPUTER SERVICE, NAMELY, ACTING AS AN APPLICATION SERVICE PROVIDER IN THE FIELD OF KNOWLEDGE MANAGEMENT TO HOST COMPUTER APPLICATION SOFTWARE FOR THE COLLECTION, EDITING, ORGANIZING, MODIFYING, BOOK MARKING, TRANSMISSION, STORAGE AND SHARING OF DATA AND INFORMATION; COMPUTER SOFTWARE DEVELOPMENT; DATA AUTOMATION AND COLLECTION SERVICE USING PROPRIETARY SOFTWARE TO EVALUATE, ANALYZE AND COLLECT SERVICE DATA; DESIGN OF HOME PAGES, COMPUTER SOFTWARE AND WEB SITES; DESIGN, DEVELOPMENT AND IMPLEMENTATION OF SOFTWARE (U.S. CLS. 100 AND 101).

FIRST USE 9-24-2004; IN COMMERCE 9-24-2004.
BARBARA A. LOUGHRAN, EXAMINING ATTORNEY

SN 78-548,316. ALEXANDER, PRESTON N., BOSTON, MA. FILED 1-15-2005.

ELECTRIFYING OPTIONS FOR A FOSSIL-FREE FUTURE!

THE MARK CONSISTS OF STANDARD CHARACTERS WITHOUT CLAIM TO ANY PARTICULAR FONT, STYLE, SIZE, OR COLOR.

CLASS 37—CONSTRUCTION AND REPAIR

FOR CUSTOMIZED INSTALLATION AND MAINTENANCE OF ALTERNATIVE ENERGY SYSTEMS, NAMELY, SOLAR, WIND, HYDROGEN FUEL-CELL TECHNOLOGY, GEOTHERMAL, HYDROELECTRIC AND OTHER RELATED ALTERNATIVE AND RENEWABLE ENERGY SYSTEMS (U.S. CLS. 100, 103 AND 106).

CLASS 41—EDUCATION AND ENTERTAINMENT

FOR EDUCATIONAL SERVICES, NAMELY, TRAINING, WORKSHOPS, SEMINARS, CLASSES AND INSTRUCTION IN THE FIELD OF USING, MAINTAINING, CONFIGURING, INSTALLING AND UNDERSTANDING ALTERNATIVE ENERGY AND THE VARIOUS SYSTEMS AND METHODS THAT CAN PRODUCE THESE ENERGIES FROM SOURCES SUCH AS SOLAR, WIND, HYDROGEN FUEL-CELL TECHNOLOGY, GEOTHERMAL, HYDROELECTRIC AND OTHER RELATED ALTERNATIVE AND RENEWABLE ENERGY METHODOLOGIES (U.S. CLS. 100, 101 AND 107).

CLASS 42—SCIENTIFIC, COMPUTER AND LEGAL SERVICES

FOR CUSTOM CONFIGURATION AND DESIGN OF ALTERNATIVE ENERGY SYSTEMS, NAMELY, SOLAR, WIND, HYDROGEN FUEL-CELL TECHNOLOGY, GEOTHERMAL, HYDROELECTRIC AND OTHER RELATED ALTERNATIVE AND RENEWABLE ENERGY SYSTEMS (U.S. CLS. 100 AND 101).

ESTHER BELENKER, EXAMINING ATTORNEY

SN 78-548,764. THINK SERVICE, INC., COLORADO SPRINGS, CO. FILED 1-17-2005.

HDI

THE MARK CONSISTS OF STANDARD CHARACTERS WITHOUT CLAIM TO ANY PARTICULAR FONT, STYLE, SIZE, OR COLOR.

CLASS 16—PAPER GOODS AND PRINTED MATTER

FOR TRAINING MANUALS, BOOKS, WHITE PAPERS, WORKBOOKS, MAGAZINES, SURVEYS AND NEWSLETTERS IN THE FIELD OF CUSTOMER SUPPORT AND TECHNICAL SUPPORT (U.S. CLS. 2, 5, 22, 23, 29, 37, 38 AND 50).

FIRST USE 9-1-2004; IN COMMERCE 9-1-2004.

CLASS 35—ADVERTISING AND BUSINESS

FOR RETAIL STORE SERVICES IN THE FIELD OF CUSTOMER SUPPORT AND TECHNICAL SUPPORT-RELATED PRODUCTS; ON-LINE RETAIL STORE SERVICES IN THE FIELD OF CUSTOMER SUPPORT AND TECHNICAL SUPPORT-RELATED PRODUCTS; MAIL ORDER SERVICES IN THE FIELD OF CUSTOMER SUPPORT AND TECHNICAL SUPPORT-RELATED PRODUCTS; ASSOCIATION SERVICES, NAMELY, PROMOTING THE INTERESTS OF CUSTOMER SUPPORT AND TECHNICAL SUPPORT PROVIDERS; AND BUSINESS SERVICES, NAMELY, CONDUCTING BUSINESS AND PRACTICE RESEARCH SURVEYS IN THE FIELD OF CUSTOMER SUPPORT AND TECHNICAL SUPPORT, PERFORMING DATA ANALYSIS IN THE FIELD OF CUSTOMER SUPPORT AND TECHNICAL SUPPORT, PROVIDING INFORMATION RELATING TO EMPLOYMENT AND CAREER COUNSELING AND PLACEMENT, ALL IN THE FIELD OF CUSTOMER SUPPORT AND TECHNICAL SUPPORT (U.S. CLS. 100, 101 AND 102).

FIRST USE 9-1-2004; IN COMMERCE 9-1-2004.

CLASS 41—EDUCATION AND ENTERTAINMENT

FOR EDUCATIONAL SERVICES, NAMELY, TRAINING, COURSES OF INSTRUCTION, SEMINARS, LECTURES AND CERTIFICATION PROGRAMS IN THE FIELD OF CUSTOMER SUPPORT AND TECHNICAL SUPPORT; ORGANIZATION OF EDUCATIONAL SEMINARS, FORUMS AND CONVENTIONS IN THE FIELD OF CUSTOMER SUPPORT AND TECHNICAL SUPPORT; PROVIDING EDUCATIONAL SPEAKERS IN THE FIELD OF CUSTOMER SUPPORT AND TECHNICAL SUPPORT; PROVIDING ON-LINE TRAINING IN THE FIELD OF CUSTOMER SUPPORT AND TECHNICAL SUPPORT; AND ONLINE LIBRARY SERVICES, NAMELY PROVIDING AN ELECTRONIC REFERENCE LIBRARY IN THE FIELD OF INFORMATION AND SOURCES OF INFORMATION OF USE TO TECHNICAL HELP DESK AND CUSTOMER SUPPORT ANALYSTS IN DIAGNOSING PROBLEMS AND ASSISTING IN TROUBLE SHOOTING AND CORRECTING SUCH PROBLEMS FOR OTHERS (U.S. CLS. 100, 101 AND 107).

FIRST USE 9-1-2004; IN COMMERCE 9-1-2004.

DAVID H. STINE, EXAMINING ATTORNEY

SN 78-548,798. THINK SERVICE, INC., COLORADO SPRINGS, CO. FILED 1-17-2005.



THE MARK CONSISTS OF IN PART A DESIGN COMPRISED OF A STYLIZED PERSON WITH ARMS AND LEGS OUTSPREAD AS IF CLIMBING AND REACHING, WITH THE LEFT KNEE BENT, IN FRONT OF A GLOBE WITH MERIDIANS AND PARALLELS ON THE LEFT HALF AND BLACK ON THE RIGHT HALF, ALL WITHIN A CIRCLE.

CLASS 16—PAPER GOODS AND PRINTED MATTER

FOR TRAINING MANUALS, BOOKS, WHITE PAPERS, WORKBOOKS, MAGAZINES, SURVEYS AND NEWSLETTERS IN THE FIELD OF CUSTOMER SUPPORT AND TECHNICAL SUPPORT (U.S. CLS. 2, 5, 22, 23, 29, 37, 38 AND 50).

FIRST USE 9-1-2004; IN COMMERCE 9-1-2004.

CLASS 35—ADVERTISING AND BUSINESS

FOR RETAIL STORE SERVICES IN THE FIELD OF CUSTOMER SUPPORT AND TECHNICAL SUPPORT-RELATED PRODUCTS; ON-LINE RETAIL STORE SERVICES IN THE FIELD OF CUSTOMER SUPPORT AND TECHNICAL SUPPORT-RELATED PRODUCTS; MAIL ORDER SERVICES IN THE FIELD OF CUSTOMER SUPPORT AND TECHNICAL SUPPORT-RELATED PRODUCTS; ASSOCIATION SERVICES, NAMELY, PROMOTING THE INTERESTS OF CUSTOMER SUPPORT AND TECHNICAL SUPPORT PROVIDERS; AND BUSINESS SERVICES, NAMELY, CONDUCTING BUSINESS AND PRACTICE RESEARCH SURVEYS IN THE FIELD OF CUSTOMER SUPPORT AND TECHNICAL SUPPORT, PERFORMING DATA ANALYSIS IN THE FIELD OF CUSTOMER SUPPORT AND TECHNICAL SUPPORT, PROVIDING INFORMATION RELATING TO EMPLOYMENT AND CAREER COUNSELING AND PLACEMENT, ALL IN THE FIELD OF CUSTOMER SUPPORT AND TECHNICAL SUPPORT (U.S. CLS. 100, 101 AND 102).

FIRST USE 9-1-2004; IN COMMERCE 9-1-2004.

CLASS 41—EDUCATION AND ENTERTAINMENT

FOR EDUCATIONAL SERVICES, NAMELY, TRAINING, COURSES OF INSTRUCTION, SEMINARS, LECTURES AND CERTIFICATION PROGRAMS IN THE FIELD OF CUSTOMER SUPPORT AND TECHNICAL SUPPORT; ORGANIZATION OF EDUCATIONAL SEMINARS, FORUMS AND CONVENTIONS IN THE FIELD OF CUSTOMER SUPPORT AND TECHNICAL SUPPORT; PROVIDING EDUCATIONAL SPEAKERS IN THE FIELD OF CUSTOMER SUPPORT AND TECHNICAL SUPPORT; PROVIDING ON-LINE TRAINING IN THE FIELD OF CUSTOMER SUPPORT AND TECHNICAL SUPPORT; AND ONLINE LIBRARY SERVICES, NAMELY PROVIDING AN ELECTRONIC REFERENCE LIBRARY IN THE FIELD OF INFORMATION AND SOURCES OF INFORMATION OF USE TO TECHNICAL HELP DESK AND CUSTOMER SUPPORT ANALYSTS IN DIAGNOSING PROBLEMS AND ASSISTING IN TROUBLE SHOOTING AND CORRECTING SUCH PROBLEMS FOR OTHERS (U.S. CLS. 100, 101 AND 107).

FIRST USE 9-1-2004; IN COMMERCE 9-1-2004.
DAVID H. STINE, EXAMINING ATTORNEY

SN 78-550,709. THREE LITTLE BAKERS, INC., WILMINGTON, DE. FILED 1-20-2005.

3LB

THE MARK CONSISTS OF STANDARD CHARACTERS WITHOUT CLAIM TO ANY PARTICULAR FONT, STYLE, SIZE, OR COLOR.

CLASS 41—EDUCATION AND ENTERTAINMENT

FOR DINNER THEATRE SERVICES; PROVIDING FACILITIES FOR GOLF (U.S. CLS. 100, 101 AND 107).
FIRST USE 1-7-2005; IN COMMERCE 1-7-2005.

CLASS 43—HOTEL AND RESTAURANT SERVICES

FOR PROVIDING BANQUET FACILITIES AND RESTAURANT SERVICES (U.S. CLS. 100 AND 101).
FIRST USE 1-7-2005; IN COMMERCE 1-7-2005.
SUE LAWRENCE, EXAMINING ATTORNEY

SN 78-552,209. TURTLE ENTERTAINMENT HOLDINGS INC., BURLINGTON, MA. FILED 1-22-2005.

Sea Rodder

THE MARK CONSISTS OF STANDARD CHARACTERS WITHOUT CLAIM TO ANY PARTICULAR FONT, STYLE, SIZE, OR COLOR.

CLASS 9—ELECTRICAL AND SCIENTIFIC APPARATUS

FOR COMPUTER GAME TAPES, COMPUTER GAME SOFTWARE; COMPUTER GAME PROGRAMS; COMPUTER GAME EQUIPMENT CONTAINING MEMORY DEVICES, NAMELY DISCS; INTERACTIVE MULTIMEDIA COMPUTER GAME PROGRAMS (U.S. CLS. 21, 23, 26, 36 AND 38).

CLASS 16—PAPER GOODS AND PRINTED MATTER

FOR PAPER GOODS, NAMELY, NOTE CARDS, BUMPER STICKER, PAPER BAGS AND SACKS (U.S. CLS. 2, 5, 22, 23, 29, 37, 38 AND 50).

CLASS 25—CLOTHING

FOR CLOTHING FOR MEN, WOMEN AND CHILDREN NAMELY HATS, PANTS, SHORTS, POLO SHIRTS, SUN VISORS, SWIMSUITS, PULLOVERS, JACKETS, HEADBANDS, WRIST BANDS, BANDANAS, UNDERWEAR, TANK TOPS, SHIRTS, SWEATSHIRTS, FOOTWEAR, SLIPPERS, JACKETS, AND T SHIRTS (U.S. CLS. 22 AND 39).

CLASS 28—TOYS AND SPORTING GOODS

FOR TOYS, NAMELY, BATTERY POWERED COMPUTER GAMES WITH LCD SCREEN WHICH FEATURES ANIMATION AND SOUND EFFECTS (U.S. CLS. 22, 23, 38 AND 50).
TARAH HARDY, EXAMINING ATTORNEY

SN 78-553,410. ASSET MARKETING SYSTEMS, LLC, SAN DIEGO, CA. FILED 1-25-2005.

SN 78-553,469. MARKS, MARTHA A., SANTA FE, NM. FILED 1-25-2005.

Smart Ideas For A Slightly Crazy World

THE MARK CONSISTS OF STANDARD CHARACTERS WITHOUT CLAIM TO ANY PARTICULAR FONT, STYLE, SIZE, OR COLOR.

CLASS 9—ELECTRICAL AND SCIENTIFIC APPARATUS

FOR PRE-RECORDED AUDIO AND VIDEO TAPES, CDS AND DVDS FEATURING TRAINING AND EDUCATIONAL MATERIAL IN THE FIELDS OF FINANCIAL PLANNING AND FINANCIAL PRODUCTS (U.S. CLS. 21, 23, 26, 36 AND 38).

CLASS 16—PAPER GOODS AND PRINTED MATTER

FOR PRINTED TRAINING AND EDUCATIONAL MATERIALS IN THE FIELDS OF FINANCIAL PLANNING AND FINANCIAL PRODUCTS (U.S. CLS. 2, 5, 22, 23, 29, 37, 38 AND 50).

CLASS 35—ADVERTISING AND BUSINESS

FOR DISTRIBUTION OF ADVERTISING MATTER FOR OTHERS VIA DIRECT MAIL, EMAIL, PRINT, RADIO AND TELEVISION, AND BUSINESS MANAGEMENT SERVICES IN THE FIELD OF FINANCIAL PLANNING AND FINANCIAL PRODUCTS (U.S. CLS. 100, 101 AND 102).

CLASS 36—INSURANCE AND FINANCIAL

FOR PROVIDING FINANCIAL INFORMATION, ANALYSIS AND CONSULTATION (U.S. CLS. 100, 101 AND 102).

CLASS 41—EDUCATION AND ENTERTAINMENT

FOR EDUCATIONAL SERVICES, NAMELY, CLASSES AND SEMINARS IN THE FIELDS OF FINANCIAL PLANNING AND FINANCIAL PRODUCTS (U.S. CLS. 100, 101 AND 107).
ATTIYA MALIK, EXAMINING ATTORNEY

MARTHA'S ART

THE MARK CONSISTS OF STANDARD CHARACTERS WITHOUT CLAIM TO ANY PARTICULAR FONT, STYLE, SIZE, OR COLOR.

NO CLAIM IS MADE TO THE EXCLUSIVE RIGHT TO USE "ART", APART FROM THE MARK AS SHOWN.

CLASS 16—PAPER GOODS AND PRINTED MATTER

FOR PAPER GOODS, NAMELY, NOTE PAPER, STATIONERY, POSTCARDS, GREETING CARDS, PHOTOGRAPHIC PRINTS, POSTERS AND CALENDARS, ALL DEPICTING WILDLIFE AND NATURE PHOTOGRAPHIC IMAGES (U.S. CLS. 2, 5, 22, 23, 29, 37, 38 AND 50).

CLASS 42—SCIENTIFIC, COMPUTER AND LEGAL SERVICES

FOR STOCK PHOTOGRAPHY SERVICES, NAMELY, LICENSING REPRODUCTION RIGHTS OF PHOTOGRAPHIC IMAGES TO OTHERS (U.S. CLS. 100 AND 101).

APRIL L. RADEMACHER, EXAMINING ATTORNEY

SN 78-553,635. MASONITE INTERNATIONAL CORPORATION, MISSISSAUGA, ONTARIO, CANADA, FILED 1-25-2005.

BARCELONA

THE MARK CONSISTS OF STANDARD CHARACTERS WITHOUT CLAIM TO ANY PARTICULAR FONT, STYLE, SIZE, OR COLOR.

CLASS 6—METAL GOODS

FOR METAL DOORS (U.S. CLS. 2, 12, 13, 14, 23, 25 AND 50).

CLASS 19—NON-METALLIC BUILDING MATERIALS

FOR NON-METAL DOORS; DOOR LITES, SIDE LITES AND TRANSOM LITES IN THE NATURE OF GLASS AND PLASTIC PANELS FOR DOORS AND DOOR AREAS; DECORATIVE GLASS FOR BUILDING (U.S. CLS. 1, 12, 33 AND 50).

AMY HELLA, EXAMINING ATTORNEY

SN 78-554,812. FAIRY TALE ACADEMY, INC., VILLANOVA, PA. FILED 1-27-2005.



CLASS 41—EDUCATION AND ENTERTAINMENT

FOR EDUCATIONAL SERVICES, NAMELY, CONDUCTING MULTIDIMENSIONAL EARLY CHILDHOOD DEVELOPMENT PROGRAMS AND CLASSES IN THE FIELDS OF COGNITIVE SKILLS, LANGUAGE AND COMMUNICATION, MATHEMATICS, EMOTIONAL DEVELOPMENT, SOCIALIZATION, GROSS AND FINE MOTOR SKILLS, CREATIVE ARTS, COMPUTER SKILLS, MUSIC AND RHYTHM, AND DRAMATIC PLAY (U.S. CLS. 100, 101 AND 107).

CLASS 43—HOTEL AND RESTAURANT SERVICES

FOR DAY CARE SERVICES FOR INFANTS AND CHILDREN (U.S. CLS. 100 AND 101).
HOWARD SMIGA, EXAMINING ATTORNEY

SN 78-555,058. OLD NAVY (APPAREL), LLC, SAN FRANCISCO, CA. FILED 1-27-2005.



CLASS 18—LEATHER GOODS

FOR BAGS, NAMELY, ALL PURPOSE SPORT BAGS, ATHLETIC BAGS, BACKPACKS, BEACH BAGS, BOOK BAGS, CARRY-ON BAGS, DAYPACKS, DUFFEL BAGS, KNAPSACKS, OVERNIGHT BAGS, OVERNIGHT CASES, SCHOOL BAGS, SHOULDER BAGS, TOILETRY CASES SOLD EMPTY, TOTE BAGS, TRAVEL BAGS, UMBRELLAS, WAIST PACKS, WALLETS (U.S. CLS. 1, 2, 3, 22 AND 41).

CLASS 25—CLOTHING

FOR CLOTHING, NAMELY, PANTS, SHORTS, SWEATPANTS, OVERALLS, SHIRTS, TEE-SHIRTS, SWEATSHIRTS, JACKETS, VESTS, COATS, RAINWEAR, SHOES, SLEEPWEAR, LOUNGEWEAR, UNDERWEAR, SWIMWEAR, GLOVES, SOCKS, BELTS, SCARVES, HATS, SLIPPERS (U.S. CLS. 22 AND 39).
CAROLYN CATALDO, EXAMINING ATTORNEY

SN 78-557,896. NICHIRIN GROUP CO., LTD., OSAKA, JAPAN, FILED 2-1-2005.

MIRACULOUS

THE MARK CONSISTS OF STANDARD CHARACTERS WITHOUT CLAIM TO ANY PARTICULAR FONT, STYLE, SIZE, OR COLOR.

CLASS 1—CHEMICALS

FOR LIQUID ADDITIVES FOR AUTOMOBILE RADIATOR COOLANTS FOR FUEL SAVING (U.S. CLS. 1, 5, 6, 10, 26 AND 46).

CLASS 12—VEHICLES

FOR FUEL SAVING APPARATUS FOR INTERNAL COMBUSTION ENGINES FOR LAND VEHICLES IN THE NATURE OF A METAL CHIP THAT IS PLACED NEAR A RADIATOR (U.S. CLS. 19, 21, 23, 31, 35 AND 44).
ROBIN CHOSID, EXAMINING ATTORNEY

SN 78-558,357. THE GLAD PRODUCTS COMPANY, OAKLAND, CA. FILED 2-1-2005.

GET GLAD

THE MARK CONSISTS OF STANDARD CHARACTERS WITHOUT CLAIM TO ANY PARTICULAR FONT, STYLE, SIZE, OR COLOR.

OWNER OF U.S. REG. NOS. 738,875, 2,424,930 AND OTHERS.

CLASS 16—PAPER GOODS AND PRINTED MATTER

FOR PLASTIC BAGS, NAMELY, TRASH AND GARBAGE BAGS, SANDWICH BAGS, FOOD STORAGE BAGS FOR HOUSEHOLD USE, GENERAL PURPOSE BAGS; PLASTIC WRAP (U.S. CLS. 2, 5, 22, 23, 29, 37, 38 AND 50).

SN 78-558,903. EURO-PRO OPERATING LLC, WEST NEWTON, MA. FILED 2-2-2005.

CLASS 21—HOUSEWARES AND GLASS

FOR RIGID PLASTIC CONTAINERS FOR FOOD (U.S. CLS. 2, 13, 23, 29, 30, 33, 40 AND 50).
HOWARD SMIGA, EXAMINING ATTORNEY

BRAVETTI

SN 78-558,654. MEXX INTERNATIONAL B.V., NORTH BERGEN, NJ. FILED 2-2-2005.

THE MARK CONSISTS OF STANDARD CHARACTERS WITHOUT CLAIM TO ANY PARTICULAR FONT, STYLE, SIZE, OR COLOR.

OWNER OF U.S. REG. NOS. 2,383,821 AND 2,610,354.

CLASS 7—MACHINERY

FOR SEWING MACHINES AND VACUUM CLEANERS (U.S. CLS. 13, 19, 21, 23, 31, 34 AND 35).

CLASS 9—ELECTRICAL AND SCIENTIFIC APPARATUS

FOR STEAM IRONS FOR DOMESTIC USE (U.S. CLS. 21, 23, 26, 36 AND 38).

CLASS 11—ENVIRONMENTAL CONTROL APPARATUS

FOR AIR PURIFIERS AND HUMIDIFIERS (U.S. CLS. 13, 21, 23, 31 AND 34).
ALLISON HOLTZ, EXAMINING ATTORNEY

**CLASS 3—COSMETICS AND CLEANING PREPARATIONS**

FOR TOILET, HAND AND BODY SOAP; PERFUME; ESSENTIAL OILS FOR PERSONAL USE; COSMETICS, EXCLUDING MEDICATED AND NON-MEDICATED POWDERS BOTH SCENTED AND UNSCENTED; AND HAIR LOTIONS (U.S. CLS. 1, 4, 6, 50, 51 AND 52).

SN 78-559,641. COMPLETE ONLINE MARKETING SOLUTIONS, LLC, SAN DIEGO, CA. FILED 2-3-2005.

CLASS 18—LEATHER GOODS

FOR LEATHER AND IMITATIONS OF LEATHER SOLD IN BULK; ANIMAL SKINS AND HIDES; TRUNKS FOR TRAVELLING AND TRAVELLING BAGS; UMBRELLAS, PARASOLS, AND WALKING STICKS; WHIPS, HARNESSSES, AND SADDLERY; POCKETBOOKS, HANDBAGS, TOTE BAGS, WALLETS, CREDIT CARD CASES, DRAWSTRING POUCHES, BACKPACKS, ATTACHE CASES, BRIEFCASE-TYPE PORTFOLIOS (U.S. CLS. 1, 2, 3, 22 AND 41).

Resource4

CLASS 25—CLOTHING

FOR ARTICLES OF CLOTHING, NAMELY PANTS, TROUSERS, SHORTS, BERMUDA SHORTS, SHIRTS, SWEATSHIRTS, T-SHIRTS, SWEATERS, CARDIGANS, JACKETS, BLAZERS, COATS, VESTS, SHIRTS, TOPS, SUITS, PANT SUITS, SKIRT SUITS, RAINCOATS, RAIN JACKETS, SKIRTS, DRESSES, OVERALLS, BLOUSES, SCARVES, GLOVES, SHOES, BOOTS, SOCKS, BELTS FOR WEAR, CAPS, HATS, TIES, FOOTWEAR, HEADWEAR (U.S. CLS. 22 AND 39).
MATTHEW MCDOWELL, EXAMINING ATTORNEY

THE MARK CONSISTS OF STANDARD CHARACTERS WITHOUT CLAIM TO ANY PARTICULAR FONT, STYLE, SIZE, OR COLOR.

CLASS 35—ADVERTISING AND BUSINESS

FOR ADVERTISING AND MARKETING SERVICES, NAMELY, PROMOTION, ADVERTISING AND MARKETING OF ON-LINE MARKETING FEATURING ON-LINE WEBSITES, HOSTING, SEARCH ENGINE OPTIMIZATION, AND PAY PER CLICK (U.S. CLS. 100, 101 AND 102).

SN 78-562,726. NEXUS DISTRIBUTION CORPORATION, ITASCA, IL. FILED 2-8-2005.

CLASS 42—SCIENTIFIC, COMPUTER AND LEGAL SERVICES

FOR DESIGN, CREATION, HOSTING, MAINTENANCE AND SEARCH ENGINE OPTIMIZATION OF WEBSITES FOR OTHERS (U.S. CLS. 100 AND 101).
JACQUELINE A. LAVINE, EXAMINING ATTORNEY

NEXUS

SN 78-559,753. PLAYBILL INCORPORATED, WOODSIDE, NY. FILED 2-3-2005.

THE MARK CONSISTS OF STANDARD CHARACTERS WITHOUT CLAIM TO ANY PARTICULAR FONT, STYLE, SIZE, OR COLOR.

PLAYBILL

CLASS 35—ADVERTISING AND BUSINESS

FOR ARRANGING FOR PICKUP, DELIVERY, STORAGE AND TRANSPORTATION OF DOCUMENTS, PACKAGES, FREIGHT AND PARCELS VIA GROUND AND AIR CARRIERS; BUSINESS CONSULTING SERVICES RELATING TO PRODUCT DISTRIBUTION, OPERATIONS MANAGEMENT SERVICES, LOGISTICS, REVERSE LOGISTICS, SUPPLY CHAIN, AND PRODUCTION SYSTEMS AND DISTRIBUTION SOLUTIONS; BUSINESS MANAGEMENT SERVICES, NAMELY, MANAGING LOGISTICS, REVERSE LOGISTICS, SUPPLY CHAIN SERVICES, SUPPLY CHAIN VISIBILITY AND SYNCHRONIZATION, SUPPLY AND DEMAND FORECASTING AND PRODUCT DISTRIBUTION PROCESSES FOR OTHERS; INFORMATION MANAGEMENT SERVICES, NAMELY, SHIPMENT PROCESSING, PREPARING SHIPPING DOCUMENTS AND INVOICES, TRACKING DOCUMENTS, PACKAGES AND FREIGHT OVER COMPUTER NETWORKS, INTRANETS AND INTERNETS; LOGISTICS MANAGEMENT IN THE FIELD OF TRANSPORTED GOODS; INVENTORY MANAGEMENT IN THE FIELD OF TRANSPORTED GOODS; PROVIDING ELECTRONIC TRACKING OF FREIGHT INFORMATION TO OTHERS; TRANSPORTATION LOGISTICS SERVICES, NAMELY, ARRANGING THE TRANSPORTATION OF GOODS FOR OTHERS; TRANSPORTATION LOGISTICS SERVICES, NAMELY, PLANNING AND SCHEDULING SHIPMENTS FOR USERS OF TRANSPORTATION SERVICES (U.S. CLS. 100, 101 AND 102).

FIRST USE 0-0-1980; IN COMMERCE 0-0-1980.

THE MARK CONSISTS OF STANDARD CHARACTERS WITHOUT CLAIM TO ANY PARTICULAR FONT, STYLE, SIZE, OR COLOR.

OWNER OF U.S. REG. NOS. 1,322,148, 2,753,119 AND OTHERS.

CLASS 9—ELECTRICAL AND SCIENTIFIC APPARATUS

FOR MUSICAL SOUND RECORDINGS (U.S. CLS. 21, 23, 26, 36 AND 38).

CLASS 41—EDUCATION AND ENTERTAINMENT

FOR BOOK PUBLISHING (U.S. CLS. 100, 101 AND 107).
PAUL E. FAHRENKOPF, EXAMINING ATTORNEY

CLASS 39—TRANSPORTATION AND STORAGE

FOR FREIGHT BROKERAGE; FREIGHT FORWARDING; FREIGHT TRANSPORTATION BY TRUCK; GOODS WAREHOUSING; PACKING ARTICLES FOR TRANSPORTATION; SUPPLY CHAIN, LOGISTICS AND REVERSE LOGISTICS SERVICES, NAMELY, STORAGE, TRANSPORTATION AND DELIVERY OF DOCUMENTS, PACKAGES, RAW MATERIALS, AND OTHER FREIGHT FOR OTHERS BY AIR, RAIL, SHIP OR TRUCK; TRANSPORT BROKERAGE; TRANSPORTATION AND DELIVERY SERVICES, NAMELY, SAME DAY SHIPMENT SERVICES; TRUCK TRANSPORT; WAREHOUSE STORAGE; WAREHOUSING SERVICES, NAMELY, STORAGE, DISTRIBUTION, PICK-UP, AND PACKING FOR SHIPMENT OF DOCUMENTS, PACKAGES, RAW MATERIALS, AND OTHER FREIGHT FOR OTHERS; WAREHOUSING SERVICES (U.S. CLS. 100 AND 105).

FIRST USE 0-0-1980; IN COMMERCE 0-0-1980.

CLASS 42—SCIENTIFIC, COMPUTER AND LEGAL SERVICES

FOR PROVIDING USE OF ONLINE NON-DOWNLOADABLE COMPUTER SOFTWARE FOR PREPARING SHIPPING DOCUMENTS OVER COMPUTER NETWORKS, INTRANETS AND THE INTERNET; PROVIDING USE OF ONLINE NON-DOWNLOADABLE COMPUTER SOFTWARE FOR TRACKING FREIGHT OVER COMPUTER NETWORKS, INTRANETS AND THE INTERNET (U.S. CLS. 100 AND 101).

FIRST USE 0-0-1999; IN COMMERCE 0-0-1999.
VIVIAN MICZNIK FIRST, EXAMINING ATTORNEY

SN 78-563,421. CAPITAL ONE FINANCIAL CORPORATION, RICHMOND, VA. FILED 2-9-2005.

NO HASSLE REWARDS

THE MARK CONSISTS OF STANDARD CHARACTERS WITHOUT CLAIM TO ANY PARTICULAR FONT, STYLE, SIZE, OR COLOR.

OWNER OF U.S. REG. NOS. 2,827,681, 2,868,359 AND 2,919,694.

NO CLAIM IS MADE TO THE EXCLUSIVE RIGHT TO USE "REWARDS", APART FROM THE MARK AS SHOWN.

CLASS 35—ADVERTISING AND BUSINESS

FOR PROMOTING THE SALE OF CREDIT CARD ACCOUNTS THROUGH THE ADMINISTRATION OF INCENTIVE AWARD PROGRAMS (U.S. CLS. 100, 101 AND 102).

FIRST USE 6-1-2004; IN COMMERCE 6-1-2004.

CLASS 36—INSURANCE AND FINANCIAL

FOR FINANCIAL SERVICES, NAMELY CREDIT CARD SERVICES (U.S. CLS. 100, 101 AND 102).

FIRST USE 6-1-2004; IN COMMERCE 6-1-2004.
CHERYL CLAYTON, EXAMINING ATTORNEY

SN 78-563,518. CAPITAL ONE FINANCIAL CORPORATION, RICHMOND, VA. FILED 2-9-2005.



OWNER OF U.S. REG. NOS. 2,827,681, 2,868,359 AND 2,919,694.

NO CLAIM IS MADE TO THE EXCLUSIVE RIGHT TO USE "REWARDS", APART FROM THE MARK AS SHOWN. THE MARK CONSISTS OF A SEMI CIRCLE WITH A CHECK MARK IN FRONT OF THE LITERAL ELEMENT.

CLASS 35—ADVERTISING AND BUSINESS

FOR PROMOTING THE SALE OF CREDIT CARD ACCOUNTS THROUGH THE ADMINISTRATION OF INCENTIVE AWARD PROGRAMS (U.S. CLS. 100, 101 AND 102).

FIRST USE 6-1-2004; IN COMMERCE 6-1-2004.

CLASS 36—INSURANCE AND FINANCIAL

FOR FINANCIAL SERVICES, NAMELY CREDIT CARD SERVICES (U.S. CLS. 100, 101 AND 102).

FIRST USE 6-1-2004; IN COMMERCE 6-1-2004.
CHERYL CLAYTON, EXAMINING ATTORNEY

SN 78-574,726. THEFACEBOOK, INC., PALO ALTO, CA. FILED 2-24-2005.

THEFACEBOOK

THE MARK CONSISTS OF STANDARD CHARACTERS WITHOUT CLAIM TO ANY PARTICULAR FONT, STYLE, SIZE, OR COLOR.

CLASS 35—ADVERTISING AND BUSINESS

FOR PROVIDING AN ONLINE DIRECTORY INFORMATION SERVICE FEATURING INFORMATION REGARDING, AND IN THE NATURE OF, COLLEGIATE LIFE, CLASSIFIEDS, VIRTUAL COMMUNITY AND SOCIAL NETWORKING (U.S. CLS. 100, 101 AND 102).

FIRST USE 2-4-2004; IN COMMERCE 2-4-2004.

CLASS 38—COMMUNICATION

FOR PROVIDING ONLINE CHAT ROOMS FOR REGISTERED USERS FOR TRANSMISSION OF MESSAGES CONCERNING COLLEGIATE LIFE, CLASSIFIEDS, VIRTUAL COMMUNITY AND SOCIAL NETWORKING (U.S. CLS. 100, 101 AND 104).

FIRST USE 2-4-2004; IN COMMERCE 2-4-2004.
MATTHEW KLINE, EXAMINING ATTORNEY

SN 78-611,800. NOVO NORDISK A/S, BAGSVAERD, DENMARK, FILED 4-19-2005.

HYPOKIT

THE MARK CONSISTS OF STANDARD CHARACTERS WITHOUT CLAIM TO ANY PARTICULAR FONT, STYLE, SIZE, OR COLOR.

CLASS 5—PHARMACEUTICALS

FOR GLUCAGON PREPARATIONS FOR THE TREATMENT OF HYPOGLYCAEMIC REACTIONS (U.S. CLS. 6, 18, 44, 46, 51 AND 52).

CLASS 10—MEDICAL APPARATUS

FOR HYPODERMIC SYRINGES (U.S. CLS. 26, 39 AND 44).

MARIA-VICTORIA SUAREZ, EXAMINING ATTORNEY

SN 78-620,112. ATKINS NUTRITIONALS, INC., RONKONKOMA, NY. FILED 4-29-2005.

ATKINS ADVANTAGE

THE MARK CONSISTS OF STANDARD CHARACTERS WITHOUT CLAIM TO ANY PARTICULAR FONT, STYLE, SIZE, OR COLOR.

OWNER OF U.S. REG. NOS. 2,437,823, 2,689,974 AND 2,918,447.

CLASS 29—MEATS AND PROCESSED FOODS

FOR FRUIT BASED, SOY BASED, AND VEGETABLE BASED READY TO EAT FOOD BARS (U.S. CL. 46).
FIRST USE 3-25-2002; IN COMMERCE 3-25-2002.

CLASS 30—STAPLE FOODS

FOR GRAIN BASED, CHOCOLATE BASED, OAT BASED, CEREAL BASED AND GRANOLA BASED READY TO EAT FOOD BARS; SHAKES; SHAKE MIXES; CHOCOLATE; CHOCOLATE BARS; AND NUTRITIONAL CANDY BARS (U.S. CL. 46).

FIRST USE 3-25-2002; IN COMMERCE 3-25-2002.
REBECCA GAN, EXAMINING ATTORNEY

SN 78-633,953. ESPN, INC., BRISTOL, CT. FILED 5-20-2005.



THE MARK CONSISTS OF A STYLIZED "X" WITH A GLOBE DEVICE, WITH THE WORD GAMES APPEARING UNDER IT.

CLASS 20—FURNITURE AND ARTICLES NOT OTHERWISE CLASSIFIED

FOR PILLOWS; BATH PILLOWS; INFLATABLE PILLOWS; TRAVEL PILLOWS; SLEEPING BAGS (U.S. CLS. 2, 13, 22, 25, 32 AND 50).

CLASS 22—CORDAGE AND FIBERS

FOR LAUNDRY BAGS (U.S. CLS. 1, 2, 7, 19, 22, 42 AND 50).

CLASS 24—FABRICS

FOR BED COVERINGS, NAMELY, COMFORTERS, DUVET COVERS, BEDSPREADS AND QUILTS; BED CANOPIES; BED SKIRTS; BED SHEETS AND BED SHEET SETS; PILLOWCASES; PILLOW SHAMS; BED BLANKETS; BLANKET TROWS; BLANKETS FOR OUTDOOR USE; DRAPERIES; FABRIC VALANCES; SHOWER CURTAINS; TOWELS NOT OF PAPER; BEACH TOWELS (U.S. CLS. 42 AND 50).

CLASS 27—FLOOR COVERINGS

FOR SCATTER/ACCENT RUGS, AREA RUGS, DOORMATS (U.S. CLS. 19, 20, 37, 42 AND 50).
THEODORE MCBRIDE, EXAMINING ATTORNEY

SN 78-975,373. EMPOWER INTERACTIVE GROUP LIMITED, LONDON, UNITED KINGDOM, FILED 6-5-2000.

EMPOWER INTERACTIVE

PRIORITY CLAIMED UNDER SEC. 44(D) ON UNITED KINGDOM APPLICATION NO. 001648237, FILED 5-10-2000.

NO CLAIM IS MADE TO THE EXCLUSIVE RIGHT TO USE "INTERACTIVE", APART FROM THE MARK AS SHOWN.

CLASS 9—ELECTRICAL AND SCIENTIFIC APPARATUS

FOR COMPUTERS; COMPUTER HARDWARE; COMPUTER SOFTWARE FOR USE IN ADVANCED AND INTELLIGENT HANDLING OF APPLICATION AND PERSON-TO-PERSON MESSAGING TO SIMPLIFY ACCESS TO THE MOBILE TELECOMMUNICATION OPERATOR'S NETWORK INFRASTRUCTURE, INCREASE THE OPERATOR'S CONTROL OVER ITS MOBILE MESSAGING NETWORK AND TO HELP OPERATORS TO RAPIDLY IMPLEMENT AND MANAGE NEW MESSAGING SERVICES OFFERING VIA WIRED AND WIRELESS DIGITAL NETWORKS; COMPUTER PERIPHERALS; INTEGRATED CIRCUITS; ELECTRONIC PUBLICATIONS, NAMELY, TECHNICAL MANUALS AND WHITE PAPERS FEATURING THE USE OF SHORT MESSAGING SERVICES AND PEER TO PEER COMPUTING, RECORDED IN COMPUTER MEDIA; COMPUTER HARDWARE AND SOFTWARE FOR DATABASE MANAGEMENT; COMPUTER PROGRAMS FOR USE IN THE DISTRIBUTION OF SHORT MESSAGES OVER CELLULAR PHONE NETWORKS, THE DISTRIBUTION OF DATA IN THE WIRELESS MARKUP LANGUAGE (WML) FORMAT OVER WIRELESS NETWORKS AND THE INTERNET, AND THE ADMINISTRATION OF END-USER ACCOUNTS OVER WIRELESS DEVICES; DOWNLOADABLE COMPUTER SOFTWARE FOR USE IN ENABLING WIRELESS DEVICES TO ACCESS THE WORLD WIDE WEB USING THE WIRELESS APPLICATION PROTOCOL (WAP); INTERACTIVE COMPUTER SOFTWARE FOR USE IN ALLOWING END USERS TO MANAGE THEIR CORPORATE EXPENSES OVER WIRELESS NETWORKS; COMPUTER SEARCH ENGINE SOFTWARE (U.S. CLS. 21, 23, 26, 36 AND 38).
FIRST USE 3-29-2000; IN COMMERCE 4-6-2000.

CLASS 35—ADVERTISING AND BUSINESS

FOR COMPUTERIZED DATABASE MANAGEMENT SERVICES (U.S. CLS. 100, 101 AND 102).
FIRST USE 3-29-2000; IN COMMERCE 4-6-2000.

CLASS 38—COMMUNICATION

FOR TELECOMMUNICATIONS SERVICES, NAMELY, ROUTING SHORT MESSAGES OVER CELLULAR PHONE NETWORKS; PROVIDING MULTIPLE USER DIAL-UP AND DEDICATED ACCESS TO THE INTERNET BY WIRELESS DEVICES USING THE WIRELESS APPLICATIONS PROTOCOL (WAP) AND GENERAL PACKET RADIO SERVICES (GNPS) OVER CELLULAR PHONE NETWORKS; WIRELESS DIGITAL MESSAGING SERVICES, NAMELY USING SIMPLE MAIL TRANSFER PROTOCOL (SMTP) TO RELAY INSTANT MESSAGES FROM THE INTERNET TO CELLULAR PHONE NETWORKS; ELECTRONIC MAIL SERVICES; TELEPHONE MESSAGE SENDING AND RECEIVING SERVICES NAMELY, SHORT MESSAGE SERVICES; AUDIO, VIDEO AND RADIO BROADCASTING SERVICES; TRANSMISSION AND DISTRIBUTION OF DATA OR AUDIO VISUAL IMAGES VIA COMPUTER TERMINALS; PROVIDING INFORMATION VIA THE INTERNET IN THE FIELD OF WIRELESS COMMUNICATIONS, AND WIRELESS INTERNET ACCESS; TELECOMMUNICATIONS CONSULTATION RELATING TO WIRELESS APPLICATION PROTOCOL (WAP) TECHNOLOGY (U.S. CLS. 100, 101 AND 104).

FIRST USE 3-29-2000; IN COMMERCE 4-6-2000.

CLASS 42—SCIENTIFIC, COMPUTER AND LEGAL SERVICES

FOR PRODUCT RESEARCH, NAMELY, COMPILATION OF WAP TECHNOLOGY RESEARCH OVER THE INTERNET; COMPUTER SOFTWARE DEVELOPMENT, NAMELY, DEVELOPMENT OF INTERACTIVE GAMES FOR WIRELESS DEVICES; COMPUTER HARDWARE AND SOFTWARE CONSULTING SERVICES; COMPUTER SERVICES, NAMELY, CREATING AND MANAGING THE WEB AND WAP SITES OF OTHERS; HOSTING THE WEB SITES OF OTHERS ON A COMPUTER SERVER FOR GLOBAL COMPUTER NETWORK; PROVIDING TEMPORARY USE OF ON-LINE AND NON-DOWNLOADABLE SOFTWARE FOR THE MANAGEMENT OF CORPORATE EXPENSES AND FOR RELAYING VIA THE INTERNET MOBILE ORIGINATED SHORT MESSAGE SERVICES (U.S. CLS. 100 AND 101).

FIRST USE 3-29-2000; IN COMMERCE 4-6-2000.
JOHN GARTNER, EXAMINING ATTORNEY

CLASS 9—ELECTRICAL AND SCIENTIFIC APPARATUS

FOR CELLULAR TELEPHONES, PERSONAL DIGITAL ASSISTANTS, HANDHELD COMPUTERS, COMPUTERS, MODEMS; VEHICLE NAVIGATION SYSTEMS, NAMELY, ELECTRONIC NAVIGATIONAL INSTRUMENTS FOR GLOBAL POSITIONING; CAMERAS; COMPUTER SEARCH ENGINE SOFTWARE, COMPUTER APPLICATION SOFTWARE DOWNLOADABLE FROM A COMPUTER COMMUNICATION NETWORK FOR USE IN MANAGEMENT OF A DATABASE, FOR USE AS A SPREADSHEET AND COMPUTER SEARCH ENGINE, FOR WORD PROCESSING, COMPUTER AIDED DESIGN (CAD), RETRIEVAL, GAMES AND UTILITY; ELECTRONIC DOWNLOADABLE PUBLICATIONS IN THE NATURE OF MAGAZINES AND BOOKLETS IN THE FIELD OF WEATHER, NEWS, MONEY AND BANKING AND FINANCE, BONDS, MOVIES, ENTERTAINMENT, LIFESTYLES, INSURANCE, TRAVEL, SHOPPING, GOURMET, TRAFFIC INFORMATION, LIVING INFORMATION, MUSIC, GAMES, FORTUNE-TELLING, SPORTS, HOBBIES, OUTDOOR, ANIMATED CARTOONS, PERSONAL COMPUTERS, IT RELATED INFORMATION, TV AND RADIO PROGRAMS, SHOW BUSINESS, AND EDUCATION; DOWNLOADABLE VIDEO RECORDINGS FEATURING WEATHER, NEWS, MONEY AND BANKING AND FINANCE, BONDS, MOVIES, ENTERTAINMENT, LIFESTYLES, INSURANCE, TRAVEL, SHOPPING, GOURMET, TRAFFIC INFORMATION, LIVING INFORMATION, MUSIC, GAMES, FORTUNE-TELLING, SPORTS, HOBBIES, OUTDOOR, ANIMATED CARTOONS, PERSONAL COMPUTERS, IT RELATED INFORMATION, TV AND RADIO PROGRAMS, SHOW BUSINESS, AND EDUCATION; DOWNLOADABLE DIGITAL MUSIC PROVIDED FOR A GLOBAL COMPUTER NETWORK; STRAPS FOR HANDHELD COMPUTERS AND PDAS; ELECTRONIC PUBLICATIONS, NAMELY, CATALOGUES, MAGAZINES, PAMPHLETS, BOOKLETS, MANUALS, PERIODICALS, LEAFLETS, NEWSLETTERS, INFORMATIONAL FLYERS, PRINTED TEACHING MATERIAL, SPECIFICATIONS, DESIGN LAYOUTS, AND TECHNICAL READING MATERIAL IN THE FIELDS OF COMMUNICATION, HANDHELD COMPUTERS, PERSONAL COMPUTERS, PDA, STRAPS FOR HANDHELD COMPUTERS AND PDAS, TELEPHONES, CAMERAS, AND COMPUTER SOFTWARE RECORDED ON COMPUTER MEDIA, NAMELY, CD-ROMS, OPTICAL DISKS, MAGNETIC DISKS, AND MAGNETO-OPTICAL DISKS (U.S. CLS. 21, 23, 26, 36 AND 38).

SN 78-976,040. NTT DOCOMO, INC., TOKYO, JAPAN, FILED 12-20-2002.



OWNER OF JAPAN REG. NO. 4703522, DATED 8-22-2005, EXPIRES 8-22-2013.

CLASS 38—COMMUNICATION

FOR PROVIDING CHAT ROOMS AND ON-LINE BULLETIN BOARDS FOR TRANSMISSION OF MESSAGES AMONG COMPUTER USERS CONCERNING ENTERTAINMENT, EDUCATION, TECHNOLOGY, CULTURE, MUSIC, SPORTS, FASHION, LANGUAGE, IMAGES, LIVING INFORMATION, PERSONAL COMPUTER, IT RELATED MATTER, CURRENT EVENTS AND LIFESTYLES; COMMUNICATION BY COMPUTER TERMINALS; CELLULAR TELEPHONE SERVICES; RADIO AND TELEPHONE PAGING SERVICES; PROVIDING TELECOMMUNICATIONS CONNECTIONS TO A GLOBAL COMPUTER NETWORK BY COMPUTER; PROVIDING TELECOMMUNICATIONS CONNECTIONS TO A GLOBAL COMPUTER NETWORK BY CELLULAR TELEPHONES; ELECTRONIC MAIL SERVICES; PROVIDING COMMUNICATIONS VALUE-ADDED NETWORK (VAN); ELECTRONIC TRANSMISSION SERVICES; PROVIDING WIRELESS LOCAL AREA NETWORK (LAN) CONNECTIONS; ELECTRONIC TRANSMISSION OF DATA, IMAGES AND DOCUMENTS VIA COMPUTER TERMINALS; RENTAL OF TELECOMMUNICATION EQUIPMENT, NAMELY, TELEPHONES, FACSIMILE MACHINES, PDA, PERSONAL COMPUTERS AND HANDHELD COMPUTERS CAPABLE OF COMMUNICATING WITH ONE ANOTHER VIA TELECOMMUNICATION NETWORK (U.S. CLS. 100, 101 AND 104).

KAREN K. BUSH, EXAMINING ATTORNEY

SN 78-976,132. GCT 11 SOLUTIONS & ENTERPRISES LTD., TORONTO, ONTARIO, CANADA, FILED 10-23-2002.

SN 79-000,500. STOXX AG; (STOXX S.A.) (STOXX LIMITED), SWITZERLAND, FILED 12-25-2003.



NO CLAIM IS MADE TO THE EXCLUSIVE RIGHT TO USE "HEALTH EDUCATION MEDIA", APART FROM THE MARK AS SHOWN.

CLASS 9—ELECTRICAL AND SCIENTIFIC APPARATUS

FOR PRE-RECORDED CD ROMS, DISKETTES AND DVDS IN THE FIELDS OF ANESTHESIA, CARDIOLOGY, CLINICAL IMMUNOLOGY AND ALLERGY, COMMUNITY MEDICINE, DERMATOLOGY, DIAGNOSTIC RADIOLOGY, EMERGENCY MEDICINE, ENDOCRINOLOGY AND METABOLISM, GASTROENTEROLOGY, GENETICS, GERIATRIC MEDICINE, HEMATOLOGY, INFECTIOUS DISEASES, INTERNAL MEDICINE, NEPHROLOGY, NEUROLOGY, NUCLEAR MEDICINE, OCCUPATIONAL MEDICINE, OBSTETRICS AND GYNECOLOGY, OPHTHALMOLOGY, ONCOLOGY, OTOLARYNGOLOGY, PEDIATRICS, PHYSICAL MEDICINE AND REHABILITATION, PSYCHIATRY, PULMANOLOGY, RESPIROLOGY, RHEUMATOLOGY, SURGERY AND UROLOGY TO HELP PROFESSIONALS COMMUNICATE TO, DEMONSTRATE TO AND EDUCATE PATIENTS AND TO HELP HEALTH PRODUCT MANUFACTURERS ADVERTISE, PROMOTE AND EDUCATE PROFESSIONALS ON HEALTH CARE ISSUES (U.S. CLS. 21, 23, 26, 36 AND 38).
FIRST USE 5-23-2002; IN COMMERCE 5-23-2002.

CLASS 16—PAPER GOODS AND PRINTED MATTER

FOR MEDICAL ANATOMICAL MODELS FOR EDUCATIONAL PURPOSES, PAPER FOLDERS, FLASH CARDS, FILING CARDS, SCRATCH PADS, POSTERS, TEACHING EASELS, CALENDARS AND PRINTED MATTER, NAMELY, BOOKS, BOOKLETS, BROCHURES, CALENDARS, MAGAZINES, AND PAMPHLETS IN THE FIELDS OF ANESTHESIA, CARDIOLOGY, CLINICAL IMMUNOLOGY AND ALLERGY, COMMUNITY MEDICINE, DERMATOLOGY, DIAGNOSTIC RADIOLOGY, EMERGENCY MEDICINE, ENDOCRINOLOGY AND METABOLISM, GASTROENTEROLOGY, GENETICS, GERIATRIC MEDICINE, HEMATOLOGY, INFECTIOUS DISEASES, INTERNAL MEDICINE, NEPHROLOGY, NEUROLOGY, NUCLEAR MEDICINE, OCCUPATIONAL MEDICINE, OBSTETRICS AND GYNECOLOGY, OPHTHALMOLOGY, ONCOLOGY, OTOLARYNGOLOGY, PEDIATRICS, PHYSICAL MEDICINE AND REHABILITATION, PSYCHIATRY, PULMANOLOGY, RESPIROLOGY, RHEUMATOLOGY, SURGERY AND UROLOGY TO HELP PROFESSIONALS COMMUNICATE TO, DEMONSTRATE TO AND EDUCATE PATIENTS AND TO HELP HEALTH PRODUCT MANUFACTURERS ADVERTISE, PROMOTE AND EDUCATE PROFESSIONALS ON HEALTH CARE ISSUES (U.S. CLS. 2, 5, 22, 23, 29, 37, 38 AND 50).
FIRST USE 5-23-2002; IN COMMERCE 5-23-2002.
BARBARA GAYNOR, EXAMINING ATTORNEY

STOXX

THE MARK CONSISTS OF STANDARD CHARACTERS WITHOUT CLAIM TO ANY PARTICULAR FONT, STYLE, SIZE, OR COLOR.

OWNER OF INTERNATIONAL REGISTRATION 0696866 DATED 6-9-1998, EXPIRES 6-9-2008.

OWNER OF U.S. REG. NOS. 2,407,406, 2,891,161 AND OTHERS.
SEC. 2(F).

CLASS 9—ELECTRICAL AND SCIENTIFIC APPARATUS

FOR SOFTWARE, NAMELY DATA AND WORD PROCESSING PROGRAMS; EQUIPMENT AND APPARATUS FOR TRANSMITTING DATA AND INFORMATION, NAMELY MODEMS, SCANNERS AND FACSIMILE MACHINES; BLANK MEMORY CARDS FOR RECORDING OF COMPUTER PROGRAMS, BLANK MAGNETIC COMPUTER TAPES, BLANK DISKS FOR COMPUTERS AND BLANK OPTICAL DISKS (U.S. CLS. 21, 23, 26, 36 AND 38).

CLASS 16—PAPER GOODS AND PRINTED MATTER

FOR PRINTED MATTER, NAMELY BOOKS AND INSTRUCTION MANUALS FEATURING INFORMATION ON USING STOCK INDEXES IN CALCULATING AND ADMINISTERING FINANCIAL INSTRUMENTS AND DERIVATIVES, BOOKS AND MANUALS ON DATA PROCESSING AND FINANCIAL INSTRUMENT CALCULATIONS; PRINTED INSTRUCTIONAL OR TEACHING MATERIAL FOR THE CALCULATION OF FINANCIAL STATISTICS, THE DEVELOPMENT OF NEW FINANCIAL INSTRUMENTS AND DERIVATIVES, AND FOR THE ADMINISTRATION AND CALCULATION OF FINANCIAL INSTRUMENTS AND DERIVATIVES (U.S. CLS. 2, 5, 22, 23, 29, 37, 38 AND 50).

CLASS 35—ADVERTISING AND BUSINESS

FOR ADVERTISING AGENCIES, NAMELY PROMOTING THE SERVICES OF BANKS, PORTFOLIO AND SECURITIES MANAGERS, AND INSURANCE SERVICES THROUGH THE DISTRIBUTION OF PRINTED AND AUDIO PROMOTIONAL MATERIAL AND BY RENDERING SALES PROMOTION ADVICE AND BUSINESS MANAGEMENT; PROVIDING STATISTICAL INFORMATION FOR BUSINESS PURPOSES, NAMELY ECONOMIC DATA; ACCOUNTING SERVICES (U.S. CLS. 100, 101 AND 102).

CLASS 36—INSURANCE AND FINANCIAL

FOR LIFE INSURANCE UNDERWRITING; FINANCIAL AFFAIRS, NAMELY BROKERAGE IN THE FIELD OF STOCKS; FINANCIAL INSTRUMENT ISSUANCE, NAMELY ISSUANCE OF BONDS, SECURITIES AND DERIVATIVES; BANKING SERVICES; FINANCIAL SERVICES, NAMELY, CALCULATION OF STATISTICAL DATA AND INDEX FIGURES ON STOCK EXCHANGE QUOTATIONS, SECURITIES, INTEREST RATES, PRICES, EXCHANGE RATES AND OTHER ECONOMIC DATA; PORTFOLIO MANAGEMENT; DETERMINING AND CALCULATING INDICES IN CONNECTION WITH STOCK QUOTED SECURITIES AND FUTURES CONTRACTS, CURRENCIES, INTEREST RATES AND COMMERCIAL FACTORS; PROVIDING STOCK MARKET, MONEY MARKET AND EXCHANGE RATES INFORMATION; PROVIDING SECURITIES MARKETS AND DEPOSITS INFORMATION; PROVIDING OTHER FINANCIAL INFORMATION; DEBIT AND CREDIT CARD SERVICES; FINANCIAL CONSULTATION (U.S. CLS. 100, 101 AND 102).

CLASS 38—COMMUNICATION

FOR ELECTRONIC TRANSMISSION OF DATA AND DOCUMENTS VIA COMPUTER TERMINALS; E-MAIL SERVICES (U.S. CLS. 100, 101 AND 104).

CLASS 41—EDUCATION AND ENTERTAINMENT

FOR TRAINING AND TEACHING IN THE FIELD OF STOCK INDEXES, RELATED STATISTICS AND OTHER ECONOMICAL DATA; PUBLICATION OF STATISTICAL DATA AND INDEX FIGURES ON STOCK EXCHANGE QUOTATIONS, SECURITIES, INTEREST RATES, PRICES, EXCHANGE RATES AND OTHER ECONOMIC DATA (U.S. CLS. 100, 101 AND 107).

CLASS 42—SCIENTIFIC, COMPUTER AND LEGAL SERVICES

FOR COMPUTER CONSULTATION ABOUT DATABASES; COMPUTER PROGRAMMING FOR OTHERS (U.S. CLS. 100 AND 101).

DORITT L. CARROLL, EXAMINING ATTORNEY

SN 79-001,074. GATE GOURMET SWITZERLAND GMBH, SWITZERLAND, FILED 11-21-2003.



PRIORITY DATE OF 8-8-2003 IS CLAIMED.
OWNER OF INTERNATIONAL REGISTRATION 0819262
DATED 11-21-2003, EXPIRES 11-21-2013.

OWNER OF U.S. REG. NO. 2,815,152.
NO CLAIM IS MADE TO THE EXCLUSIVE RIGHT TO USE "GOURMET", APART FROM THE MARK AS SHOWN.
THE STIPLING SHOWN IN THE MARK IS INTENDED TO INDICATE SHADING AND IS NOT INTENDED TO INDICATE COLOR AND FURTHER, IT IS NOT A FEATURE OF THE MARK.

THE COLORS GRAY AND BLACK ARE CLAIMED AS A FEATURE OF THE MARK.

THE COLOR GRAY APPEARS IN THE OVAL PORTION OF THE MARK, THE CHEF'S HAT AND APRON AND IN THE SERVING PLATTER.

CLASS 39—TRANSPORTATION AND STORAGE

FOR DISTRIBUTION AND DELIVERY OF MEALS FOR AIRLINE CATERING REQUIREMENTS (U.S. CLS. 100 AND 105).

CLASS 43—HOTEL AND RESTAURANT SERVICES

FOR CATERING, RESTAURANT AND SELF-SERVICE RESTAURANT SERVICES, CANTEEN AND CAFETERIAS SERVICES, PROVIDING OF FOOD AND DRINK IN RESTAURANTS IN AIRPORTS AND AIRLINES; FOOD AND DRINK PREPARATION FOR CONSUMPTION IN AIRPORTS AND FOR AIRLINES (U.S. CLS. 100 AND 101).

DAHLIA GEORGE, EXAMINING ATTORNEY

SN 79-001,242. KOSTYUK DMYTRO DMYTROYCH, UKRAINE, AND MELADZE KOSTYANTYN SHOTOVYCH, UKRAINE, FILED 12-5-2003.

Nu Virgo's

THE MARK CONSISTS OF STANDARD CHARACTERS WITHOUT CLAIM TO ANY PARTICULAR FONT, STYLE, SIZE, OR COLOR.

PRIORITY DATE OF 11-14-2003 IS CLAIMED.

OWNER OF INTERNATIONAL REGISTRATION 0820009
DATED 12-5-2003, EXPIRES 12-5-2013.

CLASS 9—ELECTRICAL AND SCIENTIFIC APPARATUS

FOR ACOUSTIC COUPLERS, CAMCORDERS, PRERECORDED VIDEO CASSETTES FEATURING MUSICAL PERFORMANCES, PRERECORDED PHONOGRAPH RECORDS FEATURING MUSICAL PERFORMANCES, PRERECORDED FLOPPY DISKS FEATURING MUSICAL PERFORMANCES, PRERECORDED MAGNETIC DISKS FEATURING MUSICAL PERFORMANCES, PRERECORDED OPTICAL DISCS FEATURING MUSICAL PERFORMANCES, PRERECORDED SOUND RECORDING DISCS FEATURING MUSICAL PERFORMANCES, PRERECORDED SOUND RECORDING CARRIERS FEATURING MUSICAL PERFORMANCES, PRERECORDED SOUND RECORDING STRIPS FEATURING MUSICAL PERFORMANCES, OPTICAL CHARACTER READERS, CINEMATOGRAPHIC CAMERAS, PHOTOGRAPHIC CARRIERS FOR DARK PLATES, CASSETTE PLAYERS, EXPOSED CINEMATOGRAPHIC FILMS, AUDIO-VIDEO COMPACT DISCS FEATURING MUSICAL PERFORMANCES, PRERECORDED VIDEOTAPES FEATURING MUSICAL PERFORMANCES, PRERECORDED MAGNETIC DATA MEDIA FEATURING MUSICAL PERFORMANCES, PRERECORDED MAGNETIC TAPES FEATURING MUSICAL PERFORMANCES, PRERECORDED OPTICAL DATA MEDIA FEATURING MUSICAL PERFORMANCES (U.S. CLS. 21, 23, 26, 36 AND 38).

CLASS 35—ADVERTISING AND BUSINESS

FOR NEWS CLIPPING SERVICES, COMMERCIAL INFORMATION AGENCIES, AUCTIONEERING, MARKETING STUDIES, OPINION POLLING, ORGANIZATION OF EXHIBITIONS FOR COMMERCIAL OR ADVERTISING PURPOSES, ORGANIZATION OF TRADE FAIRS FOR COMMERCIAL OR ADVERTISING PURPOSES, ARRANGING NEWSPAPER SUBSCRIPTIONS FOR OTHERS IN THE FIELD OF SHOW BUSINESS, PRODUCT DEMONSTRATION, BUSINESS RESEARCH, BUSINESS INFORMATION IN THE FIELD OF SHOW BUSINESS, BUSINESS APPRAISALS, BUSINESS INVESTIGATIONS, BUSINESS INQUIRIES IN THE FIELD OF SHOW BUSINESS, BUSINESS MANAGEMENT ASSISTANCE, ECONOMIC FORECASTING, EFFICIENCY EXPERTS, PUBLIC RELATIONS, OFFICE MACHINES AND EQUIPMENT RENTAL, BUSINESS MANAGEMENT OF PERFORMING ARTISTS, MODELING FOR ADVERTISING OR SALES PROMOTION, TYPING, DOCUMENT REPRODUCTION, UPDATING OF ADVERTISING MATERIAL, SHOP WINDOW DRESSING, CONDUCTING PROCUREMENT SERVICES AND ORGANIZING PROCUREMENT SERVICES FOR OTHERS; CONDUCTING SALES PROMOTION AND ORGANIZING SALES PROMOTIONS FOR OTHERS; PUBLICATION OF PUBLICITY TEXTS, RADIO ADVERTISING, ADVERTISING BY MAIL ORDER, ADVERTISING AGENCIES, ON-LINE ADVERTISING ON A COMPUTER NETWORK, BILL-POSTING, PREPARING AND PLACING OUTDOOR ADVERTISING, DISSEMINATION OF ADVERTISING MATTER, DIRECT MAIL ADVERTISING, STATISTICAL INFORMATION, TELEVISION ADVERTISING (U.S. CLS. 100, 101 AND 102).

CLASS 41—EDUCATION AND ENTERTAINMENT

FOR ORGANIZATION OF EXHIBITIONS FOR CULTURAL OR EDUCATIONAL PURPOSES IN THE FIELD OF SHOW BUSINESS; ORGANIZATION OF SHOWS, NAMELY, IMPRESARIO SERVICES; CONDUCTING OF BEAUTY CONTESTS AND ORGANIZING BEAUTY CONTESTS FOR OTHERS; PRODUCING OF RADIO AND TELEVISION PROGRAMS AND ORGANIZING SUCH PROGRAMS FOR OTHERS; AMUSEMENTS ARCADES, CLUB SERVICES IN THE FIELD OF ENTERTAINMENT AND EDUCATION; PROVIDING AMUSEMENT ARCADE SERVICES, VIDEOTAPING, MICROFILMING, PROVIDING RECREATION INFORMATION IN THE FIELD OF SHOW BUSINESS, PROVIDING ENTERTAINMENT INFORMATION IN THE FIELD OF SHOW BUSINESS, PROVIDING KARAOKE SERVICES, MOVIE STUDIOS, MUSIC-HALLS, VIDEOTAPE EDITING; RENTAL SERVICES OF AUDIO EQUIPMENT, VIDEO CAMERAS, VIDEOTAPES, SHOW SCENERY, SOUND RECORDINGS, LIGHTING APPARATUS FOR THEATRICAL SETS AND TELEVISION STUDIOS; RENTAL SERVICES OF MOVIE PROJECTORS AND ACCESSORIES; RENTAL SERVICES OF CINE-FILMS, RADIO AND TELEVISION SETS; RENTAL SERVICES OF STAGE SCENERY; NIGHT CLUBS, PROVIDING RECREATION FACILITIES, PROVIDING CASINO FACILITIES FOR GAMBLING, PARTY PLANNING SERVICES FOR ENTERTAINMENT, DISCOTHEQUE SERVICES, RECORDING STUDIO SERVICES, SCRIPTWRITING SERVICES, DIGITAL IMAGING SERVICES, BOOKING OF SEATS FOR SHOWS, PRESENTATION OF LIVE PERFORMANCES IN THE NATURE OF MUSICAL PERFORMANCES, RADIO ENTERTAINMENT IN THE NATURE OF MUSICAL PERFORMANCES, ENTERTAINMENT IN THE NATURE OF MUSICAL PERFORMANCES, ENTERTAINER SERVICES IN THE NATURE OF PROVIDING LIVE ENTERTAINERS FOR PARTIES, PRODUCTION OF SHOWS, VIDEOTAPE FILM PRODUCTION, FILM PRODUCTION, THEATRE PRODUCTIONS, TELEVISION ENTERTAINMENT IN THE NATURE OF ONGOING TELEVISION PROGRAMS IN THE FIELD OF MUSICAL PERFORMANCES; PHOTOGRAPHY (U.S. CLS. 100, 101 AND 107).

JENNIFER KRISP, EXAMINING ATTORNEY

SN 79-001,438. HAGER & WERKEN GMBH & CO. KG, DUISBURG, FED REP GERMANY, FILED 1-21-2004.

MIRATRAY

THE MARK CONSISTS OF STANDARD CHARACTERS WITHOUT CLAIM TO ANY PARTICULAR FONT, STYLE, SIZE, OR COLOR.

PRIORITY DATE OF 7-28-2003 IS CLAIMED.
OWNER OF INTERNATIONAL REGISTRATION 0820781 DATED 1-21-2004, EXPIRES 1-21-2014.

CLASS 5—PHARMACEUTICALS

FOR SPRAY ADHESIVES FOR DENTAL USE (U.S. CLS. 6, 18, 44, 46, 51 AND 52).

CLASS 10—MEDICAL APPARATUS

FOR DENTAL INSTRUMENTS AND APPARATUS, NAMELY DENTAL TRAYS (U.S. CLS. 26, 39 AND 44).
CURTIS FRENCH, EXAMINING ATTORNEY

SN 79-001,473. PERKINS HOLDINGS LIMITED, UNITED KINGDOM, FILED 2-20-2004.

ECOPLUS

THE MARK CONSISTS OF STANDARD CHARACTERS WITHOUT CLAIM TO ANY PARTICULAR FONT, STYLE, SIZE, OR COLOR.

OWNER OF INTERNATIONAL REGISTRATION 0820991 DATED 2-20-2004, EXPIRES 2-20-2014.

CLASS 7—MACHINERY

FOR ENGINES, EXCEPT FOR LAND VEHICLES, FILTERS, NAMELY OIL FILTERS, AIR FILTERS AND FUEL FILTERS FOR MOTORS AND ENGINES (U.S. CLS. 13, 19, 21, 23, 31, 34 AND 35).

CLASS 12—VEHICLES

FOR ENGINES FOR LAND VEHICLES (U.S. CLS. 19, 21, 23, 31, 35 AND 44).

CLASS 37—CONSTRUCTION AND REPAIR

FOR REPAIR, MAINTENANCE AND SERVICE OF ENGINES, GENERATORS AND MOTORS FOR LAND VEHICLES, MARINE ENGINES AND FOR GENERATORS PROVIDED THROUGH AUTHORIZED DEALERSHIPS AND CHANNELS (U.S. CLS. 100, 103 AND 106).

H. M. FISHER, EXAMINING ATTORNEY

SN 79-001,568. BRUN DE VIAN-TIRAN, FRANCE, FILED 2-25-2004.



BRUN DE VIAN-TIRAN

Manufacture Lainière depuis 1808

PRIORITY DATE OF 9-9-2003 IS CLAIMED.
OWNER OF INTERNATIONAL REGISTRATION 0821220 DATED 2-25-2004, EXPIRES 2-25-2014.

NO CLAIM IS MADE TO THE EXCLUSIVE RIGHT TO USE MANUFACTURE LAINIÈRE DEPUIS 1808, APART FROM THE MARK AS SHOWN.

THE DESIGN ELEMENT OF THE MARK INCLUDES A LOGO WITH A DRAWING OF A SHEEP/RAM WITH THE LETTERS B, V, T.

THE ENGLISH TRANSLATION OF MANUFACTURE LAINIÈRE DEPUIS 1808 IS WOOL FACOTRY SINCE 1808.

CLASS 24—FABRICS

FOR BLANKETS, TRAVELING RUGS, QUILTS, FEATHER-BEDS, BED COVERS, COVERS FOR MATTRESSES AND MATTRESS PADS (U.S. CLS. 42 AND 50).

CLASS 27—FLOOR COVERINGS

FOR CARPETS, NON-TEXTILE WALL HANGINGS AND FLOOR COVERINGS (U.S. CLS. 19, 20, 37, 42 AND 50).

CHRISTOPHER BUONGIORNO, EXAMINING ATTORNEY

SN 79-001,635. TREIBACHER INDUSTRIE AG, A-9330 TREIBACH-ALTHOFEN, AUSTRIA, FILED 2-10-2004.

TREIBACHER

THE MARK CONSISTS OF STANDARD CHARACTERS WITHOUT CLAIM TO ANY PARTICULAR FONT, STYLE, SIZE, OR COLOR.

PRIORITY DATE OF 10-14-2003 IS CLAIMED.
OWNER OF INTERNATIONAL REGISTRATION 0821591 DATED 2-10-2004, EXPIRES 2-10-2014.

CLASS 1—CHEMICALS

FOR CHEMICAL PRODUCTS, NAMELY FERROVANADIUM, FERROMOLYBDENUM, CARBIDES, BORIDES, NITRIDES, RARE EARTHS, RARE EARTH OXIDES, RARE EARTH COMPOUNDS, VANADIUM CHEMICALS, METAL HYDRIDES FOR THE STORAGE OF HYDROGEN, MIXED METAL OXIDES, FLINTS, CERAMIC POWDERS, TOP SLAGS, NIOBATES, TITANATES, COBALTATES, MANGANATES, TUNGSTATES, ZIRCONATES, NICKELATES, CHROMITES, FERRITES, ALUMINATES, FOR INDUSTRIAL, SCIENTIFIC AND AGRICULTURAL PURPOSES (U.S. CLS. 1, 5, 6, 10, 26 AND 46).

CLASS 6—METAL GOODS

FOR BASE METALS AND THE ALLOYS THEREOF (U.S. CLS. 2, 12, 13, 14, 23, 25 AND 50).

CLASS 21—HOUSEWARES AND GLASS

FOR GOODS MADE OF CERAMICS, IN PARTICULAR, PORCELAIN AND CROCKERY, NAMELY CERAMIC GRINDING BEADS (U.S. CLS. 2, 13, 23, 29, 30, 33, 40 AND 50).

JANICE L. MCMORROW, EXAMINING ATTORNEY

SN 79-001,646. IVECO SPA, I-10156 TORINO, ITALY, FILED 1-13-2004.

NEF

PRIORITY DATE OF 11-5-2003 IS CLAIMED.
OWNER OF INTERNATIONAL REGISTRATION 0821619 DATED 1-13-2004, EXPIRES 1-13-2014.

CLASS 7—MACHINERY

FOR INTERNAL COMBUSTION ENGINES NOT FOR LAND VEHICLES AND REPLACEMENT PARTS THEREFORE; INTERNAL COMBUSTION ENGINE PARTS, NAMELY, CONTACT POINTS, CONDENSERS, POINTS, PISTON RINGS, PISTONS, CONNECTING RODS, COILS, DISTRIBUTOR CAPS, DISTRIBUTOR ROTORS AND FUEL INJECTOR PARTS; MECHANICAL INTERNAL COMBUSTION ENGINE PARTS FOR LAND VEHICLES AND REPLACEMENT PARTS THEREFORE; INTERNAL COMBUSTION ENGINE PARTS, NAMELY OIL TANKS, OIL TANK PLUGS AND CAPS, CRANKCASE BREATHERS, OIL COOLERS, PUSH RODS (U.S. CLS. 13, 19, 21, 23, 31, 34 AND 35).

CLASS 12—VEHICLES

FOR INTERNAL COMBUSTION ENGINES FOR LAND VEHICLES AND REPLACEMENT PARTS THEREFORE; ENGINES FOR LAND VEHICLES AND REPLACEMENT PARTS THEREFORE; LAND VEHICLE PARTS, NAMELY, TRANSMISSIONS AND REPLACEMENT PARTS THEREOF, WHEELS, WINDSHIELDS, DIFFERENTIALS, FENDER FLARES, DRIVE BELTS, DRIVE GEARS, FENDERS, MUD GUARDS AND RUNNING BOARDS; LAND VEHICLE SUSPENSION PARTS, NAMELY, TORSION/SWAY BARS, COIL SPRINGS, LEAF SPRINGS; LAND VEHICLES, NAMELY TRUCKS, LORRIES, BUSES, TRACTORS (U.S. CLS. 19, 21, 23, 31, 35 AND 44).

KELLY CHOE, EXAMINING ATTORNEY

SN 79-001,679. FRESH & CO. D.O.O.; FABRIKA ZA PRERADU VOCA, CS-24000 SUBOTICA, YUGOSLAVIA, FILED 1-20-2004.

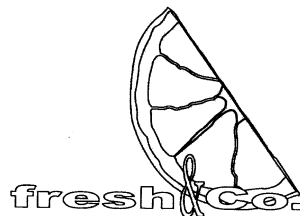

OWNER OF INTERNATIONAL REGISTRATION 0776970 DATED 2-20-2002, EXPIRES 2-20-2012.

CLASS 32—LIGHT BEVERAGES

FOR NON-ALCOHOLIC BEVERAGES, NAMELY, FRUIT-FLAVORED BEVERAGES, FRUIT DRINKS, FRUIT NECTARS AND FRUIT JUICES; SYRUPS, FRUIT NECTARS, FRUIT DRINKS, FRUIT JUICES USED IN THE PREPARATION OF FRUIT JUICES AND FRUIT BEVERAGES (U.S. CLS. 45, 46 AND 48).

CLASS 35—ADVERTISING AND BUSINESS

FOR IMPORT-EXPORT AGENCIES (U.S. CLS. 100, 101 AND 102).

MICHAEL ENGEL, EXAMINING ATTORNEY

SN 79-001,680. SCHWEIZERISCHE ZENTRALE FÜR; HANDELSFÖRDERUNG OSEC, SWITZERLAND, FILED 2-26-2004.



OWNER OF INTERNATIONAL REGISTRATION 0781363 DATED 4-18-2002, EXPIRES 4-18-2012.

NO CLAIM IS MADE TO THE EXCLUSIVE RIGHT TO USE BUSINESS NETWORK SWITZERLAND, APART FROM THE MARK AS SHOWN.

CLASS 35—ADVERTISING AND BUSINESS

FOR DISSEMINATION OF ADVERTISING MATTER; DATA PROCESSING SERVICES; PROVIDING INFORMATION CONCERNING THE BUSINESS ECONOMY; PROVIDING COMMERCIAL INFORMATION, NAMELY, INFORMATION CONCERNING EXCHANGES BETWEEN SWITZERLAND AND ABROAD; PROVIDING INFORMATION ON SWISS EXPORTS AND ECONOMIC INFORMATION; CONSULTING IN THE FIELD OF FOREIGN MARKETS; BUSINESS NETWORKING AGENCIES FOR BUSINESS RELATIONS AND COMMERCIAL OPPORTUNITIES, NAMELY, EXECUTION OF FAIRS AND SPECIAL EVENTS FOR NETWORKING AMONGST BUSINESS; BUSINESS MANAGEMENT CONSULTING CONCERNING INTERNATIONAL MARKETS AND INFORMATION ON FOREIGN MARKETS (U.S. CLS. 100, 101 AND 102).

CLASS 41—EDUCATION AND ENTERTAINMENT

FOR ORGANIZATION OF CONVENTIONS, CONFERENCES AND SYMPOSIA FOR GOODS AND SERVICES THAT ARE PRODUCED BY SWISS COMPANIES (U.S. CLS. 100, 101 AND 107).

KEVON CHISOLM, EXAMINING ATTORNEY

SN 79-001,687. ATAÇ KOZMETİK VE KİMYA; SANAYİ VE TİCARET ANONİM ŞİRKETİ, TURKEY, FILED 3-2-2004.

OWNER OF INTERNATIONAL REGISTRATION 0813750 DATED 7-25-2003, EXPIRES 7-25-2013.

THE ENGLISH TRANSLATION OF MODA IS "FASHION".

CLASS 3—COSMETICS AND CLEANING PREPARATIONS

FOR NAIL POLISH, NAIL VARNISH, NAIL CARE PREPARATIONS, HAND LOTIONS, EYE SHADOWS IN THE FORM OF POWDER, CREAM AND STICK, EYELINERS, MASCARAS, EYEBROW PENCILS, LIPSTICKS, MAKE-UP POWDERS, BLUSHERS, FOUNDATIONS, FACE AND BODY LOTIONS, EAU DE COLOGNE, PERFUMES, HAIR DYES, DEODORANTS; SUN TANNING OILS AND MILKS, HAIR SPRAYS; CLEANSING LOTIONS, DEPILATORY PREPARATIONS, HAIR WAVING PREPARATIONS, SHAMPOOS, SOAPS FOR TOILETS, BABY POWDERS AND OILS, ANTI-WRINKLE CREAMS, ANTI-FRECKLE CREAMS, NAIL HARDENERS, NAIL STRENGTHENERS, HAIR DECOLORANTS, SHAVING CREAMS, LOTIONS AND SOAPS, BRILLIANTINE, HAIR BOOSTERS (U.S. CLS. 1, 4, 6, 50, 51 AND 52).

CLASS 5—PHARMACEUTICALS

FOR AIR PURIFYING AND AIR FRESHENING SPRAYS (U.S. CLS. 6, 18, 44, 46, 51 AND 52).

JULIA HARDY COFIELD, EXAMINING ATTORNEY

SN 79-001,688. ATAÇ KOZMETİK VE KİMYA; SANAYİ VE TİCARET ANONİM ŞİRKETİ, TURKEY, FILED 3-2-2004.

OWNER OF INTERNATIONAL REGISTRATION 0813829 DATED 7-25-2003, EXPIRES 7-25-2013.

CLASS 3—COSMETICS AND CLEANING PREPARATIONS

FOR NAIL POLISH, NAIL VARNISH, NAIL CARE PREPARATIONS, NAIL HARDENERS AND STRENGTHENERS, NAIL POLISH REMOVERS, HAND LOTIONS, EYE SHADOWS IN THE FORM OF POWDER, CREAM AND STICK EYE SHADOWS, EYELINERS, MASCARAS, EYEBROW PENCILS, LIPSTICKS, MAKE-UP POWDERS, MAKE-UP POWDERS IN THE FORM OF CREAM; BLUSHERS, FOUNDATIONS, MAKE-UP REMOVERS; FACE AND BODY LOTIONS, MILKS AND OILS, EAU DE COLOGNE, PERFUMES, ESSENTIAL OILS FOR PERSONAL USE, CREAMS, HAIR CARE AND EMBELLISHMENT PREPARATIONS, HAIR DYES, HAIR SPRAYS, DECOLORANTS FOR HAIR, HAIR BOOSTERS, TONICS, ANTI-DANDRUFF SHAMPOOS, DEODORANTS, SUN TANNING OILS, CLEANSING LOTIONS, DEPILATORY PREPARATIONS, SHAMPOOS, SOAPS FOR TOILETS, SOAPS IN THE FORM OF POWDER AND CREAM, LAUNDRY SOAPS, SOAPS FOR PERSONAL USE, BABY POWDERS AND OILS, SKIN WHITENING PREPARATIONS, BALMS, ANTI-WRINKLE CREAMS, ANTI-FRECKLE CREAMS, EYE-LINER, SHAVING CREAMS; LOTIONS; BRILLIANTINE, LIPSTICKS, MOISTURIZERS FOR HAIR AND SKIN, PERMANENT HAIR WAVING PREPARATIONS (U.S. CLS. 1, 4, 6, 50, 51 AND 52).

CLASS 8—HAND TOOLS

FOR NON-ELECTRIC HAND IMPLEMENTS FOR HAIR CURLING, PLIERS (U.S. CLS. 23, 28 AND 44).

CLASS 21—HOUSEWARES AND GLASS

FOR HAIR BRUSHES AND COMBS (U.S. CLS. 2, 13, 23, 29, 30, 33, 40 AND 50).

CLASS 26—FANCY GOODS

FOR HAIR STYLING DEVICES, NAMELY NON-ELECTRIC CURLERS, HAIR PINS, HAIR CLIPS, HAIR GRIPS, HAIR BOWS AND BANDS (U.S. CLS. 37, 39, 40, 42 AND 50).

JULIA HARDY COFIELD, EXAMINING ATTORNEY

SN 79-001,760. LU FRANCE, F-94150 RUNGIS, FRANCE, FILED 2-5-2004.



PRIORITY DATE OF 8-29-2003 IS CLAIMED.
OWNER OF INTERNATIONAL REGISTRATION 0822000 DATED 2-5-2004, EXPIRES 2-5-2014.

THE COLOR(S) PANTONE BROWN 4625, PANTONE RED 485 AND PANTONE YELLOW IS/ARE CLAIMED AS A FEATURE OF THE MARK.

THE COLORS YELLOW AND RED COMPRISE THE TRIANGULAR DESIGN RUNNING ALONG THE HAT BRIM.

CLASS 29—MEATS AND PROCESSED FOODS

FOR MEAT, FISH, HAM, POULTRY, GAME, CHARCUTERIE; DRIED, PRESERVED AND/OR COOKED FRUITS AND VEGETABLES; COMPOTES, JAMS, FRUIT SAUCES, JELLIES; SOUPS; CANNED FOOD MAINLY CONTAINING MEAT, FISH, HAM, POULTRY AND/OR GAME; PREPARED, DEHYDRATED, COOKED, PRESERVED AND DEEP-FROZEN DISHES, ESSENTIALLY CONTAINING MEAT, FISH, HAM, POULTRY AND/OR GAME; SAVORY OR SWEET COCKTAIL PRODUCTS MADE FROM FRUIT OR VEGETABLES LIKE POTATOES; PLAIN OR FLAVORED; CHIPS, DRIED FRUIT MIXES; PREPARED NUTS, HAZELNUTS, PEANUTS, CASHEW NUTS; COCKTAIL SNACKS MADE OF CHARCUTERIE; MILK, POWDERED MILK; FLAVORED, GELLED AND WHIPPED MILK, DAIRY PRODUCTS, NAMELY, MILK DESSERTS, YOGURTS, YOGURT BASED BEVERAGES, MOUSSES, CREAMS, CREAM DESSERTS, FRESH CREAM, BUTTER, CHEESE SPREADS, CHEESES, RIPENED CHEESES, MOLD-RIPENED CHEESES, FRESH UNRIPENED CHEESES AND CHEESE IN BRINE, SOFT WHITE CHEESE, PLAIN OR AROMATIZED FRESH CHEESES SOLD IN PASTE OR LIQUID FORM; BEVERAGES MAINLY CONSISTING OF MILK OR DAIRY PRODUCTS, MILK BEVERAGES WITH HIGH MILK CONTENT, MILK BEVERAGES CONTAINING FRUITS; PLAIN OR AROMATIZED FERMENTED DAIRY PRODUCTS, NAMELY, YOGURT AND COTTAGE CHEESE; EDIBLE OILS, OLIVE OIL, EDIBLE FATS (U.S. CL. 46).

CLASS 30—STAPLE FOODS

FOR COFFEE, TEA, COCOA, CHOCOLATE, COFFEE-BASED BEVERAGES, COCOA-BASED BEVERAGES, CHOCOLATE-BASED BEVERAGES, SUGAR, RICE, PUFFED RICE, TAPIOCA; FLOURS, SWEET AND SAVORY TARTS AND PIES PIZZAS; PLAIN OR FLAVORED AND/OR FILLED PASTA, CEREAL PREPARATIONS, BREAKFAST CEREALS; PREPARED DISHES MAINLY CONTAINING PASTA; PREPARED DISHES ESSENTIALLY CONSISTING OF PASTRY, BREAD, RUSKS, SWEET OR SAVORY BISCUITS, WAFERS, WAFFLES, CAKES, PASTRIES; ALL THESE GOODS BEING PLAIN AND/OR TOPPED AND/OR FILLED AND/OR FLAVORED; SAVORY OR SWEET COCKTAIL GOODS, NAMELY, APPETIZERS CONTAINING BAKING DOUGH, BISCUIT MIXTURE OR PASTRY MIXTURE; CONFECTIONERY, EDIBLE ICES, ICE CREAMS ESSENTIALLY MADE WITH YOGURT, ICE CREAM, SHERBETS, FROZEN YOGURT, FLAVORED FROZEN WATER; HONEY, SALT, MUSTARD, VINEGAR, CONDIMENTS, NAMELY, SAUCES, SWEET SAUCES, PASTA SAUCES, SPICES (U.S. CL. 46).

CLASS 32—LIGHT BEVERAGES

FOR BEERS; MINERAL AND NON-MINERAL STILL OR SPARKLING WATER, FRUIT OR VEGETABLE JUICES, FRUIT OR VEGETABLE BASED BEVERAGES; LEMONADES, SODAS, GINGER BEERS, BEVERAGE SHERBETS; PREPARATIONS FOR MAKING BEVERAGES, SYRUPS FOR BEVERAGES, NON-ALCOHOLIC FRUIT OR VEGETABLE EXTRACTS; NON-ALCOHOLIC BEVERAGES CONTAINING LACTIC FERMENTS (U.S. CLS. 45, 46 AND 48).

BRIAN NEVILLE, EXAMINING ATTORNEY

SN 79-001,799. SCHWEIZERISCHE ZENTRALE FÜR; HANDELSFÖRDERUNG OSEC, CH-8035 ZÜRICH, SWITZERLAND, FILED 2-26-2004.

osec

business network
switzerland

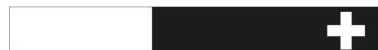

OWNER OF INTERNATIONAL REGISTRATION 0780706 DATED 4-18-2002, EXPIRES 4-18-2012.

NO CLAIM IS MADE TO THE EXCLUSIVE RIGHT TO USE BUSINESS NETWORK SWITZERLAND, APART FROM THE MARK AS SHOWN.

CLASS 35—ADVERTISING AND BUSINESS

FOR DISSEMINATION OF ADVERTISING MATTER; DATA PROCESSING SERVICES; PROVIDING BUSINESS INFORMATION, NAMELY INFORMATION ABOUT EXCHANGES BETWEEN SWITZERLAND AND OTHER COUNTRIES, NAMELY, INFORMATION CONCERNING SWISS EXPORTS, ECONOMIC INFORMATION AND ADVICE CONCERNING FOREIGN MARKETS; BUSINESS NETWORKING AGENCIES FOR BUSINESS RELATIONS AND COMMERCIAL OPPORTUNITIES, NAMELY, EXECUTION OF FAIRS AND SPECIAL EVENTS FOR NETWORKING AMONGST BUSINESS; BUSINESS MANAGEMENT CONSULTING CONCERNING INTERNATIONAL MARKETS AND INFORMATION ON FOREIGN MARKETS. (U.S. CLS. 100, 101 AND 102).

CLASS 41—EDUCATION AND ENTERTAINMENT

FOR ORGANIZATION OF CONVENTIONS, CONFERENCES AND SYMPOSIA FOR GOODS AND SERVICES THAT ARE PRODUCED BY SWISS COMPANIES (U.S. CLS. 100, 101 AND 107).
KEVON CHISOLM, EXAMINING ATTORNEY

SN 79-001,959. FIRMENICH SA, CH-1211 GENÈVE 8, SWITZERLAND, FILED 3-29-2004.

NEUTRABLOOM

THE MARK CONSISTS OF STANDARD CHARACTERS WITHOUT CLAIM TO ANY PARTICULAR FONT, STYLE, SIZE, OR COLOR.

PRIORITY DATE OF 10-30-2003 IS CLAIMED.
OWNER OF INTERNATIONAL REGISTRATION 0822660 DATED 3-29-2004, EXPIRES 3-29-2014.

CLASS 1—CHEMICALS

FOR CHEMICAL ADDITIVES FOR USE IN PERFUMERY (U.S. CLS. 1, 5, 6, 10, 26 AND 46).

CLASS 3—COSMETICS AND CLEANING PREPARATIONS

FOR NATURAL AND ARTIFICIAL PERFUMES; ESSENTIAL OILS INTENDED FOR USE IN PERFUMES, COSMETICS, SOAPS AND FOOD PRODUCTS, BEVERAGES AND PHARMACEUTICAL PRODUCTS AND MOUTH-CARE PRODUCTS; SOAPS; DETERGENTS OTHER THAN FOR USE IN MANUFACTURING OPERATIONS AND FOR MEDICAL PURPOSES; AND COSMETICS (U.S. CLS. 1, 4, 6, 50, 51 AND 52).

ALICE SUE CARRUTHERS, EXAMINING ATTORNEY

SN 79-002,002. SCUDERIA BIZZARRINI S.A.S., ITALY, FILED 11-6-2003.



PRIORITY DATE OF 5-6-2003 IS CLAIMED.
OWNER OF INTERNATIONAL REGISTRATION 0822764 DATED 11-6-2003, EXPIRES 11-6-2013.

THE TRADEMARK CONSISTS OF THE WORD "GRIFO" IN FANCY DARK CHARACTERS.
THE ENGLISH TRANSLATION OF GRIFO IS GRIFFIN.

CLASS 3—COSMETICS AND CLEANING PREPARATIONS

FOR BATH SOAPS IN LIQUID, SOLID OR GEL FORM, BODY CREAM SOAPS, COSMETIC SOAPS, DEODORANT SOAP, HAND SOAPS, LIQUID SOAPS FOR HANDS, FACE AND BODY, PERFUMED SOAPS, SKIN SOAP, SOAPS FOR BODY CARE; PERFUMERY; ESSENTIAL OILS FOR PERSONAL USE; COSMETICS (U.S. CLS. 1, 4, 6, 50, 51 AND 52).

CLASS 12—VEHICLES

FOR LAND VEHICLES, NAMELY, AUTOMOBILES; MOTORIZED VEHICLES, NAMELY GO-CARTS; SPORTS UTILITY VEHICLES; MOTOR RACING CARS; BOATS; AIRPLANES (U.S. CLS. 19, 21, 23, 31, 35 AND 44).

CLASS 14—JEWELRY

FOR PRECIOUS METALS; PRECIOUS METAL ALLOYS; GOODS COATED WITH PRECIOUS METALS AND THEIR ALLOYS, NAMELY MONEY CLIPS, ASH-TRAYS FOR SMOKERS, PENS, CIGARETTE LIGHTERS, ALARM CLOCKS, BEAKERS, BOTTLE BASKETS, CIGAR AND CIGARETTES BOXES, BUSINESS CARD CASES, MEDALLIONS; JEWELER; PRECIOUS STONES; HOROLOGICAL AND CHRONOMETRIC INSTRUMENTS, NAMELY CHRONOMETERS, WATCHES (U.S. CLS. 2, 27, 28 AND 50).

CLASS 18—LEATHER GOODS

FOR LEATHER SOLD IN BULK; IMITATION LEATHER SOLD IN BULK; GOODS MADE OF LEATHER AND OF IMITATION LEATHER, NAMELY PURSES, HANDBAGS, BACKPACKS; CASES FOR CREDIT CARDS; KEY CASES; WALLETS; TRUNKS; TRAVELING BAGS; ALL PURPOSE SPORT BAGS; UMBRELLAS; BEACH UMBRELLAS; WALKING STICKS (U.S. CLS. 1, 2, 3, 22 AND 41).

CLASS 28—TOYS AND SPORTING GOODS

FOR GAMES AND PLAYTHINGS, NAMELY BOARD GAMES; TOY CAR TRACKS; TOY CONSTRUCTION BRICKS; DOLLS; GYMNASTIC AND SPORTING ARTICLES, NAMELY SPORT BALLS; BAGS SPECIALLY ADAPTED FOR SPORTS EQUIPMENT; NON-ILLUMINATED, NONCONFECTIONARY CHRISTMAS TREE ORNAMENTS (U.S. CLS. 22, 23, 38 AND 50).

CLASS 37—CONSTRUCTION AND REPAIR

FOR REPAIR AND MAINTENANCE OF MOTOR RACING CARS (U.S. CLS. 100, 103 AND 106).

CLASS 41—EDUCATION AND ENTERTAINMENT

FOR ORGANIZING AUTOMOTIVE RACING EXHIBITIONS; ENTERTAINMENT IN THE NATURE OF AUTOMOBILE RACES (U.S. CLS. 100, 101 AND 107).
ELISSA GARBER KON, EXAMINING ATTORNEY

SN 79-002,045. KNEIPP-WERKE KNEIPP-MITTEL-ZENTRALE; GMBH & CO. KG, FED REP GERMANY, FILED 11-13-2003.



PRIORITY DATE OF 5-13-2003 IS CLAIMED.
OWNER OF INTERNATIONAL REGISTRATION 0823002 DATED 11-13-2003, EXPIRES 11-13-2013.
NO CLAIM IS MADE TO THE EXCLUSIVE RIGHT TO USE SPA, APART FROM THE MARK AS SHOWN.

CLASS 3—COSMETICS AND CLEANING PREPARATIONS

FOR PERFUMERY, COSMETIC PREPARATIONS FOR BATHS, NAMELY BATH SALTS, BATH OILS, HERBAL BATHS, HERBAL SHOWER PREPARATIONS, NAMELY HERBAL SHOWER GELS AND FOAMS; SOAPS, PERFUMES, ESSENTIAL OILS, FRAGRANT SPRAYS, COSMETICS, NAMELY SKIN MILKS, SKIN CREAMS, FACIAL MASKS, CREAMS AND SCRUBS, HAIR LOTIONS, MASSAGE OILS, SKIN OILS, FOOT BALM, FOOT BATH SALTS, FOOT SPRAY, FOOT BATH TABLETS, BATH TABLETS, SPARKLING BATH TABLETS, INCLUDING ALL THE AFORESAID GOODS WITH HERBS; DENTIFRICES, DENTAL AND MOUTHWASHES (U.S. CLS. 1, 4, 6, 50, 51 AND 52).

CLASS 5—PHARMACEUTICALS

FOR PHARMACEUTICAL PREPARATIONS FOR STRENGTHENING THE IMMUNE SYSTEM, WEIGHT MANAGEMENT AND LIFE ENHANCEMENT, WITH DIURETIC EFFECT, AGAINST WRINKLES, FOR STIMULATING BLOOD CIRCULATION, WITH ANTI DEPRESSIVE EFFECT, FOR THE TREATMENT OF RHEUMATISM, MUSCLE ACHES AND PAINS, HEADACHE, MIGRAINE, INSOMNIA, STRESS, AGEING, CIRCULATION, CELLULITIS, HIGH BLOOD PRESSURE, HEAVY AND TIRED LEGS, CYSTITIS, NEURODERMATITIS, PSORIASIS, ALLERGIES, ACUTE AND CHRONIC COLDS (CATARRHS), OF THE RESPIRATORY TRACTS, ARTHROSIS, GALL ILLNESSES, KIDNEY ILLNESSES, CARDIAC TROUBLES, DIGESTIVE TROUBLES, ARTERIOSCLEROSIS, BLOOD CIRCULATION DISTURBANCES, FURUNCLE, COUGH, DEHYDRATION, CONSTIPATION, COLDS, THE BILE, DEPRESSIONS, MEDICINAL PHARMACEUTICALS IN THE FORM OF MEDICINES EXTRACTED FROM MEDICINAL PLANTS AND HERBS, NAMELY, SWEETMEATS (CANDY), PILLS, DRAGEES, POWDERS, PACKAGES, SALVES, BALMS, OILS, DROPS AND JUICES FOR THE TREATMENT OF RHEUMATISM, MUSCLE ACHES AND PAINS, HEADACHE, MIGRAINE, INSOMNIA, STRESS, AGING, CIRCULATION, CELLULITIS, AND FOR STRENGTHENING THE IMMUNE SYSTEM, PHARMACEUTICAL BATH ADDITIVES; COUGH EXPECTORANTS, LOZENGES AND SYRUPS, MEDICATED FOOT POWDER, GARGLES, LINIMENTS; PHARMACEUTICAL, VETERINARY AND SANITARY PREPARATIONS FOR STRENGTHENING THE IMMUNE SYSTEM, WEIGHT MANAGEMENT AND LIFE ENHANCEMENT, WITH DIURETIC EFFECT, AGAINST WRINKLES, FOR STIMULATING BLOOD CIRCULATION, FOR THE TREATMENT OF RHEUMATISM, MUSCLE ACHES AND PAINS, HEADACHE, MIGRAINE, INSOMNIA, STRESS, AGEING, CIRCULATION, CELLULITIS, HIGH BLOOD PRESSURE, HEAVY AND TIRED LEGS, LEG PAIN, CYSTITIS, NEURODERMATITIS, ALLERGIES, ACUTE AND CHRONIC COLDS (CATARRHS) OF THE

RESPIRATORY TRACTS, ARTHROSIS, GALL ILLNESSES, KIDNEY ILLNESSES, CARDIAC TROUBLES, DIGESTIVE TROUBLES, ARTERIOSCLEROSIS, BLOOD CIRCULATION DISTURBANCES, FURUNCLE, COUGH, DEHYDRATION, CONSTIPATION, COLDS, THE BILE; PHYTOTHERAPEUTIC MEDICINAL PREPARATIONS FOR STRENGTHENING THE IMMUNE SYSTEM, WEIGHT MANAGEMENT AND LIFE ENHANCEMENT, WITH DIURETIC EFFECT, AGAINST WRINKLES, FOR STIMULATING BLOOD CIRCULATION, FOR THE TREATMENT OF RHEUMATISM, MUSCLE ACHES AND PAINS, HEADACHE, MIGRAINE, INSOMNIA, STRESS, AGEING, CIRCULATION, CELLULITIS, HIGH BLOOD PRESSURE, HEAVY AND TIRED LEGS, CYSTITIS, NEURODERMATITIS, ALLERGIES, ACUTE AND CHRONIC COLDS (CATARRHS) OF THE RESPIRATORY TRACTS, ARTHROSIS, GALL ILLNESSES, KIDNEY ILLNESSES, CARDIAC TROUBLES, DIGESTIVE TROUBLES, ARTERIOSCLEROSIS, BLOOD CIRCULATION DISTURBANCES, FURUNCLE, COUGH, DEHYDRATION, CONSTIPATION, COLDS, THE BILE; HEALTH CARE PREPARATIONS, NAMELY, MEDICINAL PREPARATIONS USING NATURAL PLANT EXTRACTS USED IN THE TREATMENT OF RHEUMATISM, MUSCLE ACHES AND PAINS, HEADACHE, MIGRAINE, INSOMNIA, STRESS, AGEING, AGAINST WRINKLES, CIRCULATION, CELLULITIS, FOR STRENGTHENING THE IMMUNE SYSTEM, WEIGHT MANAGEMENT AND LIFE ENHANCEMENT; MEDICAL HERBS FOR STRENGTHENING THE IMMUNE SYSTEM, WEIGHT MANAGEMENT AND LIFE ENHANCEMENT, WITH DIURETIC EFFECT, AGAINST WRINKLES, FOR STIMULATING BLOOD CIRCULATION, FOR THE TREATMENT OF RHEUMATISM, MUSCLE ACHES AND PAINS, HEADACHE, MIGRAINE, INSOMNIA, STRESS, AGEING, CIRCULATION, CELLULITIS, HIGH BLOOD PRESSURE, HEAVY AND TIRED LEGS, CYSTITIS, NEURODERMATITIS, ALLERGIES, ACUTE AND CHRONIC COLDS (CATARRHS) OF THE RESPIRATORY TRACTS, ARTHROSIS, GALL ILLNESSES, KIDNEY ILLNESSES, CARDIAC TROUBLES, DIGESTIVE TROUBLES, ARTERIOSCLEROSIS, BLOOD CIRCULATION DISTURBANCES, FURUNCLE, COUGH, DEHYDRATION, CONSTIPATION, COLDS, THE BILE; MEDICINAL DIETETIC PREPARATIONS, NAMELY, DIETETIC FOOD STUFFS FOR INVALIDS AND/OR FOOD FOR MEDICALLY RESTRICTED DIETS, NAMELY FRUIT-FIBRE LOZENGES; DIETETIC SUBSTANCES ADAPTED FOR MEDICAL USE, FOOD FOR BABIES; NUTRITIONALLY FORTIFIED MEDICINAL WATER SALTS, ALSO IN THE FORM OF TABLETS AND PASTILLES AS BOILED SWEETS OR FOR OTHER ORAL FEEDING; HEALTH TREATMENT SUPPLEMENTS INCLUDED IN THIS CLASS, NAMELY FOR SATISFYING THE HUMAN VITAMIN, MINERAL, FIBRE AND ROUGHAGE REQUIREMENTS, PROTEINS, PROTEIN HYDROLYSATES, AMINO ACIDS, CARBOHYDRATES, MEDICINAL REMEDIES USED ADDITIONALLY TO CURES, NAMELY HAY BLOSSOM PREPARATIONS, HERBAL ESSENCES WITH ALCOHOL FOR MEDICAL PURPOSES, HERBAL TINCTURES, HERBAL PACKS, LOAM AND CLAY PACKS, MOOR PACKS AND FANGO PACKS FOR THE TREATMENT OF PAIN, CIRCULATION, STRESS, IMMUNE SYSTEM, RHEUMATISM, DIETETIC SUBSTANCES FOR MEDICAL USE, NAMELY FRUIT-FIBRE LOZENGES; TEAS CONTAINING MEDICINAL DRUGS, MEDICINAL TEAS, TEAS MADE OF MEDICINAL HERBS, MEDICINAL VINEGAR, MEDICINAL WINES, HERBAL ESSENCES WITH ALCOHOL FOR MEDICAL PURPOSES, MEDICINAL JUICES, NAMELY, PLANT JUICES, MIXED DRINKS FOR MEDICAL PURPOSES MADE FROM THE AFORESAID BEVERAGES, MEDICINAL HONEY ALL USED FOR THE TREATMENT OF MUSCLE ACHES AND PAINS, INSOMNIA, STRESS, AGING, AGAINST WRINKLES, CIRCULATION, CELLULITIS, AND FOR STRENGTHENING THE IMMUNE SYSTEM, CYSTITIS, NEURODERMATITIS, ALLERGIES, ACUTE AND CHRONIC COLDS (CATARRHS) OF THE RESPIRATORY TRACTS, DIGESTIVE TROUBLES, COUGH, COLDS; PREPARATIONS FOR SUPPLYING THE HUMAN REQUIREMENTS WITH VITAMIN, MINERAL, FIBRE AND/OR ROUGHAGE; MEDICATED BATH PREPARATIONS; MEDICATED SANITARY COMPRESSIONS AND BANDAGES FOR DRESSINGS (U.S. CLS. 6, 18, 44, 46, 51 AND 52).

CLASS 30—STAPLE FOODS

FOR COFFEE; ARTIFICIAL COFFEE; TEA, INFUSIONS FOR FOOD PURPOSES, NAMELY, TEAS MADE FROM HERBAL MIXTURES, TEA SUBSTITUTES, TEA DRINKS FOR FOOD PURPOSES, NAMELY MIXED DRINKS CONTAINING TEA TOGETHER WITH FRUIT AND/OR HERBAL SUBSTANCES; CONFECTIONERY AND CHOCOLATE PRODUCTS, NAMELY BARS, TABLETS OF CHOCOLATE, BEANS, WAFFLES, DROPS; SUGAR CONFECTIONERY, NAMELY CANDIES; SUGAR, RICE, TAPIOKA, SAGO; FLOUR AND PREPARATIONS MADE FROM CEREALS, NAMELY READY TO EAT CEREALS; FOODS MADE FROM RICE, NAMELY RICE FLAKES, PUFFED RICE, PROCESSED GRAINS FOR EATING, NAMELY CORN, WHEAT, RICE, OATS, BRAN, BARLEY AND SNACK FOODS PREPARED FROM AFOREMENTIONED GRAINS, CREPES, PASTA, PROCESSED CEREALS, NAMELY CAKES, PIES, BREADS, BISCUITS, COOKIES, PANCAKES, POPCORN, PIZZAS AND WAFFLES, BARS AND ROUGHAGE BARS MADE OF BARLEY MALT OR OTHER GRAINS, NAMELY, CEREALS, MALT COFFEE; FLOUR OR CEREALS, ALSO IN THE FORM OF COOKED AND PRESERVED DISHES, NAMELY RICE FLAKES, PUFFED RICE, SNACK FOODS, CREPES, PASTA, CAKES, PIES, BREADS, BISCUITS, COOKIES, PANCAKES, POPCORN, PIZZAS AND WAFFLES, BARS AND ROUGHAGE BARS, BREAKFAST CEREALS; DESSERTS CONSISTING PRINCIPALLY OF RICE, SEMOLINA AND/OR STARCH, PUDDINGS, NAMELY DESSERT PUDDINGS; EDIBLE ICES, PRODUCTS FOR MAKING EDIBLE ICES, NAMELY ICE-CREAM POWDER, CONES FOR ICE-CREAM AND ICE CREAM MIXES FOR EDIBLE FRUIT ICES AND ICE-CREAM; HONEY AND HONEY SUBSTITUTES, TREACLE; YEAST, BAKING POWDER, SALT, MUSTARD; VINEGAR; SAUCE CONDIMENTS, NAMELY SEASONINGS MADE OF BARLEY, MALT OR OTHER GRAINS, NAMELY, CEREALS, PEPPER, JUNIPER, ROSEMARY, THYME, CAYENNE PEPPER, GINGER, CLOVES; MAYONNAISE; PRODUCTS FOR FLAVORING OR SEASONING FOODSTUFFS, NAMELY BARLEY, MALT OR OTHER GRAINS, NAMELY, CEREALS, MALT COFFEE, PEPPER, JUNIPER, ROSEMARY, THYME, CAYENNE PEPPER, GINGER, CLOVES; BAKERY GOODS; PASTRIES AND CONFECTIONERY, NAMELY SUGAR CONFECTIONERY, NAMELY CANDY, MINTS AND CHEWING GUM, DROPS; BREAD, AND CEREAL BASED FOOD SUPPLEMENTS, INCLUDED IN THIS CLASS, NAMELY VITAMINS AND MINERAL, MEAL REPLACEMENT BARS, HERBS AND PROTEINS, FIBRE AND ROUGHAGE; ICE (U.S. CL. 46).
SEAN DWYER, EXAMINING ATTORNEY

SN 79-002,115. EDITIONS DE SANTE, FRANCE, FILED 3-31-2004.

**JOURNAL OF DRUG DELIVERY
SCIENCE AND TECHNOLOGY
(JDDST)**

THE MARK CONSISTS OF STANDARD CHARACTERS WITHOUT CLAIM TO ANY PARTICULAR FONT, STYLE, SIZE, OR COLOR.

PRIORITY DATE OF 10-16-2003 IS CLAIMED.
OWNER OF INTERNATIONAL REGISTRATION 0823293 DATED 3-31-2004, EXPIRES 3-31-2014.

NO CLAIM IS MADE TO THE EXCLUSIVE RIGHT TO USE "JOURNAL OF DRUG DELIVERY SCIENCE AND TECHNOLOGY", APART FROM THE MARK AS SHOWN.

CLASS 16—PAPER GOODS AND PRINTED MATTER

FOR PRINTED MATTER, NAMELY, BOOKS, MAGAZINES AND JOURNALS IN THE FIELD OF SCIENCE AND OF TECHNOLOGY (U.S. CLS. 2, 5, 22, 23, 29, 37, 38 AND 50).

CLASS 38—COMMUNICATION

FOR TELECOMMUNICATIONS, NAMELY, COMMUNICATIONS VIA COMPUTER TERMINALS (U.S. CLS. 100, 101 AND 104).

CLASS 41—EDUCATION AND ENTERTAINMENT

FOR TRAINING, NAMELY PROVIDING CLASSES IN DRUG DELIVERY SCIENCE AND TECHNOLOGY (U.S. CLS. 100, 101 AND 107).

KELLY CHOE, EXAMINING ATTORNEY

SN 79-002,213. DERBY A/S, DENMARK, FILED 4-19-2004.



OWNER OF INTERNATIONAL REGISTRATION 0787405 DATED 9-4-2002, EXPIRES 9-4-2012.

CLASS 11—ENVIRONMENTAL CONTROL APPARATUS

FOR AIR CONDITIONERS; AIR CONDITIONING UNITS, AIR FILTERS FOR AIR CONDITIONING UNITS, AIR FILTERS FOR INDUSTRIAL INSTALLATIONS, BARBECUE GRILLS, CERAMIC PLATES SOLD AS PARTS OF OVENS, CERAMIC PLATES SOLD AS PARTS OF STOVES, CHARCOAL GRILLS, CLOTHES DRYING MACHINES (ELECTRIC, FOR HOUSEHOLD PURPOSES), DEEP FAT FRYERS, DOMESTIC COOKING OVENS, ELECTRIC COOKING OVENS, ELECTRIC DEEP FRYERS, ELECTRIC FURNACES (FOR INDUSTRIAL PURPOSES), ELECTROMAGNETIC INDUCTION COOKERS (FOR HOUSEHOLD PURPOSES), ELECTRO MAGNETIC INDUCTION COOKERS FOR INDUSTRIAL PURPOSES, FREEZERS, GAS COOKERS, GAS GRILLS, GAS REFRIGERATORS, GAS WATER HEATERS, MICROWAVE OVENS FOR COOKING, MICROWAVE OVENS FOR INDUSTRIAL USE, REFRIGERATING OR FREEZING SHOWCASES, REFRIGERATION EQUIPMENT, NAMELY, FOOD AND BEVERAGE CHILLING UNITS, REFRIGERATORS, STEAM HEATING APPARATUS (FOR INDUSTRIAL PURPOSES), WALK-IN COOLERS, WALK-IN FREEZERS, WATER COOLERS (U.S. CLS. 13, 21, 23, 31 AND 34).

CLASS 37—CONSTRUCTION AND REPAIR

FOR REPAIR AND INSTALLATION SERVICES, NAMELY REPAIR AND INSTALLATION OF REFRIGERATORS AND FREEZERS (U.S. CLS. 100, 103 AND 106).
SEAN DWYER, EXAMINING ATTORNEY

SN 79-002,284. PROJECT ZOLTAR LIMITED, LONDON SW1Y 6HA, UNITED KINGDOM, FILED 2-10-2004.



OWNER OF INTERNATIONAL REGISTRATION 0823899 DATED 2-10-2004, EXPIRES 2-10-2014.

CLASS 14—JEWELRY

FOR PRECIOUS METALS AND THEIR ALLOYS; GOODS OF PRECIOUS METALS OR COATED THEREWITH, NOT INCLUDED IN OTHER CLASSES, NAMELY, EARRINGS, NECKLACES AND RINGS; JEWELRY AND IMITATION JEWELRY; PRECIOUS STONES; BADGES OF PRECIOUS METAL; KEY RINGS OF PRECIOUS METAL; TIE CLIPS AND FASTENERS, TIE PINS; CUFF LINKS; WATCHES AND CLOCKS; HOROLOGICAL AND CHRONOMETRIC INSTRUMENTS AND PARTS THEREOF (U.S. CLS. 2, 27, 28 AND 50).

CLASS 18—LEATHER GOODS

FOR LEATHER AND IMITATION LEATHER SOLD IN BULK, AND GOODS MADE OF LEATHER AND IMITATION LEATHER, NAMELY, LEATHER AND IMITATION LEATHER BAGS; WALLETS AND PURSES; LUGGAGE, BAGS, NAMELY ATHLETIC BAGS, HANDBAGS, RUCKSACKS, SUITCASES AND SUITERS, NAMELY SUIT BAGS; TRUNKS AND TRAVEL BAGS; UMBRELLAS, PARASOLS AND WALKING STICKS (U.S. CLS. 1, 2, 3, 22 AND 41).

CLASS 20—FURNITURE AND ARTICLES NOT OTHERWISE CLASSIFIED

FOR FURNITURE AND OFFICE FURNITURE INCLUDING CHAIRS, FOOT STOOLS AND CUSHIONS; STORAGE UNITS, NAMELY, PLASTIC STORAGE CONTAINERS, CUPBOARDS, MIRRORS, PICTURE FRAMES; BEDS, CHAIRS, TABLES, DESKS, SHELVES, SOFAS; GOODS OF WOOD, CORK, REED, CANE, WICKER, HORN, BONE AND SHELL OR OF PLASTIC, NAMELY, WOOD KNOBS, DRAWER PULLS OF WOOD, CORK, REED, CANE, WICKER, HORN, BONE, SHELL AND PLASTIC (U.S. CLS. 2, 13, 22, 25, 32 AND 50).

CLASS 24—FABRICS

FOR TEXTILES AND TEXTILE GOODS, NOT INCLUDED IN OTHER CLASSES, NAMELY, TEXTILE LABELS, TEXTILE NAPKINS AND TEXTILE FABRICS FOR THE MANUFACTURE OF CLOTHING; FABRICS FOR THE MANUFACTURE OF CLOTHING, LINENS AND TOWELS; BED AND TABLE COVERS, NAMELY, BED SHEETS, BED SPREADS, TABLE CLOTHS NOT OF PAPER; BED BLANKETS; BED, BATH AND TABLE LINENS; TOWELS OF TEXTILE; CURTAINS OF TEXTILE OR PLASTIC; TEXTILE WALL HANGINGS (U.S. CLS. 42 AND 50).

CLASS 25—CLOTHING

FOR ARTICLES OF CLOTHING, NAMELY, T-SHIRTS, SWEATSHIRTS, HOODED SWEATSHIRTS, JEANS, PANTS, SHORTS, TOPS, LEATHER BELTS; FOOTWEAR, HEADGEAR, NAMELY, HATS AND CAPS (U.S. CLS. 22 AND 39).

JENNIFER MARTIN, EXAMINING ATTORNEY

SN 79-002,477. INTERVISIO OY, FINLAND, FILED 2-6-2004.

STARAOKE

PRIORITY DATE OF 9-26-2003 IS CLAIMED.
OWNER OF INTERNATIONAL REGISTRATION 0824517
DATED 2-6-2004, EXPIRES 2-6-2014.

CLASS 9—ELECTRICAL AND SCIENTIFIC APPARATUS

FOR PRERECORDED MAGNETIC DATA CARRIERS FEATURING SINGING ANIMATED CHARACTERS; COMPUTER SOFTWARE FOR USE IN INTERACTIVE COMPUTER GAMES; VIDEO GAME CARTRIDGES, VIDEO GAME DISCS, VIDEO GAME SOFTWARE, AND VIDEO GAME MACHINES FOR USE WITH TELEVISIONS AND COMPUTERS (U.S. CLS. 21, 23, 26, 36 AND 38).

CLASS 41—EDUCATION AND ENTERTAINMENT

FOR ENTERTAINMENT SERVICES, NAMELY, PROVIDING ON-LINE COMPUTER GAMES; AND ENTERTAINMENT IN THE NATURE OF A TELEVISION SERIES, NAMELY, SONG CONTESTS FOR CHILDREN; AND ORGANIZING SONG CONTEST EVENTS FOR CHILDREN (U.S. CLS. 100, 101 AND 107).

MARC LEIPZIG, EXAMINING ATTORNEY

SN 79-002,538. QUICK S.R.L., ITALY, FILED 2-19-2004.

quick

THE MARK CONSISTS OF STANDARD CHARACTERS WITHOUT CLAIM TO ANY PARTICULAR FONT, STYLE, SIZE, OR COLOR.

PRIORITY DATE OF 2-19-2004 IS CLAIMED.

OWNER OF INTERNATIONAL REGISTRATION 0824751
DATED 2-19-2004, EXPIRES 2-19-2014.

CLASS 6—METAL GOODS

FOR ANCHORS (U.S. CLS. 2, 12, 13, 14, 23, 25 AND 50).

CLASS 7—MACHINERY

FOR ANCHOR WINCHES, WINDLASSES, WINCHES, AND BOW THRUSTERS FOR BOATS (U.S. CLS. 13, 19, 21, 23, 31, 34 AND 35).

CLASS 9—ELECTRICAL AND SCIENTIFIC APPARATUS

FOR REMOTE CONTROL FOOT SWITCH, HANDHELD REMOTE CONTROL, CHAIN COUNTER, MANUAL BILGE PUMPS, AND FIRE EXTINGUISHERS, ALL FOR BOATS (U.S. CLS. 21, 23, 26, 36 AND 38).

CLASS 11—ENVIRONMENTAL CONTROL APPARATUS

FOR WATER HEATERS OR BOILERS FOR BOATS; SIGNAL LAMPS FOR BOATS; LAMPS (U.S. CLS. 13, 21, 23, 31 AND 34).

PRISCILLA MILTON, EXAMINING ATTORNEY

SN 79-002,618. DICOM AG, CH-6343 ROTKREUZ, SWITZERLAND, FILED 4-24-2004.

SN 79-002,639. AUTOMOBILE CLUB DE MONACO, MONACO, FILED 2-26-2004.

ETEMIS

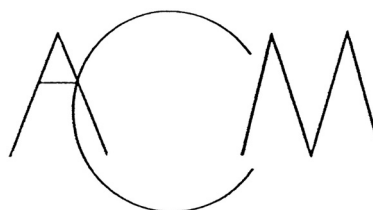

automobile club de monaco

PRIORITY DATE OF 12-9-2003 IS CLAIMED.
OWNER OF INTERNATIONAL REGISTRATION 0825080
DATED 2-26-2004, EXPIRES 2-26-2014.

NO CLAIM IS MADE TO THE EXCLUSIVE RIGHT TO
USE AUTOMOBILE CLUB AND MONACO, APART FROM
THE MARK AS SHOWN.

THE MARK CONSISTS OF STANDARD CHARACTERS
WITHOUT CLAIM TO ANY PARTICULAR FONT, STYLE,
SIZE, OR COLOR.

OWNER OF INTERNATIONAL REGISTRATION 0786037
DATED 6-19-2002, EXPIRES 6-19-2012.

CLASS 9—ELECTRICAL AND SCIENTIFIC APPARATUS

FOR COMPUTER HARDWARE; COMPUTER GRAPHICS SOFTWARE; COMPUTER SOFTWARE FOR ORGANIZING AND VIEWING DIGITAL IMAGES AND PHOTOGRAPHS; COMPUTER SOFTWARE FOR USE IN RELATION TO DIGITAL ANIMATION AND SPECIAL EFFECTS OF IMAGES; COMPUTER SOFTWARE TO ENHANCE THE AUDIO-VISUAL CAPABILITIES OF MULTIMEDIA APPLICATIONS, NAMELY, FOR THE INTEGRATION OF TEXT, AUDIO, GRAPHICS, STILL IMAGES AND MOVING PICTURES; EDUCATIONAL COMPUTER SOFTWARE FEATURING INSTRUCTION IN THE FIELD OF INFORMATION TECHNOLOGY; GRAPHICAL USER INTERFACE SOFTWARE (U.S. CLS. 21, 23, 26, 36 AND 38).

CLASS 37—CONSTRUCTION AND REPAIR

FOR INSTALLATION AND MAINTENANCE OF COMPUTERS (U.S. CLS. 100, 103 AND 106).

CLASS 38—COMMUNICATION

FOR TELECOMMUNICATIONS SERVICES, NAMELY, TRANSFER OF DATA BY TELECOMMUNICATION; TELECOMMUNICATIONS SERVICES, NAMELY, LOCAL AND LONG DISTANCE TRANSMISSION OF VOICE, DATA, GRAPHICS BY MEANS OF TELEPHONE, TELEGRAPHIC, CABLE AND SATELLITE TRANSMISSIONS; TELECOMMUNICATIONS SERVICES, NAMELY, ISDN SERVICES; TELECOMMUNICATIONS SERVICES, NAMELY, PERSONAL COMMUNICATIONS SERVICES; TRANSMISSION AND RECEPTION OF DATABASE INFORMATION VIA THE TELECOMMUNICATION NETWORK; TELECOMMUNICATIONS CONSULTATION SERVICES (U.S. CLS. 100, 101 AND 104).

CLASS 41—EDUCATION AND ENTERTAINMENT

FOR TRAINING IN THE FIELD OF INFORMATION TECHNOLOGY (U.S. CLS. 100, 101 AND 107).

CLASS 42—SCIENTIFIC, COMPUTER AND LEGAL SERVICES

FOR COMPUTER PROGRAMMING FOR OTHERS; COMPUTER SOFTWARE INSTALLATION AND MAINTENANCE (U.S. CLS. 100 AND 101).

LEIGH LOWRY, EXAMINING ATTORNEY

CLASS 9—ELECTRICAL AND SCIENTIFIC APPARATUS

FOR PERSONAL PROTECTION DEVICES AGAINST ACCIDENTS, NAMELY REFLECTIVE HELMET SKIRTS, REFLECTIVE SAFETY BANDS TO BE WORN ON CLOTHES; LIFE NETS AGAINST ACCIDENTS; PERSONAL REFLECTING DISKS FOR THE PREVENTION OF ROAD ACCIDENTS; PROTECTIVE CLOTHING AGAINST ACCIDENTS, IRRADIATION AND FIRE, NAMELY FIRE BLANKETS, FIRE RESISTANT GLOVES, LIFE BUOYS, LIFE JACKETS; SAFETY EQUIPMENT, NAMELY, BEACON LIGHTS, SIGNAL WHISTLES, SIGNALING BUOYS; PROTECTIVE HELMETS; HELMET SAFETY LIGHTS; FLASHING SAFETY LIGHTS, LIGHT EMITTING DIODE DISPLAYS, LUMINOUS SIGNS; SIGNAL BELLS; WARNING FLAGS, WARNING SIRENS, CIRCUIT BREAKERS; GASOLINE GAUGES; CONTACT LENSES CASES; TEMPERATURE INDICATORS, SPEEDOMETERS FOR VEHICLES; MOTORCYCLE HELMETS; MOTORCYCLE GOGGLES; OPTICAL BINOCULARS; OPTICAL LAMPS; EYEGLASSES, EYEGLASS FRAMES, EYEGLASS CASES, EYEGLASS LENSES, SUNGLASSES; AUTOMATIC STEERING DEVICES FOR VEHICLES; AUTOMATIC STEERING APPARATUS FOR VEHICLES; RADARS; VEHICLE RADIOS; LIFE-BUOYS, WARNING TRIANGLES FOR INDICATING VEHICLE BREAKDOWNS, EMERGENCY WARNING LIGHTS, SIRENS FOR VEHICLES, LUMINOUS OR MECHANICAL SIGNS, SIRENS, WARNING APPARATUS, NAMELY BELLS; BURGLAR ALARMS, ANTI-INTRUSION ALARMS; CAMERAS; ELECTRONIC AND OPTICAL COMMUNICATION INSTRUMENTS AND COMPONENTS, NAMELY, OPTICAL TRANSMITTERS, OPTICAL RECEIVERS, OPTICAL DATE LINKS, OPTICAL TRANSCIEVERS, CABLE TELEVISION TRANSMITTERS, DIGITAL TRANSMITTERS; PRE-RECORDED AUDIO CASSETTES AND TAPES, PRE-RECORDED DIGITAL AUDIO TAPES, PRE-RECORDED MAGNETIC DATA CARRIERS, PRE-RECORDED VIDEO CASSETTES AND TAPES, ALL FEATURING INFORMATION RELATED TO AUTOMOBILES; BLANK MAGNETIC, VIDEO AND LASER TAPES; ACOUSTIC DISKS; VIDEO TAPES; FLOPPY DISKS FOR COMPUTERS REGARDING INFORMATION TECHNOLOGY; INTERACTIVE MULTIMEDIA COMPUTER GAME PROGRAMS; INTERACTIVE MULTIMEDIA COMPUTER PROGRAMS RELATED TO AUTOMOBILES; INTERACTIVE VIDEO GAME PROGRAMS; LASER DISKS FEATURING INFORMATION RELATED TO AUTOMOBILES; VIDEO DISKS RELATED TO AUTOMOBILES; VIDEO GAME SOFTWARE CARTRIDGES, CASSETTES; OPTICAL DISKS, OPTICAL COMPACT DISKS, OPTICAL INTERACTIVE DISKS, ALL FEATURING INFORMATION RELATED TO AUTOMOBILES; COMPUTER PROGRAMS USED FOR OPERATING AUTOMOBILES; VIRTUAL REALITY GAME SOFTWARE, COMPACT DISKS; ELECTRONIC GAME PROGRAMS; INTERACTIVE GAME SOFTWARE; COMPUTERS, LAPTOP COMPUTERS AND HANDHELD PERSONAL COMPUTERS, NAMELY, ELECTRONIC BOOKS FEATURING AUTOMOBILES AND AUTOMOBILE SPORTS RECORDED ON COMPUTER MEDIA; ELECTRONIC AGENDAS; COMPUTER PERIPHERALS; COMPUTER GAME CARTRIDGES, CASSETTES, DISKS,

PROGRAMS, ALL RELATED TO AUTOMOBILE GAMES; LASER POINTERS; COMPUTER GAME JOYSTICKS; VIDEO GAME JOYSTICKS; JUKE-BOXES; BULLHORNS; CAR NAVIGATION COMPUTERS; DIGITAL AUDIO TAPE PLAYERS; DIGITAL AUDIO TAPE RECORDERS; DIGITAL CAMERAS; DIGITAL CELLULAR PHONES, DIGITAL VIDEO DISK DRIVES, DIGITAL VIDEO RECORDERS (U.S. CLS. 21, 23, 26, 36 AND 38).

CLASS 25—CLOTHING

FOR CLOTHING, NAMELY UNDERWEAR, ANKLETS, ANORAKS, APRONS, TROUSERS, BANDANAS, HEADBANDS, BASEBALL CAPS, CAPS, BATH SLIPPERS, BATHING SUITS, BATHROBES, BEACH COVERUPS, BEACH SHOES, BEACHWEAR, BED JACKETS, BERETS, BERMUDA SHORTS, GLOVES, BIKINIS, BLAZERS, BLOOMERS, BLOUSONS, SHIRTS, CARDIGANS, CHEMISETTES, CLOTHES, TIES, DENIM JACKETS, DRESSING GOWNS, DUNGAREES, EAR MUFFS, PULL-OVERS, SWEAT-SHIRTS, TEE-SHIRTS, BELTS, GLOVES, GREATCOATS, HATS, JACKETS, JEANS, LIGHT-REFLECTING COATS AND JACKETS, MOTORCYCLE GLOVES, RAINWEAR, SPORTS COATS, SUITS, WIND RESISTANT JACKETS, TROUSERS, WALKING SHORTS, DRESSES, SUNDRESSES, SHOES, ATHLETIC FOOTWEAR, GYMNASTIC SHOES, ATHLETIC UNIFORMS, BOOTS, GYM SHORTS, GYM SUITS, ESPADRILLES, FOOTBALL SHOES (U.S. CLS. 22 AND 39).

CLASS 28—TOYS AND SPORTING GOODS

FOR GAMES, TOYS, NAMELY ACTION FIGURES, ACTION FIGURES AND ACCESSORIES THEREFOR, ACTION SKILL GAMES, ACTION TARGET GAMES, MECHANICAL ACTION TOYS, ACTION-TYPE TARGET GAMES, BALLOONS, BATHTUB TOYS, BEACH BALLS, BENDABLE TOYS, CARD GAMES, CHESS SETS, COLLECTABLE TOY FIGURES, DOMINOES, ELECTRONICALLY OPERATED TOY MOTOR VEHICLES, FLYING DISKS, FOOT BALLS, JIGSAW PUZZLES, MODELED PLASTIC TOY FIGURINES, PLAY FIGURES, RADIO CONTROLLED TOY AND MODEL VEHICLES, RUBBER TOYS, TOY MODEL KIT CARS, TOY MODEL VEHICLES AND RELATED ACCESSORIES SOLD AS UNITS, TOY VEHICLES, YO-YOS, TEDDY BEARS, BODY PROTECTORS FOR AUTOMOBILE SPORTS (U.S. CLS. 22, 23, 38 AND 50).

KEVON CHISOLM, EXAMINING ATTORNEY

SN 79-002,675. COMPAGNIE FINANCIERE CSR, FRANCE, FILED 4-8-2004.

Duché de Longueville

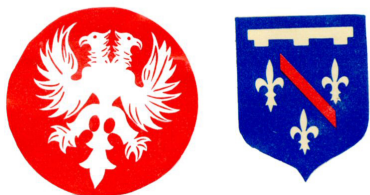

OWNER OF INTERNATIONAL REGISTRATION 0460893 DATED 6-9-1981, EXPIRES 6-9-2011.

THE COLOR(S) RED, BLACK, WHITE AND BLUE IS/ARE CLAIMED AS A FEATURE OF THE MARK.

UPPERCASE CHARACTERS IN RED. LOWERCASE CHARACTERS IN BLACK. CIRCLE WITH RED BACKGROUND FEATURING A WHITE DOUBLE-HEADED EAGLE. SHIELD WITH BLUE BACKGROUND. TOP PATTERN IN WHITE. 3 WHITE FLEUR-DE-LYS, RED DIAGONAL BAR.

THE ENGLISH TRANSLATION OF DUCHE DE LONGUEVILLE IS "DUCHY OF LONGUEVILLE".

CLASS 31—NATURAL AGRICULTURAL PRODUCTS

FOR AGRICULTURAL PRODUCTS, NAMELY FRESH APPLES, EXCEPT BEETS (U.S. CLS. 1 AND 46).

CLASS 32—LIGHT BEVERAGES

FOR FRUIT JUICES (U.S. CLS. 45, 46 AND 48).

CLASS 40—MATERIAL TREATMENT

FOR APPLE DISTILLING, CIDER MAKING (U.S. CLS. 100, 103 AND 106).

DOMINIC J. FERRAIUOLO, EXAMINING ATTORNEY

SN 79-002,767. ASSOCIATION TOUR DU MONDE; EN 80 JOURS, FRANCE, FILED 4-6-2004.

TROPHEE JULES VERNE

THE MARK CONSISTS OF STANDARD CHARACTERS WITHOUT CLAIM TO ANY PARTICULAR FONT, STYLE, SIZE, OR COLOR.

PRIORITY DATE OF 10-6-2003 IS CLAIMED.

OWNER OF INTERNATIONAL REGISTRATION 0825557 DATED 4-6-2004, EXPIRES 4-6-2014.

THE NAME "JULES VERNE" DOES NOT IDENTIFY A LIVING INDIVIDUAL.

THE FOREIGN WORDING IN THE MARK TRANSLATES INTO ENGLISH AS JULES VERNE'S TROPHY.

CLASS 12—VEHICLES

FOR VEHICLES, EXCEPT BOATS; APPARATUS FOR LOCOMOTION BY LAND AND AIR, NAMELY AUTOMOBILES, BICYCLES, AIRCRAFT AND MOTORCYCLES. (U.S. CLS. 19, 21, 23, 31, 35 AND 44).

CLASS 35—ADVERTISING AND BUSINESS

FOR ADVERTISING AND MARKETING, DISTRIBUTION OF PROSPECTUSES AND SAMPLES. (U.S. CLS. 100, 101 AND 102).

CLASS 41—EDUCATION AND ENTERTAINMENT

FOR RADIO ENTERTAINMENT PRODUCTION IN THE NATURE OF ONGOING TELEVISION PROGRAMS; PRODUCTION OF MOTION PICTURE FILMS, SOUND RECORDING STUDIOS; ORGANISATION OF COMPETITIONS IN THE FIELD OF EDUCATION OR ENTERTAINMENT, PRODUCTION OF TELEVISION SHOWS, ORGANISATION OF EXHIBITIONS FOR CULTURAL OR EDUCATIONAL PURPOSES (U.S. CLS. 100, 101 AND 107).

STEVEN JACKSON, EXAMINING ATTORNEY

SN 79-002,871. D. ANTONIO MANUEL GUERRA NAVAS Y, SPAIN, AND D^a KRISTINA ORTUBAI BALANZATEGUI, SPAIN, FILED 3-16-2004.



PRIORITY DATE OF 10-30-2003 IS CLAIMED.
OWNER OF INTERNATIONAL REGISTRATION 0825872
DATED 3-16-2004, EXPIRES 3-16-2014.

CLASS 9—ELECTRICAL AND SCIENTIFIC APPARATUS

FOR BLANK MAGNETIC RECORDING TAPES FOR TAPE RECORDERS; BLANK RECORD DISCS FOR RECORDING SOUND; AUTOMATIC VENDING MACHINES CONTAINING COIN-OPERATED MECHANISM APPARATUS FOR PROPERLY ORGANIZING AND COUNTING MONEY AND DISTRIBUTING VENDING MACHINE CONTENTS; CALCULATING MACHINES, NAMELY, CASH REGISTERS; COMPUTER HARDWARE FOR DATA PROCESSING; VIDEO GAME MACHINES FOR USE WITH TELEVISIONS; AND COMPUTER GAME SOFTWARE AND VIDEO GAME SOFTWARE (U.S. CLS. 21, 23, 26, 36 AND 38).

CLASS 28—TOYS AND SPORTING GOODS

FOR BATH TOYS; BABIES' AND CHILDRENS' MULTIPLE ACTIVITY TOYS; BATTERY-OPERATED ACTION TOYS; MECHANICAL TOYS; ACTION TARGET GAMES; ARCADE GAMES NOT INTENDED FOR USE WITH A TELEVISION; ARCADE-TYPE ELECTRONIC EDUCATION VIDEO GAMES NOT INTENDED FOR USE WITH A TELEVISION; CARD GAMES; BOARD GAMES; HAND-HELD UNIT FOR PLAYING ELECTRONIC GAMES; AND ELECTRONIC DART GAMES (U.S. CLS. 22, 23, 38 AND 50).

CHRISTOPHER ADKINS, EXAMINING ATTORNEY

SN 79-002,880. RTE AKUSTIK + PRÜFTECHNIK GMBH, FED REP GERMANY, FILED 4-8-2004.

LCVibro

THE MARK CONSISTS OF STANDARD CHARACTERS WITHOUT CLAIM TO ANY PARTICULAR FONT, STYLE, SIZE, OR COLOR.

PRIORITY DATE OF 10-10-2003 IS CLAIMED.
OWNER OF INTERNATIONAL REGISTRATION 0825902
DATED 4-8-2004, EXPIRES 4-8-2014.

CLASS 9—ELECTRICAL AND SCIENTIFIC APPARATUS

FOR SCIENTIFIC, SURVEYING, MEASURING, SIGNALING, CHECKING AND SUPERVISION APPARATUS AND INSTRUMENTS, PARTICULARLY SIGNAL PROCESSING INSTALLATIONS FOR NON-DESTRUCTIVE VIBRATION MEASUREMENT METHODS, PARTICULARLY FOR MONITORING OF PRESSES OR PROCESSING MACHINES AND FOR MONITORING OF PRODUCT ASSEMBLY; BLANK MAGNETIC DATA CARRIERS; DATA PROCESSING APPARATUS AND COMPUTERS (U.S. CLS. 21, 23, 26, 36 AND 38).

CLASS 37—CONSTRUCTION AND REPAIR

FOR REPAIR AND INSTALLATION SERVICES FOR SCIENTIFIC, SURVEYING, MEASURING, SIGNALING, CHECKING AND SUPERVISION APPARATUS AND INSTRUMENTS, PARTICULARLY SIGNAL PROCESSING INSTALLATIONS FOR NON-DESTRUCTIVE VIBRATION MEASUREMENT METHODS, PARTICULARLY FOR MONITORING OF PRESSES OR PROCESSING MACHINES AND FOR MONITORING OF PRODUCT ASSEMBLY, BLANK MAGNETIC DATA CARRIERS, DATA PROCESSING APPARATUS AND COMPUTERS (U.S. CLS. 100, 103 AND 106).

CLASS 42—SCIENTIFIC, COMPUTER AND LEGAL SERVICES

FOR SCIENTIFIC AND TECHNOLOGICAL SERVICES AND RESEARCH AND DESIGN SERVICES RELATING THERETO, PARTICULARLY IN THE FIELD OF MONITORING OF MACHINES AND OF ASSEMBLY; DESIGN AND DEVELOPMENT OF COMPUTER HARDWARE AND SOFTWARE; INDUSTRIAL ANALYSIS AND RESEARCH SERVICES, PARTICULARLY IN THE FIELD OF MONITORING OF MACHINES AND OF ASSEMBLY (U.S. CLS. 100 AND 101).

DOMINIC J. FERRAIUOLO, EXAMINING ATTORNEY

SN 79-002,913. GO OLD'50 S.R.L., ITALY, FILED 3-16-2004.

SWEET YEARS

THE MARK CONSISTS OF STANDARD CHARACTERS WITHOUT CLAIM TO ANY PARTICULAR FONT, STYLE, SIZE, OR COLOR.

PRIORITY DATE OF 11-28-2003 IS CLAIMED.
OWNER OF INTERNATIONAL REGISTRATION 0826002
DATED 3-16-2004, EXPIRES 3-16-2014.

CLASS 3—COSMETICS AND CLEANING PREPARATIONS

FOR DISH DETERGENTS; BLEACHING PRODUCTS, NAMELY, LAUNDRY BLEACH; FABRIC SOFTENERS, COSMETIC SOAPS; BLEACHING PREPARATIONS AND OTHER SUBSTANCES FOR LAUNDERING, NAMELY, LAUNDRY BLEACH; CLEANING, POLISHING, SCOURING AND ABRASIVE PREPARATIONS, NAMELY, ALL-PURPOSE CLEANERS, SCOURING LIQUID; COSMETICS IN GENERAL, NAMELY, PERFUMES, PERFUMES IN SOLID FORM, DEODORANTS FOR PERSONAL USE; FACE SOAPS; LIQUID SOAPS FOR USE ON FACE; CAKES OF SOAPS FOR USE ON FACE; BUBBLE BATHS; TALCUM POWDER; DENTIFRICES; SHAMPOOS; ESSENTIAL OILS FOR PERSONAL USE; HAIR LOTIONS; HAIR PERMANENTS; HAIR GELS; HAIR DYES; FACIAL CREAMS; MASCARA; EYELINERS; EYE SHADOWS; MAKE-UP PENCILS; FACE POWDERS; LIPSTICKS; FOUNDATIONS; BODY CREAMS; NAIL POLISH; NAIL HARDENERS; SUN TANNING OIL AND CREAMS (U.S. CLS. 1, 4, 6, 50, 51 AND 52).

CLASS 9—ELECTRICAL AND SCIENTIFIC APPARATUS

FOR ELECTRIC CABLES; ELECTRIC SWITCHES; TELEVISION APPARATUS, NAMELY TELEVISION MONITORS; RADIOS; INTEGRATED RADIOS AND RECORDERS IN THE NATURE OF AUDIO RECORDERS; RADIO TRANSMITTERS; WIRELESS TELEPHONES; RECORD PLAYERS; BLANK TAPES, PRERECORDED RECORDS, VIDEOTAPES AND TAPES FEATURING FILMS; AUDIO TAPE RECORDERS; VIDEO RECORDERS; OPTICAL DISK DRIVES; TELEVISION CAMERAS; SUNGLASSES, SPECTACLES; SPECTACLE LENSES; TELEPHONE APPARATUS; AND MOBILE TELEPHONES (U.S. CLS. 21, 23, 26, 36 AND 38).

BRIDGETT SMITH, EXAMINING ATTORNEY

SN 79-002,948. SARA LEE/DE N.V., NL-3532 AD UTRECHT, NETHERLANDS, FILED 1-9-2004.

SN 79-002,959. CHOCOLATERIE GUYLIAN N.V., BELGIUM, FILED 5-4-2004.

Senseo

PRIORITY DATE OF 10-2-2003 IS CLAIMED.
OWNER OF INTERNATIONAL REGISTRATION 0826128
DATED 1-9-2004, EXPIRES 1-9-2014.

CLASS 21—HOUSEWARES AND GLASS

FOR CARDBOARD CUPS; HAND-OPERATED COFFEE GRINDERS; NON-ELECTRIC COFFEE AND TEA MAKING APPARATUS; COFFEE AND TEA POTS, WITH OR WITHOUT FILTERS, NON-ELECTRIC, NOR OF PRECIOUS METAL; NON ELECTRIC COFFEE FILTERS, AND PLASTIC HOLDERS FOR COFFEE FILTERS; NON-ELECTRIC COFFEE PERCOLATORS; COFFEE AND TEA SETS NOT OF PRECIOUS METAL; COFFEE AND TEA BOXES NOT OF PRECIOUS METAL; COFFEE AND TEA GLASSES; COFFEE AND TEA GLASS HOLDERS NOT OF PRECIOUS METAL; COFFEE AND TEA CUPS NOT OF PRECIOUS METAL; COFFEE AND TEA MUGS NOT OF PRECIOUS METAL; SAUCERS NOT OF PRECIOUS METAL; TEA INFUSERS, NOT OF PRECIOUS METAL; TEA STRAINERS, NOT OF PRECIOUS METAL; SETS COMPRISING A SUGAR BOWL AND A SMALL CREAM JUG; CREAM BOWLS, SUGAR BOWLS AND TRAYS FOR HOUSEHOLD PURPOSES, NOT OF PRECIOUS METAL; INSULATING FLASKS; PLASTIC BEAKERS (U.S. CLS. 2, 13, 23, 29, 30, 33, 40 AND 50).

CLASS 29—MEATS AND PROCESSED FOODS

FOR MEAT, FISH, POULTRY AND GAME; MEAT EXTRACTS; PRESERVED, DRIED AND COOKED FRUITS AND VEGETABLES; JELLIES, JAMS; COMPOSTES; EGGS, MILK, MILK BEVERAGES; EDIBLE OILS AND FATS (U.S. CL. 46).

CLASS 30—STAPLE FOODS

FOR COFFEE, ALSO IN FILTER PACKING; COFFEE-BASED BEVERAGES, COFFEE BEVERAGES WITH MILK, COFFEE EXTRACTS, INSTANT COFFEE, COFFEE SUBSTITUTES, MIXTURES OF COFFEE AND COFFEE SUBSTITUTES; MIXTURES OF COFFEE, MILK POWDER AND COFFEE SUBSTITUTES; COFFEE CONTAINING CEREALS, FRUITS AND SPICES; TEA, TEA-BASED BEVERAGES, TEA EXTRACTS, TEA SUBSTITUTES; COCOA, COCOA-BASED BEVERAGES; CHOCOLATE AND CHOCOLATE EXTRACTS IN POWDER, GRANULATED OR LIQUID FORM; SUGAR, RICE, TAPIOCA, SAGO; FLOUR AND PREPARATIONS MADE FROM CEREALS, BREAD, BISCUITS, CAKES; PASTRY AND CONFECTIONERY, ICES; HONEY, TREACLE; YEAST, BAKING-POWDER; SALT, MUSTARD; PEPPER; VINEGAR, SAUCES; SPICES; HERBS FOR THE PREPARATION OF BEVERAGES; MIXTURES OF HERBS FOR THE PREPARATION OF BEVERAGES; MIXTURES MAINLY CONSISTING OF HERBS WITH ADDITION OF DRIED FRUITS FOR THE PREPARATION OF BEVERAGES; DECOCTIONS OF HERBS, NOT FOR MEDICAL USE; ICE (U.S. CL. 46).

JACQUELINE A. LAVINE, EXAMINING ATTORNEY



OWNER OF INTERNATIONAL REGISTRATION 0826169
DATED 5-4-2004, EXPIRES 5-4-2014.
THE STIPPLING IS FOR SHADING PURPOSES.

CLASS 30—STAPLE FOODS

FOR COFFEE, TEA, COCOA, SUGAR, ARTIFICIAL COFFEE; PASTRY AND ALL SUGAR AND CHOCOLATE CONFECTIONERY, ICE; CHOCOLATE, CHOCOLATES, PRALINES; PREPARED MEALS CONSISTING PRIMARILY OF PASTA AND RICE; SNACKS, NAMELY, CEREAL-BASED SNACK FOODS, RICE-BASED SNACK FOODS, WHEAT-BASED SNACK FOODS, BAKERY GOODS, CRACKER AND CHEESE COMBINATIONS, CHEESE BISCUITS, SANDWICHES, FISH SANDWICHES, BREAD, BREAD STICKS (U.S. CL. 46).

CLASS 33—WINES AND SPIRITS

FOR ALCOHOLIC BEVERAGES, NAMELY LIQUEURS (U.S. CLS. 47 AND 49).
BRIAN NEVILLE, EXAMINING ATTORNEY

SN 79-003,135. KUAN'S LIVING S.R.L., ITALY, FILED 5-5-2004.

KUAN'S LIVING

THE MARK CONSISTS OF STANDARD CHARACTERS WITHOUT CLAIM TO ANY PARTICULAR FONT, STYLE, SIZE, OR COLOR.

PRIORITY DATE OF 3-12-2004 IS CLAIMED.
OWNER OF INTERNATIONAL REGISTRATION 0826693
DATED 5-5-2004, EXPIRES 5-5-2014.

CLASS 24—FABRICS

FOR MESH-WOVEN FABRICS; ELASTIC FABRICS FOR CLOTHING; TEXTILE FABRIC OF IMITATION ANIMAL SKINS; FIBERGLASS FABRIC FOR TEXTILE USE; WOOLEN FABRIC; BED BLANKETS; LAP-ROBES; TEXTILE FABRICS FOR THE MANUFACTURE OF CLOTHING; TEXTILE TABLECLOTHS; TAPESTRIES OF TEXTILE; LINEN HANDKERCHIEFS; CLOTH FLAGS (U.S. CLS. 42 AND 50).

CLASS 25—CLOTHING

FOR BOTTOMS; TOPS; SUITS; SKIRTS; JACKETS; SWEATERS; PAJAMAS; STOCKINGS; LINGERIE; UNDERWEAR; HATS; SCARVES; NECKTIES; COATS; BATHING SUITS; BELTS; PELISSES; SASHES; GLOVES; DRESSING GOWNS; FOOTWEAR (U.S. CLS. 22 AND 39).
IRA J. GOODSaid, EXAMINING ATTORNEY

SN 79-003,182. RHODIA PERFORMANCE FIBRES, FRANCE,
FILED 3-24-2004.

NOVAL

THE MARK CONSISTS OF STANDARD CHARACTERS WITHOUT CLAIM TO ANY PARTICULAR FONT, STYLE, SIZE, OR COLOR.

OWNER OF INTERNATIONAL REGISTRATION 0713983
DATED 6-1-1999, EXPIRES 6-1-2009.
OWNER OF U.S. REG. NO. 2,661,615.

CLASS 22—CORDAGE AND FIBERS

FOR ROPES, STRING, COMMERCIAL NETS, TENTS, AWNINGS; PADDING AND STUFFING MATERIALS NOT MADE OF RUBBER AND PLASTICS; RAW FIBROUS TEXTILE MATERIALS (U.S. CLS. 1, 2, 7, 19, 22, 42 AND 50).

CLASS 27—FLOOR COVERINGS

FOR FLOOR COVERINGS, NAMELY, RUGS, DOOR MATS, MATS, LINOLEUM; NON-TEXTILE WALL HANGINGS (U.S. CLS. 19, 20, 37, 42 AND 50).
SEAN DWYER, EXAMINING ATTORNEY

SN 79-003,183. VERBAND DER; VEREINE CREDITREFORM E.V., FED REP GERMANY, FILED 5-5-2004.



OWNER OF INTERNATIONAL REGISTRATION 0724241
DATED 3-19-1999, EXPIRES 3-19-2009.
OWNER OF U.S. REG. NO. 2,743,444.

THE LINING IS A FEATURE OF THE MARK AND DOES NOT INDICATE COLOR.

THE FOREIGN WORDING IN THE MARK TRANSLATES INTO ENGLISH AS TRANSLATION OF 5 X 1 LABEL.

CLASS 9—ELECTRICAL AND SCIENTIFIC APPARATUS

FOR SOFTWARE FOR THE MANAGEMENT OF INDIVIDUALS' DEBTS AND FOR INVESTIGATIONS RELATING TO SUCH PEOPLE'S CREDIT-WORTHINESS (U.S. CLS. 21, 23, 26, 36 AND 38).

CLASS 16—PAPER GOODS AND PRINTED MATTER

FOR BOOKBINDINGS (U.S. CLS. 2, 5, 22, 23, 29, 37, 38 AND 50).

CLASS 35—ADVERTISING AND BUSINESS

FOR BUSINESS TRADE INVESTIGATIONS; MARKETING CONSULTING; CONDUCTING MARKETING STUDIES; BUSINESS MANAGEMENT CONSULTATION; BUSINESS MANAGEMENT OF FOREIGN COMMERCIAL ASSETS; PROVIDING STATISTICAL INFORMATION FOR THE ASSESSMENT OF CREDIT RISKS FOR BUSINESS PURPOSES; COMPILATION AND SYSTEMATIZATION OF INFORMATION CONTAINED IN DATABANKS (U.S. CLS. 100, 101 AND 102).

CLASS 36—INSURANCE AND FINANCIAL

FOR COLLECTION OF OUTSTANDING DEBTS (U.S. CLS. 100, 101 AND 102).

CLASS 42—SCIENTIFIC, COMPUTER AND LEGAL SERVICES

FOR DEVELOPMENT OF COMPUTER SOFTWARE FOR DEBT COLLECTION, DEBT MANAGEMENT, CREDIT-WORTHINESS INVESTIGATIONS AND FOR THE STATISTICAL ASSESSMENT OF CREDIT RISKS; DATABASE DEVELOPMENT SERVICES; ELECTRONIC VERIFICATION OF ON-LINE ORDERS OF DIGITAL CONTENT IN GENERATING ELECTRONIC PERMISSION CODES WHICH THEN ALLOW USERS TO ACCESS DIGITAL CONTENT (U.S. CLS. 100 AND 101).
IRA J. GOODSaid, EXAMINING ATTORNEY

SN 79-003,245. SACHTLEBEN CHEMIE GMBH, FED REP GERMANY, FILED 2-27-2004.

HOMBISAN

THE MARK CONSISTS OF STANDARD CHARACTERS WITHOUT CLAIM TO ANY PARTICULAR FONT, STYLE, SIZE, OR COLOR.

PRIORITY DATE OF 11-4-2003 IS CLAIMED.
OWNER OF INTERNATIONAL REGISTRATION 0826956
DATED 2-27-2004, EXPIRES 2-27-2014.

CLASS 1—CHEMICALS

FOR CHEMICALS USED IN INDUSTRY, NAMELY, ZINC SULFIDE (U.S. CLS. 1, 5, 6, 10, 26 AND 46).

CLASS 2—PAINTS

FOR PIGMENTS, NAMELY, PIGMENTS CONTAINING OR CONSISTING OF ZINC SULFIDE (U.S. CLS. 6, 11 AND 16).

CLASS 5—PHARMACEUTICALS

FOR ALL-PURPOSE SANITARY PREPARATIONS AND DISINFECTANTS CONTAINING OR CONSISTING OF ZINC SULFIDE AND ALL-PURPOSE DISINFECTANTS FOR HYGIENIC, SANITARY AND DOMESTIC USE (U.S. CLS. 6, 18, 44, 46, 51 AND 52).
BRIAN PINO, EXAMINING ATTORNEY

SN 79-003,256. WERA WERK HERMANN WERNER GMBH & CO. KG, FED REP GERMANY, FILED 5-4-2004.

Rapidaptor

THE MARK CONSISTS OF STANDARD CHARACTERS WITHOUT CLAIM TO ANY PARTICULAR FONT, STYLE, SIZE, OR COLOR.

PRIORITY DATE OF 11-6-2003 IS CLAIMED.

OWNER OF INTERNATIONAL REGISTRATION 0827001 DATED 5-4-2004, EXPIRES 5-4-2014.

CLASS 7—MACHINERY

FOR MACHINE-OPERATED TOOLS, NAMELY, SCREWDRIVERS, AND PARTS OF THESE TOOLS, NAMELY, BITS FOR SCREWDRIVERS; QUICK RELEASE CHUCKS; PARTS AND SPARE PARTS OF THE AFOREMENTIONED GOODS (U.S. CLS. 13, 19, 21, 23, 31, 34 AND 35).

CLASS 8—HAND TOOLS

FOR HAND-OPERATED TOOLS, NAMELY, SCREWDRIVERS, AND PARTS OF THESE TOOLS, NAMELY, BITS FOR SCREWDRIVERS; QUICK RELEASE CHUCKS; PARTS AND SPARE PARTS OF THE AFOREMENTIONED GOODS (U.S. CLS. 23, 28 AND 44).
BRIAN NEVILLE, EXAMINING ATTORNEY

SN 79-003,412. PIERLUIGI VINCENTI, ITALY, FILED 3-31-2004.



Joe Rivetto

PRIORITY DATE OF 12-23-2003 IS CLAIMED.
OWNER OF INTERNATIONAL REGISTRATION 0827647 DATED 3-31-2004, EXPIRES 3-31-2014.
"JOE RIVETTO" DOES NOT IDENTIFY A LIVING INDIVIDUAL.

CLASS 16—PAPER GOODS AND PRINTED MATTER

FOR CARDBOARD; INKSTANDS, PENS, PAINTBRUSHES, PENCILS; STATIONERY, GREETING CARDS; DRAWING INSTRUMENTS; NEWSPAPERS, MAGAZINES, PERIODICALS, PAMPHLETS, BOOKS, INSTRUCTION MANUALS, REFERENCE GUIDES AND CATALOGUES IN THE FIELD OF YOUTH FASHION, MUSIC AND TRAVEL; DIARIES, POSTERS, CALENDARS, LITHOGRAPHS AND ENGRAVINGS, PHOTOGRAPHS, ADHESIVE LABELS; AND PRINTED TEACHING MATERIAL IN THE FIELD OF YOUTH MUSIC AND TRAVEL (U.S. CLS. 2, 5, 22, 23, 29, 37, 38 AND 50).

CLASS 18—LEATHER GOODS

FOR HANDBAGS, SUITCASES, PURSES, BRIEFCASES AND KEY CASES MADE OF ANIMAL SKINS AND IMITATION LEATHER (U.S. CLS. 1, 2, 3, 22 AND 41).

CLASS 25—CLOTHING

FOR CLOTHING FOR MEN, WOMEN AND CHILDREN, NAMELY, DRESSES, SKIRTS, TROUSERS, SHORTS, JACKETS AND GREATCOATS, RAINCOATS, OVERCOATS, SHIRTS, T-SHIRTS, SPORTS JERSEYS, PULLOVERS, SWEATSHIRTS, SWIMSUITS, UNDERWEAR, BELTS, HATS, SCARVES, TIES, GLOVES; SHOES, SLIPPERS, BOOTS, AND SHOES FOR GYMNASTICS AND SPORTS (U.S. CLS. 22 AND 39).

DANIEL CAPSHAW, EXAMINING ATTORNEY

SN 79-003,429. RELIUS COATINGS GMBH & CO., FED REP GERMANY, FILED 3-5-2004.

Relius

THE MARK CONSISTS OF STANDARD CHARACTERS WITHOUT CLAIM TO ANY PARTICULAR FONT, STYLE, SIZE, OR COLOR.

OWNER OF INTERNATIONAL REGISTRATION 0253124 DATED 3-3-1962, EXPIRES 3-3-2012.

CLASS 1—CHEMICALS

FOR ADHESIVES FOR USE IN CONSTRUCTION FOR EXTERIOR BUILDING WALL COVERINGS (U.S. CLS. 1, 5, 6, 10, 26 AND 46).

CLASS 2—PAINTS

FOR COLORANTS AND COLOURS FOR USE IN THE MANUFACTURE OF COATINGS, NAMELY, PAINTS; ANTI-CORROSIVE PAINTS; VARNISHES AND LACQUERS (U.S. CLS. 6, 11 AND 16).

TRACY WHITAKER-BOWN, EXAMINING ATTORNEY

SN 79-003,452. KPM-KÖNIGLICHE PORZELLAN-MANUFAKTUR; BERLIN GMBH, FED REP GERMANY, FILED 4-30-2004.

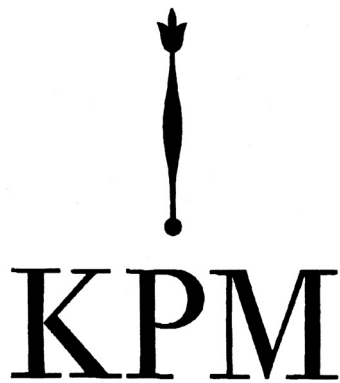

OWNER OF INTERNATIONAL REGISTRATION 0743736 DATED 6-6-2000, EXPIRES 6-6-2010.
OWNER OF U.S. REG. NO. 1,515,418.
THE MARK CONSISTS OF THE INITIALS KPM ACCOMPANIED WITH THE DESIGN ELEMENT OF A SCEPTRE AND A BOWL AND CROWN DESIGN.

CLASS 8—HAND TOOLS

FOR CUTLERY (U.S. CLS. 23, 28 AND 44).

CLASS 11—ENVIRONMENTAL CONTROL APPARATUS

FOR LAMPS (U.S. CLS. 13, 21, 23, 31 AND 34).

CLASS 14—JEWELRY

FOR GOODS MADE OF PRECIOUS METALS AND THEIR ALLOYS OR COATED THEREWITH, NAMELY, SERVING TRAYS, ASH TRAYS FOR SMOKERS, BOTTLE CAPS, BRACELETS, CIGAR AND CIGARETTE BOXES, COFFEE SERVICES, DECORATIVE BOXES, EGG CUPS, FIGURES, FLOWER VASES AND BOWLS, JEWELRY BOXES AND CASES, NAPKINS HOLDERS, JEWELRY, NAMELY, JEWELRY MADE OF GLASS, PORCELAIN AND EARTHENWARE, HOROLOGICAL AND CHRONOMETRIC INSTRUMENTS (U.S. CLS. 2, 27, 28 AND 50).

CLASS 21—HOUSEWARES AND GLASS

FOR BEVERAGE GLASSWARE, PORCELAIN AND EARTHENWARE, NAMELY, MUGS, DINNERWARE, FIGURINES, VASES, BASKET, BOWLS, CANDLESTICKS AND DECORATIVE BOXES (U.S. CLS. 2, 13, 23, 29, 30, 33, 40 AND 50).

CLASS 24—FABRICS

FOR TEXTILE FABRICS FOR THE MANUFACTURE OF CLOTHING, NAMELY, DAMASKS, LINEN AND SILK, TEXTILE GOODS, NAMELY, BED AND TABLE CLOTHS, TEXTILE AND DECORATION FABRICS, NAMELY, CURTAIN FABRICS, NET CURTAINS AND TEXTILE WALLPAPERS, UNFITTED PROTECTIVE FURNITURE COVERS, PILLOW COVERS, MATTRESS COVERS, COVERS FOR CUSHIONS (U.S. CLS. 42 AND 50).

FLORENTINA BLANDU, EXAMINING ATTORNEY

SN 79-003,487. SALOMON S.A., FRANCE, AND SKIS ROSIGNOL S.A., FRANCE, FILED 5-11-2004.



PRIORITY DATE OF 12-5-2003 IS CLAIMED.
OWNER OF INTERNATIONAL REGISTRATION 0827771 DATED 5-11-2004, EXPIRES 5-11-2014.
NO CLAIM IS MADE TO THE EXCLUSIVE RIGHT TO USE THE DESIGN OF A SKI BOOT AND SKI BINDING, APART FROM THE MARK AS SHOWN.

CLASS 25—CLOTHING

FOR FOOTWEAR, NAMELY HIKING BOOTS AND SHOES, SKI AND AFTER-SKI BOOTS, SNOWBOARD BOOTS AND THEIR INNER BOOTS AND THEIR REAR QUARTERS (U.S. CLS. 22 AND 39).

CLASS 28—TOYS AND SPORTING GOODS

FOR GYMNASTICS AND SPORTS ARTICLES NAMELY SNOW SKIS, SURFBOARDS, SKI AND SURF BINDINGS (U.S. CLS. 22, 23, 38 AND 50).
HENRY S. ZAK, EXAMINING ATTORNEY

SN 79-003,598. DR. HANS LAUTENSCHLÄGER, FED REP GERMANY, FILED 6-23-2004.

dermaviduals

THE MARK CONSISTS OF STANDARD CHARACTERS WITHOUT CLAIM TO ANY PARTICULAR FONT, STYLE, SIZE, OR COLOR.

OWNER OF INTERNATIONAL REGISTRATION 0803413 DATED 5-9-2003, EXPIRES 5-9-2013.

CLASS 3—COSMETICS AND CLEANING PREPARATIONS

FOR SOAPS, NAMELY SKIN SOAPS, SHAVING SOAPS, BATH SOAPS IN LIQUID, SOLID, OR GEL FORM, BATH GEL, CLEANSING AND SHOWER GEL, CLEANSING MILK, AND SHOWER CREAMS; DENTIFRICES; COSMETICS (U.S. CLS. 1, 4, 6, 50, 51 AND 52).

CLASS 5—PHARMACEUTICALS

FOR PHARMACEUTICAL AND VETERINARY PRODUCTS, NAMELY PHARMACEUTICAL PREPARATIONS FOR USE IN TREATING SKIN DISORDERS IN HUMANS AND ANIMALS (U.S. CLS. 6, 18, 44, 46, 51 AND 52).

ODESSA BIBBINS, EXAMINING ATTORNEY

SN 79-003,611. TOF SRL, ITALY, FILED 5-21-2004.

SN 79-003,833. MADAME SANDRINE BENATTAR, FRANCE, FILED 2-19-2004.

TOF

OWNER OF INTERNATIONAL REGISTRATION 0823334 DATED 11-19-2003, EXPIRES 11-19-2013.

CLASS 11—ENVIRONMENTAL CONTROL APPARATUS

FOR VALVES FOR WATER OR GAS APPARATUS AND PIPES; VALVES FOR CONTROLLING TUB PIPES; VALVES FOR CONTROLLING SHOWERS; TAPS WHICH ARE FAUCETS; LABORATORY FAUCETS; SAFETY SHOWERS; AND SHOWER TAPS (U.S. CLS. 13, 21, 23, 31 AND 34).

CLASS 17—RUBBER GOODS

FOR JOINT PACKINGS FOR EFFECTUATING SEALS IN PLASTIC CONDUIT USED IN BEVERAGE DISPENSING MACHINES; JOINT PACKINGS FOR EFFECTUATING SEALS IN RUBBER HYDRAULIC HOSES; JOINT PACKINGS FOR EFFECTUATING SEALS IN NON-METAL PIPE COUPLINGS AND JOINTS; JOINT PACKINGS FOR NON-METAL TUBING AND TUBING COUPLINGS FOR JOINING AND TERMINATING PIPES (U.S. CLS. 1, 5, 12, 13, 35 AND 50).

MARY ROSSMAN, EXAMINING ATTORNEY

SN 79-003,723. SATORI STOCKTEC GMBH, FED REP GERMANY, FILED 2-19-2004.

STOCK STERILISATIONSSYSTEME

OWNER OF INTERNATIONAL REGISTRATION 0808963 DATED 6-4-2003, EXPIRES 6-4-2013.

NO CLAIM IS MADE TO THE EXCLUSIVE RIGHT TO USE "STERILISATIONSSYSTEME", APART FROM THE MARK AS SHOWN.

CLASS 7—MACHINERY

FOR MACHINES AND MACHINE TOOLS FOR MANUFACTURING FOODSTUFFS (U.S. CLS. 13, 19, 21, 23, 31, 34 AND 35).

CLASS 10—MEDICAL APPARATUS

FOR AUTOCLAVES FOR MEDICAL USE (U.S. CLS. 26, 39 AND 44).

CLASS 11—ENVIRONMENTAL CONTROL APPARATUS

FOR AUTOCLAVES, STEAM GENERATORS, REFRIGERATING MACHINES, FOODSTUFF COOKERS (U.S. CLS. 13, 21, 23, 31 AND 34).

PRISCILLA MILTON, EXAMINING ATTORNEY

ENFANDISES

OWNER OF INTERNATIONAL REGISTRATION 0828826 DATED 2-19-2004, EXPIRES 2-19-2014.

CLASS 16—PAPER GOODS AND PRINTED MATTER

FOR PAPER, NAMELY, ART PAPER, CRAFT PAPER, CARDBOARD, STATIONERY, WRAPPING PAPER, PAPER OR PLASTIC PACKAGING BAGS, PAPER SACHETS AND PAPER SHEETS FOR WRITING; PRINTED MATTER, NAMELY, BOOKS AND MAGAZINES FOR CHILDREN, NOTEBOOKS, ADDRESS BOOKS AND DIARIES; ARTISTS SUPPLIES, NAMELY, PENCILS, PENS AND PAINT BRUSHES; TYPEWRITERS AND OFFICE REQUISITES, NAMELY, STAPLERS, RULERS, RUBBER BANDS, AND ADHESIVE TAPE; PRINTED INSTRUCTIONAL AND TEACHING MATERIALS IN THE FIELD OF CHILDREN'S EDUCATION RELATED TO DRAWING AND WRITING; POSTCARDS, PRINTING BLOCKS, PAINTINGS, PICTURES AND ENGRAVINGS, POSTERS (U.S. CLS. 2, 5, 22, 23, 29, 37, 38 AND 50).

CLASS 18—LEATHER GOODS

FOR LEATHER AND IMITATION LEATHER SOLD IN BULK; GOODS OF LEATHER OR IMITATION LEATHER, PARTICULARLY BACKPACKS, HANDBAGS, TRAVEL BAGS, SCHOOL BAGS, SUITCASES, CHANGE PURSES, WALLETS, GARMENT COVERS, TRUNKS AND SUITCASES; UMBRELLAS, PARASOLS AND WALKING STICKS (U.S. CLS. 1, 2, 3, 22 AND 41).

CLASS 24—FABRICS

FOR TEXTILE FABRICS FOR BEDS; TEXTILE GOODS, NAMELY, QUILTS, INFANT BLANKETS, CRIB BLANKETS, BLANKET THROWS AND TEXTILE PLACEMATS; TABLE AND HOUSEHOLD LINEN, EXCLUDING PAPER TABLE LINEN, BLANKETS, NAMELY, BED BLANKETS; BED SHEETS, BATHROOM LINEN AND DUVET COVERS (U.S. CLS. 42 AND 50).

CLASS 25—CLOTHING

FOR CLOTHING, NAMELY, PANTS, TROUSERS, DRESSES, COATS, RAINCOATS, VESTS, T-SHIRTS, SWEATSHIRTS, SKIRTS, SOCKS, SWIMSUITS, SARONGS, UNDERWEAR, BERMUDA SHORTS, SHORTS, PAJAMAS, NIGHT DRESSES, SCARVES, GLOVES, CAPS, FOOTWEAR AND HEADWEAR (U.S. CLS. 22 AND 39).

PRISCILLA MILTON, EXAMINING ATTORNEY

SN 79-003,888. ATOMIC AUSTRIA GMBH, AUSTRIA, FILED 4-23-2004.

SN 79-003,931. SCHWEIZERISCHE LEBENSVERSICHERUNGS- UND RENTENANSTALT, SWITZERLAND, FILED 4-30-2004.

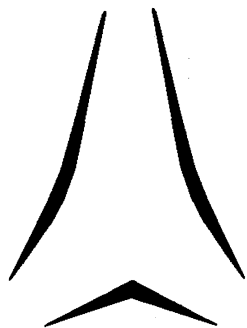

PRIORITY DATE OF 11-3-2003 IS CLAIMED.
OWNER OF INTERNATIONAL REGISTRATION 0829032
DATED 4-23-2004, EXPIRES 4-23-2014.

CLASS 18—LEATHER GOODS

FOR LEATHER BAGS, TRAVEL BAGS OF PLASTIC, TEXTILE SHOPPING BAGS, BAGS FOR CARRYING SPORTS SHOES, BUM BAGS, CARRYING AND SHOULDER BAGS, BACKPACKS AND SPORTS BAGS (U.S. CLS. 1, 2, 3, 22 AND 41).

CLASS 25—CLOTHING

FOR CLOTHING, NAMELY BOOTS AND SHOES; HEADWEAR, GLOVES, SPORTS CLOTHING, NAMELY ALPINE SKI, CROSS-COUNTRY SKIWEAR; SNOWBOARD SUITS, HEADBANDS, SCARVES; ALPINE SKI, CROSS-COUNTRY SKI AND SNOWBOARD BOOTS AND STRUCTURAL PARTS THEREFOR (U.S. CLS. 22 AND 39).

CLASS 28—TOYS AND SPORTING GOODS

FOR SPORTS, GYMNASIAC AND PLAYING EQUIPMENT, NAMELY ROLLER SKATES, IN-LINE SKATES, ALPINE SKIS, CROSS-COUNTRY SKIS, SNOWBOARDS, SKIBOBS, SLEDS, AND ALPINE SKI AND CROSS-COUNTRY SKI POLES AND STRUCTURAL PARTS THEREFORE; FITTED COVERS, BAGS AND CONTAINERS FOR ALPINE SKIS, CROSS-COUNTRY SKIS, SNOWBOARDS AND SKI POLES, FITTED COVERS FOR SKI BINDINGS, SKI WAXES (U.S. CLS. 22, 23, 38 AND 50).

SAMUEL E. SHARPER JR., EXAMINING ATTORNEY



PRIORITY DATE OF 10-31-2003 IS CLAIMED.
OWNER OF INTERNATIONAL REGISTRATION 0829188
DATED 4-30-2004, EXPIRES 4-30-2014.
OWNER OF U.S. REG. NOS. 2,064,418 AND 2,068,316.
NO CLAIM IS MADE TO THE EXCLUSIVE RIGHT TO USE "SWISS LIFE", APART FROM THE MARK AS SHOWN.

CLASS 35—ADVERTISING AND BUSINESS

FOR BUSINESS ADMINISTRATION AND MANAGEMENT SERVICES FOR SAVINGS INSTITUTIONS (U.S. CLS. 100, 101 AND 102).

CLASS 36—INSURANCE AND FINANCIAL

FOR INSURANCE UNDERWRITING FOR ALL TYPES OF INSURANCE; INSURANCE CONSULTATION; FINANCIAL AFFAIRS, NAMELY, FINANCIAL MANAGEMENT AND FINANCIAL ANALYSIS AND CONSULTATION; BANKING; REAL ESTATE AFFAIRS, NAMELY, APPRAISALS FOR INSURANCE CLAIMS OF REAL ESTATE, REAL ESTATE CONSULTATION, REAL ESTATE TRUSTEE SERVICES AND REAL ESTATE INVESTMENT; PROVISION OF FINANCIAL INFORMATION VIA COMPUTER SYSTEMS; INTERACTIVE ELECTRONIC PROVISION OF INSURANCE AND FINANCIAL SERVICES, NAMELY, PROVIDING ONLINE STORED VALUE ACCOUNTS IN AN ELECTRONIC ENVIRONMENT; FISCAL VALUATIONS AND ASSESSMENTS; AND FINANCIAL SPONSORSHIP IN THE FIELDS OF CULTURE; SPORTS, ECONOMICS, LAW AND TAX RESEARCH (U.S. CLS. 100, 101 AND 102).
FLORENTINA BLANDU, EXAMINING ATTORNEY

SN 79-004,036. UBS AG, SWITZERLAND, FILED 4-2-2004.

WOLFSBERG

THE MARK CONSISTS OF STANDARD CHARACTERS WITHOUT CLAIM TO ANY PARTICULAR FONT, STYLE, SIZE, OR COLOR.

OWNER OF INTERNATIONAL REGISTRATION 0829441
DATED 4-2-2004, EXPIRES 4-2-2014.

CLASS 16—PAPER GOODS AND PRINTED MATTER

FOR PRINTED MATTER, NAMELY, NEWSLETTERS, BROCHURES, AND PRINTED TEACHING MATERIALS IN THE FIELDS OF TRAINING, SPORTING, AND CULTURAL ACTIVITIES (U.S. CLS. 2, 5, 22, 23, 29, 37, 38 AND 50).

CLASS 35—ADVERTISING AND BUSINESS

FOR CONSULTING SERVICES CONCERNING BUSINESS ORGANIZATION, MANAGEMENT, AND OFFICE FUNCTIONS (U.S. CLS. 100, 101 AND 102).

CLASS 41—EDUCATION AND ENTERTAINMENT

FOR TRAINING SERVICES IN THE FIELDS OF BUSINESS, POLITICS, AND CULTURE; ORGANIZING COMMUNITY, SPORTING, AND CULTURAL ACTIVITIES (U.S. CLS. 100, 101 AND 107).

MICHELLE S. WISEMAN, EXAMINING ATTORNEY

SN 79-004,040. CHOCOLATERIE GUYLIAN N.V., BELGIUM, FILED 5-4-2004.

GUYLIAN

THE MARK CONSISTS OF STANDARD CHARACTERS WITHOUT CLAIM TO ANY PARTICULAR FONT, STYLE, SIZE, OR COLOR.

OWNER OF INTERNATIONAL REGISTRATION 0829470 DATED 5-4-2004, EXPIRES 5-4-2014.

OWNER OF U.S. REG. NOS. 1,462,127, 2,720,942 AND OTHERS.

CLASS 30—STAPLE FOODS

FOR COFFEE, TEA, COCOA, SUGAR, ARTIFICIAL COFFEE; PASTRY AND ALL SUGAR AND CHOCOLATE CONFECTIONERY, ICE; CHOCOLATE, CHOCOLATES, PRALINES; PREPARED MEALS CONSISTING PRIMARILY OF PASTA AND RICE; SNACKS, NAMELY, CEREAL-BASED SNACK FOODS, RICE-BASED SNACK FOODS, WHEAT-BASED SNACK FOODS, BAKERY GOODS, CRACKER AND CHEESE COMBINATIONS, CHEESE BISCUITS, SANDWICHES, FISH SANDWICHES, BREAD, BREAD STICKS (U.S. CL. 46).

CLASS 33—WINES AND SPIRITS

FOR ALCOHOLIC BEVERAGES, NAMELY LIQUEURS (U.S. CLS. 47 AND 49).

CLASS 43—HOTEL AND RESTAURANT SERVICES

FOR SERVICES FOR PROVIDING FOOD AND DRINK, NAMELY, COFFEE SHOPS (U.S. CLS. 100 AND 101).

WILLIAM VERHOSEK, EXAMINING ATTORNEY

SN 79-004,044. ALCEA (SOCIÉTÉ ANONYME), FRANCE, FILED 2-2-2004.



OWNER OF INTERNATIONAL REGISTRATION 0829504 DATED 2-2-2004, EXPIRES 2-2-2014.

CLASS 9—ELECTRICAL AND SCIENTIFIC APPARATUS

FOR BAGS FOR COMPACT DISKS (U.S. CLS. 21, 23, 26, 36 AND 38).

CLASS 18—LEATHER GOODS

FOR HANDBAGS, SHOPPING BAGS, TRAVELING BAGS, SUITCASES, SCHOOL BAGS, SATCHELS; VANITY CASES AND TOILETRY CASES SOLD EMPTY; SPORT BAGS (U.S. CLS. 1, 2, 3, 22 AND 41).

IRA J. GOODSAY, EXAMINING ATTORNEY

SN 79-004,143. GENERAL MOTORS CORPORATION, UNITED STATES, FILED 2-25-2004.

ALLOYTEC

THE MARK CONSISTS OF STANDARD CHARACTERS WITHOUT CLAIM TO ANY PARTICULAR FONT, STYLE, SIZE, OR COLOR.

OWNER OF INTERNATIONAL REGISTRATION 0829863 DATED 2-25-2004, EXPIRES 2-25-2014.

CLASS 12—VEHICLES

FOR ENGINES FOR MOTOR VEHICLES (U.S. CLS. 19, 21, 23, 31, 35 AND 44).

CLASS 37—CONSTRUCTION AND REPAIR

FOR MAINTENANCE, SERVICING AND REPAIR OF ENGINES FOR MOTOR VEHICLES (U.S. CLS. 100, 103 AND 106).

TRACY CROSS, EXAMINING ATTORNEY

SN 79-004,347. OPEN SELLING LIMITED, CAMBERLEY SURREY GU15 1DR, UNITED KINGDOM, FILED 4-28-2004.

NOSTRADAMUS

THE MARK CONSISTS OF STANDARD CHARACTERS WITHOUT CLAIM TO ANY PARTICULAR FONT, STYLE, SIZE, OR COLOR.

PRIORITY DATE OF 11-5-2003 IS CLAIMED.

OWNER OF INTERNATIONAL REGISTRATION 0830498 DATED 4-28-2004, EXPIRES 4-28-2014.

THE NAME(S), PORTRAIT(S), AND/OR SIGNATURE(S) SHOWN IN THE MARK DOES NOT IDENTIFY A PARTICULAR LIVING INDIVIDUAL.

CLASS 9—ELECTRICAL AND SCIENTIFIC APPARATUS

FOR PRE-RECORDED DISCS, TAPES, CDS, DIGITAL VIDEO DISCS, VIDEO TAPES, CD ROMS, ALL RELATING TO BUSINESS CONSULTANCY SERVICES, BUSINESS MANAGEMENT AND ORGANISATION CONSULTANCY SERVICES, MANAGEMENT CONSULTANCY SERVICES, EFFECTIVENESS CONSULTANCY SERVICES, AND TO TRAINING AND EDUCATION SERVICES, TRAINING AND EDUCATION SERVICES IN CONNECTION WITH SALES, LEADERSHIP, COMMERCIAL SKILLS, SALES EFFECTIVENESS, MANAGEMENT, MARKETING, NEGOTIATIONS, BUYING, BEHAVIOUR ANALYSIS AND COACHING (U.S. CLS. 21, 23, 26, 36 AND 38).

CLASS 16—PAPER GOODS AND PRINTED MATTER

FOR PRINTED MATTER AND PUBLICATIONS, NAMELY, INSTRUCTION MANUALS, WORKBOOKS, EXERCISE BOOKS, WORKSHEETS, PRESS RELEASES, JOURNALS, NEWSLETTERS, MAGAZINES, BROCHURES, FLYERS, PAMPHLETS, HAND-OUTS, CASE STUDIES, WHITE PAPERS; BOOKS; INSTRUCTIONAL AND TEACHING MATERIAL AND STATIONERY ALL IN THE FIELD OF BUSINESS EDUCATION, SALES AND MANAGEMENT TRAINING (U.S. CLS. 2, 5, 22, 23, 29, 37, 38 AND 50).

CLASS 35—ADVERTISING AND BUSINESS

FOR BUSINESS CONSULTANCY SERVICES, BUSINESS MANAGEMENT AND ORGANISATION CONSULTANCY SERVICES, MANAGEMENT CONSULTANCY SERVICES; BUSINESS EFFECTIVENESS CONSULTANCY SERVICES (U.S. CLS. 100, 101 AND 102).

CLASS 41—EDUCATION AND ENTERTAINMENT

FOR TRAINING AND EDUCATION SERVICES BY MANNER OF SEMINARS, WORKSHOPS, CLASSES, COURSES, PROGRAMMES, WEBINARS, WEB LEARNING, INTERNET LEARNING, E-LEARNING, E-MAIL, TUTORIALS, COACHING, MENTORING, CORRESPONDENCE COURSES, CONFERENCE CALLS, TELEPHONE CALLS AND INDIVIDUAL DISCUSSIONS, IN CONNECTION WITH SALES, LEADERSHIP, COMMERCIAL SKILLS, SALES EFFECTIVENESS, MANAGEMENT, MARKETING, NEGOTIATIONS, BUYING, BEHAVIOUR ANALYSIS AND COACHING (U.S. CLS. 100, 101 AND 107).

KATHRYN COWARD, EXAMINING ATTORNEY

SN 79-004,371. COPERION WERNER & PFLEIDERER; GMBH & CO. KG, FED REP GERMANY, FILED 4-8-2004.



OWNER OF INTERNATIONAL REGISTRATION 0171348 DATED 9-7-1953, EXPIRES 9-7-2013.

CLASS 7—MACHINERY

FOR MACHINES FOR THE FOOD AND CHEMICALS INDUSTRIES, NAMELY FEED MIXERS, GRANULATING MACHINES, GRINDING MILLS FOR CHEMICAL PROCESSING, HYDRAULIC TORQUE CONVERTERS, HYDRAULIC VALVE ACTUATORS, INJECTION PLASTIC MOULDING MACHINES, KNEADING MACHINES FOR FOOD AND CHEMICAL PROCESSING, POWER AND TRANSMISSIONS AND GEARING FOR MACHINES FOR THE FOOD AND CHEMICALS INDUSTRIES. GEAR PUMPS, PISTON PUMPS, CENTRIFUGAL PUMPS, MEMBRANE PUMPS, ROTARY PUMPS, RUBBER MIXING MACHINES, SCREW CONVEYORS, SCREW PUMPS, MACHINES FOR FEEDING OVENS (U.S. CLS. 13, 19, 21, 23, 31, 34 AND 35).

CLASS 11—ENVIRONMENTAL CONTROL APPARATUS

FOR OVENS, APPARATUS FOR REFRIGERATING DOUGH, APPARATUS FOR REFRIGERATING WATER, REFRIGERATORS, HEAT PUMPS, HEAT ACCUMULATORS FOR PRESS INSTALLATIONS, ELECTRIC COOKING STOVES (U.S. CLS. 13, 21, 23, 31 AND 34).

DOMINIC J. FERRAIUOLO, EXAMINING ATTORNEY

SN 79-004,431. WE ROCK AB, SWEDEN, FILED 5-17-2004.



THE MARK CONSISTS OF STANDARD CHARACTERS WITHOUT CLAIM TO ANY PARTICULAR FONT, STYLE, SIZE, OR COLOR.

PRIORITY DATE OF 3-23-2004 IS CLAIMED.

OWNER OF INTERNATIONAL REGISTRATION 0830706 DATED 5-17-2004, EXPIRES 5-17-2014.

CLASS 18—LEATHER GOODS

FOR GOODS MADE OF LEATHER AND IMITATIONS OF LEATHER, NAMELY, LEATHER SHOPPING BAGS, LEATHER BUSINESS CARD CASES, LEATHER BUSINESS CASES, LEATHER KEY CASES, LEATHER ATTACHE CASES, LEATHER WALLETS, LEATHER FELT POUCHES, LEATHER DRAWSTRING POUCHES, LEATHER TOOL POUCHES SOLD EMPTY, ANIMAL SKINS AND HIDES; TRUNKS AND TRAVELING BAGS; UMBRELLAS, PARASOLS AND WALKING STICKS; WHIPS, HARNESSES AND SADDLERY (U.S. CLS. 1, 2, 3, 22 AND 41).

CLASS 25—CLOTHING

FOR CLOTHING, NAMELY, WOVEN AND KNITTED JACKETS, WOVEN AND KNITTED PANTS, WOVEN AND KNITTED SHIRTS, KNITTED T-SHIRTS AND TANK TOPS, KNITTED SWEATERS AND SWEATSHIRTS, GLOVES, UNDERWEAR, MUFFLERS, SCARVES; FOOTWEAR; HEADWEAR, NAMELY, HATS, CAPS AND BANDANAS (U.S. CLS. 22 AND 39).

GEOFFREY FOSDICK, EXAMINING ATTORNEY

SN 79-004,433. WE ROCK AB, SWEDEN, FILED 5-17-2004.

WE ARE THE SUPERLATIVE CONSPIRACY

THE MARK CONSISTS OF STANDARD CHARACTERS WITHOUT CLAIM TO ANY PARTICULAR FONT, STYLE, SIZE, OR COLOR.

PRIORITY DATE OF 3-23-2004 IS CLAIMED.

OWNER OF INTERNATIONAL REGISTRATION 0830708 DATED 5-17-2004, EXPIRES 5-17-2014.

CLASS 18—LEATHER GOODS

FOR GOODS MADE OF LEATHER AND IMITATIONS OF LEATHER, NAMELY, LEATHER SHOPPING BAGS, LEATHER BUSINESS CARD CASES, LEATHER BUSINESS CASES, LEATHER KEY CASES, LEATHER ATTACHE CASES, LEATHER WALLETS, LEATHER FELT POUCHES, LEATHER DRAWSTRING POUCHES, LEATHER TOOL POUCHES SOLD EMPTY, ANIMAL SKINS AND HIDES; TRUNKS AND TRAVELING BAGS; UMBRELLAS, PARASOLS AND WALKING STICKS; WHIPS, HARNESSES SADDLERY (U.S. CLS. 1, 2, 3, 22 AND 41).

CLASS 25—CLOTHING

FOR CLOTHING, NAMELY, WOVEN AND KNITTED JACKETS, WOVEN AND KNITTED PANTS, WOVEN AND KNITTED SHIRTS, KNITTED T-SHIRTS AND TANK TOPS, KNITTED SWEATERS AND SWEAT-SHIRTS, GLOVES, UNDERWEAR, MUFFLERS, SCARVES; FOOTWEAR; HEADWEAR, NAMELY, HATS, CAPS AND BANDANAS (U.S. CLS. 22 AND 39).

GEOFFREY FOSDICK, EXAMINING ATTORNEY

SN 79-004,530. EMGS AS, N-7041 TRONDHEIM, NORWAY, FILED 4-28-2004.



SN 79-004,486. CEMECON AG, D-52146 WÜRSELEN, FED REP GERMANY, FILED 5-4-2004.

HYPERLOX

THE MARK CONSISTS OF STANDARD CHARACTERS WITHOUT CLAIM TO ANY PARTICULAR FONT, STYLE, SIZE, OR COLOR.

PRIORITY DATE OF 11-11-2003 IS CLAIMED.
OWNER OF INTERNATIONAL REGISTRATION 0830849 DATED 5-4-2004, EXPIRES 5-4-2014.

CLASS 7—MACHINERY

FOR CHIP REMOVING, SEPARATING, AND TRANSFORMING MACHINES, NAMELY, COATING MACHINES FOR USE IN COATING SUBSTRATES WITH THIN FUNCTIONAL LAYERS PRODUCED FROM THE SEPARATION OF VAPORS AND GASSES, CUTTING MACHINES, PUNCHING MACHINES, SQUEEZING MACHINES, GRINDING MACHINES, BORING MACHINES, LATHES, AND GEAR CUTTING AND FINISHING MACHINES FOR METAL WORKING IN THE FIELD OF COATINGS; MECHANICAL DEVICES, NAMELY, METALWORKING MACHINE TOOLS; MECHANICAL TOOLS FOR USE IN THE PHYSICAL VAPOR DEPOSITION COATING OF TOOLS WITH A HARDENED SURFACE MATERIAL; AND MACHINERY, NAMELY, METALWORKING MACHINE TOOLS FOR COATING TOOLS AND WORK PIECES WITH HARD MATERIALS (U.S. CLS. 13, 19, 21, 23, 31, 34 AND 35).

CLASS 8—HAND TOOLS

FOR MANUALLY OPERATED TOOLS COATED BY PHYSICAL VAPOR DEPOSITION, NAMELY, PUNCHES, HAND-HELD CUTTING TOOLS, CLAMPS, DIES, DRILLS, MANUALLY-OPERATED GRINDING WHEELS, PINCHERS, TONGS, SCRAPERS, SAWS, WRENCHES, AND VICES (U.S. CLS. 23, 28 AND 44).

CLASS 40—MATERIAL TREATMENT

FOR MATERIAL TREATMENT, NAMELY COATING OF TOOLS AND WORK PIECES OF METAL WITH HARD MATERIALS USING PVD-COATING MACHINES (U.S. CLS. 100, 103 AND 106).

JEFF DEFORD, EXAMINING ATTORNEY

PRIORITY DATE OF 10-28-2003 IS CLAIMED.
OWNER OF INTERNATIONAL REGISTRATION 0831015 DATED 4-28-2004, EXPIRES 4-28-2014.

NO CLAIM IS MADE TO THE EXCLUSIVE RIGHT TO USE ELECTROMAGNETIC GEOSERVICES AS, APART FROM THE MARK AS SHOWN.

CLASS 9—ELECTRICAL AND SCIENTIFIC APPARATUS

FOR COMPUTER SOFTWARE WHICH PROCESSES, MODELS AND INTERPRETS ELECTROMAGNETIC WAVES AND/OR ENERGY AND HELPS DETECT HYDROCARBONS IN THE SEABED PRIOR TO DRILLING FOR OIL OR GAS FOR USE IN THE SUBSEA OIL AND GAS INDUSTRY, COMPUTER PROGRAMS THAT HELPS DETECT HYDROCARBONS IN THE SEABED PRIOR TO DRILLING FOR OIL OR GAS FOR USE IN THE SUBSEA OIL AND GAS INDUSTRY AND COMPUTER HARDWARE, COMPUTER PROGRAMS THAT HELPS MONITORING PRODUCTION IN ONGOING PRODUCTION OIL AND GAS FIELDS; REPORTS, INSTRUCTIONAL AND TEACHING MATERIALS RECORDED ON ELECTRONIC DISCS, DISCS, COMPACT DISCS, DIGITAL VIDEO DISCS, DIGITAL VERSATILE DISCS, AND CASSETTES FOR USE IN THE SUBSEA OIL AND GAS INDUSTRY (U.S. CLS. 21, 23, 26, 36 AND 38).

CLASS 16—PAPER GOODS AND PRINTED MATTER

FOR PRINTED MATTERS, NAMELY, BROCHURES, PRESENTATION FOLDERS, PRINTED ARTICLES; PERIODICALS IN THE FIELD OF SUBSEA OIL AND GAS; REPORTS, INSTRUCTIONAL AND TEACHING MATERIAL IN THE FIELD OF SUBSEA OIL AND GAS (U.S. CLS. 2, 5, 22, 23, 29, 37, 38 AND 50).

CLASS 42—SCIENTIFIC, COMPUTER AND LEGAL SERVICES

FOR SCIENTIFIC AND TECHNOLOGICAL SERVICES, NAMELY USING ELECTROMAGNETIC WAVES AND/OR ENERGY TO DETECT HYDROCARBONS IN THE SEABED PRIOR TO DRILLING FOR OIL AND GAS OR MONITORING ONGOING PRODUCTION OF OIL AND GAS AND RESEARCH AND DESIGN RELATING THERETO; INDUSTRIAL ANALYSIS AND RESEARCH SERVICES, NAMELY, CONDUCTING ELECTROMAGNETIC WAVE OR ENERGY ANALYSIS AND RESEARCH FOR THE SUBSEA OIL AND GAS INDUSTRY; DESIGN AND DEVELOPMENT OF COMPUTER HARDWARE AND SOFTWARE; GEOLOGICAL RESEARCH, GEOLOGICAL SEARCHING AND GEOLOGICAL SUB-SURFACE SURVEYS; ENGINEERING (U.S. CLS. 100 AND 101).

KATHRYN COWARD, EXAMINING ATTORNEY

SN 79-004,951. IMT INTEGRAL MEDIZINTECHNIK AG, SWITZERLAND, FILED 5-13-2004.

WOODPECKER

THE MARK CONSISTS OF STANDARD CHARACTERS WITHOUT CLAIM TO ANY PARTICULAR FONT, STYLE, SIZE, OR COLOR.

PRIORITY DATE OF 11-27-2003 IS CLAIMED.
OWNER OF INTERNATIONAL REGISTRATION 0832192 DATED 5-13-2004, EXPIRES 5-13-2014.

CLASS 10—MEDICAL APPARATUS

FOR SURGICAL, MEDICAL AND VETERINARY INSTRUMENTS AND APPARATUS, NAMELY, TOOLS FOR ORTHOPEDIC AND TRAUMATOLOGICAL PURPOSES, RASPING MACHINES FOR PROSTHETIC OPERATIONS, UTENSILS AND APPARATUS FOR IMPLANTING AND EXTRACTING DONATIONS OF MARROW (U.S. CLS. 26, 39 AND 44).

CLASS 42—SCIENTIFIC, COMPUTER AND LEGAL SERVICES

FOR ENGINEERING SERVICES FOR BUILDING MEDICAL APPARATUS AND UTENSILS, SCIENTIFIC MEDICAL RESEARCH SERVICES (U.S. CLS. 100 AND 101).

SCOTT BALDWIN, EXAMINING ATTORNEY

SN 79-005,006. TEN CATE NICOLON B.V., NETHERLANDS, FILED 4-29-2004.

NICOTARP

OWNER OF INTERNATIONAL REGISTRATION 0407419 DATED 5-9-1974, EXPIRES 5-9-2014.

CLASS 19—NON-METALLIC BUILDING MATERIALS

FOR WATER RESISTANT REINFORCED MEMBRANES AND TARPAULINS THAT ARE USED IN WATER STORAGE BASINS AND WATER SILOS (U.S. CLS. 1, 12, 33 AND 50).

CLASS 24—FABRICS

FOR WATER RESISTANT FABRICS FOR USE IN THE MANUFACTURE OF TARPAULINS, COVERS, BAGS, CONCRETE VAULTS, INFLATABLE BOATS, AUTOMOBILE ROOFS AND PACKAGING MATERIALS (U.S. CLS. 42 AND 50).

HOWARD SMIGA, EXAMINING ATTORNEY

SN 79-005,022. TRAZZI LUCA, ITALY, AND MINI MASSIMO, ITALY, AND LOHMANN BIRGIT INGRID, I-20100 MILANO, FED REP GERMANY, FILED 6-8-2004.

DESIGNBOOM

THE MARK CONSISTS OF STANDARD CHARACTERS WITHOUT CLAIM TO ANY PARTICULAR FONT, STYLE, SIZE, OR COLOR.

OWNER OF INTERNATIONAL REGISTRATION 0745699 DATED 9-28-2000, EXPIRES 9-28-2010.

CLASS 16—PAPER GOODS AND PRINTED MATTER

FOR PRINTED MATTER, NAMELY, MAGAZINES, PERIODICALS AND PRINTED PUBLICATIONS IN THE FIELD OF INDUSTRIAL DESIGN (U.S. CLS. 2, 5, 22, 23, 29, 37, 38 AND 50).

CLASS 38—COMMUNICATION

FOR DATA TRANSMISSION AND RECEPTION SERVICES VIA TELECOMMUNICATION MEANS AVAILABLE VIA THE INTERNET (U.S. CLS. 100, 101 AND 104).

CLASS 41—EDUCATION AND ENTERTAINMENT

FOR EDUCATIONAL SERVICES, NAMELY, PROVIDING CLASSES AND WORKSHOPS IN THE FIELD OF INDUSTRIAL DESIGN; ORGANIZING COMMUNITY CULTURAL EVENTS (U.S. CLS. 100, 101 AND 107).

PAULA MAHONEY, EXAMINING ATTORNEY

SN 79-005,194. ANTENOVA LIMITED, UNITED KINGDOM, FILED 7-20-2004.

QUADNOVA

THE MARK CONSISTS OF STANDARD CHARACTERS WITHOUT CLAIM TO ANY PARTICULAR FONT, STYLE, SIZE, OR COLOR.

PRIORITY DATE OF 1-23-2004 IS CLAIMED.
OWNER OF INTERNATIONAL REGISTRATION 0832950 DATED 7-20-2004, EXPIRES 7-20-2014.

CLASS 9—ELECTRICAL AND SCIENTIFIC APPARATUS

FOR TELECOMMUNICATIONS APPARATUS AND INSTRUMENTS, NAMELY ANTENNAS; MOBILE PHONES; WIRELESS TELEPHONES AND RADIO HANDSETS, RECEIVERS AND TRANSMITTERS; TELECOMMUNICATIONS TERMINALS FOR TELEPHONES AND RADIOS AND PARTS AND FITTINGS FOR ALL THE AFORESAID GOODS; COMPUTER SOFTWARE FOR USE IN ANTENNA STEERING IN THE TELECOMMUNICATION FIELD. (U.S. CLS. 21, 23, 26, 36 AND 38).

CLASS 38—COMMUNICATION

FOR TELECOMMUNICATIONS SERVICES, NAMELY DATA, VIDEO AND AUDIO STREAMING AND TELEPHONY SERVICES WHICH ARE EITHER PUBLICLY BROADCAST OR COMMUNICATED. (U.S. CLS. 100, 101 AND 104).

LAURA KOVAISKY, EXAMINING ATTORNEY

SN 79-005,232. I.S.G. ITALIAN STYLISTIC GROUP S.R.L., ITALY, FILED 5-6-2004.

SN 79-005,405. RINO MASTROTTO GROUP S.P.A., ITALY, FILED 6-1-2004.



PRIORITY DATE OF 2-6-2004 IS CLAIMED.
OWNER OF INTERNATIONAL REGISTRATION 0833094 DATED 5-6-2004, EXPIRES 5-6-2014.

NO CLAIM IS MADE TO THE EXCLUSIVE RIGHT TO USE SKIN, APART FROM THE MARK AS SHOWN.

THE TRADEMARK CONSISTS OF THE WORDING "DEVIL'S SKIN" IN FANCY WORDS; BELOW SAID WORDS IS PRESENT A DESIGN REPRESENTING A DEVIL, WITH A THREE TINED FORK.

CLASS 3—COSMETICS AND CLEANING PREPARATIONS

FOR PERFUMERY; COSMETICS; SOAPS; ESSENTIAL OILS FOR PERSONAL USE; DENTIFRICES; AND HAIR LOTIONS (U.S. CLS. 1, 4, 6, 50, 51 AND 52).

CLASS 18—LEATHER GOODS

FOR GOODS MADE OF LEATHER AND IMITATION LEATHER, NAMELY, HANDBAGS, WALLETS, KEY-CASES, LUGGAGE, ATTACHE CASES, TOTE BAGS, BRIEFCASES, DOCUMENT CASES, COIN PURSES, SPORT BAGS, SHOULDER BAGS, GARMENT BAGS FOR TRAVELING, BACKPACKS, TRUNKS AND TRAVELLING BAGS; UMBRELLAS; WHIPS, HARNESSES AND SADDLERY (U.S. CLS. 1, 2, 3, 22 AND 41).

CLASS 25—CLOTHING

FOR CLOTHING; NAMELY, SHIRTS AND CHEMISES, T-SHIRTS, PANTS, SKIRTS, DRESSES, OVERCOATS, JACKETS, PULLOVERS, SWIMSUITS, UNDERWEAR, SCARVES, GLOVES; FOOTWEAR; HEADGEAR, NAMELY HATS, CAPS, BERETS AND VISORS; AND BELTS (U.S. CLS. 22 AND 39).

FRED MANDIR, EXAMINING ATTORNEY

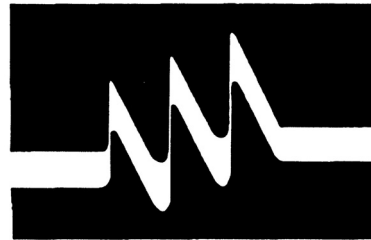

RINO MASTROTTO GROUP

OWNER OF INTERNATIONAL REGISTRATION 0683032 DATED 11-10-1997, EXPIRES 11-10-2007.

NO CLAIM IS MADE TO THE EXCLUSIVE RIGHT TO USE GROUP, APART FROM THE MARK AS SHOWN.

LETTER "M" IN STYLIZED NEGATIVE LETTERING IN A RECTANGULAR FRAME; IN THE LOWER PART THE INSCRIPTION "RINO MASTROTTO GROUP" IN CHARACTERS IN FUTURA FONT WHERE THE CENTRAL WORD IS IN BOLD TYPE.

CLASS 18—LEATHER GOODS

FOR LEATHER, SOLD IN BULK, ANIMAL SKINS, HIDES AND FUR-SKINS (U.S. CLS. 1, 2, 3, 22 AND 41).

CLASS 25—CLOTHING

FOR OVERCOATS, TROUSERS, JACKETS, SHIRTS, SKIRTS, TRACKSUITS, STOCKINGS, HATS, SHOES, AND BOOTS; WINDCHEATER (U.S. CLS. 22 AND 39).

KEVON CHISOLM, EXAMINING ATTORNEY

SN 79-005,419. MAGICORAL S.R.L., I-35123 PADOVA, ITALY, FILED 6-18-2004.

MALÍPÁRMI

THE MARK CONSISTS OF STANDARD CHARACTERS WITHOUT CLAIM TO ANY PARTICULAR FONT, STYLE, SIZE, OR COLOR.

OWNER OF INTERNATIONAL REGISTRATION 0793682 DATED 11-19-2002, EXPIRES 11-19-2012.

CLASS 18—LEATHER GOODS

FOR LEATHER AND IMITATION LEATHER SOLD IN BULK, AND GOODS MADE OF LEATHER OR OF LEATHER IMITATIONS, NAMELY HANDBAGS, PURSES, POCKET WALLETS, KEY CASES; ANIMAL SKINS AND HIDES; BAGS, NAMELY, EVENING BAGS, SUITCASES, DUFFLE BAGS, ALL PURPOSE CARRYING BAGS, HANDBAGS, SHOULDER BAGS, BELT BAGS, CLUTCH BAGS, LEATHER BAGS, BARREL BAGS, TOTE BAGS, ATHLETIC BAGS, TRUNKS AND TRAVELLING BAGS; UMBRELLAS, PARASOLS AND WALKING STICKS (U.S. CLS. 1, 2, 3, 22 AND 41).

CLASS 25—CLOTHING

FOR CLOTHING, NAMELY, DRESSES, SUITS, TROUSERS, SKIRTS, JACKETS, JERSEYS, UNDERWEAR, GLOVES, BELTS, HATS, CAPS AND SHOES, AND KNITWEAR, NAMELY, KNIT UNDERWEAR, KNIT SHIRTS, KNIT SWEATERS, KNIT SKIRTS, KNIT DRESSES, AND KNIT PANTS (U.S. CLS. 22 AND 39).

CLASS 35—ADVERTISING AND BUSINESS

FOR FRANCHISING, NAMELY OFFERING TECHNICAL ASSISTANCE IN THE ESTABLISHMENT AND/OR OPERATION OF CLOTHING STORES; RETAIL CLOTHING BOUTIQUES AND STORES (U.S. CLS. 100, 101 AND 102).

LEIGH LOWRY, EXAMINING ATTORNEY

SN 79-005,469. SULZER MANAGEMENT AG, SWITZERLAND, FILED 2-26-2004.



THE MARK CONSISTS OF STANDARD CHARACTERS WITHOUT CLAIM TO ANY PARTICULAR FONT, STYLE, SIZE, OR COLOR.

PRIORITY DATE OF 12-16-2003 IS CLAIMED.

OWNER OF INTERNATIONAL REGISTRATION 0833623 DATED 2-26-2004, EXPIRES 2-26-2014.

CLASS 6—METAL GOODS

FOR LINING MATERIALS OF METAL APPLIED TO WORK PIECES; METAL LININGS FOR USE AS PROTECTION OF SLIDING PARTS FROM WEAR; AND METAL LININGS FOR USE AS PROTECTION FROM WEAR (U.S. CLS. 2, 12, 13, 14, 23, 25 AND 50).

CLASS 7—MACHINERY

FOR MACHINE PARTS FOR USE IN DRIVE CHAINS OF VEHICLES, NAMELY MANUAL AND AUTOMATIC TRANSMISSIONS, AXLES AND PARTS THEREOF, TRANSFER CASES, CLUTCH PLATES, TORQUE CONVERTERS, SYNCHRONIZERS, LIMITED SLIP DIFFERENTIALS, SHIFT FORKS, SHIFTING ELEMENTS, AND WET RUNNING CLUTCHES; AND MACHINE PARTS, NAMELY MANUAL AND AUTOMATIC TRANSMISSIONS, AXLES AND PARTS THEREOF, TRANSFER CASES, CLUTCH PLATES, TORQUE CONVERTERS, SYNCHRONIZERS, LIMITED SLIP DIFFERENTIALS, SHIFT FORKS, SHIFTING ELEMENTS, AND WET RUNNING CLUTCHES WITH COATINGS AND/OR LININGS MADE OF METAL, CARBON, CARBON FIBER, CARBON SHEET AND/OR FRICTION LININGS (U.S. CLS. 13, 19, 21, 23, 31, 34 AND 35).

CLASS 12—VEHICLES

FOR FRICTION LININGS FOR USE IN THE DRIVE CHAIN OF A VEHICLE; FRICTION LININGS FOR USE WITH SYNCHRONIZERS, GEARBOXES AND CLUTCH FORKS; AND VEHICLE BRAKES (U.S. CLS. 19, 21, 23, 31, 35 AND 44).

CLASS 17—RUBBER GOODS

FOR REINFORCING LINING MATERIALS MADE OF CARBON FIBER; LININGS FOR PROTECTION OF SLIDING PARTS FROM WEAR; REINFORCING LININGS FOR PROTECTION FROM WEAR MADE OF CARBON FIBER MATERIALS; REINFORCING LININGS MADE OF CARBON FIBER MATERIALS; AND FRICTION LININGS FOR USE WITH VEHICLES (U.S. CLS. 1, 5, 12, 13, 35 AND 50).

CLASS 40—MATERIAL TREATMENT

FOR APPLYING METAL-CONTAINING COATINGS AND CARBON-CONTAINING LININGS TO WORK PIECES (U.S. CLS. 100, 103 AND 106).

RICHARD A. STRASER, EXAMINING ATTORNEY

SN 79-005,498. SIEMENS AKTIENGESELLSCHAFT, FED REP GERMANY, FILED 4-16-2004.



THE MARK CONSISTS OF STANDARD CHARACTERS WITHOUT CLAIM TO ANY PARTICULAR FONT, STYLE, SIZE, OR COLOR.

PRIORITY DATE OF 12-19-2003 IS CLAIMED.

OWNER OF INTERNATIONAL REGISTRATION 0833693 DATED 4-16-2004, EXPIRES 4-16-2014.

CLASS 7—MACHINERY

FOR MACHINES, MECHANICAL DEVICES AND SYSTEMS COMPOSED THEREOF, FOR INDUSTRIAL USE IN MATERIAL HANDLING AND LIFTING, NAMELY, MONORAIL SUSPENSION TRACKS, ELECTRONIC CONVEYORS AND REPLACEMENT PARTS THEREOF; ELECTRIC DRIVE MOTORS FOR INDUSTRIAL MACHINERY AND MATERIAL HANDLING AND LIFTING EQUIPMENT (U.S. CLS. 13, 19, 21, 23, 31, 34 AND 35).

CLASS 9—ELECTRICAL AND SCIENTIFIC APPARATUS

FOR COMPUTER HARDWARE AND COMPUTER SOFTWARE FOR USE IN THE OPERATION AND CONTROL OF ELECTRONIC CONVEYOR SYSTEMS USED IN INDUSTRIAL OPERATIONS, ELECTRONIC CONTROLLERS AND ELECTRONIC SWITCHES FOR CONTROLLING ELECTRONIC CONVEYOR SYSTEMS USED IN INDUSTRIAL OPERATIONS, ELECTRONIC INPUT AND OUTPUT DEVICES FOR USE IN INDUSTRIAL OPERATIONS TO COMMAND PROGRAMMABLE CONTROLLERS USED IN CONNECTION WITH ELECTRONIC CONVEYOR SYSTEMS (U.S. CLS. 21, 23, 26, 36 AND 38).

JOHN LINCOSKI, EXAMINING ATTORNEY

SN 79-005,500. QUADRANT IP AG, GRAFENAU 6; CH-6300 ZUG, SWITZERLAND, FILED 3-23-2004.



PRIORITY DATE OF 12-9-2003 IS CLAIMED.

OWNER OF INTERNATIONAL REGISTRATION 0833704 DATED 3-23-2004, EXPIRES 3-23-2014.

CLASS 12—VEHICLES

FOR THERMOPLASTIC BODY PARTS FOR AIRPLANES, AUTOMOBILES, BOATS, HELICOPTERS, MOTORCYCLES, SPACE VEHICLES, TRAINS, TRUCKS AND BICYCLES (U.S. CLS. 19, 21, 23, 31, 35 AND 44).

CLASS 17—RUBBER GOODS

FOR PLASTIC FIBERS FOR USE IN THE MANUFACTURE OF PLASTIC COMPOSITES; PLASTIC COMPOSITE MATERIAL IN THE FORM OF SHEETS, PROFILES, RODS, FOILS, PIPES AND BLOCKS FOR USE IN MANUFACTURING, LAMINATE FOIL CONSISTING PRIMARILY OF PLASTIC WITH OR WITHOUT A METAL LAYER FOR APPLICATION TO A SUBSTRATE; PLASTIC PIPES FOR PLUMBING PURPOSES (U.S. CLS. 1, 5, 12, 13, 35 AND 50).

CLASS 19—NON-METALLIC BUILDING MATERIALS

FOR NONMETALLIC TRANSPORTABLE CONSTRUCTIONS; NON-METAL CLADDING FOR CONSTRUCTION; NON-METAL FIRE-RESISTANT AND WATER-RESISTANT BOARDS AND PANELS FOR CONSTRUCTION; CONCRETE PANELS (U.S. CLS. 1, 12, 33 AND 50).

CLASS 20—FURNITURE AND ARTICLES NOT OTHERWISE CLASSIFIED

FOR FURNITURE; FURNITURE PARTS OF PLASTIC AND PLASTIC COMPOUNDS (U.S. CLS. 2, 13, 22, 25, 32 AND 50).

CLASS 21—HOUSEWARES AND GLASS

FOR FIBERGLASS WEB FOR CONVERSION INTO A VARIETY OF INDUSTRIAL AND CONSUMER GOODS, OTHER THAN FOR INSULATION OR TEXTILE USE (U.S. CLS. 2, 13, 23, 29, 30, 33, 40 AND 50).

IRA J. GOODSAD, EXAMINING ATTORNEY

CLASS 10—MEDICAL APPARATUS

FOR SURGICAL AND MEDICAL APPARATUS AND INSTRUMENTS, NAMELY, DIAGNOSTIC INSTRUMENTS AND APPARATUS USED IN OPHTHALMIC SURGICAL PROCEDURES, MEASURING EQUIPMENT FOR SKIN THICKNESS, FORCEPS, SCALPELS, MEDICAL DRILLS, SURGICAL CUTTING DEVICES, NAMELY, MICROKERATOM, DRAINAGE TUBES FOR MEDICAL PURPOSES, SPRAYERS FOR MEDICAL PURPOSES, ULTRAVIOLET LAMP THERAPEUTIC INSTRUMENT FOR MEDICAL PURPOSES, INFRARED LAMP THERAPEUTIC INSTRUMENT FOR MEDICAL PURPOSES, MEDICAL INSTRUMENT STANDS, MEDICAL INSTRUMENT TABLES, ARMCHAIRS FOR MEDICAL PURPOSES, BEDS, SPECIALLY MADE FOR MEDICAL PURPOSES, WARMING APPARATUS FOR THERAPEUTIC PURPOSES, ARTIFICIAL LIMBS, ARTIFICIAL EYES AND TEETH; LASER AND PERIPHERAL SYSTEMS IN THE FIELD OF MEDICAL TECHNOLOGY AND OPHTHALMOLOGY, NAMELY, LASER SYSTEMS FOR OPHTHALMIC SURGERY; LASER DEVICES AND THEIR COMPONENTS IN THE FIELD OF MEDICAL TECHNOLOGY AND OPHTHALMOLOGY, NAMELY, LASER DEVICES FOR OPHTHALMIC SURGERY AND LASER BEAM GUIDING DEVICES FOR MEDICAL PURPOSES (U.S. CLS. 26, 39 AND 44).

CLASS 37—CONSTRUCTION AND REPAIR

FOR INSTALLATION, ASSEMBLY, REPAIR AND MAINTENANCE OF SCIENTIFIC INSTRUMENTS AND APPARATUS FOR RESEARCH IN LABORATORIES; INSTALLATION, ASSEMBLY, REPAIR AND MAINTENANCE OF DEVICES AND EQUIPMENT FOR MEDICAL PURPOSES, LASER AND PERIPHERAL SYSTEMS, LASER DEVICES AND THEIR COMPONENTS (U.S. CLS. 100, 103 AND 106).

CLASS 41—EDUCATION AND ENTERTAINMENT

FOR TRAINING IN THE HANDLING OF SCIENTIFIC INSTRUMENTS AND APPARATUS FOR RESEARCH IN LABORATORIES; TRAINING IN THE HANDLING OF DEVICES AND EQUIPMENT FOR MEDICAL PURPOSES, LASER SYSTEMS, LASER DEVICES AND THEIR COMPONENTS (U.S. CLS. 100, 101 AND 107).

DAVID MURRAY, EXAMINING ATTORNEY

SN 79-005,527. WAVELIGHT LASER TECHNOLOGIE AG, FED REP GERMANY, FILED 4-29-2004.



PRIORITY DATE OF 10-29-2003 IS CLAIMED.
OWNER OF INTERNATIONAL REGISTRATION 0833780
DATED 4-29-2004, EXPIRES 4-29-2014.

CLASS 9—ELECTRICAL AND SCIENTIFIC APPARATUS

FOR COMPUTER HARDWARE AND COMPUTER SOFTWARE FOR OPERATING AND CONTROLLING MEDICAL APPARATUS AND INSTRUMENTS; DATA PRERECORDED CD-ROMS DATA CARRIERS FOR USE IN OPERATING AND CONTROLLING MEDICAL APPARATUS AND INSTRUMENTS (U.S. CLS. 21, 23, 26, 36 AND 38).

SN 79-005,549. CONSTRUCCIONES HISPANO GERMANAS, S.A., SPAIN, FILED 3-1-2004.

OLIVA NOVA

THE MARK CONSISTS OF STANDARD CHARACTERS WITHOUT CLAIM TO ANY PARTICULAR FONT, STYLE, SIZE, OR COLOR.

OWNER OF INTERNATIONAL REGISTRATION 0815163
DATED 6-16-2003, EXPIRES 6-16-2013.

THE NAME OLIVA NOVA DOES NOT IDENTIFY A LIVING INDIVIDUAL.

CLASS 9—ELECTRICAL AND SCIENTIFIC APPARATUS

FOR COMPUTER PROGRAMS FOR AUTOMATING THE PRODUCTION OF SOFTWARE FOR DEVELOPING APPLICATIONS (U.S. CLS. 21, 23, 26, 36 AND 38).

CLASS 35—ADVERTISING AND BUSINESS

FOR MAIL-ORDER SERVICES AND ON-LINE RETAILING SERVICES FOR COMPUTER APPARATUS AND EQUIPMENT (U.S. CLS. 100, 101 AND 102).

CLASS 38—COMMUNICATION

FOR RENTAL OF TELECOMMUNICATION APPARATUS; ELECTRONIC COMMUNICATION, NAMELY, TRANSMISSION OF DATA AND DOCUMENTS AMONG COMPUTER USERS, ELECTRONIC MAIL SERVICES, COMPUTER-AIDED MESSAGE AND IMAGE TRANSMISSION, ELECTRONIC TRANSMISSION OF MESSAGES, RENTAL OF MESSAGING TRANSMITTERS (U.S. CLS. 100, 101 AND 104).

CLASS 42—SCIENTIFIC, COMPUTER AND LEGAL SERVICES

FOR DESIGN OF COMPUTER SOFTWARE FOR THIRD PARTIES, COMPUTER CONSULTANCY, COMPUTER RENTAL, COMPUTER PROGRAMMING FOR THIRD PARTIES (U.S. CLS. 100 AND 101).

SHAUNIA WALLACE, EXAMINING ATTORNEY

SN 79-005,571. GIVAUDAN SA, SWITZERLAND, FILED 9-7-2004.

AMBROFIX

THE MARK CONSISTS OF STANDARD CHARACTERS WITHOUT CLAIM TO ANY PARTICULAR FONT, STYLE, SIZE, OR COLOR.

PRIORITY DATE OF 7-23-2004 IS CLAIMED.
OWNER OF INTERNATIONAL REGISTRATION 0833856 DATED 9-7-2004, EXPIRES 9-7-2014.

CLASS 1—CHEMICALS

FOR CHEMICALS USED FOR PREPARING PERFUMERY, COSMETICS, SOAP AND DETERGENT COMPOSITIONS (U.S. CLS. 1, 5, 6, 10, 26 AND 46).

CLASS 3—COSMETICS AND CLEANING PREPARATIONS

FOR PERFUMERY GOODS, PERFUMES, COSMETICS, SOAPS, DETERGENTS (U.S. CLS. 1, 4, 6, 50, 51 AND 52).
ALEXANDER L. POWERS, EXAMINING ATTORNEY

SN 79-005,573. EBM-PAPST MULFINGEN GMBH & CO. KG, FED REP GERMANY, FILED 2-18-2004.

ebmpapst

THE MARK CONSISTS OF STANDARD CHARACTERS WITHOUT CLAIM TO ANY PARTICULAR FONT, STYLE, SIZE, OR COLOR.

PRIORITY DATE OF 8-26-2003 IS CLAIMED.
OWNER OF INTERNATIONAL REGISTRATION 0833858 DATED 2-18-2004, EXPIRES 2-18-2014.

CLASS 6—METAL GOODS

FOR ACCESSORIES FOR ELECTROMOTIVE DRIVEN FANS, VENTILATORS AND BLOWERS, NAMELY SCREENS, SAFETY GUARDS, FILTER FRAMES, INLET RINGS, WALL RINGS, THE AFOREMENTIONED GOODS OF METAL (U.S. CLS. 2, 12, 13, 14, 23, 25 AND 50).

CLASS 7—MACHINERY

FOR ELECTRIC DRIVE MOTORS, OTHER THAN FOR LAND VEHICLES, FOR COMMERCIAL AND INDUSTRIAL USE; ELECTROMOTIVE DRIVEN FANS, VENTILATORS AND BLOWERS FOR MOTORS AND ENGINES AS WELL AS COMPONENT PARTS THEREOF; ACCESSORIES FOR ELECTROMOTIVE DRIVEN FANS, VENTILATORS AND BLOWERS FOR MOTORS AND ENGINES, NAMELY AIR AND DUST FILTERS OF METAL AND PLASTIC FOR MECHANICAL PURPOSES; ELECTROMOTIVE DRIVEN PUMPS; DUST SEPARATORS (U.S. CLS. 13, 19, 21, 23, 31, 34 AND 35).

CLASS 9—ELECTRICAL AND SCIENTIFIC APPARATUS

FOR POWER SUPPLY AND CONTROL UNITS; ELECTRONIC COMMUTATION CIRCUITS FOR MOTORS; DATA PROCESSORS, CENTRAL PROCESSING UNITS FOR DATA PROCESSING, COMPUTER PROGRAMS FOR DATA PROCESSING; ACCESSORIES FOR ELECTROMOTIVE DRIVEN FANS, VENTILATORS AND BLOWERS, NAMELY TERMINAL BOXES OF METAL AND PLASTIC, TEMPERATURE SENSORS AND MOTOR CAPACITORS (U.S. CLS. 21, 23, 26, 36 AND 38).

CLASS 11—ENVIRONMENTAL CONTROL APPARATUS

FOR VENTILATING EXHAUST FANS, ELECTROMOTIVE DRIVEN FANS AND VENTILATING FANS, REFRIGERATING MACHINES, HEATING FURNACES; ELECTROMOTIVE DRIVEN BLOWERS FOR VENTILATION AND AIR CONDITIONING UNITS (U.S. CLS. 13, 21, 23, 31 AND 34).

CLASS 20—FURNITURE AND ARTICLES NOT OTHERWISE CLASSIFIED

FOR ACCESSORIES FOR ELECTROMOTIVE DRIVEN FANS, VENTILATORS AND BLOWERS, NAMELY SCREENS, SAFETY GUARDS, FILTER FRAMES, INLET RINGS, WALL RINGS, THE AFOREMENTIONED GOODS OF PLASTICS (U.S. CLS. 2, 13, 22, 25, 32 AND 50).

CLASS 37—CONSTRUCTION AND REPAIR

FOR ADVISORY SERVICES FOR DRIVING AND VENTILATION TECHNOLOGY, IN PARTICULAR CONCERNING THE INSTALLATION OF ELECTROMOTORS, FANS, VENTILATORS AND BLOWERS (U.S. CLS. 100, 103 AND 106).

CLASS 42—SCIENTIFIC, COMPUTER AND LEGAL SERVICES

FOR TECHNICAL ADVISORY SERVICES FOR DRIVING AND VENTILATION TECHNOLOGY, IN PARTICULAR CONCERNING THE USE OF ELECTROMOTORS, FANS, VENTILATORS AND BLOWERS; TECHNICAL DEVELOPMENT OF PRODUCTS FOR THIRD PARTIES CONCERNING DRIVING, VENTILATION AND AIR CONDITIONING TECHNOLOGY (U.S. CLS. 100 AND 101).

MONTIA G. PRESSEY, EXAMINING ATTORNEY

SN 79-005,608. AVERY DENNISON ZWECKFORM OFFICE; PRODUCTS EUROPE GMBH, FED REP GERMANY, FILED 1-12-2004.



OWNER OF INTERNATIONAL REGISTRATION 0833940 DATED 1-12-2004, EXPIRES 1-12-2014.

CLASS 9—ELECTRICAL AND SCIENTIFIC APPARATUS

FOR GRAPHIC DESIGN COMPUTER SOFTWARE FOR DESIGNING BUSINESS CARDS, PRINT T-SHIRTS, CD AND DVD LABELS AND OTHER LABELS TO MARK GOODS; CD-ROMS AND DVDS FEATURING GRAPHIC DESIGN SOFTWARE (U.S. CLS. 21, 23, 26, 36 AND 38).

CLASS 16—PAPER GOODS AND PRINTED MATTER

FOR ADHESIVE NOTE PAPER, CARDBOARD, FOILS OF PLASTIC, NOTE PADS, ADHESIVE NOTE PADS, BUSINESS CARDS, PAPER AND CARDBOARD LABELS AND STICKERS FOR INFORMATION AND DECORATION PURPOSES (U.S. CLS. 2, 5, 22, 23, 29, 37, 38 AND 50).

NAAKWAMA ANKRAH, EXAMINING ATTORNEY

SN 79-005,619. PUGHON STEPHANE, FRANCE, FILED 8-2-2004.

SOPHIE YACHTS

PRIORITY DATE OF 2-12-2004 IS CLAIMED. OWNER OF INTERNATIONAL REGISTRATION 0833989 DATED 8-2-2004, EXPIRES 8-2-2014.

NO CLAIM IS MADE TO THE EXCLUSIVE RIGHT TO USE "YACHTS", APART FROM THE MARK AS SHOWN.

CLASS 12—VEHICLES

FOR BOATS AND YACHTS; VEHICLES AND APPARATUS FOR LOCOMOTION BY WATER, NAMELY SMALL POWERBOATS, PERSONAL JET BOATS, WATER SCOOTERS, CATAMARANS AND HYDROFOIL SUPPORTED CATAMARANS (U.S. CLS. 19, 21, 23, 31, 35 AND 44).

CLASS 37—CONSTRUCTION AND REPAIR

FOR CUSTOM SHIPBUILDING AND NAVAL SHIPBUILDING (U.S. CLS. 100, 103 AND 106). WARREN L. OLANDRIA, EXAMINING ATTORNEY

SN 79-005,635. AUDI AG, FED REP GERMANY, FILED 6-16-2004.

AUDI RSQ

THE MARK CONSISTS OF STANDARD CHARACTERS WITHOUT CLAIM TO ANY PARTICULAR FONT, STYLE, SIZE, OR COLOR.

PRIORITY DATE OF 3-2-2004 IS CLAIMED.

OWNER OF INTERNATIONAL REGISTRATION 0834103 DATED 6-16-2004, EXPIRES 6-16-2014.

OWNER OF U.S. REG. NOS. 1,416,538 AND 2,083,439.

CLASS 12—VEHICLES

FOR AUTOMOBILES (U.S. CLS. 19, 21, 23, 31, 35 AND 44).

CLASS 28—TOYS AND SPORTING GOODS

FOR GAMES AND PLAYTHINGS, NAMELY, TOY CARS, SCALE MODEL CARS (U.S. CLS. 22, 23, 38 AND 50).

HOWARD SMIGA, EXAMINING ATTORNEY

SN 79-005,666. C.R.F.; SOCIETÀ CONSORTILE PER AZIONI, ITALY, FILED 4-6-2004.

MODULARJET

THE MARK CONSISTS OF STANDARD CHARACTERS WITHOUT CLAIM TO ANY PARTICULAR FONT, STYLE, SIZE, OR COLOR.

PRIORITY DATE OF 10-10-2003 IS CLAIMED.

OWNER OF INTERNATIONAL REGISTRATION 0834142 DATED 4-6-2004, EXPIRES 4-6-2014.

CLASS 7—MACHINERY

FOR PARTS FOR INTERNAL COMBUSTION ENGINES, NAMELY TIMERS, VALVE LIFTERS, INJECTORS, IGNITERS, ELECTROHYDRAULIC ACTUATORS, SOLENOIDS, PISTONS, VALVES, FLUID RESERVOIRS (U.S. CLS. 13, 19, 21, 23, 31, 34 AND 35).

CLASS 12—VEHICLES

FOR INTERNAL COMBUSTION ENGINES FOR LAND VEHICLES (U.S. CLS. 19, 21, 23, 31, 35 AND 44).

ROBERT C. CLARK JR., EXAMINING ATTORNEY

SN 79-005,708. ATS AUTOMATIC TAPING SYSTEMS AG, CH-6300 ZUG, SWITZERLAND, FILED 4-27-2004.

—ATS—

PRIORITY DATE OF 1-20-2004 IS CLAIMED.

OWNER OF INTERNATIONAL REGISTRATION 0834204 DATED 4-27-2004, EXPIRES 4-27-2014.

CLASS 7—MACHINERY

FOR BAND FASTENING MACHINES, NAMELY BANDEROLING MACHINES FOR WRAPPING ITEMS IN PLASTIC AND/OR PAPER FILM AND LOOP BANDING MACHINES FOR BUNDLING PACKAGES (U.S. CLS. 13, 19, 21, 23, 31, 34 AND 35).

CLASS 22—CORDAGE AND FIBERS

FOR BANDS NOT OF METAL, MADE OF PAPER AND/OR PLASTIC, FOR USE WITH BANDEROLING MACHINES AND LOOP BANDING MACHINES FOR WRAPPING OR BINDING PACKAGES; TRANSPARENT, PRINTER AND/OR COLOURED BANDS FOR WRAPPING OR BINDING (U.S. CLS. 1, 2, 7, 19, 22, 42 AND 50).
SKYE YOUNG, EXAMINING ATTORNEY

SN 79-005,728. ZONE SYSTEMS BIH AB, SWEDEN, FILED 11-3-2003.



OWNER OF INTERNATIONAL REGISTRATION 0834271 DATED 11-3-2003, EXPIRES 11-3-2013.

THE MARK CONSISTS OF THE TERM ZONE INCLUDING A STYLIZATION OF THE LETTER "O".

CLASS 20—FURNITURE AND ARTICLES NOT OTHERWISE CLASSIFIED

FOR ADVERTISING SIGNS AND FRAMES MADE OF WOOD AND PLASTIC; SIGN AND ADVERTISING BOXES MADE OF WOOD AND PLASTIC; DISPLAY BOARDS FOR ADVERTISING AND COMMERCIAL PURPOSES; METAL SIGN AND DISPLAY STANDS (U.S. CLS. 2, 13, 22, 25, 32 AND 50).

CLASS 40—MATERIAL TREATMENT

FOR CUSTOM ASSEMBLY OF ADVERTISING SIGNS AND FRAMES, ADVERTISING BOXES, DISPLAY BOARDS AND STANDS (U.S. CLS. 100, 103 AND 106).

CLASS 42—SCIENTIFIC, COMPUTER AND LEGAL SERVICES

FOR INDUSTRIAL DESIGN RELATING TO ADVERTISING SYSTEMS AND DISPLAY CONCEPTS (U.S. CLS. 100 AND 101).

KATHRYN COWARD, EXAMINING ATTORNEY

SN 79-005,889. IMPATTO DI BALDASSARRI ALFIO E C.; S.A.S., I-60010 OSTRA VETERE (AN), ITALY, FILED 7-8-2004.



OWNER OF INTERNATIONAL REGISTRATION 0803972 DATED 4-7-2003, EXPIRES 4-7-2013.

THE TRADE MARK CONSISTS IN THE WORDS "AB SOUL" WRITTEN IN SPECIAL TYPE FOLLOWED BY THE LETTER "C" REVERSED AND PLACED ABOVE THE LAST LETTER.

CLASS 3—COSMETICS AND CLEANING PREPARATIONS

FOR LIQUID, LAUNDRY, SKIN, HAND SOAPS; PERFUMERY, ESSENTIAL OILS FOR PERSONAL USE, COSMETICS, HAIR LOTIONS (U.S. CLS. 1, 4, 6, 50, 51 AND 52).

CLASS 9—ELECTRICAL AND SCIENTIFIC APPARATUS

FOR SPECTACLES; SPECTACLE SETTINGS, NAMELY, SPECTACLE HOLDERS, SPECTACLE CHAINS; SUNGLASSES; PINCE-NEZ CASES; PINCE-NEZ CHAINS; PINCE-NEZ CORDS (U.S. CLS. 21, 23, 26, 36 AND 38).

CLASS 18—LEATHER GOODS

FOR LEATHER AND IMITATION LEATHER, NAMELY, BAGS, SUITCASES AND WALLETS; GOODS MADE FROM LEATHER AND IMITATION LEATHER, NAMELY, BAGS, SUITCASES AND WALLETS; ANIMAL SKINS; ANIMAL HIDES, TRUNKS AND SUITCASES; UMBRELLAS, PARASOLS AND WALKING STICKS; WHIPS AND SADDLERY (U.S. CLS. 1, 2, 3, 22 AND 41).

CLASS 25—CLOTHING

FOR CLOTHING, NAMELY, JACKETS, TROUSERS, JEANS, GLOVES, SOCKS, SWEATERS, CARDIGANS, BELTS, TRACKSUITS, SPORT SHIRTS, T-SHIRTS, BLOUSES, OVERCOATS, RAINCOATS, SUITS, SKIRTS, PULLOVERS, UNDERWEAR, PAJAMAS, VESTS, BIKINIS AND BEACHWEAR; FOOTWEAR; HEADWEAR (U.S. CLS. 22 AND 39).

DANIEL BRODY, EXAMINING ATTORNEY

SN 79-005,899. COLOMBIN G.M. & FIGLIO S.P.A., ITALY, FILED 5-12-2004.



PRIORITY DATE OF 12-19-2003 IS CLAIMED.
OWNER OF INTERNATIONAL REGISTRATION 0834822 DATED 5-12-2004, EXPIRES 5-12-2014.

ACRONYM C&F IN FANTASY CHARACTERS; THE CAPITAL LETTERS C AND F ARE PLACED ON THE SAME PLANE WHILE THE & SYMBOL IS PLACED LOWER AND JOINS THE ABOVE-MENTIONED LETTERS.

CLASS 6—METAL GOODS

FOR METAL STOPPERS FOR BOTTLES (U.S. CLS. 2, 12, 13, 14, 23, 25 AND 50).

CLASS 20—FURNITURE AND ARTICLES NOT OTHERWISE CLASSIFIED

FOR CORK, PARTICULARLY IN THE SHAPE OF SHEETS OR BANDS, FOR THE MANUFACTURING OF CORK STOPPERS; GOODS MADE OF CORK, NAMELY, CORK STOPPERS; AND, PLASTIC STOPPERS FOR BOTTLES (U.S. CLS. 2, 13, 22, 25, 32 AND 50).
MATTHEW KLINE, EXAMINING ATTORNEY

SN 79-006,004. MÜHLENCHEMIE GMBH & CO. KG, FED REP GERMANY, FILED 5-6-2004.

Alphamalt

SN 79-005,921. TECHINT COMPAGNIA TECNICA; INTERNAZIONALE S.P.A., ITALY, FILED 5-12-2004.

THE MARK CONSISTS OF STANDARD CHARACTERS WITHOUT CLAIM TO ANY PARTICULAR FONT, STYLE, SIZE, OR COLOR.

PRIORITY DATE OF 11-17-2003 IS CLAIMED.
OWNER OF INTERNATIONAL REGISTRATION 0835114 DATED 5-6-2004, EXPIRES 5-6-2014.

FlexyTech

OWNER OF INTERNATIONAL REGISTRATION 0834896 DATED 5-12-2004, EXPIRES 5-12-2014.

CLASS 1—CHEMICALS

FOR CHEMICAL MALT BASED ENZYMES FOR USE IN THE FOOD INDUSTRY; CHEMICAL MALT BASED ENZYMES USED FOR PRESERVING FRESHNESS AND PRESERVATION OF FOODSTUFFS, NAMELY, FLOUR AND BAKERY PRODUCTS; ENZYMES AND ENZYME PREPARATIONS USED IN INDUSTRY; ENZYMES AND ENZYME PREPARATIONS FOR THE BAKERY INDUSTRY (U.S. CLS. 1, 5, 6, 10, 26 AND 46).

CLASS 7—MACHINERY

FOR INSTALLATIONS, EQUIPMENT AND MACHINERY FOR THE METALLURGY INDUSTRY, NAMELY, HEATING AND HEAT TREATMENT FURNACES; COMPONENTS OF HEATING AND HEAT TREATMENT FURNACES, NAMELY, BURNERS AND COMBUSTION CONTROLS FOR OPTIMIZING HEATING AND REDUCING POLLUTANT EMISSIONS; CHARGING AND DISCHARGING MACHINES; CHARGE SUPPORT AND MOVEMENT MACHINES COMPRISING ROLLERS, BEAMS AND RIDERS FOR THE PROCESS CONTROL OF FURNACES (U.S. CLS. 13, 19, 21, 23, 31, 34 AND 35).

CLASS 30—STAPLE FOODS

FOR FLOUR AND PROCESSED CEREALS (U.S. CL. 46).
RICHARD A. STRASER, EXAMINING ATTORNEY

CLASS 11—ENVIRONMENTAL CONTROL APPARATUS

FOR FURNACES, AND HEATERS FOR HEAT TREATMENT, CALCINATIONS, FIRING, DIRECT REDUCTION OF PRODUCTS AND MATERIALS FOR THE METALLURGICAL INDUSTRY; BURNERS FOR FURNACES (U.S. CLS. 13, 21, 23, 31 AND 34).

SN 79-006,024. FSP-ONE, FRANCE, FILED 9-1-2004.

FSP-one

CLASS 37—CONSTRUCTION AND REPAIR

FOR INSTALLATION, SERVICING AND REPAIR SERVICES OF MACHINERY FOR THE METALLURGICAL INDUSTRY; MAINTENANCE SERVICES AS REGARDS THERMAL PROCESSING EQUIPMENT FOR THE METALLURGICAL INDUSTRY (U.S. CLS. 100, 103 AND 106).

OWNER OF INTERNATIONAL REGISTRATION 0835171 DATED 9-1-2004, EXPIRES 9-1-2014.

CLASS 42—SCIENTIFIC, COMPUTER AND LEGAL SERVICES

FOR ENGINEERING PROJECT DESIGN SERVICES FOR PROCESSES, EQUIPMENT AND INSTALLATIONS FOR METAL PROCESSING; ENGINEERING PROJECT DESIGN SERVICES FOR FURNACES, BURNERS FOR FURNACES, PROCESSES AND EQUIPMENT FOR THE HEATING, HEAT TREATMENT, CALCINATION, FIRING, DIRECT REDUCTION OF PRODUCTS AND MATERIALS FOR THE METALLURGICAL INDUSTRY; ENGINEERING PROJECT DESIGN SERVICES IN CONNECTION WITH IMPROVING AND ADAPTING THERMAL PROCESSES FOR THE METALLURGICAL INDUSTRY (U.S. CLS. 100 AND 101).
RICHARD A. STRASER, EXAMINING ATTORNEY

CLASS 6—METAL GOODS

FOR METAL WIRES AND WIRES OF COMMON METAL ALLOYS, EXCEPT FUSES (U.S. CLS. 2, 12, 13, 14, 23, 25 AND 50).

CLASS 40—MATERIAL TREATMENT

FOR METAL PLATING AND COATING AND PROVIDING INFORMATION REGARDING TREATMENT OF SUCH MATERIALS (U.S. CLS. 100, 103 AND 106).
PAULA MAHONEY, EXAMINING ATTORNEY

SN 79-006,217. F.B.A.I. FONDERIA BRONZI ARTISTICI; ITALIA S.A.S. DI PEREGO FRANCO.; CALEGARI UMBERTO EC., ITALY, FILED 5-12-2004.



PRIORITY DATE OF 12-24-2003 IS CLAIMED.
OWNER OF INTERNATIONAL REGISTRATION 0835752
DATED 5-12-2004, EXPIRES 5-12-2014.
THE TRADEMARK CONSISTS OF THE ACRONYM
F.B.A.I. PLACED WITHIN TWO SEMICIRCLES ABOVE
WHICH IS THE FANCY DEPICTION OF A CROWN.

CLASS 11—ENVIRONMENTAL CONTROL AP- PARATUS

FOR ARC LAMPS, CHANDELIERS, ELECTRIC CANDELABRAS, ELECTRIC LANTERNS, ELECTRIC LIGHTING FIXTURES, NAMELY SCONCES, LAMPS, FLOOR LAMPS, ELECTRIC NIGHT LAMPS, DOWNLIGHTERS AND CEILING LAMPS (U.S. CLS. 13, 21, 23, 31 AND 34).

CLASS 14—JEWELRY

FOR CANDLESTICKS OF PRECIOUS METAL; CLOCKS; DECORATIVE BOXES MADE OF PRECIOUS METAL; FIGURES OF PRECIOUS METAL; FIGURINES OF PRECIOUS METAL; FLOWER BOWLS OF PRECIOUS METAL; NON-ELECTRIC CANDELABRAS MADE OF PRECIOUS METAL; PARTS OF CLOCKS; POTPOURRI DISHES MADE IN WHOLE OR IN PART OF PRECIOUS METAL; STATUES OF PRECIOUS METAL; STATUETTES OF PRECIOUS METAL; VASES OF PRECIOUS METAL; ALARM CLOCKS (U.S. CLS. 2, 27, 28 AND 50).

CLASS 20—FURNITURE AND ARTICLES NOT OTHERWISE CLASSIFIED

FOR FURNITURE, FURNITURE PARTS, NAMELY TABLE LEAVES; JEWELRY BOXES NOT OF METAL; JEWELRY CASES NOT OF PRECIOUS METAL; MIRRORS; MIRROR FRAMES; NON-METALLIC BOXES; NON-METALLIC TROPHY COLUMNS, STATUES OF IVORY, BONE, PLASTER, PLASTIC, WAX AND WOOD; STATUETTES OF IVORY, BONE, PLASTER, PLASTIC, WAX AND WOOD; TABLES; DECORATIVE MOBILES; PEDESTALS (U.S. CLS. 2, 13, 22, 25, 32 AND 50).

CYNTHIA SLOAN, EXAMINING ATTORNEY

SN 79-006,221. BITBOYS OY, FINLAND, FILED 6-21-2004.

BITBOYS

THE MARK CONSISTS OF STANDARD CHARACTERS WITHOUT CLAIM TO ANY PARTICULAR FONT, STYLE, SIZE, OR COLOR.

OWNER OF INTERNATIONAL REGISTRATION 0835762
DATED 6-21-2004, EXPIRES 6-21-2014.

CLASS 9—ELECTRICAL AND SCIENTIFIC APPARATUS

FOR MICROPROCESSORS USED FOR PRODUCING THREE-DIMENSIONAL GRAPHICS ON A SCREEN AND PRODUCTS RELATED THERETO, NAMELY, SUPPLEMENTARY MATERIAL IN THE FORM OF CD- OR DVD-RECORDINGS (U.S. CLS. 21, 23, 26, 36 AND 38).

CLASS 16—PAPER GOODS AND PRINTED MATTER

FOR PRINTED BOOKS AND MANUALS FEATURING SUPPLEMENTARY PRINTED MATERIAL FOR MICROPROCESSORS USED FOR PRODUCING THREE-DIMENSIONAL GRAPHICS ON A SCREEN (U.S. CLS. 2, 5, 22, 23, 29, 37, 38 AND 50).

SEAN DWYER, EXAMINING ATTORNEY

SN 79-006,261. ALLCHEM S.R.L., ITALY, FILED 3-30-2004.

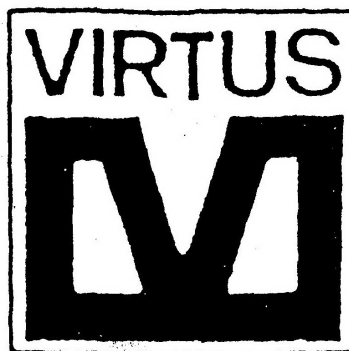

OWNER OF INTERNATIONAL REGISTRATION 0819796
DATED 10-20-2003, EXPIRES 10-20-2013.

THE TRADEMARK CONSISTS IN THE WORDING VIRTUS OVERLOOKING, IN THE CENTRAL PART, A SPECIAL V, THE ENDS OF WHICH JOINTS IN THE LOWER PART, THE WHOLE IN A THIN LINE DEFINING A SQUARE IN ANY DIMENSION OR COLOUR.

CLASS 1—CHEMICALS

FOR CHEMICALS FOR USE IN THE MANUFACTURE OF A WIDE VARIETY OF GOODS IN THE FIELDS OF INDUSTRY, SCIENCE, PHOTOGRAPHY, AGRICULTURE, HORTICULTURE AND FORESTRY; NATURAL AND CHEMICAL MANURE FOR USE IN THE FIELDS OF AGRICULTURE, HORTICULTURE AND FORESTRY; FIRE EXTINGUISHING COMPOSITIONS; TEMPERING AND SOLDERING CHEMICALS FOR USE IN THE BICYCLE, SHIPYARD, CARPENTRY, JOINERY, MARBLE, MOTORCYCLE AND AUTOMOBILE MANUFACTURING AND REPAIR, AND CAR WASH INDUSTRIES; CHEMICAL SUBSTANCES FOR PRESERVING FOODSTUFFS; TANNING SUBSTANCES; ADHESIVES USED IN THE BICYCLE, SHIPYARD, CARPENTRY, JOINERY, MARBLE, MOTORCYCLE AND AUTOMOBILE MANUFACTURING AND REPAIR, AND CAR WASH INDUSTRIES (U.S. CLS. 1, 5, 6, 10, 26 AND 46).

CLASS 2—PAINTS

FOR PAINTS, VARNISHES, LACQUERS; PRESERVATIVES AGAINST RUST AND AGAINST DETERIORATION OF WOOD; COLORANTS, MORDANTS AND RAW NATURAL RESINS FOR USE IN THE BICYCLE, SHIPYARD, CARPENTRY, JOINERY, MARBLE, MOTORCYCLE AND AUTOMOBILE MANUFACTURING AND REPAIR, AND CAR WASH INDUSTRIES; METALS IN FOIL AND POWDER FORM FOR PAINTERS AND DECORATORS (U.S. CLS. 6, 11 AND 16).

CLASS 3—COSMETICS AND CLEANING PREPARATIONS

FOR PREPARATIONS FOR POLISHING COACHWORKS; ABRASIVE PASTES (U.S. CLS. 1, 4, 6, 50, 51 AND 52).

CLASS 19—NON-METALLIC BUILDING MATERIALS

FOR PLASTERS (U.S. CLS. 1, 12, 33 AND 50).
STEVEN JACKSON, EXAMINING ATTORNEY

CLASS 16—PAPER GOODS AND PRINTED MATTER

FOR BOOKS, BOOKLETS, INFORMATIONAL SHEETS AND PRINTED DIAGRAMS IN THE FIELDS OF HYDROGRAPHY, OCEANOGRAPHY, NAVIGATION, MARITIME SAFETY AND MARITIME TELECOMMUNICATIONS; PRINTED TIDAL HEIGHT AND MOTION PREDICTIONS IN THE FORM OF TABLES AND DIAGRAMS; HYDROGRAPHIC CHARTS; NAVIGATIONAL CHARTS FOR USE BY AIRCRAFT, MARINE VESSELS AND MARINE AND MARITIME ORGANISATIONS; CHARTS AND DIAGRAMS DEPICTING HYDROGRAPHIC, OCEANOGRAPHIC, NAVIGATIONAL, ASTRONOMICAL AND METEOROLOGICAL INFORMATION; CHARTS AND DIAGRAMS DEPICTING INFORMATION RELATING TO MARITIME SAFETY; CHARTS AND DIAGRAMS DEPICTING WORLD TIME ZONES; CHARTS AND DIAGRAMS DEPICTING VARIATIONS IN THE EARTH'S MAGNETIC FIELD; PRINTED INSTRUCTIONAL MATERIAL IN THE FIELD OF MARINE NAVIGATION (U.S. CLS. 2, 5, 22, 23, 29, 37, 38 AND 50).

CLASS 42—SCIENTIFIC, COMPUTER AND LEGAL SERVICES

FOR PROVIDING TEMPORARY USE OF NON-DOWNLOADABLE SOFTWARE FEATURING TIDAL HEIGHT AND MOTION PREDICTIONS IN THE FORM OF TABLES AND DIAGRAMS BY MEANS OF A GLOBAL COMPUTER NETWORK; PROVIDING TEMPORARY USE OF NON-DOWNLOADABLE SOFTWARE FEATURING TIDAL HEIGHT AND MOTION PREDICTIONS IN THE FORM OF TABLES AND DIAGRAMS BY MEANS OF AN ON-LINE SERVICE; CONSULTATION AND RESEARCH IN THE FIELD OF HYDROGRAPHY, OCEANOGRAPHY, NAVIGATION AND MARITIME SAFETY (U.S. CLS. 100 AND 101).

ESTHER BELENKER, EXAMINING ATTORNEY

SN 79-006,333. THE SECRETARY OF STATE FOR DEFENCE.; UNITED KINGDOM, UNITED KINGDOM, FILED 7-15-2004.

ADMIRALTY CHARTS AND PUBLICATIONS

THE MARK CONSISTS OF STANDARD CHARACTERS WITHOUT CLAIM TO ANY PARTICULAR FONT, STYLE, SIZE, OR COLOR.

OWNER OF INTERNATIONAL REGISTRATION 0836061 DATED 7-15-2004, EXPIRES 7-15-2014.

NO CLAIM IS MADE TO THE EXCLUSIVE RIGHT TO USE "CHARTS AND PUBLICATIONS", APART FROM THE MARK AS SHOWN.

CLASS 9—ELECTRICAL AND SCIENTIFIC APPARATUS

FOR COMPUTER SOFTWARE FOR USE IN AERONAUTICAL AND MARINE NAVIGATION; COMPUTER SOFTWARE FOR PREDICTING TIDAL HEIGHTS AND MOTION; COMPUTER SOFTWARE FOR REPRESENTING HYDROGRAPHIC, OCEANOGRAPHIC AND NAVIGATIONAL DATA IN THE FORM OF AN ELECTRONICALLY PRODUCED IMAGE; COMPUTER SOFTWARE FEATURING ELECTRONIC CHARTS FOR AERONAUTICAL AND MARINE NAVIGATION; ELECTRONIC DATABASES RECORDED ON COMPUTER MEDIA FEATURING HYDROGRAPHIC, OCEANOGRAPHIC AND NAVIGATIONAL DATA; DOWNLOADABLE ELECTRONIC DATABASES FEATURING HYDROGRAPHIC, OCEANOGRAPHIC AND NAVIGATIONAL DATA; DOWNLOADABLE ELECTRONIC PUBLICATIONS IN THE FORM OF TABLES, INFORMATION SHEETS, BOOKLETS AND DIAGRAMS, IN THE FIELDS OF HYDROGRAPHY, OCEANOGRAPHY, NAVIGATION, MARITIME SAFETY AND MARITIME TELECOMMUNICATIONS; DOWNLOADABLE ELECTRONIC PUBLICATIONS IN THE FORM OF TABLES AND DIAGRAMS FEATURING TIDAL HEIGHT AND MOTION PREDICTIONS (U.S. CLS. 21, 23, 26, 36 AND 38).

SN 79-006,409. SEIKODO CORPORATION, JAPAN, FILED 3-11-2004.

BARCODE CATS

PRIORITY DATE OF 12-26-2003 IS CLAIMED.

OWNER OF INTERNATIONAL REGISTRATION 0836322 DATED 3-11-2004, EXPIRES 3-11-2014.

CLASS 14—JEWELRY

FOR PRECIOUS METALS; NUTCRACKERS, PEPPER POTS, SUGAR BOWLS, SALT SHAKERS, EGG CUPS, NAPKIN HOLDERS, NAPKIN RINGS, AND TOOTHPICK HOLDERS OF PRECIOUS METAL; BOXES OF PRECIOUS METAL FOR NEEDLES; CANDLE EXTINGUISHERS AND CANDLESTICKS OF PRECIOUS METAL; JEWEL CASES OF PRECIOUS METAL; FLOWER VASES AND BOWLS OF PRECIOUS METAL; PERSONAL ORNAMENTS OF PRECIOUS METAL; PURSES AND WALLETS OF PRECIOUS METAL; UNWROUGHT AND SEMI-WROUGHT PRECIOUS STONES AND THEIR IMITATIONS; POWDER COMPACTS OF PRECIOUS METAL; SHOE ORNAMENTS OF PRECIOUS METAL; CLOCKS AND WATCHES (U.S. CLS. 2, 27, 28 AND 50).

CLASS 16—PAPER GOODS AND PRINTED MATTER

FOR SEALING WAX; PRINTERS' REGLETS; PRINTING TYPES; ADDRESSING MACHINES; INKING RIBBONS; ELECTRIC STAPLERS FOR OFFICES; ENVELOPE SEALING MACHINES FOR OFFICES; DRAWING INSTRUMENTS; TYPEWRITERS; MIMEOGRAPHS; PAPER SHREDDERS FOR OFFICE USE; FRANKING MACHINES; ROTARY DUPLICATORS; MARKING TEMPLATES; ELECTRIC PENCIL SHARPENERS; DECORATORS' PAINTBRUSHES; BABIES' DIAPERS OF PAPER; INDUSTRIAL PACKAGING CONTAINERS OF PAPER; FOOD WRAPPING PLASTIC FILM FOR HOUSEHOLD USE; GARBAGE BAGS OF PAPER FOR HOUSEHOLD USE; GARBAGE BAGS OF PLASTIC FOR HOUSEHOLD USE; TAILORS' CHALK; BANNERS OF PAPER; FLAGS OF PAPER; HYGIENIC PAPER; TABLE NAPKINS OF PAPER; HAND TOWELS OF PAPER; HANDKERCHIEFS OF PAPER; PRINTED LOTTERY TICKETS OTHER THAN TOYS; TABLE CLOTHS OF PAPER; PAPER AND CARDBOARD; STATIONERY; CALENDARS; PAINTINGS AND CALLIGRAPHIC WORKS; PHOTOGRAPHS; PHOTOGRAPH STANDS (U.S. CLS. 2, 5, 22, 23, 29, 37, 38 AND 50).

CLASS 20—FURNITURE AND ARTICLES NOT OTHERWISE CLASSIFIED

FOR MEERSCHAUM; LOADING PALLETS NOT OF METAL; BEEHIVES; HAIRDRESSER'S CHAIRS; BARBERS' CHAIRS; VALVES OF PLASTIC NOT INCLUDING MACHINE ELEMENTS; CONTAINERS FOR TRANSPORT, NOT OF METAL; NUTS, SCREWS, BOLTS, AND CASTERS, NOT OF METAL; NON-ELECTRIC LOCKS NOT OF METAL; CUSHIONS; JAPANESE FLOOR CUSHIONS; PILLOWS; MATTRESSES; INDUSTRIAL PACKAGING CONTAINERS OF WOOD, BAMBOO OR PLASTICS; DRINKING STRAWS; EMBROIDERY FRAMES; NAMEPLATES AND DOOR NAMEPLATES NOT OF METAL; FLAGPOLES; HAND-HELD FLAT FANS; HAND-HELD FOLDING FANS; BEDS FOR HOUSEHOLD PETS; DOG KENNELS; STEP LADDERS AND LADDERS NOT OF METAL; LETTER BOXES NOT OF METAL OR MASONRY; TOOL BOXES NOT OF METAL; FURNITURE; INDOOR WINDOW BLINDS; BLINDS OF REED, RATTAN OR BAMBOO; BEAD CURTAINS FOR DECORATION; ORIENTAL FOLDING PARTITION SCREEN; BENCHES; UPRIGHT SIGNBOARDS OF WOOD OR PLASTICS; CRADLES; INFANT WALKERS; MANNEQUINS; COSTUME DISPLAY STANDS; SLEEPING BAGS FOR CAMPING; PICTURE FRAMES; PLASTER SCULPTURES; PLASTIC SCULPTURES; WOODEN SCULPTURES; UNWORKED OR PARTLY WORKED RATTAN; RAW OR PARTLY WORKED REEDS; RAW OR PARTLY WORKED ONIGAYA HAY; WHALEBONES; ARTIFICIAL HORNS; UNWORKED OR PARTLY WORKED IVORY; ANIMAL HORNS; ANIMAL TEETH; TORTOISESHELLS; UNWORKED OR PARTLY WORKED ANIMAL BONE; UNWORKED OR PARTLY WORKED CORAL (U.S. CLS. 2, 13, 22, 25, 32 AND 50).

CLASS 21—HOUSEWARES AND GLASS

FOR DENTAL FLOSS; UNWORKED OR SEMI-WORKED GLASS, NOT FOR BUILDING; MANGERS FOR ANIMALS; POULTRY RINGS; COOKING SKEWERS; TUB BRUSHES; BRUSHES FOR PIPES; SHIP-SCRUBBING BRUSHES; NON-ELECTRIC COOKING POTS AND PANS; NON-ELECTRIC COFFEE-POTS NOT OF PRECIOUS METAL; NON-ELECTRIC JAPANESE CAST IRON KETTLES; NON-ELECTRIC KETTLES; RICE CHESTS; FOOD PRESERVING JARS OF GLASS; DRINKING FLASKS; VACUUM BOTTLES; ICE PAILS; NON-ELECTRIC WHISKS; COOKING STRAINERS; PEPPER POTS, SUGAR BOWLS AND SALT SHAKERS, NOT OF PRECIOUS METAL; EGG CUPS, NOT OF PRECIOUS METAL; NAPKIN HOLDERS AND NAPKIN RINGS, NOT OF PRECIOUS METAL; TOOTH-PICK HOLDERS, NOT OF PRECIOUS METAL; COLANDERS; JAPANESE STYLE COOKED RICE SCOOPS; HAND-OPERATED COFFEE GRINDERS AND PEPPER MILLS; COOKING FUNNELS; JAPANESE STYLE WOODEN PESTLES; JAPANESE STYLE EARTHENWARE MORTARS; JAPANESE STYLE PERSONAL DINING TRAYS OR STANDS; BOTTLE OPENERS; COOKING

GRATERS; TART SCOOPS; CHOPSTICKS; CHOPSTICK CASES; COOKING SIEVES AND SIFTERS; CHOPPING BOARDS FOR KITCHEN USE; ROLLING PINS FOR COOKING PURPOSES; TOOTHPICKS; NON-ELECTRIC WAFFLE IRONS; LUNCH BOXES; IRONING BOARDS; STIRRERS FOR HOT BATHTUB WATER; BATHROOM PAILS; CANDLE EXTINGUISHERS AND CANDLESTICKS, NOT OF PRECIOUS METAL; CINDER SIFTERS FOR HOUSEHOLD PURPOSES; COAL SCUTTLES; FLY SWATTERS; MOUSE TRAPS; FLOWER POTS; WATERING CANS; FEEDING VESSELS FOR PETS; BRUSHES FOR PETS; BIRD CAGES; CLOTHES BRUSHES; CHAMBER POTS; TOILET PAPER HOLDERS; PIGGY BANKS NOT OF METAL; BOXES OF METAL FOR DISPENSING PAPER TOWELS; BOOT JACKS; SOAP DISPENSERS; FLOWER VASES AND BOWLS, NOT OF PRECIOUS METAL; INDOOR SCULPTURES OF GLASS OR CERAMICS; PERFUME BURNERS; SHOE BRUSHES; SHOE HORNS; SHOE SHINE CLOTHS; SHOE-TREES; PORTABLE COOKING KITS FOR OUTDOOR USE; PIG BRISTLES FOR BRUSHES (U.S. CLS. 2, 13, 23, 29, 30, 33, 40 AND 50).

CLASS 25—CLOTHING

FOR GARTERS; SOCK SUSPENDERS; SUSPENDERS; WAISTBANDS; BELTS FOR CLOTHING; FOOTWEAR; MASQUERADE COSTUMES (U.S. CLS. 22 AND 39).

CLASS 28—TOYS AND SPORTING GOODS

FOR WAX FOR SKIS; TOYS FOR DOMESTIC PETS; DOLLS; CHRISTMAS TREE ORNAMENTS; GO GAMES; JAPANESE PLAYING CARDS; JAPANESE CHESS; DICE; JAPANESE DICE GAMES; DICE CUPS; BINGO GAMES; CHESS GAMES; CHECKERS AND CHECKER SETS; DOMINOES; PLAYING CARDS; JAPANESE PLAYING CARDS; FISHING TACKLE (U.S. CLS. 22, 23, 38 AND 50).

CLASS 30—STAPLE FOODS

FOR MEAT TENDERIZERS FOR HOUSEHOLD PURPOSES; TEA; COFFEE AND COCOA; ICE; CONFECTIONERY, BREAD AND BUNS; SEASONINGS; SPICES; ICE CREAM MIXES; SHERBET MIXES; ALMOND PASTE; CHINESE STUFFED DUMPLINGS; SANDWICHES; CHINESE STEAMED DUMPLINGS; SUSHI; STEAMED BUNS STUFFED WITH MINCED MEAT; PIZZAS; MEAT PIES; RAVIOLI; SPRING ROLLS; YEAST POWDER; YEAST; BAKING POWDER; HUSKED RICE; HUSKED BARLEY; FLOUR FOR FOOD; GLUTEN FOR FOOD (U.S. CL. 46).

CARRIE ACHEN, EXAMINING ATTORNEY

SN 79-006,410. SEIKODO CORPORATION, JAPAN, FILED 3-11-2004.

FUNKY PIRATES

PRIORITY DATE OF 12-26-2003 IS CLAIMED.
OWNER OF INTERNATIONAL REGISTRATION 0836324
DATED 3-11-2004, EXPIRES 3-11-2014.

CLASS 14—JEWELRY

FOR PRECIOUS METALS; NUTCRACKERS, PEPPER POTS, SUGAR BOWLS, SALT SHAKERS, EGG CUPS, NAPKIN HOLDERS, NAPKIN RINGS, AND TOOTHPICK HOLDERS OF PRECIOUS METAL; BOXES OF PRECIOUS METAL FOR NEEDLES; CANDLE EXTINGUISHERS AND CANDLESTICKS OF PRECIOUS METAL; JEWEL CASES OF PRECIOUS METAL; FLOWER VASES AND BOWLS OF PRECIOUS METAL; PERSONAL ORNAMENTS OF PRECIOUS METAL; PURSES AND WALLETS OF PRECIOUS METAL; UNWROUGHT AND SEMI-WROUGHT PRECIOUS STONES AND THEIR IMITATIONS; POWDER COMPACTS OF PRECIOUS METAL; SHOE ORNAMENTS OF PRECIOUS METAL; CLOCKS AND WATCHES (U.S. CLS. 2, 27, 28 AND 50).

CLASS 16—PAPER GOODS AND PRINTED MATTER

FOR SEALING WAX; PRINTERS' REGLETS; PRINTING TYPES; ADDRESSING MACHINES; INKING RIBBONS; ELECTRIC STAPLERS FOR OFFICES; ENVELOPE SEALING MACHINES FOR OFFICES; DRAWING INSTRUMENTS; TYPEWRITERS; MIMEOGRAPHS; PAPER SHREDDERS FOR OFFICE USE; FRANKING MACHINES; ROTARY DUPLICATORS; MARKING TEMPLATES; ELECTRIC PENCIL SHARPENERS; DECORATORS' PAINTBRUSHES; BABIES' DIAPERS OF PAPER; INDUSTRIAL PACKAGING CONTAINERS OF PAPER; FOOD WRAPPING PLASTIC FILM FOR HOUSEHOLD USE; GARBAGE BAGS OF PAPER FOR HOUSEHOLD USE; GARBAGE BAGS OF PLASTIC FOR HOUSEHOLD USE; TAILORS' CHALK; BANNERS OF PAPER; FLAGS OF PAPER; HYGIENIC PAPER; TABLE NAPKINS OF PAPER; HAND TOWELS OF PAPER; HANDKERCHIEFS OF PAPER; PRINTED LOTTERY TICKETS OTHER THAN TOYS; TABLE CLOTHS OF PAPER; PAPER AND CARDBOARD; STATIONERY; CALENDARS; PAINTINGS AND CALLIGRAPHIC WORKS; PHOTOGRAPHS; PHOTOGRAPH STANDS (U.S. CLS. 2, 5, 22, 23, 29, 37, 38 AND 50).

CLASS 20—FURNITURE AND ARTICLES NOT OTHERWISE CLASSIFIED

FOR MEERSCHAUM; LOADING PALLETS NOT OF METAL; BEEHIVES; HAIRDRESSER'S CHAIRS; BARBERS' CHAIRS; VALVES OF PLASTIC NOT INCLUDING MACHINE ELEMENTS; CONTAINERS FOR TRANSPORT, NOT OF METAL; NUTS, SCREWS, BOLTS, AND CASTERS, NOT OF METAL; NON-ELECTRIC LOCKS NOT OF METAL; CUSHIONS; JAPANESE FLOOR CUSHIONS; PILLOWS; MATTRESSES; INDUSTRIAL PACKAGING CONTAINERS OF WOOD, BAMBOO OR PLASTICS; DRINKING STRAWS; EMBROIDERY FRAMES; NAMEPLATES AND DOOR NAMEPLATES NOT OF METAL; FLAGPOLES; HAND-HELD FLAT FANS; HAND-HELD FOLDING FANS; BEDS FOR HOUSEHOLD PETS; DOG KENNELS; STEP LADDERS AND LADDERS NOT OF METAL; LETTER BOXES NOT OF METAL OR MASONRY; TOOL BOXES NOT OF METAL; FURNITURE; INDOOR WINDOW BLINDS; BLINDS OF REED, RATTAN OR BAMBOO; BEAD CURTAINS FOR DECORATION; ORIENTAL FOLDING PARTITION SCREEN; BENCHES; UPRIGHT SIGNBOARDS OF WOOD OR PLASTICS; CRADLES; INFANT WALKERS; MANNEQUINS; COSTUME DISPLAY STANDS; SLEEPING BAGS FOR CAMPING; PICTURE FRAMES; PLASTER SCULPTURES; PLASTIC SCULPTURES; WOODEN SCULPTURES; UNWORKED OR PARTLY WORKED RATTAN; RAW OR PARTLY WORKED REEDS; RAW OR PARTLY WORKED ONIGAYA HAY; WHALEBONES; ARTIFICIAL HORNS; UNWORKED OR PARTLY WORKED IVORY; ANIMAL HORNS; ANIMAL TEETH; TORTOISESHELLS; UNWORKED OR PARTLY WORKED ANIMAL BONE; UNWORKED OR PARTLY WORKED CORAL (U.S. CLS. 2, 13, 22, 25, 32 AND 50).

CLASS 21—HOUSEWARES AND GLASS

FOR DENTAL FLOSS; UNWORKED OR SEMI-WORKED GLASS, NOT FOR BUILDING; MANGERS FOR ANIMALS; POULTRY RINGS; COOKING SKEWERS; TUB BRUSHES; BRUSHES FOR PIPES; SHIP-SCRUBBING BRUSHES; NON-ELECTRIC COOKING POTS AND PANS; NON-ELECTRIC COFFEE-POTS NOT OF PRECIOUS METAL; NON-ELECTRIC JAPANESE CAST IRON KETTLES; NON-ELECTRIC KETTLES; RICE CHESTS; FOOD PRESERVING JARS OF GLASS; DRINKING FLASKS; VACUUM BOTTLES; ICE PAILS; NON-ELECTRIC WHISKS; COOKING STRAINERS; PEPPER POTS, SUGAR BOWLS AND SALT SHAKERS, NOT OF PRECIOUS METAL; EGG CUPS, NOT OF PRECIOUS METAL; NAPKIN HOLDERS AND NAPKIN RINGS, NOT OF PRECIOUS METAL; TOOTH-PICK HOLDERS, NOT OF PRECIOUS METAL; COLANDERS; JAPANESE STYLE COOKED RICE SCOOPS; HAND-OPERATED COFFEE GRINDERS AND PEPPER MILLS; COOKING FUNNELS; JAPANESE STYLE WOODEN PESTLES; JAPANESE STYLE EARTHENWARE MORTARS; JAPANESE STYLE PERSONAL DINING TRAYS OR STANDS; BOTTLE OPENERS; COOKING

GRATERS; TART SCOOPS; CHOPSTICKS; CHOPSTICK CASES; COOKING SIEVES AND SIFTERS; CHOPPING BOARDS FOR KITCHEN USE; ROLLING PINS FOR COOKING PURPOSES; TOOTHPICKS; NON-ELECTRIC WAFFLE IRONS; LUNCH BOXES; IRONING BOARDS; STIRRERS FOR HOT BATHTUB WATER; BATHROOM PAILS; CANDLE EXTINGUISHERS AND CANDLESTICKS, NOT OF PRECIOUS METAL; CINDER SIFTERS FOR HOUSEHOLD PURPOSES; COAL SCUTTLES; FLY SWATTERS; MOUSE TRAPS; FLOWER POTS; WATERING CANS; FEEDING VESSELS FOR PETS; BRUSHES FOR PETS; BIRD CAGES; CLOTHES BRUSHES; CHAMBER POTS; TOILET PAPER HOLDERS; PIGGY BANKS NOT OF METAL; BOXES OF METAL FOR DISPENSING PAPER TOWELS; BOOT JACKS; SOAP DISPENSERS; FLOWER VASES AND BOWLS, NOT OF PRECIOUS METAL; INDOOR SCULPTURES OF GLASS OR CERAMICS; PERFUME BURNERS; SHOE BRUSHES; SHOE HORNS; SHOE SHINE CLOTHS; SHOE-TREES; PORTABLE COOKING KITS FOR OUTDOOR USE; PIG BRISTLES FOR BRUSHES (U.S. CLS. 2, 13, 23, 29, 30, 33, 40 AND 50).

CLASS 25—CLOTHING

FOR GARTERS; SOCK SUSPENDERS; SUSPENDERS; WAISTBANDS; BELTS FOR CLOTHING; FOOTWEAR; MASQUERADE COSTUMES (U.S. CLS. 22 AND 39).

CLASS 28—TOYS AND SPORTING GOODS

FOR WAX FOR SKIS; TOYS FOR DOMESTIC PETS; DOLLS; CHRISTMAS TREE ORNAMENTS; GO GAMES; JAPANESE PLAYING CARDS; JAPANESE CHESS; DICE; JAPANESE DICE GAMES; DICE CUPS; BINGO GAMES; CHESS GAMES; CHECKERS AND CHECKER SETS; DOMINOES; PLAYING CARDS; JAPANESE PLAYING CARDS; FISHING TACKLE (U.S. CLS. 22, 23, 38 AND 50).

CLASS 30—STAPLE FOODS

FOR MEAT TENDERIZERS FOR HOUSEHOLD PURPOSES; TEA; COFFEE AND COCOA; ICE; CONFECTIONERY, BREAD AND BUNS; SEASONINGS; SPICES; ICE CREAM MIXES; SHERBET MIXES; ALMOND PASTE; CHINESE STUFFED DUMPLINGS; SANDWICHES; CHINESE STEAMED DUMPLINGS; SUSHI; STEAMED BUNS STUFFED WITH MINCED MEAT; PIZZAS; MEAT PIES; RAVIOLI; SPRING ROLLS; YEAST POWDER; YEAST; BAKING POWDER; HUSKED RICE; HUSKED BARLEY; FLOUR FOR FOOD; GLUTEN FOR FOOD (U.S. CL. 46).

CARRIE ACHEN, EXAMINING ATTORNEY

SN 79-006,467. DAUNENSTEP S.P.A., ITALY, FILED 6-14-2004.



PRIORITY DATE OF 2-6-2004 IS CLAIMED.
OWNER OF INTERNATIONAL REGISTRATION 0836419 DATED 6-14-2004, EXPIRES 6-14-2014.

NO CLAIM IS MADE TO THE EXCLUSIVE RIGHT TO USE "DAUNEN", APART FROM THE MARK AS SHOWN.

THE TRADEMARK, IN SPECIAL PRINT CHARACTERS AND IN THICK FONT, IS INSERTED INSIDE AN OVAL FIGURE WITH A DARK BACKGROUND; THE WORDS "DAUNEN" AND "STEP" ARE SEPARATED BY A SQUARE FIGURE WITH A DARK BACKGROUND; AN IMAGE REPRESENTING THREE GESE IS PLACED INSIDE THE SQUARE FIGURE.

DAUNEN IS THE GERMAN WORD FOR FEATHERS/DOWN. THIS TERM DESCRIBES THE COMPOSITION OF APPLICANT'S GOODS.

CLASS 20—FURNITURE AND ARTICLES NOT OTHERWISE CLASSIFIED

FOR PILLOWS AND CUSHIONS (U.S. CLS. 2, 13, 22, 25, 32 AND 50).

CLASS 22—CORDAGE AND FIBERS

FOR FEATHERS FOR STUFFING AND DOWN FEATHERS (U.S. CLS. 1, 2, 7, 19, 22, 42 AND 50).

CLASS 24—FABRICS

FOR HOUSEHOLD LINENS - NAMELY, BEDSPREADS, QUILTS, PILLOW CASES, BED BLANKETS, BED COVERS; MATTRESS COVERS; CUSHION COVERS, SHEETS (U.S. CLS. 42 AND 50).

ANN LINNEHAN, EXAMINING ATTORNEY

SN 79-006,490. TITANIA-FABRIKATIONS-GMBH; GESELLSCHAFT FÜR KÖRPERPFLEGEPRODUKTE, D-42489 WÜLFRAH, FED REP GERMANY, FILED 2-24-2004.

TITANIA

THE MARK CONSISTS OF STANDARD CHARACTERS WITHOUT CLAIM TO ANY PARTICULAR FONT, STYLE, SIZE, OR COLOR.

OWNER OF INTERNATIONAL REGISTRATION 0836469 DATED 2-24-2004, EXPIRES 2-24-2014.

CLASS 3—COSMETICS AND CLEANING PREPARATIONS

FOR PUMICE STONES FOR PERSONAL USE, ALL-PURPOSE COTTON SWABS FOR PERSONAL USE (U.S. CLS. 1, 4, 6, 50, 51 AND 52).

CLASS 8—HAND TOOLS

FOR NAIL FILES, FINGERNAIL SCISSORS, AND TOENAIL SCISSORS; HAIR THINNING INSTRUMENTS (U.S. CLS. 23, 28 AND 44).

CLASS 21—HOUSEWARES AND GLASS

FOR DEVICES FOR THE BODY AND BEAUTY CARE, NAMELY, COMBS AND BRUSHES, TOOTHPICKS, SPONGES FOR CAR CLEANING AND HOUSEHOLD USE, SPONGES FOR BODY CARE, SMALL HOUSEHOLD ARTICLES, NAMELY, SOAP DISHES, TOOTHBRUSH BOXES, SOAP HOLDERS, TOOTHBRUSH CAPS, FILTER INSERTS FOR DRAINS (U.S. CLS. 2, 13, 23, 29, 30, 33, 40 AND 50).

HENRY S. ZAK, EXAMINING ATTORNEY

SN 79-006,538. INSTITUT CURIE, FRANCE, FILED 4-2-2004.

INSTITUT CURIE

PRIORITY DATE OF 10-22-2003 IS CLAIMED. OWNER OF INTERNATIONAL REGISTRATION 0836624 DATED 4-2-2004, EXPIRES 4-2-2014.

NO CLAIM IS MADE TO THE EXCLUSIVE RIGHT TO USE "INSTITUT", APART FROM THE MARK AS SHOWN. THE ENGLISH TRANSLATION OF THE TERM "INSTITUT" IS "INSTITUTE".

CLASS 36—INSURANCE AND FINANCIAL

FOR FUND-RAISING; CHARITABLE DONATION COLLECTIONS; FINANCIAL SPONSORSHIP OF CANCER RESEARCH; PROVIDING GRANTS TO CANCER RESEARCHERS AND PHYSICIANS (U.S. CLS. 100, 101 AND 102).

CLASS 42—SCIENTIFIC, COMPUTER AND LEGAL SERVICES

FOR RESEARCH AND DEVELOPMENT OF PRODUCTS, DIAGNOSTICS OR THERAPEUTIC METHODS IN THE FIELDS OF INDUSTRY, SCIENCE, MEDICINE, PHARMACEUTICALS, BIOLOGY, MOLECULAR BIOLOGY, MOLECULAR COMPUTING, CANCER PREVENTION AND TREATMENT, GENE THERAPY AND BIOTECHNOLOGY; SCIENTIFIC ANALYSES; RESEARCH IN THE LEGAL AND REGULATORY FIELD WITH REGARD TO MEDICINE; RESEARCH IN THE FIELDS OF BIOLOGY, BIOTECHNOLOGY, CHEMISTRY, BACTERIOLOGY, CHEMOTHERAPY; QUALITY CONTROL; MEDICAL AND CHEMICAL LABORATORIES; COMPUTER SOFTWARE DESIGN; UPDATING OF COMPUTER SOFTWARE, INSTALLATION OF COMPUTER SOFTWARE; MAINTENANCE OF COMPUTER SOFTWARE; RENTAL OF COMPUTER SOFTWARE; COMPUTER PROGRAMMING; RECOVERY OF COMPUTER DATA; MEDICAL AND SCIENTIFIC RESEARCH, NAMELY CLINICAL STUDIES; MEDICAL AND SCIENTIFIC RESEARCH, NAMELY DEVELOPMENT OF DIAGNOSTIC METHODS; DEVELOPMENT OF MEDICAL DIAGNOSTIC KITS AND TESTS (U.S. CLS. 100 AND 101).

CLASS 44—MEDICAL, BEAUTY AND AGRICULTURAL SERVICES

FOR MEDICAL SERVICES; VETERINARY SERVICES; MEDICAL ASSISTANCE; PHARMACEUTICAL CONSULTATION AND CONSULTATION WITH REGARD TO PHARMACEUTICAL PRODUCTS; CONSULTANCY WITH REGARD TO PUBLIC HEALTH; REST AND CONVALESCENT HOMES; HOSPITAL SERVICES; MEDICAL ANALYSES (U.S. CLS. 100 AND 101).

DANIEL CAPSHAW, EXAMINING ATTORNEY

SN 79-006,539. SIEMENS AKTIENGESELLSCHAFT, FED REP GERMANY, FILED 7-28-2004.

Premium Studio

THE MARK CONSISTS OF STANDARD CHARACTERS WITHOUT CLAIM TO ANY PARTICULAR FONT, STYLE, SIZE, OR COLOR.

OWNER OF INTERNATIONAL REGISTRATION 0836633 DATED 7-28-2004, EXPIRES 7-28-2014.

NO CLAIM IS MADE TO THE EXCLUSIVE RIGHT TO USE "STUDIO", APART FROM THE MARK AS SHOWN.

CLASS 9—ELECTRICAL AND SCIENTIFIC APPARATUS

FOR COMPUTER SOFTWARE FOR USE IN THE FIELD OF INDUSTRIAL AUTOMATION (U.S. CLS. 21, 23, 26, 36 AND 38).

CLASS 42—SCIENTIFIC, COMPUTER AND LEGAL SERVICES

FOR COMPUTER SOFTWARE DEVELOPMENT; RENTAL OF APPLICATION SOFTWARE (U.S. CLS. 100 AND 101).

ANN LINNEHAN, EXAMINING ATTORNEY

SN 79-006,550. IVT INSTALLATIONS- UND; VERBINDUNGSTECHNIK GMBH & CO. KG, FED REP GERMANY, FILED 4-26-2004.

LATENTO

THE MARK CONSISTS OF STANDARD CHARACTERS WITHOUT CLAIM TO ANY PARTICULAR FONT, STYLE, SIZE, OR COLOR.

OWNER OF INTERNATIONAL REGISTRATION 0836701 DATED 4-26-2004, EXPIRES 4-26-2014.

CLASS 9—ELECTRICAL AND SCIENTIFIC APPARATUS

FOR APPARATUS FOR CONVERTING ELECTRONIC RADIATION TO ELECTRICAL ENERGY, NAMELY PHOTOVOLTAIC CELLS (U.S. CLS. 21, 23, 26, 36 AND 38).

CLASS 11—ENVIRONMENTAL CONTROL APPARATUS

FOR SOLAR INSTALLATIONS, NAMELY, SOLAR SPACE HEATERS, SOLAR WATER HEATERS, SOLAR CELLS, SOLAR COLLECTORS, SOLAR HEAT COLLECTION PANELS; APPARATUS FOR ACCUMULATING HEAT, FOR TRANSFERRING HEAT, FOR HEAT RECOVERY FROM ENVIRONMENTAL ENERGY AS WELL AS FOR HEATING, INCLUDING PARTS OF THESE APPARATUS, NAMELY HEAT EXCHANGERS, HEAT PUMPS, HEATING COILS AND CIRCULATORS (U.S. CLS. 13, 21, 23, 31 AND 34).

ESTHER BELENKER, EXAMINING ATTORNEY

SN 79-006,757. KRAUSS-MAFFEI KUNSTSTOFFTECHNIK GMBH, D-80997 MÜNCHEN, FED REP GERMANY, FILED 7-27-2004.

Quick Switch

OWNER OF INTERNATIONAL REGISTRATION 0837274 DATED 2-14-2004, EXPIRES 2-14-2014.

THE COLORS BLUE AND LIGHT BLUE ARE CLAIMED AS FEATURES OF THE MARK.

THE WORDING AND UPPER ARROW IN THE MARK ARE BLUE, AND THE LOWER ARROW IS LIGHT BLUE.

CLASS 7—MACHINERY

FOR MACHINES FOR PROCESSING PLASTICS, NAMELY, EXTRUSION MACHINES, EXTRUDERS, WORM EXTRUDERS; ELECTRIC AND HYDRAULIC DRIVES FOR WORM EXTRUDERS AND BARREL EXTRUDERS; EXTRUSION MACHINES COMPRISING FEEDING EQUIPMENT FOR FEEDING IN DUROPLASTICS; MOLDING APPLIANCES, NAMELY, PIPE MOLDING APPLIANCES AND PROFILE MOLDING APPLIANCES; RAPID DIMENSIONAL CHANGE APPLIANCES, EXTRACTION APPLIANCES, SEPARATING APPLIANCES AND CUTTING APPLIANCES FOR PRODUCING PIPES, PROFILES, PLATES AND GRANULATES MADE OF PLASTIC OR MADE OF PLASTIC MIXED WITH OTHER SUBSTANCES (U.S. CLS. 13, 19, 21, 23, 31, 34 AND 35).

CLASS 9—ELECTRICAL AND SCIENTIFIC APPARATUS

FOR ELECTRICAL AND ELECTRONIC CONTROL SYSTEMS FOR PLASTIC PROCESSING MACHINES, NAMELY, FOR EXTRUSION MACHINES AND EXTRUDERS; COMPUTER PROGRAMS TO CONTROL PLASTIC PROCESSING MACHINES, NAMELY, EXTRUDERS AND EXTRUSION MACHINES; DATA CARRIERS CONTAINING PROGRAMS TO CONTROL PLASTIC PROCESSING MACHINES, NAMELY, EXTRUDERS AND EXTRUSION MACHINES; APPARATUS AND INSTRUMENTS FOR ELECTRICALLY AND ELECTRONICALLY CARRYING OUT MEASURING, SIGNALING AND MONITORING FUNCTIONS FOR OPERATING PLASTIC PROCESSING MACHINES, NAMELY, EXTRUDERS AND EXTRUSION MACHINES, DOSING EQUIPMENT, AND CALIBRATED EQUIPMENT (U.S. CLS. 21, 23, 26, 36 AND 38).

CLASS 37—CONSTRUCTION AND REPAIR

FOR MAINTENANCE AND REPAIR OF EXTRUDERS OF PLASTIC PROCESSING MACHINES, NAMELY, EXTRUSION MACHINES AND EXTRUDERS; OVERHAULING WORN AND/OR DAMAGED WORM EXTRUDERS; MAINTENANCE OF USED EXTRUDERS; MAINTENANCE OF ELECTRICAL, ELECTRONIC AND PRECISION MECHANICAL MANUFACTURING MACHINES, AND OF HEAVY ENGINEERING AND HYDRAULIC MACHINE PARTS FOR PLASTIC PROCESSING MACHINES (U.S. CLS. 100, 103 AND 106).

ALICE SUE CARRUTHERS, EXAMINING ATTORNEY

SN 79-006,852. BPT S.P.A., I-30020 CINTO CAOMAGGIORE (VE), ITALY, FILED 1-21-2004.

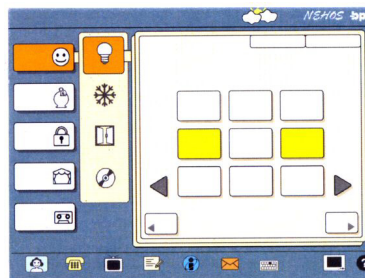

PRIORITY DATE OF 12-16-2003 IS CLAIMED. OWNER OF INTERNATIONAL REGISTRATION 0837499 DATED 1-21-2004, EXPIRES 1-21-2014.

THE COLOR(S) BLUE-AVIATION, WHITE, YELLOW, ORANGE, LIGHT GREY, LIGHT ORANGE, DARK GREY, LIGHT BLUE, BLUE AND BLACK IS/ARE CLAIMED AS A FEATURE OF THE MARK.

THE MARK CONSISTS OF A RECTANGULAR BACKGROUND IN BLUE-AVIATION COLOUR (32-0-3-47)* IN WHICH THE FANCY WORDINGS NEHOS AND BPT APPEAR IN THE UPPER RIGHT CORNER, WRITTEN IN FANCY CHARACTERS, ONE DIFFERENT FROM THE OTHER; THE SAID WORDINGS ARE PRECEDED BY THE STYLIZED REPRESENTATION OF TWO CLOUDS AND A SUN, RESPECTIVELY IN WHITE COLOUR (0-0-0-0)* AND YELLOW COLOUR (0-0-80-0)*; ALSO WITHIN THE AFOREMENTIONED RECTANGULAR BACKGROUND, STARTING FROM THE LEFT ARE: (A) A SERIES OF RECTANGULAR PANELS ONE UNDER THE OTHER, THE FIRST OF WHICH IS IN ORANGE COLOUR (0-50-100-0)* AND THE REMAINING IN LIGHT GREY COLOUR (0-0-0-9)*, WITHIN THESE ARE ALSO, RESPECTIVELY, THE STYLIZED REPRESENTATIONS OF, A SMILING FACE, A MONEY BOX, A PADLOCK, A TENT AND A CASSETTE; (B) A RECTANGULAR PANEL IN LIGHT ORANGE COLOUR (0-10-36-0)* IN WHICH THE STYLIZED REPRESENTATION OF A BULB, ARE CONTAINED WITHIN A PANEL IN ORANGE COLOUR (0-50-100-0)*, INCLUDING A SNOW-FLAKE, A MAIN DOOR AND A CD (COMPACT DISC); (C) PANELS PLACED ONE UPON THE OTHER HAVING APPROXIMATELY SQUARED FORMS AND FRAMES IN

LIGHT GREY COLOUR (0-0-0-9)*, AS WELL AS TRIANGULAR IMPRINTS IN DARK GREY COLOUR (0-0-0-70)*; FINALLY, IN THE LOWER PART OF THE SAID RECTANGULAR BACKGROUND, STARTING FROM THE LEFT APPEAR, THE STYLIZED REPRESENTATIONS OF, A FEMALE BUST WITHIN A PANEL IN LIGHT BLUE COLOUR (24-0-3-0)*, A TELEPHONE IN YELLOW COLOUR (0-0-50-0)*, A TELEVISION, A SHEET OF PAPER WITH PENCIL, A CIRCULAR IMPRINT IN BLUE COLOUR (60-0-0-0)* CONTAINING AN ORBIT AND A STYLIZED LETTER "I", AN ENVELOPE IN ORANGE COLOUR (0-37,5-75-0)*, A KEYBOARD, A MONITOR AND A CIRCULAR IMPRINT IN BLACK COLOUR (0-0-0-100)* CONTAINING A QUESTION MARK; *THE COLOUR IS EXPRESSED IN PERCENTAGES C-M-Y-K (CIANO = BLUE, MAGENTA = RED, YELLOW, BLACK), ACCORDING TO THE METHOD OF FOUR-COLOUR PROCESS.

CLASS 9—ELECTRICAL AND SCIENTIFIC APPARATUS

FOR TELEPHONES, INTERCOMS, VIDEO INTERCOMS; CLOSED-CIRCUIT TELEVISION; TELEVISION SETS, TELEVISION CAMERAS, CONTROL STATIONS FOR CONTROLLING HOME AND BUILDING APPARATUS MANAGEMENT, NAMELY TEMPERATURE, SECURITY, ENTERTAINMENT SYSTEM, ELECTRICAL SYSTEM AND TELEPHONE; IMAGE DIGITIZERS, VIDEO SELECTORS, VIDEO CAMERAS, VIDEO CIRCUIT BOARDS OR VIDEO PROCESSORS, DIGITAL VIDEO RECORDERS AND VIDEO RECORDER TIME LAPS, VIDEO MULTIPLEXERS FOR CONTROLLER SYSTEM; PARTS FOR THE FOREGOING; ALL THESE PRODUCTS BEING FOR TELECOMMUNICATION INSIDE BUILDINGS AND FOR THE REMOTE CONTROL OF BUILDINGS AND REMOTE SWITCHING OF APPARATUS PLACED INSIDE BUILDINGS (U.S. CLS. 21, 23, 26, 36 AND 38).

CLASS 38—COMMUNICATION

FOR TELECOMMUNICATION SERVICES INSIDE BUILDINGS, AND/OR TELECOMMUNICATION SERVICES IN CONNECTION WITH REMOTE MEASURING, SIGNALLING, CHECKING, LIFE-SAVING INSIDE BUILDINGS (U.S. CLS. 100, 101 AND 104).
WINSTON FOLMAR, EXAMINING ATTORNEY

SN 79-006,875. KNÜRR AG, FED REP GERMANY, FILED 7-21-2004.

CoolTherm

THE MARK CONSISTS OF STANDARD CHARACTERS WITHOUT CLAIM TO ANY PARTICULAR FONT, STYLE, SIZE, OR COLOR.

PRIORITY DATE OF 3-8-2004 IS CLAIMED.
OWNER OF INTERNATIONAL REGISTRATION 0837573 DATED 7-21-2004, EXPIRES 7-21-2014.

CLASS 9—ELECTRICAL AND SCIENTIFIC APPARATUS

FOR ELECTRICAL AND ELECTRONIC APPARATUS AND INSTRUMENTS, NAMELY MOUNTING RACKS FOR COMPUTER AND TELECOMMUNICATIONS HARDWARE IN THE NATURE OF ELECTRONIC DATA PROCESSING RACKS, NINETEEN INCH RACKS, SERVER RACKS, CLIMATIC RACKS AND STRUCTURAL PARTS THEREFOR, NAMELY HOUSINGS, CHASSIS, FRAMES, PLUG-IN UNITS IN THE NATURE OF ELECTRIC PLUGS AND PLUG CONNECTORS FOR USE WITH ELECTRONIC APPARATUS AND SUBASSEMBLIES, MODULAR COMPUTER CHASSIS, AND SUBASSEMBLIES FOR COMPUTERS AND TELECOMMUNICATIONS MOUNTING RACKS (U.S. CLS. 21, 23, 26, 36 AND 38).

CLASS 11—ENVIRONMENTAL CONTROL APPARATUS

FOR ELECTRIC FANS, ELECTRIC PLUG-IN FANS, HEAT EXCHANGERS; COOLING DEVICES, APPARATUS, AND INSTALLATIONS, NAMELY COOLING DOMES, COOLING EVAPORATORS, COOLING COILS, COOLING FANS, COOLING JACKETES, COOLING TANKS, AIR-CONDITIONING APPARATUS AND INSTALLATIONS, NAMELY, AIR-CONDITIONERS, AIR-CONDITIONING UNITS, AND STRUCTURAL PARTS THEREFORE (U.S. CLS. 13, 21, 23, 31 AND 34).

CLASS 42—SCIENTIFIC, COMPUTER AND LEGAL SERVICES

FOR PRODUCT DEVELOPMENT AND PRODUCT DEVELOPMENT CONSULTATION IN THE FIELDS OF COMPUTER AND TELECOMMUNICATIONS HARDWARE AND AIR CONDITIONING HEATING AND COOLING (U.S. CLS. 100 AND 101).
MICHAEL ENGEL, EXAMINING ATTORNEY

SN 79-007,108. OVEN CLEAN LIMITED, UNITED KINGDOM, FILED 7-16-2004.



PRIORITY DATE OF 7-9-2004 IS CLAIMED.
OWNER OF INTERNATIONAL REGISTRATION 0838347 DATED 7-16-2004, EXPIRES 7-16-2014.

NO CLAIM IS MADE TO THE EXCLUSIVE RIGHT TO USE "OVENCLEAN", APART FROM THE MARK AS SHOWN.

THE COLOR(S) BLUE AND WHITE IS/ARE CLAIMED AS A FEATURE OF THE MARK.

THE MARK CONSISTS OF A STYLIZED VERSION OF THE MARK OVENCLEAN WITH A STAR DESIGN AND THE STYLIZED WORD OVENCLEAN APPEARS IN THE MARK AS THE COLOR BLUE AND THE STAR DESIGN APPEARS IN THE MARK AS THE COLOR BLUE AND WHITE.

CLASS 3—COSMETICS AND CLEANING PREPARATIONS

FOR DETERGENTS AND SOAPS FOR CLEANING HOUSEHOLD APPLIANCES AND OVENS; WASHING, WIPING, CLEANING, POLISHING, SCOURING AND ABRASIVE PREPARATIONS; BLEACHING PREPARATIONS FOR CLEANING HOUSEHOLD APPLIANCES AND OVENS (U.S. CLS. 1, 4, 6, 50, 51 AND 52).

CLASS 21—HOUSEWARES AND GLASS

FOR SCRUBBING BRUSHES, SCRUB SPONGES, SCRAPING BRUSHES; BRUSHES, SPONGES AND SCOURERS; STEEL WOOL; DISPENSERS FOR HOUSEHOLD CLEANING AND WASHING FLUIDS OR PREPARATIONS; GLOVES FOR DOMESTIC CLEANING OR HOUSEHOLD PURPOSES; DUST PANS; CLOTHS FOR CLEANING PURPOSES; DUSTERS AND REFUSE BAGS; HOUSEHOLD CONTAINERS FOR STORING CLEANING PREPARATIONS (U.S. CLS. 2, 13, 23, 29, 30, 33, 40 AND 50).

CLASS 35—ADVERTISING AND BUSINESS

FOR BRINGING TOGETHER FOR THE BENEFIT OF OTHERS, OF A VARIETY OF GOODS, ENABLING CUSTOMERS TO CONVENIENTLY VIEW AND PURCHASE THOSE GOODS IN A RETAIL OR WHOLESALE OUTLET SPECIALIZING IN THE SALE OF CLEANING PREPARATIONS AND CLEANING ARTICLES OR FROM A MAIL ORDER CATALOGUE SPECIALIZING IN THE SALE OF CLEANING PREPARATIONS AND CLEANING ARTICLES, OR FROM A WEBSITE SPECIALIZING IN THE SALE OF CLEANING PREPARATIONS AND CLEANING ARTICLES; ADVISING AND CONSULTING SERVICES, PROVIDING INFORMATION IN THE AREA OF RETAIL AND WHOLESALE OUTLETS, MAIL ORDER SERVICES AND ELECTRONIC ONLINE ORDERING SERVICES SPECIALIZING IN CLEANING PREPARATIONS AND CLEANING ARTICLES (U.S. CLS. 100, 101 AND 102).

CLASS 37—CONSTRUCTION AND REPAIR

FOR CLEANING OF OVENS; RENTAL OF CLEANING EQUIPMENT; ADVISING AND CONSULTING AND PROVIDING INFORMATION IN THE FIELD OF IN-HOME CLEANING AND RENTAL OF CLEANING EQUIPMENT (U.S. CLS. 100, 103 AND 106).
HENRY S. ZAK, EXAMINING ATTORNEY

CLASS 35—ADVERTISING AND BUSINESS

FOR SUBSCRIPTION SERVICES TO PAY AND NON-PAY TELEVISION PROGRAMS; SERVICES OF COLLECTION OF DATA AND CENTRALIZED PROCESSING OF THIS DATA FOR SUBSCRIPTION SERVICES TO PAY AND NON-PAY TELEVISION PROGRAMS (U.S. CLS. 100, 101 AND 102).

CLASS 37—CONSTRUCTION AND REPAIR

FOR INSTALLATION OF EQUIPMENT, APPARATUS AND DEVICES FOR CONTROLLING ACCESS TO PREMISES OR TO PUBLIC AND PRIVATE SERVICES; MAINTENANCE OF THE SAID EQUIPMENT, APPARATUS AND DEVICES (U.S. CLS. 100, 103 AND 106).

CLASS 38—COMMUNICATION

FOR PAY AND NON-PAY BROADCASTING AND RECEPTION OF TELEVISION PROGRAMMES; SERVICES OF TRANSMISSION AND RECEPTION OF DATA BY TELECOMMUNICATION MEANS (U.S. CLS. 100, 101 AND 104).

CLASS 42—SCIENTIFIC, COMPUTER AND LEGAL SERVICES

FOR CONSULTING CONCERNING INFORMATION TECHNOLOGY SECURITY, IDENTIFICATION SYSTEMS AS WELL AS ON DEVICES AND INSTALLATIONS FOR CONTROLLING ACCESS TO PREMISES OR TO PUBLIC AND PRIVATE SERVICES; CONSULTING IN THE FIELD OF DATA ENCRYPTION, IN PARTICULAR FOR SECURE PAYMENT AND CUSTOMISATION OF USER CARDS; DESIGN AND CUSTOMISED PROGRAMMING OF ELECTRONIC SECURITY CARDS OR MODULES (U.S. CLS. 100 AND 101).
GRETTA YAO, EXAMINING ATTORNEY

SN 79-007,221. KUDELSKI SA, SWITZERLAND, FILED 6-24-2004.

NAGRACARD

THE MARK CONSISTS OF STANDARD CHARACTERS WITHOUT CLAIM TO ANY PARTICULAR FONT, STYLE, SIZE, OR COLOR.

PRIORITY DATE OF 4-5-2004 IS CLAIMED.
OWNER OF INTERNATIONAL REGISTRATION 0838666 DATED 6-24-2004, EXPIRES 6-24-2014.

CLASS 9—ELECTRICAL AND SCIENTIFIC APPARATUS

FOR APPARATUS AND DEVICES FOR THE AUDIO-VISUAL SECTOR, IN PARTICULAR FOR TELEVISION AND FOR COMMUNICATION, NAMELY ENCODING DEVICES FOR PAY TELEVISION CHANNELS; ELECTRONIC APPARATUS, DEVICES AND CIRCUITS, NAMELY ELECTRONIC CHIPS AND MICROPROCESSORS AND THEIR CARRIERS; APPARATUS AND INSTRUMENTS FOR ENCODING AND DECODING SIGNALS FOR PAY TELEVISION CHANNELS; ELECTRONIC APPARATUS AND DEVICES FOR SITE ACCESS CONTROL AND THE PROVISION OF PUBLIC OR PRIVATE ACCESS SERVICES, NAMELY COMBINATION KIOSK AND GATE SYSTEMS COMPRISING AUTOMATED SECURITY GATES FOR PARKING LOTS, CINEMAS, SHOW ROOMS, THEATRES, HALLS, SKILIFTS, SYMPOSIUMS AND CONFERENCES; ENCODED CHIP CARDS FOR CONTROLLING ACCESS TO PAY TELEVISION CHANNELS OR TO PUBLIC OR PRIVATE SITES; MICROPROCESSOR CARDS; ELECTRONIC SECURITY MODULES AND CARDS, ELECTRONIC IDENTIFICATION MODULES AND CARDS, ELECTRONIC AUTHENTICATION MODULES AND CARDS, ELECTRONIC MODULES AND CARDS FOR EXCHANGING AND STORING DATA; READERS FOR ELECTRONIC CARDS OR MODULES, APPARATUS FUNCTIONING WITH ELECTRONIC CARDS OR MODULES, NAMELY SET TOP BOXES AND ELECTRONIC CARD READERS; COMPUTERS FOR ANALYSIS, IMPLEMENTATION AND CUSTOMIZATION OF ELECTRONIC CARDS OR MODULES; SOFTWARE FOR ANALYSIS AND IMPLEMENTATION OF ELECTRONIC MODULES OR CARDS (U.S. CLS. 21, 23, 26, 36 AND 38).

SN 79-007,275. AUDIO RIDERS OY, FINLAND, FILED 9-8-2004.

CARERIDER

PRIORITY DATE OF 6-23-2004 IS CLAIMED.
OWNER OF INTERNATIONAL REGISTRATION 0838841 DATED 9-8-2004, EXPIRES 9-8-2014.

CLASS 9—ELECTRICAL AND SCIENTIFIC APPARATUS

FOR COMPUTER SOFTWARE FOR COLLECTING, PROCESSING AND TRANSMITTING DATA AND INFORMATION IN THE FIELD OF HEALTHCARE, COMPUTERS, SOUND AND VIDEO LEVEL METERS AND MIXERS; SOUND AND VIDEO CARDS, SHEETS, TAPES, HARD DRIVES; SOUND AND VIDEO RECORDING AND PLAYBACK MACHINES; RECEIVERS, COMPUTER, TV AND VIDEO MONITORS, HEADSETS FOR USE WITH COMPUTERS, RADIOS, TVS AND MOBILE PHONES, AUDIOVISUAL RECEIVERS FOR REPRODUCTION OF SOUND AND VIDEO SIGNALS; AMPLIFIERS, CABLES AND FIBRES FOR THE TRANSMISSION OF SOUNDS, IMAGES, TEXT AND DATA; CENTRAL PROCESSING UNITS FOR PROCESSING SOUND AND VIDEO; LOUDSPEAKERS, COMPUTER AND VIDEO SCREENS, LCD PANELS AND REMOTE CONTROLS FOR COMPUTERS, ANALYZERS AND SENSORS; SENSOR READER UNITS FOR RFID TECHNOLOGY AND PERSONAL ID TAGS; ELECTRIC OR ELECTRONIC SENSORS FOR MEASURING AND TRANSMITTING MOVEMENTS, TEMPERATURES, SOUNDS AND PICTURES AND VIDEOS IN THE FIELD OF HEALTH CARE AND SHORT RANGE DATA TRANSMISSION LINKS, SERVERS, PDA COMPUTERS; ALL THE AFOREMENTIONED GOODS FOR USE IN HEALTH CARE. (U.S. CLS. 21, 23, 26, 36 AND 38).

CLASS 44—MEDICAL, BEAUTY AND AGRICULTURAL SERVICES

FOR HEALTH CARE (U.S. CLS. 100 AND 101).
MARIA-VICTORIA SUAREZ, EXAMINING ATTORNEY

SN 79-007,276. AUDIO RIDERS OY, FINLAND, FILED 9-8-2004.

SOUND VITAMINS

OWNER OF INTERNATIONAL REGISTRATION 0838842 DATED 9-8-2004, EXPIRES 9-8-2014.
NO CLAIM IS MADE TO THE EXCLUSIVE RIGHT TO USE "SOUND", APART FROM THE MARK AS SHOWN.

CLASS 9—ELECTRICAL AND SCIENTIFIC APPARATUS

FOR COMPUTER SOFTWARE FEATURING SOUND, IMAGES, DATA AND INFORMATION DELIVERY USED IN THE FIELD OF HEALTH CARE, COMPUTERS, SOUND AND VIDEO LEVEL METERS AND MIXERS; SOUND AND VIDEO CARDS, SHEETS, TAPES, PRE-RECORDED CDS FEATURING SOUND, IMAGES, DATA AND INFORMATION USED IN THE FIELD OF HEALTH CARE, HARD DRIVES; SOUND AND VIDEO RECORDING AND PLAYBACK MACHINES; RECEIVERS, COMPUTER, TV AND VIDEO MONITORS, HEADSETS FOR USE WITH COMPUTERS, RADIOS, TVS AND MOBILE PHONES, AUDIOVISUAL RECEIVERS FOR REPRODUCTION OF SOUND AND VIDEO SIGNALS; AMPLIFIERS, CABLES AND FIBRES FOR THE TRANSMISSION OF SOUNDS, IMAGES, TEXT AND DATA; CENTRAL PROCESSING UNITS FOR PROCESSING SOUND AND VIDEO; LOUDSPEAKERS, COMPUTER AND VIDEO SCREENS, LCD PANELS AND REMOTE CONTROLS FOR COMPUTERS, RADIOS AND STEREO; SENSOR READER UNITS FOR RFID TECHNOLOGY AND PERSONAL ID TAGS; ELECTRIC OR ELECTRONIC SENSORS FOR MEASURING AND TRANSMITTING MOVEMENTS, TEMPERATURES, SOUNDS AND PICTURES AND VIDEOS IN THE FIELD OF HEALTH CARE AND SHORT RANGE DATA TRANSMISSION LINKS; SERVERS, PDA COMPUTERS; ALL THE AFOREMENTIONED GOODS FOR USE IN HEALTH CARE. (U.S. CLS. 21, 23, 26, 36 AND 38).

CLASS 44—MEDICAL, BEAUTY AND AGRICULTURAL SERVICES

FOR HEALTH CARE (U.S. CLS. 100 AND 101).
MARIA-VICTORIA SUAREZ, EXAMINING ATTORNEY

SN 79-007,315. SIEMENS AKTIENGESELLSCHAFT, FED REP GERMANY, FILED 7-22-2004.

moduleYE

THE MARK CONSISTS OF STANDARD CHARACTERS WITHOUT CLAIM TO ANY PARTICULAR FONT, STYLE, SIZE, OR COLOR.

PRIORITY DATE OF 2-26-2004 IS CLAIMED.
OWNER OF INTERNATIONAL REGISTRATION 0838949 DATED 7-22-2004, EXPIRES 7-22-2014.

CLASS 9—ELECTRICAL AND SCIENTIFIC APPARATUS

FOR INTEGRATED TRAFFIC CONTROL SYSTEMS IN THE FIELD OF MOTOR VEHICLE AND RAIL TRAFFIC AND VEHICLE PARKING WHICH ARE COMPRISED OF COMPUTER HARDWARE AND COMPUTER SOFTWARE FOR OPERATING TRAFFIC CONTROL SYSTEMS, DETECTING AND MONITORING TRAFFIC FLOW, VEHICLE PARKING DATA AND OTHER TRAFFIC DATA, COMPILING, TRANSMITTING AND INTERPRETING TRAFFIC AND VEHICLE PARKING DATA, MONITORING TRAFFIC FLOW, SIGNALING AND INFORMING DRIVERS OF POTENTIAL HAZARDS AND SLOWDOWNS, AND INFORMING TRAFFIC ENGINEERS OF TRAFFIC PATTERNS, POTENTIAL HAZARDS AND SLOWDOWNS; ELECTRONIC DETECTORS FOR COLLECTING AND TRANSMITTING TRAFFIC DATA; AND ELECTRICAL DEVICES WHICH MEASURE AND RECORD TRAFFIC FLOW (U.S. CLS. 21, 23, 26, 36 AND 38).

CLASS 42—SCIENTIFIC, COMPUTER AND LEGAL SERVICES

FOR DESIGN FOR OTHERS AND ENGINEERING OF INTEGRATED SYSTEMS USED TO DETECT, CONTROL, MONITOR, SIGNAL AND INFORM IN THE FIELD OF MOTOR VEHICLE AND RAIL TRAFFIC (U.S. CLS. 100 AND 101).
MELVIN AXILBUND, EXAMINING ATTORNEY

SN 79-007,338. ADOLF WÜRTH GMBH & CO. KG, FED REP GERMANY, FILED 9-16-2004.

ZEBRA

THE MARK CONSISTS OF STANDARD CHARACTERS WITHOUT CLAIM TO ANY PARTICULAR FONT, STYLE, SIZE, OR COLOR.

OWNER OF INTERNATIONAL REGISTRATION 0733951 DATED 5-12-1999, EXPIRES 5-12-2009.
OWNER OF U.S. REG. NOS. 1,489,852 AND 2,066,104.

CLASS 1—CHEMICALS

FOR ADHESIVE MATERIALS FOR PROFESSIONAL USE, NAMELY, ADHESIVES FOR ENGINEERING AND INDUSTRIAL USE, ADHESIVES FOR GLASS; CHEMICAL PRODUCTS USED IN THE MOTOR VEHICLE SECTOR, NAMELY ADHESIVES FOR GLASS; GLUES AS SCREW STOPS, CONTACT CHEMICAL PRODUCTS FOR TREATING ELECTRICAL CONTACTS; BRAKE FLUIDS; COOLING ADDITIVES FOR RADIATORS; LEAK DETECTING FLUIDS; ICING PRODUCTS FOR THE RAPID FREEZING OF WATER PIPES TO FACILITATE REPAIR, ESPECIALLY IN THE FORM OF SPRAY CANS; REFRIGERATING AND CRYOGENIC PRODUCTS AND ADDITIVES RELATING THERETO; ANTI-FREEZE; IMPREGNATION CHEMICALS AGENTS FOR TEXTILES AND FABRICS; VULCANISATION ACCENTUATORS FOR TIRE REPAIR; FIRE EXTINGUISHING COMPOSITIONS, FIREPROOFING PREPARATIONS; SOLDERING CHEMICALS, NAMELY BRAZING PREPARATIONS; CHEMICAL GASES FOR WELDING, CHEMICAL SPRAY FOR WELDING; FLUXING MEDIA IN THE NATURE OF SOLDERING FLUXES AND METAL WELDING FLUXES; CHEMICAL PRODUCTS FOR CUTTING AND BORING IN THE NATURE OF DRILLING FLUID, HARDENING PRODUCTS IN THE NATURE OF REACTING RESIN HARDENER; CHEMICAL PRESERVATIVES FOR USE IN THE PRODUCTION OF A WIDE VARIETY OF CHEMICALS; SOLVENTS AND THINNERS FOR INDUSTRIAL AND RESIDENTIAL USE, NAMELY, TURPENTINE GUM SPIRITS FOR USE AS A THINNER AND BRUSH CLEANER FOR OIL BASED PAINTS, VARNISH AND STAINS; TWO-COMPONENT PREMIXED ADHESIVE FOAM CEMENTS AVAILABLE IN CARTRIDGES (U.S. CLS. 1, 5, 6, 10, 26 AND 46).

CLASS 2—PAINTS

FOR RUST STABILIZERS, NAMELY, RUST PRESERVATIVES IN THE NATURE OF A COATING (U.S. CLS. 6, 11 AND 16).

CLASS 3—COSMETICS AND CLEANING PREPARATIONS

FOR BONDED INDUSTRIAL ABRASIVES FOR INDUSTRIAL USE IN THE NATURE OF GRINDING PASTES AND POLISHING PASTES, SANDPAPER, EMERY PAPER, CLOTH SANDING BELTS; RUST REMOVING PREPARATIONS (U.S. CLS. 1, 4, 6, 50, 51 AND 52).

CLASS 6—METAL GOODS

FOR METAL GOODS, NAMELY SCREWS, ADJUSTING SCREWS, WASHERS, SPACING WASHERS, SAFETY WASHERS, SAFETY SCREW RINGS, SPRING WASHERS, SPRINGS, FLANGES, COLLET CHUCKS, NAILS, PINS, FIXING BRACKETS, BOLTS, NUTS, SAFETY NUTS, ROSES, BUTTERFLY NUTS, SERRATED WASHERS, RIVETS, PEGS, BLIND RIVETS, THREADED RODS, STUD BOLTS, THREADED INSERTS, THREADED SEPARATIONS, CLAMPING TIES, CLIPS OF METAL FOR PIPES AND FLEXIBLE HOSES, SUPPORTS FOR FLEXIBLE HOSES, HOOKS, STUDS, SLEEVES, SPACING SLEEVES, SERRATED WASHERS, PLUGS, BUNGS AND CLOSING ELEMENTS FOR PIPES, QUICK-RELEASE FASTENERS, CONNECTION AND FASTENING ELEMENTS IN THE NATURE OF BRACES, PUNCHED STRIPS FOR MOUNTING PURPOSES, CABLE THIMBLES, CLAMPS FOR CABLES, CABLE HOLDER SETS COMPRISED PRIMARILY OF METAL, SCREWED CABLE COUPLINGS, CABLE HOLDERS, NON-ELECTRIC CABLE TUBES AND WIRE GRIPS; FLEXIBLE TUBE HOLDERS OF METAL; METAL PLATES FOR ASSEMBLY OF HOSES, TUBES AND PIPES; METAL BOXES, METAL SPRAY CANS SOLD EMPTY, GENERAL PURPOSE METAL STORAGE CONTAINERS, METAL CANS, MANUALLY OPERATED METAL VALVES, FLEXIBLE METAL HOSES FOR GENERAL HOUSEHOLD USE, METAL PIPE BRANCHES FOR GENERAL HOUSEHOLD USE, METAL PRESSURE MEDIUM HOSES, METAL BRAKE HOSES FOR TRUCKS (U.S. CLS. 2, 12, 13, 14, 23, 25 AND 50).

CLASS 7—MACHINERY

FOR MACHINE TOOLS FOR CRAFTSMEN IN METAL, WOOD, PLASTICS AND STONE WORKING, NAMELY ELECTRONICALLY ACTUATED, HYDRAULIC AND PNEUMATIC TOOLS FOR DRILLING, GRINDING AND MILLING METALS, WOOD, PLASTIC MATERIALS AND STONES; POWER TOOL INSERTS FOR DRILLING MACHINES, NAMELY, TWIST DRILLS, DRILLS FOR WELDING SPOTS, MACHINE SCREW TAPS, COUNTERSINK BITS, CYLINDER SAWS, MANDRELS FOR CYLINDER SAWS, CENTER DRILLS FOR CYLINDER SAWS; POWER TOOL INSERTS FOR ANGLE GRINDERS, GRINDER MACHINES, ECCENTRIC GRINDERS, AND DIE GRINDERS, NAMELY, LAMELLA FAN DISKS, MINI FIBER DISKS, GRINDING TUBES FOR GRINDING CYLINDERS, GRINDING DISCS, WIRE BRUSH WHEELS FOR ANGLE GRINDERS, GRINDING STONE WHEELS, SEPARATING DISCS, ROUGHING DISCS, DIAMOND SEPARATING DISCS, DIAMOND CUP WHEELS; POWER TOOL INSERTS FOR PLANES, NAMELY, HARD ALLOY REVOLVING KNIVES; POWER TOOLS FOR FLOOR POLISHING MACHINES, NAMELY, FLOOR POLISHING PADS; POWER TOOL INSERTS FOR CONNECTIONS TO COMPRESSED AIR DUCTS, NAMELY, COUPLINGS AND SAFETY COUPLINGS; POWER TOOL INSERTS, NAMELY, DRILL BITS, CUTTING AND TRIMMING DISKS, SAW BLADES, COMPASS SAWS, DRILL CROWNS, REVERSIBLE PLATES AND REVERSAL INDICATORS, FITTINGS FOR COMPRESSED AIR MACHINES, AS MACHINE PARTS OR FOR USE WITH MACHINES; MECHANICALLY ACTUATED APPARATUS FOR DISTRIBUTING, WINDING AND UNWINDING CABLES, HOSES, SHEETS, SANDPAPER AND ABRASIVE CLOTH; PARTS OF THE AFOREMENTIONED PRODUCTS; ALL OF THE ABOVE GOODS NOT FOR USE WITH BELT CONVEYORS (U.S. CLS. 13, 19, 21, 23, 31, 34 AND 35).

CLASS 8—HAND TOOLS

FOR HAND-OPERATED HAND TOOLS; NAMELY, TOOLS FOR WORKING WITH METALS, WOOD AND PLASTIC MATERIALS, WOODWORK AND WORKING PLASTICS AS WELL AS FOR TRADES INVOLVING CONSTRUCTION OF MACHINES, APPARATUS, VEHICLES AND BUILDINGS, NAMELY, HAND-OPERATED HAND TOOLS FOR NAILING, SIDE CUTTING NIPPERS, OPEN-END AND CLOSED-END WRENCHES, HEAVY SHEARS; HAND-OPERATED RIVETING TONGS, PLIERS, BENDING PLIERS, RIVETING GUNS, STRIPPING PLIERS, SCISSOR-LIKE GRIPS, CRIMPING PLIERS, INDENTING PLIERS, OFFSETTING PLIERS, PUNCH PLIERS, BENDING TOOLS AND COUNTERSINKS; FILES, SAWS AND SAW BLADES; CUTTING AND TRIMMING DISKS; ABRADING HAND-OPERATED HAND INSTRUMENTS, NAMELY, SHARPENING STONES, SHARPENING BRUSHES, BUFFING BLOCKS, BUFFING PINS, BUFFING WHEELS, VALVE ABRADING INSTRUMENTS, NAMELY, FINISH GRINDING BLOCKS CUTTING APPARATUS, NAMELY, SHEARS AND SHEET STEEL SHEARS; CUTLERY, NAMELY, KNIVES MADE FROM HARDENED STEEL; ROCKING ARMS, NAMELY, TOOL HOLDERS; HAND-OPERATED APPARATUS FOR DISTRIBUTING, WINDING AND UNWINDING CABLES, FLEXIBLE HOSES, SHEETS, SANDPAPER AND ABRASIVE CLOTH (U.S. CLS. 23, 28 AND 44).

CLASS 20—FURNITURE AND ARTICLES NOT OTHERWISE CLASSIFIED

FOR NON-METAL GOODS, NAMELY, SCREWS, ADJUSTING SCREWS, WASHERS OF PLASTIC FOR ASSEMBLY OF HOSES, TUBES AND PIPES, SPACING WASHERS OF PLASTIC, SAFETY WASHERS OF PLASTIC FOR ASSEMBLY OF HOSES, TUBES AND PIPES, SAFETY RINGS FOR ASSEMBLY OF HOSES, TUBES AND PIPES, SPRING WASHERS OF PLASTIC FOR ASSEMBLY OF HOSES, TUBES AND PIPES, SPRINGS, FLANGES, CLAMPING SLEEVES, NAILS, PINS, BRACKETS, BOLTS, BOLT-NAILS, NUTS, SAFETY NUTS, ROSES, BUTTERFLY NUTS, SERRATED WASHERS, RIVETS, PINTLES, BLIND RIVETS, STUD BOLTS, THREADED RODS, THREADED INSERTS, THREADED SEPARATIONS, CLAMPING TIES, PIPE BRACKETS AND HOSES, SUPPORTS FOR FLEXIBLE HOSES,

HOOKS, SPIKES, SLEEVES, SPACING SLEEVES, PLUGS, BUNGS AND CLOSING ELEMENTS FOR PIPES, QUICK-RELEASE FASTENERS, PUNCHED STRIPS FOR MOUNTING PURPOSES, CABLE THIMBLES, CLAMPING TIES FOR CABLES, CABLE HOLDERS, SCREWED CABLE COUPLINGS, NON-ELECTRIC WIRE CONNECTORS; NON-METALLIC HOSE HOLDERS; NON-METALLIC PLATES FOR ASSEMBLY OF HOSES, TUBES AND PIPES; SPRAY CANS SOLD EMPTY, CONTAINERS, CANS, VALVES FOR DOMESTIC PURPOSES, NAMELY VALVES OF PLASTIC BEING OTHER THAN MACHINE PARTS (U.S. CLS. 2, 13, 22, 25, 32 AND 50).

SUSAN STIGLITZ, EXAMINING ATTORNEY

SN 79-007,608. FABASOFT AG, AUSTRIA, FILED 10-14-2004.

ERECHT

THE MARK CONSISTS OF STANDARD CHARACTERS WITHOUT CLAIM TO ANY PARTICULAR FONT, STYLE, SIZE, OR COLOR.

OWNER OF INTERNATIONAL REGISTRATION 0839665 DATED 10-14-2004, EXPIRES 10-14-2014.

CLASS 9—ELECTRICAL AND SCIENTIFIC APPARATUS

FOR DATA PROCESSING EQUIPMENT, NAMELY, COMPUTER HARDWARE, KEYBOARDS, MONITORS, MOUSE, PRINTERS, SCANNERS AND COMPUTER PERIPHERALS; MAGNETIC DATA CARRIERS, NAMELY, PRE-RECORDED COMPACT DISCS FOR BUSINESS PROCESS MANAGEMENT AND WORKFLOW MANAGEMENT, NAMELY, AUTOMATING, SYSTEMATIZING AND STRUCTURING THE ADMINISTRATION AND MANAGEMENT OF LARGE INDUSTRIAL ENTERPRISES AND PUBLIC AUTHORITIES, TELECOMMUNICATION ENTERPRISES, AND THE SERVICES INVOLVED WITH FINANCIAL AND PLANNING SERVICES; COMPACT DISCS AND DVDS CONTAINING SOFTWARE FOR DATA PROCESSING; COMPUTERS; COMPUTER SOFTWARE FOR USE IN DATABASE MANAGEMENT AND FOR WORD PROCESSING IN THE FIELDS OF BUSINESS PROCESS MANAGEMENT AND WORKFLOW MANAGEMENT, NAMELY, AUTOMATING, SYSTEMATIZING AND STRUCTURING THE ADMINISTRATION AND MANAGEMENT OF LARGE INDUSTRIAL ENTERPRISES AND PUBLIC AUTHORITIES, TELECOMMUNICATION ENTERPRISES, AND SERVICES INVOLVED WITH FINANCIAL AND PLANNING SERVICES; COMPUTER HARDWARE (U.S. CLS. 21, 23, 26, 36 AND 38).

CLASS 35—ADVERTISING AND BUSINESS

FOR CONSULTANCY IN THE FIELD OF ELECTRONICALLY ASSISTED DATA PROCESSING (U.S. CLS. 100, 101 AND 102).

CLASS 37—CONSTRUCTION AND REPAIR

FOR MAINTENANCE AND REPAIR OF DATA PROCESSING EQUIPMENT AND COMPUTERS (U.S. CLS. 100, 103 AND 106).

CLASS 41—EDUCATION AND ENTERTAINMENT

FOR EDUCATION SERVICES, NAMELY, PROVIDING TRAINING, INSTRUCTION, AND SEMINARS IN THE FIELD OF ELECTRONICALLY ASSISTED DATA PROCESSING (U.S. CLS. 100, 101 AND 107).

CLASS 42—SCIENTIFIC, COMPUTER AND LEGAL SERVICES

FOR CONSULTANCY IN THE FIELD OF INFORMATION TECHNOLOGY; COMPUTER PROGRAMMING FOR OTHERS (U.S. CLS. 100 AND 101).

EDWARD NELSON, EXAMINING ATTORNEY

SN 79-007,671. OSRAM; GESELLSCHAFT MIT BESCHRÄNKTER HAFTUNG, FED REP GERMANY, FILED 9-14-2004.

XENARC XTREME

THE MARK CONSISTS OF STANDARD CHARACTERS WITHOUT CLAIM TO ANY PARTICULAR FONT, STYLE, SIZE, OR COLOR.

OWNER OF INTERNATIONAL REGISTRATION 0839828 DATED 9-14-2004, EXPIRES 9-14-2014.

OWNER OF U.S. REG. NO. 1,995,286.

CLASS 9—ELECTRICAL AND SCIENTIFIC APPARATUS

FOR OPERATING DEVICES FOR LIGHTING APPARATUS, NAMELY ELECTRONIC BALLAST DEVICES; PARTS OF THE AFORESAID GOODS (U.S. CLS. 21, 23, 26, 36 AND 38).

CLASS 11—ENVIRONMENTAL CONTROL APPARATUS

FOR LIGHTING APPARATUS, NAMELY ELECTRIC LAMPS AND BULBS, AND PARTS OF THE AFORESAID GOODS (U.S. CLS. 13, 21, 23, 31 AND 34).

SUNG IN, EXAMINING ATTORNEY

SN 79-007,884. TOYO SHINYAKU CO., LTD., JAPAN, FILED 5-17-2004.

FLAVANGENOL

THE MARK CONSISTS OF STANDARD CHARACTERS WITHOUT CLAIM TO ANY PARTICULAR FONT, STYLE, SIZE, OR COLOR.

OWNER OF INTERNATIONAL REGISTRATION 0840377 DATED 5-17-2004, EXPIRES 5-17-2014.

CLASS 3—COSMETICS AND CLEANING PREPARATIONS

FOR SOAPS; COSMETICS; COSMETICS CONTAINING OLIGOMERIC PROANTHOCYANIDIN EXTRACTED FROM PINE BARK; SOAPS AND SHAMPOOS CONTAINING OLIGOMERIC PROANTHOCYANIDIN EXTRACTED FROM PINE BARK (U.S. CLS. 1, 4, 6, 50, 51 AND 52).

CLASS 29—MEATS AND PROCESSED FOODS

FOR PROCESSED FOODS, NAMELY, SOY BEANS, DRIED CABBAGE, FERMENTED CABBAGE, RAISINS, AND DRIED PRUNES, IN THE FORM OF TABLETS, GRANULAR, POWDER AND LIQUID MAINLY CONTAINING EXTRACTIVES FROM PINE BARK; DIETARY SUPPLEMENTS IN POWDER, GRANULAR, HARD-CAPSULAR, SOFT-CAPSULAR, LIQUID, PASTE AND TABLET FORM CONTAINING OLIGOMERIC PROANTHOCYANIDIN EXTRACTED FROM PINE BARK (U.S. CL. 46).

CLASS 32—LIGHT BEVERAGES

FOR SOFT DRINKS; PREPARATIONS FOR MAKING SOFT DRINKS, NAMELY, CONCENTRATES CONTAINING OLIGOMERIC PROANTHOCYANIDIN EXTRACTED FROM PINE BARK, SYRUPS CONTAINING OLIGOMERIC PROANTHOCYANIDIN EXTRACTED FROM PINE BARK, POWDERS CONTAINING OLIGOMERIC PROANTHOCYANIDIN EXTRACTED FROM PINE BARK, AND GRANULES CONTAINING OLIGOMERIC PROANTHOCYANIDIN EXTRACTED FROM PINE BARK; SOFT DRINKS CONTAINING OLIGOMERIC PROANTHOCYANIDIN EXTRACTED FROM PINE BARK; FRUIT JUICES CONTAINING OLIGOMERIC PROANTHOCYANIDIN EXTRACTED FROM PINE BARK (U.S. CLS. 45, 46 AND 48).

NICHOLAS ALTREE, EXAMINING ATTORNEY

SN 79-008,109. XANDAS S.R.L., ITALY, FILED 6-4-2004.



PRIORITY DATE OF 5-31-2004 IS CLAIMED.
OWNER OF INTERNATIONAL REGISTRATION 0841014
DATED 6-4-2004, EXPIRES 6-4-2014.
THE STIPPLING IS A FEATURE OF THE MARK.

SN 79-008,081. PARADOR GMBH & CO. KG, FED REP GERMANY, FILED 5-24-2004.

trendtime

THE MARK CONSISTS OF STANDARD CHARACTERS WITHOUT CLAIM TO ANY PARTICULAR FONT, STYLE, SIZE, OR COLOR.

PRIORITY DATE OF 12-1-2003 IS CLAIMED.
OWNER OF INTERNATIONAL REGISTRATION 0840870
DATED 5-24-2004, EXPIRES 5-24-2014.

CLASS 19—NON-METALLIC BUILDING MATERIALS

FOR BUILDING MATERIALS, NOT OF METAL, NAMELY HARDWOOD BOARDS; PARQUET FLOORING MADE OF WOOD, LAMINATE AND NON-METAL SYNTHETIC MATERIAL; BUILDING PANELS, NOT OF METAL; WOOD PANELING; PARQUET FLOOR BOARDS OF WOOD AND LAMINATE; WALL LININGS, NOT OF METAL, FOR BUILDING (U.S. CLS. 1, 12, 33 AND 50).

CLASS 27—FLOOR COVERINGS

FOR FLOOR COVERINGS MADE OF VINYL; FLOOR COVERINGS; UNDERLAY FOR LAMINATE FLOORING (U.S. CLS. 19, 20, 37, 42 AND 50).

DANIEL CAPSHAW, EXAMINING ATTORNEY

CLASS 38—COMMUNICATION

FOR TELECOMMUNICATION SERVICES, NAMELY PERSONAL COMMUNICATION SERVICES; TELECOMMUNICATION SERVICES, NAMELY LOCAL TRANSMISSION AND LONG-DISTANCE TRANSMISSION OF VOICE, DATA AND GRAPHICS BY TELEPHONE, CABLE AND SATELLITE; FIXED AND MOBILE TELEPHONY SERVICES; CELLULAR AND MOBILE TELEPHONE SERVICES; ELECTRONIC TRANSMISSION OF DATA AND MESSAGES; ELECTRONIC TRANSMISSION OF RING TONES, LOGOS, SCREENS, PHOTOGRAPHS, DESIGNS, VIDEOS, SOUNDS AND SONGS TO CELLULAR TELEPHONES BY INTERNET; ELECTRONIC TRANSMISSION OF AUDIO AND VIDEO DATA VIA THE INTERNET; ELECTRONIC TRANSMISSION VIA INTERNET OF CUSTOMISED SCREENS FOR USE IN TELECOMMUNICATION APPARATUS; TELEPHONE VOICE MESSAGING SERVICES; PROVIDING TELECOMMUNICATIONS INFORMATION; PROVIDING ONLINE CHATROOMS FOR TRANSMISSION OF MESSAGES BETWEEN COMPUTER USERS CONCERNING TELECOMMUNICATIONS; MESSAGE SERVICES, NAMELY SENDING, RECEPTION AND TRANSMISSION OF MESSAGES IN THE FORM OF TEXTS, SOUND, GRAPHIC IMAGES, VIDEOS OR COMBINATIONS THEREOF; PROVIDING INFORMATION IN THE FILED OF TELEPHONE APPARATUS (U.S. CLS. 100, 101 AND 104).

CLASS 41—EDUCATION AND ENTERTAINMENT

FOR PUBLISHING OF ONLINE ELECTRONIC MAGAZINES; PROVIDING ON-LINE GAMES; PUBLISHING SERVICES OF MULTIMEDIA ENTERTAINMENT SOFTWARE; ENTERTAINMENT SERVICES PROVIDING INTERNET SITES CONTAINING SONGS, MUSICAL VIDEOS, VIDEO CLIPS, PHOTOGRAPHS AND OTHER MULTIMEDIA DATA; PROVISION OF SONGS, MUSICAL VIDEOS, VIDEO CLIPS, PHOTOGRAPHS VIA THE INTERNET AND WIRELESS NETWORKS (U.S. CLS. 100, 101 AND 107).

CLASS 42—SCIENTIFIC, COMPUTER AND LEGAL SERVICES

FOR CONSULTING IN COMPUTER HARDWARE AND SOFTWARE; COMPUTER SOFTWARE DEVELOPMENT AND UPDATING; DEVELOPMENT OF DATABASES, INTERNET SITES AND SEARCH ENGINES FOR OTHERS; CREATION OF WEB PORTALS SPECIFIC FOR THE MEETING OF INTERNET USERS AND USERS OF MOBILE PHONES (U.S. CLS. 100 AND 101).

DANIEL CAPSHAW, EXAMINING ATTORNEY

SN 79-008,287. SIEMENS AKTIENGESELLSCHAFT, FED REP GERMANY, FILED 11-18-2004.

ACT Angiographic Computed Tomography

THE MARK CONSISTS OF STANDARD CHARACTERS WITHOUT CLAIM TO ANY PARTICULAR FONT, STYLE, SIZE, OR COLOR.

PRIORITY DATE OF 8-24-2004 IS CLAIMED.

OWNER OF INTERNATIONAL REGISTRATION 0841464 DATED 11-18-2004, EXPIRES 11-18-2014.

NO CLAIM IS MADE TO THE EXCLUSIVE RIGHT TO USE "ANGIOGRAPHIC COMPUTER TOMOGRAPHY", APART FROM THE MARK AS SHOWN.

CLASS 9—ELECTRICAL AND SCIENTIFIC APPARATUS

FOR SOFTWARE FOR MEDICAL IMAGING AND DIAGNOSTICS; SOFTWARE FOR ANGIOGRAPHIC DEVICES (U.S. CLS. 21, 23, 26, 36 AND 38).

CLASS 10—MEDICAL APPARATUS

FOR ELECTROMEDICAL APPARATUS AND DEVICES FOR X-RAY DIAGNOSTIC AND THERAPY; ANGIOGRAPHIC DEVICES; REPLACEMENT PARTS OF THE AFORESAID APPARATUS AND DEVICES (U.S. CLS. 26, 39 AND 44).

DEBRA LEE, EXAMINING ATTORNEY

SN 79-008,646. ACCESS EQUIP MOTOS FRANCE, FRANCE, FILED 4-29-2004.

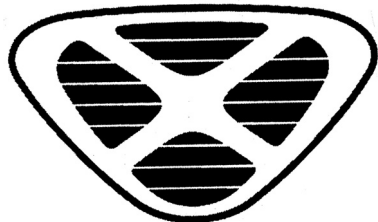

PRIORITY DATE OF 10-29-2003 IS CLAIMED.
OWNER OF INTERNATIONAL REGISTRATION 0842554 DATED 4-29-2004, EXPIRES 4-29-2014.

CLASS 12—VEHICLES

FOR BAGS, NAMELY, SADDLEBAGS FOR MOTOR BICYCLES AND MOTORCYCLES; ROAD MAP HOLDERS MADE OF LEATHER OR IMITATION LEATHER FOR MOTORCYCLES (U.S. CLS. 19, 21, 23, 31, 35 AND 44).

CLASS 18—LEATHER GOODS

FOR LEATHER AND IMITATION LEATHER SOLD IN BULK; ANIMAL SKINS AND HIDES; TRUNKS AND SUITCASES; UMBRELLAS, PARASOLS AND WALKING STICKS; WHIPS AND SADDLERY; SADDLE TREES AND STRAPS FOR HORSE SADDLES, LEATHER STRAPS; SATCHELS, CARD HOLDERS, WALLETS, AND LEATHER KEY CASES; DOCUMENT HOLDERS, PURSES NOT OF PRECIOUS METAL, SLING BAGS FOR CARRYING INFANTS, TRAVELING BAGS, BAGS FOR CAMPERS, BACKPACKS; HANDBAGS, LEATHER SHOPPING BAGS, RUCKSACKS FOR MOUNTAINEERS, BEACH BAGS, SCHOOL BAGS, FLEXIBLE BAGS FOR CLOTHING, LEATHER SATCHELS, ATHLETIC BAGS FOR HELMETS (U.S. CLS. 1, 2, 3, 22 AND 41).

CLASS 25—CLOTHING

FOR CLOTHING, NAMELY, FOOTWEAR EXCEPT ORTHOPEDIC FOOTWEAR, HEADWEAR; CLOTHING, NAMELY, FOOTWEAR, HEADWEAR OF LEATHER OR IMITATION LEATHER, WIND RESISTANT JACKETS, TROUSERS, JACKETS, ONE-PIECE SUITS PARTICULARLY FOR MOTORCYCLING; NECKERCHIEFS, CAP PEAKS, NECK SCARVES, HOODS, SOCKS, BELTS, MONEY BELTS; UNDERWEAR; SHOES, BOOTS; BOOTS FOR SPORTS; NON-SLIPPING DEVICES FOR BOOTS AND SHOES; SHOES AND BOOTS FOR MOTORCYCLING; BOOT COVERS; GLOVES, GLOVE LINERS, MITTENS (U.S. CLS. 22 AND 39).

WARREN L. OLANDRIA, EXAMINING ATTORNEY

SN 79-008,664. TONELLO S.R.L., ITALY, FILED 5-5-2004.



PRIORITY DATE OF 3-19-2004 IS CLAIMED.
OWNER OF INTERNATIONAL REGISTRATION 0842622 DATED 5-5-2004, EXPIRES 5-5-2014.
THE MARK CONSISTS, IN PART, OF A STYLIZED REPRESENTATION OF "Gi."

CLASS 7—MACHINERY

FOR SAMPLING MACHINES INTENDED FOR WASHING AND DYEING PROCESS ON SMALL QUANTITIES OF CLOTHING AND FABRICS, FOR USE IN THE TEXTILE INDUSTRY; MACHINES FOR WASHING CLOTHING AND FABRICS, DRY CLEANING MACHINES, MACHINES FOR WRINGING CLOTHING AND FABRICS, DYEING MACHINES, DYE SPRAYING MACHINES, WASHING AND DYEING MACHINES; IRONING MACHINES, BRUSHING MACHINES, MACHINE PARTS IN THE NATURE OF BRUSHES, INDUSTRIAL MACHINE PRESSES FOR CLOTHING AND FABRICS, INDUSTRIAL LASER MACHINES FOR PRODUCING VARIATIONS OF COLOR, PATTERN AND IMAGE EFFECTS ON FABRICS AND CLOTHING (U.S. CLS. 13, 19, 21, 23, 31, 34 AND 35).

CLASS 37—CONSTRUCTION AND REPAIR

FOR INSTALLATION, REPAIR AND MAINTENANCE OF MACHINES AND INSTALLATIONS FOR WASHING, DRY CLEANING, LAUNDERING, WATERPROOFING, DYEING AND BRUSHING CLOTHING AND FABRICS; CLEANING, WASHING, LAUNDERING, STEAM PRESSING OF CLOTHING AND FABRICS (U.S. CLS. 100, 103 AND 106).

VIVIAN MICZNIK FIRST, EXAMINING ATTORNEY

SN 79-008,693. DROUJESTVO S OGRANITCHENA OTGOVORNOST; "STS HOLDING GROUP" OOD, BULGARIA, FILED 8-4-2004.

LADY STYLE

THE MARK CONSISTS OF STANDARD CHARACTERS WITHOUT CLAIM TO ANY PARTICULAR FONT, STYLE, SIZE, OR COLOR.

PRIORITY DATE OF 2-6-2004 IS CLAIMED.

OWNER OF INTERNATIONAL REGISTRATION 0842691 DATED 8-4-2004, EXPIRES 8-4-2014.

CLASS 3—COSMETICS AND CLEANING PREPARATIONS

FOR PERFUMERY, COSMETICS, ESSENTIAL OILS FOR PERSONAL USE, SOAPS; HAIR LOTIONS; DENTIFRICES; COSMETIC DYES, NAMELY, HAIR DYES; HAIR SPRAY; NEUTRALIZERS FOR PERMANENT WAVING; CLEANING PREPARATIONS FOR TEETH AND DENTURES; BLEACHING PREPARATIONS AND OTHER SUBSTANCES FOR LAUNDRY USE, NAMELY STARCH, DETERGENT, AND BLUING; CLEANING, POLISHING, SCOURING AND ABRASIVE PREPARATIONS; CREAM FOR WHITENING THE SKIN; COSMETIC PREPARATIONS FOR HAIR CARE; COSMETIC PREPARATIONS FOR SKIN CARE; MAKE-UP; DEODORANTS FOR PERSONAL USE; COSMETIC KITS COMPRISED OF LIPSTICK, LIP GLOSS AND LIP LINER; COSMETIC CREAMS; HAIR WAVING PREPARATIONS; LOTIONS FOR SKIN, HAIR, FACIAL, BODY, AND HAIR WAVING; SHAMPOOS (U.S. CLS. 1, 4, 6, 50, 51 AND 52).

CLASS 5—PHARMACEUTICALS

FOR MATERIAL FOR STOPPING TEETH AND DENTAL WAX; ALL PURPOSE DISINFECTANTS; BIOLOGICAL PREPARATIONS FOR MEDICAL PURPOSES; VITAMIN PREPARATIONS; PHARMACEUTICAL PREPARATIONS FOR SKIN CARE; DISINFECTANTS FOR HYGIENE PURPOSES; DEODORANTS FOR AIR, CAR, HOUSEHOLD, AND ROOMS; CHEWING GUM FOR MEDICAL PURPOSES; MEDICATED JUJUBE LOZENGE; DENTAL AMALGAMS; REMEDIES FOR FOOT PERSPIRATION, NAMELY, ATHLETE'S FOOT PREPARATIONS; MEDICINAL MUD PACKS FOR THERAPEUTIC PURPOSES; POMADES FOR MEDICAL PURPOSES; MEDICINAL HERB TEA; MEDICINAL HERBS EXTRACTS; MEDICATED LOTIONS FOR SKIN, HAIR, SUNBURN, FACIAL, AND BODY; MEDICINAL PREPARATIONS FOR STIMULATING HAIR GROWTH; ANTIBIOTIC, ANTI-ITCH, AND HEMORRHOIDAL OINTMENTS FOR PHARMACEUTICAL PURPOSES; MINERAL WATER FOR MEDICAL PURPOSES; MILK FERMENTS FOR PHARMACEUTICAL PURPOSES; AIR FRESHENING PREPARATIONS; PHARMACEUTICAL PREPARATIONS FOR TREATING DANDRUFF; CHEMICAL PREPARATIONS FOR MEDICAL PURPOSES (U.S. CLS. 6, 18, 44, 46, 51 AND 52).

CLASS 21—HOUSEWARES AND GLASS

FOR TOOTHBRUSHES, EYEBROW BRUSHES, NAIL BRUSHES; SPRINKLERS, NAMELY, PERFUME ATOMIZERS SOLD EMPTY; PERFUME SPRAYERS SOLD EMPTY; COMBS; TOOTHBRUSH CASES NOT OF PRECIOUS METAL; DENTURE BATHS FEATURING PREPARATION BOXES FOR CLEANING TEETH AND DENTURES, NOT OF PRECIOUS METAL (U.S. CLS. 2, 13, 23, 29, 30, 33, 40 AND 50).

WARREN L. OLANDRIA, EXAMINING ATTORNEY

SN 79-009,079. THE BODY SHOP INTERNATIONAL PLC, WEST SUSSEX, UNITED KINGDOM, FILED 8-24-2004.

MADE WITH PASSION

OWNER OF INTERNATIONAL REGISTRATION 0843894 DATED 8-24-2004, EXPIRES 8-24-2014.

CLASS 3—COSMETICS AND CLEANING PREPARATIONS

FOR COSMETICS AND SKIN CARE PRODUCTS, NAMELY, FOUNDATION, CONCEALER, MASCARA, EYE SHADOW, EYE AND/OR BROW LINERS, LIPSTICK, LIP LINER, LIP BALM, FACE POWDER, BRONZER, BLUSHER, MOISTURIZERS, MAKE-UP REMOVER; NON-MEDICATED BODY POWDER; SKIN SOAPS; BATH GEL, BATH OILS, BATH SALTS, BATH BEADS, AND EFFERVESCENT BATH PREPARATIONS IN THE NATURE OF BATH FIZZIES; NON-MEDICATED SKIN CARE PREPARATIONS, NAMELY, LOTIONS, CREAMS, CLEANSERS, SCRUBS, MASKS AND TONERS; HAIR CARE AND HAIR STYLING PREPARATIONS, NAMELY, SHAMPOOS, CONDITIONERS, FINISHING SPRAY, AND GELS; PERSONAL DEODORANTS, SUN-TANNING PREPARATIONS; SUNSCREEN OILS AND LOTIONS; SHAVING PREPARATIONS; DENTIFRICES; PERFUMES, EAU DE TOILETTE, ESSENTIAL OILS FOR PERSONAL USE, PERFUME OILS; NAIL CARE PREPARATIONS; NAIL ENAMEL; PUMICE STONE, COTTON STICKS AND WOOL SWABS FOR NON-MEDICAL PURPOSES ALL FOR USE ON THE BODY; SCENTED ROOM FRAGRANCES, INCENSE STICKS, POTPOURRI AND SACHETS; POWDERED COSMETIC TISSUES; TISSUES IMPREGNATED WITH COSMETIC LOTIONS; KITS AND GIFT SETS CONTAINING SKIN AND/OR HAIR CARE PREPARATIONS (U.S. CLS. 1, 4, 6, 50, 51 AND 52).

CLASS 16—PAPER GOODS AND PRINTED MATTER

FOR MAGAZINES, CATALOGUES, INFORMATIONAL BROCHURES, PAMPHLETS, AND POSTERS IN THE FIELDS OF SKIN CARE, COSMETICS, HAIR CARE, BEAUTY, SELF-ESTEEM, SOCIAL ACTIVISM, HUMANITARIAN ISSUES, HUMAN RIGHTS, PROTECTION OF ANIMALS AND/OR ENVIRONMENTAL ISSUES; BOOKS IN THE FIELDS OF PERSONAL WELL BEING, EXERCISE, MASSAGE AND YOGA; EYE AND LIP PENCIL SHARPENERS (U.S. CLS. 2, 5, 22, 23, 29, 37, 38 AND 50).

CLASS 35—ADVERTISING AND BUSINESS

FOR RETAIL STORE SERVICES, ON-LINE RETAIL STORE SERVICES, TELEPHONE SHOP-AT-HOME ORDERING SERVICES, AND SHOP-AT-HOME PARTIES FEATURING BEAUTY PRODUCTS, COSMETICS, TOILETRIES, SKIN CARE PREPARATIONS, HAIR CARE PREPARATIONS, FRAGRANCES, AND PERSONAL CARE PRODUCTS; COMPUTERISED ON-LINE ORDERING SERVICES FEATURING BEAUTY PRODUCTS, COSMETICS, SKIN CARE PRODUCTS, FRAGRANCES, AND RELATED PRODUCTS (U.S. CLS. 100, 101 AND 102).

MAUREEN DALL, EXAMINING ATTORNEY

* * * * *

SECTION 2.— INTERNATIONAL CLASSIFICATION

The short titles associated below with the international class numbers are terms designed merely for quick identification and are not an official part of the international classification. The full names of international classes are given in section 6.1 of the trademark rules of practice.

The designation "U.S. Cl." appearing in this section refers to the U.S. class in effect prior to Sep. 1, 1973 rather than the international class which applies to applications filed on or after that date. For adoption of international classification see notice in the OFFICIAL GAZETTE of Jun. 26, 1973 (911 O.G. TM 210).

Application in one class

CLASS 1—CHEMICALS

SN 76-068,377. DAIKIN INDUSTRIES, LTD., KITA-KU, OSAKA, JAPAN, FILED 6-12-2000.

NOVATECH

OWNER OF JAPAN REG. NO. 4067708, DATED 10-9-1997, EXPIRES 10-9-2007.

FOR FLUORINATED POWDER AND FLUORINATED POWDER DISPERSION FOR USE AS INGREDIENTS IN THE MANUFACTURE OF COSMETIC PREPARATIONS (U.S. CLS. 1, 5, 6, 10, 26 AND 46).

ELLEN PERKINS, EXAMINING ATTORNEY

SN 76-533,543. ITALMATCH CHEMICALS S.P.A., 1-16149 SAN BENIGNO - GENOVA, ITALY, FILED 7-30-2003.

MELAGARD

PRIORITY CLAIMED UNDER SEC. 44(D) ON ERP N CMNTY TM OFC APPLICATION NO. 003228392, FILED 6-17-2003, REG. NO. 3228392, DATED 10-22-2004, EXPIRES 10-22-2014.

FOR CHEMICAL ADDITIVES FOR USE IN INDUSTRY AND IN SCIENCE, NAMELY, CHEMICAL ADDITIVES USED FOR PRODUCTION OF FLAME RETARDANT THERMOPLASTIC MATERIALS, SELF EXTINGUISHING ARTICLES FOR ELECTRICAL AND ELECTRONIC APPLICATIONS, INTUMESCENT PAINTS AND VARNISHES; CHEMICAL ADDITIVES FOR USE AS FIRE EXTINGUISHING COMPOSITION AND AS A FLAME RETARDANT IN THE MANUFACTURE OF PLASTICS AND COATINGS AND VARNISHES; AND CHEMICAL ADDITIVES FOR USE IN THE MANUFACTURE OF LUBRICANTS AND ADHESIVES (U.S. CLS. 1, 5, 6, 10, 26 AND 46).

BILL DAWE, EXAMINING ATTORNEY

CLASS 1—(Continued).

SN 76-546,066. WORLD WIDE IMPORTS ENTERPRISES, INC., FT. LAUDERDALE, FL. FILED 9-22-2003.



FOR SALTWATER SOLUTIONS, NAMELY NATURAL SALTWATER AND CONCENTRATED NATURAL SALTWATER SOLD IN RETAIL CONTAINERS FOR USE IN FILLING AQUARIUMS DURING INITIAL SET-UP, FOR REPLACING WATER LOST TO EVAPORATION, AND FOR AQUARIUM WATER CHANGES (U.S. CLS. 1, 5, 6, 10, 26 AND 46).

DOUGLAS LEE, EXAMINING ATTORNEY

SN 76-546,067. WORLD WIDE IMPORTS ENTERPRISES, INC., FT. LAUDERDALE, FL. FILED 9-22-2003.



NO CLAIM IS MADE TO THE EXCLUSIVE RIGHT TO USE "100% NATURAL OCEAN SALTWATER", APART FROM THE MARK AS SHOWN.

THE STIPPLING IS FOR SHADING PURPOSES.

FOR SALTWATER SOLUTIONS, NAMELY NATURAL SALTWATER AND CONCENTRATED NATURAL SALTWATER SOLD IN RETAIL CONTAINERS FOR USE IN FILLING AQUARIUMS DURING INITIAL SET-UP, FOR REPLACING WATER LOST TO EVAPORATION, AND FOR AQUARIUM WATER CHANGES (U.S. CLS. 1, 5, 6, 10, 26 AND 46).

DOUGLAS LEE, EXAMINING ATTORNEY

CLASS 1—(Continued).

SN 76-546,068. WORLD WIDE IMPORTS ENTERPRISES, INC., FT. LAUDERDALE, FL. FILED 9-22-2003.



NO CLAIM IS MADE TO THE EXCLUSIVE RIGHT TO USE "NATURALLY FILTERED", APART FROM THE MARK AS SHOWN.

FOR SALTWATER AND FRESH WATER SOLUTIONS, NAMELY NATURAL SALTWATER, NATURAL FRESHWATER, CONCENTRATED NATURAL SALTWATER AND CONCENTRATED NATURAL FRESH WATER EACH SOLD IN RETAIL CONTAINERS FOR USE IN FILLING AQUARIUMS DURING INITIAL SET-UP, FOR REPLACING WATER LOST TO EVAPORATION, AND FOR AQUARIUM WATER CHANGES (U.S. CLS. 1, 5, 6, 10, 26 AND 46).

DOUGLAS LEE, EXAMINING ATTORNEY

SN 76-557,309. STARFIRE SYSTEMS, INC., MALTA, NY. FILED 10-14-2003.



NO CLAIM IS MADE TO THE EXCLUSIVE RIGHT TO USE "SYSTEMS", APART FROM THE MARK AS SHOWN.

FOR SILICON CARBIDE PRECURSOR POLYMERS AND PRECURSOR POLYMER CONTAINING COMPOSITIONS FOR USE IN THE MANUFACTURE OF HIGH TEMPERATURE STABLE, WEAR RESISTANT ADVANCED CERAMIC ARTICLES OF MANUFACTURE AND PRODUCTS IN THE FORM OF BARS, BLOCKS, RODS, SHEETS, FILMS, TUBES, PELLETS, COATINGS AND OTHER SHAPES (U.S. CLS. 1, 5, 6, 10, 26 AND 46).

FIRST USE 12-31-2003; IN COMMERCE 2-17-2004.

LINDA M. KING, EXAMINING ATTORNEY

CLASS 1—(Continued).

SN 76-561,606. NURSERY PRO, INC., BATAVIA, IL. FILED 11-24-2003.

ECOSYSTEMS

THE MARK CONSISTS OF STANDARD CHARACTERS WITHOUT CLAIM TO ANY PARTICULAR FONT, STYLE, SIZE, OR COLOR.

FOR CHEMICALS FOR WATER TREATMENT, CONDITIONING AND CLEANING IN PONDS AND WATER GARDENS (U.S. CLS. 1, 5, 6, 10, 26 AND 46).

FIRST USE 4-1-2003; IN COMMERCE 4-1-2003.

WILLIAM VERHOSEK, EXAMINING ATTORNEY

SN 76-562,903. MIRADOR DNA DESIGN INC., MONTREAL, QUEBEC, CANADA, FILED 12-3-2003.

ACTGEL

THE MARK CONSISTS OF STANDARD CHARACTERS WITHOUT CLAIM TO ANY PARTICULAR FONT, STYLE, SIZE, OR COLOR.

PRIORITY CLAIMED UNDER SEC. 44(D) ON CANADA APPLICATION NO. 1195213, FILED 10-29-2003, REG. NO. TMA629124, DATED 12-23-2004, EXPIRES 12-23-2019.

FOR PRECAST GEL CASSETTE TO ANALYZE DNA AND PROTEINS FOR USE IN LABORATORIES (U.S. CLS. 1, 5, 6, 10, 26 AND 46).

STEVEN JACKSON, EXAMINING ATTORNEY

SN 76-569,990. YEASTERN BIOTECH CO., LTD., CHUNG-SHAN CHU, TAIPEI CITY, TAIWAN, FILED 1-14-2004.

ECOS

THE MARK CONSISTS OF STANDARD CHARACTERS WITHOUT CLAIM TO ANY PARTICULAR FONT, STYLE, SIZE, OR COLOR.

FOR MOLECULAR BIOLOGY KITS FOR SCIENTIFIC RESEARCH COMPRISED OF GRAM NEGATIVE BACTERIA PREPARATIONS; GRAM NEGATIVE BACTERIA PREPARATIONS, NAMELY, E-COLI PREPARATIONS FOR USE IN THE FIELD OF MOLECULAR BIOLOGY; AND CELLS FOR SCIENTIFIC, LABORATORY OR MEDICAL RESEARCH (U.S. CLS. 1, 5, 6, 10, 26 AND 46).

FIRST USE 3-27-2001; IN COMMERCE 6-17-2002.

RUSS HERMAN, EXAMINING ATTORNEY

CLASS 1—(Continued).

SN 76-586,948. PARATHERM CORPORATION, CONSHOHOCKEN, PA. FILED 4-13-2004.

CLASS 1—(Continued).

SN 76-594,141. PERFORMANCE INDICATOR, LLC, TOPSFIELD, MA. FILED 5-25-2004.

CR

PROMISE OF PURITY

FOR HEAT TRANSFER FLUIDS FOR INDUSTRIAL USE, NAMELY, FLUIDS THAT PROVIDE REPRODUCIBLE TEMPERATURE CONTROL FOR USE IN HEAT TRANSFER SYSTEMS IN CRYOGENICALLY-DRIVEN PROCESS APPLICATIONS FOR REDUCING RUNAWAY COIL FREEZE-UPS (U.S. CLS. 1, 5, 6, 10, 26 AND 46).
FIRST USE 9-24-2003; IN COMMERCE 9-24-2003.
TIMOTHY FINNEGAN, EXAMINING ATTORNEY

THE MARK CONSISTS OF STANDARD CHARACTERS WITHOUT CLAIM TO ANY PARTICULAR FONT, STYLE, SIZE, OR COLOR.
FOR VISUAL CHEMICAL INDICATORS, NAMELY, CHEMICAL CARRIERS TRIGGERED WHEN REACTING TO SPECIFIC CHEMICAL OR PHYSICAL CONDITIONS FOR THE PURPOSE OF AUTHENTICATION, EXPIRATION, SHELF LIFE, AND/OR TAMPER INDICATION (U.S. CLS. 1, 5, 6, 10, 26 AND 46).
RON FAIRBANKS, EXAMINING ATTORNEY

SN 76-593,532. NIOTAN, INC., MOUND HOUSE, NV. FILED 5-24-2004.

SN 76-594,468. DYMAX CORPORATION, TORRINGTON, CT. FILED 5-26-2004.

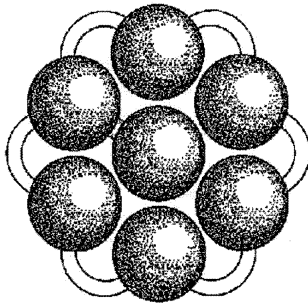

LIGHT CAP

THE STIPPLING IN THE DRAWING IS FOR SHADING PURPOSES ONLY AND IS NOT A FEATURE OF THE MARK.
FOR CHEMICAL PRODUCTS FOR INDUSTRIAL USE IN A WIDE VARIETY OF INDUSTRIAL AND MANUFACTURING APPLICATIONS, NAMELY, TANTALUM PRODUCTS, NIOBIUM PRODUCTS, AND BERYLLIUM PRODUCTS (U.S. CLS. 1, 5, 6, 10, 26 AND 46).
CHERYL STEPLIGHT, EXAMINING ATTORNEY

THE MARK CONSISTS OF STANDARD CHARACTERS WITHOUT CLAIM TO ANY PARTICULAR FONT, STYLE, SIZE, OR COLOR.
NO CLAIM IS MADE TO THE EXCLUSIVE RIGHT TO USE "LIGHT", APART FROM THE MARK AS SHOWN.
FOR CHEMICAL PRODUCTS IN THE NATURE OF RADIATION-CURABLE FORMULATION FOR FORMING AND FOR COATING LENSES OF LIGHT-EMITTING ELECTRONIC DEVICES (U.S. CLS. 1, 5, 6, 10, 26 AND 46).
FIRST USE 8-27-2003; IN COMMERCE 8-27-2003.
GEORGE LORENZO, EXAMINING ATTORNEY

CLASS 1—(Continued).

SN 76-606,330. CYCLO INDUSTRIES, LLC, PALM BEACH GARDENS, FL. FILED 8-9-2004.

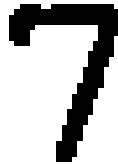

THE MARK CONSISTS OF STANDARD CHARACTERS WITHOUT CLAIM TO ANY PARTICULAR FONT, STYLE, SIZE, OR COLOR.

OWNER OF U.S. REG. NO. 731,024.
FOR AUTOMOBILE COOLING SYSTEM LEAK SEALANTS, BRAKE FLUIDS (U.S. CLS. 1, 5, 6, 10, 26 AND 46).
FIRST USE 9-13-1960; IN COMMERCE 9-13-1960.
TIMOTHY FINNEGAN, EXAMINING ATTORNEY

CLASS 1—(Continued).

SN 76-609,783. UTELITE CORPORATION, COALVILLE, UT. FILED 8-30-2004.

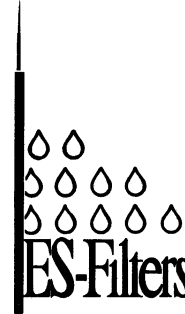

THE MARK CONSISTS OF ES-FILTERS WITH TEAR DROPS ABOVE THE LETTERS AND A BAR WITH A STEPPED, POINTED UPPER TIP IMMEDIATELY TO THE LEFT OF THE LETTERS.
FOR SOIL TREATMENT COMPOSITIONS IN THE NATURE OF EXPANDED SHALE FOR THE PURPOSES OF ABSORBING MOISTURE AND FILTRATION OF WATER (U.S. CLS. 1, 5, 6, 10, 26 AND 46).
KATHRYN COWARD, EXAMINING ATTORNEY

SN 76-619,759. FLAME SEAL PRODUCTS, INC., HOUSTON, TX. FILED 11-8-2004.



THE MARK CONSISTS OF STANDARD CHARACTERS WITHOUT CLAIM TO ANY PARTICULAR FONT, STYLE, SIZE, OR COLOR.
FOR NON-FLAMMABLE ADHESIVE FOR GENERAL INDUSTRIAL USE (U.S. CLS. 1, 5, 6, 10, 26 AND 46).
FIRST USE 8-26-2004; IN COMMERCE 8-26-2004.
SUNG IN, EXAMINING ATTORNEY

SN 76-607,538. IT'S OUR EARTH, INC., GLEN ELLYN, IL. FILED 8-18-2004.



SN 76-622,317. CHEMSTAR PRODUCTS COMPANY, MINNEAPOLIS, MN. FILED 11-26-2004.



THE MARK CONSISTS OF STANDARD CHARACTERS WITHOUT CLAIM TO ANY PARTICULAR FONT, STYLE, SIZE, OR COLOR.
FOR AGRICULTURAL AND HORTICULTURAL PRODUCTS MADE FROM RECYCLABLE MATERIALS, NAMELY FERTILIZERS, MADE FROM A BASE MATERIAL OF SPENT COFFEE GROUNDS (U.S. CLS. 1, 5, 6, 10, 26 AND 46).
FIRST USE 6-0-2004; IN COMMERCE 6-0-2004.
STANLEY I. OSBORNE, EXAMINING ATTORNEY

THE MARK CONSISTS OF STANDARD CHARACTERS WITHOUT CLAIM TO ANY PARTICULAR FONT, STYLE, SIZE, OR COLOR.
OWNER OF U.S. REG. NOS. 1,513,255 AND 1,529,164.
FOR ABSORBENT STARCH GRAFT POLYMER PRODUCED AND SOLD IN POWDER, GRANULE AND FLAKE FORM FOR USE IN SOIL EROSION CONTROL AND SOIL REMEDIATION (U.S. CLS. 1, 5, 6, 10, 26 AND 46).
EUGENIA MARTIN, EXAMINING ATTORNEY

CLASS 1—(Continued).

SN 76-622,452. GRUPO LAMOSA, S.A. DE C.V., MONTEREY, NUEVO LEON, MEXICO, FILED 11-29-2004.



FOR CERAMIC ADHESIVE (U.S. CLS. 1, 5, 6, 10, 26 AND 46).

FIRST USE 1-27-1998; IN COMMERCE 1-27-1998.
CHERYL CLAYTON, EXAMINING ATTORNEY

SN 76-622,758. WORLD WIDE IMPORTS ENTERPRISES, INC., FT. LAUDERDALE, FL. FILED 12-1-2004.

NATURAL LIVE CONCENTRATED SEAWATER

THE MARK CONSISTS OF STANDARD CHARACTERS WITHOUT CLAIM TO ANY PARTICULAR FONT, STYLE, SIZE, OR COLOR.

NO CLAIM IS MADE TO THE EXCLUSIVE RIGHT TO USE "NATURAL" AND "CONCENTRATED SEAWATER", APART FROM THE MARK AS SHOWN.

FOR SALTWATER SOLUTIONS, NAMELY, SALTWATER AND CONCENTRATED SALTWATER FOR USE IN FILLING OR WATER CHANGES IN AQUARIUMS AND AQUATIC DISPLAYS (U.S. CLS. 1, 5, 6, 10, 26 AND 46).

CYNTHIA SLOAN, EXAMINING ATTORNEY

SN 76-622,761. WORLD WIDE IMPORTS ENTERPRISES, INC., FT. LAUDERDALE, FL. FILED 12-1-2004.

NATURAL LIVE CONCENTRATED SALTWATER

THE MARK CONSISTS OF STANDARD CHARACTERS WITHOUT CLAIM TO ANY PARTICULAR FONT, STYLE, SIZE, OR COLOR.

NO CLAIM IS MADE TO THE EXCLUSIVE RIGHT TO USE "NATURAL" AND "CONCENTRATED SALTWATER", APART FROM THE MARK AS SHOWN.

FOR SALTWATER SOLUTIONS, NAMELY, SALTWATER AND CONCENTRATED SALTWATER FOR USE IN FILLING OR WATER CHANGES IN AQUARIUMS AND AQUATIC DISPLAYS (U.S. CLS. 1, 5, 6, 10, 26 AND 46).

CYNTHIA SLOAN, EXAMINING ATTORNEY

CLASS 1—(Continued).

SN 76-626,280. KELTY PARTNERSHIP, PLANKINGTON, SD. FILED 12-30-2004.

NITRO GRIP

THE MARK CONSISTS OF STANDARD CHARACTERS WITHOUT CLAIM TO ANY PARTICULAR FONT, STYLE, SIZE, OR COLOR.

NO CLAIM IS MADE TO THE EXCLUSIVE RIGHT TO USE GRIP, APART FROM THE MARK AS SHOWN.

FOR TIRE TREATMENTS, NAMELY, SPRAY ON ADHESIVE USED TO CREATE BETTER TRACTION (U.S. CLS. 1, 5, 6, 10, 26 AND 46).

JANICE L. MCMORROW, EXAMINING ATTORNEY

SN 76-627,136. FRANKLIN INTERNATIONAL, INC., COLUMBUS, OH. FILED 1-7-2005.

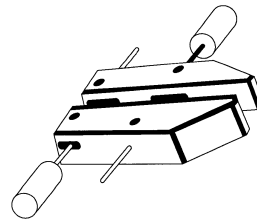

FOR ADHESIVES AND GLUES FOR WOODWORKING AND CONSTRUCTION (U.S. CLS. 1, 5, 6, 10, 26 AND 46).

FIRST USE 0-0-1991; IN COMMERCE 0-0-1991.

DEBRA LEE, EXAMINING ATTORNEY

SN 76-627,556. POWER SERVICE PRODUCTS, INC., WEATHERFORD, TX. FILED 1-10-2005.

DIESEL 911

THE MARK CONSISTS OF STANDARD CHARACTERS WITHOUT CLAIM TO ANY PARTICULAR FONT, STYLE, SIZE, OR COLOR.

OWNER OF U.S. REG. NO. 2,443,290.

NO CLAIM IS MADE TO THE EXCLUSIVE RIGHT TO USE "DIESEL", APART FROM THE MARK AS SHOWN.

FOR CHEMICAL ADDITIVES FOR USE IN COMBINATION WITH ENGINE FUELS (U.S. CLS. 1, 5, 6, 10, 26 AND 46).

FIRST USE 7-0-1999; IN COMMERCE 7-0-1999.

STEVEN R. FOSTER, EXAMINING ATTORNEY

CLASS 1—(Continued).

SN 76-628,232. MILLER CHEMICAL & FERTILIZER CORPORATION, HANOVER, PA. FILED 1-18-2005.

NUTRICHEM

THE MARK CONSISTS OF STANDARD CHARACTERS WITHOUT CLAIM TO ANY PARTICULAR FONT, STYLE, SIZE, OR COLOR.

FOR SOLUBLE FERTILIZERS FOR USE IN COMMERCIAL AGRICULTURE AND HORTICULTURE (U.S. CLS. 1, 5, 6, 10, 26 AND 46).

FIRST USE 4-30-1983; IN COMMERCE 4-30-1983.
KAREN BRACEY, EXAMINING ATTORNEY

SN 76-977,645. ROOFING SUPPLY LIMITED, HOUSTON, TX. FILED 6-11-2004.

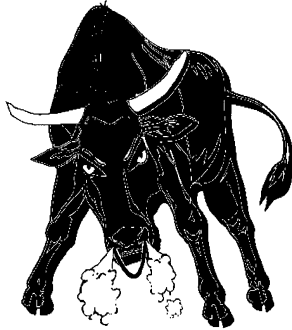

THE STIPPLING IS A FEATURE OF THE MARK. FOR ROOFING ADHESIVES. (U.S. CLS. 1, 5, 6, 10, 26 AND 46).

DORITT L. CARROLL, EXAMINING ATTORNEY

SN 78-259,490. KALO, INC., OVERLAND PARK, KS. FILED 6-6-2003.



FOR GARDEN INOCULANTS, NAMELY, NITROGEN FIXING BACTERIA (U.S. CLS. 1, 5, 6, 10, 26 AND 46).
FIRST USE 2-1-1985; IN COMMERCE 2-1-1985.
JOANNA DUKOVIC, EXAMINING ATTORNEY

CLASS 1—(Continued).

SN 78-287,193. MILLIKEN & COMPANY, SPARTANBURG, SC. FILED 8-14-2003.

**INVENTING POLYMER
ADDITIVE TECHNOLOGIES**

NO CLAIM IS MADE TO THE EXCLUSIVE RIGHT TO USE "POLYMER ADDITIVE TECHNOLOGIES", APART FROM THE MARK AS SHOWN.

FOR CHEMICAL ADDITIVES FOR THERMOPLASTIC, ELASTOMERIC AND THERMOSET POLYMERS FOR USE IN THE MANUFACTURE OF A WIDE VARIETY OF GOODS (U.S. CLS. 1, 5, 6, 10, 26 AND 46).

CHARLES JOYNER, EXAMINING ATTORNEY

SN 78-357,465. ALBEMARLE CORPORATION, BATON ROUGE, LA. FILED 1-26-2004.

ETHAPHOS

THE MARK CONSISTS OF STANDARD CHARACTERS WITHOUT CLAIM TO ANY PARTICULAR FONT, STYLE, SIZE, OR COLOR.

FOR CHEMICALS, NAMELY, ANTIOXIDANTS FOR USE IN THE MANUFACTURE OF PLASTICS, SPECIALTY CHEMICALS, POLYMERS, INDUSTRIAL CHEMICALS, ADHESIVES AND LUBRICANTS (U.S. CLS. 1, 5, 6, 10, 26 AND 46).

BARNEY CHARLON, EXAMINING ATTORNEY

CLASS 1—(Continued).

SN 78-375,683. ENVIROSPECIALISTS, INC., FORT WORTH, TX. FILED 2-27-2004.



THE MARK CONSISTS OF AN "E" THAT LOOKS LIKE IT WAS PAINTED WITH A PAINTBRUSH.

FOR WATER TREATMENT AND CONSERVATION CHEMICALS USED TO MINIMIZE SOIL HYDRATION AND ALLOW SOIL TO RETAIN MOISTURE AND REDUCE DUST (U.S. CLS. 1, 5, 6, 10, 26 AND 46).

FIRST USE 6-0-2000; IN COMMERCE 6-0-2000.
MARC LEIPZIG, EXAMINING ATTORNEY

CLASS 1—(Continued).

SN 78-412,115. KEMSOL, INC., COLORADO SPRINGS, CO. FILED 5-3-2004.

CLARIFY

THE MARK CONSISTS OF STANDARD CHARACTERS WITHOUT CLAIM TO ANY PARTICULAR FONT, STYLE, SIZE, OR COLOR.

FOR CHEMICAL PREPARATION FOR USE IN THE OIL INDUSTRY, NAMELY, A CHEMICAL ADDITIVE FOR BREAKING UP, TREATING, AND SEPARATING OIL WATER EMULSIONS FOR USE IN PETROLEUM EXPLORATION AND PRODUCTION, REFINERIES, OIL PIPELINES, OIL FIELD SLUDGES, AND PETROLEUM EXTRACTION, TRANSPORTATION, AND PROCESSING FACILITIES. (U.S. CLS. 1, 5, 6, 10, 26 AND 46).

MICHAEL TANNER, EXAMINING ATTORNEY

SN 78-411,538. JSR CORPORATION, TOKYO, JAPAN, FILED 4-30-2004.

NFR

THE MARK CONSISTS OF STANDARD CHARACTERS WITHOUT CLAIM TO ANY PARTICULAR FONT, STYLE, SIZE, OR COLOR.

OWNER OF JAPAN REG. NO. 2628169, DATED 2-28-1994, EXPIRES 2-25-2014.

FOR PHOTORESISTS (U.S. CLS. 1, 5, 6, 10, 26 AND 46).
TRACY CROSS, EXAMINING ATTORNEY

SN 78-420,228. INVITROGEN CORPORATION, CARLSBAD, CA. FILED 5-17-2004.

NOVEX

THE MARK CONSISTS OF STANDARD CHARACTERS WITHOUT CLAIM TO ANY PARTICULAR FONT, STYLE, SIZE, OR COLOR.

OWNER OF U.S. REG. NO. 2,103,461.

FOR ELECTROPHORESIS GEL AND CHROMATOGRAPHY CHEMICALS, BUFFERS, AND SOLUTIONS FOR SCIENTIFIC RESEARCH (U.S. CLS. 1, 5, 6, 10, 26 AND 46).

FIRST USE 8-17-1987; IN COMMERCE 8-17-1987.
RUSS HERMAN, EXAMINING ATTORNEY

CLASS 1—(Continued).

SN 78-427,274. CHEVRON CORPORATION, SAN RAMON, CA. FILED 5-28-2004.

CLASS 1—(Continued).

SN 78-452,964. IVEY, GEORGE, CAMPBELL RIVER, B.C., CANADA, FILED 7-19-2004.

RESPOND

Ivey-sol

THE MARK CONSISTS OF STANDARD CHARACTERS WITHOUT CLAIM TO ANY PARTICULAR FONT, STYLE, SIZE, OR COLOR.

FOR CHEMICAL ADDITIVES FOR FUEL TREATMENT (U.S. CLS. 1, 5, 6, 10, 26 AND 46).
STEVEN JACKSON, EXAMINING ATTORNEY

THE MARK CONSISTS OF STANDARD CHARACTERS WITHOUT CLAIM TO ANY PARTICULAR FONT, STYLE, SIZE, OR COLOR.

FOR PATENTED NON-IONIC SURFACTANT MIXTURE USED TO DISSOLVE OIL PRODUCTS AND HEAVY METALS (U.S. CLS. 1, 5, 6, 10, 26 AND 46).
FIRST USE 11-1-1993; IN COMMERCE 11-1-1993.
TRACY WHITAKER-BOWN, EXAMINING ATTORNEY

SN 78-444,933. MEIER, GARTH, GRAND JUNCTION, CO. FILED 7-1-2004.

SN 78-453,528. SEMEQUIP, INC., NORTH BILLERICA, MA. FILED 7-20-2004.

FREEZE SEAL

CLUSTERBORON

THE MARK CONSISTS OF STANDARD CHARACTERS WITHOUT CLAIM TO ANY PARTICULAR FONT, STYLE, SIZE, OR COLOR.

FOR FERTILIZERS (U.S. CLS. 1, 5, 6, 10, 26 AND 46).
CHARLES JOYNER, EXAMINING ATTORNEY

THE MARK CONSISTS OF STANDARD CHARACTERS WITHOUT CLAIM TO ANY PARTICULAR FONT, STYLE, SIZE, OR COLOR.

FOR DOPING COMPOUND FOR USE IN THE MANUFACTURE OF SEMICONDUCTORS (U.S. CLS. 1, 5, 6, 10, 26 AND 46).
FIRST USE 7-14-2003; IN COMMERCE 7-19-2004.
MIDGE BUTLER, EXAMINING ATTORNEY

CLASS 1—(Continued).

SN 78-478,576. CHEMENCE, INC., ALPHARETTA, GA.
FILED 9-3-2004.

ONE SHOT ADHESIVE

THE MARK CONSISTS OF STANDARD CHARACTERS WITHOUT CLAIM TO ANY PARTICULAR FONT, STYLE, SIZE, OR COLOR.

NO CLAIM IS MADE TO THE EXCLUSIVE RIGHT TO USE "ADHESIVE", APART FROM THE MARK AS SHOWN, FOR ADHESIVES FOR GENERAL INDUSTRIAL USE (U.S. CLS. 1, 5, 6, 10, 26 AND 46).

JERI J. FICKES, EXAMINING ATTORNEY

SN 78-485,236. LOVELAND PRODUCTS, INC., GREELEY, CO. FILED 9-17-2004.



OWNER OF U.S. REG. NO. 2,404,566.
THE MARK CONSISTS OF THE WORD AMPLIFY WITH SIX OUTER CIRCLES THAT START AROUND THE LETTER "A" AND GET LARGER WITH EACH OUTER CIRCLE. FOR AGRICULTURAL CHEMICALS FOR INHIBITING SPROUT GROWTH ON POTATOES IN STORAGE (U.S. CLS. 1, 5, 6, 10, 26 AND 46).
FIRST USE 9-5-2003; IN COMMERCE 9-5-2003.
MICHELLE S. WISEMAN, EXAMINING ATTORNEY

SN 78-491,248. LONG ISLAND COMPOST CORP., WESTBURY, NY. FILED 9-29-2004.

HAMPTONS ESTATE

THE MARK CONSISTS OF STANDARD CHARACTERS WITHOUT CLAIM TO ANY PARTICULAR FONT, STYLE, SIZE, OR COLOR.

FOR PLANTING AND POTTING SOIL; POTTING MIX; FERTILIZER; COMPOST AND MANURE (U.S. CLS. 1, 5, 6, 10, 26 AND 46).

HOWARD B. LEVINE, EXAMINING ATTORNEY

CLASS 1—(Continued).

SN 78-504,253. THE DOW CHEMICAL COMPANY, MIDLAND, MI. FILED 10-22-2004.

ADSORBSIA GTO

THE MARK CONSISTS OF STANDARD CHARACTERS WITHOUT CLAIM TO ANY PARTICULAR FONT, STYLE, SIZE, OR COLOR.

NO CLAIM IS MADE TO THE EXCLUSIVE RIGHT TO USE "GTO", APART FROM THE MARK AS SHOWN, FOR ABSORBENT COMPOUNDS FOR THE REMOVAL OF ARSENIC AND HEAVY METALS IN WATER TREATMENT (U.S. CLS. 1, 5, 6, 10, 26 AND 46).

NAAKWAMA ANKRAH, EXAMINING ATTORNEY

SN 78-516,367. POLY-TUFF SYSTEMS INTERNATIONAL CORPORATION, LAS VAGAS, NV. FILED 11-12-2004.

THE MARK CONSISTS OF STANDARD CHARACTERS WITHOUT CLAIM TO ANY PARTICULAR FONT, STYLE, SIZE, OR COLOR.

FOR POLYMER COATINGS FOR WATERPROOFING WOOD, CONCRETE AND STEEL SUBSTRATES (U.S. CLS. 1, 5, 6, 10, 26 AND 46).

FIRST USE 11-1-2004; IN COMMERCE 11-1-2004.
YONG KIM, EXAMINING ATTORNEY

CLASS 1—(Continued).

SN 78-518,570. IFS INDUSTRIES, INC., READING, PA. FILED 11-17-2004.

CLASS 1—(Continued).

SN 78-519,434. GRANT INDUSTRIES, INC., ELMWOOD PARK, NJ. FILED 11-18-2004.

DURA PRO

GranSmooth

THE MARK CONSISTS OF STANDARD CHARACTERS WITHOUT CLAIM TO ANY PARTICULAR FONT, STYLE, SIZE, OR COLOR.

FOR ADHESIVES, NAMELY, WATER BASED POLY-VINYL ACETATE, WATER BASED ETHYLENE VINYL ACETATE, HOT MELT ETHYLENE VINYL ACETATE, PRESSURE SENSITIVE, HOT MELT POLYURETHANE, LIQUID POLYURETHANE; ADHESIVES FOR INSTALLING FLOORING (U.S. CLS. 1, 5, 6, 10, 26 AND 46).
CIMMERIAN COLEMAN, EXAMINING ATTORNEY

THE MARK CONSISTS OF STANDARD CHARACTERS WITHOUT CLAIM TO ANY PARTICULAR FONT, STYLE, SIZE, OR COLOR.

FOR CHEMICAL ADDITIVES FOR USE IN THE MANUFACTURE OF COSMETIC HAIR TREATMENT COMPOSITIONS (U.S. CLS. 1, 5, 6, 10, 26 AND 46).
ELISSA GARBER KON, EXAMINING ATTORNEY

SN 78-519,936. GRANT INDUSTRIES, INC., ELMWOOD PARK, NJ. FILED 11-19-2004.

SN 78-519,232. AVM INDUSTRIES, INC., CANOGA PARK, CA. FILED 11-18-2004.

FOREVERCOAT

Invisa Skin

THE MARK CONSISTS OF STANDARD CHARACTERS WITHOUT CLAIM TO ANY PARTICULAR FONT, STYLE, SIZE, OR COLOR.

FOR EXTERIOR WATERPROOFING DECK COATING CONSISTING OF POLYMERIZED CEMENT AND WATER BASED ACRYLIC RESIN (U.S. CLS. 1, 5, 6, 10, 26 AND 46).
FIRST USE 11-3-2004; IN COMMERCE 11-3-2004.
BARBARA A. GOLD, EXAMINING ATTORNEY

THE MARK CONSISTS OF STANDARD CHARACTERS WITHOUT CLAIM TO ANY PARTICULAR FONT, STYLE, SIZE, OR COLOR.

NO CLAIM IS MADE TO THE EXCLUSIVE RIGHT TO USE SKIN, APART FROM THE MARK AS SHOWN.
FOR CHEMICAL ADDITIVES FOR MANUFACTURING COSMETICS AND SKIN TREATMENT COMPOSITIONS (U.S. CLS. 1, 5, 6, 10, 26 AND 46).
JOHN HWANG, EXAMINING ATTORNEY

CLASS 1—(Continued).

SN 78-520,473. BIAGRO WESTERN SALES, INC., VISALIA, CA. FILED 11-19-2004.

KAM PHITE

THE MARK CONSISTS OF STANDARD CHARACTERS WITHOUT CLAIM TO ANY PARTICULAR FONT, STYLE, SIZE, OR COLOR.

FOR AGRICULTURAL AND HORTICULTURAL FERTILIZERS; PLANT NUTRIENTS (U.S. CLS. 1, 5, 6, 10, 26 AND 46).

AMY HELLA, EXAMINING ATTORNEY

CLASS 1—(Continued).

SN 78-524,022. KOOTENAY GROWER'S SUPPLY LTD., NELSON, BRITISH COLUMBIA, CANADA, FILED 11-29-2004.



FOR FERTILIZERS (U.S. CLS. 1, 5, 6, 10, 26 AND 46).
FIRST USE 3-0-2004; IN COMMERCE 3-0-2004.
ANNE E. GUSTASON, EXAMINING ATTORNEY

SN 78-524,023. KOOTENAY GROWER'S SUPPLY LTD., NELSON, BRITISH COLUMBIA, CANADA, FILED 11-29-2004.

SN 78-521,165. GALLIPOT, INC., ST. PAUL, MN. FILED 11-22-2004.

ORA-HESIVE

THE MARK CONSISTS OF STANDARD CHARACTERS WITHOUT CLAIM TO ANY PARTICULAR FONT, STYLE, SIZE, OR COLOR.

FOR INACTIVE CHEMICAL VEHICLES AND BASE COMPOSITIONS FOR USE IN THE COMPOUNDING OF PHARMACEUTICALS (U.S. CLS. 1, 5, 6, 10, 26 AND 46).
FIRST USE 11-10-2004; IN COMMERCE 11-10-2004.

IRA J. GOODSaid, EXAMINING ATTORNEY

BIO NOVA

THE MARK CONSISTS OF STANDARD CHARACTERS WITHOUT CLAIM TO ANY PARTICULAR FONT, STYLE, SIZE, OR COLOR.

FOR FERTILIZERS (U.S. CLS. 1, 5, 6, 10, 26 AND 46).
FIRST USE 3-0-2004; IN COMMERCE 3-0-2004.

BRENDAN MCCAULEY, EXAMINING ATTORNEY

CLASS 1—(Continued).

SN 78-529,270. CHEVRON U.S.A. INC., SAN RAMON, CA. FILED 12-8-2004.

CLASS 1—(Continued).

SN 78-538,427. ENVIROSAFE, INC., WYOMING, MI. FILED 12-27-2004.

RHENIFORMING J

Bio-Builder

THE MARK CONSISTS OF STANDARD CHARACTERS WITHOUT CLAIM TO ANY PARTICULAR FONT, STYLE, SIZE, OR COLOR.

FOR CATALYST USED IN PETROLEUM REFINING PROCESSES AND IN THE MANUFACTURE OF PETRO-CHEMICALS (U.S. CLS. 1, 5, 6, 10, 26 AND 46).
CAROLINE WOOD, EXAMINING ATTORNEY

THE MARK CONSISTS OF STANDARD CHARACTERS WITHOUT CLAIM TO ANY PARTICULAR FONT, STYLE, SIZE, OR COLOR.

FOR FERTILIZER (U.S. CLS. 1, 5, 6, 10, 26 AND 46).
KELLEY WELLS, EXAMINING ATTORNEY

SN 78-535,010. M & D INDUSTRIES OF LOUISIANA, INC., LAFAYETTE, LA. FILED 12-18-2004.

SN 78-540,538. QUIMICA DEL REY, S.A. DE C.V., COAHUILA, MEXICO, FILED 12-31-2004.

ULTRA SWEEP

BIOMAC

THE MARK CONSISTS OF STANDARD CHARACTERS WITHOUT CLAIM TO ANY PARTICULAR FONT, STYLE, SIZE, OR COLOR.

OWNER OF U.S. REG. NOS. 1,706,092, 2,905,880 AND OTHERS.

NO CLAIM IS MADE TO THE EXCLUSIVE RIGHT TO USE "ULTRA", APART FROM THE MARK AS SHOWN.

FOR CHEMICAL ADDITIVE ADDED TO AN OIL OR GAS WELL AHEAD OF CEMENT TO PREVENT FALL BACK OF THE CEMENT, AND TO REDUCE LOST CIRCULATION OF DRILLING FLUID. (U.S. CLS. 1, 5, 6, 10, 26 AND 46).

FIRST USE 12-1-2004; IN COMMERCE 12-1-2004.
DOMINICK J. SALEMI, EXAMINING ATTORNEY

THE MARK CONSISTS OF STANDARD CHARACTERS WITHOUT CLAIM TO ANY PARTICULAR FONT, STYLE, SIZE, OR COLOR.

FOR MAGNESIUM HYDROXIDE (U.S. CLS. 1, 5, 6, 10, 26 AND 46).

LAURIE MAYES, EXAMINING ATTORNEY

CLASS 1—(Continued).

SN 78-546,135. AGRILIANCE LLC., ST. PAUL, MN. FILED 1-12-2005.

N-PAK

THE MARK CONSISTS OF STANDARD CHARACTERS WITHOUT CLAIM TO ANY PARTICULAR FONT, STYLE, SIZE, OR COLOR.

FOR AGRICULTURAL CHEMICAL SPRAY ADJUVANT FOR USE WITH HERBICIDES (U.S. CLS. 1, 5, 6, 10, 26 AND 46).

FIRST USE 10-1-2000; IN COMMERCE 10-1-2000.
NORA BUCHANAN WILL, EXAMINING ATTORNEY

SN 78-546,531. CROMPTON CORPORATION, MIDDLEBURY, CT. FILED 1-12-2005.

AXION

THE MARK CONSISTS OF STANDARD CHARACTERS WITHOUT CLAIM TO ANY PARTICULAR FONT, STYLE, SIZE, OR COLOR.

FOR ORGANOMETALLIC COMPOUNDS FOR USE IN MANUFACTURING IN A WIDE VARIETY OF INDUSTRIES (U.S. CLS. 1, 5, 6, 10, 26 AND 46).

JOHN GARTNER, EXAMINING ATTORNEY

CLASS 1—(Continued).

SN 78-547,199. RAINBOW TREECARE SCIENTIFIC ADVANCEMENTS, INC., MINNEAPOLIS, MN. FILED 1-13-2005.

VERDUR

THE MARK CONSISTS OF STANDARD CHARACTERS WITHOUT CLAIM TO ANY PARTICULAR FONT, STYLE, SIZE, OR COLOR.

FOR CHEMICAL COMPOSITIONS, NAMELY, TREE FERTILIZERS FOR AGRICULTURAL OR DOMESTIC USE (U.S. CLS. 1, 5, 6, 10, 26 AND 46).

FIRST USE 1-5-2005; IN COMMERCE 1-5-2005.
BARBARA A. GOLD, EXAMINING ATTORNEY

SN 78-551,111. ROYSTER-CLARK RESOURCES LLC, NORFOLK, VA. FILED 1-20-2005.

ROYSTER CLARK

THE MARK CONSISTS OF STANDARD CHARACTERS WITHOUT CLAIM TO ANY PARTICULAR FONT, STYLE, SIZE, OR COLOR.

FOR CROP NUTRIENT PRODUCTS, NAMELY FERTILIZERS AND PLANT FOOD (U.S. CLS. 1, 5, 6, 10, 26 AND 46).

FIRST USE 7-9-1992; IN COMMERCE 7-9-1992.
CHERYL CLAYTON, EXAMINING ATTORNEY

CLASS 1—(Continued).

SN 79-001,139. HONGHE CHEMICAL INC.; (ZIGONG HONGHE HUAGONG GUFEN; YOUXIAN GONGSI), CHINA, FILED 1-6-2004.



OWNER OF INTERNATIONAL REGISTRATION 0759580 DATED 5-8-2001, EXPIRES 5-8-2011.

THE NON-LATIN CHARACTER(S) IN THE MARK TRANSLITERATES INTO HE, AND THIS MEANS CRANE IN ENGLISH.

FOR BICHLORIDE OF METHANE; TRICHLORIDE OF METHANE; CARBON TETRACHLORIDE; SODIUM HYDRATE; CALCINED SODA; CARBONIC ACID SODIUM; CHLORIDE OF CALCIUM ANHYDROUS; FERTILIZER; SAL AMMONIAC; CALCIUM HYDROPHOSPHATE (U.S. CLS. 1, 5, 6, 10, 26 AND 46).

SUSAN HAYASH, EXAMINING ATTORNEY

SN 79-002,865. TOYO BOSEKI KABUSHIKI KAISHA, OSAKA-SHI, OSAKA 530-8230, JAPAN, FILED 4-2-2004.

TOYOBO GS Catalyst

PRIORITY DATE OF 3-23-2004 IS CLAIMED.

OWNER OF INTERNATIONAL REGISTRATION 0825823 DATED 4-2-2004, EXPIRES 4-2-2014.

NO CLAIM IS MADE TO THE EXCLUSIVE RIGHT TO USE CATALYST, APART FROM THE MARK AS SHOWN.

FOR CHEMICAL ADDITIVES AND CATALYSTS, NAMELY POLYMER ADDITIVES AND CATALYSTS FOR PLASTIC RESINS FOR USE IN THE MANUFACTURE OF A WIDE VARIETY OF GOODS IN THE PLASTICS AND CHEMICAL INDUSTRIES (U.S. CLS. 1, 5, 6, 10, 26 AND 46).

SKYE YOUNG, EXAMINING ATTORNEY

SN 79-003,950. SATTLER AG, AUSTRIA, FILED 3-5-2004.

TEXGARD

OWNER OF INTERNATIONAL REGISTRATION 0829238 DATED 3-5-2004, EXPIRES 3-5-2014.

FOR CHEMICAL COMPOSITIONS FOR APPLYING ON VARIOUS SURFACES TO REPEL GREASE AND OILS, DIRT AND HUMIDITY (U.S. CLS. 1, 5, 6, 10, 26 AND 46).

CHRIS WELLS, EXAMINING ATTORNEY

CLASS 1—(Continued).

SN 79-004,666. LAFFORT OENOLOGIE, FRANCE, FILED 5-27-2004.

MALOSTART

THE MARK CONSISTS OF STANDARD CHARACTERS WITHOUT CLAIM TO ANY PARTICULAR FONT, STYLE, SIZE, OR COLOR.

OWNER OF INTERNATIONAL REGISTRATION 0831467 DATED 5-27-2004, EXPIRES 5-27-2014.

FOR CHEMICAL PRODUCTS FOR USE IN THE WINE MAKING PROCESS, NAMELY FERMENTATION ACTIVATOR FOR MALOLACTIC BACTERIAE (U.S. CLS. 1, 5, 6, 10, 26 AND 46).

CIMMERIAN COLEMAN, EXAMINING ATTORNEY

SN 79-004,942. YUKEN INDUSTRY CO., LTD., JAPAN, FILED 5-7-2004.

セランダー
SERANDER

OWNER OF INTERNATIONAL REGISTRATION 0832170 DATED 5-7-2004, EXPIRES 5-7-2014.

FOR CHEMICAL ADDITIVES FOR USE IN THE MANUFACTURE OF MOLDED CERAMIC ARTICLES (U.S. CLS. 1, 5, 6, 10, 26 AND 46).

MARK SPARACINO, EXAMINING ATTORNEY

SN 79-005,447. ALUMINIUM RHEINFELDEN GMBH, D-79618 RHEINFELDEN, FED REP GERMANY, FILED 6-4-2004.

REPA

THE MARK CONSISTS OF STANDARD CHARACTERS WITHOUT CLAIM TO ANY PARTICULAR FONT, STYLE, SIZE, OR COLOR.

PRIORITY DATE OF 12-11-2003 IS CLAIMED.

OWNER OF INTERNATIONAL REGISTRATION 0833546 DATED 6-4-2004, EXPIRES 6-4-2014.

FOR CARBON RAMMING PASTES FOR USE WITH CARBON LININGS IN ELECTROLYSIS CELLS (U.S. CLS. 1, 5, 6, 10, 26 AND 46).

DAVID C. REIHNER, EXAMINING ATTORNEY

CLASS 2—PAINTS

SN 76-424,678. GENICS INC., SPRUCE GROVE ALBERTA, CANADA, FILED 6-24-2002.

GENICS

PRIORITY CLAIMED UNDER SEC. 44(D) ON CANADA APPLICATION NO. 1131621, FILED 2-25-2002, REG. NO. TMA611671, DATED 6-1-2004, EXPIRES 6-1-2019.

FOR WOOD PRESERVATIVES (U.S. CLS. 6, 11 AND 16).

YONG KIM, EXAMINING ATTORNEY

SN 76-551,391. VAN WIJHE BEHEER B.V., 8041 AL ZWOLLE, NETHERLANDS, FILED 9-23-2003.

WIJZONOL

OWNER OF BENELUX REG. NO. 0034272, DATED 5-18-1971, EXPIRES 5-18-2006.

FOR PAINTS, NAMELY, ARCHITECTURAL AND DECORATIVE HOUSE PAINTS, PAINT PIGMENTS, COLORANTS FOR USE IN THE MANUFACTURE OF ARCHITECTURAL AND DECORATIVE HOUSE PAINTS, DYES AND DYE-STUFFS FOR USE IN THE MANUFACTURE OF PAINT, LACQUERS IN THE NATURE OF A COATING, VARNISHES, RUST PRESERVATIVES IN THE NATURE OF A COATING; WOOD PRESERVATIVES FOR ANTI-DETERIORATION OF WOODS; RAW NATURAL RESINS FOR USE IN THE MANUFACTURE OF ADHESIVES; METALS IN FOIL AND POWDER FORM FOR PAINTERS, PAINT THINNER, MORDANTS FOR USE IN THE MANUFACTURE OF PAINT, COATINGS IN THE NATURE OF CRACK FILLERS FOR SMOOTHING SURFACES PRIOR TO PAINTING, SICCATIVES FOR PAINTS FOR USE AS A DRYING AGENT, COLOR PIGMENTS, PRINTERS' INK, SHELLAC FOR USE AS A SURFACE COATING (U.S. CLS. 6, 11 AND 16).

NANCY CLARKE, EXAMINING ATTORNEY

SN 76-567,401. MADISON CHEMICAL INDUSTRIES INC., MILTON, ONTARIO L9T 3Y5, CANADA, FILED 12-29-2003.

MARITHANE

THE MARK CONSISTS OF STANDARD CHARACTERS WITHOUT CLAIM TO ANY PARTICULAR FONT, STYLE, SIZE, OR COLOR.

PRIORITY CLAIMED UNDER SEC. 44(D) ON CANADA APPLICATION NO. 1200440, FILED 12-29-2003, REG. NO. TMA632416, DATED 2-9-2005, EXPIRES 2-9-2020.

FOR CORROSION RESISTANT PROTECTIVE COATINGS (U.S. CLS. 6, 11 AND 16).

FIRST USE 3-0-1991; IN COMMERCE 3-0-1991.

DARRYL SPRUILL, EXAMINING ATTORNEY

CLASS 2—(Continued).

SN 76-567,403. MADISON CHEMICAL INDUSTRIES INC., MILTON, ONTARIO L9T 3Y5, CANADA, FILED 12-29-2003.

CORROCLAD

THE MARK CONSISTS OF STANDARD CHARACTERS WITHOUT CLAIM TO ANY PARTICULAR FONT, STYLE, SIZE, OR COLOR.

PRIORITY CLAIMED UNDER SEC. 44(D) ON CANADA APPLICATION NO. 1200442, FILED 12-29-2003, REG. NO. TMA632400, DATED 2-9-2005, EXPIRES 2-9-2020.

FOR CORROSION RESISTANT PROTECTIVE COATINGS (U.S. CLS. 6, 11 AND 16).

FIRST USE 10-0-1996; IN COMMERCE 10-0-1996.

DARRYL SPRUILL, EXAMINING ATTORNEY

SN 76-586,966. RUST-OLEUM BRANDS COMPANY, VERNON HILLS, IL. FILED 4-15-2004.

ULTRA-WEAR

THE MARK CONSISTS OF STANDARD CHARACTERS WITHOUT CLAIM TO ANY PARTICULAR FONT, STYLE, SIZE, OR COLOR.

FOR URETHANE COATING FOR APPLICATION TO CONCRETE FLOORS (U.S. CLS. 6, 11 AND 16).

FIRST USE 12-14-2001; IN COMMERCE 12-14-2001.

KAREN K. BUSH, EXAMINING ATTORNEY

SN 76-598,185. ETCO INCORPORATED, WARWICK, RI. FILED 6-18-2004.

TSW-33

THE MARK CONSISTS OF STANDARD CHARACTERS WITHOUT CLAIM TO ANY PARTICULAR FONT, STYLE, SIZE, OR COLOR.

FOR ANTI-CORROSION INHIBITOR IN THE NATURE OF A COATING FOR PROTECTING ELECTRICAL, SURFACE AND MECHANICAL APPLICATIONS (U.S. CLS. 6, 11 AND 16).

SCOTT BALDWIN, EXAMINING ATTORNEY

CLASS 2—(Continued).

SN 76-615,556. E. I. DU PONT DE NEMOURS AND COMPANY, WILMINGTON, DE. FILED 10-13-2004.

STANDOX

THE MARK CONSISTS OF STANDARD CHARACTERS WITHOUT CLAIM TO ANY PARTICULAR FONT, STYLE, SIZE, OR COLOR.

OWNER OF U.S. REG. NOS. 1,457,086, 2,396,700 AND OTHERS.

FOR LACQUERS, PAINT TYPE PRIMERS, THERMOSETTING ENAMEL PAINTS AND PAINT FOR USE IN THE MANUFACTURE AND REPAIR OF AUTOMOBILES, AND FOR AGRICULTURAL MACHINERY (U.S. CLS. 6, 11 AND 16).

FIRST USE 0-0-1952; IN COMMERCE 2-0-1967.

EVELYN BRADLEY, EXAMINING ATTORNEY

CLASS 2—(Continued).

SN 76-626,032. NU-TECH WOOD FINISHES, LLC, MONTGOMERY, IN. FILED 12-27-2004.

NU-VAR

THE MARK CONSISTS OF STANDARD CHARACTERS WITHOUT CLAIM TO ANY PARTICULAR FONT, STYLE, SIZE, OR COLOR.

FOR COATINGS IN THE NATURE OF CONVERSION VARNISHES, PRE-CAT VARNISHES, STAINS AND DYES (U.S. CLS. 6, 11 AND 16).

FIRST USE 11-1-2004; IN COMMERCE 11-1-2004.

WILLIAM VERHOSEK, EXAMINING ATTORNEY

SN 76-622,697. FAUX EFFECTS INTERNATIONAL, INC., VERO BEACH, FL. FILED 11-30-2004.

FAUX EFFECTS INTERNATIONAL

THE MARK CONSISTS OF STANDARD CHARACTERS WITHOUT CLAIM TO ANY PARTICULAR FONT, STYLE, SIZE, OR COLOR.

SEC. 2(F).

FOR INTERIOR AND EXTERIOR GLAZES, FINISHES AND PAINTS (U.S. CLS. 6, 11 AND 16).

REBECCA GAN, EXAMINING ATTORNEY

SN 76-626,033. NU-TECH WOOD FINISHES, LLC, MONTGOMERY, IN. FILED 12-27-2004.

NU-TECH WOOD COATINGS

THE MARK CONSISTS OF STANDARD CHARACTERS WITHOUT CLAIM TO ANY PARTICULAR FONT, STYLE, SIZE, OR COLOR.

NO CLAIM IS MADE TO THE EXCLUSIVE RIGHT TO USE "WOOD COATINGS", APART FROM THE MARK AS SHOWN.

FOR COATINGS IN THE NATURE OF CONVERSION VARNISHES, PRE-CAT VARNISHES, STAINS AND DYES FOR WOOD (U.S. CLS. 6, 11 AND 16).

FIRST USE 6-15-2003; IN COMMERCE 6-15-2003.

WILLIAM VERHOSEK, EXAMINING ATTORNEY

SN 76-626,031. NU-TECH WOOD FINISHES, LLC, MONTGOMERY, IN. FILED 12-27-2004.

NU-CAT

SN 78-118,091. CAI INC, GEORGETOWN, MA. FILED 3-28-2002.

ADP LAM

THE MARK CONSISTS OF STANDARD CHARACTERS WITHOUT CLAIM TO ANY PARTICULAR FONT, STYLE, SIZE, OR COLOR.

FOR COATINGS IN THE NATURE OF CONVERSION VARNISHES, PRE-CAT VARNISHES, STAINS AND DYES (U.S. CLS. 6, 11 AND 16).

FIRST USE 11-1-2004; IN COMMERCE 11-1-2004.

WILLIAM VERHOSEK, EXAMINING ATTORNEY

NO CLAIM IS MADE TO THE EXCLUSIVE RIGHT TO USE "LAM", APART FROM THE MARK AS SHOWN. FOR PRINTERS' INK (U.S. CLS. 6, 11 AND 16).

DORITT L. CARROLL, EXAMINING ATTORNEY

CLASS 2—(Continued).

SN 78-411,512. AKZO NOBEL COATINGS INTERNATIONAL B.V., ARNHEM, NETHERLANDS, FILED 4-30-2004.

TOPLAC

THE MARK CONSISTS OF STANDARD CHARACTERS WITHOUT CLAIM TO ANY PARTICULAR FONT, STYLE, SIZE, OR COLOR.

FOR FINISHING PAINTS, VARNISHES AND LACQUERS FOR USE IN THE MARINE INDUSTRY (U.S. CLS. 6, 11 AND 16).

FIRST USE 1-9-2001; IN COMMERCE 1-9-2001.

STANLEY I. OSBORNE, EXAMINING ATTORNEY

CLASS 2—(Continued).

SN 78-418,277. YENKIN-MAJESTIC PAINT CORPORATION, COLUMBUS, OH. FILED 5-13-2004.

RUST PRO

THE MARK CONSISTS OF STANDARD CHARACTERS WITHOUT CLAIM TO ANY PARTICULAR FONT, STYLE, SIZE, OR COLOR.

NO CLAIM IS MADE TO THE EXCLUSIVE RIGHT TO USE "RUST", APART FROM THE MARK AS SHOWN.

FOR PAINTS (U.S. CLS. 6, 11 AND 16).

FIRST USE 5-7-2004; IN COMMERCE 5-7-2004.

MAUREEN DALL, EXAMINING ATTORNEY

SN 78-423,558. AKZO NOBEL COATINGS INTERNATIONAL B.V., ARNHEM, NETHERLANDS, FILED 5-24-2004.

MASKIN

ACTIVE WALL

THE MARK CONSISTS OF STANDARD CHARACTERS WITHOUT CLAIM TO ANY PARTICULAR FONT, STYLE, SIZE, OR COLOR.

NO CLAIM IS MADE TO THE EXCLUSIVE RIGHT TO USE "WALL", APART FROM THE MARK AS SHOWN.

FOR WALL PAINT; MAGNETIC RECEPTIVE PAINT, NAMELY MAGNETIC RECEPTIVE COATINGS CONSISTING OF PAINT, RESINS AND IRON POWDER WHICH CREATE A MAGNETIC RECEPTIVE SURFACE WHEN DRY; CHALKBOARD PAINT (U.S. CLS. 6, 11 AND 16).

CATHERINE CAIN, EXAMINING ATTORNEY

THE MARK CONSISTS OF STANDARD CHARACTERS WITHOUT CLAIM TO ANY PARTICULAR FONT, STYLE, SIZE, OR COLOR.

FOR COATINGS, NAMELY, PAINTS, VARNISHES, LACQUERS, PAINT PRIMERS, THINNERS FOR PAINTS, THICKENERS FOR PAINTS, PRESERVATIVES AGAINST RUST IN THE NATURE OF COATINGS, COLORING MATTERS, NAMELY DYESTUFFS; ACID, DISPERSE, REACTIVE AND ANILINE DYES; MORDANT DYES; NATURAL RESINS FOR USE IN MAKING ADHESIVES; METALS IN FOIL AND POWDER FORM FOR PAINTERS AND DECORATORS (U.S. CLS. 6, 11 AND 16).

LINDA POWELL, EXAMINING ATTORNEY

SN 78-414,735. FIBRON LLC, MENDON, MA. FILED 5-7-2004.

CLASS 2—(Continued).

SN 78-449,119. XIM PRODUCTS, INC., WESTLAKE, OH. FILED 7-12-2004.

X-TREME BOND

THE MARK CONSISTS OF STANDARD CHARACTERS WITHOUT CLAIM TO ANY PARTICULAR FONT, STYLE, SIZE, OR COLOR.

NO CLAIM IS MADE TO THE EXCLUSIVE RIGHT TO USE "BOND", APART FROM THE MARK AS SHOWN.

FOR SOLVENT BORNE BONDING PRIMERS, WATER BORNE BONDING PRIMERS, WATER BORNE BONDING COATINGS, SOLVENT BORNE CORROSION PROTECTORS, WATER BORNE CORROSION PROTECTORS, SOLVENT BORNE EPOXY, WATER BORNE ACRYLIC PRIMERS, SOLVENT BORNE ADHESION PRIMERS, WATER BORN STAIN BLOCKERS, WATER BORNE SEALING PRIMERS FOR USE AS INDUSTRIAL PAINTS AND PRIMERS FOR SURFACES SUCH AS WOOD, PLASTICS, AND METALS (U.S. CLS. 6, 11 AND 16).

FIRST USE 7-9-2004; IN COMMERCE 7-9-2004.

AMOS T. MATTHEWS, JR., EXAMINING ATTORNEY

CLASS 2—(Continued).

SN 78-509,654. THE SHERWIN-WILLIAMS COMPANY, CLEVELAND, OH. FILED 11-2-2004.

TERRAZZO SHIELD

THE MARK CONSISTS OF STANDARD CHARACTERS WITHOUT CLAIM TO ANY PARTICULAR FONT, STYLE, SIZE, OR COLOR.

NO CLAIM IS MADE TO THE EXCLUSIVE RIGHT TO USE "TERRAZZO", APART FROM THE MARK AS SHOWN.

FOR PROTECTIVE AND DECORATIVE COATINGS IN THE NATURE OF FLOOR FINISHES (U.S. CLS. 6, 11 AND 16).

EUGENIA MARTIN, EXAMINING ATTORNEY

SN 78-515,053. SAWGRASS TECHNOLOGIES, INC., MOUNT PLEASANT, SC. FILED 11-11-2004.

SN 78-490,154. ENVIROSAFE MANUFACTURING CORPORATION, WEST MELBOURNE, FL. FILED 9-27-2004.

TROJAN MASONRY SEALER

THE MARK CONSISTS OF STANDARD CHARACTERS WITHOUT CLAIM TO ANY PARTICULAR FONT, STYLE, SIZE, OR COLOR.

NO CLAIM IS MADE TO THE EXCLUSIVE RIGHT TO USE "MASONRY SEALER", APART FROM THE MARK AS SHOWN.

FOR COATINGS IN THE NATURE OF CONCRETE AND MASONRY SEALERS (U.S. CLS. 6, 11 AND 16).

FIRST USE 12-0-1993; IN COMMERCE 12-0-1993.

ANNE E. GUSTASON, EXAMINING ATTORNEY

ARTAINIUM

THE MARK CONSISTS OF STANDARD CHARACTERS WITHOUT CLAIM TO ANY PARTICULAR FONT, STYLE, SIZE, OR COLOR.

OWNER OF U.S. REG. NO. 2,383,305.

FOR COMPUTER PRINTER INK (U.S. CLS. 6, 11 AND 16).

FIRST USE 9-1-2002; IN COMMERCE 9-1-2002.

GEOFFREY FOSDICK, EXAMINING ATTORNEY

CLASS 2—(Continued).

SN 78-515,460. RUST-OLEUM BRANDS COMPANY, VERNON HILLS, IL. FILED 11-11-2004.

METALMAX

THE MARK CONSISTS OF STANDARD CHARACTERS WITHOUT CLAIM TO ANY PARTICULAR FONT, STYLE, SIZE, OR COLOR.

FOR SURFACE COATING COMPOSITIONS - NAMELY, PAINT-LIKE SURFACE COATING COMPOSITIONS FOR INTERIOR AND EXTERIOR USE IN THE PREVENTION OF SURFACE DETERIORATION OR CORROSION OF STEEL, GALVANIZED, ALUMINUM, WOOD AND MASONRY SURFACES, AND FOR DECORATIVE PURPOSES (U.S. CLS. 6, 11 AND 16).

FIRST USE 10-5-2000; IN COMMERCE 10-5-2000.
MARGERY A. TIERNEY, EXAMINING ATTORNEY

SN 78-516,379. POLY-TUFF SYSTEMS INTERNATIONAL CORPORATION, LAS VEGAS, NV. FILED 11-12-2004.

MARIPRIME

THE MARK CONSISTS OF STANDARD CHARACTERS WITHOUT CLAIM TO ANY PARTICULAR FONT, STYLE, SIZE, OR COLOR.

FOR POLYMER COATINGS FOR WATERPROOFING WOOD, CONCRETE AND STEEL SUBSTRATES (U.S. CLS. 6, 11 AND 16).

FIRST USE 11-1-2004; IN COMMERCE 11-1-2004.
AMY GEARIN, EXAMINING ATTORNEY

CLASS 2—(Continued).

SN 78-518,882. DEERS AUTOREFINISHES LTD., WEST VANCOUVER, BC, CANADA, FILED 11-17-2004.



THE COLOR(S) WHITE BLUE RED IS/ARE CLAIMED AS A FEATURE OF THE MARK.

THE MARK CONSISTS OF WHITE LETTERS ON NAVY BLUE BACKGROUND WITH EXTENDING PORTION OF "K" IN RED.

FOR PAINT FOR AUTOMOBILES (U.S. CLS. 6, 11 AND 16).

TINA L. SNAPP, EXAMINING ATTORNEY

SN 78-520,596. AMERICA FULLINK INTERNATIONAL INC., DIAMOND BAR, CA. FILED 11-20-2004.



THE COLOR(S) RED, WHITE, AND BLUE IS/ARE CLAIMED AS A FEATURE OF THE MARK.

THE MARK CONSISTS OF RED AND BLUE BACKGROUND; WHITE HORIZONTAL LINES; WHITE EAGLE IMAGE; FIVE WHITE STARS.

FOR PAINTS (U.S. CLS. 6, 11 AND 16).
FIRST USE 9-16-2004; IN COMMERCE 10-18-2004.
PAULA MAHONEY, EXAMINING ATTORNEY

SN 78-525,154. THE SHERWIN-WILLIAMS COMPANY, CLEVELAND, OH. FILED 12-1-2004.

HYDROGLOSS

THE MARK CONSISTS OF STANDARD CHARACTERS WITHOUT CLAIM TO ANY PARTICULAR FONT, STYLE, SIZE, OR COLOR.

FOR PROTECTIVE AND DECORATIVE COATINGS USED IN THE NATURE OF INDUSTRIAL PAINT (U.S. CLS. 6, 11 AND 16).

ROBERT C. CLARK JR., EXAMINING ATTORNEY

CLASS 2—(Continued).

SN 78-528,293. POLYONE CORPORATION, AVON LAKE, OH. FILED 12-7-2004.

CLASS 2—(Continued).

SN 78-544,553. MATRIX SYSTEM AUTOMOTIVE FINISHES, INC., WALLED LAKE, MI. FILED 1-10-2005.

SERIESONE

autoglas

THE MARK CONSISTS OF STANDARD CHARACTERS WITHOUT CLAIM TO ANY PARTICULAR FONT, STYLE, SIZE, OR COLOR.
FOR PLASTISOL PRINTING INKS AND WATER-BASED PRINTING INKS. (U.S. CLS. 6, 11 AND 16).
TEJBIR SINGH, EXAMINING ATTORNEY

THE MARK CONSISTS OF STANDARD CHARACTERS WITHOUT CLAIM TO ANY PARTICULAR FONT, STYLE, SIZE, OR COLOR.
FOR AUTOMOTIVE PAINTS AND COATINGS (U.S. CLS. 6, 11 AND 16).
FIRST USE 5-1-2004; IN COMMERCE 8-1-2004.
TINA L. SNAPP, EXAMINING ATTORNEY

SN 78-531,701. AXON PRODUCTS INC., GREENVILLE, SC. FILED 12-13-2004.

SN 78-546,249. MATRIX SYSTEM AUTOMOTIVE FINISHES, INC., WALLED LAKE, MI. FILED 1-12-2005.

Skycoat

AccuShade

THE MARK CONSISTS OF STANDARD CHARACTERS WITHOUT CLAIM TO ANY PARTICULAR FONT, STYLE, SIZE, OR COLOR.
FOR AEROSPACE COATINGS (U.S. CLS. 6, 11 AND 16).
TEJBIR SINGH, EXAMINING ATTORNEY

THE MARK CONSISTS OF STANDARD CHARACTERS WITHOUT CLAIM TO ANY PARTICULAR FONT, STYLE, SIZE, OR COLOR.
FOR AUTOMOTIVE PAINTS AND COATINGS (U.S. CLS. 6, 11 AND 16).
FIRST USE 1-1-2000; IN COMMERCE 3-1-2000.
JACQUELINE A. LAVINE, EXAMINING ATTORNEY

CLASS 2—(Continued).

SN 78-645,517. VALSPAR REFINISH, PICAYUNE, MS. FILED 6-7-2005.

KOSMIC KLEAR

THE MARK CONSISTS OF STANDARD CHARACTERS WITHOUT CLAIM TO ANY PARTICULAR FONT, STYLE, SIZE, OR COLOR.

OWNER OF U.S. REG. NOS. 1,668,157 AND 1,767,107. NO CLAIM IS MADE TO THE EXCLUSIVE RIGHT TO USE "CLEAR", APART FROM THE MARK AS SHOWN.

FOR URETHANE ENAMEL CLEAR TOPCOAT COATINGS USED FOR COATING EXTERIOR SURFACES OF MOTOR VEHICLES, MOTORCYCLES, BOATS AND ACCESSORIES THERETO AND AUTOMOTIVE PAINT FOR METAL, PLASTIC AND FIBERGLASS SURFACES (U.S. CLS. 6, 11 AND 16).

FIRST USE 10-31-1996; IN COMMERCE 10-31-1996.
SEAN DWYER, EXAMINING ATTORNEY

SN 79-002,983. VERNIS CLAESSENS, S.A., CH-1020 RENENS, SWITZERLAND, FILED 5-26-2004.

CLASSIDUR

THE MARK CONSISTS OF STANDARD CHARACTERS WITHOUT CLAIM TO ANY PARTICULAR FONT, STYLE, SIZE, OR COLOR.

OWNER OF INTERNATIONAL REGISTRATION 0424242 DATED 8-6-1976, EXPIRES 8-6-2006.

OWNER OF U.S. REG. NO. 2,201,325. FOR MATTE PAINT BASED ON SUPERACTIVATED OIL FOR INTERIOR AND EXTERIOR USE (U.S. CLS. 6, 11 AND 16).

MELISSA SHELLA, EXAMINING ATTORNEY

CLASS 3—COSMETICS AND CLEANING PREPARATIONS

SN 75-503,075. BENEFIT COSMETICS, LLC, SAN FRANCISCO, CA. FILED 6-16-1998.

EYEBRIGHT

FOR COSMETICS, NAMELY EYE PENCILS (U.S. CLS. 1, 4, 6, 50, 51 AND 52).

FIRST USE 0-0-1990; IN COMMERCE 0-0-1990.
LINDA POWELL, EXAMINING ATTORNEY

CLASS 3—(Continued).

SN 76-318,040. L'OREAL, PARIS, FRANCE, FILED 9-20-2001.

GLOSS COLOR

OWNER OF FRANCE REG. NO. 94526763, DATED 6-27-1994, EXPIRES 6-27-2014.

SEC. 2(F).
FOR HAIR COLORING PREPARATIONS AND HAIR SHAMPOOS (U.S. CLS. 1, 4, 6, 50, 51 AND 52).
MARTHA FROMM, EXAMINING ATTORNEY

SN 76-435,311. ABOUGANIM, PAULE, GUADELOUPE, FILED 7-29-2002.



NO CLAIM IS MADE TO THE EXCLUSIVE RIGHT TO USE "SENTEUR", APART FROM THE MARK AS SHOWN. THE ENGLISH TRANSLATION OF SENTEURS DES ILES IS "SCENTS OF THE ISLES".

FOR TOILET WATER (U.S. CLS. 1, 4, 6, 50, 51 AND 52).
FIRST USE 6-26-2002; IN COMMERCE 6-26-2002.
BARBARA RUTLAND, EXAMINING ATTORNEY

SN 76-491,392. PLANET BEACH FRANCHISING CORPORATION, MARRERO, LA. FILED 2-21-2003.

BRONZEN

FOR INDOOR TANNING PRODUCTS, NAMELY, SUN TAN LOTIONS, SUN TAN SPRAYS, SKIN LOTIONS AND GELS FOR ACCELERATING, ENHANCING OR EXTENDING TANS; BODY WASH, BODY LOTION, COSMETICS (U.S. CLS. 1, 4, 6, 50, 51 AND 52).

FIRST USE 3-31-2004; IN COMMERCE 3-31-2004.
ALICIA COLLINS, EXAMINING ATTORNEY

CLASS 3—(Continued).

SN 76-504,696. VOTIVO, LTD., SEATTLE, WA. FILED 4-7-2003.

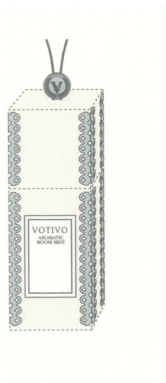

OWNER OF U.S. REG. NOS. 1,932,316, 2,766,047 AND OTHERS.

NO CLAIM IS MADE TO THE EXCLUSIVE RIGHT TO USE "AROMATIC ROOM MIST", APART FROM THE MARK AS SHOWN.

THE COLOR(S) TAN AND GRAY IS/ARE CLAIMED AS A FEATURE OF THE MARK.

THE CLAIMED MARK CONSISTS OF FOUR GRAY DECORATIVE CORNERS PLACED UPON A RIGID TAN RECYCLED CARDBOARD BOX AND LID. THE BOX LID IS TOPPED WITH BROWN TWINE, WHICH PASSES, BOB STYLE, THROUGH A SMALL GRAY METAL MEDALLION. THE MEDALLION CONTAINS THE LETTER "V" A DESIGN ELEMENT, AND THE WORD "VOTIVO". THE BOX CONTAINS A LABEL ON THE FRONT OF THE BOX WITH THE WORDING VOTIVO AROMATIC ROOM MIST SURROUNDED BY TWO RECTANGULAR BOXES. THE REPRESENTATION OF A BOX SHOWN IN DASHED LINING FORMS NO PART OF THE MARK AND MERELY SERVES TO SHOW THE POSITION OF THESE ITEMS ON THE MARK.

THE WORD VOTIVO IS AN ADJECTIVE TRANSLATABLE FROM ITALIAN AND/OR SPANISH AS EXPRESSING A WISH, DESIRE OR VOW.

SEC. 2(F).

FOR PERFUMERY, NAMELY, AROMATIC SPRAYS AND MISTS (U.S. CLS. 1, 4, 6, 50, 51 AND 52).

FIRST USE 8-2-2001; IN COMMERCE 8-2-2001.
PAULA MAHONEY, EXAMINING ATTORNEY

CLASS 3—(Continued).

SN 76-588,930. CHANEL, INC., NEW YORK, NY. FILED 4-27-2004.

ROUGE DE LEGENDE

THE MARK CONSISTS OF STANDARD CHARACTERS WITHOUT CLAIM TO ANY PARTICULAR FONT, STYLE, SIZE, OR COLOR.

NO CLAIM IS MADE TO THE EXCLUSIVE RIGHT TO USE "ROUGE", APART FROM THE MARK AS SHOWN.

THE FOREIGN WORDING IN THE MARK TRANSLATES INTO ENGLISH AS RED OF LEGEND.

FOR COSMETICS (U.S. CLS. 1, 4, 6, 50, 51 AND 52).
RON FAIRBANKS, EXAMINING ATTORNEY

SN 76-590,211. KOSE CORPORATION., CHUO-KU, TOKYO, JAPAN, FILED 5-3-2004.

清
肌
晶

SEIKISHO

THE MARK CONSISTS OF THE WORD SEIKISHO AND THE WORD SEIKISHO IN JAPANESE CHARACTERS.

THE NON-LATIN CHARACTERS IN THE MARK TRANSLITERATE TO SEIKISHO.

FOR COSMETICS, PERFUMES, COSMETIC SOAPS, COTTON FOR COSMETIC USE AND HAIR CARE PREPARATIONS (U.S. CLS. 1, 4, 6, 50, 51 AND 52).

FIRST USE 5-16-1998; IN COMMERCE 5-1-2003.
KARLA PERKINS, EXAMINING ATTORNEY

SN 76-514,417. PINEHURST, INC., VILLAGE OF PINEHURST, NC. FILED 5-15-2003.

THE SPA AT PINEHURST

OWNER OF U.S. REG. NOS. 1,517,264, 2,612,518 AND OTHERS.

NO CLAIM IS MADE TO THE EXCLUSIVE RIGHT TO USE "SPA", APART FROM THE MARK AS SHOWN.

SEC. 2(F) PINEHURST.

FOR HEALTH AND BEAUTY PRODUCTS, NAMELY, HAIR SHAMPOOS AND CONDITIONERS, BATH SOAPS AND GELS, SKIN LOTIONS, MASSAGE AND BATH OILS, FACIAL AND HAIR MASKS (U.S. CLS. 1, 4, 6, 50, 51 AND 52).

FIRST USE 3-27-2002; IN COMMERCE 3-27-2002.
ALICIA COLLINS, EXAMINING ATTORNEY

SN 76-590,426. SOY TECHNOLOGIES, LLC, NICHOLASVILLE, KY. FILED 5-4-2004.

SOYGREEN

OWNER OF U.S. REG. NO. 2,666,474.

FOR CLEANING PREPARATIONS, NAMELY, ALL-PURPOSE CLEANERS AND STRIPPER FOR PAINT, WOOD, AND FLOORS, AND GRAFFITI REMOVERS, AND ALL-PURPOSE DEGREASING PREPARATIONS NOT USED IN MANUFACTURING PROCESSES (U.S. CLS. 1, 4, 6, 50, 51 AND 52).

FIRST USE 10-15-2001; IN COMMERCE 10-22-2001.
MARK SPARACINO, EXAMINING ATTORNEY

CLASS 3—(Continued).

SN 76-592,870. 21ST CENTURY CREATIONS LLC, PISCATAWAY, NJ. FILED 5-18-2004.

PÜR PARFUM

THE MARK CONSISTS OF STANDARD CHARACTERS WITHOUT CLAIM TO ANY PARTICULAR FONT, STYLE, SIZE, OR COLOR.

NO CLAIM IS MADE TO THE EXCLUSIVE RIGHT TO USE "PARFUM", APART FROM THE MARK AS SHOWN.

THE FOREIGN WORDING IN THE MARK TRANSLATES INTO ENGLISH AS PURE.

FOR BODY SOAPS IN LIQUID AND BAR FORM, PERFUMERY, SENSUAL BODY OILS, COSMETICS AND HAIR LOTIONS (U.S. CLS. 1, 4, 6, 50, 51 AND 52).

FIRST USE 3-1-2002; IN COMMERCE 3-1-2002.

NAKWAMA ANKRAH, EXAMINING ATTORNEY

SN 76-593,769. ENVIRO-CURE SERVICES, INC., ATLANTA, GA. FILED 5-24-2004.

ENZMOLD

THE MARK CONSISTS OF STANDARD CHARACTERS WITHOUT CLAIM TO ANY PARTICULAR FONT, STYLE, SIZE, OR COLOR.

FOR ALL PURPOSE CLEANING PREPARATIONS CONTAINING ENZYMES (U.S. CLS. 1, 4, 6, 50, 51 AND 52).

FIRST USE 3-31-2003; IN COMMERCE 3-31-2003.

GRETTA YAO, EXAMINING ATTORNEY

SN 76-594,139. LAURICE EL BADRY RAHME LTD., DBA LAURICE & CO., NEW YORK, NY. FILED 5-25-2004.

EL BARRIO

THE MARK CONSISTS OF STANDARD CHARACTERS WITHOUT CLAIM TO ANY PARTICULAR FONT, STYLE, SIZE, OR COLOR.

THE FOREIGN WORDING IN THE MARK TRANSLATES INTO ENGLISH AS THE NEIGHBORHOOD.

FOR FRAGRANCES FOR PERSONAL USE, NAMELY, PERFUMES AND COLOGNES (U.S. CLS. 1, 4, 6, 50, 51 AND 52).

RONALD MCMORROW, EXAMINING ATTORNEY

CLASS 3—(Continued).

SN 76-595,181. CRUTCHER, WILBERT LEON, CHICAGO, IL. FILED 6-1-2004.

LADY SMOOTH SOOTH-TOUCH

THE MARK CONSISTS OF STANDARD CHARACTERS WITHOUT CLAIM TO ANY PARTICULAR FONT, STYLE, SIZE, OR COLOR.

NO CLAIM IS MADE TO THE EXCLUSIVE RIGHT TO USE "LADY SMOOTH", APART FROM THE MARK AS SHOWN.

FOR NON-MEDICATED SKIN CARE PREPARATIONS (U.S. CLS. 1, 4, 6, 50, 51 AND 52).

STEVEN JACKSON, EXAMINING ATTORNEY

SN 76-599,409. A&A BODY WORSHIP, INC., NEW YORK, NY, AND RHONE, SYLVIA, NEW YORK, NY. FILED 6-24-2004.

INDEPENDENT BODIES

THE MARK CONSISTS OF STANDARD CHARACTERS WITHOUT CLAIM TO ANY PARTICULAR FONT, STYLE, SIZE, OR COLOR.

FOR COSMETICS; FACIAL MAKEUP, CONCEALERS, BLUSHERS, FACIAL POWDERS, MASCARA, EYE MAKEUP, FOUNDATION MAKEUP, EYE PENCILS, EYEBROW PENCILS, FALSE EYELASHES, COSMETIC COMPACTS, COSMETIC PENCILS, LIPSTICK, LIP GLOSS, LIP POMADES, LIP PENCILS, MAKEUP REMOVERS, MAKEUP APPLICATORS IN THE NATURE OF COTTON SWABS FOR COSMETIC PURPOSES, FACIAL CLEANSERS, TONERS, FACIAL EXFOLIANTS AND SCRUBS, FACIAL CREAMS, FACIAL MOISTURIZERS, FACIAL LOTIONS AND NON-MEDICATED FACIAL TREATMENTS, WRINKLE REMOVING SKIN CARE PREPARATIONS, NAIL CARE PREPARATIONS, NAIL POLISHES, NAIL POLISH REMOVERS, NAIL CREAMS, CUTICLE REMOVING PREPARATIONS, NAIL BUFFING PREPARATIONS, SKIN MOISTURIZERS AND SKIN MOISTURIZER MASKS, SKIN CONDITIONERS, HAND CREAMS, MASSAGE OILS, ESSENTIAL OILS FOR PERSONAL USE, TALCUM POWDER, BATH BEADS, BATH CRYSTALS, BATH FOAM, BATH GELS, BATH OILS, BATH POWDERS, BATH SALTS, SKIN CLEANSERS, BODY SCRUBS, BODY FRAGRANCES, BODY AND HAND LOTIONS, BODY GELS, SHOWER GELS, BODY OILS, BODY POWDERS, BODY EXFOLIANTS, BODY MASKS, BODY MASK CREAMS AND LOTIONS, BODY CREAMS, SHAVING PREPARATIONS, SHAVING BALM, SKIN ABRASIVE PREPARATIONS, NON-MEDICATED LIP CARE PREPARATIONS, LIP CREAM, SUNSCREEN PREPARATIONS, SUNBLOCK PREPARATIONS, SUNTANNING PREPARATIONS AND AFTERSUN LOTIONS; SELF-TANNING PREPARATIONS, NAMELY, SELF-TANNING MILK AND CREAM, ACCELERATED TANNING CREAM, SELF-TANNING LOTIONS, GELS AND SPRAYS; PERFUME, COLOGNE, EAU DE TOILETTE, EAU DE PERFUME, EAU DE COLOGNE AND TOILETTE WATER; TOOTHPASTE, DEODORANT AND ANTIPERSPIRANT; COSMETIC PADS, PRE-MOISTENED COSMETIC WIPES, PRE-MOISTENED COSMETIC TISSUES AND TOWELETTES; COTTON STICKS FOR COSMETIC PURPOSES; ALL PURPOSE COTTON SWABS FOR PERSONAL USE AND COSMETIC PURPOSES; NON-MEDICATED TOPICAL SKIN CREAMS, OINTMENTS, GELS, TONERS, LOTIONS, SPRAYS AND POWDERS; AROMATHERAPY CREAMS, LOTIONS AND OILS; HAIR CARE PRODUCTS, NAMELY, SHAMPOOS, CONDITIONERS, MOUSSE, GELS, FROSTS, CREAMS, RINSES, SPRAYS, HAIR COLOR, HAIR WAVING LOTION, PERMANENT WAVE PREPARATIONS, HAIR LIGHTENERS, HAIR DYES, HAIR EMOLLIENTS, HAIR

CLASS 3—(Continued).

MASCARA, HAIR POMADES, HAIR COLOR REMOVERS, HAIR RELAXERS, HAIR RELAXING PREPARATIONS, HAIR STRAIGHTENING PREPARATIONS, HAIR STYLING PREPARATIONS, HAIR REMOVING CREAM, AND HAIR CARE PREPARATIONS; BABY WIPES; ANTIBACTERIAL PRE-MOISTENED COSMETIC WIPE PREPARATIONS FOR USE ON THE SKIN COSMETICS; DISPOSABLE WIPES IMPREGNATED WITH CHEMICALS OR COMPOUNDS FOR PERSONAL HYGIENE AND HOUSEHOLD USE; INCENSE; ROOM FRAGRANCES; FRAGRANCE EMITTING WICKS FOR ROOM FRAGRANCE; SACHETS; SACHET-LIKE EYE PILLOWS CONTAINING FRAGRANCES; SCENTED CERAMIC STONES; SCENTED LINEN SPRAYS AND SCENTED ROOM SPRAYS; SCENTED OILS USED TO PRODUCE AROMAS WHEN HEATED; SCENTED PINE CONES; POTPOURRI; AROMATHERAPY PILLOWS COMPRISING POTPOURRI IN FABRIC CONTAINERS (U.S. CLS. 1, 4, 6, 50, 51 AND 52).

CAROLYN CATALDO, EXAMINING ATTORNEY

SN 76-599,639. AMOREPACIFIC CORPORATION, SEOUL, REPUBLIC OF KOREA, FILED 6-29-2004.

WHITEGEN

MS135

FOR SKIN FRESHENERS, SKIN LOTIONS, NON-MEDICATED NUTRITIONAL MOISTURIZING SERUMS FOR THE FACE AND THE EYE, NOURISHING SKIN CREAMS, FOUNDATION CREAMS, EYE LINERS, MASCARAS, LIP STICKS, LIP GLOSS, NON-MEDICATED LIP BALMS, BLUSHERS, EYE SHADOWS, PERFUMES, BODY CLEANSERS, SHAMPOOS, LIP LINERS, EYE CREAMS, FACIAL MASKS, POWDER FOUNDATIONS, FACE POWDERS, COSMETIC SOAPS, HAIR LOTIONS, SUN BLOCK CREAMS, SUN BLOCKS LOTIONS, SKIN CLEANSING CREAMS, SKIN CLEANSING LOTIONS, HAIR DYES, SKIN WHITENING CREAMS, SKIN WHITENING SERUMS, WRINKLE TREATMENT CREAMS, ANTI-WRINKLE CREAMS, MASSAGE CREAMS, BATH SOAPS, COTTON WOOLS FOR COSMETIC PURPOSES, MAKE-UP REMOVAL TISSUES IMPREGNATED WITH COSMETICS, HAND CREAMS, HAIR SPRAYS, MASSAGE OILS, NAIL ENAMELS, BABY OILS, BABY POWDERS, EYE LINERS, COSMETIC PREPARATIONS FOR BODY CARE HAVING A BODY SLIMMING EFFECT, EAU DE COLOGNES, EAU DE PERFUMES, SOLID PERFUMES (U.S. CLS. 1, 4, 6, 50, 51 AND 52).

CAROL SPILS, EXAMINING ATTORNEY

CLASS 3—(Continued).

SN 76-600,488. L'ORÉAL, PARIS, FRANCE, FILED 7-2-2004.

RESIST & SHINE

THE MARK CONSISTS OF STANDARD CHARACTERS WITHOUT CLAIM TO ANY PARTICULAR FONT, STYLE, SIZE, OR COLOR.

PRIORITY CLAIMED UNDER SEC. 44(D) ON FRANCE APPLICATION NO. 04/3,299,001, FILED 6-22-2004, REG. NO. 43299001, DATED 6-22-2004, EXPIRES 6-22-2014.

FOR NAIL ENAMEL, NAIL LAQUERS (U.S. CLS. 1, 4, 6, 50, 51 AND 52).

ANGELA M. MICHELI, EXAMINING ATTORNEY

SN 76-602,320. LANCÔME PARFUMS ET BEAUTÉ & CIE, PARIS, FRANCE, FILED 7-14-2004.

FLASH RETOUCHE

THE MARK CONSISTS OF STANDARD CHARACTERS WITHOUT CLAIM TO ANY PARTICULAR FONT, STYLE, SIZE, OR COLOR.

THE FOREIGN WORDING IN THE MARK TRANSLATES INTO ENGLISH AS FLASH RETOUCHES.

FOR CONCEALER (U.S. CLS. 1, 4, 6, 50, 51 AND 52).

KELLEY WELLS, EXAMINING ATTORNEY

SN 76-603,236. SEGARRA, ARTEMIS R., TOA BAJA, PUERTO RICO, FILED 7-19-2004.



NO CLAIM IS MADE TO THE EXCLUSIVE RIGHT TO USE "GEL", APART FROM THE MARK AS SHOWN.

THE ENGLISH TRANSLATION OF THE WORD "DURO" IS "HARD".

FOR HAIR CARE PRODUCTS, NAMELY, STYLING GEL (U.S. CLS. 1, 4, 6, 50, 51 AND 52).

NELSON SNYDER, EXAMINING ATTORNEY

CLASS 3—(Continued).

SN 76-606,151. BIOTHERM, MONACO, MONACO, FILED 8-10-2004.

DRAINE CHOC

THE MARK CONSISTS OF STANDARD CHARACTERS WITHOUT CLAIM TO ANY PARTICULAR FONT, STYLE, SIZE, OR COLOR.

OWNER OF U.S. REG. NO. 2,439,518.
FOR COSMETICS NAMELY CREAMS, MILKS, LOTIONS, GELS AND POWDERS FOR THE FACE, THE BODY AND THE HANDS; ESSENTIAL OILS FOR PERSONAL USE (U.S. CLS. 1, 4, 6, 50, 51 AND 52).
GRETTA YAO, EXAMINING ATTORNEY

CLASS 3—(Continued).

SN 76-615,747. L'OREAL, PARIS, FRANCE, FILED 10-14-2004.

FRENCH LINER

THE MARK CONSISTS OF STANDARD CHARACTERS WITHOUT CLAIM TO ANY PARTICULAR FONT, STYLE, SIZE, OR COLOR.

NO CLAIM IS MADE TO THE EXCLUSIVE RIGHT TO USE "FRENCH", APART FROM THE MARK AS SHOWN.
FOR NAIL POLISH (U.S. CLS. 1, 4, 6, 50, 51 AND 52).
INGA ERVIN, EXAMINING ATTORNEY

SN 76-616,895. SPPC PARIS BLEU, 75017 PARIS, FRANCE, FILED 10-19-2004.

SN 76-612,351. GALUMBECK BEAUTY ENTERPRISES LLC, VIRGINIA BEACH, VA. FILED 9-21-2004.

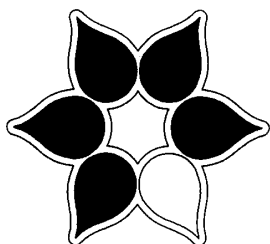

skin amnesty

CORSAGE

THE MARK CONSISTS OF STANDARD CHARACTERS WITHOUT CLAIM TO ANY PARTICULAR FONT, STYLE, SIZE, OR COLOR.

FOR PERFUMERY (U.S. CLS. 1, 4, 6, 50, 51 AND 52).
SALLY SHIH, EXAMINING ATTORNEY

SN 76-618,364. CHEMTEK, INC., YANCEYVILLE, NC. FILED 10-25-2004.

AVION

THE MARK CONSISTS OF STANDARD CHARACTERS WITHOUT CLAIM TO ANY PARTICULAR FONT, STYLE, SIZE, OR COLOR.

THE FOREIGN WORDING IN THE MARK TRANSLATES INTO ENGLISH AS AIRPLANE.
FOR CLEANERS FOR USE ON AIRPORT RUNWAYS (U.S. CLS. 1, 4, 6, 50, 51 AND 52).

FIRST USE 10-8-1987; IN COMMERCE 10-8-1987.
SUSAN STIGLITZ, EXAMINING ATTORNEY

NO CLAIM IS MADE TO THE EXCLUSIVE RIGHT TO USE "SKIN", APART FROM THE MARK AS SHOWN.

FOR COSMETICS, TOILET PREPARATIONS AND FRAGRANCES, NAMELY, SKIN AND BODY LOTIONS, CREAMS, OILS, AND MOISTURIZERS; MASSAGE OILS AND CREAMS; SKIN MASKS; SKIN EXFOLIATING LOTIONS AND CREAMS; HAIR SHAMPOOS AND CONDITIONERS; SHOWER GELS AND BODY SCRUBS; BODY WASHES; BUBBLE BATHS; BATH OILS AND LOTIONS; BATH BEADS; SKIN AND TOILET SOAPS; NON-MEDICATED BATH SALTS; BODY AND FACE MUD MASKS; BODY MISTS AND POWDERS; NON-MEDICATED FOOT POWDERS; FACIAL CLEANSERS AND CREAMS; LIP BALM AND LIP GLOSS; LIPSTICKS; PERSONAL DEODORANTS; SELF-TANNING LOTIONS AND CREAMS; SUNSCREEN LOTIONS; SHAVING CREAMS AND GELS; EAU DE TOILETTE AND FRAGRANT BODY SPRAYS; AND ROOM FRAGRANCES AND POTPOURRI (U.S. CLS. 1, 4, 6, 50, 51 AND 52).
RAMONA ORTIGA, EXAMINING ATTORNEY

CLASS 3—(Continued).

SN 76-619,500. SPPC PARIS BLEU, 75017 PARIS, FRANCE,
FILED 11-5-2004.

DIPLOMATE

THE MARK CONSISTS OF STANDARD CHARACTERS
WITHOUT CLAIM TO ANY PARTICULAR FONT, STYLE,
SIZE, OR COLOR.
FOR PERFUMERY (U.S. CLS. 1, 4, 6, 50, 51 AND 52).
FIRST USE 0-0-1996; IN COMMERCE 0-0-1996.
NORA BUCHANAN WILL, EXAMINING ATTORNEY

SN 76-620,497. MURAD, HOWARD, EL SEGUNDO, CA.
FILED 11-15-2004.

LIGHTEN & BRIGHTEN

THE MARK CONSISTS OF STANDARD CHARACTERS
WITHOUT CLAIM TO ANY PARTICULAR FONT, STYLE,
SIZE, OR COLOR.
FOR SKIN CARE PRODUCTS, NAMELY, EYE CREAM
(U.S. CLS. 1, 4, 6, 50, 51 AND 52).
KIMBERLY PERRY, EXAMINING ATTORNEY

SN 76-620,558. MRTT, INC., DBA SPECIALTY WHOLESALE,
LITTLE ROCK, AR. FILED 11-15-2004.



FOR SPRAY-ON SOLVENT, NAMELY A CLEANER
FOR GLASS AND OTHER SURFACES (U.S. CLS. 1, 4, 6,
50, 51 AND 52).
H. M. FISHER, EXAMINING ATTORNEY

SN 76-620,773. ROWPAR PHARMACEUTICALS, INC.,
SCOTTSDALE, AZ. FILED 11-16-2004.

ClōSYSII Oral Finishing Rinse

OWNER OF U.S. REG. NOS. 1,749,740 AND 2,395,656.
NO CLAIM IS MADE TO THE EXCLUSIVE RIGHT TO
USE "ORAL FINISHING RINSE", APART FROM THE
MARK AS SHOWN.
FOR MOUTHWASH (U.S. CLS. 1, 4, 6, 50, 51 AND 52).
FIRST USE 3-31-2002; IN COMMERCE 3-31-2002.
BARBARA RUTLAND, EXAMINING ATTORNEY

CLASS 3—(Continued).

SN 76-620,939. ANIMALE GROUP, S.A., 2NDO PISO, OFICI-
NA #209, PANAMA, FILED 11-17-2004.

ANIMALE AZUL

THE MARK CONSISTS OF STANDARD CHARACTERS
WITHOUT CLAIM TO ANY PARTICULAR FONT, STYLE,
SIZE, OR COLOR.

OWNER OF U.S. REG. NO. 1,419,688.
NO CLAIM IS MADE TO THE EXCLUSIVE RIGHT TO
USE "AZUL", APART FROM THE MARK AS SHOWN.
THE ENGLISH TRANSLATION OF ANIMALE AZUL IS
BLUE ANIMAL.
FOR EAU DE COLOGNE AND PERFUME (U.S. CLS. 1,
4, 6, 50, 51 AND 52).
RONALD MCMORROW, EXAMINING ATTORNEY

SN 76-620,940. ANIMALE GROUP, S.A., 2NDO PISO, OFICI-
NA #209, PANAMA, FILED 11-17-2004.

ANIMALE SPORT

THE MARK CONSISTS OF STANDARD CHARACTERS
WITHOUT CLAIM TO ANY PARTICULAR FONT, STYLE,
SIZE, OR COLOR.

OWNER OF U.S. REG. NO. 1,419,688.
NO CLAIM IS MADE TO THE EXCLUSIVE RIGHT TO
USE "SPORT", APART FROM THE MARK AS SHOWN.
THE ENGLISH TRANSLATION OF ANIMALE IS ANI-
MAL.
FOR EAU DE COLOGNE AND PERFUME (U.S. CLS. 1,
4, 6, 50, 51 AND 52).
RONALD MCMORROW, EXAMINING ATTORNEY

SN 76-621,125. U.S. COTTON, LLC, RIO RANCHO, NM.
FILED 11-16-2004.

CLASSIC

THE MARK CONSISTS OF STANDARD CHARACTERS
WITHOUT CLAIM TO ANY PARTICULAR FONT, STYLE,
SIZE, OR COLOR.

FOR HEALTH AND BEAUTY AID PRODUCTS,
NAMELY COSMETIC PADS, COSMETIC PUFFS, COT-
TON BALLS, COTTON SWABS, CIRCULAR PIECES OF
QUILTED COTTON PADS, AND SQUARE PIECES OF
QUILTED COTTON, ALL FOR PERSONAL USE (U.S.
CLS. 1, 4, 6, 50, 51 AND 52).
FIRST USE 9-15-1989; IN COMMERCE 11-15-1989.
GIANCARLO CASTRO, EXAMINING ATTORNEY

CLASS 3—(Continued).

SN 76-621,147. MARY QUANT COSMETICS JAPAN LIMITED, TOKYO, JAPAN, FILED 11-16-2004.

UV MANAGER

THE MARK CONSISTS OF STANDARD CHARACTERS WITHOUT CLAIM TO ANY PARTICULAR FONT, STYLE, SIZE, OR COLOR.

NO CLAIM IS MADE TO THE EXCLUSIVE RIGHT TO USE UV, APART FROM THE MARK AS SHOWN.

FOR COSMETICS (U.S. CLS. 1, 4, 6, 50, 51 AND 52).
GISELLE AGOSTO, EXAMINING ATTORNEY

SN 76-621,899. L'OREAL, PARIS, FRANCE, FILED 11-23-2004.

ROOT REFRESHER

THE MARK CONSISTS OF STANDARD CHARACTERS WITHOUT CLAIM TO ANY PARTICULAR FONT, STYLE, SIZE, OR COLOR.

FOR HAIR COLOR (U.S. CLS. 1, 4, 6, 50, 51 AND 52).
PAM WILLIS, EXAMINING ATTORNEY

SN 76-622,015. HIMMARSHEE SURGICAL PARTNERS, L.L.C., FORT LAUDERDALE, FL. FILED 11-24-2004.

HIMMARSHEE

THE MARK CONSISTS OF STANDARD CHARACTERS WITHOUT CLAIM TO ANY PARTICULAR FONT, STYLE, SIZE, OR COLOR.

FOR COSMETICS (U.S. CLS. 1, 4, 6, 50, 51 AND 52).
FIRST USE 7-0-2003; IN COMMERCE 7-0-2003.
INGA ERVIN, EXAMINING ATTORNEY

CLASS 3—(Continued).

SN 76-622,250. PRESTIGE COSMETICS, POMPANO BEACH, FL. FILED 11-26-2004.

BLUSHING DUO

THE MARK CONSISTS OF STANDARD CHARACTERS WITHOUT CLAIM TO ANY PARTICULAR FONT, STYLE, SIZE, OR COLOR.

FOR COSMETICS, SPECIFICALLY FACE PRODUCTS (U.S. CLS. 1, 4, 6, 50, 51 AND 52).

DOMINIC J. FERRAIUOLO, EXAMINING ATTORNEY

SN 76-622,397. ALCONOX, INC., WHITE PLAINS, NY. FILED 11-29-2004.

 The logo for ALCONOX features a stylized, jagged, downward-pointing triangle on the left, composed of several parallel lines of varying lengths. To the right of this symbol, the word "ALCONOX" is written in a bold, serif, all-caps font.

FOR ALL-PURPOSE INDUSTRIAL CLEANER AND DETERGENT (U.S. CLS. 1, 4, 6, 50, 51 AND 52).

FIRST USE 11-15-2004; IN COMMERCE 11-15-2004.
CHERYL CLAYTON, EXAMINING ATTORNEY

SN 76-622,398. ALCONOX, INC., WHITE PLAINS, NY. FILED 11-29-2004.



OWNER OF U.S. REG. NO. 2,347,344.
FOR ALL-PURPOSE INDUSTRIAL CLEANER AND DETERGENT (U.S. CLS. 1, 4, 6, 50, 51 AND 52).
FIRST USE 11-15-2004; IN COMMERCE 11-15-2004.
CHERYL CLAYTON, EXAMINING ATTORNEY

CLASS 3—(Continued).

SN 76-622,554. SOOTHING SCENTS, INC., ENTERPRISE, AL. FILED 11-30-2004.

RELIEF IS JUST A BREATH AWAY

THE MARK CONSISTS OF STANDARD CHARACTERS WITHOUT CLAIM TO ANY PARTICULAR FONT, STYLE, SIZE, OR COLOR.
FOR AROMATHERAPY PREPARATIONS CONSISTING OF ESSENTIAL OILS AND HERBS (U.S. CLS. 1, 4, 6, 50, 51 AND 52).
MELVIN AXILBUND, EXAMINING ATTORNEY

SN 76-622,598. LANCOME PARFUMS ET BEAUTE & CIE, PARIS, FRANCE, FILED 11-30-2004.

LASERIUM

THE MARK CONSISTS OF STANDARD CHARACTERS WITHOUT CLAIM TO ANY PARTICULAR FONT, STYLE, SIZE, OR COLOR.
FOR CREAM FOR THE FACE (U.S. CLS. 1, 4, 6, 50, 51 AND 52).
DAVID C. REIHNER, EXAMINING ATTORNEY

SN 76-625,716. LANCOME PARFUMS ET BEAUTE & CIE, PARIS, FRANCE, FILED 12-20-2004.

REJUVACTIVE

THE MARK CONSISTS OF STANDARD CHARACTERS WITHOUT CLAIM TO ANY PARTICULAR FONT, STYLE, SIZE, OR COLOR.
FOR COSMETICS NAMELY CREAMS, GELS, MILKS, POWDERS AND LOTIONS FOR THE FACE, BODY AND HANDS; MAKE-UP PRODUCTS NAMELY MASCARA, EYE LINER, EYE SHADOW, EYEBROW PENCIL, LIP-STICKS, NAIL POLISH, BLUSH, FOUNDATIONS CREAMS AND POWDER, BODY DEODORANTS (U.S. CLS. 1, 4, 6, 50, 51 AND 52).
KIMBERLY PERRY, EXAMINING ATTORNEY

CLASS 3—(Continued).

SN 76-626,412. LADY BURD EXCLUSIVE COSMETICS, INC., FARMINGDALE, NY. FILED 12-28-2004.

MULTI-GLO

THE MARK CONSISTS OF STANDARD CHARACTERS WITHOUT CLAIM TO ANY PARTICULAR FONT, STYLE, SIZE, OR COLOR.
FOR COSMETICS, NAMELY, CHEEK, LIP AND EYE COLORS IN COMPACT FORM (U.S. CLS. 1, 4, 6, 50, 51 AND 52).
CARRIE ACHEN, EXAMINING ATTORNEY

SN 78-189,255. VICTORIA PRINCIPAL PRODUCTIONS, INC., LOS ANGELES, CA. FILED 11-26-2002.

RECLAIM BY NIGHT

FOR SKIN AND BODY CARE PREPARATIONS NAMELY, SKIN CLEANSERS, SKIN MOISTURIZERS, SKIN LOTIONS, SKIN SOAPS, SUN SCREEN PREPARATIONS, COSMETICS, NON-MEDICATED HAIR CARE PREPARATIONS, NAIL CARE PREPARATIONS, COLOGNES, PERFUMES AND TOOTH WHITENING PREPARATIONS (U.S. CLS. 1, 4, 6, 50, 51 AND 52).
FIRST USE 11-0-2003; IN COMMERCE 11-0-2003.
NORA BUCHANAN WILL, EXAMINING ATTORNEY

SN 78-250,316. PPG INDUSTRIES OHIO, INC., CLEVELAND, OH. FILED 5-15-2003.

ULTRAX

FOR INDUSTRIAL CLEANERS FOR THE TREATMENT OF METAL SURFACES PRIOR TO PAINTING AND POWDER COATING (U.S. CLS. 1, 4, 6, 50, 51 AND 52).
ALICIA COLLINS, EXAMINING ATTORNEY

SN 78-252,843. DOMUS INDUSTRIA LLC, OAKLAND, CA. FILED 5-21-2003.

THAI MASSAGE

NO CLAIM IS MADE TO THE EXCLUSIVE RIGHT TO USE "MASSAGE", APART FROM THE MARK AS SHOWN. FOR SOAPS FOR THE BODY AND FACE (U.S. CLS. 1, 4, 6, 50, 51 AND 52).
SOPHIA S. KIM, EXAMINING ATTORNEY

CLASS 3—(Continued).

SN 78-255,312. HY-VEE, INC., WEST DES MOINES, IA. FILED 5-28-2003.

MOTHER'S CHOICE

FOR BABY PRODUCTS, NAMELY, BABY OIL, BABY POWDER, BABY LOTION AND BABY SHAMPOO (U.S. CLS. 1, 4, 6, 50, 51 AND 52).
KATHERINE STOIDES, EXAMINING ATTORNEY

SN 78-265,270. BACKSTREETPROMOTIONS.COM, ST PETERSBURG, FL. FILED 6-20-2003.

DIRTY DOG

FOR COLOGNE (U.S. CLS. 1, 4, 6, 50, 51 AND 52). FIRST USE 4-23-1998; IN COMMERCE 7-1-2003.
CATHERINE FAINT, EXAMINING ATTORNEY

SN 78-274,442. VELASQUEZ, PATRICIA, NEW YORK, NY. FILED 7-15-2003.

k a l m a

FOR COSMETICS, PERFUMES AND COLOGNES, DEODORANTS FOR PERSONAL USE; ANTIPERSPIRANTS; NON-MEDICATED BEAUTY PRODUCTS FOR THE SKIN, FACE, BODY, NAMELY, CREAMS, LOTIONS, SOAPS, GELS SCRUBS, FACIAL MOUSSE, AND CONCEALERS; SUN-TAN LOTION; SUN SCREENING PREPARATIONS; AFTER SUN CARE, NAMELY, SKIN LOTION AND MOISTURIZERS; SKIN CLEANSING CREAM; SKIN LIGHTENING CREAMS; SKIN REPAIR CREAMS; EYE CREAM; EYE GEL; EYE MAKEUP REMOVER; AGE-SPOT REDUCTION LOTIONS; SHAVING FOAM; SHAVING GEL; AFTER SHAVE GEL; LIP BALM; BODY OILS; PERFUME OILS; BABY OIL; BATH OIL; SHOWER GEL; HAIR GEL; HAIR MOUSSE; LIPSTICK; EYELINER; MASCARA; NAIL POLISH; DENTRIFICES, NAMELY, MOUTHWASHES AND TOOTH GELS (U.S. CLS. 1, 4, 6, 50, 51 AND 52).
CURTIS FRENCH, EXAMINING ATTORNEY

CLASS 3—(Continued).

SN 78-278,166. EASTHILL GROUP, INC., POTTSTOWN, PA. FILED 7-24-2003.

DEKOTE

THE MARK CONSISTS OF STANDARD CHARACTERS WITHOUT CLAIM TO ANY PARTICULAR FONT, STYLE, SIZE, OR COLOR.
OWNER OF U.S. REG. NO. 1,607,922.
FOR PAINT STRIPPER USED TO REMOVE LIQUID AND POWDER COATED AUTOMOBILE FINISHES (U.S. CLS. 1, 4, 6, 50, 51 AND 52).
FIRST USE 1-1-2003; IN COMMERCE 1-1-2003.
NAAKWAMA ANKRAH, EXAMINING ATTORNEY

SN 78-306,384. JAFER LIMITED, HAMILTON, BERMUDA, FILED 9-27-2003.

AROM SPORT

OWNER OF U.S. REG. NO. 2,251,818.
NO CLAIM IS MADE TO THE EXCLUSIVE RIGHT TO USE "SPORT", APART FROM THE MARK AS SHOWN.
FOR COLOGNE, PERFUME, EAU DE TOILETTE, EAU DE PARFUM, AFTER SHAVE LOTION, TOILET SOAP, TALCUM POWDER, BODY POWDER, DEODORANT FOR PERSONAL USE, ANTIPERSPIRANT, BODY LOTION, BODY GEL, BATH SALTS, SKIN CREAM, HAIR SHAMPOO, HAIR CONDITIONERS, SHOWER GEL, LIQUID FACIAL SOAP, LIQUID HAND SOAP, LIQUID BODY SOAP; HAND CREAM, FACIAL CREAM, BODY CREAM; COSMETIC CREAMS, FACIAL SOAP, COSMETICS, FACIAL MOISTURIZERS, SKIN AND FACIAL MASKS, MAKEUP REMOVERS, FACIAL CLEANSERS, EYE MAKEUP REMOVERS, EYELASHES MAKEUP REMOVER, EYEBROW MAKEUP REMOVER, FACIAL MAKEUP REMOVERS, ASTRINGENTS FOR COSMETIC PURPOSE, SKIN CLEANSING LOTIONS, COLD CREAMS, NIGHT CREAM, SKIN CLEANSING CREAM, VANISHING CREAM, SKIN MOISTURIZER, WRINKLE REMOVING SKIN CARE PREPARATIONS, SKIN CLARIFIERS, SKIN CLEANSING LOTIONS, SKIN LIGHTENERS, SKIN LOTIONS, SKIN TONER; COSMETICS CREAMS, LOTIONS AND GELS (U.S. CLS. 1, 4, 6, 50, 51 AND 52).
BRIDGETT SMITH, EXAMINING ATTORNEY

SN 78-316,874. A.G. PROFESSIONAL HAIR CARE PRODUCTS LTD., BURNABY, BRITISH COLUMBIA, CANADA, FILED 10-22-2003.

RE:COIL

PRIORITY CLAIMED UNDER SEC. 44(D) ON CANADA APPLICATION NO. 1176198, FILED 4-29-2003, REG. NO. TMA640845, DATED 5-31-2005, EXPIRES 5-31-2020.
FOR HAIR CARE PRODUCTS, NAMELY, CURL ACTIVATOR, POMADES AND NON-MEDICATED HAIR OINTMENTS, HAIR SETTING LOTIONS, HAIR STRAIGHTENERS, HAIR SHAMPOOS AND HAIR CONDITIONERS (U.S. CLS. 1, 4, 6, 50, 51 AND 52).
KELLY BOULTON, EXAMINING ATTORNEY

CLASS 3—(Continued).

SN 78-357,056. CARON LABORATORIES PTY LTD., GEE-LONG WEST, VICTORIA, AUSTRALIA, FILED 1-24-2004.

CLASS 3—(Continued).

SN 78-358,797. Y.Z.Y. INC., MIAMI, FL. FILED 1-28-2004.



PRIVACY

NO CLAIM IS MADE TO THE EXCLUSIVE RIGHT TO USE LABORATORIES, APART FROM THE MARK AS SHOWN.

FOR DEPILATORY AND EPILATORY PRODUCTS, NAMELY, HAIR REMOVAL WAXES SOLD THROUGH WHOLESALE CHANNELS TO BEAUTY SHOPS (U.S. CLS. 1, 4, 6, 50, 51 AND 52).

SAMUEL E. SHARPER JR., EXAMINING ATTORNEY

THE MARK CONSISTS OF STANDARD CHARACTERS WITHOUT CLAIM TO ANY PARTICULAR FONT, STYLE, SIZE, OR COLOR.

FOR PERFUMES, HAND AND BODY LOTIONS, BODY CREAMS, AND DEODORANT SPRAYS AND ROLL-ONS FOR PERSONAL USE (U.S. CLS. 1, 4, 6, 50, 51 AND 52).
SHAUNIA WALLACE, EXAMINING ATTORNEY

SN 78-357,062. CARON LABORATORIES PTY LTD, GEE-LONG WEST, VICTORIA, AUSTRALIA, FILED 1-24-2004.

SN 78-363,291. MICRO-SCIENTIFIC INDUSTRIES, INC., ROLLING MEADOWS, IL. FILED 2-5-2004.



MICRO-ZYME

THE NAME LILLIANE CARON IS FICTICIOUS; THE MARK DOES NOT IDENTIFY ANY PARTICULAR LIVING INDIVIDUAL.

FOR DEPILATORY AND EPILATORY PRODUCTS, NAMELY, HAIR REMOVAL WAXES SOLD THROUGH WHOLESALE CHANNELS TO BEAUTY SHOPS (U.S. CLS. 1, 4, 6, 50, 51 AND 52).

SAMUEL E. SHARPER JR., EXAMINING ATTORNEY

THE MARK CONSISTS OF STANDARD CHARACTERS WITHOUT CLAIM TO ANY PARTICULAR FONT, STYLE, SIZE, OR COLOR.

FOR INSTRUMENT CLEANER FOR USE ON MEDICAL, DENTAL AND SURGICAL INSTRUMENTS AND DEVICES PRIOR TO DISINFECTION (U.S. CLS. 1, 4, 6, 50, 51 AND 52).

FIRST USE 7-1-2002; IN COMMERCE 7-1-2002.
AMOS T. MATTHEWS, JR., EXAMINING ATTORNEY

CLASS 3—(Continued).

SN 78-366,013. AQUA MIX INC., SANTA FE SPRINGS, CA. FILED 2-11-2004.



THE COLOR(S) GOLD AND BLACK IS/ARE CLAIMED AS A FEATURE OF THE MARK.

THE MARK CONSISTS OF A STYLIZED TERM KNOCKDOWN IN BLACK LETTERS ON A GOLD RECTANGLE WITH VARIATIONS IN GOLD COLOR IN THE RECTANGLE SURROUNDING KNOCKDOWN; THE GOLD RECTANGLE IS OUTLINED IN BLACK AND GOLD.

FOR HONING POWDER FOR USE IN FINISHING NATURAL STONE (U.S. CLS. 1, 4, 6, 50, 51 AND 52).

FIRST USE 12-5-2003; IN COMMERCE 1-30-2004.
GIANCARLO CASTRO, EXAMINING ATTORNEY

CLASS 3—(Continued).

SN 78-398,658. BEAUTYBANK INC., NEW YORK, NY. FILED 4-8-2004.

FLIRT

THE MARK CONSISTS OF STANDARD CHARACTERS WITHOUT CLAIM TO ANY PARTICULAR FONT, STYLE, SIZE, OR COLOR.

FOR COSMETICS, NAMELY, LIPSTICK, LIP GLOSS, LIP PENCILS, LIP LINER, LIP BALM, LIP CONDITIONER, EYE PENCILS, EYE LINER, EYE SHADOW, MASCARA, EYE BROW PENCILS, FOUNDATION MAKE-UP, PRESSED POWDER, FACE POWDER, CONCEALER, ROUGE, BLUSH, AND MAKE-UP REMOVER; NAIL CARE PREPARATIONS; NAMELY, NAIL POLISH AND NAIL POLISH REMOVER; FRAGRANCES FOR PERSONAL USE; SUN CARE PREPARATIONS, NAMELY, SUNTAN OILS, GELS, CREAMS, AND LOTIONS; SUNBLOCK; SUN SCREEN; AFTER SUN OILS, GELS, CREAMS, AND LOTIONS; SUNLESS TANNING OILS, GELS, CREAMS, AND LOTIONS (U.S. CLS. 1, 4, 6, 50, 51 AND 52).

SEAN DWYER, EXAMINING ATTORNEY

SN 78-397,357. PERFORMANCE BRANDS, INC., SUNRISE, FL. FILED 4-6-2004.

BASK IN THE SUN

THE MARK CONSISTS OF STANDARD CHARACTERS WITHOUT CLAIM TO ANY PARTICULAR FONT, STYLE, SIZE, OR COLOR.

FOR SUN TANNING PRODUCTS, NAMELY SUN PROTECTION LOTION, SUN TANNING OIL, AND TANNING ACCELERATORS, NAMELY, SUN TAN LOTION, SUN TAN CREAM, SUN TAN GEL, AND SUN TAN OIL (U.S. CLS. 1, 4, 6, 50, 51 AND 52).

TONJA GASKINS, EXAMINING ATTORNEY

SN 78-406,710. ECOSAFE TECHNOLOGIES, LLC, SOUTH JORDAN, UT. FILED 4-22-2004.

OXYBALL

THE MARK CONSISTS OF STANDARD CHARACTERS WITHOUT CLAIM TO ANY PARTICULAR FONT, STYLE, SIZE, OR COLOR.

FOR CONCENTRATED, SLOW-DISSOLVE LAUNDRY DETERGENT; ALL-PURPOSE LAUNDRY CLEANING AND STAIN REMOVERS CONSISTING PRIMARILY OF OXYGENATORS, BRIGHTENERS, AND ALKALINITY BOOSTERS FOR USE IN HOUSEHOLD LAUNDRY APPLICATIONS (U.S. CLS. 1, 4, 6, 50, 51 AND 52).

ALICE BENMAMAN, EXAMINING ATTORNEY

CLASS 3—(Continued).

SN 78-406,737. PHILLIPS, SHEILA R, DENVER, CO. FILED 4-22-2004.

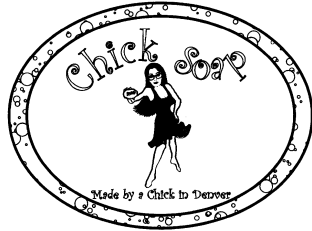

NO CLAIM IS MADE TO THE EXCLUSIVE RIGHT TO USE "SOAP", "MADE BY" AND "DENVER", APART FROM THE MARK AS SHOWN.

THE MARK CONSISTS OF AN OVAL BORDER WITH BUBBLES AND A GIRL INSIDE THE BORDER WITH EYGLASSES AND A DRESS BUT COLOR IS NOT A FEATURE OF THE MARK.

FOR BATH PRODUCTS, NAMELY, COSMETICS, SHOWER GELS, BODY LOTION, BUBBLE BATH, NON-MEDICATED BATH SALTS, BATH BEADS, NON-MEDICATED LIP BALM, AROMATHERAPY OILS, BAR BODY SOAPS, FOOT SCRUBS, BODY SCRUBS AND MASSAGE OILS (U.S. CLS. 1, 4, 6, 50, 51 AND 52).

IRENE D. WILLIAMS, EXAMINING ATTORNEY

CLASS 3—(Continued).

SN 78-417,721. DESIGNER SKIN, LLC, TEMPE, AZ. FILED 5-12-2004.

TRY ME

THE MARK CONSISTS OF STANDARD CHARACTERS WITHOUT CLAIM TO ANY PARTICULAR FONT, STYLE, SIZE, OR COLOR.

FOR INDOOR TANNING PREPARATIONS, SKIN MOISTURIZER, SKIN LOTION (U.S. CLS. 1, 4, 6, 50, 51 AND 52).

FIRST USE 11-1-2004; IN COMMERCE 11-1-2004.

CYNTHIA SLOAN, EXAMINING ATTORNEY

SN 78-414,220. BEAUTYBANK INC., NEW YORK, NY. FILED 5-6-2004.

ROOM FOR TWO

THE MARK CONSISTS OF STANDARD CHARACTERS WITHOUT CLAIM TO ANY PARTICULAR FONT, STYLE, SIZE, OR COLOR.

FOR COSMETICS; NON-MEDICATED SKINCARE PREPARATIONS; FRAGRANCES FOR PERSONAL USE; NON-MEDICATED HAIR CARE PREPARATIONS; TOILETRIES, NAMELY, BATH AND BODY SOAPS, CLEANSERS, GELS, LOTIONS, CREAMS AND SPRAYS (U.S. CLS. 1, 4, 6, 50, 51 AND 52).

JAMES A. RAUEN, EXAMINING ATTORNEY

SN 78-420,526. PARTNERS OF THE MIDWEST, LLP, TODDVILLE, IA. FILED 5-18-2004.

EMUVERA

THE MARK CONSISTS OF STANDARD CHARACTERS WITHOUT CLAIM TO ANY PARTICULAR FONT, STYLE, SIZE, OR COLOR.

SEC. 2(F).
FOR LOTIONS, SPECIFICALLY SKIN LOTIONS (U.S. CLS. 1, 4, 6, 50, 51 AND 52).

FIRST USE 9-23-1994; IN COMMERCE 9-25-1994.

CHRIS WELLS, EXAMINING ATTORNEY

CLASS 3—(Continued).

SN 78-421,127. COFF, LESLIE HOPE MAYRON, ATLANTA, GA. FILED 5-18-2004.

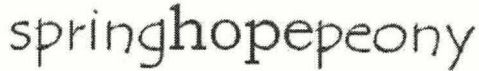

The logo for 'springhopepeony' features the brand name in a lowercase, handwritten-style font. The letters are black and set against a light yellow rectangular background.

FOR COSMETIC CREAMS FOR SKIN CARE (U.S. CLS. 1, 4, 6, 50, 51 AND 52).
FIRST USE 4-1-2004; IN COMMERCE 5-1-2004.
LAURA KOVAISKY, EXAMINING ATTORNEY

CLASS 3—(Continued).

SN 78-428,472. KAO KABUSHIKI KAISHA, AKA KAO CORPORATION, CHUO-KU, TOKYO, JAPAN, FILED 6-2-2004.

RED DEFEND COMPLEX

THE MARK CONSISTS OF STANDARD CHARACTERS WITHOUT CLAIM TO ANY PARTICULAR FONT, STYLE, SIZE, OR COLOR.

NO CLAIM IS MADE TO THE EXCLUSIVE RIGHT TO USE RED AND COMPLEX, APART FROM THE MARK AS SHOWN.

FOR HAIR CARE PREPARATIONS (U.S. CLS. 1, 4, 6, 50, 51 AND 52).

FIRST USE 1-24-2005; IN COMMERCE 1-24-2005.
NICHOLAS ALTREE, EXAMINING ATTORNEY

SN 78-421,516. L'OREAL USA CREATIVE, INC., NEW YORK, NY. FILED 5-19-2004.

KIWI BURST WET WAX

THE MARK CONSISTS OF STANDARD CHARACTERS WITHOUT CLAIM TO ANY PARTICULAR FONT, STYLE, SIZE, OR COLOR.

NO CLAIM IS MADE TO THE EXCLUSIVE RIGHT TO USE "KIWI" OR "WET WAX", APART FROM THE MARK AS SHOWN.

FOR HAIR STYLING WAX (U.S. CLS. 1, 4, 6, 50, 51 AND 52).

FIRST USE 1-1-2005; IN COMMERCE 1-1-2005.
CHRISIE B. KING, EXAMINING ATTORNEY

SN 78-431,984. EMPREDIVER, S.L., PATERNA, SPAIN, FILED 6-8-2004.

SN 78-425,513. CALIFORNIA TAN INC., LOS ANGELES, CA. FILED 5-26-2004.

CT SEVEN

THE MARK CONSISTS OF STANDARD CHARACTERS WITHOUT CLAIM TO ANY PARTICULAR FONT, STYLE, SIZE, OR COLOR.

FOR SUN TANNING PREPARATIONS FOR USE IN INDOOR TANNING SALONS AND SOLD ONLY IN INDOOR TANNING SALONS, NAMELY, GELS, LOTIONS, OILS, MOISTURIZERS, SPRAYS, MISTS, AND CREAMS FOR THE BODY AND FACE (U.S. CLS. 1, 4, 6, 50, 51 AND 52).

CATHERINE FAINT, EXAMINING ATTORNEY

REGENERIN

THE MARK CONSISTS OF STANDARD CHARACTERS WITHOUT CLAIM TO ANY PARTICULAR FONT, STYLE, SIZE, OR COLOR.

PRIORITY CLAIMED UNDER SEC. 44(D) ON ERPNTY TM OFC APPLICATION NO. 3782786, FILED 5-5-2004.

FOR PERFUMERY AND COSMETICS; TOILET SOAPS; HAIR LOTIONS; DENTIFRICES (U.S. CLS. 1, 4, 6, 50, 51 AND 52).

KIMBERLY FRYE, EXAMINING ATTORNEY

CLASS 3—(Continued).

SN 78-437,551. CHIN UP, NEW YORK, NY. FILED 6-18-2004.

chin up

THE MARK CONSISTS OF STANDARD CHARACTERS WITHOUT CLAIM TO ANY PARTICULAR FONT, STYLE, SIZE, OR COLOR.

FOR NECK FIRING GEL, NECK FIRING CREAM, NECK FIRING SERUM, NECK FIRING FLUID (U.S. CLS. 1, 4, 6, 50, 51 AND 52).

SHARI SHEFFIELD, EXAMINING ATTORNEY

SN 78-438,947. VANDESANDE, INC., LOS ANGELES, CA. FILED 6-21-2004.



NO CLAIM IS MADE TO THE EXCLUSIVE RIGHT TO USE "BIO-BOTANICAL HAIR CARE AND NOURRISSANT", APART FROM THE MARK AS SHOWN.

THE NAME(S), PORTRAIT(S), AND/OR SIGNATURE(S) SHOWN IN THE MARK IDENTIFIES RENE VANDESANDE, A LIVING INDIVIDUAL, WHOSE CONSENT(S) TO REGISTER IS SUBMITTED.

THE COLOR(S) YELLOW, GREEN AND WHITE IS/ARE CLAIMED AS A FEATURE OF THE MARK.

THE MARK CONSISTS OF THE WORDING VANDESANDE BIO-BOTANICAL HAIR CARE AND NOURRISSANT APPEARING IN GREEN LETTERING ON A WHITE BACKGROUND. ALSO FEATURED IS A SQUARE DESIGN THAT IS YELLOW AND INSIDE THE YELLOW SQUARE DESIGN THERE IS A DESIGN OF FANCIFUL FLOWERS THAT ARE WHITE.

THE FOREIGN WORDING IN THE MARK TRANSLATES INTO ENGLISH AS NOURISHING.

FOR HAIR CONDITIONER (U.S. CLS. 1, 4, 6, 50, 51 AND 52).

FIRST USE 4-20-2004; IN COMMERCE 4-21-2004.

LOURDES AYALA, EXAMINING ATTORNEY

CLASS 3—(Continued).

SN 78-440,330. MANFREDINI, FERNANDO CARLOS SALINAS, SANTIAGO, CHILE, FILED 6-23-2004.

LEVINIA MANFREDINI

THE MARK CONSISTS OF STANDARD CHARACTERS WITHOUT CLAIM TO ANY PARTICULAR FONT, STYLE, SIZE, OR COLOR.

THE NAME LEVINIA MANFREDINI DOES NOT IDENTIFY A LIVING INDIVIDUAL.

FOR COSMETICS AND PERFUMERY (U.S. CLS. 1, 4, 6, 50, 51 AND 52).

JILL C. ALT, EXAMINING ATTORNEY

SN 78-440,456. SPA ROMANOLI, LLC, MORGANTOWN, WV. FILED 6-24-2004.

N美CO

THE NON-LATIN CHARACTER(S) IN THE MARK TRANSLITERATES INTO MEI, AND THIS MEANS BEAUTIFUL IN ENGLISH.

FOR HAIR CARE PRODUCTS, NAMELY HAIR SHAMPOOS, HAIR CONDITIONERS, HAIR GELS, HAIRSPRAY, HAIR MOUSSE AND HAIR STYLING PREPARATIONS; NON-MEDICATED SKIN CARE PRODUCTS, NAMELY SKIN LOTIONS, SKIN SOAPS, SKIN CLEANSERS, SKIN CREAMS, SKIN MOISTURIZERS, SKIN EXFOLIANTS, SKIN TONERS, AND COSMETICS (U.S. CLS. 1, 4, 6, 50, 51 AND 52).

FIRST USE 10-6-2003; IN COMMERCE 10-6-2003.

ODESSA BIBBINS, EXAMINING ATTORNEY

SN 78-441,325. HEALTHTAN TECHNOLOGIES, MOUNT VERNON, OH. FILED 6-25-2004.

VITA MATRIX

THE MARK CONSISTS OF STANDARD CHARACTERS WITHOUT CLAIM TO ANY PARTICULAR FONT, STYLE, SIZE, OR COLOR.

FOR COSMETIC PREPARATIONS FOR SUNLESS TANNING AND SUNLESS TANNING SPRAYS MARKETED AS A COMPLEMENT TO PROFESSIONAL SPA SERVICES (U.S. CLS. 1, 4, 6, 50, 51 AND 52).

REBECCA GILBERT, EXAMINING ATTORNEY

CLASS 3—(Continued).

SN 78-443,912. FLAGEOLI, LTD., LAS VEGAS, NV. FILED 6-30-2004.

CLASS 3—(Continued).

SN 78-450,164. INDUSTRIA COSMÉTICA COPER LTDA., DIADEMA, BRAZIL, FILED 7-13-2004.

CELLUDUCTION

THE MARK CONSISTS OF STANDARD CHARACTERS WITHOUT CLAIM TO ANY PARTICULAR FONT, STYLE, SIZE, OR COLOR.

FOR COSMETICS AND SKIN CARE PREPARATIONS; NAMELY, CREAMS, LOTIONS, SERUMS AND MOISTURIZERS FOR THE FACE AND BODY (U.S. CLS. 1, 4, 6, 50, 51 AND 52).

JULIE WATSON, EXAMINING ATTORNEY

NEUTROX

THE MARK CONSISTS OF STANDARD CHARACTERS WITHOUT CLAIM TO ANY PARTICULAR FONT, STYLE, SIZE, OR COLOR.

FOR HAIR LOTIONS (U.S. CLS. 1, 4, 6, 50, 51 AND 52). DANIEL BRODY, EXAMINING ATTORNEY

SN 78-446,177. ZIEMBA, JOHN T., EDISON, NJ. FILED 7-6-2004.

SN 78-452,485. QVC, INC., WEST CHESTER, PA. FILED 7-19-2004.



STAIN SCIENCE

THE MARK CONSISTS OF STANDARD CHARACTERS WITHOUT CLAIM TO ANY PARTICULAR FONT, STYLE, SIZE, OR COLOR.

NO CLAIM IS MADE TO THE EXCLUSIVE RIGHT TO USE "STAIN", APART FROM THE MARK AS SHOWN.

FOR STAIN REMOVER (U.S. CLS. 1, 4, 6, 50, 51 AND 52).

JANICE L. MCMORROW, EXAMINING ATTORNEY

FOR PERSONAL FRAGRANCES (U.S. CLS. 1, 4, 6, 50, 51 AND 52).

DAVID C. REIHNER, EXAMINING ATTORNEY

CLASS 3—(Continued).

SN 78-455,006. NABROS PHARMA LIMITED, AHMEDABAD; GUJARAT, INDIA, FILED 7-22-2004.

SMOKERSCHOICE TOOTHPASTE

THE MARK CONSISTS OF STANDARD CHARACTERS WITHOUT CLAIM TO ANY PARTICULAR FONT, STYLE, SIZE, OR COLOR.

NO CLAIM IS MADE TO THE EXCLUSIVE RIGHT TO USE "TOOTHPASTE", APART FROM THE MARK AS SHOWN.

FOR BLEACHING PREPARATIONS AND OTHER SUBSTANCES FOR LAUNDRY USE, NAMELY LAUNDRY BLEACH; GENERAL PURPOSE CLEANING, POLISHING, AND ABRASIVE LIQUIDS AND POWDERS; SOAPS FOR THE BODY; PERFUMERY, ESSENTIAL OILS FOR PERSONAL USE, AND COSMETICS; HAIR LOTIONS; AND DENTIFRICES NAMELY TOOTH CLEANING PREPARATIONS, TOOTH PASTES, TOOTH GEL AND TOOTH POLISH (U.S. CLS. 1, 4, 6, 50, 51 AND 52).

LOURDES AYALA, EXAMINING ATTORNEY

SN 78-459,381. KARA VITA LLC, ORLANDO, FL. FILED 7-30-2004.

CLEARLY IT!

THE MARK CONSISTS OF STANDARD CHARACTERS WITHOUT CLAIM TO ANY PARTICULAR FONT, STYLE, SIZE, OR COLOR.

FOR NON-MEDICAL SUNSCREEN CREAMS, SKIN MOISTURIZERS, CREAMS AND LOTIONS IN THE NATURE OF COSMETICS; SKIN CARE PREPARATIONS, NAMELY, MOISTURIZERS, SUNSCREEN CREAMS, SUN BLOCK, CLEANSERS, TONERS, AND MASKS; COSMETIC SKIN CARE PRODUCTS, NAMELY, FACIAL CLEANSERS, FACIAL MINERAL SPRAYS, FACIAL LOTIONS, FACIAL TONERS, FACIAL MASKS, FACIAL MOISTURIZERS, FACIAL CREAMS FOR NORMAL, DRY, OILY AND ACNE FACIAL SKIN CONDITIONS (U.S. CLS. 1, 4, 6, 50, 51 AND 52).

FIRST USE 8-14-2003; IN COMMERCE 9-1-2003.

BILL DAWE, EXAMINING ATTORNEY

CLASS 3—(Continued).

SN 78-464,217. BISSELL HOMECARE, INC., GRAND RAPIDS, MI. FILED 8-9-2004.

STAIN DEFENSE

THE MARK CONSISTS OF STANDARD CHARACTERS WITHOUT CLAIM TO ANY PARTICULAR FONT, STYLE, SIZE, OR COLOR.

NO CLAIM IS MADE TO THE EXCLUSIVE RIGHT TO USE "STAIN", APART FROM THE MARK AS SHOWN.

FOR CLEANING PREPARATIONS FOR PROTECTING, TREATING, AND PRESERVING CARPET AND UPHOLSTERY (U.S. CLS. 1, 4, 6, 50, 51 AND 52).

BRIAN NEVILLE, EXAMINING ATTORNEY

SN 78-465,378. PARLAIN COMPANY LIMITED, ACO ROAD, TSUEN WAN, HONG KONG, FILED 8-11-2004.



T H A L A R O M A

THE STIPPLING IS A FEATURE OF THE MARK.

FOR COSMETICS NAMELY, MAKEUP, FACIAL MAKEUP, FOUNDATION MAKEUP, FOUNDATION, COMPACTS, CONCEALERS, BLUSHER, MASCARA, EYE MAKEUP, EYE MAKEUP REMOVER, EYE PENCILS, EYEBROW PENCILS, EYE COMPRESSES FOR COSMETIC PURPOSES, EYE CREAM, EYE GELS, EYE SHADOW, MASCARA, NON-MEDICATED LIP BALM, LIP CREAM, LIP LINER, LIP GLOSS, LIP GROSS PALATTE, LIPSTICK, LIP POMADES, NON-MEDICATED LIP PROTECTOR, NON-MEDICATED LIP CARE PREPARATIONS, NON-MEDICATED SKIN CARE PREPARATIONS, TONERS, COSMETIC PREPARATIONS FOR SKIN RENEWAL, EXFOLIANTS FOR SKIN, SKIN LOTIONS, SKIN ABRASIVE PREPARATIONS, HAND CREAM, NON-MEDICATED SKIN SERUM, SKIN CLARIFIERS, SKIN CLEANSERS, SKIN CONDITIONERS, SKIN CREAMS, SKIN EMOLLIENTS, SKIN LIGHTENERS, SKIN LIGHTENING CREAMS, SKIN MASKS, SKIN MOISTURIZERS, SKIN SOAP, SKIN TEXTURIZERS, SKIN WHITENING CREAMS, WRINKLE REMOVING SKIN CARE PREPARATIONS, BEAUTY MASKS; WAX STRIPS FOR REMOVING BODY HAIR; PERFUMERY; ESSENTIAL OILS FOR PERSONAL USE; SUN BLOCK PREPARATIONS (U.S. CLS. 1, 4, 6, 50, 51 AND 52).

LINDA ESTRADA, EXAMINING ATTORNEY

CLASS 3—(Continued).

SN 78-466,668. THANE INTERNATIONAL, INC., LA QUIN-
TA, CA. FILED 8-12-2004.

**Whitening Light
Smile**

THE MARK CONSISTS OF STANDARD CHARACTERS
WITHOUT CLAIM TO ANY PARTICULAR FONT, STYLE,
SIZE, OR COLOR.
NO CLAIM IS MADE TO THE EXCLUSIVE RIGHT TO
USE WHITENING, APART FROM THE MARK AS SHOWN.
FOR DENTIFRICES BLEACHING PREPARATIONS
(U.S. CLS. 1, 4, 6, 50, 51 AND 52).
NICHOLAS ALTREE, EXAMINING ATTORNEY

CLASS 3—(Continued).

SN 78-475,489. BISSELL HOMECARE, INC., GRAND RA-
PIDS, MI. FILED 8-30-2004.

OXY GEN 2

THE MARK CONSISTS OF STANDARD CHARACTERS
WITHOUT CLAIM TO ANY PARTICULAR FONT, STYLE,
SIZE, OR COLOR.
FOR CLEANING SOLUTIONS AND PREPARATIONS
FOR CARPET, UPHOLSTERY, AND FABRICS. (U.S.
CLS. 1, 4, 6, 50, 51 AND 52).
JAMES A. RAUEN, EXAMINING ATTORNEY

SN 78-480,795. FLORALIFE, INC., WALTERBORO, SC.
FILED 9-9-2004.

**FLORALIFE P.A.C.
PROFESSIONAL
AGRICULTURAL
CLEANER**

SN 78-471,300. LE BLANC LINEN WASH, INC., SEMINOLE,
FL. FILED 8-20-2004.

FABRICGARD

THE MARK CONSISTS OF STANDARD CHARACTERS
WITHOUT CLAIM TO ANY PARTICULAR FONT, STYLE,
SIZE, OR COLOR.
FOR SACHETS (U.S. CLS. 1, 4, 6, 50, 51 AND 52).
FIRST USE 7-2-2003; IN COMMERCE 7-2-2003.
ALLISON SCHRODY, EXAMINING ATTORNEY

THE MARK CONSISTS OF STANDARD CHARACTERS
WITHOUT CLAIM TO ANY PARTICULAR FONT, STYLE,
SIZE, OR COLOR.
OWNER OF U.S. REG. NOS. 398,694, 2,842,245 AND
OTHERS.
NO CLAIM IS MADE TO THE EXCLUSIVE RIGHT TO
USE "PROFESSIONAL AGRICULTURAL CLEANER",
APART FROM THE MARK AS SHOWN.
FOR HEAVY-DUTY CHLORINATED CLEANER FOR
SUCH NON-POROUS SURFACES AS STEEL, ALUMI-
NUM, IRON, CONCRETE, POLY AND GLASS, PRIMAR-
ILY FOR USE IN THE HORTICULTURE AND
AGRICULTURE INDUSTRIES (U.S. CLS. 1, 4, 6, 50, 51
AND 52).
FIRST USE 1-0-2005; IN COMMERCE 1-0-2005.
JILL C. ALT, EXAMINING ATTORNEY

CLASS 3—(Continued).

SN 78-481,316. ADVANCED INSTITUTE OF SKIN CARE, BEVERLY HILLS, CA. FILED 9-9-2004.



me
mineral essence

NO CLAIM IS MADE TO THE EXCLUSIVE RIGHT TO USE MINERAL, APART FROM THE MARK AS SHOWN. THE MARK CONSISTS OF THE LETTERS "ME" ATTACHED TOGETHER WITH A HORIZONTAL LINE UNDERNEATH THE TWO LETTERS. THE WORDS "MINERAL ESSENCE" ARE UNDERNEATH THE HORIZONTAL LINE. FOR COSMETIC MAKEUP USING MINERALS AND ANTIOXIDANTS (U.S. CLS. 1, 4, 6, 50, 51 AND 52). FIRST USE 9-1-2003; IN COMMERCE 12-1-2003. JANICE L. MCMORROW, EXAMINING ATTORNEY

CLASS 3—(Continued).

SN 78-502,615. ARC ABRASIVES, INC., TROY, OH. FILED 10-20-2004.



ARC BLU

OWNER OF U.S. REG. NOS. 2,544,269 AND 2,544,285. NO CLAIM IS MADE TO THE EXCLUSIVE RIGHT TO USE "BLUE", APART FROM THE MARK AS SHOWN. FOR COATED ABRASIVES AND SANDPAPER IN THE FORM OF SHEETS, ROLLS, AND DISCS (U.S. CLS. 1, 4, 6, 50, 51 AND 52). LINDA POWELL, EXAMINING ATTORNEY

SN 78-497,595. AUSTRALIAN GOLD, INC., INDIANAPOLIS, IN. FILED 10-11-2004.

CHOCOLATE CREME

THE MARK CONSISTS OF STANDARD CHARACTERS WITHOUT CLAIM TO ANY PARTICULAR FONT, STYLE, SIZE, OR COLOR.

OWNER OF U.S. REG. NOS. 2,392,360 AND 2,630,659. NO CLAIM IS MADE TO THE EXCLUSIVE RIGHT TO USE "CREME", APART FROM THE MARK AS SHOWN. FOR SKIN CARE PREPARATIONS, NAMELY, NON-MEDICATED INDOOR AND OUTDOOR TANNING PREPARATIONS SOLD THROUGH TANNING SALONS (U.S. CLS. 1, 4, 6, 50, 51 AND 52). GEORGIA CARTY, EXAMINING ATTORNEY

SN 78-503,327. MUNDO, L.L.C, GLEN BURNIE, MD. FILED 10-20-2004.



sevi

OWNER OF U.S. REG. NO. 2,855,354. THE COLOR(S) GREEN AND BLACK IS/ARE CLAIMED AS A FEATURE OF THE MARK.

THE MARK CONSISTS OF A GREEN LEAF. THE COLOR GREEN APPEARS ON THE LEAF IN THE MARK. THE COLOR BLACK APPEARS ON THE VERTICAL LINE IN THE MARK AND ON THE WORD SEVI.

FOR COSMETICS AND SKIN CARE PRODUCTS, NAMELY, MINERAL LOOSE AND CREAM FACE POWDERS AND CONCEALERS, BODY POWDERS, EYE SHADOWS, EYE LINERS, LIP LINERS AND BLUSHES (U.S. CLS. 1, 4, 6, 50, 51 AND 52). FIRST USE 6-15-2003; IN COMMERCE 10-10-2003. MELISSA VALLILLO, EXAMINING ATTORNEY

CLASS 3—(Continued).

SN 78-505,489. AMERICAN PRESTIGE & LUXURY BRANDS LLC, HOLLYWOOD, FL. FILED 10-25-2004.

NOBILE
ROYALTY

THE MARK CONSISTS OF STANDARD CHARACTERS WITHOUT CLAIM TO ANY PARTICULAR FONT, STYLE, SIZE, OR COLOR.

THE FOREIGN WORDING IN THE MARK TRANSLATES INTO ENGLISH AS "NOBLEMAN".

FOR COSMETICS, NON-MEDICATED SKIN CARE PRODUCTS, NAMELY LOTIONS, MOISTURIZERS AND CREAMS, BATH AND BODY PRODUCTS, NAMELY BATH AND SHOWER GELS, FRAGRANCE, PERFUME, COLOGNE, EAU DE COLOGNE, EAU DE PERFUME, EAU DE TOILETTE, DEODORANT STICKS, GELS, AND SPRAYS, AFTER SHAVE LOTIONS, GELS, AND BALMS (U.S. CLS. 1, 4, 6, 50, 51 AND 52).

FIRST USE 2-14-2005; IN COMMERCE 2-14-2005.
KARLA PERKINS, EXAMINING ATTORNEY

SN 78-506,106. ESTEE LAUDER INC., NEW YORK, NY. FILED 10-26-2004.

AQUASPHERE

THE MARK CONSISTS OF STANDARD CHARACTERS WITHOUT CLAIM TO ANY PARTICULAR FONT, STYLE, SIZE, OR COLOR.

FOR COSMETIC INGREDIENT COMPLEX SOLD AS AN INTEGRAL COMPONENT OF MOISTURIZING LOTIONS FOR THE HANDS, FACE, AND BODY (U.S. CLS. 1, 4, 6, 50, 51 AND 52).

FIRST USE 9-2-1996; IN COMMERCE 9-6-1996.
RONALD MCMORROW, EXAMINING ATTORNEY

CLASS 3—(Continued).

SN 78-507,694. REVLON CONSUMER PRODUCTS CORPORATION, NEW YORK, NY. FILED 10-28-2004.

FLAIR

THE MARK CONSISTS OF STANDARD CHARACTERS WITHOUT CLAIM TO ANY PARTICULAR FONT, STYLE, SIZE, OR COLOR.

FOR FRAGRANCES FOR PERSONAL USE (U.S. CLS. 1, 4, 6, 50, 51 AND 52).

HOWARD B. LEVINE, EXAMINING ATTORNEY

SN 78-509,670. SHERWIN-WILLIAMS COMPANY, THE, CLEVELAND, OH. FILED 11-2-2004.

LATHER CLEAN

THE MARK CONSISTS OF STANDARD CHARACTERS WITHOUT CLAIM TO ANY PARTICULAR FONT, STYLE, SIZE, OR COLOR.

NO CLAIM IS MADE TO THE EXCLUSIVE RIGHT TO USE "CLEAN", APART FROM THE MARK AS SHOWN.

FOR CLEANING PREPARATIONS IN THE NATURE OF CARPET CLEANERS AND SPOT AND STAIN REMOVERS (U.S. CLS. 1, 4, 6, 50, 51 AND 52).

STEPHANIE DAVIS, EXAMINING ATTORNEY

CLASS 3—(Continued).

SN 78-509,888. AVON PRODUCTS, INC., NEW YORK, NY. FILED 11-2-2004.

INVISIBLE TOUCH

THE MARK CONSISTS OF STANDARD CHARACTERS WITHOUT CLAIM TO ANY PARTICULAR FONT, STYLE, SIZE, OR COLOR.

OWNER OF U.S. REG. NO. 2,822,930. FOR COSMETICS, NAMELY, FACIAL FOUNDATION (U.S. CLS. 1, 4, 6, 50, 51 AND 52). GEORGE LORENZO, EXAMINING ATTORNEY

SN 78-510,025. PHOENIX BRANDS LLC, FORMERLY WINTER HOLDINGS LLC, NEW YORK, NY. FILED 11-2-2004.

PROFESSIONAL FINISH

THE MARK CONSISTS OF STANDARD CHARACTERS WITHOUT CLAIM TO ANY PARTICULAR FONT, STYLE, SIZE, OR COLOR.

OWNER OF U.S. REG. NO. 1,753,432. SEC. 2(F). FOR LAUNDRY STARCH (U.S. CLS. 1, 4, 6, 50, 51 AND 52). FIRST USE 8-1-1990; IN COMMERCE 8-1-1990. ELIZABETH J. WINTER, EXAMINING ATTORNEY

SN 78-510,525. HEDLUXURYS LLC, BOCA RATON, FL. FILED 11-3-2004.

HEDLUX ANTI-AGING HAIR

THE MARK CONSISTS OF STANDARD CHARACTERS WITHOUT CLAIM TO ANY PARTICULAR FONT, STYLE, SIZE, OR COLOR.

NO CLAIM IS MADE TO THE EXCLUSIVE RIGHT TO USE "ANTI-AGING HAIR", APART FROM THE MARK AS SHOWN. FOR HAIR CARE PREPARATIONS (U.S. CLS. 1, 4, 6, 50, 51 AND 52). INGRID C. EULIN, EXAMINING ATTORNEY

CLASS 3—(Continued).

SN 78-516,082. RIMER, JIM C., VANCOUVER, WA. FILED 11-12-2004.



NO CLAIM IS MADE TO THE EXCLUSIVE RIGHT TO USE "SOY", APART FROM THE MARK AS SHOWN.

THE MARK CONSISTS OF STYLIZED SCRIPT LETTERING WITH THE LETTERS S AND B LARGE AND IN CAPS WITH A FANCY STEM AND LARGE LEAF COMING FROM THE LOWER CASE S ATTACHED TO THE WORD BLENDS.

FOR CLEANING PREPARATIONS, NAMELY, SOLVENTS, LIVE CULTURE AND ENZYME PRODUCTS FOR BATHROOM, KITCHEN, AND CARPET CLEANING AND ODOR CONTROL (U.S. CLS. 1, 4, 6, 50, 51 AND 52).

FIRST USE 11-26-2003; IN COMMERCE 11-26-2003. EUGENIA MARTIN, EXAMINING ATTORNEY

SN 78-516,088. DERMACIA, INC., NEWPORT BEACH, CA. FILED 11-12-2004.

Aire Finish

THE MARK CONSISTS OF STANDARD CHARACTERS WITHOUT CLAIM TO ANY PARTICULAR FONT, STYLE, SIZE, OR COLOR.

NO CLAIM IS MADE TO THE EXCLUSIVE RIGHT TO USE "FINISH", APART FROM THE MARK AS SHOWN.

THE ENGLISH TRANSLATION OF THE FRENCH WORD "AIRE" IN THE MARK IS AIR.

FOR COSMETICS AND SKIN CARE PRODUCTS, NAMELY, SKIN CREAMS, MAKEUP CREAMS, FACE AND BODY POWDERS AND PREPARATIONS FOR COSMETIC AND SKIN CARE USE, PERFUMES, SKIN CLEANSERS, SKIN TONERS AND CONDITIONERS (U.S. CLS. 1, 4, 6, 50, 51 AND 52).

REBECCA GAN, EXAMINING ATTORNEY

CLASS 3—(Continued).

SN 78-516,255. MARKWINS INTERNATIONAL CORPORATION, CITY OF INDUSTRY, CA. FILED 11-12-2004.

THE SPA INSTITUTE

THE MARK CONSISTS OF STANDARD CHARACTERS WITHOUT CLAIM TO ANY PARTICULAR FONT, STYLE, SIZE, OR COLOR.

NO CLAIM IS MADE TO THE EXCLUSIVE RIGHT TO USE "SPA", APART FROM THE MARK AS SHOWN.

FOR PERSONAL CARE PRODUCTS, NAMELY, BATH SOAPS, BATH BEADS, BATH GELS, SHOWER GELS, BATH OILS, BUBBLE BATH, BATH POWDERS, BATH CRYSTALS, BATH SALTS, BATH CRYSTALS, NAMELY, BATH FIZZERS, NON-MEDICATED BATH SOAKS, BATH INCENSES, ESSENTIAL OILS FOR PERSONAL USE, BODY POWDER, BODY GLITTERS, BODY OILS, BODY SCRUBS, BODY LOTIONS, NON-MEDICATED BODY WASHES, BODY MISTS, NON-MEDICATED FOOT GELS, NON-MEDICATED FOOT OILS, NON-MEDICATED FOOT POWDERS, NON-MEDICATED FOOT SALTS, BATH CRYSTALS, NAMELY, FOOT FIZZERS, NON-MEDICATED FOOT SOAKS, NON-MEDICATED FOOT SCRUBS, FOOT LOTIONS, PERFUMES, NAMELY, FOOT SPRAYS, MASSAGE OILS AND CREAMS, SKIN EXFOLIATOR LOTIONS AND CREAMS, SKIN MOISTURIZERS, SKIN TONERS, FACIAL CLEANSERS AND CREAMS, HAIR SHAMPOOS AND CONDITIONERS, HAND LOTIONS, CUTICLE OILS AND CREAMS, PUMICE STONES FOR PERSONAL USE, AND PERSONAL CARE GIFT SETS COMPRISED OF BAGS AND CASES CONTAINING ONE OR MORE OF THE ABOVE (U.S. CLS. 1, 4, 6, 50, 51 AND 52).

FIRST USE 0-0-1997; IN COMMERCE 0-0-1997.

DORITT L. CARROLL, EXAMINING ATTORNEY

CLASS 3—(Continued).

SN 78-516,291. MARKWINS INTERNATIONAL CORPORATION, CITY OF INDUSTRY, CA. FILED 11-12-2004.

THE SPA WORKSHOP

THE MARK CONSISTS OF STANDARD CHARACTERS WITHOUT CLAIM TO ANY PARTICULAR FONT, STYLE, SIZE, OR COLOR.

OWNER OF U.S. REG. NO. 1,701,299.

NO CLAIM IS MADE TO THE EXCLUSIVE RIGHT TO USE "SPA", APART FROM THE MARK AS SHOWN.

FOR PERSONAL CARE PRODUCTS, NAMELY, BATH SOAPS, BATH BEADS, BATH GELS, SHOWER GELS, BATH OILS, BUBBLE BATH, BATH POWDERS, BATH CRYSTALS, BATH SALTS, BATH FIZZERS, BATH SOAKS, BATH INCENSES, ESSENTIAL OILS, BODY POWDER, BODY GLITTERS, BODY OILS, BODY SCRUBS, BODY LOTIONS, BODY WASHES, BODY MISTS, FOOT GELS, FOOT OILS, FOOT POWDERS, FOOT SALTS, FOOT FIZZERS, FOOT SOAKS, FOOT SCRUBS, FOOT LOTIONS, FOOT SPRAYS, MASSAGE OILS AND CREAMS, SKIN EXFOLIATOR LOTIONS AND CREAMS, SKIN MOISTURIZERS, SKIN TONERS, FACIAL CLEANSERS AND CREAMS, HAIR SHAMPOOS AND CONDITIONERS, HAND LOTIONS, CUTICLE OILS AND CREAMS, PUMICE STONES FOR PERSONAL USE, AND PERSONAL CARE GIFT SETS COMPRISED OF BAGS AND CASES CONTAINING ONE OR MORE OF THE ABOVE (U.S. CLS. 1, 4, 6, 50, 51 AND 52).

FIRST USE 0-0-1998; IN COMMERCE 0-0-1998.

EVELYN BRADLEY, EXAMINING ATTORNEY

SN 78-517,549. RODEO COSMETICS LLC, STEAMBOAT SPRINGS, CO. FILED 11-16-2004.

Soak'em Cowgirl

THE MARK CONSISTS OF STANDARD CHARACTERS WITHOUT CLAIM TO ANY PARTICULAR FONT, STYLE, SIZE, OR COLOR.

FOR BATH SALTS AND BATH SOAPS (U.S. CLS. 1, 4, 6, 50, 51 AND 52).

DOMINICK J. SALEMI, EXAMINING ATTORNEY

CLASS 3—(Continued).

SN 78-517,737. GLASS RESTORATION SPECIALISTS, INC., TACOMA, WA. FILED 11-16-2004.

CLASS 3—(Continued).

SN 78-518,074. VONACHEN, DANIEL, NICE, FRANCE, FILED 11-16-2004.

SPOT-X

orleen.com

THE MARK CONSISTS OF STANDARD CHARACTERS WITHOUT CLAIM TO ANY PARTICULAR FONT, STYLE, SIZE, OR COLOR.

FOR HARD WATER STAIN AND SPOT REMOVER; POLISHING PREPARATION (U.S. CLS. 1, 4, 6, 50, 51 AND 52).

FIRST USE 2-1-1995; IN COMMERCE 2-1-1995.
JULIE GUTTADAURO, EXAMINING ATTORNEY

THE MARK CONSISTS OF STANDARD CHARACTERS WITHOUT CLAIM TO ANY PARTICULAR FONT, STYLE, SIZE, OR COLOR.

FOR ESSENTIAL OILS FOR PERSONAL USE; ESSENTIAL OILS FOR USE IN THE MANUFACTURE OF SCENTED PRODUCTS, NAMELY, EAU DE PERFUME, LIQUID PERFUMES, PERFUMES AND PERFUME OILS; PERFUME OILS FOR THE MANUFACTURE OF COSMETIC PREPARATIONS; BLEACHING PREPARATIONS FOR COSMETIC PURPOSES; BODY AND BEAUTY CARE COSMETICS; CLEANSING CREAMS; COCOA BUTTER FOR COSMETIC PURPOSES; CONCEALER FOR COSMETIC PURPOSES; COSMETIC CREAMS; COSMETIC CREAMS FOR SKIN CARE; COSMETIC OILS; COSMETIC OILS FOR THE EPIDERMIS; COSMETIC PREPARATIONS FOR SKIN RENEWAL; COSMETIC PREPARATIONS FOR BODY CARE; COSMETIC SOAPS; COSMETIC SUN PROTECTING PREPARATIONS; FACE CREAMS FOR COSMETIC USE; FOUNDATION FOR COSMETIC USE; EXFOLIANTS FOR THE SKIN, BODY AND FACE; NON-MEDICATED SKIN CARE PREPARATIONS; NON-MEDICATED SKIN CREAMS; SKIN CLARIFIERS; SKIN CLEANSERS; SKIN CLEANSING CREAMS; SKIN CLEANSING LOTIONS; SKIN CONDITIONERS; SKIN CREAMS; SKIN CREAMS IN LIQUID AND SOLID FORM; SKIN LIGHTENERS; SKIN LIGHTENING CREAMS; SKIN LOTIONS; SKIN MASKS; SKIN MOISTURIZERS; SKIN MOISTURIZER MASKS; SKIN SOAPS; SKIN TONERS; SKIN WHITENING CREAMS; SKIN WHITENING PREPARATIONS; WRINKLE REMOVING SKIN CARE PREPARATIONS; HAIR CONDITIONERS; HAIR CARE CREAMS; HAIR CARE LOTIONS; HAIR CARE PREPARATIONS; HAIR OILS; HAIR RINSES; HAIR SHAMPOO; BATH SOAPS IN LIQUID, SOLID AND GEL FORM; BODY CREAM SOAPS; COSMETIC SOAPS; CREAM SOAPS; DISINFECTING PERFUMED SOAPS; HAND SOAPS; LIQUID SOAPS FOR HANDS, FACE AND BODY; MEDICATED SOAPS; PERFUMED SOAPS; SKIN SOAPS; SOAPS FOR WHITENING AND LIGHTENING THE SKIN; SOAPS FOR BODY CARE; COMPACTS CONTAINING MAKEUP; EYE MAKEUP; MAKEUP FOUNDATION; MAKEUP REMOVING PREPARATIONS; MAKEUP PENCILS; MAKEUP POWDERS; MAKEUP PRODUCTS FOR THE FACE AND BODY; MAKEUP REMOVERS; MAKE-UP REMOVING MILK, GEL, LOTIONS AND CREAMS (U.S. CLS. 1, 4, 6, 50, 51 AND 52).

FIRST USE 5-28-2003; IN COMMERCE 10-15-2004.
LAURA KOVAISKY, EXAMINING ATTORNEY

SN 78-517,758. GLASS RESTORATION SPECIALISTS, INC., TACOMA, WA. FILED 11-16-2004.

BLUE-JOB

THE MARK CONSISTS OF STANDARD CHARACTERS WITHOUT CLAIM TO ANY PARTICULAR FONT, STYLE, SIZE, OR COLOR.

FOR POLISHING PREPARATION FOR USE ON CHROME, COPPER, BRASS, AND STAINLESS STEEL (U.S. CLS. 1, 4, 6, 50, 51 AND 52).

FIRST USE 6-15-1995; IN COMMERCE 6-15-1995.
ANNE FARRELL, EXAMINING ATTORNEY

CLASS 3—(Continued).

SN 78-518,336. L'OREAL USA CREATIVE, INC., NEW YORK, NY. FILED 11-17-2004.

CLASS 3—(Continued).

SN 78-519,340. DIAL BRANDS, INC., SCOTTSDALE, AZ. FILED 11-18-2004.

HEAD SET

THE MARK CONSISTS OF STANDARD CHARACTERS WITHOUT CLAIM TO ANY PARTICULAR FONT, STYLE, SIZE, OR COLOR.

OWNER OF U.S. REG. NO. 2,245,103.
FOR HAIR STYLING PREPARATION, NAMELY, HAIR SPRAY (U.S. CLS. 1, 4, 6, 50, 51 AND 52).
GEORGE LORENZO, EXAMINING ATTORNEY

SN 78-519,026. BIOELEMENTS, INC., COLORADO SPRINGS, CO. FILED 11-18-2004.

YEAR-ROUND BRONZER

THE MARK CONSISTS OF STANDARD CHARACTERS WITHOUT CLAIM TO ANY PARTICULAR FONT, STYLE, SIZE, OR COLOR.

NO CLAIM IS MADE TO THE EXCLUSIVE RIGHT TO USE BRONZER, APART FROM THE MARK AS SHOWN.
FOR COSMETICS, NAMELY, BRONZING POWDER (U.S. CLS. 1, 4, 6, 50, 51 AND 52).
MARGERY A. TIERNEY, EXAMINING ATTORNEY

SN 78-519,123. PARFUMS CHRISTIAN DIOR, 75008 PARIS, FRANCE, FILED 11-18-2004.

ICEPEARL DIORSHOW

THE MARK CONSISTS OF STANDARD CHARACTERS WITHOUT CLAIM TO ANY PARTICULAR FONT, STYLE, SIZE, OR COLOR.

PRIORITY CLAIMED UNDER SEC. 44(D) ON FRANCE APPLICATION NO. FR043295686, FILED 6-4-2004, REG. NO. 043295686, DATED 6-4-2004, EXPIRES 6-4-2014.
OWNER OF U.S. REG. NOS. 2,756,372, 2,934,812 AND OTHERS.
FOR MASCARAS (U.S. CLS. 1, 4, 6, 50, 51 AND 52).
WINSTON FOLMAR, EXAMINING ATTORNEY

SPIRIT

THE MARK CONSISTS OF STANDARD CHARACTERS WITHOUT CLAIM TO ANY PARTICULAR FONT, STYLE, SIZE, OR COLOR.

FOR PERSONAL CARE PRODUCTS, NAMELY, BAR SOAP, BODY WASH, LIQUID HAND SOAP (U.S. CLS. 1, 4, 6, 50, 51 AND 52).
TIMOTHY FINNEGAN, EXAMINING ATTORNEY

SN 78-519,345. HEALTHPOINT, LTD., SAN ANTONIO, TX. FILED 11-18-2004.

GLYDRATE

THE MARK CONSISTS OF STANDARD CHARACTERS WITHOUT CLAIM TO ANY PARTICULAR FONT, STYLE, SIZE, OR COLOR.

FOR SKIN MOISTURIZER (U.S. CLS. 1, 4, 6, 50, 51 AND 52).
CATHERINE CAIN, EXAMINING ATTORNEY

CLASS 3—(Continued).

SN 78-519,395. NEDBOY, ROBIN L, NEW YORK, NY. FILED 11-18-2004.

GWYNETH HAMMOND

THE MARK CONSISTS OF STANDARD CHARACTERS WITHOUT CLAIM TO ANY PARTICULAR FONT, STYLE, SIZE, OR COLOR.

THE NAME "GWYNETH HAMMOND" DOES NOT IDENTIFY A LIVING INDIVIDUAL.

FOR NON-MEDICATED SKIN CARE PREPARATIONS, NAMELY, ANTI-AGING CREAM, ANTI-WRINKLE CREAM, ASTRINGENT FOR COSMETIC PURPOSES, BODY CREAM, BODY EMULSION, BODY LOTION, BODY MILK, BODY OIL, BODY SCRUB, BODY SPRAY, EXFOLIANTS FOR SKIN, EYE CREAM, EYE GEL, FACIAL CLEANSER, FACIAL CREAM, FACIAL EMULSIONS, FACIAL MASKS, FACIAL SCRUB, HAND CREAM, HAND LOTION, HAND SOAP, MOISTURIZING MILKS, NON-MEDICATED BODY SOAK, NON-MEDICATED FOOT CREAM, SHOWER GEL, SKIN CLARIFIERS, SKIN CLEANSERS, SKIN CLEANSING CREAM, SKIN CLEANSING LOTION, SKIN CONDITIONERS, SKIN CREAM, SKIN EMOLLIENTS, SKIN LOTION, SKIN MASKS, SKIN MOISTURIZER, SKIN SOAP, SKIN TONER, SOAP FOR COSMETIC PURPOSES; SHAVING PREPARATIONS, NAMELY, SHAVING BALM, SHAVING CREAM, SHAVING FOAM, SHAVING GEL, SHAVING LOTION, SHAVING SOAP, AFTER-SHAVE GEL, AFTER-SHAVE LOTION; BATH ADDITIVES, NAMELY, BATH BEADS, BATH CRYSTALS, BATH FOAMS, BATH GELS, BATH MILK, BATH OILS, BATH PEARLS, BUBBLE BATH, NON-MEDICATED BATH SALTS; FRAGRANCES, NAMELY, ESSENTIAL OILS FOR PERSONAL USE, POTPOURRI, SCENTED LINEN SPRAYS, SCENTED ROOM SPRAYS, PERFUME, EAU DE TOILETTE; NON-MEDICATED HAIR CARE PREPARATIONS, NAMELY, HAIR CONDITIONERS, HAIR DRESSINGS FOR MEN, HAIR EMOLLIENTS, HAIR GEL, HAIR MOUSSE, HAIR POMADES, HAIR RINSES, HAIR SHAMPOO, HAIR SPRAY, HAIR STYLING PREPARATIONS; HOUSEHOLD CLEANING PREPARATIONS, NAMELY, DISH DETERGENTS, LAUNDRY DETERGENTS, GLASS CLEANING PREPARATIONS (U.S. CLS. 1, 4, 6, 50, 51 AND 52).

FIRST USE 10-1-2001; IN COMMERCE 10-1-2001.
FRED MANDIR, EXAMINING ATTORNEY

SN 78-519,719. EBIOX LTD., LONDON, UNITED KINGDOM, FILED 11-18-2004.

EBIOX NEOZYME

THE MARK CONSISTS OF STANDARD CHARACTERS WITHOUT CLAIM TO ANY PARTICULAR FONT, STYLE, SIZE, OR COLOR.

FOR CLEANING PREPARATIONS AND DETERGENTS FOR CLEANING SURGICAL AND OTHER MEDICAL INSTRUMENTS, IN POWDER, LIQUID, AND FOAM SPRAY; SURGICAL INSTRUMENT RECONDITIONING POLISHES (U.S. CLS. 1, 4, 6, 50, 51 AND 52).

LEIGH LOWRY, EXAMINING ATTORNEY

CLASS 3—(Continued).

SN 78-519,720. PALMIOTTO ENTERPRISES, LLC, NEWPORT BEACH, CA. FILED 11-18-2004.

DOMESTIC DIVA

THE MARK CONSISTS OF STANDARD CHARACTERS WITHOUT CLAIM TO ANY PARTICULAR FONT, STYLE, SIZE, OR COLOR.

FOR PERSONAL CARE PRODUCTS, NAMELY, SOAP, MASSAGE OIL, BODY LOTION, PERFUME, COLOGNE, BODY GEL, BODY CREAM, SCENTED BODY SPRAY AND BODY POWDER; COSMETICS, NAMELY, BODY GLITTER AND FACE AND BODY PAINT (U.S. CLS. 1, 4, 6, 50, 51 AND 52).

MELVIN AXILBUND, EXAMINING ATTORNEY

SN 78-519,888. CAPO, INC., ORMOND BEACH, FL. FILED 11-19-2004.

STYLEMARK

THE MARK CONSISTS OF STANDARD CHARACTERS WITHOUT CLAIM TO ANY PARTICULAR FONT, STYLE, SIZE, OR COLOR.

FOR SUN TAN LOTIONS, SUN TAN OILS, SUN BLOCK PREPARATIONS, LIP BALMS, SUN SCREENS, SOAPS, SHAMPOOS, MAKE UP, CONDITIONER; SKIN CARE CREAMS AND LOTIONS, FACE CREAMS; NON-MEDICATED SKIN PEELING CREAMS AND GELS; SKIN ABRASIVE PREPARATIONS; FACIAL MASKS; NON-MEDICATED FOOT CREAMS AND POWDERS, NON-MEDICATED FOOT LOTIONS; NON-MEDICATED BODY LOTIONS; NON-MEDICATED BATH SALTS; AND NON-MEDICATED EYE CREAMS (U.S. CLS. 1, 4, 6, 50, 51 AND 52).

JENNIFER CHICOSKI, EXAMINING ATTORNEY

CLASS 3—(Continued).

SN 78-519,923. S&S SOAP CO., INC., BRONX, NY. FILED 11-19-2004.

CLASS 3—(Continued).

SN 78-520,151. SOLAR COSMETIC LABS, MIAMI, FL. FILED 11-19-2004.

In The Box

Club Spa

THE MARK CONSISTS OF STANDARD CHARACTERS WITHOUT CLAIM TO ANY PARTICULAR FONT, STYLE, SIZE, OR COLOR.

FOR SOAPS AND DETERGENTS (U.S. CLS. 1, 4, 6, 50, 51 AND 52).

FIRST USE 6-1-2004; IN COMMERCE 6-1-2004.
JOHN HWANG, EXAMINING ATTORNEY

THE MARK CONSISTS OF STANDARD CHARACTERS WITHOUT CLAIM TO ANY PARTICULAR FONT, STYLE, SIZE, OR COLOR.

FOR NON-MEDICATED SKIN CARE PRODUCTS, NAMELY, FACE CREAM, BODY CREAM, ANTI-WRINKLE CREAM, SKIN RENEWAL CREAM, EYE SERUM, FACIAL SERUM, BODY LOTION, BODY OIL, BATH OIL, FACIAL TONER, BODY TONER, FACIAL SOAP, BODY SOAP, BODY WASH, FOAM BATH, BATH SOAK, BODY SHOWER GEL, FACIAL CLEANSING CREAM, FACIAL CLEANSING LOTION, FACIAL MASQUE, BODY MASQUE AND FOOT MASQUE, FOOT CREAMS, FOOT SCRUBS, FOOT BALM, ANTI-CELLULITE LOTIONS, CREAMS AND GELS, SHAMPOOS AND CONDITIONERS (U.S. CLS. 1, 4, 6, 50, 51 AND 52).

HEATHER THOMPSON, EXAMINING ATTORNEY

SN 78-519,932. S&S SOAP CO., INC., BRONX, NY. FILED 11-19-2004.

SN 78-520,485. CA BOTANA INTERNATIONAL, INC., SAN DIEGO, CA. FILED 11-19-2004.

Blutex

SCIENCE.NATURE.IN
PERFECT BALANCE.
GUARANTEED.

THE MARK CONSISTS OF STANDARD CHARACTERS WITHOUT CLAIM TO ANY PARTICULAR FONT, STYLE, SIZE, OR COLOR.

OWNER OF U.S. REG. NO. 802,870.
FOR GLASS CLEANER, ALL PURPOSE CLEANER (U.S. CLS. 1, 4, 6, 50, 51 AND 52).
FIRST USE 6-1-2004; IN COMMERCE 6-1-2004.
JOHN HWANG, EXAMINING ATTORNEY

THE MARK CONSISTS OF STANDARD CHARACTERS WITHOUT CLAIM TO ANY PARTICULAR FONT, STYLE, SIZE, OR COLOR.

FOR COSMETICS (U.S. CLS. 1, 4, 6, 50, 51 AND 52).
JOHN WILKE, EXAMINING ATTORNEY

CLASS 3—(Continued).

SN 78-520,500. CA BOTANA INTERNATIONAL, INC., SAN DIEGO, CA. FILED 11-19-2004.

CLASS 3—(Continued).

SN 78-521,354. DANZE, ALEX, CORONA, CA. FILED 11-22-2004.

GINKGOLIFT

PRO-ARMOR

THE MARK CONSISTS OF STANDARD CHARACTERS WITHOUT CLAIM TO ANY PARTICULAR FONT, STYLE, SIZE, OR COLOR.
FOR COSMETICS (U.S. CLS. 1, 4, 6, 50, 51 AND 52).
MITCHELL FRONT, EXAMINING ATTORNEY

THE MARK CONSISTS OF STANDARD CHARACTERS WITHOUT CLAIM TO ANY PARTICULAR FONT, STYLE, SIZE, OR COLOR.

FOR AUTOMOBILE WAXES, CLEANERS AND POLISHES; CLEANING PREPARATIONS FOR AUTOMOBILES, MOTORCYCLES, RECREATIONAL VEHICLES, ALL-TERRAIN VEHICLES AND BOATS; ADHESIVE REMOVERS, ALL-PURPOSE CLEANING PREPARATIONS; ALL-PURPOSE CLEANERS; AUTOMOTIVE CLEANING PREPARATIONS; CARBURETOR AND CHOKE CLEANING PREPARATIONS AND CARNAUBA WAX FOR AUTOMOTIVE USE (U.S. CLS. 1, 4, 6, 50, 51 AND 52).

CHARLES L. JENKINS, EXAMINING ATTORNEY

SN 78-520,695. STEAMROOM USA, INC., ALPHARETTA, GA. FILED 11-21-2004.

SN 78-521,439. MILK AND HONEY PRINTING PRESS, LLC, NEW ORLEANS, LA. FILED 11-22-2004.

AQUALAIR

Shekinah

THE MARK CONSISTS OF STANDARD CHARACTERS WITHOUT CLAIM TO ANY PARTICULAR FONT, STYLE, SIZE, OR COLOR.

FOR AROMATHERAPY AND BATH OILS; CLEANING AND POLISHING PREPARATIONS AND SOLUTIONS FOR GLASS, ACRYLIC AND PORCELAIN SURFACES (U.S. CLS. 1, 4, 6, 50, 51 AND 52).

CHERYL CLAYTON, EXAMINING ATTORNEY

THE MARK CONSISTS OF STANDARD CHARACTERS WITHOUT CLAIM TO ANY PARTICULAR FONT, STYLE, SIZE, OR COLOR.

FOR PERFUMES, SCENTED BODY SPRAY, SCENTED ROOM SPRAY (U.S. CLS. 1, 4, 6, 50, 51 AND 52).

FIRST USE 1-31-2004; IN COMMERCE 1-31-2004.

HOWARD B. LEVINE, EXAMINING ATTORNEY

CLASS 3—(Continued).

SN 78-521,440. MILK AND HONEY PRINTING PRESS, LLC,
NEW ORLEANS, LA. FILED 11-22-2004.

CLASS 3—(Continued).

SN 78-522,525. THE PROCTER & GAMBLE COMPANY,
CINCINNATI, OH. FILED 11-24-2004.

Myrrh Delight

THE MARK CONSISTS OF STANDARD CHARACTERS
WITHOUT CLAIM TO ANY PARTICULAR FONT, STYLE,
SIZE, OR COLOR.

NO CLAIM IS MADE TO THE EXCLUSIVE RIGHT TO
USE MYRRH, APART FROM THE MARK AS SHOWN,
FOR PERFUMES, SCENTED BODY SPRAY, SCENTED
ROOM SPRAY (U.S. CLS. 1, 4, 6, 50, 51 AND 52).
FIRST USE 12-31-2003; IN COMMERCE 12-31-2003.
HOWARD B. LEVINE, EXAMINING ATTORNEY

SN 78-521,885. ASHLAND INC., COVINGTON, KY. FILED
11-23-2004.

BUCKET-FREE

THE MARK CONSISTS OF STANDARD CHARACTERS
WITHOUT CLAIM TO ANY PARTICULAR FONT, STYLE,
SIZE, OR COLOR.

FOR AUTOMOBILE CLEANER, NAMELY A PRE-
PARATION FOR WASHING AUTOMOBILE SURFACES
(U.S. CLS. 1, 4, 6, 50, 51 AND 52).
CHRISTOPHER ADKINS, EXAMINING ATTORNEY

SN 78-522,416. SCENTS OF NATURE ENTERPRISES CORP.,
MIAMI, FL. FILED 11-24-2004.

LOVE IS IN THE AIR

THE MARK CONSISTS OF STANDARD CHARACTERS
WITHOUT CLAIM TO ANY PARTICULAR FONT, STYLE,
SIZE, OR COLOR.

FOR SCENTED OILS USED TO PRODUCE AROMAS
WHEN HEATED (U.S. CLS. 1, 4, 6, 50, 51 AND 52).
G. MAYERSCHOFF, EXAMINING ATTORNEY

LIGHT LIFT FOAMING GEL

THE MARK CONSISTS OF STANDARD CHARACTERS
WITHOUT CLAIM TO ANY PARTICULAR FONT, STYLE,
SIZE, OR COLOR.

NO CLAIM IS MADE TO THE EXCLUSIVE RIGHT TO
USE "FOAMING GEL", APART FROM THE MARK AS
SHOWN.

FOR HAIR CARE PREPARATIONS, NAMELY HAIR
STYLING GEL (U.S. CLS. 1, 4, 6, 50, 51 AND 52).
FLORENTINA BLANDU, EXAMINING ATTORNEY

CLASS 3—(Continued).

SN 78-522,624. NEDBOY, ROBIN L, NEW YORK, NY. FILED 11-24-2004.

CLASS 3—(Continued).

SN 78-522,649. M. Z. BERGER & CO., INC., LONG ISLAND CITY, NY. FILED 11-24-2004.

Grape Squirt

HOME BASE

THE MARK CONSISTS OF STANDARD CHARACTERS WITHOUT CLAIM TO ANY PARTICULAR FONT, STYLE, SIZE, OR COLOR.

NO CLAIM IS MADE TO THE EXCLUSIVE RIGHT TO USE "GRAPE", APART FROM THE MARK AS SHOWN.

FOR SCENTED HAIR CARE PRODUCTS, NAMELY, SHAMPOOS, CONDITIONERS, RINSES, LOTIONS AND OTHER HAIR CARE PREPARATIONS (U.S. CLS. 1, 4, 6, 50, 51 AND 52).

WINSTON FOLMAR, EXAMINING ATTORNEY

THE MARK CONSISTS OF STANDARD CHARACTERS WITHOUT CLAIM TO ANY PARTICULAR FONT, STYLE, SIZE, OR COLOR.

FOR NON-MEDICATED SKIN CARE PREPARATIONS, NAMELY, ANTI-AGING CREAM, ANTI-WRINKLE CREAM, ASTRINGENT FOR COSMETIC PURPOSES, BODY CREAM, BODY EMULSION, BODY LOTION, BODY MILK, BODY OIL, BODY SCRUB, BODY SPRAY, EXFOLIANTS FOR SKIN, EYE CREAM, EYE GEL, FACIAL CLEANSER, FACIAL CREAM, FACIAL EMULSIONS, FACIAL MASKS, FACIAL SCRUB, HAND CREAM, HAND LOTION, HAND SOAP, MOISTURIZING MILKS, NON-MEDICATED BODY SOAK, NON-MEDICATED FOOT CREAM, SHOWER GEL, SKIN CLARIFIERS, SKIN CLEANSERS, SKIN CLEANSING CREAM, SKIN CLEANSING LOTION, SKIN CONDITIONERS, SKIN CREAM, SKIN EMOLLIENTS, SKIN LOTION, SKIN MASKS, SKIN MOISTURIZER, SKIN SOAP, SKIN TONER, SOAP FOR COSMETIC PURPOSES; SHAVING PREPARATIONS, NAMELY, SHAVING BALM, SHAVING CREAM, SHAVING FOAM, SHAVING GEL, SHAVING LOTION, SHAVING SOAP, AFTER-SHAVE GEL, AFTER-SHAVE LOTION; BATH ADDITIVES, NAMELY, BATH BEADS, BATH CRYSTALS, BATH FOAMS, BATH GELS, BATH MILK, BATH OILS, BATH PEARLS, BUBBLE BATH, NON-MEDICATED BATH SALTS; FRAGRANCES, NAMELY, ESSENTIAL OILS FOR PERSONAL USE, POTPOURRI, SCENTED LINEN SPRAYS, SCENTED ROOM SPRAYS, PERFUME, EAU DE TOILETTE; NON-MEDICATED HAIR CARE PREPARATIONS, NAMELY, HAIR CONDITIONERS, HAIR DRESSINGS FOR MEN, HAIR EMOLLIENTS, HAIR GEL, HAIR MOUSSE, HAIR POMADES, HAIR RINSES, HAIR SHAMPOO, HAIR SPRAY, HAIR STYLING PREPARATIONS; HOUSEHOLD CLEANING PREPARATIONS, NAMELY, DISH DETERGENTS, LAUNDRY DETERGENTS, GLASS CLEANING PREPARATIONS, CLEANER FOR USE ON COUNTERTOPS (U.S. CLS. 1, 4, 6, 50, 51 AND 52).

FIRST USE 3-1-2002; IN COMMERCE 3-1-2002.
WILLIAM VERHOSEK, EXAMINING ATTORNEY

SN 78-522,750. CRABTREE & EVELYN, LTD., WOODSTOCK, CT. FILED 11-24-2004.

MINI MOO COW

THE MARK CONSISTS OF STANDARD CHARACTERS WITHOUT CLAIM TO ANY PARTICULAR FONT, STYLE, SIZE, OR COLOR.

FOR TOILETRIES, NAMELY SKIN CREAMS AND SKIN LOTIONS (U.S. CLS. 1, 4, 6, 50, 51 AND 52).

CHERYL CLAYTON, EXAMINING ATTORNEY

CLASS 3—(Continued).

SN 78-523,850. MAKE-UP ART COSMETICS INC., NEW YORK, NY. FILED 11-29-2004.

CLASS 3—(Continued).

SN 78-524,397. KARA VITA LLC, ORLANDO, FL. FILED 11-30-2004.

SELECT FINISH

THE MARK CONSISTS OF STANDARD CHARACTERS WITHOUT CLAIM TO ANY PARTICULAR FONT, STYLE, SIZE, OR COLOR.

FOR COSMETICS (U.S. CLS. 1, 4, 6, 50, 51 AND 52).
DAVID YONTEF, EXAMINING ATTORNEY

SN 78-524,054. PAPA, KATHLEEN, CHERRY HILL, NJ. FILED 11-29-2004.

LIP TENDER

THE MARK CONSISTS OF STANDARD CHARACTERS WITHOUT CLAIM TO ANY PARTICULAR FONT, STYLE, SIZE, OR COLOR.

NO CLAIM IS MADE TO THE EXCLUSIVE RIGHT TO USE LIP, APART FROM THE MARK AS SHOWN.
FOR NON-MEDICATED LIP BALM, LIP CREAM, LIP GLOSS, LIP MASK; NON-MEDICATED LIP CARE PREPARATIONS (U.S. CLS. 1, 4, 6, 50, 51 AND 52).
ZHALEH DELANEY, EXAMINING ATTORNEY

Aromabliss

THE MARK CONSISTS OF STANDARD CHARACTERS WITHOUT CLAIM TO ANY PARTICULAR FONT, STYLE, SIZE, OR COLOR.

FOR COSMETICS (U.S. CLS. 1, 4, 6, 50, 51 AND 52).
ROBIN CHOSID, EXAMINING ATTORNEY

SN 78-525,748. MAKE-UP ART COSMETICS INC., NEW YORK, NY. FILED 12-2-2004.

SN 78-524,275. BIOTRON LABORATORIES, INC., CENTERVILLE, UT. FILED 11-30-2004.



THE COLOR(S) BLUE-GREEN AND PURPLE IS/ARE CLAIMED AS A FEATURE OF THE MARK.

THE MARK CONSISTS OF SPLIT HALF MOON BLUE-GREEN DESIGN IN FRONT OF WORDING IN PURPLE FONT.

FOR PROPRIETARY PROTEIN-BASED INGREDIENT MARKETED PRIMARILY TO MANUFACTURERS OF FINISHED COSMETIC PRODUCTS, AS A RAW MATERIAL THAT MAY AID IN THE REDUCTION OF THE APPEARANCE OF FINE LINES (U.S. CLS. 1, 4, 6, 50, 51 AND 52).

JENNIFER KRISP, EXAMINING ATTORNEY

GREENIFY

THE MARK CONSISTS OF STANDARD CHARACTERS WITHOUT CLAIM TO ANY PARTICULAR FONT, STYLE, SIZE, OR COLOR.

FOR PERFUMES, FRAGRANCES FOR PERSONAL USE AND COLOGNES (U.S. CLS. 1, 4, 6, 50, 51 AND 52).
BILL DAWE, EXAMINING ATTORNEY

CLASS 3—(Continued).

SN 78-526,239. KIM, SAMUEL, LOS ANGELES, CA. FILED 12-2-2004.

EPLAISIR

THE MARK CONSISTS OF STANDARD CHARACTERS WITHOUT CLAIM TO ANY PARTICULAR FONT, STYLE, SIZE, OR COLOR.

FOR COSMETICS, NAMELY, ANTI-AGING CREAMS, ANTI-WRINKLE CREAMS, AGE RETARDANT LOTIONS, COSMETIC CREAMS AND LOTIONS FOR HAIR AND SKIN REGENERATION AND REVITALIZATION, BEAUTY CREAMS, BEAUTY LOTIONS, FACIAL CREAMS, FACIAL LOTIONS, SKIN CREAMS, SKIN LOTIONS, BODY CREAMS, BODY LOTIONS, HAND CREAMS, HAND LOTIONS, NON-MEDICATED FOOT CREAMS, BATH LOTIONS, SHOWER CREAMS, SUN CREAMS, SUNSCREEN CREAMS, SUN CARE LOTIONS, SUN-BLOCK LOTIONS, COSMETIC CREAMS, HAIR CARE CREAMS, HAIR CARE LOTIONS, BODY OILS, COSMETIC OILS, BATH OILS (U.S. CLS. 1, 4, 6, 50, 51 AND 52).

DAVID MURRAY, EXAMINING ATTORNEY

SN 78-526,941. THE HARTZ MOUNTAIN CORPORATION, SECAUCUS, NJ. FILED 12-3-2004.

**ADVANCED CARE
HAIRBALL REMEDY**

THE MARK CONSISTS OF STANDARD CHARACTERS WITHOUT CLAIM TO ANY PARTICULAR FONT, STYLE, SIZE, OR COLOR.

OWNER OF U.S. REG. NOS. 2,570,402, 2,740,198 AND OTHERS.

NO CLAIM IS MADE TO THE EXCLUSIVE RIGHT TO USE "HAIRBALL REMEDY", APART FROM THE MARK AS SHOWN.

FOR NON-MEDICATED GROOMING PREPARATIONS FOR TREATING CATS WITH HAIRBALLS (U.S. CLS. 1, 4, 6, 50, 51 AND 52).

BARBARA RUTLAND, EXAMINING ATTORNEY

CLASS 3—(Continued).

SN 78-527,098. UNITED EXCHANGE CORPORATION, CERRITOS, CA. FILED 12-3-2004.

FACIAL PILLOWS

THE MARK CONSISTS OF STANDARD CHARACTERS WITHOUT CLAIM TO ANY PARTICULAR FONT, STYLE, SIZE, OR COLOR.

NO CLAIM IS MADE TO THE EXCLUSIVE RIGHT TO USE "FACIAL", APART FROM THE MARK AS SHOWN.

FOR NON-MEDICATED PADS CONTAINING SKIN CLEANSERS (U.S. CLS. 1, 4, 6, 50, 51 AND 52).

MIDGE BUTLER, EXAMINING ATTORNEY

SN 78-529,564. ESSENTIAL DENTAL SYSTEMS, INC., SOUTH HACKENSACK, NJ. FILED 12-9-2004.

SCRUB 'N GLOVE

THE MARK CONSISTS OF STANDARD CHARACTERS WITHOUT CLAIM TO ANY PARTICULAR FONT, STYLE, SIZE, OR COLOR.

FOR LIQUID HAND SOAP (U.S. CLS. 1, 4, 6, 50, 51 AND 52).

KATRINA EDGE, EXAMINING ATTORNEY

SN 78-531,250. MAKE-UP ART COSMETICS INC., NEW YORK, NY. FILED 12-13-2004.

VIOLETRIX

THE MARK CONSISTS OF STANDARD CHARACTERS WITHOUT CLAIM TO ANY PARTICULAR FONT, STYLE, SIZE, OR COLOR.

FOR PERFUMES; FRAGRANCES FOR PERSONAL USE; COLOGNES (U.S. CLS. 1, 4, 6, 50, 51 AND 52).

SUNG IN, EXAMINING ATTORNEY

CLASS 3—(Continued).

SN 78-531,267. MAKE-UP ART COSMETICS INC., NEW YORK, NY. FILED 12-13-2004.

CLASS 3—(Continued).

SN 78-534,427. CABOODLES, LLC, MEMPHIS, TN. FILED 12-17-2004.

MIRRORGLASS

THE MARK CONSISTS OF STANDARD CHARACTERS WITHOUT CLAIM TO ANY PARTICULAR FONT, STYLE, SIZE, OR COLOR.

FOR MAKEUP, NAMELY, LIPSTICK, LIP GLOSS AND LINER (U.S. CLS. 1, 4, 6, 50, 51 AND 52).
JOHN WILKE, EXAMINING ATTORNEY

SN 78-531,372. GEMSMETICS, INC., ALPHARETTA, GA. FILED 12-13-2004.

SEEIN' SPARKLES

THE MARK CONSISTS OF STANDARD CHARACTERS WITHOUT CLAIM TO ANY PARTICULAR FONT, STYLE, SIZE, OR COLOR.

NO CLAIM IS MADE TO THE EXCLUSIVE RIGHT TO USE "SPARKLES", APART FROM THE MARK AS SHOWN. FOR COSMETICS (U.S. CLS. 1, 4, 6, 50, 51 AND 52).
SUNG IN, EXAMINING ATTORNEY

SN 78-536,593. PURETEK CORPORATION, SAN FERNANDO, CA. FILED 12-21-2004.

AVOIR

THE MARK CONSISTS OF STANDARD CHARACTERS WITHOUT CLAIM TO ANY PARTICULAR FONT, STYLE, SIZE, OR COLOR.

THE FOREIGN WORDING IN THE MARK TRANSLATES INTO ENGLISH AS TO HAVE.

FOR MOISTURIZING CREAM, MOISTURIZING LOTION, EYE CREAM, SKIN ESSENCE, SKIN TONER, FACIAL SCRUB, FACIAL MASSAGE CREAM, SKIN CLEANSER, FACIAL SOAP, FACIAL MASK, ANTI WRINKLE CREAM, ANTI WRINKLE LOTION, ANTI WRINKLE ESSENCE, ANTI WRINKLE TONERS, LIPSTICKS, LIP LINERS, LIP GLOSSES, LIP LACQUERS, LIP PLUMPER, LIP SHEEN, EYE SHADOWS, SHADOW PRIMER, EYE LINERS, EYE PENCILS, LIQUID EYE LINERS, BROW PENCILS, BROW POWDER, MAS-CARAS, FACE BLUSHERS, BRONZERS, LIQUID FOUNDATION, CREAM TO POWDER FOUNDATION, STICK FOUNDATION, PRESSED POWDER, DUAL ACTIVE POWDER, FINISHING POWDER, LOOSE POWDER, CONCEALERS, COLOR CORRECTORS, MAKEUP BRUSHES, EYE LASH CURLERS, BODY GLOW, BODY BRONZER, BODY CREAM, BODY LOTION, BODY CLEANSER, SOAPS, BODY SCRUB, BODY MASK, HAIR SHAMPOO, HAIR CONDITIONER, HAIR GEL, HAIR MOUSSE, AND HAIR SPRAY (U.S. CLS. 1, 4, 6, 50, 51 AND 52).

KEVIN DINALLO, EXAMINING ATTORNEY

POSITIVE RESULTS

THE MARK CONSISTS OF STANDARD CHARACTERS WITHOUT CLAIM TO ANY PARTICULAR FONT, STYLE, SIZE, OR COLOR.

NO CLAIM IS MADE TO THE EXCLUSIVE RIGHT TO USE "RESULTS", APART FROM THE MARK AS SHOWN.

FOR ANTI-AGING CREAM, ANTI-WRINKLE CREAM, AROMATHERAPY OILS, ASTRINGENTS FOR COSMETIC PURPOSES, BATH GEL, BATH OIL, BODY CREAM, BODY EMULSIONS, BODY LOTIONS, BODY MASKS, BODY SCRUBS, SKIN CLEANSING LOTION, COLD CREAM, COMPACTS FOR COSMETIC USE, COLD CREAM, EYE CREAM, HAND CREAM, NIGHT CREAM, SKIN CLEANSING CREAM, SKIN CREAM, VANISHING CREAM, ESSENTIAL OILS FOR PERSONAL USE, EYE GEL, FACE LOTIONS, FACIAL SCRUB, SHOWER GEL, SKIN MOISTURIZER, SUN BLOCK PREPARATIONS, SUN CREAMS, AND SUNSCREEN PREPARATIONS (U.S. CLS. 1, 4, 6, 50, 51 AND 52).

STEVEN PEREZ, EXAMINING ATTORNEY

CLASS 3—(Continued).

SN 78-537,877. KISSINGFISH LLC, AURORA, CO. FILED 12-23-2004.

CLASS 3—(Continued).

SN 78-538,045. NATHAN BENDITZSON, SKOKIE, IL. FILED 12-23-2004.

SEA NO LINES

NATE B

THE MARK CONSISTS OF STANDARD CHARACTERS WITHOUT CLAIM TO ANY PARTICULAR FONT, STYLE, SIZE, OR COLOR.
FOR NON-MEDICATED SKIN CARE PREPARATIONS (U.S. CLS. 1, 4, 6, 50, 51 AND 52).
JOHN WILKE, EXAMINING ATTORNEY

THE MARK CONSISTS OF STANDARD CHARACTERS WITHOUT CLAIM TO ANY PARTICULAR FONT, STYLE, SIZE, OR COLOR.

FOR PERSONAL CARE PRODUCTS, NAMELY, SHAVING CREAM, SHAVING GEL, PRE-SHAVING PREPARATIONS, NAMELY, OIL; NON-MEDICATED ASTRINGENT AFTER-SHAVE FOR COSMETIC PURPOSES, AFTER-SHAVE BALM, AFTER-SHAVE LOTION, AFTER-SHAVE GEL, TOOTH PASTE, PERSONAL DEODORANT, FACIAL AND BODY SOAP, FACIAL AND BODY CLEANSER, ANTI-WRINKLE CREAM, BODY CLEANSING GEL, BODY SCRUB, FACIAL SCRUB, SKIN TONER, HAND AND BODY LOTION, FACIAL LOTION, SKIN MOISTURIZER, DEEP-PORE CLEANSING CLAY FACIAL MASK, LIP CREAM, EYE CREAM, SHAMPOO, HAIR CONDITIONER, HAIR CREAM, HAIR GEL, TALCUM POWDER, SUN SCREEN, SUN BLOCK, SELF TANNING LOTION, NON-MEDICATED MUSCLE RUB, LIP BALM AND COLOGNE (U.S. CLS. 1, 4, 6, 50, 51 AND 52).

ANDREW BENZMILLER, EXAMINING ATTORNEY

SN 78-537,880. KISSINGFISH LLC, AURORA, CO. FILED 12-23-2004.

SN 78-541,531. QUALITY BRANDS LLC, CARMEL, IN. FILED 1-3-2005.

AQUA LOCK

LISTEREX

THE MARK CONSISTS OF STANDARD CHARACTERS WITHOUT CLAIM TO ANY PARTICULAR FONT, STYLE, SIZE, OR COLOR.
FOR NON-MEDICATED SKIN CARE PREPARATIONS (U.S. CLS. 1, 4, 6, 50, 51 AND 52).
JOHN WILKE, EXAMINING ATTORNEY

THE MARK CONSISTS OF STANDARD CHARACTERS WITHOUT CLAIM TO ANY PARTICULAR FONT, STYLE, SIZE, OR COLOR.

FOR SKIN CLEANSER (U.S. CLS. 1, 4, 6, 50, 51 AND 52).
DOMINIC J. FERRAIUOLO, EXAMINING ATTORNEY

CLASS 3—(Continued).

SN 78-543,291. GRAYSON O. COMPANY, KANNAPOLIS, NC. FILED 1-6-2005.

CLASS 3—(Continued).

SN 78-544,895. DIAL BRANDS, INC., SCOTTSDALE, AZ. FILED 1-10-2005.

THERMADAN

BRECK

THE MARK CONSISTS OF STANDARD CHARACTERS WITHOUT CLAIM TO ANY PARTICULAR FONT, STYLE, SIZE, OR COLOR.

OWNER OF U.S. REG. NOS. 1,407,292, 2,793,442 AND OTHERS.

FOR SHAMPOO (U.S. CLS. 1, 4, 6, 50, 51 AND 52).

FIRST USE 0-0-1978; IN COMMERCE 0-0-1978.

HOWARD SMIGA, EXAMINING ATTORNEY

THE MARK CONSISTS OF STANDARD CHARACTERS WITHOUT CLAIM TO ANY PARTICULAR FONT, STYLE, SIZE, OR COLOR.

OWNER OF U.S. REG. NOS. 529,328, 874,405 AND OTHERS.

FOR PERSONAL CARE PRODUCTS, NAMELY, BODY WASH, LIQUID AND FOAMING HAND SOAP, BAR SOAP (U.S. CLS. 1, 4, 6, 50, 51 AND 52).

LINDA MICKLEBURGH, EXAMINING ATTORNEY

SN 78-544,229. ESTEE LAUDER COSMETICS LTD., ONTARIO, CANADA, FILED 1-7-2005.

SN 78-545,187. DRAGON FULL DEVELOPMENTS LIMITED, GEORGE TOWN, GRAND CAYMAN, CAYMAN ISLANDS, FILED 1-10-2005.

MAC
TECH

18
mmm



OWNER OF U.S. REG. NOS. 1,642,532, 2,495,240 AND OTHERS.

FOR COSMETICS, NAMELY FOUNDATION MAKE-UP, PRESSED POWDER, LOOSE POWDER, EYE SHADOW, EYE LINERS, LIPSTICKS, LIP LINERS, LIP GLOSS, FACIAL BRONZERS AND TINTS, MASCARA, LIQUID EYELINER, EYE LINING PENCILS, CONCEALERS (U.S. CLS. 1, 4, 6, 50, 51 AND 52).

ANDREW BENZMILLER, EXAMINING ATTORNEY

THE MARK CONSISTS OF 18 MMM AND AN ABSTRACT DRAWING SYMBOLIZING BLOOMING.

FOR COSMETICS (U.S. CLS. 1, 4, 6, 50, 51 AND 52).

FIRST USE 11-11-2004; IN COMMERCE 11-11-2004.

LESLEY LAMOTHE, EXAMINING ATTORNEY

CLASS 3—(Continued).

SN 78-545,349. KISSINGFISH, LLC, AURORA, CO. FILED 1-11-2005.

CLASS 3—(Continued).

SN 78-545,713. BADGER AIR BRUSH CO., FRANKLIN PARK, IL. FILED 1-11-2005.

OCEAN INFUSION

GLAMAIR

THE MARK CONSISTS OF STANDARD CHARACTERS WITHOUT CLAIM TO ANY PARTICULAR FONT, STYLE, SIZE, OR COLOR.
FOR NON-MEDICATED SKIN CARE PREPARATIONS (U.S. CLS. 1, 4, 6, 50, 51 AND 52).
JOHN WILKE, EXAMINING ATTORNEY

THE MARK CONSISTS OF STANDARD CHARACTERS WITHOUT CLAIM TO ANY PARTICULAR FONT, STYLE, SIZE, OR COLOR.
FOR COSMETICS (U.S. CLS. 1, 4, 6, 50, 51 AND 52).
SUSAN LESLIE DUBOIS, EXAMINING ATTORNEY

SN 78-545,658. DIVERSITECH CORPORATION, DULUTH, GA. FILED 1-11-2005.

SN 78-546,704. COLLECTIVE WELLBEING LLC, IRWIN-DALE, CA. FILED 1-12-2005.

RESTORZ

LESS IS MORE

THE MARK CONSISTS OF STANDARD CHARACTERS WITHOUT CLAIM TO ANY PARTICULAR FONT, STYLE, SIZE, OR COLOR.
FOR LIQUID AIR CONDITIONER COIL CLEANER (U.S. CLS. 1, 4, 6, 50, 51 AND 52).
KAREN K. BUSH, EXAMINING ATTORNEY

THE MARK CONSISTS OF STANDARD CHARACTERS WITHOUT CLAIM TO ANY PARTICULAR FONT, STYLE, SIZE, OR COLOR.
FOR HAIR CARE PRODUCTS, NAMELY, HAIR CARE PREPARATIONS, BABY HAIR CONDITIONER, HAIR SHAMPOO, HAIR CONDITIONERS, EXFOLIANTS FOR HAIR, HAIR GEL, HAIR CARE CREAMS, HAIR CARE LOTIONS, HAIR DRESSINGS FOR MEN, HAIR EMOLLIENTS, HAIR MOUSSE, HAIR NOURISHERS, HAIR POMADES, HAIR REMOVING CREAM, HAIR RINSES, HAIR SPRAY, HAIR STYLING PREPARATIONS, WAX STRIPS FOR REMOVING BODY HAIR (U.S. CLS. 1, 4, 6, 50, 51 AND 52).
WON TEAK OH, EXAMINING ATTORNEY

CLASS 3—(Continued).

SN 78-548,719. RICH HIPPIE INC., LOS ANGELES, CA. FILED 1-17-2005.

Marrakech

THE MARK CONSISTS OF STANDARD CHARACTERS WITHOUT CLAIM TO ANY PARTICULAR FONT, STYLE, SIZE, OR COLOR.

FOR SKIN CARE PRODUCTS AND PERFUME, NAMELY NON-MEDICATED BATH SALTS, BODY OILS, SHAMPOO, FACE CREAMS, AND PERFUMES (U.S. CLS. 1, 4, 6, 50, 51 AND 52).

FIRST USE 1-1-2001; IN COMMERCE 1-1-2001.
LAURIE MAYES, EXAMINING ATTORNEY

CLASS 3—(Continued).

SN 78-551,167. TWO FRIENDS HAND FOOT AND BODY SCRUB, INCORPORATED, IRVINE, CA. FILED 1-20-2005.

**CHANGING THE WAY
AMERICA SCRUBS**

THE MARK CONSISTS OF STANDARD CHARACTERS WITHOUT CLAIM TO ANY PARTICULAR FONT, STYLE, SIZE, OR COLOR.

FOR HAND, FOOT AND BODY SCRUB (U.S. CLS. 1, 4, 6, 50, 51 AND 52).

FIRST USE 12-2-2004; IN COMMERCE 12-2-2004.
DOMINIC J. FERRAIUOLO, EXAMINING ATTORNEY

SN 78-548,938. MOHRWESS, KATHLEEN A., FRIDAY HARBOR, WA. FILED 1-18-2005.

Bergmohr

THE MARK CONSISTS OF STANDARD CHARACTERS WITHOUT CLAIM TO ANY PARTICULAR FONT, STYLE, SIZE, OR COLOR.

FOR SKIN AND BODY COSMETIC PREPARATIONS, NAMELY SKIN CLEANSERS, SKIN MOISTURIZERS, FACIAL MASKS, BODY LOTIONS AND CREAMS, LIP AND BODY BALMS, FACIAL MASKS, BODY WASHES AND SCRUBS, AND COSMETIC SOAPS AND BATH SALTS (U.S. CLS. 1, 4, 6, 50, 51 AND 52).

FIRST USE 1-1-2005; IN COMMERCE 1-1-2005.
JOHN HWANG, EXAMINING ATTORNEY

SN 78-551,337. PADAVAN, ALISON, WESTHAMPTON, NY. FILED 1-21-2005.

**Kissable Lickable
Lips**

THE MARK CONSISTS OF STANDARD CHARACTERS WITHOUT CLAIM TO ANY PARTICULAR FONT, STYLE, SIZE, OR COLOR.

NO CLAIM IS MADE TO THE EXCLUSIVE RIGHT TO USE "LIPS", APART FROM THE MARK AS SHOWN.

FOR COSMETICS, NAMELY, LIP GLOSS, LIP STICK, FRAGRANCE FOR PERSONAL USE, SKIN MOISTURIZER, FACE POWDER, BODY POWDER, EYE SHADOW, CREAM SHIMMER EYE SHADOW, LIP GLITTER, BODY GLITTER, NAIL GLITTER, SKIN CREAM, FACE CREAM, BODY CREAM, EYE CREAM, BLUSH, MAS-CARA (U.S. CLS. 1, 4, 6, 50, 51 AND 52).

FIRST USE 1-20-2005; IN COMMERCE 1-20-2005.
BARBARA A. GOLD, EXAMINING ATTORNEY

CLASS 3—(Continued).

SN 78-553,331. ZSA ZSA VINTAGE, LLC, UPPER MON-
TCLAIR, NJ. FILED 1-25-2005.

zsazsalove

THE MARK CONSISTS OF STANDARD CHARACTERS
WITHOUT CLAIM TO ANY PARTICULAR FONT, STYLE,
SIZE, OR COLOR.
FOR COSMETICS (U.S. CLS. 1, 4, 6, 50, 51 AND 52).
ELLEN PERKINS, EXAMINING ATTORNEY

SN 78-553,492. HELENE CURTIS INC., WILMINGTON, DE.
FILED 1-25-2005.

FEELS LIKE NOTHING
ON

THE MARK CONSISTS OF STANDARD CHARACTERS
WITHOUT CLAIM TO ANY PARTICULAR FONT, STYLE,
SIZE, OR COLOR.
FOR ANTIPERSPIRANT AND DEODORANT (U.S.
CLS. 1, 4, 6, 50, 51 AND 52).
MICHAEL SOUDERS, EXAMINING ATTORNEY

SN 78-554,829. L'OREAL USA CREATIVE, INC., NEW YORK,
NY. FILED 1-27-2005.

AIRSHAPEGEL

THE MARK CONSISTS OF STANDARD CHARACTERS
WITHOUT CLAIM TO ANY PARTICULAR FONT, STYLE,
SIZE, OR COLOR.
FOR HAIR STYLING PREPARATION (U.S. CLS. 1, 4, 6,
50, 51 AND 52).
LINDA POWELL, EXAMINING ATTORNEY

CLASS 3—(Continued).

SN 78-555,158. UNIVERSAL PROMOTION SERVICES, INC.,
MIAMI, FL. FILED 1-27-2005.

BELLE-TIPS

THE MARK CONSISTS OF STANDARD CHARACTERS
WITHOUT CLAIM TO ANY PARTICULAR FONT, STYLE,
SIZE, OR COLOR.
FOR NON-MEDICATED SKIN CARE PREPARATIONS,
NAMELY, WRINKLE CREAM, MOISTURIZER, VITA-
MIN C, CLEANSER, MAKEUP REMOVER AND SUN-
BLOCK (U.S. CLS. 1, 4, 6, 50, 51 AND 52).
SHARI SHEFFIELD, EXAMINING ATTORNEY

SN 78-555,913. R.T. VANDERBILT COMPANY, INC., NOR-
WALK, CT. FILED 1-28-2005.

VANBRITE

THE MARK CONSISTS OF STANDARD CHARACTERS
WITHOUT CLAIM TO ANY PARTICULAR FONT, STYLE,
SIZE, OR COLOR.
FOR BUFFING AND POLISHING COMPOUND FOR
PRODUCTION FINISHES ON VEHICLES AND OTHER
COATED SURFACES (U.S. CLS. 1, 4, 6, 50, 51 AND 52).
MARY CRAWFORD, EXAMINING ATTORNEY

CLASS 3—(Continued).

SN 78-567,788. PANAMA JACK INTERNATIONAL, INC., ORLANDO, FL. FILED 2-15-2005.

CLASS 3—(Continued).

SN 78-580,451. KISSINGFISH LLC, AURORA, CO. FILED 3-4-2005.

**BLUE MARLIN BY
PANAMA JACK
BRANDS**

THE MARK CONSISTS OF STANDARD CHARACTERS WITHOUT CLAIM TO ANY PARTICULAR FONT, STYLE, SIZE, OR COLOR.

OWNER OF U.S. REG. NOS. 1,673,956, 2,009,466 AND OTHERS.

NO CLAIM IS MADE TO THE EXCLUSIVE RIGHT TO USE "BRANDS", APART FROM THE MARK AS SHOWN.

FOR SUN TAN LOTIONS, SUN TAN OILS, SUN BLOCK PREPARATIONS, NON-MEDICATED LIP BALMS, SUN SCREENS, SOAPS, SHAMPOOS; HAIR CONDITIONER; MAKEUP, NAMELY EYELINERS, MASCARAS AND FACE POWDERS; SKIN CARE CREAMS AND LOTIONS, FACE CREAMS; NON-MEDICATED SKIN PEELING CREAMS AND GELS; SKIN ABRASIVE PREPARATIONS; FACIAL MASKS; NON-MEDICATED FOOT CREAMS AND POWDERS, NON-MEDICATED FOOT LOTIONS; NON-MEDICATED BODY LOTIONS; NON-MEDICATED BATH SALTS; BATH GELS; BODY GELS; AND NON-MEDICATED EYE CREAMS (U.S. CLS. 1, 4, 6, 50, 51 AND 52).

CAROLINE WOOD, EXAMINING ATTORNEY

AQUA ATOMS

THE MARK CONSISTS OF STANDARD CHARACTERS WITHOUT CLAIM TO ANY PARTICULAR FONT, STYLE, SIZE, OR COLOR.

FOR NON-MEDICATED SKIN CARE PREPARATIONS (U.S. CLS. 1, 4, 6, 50, 51 AND 52).

JOHN WILKE, EXAMINING ATTORNEY

SN 78-573,611. NEAL, LINCOLN L., COOKEVILLE, TN. FILED 2-23-2005.

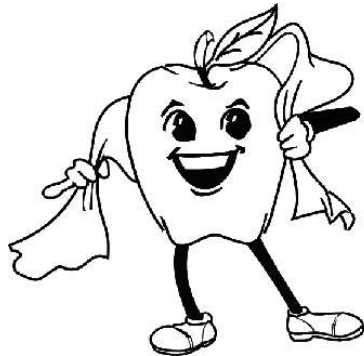

FOR MULTI-PURPOSE WET WIPES IMPREGNATED WITH CLEANSER FOR PERSONAL, FOOD, FOOD CONTACT SURFACES, OTHER INANIMATE SURFACES, AND HOUSEHOLD CLEANING; LIQUID CLEANSER FOR FOOD, FOOD CONTACT SURFACES, OTHER INANIMATE SURFACES, AND HOUSEHOLD CLEANING (U.S. CLS. 1, 4, 6, 50, 51 AND 52).

KIMBERLY PERRY, EXAMINING ATTORNEY

SN 78-580,456. KISSINGFISH LLC, AURORA, CO. FILED 3-4-2005.

ISEA WATER

THE MARK CONSISTS OF STANDARD CHARACTERS WITHOUT CLAIM TO ANY PARTICULAR FONT, STYLE, SIZE, OR COLOR.

FOR NON-MEDICATED SKIN CARE PREPARATIONS (U.S. CLS. 1, 4, 6, 50, 51 AND 52).

JOHN WILKE, EXAMINING ATTORNEY

CLASS 3—(Continued).

SN 78-589,772. KARA VITA LLC, ORLANDO, FL. FILED 3-17-2005.

EYE TENDER

THE MARK CONSISTS OF STANDARD CHARACTERS WITHOUT CLAIM TO ANY PARTICULAR FONT, STYLE, SIZE, OR COLOR.

NO CLAIM IS MADE TO THE EXCLUSIVE RIGHT TO USE "EYE", APART FROM THE MARK AS SHOWN.

FOR SKIN CARE PREPARATIONS AND COSMETIC SKIN CARE PRODUCTS, NAMELY, CLEANSERS, MASKS, TONERS, MOISTURIZERS, CREAMS AND LOTIONS; TOPICAL PREPARATIONS, NAMELY, FACE AND SKIN CLEANSERS, MASKS, TONERS MOISTURIZERS, CREAMS AND LOTIONS; COSMETIC SKIN CARE PRODUCTS, NAMELY, FACIAL CLEANSERS, FACIAL MINERAL SPRAYS, FACIAL LOTIONS, FACIAL MOISTURIZERS, FACIAL TONERS, FACIAL MASKS, FACIAL MOISTURIZERS, FACIAL CREAMS (U.S. CLS. 1, 4, 6, 50, 51 AND 52).

ZHALEH DELANEY, EXAMINING ATTORNEY

SN 78-601,091. PARFUMS CHRISTIAN DIOR, 75008 PARIS, FRANCE, FILED 4-4-2005.

DIOR 

PRIORITY CLAIMED UNDER SEC. 44(D) ON FRANCE APPLICATION NO. FR043320845, FILED 10-27-2004, REG. NO. FR043320845, DATED 10-27-2004, EXPIRES 10-27-2014.

OWNER OF U.S. REG. NOS. 2,153,858, 2,575,874 AND 2,867,329.

FOR TOILET SOAPS, PERFUME, PERFUMERY, COLOGNE WATER, TOILET WATER, COSMETICS, FACIAL MAKE-UP, ESSENTIAL OILS FOR PERSONAL USE, HAIR LOTIONS (U.S. CLS. 1, 4, 6, 50, 51 AND 52).

PRISCILLA MILTON, EXAMINING ATTORNEY

CLASS 3—(Continued).

SN 78-624,078. S & S SOAP CO., INC., BRONX, NY. FILED 5-5-2005.

Pink In The Box

THE MARK CONSISTS OF STANDARD CHARACTERS WITHOUT CLAIM TO ANY PARTICULAR FONT, STYLE, SIZE, OR COLOR.

FOR SOAPS AND DETERGENTS (U.S. CLS. 1, 4, 6, 50, 51 AND 52).

FIRST USE 6-1-2004; IN COMMERCE 6-1-2004.

JOHN HWANG, EXAMINING ATTORNEY

SN 78-626,563. PANAMA JACK INTERNATIONAL, INC., ORLANDO, FL. FILED 5-10-2005.

PANAMA JACK BEACH CLUB

THE MARK CONSISTS OF STANDARD CHARACTERS WITHOUT CLAIM TO ANY PARTICULAR FONT, STYLE, SIZE, OR COLOR.

OWNER OF U.S. REG. NOS. 1,673,956, 2,005,466 AND OTHERS.

FOR SUN TAN LOTIONS, SUN TAN OILS, SUN BLOCK PREPARATIONS, NON-MEDICATED LIP BALMS, SUN SCREENS, SOAPS, SHAMPOOS; HAIR CONDITIONER; MAKEUP, NAMELY EYELINERS, MASCARAS AND FACE POWDERS; SKIN CARE CREAMS AND LOTIONS, FACE CREAMS; NON-MEDICATED SKIN PEELING CREAMS AND GELS; SKIN ABRASIVE PREPARATIONS; FACIAL MASKS; NON-MEDICATED FOOT CREAMS AND POWDERS, NON-MEDICATED FOOT LOTIONS; NON-MEDICATED BODY LOTIONS; NON-MEDICATED BATH SALTS; BATH GELS; BODY GELS; AND NON-MEDICATED EYE CREAMS (U.S. CLS. 1, 4, 6, 50, 51 AND 52).

CAROLINE WOOD, EXAMINING ATTORNEY

CLASS 3—(Continued).

SN 78-669,066. NATE B, LLC, SKOKIE, IL. FILED 7-13-2005.



FOR PERSONAL CARE PRODUCTS, NAMELY, SHAVING CREAM, SHAVING GEL, PRE-SHAVING PREPARATIONS, NAMELY, OIL; NON-MEDICATED ASTRINGENT AFTER-SHAVE FOR COSMETIC PURPOSES, AFTER-SHAVE BALM, AFTER-SHAVE LOTION, AFTER-SHAVE GEL, TOOTH PASTE, PERSONAL DEODORANT, FACIAL AND BODY SOAP, FACIAL AND BODY CLEANSER, ANTI-WRINKLE CREAM, BODY CLEANSING GEL, BODY SCRUB, FACIAL SCRUB, SKIN TONER, HAND AND BODY LOTION, FACIAL LOTION, SKIN MOISTURIZER, DEEP-PORE CLEANSING CLAY FACIAL MASK, LIP CREAM, EYE CREAM, SHAMPOO, HAIR CONDITIONER, HAIR CREAM, HAIR GEL, TALCUM POWDER, SUN SCREEN, SUN BLOCK, SELF TANNING LOTION, NON-MEDICATED MUSCLE RUB, LIP BALM AND COLOGNE (U.S. CLS. 1, 4, 6, 50, 51 AND 52).

ANDREW BENZMILLER, EXAMINING ATTORNEY

SN 78-976,174. ROCHEM TECHNICAL SERVICES (HOLDING) AG, 1211 GENEVA 17, SWITZERLAND, FILED 8-11-2003.

KRANKWASH

SEC. 2(F).

FOR OFF-LINE COMPRESSOR CLEANING CHEMICALS FOR INDUSTRIAL AND AVIATION GAS TURBINE AND PROCESS COMPRESSORS, NAMELY COMPRESSOR CLEANING PREPARATION (U.S. CLS. 1, 4, 6, 50, 51 AND 52).

FIRST USE 3-14-1987; IN COMMERCE 3-14-1987.
KATHERINE STOIDES, EXAMINING ATTORNEY**CLASS 3—(Continued).**

SN 79-002,253. YVES SAINT LAURENT PARFUMS, FRANCE, FILED 4-13-2004.



PRIORITY DATE OF 10-17-2003 IS CLAIMED.
OWNER OF INTERNATIONAL REGISTRATION 0823785 DATED 4-13-2004, EXPIRES 4-13-2014.

THE COLOR(S) GOLD, YELLOWISH-BROWN AND DARK BLUE IS/ARE CLAIMED AS A FEATURE OF THE MARK.

THE OVERALL PACKAGE FOR THE GOOD IS YELLOWISH-BROWN AND THE FLOWER DESIGNS ARE GOLD. THE HORIZONTAL BANDS ARE COMPRISED OF GOLD AND DARK BLUE STRIPS.

FOR PERFUMES, EAUX DE TOILETTE, DEODORANTS FOR PERSONAL USE; ESSENTIAL OILS FOR PERSONAL USE; OILS FOR COSMETIC PURPOSE; SOAPS; COSMETIC MILK; COSMETICS; BEAUTY MASKS; COSMETIC PREPARATIONS FOR SLIMMING PURPOSES, FOR BATHING PURPOSES, FOR SKIN TANNING; CREAMS AND LOTIONS FOR FACE AND BODY CARE; MAKE-UP, NAMELY FOUNDATIONS, BLUSHERS, MAKE-UP POWDERS; COSMETIC PENCILS; NAIL POLISH; LIPSTICKS; HAIR LOTIONS; SHAMPOOS; AFTER-SHAVE LOTIONS; MOISTURIZING AFTER-SHAVE CREAMS; SHAVING SOAPS (U.S. CLS. 1, 4, 6, 50, 51 AND 52).

JEAN IM, EXAMINING ATTORNEY

SN 79-002,901. IOUALALEN MAHDI, FRANCE, FILED 5-7-2004.

GILLES CANTUEL PARFUMS PARIS

THE MARK CONSISTS OF STANDARD CHARACTERS WITHOUT CLAIM TO ANY PARTICULAR FONT, STYLE, SIZE, OR COLOR.

PRIORITY DATE OF 11-7-2003 IS CLAIMED.
OWNER OF INTERNATIONAL REGISTRATION 0825953 DATED 5-7-2004, EXPIRES 5-7-2014.

NO CLAIM IS MADE TO THE EXCLUSIVE RIGHT TO USE "PARFUMS PARIS", APART FROM THE MARK AS SHOWN.

THE NAME GILLES CANTUEL DOES NOT IDENTIFY A LIVING INDIVIDUAL.

THE FOREIGN WORDING IN THE MARK TRANSLATES INTO ENGLISH AS PERFUME.

FOR PERFUMERY AND COSMETICS (U.S. CLS. 1, 4, 6, 50, 51 AND 52).

KAREN K. BUSH, EXAMINING ATTORNEY

CLASS 3—(Continued).

SN 79-004,105. BEAUTE CREATEURS, FRANCE, FILED 5-17-2004.

HYDRASTRETCH

PRIORITY DATE OF 12-1-2003 IS CLAIMED.
OWNER OF INTERNATIONAL REGISTRATION 0829747
DATED 5-17-2004, EXPIRES 5-17-2014.

FOR NON-MEDICATED SKIN CARE AND CLEANING PREPARATIONS, NAMELY, CREAM, MILK, LOTION, SERUM, GEL, FLUID, AND OIL FOR MOISTURIZING THE BODY, THE FACE AND EYES; NON-MEDICATED CELLULITE-REDUCING SKIN LOTIONS AND SKIN GELS; CLEANSING, MOISTURIZING, ANTI-AGING, AND NON-MEDICATED ANTI-WRINKLE FACIAL MASKS; NON-MEDICATED MOISTURIZING LIP MASKS; ANTI-WRINKLE CREAMS FOR EYES; MASSAGE OIL; TALCUM POWDER; SUN PRODUCTS, NAMELY, SUN SCREEN, SUN TANNING OILS AND LOTIONS, SUN BLOCK, AFTER-SUN CREAM, SELF-TANNING MILK AND CREAM, ACCELERATED TANNING CREAM; COSMETICS, NAMELY, SKIN SOAP, MAKE-UP REMOVER, LIP AND EYE MAKE-UP REMOVER, NAIL POLISH, DENTIFRICES, DEPILATORIES, LIQUID FOUNDATION, TINTED SKIN CREAMS, MAKE-UP, POWDER AND CREAM BLUSHER, LIPSTICK, MASCARA, EYE SHADOW, EYELINER PENCIL; PERFUMES, NAMELY, PERFUMED WATER, TOILET WATER, COLOGNE WATER, SCENTED WATER, PERFUMED TALCUM POWDER, PERFUMED SKIN CREAM, PERFUMED BODY OILS, PERFUMED SKIN CLEANSING FOAM, ESSENTIAL OILS FOR PERSONAL USE; PERFUMED BATH PRODUCTS, NAMELY, BODY LOTIONS, BODY POWDER, BODY OILS AND PERSONAL DEODORANTS; HAIR CARE PREPARATIONS, NAMELY, SHAMPOO, CONDITIONERS, SPRAYS, LOTIONS, HAIR GELS, MOUSSE, MASKS FOAMS, SUN SCREEN AND HAIR COLOR (U.S. CLS. 1, 4, 6, 50, 51 AND 52).

DAWN FELDMAN, EXAMINING ATTORNEY

SN 79-004,754. ALFA-PARF ITALIA S.R.L., ITALY, FILED 4-16-2004.

**hair
+ power**
NANO-TECH SOLUTIONS

PRIORITY DATE OF 1-20-2004 IS CLAIMED.
OWNER OF INTERNATIONAL REGISTRATION 0831668
DATED 4-16-2004, EXPIRES 4-16-2014.

NO CLAIM IS MADE TO THE EXCLUSIVE RIGHT TO USE NANOTECH, APART FROM THE MARK AS SHOWN.

THE TRADEMARK CONSISTS OF THE FANCIFUL WORDING "HAIR POWER" PLACED ON TWO LINES IN ORIGINAL LOWER CASE PRINTING CHARACTERS PARTICULARLY STYLIZED; UNDER THIS WORDING, APPEARS THE WORDING NANO-TECH SOLUTIONS; PLACED BETWEEN THE ABOVE MENTIONED WORDINGS, IS AN HORIZONTAL LINE WHICH AT THE BEGINNING INTERSECTS A PERPENDICULAR SEGMENT OF REDUCED LENGTH.

FOR HAIR COSMETICS, NAMELY, SHAMPOOS, HAIR GELS, HAIR LOTIONS, NOURISHING HAIR BALSAMS, HAIR LACQUERS, HAIR DYES, HAIR COLOR, HAIR BLEACHING PREPARATIONS, HAIR WAVING LOTION, HAIR STYLING PREPARATIONS AND ESSENTIAL OILS FOR PERSONAL USE (U.S. CLS. 1, 4, 6, 50, 51 AND 52).

JOHN LINCOSKI, EXAMINING ATTORNEY

CLASS 3—(Continued).

SN 79-005,038. COTY B.V., NETHERLANDS, FILED 8-25-2004.

VOLUME FLASH

THE MARK CONSISTS OF STANDARD CHARACTERS WITHOUT CLAIM TO ANY PARTICULAR FONT, STYLE, SIZE, OR COLOR.

PRIORITY DATE OF 2-26-2004 IS CLAIMED.
OWNER OF INTERNATIONAL REGISTRATION 0832362
DATED 8-25-2004, EXPIRES 8-25-2014.

NO CLAIM IS MADE TO THE EXCLUSIVE RIGHT TO USE "VOLUME", APART FROM THE MARK AS SHOWN.

FOR SOAPS; PERFUMERY; ESSENTIAL OILS FOR PERSONAL USE; COSMETICS; HAIR LOTIONS (U.S. CLS. 1, 4, 6, 50, 51 AND 52).

TARAH HARDY, EXAMINING ATTORNEY

SN 79-005,358. GRANDSIRE JEAN-CHRISTOPHE, FRANCE, FILED 6-7-2004.

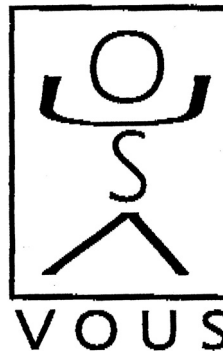

OWNER OF INTERNATIONAL REGISTRATION 0833425
DATED 6-7-2004, EXPIRES 6-7-2014.

THE DESIGN PORTION OF THE MARK CONSISTS OF A STYLIZED STICK-FIGURE DERIVED FROM LETTERS OF THE MARK WITHIN A BOX.

THE ENGLISH TRANSLATION OF THE WORD "VOUS" IN THE MARK IS "YOU".

FOR BODY CREAM SOAP, PERFUMERY GOODS NAMELY PERFUME OILS, ESSENTIAL OILS FOR PERSONAL USE (U.S. CLS. 1, 4, 6, 50, 51 AND 52).

LA TONIA FISHER, EXAMINING ATTORNEY

CLASS 3—(Continued).

SN 79-006,311. YVES SAINT LAURENT PARFUMS, FRANCE, FILED 4-13-2004.

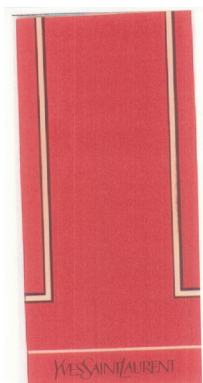

PRIORITY DATE OF 10-24-2003 IS CLAIMED.
OWNER OF INTERNATIONAL REGISTRATION 0835975 DATED 4-13-2004, EXPIRES 4-13-2014.

"YVES SAINT LAURENT" IS A LIVING INDIVIDUAL WHOSE CONSENT TO REGISTRATION IS OF RECORD.

THE COLORS PINK, GOLD AND BLACK ARE CLAIMED AS FEATURES OF THE MARK.

THE MARK CONSISTS OF A PINK RECTANGULAR BOX WITH THREE GOLD STRIPES. TWO OF THE GOLD STRIPES HAVE BLACK OUTLINES. THESE STRIPES ARE "L" SHAPED AND ARE LOCATED CLOSE TO THE SIDES OF THE RECTANGLE. THEY BEGIN AT THE TOP OF THE RECTANGLE AND RUN VERTICALLY DOWNWARD ABOUT THREE QUARTERS OF THE LENGTH OF THE RECTANGLE WHERE EACH STRIPE TURNS OUTWARD TO THE CLOSEST SIDE. THE THIRD GOLD STRIPE RUNS HORIZONTALLY ACROSS THE LOWER PART OF THE RECTANGLE, APPROXIMATELY ONE INCH FROM THE BOTTOM. BELOW THE THIRD STRIPE ARE THE WORDS "YVES SAINT LAURENT" IN BLACK LETTERS.

FOR PERFUMES, EAU-DE-TOILETTE, DEODORANTS FOR PERSONAL USE; ESSENTIAL OILS FOR PERSONAL USE; OILS FOR COSMETIC PURPOSES; SOAPS FOR PERSONAL USE; CLEANSING MILKS; COSMETICS; COSMETIC PRODUCTS FOR SKIN CARE NAMELY, BODY CREAMS AND BODY LOTIONS; BEAUTY MASKS; GEL FOR THE BATH, GEL FOR THE SHOWER; CREAMS AND LOTIONS FOR FACE AND BODY CARE PURPOSES; FOUNDATIONS, BLUSHERS, MAKE-UP POWDERS; COSMETIC PENCILS; LIPSTICKS; HAIR LOTIONS; SHAMPOOS (U.S. CLS. 1, 4, 6, 50, 51 AND 52).

DAVID MURRAY, EXAMINING ATTORNEY

CLASS 3—(Continued).

SN 79-007,064. ANTONIO PUIG, S.A., SPAIN, FILED 8-10-2004.

ANTONIO

THE MARK CONSISTS OF STANDARD CHARACTERS WITHOUT CLAIM TO ANY PARTICULAR FONT, STYLE, SIZE, OR COLOR.

PRIORITY DATE OF 2-26-2004 IS CLAIMED.

OWNER OF INTERNATIONAL REGISTRATION 0838206 DATED 8-10-2004, EXPIRES 8-10-2014.

FOR SUBSTANCES FOR LAUNDRY USE, NAMELY, BLEACHING PREPARATIONS AND LAUNDRY DETERGENT; CLEANING, POLISHING, SCOURING AND ABRASIVE LIQUID AND POWDER PREPARATIONS FOR HOUSEHOLD USE; SOAPS; PERFUMERY, ESSENTIAL OILS FOR PERSONAL USE; COSMETICS; HAIR LOTIONS; DENTIFRICES. (U.S. CLS. 1, 4, 6, 50, 51 AND 52).

LAURA KOVAISKY, EXAMINING ATTORNEY

CLASS 4—LUBRICANTS AND FUELS

SN 76-554,751. LE GROUPE FRUITS & PASSION INC./ THE FRUITS & PASSION GROUP INC., CANDIAC, QUÉBEC, CANADA, FILED 10-28-2003.

INFLUENCE

Fruits & Passion

PRIORITY CLAIMED UNDER SEC. 44(D) ON CANADA APPLICATION NO. 1186535, FILED 8-1-2003, REG. NO. TMA618,364, DATED 9-1-2004, EXPIRES 9-1-2019.

OWNER OF U.S. REG. NOS. 2,097,957 AND 2,175,134.

FOR CANDLES (U.S. CLS. 1, 6 AND 15).

CHARLES JOYNER, EXAMINING ATTORNEY

SN 76-579,665. INERGY GAS, LLC, KANSAS CITY, MO. FILED 3-8-2004.

PEARL GAS

THE MARK CONSISTS OF STANDARD CHARACTERS WITHOUT CLAIM TO ANY PARTICULAR FONT, STYLE, SIZE, OR COLOR.

NO CLAIM IS MADE TO THE EXCLUSIVE RIGHT TO USE GAS, APART FROM THE MARK AS SHOWN.

FOR LIQUID PROPANE GAS FOR USE WITH GAS APPLIANCES (U.S. CLS. 1, 6 AND 15).

FIRST USE 12-31-1980; IN COMMERCE 12-31-1980.

NICHOLAS ALTREE, EXAMINING ATTORNEY

CLASS 4—(Continued).

SN 76-587,079. RHONDA BERGEMANN, DBA SPECIAL & GIFTED, HOUSTON, TX. FILED 4-14-2004.



THE COLORS BLUE AND ORANGE ARE CLAIMED AS A FEATURE OF THE MARK.

THE WORDING WAXOLOGY IS THE COLOR BLUE AND THE PERPENDICULAR LINES ARE THE COLOR ORANGE. FOR CANDLES (U.S. CLS. 1, 6 AND 15). FIRST USE 11-1-2003; IN COMMERCE 11-1-2003. STACY WAHLBERG, EXAMINING ATTORNEY

SN 76-619,807. COOL AIR MECHANICAL, INC., ST. PAUL, MN. FILED 11-8-2004.

CAMCO

THE MARK CONSISTS OF STANDARD CHARACTERS WITHOUT CLAIM TO ANY PARTICULAR FONT, STYLE, SIZE, OR COLOR.

OWNER OF U.S. REG. NO. 2,270,576. FOR FOOD GRADE OILS FOR THE LUBRICATION OF MACHINERY USED TO PRODUCE, PROCESS, PACKAGE AND/OR TRANSPORT FOOD (U.S. CLS. 1, 6 AND 15).

FIRST USE 6-23-1987; IN COMMERCE 6-23-1987. TRICIA SONNEBORN, EXAMINING ATTORNEY

SN 76-620,951. TRUCO ENTERPRISES, INC., DALLAS, TX. FILED 11-17-2004.

GREEN LITE

THE MARK CONSISTS OF STANDARD CHARACTERS WITHOUT CLAIM TO ANY PARTICULAR FONT, STYLE, SIZE, OR COLOR.

FOR FIRE STARTERS (U.S. CLS. 1, 6 AND 15). SHARON MEIER, EXAMINING ATTORNEY

CLASS 4—(Continued).

SN 76-626,570. UNITED OIL COMPANY, INC., BALTIMORE, MD. FILED 12-30-2004.



OWNER OF U.S. REG. NO. 2,758,429. NO CLAIM IS MADE TO THE EXCLUSIVE RIGHT TO USE "HEAVY DUTY LUBRICANTS, HEAVY DUTY SERVICE.", APART FROM THE MARK AS SHOWN.

FOR LUBRICATING OILS AND GREASES FOR AUTOMOBILES AND INDUSTRIAL MACHINERY AND EQUIPMENT (U.S. CLS. 1, 6 AND 15).

EDWARD NELSON, EXAMINING ATTORNEY

SN 78-312,426. S-OIL CORPORATION, SEOUL, REPUBLIC OF KOREA, FILED 10-10-2003.

Ultra-S

THE MARK CONSISTS OF STANDARD CHARACTERS WITHOUT CLAIM TO ANY PARTICULAR FONT, STYLE, SIZE, OR COLOR.

PRIORITY CLAIMED UNDER SEC. 44(D) ON REPUBLIC OF KOREA APPLICATION NO. 0028895, FILED 6-26-2003, REG. NO. 0594394, DATED 9-30-2004, EXPIRES 9-30-2014.

FOR ALL-PURPOSE LUBRICANTS, NAMELY, BASE OILS TO BE FORMULATED WITH ADDITIVE PACKAGES TO FORM ENGINE LUBRICANTS, NOT INCLUDING FUEL, GASOLINE OR DIESEL OIL; AND BASE OILS TO BE FORMULATED WITH ADDITIVE PACKAGES FOR USE AS AN INDUSTRIAL LUBRICANT (U.S. CLS. 1, 6 AND 15).

ANDREW BENZMILLER, EXAMINING ATTORNEY

CLASS 4—(Continued).

SN 78-331,028. PENHALIGON'S LIMITED, LONDON, UNITED KINGDOM, FILED 11-20-2003.

ROYAL PALM

THE MARK CONSISTS OF STANDARD CHARACTERS WITHOUT CLAIM TO ANY PARTICULAR FONT, STYLE, SIZE, OR COLOR.

PRIORITY CLAIMED UNDER SEC. 44(D) ON UNITED KINGDOM APPLICATION NO. 2332706, FILED 5-20-2003, REG. NO. 2332706, DATED 9-24-2004, EXPIRES 5-20-2013.

FOR CANDLES; SCENTED CANDLES; MUSK SCENTED CANDLES; SCENTED TEA LIGHTS (U.S. CLS. 1, 6 AND 15).

TOMAS V. VLCEK, EXAMINING ATTORNEY

SN 78-331,034. PENHALIGON'S LIMITED, LONDON, UNITED KINGDOM, FILED 11-20-2003.

MINARET

THE MARK CONSISTS OF STANDARD CHARACTERS WITHOUT CLAIM TO ANY PARTICULAR FONT, STYLE, SIZE, OR COLOR.

PRIORITY CLAIMED UNDER SEC. 44(D) ON UNITED KINGDOM APPLICATION NO. 2332705, FILED 5-20-2003, REG. NO. 2332705, DATED 9-24-2004, EXPIRES 5-20-2013.

FOR CANDLES; SCENTED CANDLES; MUSK SCENTED CANDLES; SCENTED TEA LIGHTS (U.S. CLS. 1, 6 AND 15).

TOMAS V. VLCEK, EXAMINING ATTORNEY

CLASS 4—(Continued).

SN 78-409,766. GLENVEIGH LIMITED, ROADTOWN, TORTOLA, BR. VIRGIN ISLANDS, FILED 4-28-2004.

FASTEX

THE MARK CONSISTS OF STANDARD CHARACTERS WITHOUT CLAIM TO ANY PARTICULAR FONT, STYLE, SIZE, OR COLOR.

FOR ALL PURPOSE METAL LUBRICANTS, NAMELY, SURFACE MODIFIERS; INDUSTRIAL METAL LUBRICANTS, NAMELY, SURFACE MODIFIERS; GENERAL PURPOSE GREASES; GENERAL PURPOSE LUBRICATING AND PENETRATING OILS; INDUSTRIAL GREASES AND OILS; INDUSTRIAL LUBRICANTS; ALL PURPOSE LUBRICANTS; AUTOMOBILE LUBRICANTS; LUBRICATING OILS AND GREASES FOR BULLETS, GUNS AND FIREARMS; BLENDED INDUSTRIAL OILS, GREASES AND INDUSTRIAL LUBRICANTS, BLENDED ALL PURPOSE LUBRICANTS, BLENDED AUTOMOBILE LUBRICANTS, ALL CONTAINING SURFACE MODIFIER ADDITIVES; LUBRICATING OILS AND GREASES FOR PLANT, MACHINERY AND EQUIPMENT; HYDRAULIC OILS; (BASED ON INTENT TO USE) LUBRICANTS, OILS AND GREASES FOR PLANT AND MACHINERY UTILIZED IN THE PHARMACEUTICAL, FOOD AND BEVERAGE MANUFACTURING, PROCESSING, STORING AND PACKAGING INDUSTRIES (U.S. CLS. 1, 6 AND 15).

FIRST USE 4-0-1998; IN COMMERCE 4-0-1998.
G. MAYERSCHOFF, EXAMINING ATTORNEY

SN 78-442,242. EMPIRE CANDLE MANUFACTURING LLC, KANSAS CITY, KS. FILED 6-28-2004.

TEXTURE SCENTS

THE MARK CONSISTS OF STANDARD CHARACTERS WITHOUT CLAIM TO ANY PARTICULAR FONT, STYLE, SIZE, OR COLOR.

NO CLAIM IS MADE TO THE EXCLUSIVE RIGHT TO USE "SCENTS", APART FROM THE MARK AS SHOWN. FOR CANDLES (U.S. CLS. 1, 6 AND 15).

VERNA BETH RIRIE, EXAMINING ATTORNEY

CLASS 4—(Continued).

SN 78-444,006. BLUE SOURCE, LLC, SALT LAKE CITY, UT. FILED 6-30-2004.

Low Carb

THE MARK CONSISTS OF STANDARD CHARACTERS WITHOUT CLAIM TO ANY PARTICULAR FONT, STYLE, SIZE, OR COLOR.

FOR UNLEADED GASOLINE AVAILABLE VIA RETAIL OUTLETS AND WHOLESALE DISTRIBUTION OF WHICH THE GREENHOUSE GAS EMISSIONS ASSOCIATED WITH THE PRODUCTION, REFINING, DISTRIBUTION, OR CONSUMPTION OF A SIMILAR VOLUME OF GASOLINE HAVE BEEN OFFSET THROUGH A PROGRAM THAT PURCHASES GREENHOUSE GAS EMISSION REDUCTION RIGHTS OR OFFSETS IN ORDER TO REDUCE OR ELIMINATE THE CLIMATE CHANGE IMPACT OF THE PRODUCTION, REFINING, DISTRIBUTION OR CONSUMPTION OF A SIMILAR UNIT VOLUME OF GASOLINE (U.S. CLS. 1, 6 AND 15).
EUGENIA MARTIN, EXAMINING ATTORNEY

SN 78-455,060. AMSOIL INC., SUPERIOR, WI. FILED 7-22-2004.

SEVERE GEAR

THE MARK CONSISTS OF STANDARD CHARACTERS WITHOUT CLAIM TO ANY PARTICULAR FONT, STYLE, SIZE, OR COLOR.

NO CLAIM IS MADE TO THE EXCLUSIVE RIGHT TO USE "GEAR", APART FROM THE MARK AS SHOWN. FOR GEAR OIL; MOTOR OIL (U.S. CLS. 1, 6 AND 15).
MONTIA G. PRESSEY, EXAMINING ATTORNEY

CLASS 4—(Continued).

SN 78-475,650. YANKEE CANDLE COMPANY, INC., THE, SOUTH DEERFIELD, MA. FILED 8-30-2004.

SPLASH OF RAIN

THE MARK CONSISTS OF STANDARD CHARACTERS WITHOUT CLAIM TO ANY PARTICULAR FONT, STYLE, SIZE, OR COLOR.

FOR CANDLES; FRAGRANT WAX FOR USE IN POTPOURRI BURNERS (U.S. CLS. 1, 6 AND 15).
FIRST USE 11-29-2004; IN COMMERCE 11-29-2004.
ADA HAN, EXAMINING ATTORNEY

SN 78-487,277. CHEVRON CORPORATION, SAN RAMON, CA. FILED 9-21-2004.

REGULAR
WITH **TECHRON**

OWNER OF U.S. REG. NO. 1,612,515.
NO CLAIM IS MADE TO THE EXCLUSIVE RIGHT TO USE "REGULAR", APART FROM THE MARK AS SHOWN.

THE MARK CONSISTS OF STYLIZED WORDS "REGULAR WITH TECHRON". THE HORIZONTAL LINE IN THE "H" IN THE WORD TECHRON CONSISTS OF A THICK ROUNDED LINE.
FOR FUEL AND GASOLINE (U.S. CLS. 1, 6 AND 15).
FIRST USE 12-31-1994; IN COMMERCE 12-31-1994.
REBECCA SMITH, EXAMINING ATTORNEY

SN 78-488,593. CHEVRON CORPORATION, SAN RAMON, CA. FILED 9-23-2004.

Supreme
with **TECHRON**

OWNER OF U.S. REG. NO. 1,612,515.
NO CLAIM IS MADE TO THE EXCLUSIVE RIGHT TO USE SUPREME, APART FROM THE MARK AS SHOWN.

THE MARK CONSISTS OF STYLIZED WORDS "SUPREME WITH TECHRON". THE HORIZONTAL LINE IN THE "H" IN THE WORD TECHRON CONSISTS OF A THICK ROUNDED LINE.
FOR FUEL, NAMELY GASOLINE (U.S. CLS. 1, 6 AND 15).
FIRST USE 12-31-1994; IN COMMERCE 12-31-1994.
LINDA POWELL, EXAMINING ATTORNEY

CLASS 4—(Continued).

SN 78-521,561. DIRT CHEAP, INC., DBA DCI, TAPPAN, NY.
FILED 11-23-2004.

PERFECT FLAME

THE MARK CONSISTS OF STANDARD CHARACTERS
WITHOUT CLAIM TO ANY PARTICULAR FONT, STYLE,
SIZE, OR COLOR.

FOR ARTIFICIAL FIRE LOGS (U.S. CLS. 1, 6 AND 15).
JULIE GUTTADAURO, EXAMINING ATTORNEY

SN 78-541,408. THE YANKEE CANDLE COMPANY, INC.,
SOUTH DEERFIELD, MA. FILED 1-3-2005.

COTTAGE BREEZE

THE MARK CONSISTS OF STANDARD CHARACTERS
WITHOUT CLAIM TO ANY PARTICULAR FONT, STYLE,
SIZE, OR COLOR.

FOR CANDLES; FRAGRANT WAX FOR USE IN
POTPOURRI BURNERS (U.S. CLS. 1, 6 AND 15).
ALICIA COLLINS, EXAMINING ATTORNEY

SN 78-543,662. KABBALAH CENTRE INTERNATIONAL,
INC., LOS ANGELES, CA. FILED 1-7-2005.

KABBALAH

THE MARK CONSISTS OF STANDARD CHARACTERS
WITHOUT CLAIM TO ANY PARTICULAR FONT, STYLE,
SIZE, OR COLOR.

OWNER OF U.S. REG. NOS. 2,381,449, 2,499,273 AND
OTHERS.
FOR CANDLES (U.S. CLS. 1, 6 AND 15).
FIRST USE 8-0-2004; IN COMMERCE 8-0-2004.
MICHAEL KAZAZIAN, EXAMINING ATTORNEY

CLASS 5—PHARMACEUTICALS

SN 75-641,680. DRAXIMAGE INC., QUEBEC, CANADA,
FILED 2-16-1999.

DRAXIMAGE

PRIORITY CLAIMED UNDER SEC. 44(D) ON CANADA
APPLICATION NO. 1001994, FILED 1-14-1999, REG. NO.
924926, DATED 11-8-2004, EXPIRES 11-8-2019.

FOR DIAGNOSTIC AND THERAPEUTIC PRODUCTS;
NAMELY, RADIOPHARMACEUTICAL PREPARATIONS
INTENDED FOR THE DIAGNOSIS AND THERAPY OF
ORGANS AND TISSUES (U.S. CLS. 6, 18, 44, 46, 51 AND
52).

FIRST USE 2-0-1998; IN COMMERCE 2-0-1998.
KELLEY WELLS, EXAMINING ATTORNEY

SN 76-006,368. ASTRAZENECA UK LIMITED, LONDON
W1Y 6LN, ENGLAND, FILED 3-21-2000.

ZUVAMOR

OWNER OF UNITED KINGDOM REG. NO. 2225390,
DATED 3-10-2000, EXPIRES 3-10-2010.

FOR PHARMACEUTICAL PREPARATIONS AND SUB-
STANCES FOR THE PREVENTION AND TREATMENT
OF DISEASES AND DISORDERS OF THE RESPIRA-
TORY SYSTEM, CENTRAL NERVOUS SYSTEM, PERI-
PHERAL NERVOUS SYSTEM; CARDIOVASCULAR
SYSTEM, GASTRO-INTESTINAL SYSTEM; PHARMA-
CEUTICAL PREPARATIONS AND SUBSTANCES FOR
USE IN PAIN CONTROL, ANESTHESIA, ONCOLOGY,
INFECTION, INFLAMMATION, UROLOGY, GYNAE-
COLOGY; PHARMACEUTICAL PREPARATIONS AND
SUBSTANCES FOR THE TREATMENT AND PREVEN-
TION OF DIABETES (U.S. CLS. 6, 18, 44, 46, 51 AND 52).
JOHN DALIER, EXAMINING ATTORNEY

SN 76-090,908. ALTANA PHARMA AG, KONSTANZ, FED
REP GERMANY, FILED 7-17-2000.

MONAIRE

OWNER OF FED REP GERMANY REG. NO. 30053923,
DATED 3-30-2001, EXPIRES 3-31-2010.

FOR PHARMACEUTICAL PREPARATION FOR THE
TREATMENT OF RESPIRATORY DISEASES (U.S. CLS.
6, 18, 44, 46, 51 AND 52).

KAREN K. BUSH, EXAMINING ATTORNEY

CLASS 5—(Continued).

SN 76-111,496. ALTANA PHARMA AG, 78467 KONSTANZ, DE. FILED 8-16-2000.

QUORIO

OWNER OF FED REP GERMANY REG. NO. 30061380, DATED 11-22-2000, EXPIRES 8-31-2010.

FOR PHARMACEUTICAL PREPARATIONS FOR THE TREATMENT OF GASTROINTESTINAL, RESPIRATORY AND INFLAMMATORY DISEASES (U.S. CLS. 6, 18, 44, 46, 51 AND 52).

CURTIS FRENCH, EXAMINING ATTORNEY

CLASS 5—(Continued).

SN 76-519,568. WILLIAMS, CHAD E., YOUNGSTOWN, OH. FILED 6-4-2003.

NITRIC-X 02

NO CLAIM IS MADE TO THE EXCLUSIVE RIGHT TO USE "O2", APART FROM THE MARK AS SHOWN.

FOR NUTRITIONAL SUPPLEMENTS (U.S. CLS. 6, 18, 44, 46, 51 AND 52).

FIRST USE 4-28-2003; IN COMMERCE 4-28-2003.
BARNEY CHARLON, EXAMINING ATTORNEY

SN 76-283,444. GLAXOSMITHKLINE BIOLOGICALS S.A., RIXENSART, BELGIUM, FILED 7-11-2001.

FLUARIX

OWNER OF BENELUX REG. NO. 0530412, DATED 6-11-1993, EXPIRES 6-11-2013.

FOR VACCINES FOR HUMAN USE (U.S. CLS. 6, 18, 44, 46, 51 AND 52).

JEFF DEFORD, EXAMINING ATTORNEY

V-22

SN 76-505,660. FAR EAST BIO-TEC. CO., LTD., TAIPEI 110, TAIWAN, FILED 4-9-2003.

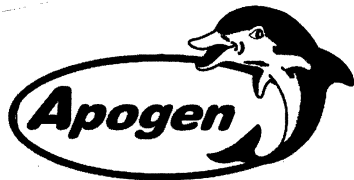

FOR DIETARY FOOD SUPPLEMENTS; NUTRITIONAL AND DIETARY FOOD SUPPLEMENTS; INGREDIENTS FOR NUTRITIONAL AND DIETARY FOOD SUPPLEMENTS, NAMELY, PROTEIN EXTRACTS FROM SPIRULINA (U.S. CLS. 6, 18, 44, 46, 51 AND 52).

EUGENIA MARTIN, EXAMINING ATTORNEY

SN 76-564,695. RANCH-WAY, INC., FORT COLLINS, CO. FILED 12-11-2003.

THE MARK CONSISTS OF STANDARD CHARACTERS WITHOUT CLAIM TO ANY PARTICULAR FONT, STYLE, SIZE, OR COLOR.

FOR VITAMIN FORTIFIED SUPPLEMENT USED IN FEEDS FOR CATTLE AND SHEEP (U.S. CLS. 6, 18, 44, 46, 51 AND 52).

FIRST USE 3-24-1949; IN COMMERCE 3-24-1949.
GINNY ISAACSON, EXAMINING ATTORNEY

SN 76-568,996. BAVARIAN NORDIC A/S, DK-3490 KVISTGAARD, DENMARK, FILED 1-9-2004.

IMVACTRA

SN 76-515,597. HEALTHCARE LABORATORIES, LLC, OREM, UT. FILED 5-20-2003.

SLIM-CARE

FOR NON-PRESCRIPTION PHARMACEUTICAL PREPARATIONS; NAMELY, APPETITE CONTROL SUPPRESSANTS AND DIETARY SUPPLEMENT AND NUTRITIONAL SUPPLEMENTS (U.S. CLS. 6, 18, 44, 46, 51 AND 52).

FIRST USE 10-20-1992; IN COMMERCE 10-20-1992.
STEVEN R. FINE, EXAMINING ATTORNEY

THE MARK CONSISTS OF STANDARD CHARACTERS WITHOUT CLAIM TO ANY PARTICULAR FONT, STYLE, SIZE, OR COLOR.

FOR PREPARATIONS FOR HUMAN AND VETERINARY USE, NAMELY FOR TREATMENT OF DISEASE INDUCED BY POXVIRUSES, SUCH AS SMALLPOX, EXCLUDING PREPARATIONS FOR POULTRY; VACCINES FOR HUMAN AND VETERINARY USE, NAMELY FOR PREVENTION OF DISEASE INDUCED BY POXVIRUSES, SUCH AS SMALLPOX EXCLUDING VACCINES FOR POULTRY (U.S. CLS. 6, 18, 44, 46, 51 AND 52).

ROBERT COGGINS, EXAMINING ATTORNEY

CLASS 5—(Continued).

SN 76-569,980. VITAPHARM INTERNATIONAL INC., JERSEY CITY, NJ. FILED 1-14-2004.



NO CLAIM IS MADE TO THE EXCLUSIVE RIGHT TO USE THE FOREIGN CHARACTERS WHICH TRANSLATE TO MEAN 'BRAND' AND THE ENGLISH WORD 'BRAND', APART FROM THE MARK AS SHOWN.

THE FOREIGN WORDING, IN THE MARK MAY BE TRANSLATED AS XIAN HE PAI, WHICH MEANS STORK BRAND.

FOR HERBAL SUPPLEMENTS (U.S. CLS. 6, 18, 44, 46, 51 AND 52).

FIRST USE 10-0-2001; IN COMMERCE 10-0-2001.
STEVEN JACKSON, EXAMINING ATTORNEY

SN 76-571,645. SOPHARMA AD, SOFIA, BULGARIA, FILED 1-23-2004.



OWNER OF BULGARIA REG. NO. 18887, DATED 6-3-1992, EXPIRES 3-13-2012.

FOR PHARMACEUTICAL PREPARATIONS, NAMELY, PREPARATIONS FOR TREATMENT OF PERIPHERAL NEURITIS AND NEURALGIA AND TREATMENT OF NEUROLOGICAL DISORDERS, PHYSICAL AND MENTAL FATIGUE; TONICS FOR THE NERVOUS SYSTEM; CAPILLARTONICS; ANTI-INFLAMMATORY PREPARATIONS AND PREPARATIONS FOR TREATMENT OF ARTERY, VEIN AND CAPILLARY DISEASES; NUTRITIONAL SUPPLEMENTS FOR IMPROVING AND REGULATING METABOLISM IN EPITHELIAL CELLS TO PROTECT THEM FROM DEGENERATIVE ALTERATIONS; NUTRITIONAL SUPPLEMENTS FOR ENHANCING AND MAINTAINING THE STATUS OF THE IMMUNE SYSTEM; NUTRITIONAL SUPPLEMENTS FOR INFLUENCING CHRONIC HEPATITIS, DYSTROPHIES AND DAMAGE OF THE LIVER; DIETETIC SUBSTANCES ADAPTED FOR MEDICAL USE (U.S. CLS. 6, 18, 44, 46, 51 AND 52).

FIRST USE 6-3-1993; IN COMMERCE 6-3-1993.
ANNE MADDEN, EXAMINING ATTORNEY

CLASS 5—(Continued).

SN 76-576,925. HERO NUTRITIONAL PRODUCTS, L.L.C., SAN CLEMENTE, CA. FILED 1-15-2004.

ENVITA LABORATORIES

THE MARK CONSISTS OF STANDARD CHARACTERS WITHOUT CLAIM TO ANY PARTICULAR FONT, STYLE, SIZE, OR COLOR.

NO CLAIM IS MADE TO THE EXCLUSIVE RIGHT TO USE "LABORATORIES", APART FROM THE MARK AS SHOWN.

FOR HOUSE MARK FOR A LINE OF MULTI-VITAMINS, NUTRACEUTICALS AND HOMEOPATHIC PHARMACEUTICAL PREPARATIONS AND SUPPLEMENTS (U.S. CLS. 6, 18, 44, 46, 51 AND 52).

DANIEL CAPSHAW, EXAMINING ATTORNEY

SN 76-581,960. MEZA BIOTECH, REDONDO BEACH, CA. FILED 3-19-2004.

SILDENAFLEX

THE MARK CONSISTS OF STANDARD CHARACTERS WITHOUT CLAIM TO ANY PARTICULAR FONT, STYLE, SIZE, OR COLOR.

FOR NUTRITIONAL SUPPLEMENT FOR ENHANCING MALE SEXUAL PERFORMANCE (U.S. CLS. 6, 18, 44, 46, 51 AND 52).

FIRST USE 2-0-2004; IN COMMERCE 2-0-2004.
NICHOLAS ALTREE, EXAMINING ATTORNEY

SN 76-587,058. ADVANCE MARKETING PLUS CORP., MIRAMAR, FL. FILED 4-16-2004.

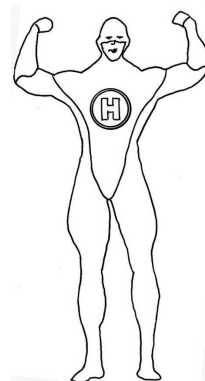

FOR ANTIFUNGAL PREPARATION (U.S. CLS. 6, 18, 44, 46, 51 AND 52).

FIRST USE 2-0-2002; IN COMMERCE 2-0-2002.
AMY HELLA, EXAMINING ATTORNEY

CLASS 5—(Continued).

SN 76-594,876. LAI YUNG SHANG SUNG FEN TANG LTD.,
WANCHAL, HONG KONG, FILED 6-1-2004.

雷允上

THE CHINESE CHARACTERS IN THE MARK TRANSLITERATE TO "LAI YUNG SHANG," WHICH IS THE NAME OF A DECEASED INDIVIDUAL.

FOR HEALTH FOOD SUPPLEMENTS AND NUTRITIONAL SUPPLEMENTS (U.S. CLS. 6, 18, 44, 46, 51 AND 52).

FIRST USE 4-15-2004; IN COMMERCE 5-1-2004.
ALICE SUE CARRUTHERS, EXAMINING ATTORNEY

SN 76-594,877. LAI YUNG SHANG SUNG FEN TANG LTD.,
WANCHAL, HONG KONG, FILED 6-1-2004.

誦芬堂

THE CHINESE CHARACTERS IN THE MARK TRANSLITERATE TO "SUNG FEN TANG," WHICH IS THE NAME OF A PLACE AND HAS NO ENGLISH TRANSLATION.

FOR HEALTH FOOD SUPPLEMENTS AND NUTRITIONAL SUPPLEMENTS (U.S. CLS. 6, 18, 44, 46, 51 AND 52).

FIRST USE 4-15-2004; IN COMMERCE 5-1-2004.
ALICE SUE CARRUTHERS, EXAMINING ATTORNEY

SN 76-596,678. OSTEOTECH, INC., EATONTOWN, NJ. FILED
6-10-2004.

GRAFTCAGE

THE MARK CONSISTS OF STANDARD CHARACTERS WITHOUT CLAIM TO ANY PARTICULAR FONT, STYLE, SIZE, OR COLOR.

FOR ARTIFICIAL SURGICAL SPINAL IMPLANTS (U.S. CLS. 6, 18, 44, 46, 51 AND 52).

MARGERÝ A. TIERNEY, EXAMINING ATTORNEY

CLASS 5—(Continued).

SN 76-597,193. C.B. FLEET INVESTMENT CORPORATION,
WILMINGTON, DE. FILED 6-14-2004.

DILUTION SOLUTION

THE MARK CONSISTS OF STANDARD CHARACTERS WITHOUT CLAIM TO ANY PARTICULAR FONT, STYLE, SIZE, OR COLOR.

FOR ORAL SOLUTION FOR USE AS A LAXATIVE AND PURGATIVE FOR TREATMENT OF CONSTIPATION AND FOR BOWEL CLEANSING (U.S. CLS. 6, 18, 44, 46, 51 AND 52).

H. M. FISHER, EXAMINING ATTORNEY

SN 76-599,392. LABELCLICK, INC., OLDSMAR, FL. FILED 6-24-2004.

EARNING YOUR TRUST ONE**PRODUCT AT A TIME**

THE MARK CONSISTS OF STANDARD CHARACTERS WITHOUT CLAIM TO ANY PARTICULAR FONT, STYLE, SIZE, OR COLOR.

FOR NUTRITIONAL SUPPLEMENTS FOR PETS AND CLINICAL PRODUCTS USED TO ADDRESS ARTHRITIS, ALLERGIES, HIP DYSPLASIA, IMMUNE FUNCTION, MUSCLE DEVELOPMENT, SKIN CARE AND THE GENERAL HEALTH AND WELL-BEING OF PETS (U.S. CLS. 6, 18, 44, 46, 51 AND 52).

GIANCARLO CASTRO, EXAMINING ATTORNEY

SN 76-600,506. NOVO NORDISK A/S, DK-2880 BAGSVAERD,
DENMARK, FILED 7-2-2004.

BRENLION

THE MARK CONSISTS OF STANDARD CHARACTERS WITHOUT CLAIM TO ANY PARTICULAR FONT, STYLE, SIZE, OR COLOR.

OWNER OF DENMARK REG. NO. VR200203169, DATED 9-12-2002, EXPIRES 9-12-2012.

FOR PHARMACEUTICAL PREPARATIONS AND SUBSTANCES, NAMELY ANTIDIABETICS (U.S. CLS. 6, 18, 44, 46, 51 AND 52).

ALICIA COLLINS, EXAMINING ATTORNEY

CLASS 5—(Continued).

SN 76-600,591. NOVAVAX, INC., MALVERN, PA. FILED 7-2-2004.

PROSTERISORB

THE MARK CONSISTS OF STANDARD CHARACTERS WITHOUT CLAIM TO ANY PARTICULAR FONT, STYLE, SIZE, OR COLOR.

FOR PHARMACEUTICAL PREPARATIONS FOR THE TREATMENT OF HORMONE IMBALANCE (U.S. CLS. 6, 18, 44, 46, 51 AND 52).

MARGERY A. TIERNEY, EXAMINING ATTORNEY

SN 76-611,772. COVEX FARMA, S.L., (MADRID), SPAIN, FILED 9-16-2004.

MEMOLEAD

THE MARK CONSISTS OF STANDARD CHARACTERS WITHOUT CLAIM TO ANY PARTICULAR FONT, STYLE, SIZE, OR COLOR.

OWNER OF U.S. REG. NOS. 2,834,410, 2,877,047 AND OTHERS.

FOR DIETARY FOOD AND DRINK SUPPLEMENTS FOR MEDICAL PURPOSES (U.S. CLS. 6, 18, 44, 46, 51 AND 52).

JOHN WILKE, EXAMINING ATTORNEY

SN 76-612,085. PEARSON, DURK, TONOPAH, NV. AND SHAW, SANDY, TONOPAH, NV. FILED 9-20-2004.

FIRST COURSE

THE MARK CONSISTS OF STANDARD CHARACTERS WITHOUT CLAIM TO ANY PARTICULAR FONT, STYLE, SIZE, OR COLOR.

FOR DIETARY SUPPLEMENTS (U.S. CLS. 6, 18, 44, 46, 51 AND 52).

FIRST USE 3-24-2000; IN COMMERCE 3-24-2000.

SANI KHOURI, EXAMINING ATTORNEY

CLASS 5—(Continued).

SN 76-612,809. AMERICAN BIO MEDICA, KINDERHOOK, NY. FILED 9-24-2004.



NO CLAIM IS MADE TO THE EXCLUSIVE RIGHT TO USE "AMERICAN", APART FROM THE MARK AS SHOWN.

THE COLORS BLUE AND LIGHT BLUE ARE CLAIMED AS A FEATURE OF THE MARK.

THE COLOR BLUE APPEARS IN THE LETTERS "A" AND "M" AND LIGHT BLUE APPEARS IN THE LETTERS "B" AND "C".

FOR IMMUNOASSAY DIAGNOSTIC TEST KITS FOR DETECTING THE PRESENCE OF DRUGS OF ABUSE IN SALIVA AND URINE SPECIMENS (U.S. CLS. 6, 18, 44, 46, 51 AND 52).

FIRST USE 8-5-2004; IN COMMERCE 8-5-2004.

MARGERY A. TIERNEY, EXAMINING ATTORNEY

SN 76-615,433. SUNSET HEALTH PRODUCTS, INC., LOS ANGELES, CA. FILED 10-12-2004.

HOLLYWOOD VITAMIRACLE 75

THE MARK CONSISTS OF STANDARD CHARACTERS WITHOUT CLAIM TO ANY PARTICULAR FONT, STYLE, SIZE, OR COLOR.

OWNER OF U.S. REG. NOS. 2,527,273 AND 2,617,578.

NO CLAIM IS MADE TO THE EXCLUSIVE RIGHT TO USE "HOLLYWOOD", APART FROM THE MARK AS SHOWN.

FOR VITAMIN AND MINERAL SUPPLEMENTS (U.S. CLS. 6, 18, 44, 46, 51 AND 52).

RAMONA ORTIGA, EXAMINING ATTORNEY

SN 76-615,553. AMERICAN BIO MEDICA, KINDERHOOK, NY. FILED 10-13-2004.

ORALSTAT

THE MARK CONSISTS OF STANDARD CHARACTERS WITHOUT CLAIM TO ANY PARTICULAR FONT, STYLE, SIZE, OR COLOR.

OWNER OF U.S. REG. NO. 2,609,651.

FOR IMMUNOASSAY DIAGNOSTIC TEST DEVICES CONTAINING REAGENT TEST STRIPS FOR DETECTING THE PRESENCE OF DRUGS OF ABUSE IN ORAL FLUIDS (U.S. CLS. 6, 18, 44, 46, 51 AND 52).

FIRST USE 7-2-2004; IN COMMERCE 7-2-2004.

LEIGH LOWRY, EXAMINING ATTORNEY

CLASS 5—(Continued).

SN 76-615,554. AMERICAN BIO MEDICA, KINDERHOOK, NY. FILED 10-13-2004.

AMERICAN BIO MEDICA

OWNER OF U.S. REG. NO. 2,468,886.
NO CLAIM IS MADE TO THE EXCLUSIVE RIGHT TO USE "AMERICAN", APART FROM THE MARK AS SHOWN, FOR IMMUNOASSAY DIAGNOSTIC TEST DEVICES CONTAINING REAGENT TEST STRIPS FOR DETECTING THE PRESENCE OF DRUGS OF ABUSE IN SALIVA AND URINE SPECIMENS (U.S. CLS. 6, 18, 44, 46, 51 AND 52).

FIRST USE 7-2-2004; IN COMMERCE 7-2-2004.
LEIGH LOWRY, EXAMINING ATTORNEY

SN 76-617,039. KRUGER, CHARLES, DES MOINES, WA. FILED 10-18-2004.

DR. KRUGER'S

THE MARK CONSISTS OF STANDARD CHARACTERS WITHOUT CLAIM TO ANY PARTICULAR FONT, STYLE, SIZE, OR COLOR.

THE NAME DR. KRUGER IDENTIFIES A LIVING INDIVIDUAL WHOSE CONSENT IS OF RECORD.

FOR FEED SUPPLEMENTS FOR PETS (U.S. CLS. 6, 18, 44, 46, 51 AND 52).

FIRST USE 11-30-1999; IN COMMERCE 11-30-1999.
KAREN BRACEY, EXAMINING ATTORNEY

SN 76-617,269. FUJISAWA PHARMACEUTICAL CO., LTD., CHUO-KU, OSAKA, JAPAN, FILED 10-21-2004.

XACROLIM

THE MARK CONSISTS OF STANDARD CHARACTERS WITHOUT CLAIM TO ANY PARTICULAR FONT, STYLE, SIZE, OR COLOR.

FOR DERMATOLOGICAL PREPARATIONS (U.S. CLS. 6, 18, 44, 46, 51 AND 52).

ELLEN B. AWRICH, EXAMINING ATTORNEY

CLASS 5—(Continued).

SN 76-620,273. CARTER-REED IP HOLDINGS, LLC, CARSON CITY, NV. FILED 11-12-2004.

RELACORE

THE MARK CONSISTS OF STANDARD CHARACTERS WITHOUT CLAIM TO ANY PARTICULAR FONT, STYLE, SIZE, OR COLOR.

OWNER OF U.S. REG. NOS. 2,702,840 AND 2,801,458.
FOR DIETARY SUPPLEMENT NAMELY FOR WEIGHT CONTROL AND OVERALL WELL-BEING (U.S. CLS. 6, 18, 44, 46, 51 AND 52).

FIRST USE 7-10-2002; IN COMMERCE 7-10-2002.
AMOS T. MATTHEWS, JR., EXAMINING ATTORNEY

SN 76-620,696. FIRST PRIORITY, ELGIN, IL. FILED 11-15-2004.

FIRST PRIORITY

THE MARK CONSISTS OF STANDARD CHARACTERS WITHOUT CLAIM TO ANY PARTICULAR FONT, STYLE, SIZE, OR COLOR.

FOR FULL LINE OF MEDICATED AND NON-MEDICATED PHARMACEUTICAL PREPARATIONS, BOTH PRESCRIPTION OVER-THE-COUNTER, FOR USE IN CONNECTION WITH ANIMAL SKIN CARE, SUPPLEMENTS, VITAMINS, AND MEDICINES FOR ANIMAL HEALTH CARE (U.S. CLS. 6, 18, 44, 46, 51 AND 52).

FIRST USE 4-30-1987; IN COMMERCE 4-30-1987.
WILLIAM VERHOSEK, EXAMINING ATTORNEY

SN 76-620,948. MERCK & CO., INC., WHITEHOUSE STATION, NJ. FILED 11-17-2004.

EFFICIB

THE MARK CONSISTS OF STANDARD CHARACTERS WITHOUT CLAIM TO ANY PARTICULAR FONT, STYLE, SIZE, OR COLOR.

FOR ANTI-INFLAMMATORY ANALGESICS; ANTI-INFECTIVES AND PHARMACEUTICAL PREPARATIONS FOR THE TREATMENT OF DIABETES AND CANCER (U.S. CLS. 6, 18, 44, 46, 51 AND 52).

SHARON MEIER, EXAMINING ATTORNEY

CLASS 5—(Continued).

SN 76-620,949. MERCK & CO., INC., WHITEHOUSE STATION, NJ. FILED 11-17-2004.

ENROTEC

THE MARK CONSISTS OF STANDARD CHARACTERS WITHOUT CLAIM TO ANY PARTICULAR FONT, STYLE, SIZE, OR COLOR.
FOR VACCINE PREPARATIONS (U.S. CLS. 6, 18, 44, 46, 51 AND 52).
SHARON MEIER, EXAMINING ATTORNEY

SN 76-620,999. ISAGENIX INTERNATIONAL, INC., PHOENIX, AZ. FILED 11-18-2004.

ISAMUNE

THE MARK CONSISTS OF STANDARD CHARACTERS WITHOUT CLAIM TO ANY PARTICULAR FONT, STYLE, SIZE, OR COLOR.
FOR NUTRITIONAL SUPPLEMENTS IN THE NATURE OF LIQUID COLOSTRUM IMMUNE SYSTEM ENHANCER (U.S. CLS. 6, 18, 44, 46, 51 AND 52).
ALLISON HOLTZ, EXAMINING ATTORNEY

SN 76-621,027. KROMAR MEDICAL CORPORATION, BIRMINGHAM, AL. FILED 11-17-2004.

WELLNESS GLUTATHIONE

THE MARK CONSISTS OF STANDARD CHARACTERS WITHOUT CLAIM TO ANY PARTICULAR FONT, STYLE, SIZE, OR COLOR.
NO CLAIM IS MADE TO THE EXCLUSIVE RIGHT TO USE "GLUTATHIONE", APART FROM THE MARK AS SHOWN.
FOR STABILIZED GLUTATHIONE PREPARATIONS; AN ANTIOXIDANT, NAMELY, STABILIZED GLUTATHIONE (U.S. CLS. 6, 18, 44, 46, 51 AND 52).
FIRST USE 4-15-1998; IN COMMERCE 4-15-1998.
SKYE YOUNG, EXAMINING ATTORNEY

CLASS 5—(Continued).

SN 76-621,044. PURE ENCAPSULATIONS, INC., SUDBURY, MA. FILED 11-17-2004.

OCULONUTRIENTS

THE MARK CONSISTS OF STANDARD CHARACTERS WITHOUT CLAIM TO ANY PARTICULAR FONT, STYLE, SIZE, OR COLOR.
FOR DIETARY SUPPLEMENTS (U.S. CLS. 6, 18, 44, 46, 51 AND 52).
FIRST USE 11-1-2004; IN COMMERCE 11-1-2004.
APRIL L. RADEMACHER, EXAMINING ATTORNEY

SN 76-621,172. ISAGENIX INTERNATIONAL, INC., PHOENIX, AZ. FILED 11-18-2004.

IONIX

THE MARK CONSISTS OF STANDARD CHARACTERS WITHOUT CLAIM TO ANY PARTICULAR FONT, STYLE, SIZE, OR COLOR.
FOR NUTRITIONAL SUPPLEMENTS CONTAINING TRACE MINERALS IN CAPSULE, POWDER AND LIQUID FORMS (U.S. CLS. 6, 18, 44, 46, 51 AND 52).
FIRST USE 6-1-2004; IN COMMERCE 6-1-2004.
DOMINIC J. FERRAIUOLO, EXAMINING ATTORNEY

SN 76-621,258. AUSPICIOUS GROUP, INC., CITY OF INDUSTRY, CA. FILED 11-19-2004.



THE STIPPLING ON THE DRAWING IS FOR SHADING PURPOSES ONLY.
FOR NUTRITIONAL SUPPLEMENTS (U.S. CLS. 6, 18, 44, 46, 51 AND 52).
BARBARA A. GOLD, EXAMINING ATTORNEY

CLASS 5—(Continued).

SN 76-621,439. GLOBAL NUTRITION, L.L.C., CROWLEY, LA. FILED 11-22-2004.

CLASS 5—(Continued).

SN 76-621,731. SOLAPHARM, INC., PLANTATION, FL. FILED 11-19-2004.

PERFORM - X

ACCU - B

THE MARK CONSISTS OF STANDARD CHARACTERS WITHOUT CLAIM TO ANY PARTICULAR FONT, STYLE, SIZE, OR COLOR.

FOR VITAMIN AND MINERAL DRY POWDER MIX FOR FORTIFIED JUICE AND BEVERAGES; POWDERED MULTI-VITAMIN PREMIX FOR USE IN LIQUIDS INCLUDING WATER (U.S. CLS. 6, 18, 44, 46, 51 AND 52).

MARGERY A. TIERNEY, EXAMINING ATTORNEY

THE MARK CONSISTS OF STANDARD CHARACTERS WITHOUT CLAIM TO ANY PARTICULAR FONT, STYLE, SIZE, OR COLOR.

FOR SEPARABLE PHARMACEUTICAL TABLETS FOR PREVENTING OR TREATING CONDITIONS, DISEASES OR DISORDERS OF THE CARDIOVASCULAR, CENTRAL NERVOUS SYSTEM, DERMATOLOGIC, ENDOCRINE, GASTRIC OR GASTROENTERIC, HEMATOLOGIC, IMMUNOLOGIC, INFLAMMATORY, OSTEOLOGIC, OR RESPIRATORY SYSTEMS; PHARMACEUTICAL PREPARATIONS FOR USE IN PREVENTION OR TREATMENT OF ALLERGIES OR ALLERGIC RESPONSES, METABOLIC DISORDERS, PSYCHIATRIC OR EMOTIONAL DISORDERS, INFECTION OR INFECTIOUS DISEASES (U.S. CLS. 6, 18, 44, 46, 51 AND 52).

RON FAIRBANKS, EXAMINING ATTORNEY

SN 76-621,730. SOLAPHARM, INC., PLANTATION, FL. FILED 11-19-2004.

SN 76-621,732. SOLAPHARM, INC., PLANTATION, FL. FILED 11-19-2004.

ACCU - A

ACCU - T

THE MARK CONSISTS OF STANDARD CHARACTERS WITHOUT CLAIM TO ANY PARTICULAR FONT, STYLE, SIZE, OR COLOR.

FOR SEPARABLE PHARMACEUTICAL TABLETS FOR PREVENTING OR TREATING CONDITIONS, DISEASES OR DISORDERS OF THE CARDIOVASCULAR, CENTRAL NERVOUS SYSTEM, DERMATOLOGIC, ENDOCRINE, GASTRIC OR GASTROENTERIC, HEMATOLOGIC, IMMUNOLOGIC, INFLAMMATORY, OSTEOLOGIC, OR RESPIRATORY SYSTEMS; PHARMACEUTICAL PREPARATIONS FOR USE IN PREVENTION OR TREATMENT OF ALLERGIES OR ALLERGIC RESPONSES, METABOLIC DISORDERS, PSYCHIATRIC OR EMOTIONAL DISORDERS, INFECTION OR INFECTIOUS DISEASES (U.S. CLS. 6, 18, 44, 46, 51 AND 52).

RON FAIRBANKS, EXAMINING ATTORNEY

THE MARK CONSISTS OF STANDARD CHARACTERS WITHOUT CLAIM TO ANY PARTICULAR FONT, STYLE, SIZE, OR COLOR.

FOR SEPARABLE PHARMACEUTICAL TABLETS FOR PREVENTING OR TREATING CONDITIONS, DISEASES OR DISORDERS OF THE CARDIOVASCULAR, CENTRAL NERVOUS SYSTEM, DERMATOLOGIC, ENDOCRINE, GASTRIC OR GASTROENTERIC, HEMATOLOGIC, IMMUNOLOGIC, INFLAMMATORY, OSTEOLOGIC, OR RESPIRATORY SYSTEMS; PHARMACEUTICAL PREPARATIONS FOR USE IN PREVENTION OR TREATMENT OF ALLERGIES OR ALLERGIC RESPONSES, METABOLIC DISORDERS, PSYCHIATRIC OR EMOTIONAL DISORDERS, INFECTION OR INFECTIOUS DISEASES (U.S. CLS. 6, 18, 44, 46, 51 AND 52).

RON FAIRBANKS, EXAMINING ATTORNEY

CLASS 5—(Continued).

SN 76-621,733. SOLAPHARM, INC., PLANTATION, FL.
FILED 11-19-2004.

ACCU-BREAK

THE MARK CONSISTS OF STANDARD CHARACTERS WITHOUT CLAIM TO ANY PARTICULAR FONT, STYLE, SIZE, OR COLOR.

FOR SEPARABLE PHARMACEUTICAL TABLETS FOR PREVENTING OR TREATING CONDITIONS, DISEASES OR DISORDERS OF THE CARDIOVASCULAR, CENTRAL NERVOUS SYSTEM, DERMATOLOGIC, ENDOCRINE, GASTRIC OR GASTROENTERIC, HEMATOLOGIC, IMMUNOLOGIC, INFLAMMATORY, OSTEOLOGIC, OR RESPIRATORY SYSTEMS; PHARMACEUTICAL PREPARATIONS FOR USE IN PREVENTION OR TREATMENT OF ALLERGIES OR ALLERGIC RESPONSES, METABOLIC DISORDERS, PSYCHIATRIC OR EMOTIONAL DISORDERS, INFECTION OR INFECTIOUS DISEASES (U.S. CLS. 6, 18, 44, 46, 51 AND 52).
RON FAIRBANKS, EXAMINING ATTORNEY

SN 76-621,742. NORGINE LABORATORIES, INC., WHITE PLAINS, NY. FILED 11-19-2004.

MOVICOL

THE MARK CONSISTS OF STANDARD CHARACTERS WITHOUT CLAIM TO ANY PARTICULAR FONT, STYLE, SIZE, OR COLOR.

FOR MEDICINAL PREPARATION USED IN THE TREATMENT OF FECAL IMPACTION AND/OR CONSTIPATION (U.S. CLS. 6, 18, 44, 46, 51 AND 52).
MARLENE BELL, EXAMINING ATTORNEY

SN 76-621,769. MCNEIL NUTRITIONALS, LLC, FORT WASHINGTON, PA. FILED 11-22-2004.

VIACTIV, THE MULTI-VITAMIN WOMEN WANT

THE MARK CONSISTS OF STANDARD CHARACTERS WITHOUT CLAIM TO ANY PARTICULAR FONT, STYLE, SIZE, OR COLOR.

OWNER OF U.S. REG. NOS. 2,248,302 AND 2,465,643.
FOR DIETARY SUPPLEMENT (U.S. CLS. 6, 18, 44, 46, 51 AND 52).
ALLISON SCHRODY, EXAMINING ATTORNEY

CLASS 5—(Continued).

SN 76-621,800. CHARLOTTE LABORATORIES, L.L.C., BETHESDA, MD. FILED 11-22-2004.

AMINA

THE MARK CONSISTS OF STANDARD CHARACTERS WITHOUT CLAIM TO ANY PARTICULAR FONT, STYLE, SIZE, OR COLOR.

FOR NUTRICEUTICAL USED IN THE TREATMENT OF FLUSHING AND HOT FLASHES (U.S. CLS. 6, 18, 44, 46, 51 AND 52).

FIRST USE 4-19-2001; IN COMMERCE 7-20-2001.

MICHAEL HALL, EXAMINING ATTORNEY

SN 76-621,965. NATURAL ORGANICS INC., MELVILLE, NY.
FILED 11-23-2004.

CHAMPAGNE OF VITAMINS

THE MARK CONSISTS OF STANDARD CHARACTERS WITHOUT CLAIM TO ANY PARTICULAR FONT, STYLE, SIZE, OR COLOR.

NO CLAIM IS MADE TO THE EXCLUSIVE RIGHT TO USE "VITAMINS", APART FROM THE MARK AS SHOWN.
FOR VITAMINS (U.S. CLS. 6, 18, 44, 46, 51 AND 52).
SUNG IN, EXAMINING ATTORNEY

SN 76-622,927. EATING FOR LIFE FOODS, INC., GOLDEN, CO. FILED 12-2-2004.

RIGHT BITE

THE MARK CONSISTS OF STANDARD CHARACTERS WITHOUT CLAIM TO ANY PARTICULAR FONT, STYLE, SIZE, OR COLOR.

FOR NUTRITIONAL AND DIETARY SUPPLEMENTS (U.S. CLS. 6, 18, 44, 46, 51 AND 52).

MIDGE BUTLER, EXAMINING ATTORNEY

CLASS 5—(Continued).

SN 76-623,040. NATURALCARE PRODUCTS, INC., OREM, UT. FILED 12-3-2004.

MOODFIX

THE MARK CONSISTS OF STANDARD CHARACTERS WITHOUT CLAIM TO ANY PARTICULAR FONT, STYLE, SIZE, OR COLOR.

FOR DIETARY SUPPLEMENT DESIGNED TO HELP RELIEVE SYMPTOMS OF DEPRESSION, MOOD SWINGS AND ANXIETY (U.S. CLS. 6, 18, 44, 46, 51 AND 52).

DAWN FELDMAN, EXAMINING ATTORNEY

CLASS 5—(Continued).

SN 76-625,828. SOLSTICE MEDICINE COMPANY, LOS ANGELES, CA. FILED 12-27-2004.

ROYAL DRAGON

THE MARK CONSISTS OF STANDARD CHARACTERS WITHOUT CLAIM TO ANY PARTICULAR FONT, STYLE, SIZE, OR COLOR.

FOR SCENTED HERBAL SPRAY FOR STIMULATIVE USE (U.S. CLS. 6, 18, 44, 46, 51 AND 52).

FIRST USE 1-6-2005; IN COMMERCE 1-6-2005.

JENNIFER WILLISTON, EXAMINING ATTORNEY

SN 76-623,074. PHARMAVITE LLC, MISSION HILLS, CA. FILED 12-3-2004.

OXYHEART

THE MARK CONSISTS OF STANDARD CHARACTERS WITHOUT CLAIM TO ANY PARTICULAR FONT, STYLE, SIZE, OR COLOR.

FOR DIETARY SUPPLEMENTS (U.S. CLS. 6, 18, 44, 46, 51 AND 52).

ZACHARY BELLO, EXAMINING ATTORNEY

SN 76-626,222. ISODIS NATURA, S.A., 92600 ASNIERÈS, FRANCE, FILED 12-23-2004.

ISODISNATURA

THE MARK CONSISTS OF STANDARD CHARACTERS WITHOUT CLAIM TO ANY PARTICULAR FONT, STYLE, SIZE, OR COLOR.

FOR NUTRITIONAL AND DIETARY SUPPLEMENTS (U.S. CLS. 6, 18, 44, 46, 51 AND 52).

CARRIE ACHEN, EXAMINING ATTORNEY

SN 76-623,313. HOPHAG RESEARCH MANAGEMENT S.A., CH - 1216 COINTRIN/GENEVA, SWITZERLAND, FILED 12-6-2004.

PREWELLE

THE MARK CONSISTS OF STANDARD CHARACTERS WITHOUT CLAIM TO ANY PARTICULAR FONT, STYLE, SIZE, OR COLOR.

FOR DIETARY AND NUTRITIONAL SUPPLEMENTS (U.S. CLS. 6, 18, 44, 46, 51 AND 52).

RONALD MCMORROW, EXAMINING ATTORNEY

SN 76-626,651. ISODIS NATURA, S.A., 92600 ASNIERÈS, FRANCE, FILED 1-3-2005.

isodisnatura OM3

FOR NUTRITIONAL AND DIETARY SUPPLEMENTS (U.S. CLS. 6, 18, 44, 46, 51 AND 52).

CARRIE ACHEN, EXAMINING ATTORNEY

CLASS 5—(Continued).

SN 76-626,652. ISODIS NATURA, S.A., 92600 ASNIÈRES, FRANCE, FILED 1-3-2005.

isodis^{natura}
CARDIOM3

FOR NUTRITIONAL AND DIETARY SUPPLEMENTS
(U.S. CLS. 6, 18, 44, 46, 51 AND 52).
CARRIE ACHEN, EXAMINING ATTORNEY

SN 76-626,708. GREEN PLANET, INC., LOS ANGELES, CA.
FILED 1-3-2005.

GREEN HORNET

THE MARK CONSISTS OF STANDARD CHARACTERS
WITHOUT CLAIM TO ANY PARTICULAR FONT, STYLE,
SIZE, OR COLOR.
FOR DIETARY SUPPLEMENTS (U.S. CLS. 6, 18, 44, 46,
51 AND 52).
ALINA MORRIS, EXAMINING ATTORNEY

SN 76-626,833. SCOTT FETZER COMPANY, THE, WES-
TLAKE, OH. FILED 1-4-2005.

ODORIFIC II

THE MARK CONSISTS OF STANDARD CHARACTERS
WITHOUT CLAIM TO ANY PARTICULAR FONT, STYLE,
SIZE, OR COLOR.
FOR ALL PURPOSE DEODORIZER FOR HOUSEHOLD
USE (U.S. CLS. 6, 18, 44, 46, 51 AND 52).
FIRST USE 4-1-1990; IN COMMERCE 4-1-1990.
IRA J. GOODSaid, EXAMINING ATTORNEY

CLASS 5—(Continued).

SN 76-627,293. MERCK & CO., INC., WHITEHOUSE STA-
TION, NJ. FILED 1-3-2005.

ZOLINZA

FOR PHARMACEUTICAL PREPARATIONS FOR THE
TREATMENT OF ADDICTION, URINARY INCONTI-
NENCE, DIABETES, CARDIOVASCULAR DISEASES
AND DISORDERS, CEREBROVASCULAR DISEASES
AND DISORDERS, ANXIETY, DEPRESSION, INSOM-
NIA, COGNITIVE DISORDERS, DISEASES AND DISOR-
DERS OF THE CENTRAL NERVOUS SYSTEM,
GASTROINTESTINAL DISEASES AND DISORDERS,
CANCER, OBESITY, INFLAMMATION AND INFLAM-
MATORY DISEASES, RESPIRATORY DISEASES AND
DISORDERS, MUSCULOSKELETAL DISORDERS, OS-
TEOPOROSIS, MENOPAUSAL SYMPTOMS AND DISOR-
DERS, ANTI-INFECTIVE PREPARATIONS, ANTI-VIRAL
PREPARATIONS, IMMUNOLOGICAL PREPARATIONS,
ANALGESIC PREPARATIONS, OPHTHALMIC PRE-
PARATIONS AND ANTIEMETIC PREPARATIONS (U.S.
CLS. 6, 18, 44, 46, 51 AND 52).
KIM SAITO, EXAMINING ATTORNEY

SN 76-627,745. ENERGY & LIFE, INC., ATLANTA, GA.
FILED 1-12-2005.



THE COLOR(S) PEACH, BLUE AND GREEN IS/ARE
CLAIMED AS A FEATURE OF THE MARK.

THE COLOR PEACH APPEARS IN THE LETTERS OF THE
WORDS "ENERGY" AND "LIFE"; THE COLOR BLUE
APPEARS AT THE TOP OF THE LEAF TO THE LEFT OF
THE WORDS, IN THE STEM AND IN THE AMPERSAND
BETWEEN THE WORDS; THE COLOR GREEN APPEARS IN
THE LOWER PORTION OF THE LEAF.

THE MARK CONSISTS OF THE IMAGE OF A LEAF
WITH THE WORDS "ENERGY" AND "LIFE" JOINED BY
AN AMPERSAND BETWEEN THEM.

FOR NUTRITIONAL SUPPLEMENTS, NAMELY VITA-
MINS AND MINERALS, AND DIETARY SUPPLEMENTS
(U.S. CLS. 6, 18, 44, 46, 51 AND 52).

JILL C. ALT, EXAMINING ATTORNEY

CLASS 5—(Continued).

SN 76-628,536. SUPER BAKERY, INCORPORATED, PITTSBURGH, PA. FILED 1-10-2005.

NUTRIDOUGH

THE MARK CONSISTS OF STANDARD CHARACTERS WITHOUT CLAIM TO ANY PARTICULAR FONT, STYLE, SIZE, OR COLOR.

FOR VITAMIN FORMULA ADDITIVES FOR USE IN MANUFACTURE OF BAKERY GOODS (U.S. CLS. 6, 18, 44, 46, 51 AND 52).

FIRST USE 3-9-1991; IN COMMERCE 3-9-1991.
JEAN IM, EXAMINING ATTORNEY

SN 78-024,572. SB PHARMCO PUERTO RICO INC., CIDRA, PUERTO RICO, FILED 9-6-2000.

**RESOLUTION AT THE
SPEED OF LIFE**

FOR PHARMACEUTICALS, NAMELY ANTIBIOTICS (U.S. CLS. 6, 18, 44, 46, 51 AND 52).

SCOTT BALDWIN, EXAMINING ATTORNEY

SN 78-045,705. PHARMACIA & UPJOHN COMPANY LLC, PEAPACK, NJ. FILED 1-30-2001.

DOLPHIN

FOR PHARMACEUTICAL PREPARATIONS FOR THE TREATMENT OF ARTHRITIS, PAIN, INFLAMMATION, CARDIOVASCULAR DISEASES, OPHTHALMOLOGICAL CONDITIONS, CENTRAL NERVOUS SYSTEM DISORDERS, AND FOR USE BY ONCOLOGISTS; MEDICAL INSTRUMENTS, NAMELY, INJECTION DEVICES IN THE NATURE OF SYRINGES AND NEEDLESS SYRINGES FILLED WITH PHARMACEUTICAL PREPARATIONS, NAMELY GROWTH HORMONES AND PREPARATIONS FOR THE TREATMENT OF ARTHRITIS, PAIN, INFLAMMATION, CARDIOVASCULAR DISEASES, OPHTHALMOLOGICAL CONDITIONS, CENTRAL NERVOUS SYSTEM DISORDERS AND FOR USE BY ONCOLOGISTS (U.S. CLS. 6, 18, 44, 46, 51 AND 52).

ELISSA GARBER KON, EXAMINING ATTORNEY

CLASS 5—(Continued).

SN 78-077,148. ALTANA PHARMA AG, KONSTANZ, DE. FILED 8-2-2001.

AQR

OWNER OF FED REP GERMANY REG. NO. 30111392, DATED 11-20-2001, EXPIRES 2-20-2011.

FOR PHARMACEUTICAL PREPARATIONS FOR THE TREATMENT OF RESPIRATORY AND GASTRO-INTESTINAL DISEASES AND CONDITIONS (U.S. CLS. 6, 18, 44, 46, 51 AND 52).

FLORENTINA BLANDU, EXAMINING ATTORNEY

SN 78-251,571. RENAISSANCE HEALTH PUBLISHING, LLC, BOCA RATON, FL. FILED 5-19-2003.

T-BOOST

THE MARK CONSISTS OF STANDARD CHARACTERS WITHOUT CLAIM TO ANY PARTICULAR FONT, STYLE, SIZE, OR COLOR.

FOR TOPICAL DIETARY SUPPLEMENT IN THE FORM OF A GEL FOR STRENGTH AND PERFORMANCE ENHANCEMENT IN ATHLETICS (U.S. CLS. 6, 18, 44, 46, 51 AND 52).

FIRST USE 11-25-2002; IN COMMERCE 5-20-2003.
CAROLINE WOOD, EXAMINING ATTORNEY

SN 78-289,049. GENERAL MARKS, INC., CLEARWATER, FL. FILED 8-19-2003.

PAIN FIX

NO CLAIM IS MADE TO THE EXCLUSIVE RIGHT TO USE "PAIN", APART FROM THE MARK AS SHOWN.

FOR LIQUID SPRAY THAT CONTAINS HERBS AND VITAMINS TO HELP RELIEVE PAIN (U.S. CLS. 6, 18, 44, 46, 51 AND 52).

FIRST USE 8-8-2003; IN COMMERCE 8-8-2003.
AMOS T. MATTHEWS, JR., EXAMINING ATTORNEY

SN 78-313,470. VERY PET CORP., MIAMI, FL. FILED 10-14-2003.

TEA-DERM

FOR MEDICATED PET SHAMPOO (U.S. CLS. 6, 18, 44, 46, 51 AND 52).

FIRST USE 9-1-2003; IN COMMERCE 9-1-2003.
DAWN HAN, EXAMINING ATTORNEY

CLASS 5—(Continued).

SN 78-339,042. HEALTH AND NUTRITION SYSTEMS INTERNATIONAL, INC., WEST PALM BEACH, FL. FILED 12-10-2003.

ALCOLIZER

THE MARK CONSISTS OF STANDARD CHARACTERS WITHOUT CLAIM TO ANY PARTICULAR FONT, STYLE, SIZE, OR COLOR.

FOR NUTRITIONAL SUPPLEMENT TO BE TAKEN IN COMBINATION WITH ALCOHOLIC BEVERAGES (U.S. CLS. 6, 18, 44, 46, 51 AND 52).

DANIEL CAPSHAW, EXAMINING ATTORNEY

SN 78-359,402. NUTRAMAX LABORATORIES, INC., EDGEWOOD, MD. FILED 1-29-2004.

Plactar

THE MARK CONSISTS OF STANDARD CHARACTERS WITHOUT CLAIM TO ANY PARTICULAR FONT, STYLE, SIZE, OR COLOR.

FOR DENTAL HYGIENE PRODUCTS FOR ANIMALS, NAMELY, MEDICATED ORAL MOUTHWASHES, MEDICATED DENTAL PASTE, MEDICATED DENTAL FLOSSES, MEDICATED DENTAL CHEWS, MEDICATED ROOT CONDITIONERS, MATERIALS FOR DENTAL SEALING PURPOSES AND BREATH-FRESHENING MINTS FOR MEDICINAL PURPOSES (U.S. CLS. 6, 18, 44, 46, 51 AND 52).

TONI HICKEY, EXAMINING ATTORNEY

CLASS 5—(Continued).

SN 78-365,919. NUTRACLEANSE LLC, PHOENIX, AZ. FILED 2-11-2004.



NO CLAIM IS MADE TO THE EXCLUSIVE RIGHT TO USE CLEANSE, APART FROM THE MARK AS SHOWN.

THE COLORS LIGHT GREEN, TAN AND LIGHT YELLOW ARE CLAIMED AS A FEATURE OF THE MARK.

THE COLOR LIGHT GREEN APPEARS ON THE LEAF PART OF THE MARK; THE COLOR LIGHT YELLOW APPEARS IN THE BACKGROUND BOX OF THE MARK AND THE COLOR TAN APPEARS AS THE OUTLINE OF THE MARK AND ALSO ON THE LETTERING OF THE NAME OF THE MARK.

FOR NUTRITIONAL SUPPLEMENT FOR HEALTH (U.S. CLS. 6, 18, 44, 46, 51 AND 52).

AMOS T. MATTHEWS, JR., EXAMINING ATTORNEY

SN 78-372,470. WYETH, MADISON, NJ. FILED 2-23-2004.



OWNER OF U.S. REG. NOS. 515,197, 1,653,444 AND 2,241,010.

NO CLAIM IS MADE TO THE EXCLUSIVE RIGHT TO USE DEXTROMETHORPHAN HBR COUGH SUPPRESSANT; COUGH SYRUP; CONTROLS COUGHS UP TO 8 HOURS; MADE WITH NATURAL GRADE A HONEY; 4 FL OZ, 118 ML, APART FROM THE MARK AS SHOWN.

THE NAME(S), PORTRAIT(S), AND/OR SIGNATURE(S) SHOWN IN THE MARK DOES NOT IDENTIFY A PARTICULAR LIVING INDIVIDUAL.

THE COLOR(S) BEIGE, LIGHT BROWN, BLACK, WHITE, GOLD, YELLOW, EMERALD GREEN, BROWN, SILVER AND REDDISH BROWN IS/ARE CLAIMED AS A FEATURE OF THE MARK.

THE MARK CONSISTS OF THE OVERALL PACKAGE DESIGN OF THE FRONT FACE OF THE PRODUCT CONTAINER AND COMPRISES A RECTILINEAR ESCUTCHEON OUTLINED BY A NARROW WHITE BORDER, THE BULK OF THE ESCUTCHEON CONSISTING OF A BEIGE COLOR IN THE TOP QUADRANT CHANGING GRADUALLY TO A LIGHT BROWN COLOR IN THE

CLASS 5—(Continued).

BOTTOM QUADRANT. AT THE TOP OF THE ESCUTCHEON CENTRALLY PLACED IS THE TRADEMARK HONEY COUGH IN BLACK LETTERS AND UNDERNEATH THE WORDS (DEXTROMETHORPHAN HBR) COUGH SUPPRESSANT AND IMMEDIATELY BELOW IS A NARROW BLACK RECTANGLE EDGED BY A THIN GOLD COLORED BORDER CONTAINING THE TRADEMARK ROBITUSSIN IN WHITE LETTERS UNDER WHICH IS THE WORD COUGH SYRUP AND WITHIN THE BOTTOM HALF OF THE ESCUTCHEON NEAR ITS CENTER APPEARS A BROAD EMERALD GREEN RECTANGLE CONTAINING THE WORDS CONTROLS COUGHS UP TO 8 HOURS IN YELLOW AND UNDER WHICH ARE THE WORDS MADE WITH NATURAL GRADE A HONEY. IN THE LOWER RIGHT QUADRANT OF THE ESCUTCHEON APPEARS A PORTION OF A SILVER SPOON CONTAINING A REDDISH BROWN COLORED LIQUID AND WHICH PROTRUDES OUTSIDE THE BOTTOM BORDER OF THE ESCUTCHEON. TO THE RIGHT AND UNDERNEATH THE TEASPOON APPEARS A BROWN AND GOLD FLOWER PETAL AND A WOODEN HONEY SPINDLE IN A POOL OF HONEY. ALL OF THE AFORESAID APPEARS ON A BACKGROUND FIELD OF ELEVEN PARALLEL VERTICAL BANDS ALTERNATING IN COLOR FROM GOLD TO REDDISH BROWN.

THE MARK CONSISTS OF PACKAGE DESIGN FOR PRODUCT.
FOR PHARMACEUTICAL PREPARATIONS NAMELY COUGH AND COLD PREPARATIONS (U.S. CLS. 6, 18, 44, 46, 51 AND 52).

TERESA M. RUPP, EXAMINING ATTORNEY

CLASS 5—(Continued).

SN 78-392,594. EISAI CO., LTD., TOKYO, JAPAN, FILED 3-29-2004.

ZEPSITAR

THE MARK CONSISTS OF STANDARD CHARACTERS WITHOUT CLAIM TO ANY PARTICULAR FONT, STYLE, SIZE, OR COLOR.

OWNER OF JAPAN REG. NO. 3334989, DATED 7-25-1997, EXPIRES 7-25-2007.

FOR PHARMACEUTICAL PREPARATIONS FOR THE TREATMENT OF DISORDERS CAUSED BY MICROORGANISMS (U.S. CLS. 6, 18, 44, 46, 51 AND 52).

CATHERINE CAIN, EXAMINING ATTORNEY

SN 78-390,885. MORNINGSTAR MINERALS CORPORATION, FARMINGTON, NM. FILED 3-25-2004.



Derma
Boost

NO CLAIM IS MADE TO THE EXCLUSIVE RIGHT TO USE "DERMA", APART FROM THE MARK AS SHOWN.

FOR MINERAL SUPPLEMENTS IN LIQUID FORM SOLD AS COMPONENTS OF TOPICAL SKIN CARE PRODUCTS (U.S. CLS. 6, 18, 44, 46, 51 AND 52).

FIRST USE 1-15-2000; IN COMMERCE 1-15-2000.

WARREN L. OLANDRIA, EXAMINING ATTORNEY

SN 78-399,125. SHEFFERMAN, RICHARD C., SCOTTSDALE, AZ. FILED 4-9-2004.

SlimPops

THE MARK CONSISTS OF STANDARD CHARACTERS WITHOUT CLAIM TO ANY PARTICULAR FONT, STYLE, SIZE, OR COLOR.

FOR LOLLIPOPS FOR USE AS A DIETARY AID IN CONJUNCTION WITH WEIGHT MANAGEMENT (U.S. CLS. 6, 18, 44, 46, 51 AND 52).

FIRST USE 8-30-2002; IN COMMERCE 8-30-2002.

WINSTON FOLMAR, EXAMINING ATTORNEY

CLASS 5—(Continued).

SN 78-406,338. MILENIA AGRO CIÊNCIAS S.A., LONDRINA
- PR, BRAZIL, FILED 4-22-2004.

CLASS 5—(Continued).

SN 78-409,166. AMCAID, INC., HUNTINGTON BEACH, CA.
FILED 4-28-2004.

PREMERLIN

THE MARK CONSISTS OF STANDARD CHARACTERS
WITHOUT CLAIM TO ANY PARTICULAR FONT, STYLE,
SIZE, OR COLOR.

OWNER OF BRAZIL REG. NO. 812068270, DATED 2-24-
1997, EXPIRES 2-24-2007.

FOR WEED KILLERS FOR AGRICULTURAL AND
DOMESTIC USE (U.S. CLS. 6, 18, 44, 46, 51 AND 52).
STEVEN R. FOSTER, EXAMINING ATTORNEY

Amino SportsPro

THE MARK CONSISTS OF STANDARD CHARACTERS
WITHOUT CLAIM TO ANY PARTICULAR FONT, STYLE,
SIZE, OR COLOR.

NO CLAIM IS MADE TO THE EXCLUSIVE RIGHT TO
USE "AMINO", APART FROM THE MARK AS SHOWN.

FOR NUTRITIONAL SUPPLEMENTS FOR SPORTS OR
ATHLETES (U.S. CLS. 6, 18, 44, 46, 51 AND 52).

FIRST USE 4-26-2004; IN COMMERCE 4-27-2004.
BARBARA A. GOLD, EXAMINING ATTORNEY

SN 78-410,026. IMPROVITA HEALTH PRODUCTS, INC.,
CLEVELAND, OH. FILED 4-29-2004.

NUTRA CHEWS

THE MARK CONSISTS OF STANDARD CHARACTERS
WITHOUT CLAIM TO ANY PARTICULAR FONT, STYLE,
SIZE, OR COLOR.

NO CLAIM IS MADE TO THE EXCLUSIVE RIGHT TO
USE CHEWS, APART FROM THE MARK AS SHOWN.

FOR DIETARY FOOD SUPPLEMENTS CONTAINING
VITAMINS AND MINERALS, NOT FOR USE AS NUTRI-
TIONAL SUPPLEMENTS FOR ANIMALS OR PETS (U.S.
CLS. 6, 18, 44, 46, 51 AND 52).

BARBARA GAYNOR, EXAMINING ATTORNEY

SN 78-408,535. BASF AGROCHEMICAL PRODUCTS B.V.,
6811 CA ARNHEM, NETHERLANDS, FILED 4-27-2004.

OKLAHOMA

SN 78-410,921. JOHNSON & JOHNSON, NEW BRUNSWICK,
NJ. FILED 4-30-2004.

SOOTHING EFFECTS

THE MARK CONSISTS OF STANDARD CHARACTERS
WITHOUT CLAIM TO ANY PARTICULAR FONT, STYLE,
SIZE, OR COLOR.

FOR PESTICIDES, INSECTICIDES AND HERBICIDES
FOR AGRICULTURAL, COMMERCIAL AND DOMES-
TIC USE; FUNGICIDES; AND PREPARATIONS FOR
DESTROYING VERMIN (U.S. CLS. 6, 18, 44, 46, 51 AND
52).

CHRISTOPHER ADKINS, EXAMINING ATTORNEY

THE MARK CONSISTS OF STANDARD CHARACTERS
WITHOUT CLAIM TO ANY PARTICULAR FONT, STYLE,
SIZE, OR COLOR.

FOR VAGINAL CARE PREPARATIONS, NAMELY,
VAGINAL MOISTURIZERS, WASHES, AND CLEANS-
ING TOWELLETES (U.S. CLS. 6, 18, 44, 46, 51 AND 52).

LESLEY LAMOTHE, EXAMINING ATTORNEY

CLASS 5—(Continued).

SN 78-411,278. AGAN CHEMICAL MANUFACTURERS LTD., ASHDOD, ISRAEL, FILED 4-30-2004.

CLASS 5—(Continued).

SN 78-414,200. CHEMCO INDUSTRIES, INC., LOS ANGELES, CA. FILED 5-6-2004.

BULLDOZER

OPTIPURE

THE MARK CONSISTS OF STANDARD CHARACTERS WITHOUT CLAIM TO ANY PARTICULAR FONT, STYLE, SIZE, OR COLOR.

OWNER OF U.S. REG. NO. 2,209,932.
FOR PESTICIDES AND HERBICIDES FOR AGRICULTURAL AND NONAGRICULTURAL USE (U.S. CLS. 6, 18, 44, 46, 51 AND 52).
DAHLIA GEORGE, EXAMINING ATTORNEY

THE MARK CONSISTS OF STANDARD CHARACTERS WITHOUT CLAIM TO ANY PARTICULAR FONT, STYLE, SIZE, OR COLOR.

OWNER OF U.S. REG. NO. 2,175,253.
FOR DIETARY AND NUTRITIONAL SUPPLEMENTS (U.S. CLS. 6, 18, 44, 46, 51 AND 52).
FIRST USE 1-1-1994; IN COMMERCE 1-1-1994.
TARAH HARDY, EXAMINING ATTORNEY

SN 78-411,541. THE ULTIMATE LIFE, SANTA BARBARA, CA. FILED 4-30-2004.

SN 78-417,770. DLC DERMACARE LLC, SCOTTSDALE, AZ. FILED 5-12-2004.

THE ULTIMATE SWEETENER

ERASE

THE MARK CONSISTS OF STANDARD CHARACTERS WITHOUT CLAIM TO ANY PARTICULAR FONT, STYLE, SIZE, OR COLOR.

OWNER OF U.S. REG. NOS. 2,028,215, 2,074,462 AND OTHERS.
NO CLAIM IS MADE TO THE EXCLUSIVE RIGHT TO USE "SWEETENER", APART FROM THE MARK AS SHOWN.
SEC. 2(F).
FOR NUTRITIONAL SUPPLEMENT (U.S. CLS. 6, 18, 44, 46, 51 AND 52).
FIRST USE 1-1-1990; IN COMMERCE 1-1-1990.
TRACY CROSS, EXAMINING ATTORNEY

THE MARK CONSISTS OF STANDARD CHARACTERS WITHOUT CLAIM TO ANY PARTICULAR FONT, STYLE, SIZE, OR COLOR.

FOR MEDICATED SKIN CARE PREPARATIONS (U.S. CLS. 6, 18, 44, 46, 51 AND 52).
MARIA-VICTORIA SUAREZ, EXAMINING ATTORNEY

CLASS 5—(Continued).

SN 78-423,129. PANZERI, EZIO, MILAN, ITALY, FILED 5-21-2004.



NO CLAIM IS MADE TO THE EXCLUSIVE RIGHT TO USE "BLOOD HEMOGLOBIN MELOXINE", APART FROM THE MARK AS SHOWN.

THE COLOR(S) GREEN, YELLOW, WHITE AND BLACK IS/ARE CLAIMED AS A FEATURE OF THE MARK.

THE COLOR GREEN IS APPLIED TO "BLOOD HEMOGLOBIN MELOXINE". THE COLORS GREEN AND BLACK ARE APPLIED TO "BHM". THE COLORS GREEN, YELLOW, WHITE AND BLACK ARE APPLIED TO THE TURTLE DESIGN.

FOR PHARMACEUTICAL PREPARATIONS FOR THE TREATMENT OF BLOOD-BORNE PATHOGENS AND DISEASES CAUSED THEREBY; PHARMACEUTICAL PREPARATIONS FOR THE TREATMENT OF VIRUSES, BACTERIA, PROTOZOA AND OTHER PATHOGENIC ORGANISMS AND DISEASES CAUSED THEREBY; PHARMACEUTICAL PREPARATIONS FOR THE PREVENTION OF NUCLEIC ACID REPLICATION (U.S. CLS. 6, 18, 44, 46, 51 AND 52).

BARBARA BROWN, EXAMINING ATTORNEY

SN 78-427,852. ADM ALLIANCE NUTRITION, INC., DECATUR, IL. FILED 6-1-2004.

PRO-LYFIC

THE MARK CONSISTS OF STANDARD CHARACTERS WITHOUT CLAIM TO ANY PARTICULAR FONT, STYLE, SIZE, OR COLOR.

FOR FEED SUPPLEMENTS FOR SWINE (U.S. CLS. 6, 18, 44, 46, 51 AND 52).

SALLY SHIH, EXAMINING ATTORNEY

CLASS 5—(Continued).

SN 78-430,905. SHORE NATURAL BEVERAGE COMPANY INC., RIO GRANDE, NJ. FILED 6-7-2004.

Shore Natural

THE MARK CONSISTS OF STANDARD CHARACTERS WITHOUT CLAIM TO ANY PARTICULAR FONT, STYLE, SIZE, OR COLOR.

NO CLAIM IS MADE TO THE EXCLUSIVE RIGHT TO USE "NATURAL", APART FROM THE MARK AS SHOWN. FOR BEVERAGES, NAMELY, NUTRITIONALLY FORTIFIED WATER (U.S. CLS. 6, 18, 44, 46, 51 AND 52).

WINSTON FOLMAR, EXAMINING ATTORNEY

SN 78-432,986. SUPERGEN, INC., DUBLIN, CA. FILED 6-10-2004.

EUROGEN

THE MARK CONSISTS OF STANDARD CHARACTERS WITHOUT CLAIM TO ANY PARTICULAR FONT, STYLE, SIZE, OR COLOR.

FOR HOUSEMARK FOR A LINE OF PHARMACEUTICALS; DIAGNOSTIC PREPARATIONS FOR MEDICAL PURPOSES; MEDICAL DIAGNOSTIC REAGENTS (U.S. CLS. 6, 18, 44, 46, 51 AND 52).

JENNIFER KRISP, EXAMINING ATTORNEY

CLASS 5—(Continued).

SN 78-436,208. INTELLIGENT NUTRIENTS, INC., MINNEAPOLIS, MN. FILED 6-16-2004.

CLASS 5—(Continued).

SN 78-438,686. WARNER-LAMBERT COMPANY LLC, MORRIS PLAINS, NJ. FILED 6-21-2004.

**LIP DELIVERY
NUTRITION**

SUDAFED PE

THE MARK CONSISTS OF STANDARD CHARACTERS WITHOUT CLAIM TO ANY PARTICULAR FONT, STYLE, SIZE, OR COLOR.

NO CLAIM IS MADE TO THE EXCLUSIVE RIGHT TO USE "LIP" AND "NUTRITION", APART FROM THE MARK AS SHOWN.

FOR LIP BALM CONTAINING DIETARY SUPPLEMENTS (U.S. CLS. 6, 18, 44, 46, 51 AND 52).
PRISCILLA MILTON, EXAMINING ATTORNEY

THE MARK CONSISTS OF STANDARD CHARACTERS WITHOUT CLAIM TO ANY PARTICULAR FONT, STYLE, SIZE, OR COLOR.

OWNER OF U.S. REG. NOS. 565,723, 1,266,826 AND 2,741,719.

NO CLAIM IS MADE TO THE EXCLUSIVE RIGHT TO USE "PE", APART FROM THE MARK AS SHOWN.

FOR PHARMACEUTICAL PREPARATION FOR THE RELIEF AND PREVENTION OF UPPER RESPIRATORY SYMPTOMS; NASAL DECONGESTANT (U.S. CLS. 6, 18, 44, 46, 51 AND 52).
DAWN FELDMAN, EXAMINING ATTORNEY

SN 78-438,598. WEIDER PUBLICATIONS, LLC, BOCA RATON, FL. FILED S.R. 6-21-2004; AM. P.R. 7-29-2005.

SN 78-439,483. JOHNSON & JOHNSON, NEW BRUNSWICK, NJ. FILED 6-22-2004.

MUSCLE & FITNESS

ZARNEST

THE MARK CONSISTS OF STANDARD CHARACTERS WITHOUT CLAIM TO ANY PARTICULAR FONT, STYLE, SIZE, OR COLOR.

OWNER OF U.S. REG. NO. 2,775,097.
SEC. 2(F).
FOR NUTRITIONAL FOOD BARS (U.S. CLS. 6, 18, 44, 46, 51 AND 52).
MICHELE SWAIN, EXAMINING ATTORNEY

THE MARK CONSISTS OF STANDARD CHARACTERS WITHOUT CLAIM TO ANY PARTICULAR FONT, STYLE, SIZE, OR COLOR.

OWNER OF U.S. REG. NO. 2,877,943.
FOR PHARMACEUTICAL, NAMELY, ANTI-CANCER DRUGS (U.S. CLS. 6, 18, 44, 46, 51 AND 52).
MATTHEW PAPPAS, EXAMINING ATTORNEY

CLASS 5—(Continued).

SN 78-441,779. RAGINGBULL MEDIA, INC., YORBA LINDA, CA. FILED 6-25-2004.

CLASS 5—(Continued).

SN 78-443,374. AMKOR PHARMA, INC., SAMMAMISH, WA. FILED 6-29-2004.

CORTISOL ASSIST

AMKOR

THE MARK CONSISTS OF STANDARD CHARACTERS WITHOUT CLAIM TO ANY PARTICULAR FONT, STYLE, SIZE, OR COLOR.

NO CLAIM IS MADE TO THE EXCLUSIVE RIGHT TO USE CORTISOL, APART FROM THE MARK AS SHOWN, FOR DIETARY SUPPLEMENTS (U.S. CLS. 6, 18, 44, 46, 51 AND 52).

MARK RADEMACHER, EXAMINING ATTORNEY

THE MARK CONSISTS OF STANDARD CHARACTERS WITHOUT CLAIM TO ANY PARTICULAR FONT, STYLE, SIZE, OR COLOR.

FOR PHARMACEUTICAL PREPARATIONS FOR USE IN THE TREATMENT OF ISCHEMIC DISORDERS AND DISEASE, NEUROLOGICAL DISORDERS AND DISEASES, STROKE, AND CARDIAC ARREST; SANITARY PREPARATIONS FOR MEDICAL PURPOSES; PHARMACEUTICAL PREPARATIONS FOR THE PREVENTION AND TREATMENT OF HUMAN DISEASES, NAMELY, ISCHEMIC DISORDERS AND DISEASE, NEUROLOGICAL DISORDERS AND DISEASES, STROKE, AND CARDIAC ARREST; NATURAL POLYMERS FOR USE IN GENERAL SURGERY; CLINICAL MEDICAL REAGENTS (U.S. CLS. 6, 18, 44, 46, 51 AND 52).

ANNE FARRELL, EXAMINING ATTORNEY

SN 78-443,329. CLUB DISPLAY, INC., ESCONDIDO, CA. FILED 6-29-2004.

SN 78-444,180. NUFARM AMERICAS INC., BURR RIDGE, IL. FILED 6-30-2004.

OPTIMOM HEALTH

VICTORY

THE MARK CONSISTS OF STANDARD CHARACTERS WITHOUT CLAIM TO ANY PARTICULAR FONT, STYLE, SIZE, OR COLOR.

NO CLAIM IS MADE TO THE EXCLUSIVE RIGHT TO USE "HEALTH", APART FROM THE MARK AS SHOWN, FOR DIETARY AND NUTRITIONAL SUPPLEMENTS (U.S. CLS. 6, 18, 44, 46, 51 AND 52).

DAVID MURRAY, EXAMINING ATTORNEY

THE MARK CONSISTS OF STANDARD CHARACTERS WITHOUT CLAIM TO ANY PARTICULAR FONT, STYLE, SIZE, OR COLOR.

FOR PESTICIDES AND HERBICIDES FOR AGRICULTURAL AND COMMERCIAL USE (U.S. CLS. 6, 18, 44, 46, 51 AND 52).

JAMES GRIFFIN, EXAMINING ATTORNEY

CLASS 5—(Continued).

SN 78-446,837. NUTRICOLOGY, INC., HAYWARD, CA.
FILED 7-7-2004.

CLASS 5—(Continued).

SN 78-456,492. THE FOOD SOURCE, INC., FRAZER, PA.
FILED 7-26-2004.

NanoTech Nutrients

Cell Basics

THE MARK CONSISTS OF STANDARD CHARACTERS WITHOUT CLAIM TO ANY PARTICULAR FONT, STYLE, SIZE, OR COLOR.

NO CLAIM IS MADE TO THE EXCLUSIVE RIGHT TO USE "NUTRIENTS", APART FROM THE MARK AS SHOWN.

FOR DIETARY SUPPLEMENTS (U.S. CLS. 6, 18, 44, 46, 51 AND 52).

ESTHER A. BORSUK, EXAMINING ATTORNEY

THE MARK CONSISTS OF STANDARD CHARACTERS WITHOUT CLAIM TO ANY PARTICULAR FONT, STYLE, SIZE, OR COLOR.

FOR NUTRITIONAL SUPPLEMENTS (U.S. CLS. 6, 18, 44, 46, 51 AND 52).

FIRST USE 9-22-2004; IN COMMERCE 9-22-2004.

CARRIE ACHEN, EXAMINING ATTORNEY

SN 78-457,162. ASTRAZENECA AB, SODERTALJE, SWEDEN, FILED 7-27-2004.

SN 78-446,862. NUTRICOLOGY, INC., HAYWARD, CA.
FILED 7-7-2004.

NanoTech Nutrience

BRILINTA

THE MARK CONSISTS OF STANDARD CHARACTERS WITHOUT CLAIM TO ANY PARTICULAR FONT, STYLE, SIZE, OR COLOR.

NO CLAIM IS MADE TO THE EXCLUSIVE RIGHT TO USE "NUTRIENCE", APART FROM THE MARK AS SHOWN.

FOR DIETARY SUPPLEMENTS (U.S. CLS. 6, 18, 44, 46, 51 AND 52).

ESTHER A. BORSUK, EXAMINING ATTORNEY

THE MARK CONSISTS OF STANDARD CHARACTERS WITHOUT CLAIM TO ANY PARTICULAR FONT, STYLE, SIZE, OR COLOR.

PRIORITY CLAIMED UNDER SEC. 44(D) ON SWEDEN APPLICATION NO. 2004/04550, FILED 6-30-2004, REG. NO. 370577, DATED 2-11-2005, EXPIRES 2-11-2015.

FOR PHARMACEUTICAL PREPARATIONS AND SUBSTANCES FOR THE PREVENTION AND TREATMENT OF CARDIOVASCULAR DISEASES AND DISORDERS (U.S. CLS. 6, 18, 44, 46, 51 AND 52).

JOANNA DUKOVIC, EXAMINING ATTORNEY

CLASS 5—(Continued).

SN 78-465,053. BRISTOL-MYERS SQUIBB COMPANY, NEW YORK, NY. FILED 8-10-2004.



THE MARK CONSISTS OF THE WORD "ORENCIA" AND A STYLIZED BIRD.

FOR PHARMACEUTICAL PREPARATIONS FOR HUMAN USE FOR THE TREATMENT AND PREVENTION OF OBESITY, DIABETES, INCONTINENCE, CARDIOVASCULAR DISEASES, CENTRAL NERVOUS SYSTEM DISEASES AND DISORDERS, STROKE, CANCER, INFLAMMATION AND INFLAMMATORY DISEASES, RESPIRATORY AND INFECTIOUS DISEASES, AUTOIMMUNE DISEASES, SOLID ORGAN TRANSPLANT REJECTION; PHARMACEUTICAL PREPARATIONS, NAMELY, ANTIBIOTICS, ANTI-FUNGALS, ANTI-VIRALS AND IMMUNOSUPPRESSANTS; DIAGNOSTIC PHARMACEUTICAL PREPARATIONS USED TO INCREASE HEART RATE AND CONTRAST IMAGING AGENTS (U.S. CLS. 6, 18, 44, 46, 51 AND 52).

DOMINIC J. FERRAIUOLO, EXAMINING ATTORNEY

CLASS 5—(Continued).

SN 78-478,327. ONCOSE, INC, ATHENS, GA. FILED 9-3-2004.

Oncose

THE MARK CONSISTS OF STANDARD CHARACTERS WITHOUT CLAIM TO ANY PARTICULAR FONT, STYLE, SIZE, OR COLOR.

FOR DIAGNOSTIC ASSAY CONTAINING ANTIBODIES AND LECTINS USED IN MEDICAL CLINICS TO DIAGNOSE VARIOUS FORMS OF CANCER (U.S. CLS. 6, 18, 44, 46, 51 AND 52).

WANDA KAY PRICE, EXAMINING ATTORNEY

SN 78-472,058. HARWOOD ENTERPRISES WORLDWIDE, LP, THE COLONY, TX. FILED 8-23-2004.

Pyrogen

THE MARK CONSISTS OF STANDARD CHARACTERS WITHOUT CLAIM TO ANY PARTICULAR FONT, STYLE, SIZE, OR COLOR.

FOR DIETARY SUPPLEMENT CONSISTING OF A BLEND OF PYRUVATE AND L-GLYCINE (U.S. CLS. 6, 18, 44, 46, 51 AND 52).

FIRST USE 8-1-2004; IN COMMERCE 8-1-2004.

GINA FINK, EXAMINING ATTORNEY

SN 78-478,328. ONCOSE, INC., ATHENS, GA. FILED 9-3-2004.

Glyco-Signature

THE MARK CONSISTS OF STANDARD CHARACTERS WITHOUT CLAIM TO ANY PARTICULAR FONT, STYLE, SIZE, OR COLOR.

FOR DIAGNOSTIC ASSAY CONTAINING ANTIBODIES AND LECTINS USED IN MEDICAL CLINICS TO DIAGNOSE VARIOUS FORMS OF CANCER (U.S. CLS. 6, 18, 44, 46, 51 AND 52).

WANDA KAY PRICE, EXAMINING ATTORNEY

CLASS 5—(Continued).

SN 78-478,652. JOWERS ENTERPRISES, LLC, COUSHATTA, LA. FILED 9-3-2004.



The logo for "Ben's Baby Butter" features the words "Ben's" and "Baby Butter" in a stylized, bubbly font. "Ben's" is in blue with a pink outline, and "Baby Butter" is in blue with a pink outline. The letters are thick and rounded.

NO CLAIM IS MADE TO THE EXCLUSIVE RIGHT TO USE "BABY BUTTER", APART FROM THE MARK AS SHOWN.

THE NAME SHOWN IN THE MARK IDENTIFIES A PARTICULAR LIVING INDIVIDUAL, BEN ROBERT JOWERS, WHOSE CONSENT TO REGISTER IS SUBMITTED.

THE COLORS BLUE, WHITE AND PINK ARE CLAIMED AS A FEATURE OF THE MARK.

THE MARK CONSISTS OF "BEN'S BABY BUTTER" WRITTEN IN BLUE OUTLINED IN WHITE AND PINK USING STYLIZED FONT.

FOR MEDICATED COMPOUNDED OINTMENT FOR RELIEF OF DIAPER RASH AND OTHER MINOR SKIN IRRITATIONS (U.S. CLS. 6, 18, 44, 46, 51 AND 52).

FIRST USE 7-16-2002; IN COMMERCE 7-16-2002.
MELISSA VALLILLO, EXAMINING ATTORNEY

CLASS 5—(Continued).

SN 78-483,557. ZENTARIS GMBH, FRANKFURT AM MAIN, FED REP GERMANY, FILED 9-14-2004.



The logo for "Cetrotide" features a stylized circular graphic on the left, composed of a pink arc, a light blue arc, and a dark blue arc. To the right of the graphic, the word "Cetrotide" is written in a bold, dark blue, sans-serif font.

OWNER OF U.S. REG. NO. 2,190,686.

THE COLOR(S) PINK, LIGHT BLUE AND DARK BLUE IS/ARE CLAIMED AS A FEATURE OF THE MARK.

THE CIRCULAR REGION AND THE SWIRL EXTENDING FROM THE CIRCULAR REGION ARE BOTH LIGHT BLUE IN COLOR. THE ARC SURROUNDING THE CIRCULAR REGION IS IN PINK COLOR, AND THE LETTERS ARE IN THE WORD CETROTIDE ARE SHOWN IN A DARK BLUE COLOR.

FOR PHARMACEUTICAL PREPARATIONS FOR THE TREATMENT OF GYNECOLOGICAL DISORDERS, FERTILITY PROBLEMS, CANCER, AND UROLOGICAL DISORDERS (U.S. CLS. 6, 18, 44, 46, 51 AND 52).

FIRST USE 8-0-2000; IN COMMERCE 8-0-2000.
DAWN FELDMAN, EXAMINING ATTORNEY

SN 78-485,165. BRISTOL-MYERS SQUIBB COMPANY, NEW YORK, NY. FILED 9-17-2004.

SN 78-480,286. CLAYTON DENTAL LABORATORY, INC., TROY, MI. FILED 9-8-2004.

SARCAMBA

HIP-Zirkonia

THE MARK CONSISTS OF STANDARD CHARACTERS WITHOUT CLAIM TO ANY PARTICULAR FONT, STYLE, SIZE, OR COLOR.

FOR MATERIALS USED FOR DENTAL CROWN AND BRIDGE SUBSTRUCTURES, NAMELY, ZIRCONIUM OXIDE (U.S. CLS. 6, 18, 44, 46, 51 AND 52).

GIANCARLO CASTRO, EXAMINING ATTORNEY

THE MARK CONSISTS OF STANDARD CHARACTERS WITHOUT CLAIM TO ANY PARTICULAR FONT, STYLE, SIZE, OR COLOR.

FOR PHARMACEUTICAL PREPARATIONS FOR HUMAN USE FOR THE TREATMENT AND PREVENTION OF OBESITY, DIABETES, INCONTINENCE, CARDIOVASCULAR DISEASES, CENTRAL NERVOUS SYSTEM DISEASES AND DISORDERS, STROKE, CANCER, INFLAMMATION AND INFLAMMATORY DISEASES, RESPIRATORY AND INFECTIOUS DISEASES, AUTOIMMUNE DISEASES, SOLID ORGAN TRANSPLANT REJECTION; PHARMACEUTICAL PREPARATIONS, NAMELY, ANTIBIOTICS, ANTI-FUNGALS, ANTI-VIRALS AND IMMUNOSUPPRESSANTS; DIAGNOSTIC PHARMACEUTICAL PREPARATIONS USED TO INCREASE HEART RATE AND CONTRAST IMAGING AGENTS (U.S. CLS. 6, 18, 44, 46, 51 AND 52).

ADA HAN, EXAMINING ATTORNEY

CLASS 5—(Continued).

SN 78-485,166. BRISTOL-MYERS SQUIBB COMPANY, NEW YORK, NY. FILED 9-17-2004.

SARCABLA

THE MARK CONSISTS OF STANDARD CHARACTERS WITHOUT CLAIM TO ANY PARTICULAR FONT, STYLE, SIZE, OR COLOR.

FOR PHARMACEUTICAL PREPARATIONS FOR HUMAN USE FOR THE TREATMENT AND PREVENTION OF OBESITY, DIABETES, INCONTINENCE, CARDIOVASCULAR DISEASES, CENTRAL NERVOUS SYSTEM DISEASES AND DISORDERS, STROKE, CANCER, INFLAMMATION AND INFLAMMATORY DISEASES, RESPIRATORY AND INFECTIOUS DISEASES, AUTOIMMUNE DISEASES, SOLID ORGAN TRANSPLANT REJECTION; PHARMACEUTICAL PREPARATIONS, NAMELY, ANTIBIOTICS, ANTI-FUNGALS, ANTI-VIRALS AND IMMUNOSUPPRESSANTS; DIAGNOSTIC PHARMACEUTICAL PREPARATIONS USED TO INCREASE HEART RATE AND CONTRAST IMAGING AGENTS (U.S. CLS. 6, 18, 44, 46, 51 AND 52).

ADA HAN, EXAMINING ATTORNEY

SN 78-488,246. FIRMAGEN NUTRACEUTICALS, INC., BOCA RATON, FL. FILED 9-23-2004.

FIRMAGEN

THE MARK CONSISTS OF STANDARD CHARACTERS WITHOUT CLAIM TO ANY PARTICULAR FONT, STYLE, SIZE, OR COLOR.

FOR NUTRACEUTICALS FOR USE AS A DIETARY SUPPLEMENT TO ENHANCE THE BEAUTY AND HEALTH OF SKIN; DIETARY SUPPLEMENTS; COSMETICALS, NAMELY MEDICATED SKIN CARE PREPARATIONS; HEALTH AND BEAUTY PRODUCTS, NAMELY MEDICATED LOTIONS FOR SKIN AND FACE (U.S. CLS. 6, 18, 44, 46, 51 AND 52).

FIRST USE 5-31-2003; IN COMMERCE 3-31-2004.
MICHAEL KAZAZIAN, EXAMINING ATTORNEY

CLASS 5—(Continued).

SN 78-488,515. BETA PHARMACEUTICAL CORP., WESTON LAKES, FL. FILED 9-23-2004.

CARVAL

THE MARK CONSISTS OF STANDARD CHARACTERS WITHOUT CLAIM TO ANY PARTICULAR FONT, STYLE, SIZE, OR COLOR.

FOR PHARMACEUTICAL, VETERINARY, AND SANITARY PREPARATIONS, NAMELY, ANTIBIOTICS, ALL PURPOSE DISINFECTANTS AND DISINFECTANTS FOR HYGIENIC AND SANITARY PURPOSES, ANTI-SEPTICS, PROBIOTICS, ANTIPARASITICS, MUCOLYTIC ENZYMES (U.S. CLS. 6, 18, 44, 46, 51 AND 52).

ELLEN PERKINS, EXAMINING ATTORNEY

SN 78-494,574. NOVARTIS AG, BASEL, SWITZERLAND, FILED 10-5-2004.

SIGNITOR

THE MARK CONSISTS OF STANDARD CHARACTERS WITHOUT CLAIM TO ANY PARTICULAR FONT, STYLE, SIZE, OR COLOR.

OWNER OF SWITZERLAND REG. NO. 524896, DATED 8-24-2004, EXPIRES 9-7-2014.

FOR PHARMACEUTICAL PREPARATIONS FOR THE PREVENTION AND TREATMENT OF DISORDERS OF THE NERVOUS SYSTEM, THE IMMUNE SYSTEM, THE CARDIOVASCULAR SYSTEM, THE RESPIRATORY SYSTEM, THE MUSCULOSKELETAL SYSTEM, THE GENITOURINARY SYSTEM, FOR THE TREATMENT OF INFLAMMATORY DISORDERS, FOR USE IN DERMATOLOGY, IN ONCOLOGY, IN HEMATOLOGY, IN TRANSPLANTATION, IN OPHTHALMOLOGY, FOR USE IN THE GASTROENTEROLOGICAL AREA AND THE PREVENTION AND TREATMENT OF OCULAR DISORDERS OR DISEASES; ANTI-INFECTIVES, PHARMACEUTICAL PREPARATIONS TREATING BACTERIA-BASED DISEASES, ANTIVIRALS, ANTIBIOTICS, ANTI-FUNGALS (U.S. CLS. 6, 18, 44, 46, 51 AND 52).

ZACHARY BELLO, EXAMINING ATTORNEY

CLASS 5—(Continued).

SN 78-495,295. ONCOLYS BIOPHARMA KABUSHIKI KAISHA, TA ONCOLYS BIOPHARMA INC., TOKYO, JAPAN, FILED 10-6-2004.

CLASS 5—(Continued).

SN 78-501,807. PFIZER INC., NEW YORK, NY. FILED 10-19-2004.

TELOMELYSIN

THE MARK CONSISTS OF STANDARD CHARACTERS WITHOUT CLAIM TO ANY PARTICULAR FONT, STYLE, SIZE, OR COLOR.

PRIORITY CLAIMED UNDER SEC. 44(D) ON JAPAN APPLICATION NO. 2004-076474, FILED 8-19-2004, REG. NO. 4855115, DATED 4-8-2005, EXPIRES 4-8-2015.

FOR PHARMACEUTICAL PREPARATIONS FOR USE IN CHEMOTHERAPY, FOR THE TREATMENT OF CANCER (U.S. CLS. 6, 18, 44, 46, 51 AND 52).

WILLIAM VERHOSEK, EXAMINING ATTORNEY

SN 78-495,998. SARA LEE CORPORATION, WINSTON-SALEM, NC. FILED 10-7-2004.

ESBELTISSIMA 2000

THE MARK CONSISTS OF STANDARD CHARACTERS WITHOUT CLAIM TO ANY PARTICULAR FONT, STYLE, SIZE, OR COLOR.

THE FOREIGN WORDING IN THE MARK TRANSLATES INTO ENGLISH AS "SLIM".

FOR PHARMACEUTICAL AND HEALTHCARE PRODUCTS, NAMELY VITAMINS AND POWDERED NUTRITIONAL SUPPLEMENTS FOR THE TREATMENT OF CELLULITE; HERBAL TEAS FOR MEDICINAL PURPOSES (U.S. CLS. 6, 18, 44, 46, 51 AND 52).

JOHN SCHUYLER YARD, EXAMINING ATTORNEY

SN 78-500,825. SPORTDOG SUPPLEMENTS, LLC, MISSOULA, MT. FILED 10-15-2004.



NO CLAIM IS MADE TO THE EXCLUSIVE RIGHT TO USE "AMERICAN SPORT DOG SUPPLEMENTS", APART FROM THE MARK AS SHOWN.

FOR FOOD SUPPLEMENTS FOR DOGS (U.S. CLS. 6, 18, 44, 46, 51 AND 52).

BARBARA BROWN, EXAMINING ATTORNEY

KENCEF

THE MARK CONSISTS OF STANDARD CHARACTERS WITHOUT CLAIM TO ANY PARTICULAR FONT, STYLE, SIZE, OR COLOR.

FOR VETERINARY PREPARATIONS AND SUBSTANCES FOR THE PREVENTION AND TREATMENT OF OCULAR DISORDERS, ORAL DISEASES, DISORDERS OF THE NERVOUS SYSTEM, THE BLOOD AND IMMUNE SYSTEM, THE CARDIO-VASCULAR SYSTEM, THE RESPIRATORY SYSTEM, THE MUSCULOSKELETAL SYSTEM, THE DIGESTIVE SYSTEM, THE GENITOURINARY SYSTEM, AND THE REPRODUCTIVE SYSTEM; VETERINARY PREPARATIONS AND SUBSTANCES FOR THE TREATMENT AND PREVENTION OF INFECTIOUS DISEASES, OBESITY, BEHAVIORAL DISORDERS AND INFLAMMATORY DISORDERS; VETERINARY PREPARATIONS AND SUBSTANCES FOR USE IN DERMATOLOGY, ONCOLOGY, HEMATOLOGY, OPHTHALMOLOGY, AND GASTROENTEROLOGY; NUTRITIONAL ADDITIVES AND FOOD SUPPLEMENTS; DENTAL CARE PREPARATIONS; ANTI-INFECTIVES; ANTI-BACTERIALS; ANTIVIRALS; ANTIBIOTICS; ANTIFUNGALS; ANTHELMINTICS; PARACITICIDES; ANALGESICS AND ALLERGENS; ALL OF THE FOREGOING FOR FELINES, CANINES, BOVINES, PORCINES, EQUINES, RABBITS, POULTRY, GOATS AND SHEEP (U.S. CLS. 6, 18, 44, 46, 51 AND 52).

CHRISIE B. KING, EXAMINING ATTORNEY

CLASS 5—(Continued).

SN 78-503,353. MACROSERVE PTE LTD, SINGAPORE, SINGAPORE, FILED 10-21-2004.

TRIMEE

THE MARK CONSISTS OF STANDARD CHARACTERS WITHOUT CLAIM TO ANY PARTICULAR FONT, STYLE, SIZE, OR COLOR.

FOR DIETARY SUPPLEMENTS IN VARIOUS FORMS SUCH AS TABLETS, CAPSULES, LIQUID ETC FOR SLIMMING (U.S. CLS. 6, 18, 44, 46, 51 AND 52).

FIRST USE 0-0-1998; IN COMMERCE 0-0-1998.

MARK RADEMACHER, EXAMINING ATTORNEY

SN 78-503,482. PT. BINTANG TOEDJOE, JAKARTA, INDONESIA, FILED 10-21-2004.



OWNER OF INDONESIA REG. NO. 418291, DATED 11-25-1998, EXPIRES 7-31-2007.

OWNER OF U.S. REG. NO. 2,882,211.

THE COLOR(S) YELLOW, BLACK, RED AND WHITE IS/ ARE CLAIMED AS A FEATURE OF THE MARK.

THE WORDING EXTRA JOSS IN RED, YELLOW AND WHITE. A CLENCHED FIST IN RED BLACK AND YELLOW IS COMING OUT OF LIQUID.

FOR DIETARY SUPPLEMENTAL DRINKS; PHARMACEUTICAL PREPARATIONS, NAMELY, ANAESTHETICS, ANTHELMINTICS AND CHLOROFORM; VETERINARY PREPARATIONS, NAMELY, BACTERIAL PREPARATIONS FOR MEDICAL AND VETERINARY USE, BIOLOGICAL PREPARATIONS FOR VETERINARY PURPOSES, CHEMICAL REAGENTS FOR MEDICAL AND VETERINARY PURPOSES; SANITARY PREPARATIONS FOR MEDICAL USE; DIETETIC FOODS ADAPTED FOR MEDICAL USE; DIETETIC SUGAR FOR MEDICAL USE; BABY FOOD; MEDICAL PLASTERS, BANDAGES AND GAUZE FOR DRESSINGS; MATERIAL FOR STOPPING TEETH; DENTAL WAX; DISINFECTANTS FOR SANITARY AND HYGIENIC PURPOSES; PREPARATIONS FOR DESTROYING VERMIN; FUNGICIDES FOR MEDICAL AND DOMESTIC USE; HERBICIDES FOR HOME AND PROFESSIONAL USE (U.S. CLS. 6, 18, 44, 46, 51 AND 52).

ERNEST SHOSHO, EXAMINING ATTORNEY

CLASS 5—(Continued).

SN 78-506,732. CERAMCO INC., BURLINGTON, NJ. FILED 10-27-2004.

SoftWear

THE MARK CONSISTS OF STANDARD CHARACTERS WITHOUT CLAIM TO ANY PARTICULAR FONT, STYLE, SIZE, OR COLOR.

FOR DENTAL COMPOUNDS, NAMELY DENTAL PORCELAIN (U.S. CLS. 6, 18, 44, 46, 51 AND 52).

FIRST USE 3-11-2004; IN COMMERCE 3-11-2004.

JULIA HARDY COFIELD, EXAMINING ATTORNEY

SN 78-509,700. ISI BRANDS, INC., GRAND RAPIDS, MI. FILED 11-2-2004.

MAXILIFE JOINT PROTECTOR

THE MARK CONSISTS OF STANDARD CHARACTERS WITHOUT CLAIM TO ANY PARTICULAR FONT, STYLE, SIZE, OR COLOR.

OWNER OF U.S. REG. NO. 1,321,725.

NO CLAIM IS MADE TO THE EXCLUSIVE RIGHT TO USE "JOINT PROTECTOR", APART FROM THE MARK AS SHOWN.

FOR DIETARY SUPPLEMENTS (U.S. CLS. 6, 18, 44, 46, 51 AND 52).

FIRST USE 10-18-1996; IN COMMERCE 10-18-1996.

ELLEN BURNS, EXAMINING ATTORNEY

CLASS 5—(Continued).

SN 78-509,834. ISI BRANDS, INC., GRAND RAPIDS, MI. FILED 11-2-2004.

**MAXILIFE BRAIN
PROTECTOR**

THE MARK CONSISTS OF STANDARD CHARACTERS WITHOUT CLAIM TO ANY PARTICULAR FONT, STYLE, SIZE, OR COLOR.

OWNER OF U.S. REG. NO. 1,321,725.
NO CLAIM IS MADE TO THE EXCLUSIVE RIGHT TO USE "BRAIN PROTECTOR", APART FROM THE MARK AS SHOWN.

FOR DIETARY SUPPLEMENTS (U.S. CLS. 6, 18, 44, 46, 51 AND 52).

FIRST USE 10-18-1996; IN COMMERCE 10-18-1996.
MELISSA VALLILLO, EXAMINING ATTORNEY

CLASS 5—(Continued).

SN 78-511,283. BURNS VETERINARY SUPPLY, INC., WEST-BURY, NY. FILED 11-4-2004.

**VETAMECTIN-CS
INJECTABLE**

THE MARK CONSISTS OF STANDARD CHARACTERS WITHOUT CLAIM TO ANY PARTICULAR FONT, STYLE, SIZE, OR COLOR.

NO CLAIM IS MADE TO THE EXCLUSIVE RIGHT TO USE "INJECTABLE", APART FROM THE MARK AS SHOWN.

FOR PARASITICIDE FOR CATTLE AND SWINE (U.S. CLS. 6, 18, 44, 46, 51 AND 52).

FIRST USE 12-3-2003; IN COMMERCE 12-3-2003.
MARIAM MAHMOUDI, EXAMINING ATTORNEY

SN 78-511,494. HISAMITSU PHARMACEUTICAL CO., INC., SAGA, JAPAN, FILED 11-4-2004.

SN 78-510,747. ADVANCED HEALTH AND NUTRITION, LLC, MADISON, CT. FILED 11-3-2004.

KEPLAT

CortiVarin

THE MARK CONSISTS OF STANDARD CHARACTERS WITHOUT CLAIM TO ANY PARTICULAR FONT, STYLE, SIZE, OR COLOR.

FOR DIETARY SUPPLEMENTS, VITAMINS, MINERAL SUPPLEMENTS AND HERBAL SUPPLEMENTS (U.S. CLS. 6, 18, 44, 46, 51 AND 52).

FIRST USE 10-0-2004; IN COMMERCE 11-3-2004.
DOUGLAS LEE, EXAMINING ATTORNEY

THE MARK CONSISTS OF STANDARD CHARACTERS WITHOUT CLAIM TO ANY PARTICULAR FONT, STYLE, SIZE, OR COLOR.

PRIORITY CLAIMED UNDER SEC. 44(D) ON JAPAN APPLICATION NO. 2004-078915, FILED 8-26-2004, REG. NO. 4851109, DATED 3-25-2005, EXPIRES 3-25-2015.

FOR MEDICATED TRANSDERMAL PATCHES, PLASTERS, PADS, CATAPLASMS AND CREAMS FOR RELIEF OF ACHEs OF RHEUMATOID ARTHRITIS, AND THE ACHEs AND PAINS OF MUSCLES, JOINTS AND TENDONS; ANTI-INFLAMMATORY AND ANALGESIC AGENTS; OTHER PHARMACEUTICALS IN THE FORM OF PATCHES, PLASTERS, PADS, CATAPLASMS AND CREAMS FOR USE IN THE TREATMENT OF LUMBAGO, NAMELY MUSCULAR AND FASCIAL LUMBAGO, SPONDYLOSIS DEFORMANS DISCOPATHY, AND SPRAIN OF LUMBAR SPINE, OSTEOARTHRITIS, HUMEROSCAPULAR PERIARTEBRITIS, TENDINITIS, TENDO-VAGINITIS, PERITENDINITIS, HUMERAL EPICONDYLITIS, TENNIS ELBOW, MYALGIA AND POST-TRAUMATIC SWELLING AND PAIN; ANTIPHLOGISTIC AND ANALGESIC SPRAY FOR THE TEMPORARY RELIEF OF MINOR MUSCULAR ACHEs AND PAINS; ANTIPHLOGISTIC AND ANALGESIC GEL FOR THE TEMPORARY RELIEF OF MINOR MUSCULAR ACHEs AND PAINS (U.S. CLS. 6, 18, 44, 46, 51 AND 52).

INGRID C. EULIN, EXAMINING ATTORNEY

CLASS 5—(Continued).

SN 78-512,271. JARROW FORMULAS, INC., LOS ANGELES, CA. FILED 11-5-2004.

CLASS 5—(Continued).

SN 78-514,210. NATURSCIENCE, INC, SUNRISE, FL. FILED 11-9-2004.

NAC SUSTAIN

LimuPlex

THE MARK CONSISTS OF STANDARD CHARACTERS WITHOUT CLAIM TO ANY PARTICULAR FONT, STYLE, SIZE, OR COLOR.

OWNER OF U.S. REG. NO. 2,735,038.
NO CLAIM IS MADE TO THE EXCLUSIVE RIGHT TO USE "NAC", APART FROM THE MARK AS SHOWN, FOR DIETARY AND NUTRITIONAL SUPPLEMENTS (U.S. CLS. 6, 18, 44, 46, 51 AND 52).
FIRST USE 9-0-1994; IN COMMERCE 9-0-1994.
CIMMERIAN COLEMAN, EXAMINING ATTORNEY

THE MARK CONSISTS OF STANDARD CHARACTERS WITHOUT CLAIM TO ANY PARTICULAR FONT, STYLE, SIZE, OR COLOR.

FOR PHARMACEUTICALS, NAMELY, DIETARY AND NUTRITIONAL SUPPLEMENTS (U.S. CLS. 6, 18, 44, 46, 51 AND 52).
FIRST USE 8-0-2004; IN COMMERCE 8-0-2004.
GEORGE LORENZO, EXAMINING ATTORNEY

SN 78-512,619. HARTMANN-CONCO, INC., ROCK HILL, SC. FILED 11-6-2004.

SN 78-514,214. NATURSCIENCE, INC, SUNRISE, FL. FILED 11-9-2004.

SORBALUX

FLEXIMUNE

THE MARK CONSISTS OF STANDARD CHARACTERS WITHOUT CLAIM TO ANY PARTICULAR FONT, STYLE, SIZE, OR COLOR.

FOR MEDICAL AND SURGICAL DRESSINGS, SPECIFICALLY, NON-WOVEN GAUZE PADS FOR USE IN THE CARE OF ABDOMINAL WOUNDS AND INCISIONS (U.S. CLS. 6, 18, 44, 46, 51 AND 52).
TONJA GASKINS, EXAMINING ATTORNEY

THE MARK CONSISTS OF STANDARD CHARACTERS WITHOUT CLAIM TO ANY PARTICULAR FONT, STYLE, SIZE, OR COLOR.

FOR PHARMACEUTICALS, NAMELY, DIETARY AND NUTRITIONAL SUPPLEMENTS (U.S. CLS. 6, 18, 44, 46, 51 AND 52).
FIRST USE 8-0-2004; IN COMMERCE 8-0-2004.
ROBERT LAVACHE, EXAMINING ATTORNEY

CLASS 5—(Continued).

SN 78-514,561. NORTH AMERICAN NUTRITION COMPANIES, INC., LEWISBURG, OH. FILED 11-10-2004.

CLASS 5—(Continued).

SN 78-516,085. SENSUA ORGANICS, INC., NEVADA CITY, CA. FILED 11-12-2004.

SENSUA ORGANICS

DEFINITION

THE MARK CONSISTS OF STANDARD CHARACTERS WITHOUT CLAIM TO ANY PARTICULAR FONT, STYLE, SIZE, OR COLOR.

OWNER OF U.S. REG. NO. 2,794,067.

NO CLAIM IS MADE TO THE EXCLUSIVE RIGHT TO USE "ORGANICS", APART FROM THE MARK AS SHOWN. FOR PERSONAL LUBRICANTS (U.S. CLS. 6, 18, 44, 46, 51 AND 52).

FIRST USE 10-28-2002; IN COMMERCE 10-28-2002.
EVELYN BRADLEY, EXAMINING ATTORNEY

THE MARK CONSISTS OF STANDARD CHARACTERS WITHOUT CLAIM TO ANY PARTICULAR FONT, STYLE, SIZE, OR COLOR.

FOR NON-MEDICATED, NUTRITIONAL SUPPLEMENT FOR LIVESTOCK (U.S. CLS. 6, 18, 44, 46, 51 AND 52).

FIRST USE 8-13-2002; IN COMMERCE 9-24-2002.
MIDGE BUTLER, EXAMINING ATTORNEY

SN 78-516,192. SENSUA ORGANICS, INC., NEVADA CITY, CA. FILED 11-12-2004.

FERTILE MAMA

THE MARK CONSISTS OF STANDARD CHARACTERS WITHOUT CLAIM TO ANY PARTICULAR FONT, STYLE, SIZE, OR COLOR.

FOR PERSONAL LUBRICANTS (U.S. CLS. 6, 18, 44, 46, 51 AND 52).

FIRST USE 6-1-2004; IN COMMERCE 6-1-2004.
DEBRA LEE, EXAMINING ATTORNEY

SN 78-515,796. SANKYO COMPANY LIMITED, TOKYO, JAPAN, FILED 11-12-2004.

EFIVAS

SN 78-516,213. SENSUA ORGANICS, INC., NEVADA CITY, CA. FILED 11-12-2004.

LUSCIOUS FLOWER

THE MARK CONSISTS OF STANDARD CHARACTERS WITHOUT CLAIM TO ANY PARTICULAR FONT, STYLE, SIZE, OR COLOR.

FOR PHARMACEUTICAL PREPARATIONS FOR THE TREATMENT OF CARDIOVASCULAR DISEASES, CHOLESTEROL REDUCTION, ATHEROSCLEROSIS, METABOLIC DISEASES, DIABETIC NEPHROPATHY AND STROKE (U.S. CLS. 6, 18, 44, 46, 51 AND 52).

PAUL F. GAST, EXAMINING ATTORNEY

THE MARK CONSISTS OF STANDARD CHARACTERS WITHOUT CLAIM TO ANY PARTICULAR FONT, STYLE, SIZE, OR COLOR.

FOR PERSONAL LUBRICANTS (U.S. CLS. 6, 18, 44, 46, 51 AND 52).

FIRST USE 6-1-2004; IN COMMERCE 6-1-2004.
JAMES A. RAUEN, EXAMINING ATTORNEY

CLASS 5—(Continued).

SN 78-517,044. JAROS, ROBERT H, SHELburnE, MA. FILED 11-15-2004.

CLASS 5—(Continued).

SN 78-517,462. CONFIDENCE INC., FLUSHING, NY. FILED 11-16-2004.

Metacare

模 特 寶

THE MARK CONSISTS OF STANDARD CHARACTERS WITHOUT CLAIM TO ANY PARTICULAR FONT, STYLE, SIZE, OR COLOR.

FOR PHARMACEUTICAL THAT AIDS IN CONTROL OF, OR SYMPTOMS OF, METASTATIC DISEASE (U.S. CLS. 6, 18, 44, 46, 51 AND 52).
YONG KIM, EXAMINING ATTORNEY

THE MARK CONSISTS OF THREE CHINESE CHARACTERS TRANSLATED "THE TREASURER OF THE MODEL". THE FOREIGN WORDING IN THE MARK TRANSLATES INTO ENGLISH AS THE TREASURER OF THE MODEL.

THE NON-LATIN CHARACTER(S) IN THE MARK TRANSLITERATES INTO MUTABO, AND THIS MEANS THE TREASURER OF THE MODEL IN ENGLISH.
FOR DIETARY SUPPLEMENTS IN CAPSULE FORM (U.S. CLS. 6, 18, 44, 46, 51 AND 52).
FIRST USE 8-11-2002; IN COMMERCE 8-11-2002.
ALEXANDER L. POWERS, EXAMINING ATTORNEY

SN 78-517,238. BIODRUX, INC., BELLEVUE, WA. FILED 11-15-2004.

SN 78-518,432. NMD NUTRITION INC., WESTWOOD, NJ. FILED 11-17-2004.

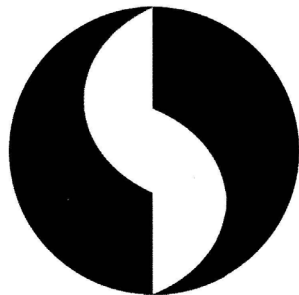

BIODRUX

Slim Desire

FOR VITAMIN AND MINERAL PREPARATIONS FOR MEDICAL USE (U.S. CLS. 6, 18, 44, 46, 51 AND 52).
MICHELE SWAIN, EXAMINING ATTORNEY

THE MARK CONSISTS OF STANDARD CHARACTERS WITHOUT CLAIM TO ANY PARTICULAR FONT, STYLE, SIZE, OR COLOR.
FOR WEIGHT LOSS DIETARY SUPPLEMENT (U.S. CLS. 6, 18, 44, 46, 51 AND 52).
DAWN FELDMAN, EXAMINING ATTORNEY

CLASS 5—(Continued).

SN 78-518,591. MARIPOSA, INC., NEW HYDE PARK, NY.
FILED 11-17-2004.

CLASS 5—(Continued).

SN 78-519,107. ARCUS MEDICAL, LLC, CHARLOTTE, NC.
FILED 11-18-2004.

INVITE STEROLS

WUNDERPAD

THE MARK CONSISTS OF STANDARD CHARACTERS
WITHOUT CLAIM TO ANY PARTICULAR FONT, STYLE,
SIZE, OR COLOR.

OWNER OF U.S. REG. NO. 2,375,951.
NO CLAIM IS MADE TO THE EXCLUSIVE RIGHT TO
USE STEROLS, APART FROM THE MARK AS SHOWN,
FOR DIETARY AND NUTRITIONAL SUPPLEMENTS
(U.S. CLS. 6, 18, 44, 46, 51 AND 52).
JEFF DEFORD, EXAMINING ATTORNEY

THE MARK CONSISTS OF STANDARD CHARACTERS
WITHOUT CLAIM TO ANY PARTICULAR FONT, STYLE,
SIZE, OR COLOR.

FOR INCONTINENCE PADS (U.S. CLS. 6, 18, 44, 46, 51
AND 52).
AMOS T. MATTHEWS, JR., EXAMINING ATTORNEY

SN 78-518,908. INNOVISION HEALTH CORP., IRVINE, CA.
FILED 11-17-2004.

SN 78-519,129. GENERATION PLUS, INC., PHOENIX, AZ.
FILED 11-18-2004.

LEVPRIN

ORGANIC CUPBOARD

THE MARK CONSISTS OF STANDARD CHARACTERS
WITHOUT CLAIM TO ANY PARTICULAR FONT, STYLE,
SIZE, OR COLOR.

FOR DIETARY SUPPLEMENTS (U.S. CLS. 6, 18, 44, 46,
51 AND 52).
STEVEN JACKSON, EXAMINING ATTORNEY

THE MARK CONSISTS OF STANDARD CHARACTERS
WITHOUT CLAIM TO ANY PARTICULAR FONT, STYLE,
SIZE, OR COLOR.

NO CLAIM IS MADE TO THE EXCLUSIVE RIGHT TO
USE "ORGANIC", APART FROM THE MARK AS SHOWN.
FOR NUTRITIONAL AND DIETARY SUPPLEMENTS
(U.S. CLS. 6, 18, 44, 46, 51 AND 52).
SUNG IN, EXAMINING ATTORNEY

CLASS 5—(Continued).

SN 78-519,199. HEALTH AUTHORITY LLC, ORLANDO, FL. FILED 11-18-2004.

CLASS 5—(Continued).

SN 78-519,703. SANTARUS, INC., SAN DIEGO, CA. FILED 11-18-2004.

ISD-10

Zegerid

THE MARK CONSISTS OF STANDARD CHARACTERS WITHOUT CLAIM TO ANY PARTICULAR FONT, STYLE, SIZE, OR COLOR.

FOR VITAMINS, NUTRITIONAL SUPPLEMENTS, DIETARY SUPPLEMENTS, HERBAL SUPPLEMENTS (U.S. CLS. 6, 18, 44, 46, 51 AND 52).

ANNE MADDEN, EXAMINING ATTORNEY

FOR PHARMACEUTICAL PREPARATIONS FOR THE TREATMENT OF GASTROINTESTINAL PROBLEMS AND DISEASES (U.S. CLS. 6, 18, 44, 46, 51 AND 52).

FIRST USE 9-9-2004; IN COMMERCE 9-9-2004.

ALICE BENMAMAN, EXAMINING ATTORNEY

SN 78-519,541. CONFIDENCE INC., FLUSHING, NY. FILED 11-18-2004.

SN 78-519,721. PALMIOTTO ENTERPRISES, LLC, NEWPORT BEACH, CA. FILED 11-18-2004.

MODELSLIM

DOMESTIC DIVA

THE MARK CONSISTS OF STANDARD CHARACTERS WITHOUT CLAIM TO ANY PARTICULAR FONT, STYLE, SIZE, OR COLOR.

FOR DIETARY SUPPLEMENTS IN CAPSULE, TABLET AND LIQUID DRINK FORM (U.S. CLS. 6, 18, 44, 46, 51 AND 52).

DORITT L. CARROLL, EXAMINING ATTORNEY

THE MARK CONSISTS OF STANDARD CHARACTERS WITHOUT CLAIM TO ANY PARTICULAR FONT, STYLE, SIZE, OR COLOR.

FOR PERSONAL LUBRICANTS, VAGINAL MOISTURIZERS AND SPERMICIDAL PREPARATIONS (U.S. CLS. 6, 18, 44, 46, 51 AND 52).

MELVIN AXILBUND, EXAMINING ATTORNEY

CLASS 5—(Continued).

SN 78-519,773. VITOGEN, INC., PALO ALTO, CA. FILED 11-18-2004.

AXCIL

THE MARK CONSISTS OF STANDARD CHARACTERS WITHOUT CLAIM TO ANY PARTICULAR FONT, STYLE, SIZE, OR COLOR.

FOR NUTRACEUTICALS FOR THE TREATMENT OF SEXUAL DYSFUNCTION, NUTRACEUTICALS FOR THE TREATMENT OF HYPOSEXUAL DESIRE DISORDER, NUTRACEUTICALS FOR THE TREATMENT OF PREMATURE EJACULATION, PHARMACEUTICALS FOR THE TREATMENT OF SEXUAL DYSFUNCTION, PHARMACEUTICALS FOR THE TREATMENT OF HYPOSEXUAL DESIRE DISORDER, PHARMACEUTICALS FOR THE TREATMENT OF PREMATURE EJACULATION (U.S. CLS. 6, 18, 44, 46, 51 AND 52).

FIRST USE 9-15-2004; IN COMMERCE 11-1-2004.
CATHERINE FAINT, EXAMINING ATTORNEY

SN 78-520,158. CARDIOKINE, INC., PHILADELPHIA, PA. FILED 11-19-2004.

AQUALIX

THE MARK CONSISTS OF STANDARD CHARACTERS WITHOUT CLAIM TO ANY PARTICULAR FONT, STYLE, SIZE, OR COLOR.

FOR PHARMACEUTICAL PREPARATIONS FOR THE TREATMENT OF DISEASE STATES ASSOCIATED WITH WATER RETENTION, NAMELY, CONGESTIVE HEART FAILURE, CIRRHOSIS, SYNDROME OF INAPPROPRIATE ANTIDIURETIC HORMONE, HYPONATREMIA AND WATER RETENTION (U.S. CLS. 6, 18, 44, 46, 51 AND 52).

LANA PHAM, EXAMINING ATTORNEY

CLASS 5—(Continued).

SN 78-520,179. CARDIOKINE, INC., PHILADELPHIA, PA. FILED 11-19-2004.

AQUILIX

THE MARK CONSISTS OF STANDARD CHARACTERS WITHOUT CLAIM TO ANY PARTICULAR FONT, STYLE, SIZE, OR COLOR.

FOR PHARMACEUTICAL PREPARATIONS FOR THE TREATMENT OF DISEASE STATES ASSOCIATED WITH WATER RETENTION, NAMELY, CONGESTIVE HEART FAILURE, CIRRHOSIS, SYNDROME OF INAPPROPRIATE ANTIDIURETIC HORMONE, HYPONATREMIA AND WATER RETENTION (U.S. CLS. 6, 18, 44, 46, 51 AND 52).

LANA PHAM, EXAMINING ATTORNEY

SN 78-520,202. CARDIOKINE, INC., PHILADELPHIA, PA. FILED 11-19-2004.

AQUITIL

THE MARK CONSISTS OF STANDARD CHARACTERS WITHOUT CLAIM TO ANY PARTICULAR FONT, STYLE, SIZE, OR COLOR.

FOR PHARMACEUTICAL PREPARATIONS FOR THE TREATMENT OF DISEASE STATES ASSOCIATED WITH WATER RETENTION, NAMELY, CONGESTIVE HEART FAILURE, CIRRHOSIS, SYNDROME OF INAPPROPRIATE ANTIDIURETIC HORMONE, HYPONATREMIA AND WATER RETENTION (U.S. CLS. 6, 18, 44, 46, 51 AND 52).

SEAN DWYER, EXAMINING ATTORNEY

CLASS 5—(Continued).

SN 78-520,281. STATLAB MEDICAL PRODUCTS, INC., LEWISVILLE, TX. FILED 11-19-2004.

CHEERUB

THE MARK CONSISTS OF STANDARD CHARACTERS WITHOUT CLAIM TO ANY PARTICULAR FONT, STYLE, SIZE, OR COLOR.

FOR MEDICATED LINIMENT BALM TO BE APPLIED EXTERNALLY FOR WARMING AND SOOTHING TIRED MUSCLES, INTENDED FOR USE BY PERSONS ENGAGING IN SPORTS AND SPORTS-RELATED ACTIVITIES; AND MEDICATED BODY RUBBING LOTION THAT IS APPLIED EXTERNALLY FOR RELIEVING MUSCLE PAIN AND DISCOMFORT CAUSED BY STRENUOUS WORK OR EXERCISE (U.S. CLS. 6, 18, 44, 46, 51 AND 52).

REBECCA GAN, EXAMINING ATTORNEY

SN 78-520,490. BUTCHER, FELINE, SHADOW HILLS, CA. FILED 11-19-2004.

Body Klär

THE MARK CONSISTS OF STANDARD CHARACTERS WITHOUT CLAIM TO ANY PARTICULAR FONT, STYLE, SIZE, OR COLOR.

THE ENGLISH TRANSLATION OF THE WORD KLÄR IN THE MARK IS CLEAR.

FOR NUTRITIONAL SUPPLEMENTS (U.S. CLS. 6, 18, 44, 46, 51 AND 52).

JOHN WILKE, EXAMINING ATTORNEY

CLASS 5—(Continued).

SN 78-520,653. PHYTOS, INC, SANANSELMO, CA. FILED 11-21-2004.

MINDEASE

THE MARK CONSISTS OF STANDARD CHARACTERS WITHOUT CLAIM TO ANY PARTICULAR FONT, STYLE, SIZE, OR COLOR.

FOR HERBAL EXTRACT OF SCUTELLARIA LATERIFLORA FOR USE AS A TRANQUILIZER AND A SEDATIVE (U.S. CLS. 6, 18, 44, 46, 51 AND 52).

JENNIFER WILLISTON, EXAMINING ATTORNEY

SN 78-520,985. VANMOOR, ARTHUR, BOCA RATON, FL. FILED 11-22-2004.

CLASH

THE MARK CONSISTS OF STANDARD CHARACTERS WITHOUT CLAIM TO ANY PARTICULAR FONT, STYLE, SIZE, OR COLOR.

FOR VITAMINS AND NUTRITIONAL SUPPLEMENTS (U.S. CLS. 6, 18, 44, 46, 51 AND 52).

MICHAEL SOUDERS, EXAMINING ATTORNEY

CLASS 5—(Continued).

SN 78-521,000. VANMOOR, ARTHUR, BOCA RATON, FL.
FILED 11-22-2004.

CLASS 5—(Continued).

SN 78-521,057. ZABECOR PHARMACEUTICAL COMPANY,
LLC, PHILADELPHIA, PA. FILED 11-22-2004.

CORRECTOR

DISARMIN

THE MARK CONSISTS OF STANDARD CHARACTERS
WITHOUT CLAIM TO ANY PARTICULAR FONT, STYLE,
SIZE, OR COLOR.
FOR VITAMINS AND NUTRITIONAL SUPPLEMENTS
(U.S. CLS. 6, 18, 44, 46, 51 AND 52).
DAWN HAN, EXAMINING ATTORNEY

THE MARK CONSISTS OF STANDARD CHARACTERS
WITHOUT CLAIM TO ANY PARTICULAR FONT, STYLE,
SIZE, OR COLOR.
FOR PHARMACEUTICALS, NAMELY, ANTI-IN-
FLAMMATORIES; PHARMACEUTICALS FOR TREAT-
ING INFECTIONS, AUTO-IMMUNE DISEASES, AND
RESPIRATORY AILMENTS (U.S. CLS. 6, 18, 44, 46, 51
AND 52).
TARAH HARDY, EXAMINING ATTORNEY

SN 78-521,018. VANMOOR, ARTHUR, BOCA RATON, FL.
FILED 11-22-2004.

SN 78-521,207. SCHERING-PLOUGH VETERINARY COR-
PORATION, RENO, NV. FILED 11-22-2004.

CONFINEMENT

GARACIN

THE MARK CONSISTS OF STANDARD CHARACTERS
WITHOUT CLAIM TO ANY PARTICULAR FONT, STYLE,
SIZE, OR COLOR.
FOR VITAMINS AND NUTRITIONAL SUPPLEMENTS
(U.S. CLS. 6, 18, 44, 46, 51 AND 52).
REBECCA HAN, EXAMINING ATTORNEY

THE MARK CONSISTS OF STANDARD CHARACTERS
WITHOUT CLAIM TO ANY PARTICULAR FONT, STYLE,
SIZE, OR COLOR.
FOR VETERINARY ANTIBIOTIC (U.S. CLS. 6, 18, 44,
46, 51 AND 52).
SCOTT OSCLICK, EXAMINING ATTORNEY

CLASS 5—(Continued).

SN 78-521,727. PLANNED PARENTHOOD FEDERATION OF AMERICA, INC., NEW YORK, NY. FILED 11-23-2004.



OWNER OF U.S. REG. NOS. 1,225,585, 1,847,118 AND 2,517,913.
 FOR PREGNANCY TEST KITS FOR HOME AND CLINICAL USE (U.S. CLS. 6, 18, 44, 46, 51 AND 52).
 FIRST USE 7-21-2004; IN COMMERCE 7-21-2004.
 MITCHELL FRONT, EXAMINING ATTORNEY

SN 78-521,818. AGELESS FOUNDATION LABORATORIES, MIAMI BEACH, FL. FILED 11-23-2004.



THE GRAY TONES IN THE DRAWING ARE FOR SHADING PURPOSES ONLY; THE MARK IS NOT IN COLOR.

THE MARK CONSISTS OF THE LETTER "A", WITH AN INFINITY SYMBOL WRAPPED AROUND THE "A", INSCRIBED WITHIN A SOLID CIRCLE AND A SECOND FINE-LINED CIRCLE.

FOR DIETARY SUPPLEMENTS (U.S. CLS. 6, 18, 44, 46, 51 AND 52).
 FIRST USE 3-0-1999; IN COMMERCE 3-0-1999.
 DAVID H. STINE, EXAMINING ATTORNEY

CLASS 5—(Continued).

SN 78-522,354. MAXYGEN, INC., REDWOOD CITY, CA. FILED 11-24-2004.

MAXYGEN

THE MARK CONSISTS OF STANDARD CHARACTERS WITHOUT CLAIM TO ANY PARTICULAR FONT, STYLE, SIZE, OR COLOR.

OWNER OF U.S. REG. NOS. 2,681,856, 2,865,593 AND OTHERS.

FOR PHARMACEUTICAL PREPARATIONS FOR THE PREVENTION AND TREATMENT OF CARDIOVASCULAR, DENTAL AND PERIODONTAL, DERMATOLOGIC, ENDOCRINE AND METABOLIC, GASTROINTESTINAL, GENETIC, HEMATOLOGIC, HEPATIC, IMMUNOLOGIC, LYMPATHATIC, OSTEOLOGIC, NEUROLOGIC, OPHTHALMIC, PSYCHIATRIC, RESPIRATORY TRACT, AND RENAL AND URINARY TRACT DISEASES AND DISORDERS; PHARMACEUTICAL PREPARATIONS, NAMELY, ANALGESICS, ANTIBIOTICS, ANTI-CANCER PREPARATIONS, ANTI-INFECTIVES, ANTI-PARASITICS, ANTIVIRALS; HORMONES; MEDICAL DIAGNOSTIC PREPARATIONS AND REAGENTS; VACCINES; ADJUVANTS FOR USE WITH VACCINES (U.S. CLS. 6, 18, 44, 46, 51 AND 52).
 AMY HELLA, EXAMINING ATTORNEY

SN 78-522,564. PINKUS, MICHAEL R., DALLAS, TX. FILED 11-24-2004.

**GET YOUR BODY
 GOING AGAIN!**

THE MARK CONSISTS OF STANDARD CHARACTERS WITHOUT CLAIM TO ANY PARTICULAR FONT, STYLE, SIZE, OR COLOR.

FOR NUTRITIONAL SUPPLEMENTS (U.S. CLS. 6, 18, 44, 46, 51 AND 52).
 FIRST USE 6-1-2004; IN COMMERCE 6-1-2004.
 DAWN FELDMAN, EXAMINING ATTORNEY

CLASS 5—(Continued).

SN 78-522,631. NORTH AMERICAN PHARMACAL, INC.,
NORWALK, CT. FILED 11-24-2004.

CLASS 5—(Continued).

SN 78-522,663. NORTH AMERICAN PHARMACAL, INC.,
NORWALK, CT. FILED 11-24-2004.

CORTIGUARD

THE MARK CONSISTS OF STANDARD CHARACTERS
WITHOUT CLAIM TO ANY PARTICULAR FONT, STYLE,
SIZE, OR COLOR.
FOR NUTRITIONAL SUPPLEMENTS (U.S. CLS. 6, 18,
44, 46, 51 AND 52).
FIRST USE 12-0-1998; IN COMMERCE 12-0-1998.
WILLIAM VERHOSEK, EXAMINING ATTORNEY

COLLINSONIA PLUS

THE MARK CONSISTS OF STANDARD CHARACTERS
WITHOUT CLAIM TO ANY PARTICULAR FONT, STYLE,
SIZE, OR COLOR.
NO CLAIM IS MADE TO THE EXCLUSIVE RIGHT TO
USE "COLLINSONIA", APART FROM THE MARK AS
SHOWN.
FOR NUTRITIONAL SUPPLEMENTS (U.S. CLS. 6, 18,
44, 46, 51 AND 52).
FIRST USE 10-0-1997; IN COMMERCE 10-0-1997.
CHRISTOPHER ADKINS, EXAMINING ATTORNEY

SN 78-522,648. NORTH AMERICAN PHARMACAL, INC.,
NORWALK, CT. FILED 11-24-2004.

SN 78-523,528. SCHERING AKTIENGESELLSCHAFT, BER-
LIN, FED REP GERMANY, FILED 11-29-2004.

HELIX PLUS

THE MARK CONSISTS OF STANDARD CHARACTERS
WITHOUT CLAIM TO ANY PARTICULAR FONT, STYLE,
SIZE, OR COLOR.
FOR NUTRITIONAL SUPPLEMENTS (U.S. CLS. 6, 18,
44, 46, 51 AND 52).
FIRST USE 9-0-1997; IN COMMERCE 9-0-1997.
ELISSA GARBER KON, EXAMINING ATTORNEY

ATENZA

THE MARK CONSISTS OF STANDARD CHARACTERS
WITHOUT CLAIM TO ANY PARTICULAR FONT, STYLE,
SIZE, OR COLOR.
FOR PHARMACEUTICAL PREPARATIONS, NAMELY
DERMATOLOGICALS FOR TOPICAL USE (U.S. CLS. 6,
18, 44, 46, 51 AND 52).
ANNE FARRELL, EXAMINING ATTORNEY

CLASS 5—(Continued).

SN 78-523,640. UNITED INDUSTRIES CORPORATION, ST. LOUIS, MO. FILED 11-29-2004.

CLASS 5—(Continued).

SN 78-524,244. SYNGENTA PARTICIPATIONS AG, BASEL, SWITZERLAND, FILED 11-30-2004.

CUTTER CLEAN

BORDER

THE MARK CONSISTS OF STANDARD CHARACTERS WITHOUT CLAIM TO ANY PARTICULAR FONT, STYLE, SIZE, OR COLOR.

OWNER OF U.S. REG. NOS. 1,341,985 AND 1,757,957. FOR INSECT REPELLENT (U.S. CLS. 6, 18, 44, 46, 51 AND 52).

JOHN E. MICHOS, EXAMINING ATTORNEY

THE MARK CONSISTS OF STANDARD CHARACTERS WITHOUT CLAIM TO ANY PARTICULAR FONT, STYLE, SIZE, OR COLOR.

FOR INSECTICIDES AND HERBICIDES FOR AGRICULTURAL AND COMMERCIAL USE (U.S. CLS. 6, 18, 44, 46, 51 AND 52).

STEVEN JACKSON, EXAMINING ATTORNEY

SN 78-523,647. PHARMAZONE LABORATORIES, LTD., ZEPHYR COVE, NV. FILED 11-29-2004.

SN 78-524,312. ALMARK PRODUCTS, INC., DELRAY BAECH, FL. FILED 11-30-2004.

nexypren

Flexitor

THE MARK CONSISTS OF STANDARD CHARACTERS WITHOUT CLAIM TO ANY PARTICULAR FONT, STYLE, SIZE, OR COLOR.

FOR DIETARY SUPPLEMENTS (U.S. CLS. 6, 18, 44, 46, 51 AND 52).

DAVID C. REIHNER, EXAMINING ATTORNEY

THE MARK CONSISTS OF STANDARD CHARACTERS WITHOUT CLAIM TO ANY PARTICULAR FONT, STYLE, SIZE, OR COLOR.

FOR DIETARY SUPPLEMENT (U.S. CLS. 6, 18, 44, 46, 51 AND 52).

DAWN HAN, EXAMINING ATTORNEY

CLASS 5—(Continued).

SN 78-524,829. BUMBLE BEE SEAFOODS, LLC, SAN DIEGO, CA. FILED 11-30-2004.

CLASS 5—(Continued).

SN 78-525,488. SWISS HERBAL REMEDIES LTD., RICHMOND HILL, ONTARIO, CANADA, FILED 12-1-2004.

BUMBLE BEE

SWISS PMS

THE MARK CONSISTS OF STANDARD CHARACTERS WITHOUT CLAIM TO ANY PARTICULAR FONT, STYLE, SIZE, OR COLOR.
FOR DIETARY SUPPLEMENTS, NAMELY, FISH OIL SUPPLEMENTS (U.S. CLS. 6, 18, 44, 46, 51 AND 52).
DOUGLAS LEE, EXAMINING ATTORNEY

THE MARK CONSISTS OF STANDARD CHARACTERS WITHOUT CLAIM TO ANY PARTICULAR FONT, STYLE, SIZE, OR COLOR.
OWNER OF U.S. REG. NO. 2,900,524.
NO CLAIM IS MADE TO THE EXCLUSIVE RIGHT TO USE "PMS", APART FROM THE MARK AS SHOWN.
FOR VITAMIN, MINERAL AND HERBAL SUPPLEMENTS, IN TABLET, CAPSULE, LIQUID OR POWDER FORM, FOR THE TREATMENT OF THE SYMPTOMS OF PRE-MENSTRUAL SYNDROME (U.S. CLS. 6, 18, 44, 46, 51 AND 52).
SAMUEL E. SHARPER JR., EXAMINING ATTORNEY

SN 78-525,284. FLIGHT VITALS, INC., COOPER CITY, FL. FILED 12-1-2004.

SN 78-526,283. REVISUALEYES, LLC, TORRANCE, CA. FILED 12-2-2004.

Uro-K

AVF

THE MARK CONSISTS OF STANDARD CHARACTERS WITHOUT CLAIM TO ANY PARTICULAR FONT, STYLE, SIZE, OR COLOR.
FOR PHARMACEUTICAL PREPARATION FOR USE IN DIURESIS AND ELECTROLYTE REPLACEMENT (U.S. CLS. 6, 18, 44, 46, 51 AND 52).
H. M. FISHER, EXAMINING ATTORNEY

THE MARK CONSISTS OF STANDARD CHARACTERS WITHOUT CLAIM TO ANY PARTICULAR FONT, STYLE, SIZE, OR COLOR.
FOR FOOD SUPPLEMENTS (U.S. CLS. 6, 18, 44, 46, 51 AND 52).
SUSAN HAYASH, EXAMINING ATTORNEY

CLASS 5—(Continued).

SN 78-526,375. F-MATIC OF AMERICA, LEHI, UT. FILED 12-2-2004.

CLASS 5—(Continued).

SN 78-526,921. THE HARTZ MOUNTAIN CORPORATION, SECAUCUS, NJ. FILED 12-3-2004.

SPRING FLOWERS

THE MARK CONSISTS OF STANDARD CHARACTERS WITHOUT CLAIM TO ANY PARTICULAR FONT, STYLE, SIZE, OR COLOR.
FOR AIR FRESHENER CARTRIDGES (U.S. CLS. 6, 18, 44, 46, 51 AND 52).
ELLEN PERKINS, EXAMINING ATTORNEY

**ADVANCED CARE ONCE
A MONTH WORMER**

THE MARK CONSISTS OF STANDARD CHARACTERS WITHOUT CLAIM TO ANY PARTICULAR FONT, STYLE, SIZE, OR COLOR.
OWNER OF U.S. REG. NOS. 1,632,024, 2,570,402 AND OTHERS.
NO CLAIM IS MADE TO THE EXCLUSIVE RIGHT TO USE "ONCE A MONTH WORMER", APART FROM THE MARK AS SHOWN.
FOR VETERINARY PREPARATIONS FOR TREATMENT OF INTESTINAL BACTERIA IN THE NATURE OF WORMERS FOR DOGS AND CATS (U.S. CLS. 6, 18, 44, 46, 51 AND 52).
JASON ROTH, EXAMINING ATTORNEY

SN 78-526,376. BUCHEIT, FRANK, SAN DIEGO, CA. FILED 12-2-2004.

SURVIVE-ALL

THE MARK CONSISTS OF STANDARD CHARACTERS WITHOUT CLAIM TO ANY PARTICULAR FONT, STYLE, SIZE, OR COLOR.
FOR FIRST AID KITS (U.S. CLS. 6, 18, 44, 46, 51 AND 52).
ELLEN PERKINS, EXAMINING ATTORNEY

SN 78-530,306. VANMOOR, ARTHUR, BOCA RATON, FL. FILED 12-10-2004.

SN 78-526,382. TYRELL, INCORPORATED, HOUSTON, TX. FILED 12-2-2004.

PARASITE

**CLEARLY OUTSMARTS
PIMPLES**

THE MARK CONSISTS OF STANDARD CHARACTERS WITHOUT CLAIM TO ANY PARTICULAR FONT, STYLE, SIZE, OR COLOR.
FOR MEDICATED PREPARATIONS FOR THE TREATMENT OF SKIN LESIONS (U.S. CLS. 6, 18, 44, 46, 51 AND 52).
STEVEN R. FINE, EXAMINING ATTORNEY

THE MARK CONSISTS OF STANDARD CHARACTERS WITHOUT CLAIM TO ANY PARTICULAR FONT, STYLE, SIZE, OR COLOR.
FOR VITAMINS AND NUTRITIONAL SUPPLEMENTS (U.S. CLS. 6, 18, 44, 46, 51 AND 52).
ZACHARY BELLO, EXAMINING ATTORNEY

CLASS 5—(Continued).

SN 78-530,981. FARMAMEDICA, S.A., GUATEMALA CITY, GUATEMALA, FILED 12-11-2004.

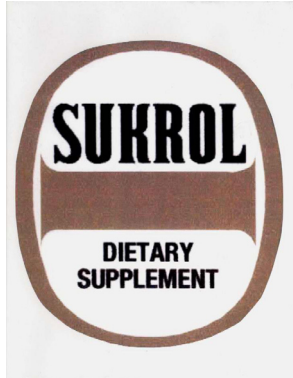

OWNER OF U.S. REG. NOS. 2,159,790, 2,271,284 AND OTHERS.

NO CLAIM IS MADE TO THE EXCLUSIVE RIGHT TO USE "DIETARY SUPPLEMENT", APART FROM THE MARK AS SHOWN.

THE COLORS BROWN, BLACK AND WHITE ARE CLAIMED AS A FEATURE OF THE MARK.

THE COLOR BROWN APPEARS IN THE OVAL AND ON THE RECTANGULAR SHAPED BANNER IN THE MIDDLE OF THE OVAL. THE COLOR BLACK APPEARS IN THE WORDING SUKROL ABOVE THE RECTANGLE AND IN THE WORDING DIETARY SUPPLEMENT BELOW THE RECTANGLE. THE COLOR WHITE APPEARS AS BACKGROUND IN THE MIDDLE OF THE OVAL.

FOR DIETARY SUPPLEMENTS AND VITAMINS FOR HUMAN CONSUMPTION (U.S. CLS. 6, 18, 44, 46, 51 AND 52).

FIRST USE 5-1-1965; IN COMMERCE 10-29-1993.
LINDA ORNDORFF, EXAMINING ATTORNEY

SN 78-531,948. ARGUS HEALTH PRODUCTS, LLC, HORSHAM, PA. FILED 12-14-2004.

ACTIONONE

THE MARK CONSISTS OF STANDARD CHARACTERS WITHOUT CLAIM TO ANY PARTICULAR FONT, STYLE, SIZE, OR COLOR.

FOR TOPICAL ANALGESICS (U.S. CLS. 6, 18, 44, 46, 51 AND 52).

LESLEY LAMOTHE, EXAMINING ATTORNEY

CLASS 5—(Continued).

SN 78-535,266. GENEREX PHARMACEUTICALS INC., TORONTO, ONTARIO, CANADA, FILED 12-20-2004.

RAPIDMIST

THE MARK CONSISTS OF STANDARD CHARACTERS WITHOUT CLAIM TO ANY PARTICULAR FONT, STYLE, SIZE, OR COLOR.

FOR METERED DOSE INHALER FILLED WITH PRESCRIPTION PHARMACEUTICAL PREPARATIONS, FOR BUCCAL DELIVERY, FOR THE TREATMENT OF DIABETES, BREAKTHROUGH CANCER PAIN, ANTICOAGULANT THERAPY IN TREATMENT OF HEART DISEASE, PROSTATE CANCER AND ENDOMETRIOSIS (U.S. CLS. 6, 18, 44, 46, 51 AND 52).

CARRIE ACHEN, EXAMINING ATTORNEY

SN 78-535,743. MYOGEN, INC., WESTMINSTER, CO. FILED 12-20-2004.

IONEER

THE MARK CONSISTS OF STANDARD CHARACTERS WITHOUT CLAIM TO ANY PARTICULAR FONT, STYLE, SIZE, OR COLOR.

FOR PHARMACEUTICALS IN THE CARDIOVASCULAR, CARDIAC, VASCULAR AND HEMATOLOGY FIELDS (U.S. CLS. 6, 18, 44, 46, 51 AND 52).

TEJBIR SINGH, EXAMINING ATTORNEY

CLASS 5—(Continued).

SN 78-535,745. MYOGEN, INC., WESTMINSTER, CO. FILED
12-20-2004.

CLASS 5—(Continued).

SN 78-537,948. MEDICAL RESEARCH INSTITUTE, INC.,
SAN FRANCISCO, CA. FILED 12-23-2004.

JOUREN

MINUS 10

THE MARK CONSISTS OF STANDARD CHARACTERS
WITHOUT CLAIM TO ANY PARTICULAR FONT, STYLE,
SIZE, OR COLOR.

FOR PHARMACEUTICALS IN THE CARDIOVASCULAR,
CARDIAC, VASCULAR AND HEMATOLOGY
FIELDS (U.S. CLS. 6, 18, 44, 46, 51 AND 52).

TEJBIR SINGH, EXAMINING ATTORNEY

THE MARK CONSISTS OF STANDARD CHARACTERS
WITHOUT CLAIM TO ANY PARTICULAR FONT, STYLE,
SIZE, OR COLOR.

FOR NUTRITIONAL AND DIETARY SUPPLEMENTS
(U.S. CLS. 6, 18, 44, 46, 51 AND 52).

SANI KHOURI, EXAMINING ATTORNEY

SN 78-536,539. NOVARTIS AG, BASEL, SWITZERLAND,
FILED 12-21-2004.

SN 78-538,956. NOVARTIS AG, BASEL, SWITZERLAND,
FILED 12-28-2004.

SOMNU SHIELD

ZYPROPION

THE MARK CONSISTS OF STANDARD CHARACTERS
WITHOUT CLAIM TO ANY PARTICULAR FONT, STYLE,
SIZE, OR COLOR.

NO CLAIM IS MADE TO THE EXCLUSIVE RIGHT TO
USE "SOMNU", APART FROM THE MARK AS SHOWN.

FOR VETERINARY VACCINES (U.S. CLS. 6, 18, 44, 46,
51 AND 52).

FIRST USE 12-31-1987; IN COMMERCE 12-31-1987.

DAVID MURRAY, EXAMINING ATTORNEY

THE MARK CONSISTS OF STANDARD CHARACTERS
WITHOUT CLAIM TO ANY PARTICULAR FONT, STYLE,
SIZE, OR COLOR.

FOR PHARMACEUTICAL PREPARATIONS FOR HUMAN
USE ACTING ON THE CENTRAL NERVOUS
SYSTEM (U.S. CLS. 6, 18, 44, 46, 51 AND 52).

MARK T. MULLEN, EXAMINING ATTORNEY

CLASS 5—(Continued).

SN 78-540,561. BERGERON SKIN CARE, OZONA, FL. FILED 12-31-2004.

CLASS 5—(Continued).

SN 78-542,154. S. C. JOHNSON & SON, INC., RACINE, WI. FILED 1-4-2005.

SLEEP-MAGIC

THE MARK CONSISTS OF STANDARD CHARACTERS WITHOUT CLAIM TO ANY PARTICULAR FONT, STYLE, SIZE, OR COLOR.

FOR NON-MEDICATED NATURAL SLEEP REMEDY CREAM (U.S. CLS. 6, 18, 44, 46, 51 AND 52).

FIRST USE 11-4-2004; IN COMMERCE 12-20-2004.
TEJBIR SINGH, EXAMINING ATTORNEY

SN 78-541,385. BIOSCIENTIFICS, INC., REDMOND, WA. FILED 1-3-2005.

BIOSCIENTIFICS

THE MARK CONSISTS OF STANDARD CHARACTERS WITHOUT CLAIM TO ANY PARTICULAR FONT, STYLE, SIZE, OR COLOR.

FOR DIETARY SUPPLEMENTS AND VITAMIN AND MINERAL SUPPLEMENTS (U.S. CLS. 6, 18, 44, 46, 51 AND 52).

DAVID YONTEF, EXAMINING ATTORNEY

SN 78-541,820. WEAVER LEATHER GOODS, INC., MT. HOPE, OH. FILED 1-4-2005.

OPT-E-HORSE

THE MARK CONSISTS OF STANDARD CHARACTERS WITHOUT CLAIM TO ANY PARTICULAR FONT, STYLE, SIZE, OR COLOR.

OWNER OF U.S. REG. NO. 2,025,596.
FOR HORSE FEED ADDITIVE FOR USE AS A NUTRITIONAL SUPPLEMENT (U.S. CLS. 6, 18, 44, 46, 51 AND 52).

FIRST USE 10-1-1995; IN COMMERCE 1-15-1996.
ZHALEH DELANEY, EXAMINING ATTORNEY

FRESCURA DEL CAMPO

THE MARK CONSISTS OF STANDARD CHARACTERS WITHOUT CLAIM TO ANY PARTICULAR FONT, STYLE, SIZE, OR COLOR.

OWNER OF U.S. REG. NO. 1,867,425.

THE FOREIGN WORDING IN THE MARK TRANSLATES INTO ENGLISH AS OUTDOOR FRESH.

FOR AIR FRESHENERS (U.S. CLS. 6, 18, 44, 46, 51 AND 52).

CHARLES L. JENKINS, EXAMINING ATTORNEY

SN 78-542,896. AXO LABORATORIES, INC., CHICAGO, IL. FILED 1-6-2005.

Mezamil

THE MARK CONSISTS OF STANDARD CHARACTERS WITHOUT CLAIM TO ANY PARTICULAR FONT, STYLE, SIZE, OR COLOR.

FOR HUMAN GROWTH HORMONE FACTOR (U.S. CLS. 6, 18, 44, 46, 51 AND 52).

FIRST USE 1-3-2005; IN COMMERCE 1-3-2005.
BILL DAWE, EXAMINING ATTORNEY

CLASS 5—(Continued).

SN 78-544,124. ECOLAB INC., ST. PAUL, MN. FILED 1-7-2005.

CLASS 5—(Continued).

SN 78-544,770. AGRILIANCE, LLC., ST. PAUL, MN. FILED 1-10-2005.

APT

SECTION

THE MARK CONSISTS OF STANDARD CHARACTERS WITHOUT CLAIM TO ANY PARTICULAR FONT, STYLE, SIZE, OR COLOR.
FOR ANTISEPTIC PREPARATIONS (U.S. CLS. 6, 18, 44, 46, 51 AND 52).
FIRST USE 4-25-2005; IN COMMERCE 4-25-2005.
JEFF DEFORD, EXAMINING ATTORNEY

THE MARK CONSISTS OF STANDARD CHARACTERS WITHOUT CLAIM TO ANY PARTICULAR FONT, STYLE, SIZE, OR COLOR.
FOR AGRICULTURAL HERBICIDE (U.S. CLS. 6, 18, 44, 46, 51 AND 52).
STEVEN R. FINE, EXAMINING ATTORNEY

SN 78-544,584. ALCON, INC., CH-6331 HÜNENBERG, SWITZERLAND, FILED 1-10-2005.

SN 78-545,351. BELL LABORATORIES, INC., MADISON, WI. FILED 1-11-2005.

OMNIPRED

RodentRid

THE MARK CONSISTS OF STANDARD CHARACTERS WITHOUT CLAIM TO ANY PARTICULAR FONT, STYLE, SIZE, OR COLOR.
FOR OPHTHALMIC PHARMACEUTICAL PREPARATIONS FOR THE TREATMENT OF INFLAMMATION (U.S. CLS. 6, 18, 44, 46, 51 AND 52).
G. MAYERSCHOFF, EXAMINING ATTORNEY

THE MARK CONSISTS OF STANDARD CHARACTERS WITHOUT CLAIM TO ANY PARTICULAR FONT, STYLE, SIZE, OR COLOR.
OWNER OF U.S. REG. NO. 1,237,007.
FOR RODENTICIDES (U.S. CLS. 6, 18, 44, 46, 51 AND 52).
KRISTINA KLOIBER, EXAMINING ATTORNEY

CLASS 5—(Continued).

SN 78-546,254. GAMMA ENTERPRISES, LLC, MELVILLE, NY. FILED 1-12-2005.

CLASS 5—(Continued).

SN 78-549,870. SANOFI-AVENTIS, PARIS, FRANCE, FILED 1-19-2005.

EVERYONE WANTS THE
BIG O

ECOMPLIA

THE MARK CONSISTS OF STANDARD CHARACTERS WITHOUT CLAIM TO ANY PARTICULAR FONT, STYLE, SIZE, OR COLOR.

FOR FOOD SUPPLEMENTS, VITAMINS, MINERAL SUPPLEMENTS, NUTRITIONAL SUPPLEMENTS, DIETARY SUPPLEMENTS, HERBAL SUPPLEMENTS, MEAL REPLACEMENT BARS; MEAL REPLACEMENT DRINK MIX; MEAL REPLACEMENT DRINKS (U.S. CLS. 6, 18, 44, 46, 51 AND 52).

TEJBIR SINGH, EXAMINING ATTORNEY

THE MARK CONSISTS OF STANDARD CHARACTERS WITHOUT CLAIM TO ANY PARTICULAR FONT, STYLE, SIZE, OR COLOR.

FOR PHARMACEUTICAL PREPARATIONS FOR THE PREVENTION OF CARDIOVASCULAR DISEASES, FOR SMOKING CESSATION AND OBESITY (U.S. CLS. 6, 18, 44, 46, 51 AND 52).

JENNIFER CHICOSKI, EXAMINING ATTORNEY

SN 78-549,027. ARKOPHARMA LLC, BEDFORD, MA. FILED 1-18-2005.

SN 78-551,430. LIFE'S REMEDIES HOLDINGS, L.L.C., WAYNE, NJ. FILED 1-21-2005.

MEMOBOOST

BRUISEAID

THE MARK CONSISTS OF STANDARD CHARACTERS WITHOUT CLAIM TO ANY PARTICULAR FONT, STYLE, SIZE, OR COLOR.

FOR NUTRITIONAL AND DIETARY SUPPLEMENTS (U.S. CLS. 6, 18, 44, 46, 51 AND 52).

FIRST USE 1-1-1990; IN COMMERCE 1-1-1993.

THEODORE MCBRIDE, EXAMINING ATTORNEY

THE MARK CONSISTS OF STANDARD CHARACTERS WITHOUT CLAIM TO ANY PARTICULAR FONT, STYLE, SIZE, OR COLOR.

FOR VITAMINS; MINERAL SUPPLEMENTS; NUTRITIONAL AND DIETARY SUPPLEMENTS; ENZYME BASED NUTRITIONAL SUPPLEMENT DESIGNED TO HELP ALLEVIATE THE SYMPTOMS ASSOCIATED WITH SOFT TISSUE TRAUMA (U.S. CLS. 6, 18, 44, 46, 51 AND 52).

YONG KIM, EXAMINING ATTORNEY

CLASS 5—(Continued).

SN 78-551,735. OLAX INTERNATIONAL, INC., LAKELAND, FL. FILED 1-21-2005.

CLASS 5—(Continued).

SN 78-557,095. NUFARM AMERICAS, INC., BURR RIDGE, IL. FILED 1-31-2005.

ULTRABOLIZER

RITEWAY

THE MARK CONSISTS OF STANDARD CHARACTERS WITHOUT CLAIM TO ANY PARTICULAR FONT, STYLE, SIZE, OR COLOR.

OWNER OF U.S. REG. NO. 2,662,884.
FOR NUTRITIONAL SUPPLEMENTS (U.S. CLS. 6, 18, 44, 46, 51 AND 52).
JENNIFER KRISP, EXAMINING ATTORNEY

THE MARK CONSISTS OF STANDARD CHARACTERS WITHOUT CLAIM TO ANY PARTICULAR FONT, STYLE, SIZE, OR COLOR.

FOR PESTICIDES AND HERBICIDES FOR DOMESTIC, AGRICULTURAL AND COMMERCIAL USE (U.S. CLS. 6, 18, 44, 46, 51 AND 52).
JOHN DALIER, EXAMINING ATTORNEY

SN 78-555,788. WATSON PHARMACEUTICALS, INC., CORONA, CA. FILED 1-28-2005.

SN 78-561,898. BETA PHARMACEUTICAL, WESTON, FL. FILED 2-7-2005.

AZURETTE

Coughenz

THE MARK CONSISTS OF STANDARD CHARACTERS WITHOUT CLAIM TO ANY PARTICULAR FONT, STYLE, SIZE, OR COLOR.

FOR PHARMACEUTICALS, NAMELY, ORAL CONTRACEPTIVES (U.S. CLS. 6, 18, 44, 46, 51 AND 52).
CHERYL CLAYTON, EXAMINING ATTORNEY

THE MARK CONSISTS OF STANDARD CHARACTERS WITHOUT CLAIM TO ANY PARTICULAR FONT, STYLE, SIZE, OR COLOR.

FOR DIETARY AND NUTRITIONAL SUPPLEMENTS (U.S. CLS. 6, 18, 44, 46, 51 AND 52).
JENNIFER WILLISTON, EXAMINING ATTORNEY

CLASS 5—(Continued).

SN 78-600,926. NOVEN PHARMACEUTICALS, INC., MIAMI, FL. FILED 4-4-2005.

ANDRODOT

THE MARK CONSISTS OF STANDARD CHARACTERS WITHOUT CLAIM TO ANY PARTICULAR FONT, STYLE, SIZE, OR COLOR.

FOR PHARMACEUTICALS PREPARATIONS, NAMELY THERAPEUTIC SYSTEMS IN THE FORM OF A BANDAGE OR PATCH FOR TRANSDERMAL OR TRANSMUCOSAL DELIVERY OF HORMONAL OR STEROIDAL ACTIVE AGENTS (U.S. CLS. 6, 18, 44, 46, 51 AND 52).

JIM RINGLE, EXAMINING ATTORNEY

SN 78-643,346. NOVEN PHARMACEUTICALS, INC., MIAMI, FL. FILED 6-3-2005.

FEMDOT

THE MARK CONSISTS OF STANDARD CHARACTERS WITHOUT CLAIM TO ANY PARTICULAR FONT, STYLE, SIZE, OR COLOR.

FOR PHARMACEUTICAL PREPARATIONS, NAMELY THERAPEUTIC SYSTEMS IN THE FORM OF A BANDAGE OR PATCH FOR TRANSDERMAL OR TRANSMUCOSAL DELIVERY OF HORMONAL OR STEROIDAL AGENTS (U.S. CLS. 6, 18, 44, 46, 51 AND 52).

JIM RINGLE, EXAMINING ATTORNEY

SN 78-657,206. WESTERN HOLDINGS, LLC, CHEYENNE, WY. FILED 6-23-2005.

ENDOTHIL

THE MARK CONSISTS OF STANDARD CHARACTERS WITHOUT CLAIM TO ANY PARTICULAR FONT, STYLE, SIZE, OR COLOR.

FOR DIETARY SUPPLEMENTS (U.S. CLS. 6, 18, 44, 46, 51 AND 52).

FIRST USE 2-4-2005; IN COMMERCE 4-1-2005.

WON TEAK OH, EXAMINING ATTORNEY

CLASS 5—(Continued).

SN 78-672,568. WHITNEY, DANIEL D., SANFORD, FL. FILED 7-18-2005.

LARRY THE CABLE GUY

THE MARK CONSISTS OF STANDARD CHARACTERS WITHOUT CLAIM TO ANY PARTICULAR FONT, STYLE, SIZE, OR COLOR.

FOR AIR FRESHENER (U.S. CLS. 6, 18, 44, 46, 51 AND 52).

FIRST USE 5-7-2005; IN COMMERCE 5-7-2005.

PAM WILLIS, EXAMINING ATTORNEY

SN 79-000,929. GREYER AG, SWITZERLAND, FILED 1-19-2004.

NEO-ANGIN

OWNER OF INTERNATIONAL REGISTRATION 0141163 DATED 4-6-1949, EXPIRES 4-6-2009.

FOR PHARMACEUTICAL PRODUCTS, NAMELY PROPRIETARY MEDICINES AGAINST THE COMMON COLD, INFLUENZA AND SORE THROAT; COUGH DROPS, LOZENGES, SWEETS FOR THE THROAT (U.S. CLS. 6, 18, 44, 46, 51 AND 52).

SHARI SHEFFIELD, EXAMINING ATTORNEY

SN 79-002,165. MEKOS LABORATORIES A/S, DENMARK, FILED 4-7-2004.

NIXEMA

THE MARK CONSISTS OF STANDARD CHARACTERS WITHOUT CLAIM TO ANY PARTICULAR FONT, STYLE, SIZE, OR COLOR.

PRIORITY DATE OF 4-2-2004 IS CLAIMED.

OWNER OF INTERNATIONAL REGISTRATION 0823440 DATED 4-7-2004, EXPIRES 4-7-2014.

FOR PHARMACEUTICAL AND VETERINARY PREPARATIONS, NAMELY, PREPARATIONS FOR DIAGNOSING CONTACT ALLERGY (U.S. CLS. 6, 18, 44, 46, 51 AND 52).

STEVEN JACKSON, EXAMINING ATTORNEY

CLASS 5—(Continued).

SN 79-002,304. MEDIVIR AB, SWEDEN, FILED 4-2-2004.

LIPSOVIR

THE MARK CONSISTS OF STANDARD CHARACTERS WITHOUT CLAIM TO ANY PARTICULAR FONT, STYLE, SIZE, OR COLOR.

PRIORITY DATE OF 10-8-2003 IS CLAIMED.
OWNER OF INTERNATIONAL REGISTRATION 0823927 DATED 4-2-2004, EXPIRES 4-2-2014.

FOR PHARMACEUTICALS, NAMELY TOPICAL CREAMS CONTAINING ANTIVIRALS SUCH AS ACYCLOVIR AND/OR GLUCOCORTICOIDS SUCH AS HYDROCORTISONE, ESPECIALLY FOR MUCOCUTANEOUS USE (U.S. CLS. 6, 18, 44, 46, 51 AND 52).

MICHELLE S. WISEMAN, EXAMINING ATTORNEY

CLASS 5—(Continued).

SN 79-004,187. CLAVIS PHARMA AS, NORWAY, FILED 5-5-2004.

CLAVIS PHARMA

THE MARK CONSISTS OF STANDARD CHARACTERS WITHOUT CLAIM TO ANY PARTICULAR FONT, STYLE, SIZE, OR COLOR.

PRIORITY DATE OF 4-1-2004 IS CLAIMED.
OWNER OF INTERNATIONAL REGISTRATION 0830038 DATED 5-5-2004, EXPIRES 5-5-2014.

NO CLAIM IS MADE TO THE EXCLUSIVE RIGHT TO USE "PHARMA", APART FROM THE MARK AS SHOWN.

FOR HOUSE MARK FOR A FULL LINE OF PHARMACEUTICAL AND VETERINARY PREPARATIONS (U.S. CLS. 6, 18, 44, 46, 51 AND 52).

CAROLYN CATALDO, EXAMINING ATTORNEY

SN 79-002,759. ASTRAZENECA UK LIMITED, UNITED KINGDOM, FILED 5-6-2004.

VERAZAIR

THE MARK CONSISTS OF STANDARD CHARACTERS WITHOUT CLAIM TO ANY PARTICULAR FONT, STYLE, SIZE, OR COLOR.

OWNER OF INTERNATIONAL REGISTRATION 0825520 DATED 5-6-2004, EXPIRES 5-6-2014.

FOR PHARMACEUTICAL PREPARATIONS AND SUBSTANCES FOR THE PREVENTION AND TREATMENT OF DISEASES AND DISORDERS OF THE RESPIRATORY SYSTEM, CENTRAL NERVOUS SYSTEM, PERIPHERAL NERVOUS SYSTEM, CARDIOVASCULAR SYSTEM, GASTRO-INTESTINAL SYSTEM; PHARMACEUTICAL PREPARATIONS AND SUBSTANCES FOR USE IN PAIN CONTROL, ARTHRITIS, ANESTHESIA, ONCOLOGY, INFECTION, INFLAMMATION, UROLOGY, GYNECOLOGY; PHARMACEUTICAL PREPARATIONS AND SUBSTANCES FOR THE TREATMENT AND PREVENTION OF DIABETES (U.S. CLS. 6, 18, 44, 46, 51 AND 52).

WILLIAM VERHOSEK, EXAMINING ATTORNEY

SN 79-005,376. MERCK KGAA, FED REP GERMANY, FILED 8-17-2004.

VADEGI

THE MARK CONSISTS OF STANDARD CHARACTERS WITHOUT CLAIM TO ANY PARTICULAR FONT, STYLE, SIZE, OR COLOR.

PRIORITY DATE OF 6-7-2004 IS CLAIMED.
OWNER OF INTERNATIONAL REGISTRATION 0833488 DATED 8-17-2004, EXPIRES 8-17-2014.

FOR PHARMACEUTICAL PREPARATIONS FOR THE PREVENTION AND TREATMENT OF DISEASES AND DISORDERS OF THE NERVOUS SYSTEM (U.S. CLS. 6, 18, 44, 46, 51 AND 52).

GIANCARLO CASTRO, EXAMINING ATTORNEY

SN 79-004,024. AYRTON SAUNDERS LIMITED, UNITED KINGDOM, FILED 5-21-2004.

GLYTRIN

THE MARK CONSISTS OF STANDARD CHARACTERS WITHOUT CLAIM TO ANY PARTICULAR FONT, STYLE, SIZE, OR COLOR.

OWNER OF INTERNATIONAL REGISTRATION 0739236 DATED 7-28-2000, EXPIRES 7-28-2010.

FOR PHARMACEUTICAL PREPARATIONS FOR THE TREATMENT OF ANGINA (U.S. CLS. 6, 18, 44, 46, 51 AND 52).

PAULA MAHONEY, EXAMINING ATTORNEY

SN 79-005,422. DANSK DROGE A/S, DENMARK, FILED 8-17-2004.

LITIZIN

THE MARK CONSISTS OF STANDARD CHARACTERS WITHOUT CLAIM TO ANY PARTICULAR FONT, STYLE, SIZE, OR COLOR.

OWNER OF INTERNATIONAL REGISTRATION 0806005 DATED 6-17-2003, EXPIRES 6-17-2013.

FOR ANTI-INFLAMMATORY AND PAIN-RELIEVING NATURAL MEDICINE AND FOOD SUPPLEMENT (U.S. CLS. 6, 18, 44, 46, 51 AND 52).

MAUREEN DALL, EXAMINING ATTORNEY

CLASS 5—(Continued).

SN 79-005,701. MERCK KGAA, FED REP GERMANY, FILED 8-16-2004.

BELCANZI

THE MARK CONSISTS OF STANDARD CHARACTERS WITHOUT CLAIM TO ANY PARTICULAR FONT, STYLE, SIZE, OR COLOR.

PRIORITY DATE OF 6-7-2004 IS CLAIMED.

OWNER OF INTERNATIONAL REGISTRATION 0834177 DATED 8-16-2004, EXPIRES 8-16-2014.

FOR PHARMACEUTICAL PREPARATIONS FOR THE PREVENTION AND TREATMENT OF DISEASES AND DISORDERS OF THE NERVOUS SYSTEM (U.S. CLS. 6, 18, 44, 46, 51 AND 52).

ESTHER BELENKER, EXAMINING ATTORNEY

CLASS 5—(Continued).

SN 79-007,740. SWISS EGOSCIENCES SA, SWITZERLAND, FILED 9-28-2004.

SAVESKIN

PRIORITY DATE OF 6-25-2004 IS CLAIMED.

OWNER OF INTERNATIONAL REGISTRATION 0839985 DATED 9-28-2004, EXPIRES 9-28-2014.

FOR PHARMACEUTICAL PREPARATIONS FOR DERMATOLOGICAL USE (U.S. CLS. 6, 18, 44, 46, 51 AND 52).

SKYE YOUNG, EXAMINING ATTORNEY

SN 79-006,192. ORGANIC & NATURAL ENTERPRISE GROUP PTY LTD, AUSTRALIA, FILED 8-13-2004.

MiVitality

THE MARK CONSISTS OF STANDARD CHARACTERS WITHOUT CLAIM TO ANY PARTICULAR FONT, STYLE, SIZE, OR COLOR.

OWNER OF INTERNATIONAL REGISTRATION 0835659 DATED 8-13-2004, EXPIRES 8-13-2014.

FOR NUTRITIONAL, DIETARY AND HERBAL SUPPLEMENTS, MEAL REPLACEMENT SHAKES, ALL BEING ORGANIC NATURAL THERAPEUTIC PREPARATIONS; THERAPEUTIC PREPARATIONS FOR THE BATH; MEDICATED CONFECTIONARY; FOOD FOR BABIES; MEDICINAL AND THERAPEUTIC HERBS, INFUSIONS, OILS, ROOTS AND TEA (U.S. CLS. 6, 18, 44, 46, 51 AND 52).

DANIEL BRODY, EXAMINING ATTORNEY

SN 79-007,940. FOURNIER LABORATORIES IRELAND LTD, IRELAND, FILED 11-16-2004.

FENORDIA

THE MARK CONSISTS OF STANDARD CHARACTERS WITHOUT CLAIM TO ANY PARTICULAR FONT, STYLE, SIZE, OR COLOR.

PRIORITY DATE OF 7-5-2004 IS CLAIMED.

OWNER OF INTERNATIONAL REGISTRATION 0840493 DATED 11-16-2004, EXPIRES 11-16-2014.

FOR PHARMACEUTICAL PREPARATION AGAINST CARDIOVASCULAR DISEASES (U.S. CLS. 6, 18, 44, 46, 51 AND 52).

PAUL E. FAHRENKOPF, EXAMINING ATTORNEY

SN 79-006,321. N.V. ORGANON, NETHERLANDS, FILED 10-27-2004.

PLURAVON

THE MARK CONSISTS OF STANDARD CHARACTERS WITHOUT CLAIM TO ANY PARTICULAR FONT, STYLE, SIZE, OR COLOR.

OWNER OF INTERNATIONAL REGISTRATION 0836011 DATED 10-27-2004, EXPIRES 10-27-2014.

FOR MEDICINES AND PHARMACEUTICAL PREPARATIONS FOR STIMULATING HUMAN FERTILITY (U.S. CLS. 6, 18, 44, 46, 51 AND 52).

RICHARD WHITE, EXAMINING ATTORNEY

SN 79-008,508. NOVARTIS AG, SWITZERLAND, FILED 1-6-2005.

MOVE-ON

THE MARK CONSISTS OF STANDARD CHARACTERS WITHOUT CLAIM TO ANY PARTICULAR FONT, STYLE, SIZE, OR COLOR.

PRIORITY DATE OF 7-12-2004 IS CLAIMED.

OWNER OF INTERNATIONAL REGISTRATION 0842253 DATED 1-6-2005, EXPIRES 1-6-2015.

FOR VETERINARY PREPARATIONS FOR THE TREATMENT AND PREVENTION OF FLEA AND TICK INFESTATION (U.S. CLS. 6, 18, 44, 46, 51 AND 52).

HOWARD SMIGA, EXAMINING ATTORNEY

CLASS 5—(Continued).

SN 79-008,509. NOVARTIS AG, SWITZERLAND, FILED 1-6-2005.

EASYSPO

THE MARK CONSISTS OF STANDARD CHARACTERS WITHOUT CLAIM TO ANY PARTICULAR FONT, STYLE, SIZE, OR COLOR.

PRIORITY DATE OF 7-12-2004 IS CLAIMED.
OWNER OF INTERNATIONAL REGISTRATION 0842254 DATED 1-6-2005, EXPIRES 1-6-2015.

FOR VETERINARY PREPARATIONS FOR THE TREATMENT AND PREVENTION OF FLEA AND TICK INFESTATION (U.S. CLS. 6, 18, 44, 46, 51 AND 52).
WARREN L. OLANDRIA, EXAMINING ATTORNEY

CLASS 5—(Continued).

SN 79-010,716. KYORITSU SEIYAKU CORPORATION, JAPAN, FILED 11-15-2004.

MASTLAC

THE MARK CONSISTS OF STANDARD CHARACTERS WITHOUT CLAIM TO ANY PARTICULAR FONT, STYLE, SIZE, OR COLOR.

PRIORITY DATE OF 9-15-2004 IS CLAIMED.
OWNER OF INTERNATIONAL REGISTRATION 0849028 DATED 11-15-2004, EXPIRES 11-15-2014.

FOR VETERINARY PREPARATIONS FOR USE IN THE TREATMENT AND PREVENTION OF MASTITIS, INFECTIOUS DISEASES, URINARY TRACT DISEASES AND RESPIRATORY DISEASES IN CATTLE (U.S. CLS. 6, 18, 44, 46, 51 AND 52).
ATTIYA MALIK, EXAMINING ATTORNEY

SN 79-008,857. FOURNIER LABORATORIES IRELAND LTD, IRELAND, FILED 12-30-2004.

SYNORDIA

THE MARK CONSISTS OF STANDARD CHARACTERS WITHOUT CLAIM TO ANY PARTICULAR FONT, STYLE, SIZE, OR COLOR.

PRIORITY DATE OF 7-5-2004 IS CLAIMED.
OWNER OF INTERNATIONAL REGISTRATION 0843240 DATED 12-30-2004, EXPIRES 12-30-2014.

FOR PHARMACEUTICAL PREPARATION AGAINST CARDIOVASCULAR DISEASES (U.S. CLS. 6, 18, 44, 46, 51 AND 52).
STEVEN PEREZ, EXAMINING ATTORNEY

CLASS 6—METAL GOODS

SN 75-350,649. I.T. VERDIN CO., THE, CINCINNATI, OH. FILED 9-2-1997.

VERDIN MILLENNIUM BELL

NO CLAIM IS MADE TO THE EXCLUSIVE RIGHT TO USE "BELL", APART FROM THE MARK AS SHOWN.

FOR CAST METAL BELLS (U.S. CLS. 2, 12, 13, 14, 23, 25 AND 50).
KATHY DE JONGE, EXAMINING ATTORNEY

SN 79-010,013. NOVARTIS AG, SWITZERLAND, FILED 12-30-2004.

IMMUNOHALE

THE MARK CONSISTS OF STANDARD CHARACTERS WITHOUT CLAIM TO ANY PARTICULAR FONT, STYLE, SIZE, OR COLOR.

OWNER OF INTERNATIONAL REGISTRATION 0711905 DATED 3-29-1999, EXPIRES 3-29-2009.

FOR INHALATORS FOR ADMINISTERING MEDICINES FOR SUPPRESSION OF THE IMMUNE SYSTEM, SOLD AS A UNIT ALONG WITH THE MEDICINES (U.S. CLS. 6, 18, 44, 46, 51 AND 52).
STEVEN PEREZ, EXAMINING ATTORNEY

SN 76-507,664. GUIDA, INC, PHILADELPHIA, PA. FILED 4-18-2003.

GUARDIAN SECURITY STORM DOORS

OWNER OF U.S. REG. NO. 2,351,398.
NO CLAIM IS MADE TO THE EXCLUSIVE RIGHT TO USE "SECURITY STORM DOORS", APART FROM THE MARK AS SHOWN.

FOR METAL SECURITY STORM DOORS (U.S. CLS. 2, 12, 13, 14, 23, 25 AND 50).
FIRST USE 4-0-1990; IN COMMERCE 4-0-1990.
ANGELA M. MICHELI, EXAMINING ATTORNEY

CLASS 6—(Continued).

SN 76-541,473. COMPUMERIC ENGINEERING, INC., ONTARIO, CA. FILED 8-28-2003.

COMPUMERIC

FOR METAL BOXES, NAMELY CHASSIS FOR THE COMPUTER AND ELECTRONICS INDUSTRIES, NOT INCLUDING THE ELECTRONIC COMPONENTS, METAL CHIMNEYS, SKYLIGHTS, ROOFS AND ROOFING TILES; METAL CONTAINERS FOR THE TRANSPORTATION OF GOODS; DECORATIVE METAL BOXES; METAL DISPLAY STANDS; METAL DOOR PANELS AND KICK PLATES; METAL FENCE, PICKETS, PANELS, GATES, GUARD RAILS; METAL FLOORING; METAL SAFES; METAL LADDERS; METAL MAIL BOXES, MAIL PLATES, MAIL SLOTS; METAL BADGES AND NAME PLATES; METAL TOOL BOXES; METAL WINDOWS, WINDOW FRAMES, WINDOW SHUTTERS; METAL RACKS FOR TELEPHONE CABLES (U.S. CLS. 2, 12, 13, 14, 23, 25 AND 50).

FIRST USE 10-31-1989; IN COMMERCE 10-31-1989.
LEIGH CAROLINE CASE, EXAMINING ATTORNEY

SN 76-555,497. UNILINE SAFETY SYSTEMS LIMITED, WORCESTERSHIRE B60 3DU, UNITED KINGDOM, FILED 10-30-2003.

ROOFSAFE

PRIORITY CLAIMED UNDER SEC. 44(D) ON UNITED KINGDOM APPLICATION NO. 2331727, FILED 5-8-2003, REG. NO. 2331727, DATED 10-3-2003, EXPIRES 5-8-2013.

FOR INDUSTRIAL SAFETY RAIL SYSTEM COMPRISED OF A METAL RAIL, ANCHORS AND FASTENERS FOR PROTECTING WORKERS FROM FALLING WHILST WORKING AT HEIGHTS (U.S. CLS. 2, 12, 13, 14, 23, 25 AND 50).

WON TEAK OH, EXAMINING ATTORNEY

SN 76-555,498. UNILINE SAFETY SYSTEMS LIMITED, BROMSGROVE, WORCESTERSHIRE B60 3DU, UNITED KINGDOM, FILED 10-30-2003.

UNIGRAB

PRIORITY CLAIMED UNDER SEC. 44(D) ON UNITED KINGDOM APPLICATION NO. 2331413, FILED 5-8-2003, REG. NO. 2331413, DATED 10-3-2003, EXPIRES 5-8-2013.

FOR ARTICLES OF METAL IN THE NATURE OF A METAL CLASP USED IN CONJUNCTION WITH SAFETY APPARATUS FOR ATTACHMENT TO FALL PROTECTION SYSTEMS FOR ARRESTING THE FALL OF PERSONS FROM STRUCTURES (U.S. CLS. 2, 12, 13, 14, 23, 25 AND 50).

WON TEAK OH, EXAMINING ATTORNEY

CLASS 6—(Continued).

SN 76-563,857. M & E MANUFACTURING COMPANY, INC., KINGSTON, NY. FILED 12-5-2003.

OVEN Z

THE MARK CONSISTS OF STANDARD CHARACTERS WITHOUT CLAIM TO ANY PARTICULAR FONT, STYLE, SIZE, OR COLOR.

NO CLAIM IS MADE TO THE EXCLUSIVE RIGHT TO USE OVEN, APART FROM THE MARK AS SHOWN.

FOR FOOD PROCESSING, HANDLING, PREPARATION, AND MERCHANDISING EQUIPMENT, NAMELY METAL NESTING RACKS (U.S. CLS. 2, 12, 13, 14, 23, 25 AND 50).

FIRST USE 0-0-2002; IN COMMERCE 0-0-2002.
RON FAIRBANKS, EXAMINING ATTORNEY

SN 76-587,512. GEM-YEAR INDUSTRIAL CO LTD, EDZ JIASHAN, ZHEJIANG, CHINA, FILED 4-19-2004.

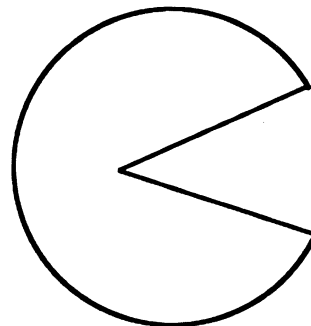

FOR METAL FASTENERS, NAMELY, BOLTS, NUTS, AND SCREWS (U.S. CLS. 2, 12, 13, 14, 23, 25 AND 50).

FIRST USE 2-1-2004; IN COMMERCE 2-1-2004.
MELVIN AXILBUND, EXAMINING ATTORNEY

CLASS 6—(Continued).

SN 76-594,261. NIOTAN, INC., MOUND HOUSE, NV. FILED 5-21-2004.

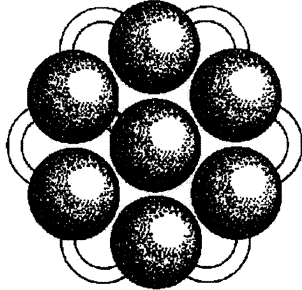

THE STIPPLING IN THE DRAWING IS FOR SHADING PURPOSES ONLY AND IS NOT A FEATURE OF THE MARK.

FOR COMMON AND SPECIALTY METALS, ALLOYS, AND ORES, NAMELY, TANTALUM, NIOBIUM, AND BERYLLIUM FOR FURTHER MANUFACTURE OF GOODS IN A VARIETY OF INDUSTRIES (U.S. CLS. 2, 12, 13, 14, 23, 25 AND 50).

CHERYL STEPLIGHT, EXAMINING ATTORNEY

SN 76-594,263. NIOTAN, INC., MOUND HOUSE, NV. FILED 5-21-2004.

NIOTAN

THE MARK CONSISTS OF STANDARD CHARACTERS WITHOUT CLAIM TO ANY PARTICULAR FONT, STYLE, SIZE, OR COLOR.

FOR COMMON AND SPECIALTY METALS, ALLOYS, AND ORES, NAMELY, TANTALUM, NIOBIUM, AND BERYLLIUM FOR FURTHER MANUFACTURE OF GOODS IN A VARIETY OF INDUSTRIES (U.S. CLS. 2, 12, 13, 14, 23, 25 AND 50).

CHERYL STEPLIGHT, EXAMINING ATTORNEY

SN 76-599,358. GREATER SEBAGO SERVICES, INC., NAPLES, ME. FILED 6-24-2004.

Alummikon

THE MARK CONSISTS OF STANDARD CHARACTERS WITHOUT CLAIM TO ANY PARTICULAR FONT, STYLE, SIZE, OR COLOR.

FOR METAL STATIONARY DOCKS, METAL FLOATING DOCKS, METAL STAIRS, METAL BOAT RACKS, METAL BOAT LIFTS, METAL GANGWAYS (U.S. CLS. 2, 12, 13, 14, 23, 25 AND 50).

FIRST USE 4-1-2004; IN COMMERCE 4-1-2004.
SKYE YOUNG, EXAMINING ATTORNEY

CLASS 6—(Continued).

SN 76-606,121. AWI LICENSING COMPANY, WILMINGTON, DE. FILED 8-6-2004.

SUPRAFINE

THE MARK CONSISTS OF STANDARD CHARACTERS WITHOUT CLAIM TO ANY PARTICULAR FONT, STYLE, SIZE, OR COLOR.

OWNER OF U.S. REG. NO. 1,352,828.
FOR METAL SUSPENDED CEILING SYSTEM COMPRISING MAIN BEAMS, CROSS TEES AND WALL MOULDING (U.S. CLS. 2, 12, 13, 14, 23, 25 AND 50).

FIRST USE 1-0-1990; IN COMMERCE 1-0-1990.
KEVIN DINALLO, EXAMINING ATTORNEY

SN 76-607,021. SEIFERD, SCOTT D., ST. CHARLES, MO. FILED 8-12-2004.

STORM DOOR & BRACKET SAVER

THE MARK CONSISTS OF STANDARD CHARACTERS WITHOUT CLAIM TO ANY PARTICULAR FONT, STYLE, SIZE, OR COLOR.

NO CLAIM IS MADE TO THE EXCLUSIVE RIGHT TO USE STORM DOOR & BRACKET, APART FROM THE MARK AS SHOWN.

FOR STEEL PLATE FOR REINFORCING STORM DOOR BRACKETS (U.S. CLS. 2, 12, 13, 14, 23, 25 AND 50).
FIRST USE 10-3-2000; IN COMMERCE 10-3-2000.
SAMUEL E. SHARPER JR., EXAMINING ATTORNEY

SN 76-619,272. KAYDON ACQUISITION XI, INC., ANN ARBOR, MI. FILED 11-4-2004.

SILVERFLO

THE MARK CONSISTS OF STANDARD CHARACTERS WITHOUT CLAIM TO ANY PARTICULAR FONT, STYLE, SIZE, OR COLOR.

FOR LEAD-FREE SOLDER CONTAINING SILVER (U.S. CLS. 2, 12, 13, 14, 23, 25 AND 50).
FIRST USE 0-0-1996; IN COMMERCE 0-0-1996.
LINDA ESTRADA, EXAMINING ATTORNEY

CLASS 6—(Continued).

SN 76-619,666. WINDSONG COATINGS, LLC, ROUND POND, ME. FILED 11-8-2004.

MT. BATTIE WILDERNESS

THE MARK CONSISTS OF STANDARD CHARACTERS WITHOUT CLAIM TO ANY PARTICULAR FONT, STYLE, SIZE, OR COLOR.

FOR METAL BELLS (U.S. CLS. 2, 12, 13, 14, 23, 25 AND 50).

FIRST USE 7-0-2003; IN COMMERCE 7-0-2003.
SCOTT OSLICK, EXAMINING ATTORNEY



SN 76-619,667. WINDSONG COATINGS, LLC, ROUND POND, ME. FILED 11-8-2004.

MT. KATAHDIN WILDERNESS

THE MARK CONSISTS OF STANDARD CHARACTERS WITHOUT CLAIM TO ANY PARTICULAR FONT, STYLE, SIZE, OR COLOR.

THE ENGLISH TRANSLATION OF THE WORD KATAHDIN IN THE MARK IS "THE GREAT MOUNTAIN".

FOR METAL BELLS (U.S. CLS. 2, 12, 13, 14, 23, 25 AND 50).

FIRST USE 7-25-2003; IN COMMERCE 7-25-2003.
SCOTT OSLICK, EXAMINING ATTORNEY



SN 76-619,668. WINDSONG COATINGS, LLC, ROUND POND, ME. FILED 11-8-2004.

MT. RAINIER WILDERNESS

THE MARK CONSISTS OF STANDARD CHARACTERS WITHOUT CLAIM TO ANY PARTICULAR FONT, STYLE, SIZE, OR COLOR.

FOR METAL BELLS (U.S. CLS. 2, 12, 13, 14, 23, 25 AND 50).

FIRST USE 1-2-2004; IN COMMERCE 1-2-2004.
SCOTT OSLICK, EXAMINING ATTORNEY



SN 76-619,669. WINDSONG COATINGS, LLC, ROUND POND, ME. FILED 11-8-2004.

MT. WASHINGTON WILDERNESS

THE MARK CONSISTS OF STANDARD CHARACTERS WITHOUT CLAIM TO ANY PARTICULAR FONT, STYLE, SIZE, OR COLOR.

FOR METAL BELLS (U.S. CLS. 2, 12, 13, 14, 23, 25 AND 50).

FIRST USE 1-2-2004; IN COMMERCE 1-2-2004.
SCOTT OSLICK, EXAMINING ATTORNEY

CLASS 6—(Continued).

SN 76-619,671. WINDSONG COATINGS, LLC, ROUND POND, ME. FILED 11-8-2004.

SAN FRANCISCO BAY

THE MARK CONSISTS OF STANDARD CHARACTERS WITHOUT CLAIM TO ANY PARTICULAR FONT, STYLE, SIZE, OR COLOR.

FOR METAL BELLS (U.S. CLS. 2, 12, 13, 14, 23, 25 AND 50).

FIRST USE 6-0-2000; IN COMMERCE 6-0-2000.
SCOTT OSLICK, EXAMINING ATTORNEY



SN 76-620,139. JEV-CAP MANUFACTURING, INC., MONTECITO, CA. FILED 11-12-2004.

HANGNAILS

THE MARK CONSISTS OF STANDARD CHARACTERS WITHOUT CLAIM TO ANY PARTICULAR FONT, STYLE, SIZE, OR COLOR.

FOR METAL FASTENERS, NAMELY NAILS (U.S. CLS. 2, 12, 13, 14, 23, 25 AND 50).

FIRST USE 9-1-2004; IN COMMERCE 9-1-2004.
PAULA MAHONEY, EXAMINING ATTORNEY



SN 76-620,706. HO'S MANDARIN IMPORT & EXPORT INC., CITY OF INDUSTRY, CA. FILED 11-15-2004.

RUCINNI

FOR JEWELRY BOX OF METAL (U.S. CLS. 2, 12, 13, 14, 23, 25 AND 50).

FIRST USE 5-23-1995; IN COMMERCE 5-23-1995.
ROBIN CHOSID, EXAMINING ATTORNEY

CLASS 6—(Continued).

SN 76-626,460. SHEREX INDUSTRIES, LTD., LANCASTER, NY. FILED 12-29-2004.



FOR METAL PLUGS, METAL THREADED INSERTS, METAL RIVETING NUTS, METAL PORT PLUGS (U.S. CLS. 2, 12, 13, 14, 23, 25 AND 50).
FIRST USE 2-29-1996; IN COMMERCE 2-29-1996.
NICHOLAS ALTREE, EXAMINING ATTORNEY

SN 76-627,141. METL-SPAN I, LTD., LEWISVILLE, TX. FILED 1-7-2005.

LOCKGUARD

THE MARK CONSISTS OF STANDARD CHARACTERS WITHOUT CLAIM TO ANY PARTICULAR FONT, STYLE, SIZE, OR COLOR.

FOR METAL INTER-CONNECTING EDGE STRUCTURE FOR THE FIRE RESISTANT MINERAL WOOL CORE OF CONSTRUCTION PANELS TO ENHANCE FIRE RESISTANCE OF PANELS (U.S. CLS. 2, 12, 13, 14, 23, 25 AND 50).

FIRST USE 12-6-2004; IN COMMERCE 12-6-2004.
DEBRA LEE, EXAMINING ATTORNEY

SN 76-642,045. VIEGA GMBH & CO. KG, D-57439 ATTEN-DORN, FED REP GERMANY, FILED 6-30-2005.

PROPRESS SYSTEM

THE MARK CONSISTS OF STANDARD CHARACTERS WITHOUT CLAIM TO ANY PARTICULAR FONT, STYLE, SIZE, OR COLOR.

OWNER OF U.S. REG. NO. 2,640,101.
NO CLAIM IS MADE TO THE EXCLUSIVE RIGHT TO USE "SYSTEM", APART FROM THE MARK AS SHOWN.

FOR WATER SYSTEM FITTINGS MADE OF METAL FOR DOMESTIC AND INDUSTRIAL INSTALLATIONS, NAMELY, PIPES, BENDS, T-PIECES, ADAPTER PIECES, COUPLINGS AND MANIFOLDS (U.S. CLS. 2, 12, 13, 14, 23, 25 AND 50).

FIRST USE 2-0-2000; IN COMMERCE 2-0-2000.
H. M. FISHER, EXAMINING ATTORNEY

CLASS 6—(Continued).

SN 78-218,518. SILGAN CONTAINERS CORPORATION, WOODLAND HILLS, CA. FILED 2-25-2003.

QUICK TOP

THE MARK CONSISTS OF THE WORDS QUICK TOP, FOR METALLIC CAN ENDS FOR PERMANENT ENGAGEMENT ON THE OPEN END OF METALLIC CAN BODIES BY FOOD PROCESSORS TO EFFECT SEALING THEREOF (U.S. CLS. 2, 12, 13, 14, 23, 25 AND 50).

JOHN DALIER, EXAMINING ATTORNEY

SN 78-270,128. ASSOCIATED STEEL COMPANY, INC., CLEVELAND, OH. FILED 7-3-2003.

CENTRICASE LS

THE MARK CONSISTS OF STANDARD CHARACTERS WITHOUT CLAIM TO ANY PARTICULAR FONT, STYLE, SIZE, OR COLOR.

NO CLAIM IS MADE TO THE EXCLUSIVE RIGHT TO USE LS, APART FROM THE MARK AS SHOWN.

FOR STEEL FOR USE IN LINEAR BEARING SHAFTS (U.S. CLS. 2, 12, 13, 14, 23, 25 AND 50).

FIRST USE 12-31-2000; IN COMMERCE 12-31-2000.
MARY CRAWFORD, EXAMINING ATTORNEY

SN 78-299,614. THYSSENKRUPP VDM GMBH, WERDOHL D-58791, FED REP GERMANY, FILED 9-12-2003.

NICORROS AL

PRIORITY CLAIMED UNDER SEC. 44(D) ON FED REP GERMANY APPLICATION NO. 30324088.1, FILED 5-14-2003, REG. NO. 30324088, DATED 7-4-2003, EXPIRES 5-31-2013.

FOR SHEETS, STRIPS, RODS, WIRE, AND TUBES MADE OF ALLOYS ESSENTIALLY CONTAINING NICKEL, COPPER AND ALUMINUM (U.S. CLS. 2, 12, 13, 14, 23, 25 AND 50).

PAULA MAHONEY, EXAMINING ATTORNEY

CLASS 6—(Continued).

SN 78-387,313. WHITE PROPERTIES LLC, LONGVIEW, WA. FILED 3-19-2004.

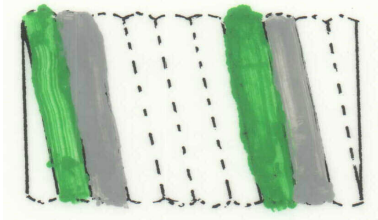

THE COLOR(S) COLOR GREEN, COLOR GREY IS/ARE CLAIMED AS A FEATURE OF THE MARK.

THE MARK CONSISTS OF THE COLORS GREEN AND GRAY AS APPLIED TO TWO ADJACENT STRANDS OF WIRE, ONE GREEN AND ONE GRAY, WHICH ARE WRAPPED AROUND ROPE'S CORE IN A SPIRAL FASHION. THE DOTTED OUTLINE OF THE GOODS IS INTENDED TO SHOW THE POSITION OF THE MARK AND IS NOT A PART OF THE MARK.

FOR WIRE ROPE (U.S. CLS. 2, 12, 13, 14, 23, 25 AND 50).

PRISCILLA MILTON, EXAMINING ATTORNEY

CLASS 6—(Continued).

SN 78-414,948. SOUTHERN EXTRUSIONS, INC., PENSACOLA, FL. FILED 5-7-2004.

STORM SECURE

THE MARK CONSISTS OF STANDARD CHARACTERS WITHOUT CLAIM TO ANY PARTICULAR FONT, STYLE, SIZE, OR COLOR.

FOR METAL WINDOW SHUTTERS (U.S. CLS. 2, 12, 13, 14, 23, 25 AND 50).

FIRST USE 8-1-2003; IN COMMERCE 8-1-2003.

LEIGH CAROLINE CASE, EXAMINING ATTORNEY

SN 78-406,644. DB PRODUCTS, INC., MUSKEGO, WI. FILED 4-22-2004.

VERSATOW

THE MARK CONSISTS OF STANDARD CHARACTERS WITHOUT CLAIM TO ANY PARTICULAR FONT, STYLE, SIZE, OR COLOR.

FOR TOWING HARDWARE MADE OF METAL COMPRISED OF HOOKS AND BENT METAL WIRE FOR USE IN TOWING REFUSE AND RECYCLING CONTAINERS (U.S. CLS. 2, 12, 13, 14, 23, 25 AND 50).

FIRST USE 7-0-2004; IN COMMERCE 7-0-2004.

ANNE E. GUSTASON, EXAMINING ATTORNEY

SN 78-420,322. MIKRON INDUSTRIES, INC, KENT, WA. FILED 5-17-2004.



NO CLAIM IS MADE TO THE EXCLUSIVE RIGHT TO USE "LOCK", APART FROM THE MARK AS SHOWN.

FOR WINDOW LOCKS AND SLIDING GLASS DOOR LOCKS COMPRISED PREDOMINANTLY OF METAL (U.S. CLS. 2, 12, 13, 14, 23, 25 AND 50).

FIRST USE 8-1-2002; IN COMMERCE 8-1-2002.

THEODORE MCBRIDE, EXAMINING ATTORNEY

SN 78-410,094. FUNK, OTIS DONALD, DBA O. D. MANUFACTURING, SHERWOOD, AR. FILED 4-29-2004.



NO CLAIM IS MADE TO THE EXCLUSIVE RIGHT TO USE "BRAND", APART FROM THE MARK AS SHOWN.

FOR DO-IT-YOURSELF METAL CARPORT KITS (U.S. CLS. 2, 12, 13, 14, 23, 25 AND 50).

FIRST USE 9-0-2003; IN COMMERCE 9-0-2003.

JULIE WATSON, EXAMINING ATTORNEY

SN 78-421,251. FTI VALVES & CONTROLS, INC., PROSPERITY, SC. FILED 5-19-2004.



FOR METAL BALL VALVES (U.S. CLS. 2, 12, 13, 14, 23, 25 AND 50).

SHARI SHEFFIELD, EXAMINING ATTORNEY

CLASS 6—(Continued).

SN 78-425,083. SINITUOTE OY, 05820 HYVINKAA, FINLAND, FILED 5-26-2004.



OWNER OF FINLAND REG. NO. 225338, DATED 9-30-2002, EXPIRES 9-30-2012.

THE COLORS DARK BROWN, BROWN, LIGHT BROWN, ORANGE AND WHITE ARE CLAIMED AS A FEATURE OF THE MARK.

THE WORD SAUV IS WRITTEN IN WHITE LETTERS OUTLINED IN DARK BROWN AND IN LIGHT BROWN BANNER. THE BACKGROUND OF THE SHIELD HAS ORANGE SPOKES. THE BORDER IS ALSO DARK BROWN.

THE MARK CONSISTS OF THE WORD SAUV WRITTEN IN WHITE LETTERS OUTLINED IN DARK BROWN DISPLAYED ACROSS A LIGHT BROWN BANNER IN THE CENTER OF A SHIELD DESIGN. THE TOP PORTION OF THE SHIELD HAS A DARK BROWN BACKGROUND WITH ORANGE SPOKES FADING DOWN TOWARD THE CENTER OF THE SAUV BANNER OUTLINED WITH A LIGHT BROWN BORDER. THE BOTTOM PORTION OF THE SHIELD IS A BRIGHT ORANGE HEMISPHERE RADIATING OUT IN A SPOKE-LIKE FASHION WITH THE OUTLINING BORDER BEING A DARK BROWN COLOR.

FOR SMOKE BAGS MADE OF ALUMINUM FOR SMOKING FISH, MEAT AND OTHER FOODSTUFFS (U.S. CLS. 2, 12, 13, 14, 23, 25 AND 50).

SKYE YOUNG, EXAMINING ATTORNEY

SN 78-429,380. TRAVELPRO INTERNATIONAL, INC., BOCA RATON, FL. FILED 6-3-2004.

TRAVELPRO SECURITY ACCESSORY

THE MARK CONSISTS OF STANDARD CHARACTERS WITHOUT CLAIM TO ANY PARTICULAR FONT, STYLE, SIZE, OR COLOR.

OWNER OF U.S. REG. NOS. 1,587,822, 2,829,620 AND OTHERS.

NO CLAIM IS MADE TO THE EXCLUSIVE RIGHT TO USE "SECURITY ACCESSORY", APART FROM THE MARK AS SHOWN.

FOR METAL LOCK FOR USE WITH LUGGAGE (U.S. CLS. 2, 12, 13, 14, 23, 25 AND 50).

INGRID C. EULIN, EXAMINING ATTORNEY

CLASS 6—(Continued).

SN 78-432,009. ACADEMY CORPORATION, ALBUQUERQUE, NM. FILED 6-8-2004.

SIL-CON

THE MARK CONSISTS OF STANDARD CHARACTERS WITHOUT CLAIM TO ANY PARTICULAR FONT, STYLE, SIZE, OR COLOR.

FOR MATERIALS OF METAL ALLOYS IN THE FORM OF STRIPS, WIRE, AND FOIL FOR USE IN THE MANUFACTURE OF ELECTRICAL CONTACTS, NAMELY RIVETS, WIRE, PLUGS, AND CONNECTORS (U.S. CLS. 2, 12, 13, 14, 23, 25 AND 50).

WILLIAM BRECKENFELD, EXAMINING ATTORNEY

SN 78-436,783. PERMAR SYSTEMS, INC., WOLCOTT, NY. FILED 6-17-2004.

Post Blazers

THE MARK CONSISTS OF STANDARD CHARACTERS WITHOUT CLAIM TO ANY PARTICULAR FONT, STYLE, SIZE, OR COLOR.

FOR NON-LUMINOUS, NON-MECHANICAL METAL SIGNS (U.S. CLS. 2, 12, 13, 14, 23, 25 AND 50).

MICHAEL HALL, EXAMINING ATTORNEY

CLASS 6—(Continued).

SN 78-445,238. SPORTSFIELD SPECIALTIES, INC., DELHI, NY. FILED 7-2-2004.

THROWFORM

THE MARK CONSISTS OF STANDARD CHARACTERS WITHOUT CLAIM TO ANY PARTICULAR FONT, STYLE, SIZE, OR COLOR.

FOR ALUMINUM FRAMING CONSTRUCTION COMPONENTS FOR CONCRETE POURING, NAMELY FOR ATHLETIC FIELD SHOT-PUT, DISCUS AND HAMMER THROW PLATFORM SYSTEMS (U.S. CLS. 2, 12, 13, 14, 23, 25 AND 50).

JEFF DEFORD, EXAMINING ATTORNEY

CLASS 6—(Continued).

SN 78-446,950. HOLLYWOOD CHAMBER OF COMMERCE, HOLLYWOOD, CA. FILED 7-7-2004.

HOLLYWOOD WALK OF FAME

THE MARK CONSISTS OF STANDARD CHARACTERS WITHOUT CLAIM TO ANY PARTICULAR FONT, STYLE, SIZE, OR COLOR.

OWNER OF U.S. REG. NOS. 1,375,017, 1,565,809 AND OTHERS.

NO CLAIM IS MADE TO THE EXCLUSIVE RIGHT TO USE "HOLLYWOOD", APART FROM THE MARK AS SHOWN.

FOR METAL KEY CHAINS (U.S. CLS. 2, 12, 13, 14, 23, 25 AND 50).

FIRST USE 1-1-1985; IN COMMERCE 1-1-1985.

ANN E. SAPPENFIELD, EXAMINING ATTORNEY

SN 78-454,655. CLOPAY BUILDING PRODUCTS R&D COMPANY, INC., DBA CLOPAY BUILDING PRODUCTS COMPANY, INC., MASON, OH. FILED 7-22-2004.

COACHMAN

THE MARK CONSISTS OF STANDARD CHARACTERS WITHOUT CLAIM TO ANY PARTICULAR FONT, STYLE, SIZE, OR COLOR.

FOR METAL GARAGE DOORS (U.S. CLS. 2, 12, 13, 14, 23, 25 AND 50).

FIRST USE 10-31-2003; IN COMMERCE 10-31-2003.

CHERYL CLAYTON, EXAMINING ATTORNEY

SN 78-446,093. C.H.I. OVERHEAD DOORS, ARTHUR, IL. FILED 7-6-2004.



THE COLOR(S) TAN - PMS 4655 GREEN - PMS 357 IS/ARE CLAIMED AS A FEATURE OF THE MARK.

THE COLOR GREEN APPEARS IN THE LEFT HALF OF THE RECTANGLE BEHIND THE WHITE LETTER N AND THE BORDER TO THE RIGHT. THE COLOR TAN APPEARS IN THE DESIGN OF THE GARAGE DOOR AND IN THE TERM NEXDOOR.

FOR METAL GARAGE DOOR SECTIONS; METAL GARAGE DOOR HARDWARE NAMELY, STRUTS, HANDLES, LOCKS, ROLLERS, STILES, HINGES, TRACK (U.S. CLS. 2, 12, 13, 14, 23, 25 AND 50).

CAROLINE WOOD, EXAMINING ATTORNEY

SN 78-462,895. VENETIAN CASINO RESORT, LLC, LAS VEGAS, NV. FILED 8-5-2004.

VENETIAN PALAZZO

THE MARK CONSISTS OF STANDARD CHARACTERS WITHOUT CLAIM TO ANY PARTICULAR FONT, STYLE, SIZE, OR COLOR.

FOR METAL KEY RINGS; METAL NOVELTY LICENSE PLATES (U.S. CLS. 2, 12, 13, 14, 23, 25 AND 50).

ANDREW RHIM, EXAMINING ATTORNEY

CLASS 6—(Continued).

SN 78-472,644. ASSOCIATED MATERIALS, INCORPORATED, DBA ALSIDE, CUYAHOGA FALLS, OH. FILED 8-24-2004.

CLASS 6—(Continued).

SN 78-473,126. AMERICAN NICKELOID COMPANY, PERU, IL. FILED 8-25-2004.

GALLERY

THE MARK CONSISTS OF STANDARD CHARACTERS WITHOUT CLAIM TO ANY PARTICULAR FONT, STYLE, SIZE, OR COLOR.
FOR STEEL SIDING (U.S. CLS. 2, 12, 13, 14, 23, 25 AND 50).
MELISSA VALLILLO, EXAMINING ATTORNEY

ALLOY PLUS

THE MARK CONSISTS OF STANDARD CHARACTERS WITHOUT CLAIM TO ANY PARTICULAR FONT, STYLE, SIZE, OR COLOR.
NO CLAIM IS MADE TO THE EXCLUSIVE RIGHT TO USE "ALLOY", APART FROM THE MARK AS SHOWN.
FOR CORROSION RESISTANT PRE-COATED STEEL BASED METAL ALLOYS FOR FURTHER MANUFACTURING (U.S. CLS. 2, 12, 13, 14, 23, 25 AND 50).
BARBARA A. LOUGHRAN, EXAMINING ATTORNEY

SN 78-472,662. RESCH ENTERPRISES, INC., ST. CLOUD, MN. FILED 8-24-2004.

SN 78-480,516. EXCELAMERICA LLC, MIAMI, FL. FILED 9-8-2004.

GORILLA WALL BRACES

THE MARK CONSISTS OF STANDARD CHARACTERS WITHOUT CLAIM TO ANY PARTICULAR FONT, STYLE, SIZE, OR COLOR.
NO CLAIM IS MADE TO THE EXCLUSIVE RIGHT TO USE "WALL BRACES", APART FROM THE MARK AS SHOWN.
FOR CONSTRUCTION ELEMENTS MADE OF METAL IN THE NATURE OF A DEVICE FOR STRAIGHTENING FOUNDATION WALLS, NAMELY, WALL BRACES (U.S. CLS. 2, 12, 13, 14, 23, 25 AND 50).
FIRST USE 6-14-2004; IN COMMERCE 6-14-2004.
BRENDAN MCCAULEY, EXAMINING ATTORNEY



THE COLOR(S) BLUE AND WHITE IS/ARE CLAIMED AS A FEATURE OF THE MARK.
THE COLORS BLUE APPEARS IN THE BACKGROUND AND THE COLOR WHITE APPEARS AS LETTERS IN THE MARK.
FOR METAL TUBING FOR USE IN GAS CONDUITS (U.S. CLS. 2, 12, 13, 14, 23, 25 AND 50).
SANJEEV VOHRA, EXAMINING ATTORNEY

CLASS 6—(Continued).

SN 78-513,774. BRAMMALL, INC., DBA TYDENBRAMMALL, ANGOLA, IN. FILED 11-9-2004.

CLASS 6—(Continued).

SN 78-523,042. TAYLOR BUILDING PRODUCTS, INC., WEST BRANCH, MI. FILED 11-25-2004.

WORLD BOLT

AMERICA'S DOORMAKER

THE MARK CONSISTS OF STANDARD CHARACTERS WITHOUT CLAIM TO ANY PARTICULAR FONT, STYLE, SIZE, OR COLOR.

NO CLAIM IS MADE TO THE EXCLUSIVE RIGHT TO USE "BOLT", APART FROM THE MARK AS SHOWN.

FOR SECURITY AND FASTENING DEVICES; NAMELY, METAL LOCKS (U.S. CLS. 2, 12, 13, 14, 23, 25 AND 50).

FIRST USE 7-21-2004; IN COMMERCE 7-21-2004.
KIMBERLY FRYE, EXAMINING ATTORNEY

THE MARK CONSISTS OF STANDARD CHARACTERS WITHOUT CLAIM TO ANY PARTICULAR FONT, STYLE, SIZE, OR COLOR.

NO CLAIM IS MADE TO THE EXCLUSIVE RIGHT TO USE "AMERICA'S", APART FROM THE MARK AS SHOWN.

FOR METAL GARAGE DOORS AND ENTRY DOORS AND PARTS THEREOF (U.S. CLS. 2, 12, 13, 14, 23, 25 AND 50).

FIRST USE 4-8-1988; IN COMMERCE 4-8-1988.
HOWARD B. LEVINE, EXAMINING ATTORNEY

SN 78-520,604. KICO LLC, SANDY, UT. FILED 11-20-2004.

SN 78-523,044. TAYLOR BUILDING PRODUCTS, INC., WEST BRANCH, MI. FILED 11-25-2004.

Bag Rollup

UNI-DOOR

THE MARK CONSISTS OF STANDARD CHARACTERS WITHOUT CLAIM TO ANY PARTICULAR FONT, STYLE, SIZE, OR COLOR.

NO CLAIM IS MADE TO THE EXCLUSIVE RIGHT TO USE BAG, APART FROM THE MARK AS SHOWN.

FOR REUSABLE FLEXIBLE METAL STRIPS HAVING A PLASTIC COVERING FOR RESEALING OPENED FOOD BAGS (U.S. CLS. 2, 12, 13, 14, 23, 25 AND 50).

FIRST USE 8-29-2002; IN COMMERCE 8-29-2002.
ZHALEH DELANEY, EXAMINING ATTORNEY

THE MARK CONSISTS OF STANDARD CHARACTERS WITHOUT CLAIM TO ANY PARTICULAR FONT, STYLE, SIZE, OR COLOR.

OWNER OF U.S. REG. NO. 948,158.
FOR STEEL ENTRANCEWAY DOOR AND/OR FRAME ASSEMBLY (U.S. CLS. 2, 12, 13, 14, 23, 25 AND 50).

FIRST USE 11-15-1968; IN COMMERCE 11-15-1968.
HOWARD B. LEVINE, EXAMINING ATTORNEY

CLASS 6—(Continued).

SN 78-523,858. WEYERHAEUSER COMPANY, FEDERAL WAY, WA. FILED 11-29-2004.

TJ-SHEARBITE

THE MARK CONSISTS OF STANDARD CHARACTERS WITHOUT CLAIM TO ANY PARTICULAR FONT, STYLE, SIZE, OR COLOR.

OWNER OF U.S. REG. NOS. 2,258,918, 2,361,123 AND OTHERS.

FOR METAL BUILDING MATERIALS, NAMELY, A METAL ANCHOR BOLT CLAMP FOR USE IN RESIDENTIAL BUILDING CONSTRUCTION (U.S. CLS. 2, 12, 13, 14, 23, 25 AND 50).

JOHN WILKE, EXAMINING ATTORNEY

CLASS 6—(Continued).

SN 78-539,456. WORLD FACTORY, INC., SOUTHLAKE, TX. FILED 12-29-2004.

YUKON

THE MARK CONSISTS OF STANDARD CHARACTERS WITHOUT CLAIM TO ANY PARTICULAR FONT, STYLE, SIZE, OR COLOR.

FOR METAL GOODS - NAMELY, EXTENSION LADDERS, STEP LADDERS, STEP STOOLS, AND PORTABLE SCAFFOLDING (U.S. CLS. 2, 12, 13, 14, 23, 25 AND 50).

BRENDAN MCCAULEY, EXAMINING ATTORNEY

SN 78-535,565. HOGANAS AB, SE-263 83 HOGANAS, SWEDEN, FILED 12-20-2004.

ASTALOY CRL

THE MARK CONSISTS OF STANDARD CHARACTERS WITHOUT CLAIM TO ANY PARTICULAR FONT, STYLE, SIZE, OR COLOR.

OWNER OF U.S. REG. NO. 2,485,678.

FOR METAL POWDERS FOR INDUSTRIAL USE (U.S. CLS. 2, 12, 13, 14, 23, 25 AND 50).

TEJBIR SINGH, EXAMINING ATTORNEY

SN 78-539,981. METAL & CABLE CORP., INC., TWINSBURG, OH. FILED 12-30-2004.

Magnemount

SN 78-537,663. COLORADO METAL CRAFT, INC., DENVER, CO. FILED 12-23-2004.

CMC COLOREDGE

THE MARK CONSISTS OF STANDARD CHARACTERS WITHOUT CLAIM TO ANY PARTICULAR FONT, STYLE, SIZE, OR COLOR.

FOR METAL LANDSCAPE EDGINGS AND BORDERS (U.S. CLS. 2, 12, 13, 14, 23, 25 AND 50).

ELISSA GARBER KON, EXAMINING ATTORNEY

THE MARK CONSISTS OF STANDARD CHARACTERS WITHOUT CLAIM TO ANY PARTICULAR FONT, STYLE, SIZE, OR COLOR.

FOR METAL AUDIO, VIDEO AND COMPUTER WALL AND CEILING MOUNTS (U.S. CLS. 2, 12, 13, 14, 23, 25 AND 50).

RONALD MCMORROW, EXAMINING ATTORNEY

CLASS 6—(Continued).

SN 78-545,659. NEW AGE FASTENING SYSTEMS, INC., DEPTFORD, NJ. FILED 1-11-2005.

CLASS 6—(Continued).

SN 78-556,173. SAFETY BY DESIGN, LLC, CHESTERFIELD, MO. FILED 1-28-2005.

THERMAL V

THE MARK CONSISTS OF STANDARD CHARACTERS WITHOUT CLAIM TO ANY PARTICULAR FONT, STYLE, SIZE, OR COLOR.

NO CLAIM IS MADE TO THE EXCLUSIVE RIGHT TO USE THERMAL, APART FROM THE MARK AS SHOWN.

FOR METALLIC POWDER-FILLED WIRE FOR USE IN THERMAL COATING PROCESS (U.S. CLS. 2, 12, 13, 14, 23, 25 AND 50).

KAREN K. BUSH, EXAMINING ATTORNEY

TURNER

THE MARK CONSISTS OF STANDARD CHARACTERS WITHOUT CLAIM TO ANY PARTICULAR FONT, STYLE, SIZE, OR COLOR.

FOR HOME SAFETY AND SECURITY PRODUCTS, NAMELY, METAL DEAD BOLT DOOR LOCKS (U.S. CLS. 2, 12, 13, 14, 23, 25 AND 50).

KEVIN DINALLO, EXAMINING ATTORNEY

SN 78-545,664. NEW AGE FASTENING SYSTEMS, INC., DEPTFORD, NJ. FILED 1-11-2005.

TWINARC X

THE MARK CONSISTS OF STANDARD CHARACTERS WITHOUT CLAIM TO ANY PARTICULAR FONT, STYLE, SIZE, OR COLOR.

FOR METALLIC POWDER-FILLED WIRE FOR USE IN THERMAL COATING PROCESS (U.S. CLS. 2, 12, 13, 14, 23, 25 AND 50).

KAREN K. BUSH, EXAMINING ATTORNEY

SN 78-660,552. UNIVERSITY OF CENTRAL FLORIDA, ORLANDO, FL. FILED 6-29-2005.



SN 78-546,090. HARBOR SALES COMPANY, TROY, MI. FILED 1-12-2005.



FOR METAL DOOR LOCKS (U.S. CLS. 2, 12, 13, 14, 23, 25 AND 50).

FIRST USE 2-21-1991; IN COMMERCE 2-21-1991.
ANNE E. GUSTASON, EXAMINING ATTORNEY

FOR KEY CHAINS, KEY FOBS, KEY HOLDERS, KEY RINGS, PIGGY BANKS, LICENSE PLATES, DOOR STOPS, FIGURINES, AND MONEY CLIPS, ALL MADE OF NON PRECIOUS METAL (U.S. CLS. 2, 12, 13, 14, 23, 25 AND 50).

FIRST USE 10-25-2004; IN COMMERCE 10-25-2004.
MARK RADEMACHER, EXAMINING ATTORNEY

CLASS 6—(Continued).

SN 79-002,305. CORUS TECHNOLOGY BV, NETHERLANDS, FILED 3-9-2004.

FalZinc

THE MARK CONSISTS OF STANDARD CHARACTERS WITHOUT CLAIM TO ANY PARTICULAR FONT, STYLE, SIZE, OR COLOR.

OWNER OF INTERNATIONAL REGISTRATION 0823929 DATED 3-9-2004, EXPIRES 3-9-2014.

FOR COMMON METALS AND THEIR ALLOYS NAMELY LEAD AND LEAD ALLOYS, STEEL AND STEEL ALLOYS, ALUMINUM AND ALUMINUM ALLOYS; COMMON METALS AND THEIR ALLOYS IN THE FORM OF BANDS, SHEETS, FOILS, PROFILES, RAILS, TUBES, RODS, JOISTS, POSTS; ALUMINUM BANDS; COILS OF ALUMINUM AND OTHER ROLLS OF ALUMINUM; PORTABLE METAL BUILDINGS; ALUMINUM BUILDING MATERIALS, NAMELY ALUMINUM BUILDING FLASHING, ALUMINUM SOFFITS, ALUMINUM FASCIA, ALUMINUM CLADDING FOR CONSTRUCTION AND BUILDING; METAL BUILDING MATERIALS NAMELY METAL BUILDING FLASHING, METAL SOFFITS, METAL FASCIA, METAL CLADDING FOR CONSTRUCTION AND BUILDING; COMMON METALS IN THE FORM OF BANDS, SHEETS, PROFILES, PANELS, RODS, OR POSTS, EITHER WITH OR WITHOUT AN ORGANIC OR METAL COATING; COMMON METALS IN THE FORM OF BANDS, SHEETS, PROFILES, PANELS, RODS, OR POSTS, EITHER WITH OR WITHOUT OR WITHOUT AN ORGANIC OR METAL COATING, FOR THE PANELLING OF OUTSIDE WALLS AND ROOFS; ROOF COVERING MATERIAL MADE OF METAL; PROFILED METAL SHEETS OR PANELS, EITHER WITH OR WITHOUT AN ORGANIC OR METAL COATING; FASTENING MATERIALS OF METAL NAMELY BOLTS, NAILS, RIVETS AND SCREWS FOR PANELS AND FOR BUILDING PURPOSES (U.S. CLS. 2, 12, 13, 14, 23, 25 AND 50).

DAHLLIA GEORGE, EXAMINING ATTORNEY

SN 79-005,853. GUANGDONG DONGTAI METAL; GOODS CO., LTD., FOSHAN, GUANGDONG, CHINA, FILED 8-31-2004.

DTC

OWNER OF INTERNATIONAL REGISTRATION 0834732 DATED 8-31-2004, EXPIRES 8-31-2014.

FOR BRANCHING PIPES OF METAL; LATCHES OF METAL; PEGS OF METAL; CHAINS OF METAL; FITTINGS OF METAL FOR FURNITURE; DOOR HANDLES OF METAL; IRONMONGERY; METAL DISPLAYS; LOCKS (OTHER THAN ELECTRIC) OF METAL; PULLERS OF METAL (OTHER THAN FOR MACHINES) (U.S. CLS. 2, 12, 13, 14, 23, 25 AND 50).

KEVON CHISOLM, EXAMINING ATTORNEY

CLASS 7—MACHINERY

SN 75-036,382. CENTRAL MFG. INC., CHICAGO, IL. FILED 12-8-1995.

STEALTH

OWNER OF U.S. REG. NO. 1,434,642.
FOR BOWLING ALLEY CLEANING MACHINES (U.S. CLS. 13, 19, 21, 23, 31, 34 AND 35).
FIRST USE 10-0-1993; IN COMMERCE 10-0-1993.
SUSAN LESLIE DUBOIS, EXAMINING ATTORNEY

SN 76-385,596. SEARS, ROEBUCK AND CO., HOFFMAN ESTATES, IL. FILED 3-21-2002.

CRAFTSMAN PROFESSIONAL

OWNER OF U.S. REG. NOS. 525,092, 2,569,359 AND OTHERS.

NO CLAIM IS MADE TO THE EXCLUSIVE RIGHT TO USE "PROFESSIONAL", APART FROM THE MARK AS SHOWN.

FOR LAWN MOWERS; POWER-OPERATED CHAIN SAWS, POWER-OPERATED GRASS/WEED TRIMMERS, POWER-OPERATED LAWN EDGERS; AND TRACTOR TOWED AGRICULTURAL IMPLEMENTS, NAMELY, PLOWS, AERATORS, AND MOWERS (U.S. CLS. 13, 19, 21, 23, 31, 34 AND 35).

MARTHA FROMM, EXAMINING ATTORNEY

SN 76-486,716. WEEDOO CORPORATION, TORONTO, ONTARIO, CANADA, FILED 2-3-2003.

WEEDOO

PRIORITY CLAIMED UNDER SEC. 44(D) ON CANADA APPLICATION NO. 1161572, FILED 12-9-2002, REG. NO. TMA622965, DATED 10-20-2004, EXPIRES 10-20-2019.

FOR SMALL MOTOR POWERED BOATS WITH INTEGRAL AQUATIC WEED CUTTERS AND RETRIEVERS, USED TO CUT WEEDS (U.S. CLS. 13, 19, 21, 23, 31, 34 AND 35).

BRIAN PINO, EXAMINING ATTORNEY

CLASS 7—(Continued).

SN 76-536,217. NOVOPRESS GMBH PRESSEN UND PRESSWERKZEUGE & CO., KG, D-41460 NEUSS, FED REP GERMANY, FILED 8-11-2003.

PRESSKID

PRIORITY CLAIMED UNDER SEC. 44(D) ON FED REP GERMANY APPLICATION NO. 3058112, FILED 2-18-2003, REG. NO. 003058112, DATED 10-29-2004, EXPIRES 2-18-2013.

FOR MOTOR DRIVEN PRESSING DEVICES, NAMELY, PRESSING TOOLS FOR CONNECTING PIPES AND FOR PRESSING PRESS-JOINTS ON PIPES; PRESSING TOOLS FOR PRESSING PRESS-FITTINGS; MESH CUTTERS; TOOLS FOR CUTTING AND BENDING REBAR; TOOLS FOR PUNCHING AND CUTTING SUPPORT RAILS AND SHEET METAL; CRIMPING TOOLS; CABLE SHEARS AND CUTTERS; TOOLS FOR BENDING, CUTTING AND PUNCHING BUSBARS; PUNCHING PRESSES, ALL THE AFOREMENTIONED GOODS BEING POWER OPERATED (U.S. CLS. 13, 19, 21, 23, 31, 34 AND 35).

ALEX KEAM, EXAMINING ATTORNEY

SN 76-585,104. DELAWARE CAPITAL FORMATION, INC., WILMINGTON, DE. FILED 4-5-2004.

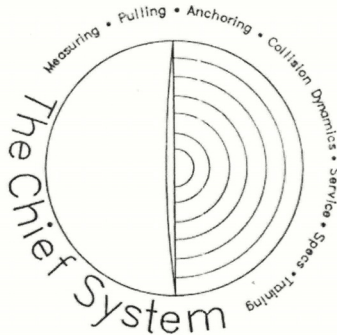

OWNER OF U.S. REG. NO. 2,015,109.
NO CLAIM IS MADE TO THE EXCLUSIVE RIGHT TO USE "SYSTEM, MEASURING, PULLING, ANCHORING, COLLISION DYNAMICS, SERVICE, SPECS AND TRAINING", APART FROM THE MARK AS SHOWN.

FOR MACHINES USED IN REPAIRING COLLISION OR STRUCTURAL DAMAGE TO VEHICLES AND PARTS THEREOF (U.S. CLS. 13, 19, 21, 23, 31, 34 AND 35).

FIRST USE 3-0-2003; IN COMMERCE 3-0-2003.
ANNE E. GUSTASON, EXAMINING ATTORNEY

CLASS 7—(Continued).

SN 76-591,904. ASADA MESH CO., LTD., MATSUBARA, OSAKA, JAPAN, FILED 5-12-2004.

PRIORITY CLAIMED UNDER SEC. 44(D) ON JAPAN APPLICATION NO. 2004/10191, FILED 2-6-2004, REG. NO. 4802254, DATED 9-10-2004, EXPIRES 9-10-2014.

NO CLAIM IS MADE TO THE EXCLUSIVE RIGHT TO USE 3D-MESH, APART FROM THE MARK AS SHOWN. FOR PRINTING MACHINES AND COMPONENTS THEREOF; AND SCREENS AND MESHES USED IN PRINTING APPLICATIONS (U.S. CLS. 13, 19, 21, 23, 31, 34 AND 35).

LEIGH CAROLINE CASE, EXAMINING ATTORNEY

SN 76-598,793. FAIRHURST, ANGELA, LOS ANGELES, CA. FILED 6-21-2004.

SCRUB GENIE

THE MARK CONSISTS OF STANDARD CHARACTERS WITHOUT CLAIM TO ANY PARTICULAR FONT, STYLE, SIZE, OR COLOR.

NO CLAIM IS MADE TO THE EXCLUSIVE RIGHT TO USE SCRUB, APART FROM THE MARK AS SHOWN.

FOR SURFACE CLEANING MACHINE, NAMELY PORTABLE MOTORIZED CLEANING SYSTEM WITH CLEANING BRUSHES AND ATTACHMENTS (U.S. CLS. 13, 19, 21, 23, 31, 34 AND 35).

TIMOTHY FINNEGAN, EXAMINING ATTORNEY

SN 76-600,253. LYROPA TOOL CORPORATION, EDDYSTONE, PA. FILED 7-1-2004.

HYBRID CHUCK

THE MARK CONSISTS OF STANDARD CHARACTERS WITHOUT CLAIM TO ANY PARTICULAR FONT, STYLE, SIZE, OR COLOR.

NO CLAIM IS MADE TO THE EXCLUSIVE RIGHT TO USE "CHUCK", APART FROM THE MARK AS SHOWN.

FOR DRIVE ADAPTER FOR POWER SCREWDRIVERS (U.S. CLS. 13, 19, 21, 23, 31, 34 AND 35).

DEZMONA MIZELLE, EXAMINING ATTORNEY

CLASS 7—(Continued).

SN 76-600,879. AES ENGINEERING LIMITED, ROTHERHAM, UNITED KINGDOM, FILED 7-7-2004.

LABTECTA

THE MARK CONSISTS OF STANDARD CHARACTERS WITHOUT CLAIM TO ANY PARTICULAR FONT, STYLE, SIZE, OR COLOR.

FOR SEALS AND/OR LEAKAGE PREVENTION OR LIMITATION DEVICES FOR SEALING MACHINE BEARINGS IN PUMP FRAMES; ELECTRIC MOTORS AND GEAR BOXES FOR LABORATORY AND INDUSTRIAL USE NAMELY, LABYRINTH SEALS, BEARING SEALS AND NON-CONTACTING SEALS; MACHINE PARTS FOR LABORATORY AND INDUSTRIAL USE, NAMELY, METAL AND NON-METAL BEARING ISOLATORS AND BEARING PROTECTORS; MACHINE PARTS, NAMELY, METAL AND NON-METAL REPELLERS AND EXPELLERS FOR USE IN LABORATORY PUMP FRAMES TO KEEP/FORCE FLUID IN AND KEEP/FORCE DEBRIS AND WATER OUT; AND PARTS FOR ALL THE AFORESAID GOODS (U.S. CLS. 13, 19, 21, 23, 31, 34 AND 35).
RUSS HERMAN, EXAMINING ATTORNEY

SN 76-620,135. WARNER ELECTRIC TECHNOLOGY, INC., SOUTH BELOIT, IL. FILED 11-12-2004.

WICHITA CLUTCH

THE MARK CONSISTS OF STANDARD CHARACTERS WITHOUT CLAIM TO ANY PARTICULAR FONT, STYLE, SIZE, OR COLOR.

NO CLAIM IS MADE TO THE EXCLUSIVE RIGHT TO USE CLUTCH, APART FROM THE MARK AS SHOWN.
FOR MACHINE COMPONENTS, NAMELY FLUID ACTUATED CLUTCHES AND BRAKES, POWER TRANSMISSION PULLEYS, AND POWER TAKE-OFF UNITS (U.S. CLS. 13, 19, 21, 23, 31, 34 AND 35).
FIRST USE 1-1-1956; IN COMMERCE 1-1-1956.
PAULA MAHONEY, EXAMINING ATTORNEY

SN 76-621,843. CONSTRUCTION TECHNOLOGY, INC., NOBLE, OK. FILED 11-22-2004.

IRONWOLF

THE MARK CONSISTS OF STANDARD CHARACTERS WITHOUT CLAIM TO ANY PARTICULAR FONT, STYLE, SIZE, OR COLOR.

FOR HEAVY-DUTY CONSTRUCTION EQUIPMENT ATTACHMENTS FOR INDUSTRIAL VEHICLES, NAMELY, CUTTERS FOR BREAKING UP GROUND SURFACES AND CLEARING TREES (U.S. CLS. 13, 19, 21, 23, 31, 34 AND 35).
LAURA KOVAISKY, EXAMINING ATTORNEY

CLASS 7—(Continued).

SN 76-621,844. GAITHER TOOL COMPANY, INC., JACKSONVILLE, IL. FILED 11-22-2004.

WINNTEC

THE MARK CONSISTS OF STANDARD CHARACTERS WITHOUT CLAIM TO ANY PARTICULAR FONT, STYLE, SIZE, OR COLOR.

FOR LOAD LIFTING MECHANICAL JACKS (U.S. CLS. 13, 19, 21, 23, 31, 34 AND 35).
FIRST USE 12-3-2003; IN COMMERCE 12-3-2003.
LAURA KOVAISKY, EXAMINING ATTORNEY

SN 76-622,080. AUTOMATIC SYSTEMS, INC., KANSAS CITY, MO. FILED 11-24-2004.

AUTOSHOCK

THE MARK CONSISTS OF STANDARD CHARACTERS WITHOUT CLAIM TO ANY PARTICULAR FONT, STYLE, SIZE, OR COLOR.

OWNER OF U.S. REG. NO. 2,050,051.
SEC. 2(F).
FOR INDUSTRIAL CONVEYOR PARTS, NAMELY, SHOCK ABSORBING TOW BARS (U.S. CLS. 13, 19, 21, 23, 31, 34 AND 35).
FIRST USE 8-30-1995; IN COMMERCE 8-30-1995.
GLENN CLARK, EXAMINING ATTORNEY

SN 76-624,213. BOWE BELL + HOWELL COMPANY, DURHAM, NC. FILED 12-9-2004.

TURBO

THE MARK CONSISTS OF STANDARD CHARACTERS WITHOUT CLAIM TO ANY PARTICULAR FONT, STYLE, SIZE, OR COLOR.

FOR MAIL PROCESSING MACHINES; INSERTERS FOR MAIL PROCESSING MACHINES; AND USER MANUALS SOLD AS A UNIT THEREWITH (U.S. CLS. 13, 19, 21, 23, 31, 34 AND 35).
FIRST USE 1-0-1996; IN COMMERCE 5-0-1996.
MATTHEW MCDOWELL, EXAMINING ATTORNEY

CLASS 7—(Continued).

SN 76-625,738. VIEGA GMBH & CO. KG, D-57439 ATTEN-DORN, FED REP GERMANY, FILED 12-21-2004.

PROGRESS

THE MARK CONSISTS OF STANDARD CHARACTERS WITHOUT CLAIM TO ANY PARTICULAR FONT, STYLE, SIZE, OR COLOR.

OWNER OF U.S. REG. NO. 2,640,101.
FOR PRESSING JAWS FOR PRESS FITTINGS USED TO CRIMP AND SEAL PIPE JOINTS; POWER PRESS TOOLS AND PRESSING JAWS FOR PRESS FITTINGS SOLD AS A UNIT (U.S. CLS. 13, 19, 21, 23, 31, 34 AND 35).
FIRST USE 4-0-2000; IN COMMERCE 4-0-2000.
H. M. FISHER, EXAMINING ATTORNEY

SN 76-628,535. HMC SOLUTIONS, LLC, LITTLE ROCK, AR, FILED 1-10-2005.

ADDS

THE MARK CONSISTS OF STANDARD CHARACTERS WITHOUT CLAIM TO ANY PARTICULAR FONT, STYLE, SIZE, OR COLOR.

FOR AUTOMATED EQUIPMENT FOR DROP OFF AND PICK-UP FOR DRY CLEANING ITEMS (U.S. CLS. 13, 19, 21, 23, 31, 34 AND 35).
FIRST USE 6-1-2004; IN COMMERCE 6-1-2004.
JEAN IM, EXAMINING ATTORNEY

SN 78-169,165. ROYAL APPLIANCE MFG. CO., GLENWILLOW, OH. FILED 9-30-2002.

POWER REACH

NO CLAIM IS MADE TO THE EXCLUSIVE RIGHT TO USE "POWER", APART FROM THE MARK AS SHOWN.

FOR ELECTRICAL VACUUM CLEANERS FOR DOMESTIC AND COMMERCIAL USE (U.S. CLS. 13, 19, 21, 23, 31, 34 AND 35).
FIRST USE 10-2-2002; IN COMMERCE 10-2-2002.
WILLIAM BRECKENFELD, EXAMINING ATTORNEY

CLASS 7—(Continued).

SN 78-222,356. TOKYO ELECTRON LIMITED, TOKYO, JAPAN, FILED 3-6-2003.

VESTA

PRIORITY CLAIMED UNDER SEC. 44(D) ON JAPAN APPLICATION NO. 2003-12646, FILED 2-19-2003, REG. NO. 4754081, DATED 3-5-2004, EXPIRES 3-5-2014.

FOR SEMI-CONDUCTOR MANUFACTURING MACHINES; FLAT PANEL DISPLAY MANUFACTURING MACHINES; PLASMA ETCHING MACHINES FOR USE WITH SEMI-CONDUCTOR MANUFACTURING MACHINES AND WITH FLAT PANEL DISPLAY MANUFACTURING MACHINES (U.S. CLS. 13, 19, 21, 23, 31, 34 AND 35).

TANYA AMOS, EXAMINING ATTORNEY

SN 78-278,490. WAIKATO MILKING SYSTEMS NZ LIMITED, HAMILTON, NEW ZEALAND, FILED 7-24-2003.



PRIORITY CLAIMED UNDER SEC. 44(D) ON NEW ZEALAND APPLICATION NO. 680593, FILED 6-9-2003, REG. NO. 680593, DATED 10-7-2004, EXPIRES 6-9-2010.

OWNER OF U.S. REG. NO. 1,941,983.
NO CLAIM IS MADE TO THE EXCLUSIVE RIGHT TO USE "MILKING SYSTEMS", APART FROM THE MARK AS SHOWN.

THE COLORS BLUE AND GREEN ARE CLAIMED AS A FEATURE OF THE MARK.

THE UPPER SECTION OF THE MARK ("WAIKATO") IS BLUE (PANTONE PMS REFLEX BLUE) WITH WHITE LETTERING. THE LOWER SECTION OF THE MARK ("MILKING SYSTEMS") IS GREEN (PANTONE PMS 348) WITH WHITE LETTERING. APPLICANT CLAIMS COLOR AS A FEATURE OF THE MARK.

SEC. 2(F).
FOR MILKING MACHINES, COMPONENTS OF MILKING MACHINES, NAMELY AIR INJECTORS, VACUUM REGULATORS, ROTARY PLATFORMS, CLUSTERWASHERS, TEAT CUP REMOVERS, PULSATORS (U.S. CLS. 13, 19, 21, 23, 31, 34 AND 35).

FIRST USE 11-30-1992; IN COMMERCE 11-30-1992.
JASON TURNER, EXAMINING ATTORNEY

SN 78-311,319. ANDERSON, ALBIN, L, RAPID RIVER, MI. FILED 10-9-2003.

BAGKEEPER

FOR ACCESSORY FOR WET/DRY VACUUM CLEANER, NAMELY, RETAINER FOR SECURING TRASH BAG IN COLLECTION TANK (U.S. CLS. 13, 19, 21, 23, 31, 34 AND 35).

MARIA-VICTORIA SUAREZ, EXAMINING ATTORNEY

CLASS 7—(Continued).

SN 78-316,674. BRANDT COMPONENTS, NEVERS, FRANCE, FILED 10-21-2003.

SELNI

PRIORITY CLAIMED UNDER SEC. 44(D) ON FRANCE APPLICATION NO. 033244295, FILED 9-5-2003, REG. NO. 033244295, DATED 9-5-2003, EXPIRES 9-5-2013.

FOR ELECTRIC MOTORS FOR MACHINES, ELECTRIC PUMPS, DRAINING PUMPS (U.S. CLS. 13, 19, 21, 23, 31, 34 AND 35).

CHERYL STEPLIGHT, EXAMINING ATTORNEY

SN 78-337,822. BLACK & DECKER CORPORATION, THE, TOWSON, MD. FILED 12-8-2003.



FOR POWER TOOL BIT HOLDERS (U.S. CLS. 13, 19, 21, 23, 31, 34 AND 35).

FIRST USE 10-15-1999; IN COMMERCE 10-15-1999.

KATHLEEN M. VANSTON, EXAMINING ATTORNEY

SN 78-369,212. AUTOPAK ENGINEERING CORP., CAGUAS, PUERTO RICO, FILED 2-17-2004.

XA

THE MARK CONSISTS OF STANDARD CHARACTERS WITHOUT CLAIM TO ANY PARTICULAR FONT, STYLE, SIZE, OR COLOR.

FOR CONVEYORS AND PARTS AND FITTINGS THEREFOR (U.S. CLS. 13, 19, 21, 23, 31, 34 AND 35).

FIRST USE 1-1-2002; IN COMMERCE 1-1-2002.

ELLEN PERKINS, EXAMINING ATTORNEY

CLASS 7—(Continued).

SN 78-391,865. ILLINOIS TOOL WORKS INC., GLENVIEW, IL. FILED 3-26-2004.

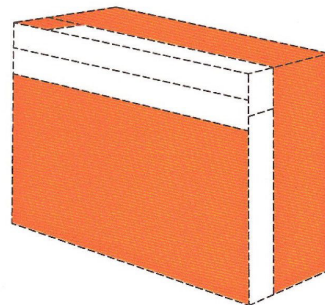

THE COLOR(S) ORANGE IS/ARE CLAIMED AS A FEATURE OF THE MARK.

THE MARK CONSISTS OF THE COLOR ORANGE AS APPLIED TO PACKAGING FOR PNEUMATIC AND GAS POWERED HAND TOOLS, NAMELY, NAILERS AND STAPLERS. THE COLOR ORANGE IS A FEATURE OF THE MARK. THE DOTTED OUTLINE OF THE GOODS IS INTENDED TO SHOW THE POSITION OF THE MARK AND IS NOT A PART OF THE MARK AND NO CLAIM IS MADE TO THE CONFIGURATION OF THE GOODS.

SEC. 2(F).

FOR PNEUMATIC AND GAS POWERED HAND TOOLS, NAMELY, NAILERS AND STAPLERS (U.S. CLS. 13, 19, 21, 23, 31, 34 AND 35).

FIRST USE 1-1-1997; IN COMMERCE 1-1-1997.

ESTHER A. BORSUK, EXAMINING ATTORNEY

SN 78-394,246. HO, MYONG, BROOMALL, PA. FILED 3-31-2004.



THE COLORS RED, BLACK, AND WHITE ARE CLAIMED AS FEATURES OF THE MARK.

THE MARK CONSISTS OF SYMBOLIZED MARK OF SUN AND MOUNTAIN ON LEFT SIDE AND CAPITALIZED LETTERS OF "NATURA". THE RED COLOR APPEARS IN SYMBOLIZED AND SIMPLIFIED FEATURES OF SUN AND MOUNTAIN WHICH ARE LOCATED FAR LEFT SIDE OF THE WHOLE MARK. THE BLACK COLOR APPEARS IN THE LETTERS "NATURA". THE WHITE COLOR APPEARS IN THE BACKGROUND OF THE MARK.

THE FOREIGN WORD "NATURA" IS A SPANISH WORD MEANING "NATURAL" IN ENGLISH.

FOR COMMERCIAL AND DOMESTIC LAUNDRY, DRY CLEANING AND WET CLEANING MACHINES, ALL FOR CLOTHES, NAMELY CLOTHES WASHERS, DRY CLEANING MACHINES FOR CLOTHES, NON-PERC DRY CLEANING MACHINES FOR CLOTHES, WET CLEANING MACHINES FOR CLOTHES, SPOTTING TABLES FOR PRETREATING SPOTS ON CLOTHES PRIOR TO FURTHER CLEANING AND COMMERCIAL CLOTHES PRESSING MACHINES (U.S. CLS. 13, 19, 21, 23, 31, 34 AND 35).

FIRST USE 1-0-2002; IN COMMERCE 1-0-2002.

DAVID H. STINE, EXAMINING ATTORNEY

CLASS 7—(Continued).

SN 78-404,060. FMC TECHNOLOGIES, INC., CHICAGO, IL.
FILED 4-19-2004.

RAMPSNAKE

THE MARK CONSISTS OF STANDARD CHARACTERS WITHOUT CLAIM TO ANY PARTICULAR FONT, STYLE, SIZE, OR COLOR.

FOR AIRCRAFT LOADERS, NAMELY, POWERED LOADERS FOR TRANSFERRING AND SORTING BAGGAGE (U.S. CLS. 13, 19, 21, 23, 31, 34 AND 35).

KIMBERLY PERRY, EXAMINING ATTORNEY

CLASS 7—(Continued).

SN 78-414,875. RAPT INDUSTRIES, INC., LIVERMORE, CA.
FILED 5-7-2004.

RAP

THE MARK CONSISTS OF STANDARD CHARACTERS WITHOUT CLAIM TO ANY PARTICULAR FONT, STYLE, SIZE, OR COLOR.

FOR PLASMA EQUIPMENT FOR SHAPING AND CLEANING WORK PIECES, NAMELY A PLASMA ETCHING AND DEPOSITING MACHINE. (U.S. CLS. 13, 19, 21, 23, 31, 34 AND 35).

ANDREW RHIM, EXAMINING ATTORNEY

SN 78-406,434. PERFORMANCE AUTOMOTIVE WHOLESALE, INC., CHATSWORTH, CA. FILED 4-22-2004.

PAW CUSTOM CLASSIC SPEED EQUIPMENT

THE MARK CONSISTS OF STANDARD CHARACTERS WITHOUT CLAIM TO ANY PARTICULAR FONT, STYLE, SIZE, OR COLOR.

OWNER OF U.S. REG. NOS. 2,855,378 AND 2,868,072.

NO CLAIM IS MADE TO THE EXCLUSIVE RIGHT TO USE "CUSTOM CLASSIC SPEED EQUIPMENT", APART FROM THE MARK AS SHOWN.

FOR AUTOMOTIVE PARTS, NAMELY INTERNAL COMBUSTION ENGINE PARTS, NAMELY, TIMING COVERS, WATER CROSSOVERS, CRANKCASE BREATHERS, PISTONS, OIL COOLERS, AND BEARINGS, VALVE COVERS, AIR CLEANERS AND AIR CLEANER ASSEMBLIES, EMISSION REDUCTION UNITS FOR MOTORS AND ENGINES, NAMELY EGR VALVES; HEADERS AS PART OF VEHICLE EXHAUST SYSTEM; NITROUS OXIDE SYSTEMS COMPRISED OF NITROUS BOTTLE, NITROUS AND FUEL SOLENOIDS, INJECTOR PLATES, FILTERS, FITTINGS, SWITCHES, BRAIDED HOSE, AND ALL OTHER NECESSARY HARDWARE FOR A COMPLETE INSTALLATION; METAL GASKETS FOR INTERNAL COMBUSTION ENGINES; ENGINE MUFFLERS; AUTOMOTIVE INTAKE MANIFOLDS; WATER PUMPS; OIL PANS; OIL FILTER ACCESS; CAMSHAFTS; CARBURETOR TOP PLATES INCLUDING BOLTS AND SCREWS; ALTERNATOR BRACKETS; AIR CLEANER ASSEMBLY COMPRISED OF CAST TOP, FILTER ELEMENT, STEEL BASE WITH CLAMP AND MOUNTING STUD; ENGINE OIL DIPSTICKS (U.S. CLS. 13, 19, 21, 23, 31, 34 AND 35).

FIRST USE 3-31-2003; IN COMMERCE 3-31-2003.

Laura KOVAISKY, EXAMINING ATTORNEY

SN 78-416,571. GESSNER INDUSTRIES, QUEENSLAND, AUSTRALIA, FILED 5-11-2004.

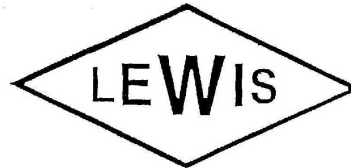

FOR EXCAVATING IMPLEMENTS, NAMELY, RIP-PERS FOR EXCAVATING EARTH (U.S. CLS. 13, 19, 21, 23, 31, 34 AND 35).

FIRST USE 1-1-1986; IN COMMERCE 12-1-1999.

ZHALEH DELANEY, EXAMINING ATTORNEY

CLASS 7—(Continued).

SN 78-418,827. DOALL COMPANY, DES PLAINES, IL. FILED 5-14-2004.

CLASS 7—(Continued).

SN 78-434,218. ACCESSORIES MARKETING, INC., GROVER BEACH, CA. FILED 6-11-2004.

DART

THE MARK CONSISTS OF STANDARD CHARACTERS WITHOUT CLAIM TO ANY PARTICULAR FONT, STYLE, SIZE, OR COLOR.

FOR SAW BANDS (U.S. CLS. 13, 19, 21, 23, 31, 34 AND 35).

FIRST USE 3-1-1960; IN COMMERCE 7-6-1960.

KATHLEEN M. VANSTON, EXAMINING ATTORNEY

Smart Spair

THE MARK CONSISTS OF STANDARD CHARACTERS WITHOUT CLAIM TO ANY PARTICULAR FONT, STYLE, SIZE, OR COLOR.

FOR AIR COMPRESSORS AND PARTS THEREFORE FOR VEHICLES (U.S. CLS. 13, 19, 21, 23, 31, 34 AND 35).

FIRST USE 3-3-2003; IN COMMERCE 3-3-2003.
LOURDES AYALA, EXAMINING ATTORNEY

SN 78-435,133. GEO GLOBAL PARTNERS, LLC, SOUTH PLAINFIELD, NJ. FILED 6-15-2004.

SN 78-426,273. MARATHON ELECTRIC MANUFACTURING CORPORATION, WAUSAU, WI. FILED 5-27-2004.

POND BASICS

MAGNASMART

THE MARK CONSISTS OF STANDARD CHARACTERS WITHOUT CLAIM TO ANY PARTICULAR FONT, STYLE, SIZE, OR COLOR.

NO CLAIM IS MADE TO THE EXCLUSIVE RIGHT TO USE "SMART", APART FROM THE MARK AS SHOWN.

FOR VARIABLE SPEED PERMANENT MAGNET GENERATORS (U.S. CLS. 13, 19, 21, 23, 31, 34 AND 35).

MICHAEL SOUDERS, EXAMINING ATTORNEY

THE MARK CONSISTS OF STANDARD CHARACTERS WITHOUT CLAIM TO ANY PARTICULAR FONT, STYLE, SIZE, OR COLOR.

NO CLAIM IS MADE TO THE EXCLUSIVE RIGHT TO USE "POND", APART FROM THE MARK AS SHOWN.

FOR WATER GARDEN PUMPS AND ACCESSORIES, NAMELY FILTERS, NOZZLES, SPLITTERS, REDUCERS, VALVES AND TUBING FOR WATER PUMPS (U.S. CLS. 13, 19, 21, 23, 31, 34 AND 35).

KAREN K. BUSH, EXAMINING ATTORNEY

CLASS 7—(Continued).

SN 78-435,139. GEO GLOBAL PARTNERS, LLC, SOUTH PLAINFIELD, NJ. FILED 6-15-2004.

CLASS 7—(Continued).

SN 78-455,052. GMCA PTY LTD., VICTORIA, AUSTRALIA, FILED 7-22-2004.

POND WORLD

THE MARK CONSISTS OF STANDARD CHARACTERS WITHOUT CLAIM TO ANY PARTICULAR FONT, STYLE, SIZE, OR COLOR.

NO CLAIM IS MADE TO THE EXCLUSIVE RIGHT TO USE "POND", APART FROM THE MARK AS SHOWN.

FOR WATER GARDEN PUMPS AND ACCESSORIES, NAMELY FILTERS, NOZZLES, SPLITTERS, REDUCERS, VALVES AND TUBING FOR WATER PUMPS (U.S. CLS. 13, 19, 21, 23, 31, 34 AND 35).

MICHAEL HALL, EXAMINING ATTORNEY

FIREYE

THE MARK CONSISTS OF STANDARD CHARACTERS WITHOUT CLAIM TO ANY PARTICULAR FONT, STYLE, SIZE, OR COLOR.

PRIORITY CLAIMED UNDER SEC. 44(D) ON ERPN CMNTY TM OFC APPLICATION NO. 003935401, FILED 7-21-2004, REG. NO. 003935401, DATED 7-21-2004, EXPIRES 7-21-2014.

FOR MACHINE AND MACHINE TOOLS AND POWER TOOLS, NAMELY, AC POWER OPERATED DRILLS, BATTERY OPERATED DRILLS, DRILL BITS, PILE-DRIVERS, ROTARY HAMMERS, AC POWER OPERATED CIRCULAR SAWS, AC POWER OPERATED JIGSAWS, BATTERY OPERATED JIGSAWS, AC POWER OPERATED MITER SAWS, AC POWER OPERATED BENCH SAWS, AC POWER OPERATED SAWS, BATTERY OPERATED SAWS, AC POWER OPERATED SANDERS, AC POWER OPERATED ORBITAL SANDERS, BATTERY OPERATED ORBITAL SANDERS, AC POWER OPERATED BELT SANDERS, AC POWER OPERATED PALM SANDERS, BATTERY OPERATED PALM SANDERS, AC POWER OPERATED SANDERS, BATTERY OPERATED SANDERS, AC POWER OPERATED PLANERS, BATTERY OPERATED PLANERS, AC POWER OPERATED POLISHERS, AC POWER OPERATED CHAINSAWS, GASOLINE OPERATED CHAINSAWS, AC POWER OPERATED ANGLE GRINDERS, BATTERY OPERATED GRINDERS, AC POWER OPERATED GRINDERS, AC POWER OPERATED ROUTERS, BATTERY OPERATED SCREWDRIVERS, AC POWER OPERATED GARDEN TOOLS, GASOLINE OPERATED GARDEN TOOLS, NAMELY, AC POWER OPERATED BRUSH CUTTERS, GASOLINE OPERATED BRUSH CUTTERS, AC POWER OPERATED GRASS CUTTERS, AC POWER OPERATED HEDGE TRIMMERS, BATTERY OPERATED HEDGE TRIMMERS, AC POWER OPERATED LINE TRIMMERS, AC POWER OPERATED TRIMMERS, BATTERY OPERATED TRIMMERS, AC POWER OPERATED GRASS SHEARS, AC POWER OPERATED SHEARS, BATTERY OPERATED SHEARS, AC POWER OPERATED VACUUM/BLOWERS, BATTERY OPERATED HAND VACUUMS, AC POWER OPERATED HEAT GUNS; AND REPLACEMENT PARTS THEREFORE (U.S. CLS. 13, 19, 21, 23, 31, 34 AND 35).

STEVEN JACKSON, EXAMINING ATTORNEY

SN 78-450,671. COE PRESS EQUIPMENT CORPORATION, STERLING HEIGHTS, MI. FILED 7-14-2004.

THE SPACEMASTER SERIES

THE MARK CONSISTS OF STANDARD CHARACTERS WITHOUT CLAIM TO ANY PARTICULAR FONT, STYLE, SIZE, OR COLOR.

NO CLAIM IS MADE TO THE EXCLUSIVE RIGHT TO USE SERIES, APART FROM THE MARK AS SHOWN.

FOR METAL-FORMING EQUIPMENT, NAMELY, AIRFEEDS, ROLLFEEDS, ELECTRONIC ROLLFEEDS, STRAIGHTENERS, POWERED STRAIGHTENERS, COIL REELS, DOUBLE ENDED COIL REELS, COIL CRADLES, COIL CARS, STAMPING DIES, POWER-OPERATED CUTTING SHEARS, CUT-TO-LENGTH LINES, UNCOILERS, AND STAMPING PRESS, FOR THE HANDLING OF METAL COILS AND METAL BLANKS (U.S. CLS. 13, 19, 21, 23, 31, 34 AND 35).

FIRST USE 1-1-2004; IN COMMERCE 1-1-2004.
DAVID MURRAY, EXAMINING ATTORNEY

CLASS 7—(Continued).

SN 78-457,523. DOLPHIN INNOVATIONS, LTD., WINNIPEG, MANITOBA, CANADA, FILED 7-27-2004.

DISPOZ-A-BAG

THE MARK CONSISTS OF STANDARD CHARACTERS WITHOUT CLAIM TO ANY PARTICULAR FONT, STYLE, SIZE, OR COLOR.

PRIORITY CLAIMED UNDER SEC. 44(D) ON CANADA APPLICATION NO. 1220012, FILED 6-4-2004, REG. NO. TMA638697, DATED 4-29-2005, EXPIRES 4-29-2020.

FOR LAWN MOWER BAGS, NAMELY BAGS THAT ATTACH TO A LAWN MOWER FOR COLLECTING GRASS CLIPPINGS AND LEAVES (U.S. CLS. 13, 19, 21, 23, 31, 34 AND 35).

CHRISTOPHER ADKINS, EXAMINING ATTORNEY

SN 78-458,650. CANAVAC SYSTEMS INC., OWEN SOUND, ONTARIO, CANADA, FILED 7-29-2004.



NO CLAIM IS MADE TO THE EXCLUSIVE RIGHT TO USE "VAC", APART FROM THE MARK AS SHOWN.

THE COLOR(S) RED, BLACK, WHITE AND GREY IS/ARE CLAIMED AS A FEATURE OF THE MARK.

THE MARK CONSISTS OF THE WORD "RHINO" IS RED, OUTLINED WITH WHITE AND DROP-SHADOWED IN BLACK. THE WORD "VAC" IS WHITE AND DROP-SHADOWED IN BLACK. THE RHINOCEROS FIGURE IS GREY WITH BLACK SHADED PORTIONS. THE EYE OF THE RHINOCEROS IS RED.

FOR CENTRAL VACUUM SYSTEMS COMPRISING SUCTION NOZZLES, VACUUM HOSES, VACUUM BRUSHES, BAGS FOR USE WITH VACUUM CLEANERS, AND PARTS AND FITTINGS FOR THE FOREGOING; BUILT-IN VACUUM SYSTEMS COMPRISING SUCTION NOZZLES, VACUUM HOSES, VACUUM BRUSHES, BAGS FOR USE WITH VACUUM CLEANERS, AND PARTS AND FITTINGS FOR THE FOREGOING (U.S. CLS. 13, 19, 21, 23, 31, 34 AND 35).

RON FAIRBANKS, EXAMINING ATTORNEY

CLASS 7—(Continued).

SN 78-458,854. LONATI SPA, BRESCIA, ITALY, FILED 7-29-2004.

THE MARK CONSISTS OF THE TERM LONATI IN STYLIZED LETTERS.

FOR MACHINES FOR THE TEXTILE INDUSTRY, NAMELY, MACHINES FOR PRODUCING STOCKINGS, MACHINES FOR PRODUCING SOCKS, KNITTING MACHINES, TRIM-MING MACHINES, DYEING MACHINES, SEWING MACHINES, WASHING MACHINES, IRONING MACHINES, BOARDING MACHINES FOR SOCKS AND STOCKINGS, WEAVING LOOMS, HOSIERY LOOMS (U.S. CLS. 13, 19, 21, 23, 31, 34 AND 35).

FIRST USE 12-31-1976; IN COMMERCE 12-31-1976.
JENNIFER CHICOSKI, EXAMINING ATTORNEY

SN 78-459,559. HOLLEY PERFORMANCE PRODUCTS, INC., BOWLING GREEN, KY. FILED 7-30-2004.

SLEDGEHAMMER

THE MARK CONSISTS OF STANDARD CHARACTERS WITHOUT CLAIM TO ANY PARTICULAR FONT, STYLE, SIZE, OR COLOR.

FOR CRANKSHAFTS FOR AUTOMOBILE ENGINES; INTERNAL ENGINE COMPONENTS, NAMELY, CAM-SHAFTS, PUSHRODS, ROCKER ARMS, VALVE SPRINGS, TIMING CHAIN SETS, FOR AUTOMOBILE ENGINES (U.S. CLS. 13, 19, 21, 23, 31, 34 AND 35).

TRACY FLETCHER, EXAMINING ATTORNEY

SN 78-459,615. HOLLEY PERFORMANCE PRODUCTS, INC., BOWLING GREEN, KY. FILED 7-30-2004.



OWNER OF U.S. REG. NO. 2,348,293.

FOR CRANKSHAFTS FOR AUTOMOBILE ENGINES; INTERNAL ENGINE COMPONENTS, NAMELY, CAM-SHAFTS, PUSHRODS, ROCKER ARMS, VALVE SPRINGS, TIMING CHAIN SETS, FOR AUTOMOBILE ENGINES (U.S. CLS. 13, 19, 21, 23, 31, 34 AND 35).

MICHAEL SOUDERS, EXAMINING ATTORNEY

CLASS 7—(Continued).

SN 78-465,275. S-E-S KABUSHIKI KAISHA, TA S-E-S CO., LTD., TOKYO, JAPAN, FILED 8-10-2004.

CLASS 7—(Continued).

SN 78-480,222. MITEK HOLDINGS, INC., WILMINGTON, DE. FILED 9-8-2004.

ZERO-SYSTEM

THE MARK CONSISTS OF STANDARD CHARACTERS WITHOUT CLAIM TO ANY PARTICULAR FONT, STYLE, SIZE, OR COLOR.
FOR SEMICONDUCTOR WAFER PROCESSING MACHINES, SEMICONDUCTOR DRYING MACHINES; WAFER WASHING MACHINES (U.S. CLS. 13, 19, 21, 23, 31, 34 AND 35).
MICHELE SWAIN, EXAMINING ATTORNEY

EZWAL

THE MARK CONSISTS OF STANDARD CHARACTERS WITHOUT CLAIM TO ANY PARTICULAR FONT, STYLE, SIZE, OR COLOR.
FOR WALL PANEL FABRICATING MACHINES; JIGS AND ASSEMBLY TABLES FOR MANUFACTURING WALL PANELS (U.S. CLS. 13, 19, 21, 23, 31, 34 AND 35).
KARANENDRA S. CHHINA, EXAMINING ATTORNEY

SN 78-498,732. TECHNOFLANGE, INC., WHITBY, ONTARIO, CANADA, FILED 10-12-2004.

SN 78-474,351. WORLD TRADING, SUGARLAND, TX. FILED 8-26-2004.



PRIORITY CLAIMED UNDER SEC. 44(D) ON CANADA APPLICATION NO. 1213035, FILED 4-13-2004, REG. NO. TMA640061, DATED 5-18-2005, EXPIRES 5-18-2020.
NO CLAIM IS MADE TO THE EXCLUSIVE RIGHT TO USE "TUNED PERFORMANCE PRODUCTS", APART FROM THE MARK AS SHOWN.
FOR EXHAUST MUFFLERS, EXHAUST TIPS (U.S. CLS. 13, 19, 21, 23, 31, 34 AND 35).
MARIA-VICTORIA SUAREZ, EXAMINING ATTORNEY



SN 78-503,574. DOUGLAS MACHINE INC., ALEXANDRIA, MN. FILED 10-21-2004.



NO CLAIM IS MADE TO THE EXCLUSIVE RIGHT TO USE "PERFORMANCE ELECTRIC FUEL PUMP ENGINEERED FOR QUALITY", APART FROM THE MARK AS SHOWN.
THE COLOR(S) GRAY IS/ARE CLAIMED AS A FEATURE OF THE MARK.
THE COLOR GRAY IS A FEATURE OF THE MARK. THE COLOR GREY APPEARS IN THE LOGO.
FOR FUEL PUMPS FOR LAND VEHICLES (U.S. CLS. 13, 19, 21, 23, 31, 34 AND 35).
FIRST USE 12-16-2003; IN COMMERCE 12-16-2003.
FLORENTINA BLANDU, EXAMINING ATTORNEY

OWNER OF U.S. REG. NO. 2,952,996.
FOR PACKAGING MACHINERY (U.S. CLS. 13, 19, 21, 23, 31, 34 AND 35).
FIRST USE 10-15-2004; IN COMMERCE 10-15-2004.
CHRISIE B. KING, EXAMINING ATTORNEY

CLASS 7—(Continued).

SN 78-508,481. AMEC E & C SERVICES, INC., TUCKER, GA.
FILED 10-29-2004.

CLASS 7—(Continued).

SN 78-511,871. INTEGRATED DESIGNS, L.P., CARROLL-
TON, TX. FILED 11-5-2004.

TASPS

THE MARK CONSISTS OF STANDARD CHARACTERS WITHOUT CLAIM TO ANY PARTICULAR FONT, STYLE, SIZE, OR COLOR.

FOR MACHINE FOR FILLING POUCHES IN THE HUMAN FOOD AND BEVERAGE INDUSTRY, IN THE ANIMAL FOOD INDUSTRY, IN THE CONSUMER PRODUCTS INDUSTRY AND IN THE NUTRACEUTICALS INDUSTRY (U.S. CLS. 13, 19, 21, 23, 31, 34 AND 35).

GEORGIA CARTY, EXAMINING ATTORNEY

CYBOR

THE MARK CONSISTS OF STANDARD CHARACTERS WITHOUT CLAIM TO ANY PARTICULAR FONT, STYLE, SIZE, OR COLOR.

FOR SEMICONDUCTOR MANUFACTURING MACHINES, NAMELY, LIQUID DISPENSING PUMPS FOR USE IN DISPENSING CHEMICALS DURING SEMICONDUCTOR MANUFACTURING FABRICATION (U.S. CLS. 13, 19, 21, 23, 31, 34 AND 35).

FIRST USE 0-0-1986; IN COMMERCE 0-0-1986.
SANI KHOURI, EXAMINING ATTORNEY

SN 78-511,868. INTEGRATED DESIGNS, L.P., CARROLL-
TON, TX. FILED 11-5-2004.

SN 78-513,227. ISCAR LTD., TEFEN, ISRAEL, FILED 11-8-
2004.

IDI

THE MARK CONSISTS OF STANDARD CHARACTERS WITHOUT CLAIM TO ANY PARTICULAR FONT, STYLE, SIZE, OR COLOR.

OWNER OF U.S. REG. NO. 2,392,537.
FOR SEMICONDUCTOR MANUFACTURING MACHINES, NAMELY, LIQUID DISPENSING PUMPS FOR USE IN DISPENSING CHEMICALS DURING SEMICONDUCTOR MANUFACTURING FABRICATION (U.S. CLS. 13, 19, 21, 23, 31, 34 AND 35).

FIRST USE 5-13-1988; IN COMMERCE 5-13-1988.
GIANCARLO CASTRO, EXAMINING ATTORNEY

HELIDO

THE MARK CONSISTS OF STANDARD CHARACTERS WITHOUT CLAIM TO ANY PARTICULAR FONT, STYLE, SIZE, OR COLOR.

FOR CUTTING TOOLS FOR USE WITH POWER OPERATED MACHINES, NAMELY, MILLING CUTTERS AND END MILLS AND CUTTING INSERTS THEREFOR (U.S. CLS. 13, 19, 21, 23, 31, 34 AND 35).

TRACY FLETCHER, EXAMINING ATTORNEY

CLASS 7—(Continued).

SN 78-513,235. ISCAR LTD., TEFEN, ISRAEL, FILED 11-8-2004.

CLASS 7—(Continued).

SN 78-515,319. GEORGE GORDON ASSOCIATES INCORPORATED, MERRIMACK, NH. FILED 11-11-2004.

TANG-GRIP



THE MARK CONSISTS OF STANDARD CHARACTERS WITHOUT CLAIM TO ANY PARTICULAR FONT, STYLE, SIZE, OR COLOR.

OWNER OF U.S. REG. NO. 2,882,219.
FOR CUTTING TOOLS FOR USE WITH POWER OPERATED MACHINES, NAMELY, GROOVING TOOLS AND PARTING TOOLS AND CUTTING INSERTS THEREFOR (U.S. CLS. 13, 19, 21, 23, 31, 34 AND 35).
ADA HAN, EXAMINING ATTORNEY

FOR PACKAGING MACHINERY, SPECIFICALLY FOR FOOD-GRADE APPLICATIONS (U.S. CLS. 13, 19, 21, 23, 31, 34 AND 35).

FIRST USE 10-27-2004; IN COMMERCE 10-28-2004.
CHRISTOPHER ADKINS, EXAMINING ATTORNEY

SN 78-514,025. PORTEC, INC., TOLEDO, OH. FILED 11-9-2004.

SN 78-517,000. ELECTROLUX HOME CARE PRODUCTS, LTD., CLEVELAND, OH. FILED 11-15-2004.

QUEUE-FLO

DE-CINDER

THE MARK CONSISTS OF STANDARD CHARACTERS WITHOUT CLAIM TO ANY PARTICULAR FONT, STYLE, SIZE, OR COLOR.

FOR BELT CONVEYORS (U.S. CLS. 13, 19, 21, 23, 31, 34 AND 35).
FIRST USE 11-0-2002; IN COMMERCE 11-0-2002.
ANDREA SAUNDERS, EXAMINING ATTORNEY

THE MARK CONSISTS OF STANDARD CHARACTERS WITHOUT CLAIM TO ANY PARTICULAR FONT, STYLE, SIZE, OR COLOR.

FOR CENTRAL VACUUM CLEANER COMPONENTS, NAMELY DUST AND ASH SEPARATORS (U.S. CLS. 13, 19, 21, 23, 31, 34 AND 35).
G. MAYERSCHOFF, EXAMINING ATTORNEY

CLASS 7—(Continued).

SN 78-517,138. D & S CAR WASH EQUIPMENT COMPANY, HIGH RIDGE, MO. FILED 11-15-2004.



NO CLAIM IS MADE TO THE EXCLUSIVE RIGHT TO USE "CAR WASH SYSTEMS", APART FROM THE MARK AS SHOWN.

THE MARK CONSISTS OF THE LETTERS "D & S" IN STYLIZED TEXT WITH THE WORDS "CAR WASH SYSTEMS" BELOW IT. THE ENTIRE DESIGN IMAGE IS CONTAINED WITHIN A CREST DESIGN WITH AN OUTLINE AROUND THE CREST DESIGN.

FOR CAR AND AUTOMOBILE WASHING EQUIPMENT AND MACHINERY SOLD AS A UNIT, NAMELY, MANUALLY-OPERATED VEHICLE WASHERS, PRESSURE WASHERS, WATER PUMPS, AND CAR CARE PRODUCT VENDING EQUIPMENT; FULLY-AUTOMATED AUTOMATIC CAR WASH SYSTEMS CONSISTING PRIMARILY OF VEHICLE WASHING EQUIPMENT AND MACHINERY, VEHICLE RINSING EQUIPMENT AND MACHINERY, VEHICLE DRYING EQUIPMENT AND MACHINERY, VEHICLE COATING EQUIPMENT AND MACHINERY, TANKS, AND ANCILLARY AND MECHANICAL AND ELECTRONIC COMPONENTS SOLD TOGETHER AS A UNIT (U.S. CLS. 13, 19, 21, 23, 31, 34 AND 35).

FIRST USE 9-0-2004; IN COMMERCE 9-0-2004.
SEAN DWYER, EXAMINING ATTORNEY

SN 78-517,761. JAMES L. TAYLOR MANUFACTURING COMPANY, POUGHKEEPSIE, NY. FILED 11-16-2004.

OPTI-MATCH

THE MARK CONSISTS OF STANDARD CHARACTERS WITHOUT CLAIM TO ANY PARTICULAR FONT, STYLE, SIZE, OR COLOR.

FOR MACHINE TO AUTOMATE THE COLOR MATCHING PROCESS FOR WOOD PANELS (U.S. CLS. 13, 19, 21, 23, 31, 34 AND 35).

FIRST USE 12-31-2001; IN COMMERCE 3-31-2002.
REBECCA GAN, EXAMINING ATTORNEY

CLASS 7—(Continued).

SN 78-518,477. WORLD PRODUCTS, INC., RONKONKOMA, NY. FILED 11-17-2004.

WARFARE

THE MARK CONSISTS OF STANDARD CHARACTERS WITHOUT CLAIM TO ANY PARTICULAR FONT, STYLE, SIZE, OR COLOR.

FOR AUTOMOTIVE ENGINE CASTINGS, NAMELY, ORIGINAL AND REPLACEMENT CYLINDER HEADS, ENGINE BLOCKS, INTAKE MANIFOLDS AND VALVE COVERS (U.S. CLS. 13, 19, 21, 23, 31, 34 AND 35).

ELLEN B. AWRICH, EXAMINING ATTORNEY

SN 78-518,493. ZOELLER PUMP COMPANY, LLC, LOUISVILLE, KY. FILED 11-17-2004.

OIL GUARD

THE MARK CONSISTS OF STANDARD CHARACTERS WITHOUT CLAIM TO ANY PARTICULAR FONT, STYLE, SIZE, OR COLOR.

NO CLAIM IS MADE TO THE EXCLUSIVE RIGHT TO USE "OIL", APART FROM THE MARK AS SHOWN.

FOR SUMP PUMP AND ATTACHMENTS THERETO, NAMELY A SENSING DEVICE FOR SENSING THE DIFFERENCE BETWEEN OIL AND WATER PRESENT IN A VAULT OR SUMP AND AN ACTUATING SWITCH FOR SAID PUMP (U.S. CLS. 13, 19, 21, 23, 31, 34 AND 35).

ELLEN B. AWRICH, EXAMINING ATTORNEY

CLASS 7—(Continued).

SN 78-518,778. GALE BANKS ENGINEERING, AZUSA, CA.
FILED 11-17-2004.

CLASS 7—(Continued).

SN 78-518,808. GALE BANKS ENGINEERING, AZUSA, CA.
FILED 11-17-2004.

TECHNI-COOLER

THE MARK CONSISTS OF STANDARD CHARACTERS WITHOUT CLAIM TO ANY PARTICULAR FONT, STYLE, SIZE, OR COLOR.
FOR INTERCOOLERS FOR LAND VEHICLES (U.S. CLS. 13, 19, 21, 23, 31, 34 AND 35).
FIRST USE 11-30-1998; IN COMMERCE 11-30-1998.
ODESSA BIBBINS, EXAMINING ATTORNEY

SN 78-518,786. N.E. HAGEDORN & SONS LIMITED, PAISLEY, ONTARIO, CANADA, FILED 11-17-2004.

HYDRA-SPREAD

THE MARK CONSISTS OF STANDARD CHARACTERS WITHOUT CLAIM TO ANY PARTICULAR FONT, STYLE, SIZE, OR COLOR.
FOR AGRICULTURAL IMPLEMENTS, NAMELY, MANURE SPREADERS (U.S. CLS. 13, 19, 21, 23, 31, 34 AND 35).
FIRST USE 1-31-1990; IN COMMERCE 7-31-1990.
ANNE E. GUSTASON, EXAMINING ATTORNEY

GIT KIT

THE MARK CONSISTS OF STANDARD CHARACTERS WITHOUT CLAIM TO ANY PARTICULAR FONT, STYLE, SIZE, OR COLOR.
NO CLAIM IS MADE TO THE EXCLUSIVE RIGHT TO USE "KIT", APART FROM THE MARK AS SHOWN.
FOR EXHAUST SYSTEM KITS FOR LAND VEHICLES, COMPRISED OF, MUFFLERS, EXHAUST PIPES, TAIL PIPES, BRACKETS, WASTE GATE ACTUATORS, AND CALIBRATION DEVICES FOR MEASURING FUEL CONSUMPTION, ALL SOLD AS A UNIT (U.S. CLS. 13, 19, 21, 23, 31, 34 AND 35).
FIRST USE 12-31-1998; IN COMMERCE 12-31-1998.
BARBARA A. GOLD, EXAMINING ATTORNEY

SN 78-518,915. EQUIPMENT MANUFACTURING CORPORATION, SANTA FE SPRINGS, CA. FILED 11-17-2004.

POWERJET

THE MARK CONSISTS OF STANDARD CHARACTERS WITHOUT CLAIM TO ANY PARTICULAR FONT, STYLE, SIZE, OR COLOR.
OWNER OF U.S. REG. NO. 2,290,685.
SEC. 2(F).
FOR INDUSTRIAL WASHING MACHINES FOR REMOVING OIL AND OTHER CONTAMINANTS FROM MACHINED PARTS (U.S. CLS. 13, 19, 21, 23, 31, 34 AND 35).
FIRST USE 2-16-1998; IN COMMERCE 2-16-1998.
SAMUEL E. SHARPER JR., EXAMINING ATTORNEY

CLASS 7—(Continued).

SN 78-519,294. WRIGHT PUMP, INC., WAUKESHA, WI. FILED 11-18-2004.

CLASS 7—(Continued).

SN 78-521,009. WHITFIELD INNOVATIONS AND TECHNOLOGIES COMPANY, INC., DBA WHITCO, SOUTH STRAFFORD, VT. FILED 11-22-2004.

TRA

WHITCO

THE MARK CONSISTS OF STANDARD CHARACTERS WITHOUT CLAIM TO ANY PARTICULAR FONT, STYLE, SIZE, OR COLOR.

FOR ROTARY POSITIVE DISPLACEMENT PUMPS FOR SANITARY AND INDUSTRIAL APPLICATIONS (U.S. CLS. 13, 19, 21, 23, 31, 34 AND 35).

GENE MACIOL, EXAMINING ATTORNEY

THE MARK CONSISTS OF STANDARD CHARACTERS WITHOUT CLAIM TO ANY PARTICULAR FONT, STYLE, SIZE, OR COLOR.

FOR POWER OPERATED SPRAY GUNS FOR METALLIZING SURFACES, AND PARTS THEREFOR (U.S. CLS. 13, 19, 21, 23, 31, 34 AND 35).

ESTHER BELENKER, EXAMINING ATTORNEY

SN 78-520,079. BORGWARNER INC., AUBURN HILLS, MI. FILED 11-19-2004.

SN 78-522,829. MARK VII EQUIPMENT LLC, ARVADA, CO. FILED 11-24-2004.

HY-VO TEC

AQUASPRAY

THE MARK CONSISTS OF STANDARD CHARACTERS WITHOUT CLAIM TO ANY PARTICULAR FONT, STYLE, SIZE, OR COLOR.

OWNER OF U.S. REG. NO. 541,802.
FOR ENGINE TIMING SYSTEMS, NAMELY, ENGINE TIMING CHAINS, CAMSHAFT SPROCKETS AND CRANKSHAFT SPROCKETS (U.S. CLS. 13, 19, 21, 23, 31, 34 AND 35).

JOHN E. MICHOS, EXAMINING ATTORNEY

THE MARK CONSISTS OF STANDARD CHARACTERS WITHOUT CLAIM TO ANY PARTICULAR FONT, STYLE, SIZE, OR COLOR.

FOR CAR WASHING EQUIPMENT, NAMELY, MANUALLY OPERATED MACHINES FOR WASHING THE EXTERIOR SURFACE OF AN AUTOMOTIVE VEHICLE AND VACUUMING THE INTERIOR OF SUCH VEHICLE (U.S. CLS. 13, 19, 21, 23, 31, 34 AND 35).

JOHN DALIER, EXAMINING ATTORNEY

CLASS 7—(Continued).

SN 78-523,468. SIDEL, OCTEVILLE SUR MER, FRANCE, FILED 11-29-2004.

CLASS 7—(Continued).

SN 78-524,145. RAGGED POINT INDUSTRIES, MID-LOTHIAN, VA. FILED 11-30-2004.

AIDLIN

The Ice Wizard

THE MARK CONSISTS OF STANDARD CHARACTERS WITHOUT CLAIM TO ANY PARTICULAR FONT, STYLE, SIZE, OR COLOR.

OWNER OF U.S. REG. NO. 2,703,391.
FOR CONVEYORS, NAMELY, AUTOMATIC AND SEMI-AUTOMATIC FOR ORIENTING, FEEDING, AND CONVEYING CAPS AND COVERS FOR CONTAINERS SUCH AS BOTTLES, JARS, TUBES, AND VIALS (U.S. CLS. 13, 19, 21, 23, 31, 34 AND 35).

FIRST USE 11-28-1979, THE MARK WAS FIRST USED ANYWHERE IN A DIFFERENT FORM OTHER THAN THAT SOUGHT TO BE REGISTERED ON 12/01/1964.; IN COMMERCE 11-28-1979, THE MARK WAS FIRST USED IN COMMERCE IN A DIFFERENT FORM OTHER THAN THAT SOUGHT TO BE REGISTERED ON 12/01/1964..

JIM RINGLE, EXAMINING ATTORNEY

THE MARK CONSISTS OF STANDARD CHARACTERS WITHOUT CLAIM TO ANY PARTICULAR FONT, STYLE, SIZE, OR COLOR.

NO CLAIM IS MADE TO THE EXCLUSIVE RIGHT TO USE ICE, APART FROM THE MARK AS SHOWN.
FOR ICE RESURFACING MACHINES (U.S. CLS. 13, 19, 21, 23, 31, 34 AND 35).

TARAH HARDY, EXAMINING ATTORNEY

SN 78-524,396. KABUSHIKI KAISHA MIYANAGA, DBA MIYANAGA CO., LTD., MIKI, JAPAN, FILED 11-30-2004.

SN 78-523,851. H-P PRODUCTS, INC., LOUISVILLE, OH. FILED 11-29-2004.

MEDALLION

DLMB

THE MARK CONSISTS OF STANDARD CHARACTERS WITHOUT CLAIM TO ANY PARTICULAR FONT, STYLE, SIZE, OR COLOR.

FOR CLEANING SYSTEMS WHICH COMPRISE A CENTRAL VACUUM UNIT AND CONNECTED CONDUITS AND CLEANING NOZZLES AND PARTS THEREFOR (U.S. CLS. 13, 19, 21, 23, 31, 34 AND 35).

DAVID YONTEF, EXAMINING ATTORNEY

THE MARK CONSISTS OF STANDARD CHARACTERS WITHOUT CLAIM TO ANY PARTICULAR FONT, STYLE, SIZE, OR COLOR.

FOR METAL WORKING MACHINES, NAMELY, BORERS, PUNCHING PRESSES, BORING MACHINES, AND DRILLING MACHINES; AND ADAPTERS, HOLE SAWS, AND CUTTERS FOR AFORESAID GOODS (U.S. CLS. 13, 19, 21, 23, 31, 34 AND 35).

KATHLEEN M. VANSTON, EXAMINING ATTORNEY

CLASS 7—(Continued).

SN 78-538,922. RICH STAR PRECISION INDUSTRIAL CO., LTD., TAICHUNG, TAIWAN, FILED 12-28-2004.

CLASS 7—(Continued).

SN 78-543,234. TAYLOR PITTSBURGH MANUFACTURING, INC, ATHENS, TN. FILED 1-6-2005.

EVO-T

TAYLOR-WAY

THE MARK CONSISTS OF STANDARD CHARACTERS WITHOUT CLAIM TO ANY PARTICULAR FONT, STYLE, SIZE, OR COLOR.

FOR SPRAYING MACHINES AND SPRAY GUNS FOR USE IN SPRAYING PAINTS; AIR COMPRESSORS FOR USE WITH POWER OPERATED TOOLS, NAMELY, DRILL HAMMERS, GRINDERS, AND BUFFERS; ELECTRICALLY OPERATED HAND TOOLS, NAMELY, ELECTRIC HAND-HELD DRILLS; HYDRAULICALLY OPERATED HAND TOOLS, NAMELY, HYDRAULIC JACKS, LIFT TABLES, AND VALVE ACTUATORS; PNEUMATIC AND HYDRAULIC MACHINES FOR SPRAYING PAINT (U.S. CLS. 13, 19, 21, 23, 31, 34 AND 35).

JANICE L. MCMORROW, EXAMINING ATTORNEY

THE MARK CONSISTS OF STANDARD CHARACTERS WITHOUT CLAIM TO ANY PARTICULAR FONT, STYLE, SIZE, OR COLOR.

FOR POWER-OPERATED GRASS/WEED TRIMMER (U.S. CLS. 13, 19, 21, 23, 31, 34 AND 35).

FIRST USE 12-31-1947; IN COMMERCE 12-31-1947.

APRIL L. RADEMACHER, EXAMINING ATTORNEY

SN 78-543,418. NATIONAL OPTRONICS, INC., CHARLOTTEVILLE, VA. FILED 1-6-2005.

SN 78-541,382. SEARS BRANDS, LLC, HOFFMAN ESTATES, IL. FILED 1-3-2005.

2G

COMPLETE START

THE MARK CONSISTS OF STANDARD CHARACTERS WITHOUT CLAIM TO ANY PARTICULAR FONT, STYLE, SIZE, OR COLOR.

FOR LAWN MOWERS (U.S. CLS. 13, 19, 21, 23, 31, 34 AND 35).

DAVID YONTEF, EXAMINING ATTORNEY

THE MARK CONSISTS OF STANDARD CHARACTERS WITHOUT CLAIM TO ANY PARTICULAR FONT, STYLE, SIZE, OR COLOR.

FOR EYEGLASS LENS GENERATING MACHINES (U.S. CLS. 13, 19, 21, 23, 31, 34 AND 35).

FIRST USE 1-1-2005; IN COMMERCE 2-20-2005.

MARIA-VICTORIA SUAREZ, EXAMINING ATTORNEY

CLASS 7—(Continued).

SN 78-543,663. NATIONAL OPTRONICS, INC., CHARLOTTESVILLE, VA. FILED 1-7-2005.

CLASS 7—(Continued).

SN 78-548,522. LOG MAX, INC., VANCOUVER, WA. FILED 1-17-2005.

4T

THE MARK CONSISTS OF STANDARD CHARACTERS WITHOUT CLAIM TO ANY PARTICULAR FONT, STYLE, SIZE, OR COLOR.
FOR TRACING MACHINES FOR EYEGLASS LENSES (U.S. CLS. 13, 19, 21, 23, 31, 34 AND 35).
FIRST USE 1-1-2005; IN COMMERCE 2-20-2005.
MICHAEL KAZAZIAN, EXAMINING ATTORNEY

GET A GRIP

THE MARK CONSISTS OF STANDARD CHARACTERS WITHOUT CLAIM TO ANY PARTICULAR FONT, STYLE, SIZE, OR COLOR.
FOR TIMBER HARVESTING MACHINES (U.S. CLS. 13, 19, 21, 23, 31, 34 AND 35).
FIRST USE 1-0-2004; IN COMMERCE 1-0-2004.
BARBARA BROWN, EXAMINING ATTORNEY

SN 78-546,903. TENNANT COMPANY, MINNEAPOLIS, MN. FILED 1-13-2005.

SN 78-550,853. PROCESSING TECHNOLOGIES, INC., AURORA, IL. FILED 1-20-2005.



REVOLUTION

OWNER OF U.S. REG. NO. 2,834,529.
THE MARK CONSISTS OF THE WORD FAST WITH SOAP BUBBLES IN CAPITAL LETTERS EXCEPT FOR THE LOWER CASE "A".
FOR FLOOR MAINTENANCE EQUIPMENT, NAMELY, CLEANING MACHINES EMPLOYING A FOAM SCRUBBING PROCESS (U.S. CLS. 13, 19, 21, 23, 31, 34 AND 35).
FIRST USE 7-18-2002; IN COMMERCE 7-18-2002.
ALICE BENMAMAN, EXAMINING ATTORNEY

THE MARK CONSISTS OF STANDARD CHARACTERS WITHOUT CLAIM TO ANY PARTICULAR FONT, STYLE, SIZE, OR COLOR.
FOR MATERIAL HANDLING MACHINES, NAMELY, ROLL STANDS (U.S. CLS. 13, 19, 21, 23, 31, 34 AND 35).
FIRST USE 8-1-2003; IN COMMERCE 8-1-2003.
LINDA M. KING, EXAMINING ATTORNEY

CLASS 7—(Continued).

SN 78-551,209. PURE POWER! INCORPORATED, HUNTINGTON BEACH, CA. FILED 1-20-2005.

PURE POWER!

THE MARK CONSISTS OF STANDARD CHARACTERS WITHOUT CLAIM TO ANY PARTICULAR FONT, STYLE, SIZE, OR COLOR.

FOR FUEL AND OIL FILTERS (U.S. CLS. 13, 19, 21, 23, 31, 34 AND 35).

FIRST USE 0-0-1995; IN COMMERCE 0-0-1995.
AMY GEARIN, EXAMINING ATTORNEY

SN 79-002,976. WALDRICH SIEGEN WERKZEUGMASCHINEN GMBH, D-57299 BURBACH, FED REP GERMANY, FILED 3-22-2004.

MultiRond

THE MARK CONSISTS OF STANDARD CHARACTERS WITHOUT CLAIM TO ANY PARTICULAR FONT, STYLE, SIZE, OR COLOR.

OWNER OF INTERNATIONAL REGISTRATION 0826230 DATED 3-22-2004, EXPIRES 3-22-2014.

FOR METAL, WOOD, PLASTICS WORKING MACHINES, NAMELY, HORIZONTAL MACHINING CENTER FOR COMPLEX MACHINING; MACHINE TOOLS, NAMELY, MILLING MACHINE, TURNING MACHINES, 5 AXIS MILLING MACHINES, TURN MILLING MACHINES, DEEP-DRILLING MACHINES, GEAR CUTTING MACHINES AND GRINDING MACHINES; PARTS OF THE AFOREMENTIONED GOODS, AS FAR AS CONTAINED IN THIS CLASS (U.S. CLS. 13, 19, 21, 23, 31, 34 AND 35).

ANDREA SAUNDERS, EXAMINING ATTORNEY

SN 79-003,537. ALEXANDERWERK AG, FED REP GERMANY, FILED 4-21-2004.

PowerFactor

THE MARK CONSISTS OF STANDARD CHARACTERS WITHOUT CLAIM TO ANY PARTICULAR FONT, STYLE, SIZE, OR COLOR.

PRIORITY DATE OF 10-27-2003 IS CLAIMED.

OWNER OF INTERNATIONAL REGISTRATION 0827945 DATED 4-21-2004, EXPIRES 4-21-2014.

FOR PROCESSING MACHINES FOR POWDERY SUBSTANCES, NAMELY ROLL PRESSES FOR USE IN CHEMICAL, PHARMACEUTICAL AND INDUSTRIAL INDUSTRY. (U.S. CLS. 13, 19, 21, 23, 31, 34 AND 35).

JENNIFER MARTIN, EXAMINING ATTORNEY

CLASS 7—(Continued).

SN 79-004,355. ASM INTERNATIONAL N.V., NETHERLANDS, FILED 5-10-2004.

EMERALD

THE MARK CONSISTS OF STANDARD CHARACTERS WITHOUT CLAIM TO ANY PARTICULAR FONT, STYLE, SIZE, OR COLOR.

PRIORITY DATE OF 12-4-2003 IS CLAIMED.

OWNER OF INTERNATIONAL REGISTRATION 0830517 DATED 5-10-2004, EXPIRES 5-10-2014.

FOR MACHINES AND MACHINE TOOLS, NAMELY SEMI-CONDUCTOR WAFER PROCESSING EQUIPMENT, INCLUDING THERMAL TREATMENT REACTORS AND CHEMICAL VAPOR DEPOSITION REACTORS (U.S. CLS. 13, 19, 21, 23, 31, 34 AND 35).

PATRICIA EVANKO, EXAMINING ATTORNEY

SN 79-004,393. URPEMAK, S.L., SPAIN, FILED 4-26-2004.

OWNER OF INTERNATIONAL REGISTRATION 0813233 DATED 9-26-2003, EXPIRES 9-26-2013.

THE TRADEMARK COMPRISES THE DENOMINATION URPE AND TWO CURVED LINES.

FOR MACHINES FOR CENTRIFUGAL CASTING, MORTISING MACHINES, CASTING-FLOW FEED AND DOSING MACHINES (U.S. CLS. 13, 19, 21, 23, 31, 34 AND 35).

CHERYL CLAYTON, EXAMINING ATTORNEY

CLASS 7—(Continued).

SN 79-004,489. TANAKA KOGYO CO., LTD., JAPAN, FILED 6-2-2004.

SMARTFIT

THE MARK CONSISTS OF STANDARD CHARACTERS WITHOUT CLAIM TO ANY PARTICULAR FONT, STYLE, SIZE, OR COLOR.

OWNER OF INTERNATIONAL REGISTRATION 0830854 DATED 6-2-2004, EXPIRES 6-2-2014.

FOR EXCAVATING MACHINES; FOUNDATION WORK MACHINES; GROUND SURFACE FINISHING AND COMPACTING MACHINES; CONCRETE PAVING MACHINES; CONCRETE MIXERS; ASPHALT PAVING MACHINES; DREDGING MACHINES; LUMBERING BAND SAWS; CHAIN SAWS; SAW-TOOTH SETTING MACHINES FOR LUMBERING OR WOODWORKING SAWS; CIRCULAR SAWS FOR WOODWORKING; SANDING MACHINES FOR WOODWORKING; WOOD PLANING MACHINES; WOOD MILLING MACHINES; WOOD DRILLING MACHINES; WOOD SAWING MACHINES; VENEER OR PLYWOOD MAKING MACHINES; ELECTRIC OR POWER-OPERATED BRUSH CUTTERS; ELECTRIC OR POWER-OPERATED HEDGE TRIMMERS; ELECTRIC OR POWER-OPERATED CULTIVATORS; ELECTRIC OR POWER-OPERATED GRASS TRIMMERS; STUBBLE CUTTING MACHINES; POWER TILLERS; REAPERS; HARVEST DRYING MACHINES; CORN HUSKING MACHINES; RICE GRAIN SORTING MACHINES; HAY BINDING MACHINES; RICE HUSKERS; ENGINES NOT FOR LAND VEHICLES; AND LAWNMOWERS (U.S. CLS. 13, 19, 21, 23, 31, 34 AND 35).

KIM SAITO, EXAMINING ATTORNEY

SN 79-007,208. M.G.M. MOTORI ELETTRICI S.P.A., ITALY, FILED 8-12-2004.



PRIORITY DATE OF 4-26-2004 IS CLAIMED.
OWNER OF INTERNATIONAL REGISTRATION 0838631 DATED 8-12-2004, EXPIRES 8-12-2014.

THE TRADEMARK ESSENTIALLY CONSISTS IN THE LIGHT-COLORED INITIALS "MGM" DEPICTED INSIDE A DARK SQUARE, THE SECOND "M" SITUATED BELOW THE LETTER "G".

FOR ELECTRIC MOTORS OTHER THAN FOR LAND VEHICLES (U.S. CLS. 13, 19, 21, 23, 31, 34 AND 35).
CHERYL CLAYTON, EXAMINING ATTORNEY

CLASS 7—(Continued).

SN 79-007,211. EMITEC GESELLSCHAFT; FÜR EMISSIONSTECHNOLOGIE MBH, FED REP GERMANY, FILED 8-6-2004.

AT-Cat

THE MARK CONSISTS OF STANDARD CHARACTERS WITHOUT CLAIM TO ANY PARTICULAR FONT, STYLE, SIZE, OR COLOR.

PRIORITY DATE OF 3-17-2004 IS CLAIMED.

OWNER OF INTERNATIONAL REGISTRATION 0838634 DATED 8-6-2004, EXPIRES 8-6-2014.

FOR CATALYTIC CONVERTERS FOR INTERNAL COMBUSTION ENGINES FOR USES OTHER THAN IN AGRICULTURAL TRACTORS; CATALYTIC CONVERTERS FOR THE TRACTION OR PROPULSION SYSTEMS OF AIRCRAFT, WATERCRAFT AND LAND VEHICLES OTHER THAN AGRICULTURAL VEHICLES (U.S. CLS. 13, 19, 21, 23, 31, 34 AND 35).

JOHN DALIER, EXAMINING ATTORNEY

SN 79-007,212. EMITEC GESELLSCHAFT; FÜR EMISSIONSTECHNOLOGIE MBH, FED REP GERMANY, FILED 8-6-2004.

AT-Catalyst

THE MARK CONSISTS OF STANDARD CHARACTERS WITHOUT CLAIM TO ANY PARTICULAR FONT, STYLE, SIZE, OR COLOR.

PRIORITY DATE OF 3-17-2004 IS CLAIMED.

OWNER OF INTERNATIONAL REGISTRATION 0838635 DATED 8-6-2004, EXPIRES 8-6-2014.

FOR CATALYTIC CONVERTERS FOR INTERNAL COMBUSTION ENGINES FOR USES OTHER THAN IN AGRICULTURAL TRACTORS; CATALYTIC CONVERTERS FOR THE TRACTION OR PROPULSION SYSTEMS OF AIRCRAFT, WATERCRAFT AND LAND VEHICLES OTHER THAN AGRICULTURAL VEHICLES (U.S. CLS. 13, 19, 21, 23, 31, 34 AND 35).

JOHN DALIER, EXAMINING ATTORNEY

SN 79-007,491. SITMA S.P.A., ITALY, FILED 9-15-2004.

VARIAWRAP

THE MARK CONSISTS OF STANDARD CHARACTERS WITHOUT CLAIM TO ANY PARTICULAR FONT, STYLE, SIZE, OR COLOR.

PRIORITY DATE OF 4-9-2004 IS CLAIMED.

OWNER OF INTERNATIONAL REGISTRATION 0839372 DATED 9-15-2004, EXPIRES 9-15-2014.

FOR MACHINES FOR PACKING NEWSPAPERS, BOOKS, MAGAZINES, PRINTED MATTER AND BROCHURES (U.S. CLS. 13, 19, 21, 23, 31, 34 AND 35).

LAURIE MAYES, EXAMINING ATTORNEY

CLASS 8—HAND TOOLS

SN 76-469,679. GREAT NECK SAW MANUFACTURERS, INC., MINEOLA, NY. FILED 11-25-2002.

ESSENTIALS

OWNER OF U.S. REG. NO. 2,674,032.
FOR HAND TOOLS, NAMELY, WRENCHES, STAR DRIVERS, NUT DRIVERS, CAULKING GUNS, WRECKING AND PRY BARS, PUNCHES, SOCKETS, RATCHETS AND RATCHET DRIVES, CUTTERS, NAMELY SNIPS, SAWS, SAW BLADES AND HOSE, WOOD AND PLASTIC CUTTERS, CRIMPING TOOLS, WIRE STRIPPERS, KNIVES, HAND PRUNING KNIVES AND SNIPS, SCREW DRIVERS, HAMMERS, HAND AXES, HATCHETS AND MALLETS, PLANES, AWLS, MITRE BOXES, SQUARES, PLIERS, FILES AND RASPS; AUTOMOTIVE HAND TOOLS, NAMELY, PISTON RING CONNECTION AND DISCONNECTION TOOLS, BRAKE SPRING TOOLS, HONING TOOLS FOR ENGINE AND BRAKE CYLINDERS, SPARK PLUG ADJUSTING TOOLS, VALVE AND PISTON RING COMPRESSING TOOLS (U.S. CLS. 23, 28 AND 44).

RAUL CORDOVA, EXAMINING ATTORNEY

SN 76-533,448. NAMBE MILLS, INC., SANTA FE, NM. FILED 7-30-2003.

DESIGN YOUR LIFE

FOR FLATWARE, NAMELY, KNIVES, FORKS AND SPOONS (U.S. CLS. 23, 28 AND 44).
FIRST USE 10-2-2003; IN COMMERCE 10-2-2003.
WON TEAK OH, EXAMINING ATTORNEY

SN 76-593,702. CRI 2000, LP, SAN DIEGO, CA. FILED 5-24-2004.

CUTTING EDGE

THE MARK CONSISTS OF STANDARD CHARACTERS WITHOUT CLAIM TO ANY PARTICULAR FONT, STYLE, SIZE, OR COLOR.
FOR ARTS AND CRAFTS SCISSORS FOR CHILDREN (U.S. CLS. 23, 28 AND 44).
BRIDGETT SMITH, EXAMINING ATTORNEY

CLASS 8—(Continued).

SN 76-601,361. SECCO INTERNATIONAL, INC., SANTA BARBARA, CA. FILED 7-8-2004.

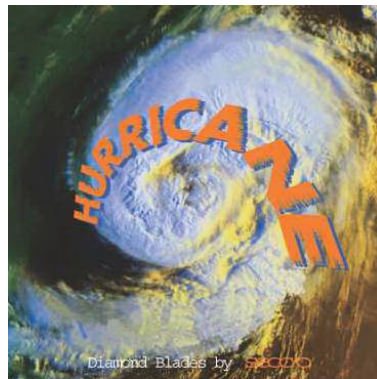

NO CLAIM IS MADE TO THE EXCLUSIVE RIGHT TO USE "DIAMOND BLADES BY SECCO", APART FROM THE MARK AS SHOWN.

THE COLOR(S) ORANGE IS/ARE CLAIMED AS A FEATURE OF THE MARK.

THE COLOR(S) THE WORD "HURRICANE" IN ORANGE LETTERS IN AN ARC, SUPERIMPOSED OVER AN AERIAL COLOR PHOTOGRAPH OF A HURRICANE. THE WORDS "DIAMOND BLADES BY" IN THE COLOR WHITE, "SECCO" IN THE COLOR ORANGE UNDERNEATH IN A STRAIGHT LINE IS/ARE CLAIMED AS A FEATURE OF THE MARK.

FOR SAW BLADES IMPREGNATED WITH DIAMONDS FOR USE WITH TILE AND STONE (U.S. CLS. 23, 28 AND 44).

FIRST USE 9-1-1998; IN COMMERCE 9-1-1998.
KEVON CHISOLM, EXAMINING ATTORNEY

SN 76-607,645. BEST BUYS DIRECT, INC., WAYNE, NJ. FILED 8-19-2004.

SECURE PRO

THE MARK CONSISTS OF STANDARD CHARACTERS WITHOUT CLAIM TO ANY PARTICULAR FONT, STYLE, SIZE, OR COLOR.

FOR HAND TOOLS, NAMELY, ENGRAVERS FOR MARKING (U.S. CLS. 23, 28 AND 44).

FIRST USE 4-0-2004; IN COMMERCE 4-0-2004.
JOANNA DUKOVIC, EXAMINING ATTORNEY

CLASS 8—(Continued).

SN 76-609,865. SNAP-ON INCORPORATED, PLEASANT PRAIRIE, WI. FILED 8-30-2004.

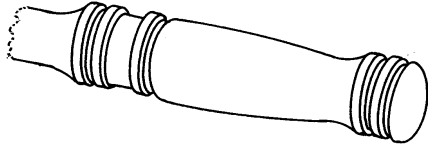

OWNER OF U.S. REG. NOS. 2,689,961, 2,717,021 AND OTHERS.

THE MARK CONSISTS OF A PORTION OF THE HANDLE OF A SOCKET DRIVER INCLUDING TWO SPACED CIRCUMFERENTIAL GROOVES NEAR THE FREE END OF THE HANDLE OF THE DRIVER AND THREE SPACED CIRCUMFERENTIAL GROOVES NEAR THE MIDDLE OF THE HANDLE OF THE DRIVER.

FOR HAND TOOLS NAMELY, SOCKET DRIVERS, NAMELY, RATCHETS, BREAKER BARS AND SPEE-
DERS (U.S. CLS. 23, 28 AND 44).

FIRST USE 0-0-1948; IN COMMERCE 0-0-1948.
CHRISIE B. KING, EXAMINING ATTORNEY

SN 76-615,802. NORTH AMERICAN GREEN, INC., EVANSVILLE, IN. FILED 10-12-2004.

SURE LOCK

THE MARK CONSISTS OF STANDARD CHARACTERS WITHOUT CLAIM TO ANY PARTICULAR FONT, STYLE, SIZE, OR COLOR.

FOR STAKE INSERTING DEVICES, NAMELY, HAND-POWERED OPERATED STAPLE GUNS (U.S. CLS. 23, 28 AND 44).

FIRST USE 6-0-1986; IN COMMERCE 6-0-1986.
PAULA MAHONEY, EXAMINING ATTORNEY

SN 76-617,079. STAR ASIA, U.S.A., LLC, RENTON, WA. FILED 10-18-2004.

TEKZ

THE MARK CONSISTS OF STANDARD CHARACTERS WITHOUT CLAIM TO ANY PARTICULAR FONT, STYLE, SIZE, OR COLOR.

FOR HAND TOOLS, NAMELY SCREWDRIVERS, PLIERS, RATCHETS AND SOCKETS (U.S. CLS. 23, 28 AND 44).

MICHAEL SOUDERS, EXAMINING ATTORNEY

CLASS 8—(Continued).

SN 76-622,143. SANRIO COMPANY, LTD., TOKYO 141, JAPAN, FILED 11-26-2004.

CHOCOCAT

THE MARK CONSISTS OF STANDARD CHARACTERS WITHOUT CLAIM TO ANY PARTICULAR FONT, STYLE, SIZE, OR COLOR.

OWNER OF U.S. REG. NOS. 2,842,707 AND 2,845,315. FOR NAIL CLIPPERS AND NAIL FILES (U.S. CLS. 23, 28 AND 44).

FIRST USE 9-15-2000; IN COMMERCE 9-15-2000.
JOANNA DUKOVIC, EXAMINING ATTORNEY

SN 76-625,967. MARSHALLTOWN COMPANY, MARSHALLTOWN, IA. FILED 12-22-2004.

DIRECT PRESSURE

THE MARK CONSISTS OF STANDARD CHARACTERS WITHOUT CLAIM TO ANY PARTICULAR FONT, STYLE, SIZE, OR COLOR.

FOR HAND TOOLS, NAMELY TAPING KNIVES, DRYWALL KNIVES, TROWELS, FLOATS, PUTTY KNIVES, JOINT KNIVES, KNOCKDOWN KNIVES, BROAD KNIVES, SCRAPERS, EDGERS, AND GROOVERS (U.S. CLS. 23, 28 AND 44).

FIRST USE 12-31-2004; IN COMMERCE 12-31-2004.
ZACHARY BELLO, EXAMINING ATTORNEY

SN 78-330,322. MAXIS LLC, GILBERT, AZ. FILED 11-19-2003.



NO CLAIM IS MADE TO THE EXCLUSIVE RIGHT TO USE MAXIS, APART FROM THE MARK AS SHOWN.

FOR HAND TOOLS FOR ELECTRICIANS, NAMELY CONDUIT LAYOUT TOOLS, NAMELY A TOOL FOR QUICKLY AND EASILY SETTING OUT THE PROPER CONDUIT SIZE AND SPACING FOR A PARTICULAR ELECTRICAL CONDUIT INSTALLATION (U.S. CLS. 23, 28 AND 44).

FIRST USE 1-0-2002; IN COMMERCE 12-15-2003.
DAVID TAYLOR, EXAMINING ATTORNEY

CLASS 8—(Continued).

SN 78-407,182. FLUSH QUIP INC., WINNIPEG, MANITOBA, CANADA, FILED 4-23-2004.

CLASS 8—(Continued).

SN 78-417,280. IRWIN INDUSTRIAL TOOL COMPANY, FREEPORT, IL. FILED 5-12-2004.

GRAB-ALL

9AC

THE MARK CONSISTS OF STANDARD CHARACTERS WITHOUT CLAIM TO ANY PARTICULAR FONT, STYLE, SIZE, OR COLOR.

FOR HAND-OPERATED HAND TOOL, NAMELY, A DEVICE CONSISTING OF A ROPE, POLE AND JAWS FOR REMOVING FOREIGN OBJECTS FROM CONFINED SPACES (U.S. CLS. 23, 28 AND 44).

FIRST USE 10-21-1994; IN COMMERCE 10-21-1994.
MICHAEL HALL, EXAMINING ATTORNEY

THE MARK CONSISTS OF STANDARD CHARACTERS WITHOUT CLAIM TO ANY PARTICULAR FONT, STYLE, SIZE, OR COLOR.

OWNER OF U.S. REG. NOS. 793,363, 1,407,398 AND OTHERS.

FOR HAND TOOLS, NAMELY, LOCKING CLAMPS (U.S. CLS. 23, 28 AND 44).

FIRST USE 1-1-1994; IN COMMERCE 1-1-1994.
GLENN CLARK, EXAMINING ATTORNEY

SN 78-407,332. HI-FIVE PRODUCTS DEVELOPING CO., LTD., TAICHUNG, TAIWAN, FILED 4-23-2004.

SN 78-421,454. GSB OF DC INC, NORTH PALM BEACH, FL. FILED 5-19-2004.

GEARPLUS WRENCH

MAGIC SAW

THE MARK CONSISTS OF STANDARD CHARACTERS WITHOUT CLAIM TO ANY PARTICULAR FONT, STYLE, SIZE, OR COLOR.

NO CLAIM IS MADE TO THE EXCLUSIVE RIGHT TO USE WRENCH, APART FROM THE MARK AS SHOWN.

FOR HAND TOOLS, NAMELY, BOX WRENCHES, SPOKE WRENCHES, SOCKET WRENCHES, PLIERS, AXES, HATCHETS, WRENCHES, NON-ELECTRIC CAN OPENERS, NAIL FILES, SCREWDRIVERS, HAMMERS, TWEEZERS, COMPOSITION WRENCHES, SOCKET SETS, LOCKING WRENCHES, ADJUSTABLE WRENCHES, AND HOOK SCREWDRIVERS; HANDLES FOR HEX KEY WRENCHES; HAND-OPERATED DECORTICATING TOOLS, NAMELY, CRIMPING AND WIRE STRIPPING TOOLS FOR ELECTRIC WIRES; AND EXTENSION BARS FOR WRENCHES (U.S. CLS. 23, 28 AND 44).

FIRST USE 9-16-2003; IN COMMERCE 9-16-2003.
RICHARD WHITE, EXAMINING ATTORNEY

THE MARK CONSISTS OF STANDARD CHARACTERS WITHOUT CLAIM TO ANY PARTICULAR FONT, STYLE, SIZE, OR COLOR.

NO CLAIM IS MADE TO THE EXCLUSIVE RIGHT TO USE "SAW", APART FROM THE MARK AS SHOWN.

FOR NON-ELECTRIC HAND TOOLS, NAMELY, SAWS (U.S. CLS. 23, 28 AND 44).

WINSTON FOLMAR, EXAMINING ATTORNEY

CLASS 8—(Continued).

SN 78-443,099. BUFFETT, JIMMY, KEY WEST, FL. FILED 6-29-2004.

CLASS 8—(Continued).

SN 78-458,917. STENMAN, BRUCE W., PRUNEDALE, CA. FILED 7-29-2004.

MARGARITAVILLE

Hole Pro

THE MARK CONSISTS OF STANDARD CHARACTERS WITHOUT CLAIM TO ANY PARTICULAR FONT, STYLE, SIZE, OR COLOR.

OWNER OF U.S. REG. NOS. 2,116,314, 2,132,893 AND OTHERS.

FOR DINING UTENSILS, NAMELY KNIVES, FORKS, AND SPOONS; STEAK KNIVES; NON-ELECTRIC CAN OPENERS; NON-ELECTRIC ICE CRUSHERS; MANUALLY OPERATED FOOD SLICERS; EGG SLICERS; NON-ELECTRIC CHEESE SLICERS; AND MANUALLY OPERATED FOOD CHOPPERS (U.S. CLS. 23, 28 AND 44).
ELISSA GARBER KON, EXAMINING ATTORNEY

THE MARK CONSISTS OF STANDARD CHARACTERS WITHOUT CLAIM TO ANY PARTICULAR FONT, STYLE, SIZE, OR COLOR.

NO CLAIM IS MADE TO THE EXCLUSIVE RIGHT TO USE "HOLE", APART FROM THE MARK AS SHOWN.

FOR HAND TOOLS, NAMELY, HOLE CUTTING TOOLS (U.S. CLS. 23, 28 AND 44).
GINA FINK, EXAMINING ATTORNEY

SN 78-449,703. FROST, JAMES A., DBA FROST CUTLERY, OOLTEWAH, TN. FILED 7-13-2004.

SN 78-461,519. ROLLING RAZOR, LLC, MARINA DEL REY, CA. FILED 8-4-2004.

POCKET ROCKET

Rolling Razor

THE MARK CONSISTS OF STANDARD CHARACTERS WITHOUT CLAIM TO ANY PARTICULAR FONT, STYLE, SIZE, OR COLOR.

FOR CUTLERY, NAMELY POCKET AND COLLECTOR'S KNIVES (U.S. CLS. 23, 28 AND 44).
FIRST USE 12-31-1999; IN COMMERCE 12-31-1999.
MARK T. MULLEN, EXAMINING ATTORNEY

THE MARK CONSISTS OF STANDARD CHARACTERS WITHOUT CLAIM TO ANY PARTICULAR FONT, STYLE, SIZE, OR COLOR.

NO CLAIM IS MADE TO THE EXCLUSIVE RIGHT TO USE "RAZOR", APART FROM THE MARK AS SHOWN.

FOR WET SHAVING, HAND-HELD RAZORS AND ELECTRIC RAZORS FOR USE IN SHAVING (U.S. CLS. 23, 28 AND 44).
ANDREW BENZMILLER, EXAMINING ATTORNEY

CLASS 8—(Continued).

SN 78-462,576. H-D MICHIGAN, INC., ANN ARBOR, MI. FILED 8-5-2004.



FOR FOLDING KNIVES (U.S. CLS. 23, 28 AND 44).
FIRST USE 1-0-2004; IN COMMERCE 1-0-2004.
LEIGH LOWRY, EXAMINING ATTORNEY

SN 78-486,703. WOFFORD, BARRY, TOLEDO, OH. FILED 9-21-2004.

JEWELRY HELPER

THE MARK CONSISTS OF STANDARD CHARACTERS WITHOUT CLAIM TO ANY PARTICULAR FONT, STYLE, SIZE, OR COLOR.

NO CLAIM IS MADE TO THE EXCLUSIVE RIGHT TO USE "JEWELRY", APART FROM THE MARK AS SHOWN. FOR HAND TOOLS, NAMELY, A DEVICE FOR FACILITATING THE HOOKUP OF CLASPS ON BRACELETS AND NECKLACES (U.S. CLS. 23, 28 AND 44).

FIRST USE 11-1-2003; IN COMMERCE 11-1-2003.
SUNG IN, EXAMINING ATTORNEY

CLASS 8—(Continued).

SN 78-521,247. TICERA, SAN FRANCISCO, CA. FILED 11-22-2004.

TICERA

THE MARK CONSISTS OF STANDARD CHARACTERS WITHOUT CLAIM TO ANY PARTICULAR FONT, STYLE, SIZE, OR COLOR.

FOR CUTLERY, KITCHEN KNIVES, SCISSORS, KNIFE SHARPENERS, HAND-OPERATED SLICERS, NON-ELECTRIC FRUIT PEELERS, NON-ELECTRIC VEGETABLE PEELERS (U.S. CLS. 23, 28 AND 44).
GINNY ISAACSON, EXAMINING ATTORNEY

SN 78-521,851. TRUE VALUE COMPANY, CHICAGO, IL. FILED 11-23-2004.

BUYER'S VALUE

THE MARK CONSISTS OF STANDARD CHARACTERS WITHOUT CLAIM TO ANY PARTICULAR FONT, STYLE, SIZE, OR COLOR.

FOR HAND TOOLS AND PARTS OF HAND TOOLS, NAMELY, HAMMERS, MALLETS, PRY BARS, CHISEL SETS AND CHISELS, UTILITY KNIVES, SNAP BLADE KNIVES, UTILITY HOOK BLADES, HACKSAWS, PLIERS, SNIPS, TIN SNIPS, CUTTERS AND REPLACEMENT BLADES FOR CUTTERS, BOLT CUTTERS, WRENCHES, PIPE WRENCHES, SCREW SETS AND SCREWDRIVERS, CLAMPS, C-CLAMP SETS AND C-CLAMPS, AND MAGNET PICK-UP TOOLS (U.S. CLS. 23, 28 AND 44).

FIRST USE 3-26-2004; IN COMMERCE 3-26-2004.
MATTHEW KLINE, EXAMINING ATTORNEY

CLASS 8—(Continued).

SN 78-522,232. ELLISON EDUCATIONAL EQUIPMENT, INC., LAKE FOREST, CA. FILED 11-23-2004.

CLASS 8—(Continued).

SN 78-523,979. ELLISON EDUCATIONAL EQUIPMENT, INC., LAKE FOREST, CA. FILED 11-29-2004.

ALLSTAR

QWINK

THE MARK CONSISTS OF STANDARD CHARACTERS WITHOUT CLAIM TO ANY PARTICULAR FONT, STYLE, SIZE, OR COLOR.

FOR HAND-OPERATED DIE CUTTING, EMBOSsing, AND PRESSING IMPLEMENTS; DIES TO BE USED WITH SAID HAND-OPERATED IMPLEMENTS (U.S. CLS. 23, 28 AND 44).

ANN E. SAPPENFIELD, EXAMINING ATTORNEY

THE MARK CONSISTS OF STANDARD CHARACTERS WITHOUT CLAIM TO ANY PARTICULAR FONT, STYLE, SIZE, OR COLOR.

FOR HAND-OPERATED TOOLS FOR DIE CUTTING OR EMBOSsing AND PRESSING OF OTHER MATERIALS; DIES TO BE USED WITH THE FOREGOING (U.S. CLS. 23, 28 AND 44).

IRA J. GOODSaid, EXAMINING ATTORNEY

SN 78-523,496. THE GILLETTE COMPANY, BOSTON, MA. FILED 11-29-2004.

SN 78-526,768. RA BRANDS, L.L.C., MADISON, NC. FILED 12-3-2004.

VENUS VIBRANCE

MAVERICK

THE MARK CONSISTS OF STANDARD CHARACTERS WITHOUT CLAIM TO ANY PARTICULAR FONT, STYLE, SIZE, OR COLOR.

FOR RAZORS AND RAZOR BLADES; DISPENSERS, CASSETTES, HOLDERS AND CARTRIDGES ALL CONTAINING BLADES; AND STRUCTURAL PARTS THEREFOR (U.S. CLS. 23, 28 AND 44).

MICHELLE DUBOIS, EXAMINING ATTORNEY

THE MARK CONSISTS OF STANDARD CHARACTERS WITHOUT CLAIM TO ANY PARTICULAR FONT, STYLE, SIZE, OR COLOR.

FOR CUTLERY, NAMELY, KNIVES (U.S. CLS. 23, 28 AND 44).

STEPHANIE DAVIS, EXAMINING ATTORNEY

CLASS 8—(Continued).

SN 78-527,218. PHELPS, MEHRUNISSA N., AKRON, OH.
FILED 12-5-2004.

CLASS 8—(Continued).

SN 78-543,742. KANZAWA SEIKO CO., LTD., HYOGO-KEN,
JAPAN, FILED 1-7-2005.

Twenty-Eighth Amendment ERA

THE MARK CONSISTS OF STANDARD CHARACTERS
WITHOUT CLAIM TO ANY PARTICULAR FONT, STYLE,
SIZE, OR COLOR.

FOR POCKET KNIFE (U.S. CLS. 23, 28 AND 44).
JIM RINGLE, EXAMINING ATTORNEY

SAMURAI ICHIBAN

THE MARK CONSISTS OF STANDARD CHARACTERS
WITHOUT CLAIM TO ANY PARTICULAR FONT, STYLE,
SIZE, OR COLOR.

OWNER OF U.S. REG. NOS. 2,320,414 AND 2,965,335.
THE FOREIGN WORDING IN THE MARK TRANSLATES
INTO ENGLISH AS NUMBER ONE.
FOR HAND TOOLS, NAMELY, SAWS (U.S. CLS. 23, 28
AND 44).

G. MAYERSCHOFF, EXAMINING ATTORNEY

SN 78-529,683. QUEEN CUTLERY COMPANY, TITUSVILLE,
PA. FILED 12-9-2004.

SN 78-547,405. BENCHMADE KNIFE CO., INC., OREGON
CITY, OR. FILED 1-13-2005.

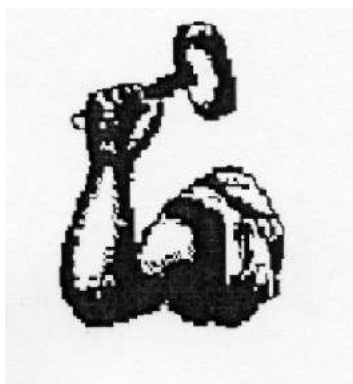

RESISTOR

THE MARK CONSISTS OF STANDARD CHARACTERS
WITHOUT CLAIM TO ANY PARTICULAR FONT, STYLE,
SIZE, OR COLOR.

FOR KNIVES, NAMELY, POCKET KNIVES, FIXED
BLADE KNIVES, AUTOMATIC SWITCHBLADE KNIVES,
COLLECTOR KNIVES, FOLDING KNIVES, SPORT KNI-
VES, RESCUE KNIVES, UTILITY KNIVES, TACTICAL
KNIVES, FISHING KNIVES, HUNTING KNIVES, CAMP-
ING KNIVES, AND SURVIVAL KNIVES (U.S. CLS. 23, 28
AND 44).

FIRST USE 3-5-2004; IN COMMERCE 3-5-2004.
GWEN STOKOLS, EXAMINING ATTORNEY

THE MARK CONSISTS OF AN ARM HOLDING A
HAMMER.

FOR KNIVES USED FOR HUNTING, SPORT, MILI-
TARY, LAW ENFORCEMENT, EMERGENCY SERVICES,
FOOD PREPARATION AND HOUSEHOLD USE (U.S.
CLS. 23, 28 AND 44).

NAKWAMA ANKRAH, EXAMINING ATTORNEY

CLASS 8—(Continued).

SN 79-004,518. TOOLBOX INTERNATIONAL BV, NETHERLANDS, FILED 6-10-2004.



OWNER OF INTERNATIONAL REGISTRATION 0830981 DATED 6-10-2004, EXPIRES 6-10-2014.

NO CLAIM IS MADE TO THE EXCLUSIVE RIGHT TO USE "QUALITY TOOLS", APART FROM THE MARK AS SHOWN.

THE COLOR(S) RED, BLUE, WHITE IS/ARE CLAIMED AS A FEATURE OF THE MARK.

THE COLOR RED APPEARS IN THE RECTANGULAR BACKGROUND AND THE SHADOW OF THE LETTERS QUAL, AND THE COLOR BLUE APPEARS IN THE WORDS QUALITY TOOLS.

FOR MANUALLY OPERATED HAND TOOLS, NAMELY, CIRCULAR SAW BLADES, ROUTER BITS, AND DRILLS (U.S. CLS. 23, 28 AND 44).

VIVIAN MICZNIK FIRST, EXAMINING ATTORNEY

CLASS 9—ELECTRICAL AND SCIENTIFIC APPARATUS

SN 75-485,752. VIEWSONIC CORPORATION, WALNUT, CA. FILED 5-15-1998.

WEBPARTNER

FOR COMPUTER SOFTWARE FOR USE IN PROGRAMMING, INTEGRATING, TESTING, CONTROLLING, FUNCTIONING, CONFIGURING, DESIGNING AND OPERATING NETWORK COMPUTERS AND PERSONAL ELECTRONIC COMMUNICATIONS DEVICES; COMPUTER HARDWARE (U.S. CLS. 21, 23, 26, 36 AND 38).

FLORENTINA BLANDU, EXAMINING ATTORNEY

SN 75-531,935. PIONEER KABUSHIKI KAISHA, DBA PIONEER ELECTRONIC CORPORATION, TOKYO 153-8854, JAPAN, FILED 8-6-1998.

PASSPORT

FOR COMPUTER SOFTWARE FOR CABLE TELEVISION CHANNEL SELECTOR BOXES TO CONTROL ON-SCREEN MENU PICTURES (U.S. CLS. 21, 23, 26, 36 AND 38).

FIRST USE 1-0-1998; IN COMMERCE 1-0-1998.

KAREN BRACEY, EXAMINING ATTORNEY

SN 76-071,769. FUJITSU NETWORK COMMUNICATIONS, INC., RICHARDSON, TX. FILED 6-16-2000.

FLASH

FOR OPTICAL NETWORKING TRANSMISSION SYSTEMS, NAMELY TELECOMMUNICATIONS HARDWARE, TELECOMMUNICATIONS SOFTWARE, MULTIPLEXERS, AMPLIFIERS, TRANSMITTERS, RECEIVERS AND ROUTERS FOR THE TRANSMISSION, SWITCHING AND MANAGEMENT OF VOICE, DATA AND VIDEO SIGNALS (U.S. CLS. 21, 23, 26, 36 AND 38).

FIRST USE 6-19-1996; IN COMMERCE 6-19-1996.

ALICE BENMAMAN, EXAMINING ATTORNEY

SN 79-005,896. ZHEJIANG FLYCO ELECTRICAL; APPLIANCE CO., LTD., CHINA, FILED 8-3-2004.

The logo for FLYCO consists of the word "FLYCO" in a very bold, black, sans-serif font. The letters are thick and closely spaced, with a slightly irregular, hand-drawn appearance.

THE MARK CONSISTS OF STANDARD CHARACTERS WITHOUT CLAIM TO ANY PARTICULAR FONT, STYLE, SIZE, OR COLOR.

OWNER OF INTERNATIONAL REGISTRATION 0834814 DATED 8-3-2004, EXPIRES 8-3-2014.

FOR BEARD CLIPPERS; CASES FOR RAZORS; MANICURE SETS; ELECTRIC AND NON-ELECTRIC HAIR CLIPPERS FOR PERSONAL USE; RAZORS, ELECTRIC OR NON-ELECTRIC; SCISSORS; TABLE CUTLERY, NAMELY, KNIVES, FORKS AND SPOONS; HAND TOOLS, NAMELY, DRILLS, HAND JACKS, AUGERS, AWLS, CLAMPS, FILES, HAMMERS, PINCERS, PLANERS, PUNCHES, WRENCHES, SAWS, SCREWDRIVERS, TONGS, NIPPERS, WIRE STRIPPERS, VICES, PRUNERS, CHISELS; RAZOR BLADES; ELECTRIC AND NON-ELECTRIC DEPILATION APPLIANCES; RAZOR CASES (U.S. CLS. 23, 28 AND 44).

JOANNA DUKOVIC, EXAMINING ATTORNEY

SN 76-102,634. PITNEY BOWES INC., STAMFORD, CT. FILED 8-3-2000.

CONQUEST

FOR COMPUTER SOFTWARE FOR INTEGRATED TRANSPORTATION AND ORDER FULFILLMENT, NAMELY, ORDER AND SHIPMENT PROCESSING OF PARCELS AND PACKAGES, PROCESSING DOCUMENTATION AND CONFIRMATION; PREPARATION OF SHIPPING FORMS INCLUDING LABELS, INVOICES, BILL OF LADING, INTERNATIONAL DOCUMENTATION, PACKAGING REQUIREMENTS, EXPORT LICENSES, HARMONIZED TARIFF SCHEDULE (HTS), LETTERS OF CREDIT AND PORT DATA; TASK SCHEDULING; SHIP AND DELIVERY STATUS; CARRIER RATE DATA; AND ELECTRONIC DATA TRANSMISSION (U.S. CLS. 21, 23, 26, 36 AND 38).

FIRST USE 3-26-1999; IN COMMERCE 3-26-1999.

LINDA E. BLOHM, EXAMINING ATTORNEY

CLASS 9—(Continued).

SN 76-148,807. ATRONIC INTERNATIONAL GMBH, LUB-
BECKE, FED REP GERMANY, FILED 10-12-2000.



THE MARK CONSISTS OF AN ERUPTING VOLCANO
FLANKED BY PALM TREES. THE VOLCANO IS SPEWING
FORTH GOLD COINS BEARING THE MARK "ATRONIC".
FOR GAMING MACHINES; GAMING MACHINES
FEATURING SLOT MACHINE TYPE GAMES VIA VI-
DEO DISPLAYS; ELECTRONIC SLOT MACHINES IN-
CORPORATING OPERATING SOFTWARE (U.S. CLS. 21,
23, 26, 36 AND 38).

FIRST USE 11-9-1994; IN COMMERCE 11-9-1994.
MICHAEL ENGEL, EXAMINING ATTORNEY

SN 76-149,734. BICKERTON, JOHN DAVID, BROOKLYN,
NY. FILED 10-20-2000.

UNIQUETRACKS

THE MARK CONSISTS OF STANDARD CHARACTERS
WITHOUT CLAIM TO ANY PARTICULAR FONT, STYLE,
SIZE, OR COLOR.

FOR PRE-RECORDED AUDIO PHONOGRAPH RE-
CORDS, LASER DISCS, CASSETTES AND COMPACT
DISCS FEATURING MUSIC SOLD DIRECTLY TO CON-
SUMERS (U.S. CLS. 21, 23, 26, 36 AND 38).

FIRST USE 7-1-2000; IN COMMERCE 8-24-2000.
TANYA AMOS, EXAMINING ATTORNEY

SN 76-231,672. PSINAPTIC INC., CALGARY, ALBERTA,
CANADA, FILED 3-28-2001.

PSINODE

PRIORITY CLAIMED UNDER SEC. 44(D) ON CANADA
APPLICATION NO. 1,079,276, FILED 10-19-2000, REG. NO.
TMA639,157, DATED 5-5-2005, EXPIRES 5-5-2020.

FOR COMPUTER HARDWARE WITH EMBEDDED
SOFTWARE THAT ENABLES NETWORK COMMUNICA-
TION BETWEEN COMPUTERS AND COMPUTERS AND
OTHER ELECTRONIC EMBEDDED COMPUTER HARD-
WARE AND EQUIPMENT TO PROVIDE AND RECEIVE
INFORMATION (U.S. CLS. 21, 23, 26, 36 AND 38).

MELVIN AXILBUND, EXAMINING ATTORNEY

CLASS 9—(Continued).

SN 76-337,447. QUANTITATIVE DECISION SUPPORT INC.,
OTTAWA, ONTARIO K1V 9L1, CANADA, FILED 11-13-
2001.

PRIM CHART

PRIORITY CLAIMED UNDER SEC. 44(D) ON CANADA
APPLICATION NO. 1102970, FILED 5-15-2001, REG. NO.
TMA612130, DATED 6-4-2004, EXPIRES 6-4-2019.

NO CLAIM IS MADE TO THE EXCLUSIVE RIGHT TO
USE "CHART", APART FROM THE MARK AS SHOWN.

FOR BUSINESS MANAGEMENT COMPUTER SOFT-
WARE, NAMELY, STATISTICAL ANALYSIS SOFTWARE
FOR USE IN THE FIELD OF PROJECT MANAGEMENT,
RISK MANAGEMENT AND CONTINGENCY PLAN-
NING, AND INSTRUCTION MANUALS FOR USE IN
CONJUNCTION THEREWITH SOLD AS A UNIT (U.S.
CLS. 21, 23, 26, 36 AND 38).

DANIEL CAPSHAW, EXAMINING ATTORNEY

SN 76-384,195. DAIMLERCHRYSLER AG, 70567 STUTT-
GART, FED REP GERMANY, FILED 3-18-2002.

NITEVIEW

PRIORITY CLAIMED UNDER SEC. 44(D) ON FED REP
GERMANY APPLICATION NO. 30155222.3/0, FILED 3-15-
2002, REG. NO. 002615466, DATED 8-26-2003, EXPIRES 3-31-
2012.

FOR ELECTRONIC AND OPTO-ELECTRONIC DE-
VICES FOR RECOGNIZING OBSTACLES, NAMELY,
SENSORS AND MICROPROCESSORS (U.S. CLS. 21, 23,
26, 36 AND 38).

MARY ROSSMAN, EXAMINING ATTORNEY

SN 76-422,335. SAORA KABUSHIKI KAISHA, YOKOHAMA-
SHI, KANAGAWA 230-0077, JAPAN, FILED 6-18-2002.

KEEPCONTENT

FOR COMPUTER SOFTWARE, NAMELY, SOFTWARE
APPLICATION FOR ARCHIVING, MANAGING, ORGA-
NIZING, RETRIEVING, INDEXING AND DISTRIBU-
TING INFORMATION GATHERED FROM A GLOBAL
COMPUTER NETWORK (U.S. CLS. 21, 23, 26, 36 AND
38).

SOPHIA S. KIM, EXAMINING ATTORNEY

SN 76-422,538. MIRAMA ENTERPRISES INC., SAN DIEGO,
CA. FILED 6-17-2002.

CHE-EZ

FOR ELECTRONICS EQUIPMENT CONSISTING OF
THE FOLLOWING MULTI-FUNCTION DIGITAL CAM-
ERAS AND DIGITAL CAMCORDERS (U.S. CLS. 21, 23,
26, 36 AND 38).

FIRST USE 1-10-2002; IN COMMERCE 1-10-2002.
SOPHIA S. KIM, EXAMINING ATTORNEY

CLASS 9—(Continued).

SN 76-468,883. GARDEROS SOFTWARE INNOVATIONS GMBH, D-81677 MUNICH, FED REP GERMANY, FILED 11-21-2002.



PRIORITY CLAIMED UNDER SEC. 44(D) ON ERPN CMNTY TM OFC APPLICATION NO. 002834703, FILED 8-27-2002, REG. NO. 002834703, DATED 4-6-2004, EXPIRES 8-27-2012.

FOR DATA PROCESSORS AND COMPUTERS; COMPUTER NETWORKS, NAMELY, ROUTERS, SERVERS, CABLES, CONNECTORS, SOCKETS AND SWITCHES; SCANNERS; DATA SWITCHERS; COMPUTER HARDWARE AND COMPUTER NETWORKING HARDWARE; WIRELESS HARDWARE; AUDIO SPEAKERS; MICROPHONES; HEADPHONES; COMPUTER SOFTWARE FOR PROVIDING HIGH SPEED ACCESS TO AREA NETWORKS AND TO A GLOBAL COMPUTER INFORMATION NETWORK, FOR PROVIDING MULTIPLE USER DIAL-UP AND DEDICATED ACCESS TO THE INTERNET, AND FOR PROVIDING MULTIPLE-USER ACCESS TO A GLOBAL COMPUTER INFORMATION NETWORK; COMPUTER SOFTWARE FOR ACCOUNTING SERVICES AND BILL PAYMENT SERVICES (U.S. CLS. 21, 23, 26, 36 AND 38).

STEPHANIE DAVIS, EXAMINING ATTORNEY

SN 76-484,366. DAIWOO LUCOMS CO., LTD., YEONG-DEUNGPO-GU, SEOUL, REPUBLIC OF KOREA, FILED 1-22-2003.



FOR COMPUTER MONITORS; ELECTRON TUBES, NAMELY CATHODE RAY TUBES; VIDEO SCREENS; VIDEO GAME MACHINE FOR USE WITH TELEVISION RECEIVERS; COMPUTER PRINTERS; MODEMS; CD-ROM DRIVES; COMPUTER SOFTWARE FOR OPERATION OF COMPUTER MONITORS, VIDEO SCREENS, TELEVISION RECEIVERS, COMPUTER PRINTERS, MODEMS, AND CD-ROM DRIVES; INTEGRATED CIRCUITS; ELECTRONIC PAPER, NAMELY, DISPLAY DEVICES MADE OF FILM FOR DISPLAYING ELECTRONIC PUBLICATIONS; INVERTERS; ELECTRIC CALCULATORS; AND EYE-PROTECTION APPARATUS FOR USE WITH DISPLAY DEVICES, NAMELY ANTIDAZZLE SHADES (U.S. CLS. 21, 23, 26, 36 AND 38).

DOUGLAS LEE, EXAMINING ATTORNEY

CLASS 9—(Continued).

SN 76-500,508. AMERICAN GIRL, LLC, EL SEGUNDO, CA, FILED 2-14-2003.

AMERICAN GIRL

OWNER OF U.S. REG. NOS. 1,506,148, 2,673,224 AND OTHERS.

FOR PRE-RECORDED AUDIO TAPES FEATURING FICTIONAL STORIES FOR CHILDREN IN THE FIELD OF HISTORICAL MYSTERIES (U.S. CLS. 21, 23, 26, 36 AND 38).

FIRST USE 3-31-2003; IN COMMERCE 3-31-2003.

JOHN SCHUYLER YARD, EXAMINING ATTORNEY

SN 76-509,039. FINE POINT TECHNOLOGIES, INC., NEW YORK, NY, FILED 4-23-2003.

SELF-REPAIR TECHNICIAN

NO CLAIM IS MADE TO THE EXCLUSIVE RIGHT TO USE SELF-REPAIR, APART FROM THE MARK AS SHOWN.

FOR COMPUTER SOFTWARE USED FOR CONFIGURING A COMPUTER TO ACCESS A NETWORK (U.S. CLS. 21, 23, 26, 36 AND 38).

JOHN HWANG, EXAMINING ATTORNEY

SN 76-514,191. GN RESOUND A/S, 2630 TAASTRUP, DENMARK, FILED 5-14-2003.

BELTONE TOOLKIT

PRIORITY CLAIMED UNDER SEC. 44(D) ON DENMARK APPLICATION NO. VA200301429, FILED 4-10-2003, REG. NO. VR200301496, DATED 5-1-2003, EXPIRES 5-1-2013.

NO CLAIM IS MADE TO THE EXCLUSIVE RIGHT TO USE "TOOLKIT", APART FROM THE MARK AS SHOWN.

FOR COMPUTER SOFTWARE FOR APPLICATION IN THE FIELD OF AUDIOLOGY FOR THE PURPOSE OF TESTING, MEASURING, CALIBRATING, SIGNALING, ADJUSTING, CONTROLLING AND FITTING HEARING AIDS AND AUDIOLOGICAL TESTING OF PERSONS BY AUDIOLOGY TECHNICIANS AND SPECIALISTS (U.S. CLS. 21, 23, 26, 36 AND 38).

ROBERT LAVACHE, EXAMINING ATTORNEY

SN 76-524,347. WISDOMWORKS MINISTRIES, INC., IRVING, TX, FILED 6-20-2003.

WISDOMWORKS

FOR PRE-RECORDED VIDEO TAPES, PRE-RECORDED AUDIO TAPES, CDS, CD-ROMS, DVDS, MULTIMEDIA SOFTWARE RECORDED ON CD-ROMS, AND DOWNLOADABLE AUDIO AND VIDEO RECORDINGS, ALL IN THE FIELDS OF CHRISTIANITY, RELIGION, THEOLOGY, SPIRITUALITY, ETHICS, VALUES, CULTURAL AND SOCIAL ISSUES, FAMILY, RELATIONSHIPS, YOUTH CULTURE, POETRY, SPORTS, MOVIES, AND MUSIC (U.S. CLS. 21, 23, 26, 36 AND 38).

FIRST USE 0-0-1997; IN COMMERCE 0-0-1997.

SCOTT OSLICK, EXAMINING ATTORNEY

CLASS 9—(Continued).

SN 76-534,395. MESTRA AG, CH-4153 REINACH, SWITZERLAND, FILED 8-1-2003.

MEMOSENS

OWNER OF SWITZERLAND REG. NO. 510049, DATED 5-21-2001, EXPIRES 5-21-2011.

FOR AMPEROMETRIC SENSORS FOR SENSING THE CONCENTRATION OF DISSOLVED GASSES IN FLUIDS; AMPEROMETRIC TRANSMITTERS FOR SENSING THE CONCENTRATION OF DISSOLVED GASSES IN FLUIDS; POTENTIOMETRIC SENSORS FOR SENSING PH OR OXIDATION-REDUCTION-POTENTIALS; POTENTIOMETRIC TRANSMITTERS FOR SENSING PH OR OXIDATION-REDUCTION-POTENTIALS; DIGITAL POTENTIOMETRIC SENSORS FOR SENSING PH OR OXIDATION-REDUCTION-POTENTIALS AND TRANSMITTERS; DIGITAL SENSOR FOR SENSING PARAMETERS OF FLUIDS, NAMELY, PH, OXIDATION REDUCTION POTENTIAL, CARBON DIOXIDE CONTENTS TOTAL ORGANIC CONTENTS, TURBIDITY, OXYGEN CONTENT, CHLORINE CONTENT, ACETIC ACID CONTENT, NITRATE CONTENT, CONDUCTIVITY, BIOLOGICAL OXYGEN DEMAND, CHEMICAL OXYGEN DEMAND, TEMPERATURE, OR PRESSURE, COMPRISING A CONNECTOR PLUG WITH INDUCTIVE COUPLING FOR THE TRANSMISSION OF MEASURED DATA, NAMELY, THE MEASURED VALUE OF THE RESPECTIVE SENSED PARAMETER, FOR USE IN THE FIELDS OF INDUSTRIAL PROCESS AUTOMATION, WATER ANALYSIS, ENVIRONMENTAL ANALYSIS, WASTE WATER TREATMENT, BREWERIES, FOOD PROCESSING, CHEMICAL PROCESSING, PHARMACEUTICAL PROCESSING, AND PETROCHEMICAL PROCESSING, RESPECTIVELY; ELECTRONIC SEMICONDUCTOR MEMORY MODULE FOR STORING SENSOR PARAMETERS, CALIBRATION DATA, AND DATA OF ELECTRONIC SIGNATURES; INTERCONNECTING ELECTRICAL CABLE; INTERCONNECTING ELECTRICAL CABLES FOR PROVIDING A GALVANICALLY ISOLATED CONNECTION BETWEEN SENSORS FOR MEASURING PH-VALUES AND OTHER ELECTROCHEMICAL POTENTIALS, ANALYZING DEVICES, NAMELY MEASURING TRANSMITTERS FOR MEASURING PARAMETERS OF FLUIDS, NAMELY, PH, OXIDATION REDUCTION POTENTIAL, CARBON DIOXIDE CONTENTS TOTAL ORGANIC CONTENTS, TURBIDITY, OXYGEN CONTENT, CHLORINE CONTENT, ACETIC ACID CONTENT, NITRATE CONTENT, CONDUCTIVITY, BIOLOGICAL OXYGEN DEMAND, CHEMICAL OXYGEN DEMAND, TEMPERATURE, OR PRESSURE, COMPRISING A CONNECTOR PLUG WITH INDUCTIVE COUPLING FOR THE TRANSMISSION OF MEASURED DATA, NAMELY, THE MEASURED VALUE OF THE RESPECTIVE SENSED PARAMETER, FOR USE IN THE FIELDS OF INDUSTRIAL PROCESS AUTOMATION, WATER ANALYSIS, ENVIRONMENTAL ANALYSIS, WASTE WATER TREATMENT, BREWERIES, FOOD PROCESSING, CHEMICAL PROCESSING, PHARMACEUTICAL PROCESSING, AND PETROCHEMICAL PROCESSING, RESPECTIVELY, AND PERSONAL COMPUTERS; INTERCONNECTION COMPUTER CABLES FOR PROVIDING CONNECTION FOR DIGITIZED ANALOG SIGNALS (U.S. CLS. 21, 23, 26, 36 AND 38).

SUELLEN HICKEY, EXAMINING ATTORNEY

CLASS 9—(Continued).

SN 76-546,257. PROXIMA TECHNOLOGY, LTD., BERKSHIRE, ENGLAND, UNITED KINGDOM, FILED 9-22-2003.

CENTAURI BUSINESS SERVICE MANAGER

NO CLAIM IS MADE TO THE EXCLUSIVE RIGHT TO USE "BUSINESS SERVICE MANAGER", APART FROM THE MARK AS SHOWN.

FOR COMPUTER SOFTWARE FOR MONITORING, REPORTING AND MANAGING THE PERFORMANCE OF OTHER COMPUTER SYSTEMS USED IN IT AND DATA PROCESSING APPLICATIONS, NAMELY GENERATING PERFORMANCE DATA RELATING TO THE OPERATION OF THOSE COMPUTER SYSTEMS, REPORTING THE DATA TO THE USER OF THE COMPUTER SOFTWARE, AND MANAGING THE OPERATION OF THE OTHER COMPUTER SYSTEMS BASED ON THE DATA (U.S. CLS. 21, 23, 26, 36 AND 38).

TONI HICKEY, EXAMINING ATTORNEY

SN 76-551,302. UNITED AUTOCOMP COMPUTER, INC., SANTA ANA, CA. FILED 10-9-2003.

DealerClick
The Complete Solution for the Automotive Industry

NO CLAIM IS MADE TO THE EXCLUSIVE RIGHT TO USE "SOLUTION FOR THE AUTOMOTIVE INDUSTRY", APART FROM THE MARK AS SHOWN.

THE COLORS RED AND BLUE ARE CLAIMED AS A FEATURE OF THE MARK.

THE COLOR RED APPEARS IN DEALER CLICK AND THE COLOR BLUE APPEARS IN THE WORDS THE COMPLETE SOLUTION FOR THE AUTOMOTIVE INDUSTRY.

FOR COMPUTER SOFTWARE FOR AUTO DEALERSHIPS FOR COMPUTING THE FINANCING OF PURCHASES, FOR ALLOWING COMMUNICATION BETWEEN AUTO BUYERS WITH ANY DEPARTMENT OF MOTOR VEHICLE IN THE COUNTRY, AND FOR REGISTERING AUTO BUYERS WITH ANY DEPARTMENT OF MOTOR VEHICLE IN THE COUNTRY (U.S. CLS. 21, 23, 26, 36 AND 38).

FIRST USE 1-1-1996; IN COMMERCE 1-1-2002.

ALEX KEAM, EXAMINING ATTORNEY

SN 76-554,259. MICROBRIDGE TECHNOLOGIES, INC., MONTREAL, QUEBEC, CANADA, FILED 10-27-2003.

MICROBRIDGE

THE MARK CONSISTS OF STANDARD CHARACTERS WITHOUT CLAIM TO ANY PARTICULAR FONT, STYLE, SIZE, OR COLOR.

PRIORITY CLAIMED UNDER SEC. 44(D) ON CANADA APPLICATION NO. 1,190,407, FILED 9-11-2003, REG. NO. TMA629186, DATED 12-31-2004, EXPIRES 12-31-2019.

FOR ELECTRONIC COMPONENTS, NAMELY ADJUSTABLE RESISTORS (U.S. CLS. 21, 23, 26, 36 AND 38).

RON FAIRBANKS, EXAMINING ATTORNEY

CLASS 9—(Continued).

SN 76-554,309. HEIDELBERGER DRUCKMASCHINEN AG, 69115 HEIDELBERG, FED REP GERMANY, FILED 10-24-2003.

ELDORADO

OWNER OF FED REP GERMANY REG. NO. 39549439, DATED 1-9-1996, EXPIRES 12-31-2005.

OWNER OF U.S. REG. NO. 2,258,359.

FOR TYPOGRAPHIC TYPEFACES ON MACHINE READING DATA CARRIERS, NAMELY, DISKS (U.S. CLS. 21, 23, 26, 36 AND 38).

MICHAEL LEVY, EXAMINING ATTORNEY

SN 76-555,496. UNILINE SAFETY SYSTEMS LIMITED, BROMSGROVE, WORCESTERSHIRE B60 3DU, UNITED KINGDOM, FILED 10-30-2003.

UNIRAIL

PRIORITY CLAIMED UNDER SEC. 44(D) ON UNITED KINGDOM APPLICATION NO. 2,340,295, FILED 8-12-2003, REG. NO. 2340295, DATED 1-16-2004, EXPIRES 8-12-2013.

FOR INDUSTRIAL SAFETY RAIL SYSTEM COMPRISED OF A METAL RAIL, ANCHORS AND FASTENERS FOR PROTECTING WORKERS FROM FALLING WHILST WORKING AT HEIGHTS (U.S. CLS. 21, 23, 26, 36 AND 38).

WON TEAK OH, EXAMINING ATTORNEY

SN 76-556,465. EYEKING, LLC, PLAINVIEW, NY. FILED 11-4-2003.

HYDROREFLECTIVE

FOR SUNGLASSES, SUNGLASS LENSES, OPHTHALMIC LENSES (U.S. CLS. 21, 23, 26, 36 AND 38).

LINDA MICKLEBURGH, EXAMINING ATTORNEY

CLASS 9—(Continued).

SN 76-557,618. MEYER TOOL, INC., CINCINNATI, OH. FILED 10-20-2003.



FOR ELECTRONIC DIGITAL GAUGING SYSTEM FOR USE IN THE AUTOMOTIVE AND AEROSPACE INDUSTRIES, COMPRISED OF DIGITAL DISPLAY UNITS, GAUGING PROBES, SOFTWARE AND COMPUTERS FOR USE IN INDUSTRIAL PROCESS AND INDUSTRIAL PRODUCTION MANAGEMENT APPLICATIONS INCLUDING STATISTICAL PROCESS CONTROL DATA ANALYSIS; ELECTRICAL INSTRUMENTATION, NAMELY, PROCESS MONITORS FOR CONTROLLING AND ALLOWING INPUT AND REVIEW OF INDUSTRIAL MACHINE PRODUCT AND PROCESS DATA; EQUIPMENT FOR USE IN STATISTICAL PROCESS ANALYSIS FOR CONTROLLING OPERATIONAL FUNCTIONS WITHIN INDUSTRIAL MACHINE OPERATIONS; AND PRODUCTION MONITORING EQUIPMENT FOR DATA COLLECTION AND LOGGING FOR USE IN MONITORING INDUSTRIAL MACHINE FUNCTIONS IN INDUSTRIAL PROCESSES (U.S. CLS. 21, 23, 26, 36 AND 38).

FLORENTINA BLANDU, EXAMINING ATTORNEY

SN 76-558,058. ITERIS, INC., ANAHEIM, CA. FILED 11-7-2003.

VANTAGE

THE MARK CONSISTS OF STANDARD CHARACTERS WITHOUT CLAIM TO ANY PARTICULAR FONT, STYLE, SIZE, OR COLOR.

FOR ELECTRONIC DEVICES, NAMELY, VIDEO TRAFFIC DETECTION SYSTEMS AND EQUIPMENT COMPRISED OF ANALOG OR DIGITAL OUTDOOR VIDEO CAMERAS, IMAGE PROCESSORS, VIDEO SIGNAL DISTRIBUTION DEVICES, NAMELY, SHORT-RANGE WIRELESS TRANSMITTERS AND MODEMS, AND ANCILLARY EQUIPMENT, NAMELY, VIDEO MONITORS, ELECTRICAL POWER SUPPLIES/CONVERTERS, AND INPUT/OUTPUT DISTRIBUTION PANELS TO DETECT THE PRESENCE AND MOTION CHARACTERISTICS OF VEHICLES AND TRAFFIC ON ROADWAYS AND INTERSECTIONS, AND TO PROVIDE OUTPUTS TO TRAFFIC SIGNAL CONTROLLERS (U.S. CLS. 21, 23, 26, 36 AND 38).

FIRST USE 4-0-1995; IN COMMERCE 4-0-1995.

TONJA GASKINS, EXAMINING ATTORNEY

CLASS 9—(Continued).

SN 76-558,671. DEGARMO, JAMES R, CANTON, OH. FILED 11-10-2003.

EAR BUDDY

THE MARK CONSISTS OF STANDARD CHARACTERS WITHOUT CLAIM TO ANY PARTICULAR FONT, STYLE, SIZE, OR COLOR.

NO CLAIM IS MADE TO THE EXCLUSIVE RIGHT TO USE EAR, APART FROM THE MARK AS SHOWN.

FOR WIRELESS SYSTEM NAMELY MULTIPLE TRANSMITTER, WIRELESS RECEIVER, CHARGING STATION, AND PROGRAMMABLE FREQUENCY SCANNER FOR INDIVIDUALLY LISTENING TO TV OR OTHER AUDIO (U.S. CLS. 21, 23, 26, 36 AND 38).

MARY I. SPARROW, EXAMINING ATTORNEY

CLASS 9—(Continued).

SN 76-568,016. JETPUBS INC., EAGAN, MN. FILED 12-31-2003.

JETPUBS

THE MARK CONSISTS OF STANDARD CHARACTERS WITHOUT CLAIM TO ANY PARTICULAR FONT, STYLE, SIZE, OR COLOR.

FOR INTERACTIVE TRAINING SOFTWARE FOR THE AVIATION INDUSTRY FOR SIMULATING FLIGHT OPERATIONS AND PROBLEMS IN GROUND SERVICES, MAINTENANCE, AND AIRCRAFT SYSTEMS, AND PROVIDING INSTRUCTION REGARDING REGULATIONS, AIRSPACE, AND FLIGHT ATTENDANT SERVICES; ELECTRONIC PUBLICATIONS RECORDED ON COMPUTER MEDIA IN THE NATURE OF MANUALS FOR USE IN AIRPLANES OR AVIATION, NAMELY, FLIGHT OPERATIONS, AIRCRAFT SYSTEMS, AIRLINE POLICIES AND PROCEDURES, AND FLIGHT STANDARDS; AND FLIGHT SIMULATION SOFTWARE USED IN TRAINING WITH THREE-DIMENSIONAL STATIC COCKPIT DISPLAYS AND COCKPIT LAYOUT POSTERS (U.S. CLS. 21, 23, 26, 36 AND 38).

FIRST USE 7-0-2003; IN COMMERCE 7-0-2003.

CATHERINE CAIN, EXAMINING ATTORNEY

SN 76-566,428. AGILQUEST CORPORATION, RICHMOND, VA. FILED 12-22-2003.

IPPI

THE MARK CONSISTS OF STANDARD CHARACTERS WITHOUT CLAIM TO ANY PARTICULAR FONT, STYLE, SIZE, OR COLOR.

FOR COMPUTER INTERFACE SOFTWARE FOR USE IN CONNECTING INTERNET PROTOCOL TELEPHONES TO RESOURCE MANAGEMENT APPLICATIONS SOFTWARE (U.S. CLS. 21, 23, 26, 36 AND 38).

FIRST USE 9-3-2003; IN COMMERCE 9-3-2003.

SAMUEL E. SHARPER JR., EXAMINING ATTORNEY

SN 76-570,197. OKIOK DATA LTEE, LAVAL (QUÉBEC) H7T 1B7, QUÉBEC, FILED 1-15-2004.

GLOBAL TRUST

THE MARK CONSISTS OF STANDARD CHARACTERS WITHOUT CLAIM TO ANY PARTICULAR FONT, STYLE, SIZE, OR COLOR.

PRIORITY CLAIMED UNDER SEC. 44(D) ON CANADA APPLICATION NO. 1200032, FILED 12-18-2003, REG. NO. TMA634003, DATED 3-1-2005, EXPIRES 3-1-2020.

FOR ACCESS MANAGEMENT SOFTWARE AND PERMISSION MANAGEMENT SOFTWARE THAT SETS THE GROUND RULES FOR WEB-BASED ACCESS TO DATA AND APPLICATIONS, DESIGNED TO PROTECT AND SECURE WEB SERVICES AND WEB-BASED APPLICATIONS AND PORTALS BY MANAGING IDENTITIES AND SECURING, THROUGH THE ENFORCEMENT OF ROLE BASED POLICIES, AUTHENTICATION, AUTHORIZATION, AUDITING AND PRIVACY (U.S. CLS. 21, 23, 26, 36 AND 38).

KARANENDRA S. CHHINA, EXAMINING ATTORNEY

CLASS 9—(Continued).

SN 76-574,862. WEST-COM NURSE CALL SYSTEMS, INC., DANVILLE, CA. FILED 2-10-2004.

REVOLUTIONIZING THE PATIENT CARE ENVIRONMENT

THE MARK CONSISTS OF STANDARD CHARACTERS WITHOUT CLAIM TO ANY PARTICULAR FONT, STYLE, SIZE, OR COLOR.

FOR ELECTRONIC HEALTHCARE COMMUNICATIONS SYSTEMS, INSTRUMENTS AND COMPONENTS ALL SOLD AS A UNIT FOR MONITORING PATIENT REQUESTS, NAMELY INTERCOMS, ELECTRONIC NURSE CALLS IN THE NATURE OF CALL BELLS, LIGHT SIGNALS AND LIGHT PANELS FOR MONITORING PATIENTS AT A CENTRAL STATION, PAGERS, SPEAKERS, PULL CORDS, ALARMS, INFRARED SENSORS FOR MONITORING PATIENT MOVEMENT AND TOUCH SCREEN COMPUTER SOFTWARE FOR MONITORING ALL OF THE ABOVE COMPONENTS USED IN HOSPITALS, NURSING HOMES AND HEALTHCARE FACILITIES (U.S. CLS. 21, 23, 26, 36 AND 38).

FIRST USE 2-0-2003; IN COMMERCE 2-0-2003.
GINNY ISAACSON, EXAMINING ATTORNEY

SN 76-579,466. MY GIANT WORLD CORP., OVERLAND PARK, KS. FILED 3-5-2004.



FOR PRERECORDED VIDEO TAPES AND DISCS FEATURING EDUCATIONAL THEMES FOR INFANTS (U.S. CLS. 21, 23, 26, 36 AND 38).

FIRST USE 3-2-2004; IN COMMERCE 3-2-2004.
ANNE MADDEN, EXAMINING ATTORNEY

SN 76-582,308. MEASUREMENT COMPUTING CORPORATION, AUSTIN, TX. FILED 3-22-2004.

TRACERDAQ

THE MARK CONSISTS OF STANDARD CHARACTERS WITHOUT CLAIM TO ANY PARTICULAR FONT, STYLE, SIZE, OR COLOR.

FOR COMPUTER HARDWARE AND SOFTWARE USED FOR DATA LOGGER AND CHART RECORDER APPLICATIONS (U.S. CLS. 21, 23, 26, 36 AND 38).

FIRST USE 1-0-2004; IN COMMERCE 3-11-2004.
ROBERT COGGINS, EXAMINING ATTORNEY

CLASS 9—(Continued).

SN 76-584,234. SONY COMPUTER ENTERTAINMENT INC., MINATO-KU, TOKYO, JAPAN, FILED 3-31-2004.

TALKMAN

THE MARK CONSISTS OF STANDARD CHARACTERS WITHOUT CLAIM TO ANY PARTICULAR FONT, STYLE, SIZE, OR COLOR.

FOR COMPUTER GAME SOFTWARE AND VIDEO GAME SOFTWARE; RECORDING MEDIA, NAMELY, PRERECORDED MAGNETIC DISCS, PRERECORDED OPTICAL DISCS AND PRERECORDED MEMORY CARDS CONTAINING LANGUAGE GAMES AND TRANSLATIONS DESIGNED TO FACILITATE LEARNING A FOREIGN LANGUAGE; COMPUTER PROGRAMS FOR PRERECORDED GAMES (U.S. CLS. 21, 23, 26, 36 AND 38).

MIDGE BUTLER, EXAMINING ATTORNEY

SN 76-584,993. DESA IP, LLC, MIAMI, FL. FILED 3-31-2004.



NO CLAIM IS MADE TO THE EXCLUSIVE RIGHT TO USE "360° DETECTION ZONE", APART FROM THE MARK AS SHOWN.

THE LINING IS A FEATURE OF THE MARK. FOR MOTION-SENSING SECURITY LIGHTS (U.S. CLS. 21, 23, 26, 36 AND 38).

FIRST USE 12-0-2002; IN COMMERCE 12-0-2002.
CATHERINE CAIN, EXAMINING ATTORNEY

CLASS 9—(Continued).

SN 76-584,994. DESA IP, LLC, MIAMI, FL. FILED 3-31-2004.



NO CLAIM IS MADE TO THE EXCLUSIVE RIGHT TO USE "240° DETECTION ZONE RANGE BOOSTER", APART FROM THE MARK AS SHOWN.

THE LINING IS A FEATURE OF THE MARK. FOR MOTION-SENSING SECURITY LIGHTS (U.S. CLS. 21, 23, 26, 36 AND 38).

FIRST USE 12-0-2002; IN COMMERCE 12-0-2002. CATHERINE CAIN, EXAMINING ATTORNEY

SN 76-584,995. DESA IP, LLC, MIAMI, FL. FILED 3-31-2004.



NO CLAIM IS MADE TO THE EXCLUSIVE RIGHT TO USE "180° DETECTION ZONE", APART FROM THE MARK AS SHOWN.

THE LINING IS A FEATURE OF THE MARK. FOR MOTION-SENSING SECURITY LIGHTS (U.S. CLS. 21, 23, 26, 36 AND 38).

FIRST USE 12-0-2002; IN COMMERCE 12-0-2002. CATHERINE CAIN, EXAMINING ATTORNEY

CLASS 9—(Continued).

SN 76-585,117. ARTHUR, BEN, NEW YORK, NY. FILED 4-5-2004.

BEN ARTHUR

THE MARK CONSISTS OF STANDARD CHARACTERS WITHOUT CLAIM TO ANY PARTICULAR FONT, STYLE, SIZE, OR COLOR.

FOR SERIES OF MUSICAL RECORDINGS AND PRE-RECORDED VIDEOS FEATURING, PERFORMANCES OF MUSICAL ARTIST OR GROUP; DOWNLOADABLE MUSICAL SOUND RECORDINGS (U.S. CLS. 21, 23, 26, 36 AND 38).

FIRST USE 1-1-1993; IN COMMERCE 1-1-1997. STEVEN JACKSON, EXAMINING ATTORNEY

SN 76-585,728. ERL, LLC, LANSING, MI. FILED 4-8-2004.

ERLTHINK

THE MARK CONSISTS OF STANDARD CHARACTERS WITHOUT CLAIM TO ANY PARTICULAR FONT, STYLE, SIZE, OR COLOR.

FOR COMPUTER SOFTWARE, NAMELY A COMPONENT OF SOFTWARE DESCRIBING THE LOGIC THAT IS USED TO CALCULATE COMFORTABLE POSTURES FOR AN ERGONOMIC TASK (U.S. CLS. 21, 23, 26, 36 AND 38).

FIRST USE 10-1-2003; IN COMMERCE 10-1-2003. ALICIA COLLINS, EXAMINING ATTORNEY

SN 76-585,773. FIELD, PATRICIA, NEW YORK, NY. FILED 4-8-2004.

PATRICIA FIELD

THE MARK CONSISTS OF STANDARD CHARACTERS WITHOUT CLAIM TO ANY PARTICULAR FONT, STYLE, SIZE, OR COLOR.

OWNER OF U.S. REG. NO. 2,898,610. THE NAME(S), PORTRAIT(S), AND/OR SIGNATURE(S) SHOWN IN THE MARK IDENTIFIES PATRICIA FIELD, WHOSE CONSENT(S) TO REGISTER IS SUBMITTED.

FOR EYEWEAR, NAMELY, GLASSES, SUNGLASSES, EYEGLASSES, AND READING GLASSES (U.S. CLS. 21, 23, 26, 36 AND 38).

STANLEY I. OSBORNE, EXAMINING ATTORNEY

CLASS 9—(Continued).

SN 76-587,878. MAZZY STAR, ENCINO, CA. FILED 4-21-2004.

MAZZY STAR

THE MARK CONSISTS OF STANDARD CHARACTERS WITHOUT CLAIM TO ANY PARTICULAR FONT, STYLE, SIZE, OR COLOR.

THE NAME "MAZZY STAR" DOES NOT IDENTIFY A LIVING INDIVIDUAL.

FOR SOUND RECORDINGS; NAMELY, PRE-RECORDED PHONOGRAPH RECORDS, AUDIO TAPES, COMPACT DISCS, VIDEOTAPES, VIDEO CASSETTE TAPES, DIGITAL AUDIO TAPES, COMPACT VIDEO DISCS, AUDIO AND VIDEO TAPES, COMPACT DISC AND DIGITAL VIDEO DISCS (DVDs) FORMATTED FOR TELEVISION USE, MOTION PICTURE FILM AND LASER DISCS FEATURING MUSIC ENTERTAINMENT (U.S. CLS. 21, 23, 26, 36 AND 38).

FIRST USE 12-31-1990; IN COMMERCE 12-31-1990.
KATHERINE STOIDES, EXAMINING ATTORNEY

SN 76-588,921. TAKE-TWO INTERACTIVE SOFTWARE, INC., NEW YORK, NY. FILED 4-27-2004.

TAKE2

THE MARK CONSISTS OF STANDARD CHARACTERS WITHOUT CLAIM TO ANY PARTICULAR FONT, STYLE, SIZE, OR COLOR.

FOR COMPUTER GAME SOFTWARE; ELECTRONIC GAME PROGRAMS; VIDEO GAME DISKS AND CARTRIDGES (U.S. CLS. 21, 23, 26, 36 AND 38).

RON FAIRBANKS, EXAMINING ATTORNEY

SN 76-590,645. DRIKTECH, LLC, FARMINGTON HILLS, MI. FILED 5-3-2004.

DRIKXL

THE MARK CONSISTS OF STANDARD CHARACTERS WITHOUT CLAIM TO ANY PARTICULAR FONT, STYLE, SIZE, OR COLOR.

FOR ENGINEERED PRODUCTS, NAMELY, COMPUTER-OPERATED PROCESS CONTROLS (U.S. CLS. 21, 23, 26, 36 AND 38).

C. DIONNE CLYBURN, EXAMINING ATTORNEY

CLASS 9—(Continued).

SN 76-591,593. CANON KABUSHIKI KAISHA, OHTA-KU, TOKYO, JAPAN, FILED 5-11-2004.

PICTCELLAR

THE MARK CONSISTS OF STANDARD CHARACTERS WITHOUT CLAIM TO ANY PARTICULAR FONT, STYLE, SIZE, OR COLOR.

FOR MULTI-FUNCTION DEVICES FOR RECORDING, EDITING, PLAYBACK AND PRINTING OF IMAGE DATA, NAMELY, DIGITAL DEVICES WHICH PERMIT DOWNLOADING, STORAGE, VIEWING, EDITING, AND PRINTING OF PHOTOS AND VIDEO, AND TRANSFER OF PHOTOS AND VIDEO FROM THE DEVICE TO A MEMORY CARD OR COMPUTER (U.S. CLS. 21, 23, 26, 36 AND 38).

BRIAN PINO, EXAMINING ATTORNEY

SN 76-592,058. TELVUE CORPORATION, MT. LAUREL, NJ. FILED 5-13-2004.

WEBUS

THE MARK CONSISTS OF STANDARD CHARACTERS WITHOUT CLAIM TO ANY PARTICULAR FONT, STYLE, SIZE, OR COLOR.

FOR COMPUTER SOFTWARE TO MANAGE, UPDATE AND SYNCHRONIZE INFORMATION AT A REMOTE SITE WITH INFORMATION STORED IN A CENTRAL DATABASE (U.S. CLS. 21, 23, 26, 36 AND 38).

FIRST USE 8-5-2003; IN COMMERCE 8-5-2003.

DOMINIC J. FERRAIUOLO, EXAMINING ATTORNEY

SN 76-592,399. SONY KABUSHIKI KAISHA, TA SONY CORPORATION, TOKYO, JAPAN, FILED 5-14-2004.

SUPER XTRA POWER

THE MARK CONSISTS OF STANDARD CHARACTERS WITHOUT CLAIM TO ANY PARTICULAR FONT, STYLE, SIZE, OR COLOR.

NO CLAIM IS MADE TO THE EXCLUSIVE RIGHT TO USE "EXTRA POWER", APART FROM THE MARK AS SHOWN.

FOR BATTERIES (U.S. CLS. 21, 23, 26, 36 AND 38).

LINDA MICKLEBURGH, EXAMINING ATTORNEY

CLASS 9—(Continued).

SN 76-592,456. SANFORD SYSTEMS, INC., WILDOMAR, CA.
FILED 5-17-2004.

INSPECT

THE MARK CONSISTS OF STANDARD CHARACTERS WITHOUT CLAIM TO ANY PARTICULAR FONT, STYLE, SIZE, OR COLOR.

FOR ELECTRONIC DATABASE IN THE FIELD OF EDUCATION WHICH INCLUDES ITEMS DESIGNED TO TEST STUDENT KNOWLEDGE AND APTITUDE IN CONFORMITY WITH VARIOUS STANDARDS RECORDED ON COMPUTER MEDIA (U.S. CLS. 21, 23, 26, 36 AND 38).

FIRST USE 5-1-2004; IN COMMERCE 5-1-2004.
BRIDGETT SMITH, EXAMINING ATTORNEY

SN 76-593,559. SANUK TECHNOLOGY INTERNATIONAL CORPORATION, GREAT FALLS, VA. FILED 5-24-2004.

RDK

THE MARK CONSISTS OF STANDARD CHARACTERS WITHOUT CLAIM TO ANY PARTICULAR FONT, STYLE, SIZE, OR COLOR.

FOR COMPUTER SOFTWARE THAT IMPLEMENTS A WIZARD FOR CREATING CONNECTORS TO SENSOR-BASED DEVICES, SUCH AS MOTES AND RFID READERS THAT ARE THEN INTEGRATED INTO COMPUTER SOFTWARE FOR COLLECTION, STORAGE AND DISTRIBUTION OF EPC TAG DATA (U.S. CLS. 21, 23, 26, 36 AND 38).

BRIDGETT SMITH, EXAMINING ATTORNEY

SN 76-593,675. FIRESTAR SOFTWARE, INC., ACTON, MA.
FILED 5-24-2004.

OBJECTSPARK

THE MARK CONSISTS OF STANDARD CHARACTERS WITHOUT CLAIM TO ANY PARTICULAR FONT, STYLE, SIZE, OR COLOR.

FOR COMPUTER SOFTWARE FOR DATA SERVICES MANAGEMENT, NAMELY SOFTWARE FOR CONNECTING AND INTEGRATING APPLICATIONS TO MULTIPLE DATA SOURCES FOR USE IN DISTRIBUTED COMPUTING (U.S. CLS. 21, 23, 26, 36 AND 38).

FIRST USE 6-0-2000; IN COMMERCE 9-0-2000.
EUGENIA MARTIN, EXAMINING ATTORNEY

CLASS 9—(Continued).

SN 76-594,232. THQ WIRELESS INC., CALABASAS HILLS, CA. FILED 5-21-2004.



OWNER OF U.S. REG. NOS. 1,744,660, 2,614,259 AND OTHERS.

NO CLAIM IS MADE TO THE EXCLUSIVE RIGHT TO USE "WIRELESS", APART FROM THE MARK AS SHOWN.

THE MARK CONSISTS OF THE LETTERS THQ IN STYLIZED TYPE APPEARING ON A PARALLELOGRAM BACKGROUND. THE STYLIZED LETTERS THQ ARE UNDERLINED BY A LINE ON THE PARALLELOGRAM BACKGROUND. BELOW, THE LETTERS WIRELESS IN STYLIZED TYPE APPEAR PARTIALLY SURROUNDED BY A CRESCENT SHAPE.

FOR COMPUTER SOFTWARE FOR ELECTRONIC GAMES AND ENTERTAINMENT, NAMELY, COMPUTER GAME SOFTWARE USED AND PLAYED ON MOBILE AND CELLULAR TELEPHONES, HANDHELD COMPUTERS, PERSONAL COMPUTERS AND PERSONAL DIGITAL ASSISTANTS; COMPUTER SOFTWARE THAT IS DOWNLOADABLE FROM A REMOTE COMPUTER SITE, NAMELY, ELECTRONIC GAME PROGRAMS, RING TONES AND VOICE RINGERS FOR MOBILE TELECOMMUNICATIONS DEVICES, WALL PAPERS, SCREEN SAVERS, ANIMATED IMAGES AND PROGRAMS FOR DOWNLOADING IMAGES; AND COMPUTER SOFTWARE FOR USE IN THE DESIGN, DEVELOPMENT AND EXECUTION OF WIRELESS COMPUTER GAMES (U.S. CLS. 21, 23, 26, 36 AND 38).

KELLY BOULTON, EXAMINING ATTORNEY

SN 76-594,863. CREATIVE PRODUCTS TECHNOLOGY (H.K.) LTD., KWUN TONG, KOWLOON, HONG KONG, FILED 6-1-2004.

Digi↑Comp

FOR THERMOMETERS, HYGROMETERS, COMPASSES, MARINE COMPASSES, DYNAMOMETERS, PYROMETERS, DETECTORS, NAMELY, SMOKE DETECTORS AND GAS DETECTORS FOR DETECTING THE PRESENCE OF GAS (U.S. CLS. 21, 23, 26, 36 AND 38).

DOMINICK J. SALEMI, EXAMINING ATTORNEY

CLASS 9—(Continued).

SN 76-596,032. RICOH COMPANY, LTD., OHTA-KU, TOKYO, JAPAN, FILED 6-7-2004.

SCANROUTER INPUT OPTION

THE MARK CONSISTS OF STANDARD CHARACTERS WITHOUT CLAIM TO ANY PARTICULAR FONT, STYLE, SIZE, OR COLOR.

OWNER OF U.S. REG. NOS. 2,848,279 AND 2,897,676.

NO CLAIM IS MADE TO THE EXCLUSIVE RIGHT TO USE "INPUT OPTION", APART FROM THE MARK AS SHOWN.

FOR COMPUTER SOFTWARE FOR CONTROLLING INPUT FUNCTION AND ENTRY FUNCTION FOR USE IN STORING, SENDING, IMPORTING AND EXPORTING DOCUMENT FILES FROM PAPER DOCUMENT VIA SCANNER TO IMAGE DOCUMENT ON A COMPUTER NETWORK, COMPUTER SOFTWARE WHICH STORES, RETRIEVES, PRINTS, SENDS, DISTRIBUTES, IMPORTS AND EXPORTS DOCUMENT FILES FOR MANAGEMENT OF DOCUMENTS FROM PAPER DOCUMENT VIA SCANNER TO IMAGE DOCUMENT ON A COMPUTER NETWORK (U.S. CLS. 21, 23, 26, 36 AND 38).

ANDREW RHIM, EXAMINING ATTORNEY

SN 76-596,433. ADVANCED LIGHTING TECHNOLOGIES, INC., SOLON, OH. FILED 6-9-2004.

SMART IGNITOR

FOR ELECTRIC AND ELECTRONIC COMPONENTS FOR OPERATING LAMPS, NAMELY, STARTING CIRCUITS FOR HIGH INTENSITY DISCHARGE LAMPS (U.S. CLS. 21, 23, 26, 36 AND 38).

WANDA KAY PRICE, EXAMINING ATTORNEY

SN 76-596,486. REDCOM LABORATORIES, INC., VICTOR, NY. FILED 6-10-2004.

TELETRAFFIC GENERATOR

THE MARK CONSISTS OF STANDARD CHARACTERS WITHOUT CLAIM TO ANY PARTICULAR FONT, STYLE, SIZE, OR COLOR.

NO CLAIM IS MADE TO THE EXCLUSIVE RIGHT TO USE GENERATOR, APART FROM THE MARK AS SHOWN.

FOR APPARATUS FOR LOAD TESTING TELEPHONE SWITCHING SYSTEMS, NAMELY A TEST INSTRUMENT FOR GENERATING MANY TELEPHONE CALLS TO A TELEPHONE SWITCHING SYSTEM UNDER TEST, AND VERIFYING THE RESULTS TO ASSURE PROPER OPERATION OF THE SWITCH (U.S. CLS. 21, 23, 26, 36 AND 38).

FIRST USE 6-20-1980; IN COMMERCE 6-20-1980.

BRIAN NEVILLE, EXAMINING ATTORNEY

CLASS 9—(Continued).

SN 76-596,489. REDCOM LABORATORIES, INC., VICTOR, NY. FILED 6-10-2004.

TOLL-GATE

THE MARK CONSISTS OF STANDARD CHARACTERS WITHOUT CLAIM TO ANY PARTICULAR FONT, STYLE, SIZE, OR COLOR.

FOR COMPUTER SOFTWARE AND HARDWARE OPERATED BY SOFTWARE, WHICH HARDWARE AND SOFTWARE IS AN ADJUNCT TO A TELEPHONE SWITCHING SYSTEM FOR A TELEPHONE EXCHANGE WHICH PROVIDES OPERATOR SERVICES AND BILLING FOR OPERATOR ASSISTED CALLS (U.S. CLS. 21, 23, 26, 36 AND 38).

FIRST USE 5-3-1994; IN COMMERCE 1-22-1995.

BRIAN NEVILLE, EXAMINING ATTORNEY

SN 76-596,797. MAC S.A., YUMBO-VALLE, COLOMBIA, FILED 6-14-2004.

MAC BATTERIES

THE MARK CONSISTS OF STANDARD CHARACTERS WITHOUT CLAIM TO ANY PARTICULAR FONT, STYLE, SIZE, OR COLOR.

NO CLAIM IS MADE TO THE EXCLUSIVE RIGHT TO USE "BATTERIES", APART FROM THE MARK AS SHOWN. FOR AUTOMOTIVE BATTERIES (U.S. CLS. 21, 23, 26, 36 AND 38).

INGRID C. EULIN, EXAMINING ATTORNEY

SN 76-597,364. WILOPEN PRODUCTS, LC., DEERFIELD BEACH, FL. FILED 6-14-2004.

BIRTHDAY CARD

THE MARK CONSISTS OF STANDARD CHARACTERS WITHOUT CLAIM TO ANY PARTICULAR FONT, STYLE, SIZE, OR COLOR.

FOR MAGNETICALLY ENCODED CREDIT AND DEBIT CARDS (U.S. CLS. 21, 23, 26, 36 AND 38).

GRETTA YAO, EXAMINING ATTORNEY

CLASS 9—(Continued).

SN 76-598,322. NIGHTINGALE-CONANT CORPORATION,
NILES, IL. FILED 6-17-2004.

FAST CASH

THE MARK CONSISTS OF STANDARD CHARACTERS
WITHOUT CLAIM TO ANY PARTICULAR FONT, STYLE,
SIZE, OR COLOR.

FOR SOUND RECORDED COMPACT DISCS AND
WORK BOOKS, ALL SOLD AS A UNIT, CONCERNING
DEVELOPMENT OF AN ON-LINE AUCTION BUSINESS
(U.S. CLS. 21, 23, 26, 36 AND 38).

FIRST USE 3-0-2004; IN COMMERCE 3-0-2004.
WON TEAK OH, EXAMINING ATTORNEY

SN 76-598,892. ROVING PLANET, INC., WESTMINSTER, CO.
FILED 6-23-2004.

ROVING PLANET

THE MARK CONSISTS OF STANDARD CHARACTERS
WITHOUT CLAIM TO ANY PARTICULAR FONT, STYLE,
SIZE, OR COLOR.

NO CLAIM IS MADE TO THE EXCLUSIVE RIGHT TO
USE ROVING, APART FROM THE MARK AS SHOWN.

FOR COMPUTER HARDWARE AND SOFTWARE FOR
CONTROLLING, INTEGRATING AND SECURING
WIRELESS SYSTEMS (U.S. CLS. 21, 23, 26, 36 AND 38).

FIRST USE 2-20-2002; IN COMMERCE 3-1-2002.
KATHLEEN M. VANSTON, EXAMINING ATTORNEY

SN 76-599,044. OPTICAL SYSTEMS TECHNOLOGY, INC.,
FREEPORT, PA. FILED 6-24-2004.

UNIVERSAL NIGHT SIGHT

THE MARK CONSISTS OF STANDARD CHARACTERS
WITHOUT CLAIM TO ANY PARTICULAR FONT, STYLE,
SIZE, OR COLOR.

NO CLAIM IS MADE TO THE EXCLUSIVE RIGHT TO
USE NIGHT SIGHT, APART FROM THE MARK AS
SHOWN.

FOR OPTICAL SCOPES FOR FIREARMS (U.S. CLS. 21,
23, 26, 36 AND 38).

FIRST USE 9-0-2002; IN COMMERCE 9-0-2002.
TARAH HARDY, EXAMINING ATTORNEY

CLASS 9—(Continued).

SN 76-599,378. OPTICAL SYSTEMS TECHNOLOGY, INC.,
FREEPORT, PA. FILED 6-24-2004.

MAGNUM UNIVERSAL NIGHT SIGHT

THE MARK CONSISTS OF STANDARD CHARACTERS
WITHOUT CLAIM TO ANY PARTICULAR FONT, STYLE,
SIZE, OR COLOR.

NO CLAIM IS MADE TO THE EXCLUSIVE RIGHT TO
USE NIGHT SIGHT, APART FROM THE MARK AS
SHOWN.

FOR OPTICAL SCOPE FOR FIREARMS (U.S. CLS. 21,
23, 26, 36 AND 38).

FIRST USE 12-0-2003; IN COMMERCE 12-0-2003.
GIANCARLO CASTRO, EXAMINING ATTORNEY

SN 76-599,775. KONINKLIJKE PHILIPS ELECTRONICS N.V.,
EINDHOVEN, NETHERLANDS, FILED 6-28-2004.

REZI

FOR ELECTRONIC BALLAST, FOR FLUORESCENT
LIGHTING (U.S. CLS. 21, 23, 26, 36 AND 38).

PAULA MAHONEY, EXAMINING ATTORNEY

SN 76-600,239. SONY KABUSHIKI KAISHA, TA SONY
CORPORATION, SHINAGAWA-KU, TOKYO, JAPAN,
FILED 7-1-2004.

JUST EDIT

THE MARK CONSISTS OF STANDARD CHARACTERS
WITHOUT CLAIM TO ANY PARTICULAR FONT, STYLE,
SIZE, OR COLOR.

NO CLAIM IS MADE TO THE EXCLUSIVE RIGHT TO
USE "EDIT", APART FROM THE MARK AS SHOWN.

FOR AUDIO AND VIDEO EDITING SYSTEM COM-
PRISED OF A SWITCHER, AUDIO AND VIDEO DISC
PLAYER AND RECORDER, AUDIO AND VIDEO TAPE
PLAYER AND RECORDER, AUDIO/VIDEO SERVER,
HARD DISC DRIVE, SYSTEM CONTROL PANEL, COM-
PUTER HARDWARE AND APPLICATION SOFTWARE
TO OPERATE SAID SYSTEM (U.S. CLS. 21, 23, 26, 36
AND 38).

PATRICIA EVANKO, EXAMINING ATTORNEY

CLASS 9—(Continued).

SN 76-600,243. SONY KABUSHIKI KAISHA, TA SONY CORPORATION, SHINAGAWA-KU, TOKYO, JAPAN, FILED 7-1-2004.

DIGEST EDIT

THE MARK CONSISTS OF STANDARD CHARACTERS WITHOUT CLAIM TO ANY PARTICULAR FONT, STYLE, SIZE, OR COLOR.

NO CLAIM IS MADE TO THE EXCLUSIVE RIGHT TO USE "EDIT", APART FROM THE MARK AS SHOWN.

FOR AUDIO AND VIDEO EDITING SYSTEM COMPRISED OF A SWITCHER, AUDIO AND VIDEO DISC PLAYER AND RECORDER, AUDIO AND VIDEO TAPE PLAYER AND RECORDER, AUDIO/VIDEO SERVER, HARD DISC DRIVE, SYSTEM CONTROL PANEL, COMPUTER HARDWARE AND APPLICATION SOFTWARE TO OPERATE SAID SYSTEM (U.S. CLS. 21, 23, 26, 36 AND 38).

PATRICIA EVANKO, EXAMINING ATTORNEY

SN 76-600,366. ROCKIES GLOBAL MARKETING, L.L.C., ENGLEWOOD, CO. FILED 6-30-2004.

MAG-IT

FOR MAGNETIC DEVICE, NAMELY, HANDHELD DEVICE FOR ATTRACTING MAGNETIC OBJECTS, SUCH AS FILINGS (U.S. CLS. 21, 23, 26, 36 AND 38).

INGA ERVIN, EXAMINING ATTORNEY

SN 76-600,752. TOMMYCO KNEE - PADS INC., SURREY, BRITISH COLUMBIA, CANADA, FILED 7-6-2004.

GELITE

THE MARK CONSISTS OF STANDARD CHARACTERS WITHOUT CLAIM TO ANY PARTICULAR FONT, STYLE, SIZE, OR COLOR.

PRIORITY CLAIMED UNDER SEC. 44(D) ON CANADA APPLICATION NO. 1220761, FILED 6-17-2004, REG. NO. TMA638132, DATED 4-22-2005, EXPIRES 4-22-2020.

FOR PROTECTIVE KNEE PADS AND PROTECTIVE KNEELING PADS FOR USE BY GARDNERS AND CONSTRUCTION WORKERS (U.S. CLS. 21, 23, 26, 36 AND 38).

AMY GEARIN, EXAMINING ATTORNEY

CLASS 9—(Continued).

SN 76-600,847. SNUBA INTERNATIONAL, INC., DIAMOND SPRINGS, CA. FILED 7-6-2004.

GO BEYOND SNORKELING

THE MARK CONSISTS OF STANDARD CHARACTERS WITHOUT CLAIM TO ANY PARTICULAR FONT, STYLE, SIZE, OR COLOR.

FOR UNDER WATER DIVING SYSTEM COMPRISED OF A FLOTATION BODY, COMPRESSED AIR CYLINDER AND TWO STAGE REGULATOR (U.S. CLS. 21, 23, 26, 36 AND 38).

FIRST USE 5-24-1988; IN COMMERCE 5-24-1988.

RON FAIRBANKS, EXAMINING ATTORNEY

SN 76-604,602. UNIVERSITY OF MARYLAND, BALTIMORE, BALTIMORE, MD. FILED 7-29-2004.

eDITH

THE MARK CONSISTS OF STANDARD CHARACTERS WITHOUT CLAIM TO ANY PARTICULAR FONT, STYLE, SIZE, OR COLOR.

FOR COMPUTER SOFTWARE FOR USE IN DEVELOPING BILLING CODES THAT SPECIFY THE TYPE OF MEDICAL CARE PROVIDED BY THE HEALTHCARE PROVIDER (U.S. CLS. 21, 23, 26, 36 AND 38).

TIMOTHY FINNEGAN, EXAMINING ATTORNEY

SN 76-605,156. RADIXON SYSTEMS PTY. LTD., OAKLEIGH, VICTORIA 3166, AUSTRALIA, FILED 8-2-2004.

RADIXON

THE MARK CONSISTS OF STANDARD CHARACTERS WITHOUT CLAIM TO ANY PARTICULAR FONT, STYLE, SIZE, OR COLOR.

FOR COMPUTER CONTROLLED RADIOS, COMPUTER CONTROLLED VIDEO AND DATA RECEIVERS, TRANSMITTERS, AND TRANSCEIVERS (U.S. CLS. 21, 23, 26, 36 AND 38).

FIRST USE 2-17-2004; IN COMMERCE 2-17-2004.

NORA BUCHANAN WILL, EXAMINING ATTORNEY

CLASS 9—(Continued).

SN 76-609,279. TRICERAT, INC., COLUMBIA, MD. FILED 8-30-2004.

SIMPLIFY PRINTING

THE MARK CONSISTS OF STANDARD CHARACTERS WITHOUT CLAIM TO ANY PARTICULAR FONT, STYLE, SIZE, OR COLOR.

NO CLAIM IS MADE TO THE EXCLUSIVE RIGHT TO USE "PRINTING", APART FROM THE MARK AS SHOWN. FOR COMPUTER SOFTWARE AND COMPUTER SOFTWARE ARCHITECTURE AND DOWNLOADABLE COMPUTER SOFTWARE FOR OPERATING AND SELF CONFIGURING PRINTERS AND PRINTING SYSTEMS (U.S. CLS. 21, 23, 26, 36 AND 38).

FIRST USE 10-0-2002; IN COMMERCE 10-0-2002.
MICHELE SWAIN, EXAMINING ATTORNEY

SN 76-610,624. QUALITY VISION INTERNATIONAL, INC., ROCHESTER, NY. FILED 9-9-2004.

QVI

THE MARK CONSISTS OF STANDARD CHARACTERS WITHOUT CLAIM TO ANY PARTICULAR FONT, STYLE, SIZE, OR COLOR.

FOR VIDEO MEASURING MICROSCOPES, OPTICAL COMPARATORS FOR OPTICAL INSPECTION AND DIMENSIONAL MEASUREMENT OF PARTS, AND COMPUTER SOFTWARE THEREFOR, DEVICES FOR CALIBRATING THE MAGNIFICATION OF ZOOM OPTICAL SYSTEMS, AND MOTORIZED VIDEO MICROSCOPE WITH ZOOM OPTICAL SYSTEM, VIDEO CAMERA, AND ASSOCIATED SOFTWARE FOR DIMENSIONAL INSPECTION OF PARTS (U.S. CLS. 21, 23, 26, 36 AND 38).

FIRST USE 4-1-2001; IN COMMERCE 4-1-2001.
TEJBIR SINGH, EXAMINING ATTORNEY

SN 76-611,713. MATERIAL CONTROL, INC., CROSWELL, MI. FILED 9-13-2004.

ROTO-LEVEL CONTROL

THE MARK CONSISTS OF STANDARD CHARACTERS WITHOUT CLAIM TO ANY PARTICULAR FONT, STYLE, SIZE, OR COLOR.

NO CLAIM IS MADE TO THE EXCLUSIVE RIGHT TO USE "CONTROL", APART FROM THE MARK AS SHOWN.

FOR ROTATING PADDLE SENSOR MECHANISM FOR INDICATING THE LEVEL OF FLOWABLE MATERIAL IN A STORAGE BIN (U.S. CLS. 21, 23, 26, 36 AND 38).

FIRST USE 1-0-1978; IN COMMERCE 1-0-1978.
DAVID TAYLOR, EXAMINING ATTORNEY

CLASS 9—(Continued).

SN 76-611,832. HIV AND HEPATITIS TREATMENT ADVOCATES, INC., SAN FRANCISCO, CA. FILED 9-17-2004.



NO CLAIM IS MADE TO THE EXCLUSIVE RIGHT TO USE HIVANDHEPATITIS.COM, APART FROM THE MARK AS SHOWN.

THE MARK COMPRISES THE WORDS HIVANDHEPATITIS.COM AS ONE WORD WITH A SWIRL PATTERN ABOVE THE WORD AND.

FOR DOWNLOADABLE ELECTRONIC PUBLICATIONS IN THE NATURE OF MEDICAL JOURNALS, MAGAZINES AND ELECTRONIC MAGAZINES IN THE FIELDS OF INFECTIOUS DISEASES, VIRAL DISEASES, IMMUNOTHERAPIES, INFECTIOUS DISEASE THERAPIES, SUPPRESSION OF VIRAL INFECTIONS, ANTIRETROVIRAL THERAPY, IMMUNOCOMPETENCE, AND TREATMENTS FOR IMMUNORESTORATION (U.S. CLS. 21, 23, 26, 36 AND 38).

FIRST USE 5-31-1999; IN COMMERCE 5-31-1999.
MATTHEW KLINE, EXAMINING ATTORNEY

SN 76-613,366. MAC S.A., YUMBO-VALLE, COLOMBIA, FILED 9-29-2004.



NO CLAIM IS MADE TO THE EXCLUSIVE RIGHT TO USE "POWER PACK", APART FROM THE MARK AS SHOWN.

FOR AUTOMOTIVE BATTERIES (U.S. CLS. 21, 23, 26, 36 AND 38).

ALEX KEAM, EXAMINING ATTORNEY

CLASS 9—(Continued).

SN 76-613,452. PINNACLE SYSTEMS, INC., MOUNTAIN VIEW, CA. FILED 9-27-2004.

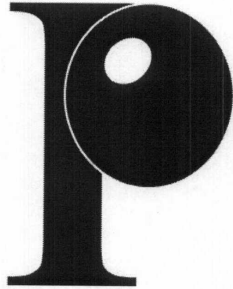

OWNER OF U.S. REG. NO. 2,119,067.
THE MARK CONSISTS OF THE LETTER "P" WITH A SPHERE.

FOR COMPUTER HARDWARE; COMPUTER SOFTWARE AND COMPUTER HARDWARE, ALL FOR EDITING, COMPRESSION, DECOMPRESSION, ELECTRONIC OR OPTICAL DELIVERY, RECORDING, PLAYBACK, BROADCASTING, PRODUCTION, CREATION, VIEWING, STORAGE AND ANALYSIS OF VIDEO, AUDIO, GRAPHICAL AND MULTIMEDIA CONTENT; COMPUTER HARDWARE FOR MEDICAL IMAGING (U.S. CLS. 21, 23, 26, 36 AND 38).

FIRST USE 2-0-1996; IN COMMERCE 2-0-1996.
LAURIE MAYES, EXAMINING ATTORNEY

SN 76-614,155. SURGISOFT, L.P., DALLAS, TX. FILED 9-29-2004.

SURGISOFT

THE MARK CONSISTS OF STANDARD CHARACTERS WITHOUT CLAIM TO ANY PARTICULAR FONT, STYLE, SIZE, OR COLOR.

FOR COMPUTER SOFTWARE FOR USE IN PROFIT FORECASTING, TRACKING OF COMMISSIONS AND PURCHASE ORDERS, INVENTORY MANAGEMENT, PRICING, SUPPORT AND EVALUATION OF CONTRACTS, PRODUCT ORDERING, AND SALES FORCE AUTOMATION FOR USE IN THE MEDICAL DEVICE FIELD (U.S. CLS. 21, 23, 26, 36 AND 38).

FIRST USE 6-1-2004; IN COMMERCE 6-1-2004.
JOHN GARTNER, EXAMINING ATTORNEY

SN 76-614,193. CARRIER LOGISTICS INC., TARRYTOWN, NY. FILED 9-30-2004.

FACTSview

FOR COMPUTER SOFTWARE FOR PRODUCING SPREADSHEETS AND CALCULATOR PROGRAMS WHICH ANALYZE AND EVALUATE PERFORMANCE, COSTS, SALES, AND REVENUE IN THE TRANSPORTATION INDUSTRY (U.S. CLS. 21, 23, 26, 36 AND 38).

FIRST USE 7-8-2004; IN COMMERCE 7-8-2004.
TONI HICKEY, EXAMINING ATTORNEY

CLASS 9—(Continued).

SN 76-614,216. SMILEY, CHARLES RANSOM, NORTH-RIDGE, CA. FILED 10-1-2004.

CHARLES SMILEY PRESENTS

THE MARK CONSISTS OF STANDARD CHARACTERS WITHOUT CLAIM TO ANY PARTICULAR FONT, STYLE, SIZE, OR COLOR.

FOR SERIES OF AUDIOVISUAL WORKS IN DVD AND VHS TAPE FORMAT, IN THE FIELD OF TRANSPORTATION (U.S. CLS. 21, 23, 26, 36 AND 38).

FIRST USE 1-1-1994; IN COMMERCE 1-1-1994.
TEJBIR SINGH, EXAMINING ATTORNEY

SN 76-616,979. INFOSYNCH, INC., BOHEMIA, NY. FILED 10-21-2004.

ezbizlinks

THE MARK CONSISTS OF STANDARD CHARACTERS WITHOUT CLAIM TO ANY PARTICULAR FONT, STYLE, SIZE, OR COLOR.

FOR COMPUTER SOFTWARE USED TO IMPROVE THE ACCURACY OF BUSINESS DATA INFORMATION AND TO ENHANCE INTERACTION BETWEEN BUSINESSES, THEIR CUSTOMERS AND THEIR VENDORS, BY COLLECTING, ANALYZING, AND PROCESSING CUSTOMER SALES HISTORY FOR MARKETING PURPOSES USING LINKS TO THIRD PARTIES ESTABLISHED BY TRANSMISSION CONTROL PROTOCOL/INTERNET PROTOCOL (TCP/IP) CONNECTIONS OVER THE INTERNET (U.S. CLS. 21, 23, 26, 36 AND 38).

ANDREW RHIM, EXAMINING ATTORNEY

SN 76-617,210. EMPLOYMENT TECHNOLOGIES CORPORATION, WINTER PARK, FL. FILED 10-21-2004.

NO CLAIM IS MADE TO THE EXCLUSIVE RIGHT TO USE ELECTRONIC ASSESSMENT SYSTEMS, APART FROM THE MARK AS SHOWN.

FOR SIMULATION COMPUTER SOFTWARE PROGRAMS TO BE USED IN EMPLOYEE ASSESSMENT AND OR TRAINING AND INSTRUCTIONAL MANUALS RELATED THERETO, TO BE SOLD AS A UNIT (U.S. CLS. 21, 23, 26, 36 AND 38).

FIRST USE 4-1-1995; IN COMMERCE 4-1-1995.
BRIDGETT SMITH, EXAMINING ATTORNEY

CLASS 9—(Continued).

SN 76-618,404. LEE, HEE CHUL, TORRANCE, CA. FILED 10-29-2004.

PRIMESIGNAL

THE MARK CONSISTS OF STANDARD CHARACTERS WITHOUT CLAIM TO ANY PARTICULAR FONT, STYLE, SIZE, OR COLOR.

FOR ELECTRONIC TELECOMMUNICATION EQUIPMENT, NAMELY A WIRELESS CELLULAR PHONE REPEATER USED TO AMPLIFY THE WEAK SIGNAL OF THE CELLULAR PHONE (U.S. CLS. 21, 23, 26, 36 AND 38).

GENE MACIOL, EXAMINING ATTORNEY

SN 76-618,565. SOLIDWORKS CORPORATION, CONCORD, MA. FILED 10-29-2004.

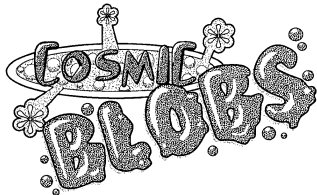

OWNER OF U.S. REG. NO. 2,954,951.
 THE STIPLING IS FOR SHADING PURPOSES.
 FOR COMPUTER SOFTWARE FOR THE INTERACTIVE MODELING OR DESIGN OF THREE-DIMENSIONAL OBJECTS; COMPUTER ENTERTAINMENT OR GAME SOFTWARE (U.S. CLS. 21, 23, 26, 36 AND 38).
 FIRST USE 8-11-2004; IN COMMERCE 8-11-2004.
 BRENDAN MCCAULEY, EXAMINING ATTORNEY

SN 76-618,864. TYRESONIC, INC., TEMPLE CITY, CA. FILED 11-1-2004.

TYRESONIC

THE MARK CONSISTS OF STANDARD CHARACTERS WITHOUT CLAIM TO ANY PARTICULAR FONT, STYLE, SIZE, OR COLOR.

FOR TIRE PRESSURE MONITORING SYSTEM COMPRISED OF A SENSOR, RECEIVER, AND DISPLAY (U.S. CLS. 21, 23, 26, 36 AND 38).

MATTHEW KLINE, EXAMINING ATTORNEY

CLASS 9—(Continued).

SN 76-618,885. XM SATELLITE RADIO INC., WASHINGTON, DC. FILED 11-1-2004.

XM DIGITAL TRANSCEIVER

THE MARK CONSISTS OF STANDARD CHARACTERS WITHOUT CLAIM TO ANY PARTICULAR FONT, STYLE, SIZE, OR COLOR.

OWNER OF U.S. REG. NOS. 2,547,677, 2,583,273 AND OTHERS.

NO CLAIM IS MADE TO THE EXCLUSIVE RIGHT TO USE "DIGITAL TRANSCEIVER", APART FROM THE MARK AS SHOWN.

FOR SATELLITE RADIO HARDWARE, NAMELY, SATELLITE RADIO TUNERS, TRANSCEIVERS, TELECOMMUNICATIONS TRANSMITTERS, REMOTE CONTROLS FOR SATELLITE RADIO, ELECTRONIC CONTROL PANELS, BATTERIES, BATTERY CHARGERS; SATELLITE RADIO RECEIVERS AND ANTENNAS (U.S. CLS. 21, 23, 26, 36 AND 38).

SAMUEL E. SHARPER JR., EXAMINING ATTORNEY

SN 76-619,235. J.A. WOOLLAM CO. INC., LINCOLN, NE. FILED 11-2-2004.

GENOSC

THE MARK CONSISTS OF STANDARD CHARACTERS WITHOUT CLAIM TO ANY PARTICULAR FONT, STYLE, SIZE, OR COLOR.

FOR EQUIPMENT, NAMELY ELLIPSOMETER BASED APPARATUS FOR MEASURING THICKNESS AND OPTICAL PROPERTIES OF SEMICONDUCTOR, DISK DRIVE, MAGNETIC DATA STORAGE MEDIA, OPTICAL DATA STORAGE MEDIA, THIN FILMS AND MULTIPLE LAYER FILMS ON SUBSTRATES AND COATINGS, INCLUDING TEMPERATURE CAUSED EFFECTS, AND COMPUTER PROGRAMS NECESSARY FOR CONTROLLING THE ELLIPSOMETER BASED APPARATUS AND FOR ANALYZING ACQUIRED ELLIPSOMETRIC DATA (U.S. CLS. 21, 23, 26, 36 AND 38).

ANNE MADDEN, EXAMINING ATTORNEY

CLASS 9—(Continued).

SN 76-619,733. MERIT AUDIO VISUAL, INC., DBA MERIT SOFTWARE, NEW YORK, NY. FILED 11-8-2004.

MERIT

THE MARK CONSISTS OF STANDARD CHARACTERS WITHOUT CLAIM TO ANY PARTICULAR FONT, STYLE, SIZE, OR COLOR.

FOR EDUCATIONAL SOFTWARE, NAMELY, COMPUTER SOFTWARE FOR TEACHING READING, WRITING, VOCABULARY, GRAMMAR AND MATHEMATICS TO SCHOOL CHILDREN IN GRADES 3 THROUGH 12, TO ENGLISH AS A SECOND LANGUAGE STUDENTS, TO COLLEGE AND COLLEGE PREPARATORY STUDENTS, AND TO ADULT EDUCATION STUDENTS (U.S. CLS. 21, 23, 26, 36 AND 38).

FIRST USE 0-0-1983; IN COMMERCE 0-0-1983.
CHRIS WELLS, EXAMINING ATTORNEY

SN 76-620,055. CARL ZEISS AG, 73447 OBERKOCHEN, FED REP GERMANY, FILED 11-10-2004.

PRO

THE MARK CONSISTS OF STANDARD CHARACTERS WITHOUT CLAIM TO ANY PARTICULAR FONT, STYLE, SIZE, OR COLOR.

OWNER OF FED REP GERMANY REG. NO. 30318245, DATED 5-8-2003, EXPIRES 4-30-2013.

FOR COORDINATE MEASURING MACHINES AND THEIR PARTS (U.S. CLS. 21, 23, 26, 36 AND 38).

JOHN LINCOSKI, EXAMINING ATTORNEY

SN 76-620,393. DIPLOMAT TRADING, INC., MIAMI, FL. FILED 11-12-2004.

DTI

THE MARK CONSISTS OF STANDARD CHARACTERS WITHOUT CLAIM TO ANY PARTICULAR FONT, STYLE, SIZE, OR COLOR.

FOR ELECTRICAL AUDIO COMPONENTS FOR VEHICLES, NAMELY, RADIOS, COMPACT DISC PLAYERS, AMPLIFIERS AND SPEAKERS; ANTI-THEFT ALARMS FOR VEHICLES (U.S. CLS. 21, 23, 26, 36 AND 38).

FIRST USE 8-23-2001; IN COMMERCE 10-9-2001.
ZACHARY BELLO, EXAMINING ATTORNEY

CLASS 9—(Continued).

SN 76-620,542. ALLEN, ELIOT, PORTLAND, OR. FILED 11-15-2004.

INDEX PLANWORKS

NO CLAIM IS MADE TO THE EXCLUSIVE RIGHT TO USE INDEX, APART FROM THE MARK AS SHOWN.

FOR COMPUTER SOFTWARE FOR ON-LINE PROCESS MANAGEMENT OF COMMUNITY AND REGIONAL PLAN PREPARATION, INCLUDING MULTIPLE AUTHORSHIP OF PLAN DOCUMENTS, HYPER-LINKED TEXT AND MAPPING IN DOCUMENTS, SOLICITATION AND PROCESSING OF CITIZEN COMMENTS, AND CHANGE ORDER MANAGEMENT FOR FINALIZATION OF PLAN DOCUMENTS (U.S. CLS. 21, 23, 26, 36 AND 38).

FIRST USE 8-0-2004; IN COMMERCE 8-0-2004.
JOHN E. MICHOS, EXAMINING ATTORNEY

SN 76-620,793. GOEBBELS, SWEN, 52078 AACHEN, FED REP GERMANY, FILED 11-16-2004.

CARSTUCKGIRLS

THE MARK CONSISTS OF STANDARD CHARACTERS WITHOUT CLAIM TO ANY PARTICULAR FONT, STYLE, SIZE, OR COLOR.

PRIORITY CLAIMED UNDER SEC. 44(D) ON FED REP GERMANY APPLICATION NO. 30428947.7, FILED 5-19-2004, REG. NO. 30428947, DATED 10-20-2004, EXPIRES 5-31-2014.

FOR PRERECORDED MAGNETIC DATA CARRIERS, VIDEO TAPES, VIDEO CASSETTES AND OPTICAL DISCS FEATURING ENTERTAINMENT IN THE NATURE OF FEMALES WITH VEHICLES; DOWNLOADABLE VIDEO RECORDINGS FEATURING ENTERTAINMENT IN THE NATURE OF FEMALES WITH VEHICLES; SOUND RECORDINGS FEATURING MUSIC (U.S. CLS. 21, 23, 26, 36 AND 38).

FIRST USE 2-4-2003; IN COMMERCE 2-4-2003.
BRENDAN REGAN, EXAMINING ATTORNEY

CLASS 9—(Continued).

SN 76-620,845. ELECTRONIC CONTROLS, BOISE, ID. FILED 11-16-2004.



OWNER OF U.S. REG. NO. 1,301,314.
NO CLAIM IS MADE TO THE EXCLUSIVE RIGHT TO USE A DIVISION OF, APART FROM THE MARK AS SHOWN.

FOR WARNING ALARMS AND EMERGENCY WARNING LIGHTS FOR MOBILE CONSTRUCTION, MINING, AND INDUSTRIAL EQUIPMENT (U.S. CLS. 21, 23, 26, 36 AND 38).

FIRST USE 1-31-2004; IN COMMERCE 1-31-2004.
LINDA POWELL, EXAMINING ATTORNEY

SN 76-621,023. CLINIMED SYSTEMS, INC., EAST SYRACUSE, NY. FILED 11-18-2004.

The logo for CiniMed features the word "CiniMed" in a serif font. The letter "i" is stylized with a caduceus symbol (a staff with two snakes) integrated into it.

FOR MEDICAL PRACTICE MANAGEMENT SOFTWARE USED FOR APPOINTMENT SCHEDULING, OFFICE BILLING AND ELECTRONIC MEDICAL RECORD-KEEPING (U.S. CLS. 21, 23, 26, 36 AND 38).

FIRST USE 4-1-1989; IN COMMERCE 5-1-1990.
DAWN FELDMAN, EXAMINING ATTORNEY

SN 76-621,194. BORN BEAUTIFUL, INC., NEW YORK, NY. FILED 11-18-2004.

BORN BEAUTIFUL

THE MARK CONSISTS OF STANDARD CHARACTERS WITHOUT CLAIM TO ANY PARTICULAR FONT, STYLE, SIZE, OR COLOR.

FOR PRERECORDED VIDEO TAPES, AUDIO TAPES, LASER DISCS, VIDEO DISCS, COMPACT DISCS, CD-ROMS AND DVDS IN THE FIELDS OF EXERCISE, FITNESS, WELLNESS AND BEAUTY, AND INSTRUCTION MANUALS SOLD THEREWITH (U.S. CLS. 21, 23, 26, 36 AND 38).

MICHELLE DUBOIS, EXAMINING ATTORNEY

CLASS 9—(Continued).

SN 76-621,214. DOUGLAS EQUIPMENT LTD, CHELTENHAM GLOUCESTERSHIRE, GREAT BRITAIN, FILED 11-18-2004.

SLIPSTREAM

THE MARK CONSISTS OF STANDARD CHARACTERS WITHOUT CLAIM TO ANY PARTICULAR FONT, STYLE, SIZE, OR COLOR.

FOR FRICTION MEASURING APPARATUS IN PARTICULAR FOR USE ON ROADS AND RUNWAYS (U.S. CLS. 21, 23, 26, 36 AND 38).

JASON TURNER, EXAMINING ATTORNEY

SN 76-621,231. GUCCI AMERICA, INC., NEW YORK, NY. FILED 11-17-2004.



OWNER OF U.S. REG. NOS. 1,158,170 AND 1,464,522.
FOR EYEGLASS FRAMES AND SUNGLASSES (U.S. CLS. 21, 23, 26, 36 AND 38).

FIRST USE 10-0-2003; IN COMMERCE 10-0-2003.
AMOS T. MATTHEWS, JR., EXAMINING ATTORNEY

SN 76-621,279. SO SOUND SOLUTIONS LLC., LAFAYETTE, CO. FILED 11-22-2004.

SO SoundHeart

THE MARK CONSISTS OF STANDARD CHARACTERS WITHOUT CLAIM TO ANY PARTICULAR FONT, STYLE, SIZE, OR COLOR.

FOR ELECTRONIC SOUND AND VIBRATIONAL DEVICES, NAMELY TRANSDUCERS, TACTILE VIBRATION SOUND DEVICES, AND SPEAKER DEVICES THAT EMIT VIBRATIONS (U.S. CLS. 21, 23, 26, 36 AND 38).

ROBIN CHOSID, EXAMINING ATTORNEY

CLASS 9—(Continued).

SN 76-621,374. COMMSCOPE PROPERTIES, LLC, SPARKS, NV. FILED 11-19-2004.

COMMSCOPE ENTERPRISE SOLUTIONS

THE MARK CONSISTS OF STANDARD CHARACTERS WITHOUT CLAIM TO ANY PARTICULAR FONT, STYLE, SIZE, OR COLOR.

OWNER OF U.S. REG. NOS. 898,651, 2,678,856 AND OTHERS.

NO CLAIM IS MADE TO THE EXCLUSIVE RIGHT TO USE "ENTERPRISE SOLUTIONS", APART FROM THE MARK AS SHOWN.

FOR COMMUNICATIONS CABLE, NAMELY, COAXIAL CABLE, TWISTED PAIR CABLE, FIBER OPTIC CABLE, AND HYBRIDS THEREOF, AND CABLE CONNECTORS THEREFOR; FIBER OPTIC WIRE, CORDS AND CABLES; WIRE PATCH CORDS; FIBER OPTIC INTERCONNECTION CABLES; TELECOMMUNICATIONS ADAPTORS; TELECOMMUNICATIONS CONNECTORS, PLUGS, JACKS AND CONNECTING BLOCKS; TELECOMMUNICATIONS DEVICES THAT REPEAT, RESHAPE, OR REFORMAT SIGNALS FROM DATA TERMINALS AND CONTROLLERS; TELECOMMUNICATIONS BRACKETS, CLIPS AND CLAMPS TO HOUSE AND SUPPORT CABLE AND TELECOMMUNICATIONS EQUIPMENT ALL DISTRIBUTED AS A UNIT AND; ELECTRICAL WIRE FOR USE IN THE TELECOMMUNICATIONS INDUSTRY (U.S. CLS. 21, 23, 26, 36 AND 38).

VERNA BETH RIRIE, EXAMINING ATTORNEY

SN 76-621,376. COMMSCOPE PROPERTIES, LLC, SPARKS, NV. FILED 11-19-2004.

COMMSCOPE BROADBAND SOLUTIONS

THE MARK CONSISTS OF STANDARD CHARACTERS WITHOUT CLAIM TO ANY PARTICULAR FONT, STYLE, SIZE, OR COLOR.

OWNER OF U.S. REG. NOS. 898,651, 2,929,129 AND OTHERS.

NO CLAIM IS MADE TO THE EXCLUSIVE RIGHT TO USE "BROADBAND SOLUTIONS", APART FROM THE MARK AS SHOWN.

FOR COMMUNICATIONS CABLE, NAMELY, COAXIAL CABLES, TWISTED PAIR CABLES, FIBER OPTIC CABLES, AND HYBRIDS THEREOF, AND CABLE CONNECTORS THEREFOR (U.S. CLS. 21, 23, 26, 36 AND 38).

DARRYL SPRUILL, EXAMINING ATTORNEY

SN 76-621,391. GLASPIE, MICHAEL T., SAUGATUCK, MI. FILED 11-19-2004.

ICONALERT.

THE MARK CONSISTS OF STANDARD CHARACTERS WITHOUT CLAIM TO ANY PARTICULAR FONT, STYLE, SIZE, OR COLOR.

FOR COMPUTER SOFTWARE DEVELOPMENT TOOLS (U.S. CLS. 21, 23, 26, 36 AND 38).

PAULA MAHONEY, EXAMINING ATTORNEY

CLASS 9—(Continued).

SN 76-621,533. RUDNICK, BENJAMIN D., ARLINGTON, MA. FILED 11-22-2004.

BARTLETT AVE. RECORDS

THE MARK CONSISTS OF STANDARD CHARACTERS WITHOUT CLAIM TO ANY PARTICULAR FONT, STYLE, SIZE, OR COLOR.

NO CLAIM IS MADE TO THE EXCLUSIVE RIGHT TO USE "RECORDS", APART FROM THE MARK AS SHOWN.

FOR PHONOGRAPH RECORDS FEATURING MUSIC; AUDIO CASSETTE TAPES FEATURING MUSIC; COMPACT DISCS FEATURING MUSIC; DOWNLOADABLE DIGITAL AUDIO FILES THROUGH THE INTERNET FEATURING MUSIC; DVDS FEATURING MUSIC; ENHANCED CDS FEATURING MUSIC; PRERECORDED VIDEO TAPES FEATURING MUSIC; VIDEO GAME DISCS; VIDEO DISCS FEATURING MUSIC (U.S. CLS. 21, 23, 26, 36 AND 38).

AMY GEARIN, EXAMINING ATTORNEY

SN 76-621,561. S.J. INTERNATIONAL, CO., SANTA FE SPRINGS, CA. FILED 11-22-2004.



FOR BLANK MEDIA AND MEMORY PRODUCTS, NAMELY, COMPUTER MEMORIES AND ELECTRONIC MEMORIES (U.S. CLS. 21, 23, 26, 36 AND 38).

FIRST USE 9-1-2002; IN COMMERCE 9-1-2002.

FRED MANDIR, EXAMINING ATTORNEY

SN 76-621,576. DIPLOMAT TRADING, INC., MIAMI, FL. FILED 11-22-2004.

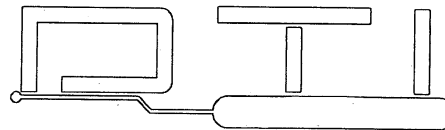

FOR ELECTRICAL AUDIO COMPONENTS FOR VEHICLES, NAMELY, RADIOS, COMPACT DISC PLAYERS, AMPLIFIERS AND SPEAKERS; ANTI-THEFT ALARMS FOR VEHICLES (U.S. CLS. 21, 23, 26, 36 AND 38).

FIRST USE 1-15-2003; IN COMMERCE 3-20-2003.

ZACHARY BELLO, EXAMINING ATTORNEY

CLASS 9—(Continued).

SN 76-621,602. CABLECO TECHNOLOGIES CORPORATION, DUBLIN, CA. FILED 11-22-2004.

POWERRAIL

THE MARK CONSISTS OF STANDARD CHARACTERS WITHOUT CLAIM TO ANY PARTICULAR FONT, STYLE, SIZE, OR COLOR.

FOR PLUGGABLE BUS BAR USED IN ELECTRICAL AND ELECTRONIC EQUIPMENT (U.S. CLS. 21, 23, 26, 36 AND 38).

MIDGE BUTLER, EXAMINING ATTORNEY

CLASS 9—(Continued).

SN 76-621,608. CYBERLINK CORP., SHINDIAN CITY, TAIPEI, TAIWAN, FILED 11-22-2004.

CLVS

THE MARK CONSISTS OF STANDARD CHARACTERS WITHOUT CLAIM TO ANY PARTICULAR FONT, STYLE, SIZE, OR COLOR.

FOR SOFTWARE FOR AUDIO AND VIDEO PRODUCING, PLAYING AND RECORDING-COMPUTER PROGRAMS ON COMPACT AND FLOPPY DISCS FOR USE IN AUDIO AND VIDEO EDITING, PRODUCING, PLAYING AND RECORDING (U.S. CLS. 21, 23, 26, 36 AND 38).

SUSAN HAYASH, EXAMINING ATTORNEY

SN 76-621,605. HUBBELL INCORPORATED, ORANGE, CT. FILED 11-22-2004.

AUTOGUARD

THE MARK CONSISTS OF STANDARD CHARACTERS WITHOUT CLAIM TO ANY PARTICULAR FONT, STYLE, SIZE, OR COLOR.

FOR ELECTRICAL RECEPTACLES (U.S. CLS. 21, 23, 26, 36 AND 38).

SUSAN HAYASH, EXAMINING ATTORNEY

SN 76-621,620. ITG SOFTWARE SOLUTIONS, INC., CULVER CITY, CA. FILED 11-22-2004.

ITG LOGIC

THE MARK CONSISTS OF STANDARD CHARACTERS WITHOUT CLAIM TO ANY PARTICULAR FONT, STYLE, SIZE, OR COLOR.

OWNER OF U.S. REG. NOS. 2,581,518, 2,780,057 AND OTHERS.

FOR COMPUTER PROGRAMS FOR USE IN PROVIDING AND MANAGING AUTOMATED SECURITIES BROKERAGE, TRADING AND TRADING STRATEGIES (U.S. CLS. 21, 23, 26, 36 AND 38).

FIRST USE 10-30-2004; IN COMMERCE 10-30-2004.

JEAN IM, EXAMINING ATTORNEY

SN 76-621,607. CYBERLINK CORP., SHINDIAN CITY, TAIPEI, TAIWAN, FILED 11-22-2004.

CLHP

THE MARK CONSISTS OF STANDARD CHARACTERS WITHOUT CLAIM TO ANY PARTICULAR FONT, STYLE, SIZE, OR COLOR.

FOR COMPUTER SOFTWARE FOR AUDIO AND VIDEO PRODUCING, PLAYING AND RECORDING; COMPUTER PROGRAMS ON COMPACT AND FLOPPY DISCS FOR USE IN AUDIO AND VIDEO EDITING, PRODUCING, PLAYING AND RECORDING (U.S. CLS. 21, 23, 26, 36 AND 38).

SUSAN HAYASH, EXAMINING ATTORNEY

SN 76-621,744. DAVIS CENTERS, INC., BUDD LAKE, NJ. FILED 11-17-2004.

SONIC ADVANTAGE

THE MARK CONSISTS OF STANDARD CHARACTERS WITHOUT CLAIM TO ANY PARTICULAR FONT, STYLE, SIZE, OR COLOR.

FOR PERSONAL ENHANCEMENT LISTENING AUDIO RECORDINGS WHICH CREATES SOUNDS THAT STIMULATE AND RE-PATTERN THE CONNECTION OF THE VOICE TO THE EAR TO THE BRAIN (U.S. CLS. 21, 23, 26, 36 AND 38).

KEVIN DINALLO, EXAMINING ATTORNEY

CLASS 9—(Continued).

SN 76-621,746. DAVIS CENTERS, INC., BUDD LAKE, NJ.
FILED 11-17-2004.

SONIC JUMPSTART

THE MARK CONSISTS OF STANDARD CHARACTERS WITHOUT CLAIM TO ANY PARTICULAR FONT, STYLE, SIZE, OR COLOR.

FOR PERSONAL ENHANCEMENT LISTENING AUDIO RECORDINGS FOR INFANTS AND PRE-SCHOOL CHILDREN WHICH CREATES SOUNDS THAT STIMULATE AND RE-PATTERN THE CONNECTION OF THE VOICE TO THE EAR TO THE BRAIN (U.S. CLS. 21, 23, 26, 36 AND 38).

KEVIN DINALLO, EXAMINING ATTORNEY

CLASS 9—(Continued).

SN 76-621,749. DAVIS CENTERS, INC., BUDD LAKE, NJ.
FILED 11-17-2004.

SUPERSONIC SENIORS

THE MARK CONSISTS OF STANDARD CHARACTERS WITHOUT CLAIM TO ANY PARTICULAR FONT, STYLE, SIZE, OR COLOR.

NO CLAIM IS MADE TO THE EXCLUSIVE RIGHT TO USE "SENIORS", APART FROM THE MARK AS SHOWN.

FOR PERSONAL ENHANCEMENT LISTENING AUDIO RECORDINGS FOR SENIOR CITIZENS WHICH CREATES SOUNDS THAT STIMULATE AND RE-PATTERN THE CONNECTION OF THE VOICE TO THE EAR TO THE BRAIN (U.S. CLS. 21, 23, 26, 36 AND 38).

KEVIN DINALLO, EXAMINING ATTORNEY

SN 76-621,747. DAVIS CENTERS, INC., BUDD LAKE, NJ.
FILED 11-17-2004.

SONIC INCUBATOR

THE MARK CONSISTS OF STANDARD CHARACTERS WITHOUT CLAIM TO ANY PARTICULAR FONT, STYLE, SIZE, OR COLOR.

FOR PERSONAL ENHANCEMENT LISTENING AUDIO RECORDINGS FOR BABIES IN UTERO WHICH CREATES SOUNDS THAT STIMULATE AND RE-PATTERN THE CONNECTION OF THE VOICE TO THE EAR TO THE BRAIN (U.S. CLS. 21, 23, 26, 36 AND 38).

KEVIN DINALLO, EXAMINING ATTORNEY

SN 76-621,767. CVISION TECHNOLOGIES, LLC, QUEENS, NY. FILED 11-22-2004.

CVIEW

THE MARK CONSISTS OF STANDARD CHARACTERS WITHOUT CLAIM TO ANY PARTICULAR FONT, STYLE, SIZE, OR COLOR.

FOR COMPUTER SOFTWARE FOR IMAGE VIEWING AND IMAGE EDITING (U.S. CLS. 21, 23, 26, 36 AND 38).

BRENDAN MCCAULEY, EXAMINING ATTORNEY

SN 76-621,748. DAVIS CENTERS, INC., BUDD LAKE, NJ.
FILED 11-17-2004.

SONIC SYNCHRONY

THE MARK CONSISTS OF STANDARD CHARACTERS WITHOUT CLAIM TO ANY PARTICULAR FONT, STYLE, SIZE, OR COLOR.

FOR PERSONAL ENHANCEMENT LISTENING AUDIO RECORDINGS FOR ADULTS WHICH CREATES SOUNDS THAT STIMULATE AND RE-PATTERN THE CONNECTION OF THE VOICE TO THE EAR TO THE BRAIN (U.S. CLS. 21, 23, 26, 36 AND 38).

KEVIN DINALLO, EXAMINING ATTORNEY

SN 76-621,938. COLLEY, KEITH, FREELAND, WA. AND COLLEY, LINDA, FREELAND, WA. FILED 11-24-2004.

CAN-DO-KIDS

THE MARK CONSISTS OF STANDARD CHARACTERS WITHOUT CLAIM TO ANY PARTICULAR FONT, STYLE, SIZE, OR COLOR.

FOR SERIES OF PRE-RECORDED COMPACT DISCS FEATURING MUSIC (U.S. CLS. 21, 23, 26, 36 AND 38).

FIRST USE 12-30-2003; IN COMMERCE 1-14-2004.

DAVID MURRAY, EXAMINING ATTORNEY

CLASS 9—(Continued).

SN 76-622,042. SOUTHERN CALIFORNIA EDISON COMPANY, ROSEMEAD, CA. FILED 11-24-2004.

ENERGY ORB

THE MARK CONSISTS OF STANDARD CHARACTERS WITHOUT CLAIM TO ANY PARTICULAR FONT, STYLE, SIZE, OR COLOR.

FOR RADIO FREQUENCY RECEIVERS HAVING A COLOR CHANGING DISPLAY FOR VISUALLY INDICATING CHANGING ELECTRICAL RATES IN A GIVEN SERVICE AREA (U.S. CLS. 21, 23, 26, 36 AND 38).

KIMBERLY PERRY, EXAMINING ATTORNEY

SN 76-622,043. SOUTHERN CALIFORNIA EDISON COMPANY, ROSEMEAD, CA. FILED 11-24-2004.

SCE ENERGY ORB

THE MARK CONSISTS OF STANDARD CHARACTERS WITHOUT CLAIM TO ANY PARTICULAR FONT, STYLE, SIZE, OR COLOR.

FOR RADIO FREQUENCY RECEIVERS HAVING A COLOR CHANGING DISPLAY FOR VISUALLY INDICATING CHANGING ELECTRICAL RATES IN A GIVEN SERVICE AREA (U.S. CLS. 21, 23, 26, 36 AND 38).

KIMBERLY PERRY, EXAMINING ATTORNEY

SN 76-622,197. STACO ENERGY PRODUCTS, DAYTON, OH. FILED 11-26-2004.

REDDI

THE MARK CONSISTS OF STANDARD CHARACTERS WITHOUT CLAIM TO ANY PARTICULAR FONT, STYLE, SIZE, OR COLOR.

OWNER OF U.S. REG. NO. 2,107,059. FOR REMOTE EVENT DRIVEN DIAANOSTIC INTERFACE SOFTWARE FOR UNINTERRUPTIBLE POWER SUPPLIES, POWER SYSTEMS, AND THEIR RELATED CONTROLS (U.S. CLS. 21, 23, 26, 36 AND 38).

FIRST USE 2-1-1996; IN COMMERCE 2-1-1996. ZHALEH DELANEY, EXAMINING ATTORNEY

CLASS 9—(Continued).

SN 76-622,230. CAPACA USA, INC., CITY OF INDUSTRY, CA. FILED 11-29-2004.

CAPACA

THE MARK CONSISTS OF STANDARD CHARACTERS WITHOUT CLAIM TO ANY PARTICULAR FONT, STYLE, SIZE, OR COLOR.

FOR MOTOR STARTING AND RUNNING CAPACITORS (U.S. CLS. 21, 23, 26, 36 AND 38).

CHRISTOPHER ADKINS, EXAMINING ATTORNEY

SN 76-622,315. B.J.T SALES & MARKETING L.L.C., RAY-TOWN, MO. FILED 11-26-2004.

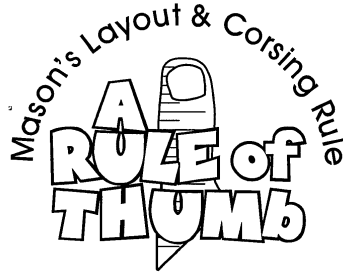

NO CLAIM IS MADE TO THE EXCLUSIVE RIGHT TO USE "MASON'S LAYOUT & CORSING RULE", APART FROM THE MARK AS SHOWN.

FOR TAPE MEASURE FOR MEASURING BRICKS (U.S. CLS. 21, 23, 26, 36 AND 38).

FIRST USE 8-3-2004; IN COMMERCE 8-3-2004. EUGENIA MARTIN, EXAMINING ATTORNEY

SN 76-622,379. AUTOMOTIVE REFINISH TECHNOLOGIES, INC., SOUTHFIELD, MI. FILED 11-29-2004.

SMARTTIME

THE MARK CONSISTS OF STANDARD CHARACTERS WITHOUT CLAIM TO ANY PARTICULAR FONT, STYLE, SIZE, OR COLOR.

FOR COMPUTER SOFTWARE, NAMELY, DATABASE MANAGEMENT SOFTWARE FOR USE IN THE COLLISION REPAIR/REFINISH INDUSTRY AS IT RELATES TO REFINISH PAINTS (U.S. CLS. 21, 23, 26, 36 AND 38).

FRED MANDIR, EXAMINING ATTORNEY

CLASS 9—(Continued).

SN 76-622,409. BRIDGE INFORMATION TECHNOLOGY, LTD, BARBOURSVILLE, WV. FILED 11-29-2004.

CLASS 9—(Continued).

SN 76-622,586. COMMODITY GLOVE COMPANY, INC., WAYNE, PA. FILED 11-30-2004.

COGENTPOINT

DOMINATOR

THE MARK CONSISTS OF STANDARD CHARACTERS WITHOUT CLAIM TO ANY PARTICULAR FONT, STYLE, SIZE, OR COLOR.

FOR COMPUTER SOFTWARE USED FOR DATABASE MANAGEMENT AND POINT OF SALE INVENTORY CONTROL (U.S. CLS. 21, 23, 26, 36 AND 38).
FIRST USE 12-0-2003; IN COMMERCE 5-0-2004.
CHERYL CLAYTON, EXAMINING ATTORNEY

THE MARK CONSISTS OF STANDARD CHARACTERS WITHOUT CLAIM TO ANY PARTICULAR FONT, STYLE, SIZE, OR COLOR.

FOR CUT-RESISTANT GLOVES FOR INDUSTRIAL USE (U.S. CLS. 21, 23, 26, 36 AND 38).
STEVEN R. FOSTER, EXAMINING ATTORNEY

SN 76-622,542. BALTIC LATVIAN UNIVERSAL ELECTRONICS, LLC, WESTLAKE VILLAGE, CA. FILED 11-29-2004.

SN 76-623,340. WALKSTYLES, INC., LAGUNA HILLS, CA. FILED 12-6-2004.

WOODPECKER

DASHTRAK

THE MARK CONSISTS OF STANDARD CHARACTERS WITHOUT CLAIM TO ANY PARTICULAR FONT, STYLE, SIZE, OR COLOR.

FOR MICROPHONES (U.S. CLS. 21, 23, 26, 36 AND 38).
MELISSA VALLILLO, EXAMINING ATTORNEY

THE MARK CONSISTS OF STANDARD CHARACTERS WITHOUT CLAIM TO ANY PARTICULAR FONT, STYLE, SIZE, OR COLOR.

FOR PEDOMETERS (U.S. CLS. 21, 23, 26, 36 AND 38).
ALEX KEAM, EXAMINING ATTORNEY

SN 76-622,581. U.S. ROBOTICS CORPORATION, SCHAUMBURG, IL. FILED 11-30-2004.

SN 76-623,379. GT MERCHANDISING & LICENSING LLC, NEW YORK, NY. FILED 12-6-2004.

Maxg

ULTIMATE CALORIE BLASTER

THE MARK CONSISTS OF STANDARD CHARACTERS WITHOUT CLAIM TO ANY PARTICULAR FONT, STYLE, SIZE, OR COLOR.

FOR WIRELESS COMMUNICATION EQUIPMENT, NAMELY, ROUTERS, ADAPTERS, ACCESS POINTS AND PC CARDS (U.S. CLS. 21, 23, 26, 36 AND 38).
LESLEY LAMOTHE, EXAMINING ATTORNEY

THE MARK CONSISTS OF STANDARD CHARACTERS WITHOUT CLAIM TO ANY PARTICULAR FONT, STYLE, SIZE, OR COLOR.

OWNER OF U.S. REG. NO. 2,962,950.
FOR PRERECORDED MAGNETIC DATA CARRIERS FEATURING EXERCISE ROUTINES AND INSTRUCTIONS (U.S. CLS. 21, 23, 26, 36 AND 38).
BRENDAN REGAN, EXAMINING ATTORNEY

CLASS 9—(Continued).

SN 76-623,627. KABUSHIKI KAISHA SONY COMPUTER ENTERTAINMENT, TA SONY COMPUTER ENTERTAINMENT INC., MINATO-KU TOKYO, 107-0062, JAPAN, FILED 12-7-2004.

I.Q INTELLIGENT QUBE

THE MARK CONSISTS OF STANDARD CHARACTERS WITHOUT CLAIM TO ANY PARTICULAR FONT, STYLE, SIZE, OR COLOR.

NO CLAIM IS MADE TO THE EXCLUSIVE RIGHT TO USE "INTELLIGENT", APART FROM THE MARK AS SHOWN.

FOR COMPUTER APPLICATION SOFTWARE FOR MOBILE PHONES AND MOBILE HAND HELD DEVICES (U.S. CLS. 21, 23, 26, 36 AND 38).

H. M. FISHER, EXAMINING ATTORNEY

SN 76-623,636. SONY KABUSHIKI KAISHA, TA SONY CORPORATION, TOKYO, JAPAN, FILED 12-7-2004.

CHROMAVUE

THE MARK CONSISTS OF STANDARD CHARACTERS WITHOUT CLAIM TO ANY PARTICULAR FONT, STYLE, SIZE, OR COLOR.

FOR SCREENS FOR USE WITH PROJECTORS (U.S. CLS. 21, 23, 26, 36 AND 38).

SUSAN STIGLITZ, EXAMINING ATTORNEY

SN 76-623,993. ZOOM INFORMATION INC., CAMBRIDGE, MA. FILED 12-7-2004.

ZOOM

THE MARK CONSISTS OF STANDARD CHARACTERS WITHOUT CLAIM TO ANY PARTICULAR FONT, STYLE, SIZE, OR COLOR.

FOR COMPUTER SOFTWARE FOR ACCESSING, EXTRACTING, AND ORGANIZING INFORMATION FROM THE INTERNET AND OTHER SOURCES REGARDING PEOPLE, COMPANIES, PRODUCTS, MARKETS, INDUSTRIES, AND OTHER CATEGORIES TO DEVELOP DATABASES OF INFORMATION AND TO ENABLE SEARCHING OF THOSE DATABASES (U.S. CLS. 21, 23, 26, 36 AND 38).

MITCHELL FRONT, EXAMINING ATTORNEY

CLASS 9—(Continued).

SN 76-623,995. ZOOM INFORMATION INC., CAMBRIDGE, MA. FILED 12-7-2004.

ZOOMINFO

THE MARK CONSISTS OF STANDARD CHARACTERS WITHOUT CLAIM TO ANY PARTICULAR FONT, STYLE, SIZE, OR COLOR.

FOR COMPUTER SOFTWARE FOR ACCESSING, EXTRACTING, AND ORGANIZING INFORMATION FROM THE INTERNET AND OTHER SOURCES REGARDING PEOPLE, COMPANIES, PRODUCTS, MARKETS, INDUSTRIES, AND OTHER CATEGORIES TO DEVELOP DATABASES OF INFORMATION AND TO ENABLE SEARCHING OF THOSE DATABASES (U.S. CLS. 21, 23, 26, 36 AND 38).

MITCHELL FRONT, EXAMINING ATTORNEY

SN 76-624,242. HARMONIZED RECORDS, LLC, MEBANE, NC. FILED 12-13-2004.

HARMONIZED RECORDS

THE MARK CONSISTS OF STANDARD CHARACTERS WITHOUT CLAIM TO ANY PARTICULAR FONT, STYLE, SIZE, OR COLOR.

NO CLAIM IS MADE TO THE EXCLUSIVE RIGHT TO USE "RECORDS", APART FROM THE MARK AS SHOWN, FOR COMPACT DISCS FEATURING MUSICAL SOUND RECORDINGS (U.S. CLS. 21, 23, 26, 36 AND 38).

FIRST USE 2-0-2002; IN COMMERCE 2-0-2002.

MARK T. MULLEN, EXAMINING ATTORNEY

SN 76-624,405. GFG INSTRUMENTATION, ANN ARBOR, MI. FILED 12-15-2004.

AIRPAL

THE MARK CONSISTS OF STANDARD CHARACTERS WITHOUT CLAIM TO ANY PARTICULAR FONT, STYLE, SIZE, OR COLOR.

FOR INSTRUMENTS FOR MONITORING THE COMPOSITION AND CONCENTRATION OF GASES (U.S. CLS. 21, 23, 26, 36 AND 38).

GEORGIA CARTY, EXAMINING ATTORNEY

CLASS 9—(Continued).

SN 76-624,814. Z-ONE ELECTRONIC TECHNOLOGY, INC., SAN GABRIEL, CA. FILED 12-15-2004.



FOR COMPUTER HARDWARE PERIPHERALS FOR INTERACTIVE VIDEO GAME PLAYING ON COMPUTERS; AND VIDEO GAME CONSOLE ACCESSORIES AND ATTACHMENTS AND ELECTRONIC HAND-HELD GAME ACCESSORIES AND ATTACHMENTS, NAMELY, JOYSTICKS, CONTROLLERS, MEMORY CARDS AND MULTI-TAP CONNECTOR (U.S. CLS. 21, 23, 26, 36 AND 38).

RICHARD WHITE, EXAMINING ATTORNEY

SN 76-624,983. WILLIAMS HEALTHCARE SYSTEMS LLC, ELGIN, IL. FILED 12-20-2004.

POSTURE-LYZER

THE MARK CONSISTS OF STANDARD CHARACTERS WITHOUT CLAIM TO ANY PARTICULAR FONT, STYLE, SIZE, OR COLOR.

FOR ELECTRONIC SCALES FOR DETERMINING THE WEIGHT AND BALANCE OF A PATIENT (U.S. CLS. 21, 23, 26, 36 AND 38).

LINDA E. BLOHM, EXAMINING ATTORNEY

SN 76-625,095. EOLAS TECHNOLOGIES INCORPORATED, WHEATON, IL. FILED 12-16-2004.

EOLIX

THE MARK CONSISTS OF STANDARD CHARACTERS WITHOUT CLAIM TO ANY PARTICULAR FONT, STYLE, SIZE, OR COLOR.

OWNER OF U.S. REG. NO. 2,189,547.

FOR COMPUTER SOFTWARE FOR COMPUTER NETWORKING APPLICATIONS (U.S. CLS. 21, 23, 26, 36 AND 38).

LEIGH CAROLINE CASE, EXAMINING ATTORNEY

CLASS 9—(Continued).

SN 76-625,104. MOBILITY ELECTRONICS, INC., SCOTTSDALE, AZ. FILED 12-20-2004.

IGO

THE MARK CONSISTS OF STANDARD CHARACTERS WITHOUT CLAIM TO ANY PARTICULAR FONT, STYLE, SIZE, OR COLOR.

OWNER OF U.S. REG. NOS. 2,086,551, 2,954,602 AND OTHERS.

FOR BATTERIES FOR NOTEBOOK AND LAPTOP COMPUTERS; INTERCHANGEABLE TIPS, CORDS, CABLES, POWER SUPPLIES, CRADLES, AND ADAPTERS FOR POWERING AND CHARGING CELL PHONES, PORTABLE DIGITAL ASSISTANTS, PORTABLE ELECTRONIC UNITS FOR THE TRANSMISSION AND RECEIPT OF ELECTRONIC MAIL, DIGITAL CAMERAS, PORTABLE GAME CONSOLES, CAMCORDERS, DIGITAL VIDEO DISC PLAYERS, AND PORTABLE ELECTRONIC UNITS FOR THE STORAGE AND TRANSMISSION OF DIGITAL AND ELECTRONIC DATA; COMPUTER HARDWARE AND SOFTWARE FOR WIRELESS TRANSMISSION OF GRAPHIC PRESENTATIONS FROM HANDHELD DEVICES, NAMELY PERSONAL DIGITAL ASSISTANTS, HANDHELD COMPUTERS AND SMART PHONES, TO DISPLAY HARDWARE DEVICES NAMELY, PROJECTORS AND MONITORS; STANDS FOR COMPUTER MONITORS, NOTEBOOK COMPUTERS AND LAPTOP COMPUTERS; NOISE CANCELING HEADPHONES; NOTEBOOK AND LAPTOP COMPUTER PORT REPLICATORS AND DOCKING STATIONS (U.S. CLS. 21, 23, 26, 36 AND 38).

FIRST USE 8-26-2002; IN COMMERCE 8-26-2002.

EDWARD NELSON, EXAMINING ATTORNEY

SN 76-625,457. SKYHAWKE TECHNOLOGIES, LLC., RIDGE-LAND, MS. FILED 12-23-2004.

SKY CADDY

THE MARK CONSISTS OF STANDARD CHARACTERS WITHOUT CLAIM TO ANY PARTICULAR FONT, STYLE, SIZE, OR COLOR.

OWNER OF U.S. REG. NO. 2,977,019.

FOR ELECTRONIC SATELLITE TRACKING AND INFORMATION SYSTEM COMPRISING COMPUTER HARDWARE AND COMPUTER SOFTWARE USED TO DETERMINE DISTANCES ON GOLF COURSES AND FOR ACCESSING RELEVANT DATA AND STATISTICS PERTINENT THERETO (U.S. CLS. 21, 23, 26, 36 AND 38).

JOHN DWYER, EXAMINING ATTORNEY

CLASS 9—(Continued).

SN 76-625,833. AUDIENCE ANALYTICS, PROVO, UT. FILED 12-27-2004.

AUDIENCE WATCH

THE MARK CONSISTS OF STANDARD CHARACTERS WITHOUT CLAIM TO ANY PARTICULAR FONT, STYLE, SIZE, OR COLOR.

NO CLAIM IS MADE TO THE EXCLUSIVE RIGHT TO USE "AUDIENCE", APART FROM THE MARK AS SHOWN.

FOR SOFTWARE FOR ANALYZING THE EXPOSURE PATTERNS OF AUDIENCES TO TELEVISION, RADIO, AND OTHER MEDIA; SOFTWARE FOR ANALYZING THE CHARACTERISTICS OF MEDIA AUDIENCES; SOFTWARE FOR ASSISTING MEDIA PLANNERS IN ESTABLISHING PROGRAMMING AND ADVERTISING SCHEDULES; AND SOFTWARE FOR ASSESSING THE COMPETITIVE MEDIA ENTERTAINMENT ENVIRONMENT (U.S. CLS. 21, 23, 26, 36 AND 38).

FIRST USE 7-16-2002; IN COMMERCE 7-16-2002.
TANYA AMOS, EXAMINING ATTORNEY

SN 76-625,872. EDISON SOURCE, IRVINE, CA. FILED 12-27-2004.

MINIT-TRAK

THE MARK CONSISTS OF STANDARD CHARACTERS WITHOUT CLAIM TO ANY PARTICULAR FONT, STYLE, SIZE, OR COLOR.

OWNER OF U.S. REG. NOS. 1,783,254, 2,723,587 AND OTHERS.

FOR COMPUTER SOFTWARE FOR ANALYZING DATA AND GENERATING GRAPHIC REPRESENTATIONS OF PERFORMANCE PARAMETERS FOR BATTERY POWERED VEHICLES (U.S. CLS. 21, 23, 26, 36 AND 38).

BARBARA A. GOLD, EXAMINING ATTORNEY

SN 76-625,875. AROA MARKETING, INC., SYLMAR, CA. FILED 12-27-2004.

SPION

THE MARK CONSISTS OF STANDARD CHARACTERS WITHOUT CLAIM TO ANY PARTICULAR FONT, STYLE, SIZE, OR COLOR.

FOR DIGITAL SURVEILLANCE CAMERAS, VIDEO CAMERAS, AND BINOCULARS (U.S. CLS. 21, 23, 26, 36 AND 38).

BARBARA A. GOLD, EXAMINING ATTORNEY

CLASS 9—(Continued).

SN 76-625,885. CORKEY CONTROL SYSTEMS, INC., BURLINGAME, CA. FILED 12-27-2004.

COR-KIT

THE MARK CONSISTS OF STANDARD CHARACTERS WITHOUT CLAIM TO ANY PARTICULAR FONT, STYLE, SIZE, OR COLOR.

OWNER OF U.S. REG. NO. 1,318,986.

FOR SECURITY EQUIPMENT, NAMELY MECHANICALLY-CODED CARD (U.S. CLS. 21, 23, 26, 36 AND 38).

FIRST USE 1-0-1975; IN COMMERCE 1-0-1975.

ANN LINNEHAN, EXAMINING ATTORNEY

SN 76-625,993. BOWE BELL + HOWELL SCANNERS, L.L.C., WHEELING, IL. FILED 12-29-2004.

TRUPER

THE MARK CONSISTS OF STANDARD CHARACTERS WITHOUT CLAIM TO ANY PARTICULAR FONT, STYLE, SIZE, OR COLOR.

FOR OPTICAL SCANNERS (U.S. CLS. 21, 23, 26, 36 AND 38).

WILLIAM BRECKENFELD, EXAMINING ATTORNEY

SN 76-626,338. SONAR SAFETY SYSTEMS, INC., SANTA FE SPRINGS, CA. FILED 12-30-2004.

HINDSIGHT 20/20

THE MARK CONSISTS OF STANDARD CHARACTERS WITHOUT CLAIM TO ANY PARTICULAR FONT, STYLE, SIZE, OR COLOR.

OWNER OF U.S. REG. NOS. 2,354,077, 2,354,078 AND 2,406,823.

FOR ULTRASONIC BACKUP COLLISION DETECTOR FOR USE ON RECREATIONAL VEHICLES, BUSES, TRUCKS AND AUTOMOBILES (U.S. CLS. 21, 23, 26, 36 AND 38).

FIRST USE 2-11-1992; IN COMMERCE 2-11-1992.

IRA J. GOODSaid, EXAMINING ATTORNEY

CLASS 9—(Continued).

SN 76-627,158. PECO, INC., PORTLAND, OR. FILED 1-5-2005.

CLASS 9—(Continued).

SN 76-627,694. ANDERSON, LISA, BALTIMORE, MD. FILED 1-11-2005.

HOSPITALITY

MILKSHAKE

THE MARK CONSISTS OF STANDARD CHARACTERS WITHOUT CLAIM TO ANY PARTICULAR FONT, STYLE, SIZE, OR COLOR.
FOR THERMOSTATS AND OCCUPANCY SENSORS (U.S. CLS. 21, 23, 26, 36 AND 38).
FIRST USE 11-0-2004; IN COMMERCE 11-0-2004.
MARY CRAWFORD, EXAMINING ATTORNEY

THE MARK CONSISTS OF STANDARD CHARACTERS WITHOUT CLAIM TO ANY PARTICULAR FONT, STYLE, SIZE, OR COLOR.
OWNER OF U.S. REG. NO. 2,937,609.
FOR MUSICAL SOUND RECORDINGS BY A MUSICAL GROUP (U.S. CLS. 21, 23, 26, 36 AND 38).
FIRST USE 8-15-2002; IN COMMERCE 8-15-2002.
IRA J. GOODSAD, EXAMINING ATTORNEY

SN 76-627,232. PASCO SCIENTIFIC, INC., ROSEVILLE, CA. FILED 1-6-2005.

SN 76-627,876. ARISTOCRAT TECHNOLOGIES AUSTRALIA PTY LTD, LANE COVE, NEW SOUTH WALES 2066, AUSTRALIA, FILED 1-13-2005.



EGGSTREME RICHES

OWNER OF U.S. REG. NO. 2,510,341.
FOR GRAPHING DATA LOGGER (U.S. CLS. 21, 23, 26, 36 AND 38).
CHARLES L. JENKINS, EXAMINING ATTORNEY

THE MARK CONSISTS OF STANDARD CHARACTERS WITHOUT CLAIM TO ANY PARTICULAR FONT, STYLE, SIZE, OR COLOR.
FOR GAMING DEVICES, NAMELY, GAMING MACHINES AND COMPUTER SOFTWARE USED THEREWITH TO ENABLE THE GAMING MACHINE TO RUN (U.S. CLS. 21, 23, 26, 36 AND 38).
SALLY SHIH, EXAMINING ATTORNEY

SN 76-627,562. VENDAPIN L.L.C., BROOKSVILLE, FL. FILED 1-10-2005.

SN 76-628,000. COMPUSA MANAGEMENT COMPANY, DALLAS, TX. FILED 1-14-2005.

VENDAPRINT



THE MARK CONSISTS OF STANDARD CHARACTERS WITHOUT CLAIM TO ANY PARTICULAR FONT, STYLE, SIZE, OR COLOR.
FOR PAY-FOR-PRINT SOFTWARE FOR CONTROLLING PRINTERS, OFFICE PERIPHERAL EQUIPMENT AND COPIERS, FOR USE IN LIBRARIES, UNIVERSITIES, COLLEGES, AND INSTITUTIONS (U.S. CLS. 21, 23, 26, 36 AND 38).
FIRST USE 0-0-1995; IN COMMERCE 0-0-1995.
AISHA CLARKE, EXAMINING ATTORNEY

FOR PERSONAL COMPUTERS, COMPUTER PRINTERS, OPTICAL SCANNERS, COMPUTER JOY STICKS, COMPUTER POINTING DEVICES, COMPUTER MONITORS, COMPUTER KEYBOARDS, AND COMPUTER PERIPHERALS; ACCESSORIES FOR PERSONAL COMPUTERS, NAMELY, CABLES AND MODEMS, AND RELATED MANUALS AND BOOKS SOLD THEREWITH (U.S. CLS. 21, 23, 26, 36 AND 38).
KAREN BRACEY, EXAMINING ATTORNEY

CLASS 9—(Continued).

SN 76-628,750. ITOONS CORPORATION, CHICAGO, IL. FILED 1-21-2005.

SNAP2PLAY

THE MARK CONSISTS OF STANDARD CHARACTERS WITHOUT CLAIM TO ANY PARTICULAR FONT, STYLE, SIZE, OR COLOR.

FOR ELECTRONIC GAME PROGRAMS; DOWNLOADABLE ELECTRONIC GAME PROGRAMS; ELECTRONIC GAME SOFTWARE; COMPUTER GAME PROGRAMS; DOWNLOADABLE COMPUTER GAME PROGRAMS; INTERACTIVE GAME PROGRAMS; INTERACTIVE GAME SOFTWARE (U.S. CLS. 21, 23, 26, 36 AND 38).
DOMINICK J. SALEMI, EXAMINING ATTORNEY

SN 76-635,701. UTOPIAN REALITIES, INC., LAKE MARY, FL. FILED 4-11-2005.



THE MARK CONSISTS OF STYLIZED LETTERS "XPX EXPANSION XPERIENCE". THE LETTERS "X" AND "P" ARE CONNECTED WITH A HORIZONTAL LINE BETWEEN THE BOTTOM OF EACH LETTER AND THE SECOND LETTER "X" FOLLOWS THE LETTER "P" AS A STANDALONE LETTER, AND "XPANSION XPERIENCE" IS DEPICTED BELOW "XPX".

FOR DATA PROCESSING EQUIPMENT AND COMPUTERS, NAMELY COMPUTER HARDWARE, COMPUTER CENTRAL PROCESSING UNITS, COMPUTER CAMERAS, CARRYING CASES, CHASSIS, CHIPS, CHIPSET FOR USE IN TRANSMITTING DATA, CURSOR CONTROL DEVICES, DISC DRIVES, DOCKING STATIONS, FAX MODEM CARDS, GAME JOYSTICKS, HARDWARE, HEAT SINKS, INTERFACE BOARDS, JOYSTICKS, KEYBOARDS, KEYPADS, MEMORIES, MEMORY HARDWARE, MONITOR FRAMES, MONITORS, COMPUTER MOUSE, COMPUTER MOUSE TRACKBALLS, COMPUTER MOUSE TOUCHPADS, NETWORK ADAPTERS, NETWORK HUBS, SWITCHES AND ROUTERS, NETWORKING HARDWARE, COMPUTER PERIPHERALS, PRINTERS, COMPUTER PROGRAMS FOR DOCUMENT MANAGEMENT, AND COMPUTER SCREEN FILTERS (U.S. CLS. 21, 23, 26, 36 AND 38).

FIRST USE 6-5-2002; IN COMMERCE 6-5-2002.
KATHLEEN M. VANSTON, EXAMINING ATTORNEY

CLASS 9—(Continued).

SN 78-058,741. CONNECTIVITY SYSTEMS INCORPORATED, WILLIAMSPORT, OH. FILED 4-17-2001.

CSI INTERNATIONAL

NO CLAIM IS MADE TO THE EXCLUSIVE RIGHT TO USE "INTERNATIONAL", APART FROM THE MARK AS SHOWN.

FOR COMPUTER SOFTWARE FOR MAINFRAME COMPUTERS, UTILIZING VIRTUAL STORAGE EXTENDED/ENTERPRISE SYSTEM ARCHITECTURE OPERATING SYSTEMS (U.S. CLS. 21, 23, 26, 36 AND 38).
MATTHEW PAPPAS, EXAMINING ATTORNEY

SN 78-058,742. CONNECTIVITY SYSTEMS, WILLIAMSPORT, OH. FILED 4-17-2001.

CSI

FOR COMPUTER SOFTWARE FOR MAINFRAME COMPUTERS, UTILIZING VIRTUAL STORAGE EXTENDED/ENTERPRISE SYSTEM ARCHITECTURE OPERATING SYSTEMS (U.S. CLS. 21, 23, 26, 36 AND 38).
MATTHEW PAPPAS, EXAMINING ATTORNEY

SN 78-065,384. SERVERZERO INC., RANCHO SANTA FE, CA. FILED 5-23-2001.

MATRIX

FOR COMPUTER HARDWARE INCLUDING PARTS ASSOCIATED WITH HOUSING THE PROCESSOR, MOTHERBOARD/MAIN BOARD AND ASSOCIATED PROCESSING HARDWARE, EXCLUDING COMPUTER DISPLAYS, EXCLUDING CONNECTORS BETWEEN COMPUTERS, AND EXCLUDING COMPUTER PERIPHERALS NOT HOUSING THE PROCESSORS, MAINBOARD (U.S. CLS. 21, 23, 26, 36 AND 38).

FIRST USE 1-2-2001; IN COMMERCE 3-12-2001.
SAMUEL E. SHARPER JR., EXAMINING ATTORNEY

SN 78-066,886. MACK TRUCKS, INC., ALLENTOWN, PA. FILED 6-1-2001.

GUARD DOG

FOR ROUTINE MAINTENANCE MONITORING SYSTEM FOR HEAVY DUTY TRUCKS CONSISTING OF A SERIES OF SENSORS LOCATED THROUGHOUT THE VEHICLE TO ALERT DRIVERS WHEN MAINTENANCE IS NEEDED (U.S. CLS. 21, 23, 26, 36 AND 38).

FIRST USE 2-0-2002; IN COMMERCE 2-0-2002.
JOSETTE BEVERLY, EXAMINING ATTORNEY

CLASS 9—(Continued).

SN 78-111,637. FOSS ELECTRIC A/S, 3400 HILLERØD, DENMARK, FILED 2-28-2002.

MICROFOSS

PRIORITY CLAIMED UNDER SEC. 44(D) ON ERPN CMNTY TM OFC APPLICATION NO. 002481786, FILED 11-28-2001, REG. NO. 002481786, DATED 4-16-2003, EXPIRES 11-28-2011.

FOR SCIENTIFIC, ELECTRIC, PHOTOGRAPHIC, CINEMATOGRAPHIC APPARATUS AND INSTRUMENTS AND APPARATUS AND INSTRUMENTS FOR WEIGHING, MEASURING, CHECKING, ANALYZING, DETECTING, TESTING, CONTROLLING, CELL COUNTING, ADJUSTING, SAMPLE HANDLING AND IDENTIFICATION APPARATUS AND INSTRUMENTS FOR USE IN THE DAIRY, FOOD, BEVERAGE, MICROBIOLOGICAL, FEED, GRAIN, CHEMICAL AND PHARMACEUTICAL INDUSTRY AND FOR USE IN LABORATORIES, NAMELY, LIGHT EMITTING DIODES(LED) CELLS, VIALS FOR LIQUIDS, MEDIAS WITH PH-INDICATOR OR GASES-INDICATOR, AGAR PLUGS, ALL FOR MEASURING SPECTRAL VARIATIONS DUE TO METABOLIC ACTIVITY OF MICROORGANISMS AND DETECTING DIFFERENCES IN OPTICAL UNITS; APPARATUS FOR RECORDING, TRANSMISSION AND REPRODUCTION OF SOUND OR IMAGES AND DATA AND RESULTS OF ANALYSES, MEASUREMENTS AND TESTS FOR USE IN THE FOOD, BEVERAGE, DAIRY, MICROBIOLOGICAL, GRAIN, FEED, CHEMICAL AND PHARMACEUTICAL INDUSTRY AND IN LABORATORIES, NAMELY, LED CELLS, OPTICAL DETECTION UNITS, MEDIA WITH PH-INDICATOR OR CO₂-INDICATOR, AND SENSORS FOR RECORDING SPECTRAL VARIATIONS; PRERECORDED MAGNETIC DATA CARRIERS FEATURING COMPUTER SOFTWARE FOR STEERING, INTEGRATING AND CONTROLLING THE TESTING, MEASURING, ANALYZING, CONTROLLING, CELL COUNTING, SAMPLE HANDLING, IDENTIFICATION AND ADJUSTMENT APPARATUS AND INSTRUMENTS; CALCULATORS AND DATA PROCESSORS AND COMPUTERS; RECORDED COMPUTER SOFTWARE FOR STEERING, INTEGRATION AND CONTROL AND ANALYZING, MEASURING, TESTING, CONTROLLING, CELL COUNTING, SAMPLE HANDLING AND ADJUSTMENT APPARATUS AND INSTRUMENTS FOR USE IN THE FOOD, BEVERAGE, DAIRY, MICROBIOLOGICAL, FEED, GRAIN, CHEMICAL AND PHARMACEUTICAL INDUSTRY AND IN LABORATORIES FOR USE IN CONNECTION WITH THE MENTIONED APPARATUS AND INSTRUMENTS (U.S. CLS. 21, 23, 26, 36 AND 38).

FIRST USE 1-1-2001; IN COMMERCE 1-1-2001.
BRIDGETT SMITH, EXAMINING ATTORNEY

SN 78-112,071. DIRECT IMPRESSIONS, AURORA, CO. FILED 3-1-2002.

CAMP WIN A LOTA

FOR GAMING MACHINES (U.S. CLS. 21, 23, 26, 36 AND 38).

ELISSA GARBER KON, EXAMINING ATTORNEY

CLASS 9—(Continued).

SN 78-144,670. XG TECHNOLOGY, LLC, SARASOTA, FL. FILED 7-17-2002.

XG

FOR ELECTRONIC DATA COMMUNICATION EQUIPMENT AND CIRCUITRY, NAMELY MODULATORS, DEMODULATORS, AND COMPUTER INTERFACE BOARDS FOR TELEPHONE, AUDIO, VIDEO, AND DIGITAL DATA TRANSMITTERS AND RECEIVERS (U.S. CLS. 21, 23, 26, 36 AND 38).

FIRST USE 7-7-2002; IN COMMERCE 7-7-2002.
SUSAN STIGLITZ, EXAMINING ATTORNEY

SN 78-183,370. MAJOR LEAGUE BASEBALL PROPERTIES, INC., NEW YORK, NY. FILED 11-8-2002.

MLB TV

OWNER OF U.S. REG. NOS. 1,055,315 AND 2,188,192.
NO CLAIM IS MADE TO THE EXCLUSIVE RIGHT TO USE "TV", APART FROM THE MARK AS SHOWN.

FOR ELECTRICAL AND SCIENTIFIC APPARATUS, NAMELY, PRE-RECORDED VIDEOTAPES, PRE-RECORDED VIDEODISCS, PRE-RECORDED COMPACT DISCS, PRE-RECORDED AUDIO DISCS, AND PRE-RECORDED AUDIO TAPES RELATING TO BASEBALL; VIDEO AND COMPUTER GAME CARTRIDGES; VIDEO AND COMPUTER GAME DISCS; VIDEO AND COMPUTER GAME CASSETTES; VIDEO AND ELECTRONIC GAME PROGRAMS FOR USE WITH HAND HELD GAME UNITS, COMPUTER GAME PROGRAMS AND COMPUTER GAME PROGRAMS DOWNLOADABLE FROM A GLOBAL COMPUTER NETWORK IN THE FIELD OF BASEBALL (U.S. CLS. 21, 23, 26, 36 AND 38).

SCOTT BALDWIN, EXAMINING ATTORNEY

SN 78-201,457. PIONEER KABUSHIKI KAISHA, DBA PIONEER CORPORATION, MEGURO-KU, TOKYO 153-8654, JAPAN, FILED 1-9-2003.

PASSPORT ECHO

FOR COMPUTER SOFTWARE FOR CABLE TELEVISION CHANNEL SELECTOR BOXES TO CONTROL ONSCREEN MENUS (U.S. CLS. 21, 23, 26, 36 AND 38).

INGA ERVIN, EXAMINING ATTORNEY

SN 78-238,073. APPLIED MICRO CIRCUITS CORPORATION, SAN DIEGO, CA. FILED 4-15-2003.

MISSION

FOR SEMICONDUCTORS AND INTEGRATED CIRCUITS (U.S. CLS. 21, 23, 26, 36 AND 38).

APRIL L. RADEMACHER, EXAMINING ATTORNEY

CLASS 9—(Continued).

SN 78-252,581. MEDEA CORPORATION, CALABASAS, CA. FILED 5-21-2003.

FIRESTOR

FOR COMPUTER PERIPHERALS (U.S. CLS. 21, 23, 26, 36 AND 38).
FLORENTINA BLANDU, EXAMINING ATTORNEY

SN 78-264,732. O'DEA, DENNIS, JUSTIN, DBA PROPOR-TABLE, DALTON, PA. FILED 6-19-2003.



FOR DESKTOP COMPUTERS, NOTEBOOK COMPUTERS, TABLET COMPUTERS, POCKET COMPUTERS (U.S. CLS. 21, 23, 26, 36 AND 38).
FIRST USE 1-1-2003; IN COMMERCE 9-1-2003.
MARK T. MULLEN, EXAMINING ATTORNEY

SN 78-285,752. AZIMUTH SYSTEMS, INC., ACTON, MA. FILED 8-11-2003.

TESTMAC

FOR COMPUTER HARDWARE AND SOFTWARE USED TO EMULATE MULTIPLE WIRELESS ENDPOINTS TO BUILD SCALABLE TEST CONFIGURATION FOR WIRELESS LOCAL AREA NETWORK EQUIPMENT TESTING (U.S. CLS. 21, 23, 26, 36 AND 38).
PAULA MAYS, EXAMINING ATTORNEY

SN 78-294,239. SUPERMICRO COMPUTERS, INC., SAN JOSE, CA. FILED 8-29-2003.

S-SERVER

FOR COMPUTER HARDWARE, NAMELY, MOTHERBOARDS; COMPUTER SERVERS FOR USE WITH COMPUTER NETWORKS AND COMPUTER WORKSTATIONS; COMPUTER SERVER SYSTEMS CONSISTING OF MOTHERBOARDS, CHASSIS, CENTRAL PROCESSING UNITS, MEMORY MODULES, MEMORY CARDS, HOST BUS ADAPTER CARDS, AND HARD DRIVES (U.S. CLS. 21, 23, 26, 36 AND 38).
JACQUELINE A. LAVINE, EXAMINING ATTORNEY

CLASS 9—(Continued).

SN 78-308,266. ACI COMMUNICATIONS, INC., KENT, WA. FILED 10-1-2003.



NO CLAIM IS MADE TO THE EXCLUSIVE RIGHT TO USE "COMMUNICATIONS, INC.", APART FROM THE MARK AS SHOWN.

FOR RF AMPLIFIERS, FIBER OPTIC NODES AND WIRELESS WI-FI ACCESS POINTS FOR USE WITH CABLE TELEVISION NETWORKS (U.S. CLS. 21, 23, 26, 36 AND 38).

FIRST USE 8-1-1999; IN COMMERCE 8-1-1999.
MARIA-VICTORIA SUAREZ, EXAMINING ATTORNEY

SN 78-308,560. COM NET, INC., WAPAKONETA, OH. FILED 10-2-2003.

BEAST

FOR COMPUTER NETWORK HARDWARE AND SOFTWARE AND FOR USE IN ADMINISTERING DSL, WIRELESS AND LAN AND WAN NETWORKS (U.S. CLS. 21, 23, 26, 36 AND 38).

MICHAEL HALL, EXAMINING ATTORNEY

SN 78-317,534. DIRECT SOURCE SPECIAL PRODUCTS INC., LASALLE, QUEBEC, CANADA, FILED 10-23-2003.



NO CLAIM IS MADE TO THE EXCLUSIVE RIGHT TO USE "COUNTRY MUSIC AMERICA", APART FROM THE MARK AS SHOWN.

FOR COMPACT DISCS AND DIGITAL VIDEO DISKS FEATURING COUNTRY MUSIC (U.S. CLS. 21, 23, 26, 36 AND 38).

FIRST USE 3-18-2003; IN COMMERCE 3-18-2003.
TERESA M. RUPP, EXAMINING ATTORNEY

CLASS 9—(Continued).

SN 78-318,240. INTERNATIONAL RECTIFIER CORPORATION, EL SEGUNDO, CA. FILED 10-24-2003.

ACCELERATOR

FOR COMPUTER SOFTWARE PLATFORMS, GRAPHICAL USER INTERFACE, SIGNAL PROCESSING HARDWARE, INTEGRATED CIRCUITS AND SEMICONDUCTOR DEVICES FOR THE USE IN THE DESIGN AND DEVELOPMENT OF MOTION CONTROL ALGORITHMS AND MOTION CONTROL FUNCTIONS FOR ELECTRONIC MOTORS (U.S. CLS. 21, 23, 26, 36 AND 38).
INGA ERVIN, EXAMINING ATTORNEY

SN 78-321,118. QWEST COMMUNICATIONS INTERNATIONAL INC., DENVER, CO. FILED 10-30-2003.

NORTHWESTERN

OWNER OF U.S. REG. NOS. 1,459,201 AND 1,574,448. SEC. 2(F).
FOR TELECOMMUNICATIONS EQUIPMENT; NAMELY, TELEPHONES, TELEPHONE ANSWERING MACHINES, FACSIMILE MACHINES, TELEPHONES CONTAINING BUILT-IN CLOCK RADIOS, CORDLESS TELEPHONES, TELEPHONE WALL JACKS, TELEPHONE EXTENSION CORDS, TELEPHONE ADAPTERS, PAGERS, WIRELESS TELEPHONES AND TWO-WAY RADIOS (U.S. CLS. 21, 23, 26, 36 AND 38).
AMOS T. MATTHEWS, JR., EXAMINING ATTORNEY

SN 78-326,180. PIONEER MAGNETICS, INC., SANTA MONICA, CA. FILED 11-11-2003.

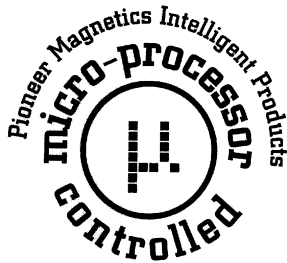

NO CLAIM IS MADE TO THE EXCLUSIVE RIGHT TO USE "MICRO-PROCESSOR CONTROLLED" AND "INTELLIGENT PRODUCTS", APART FROM THE MARK AS SHOWN.

THE MARK CONSISTS OF IN PART OF THE GREEK LETTER "U" (PRONOUNCED "MU") WHICH IS THE SCIENTIFIC NOTATION FOR "MICRO".

FOR MICRO-COMPUTERS AND RELATED SOFTWARE USED TO CONTROL AND MONITOR POWER SUPPLIES (U.S. CLS. 21, 23, 26, 36 AND 38).

FIRST USE 5-0-2003; IN COMMERCE 5-15-2003.
TRACY FLETCHER, EXAMINING ATTORNEY

CLASS 9—(Continued).

SN 78-334,305. NAVMAN NZ LIMITED, NORTHCOTE, AUCKLAND, NEW ZEALAND, FILED 12-1-2003.

SMARTEXPLORER

THE MARK CONSISTS OF STANDARD CHARACTERS WITHOUT CLAIM TO ANY PARTICULAR FONT, STYLE, SIZE, OR COLOR.

PRIORITY CLAIMED UNDER SEC. 44(D) ON NEW ZEALAND APPLICATION NO. 704907, FILED 11-24-2003, REG. NO. 704907, DATED 5-27-2004, EXPIRES 11-24-2013.

FOR NAVIGATIONAL APPARATUS AND EQUIPMENT, NAMELY, MARINE AND LAND-BASED NAVIGATIONAL EQUIPMENT CONSISTING OF HANDHELD GPS UNITS, TRANSFERABLE NAVIGATION UNITS, AND EMBEDDED NAVIGATION COMPUTER SOFTWARE; GLOBAL POSITIONING SYSTEMS AND PARTS THEREOF, NAMELY, GPS ANTENNAS AND SENSORS; ELECTRICAL AND ELECTRONIC COMMUNICATIONS EQUIPMENT FOR NAVIGATION, NAMELY, COMPUTERIZED PHONES; SATELLITES AND SATELLITE COMMUNICATIONS PROCESSORS; COMPUTER SOFTWARE AND HARDWARE RELATING TO ROUTE PLANNING AND NAVIGATION AND GPS AND GPS ENABLED POCKET PERSONAL COMPUTERS (U.S. CLS. 21, 23, 26, 36 AND 38).

RAÚL CORDOVA, EXAMINING ATTORNEY

SN 78-334,957. NANCY A VALENTE, CHICAGO, IL. FILED 12-2-2003.

THE COLOR(S) BLUE IS/ARE CLAIMED AS A FEATURE OF THE MARK.

THE WORDING "PETALK" APPEARS IN THE COLOR BLUE.

FOR RECORDING DEVICE CONSISTING OF A COMBINATION DIGITAL VOICE CHIP WHICH IS ACTIVATED BY MEANS OF A MICROPROCESSOR COMPUTER CHIP WHICH HAS BEEN PROGRAMMED UTILIZING A SOFTWARE PROGRAM WRITTEN SPECIFICALLY FOR ITS' FUNCTION IN ORDER TO PLAYBACK RECORDED MESSAGES AT PRESET TIMED INTERVALS (U.S. CLS. 21, 23, 26, 36 AND 38).

FIRST USE 0-0-2000; IN COMMERCE 11-1-2000.
CHRISTOPHER ADKINS, EXAMINING ATTORNEY

CLASS 9—(Continued).

SN 78-335,378. 24/7 REAL MEDIA, INC., NEW YORK, NY.
FILED 12-2-2003.

OPEN ADVERTISER

THE MARK CONSISTS OF STANDARD CHARACTERS WITHOUT CLAIM TO ANY PARTICULAR FONT, STYLE, SIZE, OR COLOR.

NO CLAIM IS MADE TO THE EXCLUSIVE RIGHT TO USE ADVERTISER, APART FROM THE MARK AS SHOWN. FOR COMPUTER SOFTWARE FOR ADVERTISING MANAGEMENT AND ADVERTISING TARGETING FOR USE BY ADVERTISING AGENCIES, ADVERTISERS AND MEDIA BUYING ORGANIZATIONS (U.S. CLS. 21, 23, 26, 36 AND 38).

FIRST USE 12-1-2000; IN COMMERCE 3-1-2001.
LINDA E. BLOHM, EXAMINING ATTORNEY

SN 78-336,545. SYNTHESYS RESEARCH INCORPORATED,
MENLO PARK, CA. FILED 12-4-2003.

ScopeBert

THE MARK CONSISTS OF STANDARD CHARACTERS WITHOUT CLAIM TO ANY PARTICULAR FONT, STYLE, SIZE, OR COLOR.

FOR ELECTRONIC TEST EQUIPMENT, NAMELY DIGITAL VIDEO SIGNAL TESTERS AND DIGITAL COMMUNICATION TESTERS (U.S. CLS. 21, 23, 26, 36 AND 38).

MICHELE SWAIN, EXAMINING ATTORNEY

CLASS 9—(Continued).

SN 78-339,231. BSH HOME APPLIANCES CORPORATION,
HUNTINGTON BEACH, CA. FILED 12-11-2003.

OPTISTEAM

THE MARK CONSISTS OF STANDARD CHARACTERS WITHOUT CLAIM TO ANY PARTICULAR FONT, STYLE, SIZE, OR COLOR.

FOR ELECTRIC IRONS AND REPLACEMENT PARTS THEREFOR. (U.S. CLS. 21, 23, 26, 36 AND 38).

GINA FINK, EXAMINING ATTORNEY

SN 78-339,441. LIGHTING ELYSIUM, LLC, RAMSEY, NJ.
FILED 12-11-2003.



NO CLAIM IS MADE TO THE EXCLUSIVE RIGHT TO USE "LIGHTING", APART FROM THE MARK AS SHOWN.

FOR INDOOR AND OUTDOOR LIGHTING EQUIPMENT AND SUPPLIES, NAMELY, ELECTRICAL SWITCHES, ELECTRICAL CABLES, AND MANUAL AND AUTOMATED LIGHTING CONTROLS (U.S. CLS. 21, 23, 26, 36 AND 38).

FIRST USE 8-1-2003; IN COMMERCE 8-1-2003.
GEORGIA CARTY, EXAMINING ATTORNEY

SN 78-340,334. INGEENI STUDIOS, INC., CAMBRIDGE, MA.
FILED 12-12-2003.

GENIE BABY

THE MARK CONSISTS OF STANDARD CHARACTERS WITHOUT CLAIM TO ANY PARTICULAR FONT, STYLE, SIZE, OR COLOR.

FOR COMPUTER SOFTWARE, NAMELY, ARTIFICIAL INTELLIGENCE COMPUTER GAME SOFTWARE; COMPUTER SOFTWARE FOR USE IN WEBSITE CONTENT DEVELOPMENT (U.S. CLS. 21, 23, 26, 36 AND 38).

RENEE MCCRAY, EXAMINING ATTORNEY

CLASS 9—(Continued).

SN 78-341,551. FUJITSU LIMITED, KANAGAWA-KEN, JAPAN, FILED 12-16-2003.



PRIORITY CLAIMED UNDER SEC. 44(D) ON JAPAN APPLICATION NO. 2003-071216, FILED 8-21-2003, REG. NO. 4748419, DATED 2-20-2004, EXPIRES 2-20-2014.

THE COLOR(S) BLUE, AND WHITE IS/ARE CLAIMED AS A FEATURE OF THE MARK.

THE COLOR WHITE APPEARS IN THE TWO CURVED BANDS AND THE COLOR BLUE APPEARS IN THE BACKGROUND WITH A DARKER SHADE OF BLUE AT THE TOP PORTION OF THE BACKGROUND AND A LIGHTER SHADE OF BLUE AT THE BOTTOM PORTION OF THE BACKGROUND.

THE MARK CONSISTS OF A MISCELLANEOUS DESIGN INCLUDING THE COLORS WHITE, BLUE, AND HUES OF BLUE.

FOR COMPUTER HARDWARE AND SOFTWARE FOR USE IN BIOINFORMATICS AND GENOMICS, NAMELY, FOR USE IN THE PROCESSING, ANALYZING, STORING AND RETRIEVAL OF COMPLEX BIOLOGICAL INFORMATION WITH PARTICULAR REFERENCE TO THE HUMAN GENOME AND HUMAN PROTEOME (U.S. CLS. 21, 23, 26, 36 AND 38).

ALEX KEAM, EXAMINING ATTORNEY

SN 78-345,297. PRISM TECHNOLOGY LIMITED, KOWLOON BAY, HONG KONG, FILED 12-24-2003.

GAMEXPERT

THE MARK CONSISTS OF STANDARD CHARACTERS WITHOUT CLAIM TO ANY PARTICULAR FONT, STYLE, SIZE, OR COLOR.

FOR COMPUTER GAME JOYPAD; COMPUTER GAME MEMORY CARD; COMPUTER GAME SOUND SYSTEMS, NAMELY, SOUND CARDS AND AUDIO SPEAKERS; COMPUTER GAME POWER PACK; COMPUTER GAME HARDWARE; COMPUTER GAME SOFTWARE; COMPUTER GAME EQUIPMENT CONNECTIVITIES, NAMELY, COMPUTER CABLE AND ELECTRICAL CONNECTORS (U.S. CLS. 21, 23, 26, 36 AND 38).

ODESSA BIBBINS, EXAMINING ATTORNEY

CLASS 9—(Continued).

SN 78-345,338. LEVITON MANUFACTURING CO., INC., LITTLE NECK, NY, FILED 12-24-2003.

QUAD DIMMER

THE MARK CONSISTS OF STANDARD CHARACTERS WITHOUT CLAIM TO ANY PARTICULAR FONT, STYLE, SIZE, OR COLOR.

NO CLAIM IS MADE TO THE EXCLUSIVE RIGHT TO USE DIMMER, APART FROM THE MARK AS SHOWN.

FOR ELECTRIC DIMMERS AND DIMMER CABINETS FOR CONTROLLING POWER FOR USE IN ENTERTAINMENT AND COMMERCIAL ENVIRONMENTS (U.S. CLS. 21, 23, 26, 36 AND 38).

SUSAN HAYASH, EXAMINING ATTORNEY

SN 78-349,320. GOSCH, TIMOTHY JOHN, CHARLOTTE, NC, FILED 1-8-2004.

Dojo Master

THE MARK CONSISTS OF STANDARD CHARACTERS WITHOUT CLAIM TO ANY PARTICULAR FONT, STYLE, SIZE, OR COLOR.

SEC. 2(F).

FOR COMPUTER SOFTWARE FOR USE IN THE ADMINISTRATION AND MANAGEMENT OF MARTIAL ARTS SCHOOLS (U.S. CLS. 21, 23, 26, 36 AND 38).

FIRST USE 1-1-1991; IN COMMERCE 1-1-1991.

NELSON SNYDER, EXAMINING ATTORNEY

CLASS 9—(Continued).

SN 78-351,975. VETTRO CORPORATION, NEW YORK, NY.
FILED 1-14-2004.

VETTRO RAINMAKER

THE MARK CONSISTS OF STANDARD CHARACTERS WITHOUT CLAIM TO ANY PARTICULAR FONT, STYLE, SIZE, OR COLOR.

OWNER OF U.S. REG. NOS. 284,670 AND 2,583,658.

FOR COMPUTER SOFTWARE, NAMELY, AN APPLICATION ALLOWING SALES AND FIELD SERVICE EMPLOYEES TO UPDATE AND RECEIVE DATA STORED IN AN ENTERPRISE'S COMPUTER DATABASES IN REAL TIME, USING A MOBILE DEVICE, WITH FULL TELEPHONY INTEGRATION WITH THE PHONE AND/OR SOFTWARE FEATURES OF THE MOBILE DEVICE (U.S. CLS. 21, 23, 26, 36 AND 38).

FIRST USE 11-9-2003; IN COMMERCE 11-9-2003.
MICHAEL SOUDERS, EXAMINING ATTORNEY

SN 78-352,406. WATERS INVESTMENTS LIMITED, MILFORD, MA. FILED 1-15-2004.

AcQuity UPLC

THE MARK CONSISTS OF STANDARD CHARACTERS WITHOUT CLAIM TO ANY PARTICULAR FONT, STYLE, SIZE, OR COLOR.

FOR LABORATORY EQUIPMENT FOR PERFORMING CHEMICAL AND DIAGNOSTIC ANALYSIS THROUGH BIOLOGICAL AND CHEMICAL SEPARATION, PURIFICATION, SCREENING AND IDENTIFICATION, NAMELY, LIQUID AND GAS CHROMATOGRAPHY APPARATUS AND SYSTEMS, WHEREIN THE SYSTEMS ARE COMPRISED OF PUMPS, DETECTORS, INJECTORS, AUTOSAMPLERS AND OPERATING SOFTWARE FOR USE THEREWITH (U.S. CLS. 21, 23, 26, 36 AND 38).

STEVEN R. FINE, EXAMINING ATTORNEY

CLASS 9—(Continued).

SN 78-352,951. RS&I, INC., IDAHO FALLS, ID. FILED 1-16-2004.

EZ-Trac

THE MARK CONSISTS OF STANDARD CHARACTERS WITHOUT CLAIM TO ANY PARTICULAR FONT, STYLE, SIZE, OR COLOR.

FOR COMPUTER SOFTWARE FOR COMPREHENSIVE TRACKING OF COMMISSIONS, INVOICES, PAPERWORK, PRODUCTS, AND ON-LINE BUSINESS RULES; NAMELY FOR USE IN THE SATELLITE TELEVISION AND HOME SECURITY INDUSTRIES (U.S. CLS. 21, 23, 26, 36 AND 38).

SOPHIA S. KIM, EXAMINING ATTORNEY

SN 78-353,432. MEL-USA, INC., MARIETTA, GA. FILED 1-17-2004.

Multi Easy Link

THE MARK CONSISTS OF STANDARD CHARACTERS WITHOUT CLAIM TO ANY PARTICULAR FONT, STYLE, SIZE, OR COLOR.

NO CLAIM IS MADE TO THE EXCLUSIVE RIGHT TO USE "LINK", APART FROM THE MARK AS SHOWN.

FOR COMPUTER SOFTWARE FOR THE COLLECTION, EDITING, ORGANIZING, MODIFYING, BOOK MARKING, TRANSMISSION STORAGE AND SHARING OF DATA AND INFORMATION (U.S. CLS. 21, 23, 26, 36 AND 38).

FIRST USE 3-1-1999; IN COMMERCE 3-1-1999.
DAVID TAYLOR, EXAMINING ATTORNEY

CLASS 9—(Continued).

SN 78-354,312. FMC TECHNOLOGIES, INC., CHICAGO, IL. FILED 1-20-2004.

LINK

THE MARK CONSISTS OF STANDARD CHARACTERS WITHOUT CLAIM TO ANY PARTICULAR FONT, STYLE, SIZE, OR COLOR.

OWNER OF U.S. REG. NO. 2,795,385.

FOR COMPUTER SOFTWARE, NAMELY PROCESS CONTROL SOFTWARE USED TO ANALYZE FOOD PROCESSING AND FOOD QUALITY DATA FROM FOOD HANDLING EQUIPMENT AND FOOD PROCESSING LINES, AND COMPUTER SOFTWARE AND HARDWARE, NAMELY, CONTROL SOFTWARE AND HARDWARE USED TO OPERATE, MAINTAIN, MANAGE, MONITOR AND COLLECT DATA RELATED TO FOOD PROCESSING AND HANDLING IN THE FOOD PROCESSING INDUSTRY (U.S. CLS. 21, 23, 26, 36 AND 38).

FIRST USE 1-1-2000; IN COMMERCE 1-1-2000. LAURA KOVAISKY, EXAMINING ATTORNEY

SN 78-358,405. MONSTER, LLC, LAS VEGAS, NV. FILED 1-27-2004.

HOME THEATER MUSIC

THE MARK CONSISTS OF STANDARD CHARACTERS WITHOUT CLAIM TO ANY PARTICULAR FONT, STYLE, SIZE, OR COLOR.

NO CLAIM IS MADE TO THE EXCLUSIVE RIGHT TO USE HOME THEATER, APART FROM THE MARK AS SHOWN.

FOR ELECTRICAL AND ELECTROMAGNETIC SIGNAL TRANSMITTING, AMPLIFYING, RECEIVING AND CONVERTING DEVICES, NAMELY, CABLES, WIRES, CONNECTORS, AND CONTROLLERS FOR USE WITH ELECTRICAL, ELECTRONIC AND COMPUTER DEVICES; LOUDSPEAKERS; STEREO AMPLIFIERS; AUDIO EQUIPMENT AND ACCESSORIES, NAMELY, AUDIO CABLES AND CONNECTORS; VIDEO EQUIPMENT AND ACCESSORIES, NAMELY, VIDEO CABLES AND CONNECTORS; ELECTRONIC GAME EQUIPMENT AND ACCESSORIES, NAMELY, ELECTRONIC GAME CABLES AND CONNECTORS; ELECTRICAL POWER CONTROLLERS; ENERGY CONDITIONERS; VOLTAGE STABILIZERS (U.S. CLS. 21, 23, 26, 36 AND 38).

KIMBERLY PERRY, EXAMINING ATTORNEY

CLASS 9—(Continued).

SN 78-359,366. PASS & SEYMOUR, INC., SOLVAY, NY. FILED 1-29-2004.

CREATE-A-PLATE

THE MARK CONSISTS OF STANDARD CHARACTERS WITHOUT CLAIM TO ANY PARTICULAR FONT, STYLE, SIZE, OR COLOR.

OWNER OF U.S. REG. NO. 2,104,426. SEC. 2(F).

FOR ELECTRICAL SWITCH PLATES THAT CAN BE COMBINED TO FIT ANY WALL PLATE CONFIGURATION (U.S. CLS. 21, 23, 26, 36 AND 38).

FIRST USE 11-30-1992; IN COMMERCE 11-30-1992. TONI HICKEY, EXAMINING ATTORNEY

SN 78-359,395. MULTIMEDIACARD ASSOCIATION, CUPERTINO, CA. FILED 1-29-2004.

MMC MAX

THE MARK CONSISTS OF STANDARD CHARACTERS WITHOUT CLAIM TO ANY PARTICULAR FONT, STYLE, SIZE, OR COLOR.

NO CLAIM IS MADE TO THE EXCLUSIVE RIGHT TO USE "MMC", APART FROM THE MARK AS SHOWN.

FOR CARDS CONTAINING AN INTEGRATED CIRCUIT MEMORY COMPONENT FOR STORING DIGITAL DATA THAT INTERFACES WITH TELECOMMUNICATION DEVICES, TESTERS, INTEGRATED CIRCUITS, HOST HANDHELD DEVICES SUCH AS PERSONAL DIGITAL ASSISTANTS WHICH CONTAIN, ACCEPT, READ, RECOGNIZE AND/OR UTILIZE SUCH CARDS AS ALL OR PART OF THEIR FUNCTION (U.S. CLS. 21, 23, 26, 36 AND 38).

TONI HICKEY, EXAMINING ATTORNEY

CLASS 9—(Continued).

SN 78-361,377. ADTRAN, INC., HUNTSVILLE, AL. FILED 2-2-2004.

CLASS 9—(Continued).

SN 78-366,813. INFORMATION OPTICS CORPORATION, CHERRY HILL, NJ. FILED 2-12-2004.

OPTI-3

THE MARK CONSISTS OF STANDARD CHARACTERS WITHOUT CLAIM TO ANY PARTICULAR FONT, STYLE, SIZE, OR COLOR.

FOR TELECOMMUNICATIONS HARDWARE AND SOFTWARE AND COMPUTER NETWORKING EQUIPMENT FOR DATA TRANSMISSION, NAMELY MULTIPLEXERS AND FIBER-OPTIC, SONET-BASED UNIS ALSO KNOWN AS SYNCHRONOUS OPTICAL NETWORKING USER NETWORK INTERFACES (U.S. CLS. 21, 23, 26, 36 AND 38).

FIRST USE 3-26-2002; IN COMMERCE 3-26-2002.
MICHAEL ENGEL, EXAMINING ATTORNEY

INFO OPTICS

THE MARK CONSISTS OF STANDARD CHARACTERS WITHOUT CLAIM TO ANY PARTICULAR FONT, STYLE, SIZE, OR COLOR.

NO CLAIM IS MADE TO THE EXCLUSIVE RIGHT TO USE "INFO", APART FROM THE MARK AS SHOWN.

FOR COMPUTER SOFTWARE FOR APPLICATION AND DATABASE INTEGRATION; DATABASE MANAGEMENT SOFTWARE; COMPUTER SOFTWARE THAT PROVIDES INTEROPERABILITY BETWEEN DATABASES; COMPUTER SOFTWARE THAT FUNCTIONS AS A UNIVERSAL DATA TRANSLATOR BETWEEN VARIOUS DATABASES (U.S. CLS. 21, 23, 26, 36 AND 38).

FIRST USE 3-13-2003; IN COMMERCE 3-13-2003.
BARBARA RUTLAND, EXAMINING ATTORNEY

SN 78-363,624. PROVIDENT LABEL GROUP LLC, NEW YORK, NY. FILED 2-6-2004.

SN 78-373,681. PROVIDENT LABEL GROUP LLC, NEW YORK, NY. FILED 2-25-2004.

MASTERTRAX



THE MARK CONSISTS OF STANDARD CHARACTERS WITHOUT CLAIM TO ANY PARTICULAR FONT, STYLE, SIZE, OR COLOR.

OWNER OF U.S. REG. NO. 1,363,006.
FOR PRE-RECORDED CDS AND AUDIO CASSETTE TAPES FEATURING A SERIES OF MUSICAL SOUND RECORDINGS (U.S. CLS. 21, 23, 26, 36 AND 38).

FIRST USE 6-29-1983; IN COMMERCE 6-29-1983.
WON TEAK OH, EXAMINING ATTORNEY

OWNER OF U.S. REG. NO. 1,363,006.
FOR PRE-RECORDED CDS AND AUDIO CASSETTE TAPES FEATURING A SERIES OF MUSICAL SOUND RECORDINGS (U.S. CLS. 21, 23, 26, 36 AND 38).

FIRST USE 5-0-2001; IN COMMERCE 5-0-2001.
WON TEAK OH, EXAMINING ATTORNEY

CLASS 9—(Continued).

SN 78-376,325. STEPHEN D. MILLER III, RIMROCK, AZ. FILED 3-1-2004.

Akataka

THE MARK CONSISTS OF STANDARD CHARACTERS WITHOUT CLAIM TO ANY PARTICULAR FONT, STYLE, SIZE, OR COLOR.

THE NAME AKATAKA IN THE MARK DOES NOT REPRESENT A LIVING INDIVIDUAL.

THE FOREIGN WORDING IN THE MARK TRANSLATES INTO ENGLISH AS RED HAWK.

FOR PRE-RECORDED VIDEOS, CDS, AND CASSETTES FEATURING MUSIC (U.S. CLS. 21, 23, 26, 36 AND 38).

FIRST USE 1-5-2004; IN COMMERCE 2-2-2004.
PAULA MAYS, EXAMINING ATTORNEY

CLASS 9—(Continued).

SN 78-379,907. ROCK BIT INTERNATIONAL, INC., FORT WORTH, TX. FILED 3-7-2004.

QUIKSHOT

THE MARK CONSISTS OF STANDARD CHARACTERS WITHOUT CLAIM TO ANY PARTICULAR FONT, STYLE, SIZE, OR COLOR.

FOR SURVEYING MACHINES AND INSTRUMENTS FOR OIL WELL DRILLING, NAMELY DOWNHOLE SURVEY EQUIPMENT USED TO DETERMINE THE POSITION OF A BORE IN DIRECTIONAL DRILLING OR IN SITE INVESTIGATION (U.S. CLS. 21, 23, 26, 36 AND 38).

FIRST USE 6-1-2002; IN COMMERCE 6-1-2002.
MICHAEL ENGEL, EXAMINING ATTORNEY

SN 78-380,342. RIOUX VISION INC., ELGIN, SC. FILED 3-8-2004.

SN 78-378,829. PROVIDENT LABEL GROUP LLC, NEW YORK, NY. FILED 3-4-2004.

SOUND PERFORMANCE
SOUNDTRACKS

NO CLAIM IS MADE TO THE EXCLUSIVE RIGHT TO USE "SOUNDTRACKS", APART FROM THE MARK AS SHOWN.

FOR PRE-RECORDED CDS AND AUDIO CASSETTE TAPES FEATURING A SERIES OF MUSICAL SOUND RECORDINGS (U.S. CLS. 21, 23, 26, 36 AND 38).

FIRST USE 2-28-1994; IN COMMERCE 2-28-1994.
DAWN FELDMAN, EXAMINING ATTORNEY

ALLIANCE

THE MARK CONSISTS OF STANDARD CHARACTERS WITHOUT CLAIM TO ANY PARTICULAR FONT, STYLE, SIZE, OR COLOR.

FOR ROLLING MEDICATION CART WORKSTATION WITH COMPUTER AND ELECTRONIC LOCK (U.S. CLS. 21, 23, 26, 36 AND 38).

FIRST USE 12-31-2003; IN COMMERCE 12-31-2003.
PAULA MAYS, EXAMINING ATTORNEY

CLASS 9—(Continued).

SN 78-384,305. MARKET CENTRAL, INC., PITTSBURGH, PA. FILED 3-15-2004.

SWITCHMASTER

THE MARK CONSISTS OF STANDARD CHARACTERS WITHOUT CLAIM TO ANY PARTICULAR FONT, STYLE, SIZE, OR COLOR.

FOR NETWORK SECURITY SWITCHES, GAUGED A/B SWITCHES, FIBER-OPTIC SWITCHES, AND DATA SWITCHES (U.S. CLS. 21, 23, 26, 36 AND 38).

FIRST USE 9-23-1985; IN COMMERCE 9-23-1985.
MARY ROSSMAN, EXAMINING ATTORNEY

SN 78-387,078. ASPECT MEDICAL SYSTEMS, INC., NEWTON, MA. FILED 3-18-2004.

BISX

THE MARK CONSISTS OF STANDARD CHARACTERS WITHOUT CLAIM TO ANY PARTICULAR FONT, STYLE, SIZE, OR COLOR.

OWNER OF U.S. REG. NOS. 2,226,557, 2,229,392 AND OTHERS.

FOR COMPUTER PROGRAMS FOR USE IN ASSESSING NEUROLOGICAL AND COGNITIVE FUNCTION AND DYSFUNCTION, FOR PREDICTING AND MEASURING RESPONSE TO PSYCHOACTIVE MEDICATIONS, FOR ASSESSING PSYCHOLOGICAL STATE, FOR PERFORMING NEURODIAGNOSTICS AND FOR USE IN ASSESSING HYPNOTIC LEVELS AND PATIENT AWARENESS; COMPUTER PROGRAMS FOR USE IN MONITORING AND PROCESSING ELECTROENCEPHALOGRAPH SIGNALS (U.S. CLS. 21, 23, 26, 36 AND 38).

KATHY DE JONGE, EXAMINING ATTORNEY

CLASS 9—(Continued).

SN 78-387,138. VTODVD SYSTEMS, LLC, LYNNWOOD, WA. FILED 3-18-2004.



NO CLAIM IS MADE TO THE EXCLUSIVE RIGHT TO USE "DVD" AND "PROFESSIONAL", APART FROM THE MARK AS SHOWN.

THE COLORS YELLOW, ORANGE AND RED ARE CLAIMED AS A FEATURE OF THE MARK.

THE MARK CONSISTS OF THE WORDS ROCKET, DVD (ITALICIZED) AND THE ACRONYM DVD AS ONE WORD I.E. "ROCKET DVD" IN BLACK LETTERING. THE ACRONYM "DVD" IS PLACED IN A YELLOW AND ORANGE CIRCLE. THE MARK HAS A ORANGE AND YELLOW SWOOSH GOING FROM THE LOWER PORTION OF THE YELLOW AND ORANGE CIRCLE THROUGH THE "O" IN ROCKET AND ENDS UP AT THE TAIL END OF A BLACK STYLIZED FIGURE OF A ROCKET WHICH PENETRATES THE UPPER PORTION OF THE YELLOW AND ORANGE CIRCLE. THE WORD "PROFESSIONAL" IS IN RED UNDER THE WORD ROCKET AND IS ITALICIZED THE LENGTH OF WHICH IS FROM THE "R" IN ROCKET TO THE "K" IN ROCKET.

FOR COMPUTER SOFTWARE FEATURING AN AUTOMATED DVD AUTHORING AND PRODUCTION PC BASED SYSTEM THAT COMBINES INDUSTRY STANDARD PC HARDWARE WITH PROPRIETARY SOFTWARE (U.S. CLS. 21, 23, 26, 36 AND 38).

FIRST USE 8-22-2003; IN COMMERCE 8-22-2003.
SEAN DWYER, EXAMINING ATTORNEY

SN 78-387,631. TICKETSNOW.COM, CRYSTAL LAKE, IL. FILED 3-19-2004.

EI BOX OFFICE

THE MARK CONSISTS OF STANDARD CHARACTERS WITHOUT CLAIM TO ANY PARTICULAR FONT, STYLE, SIZE, OR COLOR.

NO CLAIM IS MADE TO THE EXCLUSIVE RIGHT TO USE "BOX OFFICE", APART FROM THE MARK AS SHOWN.

FOR COMPUTER SOFTWARE, NAMELY, COMPUTER SOFTWARE FOR USE BY TICKET VENDORS FOR ASSISTING IN ACTUALIZING INTERNET BASED TICKET SALES (U.S. CLS. 21, 23, 26, 36 AND 38).

ANDREA SAUNDERS, EXAMINING ATTORNEY

CLASS 9—(Continued).

SN 78-387,653. ARUZE CORPORATION, TOKYO, JAPAN, FILED 3-19-2004.

**SINBAD'S
ADVENTURES**

THE MARK CONSISTS OF STANDARD CHARACTERS WITHOUT CLAIM TO ANY PARTICULAR FONT, STYLE, SIZE, OR COLOR.

PRIORITY CLAIMED UNDER SEC. 44(D) ON AUSTRALIA APPLICATION NO. 972578, FILED 10-1-2003, REG. NO. 972578, DATED 10-1-2003, EXPIRES 10-1-2013.

FOR MEDIA STORAGE COMPUTER SOFTWARE, NAMELY, COMPUTER SOFTWARE FOR CONTROLLING SLOT MACHINES AND GAME MACHINES, AND COMPUTER GAME SOFTWARE FOR GAME MACHINES AND SLOT MACHINES (U.S. CLS. 21, 23, 26, 36 AND 38).

TINA L. SNAPP, EXAMINING ATTORNEY

CLASS 9—(Continued).

SN 78-389,718. CASE REVOLUTION INC, SAN DIEGO, CA. FILED 3-24-2004.

CTAM SYSTEMS

THE MARK CONSISTS OF STANDARD CHARACTERS WITHOUT CLAIM TO ANY PARTICULAR FONT, STYLE, SIZE, OR COLOR.

NO CLAIM IS MADE TO THE EXCLUSIVE RIGHT TO USE SYSTEMS, APART FROM THE MARK AS SHOWN.

FOR COMPUTER SOFTWARE FOR THE COLLECTION, EDITING, ORGANIZING, MODIFYING, BOOK MARKING, TRANSMISSION STORAGE AND SHARING OF DATA AND INFORMATION (U.S. CLS. 21, 23, 26, 36 AND 38).

FIRST USE 1-1-2003; IN COMMERCE 1-1-2004.
NICHOLAS ALTREE, EXAMINING ATTORNEY

SN 78-389,161. CHIPX, INCORPORATED, SANTA CLARA, CA. FILED 3-23-2004.

CHIP[X]

THE MARK CONSISTS OF STANDARD CHARACTERS WITHOUT CLAIM TO ANY PARTICULAR FONT, STYLE, SIZE, OR COLOR.

FOR SEMICONDUCTORS; APPLICATION SPECIFIC INTEGRATED CIRCUITS AND APPLICATION SPECIFIC INTEGRATED CIRCUIT LAYOUTS; COMPUTER SOFTWARE FOR USE IN CUSTOMIZING APPLICATION SPECIFIC INTEGRATED CIRCUITS AND IN MANUFACTURING CUSTOMIZED INTEGRATED CIRCUITS AND APPLICATION SPECIFIC INTEGRATED CIRCUIT LAYOUTS (U.S. CLS. 21, 23, 26, 36 AND 38).

KELLY CHOE, EXAMINING ATTORNEY

SN 78-393,982. BLACKSMITH APPLICATIONS, INC., WILMINGTON, MA. FILED 3-31-2004.

SHIELD

THE MARK CONSISTS OF STANDARD CHARACTERS WITHOUT CLAIM TO ANY PARTICULAR FONT, STYLE, SIZE, OR COLOR.

FOR COMPUTER SOFTWARE TOOLS FOR AUTOMATING THE MANAGEMENT OF CONTRACTS IN THE FOOD SERVICE INDUSTRY BY CENTRALIZING ALL CONTRACTS, AUTOMATING APPROVALS, CALCULATING PAYMENTS AND VALIDATING DATA (U.S. CLS. 21, 23, 26, 36 AND 38).

AMOS T. MATTHEWS, JR., EXAMINING ATTORNEY

CLASS 9—(Continued).

SN 78-396,253. HARCOURT, INC., ORLANDO, FL. FILED 4-5-2004.

CLASS 9—(Continued).

SN 78-397,321. EMS TECHNOLOGIES CANADA, LTD., NORCROSS, GA. FILED 4-6-2004.

NUEVAS VISTAS

CNX

THE MARK CONSISTS OF STANDARD CHARACTERS WITHOUT CLAIM TO ANY PARTICULAR FONT, STYLE, SIZE, OR COLOR.

THE ENGLISH TRANSLATION OF THE WORDS NUEVAS AND VISTAS IS "NEW" AND "VIEWS".

FOR PRERECORDED VIDEO TAPES, AUDIO DISCS, VIDEO DISCS AND COMPUTER SOFTWARE FEATURING LESSON PLANS, TEACHING SUGGESTIONS, TESTS, PRACTICE EXAMS, STORIES AND AUDIO AND VIDEO RECORDINGS FOR USE IN TEACHING SPANISH TO MIDDLE SCHOOL AND HIGH SCHOOL STUDENTS (U.S. CLS. 21, 23, 26, 36 AND 38).

FIRST USE 11-0-2001; IN COMMERCE 11-0-2001.
LA TONIA FISHER, EXAMINING ATTORNEY

THE MARK CONSISTS OF STANDARD CHARACTERS WITHOUT CLAIM TO ANY PARTICULAR FONT, STYLE, SIZE, OR COLOR.

FOR GROUND-BASED WIDE-AREA NETWORK OPTIMIZATION DEVICE IN THE NATURE OF A COMPUTER NETWORK ROUTER WITH AN ETHERNET HUB (U.S. CLS. 21, 23, 26, 36 AND 38).

FIRST USE 9-15-2003; IN COMMERCE 10-1-2003.
WON TEAK OH, EXAMINING ATTORNEY

SN 78-397,446. ALLEGRO MULTIMEDIA, INC., SEFFNER, FL. FILED 4-6-2004.

SN 78-397,212. TURNER BIOSYSTEMS, INC., SUNNYVALE, CA. FILED 4-6-2004.

BAND COMMANDO



FOR BIOTECHNOLOGICAL INSTRUMENTS AND DEVICES, NAMELY, PHOTOMETERS USED FOR MEASURING VERY LOW LIGHT LEVELS IN BIOLOGIC MATERIALS (U.S. CLS. 21, 23, 26, 36 AND 38).

KIMBERLY PERRY, EXAMINING ATTORNEY

THE MARK CONSISTS OF STANDARD CHARACTERS WITHOUT CLAIM TO ANY PARTICULAR FONT, STYLE, SIZE, OR COLOR.

NO CLAIM IS MADE TO THE EXCLUSIVE RIGHT TO USE "BAND", APART FROM THE MARK AS SHOWN.

FOR COMPUTER GAME SOFTWARE (U.S. CLS. 21, 23, 26, 36 AND 38).

MARC LEIPZIG, EXAMINING ATTORNEY

CLASS 9—(Continued).

SN 78-397,457. ALLEGRO MULTIMEDIA, INC., SEFFNER, FL. FILED 4-6-2004.

CLASS 9—(Continued).

SN 78-400,401. HENRY PRATT COMPANY, AURORA, IL. FILED 4-12-2004.

DRUM COMMANDO

THE MARK CONSISTS OF STANDARD CHARACTERS WITHOUT CLAIM TO ANY PARTICULAR FONT, STYLE, SIZE, OR COLOR.

NO CLAIM IS MADE TO THE EXCLUSIVE RIGHT TO USE "DRUM", APART FROM THE MARK AS SHOWN. FOR COMPUTER GAME SOFTWARE (U.S. CLS. 21, 23, 26, 36 AND 38).

MARC LEIPZIG, EXAMINING ATTORNEY

POSITROL

THE MARK CONSISTS OF STANDARD CHARACTERS WITHOUT CLAIM TO ANY PARTICULAR FONT, STYLE, SIZE, OR COLOR.

OWNER OF U.S. REG. NOS. 983,763 AND 990,740. FOR ELECTRIC ACTUATORS FOR BUTTERFLY VALVES (U.S. CLS. 21, 23, 26, 36 AND 38).

FIRST USE 4-0-1985; IN COMMERCE 4-0-1985. JASON LOTT, EXAMINING ATTORNEY

SN 78-397,468. ALLEGRO MULTIMEDIA, INC., SEFFNER, FL. FILED 4-6-2004.

KARAOKE COMMANDO

THE MARK CONSISTS OF STANDARD CHARACTERS WITHOUT CLAIM TO ANY PARTICULAR FONT, STYLE, SIZE, OR COLOR.

NO CLAIM IS MADE TO THE EXCLUSIVE RIGHT TO USE "KARAOKE", APART FROM THE MARK AS SHOWN. FOR COMPUTER GAME SOFTWARE (U.S. CLS. 21, 23, 26, 36 AND 38).

MARC LEIPZIG, EXAMINING ATTORNEY

SN 78-401,697. NEXTEST SYSTEMS CORPORATION, SAN JOSE, CA. FILED 4-14-2004.

SN 78-399,544. PARKERVISION, INC., JACKSONVILLE, FL. FILED 4-9-2004.

EXTREME WIRELESS

THE MARK CONSISTS OF STANDARD CHARACTERS WITHOUT CLAIM TO ANY PARTICULAR FONT, STYLE, SIZE, OR COLOR.

NO CLAIM IS MADE TO THE EXCLUSIVE RIGHT TO USE "WIRELESS", APART FROM THE MARK AS SHOWN.

FOR WIRELESS NETWORKING INTERFACE CARDS; WIRELESS NETWORKING INTERFACE CARDS, NAMELY, PCMCIA CARDS, MINI-PCI CARDS AND USB CARDS; WIRELESS ACCESS POINTS; AND SEMI-CONDUCTORS, INTEGRATED CIRCUITS, AND WIRED AND WIRELESS RADIO FREQUENCY (RF) COMMUNICATION RECEIVERS AND TRANSMITTERS (U.S. CLS. 21, 23, 26, 36 AND 38).

RON FAIRBANKS, EXAMINING ATTORNEY

MAVERICK

THE MARK CONSISTS OF STANDARD CHARACTERS WITHOUT CLAIM TO ANY PARTICULAR FONT, STYLE, SIZE, OR COLOR.

FOR AUTOMATIC TEST EQUIPMENT FOR SEMI-CONDUCTORS (U.S. CLS. 21, 23, 26, 36 AND 38).

FIRST USE 8-0-1997; IN COMMERCE 8-0-1997. STACY WAHLBERG, EXAMINING ATTORNEY

CLASS 9—(Continued).

SN 78-403,317. HITACHI MAXELL, LTD., OSAKA, JAPAN,
FILED 4-16-2004.



NO CLAIM IS MADE TO THE EXCLUSIVE RIGHT TO USE SMART, APART FROM THE MARK AS SHOWN.

THE LINING OR STIPPLING IN THE DRAWING IS FOR THE PURPOSE OF SHOWING SHADING AND IS NOT A FEATURE OF THE MARK.

THE MARK CONSISTS OF IN PART OF THE STYLIZED LETTER "S".

FOR BLANK AND FORMATTED MAGNETIC COMPUTER TAPE CARTRIDGES (U.S. CLS. 21, 23, 26, 36 AND 38).

FIRST USE 7-0-2004; IN COMMERCE 11-0-2004.
STEVEN R. FINE, EXAMINING ATTORNEY

SN 78-407,087. MITSUBISHI ELECTRIC ENGINEERING CO.,
LTD., TOKYO, JAPAN, FILED 4-23-2004.

TB-MARKER

THE MARK CONSISTS OF STANDARD CHARACTERS WITHOUT CLAIM TO ANY PARTICULAR FONT, STYLE, SIZE, OR COLOR.

PRIORITY CLAIMED UNDER SEC. 44(D) ON JAPAN APPLICATION NO. 2004-033797, FILED 4-9-2004, REG. NO. 4818220, DATED 11-12-2004, EXPIRES 11-12-2014.

FOR COMPUTER SOFTWARE FOR PRINTING LABELS, LETTERS, INVITATIONS AND TAGS (U.S. CLS. 21, 23, 26, 36 AND 38).

DAWN HAN, EXAMINING ATTORNEY

CLASS 9—(Continued).

SN 78-407,942. VANTAGE TECHNOLOGIES KNOWLEDGE ASSESSMENT, L.L.C., DBA VANTAGE LEARNING, NEW-TOWN, PA. FILED 4-26-2004.

VanScan

THE MARK CONSISTS OF STANDARD CHARACTERS WITHOUT CLAIM TO ANY PARTICULAR FONT, STYLE, SIZE, OR COLOR.

FOR COMPUTER HARDWARE AND SOFTWARE, NAMELY, SCANNING HARDWARE AND SOFTWARE THAT SCANS OPTICALLY SCANNABLE FORMS TO CAPTURE, RECORD, SYNCHRONIZE, EDIT, CORRECT AND UPLOAD VIA THE INTERNET, TEXTUAL INFORMATION AND DATA FROM THE SCANNED FORMS (U.S. CLS. 21, 23, 26, 36 AND 38).

FIRST USE 7-4-2003; IN COMMERCE 7-4-2003.
CHERYL CLAYTON, EXAMINING ATTORNEY

SN 78-408,936. COMPUTERLOGIC, INC., MACON, GA.
FILED 4-27-2004.

MIXLOGIC

THE MARK CONSISTS OF STANDARD CHARACTERS WITHOUT CLAIM TO ANY PARTICULAR FONT, STYLE, SIZE, OR COLOR.

FOR COMPUTER SOFTWARE USED TO MATCH AND MIX AUTOMOTIVE PAINT (U.S. CLS. 21, 23, 26, 36 AND 38).

FIRST USE 1-0-2002; IN COMMERCE 1-0-2002.
MICHAEL SOUDERS, EXAMINING ATTORNEY

CLASS 9—(Continued).

SN 78-409,211. SOFTWARE PERFORMANCE SYSTEMS INC, FALLS CHURCH, VA. FILED 4-28-2004.

CLASS 9—(Continued).

SN 78-410,438. OVERLAND STORAGE, INC., SAN DIEGO, CA. FILED 4-29-2004.

ENTRÉEACCESS

REO 4000

THE MARK CONSISTS OF STANDARD CHARACTERS WITHOUT CLAIM TO ANY PARTICULAR FONT, STYLE, SIZE, OR COLOR.

FOR COMPUTER SOFTWARE, NAMELY POINT-OF-SALE SOFTWARE FOR RESTAURANT MENU MANAGEMENT, DATA ANALYSIS, AND FINANCIAL, TIME AND ATTENDANCE REPORTING FOR RESTAURANTS AND OTHERS IN THE HOSPITALITY INDUSTRY (U.S. CLS. 21, 23, 26, 36 AND 38).

FIRST USE 3-26-2004; IN COMMERCE 3-26-2004.
BRENDAN REGAN, EXAMINING ATTORNEY

THE MARK CONSISTS OF STANDARD CHARACTERS WITHOUT CLAIM TO ANY PARTICULAR FONT, STYLE, SIZE, OR COLOR.

NO CLAIM IS MADE TO THE EXCLUSIVE RIGHT TO USE "4000", APART FROM THE MARK AS SHOWN.

FOR COMPUTER HARDWARE, NAMELY, DISK-BASED APPLIANCES FOR DATA BACKUP, RECOVERY, TRANSFER AND STORAGE (U.S. CLS. 21, 23, 26, 36 AND 38).

FIRST USE 1-31-2004; IN COMMERCE 4-23-2004.
CAROL SPILS, EXAMINING ATTORNEY

SN 78-409,525. GERBER SCIENTIFIC, INC., SOUTH WINDSOR, CT. FILED 4-28-2004.

SN 78-411,479. THE BOOKCHIP CORPORATION, SEATTLE, WA. FILED 4-30-2004.

P2C

BOOKCHIP

THE MARK CONSISTS OF STANDARD CHARACTERS WITHOUT CLAIM TO ANY PARTICULAR FONT, STYLE, SIZE, OR COLOR.

FOR PLOTTER FOR USE WITH THE AUTOMATED CUTTING OF DIGITALLY PRINTED GRAPHICS (U.S. CLS. 21, 23, 26, 36 AND 38).

LA TONIA FISHER, EXAMINING ATTORNEY

THE MARK CONSISTS OF STANDARD CHARACTERS WITHOUT CLAIM TO ANY PARTICULAR FONT, STYLE, SIZE, OR COLOR.

FOR ELECTRONIC BOOKS FEATURING EDUCATIONAL TEXTBOOKS AND GENERAL TEXTS IN THE FIELDS OF ARTS, SCIENCES, LITERATURE, BUSINESS, LAW AND HISTORY RECORDED ON MEMORY CARDS AND RELATED PRODUCTS AND SYSTEMS COMPRISED OF ELECTRONIC READING DEVICES WITH DISPLAY PANELS (U.S. CLS. 21, 23, 26, 36 AND 38).

HEATHER THOMPSON, EXAMINING ATTORNEY

CLASS 9—(Continued).

SN 78-411,548. COBRA ELECTRONICS CORPORATION, CHICAGO, IL. FILED 4-30-2004.

NAV ONE 1

THE MARK CONSISTS OF STANDARD CHARACTERS WITHOUT CLAIM TO ANY PARTICULAR FONT, STYLE, SIZE, OR COLOR.

NO CLAIM IS MADE TO THE EXCLUSIVE RIGHT TO USE "NAV", APART FROM THE MARK AS SHOWN.

FOR NAVIGATION DEVICES, NAMELY, HAND HELD AND MOBILE SATELLITE NAVIGATIONAL SYSTEMS, NAMELY, GLOBAL POSITIONING RECEIVERS (GPS); ACCESSORIES USED IN CONNECTION WITH ELECTRONIC NAVIGATION DEVICES, NAMELY, AC POWER ADAPTERS, CARRYING CASES, EXTERNAL ANTENNAS, UNIVERSAL SERIAL BUS (USB) CABLES AND MAPPING SOFTWARE UPGRADE KITS COMPRISING SOFTWARE THAT INCORPORATES UPDATED COMPUTER CODE, DATABASES AND/OR MAP DATA (U.S. CLS. 21, 23, 26, 36 AND 38).

TRACY CROSS, EXAMINING ATTORNEY

SN 78-411,566. COBRA ELECTRONICS CORPORATION, CHICAGO, IL. FILED 4-30-2004.



NO CLAIM IS MADE TO THE EXCLUSIVE RIGHT TO USE "NAV", APART FROM THE MARK AS SHOWN.

THE MARK CONSISTS OF STYLIZED LETTERS N A V O N E WITH THE STYLIZED NUMERAL 1 IN THE STYLIZED LETTER O. ABOVE THE STYLIZED LETTERS AND NUMERAL IS AN ARC.

FOR NAVIGATION DEVICES, NAMELY, HAND HELD AND MOBILE SATELLITE NAVIGATIONAL SYSTEMS, NAMELY, GLOBAL POSITIONING RECEIVERS (GPS); ACCESSORIES USED IN CONNECTION WITH ELECTRONIC NAVIGATION DEVICES, NAMELY, AC POWER ADAPTERS, CARRYING CASES, EXTERNAL ANTENNAS, UNIVERSAL SERIAL BUS (USB) CABLES AND MAPPING SOFTWARE UPGRADE KITS COMPRISING SOFTWARE THAT INCORPORATES UPDATED COMPUTER CODE, DATABASES AND/OR MAP DATA (U.S. CLS. 21, 23, 26, 36 AND 38).

TRACY CROSS, EXAMINING ATTORNEY

CLASS 9—(Continued).

SN 78-411,692. RICAVISION INTERNATIONAL, INC., NEWPORT BEACH, CA. FILED 4-30-2004.

ricavision

THE MARK CONSISTS OF THE WORDS RICAVISION CONNECTED AS ONE WORD AND USING A GRAPHIC OF AN EYE AS THE "O" IN VISION.

FOR COMPUTER MEDIA SYSTEM COMPOSED OF COMPUTER HARDWARE, TELEVISION TUNER, MULTIMEDIA COMPUTER DISC DRIVE, AUDIO SPEAKERS, AND DVD PLAYER (U.S. CLS. 21, 23, 26, 36 AND 38).

FIRST USE 3-24-2003; IN COMMERCE 3-25-2003.

ROBIN CHOSID, EXAMINING ATTORNEY

SN 78-413,816. IRON SPEED, INC., MOUNTAIN VIEW, CA. FILED 5-5-2004.

**Some things are
just faster**

THE MARK CONSISTS OF STANDARD CHARACTERS WITHOUT CLAIM TO ANY PARTICULAR FONT, STYLE, SIZE, OR COLOR.

FOR COMPUTER SOFTWARE DEVELOPMENT TOOLS; COMPUTER SOFTWARE FOR OPTIMIZING CODE CREATION AND COMPILATION; COMPUTER SOFTWARE FOR DECREASING OVERALL APPLICATION DEVELOPMENT TIME AND INCREASING PERFORMANCE; COMPUTER SOFTWARE FOR APPLICATION AND DATABASE INTEGRATION; COMPUTER SOFTWARE FOR USE IN WEBSITE DEVELOPMENT (U.S. CLS. 21, 23, 26, 36 AND 38).

FIRST USE 8-15-2003; IN COMMERCE 8-15-2003.

DOUGLAS LEE, EXAMINING ATTORNEY

CLASS 9—(Continued).

SN 78-415,225. CLARKSON COMPANY, THE, PORTSMOUTH, NH. FILED 5-7-2004.

CLASS 9—(Continued).

SN 78-416,238. AMERA-CHEM, INC, GRAND JUNCTION, CO. FILED 5-10-2004.

KGD

RX-ID

THE MARK CONSISTS OF STANDARD CHARACTERS WITHOUT CLAIM TO ANY PARTICULAR FONT, STYLE, SIZE, OR COLOR.

FOR CONTROL VALVES, NAMELY, KINFE-GATE VALVES (U.S. CLS. 21, 23, 26, 36 AND 38).

FIRST USE 8-0-1992; IN COMMERCE 8-0-1992.
INGRID C. EULIN, EXAMINING ATTORNEY

THE MARK CONSISTS OF STANDARD CHARACTERS WITHOUT CLAIM TO ANY PARTICULAR FONT, STYLE, SIZE, OR COLOR.

FOR CD-ROM CONSISTING OF A DATABASE DESCRIBING PHARMACEUTICAL TABLETS AND CAPSULES (U.S. CLS. 21, 23, 26, 36 AND 38).

FIRST USE 7-31-2003; IN COMMERCE 7-31-2003.
ALICE SUE CARRUTHERS, EXAMINING ATTORNEY

SN 78-415,944. SIEMENS AKTIENGESELLSCHAFT, MUNICH, FED REP GERMANY, FILED 5-10-2004.

SN 78-416,274. FINANCIAL PROCESSING SYSTEMS CORPORATION, SANTA ANA, CA. FILED 5-10-2004.

SIGAP



THE MARK CONSISTS OF STANDARD CHARACTERS WITHOUT CLAIM TO ANY PARTICULAR FONT, STYLE, SIZE, OR COLOR.

FOR VOLTAGE SURGE PROTECTORS, NAMELY, HIGH VOLTAGE GAPS COMPRISED OF HIGH VOLTAGE SPARK GAPS FOR THE PROTECTION OF SERIAL CAPACITORS IN HIGH VOLTAGE LINES (U.S. CLS. 21, 23, 26, 36 AND 38).

ANNE E. GUSTASON, EXAMINING ATTORNEY

THE STIPPLING SHOWN IN THE DRAWING IS A FEATURE OF THE MARK.

FOR COMPUTER PROGRAMS FOR REAL ESTATE ESCROW APPLICATIONS, NAMELY, PROVIDING REAL ESTATE TITLE SEARCHES AND PREPARING REAL ESTATE CLOSINGS (U.S. CLS. 21, 23, 26, 36 AND 38).

FIRST USE 1-1-1999; IN COMMERCE 1-1-1999.
CHARLES JOYNER, EXAMINING ATTORNEY

CLASS 9—(Continued).

SN 78-416,604. SAFENTRY, LLC, GREENSBURG, PA. FILED 5-11-2004.

NOTHING ESCAPES US

THE MARK CONSISTS OF STANDARD CHARACTERS WITHOUT CLAIM TO ANY PARTICULAR FONT, STYLE, SIZE, OR COLOR.

FOR SECURITY MANAGEMENT DEVICES, NAMELY, ENTRY/EGRESS ACCESS CONTROL SYSTEMS COMPRISING AUTOMATED SECURITY GATES AND AUTHENTICATION SYSTEMS COMPRISING, MAGNETIC ENCODED CARD READERS, BIOMETRIC READERS, EXPLOSIVE DETECTORS, VAPOR ANALYZERS, SPECTROPHOTOMETRIC DETECTORS, VIDEO CAMERAS, MOTION SENSORS, METAL DETECTORS, COMPUTER TOMOGRAPHY (CT) MACHINES, X-RAY MACHINES, FINGER PRINT/PALM ANALYSIS MACHINES, AND PASSWORD VERIFICATION MACHINES (U.S. CLS. 21, 23, 26, 36 AND 38).

SCOTT BALDWIN, EXAMINING ATTORNEY

SN 78-416,636. BONDWAVE LLC, LISLE, IL. FILED 5-11-2004.

**PORTFOLIO CLIENT
BUILDER**

THE MARK CONSISTS OF STANDARD CHARACTERS WITHOUT CLAIM TO ANY PARTICULAR FONT, STYLE, SIZE, OR COLOR.

NO CLAIM IS MADE TO THE EXCLUSIVE RIGHT TO USE "PORTFOLIO", APART FROM THE MARK AS SHOWN.

FOR COMPUTER SOFTWARE FOR USE IN DATABASE MANAGEMENT CONTAINING A PLATFORM USED IN CONDUCTING STATISTICAL ANALYSIS IN THE FIELD OF FINANCIAL PORTFOLIO MANAGEMENT (U.S. CLS. 21, 23, 26, 36 AND 38).

DAVID C. REIHNER, EXAMINING ATTORNEY

CLASS 9—(Continued).

SN 78-416,790. PARKERVISION, INC., JACKSONVILLE, FL. FILED 5-11-2004.

**WIRELESS TO THE
MAX**

THE MARK CONSISTS OF STANDARD CHARACTERS WITHOUT CLAIM TO ANY PARTICULAR FONT, STYLE, SIZE, OR COLOR.

FOR WIRELESS NETWORKING INTERFACE CARDS, NAMELY, PCMCIA CARDS, MINI-PCI CARDS AND USB CARDS, AND WIRELESS ACCESS POINTS. (U.S. CLS. 21, 23, 26, 36 AND 38).

RON FAIRBANKS, EXAMINING ATTORNEY

SN 78-417,326. PARKERVISION, INC., JACKSONVILLE, FL. FILED 5-12-2004.

**PARKERVISION
TAKING WIRELESS TO
THE MAX**

THE MARK CONSISTS OF STANDARD CHARACTERS WITHOUT CLAIM TO ANY PARTICULAR FONT, STYLE, SIZE, OR COLOR.

OWNER OF U.S. REG. NOS. 1,701,588 AND 2,788,645.

FOR WIRELESS NETWORKING INTERFACE CARDS, NAMELY, PCMCIA CARDS, MINI-PCI CARDS AND USB CARDS, AND WIRELESS ACCESS POINTS (U.S. CLS. 21, 23, 26, 36 AND 38).

RON FAIRBANKS, EXAMINING ATTORNEY

SN 78-417,878. ST. JAMES WINERY, INC., ST. JAMES, MO. FILED 5-13-2004.

ST. JAMES WINERY

THE MARK CONSISTS OF STANDARD CHARACTERS WITHOUT CLAIM TO ANY PARTICULAR FONT, STYLE, SIZE, OR COLOR.

OWNER OF U.S. REG. NO. 2,951,837.

SEC. 2(F) AS TO ST. JAMES.

FOR MAGNETS (U.S. CLS. 21, 23, 26, 36 AND 38).

FIRST USE 6-2-2000; IN COMMERCE 6-2-2000.

PAULA MAHONEY, EXAMINING ATTORNEY

CLASS 9—(Continued).

SN 78-418,717. RYAN GREGERSON, CEDAR CITY, UT. FILED 5-14-2004.

AVAIL SOFTWARE

THE MARK CONSISTS OF STANDARD CHARACTERS WITHOUT CLAIM TO ANY PARTICULAR FONT, STYLE, SIZE, OR COLOR.

NO CLAIM IS MADE TO THE EXCLUSIVE RIGHT TO USE "SOFTWARE", APART FROM THE MARK AS SHOWN.

FOR COMPUTER SOFTWARE FOR CALL MANAGEMENT, CALL RECORDING, CALL MONITORING, ACCOUNTING, AND LEAD SCRUBBING FOR USE IN CALL CENTERS AND IN THE FIELD OF DIRECT MARKETING (U.S. CLS. 21, 23, 26, 36 AND 38).

FIRST USE 1-31-2004; IN COMMERCE 1-31-2004.
JEFF DEFORD, EXAMINING ATTORNEY

CLASS 9—(Continued).

SN 78-418,985. TOWERCARE TECHNOLOGIES, CRANBURY TOWNSHIP, PA. FILED 5-14-2004.



THE COLOR(S) BLUE, GREEN, BLACK AND GRAY IS/ ARE CLAIMED AS A FEATURE OF THE MARK.

THE TOP BOLT IS BLUE, THE CENTER CIRCLE IS GRAY, THE BOTTOM BOLT IS GREEN AND THE WORD DEPICTION OF THE MARK IS BLACK.

THE MARK CONSISTS OF A STYLIZED LOGO BESIDE THE WORD PORTION OF THE TRADEMARK.

FOR COMPUTER SOFTWARE FOR FUNDRAISING APPLICATIONS, NAMELY PROGRAMS DIRECTED TO TRACKING CONTRIBUTIONS AND CONTRIBUTORS AND ASSOCIATED ACTIVITIES (U.S. CLS. 21, 23, 26, 36 AND 38).

FIRST USE 3-26-2004; IN COMMERCE 3-26-2004.
DOUGLAS LEE, EXAMINING ATTORNEY

SN 78-418,840. POWER STEERING SOFTWARE, INC., CAMBRIDGE, MA. FILED 5-14-2004.

Power Six Sigma

THE MARK CONSISTS OF STANDARD CHARACTERS WITHOUT CLAIM TO ANY PARTICULAR FONT, STYLE, SIZE, OR COLOR.

NO CLAIM IS MADE TO THE EXCLUSIVE RIGHT TO USE "SIX SIGMA", APART FROM THE MARK AS SHOWN.

FOR COMPUTER SOFTWARE FOR USE IN ENTERPRISE PROGRAM MANAGEMENT, NAMELY WEB-BASED SOFTWARE FOR CAPTURING, STORING, TRACKING, ANALYZING AND REPORTING DATA, METRICS AND INFORMATION RELATED TO QUALITY OR SIX SIGMA PROJECTS (U.S. CLS. 21, 23, 26, 36 AND 38).

RAUL CORDOVA, EXAMINING ATTORNEY

SN 78-419,973. SOFTWARE PERFORMANCE SYSTEMS, INC., FALLS CHURCH, VA. FILED 5-17-2004.

**SPS GOLF
MANAGEMENT
SOLUTIONS**

THE MARK CONSISTS OF STANDARD CHARACTERS WITHOUT CLAIM TO ANY PARTICULAR FONT, STYLE, SIZE, OR COLOR.

NO CLAIM IS MADE TO THE EXCLUSIVE RIGHT TO USE "GOLF MANAGEMENT SOLUTIONS", APART FROM THE MARK AS SHOWN.

FOR COMPUTER SOFTWARE, NAMELY, SOFTWARE FOR WEB-BASED GOLF RESERVATION, POINT OF SALE SOFTWARE FOR MARKETING AND MANAGEMENT OF TEE SHEET, TEE TIME INVENTORY, DATA ANALYSIS AND REPORTING IN THE GOLF AND HOSPITALITY INDUSTRIES (U.S. CLS. 21, 23, 26, 36 AND 38).

FIRST USE 1-21-2004; IN COMMERCE 1-21-2004.
CAROLYN GRAY, EXAMINING ATTORNEY

CLASS 9—(Continued).

SN 78-421,447. NBOR CORPORATION, OAKLAND, CA. FILED 5-19-2004.

NBOR

THE MARK CONSISTS OF STANDARD CHARACTERS WITHOUT CLAIM TO ANY PARTICULAR FONT, STYLE, SIZE, OR COLOR.

FOR DOWNLOADABLE COMPUTER PROGRAMS FOR USE IN ASSISTING THE COMPUTER OPERATING SYSTEM TO RUN MORE EFFICIENTLY; DOWNLOADABLE COMPUTER SOFTWARE AND PROGRAMS USED FOR ACCESSING COMPUTER NETWORKS, IN GENERAL, AND FOR ACCESSING THOSE THAT HAVE A GRAPHICAL USER INTERFACE (U.S. CLS. 21, 23, 26, 36 AND 38).

FIRST USE 3-15-2004; IN COMMERCE 3-15-2004. WINSTON FOLMAR, EXAMINING ATTORNEY

CLASS 9—(Continued).

SN 78-423,531. CHARLYN INDUSTRIES, LLC, WALDEN, NY. FILED 5-23-2004.

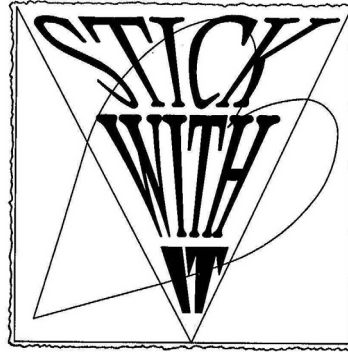

FOR DIET KIT CONSISTING OF PRIMARILY OF MAGNETS REPRESENTING VARIOUS FOOD GROUPS USED TO KEEP TRACK OF VARIOUS DIETS, AS WELL AS AN INSTRUCTION BOOKLET AND REFERENCE CARD PERTAINING TO PORTION CONTROL ALL SOLD AS A UNIT WITH OR WITHOUT A CASE. (U.S. CLS. 21, 23, 26, 36 AND 38).

SUE LAWRENCE, EXAMINING ATTORNEY

SN 78-425,390. ALESIS, LLC, CUMBERLAND, RI. FILED 5-26-2004.

POWERED BY ALESIS

SN 78-423,320. TRI-MAST INTERNATIONAL, LLC, PROVO, UT. FILED 5-21-2004.



FOR HEADSETS HAVING THROAT MICROPHONES AND EARPHONES (U.S. CLS. 21, 23, 26, 36 AND 38).

FIRST USE 8-1-2003; IN COMMERCE 9-15-2003. STACY WAHLBERG, EXAMINING ATTORNEY

THE MARK CONSISTS OF STANDARD CHARACTERS WITHOUT CLAIM TO ANY PARTICULAR FONT, STYLE, SIZE, OR COLOR.

OWNER OF U.S. REG. NO. 1,447,267. FOR AUDIO AND VIDEO ELECTRONIC EQUIPMENT FOR PROFESSIONAL AND CONSUMER USE; NAMELY, SOUNDBOARDS, MIXERS, AMPLIFIERS, SPEAKERS, TURNTABLES, COMPACT DISK PLAYERS, CASSETTE TAPE DECKS, MICROPHONES, ELECTRONIC VIDEO SWITCHES AND ACCESSORIES; NAMELY, CONNECTORS, CABLES, CORDS, ANTENNAS AND PARTS THEREFORE FOR SOUND AND VIDEO EQUIPMENT (U.S. CLS. 21, 23, 26, 36 AND 38).

FIRST USE 5-0-2002; IN COMMERCE 5-0-2002. MARK SPARACINO, EXAMINING ATTORNEY

CLASS 9—(Continued).

SN 78-425,676. VIRAGE LOGIC CORPORATION, FREMONT, CA. FILED 5-26-2004.

CLASS 9—(Continued).

SN 78-426,286. CONSISTENT PERFORMANCE GOLF, LLC, CHARDON, OH. FILED 5-27-2004.

IPRIMA MOBILE

**FAIRWAY FORE
FITNESS**

THE MARK CONSISTS OF STANDARD CHARACTERS WITHOUT CLAIM TO ANY PARTICULAR FONT, STYLE, SIZE, OR COLOR.

NO CLAIM IS MADE TO THE EXCLUSIVE RIGHT TO USE "MOBILE", APART FROM THE MARK AS SHOWN.

FOR COMPUTER SOFTWARE FOR DESIGN AND MANUFACTURE OF INTEGRATED CIRCUITS, AND MANUALS PACKAGED AS A UNIT (U.S. CLS. 21, 23, 26, 36 AND 38).

ANN E. SAPPENFIELD, EXAMINING ATTORNEY

THE MARK CONSISTS OF STANDARD CHARACTERS WITHOUT CLAIM TO ANY PARTICULAR FONT, STYLE, SIZE, OR COLOR.

NO CLAIM IS MADE TO THE EXCLUSIVE RIGHT TO USE "FITNESS", APART FROM THE MARK AS SHOWN.

FOR PRERECORDED CD'S, VIDEO TAPES, LASER DISKS AND DVD'S FEATURING FITNESS TRAINING AND EDUCATION AND, IN PARTICULAR, FITNESS TRAINING AND EDUCATION FOR GOLFERS (U.S. CLS. 21, 23, 26, 36 AND 38).

KAREN BRACEY, EXAMINING ATTORNEY

SN 78-427,231. CAMIANT, INC., MARLBOROUGH, MA. FILED 5-28-2004.

SN 78-425,707. E-MAGINATION SYSTEM DESIGN, INC., SURFSIDE, FL. FILED 5-26-2004.

QBUS

FileFox

THE MARK CONSISTS OF STANDARD CHARACTERS WITHOUT CLAIM TO ANY PARTICULAR FONT, STYLE, SIZE, OR COLOR.

FOR COMPUTER SOFTWARE FOR DOCUMENT MANAGEMENT PURPOSES (U.S. CLS. 21, 23, 26, 36 AND 38).

BRENDAN MCCAULEY, EXAMINING ATTORNEY

THE MARK CONSISTS OF STANDARD CHARACTERS WITHOUT CLAIM TO ANY PARTICULAR FONT, STYLE, SIZE, OR COLOR.

FOR COMPUTER PROGRAMS FOR USE IN CONTROLLING, MONITORING, MEASURING AND MANAGING NETWORK RESOURCES OVER BROADBAND, WIRELESS AND ENTERPRISE NETWORKS; COMPUTER PROGRAMS FOR USE IN INTEGRATING BROADBAND NETWORKS, APPLICATIONS DEPLOYED OVER THOSE NETWORKS AND THE SUBSCRIBERS WHO USE THOSE APPLICATIONS; COMPUTER HARDWARE, NAMELY, ROUTERS, SWITCHES, COMPUTER GATEWAY HARDWARE, COMPUTER APPLICATION SERVER HARDWARE AND COMPUTER POLICY SERVER HARDWARE (U.S. CLS. 21, 23, 26, 36 AND 38).

MELISSA SHELLA, EXAMINING ATTORNEY

CLASS 9—(Continued).

SN 78-427,238. CLEAR CHANNEL BROADCASTING, INC.,
SAN ANTONIO, TX. FILED 5-28-2004.

CLASS 9—(Continued).

SN 78-431,144. ILLINOIS TOOL WORKS INC., GLENVIEW,
IL. FILED 6-7-2004.

RADIO FUSION

THE MARK CONSISTS OF STANDARD CHARACTERS
WITHOUT CLAIM TO ANY PARTICULAR FONT, STYLE,
SIZE, OR COLOR.

NO CLAIM IS MADE TO THE EXCLUSIVE RIGHT TO
USE "RADIO", APART FROM THE MARK AS SHOWN.

FOR COMPUTER SOFTWARE FOR THE INTEGRA-
TION OF STRATEGIC SYSTEMS FOR END TO END
SALES PROCESS TRACKING AND FOR THE MANAGE-
MENT OF SALES PERFORMANCE (U.S. CLS. 21, 23, 26,
36 AND 38).

MELISSA SHELLA, EXAMINING ATTORNEY

RMD

THE MARK CONSISTS OF STANDARD CHARACTERS
WITHOUT CLAIM TO ANY PARTICULAR FONT, STYLE,
SIZE, OR COLOR.

FOR IDENTIFIABLE FEATURE OF A WELDING
MACHINE, NAMELY, SOFTWARE USED TO CONTROL
THE WELD ARC (U.S. CLS. 21, 23, 26, 36 AND 38).

FIRST USE 10-0-2003; IN COMMERCE 10-0-2003.
JOHN LINCOSKI, EXAMINING ATTORNEY

SN 78-429,425. VISIONARTS, INC., TOKYO, JAPAN, FILED
6-3-2004.

SN 78-431,872. PRODUCT ACCELERATION INC., SAN JOSE,
CA. FILED 6-8-2004.

GRAPH NETWORK

THE MARK CONSISTS OF STANDARD CHARACTERS
WITHOUT CLAIM TO ANY PARTICULAR FONT, STYLE,
SIZE, OR COLOR.

OWNER OF JAPAN REG. NO. 4768451, DATED 4-30-2004,
EXPIRES 4-30-2014.

NO CLAIM IS MADE TO THE EXCLUSIVE RIGHT TO
USE "NETWORK", APART FROM THE MARK AS SHOWN.

FOR COMPUTER SOFTWARE, NAMELY, SOFTWARE
THAT ENABLES A COMPUTER TO COMMUNICATE
WITH OTHER COMPUTERS (U.S. CLS. 21, 23, 26, 36 AND
38).

DAVID C. REIHNER, EXAMINING ATTORNEY

THINK. SHIP!

THE MARK CONSISTS OF STANDARD CHARACTERS
WITHOUT CLAIM TO ANY PARTICULAR FONT, STYLE,
SIZE, OR COLOR.

FOR COMPUTER SOFTWARE FOR THE ELECTRO-
NICS INDUSTRY, NAMELY COMPUTER SOFTWARE
FOR FACILITATING THE ANALYSIS OF THE PROCESS
OF DESIGNING, MANUFACTURING, AND TESTING
ELECTRONICS PRODUCTS (U.S. CLS. 21, 23, 26, 36 AND
38).

LINDA ESTRADA, EXAMINING ATTORNEY

CLASS 9—(Continued).

SN 78-432,769. THINK HOLDINGS LLC, CORAL SPRINGS, FL. FILED 6-9-2004.



THE COLORS BLUE AND GREY ARE CLAIMED AS A FEATURE OF THE MARK.

THE MARK CONSISTS OF THE STYLIZED LETTERS N AND X IN BLUE AND GREY FROM LEFT TO RIGHT AND ACCOMPANIED BY THE WORD "NETXPRESSION" WITH "NET" BEING BLUE AND "XPRESSION" BEING GRAY.

FOR COMPUTER SOFTWARE FOR CREATING MULTIMEDIA PRESENTATIONS (U.S. CLS. 21, 23, 26, 36 AND 38).

FIRST USE 6-1-2004; IN COMMERCE 6-1-2004.
JOHN LINCOSKI, EXAMINING ATTORNEY

CLASS 9—(Continued).

SN 78-438,064. WESTERN DIGITAL TECHNOLOGIES, INC., LAKE FOREST, CA. FILED 6-18-2004.

THE MARK CONSISTS OF STANDARD CHARACTERS WITHOUT CLAIM TO ANY PARTICULAR FONT, STYLE, SIZE, OR COLOR.

OWNER OF U.S. REG. NOS. 2,255,308, 2,521,071 AND OTHERS.

FOR COMPUTER PRODUCTS, NAMELY HARD DRIVES (U.S. CLS. 21, 23, 26, 36 AND 38).

FIRST USE 0-0-1996; IN COMMERCE 0-0-1996.
KARLA PERKINS, EXAMINING ATTORNEY

SN 78-437,033. SKYPILOT NETWORKS, INC., SANTA CLARA, CA. FILED 6-17-2004.

SKYEXTENDER

THE MARK CONSISTS OF STANDARD CHARACTERS WITHOUT CLAIM TO ANY PARTICULAR FONT, STYLE, SIZE, OR COLOR.

FOR COMPUTER HARDWARE FOR USE IN TELECOMMUNICATIONS; COMPUTER SOFTWARE FOR USE IN TELECOMMUNICATIONS, NAMELY SOFTWARE FOR ACCESSING EXPANDING, ROUTING, MANAGING AND IMPROVING CONNECTIONS FOR COMMUNICATION NETWORK SERVICES TO REMOTE SUBSCRIBERS (U.S. CLS. 21, 23, 26, 36 AND 38).

ANNE FARRELL, EXAMINING ATTORNEY

SN 78-438,585. CONSISTENT PERFORMANCE GOLF, LLC, CHARDON, OH. FILED 6-21-2004.



NO CLAIM IS MADE TO THE EXCLUSIVE RIGHT TO USE "FITNESS", APART FROM THE MARK AS SHOWN.

FOR PRERECORDED CD'S, VIDEO TAPES, LASER DISKS AND DVD'S FEATURING FITNESS TRAINING AND EDUCATION, NAMELY, FITNESS TRAINING AND EDUCATION FOR GOLFERS (U.S. CLS. 21, 23, 26, 36 AND 38).

MICHAEL TANNER, EXAMINING ATTORNEY

CLASS 9—(Continued).

SN 78-439,112. EARTHWALK COMMUNICATIONS, INC.,
MANASSAS, VA. FILED 6-22-2004.

CLASS 9—(Continued).

SN 78-439,967. JOHNSON PUBLISHING COMPANY, INC.,
CHICAGO, IL. FILED 6-23-2004.

L BUDDY

THE MARK CONSISTS OF STANDARD CHARACTERS
WITHOUT CLAIM TO ANY PARTICULAR FONT, STYLE,
SIZE, OR COLOR.

FOR LAPTOP COMPUTERS (U.S. CLS. 21, 23, 26, 36
AND 38).

MARK SPARACINO, EXAMINING ATTORNEY

EBONY

SN 78-439,959. JOHNSON PUBLISHING COMPANY, INC.,
CHICAGO, IL. FILED 6-23-2004.

EBONY/JET

THE MARK CONSISTS OF STANDARD CHARACTERS
WITHOUT CLAIM TO ANY PARTICULAR FONT, STYLE,
SIZE, OR COLOR.

OWNER OF U.S. REG. NOS. 423,815, 1,050,396 AND
OTHERS.

FOR PRERECORDED VIDEO TAPES AND DIGITAL
VIDEO DISKS FEATURING EDUCATIONAL AND EN-
TERTAINMENT PROGRAMS ON HEALTH, FINANCE,
BEAUTY, FASHION, COSMETICS AND PERSONAL
CARE FOR MEN AND WOMEN, HOME DESIGN, LIFE-
STYLES, AFRICAN AMERICAN ARTISTS AND SUB-
JECTS OF INTEREST TO AFRICAN AMERICANS (U.S.
CLS. 21, 23, 26, 36 AND 38).

SUSAN HAYASH, EXAMINING ATTORNEY

THE MARK CONSISTS OF STANDARD CHARACTERS
WITHOUT CLAIM TO ANY PARTICULAR FONT, STYLE,
SIZE, OR COLOR.

OWNER OF U.S. REG. NOS. 423,815, 1,050,396 AND
OTHERS.

FOR PRERECORDED VIDEO TAPES AND DIGITAL
VIDEO DISKS FEATURING EDUCATIONAL AND EN-
TERTAINMENT PROGRAMS ON HEALTH, FINANCE,
BEAUTY, FASHION, COSMETICS AND PERSONAL
CARE FOR MEN AND WOMEN, HOME DESIGN, LIFE-
STYLES, AFRICAN AMERICAN ARTISTS AND SUB-
JECTS OF INTEREST TO AFRICAN AMERICANS (U.S.
CLS. 21, 23, 26, 36 AND 38).

SUSAN HAYASH, EXAMINING ATTORNEY

CLASS 9—(Continued).

SN 78-440,036. WANLIDA GROUP CO., LTD., XIAMEN CITY, CHINA, FILED 6-23-2004.

WANLIDA

CLASS 9—(Continued).

SN 78-440,738. FEINGOLD, STANLEY Z., DBA VISUAL HORIZONS, ROCHESTER, NY. FILED 6-24-2004.

VISUAL HORIZONS

THE MARK CONSISTS OF STANDARD CHARACTERS WITHOUT CLAIM TO ANY PARTICULAR FONT, STYLE, SIZE, OR COLOR.

OWNER OF U.S. REG. NO. 1,094,275.

FOR PRESENTATION MATERIALS, NAMELY PHOTOGRAPHIC SLIDE TRANSPARENCIES AND PRE-RECORDED CDS FEATURING VARIOUS PRESENTATION SUBJECTS, NAMELY CARD AND ENVELOPE CREATION; SEWING AND QUILTING; SCRAPBOOKING AND CLIP ART; STOCK PHOTOGRAPHY; CARTOONS; PRESENTATION GRAPHICS, AND PHOTO ACCENTS FOR USE WITH POWER POINT PRESENTATIONS; POWER POINT AND MS WORD BACKGROUNDS; LETTERHEAD AND ENVELOPE DESIGNS; NAME BADGE DESIGNS; AWARD AND CERTIFICATE DESIGNS; TEMPLATES; LABELS AND FORMS; SCANNED SLIDES, X-RAYS, TRANSPARENCIES, ARTWORK, BROCHURES, PHOTOS AND OTHER PRINTED MATERIAL FOR USE WITH POWER POINT, ON WEB SITES, OR FOR PRINTING (U.S. CLS. 21, 23, 26, 36 AND 38).

FIRST USE 8-31-1973; IN COMMERCE 8-31-1973.

ANNE E. GUSTASON, EXAMINING ATTORNEY

SN 78-441,193. SHELTON & SPENCE, LONG BEACH, CA. FILED 6-25-2004.

THE MARK CONSISTS OF STANDARD CHARACTERS WITHOUT CLAIM TO ANY PARTICULAR FONT, STYLE, SIZE, OR COLOR.

THE FOREIGN WORDING IN THE MARK TRANSLATES INTO ENGLISH AS TEN THOUSAND PROFITS/BENEFITS ATTAINED.

FOR AUDIO-VISUAL MACHINES AND APPARATUS, NAMELY, VIDEO AND CD PERSONAL STEREO PLAYERS, VIDEO CASSETTE RECORDERS, VIDEO-CAMERA RECORDERS, LASER DISC PLAYERS, VIDEO FLOPPY DISC RECORDERS, TELEVISION RECEIVERS, ANTENNAS, CABLE TELEVISION RECEIVERS, SATELLITE BROADCAST RECEIVERS, OPTICAL RECORDING AND REPRODUCING APPARATUS, NAMELY DIGITAL VIDEO DISC PLAYERS AND OPTICAL DISC PLAYERS, BLANK OPTICAL RECORDING AND REPRODUCING MEDIA IN THE FORM OF TAPES, CARTRIDGES, AND DISCS, COMMUNICATIONS MACHINES AND APPARATUS, NAMELY FACSIMILE MACHINES, TELEPHONES, PORTABLE TELEPHONES, AUTOMATIC TELEPHONE ANSWERING MACHINES, ANSWERING TELEPHONES, MODULAR TELECOMMUNICATIONS EXCHANGERS FOR TELEPHONES, GLOBAL POSITIONING SYSTEM RECEIVERS, RADIO TELEPHONES, MARINE RADAR, CELLULAR MOBILE TELEPHONES, RADIO PAGERS (U.S. CLS. 21, 23, 26, 36 AND 38).

TONI HICKEY, EXAMINING ATTORNEY

Prelim Solutions

THE MARK CONSISTS OF STANDARD CHARACTERS WITHOUT CLAIM TO ANY PARTICULAR FONT, STYLE, SIZE, OR COLOR.

NO CLAIM IS MADE TO THE EXCLUSIVE RIGHT TO USE "SOLUTIONS", APART FROM THE MARK AS SHOWN.

FOR COMPUTER SOFTWARE FOR PROCESSING PRELIMINARY NOTICES AND LIEN RELEASES (U.S. CLS. 21, 23, 26, 36 AND 38).

JOHN WILKE, EXAMINING ATTORNEY

CLASS 9—(Continued).

SN 78-441,396. SPL DEVELOPMENT, INCORPORATED,
REDWOOD CITY, CA. FILED 6-25-2004.

CLASS 9—(Continued).

SN 78-443,019. OEMTEC LTD, BRIDGETOWN, BARBADOS,
FILED 6-29-2004.

LACE

Yaplock

THE MARK CONSISTS OF STANDARD CHARACTERS
WITHOUT CLAIM TO ANY PARTICULAR FONT, STYLE,
SIZE, OR COLOR.

FOR COMPUTER SOFTWARE FOR THE PURPOSE OF
MAINTAINING OR IMPROVING COGNITIVE PERFORM-
ANCE AND/OR BRAIN PLASTICITY (U.S. CLS. 21, 23,
26, 36 AND 38).

JAMES A. RAUEN, EXAMINING ATTORNEY

THE MARK CONSISTS OF STANDARD CHARACTERS
WITHOUT CLAIM TO ANY PARTICULAR FONT, STYLE,
SIZE, OR COLOR.

FOR COMPUTER SECURITY SOFTWARE FOR IN-
STANT MESSAGING (U.S. CLS. 21, 23, 26, 36 AND 38).

ELIZABETH HUGHITT, EXAMINING ATTORNEY

SN 78-442,310. HALE, STEVEN C., CENTRAL POINT, OR.
FILED 6-28-2004.

SN 78-443,350. HOT TOPIC, INC., CITY OF INDUSTRY, CA.
FILED 6-29-2004.

HoloDark

HT ROCK

THE MARK CONSISTS OF STANDARD CHARACTERS
WITHOUT CLAIM TO ANY PARTICULAR FONT, STYLE,
SIZE, OR COLOR.

FOR REAR PROJECTION SCREENS (U.S. CLS. 21, 23,
26, 36 AND 38).

FIRST USE 1-1-2002; IN COMMERCE 1-1-2002.
LINDA POWELL, EXAMINING ATTORNEY

THE MARK CONSISTS OF STANDARD CHARACTERS
WITHOUT CLAIM TO ANY PARTICULAR FONT, STYLE,
SIZE, OR COLOR.

NO CLAIM IS MADE TO THE EXCLUSIVE RIGHT TO
USE "ROCK", APART FROM THE MARK AS SHOWN.

FOR PRE-RECORDED CD'S, VIDEO TAPES, LASER
DISKS, DVD'S, AUDIO CASSETTES, VIDEO CASSETTES,
AND PHONOGRAPH RECORDS, ALL FEATURING
MUSIC (U.S. CLS. 21, 23, 26, 36 AND 38).

RUSS HERMAN, EXAMINING ATTORNEY

CLASS 9—(Continued).

SN 78-443,704. DANSKIN, INC., NEW YORK, NY. FILED 6-30-2004.



FOR EYEGLASSES; SUNGLASSES; PRE-RECORDED CD'S, VIDEO TAPES, LASER DISKS AND DVD'S ALL RELATED TO HEALTH, NUTRITION, FITNESS, EXERCISE AND AN ACTIVE LIFESTYLE NOT RELATED TO SOFTWARE AND MUSIC (U.S. CLS. 21, 23, 26, 36 AND 38).

SHARI SHEFFIELD, EXAMINING ATTORNEY

CLASS 9—(Continued).

SN 78-446,690. BAKER HUGHES INCORPORATED, HOUSTON, TX. FILED 7-7-2004.

XOTLIVE

THE MARK CONSISTS OF STANDARD CHARACTERS WITHOUT CLAIM TO ANY PARTICULAR FONT, STYLE, SIZE, OR COLOR.

FOR COMPUTER SOFTWARE USED TO PLAN COMPLETION OPERATIONS FOR OIL AND GAS WELLS (U.S. CLS. 21, 23, 26, 36 AND 38).

MARY ROSSMAN, EXAMINING ATTORNEY

SN 78-445,633. SPECTRUM RISK DECISIONS, L.P., HOUSTON, TX. FILED 7-2-2004.

CreditPrime

THE MARK CONSISTS OF STANDARD CHARACTERS WITHOUT CLAIM TO ANY PARTICULAR FONT, STYLE, SIZE, OR COLOR.

FOR COMPUTER SOFTWARE FOR ANALYZING CREDIT WORTHINESS OF ENTITIES, MANAGING CREDIT ADMINISTRATION FUNCTIONS, PRODUCING ANALYTICAL REPORTS INCLUDING SPREADSHEETS, AND DETERMINING NET CREDIT EXPOSURES FOR CREDIT RISK MANAGEMENT (U.S. CLS. 21, 23, 26, 36 AND 38).

FIRST USE 1-1-2004; IN COMMERCE 1-1-2004.

JANICE L. MCMORROW, EXAMINING ATTORNEY

SN 78-446,696. BAKER HUGHES INCORPORATED, HOUSTON, TX. FILED 7-7-2004.

XOTMOVE

THE MARK CONSISTS OF STANDARD CHARACTERS WITHOUT CLAIM TO ANY PARTICULAR FONT, STYLE, SIZE, OR COLOR.

FOR COMPUTER SOFTWARE USED TO PLAN COMPLETION OPERATIONS FOR OIL AND GAS WELLS (U.S. CLS. 21, 23, 26, 36 AND 38).

MARY ROSSMAN, EXAMINING ATTORNEY

CLASS 9—(Continued).

SN 78-447,981. COORSTEK, INC., GOLDEN, CO. FILED 7-8-2004.

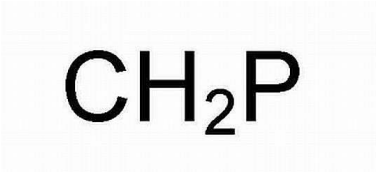

FOR FUEL CELLS (U.S. CLS. 21, 23, 26, 36 AND 38).
JENNIFER CHICOSKI, EXAMINING ATTORNEY

CLASS 9—(Continued).

SN 78-452,541. SERVERENGINES, LLC, SANTA CLARA, CA. FILED 7-19-2004.

BladeXchange

SN 78-448,657. MAKEMUSIC! INC., EDEN PRAIRIE, MN. FILED 7-9-2004.

HUMAN PLAYBACK

THE MARK CONSISTS OF STANDARD CHARACTERS WITHOUT CLAIM TO ANY PARTICULAR FONT, STYLE, SIZE, OR COLOR.

NO CLAIM IS MADE TO THE EXCLUSIVE RIGHT TO USE "PLAYBACK", APART FROM THE MARK AS SHOWN.

FOR COMPUTER SOFTWARE FOR USE IN COMPOSING, PERFORMING, PUBLISHING, ARRANGING AND PRINTING MUSIC (U.S. CLS. 21, 23, 26, 36 AND 38).

FIRST USE 8-21-2003; IN COMMERCE 8-21-2003.
RENEE MCCRAY, EXAMINING ATTORNEY

THE MARK CONSISTS OF STANDARD CHARACTERS WITHOUT CLAIM TO ANY PARTICULAR FONT, STYLE, SIZE, OR COLOR.

FOR SEMICONDUCTORS AND INTEGRATED CIRCUIT CHIPS (U.S. CLS. 21, 23, 26, 36 AND 38).

CAROLYN GRAY, EXAMINING ATTORNEY

SN 78-449,803. NOVODYNAMICS, INC., ANN ARBOR, MI. FILED 7-13-2004.

ARBORCHEM

THE MARK CONSISTS OF STANDARD CHARACTERS WITHOUT CLAIM TO ANY PARTICULAR FONT, STYLE, SIZE, OR COLOR.

FOR COMPUTER SOFTWARE FOR USE BY SCIENTISTS IN CHEMICAL RESEARCH AND DEVELOPMENT OF CATALYSTS, MATERIALS, PRODUCTS, AND FORMULATED SYSTEMS USING CONVENTIONAL AND HIGH THROUGHPUT DISCOVERY AND RESEARCH TECHNIQUES WITH FEATURES FOR EXPERIMENT PLANNING, EXPERIMENT INTERPRETATION, PREDICTIVE MODELING, IMAGE ANALYSIS, DATA MANAGEMENT, AND DATA ANALYSIS (U.S. CLS. 21, 23, 26, 36 AND 38).

FIRST USE 4-13-2004; IN COMMERCE 4-13-2004.
RUSS HERMAN, EXAMINING ATTORNEY

SN 78-453,675. MATTHEW CHARLES WEISS, EDMONDS, WA. FILED 7-20-2004.



NO CLAIM IS MADE TO THE EXCLUSIVE RIGHT TO USE "PRODUCTIONS", APART FROM THE MARK AS SHOWN.

THE COLOR(S) GOLD AND BLACK IS/ARE CLAIMED AS A FEATURE OF THE MARK.

THE MARK CONSISTS OF A CIRCULAR GRAPHIC FROM A BUDDHIST THANKA PAINTING, TEXT IN GOLDS ON BLACK BACKGROUND.

THE FOREIGN WORDING IN THE MARK TRANSLATES INTO ENGLISH AS LIFE FORCE SKY.

FOR AUDIO RECORDINGS FEATURING MUSIC; MUSICAL VIDEO RECORDINGS; PRE-RECORDED CD'S, VIDEO TAPES, LASER DISKS AND DVD'S FEATURING MUSIC; DOWNLOADABLE VIDEO RECORDINGS FEATURING MUSIC; DOWNLOADABLE MUSICAL SOUND RECORDINGS; CINEMATOGRAPHIC FILMS FEATURING MUSIC; MOTION PICTURE FILMS FEATURING MUSIC (U.S. CLS. 21, 23, 26, 36 AND 38).

TEJBIR SINGH, EXAMINING ATTORNEY

CLASS 9—(Continued).

SN 78-453,838. CAST GROUP OF COMPANIES, INC., TORONTO, ONTARIO, CANADA, FILED 7-21-2004.

CLASS 9—(Continued).

SN 78-458,043. DISNEY ENTERPRISES, INC., BURBANK, CA. FILED 7-28-2004.

VIVIEN

DISNEY PIX

THE MARK CONSISTS OF STANDARD CHARACTERS WITHOUT CLAIM TO ANY PARTICULAR FONT, STYLE, SIZE, OR COLOR.

PRIORITY CLAIMED UNDER SEC. 44(D) ON CANADA APPLICATION NO. 1,223,871, FILED 7-16-2004, REG. NO. TMA640,708, DATED 5-30-2005, EXPIRES 5-30-2020.

FOR COMPUTER SOFTWARE FOR EVENT AND MEETING DESIGN AND PLANNING, NAMELY: SOFTWARE FOR LAYING OUT PHYSICAL ARRANGEMENTS AND GENERATING VIRTUAL IMAGES OF LAYOUTS (U.S. CLS. 21, 23, 26, 36 AND 38).

JULIE WATSON, EXAMINING ATTORNEY

THE MARK CONSISTS OF STANDARD CHARACTERS WITHOUT CLAIM TO ANY PARTICULAR FONT, STYLE, SIZE, OR COLOR.

NO CLAIM IS MADE TO THE EXCLUSIVE RIGHT TO USE "PICS", APART FROM THE MARK AS SHOWN.

FOR CAMERAS AND COMPUTER SOFTWARE ENABLING USERS TO CREATE ARTWORK USING PHOTOGRAPHS (U.S. CLS. 21, 23, 26, 36 AND 38).

MATTHEW PAPPAS, EXAMINING ATTORNEY

SN 78-457,095. WAER SYSTEMS, INC., NAPERVILLE, IL. FILED 7-27-2004.

SN 78-458,047. DISNEY ENTERPRISES, INC., BURBANK, CA. FILED 7-28-2004.

AEROSCAPE

DISNEY MIX

THE MARK CONSISTS OF STANDARD CHARACTERS WITHOUT CLAIM TO ANY PARTICULAR FONT, STYLE, SIZE, OR COLOR.

FOR COMPUTER HARDWARE FOR MANUFACTURER SUPPLY CHAIN MANAGEMENT; COMPUTER SOFTWARE FOR INVENTORY CONTROL IN THE FIELD OF MANUFACTURER SUPPLY CHAIN MANAGEMENT (U.S. CLS. 21, 23, 26, 36 AND 38).

TRACY FLETCHER, EXAMINING ATTORNEY

THE MARK CONSISTS OF STANDARD CHARACTERS WITHOUT CLAIM TO ANY PARTICULAR FONT, STYLE, SIZE, OR COLOR.

NO CLAIM IS MADE TO THE EXCLUSIVE RIGHT TO USE "MIX", APART FROM THE MARK AS SHOWN.

FOR COMPUTER SOFTWARE ENABLING USERS TO CREATE MUSICAL COMPOSITIONS (U.S. CLS. 21, 23, 26, 36 AND 38).

MATTHEW PAPPAS, EXAMINING ATTORNEY

CLASS 9—(Continued).

SN 78-458,049. DISNEY ENTERPRISES, INC., BURBANK, CA. FILED 7-28-2004.

DISNEY DREAM DESK

THE MARK CONSISTS OF STANDARD CHARACTERS WITHOUT CLAIM TO ANY PARTICULAR FONT, STYLE, SIZE, OR COLOR.

FOR PERSONAL COMPUTERS AND ACCESSORIES, NAMELY, COMPUTER MOUSE, COMPUTER KEYBOARDS, COMPUTER JOYSTICKS AND COMPUTER PRINTERS (U.S. CLS. 21, 23, 26, 36 AND 38).

MATTHEW PAPPAS, EXAMINING ATTORNEY

CLASS 9—(Continued).

SN 78-459,896. WD MUSIC PRODUCTS, INC., FORT MYERS, FL. FILED 7-30-2004.

RED RANGER

THE MARK CONSISTS OF STANDARD CHARACTERS WITHOUT CLAIM TO ANY PARTICULAR FONT, STYLE, SIZE, OR COLOR.

NO CLAIM IS MADE TO THE EXCLUSIVE RIGHT TO USE "RED", APART FROM THE MARK AS SHOWN.

FOR ELECTRONIC SOUND MODIFIERS FOR STRINGED MUSICAL INSTRUMENTS (U.S. CLS. 21, 23, 26, 36 AND 38).

FIRST USE 2-26-1988; IN COMMERCE 2-26-1988.
EUGENIA MARTIN, EXAMINING ATTORNEY

SN 78-459,376. SW-SOFT HOLDINGS, LTD., HERNDON, VA. FILED 7-30-2004.



THE MARK CONSISTS OF A STYLIZED COMPUTER RACK.

FOR COMPUTER SOFTWARE FOR USE IN ENTERPRISE MANAGEMENT FOR OPERATION SUPPORT SYSTEMS (OSS) AND BUSINESS SUPPORT SYSTEMS (BSS) IN THE FIELD OF COMPUTERS (U.S. CLS. 21, 23, 26, 36 AND 38).

FIRST USE 6-0-2004; IN COMMERCE 6-0-2004.
STEVEN JACKSON, EXAMINING ATTORNEY

SN 78-461,024. RAYTHEON COMPANY, WALTHAM, MA. FILED 8-3-2004.

EQUINOX

THE MARK CONSISTS OF STANDARD CHARACTERS WITHOUT CLAIM TO ANY PARTICULAR FONT, STYLE, SIZE, OR COLOR.

FOR RESOURCE ALLOCATION SOFTWARE FOR USE BY SATELLITE OPERATORS IN MANAGING THE TASKING OF SATELLITES (U.S. CLS. 21, 23, 26, 36 AND 38).

DAVID MURRAY, EXAMINING ATTORNEY

CLASS 9—(Continued).

SN 78-462,904. VENETIAN CASINO RESORT, LLC, LAS VEGAS, NV. FILED 8-5-2004.

CLASS 9—(Continued).

SN 78-464,294. STENOGRAPH, L.L.C., MOUNT PROSPECT, IL. FILED 8-9-2004.

VENETIAN PALAZZO

CATalyst BCS

THE MARK CONSISTS OF STANDARD CHARACTERS WITHOUT CLAIM TO ANY PARTICULAR FONT, STYLE, SIZE, OR COLOR.
FOR SUNGLASSES; CASES FOR SUNGLASSES; SUNGLASS FRAMES (U.S. CLS. 21, 23, 26, 36 AND 38).
ANDREW RHIM, EXAMINING ATTORNEY

THE MARK CONSISTS OF STANDARD CHARACTERS WITHOUT CLAIM TO ANY PARTICULAR FONT, STYLE, SIZE, OR COLOR.
FOR COMPUTER SOFTWARE FOR TELEVISION BROADCAST CAPTIONING REGARDING REALTIME FOR SUBTITLING IN MULTIPLE LANGUAGES (U.S. CLS. 21, 23, 26, 36 AND 38).
FIRST USE 5-13-2004; IN COMMERCE 7-29-2004.
WILLIAM VERHOSEK, EXAMINING ATTORNEY

SN 78-464,137. HORIZON HOBBY, INC., CHAMPAIGN, IL. FILED 8-9-2004.

SN 78-467,114. JOBLO MEDIA INC., MONTREAL, QUEBEC, CANADA, FILED 8-13-2004.

DSM

JOBLO

THE MARK CONSISTS OF STANDARD CHARACTERS WITHOUT CLAIM TO ANY PARTICULAR FONT, STYLE, SIZE, OR COLOR.
FOR DIGITAL SEQUENCING SPREAD SPECTRUM MODULES AND TRANSCEIVERS FOR INSTALLATION INTO HOBBY MODEL VEHICLES FOR DIGITAL ENCODING (U.S. CLS. 21, 23, 26, 36 AND 38).
FIRST USE 1-27-2005; IN COMMERCE 1-27-2005.
NAAKWAMA ANKRAH, EXAMINING ATTORNEY

THE MARK CONSISTS OF STANDARD CHARACTERS WITHOUT CLAIM TO ANY PARTICULAR FONT, STYLE, SIZE, OR COLOR.
FOR PRE-RECORDED VIDEO CASSETTE TAPES, PRE-RECORDED DIGITAL VIDEO DISCS ALL FEATURING SUBJECTS RELATED TO MOVIES, THE INTERNET OR ENTERTAINMENT (U.S. CLS. 21, 23, 26, 36 AND 38).
JOHN LINCOSKI, EXAMINING ATTORNEY

CLASS 9—(Continued).

SN 78-470,129. THUNDER SCIENTIFIC CORPORATION,
ALBUQUERQUE, NM. FILED 8-19-2004.

HUMICALC

THE MARK CONSISTS OF STANDARD CHARACTERS
WITHOUT CLAIM TO ANY PARTICULAR FONT, STYLE,
SIZE, OR COLOR.

FOR COMPUTER SOFTWARE FOR PERFORMING
GAS HUMIDITY ANALYSIS (U.S. CLS. 21, 23, 26, 36
AND 38).

FIRST USE 4-19-1990; IN COMMERCE 4-19-1990.
TIMOTHY FINNEGAN, EXAMINING ATTORNEY

SN 78-470,725. XTENSIBLE SOLUTIONS, INC., SATELLITE
BEACH, FL. FILED 8-20-2004.

MDI

THE MARK CONSISTS OF STANDARD CHARACTERS
WITHOUT CLAIM TO ANY PARTICULAR FONT, STYLE,
SIZE, OR COLOR.

FOR DOWNLOADABLE ELECTRONIC PUBLICA-
TIONS IN THE NATURE OF ARTICLES, BOOKS,
PAMPHLETS, NEWSLETTERS, PERIODICALS, IN-
STRUCTIONAL MATERIALS, AND MANUALS PER-
TAINING TO ELECTRONIC INDUSTRY TECHNICAL
STANDARDS, SPECIFICATIONS, COMPUTER PRO-
GRAMMING AND COMPUTER PROGRAMMING LAN-
GUAGES, PLATFORMS AND SOFTWARE
DEVELOPMENT (U.S. CLS. 21, 23, 26, 36 AND 38).

KEVIN DINALLO, EXAMINING ATTORNEY

CLASS 9—(Continued).

SN 78-472,772. HELMER LABS INC., NOBLESVILLE, IN.
FILED 8-24-2004.

MAXSPIN

THE MARK CONSISTS OF STANDARD CHARACTERS
WITHOUT CLAIM TO ANY PARTICULAR FONT, STYLE,
SIZE, OR COLOR.

FOR LABORATORY APPARATUS, NAMELY, CEN-
TRIFUGES USED FOR SPINNING A LARGE NUMBER
OF TUBES WITH DECREASED TURNAROUND TIMES
(U.S. CLS. 21, 23, 26, 36 AND 38).

FIRST USE 9-23-2003; IN COMMERCE 9-23-2003.
KATRINA EDGE, EXAMINING ATTORNEY

SN 78-473,233. ACEA BIOSCIENCES, INC., SAN DIEGO, CA.
FILED 8-25-2004.

ACEA BIOSCIENCES

THE MARK CONSISTS OF STANDARD CHARACTERS
WITHOUT CLAIM TO ANY PARTICULAR FONT, STYLE,
SIZE, OR COLOR.

NO CLAIM IS MADE TO THE EXCLUSIVE RIGHT TO
USE "BIOSCIENCES", APART FROM THE MARK AS
SHOWN.

FOR SCIENTIFIC APPARATUS FOR MEASUREMENT
OF ELECTRONIC SIGNALS SUCH AS IMPEDANCE,
VOLTAGE, AND CURRENT OF BIOLOGICAL SYSTEMS
INCLUDING MOLECULES, CELLS AND TISSUES,
NAMELY, ELECTRONIC SIGNAL ANALYZERS,
PLATES, GLASS SLIDES OR CHIPS HAVING MULTIPLE
WELL ARRAYS THAT CAN BE USED IN CHEMICAL
ANALYSIS, BIOLOGICAL ANALYSIS OR PATTERNING
FOR SCIENTIFIC, LABORATORY OR MEDICAL RE-
SEARCH (U.S. CLS. 21, 23, 26, 36 AND 38).

FIRST USE 5-1-2002; IN COMMERCE 6-9-2003.
GINA FINK, EXAMINING ATTORNEY

CLASS 9—(Continued).

SN 78-475,989. OPEN SPATIAL INC, CLEARWATER, FL. FILED 8-30-2004.

CLASS 9—(Continued).

SN 78-484,336. LRI HOLDINGS COMPANY, LLC, OMAHA, NE. FILED 9-15-2004.

Munsys

AMP

THE MARK CONSISTS OF STANDARD CHARACTERS WITHOUT CLAIM TO ANY PARTICULAR FONT, STYLE, SIZE, OR COLOR.

FOR COMPUTER SOFTWARE FOR MANAGING GEOGRAPHIC INFORMATION USED BY GOVERNMENT AND UTILITY ORGANIZATIONS (U.S. CLS. 21, 23, 26, 36 AND 38).

FIRST USE 1-1-1996; IN COMMERCE 1-1-2000.
BRENDAN MCCAULEY, EXAMINING ATTORNEY

THE MARK CONSISTS OF STANDARD CHARACTERS WITHOUT CLAIM TO ANY PARTICULAR FONT, STYLE, SIZE, OR COLOR.

FOR EYEGLASSES; SUNGLASSES (U.S. CLS. 21, 23, 26, 36 AND 38).

FIRST USE 12-30-2004; IN COMMERCE 12-30-2004.
YONG KIM, EXAMINING ATTORNEY

SN 78-480,942. MEEKER & ASSOCIATES, INC., LARCHMONT, NY. FILED 9-9-2004.

SN 78-484,903. HISTORX, INC., NEW HAVEN, CT. FILED 9-16-2004.

CLEARVIEWONE

HISTORX

THE MARK CONSISTS OF STANDARD CHARACTERS WITHOUT CLAIM TO ANY PARTICULAR FONT, STYLE, SIZE, OR COLOR.

OWNER OF U.S. REG. NOS. 2,255,718, 2,257,252 AND 2,797,758.

NO CLAIM IS MADE TO THE EXCLUSIVE RIGHT TO USE "CLEARVIEW", APART FROM THE MARK AS SHOWN.

FOR TYPEFACE FONTS RECORDED ON MAGNETIC AND OPTICAL MEDIA (U.S. CLS. 21, 23, 26, 36 AND 38).
FIRST USE 4-1-1996; IN COMMERCE 4-1-1996.
ROBERT LORENZO, EXAMINING ATTORNEY

THE MARK CONSISTS OF STANDARD CHARACTERS WITHOUT CLAIM TO ANY PARTICULAR FONT, STYLE, SIZE, OR COLOR.

FOR COMPUTER SOFTWARE FOR MEDICAL RESEARCH IN THE PHARMACEUTICAL AND DIAGNOSTIC FIELDS, NAMELY SOFTWARE FOR THE IMAGING AND ANALYSIS OF TISSUE SAMPLES (U.S. CLS. 21, 23, 26, 36 AND 38).

FIRST USE 9-15-2004; IN COMMERCE 9-15-2004.
GENE MACIOL, EXAMINING ATTORNEY

CLASS 9—(Continued).

SN 78-485,355. PANTA SYSTEMS, INC., CUPERTINO, CA. FILED 9-17-2004.

PANTA

THE MARK CONSISTS OF STANDARD CHARACTERS WITHOUT CLAIM TO ANY PARTICULAR FONT, STYLE, SIZE, OR COLOR.

FOR COMPUTER HARDWARE; COMPUTER HARDWARE, NAMELY SERVERS, SWITCHES, ROUTERS, CONNECTORS AND INTEGRATED CIRCUITS; COMPUTER SOFTWARE FOR INTEGRATING, OPERATING, MONITORING AND MANAGING COMPUTER SERVERS (U.S. CLS. 21, 23, 26, 36 AND 38).

TIMOTHY FINNEGAN, EXAMINING ATTORNEY

CLASS 9—(Continued).

SN 78-487,238. PARASCRIPT, LLC, BOULDER, CO. FILED 9-21-2004.

SCRIPTSEARCH

THE MARK CONSISTS OF STANDARD CHARACTERS WITHOUT CLAIM TO ANY PARTICULAR FONT, STYLE, SIZE, OR COLOR.

FOR COMPUTER PROGRAMS FOR RECOGNIZING CURSIVE AND PRINTED HANDWRITING, MACHINE-GENERATED TEXT, AND FACSIMILE TRANSMISSION FILES (U.S. CLS. 21, 23, 26, 36 AND 38).

MELVIN AXILBUND, EXAMINING ATTORNEY

SN 78-485,903. TOTALLY PRODUCTIVE GROUP, INC., CAPE CORAL, FL. FILED 9-19-2004.

Project Perfect

THE MARK CONSISTS OF STANDARD CHARACTERS WITHOUT CLAIM TO ANY PARTICULAR FONT, STYLE, SIZE, OR COLOR.

FOR COMPUTER SOFTWARE FOR USE IN THE CONSTRUCTION INDUSTRY FOR MANAGEMENT OF CONSTRUCTION PROJECTS, NAMELY, COMPUTER SOFTWARE FOR USE IN MANAGING THE SCHEDULE OF CONSTRUCTION PROJECTS WITH RESPECT TO COMPLETION OF CONSTRUCTION TASKS, MEASURING QUALITY CONTROL DURING CONSTRUCTION AND ON THE CONSTRUCTION JOBSITE BY MEANS OF QUALITY CHECKLISTS WHICH ARE GENERATED BY THE SOFTWARE DATABASES AND GENERATING REPORTS FOR PROJECT PERSONNEL INVOLVED IN THE CONSTRUCTION PROJECTS REGARDING SCHEDULING INFORMATION AND CONSTRUCTION DEFECTS (U.S. CLS. 21, 23, 26, 36 AND 38).

FIRST USE 7-8-2001; IN COMMERCE 7-8-2001.

BRENDAN MCCAULEY, EXAMINING ATTORNEY

SN 78-487,350. WESTERN DIGITAL TECHNOLOGIES, INC., LAKE FOREST, CA. FILED 9-21-2004.

WESTERN DIGITAL

THE MARK CONSISTS OF STANDARD CHARACTERS WITHOUT CLAIM TO ANY PARTICULAR FONT, STYLE, SIZE, OR COLOR.

OWNER OF U.S. REG. NOS. 1,016,514 AND 2,256,629.
NO CLAIM IS MADE TO THE EXCLUSIVE RIGHT TO USE "DIGITAL", APART FROM THE MARK AS SHOWN.
FOR COMPUTER PRODUCTS, NAMELY HARD DRIVES AND DISK DRIVES (U.S. CLS. 21, 23, 26, 36 AND 38).

FIRST USE 0-0-1989; IN COMMERCE 0-0-1989.

CHRISIE B. KING, EXAMINING ATTORNEY

CLASS 9—(Continued).

SN 78-488,070. DEES, ANNA C., LOS ANGELES, CA. FILED 9-22-2004.

CLASS 9—(Continued).

SN 78-488,697. COOK, TORREY, RIVERDALE, GA. FILED 9-23-2004.

Shirtz & Skinz Sportz

PLAYAZ CIRCLE

THE MARK CONSISTS OF STANDARD CHARACTERS WITHOUT CLAIM TO ANY PARTICULAR FONT, STYLE, SIZE, OR COLOR.

NO CLAIM IS MADE TO THE EXCLUSIVE RIGHT TO USE "SPORTS", APART FROM THE MARK AS SHOWN.

FOR VIDEO PRODUCTS FEATURING ADULT SPORTS ENTERTAINMENT; NAMELY, PRERECORDED COMPACT DISCS AND VIDEO CASSETTES FEATURING ADULT CONTENT SPORTS (U.S. CLS. 21, 23, 26, 36 AND 38).

LINDA MICKLEBURGH, EXAMINING ATTORNEY

THE MARK CONSISTS OF STANDARD CHARACTERS WITHOUT CLAIM TO ANY PARTICULAR FONT, STYLE, SIZE, OR COLOR.

FOR MUSICAL SOUND RECORDINGS; PRE-RECORDED CD'S FEATURING MUSIC (U.S. CLS. 21, 23, 26, 36 AND 38).

FIRST USE 3-0-1999; IN COMMERCE 3-0-1999.

KEVIN DINALLO, EXAMINING ATTORNEY

SN 78-489,253. IRWIN, RONALD, THATCHER, AZ. FILED 9-24-2004.

SN 78-488,312. MARION SUMMERS ENTERPRISES, INC., LITHONIA, GA. FILED 9-23-2004.

DMM Technology

STYLING SECRETS

THE MARK CONSISTS OF STANDARD CHARACTERS WITHOUT CLAIM TO ANY PARTICULAR FONT, STYLE, SIZE, OR COLOR.

NO CLAIM IS MADE TO THE EXCLUSIVE RIGHT TO USE "STYLING", APART FROM THE MARK AS SHOWN.

FOR EDUCATIONAL DVDS AND VIDEOTAPES TO TEACH HAIR MAINTENANCE OR HAIR CARE (U.S. CLS. 21, 23, 26, 36 AND 38).

CAROLINE WOOD, EXAMINING ATTORNEY

THE MARK CONSISTS OF STANDARD CHARACTERS WITHOUT CLAIM TO ANY PARTICULAR FONT, STYLE, SIZE, OR COLOR.

NO CLAIM IS MADE TO THE EXCLUSIVE RIGHT TO USE TECHNOLOGY, APART FROM THE MARK AS SHOWN.

FOR FACTORY AUTOMATION COMPUTERS AND SOFTWARE, TO INTEGRATE MANUFACTURING MACHINE OPERATIONS, TRACK PROBLEMS AND GENERATE PRODUCTION REPORTS (U.S. CLS. 21, 23, 26, 36 AND 38).

CHRISTOPHER ADKINS, EXAMINING ATTORNEY

CLASS 9—(Continued).

SN 78-491,494. CARTWRIGHT-JONES, CATHERINE J., STOW, OH. FILED 9-29-2004.

TapDancing Lizard

THE MARK CONSISTS OF STANDARD CHARACTERS WITHOUT CLAIM TO ANY PARTICULAR FONT, STYLE, SIZE, OR COLOR.

THE MARK IS PRESENTED IN STANDARD CHARACTERS, WITHOUT CLAIM TO ANY PARTICULAR FONT, STYLE, SIZE OR COLOR

FOR ELECTRONIC PUBLICATIONS NAMELY BOOKS AND MANUALS ABOUT BODY ADORNMENT RECORDED ON COMPUTER MEDIA (U.S. CLS. 21, 23, 26, 36 AND 38).

FIRST USE 0-0-1991; IN COMMERCE 0-0-1996.
VERNA BETH RIRIE, EXAMINING ATTORNEY

CLASS 9—(Continued).

SN 78-491,926. LEARNING RESOURCES, INC., VERNON HILLS, IL. FILED 9-30-2004.

RIGHT TIMER

THE MARK CONSISTS OF STANDARD CHARACTERS WITHOUT CLAIM TO ANY PARTICULAR FONT, STYLE, SIZE, OR COLOR.

NO CLAIM IS MADE TO THE EXCLUSIVE RIGHT TO USE TIMER, APART FROM THE MARK AS SHOWN. FOR ELECTRONIC EVENT AND ACTIVITY TIMER (U.S. CLS. 21, 23, 26, 36 AND 38).

REBECCA GAN, EXAMINING ATTORNEY

SN 78-491,966. PRINCIOTTA, JOSEPH, ADELPHIA, NJ. FILED 9-30-2004.

WHO's THE DON

THE MARK CONSISTS OF STANDARD CHARACTERS WITHOUT CLAIM TO ANY PARTICULAR FONT, STYLE, SIZE, OR COLOR.

FOR COMPUTER GAME SOFTWARE (U.S. CLS. 21, 23, 26, 36 AND 38).

FLORENTINA BLANDU, EXAMINING ATTORNEY

SN 78-492,653. PERFORMANCE HEALTH TECHNOLOGIES, INC., BOULDER, CO. FILED 9-30-2004.

MAX PROTECT

THE MARK CONSISTS OF STANDARD CHARACTERS WITHOUT CLAIM TO ANY PARTICULAR FONT, STYLE, SIZE, OR COLOR.

FOR INTERNET FILTERING SOFTWARE PROGRAM (U.S. CLS. 21, 23, 26, 36 AND 38).

FIRST USE 9-22-2004; IN COMMERCE 9-22-2004.
ALEXANDER L. POWERS, EXAMINING ATTORNEY



THE MARK CONSISTS OF THE STYLIZED WORD MOTIONTRACK WITH AN ARC ABOVE MOTION.

FOR WIRELESS MOTION SENSING SYSTEM COMPRISED OF GYROSCOPES, ACCELEROMETERS, OR BEND SENSORS AND MICROPROCESSORS, FOR THE PURPOSE OF EXERCISE, REHABILITATION AND/OR POSTURAL AWARENESS (U.S. CLS. 21, 23, 26, 36 AND 38).

CAROLYN CATALDO, EXAMINING ATTORNEY

CLASS 9—(Continued).

SN 78-493,358. BOARD OF CONTROL OF MICHIGAN TECHNOLOGICAL UNIVERSITY, HOUGHTON, MI. FILED 10-1-2004.

CLASS 9—(Continued).

SN 78-493,740. WMS GAMING INC., WAUKEGAN, IL. FILED 10-4-2004.



**FLUSH FORTUNE
POKER**

NO CLAIM IS MADE TO THE EXCLUSIVE RIGHT TO USE "GIS", APART FROM THE MARK AS SHOWN.

THE MARK IS COMPRISED OF THE STYLIZED WORDING ROADSOFT GIS. THE S IN ROADSOFT IS COMPRISED OF A CURVED ROAD.

FOR COMPUTER SOFTWARE, NAMELY GRAPHICALLY INTERFACED INTEGRATED ROADWAY MANAGEMENT SOFTWARE FOR ANALYSIS AND REPORTING OF ROADWAY INVENTORY, SAFETY, AND CONDITION DATA (U.S. CLS. 21, 23, 26, 36 AND 38).

FIRST USE 1-1-1990; IN COMMERCE 10-22-1993.
ELISSA GARBER KON, EXAMINING ATTORNEY

THE MARK CONSISTS OF STANDARD CHARACTERS WITHOUT CLAIM TO ANY PARTICULAR FONT, STYLE, SIZE, OR COLOR.

OWNER OF U.S. REG. NOS. 2,748,790, 2,846,464 AND 2,887,837.

NO CLAIM IS MADE TO THE EXCLUSIVE RIGHT TO USE "POKER", APART FROM THE MARK AS SHOWN.

FOR GAMING MACHINES (U.S. CLS. 21, 23, 26, 36 AND 38).

MICHAEL HALL, EXAMINING ATTORNEY

SN 78-493,709. LOCKHEED MARTIN CORPORATION, BETHESDA, MD. FILED 10-4-2004.

SN 78-494,146. ZAXEL SYSTEMS, INC., LOS ALTOS HILLS, CA. FILED 10-4-2004.

ID Book

ZAXIO

THE MARK CONSISTS OF STANDARD CHARACTERS WITHOUT CLAIM TO ANY PARTICULAR FONT, STYLE, SIZE, OR COLOR.

NO CLAIM IS MADE TO THE EXCLUSIVE RIGHT TO USE ID, APART FROM THE MARK AS SHOWN.

FOR COMPUTER SOFTWARE FOR USE WITH MOBILE FINGERPRINT READER AND MATCHER (U.S. CLS. 21, 23, 26, 36 AND 38).

FIRST USE 2-14-2004; IN COMMERCE 2-14-2004.
LINDA MICKLEBURGH, EXAMINING ATTORNEY

THE MARK CONSISTS OF STANDARD CHARACTERS WITHOUT CLAIM TO ANY PARTICULAR FONT, STYLE, SIZE, OR COLOR.

FOR HIGH DEFINITION VIDEO DISK RECORDERS AND VIDEO SERVERS (U.S. CLS. 21, 23, 26, 36 AND 38).

FIRST USE 9-0-2004; IN COMMERCE 9-0-2004.
BRENDAN REGAN, EXAMINING ATTORNEY

CLASS 9—(Continued).

SN 78-495,908. HANSEN, MARLON SCOTT, ROUND ROCK, TX. FILED 10-6-2004.

MyVerses

THE MARK CONSISTS OF STANDARD CHARACTERS WITHOUT CLAIM TO ANY PARTICULAR FONT, STYLE, SIZE, OR COLOR.

FOR COMPUTER SOFTWARE FOR THE COLLECTION, EDITING, ORGANIZING, MODIFYING, BOOK MARKING, TRANSMISSION STORAGE AND SHARING OF DATA AND INFORMATION IN THE FIELD OF SCRIPTURE MEMORIZATION AND MEDITATION (U.S. CLS. 21, 23, 26, 36 AND 38).

FIRST USE 1-8-2004; IN COMMERCE 9-25-2004.
ALICE BENMAMAN, EXAMINING ATTORNEY

SN 78-496,059. EYESEE360, INC., PITTSBURGH, PA. FILED 10-7-2004.

REVOLUTION

THE MARK CONSISTS OF STANDARD CHARACTERS WITHOUT CLAIM TO ANY PARTICULAR FONT, STYLE, SIZE, OR COLOR.

FOR PANORAMIC IMAGING EQUIPMENT, NAMELY, PANORAMIC OPTICAL MIRRORS, AND HARDWARE FOR MOUNTING PANORAMIC OPTICAL MIRRORS ON CAMERAS AND CAMCORDERS (U.S. CLS. 21, 23, 26, 36 AND 38).

SHAUNIA WALLACE, EXAMINING ATTORNEY

CLASS 9—(Continued).

SN 78-497,536. THURSBY SOFTWARE SYSTEMS, INC., ARLINGTON, TX. FILED 10-11-2004.

ADMITMAC

THE MARK CONSISTS OF STANDARD CHARACTERS WITHOUT CLAIM TO ANY PARTICULAR FONT, STYLE, SIZE, OR COLOR.

FOR COMPUTER SOFTWARE FOR SHARING FILES AND PERIPHERALS BETWEEN DISPARATE COMPUTER SYSTEMS AND ACCOMPANYING MANUALS SOLD AS A UNIT (U.S. CLS. 21, 23, 26, 36 AND 38).

FIRST USE 4-0-2003; IN COMMERCE 5-12-2003.
AMOS T. MATTHEWS, JR., EXAMINING ATTORNEY

SN 78-499,006. OZ DEVELOPMENT, INC., WESTBOROUGH, MA. FILED 10-13-2004.

OZLink

THE MARK CONSISTS OF STANDARD CHARACTERS WITHOUT CLAIM TO ANY PARTICULAR FONT, STYLE, SIZE, OR COLOR.

FOR COMPUTER SOFTWARE FOR INTEGRATING APPLICATIONS, NAMELY, A MIDDLEWARE PROGRAM FOR SHIPPING SYSTEMS, ACCOUNTING SYSTEMS, WAREHOUSE MANAGEMENT, CUSTOMER RELATIONSHIP MANAGEMENT, TRANSPORTATION, ENTERPRISE RESOURCE PLANNING, AND SYSTEMS INTEGRATION (U.S. CLS. 21, 23, 26, 36 AND 38).

FIRST USE 10-15-2003; IN COMMERCE 1-2-2004.
MICHAEL ENGEL, EXAMINING ATTORNEY

CLASS 9—(Continued).

SN 78-499,268. FLOODTRONICS INC., RYDAL, PA. FILED 10-13-2004.

CLASS 9—(Continued).

SN 78-500,366. SALMON, BEACH, AND COMPANY, A PROFESSIONAL CORPORATION, DALLAS, TX. FILED 10-15-2004.

FLOOD WATCH

THE MARK CONSISTS OF STANDARD CHARACTERS WITHOUT CLAIM TO ANY PARTICULAR FONT, STYLE, SIZE, OR COLOR.

FOR ELECTRONIC LEAK DETECTION AND SHUT OFF SYSTEM, COMPRISED PRIMARILY OF A COMPUTERIZED MONITORING AND CONTROL PANEL, MOISTURE SENSORS, TEMPERATURE SENSORS, LIQUID-LEVEL SENSORS, AND ELECTRONIC SOLENOID VALVES FOR MONITORING AND CONTROLLING WATER, LIQUID AND TEMPERATURE IN ORDER TO PROTECT BUILDINGS, PLUMBING SYSTEMS AND MECHANICAL EQUIPMENT (U.S. CLS. 21, 23, 26, 36 AND 38).

FIRST USE 4-5-1986; IN COMMERCE 8-11-1989.
ALLISON SCHRODY, EXAMINING ATTORNEY

SchoolDocs

THE MARK CONSISTS OF STANDARD CHARACTERS WITHOUT CLAIM TO ANY PARTICULAR FONT, STYLE, SIZE, OR COLOR.

FOR WEB AND NETWORK-BASED COMPUTER SOFTWARE APPLICATION FOR USE IN MANAGEMENT AND TRACKING OF ALL TYPES OF STUDENT RECORDS AND DATA, PROVIDING SECURE, REMOTE ACCESS TO ALL TYPES OF STUDENT FILES (U.S. CLS. 21, 23, 26, 36 AND 38).

JOHN WILKE, EXAMINING ATTORNEY

SN 78-499,465. NYTECH, INC., EDISON, NJ. FILED 10-14-2004.

SN 78-501,277. QUALITY CALL SOLUTIONS, INC, SANTA CLARA, CA. FILED 10-18-2004.

Moolmantra

THE MARK CONSISTS OF STANDARD CHARACTERS WITHOUT CLAIM TO ANY PARTICULAR FONT, STYLE, SIZE, OR COLOR.

FOR PRE-RECORDED CD'S, VIDEO TAPES, LASER DISKS AND DVD'S FEATURING CONTENT OF A CULTURAL OR RELIGIOUS NATURE, NAMELY- RELIGIOUS RITUALS, RELIGIOUS AND CULTURAL DISCOURSES, YOGA AND MEDITATION, RELIGIOUS CHANTS, RELIGIOUS SELF-HELP, STORIES FOR CHILDREN AND ADULTS, MUSIC AND DANCE (U.S. CLS. 21, 23, 26, 36 AND 38).

TEJBIR SINGH, EXAMINING ATTORNEY

QLocator

THE COLOR(S) BLUE IS/ARE CLAIMED AS A FEATURE OF THE MARK.

THE ENTIRE MARK CONSIST OF THE COLOR BLUE. FOR COMPUTER TELEPHONY SOFTWARE ENABLES TELEPHONE ACTIVITIES TO BE PERFORMED THROUGH A COMPUTER (U.S. CLS. 21, 23, 26, 36 AND 38).

FIRST USE 10-25-2001; IN COMMERCE 10-25-2001.
DORITT L. CARROLL, EXAMINING ATTORNEY

CLASS 9—(Continued).

SN 78-501,434. VICTOROVICH, SAZHIN VICTOR, MOSCOW, RUSSIAN FED., FILED 10-18-2004.

CLASS 9—(Continued).

SN 78-503,676. INTOTO, INC., SANTA CLARA, CA. FILED 10-21-2004.

VicMan

INTRUPRO

THE MARK CONSISTS OF STANDARD CHARACTERS WITHOUT CLAIM TO ANY PARTICULAR FONT, STYLE, SIZE, OR COLOR.
 FOR COMPUTER SOFTWARE FOR DIGITAL IMAGE PROCESSING (U.S. CLS. 21, 23, 26, 36 AND 38).
 FIRST USE 8-16-1998; IN COMMERCE 1-10-2000.
 FRED MANDIR, EXAMINING ATTORNEY

THE MARK CONSISTS OF STANDARD CHARACTERS WITHOUT CLAIM TO ANY PARTICULAR FONT, STYLE, SIZE, OR COLOR.
 FOR COMPUTER NETWORK SECURITY SOFTWARE (U.S. CLS. 21, 23, 26, 36 AND 38).
 FIRST USE 7-1-2004; IN COMMERCE 7-1-2004.
 SCOTT OSCLICK, EXAMINING ATTORNEY

SN 78-502,339. GEM POWER, LLC, REDLANDS, CA. FILED 10-19-2004.

SN 78-504,069. YANG, WEI XIN, NEW YORK, NY. FILED 10-21-2004.

GEM POWER

Take

THE MARK CONSISTS OF STANDARD CHARACTERS WITHOUT CLAIM TO ANY PARTICULAR FONT, STYLE, SIZE, OR COLOR.
 NO CLAIM IS MADE TO THE EXCLUSIVE RIGHT TO USE "POWER", APART FROM THE MARK AS SHOWN.
 FOR COMPUTER SOFTWARE FOR DIAGNOSIS OF BATTERY CONDITION AND CONTROL OF BATTERY CHARGING PROCESS IN THE FIELD OF STORAGE BATTERIES; UNIVERSAL BATTERY CHARGERS (U.S. CLS. 21, 23, 26, 36 AND 38).
 FIRST USE 11-3-2004; IN COMMERCE 11-3-2004.
 ANNE E. GUSTASON, EXAMINING ATTORNEY

THE MARK CONSISTS OF STANDARD CHARACTERS WITHOUT CLAIM TO ANY PARTICULAR FONT, STYLE, SIZE, OR COLOR.
 FOR EYE-GLASS FRAMES (U.S. CLS. 21, 23, 26, 36 AND 38).
 WON TEAK OH, EXAMINING ATTORNEY

CLASS 9—(Continued).

SN 78-505,312. UTILITY SOLUTIONS, INC., HICKORY, NC. FILED 10-25-2004.

BLUE STRIPE

THE MARK CONSISTS OF STANDARD CHARACTERS WITHOUT CLAIM TO ANY PARTICULAR FONT, STYLE, SIZE, OR COLOR.

FOR FIRE FIGHTING SAFETY EQUIPMENT, NAMELY, PIKE POLES AND HOT STICKS TO REDUCE RISK OF ACCIDENTAL ELECTROCUTION; SAFETY EQUIPMENT FOR TELEPHONE AND CABLE LINE-MAN, NAMELY, HOT STICKS TO REDUCE RISK OF ACCIDENTAL ELECTROCUTION AND PIKE POLES; LAND AND BUILDING SURVEYING APPARATUS AND INSTRUMENTS, NAMELY, RANGING POLES AND OTHER POLES, NAMELY, EXTENSIBLE POLES ADAPTED TO HAVE ELECTRICAL TOOLS, NAMELY ELECTRICAL PLUMP BOBS, ELECTRICAL CUT-OUTS OR SECTIONALIZERS, FUSE TUBE ASSEMBLIES, FUSE TUBES, OR ELECTRICAL BRACKET ASSEMBLIES, ATTACHED THERETO (U.S. CLS. 21, 23, 26, 36 AND 38).
FIRST USE 10-0-2003; IN COMMERCE 10-0-2003.

ROBERT C. CLARK JR., EXAMINING ATTORNEY

SN 78-505,475. ROBBINS, WENDY, PINE MOUNTAIN, CA. FILED 10-25-2004.

SLEEP YOUR WAY TO SUCCESS

THE MARK CONSISTS OF STANDARD CHARACTERS WITHOUT CLAIM TO ANY PARTICULAR FONT, STYLE, SIZE, OR COLOR.

FOR COMPACT DISCS IN THE FIELD OF PERSONAL AWARENESS AND SELF AWARENESS (U.S. CLS. 21, 23, 26, 36 AND 38).

SUNG IN, EXAMINING ATTORNEY

CLASS 9—(Continued).

SN 78-506,788. LINDNER TECHNOLOGY GROUP, INC., ROCHESTER, MI. FILED 10-27-2004.

CONTACT CENTRAL

THE MARK CONSISTS OF STANDARD CHARACTERS WITHOUT CLAIM TO ANY PARTICULAR FONT, STYLE, SIZE, OR COLOR.

NO CLAIM IS MADE TO THE EXCLUSIVE RIGHT TO USE "CONTACT", APART FROM THE MARK AS SHOWN. FOR COMPUTER SOFTWARE FOR CREATING AND MAINTAINING AN ONLINE DIRECTORY OF EMPLOYEES (U.S. CLS. 21, 23, 26, 36 AND 38).

STEVEN PEREZ, EXAMINING ATTORNEY

SN 78-507,352. HEALTHCARE FINANCE SOLUTIONS INC., SAINT PAUL, MN. FILED 10-28-2004.

HealthAccountPro

THE MARK CONSISTS OF STANDARD CHARACTERS WITHOUT CLAIM TO ANY PARTICULAR FONT, STYLE, SIZE, OR COLOR.

FOR COMPUTER SOFTWARE FOR PROCESSING AND/OR ADJUDICATING HEALTH CARE CLAIMS AND FINANCIAL ACCOUNTING PURPOSES (U.S. CLS. 21, 23, 26, 36 AND 38).

FIRST USE 6-0-2003; IN COMMERCE 6-0-2003.

DOUGLAS LEE, EXAMINING ATTORNEY

SN 78-507,604. LOCKHEED MARTIN CORPORATION, BETHESDA, MD. FILED 10-28-2004.

LASERNET FINES

THE MARK CONSISTS OF STANDARD CHARACTERS WITHOUT CLAIM TO ANY PARTICULAR FONT, STYLE, SIZE, OR COLOR.

NO CLAIM IS MADE TO THE EXCLUSIVE RIGHT TO USE "FINES", APART FROM THE MARK AS SHOWN.

FOR OPTICAL OIL DEBRIS ANALYZER USING PARTICLE COUNTING AND PARTICLE SHAPE CLASSIFICATION (U.S. CLS. 21, 23, 26, 36 AND 38).

MARY BOAGNI, EXAMINING ATTORNEY

CLASS 9—(Continued).

SN 78-507,940. NIMAYA INC., RESTON, VA. FILED 10-28-2004.

CLASS 9—(Continued).

SN 78-508,340. WORLDWIDE MULTI-MEDIA LLC, TAMPA, FL. FILED 10-29-2004.

CUSTOMER GRID

THE MARK CONSISTS OF STANDARD CHARACTERS WITHOUT CLAIM TO ANY PARTICULAR FONT, STYLE, SIZE, OR COLOR.

NO CLAIM IS MADE TO THE EXCLUSIVE RIGHT TO USE "CUSTOMER", APART FROM THE MARK AS SHOWN.

FOR COMPUTER SOFTWARE FOR CUSTOMER RELATIONSHIP MANAGEMENT (U.S. CLS. 21, 23, 26, 36 AND 38).

MARGERY A. TIERNEY, EXAMINING ATTORNEY

SN 78-508,113. FIELDS AND SCREENS, ADDISON, TX. FILED 10-29-2004.

THE MARK CONSISTS OF STANDARD CHARACTERS WITHOUT CLAIM TO ANY PARTICULAR FONT, STYLE, SIZE, OR COLOR.

FOR COMPUTER HARDWARE AND SOFTWARE COMBINATION FOR INTERNET COMMUNICATION; INTERNET EQUIPMENT HARDWARE, NAMELY, PLUG AND PLAY SERVERS (U.S. CLS. 21, 23, 26, 36 AND 38).

NAKWAMA ANKRAH, EXAMINING ATTORNEY

SN 78-508,516. PEMSOFT PTY. LTD., OAKLAND, CA. FILED 10-29-2004.

WOW!

THE MARK CONSISTS OF STANDARD CHARACTERS WITHOUT CLAIM TO ANY PARTICULAR FONT, STYLE, SIZE, OR COLOR.

FOR SOFTWARE FOR PROPERTY MANAGERS, FACILITY MANAGERS AND RETAILERS TO MANAGE SCHEDULED AND UNSCHEDULED FACILITIES MAINTENANCE, COST ACCOUNTING, EVENT PLANNING, DATA ARCHIVAL, STATISTICAL ANALYSIS, VENDOR MANAGEMENT AND INTERFACE, LABOR TRACKING, INVENTORY TRACKING, TRACKING OF EQUIPMENT COST, TRACKING AND ANALYSIS OF MAINTENANCE COST, AND ANALYSIS OF EQUIPMENT REPAIR VERSUS REPLACEMENT COST (U.S. CLS. 21, 23, 26, 36 AND 38).

FIRST USE 9-0-1995; IN COMMERCE 9-0-1995.

JEAN IM, EXAMINING ATTORNEY

THE MARK CONSISTS OF STANDARD CHARACTERS WITHOUT CLAIM TO ANY PARTICULAR FONT, STYLE, SIZE, OR COLOR.

FOR COMPUTER SOFTWARE, NAMELY, CLINICAL DECISION SUPPORT SOFTWARE FOR USE IN PEDIATRIC EMERGENCY MEDICINE (U.S. CLS. 21, 23, 26, 36 AND 38).

DORITT L. CARROLL, EXAMINING ATTORNEY

PEMSOft

CLASS 9—(Continued).

SN 78-508,677. HIGHWAY IMAGE INC., RED BANK, NJ.
FILED 10-29-2004.



FOR DESIGNER COVER FOR ELECTRONIC TRANSPONDERS USED IN HIGHWAY TOLL COLLECTION, AUTOMOBILE PARKING GARAGE PAYMENT COLLECTION, PARKING GARAGE SECURITY SERVICES, VEHICLE WEIGH STATIONS, AND OTHER AUTOMATED TRANSACTIONS INVOLVING MOTOR VEHICLES (U.S. CLS. 21, 23, 26, 36 AND 38).

FIRST USE 8-1-2003; IN COMMERCE 8-1-2003.
RUSS HERMAN, EXAMINING ATTORNEY

SN 78-509,038. BARKLEY VENTURES, INC., OAKLAND PARK, FL. FILED 11-1-2004.

Barkware

THE MARK CONSISTS OF STANDARD CHARACTERS WITHOUT CLAIM TO ANY PARTICULAR FONT, STYLE, SIZE, OR COLOR.

FOR SOFTWARE FOR MANAGING PET DAY CARE PROGRAM (U.S. CLS. 21, 23, 26, 36 AND 38).
FIRST USE 11-15-2003; IN COMMERCE 11-15-2003.
BRENDAN REGAN, EXAMINING ATTORNEY

CLASS 9—(Continued).

SN 78-509,196. MACE SECURITY PRODUCTS, INC., HOLLYWOOD, FL. FILED 11-1-2004.

vernex

THE MARK CONSISTS OF STANDARD CHARACTERS WITHOUT CLAIM TO ANY PARTICULAR FONT, STYLE, SIZE, OR COLOR.

FOR PLASMA TV/MONITOR, LCD TV/MONITOR, INDUSTRIAL LCD MONITOR, AUDIO AND VIDEO EQUIPMENT, NAMELY, TV CAMERAS AND TV MONITORS, DIGITAL VIDEO RECORDERS, STEREO AMPLIFIERS, STEREO RECEIVERS, STEREO TUNERS, STEREO SPEAKERS (U.S. CLS. 21, 23, 26, 36 AND 38).
FIRST USE 12-1-1999; IN COMMERCE 1-1-2000.
PAM WILLIS, EXAMINING ATTORNEY

SN 78-509,265. LEARNWRIGHT, INC., ROCKVILLE, MD.
FILED 11-1-2004.

LEARNWRIGHT

THE MARK CONSISTS OF STANDARD CHARACTERS WITHOUT CLAIM TO ANY PARTICULAR FONT, STYLE, SIZE, OR COLOR.

OWNER OF U.S. REG. NO. 2,649,473.
FOR COMPUTER SOFTWARE FOR INTERACTIVE, COMPUTER BASED, STRUCTURED COMPLIANCE TRAINING AND EVALUATION, IN LARGE, HIGHLY REGULATED AND CONTROLLED INDUSTRIES, SUCH AS THE PHARMACEUTICAL INDUSTRY (U.S. CLS. 21, 23, 26, 36 AND 38).
FIRST USE 8-31-2000; IN COMMERCE 8-31-2000.
VERNA BETH RIRIE, EXAMINING ATTORNEY

CLASS 9—(Continued).

SN 78-509,283. LEARNWRIGHT, INC., ROCKVILLE, MD.
FILED 11-1-2004.

PHARMATRAN

THE MARK CONSISTS OF STANDARD CHARACTERS WITHOUT CLAIM TO ANY PARTICULAR FONT, STYLE, SIZE, OR COLOR.

FOR COMPUTER SOFTWARE FOR PROFESSIONAL TRAINING IN THE FIELD OF HEALTHCARE (U.S. CLS. 21, 23, 26, 36 AND 38).

FIRST USE 10-1-2004; IN COMMERCE 10-1-2004.
ANGELA M. MICHELI, EXAMINING ATTORNEY

SN 78-509,450. MONSTER CABLE PRODUCTS, INC., BRISBANE, CA. FILED 11-1-2004.

MONSTER ULTRA

THE MARK CONSISTS OF STANDARD CHARACTERS WITHOUT CLAIM TO ANY PARTICULAR FONT, STYLE, SIZE, OR COLOR.

OWNER OF U.S. REG. NOS. 2,184,002, 2,728,729 AND OTHERS.

FOR ELECTRICAL AND ELECTROMAGNETIC SIGNAL TRANSMITTING, AMPLIFYING, RECEIVING, AND CONVERTING DEVICES, NAMELY, CABLES, WIRES, CONNECTORS, AND CONTROLS FOR USE WITH ELECTRICAL, ELECTRONIC, AND COMPUTER DEVICES; LOUDSPEAKERS; STEREO AMPLIFIERS; RECORDING MEDIA, NAMELY, COMPACT DISCS HAVING PRERECORDED MUSIC; TELEPHONE ACCESSORIES, NAMELY, TELEPHONE CABLES AND TELEPHONE CONNECTORS; MOBILE PHONE EQUIPMENT AND ACCESSORIES, NAMELY, MOBILE TELEPHONE CHARGERS, MOBILE TELEPHONE CABLES AND MOBILE TELEPHONE CONNECTORS; COMPUTER COMPONENTS AND ACCESSORIES, NAMELY, COMPUTER CABLES AND COMPUTER CONNECTORS; AUDIO EQUIPMENT AND ACCESSORIES, NAMELY, AUDIO CABLES AND AUDIO CONNECTORS; TV DISPLAYS, NAMELY, CRT, LCD AND PLASMA TV DISPLAYS; VIDEO DISPLAYS, NAMELY, CRT, LCD AND PLASMA VIDEO DISPLAYS; LCD AND DLP PROJECTORS; VIDEO EQUIPMENT AND ACCESSORIES, NAMELY, VIDEO CABLES AND VIDEO CONNECTORS; DATA STORAGE, ARCHIVAL, AND RETRIEVAL DEVICES, NAMELY, FIXED DISK DATA STORAGE AND REMOVABLE DISK DATA STORAGE; ELECTRONIC GAME EQUIPMENT AND ACCESSORIES, NAMELY, ELECTRONIC GAME CABLES AND GAME CONNECTORS; ELECTRICAL POWER CONTROL COMPONENTS AND ACCESSORIES, NAMELY, VOLTAGE STABILIZING DEVICES, ENERGY CONDITIONING DEVICES, NAMELY POWER NOISE REDUCTION DEVICES; RECHARGEABLE AND NON-RECHARGEABLE POWER CELLS, AND POWER CELL RE-CHARGERS (U.S. CLS. 21, 23, 26, 36 AND 38).

FIRST USE 7-25-2002; IN COMMERCE 7-25-2002.
JACQUELINE A. LAVINE, EXAMINING ATTORNEY

CLASS 9—(Continued).

SN 78-509,610. NAVITAIRE INC., MINNEAPOLIS, MN.
FILED 11-2-2004.

SKYPAIR

THE MARK CONSISTS OF STANDARD CHARACTERS WITHOUT CLAIM TO ANY PARTICULAR FONT, STYLE, SIZE, OR COLOR.

OWNER OF U.S. REG. NOS. 2,697,286, 2,770,798 AND OTHERS.

FOR DECISION SUPPORT SOFTWARE FOR THE AIRLINE INDUSTRY, NAMELY, SOFTWARE TO MANAGE AIRLINE CREWS (U.S. CLS. 21, 23, 26, 36 AND 38).

FIRST USE 12-22-2004; IN COMMERCE 12-22-2004.
CHRIS WELLS, EXAMINING ATTORNEY

SN 78-509,854. LOTO LLC, FLUSHING, NY. FILED 11-2-2004.



THE FOREIGN WORDING IN THE MARK TRANSLATES INTO ENGLISH AS CRAZY FAST OR POWERFUL SPEED AND FORCE.

THE NON-LATIN CHARACTER(S) IN THE MARK TRANSLITERATES INTO KUANG BIAO YI ZU, AND THIS MEANS CRAZY FAST OR POWERFUL SPEED AND FORCE IN ENGLISH.

FOR COMPUTER PROGRAMS FOR TRANSLATION AND LANGUAGE LEARNING PURPOSES, NAMELY, LANGUAGE TRANSLATION SOFTWARE; COMPUTER PROGRAMS FOR VOICE RECOGNITION AND SPEECH PURPOSES, NAMELY, VOICE RECOGNITION SOFTWARE THAT CONVERTS SPOKEN VOICE SPEECH INTO TEXT CHARACTERS AND CONVERTS TEXT CHARACTERS INTO SPOKEN VOICE SPEECH; COMPUTER PROGRAMS FOR HANDWRITING RECOGNITION AND OPTICAL CHARACTER RECOGNITION PURPOSES, NAMELY, SOFTWARE FOR CONVERTING HANDWRITTEN OR TYPED CHARACTERS INTO DIGITAL FORMATS; COMPUTER PROGRAMS FOR IMAGE RECOGNITION AND IMAGE PROCESSING PURPOSES, NAMELY, IMAGE RECOGNITION SOFTWARE FOR USE IN ANALYZING, RECOGNIZING, AND IDENTIFYING OBJECTS AND FACES; COMPUTER PROGRAMS FOR TRANSLATION AND LANGUAGE LEARNING PURPOSES, NAMELY, LANGUAGE

CLASS 9—(Continued).

TRANSLATION SOFTWARE THAT MAY BE DOWNLOADED FROM A GLOBAL COMPUTER NETWORK; COMPUTER PROGRAMS FOR VOICE RECOGNITION AND SPEECH PURPOSES, NAMELY, VOICE RECOGNITION SOFTWARE THAT CONVERTS SPOKEN VOICE SPEECH INTO TEXT CHARACTERS AND CONVERTS TEXT CHARACTERS INTO SPOKEN VOICE SPEECH THAT MAY BE DOWNLOADED FROM A GLOBAL COMPUTER NETWORK; COMPUTER PROGRAMS FOR HANDWRITING RECOGNITION AND OPTICAL CHARACTER RECOGNITION PURPOSES, NAMELY, SOFTWARE FOR CONVERTING HANDWRITTEN OR TYPED CHARACTERS INTO DIGITAL FORMATS THAT MAY BE DOWNLOADED FROM A GLOBAL COMPUTER NETWORK; COMPUTER PROGRAMS FOR IMAGE RECOGNITION AND IMAGE PROCESSING PURPOSES, NAMELY, IMAGE RECOGNITION SOFTWARE FOR USE IN ANALYZING, RECOGNIZING, AND IDENTIFYING OBJECTS AND FACES THAT MAY BE DOWNLOADED FROM A GLOBAL COMPUTER NETWORK (U.S. CLS. 21, 23, 26, 36 AND 38).

MICHAEL TANNER, EXAMINING ATTORNEY

CLASS 9—(Continued).

SN 78-510,539. EDGEWALKER ENTERPRISES, INC, DBA FUNDRAISER SOFTWARE, WEST PLAINS, MO. FILED 11-3-2004.

FUNDRAISER PRO

THE MARK CONSISTS OF STANDARD CHARACTERS WITHOUT CLAIM TO ANY PARTICULAR FONT, STYLE, SIZE, OR COLOR.

OWNER OF U.S. REG. NO. 2,874,806.

NO CLAIM IS MADE TO THE EXCLUSIVE RIGHT TO USE "FUNDRAISER", APART FROM THE MARK AS SHOWN.

FOR DATABASE MANAGEMENT SOFTWARE FOR USE IN FUNDRAISING (U.S. CLS. 21, 23, 26, 36 AND 38).

FIRST USE 4-1-1987; IN COMMERCE 2-1-1989.

RENEE MCCRAY, EXAMINING ATTORNEY

SN 78-510,398. INTERVIDEO, INC., FREMONT, CA. FILED 11-3-2004.

InterVideo PhotoAlbum

OWNER OF U.S. REG. NO. 2,331,993.
NO CLAIM IS MADE TO THE EXCLUSIVE RIGHT TO USE "PHOTOALBUM", APART FROM THE MARK AS SHOWN.

THE MARK IS A SPECIAL-FORM DRAWING AND CONSISTS OF STYLIZED LETTERS "INTERVIDEO PHOTOALBUM".

FOR COMPUTER SOFTWARE FOR USE IN DOWNLOADING, TRANSMITTING, RECEIVING, EXTRACTING, ENCODING, DECODING, PLAYING, STORING AND ORGANIZING AUDIO, VIDEO, TEXT AND OTHER DATA VIA LOCAL AND GLOBAL COMPUTER, CABLE AND WIRELESS NETWORKS (U.S. CLS. 21, 23, 26, 36 AND 38).

DAVID MURRAY, EXAMINING ATTORNEY

SN 78-511,141. LINDSAY MANUFACTURING COMPANY, LINDSAY, NE. FILED 11-4-2004.

FIELDSENTRY

THE MARK CONSISTS OF STANDARD CHARACTERS WITHOUT CLAIM TO ANY PARTICULAR FONT, STYLE, SIZE, OR COLOR.

FOR COMPUTER PROGRAMS USED TO ACCESS BY THE INTERNET TELEMETRY DATA FROM AND CONTROL SIGNALS FOR IRRIGATION EQUIPMENT, NAMELY, CENTER PIVOT MACHINES, LATERAL MOVE MACHINES, PUMPS, CHEMICAL INJECTORS, MOISTURE SENSORS AND CROP VIGOR MONITORS (U.S. CLS. 21, 23, 26, 36 AND 38).

FIRST USE 9-15-2004; IN COMMERCE 9-15-2004.

NANCY CLARKE, EXAMINING ATTORNEY

CLASS 9—(Continued).

SN 78-511,575. POPCAP GAMES, INC., SEATTLE, WA. FILED 11-4-2004.

TYPER SHARK

THE MARK CONSISTS OF STANDARD CHARACTERS WITHOUT CLAIM TO ANY PARTICULAR FONT, STYLE, SIZE, OR COLOR.

NO CLAIM IS MADE TO THE EXCLUSIVE RIGHT TO USE "SHARK", APART FROM THE MARK AS SHOWN.

FOR ELECTRONIC GAME PROGRAMS; DOWNLOADABLE ELECTRONIC GAME PROGRAMS; ELECTRONIC GAME SOFTWARE; COMPUTER GAME PROGRAMS; DOWNLOADABLE COMPUTER GAME PROGRAMS; INTERACTIVE GAME PROGRAMS; AND INTERACTIVE GAME SOFTWARE (U.S. CLS. 21, 23, 26, 36 AND 38).

FIRST USE 6-0-2003; IN COMMERCE 6-0-2003.
PRISCILLA MILTON, EXAMINING ATTORNEY

SN 78-512,151. NUCLIDE.COM BVBA, ANTWERP, BELGIUM, FILED 11-5-2004.

ROCKET MANIA

THE MARK CONSISTS OF STANDARD CHARACTERS WITHOUT CLAIM TO ANY PARTICULAR FONT, STYLE, SIZE, OR COLOR.

FOR ELECTRONIC GAME PROGRAMS; DOWNLOADABLE ELECTRONIC GAME PROGRAMS; ELECTRONIC GAME SOFTWARE; COMPUTER GAME PROGRAMS; DOWNLOADABLE COMPUTER GAME PROGRAMS; INTERACTIVE GAME PROGRAMS; AND INTERACTIVE GAME SOFTWARE (U.S. CLS. 21, 23, 26, 36 AND 38).

FIRST USE 8-0-2003; IN COMMERCE 8-0-2003.
ARETHA SOMERVILLE, EXAMINING ATTORNEY

CLASS 9—(Continued).

SN 78-512,317. SINGH, KRISHNA P., SOUTHAMPTON, NJ. FILED 11-5-2004.

**STEREO TRANSMITTED
DISEASE**

THE MARK CONSISTS OF STANDARD CHARACTERS WITHOUT CLAIM TO ANY PARTICULAR FONT, STYLE, SIZE, OR COLOR.

NO CLAIM IS MADE TO THE EXCLUSIVE RIGHT TO USE "STEREO", APART FROM THE MARK AS SHOWN.

FOR SERIES OF MUSICAL SOUND RECORDINGS, NAMELY, PRERECORDED AUDIO AND VIDEO TAPES AND DIGITALLY FORMATTED DISCS FEATURING DRAMATIC AND NON-DRAMATIC PERFORMANCES OF MUSICAL WORKS; DOWNLOADABLE MUSICAL SOUND RECORDINGS FEATURING DRAMATIC AND NON-DRAMATIC PERFORMANCES OF MUSICAL WORKS (U.S. CLS. 21, 23, 26, 36 AND 38).

INGA ERVIN, EXAMINING ATTORNEY

SN 78-512,780. CONNEXIUM TECHNOLOGIES INTERNATIONAL LLC, ACTON, MA. FILED 11-7-2004.

NXTCO

THE MARK CONSISTS OF STANDARD CHARACTERS WITHOUT CLAIM TO ANY PARTICULAR FONT, STYLE, SIZE, OR COLOR.

THE MARK IS PRESENTED IN STANDARD CHARACTERS, WITHOUT CLAIM TO ANY PARTICULAR FONT, STYLE, SIZE OR COLOR

FOR BINOCULARS (U.S. CLS. 21, 23, 26, 36 AND 38).

FIRST USE 8-1-2002; IN COMMERCE 8-1-2002.
LINDA ESTRADA, EXAMINING ATTORNEY

CLASS 9—(Continued).

SN 78-512,797. AMERICA BELL ELECTRICAL (HONGKONG) INTERNATIONAL LIMITED, MONGKOK, KOWLOON, HONG KONG, FILED 11-8-2004.

CLASS 9—(Continued).

SN 78-512,917. NATIONAL OCEANIC AND ATMOSPHERIC ADMINISTRATION (NOAA), BOULDER, CO. FILED 11-8-2004.

Science On a Sphere



THE MARK CONSISTS OF STANDARD CHARACTERS WITHOUT CLAIM TO ANY PARTICULAR FONT, STYLE, SIZE, OR COLOR.

FOR COMPUTER SYSTEM COMPRISING, PROJECTOR, COMPUTER HARDWARE AND SOFTWARE THAT DISPLAYS ANIMATED AND STILL IMAGES SEAMLESSLY ONTO A SPHERICAL PROJECTION SURFACE THAT IS IDEALLY SUITED TO DISPLAY EARTH AND OTHER PLANETARY INFORMATION, NAMELY, SCIENTIFIC, EDUCATIONAL, ENTERTAINMENT AND DEMOGRAPHIC DATA (U.S. CLS. 21, 23, 26, 36 AND 38).
KELLY CHOE, EXAMINING ATTORNEY

SN 78-513,110. KUSTOM MUSICAL AMPLIFICATION INC., CINCINNATI, OH. FILED 11-8-2004.

FOR OPTICAL LENSES; CAMCORDERS; VIDEO TAPE RECORDERS; DIGITAL VIDEO RECORDERS; ELECTRONIC AND OPTICAL COMMUNICATIONS INSTRUMENTS AND COMPONENTS, NAMELY, OPTICAL TRANSCEIVERS, OPTICAL RECEIVERS, OPTICAL TRANSMITTERS; ELECTRONIC CONTROL SYSTEMS FOR MACHINES; COMPUTER TERMINALS; COMPUTERS; COMPUTER SOFTWARE FOR ORGANIZING AND VIEWING DIGITAL IMAGES AND PHOTOGRAPHS; CARDS WITH INTEGRATED CIRCUITS; TIMERS; TELECOMMUNICATION TRANSMITTERS; AUTOMATIC TELEPHONE EXCHANGES; CABINETS FOR LOUDSPEAKERS; LOUDSPEAKERS; AUDIO-VIDEO RECEIVERS; MICROPHONES; HORNS FOR LOUDSPEAKERS; ACOUSTIC COUPLERS; ACOUSTIC MEMBRANES; AUDIO AMPLIFIERS; DIGITAL AUDIO PLAYERS; ELECTRONIC SEMI-CONDUCTORS; RADAR DETECTORS; METAL DETECTORS; VIDEO PROJECTORS; STEREO AMPLIFIERS; TELEVISION APPARATUS FOR PROJECTION PURPOSES; ELECTRIC WIRES; INTEGRATED CIRCUITS; ELECTRICAL CONDUCTORS; ELECTROACOUSTIC TRANSDUCERS; LIGHTNING ARRESTERS; THEFT ALARMS; WALKIE-TALKIES; ELECTRIC DOOR OPENERS; ELECTRONIC DOOR CLOSING SYSTEMS; ELECTRIC DOOR BELLS; SMOKE DETECTORS; AUDIO TAPE RECORDERS; APPARATUS FOR RECORDING, TRANSMISSION OR REPRODUCTION OF SOUND; OPTICAL FIBER CABLES; TELEVISION SETS (U.S. CLS. 21, 23, 26, 36 AND 38).

FIRST USE 2-28-1999; IN COMMERCE 9-30-2001.

ALICE SUE CARRUTHERS, EXAMINING ATTORNEY

'72 COUPE

THE MARK CONSISTS OF STANDARD CHARACTERS WITHOUT CLAIM TO ANY PARTICULAR FONT, STYLE, SIZE, OR COLOR.

FOR MUSICAL INSTRUMENT AMPLIFIERS AND RELATED COMPONENTS, NAMELY AMPLIFIER UNITS, SPEAKERS, SPEAKER CABINETS, CONTROL FUNCTION PANELS AND RELATED ACCESSORIES FOR THE FOREGOING, NAMELY, CONNECTING CABLES AND PROTECTIVE VINYL COVERS FOR SAID COMPONENTS. (U.S. CLS. 21, 23, 26, 36 AND 38).

BRENDAN MCCAULEY, EXAMINING ATTORNEY

CLASS 9—(Continued).

SN 78-513,758. PITNEY BOWES INC., STAMFORD, CT.
FILED 11-9-2004.

DM100

THE MARK CONSISTS OF STANDARD CHARACTERS WITHOUT CLAIM TO ANY PARTICULAR FONT, STYLE, SIZE, OR COLOR.

FOR DIGITAL POSTAGE METER FEATURING POSTAGE METERING, SORTING, FEEDING AND WEIGHING (U.S. CLS. 21, 23, 26, 36 AND 38).

FIRST USE 2-28-2004; IN COMMERCE 2-28-2004.
TEJBIR SINGH, EXAMINING ATTORNEY

SN 78-513,812. K-RAIN MANUFACTURING CORPORATION, RIVIERA BEACH, FL. FILED 11-9-2004.



NO CLAIM IS MADE TO THE EXCLUSIVE RIGHT TO USE "MODULAR CONTROLLER", APART FROM THE MARK AS SHOWN.

FOR IRRIGATION APPARATUS FOR CONTROLLABLY WATERING TURF, LAWNS AND GARDENS; NAMELY ELECTRONIC CONTROLLERS AND STRUCTURAL OR REPLACEMENT PARTS (U.S. CLS. 21, 23, 26, 36 AND 38).

MARIA-VICTORIA SUAREZ, EXAMINING ATTORNEY

SN 78-513,835. K-RAIN MANUFACTURING CORPORATION, RIVIERA BEACH, FL. FILED 11-9-2004.



NO CLAIM IS MADE TO THE EXCLUSIVE RIGHT TO USE "CONTROLLER", APART FROM THE MARK AS SHOWN.

FOR IRRIGATION APPARATUS FOR CONTROLLABLY WATERING TURF, LAWNS AND GARDENS; NAMELY ELECTRONIC CONTROLLERS AND STRUCTURAL OR REPLACEMENT PARTS (U.S. CLS. 21, 23, 26, 36 AND 38).

MARIA-VICTORIA SUAREZ, EXAMINING ATTORNEY

CLASS 9—(Continued).

SN 78-513,867. CLASSIC MEDIA, INC., NEW YORK, NY.
FILED 11-9-2004.

GERALD MCBOING BOING

THE MARK CONSISTS OF STANDARD CHARACTERS WITHOUT CLAIM TO ANY PARTICULAR FONT, STYLE, SIZE, OR COLOR.

THE NAME IN THE MARK DOES NOT IDENTIFY A LIVING INDIVIDUAL.

FOR PRERECORDED AUDIO CASSETTES, VIDEO CASSETTES, AUDIO TAPES, VIDEO TAPES, COMPACT DISCS, PHONOGRAPH RECORDS AND DVD'S FEATURING MUSIC AND/OR ANIMATED ENTERTAINMENT; INTERACTIVE MULTIMEDIA SOFTWARE PROGRAMS FOR ENTERTAINMENT (U.S. CLS. 21, 23, 26, 36 AND 38).

JEFF DEFORD, EXAMINING ATTORNEY

SN 78-514,093. REMOTE MDX, INC, SALT LAKE CITY, UT.
FILED 11-9-2004.

HOMEPAL

THE MARK CONSISTS OF STANDARD CHARACTERS WITHOUT CLAIM TO ANY PARTICULAR FONT, STYLE, SIZE, OR COLOR.

FOR PERSONAL TRANSMITTING AND RECEIVING SYSTEM COMPRISED OF A LOCAL SENDING UNIT AND A TRANSMITTING AND RECEIVING UNIT FOR RECEIVING THE INPUT OF THE LOCAL SENDING UNIT AND PROVIDING ACCESS TO REMOTE EMERGENCY AND CONVENIENCE SUPPORT SERVICES (U.S. CLS. 21, 23, 26, 36 AND 38).

FIRST USE 2-19-2004; IN COMMERCE 2-25-2004.
KAREN K. BUSH, EXAMINING ATTORNEY

CLASS 9—(Continued).

SN 78-514,888. PAVILION TECHNOLOGIES, INC., AUSTIN, TX. FILED 11-10-2004.

CLASS 9—(Continued).

SN 78-515,091. DATACOLOR HOLDING AG, LUZERN, SWITZERLAND, FILED 11-11-2004.

BLUEVUE



THE MARK CONSISTS OF STANDARD CHARACTERS WITHOUT CLAIM TO ANY PARTICULAR FONT, STYLE, SIZE, OR COLOR.

FOR COMPUTER SOFTWARE FOR USE AS AN EMBEDDED TECHNOLOGY PLATFORM; COMPUTER SOFTWARE CONSISTING OF A COMMON DEVELOPMENT AND EXECUTION ENVIRONMENT FOR EMPIRICAL, FIRST-PRINCIPLE, PROCEDURAL AND RULE-BASED MODELS; COMPUTER SOFTWARE THAT SUPPORTS TIME-SERIES, DISCONTINUOUS TIME-SERIES AND TRANSACTIONAL DATA; COMPUTER SOFTWARE FOR USE IN PERFORMANCE MANAGEMENT, PREDICTION AND ANALYSIS FUNCTIONALITY IN THE PROCESS MANUFACTURING, FINANCIAL SERVICES, AUTOMATION, AND SOFTWARE DEVELOPMENT MARKETS; COMPUTER SOFTWARE FOR USE IN EMISSIONS CONTROL, ADVANCED PROCESS CONTROL, ENVIRONMENTAL COMPLIANCE, AND DATA PROCESSING (U.S. CLS. 21, 23, 26, 36 AND 38).
REBECCA GAN, EXAMINING ATTORNEY

OWNER OF U.S. REG. NO. 1,423,732.
NO CLAIM IS MADE TO THE EXCLUSIVE RIGHT TO USE "MONITOR", APART FROM THE MARK AS SHOWN.

THE COLOR(S) BLACK, GRAY, WHITE, BLUE AND RED IS/ARE CLAIMED AS A FEATURE OF THE MARK.
THE COLOR BLACK APPEARS IN THE WORDING "DATACOLOR" AND THE UNDERLINE, THE COLOR GRAY APPEARS IN THE WORDING "MONITOR", THE COLORS BLUE AND WHITE APPEAR IN THE SQUARE DESIGN, AND THE COLOR RED APPEAR IN THE RECTANGLE.

FOR COLOR MEASUREMENT SYSTEM COMPRISED OF COLOR MEASURING APPARATUS AND COLOR MEASURING COMPUTER SOFTWARE FOR DETERMINING COLOR DEVIATIONS WITHIN A UNITARY PIECE OF MATERIAL SUCH AS A FABRIC AND REPORTING THE AMOUNT AND LOCATIONS OF THE COLOR DEVIATIONS (U.S. CLS. 21, 23, 26, 36 AND 38).

ANNE FARRELL, EXAMINING ATTORNEY

SN 78-515,013. KALLIDUS INC., SAN FRANCISCO, CA. FILED 11-11-2004.

SN 78-515,347. MIKOHN GAMING CORPORATION, LAS VEGAS, NV. FILED 11-11-2004.

Battle Fleet

OFFICE DAZE

THE MARK CONSISTS OF STANDARD CHARACTERS WITHOUT CLAIM TO ANY PARTICULAR FONT, STYLE, SIZE, OR COLOR.

FOR COMPUTER GAME SOFTWARE FOR MOBILE PHONES (U.S. CLS. 21, 23, 26, 36 AND 38).
FIRST USE 10-0-2004; IN COMMERCE 11-8-2004.
BARBARA GAYNOR, EXAMINING ATTORNEY

THE MARK CONSISTS OF STANDARD CHARACTERS WITHOUT CLAIM TO ANY PARTICULAR FONT, STYLE, SIZE, OR COLOR.

FOR ELECTRONIC GAMING MACHINES (U.S. CLS. 21, 23, 26, 36 AND 38).
CHRIS WELLS, EXAMINING ATTORNEY

CLASS 9—(Continued).

SN 78-515,357. ARZEL ZONING TECHNOLOGY, INC.,
CLEVELAND, OH. FILED 11-11-2004.

CLASS 9—(Continued).

SN 78-515,645. Z MICROSYSTEMS, INC., SAN DIEGO, CA.
FILED 11-11-2004.

AirBoss

TRANZPAK

THE MARK CONSISTS OF STANDARD CHARACTERS
WITHOUT CLAIM TO ANY PARTICULAR FONT, STYLE,
SIZE, OR COLOR.

FOR ELECTRIC ZONE CONTROL PANEL FOR HVAC
SYSTEMS (U.S. CLS. 21, 23, 26, 36 AND 38).

FIRST USE 2-1-2001; IN COMMERCE 2-1-2001.
JENNIFER MARTIN, EXAMINING ATTORNEY

THE MARK CONSISTS OF STANDARD CHARACTERS
WITHOUT CLAIM TO ANY PARTICULAR FONT, STYLE,
SIZE, OR COLOR.

FOR REMOVABLE COMPUTER DATA STORAGE
MODULES AND BASE UNITS (U.S. CLS. 21, 23, 26, 36
AND 38).

FIRST USE 6-27-1989; IN COMMERCE 6-27-1989.
THEODORE MCBRIDE, EXAMINING ATTORNEY

SN 78-515,440. PEAVEY ELECTRONICS CORPORATION,
MERIDIAN, MS. FILED 11-11-2004.

SN 78-515,731. REASONABLY SANE INC., BOULDER, CO.
FILED 11-12-2004.

AUTOMIX

RSane

THE MARK CONSISTS OF STANDARD CHARACTERS
WITHOUT CLAIM TO ANY PARTICULAR FONT, STYLE,
SIZE, OR COLOR.

SEC. 2(F).
FOR AUDIO MIXERS AND ELECTRONIC CIRCUITRY
INCORPORATED AS A COMPONENT PART OF
AUDIO MIXERS (U.S. CLS. 21, 23, 26, 36 AND 38).

FIRST USE 9-0-1995; IN COMMERCE 9-0-1995.
TARAH HARDY, EXAMINING ATTORNEY

THE MARK CONSISTS OF STANDARD CHARACTERS
WITHOUT CLAIM TO ANY PARTICULAR FONT, STYLE,
SIZE, OR COLOR.

FOR DOWNLOADABLE COMPUTER SOFTWARE FOR
AUTOMATED COLLABORATIVE PUBLISHING OR
WORKS AND DOCUMENTS (U.S. CLS. 21, 23, 26, 36
AND 38).

FIRST USE 6-28-2002; IN COMMERCE 11-6-2004.
ROBIN CHOSID, EXAMINING ATTORNEY

CLASS 9—(Continued).

SN 78-515,759. ARZEL ZONING TECHNOLOGY, INC., CLEVELAND, OH. FILED 11-12-2004.

CLASS 9—(Continued).

SN 78-516,079. COUNT5, LLC, ATLANTA, GA. FILED 11-12-2004.

ModuPASS

COUNT5

THE MARK CONSISTS OF STANDARD CHARACTERS WITHOUT CLAIM TO ANY PARTICULAR FONT, STYLE, SIZE, OR COLOR.

FOR SPECIAL ELECTRONIC CONTROL APPARATUS FOR RELIEVING STATIC PRESSURE IN AN HVAC SYSTEM THAT PRECISELY MODULATES A DAMPER WITHIN THE SYSTEM TO ALLOW AIR FLOW (U.S. CLS. 21, 23, 26, 36 AND 38).

FIRST USE 7-1-2004; IN COMMERCE 7-1-2004.
CHRISTOPHER ADKINS, EXAMINING ATTORNEY

THE MARK CONSISTS OF STANDARD CHARACTERS WITHOUT CLAIM TO ANY PARTICULAR FONT, STYLE, SIZE, OR COLOR.

FOR COMPUTER SOFTWARE FOR USE IN THE CREATION AND DELIVERY OF TESTS, QUIZZES, SURVEYS AND OTHER TRAINING CONTENT (U.S. CLS. 21, 23, 26, 36 AND 38).

REBECCA GAN, EXAMINING ATTORNEY

SN 78-516,057. I-COAT COMPANY, LLC, SANTA FE SPRINGS, CA. FILED 11-12-2004.

SN 78-516,083. TEST-UM, INC, CAMARILLO, CA. FILED 11-12-2004.

VIVIX ICE

RANGER

THE MARK CONSISTS OF STANDARD CHARACTERS WITHOUT CLAIM TO ANY PARTICULAR FONT, STYLE, SIZE, OR COLOR.

FOR OPTICAL LENSES HAVING ANTI-REFLECTIVE COATINGS (U.S. CLS. 21, 23, 26, 36 AND 38).

FIRST USE 9-1-2004; IN COMMERCE 9-1-2004.
JOHN GARTNER, EXAMINING ATTORNEY

THE MARK CONSISTS OF STANDARD CHARACTERS WITHOUT CLAIM TO ANY PARTICULAR FONT, STYLE, SIZE, OR COLOR.

FOR TELEPHONE TESTING APPARATUS (U.S. CLS. 21, 23, 26, 36 AND 38).

FIRST USE 12-1-2002; IN COMMERCE 12-1-2002.
EUGENIA MARTIN, EXAMINING ATTORNEY

CLASS 9—(Continued).

SN 78-516,106. INTERNATIONAL BARCODE CORPORATION, DBA BARCODE TECHNOLOGY, NEW YORK, NY. FILED 11-12-2004.

LABEL PRESS

THE MARK CONSISTS OF STANDARD CHARACTERS WITHOUT CLAIM TO ANY PARTICULAR FONT, STYLE, SIZE, OR COLOR.

NO CLAIM IS MADE TO THE EXCLUSIVE RIGHT TO USE "LABEL", APART FROM THE MARK AS SHOWN.

FOR COMPUTER PROGRAMS FOR THE CREATION AND PRINTING OF BAR CODES (U.S. CLS. 21, 23, 26, 36 AND 38).

FIRST USE 2-1-1994; IN COMMERCE 2-1-1994.
ARETHA SOMERVILLE, EXAMINING ATTORNEY

CLASS 9—(Continued).

SN 78-516,257. LINE4, INC., ALAMEDA, CA. FILED 11-12-2004.

LIVETOUCH

THE MARK CONSISTS OF STANDARD CHARACTERS WITHOUT CLAIM TO ANY PARTICULAR FONT, STYLE, SIZE, OR COLOR.

FOR COMPUTER SOFTWARE FOR LINKING WEB SITES TO CALL CENTERS AND DATABASES (U.S. CLS. 21, 23, 26, 36 AND 38).

FIRST USE 9-19-1996; IN COMMERCE 10-22-1996.
MELISSA VALLILLO, EXAMINING ATTORNEY

SN 78-516,168. PIERCE, CHONDA, FRANKLIN, TN. FILED 11-12-2004.

NO WHINING PRODUCTIONS

THE MARK CONSISTS OF STANDARD CHARACTERS WITHOUT CLAIM TO ANY PARTICULAR FONT, STYLE, SIZE, OR COLOR.

NO CLAIM IS MADE TO THE EXCLUSIVE RIGHT TO USE "PRODUCTIONS", APART FROM THE MARK AS SHOWN.

FOR PRE-RECORDED AUDIO CASSETTES, VIDEO CASSETTES, RECORDS, COMPACT DISCS, VIDEO DISCS, DVD DISCS, AND CD-ROMS FEATURING MUSIC, TELEVISION PROGRAMS AND COMEDY (U.S. CLS. 21, 23, 26, 36 AND 38).

FIRST USE 5-0-2002; IN COMMERCE 8-0-2002.
DAVID MURRAY, EXAMINING ATTORNEY

SN 78-516,268. TMW SYSTEMS, INC., BEACHWOOD, OH. FILED 11-12-2004.



THE COLOR(S) BROWN, WHITE, BLACK AND SILVER ARE CLAIMED AS A FEATURE OF THE MARK.

THE MARK CONSISTS OF A DOG THAT APPEARS MOSTLY IN BROWN, WITH TEETH AND OUTER EYES THAT APPEAR IN WHITE, A NOSE, COLLAR AND INNER EYES THAT APPEAR IN BLACK, AND SPIKES ON THE COLLAR AND A DOG TAG THAT APPEAR IN SILVER. THE TAG BEARS THE LETTERS "TMW".

FOR COMPUTER SOFTWARE MANAGEMENT TOOL THAT PROVIDES ALERTS AND EXCEPTION REPORTS TO USERS OF SOFTWARE FOR EXTRACTING DATA AND COMPARING IT TO INDUSTRY BENCHMARKS AND BEST PRACTICES (U.S. CLS. 21, 23, 26, 36 AND 38).

JAMES A. RAUEN, EXAMINING ATTORNEY

CLASS 9—(Continued).

SN 78-516,275. VIATRAN CORPORATION, GRAND ISLAND, NY. FILED 11-12-2004.



THE MARK CONSISTS OF A STYLIZED LETTER "V" WITH A DOT DESIGN OVER THE "I".
FOR ELECTRICAL APPARATUS, NAMELY, PRESSURE TRANSDUCERS AND TRANSMITTERS, PRESSURE GAUGES, ELECTRICAL CONVERTERS AND PROGRAMMABLE CONTROLLERS (U.S. CLS. 21, 23, 26, 36 AND 38).
FIRST USE 12-31-1992; IN COMMERCE 12-31-1992.
IRENE D. WILLIAMS, EXAMINING ATTORNEY

CLASS 9—(Continued).

SN 78-516,565. DSN SOFTWARE, INC., CENTRALIA, WA. FILED 11-14-2004.



THE MARK CONSISTS OF THE UNDERLINED WORDS "PERIO" AND "EXEC" JOINED BY AN UPWARD-SLANTING (LEFT TO RIGHT) EM DASH.
FOR COMPUTER PROGRAMS FOR USE IN HEALTH CARE PROVIDER PRACTICE MANAGEMENT AND USER MANUALS SOLD AS A UNIT (U.S. CLS. 21, 23, 26, 36 AND 38).
FIRST USE 10-30-1997; IN COMMERCE 11-26-1997.
GINA HAYES, EXAMINING ATTORNEY

SN 78-516,688. AHURA CORPORATION, WILMINGTON, MA. FILED 11-15-2004.

SN 78-516,289. RELION, INC., SPOKANE, WA. FILED 11-12-2004.

T-1000

DEFENDER

THE MARK CONSISTS OF STANDARD CHARACTERS WITHOUT CLAIM TO ANY PARTICULAR FONT, STYLE, SIZE, OR COLOR.
FOR ELECTRICAL ENERGY CELLS; AND FUEL CELL AND ENERGY AND FUEL CELL COMPONENTS, NAMELY, ELECTRODES AND CONTROLLERS (U.S. CLS. 21, 23, 26, 36 AND 38).
KAREN K. BUSH, EXAMINING ATTORNEY

THE MARK CONSISTS OF STANDARD CHARACTERS WITHOUT CLAIM TO ANY PARTICULAR FONT, STYLE, SIZE, OR COLOR.
FOR SPECTROSCOPIC INSTRUMENTS, NAMELY PORTABLE DETECTION AND IDENTIFICATION INSTRUMENTS USING LIGHT SOURCE AND LIGHT DETECTORS FOR DETECTING AND IDENTIFYING CHEMICAL SUBSTANCES; AND SPECTROSCOPIC INSTRUMENTS, NAMELY PORTABLE DETECTION AND IDENTIFICATION INSTRUMENTS USING LIGHT SOURCES AND LIGHT DETECTORS FOR DETECTING AND IDENTIFYING BIOLOGICAL SUBSTANCES (U.S. CLS. 21, 23, 26, 36 AND 38).
TIMOTHY FINNEGAN, EXAMINING ATTORNEY

CLASS 9—(Continued).

SN 78-516,868. NMS COMMUNICATIONS CORPORATION,
FRAMINGHAM, MA. FILED 11-15-2004.

MOBILE PLACE

THE MARK CONSISTS OF STANDARD CHARACTERS
WITHOUT CLAIM TO ANY PARTICULAR FONT, STYLE,
SIZE, OR COLOR.

NO CLAIM IS MADE TO THE EXCLUSIVE RIGHT TO
USE MOBILE, APART FROM THE MARK AS SHOWN.

FOR COMPUTER HARDWARE; AND COMPUTER
SOFTWARE FOR STORING, INTEGRATING AND
MANAGING AUDIO, DATA AND VIDEO CONTENT
AND DEVELOPING AND DEPLOYING AUDIO, DATA
AND VIDEO APPLICATIONS OR SERVICES ON MO-
BILE TELECOMMUNICATIONS NETWORKS (U.S. CLS.
21, 23, 26, 36 AND 38).

SHARON MEIER, EXAMINING ATTORNEY

SN 78-516,925. OFFUTT, JANE, PITTSBURGH, PA. FILED 11-
15-2004.

ACCOMPLISH 2001

THE MARK CONSISTS OF STANDARD CHARACTERS
WITHOUT CLAIM TO ANY PARTICULAR FONT, STYLE,
SIZE, OR COLOR.

FOR EDUCATIONAL SOFTWARE FOR IMPROVING
READING COMPREHENSION (U.S. CLS. 21, 23, 26, 36
AND 38).

FIRST USE 8-10-2004; IN COMMERCE 8-10-2004.
IRA J. GOODSaid, EXAMINING ATTORNEY

CLASS 9—(Continued).

SN 78-517,018. EDGEWALKER ENTERPRISES, INC, DBA
FUNDRAISER SOFTWARE, WEST PLAINS, MO. FILED
11-15-2004.

Fundraiser Select

THE MARK CONSISTS OF STANDARD CHARACTERS
WITHOUT CLAIM TO ANY PARTICULAR FONT, STYLE,
SIZE, OR COLOR.

OWNER OF U.S. REG. NO. 2,874,806.

NO CLAIM IS MADE TO THE EXCLUSIVE RIGHT TO
USE "FUNDRAISER", APART FROM THE MARK AS
SHOWN.

FOR DATABASE MANAGEMENT SOFTWARE FOR
USE IN FUNDRAISING (U.S. CLS. 21, 23, 26, 36 AND 38).

ROBERT LORENZO, EXAMINING ATTORNEY

SN 78-517,104. BILLINGS, ROGER E., GALLATIN, MO.
FILED 11-15-2004.

LANcraft

THE MARK CONSISTS OF STANDARD CHARACTERS
WITHOUT CLAIM TO ANY PARTICULAR FONT, STYLE,
SIZE, OR COLOR.

FOR COMPUTER NETWORKING HARDWARE
NAMELY, NETWORKING CATEGORY 5 CABLES, NET-
WORKING CATEGORY 5 CONNECTORS, FIBER OPTIC
CABLES AND CONNECTORS, PATCH PANELS FOR
NETWORK CABLES, WALL PLATES FOR NETWORK
CABLES, RACKS TO MOUNT NETWORKING HARD-
WARE, NAMELY, NETWORK SWITCHES, SERVERS
AND PATCH PANELS, USB NETWORK CABLES AND
ADAPTERS, COMPUTER KEYBOARDS, COMPUTER
HEADPHONES (U.S. CLS. 21, 23, 26, 36 AND 38).

FIRST USE 11-15-2004; IN COMMERCE 11-15-2004.
GEOFFREY FOSDICK, EXAMINING ATTORNEY

CLASS 9—(Continued).

SN 78-517,140. SCANSOFT, INC., PEABODY, MA. FILED 11-15-2004.

CLASS 9—(Continued).

SN 78-517,159. CLEAR CHANNEL BROADCASTING, INC., ALISO VIEJO, CA. FILED 11-15-2004.

SPEECHPAK

THE MARK CONSISTS OF STANDARD CHARACTERS WITHOUT CLAIM TO ANY PARTICULAR FONT, STYLE, SIZE, OR COLOR.

FOR SPEECH APPLICATION SOFTWARE; AND INTERACTIVE VOICE APPLICATION SOFTWARE (U.S. CLS. 21, 23, 26, 36 AND 38).

FIRST USE 9-14-2004; IN COMMERCE 9-14-2004.
SEAN DWYER, EXAMINING ATTORNEY

TRAFFIC C.O.P.

THE MARK CONSISTS OF STANDARD CHARACTERS WITHOUT CLAIM TO ANY PARTICULAR FONT, STYLE, SIZE, OR COLOR.

FOR COMPUTER SOFTWARE FOR USE IN THE MANAGEMENT OF ADVERTISEMENT PLACEMENT (U.S. CLS. 21, 23, 26, 36 AND 38).

FIRST USE 1-3-2005; IN COMMERCE 1-3-2005.
BRIAN NEVILLE, EXAMINING ATTORNEY

SN 78-517,181. MINDBOX, LLC, WESTLAKE VILLAGE, CA. FILED 11-15-2004.

SN 78-517,151. HO SPORTS COMPANY, INC., REDMOND, WA. FILED 11-15-2004.

ARTPRICE

CHAMPION

THE MARK CONSISTS OF STANDARD CHARACTERS WITHOUT CLAIM TO ANY PARTICULAR FONT, STYLE, SIZE, OR COLOR.

OWNER OF U.S. REG. NOS. 1,430,923, 1,552,660 AND 1,857,208.

FOR COMPUTER SOFTWARE, NAMELY, COMPUTER SOFTWARE MODULES FOR AUTOMATING BUSINESS PROCESSES BY COLLECTING INFORMATION CONCERNING HOW INTERMEDIATE AND FINAL CREDIT DECISIONS ARE ACHIEVED, AND FOR LINKING BACK OFFICE BUSINESS OPERATIONS WITH FRONT OFFICE OPERATIONS, AND FOR INTERFACING WITH COMPUTER NETWORKS AND TELECOMMUNICATION EQUIPMENT; AND MANUALS SOLD AS A UNIT THEREFOR (U.S. CLS. 21, 23, 26, 36 AND 38).

FIRST USE 3-0-2001; IN COMMERCE 3-0-2001.
GRETTA YAO, EXAMINING ATTORNEY

THE MARK CONSISTS OF STANDARD CHARACTERS WITHOUT CLAIM TO ANY PARTICULAR FONT, STYLE, SIZE, OR COLOR.

FOR WATER SAFETY FLOATATION VESTS (U.S. CLS. 21, 23, 26, 36 AND 38).

FIRST USE 7-9-2003; IN COMMERCE 7-9-2003.
JANICE L. MCMORROW, EXAMINING ATTORNEY

CLASS 9—(Continued).

SN 78-517,208. AMERICAN TECHNOLOGY CORPORATION,
SAN DIEGO, CA. FILED 11-15-2004.

CLASS 9—(Continued).

SN 78-517,879. LRI HOLDINGS COMPANY, LLC, OMAHA,
NE. FILED 11-16-2004.

SOUNDCLUSTER

THE MARK CONSISTS OF STANDARD CHARACTERS
WITHOUT CLAIM TO ANY PARTICULAR FONT, STYLE,
SIZE, OR COLOR.

FOR LOUDSPEAKERS; LOUDSPEAKERS USED AS A
COMMUNICATION DEVICE (U.S. CLS. 21, 23, 26, 36
AND 38).

KATHRYN COWARD, EXAMINING ATTORNEY

SUNRUNNER

THE MARK CONSISTS OF STANDARD CHARACTERS
WITHOUT CLAIM TO ANY PARTICULAR FONT, STYLE,
SIZE, OR COLOR.

FOR EYEGLASSES AND SUNGLASSES (U.S. CLS. 21,
23, 26, 36 AND 38).

FIRST USE 9-0-1985; IN COMMERCE 9-0-1985.

TANYA AMOS, EXAMINING ATTORNEY

SN 78-517,545. CORVIGO LLC, REDWOOD CITY, CA. FILED
11-16-2004.

MAILGATE EDGE

THE MARK CONSISTS OF STANDARD CHARACTERS
WITHOUT CLAIM TO ANY PARTICULAR FONT, STYLE,
SIZE, OR COLOR.

OWNER OF U.S. REG. NO. 2,853,968.
FOR COMPUTER HARDWARE, NAMELY, A COM-
MUNICATION SERVER ACCESSORY FOR PROCES-
SING INCOMING E-MAIL AND FILTERING JUNK E-
MAIL (U.S. CLS. 21, 23, 26, 36 AND 38).

DOMINICK J. SALEMI, EXAMINING ATTORNEY

SN 78-518,134. BEST IT SOLUTIONS, INC., DULUTH, GA.
FILED 11-16-2004.

SN 78-517,742. KNOWLEDGE MATTERS, INC., NORTH-
AMPTON, MA. FILED 11-16-2004.

PhotoOne**VIRTUAL BUSINESS**

THE MARK CONSISTS OF STANDARD CHARACTERS
WITHOUT CLAIM TO ANY PARTICULAR FONT, STYLE,
SIZE, OR COLOR.

OWNER OF U.S. REG. NO. 2,360,928.
SEC. 2(F).
FOR COMPUTER SOFTWARE, NAMELY EDUCA-
TIONAL SOFTWARE IN THE FIELD OF EXPERIENCE-
BASED VOCATIONAL/MANAGERIAL TRAINING AND
INSTRUCTION MANUALS PROVIDED IN CONNEC-
TION THEREWITH (U.S. CLS. 21, 23, 26, 36 AND 38).

FIRST USE 8-3-1999; IN COMMERCE 8-3-1999.
JULIE GUTTADAURO, EXAMINING ATTORNEY

THE MARK CONSISTS OF STANDARD CHARACTERS
WITHOUT CLAIM TO ANY PARTICULAR FONT, STYLE,
SIZE, OR COLOR.

FOR DIGITAL IMAGING SOFTWARE FOR PROCES-
SING DIGITAL PHOTOGRAPHS, IMAGES AND PIC-
TURES (U.S. CLS. 21, 23, 26, 36 AND 38).

FIRST USE 6-2-2003; IN COMMERCE 6-2-2003.
DOUGLAS LEE, EXAMINING ATTORNEY

CLASS 9—(Continued).

SN 78-518,149. JERRY GARCIA ESTATE LLC, SAUSALITO, CA. FILED 11-16-2004.



OWNER OF U.S. REG. NOS. 2,298,506, 2,302,439 AND 2,363,464.

THE NAME(S), PORTRAIT(S), AND/OR SIGNATURE(S) SHOWN IN THE MARK DOES NOT IDENTIFY A PARTICULAR LIVING INDIVIDUAL.

THE MARK CONSISTS OF DECEASED MUSICIAN AND ARTIST JERRY GARCIA'S OWN INDIVIDUAL HAND-PRINT WITH A MISSING MIDDLE FINGER AND SHOWING GARCIA'S DISTINCTIVE FINGER PRINTS, PALM PRINT AND LIFE LINES, AND JERRY GARCIA'S SIGNATURE, "J. GARCIA," SIGNED ACROSS THE PALM, ALL WITHIN A CIRCLE.

FOR PRERECORDED AUDIO AND VIDEO GOODS FEATURING MUSIC AND MUSICAL ENTERTAINMENT, NAMELY PHONOGRAPH RECORDS, ANALOG AND DIGITAL TAPES AND CASSETTES, ANALOG AND DIGITAL DISCS, COMPACT DISCS, CDS, MINI-DISCS, DIGITAL VIDEO DISCS, DVDS, LASER DISCS, VIDEO DISCS, AND CD-ROMS; DOWNLOADABLE AUDIO AND VIDEO RECORDINGS FEATURING MUSIC AND MUSICAL ENTERTAINMENT; MULTIMEDIA SOFTWARE RECORDED ON CD, CD-ROM, DVD AND DIGITAL RECORDING MEDIA FEATURING MUSICAL ENTERTAINMENT; MOTION PICTURE FILMS FEATURING MUSICAL ENTERTAINMENT (U.S. CLS. 21, 23, 26, 36 AND 38).

FIRST USE 4-8-2004; IN COMMERCE 4-8-2004.
ALLISON HOLTZ, EXAMINING ATTORNEY

SN 78-518,171. JET WAY INFORMATION CO., LTD., CHUNG HO CITY, TAIWAN, FILED 11-17-2004.

AVIDAV

FOR COMPUTER MONITORS; LIQUID CRYSTAL DISPLAY SCREENS (U.S. CLS. 21, 23, 26, 36 AND 38).
FIRST USE 10-7-2004; IN COMMERCE 10-7-2004.
THEODORE MCBRIDE, EXAMINING ATTORNEY

CLASS 9—(Continued).

SN 78-518,578. GERHARDT, PAUL L, TACOMA, WA. FILED 11-17-2004.

LeadershipSuccess

THE MARK CONSISTS OF STANDARD CHARACTERS WITHOUT CLAIM TO ANY PARTICULAR FONT, STYLE, SIZE, OR COLOR.

FOR AUDIO, VISUAL, AND DIGITAL EDUCATIONAL PRODUCTS, NAMELY, PRE-RECORDED CDS, DVDS, AND MULTIMEDIA SOFTWARE RECORDED ON CD-ROMS FEATURING INSTRUCTION IN ORGANIZATIONAL LEADERSHIP AND PERSONAL INTELLECTUAL GROWTH (U.S. CLS. 21, 23, 26, 36 AND 38).

ROBERT LAVACHE, EXAMINING ATTORNEY

SN 78-518,649. E2INTERACTIVE, INC., DBA E2INTERACTIVE, INC., ATLANTA, GA. FILED 11-17-2004.

INCOMM

THE MARK CONSISTS OF STANDARD CHARACTERS WITHOUT CLAIM TO ANY PARTICULAR FONT, STYLE, SIZE, OR COLOR.

OWNER OF U.S. REG. NOS. 2,266,684, 2,549,126 AND OTHERS.

FOR MAGNETICALLY ENCODED PREPAID DEBIT AND STORED VALUE CARDS (U.S. CLS. 21, 23, 26, 36 AND 38).

FIRST USE 9-1-1992; IN COMMERCE 9-1-1992.
KAREN BRACEY, EXAMINING ATTORNEY

CLASS 9—(Continued).

SN 78-518,727. NBOR CORPORATION, OAKLAND, CA. FILED 11-17-2004.

CLASS 9—(Continued).

SN 78-518,734. DOLBY LABORATORIES LICENSING CORPORATION, SAN FRANCISCO, CA. FILED 11-17-2004.

Pix Speak

THE MARK CONSISTS OF STANDARD CHARACTERS WITHOUT CLAIM TO ANY PARTICULAR FONT, STYLE, SIZE, OR COLOR.

NO CLAIM IS MADE TO THE EXCLUSIVE RIGHT TO USE "PIX", APART FROM THE MARK AS SHOWN.

FOR COMPUTER SOFTWARE FOR USE IN CREATING, EDITING, REPRODUCING, MANIPULATING, AND ANIMATING GRAPHIC IMAGES, AND FOR RECORDING AND MANIPULATING AUDIO SIGNALS AND TEXT IN CONNECTION THEREWITH (U.S. CLS. 21, 23, 26, 36 AND 38).

FIRST USE 11-15-2004; IN COMMERCE 11-15-2004.
LINDA M. KING, EXAMINING ATTORNEY

SN 78-518,730. TIM J ARION, MELBOURNE, FL. FILED 11-17-2004.



THE COLOR(S) BLACK AND WHITE IS/ARE CLAIMED AS A FEATURE OF THE MARK.

THE MARK CONSISTS OF BLACK CIRCLE WITH WHITE WOLF HEAD.

FOR THERMAL IMAGING CAMERAS FOR SURVEILLANCE (U.S. CLS. 21, 23, 26, 36 AND 38).

ANDREW BENZMILLER, EXAMINING ATTORNEY

AUDISTRY

THE MARK CONSISTS OF STANDARD CHARACTERS WITHOUT CLAIM TO ANY PARTICULAR FONT, STYLE, SIZE, OR COLOR.

FOR DIGITAL SIGNAL PROCESSING CHIPS, INTEGRATED CIRCUITS, DVD VIDEO PLAYERS, DVD AUDIO PLAYERS, SET TOP CABLE BOXES, SATELLITE RECEIVERS, TELEVISION RECEIVERS, DIGITAL TELEVISION RECEIVERS, AUDIO AND VIDEO PLAYERS AND RECORDERS, COMPUTERS, VIDEO GAME CONSOLES, AUDIO AND VIDEO SURROUND SOUND CONTROLLERS; PORTABLE AUDIO EQUIPMENT; NAMELY, CASSETTE PLAYERS AND RECORDERS, COMPACT DISC PLAYERS, PORTABLE AND HANDHELD DIGITAL ELECTRONIC DEVICES FOR PROCESSING, RECORDING, REPRODUCING, TRANSMITTING, RECEIVING, AND PLAYING AUDIO FILES, MP3 PLAYERS, AND MINIDISC PLAYERS; COMPUTER SOFTWARE FOR PROCESSING AUDIO AND VIDEO SOUND SIGNALS AND FOR PLAYING AUDIO FILES, AND COMPUTER SOFTWARE THAT DELIVERS AUDIO SOUND FROM DVDS LOADED INTO A COMPUTER; MULTI-CHANNEL SOUND PROCESSORS; AUDIO/VIDEO AMPLIFIERS AND RECEIVERS; VIDEO MONITORS; VIDEO TUNERS; AUDIO AND VIDEO DISC PLAYERS; AUDIO AND VIDEO DISC DUBBING DECKS; CABLE TELEVISION RECEIVERS AND DECODERS; COMPUTER PROGRAMS HAVING SOUND GENERATING CAPABILITIES, NAMELY, SOFTWARE USED TO DIGITALLY ENCODE AND DECODE MULTI-CHANNEL SOUND FOR PRE-RECORDED AUDIO DISCS, VIDEO DISCS, LASER DISCS, DVD VIDEO DISCS, AND DVD AUDIO DISCS; ELECTRONIC BROADCAST SIGNAL PROCESSORS; ELECTRONIC SATELLITE BROADCAST SIGNAL PROCESSORS, AND ELECTRONIC AUDIO ENCODERS AND DECODERS FOR DIGITAL AUDIO SOUND SIGNALS, CABLE TELEVISION, HIGH DEFINITION TELEVISION, AND RADIO (U.S. CLS. 21, 23, 26, 36 AND 38).

ANDREW BENZMILLER, EXAMINING ATTORNEY

CLASS 9—(Continued).

SN 78-518,741. 1-800 CONTACTS, INC., DRAPER, UT. FILED 11-17-2004.

CLASS 9—(Continued).

SN 78-519,221. DYNAL BIOTECH LLC, BROWN DEER, WI. FILED 11-18-2004.

CLEARCOLOR

MATCHPRO

THE MARK CONSISTS OF STANDARD CHARACTERS WITHOUT CLAIM TO ANY PARTICULAR FONT, STYLE, SIZE, OR COLOR.
FOR CONTACT LENSES (U.S. CLS. 21, 23, 26, 36 AND 38).
ANGELA M. MICHELI, EXAMINING ATTORNEY

THE MARK CONSISTS OF STANDARD CHARACTERS WITHOUT CLAIM TO ANY PARTICULAR FONT, STYLE, SIZE, OR COLOR.
FOR COMPUTER SOFTWARE FOR ANALYZING THE DATA OBTAINED FROM DIAGNOSTIC KITS (U.S. CLS. 21, 23, 26, 36 AND 38).
FIRST USE 8-31-2004; IN COMMERCE 8-31-2004.
FRED MANDIR, EXAMINING ATTORNEY

SN 78-519,119. BOVEE, ALEXANDER, RICHWOOD, TX. FILED 11-18-2004.

SN 78-519,303. GLASSMAN, ROBERTA S., CALABASAS, CA. FILED 11-18-2004.

TrainOnTrack

ClaimExchange

THE MARK CONSISTS OF STANDARD CHARACTERS WITHOUT CLAIM TO ANY PARTICULAR FONT, STYLE, SIZE, OR COLOR.
FOR SOFTWARE FOR TRAINING MANAGEMENT, NAMELY, AN INTERNET BASED ELECTRONIC LEARNING SOFTWARE APPLICATION THAT MANAGES, DELIVERS AND TRACKS INFORMATION AND DATA RELATED TO COURSES IN VARIOUS FIELDS (U.S. CLS. 21, 23, 26, 36 AND 38).
FIRST USE 3-15-2004; IN COMMERCE 3-15-2004.
SKYE YOUNG, EXAMINING ATTORNEY

THE MARK CONSISTS OF STANDARD CHARACTERS WITHOUT CLAIM TO ANY PARTICULAR FONT, STYLE, SIZE, OR COLOR.
FOR COMPUTER SOFTWARE FOR PROCESSING HEALTHCARE TRANSACTIONS ELECTRONICALLY (U.S. CLS. 21, 23, 26, 36 AND 38).
FIRST USE 9-1-2001; IN COMMERCE 9-1-2001.
SALLY SHIH, EXAMINING ATTORNEY

CLASS 9—(Continued).

SN 78-519,312. ALESSI MORITZ DESIGN LLC, PORT WASHINGTON, NY. FILED 11-18-2004.

CLASS 9—(Continued).

SN 78-519,518. TARGET BRANDS, INC., MINNEAPOLIS, MN. FILED 11-18-2004.

FONY JEWELS

TRUTECH

THE MARK CONSISTS OF STANDARD CHARACTERS WITHOUT CLAIM TO ANY PARTICULAR FONT, STYLE, SIZE, OR COLOR.

NO CLAIM IS MADE TO THE EXCLUSIVE RIGHT TO USE "JEWELS", APART FROM THE MARK AS SHOWN.

FOR CELL PHONE COVER WITH NECKLACE THAT CAN BE HUNG ON THE NECK OR BELT LOOP (U.S. CLS. 21, 23, 26, 36 AND 38).

APRIL L. RADEMACHER, EXAMINING ATTORNEY

THE MARK CONSISTS OF STANDARD CHARACTERS WITHOUT CLAIM TO ANY PARTICULAR FONT, STYLE, SIZE, OR COLOR.

FOR CONSUMER ELECTRONICS, NAMELY, TELEVISIONS; TELEPHONES; DIGITAL CAMERAS; PORTABLE MP3 PLAYERS; COMPACT DISC PLAYERS; PORTABLE COMPACT DISC PLAYERS; DVD PLAYERS; DVD RECORDERS; PORTABLE DVD PLAYERS; VIDEO CASSETTE PLAYERS AND RECORDERS; STEREO; PORTABLE STEREO; SHELF STEREO SYSTEMS COMPRISED OF RADIO, CD AND CASSETTE PLAYERS AND SPEAKERS; HEADPHONES (U.S. CLS. 21, 23, 26, 36 AND 38).

TARAH HARDY, EXAMINING ATTORNEY

SN 78-519,501. NEWT, INC., BOZEMAN, MT. FILED 11-18-2004.

SN 78-519,548. SIMPLETECH, INC., SANTA ANA, CA. FILED 11-18-2004.



SimpleTransfer

OWNER OF U.S. REG. NO. 2,893,754. NO CLAIM IS MADE TO THE EXCLUSIVE RIGHT TO USE "WAITER", APART FROM THE MARK AS SHOWN.

THE MARK CONSISTS OF 2 STYLIZED W W. FOR COMPUTER SOFTWARE FOR WAITERS/BARTENDERS TO PLACE FOOD AND DRINK ORDERS THROUGH (U.S. CLS. 21, 23, 26, 36 AND 38).

FIRST USE 5-2-2004; IN COMMERCE 5-2-2004. CAROLINE WEIMER, EXAMINING ATTORNEY

THE MARK CONSISTS OF STANDARD CHARACTERS WITHOUT CLAIM TO ANY PARTICULAR FONT, STYLE, SIZE, OR COLOR.

FOR COMPUTER HARDWARE AND SOFTWARE FOR THE TRANSFER OF FILES AND FOLDERS AND FOR THE BACKUP OF DATA (U.S. CLS. 21, 23, 26, 36 AND 38).

SALLY SHIH, EXAMINING ATTORNEY

CLASS 9—(Continued).

SN 78-519,583. SIMPLTECH, INC., SANTA ANA, CA. FILED 11-18-2004.

SimpleShare

THE MARK CONSISTS OF STANDARD CHARACTERS WITHOUT CLAIM TO ANY PARTICULAR FONT, STYLE, SIZE, OR COLOR.

FOR COMPUTER HARDWARE AND SOFTWARE APPLICATIONS TO BE USED FOR CONTENT SHARING SUCH AS MUSIC FILES, DIGITAL PHOTOS, AND STORAGE DATA (U.S. CLS. 21, 23, 26, 36 AND 38).
RICHARD WHITE, EXAMINING ATTORNEY

SN 78-519,624. MICROVISION OPTICAL, INC., SAN DIEGO, CA. FILED 11-18-2004.

TEMPLELOCK

THE MARK CONSISTS OF STANDARD CHARACTERS WITHOUT CLAIM TO ANY PARTICULAR FONT, STYLE, SIZE, OR COLOR.

FOR EYEGLASS FRAMES AND FITTINGS (U.S. CLS. 21, 23, 26, 36 AND 38).
RAUL CORDOVA, EXAMINING ATTORNEY

CLASS 9—(Continued).

SN 78-519,628. PHOTOFLEX, INC., WATSONVILLE, CA. FILED 11-18-2004.

CINEDOME

THE MARK CONSISTS OF STANDARD CHARACTERS WITHOUT CLAIM TO ANY PARTICULAR FONT, STYLE, SIZE, OR COLOR.

OWNER OF U.S. REG. NO. 2,675,072.
FOR COLLAPSIBLE LIGHT DIRECTORS AND DIFFUSERS FOR USE WITH PHOTOGRAPHIC LIGHTING EQUIPMENT FOR PROFESSIONAL AND HIGH-END PHOTOGRAPHY (U.S. CLS. 21, 23, 26, 36 AND 38).
FIRST USE 1-31-2001; IN COMMERCE 1-31-2001.
RAUL CORDOVA, EXAMINING ATTORNEY

SN 78-519,702. NETWORK APPLIANCE, INC., SUNNYVALE, CA. FILED 11-18-2004.

SNAPCACHE

THE MARK CONSISTS OF STANDARD CHARACTERS WITHOUT CLAIM TO ANY PARTICULAR FONT, STYLE, SIZE, OR COLOR.

OWNER OF U.S. REG. NOS. 2,480,545, 2,488,676 AND OTHERS.
FOR COMPUTER HARDWARE AND SOFTWARE FOR OPTIMIZING THE PROTECTION, BACKUP, REPLICATION, MANAGEMENT, ADMINISTRATION, AND RESTORATION OF DATA, AND INSTRUCTION AND USER MANUALS SOLD THEREWITH (U.S. CLS. 21, 23, 26, 36 AND 38).
ALICE BENMAMAN, EXAMINING ATTORNEY

CLASS 9—(Continued).

SN 78-519,736. GROKSTER, LTD., CHARLESTOWN, ST. CHRIST-NEVIS, FILED 11-18-2004.

Grokster

THE MARK CONSISTS OF STANDARD CHARACTERS WITHOUT CLAIM TO ANY PARTICULAR FONT, STYLE, SIZE, OR COLOR.

FOR FILE SHARING SOFTWARE (U.S. CLS. 21, 23, 26, 36 AND 38).

FIRST USE 1-1-2001; IN COMMERCE 1-1-2001.

MONTIA G. PRESSEY, EXAMINING ATTORNEY

CLASS 9—(Continued).

SN 78-519,756. PHOTOFLEX, INC., WATSONVILLE, CA. FILED 11-18-2004.

MULTIDOME

THE MARK CONSISTS OF STANDARD CHARACTERS WITHOUT CLAIM TO ANY PARTICULAR FONT, STYLE, SIZE, OR COLOR.

FOR COLLAPSIBLE LIGHT DIRECTORS AND DIFFUSERS FOR USE WITH PHOTOGRAPHIC LIGHTING EQUIPMENT FOR PROFESSIONAL AND HIGH-END PHOTOGRAPHY (U.S. CLS. 21, 23, 26, 36 AND 38).

FIRST USE 2-28-1993; IN COMMERCE 2-28-1993.

STEVEN PEREZ, EXAMINING ATTORNEY

SN 78-519,752. THORRY M KOREN, ASTORIA, NY. FILED 11-18-2004.

THE KIN

THE MARK CONSISTS OF STANDARD CHARACTERS WITHOUT CLAIM TO ANY PARTICULAR FONT, STYLE, SIZE, OR COLOR.

FOR RECORDING MEDIA, NAMELY, PHONOGRAPH RECORDINGS FEATURING MUSIC, PRE-RECORDED AUDIO CASSETTE TAPES AND COMPACT DISCS FEATURING MUSIC, PRE-RECORDED VIDEO TAPES AND LASER DISCS FEATURING MUSIC PERFORMANCES (U.S. CLS. 21, 23, 26, 36 AND 38).

WILLIAM P. SHANAHAN, EXAMINING ATTORNEY

SN 78-519,760. PHOTOFLEX, INC., WATSONVILLE, CA. FILED 11-18-2004.

OCTODOME

THE MARK CONSISTS OF STANDARD CHARACTERS WITHOUT CLAIM TO ANY PARTICULAR FONT, STYLE, SIZE, OR COLOR.

OWNER OF U.S. REG. NO. 2,675,072.

FOR COLLAPSIBLE LIGHT DIRECTORS AND DIFFUSERS FOR USE WITH PHOTOGRAPHIC LIGHTING EQUIPMENT FOR PROFESSIONAL AND HIGH-END PHOTOGRAPHY (U.S. CLS. 21, 23, 26, 36 AND 38).

FIRST USE 1-31-2001; IN COMMERCE 1-31-2001.

ZACHARY BELLO, EXAMINING ATTORNEY

CLASS 9—(Continued).

SN 78-519,971. TLV CO., LTD., HYOGO-KEN, JAPAN, FILED 11-19-2004.

CLASS 9—(Continued).

SN 78-520,090. ZYNX HEALTH INCORPORATED, LOS ANGELES, CA. FILED 11-19-2004.

AUTHORSPACE

SONICMAN

THE MARK CONSISTS OF STANDARD CHARACTERS WITHOUT CLAIM TO ANY PARTICULAR FONT, STYLE, SIZE, OR COLOR.

FOR COMPUTER PROGRAMS FOR EDITING MEDICAL DATA (U.S. CLS. 21, 23, 26, 36 AND 38).
TRACY CROSS, EXAMINING ATTORNEY

THE MARK CONSISTS OF STANDARD CHARACTERS WITHOUT CLAIM TO ANY PARTICULAR FONT, STYLE, SIZE, OR COLOR.

FOR ULTRASONIC DETECTORS USED FOR DETECTING AND DETERMINING THE RATE OF FLOW OF FLUID FROM PRESSURIZED SYSTEMS (U.S. CLS. 21, 23, 26, 36 AND 38).

WANDA KAY PRICE, EXAMINING ATTORNEY

SN 78-520,242. RENDITION NETWORKS, INC., REDMOND, WA. FILED 11-19-2004.

TRUECONTROL

THE MARK CONSISTS OF STANDARD CHARACTERS WITHOUT CLAIM TO ANY PARTICULAR FONT, STYLE, SIZE, OR COLOR.

FOR COMPUTER SOFTWARE WHICH MANAGES, AUTOMATES AND PROGRAMS SERVERS, ROUTERS, SWITCHES AND HUBS WHICH FORM A COMPUTER NETWORK (U.S. CLS. 21, 23, 26, 36 AND 38).

FIRST USE 11-19-2001; IN COMMERCE 11-19-2001.
IRA J. GOODSAD, EXAMINING ATTORNEY

SN 78-520,055. CAPO, INC., ORMOND BEACH, FL. FILED 11-19-2004.

SN 78-520,318. VENTUREDYNE, LTD., PEWAUKEE, WI. FILED 11-19-2004.

STYLEMARK

THERM-ALARM

THE MARK CONSISTS OF STANDARD CHARACTERS WITHOUT CLAIM TO ANY PARTICULAR FONT, STYLE, SIZE, OR COLOR.

FOR SUNGLASSES, EYEGLASSES, EYEGLASS FRAMES AND EYEGLASS CASES (U.S. CLS. 21, 23, 26, 36 AND 38).

JENNIFER CHICOSKI, EXAMINING ATTORNEY

THE MARK CONSISTS OF STANDARD CHARACTERS WITHOUT CLAIM TO ANY PARTICULAR FONT, STYLE, SIZE, OR COLOR.

OWNER OF U.S. REG. NO. 2,132,714.
FOR TEMPERATURE-LIMIT CONTROLS AND ALARMS FOR INDUSTRIAL TEST CHAMBERS (U.S. CLS. 21, 23, 26, 36 AND 38).

FIRST USE 1-28-1987; IN COMMERCE 1-28-1987.
JILL C. ALT, EXAMINING ATTORNEY

CLASS 9—(Continued).

SN 78-520,407. MICRON TECHNOLOGY, INC., BOISE, ID. FILED 11-19-2004.

HYPERSHRINK

THE MARK CONSISTS OF STANDARD CHARACTERS WITHOUT CLAIM TO ANY PARTICULAR FONT, STYLE, SIZE, OR COLOR.

FOR SEMICONDUCTOR DEVICES AND PRINTED CIRCUIT BOARDS INCORPORATING SUCH SEMICONDUCTOR DEVICES; COMPUTER CARD ADAPTERS; COMPUTER MEMORIES; COMPUTER MEMORY HARDWARE; FLASH CARDS; FLASH CARD ADAPTERS; FLASH CARD READERS; FLASH MEMORY CARDS; RAM (RANDOM ACCESS MEMORY) CARDS; PERSONAL COMPUTER COMPONENTS; USB FLASH DRIVES; VIDEO CARDS; VIDEO GRAPHICS ACCELERATORS; VIDEO GRAPHICS CONTROLLERS (U.S. CLS. 21, 23, 26, 36 AND 38).

LESLEY LAMOTHE, EXAMINING ATTORNEY



SN 78-520,430. FRYE, MICHAEL, ROUND ROCK, TX. FILED 11-19-2004.

Y2K AND BEYOND

THE MARK CONSISTS OF STANDARD CHARACTERS WITHOUT CLAIM TO ANY PARTICULAR FONT, STYLE, SIZE, OR COLOR.

FOR SOFTWARE FOR CALCULATING CONSTRUCTION CONTRACT BIDS (U.S. CLS. 21, 23, 26, 36 AND 38).

REBECCA GAN, EXAMINING ATTORNEY

CLASS 9—(Continued).

SN 78-520,460. MEDISERVE INFORMATION SYSTEMS, INC., TEMPE, AZ. FILED 11-19-2004.

VENTLINK

THE MARK CONSISTS OF STANDARD CHARACTERS WITHOUT CLAIM TO ANY PARTICULAR FONT, STYLE, SIZE, OR COLOR.

FOR COMPUTER SOFTWARE THAT ENABLES REMOTE DEVICE DATA ACQUISITION AND MANAGEMENT FROM ONE OR MORE MECHANICAL VENTILATORS TO CREATE AN INTERFACE BETWEEN THE VENTILATOR AND A CLINICAL INFORMATION SYSTEM FOR USE IN THE HEALTHCARE INDUSTRY (U.S. CLS. 21, 23, 26, 36 AND 38).

ZACHARY BELLO, EXAMINING ATTORNEY



SN 78-520,471. PERFECTNOTES CORPORATION, OREM, UT. FILED 11-19-2004.

PerfectNotes

THE MARK CONSISTS OF STANDARD CHARACTERS WITHOUT CLAIM TO ANY PARTICULAR FONT, STYLE, SIZE, OR COLOR.

FOR COMPUTER SOFTWARE FOR TAKING NOTES; MICROPHONES; DOWNLOADABLE SOFTWARE FOR TAKING NOTES (U.S. CLS. 21, 23, 26, 36 AND 38).

AMY HELLA, EXAMINING ATTORNEY

CLASS 9—(Continued).

SN 78-520,619. CIL LLC, BERKELEY, CA. FILED 11-20-2004.



THE COLORS GREY AND ORANGE ARE CLAIMED AS A FEATURE OF THE MARK.

THE MARK CONSISTS OF GREY LOWER-CASE LETTERS IN CENTURY GOTHIC BOLD FONT WITH AN ORANGE 3-D APPEARING SPHERE AS THE "DOT" ON THE LOWER-CASE LETTER "I".

FOR COMPUTER PROGRAMS FOR THE USE IN THE COLLECTION, CONSOLIDATION, ANALYSIS, REPORTING AND PRESENTATION OF MANAGEMENT INFORMATION (U.S. CLS. 21, 23, 26, 36 AND 38).

FIRST USE 11-19-2004; IN COMMERCE 11-19-2004.
DANIEL BRODY, EXAMINING ATTORNEY

CLASS 9—(Continued).

SN 78-520,830. PHARMACEUTICAL SYSTEMS INC., MUNDELEIN, IL. FILED 11-22-2004.

VHYPER

THE MARK CONSISTS OF STANDARD CHARACTERS WITHOUT CLAIM TO ANY PARTICULAR FONT, STYLE, SIZE, OR COLOR.

FOR LABORATORY INSTRUMENT FOR EVALUATING THE RESISTANCE OF STERILIZATION PROCESS BIOLOGICAL INDICATORS, NAMELY, AN ASSEMBLY OF SPECIALLY DESIGNED AND FABRICATED COMPONENTS AND HARDWARE COMPRISING AN AIR DRYER, HEATER, FLOW METERING AND INJECTION NOZZLE, CHAMBER FOR EVAPORATION OF PEROXIDE VAPOR, SAMPLE HOLDING FIXTURE WITH TRANSPORT MECHANISM, EXPOSURE CHAMBER, SENSORS, TIMERS AND CONVEYANCE CONDUITS, THAT ALLOWS PRECISE CONTROL OF TEMPERATURE, MOISTURE AND HYDROGEN PEROXIDE CONCENTRATION FOR TESTING THE PERFORMANCE OF SUCH INDICATORS (U.S. CLS. 21, 23, 26, 36 AND 38).
BRENDAN MCCAULEY, EXAMINING ATTORNEY

SN 78-520,623. VISUAL SOUND LLC, THOMPSONS STATION, TN. FILED 11-20-2004.

Real Tone for Real People

THE MARK CONSISTS OF STANDARD CHARACTERS WITHOUT CLAIM TO ANY PARTICULAR FONT, STYLE, SIZE, OR COLOR.

FOR MUSICAL INSTRUMENT AMPLIFIERS; ELECTRONIC EFFECT PEDALS FOR USE WITH SOUND AMPLIFIERS; HIGH-FREQUENCY SWITCHING POWER SUPPLIES; TELEPHONE APPARATUS, NAMELY MUSIC-ON-HOLD ADAPTER (U.S. CLS. 21, 23, 26, 36 AND 38).

FIRST USE 12-13-2001; IN COMMERCE 12-13-2001.
VERNA BETH RIRIE, EXAMINING ATTORNEY

SN 78-520,995. THE DEPARTMENT OF THE NAVY, WASHINGTON, DC. FILED 11-22-2004.

TWEZER

THE MARK CONSISTS OF STANDARD CHARACTERS WITHOUT CLAIM TO ANY PARTICULAR FONT, STYLE, SIZE, OR COLOR.

FOR COMPUTER SOFTWARE FOR IMPLEMENTING SUPER-RESOLUTION VIDEO ENHANCEMENT (U.S. CLS. 21, 23, 26, 36 AND 38).

DAWN HAN, EXAMINING ATTORNEY

CLASS 9—(Continued).

SN 78-521,055. ALISTA TECHNOLOGIES, INC., BELLEVUE, WA. FILED 11-22-2004.

CLASS 9—(Continued).

SN 78-521,394. AAR HOLDINGS, INC., WOODLAND HILLS, CA. FILED 11-22-2004.

BRINGING AUDIO BACK TO LIFE

ACUMEN

THE MARK CONSISTS OF STANDARD CHARACTERS WITHOUT CLAIM TO ANY PARTICULAR FONT, STYLE, SIZE, OR COLOR.

FOR COMPUTER SOFTWARE FOR USE IN ASSISTING INDIVIDUALS AND BUSINESSES TO TRANSFER DATA AND SETTINGS FROM ONE ELECTRONIC DEVICE TO ANOTHER, BY MEANS OF A GLOBAL COMPUTER NETWORK (U.S. CLS. 21, 23, 26, 36 AND 38).

TARAH HARDY, EXAMINING ATTORNEY

THE MARK CONSISTS OF STANDARD CHARACTERS WITHOUT CLAIM TO ANY PARTICULAR FONT, STYLE, SIZE, OR COLOR.

FOR CONSUMER ELECTRONICS, NAMELY, TELEVISION RECEIVERS; TELEVISION MONITOR RECEIVERS; VIDEO CAMERAS; RADIO RECEIVERS; AUDIO TUNERS; COMBINED RADIO AND TELEVISION RECEIVERS; COMBINED TAPE RECORDERS AND RADIO RECEIVERS; COMBINED TAPE RECORDERS AND RADIO AND TELEVISION RECEIVERS; AUDIO AMPLIFIERS; LOUD SPEAKERS; SPEAKER-BOXES; MICROPHONES; EAR PHONES; HEAD PHONES; MICROPHONES FOR HEAD PHONES; PUBLIC ADDRESS SYSTEMS; ELECTRIC PHONOGRAPH NEEDLES; COMBINED RADIO RECEIVERS AND ELECTRIC PHONOGRAPHS; MAGNETIC TAPE RECORDERS; DRY BATTERIES; VIDEO TAPE RECORDERS; REMOTE CONTROLS FOR AUDIO AND VIDEO EQUIPMENT, DVD RECORDERS AND EQUIPMENT (U.S. CLS. 21, 23, 26, 36 AND 38).

DORITT L. CARROLL, EXAMINING ATTORNEY

SN 78-521,526. EXELE INFORMATION SYSTEMS, INC., E. ROCHESTER, NY. FILED 11-23-2004.

SN 78-521,209. MIKOHN GAMING CORPORATION, LAS VEGAS, NV. FILED 11-22-2004.

REY DEL MAMBO

THE MARK CONSISTS OF STANDARD CHARACTERS WITHOUT CLAIM TO ANY PARTICULAR FONT, STYLE, SIZE, OR COLOR.

THE ENGLISH TRANSLATION OF "REY DEL MAMBO" IS "KING OF THE MAMBO" OR "MAMBO KING".

FOR ELECTRONIC GAMING MACHINES (U.S. CLS. 21, 23, 26, 36 AND 38).

SCOTT OSLICK, EXAMINING ATTORNEY

TOPVIEW

THE MARK CONSISTS OF STANDARD CHARACTERS WITHOUT CLAIM TO ANY PARTICULAR FONT, STYLE, SIZE, OR COLOR.

FOR SOFTWARE USED IN INDUSTRY TO MONITOR AND REPORT PROCESS STATUS (U.S. CLS. 21, 23, 26, 36 AND 38).

FIRST USE 2-22-1996; IN COMMERCE 6-13-1996.

DAVID H. STINE, EXAMINING ATTORNEY

CLASS 9—(Continued).

SN 78-521,527. INNOLUX DISPLAY CORPORATION, CHUNAN 350, MIAO-LI COUNTY, TAIWAN, FILED 11-23-2004.

CLASS 9—(Continued).

SN 78-521,628. FRONTIER FARM CREDIT, ACA, MANHATTAN, KS. FILED 11-23-2004.

群創

Frontier FAST

THE ENGLISH TRANSLATION OF THE NON-LATIN CHARACTERS IS "INNOVATION OF TEAMWORK".

THE NON-LATIN CHARACTER(S) IN THE MARK TRANSLITERATE INTO QUNCHUANG.

FOR LIQUID CRYSTAL DISPLAYS FOR USE IN COMPUTER MONITORS, NOTEBOOK COMPUTERS, TELEVISIONS, DIGITAL CAMERAS, VIDEO GAME MACHINES FOR USE WITH TELEVISIONS, MOBILE PHONES, PERSONAL DIGITAL ASSISTANTS AND GLOBAL POSITIONING SYSTEMS; LIQUID CRYSTAL DISPLAY MODULES; AND LIQUID CRYSTAL DISPLAY PANELS (U.S. CLS. 21, 23, 26, 36 AND 38).

DAVID H. STINE, EXAMINING ATTORNEY

THE MARK CONSISTS OF STANDARD CHARACTERS WITHOUT CLAIM TO ANY PARTICULAR FONT, STYLE, SIZE, OR COLOR.

FOR MAGNETICALLY-CODED CREDIT CARD (U.S. CLS. 21, 23, 26, 36 AND 38).

JULIE WATSON, EXAMINING ATTORNEY

SN 78-521,617. WEIDENHAMMER SYSTEMS CORPORATION, WYOMISSING, PA. FILED 11-23-2004.

SN 78-521,731. JAKKS PACIFIC, INC., MALIBU, CA. FILED 11-23-2004.

PocketSchool

GAMEKEY

THE MARK CONSISTS OF STANDARD CHARACTERS WITHOUT CLAIM TO ANY PARTICULAR FONT, STYLE, SIZE, OR COLOR.

FOR COMPUTER SOFTWARE APPLICATION FOR USE ON A HANDHELD DEVICE HAVING THE CAPABILITY TO SEARCH, LOCATE, AND VIEW STUDENT INFORMATION SUCH AS BASIC STUDENT IDENTIFICATION INFORMATION, STUDENT ATTENDANCE INFORMATION, STUDENT SCHEDULE INFORMATION, STUDENT DISCIPLINARY INFORMATION, AND CUSTOM STUDENT INFORMATION (U.S. CLS. 21, 23, 26, 36 AND 38).

FIRST USE 10-11-2004; IN COMMERCE 10-11-2004.
JOANNA DUKOVIC, EXAMINING ATTORNEY

THE MARK CONSISTS OF STANDARD CHARACTERS WITHOUT CLAIM TO ANY PARTICULAR FONT, STYLE, SIZE, OR COLOR.

FOR ELECTRONIC GAMES, NAMELY PORTABLE GAMING SYSTEMS FOR USE WITH TELEVISIONS (U.S. CLS. 21, 23, 26, 36 AND 38).

ZACHARY BELLO, EXAMINING ATTORNEY

CLASS 9—(Continued).

SN 78-521,958. CENTAUR ENTERTAINMENT, INC.,
BROOKLYN, NY. FILED 11-23-2004.

CLASS 9—(Continued).

SN 78-522,246. ADRENALIN GAMING, LLC., LADERA
RANCH, CA. FILED 11-23-2004.

WINTER PARTY

THE MARK CONSISTS OF STANDARD CHARACTERS
WITHOUT CLAIM TO ANY PARTICULAR FONT, STYLE,
SIZE, OR COLOR.

FOR SERIES OF PRE-RECORDED PHONOGRAPH
RECORDS, AUDIO CASSETTES, COMPACT DISCS, DI-
GITAL AUDIO TAPES, VIDEO CASSETTES, VIDEO
DISCS, LASER DISCS, AND DIGITIZED AUDIO AND
VIDEO RECORDINGS DOWNLOADED FROM A GLO-
BAL COMPUTER NETWORK AND RECORDED ON
MAGNETIC MEDIA, ALL OF THE FOREGOING FEAT-
URING MUSIC; AND CD STORAGE WALLETS (U.S.
CLS. 21, 23, 26, 36 AND 38).

FIRST USE 3-10-1998; IN COMMERCE 3-10-1998.
BARBARA BROWN, EXAMINING ATTORNEY

DISCO DOLLARS

THE MARK CONSISTS OF STANDARD CHARACTERS
WITHOUT CLAIM TO ANY PARTICULAR FONT, STYLE,
SIZE, OR COLOR.

NO CLAIM IS MADE TO THE EXCLUSIVE RIGHT TO
USE "DOLLARS", APART FROM THE MARK AS SHOWN.
FOR GAMING MACHINES, NAMELY, SLOT MA-
CHINES WITH OR WITHOUT VIDEO OUTPUT; COM-
PUTERIZED VIDEO TABLE GAMES FOR GAMING
PURPOSES (U.S. CLS. 21, 23, 26, 36 AND 38).

CHERYL CLAYTON, EXAMINING ATTORNEY

SN 78-521,974. MASTERCARD INTERNATIONAL INCOR-
PORATED, PURCHASE, NY. FILED 11-23-2004.

SN 78-522,375. OPTICAL SCIENCE COMPANY, INC., ROS-
WELL, GA. FILED 11-24-2004.

**AVACS**

THE MARK CONSISTS OF FOUR CIRCLES THAT
INCREASE IN SIZE FROM LEFT TO RIGHT.

FOR COMPUTER HARDWARE IN THE NATURE OF
SMART CARDS CONTAINING PROXIMITY PAYMENT
DEVICES KNOWN AS TRANSPONDERS; CARD READ-
ERS FOR MAGNETICALLY ENCODED CARDS AND
CARDS CONTAINING AN INTEGRATED CIRCUIT
CHIP; TELECOMMUNICATIONS EQUIPMENT,
NAMELY, TRANSPONDERS (U.S. CLS. 21, 23, 26, 36
AND 38).

FIRST USE 12-0-2002; IN COMMERCE 12-0-2002.
G. MAYERSCHOFF, EXAMINING ATTORNEY

THE MARK CONSISTS OF STANDARD CHARACTERS
WITHOUT CLAIM TO ANY PARTICULAR FONT, STYLE,
SIZE, OR COLOR.

FOR COMPUTER SOFTWARE FOR INTEGRATING
SURVEILLANCE SYSTEM COMPONENTS, NAMELY,
LENSES, CAMERAS, POSITIONING HARDWARE, AND
LASER RANGE-DETECTING DEVICES AND FOR IM-
AGE PROCESSING (U.S. CLS. 21, 23, 26, 36 AND 38).

CHERYL STEPLIGHT, EXAMINING ATTORNEY

CLASS 9—(Continued).

SN 78-522,655. APPLIED NANOFLUORESCENCE LLC, HOUSTON, TX. FILED 11-24-2004.

CLASS 9—(Continued).

SN 78-522,865. BELLE VUE SUNSHINE TOURING, INC., WOODLAND HILLS, CA. FILED 11-24-2004.

NanoSpectralyzer

MOTÖRHEAD

THE MARK CONSISTS OF STANDARD CHARACTERS WITHOUT CLAIM TO ANY PARTICULAR FONT, STYLE, SIZE, OR COLOR.

FOR SCIENTIFIC MEASURING APPARATUS FOR THE ANALYSIS OF SINGLE-WALLED CARBON NANOTUBE SAMPLES BY SPECTROSCOPY (U.S. CLS. 21, 23, 26, 36 AND 38).

ELISSA GARBER KON, EXAMINING ATTORNEY

THE MARK CONSISTS OF STANDARD CHARACTERS WITHOUT CLAIM TO ANY PARTICULAR FONT, STYLE, SIZE, OR COLOR.

FOR SERIES OF MUSICAL SOUND RECORDINGS AND VIDEO RECORDINGS (U.S. CLS. 21, 23, 26, 36 AND 38).

FIRST USE 9-24-1977; IN COMMERCE 9-24-1977.
MARK RADEMACHER, EXAMINING ATTORNEY

SN 78-522,778. INNOVALINK CORPORATION, EVANSTON, IL. FILED 11-24-2004.

SN 78-523,008. ASTAV, INC., PALO ALTO, CA. FILED 11-25-2004.

DBNEWS

NOPHISH

THE MARK CONSISTS OF STANDARD CHARACTERS WITHOUT CLAIM TO ANY PARTICULAR FONT, STYLE, SIZE, OR COLOR.

FOR COMPUTER SOFTWARE FOR MONITORING, EXTRACTING, FORMATTING, AND PROVIDING INFORMATION STORED IN ELECTRONIC DATABASES (U.S. CLS. 21, 23, 26, 36 AND 38).

FIRST USE 4-18-2000; IN COMMERCE 8-22-2000.
GIANCARLO CASTRO, EXAMINING ATTORNEY

THE MARK CONSISTS OF STANDARD CHARACTERS WITHOUT CLAIM TO ANY PARTICULAR FONT, STYLE, SIZE, OR COLOR.

FOR COMPUTER SOFTWARE FOR USE IN PROTECTING WEBSITE USERS AND OPERATORS FROM FRAUDULENT SCHEMES AND ATTACKS THAT ATTEMPT TO STEAL MONEY AND/OR PERSONAL INFORMATION (U.S. CLS. 21, 23, 26, 36 AND 38).

RICHARD WHITE, EXAMINING ATTORNEY

CLASS 9—(Continued).

SN 78-523,020. ARTECH CONSULTORES S.R.L., MONTEVIDEO, OTHER, URUGUAY, FILED 11-25-2004.

CLASS 9—(Continued).

SN 78-523,206. HANGZHOU HUAWAI-3COM TECH. CO., LTD., HANGZHOU, CHINA, FILED 11-26-2004.

DEKLARIT

THE MARK CONSISTS OF STANDARD CHARACTERS WITHOUT CLAIM TO ANY PARTICULAR FONT, STYLE, SIZE, OR COLOR.

FOR COMPUTER SOFTWARE, NAMELY, TOOL USED BY DEVELOPERS TO BUILD ENTERPRISE DATA AND BUSINESS LAYERS (U.S. CLS. 21, 23, 26, 36 AND 38).

FIRST USE 2-1-2002; IN COMMERCE 4-6-2002.
BARBARA BROWN, EXAMINING ATTORNEY

IRF

THE MARK CONSISTS OF STANDARD CHARACTERS WITHOUT CLAIM TO ANY PARTICULAR FONT, STYLE, SIZE, OR COLOR.

FOR COMPUTERS; COMPUTER OPERATING PROGRAMS; COMPUTER UTILITY PROGRAMS FOR PERFORMING COMPUTER MAINTENANCE WORK; COMPUTER GAME SOFTWARE; COMPUTER GRAPHICS SOFTWARE; COMPUTER SEARCH ENGINE SOFTWARE; COMPUTER SCREEN SAVER SOFTWARE; COMPUTER SOFTWARE FOR USE IN DATABASE MANAGEMENT; COMPUTER SOFTWARE FOR USE AS A SPREADSHEET; COMPUTER SOFTWARE FOR WORD PROCESSING; COMPUTER SOFTWARE FOR THE COLLECTION, EDITING, ORGANIZING, MODIFYING, BOOK MARKING, TRANSMISSION, STORAGE AND SHARING OF DATA AND INFORMATION; COMPUTER SOFTWARE FOR COMMUNICATING WITH USERS OF HAND-HELD COMPUTERS; COMPUTER SOFTWARE FOR ACCESSING INFORMATION DIRECTORIES THAT MAY BE DOWNLOADED FROM THE GLOBAL COMPUTER NETWORK; DOWNLOADABLE SOFTWARE FOR USE IN DATABASE MANAGEMENT; DOWNLOADABLE SOFTWARE FOR USE AS A SPREADSHEET; DOWNLOADABLE SOFTWARE FOR WORD PROCESSING; COMPUTER SOFTWARE DEVELOPMENT TOOLS; VIDEO TELEPHONES; MOBILE TELEPHONES; WIRELESS TELEPHONES; WALKIE-TALKIES; ELECTRONIC AND OPTICAL COMMUNICATIONS INSTRUMENTS AND COMPONENTS, NAMELY, OPTICAL TRANSMITTERS, OPTICAL RECEIVERS, OPTICAL DATA LINKS, OPTICAL TRANSCEIVERS, CABLE TELEVISION TRANSMITTERS, DIGITAL TRANSMITTERS AND COMMUNICATION LINK TESTERS FOR TESTING COMMUNICATION LINKS; AUTOMATIC TELEPHONE EXCHANGES; NETWORK COMMUNICATION APPARATUS, NAMELY, COMPUTER NETWORK ADAPTERS, COMPUTER NETWORK HUBS, SWITCHES AND ROUTERS, LAN (LOCAL AREA NETWORK) ACCESS POINTS FOR CONNECTING NETWORK COMPUTER USERS AND NETWORK ACCESS SERVER HARDWARE (U.S. CLS. 21, 23, 26, 36 AND 38).

KEVIN DINALLO, EXAMINING ATTORNEY

SN 78-523,204. YUHAO, CHEN, FOSHAN CITY, CHINA, FILED 11-26-2004.

Marriola

FOR FLAT PANEL DISPLAY SCREENS; LCD LARGE-SCREEN DISPLAYS; CABINETS FOR LOUDSPEAKERS; LOUDSPEAKERS; APPARATUS FOR RECORDING, TRANSMISSION OR REPRODUCTION OF SOUND AND IMAGES; SOUND MIXERS; TELEVISION SETS; VIDEO GAME MACHINES FOR USE WITH TELEVISIONS; VIDEO OUTPUT GAME MACHINES FOR USE WITH TELEVISIONS; RADIOS FOR VEHICLES; PERSONAL STEREOS; VIDEO AND AUDIO APPARATUS FOR VEHICLES, NAMELY LIQUID CRYSTAL DISPLAYS, DVD PLAYERS FOR VEHICLES, SOUND AMPLIFIERS, SUB-WOOFERS, WOOFERS; POWER AMPLIFIERS (U.S. CLS. 21, 23, 26, 36 AND 38).

KEVIN DINALLO, EXAMINING ATTORNEY

CLASS 9—(Continued).

SN 78-523,348. ALERT SENTRY, LLC, SEEKONK, MA.
FILED 11-28-2004.

CLASS 9—(Continued).

SN 78-523,540. COOL SHADES, INC., ST. PETERSBURG, FL.
FILED 11-29-2004.

Alert Sentry

PRECISION GOLF

THE MARK CONSISTS OF STANDARD CHARACTERS WITHOUT CLAIM TO ANY PARTICULAR FONT, STYLE, SIZE, OR COLOR.

OWNER OF U.S. REG. NO. 2,814,994.
FOR SUNGLASSES (U.S. CLS. 21, 23, 26, 36 AND 38).
FIRST USE 1-1-2002; IN COMMERCE 1-1-2002.
DAVID C. REIHNER, EXAMINING ATTORNEY

THE MARK CONSISTS OF STANDARD CHARACTERS WITHOUT CLAIM TO ANY PARTICULAR FONT, STYLE, SIZE, OR COLOR.

FOR PERSONAL EMERGENCY MEDICAL RESPONSE SYSTEM, NAMELY, AN ELECTRONIC TABLETOP CONSOLE AND WIRELESS TRANSMITTERS IN THE FORM OF WATCH-LIKE AND NECKLACE PENDANTS (U.S. CLS. 21, 23, 26, 36 AND 38).

RONALD MCMORROW, EXAMINING ATTORNEY

SN 78-523,768. HOTEL SALES PRO, LLC, MARIETTA, GA.
FILED 11-29-2004.

SN 78-523,539. CLASSIC WRESTLING PRODUCTIONS, LLC,
GREENWICH, CT. FILED 11-29-2004.

hotel Sales & CateringPro

MEGA MOMENTS

THE MARK CONSISTS OF STANDARD CHARACTERS WITHOUT CLAIM TO ANY PARTICULAR FONT, STYLE, SIZE, OR COLOR.

NO CLAIM IS MADE TO THE EXCLUSIVE RIGHT TO USE "HOTEL SALES", APART FROM THE MARK AS SHOWN.

FOR DOWNLOADABLE SOFTWARE FOR USE BY HOTELS AND OTHER HOSPITALITY-RELATED BUSINESSES TO ORGANIZE, TRACK AND MANAGE SALES AND FACILITY USAGE AND CATERING AND RELATED ACTIVITIES (U.S. CLS. 21, 23, 26, 36 AND 38).
FIRST USE 10-29-1996; IN COMMERCE 10-29-1996.

WILLIAM P. SHANAHAN, EXAMINING ATTORNEY

THE MARK CONSISTS OF STANDARD CHARACTERS WITHOUT CLAIM TO ANY PARTICULAR FONT, STYLE, SIZE, OR COLOR.

FOR PRERECORDED VIDEOTAPES, CASSETTES AND DIGITAL VIDEO DISCS FEATURING SPORTS ENTERTAINMENT (U.S. CLS. 21, 23, 26, 36 AND 38).

FIRST USE 5-1-2005; IN COMMERCE 5-1-2005.
ZHALEH DELANEY, EXAMINING ATTORNEY

CLASS 9—(Continued).

SN 78-523,780. BLUE MARBLE GROUP, INC., GARDINER, ME. FILED 11-29-2004.

GEOCALC

THE MARK CONSISTS OF STANDARD CHARACTERS WITHOUT CLAIM TO ANY PARTICULAR FONT, STYLE, SIZE, OR COLOR.

FOR COMPUTER SOFTWARE, NAMELY A SOFTWARE LIBRARY AND TOOL WHICH ALLOWS THE USER TO TRANSFORM GEOGRAPHIC COORDINATE POINTS AND PERFORM COMPLEX COORDINATE CONVERSIONS (U.S. CLS. 21, 23, 26, 36 AND 38).

FIRST USE 7-1-1994; IN COMMERCE 7-1-1994.
DAVID H. STINE, EXAMINING ATTORNEY

SN 78-523,812. SESMA, INC., IRVINE, CA. FILED 11-29-2004.

SESMA

THE MARK CONSISTS OF STANDARD CHARACTERS WITHOUT CLAIM TO ANY PARTICULAR FONT, STYLE, SIZE, OR COLOR.

FOR COMPUTER SOFTWARE USED FOR APPLICATION SHARING AND COMPUTER PROGRAM INTEGRATION AND FOR DEVELOPMENT, MODIFICATION, AND DEPLOYMENT OF OTHER COMPUTERS PROGRAMS (U.S. CLS. 21, 23, 26, 36 AND 38).

FIRST USE 8-30-2001; IN COMMERCE 11-1-2003.
BRENDAN MCCAULEY, EXAMINING ATTORNEY

CLASS 9—(Continued).

SN 78-523,900. BTECH, INC., MORRIS PLAINS, NJ. FILED 11-29-2004.

BTECH

THE MARK CONSISTS OF BTECH & DESIGN. FOR ELECTRONIC MEASUREMENT APPARATUS FOR USE IN THE MEASUREMENT OF BATTERY HEALTH AND PERFORMANCE; BATTERY MONITORING AND TESTING SYSTEM CONSISTING PRIMARILY OF MEASUREMENT INSTRUMENTATION, A COMPUTER MONITOR, A KEYBOARD, PRINTER AND PARTS THEREOF, USED TO MONITOR BATTERY PERFORMANCE, PREDICT AND DIAGNOSE A WIDE VARIETY OF PROBLEMS, AND ARCHIVE DATA RELATED TO THE FOREGOING (U.S. CLS. 21, 23, 26, 36 AND 38).

FIRST USE 9-30-2004; IN COMMERCE 9-30-2004.
INGA ERVIN, EXAMINING ATTORNEY

SN 78-523,929. PROVATION MEDICAL, INC., MINNEAPOLIS, MN. FILED 11-29-2004.

DOCUDIAGRAMS

THE MARK CONSISTS OF STANDARD CHARACTERS WITHOUT CLAIM TO ANY PARTICULAR FONT, STYLE, SIZE, OR COLOR.

FOR SOFTWARE FOR MEDICAL SPECIALTIES PROCEDURE DOCUMENTATION; SOFTWARE WHICH ENABLES PHYSICIANS AND MEDICAL PERSONNEL TO USE A BI-FUNCTIONAL, GRAPHICAL METHOD FOR DOCUMENTING FUNCTION AND FINDINGS DATA THROUGH CREATION OF DIAGRAMS AND POPULATED CODES AND TEXT WITHIN PROCEDURE NOTES; SOFTWARE THAT ALLOWS PHYSICIANS AND MEDICAL PERSONNEL TO CREATE A CLINICAL RECORD DIRECTLY FROM THEIR PROCEDURES BY INTEGRATING IMAGE CAPTURE AND ADVANCED GRAPHICS WITH PROCEDURE-SENSITIVE MEDICAL KNOWLEDGE (U.S. CLS. 21, 23, 26, 36 AND 38).

SANI KHOURI, EXAMINING ATTORNEY

CLASS 9—(Continued).

SN 78-523,959. "2012" CREATIVE CONSULTING, MESA, AZ. FILED 11-29-2004.

CLASS 9—(Continued).

SN 78-524,346. YOSEMITE TECHNOLOGIES, INC., FRESNO, CA. FILED 11-30-2004.

YOSEMITE BACKUP

IQ!

THE MARK CONSISTS OF STANDARD CHARACTERS WITHOUT CLAIM TO ANY PARTICULAR FONT, STYLE, SIZE, OR COLOR.

FOR COMPUTER SOFTWARE FOR EDUCATION AND TRAINING (U.S. CLS. 21, 23, 26, 36 AND 38). FIRST USE 3-1-2002; IN COMMERCE 5-1-2002. CAROLYN GRAY, EXAMINING ATTORNEY

THE MARK CONSISTS OF STANDARD CHARACTERS WITHOUT CLAIM TO ANY PARTICULAR FONT, STYLE, SIZE, OR COLOR.

OWNER OF U.S. REG. NO. 2,721,476. NO CLAIM IS MADE TO THE EXCLUSIVE RIGHT TO USE "BACKUP", APART FROM THE MARK AS SHOWN.

FOR COMPUTER SOFTWARE FOR BACKING UP AND RESTORING DATA THAT RESIDES ON COMPUTERS; SOFTWARE THAT RESTORES A SERVER AND/OR PC IN THE CASE OF A DISASTER; SOFTWARE FOR ARCHIVING, RETRIEVING, PROTECTING, AND RESTORING COMPUTER DATA AND FILES; ELECTRONIC PUBLICATIONS IN THE NATURE OF REFERENCE GUIDES AND INSTRUCTIONAL MANUALS RECORDED ON COMPUTER-READABLE MEDIA OR DOWNLOADABLE VIA COMPUTER AND COMMUNICATION NETWORKS IN THE FIELD OF OPERATING BACKUP COMPUTER SOFTWARE AND SUPPLIED FOR USE WITH THE FOREGOING (U.S. CLS. 21, 23, 26, 36 AND 38).

RENEE MCCRAY, EXAMINING ATTORNEY

SN 78-524,390. YOSEMITE TECHNOLOGIES, INC., FRESNO, CA. FILED 11-30-2004.

SN 78-524,309. ARRAY PRODUCTS COMPANY, L.L.C., MUSKOGEE, OK. FILED 11-30-2004.

THE NEW NAME FOR DATA PROTECTION

ACCUSEAL

THE MARK CONSISTS OF STANDARD CHARACTERS WITHOUT CLAIM TO ANY PARTICULAR FONT, STYLE, SIZE, OR COLOR.

NO CLAIM IS MADE TO THE EXCLUSIVE RIGHT TO USE DATA PROTECTION, APART FROM THE MARK AS SHOWN.

FOR SOFTWARE FOR BACKING UP AND RESTORING DATA THAT RESIDES ON COMPUTERS; SOFTWARE THAT RESTORES A SERVER AND/OR PC IN THE CASE OF A DISASTER; SOFTWARE FOR ARCHIVING, RETRIEVING, PROTECTING, AND RESTORING COMPUTER DATA AND FILES; REFERENCE GUIDES AND INSTRUCTIONAL MANUALS ON COMPUTER-READABLE MEDIA OR DOWNLOADABLE VIA COMPUTER AND COMMUNICATION NETWORKS SUPPLIED FOR USE WITH THE FOREGOING (U.S. CLS. 21, 23, 26, 36 AND 38).

ZHALEH DELANEY, EXAMINING ATTORNEY

THE MARK CONSISTS OF STANDARD CHARACTERS WITHOUT CLAIM TO ANY PARTICULAR FONT, STYLE, SIZE, OR COLOR.

FOR CONTROL VALVES FOR REGULATING THE FLOW OF GASES AND LIQUIDS (U.S. CLS. 21, 23, 26, 36 AND 38).

JENNIFER KRISP, EXAMINING ATTORNEY

CLASS 9—(Continued).

SN 78-524,715. KONAMI GAMING, INC., LAS VEGAS, NV. FILED 11-30-2004.

CLASS 9—(Continued).

SN 78-524,844. LEAN DEPOT LLC, MADISON, CT. FILED 11-30-2004.

WHITE RUSSIA

PULSE

THE MARK CONSISTS OF STANDARD CHARACTERS WITHOUT CLAIM TO ANY PARTICULAR FONT, STYLE, SIZE, OR COLOR.

FOR GAMING EQUIPMENT, NAMELY, SLOT MACHINES, GAMING MACHINES AND GAME SOFTWARE USED THEREWITH (U.S. CLS. 21, 23, 26, 36 AND 38).
DAWN FELDMAN, EXAMINING ATTORNEY

THE MARK CONSISTS OF STANDARD CHARACTERS WITHOUT CLAIM TO ANY PARTICULAR FONT, STYLE, SIZE, OR COLOR.

FOR COMPUTER SOFTWARE, NAMELY, AN INVENTORY-MANAGEMENT SOFTWARE FACILITATING A VISUAL KANBAN MODEL REPLENISHMENT SYSTEM WHERE PROCUREMENT IS TRIGGERED BY ACTUAL CONSUMPTION OF ON-HAND ITEMS (U.S. CLS. 21, 23, 26, 36 AND 38).
CAROLYN GRAY, EXAMINING ATTORNEY

SN 78-524,838. NOBELTEC CORPORATION, PORTLAND, OR. FILED 11-30-2004.

SN 78-525,020. LIFE REFLECTIONS, INC., OMAHA, NE. FILED 12-1-2004.

CHARTGRIDDING

LIFE REFLECTIONS

THE MARK CONSISTS OF STANDARD CHARACTERS WITHOUT CLAIM TO ANY PARTICULAR FONT, STYLE, SIZE, OR COLOR.

FOR COMPUTER SOFTWARE FOR USE IN ASSOCIATION WITH NAVIGATION SOFTWARE FOR USE IN THE AEROSPACE, MARINE AND NAUTICAL FIELDS; COMPUTER SOFTWARE FEATURING MARINE, NAUTICAL AND AEROSPACE INFORMATION (U.S. CLS. 21, 23, 26, 36 AND 38).
CAROLYN GRAY, EXAMINING ATTORNEY

THE MARK CONSISTS OF STANDARD CHARACTERS WITHOUT CLAIM TO ANY PARTICULAR FONT, STYLE, SIZE, OR COLOR.

FOR TOUCH-SCREEN CENTRAL KIOSK CONTAINING A FILE SERVER AND ASSOCIATED REMOTE TOUCH-SCREENS PROVIDING ACCESS TO CONTENT DOWNLOADED VIA THE INTERNET FROM A CENTRAL SERVER/PRODUCTION FACILITY (U.S. CLS. 21, 23, 26, 36 AND 38).
AISHA CLARKE, EXAMINING ATTORNEY

CLASS 9—(Continued).

SN 78-525,050. GLENBROOK TECHNOLOGIES, INC., RANDOLPH, NJ. FILED 12-1-2004.

CLASS 9—(Continued).

SN 78-525,266. JAMDAT MOBILE INC., LOS ANGELES, CA. FILED 12-1-2004.

MXRA

JAMCAST

THE MARK CONSISTS OF STANDARD CHARACTERS WITHOUT CLAIM TO ANY PARTICULAR FONT, STYLE, SIZE, OR COLOR.

FOR X-RAY APPARATUS IN THE NATURE OF AN X-RAY MICROSCOPE CAMERA FOR NON-MEDICAL USE (U.S. CLS. 21, 23, 26, 36 AND 38).

RENEE MCCRAY, EXAMINING ATTORNEY

THE MARK CONSISTS OF STANDARD CHARACTERS WITHOUT CLAIM TO ANY PARTICULAR FONT, STYLE, SIZE, OR COLOR.

FOR COMPUTER SOFTWARE FOR DISTRIBUTING TEXT MESSAGING, VOICE AND OTHER INFORMATION TO AND FROM MOBILE AND STATIONARY USERS VIA A GLOBAL COMMUNICATION NETWORK (U.S. CLS. 21, 23, 26, 36 AND 38).

JEAN IM, EXAMINING ATTORNEY

SN 78-525,057. FEKETE ASSOCIATES INC., CALGARY, ALBERTA, CANADA, FILED 12-1-2004.

SN 78-525,366. OPTIMUS CORPORATION, FORT COLLINS, CO. FILED 12-1-2004.

**F.A.S.T.
DECLINEPLUS**

@SeRT

THE MARK CONSISTS OF STANDARD CHARACTERS WITHOUT CLAIM TO ANY PARTICULAR FONT, STYLE, SIZE, OR COLOR.

OWNER OF U.S. REG. NOS. 1,987,145, 2,874,141 AND OTHERS.

FOR COMPUTER SOFTWARE NAMELY; SOFTWARE USED FOR DATA ACQUISITION AND CALCULATIONS IN THE PETROLEUM INDUSTRY (U.S. CLS. 21, 23, 26, 36 AND 38).

JENNIFER CHICOSKI, EXAMINING ATTORNEY

FOR COMPUTER SOFTWARE FOR DATA STREAM AND DATABASE SEARCH, RETRIEVAL AND MANAGEMENT, NAMELY, THE SEARCH, CAPTURE, TRANSFORMATION, STORAGE, MANAGEMENT AND DISTRIBUTION OF HIGH VOLUMES OF INFORMATION OVER COMPUTER NETWORKS (U.S. CLS. 21, 23, 26, 36 AND 38).

JOHN DWYER, EXAMINING ATTORNEY

CLASS 9—(Continued).

SN 78-525,373. OPTIMUS CORPORATION, FORT COLLINS, CO. FILED 12-1-2004.

@SeRT

THE MARK CONSISTS OF STANDARD CHARACTERS WITHOUT CLAIM TO ANY PARTICULAR FONT, STYLE, SIZE, OR COLOR.

FOR COMPUTER SOFTWARE FOR DATA STREAM AND DATABASE SEARCH, RETRIEVAL AND MANAGEMENT, NAMELY, THE SEARCH, CAPTURE, TRANSFORMATION, STORAGE, MANAGEMENT AND DISTRIBUTION OF HIGH VOLUMES OF INFORMATION OVER COMPUTER NETWORKS (U.S. CLS. 21, 23, 26, 36 AND 38).

JOHN DWYER, EXAMINING ATTORNEY

SN 78-525,388. OPTIMUS CORPORATION, FORT COLLINS, CO. FILED 12-1-2004.

ASERT

THE MARK CONSISTS OF STANDARD CHARACTERS WITHOUT CLAIM TO ANY PARTICULAR FONT, STYLE, SIZE, OR COLOR.

FOR COMPUTER SOFTWARE FOR DATA STREAM AND DATABASE SEARCH, RETRIEVAL AND MANAGEMENT, NAMELY, THE SEARCH, CAPTURE, TRANSFORMATION, STORAGE, MANAGEMENT AND DISTRIBUTION OF HIGH VOLUMES OF INFORMATION OVER COMPUTER NETWORKS (U.S. CLS. 21, 23, 26, 36 AND 38).

JOHN DWYER, EXAMINING ATTORNEY

CLASS 9—(Continued).

SN 78-525,497. VIDEOJET TECHNOLOGIES INC., WOOD DALE, IL. FILED 12-1-2004.

Q-CINK

THE MARK CONSISTS OF STANDARD CHARACTERS WITHOUT CLAIM TO ANY PARTICULAR FONT, STYLE, SIZE, OR COLOR.

FOR COMPUTER SOFTWARE, NAMELY, PRINTER MANAGEMENT SOFTWARE (U.S. CLS. 21, 23, 26, 36 AND 38).

ZHALEH DELANEY, EXAMINING ATTORNEY

SN 78-525,523. SCIENTIFIC PLASTIC PRODUCTS, INC., OCEANSIDE, CA. FILED 12-1-2004.

SINGLE STEP

THE MARK CONSISTS OF THE LETTERS "SINGLE STEP" WITH STYLIZED LETTER "I" AND "T" RESEMBLING CHROMATOGRAPHIC PEAKS.

FOR LIQUID CHROMATOGRAPHY COLUMNS (U.S. CLS. 21, 23, 26, 36 AND 38).

INGA ERVIN, EXAMINING ATTORNEY

SN 78-525,919. LEBUTT, EDWIN G., KALKASKA, MI. FILED 12-2-2004.

TURBO GRAMMAR

THE MARK CONSISTS OF STANDARD CHARACTERS WITHOUT CLAIM TO ANY PARTICULAR FONT, STYLE, SIZE, OR COLOR.

NO CLAIM IS MADE TO THE EXCLUSIVE RIGHT TO USE "GRAMMAR", APART FROM THE MARK AS SHOWN. FOR COMPUTER SOFTWARE CONTAINING INTERACTIVE ENGLISH GRAMMAR TUTORIALS (U.S. CLS. 21, 23, 26, 36 AND 38).

BRIDGETT SMITH, EXAMINING ATTORNEY

CLASS 9—(Continued).

SN 78-526,241. IGT, RENO, NV. FILED 12-2-2004.

CLASS 9—(Continued).

SN 78-527,626. CABOT SAFETY INTERMEDIATE CORPORATION, NEWARK, DE. FILED 12-6-2004.

MONEY TOAD

BLOCKADE

THE MARK CONSISTS OF STANDARD CHARACTERS WITHOUT CLAIM TO ANY PARTICULAR FONT, STYLE, SIZE, OR COLOR.

FOR GAMING MACHINES, NAMELY, DEVICES WHICH ACCEPT A WAGER AND COMPONENTS THEREFOR, NAMELY, CONTROLLERS, DISPLAYS, BUTON PANELS, BOLSTERS, ELECTRICAL WIRING, AND COMPUTER HARDWARE AND SOFTWARE ASSOCIATED THEREWITH (U.S. CLS. 21, 23, 26, 36 AND 38).

PAUL F. GAST, EXAMINING ATTORNEY

THE MARK CONSISTS OF STANDARD CHARACTERS WITHOUT CLAIM TO ANY PARTICULAR FONT, STYLE, SIZE, OR COLOR.

FOR PROTECTIVE EYEWEAR (U.S. CLS. 21, 23, 26, 36 AND 38).

LAURA KOVAISKY, EXAMINING ATTORNEY

SN 78-527,575. CABOT SAFETY INTERMEDIATE CORPORATION, NEWARK, DE. FILED 12-6-2004.

SN 78-527,627. REXEL INTERNATIONAL TRADING CORP., VERNON, CA. FILED 12-6-2004.

SIMPLICITY

REXCELL

THE MARK CONSISTS OF STANDARD CHARACTERS WITHOUT CLAIM TO ANY PARTICULAR FONT, STYLE, SIZE, OR COLOR.

FOR PROTECTIVE EYEWEAR (U.S. CLS. 21, 23, 26, 36 AND 38).

STACY WAHLBERG, EXAMINING ATTORNEY

THE MARK CONSISTS OF STANDARD CHARACTERS WITHOUT CLAIM TO ANY PARTICULAR FONT, STYLE, SIZE, OR COLOR.

FOR DRY CELL BATTERIES (U.S. CLS. 21, 23, 26, 36 AND 38).

LAURA KOVAISKY, EXAMINING ATTORNEY

CLASS 9—(Continued).

SN 78-529,110. AKER WADE TECHNOLOGIES, LLC, CHARLOTTESVILLE, VA. FILED 12-8-2004.

UNIMAX EP

THE MARK CONSISTS OF STANDARD CHARACTERS WITHOUT CLAIM TO ANY PARTICULAR FONT, STYLE, SIZE, OR COLOR.

FOR BATTERY CHARGERS (U.S. CLS. 21, 23, 26, 36 AND 38).

CAROLYN CATALDO, EXAMINING ATTORNEY

SN 78-529,147. DESTINEER PUBLISHING CORP., PLYMOUTH, MN. FILED 12-8-2004.

"THE REAL-LIFE
COMBAT
EXPERIENCES OF THE
PROUD FEW"

THE MARK CONSISTS OF STANDARD CHARACTERS WITHOUT CLAIM TO ANY PARTICULAR FONT, STYLE, SIZE, OR COLOR.

FOR COMPUTER GAME SOFTWARE FOR USE WITH PERSONAL COMPUTERS AND VIDEO GAME CONSOLES; DOWNLOADABLE COMPUTER GAME SOFTWARE FOR USE WITH CABLE AND SATELLITE ACCESSIBLE VIDEO CONTROLLERS AND PORTABLE VIDEO DISPLAYS (U.S. CLS. 21, 23, 26, 36 AND 38).

TEJBIR SINGH, EXAMINING ATTORNEY

CLASS 9—(Continued).

SN 78-529,296. CRITICAL TELECOM CORP., OTTAWA, CANADA, FILED 12-8-2004.

DEEP SERVICE

THE MARK CONSISTS OF STANDARD CHARACTERS WITHOUT CLAIM TO ANY PARTICULAR FONT, STYLE, SIZE, OR COLOR.

NO CLAIM IS MADE TO THE EXCLUSIVE RIGHT TO USE "SERVICE", APART FROM THE MARK AS SHOWN.

FOR TELECOMMUNICATIONS HARDWARE, NAMELY, MULTIPLEXERS, MODULATORS, OPTICAL TRANSCEIVERS, OPTICAL TRANSPONDERS, OPTICAL TRANSMITTERS, OPTICAL RECEIVERS, OPTICAL AMPLIFIERS, OPTICAL FIBER GRATINGS, OPTICAL REPEATER NODES, OPTICAL PUMPS FOR USE WITH NON-MEDICAL LASERS, OPTICAL CHANNEL SELECTORS, OPTICAL CONVERTERS, SWITCHES, ROUTERS, COUPLERS, CONNECTORS AND SIGNAL CONVERTERS; WIRELINE NETWORK EXTENDERS, NAMELY, TELECOMMUNICATIONS NETWORKING HARDWARE COMPONENTS USED TO EXTEND THE REACH OF WIRELINE DSL NETWORKS AND OTHER TELECOMMUNICATIONS NETWORKS (U.S. CLS. 21, 23, 26, 36 AND 38).

ANN LINNEHAN, EXAMINING ATTORNEY

SN 78-529,576. DREAMVUE HOLDINGS CORP, AUSTIN, TX. FILED 12-9-2004.

PillowVue

THE MARK CONSISTS OF STANDARD CHARACTERS WITHOUT CLAIM TO ANY PARTICULAR FONT, STYLE, SIZE, OR COLOR.

FOR VIDEO PROJECTOR (U.S. CLS. 21, 23, 26, 36 AND 38).

ANDREA K. NADELMAN, EXAMINING ATTORNEY

CLASS 9—(Continued).

SN 78-529,662. E. I. DU PONT DE NEMOURS AND COMPANY, WILMINGTON, DE. FILED 12-9-2004.

CLASS 9—(Continued).

SN 78-529,966. JEFFERSON PROJECT, LLC, THE, NORTH OGDEN, UT. FILED 12-9-2004.

UPBASE

Passage Express

THE MARK CONSISTS OF STANDARD CHARACTERS WITHOUT CLAIM TO ANY PARTICULAR FONT, STYLE, SIZE, OR COLOR.

FOR COMPUTER SOFTWARE FOR TRACKING PRODUCTION EFFICIENCY IN MANUFACTURING OR DISTRIBUTION OPERATIONS (U.S. CLS. 21, 23, 26, 36 AND 38).

ANDREA K. NADELMAN, EXAMINING ATTORNEY

THE MARK CONSISTS OF STANDARD CHARACTERS WITHOUT CLAIM TO ANY PARTICULAR FONT, STYLE, SIZE, OR COLOR.

FOR MULTIMEDIA SOFTWARE RECORDED ON CD-ROM FOR THE PURPOSE OF ORGANIZING, DISPLAYING AND/OR PLAYING, ARCHIVING AND RETRIEVING COMPUTER FILES AND DESIGNING ACCOMPANYING MENUS TO ACCESS THOSE FILES AND PROVIDING MEANS TO PUBLISH TO COMPUTER MEDIA IN THE FIELD OF GENEALOGY AND FAMILY HISTORY (U.S. CLS. 21, 23, 26, 36 AND 38).

CHRIS WELLS, EXAMINING ATTORNEY

SN 78-529,728. ACCESS DATA CORPORATION, PITTSBURGH, PA. FILED 12-9-2004.

SN 78-530,450. GAMETEC, INC., LAS VEGAS, NV. FILED 12-10-2004.

**ACCESS DATA
SALESVIEW**

Fast & Beautiful

THE MARK CONSISTS OF STANDARD CHARACTERS WITHOUT CLAIM TO ANY PARTICULAR FONT, STYLE, SIZE, OR COLOR.

OWNER OF U.S. REG. NOS. 2,596,665 AND 2,611,251.
FOR COMPUTER SOFTWARE FOR TRANSACTION REPORTING AND ANALYSIS FOR USE IN THE FINANCIAL SERVICES SECTOR (U.S. CLS. 21, 23, 26, 36 AND 38).

DAWN FELDMAN, EXAMINING ATTORNEY

THE MARK CONSISTS OF STANDARD CHARACTERS WITHOUT CLAIM TO ANY PARTICULAR FONT, STYLE, SIZE, OR COLOR.

FOR GAMING EQUIPMENT, NAMELY, SLOT MACHINES WITH OR WITHOUT VIDEO OUTPUT (U.S. CLS. 21, 23, 26, 36 AND 38).

GENE MACIOL, EXAMINING ATTORNEY

CLASS 9—(Continued).

SN 78-530,461. GAMETEC, INC., LAS VEGAS, NV. FILED 12-10-2004.

CLASS 9—(Continued).

SN 78-531,668. IGT, RENO, NV. FILED 12-13-2004.

Fruit Party

THE MARK CONSISTS OF STANDARD CHARACTERS WITHOUT CLAIM TO ANY PARTICULAR FONT, STYLE, SIZE, OR COLOR.

FOR GAMING EQUIPMENT, NAMELY, SLOT MACHINES WITH OR WITHOUT VIDEO OUTPUT (U.S. CLS. 21, 23, 26, 36 AND 38).

GENE MACIOL, EXAMINING ATTORNEY

MOONSHINE

THE MARK CONSISTS OF STANDARD CHARACTERS WITHOUT CLAIM TO ANY PARTICULAR FONT, STYLE, SIZE, OR COLOR.

OWNER OF U.S. REG. NO. 2,798,285.

FOR GAMING MACHINES, NAMELY, DEVICES WHICH ACCEPT A WAGER AND COMPONENTS THEREFOR, NAMELY, CONTROLLERS, DISPLAYS, BUTTON PANELS, BOLSTERS, ELECTRICAL WIRING, AND COMPUTER HARDWARE AND SOFTWARE ASSOCIATED THEREWITH (U.S. CLS. 21, 23, 26, 36 AND 38).

CATHERINE FAINT, EXAMINING ATTORNEY

SN 78-530,486. LIM, JONATHAN, SAN FRANCISCO, CA. FILED 12-10-2004.

SN 78-531,671. IGT, RENO, NV. FILED 12-13-2004.

iPouch

THE MARK CONSISTS OF STANDARD CHARACTERS WITHOUT CLAIM TO ANY PARTICULAR FONT, STYLE, SIZE, OR COLOR.

FOR OVER-THE SHOULDER POUCH FOR CARRYING SMALL PORTABLE ELECTRONIC DEVICES (U.S. CLS. 21, 23, 26, 36 AND 38).

FIRST USE 6-11-2005; IN COMMERCE 6-11-2005.
HEATHER THOMPSON, EXAMINING ATTORNEY

BLUE BLAZES

THE MARK CONSISTS OF STANDARD CHARACTERS WITHOUT CLAIM TO ANY PARTICULAR FONT, STYLE, SIZE, OR COLOR.

FOR GAMING MACHINES, NAMELY, DEVICES WHICH ACCEPT A WAGER AND COMPONENTS THEREFOR, NAMELY, CONTROLLERS, DISPLAYS, BUTTON PANELS, BOLSTERS, ELECTRICAL WIRING, AND COMPUTER HARDWARE AND SOFTWARE ASSOCIATED THEREWITH (U.S. CLS. 21, 23, 26, 36 AND 38).

CATHERINE FAINT, EXAMINING ATTORNEY

CLASS 9—(Continued).

SN 78-532,153. TOWERS CONSULTING INCORPORATED, HOPKINTON, MA. FILED 12-14-2004.

ELIGIBILITYPRO

THE MARK CONSISTS OF STANDARD CHARACTERS WITHOUT CLAIM TO ANY PARTICULAR FONT, STYLE, SIZE, OR COLOR.

FOR COMPUTER SOFTWARE APPLICATION THAT PROVIDES STATE-SPECIFIC MEDICAID HEALTH INSURANCE ELIGIBILITY INFORMATION (U.S. CLS. 21, 23, 26, 36 AND 38).

REBECCA GAN, EXAMINING ATTORNEY



SN 78-532,258. FISKARS BRANDS, INC., MADISON, WI. FILED 12-14-2004.

ZENGO

THE MARK CONSISTS OF STANDARD CHARACTERS WITHOUT CLAIM TO ANY PARTICULAR FONT, STYLE, SIZE, OR COLOR.

FOR CABLES FOR USE WITH COMPUTERS, NAMELY UNIVERSAL SERIAL BUS CONNECTION CABLES, NETWORK CABLES; AND MODEM CABLES; AND COMPUTER ACCESSORIES, NAMELY COMPUTER MOUSE, USB HUBS, USB ADAPTERS, USB LIGHTS, NETWORK ADAPTERS, MODEM ADAPTERS, HEADSETS, MICROPHONES, AND MODEM CORDS (U.S. CLS. 21, 23, 26, 36 AND 38).

TEJBIR SINGH, EXAMINING ATTORNEY

CLASS 9—(Continued).

SN 78-534,050. KENAI SYSTEMS, INC., ROCKLIN, CA. FILED 12-16-2004.

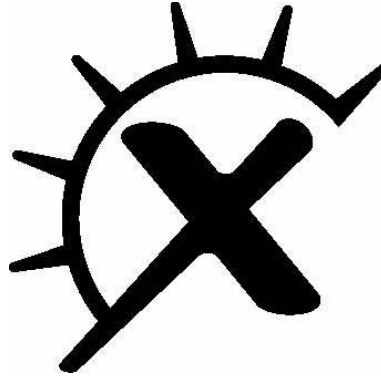

THE MARK CONSISTS OF A PARTIAL SUN WITH A STYLIZED LETTER X.

FOR COMPUTER SOFTWARE FOR TESTING AND MONITORING THE SECURITY FEATURES OF APPLICATIONS USED TO TRANSMIT INFORMATION OVER THE INTERNET (U.S. CLS. 21, 23, 26, 36 AND 38).

NELSON SNYDER, EXAMINING ATTORNEY



SN 78-534,967. MELEXIS N.V., IEPER, BELGIUM, FILED 12-17-2004.

MELEXIS

THE MARK CONSISTS OF STANDARD CHARACTERS WITHOUT CLAIM TO ANY PARTICULAR FONT, STYLE, SIZE, OR COLOR.

FOR ELECTRONIC AND MICROELECTRONIC DEVICES, NAMELY INTEGRATED CIRCUITS, CONTROLLERS, SWITCHES AND PROXIMITY, MAGNETIC FIELD AND ELECTRICAL CURRENT SENSORS (U.S. CLS. 21, 23, 26, 36 AND 38).

FIRST USE 7-25-1996; IN COMMERCE 7-25-1996. AMY HELLA, EXAMINING ATTORNEY

CLASS 9—(Continued).

SN 78-535,003. EAST-WEST COMMERCE CO., INC., BELVIDERE, IL. FILED 12-18-2004.



THE COLORS YELLOW, WHITE, BLACK AND RED ARE CLAIMED AS A FEATURE OF THE MARK.

THE RECTANGLE IS BLACK, THE CHARACTER MEGA IS IN RED, THE CHARACTER ALL IS IN WHITE AND THE FLASH WITH THE STAR IS IN YELLOW.

FOR ALKALINE BATTERY CARBON ZINC BATTERY (U.S. CLS. 21, 23, 26, 36 AND 38).

DOMINICK J. SALEMI, EXAMINING ATTORNEY

CLASS 9—(Continued).

SN 78-536,501. ST-INFONOX INCORPORATED, CAMPBELL, CA. FILED 12-21-2004.

MSP

THE MARK CONSISTS OF STANDARD CHARACTERS WITHOUT CLAIM TO ANY PARTICULAR FONT, STYLE, SIZE, OR COLOR.

FOR COMPUTER SOFTWARE TO COLLECT, AGGREGATE, ANALYZE, MONITOR, AND/OR EVALUATE DATA COLLECTED FROM MULTIPLE DISTRIBUTED SENSORS; COMPUTER SOFTWARE TO MONITOR, TICKET, AND/OR GENERATE REPORTS WITH DATA COLLECTED FROM DISPARATE SOURCES; COMPUTER SOFTWARE TO MONITOR ACTIVITY OF AND/OR IDENTIFY FAULTS IN COMMERCIAL, BUSINESS, SURVEILLANCE, COMMAND AND CONTROL, AND/OR GOVERNMENT SYSTEMS WITH DATA COLLECTED FROM DISPARATE SOURCES; COMPUTER SOFTWARE TO PROVIDE EARLY THREAT DETECTION TO COMMERCIAL, BUSINESS, SURVEILLANCE, COMMAND AND CONTROL, AND/OR GOVERNMENT SYSTEMS WITH DATA COLLECTED FROM DISPARATE SOURCES (U.S. CLS. 21, 23, 26, 36 AND 38).

KATHRYN COWARD, EXAMINING ATTORNEY

SN 78-535,571. BLUE LANE TECHNOLOGIES, INC., SANTA CLARA, CA. FILED 12-20-2004.

BLUE LANE

SN 78-536,811. GVI SECURITY, INC., CARROLLTON, TX. FILED 12-22-2004.

ENCOMPASS

THE MARK CONSISTS OF STANDARD CHARACTERS WITHOUT CLAIM TO ANY PARTICULAR FONT, STYLE, SIZE, OR COLOR.

FOR COMPUTER HARDWARE AND SOFTWARE USED TO PROVIDE DATA SECURITY FOR COMPUTER NETWORKS (U.S. CLS. 21, 23, 26, 36 AND 38).

TEJBIR SINGH, EXAMINING ATTORNEY

THE MARK CONSISTS OF STANDARD CHARACTERS WITHOUT CLAIM TO ANY PARTICULAR FONT, STYLE, SIZE, OR COLOR.

FOR CLOSED CIRCUIT TELEVISION EQUIPMENT AND SYSTEMS COMPRISING SENSORS, MONITORS, DETECTORS, CAMERAS AND ELECTRONIC POSITIONING EQUIPMENT THEREFORE, VIDEO RECORDERS, MATRIX SWITCHING EQUIPMENT, WIRELESS VIDEO TRANSMITTERS AND RECEIVERS, AND ARMORED AND WEATHERPROOF VIDEO CAMERA CONTAINERS (U.S. CLS. 21, 23, 26, 36 AND 38).

RONALD MCMORROW, EXAMINING ATTORNEY

CLASS 9—(Continued).

SN 78-537,040. MONARCH COMPUTER SYSTEMS, INC., TUCKER, GA. FILED 12-22-2004.

CLASS 9—(Continued).

SN 78-537,660. CALLMINER, INC., CAPE CORAL, FL. FILED 12-23-2004.

www.gsamonarch.com

THE MARK CONSISTS OF STANDARD CHARACTERS WITHOUT CLAIM TO ANY PARTICULAR FONT, STYLE, SIZE, OR COLOR.
FOR COMPUTER HARDWARE AND PERIPHERALS THEREOF (U.S. CLS. 21, 23, 26, 36 AND 38).
ALICE BENMAMAN, EXAMINING ATTORNEY

TOPICMINER

SN 78-537,250. PORTALPLAYER, INC., SANTA CLARA, CA. FILED 12-22-2004.

THE MARK CONSISTS OF STANDARD CHARACTERS WITHOUT CLAIM TO ANY PARTICULAR FONT, STYLE, SIZE, OR COLOR.
FOR SOFTWARE FOR ANALYZING AUDIO DATA (U.S. CLS. 21, 23, 26, 36 AND 38).
EVELYN BRADLEY, EXAMINING ATTORNEY

FEATUREFLASH

THE MARK CONSISTS OF STANDARD CHARACTERS WITHOUT CLAIM TO ANY PARTICULAR FONT, STYLE, SIZE, OR COLOR.
FOR COMPUTER HARDWARE AND COMPUTER SOFTWARE FOR USE IN THE MANAGEMENT OF DIGITAL AUDIO AND VIDEO MEDIA (U.S. CLS. 21, 23, 26, 36 AND 38).
JILL PRATER, EXAMINING ATTORNEY

SN 78-537,897. IDEAL INDUSTRIES, INC., SYCAMORE, IL. FILED 12-23-2004.

SN 78-537,332. MOTOROLA, INC., SCHAUMBURG, IL. FILED 12-22-2004.

MOTOBIDGE

15

THE MARK CONSISTS OF STANDARD CHARACTERS WITHOUT CLAIM TO ANY PARTICULAR FONT, STYLE, SIZE, OR COLOR.
FOR TWO-WAY RADIOS; AUDIO SPEAKERS; MICROPHONES; RADIO GATEWAY UNITS AND SOFTWARE USED IN CONNECTION WITH A GATEWAY COMMUNICATIONS NETWORK THAT ENABLES DISPARATE VOICE RADIO COMMUNICATIONS SYSTEMS TO TALK TO EACH OTHER FOR USE IN THE PUBLIC SAFETY FIELD (U.S. CLS. 21, 23, 26, 36 AND 38).
EVELYN BRADLEY, EXAMINING ATTORNEY

THE MARK CONSISTS OF STANDARD CHARACTERS WITHOUT CLAIM TO ANY PARTICULAR FONT, STYLE, SIZE, OR COLOR.
FOR ELECTRICAL WIRE CONNECTORS (U.S. CLS. 21, 23, 26, 36 AND 38).
JENNIFER MARTIN, EXAMINING ATTORNEY

CLASS 9—(Continued).

SN 78-538,239. TEXAS INSTRUMENTS INCORPORATED, DALLAS, TX. FILED 12-24-2004.

CLASS 9—(Continued).

SN 78-538,388. PENHALIGON, ANGELA D., KANSAS CITY, MO. FILED 12-26-2004.

View3

PINEY GIR

THE MARK CONSISTS OF STANDARD CHARACTERS WITHOUT CLAIM TO ANY PARTICULAR FONT, STYLE, SIZE, OR COLOR.

FOR COMPUTER PROGRAMS FOR EDUCATIONAL PURPOSES; NAMELY, PROGRAMS FOR TEACHING CALCULATOR FUNCTIONS, AND FOR TEACHING STUDENTS HOW TO USE A CALCULATOR (U.S. CLS. 21, 23, 26, 36 AND 38).

WILLIAM P. SHANAHAN, EXAMINING ATTORNEY

THE MARK CONSISTS OF STANDARD CHARACTERS WITHOUT CLAIM TO ANY PARTICULAR FONT, STYLE, SIZE, OR COLOR.

THE NAME PINEY GIR DOES NOT IDENTIFY A LIVING INDIVIDUAL.
FOR MUSICAL SOUND RECORDINGS (U.S. CLS. 21, 23, 26, 36 AND 38).

FIRST USE 10-4-2003; IN COMMERCE 10-4-2003.
WON TEAK OH, EXAMINING ATTORNEY

SN 78-538,310. KIDBY, MICHELLE A., PORTLAND, OR. AND PADILLA, MARCO, PORTLAND, OR. FILED 12-25-2004.

SN 78-538,656. MIDWAY AMUSEMENT GAMES, LLC, CHICAGO, IL. FILED 12-27-2004.

Mortal Clay

BLITZ: THE LEAGUE

THE MARK CONSISTS OF STANDARD CHARACTERS WITHOUT CLAIM TO ANY PARTICULAR FONT, STYLE, SIZE, OR COLOR.

FOR PRE-RECORDED COMPACT DISCS, PHONOGRAPH RECORDS, AUDIO TAPES, VIDEO CASSETTES AND OPTICAL DISCS, NAMELY, LASER DISCS, ALL FEATURING MUSICAL PERFORMANCES (U.S. CLS. 21, 23, 26, 36 AND 38).

ELISSA GARBER KON, EXAMINING ATTORNEY

THE MARK CONSISTS OF STANDARD CHARACTERS WITHOUT CLAIM TO ANY PARTICULAR FONT, STYLE, SIZE, OR COLOR.

FOR COMPUTER AND VIDEO GAME PROGRAMS RECORDED ON CARTRIDGES, DISCS, CD-ROMS, CASSETTES, TAPES AND MINI DISCS; VIDEO AND COMPUTER GAME SOFTWARE (U.S. CLS. 21, 23, 26, 36 AND 38).

BRENDAN MCCAULEY, EXAMINING ATTORNEY

CLASS 9—(Continued).

SN 78-538,666. TOSHIBA TRANSPORT ENGINEERING INC., TOKYO, JAPAN, FILED 12-27-2004.



OWNER OF U.S. REG. NO. 2,714,631.
THE COLOR(S) RED, BLUE AND GREEN IS/ARE CLAIMED AS A FEATURE OF THE MARK.

THE COLOR RED APPEARS IN THE OUTERMOST CIRCLE OF THE MARK, THE COLOR BLUE APPEARS IN THE MIDDLE CIRCLE NEXT TO THE RED CIRCLE, THE COLOR GREEN APPEARS IN THE CIRCLE IN THE CENTER OF THE MARK, AND THE COLOR WHITE APPEARS IN THE WORDS AND THE UNDERLINING UNDER THE WORDS IN THE MARK.

FOR ELECTRONIC NOTICE BOARDS (U.S. CLS. 21, 23, 26, 36 AND 38).
ESTHER BELENKER, EXAMINING ATTORNEY

SN 78-538,896. ALUX, INC., BOTHELL, WA. FILED 12-28-2004.

ALUX

THE MARK CONSISTS OF STANDARD CHARACTERS WITHOUT CLAIM TO ANY PARTICULAR FONT, STYLE, SIZE, OR COLOR.

FOR TELEVISION SETS, TELEVISION MONITORS, COMPUTER MONITORS, DVD PLAYERS, AUDIO PRODUCTS, NAMELY STEREO RECEIVERS, PERSONAL MUSIC PLAYERS, AMPLIFIERS, TUNERS, SPEAKERS, HEADPHONES, CD PLAYERS, MINIDISK PLAYERS, CASSETTE TAPE PLAYERS (U.S. CLS. 21, 23, 26, 36 AND 38).

TEJIBIR SINGH, EXAMINING ATTORNEY

CLASS 9—(Continued).

SN 78-538,941. PRIDE BUSINESS DEVELOPMENT HOLDINGS, INC., ENCINO, CA. FILED 12-28-2004.

BODYGUARD

THE MARK CONSISTS OF STANDARD CHARACTERS WITHOUT CLAIM TO ANY PARTICULAR FONT, STYLE, SIZE, OR COLOR.

FOR BULLET RESISTANT PERSONAL BODY ARMOR, STAB RESISTANT PERSONAL BODY ARMOR, BULLET RESISTANT PERSONAL BODY ARMOR CARRIERS, STAB RESISTANT PERSONAL BODY ARMOR CARRIERS (U.S. CLS. 21, 23, 26, 36 AND 38).

JANICE L. MCMORROW, EXAMINING ATTORNEY

SN 78-539,021. AUGUST TECHNOLOGY CORPORATION, BLOOMINGTON, MN. FILED 12-28-2004.

E20

THE MARK CONSISTS OF STANDARD CHARACTERS WITHOUT CLAIM TO ANY PARTICULAR FONT, STYLE, SIZE, OR COLOR.

FOR INSPECTION MODULES FOR USE WITH INSPECTION EQUIPMENT AND DEVICES, NAMELY, EQUIPMENT AND DEVICES THAT SENSE AND/OR CAPTURE IMAGES OF SEMICONDUCTOR AND ELECTRONIC RELATED COMPONENTS INCLUDING SEMICONDUCTOR WAFERS, SEMICONDUCTOR DIE, PACKAGED INTEGRATED CIRCUITS, PRINTED CIRCUIT BOARDS, LIQUID CRYSTAL DISPLAYS, ELECTRONIC DISPLAYS, AND DISK STORAGE MEDIA, AND AUTOMATICALLY INSPECT THESE IMAGES FOR INFORMATION SUCH AS DEFECTS, COORDINATE OR POSITION DETERMINATION, IDENTIFICATION, AND/OR PRESENCE OR ABSENCE OF SOMETHING THEREON (U.S. CLS. 21, 23, 26, 36 AND 38).

YSA DEJESUS, EXAMINING ATTORNEY

CLASS 9—(Continued).

SN 78-539,256. PATIENT CARE TECHNOLOGY SYSTEMS, LLC., ALISO VIEJO, CA. FILED 12-28-2004.

CLASS 9—(Continued).

SN 78-539,310. FIRSTECH, LLC, SEATTLE, WA. FILED 12-28-2004.

Amelior EDTracker

IDATALINK

THE MARK CONSISTS OF STANDARD CHARACTERS WITHOUT CLAIM TO ANY PARTICULAR FONT, STYLE, SIZE, OR COLOR.

NO CLAIM IS MADE TO THE EXCLUSIVE RIGHT TO USE EDTRACKER, APART FROM THE MARK AS SHOWN.

FOR COMPUTER SOFTWARE FOR TRACKING AND COMMUNICATING THE LOCATION AND MEDICAL TREATMENT STATUS OF PATIENTS, AND THE LOCATION OF MEDICAL STAFF AND MEDICAL EQUIPMENT IN HOSPITAL EMERGENCY DEPARTMENTS (U.S. CLS. 21, 23, 26, 36 AND 38).

ALICE BENMAMAN, EXAMINING ATTORNEY

THE MARK CONSISTS OF STANDARD CHARACTERS WITHOUT CLAIM TO ANY PARTICULAR FONT, STYLE, SIZE, OR COLOR.

FOR DATA INTERFACE DEVICE ADAPTED TO COMMUNICATE WITH AN AUTOMOBILE'S COMPUTER THROUGH A COMPUTER DATA PORT, THE DEVICE ALSO ADAPTED TO RECEIVE A SIGNAL TRANSMISSION FROM ANOTHER DEVICE WHICH SIGNAL CONTROLS ONE OR MORE AUTOMOBILE FUNCTIONS, USEFUL FOR AUTOMOBILE DOOR LOCK/UNLOCK, TRUNK RELEASE, AND ENGINE START/DISABLE (U.S. CLS. 21, 23, 26, 36 AND 38).

FIRST USE 9-24-2004; IN COMMERCE 9-24-2004.
DORITT L. CARROLL, EXAMINING ATTORNEY

SN 78-539,270. PATIENT CARE TECHNOLOGY SYSTEMS, LLC., ALISO VIEJO, CA. FILED 12-28-2004.

SN 78-539,320. IVRAS INC., FOSTER CITY, CA. FILED 12-28-2004.

Amelior OPSTracker

IVATRIAL

THE MARK CONSISTS OF STANDARD CHARACTERS WITHOUT CLAIM TO ANY PARTICULAR FONT, STYLE, SIZE, OR COLOR.

FOR COMPUTER SOFTWARE FOR TRACKING AND COMMUNICATING THE LOCATION AND MEDICAL TREATMENT STATUS OF PATIENTS, AND THE LOCATION OF MEDICAL STAFF AND MEDICAL EQUIPMENT IN HOSPITAL OUTPATIENT SERVICE AREAS (U.S. CLS. 21, 23, 26, 36 AND 38).

NAAKWAMA ANKRAH, EXAMINING ATTORNEY

THE MARK CONSISTS OF STANDARD CHARACTERS WITHOUT CLAIM TO ANY PARTICULAR FONT, STYLE, SIZE, OR COLOR.

FOR COMPUTER SOFTWARE FOR USE IN VOICE DATA CAPTURE (U.S. CLS. 21, 23, 26, 36 AND 38).

ALINA MORRIS, EXAMINING ATTORNEY

CLASS 9—(Continued).

SN 78-539,800. RELIASOFT CORPORATION, TUCSON, AZ. FILED 12-29-2004.

CLASS 9—(Continued).

SN 78-540,028. ZIPCAR, INC., CAMBRIDGE, MA. FILED 12-30-2004.

ALTA

FASTFLEET

THE MARK CONSISTS OF STANDARD CHARACTERS WITHOUT CLAIM TO ANY PARTICULAR FONT, STYLE, SIZE, OR COLOR.

FOR COMPUTER SOFTWARE FOR PRODUCT FAILURE ANALYSIS, NAMELY QUANTITATIVE ACCELERATED LIFE TESTING ANALYSIS AS IT APPLIES TO THE FIELD OF RELIABILITY ENGINEERING (U.S. CLS. 21, 23, 26, 36 AND 38).

FIRST USE 6-0-1997; IN COMMERCE 1-0-1998.
DORITT L. CARROLL, EXAMINING ATTORNEY

THE MARK CONSISTS OF STANDARD CHARACTERS WITHOUT CLAIM TO ANY PARTICULAR FONT, STYLE, SIZE, OR COLOR.

FOR COMPUTER PROGRAMS AND COMPUTER HARDWARE FOR SCHEDULING, MAINTAINING, AND COMMUNICATING WITH VEHICLES AND OTHER MOVEABLE HARD ASSETS (U.S. CLS. 21, 23, 26, 36 AND 38).

ALEXANDER L. POWERS, EXAMINING ATTORNEY

SN 78-539,911. SCHEMATODOC ENTERPRISES, PROVIDENCE, RI. FILED 12-30-2004.

SN 78-540,057. GENERAL ELECTRIC COMPANY, SCHECTADY, NY. FILED 12-30-2004.

QueryToDoc

SYMVEO

THE MARK CONSISTS OF STANDARD CHARACTERS WITHOUT CLAIM TO ANY PARTICULAR FONT, STYLE, SIZE, OR COLOR.

FOR COMPUTER SOFTWARE FOR EXPORTING THE RESULTS OF A DATABASE QUERY TO AN ELECTRONIC DOCUMENT (U.S. CLS. 21, 23, 26, 36 AND 38).

FIRST USE 12-18-2004; IN COMMERCE 12-27-2004.
LINDA M. KING, EXAMINING ATTORNEY

THE MARK CONSISTS OF STANDARD CHARACTERS WITHOUT CLAIM TO ANY PARTICULAR FONT, STYLE, SIZE, OR COLOR.

FOR NETWORK CAMERAS FOR USE WITH CLOSED CIRCUIT TELEVISION SECURITY SYSTEMS (U.S. CLS. 21, 23, 26, 36 AND 38).

YSA DEJESUS, EXAMINING ATTORNEY

CLASS 9—(Continued).

SN 78-540,260. ROBIN, STEPHEN LEIGH, SHERMAN OAKS, CA. FILED 12-30-2004.

CREATIVE CONTROL!

THE MARK CONSISTS OF STANDARD CHARACTERS WITHOUT CLAIM TO ANY PARTICULAR FONT, STYLE, SIZE, OR COLOR.
FOR COMPUTER SOFTWARE FOR BUSINESS MANAGEMENT (U.S. CLS. 21, 23, 26, 36 AND 38).
BARBARA RUTLAND, EXAMINING ATTORNEY

SN 78-540,457. LEATHERWOOD, JAMES M., LINGLEVILLE, TX. FILED 12-31-2004.

MALCOLM

THE MARK CONSISTS OF STANDARD CHARACTERS WITHOUT CLAIM TO ANY PARTICULAR FONT, STYLE, SIZE, OR COLOR.
FOR RIFLE SCOPES AND RIFLE SCOPE MOUNTS (U.S. CLS. 21, 23, 26, 36 AND 38).
JILL PRATER, EXAMINING ATTORNEY

CLASS 9—(Continued).

SN 78-541,174. TRS QUALITY, INC., FORT WORTH, TX. FILED 1-3-2005.

PRESIDIAN

THE MARK CONSISTS OF STANDARD CHARACTERS WITHOUT CLAIM TO ANY PARTICULAR FONT, STYLE, SIZE, OR COLOR.
FOR CONSUMER ELECTRONIC PRODUCTS, NAMELY, INDOOR/OUTDOOR SPEAKERS, WALL AND CEILING SPEAKERS, BOOKSHELF SPEAKERS, CD PLAYERS, BOOM BOXES, VCR, VCR/DVD COMBINATIONS, DVD RECORDER, HOME THEATRE SETS, AND STEREO SHELF SYSTEMS COMPRISING STEREO, SPEAKERS, AND ELECTRICAL CONNECTIONS (U.S. CLS. 21, 23, 26, 36 AND 38).
RICHARD A. STRASER, EXAMINING ATTORNEY

SN 78-544,819. NYCE CORPORATION, MONTVALE, NJ. FILED 1-10-2005.

SAFEDEBIT

THE MARK CONSISTS OF STANDARD CHARACTERS WITHOUT CLAIM TO ANY PARTICULAR FONT, STYLE, SIZE, OR COLOR.
FOR COMPUTER SOFTWARE AND ENCRYPTED DATA RECORDED ON CD-ROM DISKS AND MAGNETICALLY ENCODED SMART CARDS CONTAINING PROGRAMMING FOR USE IN VERIFYING, PROCESSING AND COMPLETING FINANCIAL TRANSACTIONS OVER COMPUTER NETWORKS (U.S. CLS. 21, 23, 26, 36 AND 38).
LINDA E. BLOHM, EXAMINING ATTORNEY

CLASS 9—(Continued).

SN 78-545,132. PLANTRONICS, INC., SANTA CRUZ, CA. FILED 1-10-2005.

CLASS 9—(Continued).

SN 78-545,558. BAY CONTROLS, INC., MAUMEE, OH. FILED 1-11-2005.

PERSONOCALL

THE MARK CONSISTS OF STANDARD CHARACTERS WITHOUT CLAIM TO ANY PARTICULAR FONT, STYLE, SIZE, OR COLOR.

FOR SOFTWARE FOR OPERATION, MANAGEMENT AND CONNECTION OF HEADSETS WITH COMPUTERS, INTERNET TELEPHONY, VOICE OVER INTERNET PROTOCOL (VOIP), SOFTPHONES AND TELEPHONES (U.S. CLS. 21, 23, 26, 36 AND 38).

FIRST USE 1-4-2005; IN COMMERCE 1-4-2005.
ESTHER BELENKER, EXAMINING ATTORNEY

WAVESYNC

THE MARK CONSISTS OF STANDARD CHARACTERS WITHOUT CLAIM TO ANY PARTICULAR FONT, STYLE, SIZE, OR COLOR.

FOR POWER FLUCTUATION MONITOR AND CONTROLLERS FOR AC INDUCTION MOTORS (U.S. CLS. 21, 23, 26, 36 AND 38).

KAREN BRACEY, EXAMINING ATTORNEY

SN 78-545,137. SECURITY FRAMEWORKS, LLC, LOS ANGELES, CA. FILED 1-10-2005.

SN 78-545,798. SYMON COMMUNICATIONS, INC., PLANO, TX. FILED 1-11-2005.

ACCENDO

THE MARK CONSISTS OF STANDARD CHARACTERS WITHOUT CLAIM TO ANY PARTICULAR FONT, STYLE, SIZE, OR COLOR.

FOR COMPUTER SOFTWARE FOR USE IN FACILITIES MANAGEMENT, INFRASTRUCTURE OPERATIONS, SECURITY, INCIDENT REPORTS PREPARATION, LOSS PREVENTION, RISK MITIGATION, SAFETY AND EMERGENCY PREPAREDNESS SOLUTIONS, AND MANAGEMENT OF TECHNOLOGY ASSETS AND INFRASTRUCTURE (U.S. CLS. 21, 23, 26, 36 AND 38).

ANN LINNEHAN, EXAMINING ATTORNEY

SYMON COMMUNITY

THE MARK CONSISTS OF STANDARD CHARACTERS WITHOUT CLAIM TO ANY PARTICULAR FONT, STYLE, SIZE, OR COLOR.

OWNER OF U.S. REG. NOS. 2,853,599, 2,857,967 AND 2,912,745.

FOR COMPUTER SOFTWARE FOR PLANNING, BUDGETING AND SCHEDULING OF PERSONNEL IN COMMUNICATION CENTERS TO HANDLE TELEPHONE CALLS, ELECTRONIC MAIL, WEB CHAT AND OTHER FORMS OF COMMUNICATION, WHEREIN PLANNING, BUDGETING AND SCHEDULING ARE BASED ON A DERIVED FORECAST OF REQUIRED LANGUAGE AND TECHNICAL SKILLS, TIME OF DAY AND COMMUNICATION VOLUME (U.S. CLS. 21, 23, 26, 36 AND 38).

FIRST USE 1-31-2004; IN COMMERCE 1-31-2004.
JOHN SCHUYLER YARD, EXAMINING ATTORNEY

CLASS 9—(Continued).

SN 78-546,071. CBS BROADCASTING INC, NEW YORK, NY.
FILED 1-12-2005.

CLASS 9—(Continued).

SN 78-546,774. LIVERMORE SOFTWARE TECHNOLOGY
CORPORATION, LIVERMORE, CA. FILED 1-13-2005.

THE TWILIGHT ZONE

THE MARK CONSISTS OF STANDARD CHARACTERS
WITHOUT CLAIM TO ANY PARTICULAR FONT, STYLE,
SIZE, OR COLOR.

OWNER OF U.S. REG. NOS. 1,398,021, 2,849,149 AND
OTHERS.

FOR DVDS, FEATURING A TELEVISION SERIES (U.S.
CLS. 21, 23, 26, 36 AND 38).

FIRST USE 12-30-2004; IN COMMERCE 12-30-2004.

PAUL E. FAHRENKOPF, EXAMINING ATTORNEY

ls-opt

THE MARK CONSISTS OF STANDARD CHARACTERS
WITHOUT CLAIM TO ANY PARTICULAR FONT, STYLE,
SIZE, OR COLOR.

FOR COMPUTER SOFTWARE FOR USE IN THE
FIELD OF ENGINEERING ANALYSIS (U.S. CLS. 21, 23,
26, 36 AND 38).

FIRST USE 1-1-1999; IN COMMERCE 1-1-1999.

KRISTINA KLOIBER, EXAMINING ATTORNEY

SN 78-546,467. ZOOM EYEWORKS, INC., BERKELEY, CA.
FILED 1-12-2005.

SN 78-546,829. SYNERGON SOLUTIONS, INC., DBA STAN-
CIL SOLUTIONS, MELBOURNE, FL. FILED 1-13-2005.

GUIDELINE

THE MARK CONSISTS OF STANDARD CHARACTERS
WITHOUT CLAIM TO ANY PARTICULAR FONT, STYLE,
SIZE, OR COLOR.

FOR EYEGLASSES, SUNGLASSES, AND EYEGLASS
AND SUNGLASS ACCESSORIES, NAMELY, CASES,
CHAINS, AND LEASHES (U.S. CLS. 21, 23, 26, 36 AND
38).

FIRST USE 7-1-2001; IN COMMERCE 9-1-2001.

MONTIA G. PRESSEY, EXAMINING ATTORNEY

IdentiCall

THE MARK CONSISTS OF STANDARD CHARACTERS
WITHOUT CLAIM TO ANY PARTICULAR FONT, STYLE,
SIZE, OR COLOR.

FOR TELEPHONE RECORDER (U.S. CLS. 21, 23, 26, 36
AND 38).

TEJBIR SINGH, EXAMINING ATTORNEY

CLASS 9—(Continued).

SN 78-547,345. ARTHROPODA PRODUCTIONS, LLC, SANTA MONICA, CA. FILED 1-13-2005.

CLASS 9—(Continued).

SN 78-548,090. CONVERSANT, INC., JOPLIN, MO. FILED 1-14-2005.

ARTHROPODA

THE MARK CONSISTS OF STANDARD CHARACTERS WITHOUT CLAIM TO ANY PARTICULAR FONT, STYLE, SIZE, OR COLOR.

FOR PRE-RECORDED AUDIO COMPACT DISCS FEATURING MUSIC (U.S. CLS. 21, 23, 26, 36 AND 38).

FIRST USE 10-0-2002; IN COMMERCE 10-0-2002.

WENDY GOODMAN, EXAMINING ATTORNEY

CUSTOMER WATCH

THE MARK CONSISTS OF STANDARD CHARACTERS WITHOUT CLAIM TO ANY PARTICULAR FONT, STYLE, SIZE, OR COLOR.

NO CLAIM IS MADE TO THE EXCLUSIVE RIGHT TO USE "CUSTOMER", APART FROM THE MARK AS SHOWN. FOR COMPUTER SOFTWARE FOR CUSTOMER CARE AND BILLING (U.S. CLS. 21, 23, 26, 36 AND 38).

FIRST USE 8-1-2002; IN COMMERCE 8-1-2002.

TEJBIR SINGH, EXAMINING ATTORNEY

SN 78-547,901. NETWORK APPLIANCE, INC., SUNNYVALE, CA. FILED 1-14-2005.

SNAPDIRECTOR

THE MARK CONSISTS OF STANDARD CHARACTERS WITHOUT CLAIM TO ANY PARTICULAR FONT, STYLE, SIZE, OR COLOR.

OWNER OF U.S. REG. NOS. 2,480,545, 2,485,892 AND 2,488,676.

FOR COMPUTER HARDWARE AND SOFTWARE FOR MANAGING THE PROTECTION, BACKUP, REPLICATION, AND RESTORATION OF DATA ON ELECTRONIC DATA STORAGE SYSTEMS, COMPUTER NETWORKS, AND ON ELECTRONIC DATABASES VIA GLOBAL COMPUTER NETWORKS; AND INSTRUCTION AND USER MANUALS SOLD AS A UNIT THEREWITH (U.S. CLS. 21, 23, 26, 36 AND 38).

G. MAYERSCHOFF, EXAMINING ATTORNEY

SN 78-549,069. CENTERPOINTE RESEARCH INSTITUTE, INC., BEAVERTON, OR. FILED 1-18-2005.

THE LIFE PRINCIPLES INTEGRATION PROCESS

THE MARK CONSISTS OF STANDARD CHARACTERS WITHOUT CLAIM TO ANY PARTICULAR FONT, STYLE, SIZE, OR COLOR.

FOR PRERECORDED AUDIO CDS IN THE FIELD OF SELF IMPROVEMENT, RELAXATION, MEDITATION AND PERSONAL GROWTH (U.S. CLS. 21, 23, 26, 36 AND 38).

FIRST USE 4-15-2003; IN COMMERCE 4-15-2003.

ANNE E. GUSTASON, EXAMINING ATTORNEY

CLASS 9—(Continued).

SN 78-549,185. ENFORSYS IP, INC., WHIPPANY, NJ. FILED 1-18-2005.

POLISYS

THE MARK CONSISTS OF STANDARD CHARACTERS WITHOUT CLAIM TO ANY PARTICULAR FONT, STYLE, SIZE, OR COLOR.

FOR COMPUTER SOFTWARE FOR SERVERS, CLIENTS AND MOBILE TERMINALS FOR MANAGING RECORDS, SEARCHING RECORDS, WRITING REPORTS, MANAGING PERSONNEL TIME AND ATTENDANCE, DISPATCHING EMERGENCY VEHICLES AND PERSONNEL, DISASTER RECOVERY AND PROVIDING MEDICAL, SECURITY AND INTELLIGENCE INFORMATION OVER A COMPUTER NETWORK FOR GOVERNMENTAL DEPARTMENTS, GOVERNMENTAL BUREAUS AND CORPORATIONS (U.S. CLS. 21, 23, 26, 36 AND 38).

FIRST USE 1-1-2002; IN COMMERCE 1-1-2002.
NAAKWAMA ANKRAH, EXAMINING ATTORNEY

SN 78-549,605. CHIMENTI, JOHN R., CONCORD, CA. FILED 1-18-2005.

Blue Bayou f/x

THE MARK CONSISTS OF STANDARD CHARACTERS WITHOUT CLAIM TO ANY PARTICULAR FONT, STYLE, SIZE, OR COLOR.

NO CLAIM IS MADE TO THE EXCLUSIVE RIGHT TO USE "F/X", APART FROM THE MARK AS SHOWN.

FOR GUITAR ELECTRONIC EFFECT PEDALS FOR USE WITH SOUND AMPLIFIERS (U.S. CLS. 21, 23, 26, 36 AND 38).

FIRST USE 11-23-2004; IN COMMERCE 11-23-2004.
JUDITH HELFMAN, EXAMINING ATTORNEY

CLASS 9—(Continued).

SN 78-549,898. WELLSCAPE LLC, EUGENE, OR. FILED 1-19-2005.

Physi-Calc

THE MARK CONSISTS OF STANDARD CHARACTERS WITHOUT CLAIM TO ANY PARTICULAR FONT, STYLE, SIZE, OR COLOR.

FOR COMPUTER SOFTWARE FOR USE IN PROVIDING DRUG AND MEDICAL INFORMATION (U.S. CLS. 21, 23, 26, 36 AND 38).

FIRST USE 8-1-2004; IN COMMERCE 8-1-2004.
DAVID H. STINE, EXAMINING ATTORNEY

SN 78-550,274. MCKEON ROLLING STEEL DOOR CO., INC., BROOKLYN, NY. FILED 1-19-2005.

TRUE TEST

THE MARK CONSISTS OF STANDARD CHARACTERS WITHOUT CLAIM TO ANY PARTICULAR FONT, STYLE, SIZE, OR COLOR.

FOR OPERATION MONITOR AND CONTROLLER FOR FIRE DOORS (U.S. CLS. 21, 23, 26, 36 AND 38).

FIRST USE 4-30-1995; IN COMMERCE 4-30-1995.
VIVIAN MICZNIK FIRST, EXAMINING ATTORNEY

CLASS 9—(Continued).

SN 78-550,288. MCKEON ROLLING STEEL DOOR CO., INC.,
BROOKLYN, NY. FILED 1-19-2005.

CLASS 9—(Continued).

SN 78-551,064. INTERGRAPH CORPORATION, HUNTS-
VILLE, AL. FILED 1-20-2005.

AUTO-SET

**Discover what you
can uncover**

THE MARK CONSISTS OF STANDARD CHARACTERS
WITHOUT CLAIM TO ANY PARTICULAR FONT, STYLE,
SIZE, OR COLOR.

OWNER OF U.S. REG. NO. 1,987,744.
SEC. 2(F).
FOR ELECTRONIC CONTROLLER FOR FIRE DOORS
(U.S. CLS. 21, 23, 26, 36 AND 38).
FIRST USE 12-1-1995; IN COMMERCE 12-1-1995.
HEATHER THOMPSON, EXAMINING ATTORNEY

THE MARK CONSISTS OF STANDARD CHARACTERS
WITHOUT CLAIM TO ANY PARTICULAR FONT, STYLE,
SIZE, OR COLOR.

FOR COMPUTER HARDWARE; COMPUTER HARD-
WARE AND SOFTWARE FOR ENHANCING VIDEO,
AND INSTRUCTIONAL MANUALS SOLD THEREWITH
(U.S. CLS. 21, 23, 26, 36 AND 38).
JENNIFER KRISP, EXAMINING ATTORNEY

SN 78-551,061. TRANSPORTATION RESOURCE ASSOCI-
ATES, INC., PHILADELPHIA, PA. FILED 1-20-2005.

SN 78-551,582. AIRWARE, INC., GOLETA, CA. FILED 1-21-
2005.

TransitSafe

EverRipe

THE MARK CONSISTS OF STANDARD CHARACTERS
WITHOUT CLAIM TO ANY PARTICULAR FONT, STYLE,
SIZE, OR COLOR.

FOR COMPUTER SOFTWARE FOR USE IN SAFETY
MANAGEMENT BY TRANSIT AND MASS TRANSPOR-
TATION AGENCIES (U.S. CLS. 21, 23, 26, 36 AND 38).
FIRST USE 9-0-2000; IN COMMERCE 9-0-2000.
ANNE MADDEN, EXAMINING ATTORNEY

THE MARK CONSISTS OF STANDARD CHARACTERS
WITHOUT CLAIM TO ANY PARTICULAR FONT, STYLE,
SIZE, OR COLOR.

FOR NDIR GAS SENSORS TO DETECT RIPENESS OF
FRUITS AND VEGETABLES (U.S. CLS. 21, 23, 26, 36
AND 38).
TRACY CROSS, EXAMINING ATTORNEY

CLASS 9—(Continued).

SN 78-553,414. DAVCO TECHNOLOGY, LLC, SALINE, MI.
FILED 1-25-2005.

CLASS 9—(Continued).

SN 78-554,775. CHARMANT INC., FUKUI-KEN, JAPAN,
FILED 1-27-2005.

EYEMAX

CFX

THE MARK CONSISTS OF STANDARD CHARACTERS
WITHOUT CLAIM TO ANY PARTICULAR FONT, STYLE,
SIZE, OR COLOR.

FOR LIQUID LEVEL SENSORS (U.S. CLS. 21, 23, 26, 36
AND 38).

ATTIYA MALIK, EXAMINING ATTORNEY

THE MARK CONSISTS OF STANDARD CHARACTERS
WITHOUT CLAIM TO ANY PARTICULAR FONT, STYLE,
SIZE, OR COLOR.

FOR EYEGLASS FRAMES (U.S. CLS. 21, 23, 26, 36 AND
38).

STEVEN R. FINE, EXAMINING ATTORNEY

SN 78-553,826. JIWIWI, INC., SOUTH SAN FRANCISCO, CA.
FILED 1-25-2005.

SN 78-555,008. SKYWORKS TECHNOLOGIES, INC., HACK-
ENSACK, NJ. FILED 1-27-2005.

SPOTLOCK

DRIVE FOR DOUGH
PUTT FOR SHOW

THE MARK CONSISTS OF STANDARD CHARACTERS
WITHOUT CLAIM TO ANY PARTICULAR FONT, STYLE,
SIZE, OR COLOR.

FOR COMPUTER SOFTWARE FOR SECURING BOTH
WIRED AND WIRELESS INTERNET CONNECTIONS
AND EMAIL TRANSMISSIONS (U.S. CLS. 21, 23, 26, 36
AND 38).

AMY GEARIN, EXAMINING ATTORNEY

THE MARK CONSISTS OF STANDARD CHARACTERS
WITHOUT CLAIM TO ANY PARTICULAR FONT, STYLE,
SIZE, OR COLOR.

FOR VIDEO GAME AND COMPUTER GAME SOFT-
WARE (U.S. CLS. 21, 23, 26, 36 AND 38).

TEJBIR SINGH, EXAMINING ATTORNEY

CLASS 9—(Continued).

SN 78-555,277. AMERICAN ACOUSTIC DEVELOPMENT, LLC, CHESTERFIELD, MO. FILED 1-27-2005.

CLASS 9—(Continued).

SN 78-555,479. BEAUTY ELITE GROUP INC., HOUSTON, TX. FILED 1-27-2005.

BRIEFCASE

CHE

THE MARK CONSISTS OF STANDARD CHARACTERS WITHOUT CLAIM TO ANY PARTICULAR FONT, STYLE, SIZE, OR COLOR.

FOR AUDIO SPEAKERS AND AUDIO SPEAKERS HAVING INTEGRATED AUDIO AMPLIFIERS (U.S. CLS. 21, 23, 26, 36 AND 38).

JENNIFER WILLISTON, EXAMINING ATTORNEY

THE MARK CONSISTS OF STANDARD CHARACTERS WITHOUT CLAIM TO ANY PARTICULAR FONT, STYLE, SIZE, OR COLOR.

FOR ELECTRIC HAIR CURLERS, ELECTRIC HAIR ROLLERS, ELECTRIC CURLING IRONS, ELECTRIC HAIR CRIMPERS, ELECTRIC HAIR STRAIGHTENERS, HOT AIR HAIR BRUSHES (U.S. CLS. 21, 23, 26, 36 AND 38).

STEVEN JACKSON, EXAMINING ATTORNEY

SN 78-555,465. SIRA TECHNOLOGIES, PASADENA, CA. FILED 1-27-2005.

SN 78-555,550. MECCO PARTNERS LLC, INGOMAR, PA. FILED 1-28-2005.

SIRA

M **ARKIT**

THE MARK CONSISTS OF STANDARD CHARACTERS WITHOUT CLAIM TO ANY PARTICULAR FONT, STYLE, SIZE, OR COLOR.

FOR DEVICES IN THE NATURE OF CHEMICAL INDICATORS, BIOLOGICAL INDICATORS, LIGHT SENSITIVE INDICATORS AND TIME TEMPERATURE INDICATORS FOR DETECTING, TRACKING, MONITORING, AND REPORTING CONTAMINATION OF GOODS, NAMELY, PHARMACEUTICALS, BIOLOGICALS, AND FOOD (U.S. CLS. 21, 23, 26, 36 AND 38).

KEVIN DINALLO, EXAMINING ATTORNEY

FOR FACTORY AUTOMATION SOFTWARE, NAMELY, SOFTWARE TO INTEGRATE MANUFACTURING MACHINE OPERATIONS, TRACK PROBLEMS AND GENERATE PRODUCTION REPORTS (U.S. CLS. 21, 23, 26, 36 AND 38).

STANLEY I. OSBORNE, EXAMINING ATTORNEY

CLASS 9—(Continued).

SN 78-555,787. PASTRE, THOMAS, CRESSKILL, NJ. AND GORGONNE, CAROL, ALPHARETTA, GA. FILED 1-28-2005.

Greeting Cars

THE MARK CONSISTS OF STANDARD CHARACTERS WITHOUT CLAIM TO ANY PARTICULAR FONT, STYLE, SIZE, OR COLOR.

FOR DECORATIVE MAGNETS (U.S. CLS. 21, 23, 26, 36 AND 38).

JENNIFER WILLISTON, EXAMINING ATTORNEY

SN 78-555,858. BOEING MANAGEMENT COMPANY, SEAL BEACH, CA. FILED 1-28-2005.

F-4 PHANTOM II

THE MARK CONSISTS OF STANDARD CHARACTERS WITHOUT CLAIM TO ANY PARTICULAR FONT, STYLE, SIZE, OR COLOR.

FOR COMPUTER GAME PROGRAMS; COMPUTER GAME SOFTWARE; COMPUTER GAME PROGRAMS ON DISKETTE AND CD-ROM SOFTWARE; COMPUTER SOFTWARE PROGRAMS FOR FLIGHT SIMULATION; COMPUTER SOFTWARE PROGRAMS ON CD-ROM FOR USE IN FLIGHT SIMULATION; COMPUTER PERIPHERALS, NAMELY MOUSEPADS (U.S. CLS. 21, 23, 26, 36 AND 38).

JEFFERY COWARD, EXAMINING ATTORNEY

CLASS 9—(Continued).

SN 78-556,858. YOBON INC., SAN JOSE, CA. FILED 1-31-2005.

BUZZVISION

THE MARK CONSISTS OF STANDARD CHARACTERS WITHOUT CLAIM TO ANY PARTICULAR FONT, STYLE, SIZE, OR COLOR.

FOR COMPUTER SOFTWARE FOR CONSOLIDATING, MANAGING AND FACILITATING USE OF ON-LINE ACCOUNTS AND ON-LINE INFORMATION REQUESTS, ENABLING AUTOMATIC SIGN-IN TO ON-LINE ACCOUNTS, AND DISPLAYING IMAGES AND INFORMATION AND PROVIDING NOTIFICATIONS TO THE USER (U.S. CLS. 21, 23, 26, 36 AND 38).

JEFFERY COWARD, EXAMINING ATTORNEY

SN 78-557,272. QUOVADX, INC., ENGLEWOOD, CO. FILED 1-31-2005.



THE COLOR(S) GREEN IS/ARE CLAIMED AS A FEATURE OF THE MARK.

THE MARK CONSISTS OF FOUR LEAF CLOVER LEAF WHICH IS SOLID GREEN.

FOR COMPUTER SOFTWARE, NAMELY ENTERPRISE APPLICATION INTEGRATION SOFTWARE FOR BUSINESS AND ENTERPRISE APPLICATIONS, NAMELY, SOFTWARE FOR USE IN BUSINESS PROCESS MANAGEMENT, APPLICATION INTEGRATION, APPLICATION INTERFACE MONITORING, DISPLAY, DATA CONTROL, AND DATA ACCESS; GRAPHICAL USER INTERFACE SOFTWARE FOR BUSINESS PROCESS MANAGEMENT; COMPUTER SOFTWARE FOR THE MANAGEMENT AND AUTOMATION OF THE EXCHANGE OF INFORMATION AND DATA IN BUSINESS APPLICATIONS; COMPUTER SOFTWARE FOR INTEGRATING BUSINESS APPLICATIONS; INTERFACE MONITORING AND MANAGEMENT COMPUTER SOFTWARE; MANUALS DISTRIBUTED WITH THE FOREGOING (U.S. CLS. 21, 23, 26, 36 AND 38).

LAURIE MAYES, EXAMINING ATTORNEY

CLASS 9—(Continued).

SN 78-557,643. INTERNATIONAL ELECTRONICS, INC., VANCOUVER, WA. FILED 2-1-2005.

CLASS 9—(Continued).

SN 78-559,066. BRUE, VESTA, SANTA BARBARA, CA. FILED 2-2-2005.

CUT THE CORD

THE MARK CONSISTS OF STANDARD CHARACTERS WITHOUT CLAIM TO ANY PARTICULAR FONT, STYLE, SIZE, OR COLOR.

FOR WIRELESS HEADSET FOR USE WITH CELLULAR PHONES, CORDED PHONES, CORDLESS PHONES, AND MUSIC PLAYBACK DEVICES, AND USER MANUALS SOLD THEREWITH (U.S. CLS. 21, 23, 26, 36 AND 38).

APRIL L. RADEMACHER, EXAMINING ATTORNEY

KIDSIGNALS

THE MARK CONSISTS OF STANDARD CHARACTERS WITHOUT CLAIM TO ANY PARTICULAR FONT, STYLE, SIZE, OR COLOR.

FOR ELECTRONIC COMPUTERS USED TO AID COMPLIANCE WITH A MEDICATION OR PHYSICAL THERAPY REGIMEN (U.S. CLS. 21, 23, 26, 36 AND 38).

LINDA ORNDORFF, EXAMINING ATTORNEY

SN 78-558,098. HSI SERVICE CORP., NEWARK, DE. FILED 2-1-2005.

dermis
ELECTRONIC MEDICAL RECORDS

NO CLAIM IS MADE TO THE EXCLUSIVE RIGHT TO USE ELECTRONIC MEDICAL RECORDS, APART FROM THE MARK AS SHOWN.

FOR COMPUTER SOFTWARE FOR OFFICE PRACTICE MANAGEMENT (U.S. CLS. 21, 23, 26, 36 AND 38).

LINDA E. BLOHM, EXAMINING ATTORNEY

SN 78-559,378. WAVESTREAM CORPORATION, SAN DIMAS, CA. FILED 2-2-2005.

SN 78-558,585. SPEAKINGSOLUTIONS, INC., UNION, NE. FILED 2-2-2005.

**SpeakingSolutions,
Inc.**

THE MARK CONSISTS OF STANDARD CHARACTERS WITHOUT CLAIM TO ANY PARTICULAR FONT, STYLE, SIZE, OR COLOR.

NO CLAIM IS MADE TO THE EXCLUSIVE RIGHT TO USE "INC", APART FROM THE MARK AS SHOWN.

FOR SPEECH RECOGNITION SOFTWARE, HEADSETS, MANUALS AND PRINTED MATERIALS SOLD THEREWITH (U.S. CLS. 21, 23, 26, 36 AND 38).

AISHA CLARKE, EXAMINING ATTORNEY

WAVESTREAM

THE MARK CONSISTS OF STANDARD CHARACTERS WITHOUT CLAIM TO ANY PARTICULAR FONT, STYLE, SIZE, OR COLOR.

FOR AMPLIFIERS (U.S. CLS. 21, 23, 26, 36 AND 38).

CIMMERIAN COLEMAN, EXAMINING ATTORNEY

CLASS 9—(Continued).

SN 78-567,443. MINDWORKS LEARNING, INC., ANN ARBOR, MI. FILED 2-15-2005.

**SKATEKIDS EXTREME
LEARNING
ADVENTURES**

THE MARK CONSISTS OF STANDARD CHARACTERS WITHOUT CLAIM TO ANY PARTICULAR FONT, STYLE, SIZE, OR COLOR.

NO CLAIM IS MADE TO THE EXCLUSIVE RIGHT TO USE "LEARNING", APART FROM THE MARK AS SHOWN.

FOR COMPUTER SOFTWARE, NAMELY, EDUCATIONAL SOFTWARE FOR CHILDREN AND ADULTS FEATURING TRAINING AND INSTRUCTIONAL EXERCISES FOR IMPROVING COGNITIVE PROCESSING SKILLS (U.S. CLS. 21, 23, 26, 36 AND 38).

LAURIE MAYES, EXAMINING ATTORNEY

CLASS 9—(Continued).

SN 78-570,842. CLEVELAND UNLIMITED, INC., INDEPENDENCE, OH. FILED 2-18-2005.



FOR CELLULAR TELEPHONES AND RELATED ACCESSORIES IN THE NATURE OF MOBILE PHONE STRAPS, HOLSTERS FOR CARRYING CELLULAR PHONES, SOFTWARE FOR MOBILE PHONES (U.S. CLS. 21, 23, 26, 36 AND 38).

ANN E. SAPPENFIELD, EXAMINING ATTORNEY

SN 78-567,820. PANAMA JACK INTERNATIONAL, INC., ORLANDO, FL. FILED 2-15-2005.

**BLUE MARLIN BY
PANAMA JACK
BRANDS**

THE MARK CONSISTS OF STANDARD CHARACTERS WITHOUT CLAIM TO ANY PARTICULAR FONT, STYLE, SIZE, OR COLOR.

OWNER OF U.S. REG. NOS. 1,776,347, 2,802,253 AND OTHERS.

NO CLAIM IS MADE TO THE EXCLUSIVE RIGHT TO USE "BRANDS", APART FROM THE MARK AS SHOWN.

FOR SUNGLASSES, SUNGLASS CASES, EYEGLASSES, EYEGLASS FRAMES AND EYEGLASS ACCESSORIES NAMELY, CASES, CORDS AND NOSE PADS (U.S. CLS. 21, 23, 26, 36 AND 38).

CAROLINE WOOD, EXAMINING ATTORNEY

SN 78-570,850. CLEVELAND UNLIMITED, INC., INDEPENDENCE, OH. FILED 2-18-2005.



FOR CELLULAR TELEPHONES AND RELATED ACCESSORIES IN THE NATURE OF MOBILE PHONE STRAPS, HOLSTERS FOR CARRYING CELLULAR PHONES, SOFTWARE FOR MOBILE PHONES (U.S. CLS. 21, 23, 26, 36 AND 38).

ANN E. SAPPENFIELD, EXAMINING ATTORNEY

CLASS 9—(Continued).

SN 78-626,590. PANAMA JACK INTERNATIONAL, INC., ORLANDO, FL. FILED 5-10-2005.

CLASS 9—(Continued).

SN 79-000,547. IC! BERLIN BRILLEN GMBH, FED REP GERMANY, FILED 12-22-2003.

PANAMA JACK BEACH CLUB

THE MARK CONSISTS OF STANDARD CHARACTERS WITHOUT CLAIM TO ANY PARTICULAR FONT, STYLE, SIZE, OR COLOR.

OWNER OF U.S. REG. NOS. 1,776,347, 2,802,253 AND OTHERS.

FOR SUNGLASSES, SUNGLASS CASES, EYEGLASSES, EYEGLASS FRAMES AND EYEGLASS ACCESSORIES NAMELY, CASES, CORDS AND NOSE PADS (U.S. CLS. 21, 23, 26, 36 AND 38).

CAROLINE WOOD, EXAMINING ATTORNEY

SN 78-975,925. BELKIN CORPORATION, COMPTON, CA. FILED 6-2-2004.

BLUE SERIES

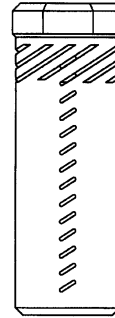

THE MARK CONSISTS OF STANDARD CHARACTERS WITHOUT CLAIM TO ANY PARTICULAR FONT, STYLE, SIZE, OR COLOR.

NO CLAIM IS MADE TO THE EXCLUSIVE RIGHT TO USE SERIES, APART FROM THE MARK AS SHOWN.

FOR SURGE PROTECTORS; UNINTERRUPTABLE POWER SUPPLIES (U.S. CLS. 21, 23, 26, 36 AND 38).

JOHN LINCOSKI, EXAMINING ATTORNEY

SN 79-000,516. MUTOH INDUSTRIES LTD., JAPAN, FILED 12-26-2003.

MUTOH

OWNER OF INTERNATIONAL REGISTRATION 0787504 DATED 8-20-2002, EXPIRES 8-20-2012.

OWNER OF U.S. REG. NO. 1,638,195.

FOR INKJET PRINTERS; LARGE FORMAT INKJET PRINTERS; INKJET PLOTTERS; PRINTERS; PLOTTERS; CUTTING PLOTTERS; SCANNERS; COMPUTERIZED WRITING TABLETS; DIGITIZERS; COMPUTERS; COMPUTER PROGRAMS FOR DRIVING PRINTERS AND/OR PLOTTERS; COMPUTER SOFTWARE FOR PRINTING AND SCANNING LARGE AND SMALL FORMAT DIGITAL COLOR IMAGES; COMPUTER SOFTWARE FOR EDITING COLOR MANAGEMENT AND FOR DOCUMENT MANAGEMENT SUPPORT ON A VARIETY OF OUTPUT DEVICES (U.S. CLS. 21, 23, 26, 36 AND 38).

JENNIFER KRISP, EXAMINING ATTORNEY

PRIORITY DATE OF 7-25-2003 IS CLAIMED. OWNER OF INTERNATIONAL REGISTRATION 0817061 DATED 12-22-2003, EXPIRES 12-22-2013.

THE MARK IS COMPRISED OF A CONFIGURATION OF PACKAGING FOR GOODS, NAMELY A CYLINDRICAL CONTAINER WITH A SCREW TOP CLOSURE COMPRISING A HEXAGONAL LID AT THE TOP OF A SECOND AND SLIGHTLY SMALLER CYLINDER WHICH EXTENDS THE LENGTH OF THE INTERIOR OF THE CONTAINER AND HAS THREADS FOR ENGAGING THE THREADS WITHIN THE UPPER PORTION OF THE CONTAINER PORTION.

SEC. 2(F). FOR SPECTACLES AND SUNGLASSES (U.S. CLS. 21, 23, 26, 36 AND 38).

EUGENIA MARTIN, EXAMINING ATTORNEY

CLASS 9—(Continued).

SN 79-002,364. STMICROELECTRONICS SA, FRANCE,
FILED 3-3-2004.

E-STRAP

THE MARK CONSISTS OF STANDARD CHARACTERS WITHOUT CLAIM TO ANY PARTICULAR FONT, STYLE, SIZE, OR COLOR.

PRIORITY DATE OF 9-18-2003 IS CLAIMED.

OWNER OF INTERNATIONAL REGISTRATION 0824105 DATED 3-3-2004, EXPIRES 3-3-2014.

FOR BLANK ELECTRONIC CHIP CARDS AND STRUCTURAL COMPONENT PARTS THEREFOR; ENCODED ELECTRONIC CHIP CARDS, AND STRUCTURAL COMPONENT PARTS THEREFOR, USED TO STORE INFORMATION; ENCODED ELECTRONIC CHIP CARDS, AND STRUCTURAL COMPONENT PARTS THEREFOR, USED TO STORE INFORMATION AND TO ALLOW PHYSICAL AND MATERIAL ACCESS OR TO ALLOW THE EXCHANGE OF DATA; INTEGRATED CIRCUITS AND STRUCTURAL COMPONENT PARTS THEREFOR; ELECTRONIC TAGS, AND STRUCTURAL COMPONENT PARTS THEREFOR, COMPRISING AN INTEGRATED CIRCUIT CONTAINING HARDWIRED OR SOFTWARE PROGRAMMING MOUNTED OR EMBEDDED THEREIN USED TO RECORD AND STORE INFORMATION; ELECTRONIC TAGS, AND STRUCTURAL COMPONENT PARTS THEREFOR, COMPRISING AN INTEGRATED CIRCUIT CONTAINING HARDWIRED OR SOFTWARE PROGRAMMING MOUNTED OR EMBEDDED THEREIN USED TO RECORD AND STORE INFORMATION FOR THE IDENTIFICATION OF GOODS; ELECTRONIC BADGES, AND STRUCTURAL COMPONENT PARTS THEREFOR, COMPRISING AN INTEGRATED CIRCUIT CONTAINING HARDWIRED OR SOFTWARE PROGRAMMING MOUNTED OR EMBEDDED THEREIN USED TO RECORD AND STORE INFORMATION; AND ELECTRONIC BADGES, AND STRUCTURAL COMPONENT PARTS THEREFOR, COMPRISING AN INTEGRATED CIRCUIT CONTAINING HARDWIRED OR SOFTWARE PROGRAMMING MOUNTED OR EMBEDDED THEREIN USED TO RECORD AND STORE INFORMATION FOR THE IDENTIFICATION OF GOODS (U.S. CLS. 21, 23, 26, 36 AND 38).

ZHALEH DELANEY, EXAMINING ATTORNEY

SN 79-002,818. FELIX FÖRSTER, FED REP GERMANY,
FILED 5-7-2004.

METEX

OWNER OF INTERNATIONAL REGISTRATION 0414102 DATED 2-7-1975, EXPIRES 2-7-2015.

FOR APPARATUS FOR SEARCHING FOR METAL OR FERROMAGNETIC PARTS, AS WELL AS FOR SEARCHING FOR LIVING ORGANISMS, OBJECTS OR PLACES SIGNALLED BY METAL OR FERROMAGNETIC PARTS (U.S. CLS. 21, 23, 26, 36 AND 38).

KAREN K. BUSH, EXAMINING ATTORNEY

CLASS 9—(Continued).

SN 79-002,905. FASTLITE, FRANCE, FILED 12-23-2003.

DAZZLER

PRIORITY DATE OF 8-7-2003 IS CLAIMED.

OWNER OF INTERNATIONAL REGISTRATION 0825987 DATED 12-23-2003, EXPIRES 12-23-2013.

FOR SCIENTIFIC APPARATUS FOR USE IN THE FIELD OF ULTRA FAST LASER, NAMELY ACOUSTO-OPTIC PROGRAMMABLE DEVICE NAMELY TEMPORAL FILTER OF AMPLITUDE AND PHASE STAGE; COMPUTER SOFTWARE PROGRAMS FOR DRIVING THE ACOUSTO-OPTIC PROGRAMMABLE DEVICE, NAMELY TEMPORAL FILTER OF AMPLITUDE AND PHASE STAGE (U.S. CLS. 21, 23, 26, 36 AND 38).

ALEX KEAM, EXAMINING ATTORNEY

SN 79-003,023. ANELDA AB, SWEDEN, FILED 4-30-2004.

CVA

THE MARK CONSISTS OF STANDARD CHARACTERS WITHOUT CLAIM TO ANY PARTICULAR FONT, STYLE, SIZE, OR COLOR.

OWNER OF INTERNATIONAL REGISTRATION 0826300 DATED 4-30-2004, EXPIRES 4-30-2014.

FOR RECORDED COMPUTER PROGRAMS IN THE FIELD OF FINANCIAL MANAGEMENT AND DECISION ANALYSIS USED IN ANALYZING THE FINANCIAL POSITION OF CORPORATIONS ON A CASH FLOW BASIS (U.S. CLS. 21, 23, 26, 36 AND 38).

CHRISIE B. KING, EXAMINING ATTORNEY

SN 79-003,059. SIEMENS AKTIENGESELLSCHAFT, FED REP GERMANY, FILED 5-3-2004.

INTERSPEC

THE MARK CONSISTS OF STANDARD CHARACTERS WITHOUT CLAIM TO ANY PARTICULAR FONT, STYLE, SIZE, OR COLOR.

PRIORITY DATE OF 2-19-2004 IS CLAIMED.

OWNER OF INTERNATIONAL REGISTRATION 0826425 DATED 5-3-2004, EXPIRES 5-3-2014.

FOR SOFTWARE FOR MANAGEMENT OF PRODUCT SPECIFICATIONS QUALITY CONTROL (U.S. CLS. 21, 23, 26, 36 AND 38).

MARK RADEMACHER, EXAMINING ATTORNEY

CLASS 9—(Continued).

SN 79-003,259. BESAM INTERNATIONAL HB, SWEDEN, FILED 4-19-2004.



PRIORITY DATE OF 12-5-2003 IS CLAIMED.
OWNER OF INTERNATIONAL REGISTRATION 0827009 DATED 4-19-2004, EXPIRES 4-19-2014.
OWNER OF U.S. REG. NO. 1,905,289.
THE COLOR(S) BLACK AND GREEN IS/ARE CLAIMED AS A FEATURE OF THE MARK.
THE TRADEMARK CONSISTS OF THE TERMS ENTRE MATIC IN BLACK, WHICH ARE SEPARATED BY TWO TRIANGLES IN GREEN. THE TRIANGLES POINT UPWARDS AND DOWNWARDS.
THE ENGLISH TRANSLATION OF THE WORD ENTRE IN THE MARK IS ENTRANCE OR BETWEEN.
FOR ELECTRONICALLY CONTROLLED, ELECTRO-MECHANIC, ELECTRO-HYDRAULIC AND ELECTRO-PNEUMATIC DOOR OPENERS; ELECTRONIC SENSORS FOR OPENING, CLOSING AND STOPPING OF DOORS FOR ENTRY AND EXIT (U.S. CLS. 21, 23, 26, 36 AND 38).
CIMMERIAN COLEMAN, EXAMINING ATTORNEY

SN 79-003,472. JPK INSTRUMENTS AG, FED REP GERMANY, FILED 5-6-2004.

CellHesion

THE MARK CONSISTS OF STANDARD CHARACTERS WITHOUT CLAIM TO ANY PARTICULAR FONT, STYLE, SIZE, OR COLOR.
PRIORITY DATE OF 11-7-2003 IS CLAIMED.
OWNER OF INTERNATIONAL REGISTRATION 0827679 DATED 5-6-2004, EXPIRES 5-6-2014.
THE MARK IS WRITTEN WITHOUT SPACE BETWEEN "CELL" AND "HESION"; ONLY THE C IN THE BEGINNING OF "CELL" AND THE H IN THE BEGINNING OF HESION ARE WRITTEN IN CAPITAL LETTERS.
FOR MICROSCOPES, NAMELY SCANNING PROBE MICROSCOPES AND ATOMIC FORCE MICROSCOPES FOR ANALYZING AND MANIPULATING SURFACES AT THE NANOMETER SCALE BY MEANS OF A ATOMICALLY FINE TIP, THAT SCANS OVER THE SURFACE OF A SAMPLE (U.S. CLS. 21, 23, 26, 36 AND 38).
JENNIFER KRISP, EXAMINING ATTORNEY

CLASS 9—(Continued).

SN 79-003,499. WOLFSON MICROELECTRONICS PLC, EDINBURGH EH11 2QW, UNITED KINGDOM, FILED 4-23-2004.

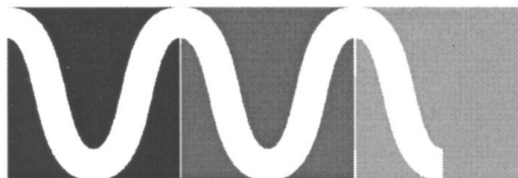

OWNER OF INTERNATIONAL REGISTRATION 0827826 DATED 4-23-2004, EXPIRES 4-23-2014.
THE COLOR GRAY AND WHITE ARE CLAIMED AS A FEATURE OF THE MARK.
THE COLOR WHITE APPEARS IN THE WAVY LINE OF THE DESIGN AND THE COLOR GRAY APPEARS IN EACH OF THE 3 SQUARES THAT SERVE AS A BACKGROUND FOR THE WAVY LINE IN THE DESIGN.
FOR INTEGRATED CIRCUITS; SIGNAL PROCESSORS; SEMICONDUCTOR DEVICES FOR USE IN DATA ACQUISITION; SEMICONDUCTOR DEVICES FOR USE IN DIGITAL COMPUTER INTERFACING; SEMICONDUCTOR DEVICES, NAMELY, DIGITAL IMAGING AND LINEAR INTERFACE DEVICES FOR IMAGING APPLICATIONS; CONVERTERS, NAMELY, SINGLE AND MULTIPLE CHANNEL DIGITAL TO ANALOG AND ANALOG TO DIGITAL CONVERTERS, AND STEREO AUDIO DIGITAL CONVERTERS; POWER MANAGEMENT DEVICES FOR MOBILE COMMUNICATIONS APPLICATIONS, NAMELY, SEMI-CONDUCTOR CHIPS; SEMICONDUCTOR DEVICES FOR USE IN DATA PROCESSING DEVICES FOR COMMUNICATIONS APPLICATIONS; AND PARTS AND FITTINGS FOR ALL THE AFORESAID GOODS (U.S. CLS. 21, 23, 26, 36 AND 38).
TRACY WHITAKER-BOWN, EXAMINING ATTORNEY

SN 79-003,629. OTOWA ELECTRIC CO., LTD, JAPAN, FILED 4-16-2004.

OTOWA

THE MARK CONSISTS OF STANDARD CHARACTERS WITHOUT CLAIM TO ANY PARTICULAR FONT, STYLE, SIZE, OR COLOR.
PRIORITY DATE OF 10-17-2003 IS CLAIMED.
OWNER OF INTERNATIONAL REGISTRATION 0828127 DATED 4-16-2004, EXPIRES 4-16-2014.
THE WORD "OTOWA" IS THE NAME OF AN AREA IN TOKYO AND THE NAME OF A MOUNTAIN IN KYOTO. IN ADDITION, THE WORD "OTOWA" IS USED IN CONNECTION WITH A WATERFALL NAMED "OTOWA-NO-TAKI."
FOR LIGHTNING ARRESTERS; VOLTAGE SURGE PROTECTORS (U.S. CLS. 21, 23, 26, 36 AND 38).
JOHN LINCOSKI, EXAMINING ATTORNEY

CLASS 9—(Continued).

SN 79-003,662. ENDRESS + HAUSER FLOWTEC AG, SWITZERLAND, FILED 6-14-2004.

AGRIMAG

THE MARK CONSISTS OF STANDARD CHARACTERS WITHOUT CLAIM TO ANY PARTICULAR FONT, STYLE, SIZE, OR COLOR.

PRIORITY DATE OF 12-18-2003 IS CLAIMED.

OWNER OF INTERNATIONAL REGISTRATION 0828307 DATED 6-14-2004, EXPIRES 6-14-2014.

FOR FLOWMETERS FOR USE IN MEASURING MASS FLOW OR VOLUME FLOW OF FLOWABLE FLUIDS (U.S. CLS. 21, 23, 26, 36 AND 38).

ANNE E. GUSTASON, EXAMINING ATTORNEY

SN 79-003,682. RAYMARINE LIMITED, UNITED KINGDOM, AND DB RESEARCH LIMITED, BOOTLE, MERSEYSIDE L20 3BG, UNITED KINGDOM, FILED 3-26-2004.

H6

THE MARK CONSISTS OF STANDARD CHARACTERS WITHOUT CLAIM TO ANY PARTICULAR FONT, STYLE, SIZE, OR COLOR.

PRIORITY DATE OF 9-27-2003 IS CLAIMED.

OWNER OF INTERNATIONAL REGISTRATION 0828362 DATED 3-26-2004, EXPIRES 3-26-2014.

FOR ELECTRONIC AND ELECTRICAL APPARATUS AND EQUIPMENT ALL FOR MARINE AND NAUTICAL USE, NAMELY, NAVIGATION APPARATUS, RADAR APPARATUS, FLAT PANEL DISPLAY SCREENS, LCD PANELS, PLASMA DISPLAY PANELS, EQUIPMENT FOR MULTI-MEDIA ENTERTAINMENT IN THE NATURE OF AMPLIFIERS, AUDIO SPEAKERS, SPEAKER HOUSINGS AND REMOTE CONTROLS THEREFOR, CLOSED-CIRCUIT TELEVISION AND VIDEO-SURVEILLANCE INSTALLATIONS AND APPARATUS, RADIO TRANSMITTERS FOR CREW SAFETY TO ALERT ABOUT, AND HELP OBTAIN THE POSITION OF, A PERSON FALLEN OVERBOARD, COMPUTER HARDWARE, TRACKBALLS AND COMPUTER SOFTWARE FOR OPERATING AND INTERFACING ANY OR ALL OF THE FOREGOING; PARTS AND FITTINGS FOR THE AFOREMENTIONED GOODS (U.S. CLS. 21, 23, 26, 36 AND 38).

H. M. FISHER, EXAMINING ATTORNEY

CLASS 9—(Continued).

SN 79-003,698. JSAT KABUSHIKI KAISHA; (JSAT CORPORATION), JAPAN, FILED 6-10-2004.

Lune Q ルネキュー

PRIORITY DATE OF 2-12-2004 IS CLAIMED.

OWNER OF INTERNATIONAL REGISTRATION 0828446 DATED 6-10-2004, EXPIRES 6-10-2014.

THE JAPANESE CHARACTERS IN THE MARK TRANSLITERATE TO THE ROMAN CHARACTER ELEMENTS SHOWN IN THE MARK WHICH MEAN "LUNE-Q" IN THE ENGLISH LANGUAGE.

FOR ANTENNAS; RADIO WAVE LENS FOR USE IN MICROWAVE AND MILLIMETER-WAVE COMMUNICATIONS; AND RADAR REFLECTORS (U.S. CLS. 21, 23, 26, 36 AND 38).

JOANNA DUKOVIC, EXAMINING ATTORNEY

SN 79-003,775. ESCHA BAUELEMENTE GMBH, FED REP GERMANY, AND LUMBERG AUTOMATION COMPONENTS; GMBH + CO. KG, FED REP GERMANY, FILED 3-23-2004.

FIXCON

THE MARK CONSISTS OF STANDARD CHARACTERS WITHOUT CLAIM TO ANY PARTICULAR FONT, STYLE, SIZE, OR COLOR.

OWNER OF INTERNATIONAL REGISTRATION 0828552 DATED 3-23-2004, EXPIRES 3-23-2014.

FOR ELECTRICAL PLUG CONNECTORS (U.S. CLS. 21, 23, 26, 36 AND 38).

PAULA MAYS, EXAMINING ATTORNEY

SN 79-003,916. SIEMENS AKTIENGESSELLSCHAFT, FED REP GERMANY, FILED 5-3-2004.

RCOAX

THE MARK CONSISTS OF STANDARD CHARACTERS WITHOUT CLAIM TO ANY PARTICULAR FONT, STYLE, SIZE, OR COLOR.

PRIORITY DATE OF 2-13-2004 IS CLAIMED.

OWNER OF INTERNATIONAL REGISTRATION 0829094 DATED 5-3-2004, EXPIRES 5-3-2014.

FOR ELECTRIC CABLES (U.S. CLS. 21, 23, 26, 36 AND 38).

MARK RADEMACHER, EXAMINING ATTORNEY

CLASS 9—(Continued).

SN 79-003,988. OTOWA ELECTRIC CO., LTD., JAPAN,
FILED 4-16-2004.



PRIORITY DATE OF 10-17-2003 IS CLAIMED.
OWNER OF INTERNATIONAL REGISTRATION 0829376
DATED 4-16-2004, EXPIRES 4-16-2014.
THE WORD "OTOWA" IS THE NAME OF AN AREA IN
TOKYO AND THE NAME OF A MOUNTAIN IN KYOTO. IN
ADDITION, THE WORD "OTOWA" IS USED IN CONNEC-
TION WITH A WATERFALL NAMED "OTOWA-NO-TAKI."
FOR LIGHTNING ARRESTERS; VOLTAGE SURGE
PROTECTORS (U.S. CLS. 21, 23, 26, 36 AND 38).
JOHN LINCOSKI, EXAMINING ATTORNEY

SN 79-003,990. OTOWA ELECTRIC CO., LTD., JAPAN,
FILED 4-16-2004.

OTOWA ELECTRIC CO.,LTD.

PRIORITY DATE OF 10-17-2003 IS CLAIMED.
OWNER OF INTERNATIONAL REGISTRATION 0829378
DATED 4-16-2004, EXPIRES 4-16-2014.
NO CLAIM IS MADE TO THE EXCLUSIVE RIGHT TO
USE "ELECTRIC CO. LTD.", APART FROM THE MARK AS
SHOWN.
THE WORD "OTOWA" IS THE NAME OF AN AREA IN
TOKYO AND THE NAME OF A MOUNTAIN IN KYOTO. IN
ADDITION, THE WORD "OTOWA" IS USED IN CONNEC-
TION WITH A WATERFALL NAMED "OTOWA-NO-TAKI."
FOR LIGHTNING ARRESTERS, VOLTAGE SURGE
PROTECTORS (U.S. CLS. 21, 23, 26, 36 AND 38).
JOHN LINCOSKI, EXAMINING ATTORNEY

SN 79-004,336. IC! BERLIN BRILLEN GMBH, FED REP
GERMANY, FILED 6-22-2004.

THE MARK CONSISTS OF STANDARD CHARACTERS
WITHOUT CLAIM TO ANY PARTICULAR FONT, STYLE,
SIZE, OR COLOR.
OWNER OF INTERNATIONAL REGISTRATION 0830474
DATED 6-22-2004, EXPIRES 6-22-2014.
FOR SPECTACLES, SUNGLASSES, SPECTACLE
FRAMES, SPECTACLE GLASSES, SPECTACLE CASES
(U.S. CLS. 21, 23, 26, 36 AND 38).
SEAN DWYER, EXAMINING ATTORNEY

CLASS 9—(Continued).

SN 79-004,348. BUFFALO INC., JAPAN, FILED 3-26-2004.

THE MARK CONSISTS OF STANDARD CHARACTERS
WITHOUT CLAIM TO ANY PARTICULAR FONT, STYLE,
SIZE, OR COLOR.

OWNER OF INTERNATIONAL REGISTRATION 0830502
DATED 3-26-2004, EXPIRES 3-26-2014.

FOR CONVERTERS, INCLUDING ELECTRIC CON-
VERTERS; WIRE COMMUNICATION MACHINES AND
APPARATUS, NAMELY, TELEPHONES AND FAX MA-
CHINES; BROADCASTING MACHINES AND APPARA-
TUS, NAMELY, AUDIO SPEAKERS AND AUDIO
AMPLIFIERS; TELEVISION RECEIVERS; TELEVISION
TRANSMITTERS; RADIO COMMUNICATION MA-
CHINES AND APPARATUS, NAMELY, RADIOS, DIS-
PATCH RADIOS, RADIO TRANSMITTERS AND
RECEIVERS; PORTABLE RADIO COMMUNICATION
MACHINES AND APPARATUS, NAMELY, PORTABLE
RADIOS AND MOBILE RADIOS; VIDEO FREQUENCY
MACHINES AND APPARATUS, NAMELY, VIDEO FRE-
QUENCY METERS AND CONVERTERS; PARTS AND
ACCESSORIES FOR TELECOMMUNICATION MA-
CHINES AND APPARATUS, NAMELY, COMPUTER
MOUSE; COMPUTERS; COMPUTER PROGRAMS FOR
IMAGE PROCESSING; COMPUTER NETWORK HARD-
WARE AND PERIPHERALS, NAMELY NETWORK IN-
TERFACE CARDS FOR DATA PROCESSING IN THE
FORM OF PRINT CIRCUITS, MODEMS AND COMPU-
TER FAX MODEM CARDS, WIRELESS MODEMS,
TERMINAL ADAPTERS, HUBS, LOCAL AREA NET-
WORK SWITCHES, WIDE AREA NETWORK SWITCHES,
ROUTERS, SERVERS, PRINT SERVERS, CONCENTRA-
TORS FOR PROVIDING WIRED AND WIRELESS CON-
NECTIVITY BETWEEN LOCAL AND WIDE AREA
NETWORKS, ELECTRICAL CONNECTORS, COMPUTER
CABLES, AND ELECTRONIC CONVERTERS USED AS
INTERFACES BETWEEN COMPUTERS AND TELEVI-
SION SETS THAT ENABLE THE CONVERSION OF
DIGITAL SIGNALS TO IMAGES (U.S. CLS. 21, 23, 26,
36 AND 38).

ZHALEH DELANEY, EXAMINING ATTORNEY

SN 79-004,635. ELECTRONICA INTEGRAL DE SONIDO,
S.A., SPAIN, FILED 4-22-2004.

PRIORITY DATE OF 3-22-2004 IS CLAIMED.
OWNER OF INTERNATIONAL REGISTRATION 0831283
DATED 4-22-2004, EXPIRES 4-22-2014.

THE MARK CONSISTS OF A STYLIZED DESIGN OF A
LOUDSPEAKER ADJACENT TO THE TERM "KBSOUND".
FOR LOUDSPEAKERS, STEREO RECEIVERS, RE-
MOTE CONTROLS FOR STEREO RECEIVERS AND
LOUDSPEAKERS (U.S. CLS. 21, 23, 26, 36 AND 38).

JOHN HWANG, EXAMINING ATTORNEY

CLASS 9—(Continued).

SN 79-004,646. SWISSVOICE AG, SWITZERLAND, AND AASTRA TECHNOLOGIES LIMITED, CANADA, FILED 5-10-2004.



PRIORITY DATE OF 11-13-2003 IS CLAIMED.
OWNER OF INTERNATIONAL REGISTRATION 0831340 DATED 5-10-2004, EXPIRES 5-10-2014.

FOR ELECTRIC CURRENT CONVERTERS, CIRCUITS FOR HEAVY CURRENT, AUDIO CASSETTE RECORDERS AND PLAYERS, DIGITAL VIDEO RECORDERS AND COMPACT DISC PLAYERS; AUTOMATIC VENDING MACHINES AND MECHANISMS FOR COIN-OPERATED APPARATUS; CASH REGISTERS, CALCULATING MACHINES; DATA PROCESSING AND COMPUTER EQUIPMENT, NAMELY, PRIVATE AND PUBLIC AUTOMATED SWITCHBOARDS, TELEPHONES, WIRELESS TELEPHONES, AND PARTS THEREOF, NAMELY, INTELLIGENT BUTTON FOR GUIDING USERS, AND KEYBOARDS (U.S. CLS. 21, 23, 26, 36 AND 38).
PATRICIA EVANKO, EXAMINING ATTORNEY

SN 79-004,839. TARGET SYSTEMELECTRONIC GMBH, FED REP GERMANY, FILED 6-17-2004.

identiFINDER

THE MARK CONSISTS OF STANDARD CHARACTERS WITHOUT CLAIM TO ANY PARTICULAR FONT, STYLE, SIZE, OR COLOR.

PRIORITY DATE OF 12-17-2003 IS CLAIMED.
OWNER OF INTERNATIONAL REGISTRATION 0831892 DATED 6-17-2004, EXPIRES 6-17-2014.

FOR DETECTORS FOR THE MEASUREMENT OF VARIOUS RADIATIONS; PHOTOMULTIPLIERS; MULTI CHANNEL ANALYZERS FOR THE MEASUREMENT OF VARIOUS RADIATIONS; DATA PROCESSORS AND COMPUTERS USED FOR THE DETECTION OF RADIATION (U.S. CLS. 21, 23, 26, 36 AND 38).
RUSS HERMAN, EXAMINING ATTORNEY

CLASS 9—(Continued).

SN 79-005,197. POLYCORE OPTICAL PTE LTD, SINGAPORE, FILED 7-21-2004.

OWNER OF INTERNATIONAL REGISTRATION 0832960 DATED 7-21-2004, EXPIRES 7-21-2014.

THE COLOR BLUE IS CLAIMED AS A FEATURE OF THE MARK.

THE MARK CONSISTS OF THE WORD POLYCORE IN BLUE LETTERS BESIDE A BLUE CURVED LINE DESIGN.

FOR OPHTHALMIC LENSES, OPTICAL FRAMES, OPTICAL GLASSES, OPTICAL LENSES, OPTICAL LENSES FOR USE WITH SPECTACLES, OPTICAL LENSES FOR USE WITH SUNGLASSES, OPTICAL SPECTACLES, OPHTHALMIC FRAMES, OPHTHALMIC GLASSES; SPECTACLE FRAMES, SPECTACLE GLASSES, SPECTACLE LENSES, SPECTACLES (U.S. CLS. 21, 23, 26, 36 AND 38).
KATHY DE JONGE, EXAMINING ATTORNEY

SN 79-005,205. INFINEON TECHNOLOGIES AG, FED REP GERMANY, FILED 6-3-2004.

LOT tec

THE MARK CONSISTS OF STANDARD CHARACTERS WITHOUT CLAIM TO ANY PARTICULAR FONT, STYLE, SIZE, OR COLOR.

PRIORITY DATE OF 2-4-2004 IS CLAIMED.
OWNER OF INTERNATIONAL REGISTRATION 0832991 DATED 6-3-2004, EXPIRES 6-3-2014.

NO CLAIM IS MADE TO THE EXCLUSIVE RIGHT TO USE "TEC", APART FROM THE MARK AS SHOWN.

FOR SEMICONDUCTOR COMPONENTS, NAMELY, DISCRETE AND INTEGRATED COMPONENTS, NAMELY, ANALOG AND DIGITAL CIRCUITS, CHIP PACKAGE COMPRISING SEMICONDUCTOR CHIPS; TRANSISTORS; TRANSCEIVERS; MICROCONTROLLERS AND MICROPROCESSORS; SEMICONDUCTOR MEMORIES (U.S. CLS. 21, 23, 26, 36 AND 38).
ALEX KEAM, EXAMINING ATTORNEY

SN 79-005,375. MERCK KGAA, D-64293 DARMSTADT, FED REP GERMANY, FILED 8-13-2004.

READYQUANT

THE MARK CONSISTS OF STANDARD CHARACTERS WITHOUT CLAIM TO ANY PARTICULAR FONT, STYLE, SIZE, OR COLOR.

PRIORITY DATE OF 2-20-2004 IS CLAIMED.
OWNER OF INTERNATIONAL REGISTRATION 0833487 DATED 8-13-2004, EXPIRES 8-13-2014.

FOR APPARATUS AND INSTRUMENTS FOR SCIENTIFIC PURPOSES, NAMELY, EQUIPMENT AND INSTRUMENTS FOR DETECTING THE PRESENCE OR ABSENCE OF DISEASE-CAUSING AGENTS IN LIQUID SAMPLES (U.S. CLS. 21, 23, 26, 36 AND 38).
DANIEL BRODY, EXAMINING ATTORNEY

CLASS 9—(Continued).

SN 79-005,629. SAES GETTERS S.P.A., ITALY, FILED 5-17-2004.

REL-HY

THE MARK CONSISTS OF STANDARD CHARACTERS WITHOUT CLAIM TO ANY PARTICULAR FONT, STYLE, SIZE, OR COLOR.

PRIORITY DATE OF 4-9-2004 IS CLAIMED.

OWNER OF INTERNATIONAL REGISTRATION 0834072 DATED 5-17-2004, EXPIRES 5-17-2014.

FOR APPARATUS AND INSTRUMENTS FOR SELECTIVE ABSORPTION OF GASES, NAMELY GETTERS (U.S. CLS. 21, 23, 26, 36 AND 38).

MICHAEL ENGEL, EXAMINING ATTORNEY

CLASS 9—(Continued).

SN 79-006,058. BEISSBARTH GMBH, FED REP GERMANY, FILED 6-29-2004.



OWNER OF INTERNATIONAL REGISTRATION 0662611 DATED 9-24-1996, EXPIRES 9-24-2006.

OWNER OF U.S. REG. NO. 2,224,549.

THE COLORS TURQUOISE, ORANGE, LIGHT GREEN ARE CLAIMED AS A FEATURE OF THE MARK.

THE COLOR TURQUOISE APPEARS IN THE WORDING OF THE MARK, THE COLOR LIGHT GREEN APPEARS IN THE CIRCLE AT THE BEGINNING OF THE MARK AND THE COLOR ORANGE APPEARS IN THE MIDDLE OF THE AFORESAID CIRCLE.

FOR DEVICES AND MACHINES FOR SERVICING VEHICLES, NAMELY WHEEL BALANCING DEVICES, WHEEL BALANCING MACHINES, DEVICES AND MACHINES FOR MEASURING THE POSITION OF AUTOMOBILE WHEELS, DEVICES AND MACHINES FOR CHECKING BRAKES, DEVICES AND MACHINES FOR MOUNTING AND CHANGING TIRES, DEVICES AND MACHINES FOR CHECKING SHOCK ABSORBERS, DEVICES FOR TESTING COMBUSTION GASES, DEVICES FOR TESTING ENGINES (U.S. CLS. 21, 23, 26, 36 AND 38).

REBECCA GILBERT, EXAMINING ATTORNEY

SN 79-005,854. HITEX DEVELOPMENT TOOLS GMBH, D-76229 KARLSRUHE, FED REP GERMANY, FILED 8-4-2004.

Tantino

THE MARK CONSISTS OF STANDARD CHARACTERS WITHOUT CLAIM TO ANY PARTICULAR FONT, STYLE, SIZE, OR COLOR.

PRIORITY DATE OF 2-17-2004 IS CLAIMED.

OWNER OF INTERNATIONAL REGISTRATION 0834733 DATED 8-4-2004, EXPIRES 8-4-2014.

FOR ELECTRIC AND ELECTRONIC TESTERS AND ANALYZERS FOR COMPUTER SOFTWARE AND COMPUTER HARDWARE COMPONENTS; SOFTWARE FOR TESTING AND ANALYZING OF SOFTWARE AND HARDWARE COMPONENTS (U.S. CLS. 21, 23, 26, 36 AND 38).

ANGELA M. MICHELI, EXAMINING ATTORNEY

SN 79-006,929. CHINA NATIONAL ELECTRONICS; IMPORT & EXPORT SHENZHEN COMPANY, CHINA, FILED 5-24-2004.



OWNER OF INTERNATIONAL REGISTRATION 0837780 DATED 5-24-2004, EXPIRES 5-24-2014.

FOR APPARATUS FOR RECORDING SOUND OR IMAGES, LOUDSPEAKERS, AMPLIFIERS, RADIOS, MICROPHONES, SOUND BOXES FOR LOUDSPEAKERS, AUDIO CASSETTE PLAYERS AND TAPE RECORDERS, HEADPHONES (U.S. CLS. 21, 23, 26, 36 AND 38).

GINA FINK, EXAMINING ATTORNEY

CLASS 10—MEDICAL APPARATUS

SN 76-522,607. FINE SURGICAL INSTRUMENTS, INC., HEMPSTEAD, NY. FILED 6-13-2003.

KROWN

FOR MEDICAL AND SURGICAL INSTRUMENTS, NAMELY, SCISSORS, HEMOSTATS, NEEDLE HOLDERS, RETRACTORS, CLAMPS, FORCEPS, PROBES, USED IN MEDICAL OPERATING PROCEDURES, ANESTHESIA PROCEDURES, DIAGNOSTIC PROCEDURES, STERILIZING PROCEDURES, GYNECOLOGICAL PROCEDURES, ORAL MAXILLO-FACIAL PROCEDURES, ORTHOPEDIC PROCEDURES, POST MORTEM PROCEDURES, VETERINARY PROCEDURES, AND VARIOUS OTHER GENERAL SURGERY PROCEDURES (U.S. CLS. 26, 39 AND 44).

FIRST USE 1-1-2000; IN COMMERCE 1-1-2000.
TRICIA THOMPCKINS, EXAMINING ATTORNEY

SN 76-522,610. FINE SURGICAL INSTRUMENTS, INC., HEMPSTEAD, NY. FILED 6-13-2003.

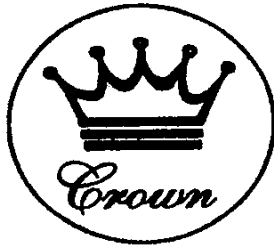

FOR MEDICAL AND SURGICAL INSTRUMENTS, NAMELY SCISSORS, HEMOSTATS, NEEDLE HOLDERS, RETRACTORS, CLAMPS, FORCEPS, PROBES, USED IN MEDICAL OPERATING PROCEDURES, ANESTHESIA PROCEDURES, DIAGNOSTIC PROCEDURES, STERILIZING PROCEDURES, GYNECOLOGICAL PROCEDURES, ORAL MAXILLO-FACIAL PROCEDURES, ORTHOPEDIC PROCEDURES, POST-MORTEM PROCEDURES, VETERINARY PROCEDURES, AND VARIOUS OTHER GENERAL SURGERY PROCEDURES (U.S. CLS. 26, 39 AND 44).

FIRST USE 1-1-1950; IN COMMERCE 1-1-1950.
TRICIA THOMPCKINS, EXAMINING ATTORNEY

SN 76-568,471. PERCARDIA INC., MERRIMACK, NH. FILED 1-6-2004.

VSHUNT

THE MARK CONSISTS OF STANDARD CHARACTERS WITHOUT CLAIM TO ANY PARTICULAR FONT, STYLE, SIZE, OR COLOR.

FOR MEDICAL INSTRUMENTS AND DEVICES, NAMELY, STENTS, STENT-GRAFTS, AND VASCULAR SHUNTS (U.S. CLS. 26, 39 AND 44).

BRIDGETT SMITH, EXAMINING ATTORNEY

CLASS 10—(Continued).

SN 76-593,429. S.S. WHITE TECHNOLOGIES INC., PISCATAWAY, NJ. FILED 5-21-2004.

XTRACT-ALL

THE MARK CONSISTS OF STANDARD CHARACTERS WITHOUT CLAIM TO ANY PARTICULAR FONT, STYLE, SIZE, OR COLOR.

FOR HAND-HELD AND MANUALLY OPERATED MEDICAL TOOLS AND INSTRUMENTS USED IN ORTHOPEDIC IMPLANT REMOVAL PROCEDURES, NAMELY MALLETS, RATCHETS, SOCKETS, WRENCHES, PLIERS, SCREWDRIVERS, UNIVERSAL NAIL AND ROD EXTRACTION SYSTEMS CONSISTING PRIMARILY OF ORTHOPEDIC NAILS AND NAIL ROD EXTRACTORS FOR USE IN ORTHOPEDIC IMPLANT REMOVAL PROCEDURES, UNIVERSAL SPINE IMPLANT REMOVAL SYSTEMS CONSISTING PRIMARILY OF THORACOLUMBAR CONSTRUCT EXTRACTORS, ROD CLAMPING PLIERS, OPEN-END WRENCHES AND COUNTER-TORQUE DRIVERS, UNIVERSAL MAXI RATCHETING SCREWDRIVER SYSTEM CONSISTING PRIMARILY OF BONE SCREWDRIVER SHAFTS AND RATCHETING SCREWDRIVER HANDLE, UNIVERSAL MINI RATCHETING SCREWDRIVER REMOVAL SYSTEM CONSISTING PRIMARILY OF SMALL BONE SCREWDRIVER SHAFTS AND A MINI RATCHETING SCREWDRIVER, UNIVERSAL COMPRESSION HIP SCREW REMOVAL SYSTEM CONSISTING PRIMARILY OF TREPHINES, CHISELS, EXTRACTORS, AND SCREWDRIVER, UNIVERSAL BROKEN BONE SCREW REMOVAL SYSTEM CONSISTING PRIMARILY OF BROKEN BONE EXTRACTOR SHAFTS AND SCREWDRIVER HANDLE, UNIVERSAL STRIPPED BONE SCREW REMOVAL SYSTEM CONSISTING PRIMARILY OF STRIPPED BONE SCREW EXTRACTOR SHAFTS, AND STERILIZATION CASES (U.S. CLS. 26, 39 AND 44).

FIRST USE 3-10-2004; IN COMMERCE 3-10-2004.
JOANNA DUKOVIC, EXAMINING ATTORNEY

SN 76-593,984. SELANE PRODUCTS, INC., DBA SPACE MAINTAINERS LABORATORY, CHATSWORTH, CA. FILED 5-26-2004.

MEMRX

THE MARK CONSISTS OF STANDARD CHARACTERS WITHOUT CLAIM TO ANY PARTICULAR FONT, STYLE, SIZE, OR COLOR.

FOR SPRING-LOADED FIXED ORTHODONTIC APPLIANCES USED FOR EXPANDING ARCHES AND ALIGNING TEETH (U.S. CLS. 26, 39 AND 44).

FIRST USE 5-11-2004; IN COMMERCE 5-11-2004.
WINSTON FOLMAR, EXAMINING ATTORNEY

CLASS 10—(Continued).

SN 76-594,405. ORTHOLOGO, INC., DALLAS, TX. FILED 5-27-2004.

ORTHO-STRIPS-SET

THE MARK CONSISTS OF STANDARD CHARACTERS WITHOUT CLAIM TO ANY PARTICULAR FONT, STYLE, SIZE, OR COLOR.

FOR DENTAL INSTRUMENTS, NAMELY DENTAL STRIPS FOR POLISHING AND REDUCING TOOTH SIZE, CROWNS AND DENTAL RESTORATIONS (U.S. CLS. 26, 39 AND 44).

DANIEL CAPSHAW, EXAMINING ATTORNEY



SN 76-599,178. GALDERMA S.A., CH-6330 CHAM, SWITZERLAND, FILED 6-24-2004.

SILKIDOSE

THE MARK CONSISTS OF STANDARD CHARACTERS WITHOUT CLAIM TO ANY PARTICULAR FONT, STYLE, SIZE, OR COLOR.

FOR RECEPTACLE IN THE NATURE OF A DRUG DELIVERY DEVICE, NAMELY, A HANDHELD APPLICATOR FOR DELIVERING MEASURED AMOUNTS OF MEDICATION TO THE SKIN FOR THE TREATMENT OF DERMATOLOGICAL DISORDERS (U.S. CLS. 26, 39 AND 44).

BRENDAN REGAN, EXAMINING ATTORNEY



SN 76-609,343. PROFOOT, INC., NEW YORK, NY. FILED 8-26-2004.

COMFRATEX

THE MARK CONSISTS OF STANDARD CHARACTERS WITHOUT CLAIM TO ANY PARTICULAR FONT, STYLE, SIZE, OR COLOR.

FOR ORTHOPEDIC SHOE INSERTS AND INSOLES (U.S. CLS. 26, 39 AND 44).

GWEN STOKOLS, EXAMINING ATTORNEY

CLASS 10—(Continued).

SN 76-609,699. DRÄGER MEDICAL AG & CO. KGAA, D-23558 LÜBECK, FED REP GERMANY, FILED 8-27-2004.

SMARTCARE

THE MARK CONSISTS OF STANDARD CHARACTERS WITHOUT CLAIM TO ANY PARTICULAR FONT, STYLE, SIZE, OR COLOR.

FOR MEDICAL RESPIRATORS AND ANESTHETIC DELIVERY MACHINES (U.S. CLS. 26, 39 AND 44).

ALICE SUE CARRUTHERS, EXAMINING ATTORNEY



SN 76-616,102. SCHAEERER MAYFIELD USA, INC., CINCINNATI, OH. FILED 10-15-2004.

UNISPEED

THE MARK CONSISTS OF STANDARD CHARACTERS WITHOUT CLAIM TO ANY PARTICULAR FONT, STYLE, SIZE, OR COLOR.

FOR MEDICAL SURGICAL APPARATUS FOR DRILLING, CUTTING, AND DISSECTING TISSUE AND BONE INCLUDING A PNEUMATIC ROTARY MOTOR AND ASSOCIATED CUTTING, DRILLING AND DISSECTING TOOLS (U.S. CLS. 26, 39 AND 44).

TEJBIR SINGH, EXAMINING ATTORNEY



SN 76-616,103. SCHAEERER MAYFIELD USA, INC., CINCINNATI, OH. FILED 10-15-2004.

UNISPINE

THE MARK CONSISTS OF STANDARD CHARACTERS WITHOUT CLAIM TO ANY PARTICULAR FONT, STYLE, SIZE, OR COLOR.

FOR MEDICAL SURGICAL INSTRUMENTS AND APPARATUS, NAMELY, INTERNAL SPINAL IMPLANTS, PEDICLE SCREWS, SPACERS, PLATES AND STABILIZING ROD INCLUDING MEASURING, POSITIONING, MATING, TENSIONING, TIGHTENING AND EXPANDING INSTRUMENTS FOR IMPLANTS, SCREWS, SPACERS, PLATES AND RODS (U.S. CLS. 26, 39 AND 44).

TEJBIR SINGH, EXAMINING ATTORNEY

CLASS 10—(Continued).

SN 76-619,767. HEALTH ENTERPRISES, INC., NORTH ATTLEBORO, MA. FILED 11-8-2004.

FINGER BUDDIES

THE MARK CONSISTS OF STANDARD CHARACTERS WITHOUT CLAIM TO ANY PARTICULAR FONT, STYLE, SIZE, OR COLOR.

NO CLAIM IS MADE TO THE EXCLUSIVE RIGHT TO USE "FINGER", APART FROM THE MARK AS SHOWN.

FOR SELF-FASTENING STRAP FOR HOLDING A SPRAINED OR BROKEN DIGIT TIGHTLY AGAINST A NEXT ADJACENT DIGIT (U.S. CLS. 26, 39 AND 44).

FIRST USE 1-13-2005; IN COMMERCE 1-13-2005.

JULIE WATSON, EXAMINING ATTORNEY

CLASS 10—(Continued).

SN 76-621,428. MEDEX CARDIO-PULMONARY, INC., CARLSBAD, CA. FILED 11-22-2004.

QUICKSTRAP

THE MARK CONSISTS OF STANDARD CHARACTERS WITHOUT CLAIM TO ANY PARTICULAR FONT, STYLE, SIZE, OR COLOR.

FOR MEDICAL DEVICES, NAMELY, ENDOTRACHEAL TUBE HOLDERS (U.S. CLS. 26, 39 AND 44).

FIRST USE 1-1-1994; IN COMMERCE 1-1-1994.

GIANCARLO CASTRO, EXAMINING ATTORNEY

SN 76-620,858. PRESSURE PRODUCTS MEDICAL SUPPLIES INC., SANTA BARBARA, CA. FILED 11-15-2004.

D-PRO

THE MARK CONSISTS OF STANDARD CHARACTERS WITHOUT CLAIM TO ANY PARTICULAR FONT, STYLE, SIZE, OR COLOR.

FOR VASCULAR INTRODUCERS, NAMELY, SPLITTABLE DIALYSIS INTRODUCERS AND ENDOVASCULAR DIALYSIS INTRODUCERS (U.S. CLS. 26, 39 AND 44).

CAROLYN GRAY, EXAMINING ATTORNEY

SN 76-621,650. F.L.A ORTHOPEDICS, INC., MIRAMAR, FL. FILED 11-22-2004.



NO CLAIM IS MADE TO THE EXCLUSIVE RIGHT TO USE "SUPPORTS", APART FROM THE MARK AS SHOWN.

FOR ORTHOPEDIC SUPPORTS (U.S. CLS. 26, 39 AND 44).

FIRST USE 11-8-2004; IN COMMERCE 11-8-2004.

STEVEN PEREZ, EXAMINING ATTORNEY

SN 76-621,393. REIZENSON, IGOR, SMYRNA, GA. FILED 11-19-2004.

CLEAR SMILE

THE MARK CONSISTS OF STANDARD CHARACTERS WITHOUT CLAIM TO ANY PARTICULAR FONT, STYLE, SIZE, OR COLOR.

FOR DENTAL INSTRUMENTS, NAMELY TEETH AND GUM CLEANING INSTRUMENTS AND APPARATUSSES, DENTAL BLEACHING INSTRUMENTS AND APPARATUSSES, MOUTH CLEANING DEVICES AND APPARATUSSES, AND DENTAL ANESTHETIC DELIVERY DEVICES AND APPARATUSSES (U.S. CLS. 26, 39 AND 44).

PAULA MAHONEY, EXAMINING ATTORNEY

SN 76-621,932. SANI-DOVE L.L.C., LEXINGTON, VA. FILED 11-24-2004.

SANI-DOVE

THE MARK CONSISTS OF STANDARD CHARACTERS WITHOUT CLAIM TO ANY PARTICULAR FONT, STYLE, SIZE, OR COLOR.

FOR PORTABLE DEVICE FOR URINE DISPOSAL (U.S. CLS. 26, 39 AND 44).

KIMBERLY FRYE, EXAMINING ATTORNEY

CLASS 10—(Continued).

SN 76-623,045. BACASTOW, DAVID, ATHENS, GA. FILED 12-3-2004.

CLAVICLE JOYSTICK

THE MARK CONSISTS OF STANDARD CHARACTERS WITHOUT CLAIM TO ANY PARTICULAR FONT, STYLE, SIZE, OR COLOR.

NO CLAIM IS MADE TO THE EXCLUSIVE RIGHT TO USE "CLAVICLE", APART FROM THE MARK AS SHOWN.

FOR MEDICAL DEVICE TO FACILITATE SURGERY ON THE DISTAL CLAVICLE (U.S. CLS. 26, 39 AND 44).
DAWN FELDMAN, EXAMINING ATTORNEY

SN 76-625,316. KINETIKOS MEDICAL INCORPORATED, CARLSBAD, CA. FILED 12-21-2004.

VIPER

THE MARK CONSISTS OF STANDARD CHARACTERS WITHOUT CLAIM TO ANY PARTICULAR FONT, STYLE, SIZE, OR COLOR.

FOR MEDICAL AND SURGICAL APPARATUS, NAMELY, ORTHOPAEDIC INTERNAL FIXATION PLATE FOR RADIAL FRACTURES, PARTS THEREFOR AND INSTRUMENTS TO BE USED IN CONNECTION WITH THE INSERTION OF SUCH FIXATION PLATES (U.S. CLS. 26, 39 AND 44).

JULIE GUTTADAURO, EXAMINING ATTORNEY

SN 76-625,418. AXIS DENTAL CORPORATION, IRVING, TX. FILED 12-22-2004.

PDQ

THE MARK CONSISTS OF STANDARD CHARACTERS WITHOUT CLAIM TO ANY PARTICULAR FONT, STYLE, SIZE, OR COLOR.

FOR DENTAL INSTRUMENTS, NAMELY TOOTH AND DENTAL MATERIAL POLISHERS (U.S. CLS. 26, 39 AND 44).

FIRST USE 6-1-2002; IN COMMERCE 6-1-2002.

NAAKWAMA ANKRAH, EXAMINING ATTORNEY

CLASS 10—(Continued).

SN 76-625,746. BODY-VAC PRODUCTS, INC., GLENDALE HEIGHTS, IL. FILED 12-21-2004.

HEART-IN-SOLE

THE MARK CONSISTS OF STANDARD CHARACTERS WITHOUT CLAIM TO ANY PARTICULAR FONT, STYLE, SIZE, OR COLOR.

FOR FOOT MASSAGE APPARATUS (U.S. CLS. 26, 39 AND 44).

FIRST USE 6-3-2003; IN COMMERCE 10-21-2003.

SOPHIA S. KIM, EXAMINING ATTORNEY

SN 78-156,920. APPLE COMPUTER, INC., CUPERTINO, CA. FILED 8-22-2002.



PRIORITY CLAIMED UNDER SEC. 44(D) ON ERPN CMNTY TM OFC APPLICATION NO. 2593127, FILED 2-26-2002, REG. NO. 002593127, DATED 2-20-2004, EXPIRES 2-26-2012.

OWNER OF U.S. REG. NOS. 113,028, 1,421,062 AND OTHERS.

THE MARK CONSISTS OF THE DESIGN OF AN APPLE WITH A BITE REMOVED.

FOR MEDICAL INSTRUMENTS FOR CARDIOVASCULAR DIAGNOSTICS; X-RAY APPARATUS FOR MEDICAL USE; RADIATION THERAPY MACHINES; ELECTROMAGNETIC MEDICAL DIAGNOSTIC IMAGING APPARATUS AND MEDICAL X-RAY SCANNERS; LASER POINTERS AND LASERS FOR MEDICAL USE; ULTRASONIC MEDICAL DIAGNOSTIC APPARATUS; X-RAY PHOTOGRAPHS FOR MEDICAL PURPOSES; PARTS AND FITTINGS FOR ALL THE AFORESAID GOODS (U.S. CLS. 26, 39 AND 44).

JAMES A. RAUEN, EXAMINING ATTORNEY

SN 78-255,347. HY-VEE, INC., WEST DES MOINES, IA. FILED 5-28-2003.

MOTHER'S CHOICE

FOR BABY PRODUCTS, NAMELY, BABY BOTTLE LINERS (U.S. CLS. 26, 39 AND 44).

KATHERINE STOIDES, EXAMINING ATTORNEY

CLASS 10—(Continued).

SN 78-259,711. KIRK A. MILLER MD, DBA THE BACKJACK LLC, BOISE, ID. FILED 6-8-2003.

OMEGATRAX

FOR PORTABLE LUMBAR TRACTION DEVICE FOR TREATING LOWER BACK PAIN (U.S. CLS. 26, 39 AND 44).

GINA FINK, EXAMINING ATTORNEY

SN 78-283,449. DADE BEHRING MARBURG GMBH, D-35041 MARBURG, FED REP GERMANY, FILED 8-5-2003.

BEP 2000 Advance

THE MARK CONSISTS OF STANDARD CHARACTERS WITHOUT CLAIM TO ANY PARTICULAR FONT, STYLE, SIZE, OR COLOR.

OWNER OF FED REP GERMANY REG. NO. 30337379, DATED 9-16-2003, EXPIRES 9-16-2013.

OWNER OF U.S. REG. NO. 2,110,748.

FOR ANALYTICAL EQUIPMENT FOR MEDICAL AND VETERINARY PURPOSES, NAMELY, ANALYZERS FOR ENZYME IMMUNOASSAYS (U.S. CLS. 26, 39 AND 44).

EDWARD NELSON, EXAMINING ATTORNEY

SN 78-300,760. MEDIMOP MEDICAL PROJECTS LTD., RAANANA, ISRAEL, FILED 9-16-2003.

MIX2VIAL

PRIORITY CLAIMED UNDER SEC. 44(D) ON ISRAEL APPLICATION NO. 166878, FILED 9-11-2003, REG. NO. 166878, DATED 4-5-2005, EXPIRES 9-11-2010.

FOR MEDICAL DEVICES, NAMELY, DISPOSABLE VIAL ADAPTERS ALLOWING MIXING BETWEEN TWO SUBSTANCES IN SEPARATE VIALS AND IMMEDIATE TRANSFER OF THE MIXTURE INTO SYRINGES FOR INJECTIONS (U.S. CLS. 26, 39 AND 44).

TONJA GASKINS, EXAMINING ATTORNEY

SN 78-309,877. VIVATONE HEARING SYSTEMS, LLC, WESTPORT, CT. FILED 10-6-2003.

TOTALLY OPEN CANAL

NO CLAIM IS MADE TO THE EXCLUSIVE RIGHT TO USE OPEN CANAL, APART FROM THE MARK AS SHOWN.

FOR HEARING AIDS AND COMPONENT PARTS THEREOF; HEARING AID ACCESSORIES, NAMELY, PROGRAMMING CABLES THEREFOR (U.S. CLS. 26, 39 AND 44).

TRICIA THOMPSON, EXAMINING ATTORNEY

CLASS 10—(Continued).

SN 78-332,419. POLYMEDICA CORPORATION, BOSTON, MA. FILED 11-24-2003.



FOR BLOOD GLUCOSE METERS; HEMOGLOBIN TEST KITS COMPRISING FILTER PAPER TO COLLECT HEMOGLOBIN SPECIMENS, PLASTIC SPECIMEN BAGS AND INSTRUCTIONS; LANCETS AND LANCING DEVICES; MEDICAL SYRINGES; AND NEBULIZERS FOR RESPIRATION THERAPY (U.S. CLS. 26, 39 AND 44).

FIRST USE 8-1-2001; IN COMMERCE 8-1-2001.

ROBERT COGGINS, EXAMINING ATTORNEY

SN 78-367,382. LANCER ORTHODONTICS, INC., SAN MARCOS, CA. FILED 2-12-2004.

PRAXIS

THE MARK CONSISTS OF STANDARD CHARACTERS WITHOUT CLAIM TO ANY PARTICULAR FONT, STYLE, SIZE, OR COLOR.

FOR ORTHODONTICS DEVICES AND EQUIPMENT, NAMELY, BRACES, BRACKETS, WIRES, ARCHES, AND BUCAL TUBES (U.S. CLS. 26, 39 AND 44).

FIRST USE 5-1-2004; IN COMMERCE 5-1-2004.

TINA L. SNAPP, EXAMINING ATTORNEY

CLASS 10—(Continued).

SN 78-387,077. ASPECT MEDICAL SYSTEMS, INC., NEWTON, MA. FILED 3-18-2004.

BISX

THE MARK CONSISTS OF STANDARD CHARACTERS WITHOUT CLAIM TO ANY PARTICULAR FONT, STYLE, SIZE, OR COLOR.

OWNER OF U.S. REG. NOS. 2,226,557, 2,229,392 AND OTHERS.

FOR ELECTROENCEPHALOGRAPH MONITORS AND SENSORS; MONITORS AND SENSORS FOR USE IN ASSESSING NEUROLOGICAL AND COGNITIVE FUNCTION AND DYSFUNCTION, FOR PREDICTING AND MEASURING RESPONSE TO PSYCHOACTIVE MEDICATIONS, FOR ASSESSING PSYCHOLOGICAL STATE, FOR PERFORMING NEURODIAGNOSTICS AND FOR ASSESSING HYPNOTIC LEVELS AND PATIENT AWARENESS (U.S. CLS. 26, 39 AND 44).
KATHY DE JONGE, EXAMINING ATTORNEY

SN 78-392,010. ABRASMON, MARK, REDWOOD CITY, CA. FILED 3-27-2004.

OASYS ORAL/NASAL AIRWAY SYSTEM

THE MARK CONSISTS OF STANDARD CHARACTERS WITHOUT CLAIM TO ANY PARTICULAR FONT, STYLE, SIZE, OR COLOR.

NO CLAIM IS MADE TO THE EXCLUSIVE RIGHT TO USE "ORAL/NASAL AIRWAY SYSTEM", APART FROM THE MARK AS SHOWN.

FOR DENTAL/MEDICAL DEVICE IN THE NATURE OF AN INTRAORAL MANDIBULAR REPOSITIONER AND NASAL DILATOR TO IMPROVE AND MAINTAIN BREATHING PASSAGE IN THE NOSE AND THROAT FOR TREATMENT OF SNORING AND SLEEP APNEA (U.S. CLS. 26, 39 AND 44).

FIRST USE 3-15-2002; IN COMMERCE 3-15-2003.
WON TEAK OH, EXAMINING ATTORNEY

CLASS 10—(Continued).

SN 78-394,089. MEDRAD, INC., INDIANOLA, PA. FILED 3-31-2004.

ACUMEN

THE MARK CONSISTS OF STANDARD CHARACTERS WITHOUT CLAIM TO ANY PARTICULAR FONT, STYLE, SIZE, OR COLOR.

FOR MEDICAL DEVICES FOR USE IN DIAGNOSTIC, THERAPEUTIC OR INTERVENTIONAL CARDIOVASCULAR PROCEDURES, NAMELY, MEDICAL INJECTORS, SYRINGES, CATHETERS AND DISPOSABLE FLUID PATH TUBING SETS (U.S. CLS. 26, 39 AND 44).
JIM RINGLE, EXAMINING ATTORNEY

SN 78-402,590. SCIENT'X USA, INC., MAITLAND, FL. FILED 4-15-2004.

MX SYSTEM

THE MARK CONSISTS OF STANDARD CHARACTERS WITHOUT CLAIM TO ANY PARTICULAR FONT, STYLE, SIZE, OR COLOR.

NO CLAIM IS MADE TO THE EXCLUSIVE RIGHT TO USE "SYSTEM", APART FROM THE MARK AS SHOWN.

FOR IMPLANTS FOR STABILIZING THE SPINE, NAMELY, LUMBAR PEDICULAR SCREWS, SEMI RIGID PLATES, SCREWS, RODS AND RELATED DEVICES, NAMELY, NUTS, WASHERS, CONNECTING BARS, HOOKS, CAGES, SPACERS, SPRINGS, ARTIFICIAL SPINAL PROSTHESIS, ARTIFICIAL DISC PROSTHESIS; VERTEBRAL BODY REPLACEMENT OR FUSION IMPLANTS, NAMELY, SEMI RIGID PLATES, SCREWS, RODS AND RELATED DEVICES, NAMELY, NUTS, WASHERS, AND CONNECTING BARS (U.S. CLS. 26, 39 AND 44).

FIRST USE 2-0-2004; IN COMMERCE 3-0-2004.
JEFF DEFORD, EXAMINING ATTORNEY

CLASS 10—(Continued).

SN 78-407,589. SPAULDING, THOMAS C., PALM COAST, FL. FILED 4-25-2004.

QuickPik

THE MARK CONSISTS OF STANDARD CHARACTERS WITHOUT CLAIM TO ANY PARTICULAR FONT, STYLE, SIZE, OR COLOR.

FOR ORAL IRRIGATION DEVICE, NAMELY, DENTAL PICK (U.S. CLS. 26, 39 AND 44).
SEAN DWYER, EXAMINING ATTORNEY

CLASS 10—(Continued).

SN 78-407,871. TIOLAT OY, HELSINKI, FINLAND, FILED 4-26-2004.

TonoVet

OWNER OF FINLAND REG. NO. 230633, DATED 6-30-2004, EXPIRES 6-30-2014.

FOR APPARATUS FOR CLINICAL DIAGNOSIS; DEVICES FOR MEASURING INTRAOCULAR PRESSURE; TONOMETERS (U.S. CLS. 26, 39 AND 44).

KIMBERLY PERRY, EXAMINING ATTORNEY

SN 78-407,806. LEVITRONIX LLC, WALTHAM, MA. FILED 4-26-2004.

PediVAS

THE MARK CONSISTS OF STANDARD CHARACTERS WITHOUT CLAIM TO ANY PARTICULAR FONT, STYLE, SIZE, OR COLOR.

FOR CIRCULATORY ASSIST DEVICES, NAMELY BLOOD PUMPS AND ASSOCIATED CONTROLS FOR STABILIZING BLOOD FLOW DURING ACUTE HEART FAILURE AND CIRCULATORY SUPPORT DURING CARDIAC INTERVENTION; PERCUTANEOUS ASSIST DEVICES, NAMELY BLOOD PUMPS, CANNULAE AND ASSOCIATED CONTROLS FOR CONNECTION TO THE CIRCULATORY SYSTEM VIA CANNULAE INSERTED THROUGH THE SKIN FOR STABILIZING BLOOD FLOW DURING ACUTE HEART FAILURE AND CIRCULATORY SUPPORT DURING CARDIAC INTERVENTION; IMPLANTABLE ASSIST DEVICES, NAMELY BLOOD PUMPS AND ASSOCIATED CONTROLS FOR IMPLANTATION IN A PATIENT (U.S. CLS. 26, 39 AND 44).

CATHERINE CAIN, EXAMINING ATTORNEY

SN 78-410,205. DRAEGER MEDICAL SYSTEMS, INC., DANVERS, MA. FILED 4-29-2004.

MONOLEAD

THE MARK CONSISTS OF STANDARD CHARACTERS WITHOUT CLAIM TO ANY PARTICULAR FONT, STYLE, SIZE, OR COLOR.

FOR MEDICAL EQUIPMENT NAMELY, MEDICAL CABLES CAPABLE OF CONVEYING PATIENT PARAMETERS DERIVED FROM PATIENT ATTACHED SENSORS TO PATIENT MONITORING DEVICES (U.S. CLS. 26, 39 AND 44).

FIRST USE 11-19-2003; IN COMMERCE 11-19-2003.

WON TEAK OH, EXAMINING ATTORNEY

CLASS 10—(Continued).

SN 78-418,403. LORDEX, INC., HOUSTON, TX. FILED 5-13-2004.

LDT

THE MARK CONSISTS OF STANDARD CHARACTERS WITHOUT CLAIM TO ANY PARTICULAR FONT, STYLE, SIZE, OR COLOR.

FOR MEDICAL REHABILITATION MACHINES FOR THE TREATMENT OF LOWER BACK PAIN, NAMELY AN EXTENSIBLE TABLE AND HARNESS FOR APPLYING DECOMPRESSION TO THE LOWER BACK (U.S. CLS. 26, 39 AND 44).

FIRST USE 12-2-2004; IN COMMERCE 12-2-2004.
ELLEN PERKINS, EXAMINING ATTORNEY

SN 78-418,919. OHIO WILLOW WOOD COMPANY, THE, MT. STERLING, OH. FILED 5-14-2004.

OWW

THE MARK CONSISTS OF STANDARD CHARACTERS WITHOUT CLAIM TO ANY PARTICULAR FONT, STYLE, SIZE, OR COLOR.

FOR MEDICAL DEVICES FOR AMPUTEES, NAMELY, PROSTHETIC LIMBS; PROSTHETIC LIMB COMPONENTS, NAMELY, PROSTHETIC FEET, ARTIFICIAL ANKLE JOINTS, ARTIFICIAL KNEE JOINTS, PROSTHETIC SOCKET ATTACHMENT BLOCKS, PYRAMID ADAPTERS, PYLONS, SUCTION SUSPENSION MECHANISMS, PIN-LOCK SUSPENSION MECHANISMS, LANYARD SUSPENSION MECHANISMS, SOCKET PADS, VOLUME MANAGEMENT PADS, AIR EXPULSION VALVES, AND COSMETIC COVERS USED FOR COVERING ARTIFICIAL LEGS AND ARTIFICIAL ARMS; ORTHOTIC BRACES FOR KNEES, ANKLES, LEGS, ELBOWS, WRISTS AND ARMS; FITTING SYSTEMS IN THE NATURE OF PROSTHETIC SOCKETS USED TO FASTEN PROSTHETIC LIMBS TO THE BODY; PROSTHETIC LINERS AND SLEEVES FOR LIMBS THAT ACCEPT PROSTHETIC DEVICES (U.S. CLS. 26, 39 AND 44).

FIRST USE 1-1-1972; IN COMMERCE 1-1-1972.
ANDREW RHIM, EXAMINING ATTORNEY

CLASS 10—(Continued).

SN 78-419,875. EMBO-OPTICS, LLC, GLOUCESTER, MA. FILED 5-17-2004.

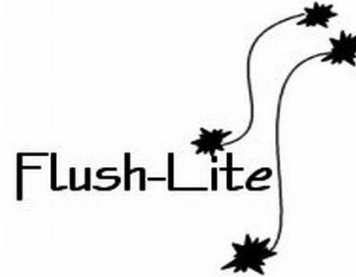

FOR LIGHTS FOR USE IN MEDICAL APPLICATIONS, NAMELY, CHEMICALLY-ACTIVATED LIGHT STICKS FOR MARKING AND HIGHLIGHTING OF INTRAVENOUS FLUIDS AND WITHDRAWAL LINES (U.S. CLS. 26, 39 AND 44).

BARBARA GAYNOR, EXAMINING ATTORNEY

SN 78-420,172. NORTHGATE TECHNOLOGIES INC., ELGIN, IL. FILED 5-17-2004.

FLO-ASSISTANT

THE MARK CONSISTS OF STANDARD CHARACTERS WITHOUT CLAIM TO ANY PARTICULAR FONT, STYLE, SIZE, OR COLOR.

FOR ENDOSCOPIC EQUIPMENT, NAMELY, TUBING SETS AND IRRIGATION PUMPS (U.S. CLS. 26, 39 AND 44).

ANNE E. GUSTASON, EXAMINING ATTORNEY

SN 78-426,187. NEUROLOGICA CORP., DANVERS, MA. FILED 5-27-2004.

NEUROLOGICA

THE MARK CONSISTS OF STANDARD CHARACTERS WITHOUT CLAIM TO ANY PARTICULAR FONT, STYLE, SIZE, OR COLOR.

FOR MEDICAL IMAGING EQUIPMENT, NAMELY, ELECTROMAGNETIC MEDICAL DIAGNOSTIC IMAGING APPARATUS AND PERIPHERALS AND SOFTWARE SOLD AS AN INTEGRAL COMPONENT THEREFORE (U.S. CLS. 26, 39 AND 44).

APRIL L. RADEMACHER, EXAMINING ATTORNEY

CLASS 10—(Continued).

SN 78-426,197. SDGI HOLDINGS, INC., WILMINGTON, DE. FILED 5-27-2004.

BRYAN ACCEL

THE MARK CONSISTS OF STANDARD CHARACTERS WITHOUT CLAIM TO ANY PARTICULAR FONT, STYLE, SIZE, OR COLOR.

OWNER OF U.S. REG. NOS. 2,549,974 AND 2,643,395. FOR SPINAL IMPLANT SURGICAL SYSTEM CONSISTING PRIMARILY OF A SPINAL IMPLANT PROSTHESIS DEVICE AND SURGICAL TOOLS FOR USE IN SURGICAL IMPLANT PROCEDURES (U.S. CLS. 26, 39 AND 44).

JIM RINGLE, EXAMINING ATTORNEY



SN 78-426,502. NEUROLOGICA CORP., DANVERS, MA. FILED 5-27-2004.

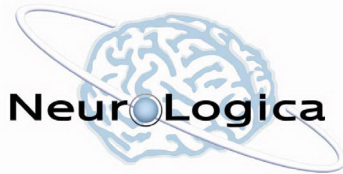

THE COLOR(S) BLUE, WHITE AND BLACK IS/ARE CLAIMED AS A FEATURE OF THE MARK.

THE BLUE IMAGE OF BRAIN ENCIRCLED BY A WHITE RING SHADED IN BLUE, WITH THE STYLIZED WORD NEUROLOGICA SUPERIMPOSED OVER THE BRAIN AND THE RING, WITH A STYLIZED LETTER "O" IN NEUROLOGICA FORMED BY A BLUE CIRCLE WITH A BLACK RING IN SURROUNDING CONFIGURATION, AND WITH THE REMAINDER OF THE LETTERS IN BLACK.

FOR MEDICAL IMAGING EQUIPMENT, NAMELY, ELECTROMAGNETIC MEDICAL DIAGNOSTIC IMAGING APPARATUS AND PERIPHERALS AND SOFTWARE SOLD AS AN INTEGRAL COMPONENT THEREFORE (U.S. CLS. 26, 39 AND 44).

APRIL L. RADEMACHER, EXAMINING ATTORNEY

CLASS 10—(Continued).

SN 78-428,720. LRC PRODUCTS LIMITED, LONDON, UNITED KINGDOM, FILED 6-2-2004.

ELLIPSE

THE MARK CONSISTS OF STANDARD CHARACTERS WITHOUT CLAIM TO ANY PARTICULAR FONT, STYLE, SIZE, OR COLOR.

FOR ELECTRIC AND ELECTRONIC MESSAGE APPARATUS, INSTRUMENTS AND APPLIANCES, NAMELY, ELECTRICAL AND BATTERY OPERATED BODY MASSAGERS, ELECTRICAL AND BATTERY OPERATED PERSONAL MASSAGERS, VIBROMASSAGE APPARATUS; ELECTRICAL AND BATTERY OPERATED VIBRATORS FOR PERSONAL USE; MARITAL AIDS AND SEX AIDS, NAMELY, VIBRATING RINGS, GENITAL RINGS OF METAL OR RUBBER; PARTS AND FITTINGS FOR ALL THE AFORESAID GOODS (U.S. CLS. 26, 39 AND 44).

JOHN LINCOSKI, EXAMINING ATTORNEY



SN 78-428,989. BAMBURGH MARRSH, LLC, VANCOUVER, WA. FILED 6-2-2004.

VERSI-SAL

THE MARK CONSISTS OF STANDARD CHARACTERS WITHOUT CLAIM TO ANY PARTICULAR FONT, STYLE, SIZE, OR COLOR.

FOR MEDICAL DIAGNOSTIC APPARATUS, NAMELY ORAL FLUID ANALYZERS FOR MEASURING SALIVA CONTENT (U.S. CLS. 26, 39 AND 44).

MICHAEL ENGEL, EXAMINING ATTORNEY

CLASS 10—(Continued).

SN 78-438,495. THE SEABERG COMPANY, INC., NEWPORT, OR. FILED 6-21-2004.

CLASS 10—(Continued).

SN 78-439,780. BAUSCH & LOMB INCORPORATED, ROCHESTER, NY. FILED 6-23-2004.

SAM SUGAR TONG

ENVISION

THE MARK CONSISTS OF STANDARD CHARACTERS WITHOUT CLAIM TO ANY PARTICULAR FONT, STYLE, SIZE, OR COLOR.

OWNER OF U.S. REG. NOS. 1,384,137 AND 2,918,142. NO CLAIM IS MADE TO THE EXCLUSIVE RIGHT TO USE "SUGAR TONG", APART FROM THE MARK AS SHOWN.

FOR ORTHOPEDIC SPLINTS, FOREARM ORTHOSES, ANKLE ORTHOSES, ANKLE BRACES, AND FOREARM BRACES (U.S. CLS. 26, 39 AND 44).

LINDA ESTRADA, EXAMINING ATTORNEY

THE MARK CONSISTS OF STANDARD CHARACTERS WITHOUT CLAIM TO ANY PARTICULAR FONT, STYLE, SIZE, OR COLOR.

OWNER OF U.S. REG. NO. 2,314,419. FOR INTRAOCULAR IMPLANTS WHICH RELEASE PHARMACEUTICALS FOR TREATING EYE AND VISION CONDITIONS (U.S. CLS. 26, 39 AND 44).

MARK SPARACINO, EXAMINING ATTORNEY

SN 78-439,484. ABBOTT LABORATORIES, ABBOTT PARK, IL. FILED 6-22-2004.

SN 78-443,170. MACAN ENGINEERING & MANUFACTURING COMPANY, CHICAGO, IL. FILED 6-29-2004.



BAREWIRE

NO CLAIM IS MADE TO THE EXCLUSIVE RIGHT TO USE "RADIO", APART FROM THE MARK AS SHOWN.

FOR MEDICAL INSTRUMENTS, ELECTROSURGICAL INSTRUMENTS AND ATTACHMENTS FOR DENTAL SURGERY, NAMELY- HIGH-FREQUENCY ELECTRICAL ENERGY POWER SUPPLY IN THE NATURE OF ELECTROSURGICAL AND HIGH FREQUENCY SURGICAL GENERATORS; RIGID AND BENDABLE MEDICAL ELECTRODES; DENTAL HANDPIECES; BIPOLAR FORCEPS; ELECTROSURGICAL PADS; THERMOPLASTIC COATED DISPERSIVE PLATES AND DISPERSIVE CORDS; AND DENTAL INSTRUMENTS, NAMELY ELECTROSURGICAL INSTRUMENTS AND ATTACHMENTS FOR DENTAL SURGERY NAMELY; HIGH-FREQUENCY VOLTAGE ELECTRICAL POWER SUPPLY IN THE NATURE OF ELECTROSURGICAL AND HIGH FREQUENCY SURGICAL GENERATORS; RIGID AND BENDABLE MEDICAL ELECTRODES; DENTAL HANDPIECES; BIPOLAR FORCEPS; ELECTROSURGICAL PADS; THERMOPLASTIC COATED DISPERSIVE PLATES AND DISPERSIVE CORDS (U.S. CLS. 26, 39 AND 44).

FIRST USE 12-1-2002; IN COMMERCE 12-1-2002.

ELLEN PERKINS, EXAMINING ATTORNEY

THE MARK CONSISTS OF STANDARD CHARACTERS WITHOUT CLAIM TO ANY PARTICULAR FONT, STYLE, SIZE, OR COLOR.

FOR MEDICAL DEVICES, NAMELY, EMBOLIC PROTECTION DEVICES FOR USE IN VASCULAR PROCEDURES. (U.S. CLS. 26, 39 AND 44).

MATTHEW PAPPAS, EXAMINING ATTORNEY

CLASS 10—(Continued).

SN 78-444,328. COMPEX TECHNOLOGIES, INC., NEW BRIGHTON, MN. FILED 7-1-2004.



NO CLAIM IS MADE TO THE EXCLUSIVE RIGHT TO USE IF, APART FROM THE MARK AS SHOWN.

FOR ELECTROMEDICAL REHABILITATIVE AND PAIN MANAGEMENT PRODUCTS FOR CLINICAL AND HOME USE, NAMELY, TRANSCUTANEOUS ELECTRICAL NERVE STIMULATION DEVICES, ELECTRICAL MUSCLE STIMULATION DEVICES, INTERFERENTIAL DEVICES, HI-VOLT PULSED GALVANIC DEVICES, AND MICROCURRENT ELECTROTHERAPY DEVICES (U.S. CLS. 26, 39 AND 44).

PRISCILLA MILTON, EXAMINING ATTORNEY



SN 78-445,717. PRO-DEX, INC., SANTA ANA, CA. FILED 7-2-2004.

PDL

THE MARK CONSISTS OF STANDARD CHARACTERS WITHOUT CLAIM TO ANY PARTICULAR FONT, STYLE, SIZE, OR COLOR.

FOR DRIVE MOTORS AND HANDPIECE ATTACHMENTS FOR USE WITH ENDODONTIC DENTAL INSTRUMENTS (U.S. CLS. 26, 39 AND 44).

CURTIS FRENCH, EXAMINING ATTORNEY

CLASS 10—(Continued).

SN 78-446,755. GI DYNAMICS, INC., NEWTON, MA. FILED 7-7-2004.

GI SLEEVE

THE MARK CONSISTS OF STANDARD CHARACTERS WITHOUT CLAIM TO ANY PARTICULAR FONT, STYLE, SIZE, OR COLOR.

NO CLAIM IS MADE TO THE EXCLUSIVE RIGHT TO USE GI, APART FROM THE MARK AS SHOWN.

FOR GASTROINTESTINAL LINERS (U.S. CLS. 26, 39 AND 44).

KHANH LE, EXAMINING ATTORNEY



SN 78-447,025. HAPCAM, INC., FARMINGDALE, NY. FILED 7-7-2004.

ANACONDOM

THE MARK CONSISTS OF STANDARD CHARACTERS WITHOUT CLAIM TO ANY PARTICULAR FONT, STYLE, SIZE, OR COLOR.

FOR CONDOMS (U.S. CLS. 26, 39 AND 44).

LINDA POWELL, EXAMINING ATTORNEY

CLASS 10—(Continued).

SN 78-453,213. MEDICAL INDUSTRIES AMERICA, INC., ADEL, IA. FILED 7-20-2004.

CLASS 10—(Continued).

SN 78-457,935. FISHER AND PAYKEL HEALTHCARE LIMITED, AUCKLAND, NEW ZEALAND, FILED 7-28-2004.

EVO

THE MARK CONSISTS OF STANDARD CHARACTERS WITHOUT CLAIM TO ANY PARTICULAR FONT, STYLE, SIZE, OR COLOR.

FOR MEDICAL DEVICES FOR THE TREATMENT OF RESPIRATORY DISORDERS, NAMELY RESPIRATORY MONITORING EQUIPMENT, INHALERS, VENTILATORS AND NEBULIZERS (U.S. CLS. 26, 39 AND 44).

ELLEN PERKINS, EXAMINING ATTORNEY

SN 78-455,612. INVATEC S.R.L., 25030 RONCADELLE (BRES-CIA), ITALY, FILED 7-23-2004.

MARIS

THE MARK CONSISTS OF STANDARD CHARACTERS WITHOUT CLAIM TO ANY PARTICULAR FONT, STYLE, SIZE, OR COLOR.

OWNER OF ITALY REG. NO. 907981, DATED 9-17-2003, EXPIRES 7-9-2013.

FOR SURGICAL AND MEDICAL DEVICES, NAMELY CATHETERS; AND PERMANENT METAL PROSTHESIS FOR THE TREATMENT OF OBSTRUCTIVE PERIPHERAL ARTERY DISEASES AND OBSTRUCTIVE CORONARY ARTERY DISEASES, NAMELY, PERIPHERAL STENTS AND CORONARY STENTS (U.S. CLS. 26, 39 AND 44).

MARK T. MULLEN, EXAMINING ATTORNEY

THERMOSMART

THE MARK CONSISTS OF STANDARD CHARACTERS WITHOUT CLAIM TO ANY PARTICULAR FONT, STYLE, SIZE, OR COLOR.

PRIORITY CLAIMED UNDER SEC. 44(D) ON NEW ZEALAND APPLICATION NO. 715552, FILED 7-20-2004, REG. NO. 715552, DATED 7-20-2004, EXPIRES 7-20-2014.

FOR MEDICAL APPARATUS AND INSTRUMENTS, NAMELY, RESPIRATORS AND ARTIFICIAL RESPIRATION APPARATUS; APPARATUS FOR MEDICAL USE, NAMELY, HUMIDIFIERS; MEDICAL APPARATUS, NAMELY, VENTILATION AND NON-INVASIVE VENTILATION APPARATUS AND INSTRUMENTS; MEDICAL APPARATUS AND INSTRUMENTS FOR CONTINUOUS POSITIVE AIRWAY PRESSURE, ALSO KNOWN AS CPAP AND BI-LEVEL THERAPY; MEDICAL APPARATUS, NAMELY, HUMIDIFIERS AND METERS FOR CONTINUOUS POSITIVE AIRWAY PRESSURE, ALSO KNOWN AS CPAP AND BI-LEVEL THERAPY; MEDICAL APPARATUS, NAMELY, SLEEP APNEA MONITORS; MEDICAL APPARATUS, NAMELY, FACIAL MASKS, ORAL MASKS, NASAL MASKS, MOUTHPIECES, NASAL GUARDS, FACIAL GUARDS, AND HEADGEAR FOR USE BY PATIENTS; PARTS AND FITTINGS FOR ALL THE AFOREMENTIONED GOODS (U.S. CLS. 26, 39 AND 44).

DAVID MURRAY, EXAMINING ATTORNEY

SN 78-459,493. BETA HOLDINGS, INC, EAST HANOVER, NJ. FILED 7-30-2004.



NO CLAIM IS MADE TO THE EXCLUSIVE RIGHT TO USE "TAPE", APART FROM THE MARK AS SHOWN.

THE MARK CONSISTS OF THE LETTERS EZ WITHIN A CIRCLE FOLLOWED BY THE WORD TAPE.

FOR ORTHOPEDIC CASTING TAPE (U.S. CLS. 26, 39 AND 44).

JOHN WILKE, EXAMINING ATTORNEY

CLASS 10—(Continued).

SN 78-481,369. SMITH & NEPHEW, INC., MEMPHIS, TN.
FILED 9-10-2004.

EMPERION

THE MARK CONSISTS OF STANDARD CHARACTERS WITHOUT CLAIM TO ANY PARTICULAR FONT, STYLE, SIZE, OR COLOR.

FOR ORTHOPAEDIC JOINT IMPLANTS, NAMELY HIP STEMS; STERILIZATION CASES FOR MEDICAL PURPOSES; AND SURGICAL INSTRUMENTS FOR USE IN IMPLANTING HIP STEMS, NAMELY, MILLING FRAMES, REAMERS, CUTTERS, TRIAL REMOVAL HANDLES, IMPACTORS, BROACHES, HAMMERS, TRIAL REMOVAL HOOKS, AND OSTEOTOMY GUIDES (U.S. CLS. 26, 39 AND 44).

NELSON SNYDER, EXAMINING ATTORNEY

SN 78-490,523. POLY-MED, INC., ANDERSON, SC. FILED 9-28-2004.

BACTOPRENE

THE MARK CONSISTS OF STANDARD CHARACTERS WITHOUT CLAIM TO ANY PARTICULAR FONT, STYLE, SIZE, OR COLOR.

FOR DRUG DELIVERY SYSTEM COMPRISING A POLYMERIC COMPOSITE FOR INSERTION INTO A BODY CAVITY FOR THE RELEASE OF ANTIBACTERIAL AGENTS (U.S. CLS. 26, 39 AND 44).

ROBIN CHOSID, EXAMINING ATTORNEY

CLASS 10—(Continued).

SN 78-497,020. GENERAL ELECTRIC COMPANY, SCHE-
NECTADY, NY. FILED 10-8-2004.

TRUVOLUME

THE MARK CONSISTS OF STANDARD CHARACTERS WITHOUT CLAIM TO ANY PARTICULAR FONT, STYLE, SIZE, OR COLOR.

FOR ULTRASOUND MEDICAL IMAGING APPARATUS CONSISTING OF SOFTWARE, COMPUTER HARDWARE AND TRANSDUCERS FOR MULTIDIMENSIONAL MEDICAL IMAGING (U.S. CLS. 26, 39 AND 44).

MATTHEW PAPPAS, EXAMINING ATTORNEY

SN 78-500,725. BIEDERMANN MOTECH GMBH, VS-
SCHWENNINGEN, FED REP GERMANY, FILED 10-15-
2004.

DYNA-CAGE

THE MARK CONSISTS OF STANDARD CHARACTERS WITHOUT CLAIM TO ANY PARTICULAR FONT, STYLE, SIZE, OR COLOR.

OWNER OF FED REP GERMANY REG. NO. 30422339,
DATED 7-5-2004, EXPIRES 4-30-2014.

FOR SURGICAL, MEDICAL, DENTAL AND VETERINARY APPARATUS AND INSTRUMENTS, NAMELY, ARTIFICIAL LIMBS, EYES AND TEETH; ORTHOPEDIC ARTICLES, NAMELY, SURGICAL IMPLANTS COMPRISING ARTIFICIAL MATERIALS; SUTURES (U.S. CLS. 26, 39 AND 44).

ANDREA SAUNDERS, EXAMINING ATTORNEY

CLASS 10—(Continued).

SN 78-501,615. INNOVATION SPORTS, INC., FOOTHILL RANCH, CA. FILED 10-18-2004.

CLASS 10—(Continued).

SN 78-513,987. BECTON, DICKINSON AND COMPANY, FRANKLIN LAKES, NJ. FILED 11-9-2004.

GEL FIT

ACE GOLD

THE MARK CONSISTS OF STANDARD CHARACTERS WITHOUT CLAIM TO ANY PARTICULAR FONT, STYLE, SIZE, OR COLOR.

NO CLAIM IS MADE TO THE EXCLUSIVE RIGHT TO USE "GEL", APART FROM THE MARK AS SHOWN.

FOR LINERS AND CONDYLAR PADS FOR ORTHOPEDIC BRACES (U.S. CLS. 26, 39 AND 44).
CAROLINE WOOD, EXAMINING ATTORNEY

THE MARK CONSISTS OF STANDARD CHARACTERS WITHOUT CLAIM TO ANY PARTICULAR FONT, STYLE, SIZE, OR COLOR.

OWNER OF U.S. REG. NOS. 1,141,176 AND 1,399,295. FOR MEDICAL HOSIERY, NAMELY, COMPRESSION PANTYHOSE (U.S. CLS. 26, 39 AND 44).

FIRST USE 10-31-2004; IN COMMERCE 10-31-2004.
ANDREA SAUNDERS, EXAMINING ATTORNEY

SN 78-514,150. LENORE HENNING ENTERPRISES, INC., GLEN ELLYN, IL. FILED 11-9-2004.

SN 78-510,538. JENERIC/PENTRON, INC., WALLINGFORD, CT. FILED 11-3-2004.

FIBREKLEER

**Bringing Safety
Back to the
Bedside**

THE MARK CONSISTS OF STANDARD CHARACTERS WITHOUT CLAIM TO ANY PARTICULAR FONT, STYLE, SIZE, OR COLOR.

OWNER OF U.S. REG. NO. 2,127,868. FOR ENDODONTIC DENTAL POSTS (U.S. CLS. 26, 39 AND 44).
LINDA MICKLEBURGH, EXAMINING ATTORNEY

THE MARK CONSISTS OF STANDARD CHARACTERS WITHOUT CLAIM TO ANY PARTICULAR FONT, STYLE, SIZE, OR COLOR.

FOR MEDICAL APPARATUS, NAMELY, A CLASP THAT ATTACHES TO HOSPITAL BEDS FOR THE PURPOSE OF HOLDING AND DISENTANGLING PATIENT MEDICAL TUBING (U.S. CLS. 26, 39 AND 44).
ALLISON SCHRODY, EXAMINING ATTORNEY

CLASS 10—(Continued).

SN 78-515,811. FULL LIFE PRODUCTS, LLC, MOORESTOWN, NJ. FILED 11-12-2004.

FULL LIFE PRODUCTS

THE MARK CONSISTS OF STANDARD CHARACTERS WITHOUT CLAIM TO ANY PARTICULAR FONT, STYLE, SIZE, OR COLOR.

NO CLAIM IS MADE TO THE EXCLUSIVE RIGHT TO USE "PRODUCTS", APART FROM THE MARK AS SHOWN. FOR WALKING AIDS FOR MEDICAL PURPOSES, CANES FOR MEDICAL PURPOSES, CRUTCHES (U.S. CLS. 26, 39 AND 44).

ALINA MORRIS, EXAMINING ATTORNEY

SN 78-517,776. ADVANCED STENT TECHNOLOGIES, INC., PLEASANTON, CA. FILED 11-16-2004.

SLK-VIEW

THE MARK CONSISTS OF STANDARD CHARACTERS WITHOUT CLAIM TO ANY PARTICULAR FONT, STYLE, SIZE, OR COLOR.

OWNER OF U.S. REG. NOS. 2,705,084 AND 2,933,458. FOR MEDICAL DEVICES FOR THE DELIVERY OF STENTS (U.S. CLS. 26, 39 AND 44).

FIRST USE 10-23-2002; IN COMMERCE 10-23-2002.
JOHN HWANG, EXAMINING ATTORNEY

CLASS 10—(Continued).

SN 78-518,368. MEDLINE INDUSTRIES, INC., MUNDELEIN, IL. FILED 11-17-2004.

EUDERMIC

THE MARK CONSISTS OF STANDARD CHARACTERS WITHOUT CLAIM TO ANY PARTICULAR FONT, STYLE, SIZE, OR COLOR.

FOR GLOVES FOR MEDICAL USE (U.S. CLS. 26, 39 AND 44).

FIRST USE 0-0-1969; IN COMMERCE 0-0-1969.

KARANENDRA S. CHHINA, EXAMINING ATTORNEY

SN 78-518,696. JOHNSON & JOHNSON, NEW BRUNSWICK, NJ. FILED 11-17-2004.

STERRAD NX

THE MARK CONSISTS OF STANDARD CHARACTERS WITHOUT CLAIM TO ANY PARTICULAR FONT, STYLE, SIZE, OR COLOR.

FOR STERILIZATION UNIT USED TO STERILIZE MEDICAL AND SURGICAL EQUIPMENT (U.S. CLS. 26, 39 AND 44).

KAREN BRACEY, EXAMINING ATTORNEY

CLASS 10—(Continued).

SN 78-519,472. COOK INCORPORATED, BLOOMINGTON, IN. FILED 11-18-2004.

RISE

THE MARK CONSISTS OF STANDARD CHARACTERS WITHOUT CLAIM TO ANY PARTICULAR FONT, STYLE, SIZE, OR COLOR.

FOR RAPID EXCHANGE DELIVERY SYSTEM FOR A SELF-EXPANDING STENT (U.S. CLS. 26, 39 AND 44).
ZACHARY BELLO, EXAMINING ATTORNEY

SN 78-519,856. SMITHS MEDICAL ASD, INC., KEENE, NH. FILED 11-19-2004.

AQUINOX

THE MARK CONSISTS OF STANDARD CHARACTERS WITHOUT CLAIM TO ANY PARTICULAR FONT, STYLE, SIZE, OR COLOR.

FOR RESPIRATORY THERAPY AND CARE UNITS (U.S. CLS. 26, 39 AND 44).
FLORENTINA BLANDU, EXAMINING ATTORNEY

CLASS 10—(Continued).

SN 78-521,156. PARI GMBH SPEZIALISTEN FUER EFFEKTIVE INHALATION, STARNBERG, FED REP GERMANY, FILED 11-22-2004.



PRIORITY CLAIMED UNDER SEC. 44(D) ON ERPN CMNTY TM OFC APPLICATION NO. 004079596, FILED 10-19-2004.

NO CLAIM IS MADE TO THE EXCLUSIVE RIGHT TO USE TECHNOLOGY, APART FROM THE MARK AS SHOWN.

THE MARK CONSISTS OF THE WORDS TOUCHSPRAY TECHNOLOGY UNDERNEATH A DESIGN CONSISTING OF A LARGE SOLID CIRCLE WITH SMALLER SOLID CIRCLES EMANATING FROM THE RIGHT SIDE OF THE LARGER CIRCLE, FORMING AN ARROW OR POINT.

FOR MEDICAL AND HEALTH APPARATUS AND INSTRUMENTS, NAMELY INHALATION, ATOMIZATION, RADIATION, VAPORIZATION, AIR-SPRAYING AND GAS-SPRAYING APPARATUS AND INSTRUMENTS, VACUUM FILTRATION APPARATUS AND INSTRUMENTS (U.S. CLS. 26, 39 AND 44).

FIRST USE 10-14-2004; IN COMMERCE 10-14-2004.
ANN LINNEHAN, EXAMINING ATTORNEY

SN 78-521,255. AA ADVANCED TECHNOLOGY INC., CHICAGO, IL. FILED 11-22-2004.

MESOS

THE MARK CONSISTS OF STANDARD CHARACTERS WITHOUT CLAIM TO ANY PARTICULAR FONT, STYLE, SIZE, OR COLOR.

FOR MEDICAL DEVICES, NAMELY, A TRANSDERMAL DRUG DELIVERY DEVICE USING ELECTROPORATION (U.S. CLS. 26, 39 AND 44).

TONI HICKEY, EXAMINING ATTORNEY

CLASS 10—(Continued).

SN 78-523,482. MEDTRONIC, INC., MINNEAPOLIS, MN. FILED 11-29-2004.

CLASS 10—(Continued).

SN 78-524,177. NELLCOR PURITAN BENNETT INCORPORATED, PLEASANTON, CA. FILED 11-30-2004.

SENSIA

DREAMFIT

THE MARK CONSISTS OF STANDARD CHARACTERS WITHOUT CLAIM TO ANY PARTICULAR FONT, STYLE, SIZE, OR COLOR.

FOR IMPLANTABLE HEART PACEMAKERS AND ASSOCIATED CONTROLLER APPARATUS (U.S. CLS. 26, 39 AND 44).

JOHN DALIER, EXAMINING ATTORNEY

THE MARK CONSISTS OF STANDARD CHARACTERS WITHOUT CLAIM TO ANY PARTICULAR FONT, STYLE, SIZE, OR COLOR.

FOR RESPIRATORY THERAPEUTIC APPARATUS, NAMELY A MASK FOR TREATING PATIENTS WITH SLEEP APNEA (U.S. CLS. 26, 39 AND 44).

DOUGLAS LEE, EXAMINING ATTORNEY

SN 78-523,965. VEGA GRIESHABER KG, WOLFACH, FED REP GERMANY, FILED 11-29-2004.

SN 78-536,173. VAN GIESON, DAVID C, THOUSAND OAKS, CA. FILED 12-21-2004.

VEGA BIO-EXPERT

BEVERAGE BUDDY

THE MARK CONSISTS OF STANDARD CHARACTERS WITHOUT CLAIM TO ANY PARTICULAR FONT, STYLE, SIZE, OR COLOR.

FOR MEDICAL APPARATUS AND INSTRUMENTS, IN PARTICULAR BIOFEEDBACK APPARATUS (U.S. CLS. 26, 39 AND 44).

FIRST USE 5-1-2001; IN COMMERCE 5-1-2001.
CAROLYN GRAY, EXAMINING ATTORNEY

THE MARK CONSISTS OF STANDARD CHARACTERS WITHOUT CLAIM TO ANY PARTICULAR FONT, STYLE, SIZE, OR COLOR.

NO CLAIM IS MADE TO THE EXCLUSIVE RIGHT TO USE "BEVERAGE", APART FROM THE MARK AS SHOWN. FOR DRINKING STRAW SPECIALLY ADAPTED FOR USE BY HANDICAPPED INDIVIDUALS (U.S. CLS. 26, 39 AND 44).

REBECCA GILBERT, EXAMINING ATTORNEY

CLASS 10—(Continued).

SN 78-538,453. ESSEN NUTRITION CORPORATION, ROMEOVILLE, IL. FILED 12-27-2004.

CLASS 10—(Continued).

SN 78-539,939. FLIP EASY INC., BRAMPTON, ONTARIO, CANADA, FILED 12-30-2004.

LORD OF LIFE

BREAK THROUGH IN PROTECTION

THE MARK CONSISTS OF STANDARD CHARACTERS WITHOUT CLAIM TO ANY PARTICULAR FONT, STYLE, SIZE, OR COLOR.
FOR MALE CONDOMS (U.S. CLS. 26, 39 AND 44).
CYNTHIA SLOAN, EXAMINING ATTORNEY

THE MARK CONSISTS OF STANDARD CHARACTERS WITHOUT CLAIM TO ANY PARTICULAR FONT, STYLE, SIZE, OR COLOR.
NO CLAIM IS MADE TO THE EXCLUSIVE RIGHT TO USE "PROTECTION", APART FROM THE MARK AS SHOWN.
FOR PROPHYLACTIC DEVICES FOR THE PREVENTION OF DISEASE AND CONCEPTION IN THE NATURE OF CONDOMS (U.S. CLS. 26, 39 AND 44).
JEAN IM, EXAMINING ATTORNEY

SN 78-538,458. ESSEN NUTRITION CORPORATION, ROMEOVILLE, IL. FILED 12-27-2004.

LORD OF LOVE

GO ALL IN!

THE MARK CONSISTS OF STANDARD CHARACTERS WITHOUT CLAIM TO ANY PARTICULAR FONT, STYLE, SIZE, OR COLOR.
FOR MALE CONDOMS (U.S. CLS. 26, 39 AND 44).
CYNTHIA SLOAN, EXAMINING ATTORNEY

SN 78-540,648. WASON, ERIC H, SAN FRANCISCO, CA. FILED 12-31-2004.

SN 78-538,976. VERAXIS INT'L INC., TELLURIDE, CO. FILED 12-28-2004.

Experiment

THE MARK CONSISTS OF STANDARD CHARACTERS WITHOUT CLAIM TO ANY PARTICULAR FONT, STYLE, SIZE, OR COLOR.
FOR CONDOMS (U.S. CLS. 26, 39 AND 44).
JILL C. ALT, EXAMINING ATTORNEY

THE MARK CONSISTS OF STANDARD CHARACTERS WITHOUT CLAIM TO ANY PARTICULAR FONT, STYLE, SIZE, OR COLOR.
FOR PROPHYLACTICS, NAMELY CONDOMS (U.S. CLS. 26, 39 AND 44).
WILLIAM P. SHANAHAN, EXAMINING ATTORNEY

CLASS 10—(Continued).

SN 78-541,728. ASAHI KASEI MEDICAL CO., LTD., TOKYO, JAPAN, FILED 1-4-2005.

CLASS 10—(Continued).

SN 78-544,197. DUSA PHARMACEUTICALS, INC., WILMINGTON, MA. FILED 1-7-2005.

Vie

THE MARK CONSISTS OF STANDARD CHARACTERS WITHOUT CLAIM TO ANY PARTICULAR FONT, STYLE, SIZE, OR COLOR.

FOR ARTIFICIAL KIDNEYS, HOLLOW FIBER DIALYZERS, HEMOFILTERS (U.S. CLS. 26, 39 AND 44).
FRED MANDIR, EXAMINING ATTORNEY

THE MARK CONSISTS OF STANDARD CHARACTERS WITHOUT CLAIM TO ANY PARTICULAR FONT, STYLE, SIZE, OR COLOR.

FOR PHOTOTHERAPY LAMP FOR MEDICAL USE FOR USE IN THE TREATMENT OF DERMATOLOGIC CONDITIONS (U.S. CLS. 26, 39 AND 44).

FIRST USE 11-5-2004; IN COMMERCE 11-5-2004.
SEAN DWYER, EXAMINING ATTORNEY

PANALIGHT-BLU

SN 78-544,889. VERAXIS INT'L INC., TELLURIDE, CO. FILED 1-10-2005.

SN 78-543,931. DRISKILL, CLAUDE V., FOREST, VA. FILED 1-7-2005.

Breathe Healthy

THE MARK CONSISTS OF STANDARD CHARACTERS WITHOUT CLAIM TO ANY PARTICULAR FONT, STYLE, SIZE, OR COLOR.

FOR RESPIRATORY MASKS FOR MEDICAL PURPOSES (U.S. CLS. 26, 39 AND 44).
JOHN WILKE, EXAMINING ATTORNEY

FEEL

THE MARK CONSISTS OF STANDARD CHARACTERS WITHOUT CLAIM TO ANY PARTICULAR FONT, STYLE, SIZE, OR COLOR.

FOR PROPHYLACTICS, NAMELY CONDOMS (U.S. CLS. 26, 39 AND 44).
TEJBIR SINGH, EXAMINING ATTORNEY

CLASS 10—(Continued).

SN 78-546,527. KALTENBACH & VOIGT GMBH, BIBERACH, FED REP GERMANY, FILED 1-12-2005.

CLASS 10—(Continued).

SN 78-550,139. W.M.S. TRADE GROUP INTERNATIONAL, INC., SARASOTA, FL. FILED 1-19-2005.

KAVO

MassagerToes

THE MARK CONSISTS OF STANDARD CHARACTERS WITHOUT CLAIM TO ANY PARTICULAR FONT, STYLE, SIZE, OR COLOR.

OWNER OF U.S. REG. NOS. 597,438, 2,352,527 AND 2,668,237.

FOR DENTAL DRILLING MACHINES, DRIVES THEREFOR, NAMELY, FLEXIBLE HOSE TUBING, ARTICULATED SLIDING CONNECTIONS, RODS, RIGID AND FLEXIBLE; DRIVE SHAFTS; HARD AND ANGLE PIECES ATTACHED TO THE DRIVE AND DRILLING MACHINES (U.S. CLS. 26, 39 AND 44).

FIRST USE 0-0-1978; IN COMMERCE 0-0-1980.

MELVIN AXILBUND, EXAMINING ATTORNEY

THE MARK CONSISTS OF STANDARD CHARACTERS WITHOUT CLAIM TO ANY PARTICULAR FONT, STYLE, SIZE, OR COLOR.

FOR BODY AND FOOT MASSAGERS (U.S. CLS. 26, 39 AND 44).

FIRST USE 10-29-2004; IN COMMERCE 10-29-2004.

STEVEN R. FOSTER, EXAMINING ATTORNEY

SN 78-548,521. CONKIN SURGICAL INSTRUMENTS, LLC, OLD LYME, CT. FILED 1-17-2005.

SN 78-554,806. DAVIS, DAVID T., BETHLEHEM, PA. FILED 1-27-2005.

VALTCHEV

TRANSMAXX

THE MARK CONSISTS OF STANDARD CHARACTERS WITHOUT CLAIM TO ANY PARTICULAR FONT, STYLE, SIZE, OR COLOR.

FOR SURGICAL INSTRUMENTS USED IN GYNECOLOGY AND UROLOGY (U.S. CLS. 26, 39 AND 44).

FIRST USE 12-10-1975; IN COMMERCE 12-10-1975.

BARBARA BROWN, EXAMINING ATTORNEY

THE MARK CONSISTS OF STANDARD CHARACTERS WITHOUT CLAIM TO ANY PARTICULAR FONT, STYLE, SIZE, OR COLOR.

FOR AIR MATTRESS FOR TRANSFER OF MEDICAL PATIENTS (U.S. CLS. 26, 39 AND 44).

DOMINICK J. SALEMI, EXAMINING ATTORNEY

CLASS 10—(Continued).

SN 78-555,228. GLENGOWAN B.V., THE NETHERLANDS, NETHERLANDS, FILED 1-27-2005.

SUTUREAID

THE MARK CONSISTS OF STANDARD CHARACTERS WITHOUT CLAIM TO ANY PARTICULAR FONT, STYLE, SIZE, OR COLOR.

FOR SURGICAL INSTRUMENT COMPRISING CUSTOMIZED FORCEPS OR ENDOSCOPIC INSTRUMENT DESIGNED TO FACILITATE THE SUTURING PROCESS FOR USE IN DIAGNOSIS AND SURGERY (U.S. CLS. 26, 39 AND 44).

IRENE D. WILLIAMS, EXAMINING ATTORNEY

SN 78-558,901. ABBOTT LABORATORIES, ABBOTT PARK, IL. FILED 2-2-2005.

OCC

THE MARK CONSISTS OF STANDARD CHARACTERS WITHOUT CLAIM TO ANY PARTICULAR FONT, STYLE, SIZE, OR COLOR.

FOR STENTS (U.S. CLS. 26, 39 AND 44).

MONTIA G. PRESSEY, EXAMINING ATTORNEY

SN 78-976,130. RAMOND, GERARD, GRAGNAGUE, FRANCE, FILED 12-31-2002.

LES COMPLEXES BIOTECHNIQUES

FOR MEDICAL AND SURGICAL APPARATUS AND INSTRUMENTS IN THE NATURE OF COSMETOLOGY EQUIPMENT, NAMELY, ELECTRIC APPARATUS FOR THE FACE AND BODY MASSAGE USING STIMULATION, IONIZATION, LOW FREQUENCY VIBRATION, AND ULTRASONIC (U.S. CLS. 26, 39 AND 44).

FIRST USE 1-29-2001; IN COMMERCE 1-29-2001.

JEAN IM, EXAMINING ATTORNEY

CLASS 10—(Continued).

SN 79-000,704. AESCULAP AG & CO. KG, D-78532 TUTTLINGEN, FED REP GERMANY, FILED 11-26-2003.

ERGOPLANT

THE MARK CONSISTS OF STANDARD CHARACTERS WITHOUT CLAIM TO ANY PARTICULAR FONT, STYLE, SIZE, OR COLOR.

OWNER OF INTERNATIONAL REGISTRATION 0817795 DATED 11-26-2003, EXPIRES 11-26-2013.

FOR DENTAL INSTRUMENTS, NAMELY, SURGICAL FORCEPS, ATRAUMATIC FORCEPS, SOFT TISSUE FORCEPS, TOWEL HOLDING FORCEPS, PICKS, BURRS AND MIRRORS, MIRROR HOLDERS, CHEEK RETRACTORS, VESTIBULUM HOOKS, SOFT TISSUE HOOKS, TONGUE RETRACTORS, TONGUE SPATULAS, ORAL SILICONE WEDGES, CHAINS WITH CLIP LOCK FOR USE IN DENTISTRY, RASPATORIES, SPECIAL LUCAS SPOON FOR USE IN DENTISTRY, EXCAVATORS, CURETTES, FILES, BONE FILES, FURCATION PROBES, PERITOMES FOR USE IN SURGICAL DENTISTRY, NAMELY, THIN BLADED INSTRUMENTS, SOFT TISSUE SPOONS, SPATULAS, PAPILLA ELEVATOR, KNIVES, BONE CUTTING FORCEPS, BONE CHISELS, BONE CONDENSERS, SINUS ELEVATORS, SINUTOME STRAIGHT, NAMELY, SINUS LIFT TOOLS WITH EFFICIENCY IN BONE CONDENSATION, AUGMENTATION, AND BONE IMPLANTOLOGY MEMBRANE PLACEMENT INSTRUMENTS (U.S. CLS. 26, 39 AND 44).

JOHN GARTNER, EXAMINING ATTORNEY

SN 79-004,559. HOCOMA AG, SWITZERLAND, FILED 7-15-2004.

Lokomat

THE MARK CONSISTS OF STANDARD CHARACTERS WITHOUT CLAIM TO ANY PARTICULAR FONT, STYLE, SIZE, OR COLOR.

OWNER OF INTERNATIONAL REGISTRATION 0831087 DATED 7-15-2004, EXPIRES 7-15-2014.

FOR APPARATUS FOR PHYSICAL TRAINING FOR MEDICAL USE (U.S. CLS. 26, 39 AND 44).

DAVID C. REIHNER, EXAMINING ATTORNEY

CLASS 10—(Continued).

SN 79-004,833. ASTRA TECH AB, SWEDEN, FILED 7-1-2004.



OWNER OF INTERNATIONAL REGISTRATION 0831876 DATED 7-1-2004, EXPIRES 7-1-2014.

NO CLAIM IS MADE TO THE EXCLUSIVE RIGHT TO USE 'TECH' AND 'IMPLANTS', APART FROM THE MARK AS SHOWN.

"THE DESIGN PORTION OF THE MARK CONSISTS OF A STYLIZED VERSION OF THE LETTER 'A'."

FOR DENTAL APPARATUS AND INSTRUMENTS, NAMELY DENTAL IMPLANTS, DENTAL BRIDGES, DENTAL DRILLS; ARTIFICIAL TEETH; ARTIFICIAL JAWS; DENTAL TOOLS IN THE NATURE OF DENTAL BURRS FOR CUTTING AND GRINDING DENTAL MATERIAL; DENTAL PINS FOR ANCHORING ARTIFICIAL TEETH (U.S. CLS. 26, 39 AND 44).

ZHALEH DELANEY, EXAMINING ATTORNEY

SN 79-006,346. IMPELLA CARDIOSYSTEMS AG, FED REP GERMANY, FILED 8-10-2004.

RECOVER

THE MARK CONSISTS OF STANDARD CHARACTERS WITHOUT CLAIM TO ANY PARTICULAR FONT, STYLE, SIZE, OR COLOR.

OWNER OF INTERNATIONAL REGISTRATION 0836122 DATED 8-10-2004, EXPIRES 8-10-2014.

FOR BLOOD PUMPS (U.S. CLS. 26, 39 AND 44).

LA TONIA FISHER, EXAMINING ATTORNEY

SN 79-006,576. BINDEFELD HERVÉ, FRANCE, FILED 9-17-2004.

STETHOFLUX

THE MARK CONSISTS OF STANDARD CHARACTERS WITHOUT CLAIM TO ANY PARTICULAR FONT, STYLE, SIZE, OR COLOR.

OWNER OF INTERNATIONAL REGISTRATION 0836815 DATED 9-17-2004, EXPIRES 9-17-2014.

FOR MEDICAL APPARATUS AND INSTRUMENTS, NAMELY STETHOSCOPES AND ULTRASONOGRAPHIC DIAGNOSTIC APPARATUS (U.S. CLS. 26, 39 AND 44).

LA TONIA FISHER, EXAMINING ATTORNEY

CLASS 11—ENVIRONMENTAL CONTROL APPARATUS

SN 76-499,598. WAHL CLIPPER CORPORATION, STERLING, IL. FILED 3-24-2003.

COMPLEMENT

FOR HAND HELD ELECTRIC HAIR DRYERS (U.S. CLS. 13, 21, 23, 31 AND 34).

TRICIA SONNEBORN, EXAMINING ATTORNEY

SN 76-533,407. AKTIEBOLAGET ELECTROLUX, SE-105 45 STOCKHOLM, SWEDEN, FILED 7-30-2003.

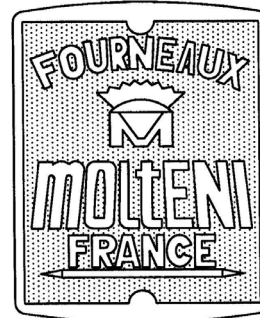

NO CLAIM IS MADE TO THE EXCLUSIVE RIGHT TO USE FOURNEAUX, APART FROM THE MARK AS SHOWN. THE STIPPLING IS FOR SHADING PURPOSES.

THE MARK CONSISTS OF IN PART, THE LETTER "M". THE FOREIGN WORDING IN THE MARK TRANSLATES INTO ENGLISH AS FURNACES.

FOR COMMERCIAL AND DOMESTIC COOKING APPLIANCES, NAMELY GAS AND ELECTRIC RANGES, STOVES, OVENS, SALAMANDERS AND ROTISSERIES (U.S. CLS. 13, 21, 23, 31 AND 34).

FIRST USE 12-31-2000; IN COMMERCE 12-31-2000.

MICHAEL ENGEL, EXAMINING ATTORNEY

SN 76-549,092. TRUCK-LITE CO., INC., FALCONER, NY. FILED 10-6-2003.

SUPER 10

OWNER OF U.S. REG. NOS. 366,340, 2,717,810 AND OTHERS.

FOR LIGHTING PRODUCTS FOR VEHICLES, NAMELY, HEADLIGHTS; TAIL LIGHTS; MARKER LIGHTS; CLEARANCE LIGHTS; IDENTIFICATION LIGHTS; STOP LIGHTS; TURN LIGHTS; LIGHTING KITS COMPRISED OF LAMPS, GROMMETS, PLUGS AND FLANGES; LICENSE PLATE LIGHTS; BACK-UP LIGHTS; INTERIOR AND UTILITY LIGHTS; SNOW PLOW LIGHTS; FOG AND DRIVING LIGHTS; DAY-TIME RUNNING LIGHTS; AND FLASHING LIGHTS (U.S. CLS. 13, 21, 23, 31 AND 34).

FIRST USE 7-3-1991; IN COMMERCE 7-3-1991.

DOMINIC J. FERRAIUOLO, EXAMINING ATTORNEY

CLASS 11—(Continued).

SN 76-554,379. AMERICAN PERMANENT WARE COMPANY, DALLAS, TX. FILED 10-8-2003.

X*WAV

THE MARK CONSISTS OF STANDARD CHARACTERS WITHOUT CLAIM TO ANY PARTICULAR FONT, STYLE, SIZE, OR COLOR.

FOR FOOD SERVICE EQUIPMENT, NAMELY, ELECTRIC EQUIPMENT FOR COOKING, PREPARING, STORING, SERVING AND DISPENSING FOOD AND BEVERAGES, NAMELY, ELECTRIC GRIDDLES, BROTHERS, ELECTRIC FRYERS, ELECTRIC STEAMERS, ELECTRIC HOT PLATES, OVENS, AND TOASTERS (U.S. CLS. 13, 21, 23, 31 AND 34).

FIRST USE 6-0-2003; IN COMMERCE 6-0-2003.

STANLEY I. OSBORNE, EXAMINING ATTORNEY

SN 76-562,438. NOVOCO LTD., ST. PETER PORT, GUERNSEY, FILED 11-14-2003.

CUSTOMAIR *Teba*

OWNER OF U.S. REG. NOS. 2,122,946 AND 2,492,829. FOR VENTILATING AIR CONDITIONING UNITS, FAN-COIL UNITS FOR ROOM HEATERS, AIR CONDITIONERS FOR COMMERCIAL AND INDUSTRIAL USE, WATER CHILLING UNITS (U.S. CLS. 13, 21, 23, 31 AND 34).

FIRST USE 2-19-1998; IN COMMERCE 2-19-1998.

ANDREA SAUNDERS, EXAMINING ATTORNEY

SN 76-569,118. LIGHTING WORLD INC., OCEAN, NJ. FILED 12-1-2003.

MARTINI

FOR ELECTRIC LIGHTING FIXTURES (U.S. CLS. 13, 21, 23, 31 AND 34).

FIRST USE 6-0-2000; IN COMMERCE 6-0-2000.

INGA ERVIN, EXAMINING ATTORNEY

CLASS 11—(Continued).

SN 76-573,610. ENERCO TECHNICAL PRODUCTS, INC., CLEVELAND, OH. FILED 1-30-2004.

HEAT STAR
by **ENERCO**



OWNER OF U.S. REG. NO. 1,623,523.

THE "HEAT" PORTION OF THE MARK ON THE ENCLOSED DRAWING IS SHADED FOR THE COLOR GRAY, BUT THE COLOR IS NOT CLAIMED AS A DISTINCTIVE FEATURE OF THE MARK.

FOR RADIANT COMBUSTION HEATERS, NAMELY, PATIO HEATERS, FORCED AIR KEROSENE HEATERS, FORCED AIR PROPANE HEATERS, PORTABLE RADIANT HEATERS, RADIANT TUBE HEATERS, RADIANT OVERHEAD HEATERS, AND CONVECTION HEATERS (U.S. CLS. 13, 21, 23, 31 AND 34).

FIRST USE 9-0-2003; IN COMMERCE 9-0-2003.

PAULA MAYS, EXAMINING ATTORNEY

SN 76-591,926. THE SY-KLONE COMPANY, INC., JACKSONVILLE, FL. FILED 5-13-2004.

GIDEON

THE MARK CONSISTS OF STANDARD CHARACTERS WITHOUT CLAIM TO ANY PARTICULAR FONT, STYLE, SIZE, OR COLOR.

FOR AIR INTAKE SYSTEMS FOR THE AIR INTAKE OF ENGINES, VENTILATION SYSTEMS, AND OTHER APPARATUS THAT DRAW IN AIR LADEN WITH DEBRIS COMPRISED OF A HOUSING AND IMPELLER ROTATABLY MOUNTED WITHIN THE HOUSING FOR CLEANING INTAKE AIR BY SPINNING THE INTAKE AIR AT HIGH SPEED TO SEPARATE HEAVIER-THAN-AIR CONTAMINATES THEREFROM BY CENTRIFUGAL FORCE HAVING ONE OR MORE STAGES FOR SEPARATING AND REMOVING PARTICLES OF DEBRIS FROM THE AIR FLOW AND A MOTOR IN THE SYSTEM FOR ROTATING THE IMPELLER (U.S. CLS. 13, 21, 23, 31 AND 34).

FIRST USE 6-0-1999; IN COMMERCE 6-0-1999.

MARY CRAWFORD, EXAMINING ATTORNEY

CLASS 11—(Continued).

SN 76-591,927. THE SY-KLONE COMPANY, INC., JACKSONVILLE, FL. FILED 5-13-2004.

SERIES 9000

THE MARK CONSISTS OF STANDARD CHARACTERS WITHOUT CLAIM TO ANY PARTICULAR FONT, STYLE, SIZE, OR COLOR.

NO CLAIM IS MADE TO THE EXCLUSIVE RIGHT TO USE "SERIES", APART FROM THE MARK AS SHOWN.

FOR AIR INTAKES OF ENGINES, VENTILATION SYSTEMS, AND OTHER APPARATUS THAT DRAW IN AIR LADEN WITH DEBRIS, COMPRISING A HOUSING AND AN IMPELLER ROTATABLY MOUNTED WITHIN THE HOUSING FOR CLEANING INTAKE AIR BY SPINNING THE INTAKE AIR AT HIGH SPEED TO SEPARATE HEAVIER-THAN-AIR CONTAMINATES THEREFROM BY CENTRIFUGAL FORCE (U.S. CLS. 13, 21, 23, 31 AND 34).

FIRST USE 5-0-1997; IN COMMERCE 5-0-1997.

MARY CRAWFORD, EXAMINING ATTORNEY

SN 76-592,306. WAHL CLIPPER CORPORATION, STERLING, IL. FILED 5-14-2004.

IONIC ADVANTAGE

THE MARK CONSISTS OF STANDARD CHARACTERS WITHOUT CLAIM TO ANY PARTICULAR FONT, STYLE, SIZE, OR COLOR.

NO CLAIM IS MADE TO THE EXCLUSIVE RIGHT TO USE "IONIC", APART FROM THE MARK AS SHOWN.

FOR HAND-HELD ELECTRIC HAIR DRYERS (U.S. CLS. 13, 21, 23, 31 AND 34).

BRIAN NEVILLE, EXAMINING ATTORNEY

SN 76-597,975. BEUTLER CORPORATION, MCCLELLAN, CA. FILED 6-18-2004.

BEUTLER HOME MANAGER

THE MARK CONSISTS OF STANDARD CHARACTERS WITHOUT CLAIM TO ANY PARTICULAR FONT, STYLE, SIZE, OR COLOR.

NO CLAIM IS MADE TO THE EXCLUSIVE RIGHT TO USE "HOME", APART FROM THE MARK AS SHOWN.

FOR INTEGRATED CONTROLS FOR RESIDENTIAL HVAC, THERMOSTAT AND SECURITY ALARM SYSTEMS (U.S. CLS. 13, 21, 23, 31 AND 34).

FIRST USE 11-0-2002; IN COMMERCE 11-0-2002.

BARBARA A. GOLD, EXAMINING ATTORNEY

CLASS 11—(Continued).

SN 76-598,668. NICOTRA S.P.A., MILANO, ITALY, AND TWIN CITY FAN COMPANIES, LTD., PLYMOUTH, MN. FILED 6-21-2004.

TWIN CITY NICOTRA

THE MARK CONSISTS OF STANDARD CHARACTERS WITHOUT CLAIM TO ANY PARTICULAR FONT, STYLE, SIZE, OR COLOR.

OWNER OF U.S. REG. NO. 1,448,338.

NO CLAIM IS MADE TO THE EXCLUSIVE RIGHT TO USE TWIN CITY, APART FROM THE MARK AS SHOWN.

FOR HEATING, VENTILATING AND AIR CONDITIONING FANS FOR COMMERCIAL USE AND PARTS THEREOF (U.S. CLS. 13, 21, 23, 31 AND 34).

SUE LAWRENCE, EXAMINING ATTORNEY

SN 76-600,099. HESS LIGHTING II, INC., SHELBY, NC. FILED 7-1-2004.

AVANGARDO

THE MARK CONSISTS OF STANDARD CHARACTERS WITHOUT CLAIM TO ANY PARTICULAR FONT, STYLE, SIZE, OR COLOR.

FOR ELECTRIC LIGHTING FIXTURES (U.S. CLS. 13, 21, 23, 31 AND 34).

FIRST USE 5-1-1997; IN COMMERCE 10-1-1997.

MARTHA FROMM, EXAMINING ATTORNEY

SN 76-600,383. TRASK, RUSSELL B., MELVILLE, NY. FILED 6-30-2004.

KOOLTRONIK

THE MARK CONSISTS OF STANDARD CHARACTERS WITHOUT CLAIM TO ANY PARTICULAR FONT, STYLE, SIZE, OR COLOR.

FOR PORTABLE PERSONAL ELECTRIC FANS (U.S. CLS. 13, 21, 23, 31 AND 34).

FIRST USE 10-26-2003; IN COMMERCE 1-13-2004.

KELLY BOULTON, EXAMINING ATTORNEY

CLASS 11—(Continued).

SN 76-603,260. THE TITAN CORPORATION, RESTON, VA.
FILED 7-21-2004.

SEASCAN

THE MARK CONSISTS OF STANDARD CHARACTERS WITHOUT CLAIM TO ANY PARTICULAR FONT, STYLE, SIZE, OR COLOR.

FOR PORTABLE DECONTAMINATION STERILIZATION MODULAR SYSTEM VIA A WATER-BORNE PLATFORM VESSEL USING AN IONIZING RADIATION SOURCE COMPRISING OF A LINEAR ACCELERATOR SYSTEM, X-RAY CONVERTER, CONVEYOR SYSTEM, CONTROL SYSTEMS, POWER CONDITIONING SYSTEM, OPTIONAL POWER GENERATION SYSTEM, INTRINSIC RADIATION SHIELDING, FIELD-EXPEDIENT RADIATION SHIELDING AND PRIMARY RADIATION SHIELDING (U.S. CLS. 13, 21, 23, 31 AND 34).

DAVID H. STINE, EXAMINING ATTORNEY

SN 76-609,542. MASTER WEALTH PLANS, INC., COPPELL, TX. FILED 8-30-2004.

MISTER RANGE

THE MARK CONSISTS OF STANDARD CHARACTERS WITHOUT CLAIM TO ANY PARTICULAR FONT, STYLE, SIZE, OR COLOR.

NO CLAIM IS MADE TO THE EXCLUSIVE RIGHT TO USE "MISTER", APART FROM THE MARK AS SHOWN.

FOR PORTABLE ELECTRIC WATER MISTING DEVICE FOR INDIVIDUALS PARTICIPATING IN OUTDOOR ACTIVITIES (U.S. CLS. 13, 21, 23, 31 AND 34).

TINA L. SNAPP, EXAMINING ATTORNEY

SN 76-610,335. RESTIVO & HOLLAND, LLC, WALKER, LA. FILED 9-7-2004.

PIPE WATCHMAN

THE MARK CONSISTS OF STANDARD CHARACTERS WITHOUT CLAIM TO ANY PARTICULAR FONT, STYLE, SIZE, OR COLOR.

NO CLAIM IS MADE TO THE EXCLUSIVE RIGHT TO USE "PIPE", APART FROM THE MARK AS SHOWN.

FOR PLUMBING FITTINGS, NAMELY, FREEZE PREVENTION VALVES AND DRIP VALVES (U.S. CLS. 13, 21, 23, 31 AND 34).

NELSON SNYDER, EXAMINING ATTORNEY

CLASS 11—(Continued).

SN 76-610,914. CONSERVATION TECHNOLOGY, L.L.C., NORTHBROOK, IL. FILED 9-7-2004.

GYRO

THE MARK CONSISTS OF STANDARD CHARACTERS WITHOUT CLAIM TO ANY PARTICULAR FONT, STYLE, SIZE, OR COLOR.

FOR ELECTRICAL LIGHTING PRODUCTS, NAMELY TRACK LIGHTING FIXTURES (U.S. CLS. 13, 21, 23, 31 AND 34).

FIRST USE 10-0-1998; IN COMMERCE 6-0-1999.

MAUREEN DALL, EXAMINING ATTORNEY

SN 76-616,693. SHARP KABUSHIKI KAISHA, TA SHARP CORPORATION, OSAKA 545-8522, JAPAN, FILED 10-18-2004.

INSIGHT

THE MARK CONSISTS OF STANDARD CHARACTERS WITHOUT CLAIM TO ANY PARTICULAR FONT, STYLE, SIZE, OR COLOR.

FOR COOKING APPLIANCE FOR HOUSEHOLD USE, CONSISTING OF A COOK TOP HAVING RADIANT ELECTRIC HEATERS, A MICROWAVE OVEN AND AN ELECTRIC OVEN (U.S. CLS. 13, 21, 23, 31 AND 34).

FIRST USE 9-13-2004; IN COMMERCE 9-13-2004.

JEFF DEFORD, EXAMINING ATTORNEY

SN 76-617,943. BRAND MARKETING GROUP, L.L.C., BEVERLY HILLS, CA. FILED 10-21-2004.

THERMABLASTER

THE MARK CONSISTS OF STANDARD CHARACTERS WITHOUT CLAIM TO ANY PARTICULAR FONT, STYLE, SIZE, OR COLOR.

FOR FIREPLACES - GAS SPACE HEATERS AND VENT-FREE GAS SPACE HEATERS (U.S. CLS. 13, 21, 23, 31 AND 34).

BRENDAN MCCAULEY, EXAMINING ATTORNEY

CLASS 11—(Continued).

SN 76-619,214. DIMENSION ONE SPAS, INC., VISTA, CA.
FILED 11-3-2004.

NECKFLEX JET PILLOW

THE MARK CONSISTS OF STANDARD CHARACTERS WITHOUT CLAIM TO ANY PARTICULAR FONT, STYLE, SIZE, OR COLOR.

NO CLAIM IS MADE TO THE EXCLUSIVE RIGHT TO USE "JET", APART FROM THE MARK AS SHOWN.

FOR SPA APPARATUS IN THE NATURE OF AN INTERACTIVE AND HEIGHT ADJUSTABLE DEVICE FOR CREATING REAR UPPER-BODY MASSAGE UTILIZING JETS OF WATER COMBINED WITH AIR FOR SPAS, HEATED POOLS, WHIRLPOOLS, BATHTUBS, HOT TUBS, SWIM SPAS, WHIRLPOOLS BATHS AND RECREATIONAL POOLS (U.S. CLS. 13, 21, 23, 31 AND 34).

FIRST USE 12-12-2001; IN COMMERCE 12-12-2001.
ROBERT LORENZO, EXAMINING ATTORNEY

CLASS 11—(Continued).

SN 76-621,583. DIVERSIFIED MARKETING SYSTEMS, LLC, DBA TRADE BRIDGE INTERNATIONAL, OMAHA, NE.
FILED 11-22-2004.

QUICK-NIC

THE MARK CONSISTS OF STANDARD CHARACTERS WITHOUT CLAIM TO ANY PARTICULAR FONT, STYLE, SIZE, OR COLOR.

FOR DISPOSABLE BARBECUE GRILLS (U.S. CLS. 13, 21, 23, 31 AND 34).

FIRST USE 1-29-2003; IN COMMERCE 1-29-2003.
LOURDES AYALA, EXAMINING ATTORNEY

SN 76-620,276. EBERT, THOMAS P., CAVE CREEK, AZ.
FILED 11-12-2004.

WHIRLBATHE

THE MARK CONSISTS OF STANDARD CHARACTERS WITHOUT CLAIM TO ANY PARTICULAR FONT, STYLE, SIZE, OR COLOR.

OWNER OF U.S. REG. NO. 1,310,978.
FOR WHIRPOOL BATH ASSEMBLIES PRIMARILY COMPRISING WHIRLPOOL JETS AND PUMPS (U.S. CLS. 13, 21, 23, 31 AND 34).

FIRST USE 5-22-1981; IN COMMERCE 2-28-1983.
AMOS T. MATTHEWS, JR., EXAMINING ATTORNEY

SN 76-621,604. HUBBELL INCORPORATED, ORANGE, CT.
FILED 11-22-2004.

RAVEN

THE MARK CONSISTS OF STANDARD CHARACTERS WITHOUT CLAIM TO ANY PARTICULAR FONT, STYLE, SIZE, OR COLOR.

FOR LIGHTING FIXTURES (U.S. CLS. 13, 21, 23, 31 AND 34).

SUSAN HAYASH, EXAMINING ATTORNEY

SN 76-620,344. ACUITY BRANDS, INC., ATLANTA, GA.
FILED 11-12-2004.

ELEVATIONS

THE MARK CONSISTS OF STANDARD CHARACTERS WITHOUT CLAIM TO ANY PARTICULAR FONT, STYLE, SIZE, OR COLOR.

FOR ELECTRIC LIGHTING FIXTURES (U.S. CLS. 13, 21, 23, 31 AND 34).

DOMINICK J. SALEMI, EXAMINING ATTORNEY

SN 76-622,095. ACUITY BRANDS, INC., ATLANTA, GA.
FILED 11-24-2004.

ILLUMIBAY

THE MARK CONSISTS OF STANDARD CHARACTERS WITHOUT CLAIM TO ANY PARTICULAR FONT, STYLE, SIZE, OR COLOR.

FOR ELECTRIC LIGHTING FIXTURES (U.S. CLS. 13, 21, 23, 31 AND 34).

KIMBERLY FRYE, EXAMINING ATTORNEY

CLASS 11—(Continued).

SN 76-622,156. MINKA LIGHTING, INC., CORONA, CA.
FILED 11-24-2004.

CHINA BEACH

THE MARK CONSISTS OF STANDARD CHARACTERS
WITHOUT CLAIM TO ANY PARTICULAR FONT, STYLE,
SIZE, OR COLOR.
FOR CEILING FANS (U.S. CLS. 13, 21, 23, 31 AND 34).
JOHN DALIER, EXAMINING ATTORNEY

SN 76-622,157. MINKA LIGHTING, INC., CORONA, CA.
FILED 11-24-2004.

LAKE ALICE

THE MARK CONSISTS OF STANDARD CHARACTERS
WITHOUT CLAIM TO ANY PARTICULAR FONT, STYLE,
SIZE, OR COLOR.
FOR CEILING FANS (U.S. CLS. 13, 21, 23, 31 AND 34).
JOHN DALIER, EXAMINING ATTORNEY

SN 76-622,158. MINKA LIGHTING, INC., CORONA, CA.
FILED 11-24-2004.

ARCTURUS CLOUD

THE MARK CONSISTS OF STANDARD CHARACTERS
WITHOUT CLAIM TO ANY PARTICULAR FONT, STYLE,
SIZE, OR COLOR.
FOR CEILING FANS (U.S. CLS. 13, 21, 23, 31 AND 34).
JOHN DALIER, EXAMINING ATTORNEY

SN 76-622,159. MINKA LIGHTING, INC., CORONA, CA.
FILED 11-24-2004.

ROCK CREEK

THE MARK CONSISTS OF STANDARD CHARACTERS
WITHOUT CLAIM TO ANY PARTICULAR FONT, STYLE,
SIZE, OR COLOR.
FOR CEILING FANS (U.S. CLS. 13, 21, 23, 31 AND 34).
JOHN DALIER, EXAMINING ATTORNEY

CLASS 11—(Continued).

SN 76-623,146. FAN MAN, INC., NEW HOPE, MN. FILED 12-
3-2004.

MESA VISTA

THE MARK CONSISTS OF STANDARD CHARACTERS
WITHOUT CLAIM TO ANY PARTICULAR FONT, STYLE,
SIZE, OR COLOR.
FOR CEILING FANS (U.S. CLS. 13, 21, 23, 31 AND 34).
REBECCA GAN, EXAMINING ATTORNEY

SN 76-623,541. JACK BARROS AND DANA TARDIFF
PARTNERSHIP, THE, DBA DANA'S TOUCH, NEW BED-
FORD, MA. FILED 12-7-2004.

LIGHT TOUCH

THE MARK CONSISTS OF STANDARD CHARACTERS
WITHOUT CLAIM TO ANY PARTICULAR FONT, STYLE,
SIZE, OR COLOR.
FOR FLAME-PRODUCING LIGHTER PRIMARILY
FOR LIGHTING GRILLS, FIREPLACES, AND CANDLES
(U.S. CLS. 13, 21, 23, 31 AND 34).
GINA HAYES, EXAMINING ATTORNEY

SN 76-626,127. MINKA LIGHTING, INC., CORONA, CA.
FILED 12-28-2004.

ARUBA

THE MARK CONSISTS OF STANDARD CHARACTERS
WITHOUT CLAIM TO ANY PARTICULAR FONT, STYLE,
SIZE, OR COLOR.
FOR CEILING FANS (U.S. CLS. 13, 21, 23, 31 AND 34).
LINDA POWELL, EXAMINING ATTORNEY

SN 76-626,129. MINKA LIGHTING, INC., CORONA, CA.
FILED 12-28-2004.

BATTERY PARK

THE MARK CONSISTS OF STANDARD CHARACTERS
WITHOUT CLAIM TO ANY PARTICULAR FONT, STYLE,
SIZE, OR COLOR.
FOR CEILING FANS (U.S. CLS. 13, 21, 23, 31 AND 34).
LINDA POWELL, EXAMINING ATTORNEY

CLASS 11—(Continued).

SN 76-626,173. MINKA LIGHTING, INC., CORONA, CA. FILED 12-28-2004.

RIO GRANDE

THE MARK CONSISTS OF STANDARD CHARACTERS WITHOUT CLAIM TO ANY PARTICULAR FONT, STYLE, SIZE, OR COLOR.
FOR CEILING FANS (U.S. CLS. 13, 21, 23, 31 AND 34).
SOPHIA S. KIM, EXAMINING ATTORNEY

SN 76-626,174. MINKA LIGHTING, INC., CORONA, CA. FILED 12-28-2004.

ICELANDIC

THE MARK CONSISTS OF STANDARD CHARACTERS WITHOUT CLAIM TO ANY PARTICULAR FONT, STYLE, SIZE, OR COLOR.
FOR CEILING FANS (U.S. CLS. 13, 21, 23, 31 AND 34).
SOPHIA S. KIM, EXAMINING ATTORNEY

SN 76-626,293. HELEN OF TROY LIMITED, ST. MICHAEL, BARBADOS, FILED 12-30-2004.

HOTSPA HOT TUB

THE MARK CONSISTS OF STANDARD CHARACTERS WITHOUT CLAIM TO ANY PARTICULAR FONT, STYLE, SIZE, OR COLOR.
OWNER OF U.S. REG. NOS. 2,175,858, 2,963,623 AND 2,966,131.
NO CLAIM IS MADE TO THE EXCLUSIVE RIGHT TO USE "HOT TUB", APART FROM THE MARK AS SHOWN.
SEC. 2(F) AS TO "HOTSPA".
FOR ELECTRIC FOOT BATHS AND HAND/FINGER BATHS (U.S. CLS. 13, 21, 23, 31 AND 34).
MARY BOAGNI, EXAMINING ATTORNEY

CLASS 11—(Continued).

SN 78-311,130. STORMWATER MANAGEMENT, INC., PORTLAND, OR. FILED 10-8-2003.



OWNER OF U.S. REG. NO. 2,315,408.
NO CLAIM IS MADE TO THE EXCLUSIVE RIGHT TO USE STORMWATER MANAGEMENT, APART FROM THE MARK AS SHOWN.
THE STIPPLING IS FOR SHADING PURPOSES ONLY.
SEC. 2(F) AS TO "STORMWATER".
FOR STORM WATER FILTRATION AND CLEANING SYSTEMS, NAMELY, SCREENS FOR REMOVING TRASH AND DEBRIS, GATE SEPARATORS FOR SETTLING OUT SOLIDS, FILTERS, FILTER HOUSINGS, FILTER CARTRIDGES, FILTER MEDIA, PEARLITE FILTER MEDIA, ZEOLITE FILTER MEDIA, ORGANIC FILTER MEDIA, PLEATED FABRIC FILTER MEDIA, FABRIC FILTER MEDIA, OPEN CELL FOAM FILTER MEDIA, GRANULATED ACTIVATED CARBON FILTER MEDIA, AND IRON INFUSED FILTER MEDIA (U.S. CLS. 13, 21, 23, 31 AND 34).
FIRST USE 1-26-2000; IN COMMERCE 1-26-2000.
ALICE BENMAMAN, EXAMINING ATTORNEY

SN 78-336,260. BAUER APPLIANCES (PROPRIETARY) LIMITED, SANDTON, GAUTENG, SOUTH AFRICA, FILED 12-4-2003.



OWNER OF SOUTH AFRICA REG. NO. 960441, DATED 1-15-1996, EXPIRES 1-15-2006.
NO CLAIM IS MADE TO THE EXCLUSIVE RIGHT TO USE "APPLIANCES", APART FROM THE MARK AS SHOWN.
FOR AIR CONDITIONING UNITS, ELECTRIC SPACE HEATERS, ELECTRIC HEATING FANS, OVEN AND STOVE VENTILATOR HOODS, REFRIGERATORS, FREEZERS, ELECTRIC STOVES AND OVENS, GAS STOVES AND OVENS, ELECTRIC FOOD WARMING UNITS, MICROWAVE OVENS FOR COOKING, CLOTHES DRYERS, BARBEQUE GRILLS, ELECTRIC KETTLES, TOASTERS, SPARE REPLACEMENT PARTS FOR ALL OF THE ABOVE (U.S. CLS. 13, 21, 23, 31 AND 34).
BRENDAN MCCAULEY, EXAMINING ATTORNEY

CLASS 11—(Continued).

SN 78-343,221. ARMAMENT SYSTEMS AND PROCEDURES, INC., APPLETON, WI. FILED 12-19-2003.

CLASS 11—(Continued).

SN 78-362,408. VERILUX, INC., STAMFORD, CT. FILED 2-4-2004.

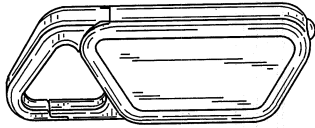

HAPPYSKIN

OWNER OF U.S. REG. NO. 2,927,732.
THE LINING SHOWN IN THE MARK IS MERELY TO INDICATE SHADING.

THE MARK COMPRISES A FLASHLIGHT WITH THE OVERALL SHAPE OF A PARALLELOGRAM WITH TRIANGULAR CUTOUT AND TRAPEZOID FEATURE.

SEC. 2(F).

FOR FLASHLIGHTS (U.S. CLS. 13, 21, 23, 31 AND 34).
FIRST USE 10-0-1998; IN COMMERCE 10-0-1998.
PAULA MAYS, EXAMINING ATTORNEY

THE MARK CONSISTS OF STANDARD CHARACTERS WITHOUT CLAIM TO ANY PARTICULAR FONT, STYLE, SIZE, OR COLOR.

OWNER OF U.S. REG. NOS. 2,327,062 AND 2,553,952.
FOR LIGHT FIXTURES, NAMELY LAMPS (U.S. CLS. 13, 21, 23, 31 AND 34).

FIRST USE 8-18-2000; IN COMMERCE 8-18-2000.
HEATHER THOMPSON, EXAMINING ATTORNEY

SN 78-351,901. PURE BEVERAGE SYSTEMS, INC., CRANSTON, RI. FILED 1-14-2004.

SN 78-392,782. AMBI-RAD LIMITED, BRIERLEY HILL, WET MIDLANDS, UNITED KINGDOM, FILED 3-29-2004.



AIRBLOC

NO CLAIM IS MADE TO THE EXCLUSIVE RIGHT TO USE "PURE BEVERAGE SYSTEMS, INC.", APART FROM THE MARK AS SHOWN.

THE STIPPLING IS FOR SHADING PURPOSES.

FOR WATER TREATMENT EQUIPMENT, NAMELY, STERILIZATION AND FILTRATION UNITS FOR RESIDENTIAL, INDUSTRIAL AND COMMERCIAL USE (U.S. CLS. 13, 21, 23, 31 AND 34).

MICHAEL SOUDERS, EXAMINING ATTORNEY

THE MARK CONSISTS OF STANDARD CHARACTERS WITHOUT CLAIM TO ANY PARTICULAR FONT, STYLE, SIZE, OR COLOR.

OWNER OF ERPN CMNTY TM OFC REG. NO. 000863928, DATED 2-28-2000, EXPIRES 6-30-2008.

FOR AIR CURTAINS (U.S. CLS. 13, 21, 23, 31 AND 34).
KIMBERLY FRYE, EXAMINING ATTORNEY

CLASS 11—(Continued).

SN 78-402,666. ORECK HOLDINGS, LLC, CHEYENNE, WY. FILED 4-15-2004.

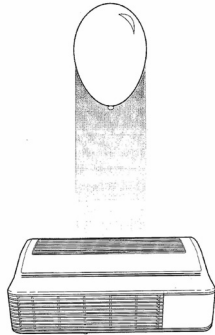

NO CLAIM IS MADE TO THE EXCLUSIVE RIGHT TO USE THE PICTORIAL REPRESENTATION OF THE AIR FILTER, APART FROM THE MARK AS SHOWN. THE MARK CONSISTS OF BALLOON OVER AIR CLEANER.

FOR AIR CLEANER FOR COMMERCIAL AND RESIDENTIAL USE; AND PARTS THEREFOR AND ACCESSORIES SOLD THEREWITH, NAMELY LIGHTS AND FILTERS (U.S. CLS. 13, 21, 23, 31 AND 34).
KELLY CHOE, EXAMINING ATTORNEY

SN 78-405,569. DM INDUSTRIES, OPA LOCKA, FL. FILED 4-21-2004.

American Traditions

THE MARK CONSISTS OF STANDARD CHARACTERS WITHOUT CLAIM TO ANY PARTICULAR FONT, STYLE, SIZE, OR COLOR.

NO CLAIM IS MADE TO THE EXCLUSIVE RIGHT TO USE AMERICAN, APART FROM THE MARK AS SHOWN. FOR OUTDOOR BARBECUE GRILL ISLANDS (U.S. CLS. 13, 21, 23, 31 AND 34).
DEZMONA MIZELLE, EXAMINING ATTORNEY

CLASS 11—(Continued).

SN 78-408,826. TRINC. ORG, HAMAMATSU-CITY, SHIZUOKA-PRE., JAPAN, FILED 4-27-2004.

TRINC

THE MARK CONSISTS OF STANDARD CHARACTERS WITHOUT CLAIM TO ANY PARTICULAR FONT, STYLE, SIZE, OR COLOR.

OWNER OF JAPAN REG. NO. 4579094, DATED 6-21-2002, EXPIRES 6-21-2012.

FOR IONIZERS FOR AIR TREATMENT AND ELIMINATION OF STATIC CHARGES, FOR DOMESTIC, COMMERCIAL AND INDUSTRIAL USE (U.S. CLS. 13, 21, 23, 31 AND 34).

FIRST USE 0-0-1999; IN COMMERCE 0-0-2000.
TRACY CROSS, EXAMINING ATTORNEY

SN 78-412,201. GLOBAL ENERGY GROUP, INC., PLANO, TX. FILED 5-3-2004.

INVENTOR SERIES

THE MARK CONSISTS OF STANDARD CHARACTERS WITHOUT CLAIM TO ANY PARTICULAR FONT, STYLE, SIZE, OR COLOR.

NO CLAIM IS MADE TO THE EXCLUSIVE RIGHT TO USE "SERIES", APART FROM THE MARK AS SHOWN. FOR AIR CONDITIONERS (U.S. CLS. 13, 21, 23, 31 AND 34).

FIRST USE 11-1-2002; IN COMMERCE 9-1-2003.
PAUL F. GAST, EXAMINING ATTORNEY

CLASS 11—(Continued).

SN 78-416,684. HANS GROHE AG, SCHILTACH, FED REP GERMANY, FILED 5-11-2004.

RAINDANCE

THE MARK CONSISTS OF STANDARD CHARACTERS WITHOUT CLAIM TO ANY PARTICULAR FONT, STYLE, SIZE, OR COLOR.

FOR PLUMBING FITTINGS, NAMELY, VALVES, MIXING VALVES, MIXER TAPS FOR WASH STANDS, SHOWER NOZZLES AND PARTS THEREFORE; HAND SHOWERS, SHOWER HEADS AND FITTINGS THEREFOR, BATH TUBS AND SHOWERS, WHIRLPOOL BATHS, SHOWER ENCLOSURES, BIDETS, DRAIN SIPHONS AND ELECTRIC LIGHTING FIXTURES FOR SANITARY FITMENTS (U.S. CLS. 13, 21, 23, 31 AND 34).

FIRST USE 8-13-2003; IN COMMERCE 8-13-2003.
JENNIFER CHICOSKI, EXAMINING ATTORNEY

CLASS 11—(Continued).

SN 78-428,926. EAST COAST U.S.A. DISTRIBUTORS, INC., NEW HYDE PARK, NY. FILED 6-2-2004.

ZENNEX

THE MARK CONSISTS OF STANDARD CHARACTERS WITHOUT CLAIM TO ANY PARTICULAR FONT, STYLE, SIZE, OR COLOR.

FOR AUTOMOBILE LIGHT BULBS AND LIGHT BULBS FOR AUTOMOBILE STEREOS AND VIDEO DISK PLAYERS (U.S. CLS. 13, 21, 23, 31 AND 34).

MICHAEL TANNER, EXAMINING ATTORNEY

SN 78-430,763. CINDERS BARBECUES LIMITED, LANCASTER, LANCASHIRE, UNITED KINGDOM, FILED 6-7-2004.

SN 78-417,390. DISTINCTIVE CULINARY CONCEPTS, LTD., AVON, OH. FILED 5-12-2004.

REVOLUTIONIZING GRILLING!

THE MARK CONSISTS OF STANDARD CHARACTERS WITHOUT CLAIM TO ANY PARTICULAR FONT, STYLE, SIZE, OR COLOR.

NO CLAIM IS MADE TO THE EXCLUSIVE RIGHT TO USE "GRILLING", APART FROM THE MARK AS SHOWN. FOR NON-FLAMMABLE CERAMIC BRIQUETTES FOR USE IN BARBECUE GRILLS (U.S. CLS. 13, 21, 23, 31 AND 34).

FIRST USE 4-8-2002; IN COMMERCE 4-8-2002.
RAMONA ORTIGA, EXAMINING ATTORNEY

SLIMFOLD

THE MARK CONSISTS OF STANDARD CHARACTERS WITHOUT CLAIM TO ANY PARTICULAR FONT, STYLE, SIZE, OR COLOR.

FOR BARBECUE GRILLS (U.S. CLS. 13, 21, 23, 31 AND 34).

FIRST USE 2-10-2004; IN COMMERCE 2-10-2004.
WON TEAK OH, EXAMINING ATTORNEY

CLASS 11—(Continued).

SN 78-434,259. LORENZO, MANUEL E, MIAMI SPRINGS, FL. FILED 6-11-2004.

CLASS 11—(Continued).

SN 78-460,368. VALUE CAPITAL LTD., TORONTO, ONTARIO, CANADA, FILED 8-2-2004.

Whirltemp

LIQUIPLUS

THE COLOR(S) RED AND BLUE IS/ARE CLAIMED AS A FEATURE OF THE MARK.

THE WORD IN THE MARK APPEARS IN THE COLOR RED AND IS UNDERLINED BY THE COLOR BLUE.

FOR HEATING EQUIPMENT AND VENTILATION EQUIPMENT, NAMELY, FURNACES, HEAT PUMPS, AIR CONDITIONING UNITS, REFRIGERATING MACHINES, EVAPORATIVE AIR COOLING UNITS FOR DOMESTIC USE, FREEZERS, COMBINATION REFRIGERATOR-FREEZERS, THERMOELECTRIC COOLER/HEATER FOR FOOD AND BEVERAGES (U.S. CLS. 13, 21, 23, 31 AND 34).

KIMBERLY PERRY, EXAMINING ATTORNEY

THE MARK CONSISTS OF STANDARD CHARACTERS WITHOUT CLAIM TO ANY PARTICULAR FONT, STYLE, SIZE, OR COLOR.

FOR MACHINES NAMELY ELECTRONIC MACHINES USED FOR DESCALING AND CONDITIONING WATER (U.S. CLS. 13, 21, 23, 31 AND 34).

DAYNA BROWNE, EXAMINING ATTORNEY

SN 78-439,495. ALPINE TECHNOLOGIES, INC., GREENEVILLE, TN. FILED 6-22-2004.

SN 78-470,308. WHITE, KATHRYN GOETZKE, ANNAPOLIS, MD. FILED 8-19-2004.

HYPHER AIR

Tranquility

THE MARK CONSISTS OF STANDARD CHARACTERS WITHOUT CLAIM TO ANY PARTICULAR FONT, STYLE, SIZE, OR COLOR.

NO CLAIM IS MADE TO THE EXCLUSIVE RIGHT TO USE "AIR", APART FROM THE MARK AS SHOWN.

FOR AIR PURIFYING UNITS FOR RESIDENTIAL AND COMMERCIAL USE. (U.S. CLS. 13, 21, 23, 31 AND 34).

JOHN WILKE, EXAMINING ATTORNEY

THE MARK CONSISTS OF STANDARD CHARACTERS WITHOUT CLAIM TO ANY PARTICULAR FONT, STYLE, SIZE, OR COLOR.

FOR ELECTRIC LIGHT BULBS (U.S. CLS. 13, 21, 23, 31 AND 34).

STEVEN JACKSON, EXAMINING ATTORNEY

CLASS 11—(Continued).

SN 78-480,685. BOSCH UND SIEMENS HAUSGERÄTE GMBH, MUNICH, FED REP GERMANY, FILED 9-9-2004.

FITFRY

THE MARK CONSISTS OF STANDARD CHARACTERS WITHOUT CLAIM TO ANY PARTICULAR FONT, STYLE, SIZE, OR COLOR.

PRIORITY CLAIMED UNDER SEC. 44(D) ON FED REP GERMANY APPLICATION NO. 30413438407, FILED 3-10-2004, REG. NO. 30413438, DATED 4-22-2004, EXPIRES 3-31-2014.

FOR ELECTRIC AND/OR FUEL OPERATED KITCHEN APPLIANCES FOR COOKING AND FRYING OF FOODS, NAMELY IMMERSION HEATERS, DEEP FRYERS AND PARTS THEREFORE (U.S. CLS. 13, 21, 23, 31 AND 34).

ATTIYA MALIK, EXAMINING ATTORNEY

SN 78-481,824. B&P LAMP SUPPLY, INC., MCMINNVILLE, TN. FILED 9-10-2004.

POLYBEESWAX

THE MARK CONSISTS OF STANDARD CHARACTERS WITHOUT CLAIM TO ANY PARTICULAR FONT, STYLE, SIZE, OR COLOR.

FOR LIGHTING FIXTURES, PORTABLE LAMPS, AND LAMP PARTS, NAMELY, LAMP SHADES AND CANDLE COVERS, NAMELY, TUBES THAT SLIP OVER AND COVER AN INDIVIDUAL LAMP HOLDER OR SOCKET OF LIGHTING FIXTURES AND PORTABLE LAMPS FOR DECORATIVE PURPOSE (U.S. CLS. 13, 21, 23, 31 AND 34).

FIRST USE 5-3-2004; IN COMMERCE 7-15-2004.
BILL DAWE, EXAMINING ATTORNEY

CLASS 11—(Continued).

SN 78-497,547. HUBER SERVICE USA INC, MARIETTA, OH. FILED 10-11-2004.

Unistat

THE MARK CONSISTS OF STANDARD CHARACTERS WITHOUT CLAIM TO ANY PARTICULAR FONT, STYLE, SIZE, OR COLOR.

FOR RECIRCULATING HYDRAULICALLY-SEALED FLUID HEATING AND COOLING MACHINE USED FOR PRECISE TEMPERATURE CONTROL OF AN EXTERNAL CONNECTED FLUID CIRCUIT USING A FLUID AS A HEAT TRANSFER MEDIUM, THE UNITS HAVING MINIMAL INTERNAL FLUID VOLUME, CREATING HIGH COOLING AND HEATING POWER DENSITIES, TO FACILITATE RAPID TEMPERATURE CHANGE AND CONTROL, INTENDED FOR USE IN PHARMACEUTICAL, SEMICONDUCTOR, AND CHEMICAL APPLICATIONS (U.S. CLS. 13, 21, 23, 31 AND 34).

FIRST USE 12-31-1990; IN COMMERCE 12-31-1990.
ALEX KEAM, EXAMINING ATTORNEY

SN 78-497,550. HUBER SERVICE USA INC, MARIETTA, OH. FILED 10-11-2004.

Ministat

THE MARK CONSISTS OF STANDARD CHARACTERS WITHOUT CLAIM TO ANY PARTICULAR FONT, STYLE, SIZE, OR COLOR.

FOR RECIRCULATING FLUID HEATING AND COOLING UNIT USED FOR PRECISE TEMPERATURE CONTROL OF ITS INTERNAL FLUID BATH AND EXTERNAL CONNECTED FLUID CIRCUIT USING A FLUID AS A HEAT TRANSFER MEDIUM, INTENDED FOR USE IN PHARMACEUTICAL, SEMICONDUCTOR, AND CHEMICAL APPLICATIONS (U.S. CLS. 13, 21, 23, 31 AND 34).

FIRST USE 12-31-1976; IN COMMERCE 12-31-1976.
ALEX KEAM, EXAMINING ATTORNEY

CLASS 11—(Continued).

SN 78-497,586. MENARD, INC., EAU CLAIRE, WI. FILED 10-11-2004.

CLASS 11—(Continued).

SN 78-504,382. HUBER SERVICE USA INC, MARIETTA, OH. FILED 10-22-2004.

ANTOINETTE

Unistat Tango

THE MARK CONSISTS OF STANDARD CHARACTERS WITHOUT CLAIM TO ANY PARTICULAR FONT, STYLE, SIZE, OR COLOR.

THE NAME DOES NOT IDENTIFY A LIVING INDIVIDUAL

FOR WHIRLPOOLS (U.S. CLS. 13, 21, 23, 31 AND 34).
FIRST USE 8-8-2003; IN COMMERCE 9-1-2003.
GEORGIA CARTY, EXAMINING ATTORNEY

THE MARK CONSISTS OF STANDARD CHARACTERS WITHOUT CLAIM TO ANY PARTICULAR FONT, STYLE, SIZE, OR COLOR.

FOR RECIRCULATING HYDRAULICALLY-SEALED FLUID HEATING AND COOLING MACHINE USED FOR PRECISE TEMPERATURE CONTROL OF AN EXTERNAL CONNECTED FLUID CIRCUIT USING A FLUID AS A HEAT TRANSFER MEDIUM, THE UNITS HAVING MINIMAL INTERNAL FLUID VOLUME, CREATING HIGH COOLING AND HEATING POWER DENSITIES, TO FACILITATE RAPID TEMPERATURE CHANGE AND CONTROL, INTENDED FOR USE IN PHARMACEUTICAL, SEMICONDUCTOR, AND CHEMICAL APPLICATIONS (U.S. CLS. 13, 21, 23, 31 AND 34).

FIRST USE 12-31-1990; IN COMMERCE 12-31-1990.
ALEX KEAM, EXAMINING ATTORNEY

SN 78-498,119. THE VOLLRATH COMPANY, L.L.C., SHEBOYGAN, WI. FILED 10-12-2004.

SN 78-506,837. SPRITE INDUSTRIES, INC., CORONA, CA. FILED 10-27-2004.

CAYENNE

LIVING PURE

THE MARK CONSISTS OF STANDARD CHARACTERS WITHOUT CLAIM TO ANY PARTICULAR FONT, STYLE, SIZE, OR COLOR.

FOR OVERHEAD ELECTRIC FOOD WARMERS FOR COMMERCIAL, INSTITUTIONAL AND RESTAURANT USE (U.S. CLS. 13, 21, 23, 31 AND 34).
DAYNA BROWNE, EXAMINING ATTORNEY

THE MARK CONSISTS OF STANDARD CHARACTERS WITHOUT CLAIM TO ANY PARTICULAR FONT, STYLE, SIZE, OR COLOR.

FOR FILTERS, NAMELY, AIR FILTERS FOR DOMESTIC USE, WATER FILTERS, WATER FILTERS FOR SHOWERS (U.S. CLS. 13, 21, 23, 31 AND 34).
FIRST USE 10-26-2004; IN COMMERCE 10-26-2004.
AMY HELLA, EXAMINING ATTORNEY

CLASS 11—(Continued).

SN 78-509,461. KNOWLES, ART, ANDALUSIA, AL. FILED 11-1-2004.

**The Practical
Pleat**

THE MARK CONSISTS OF STANDARD CHARACTERS WITHOUT CLAIM TO ANY PARTICULAR FONT, STYLE, SIZE, OR COLOR.

NO CLAIM IS MADE TO THE EXCLUSIVE RIGHT TO USE "PLEAT", APART FROM THE MARK AS SHOWN.

FOR EXTENDED SURFACE PLEAT AIR FILTER FOR RESIDENTIAL AND COMMERCIAL USE (U.S. CLS. 13, 21, 23, 31 AND 34).

FIRST USE 3-29-2004; IN COMMERCE 3-29-2004.
ANNE E. GUSTASON, EXAMINING ATTORNEY

CLASS 11—(Continued).

SN 78-511,066. WEBSTONE COMPANY, INC., WORCESTER, MA. FILED 11-4-2004.

PRO-PAL

THE MARK CONSISTS OF STANDARD CHARACTERS WITHOUT CLAIM TO ANY PARTICULAR FONT, STYLE, SIZE, OR COLOR.

FOR COMMERCIAL AND RESIDENTIAL PLUMBING VALVES (U.S. CLS. 13, 21, 23, 31 AND 34).

FIRST USE 6-1-2004; IN COMMERCE 6-1-2004.
CHARLES L. JENKINS, EXAMINING ATTORNEY

SN 78-513,530. MERIDIAN AUTOMOTIVE SYSTEMS, INC., DEARBORN, MI. FILED 11-9-2004.

SN 78-510,092. BOOTZ MANUFACTURING COMPANY, EVANSVILLE, IN. FILED 11-2-2004.



MER

NO CLAIM IS MADE TO THE EXCLUSIVE RIGHT TO USE "INDUSTRIES", APART FROM THE MARK AS SHOWN.

FOR PLUMBING FIXTURES; NAMELY, BATHTUBS, SINKS AND LAVATORIES (U.S. CLS. 13, 21, 23, 31 AND 34).

FIRST USE 11-19-2004; IN COMMERCE 11-19-2004.
KIMBERLY FRYE, EXAMINING ATTORNEY

THE MARK CONSISTS OF STANDARD CHARACTERS WITHOUT CLAIM TO ANY PARTICULAR FONT, STYLE, SIZE, OR COLOR.

FOR VEHICLE HEADLAMPS AND REPLACEMENT PARTS THEREFOR (U.S. CLS. 13, 21, 23, 31 AND 34).

FIRST USE 3-0-2001; IN COMMERCE 3-0-2001.
KEVIN DINALLO, EXAMINING ATTORNEY

CLASS 11—(Continued).

SN 78-514,306. CARRIER COMMERCIAL REFRIGERATION, INC., AURORA, IL. FILED 11-10-2004.

ALLEGRO

THE MARK CONSISTS OF STANDARD CHARACTERS WITHOUT CLAIM TO ANY PARTICULAR FONT, STYLE, SIZE, OR COLOR.

THE MARK CONSISTS OF "ALLEGRO" MEANING "QUICK, BRISK, OR LIVELY" IN ENGLISH.

FOR REFRIGERATED DISPLAY MERCHANDISERS (U.S. CLS. 13, 21, 23, 31 AND 34).

FIRST USE 7-29-2004; IN COMMERCE 7-29-2004.
RICHARD A. STRASER, EXAMINING ATTORNEY

CLASS 11—(Continued).

SN 78-515,222. PENTAIR FILTRATION, INC., SHEBOYGAN, WI. FILED 11-11-2004.

SEAL-SAFE

THE MARK CONSISTS OF STANDARD CHARACTERS WITHOUT CLAIM TO ANY PARTICULAR FONT, STYLE, SIZE, OR COLOR.

FOR WATER FILTER CARTRIDGES (U.S. CLS. 13, 21, 23, 31 AND 34).

FIRST USE 3-19-2004; IN COMMERCE 3-19-2004.
CAROLINE WEIMER, EXAMINING ATTORNEY

SN 78-517,318. HI-HEAT INDUSTRIES, INC., LEWISTOWN, MT. FILED 11-15-2004.

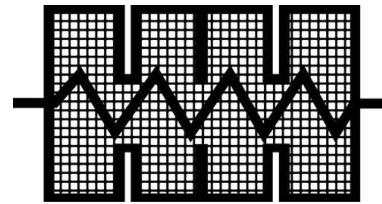

FOR ELECTRICAL HEATING ELEMENTS FOR INDUSTRIAL USE; ELECTRICAL HEATERS FOR COMMERCIAL USE (U.S. CLS. 13, 21, 23, 31 AND 34).

FIRST USE 9-15-2004; IN COMMERCE 9-15-2004.
JOHN DALIER, EXAMINING ATTORNEY

SN 78-515,035. WHITE, KATHRYN GOETZKE, ANNAPOLIS, MD. FILED 11-11-2004.

**Light Bulbs for
Your Lifestyle**

THE MARK CONSISTS OF STANDARD CHARACTERS WITHOUT CLAIM TO ANY PARTICULAR FONT, STYLE, SIZE, OR COLOR.

NO CLAIM IS MADE TO THE EXCLUSIVE RIGHT TO USE LIGHT BULBS, APART FROM THE MARK AS SHOWN.

FOR ELECTRIC LIGHT BULBS (U.S. CLS. 13, 21, 23, 31 AND 34).

GISELLE AGOSTO, EXAMINING ATTORNEY

SN 78-517,867. PLH PRODUCTS, INC., BUENA PARK, CA. FILED 11-16-2004.

HEALTH PARTNER

THE MARK CONSISTS OF STANDARD CHARACTERS WITHOUT CLAIM TO ANY PARTICULAR FONT, STYLE, SIZE, OR COLOR.

NO CLAIM IS MADE TO THE EXCLUSIVE RIGHT TO USE HEALTH, APART FROM THE MARK AS SHOWN.

FOR SAUNAS, NAMELY, INFRA-RED SAUNAS, STEAM SAUNAS, AND DRY SAUNAS FOR HEATING PURPOSES (U.S. CLS. 13, 21, 23, 31 AND 34).

FIRST USE 3-1-2004; IN COMMERCE 3-1-2004.
RUSS HERMAN, EXAMINING ATTORNEY

CLASS 11—(Continued).

SN 78-517,996. SIMPSON, RÉMY M., LEXINGTON, KY.
FILED 11-16-2004.

Scent-o-matic

THE MARK CONSISTS OF STANDARD CHARACTERS
WITHOUT CLAIM TO ANY PARTICULAR FONT, STYLE,
SIZE, OR COLOR.

FOR FRAGRANCE DISPENSING UNIT FOR AIR
FRESHENING (U.S. CLS. 13, 21, 23, 31 AND 34).

FIRST USE 11-1-2004; IN COMMERCE 11-10-2004.

CIMMERIAN COLEMAN, EXAMINING ATTORNEY

CLASS 11—(Continued).

SN 78-520,262. AQUA PRODUCTS, INC., CEDAR GROVE,
NJ. FILED 11-19-2004.

THUNDER JET

THE MARK CONSISTS OF STANDARD CHARACTERS
WITHOUT CLAIM TO ANY PARTICULAR FONT, STYLE,
SIZE, OR COLOR.

NO CLAIM IS MADE TO THE EXCLUSIVE RIGHT TO
USE "JET", APART FROM THE MARK AS SHOWN.

FOR ROBOTIC SWIMMING POOL WATER CLEAN-
ING UNITS (U.S. CLS. 13, 21, 23, 31 AND 34).

FIRST USE 0-0-2001; IN COMMERCE 0-0-2001.

JIM RINGLE, EXAMINING ATTORNEY

SN 78-520,269. WOODS INDUSTRIES, INC., CARMEL, IN.
FILED 11-19-2004.

III Woods

CHALLENGER

SN 78-519,338. BARBEQUES GALORE, INC., LAKE FOREST,
CA. FILED 11-18-2004.

THE MARK CONSISTS OF STANDARD CHARACTERS
WITHOUT CLAIM TO ANY PARTICULAR FONT, STYLE,
SIZE, OR COLOR.

FOR BARBECUE GRILLS (U.S. CLS. 13, 21, 23, 31 AND
34).

TIMOTHY FINNEGAN, EXAMINING ATTORNEY

OWNER OF U.S. REG. NO. 1,603,454.

FOR WORK LIGHTS, TROUBLE LIGHTS, TASK
LIGHTS, NIGHT LIGHTS, ELECTRIC LAMPS, FLUOR-
ESCENT LIGHTS, DECORATIVE ELECTRIC LIGHT
STRINGS, DECORATIVE ELECTRIC PATIO AND GAR-
DEN LIGHTING, LANDSCAPE LIGHTING, FIXTURES
FOR FLOOD LIGHTS, BATTERY-OPERATED LIGHTS,
AND LIGHTING FIXTURES (U.S. CLS. 13, 21, 23, 31
AND 34).

FIRST USE 3-15-1985; IN COMMERCE 3-15-1985.

HENRY S. ZAK, EXAMINING ATTORNEY

CLASS 11—(Continued).

SN 78-520,280. AQUA PRODUCTS, INC., CEDAR GROVE, NJ. FILED 11-19-2004.

CLASS 11—(Continued).

SN 78-520,697. STEAMROOM USA, INC., ALPHARETTA, GA. FILED 11-21-2004.

TURBO BOT

AQUALAIR

THE MARK CONSISTS OF STANDARD CHARACTERS WITHOUT CLAIM TO ANY PARTICULAR FONT, STYLE, SIZE, OR COLOR.

OWNER OF U.S. REG. NO. 2,700,593.
NO CLAIM IS MADE TO THE EXCLUSIVE RIGHT TO USE "BOT", APART FROM THE MARK AS SHOWN.
FOR ROBOTIC SWIMMING POOL WATER CLEANING UNITS (U.S. CLS. 13, 21, 23, 31 AND 34).
FIRST USE 0-0-2004; IN COMMERCE 0-0-2004.
JIM RINGLE, EXAMINING ATTORNEY

THE MARK CONSISTS OF STANDARD CHARACTERS WITHOUT CLAIM TO ANY PARTICULAR FONT, STYLE, SIZE, OR COLOR.

FOR BATHROOM AND SPA FIXTURES, NAMELY, SHOWERS, STEAM ROOMS, WHIRLPOOL TUBS, TOILETS, BIDETS AND SINKS (U.S. CLS. 13, 21, 23, 31 AND 34).
CHERYL CLAYTON, EXAMINING ATTORNEY

SN 78-520,366. AQUA PRODUCTS, INC., CEDAR GROVE, NJ. FILED 11-19-2004.

SN 78-520,973. INTERNATIONAL SURFACE PREPARATION GROUP, INC., GOLDEN, CO. FILED 11-22-2004.

ULTRA MAX

MPF

THE MARK CONSISTS OF STANDARD CHARACTERS WITHOUT CLAIM TO ANY PARTICULAR FONT, STYLE, SIZE, OR COLOR.

FOR ROBOTIC SWIMMING POOL WATER CLEANING UNITS (U.S. CLS. 13, 21, 23, 31 AND 34).
FIRST USE 0-0-1994; IN COMMERCE 0-0-1994.
JIM RINGLE, EXAMINING ATTORNEY

THE MARK CONSISTS OF STANDARD CHARACTERS WITHOUT CLAIM TO ANY PARTICULAR FONT, STYLE, SIZE, OR COLOR.

FOR UNITS FOR REMOVING PARTICLES FROM AN AIR STREAM COMPRISED OF HOUSINGS, FANS AND FILTER ELEMENTS. (U.S. CLS. 13, 21, 23, 31 AND 34).
MARIA-VICTORIA SUAREZ, EXAMINING ATTORNEY

CLASS 11—(Continued).

SN 78-521,089. HP INTELLECTUAL CORP., WILMINGTON, DE. FILED 11-22-2004.

CLASS 11—(Continued).

SN 78-522,286. CHAMPION INDUSTRIES, INC., WINSTON-SALEM, NC. FILED 11-23-2004.

SMART CAT

LAINOX

THE MARK CONSISTS OF STANDARD CHARACTERS WITHOUT CLAIM TO ANY PARTICULAR FONT, STYLE, SIZE, OR COLOR.
FOR AIR CLEANERS FOR DOMESTIC USE (U.S. CLS. 13, 21, 23, 31 AND 34).
MICHAEL KAZAZIAN, EXAMINING ATTORNEY

THE MARK CONSISTS OF STANDARD CHARACTERS WITHOUT CLAIM TO ANY PARTICULAR FONT, STYLE, SIZE, OR COLOR.
FOR COMMERCIAL COMBINATION OVEN/STEAMER COOKING SYSTEMS FOR COMMERCIAL FOOD PREPARATION (U.S. CLS. 13, 21, 23, 31 AND 34).
FIRST USE 8-0-2001; IN COMMERCE 8-0-2001.
CHERYL CLAYTON, EXAMINING ATTORNEY

SN 78-522,365. ENDLESS POOLS, INC., ASTON, PA. FILED 11-24-2004.

SN 78-521,601. HUNTER FAN COMPANY, MEMPHIS, TN. FILED 11-23-2004.

FastLane

PIEDMONT

THE MARK CONSISTS OF STANDARD CHARACTERS WITHOUT CLAIM TO ANY PARTICULAR FONT, STYLE, SIZE, OR COLOR.
FOR CEILING FANS (U.S. CLS. 13, 21, 23, 31 AND 34).
LINDA E. BLOHM, EXAMINING ATTORNEY

THE MARK CONSISTS OF STANDARD CHARACTERS WITHOUT CLAIM TO ANY PARTICULAR FONT, STYLE, SIZE, OR COLOR.
FOR HYDRAULIC/ELECTRIC UNIT DESIGNED TO BE ATTACHED TO OR BUILT INTO WALL OF A SWIMMING POOL TO GENERATE A CURRENT AGAINST WHICH THE USER CAN SWIM, EXERCISE, ENGAGE IN PHYSICAL THERAPY, OR PLAY, COMPRISED OF A MOTOR, POWER UNIT, CHANNELING DEVICE, AND HYDRAULIC HOSES THAT GENERATES A CURRENT IN A SWIMMING POOL (U.S. CLS. 13, 21, 23, 31 AND 34).
AMY HELLA, EXAMINING ATTORNEY

CLASS 11—(Continued).

SN 78-522,688. SOCIETE INDUSTRIELLE DE LACANCHE, ARNAY LE DUC, FRANCE, FILED 11-24-2004.

CLASS 11—(Continued).

SN 78-523,999. COMMEMORATIVE DISPLAYS, MIAMISBURG, OH. FILED 11-29-2004.

FONTENAY

Honor Lights

THE MARK CONSISTS OF STANDARD CHARACTERS WITHOUT CLAIM TO ANY PARTICULAR FONT, STYLE, SIZE, OR COLOR.

FOR ELECTRIC AND GAS STOVES, COOKERS AND COOKING RANGES (U.S. CLS. 13, 21, 23, 31 AND 34).

FIRST USE 0-0-1993; IN COMMERCE 3-0-1998.

JOHN HWANG, EXAMINING ATTORNEY

THE MARK CONSISTS OF STANDARD CHARACTERS WITHOUT CLAIM TO ANY PARTICULAR FONT, STYLE, SIZE, OR COLOR.

NO CLAIM IS MADE TO THE EXCLUSIVE RIGHT TO USE "LIGHTS", APART FROM THE MARK AS SHOWN.

FOR SOLAR LIGHT FIXTURES, NAMELY, INDOOR AND OUTDOOR SOLAR POWERED LIGHTING UNITS AND FIXTURES WHICH CAN BE USED AS A MEMORIAL (U.S. CLS. 13, 21, 23, 31 AND 34).

DOUGLAS LEE, EXAMINING ATTORNEY

SN 78-522,741. SOCIETE INDUSTRIELLE DE LACANCHE, ARNAY LE DUC, FRANCE, FILED 11-24-2004.

SN 78-526,327. AAA SERVICE NETWORK, INC., HOWELL, MI. FILED 12-2-2004.

CORMATIN



THE MARK CONSISTS OF STANDARD CHARACTERS WITHOUT CLAIM TO ANY PARTICULAR FONT, STYLE, SIZE, OR COLOR.

FOR ELECTRIC AND GAS STOVES, COOKERS AND COOKING RANGES (U.S. CLS. 13, 21, 23, 31 AND 34).

FIRST USE 0-0-1993; IN COMMERCE 9-0-1995.

HOWARD B. LEVINE, EXAMINING ATTORNEY

FOR FURNACES, WATER SOFTENING UNITS, WATER FILTERS, AIR CONDITIONING UNITS, HUMIDIFIERS, AND CENTRAL AIR PURIFIERS (U.S. CLS. 13, 21, 23, 31 AND 34).

FLORENTINA BLANDU, EXAMINING ATTORNEY

CLASS 11—(Continued).

SN 78-526,851. NATIONAL DIVERSIFIED SALES, INC.,
LINDSAY, CA. FILED 12-3-2004.

DRIPSTAR

THE MARK CONSISTS OF STANDARD CHARACTERS
WITHOUT CLAIM TO ANY PARTICULAR FONT, STYLE,
SIZE, OR COLOR.

FOR DRIP BUBBLERS FOR A DRIP IRRIGATION
SYSTEM (U.S. CLS. 13, 21, 23, 31 AND 34).
LANA PHAM, EXAMINING ATTORNEY

CLASS 11—(Continued).

SN 78-528,132. ALSONS CORPORATION, HILLSDALE, MI.
FILED 12-7-2004.

THE INCREDIBLE HEAD

THE MARK CONSISTS OF STANDARD CHARACTERS
WITHOUT CLAIM TO ANY PARTICULAR FONT, STYLE,
SIZE, OR COLOR.

NO CLAIM IS MADE TO THE EXCLUSIVE RIGHT TO
USE "HEAD", APART FROM THE MARK AS SHOWN.

FOR PLUMBING PRODUCTS, NAMELY, SHOWER
HEADS (U.S. CLS. 13, 21, 23, 31 AND 34).

ESTHER BELENKER, EXAMINING ATTORNEY

SN 78-529,512. NANOMIST SYSTEMS, LLC, WARNER RO-
BINS, GA. FILED 12-8-2004.

SN 78-526,860. NATIONAL DIVERSIFIED SALES, INC.,
LINDSAY, CA. FILED 12-3-2004.

HYDRO-PORT

THE MARK CONSISTS OF STANDARD CHARACTERS
WITHOUT CLAIM TO ANY PARTICULAR FONT, STYLE,
SIZE, OR COLOR.

FOR DRIP BUBBLERS FOR A DRIP IRRIGATION
SYSTEM (U.S. CLS. 13, 21, 23, 31 AND 34).

STEPHANIE DAVIS, EXAMINING ATTORNEY

nHelix

THE MARK CONSISTS OF STANDARD CHARACTERS
WITHOUT CLAIM TO ANY PARTICULAR FONT, STYLE,
SIZE, OR COLOR.

FOR REACTORS, NAMELY HEAT BASED REACTORS
FOR PRODUCTION OF NANOSTRUCTURED AND MI-
CRON SIZED MATERIALS (U.S. CLS. 13, 21, 23, 31 AND
34).

TEJBIR SINGH, EXAMINING ATTORNEY

CLASS 11—(Continued).

SN 78-533,397. RADIANT RENOVATION, LLC, MADISON, CT. FILED 12-16-2004.

CLASS 11—(Continued).

SN 78-536,347. DIDIER, PAUL, CHICAGO, IL. FILED 12-21-2004.

OVERBOARDS

THE MARK CONSISTS OF STANDARD CHARACTERS WITHOUT CLAIM TO ANY PARTICULAR FONT, STYLE, SIZE, OR COLOR.

FOR DECORATIVE COVERS FITTED TO BASEBOARD HEATERS, RADIATORS, AND SPACE HEATERS (U.S. CLS. 13, 21, 23, 31 AND 34).

LEIGH CAROLINE CASE, EXAMINING ATTORNEY



SN 78-533,515. TARGET BRANDS, INC., MINNEAPOLIS, MN. FILED 12-16-2004.

FLAGBRIGHT

THE MARK CONSISTS OF STANDARD CHARACTERS WITHOUT CLAIM TO ANY PARTICULAR FONT, STYLE, SIZE, OR COLOR.

FOR SOLAR AND BATTERY OPERATED LIGHTING FIXTURES FOR FLAG POLES (U.S. CLS. 13, 21, 23, 31 AND 34).

MARLENE BELL, EXAMINING ATTORNEY



SN 78-538,082. YANKEE CANDLE COMPANY, INC., THE, SOUTH DEERFIELD, MA. FILED 12-23-2004.

DOTTIE LOVES...

THE MARK CONSISTS OF STANDARD CHARACTERS WITHOUT CLAIM TO ANY PARTICULAR FONT, STYLE, SIZE, OR COLOR.

FOR NIGHT LIGHTS; LAMPS (U.S. CLS. 13, 21, 23, 31 AND 34).

CAROLINE WOOD, EXAMINING ATTORNEY



SN 78-536,128. HUNTER FAN COMPANY, MEMPHIS, TN. FILED 12-21-2004.

MEADOW MIST

THE MARK CONSISTS OF STANDARD CHARACTERS WITHOUT CLAIM TO ANY PARTICULAR FONT, STYLE, SIZE, OR COLOR.

FOR ELECTRIC FRAGRANCE DISPENSERS (U.S. CLS. 13, 21, 23, 31 AND 34).

JULIE GUTTADAURO, EXAMINING ATTORNEY



SN 78-538,489. HALOGEN LIGHTING PRODUCTS CORPORATION, KANEVILLE, IL. FILED 12-27-2004.

CORAL BAY

THE MARK CONSISTS OF STANDARD CHARACTERS WITHOUT CLAIM TO ANY PARTICULAR FONT, STYLE, SIZE, OR COLOR.

FOR CEILING FANS (U.S. CLS. 13, 21, 23, 31 AND 34).

LAURA KOVAISKY, EXAMINING ATTORNEY

SHATTERPROOF²

NO CLAIM IS MADE TO THE EXCLUSIVE RIGHT TO USE "SHATTERPROOF", APART FROM THE MARK AS SHOWN.

FOR ELECTRIC LIGHTING FIXTURES (U.S. CLS. 13, 21, 23, 31 AND 34).

LOURDES AYALA, EXAMINING ATTORNEY

CLASS 11—(Continued).

SN 78-538,946. GREAT 2000 ENTERPRISES, INC., DBA CONCORD FANS & LIGHTING, CORONA, CA. FILED 12-28-2004.

All About Looks

THE MARK CONSISTS OF STANDARD CHARACTERS WITHOUT CLAIM TO ANY PARTICULAR FONT, STYLE, SIZE, OR COLOR.

FOR ELECTRIC CEILING FANS FOR NON-INDUSTRIAL USE (U.S. CLS. 13, 21, 23, 31 AND 34).
ALLISON HOLTZ, EXAMINING ATTORNEY

SN 78-539,923. LIN, DON, S EL MONTE, CA. FILED 12-30-2004.

Smart-Chef

THE MARK CONSISTS OF STANDARD CHARACTERS WITHOUT CLAIM TO ANY PARTICULAR FONT, STYLE, SIZE, OR COLOR.

FOR ELECTRIC COOKING APPLIANCES, NAMELY ELECTRIC RICE COOKER, ELECTRIC SLOW COOKER, ELECTRIC MULTI-COOKERS, NAMELY, ELECTRIC FOOD WARMER, ELECTRIC HOT WATER POT, ELECTRIC KETTLES, ELECTRIC COOKING OVENS, ELECTRIC TOASTERS (U.S. CLS. 13, 21, 23, 31 AND 34).

FIRST USE 1-1-2004; IN COMMERCE 11-1-2004.
TEJBIR SINGH, EXAMINING ATTORNEY

CLASS 11—(Continued).

SN 78-543,338. GRAVER TECHNOLOGIES, INC., GLASGOW, DE. FILED 1-6-2005.

SCEPTER

THE MARK CONSISTS OF STANDARD CHARACTERS WITHOUT CLAIM TO ANY PARTICULAR FONT, STYLE, SIZE, OR COLOR.

FOR MEMBRANE FILTERING UNITS AND MODULES CONTAINING MEMBRANE FILTERING UNITS FOR WATER TREATMENT (U.S. CLS. 13, 21, 23, 31 AND 34).

FIRST USE 5-10-1995; IN COMMERCE 5-10-1995.
ALEXANDER L. POWERS, EXAMINING ATTORNEY

SN 78-545,391. FAMOUS NAME COMPANY (PTY) LIMITED, GAUNTENG, SOUTH AFRICA, FILED 1-11-2005.

JEEVES

THE MARK CONSISTS OF STANDARD CHARACTERS WITHOUT CLAIM TO ANY PARTICULAR FONT, STYLE, SIZE, OR COLOR.

OWNER OF U.S. REG. NO. 2,489,899.
FOR ELECTRICAL HEATED TOWEL RAILS AND ELECTRICAL TOWEL WARMERS; HEATED TOWEL RAILS AND TOWEL WARMERS, BOTH AS FIXTURES FOR CONNECTION TO CENTRAL HEATING SYSTEMS (U.S. CLS. 13, 21, 23, 31 AND 34).

HOWARD SMIGA, EXAMINING ATTORNEY

CLASS 11—(Continued).

SN 78-545,437. P.J. LODGE, NAPLES INC., NAPLES, FL. FILED 1-11-2005.

CLASS 11—(Continued).

SN 78-554,798. AZ EVAP, LLC, PHOENIX, AZ. FILED 1-27-2005.

CHANDELIERIOUS

**DIFFERENTIATED BY
DESIGN...
ENGINEERED TO
ADAPT AND ENDURE**

THE MARK CONSISTS OF STANDARD CHARACTERS WITHOUT CLAIM TO ANY PARTICULAR FONT, STYLE, SIZE, OR COLOR.
FOR DECORATIVE CHANDELIER CRYSTALS (U.S. CLS. 13, 21, 23, 31 AND 34).
MATTHEW KLINE, EXAMINING ATTORNEY

THE MARK CONSISTS OF STANDARD CHARACTERS WITHOUT CLAIM TO ANY PARTICULAR FONT, STYLE, SIZE, OR COLOR.
FOR EVAPORATIVE AIR COOLERS AND COMPONENTS THEREOF (U.S. CLS. 13, 21, 23, 31 AND 34).
DOMINICK J. SALEMI, EXAMINING ATTORNEY

SN 78-553,986. LESLIE'S POOLMART, INC., PHOENIX, AZ. FILED 1-26-2005.

SN 78-557,308. TOSHIBA LIGHTTEC KABUSHIKI KAISHA, DBA TOSHIBA LIGHTING & TECHNOLOGY CORPORATION, TOKYO, JAPAN, FILED 1-31-2005.

SANI-TOWER

NEOBALL

THE MARK CONSISTS OF STANDARD CHARACTERS WITHOUT CLAIM TO ANY PARTICULAR FONT, STYLE, SIZE, OR COLOR.
FOR WATER TREATMENT EQUIPMENT, NAMELY SANITIZING UNITS UTILIZING CHLORINE TABLETS FOR USE IN SWIMMING POOLS (U.S. CLS. 13, 21, 23, 31 AND 34).
GINA FINK, EXAMINING ATTORNEY

FOR ELECTRIC LAMPS; LIGHTING FIXTURES; FLUORESCENT LAMPS, TUBES, BULBS (U.S. CLS. 13, 21, 23, 31 AND 34).
LINDA E. BLOHM, EXAMINING ATTORNEY

CLASS 11—(Continued).

SN 78-598,559. JACUZZI INC., DALLAS, TX. FILED 3-30-2005.

MAXIMA

THE MARK CONSISTS OF STANDARD CHARACTERS WITHOUT CLAIM TO ANY PARTICULAR FONT, STYLE, SIZE, OR COLOR.

FOR WHIRLPOOL BATHS (U.S. CLS. 13, 21, 23, 31 AND 34).

JASON ROTH, EXAMINING ATTORNEY

SN 79-000,436. KONINKLIJKE PHILIPS ELECTRONICS N.V., NETHERLANDS, FILED 11-19-2003.

SPEEDIUM

THE MARK CONSISTS OF STANDARD CHARACTERS WITHOUT CLAIM TO ANY PARTICULAR FONT, STYLE, SIZE, OR COLOR.

PRIORITY DATE OF 6-4-2003 IS CLAIMED.

OWNER OF INTERNATIONAL REGISTRATION 0816653 DATED 11-19-2003, EXPIRES 11-19-2013.

FOR ELECTRIC LAMPS, INFRARED LAMPS, AND INFRARED HIGH-POWERED HEAT SOURCE COMPRISING INFRARED LAMPS TO BE USED FOR PAINT DRYING IN TUNNELS AND BODY SHOPS; BLOWING OF PETP (POLYETHYLENE TEREPHTHALATE) BOTTLES; PLASTICS THERMOFORMING; EPITAXY, CVD (CHEMICAL VAPOR DEPOSITION), RTP (RAPID THERMAL PROCESSING), OXIDATION PROCESSES IN SEMICONDUCTOR INDUSTRY; HEATING OF FOOD AND KEEPING IT WARM; PAPER DRYING IN MILLS; DRYING OF LACQUER, PRINTING INKS; PRE-HEATING OF WOOD PRIOR TO LACQUERING; HEAT STERILIZATION; SOFTENING AND MELTING OF PLASTICS; STRUCTURAL PARTS OF THE AFORESAID GOODS (U.S. CLS. 13, 21, 23, 31 AND 34).

SEAN DWYER, EXAMINING ATTORNEY

CLASS 11—(Continued).

SN 79-002,405. PAGETTE SANITÄR; PRODUKTIONS- UND VERTRIEBS-GMBH, FED REP GERMANY, FILED 4-15-2004.

PAGETTE

OWNER OF INTERNATIONAL REGISTRATION 0182167 DATED 1-22-1955, EXPIRES 1-22-2015.

FOR SYNTHETIC MATERIAL PARTS FOR LIGHTING, HEATING, COOKING, REFRIGERATING, DRYING AND VENTILATING APPARATUS AND UTENSILS, WATER PIPES, BATHROOM AND WASHROOM INSTALLATIONS, NAMELY LAVATORY SEATS, TOILET TANKS, TOILET BOWLS, MIXER FAUCETS FOR WATER PIPES, PIPES BEING PARTS OF SANITARY FACILITIES, PIPES FOR HEATING BOILERS, PORTABLE BATH SEAT, PORTABLE URINALS FOR OUTDOOR ACTIVITIES, URINALS [SANITATION FIX-TURES], WATER CLOSETS, OZONE SANITIZERS FOR AIR AND WATER (U.S. CLS. 13, 21, 23, 31 AND 34).

PRISCILLA MILTON, EXAMINING ATTORNEY

SN 79-003,859. ECOLAB GMBH & CO. OHG, FED REP GERMANY, FILED 5-13-2004.

AQUACYCLER

THE MARK CONSISTS OF STANDARD CHARACTERS WITHOUT CLAIM TO ANY PARTICULAR FONT, STYLE, SIZE, OR COLOR.

PRIORITY DATE OF 2-3-2004 IS CLAIMED.

OWNER OF INTERNATIONAL REGISTRATION 0828941 DATED 5-13-2004, EXPIRES 5-13-2014.

FOR WASTE WATER PURIFICATION UNITS; WATER PURIFICATION UNITS AND WATER PURIFICATION TANKS (U.S. CLS. 13, 21, 23, 31 AND 34).

CATHERINE CAIN, EXAMINING ATTORNEY

SN 79-003,860. ECOLAB GMBH & CO. OHG, FED REP GERMANY, FILED 5-13-2004.

AQUAROTOR 55

THE MARK CONSISTS OF STANDARD CHARACTERS WITHOUT CLAIM TO ANY PARTICULAR FONT, STYLE, SIZE, OR COLOR.

PRIORITY DATE OF 2-3-2004 IS CLAIMED.

OWNER OF INTERNATIONAL REGISTRATION 0828942 DATED 5-13-2004, EXPIRES 5-13-2014.

FOR BIOREACTOR FOR USE IN THE TREATMENT OF INDUSTRIAL WASTEWATER; WASTE WATER PURIFICATION UNITS AND WATER PURIFICATION UNITS (U.S. CLS. 13, 21, 23, 31 AND 34).

CATHERINE CAIN, EXAMINING ATTORNEY

CLASS 11—(Continued).

SN 79-004,621. S.B.P. S.P.A., ITALY, FILED 6-10-2004.



*PERFORMANCE
IN LIGHTING*

OWNER OF INTERNATIONAL REGISTRATION 0680394 DATED 9-3-1997, EXPIRES 9-3-2007.

THE MARK CONSISTS OF A DARK RECTANGLE ARRANGED VERTICALLY, DIVIDED BY A LIGHT HORIZONTAL LINE IN AN UPPER SQUARE AND A LOWER HORIZONTAL RECTANGLE; THE SQUARE FEATURES TWO CIRCULAR LIGHT SECTIONS ARRANGED SYMMETRICALLY ON EACH SIDE OF A FIGURE RESEMBLING A CENTRAL BEACON, THE LOWER RECTANGLE FEATURING THE LETTERS S B P IN UPPERCASE PRINTING TYPE, THE DESIGN IS ABOVE THE WORDS PERFORMANCE IN LIGHTING AND MAY BE REPRODUCED IN ANY SIZE AND COLOR.

FOR LIGHTING FIXTURES (U.S. CLS. 13, 21, 23, 31 AND 34).

VIVIAN MICZNIK FIRST, EXAMINING ATTORNEY

CLASS 12—VEHICLES

SN 76-328,372. BRUNSWICK COMMERCIAL & GOVERNMENT PRODUCTS, INC., EDGEWATER, FL. FILED 10-22-2001.

GUARDIAN

FOR SPECIALTY UTILITY AND INDUSTRIAL WORK BOATS, NAMELY, MILITARY, LAW ENFORCEMENT, FIRE, RESCUE, HARBOR TENDERS, CHARTER FISHING, COMMERCIAL DIVING, PILOT, OFFSHORE DRILLING SHUTTLES, AND ENVIRONMENTAL BOATS, AND THE LIKE (U.S. CLS. 19, 21, 23, 31, 35 AND 44).

FIRST USE 0-0-1985; IN COMMERCE 0-0-1985.

VIVIAN MICZNIK FIRST, EXAMINING ATTORNEY

SN 76-521,615. PIRELLI PNEUMATICI S.P.A., ITALY, FILED 6-10-2003.

SOTTOZERO

PRIORITY CLAIMED UNDER SEC. 44(D) ON ITALY APPLICATION NO. M12003C00522, FILED 5-22-2003, REG. NO. 899275, DATED 5-22-2003, EXPIRES 5-22-2013.

THE ENGLISH TRANSLATION OF THE WORD SOTTOZERO IS "SUB ZERO" OR "BELOW ZERO".

FOR TIRES; PNEUMATIC, SEMI-PNEUMATIC AND SOLID TIRES FOR VEHICLE WHEELS; WHEELS FOR VEHICLES, INNER TUBES, RIMS AND STRUCTURAL AND REPLACEMENT PARTS FOR ALL THE AFORESAID GOODS (U.S. CLS. 19, 21, 23, 31, 35 AND 44).

JENNIFER CHICOSKI, EXAMINING ATTORNEY

SN 79-006,034. GOLD PEG INTERNATIONAL PTY LTD, AUSTRALIA, FILED 6-18-2004.

GOLD PEG

THE MARK CONSISTS OF STANDARD CHARACTERS WITHOUT CLAIM TO ANY PARTICULAR FONT, STYLE, SIZE, OR COLOR.

PRIORITY DATE OF 6-15-2004 IS CLAIMED.

OWNER OF INTERNATIONAL REGISTRATION 0835216 DATED 6-18-2004, EXPIRES 6-18-2014.

FOR STEAM FUSION CONTINUOUS COOKING SYSTEM, NAMELY, DIRECT STEAM INJECTION COOKERS (U.S. CLS. 13, 21, 23, 31 AND 34).

WILLIAM BRECKENFELD, EXAMINING ATTORNEY

SN 76-544,482. TPM PRODUCTS, BOONTON, NJ. FILED 9-2-2003.

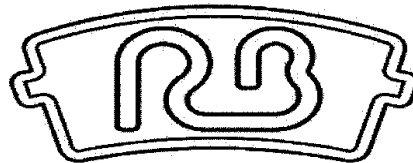

FOR BRAKE SYSTEM COMPONENTS FOR LAND VEHICLES, NAMELY, BRAKE HARDWARE, BRAKE DRUMS, BRAKE PADS, BRAKE SHOES, BRAKE CALIPERS AND PARTS THEREOF, BRAKE HOSES, MASTER CYLINDER AND PARTS THEREOF, AND WHEEL CYLINDERS; DISC BRAKES FOR LAND VEHICLES (U.S. CLS. 19, 21, 23, 31, 35 AND 44).

FIRST USE 7-31-2003; IN COMMERCE 7-31-2003.

CHRISTOPHER BUONGIORNO, EXAMINING ATTORNEY

CLASS 12—(Continued).

SN 76-560,626. CALDWELL, JOHN R., PLANO, TX. FILED 11-18-2003.

BICEPS BIKE

THE MARK CONSISTS OF STANDARD CHARACTERS WITHOUT CLAIM TO ANY PARTICULAR FONT, STYLE, SIZE, OR COLOR.

NO CLAIM IS MADE TO THE EXCLUSIVE RIGHT TO USE BIKE, APART FROM THE MARK AS SHOWN.

FOR BICYCLES, NAMELY A HAND-PROPELLED WHEELED DEVICE FOR A RIDER (U.S. CLS. 19, 21, 23, 31, 35 AND 44).

BARNEY CHARLON, EXAMINING ATTORNEY

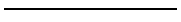

SN 76-570,494. GREENBALL CORPORATION, LONG BEACH, CA. FILED 1-16-2004.

HWY

THE MARK CONSISTS OF STANDARD CHARACTERS WITHOUT CLAIM TO ANY PARTICULAR FONT, STYLE, SIZE, OR COLOR.

FOR LAND VEHICLE PARTS, NAMELY, AXLES, WHEEL HUBS FOR AUTOMOBILES AND TRAILERS, BRAKES AND THEIR COMPONENTS (U.S. CLS. 19, 21, 23, 31, 35 AND 44).

ALICIA COLLINS, EXAMINING ATTORNEY

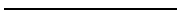

SN 76-582,415. SMA-PATENTS, L.L.C., SCOTTSDALE, AZ. FILED 3-23-2004.

**WORLD'S MOST
SERIOUS
4 X 4**

THE MARK CONSISTS OF STANDARD CHARACTERS WITHOUT CLAIM TO ANY PARTICULAR FONT, STYLE, SIZE, OR COLOR.

NO CLAIM IS MADE TO THE EXCLUSIVE RIGHT TO USE "4 X 4", APART FROM THE MARK AS SHOWN.

FOR DECORATIVE FITTED COVERS FOR VEHICLE (U.S. CLS. 19, 21, 23, 31, 35 AND 44).

FIRST USE 3-5-2004; IN COMMERCE 3-5-2004.
SHARI SHEFFIELD, EXAMINING ATTORNEY

CLASS 12—(Continued).

SN 76-584,737. KTM NORTH AMERICA, INC., AMHERST, OH. FILED 4-5-2004.

MXC

THE MARK CONSISTS OF STANDARD CHARACTERS WITHOUT CLAIM TO ANY PARTICULAR FONT, STYLE, SIZE, OR COLOR.

FOR MOTORCYCLES (U.S. CLS. 19, 21, 23, 31, 35 AND 44).

FIRST USE 0-0-1993; IN COMMERCE 0-0-1993.

TIMOTHY FINNEGAN, EXAMINING ATTORNEY

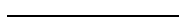

SN 76-591,510. MARUI LTD., KOBE, JAPAN, FILED 5-10-2004.

SPYDER WEB

THE MARK CONSISTS OF STANDARD CHARACTERS WITHOUT CLAIM TO ANY PARTICULAR FONT, STYLE, SIZE, OR COLOR.

FOR BICYCLE SADDLES (U.S. CLS. 19, 21, 23, 31, 35 AND 44).

TIMOTHY FINNEGAN, EXAMINING ATTORNEY



SN 76-607,716. MEDITERRANEAN YACHT CORPORATION, SANTA ANA, CA. FILED 8-16-2004.



NO CLAIM IS MADE TO THE EXCLUSIVE RIGHT TO USE "YACHTS", APART FROM THE MARK AS SHOWN. THE COLORS ORANGE AND BLUE ARE CLAIMED AS A FEATURE OF THE MARK.

THE MARK CONSISTS OF A BILL FISH JUMPING ACROSS AN ORANGE SUN ATTACHED TO THE NAME MEDITERRANEAN YACHTS. THE SUN IS ORANGE AND THE FISH AND THE NAME ARE BLUE.

SEC. 2(F) AS TO "MEDITERRANEAN YACHTS".

FOR YACHT (U.S. CLS. 19, 21, 23, 31, 35 AND 44).

FIRST USE 6-1-1984; IN COMMERCE 6-1-1984.

JOHN LINCOSKI, EXAMINING ATTORNEY

CLASS 12—(Continued).

SN 76-616,114. LUND INTERNATIONAL, INC., ANOKA, MN. FILED 10-14-2004.

LYNXWING

THE MARK CONSISTS OF STANDARD CHARACTERS WITHOUT CLAIM TO ANY PARTICULAR FONT, STYLE, SIZE, OR COLOR.
FOR SPOILERS FOR VEHICLES (U.S. CLS. 19, 21, 23, 31, 35 AND 44).
IRENE D. WILLIAMS, EXAMINING ATTORNEY

SN 76-618,791. RING & PINION SERVICE INC., EVERETT, WA. FILED 11-1-2004.

VALUE GEAR

THE MARK CONSISTS OF STANDARD CHARACTERS WITHOUT CLAIM TO ANY PARTICULAR FONT, STYLE, SIZE, OR COLOR.
NO CLAIM IS MADE TO THE EXCLUSIVE RIGHT TO USE GEAR, APART FROM THE MARK AS SHOWN.
FOR LAND VEHICLE PARTS, NAMELY AXLES, DIFFERENTIALS AND COMPONENTS THEREFORE, NAMELY RING AND PINIONS (U.S. CLS. 19, 21, 23, 31, 35 AND 44).
FIRST USE 7-2-2001; IN COMMERCE 7-2-2001.
MATTHEW KLINE, EXAMINING ATTORNEY

SN 76-620,653. CANNONDALE BICYCLE CORPORATION, BETHEL, CT. FILED 11-15-2004.

SYNAPSE

THE MARK CONSISTS OF STANDARD CHARACTERS WITHOUT CLAIM TO ANY PARTICULAR FONT, STYLE, SIZE, OR COLOR.
FOR BICYCLES (U.S. CLS. 19, 21, 23, 31, 35 AND 44).
CURTIS FRENCH, EXAMINING ATTORNEY

CLASS 12—(Continued).

SN 76-621,102. CHADCO ENTERPRISES, INC., DBA HARMAR MOBILITY, SARASOTA, FL. FILED 11-18-2004.

TILT-N-TOTE

THE MARK CONSISTS OF STANDARD CHARACTERS WITHOUT CLAIM TO ANY PARTICULAR FONT, STYLE, SIZE, OR COLOR.
FOR EXTERNALLY ATTACHED WHEELCHAIR CARRIERS FOR USE ON LAND VEHICLES (U.S. CLS. 19, 21, 23, 31, 35 AND 44).
FIRST USE 2-1-2004; IN COMMERCE 2-1-2004.
RONALD MCMORROW, EXAMINING ATTORNEY

SN 76-621,566. COACH SERVICES, INC., NEW YORK, NY. FILED 11-22-2004.

COACH

THE MARK CONSISTS OF STANDARD CHARACTERS WITHOUT CLAIM TO ANY PARTICULAR FONT, STYLE, SIZE, OR COLOR.
FOR BICYCLES AND BICYCLE PARTS, NAMELY, BICYCLE SADDLES AND BICYCLE SADDLE COVERS (U.S. CLS. 19, 21, 23, 31, 35 AND 44).
YONG KIM, EXAMINING ATTORNEY

SN 76-621,567. COACH SERVICES, INC., NEW YORK, NY. FILED 11-22-2004.

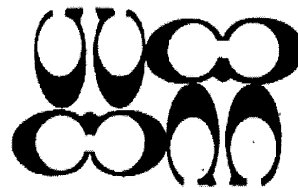

FOR BICYCLES AND BICYCLE PARTS, NAMELY, BICYCLE SADDLES AND BICYCLE SADDLE COVERS (U.S. CLS. 19, 21, 23, 31, 35 AND 44).
YONG KIM, EXAMINING ATTORNEY

CLASS 12—(Continued).

SN 76-621,614. STARCRAFT MARINE, L.L.C., TOPEKA, IN. FILED 11-22-2004.

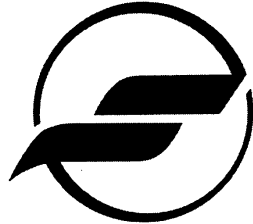

FOR BOATS AND STRUCTURAL PARTS FOR BOATS AND ACCESSORIES FOR BOATS; NAMELY, TRAILERS (U.S. CLS. 19, 21, 23, 31, 35 AND 44). FIRST USE 7-1-1999; IN COMMERCE 7-1-1999. JEAN IM, EXAMINING ATTORNEY

SN 76-621,688. CARLISLE INTANGIBLE COMPANY, SYRACUSE, NY. FILED 11-23-2004.

QUADTRAX

THE MARK CONSISTS OF STANDARD CHARACTERS WITHOUT CLAIM TO ANY PARTICULAR FONT, STYLE, SIZE, OR COLOR. FOR TIRES FOR LAND VEHICLES (U.S. CLS. 19, 21, 23, 31, 35 AND 44). TIMOTHY FINNEGAN, EXAMINING ATTORNEY

SN 76-622,293. LYNCH, RICHARD Q., ISLE OF PALMS, SC. FILED 11-29-2004.

TOP LOCKER

FOR CARGO CONTAINER FOR ATTACHMENT TO THE TOP OF A VEHICLE OR WATERCRAFT (U.S. CLS. 19, 21, 23, 31, 35 AND 44). JOHN WILKE, EXAMINING ATTORNEY

CLASS 12—(Continued).

SN 76-622,850. CENTER LINE MACHINING, INC., SULPHUR, LA. FILED 12-2-2004.



NO CLAIM IS MADE TO THE EXCLUSIVE RIGHT TO USE "VEHICLE POSITIONING SYSTEM", APART FROM THE MARK AS SHOWN. FOR TRAILER HITCH ALIGNMENT GUIDES (U.S. CLS. 19, 21, 23, 31, 35 AND 44). BARBARA A. GOLD, EXAMINING ATTORNEY

SN 76-622,851. CENTER LINE MACHINING, INC., SULPHUR, LA. FILED 12-2-2004.

VPS

THE MARK CONSISTS OF STANDARD CHARACTERS WITHOUT CLAIM TO ANY PARTICULAR FONT, STYLE, SIZE, OR COLOR. FOR TRAILER HITCH ALIGNMENT GUIDES (U.S. CLS. 19, 21, 23, 31, 35 AND 44). BARBARA A. GOLD, EXAMINING ATTORNEY

SN 76-625,084. MAX-TRAC TIRE CO., INC., STOW, OH. FILED 12-16-2004.

DICK CEPEK MUD COUNTRY

THE MARK CONSISTS OF STANDARD CHARACTERS WITHOUT CLAIM TO ANY PARTICULAR FONT, STYLE, SIZE, OR COLOR. OWNER OF U.S. REG. NOS. 999,857 AND 2,581,071. DICK CEPEK DOES NOT IDENTIFY A LIVING INDIVIDUAL. FOR TIRES (U.S. CLS. 19, 21, 23, 31, 35 AND 44). TIMOTHY FINNEGAN, EXAMINING ATTORNEY

CLASS 12—(Continued).

SN 76-625,334. THE PEP BOYS MANNY, MOE & JACK OF CALIFORNIA, PHILADELPHIA, PA. FILED 12-21-2004.

DEFINITY

THE MARK CONSISTS OF STANDARD CHARACTERS WITHOUT CLAIM TO ANY PARTICULAR FONT, STYLE, SIZE, OR COLOR.
FOR TIRES (U.S. CLS. 19, 21, 23, 31, 35 AND 44).
ANNE E. GUSTASON, EXAMINING ATTORNEY

SN 76-626,302. CARLISLE INTANGIBLE COMPANY, SYRACUSE, NY. FILED 12-30-2004.

CONESTOGA

THE MARK CONSISTS OF STANDARD CHARACTERS WITHOUT CLAIM TO ANY PARTICULAR FONT, STYLE, SIZE, OR COLOR.
FOR TIRES (U.S. CLS. 19, 21, 23, 31, 35 AND 44).
SALLY SHIH, EXAMINING ATTORNEY

SN 78-173,440. CEQUENT TOWING PRODUCTS, INC., PLYMOUTH, MI. FILED 10-11-2002.

THE GOOSE

FOR TRAILER HITCHES (U.S. CLS. 19, 21, 23, 31, 35 AND 44).
MARY CRAWFORD, EXAMINING ATTORNEY

SN 78-180,225. DAIMLERCHRYSLER CORPORATION, AUBURN HILLS, MI. FILED 10-30-2002.

THUNDER ROAD HEMI

OWNER OF U.S. REG. NO. 1,741,153.
NO CLAIM IS MADE TO THE EXCLUSIVE RIGHT TO USE "HEMI", APART FROM THE MARK AS SHOWN.
SEC. 2(F) AS TO "HEMI".
FOR MOTOR VEHICLES, NAMELY TRUCKS AND AUTOMOBILES, AND STRUCTURAL PARTS AND ENGINES THEREFOR (U.S. CLS. 19, 21, 23, 31, 35 AND 44).
JOANNA DUKOVIC, EXAMINING ATTORNEY

CLASS 12—(Continued).

SN 78-206,254. TIMONEY HOLDINGS LIMITED, NAVAN, CO. MEATH, IRELAND, FILED 1-23-2003.

TIMONEY

OWNER OF U.S. REG. NO. 2,968,244.
SEC. 2(F).
FOR INDEPENDENT SUSPENSION SYSTEMS FOR USE WITH ON-HIGHWAY AND OFF-HIGHWAY TRUCKS, FIRE TRUCKS, BUSES, MOTOR HOMES, MILITARY LAND VEHICLES, AND UNMANNED LAND VEHICLES (U.S. CLS. 19, 21, 23, 31, 35 AND 44).
FIRST USE 3-1-1990; IN COMMERCE 3-1-1990.
ALICIA COLLINS, EXAMINING ATTORNEY

SN 78-298,964. TIRE GROUP INTERNATIONAL, INC., MIAMI, FL. FILED 9-11-2003.



OWNER OF U.S. REG. NOS. 2,177,095 AND 2,277,645.
NO CLAIM IS MADE TO THE EXCLUSIVE RIGHT TO USE "TIRES", APART FROM THE MARK AS SHOWN.
FOR TIRES, INNER TUBES FOR VEHICLE TIRES, AND TIRE TREADS (U.S. CLS. 19, 21, 23, 31, 35 AND 44).
FIRST USE 0-0-1995; IN COMMERCE 0-0-1995.
CATHERINE CAIN, EXAMINING ATTORNEY

SN 78-303,582. LAND ROVER, WARWICKSHIRE, UNITED KINGDOM, FILED 9-22-2003.

INTEGRATED BODY FRAME

NO CLAIM IS MADE TO THE EXCLUSIVE RIGHT TO USE "BODY FRAME", APART FROM THE MARK AS SHOWN.
FOR LAND MOTOR VEHICLES, NAMELY, AUTOMOBILES AND STRUCTURAL PARTS THEREFOR (U.S. CLS. 19, 21, 23, 31, 35 AND 44).
FIRST USE 11-1-2004; IN COMMERCE 11-1-2004.
ALLISON HOLTZ, EXAMINING ATTORNEY

CLASS 12—(Continued).

SN 78-307,450. GOODYEAR TIRE & RUBBER COMPANY, THE, AKRON, OH. FILED 9-30-2003.

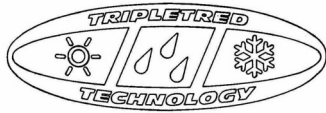

NO CLAIM IS MADE TO THE EXCLUSIVE RIGHT TO USE "TECHNOLOGY", APART FROM THE MARK AS SHOWN.

SEC. 2(F).
FOR TIRES (U.S. CLS. 19, 21, 23, 31, 35 AND 44).
FIRST USE 2-28-2004; IN COMMERCE 2-28-2004.
ANDREA SAUNDERS, EXAMINING ATTORNEY

CLASS 12—(Continued).

SN 78-321,859. DISC BRAKES AUSTRALIA PTY LTD, SILVERWATER DC, NSW, AUSTRALIA, FILED 10-31-2003.



NO CLAIM IS MADE TO THE EXCLUSIVE RIGHT TO USE "THERMAL STABILITY PROFILING", APART FROM THE MARK AS SHOWN.

FOR DISC BRAKES AND BRAKE PARTS FOR VEHICLES; DISC BRAKE ROTORS; DISC BRAKE PADS (U.S. CLS. 19, 21, 23, 31, 35 AND 44).
DAVID ELTON, EXAMINING ATTORNEY

SN 78-314,837. KABUSHIKI KAISHA MONTBELL, OSAKA, JAPAN, FILED 10-16-2003.

ARFEQ

OWNER OF JAPAN REG. NO. 4361591, DATED 2-10-2000, EXPIRES 2-10-2010.

FOR CANOE; KAYAK; PADDLES FOR CANOE OR KAYAK; OARS; MOTORCYCLES; BICYCLES; SADDLE COVERS FOR BICYCLES OR MOTORCYCLES; SLEIGH (U.S. CLS. 19, 21, 23, 31, 35 AND 44).
SUSAN STIGLITZ, EXAMINING ATTORNEY

SN 78-322,048. SAVIA LIMITED, KOWLOON, HONG KONG, FILED 11-3-2003.

FLAMIN'

SN 78-321,857. DISC BRAKES AUSTRALIA PTY LTD, SILVERWATER DC, NSW, AUSTRALIA, FILED 10-31-2003.



NO CLAIM IS MADE TO THE EXCLUSIVE RIGHT TO USE "THERMO-GRAPHIC TEMPERATURE MONITORING", APART FROM THE MARK AS SHOWN.

FOR DISC BRAKES AND BRAKE PARTS FOR VEHICLES; DISC BRAKE ROTORS; DISC BRAKE PADS (U.S. CLS. 19, 21, 23, 31, 35 AND 44).
DAVID ELTON, EXAMINING ATTORNEY

THE MARK CONSISTS OF STANDARD CHARACTERS WITHOUT CLAIM TO ANY PARTICULAR FONT, STYLE, SIZE, OR COLOR.

FOR AUTOMOBILES, MOTORCYCLES, MOTORBIKES, MOTORIZED SCOOTERS AND THEIR ACCESSORIES AND PARTS, NAMELY, REAR VIEW MIRRORS, FUEL TANK COVERS, FULL TANKS, FUEL GAUGES, HANDLE BARS, REAR WHEEL RIMS, FRONT AND REAR FENDERS, BRAKE LEVERS, HANDLE BAR CONTROL SWITCHES, CLUTCHES, SHIFT LEVERS, DISC BRAKES, FRONT AND BACK FORKS, BODY CYLINDER HEADS AND CYLINDER BLOCKS, BALL AND NEEDLE BEARINGS FOR WHEELS; ALL THE AFORESAID GOODS FOR USE WITH AUTOMOBILES, MOTORCYCLES, MOTORBIKES AND MOTORIZED SCOOTERS (U.S. CLS. 19, 21, 23, 31, 35 AND 44).
ANN E. SAPPENFIELD, EXAMINING ATTORNEY

CLASS 12—(Continued).

SN 78-335,448. SEA CURE TECHNOLOGY, INC., ACME, WA.
FILED 12-2-2003.



FOR MARINE AND BOAT RELATED ITEMS AND PARTS, NAMELY, THRU HULL FITTINGS, VEHICLE HORNS, BOAT CLEATS, BOAT AND STRUCTURAL BOAT PARTS, NAMELY, MARINE LADDERS, MARINE BOW RAILING ASSEMBLIES COMPRISED OF RAIL BASES, RAIL BOW FORMS, RAIL BRACES, DECK HINGES, ELBOWS, RAIL ENDS AND END EYE, FLAT STAFFS AND SOCKETS, LIFE LINE PARTS AND RAIL PARTS, NAMELY, RAIL STANCHIONS, RAIL SLEEVES, RAIL STEPS, RAIL TEES, RAIL LEGS, LOCKS AND LATCHES, AND RAIL MOLDINGS, MARINE RELATED DOORS AND WINDOWS, RUB RAILS FOR MARINE VEHICLES, MARINE WINDSHIELD WIPER EQUIPMENT, NAMELY, WINDSHIELD WIPERS AND BLADES, MARINE STEERING WHEELS, MARINE HYDRAULIC STEERING COMPONENTS, NAMELY, STEERING WHEELS AND STEERING ADAPTERS, BOW PULPITS, RADAR MASS, COCKPIT PATCHES, COMPANION WAY HATCHES, ESCAPE HATCHES, FISH BOX HATCHES, TRANSOM DOORS, TRANSOM STEPS, MARINE TEAK STEPS, SEA RAILS FLY BRIDGES AND CONSOLES, MARINE AND BOAT RELATED ITEMS, NAMELY, ROTORS, PROPELLER STRUTS, PROPELLER SHAFTS, TILLER ARMS AND RUDDER COLLARS, RUDDER TIE RODS (U.S. CLS. 19, 21, 23, 31, 35 AND 44).

FIRST USE 12-31-1984; IN COMMERCE 12-31-1984.
BARBARA BROWN, EXAMINING ATTORNEY

SN 78-349,670. HIRAM ENGINEERING LLC, SOLON, OH.
FILED 1-9-2004.

BREADY

THE MARK CONSISTS OF STANDARD CHARACTERS WITHOUT CLAIM TO ANY PARTICULAR FONT, STYLE, SIZE, OR COLOR.

FOR POWER OPERATED TRACTORS (U.S. CLS. 19, 21, 23, 31, 35 AND 44).
PRISCILLA MILTON, EXAMINING ATTORNEY

CLASS 12—(Continued).

SN 78-366,852. KAWASAKI JUKOGYO KABUSHIKI KAISHA, DBA KAWASAKI HEAVY INDUSTRIES, LTD., KOBE, JAPAN, FILED 2-12-2004.

BRUTE FORCE

THE MARK CONSISTS OF STANDARD CHARACTERS WITHOUT CLAIM TO ANY PARTICULAR FONT, STYLE, SIZE, OR COLOR.

FOR ALL-TERRAIN VEHICLES AND STRUCTURAL PARTS THEREFOR (U.S. CLS. 19, 21, 23, 31, 35 AND 44).
MARTHA FROMM, EXAMINING ATTORNEY

SN 78-394,346. THULE TRAILERS, INC., WINSLOW, ME.
FILED 3-31-2004.

T-PRO

THE MARK CONSISTS OF STANDARD CHARACTERS WITHOUT CLAIM TO ANY PARTICULAR FONT, STYLE, SIZE, OR COLOR.

OWNER OF U.S. REG. NOS. 2,487,721 AND 2,571,520.
FOR VEHICLE TOWING APPARATUS, NAMELY, TRAILERS AND CARRIAGES FOR THE TRANSPORTATION OF TOWING VEHICLES; SNOWMOBILE AND RECREATIONAL VEHICLE TRAILERS, CARGO TRAILERS, MOTORCYCLE TRAILERS, CAR HAULING TRAILERS, AND ATV TRAILERS, TRAILER HITCHES, CARGO OVERHEAD CARRIERS FOR VEHICLES AND TRAILERS, AND TRAILER TOWING ACCESSORIES, NAMELY, AERO-DYNAMIC FAIRINGS FOR VEHICLES AND TRAILERS, ADJUSTMENT CHAINS, HITCHES AND TOW BARS FOR VEHICLES AND TRAILERS, AND STRUCTURAL PARTS THEREFOR (U.S. CLS. 19, 21, 23, 31, 35 AND 44).
JAMES A. RAUEN, EXAMINING ATTORNEY

CLASS 12—(Continued).

SN 78-394,355. THULE TRAILERS, INC., WINSLOW, ME. FILED 3-31-2004.

CLASS 12—(Continued).

SN 78-394,358. THULE TRAILERS, INC., WINSLOW, ME. FILED 3-31-2004.

SPRO

CPRO

THE MARK CONSISTS OF STANDARD CHARACTERS WITHOUT CLAIM TO ANY PARTICULAR FONT, STYLE, SIZE, OR COLOR.

OWNER OF U.S. REG. NOS. 2,487,721 AND 2,571,520.
FOR VEHICLE TOWING APPARATUS, NAMELY, TRAILERS AND CARRIAGES FOR THE TRANSPORTATION OF TOWING VEHICLES; SNOWMOBILE AND RECREATIONAL VEHICLE TRAILERS, CARGO TRAILERS, MOTORCYCLE TRAILERS, CAR HAULING TRAILERS, AND ATV TRAILERS, TRAILER HITCHES, CARGO OVERHEAD CARRIERS FOR VEHICLES AND TRAILERS, AND TRAILER TOWING ACCESSORIES, NAMELY, AERO-DYNAMIC FAIRINGS FOR VEHICLES AND TRAILERS, ADJUSTMENT CHAINS, HITCHES AND TOW BARS FOR VEHICLES AND TRAILERS, AND STRUCTURAL PARTS THEREFOR (U.S. CLS. 19, 21, 23, 31, 35 AND 44).

JAMES A. RAUEN, EXAMINING ATTORNEY

SN 78-398,218. AIRTRAX, INC., HAMMONTON, NJ. FILED 4-7-2004.

PHOENIX

THE MARK CONSISTS OF STANDARD CHARACTERS WITHOUT CLAIM TO ANY PARTICULAR FONT, STYLE, SIZE, OR COLOR.

OWNER OF U.S. REG. NOS. 2,487,721 AND 2,571,520.
FOR VEHICLE TOWING APPARATUS, NAMELY, TRAILERS AND CARRIAGES FOR THE TRANSPORTATION OF TOWING VEHICLES; SNOWMOBILE AND RECREATIONAL VEHICLE TRAILERS, CARGO TRAILERS, MOTORCYCLE TRAILERS, CAR HAULING TRAILERS, AND ATV TRAILERS, TRAILER HITCHES, CARGO OVERHEAD CARRIERS FOR VEHICLES AND TRAILERS, AND TRAILER TOWING ACCESSORIES, NAMELY, AERO-DYNAMIC FAIRINGS FOR VEHICLES AND TRAILERS, ADJUSTMENT CHAINS, HITCHES AND TOW BARS FOR VEHICLES AND TRAILERS, AND STRUCTURAL PARTS THEREFOR (U.S. CLS. 19, 21, 23, 31, 35 AND 44).

JAMES A. RAUEN, EXAMINING ATTORNEY

THE MARK CONSISTS OF STANDARD CHARACTERS WITHOUT CLAIM TO ANY PARTICULAR FONT, STYLE, SIZE, OR COLOR.

FOR AERIAL WORK PLATFORM VEHICLES CAPABLE OF MOVEMENT IN ALL DIRECTIONS (U.S. CLS. 19, 21, 23, 31, 35 AND 44).

FIRST USE 2-27-2004; IN COMMERCE 2-27-2004.
WINSTON FOLMAR, EXAMINING ATTORNEY

CLASS 12—(Continued).

SN 78-406,813. BRZEZNIAK, STANLEY A., LEMONT, IL. FILED 4-22-2004.

LiquiSeat

THE MARK CONSISTS OF STANDARD CHARACTERS WITHOUT CLAIM TO ANY PARTICULAR FONT, STYLE, SIZE, OR COLOR.
FOR LIQUID SEATING COMPONENTS, NAMELY, LIQUID FILLED SEAT CUSHIONS, FOR MOTORCYCLE SEATS (U.S. CLS. 19, 21, 23, 31, 35 AND 44).
STEVEN JACKSON, EXAMINING ATTORNEY

CLASS 12—(Continued).

SN 78-417,630. WANG, JOHN, ENCINITAS, CA. FILED 5-12-2004.



NO CLAIM IS MADE TO THE EXCLUSIVE RIGHT TO USE "ELECTRIC MOPED", APART FROM THE MARK AS SHOWN.
FOR ELECTRIC MOTORIZED MOPED (U.S. CLS. 19, 21, 23, 31, 35 AND 44).
FIRST USE 10-5-2003; IN COMMERCE 10-5-2003.
SOPHIA S. KIM, EXAMINING ATTORNEY

SN 78-418,625. PILKINGTON PLC, ST. HELEN'S, UNITED KINGDOM, FILED 5-14-2004.

SN 78-408,077. SPMT ALLIANCE, EDMONTON, ALBERTA, CANADA, FILED 4-26-2004.

SPMT ALLIANCE

THE MARK CONSISTS OF STANDARD CHARACTERS WITHOUT CLAIM TO ANY PARTICULAR FONT, STYLE, SIZE, OR COLOR.
PRIORITY CLAIMED UNDER SEC. 44(D) ON CANADA APPLICATION NO. 1194593, FILED 10-24-2003, REG. NO. TMA634654, DATED 3-8-2005, EXPIRES 3-8-2020.
FOR DECKS WITH WHEELS, NAMELY, EQUIPMENT TRAILERS FOR USE IN TRANSPORTING HEAVY EQUIPMENT (U.S. CLS. 19, 21, 23, 31, 35 AND 44).
RENEE MCCRAY, EXAMINING ATTORNEY

INTERKOOL

THE MARK CONSISTS OF STANDARD CHARACTERS WITHOUT CLAIM TO ANY PARTICULAR FONT, STYLE, SIZE, OR COLOR.
OWNER OF UNITED KINGDOM REG. NO. 2349321, DATED 11-20-2003, EXPIRES 11-20-2013.
FOR VEHICLE WINDOWS (U.S. CLS. 19, 21, 23, 31, 35 AND 44).
RAUL CORDOVA, EXAMINING ATTORNEY

CLASS 12—(Continued).

SN 78-420,075. H-D MICHIGAN, INC., ANN ARBOR, MI. FILED 5-17-2004.

SIDEKICK

THE MARK CONSISTS OF STANDARD CHARACTERS WITHOUT CLAIM TO ANY PARTICULAR FONT, STYLE, SIZE, OR COLOR.
FOR MOTORCYCLE SEATS (U.S. CLS. 19, 21, 23, 31, 35 AND 44).

BARBARA BROWN, EXAMINING ATTORNEY

SN 78-425,045. IBIS TEK, LLC, BUTLER, PA. FILED 5-25-2004.

MASTC

THE MARK CONSISTS OF STANDARD CHARACTERS WITHOUT CLAIM TO ANY PARTICULAR FONT, STYLE, SIZE, OR COLOR.

FOR SPARE TIRE CARRIERS FOR VEHICLES (U.S. CLS. 19, 21, 23, 31, 35 AND 44).

BARNEY CHARLON, EXAMINING ATTORNEY

CLASS 12—(Continued).

SN 78-429,768. PROGRESS MFG. INC., PROVO, UT. FILED 6-3-2004.

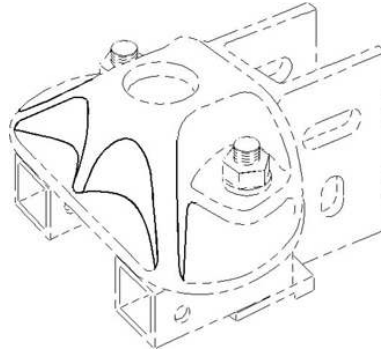

THE MARK CONSISTS OF A PRODUCT DESIGN CONFIGURATION OF THE WING PORTION OF A HITCH HEAD. THE BROKEN LINES INDICATE THE PLACEMENT OF THE MARK ON THE GOODS AND ARE NOT FEATURES OF THE MARK. THE DRAWING DEPICTS THE PRODUCT CONFIGURATION AND NO LIMITATION ON SIZE IS INTENDED.

SEC. 2(F).

FOR TRAILER HITCHES (U.S. CLS. 19, 21, 23, 31, 35 AND 44).

FIRST USE 0-0-1969; IN COMMERCE 0-0-1969.

MARC LEIPZIG, EXAMINING ATTORNEY

SN 78-440,784. LE PIERRE IMPORT & EXPORT, INC., MIAMI, FL. FILED 6-24-2004.

VERUCCI

THE MARK CONSISTS OF STANDARD CHARACTERS WITHOUT CLAIM TO ANY PARTICULAR FONT, STYLE, SIZE, OR COLOR.

SEC. 2(F).

FOR MOTORCYCLES, BICYCLES, ELECTRIC POWERED SCOOTERS, AND GAS POWERED SCOOTERS (U.S. CLS. 19, 21, 23, 31, 35 AND 44).

FIRST USE 6-0-2000; IN COMMERCE 6-0-2000.

LAURA KOVAISKY, EXAMINING ATTORNEY

CLASS 12—(Continued).

SN 78-446,767. PPG INDUSTRIES OHIO, INC., CLEVELAND, OH. FILED 7-7-2004.

CLASS 12—(Continued).

SN 78-493,190. GRANT PRODUCTS INTERNATIONAL, INC., GLENDALE, CA. FILED 10-1-2004.

MORE THAN GLASS

GRANT

THE MARK CONSISTS OF STANDARD CHARACTERS WITHOUT CLAIM TO ANY PARTICULAR FONT, STYLE, SIZE, OR COLOR.

NO CLAIM IS MADE TO THE EXCLUSIVE RIGHT TO USE "GLASS", APART FROM THE MARK AS SHOWN.

FOR AUTOMOTIVE REPLACEMENT GLASS, NAMELY, WINDOWS, WINDSHIELDS, SUNROOFS AND VEHICLE TRANSPARENCIES (U.S. CLS. 19, 21, 23, 31, 35 AND 44).

ANNE MADDEN, EXAMINING ATTORNEY

THE MARK CONSISTS OF STANDARD CHARACTERS WITHOUT CLAIM TO ANY PARTICULAR FONT, STYLE, SIZE, OR COLOR.

OWNER OF U.S. REG. NO. 1,419,114.

FOR AUTOMOBILE, MARINE VEHICLE AND GOLF CART PARTS AND ACCESSORIES, NAMELY, STEERING WHEELS, STEERING WHEEL INSTALLATION KITS CONTAINING RETAINER CONTACT RINGS, WIRE LEADS, SHOULDER BOLTS, STEERING SHAFT NUTS, WHEEL RETAINER NUTS, SPRINGS, HORN CAPS, POST COVERS, HUBS, TURN SIGNAL CAMS, SPLINED SHAFTS, WHEEL PULLERS, ROLL PINS AND ADAPTOR PLATES; STEERING WHEEL COVERS, STEERING WHEEL HORN BUTTONS, STEERING COLUMN SECURITY SYSTEMS COMPRISING ANTI-THEFT SYSTEMS COMPRISED OF STEERING WHEEL HUBS AND REMOVABLE STEERING WHEELS, STEERING COLUMN LOCK MECHANISMS AND GEAR SHIFT KNOBS; SEAT COVERS AND GEAR SHIFT KNOBS (U.S. CLS. 19, 21, 23, 31, 35 AND 44).

FIRST USE 0-0-1922; IN COMMERCE 0-0-1922.

CAROLINE WOOD, EXAMINING ATTORNEY

SN 78-478,891. KUN TENG INDUSTRY CO., LTD., TAI-CHUNG HSIEN, TAIWAN, FILED 9-3-2004.

SN 78-503,503. HUBER, HARTMUT, LANTANA, FL. FILED 10-21-2004.



TravelScoot

NO CLAIM IS MADE TO THE EXCLUSIVE RIGHT TO USE "EASY-LOCK ROTOR SYSTEM", APART FROM THE MARK AS SHOWN.

THE MARK CONSISTS OF A STYLIZED LETTER "Q" AND A STYLIZED FORM OF THE WORD "LOCK".

FOR BICYCLES; BICYCLE STRUCTURAL PARTS, NAMELY, ALUMINUM ALLOY HUBS, STEEL HUBS, BICYCLE HUBS, COASTER BRAKE HUBS, SKEWERS, AXLE SETS, SEAT PINS (U.S. CLS. 19, 21, 23, 31, 35 AND 44).

FIRST USE 8-3-2004; IN COMMERCE 8-3-2004.

WON TEAK OH, EXAMINING ATTORNEY

THE MARK CONSISTS OF STANDARD CHARACTERS WITHOUT CLAIM TO ANY PARTICULAR FONT, STYLE, SIZE, OR COLOR.

FOR ELECTRIC MOTORIZED MOBILITY SCOOTER (U.S. CLS. 19, 21, 23, 31, 35 AND 44).

RAMONA ORTIGA, EXAMINING ATTORNEY

CLASS 12—(Continued).

SN 78-503,709. UOV LLC, KING GEORGE, VA. FILED 10-21-2004.

UOV

THE MARK CONSISTS OF STANDARD CHARACTERS WITHOUT CLAIM TO ANY PARTICULAR FONT, STYLE, SIZE, OR COLOR.

FOR UNMANNED OCEAN VEHICLES FOR OCEAN RESEARCH, NAMELY, BOATS (U.S. CLS. 19, 21, 23, 31, 35 AND 44).

FIRST USE 8-6-2004; IN COMMERCE 10-8-2004.
STACY WAHLBERG, EXAMINING ATTORNEY

CLASS 12—(Continued).

SN 78-512,346. JERRY FORD CO., LLC, ST. CHARLES, MN. FILED 11-5-2004.

JERRY-LOCK BRAKE SYSTEM

THE MARK CONSISTS OF STANDARD CHARACTERS WITHOUT CLAIM TO ANY PARTICULAR FONT, STYLE, SIZE, OR COLOR.

NO CLAIM IS MADE TO THE EXCLUSIVE RIGHT TO USE BRAKE SYSTEM, APART FROM THE MARK AS SHOWN.

FOR BRAKING DEVICE FOR WHEELCHAIRS AND PARTS THEREFOR (U.S. CLS. 19, 21, 23, 31, 35 AND 44).
GEORGIA CARTY, EXAMINING ATTORNEY

SN 78-512,687. CS VELO FL. INC., PONTE VEDRA BEACH, FL. FILED 11-7-2004.

gazelle

SN 78-509,555. CS VELO FL, INC., PONTE VEDRA BEACH, FL. FILED 11-2-2004.

THE MARK CONSISTS OF STANDARD CHARACTERS WITHOUT CLAIM TO ANY PARTICULAR FONT, STYLE, SIZE, OR COLOR.

FOR BICYCLES (U.S. CLS. 19, 21, 23, 31, 35 AND 44).

FIRST USE 11-1-2004; IN COMMERCE 11-1-2004.
SHARON MEIER, EXAMINING ATTORNEY

BILLATO

SN 78-514,562. BENNINGTON-MARINE, LLC, ELKHART, IN. FILED 11-10-2004.

BENNINGTON

THE MARK CONSISTS OF STANDARD CHARACTERS WITHOUT CLAIM TO ANY PARTICULAR FONT, STYLE, SIZE, OR COLOR.

FOR BICYCLES AND BICYCLE FRAMES (U.S. CLS. 19, 21, 23, 31, 35 AND 44).

FIRST USE 10-15-2004; IN COMMERCE 10-15-2004.
ALICIA COLLINS, EXAMINING ATTORNEY

FOR RECREATIONAL BOATS (U.S. CLS. 19, 21, 23, 31, 35 AND 44).

FIRST USE 8-31-2000; IN COMMERCE 8-31-2000.
YONG KIM, EXAMINING ATTORNEY

CLASS 12—(Continued).

SN 78-515,195. THE COLEMAN COMPANY, INC., WICHITA, KS. FILED 11-11-2004.

CLASS 12—(Continued).

SN 78-517,357. HORNLING INDUSTRIAL INC., TAINAN, TAIWAN, FILED 11-16-2004.

NAVIGATOR



THE MARK CONSISTS OF STANDARD CHARACTERS WITHOUT CLAIM TO ANY PARTICULAR FONT, STYLE, SIZE, OR COLOR.

FOR INFLATABLE BOATS (U.S. CLS. 19, 21, 23, 31, 35 AND 44).

FIRST USE 8-18-2001; IN COMMERCE 8-18-2001.
ATTIYA MALIK, EXAMINING ATTORNEY

THE MARK CONSISTS OF THE STYLIZED WORD "HORNLIN" WITHIN A MISCELLANEOUS DESIGN.

FOR AIRPLANES AND STRUCTURAL PARTS THEREFOR; AMBULANCES AND STRUCTURAL PARTS THEREFOR; AUTOMOBILES AND STRUCTURAL PARTS THEREFOR; BABY CARRIAGES; LAND VEHICLE PARTS, NAMELY, DRIVE BELTS; SEAT BELTS FOR USE IN VEHICLES; RECREATIONAL JET BOATS; BOATS AND STRUCTURAL PARTS THEREFOR; BUSES AND STRUCTURAL PARTS THEREFOR; CHILDREN'S CAR SEATS; CLUTCHES FOR LAND VEHICLES; FORK LIFT TRUCKS; VEHICLE SEATS; SNOW MOBILES; SPACE VEHICLES; TRACTORS; CAMPING TRAILERS; CARGO TRAILERS; REFRIGERATED TRAILERS; TRAVEL TRAILERS; VANS; WHEEL CHAIRS (U.S. CLS. 19, 21, 23, 31, 35 AND 44).

FIRST USE 5-20-1994; IN COMMERCE 5-20-1994.
MARGERY A. TIERNEY, EXAMINING ATTORNEY

SN 78-515,353. FREEDOM TRAILER RENTALS, INC., SPRINGVILLE, NY. FILED 11-11-2004.

SN 78-517,847. PAN-MAR CORPORATION, PLAINVIEW, NY. FILED 11-16-2004.

RALLYTIME

PRIVAT

THE MARK CONSISTS OF STANDARD CHARACTERS WITHOUT CLAIM TO ANY PARTICULAR FONT, STYLE, SIZE, OR COLOR.

FOR TRAILERS (U.S. CLS. 19, 21, 23, 31, 35 AND 44).
ADA HAN, EXAMINING ATTORNEY

THE MARK CONSISTS OF STANDARD CHARACTERS WITHOUT CLAIM TO ANY PARTICULAR FONT, STYLE, SIZE, OR COLOR.

FOR AUTOMOBILE PARTS AND ACCESSORIES, NAMELY, WHEELS, RIMS, AND HUBS (U.S. CLS. 19, 21, 23, 31, 35 AND 44).

FIRST USE 9-0-2002; IN COMMERCE 9-0-2002.
BARBARA RUTLAND, EXAMINING ATTORNEY

CLASS 12—(Continued).

SN 78-518,224. QINGDAO SENTAIDA RUBBER CO., LTD.,
QINGDAO, CHINA, FILED 11-17-2004.

SENTAIDA

THE MARK CONSISTS OF STANDARD CHARACTERS
WITHOUT CLAIM TO ANY PARTICULAR FONT, STYLE,
SIZE, OR COLOR.

FOR TIRES FOR VEHICLES; TREADS FOR RE-
TREADING AND RECAPPING TIRES FOR VEHICLES;
TREADS, NAMELY ROLLER BELTS FOR VEHICLES;
RIMS FOR VEHICLE WHEELS; CASING FOR PNEU-
MATIC TIRES; SOLID TIRES FOR VEHICLES; REPAIR
OUTFITS, NAMELY, ADHESIVE RUBBER PLUGS AND
PATCHES FOR REPAIRING TUBES OR TIRES; PNEU-
MATIC TIRES; SPIKES FOR TIRES (U.S. CLS. 19, 21, 23,
31, 35 AND 44).

FIRST USE 7-17-2004; IN COMMERCE 7-17-2004.
REBECCA GILBERT, EXAMINING ATTORNEY

SN 78-518,516. MIDWEST MOTORCYCLE SUPPLY DISTRI-
BUTORS CORP., ARNOLD, MO. FILED 11-17-2004.

ONE EYED JACK

THE MARK CONSISTS OF STANDARD CHARACTERS
WITHOUT CLAIM TO ANY PARTICULAR FONT, STYLE,
SIZE, OR COLOR.

FOR MOTORCYCLES AND STRUCTURAL PARTS
THEREFOR (U.S. CLS. 19, 21, 23, 31, 35 AND 44).
ODESSA BIBBINS, EXAMINING ATTORNEY

CLASS 12—(Continued).

SN 78-519,161. CRYOTEC, INC., INDIANAPOLIS, IN. FILED
11-18-2004.

THE DRY HUMP

THE MARK CONSISTS OF STANDARD CHARACTERS
WITHOUT CLAIM TO ANY PARTICULAR FONT, STYLE,
SIZE, OR COLOR.

FOR CARGO CARRIERS FOR PICK-UP TRUCK BEDS
(U.S. CLS. 19, 21, 23, 31, 35 AND 44).

BARNEY CHARLON, EXAMINING ATTORNEY

SN 78-519,393. TRUVATIV INTERNATIONAL CO. LTD., TA
LI CITY, TAICHUNG HSIEN, TAIWAN, FILED 11-18-2004.

RUKTION

THE MARK CONSISTS OF STANDARD CHARACTERS
WITHOUT CLAIM TO ANY PARTICULAR FONT, STYLE,
SIZE, OR COLOR.

FOR BICYCLES; BICYCLE PARTS, NAMELY,
CRANKS AND BOLTS BEING PART OF CRANKS (U.S.
CLS. 19, 21, 23, 31, 35 AND 44).

BARBARA BROWN, EXAMINING ATTORNEY

SN 78-519,484. SIMMONS, OTIS, KANSAS CITY, KS. FILED
11-18-2004.

PROTECT-O-PLATE

THE MARK CONSISTS OF STANDARD CHARACTERS
WITHOUT CLAIM TO ANY PARTICULAR FONT, STYLE,
SIZE, OR COLOR.

FOR PROTECTIVE COVER FOR LICENSE PLATES
(U.S. CLS. 19, 21, 23, 31, 35 AND 44).

CHARLES L. JENKINS, EXAMINING ATTORNEY

CLASS 12—(Continued).

SN 78-519,538. WESTERN BRANCH METALS, LC, PORTSMOUTH, VA. FILED 11-18-2004.

CLASS 12—(Continued).

SN 78-519,646. DURAKON INDUSTRIES, INC., LAPEER, MI. FILED 11-18-2004.

AQUATECH

DURASTAR

THE MARK CONSISTS OF STANDARD CHARACTERS WITHOUT CLAIM TO ANY PARTICULAR FONT, STYLE, SIZE, OR COLOR.

OWNER OF U.S. REG. NO. 1,510,047.
FOR SPECIALTY STEEL PRODUCTS, NAMELY, STAINLESS STEEL BOAT SHAFTING FOR USE AS A STRUCTURAL PART (U.S. CLS. 19, 21, 23, 31, 35 AND 44).

FIRST USE 4-30-2004; IN COMMERCE 4-30-2004.
BARBARA RUTLAND, EXAMINING ATTORNEY

THE MARK CONSISTS OF STANDARD CHARACTERS WITHOUT CLAIM TO ANY PARTICULAR FONT, STYLE, SIZE, OR COLOR.

FOR FITTED AND SEMI-FITTED COVERS FOR CARGO AREAS OF TRUCKS, CARS AND VANS (U.S. CLS. 19, 21, 23, 31, 35 AND 44).
ROBERT LAVACHE, EXAMINING ATTORNEY

SN 78-519,642. DURAKON INDUSTRIES, INC., LAPEER, MI. FILED 11-18-2004.

SN 78-520,195. LUND INTERNATIONAL, INC., ANOKA, MN. FILED 11-19-2004.

DURASTAT

CHROMEFLLECTOR

THE MARK CONSISTS OF STANDARD CHARACTERS WITHOUT CLAIM TO ANY PARTICULAR FONT, STYLE, SIZE, OR COLOR.

FOR FITTED AND SEMI-FITTED COVERS FOR CARGO AREAS OF TRUCKS, CARS AND VANS (U.S. CLS. 19, 21, 23, 31, 35 AND 44).

NELSON SNYDER, EXAMINING ATTORNEY

THE MARK CONSISTS OF STANDARD CHARACTERS WITHOUT CLAIM TO ANY PARTICULAR FONT, STYLE, SIZE, OR COLOR.

OWNER OF U.S. REG. NOS. 1,703,109, 2,169,476 AND OTHERS.

FOR LAND VEHICLE ACCESSORIES, NAMELY, HOOD SHIELDS (U.S. CLS. 19, 21, 23, 31, 35 AND 44).

SUNG IN, EXAMINING ATTORNEY

CLASS 12—(Continued).

SN 78-520,807. HONDA MOTOR CO., LTD., TOKYO 107-8556, JAPAN, FILED 11-22-2004.

CLASS 12—(Continued).

SN 78-522,268. KINESIS MOTORSPORT CORP., VISTA, CA. FILED 11-23-2004.

ZDX

KINESIS

THE MARK CONSISTS OF STANDARD CHARACTERS WITHOUT CLAIM TO ANY PARTICULAR FONT, STYLE, SIZE, OR COLOR.
FOR AUTOMOBILES AND STRUCTURAL PARTS THEREFOR (U.S. CLS. 19, 21, 23, 31, 35 AND 44).
CHARLES L. JENKINS, EXAMINING ATTORNEY

THE MARK CONSISTS OF STANDARD CHARACTERS WITHOUT CLAIM TO ANY PARTICULAR FONT, STYLE, SIZE, OR COLOR.
FOR HIGH PERFORMANCE WHEELS FOR AUTOMOBILES (U.S. CLS. 19, 21, 23, 31, 35 AND 44).
FIRST USE 1-1-1995; IN COMMERCE 1-1-1995.
ELLEN BURNS, EXAMINING ATTORNEY

SN 78-521,692. FORD MOTOR COMPANY, DEARBORN, MI. FILED 11-23-2004.

SN 78-523,605. JAY-EM CORPORATION, CUYAHOGA FALLS, OH. FILED 11-29-2004.

FAIRLANE

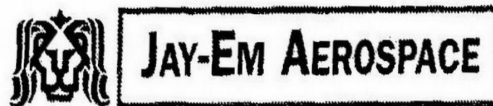

THE MARK CONSISTS OF STANDARD CHARACTERS WITHOUT CLAIM TO ANY PARTICULAR FONT, STYLE, SIZE, OR COLOR.
FOR LAND MOTOR VEHICLES, NAMELY, AUTOMOBILES AND THEIR STRUCTURAL PARTS (U.S. CLS. 19, 21, 23, 31, 35 AND 44).
FIRST USE 11-12-1954; IN COMMERCE 11-12-1954.
ALEX KEAM, EXAMINING ATTORNEY

NO CLAIM IS MADE TO THE EXCLUSIVE RIGHT TO USE "JAY-EM AEROSPACE", APART FROM THE MARK AS SHOWN.
THE MARK CONSISTS OF A STYLIZED LION'S HEAD IN LINE DRAWING AND THE COMPANY NAME, JAY-EM AEROSPACE.
FOR AIRPLANE PARTS, NAMELY, LANDING GEAR; AIRPLANE BRAKES AND WHEELS (U.S. CLS. 19, 21, 23, 31, 35 AND 44).
FIRST USE 5-1-1996; IN COMMERCE 5-1-1996.
BARBARA BROWN, EXAMINING ATTORNEY

CLASS 12—(Continued).

SN 78-524,208. TECHSPHERE SYSTEMS INTERNATIONAL LLC, ATLANTA, GA. FILED 11-30-2004.

CLASS 12—(Continued).

SN 78-540,026. AUTOTECH ACCESSORIES, INC., SANTA CLARITA, CA. FILED 12-30-2004.

AEROSPHERE

DEMODA

THE MARK CONSISTS OF STANDARD CHARACTERS WITHOUT CLAIM TO ANY PARTICULAR FONT, STYLE, SIZE, OR COLOR.
FOR HIGH ALTITUDE AIRCRAFT (U.S. CLS. 19, 21, 23, 31, 35 AND 44).
KATHLEEN M. VANSTON, EXAMINING ATTORNEY

THE MARK CONSISTS OF STANDARD CHARACTERS WITHOUT CLAIM TO ANY PARTICULAR FONT, STYLE, SIZE, OR COLOR.
FOR WHEELS AND RIMS FOR AUTOMOBILES (U.S. CLS. 19, 21, 23, 31, 35 AND 44).
BRENDAN MCCAULEY, EXAMINING ATTORNEY

SN 78-539,195. DYNACRAFT BSC, INC., SAN RAFAEL, CA. FILED 12-28-2004.

SN 78-540,281. COMPOSICRAFT, INC., PEYTON, CO. FILED 12-30-2004.

VBX3000

Nexaer

THE MARK CONSISTS OF STANDARD CHARACTERS WITHOUT CLAIM TO ANY PARTICULAR FONT, STYLE, SIZE, OR COLOR.
FOR BICYCLES (U.S. CLS. 19, 21, 23, 31, 35 AND 44).
ALICE SUE CARRUTHERS, EXAMINING ATTORNEY

THE MARK CONSISTS OF STANDARD CHARACTERS WITHOUT CLAIM TO ANY PARTICULAR FONT, STYLE, SIZE, OR COLOR.
FOR AIRPLANES AND STRUCTURAL PARTS THEREFOR (U.S. CLS. 19, 21, 23, 31, 35 AND 44).
ALEXANDER L. POWERS, EXAMINING ATTORNEY

CLASS 12—(Continued).

SN 78-541,088. DAYCO PRODUCTS, LLC, MIAMISBURG, OH. FILED 1-3-2005.

CLASS 12—(Continued).

SN 78-549,028. MIKE COKE AUCTION, INC., DBA PRICEBUSTERS, MADISONVILLE, KY. FILED 1-18-2005.

TOP COG

SOJO

THE MARK CONSISTS OF STANDARD CHARACTERS WITHOUT CLAIM TO ANY PARTICULAR FONT, STYLE, SIZE, OR COLOR.

NO CLAIM IS MADE TO THE EXCLUSIVE RIGHT TO USE "COG", APART FROM THE MARK AS SHOWN.

FOR LAND VEHICLE PARTS, NAMELY, POWER TRANSMISSION BELTS (U.S. CLS. 19, 21, 23, 31, 35 AND 44).

FIRST USE 1-8-1982; IN COMMERCE 1-8-1982.
ANGELA M. MICHELI, EXAMINING ATTORNEY

THE MARK CONSISTS OF STANDARD CHARACTERS WITHOUT CLAIM TO ANY PARTICULAR FONT, STYLE, SIZE, OR COLOR.

FOR ALL TERRAIN FOUR-WHEELED VEHICLES AND PARTS THEREFOR (U.S. CLS. 19, 21, 23, 31, 35 AND 44).

FIRST USE 3-12-2005; IN COMMERCE 3-12-2005.
THEODORE MCBRIDE, EXAMINING ATTORNEY

SN 78-541,263. TREK BICYCLE CORPORATION, WATERLOO, WI. FILED 1-3-2005.

SN 78-560,099. FLORIDA DETROIT DIESEL - ALLISON, INC., MIAMI, FL. FILED 2-3-2005.

Grommet

BUILD-RITE

THE MARK CONSISTS OF STANDARD CHARACTERS WITHOUT CLAIM TO ANY PARTICULAR FONT, STYLE, SIZE, OR COLOR.

FOR BICYCLES, BICYCLE FRAMES, AND BICYCLE STRUCTURAL PARTS THEREFOR (U.S. CLS. 19, 21, 23, 31, 35 AND 44).

FIRST USE 8-1-2004; IN COMMERCE 8-1-2004.
ALEXANDER L. POWERS, EXAMINING ATTORNEY

THE MARK CONSISTS OF STANDARD CHARACTERS WITHOUT CLAIM TO ANY PARTICULAR FONT, STYLE, SIZE, OR COLOR.

FOR LAND VEHICLE TRANSMISSIONS AND REPLACEMENT PARTS THEREOF (U.S. CLS. 19, 21, 23, 31, 35 AND 44).

GIANCARLO CASTRO, EXAMINING ATTORNEY

CLASS 12—(Continued).

SN 78-582,005. LAWRENCE B. HARTMAN, BELLAIRE, TX.
FILED 3-7-2005.

Cycle Vibes

THE MARK CONSISTS OF STANDARD CHARACTERS WITHOUT CLAIM TO ANY PARTICULAR FONT, STYLE, SIZE, OR COLOR.

NO CLAIM IS MADE TO THE EXCLUSIVE RIGHT TO USE "CYCLE", APART FROM THE MARK AS SHOWN.

FOR ACCESSORY FOR NON-MOTORIZED CYCLES, IN THE NATURE OF A PLASTIC STRAP THAT ATTACHES TO THE CYCLE FRAME AND SIMULATES A MOTOR SOUND AS IT HITS THE WHEEL SPIKES (U.S. CLS. 19, 21, 23, 31, 35 AND 44).

FIRST USE 12-15-2004; IN COMMERCE 3-25-2005.
ELISSA GARBER KON, EXAMINING ATTORNEY

SN 79-002,997. WILHELM HUMPERT GMBH & CO. KG, D-58732 WICKEDE, FED REP GERMANY, FILED 2-18-2004.

X-TAS-Y

OWNER OF INTERNATIONAL REGISTRATION 0660314 DATED 12-8-1995, EXPIRES 12-8-2015.

FOR BICYCLES; BICYCLE PARTS, NAMELY, FRAMES, FORKS, SUSPENSION FORKS, WHEEL, AXIS AND FORK BEARINGS, GEARS, BRAKES, CRANKS, PEDAL HOUSINGS, STEERING BEARING KITS FOR BICYCLES, PEDALS, WHEEL HUBS, QUICK RELEASE SKEWERS AND LEVERS, WHEEL RIMS, TIRES, HANDLE BAR STEMS, HANDLEBARS, HANDLEBAR EXTENSIONS, SEAT PILLARS, MUDGUARDS, LIGHTS, SPOKES, AND FRAMES FOR LUGGAGE CARRIERS FOR BICYCLES (U.S. CLS. 19, 21, 23, 31, 35 AND 44).

JOHN GARTNER, EXAMINING ATTORNEY

CLASS 12—(Continued).

SN 79-004,598. THULE SPA, ITALY, FILED 5-4-2004.

The logo consists of the word "KÖNIG" in a bold, black, sans-serif font with a full background. Below it, the letters "T9" are rendered in a white, outlined, sans-serif font.

PRIORITY DATE OF 1-29-2004 IS CLAIMED.
OWNER OF INTERNATIONAL REGISTRATION 0831204 DATED 5-4-2004, EXPIRES 5-4-2014.

OWNER OF U.S. REG. NOS. 1,357,929 AND 2,763,454.
THIS TRADEMARK CONSISTS IN THE FANCIFUL WORDING KÖNIG T9 IN ORIGINAL PRINTING CHARACTERS REPRODUCED ON TWO LINES; THE WORDING KÖNIG APPEARS WITH A FULL BACKGROUND, T9 IN CONTRASTING TONALITY WITH SHADES DECREASING IN INTENSITY FROM THE BOTTOM TO THE TOP.

THE ENGLISH TRANSLATION OF "KÖNIG" IS "KING," FOR ANTI-SKID TYRE CHAINS (U.S. CLS. 19, 21, 23, 31, 35 AND 44).

JEFF DEFORD, EXAMINING ATTORNEY

SN 79-005,086. IVECO S.P.A., ITALY, FILED 5-27-2004.

T R A K K E R

PRIORITY DATE OF 4-20-2004 IS CLAIMED.
OWNER OF INTERNATIONAL REGISTRATION 0832498 DATED 5-27-2004, EXPIRES 5-27-2014.

FOR HEAVY OFF-ROAD TRUCKS (U.S. CLS. 19, 21, 23, 31, 35 AND 44).

KELLY BOULTON, EXAMINING ATTORNEY

SN 79-005,674. AIXAM MEGA, FRANCE, FILED 8-3-2004.

AIXAM

THE MARK CONSISTS OF STANDARD CHARACTERS WITHOUT CLAIM TO ANY PARTICULAR FONT, STYLE, SIZE, OR COLOR.

OWNER OF INTERNATIONAL REGISTRATION 0834188 DATED 8-3-2004, EXPIRES 8-3-2014.

FOR VEHICLES, NAMELY, AUTOMOBILES, CARS, TRUCKS, MOTORCYCLES AND QUADRICYCLES (U.S. CLS. 19, 21, 23, 31, 35 AND 44).

JOANNA DUKOVIC, EXAMINING ATTORNEY

CLASS 12—(Continued).

SN 79-006,612. MATADOR, A.S., SLOVAKIA, FILED 8-12-2004.

MASSIVE

THE MARK CONSISTS OF STANDARD CHARACTERS WITHOUT CLAIM TO ANY PARTICULAR FONT, STYLE, SIZE, OR COLOR.

OWNER OF INTERNATIONAL REGISTRATION 0781014 DATED 4-15-2002, EXPIRES 4-15-2012.

FOR TYRES, PNEUMATIC TYRES (U.S. CLS. 19, 21, 23, 31, 35 AND 44).

GEORGE LORENZO, EXAMINING ATTORNEY

SN 79-006,812. THE YOKOHAMA RUBBER; COMPANY LIMITED, MINATO-KU, TOKYO 105-8685, JAPAN, FILED 1-23-2004.



OWNER OF INTERNATIONAL REGISTRATION 0837379 DATED 1-23-2004, EXPIRES 1-23-2014.

OWNER OF U.S. REG. NOS. 864,491, 1,307,949 AND 1,527,768.

FOR TIRES FOR AIRCRAFTS, INNER TUBES FOR AIRCRAFTS, FUEL TANKS FOR AIRCRAFTS, COMPONENTS OF AIRCRAFT WINGS NAMELY, APPARATUS FOR ELIMINATING ICE ADHERED ON THE SURFACE OF AIRCRAFT WINGS, SAFETY DEVICES FOR AUTOMOBILES NAMELY AIR BAGS, WIND-SCREENS FOR MOTOR CARS, AIR PUMPS FOR AUTOMOBILES, CLUTCHES FOR AUTOMOBILES, HORNS FOR AUTOMOBILES, AUTOMOBILE SEATS, SEAT COVERS FOR AUTOMOBILES, CHASSIS FOR AUTOMOBILES, AUTOMOBILE BODIES, FITTED COVERS FOR AUTOMOBILE BODIES, AUTOMOBILE WHEELS, SPOKES FOR AUTOMOBILE WHEELS, AUTOMOBILE TIRES, INNER TUBES FOR AUTOMOBILES, AUTOMOBILE DOOR HANDLES, DOORS FOR AUTOMOBILES, MUDGUARDS FOR AUTOMOBILES, CARGO CARRIERS FOR AUTOMOBILES, VEHICLE PARTS NAMELY, REARVIEW MIRRORS AND STEERING WHEELS, COVERS FOR STEERING WHEELS, BUMPERS FOR AUTOMOBILES, AUTOMOBILE WINDSHIELDS, TURN SIGNALS FOR AUTOMOBILES, HOODS FOR AUTOMOBILES, BONNETS FOR AUTOMOBILES, SUN-BLINDS ADAPTED FOR AUTOMOBILES, AUTOMOBILE SPARE WHEEL HOLDERS, WHEEL RIMS FOR AUTOMOBILES, ROOF RACKS FOR AUTOMOBILES, WINDSCREEN WIPERS FOR AUTOMOBILES, TIRES FOR BICYCLES OR CYCLES, WHEEL RIMS FOR BICYCLES OR CYCLES, POWER TRANSMISSION BELTS FOR VEHICLES, AIR SPRINGS FOR VEHICLE SUSPENSION COMPONENTS FOR CUSHIONING DRIVER'S SEATS AND CABS, SPRING SHOCK ABSORBERS FOR VEHICLES, SPRING-ASSISTED HYDRAULIC SHOCK ABSORBERS FOR VEHICLES, SPIRAL SUSPENSION SPRINGS FOR VEHICLES, LAMELLAR SUSPENSION SPRINGS FOR VEHICLES, HELICAL SUSPENSION SPRINGS FOR VEHICLES, BRAKES FOR VEHICLES, ADHESIVE RUBBER PATCHES FOR REPAIRING INNER TUBES OR TIRES, ANTI-THEFT ALARMS FOR VEHICLES (U.S. CLS. 19, 21, 23, 31, 35 AND 44).

DAVID MURRAY, EXAMINING ATTORNEY

CLASS 12—(Continued).

SN 79-010,547. CONTINENTAL AKTIENGESELLSCHAFT, FED REP GERMANY, FILED 11-16-2004.

CSE

THE MARK CONSISTS OF STANDARD CHARACTERS WITHOUT CLAIM TO ANY PARTICULAR FONT, STYLE, SIZE, OR COLOR.

OWNER OF INTERNATIONAL REGISTRATION 0848559 DATED 11-16-2004, EXPIRES 11-16-2014.

FOR VEHICLE TIRES, SOLID TIRES (U.S. CLS. 19, 21, 23, 31, 35 AND 44).

REBECCA SMITH, EXAMINING ATTORNEY

SN 79-010,749. RIVA S.P.A., ITALY, FILED 11-29-2004.

AQUARAMA

THE MARK CONSISTS OF STANDARD CHARACTERS WITHOUT CLAIM TO ANY PARTICULAR FONT, STYLE, SIZE, OR COLOR.

OWNER OF INTERNATIONAL REGISTRATION 0849161 DATED 11-29-2004, EXPIRES 11-29-2014.

FOR BOATS; MARINE ENGINES (U.S. CLS. 19, 21, 23, 31, 35 AND 44).

MATTHEW KLINE, EXAMINING ATTORNEY

SN 79-010,771. KABUSHIKI KAISHA NANSIN, JAPAN, FILED 10-25-2004.

SILENT MASTER

THE MARK CONSISTS OF STANDARD CHARACTERS WITHOUT CLAIM TO ANY PARTICULAR FONT, STYLE, SIZE, OR COLOR.

PRIORITY DATE OF 10-21-2004 IS CLAIMED.

OWNER OF INTERNATIONAL REGISTRATION 0849205 DATED 10-25-2004, EXPIRES 10-25-2014.

FOR GOODS HANDLING CARTS; DOLLIES (U.S. CLS. 19, 21, 23, 31, 35 AND 44).

CATHERINE CAIN, EXAMINING ATTORNEY

CLASS 13—FIREARMS

CLASS 13—(Continued).

SN 76-620,389. SPC RESOURCES, INC., HARTSVILLE, SC.
FILED 11-10-2004.

SN 78-338,760. PRIDE FOWLER INDUSTRIES, INC., LA
VERNE, CA. FILED 12-10-2003.

BARRELGUARD

THE MARK CONSISTS OF STANDARD CHARACTERS WITHOUT CLAIM TO ANY PARTICULAR FONT, STYLE, SIZE, OR COLOR.

FOR TUBES FOR INSERTION IN GUN BARRELS TO PROTECT THE BARREL AND PREVENT CORROSION (U.S. CLS. 2 AND 9).

FIRST USE 0-0-1990; IN COMMERCE 0-0-1990.
DAWN HAN, EXAMINING ATTORNEY

THE RAPID RETICLE

SN 76-620,553. ALAMO FIREWORKS, INC., SAN ANTONIO, TX. FILED 11-15-2004.

BIG BOY

THE MARK CONSISTS OF STANDARD CHARACTERS WITHOUT CLAIM TO ANY PARTICULAR FONT, STYLE, SIZE, OR COLOR.

FOR FIREWORKS (U.S. CLS. 2 AND 9).
TRACY WHITAKER-BOWN, EXAMINING ATTORNEY

NO CLAIM IS MADE TO THE EXCLUSIVE RIGHT TO USE RETICLE, APART FROM THE MARK AS SHOWN.

THE COLOR(S) LETTERS ARE IN BLUE IS/ARE CLAIMED AS A FEATURE OF THE MARK.

THE MARK CONSISTS OF BLUE LETTERING IN "STENCIL" TYPE CAPITALIZED LETTERS.

FOR SIGHTS FOR FIREARMS, NAMELY, RETICLES FOR ALIGNMENT OF RIFLES AND PISTOLS WITH A TARGET (U.S. CLS. 2 AND 9).

TONI HICKEY, EXAMINING ATTORNEY

SN 78-323,366. PARKER, BOBBY J., SPRING CREEK, NV. FILED 11-5-2003.

SN 78-362,148. OERLIKON CONTRAVES AG, ZÜRICH, SWITZERLAND, FILED 2-4-2004.

Hydra-con

SkyShield

THE MARK CONSISTS OF STANDARD CHARACTERS WITHOUT CLAIM TO ANY PARTICULAR FONT, STYLE, SIZE, OR COLOR.

FOR BULLETS (U.S. CLS. 2 AND 9).
FIRST USE 6-1-1998; IN COMMERCE 6-1-1998.
ALICIA COLLINS, EXAMINING ATTORNEY

OWNER OF SWITZERLAND REG. NO. 419405, DATED 9-28-1995, RENEWED AS REG. NO. P-419045, DATED 1-13-2005, EXPIRES 9-28-2015.

FOR WEAPONS SYSTEMS CONSISTING OF CANNONS, AND DEVICES FOR FIRING CANNONS AND MISSILES (U.S. CLS. 2 AND 9).

GLENN CLARK, EXAMINING ATTORNEY

CLASS 13—(Continued).

SN 78-422,399. DIANE INVESTMENTS, S.A., LUXEMBOURG, LUXEMBOURG, FILED 5-20-2004.

MAROCCHI

THE MARK CONSISTS OF STANDARD CHARACTERS WITHOUT CLAIM TO ANY PARTICULAR FONT, STYLE, SIZE, OR COLOR.

SEC. 2(F).

FOR GUNS (U.S. CLS. 2 AND 9).

FIRST USE 12-0-1981; IN COMMERCE 12-0-1981.

G. MAYERSCHOFF, EXAMINING ATTORNEY

CLASS 13—(Continued).

SN 78-497,366. LDE CORPORATION, GILLETTE, WY. FILED 10-9-2004.

LDE CORPORATION

THE MARK CONSISTS OF STANDARD CHARACTERS WITHOUT CLAIM TO ANY PARTICULAR FONT, STYLE, SIZE, OR COLOR.

NO CLAIM IS MADE TO THE EXCLUSIVE RIGHT TO USE "CORPORATION", APART FROM THE MARK AS SHOWN.

FOR EXPLOSIVES (U.S. CLS. 2 AND 9).

FIRST USE 1-0-2002; IN COMMERCE 1-0-2002.

DOMINICK J. SALEMI, EXAMINING ATTORNEY

SN 78-508,215. TACTICAL LINK, L.L.C., BELLEVUE, WA. FILED 10-29-2004.

SN 78-492,320. WYSIWYG.DOC INC., GREENVILLE, SC. FILED 9-30-2004.

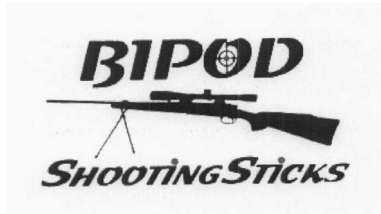

NO CLAIM IS MADE TO THE EXCLUSIVE RIGHT TO USE "BIPOD AND SHOOTING STICKS", APART FROM THE MARK AS SHOWN.

FOR FIREARM ACCESSORIES, NAMELY, MULTI-FUNCTIONAL BIPODS AND STANDS FOR RIFLES, SHOTGUNS, HANDGUNS, MUZZLELOADERS AND BOWS (U.S. CLS. 2 AND 9).

FIRST USE 12-2-2001; IN COMMERCE 12-2-2001.

SAMUEL E. SHARPER JR., EXAMINING ATTORNEY

Ready Set

THE MARK CONSISTS OF STANDARD CHARACTERS WITHOUT CLAIM TO ANY PARTICULAR FONT, STYLE, SIZE, OR COLOR.

FOR SLINGS FOR FIREARMS, MOUNTING APPARATUS FOR MOUNTING SLINGS TO FIREARMS, SLING MOUNTS FOR FIREARMS (U.S. CLS. 2 AND 9).

FIRST USE 8-17-2004; IN COMMERCE 10-26-2004.

ALEXANDER L. POWERS, EXAMINING ATTORNEY

SN 78-521,730. MCLAREN, ROBERT R., COLORADO SPRINGS, CO. FILED 11-23-2004.

SN 78-492,641. NOSLER, INC., BEND, OR. FILED 9-30-2004.

NOSLERCUSTOM

THE MARK CONSISTS OF STANDARD CHARACTERS WITHOUT CLAIM TO ANY PARTICULAR FONT, STYLE, SIZE, OR COLOR.

OWNER OF U.S. REG. NOS. 1,419,934, 2,176,410 AND 2,234,253.

FOR AMMUNITION AND COMPONENTS THEREOF; RIFLES (U.S. CLS. 2 AND 9).

BRIAN PINO, EXAMINING ATTORNEY

REAL LIFE SAVE-R

THE MARK CONSISTS OF STANDARD CHARACTERS WITHOUT CLAIM TO ANY PARTICULAR FONT, STYLE, SIZE, OR COLOR.

FOR GUN LOCKS (U.S. CLS. 2 AND 9).

SANI KHOURI, EXAMINING ATTORNEY

CLASS 13—(Continued).

SN 78-525,436. INGRAM ENTERPRISES, INC., SPRINGFIELD, MO. FILED 12-1-2004.

CLASS 13—(Continued).

SN 78-525,439. INGRAM ENTERPRISES, INC., SPRINGFIELD, MO. FILED 12-1-2004.

LAVA LAMP

HOT POTS

THE MARK CONSISTS OF STANDARD CHARACTERS WITHOUT CLAIM TO ANY PARTICULAR FONT, STYLE, SIZE, OR COLOR.

FOR FIREWORKS (U.S. CLS. 2 AND 9).
KEVIN DINALLO, EXAMINING ATTORNEY

THE MARK CONSISTS OF STANDARD CHARACTERS WITHOUT CLAIM TO ANY PARTICULAR FONT, STYLE, SIZE, OR COLOR.

FOR FIREWORKS (U.S. CLS. 2 AND 9).
KEVIN DINALLO, EXAMINING ATTORNEY

SN 78-525,438. INGRAM ENTERPRISES, INC., SPRINGFIELD, MO. FILED 12-1-2004.

SN 78-536,837. BERETTA USA CORP., ACCOKEEK, MD. FILED 12-22-2004.

HANG TEN

STATESMAN

THE MARK CONSISTS OF STANDARD CHARACTERS WITHOUT CLAIM TO ANY PARTICULAR FONT, STYLE, SIZE, OR COLOR.

FOR FIREWORKS (U.S. CLS. 2 AND 9).
KEVIN DINALLO, EXAMINING ATTORNEY

THE MARK CONSISTS OF STANDARD CHARACTERS WITHOUT CLAIM TO ANY PARTICULAR FONT, STYLE, SIZE, OR COLOR.

FOR FIREARMS (U.S. CLS. 2 AND 9).
PRISCILLA MILTON, EXAMINING ATTORNEY

CLASS 13—(Continued).

SN 78-548,470. BLACKHAWK INDUSTRIES PRODUCT GROUP UNLIMITED LLC, NORFOLK, VA. FILED 1-17-2005.

S.T.R.I.K.E.

THE MARK CONSISTS OF STANDARD CHARACTERS WITHOUT CLAIM TO ANY PARTICULAR FONT, STYLE, SIZE, OR COLOR.

FOR HOLSTERS; PISTOL HOLSTERS; SHOULDER HOLSTER HARNESSSES; LEG-MOUNTED HARNESSSES; LEG-MOUNTED HOLSTERS; LEG-MOUNTED POUCHES, PACKS, AND CARRIERS; CARTRIDGE POUCHES, PACKS, AND CARRIERS; AMMUNITION MAGAZINE POUCHES, PACKS, AND CARRIERS; AMMUNITION POUCHES, PACKS, AND CARRIERS; POUCHES, CARRIERS, AND KEEPERS FOR AFFIXATION TO BELTS, VESTS, AND BACKPACKS (U.S. CLS. 2 AND 9).

FIRST USE 1-0-2003; IN COMMERCE 1-0-2003.
JILL C. ALT, EXAMINING ATTORNEY

CLASS 14—JEWELRY

SN 75-870,854. KABUSHIKI KAISHA SONY COMPUTER ENTERTAINMENT, TA SONY COMPUTER ENTERTAINMENT INC., MINATO-KU, TOKYO, JAPAN, FILED 12-13-1999.

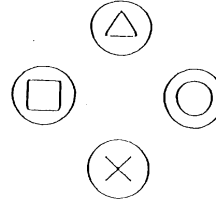

OWNER OF JAPAN REG. NO. 4790376, DATED 7-30-2004, EXPIRES 7-30-2014.

FOR HOROLOGICAL AND CHRONOMETIC APPARATUS AND INSTRUMENTS, NAMELY, CLOCKS, WATCHES, JEWELRY; PRECIOUS STONES AND PRECIOUS METALS; GOODS MADE FROM PRECIOUS STONES AND METALS OR IMITATIONS THEREOF, NAMELY, NUTCRACKERS, PEPPER POTS, SUGAR BOWLS, SALT SHAKERS, DISHES, CIGAR CASES, NAPKIN HOLDERS, FLOWER BOWLS, JEWEL CASES, CANDLESTICKS, COMPACTS, BADGES, CUFF LINKS; IMITATION JEWELRY (U.S. CLS. 2, 27, 28 AND 50).

FLORENTINA BLANDU, EXAMINING ATTORNEY

SN 79-002,641. ORTACKA RADNJA ZA IZRADU.; MONTAU I SERVIS ELECTRICNIH; UREDJAJA "TRIO", YUGOSLAVIA, FILED 3-18-2004.

TRIO
333

PRIORITY DATE OF 10-15-2003 IS CLAIMED.
OWNER OF INTERNATIONAL REGISTRATION 0825098 DATED 3-18-2004, EXPIRES 3-18-2014.

FOR MACHINES FOR ARMING MINES, MACHINES FOR ARMING ELECTRIC BLASTING CAPS (U.S. CLS. 2 AND 9).

STEVEN JACKSON, EXAMINING ATTORNEY

SN 76-253,091. MARC JACOBS TRADEMARKS, L.L.C., NEW YORK, NY. FILED 5-7-2001.

MARC JACOBS

OWNER OF ERPN CMNTY TM OFC REG. NO. 000481465, DATED 10-2-1998, EXPIRES 3-5-2007.

OWNER OF U.S. REG. NOS. 1,967,123 AND 2,046,695.
"MARC JACOBS" IS A LIVING INDIVIDUAL WHOSE WRITTEN CONSENT TO USE AND REGISTER THE NAME IS OF RECORD.

FOR JEWELRY, NAMELY BRACELETS, RINGS, KEY RINGS, EARRINGS, BROOCHES, NECKLACES, PINS, CUFF LINKS, MEDALLIONS, BUCKLES, CHARMS, STRAPS FOR WRIST-WATCHES, WRIST WATCHES, CLOCKS, CASES FOR WATCHES, WATCHES (U.S. CLS. 2, 27, 28 AND 50).

JILL C. ALT, EXAMINING ATTORNEY

CLASS 14—(Continued).

SN 76-381,821. ZENITH INTERNATIONAL S.A., LE LOCLE, SWITZERLAND, FILED 3-13-2002.

El Primero

OWNER OF SWITZERLAND REG. NO. 439600, DATED 11-4-1996, EXPIRES 11-4-2006.

THE ENGLISH TRANSLATION OF EL PRIMERO IS THE FIRST.

FOR WATCHES, CHRONOGRAPHS FOR USE AS WATCHES, CHRONOMETERS, WATCH MOVEMENTS (U.S. CLS. 2, 27, 28 AND 50).

FIRST USE 4-12-1969; IN COMMERCE 3-6-2001.
DAHLIA GEORGE, EXAMINING ATTORNEY

SN 76-533,447. NAMBE MILLS, INC., SANTA FE, NM. FILED 7-30-2003.

DESIGN YOUR LIFE

FOR JEWELRY AND CLOCKS (U.S. CLS. 2, 27, 28 AND 50).

FIRST USE 10-2-2003; IN COMMERCE 10-0-2003.
WON TEAK OH, EXAMINING ATTORNEY

SN 76-556,348. WESTRIM, INC., VAN NUYS, CA. FILED 11-3-2003.

Blue
Moon
Beads 

NO CLAIM IS MADE TO THE EXCLUSIVE RIGHT TO USE BEADS, APART FROM THE MARK AS SHOWN.

FOR BEADS, GLASS BEADS, PLASTIC BEADS, STONE BEADS, CLOISSONNE BEADS, METAL BEADS, STRINGS OF BEADS, CLASPS, EAR WIRES, CHARMS, FINDINGS, BRACELETS AND STRINGS OF BEADS, ALL FOR USE IN THE MANUFACTURE OF JEWELRY (U.S. CLS. 2, 27, 28 AND 50).

FIRST USE 12-0-1997; IN COMMERCE 12-0-1997.
MICHAEL ENGEL, EXAMINING ATTORNEY

CLASS 14—(Continued).

SN 76-571,005. RBJ, INC., LOS ANGELES, CA. FILED 1-20-2004.



NO CLAIM IS MADE TO THE EXCLUSIVE RIGHT TO USE "RB", APART FROM THE MARK AS SHOWN.

FOR JEWELRY (U.S. CLS. 2, 27, 28 AND 50).
FIRST USE 6-12-1991; IN COMMERCE 6-12-1991.
MICHAEL ENGEL, EXAMINING ATTORNEY

SN 76-597,817. MVI MARKETING LTD., PASO ROBLES, CA. FILED 6-16-2004.



Arctic Reflections
Diamond Jewelry from The North

NO CLAIM IS MADE TO THE EXCLUSIVE RIGHT TO USE DIAMOND JEWELRY FROM THE NORTH, APART FROM THE MARK AS SHOWN.

THE MARK CONSISTS OF THE WORDS "ARCTIC REFLECTIONS DIAMOND JEWELRY FROM THE NORTH" AND THE DESIGN, AS SHOWN IN THE DRAWING.

FOR JEWELRY (U.S. CLS. 2, 27, 28 AND 50).
BILL DAWE, EXAMINING ATTORNEY

SN 76-599,048. EMA USA INC., NEW YORK, NY. FILED 6-24-2004.

LE LUMIERE

THE MARK CONSISTS OF STANDARD CHARACTERS WITHOUT CLAIM TO ANY PARTICULAR FONT, STYLE, SIZE, OR COLOR.

THE ENGLISH TRANSLATION OF THE WORD LE IS THE, HIM, HER, OR SO; AND THE ENGLISH TRANSLATION OF THE FRENCH FEMININE GENDER NOUN LUMIERE IS "LIGHT, DAYLIGHT, DAY, LAMP, AND LUMINARY", AMONG OTHER MEANINGS.

FOR DIAMONDS, RINGS, PENDANTS, EARRINGS, AND BRACELETS (U.S. CLS. 2, 27, 28 AND 50).
TARAH HARDY, EXAMINING ATTORNEY

CLASS 14—(Continued).

SN 76-599,168. CINCO STAR LLC, EDISON, NJ. FILED 6-25-2004.

DANGLING DIAMONDS

THE MARK CONSISTS OF STANDARD CHARACTERS WITHOUT CLAIM TO ANY PARTICULAR FONT, STYLE, SIZE, OR COLOR.

NO CLAIM IS MADE TO THE EXCLUSIVE RIGHT TO USE "DIAMONDS", APART FROM THE MARK AS SHOWN. FOR JEWELRY (U.S. CLS. 2, 27, 28 AND 50).
KELLY BOULTON, EXAMINING ATTORNEY

SN 76-599,408. A&A BODY WORSHIP, INC., NEW YORK, NY. AND RHONE, SYLVIA, NEW YORK, NY. FILED 6-24-2004.

INDEPENDENT BODIES

THE MARK CONSISTS OF STANDARD CHARACTERS WITHOUT CLAIM TO ANY PARTICULAR FONT, STYLE, SIZE, OR COLOR.

FOR JEWELRY; JEWELRY FINDINGS; PENDANTS; LAPEL PINS; ORNAMENTAL LAPEL PINS; PINS BEING JEWELRY; EAR CLIPS; TIE PINS AND CLIPS; BOLO TIES WITH PRECIOUS METAL TIPS; CUFF-LINKS; BADGES OF PRECIOUS METAL; BELT BUCKLES OF PRECIOUS METAL; JEWELRY; COSTUME JEWELRY; JEWELRY CHAINS; JEWELRY PINS FOR USE ON HATS; HAT ORNAMENTS AND PINS OF PRECIOUS METAL; SHOE ORNAMENTS MADE OF PRECIOUS METAL; HOLIDAY ORNAMENTS OF PRECIOUS METAL; JEWELRY BOXES AND CASES OF PRECIOUS METAL; MATCH BOXES OF PRECIOUS METAL; SNUFF BOXES AND SERVIETTE RINGS OF PRECIOUS METAL; WATCHES AND RELATED ACCESSORIES; WRIST-WATCHES; POCKET WATCHES; STOP WATCHES; WATCH STRAPS AND BANDS; WATCH CHAINS AND FOBS; WATCH CASES; CLOCKS; ALARM CLOCKS; CLOCKS INCORPORATING RADIOS; WALL CLOCKS; FIGURINES AND SCULPTURES OF PRECIOUS METAL; PIGGY BANKS MADE OF PRECIOUS METAL; BOOK MARKERS OF PRECIOUS METAL; PRECIOUS METAL MONEY CLIPS; ASHTRAYS OF PRECIOUS METAL; BOTTLE CLOSURES OF PRECIOUS METAL; COFFEE SERVICES, TEA SERVICES AND TOOTHPICK HOLDERS OF PRECIOUS METAL; VASES OF PRECIOUS METAL; CRUETS OF PRECIOUS METAL; CRUET STANDS FOR OIL OR VINEGAR OF PRECIOUS METAL; FLOWER BOWLS OF PRECIOUS METAL; BUSTS, FIGURES, FIGURINES, STATUES, STATUETTES AND STIRRING RODS OF PRECIOUS METAL; CANDLESTICKS, CANDLE HOLDERS, CANDLE RINGS AND CANDLE HOLDERS OF PRECIOUS METAL; NON-ELECTRIC CANDELABRAS MADE OF PRECIOUS METAL; CIGARETTE HOLDERS AND LIGHTERS OF PRECIOUS METAL; MATCH BOXES AND HOLDERS OF PRECIOUS METAL; LETTER OPENERS OF PRECIOUS METAL; POTPOURRI DISHES MADE IN WHOLE OR IN PART OF PRECIOUS METAL (U.S. CLS. 2, 27, 28 AND 50).

CAROLYN CATALDO, EXAMINING ATTORNEY

CLASS 14—(Continued).

SN 76-609,836. RHODE ISLAND BEAD & COMPONENTS, INC., CRANSTON, RI. FILED 8-30-2004.

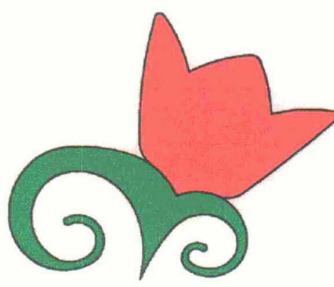

THE COLORS RED AND GREEN ARE CLAIMED AS A FEATURE OF THE MARK.

THE MARK INCLUDES THE COLOR RED FOR THE FLOWER PORTION OF THE DESIGN AND THE COLOR GREEN FOR THE STEM PORTION THEREOF.

THE MARK CONSISTS OF THE DESIGN OF A TULIP. FOR JEWELRY (U.S. CLS. 2, 27, 28 AND 50).
FIRST USE 1-0-2004; IN COMMERCE 1-0-2004.
TRICIA SONNEBORN, EXAMINING ATTORNEY

SN 76-618,170. JIMLAR CORPORATION, GREAT NECK, NY. FILED 10-28-2004.

FRYE

THE MARK CONSISTS OF STANDARD CHARACTERS WITHOUT CLAIM TO ANY PARTICULAR FONT, STYLE, SIZE, OR COLOR.

OWNER OF U.S. REG. NO. 1,110,961.
SEC. 2(F).

FOR JEWELRY, NAMELY, PENDANTS, NECKLACES, BRACELETS, RINGS, EARRINGS AND BELT BUCKLES OF PRECIOUS METALS (U.S. CLS. 2, 27, 28 AND 50).

BILL DAWE, EXAMINING ATTORNEY

CLASS 14—(Continued).

SN 76-618,171. JIMLAR CORPORATION, GREAT NECK, NY.
FILED 10-28-2004.



OWNER OF U.S. REG. NO. 1,244,640.
FOR JEWELRY, NAMELY, PENDANTS, NECKLACES,
BRACELETS, RINGS, EARRINGS AND BELT BUCKLES
OF PRECIOUS METALS (U.S. CLS. 2, 27, 28 AND 50).
BILL DAWE, EXAMINING ATTORNEY

SN 76-618,601. THE HOLLYWOOD COMPANY, LLC, LOS
ANGELES, CA. FILED 11-1-2004.

HOT IN HOLLYWOOD

THE MARK CONSISTS OF STANDARD CHARACTERS
WITHOUT CLAIM TO ANY PARTICULAR FONT, STYLE,
SIZE, OR COLOR.

NO CLAIM IS MADE TO THE EXCLUSIVE RIGHT TO
USE HOLLYWOOD, APART FROM THE MARK AS
SHOWN.

FOR JEWELRY AND WATCHES (U.S. CLS. 2, 27, 28
AND 50).

FIRST USE 3-23-2003; IN COMMERCE 3-23-2003.
KAREN K. BUSH, EXAMINING ATTORNEY

SN 76-620,741. DESANNOIS ENTERPRISES LLC, NEW
ROCHELLE, NY. FILED 11-15-2004.

SKINSHIPPS

THE MARK CONSISTS OF STANDARD CHARACTERS
WITHOUT CLAIM TO ANY PARTICULAR FONT, STYLE,
SIZE, OR COLOR.

FOR BRACELETS, EARRINGS, JEWELRY PINS,
NECKLACES, CHARMS, CHAINS, EAR CLIPS, TIE
CLIPS, TIE PINS, TIE TACKS, CUFF LINKS, LAPEL
PINS, NECKTIE FASTENERS, PENDANTS, CLOCKS,
WATCHES, AND WATCH STRAPS (U.S. CLS. 2, 27, 28
AND 50).

EDWARD NELSON, EXAMINING ATTORNEY

CLASS 14—(Continued).

SN 76-620,742. DESANNOIS ENTERPRISES LLC, NEW
ROCHELLE, NY. FILED 11-15-2004.

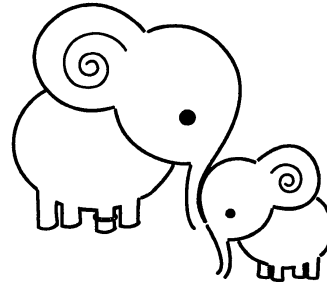

FOR BRACELETS, EARRINGS, JEWELRY PINS,
NECKLACES, CHARMS, CHAINS, EAR CLIPS, TIE
CLIPS, TIE PINS, TIE TACKS, CUFF LINKS, LAPEL
PINS, NECKTIE FASTENERS, PENDANTS, CLOCKS,
WATCHES, AND WATCH STRAPS (U.S. CLS. 2, 27, 28
AND 50).

EDWARD NELSON, EXAMINING ATTORNEY

SN 76-621,248. TRANS AMERICAN JEWELRY CO., INC.,
NEW YORK, NY. FILED 11-15-2004.

AMADENA

THE MARK CONSISTS OF STANDARD CHARACTERS
WITHOUT CLAIM TO ANY PARTICULAR FONT, STYLE,
SIZE, OR COLOR.

FOR JEWELRY (U.S. CLS. 2, 27, 28 AND 50).

FIRST USE 10-14-2004; IN COMMERCE 10-14-2004.
DAWN HAN, EXAMINING ATTORNEY

SN 76-621,276. ALCO INDUSTRIES, INC., CRANBURY, NJ.
FILED 11-19-2004.

MELRICH

THE MARK CONSISTS OF STANDARD CHARACTERS
WITHOUT CLAIM TO ANY PARTICULAR FONT, STYLE,
SIZE, OR COLOR.

FOR CLOCKS (U.S. CLS. 2, 27, 28 AND 50).

PAULA MAHONEY, EXAMINING ATTORNEY

CLASS 14—(Continued).

SN 76-621,950. BENHAM JEWELRY CO., NEW YORK, NY.
FILED 11-19-2004.

SIMPLY CHARMING

THE MARK CONSISTS OF STANDARD CHARACTERS
WITHOUT CLAIM TO ANY PARTICULAR FONT, STYLE,
SIZE, OR COLOR.

FOR JEWELRY (U.S. CLS. 2, 27, 28 AND 50).
IRENE D. WILLIAMS, EXAMINING ATTORNEY

SN 76-622,842. DYNAMIC DESIGN GROUP, INC., NEW
YORK, NY. FILED 12-2-2004.

JULIANNA

THE MARK CONSISTS OF STANDARD CHARACTERS
WITHOUT CLAIM TO ANY PARTICULAR FONT, STYLE,
SIZE, OR COLOR.

FOR JEWELRY (U.S. CLS. 2, 27, 28 AND 50).
BARBARA A. GOLD, EXAMINING ATTORNEY

SN 76-622,844. SCHWARTZ, KAREN, LOS ANGELES, CA.
FILED 12-2-2004.

ANTI-TERRORISM

THE MARK CONSISTS OF STANDARD CHARACTERS
WITHOUT CLAIM TO ANY PARTICULAR FONT, STYLE,
SIZE, OR COLOR.

FOR STRETCHABLE BAND TYPE BRACELETS AND
ANKLE BRACELETS (U.S. CLS. 2, 27, 28 AND 50).
MICHELLE DUBOIS, EXAMINING ATTORNEY

SN 76-625,863. BYARD F. BROGAN INCORPORATED,
GLENSIDE, PA. FILED 12-27-2004.

PRINCESSE LEGACY COLLECTION

THE MARK CONSISTS OF STANDARD CHARACTERS
WITHOUT CLAIM TO ANY PARTICULAR FONT, STYLE,
SIZE, OR COLOR.

NO CLAIM IS MADE TO THE EXCLUSIVE RIGHT TO
USE COLLECTION, APART FROM THE MARK AS SHOWN.
FOR PEARLS (U.S. CLS. 2, 27, 28 AND 50).
AMY GEARIN, EXAMINING ATTORNEY

CLASS 14—(Continued).

SN 76-627,413. KRIEGER WATCH CORPORATION, MIAMI
BEACH, FL. FILED 1-10-2005.

GIGANTIUM

THE MARK CONSISTS OF STANDARD CHARACTERS
WITHOUT CLAIM TO ANY PARTICULAR FONT, STYLE,
SIZE, OR COLOR.

FOR WATCHES (U.S. CLS. 2, 27, 28 AND 50).
FIRST USE 6-10-2004; IN COMMERCE 6-10-2004.
DAVID C. REIHNER, EXAMINING ATTORNEY

SN 78-200,579. MAGNOLIA EXPORT LOGISTICS LTD.,
KFAR SABA, ISRAEL, FILED 1-7-2003.

MAGNOLIA SILVER

PRIORITY CLAIMED UNDER SEC. 44(D) ON ISRAEL
APPLICATION NO. 161933, FILED 12-22-2002, REG. NO.
161933, DATED 2-3-2004, EXPIRES 12-22-2009.

NO CLAIM IS MADE TO THE EXCLUSIVE RIGHT TO
USE "SILVER", APART FROM THE MARK AS SHOWN.

FOR JEWELRY MADE SUBSTANTIALLY OF SILVER,
NOT INCLUDING WATCHES (U.S. CLS. 2, 27, 28 AND
50).

JULIE WATSON, EXAMINING ATTORNEY

SN 78-269,459. FACONNABLE SAS, NICE, FRANCE, FILED
7-1-2003.

COCOON

PRIORITY CLAIMED UNDER SEC. 44(D) ON FRANCE
APPLICATION NO. 033212205, FILED 2-27-2003, REG. NO.
033212205, DATED 2-27-2003, EXPIRES 2-27-2013.

FOR ITEMS OF PRECIOUS METALS AND THEIR
ALLOYS, NAMELY, CIGAR CASES, CIGARETTE
CASES, ASHTRAYS, SNUFF BOXES, CIGAR HOLDERS,
CIGARETTE HOLDERS; JEWEL CASES OF PRECIOUS
METALS; JEWELRY, CUFF LINKS, RINGS, BRACE-
LETS, NECKLACES, TIE PINS, EARRINGS; CLOCKS,
WATCHES, WRIST WATCHES, CHRONOGRAPHS,
CHRONOMETERS, WATCH STRAPS, WATCH CHAINS,
WATCH CASES, CASES FOR CLOCKS (U.S. CLS. 2, 27, 28
AND 50).

RICHARD A. STRASER, EXAMINING ATTORNEY

CLASS 14—(Continued).

SN 78-332,883. GILSON, MARY KAY, LAFAYETTE, CO. FILED 11-25-2003.

CLASS 14—(Continued).

SN 78-403,769. DUEN HONGSAI, SAN FRANCISCO, CA. FILED 4-19-2004.

LET IT SHINE

THE MARK CONSISTS OF STANDARD CHARACTERS WITHOUT CLAIM TO ANY PARTICULAR FONT, STYLE, SIZE, OR COLOR.
FOR JEWELRY, NAMELY CHRISTIAN JEWELRY (U.S. CLS. 2, 27, 28 AND 50).
ANGELA M. MICHELI, EXAMINING ATTORNEY

PKok

THE MARK CONSISTS OF STANDARD CHARACTERS WITHOUT CLAIM TO ANY PARTICULAR FONT, STYLE, SIZE, OR COLOR.
FOR JEWELRY (U.S. CLS. 2, 27, 28 AND 50).
FIRST USE 2-0-2002; IN COMMERCE 2-0-2002.
JOHN DALIER, EXAMINING ATTORNEY

SN 78-350,226. LAKE, SUSAN, SANTA BARBARA, CA. FILED 1-9-2004.

animulet

SN 78-411,677. 500 B.C., GREAT FALLS, VA. FILED 4-30-2004.

THE MARK CONSISTS OF STANDARD CHARACTERS WITHOUT CLAIM TO ANY PARTICULAR FONT, STYLE, SIZE, OR COLOR.
FOR PET JEWELRY (U.S. CLS. 2, 27, 28 AND 50).
FIRST USE 1-9-2004; IN COMMERCE 1-9-2004.
MICHELE SWAIN, EXAMINING ATTORNEY

500 BC

SN 78-368,273. LECLAIR, ROBERT S., HOUSTON, TX. FILED 2-14-2004.

**IN GOD WE STILL
TRUST**

THE MARK CONSISTS OF STANDARD CHARACTERS WITHOUT CLAIM TO ANY PARTICULAR FONT, STYLE, SIZE, OR COLOR.
FOR JEWELRY, NAMELY NECKLACES, PENDANTS, LAPEL PINS, RINGS, AND KEYRINGS MADE OF BASE METALS (U.S. CLS. 2, 27, 28 AND 50).
GEORGIA CARTY, EXAMINING ATTORNEY

THE MARK CONSISTS OF STANDARD CHARACTERS WITHOUT CLAIM TO ANY PARTICULAR FONT, STYLE, SIZE, OR COLOR.
FOR JEWELRY OF A CELTIC THEME (U.S. CLS. 2, 27, 28 AND 50).
FIRST USE 3-8-2004; IN COMMERCE 3-8-2004.
CHRISTOPHER ADKINS, EXAMINING ATTORNEY

CLASS 14—(Continued).

SN 78-417,883. ST. JAMES WINERY, INC., ST. JAMES, MO.
FILED 5-13-2004.

CLASS 14—(Continued).

SN 78-419,818. PRO ARTE, INC., PORTLAND, ME. FILED 5-17-2004.

ST. JAMES WINERY

THE MARK CONSISTS OF STANDARD CHARACTERS WITHOUT CLAIM TO ANY PARTICULAR FONT, STYLE, SIZE, OR COLOR.

OWNER OF U.S. REG. NO. 2,951,837.
SEC. 2(F) AS TO ST. JAMES.
FOR LAPEL PINS AND EARRINGS (U.S. CLS. 2, 27, 28 AND 50).

FIRST USE 7-2-2001; IN COMMERCE 7-2-2001.
PAULA MAHONEY, EXAMINING ATTORNEY

PRO ARTE

SN 78-417,944. LNJ, CONROE, TX. FILED 5-13-2004.

THE MARK CONSISTS OF STANDARD CHARACTERS WITHOUT CLAIM TO ANY PARTICULAR FONT, STYLE, SIZE, OR COLOR.

NO CLAIM IS MADE TO THE EXCLUSIVE RIGHT TO USE "ARTE", APART FROM THE MARK AS SHOWN.

THE FOREIGN WORDING IN THE MARK TRANSLATES INTO ENGLISH AS "FOR THE SAKE OF ART," OR "FOR ART'S SAKE".

FOR JEWELRY (U.S. CLS. 2, 27, 28 AND 50).
FIRST USE 1-24-1997; IN COMMERCE 9-0-2003.
MARK RADEMACHER, EXAMINING ATTORNEY

DANNINI

FOR DIAMOND JEWELRY, 18KT GOLD JEWELRY (U.S. CLS. 2, 27, 28 AND 50).

FIRST USE 1-15-2004; IN COMMERCE 3-9-2004.
NORA BUCHANAN WILL, EXAMINING ATTORNEY

SN 78-436,750. PEARLABELLA, INC., SOUTHFIELD, MI.
FILED 6-17-2004.

SN 78-418,718. DAYER, RAY, CONWAY, AR. FILED 5-14-2004.

PEARLABELLA**FLEX-E TOE RING**

THE MARK CONSISTS OF STANDARD CHARACTERS WITHOUT CLAIM TO ANY PARTICULAR FONT, STYLE, SIZE, OR COLOR.

NO CLAIM IS MADE TO THE EXCLUSIVE RIGHT TO USE TOE RING, APART FROM THE MARK AS SHOWN.

FOR JEWELRY, NAMELY CUSTOM-DESIGN RINGS TO BE WORN ON THE TOE (U.S. CLS. 2, 27, 28 AND 50).
JEFF DEFORD, EXAMINING ATTORNEY

THE MARK CONSISTS OF STANDARD CHARACTERS WITHOUT CLAIM TO ANY PARTICULAR FONT, STYLE, SIZE, OR COLOR.

THE ENGLISH TRANSLATION OF THE WORDING "A BELLA" IS "IS BEAUTIFUL."

FOR JEWELRY, NECKLACES, AND PEARL NECKLACES (U.S. CLS. 2, 27, 28 AND 50).

FIRST USE 9-30-2004; IN COMMERCE 9-30-2004.
WON TEAK OH, EXAMINING ATTORNEY

CLASS 14—(Continued).

SN 78-442,116. SAMUEL AARON, INC., LONG ISLAND CITY, NY. FILED 6-28-2004.

**OLD WORLD GEM
TREASURES**

THE MARK CONSISTS OF STANDARD CHARACTERS WITHOUT CLAIM TO ANY PARTICULAR FONT, STYLE, SIZE, OR COLOR.
NO CLAIM IS MADE TO THE EXCLUSIVE RIGHT TO USE "GEM", APART FROM THE MARK AS SHOWN.
FOR JEWELRY (U.S. CLS. 2, 27, 28 AND 50).
SALLY SHIH, EXAMINING ATTORNEY

SN 78-447,229. BABY GOLD, LLC, WARWICK, RI. FILED 7-7-2004.

BG 925

THE MARK CONSISTS OF STANDARD CHARACTERS WITHOUT CLAIM TO ANY PARTICULAR FONT, STYLE, SIZE, OR COLOR.
OWNER OF U.S. REG. NO. 1,927,170.
NO CLAIM IS MADE TO THE EXCLUSIVE RIGHT TO USE "925", APART FROM THE MARK AS SHOWN.
FOR JEWELRY (U.S. CLS. 2, 27, 28 AND 50).
EVELYN BRADLEY, EXAMINING ATTORNEY

CLASS 14—(Continued).

SN 78-450,569. J.B. JEWELRY (HK) LIMITED, HUNGHOM, KOWLOON, HONG KONG, FILED 7-14-2004.

"JULIA" DOES NOT IDENTIFY A LIVING INDIVIDUAL.

THE MARK CONSISTS OF THE STYLIZED WORD JULIA.
FOR JEWELRY, PRECIOUS STONES, ALARM CLOCKS; ANKLE BRACELETS; BEADS FOR USE IN THE MANUFACTURE OF JEWELRY; BELT BUCKLES OF PRECIOUS METAL; BODY-PIERCING RINGS; BODY-PIERCING STUDS; BOLO TIES WITH PRECIOUS METAL TIPS; BOOK MARKERS OF PRECIOUS METAL; BRACELETS; BRACELETS OF PRECIOUS METAL; BROOCHES; BUSTS OF PRECIOUS METAL; CANDLE HOLDERS OF PRECIOUS METAL; CHARMS; CHOKERS; CHRONOGRAPHS FOR USE AS WATCHES; CHRONOMETERS; CHRONOSCOPES; CLIP EARRINGS; CLOCK DIALS; CLOCKS; CLOCKS INCORPORATING RADIOS; CLOISONNE PINS; COLLECTIBLE COINS; COMMEMORATIVE COINS; COMMEMORATIVE STATUARY CUPS MADE OF PRECIOUS METAL; COSTUME JEWELRY; CRUETS OF PRECIOUS METAL; CUFFLINKS; DECORATIVE BOXES MADE OF PRECIOUS METAL; DESKTOP STATUARY MADE OF PRECIOUS METAL; DIAMONDS; EAR CLIPS; EARRINGS; EMERALDS; HAT ORNAMENTS OF PRECIOUS METAL; HAT PINS OF PRECIOUS METAL; HOLIDAY ORNAMENTS OF PRECIOUS METAL; IDENTIFICATION BRACELETS; INGOTS OF PRECIOUS METAL; JEWELRY BOXES OF PRECIOUS METAL; JEWELRY CASES OF PRECIOUS METAL; JEWELRY CHAINS; JEWELRY FINDINGS; JEWELRY PINS FOR USE ON HATS; JEWELRY, NAMELY, AMULETS, CROSSES; LAPEL PINS; LETTER OPENERS OF PRECIOUS METAL; MEDALLIONS; MEDALS; NECK CHAINS; NECKLACES; NECKTIE FASTENERS; NON-MONETARY COINS; ORNAMENTAL LAPEL PINS; ORNAMENTAL PINS; ORNAMENTS OF PRECIOUS METAL; PARTS FOR CLOCKS; PARTS FOR WATCHES; PEARLS; PENDANTS; PENDULUM CLOCKS; PINS BEING JEWELRY; POCKET WATCHES; POTPOURRI DISHES MADE IN WHOLE OR IN PART OF PRECIOUS METAL; PRECIOUS GEMSTONES; PRECIOUS METAL ALLOYS; PRECIOUS METAL MONEY CLIPS; PRECIOUS METALS AND THEIR ALLOYS IN GENERAL; RINGS BEING JEWELRY; SEMI-PRECIOUS GEMSTONES; SERVIETTE RINGS OF PRECIOUS METAL; SHOE ORNAMENTS OF PRECIOUS METAL; SLIDES FOR BOLO TIES; SNUFF BOXES OF PRECIOUS METAL; STOP WATCHES; TANKARDS OF PRECIOUS METAL; TIARAS; TIE CLIPS; TIE FASTENERS; TIE PINS; TIE TACKS; TOOTHPICK HOLDERS OF PRECIOUS METAL; VASES OF PRECIOUS METAL; WALL CLOCKS; WATCH BANDS; WATCH CASES; WATCH CHAINS; WATCH FACES; WATCH FOBS; WATCH MOVEMENTS; WATCH STRAPS; WATCH WINDERS; WATCH WINDING BUTTONS; WATCHES; WATCHES CONTAINING AN ELECTRONIC GAME FUNCTION; WATCHES CONTAINING A GAME FUNCTION; WEDDING BANDS; WRISTWATCHES; HOROLOGICAL AND CHRONOMETRIC INSTRUMENTS (U.S. CLS. 2, 27, 28 AND 50).
MELVIN AXILBUND, EXAMINING ATTORNEY

CLASS 14—(Continued).

SN 78-451,800. EASTERN MERCHANDISE CO., INC., SEATTLE, WA. FILED 7-16-2004.

ALASKA TOPAZ

THE MARK CONSISTS OF STANDARD CHARACTERS WITHOUT CLAIM TO ANY PARTICULAR FONT, STYLE, SIZE, OR COLOR.

NO CLAIM IS MADE TO THE EXCLUSIVE RIGHT TO USE "TOPAZ", APART FROM THE MARK AS SHOWN. FOR JEWELRY (U.S. CLS. 2, 27, 28 AND 50). FIRST USE 3-21-2003; IN COMMERCE 3-21-2003. BRIAN NEVILLE, EXAMINING ATTORNEY

SN 78-451,809. EASTERN MERCHANDISE CO., INC., SEATTLE, WA. FILED 7-16-2004.

CARIBBEAN TOPAZ

THE MARK CONSISTS OF STANDARD CHARACTERS WITHOUT CLAIM TO ANY PARTICULAR FONT, STYLE, SIZE, OR COLOR.

NO CLAIM IS MADE TO THE EXCLUSIVE RIGHT TO USE "TOPAZ", APART FROM THE MARK AS SHOWN. FOR JEWELRY (U.S. CLS. 2, 27, 28 AND 50). FIRST USE 4-5-2003; IN COMMERCE 4-5-2003. MAUREEN DALL, EXAMINING ATTORNEY

SN 78-462,907. VENETIAN CASINO RESORT, LLC, LAS VEGAS, NV. FILED 8-5-2004.

VENETIAN PALAZZO

THE MARK CONSISTS OF STANDARD CHARACTERS WITHOUT CLAIM TO ANY PARTICULAR FONT, STYLE, SIZE, OR COLOR.

FOR JEWELRY; LAPEL PINS; TIE CLIPS; CUFF LINKS (U.S. CLS. 2, 27, 28 AND 50). ANDREW RHIM, EXAMINING ATTORNEY

CLASS 14—(Continued).

SN 78-465,151. ASHTON, MICHELE, KEALAKEKUA, HI. FILED 8-10-2004.

Shankari

THE MARK CONSISTS OF STANDARD CHARACTERS WITHOUT CLAIM TO ANY PARTICULAR FONT, STYLE, SIZE, OR COLOR.

FOR JEWELRY; BRACELETS; NECKLACES; PENDANTS; CHAINS; EARRINGS; RINGS; TIARAS; CROWNS; OBJECTS OF ART, NAMELY, SCULPTURES OF PRECIOUS METAL; SACRED OBJECTS, NAMELY, CROSSES; PINS; BROOCHES; AND ANKLE BRACELETS (U.S. CLS. 2, 27, 28 AND 50).

FIRST USE 12-31-1990; IN COMMERCE 12-31-1990. ANNE FARRELL, EXAMINING ATTORNEY

SN 78-477,674. BELCHIE, BRANSON, NEW YORK, NY. FILED 9-2-2004.

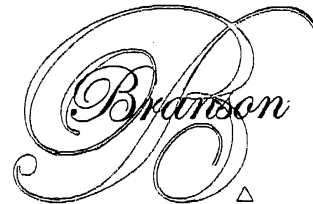

THE NAME(S), PORTRAIT(S), AND/OR SIGNATURE(S) SHOWN IN THE MARK IDENTIFIES A LIVING INDIVIDUAL, WHOSE CONSENT(S) TO REGISTER IS SUBMITTED.

THE MARK CONSISTS OF THE WORD BRANSON AND THE LETTER B. IN STYLIZED LETTERING.

FOR JEWELRY AND WATCHES (U.S. CLS. 2, 27, 28 AND 50).

TRICIA SONNEBORN, EXAMINING ATTORNEY

CLASS 14—(Continued).

SN 78-482,822. CHRISTIAN, MARTHA, ALTA DENA, CA. FILED 9-13-2004.

ZIPPORAH

THE MARK CONSISTS OF STANDARD CHARACTERS WITHOUT CLAIM TO ANY PARTICULAR FONT, STYLE, SIZE, OR COLOR.
FOR JEWELRY (U.S. CLS. 2, 27, 28 AND 50).
FIRST USE 7-30-2004; IN COMMERCE 7-30-2004.
DAWN HAN, EXAMINING ATTORNEY

CLASS 14—(Continued).

SN 78-505,933. DONAHUE, LISA GRACE, SPANISH FORK, UT. FILED 10-26-2004.

Selvaggio

THE MARK CONSISTS OF STANDARD CHARACTERS WITHOUT CLAIM TO ANY PARTICULAR FONT, STYLE, SIZE, OR COLOR.
THE MARK TRANSLATES INTO ENGLISH AS "SAVAGE".
FOR JEWELRY, NECKLACES, EARRINGS, AND BRACELETS (U.S. CLS. 2, 27, 28 AND 50).
PAUL F. GAST, EXAMINING ATTORNEY

SN 78-507,449. OWENS, EDWARD J., HENDERSON, NV. FILED 10-28-2004.

SN 78-500,576. DEUTSCHE TELEKOM AG, BONN, FED REP GERMANY, FILED 10-15-2004.

T-Mobile

PRIORITY CLAIMED UNDER SEC. 44(D) ON FED REP GERMANY APPLICATION NO. 30421576.735, FILED 4-15-2004, REG. NO. 30421576, DATED 9-9-2004, EXPIRES 4-30-2014.

OWNER OF U.S. REG. NO. 2,282,432.
THE COLOR MAGENTA AND GREY ARE CLAIMED AS A FEATURE OF THE MARK.

THE COLOR MAGENTA APPEARS IN THE LETTER "T" AND THE COLOR GREY APPEARS IN THE WORD "MOBILE" AND THE SQUARES.

FOR JEWELRY, NAMELY CHAINS, LAPEL PINS AND PINS BEING JEWELRY, PENDANTS, EARRINGS, BRACELETS, RINGS, ALL MADE EITHER OF PRECIOUS METALS, COATED THEREWITH OR FOR COSTUME JEWELRY: PRECIOUS STONES, NAMELY DIAMONDS, RUBIES, EMERALDS, PEARLS; HOROLOGICAL INSTRUMENTS, NAMELY, CLOCKS AND WATCHES; CHRONOMETERS AND CHRONOGRAPHS (U.S. CLS. 2, 27, 28 AND 50).
ROBERT C. CLARK JR., EXAMINING ATTORNEY

EARSPRINGS

THE MARK CONSISTS OF STANDARD CHARACTERS WITHOUT CLAIM TO ANY PARTICULAR FONT, STYLE, SIZE, OR COLOR.
FOR JEWELRY (U.S. CLS. 2, 27, 28 AND 50).
FIRST USE 8-22-1986; IN COMMERCE 2-3-1996.
ELLEN PERKINS, EXAMINING ATTORNEY

SN 78-509,714. AURAFIN LLC, TAMARAC, FL. FILED 11-2-2004.

m·line

FOR JEWELRY (U.S. CLS. 2, 27, 28 AND 50).
DEZMONA MIZELLE, EXAMINING ATTORNEY

CLASS 14—(Continued).

SN 78-509,913. GINS, CATHY, NEW YORK, NY. FILED 11-2-2004.

**SENTIMENTAL
ATTACHMENTS**

THE MARK CONSISTS OF STANDARD CHARACTERS WITHOUT CLAIM TO ANY PARTICULAR FONT, STYLE, SIZE, OR COLOR.
FOR JEWELRY AND WATCHES (U.S. CLS. 2, 27, 28 AND 50).
CHRIS WELLS, EXAMINING ATTORNEY

CLASS 14—(Continued).

SN 78-517,988. HIGH GEAR USA, INC., FLETCHER, NC. FILED 11-16-2004.

ALTERRA

THE MARK CONSISTS OF STANDARD CHARACTERS WITHOUT CLAIM TO ANY PARTICULAR FONT, STYLE, SIZE, OR COLOR.

FOR ELECTRONIC WATCHES THAT DISPLAY A COMBINATION OF INFORMATION, NAMELY, TIME, BAROMETRIC PRESSURE, DIRECTION, ALTITUDE, GEOGRAPHIC POSITION, OR TEMPERATURE (U.S. CLS. 2, 27, 28 AND 50).

FIRST USE 5-10-2004; IN COMMERCE 5-10-2004.
CATHERINE CAIN, EXAMINING ATTORNEY

SN 78-513,292. GUARDDOG WATCH AND CLOCK, LLC, MINNEAPOLIS, MN. FILED 11-8-2004.

ÜBERBAND

THE MARK CONSISTS OF STANDARD CHARACTERS WITHOUT CLAIM TO ANY PARTICULAR FONT, STYLE, SIZE, OR COLOR.
THE ENGLISH TRANSLATION OF THE WORD UBER IN THE MARK IS OVER OR ABOVE.
FOR WATCH BANDS (U.S. CLS. 2, 27, 28 AND 50).
EDWARD NELSON, EXAMINING ATTORNEY

SN 78-517,991. HIGH GEAR USA, INC., FLETCHER, NC. FILED 11-16-2004.

AERIAL

THE MARK CONSISTS OF STANDARD CHARACTERS WITHOUT CLAIM TO ANY PARTICULAR FONT, STYLE, SIZE, OR COLOR.

FOR ELECTRONIC WATCHES THAT DISPLAY A COMBINATION OF INFORMATION, NAMELY, TIME, BAROMETRIC PRESSURE, DIRECTION, ALTITUDE, GEOGRAPHIC POSITION, OR TEMPERATURE (U.S. CLS. 2, 27, 28 AND 50).

FIRST USE 5-10-2004; IN COMMERCE 5-10-2004.
CATHERINE CAIN, EXAMINING ATTORNEY

CLASS 14—(Continued).

SN 78-518,870. DIRECT GP, INC., PLANO, TX. FILED 11-17-2004.

HOPE FAITH LOVE

THE MARK CONSISTS OF STANDARD CHARACTERS WITHOUT CLAIM TO ANY PARTICULAR FONT, STYLE, SIZE, OR COLOR.

FOR JEWELRY (U.S. CLS. 2, 27, 28 AND 50).
NELSON SNYDER, EXAMINING ATTORNEY

CLASS 14—(Continued).

SN 78-520,687. MEYER, MICHAEL S., MILL CREEK, WA. FILED 11-21-2004.

Petals & Pearls

THE MARK CONSISTS OF STANDARD CHARACTERS WITHOUT CLAIM TO ANY PARTICULAR FONT, STYLE, SIZE, OR COLOR.

FOR JEWELRY, NECKLACES, BRACELETS, RINGS, EARRINGS, PENDANTS, BROOCHES; COSTUME JEWELRY, FINE JEWELRY, HAND MADE JEWELRY; PEARLS (U.S. CLS. 2, 27, 28 AND 50).

ZACHARY BELLO, EXAMINING ATTORNEY

SN 78-519,196. HIS WORKS, INC., LULING, TX. FILED 11-18-2004.

His Words

SN 78-520,904. TOMMY HILFIGER LICENSING, INC., NEWARK, DE. FILED 11-22-2004.

FOR JEWELRY (U.S. CLS. 2, 27, 28 AND 50).
FIRST USE 11-10-2004; IN COMMERCE 11-12-2004.
BRENDAN MCCAULEY, EXAMINING ATTORNEY

SN 78-520,074. STYLEMARK, INC., ORMOND BEACH, FL. FILED 11-19-2004.

STYLEMARK

THE MARK CONSISTS OF STANDARD CHARACTERS WITHOUT CLAIM TO ANY PARTICULAR FONT, STYLE, SIZE, OR COLOR.

FOR WATCHES (U.S. CLS. 2, 27, 28 AND 50).
JOHN E. MICHOS, EXAMINING ATTORNEY



OWNER OF U.S. REG. NOS. 2,522,274, 2,617,339 AND 2,648,299.

"TOMMY HILFIGER" IDENTIFIES A LIVING INDIVIDUAL WHOSE CONSENT IS OF RECORD.

THE COLOR(S) RED, WHITE AND BLUE IS/ARE CLAIMED AS A FEATURE OF THE MARK.

THE MARK CONSISTS OF A DESIGN ELEMENT WHICH IS A FLAG WITH BLUE BARS AT THE TOP AND BOTTOM, A RED BLOCK IN THE MIDDLE SECTION OF THE MARK TO THE RIGHT AND A WHITE BLOCK TO THE LEFT.

FOR WATCHES, TIE TACKS, JEWELRY MADE OF PRECIOUS AND NON-PRECIOUS STONES, JEWELRY MADE OF PRECIOUS AND NON-PRECIOUS METALS; CUFF LINKS; BRACELETS; NECKLACES; BROOCHES AND RINGS (U.S. CLS. 2, 27, 28 AND 50).

ELLEN B. AWRICH, EXAMINING ATTORNEY

CLASS 14—(Continued).

SN 78-522,349. ALFRED INTERNATIONAL LIMITED,
KWUN TONG, HONG KONG, FILED 11-24-2004.

Modex

THE MARK CONSISTS OF STANDARD CHARACTERS WITHOUT CLAIM TO ANY PARTICULAR FONT, STYLE, SIZE, OR COLOR.

FOR HOROLOGICAL AND CHRONOMETRIC APPARATUS AND INSTRUMENTS; WATCHES; CLOCKS; JEWELRY; PARTS AND FITTINGS FOR ALL THE AFORESAID GOODS (U.S. CLS. 2, 27, 28 AND 50).

ESTHER A. BORSUK, EXAMINING ATTORNEY

CLASS 14—(Continued).

SN 78-525,347. DILARO JEWELRY, INC, NEW YORK, NY.
FILED 12-1-2004.

JOHN APEL

THE MARK CONSISTS OF STANDARD CHARACTERS WITHOUT CLAIM TO ANY PARTICULAR FONT, STYLE, SIZE, OR COLOR.

"JOHN APEL" DOES NOT IDENTIFY A PARTICULAR LIVING INDIVIDUAL.

FOR RINGS, BRACELETS AND EARRINGS MADE OF GOLD, PRECIOUS AND SEMI-PRECIOUS STONES (U.S. CLS. 2, 27, 28 AND 50).

FIRST USE 4-1-1996; IN COMMERCE 4-1-1996.

MICHELLE DUBOIS, EXAMINING ATTORNEY

SN 78-522,893. LESTER LAMPERT, INC., CHICAGO, IL.
FILED 11-24-2004.

PERPETUAL LOVE

THE MARK CONSISTS OF STANDARD CHARACTERS WITHOUT CLAIM TO ANY PARTICULAR FONT, STYLE, SIZE, OR COLOR.

FOR PENDANTS USED TO CONTAIN THE ASHES OF DECEASED PETS (U.S. CLS. 2, 27, 28 AND 50).

EDWARD NELSON, EXAMINING ATTORNEY

SN 78-529,882. VISAGE, INC., NEW YORK, NY. FILED 12-9-2004.

SN 78-523,976. SB CORNERSTONES, INC., OCEANSIDE, NY.
FILED 11-29-2004.

The Bacchus Collection

THE MARK CONSISTS OF STANDARD CHARACTERS WITHOUT CLAIM TO ANY PARTICULAR FONT, STYLE, SIZE, OR COLOR.

NO CLAIM IS MADE TO THE EXCLUSIVE RIGHT TO USE "COLLECTION", APART FROM THE MARK AS SHOWN.

FOR JEWELRY AND WATCHES (U.S. CLS. 2, 27, 28 AND 50).

ELISSA GARBER KON, EXAMINING ATTORNEY

VOTRE

THE MARK CONSISTS OF STANDARD CHARACTERS WITHOUT CLAIM TO ANY PARTICULAR FONT, STYLE, SIZE, OR COLOR.

THE ENGLISH TRANSLATION OF THE FRENCH WORDING "VOTRE" IS "YOUR"

FOR HOROLOGICAL INSTRUMENTS, NAMELY, CLOCKS, WATCHES, WRIST WATCHES, TABLE CLOCKS, WALL CLOCKS, AUTOMOBILE CLOCKS, AND WALLET CLOCKS (U.S. CLS. 2, 27, 28 AND 50).

BARBARA A. GOLD, EXAMINING ATTORNEY

CLASS 14—(Continued).

SN 78-530,214. PETERS, AILEEN L., ANDOVER, MA. AND GOLDSTEIN, SHERRY, RIVERWOODS, IL. FILED 12-9-2004.

CLASS 14—(Continued).

SN 78-532,098. QVC, INC., WEST CHESTER, PA. FILED 12-14-2004.

WRISTABOUTS

SKYLIT

THE MARK CONSISTS OF STANDARD CHARACTERS WITHOUT CLAIM TO ANY PARTICULAR FONT, STYLE, SIZE, OR COLOR.

FOR JEWELRY, NAMELY BRACELETS, ANKLE BRACELETS, IDENTIFICATION BRACELETS, WATCH BRACELETS, WATCH BANDS AND STRAPS, WRISTWATCHES, CHARMS, NECKLACES AND RINGS (U.S. CLS. 2, 27, 28 AND 50).

REBECCA SMITH, EXAMINING ATTORNEY

THE MARK CONSISTS OF STANDARD CHARACTERS WITHOUT CLAIM TO ANY PARTICULAR FONT, STYLE, SIZE, OR COLOR.

FOR JEWELRY (U.S. CLS. 2, 27, 28 AND 50).

REBECCA GAN, EXAMINING ATTORNEY

SN 78-531,872. ENERGY MUSE JEWELRY, LLC, MANHATTAN BEACH, CA. FILED 12-13-2004.

SN 78-538,583. LIPKIN, MARJORIE B., BELMONT, MA. FILED 12-27-2004.

Necklaces With A Purpose

EmbraceLife

THE MARK CONSISTS OF STANDARD CHARACTERS WITHOUT CLAIM TO ANY PARTICULAR FONT, STYLE, SIZE, OR COLOR.

NO CLAIM IS MADE TO THE EXCLUSIVE RIGHT TO USE "NECKLACES", APART FROM THE MARK AS SHOWN.

FOR JEWELRY (U.S. CLS. 2, 27, 28 AND 50).
SCOTT OSLICK, EXAMINING ATTORNEY

THE MARK CONSISTS OF STANDARD CHARACTERS WITHOUT CLAIM TO ANY PARTICULAR FONT, STYLE, SIZE, OR COLOR.

FOR JEWELRY (U.S. CLS. 2, 27, 28 AND 50).
GIANCARLO CASTRO, EXAMINING ATTORNEY

CLASS 14—(Continued).

SN 78-538,996. HALLMARK LICENSING, INC., KANSAS CITY, MO. FILED 12-28-2004.

CLASS 14—(Continued).

SN 78-541,983. HIDEKI ELECTRONICS, INC., TUALATIN, OR. FILED 1-4-2005.

HAUNTINGTON

DIGIVIEW

THE MARK CONSISTS OF STANDARD CHARACTERS WITHOUT CLAIM TO ANY PARTICULAR FONT, STYLE, SIZE, OR COLOR.

FOR JEWELRY (U.S. CLS. 2, 27, 28 AND 50).
JOHN DALIER, EXAMINING ATTORNEY

THE MARK CONSISTS OF STANDARD CHARACTERS WITHOUT CLAIM TO ANY PARTICULAR FONT, STYLE, SIZE, OR COLOR.

FOR ANALOG AND DIGITAL ATOMIC TIMEPIECES AND CLOCKS (U.S. CLS. 2, 27, 28 AND 50).
FRED MANDIR, EXAMINING ATTORNEY

SN 78-539,858. SIGNATURES NETWORK, INC., SAN FRANCISCO, CA. FILED 12-29-2004.

SN 78-545,431. WILLIAMSON, JOANNA NMI, GAINESVILLE, FL. FILED 1-11-2005.

WINTERLAND

Atta Girl!

THE MARK CONSISTS OF STANDARD CHARACTERS WITHOUT CLAIM TO ANY PARTICULAR FONT, STYLE, SIZE, OR COLOR.

OWNER OF U.S. REG. NOS. 1,452,076, 2,368,379 AND OTHERS.
FOR WRIST WATCHES AND JEWELRY (U.S. CLS. 2, 27, 28 AND 50).
ELIZABETH HUGHITT, EXAMINING ATTORNEY

THE MARK CONSISTS OF STANDARD CHARACTERS WITHOUT CLAIM TO ANY PARTICULAR FONT, STYLE, SIZE, OR COLOR.

FOR JEWELRY, SYNTHETIC OR REAL, DESIGNED TO BE WORN ON NECKLACE OR BRACELET (U.S. CLS. 2, 27, 28 AND 50).
MATTHEW KLINE, EXAMINING ATTORNEY

CLASS 14—(Continued).

SN 78-547,633. THOMAS A. DANIEL, CARLSBAD, CA. FILED 1-14-2005.

CLASS 14—(Continued).

SN 78-555,634. QVC, INC., WEST CHESTER, PA. FILED 1-28-2005.

Bling-String

DETOUR

THE MARK CONSISTS OF STANDARD CHARACTERS WITHOUT CLAIM TO ANY PARTICULAR FONT, STYLE, SIZE, OR COLOR.
FOR MAGNETIC BEADED JEWELRY (U.S. CLS. 2, 27, 28 AND 50).
FIRST USE 11-3-2004; IN COMMERCE 11-3-2004.
MARCIE MILONE, EXAMINING ATTORNEY

THE MARK CONSISTS OF STANDARD CHARACTERS WITHOUT CLAIM TO ANY PARTICULAR FONT, STYLE, SIZE, OR COLOR.
FOR JEWELRY (U.S. CLS. 2, 27, 28 AND 50).
JOHN DALIER, EXAMINING ATTORNEY

SN 78-567,859. PANAMA JACK INTERNATIONAL, INC., ORLANDO, FL. FILED 2-15-2005.

SN 78-547,646. THOMAS A. DANIEL, CARLSBAD, CA. FILED 1-14-2005.

**BLUE MARLIN BY
PANAMA JACK
BRANDS**

The Bling-String

THE MARK CONSISTS OF STANDARD CHARACTERS WITHOUT CLAIM TO ANY PARTICULAR FONT, STYLE, SIZE, OR COLOR.
FOR MAGNETIC BEADED JEWELRY (U.S. CLS. 2, 27, 28 AND 50).
FIRST USE 11-3-2004; IN COMMERCE 11-3-2004.
MARCIE MILONE, EXAMINING ATTORNEY

THE MARK CONSISTS OF STANDARD CHARACTERS WITHOUT CLAIM TO ANY PARTICULAR FONT, STYLE, SIZE, OR COLOR.
OWNER OF U.S. REG. NOS. 1,354,251, 2,811,058 AND OTHERS.
NO CLAIM IS MADE TO THE EXCLUSIVE RIGHT TO USE "BRANDS", APART FROM THE MARK AS SHOWN.
FOR JEWELRY, RINGS, ANKLETS, BRACELETS, NECKLACES, EARRINGS, PENDANTS AND ORNAMENTAL PINS; BODY PIERCING RINGS, CHARMS, CLOCKS; JEWELRY CHAINS; WATCHES (U.S. CLS. 2, 27, 28 AND 50).
CAROLINE WOOD, EXAMINING ATTORNEY

CLASS 14—(Continued).

SN 78-618,624. JONES INVESTMENT CO. INC., WILMINGTON, DE. FILED 4-28-2005.

JONES NEW YORK

THE MARK CONSISTS OF STANDARD CHARACTERS WITHOUT CLAIM TO ANY PARTICULAR FONT, STYLE, SIZE, OR COLOR.

OWNER OF U.S. REG. NOS. 941,013, 1,399,556 AND OTHERS.

NO CLAIM IS MADE TO THE EXCLUSIVE RIGHT TO USE "NEW YORK", APART FROM THE MARK AS SHOWN.

FOR WOMEN'S JEWELRY, NAMELY, EARRINGS, BRACELETS, NECKLACES, PINS, PENDANTS, RINGS AND WATCHES (U.S. CLS. 2, 27, 28 AND 50).

WILLIAM BRECKENFELD, EXAMINING ATTORNEY

CLASS 14—(Continued).

SN 79-004,066. PIERRE LANG EUROPE: HANDELSGESELLSCHAFT M.B.H., AUSTRIA, FILED 6-14-2004.



PRIORITY DATE OF 1-13-2004 IS CLAIMED.
OWNER OF INTERNATIONAL REGISTRATION 0829575 DATED 6-14-2004, EXPIRES 6-14-2014.

THE MARK CONSISTS OF THE LETTERS PL AND THE DESIGN OF A (FINGER) RING.

FOR PRECIOUS METALS IN THE NATURE OF GOLD AND SILVER AND THEIR ALLOYS; GOODS OF PRECIOUS METALS OR COATED THEREWITH INCLUDED IN THIS CLASS, NAMELY, BROOCHES, RINGS, BRACELETS, NECKLACES; JEWELRY, PRECIOUS STONES; HOROLOGICAL AND CHRONOMETRIC INSTRUMENTS (U.S. CLS. 2, 27, 28 AND 50).

TANYA AMOS, EXAMINING ATTORNEY

SN 78-626,615. PANAMA JACK INTERNATIONAL, INC., ORLANDO, FL. FILED 5-10-2005.

PANAMA JACK BEACH CLUB

THE MARK CONSISTS OF STANDARD CHARACTERS WITHOUT CLAIM TO ANY PARTICULAR FONT, STYLE, SIZE, OR COLOR.

OWNER OF U.S. REG. NOS. 1,354,251, 2,811,058 AND OTHERS.

FOR JEWELRY, RINGS, ANKLETS, BRACELETS, NECKLACES, EARRINGS, PENDANTS AND ORNAMENTAL PINS; BODY PIERCING RINGS, CHARMS, CLOCKS; JEWELRY CHAINS; WATCHES (U.S. CLS. 2, 27, 28 AND 50).

CAROLINE WOOD, EXAMINING ATTORNEY

SN 79-005,637. GA MODEFINE S.A., CH-6850 MENDRISIO, SWITZERLAND, FILED 7-7-2004.



OWNER OF INTERNATIONAL REGISTRATION 0834108 DATED 7-7-2004, EXPIRES 7-7-2014.

OWNER OF U.S. REG. NOS. 1,156,891, 2,883,471 AND OTHERS.

FOR PRECIOUS METALS AND THEIR ALLOYS AND GOODS MADE OF OR COATED WITH THESE MATERIALS, NAMELY, EARRINGS, BRACELETS, NECKLACES, RINGS BEING JEWELRY, PENDANTS, BROOCHES, CHAINS BEING JEWELRY, PINS BEING JEWELRY, DIADEMMS, MEDALLIONS, CUFFLINKS, TIE CLIPS, WATCHES, CLOCKS, CHRONOMETERS, WATCH STRAPS, JEWELRY AND WATCH CASES, TRAYS AND ASHTRAYS, CIGARETTE BOXES, NAPKIN RINGS; JEWELRY, PRECIOUS STONES, TIMEPIECES AND CHRONOMETRIC INSTRUMENTS (U.S. CLS. 2, 27, 28 AND 50).

AMY GEARIN, EXAMINING ATTORNEY

CLASS 14—(Continued).

SN 79-006,151. LOUIS VUITTON MALLETIER, FRANCE,
FILED 9-10-2004.

EMPRISE

THE MARK CONSISTS OF STANDARD CHARACTERS WITHOUT CLAIM TO ANY PARTICULAR FONT, STYLE, SIZE, OR COLOR.

PRIORITY DATE OF 3-15-2004 IS CLAIMED.

OWNER OF INTERNATIONAL REGISTRATION 0835513 DATED 9-10-2004, EXPIRES 9-10-2014.

FOR JEWELS, NAMELY RINGS, BELT BUCKLES OF PRECIOUS METAL FOR CLOTHING, BUCKLES FOR WATCH STRAPS, EARRINGS, BRACELETS, CHARMS, BROOCHES, NECKLACES, PERSONAL ORNAMENTS OF PRECIOUS METAL, MEDALLIONS (U.S. CLS. 2, 27, 28 AND 50).

TANYA AMOS, EXAMINING ATTORNEY

SN 79-006,268. JOHN ERMEL, SWITZERLAND, FILED 10-12-2004.

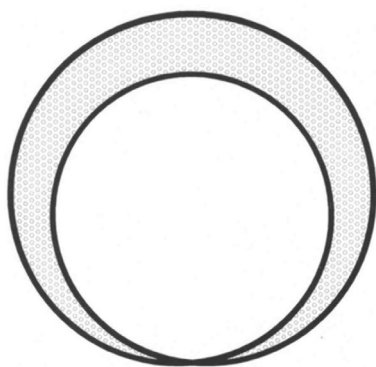

PRIORITY DATE OF 4-13-2004 IS CLAIMED.
OWNER OF INTERNATIONAL REGISTRATION 0835821 DATED 10-12-2004, EXPIRES 10-12-2014.

THE STIPPLING IS FOR SHADING PURPOSES ONLY.
FOR PRECIOUS STONES; TIMEPIECES AND CHRONOMETIC INSTRUMENTS, NAMELY WATCHES AND CLOCKS (U.S. CLS. 2, 27, 28 AND 50).
ANDREW RHIM, EXAMINING ATTORNEY

CLASS 14—(Continued).

SN 79-006,643. BOUCHERON HOLDING, FRANCE, FILED 9-15-2004.

LES SYMBOLIQUES DE BOUCHERON

PRIORITY DATE OF 4-1-2004 IS CLAIMED.

OWNER OF INTERNATIONAL REGISTRATION 0836937 DATED 9-15-2004, EXPIRES 9-15-2014.

OWNER OF U.S. REG. NOS. 1,114,483, 2,266,220 AND 2,355,043.

THE FOREIGN WORDING IN THE MARK TRANSLATES INTO ENGLISH AS THE SYMBOLICS OF.

FOR JEWELRY AND PRECIOUS STONES: ARTICLES MADE OF PRECIOUS METALS OR COATED THEREWITH, NAMELY RINGS, BRACELETS, JEWELRY NECKLACES, EARRINGS, JEWELRY BROOCHES, JEWELRY PENDANTS; TABLEWARE OF PRECIOUS METAL, NAMELY NAPKIN RINGS OF PRECIOUS METAL; HOROLOGICAL AND CHRONOMETRIC INSTRUMENTS; WATCHES, WRISTWATCHES, CLOCKS, PENDULUM CLOCKS, CHRONOMETERS, CHRONOGRAPHS FOR USE AS WATCHES, WATCH STRAPS, WATCH CHAINS, WATCH GLASSES, WATCH CASES, CASES FOR CLOCK AND WATCH-MAKING (U.S. CLS. 2, 27, 28 AND 50).

DAHLIA GEORGE, EXAMINING ATTORNEY

SN 79-009,226. MARY TIN FUNG HEMRAJANI, LONDON W1K5JT, UNITED KINGDOM, FILED 7-5-2004.

KUDOS

THE MARK CONSISTS OF STANDARD CHARACTERS WITHOUT CLAIM TO ANY PARTICULAR FONT, STYLE, SIZE, OR COLOR.

OWNER OF INTERNATIONAL REGISTRATION 0844282 DATED 7-5-2004, EXPIRES 7-5-2014.

FOR HOROLOGICAL AND CHRONOMETRIC INSTRUMENTS (U.S. CLS. 2, 27, 28 AND 50).
ALEX KEAM, EXAMINING ATTORNEY

CLASS 15—MUSICAL INSTRUMENTS

SN 78-461,363. BURNS LONDON LTD., OTTERSHAW, SURREY, UNITED KINGDOM, FILED 8-3-2004.

REZ-O-TUBE

THE MARK CONSISTS OF STANDARD CHARACTERS WITHOUT CLAIM TO ANY PARTICULAR FONT, STYLE, SIZE, OR COLOR.

FOR STRINGED MUSICAL INSTRUMENTS, NAMELY, GUITARS AND BASS GUITARS; MUSICAL INSTRUMENT PARTS, NAMELY GUITAR BRIDGES, VIBRATO UNITS, TREMOLO, WHAMMY BARS (U.S. CLS. 2, 21 AND 36).

FIRST USE 12-31-1964; IN COMMERCE 12-31-1964.
ANN LINNEHAN, EXAMINING ATTORNEY

SN 78-464,713. BASDEN, TIMOTHY D., LAS VEGAS, NV, FILED 8-10-2004.

CLOUD 9 GUITARS

THE MARK CONSISTS OF STANDARD CHARACTERS WITHOUT CLAIM TO ANY PARTICULAR FONT, STYLE, SIZE, OR COLOR.

NO CLAIM IS MADE TO THE EXCLUSIVE RIGHT TO USE "GUITARS", APART FROM THE MARK AS SHOWN. SEC. 2(F).

FOR MUSICAL INSTRUMENTS, NAMELY GUITARS, BASS GUITARS; CHAMBERED INSTRUMENTS IN THE NATURE OF GUITARS, BASS GUITARS, BANJOS, AND MANDOLINS; HOLLOW INSTRUMENTS IN THE NATURE OF GUITARS, BASS GUITARS, BANJOS, AND MANDOLINS; THIN-LINE INSTRUMENTS IN THE NATURE OF GUITARS, BASS GUITARS, BANJOS, AND MANDOLINS; SOLID BODY INSTRUMENTS IN THE NATURE OF GUITARS, BASS GUITARS, BANJOS, AND MANDOLINS; ELECTRIC AND ACOUSTIC INSTRUMENTS IN THE NATURE OF GUITARS, BASS GUITARS, BANJOS AND MANDOLINS; GUITAR PARTS NAMELY, BRIDGES, KNOBS, AND PICKUP COVERS (U.S. CLS. 2, 21 AND 36).

FIRST USE 5-26-1994; IN COMMERCE 5-26-1994.
CIMMERIAN COLEMAN, EXAMINING ATTORNEY

CLASS 15—(Continued).

SN 78-521,297. GUITAR CENTER, INC., WESTLAKE VILLAGE, CA. FILED 11-22-2004.

SOUND PERCUSSION

THE MARK CONSISTS OF STANDARD CHARACTERS WITHOUT CLAIM TO ANY PARTICULAR FONT, STYLE, SIZE, OR COLOR.

OWNER OF U.S. REG. NO. 2,932,518.

NO CLAIM IS MADE TO THE EXCLUSIVE RIGHT TO USE "PERCUSSION", APART FROM THE MARK AS SHOWN.

FOR DRUMS, DRUM SETS, SNARE DRUMS, HAND PERCUSSION INSTRUMENTS, ELECTRONIC PERCUSSION INSTRUMENTS, OTHER PERCUSSION/DRUM RELATED MUSICAL INSTRUMENTS AND ACCESSORIES, NAMELY DRUM STICKS AND DRUM HARDWARE (U.S. CLS. 2, 21 AND 36).

FIRST USE 9-1-1993; IN COMMERCE 9-1-1993.

WENDY GOODMAN, EXAMINING ATTORNEY

SN 78-530,380. CLARE L. HOKE, UPLAND, CA. FILED 12-10-2004.

Linc Luthier 

NO CLAIM IS MADE TO THE EXCLUSIVE RIGHT TO USE LUTHIER, APART FROM THE MARK AS SHOWN.

FOR MUSICAL INSTRUMENTS (U.S. CLS. 2, 21 AND 36).

FIRST USE 5-11-1989; IN COMMERCE 1-7-1992.

PAULA MAHONEY, EXAMINING ATTORNEY

SN 79-003,433. GUSTAV PIRAZZI & COMP., FED REP GERMANY, FILED 6-4-2004.

CHROMCOR

OWNER OF INTERNATIONAL REGISTRATION 0484180 DATED 3-14-1984, EXPIRES 3-14-2014.

FOR STRINGS FOR MUSICAL INSTRUMENTS (U.S. CLS. 2, 21 AND 36).

ANDREA SAUNDERS, EXAMINING ATTORNEY

CLASS 16—PAPER GOODS AND PRINTED MATTER

SN 76-267,867. CHERRY, RONA, NEW YORK, NY. FILED 6-6-2001.

CLASS 16—(Continued).

SN 76-477,031. PHAT FASHIONS LLC, NEW YORK, NY. FILED 12-20-2002.

LOVE MAGAZINE

NO CLAIM IS MADE TO THE EXCLUSIVE RIGHT TO USE MAGAZINE, APART FROM THE MARK AS SHOWN. FOR MAGAZINE AND NEWSLETTER IN THE FIELDS OF LIVING AND HEALING (U.S. CLS. 2, 5, 22, 23, 29, 37, 38 AND 50).

TONI HICKEY, EXAMINING ATTORNEY

PHAT FARM

SN 76-406,518. CLOUD 9 DESIGN, INC., MAPLE GROVE, MN. FILED 5-13-2002.

CLOUD 9

THE MARK CONSISTS OF STANDARD CHARACTERS WITHOUT CLAIM TO ANY PARTICULAR FONT, STYLE, SIZE, OR COLOR.

FOR SCRAPBOOKING PAPER AND STICKERS (U.S. CLS. 2, 5, 22, 23, 29, 37, 38 AND 50).

LOURDES AYALA, EXAMINING ATTORNEY

FOR PRINTED AND RELATED MATTER, NAMELY, POSTERS, CALENDARS, TEMPORARY TATTOOS, STICKERS, BUMPER STICKERS, DECALS, PASSPORT HOLDERS, NOTE CARDS, POSTCARDS, PLACE CARDS, RECORD CARDS, SCORE CARDS, TRADING CARDS, SCRAPBOOKS, STATIONERY, NOTE PADS, PAPER NOTE TABLETS, WRITING TABLETS AND PAPER, NOTEBOOKS, FOLDERS, BOOKMARKS, PAPER PENNANTS, BINDERS, ENVELOPES, APPOINTMENT BOOKS, ADDRESS BOOKS AND DESK PADS; PERSONAL ORGANIZERS, DESK TOP ORGANIZERS, ORGANIZERS FOR STATIONERY USE AND STATIONERY-TYPE PORTFOLIOS, PAPER FLAGS, MOUNTS FOR STAMPS, RUBBER STAMPS, RUBBER DOCUMENT STAMPS, STAMP ALBUMS, STAMP PAD INKS, STAMP PADS, SLEEVES FOR HOLDING AND PROTECTING STAMPS, PAPER BANNERS, HOLDERS FOR DESK ACCESSORIES, LETTER OPENERS, LETTER TRAYS, LETTER RACKS, PEN AND PENCIL CUPS HOLDERS, PENS, PENCILS, MARKERS, PEN AND PENCIL SETS COMPRISED OF PENS, PENCILS AND CARRYING CASES, STICK MARKERS, ERASERS, DRAWING AND DRAFTING RULERS, PENCIL SHARPENERS, BOOK ENDS, BOOK COVERS, CHECKBOOK COVERS, BOOK HOLDERS, PHOTOGRAPH AND COIN ALBUMS; BULLETIN BOARDS; PHOTOGRAPHIC AND ART MOUNTS; PHOTOGRAPHIC PRINTS; PHOTOGRAPHS; LITHOGRAPHS; DECORATIVE PAPER CENTERPIECES; DECORATIVE PENCIL-TOP ORNAMENTS; PICTURE BOOKS; PAPER AND CARDBOARD PICTURE MOUNTS; PAPERWEIGHTS; PAPER CLIP HOLDERS; PAPER SIGN HOLDERS; PRINTED PAPER SIGNS; TABLE CLOTHS OF PAPER; CATALOGS AND BROCHURES FEATURING CLOTHING, BAGS, JEWELRY, COSMETICS AND ACCESSORIES (U.S. CLS. 2, 5, 22, 23, 29, 37, 38 AND 50).

TONI HICKEY, EXAMINING ATTORNEY

CLASS 16—(Continued).

SN 76-477,032. PHAT FASHIONS LLC, NEW YORK, NY. FILED 12-20-2002.

BABY PHAT

FOR PRINTED AND RELATED MATTER, NAMELY, POSTERS, CALENDARS, TEMPORARY TATTOOS, STICKERS, BUMPER STICKERS, DECALS, PASSPORT HOLDERS, NOTE CARDS, POSTCARDS, PLACE CARDS, RECORD CARDS, SCORE CARDS, TRADING CARDS, SCRAPBOOKS, STATIONERY, NOTE PADS, PAPER NOTE TABLETS, WRITING TABLETS AND PAPER, NOTEBOOKS, FOLDERS, BOOKMARKS, PAPER PENNANTS, BINDERS, ENVELOPES, APPOINTMENT BOOKS, ADDRESS BOOKS AND DESK PADS; PERSONAL ORGANIZERS, DESK TOP ORGANIZERS, ORGANIZERS FOR STATIONERY USE AND STATIONERY-TYPE PORTFOLIOS, PAPER FLAGS, MOUNTS FOR STAMPS, RUBBER STAMPS, RUBBER DOCUMENT STAMPS, STAMP ALBUMS, STAMP PAD INKS, STAMP PADS, SLEEVES FOR HOLDING AND PROTECTING STAMPS, PAPER BANNERS, HOLDERS FOR DESK ACCESSORIES, LETTER OPENERS, LETTER TRAYS, LETTER RACKS, PEN AND PENCIL CUPS HOLDERS, PENS, PENCILS, MARKERS, PEN AND PENCIL SETS COMPRISED OF PENS, PENCILS AND CARRYING CASES, STICK MARKERS, ERASERS, DRAWING AND DRAFTING RULERS, PENCIL SHARPENERS, BOOK ENDS, BOOK COVERS, CHECKBOOK COVERS, BOOK HOLDERS, PHOTOGRAPH AND COIN ALBUMS; BULLETIN BOARDS; PHOTOGRAPHIC AND ART MOUNTS; PHOTOGRAPHIC PRINTS; PHOTOGRAPHS; LITHOGRAPHS; DECORATIVE PAPER CENTERPIECES; DECORATIVE PENCIL-TOP ORNAMENTS; PICTURE BOOKS; PAPER AND CARDBOARD PICTURE MOUNTS; PAPERWEIGHTS; PAPER CLIP HOLDERS; PAPER SIGN HOLDERS; PRINTED PAPER SIGNS; TABLE CLOTHS OF PAPER; CATALOGS AND BROCHURES FEATURING CLOTHING, BAGS, JEWELRY, COSMETICS AND ACCESSORIES (U.S. CLS. 2, 5, 22, 23, 29, 37, 38 AND 50).
TONI HICKEY, EXAMINING ATTORNEY

SN 76-486,483. NETWORK TELEPHONE SERVICES INC., WOODLAND HILLS, CA. FILED 1-31-2003.

HARDMEN

FOR PUBLICATIONS AND MAILERS, NAMELY, A MAGAZINE DIRECTED TOWARD ADULT SUBJECT MATTER (U.S. CLS. 2, 5, 22, 23, 29, 37, 38 AND 50).
FIRST USE 11-0-1997; IN COMMERCE 11-0-1997.
JOHN LINCOSKI, EXAMINING ATTORNEY

SN 76-522,846. LARAFIT, INC, BEVERLY HILLS, CA. FILED 6-16-2003.

NUTRITION BOOT CAMP

NO CLAIM IS MADE TO THE EXCLUSIVE RIGHT TO USE "NUTRITION", APART FROM THE MARK AS SHOWN.

FOR LUNCH BOX CONTAINING INFORMATIONAL MATERIALS, NAMELY A BOOK, WORKBOOK, MAGNETS AND VIDEOS EDUCATING AND MOTIVATING PEOPLE TO THINK FIT, EAT FIT AND BE FIT (U.S. CLS. 2, 5, 22, 23, 29, 37, 38 AND 50).

FIRST USE 1-0-2002; IN COMMERCE 5-0-2002.
NAAKWAMA ANKRAH, EXAMINING ATTORNEY

CLASS 16—(Continued).

SN 76-524,346. WISDOMWORKS MINISTRIES, INC., IRVING, TX. FILED 6-20-2003.

WISDOMWORKS

FOR PUBLICATIONS AND OTHER PRINTED MATERIALS, NAMELY, WORKBOOKS, STUDY GUIDES, BOOKLETS, PAMPHLETS, LEAFLETS, BROCHURES, BULLETINS, NEWSLETTERS, MAGAZINES, REPORTS, CIRCULARS, BOOKS, PRINTED SURVEY ANSWER SHEETS, AND PRINTED EDUCATIONAL MATERIALS IN THE FIELDS OF CHRISTIANITY, RELIGION, THEOLOGY, SPIRITUALITY, ETHICS, VALUES, CULTURAL AND SOCIAL ISSUES, FAMILY, RELATIONSHIPS, YOUTH CULTURE, POETRY, SPORTS, MOVIES, AND MUSIC; BIBLES; PAPER BAGS, TRADING CARDS; POSTCARDS; ADDRESS BOOKS; BOOK COVERS; BOOK ENDS, CALENDARS, ACTIVITY BOOKS; DAILY PLANNERS; DECALS; DESK PADS; DESK SETS; DIARIES; FOLDERS; GREETING CARDS, GIFT CARDS, NOTEBOOKS; NOTE PADS; PAPER BANNERS; PAPER BAGS; PRINTED PAPER SIGNS; PAPERWEIGHTS; WRITING PAPER; PENS; PENCILS; PEN OR PENCIL HOLDERS; AND STATIONERY (U.S. CLS. 2, 5, 22, 23, 29, 37, 38 AND 50).

FIRST USE 0-0-1997; IN COMMERCE 0-0-1997.
SCOTT OSCLICK, EXAMINING ATTORNEY

SN 76-539,503. SERICO INC., DRUMMONDVILLE, QUEBEC, CANADA, FILED 8-22-2003.



PRIORITY CLAIMED UNDER SEC. 44(D) ON CANADA APPLICATION NO. 1184076, FILED 7-10-2003, REG. NO. TMA635419, DATED 3-16-2005, EXPIRES 3-16-2020.

NO CLAIM IS MADE TO THE EXCLUSIVE RIGHT TO USE "DECAL", APART FROM THE MARK AS SHOWN.

FOR DECALS AND OTHER SERIGRAPHY PRODUCTS, NAMELY, OVERLAY STICKERS IN THE NATURE OF PLASTIC SHEETS FOR MOUSE PADS, REFRIGERATOR MAGNETS, SIGNS AND POSTERS; THREE DIMENSIONAL PRODUCTS, NAMELY, DECALS (U.S. CLS. 2, 5, 22, 23, 29, 37, 38 AND 50).

SUE LAWRENCE, EXAMINING ATTORNEY

CLASS 16—(Continued).

SN 76-539,934. MERKOS L'INYONEI CHINUCH, INC., BROOKLYN, NY. FILED 8-11-2003.



THE MARK IS IN THE FORM OF A RECTANGULAR DESIGN, WHICH MAY BE DESCRIBED AS FOLLOWS—THE LEFT SIDE OF THE DESIGN INCORPORATES THE HEBREW WORDS "MERKOS L'INYONEI CHINUCH", WHICH, IN ENGLISH, MEANS "CENTRAL ORGANIZATION FOR JEWISH EDUCATION". ON THE BOTTOM OF THE DESIGN IS A TRANSLITERATION INTO ENGLISH OF THE HEBREW WORDS "MERKOS L'INYONEI CHINUCH". IN THE CENTER OF THE DESIGN IS A REPRESENTATION OF A PORTION OF THE GLOBE OF THE WORLD AND A REPRESENTATION OF THE TWO SQUARE TABLETS OF THE TEN COMMANDMENTS AND RAYS EMANATING FROM THE ABOVE-MENTIONED WORDS TO THE GLOBE.

THE ENGLISH TRANSLATION OF MERKOS L'INYONEI CHINUCH AND ITS REPETITION IN HEBREW LETTERS IS CENTRAL ORGANIZATION OF JEWISH EDUCATION.

SEC. 2(F) AS TO MERKOS L'INYONEI CHINUCH AND ITS HEBREW EQUIVALENT.

FOR HEBREW ALPHABET CHARTS AND JEWISH HISTORY CHARTS; JEWISH PRAYER BOOKS, CHILDREN'S BOOKS DEALING WITH JEWISH LIFE AND EDUCATIONAL BOOKS DEALING WITH JEWISH LIFE (U.S. CLS. 2, 5, 22, 23, 29, 37, 38 AND 50).

FIRST USE 0-0-1942; IN COMMERCE 0-0-1942.
DAVID TAYLOR, EXAMINING ATTORNEY

CLASS 16—(Continued).

SN 76-540,993. JOHNSON PAPER LP, CHICAGO, IL. FILED 8-29-2003.

SILLY LICKS

FOR FLAVORED AND SCENTED ENVELOPE SEALANT GLUE (U.S. CLS. 2, 5, 22, 23, 29, 37, 38 AND 50).
YONG KIM, EXAMINING ATTORNEY

SN 76-549,933. "WYDAWNICTWO PRZEKROJ", 00-048 WARSZAWA, POLAND, FILED 10-2-2003.

SN 76-540,925. ERNEST PAPER PRODUCTS, INC., COMMERCE, CA. FILED 8-28-2003.



NO CLAIM IS MADE TO THE EXCLUSIVE RIGHT TO USE "BOARD", APART FROM THE MARK AS SHOWN.

FOR PAPER CONTAINERS MADE OF CORRUGATED PAPER; PADDING MADE OF CORRUGATED PAPER FOR PACKING PURPOSES AND MOLDED CORRUGATED PAPER FIBERS FOR STUFFING USED IN PACKAGING CONTAINERS (U.S. CLS. 2, 5, 22, 23, 29, 37, 38 AND 50).

FIRST USE 7-0-2003; IN COMMERCE 7-0-2003.
EDWARD NELSON, EXAMINING ATTORNEY



THE ENGLISH TRANSLATION OF THE WORD PRZEKROJ IN THE MARK IS CROSS SECTION.

THE NON-LATIN CHARACTER IN THE MARK, NAMELY THE LETTER "O", TRANSLITERATE TO "U".

FOR PRINTED PUBLICATIONS, NAMELY, NEWSPAPERS, JOURNALS, MAGAZINES, NEWSLETTERS AND BOOKLETS, FEATURING INFORMATION ABOUT POLITICAL, CULTURAL, SPORT, FINANCIAL AND SOCIOLOGICAL EVENTS; BOOKS FEATURING INFORMATION ABOUT POLITICAL, CULTURAL, SPORT, FINANCIAL AND SOCIOLOGICAL EVENTS (U.S. CLS. 2, 5, 22, 23, 29, 37, 38 AND 50).

FIRST USE 12-31-2002; IN COMMERCE 12-31-2002.
AMOS T. MATTHEWS, JR., EXAMINING ATTORNEY

CLASS 16—(Continued).

SN 76-559,829. THE 12 VOLT GROUP, LLC, SHREVEPORT, LA. FILED 10-29-2003.

12 VOLT STREET NEWS

NO CLAIM IS MADE TO THE EXCLUSIVE RIGHT TO USE "12 VOLT" AND "NEWS", APART FROM THE MARK AS SHOWN.

FOR PRINTED PUBLICATIONS, NAMELY, PRINTED JOURNALS IN THE FIELD OF AUTOMOTIVE ELECTRONIC EQUIPMENT, STEREO EQUIPMENT, AND VIDEO EQUIPMENT; PRINTED TRADE JOURNALS IN THE FIELD OF AUTOMOTIVE ELECTRONIC EQUIPMENT, STEREO EQUIPMENT, AND VIDEO EQUIPMENT; PRINTED MAGAZINES IN THE FIELD OF AUTOMOTIVE ELECTRONIC EQUIPMENT, STEREO EQUIPMENT, AND VIDEO EQUIPMENT; PRINTED NEWSLETTERS IN THE FIELD OF AUTOMOTIVE ELECTRONIC EQUIPMENT, STEREO EQUIPMENT, AND VIDEO EQUIPMENT; AND PRINTED NEWSPAPERS IN THE FIELD OF AUTOMOTIVE ELECTRONIC EQUIPMENT, STEREO EQUIPMENT, AND VIDEO EQUIPMENT; PRINTED PUBLICATIONS, NAMELY, PRINTED JOURNALS, PRINTED TRADE JOURNALS, PRINTED MAGAZINES, PRINTED NEWSLETTERS AND PRINTED NEWSPAPERS, CONCERNING THE STEREO AND VIDEO INDUSTRY, THE AUTOMOBILE STEREO AND VIDEO INDUSTRY, THE AUTOMOBILE INDUSTRY, AND THE AUTOMOBILE ENHANCEMENT INDUSTRY (U.S. CLS. 2, 5, 22, 23, 29, 37, 38 AND 50).

FIRST USE 9-0-2002; IN COMMERCE 9-0-2002.

STACY WAHLBERG, EXAMINING ATTORNEY

SN 76-573,234. INTEGRADORA DE MEDIOS Y SERVICIOS, S.C., MEXICO, D.F., MEXICO, FILED 1-30-2004.

Diario de **México**

NO CLAIM IS MADE TO THE EXCLUSIVE RIGHT TO USE DIARIO DE MEXICO, APART FROM THE MARK AS SHOWN.

THE FOREIGN WORDING IN THE MARK TRANSLATES INTO ENGLISH AS "DAILY NEWSPAPER OF MEXICO" OR "MEXICO'S NEWSPAPER".

FOR NEWSPAPERS (U.S. CLS. 2, 5, 22, 23, 29, 37, 38 AND 50).

FIRST USE 3-9-1978; IN COMMERCE 8-0-2002.

CHRISTOPHER BUONGIORNO, EXAMINING ATTORNEY

CLASS 16—(Continued).

SN 76-577,737. NATIONAL DENTAL NETWORK, LP, PLANO, TX. FILED 2-24-2004.

SMILE RX

THE MARK CONSISTS OF STANDARD CHARACTERS WITHOUT CLAIM TO ANY PARTICULAR FONT, STYLE, SIZE, OR COLOR.

FOR PRINTED MATERIALS, NAMELY A CUSTOMIZED, FULL-COLOR, GLOSSY MAGAZINE FEATURING DENTAL HEALTH INFORMATION, COSMETIC DENTISTRY INFORMATION, NON-DENTAL HEALTH/LIFESTYLE INFORMATION, AND DENTAL SERVICES ADVERTISEMENTS (U.S. CLS. 2, 5, 22, 23, 29, 37, 38 AND 50).

FIRST USE 10-1-2003; IN COMMERCE 1-22-2004.

BILL DAWE, EXAMINING ATTORNEY

SN 76-579,897. NATIVE STYLE, INC., SEATTLE, WA. FILED 3-8-2004.

NATIVE STYLE

THE MARK CONSISTS OF STANDARD CHARACTERS WITHOUT CLAIM TO ANY PARTICULAR FONT, STYLE, SIZE, OR COLOR.

NO CLAIM IS MADE TO THE EXCLUSIVE RIGHT TO USE STYLE, APART FROM THE MARK AS SHOWN.

FOR PRINTED PUBLICATIONS, NAMELY, NEWSLETTERS, BOOKS, MAGAZINES, NEWSPAPERS AND CATALOGUES IN THE FIELDS OF MUSIC, TELEVISION, MOVIES, SELF-IMPROVEMENT, EDUCATION, CLOTHING, AND FASHION (U.S. CLS. 2, 5, 22, 23, 29, 37, 38 AND 50).

LEIGH CAROLINE CASE, EXAMINING ATTORNEY

SN 76-586,533. ZEBRA PEN CORPORATION, EDISON, NJ. FILED 4-13-2004.

MARATHON

THE MARK CONSISTS OF STANDARD CHARACTERS WITHOUT CLAIM TO ANY PARTICULAR FONT, STYLE, SIZE, OR COLOR.

FOR WRITING INSTRUMENTS (U.S. CLS. 2, 5, 22, 23, 29, 37, 38 AND 50).

MICHELE SWAIN, EXAMINING ATTORNEY

CLASS 16—(Continued).

SN 76-586,949. BUA, JUSTIN, LOS ANGELES, CA. FILED 4-13-2004.

BUA

THE MARK CONSISTS OF STANDARD CHARACTERS WITHOUT CLAIM TO ANY PARTICULAR FONT, STYLE, SIZE, OR COLOR.

SEC. 2(F).
FOR POSTERS, PRINTS AND DRAWINGS (U.S. CLS. 2, 5, 22, 23, 29, 37, 38 AND 50).
FIRST USE 9-6-1994; IN COMMERCE 9-6-1994.
DANIEL BRODY, EXAMINING ATTORNEY

SN 76-587,131. GOSS, ROY, TUCSON, AZ. FILED 4-16-2004.

POWER PLUS TATTOO'S

THE MARK CONSISTS OF STANDARD CHARACTERS WITHOUT CLAIM TO ANY PARTICULAR FONT, STYLE, SIZE, OR COLOR.

NO CLAIM IS MADE TO THE EXCLUSIVE RIGHT TO USE "TATTOO", APART FROM THE MARK AS SHOWN.
FOR STICKER GRAPHICS AND DECALS FOR AUTOMOBILES, TRUCKS, VEHICLES, MOTORCYCLES, AND BICYCLES (U.S. CLS. 2, 5, 22, 23, 29, 37, 38 AND 50).
FIRST USE 3-15-2004; IN COMMERCE 8-9-2003.
DAVID H. STINE, EXAMINING ATTORNEY

SN 76-590,112. INTERNATIONAL RECORDING MEDIA ASSOCIATION, PRINCETON, NJ. FILED 5-3-2004.

MEDIAWARE

THE MARK CONSISTS OF STANDARD CHARACTERS WITHOUT CLAIM TO ANY PARTICULAR FONT, STYLE, SIZE, OR COLOR.

FOR PRINTED PERIODICALS, NAMELY MAGAZINES, IN THE FIELD OF SOUND AND VIDEO RECORDING MEDIA AND DIGITAL DELIVERY (U.S. CLS. 2, 5, 22, 23, 29, 37, 38 AND 50).
FIRST USE 3-0-2003; IN COMMERCE 3-0-2003.
KATHLEEN M. VANSTON, EXAMINING ATTORNEY

CLASS 16—(Continued).

SN 76-590,634. LYNCH, KIMBERLEE, DENVER, CO. FILED 5-3-2004.

COLORADO CREATIVE LIVING

THE MARK CONSISTS OF STANDARD CHARACTERS WITHOUT CLAIM TO ANY PARTICULAR FONT, STYLE, SIZE, OR COLOR.

NO CLAIM IS MADE TO THE EXCLUSIVE RIGHT TO USE "COLORADO", APART FROM THE MARK AS SHOWN.

FOR SERIES OF BOOKS ABOUT ENHANCING COLORADO LIFESTYLE THROUGH GARDENING, COOKING AND CRAFTS (U.S. CLS. 2, 5, 22, 23, 29, 37, 38 AND 50).

FIRST USE 4-22-2002; IN COMMERCE 4-22-2002.
C. DIONNE CLYBURN, EXAMINING ATTORNEY

SN 76-591,015. CHIVALRY PRESS, INC., NORTH OAKS, MN. FILED 5-7-2004.

DRAWING DRAWER

THE MARK CONSISTS OF STANDARD CHARACTERS WITHOUT CLAIM TO ANY PARTICULAR FONT, STYLE, SIZE, OR COLOR.

FOR PRINTED CARDS, NAMELY, POSTCARDS, GREETING CARDS, AND CARDS DISPLAYING REPRODUCED LABELS, REPRODUCED ORIGINAL ARTWORK, REPRODUCED ORIGINAL WRITINGS AND PHOTOGRAPHIC IMAGES (U.S. CLS. 2, 5, 22, 23, 29, 37, 38 AND 50).

MARLENE BELL, EXAMINING ATTORNEY

SN 76-591,386. SILVERS, STEVEN A., WEST PALM BEACH, FL. FILED 5-7-2004.

GOOGLES EDUTAINMENT

FOR PRINTED BOOKS AND MAGAZINES FEATURING CHILDREN'S STORIES, GAMES AND EDUCATIONAL MATERIAL (U.S. CLS. 2, 5, 22, 23, 29, 37, 38 AND 50).

ERNEST SHOSHO, EXAMINING ATTORNEY

CLASS 16—(Continued).

SN 76-592,075. THE PRINCIPLE FOUNDATION, KANSAS CITY, MO. FILED 5-13-2004.

THE PRINCIPLE FOUNDATION

THE MARK CONSISTS OF STANDARD CHARACTERS WITHOUT CLAIM TO ANY PARTICULAR FONT, STYLE, SIZE, OR COLOR.

NO CLAIM IS MADE TO THE EXCLUSIVE RIGHT TO USE "FOUNDATION", APART FROM THE MARK AS SHOWN.

FOR PRINTED EDUCATIONAL MATERIALS, NAMELY, NEWSLETTERS, BROCHURES AND WORKBOOKS FOR SELF AND WORLD IMPROVEMENT (U.S. CLS. 2, 5, 22, 23, 29, 37, 38 AND 50).

FIRST USE 1-0-1987; IN COMMERCE 1-0-1987.

DOMINIC J. FERRAIUOLO, EXAMINING ATTORNEY

SN 76-592,323. IMAGINATIONS GROUP, INC., PASADENA, MD. FILED 5-14-2004.

IMAGINATIONS ENVISION ENGAGE EMPOWER

THE MARK CONSISTS OF STANDARD CHARACTERS WITHOUT CLAIM TO ANY PARTICULAR FONT, STYLE, SIZE, OR COLOR.

FOR PRINTED INSTRUCTIONAL AND TEACHING MANUALS, STUDY GUIDES, WORKBOOKS, NEWSLETTERS, BOOKS, BOOKLETS, BROCHURES, PAMPHLETS, PRINTED REPORTS, MAGAZINES, JOURNALS, AND PRINTED TEACHING MATERIALS IN THE NATURE OF A SERIES OF ARTICLES, ALL IN THE FIELDS OF YOUTH AND HUMAN DEVELOPMENT, YOUTH ADVOCACY, YOUTH EMPOWERMENT, VOLUNTEERISM AND COMMUNITY SERVICE, COMMUNITY ORGANIZING, POLITICAL AND SOCIAL ACTIVISM, PHILANTHROPY, SOCIAL RESPONSIBILITY, LIFE SKILLS AND TALENTS, RELIGION, ETHICS AND VALUES, MORALITY, SEXUALITY, FAMILY, RELATIONSHIPS, CAREERS AND EMPLOYMENT, ENTREPRENEURSHIP, DRUGS AND ALCOHOL, CRIME, HEALTH, POLITICS, LEADERSHIP, GOVERNMENT, ECONOMICS, CURRENT EVENTS, BUSINESS, SOCIOLOGY, CULTURAL STUDIES, RACE AND ETHNICITY, EDUCATION, MEDIA AND COMMUNICATIONS, ECONOMIC DEVELOPMENT, INTERNATIONAL RELATIONS, AND HUMAN RIGHTS (U.S. CLS. 2, 5, 22, 23, 29, 37, 38 AND 50).

ELIZABETH J. WINTER, EXAMINING ATTORNEY

SN 76-593,335. ATLAS PAPER MILLS, LTD., HIALEAH, FL. FILED 5-20-2004.

BUNNY SOFT

THE MARK CONSISTS OF STANDARD CHARACTERS WITHOUT CLAIM TO ANY PARTICULAR FONT, STYLE, SIZE, OR COLOR.

NO CLAIM IS MADE TO THE EXCLUSIVE RIGHT TO USE "SOFT", APART FROM THE MARK AS SHOWN.

FOR PAPER PRODUCTS, NAMELY PAPER TISSUES, TOILET PAPER, FACIAL TISSUES, AND PAPER TOWELS (U.S. CLS. 2, 5, 22, 23, 29, 37, 38 AND 50).

SUSAN LESLIE DUBOIS, EXAMINING ATTORNEY

CLASS 16—(Continued).

SN 76-596,854. WASHINGTON NATIONAL OPERA, WASHINGTON, DC. FILED 6-10-2004.

WASHINGTON NATIONAL OPERA

THE MARK CONSISTS OF STANDARD CHARACTERS WITHOUT CLAIM TO ANY PARTICULAR FONT, STYLE, SIZE, OR COLOR.

NO CLAIM IS MADE TO THE EXCLUSIVE RIGHT TO USE "OPERA", APART FROM THE MARK AS SHOWN.

SEC. 2(F).

FOR MAGAZINES ON THE SUBJECTS OF OPERA AND MUSIC; POSTERS; POSTCARDS; SHOW PROGRAMS ON THE SUBJECTS OF OPERA AND MUSICAL PERFORMANCES (U.S. CLS. 2, 5, 22, 23, 29, 37, 38 AND 50).

FIRST USE 3-0-2004; IN COMMERCE 3-0-2004.

MIDGE BUTLER, EXAMINING ATTORNEY

SN 76-599,499. CANTER & ASSOCIATES, INC., LOS ANGELES, CA. FILED 6-28-2004.

LEE CANTER'S ASSERTIVE DISCIPLINE

THE MARK CONSISTS OF STANDARD CHARACTERS WITHOUT CLAIM TO ANY PARTICULAR FONT, STYLE, SIZE, OR COLOR.

OWNER OF U.S. REG. NOS. 1,123,876, 2,154,187 AND OTHERS.

THE NAME LEE CANTER IDENTIFIES A LIVING INDIVIDUAL WHOSE CONSENT IS OF RECORD.

SEC. 2(F) ASSERTIVE DISCIPLINE.

FOR SERIES OF BOOKS AND GUIDES IN THE FIELD OF EDUCATION, CLASSROOM MANAGEMENT AND BEHAVIOR MANAGEMENT (U.S. CLS. 2, 5, 22, 23, 29, 37, 38 AND 50).

FIRST USE 0-0-1992; IN COMMERCE 0-0-1992.

KARLA PERKINS, EXAMINING ATTORNEY

SN 76-600,718. CRI2000, LP, SAN DIEGO, CA. FILED 7-6-2004.

PHOTOSTOR

THE MARK CONSISTS OF STANDARD CHARACTERS WITHOUT CLAIM TO ANY PARTICULAR FONT, STYLE, SIZE, OR COLOR.

FOR PHOTO ALBUMS (U.S. CLS. 2, 5, 22, 23, 29, 37, 38 AND 50).

JOHN LINCOSKI, EXAMINING ATTORNEY

CLASS 16—(Continued).

SN 76-600,740. SAN FRANCISCO FERTILITY CENTERS, A MEDICAL CORPORATION, SAN FRANCISCO, CA. FILED 7-6-2004.

FERTILITY FLASH

THE MARK CONSISTS OF STANDARD CHARACTERS WITHOUT CLAIM TO ANY PARTICULAR FONT, STYLE, SIZE, OR COLOR.

NO CLAIM IS MADE TO THE EXCLUSIVE RIGHT TO USE "FERTILITY", APART FROM THE MARK AS SHOWN.

FOR NEWSLETTER IN THE FIELD OF HUMAN REPRODUCTIVE TECHNOLOGY AND REPRODUCTIVE TREATMENT (U.S. CLS. 2, 5, 22, 23, 29, 37, 38 AND 50).

FIRST USE 9-0-2003; IN COMMERCE 9-0-2003.
DORITT L. CARROLL, EXAMINING ATTORNEY

SN 76-603,593. SCHOLASTIC INC., NEW YORK, NY. FILED 7-22-2004.



NO CLAIM IS MADE TO THE EXCLUSIVE RIGHT TO USE "BIG". APART FROM THE MARK AS SHOWN.

FOR CHILDREN'S BOOKS (U.S. CLS. 2, 5, 22, 23, 29, 37, 38 AND 50).

FIRST USE 2-21-2004; IN COMMERCE 2-21-2004.
APRIL L. RADEMACHER, EXAMINING ATTORNEY

CLASS 16—(Continued).

SN 76-604,336. CORAL RIDGE MINISTRIES MEDIA, INC., FORT LAUDERDALE, FL. FILED 7-28-2004.



The D. James Kennedy
**CENTER FOR CHRISTIAN
STATESMANSHIP**

OWNER OF U.S. REG. NOS. 2,773,190, 2,794,111 AND OTHERS.

NO CLAIM IS MADE TO THE EXCLUSIVE RIGHT TO USE "CENTER FOR CHRISTIAN STATESMANSHIP", APART FROM THE MARK AS SHOWN.

I, D. JAMES KENNEDY, IN MY PERSONAL CAPACITY AS PRESIDENT AND FOUNDER OF CORAL RIDGE MINISTRIES MEDIA, INC., HEREBY AUTHORIZE CORAL RIDGE MINISTRIES MEDIA, INC. TO REGISTER MY NAME IN THE TRADEMARK D. JAMES KENNEDY CENTER FOR CHRISTIAN STATESMANSHIP & DESIGN.

FOR PUBLICATIONS AND OTHER PRINTED MATERIAL, NAMELY, BROCHURES, MANUALS, REPORTS, BOOKLETS, BOOKS, PAMPHLETS, NEWSLETTERS, AND PRINTED INSTRUCTIONAL, EDUCATIONAL AND TEACHING MATERIALS, ALL IN THE FIELDS OF RELIGION, SPIRITUALITY, ETHICS, POLITICS, GOVERNMENT, AND CULTURAL, MORAL AND SOCIAL ISSUES (U.S. CLS. 2, 5, 22, 23, 29, 37, 38 AND 50).

FIRST USE 3-1-1995; IN COMMERCE 3-1-1995.
JEAN IM, EXAMINING ATTORNEY

SN 76-606,107. FISHER, JUANITA, VALLEJO, CA. FILED 8-6-2004.



FOR GREETING CARDS (U.S. CLS. 2, 5, 22, 23, 29, 37, 38 AND 50).

KATRINA EDGE, EXAMINING ATTORNEY

CLASS 16—(Continued).

SN 76-606,861. WAUSAU-MOSINEE PAPER CORPORATION, MOSINEE, WI. FILED 8-11-2004.

PROTEC

THE MARK CONSISTS OF STANDARD CHARACTERS WITHOUT CLAIM TO ANY PARTICULAR FONT, STYLE, SIZE, OR COLOR.

FOR PAPER WITH BARRIER PROPERTIES AND HIGH-QUALITY PRINTING SURFACE FOR USE IN FLEXIBLE PACKAGING APPLICATIONS, NAMELY PACKAGING FOR FOOD, BEVERAGES AND HOUSEHOLD COMMODITIES, SOLD TO COMMERCIAL CUSTOMERS FOR FURTHER MANUFACTURE AND PRINTING BY THE CUSTOMER (U.S. CLS. 2, 5, 22, 23, 29, 37, 38 AND 50).

LEIGH CAROLINE CASE, EXAMINING ATTORNEY

SN 76-608,907. ROBERTS, BERT M., TUCSON, AZ. FILED 8-23-2004.

QUEEN WIRE

THE MARK CONSISTS OF STANDARD CHARACTERS WITHOUT CLAIM TO ANY PARTICULAR FONT, STYLE, SIZE, OR COLOR.

FOR PRINTED MATTER AND PAPER GOODS—NAMELY, BOOKS FEATURING CHARACTERS FROM ANIMATED, ACTION ADVENTURE, COMEDY AND DRAMA FEATURES, COMIC BOOKS, CHILDREN'S BOOKS, MAGAZINES FEATURING CHARACTERS FROM ANIMATED, ACTION ADVENTURE, COMEDY AND DRAMA FEATURES, COLORING BOOKS, CHILDREN'S ACTIVITY BOOKS; STATIONERY, WRITING PAPER, ENVELOPES, NOTEBOOKS, DIARIES, NOTE CARDS, GREETING CARDS, TRADING CARDS; LITHOGRAPHS; PENS, PENCILS, CASES THEREFOR, ERASERS, CRAYONS, MARKERS, COLORED PENCILS, PAINTING SETS, CHALK AND CHALKBOARDS; DECALS, HEAT TRANSFERS; POSTERS; MOUNTED AND UNMOUNTED PHOTOGRAPHS; BOOK COVERS, BOOK MARKS, CALENDARS, GIFT WRAPPING PAPER; PAPER PARTY FAVORS AND PAPER PARTY DECORATIONS—NAMELY, PAPER NAPKINS, PAPER DOILIES, PAPER PLACE MATS, CREPE PAPER, PAPER HATS, INVITATIONS, PAPER TABLE CLOTHS, PAPER CAKE DECORATIONS; APPLIQUES IN THE FORM OF DECALS AND IRON ON PRINTED TRANSFERS FOR EMBROIDERY OR FABRIC; PRINTED PATTERNS FOR COSTUMES, PAJAMAS, SWEATSHIRTS AND T-SHIRTS (U.S. CLS. 2, 5, 22, 23, 29, 37, 38 AND 50).

KELLY CHOE, EXAMINING ATTORNEY

CLASS 16—(Continued).

SN 76-609,955. INTERNATIONAL ASSOCIATION OF STRUCTURAL MOVERS, INC., LEXINGTON, SC. FILED 8-30-2004.

International Association of Structural Movers, Inc.

THE MARK CONSISTS OF STANDARD CHARACTERS WITHOUT CLAIM TO ANY PARTICULAR FONT, STYLE, SIZE, OR COLOR.

NO CLAIM IS MADE TO THE EXCLUSIVE RIGHT TO USE INC., APART FROM THE MARK AS SHOWN. SEC. 2(F).

FOR PRINTED PUBLICATIONS, NAMELY MAGAZINES, EDUCATIONAL MATERIALS, MEMBERSHIP DIRECTORIES, MEMBERSHIP NEWSLETTERS AND INDUSTRY BROCHURES FOR SAFETY AND OPERATING FUNCTIONS, ALL OF THE ABOVE ON THE SUBJECT OF LARGE BUILDING MOVES AND STRUCTURAL TRANSPORTATION (U.S. CLS. 2, 5, 22, 23, 29, 37, 38 AND 50).

FIRST USE 3-21-1990; IN COMMERCE 3-21-1990.

KELLY BOULTON, EXAMINING ATTORNEY

SN 76-613,297. HANSEN, MARK V., COSTA MESA, CA. AND CANFIELD, JOHN T., SANTA BARBARA, CA. FILED 9-22-2004.

CHICKEN SOUP FOR THE AMERICAN SOUL

THE MARK CONSISTS OF STANDARD CHARACTERS WITHOUT CLAIM TO ANY PARTICULAR FONT, STYLE, SIZE, OR COLOR.

OWNER OF U.S. REG. NOS. 2,322,138, 2,732,536 AND OTHERS.

FOR MONTHLY MAGAZINES IN THE FIELD OF MOTIVATIONAL DEVELOPMENT, PERSONAL AND PROFESSIONAL INSPIRATION AND ACHIEVEMENT AND INCREASING SELF-ESTEEM (U.S. CLS. 2, 5, 22, 23, 29, 37, 38 AND 50).

TONI HICKEY, EXAMINING ATTORNEY

SN 76-613,450. BREIWICK, GARY D., ROBBINSDALE, MN. AND BREIWICK, DAVID J., ROBBINSDALE, MN. FILED 9-27-2004.

MINI WINGS

THE MARK CONSISTS OF STANDARD CHARACTERS WITHOUT CLAIM TO ANY PARTICULAR FONT, STYLE, SIZE, OR COLOR.

FOR PRINTED PUBLICATION, NAMELY, BOOKLET SHOWING HOW TO MAKE PAPER AIRPLANES (U.S. CLS. 2, 5, 22, 23, 29, 37, 38 AND 50).

FIRST USE 8-1-2002; IN COMMERCE 8-1-2002.

LAURIE MAYES, EXAMINING ATTORNEY

CLASS 16—(Continued).

SN 76-613,549. THE H.W. WILSON COMPANY, BRONX, NY. FILED 9-24-2004.

THE H.W. WILSON COMPANY

THE MARK CONSISTS OF STANDARD CHARACTERS WITHOUT CLAIM TO ANY PARTICULAR FONT, STYLE, SIZE, OR COLOR.

OWNER OF U.S. REG. NOS. 1,320,037, 2,288,671 AND OTHERS.

NO CLAIM IS MADE TO THE EXCLUSIVE RIGHT TO USE "COMPANY", APART FROM THE MARK AS SHOWN.

THE NAME DOES NOT IDENTIFY A LIVING INDIVIDUAL.

SEC. 2(F).

FOR SERIES OF NON-FICTIONAL BOOKS ABOUT A VARIETY OF SUBJECTS INCLUDING INDICES AND CATALOGS OF PUBLICATIONS (U.S. CLS. 2, 5, 22, 23, 29, 37, 38 AND 50).

FIRST USE 0-0-1898; IN COMMERCE 0-0-1898.

BRENDAN REGAN, EXAMINING ATTORNEY

SN 76-614,272. HASBRO, INC., PAWTUCKET, RI. FILED 10-1-2004.

ROBOT REBELLION

THE MARK CONSISTS OF STANDARD CHARACTERS WITHOUT CLAIM TO ANY PARTICULAR FONT, STYLE, SIZE, OR COLOR.

NO CLAIM IS MADE TO THE EXCLUSIVE RIGHT TO USE ROBOT, APART FROM THE MARK AS SHOWN.

FOR PRINTED MATTER, NAMELY, ADDRESS BOOKS; CHILDREN'S ACTIVITY BOOKS; COMIC BOOKS; COLORING BOOKS; SPIRAL NOTEBOOKS; COMPOSITION BOOKS; COPY BOOKS; EXERCISE BOOKS; GUEST BOOKS; PICTURE BOOKS; CHILDREN'S BOOKS; BOOKS CONTAINING PUZZLES AND GAMES; INSTRUCTIONAL MANUALS AND STRATEGY GUIDES FOR GAMES; BOOK COVERS; COIN ALBUMS; SCRAPBOOK ALBUMS; ARTS AND CRAFTS KITS FOR PAINTING, MODEL-MAKING AND DRAWING; STAMP ALBUMS; PHOTOGRAPH ALBUMS; COLLECTOR ALBUMS; DECORATIVE RUBBER STAMPS; DIARIES; PAPER DOORKNOB HANGERS; HEIGHT CHARTS; PRINTED INVITATIONS; LUNCH BAGS; MODELING MATERIALS AND COMPOUNDS FOR USE BY CHILDREN; PERSONAL ORGANIZERS; ORIGINAL ARTWORK PRINTS; PAPER NAME BADGES; PAPER MACHE; PAPER MACHE FIGURINES; PAPER TABLE CLOTHS; PHOTOGRAPHIC PRINTS; RIBBONS FOR GIFT WRAPPING; SOCIAL NOTE CARDS; BLANK NOTE CARDS; TISSUE PAPER; TRADING CARDS; WALLET CARDS; WRITING PADS; TRADING CARD MILK BOTTLE CAPS; POSTERS; BOOK PLATES; BOOK MARKS; CHECKBOOK HOLDERS AND COVERS; NON-ELECTRONIC PERSONAL PLANNERS AND ORGANIZERS; ARTIST MATERIALS, NAMELY, PENCILS, PENS, PAINTING SETS; PAINT BRUSHES; PAINTING SETS; PRINTED PAPER PATTERNS; RUB DOWN TRANSFERS; SKETCHBOOKS; BASKETS FOR DESK ACCESSORIES; GIFT WRAP, GIFT TAGS; GIFT BAGS; GIFT BOXES; CORRESPONDENCE NOTE PAPER; GREETING CARDS; PAPER PARTY DECORATIONS; PAPER NAPKINS; PAPER RIBBONS; PAPER PARTY BAGS; PAPER PARTY HATS; POSTCARDS; GIFT PACKAGE DECORATIONS MADE OF PAPER; STICKERS; STICKER BOOKS; STICKER KITS; CORK BOARDS; CHALK BOARDS; MEMORANDUM BOARDS; SCRAPBOOKS; NON-MAGNETICALLY CODED TELEPHONE CALLING CARDS; ART REPRODUCTIONS; LITHOGRAPHS; LITHOGRAPHIC PRINTS; IRON-ON PATCHES; CALENDARS; CARDBOARD FIGURES; TEMPORARY TATTOOS; SCHOOL AND OFFICE SUPPLIES, NAMELY, DRAFTING AND DRAWING RULERS, PENCILS, PENS, MARKERS, GLUE FOR STATIONERY OR HOUSEHOLD USE DESK TOP ORGANIZERS, DESK STANDS AND

CLASS 16—(Continued).

HOLDERS FOR PENCILS, PENS, TAPE, PAPER CLIPS, AND NOTEPADS; BINDERS; DISPENSERS FOR ADHESIVE TAPES FOR STATIONERY OR HOUSEHOLD PURPOSES, CLIP BOARDS, STATIONERY, NOTEPADS, AND PENCIL SETS, NOTEPADS, ORGANIZERS FOR STATIONERY USE, PENCIL CASES; PENCIL SHARPENERS, STATIONERY PORTFOLIOS, DESK PADS AND STATIONERY SETS COMPRISED OF PAPER, ENVELOPE, SEALS, NOTEPADS; STENCILS; SHEET MUSIC; READ-ALONG BOOKS AND CASSETTE TAPES SOLD AS A UNIT; PAPER CAKE DECORATIONS; BANK CHECKS; LETTER OPENERS; PATTERNS FOR MAKING COSTUMES; LAP DESKS; EASELS; STENCILS; CRAFT KITS CONTAINING PAINT; PAINT BRUSHES; WOOD PIECES AND STENCILS; ARTS AND CRAFTS PAINT KITS CONTAINING SPONGES; PAINT AND PAINT CUPS ACTIVITY KITS CONTAINING STAMPER MARKERS; RUBBER STAMPERS; INK PAD; COLORED PENCILS; STAMPER HOLDER; PAPER ACTIVITY KITS CONSISTING OF WRITING AND DRAWING IMPLEMENTS, DRAWING TEMPLATES, AND PAPER; PUTTY, DOUGH AND MODELING CLAY AND ACCESSORIES FOR USE WITH MODELING COMPOUNDS; CRAYON AND COLOR BY NUMBER KITS; ACTIVITY KITS CONSISTING OF MODELING COMPOUND AND RELATED ACCESSORIES FOR USE WITH MODELING COMPOUND SOLD AS A UNIT; SERIES OF FICTION BOOKS IN THE FIELD OF ENTERTAINMENT AND SCIENCE FICTION (U.S. CLS. 2, 5, 22, 23, 29, 37, 38 AND 50).

JANICE L. MCMORROW, EXAMINING ATTORNEY

SN 76-616,125. WOOD, FRED, SAN FRANCISCO, CA. FILED 10-13-2004.

GREEN*LIGHT

THE MARK CONSISTS OF STANDARD CHARACTERS WITHOUT CLAIM TO ANY PARTICULAR FONT, STYLE, SIZE, OR COLOR.

FOR PERIODICAL MAGAZINE FEATURING INFORMATION ON SOCIALLY RESPONSIBLE AND EARTH-FRIENDLY NUTRITION, HEALTH AND LIFESTYLE CHOICES (U.S. CLS. 2, 5, 22, 23, 29, 37, 38 AND 50).

KELLEY WELLS, EXAMINING ATTORNEY

SN 76-617,888. ARAMARK UNIFORM & CAREER APPAREL, INC., BURBANK, CA. FILED 10-25-2004.

PULSE - THE BEAT OF HEALTHCARE FASHION

THE MARK CONSISTS OF STANDARD CHARACTERS WITHOUT CLAIM TO ANY PARTICULAR FONT, STYLE, SIZE, OR COLOR.

NO CLAIM IS MADE TO THE EXCLUSIVE RIGHT TO USE "HEALTHCARE FASHION", APART FROM THE MARK AS SHOWN.

FOR PRINTED MATTER, NAMELY MAGAZINES AND CATALOGUES FEATURING CLOTHING AND UNIFORMS FOR THE HEALTHCARE INDUSTRY (U.S. CLS. 2, 5, 22, 23, 29, 37, 38 AND 50).

GLENN CLARK, EXAMINING ATTORNEY

CLASS 16—(Continued).

SN 76-619,049. HERITAGE PAPERS, INC., DBA MERCHANT NET, GRAND RAPIDS, MI. FILED 11-1-2004.

MERCHANTNET

THE MARK CONSISTS OF STANDARD CHARACTERS WITHOUT CLAIM TO ANY PARTICULAR FONT, STYLE, SIZE, OR COLOR.

FOR PRINTING PAPER (U.S. CLS. 2, 5, 22, 23, 29, 37, 38 AND 50).

FIRST USE 9-1-1993; IN COMMERCE 9-1-1993.
DARRYL SPRUILL, EXAMINING ATTORNEY

SN 76-619,147. ANTHOLOGY OF POETRY, INC., THE, ASHEBORO, NC. FILED 11-3-2004.

TEACHER'S SELECTION

THE MARK CONSISTS OF STANDARD CHARACTERS WITHOUT CLAIM TO ANY PARTICULAR FONT, STYLE, SIZE, OR COLOR.

OWNER OF U.S. REG. NO. 2,265,888.

SEC. 2(F).

FOR SERIES OF BOOKS CONTAINING POETRY (U.S. CLS. 2, 5, 22, 23, 29, 37, 38 AND 50).

FIRST USE 2-0-1996; IN COMMERCE 2-0-1996.
TIMOTHY FINNEGAN, EXAMINING ATTORNEY

SN 76-619,502. ADVANCE MAGAZINE PUBLISHERS INC., NEW YORK, NY. FILED 11-5-2004.

PARADE PICKS

THE MARK CONSISTS OF STANDARD CHARACTERS WITHOUT CLAIM TO ANY PARTICULAR FONT, STYLE, SIZE, OR COLOR.

OWNER OF U.S. REG. NOS. 254,966 AND 740,934.

NO CLAIM IS MADE TO THE EXCLUSIVE RIGHT TO USE "PICKS", APART FROM THE MARK AS SHOWN.

FOR PERIODIC COLUMN IN A MAGAZINE (U.S. CLS. 2, 5, 22, 23, 29, 37, 38 AND 50).

FIRST USE 9-26-2004; IN COMMERCE 9-26-2004.
NORA BUCHANAN WILL, EXAMINING ATTORNEY

CLASS 16—(Continued).

SN 76-620,301. HAMILTON COUNTY SCHOOLS FUND FOR EXCELLENCE, CHATTANOOGA, TN. FILED 11-12-2004.

KIDS FIRST

THE MARK CONSISTS OF STANDARD CHARACTERS WITHOUT CLAIM TO ANY PARTICULAR FONT, STYLE, SIZE, OR COLOR.

OWNER OF U.S. REG. NO. 1,716,407.

FOR COUPON BOOKS AND COUPONS (U.S. CLS. 2, 5, 22, 23, 29, 37, 38 AND 50).

FIRST USE 5-22-1989; IN COMMERCE 5-22-1989.
GENE MACIOL, EXAMINING ATTORNEY

SN 76-620,335. VENABLE LLP, WASHINGTON, DC. FILED 11-12-2004.

FREQUENCY

THE MARK CONSISTS OF STANDARD CHARACTERS WITHOUT CLAIM TO ANY PARTICULAR FONT, STYLE, SIZE, OR COLOR.

FOR NEWSLETTERS IN THE FIELD OF COMMUNICATIONS AND TELECOMMUNICATIONS ISSUES (U.S. CLS. 2, 5, 22, 23, 29, 37, 38 AND 50).

FIRST USE 9-1-2003; IN COMMERCE 9-1-2003.
JOHN WILKE, EXAMINING ATTORNEY

SN 76-620,843. ICMI, INC., ANNAPOLIS, MD. FILED 11-16-2004.

CALL CENTER PRESS

THE MARK CONSISTS OF STANDARD CHARACTERS WITHOUT CLAIM TO ANY PARTICULAR FONT, STYLE, SIZE, OR COLOR.

OWNER OF U.S. REG. NO. 2,170,595.

NO CLAIM IS MADE TO THE EXCLUSIVE RIGHT TO USE PRESS, APART FROM THE MARK AS SHOWN.

SEC. 2(F).

FOR PRINTED INSTRUCTIONAL EDUCATIONAL TEACHING MATERIALS PERTAINING TO TELEPHONE CALL CENTERS AND OTHER TELECOMMUNICATIONS APPLICATIONS (U.S. CLS. 2, 5, 22, 23, 29, 37, 38 AND 50).

FIRST USE 6-30-1997; IN COMMERCE 6-30-1997.
LINDA POWELL, EXAMINING ATTORNEY

CLASS 16—(Continued).

SN 76-621,556. THE HEALTHY PLANET, L.L.C., WEBSTER GROVES, MO. FILED 11-22-2004.

THE HEALTHY PLANET

THE MARK CONSISTS OF STANDARD CHARACTERS WITHOUT CLAIM TO ANY PARTICULAR FONT, STYLE, SIZE, OR COLOR.

FOR MAGAZINE FOCUSED ON HEALTH, WELLNESS, NATURAL LIVING AND THE ENVIRONMENT ISSUES (U.S. CLS. 2, 5, 22, 23, 29, 37, 38 AND 50).

FIRST USE 5-0-1997; IN COMMERCE 5-0-1997.
SUSAN HAYASH, EXAMINING ATTORNEY

SN 76-621,654. SLAVTCHEFF, PATRICIA, LYMAN, NH. FILED 11-22-2004.

MENO-PAWS

THE MARK CONSISTS OF STANDARD CHARACTERS WITHOUT CLAIM TO ANY PARTICULAR FONT, STYLE, SIZE, OR COLOR.

FOR GREETING CARDS (U.S. CLS. 2, 5, 22, 23, 29, 37, 38 AND 50).
KATHERINE STOIDES, EXAMINING ATTORNEY

SN 76-621,697. WORKMAN PUBLISHING CO., INC., NEW YORK, NY. FILED 11-23-2004.

1,000 ... BEFORE YOU DIE

THE MARK CONSISTS OF STANDARD CHARACTERS WITHOUT CLAIM TO ANY PARTICULAR FONT, STYLE, SIZE, OR COLOR.

FOR SERIES OF NON-FICTION BOOKS IN THE FIELDS OF TRAVEL, ENTERTAINMENT, FOOD AND COOKING, HUMOR, SPORTS AND GAMES, ARTS AND CRAFTS, SELF-HELP, STYLE AND BEAUTY, HEALTH AND FITNESS, PREGNANCY AND PARENTING, SCIENCE, SCIENCE FICTION, GARDENING, PETS, GENERAL REFERENCE, AND BUSINESS AND FINANCE; CALENDARS (U.S. CLS. 2, 5, 22, 23, 29, 37, 38 AND 50).

ELLEN PERKINS, EXAMINING ATTORNEY

CLASS 16—(Continued).

SN 76-621,762. SKUDERA, GEORGE F., FARMINGDALE, NJ. FILED 11-22-2004.



FOR ADDRESS BOOKS; PHOTOGRAPH ALBUMS; APPLIQUES IN THE FORM OF DECALS; APPOINTMENT BOOKS; ARTS AND CRAFT PAINT KITS; AUTOGRAPH BOOKS; BABY BOOKS; PAPER PARTY BAGS; BALL-POINT PENS; BINDERS; BOOKENDS; BOOKMARKS; SERIES OF FICTION BOOKS; MAGAZINES AND NEWSPAPERS, ALL FEATURING STORIES, GAMES AND ACTIVITIES FOR CHILDREN; PAPER GIFT WRAP BOWS; PAPER CAKE DECORATIONS; CALENDARS; GIFT CARDS; GREETING CARDS; CARTOON PRINTS, CARTOON STRIPS AND NEWSPAPER CARTOONS; PEN AND PENCIL CASES; DECORATIVE PAPER CENTERPIECES; CHALK; CHILDREN'S ACTIVITY BOOKS; MODELING CLAY; PAPER TABLE CLOTHS; COLORING BOOKS; COMIC STRIPS; COMIC BOOKS; PAPER PARTY DECORATIONS; DIARIES; GIFT WRAPPING PAPER; PAPER PARTY HATS; PAPER NAPKINS; PENS; PENCILS; STATIONERY; STICKERS; POSTERS; NOTEBOOKS; MEMO PADS; ERASERS; PENCIL SHARPENERS; STAPLERS; WRITING PAPER; ENVELOPES; PAPER WEIGHTS; PAPER COASTERS; PAPER MATS; NON-CALIBRATED DRAWING RULERS; PHOTOGRAPHS; POSTCARDS; TRADING CARDS (U.S. CLS. 2, 5, 22, 23, 29, 37, 38 AND 50).

ALEX KEAM, EXAMINING ATTORNEY

SN 76-621,826. ABC TELECOM INC., ROSLYN HEIGHTS, NY. FILED 11-22-2004.

AFRICA WINDOW PHONECARD

THE MARK CONSISTS OF STANDARD CHARACTERS WITHOUT CLAIM TO ANY PARTICULAR FONT, STYLE, SIZE, OR COLOR.

NO CLAIM IS MADE TO THE EXCLUSIVE RIGHT TO USE "AFRICA" OR "PHONECARD", APART FROM THE MARK AS SHOWN.

FOR PREPAID TELEPHONE CALLING CARDS NOT MAGNETICALLY ENCODED (U.S. CLS. 2, 5, 22, 23, 29, 37, 38 AND 50).

FIRST USE 7-1-2004; IN COMMERCE 7-1-2004.

ANGELA M. MICHELI, EXAMINING ATTORNEY

CLASS 16—(Continued).

SN 76-621,962. INTERNATIONAL SUZUKI ASSOCIATION, RICHARDSON, TX. FILED 11-23-2004.

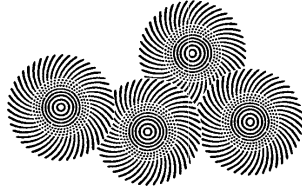

OWNER OF U.S. REG. NOS. 1,356,347 AND 1,800,673. FOR PRINTED MUSIC BOOKS (U.S. CLS. 2, 5, 22, 23, 29, 37, 38 AND 50).
FIRST USE 1-0-2004; IN COMMERCE 1-0-2004.
WILLIAM VERHOSEK, EXAMINING ATTORNEY

SN 76-621,988. DELTA EDUCATION, LLC, NASHUA, NH. FILED 11-22-2004.



OWNER OF U.S. REG. NOS. 2,167,116, 2,292,743 AND OTHERS.

FOR FULL LINE OF INSTRUCTIONAL BOOKS, CHILDREN'S BOOKS, DICTIONARIES, PRINTED TEACHING MATERIALS, STUDY GUIDES, JOURNALS, RESEARCH PAPERS, LESSONS, WORKBOOKS, INSTRUCTIONAL BOOKLETS, PRINTED WORKSHEETS, AND PRINTED EDUCATIONAL TESTING AND ASSESSMENT MATERIALS, ALL DEALING WITH A VARIETY OF EDUCATIONAL, INSTRUCTIONAL, AND PROFESSIONAL DEVELOPMENT TOPICS FOR THE PRIMARY, MIDDLE AND SECONDARY GRADE LEVELS (U.S. CLS. 2, 5, 22, 23, 29, 37, 38 AND 50).

FIRST USE 6-0-2003; IN COMMERCE 6-0-2003.
STEVEN R. FINE, EXAMINING ATTORNEY

SN 76-622,105. PENTEL OF AMERICA, LTD., TORRANCE, CA. FILED 11-26-2004.

IMPULSE

THE MARK CONSISTS OF STANDARD CHARACTERS WITHOUT CLAIM TO ANY PARTICULAR FONT, STYLE, SIZE, OR COLOR.

FOR WRITING INSTRUMENTS, NAMELY, BALL POINT PENS (U.S. CLS. 2, 5, 22, 23, 29, 37, 38 AND 50).
GISELLE AGOSTO, EXAMINING ATTORNEY

CLASS 16—(Continued).

SN 76-622,334. WORLD PUBLICATIONS LLC, WINTER PARK, FL. FILED 11-26-2004.

Caribbean Travel & Life

THE MARK CONSISTS OF STANDARD CHARACTERS WITHOUT CLAIM TO ANY PARTICULAR FONT, STYLE, SIZE, OR COLOR.

OWNER OF U.S. REG. NO. 2,350,990.
NO CLAIM IS MADE TO THE EXCLUSIVE RIGHT TO USE CARIBBEAN TRAVEL, APART FROM THE MARK AS SHOWN.

SEC. 2(F).
FOR MAGAZINE IN THE FIELD OF TRAVEL (U.S. CLS. 2, 5, 22, 23, 29, 37, 38 AND 50).
FIRST USE 1-1-1986; IN COMMERCE 1-1-1986.
MELVIN AXILBUND, EXAMINING ATTORNEY

SN 76-622,544. RIGHTSIDE ADVISORS, INC., BEVERLY HILLS, CA. FILED 11-29-2004.

RIGHTSIDE ADVISORS

THE MARK CONSISTS OF STANDARD CHARACTERS WITHOUT CLAIM TO ANY PARTICULAR FONT, STYLE, SIZE, OR COLOR.

FOR PERIODICAL PUBLICATIONS, NAMELY, NEWSLETTERS IN THE FIELDS OF INVESTING AND INVESTMENT STRATEGY (U.S. CLS. 2, 5, 22, 23, 29, 37, 38 AND 50).

FIRST USE 4-14-2003; IN COMMERCE 4-14-2003.
BRENDAN MCCAULEY, EXAMINING ATTORNEY

SN 76-623,133. DANIEL O. REICH INCORPORATED, DBA REICH PAPER, BROOKLYN, NY. FILED 12-3-2004.

LUSH

THE MARK CONSISTS OF STANDARD CHARACTERS WITHOUT CLAIM TO ANY PARTICULAR FONT, STYLE, SIZE, OR COLOR.

FOR PRINTING PAPER; WRITING PAPER; ENVELOPES; ART PAPER; CRAFT PAPER; LUMINOUS PAPER; AND FLUORESCENT PAPER (U.S. CLS. 2, 5, 22, 23, 29, 37, 38 AND 50).

MONTIA G. PRESSEY, EXAMINING ATTORNEY

CLASS 16—(Continued).

SN 76-623,566. HEALTH COMMUNICATIONS, INC., DEER-FIELD BEACH, FL. FILED 12-7-2004.

THE VELVETEEN PRINCIPLES

THE MARK CONSISTS OF STANDARD CHARACTERS WITHOUT CLAIM TO ANY PARTICULAR FONT, STYLE, SIZE, OR COLOR.

FOR SERIES OF SELF-HELP BOOKS (U.S. CLS. 2, 5, 22, 23, 29, 37, 38 AND 50).

DAVID MURRAY, EXAMINING ATTORNEY

SN 76-624,388. EVENING BULLETIN, INC., THE, PHILADELPHIA, PA. FILED 12-13-2004.

TODAY'S NEWS TODAY

THE MARK CONSISTS OF STANDARD CHARACTERS WITHOUT CLAIM TO ANY PARTICULAR FONT, STYLE, SIZE, OR COLOR.

NO CLAIM IS MADE TO THE EXCLUSIVE RIGHT TO USE "NEWS", APART FROM THE MARK AS SHOWN.

FOR PUBLICATION, NAMELY, NEWSPAPERS (U.S. CLS. 2, 5, 22, 23, 29, 37, 38 AND 50).

FIRST USE 11-22-2004; IN COMMERCE 11-22-2004.

EDWARD NELSON, EXAMINING ATTORNEY

SN 76-624,446. JSJ PRODUCTIONS, INC., AUSTIN, TX. FILED 12-13-2004.

ROTOWORLD

THE MARK CONSISTS OF STANDARD CHARACTERS WITHOUT CLAIM TO ANY PARTICULAR FONT, STYLE, SIZE, OR COLOR.

FOR MAGAZINES FOR THE MOLDING INDUSTRY (U.S. CLS. 2, 5, 22, 23, 29, 37, 38 AND 50).

LOURDES AYALA, EXAMINING ATTORNEY

SN 76-624,774. REVOLUTION PHOTO, INC., ATLANTA, GA. FILED 12-17-2004.

**PHOTOGRAPHY IS
COOL/REVOLUTIONPHOTO.COM**

THE MARK CONSISTS OF STANDARD CHARACTERS WITHOUT CLAIM TO ANY PARTICULAR FONT, STYLE, SIZE, OR COLOR.

FOR PHOTOGRAPHS; MOUNTED AND UNMOUNTED PHOTOGRAPHS; PHOTOGRAPHIC PRINTS; FINE ART PHOTOGRAPHIC PRINTS (U.S. CLS. 2, 5, 22, 23, 29, 37, 38 AND 50).

DAVID TAYLOR, EXAMINING ATTORNEY

CLASS 16—(Continued).

SN 76-625,586. BENNETT, JARRATT G., FAIRFAX, VA. FILED 12-21-2004.

MAKING THE MONEY LAST

THE MARK CONSISTS OF STANDARD CHARACTERS WITHOUT CLAIM TO ANY PARTICULAR FONT, STYLE, SIZE, OR COLOR.

FOR EDUCATIONAL PUBLICATIONS, NAMELY, GUIDEBOOKS AND PRINTED ORGANIZATIONAL AID FOR FILING PAPERS IN THE FIELD OF FINANCIAL PLANNING FOR WIDOWERS (U.S. CLS. 2, 5, 22, 23, 29, 37, 38 AND 50).

FIRST USE 12-3-2004; IN COMMERCE 12-3-2004.

JEAN IM, EXAMINING ATTORNEY

SN 76-627,474. THE PROVINCETOWN BANNER, INC., PROVINCETOWN, MA. FILED 1-10-2005.

OUTER CAPE LIVING

THE MARK CONSISTS OF STANDARD CHARACTERS WITHOUT CLAIM TO ANY PARTICULAR FONT, STYLE, SIZE, OR COLOR.

NO CLAIM IS MADE TO THE EXCLUSIVE RIGHT TO USE "OUTER CAPE", APART FROM THE MARK AS SHOWN.

FOR NEWSPAPERS FOR GENERAL CIRCULATION (U.S. CLS. 2, 5, 22, 23, 29, 37, 38 AND 50).

DAVID C. REIHNER, EXAMINING ATTORNEY

SN 76-627,985. DEFLECTO CORPORATION, INDIANAPOLIS, IN. FILED 1-14-2005.

FLOAT-A-SIGN

THE MARK CONSISTS OF STANDARD CHARACTERS WITHOUT CLAIM TO ANY PARTICULAR FONT, STYLE, SIZE, OR COLOR.

FOR HOLDERS FOR THE DISPLAY OF PRINTED MATERIALS (U.S. CLS. 2, 5, 22, 23, 29, 37, 38 AND 50).

JENNIFER CHICOSKI, EXAMINING ATTORNEY

CLASS 16—(Continued).

SN 76-635,766. GAULT, ROSETTE, SEATTLE, WA. FILED 4-11-2005.

P¹ CLAY

THE MARK CONSISTS OF STANDARD CHARACTERS WITHOUT CLAIM TO ANY PARTICULAR FONT, STYLE, SIZE, OR COLOR.

FOR MODELING CLAY (U.S. CLS. 2, 5, 22, 23, 29, 37, 38 AND 50).

FIRST USE 6-1-1993; IN COMMERCE 1-13-1995.
PATRICIA EVANKO, EXAMINING ATTORNEY

SN 78-024,569. SB PHARMCO PUERTO RICO INC., CIDRA, PUERTO RICO, FILED 9-6-2000.

RESOLUTION AT THE SPEED OF LIFE

FOR PRINTED EDUCATIONAL MATERIALS, NAMELY, BROCHURES, PAMPHLETS AND BOOKLETS CONCERNING RESPIRATORY TRACT INFECTIONS AND TREATMENTS THEREOF (U.S. CLS. 2, 5, 22, 23, 29, 37, 38 AND 50).

SCOTT BALDWIN, EXAMINING ATTORNEY

SN 78-204,526. THE TEMPLAR COMPANY PLC, DORKING, SURREY, UNITED KINGDOM, FILED 1-17-2003.

AMAZING BABY

PRIORITY CLAIMED UNDER SEC. 44(D) ON ERP CMNTY TM OFC APPLICATION NO. 002958882, FILED 11-26-2002, REG. NO. 002958882, DATED 5-23-2005, EXPIRES 11-26-2012.

NO CLAIM IS MADE TO THE EXCLUSIVE RIGHT TO USE BABY, APART FROM THE MARK AS SHOWN.

FOR PRINTED MATTER, NAMELY BOOKS FOR INFANTS AND CHILDREN; NEWSLETTERS FOR INFANTS AND CHILDREN; MAGAZINES FOR INFANTS AND CHILDREN; PAPER PRODUCTS, NAMELY, CONTAINERS OF PAPER AND CARDBOARD; STATIONERY; GREETING CARDS; CALENDARS; SCRAP BOOKS; DECALCOMANIAS; BOOKENDS; BOOKMARKS; CALCULATING TABLES; PHOTOGRAPHS; PHOTOGRAPH ALBUMS; IMPLEMENTS FOR WRITING AND DRAWING, NAMELY, PENS AND PENCILS; WRITING AND DRAWING PADS; HOLDERS FOR PENS AND PENCILS; PENCIL SHARPENERS; DRAWING BOARDS; CRAYONS; PAINT BRUSHES; PAINT BOXES; GLOBES; PAPERWEIGHTS; ERASERS; GLUE FOR HOUSEHOLD PURPOSES; ADHESIVE TAPE FOR STATIONERY OR HOUSEHOLD PURPOSES; MODELLING MATERIALS, NAMELY, MODELLING CLAY FOR USE BY CHILDREN; PAPER HANDKERCHIEFS; PAPER NAPKINS; PAPER TABLECLOTHS; PAPER TABLE MATS; DISPOSABLE BABIES' DIAPERS; BABY BIBS OF PAPER (U.S. CLS. 2, 5, 22, 23, 29, 37, 38 AND 50).

JENNIFER MARTIN, EXAMINING ATTORNEY

CLASS 16—(Continued).

SN 78-221,875. PAPERCEL-VENDAS E GESTAO COMERCIAL, S.A., FIGUEIRA DA FOZ, PORTUGAL, FILED 3-5-2003.

INSTINCT

PRIORITY CLAIMED UNDER SEC. 44(D) ON PORTUGAL APPLICATION NO. 366505, FILED 9-6-2002, REG. NO. 366505, DATED 1-21-2003, EXPIRES 9-6-2012.

FOR PAPER ARTICLES, NAMELY, STATIONERY, PRINTING PAPER, WRITING PAPER, PHOTOCOPY PAPER, OFFSET PRINTING PAPER, CONTINUOUS FEED PRINTED PAPER FORMS AND ENVELOPES, CARDBOARD; PHOTOGRAPHS, ADHESIVES FOR STATIONERY OR HOUSEHOLD PURPOSES; TYPEWRITERS AND OFFICE REQUISITES, NAMELY, PAPER CLIPS, STAPLERS, PAPER HOLE PUNCHES, PENS AND PENCILS; PLASTIC MATERIAL FOR PACKAGING, NAMELY, PLASTIC BAGS, PRINTING TYPE; PRINTING BLOCKS (U.S. CLS. 2, 5, 22, 23, 29, 37, 38 AND 50).

YONG KIM, EXAMINING ATTORNEY

SN 78-261,286. NATIONAL FEDERATION OF PARALEGAL ASSOCIATIONS, INC., SEATTLE, WA. FILED 6-11-2003.

NATIONAL PARALEGAL REPORTER

NO CLAIM IS MADE TO THE EXCLUSIVE RIGHT TO USE "REPORTER", APART FROM THE MARK AS SHOWN. SEC. 2(F).

FOR LEGAL MAGAZINE (U.S. CLS. 2, 5, 22, 23, 29, 37, 38 AND 50).

FIRST USE 10-19-1976; IN COMMERCE 10-19-1976.
WON TEAK OH, EXAMINING ATTORNEY

SN 78-282,989. DESERT PUBLICATIONS INC., PALM SPRINGS, CA. FILED 8-4-2003.

El Paseo
CATALOGUE

NO COLORS ARE CLAIMED AS FEATURES OF THE MARKS.

THE FOREIGN WORDING IN THE MARK TRANSLATES INTO ENGLISH AS THE WALK.

FOR PRINTED MATTER, NAMELY, MAGAZINES, RELATED TO SHOPPING, FOOD AND ART COMMENTARY (U.S. CLS. 2, 5, 22, 23, 29, 37, 38 AND 50).

NAKWAMA ANKRAH, EXAMINING ATTORNEY

CLASS 16—(Continued).

SN 78-305,807. PHARMACY MANAGEMENT COMPANIES, FORT WORTH, TX. FILED 9-26-2003.

EZRX

FOR NON-MAGNETICALLY CODED CARDS FOR USE BY CLIENTS OF PERSONAL INJURY ATTORNEYS TO OBTAIN PRESCRIPTION DRUGS (U.S. CLS. 2, 5, 22, 23, 29, 37, 38 AND 50).

KATHRYN COWARD, EXAMINING ATTORNEY

SN 78-308,156. MN-HI, INC., MINNEAPOLIS, MN. FILED 10-1-2003.

MagiCrayon

FOR ARTS AND CRAFTS COLORING KITS, FEATURING WRITING IMPLEMENTS, NAMELY, CRAYONS, MARKERS AND GLITTER FORMULATED FOR WRITING OR COLORING ON TEXTILES AND REMAINING PERMANENT, AND SHIRTS TO BE COLORED ON (U.S. CLS. 2, 5, 22, 23, 29, 37, 38 AND 50).

FIRST USE 12-1-2001; IN COMMERCE 1-23-2002.
ANN E. SAPPENFIELD, EXAMINING ATTORNEY

SN 78-319,136. ILLINOIS TOOL WORKS INC., GLENVIEW, IL. FILED 10-27-2003.

STACKMASTER

FOR FABRICATED LAMINATED PAPER MEMBERS FOR USE IN PROTECTING GOODS AND PROVIDING STACKING STRENGTH FOR CONTAINERS AND THE LIKE (U.S. CLS. 2, 5, 22, 23, 29, 37, 38 AND 50).

FIRST USE 12-28-1998; IN COMMERCE 12-28-1998.
ZACHARY BELLO, EXAMINING ATTORNEY

CLASS 16—(Continued).

SN 78-328,133. DOGS IN HATS CHILDREN'S PUBLISHING LLC, ELMHURST, IL. FILED 11-14-2003.

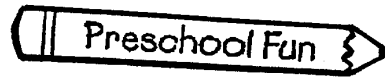

NO CLAIM IS MADE TO THE EXCLUSIVE RIGHT TO USE "PRESCHOOL", APART FROM THE MARK AS SHOWN.

THE DESIGN PORTION OF THE MARK CONSISTS OF A STYLIZED PENCIL SHARPENED ON THE ONE END AND HAVING AN ERASER ON THE OTHER.

FOR CHILDREN'S BOOKS, COLORING BOOKS, EDUCATIONAL PRODUCTS, NAMELY WORKBOOKS, FLASHCARDS, STORYBOOKS AND ACTIVITY BOOKS (U.S. CLS. 2, 5, 22, 23, 29, 37, 38 AND 50).

FIRST USE 8-15-2003; IN COMMERCE 10-15-2003.
SOPHIA S. KIM, EXAMINING ATTORNEY

SN 78-331,282. AMERIGO IMPORTS, INC., ATLANTA, GA. FILED 11-21-2003.



NO CLAIM IS MADE TO THE EXCLUSIVE RIGHT TO USE "SOUTH AFRICAN", APART FROM THE MARK AS SHOWN.

THE COLOR(S) GREEN AND GOLD IS/ARE CLAIMED AS A FEATURE OF THE MARK.

THE MARK CONSISTS OF A STYLIZED CAPITAL LETTER S IN GREEN, A STYLIZED CAPITAL LETTER A IN GREEN, AND A STYLIZED CAPITAL LETTER E IN GREEN. REMAINING LETTERS LOWER CASE ARE GOLD. THE WORDS SOUTH AFRICAN EXPERIENCE ARE NESTED AROUND A GREEN STYLIZED TREE, AND TO THE RIGHT OF THE TREE IS A STYLIZED SILHOUETTED GREEN GIRAFFE.

FOR WINE LABELS (U.S. CLS. 2, 5, 22, 23, 29, 37, 38 AND 50).

FIRST USE 11-1-2003; IN COMMERCE 11-1-2003.
GEORGIA CARTY, EXAMINING ATTORNEY

CLASS 16—(Continued).

SN 78-359,834. MEDIA MAVERICK INCORPORATED, SAN LUIS OBISPO, CA. FILED 1-29-2004.

**10 THINGS YOU ARE
AFRAID TO KNOW
ABOUT**

THE MARK CONSISTS OF STANDARD CHARACTERS WITHOUT CLAIM TO ANY PARTICULAR FONT, STYLE, SIZE, OR COLOR.

FOR SERIES OF NON-FICTION BOOKS IN THE FIELDS OF RELIGION, HOW-TO, DAILY TASKS, AND SELF-HELP (U.S. CLS. 2, 5, 22, 23, 29, 37, 38 AND 50).
DANIEL CAPSHAW, EXAMINING ATTORNEY

SN 78-361,114. FERLAND, DONALD F., SEEKONK, MA. FILED 2-2-2004.

SIMCOLLEGE

THE MARK CONSISTS OF STANDARD CHARACTERS WITHOUT CLAIM TO ANY PARTICULAR FONT, STYLE, SIZE, OR COLOR.

FOR PRINTED PRODUCT, NAMELY, FLASH CARDS USED FOR INTERACTIVE EDUCATIONAL CURRICULUM (U.S. CLS. 2, 5, 22, 23, 29, 37, 38 AND 50).
FIRST USE 1-1-2000; IN COMMERCE 1-5-2000.
GLENN CLARK, EXAMINING ATTORNEY

CLASS 16—(Continued).

SN 78-369,135. ACCO WORLD CORPORATION, LINCOLN-SHIRE, IL. FILED 2-17-2004.

WILSON JONES

THE MARK CONSISTS OF STANDARD CHARACTERS WITHOUT CLAIM TO ANY PARTICULAR FONT, STYLE, SIZE, OR COLOR.

OWNER OF U.S. REG. NOS. 708,710 AND 720,013.

THE NAME SHOWN IN THE MARK DOES NOT IDENTIFY A PARTICULAR LIVING INDIVIDUAL.

FOR PORTABLE PAPER SHEET BINDING MACHINES IN THE NATURE OF DOCUMENT BINDING MACHINES FOR HOME AND OFFICE USE; MACHINES, BOTH ELECTRIC AND MANUAL, NAMELY DOCUMENT BINDING MACHINES FOR HOME AND OFFICE USE FOR USE IN CUTTING, PUNCHING AND BINDING ARTICLES OF PAPER AND CARDBOARD; BINDING EQUIPMENT AND SUPPLIES FOR OFFICE APPLICATION, NAMELY, BINDING PUNCHES AND HOLE PUNCHES; PRE-PUNCHED COPY PAPER; BINDING SPINES; AND KITS COMPRISED OF BINDING SPINES, BINDING PUNCHES, HOLE PUNCHES AND PRE-PUNCHED COPY PAPER; OFFICE PRODUCTS, NAMELY, DOCUMENT AND PHOTO LAMINATORS, AND LAMINATING MATERIALS FOR DOCUMENT AND PHOTO LAMINATORS, NAMELY, PLASTIC POUCHES, LAMINATING FILM, LAMINATING FOIL PAPER FOR HOME AND OFFICE USE; AND LAMINATING SUPPLIES, NAMELY, LAMINATING SHEETS AND LAMINATING POUCHES FOR HOME AND OFFICE USE (U.S. CLS. 2, 5, 22, 23, 29, 37, 38 AND 50).

FIRST USE 9-0-2003; IN COMMERCE 9-0-2003.
BRIDGETT SMITH, EXAMINING ATTORNEY

SN 78-380,891. STERLING, ELIZABETH A., OLNEY, MD. FILED 3-9-2004.

SHORE THINGS

THE MARK CONSISTS OF STANDARD CHARACTERS WITHOUT CLAIM TO ANY PARTICULAR FONT, STYLE, SIZE, OR COLOR.

FOR PHOTOGRAPHS (U.S. CLS. 2, 5, 22, 23, 29, 37, 38 AND 50).

JERI J. FICKES, EXAMINING ATTORNEY

CLASS 16—(Continued).

SN 78-393,279. GREEN, CHRISTOPHER, CHULUOTA, FL. FILED 3-30-2004.

CLASS 16—(Continued).

SN 78-404,882. BONSEN, JOOST PAUL, CAMBRIDGE, MA. AND GRIFFITH, SAUL, CAMBRIDGE, MA. FILED 4-20-2004.

AMERICLE

HOWTOONS

THE MARK CONSISTS OF STANDARD CHARACTERS WITHOUT CLAIM TO ANY PARTICULAR FONT, STYLE, SIZE, OR COLOR.

FOR PRINTED MATERIALS, NAMELY A SERIES OF BOOKS AND PAMPHLETS FEATURING PHOTOGRAPHS, NON-FICTION ACCOUNTS AND FICTIONAL STORIES; STICKERS, BUMPER STICKERS; DECALS, POSTERS, POSTCARDS, NOTEBOOKS AND PRE-PAID TELEPHONE CALLING CARDS NOT MAGNETICALLY ENCODED (U.S. CLS. 2, 5, 22, 23, 29, 37, 38 AND 50).

DAVID ELTON, EXAMINING ATTORNEY

THE MARK CONSISTS OF STANDARD CHARACTERS WITHOUT CLAIM TO ANY PARTICULAR FONT, STYLE, SIZE, OR COLOR.

FOR COMIC STRIPS; COMIC BOOKS; SERIES OF BOOKS IN THE AREA OF INSTRUCTING PEOPLE HOW TO BUILD THINGS; MAGAZINES IN THE FIELD OF INSTRUCTING PEOPLE HOW TO BUILD THINGS; COLORING BOOKS; MODELING MATERIALS AND COMPOUNDS FOR CHILDREN. (U.S. CLS. 2, 5, 22, 23, 29, 37, 38 AND 50).

RON FAIRBANKS, EXAMINING ATTORNEY

SN 78-403,748. SURBEY, SUZI, V., BOTHELL, WA. FILED 4-18-2004.

SN 78-406,318. CONWAY, JEFFREY, D., LONG BEACH, NY. FILED 4-22-2004.

VinMaps

MOTHER'S
LITTLE HELPER

THE MARK CONSISTS OF STANDARD CHARACTERS WITHOUT CLAIM TO ANY PARTICULAR FONT, STYLE, SIZE, OR COLOR.

FOR MAPS, SPECIFICALLY, WINE REGION AND VINEYARD MAPS (U.S. CLS. 2, 5, 22, 23, 29, 37, 38 AND 50).

FIRST USE 6-1-2001; IN COMMERCE 9-1-2002.
STACY WAHLBERG, EXAMINING ATTORNEY

FOR EDUCATIONAL HEALTH PUBLICATION, NAMELY BOOKLET FEATURING INFORMATION FOR PARENTS IN THE FIELD OF NEWBORNS AND TODDLERS (U.S. CLS. 2, 5, 22, 23, 29, 37, 38 AND 50).

TIMOTHY FINNEGAN, EXAMINING ATTORNEY

CLASS 16—(Continued).

SN 78-407,993. FLYING COLORS TOYS, INC., MALIBU, CA.
FILED 4-26-2004.

CLASS 16—(Continued).

SN 78-410,440. LEE PROCUREMENT SOLUTIONS CO.,
DAVENPORT, IA. FILED 4-29-2004.

POP-UP PICS

THE MARK CONSISTS OF STANDARD CHARACTERS WITHOUT CLAIM TO ANY PARTICULAR FONT, STYLE, SIZE, OR COLOR.

NO CLAIM IS MADE TO THE EXCLUSIVE RIGHT TO USE "POP-UP", APART FROM THE MARK AS SHOWN.

FOR SCRAPBOOKS; SCRAPBOOK KITS CONSISTING PRIMARILY OF A SCRAPBOOK ALBUM, SCRAPBOOK PAPERS AND PHOTOGRAPHIC MOUNTS FOR PRESERVING DOCUMENTS AND PHOTOGRAPHS; WRITING INSTRUMENTS NAMELY PENS, PENCILS, MARKERS AND CRAYONS; PAPER PRODUCTS NAMELY NOTEBOOK PAPER, NOTE PADS, DIE CUT NOTE PADS, COLORED CRAFT PAPER, CONSTRUCTION PAPER; STICKERS; STENCILS; ENVELOPES; PHOTO MOUNTING CORNERS; RUBBER STAMPS (U.S. CLS. 2, 5, 22, 23, 29, 37, 38 AND 50).

ESTHER BELENKER, EXAMINING ATTORNEY

GLOBE GAZETTE

THE MARK CONSISTS OF STANDARD CHARACTERS WITHOUT CLAIM TO ANY PARTICULAR FONT, STYLE, SIZE, OR COLOR.

NO CLAIM IS MADE TO THE EXCLUSIVE RIGHT TO USE "GAZETTE", APART FROM THE MARK AS SHOWN.

FOR DAILY NEWSPAPER (U.S. CLS. 2, 5, 22, 23, 29, 37, 38 AND 50).

FIRST USE 5-20-1964; IN COMMERCE 5-20-1964.

CAROL SPILS, EXAMINING ATTORNEY

SN 78-411,371. THE COUSTEAU SOCIETY, INC., CHESAPEAKE, VA. FILED 4-30-2004.

SN 78-408,413. AXEUS, INC., CARLSBAD, CA. FILED 4-27-2004.

Cousteau Kids**DASH**

THE MARK CONSISTS OF STANDARD CHARACTERS WITHOUT CLAIM TO ANY PARTICULAR FONT, STYLE, SIZE, OR COLOR.

OWNER OF U.S. REG. NO. 2,866,047.

NO CLAIM IS MADE TO THE EXCLUSIVE RIGHT TO USE "KIDS", APART FROM THE MARK AS SHOWN.

THE NAME "COUSTEAU" DOES NOT IDENTIFY A LIVING INDIVIDUAL.

FOR STATIONERY, WRITING PAPER, ENVELOPES; BROCHURES, BOOKS AND MAGAZINES DEALING WITH UNDERSEA EXPLORATION, NATURE, AND THE ENVIRONMENT; CALENDARS, POSTERS, DECALS, POSTCARDS, GREETING CARDS, RUBBER STAMPS, PHOTO ALBUMS, NOTE PADS, PENCILS, PENS, MAPS, BOOKMARKS, PHOTOGRAPHS AND PAINTING (U.S. CLS. 2, 5, 22, 23, 29, 37, 38 AND 50).

STEVEN JACKSON, EXAMINING ATTORNEY

THE MARK CONSISTS OF STANDARD CHARACTERS WITHOUT CLAIM TO ANY PARTICULAR FONT, STYLE, SIZE, OR COLOR.

FOR ELECTRONIC EQUIPMENT, NAMELY PAPER AND MEDIA SHREDDERS, STAPLERS, AND PAPER LAMINATORS, FOR OFFICE USE. (U.S. CLS. 2, 5, 22, 23, 29, 37, 38 AND 50).

STEVEN JACKSON, EXAMINING ATTORNEY

CLASS 16—(Continued).

SN 78-414,180. STUDENT & YOUTH TRAVEL ASSOCIATION OF NORTH AMERICA, CLARKSTON, MI. FILED 5-6-2004.

CLASS 16—(Continued).

SN 78-415,567. WALLRAFF, BARBARA, BROOKLINE, MA. FILED 5-9-2004.

SYTA'S STUDENT & YOUTH TRAVELER

THE MARK CONSISTS OF STANDARD CHARACTERS WITHOUT CLAIM TO ANY PARTICULAR FONT, STYLE, SIZE, OR COLOR.

OWNER OF U.S. REG. NO. 2,946,209. NO CLAIM IS MADE TO THE EXCLUSIVE RIGHT TO USE "STUDENT & YOUTH TRAVELER", APART FROM THE MARK AS SHOWN.

FOR PUBLICATIONS, NAMELY, MAGAZINES IN THE FIELD OF TRAVEL (U.S. CLS. 2, 5, 22, 23, 29, 37, 38 AND 50).

FIRST USE 2-28-2001; IN COMMERCE 2-28-2001. ANDREW RHIM, EXAMINING ATTORNEY

Ms. Grammar

THE MARK CONSISTS OF STANDARD CHARACTERS WITHOUT CLAIM TO ANY PARTICULAR FONT, STYLE, SIZE, OR COLOR.

FOR MAGAZINES AND NEWSPAPERS IN THE FIELD OF GRAMMAR, LANGUAGE AND COPY-EDITING (U.S. CLS. 2, 5, 22, 23, 29, 37, 38 AND 50).

LINDA M. KING, EXAMINING ATTORNEY

SN 78-416,129. UNITED WAY OF AMERICA, ALEXANDRIA, VA. FILED 5-10-2004.

SN 78-415,515. LEQUIN, MICHELLE, SAN MARCOS, CA. FILED 5-8-2004.



Planet Menopause

THE MARK CONSISTS OF STANDARD CHARACTERS WITHOUT CLAIM TO ANY PARTICULAR FONT, STYLE, SIZE, OR COLOR.

FOR GREETING CARDS, BUMPER STICKERS (U.S. CLS. 2, 5, 22, 23, 29, 37, 38 AND 50).

ADA HAN, EXAMINING ATTORNEY

THE COLOR(S) DARK BLUE, ORANGE, YELLOW, RED IS/ARE CLAIMED AS A FEATURE OF THE MARK.

THE COLOR(S) WHITE FOR THE LETTERING OF THE WORDS UNITED WAY, DARK BLUE FOR THE BACKGROUND, DARK BLUE FOR THE HAND, ORANGE FOR THE RAINBOW THAT FADES TO YELLOW ON EITHER END, RED FOR THE PERSON FIGURE IS/ARE CLAIMED AS A FEATURE OF THE MARK.

THE MARK CONSISTS OF THE WORDS UNITED WAY AND A DESIGN COMPRISING A HAND, RAINBOW AND PERSON IN TWO ADJACENT SQUARES.

FOR PAPER GOODS, NAMELY STATIONERY, NAMELY LETTER-HEAD TYPE PAPER AND EMBOSSSED OR ENGRAVED ENVELOPES, PRINTED AWARD CERTIFICATES, POSTERS, NOTE CARDS, STICKERS, PRINTED PAPER SIGNS AND ADVERTISING SIGNS OF PAPER OR CARDBOARD, BUSINESS FORMS; PENS AND PEN SETS, COMPRISING A PEN AND PENCIL, DESK ORGANIZERS COMPRISING PAPER CLIP, PENCIL CADDY AND PAPER HOLDER; LETTER OPENERS (U.S. CLS. 2, 5, 22, 23, 29, 37, 38 AND 50).

ALICE BENMAMAN, EXAMINING ATTORNEY

CLASS 16—(Continued).

SN 78-417,904. SAXON, INC., FERNDALE, MI. FILED 5-13-2004.

ZIPPER TAG

THE MARK CONSISTS OF STANDARD CHARACTERS WITHOUT CLAIM TO ANY PARTICULAR FONT, STYLE, SIZE, OR COLOR.

NO CLAIM IS MADE TO THE EXCLUSIVE RIGHT TO USE "TAG", APART FROM THE MARK AS SHOWN.

FOR LABELS MADE PRIMARILY OF PAPER FOR USE IN CONJUNCTION WITH REUSABLE MICROCHIPS (U.S. CLS. 2, 5, 22, 23, 29, 37, 38 AND 50).

FIRST USE 10-23-2002; IN COMMERCE 10-23-2002.
PAULA MAHONEY, EXAMINING ATTORNEY

CLASS 16—(Continued).

SN 78-420,487. DETROIT NEWSPAPER AGENCY, DETROIT, MI. FILED 5-18-2004.



NO CLAIM IS MADE TO THE EXCLUSIVE RIGHT TO USE "ON AUTOMOBILES", APART FROM THE MARK AS SHOWN.

THE COLOR(S) BLUE AND WHITE ARE CLAIMED AS A FEATURE OF THE MARK.

THE LICENSE PLATE APPEARS IN THE COLOR BLUE. THE LETTERS AND NUMBER ON THE LICENSE PLATE APPEARS IN THE COLOR WHITE.

THE MARK CONSISTS OF A MOTOR VEHICLE LICENSE PLATE.

FOR MAGAZINE CONTAINING PHOTOGRAPHS AND PRICES OF MOTOR VEHICLES OFFERED FOR SALE (U.S. CLS. 2, 5, 22, 23, 29, 37, 38 AND 50).

JAMES A. RAUEN, EXAMINING ATTORNEY

SN 78-418,415. CONVENTURES, INC., BOSTON, MA. FILED 5-13-2004.

FORT POINT FIRE

THE MARK CONSISTS OF STANDARD CHARACTERS WITHOUT CLAIM TO ANY PARTICULAR FONT, STYLE, SIZE, OR COLOR.

NO CLAIM IS MADE TO THE EXCLUSIVE RIGHT TO USE "FORT POINT", APART FROM THE MARK AS SHOWN.

FOR WRITING INSTRUMENTS, NAMELY PENS AND PENCILS; PRINTED MATERIAL, NAMELY STATIONERY; BROCHURES ON ENTERTAINMENT SERVICES IN THE NATURE OF FESTIVALS, SPECIAL EVENTS, COMMUNITY FAIRS, THEATRICAL PERFORMANCES, AND CONCERTS; FOLDERS; PROGRAMS; INVITATION CARDS; POSTERS; PENNANTS, BANNERS, AND FLAGS MADE OF PAPER; AND BUMPER STICKERS (U.S. CLS. 2, 5, 22, 23, 29, 37, 38 AND 50).

EUGENIA MARTIN, EXAMINING ATTORNEY

SN 78-420,672. JEMAS, WILLIAM JR., PRINCETON, NJ. FILED 5-18-2004.

BIOGRAPHICS

THE MARK CONSISTS OF STANDARD CHARACTERS WITHOUT CLAIM TO ANY PARTICULAR FONT, STYLE, SIZE, OR COLOR.

FOR PRINTED MATTER IN THE NATURE OF BOOKMARKS, BOOK COVERS, FLASHCARDS, POSTERS, GREETING CARDS, TRADING CARDS, AND A SERIES OF NON-FICTION BOOKS AND PERIODICALS FEATURING BODY ILLUSTRATIONS OF FAMOUS AND NON-FAMOUS PEOPLE USED IN BUSINESS, EDUCATION AND ENTERTAINMENT (U.S. CLS. 2, 5, 22, 23, 29, 37, 38 AND 50).

CHRISTOPHER ADKINS, EXAMINING ATTORNEY

CLASS 16—(Continued).

SN 78-425,463. MEADWESTVACO CORPORATION, STAMFORD, CT. FILED 5-26-2004.

CLASS 16—(Continued).

SN 78-433,174. HALLMARK LICENSING, INC., KANSAS CITY, MO. FILED 6-10-2004.

SELF-SEAL SECURITY

THE MARK CONSISTS OF STANDARD CHARACTERS WITHOUT CLAIM TO ANY PARTICULAR FONT, STYLE, SIZE, OR COLOR.

OWNER OF U.S. REG. NOS. 616,567, 1,174,173 AND OTHERS.

NO CLAIM IS MADE TO THE EXCLUSIVE RIGHT TO USE "SECURITY", APART FROM THE MARK AS SHOWN. SEC. 2(F) SELF-SEAL.

FOR ENVELOPES (U.S. CLS. 2, 5, 22, 23, 29, 37, 38 AND 50).

FIRST USE 1-2-2004; IN COMMERCE 1-2-2004.
GINNY ISAACSON, EXAMINING ATTORNEY



SN 78-426,359. CENTRAL PARK MEDIA CORPORATION, NEW YORK, NY. FILED 5-27-2004.

DOGGY POO

THE MARK CONSISTS OF STANDARD CHARACTERS WITHOUT CLAIM TO ANY PARTICULAR FONT, STYLE, SIZE, OR COLOR.

FOR CHILDREN'S BOOKS, COMIC BOOKS AND MAGAZINES BASED ON CHILDREN'S BOOKS, COLORING BOOKS, TRADING CARDS, POSTERS, STICKERS, AND STATIONERY, PENS, PENCILS, NOTE PADS, MESSAGE PADS, NOTEBOOKS, THREE-RING BINDERS, BUMPER STICKERS, DECALS AND PAPER BANNERS, DIARIES, DIARY-TYPE JOURNALS, ADDRESS BOOKS AND PHOTO ALBUMS, CLIPBOARDS, DESK SETS, MEMO PADS, PAPERWEIGHTS, PAPER COASTERS, CALENDARS, STATIONERY-TYPE PORTFOLIOS, BOOK COVERS, STICKER BOOKS (U.S. CLS. 2, 5, 22, 23, 29, 37, 38 AND 50).

KATHY DE JONGE, EXAMINING ATTORNEY

STICKERONI

THE MARK CONSISTS OF STANDARD CHARACTERS WITHOUT CLAIM TO ANY PARTICULAR FONT, STYLE, SIZE, OR COLOR.

FOR STICKERS; CHILDREN'S ACTIVITY BOOKS, ACTIVITY KITS CONSISTING PRIMARILY OF STICKERS FOR USE BY CHILDREN; BINDERS AND ALBUMS FOR COLLECTING AND DISPLAYING STICKERS; VINYL BAGS, NAMELY PLASTIC BAGS FOR CARRYING STICKERS; CARDBOARD CONTAINERS FOR CARRYING STICKERS; TOY KITS CONSISTING PRIMARILY OF STICKERS FOR USE BY CHILDREN; TOY CARRYING CASES FOR CONTAINING STICKERS (U.S. CLS. 2, 5, 22, 23, 29, 37, 38 AND 50).

ANDREW RHIM, EXAMINING ATTORNEY



SN 78-433,288. HALLMARK LICENSING, INC., KANSAS CITY, MO. FILED 6-10-2004.



THE MARK CONSISTS OF AN ANTHROPOMORPHIC CURVED CYLINDER.

FOR STICKERS; CHILDREN'S ACTIVITY BOOKS, ACTIVITY KITS CONSISTING PRIMARILY OF STICKERS FOR USE BY CHILDREN; BINDERS AND ALBUMS FOR COLLECTING AND DISPLAYING STICKERS; VINYL BAGS, NAMELY PLASTIC BAGS FOR CARRYING STICKERS; CARDBOARD CONTAINERS FOR CARRYING STICKERS; TOY KITS CONSISTING PRIMARILY OF STICKERS FOR USE BY CHILDREN; TOY CARRYING CASES FOR CONTAINING STICKERS (U.S. CLS. 2, 5, 22, 23, 29, 37, 38 AND 50).

ANDREW RHIM, EXAMINING ATTORNEY

CLASS 16—(Continued).

SN 78-433,325. HALLMARK LICENSING, INC., KANSAS CITY, MO. FILED 6-10-2004.



THE MARK CONSISTS OF THE WORD STICKERONI AND AN ANTHROPOMORPHIC CURVED CYLINDER. FOR STICKERS; CHILDREN'S ACTIVITY BOOKS, ACTIVITY KITS CONSISTING PRIMARILY OF STICKERS FOR USE BY CHILDREN; BINDERS AND ALBUMS FOR COLLECTING AND DISPLAYING STICKERS; VINYL BAGS, NAMELY PLASTIC BAGS FOR CARRYING STICKERS; CARDBOARD CONTAINERS FOR CARRYING STICKERS; TOY KITS CONSISTING PRIMARILY OF STICKERS FOR USE BY CHILDREN; TOY CARRYING CASES FOR CONTAINING STICKERS (U.S. CLS. 2, 5, 22, 23, 29, 37, 38 AND 50).

ANDREW RHIM, EXAMINING ATTORNEY

SN 78-436,571. MOLDAUER, PERRY, WEST HOLLYWOOD, CA. FILED 6-16-2004.

Make Love Not War

THE MARK CONSISTS OF STANDARD CHARACTERS WITHOUT CLAIM TO ANY PARTICULAR FONT, STYLE, SIZE, OR COLOR.

FOR BUMPER STICKERS AND POSTERS (U.S. CLS. 2, 5, 22, 23, 29, 37, 38 AND 50).

MATTHEW KLINE, EXAMINING ATTORNEY

SN 78-437,965. MEREDITH CORPORATION, DES MOINES, IA. FILED 6-18-2004.

BARGAIN STYLE

THE MARK CONSISTS OF STANDARD CHARACTERS WITHOUT CLAIM TO ANY PARTICULAR FONT, STYLE, SIZE, OR COLOR.

NO CLAIM IS MADE TO THE EXCLUSIVE RIGHT TO USE "BARGAIN", APART FROM THE MARK AS SHOWN.

FOR PERIODIC PUBLICATION, NAMELY A MAGAZINE FEATURING ARTICLES AND INFORMATION ON LOW-COST AND BUDGET WAYS TO DECORATE A HOME (U.S. CLS. 2, 5, 22, 23, 29, 37, 38 AND 50).

STEPHANIE DAVIS, EXAMINING ATTORNEY

CLASS 16—(Continued).

SN 78-438,141. DALLCO MARKETING SERVICES, INC., GARLAND, TX. FILED 6-19-2004.

PICTUREPRICE

THE MARK CONSISTS OF STANDARD CHARACTERS WITHOUT CLAIM TO ANY PARTICULAR FONT, STYLE, SIZE, OR COLOR.

FOR PAPER SHELF TAGS FOR DISPLAYING PRODUCT AND PRICING INFORMATION IN ASSOCIATION WITH MERCHANDISE DISPLAY SHELVING ON WHICH GOODS ARE DISPLAYED FOR PURCHASE BY RETAIL CUSTOMERS IN GROCERY STORES, SUPERMARKETS, DEPARTMENT STORES, PHARMACIES, HARDWARE STORES, OFFICE SUPPLY DEPOTS AND THE LIKE (U.S. CLS. 2, 5, 22, 23, 29, 37, 38 AND 50).

JOHN E. MICHOS, EXAMINING ATTORNEY

SN 78-442,069. DYNAMIC PAINT PRODUCTS INC., MISSISSAUGA, CANADA, FILED 6-28-2004.

FOR PAINT BRUSHES (U.S. CLS. 2, 5, 22, 23, 29, 37, 38 AND 50).

DAWN FELDMAN, EXAMINING ATTORNEY

SN 78-442,548. SUNDBERG, PEGGY, COLORADO CITY, CO. FILED 6-28-2004.

A COWGIRL PEG BOOK

THE MARK CONSISTS OF STANDARD CHARACTERS WITHOUT CLAIM TO ANY PARTICULAR FONT, STYLE, SIZE, OR COLOR.

NO CLAIM IS MADE TO THE EXCLUSIVE RIGHT TO USE "BOOK", APART FROM THE MARK AS SHOWN.

FOR CHILDREN'S BOOKS (U.S. CLS. 2, 5, 22, 23, 29, 37, 38 AND 50).

FIRST USE 11-0-2003; IN COMMERCE 11-0-2003.

CHRISTOPHER ADKINS, EXAMINING ATTORNEY

CLASS 16—(Continued).

SN 78-444,439. RESTORING ORDER LLC, SHERWOOD, OR.
FILED 7-1-2004.

CLASS 16—(Continued).

SN 78-446,284. BUFFALO RISING LLC, BUFFALO, NY.
FILED 7-6-2004.

PROJECT CENTER

BUFFALO RISING

THE MARK CONSISTS OF STANDARD CHARACTERS WITHOUT CLAIM TO ANY PARTICULAR FONT, STYLE, SIZE, OR COLOR.

FOR DESK TOP ORGANIZERS; FILE TRAYS; FILE SORTERS; DESK TOP DOCUMENT RACKS AND STANDS; MAGAZINE AND LETTER RACKS; PAPER RACKS; PAPER CONTAINERS; LETTER TRAYS (U.S. CLS. 2, 5, 22, 23, 29, 37, 38 AND 50).

RENEE MCCRAY, EXAMINING ATTORNEY

THE MARK CONSISTS OF STANDARD CHARACTERS WITHOUT CLAIM TO ANY PARTICULAR FONT, STYLE, SIZE, OR COLOR.

FOR MAGAZINE PUBLICATION IN PRINTED FORM FEATURING ADVERTISEMENTS, PHOTOGRAPHS, ARTICLES, COMIC STRIPS AND VARIOUS INFORMATION IN THE FIELDS OF THE ARTS, ENTERTAINMENT, TRAVEL, RESTAURANTS AND COMMUNITY ISSUES (U.S. CLS. 2, 5, 22, 23, 29, 37, 38 AND 50).

FIRST USE 5-26-2004; IN COMMERCE 6-6-2004.
YSA DEJESUS, EXAMINING ATTORNEY

SN 78-445,898. MISTOR, PAUL G., WINSTON-SALEM, NC.
FILED 7-5-2004.

SN 78-451,532. KUAN, KELVIN, CARSON, CA. FILED 7-15-2004.

Travel Mania

TECH KUAN DO

THE MARK CONSISTS OF STANDARD CHARACTERS WITHOUT CLAIM TO ANY PARTICULAR FONT, STYLE, SIZE, OR COLOR.

NO CLAIM IS MADE TO THE EXCLUSIVE RIGHT TO USE "TRAVEL", APART FROM THE MARK AS SHOWN.

FOR PRINTED MATERIAL, NAMELY, COLORING BOOKS, BOOKS, AND BROCHURES IN THE FIELD OF TRAVEL AND GEOGRAPHY (U.S. CLS. 2, 5, 22, 23, 29, 37, 38 AND 50).

CHRISTOPHER ADKINS, EXAMINING ATTORNEY

THE MARK CONSISTS OF STANDARD CHARACTERS WITHOUT CLAIM TO ANY PARTICULAR FONT, STYLE, SIZE, OR COLOR.

FOR BOOKS IN THE FIELD OF COMPUTER TRAINING AND THE USE OF CONSUMER ELECTRONICS AND COMPUTERS (U.S. CLS. 2, 5, 22, 23, 29, 37, 38 AND 50).

ESTHER BELENKER, EXAMINING ATTORNEY

CLASS 16—(Continued).

SN 78-454,803. PICART, KRISHNA, BRIARWOOD, NY.
FILED 7-22-2004.

Break The Cycle

THE MARK CONSISTS OF STANDARD CHARACTERS WITHOUT CLAIM TO ANY PARTICULAR FONT, STYLE, SIZE, OR COLOR.

FOR PRINTED MATTER AND PUBLICATIONS, NAMELY, NOTE CARDS; BOOK COVERS; BOOKMARKS; BOOKPLATES; CALENDARS; NOTEBOOKS; NOTEPADS; PAPER BANNERS; PAPERBACK BOOKS ABOUT HISTORY; PICTURE STORYBOOKS; POSTCARDS; POSTERS; SCRAPBOOKS; SCRATCH PADS; STATIONERY-TYPE PORTFOLIOS; STICKERS; STORYBOOKS; TRADING CARDS; PICTURES, PHOTOGRAPHIC PRINTS, MOUNTED PHOTOGRAPHS, UNMOUNTED PHOTOGRAPHS, AND ART REPRODUCTIONS; EDUCATIONAL MAGAZINES ABOUT HISTORY AND MAGAZINES IN THE FIELD OF ENTERTAINMENT; BOOKS ABOUT HISTORY, PICTURE BOOKS, CHILDREN'S ACTIVITY BOOKS, NOTEBOOKS, SCRAP BOOKS, DIARIES, COMPOSITION BOOKS, COLORING AND CHILDREN'S ACTIVITY BOOKS; COMIC BOOKS; GREETING CARDS; INVITATION CARDS; IRON-ON TRANSFERS; MEMO BOARDS; MEMO PADS; SERIES OF COMIC BOOKS; CARTOON PRINTS, NEWSPAPER CARTOONS, NEWSPAPER COMIC STRIPS; DECALS, STICKERS, BUMPER STICKERS (U.S. CLS. 2, 5, 22, 23, 29, 37, 38 AND 50).

FIRST USE 2-1-2003; IN COMMERCE 5-21-2003.
CATHERINE CAIN, EXAMINING ATTORNEY

SN 78-455,507. BEEK, DANIEL VAN DER, EAST HAMPTON, NY. FILED 7-23-2004.



FOR EDUCATIONAL COOKING MATERIALS, NAMELY AN INTERNATIONAL CUISINE INGREDIENT/DISH CROSS REFERENCE INDEX CHART (U.S. CLS. 2, 5, 22, 23, 29, 37, 38 AND 50).

STEPHANIE DAVIS, EXAMINING ATTORNEY

CLASS 16—(Continued).

SN 78-456,752. PIONEER PHOTO ALBUMS, INC., CHATSWORTH, CA. FILED 7-26-2004.



NO CLAIM IS MADE TO THE EXCLUSIVE RIGHT TO USE "GLUE STICK", APART FROM THE MARK AS SHOWN.

FOR GLUE FOR STATIONERY, CRAFT, OR HOUSEHOLD PURPOSES; GLUE STICKS FOR STATIONERY, CRAFT OR HOUSEHOLD PURPOSES; OFFICE GLUE (U.S. CLS. 2, 5, 22, 23, 29, 37, 38 AND 50).

SUE LAWRENCE, EXAMINING ATTORNEY

SN 78-458,857. UNIVERSAL COMMUNICATIONS OF MIAMI, INC., NEW YORK, NY. FILED 7-29-2004.

ELITE WEALTH MANAGEMENT

THE MARK CONSISTS OF STANDARD CHARACTERS WITHOUT CLAIM TO ANY PARTICULAR FONT, STYLE, SIZE, OR COLOR.

NO CLAIM IS MADE TO THE EXCLUSIVE RIGHT TO USE "WEALTH MANAGEMENT", APART FROM THE MARK AS SHOWN.

FOR MAGAZINES AND SECTIONS OF MAGAZINES IN THE FIELD OF FINANCIAL ADVICE (U.S. CLS. 2, 5, 22, 23, 29, 37, 38 AND 50).

ANNE MADDEN, EXAMINING ATTORNEY

SN 78-461,139. LA VOZ PUBLISHING CORPORATION, HOUSTON, TX. FILED 8-3-2004.

LA VOZ DE HOUSTON

THE MARK CONSISTS OF STANDARD CHARACTERS WITHOUT CLAIM TO ANY PARTICULAR FONT, STYLE, SIZE, OR COLOR.

NO CLAIM IS MADE TO THE EXCLUSIVE RIGHT TO USE "HOUSTON", APART FROM THE MARK AS SHOWN.

THE FOREIGN WORDING IN THE MARK TRANSLATES INTO ENGLISH AS "VOICE".

FOR NEWSPAPER PRINTED IN THE SPANISH LANGUAGE (U.S. CLS. 2, 5, 22, 23, 29, 37, 38 AND 50).

FIRST USE 5-22-1980; IN COMMERCE 5-22-1980.

JOHN DALIER, EXAMINING ATTORNEY

CLASS 16—(Continued).

SN 78-462,696. ROBINSON, FORREST, ATLANTA, GA.
FILED 8-5-2004.

AdStacker

THE MARK CONSISTS OF STANDARD CHARACTERS WITHOUT CLAIM TO ANY PARTICULAR FONT, STYLE, SIZE, OR COLOR.

FOR PAPER SLEEVES USED TO PROTECT AND STORE CD'S AND DVD'S; PAPER SLEEVES USED TO PROTECT AND STORE CD'S AND DVD'S, THE SLEEVES HAVING OPTIONAL PRINTED ADVERTISING ON THEM, SERIES OF PAPER SLEEVES WITH TABS TO BE USED TO FILE AND PROTECT CD'S AND DVD'S (U.S. CLS. 2, 5, 22, 23, 29, 37, 38 AND 50).
PAUL F. GAST, EXAMINING ATTORNEY

SN 78-473,259. KAMSUT, INC., WESTLAKE VILLAGE, CA.
FILED 8-25-2004.

KAMA SUTRA

THE MARK CONSISTS OF STANDARD CHARACTERS WITHOUT CLAIM TO ANY PARTICULAR FONT, STYLE, SIZE, OR COLOR.

FOR PRINTED MATTER, NAMELY STATIONERY, BOOKS AND PAMPHLETS ON THE SUBJECT OF LOVE, SEX, ROMANCE AND RELATIONSHIPS; BOOKMARKS OF PAPER, CALENDARS, DIARIES AND JOURNALS HAVING BLANK OR PARTIALLY PRINTED BOUND PAGES, GREETING CARDS AND POSTCARDS, NOTE PAPER; PAPER FOR WRAPPING AND PACKAGING GIFT ITEMS, GIFT BAGS OF PAPER; NAPKINS, PAPER PLACE MATS, AND PARTY DECORATIONS AND ORNAMENTS OF PAPER FOR THE TABLE; PICTURE POSTCARDS, PILLOW BOOKS, NAMELY, JOURNALS KEPT BY THE PILLOW IN WHICH TO RECORD STRAY THOUGHTS, IMPRESSIONS AND INFORMATION COLLECTIONS OF NOTES, HAVING BLANK OR PARTIALLY PRINTED PAGES; RIBBONS AND BOWS OF PAPER FOR WRAPPING GIFTS, WRITING PADS FOR DESKTOPS, WRITING PAPER AND ENVELOPES (U.S. CLS. 2, 5, 22, 23, 29, 37, 38 AND 50).
STEPHANIE DAVIS, EXAMINING ATTORNEY

CLASS 16—(Continued).

SN 78-474,504. CARING-PRODUCTS.COM, INC, SAN DIEGO, CA. FILED 8-26-2004.

CAMP STAMP

THE MARK CONSISTS OF STANDARD CHARACTERS WITHOUT CLAIM TO ANY PARTICULAR FONT, STYLE, SIZE, OR COLOR.

NO CLAIM IS MADE TO THE EXCLUSIVE RIGHT TO USE STAMP, APART FROM THE MARK AS SHOWN.
SEC. 2(F).

FOR STAMPING MACHINES FOR OFFICE OR HOUSEHOLD PURPOSES AND MARKING STAMPS MADE FROM RUBBER, POLYMER, OR OTHER IMPRINTING MATERIAL FOR IDENTIFYING OR MARKING CHILDREN OR ADULTS' CLOTHING FOR CAMPS, SCHOOLS, AND OTHER INSTITUTIONS LIKE NURSING HOMES AND THE MILITARY, ELIMINATING THE NEED FOR IRON-ONS AND MESSY MARKERS (U.S. CLS. 2, 5, 22, 23, 29, 37, 38 AND 50).

FIRST USE 0-0-1989; IN COMMERCE 0-0-1989.

ANN E. SAPPENFIELD, EXAMINING ATTORNEY

SN 78-477,130. NATIONAL SHOOTING SPORTS FOUNDATION, INC., NEWTOWN, CT. FILED 9-1-2004.

SHOT BUSINESS

THE MARK CONSISTS OF STANDARD CHARACTERS WITHOUT CLAIM TO ANY PARTICULAR FONT, STYLE, SIZE, OR COLOR.

NO CLAIM IS MADE TO THE EXCLUSIVE RIGHT TO USE "BUSINESS", APART FROM THE MARK AS SHOWN.

FOR TRADE MAGAZINE IN THE FIELD OF SHOOTING, HUNTING AND RELATED OUTDOOR ACTIVITIES (U.S. CLS. 2, 5, 22, 23, 29, 37, 38 AND 50).

FIRST USE 9-0-1992; IN COMMERCE 9-0-1992.

MARK SPARACINO, EXAMINING ATTORNEY

CLASS 16—(Continued).

SN 78-478,057. STANDEX INTERNATIONAL CORPORATION, SALEM, NH. FILED 9-2-2004.

CLASS 16—(Continued).

SN 78-482,429. QUAD INT'L. INCORPORATED, DBA THE SCORE GROUP, MIAMI, FL. FILED 9-13-2004.

**BIBLICAL CHOICES
FOR A NEW
GENERATION**

MAMAZON

THE MARK CONSISTS OF STANDARD CHARACTERS WITHOUT CLAIM TO ANY PARTICULAR FONT, STYLE, SIZE, OR COLOR.

OWNER OF U.S. REG. NOS. 1,854,610 AND 2,619,802.
FOR PRINTED BIBLE STUDY MATERIALS FOR USE IN ELEMENTARY SCHOOL CURRICULUM (U.S. CLS. 2, 5, 22, 23, 29, 37, 38 AND 50).

FIRST USE 8-1-1992; IN COMMERCE 8-1-1992.
MAUREEN DALL, EXAMINING ATTORNEY

THE MARK CONSISTS OF STANDARD CHARACTERS WITHOUT CLAIM TO ANY PARTICULAR FONT, STYLE, SIZE, OR COLOR.

FOR MAGAZINES IN THE FIELD OF ADULT ENTERTAINMENT (U.S. CLS. 2, 5, 22, 23, 29, 37, 38 AND 50).
FIRST USE 9-17-2002; IN COMMERCE 9-17-2002.
STEVEN PEREZ, EXAMINING ATTORNEY

SN 78-482,168. DICKERSON, KIMBERLY, NEW YORK, NY. FILED 9-12-2004.

SN 78-484,876. WORLD TRIATHLON CORPORATION, TARPON SPRINGS, FL. FILED 9-16-2004.

JadaSunshine 

IRONMAN 

FOR SERIES OF FICTION CHILDREN'S BOOKS; NON-FICTION CHILDREN'S BOOKS; MAGAZINES PERTAINING TO CHILDREN'S ISSUES; PAMPHLETS PERTAINING TO CHILDREN'S ISSUES; NEWSPAPERS; NEWSLETTERS PERTAINING TO CHILDREN'S ISSUES; JOURNALS PERTAINING TO CHILDREN'S ISSUES; AND INFORMATIONAL BUSINESS LETTERS PERTAINING TO CHILDREN'S ISSUES (U.S. CLS. 2, 5, 22, 23, 29, 37, 38 AND 50).

CYNTHIA SLOAN, EXAMINING ATTORNEY

OWNER OF U.S. REG. NOS. 1,353,313, 2,325,508 AND OTHERS.

FOR SERIES OF NON-FICTION BOOKS FEATURING HEALTH, NUTRITION AND FITNESS INFORMATION; PRINTED PROMOTIONAL MATERIALS NAMELY EVENT GUIDES AND EVENT PROGRAMS IN ASSOCIATION WITH CONTESTS CONSISTING OF RUNNING, BIKING AND SWIMMING (U.S. CLS. 2, 5, 22, 23, 29, 37, 38 AND 50).

FIRST USE 1-1-1982; IN COMMERCE 10-1-1982.
LINDA ESTRADA, EXAMINING ATTORNEY

CLASS 16—(Continued).

SN 78-486,890. WILDLIFE EDUCATION, LTD., POWAY, CA.
FILED 9-21-2004.



OWNER OF U.S. REG. NOS. 1,748,432, 1,790,741 AND 1,941,567.

THE COLORS BLUE, GREEN, YELLOW, ORANGE, RED, BLACK, AND WHITE ARE CLAIMED AS A FEATURE OF THE MARK.

THE MARK CONSISTS OF THE WORD ZOOBOOKS IN STYLIZED FORMAT, COLORED IN A RAINBOW FASHION FROM BLUE ON THE LEFT TO RED ON THE RIGHT, THE LETTER Z PREDOMINATELY IN BLUE, THE TWO LETTERS O FOLLOWING THE Z IN GREEN, THE B IN YELLOW, THE FIRST FOLLOWING O IN YELLOW AND ORANGE, THE SECOND FOLLOWING O AND THE K IN ORANGE, AND THE S IN RED, ALL LETTERS FEATURING WHITE HIGHLIGHTS.

FOR BOOKS AND MAGAZINES ABOUT ANIMALS (U.S. CLS. 2, 5, 22, 23, 29, 37, 38 AND 50).

FIRST USE 7-31-2004, THE MARK WAS FIRST USED ANYWHERE IN A DIFFERENT FORM OTHER THAN THAT SOUGHT TO BE REGISTERED ON 10/31/1991.; IN COMMERCE 7-31-2004, THE MARK WAS FIRST USED IN COMMERCE IN A DIFFERENT FORM OTHER THAN THAT SOUGHT TO BE REGISTERED ON 10/31/1991..

DAHLIA GEORGE, EXAMINING ATTORNEY

CLASS 16—(Continued).

SN 78-489,757. LASS, DEBRA J., NEW YORK, NY. FILED 9-27-2004.

Sophistibitch

THE MARK CONSISTS OF STANDARD CHARACTERS WITHOUT CLAIM TO ANY PARTICULAR FONT, STYLE, SIZE, OR COLOR.

FOR CARTOON STRIPS, COMIC BOOKS, CALENDARS, DAILY PLANNERS, POSTERS, POSTCARDS, NOTEPADS, GREETING CARDS (U.S. CLS. 2, 5, 22, 23, 29, 37, 38 AND 50).

MARLENE BELL, EXAMINING ATTORNEY

SN 78-489,032. EMSBO CORP., INC., BLOCK ISLAND, RI.
FILED 9-24-2004.

ORTON-GILLINGHAM,
FROM THEORY TO
PRACTICE

THE MARK CONSISTS OF STANDARD CHARACTERS WITHOUT CLAIM TO ANY PARTICULAR FONT, STYLE, SIZE, OR COLOR.

FOR EDUCATIONAL MATERIALS IN THE FIELD OF READING AND DYSLEXIA CONSISTING OF FLASH CARDS, PRINTED CHARTS AND MANUALS AND KITS CONTAINING THE SAME; BROCHURES AND PRINTED FLIERS IN THE FIELD OF READING AND DYSLEXIA (U.S. CLS. 2, 5, 22, 23, 29, 37, 38 AND 50).

FIRST USE 6-30-2004; IN COMMERCE 6-30-2004.
DANIEL CAPSHAW, EXAMINING ATTORNEY

SN 78-489,954. PICCOLA, MICHELLE L, VANCOUVER, WA.
FILED 9-27-2004.

If Animals Could Talk

THE MARK CONSISTS OF STANDARD CHARACTERS WITHOUT CLAIM TO ANY PARTICULAR FONT, STYLE, SIZE, OR COLOR.

FOR EMERGENCY PET RESCUE STICKER (U.S. CLS. 2, 5, 22, 23, 29, 37, 38 AND 50).

TEJBIR SINGH, EXAMINING ATTORNEY

CLASS 16—(Continued).

SN 78-490,356. ROS AND ROOT VENTURES, LLC, BEDMINSTER, NJ. FILED 9-27-2004.

CLASS 16—(Continued).

SN 78-492,046. DEUTSCHE TELEKOM AG, BONN, FED REP GERMANY, FILED 9-30-2004.

t-finder

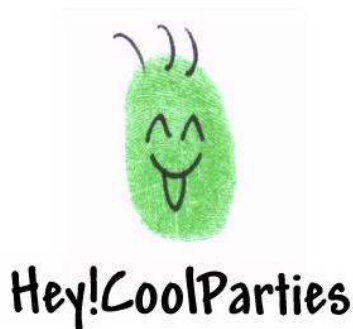

THE COLOR(S) EMERALD GREEN AND BLACK IS/ARE CLAIMED AS A FEATURE OF THE MARK.

THE MARK CONSISTS OF EMERALD GREEN THUMBPRINT WITH BLACK EYES, MOUTH AND HAIR DRAWN ON THE PRINT.

FOR PRINTED MATERIAL NAMELY BOND PAPER FOR STATIONERY AND ENVELOPES, AND PARTY INSTRUCTIONAL MATERIAL (U.S. CLS. 2, 5, 22, 23, 29, 37, 38 AND 50).

FIRST USE 7-17-2004; IN COMMERCE 7-30-2004.
MARK RADEMACHER, EXAMINING ATTORNEY

THE MARK CONSISTS OF STANDARD CHARACTERS WITHOUT CLAIM TO ANY PARTICULAR FONT, STYLE, SIZE, OR COLOR.

PRIORITY CLAIMED UNDER SEC. 44(D) ON FED REP GERMANY APPLICATION NO. 30418462438, FILED 4-2-2004, REG. NO. 30418462, DATED 5-10-2004, EXPIRES 4-30-2014.

FOR PRINTED MATTER, NAMELY, TELEPHONE DIRECTORIES, SERIES OF BOOKS, NEWSLETTERS, PAMPHLETS, BROCHURES, MAGAZINES AND PAPERBACKS, ALL IN THE FIELD OF TELECOMMUNICATIONS; PRINTED AND STAMPED PLASTIC AND CARDBOARD GREETING, BLANK, NOTE, AND INDEX CARDS; NOTE PAPER AND ENVELOPES; NAMETAGS AND LABELS MADE FROM PAPER OR CARDBOARD; NOTEBOOKS; NOTE PADS; STATIONERY; PAPER, NAMELY, BOND PAPER AND ART PAPER; GIFT-WRAP PAPER; DIARIES; ADDRESS BOOKS; STUDENT CALENDARS; STAMP ALBUMS AND PHOTO-ALBUMS; FOLDERS FOR LETTERS AND LOOSE PAPERS; STATIONERY CLEAR HOLE TAB REINFORCEMENTS; RUBBER STAMPS AND IMPRESSION STAMPS; PAPER WEIGHTS; LETTER OPENERS; DRAWING AND UNGRADUATED RULERS; ERASERS; STAPLERS; PAPER CLIPS; BLOTTER PADS; DESK FILE TRAYS; DESK STANDS AND HOLDERS FOR HOLDING STATIONERY AND OFFICE IMPLEMENTS; PRINTED INSTRUCTIONAL AND TEACHING MATERIALS, ALL IN THE FIELDS OF TELECOMMUNICATIONS, INFORMATION TECHNOLOGY, SAFETY, NEWS, SPORTS, ENTERTAINMENT, CULTURE, BUSINESS AND FINANCE, WEATHER AND TRAVEL; BOOKMARKERS; STENCILS; SCRATCH PICTURES; PVC STICKERS; BLACKBOARDS; CHALK STICKS; ADHESIVES FOR STATIONERY OR HOUSEHOLD PURPOSES; DRAWING AND PAINTING MATERIALS, NAMELY, PENCILS, DRAWING PENCILS, PENS, DRAWING PENS, PAINT TRAYS, PAINTING SETS FOR ARTISTS, PAINTING SETS FOR CHILDREN, ARTS AND CRAFT PAINT KITS, AND PENCIL CASES; NON-MAGNETICALLY ENCODED PREPAID TELEPHONE CALLING CARDS (U.S. CLS. 2, 5, 22, 23, 29, 37, 38 AND 50).

MICHAEL SOUDERS, EXAMINING ATTORNEY

CLASS 16—(Continued).

SN 78-494,274. OSF HEALTHPLANS INC., PEORIA, IL.
FILED 10-4-2004.

OSF Member Notes

NO CLAIM IS MADE TO THE EXCLUSIVE RIGHT TO USE "MEMBER NOTES", APART FROM THE MARK AS SHOWN.

THE MARK CONSISTS OF THE WORDING OSF MEMBER NOTES, AND THE LETTER O WHICH APPEARS IN BOTH THE ACRONYM OSF AND NOTES, IS STYLIZED AND DESIGNED TO ENCOMPASS A DOVE IN THE LETTER.

FOR HEALTH INSURANCE COMPANY NEWSLETTER FOR INSURED MEMBERS (U.S. CLS. 2, 5, 22, 23, 29, 37, 38 AND 50).

FIRST USE 6-8-2004; IN COMMERCE 6-8-2004.
DARRYL SPRUILL, EXAMINING ATTORNEY

CLASS 16—(Continued).

SN 78-499,721. ROCKING CHAIR STUDIO, KINTNERVILLE, PA. FILED 10-14-2004.



THE MARK CONSISTS OF THE TERM "CARD" DISPOSED OVER THE TERM "GAMES", THE TERMS SHOWN IN FRONT OF A SPLIT RAIL FENCE, WITH A TREE ALONG THE RIGHT-HAND SIDE OF THE FENCE. A NUMBER OF ANIMALS ARE SHOWN AS SURROUNDING THE TERMS AND THE TREE, AS WELL AS ON THE SPLIT RAIL FENCE.

FOR GREETING CARDS, WRAPPING PAPER, PAPER PARTY FAVORS, PAPER PARTY HATS, PAPER GIFT BAGS, STATIONERY, CHILDREN'S BOOKS, ENVELOPES, POSTCARDS, PAPER GIFT TAGS, PAPER NAPKINS, PAPER TABLE CLOTHS (U.S. CLS. 2, 5, 22, 23, 29, 37, 38 AND 50).

LAURIE MAYES, EXAMINING ATTORNEY

SN 78-494,680. CHRISTIAN MUSIC TODAY, SAN JOSE, CA.
FILED 10-5-2004.

**CHRISTIAN MUSIC
TODAY!**

THE MARK CONSISTS OF STANDARD CHARACTERS WITHOUT CLAIM TO ANY PARTICULAR FONT, STYLE, SIZE, OR COLOR.

NO CLAIM IS MADE TO THE EXCLUSIVE RIGHT TO USE "CHRISTIAN MUSIC", APART FROM THE MARK AS SHOWN.

FOR PRINTED NEWSLETTERS FEATURING CONTENT RELATING TO MUSIC AND MUSIC ARTISTS (U.S. CLS. 2, 5, 22, 23, 29, 37, 38 AND 50).

FIRST USE 6-1-1989; IN COMMERCE 6-1-1989.
TINA L. SNAPP, EXAMINING ATTORNEY

SN 78-501,964. CLARKE AMERICAN CHECKS, INC., SAN ANTONIO, TX. FILED 10-19-2004.

EASY AS 1,2,3!

THE MARK CONSISTS OF STANDARD CHARACTERS WITHOUT CLAIM TO ANY PARTICULAR FONT, STYLE, SIZE, OR COLOR.

FOR PRINTED TRAINING AND INSTRUCTION MATERIALS, NAMELY, INFORMATION PIECES FOR USE BY FINANCIAL INSTITUTIONS IN PROMOTIONAL AND MARKETING EFFORTS IN THE FIELD OF FINANCIAL DOCUMENTS AND ACCESSORIES (U.S. CLS. 2, 5, 22, 23, 29, 37, 38 AND 50).

RONALD MCMORROW, EXAMINING ATTORNEY

CLASS 16—(Continued).

SN 78-502,317. WAVERLY PLASTICS COMPANY, WAVERLY, IA. FILED 10-19-2004.

WAVERLY PLASTICS

THE MARK CONSISTS OF STANDARD CHARACTERS WITHOUT CLAIM TO ANY PARTICULAR FONT, STYLE, SIZE, OR COLOR.

OWNER OF U.S. REG. NO. 2,939,594.

NO CLAIM IS MADE TO THE EXCLUSIVE RIGHT TO USE "PLASTICS", APART FROM THE MARK AS SHOWN.

FOR PLASTIC BAGS, NAMELY, GENERAL PURPOSE BAGS, TRASH CAN LINERS, PLASTIC FOOD AND UTILITY BAGS FOR INDUSTRIAL USE AND SOLD IN BULK AND NOT FOR RESALE TO RETAIL CONSUMERS (U.S. CLS. 2, 5, 22, 23, 29, 37, 38 AND 50).

FIRST USE 7-0-1990; IN COMMERCE 7-0-1990.

LINDA MICKLEBURGH, EXAMINING ATTORNEY

CLASS 16—(Continued).

SN 78-503,613. COURAGE U.S.A., INC., LAS VEGAS, NV. FILED 10-21-2004.



THE MARK CONSISTS OF THE "OO" IN KOOKY IS A SET OF EYES WITH A NOSE.

FOR WRITING INSTRUMENT, PENS (U.S. CLS. 2, 5, 22, 23, 29, 37, 38 AND 50).

FIRST USE 8-1-2004; IN COMMERCE 8-1-2004.

CIMMERIAN COLEMAN, EXAMINING ATTORNEY

SN 78-502,398. DE VIE LLC, LARKSPUR, CA. FILED 10-19-2004.



NO CLAIM IS MADE TO THE EXCLUSIVE RIGHT TO USE "PINK RIBBON MEN" AND THE REPRESENTATION OF THE DESIGN OF THE RIBBON, APART FROM THE MARK AS SHOWN.

FOR CALENDARS AND GREETING CARDS (U.S. CLS. 2, 5, 22, 23, 29, 37, 38 AND 50).

PAUL F. GAST, EXAMINING ATTORNEY

SN 78-504,933. RED JACKET PRESS, MOHEGAN LAKE, NY, AND KERRY M. KYLE PARTNERSHIP, THE, MOHEGAN LAKE, NY. FILED 10-24-2004.



NO CLAIM IS MADE TO THE EXCLUSIVE RIGHT TO USE "PRESS", APART FROM THE MARK AS SHOWN.

THE COLOR(S) RED, BLACK IS/ARE CLAIMED AS A FEATURE OF THE MARK.

THE COLOR RED APPEARS IN THE SUIT JACKET LAPEL, THE OUTLINE OF THE WORDS "RED" AND "JACKET", AND THE WORD "PRESS". THE COLOR BLACK APPEARS IN THE SUIT JACKET, TIE, THE OUTLINE OF THE CIRCLE, AND THE WORDS "RED JACKET".

THE MARK CONSISTS OF THE WORDS "RED JACKET PRESS" AND A DESIGN, NAMELY, A STYLIZED DEPICTION OF A SUIT JACKET LAPEL AND TIE IN A CIRCLE.

FOR SERIES OF FICTION BOOKS; SERIES OF NON-FICTION BOOKS IN THE FIELD OF SCIENCE FICTION AND FANTASY (U.S. CLS. 2, 5, 22, 23, 29, 37, 38 AND 50).

FIRST USE 3-0-2004; IN COMMERCE 6-0-2004.
WANDA KAY PRICE, EXAMINING ATTORNEY

CLASS 16—(Continued).

SN 78-505,258. STAMPIN' UP! INC., SANDY, UT. FILED 10-25-2004.

AQUA PAINTER

THE MARK CONSISTS OF STANDARD CHARACTERS WITHOUT CLAIM TO ANY PARTICULAR FONT, STYLE, SIZE, OR COLOR.

NO CLAIM IS MADE TO THE EXCLUSIVE RIGHT TO USE AQUA, APART FROM THE MARK AS SHOWN.

FOR WATER CONTAINER AND BRUSH COMBINATION FOR ART USE (U.S. CLS. 2, 5, 22, 23, 29, 37, 38 AND 50).

FIRST USE 7-19-2004; IN COMMERCE 7-19-2004.
KARLA PERKINS, EXAMINING ATTORNEY

CLASS 16—(Continued).

SN 78-506,876. LOLLEY, RICHARD R., THOUSAND OAKS, CA. FILED 10-27-2004.

QUAKE SECURE!

THE MARK CONSISTS OF STANDARD CHARACTERS WITHOUT CLAIM TO ANY PARTICULAR FONT, STYLE, SIZE, OR COLOR.

NO CLAIM IS MADE TO THE EXCLUSIVE RIGHT TO USE "QUAKE", APART FROM THE MARK AS SHOWN.

FOR PLIABLE PUTTY PRODUCT WHICH IS USED AS A REMOVEABLE ADHESIVE FOR SECURING ITEMS TO PREVENT BREAKAGE OR DAMAGE DUE TO EARTHQUAKES AND OTHER GENERAL MISHAPS AND ALSO USED TO STICK POSTERS, PICTURES AND SIGNS TO WALLS AND OTHER SURFACES (U.S. CLS. 2, 5, 22, 23, 29, 37, 38 AND 50).

FIRST USE 1-1-1995; IN COMMERCE 1-1-1995.
ASMAT KHAN, EXAMINING ATTORNEY

SN 78-506,151. ELMER'S INVESTMENTS LLC, COLUMBUS, OH. FILED 10-26-2004.



OWNER OF U.S. REG. NO. 2,330,589.
THE COLORS ORANGE AND WHITE ARE CLAIMED AS A FEATURE OF THE MARK.

THE MARK CONSISTS OF A COLOR COMBINATION APPLIED TO PACKAGING FOR THE GOODS, NAMELY, A WHITE BOTTLE WITH AN ORANGE CAP.

SEC. 2(F).
FOR GLUE FOR HOUSEHOLD AND STATIONERY USE (U.S. CLS. 2, 5, 22, 23, 29, 37, 38 AND 50).

FIRST USE 0-0-1963; IN COMMERCE 0-0-1963.
JUDITH HELFMAN, EXAMINING ATTORNEY

SN 78-508,671. DORCHESTER MEDIA, LLC, NEW YORK, NY. FILED 10-29-2004.

THE BEST OF TRUE CONFESSIONS

THE MARK CONSISTS OF STANDARD CHARACTERS WITHOUT CLAIM TO ANY PARTICULAR FONT, STYLE, SIZE, OR COLOR.

OWNER OF U.S. REG. NOS. 1,438,578 AND 1,455,245.
FOR MAGAZINES FEATURING SHORT STORIES AND ARTICLES ABOUT ROMANCE, PERSONAL RELATIONSHIPS AND FAMILY (U.S. CLS. 2, 5, 22, 23, 29, 37, 38 AND 50).

FIRST USE 1-0-1983; IN COMMERCE 1-0-1983.
ELISSA GARBER KON, EXAMINING ATTORNEY

CLASS 16—(Continued).

SN 78-511,226. CELPLAST METALLIZED PRODUCTS LTD., TORONTO, ONTARIO, CANADA, FILED 11-4-2004.

CLASS 16—(Continued).

SN 78-512,953. RODALE INC., EMMAUS, PA. FILED 11-8-2004.

SUPERMET

**WE BREAK THINGS SO
YOU DON'T HAVE TO**

THE MARK CONSISTS OF STANDARD CHARACTERS WITHOUT CLAIM TO ANY PARTICULAR FONT, STYLE, SIZE, OR COLOR.

FOR FLEXIBLE PLASTIC FILM PACKAGING MATERIAL COATED WITH A THIN LAYER OF ALUMINUM FOR USE IN THE MANUFACTURE OF POUCHES, BAGS AND LIDS (U.S. CLS. 2, 5, 22, 23, 29, 37, 38 AND 50).

MICHAEL TANNER, EXAMINING ATTORNEY

THE MARK CONSISTS OF STANDARD CHARACTERS WITHOUT CLAIM TO ANY PARTICULAR FONT, STYLE, SIZE, OR COLOR.

FOR MAGAZINE SECTION FEATURING REPORTS ON TESTING OF OUTDOOR EQUIPMENT AND SUPPLIES (U.S. CLS. 2, 5, 22, 23, 29, 37, 38 AND 50).

FIRST USE 8-9-2004; IN COMMERCE 8-9-2004.
ALEX KEAM, EXAMINING ATTORNEY

SN 78-513,025. CODY ENTERPRISE, LLP, CODY, WY. FILED 11-8-2004.

SN 78-512,034. VERIZON INFORMATION SERVICES PUERTO RICO, INC., SAN JUAN, UNITED STATES, FILED 11-5-2004.



Páginas Útiles

pulse

NO CLAIM IS MADE TO THE EXCLUSIVE RIGHT TO USE "PAGINAS UTILES", APART FROM THE MARK AS SHOWN.

THE MARK CONSISTS OF A STYLIZED REPRESENTATION OF PAGES.

THE FOREIGN WORDING IN THE MARK TRANSLATES INTO ENGLISH AS USEFUL PAGES.

FOR COMMERCIAL TELEPHONE DIRECTORY (U.S. CLS. 2, 5, 22, 23, 29, 37, 38 AND 50).

FIRST USE 6-20-2003; IN COMMERCE 6-20-2003.
TARAH HARDY, EXAMINING ATTORNEY

THE MARK CONSISTS OF STANDARD CHARACTERS WITHOUT CLAIM TO ANY PARTICULAR FONT, STYLE, SIZE, OR COLOR.

FOR MAGAZINE ABOUT CULTURE AND ENTERTAINMENT IN NORTHWESTERN WYOMING AND SOUTH CENTRAL MONTANA (U.S. CLS. 2, 5, 22, 23, 29, 37, 38 AND 50).

FIRST USE 3-5-2004; IN COMMERCE 3-5-2004.
MARK T. MULLEN, EXAMINING ATTORNEY

CLASS 16—(Continued).

SN 78-513,449. TWENTIETH CENTURY FOX FILM CORPORATION, LOS ANGELES, CA. FILED 11-8-2004.

AMERICAN DAD

THE MARK CONSISTS OF STANDARD CHARACTERS WITHOUT CLAIM TO ANY PARTICULAR FONT, STYLE, SIZE, OR COLOR.

FOR STATIONERY, WRITING PAPER AND ENVELOPES; POSTERS; DESK CALENDARS; WALL CALENDARS; GREETING CARDS; POSTCARDS; TRADING CARDS; COLORING BOOKS; STICKERS; NOTE PADS; DIARIES; BLANK WRITING JOURNALS; ADDRESS BOOKS; DATE BOOKS; GREETING CARDS; PERSONAL ORGANIZERS; NOTEBOOKS; LOOSE-LEAF BINDERS; HUMOR BOOKS; COMIC BOOKS; WRAPPING PAPER; PAPER GIFT TAGS; PARTY INVITATIONS; THANK YOU NOTES; PAPER PARTY HATS; PAPER PARTY FAVORS; BUMPER STICKERS; PENS AND PENCILS; PEN AND PENCIL CUPS; PEN AND PENCIL CASES; TEMPORARY TATTOOS; MOUNTED AND UNMOUNTED PHOTOGRAPHS; PHOTOGRAPH ALBUMS; PAPER BANNERS (U.S. CLS. 2, 5, 22, 23, 29, 37, 38 AND 50).

TRACY FLETCHER, EXAMINING ATTORNEY

CLASS 16—(Continued).

SN 78-514,430. FRAZIER, ERIC, EAST ELMHURST, NY. FILED 11-10-2004.

BLUSH CARD

THE MARK CONSISTS OF STANDARD CHARACTERS WITHOUT CLAIM TO ANY PARTICULAR FONT, STYLE, SIZE, OR COLOR.

NO CLAIM IS MADE TO THE EXCLUSIVE RIGHT TO USE "CARD", APART FROM THE MARK AS SHOWN.

FOR PRINTER PAPER PRODUCTS, NAMELY, GREETING AND ANNOUNCEMENT CARDS, GREETING CARDS IN THE NATURE OF INTRODUCTION CARDS, ENVELOPES, STATIONERY, AND PERSONALIZED GREETING CARDS (U.S. CLS. 2, 5, 22, 23, 29, 37, 38 AND 50).

FIRST USE 6-10-2004; IN COMMERCE 6-10-2004.
ELISSA GARBER KON, EXAMINING ATTORNEY

SN 78-514,392. THE DALLAS GROUP OF AMERICA, INC., WHITEHOUSE, NJ. FILED 11-10-2004.

DALFLOW

THE MARK CONSISTS OF STANDARD CHARACTERS WITHOUT CLAIM TO ANY PARTICULAR FONT, STYLE, SIZE, OR COLOR.

FOR COOKING OIL FILTERS, NAMELY FILTER PAPERS FOR FILTERING COOKING OIL (U.S. CLS. 2, 5, 22, 23, 29, 37, 38 AND 50).

FIRST USE 2-28-2003; IN COMMERCE 2-28-2003.
MIDGE BUTLER, EXAMINING ATTORNEY

SN 78-514,590. OVERTON, DEBBIE SYKES, ROCKY MOUNT, NC. FILED 11-10-2004.

BEHIND BARZ

THE MARK CONSISTS OF STANDARD CHARACTERS WITHOUT CLAIM TO ANY PARTICULAR FONT, STYLE, SIZE, OR COLOR.

FOR MOTORCYCLE MAGAZINE (U.S. CLS. 2, 5, 22, 23, 29, 37, 38 AND 50).

FIRST USE 1-1-2004; IN COMMERCE 4-3-2004.
RAUL CORDOVA, EXAMINING ATTORNEY

CLASS 16—(Continued).

SN 78-515,295. WORLD PUBLICATIONS LLC, WINTER PARK, FL. FILED 11-11-2004.

**Sailing World Best
of Dr. Crash**

THE MARK CONSISTS OF STANDARD CHARACTERS WITHOUT CLAIM TO ANY PARTICULAR FONT, STYLE, SIZE, OR COLOR.

OWNER OF U.S. REG. NOS. 1,447,406 AND 2,106,613.

NO CLAIM IS MADE TO THE EXCLUSIVE RIGHT TO USE "SAILING", APART FROM THE MARK AS SHOWN.

FOR PRINTED MATERIALS, NAMELY: CALENDARS, WALL CALENDARS, MINI CALENDARS, MONTHLY PLANNERS, AND ADDRESS BOOKS IN THE FIELD OF BOATING AND SAILING (U.S. CLS. 2, 5, 22, 23, 29, 37, 38 AND 50).

FIRST USE 11-4-2003; IN COMMERCE 11-4-2003.
SANI KHOURI, EXAMINING ATTORNEY

CLASS 16—(Continued).

SN 78-515,706. 2NOIT MEDIA, LLC, HOMESTEAD, FL. FILED 11-11-2004.



THE COLOR(S) RED, BLACK AND WHITE, GRAY IS/ ARE CLAIMED AS A FEATURE OF THE MARK.

THE MARK CONSISTS OF NUMBER 2 IS IN RED; L NOIT IS IN BLACK; CIRCLED IN RED AND GRAY IN THE BACKGROUND.

FOR MAGAZINES FEATURING SUBJECT MATTER RELATED TO HIP HOP MUSIC (U.S. CLS. 2, 5, 22, 23, 29, 37, 38 AND 50).

FIRST USE 8-20-2004; IN COMMERCE 8-20-2004.
KATHERINE STOIDES, EXAMINING ATTORNEY

SN 78-515,624. JENNIFER G. STRAIT, PORTAND, OR. FILED 11-11-2004.



NO CLAIM IS MADE TO THE EXCLUSIVE RIGHT TO USE "COLLECTION", APART FROM THE MARK AS SHOWN.

THE MARK CONSISTS OF A NEW WORD "SHOENIVERSE" WITH STYLIZED SHOE ILLUSTRATIONS OVER THE "T H O N V R" LETTERS. THE WORD "COLLECTION" IS SURROUNDED BY A BLACK OVAL WITH DROP SHADOW.

FOR PAPER PRODUCTS, NAMELY, CALENDARS, STATIONERY, FINE ART PRINTS AND PRINTED ART REPRODUCTIONS (U.S. CLS. 2, 5, 22, 23, 29, 37, 38 AND 50).

FIRST USE 8-21-2002; IN COMMERCE 7-1-2003.
MELISSA VALLILLO, EXAMINING ATTORNEY

SN 78-515,766. KRAUSE PUBLICATIONS, INC., IOLA, WI. FILED 11-12-2004.



OWNER OF U.S. REG. NO. 2,430,983.

THE MARK CONSISTS OF THE WORDS "GUNLIST" IN STYLIZED FONT WITH THE DESIGN OF A TELESCOPIC SIGHT.

SEC. 2(F) IN PART, AS TO "GUNLIST".

FOR MAGAZINES PUBLISHED PERIODICALLY RELATING TO FIREARMS (U.S. CLS. 2, 5, 22, 23, 29, 37, 38 AND 50).

FIRST USE 10-15-2004; IN COMMERCE 10-15-2004.
CHRISTOPHER ADKINS, EXAMINING ATTORNEY

CLASS 16—(Continued).

SN 78-516,036. WOODWORTH, DAVID C., DBA CREATION CAPTURED, TUSTIN, CA. FILED 11-12-2004.

CREATION CAPTURED

THE MARK CONSISTS OF STANDARD CHARACTERS WITHOUT CLAIM TO ANY PARTICULAR FONT, STYLE, SIZE, OR COLOR.

FOR POSTERS (U.S. CLS. 2, 5, 22, 23, 29, 37, 38 AND 50).

FIRST USE 7-31-1975; IN COMMERCE 7-31-1975.
MICHAEL TANNER, EXAMINING ATTORNEY

SN 78-516,100. WEIDER PUBLICATIONS, LLC., BOCA RATON, FL. FILED 11-12-2004.

**SUCCESSFUL
SLIMMING**

THE MARK CONSISTS OF STANDARD CHARACTERS WITHOUT CLAIM TO ANY PARTICULAR FONT, STYLE, SIZE, OR COLOR.

NO CLAIM IS MADE TO THE EXCLUSIVE RIGHT TO USE "SLIMMING", APART FROM THE MARK AS SHOWN.

FOR PUBLICATIONS, NAMELY, A MAGAZINE CONTAINING DIET, HEALTH, AND FITNESS INFORMATION (U.S. CLS. 2, 5, 22, 23, 29, 37, 38 AND 50).

SANI KHOURI, EXAMINING ATTORNEY

SN 78-516,234. LINEWEAVER DESIGNS, LLC, ATLANTA, GA. FILED 11-12-2004.

LINEWEAVER

THE MARK CONSISTS OF STANDARD CHARACTERS WITHOUT CLAIM TO ANY PARTICULAR FONT, STYLE, SIZE, OR COLOR.

FOR GREETING CARDS, BLANK FOLD-OVER CARDS, THANK YOU NOTES, NOTE PADS, BLANK JOURNAL BOOKS, AND GIFT WRAPPING PAPER (U.S. CLS. 2, 5, 22, 23, 29, 37, 38 AND 50).

FIRST USE 5-18-2003; IN COMMERCE 5-18-2003.
JASON LOTT, EXAMINING ATTORNEY

CLASS 16—(Continued).

SN 78-516,614. JENNIFER L. EKLUND, DBA PIANO PRONTO, COSTA MESA, CA. FILED 11-14-2004.

Piano Pronto

THE MARK CONSISTS OF STANDARD CHARACTERS WITHOUT CLAIM TO ANY PARTICULAR FONT, STYLE, SIZE, OR COLOR.

NO CLAIM IS MADE TO THE EXCLUSIVE RIGHT TO USE "PIANO", APART FROM THE MARK AS SHOWN.

FOR PRINTED MUSIC BOOKS FOR PIANO INSTRUCTION (U.S. CLS. 2, 5, 22, 23, 29, 37, 38 AND 50).

FIRST USE 4-1-2004; IN COMMERCE 5-17-2004.
JEAN IM, EXAMINING ATTORNEY

SN 78-516,694. CASLER, JEFFREY, BOSTON, MA. FILED 11-15-2004.

BLUE STATE OF MIND

THE MARK CONSISTS OF STANDARD CHARACTERS WITHOUT CLAIM TO ANY PARTICULAR FONT, STYLE, SIZE, OR COLOR.

FOR ADDRESS BOOKS, ADHESIVE NOTE PADS, APPLIQUES IN THE FORM OF DECALS, BALL POINT PENS, BALL PENS, BANNERS OF PAPER, GREETING CARDS, BLANK NOTE CARDS, BUMPER STICKERS, CALENDARS, PENCILS, DAY PLANNERS, DESKTOP PLANNERS, DESK PADS, NOTE PADS, ENVELOPES, PENS, FELT TIP MARKERS, FOLDERS, MEMO PADS, GIFT WRAP PAPER, MAPS, NOTE PAPER, PRINTED EMBLEMS, PAPER FLAGS, STATIONERY, POSTCARDS, POSTERS, STICKERS AND RUBBER STAMPS (U.S. CLS. 2, 5, 22, 23, 29, 37, 38 AND 50).

CARRIE ACHEN, EXAMINING ATTORNEY

CLASS 16—(Continued).

SN 78-516,713. TARA MATERIALS, INC., LAWRENCEVILLE, GA. FILED 11-15-2004.

SEWPAINTABLE

THE MARK CONSISTS OF STANDARD CHARACTERS WITHOUT CLAIM TO ANY PARTICULAR FONT, STYLE, SIZE, OR COLOR.

FOR CANVAS PANELS FOR ARTISTS (U.S. CLS. 2, 5, 22, 23, 29, 37, 38 AND 50).

AMY GEARIN, EXAMINING ATTORNEY

SN 78-517,206. EXPRESS COMMUNICATIONS, INC., DALLAS, TX. FILED 11-15-2004.

TELECROWN

THE MARK CONSISTS OF STANDARD CHARACTERS WITHOUT CLAIM TO ANY PARTICULAR FONT, STYLE, SIZE, OR COLOR.

FOR PRE-PAID TELEPHONE CALLING CARDS, NOT MAGNETICALLY ENCODED (U.S. CLS. 2, 5, 22, 23, 29, 37, 38 AND 50).

FIRST USE 12-16-2003; IN COMMERCE 12-16-2003.
CARRIE ACHEN, EXAMINING ATTORNEY

SN 78-517,446. THE STUDER GROUP, L.L.C., GULF BREEZE, FL. FILED 11-16-2004.

HARDWIRED RESULTS

THE MARK CONSISTS OF STANDARD CHARACTERS WITHOUT CLAIM TO ANY PARTICULAR FONT, STYLE, SIZE, OR COLOR.

FOR MAGAZINE THAT FOCUSES ON HEALTHCARE SERVICE AND OPERATIONAL EXCELLENCE THEMES (U.S. CLS. 2, 5, 22, 23, 29, 37, 38 AND 50).

FIRST USE 9-15-2004; IN COMMERCE 9-15-2004.
CAROLINE WOOD, EXAMINING ATTORNEY

CLASS 16—(Continued).

SN 78-517,600. POCKET REFERENCE JOURNALS, INC., FOUNTAIN VALLEY, CA. FILED 11-16-2004.

STEP ON IT!

THE MARK CONSISTS OF STANDARD CHARACTERS WITHOUT CLAIM TO ANY PARTICULAR FONT, STYLE, SIZE, OR COLOR.

FOR PRINTED MATERIALS, NAMELY, JOURNALS ON THE SUBJECT OF DIET AND EXERCISE (U.S. CLS. 2, 5, 22, 23, 29, 37, 38 AND 50).

FIRST USE 10-25-2004; IN COMMERCE 10-25-2004.
GRETTA YAO, EXAMINING ATTORNEY

SN 78-517,702. INTERNATIONAL SPEEDWAY CORPORATION, DAYTONA BEACH, FL. FILED 11-16-2004.



NO CLAIM IS MADE TO THE EXCLUSIVE RIGHT TO USE "PRESS", APART FROM THE MARK AS SHOWN.

FOR PUBLICATIONS, NAMELY, BOOKS, MAGAZINES AND NEWSLETTERS IN THE FIELD OF MOTORSPORTS RACING (U.S. CLS. 2, 5, 22, 23, 29, 37, 38 AND 50).

FIRST USE 10-10-2004; IN COMMERCE 10-10-2004.
GIANCARLO CASTRO, EXAMINING ATTORNEY

SN 78-517,771. PAPIQUE, LLC, CHARLOTTE, NC. FILED 11-16-2004.

PAPER WITH A PUNCH

THE MARK CONSISTS OF STANDARD CHARACTERS WITHOUT CLAIM TO ANY PARTICULAR FONT, STYLE, SIZE, OR COLOR.

FOR PAPER STATIONERY, GIFT CARDS, NOTE PADS, AND PAPER CONFETTI (U.S. CLS. 2, 5, 22, 23, 29, 37, 38 AND 50).

FIRST USE 11-15-2004; IN COMMERCE 11-15-2004.
JOHN HWANG, EXAMINING ATTORNEY

CLASS 16—(Continued).

SN 78-517,813. LAKEWOOD CHURCH, HOUSTON, TX. FILED 11-16-2004.

CLASS 16—(Continued).

SN 78-519,116. PETER LI, INC., DAYTON, OH. FILED 11-18-2004.

LifeNow

CREATIVE CATECHIST

THE MARK CONSISTS OF STANDARD CHARACTERS WITHOUT CLAIM TO ANY PARTICULAR FONT, STYLE, SIZE, OR COLOR.

FOR RELIGIOUS MAGAZINE (U.S. CLS. 2, 5, 22, 23, 29, 37, 38 AND 50).

FIRST USE 6-9-2004; IN COMMERCE 6-9-2004.

WILLIAM BRECKENFELD, EXAMINING ATTORNEY

THE MARK CONSISTS OF STANDARD CHARACTERS WITHOUT CLAIM TO ANY PARTICULAR FONT, STYLE, SIZE, OR COLOR.

OWNER OF U.S. REG. NO. 1,813,657.

FOR BOOKS AND MAGAZINES DEALING WITH RELIGION AND EDUCATION (U.S. CLS. 2, 5, 22, 23, 29, 37, 38 AND 50).

DAWN HAN, EXAMINING ATTORNEY

SN 78-518,656. E2INTERACTIVE, INC., DBA E2INTERACTIVE, INC., ATLANTA, GA. FILED 11-17-2004.

SN 78-519,213. CAROLRHODA BOOKS, INC., MINNEAPOLIS, MN. FILED 11-18-2004.

INCOMM

WORDS ARE CATEGORICAL

THE MARK CONSISTS OF STANDARD CHARACTERS WITHOUT CLAIM TO ANY PARTICULAR FONT, STYLE, SIZE, OR COLOR.

OWNER OF U.S. REG. NOS. 2,266,684, 2,549,126 AND OTHERS.

FOR NON-MAGNETICALLY ENCODED PREPAID DEBIT AND STORED VALUE CARDS (U.S. CLS. 2, 5, 22, 23, 29, 37, 38 AND 50).

FIRST USE 9-1-1992; IN COMMERCE 9-1-1992.

KAREN BRACEY, EXAMINING ATTORNEY

THE MARK CONSISTS OF STANDARD CHARACTERS WITHOUT CLAIM TO ANY PARTICULAR FONT, STYLE, SIZE, OR COLOR.

FOR SERIES OF BOOKS ON THE SUBJECT OF WORDS AND LANGUAGE (U.S. CLS. 2, 5, 22, 23, 29, 37, 38 AND 50).

FIRST USE 1-15-1999; IN COMMERCE 1-15-1999.

JOHN HWANG, EXAMINING ATTORNEY

CLASS 16—(Continued).

SN 78-519,506. QUARASAN GROUP, INC., THE, CHICAGO, IL. FILED 11-18-2004.

GIOPACK

THE MARK CONSISTS OF STANDARD CHARACTERS WITHOUT CLAIM TO ANY PARTICULAR FONT, STYLE, SIZE, OR COLOR.

FOR KIT OF GRAPHICS MATERIALS TO INSPIRE, MOTIVATE AND ENCOURAGE VISUAL ARTICULATION OF CONCEPTUAL IDEAS CONTAINING A NOTEBOOK WITH VARIOUS TYPES OF PAPER, DESIGN QUIZ AND GRAPHIC DESIGN PROMPTS, ZIPPERED BAG WITH GRAPHIC IDENTIFICATION TAG, TEMPLATES, DIFFERENT COLOR AND TYPES OF WRITING INSTRUMENTS AND STORAGE FOLDERS (U.S. CLS. 2, 5, 22, 23, 29, 37, 38 AND 50).

KATHY DE JONGE, EXAMINING ATTORNEY

CLASS 16—(Continued).

SN 78-519,588. BARGER, DAVID A., LOUISVILLE, KY. FILED 11-18-2004.

tiəəɪlɪzA

THE MARK CONSISTS OF THE WORDING "AS I SEE IT" SPELLED BACKWARDS.

FOR GREETING CARDS, CALENDARS, BOOKMARKS, BOOKLETS IN THE FIELD OF ART DRAWINGS, POSTERS, ART PRINTS (U.S. CLS. 2, 5, 22, 23, 29, 37, 38 AND 50).

FIRST USE 12-20-2004; IN COMMERCE 12-20-2004.
BARBARA RUTLAND, EXAMINING ATTORNEY

SN 78-520,127. STANDEX INTERNATIONAL CORPORATION, SALEM, NH. FILED 11-19-2004.

SN 78-519,535. LEASE ONE, INC., FRANKFORT, IL. FILED 11-18-2004.

**NEIGHBORHOOD
TRADER**

THE MARK CONSISTS OF STANDARD CHARACTERS WITHOUT CLAIM TO ANY PARTICULAR FONT, STYLE, SIZE, OR COLOR.

NO CLAIM IS MADE TO THE EXCLUSIVE RIGHT TO USE TRADER, APART FROM THE MARK AS SHOWN.

FOR PERIODIC PUBLICATION, NAMELY MAGAZINES FEATURING CLASSIFIED AND DISPLAY ADVERTISING, AND CONSUMER REFERENCE MANUAL (U.S. CLS. 2, 5, 22, 23, 29, 37, 38 AND 50).

FIRST USE 1-0-2004; IN COMMERCE 6-0-2004.
GISELLE AGOSTO, EXAMINING ATTORNEY

**TRADING PLACES
WHERE JESUS MAKES
A WORLD OF
DIFFERENCE**

THE MARK CONSISTS OF STANDARD CHARACTERS WITHOUT CLAIM TO ANY PARTICULAR FONT, STYLE, SIZE, OR COLOR.

FOR PRINTED MATTER, NAMELY EDUCATIONAL BOOKS FEATURING RELIGIOUS CONTENT (U.S. CLS. 2, 5, 22, 23, 29, 37, 38 AND 50).

MONTIA G. PRESSEY, EXAMINING ATTORNEY

CLASS 16—(Continued).

SN 78-520,626. WONDER WORKS WELLNESS LLC, MEDINA, OH. FILED 11-20-2004.

CLASS 16—(Continued).

SN 78-520,741. INTERNATIONAL PAPER COMPANY, STAMFORD, CT. FILED 11-22-2004.

Love Knows The Way

**WE PACKAGE
EXCELLENCE**

THE MARK CONSISTS OF STANDARD CHARACTERS WITHOUT CLAIM TO ANY PARTICULAR FONT, STYLE, SIZE, OR COLOR.

FOR SERIES OF FICTITIOUS BOOKS, GREETING CARDS, STATIONERY WRITING PAPER AND ENVELOPES, PAPER NOTE TABLETS, WRITING TABLETS (U.S. CLS. 2, 5, 22, 23, 29, 37, 38 AND 50).

MARY BOAGNI, EXAMINING ATTORNEY

THE MARK CONSISTS OF STANDARD CHARACTERS WITHOUT CLAIM TO ANY PARTICULAR FONT, STYLE, SIZE, OR COLOR.

OWNER OF U.S. REG. NO. 2,929,567. FOR CORRUGATED CONTAINERS (U.S. CLS. 2, 5, 22, 23, 29, 37, 38 AND 50).

FIRST USE 9-1-2004; IN COMMERCE 9-1-2004. TARAH HARDY, EXAMINING ATTORNEY

SN 78-520,690. KOLEDIN, ALICIA L., NEW YORK, NY. FILED 11-21-2004.

SN 78-521,060. INGRAM, TERESSA, DALLAS, TX. FILED 11-22-2004.

Sellout Magazine

SWEET PRINCESS

THE MARK CONSISTS OF STANDARD CHARACTERS WITHOUT CLAIM TO ANY PARTICULAR FONT, STYLE, SIZE, OR COLOR.

NO CLAIM IS MADE TO THE EXCLUSIVE RIGHT TO USE MAGAZINE, APART FROM THE MARK AS SHOWN.

FOR MAGAZINE PROVIDING INFORMATION RELATING PRIMARILY TO MUSIC, OTHER FORMS OF ENTERTAINMENT, POLITICS, AND SOCIAL ISSUES (U.S. CLS. 2, 5, 22, 23, 29, 37, 38 AND 50).

HOWARD B. LEVINE, EXAMINING ATTORNEY

THE MARK CONSISTS OF STANDARD CHARACTERS WITHOUT CLAIM TO ANY PARTICULAR FONT, STYLE, SIZE, OR COLOR.

FOR CHILDREN'S BOOKS, CHILDREN'S MAGAZINES, STATIONERY, STICKERS, GREETING CARDS, AND PARTY SUPPLIES, NAMELY, PAPER PARTY DECORATIONS AND HATS (U.S. CLS. 2, 5, 22, 23, 29, 37, 38 AND 50).

TARAH HARDY, EXAMINING ATTORNEY

CLASS 16—(Continued).

SN 78-521,087. SAMUEL, JENNIFER, SAINT LOUIS PARK, MN. FILED 11-22-2004.

52 Fights

THE MARK CONSISTS OF STANDARD CHARACTERS WITHOUT CLAIM TO ANY PARTICULAR FONT, STYLE, SIZE, OR COLOR.

FOR SERIES OF BOOKS IN THE FIELD OF RELATIONSHIPS (U.S. CLS. 2, 5, 22, 23, 29, 37, 38 AND 50).
MICHAEL KAZAZIAN, EXAMINING ATTORNEY

CLASS 16—(Continued).

SN 78-521,864. SIMON & SCHUSTER, INC., NEW YORK, NY. FILED 11-23-2004.



OWNER OF U.S. REG. NO. 1,198,663.
NO CLAIM IS MADE TO THE EXCLUSIVE RIGHT TO USE "PRESS", APART FROM THE MARK AS SHOWN.

FOR SERIES OF FICTION AND NON-FICTION BOOKS ON A VARIETY OF SUBJECTS (U.S. CLS. 2, 5, 22, 23, 29, 37, 38 AND 50).

DAVID H. STINE, EXAMINING ATTORNEY

SN 78-522,150. RED ROCK INNOVATIONS, INC., MOAB, UT. FILED 11-23-2004.

SN 78-521,314. KC PET PRODUCTS LLC, PORTLAND, OR. FILED 11-22-2004.



Kayenta

THE COLOR GRAY IS INTENDED TO INDICATE SHADING OR CONTRAST ONLY, THE MARK IS NOT IN COLOR.
THE MARK CONSISTS OF FANCIFUL WORD "DRY-FUR".

FOR PAPER DISPOSABLE CRATE MATS FOR PET CARRIERS (U.S. CLS. 2, 5, 22, 23, 29, 37, 38 AND 50).
ROBERT C. CLARK JR., EXAMINING ATTORNEY

THE MARK CONSISTS OF STANDARD CHARACTERS WITHOUT CLAIM TO ANY PARTICULAR FONT, STYLE, SIZE, OR COLOR.

FOR FINE ART PAPERS FOR INKJET PRINTING IN THE FORM OF ROLLS AND CUT SHEET SIZES (U.S. CLS. 2, 5, 22, 23, 29, 37, 38 AND 50).

FIRST USE 2-1-2004; IN COMMERCE 2-1-2004.

PAUL F. GAST, EXAMINING ATTORNEY

CLASS 16—(Continued).

SN 78-522,529. HATTON INTERSESTS, INC., HOUSTON, TX. FILED 11-24-2004.

CLASS 16—(Continued).

SN 78-522,790. OLYMPIC MOUNTAIN SCHOOL PRESS, GIG HARBOR, WA. FILED 11-24-2004.

Prayorities

88 Secrets

THE MARK CONSISTS OF STANDARD CHARACTERS WITHOUT CLAIM TO ANY PARTICULAR FONT, STYLE, SIZE, OR COLOR.

FOR CALENDARS; PERSONAL ORGANIZERS, DAILY PLANNERS, AND DATE BOOKS; DIARIES AND JOURNALS; RELIGIOUS BOOKS; PRINTED GUIDES AND WORKBOOKS DIRECTED TO DEVOTIONAL STUDIES (U.S. CLS. 2, 5, 22, 23, 29, 37, 38 AND 50).
DAWN HAN, EXAMINING ATTORNEY

THE MARK CONSISTS OF STANDARD CHARACTERS WITHOUT CLAIM TO ANY PARTICULAR FONT, STYLE, SIZE, OR COLOR.

FOR SERIES OF NON-FICTION BOOKS ON PHOTOGRAPHY (U.S. CLS. 2, 5, 22, 23, 29, 37, 38 AND 50).
FIRST USE 7-1-2004; IN COMMERCE 8-28-2004.
ERNEST SHOSHO, EXAMINING ATTORNEY

SN 78-522,733. NEUTRAL TERRITORY LLC, OXNARD, CA. FILED 11-24-2004.

SN 78-523,837. NEAL PUBLICATIONS, INC., PERRYSBURG, OH. FILED 11-29-2004.

B-MAIL

AppraisalPro

THE MARK CONSISTS OF STANDARD CHARACTERS WITHOUT CLAIM TO ANY PARTICULAR FONT, STYLE, SIZE, OR COLOR.

FOR SOCIAL NOTE CARDS, PAPER TAGS, LABELS, AND NAPKINS; BLANK NOTE CARDS, BLANK PAPER TAGS, LABELS, AND NAPKINS; PREPRINTED NOTE CARDS, PAPER TAGS, LABELS, AND NAPKINS (U.S. CLS. 2, 5, 22, 23, 29, 37, 38 AND 50).
DAHLIA GEORGE, EXAMINING ATTORNEY

THE MARK CONSISTS OF STANDARD CHARACTERS WITHOUT CLAIM TO ANY PARTICULAR FONT, STYLE, SIZE, OR COLOR.

FOR BOOKS IN THE FIELDS OF HUMAN RESOURCES, BUSINESS MANAGEMENT, AND SELF HELP (U.S. CLS. 2, 5, 22, 23, 29, 37, 38 AND 50).
ROBIN CHOSID, EXAMINING ATTORNEY

CLASS 16—(Continued).

SN 78-523,868. THE MORNING CALL, INC., ALLENTOWN, PA. FILED 11-29-2004.

MERGE

THE MARK CONSISTS OF STANDARD CHARACTERS WITHOUT CLAIM TO ANY PARTICULAR FONT, STYLE, SIZE, OR COLOR.

FOR NEWSPAPERS FOR GENERAL CIRCULATION (U.S. CLS. 2, 5, 22, 23, 29, 37, 38 AND 50).
JOHN WILKE, EXAMINING ATTORNEY

SN 78-525,537. FLORA, CHARLIE, SIMI VALLEY, CA. FILED 12-1-2004.



THE MARK CONSISTS OF STYLIZED LETTERING. FOR GUIDE BOOKS TO A CITY WHICH WILL INCLUDE ADVERTISEMENTS FOR LOCAL BUSINESSES AND PICTURES AND MAPS OF THE AREA BEING REPRESENTED (U.S. CLS. 2, 5, 22, 23, 29, 37, 38 AND 50).

CHRISTOPHER ADKINS, EXAMINING ATTORNEY

SN 78-526,108. TRIBUNE MEDIA SERVICES, INC., CHICAGO, IL. FILED 12-2-2004.

SATISFACTION

THE MARK CONSISTS OF STANDARD CHARACTERS WITHOUT CLAIM TO ANY PARTICULAR FONT, STYLE, SIZE, OR COLOR.

FOR GENERAL FEATURE MAGAZINES (U.S. CLS. 2, 5, 22, 23, 29, 37, 38 AND 50).
JASON TURNER, EXAMINING ATTORNEY

CLASS 16—(Continued).

SN 78-527,402. \$1,000,000AIRE BLUEPRINTS, ARLINGTON, TX. FILED 12-6-2004.



THE COLOR(S) GOLD, BLUE, AND GRAY IS/ARE CLAIMED AS A FEATURE OF THE MARK.

THE TERMS "\$1,000,000" AND "AIRE" IN THE COLOR GOLD WITH A GRAY SHADOWING AROUND THE TERMS. THE WORD "BLUEPRINTS" AND THE BLUEPRINT DESIGN ARE IN THE COLOR BLUE WITH GRAY SHADOWING.

FOR MAGAZINES IN THE FIELD OF BUSINESS (U.S. CLS. 2, 5, 22, 23, 29, 37, 38 AND 50).

DOUGLAS LEE, EXAMINING ATTORNEY

SN 78-529,604. CUNNEEN, EDWARD J., LOMBARD, IL. FILED 12-9-2004.



FOR VINYL DECALS (U.S. CLS. 2, 5, 22, 23, 29, 37, 38 AND 50).

STANLEY I. OSBORNE, EXAMINING ATTORNEY

SN 78-529,723. OUTDOOR LIFE NETWORK, L.L.C., STAMFORD, CT. FILED 12-9-2004.

GRAVITY

THE MARK CONSISTS OF STANDARD CHARACTERS WITHOUT CLAIM TO ANY PARTICULAR FONT, STYLE, SIZE, OR COLOR.

OWNER OF U.S. REG. NOS. 2,522,255, 2,531,919 AND 2,872,255.

FOR MAGAZINES FEATURING ARTICLES AND FEATURES OF INTEREST ABOUT ACTION SPORTS (U.S. CLS. 2, 5, 22, 23, 29, 37, 38 AND 50).

DAWN FELDMAN, EXAMINING ATTORNEY

CLASS 16—(Continued).

SN 78-529,730. PREFERRED SERVICES NETWORK, INC., SUNRISE, FL. FILED 12-9-2004.

Desi-Keep

THE MARK CONSISTS OF STANDARD CHARACTERS WITHOUT CLAIM TO ANY PARTICULAR FONT, STYLE, SIZE, OR COLOR.

FOR MEMORY BOOKS (U.S. CLS. 2, 5, 22, 23, 29, 37, 38 AND 50).

DAWN FELDMAN, EXAMINING ATTORNEY

SN 78-529,897. LITHGOW, JOHN, BEVERLY HILLS, CA. FILED 12-9-2004.

LITHGOW PALOOZA!

THE MARK CONSISTS OF STANDARD CHARACTERS WITHOUT CLAIM TO ANY PARTICULAR FONT, STYLE, SIZE, OR COLOR.

THE NAME SHOWN IN THE MARK IDENTIFIES JOHN LITHGOW, WHOSE CONSENT TO REGISTER IS SUBMITTED.

FOR PRINTED MATTER, NAMELY, CHILDREN'S BOOKS, CHILDREN'S ACTIVITY BOOKS AND CHILDREN'S STORY BOOKS, CHILDREN'S MAGAZINES, CHILDREN'S ACTIVITY MAGAZINES AND CHILDREN'S STORY MAGAZINES, NEWSPAPERS, CALENDARS, PHOTOGRAPHS, POSTERS AND DECALS (U.S. CLS. 2, 5, 22, 23, 29, 37, 38 AND 50).

LINDA E. BLOHM, EXAMINING ATTORNEY

CLASS 16—(Continued).

SN 78-531,048. ENLIGHTENNEXT, INC., DBA ENLIGHTENNEXT, LENOX, MA. FILED 12-11-2004.

What is Enlightenment?

THE MARK CONSISTS OF STANDARD CHARACTERS WITHOUT CLAIM TO ANY PARTICULAR FONT, STYLE, SIZE, OR COLOR.

FOR MAGAZINES FEATURING ARTICLES, INTERVIEWS AND GRAPHICS ON THE TOPIC OF EVOLUTIONARY THINKING AND DEVELOPMENT IN BUSINESS AND ECONOMY, CULTURE AND SOCIETY, ENLIGHTENMENT AND SPIRITUAL LIFE, GOVERNANCE, HEALTH, PHILOSOPHY, POLITICS AND GLOBAL CONDITIONS, PSYCHOLOGY, RELIGIOUS TRADITIONS AND SPIRITUAL PATHS, SCIENCE AND TECHNOLOGY. (U.S. CLS. 2, 5, 22, 23, 29, 37, 38 AND 50).

FIRST USE 12-1-1991; IN COMMERCE 12-1-1991.

JILL PRATER, EXAMINING ATTORNEY

SN 78-532,152. PARAMOUNT PICTURES CORPORATION, HOLLYWOOD, CA. FILED 12-14-2004.

STAR TREK TITAN

THE MARK CONSISTS OF STANDARD CHARACTERS WITHOUT CLAIM TO ANY PARTICULAR FONT, STYLE, SIZE, OR COLOR.

OWNER OF U.S. REG. NOS. 2,157,598, 2,697,028 AND OTHERS.

FOR PAPER GOODS AND PRINTED MATTER, NAMELY A SERIES OF FICTION BOOKS (U.S. CLS. 2, 5, 22, 23, 29, 37, 38 AND 50).

REBECCA GAN, EXAMINING ATTORNEY

CLASS 16—(Continued).

SN 78-533,216. TRAN, MARK T., HOUSTON, TX. FILED 12-15-2004.

Than Tai Magazine

THE MARK CONSISTS OF STANDARD CHARACTERS WITHOUT CLAIM TO ANY PARTICULAR FONT, STYLE, SIZE, OR COLOR.

NO CLAIM IS MADE TO THE EXCLUSIVE RIGHT TO USE "MAGAZINE", APART FROM THE MARK AS SHOWN. THE ENGLISH TRANSLATION OF THE VIETNAMESE WORDING "THAN TAI" IS "GOD OF FORTUNE".

FOR GENERAL INTEREST MAGAZINE (U.S. CLS. 2, 5, 22, 23, 29, 37, 38 AND 50).

BARBARA A. GOLD, EXAMINING ATTORNEY

SN 78-536,882. SEALED AIR CORPORATION (US), SADDLE BROOK, NJ. FILED 12-22-2004.

TUFFGARD EXTREME

THE MARK CONSISTS OF STANDARD CHARACTERS WITHOUT CLAIM TO ANY PARTICULAR FONT, STYLE, SIZE, OR COLOR.

OWNER OF U.S. REG. NO. 2,460,507. FOR MAILING ENVELOPES (U.S. CLS. 2, 5, 22, 23, 29, 37, 38 AND 50).

GIANCARLO CASTRO, EXAMINING ATTORNEY

SN 78-539,019. WILLIAMS, ERIC R., PROSPECT, KY. FILED 12-28-2004.

**Sophisticated
Living**

THE MARK CONSISTS OF STANDARD CHARACTERS WITHOUT CLAIM TO ANY PARTICULAR FONT, STYLE, SIZE, OR COLOR.

FOR GENERAL FEATURE MAGAZINES (U.S. CLS. 2, 5, 22, 23, 29, 37, 38 AND 50).

ELLEN B. AWRICH, EXAMINING ATTORNEY

CLASS 16—(Continued).

SN 78-539,324. WILLITTS DESIGNS INTERNATIONAL, INC., PETALUMA, CA. FILED 12-28-2004.

PENTASTIC PEN PALS

THE MARK CONSISTS OF STANDARD CHARACTERS WITHOUT CLAIM TO ANY PARTICULAR FONT, STYLE, SIZE, OR COLOR.

FOR DECORATIVE PENS, PEN HOLDERS AND PEN TOP ORNAMENTS (U.S. CLS. 2, 5, 22, 23, 29, 37, 38 AND 50).

ALINA MORRIS, EXAMINING ATTORNEY

SN 78-539,369. IRIS PROPERTIES, INC, NEW YORK, NY. FILED 12-29-2004.

THE BOSTON SOUND

THE MARK CONSISTS OF STANDARD CHARACTERS WITHOUT CLAIM TO ANY PARTICULAR FONT, STYLE, SIZE, OR COLOR.

OWNER OF U.S. REG. NOS. 2,459,890 AND 2,515,554. NO CLAIM IS MADE TO THE EXCLUSIVE RIGHT TO USE BOSTON, APART FROM THE MARK AS SHOWN.

FOR PAPER GOODS, NAMELY, BOOKS, CONCERT TOUR BOOKS, AND PROGRAMS, ALL ON THE SUBJECT OF VOCAL AND INSTRUMENTAL MUSICAL GROUPS, POSTERS, BANNERS, CALENDARS, STICKERS, PHOTOGRAPHS, NOTEBOOKS AND BOOK COVERS, NAPKINS AND TOWELS, TISSUE, POST CARDS, NAME TAGS, STATIONERY, PRINTED INVITATIONS (U.S. CLS. 2, 5, 22, 23, 29, 37, 38 AND 50).

ALICE BENMAMAN, EXAMINING ATTORNEY

SN 78-541,167. TIME INC., NEW YORK, NY. FILED 1-3-2005.

READY, SET, SUMMER

THE MARK CONSISTS OF STANDARD CHARACTERS WITHOUT CLAIM TO ANY PARTICULAR FONT, STYLE, SIZE, OR COLOR.

FOR ACTIVITY BOOKS FOR CHILDREN (U.S. CLS. 2, 5, 22, 23, 29, 37, 38 AND 50).

ALLISON SCHRODY, EXAMINING ATTORNEY

CLASS 16—(Continued).

SN 78-543,825. DEUTSCHE TELEKOM AG, BONN, FED REP GERMANY, FILED 1-7-2005.

CLASS 16—(Continued).

SN 78-544,818. MORGAN STANLEY, NEW YORK, NY. FILED 1-10-2005.

JOURNAL OF APPLIED CORPORATE FINANCE

T-Mobile Thanx

THE MARK CONSISTS OF STANDARD CHARACTERS WITHOUT CLAIM TO ANY PARTICULAR FONT, STYLE, SIZE, OR COLOR.

NO CLAIM IS MADE TO THE EXCLUSIVE RIGHT TO USE "JOURNAL", APART FROM THE MARK AS SHOWN. SEC. 2(F).

FOR JOURNALS IN THE FIELD OF FINANCE (U.S. CLS. 2, 5, 22, 23, 29, 37, 38 AND 50).

FIRST USE 12-31-1988; IN COMMERCE 12-31-1988. STEVEN PEREZ, EXAMINING ATTORNEY

THE MARK CONSISTS OF STANDARD CHARACTERS WITHOUT CLAIM TO ANY PARTICULAR FONT, STYLE, SIZE, OR COLOR.

OWNER OF FED REP GERMANY REG. NO. 30441826, DATED 8-16-2004, EXPIRES 7-31-2014.

OWNER OF U.S. REG. NOS. 2,282,432, 2,908,563 AND OTHERS.

FOR PRINTED MATTER, NAMELY, TELEPHONE DIRECTORIES, SERIES OF BOOKS, NEWSLETTERS, PAMPHLETS, BROCHURES, MAGAZINES AND PAPERBACKS, ALL IN THE FIELD OF TELECOMMUNICATIONS; PRINTED AND STAMPED PLASTIC AND CARDBOARD GREETING, BLANK, NOTE, AND INDEX CARDS; NOTE PAPER AND ENVELOPES; NAMETAGS AND LABELS MADE FROM PAPER OR CARDBOARD; NOTEBOOKS; NOTE PADS; STATIONERY; PAPER, NAMELY, BOND PAPER AND ART PAPER; GIFT-WRAP PAPER; DIARIES; ADDRESS BOOKS; STUDENT CALENDARS; STAMP ALBUMS AND PHOTO-ALBUMS; FOLDERS FOR LETTERS AND LOOSE PAPERS; STATIONERY CLEAR HOLE TAB REINFORCEMENTS; RUBBER STAMPS AND IMPRESSION STAMPS; PAPER WEIGHTS; LETTER OPENERS; DRAWING AND UNGRADUATED RULERS; ERASERS; STAPLERS; PAPER CLIPS; BLOTTING PADS; DESK FILE TRAYS; DESK STANDS AND HOLDERS FOR HOLDING STATIONERY AND OFFICE IMPLEMENTS; PRINTED INSTRUCTIONAL AND TEACHING MATERIALS, ALL IN THE FIELDS OF TELECOMMUNICATIONS, INFORMATION TECHNOLOGY, SAFETY, NEWS, SPORTS, ENTERTAINMENT, CULTURE, BUSINESS AND FINANCE, WEATHER AND TRAVEL; BOOKMARKERS; STENCILS; SCRATCH PICTURES; PVC STICKERS; BLACKBOARDS; CHALK STICKS; ADHESIVES FOR STATIONERY OR HOUSEHOLD PURPOSES; DRAWING AND PAINTING MATERIALS, NAMELY, PENCILS, DRAWING PENCILS, PENS, DRAWING PENS, PAINT TRAYS, PAINTING SETS FOR ARTISTS, PAINTING SETS FOR CHILDREN, ARTS AND CRAFT PAINT KITS, AND PENCIL CASES; NON-MAGNETICALLY ENCODED PREPAID TELEPHONE CALLING CARDS (U.S. CLS. 2, 5, 22, 23, 29, 37, 38 AND 50).

LAURIE MAYES, EXAMINING ATTORNEY

SN 78-544,878. MEADWESTVACO CORPORATION, STAMFORD, CT. FILED 1-10-2005.

MARK-A-DAY

THE MARK CONSISTS OF STANDARD CHARACTERS WITHOUT CLAIM TO ANY PARTICULAR FONT, STYLE, SIZE, OR COLOR.

FOR LAMINATED AND PAPER ORGANIZATIONAL PRODUCTS, NAMELY, CALENDARS (U.S. CLS. 2, 5, 22, 23, 29, 37, 38 AND 50).

FIRST USE 4-1-1984; IN COMMERCE 4-1-1984. ELLEN PERKINS, EXAMINING ATTORNEY

CLASS 16—(Continued).

SN 78-544,913. BUFFETT, JIMMY, KEY WEST, FL. FILED 1-10-2005.

LAST MANGO

THE MARK CONSISTS OF STANDARD CHARACTERS WITHOUT CLAIM TO ANY PARTICULAR FONT, STYLE, SIZE, OR COLOR.

FOR PAPER GOODS AND PRINTED MATTER, NAMELY POSTERS, LITHOGRAPHS, CALENDARS, DECALS AND STICKERS, NOTE PADS, PENS AND PENCILS, AND GREETING CARDS (U.S. CLS. 2, 5, 22, 23, 29, 37, 38 AND 50).

WILLIAM VERHOSEK, EXAMINING ATTORNEY

CLASS 16—(Continued).

SN 78-545,332. NATIONAL AUTO RESEARCH DIVISION, HEARST BUSINESS MEDIA CORPORATION, NEW YORK, NY. FILED 1-11-2005.

CARS OF PARTICULAR INTEREST

THE MARK CONSISTS OF STANDARD CHARACTERS WITHOUT CLAIM TO ANY PARTICULAR FONT, STYLE, SIZE, OR COLOR.

NO CLAIM IS MADE TO THE EXCLUSIVE RIGHT TO USE "CARS", APART FROM THE MARK AS SHOWN.

FOR MAGAZINES FEATURING THE PUBLISHER'S OPINION OF THE CURRENT MARKET VALUE OF COLLECTIBLE VEHICLES PUBLISHED BI-MONTHLY OR AT OTHER INTERVALS (U.S. CLS. 2, 5, 22, 23, 29, 37, 38 AND 50).

FIRST USE 4-0-1977; IN COMMERCE 4-0-1977.
RICHARD WHITE, EXAMINING ATTORNEY

SN 78-545,263. PINK STREET LLC, ATLANTA, GA. FILED 1-11-2005.

PINC

THE MARK CONSISTS OF STANDARD CHARACTERS WITHOUT CLAIM TO ANY PARTICULAR FONT, STYLE, SIZE, OR COLOR.

FOR WOMEN'S MAGAZINE FOCUSED ON THE CAREER WOMAN (U.S. CLS. 2, 5, 22, 23, 29, 37, 38 AND 50).

CYNTHIA SLOAN, EXAMINING ATTORNEY

SN 78-545,371. VIACOM INTERNATIONAL INC., NEW YORK, NY. FILED 1-11-2005.

THE N ZINE

THE MARK CONSISTS OF STANDARD CHARACTERS WITHOUT CLAIM TO ANY PARTICULAR FONT, STYLE, SIZE, OR COLOR.

FOR GENERAL INTEREST MAGAZINE FOR PRE-TEENS, ADOLESCENTS AND YOUNG ADULTS (U.S. CLS. 2, 5, 22, 23, 29, 37, 38 AND 50).

FIRST USE 6-1-2003; IN COMMERCE 6-1-2003.
LINDA E. BLOHM, EXAMINING ATTORNEY

CLASS 16—(Continued).

SN 78-545,489. DEUTSCHE TELEKOM AG, BONN, FED REP GERMANY, FILED 1-11-2005.

CLASS 16—(Continued).

SN 78-545,917. LOEW-CORNELL, INC., TEANECK, NJ. FILED 1-11-2005.

T-Mobile Dial a Smile

THE MARK CONSISTS OF STANDARD CHARACTERS WITHOUT CLAIM TO ANY PARTICULAR FONT, STYLE, SIZE, OR COLOR.

PRIORITY CLAIMED UNDER SEC. 44(D) ON FED REP GERMANY APPLICATION NO. 30441824238, FILED 7-21-2004, REG. NO. 30441824, DATED 8-31-2004, EXPIRES 7-31-2014.

OWNER OF U.S. REG. NOS. 2,282,432, 2,908,563 AND OTHERS.

FOR PRINTED MATTER, NAMELY, TELEPHONE DIRECTORIES, SERIES OF BOOKS, NEWSLETTERS, PAMPHLETS, BROCHURES, MAGAZINES AND PAPERBACKS, ALL IN THE FIELD OF TELECOMMUNICATIONS; PRINTED AND STAMPED PLASTIC AND CARDBOARD GREETING, BLANK, NOTE, AND INDEX CARDS; NOTE PAPER AND ENVELOPES; NAMETAGS AND LABELS MADE FROM PAPER OR CARDBOARD; NOTEBOOKS; NOTE PADS; STATIONERY; PAPER, NAMELY, BOND PAPER AND ART PAPER; GIFT-WRAP PAPER; DIARIES; ADDRESS BOOKS; STUDENT CALENDARS; STAMP ALBUMS AND PHOTO-ALBUMS; FOLDERS FOR LETTERS AND LOOSE PAPERS; STATIONERY CLEAR HOLE TAB REINFORCEMENTS; RUBBER STAMPS AND IMPRESSION STAMPS; PAPER WEIGHTS; LETTER OPENERS; DRAWING AND UNGRADUATED RULERS; ERASERS; STAPLERS; PAPER CLIPS; BLOTTING PADS; DESK FILE TRAYS; DESK STANDS AND HOLDERS FOR HOLDING STATIONERY AND OFFICE IMPLEMENTS; PRINTED INSTRUCTIONAL AND TEACHING MATERIALS, ALL IN THE FIELDS OF TELECOMMUNICATIONS, INFORMATION TECHNOLOGY, SAFETY, NEWS, SPORTS, ENTERTAINMENT, CULTURE, BUSINESS AND FINANCE, WEATHER AND TRAVEL; BOOKMARKERS; STENCILS; SCRATCH PICTURES; PVC STICKERS; BLACKBOARDS; CHALK STICKS; ADHESIVES FOR STATIONERY OR HOUSEHOLD PURPOSES; DRAWING AND PAINTING MATERIALS, NAMELY, PENCILS, DRAWING PENCILS, PENS, DRAWING PENS, PAINT TRAYS, PAINTING SETS FOR ARTISTS, PAINTING SETS FOR CHILDREN, ARTS AND CRAFT PAINT KITS, AND PENCIL CASES; NON-MAGNETICALLY ENCODED PREPAID TELEPHONE CALLING CARDS (U.S. CLS. 2, 5, 22, 23, 29, 37, 38 AND 50).

LAURIE MAYES, EXAMINING ATTORNEY

SPONGIT STICKS

THE MARK CONSISTS OF STANDARD CHARACTERS WITHOUT CLAIM TO ANY PARTICULAR FONT, STYLE, SIZE, OR COLOR.

OWNER OF U.S. REG. NO. 2,760,393.

NO CLAIM IS MADE TO THE EXCLUSIVE RIGHT TO USE "STICKS", APART FROM THE MARK AS SHOWN.

FOR APPLICATORS FOR PAINTS (U.S. CLS. 2, 5, 22, 23, 29, 37, 38 AND 50).

CYNTHIA SLOAN, EXAMINING ATTORNEY

SN 78-545,928. DONNLEE ENTERPRISES, LLC, MUNCY, PA. FILED 1-11-2005.

MY MEDICAL ASSISTANT

THE MARK CONSISTS OF STANDARD CHARACTERS WITHOUT CLAIM TO ANY PARTICULAR FONT, STYLE, SIZE, OR COLOR.

NO CLAIM IS MADE TO THE EXCLUSIVE RIGHT TO USE MEDICAL, APART FROM THE MARK AS SHOWN.

FOR BLANK JOURNALS WITH FORMS FOR LISTING PERSONAL MEDICAL INFORMATION (U.S. CLS. 2, 5, 22, 23, 29, 37, 38 AND 50).

FIRST USE 8-1-2003; IN COMMERCE 8-1-2003.

ESTHER BELENKER, EXAMINING ATTORNEY

CLASS 16—(Continued).

SN 78-546,154. NATIONAL FIRE PROTECTION ASSOCIATION, INC., QUINCY, MA. FILED 1-12-2005.

NATIONAL FIRE ALARM CODE

THE MARK CONSISTS OF STANDARD CHARACTERS WITHOUT CLAIM TO ANY PARTICULAR FONT, STYLE, SIZE, OR COLOR.

OWNER OF U.S. REG. NO. 1,924,881.

NO CLAIM IS MADE TO THE EXCLUSIVE RIGHT TO USE "CODE", APART FROM THE MARK AS SHOWN.

SEC. 2(F).

FOR PERIODICAL PUBLICATIONS, NAMELY, BOOKS, BOOKLETS AND PAMPHLETS IN THE FIELD OF FIRE SAFETY AND FIRE ALARM SYSTEMS (U.S. CLS. 2, 5, 22, 23, 29, 37, 38 AND 50).

FIRST USE 1-29-1993; IN COMMERCE 8-30-1993.

KATHRYN COWARD, EXAMINING ATTORNEY

CLASS 16—(Continued).

SN 78-546,861. BEST-RITE CHALK BOARD COMPANY, DBA BEST RITE MANUFACTURING, TEMPLE, TX. FILED 1-13-2005.

PALE-RITER

THE MARK CONSISTS OF STANDARD CHARACTERS WITHOUT CLAIM TO ANY PARTICULAR FONT, STYLE, SIZE, OR COLOR.

FOR DRY ERASE WRITING BOARDS AND WRITING SURFACES; EASELS (U.S. CLS. 2, 5, 22, 23, 29, 37, 38 AND 50).

FIRST USE 1-10-2005; IN COMMERCE 1-10-2005.

IRA J. GOODSAY, EXAMINING ATTORNEY

SN 78-546,700. DEVELOPMENTAL STUDIES CENTER, OAKLAND, CA. FILED 1-12-2005.

SIPPS

THE MARK CONSISTS OF STANDARD CHARACTERS WITHOUT CLAIM TO ANY PARTICULAR FONT, STYLE, SIZE, OR COLOR.

FOR BOOKS, WORKBOOKS, AND PREPRINTED CARDS DESIGNED AS A COMPREHENSIVE READING DECODING PROGRAM FOR CHILDREN GRADES KINDERGARTEN THROUGH 6TH GRADE (U.S. CLS. 2, 5, 22, 23, 29, 37, 38 AND 50).

BRENDAN MCCAULEY, EXAMINING ATTORNEY

SN 78-548,471. HEBERT, DAVID, ROCHESTER, NY. FILED 1-17-2005.

SIT PROUD

THE MARK CONSISTS OF STANDARD CHARACTERS WITHOUT CLAIM TO ANY PARTICULAR FONT, STYLE, SIZE, OR COLOR.

FOR BUMPER STICKERS AND DECALS (U.S. CLS. 2, 5, 22, 23, 29, 37, 38 AND 50).

FIRST USE 10-1-2004; IN COMMERCE 10-1-2004.

JILL C. ALT, EXAMINING ATTORNEY

CLASS 16—(Continued).

SN 78-548,803. LEE PRODUCTS COMPANY, MINNEAPOLIS, MN. FILED 1-17-2005.

PAPERCREME

THE MARK CONSISTS OF STANDARD CHARACTERS WITHOUT CLAIM TO ANY PARTICULAR FONT, STYLE, SIZE, OR COLOR.

OWNER OF U.S. REG. NO. 954,267.
FOR HYGROSCOPIC COMPOSITION FOR MOISTENING FINGERTIPS (U.S. CLS. 2, 5, 22, 23, 29, 37, 38 AND 50).

FIRST USE 5-7-1969; IN COMMERCE 5-7-1969.
CHRIS WELLS, EXAMINING ATTORNEY

CLASS 16—(Continued).

SN 78-550,111. THE NEW YORK TIMES COMPANY, NEW YORK, NY. FILED 1-19-2005.

A NIGHT OUT WITH

THE MARK CONSISTS OF STANDARD CHARACTERS WITHOUT CLAIM TO ANY PARTICULAR FONT, STYLE, SIZE, OR COLOR.

SEC. 2(F).
FOR NEWSPAPER FEATURE, NAMELY, AN ONGOING GENERAL INTEREST NEWS COLUMN (U.S. CLS. 2, 5, 22, 23, 29, 37, 38 AND 50).

FIRST USE 7-5-1998; IN COMMERCE 7-5-1998.
REBECCA GAN, EXAMINING ATTORNEY

SN 78-550,893. NEW YORK TIMES COMPANY, THE, NEW YORK, NY. FILED 1-20-2005.

ECONOMIC SCENE

THE MARK CONSISTS OF STANDARD CHARACTERS WITHOUT CLAIM TO ANY PARTICULAR FONT, STYLE, SIZE, OR COLOR.

SEC. 2(F).
FOR NEWSPAPER FEATURE, NAMELY, AN ONGOING NEWSPAPER COLUMN CONCERNING FINANCIAL ISSUES (U.S. CLS. 2, 5, 22, 23, 29, 37, 38 AND 50).

FIRST USE 7-16-1972; IN COMMERCE 7-16-1972.
WILLIAM BRECKENFELD, EXAMINING ATTORNEY

SN 78-550,075. THE NEW YORK TIMES COMPANY, NEW YORK, NY. FILED 1-19-2005.

FOOD STUFF

THE MARK CONSISTS OF STANDARD CHARACTERS WITHOUT CLAIM TO ANY PARTICULAR FONT, STYLE, SIZE, OR COLOR.

SEC. 2(F).
FOR NEWSPAPER FEATURE, NAMELY, AN ONGOING NEWSPAPER COLUMN CONCERNING FOOD, RESTAURANTS, DINING, AND COOKING (U.S. CLS. 2, 5, 22, 23, 29, 37, 38 AND 50).

FIRST USE 9-17-1997; IN COMMERCE 9-17-1997.
MICHAEL WEBSTER, EXAMINING ATTORNEY

SN 78-550,905. THE NEW YORK TIMES COMPANY, NEW YORK, NY. FILED 1-20-2005.

WORD FOR WORD

THE MARK CONSISTS OF STANDARD CHARACTERS WITHOUT CLAIM TO ANY PARTICULAR FONT, STYLE, SIZE, OR COLOR.

SEC. 2(F).
FOR NEWSPAPER FEATURE, NAMELY, AN ONGOING GENERAL INTEREST NEWS COLUMN (U.S. CLS. 2, 5, 22, 23, 29, 37, 38 AND 50).

FIRST USE 2-20-1994; IN COMMERCE 2-20-1994.
AMY HELLA, EXAMINING ATTORNEY

CLASS 16—(Continued).

SN 78-551,059. PANTONE, INC., CARLSTADT, NJ. FILED 1-20-2005.

PANTONE COLOR BRIDGE

THE MARK CONSISTS OF STANDARD CHARACTERS WITHOUT CLAIM TO ANY PARTICULAR FONT, STYLE, SIZE, OR COLOR.

OWNER OF U.S. REG. NOS. 811,718, 1,889,838 AND OTHERS.

NO CLAIM IS MADE TO THE EXCLUSIVE RIGHT TO USE "COLOR", APART FROM THE MARK AS SHOWN.

FOR PRINTED GUIDES FOR COLOR VALUE, COLOR CONSISTENCY, AND COLOR PRINT AND PRODUCTION QUALITY (U.S. CLS. 2, 5, 22, 23, 29, 37, 38 AND 50).
LINDA M. KING, EXAMINING ATTORNEY

SN 78-551,831. SAN ANTONIO LIVESTOCK EXPOSITION, INC., SAN ANTONIO, TX. FILED 1-21-2005.

MORE THAN AN 8 SECOND RIDE

THE MARK CONSISTS OF STANDARD CHARACTERS WITHOUT CLAIM TO ANY PARTICULAR FONT, STYLE, SIZE, OR COLOR.

FOR BUMPER STICKERS, PAPER BANNERS, NOTE CARDS AND POSTCARDS (U.S. CLS. 2, 5, 22, 23, 29, 37, 38 AND 50).

JOSETTE BEVERLY, EXAMINING ATTORNEY

SN 78-552,882. PHIFER WIRE PRODUCTS, INC., TUSCALOOSA, AL. FILED 1-24-2005.

PHIFERREADER TRAVELER

THE MARK CONSISTS OF STANDARD CHARACTERS WITHOUT CLAIM TO ANY PARTICULAR FONT, STYLE, SIZE, OR COLOR.

OWNER OF U.S. REG. NO. 2,949,312.
FOR BOOKHOLDERS (U.S. CLS. 2, 5, 22, 23, 29, 37, 38 AND 50).

DEZMONA MIZELLE, EXAMINING ATTORNEY

CLASS 16—(Continued).

SN 78-554,720. ADELMAN, GREGORY, MARC, BOULDER, CO. FILED 1-27-2005.

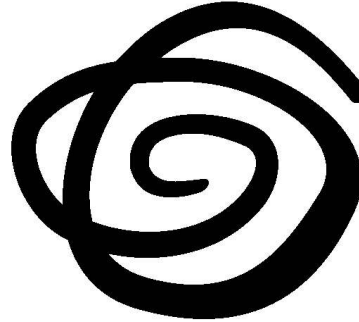

THE MARK CONSISTS OF A SPIRAL PATTERN WITH THICK LINES THAT VARY SOME IN THICKNESS. THE PATTERN LOOKS LIKE IT WAS WRITTEN FREEHAND AND HAS THE APPEARANCE OF A SCRIBBLE.

FOR WRITING INSTRUMENTS NAMELY PENS, PENCILS, PEN INK REFILLS AND MARKERS; WRITING INSTRUMENTS WITH ADDITIONAL FEATURES NAMELY FLASHLIGHTS, TOOLS AND PDA STYLUS; WRITING PAPER PRODUCTS NAMELY NOTEBOOKS, PADS, BINDERS, CALENDARS, AND STATIONERY (U.S. CLS. 2, 5, 22, 23, 29, 37, 38 AND 50).

KARLA PERKINS, EXAMINING ATTORNEY

SN 78-555,000. HARRISON, BARRY M., SAN FRANCISCO, CA. AND SIMS, NEIL, SAN FRANCISCO, CA. FILED 1-27-2005.

HOMOBILIA

THE MARK CONSISTS OF STANDARD CHARACTERS WITHOUT CLAIM TO ANY PARTICULAR FONT, STYLE, SIZE, OR COLOR.

FOR MEMORABILIA OF PARTICULAR INTEREST TO GAYS AND LESBIANS, NAMELY, GREETING CARDS, CALENDARS, SHEET MUSIC, PHOTOGRAPHS, PRINTS, BOOKS IN THE FIELD OF HOMOSEXUALITY, AND PULP FICTION NOVELS, POSTERS, MAGAZINES IN THE FIELD OF GAY CULTURE AND HOMOSEXUALITY, AND POSTCARDS (U.S. CLS. 2, 5, 22, 23, 29, 37, 38 AND 50).

ESTHER BELENKER, EXAMINING ATTORNEY

CLASS 16—(Continued).

SN 78-555,097. EXECUTIVE MACHINES, INC., BROOKLYN, NY. FILED 1-27-2005.

CLASS 16—(Continued).

SN 78-582,886. DEUTSCHE TELEKOM AG, BONN, FED REP GERMANY, FILED 3-8-2005.

MILITARY CUT

THE MARK CONSISTS OF STANDARD CHARACTERS WITHOUT CLAIM TO ANY PARTICULAR FONT, STYLE, SIZE, OR COLOR.

FOR PAPER SHREDDERS FOR OFFICE USE (U.S. CLS. 2, 5, 22, 23, 29, 37, 38 AND 50).
INGA ERVIN, EXAMINING ATTORNEY

SN 78-558,846. SPORTS NUTS INC., PLANT CITY, FL. FILED 2-2-2005.

GOLF NUT

THE MARK CONSISTS OF STANDARD CHARACTERS WITHOUT CLAIM TO ANY PARTICULAR FONT, STYLE, SIZE, OR COLOR.

FOR NOVELTY PAPERWEIGHTS (U.S. CLS. 2, 5, 22, 23, 29, 37, 38 AND 50).
ALLISON HOLTZ, EXAMINING ATTORNEY

**T-Systems
Enterprise Services**

THE MARK CONSISTS OF STANDARD CHARACTERS WITHOUT CLAIM TO ANY PARTICULAR FONT, STYLE, SIZE, OR COLOR.

PRIORITY CLAIMED UNDER SEC. 44(D) ON FED REP GERMANY APPLICATION NO. 30452358542, FILED 9-9-2004, REG. NO. 30452358, DATED 11-15-2004, EXPIRES 9-30-2014.

OWNER OF U.S. REG. NOS. 2,448,571 AND 2,880,613.
NO CLAIM IS MADE TO THE EXCLUSIVE RIGHT TO USE "ENTERPRISE SERVICES", APART FROM THE MARK AS SHOWN.

FOR PRINTED MATTER, NAMELY, TELEPHONE DIRECTORIES, SERIES OF BOOKS, NEWSLETTERS, PAMPHLETS, BROCHURES, MAGAZINES AND PAPERBACKS, ALL IN THE FIELD OF TELECOMMUNICATIONS; PRINTED AND STAMPED PLASTIC AND CARDBOARD GREETING, BLANK, NOTE, AND INDEX CARDS; NOTE PAPER AND ENVELOPES; NAMETAGS AND LABELS MADE FROM PAPER OR CARDBOARD; NOTEBOOKS; NOTE PADS; STATIONERY; PAPER, NAMELY, BOND PAPER AND ART PAPER; GIFT-WRAP PAPER; DIARIES; ADDRESS BOOKS; STUDENT CALENDARS; STAMP ALBUMS AND PHOTO-ALBUMS; FOLDERS FOR LETTERS AND LOOSE PAPERS; STATIONERY CLEAR HOLE TAB REINFORCEMENTS; RUBBER STAMPS AND IMPRESSION STAMPS; PAPER WEIGHTS; LETTER OPENERS; DRAWING AND UNGRADUATED RULERS; ERASERS; STAPLERS; PAPER CLIPS; BLOTTER PADS; DESK FILE TRAYS; DESK STANDS AND HOLDERS FOR HOLDING STATIONERY AND OFFICE IMPLEMENTS; PRINTED INSTRUCTIONAL AND TEACHING MATERIALS, ALL IN THE FIELDS OF TELECOMMUNICATIONS, INFORMATION TECHNOLOGY, SAFETY, NEWS, SPORTS, ENTERTAINMENT, CULTURE, BUSINESS AND FINANCE, WEATHER AND TRAVEL; BOOKMARKERS; STENCILS; SCRATCH PICTURES; PVC STICKERS; BLACKBOARDS; CHALK STICKS; ADHESIVES FOR STATIONERY OR HOUSEHOLD PURPOSES; DRAWING AND PAINTING MATERIALS, NAMELY, PENCILS, DRAWING PENCILS, PENS, DRAWING PENS, PAINT TRAYS, PAINTING SETS FOR ARTISTS, PAINTING SETS FOR CHILDREN, ARTS AND CRAFT PAINT KITS, AND PENCIL CASES; NON-MAGNETICALLY ENCODED PREPAID TELEPHONE CALLING CARDS (U.S. CLS. 2, 5, 22, 23, 29, 37, 38 AND 50).

Laurie Mayes, Examining Attorney

CLASS 16—(Continued).

SN 78-976,176. THE COCA-COLA COMPANY, ATLANTA, GA. FILED 9-23-2004.

CLASS 16—(Continued).

SN 79-008,025. SAKURA COLOR PRODUCTS CORPORATION, JAPAN, FILED 4-27-2004.

REFRESHING NEWS

THE MARK CONSISTS OF STANDARD CHARACTERS WITHOUT CLAIM TO ANY PARTICULAR FONT, STYLE, SIZE, OR COLOR.

NO CLAIM IS MADE TO THE EXCLUSIVE RIGHT TO USE "NEWS", APART FROM THE MARK AS SHOWN.

FOR PUBLICATIONS, NAMELY NEWSLETTERS DIRECTED TO PERSONS IN THE RETAIL FOOD SERVICE AND RESTAURANT SERVICE INDUSTRIES (U.S. CLS. 2, 5, 22, 23, 29, 37, 38 AND 50).

FIRST USE 9-13-2004; IN COMMERCE 9-13-2004.
GINA HAYES, EXAMINING ATTORNEY

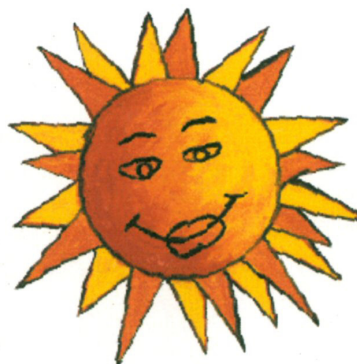

SN 79-002,377. HENKEL KGAA, FED REP GERMANY, FILED 3-17-2004.



PRIORITY DATE OF 10-11-2003 IS CLAIMED.
OWNER OF INTERNATIONAL REGISTRATION 0824166 DATED 3-17-2004, EXPIRES 3-17-2014.

THE COLOR(S) SILVER, WHITE AND DARK GREY IS/ARE CLAIMED AS A FEATURE OF THE MARK.

THE COLOR SILVER IS USED FOR THE BODY OF THE SHARK. THE COLOR DARK GREY IS USED FOR THE SHARK FIN, THE BELLY OF THE SHARK, AND THE EYE. WHITE IS USED FOR THE MOUTH/BLADE COVER.

THE MARK CONSISTS OF THE THREE-DIMENSIONAL DESIGN OF A TAPE DISPENSER, HAVING THE STYLIZED SHAPE OF A SHARK. THE MATTER SHOWN IN BROKEN LINES, THE TAPE ROLL, IS NOT CLAIMED AS A FEATURE OF THE MARK.

FOR ADHESIVES IN THE FORM OF TAPE DISPENSERS FOR STATIONERY, HOUSEHOLD AND DO-IT-YOURSELF PURPOSES (U.S. CLS. 2, 5, 22, 23, 29, 37, 38 AND 50).

JOSETTE BEVERLY, EXAMINING ATTORNEY

PRIORITY DATE OF 3-25-2004 IS CLAIMED.
OWNER OF INTERNATIONAL REGISTRATION 0840768 DATED 4-27-2004, EXPIRES 4-27-2014.

THE COLOR(S) BLACK, YELLOW AND ORANGE IS/ARE CLAIMED AS A FEATURE OF THE MARK.

THE COLOR BLACK APPEARS ON THE BORDER AND THE COLORS ORANGE AND YELLOW APPEAR WITHIN THE SUN DESIGN.

FOR WRITING INSTRUMENTS, PENS, PEN REFILLS IN THE FORM OF BALLS FOR BALLPOINT PENS, WHITE BOARD MARKERS, WRITING BOARD ERASERS, BALLPOINT PENS OR WATER BASED ROLLER PENS, REFILL CARTRIDGES FOR BALLPOINT PENS, FOUNTAIN PENS, MECHANICAL PENCILS, WRITING BRUSHES, PENCILS, PENCIL LEADS, PERMANENT OR WATER BASED MARKERS FOR STATIONERY OR INDUSTRIAL PURPOSES, INK, INDIA INK, STATIONERY, SCHOOL SUPPLIES, NAMELY, NOTEBOOKS, PEN CASES, AND CORRECTING FLUIDS FOR PENS; ERASING PRODUCTS, NAMELY, RUBBER ERASERS; ADHESIVES, NAMELY, GLUE AND PASTE FOR STATIONERY OR HOUSEHOLD PURPOSES; DRAWING PADS; EASELS; ARTICLES FOR USE IN SCHOOL, NAMELY, PALETES FOR PAINTERS, PASTELS, CRAYONS, OIL PASTELS, BRUSHES FOR PAINTING OR DRAWING, STENCILS, PAPER, FOOD AND COIN WRAPPERS, PHOTO AND STAMP ALBUMS, LOOSE LEAF BINDERS, AND DOCUMENT FILES AND FILES FOR OFFICE REQUISITES; PHOTOGRAPH STANDS, NAMELY, DESKTOP DOCUMENT STANDS; TEACHING MATERIALS, NAMELY, WRITING AND DRAWING BOOKS AND WRITING PAPER (U.S. CLS. 2, 5, 22, 23, 29, 37, 38 AND 50).

INGRID C. EULIN, EXAMINING ATTORNEY

CLASS 17—RUBBER GOODS

SN 76-524,843. WESTLAKE PLASTICS COMPANY, INC.,
LENNI, PA. FILED 6-20-2003.

ULTRA ETHYLUX

NO CLAIM IS MADE TO THE EXCLUSIVE RIGHT TO
USE ULTRA, APART FROM THE MARK AS SHOWN.

FOR POLYETHYLENE IN ROD, SHEET AND TUBU-
LAR FORMS FOR USE PRINCIPALLY BY BUILDERS,
CONSTRUCTORS AND MANUFACTURERS WHO SAW,
CUT OR OTHERWISE FORM THE RODS, SHEETS AND
TUBES OF POLYETHYLENE INTO DESIRED SHAPES
HAVING DESIRED DIMENSIONS (U.S. CLS. 1, 5, 12, 13,
35 AND 50).

FIRST USE 2-6-1958; IN COMMERCE 2-6-1958.
SCOTT OSLUCK, EXAMINING ATTORNEY

SN 76-552,725. PARKER INTANGIBLES LLC, CLEVELAND,
OH. FILED 10-20-2003.

HYBRID

SEC. 2(F).
FOR HYDRAULIC AND PNEUMATIC HOSES OF
RUBBER OR PLASTIC (U.S. CLS. 1, 5, 12, 13, 35 AND 50).
FIRST USE 1-1-1989; IN COMMERCE 1-1-1989.
JENNIFER CHICOSKI, EXAMINING ATTORNEY

SN 76-580,862. RMD, LLC, LENEXA, KS. FILED 3-15-2004.

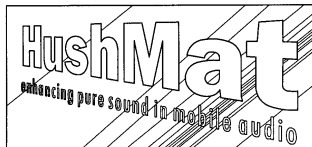

THE LINING IN THE MARK IS MEANT TO INDICATE
SHADING.

THE MARK CONSISTS IN PART OF THE WORDING
HUSHMAT ENHANCING PURE SOUND IN MOBILE
AUDIO.

FOR VIBRATION DAMPING, SOUND ABSORPTION
MATS AND TAPE FOR USE WITH MOBILE ELECTRO-
NICS (U.S. CLS. 1, 5, 12, 13, 35 AND 50).

FIRST USE 6-15-2003; IN COMMERCE 6-15-2003.
CATHERINE FAINT, EXAMINING ATTORNEY

CLASS 17—(Continued).

SN 76-587,235. AMERICAN EXCELSIOR COMPANY, AR-
LINGTON, TX. FILED 4-16-2004.

ECO FLOW

THE MARK CONSISTS OF STANDARD CHARACTERS
WITHOUT CLAIM TO ANY PARTICULAR FONT, STYLE,
SIZE, OR COLOR.

OWNER OF U.S. REG. NO. 2,454,094.
FOR BIODEGRADABLE LOOSE FILL PACKAGING
MATERIAL, NAMELY, STARCH BASED LOOSE FILL
PACKAGING (U.S. CLS. 1, 5, 12, 13, 35 AND 50).
FIRST USE 7-15-1999; IN COMMERCE 7-15-1999.
MELISSA SHELLA, EXAMINING ATTORNEY

SN 76-592,074. J.V. CONVERTING COMPANY, INC., FAIR-
LESS HILLS, PA. FILED 5-13-2004.

JVCC SPIKE PACK

THE MARK CONSISTS OF STANDARD CHARACTERS
WITHOUT CLAIM TO ANY PARTICULAR FONT, STYLE,
SIZE, OR COLOR.

NO CLAIM IS MADE TO THE EXCLUSIVE RIGHT TO
USE "SPIKE PACK", APART FROM THE MARK AS
SHOWN.

FOR ADHESIVE TAPES FOR USE IN THE ENTER-
TAINMENT INDUSTRY, BOOK BINDING, AND UP-
HOLSTERY REPAIR (U.S. CLS. 1, 5, 12, 13, 35 AND 50).

FIRST USE 12-30-2003; IN COMMERCE 12-30-2003.
DOMINIC J. FERRAIUOLO, EXAMINING ATTORNEY

SN 76-618,520. AEP INDUSTRIES INC., SOUTH HACKEN-
SACK, NJ. FILED 10-29-2004.

X-R

THE MARK CONSISTS OF STANDARD CHARACTERS
WITHOUT CLAIM TO ANY PARTICULAR FONT, STYLE,
SIZE, OR COLOR.

FOR PLASTIC FILM FOR INDUSTRIAL AND COM-
MERCIAL PACKING USE (U.S. CLS. 1, 5, 12, 13, 35 AND
50).

RUDY R. SINGLETON, EXAMINING ATTORNEY

CLASS 17—(Continued).

SN 76-619,155. SWARCO AMERICA, INC., COLUMBIA, TN.
FILED 11-3-2004.

VISA-MARK

THE MARK CONSISTS OF STANDARD CHARACTERS WITHOUT CLAIM TO ANY PARTICULAR FONT, STYLE, SIZE, OR COLOR.

FOR PAVEMENT MARKING TAPE USED FOR EDUCATIONAL SCHOOL PLAYGROUND MARKINGS, INDUSTRIAL SAFETY FLOOR MARKINGS, DURABLE PARKING LOT MARKINGS, AND CUSTOMIZED PROMOTIONAL CORPORATE/ATHLETIC LOGO MARKINGS (U.S. CLS. 1, 5, 12, 13, 35 AND 50).

FIRST USE 7-1-2004; IN COMMERCE 7-1-2004.

TIMOTHY FINNEGAN, EXAMINING ATTORNEY

SN 76-619,541. AEP INDUSTRIES INC., SOUTH HACKENSACK, NJ. FILED 11-5-2004.

EXCALIBUR

THE MARK CONSISTS OF STANDARD CHARACTERS WITHOUT CLAIM TO ANY PARTICULAR FONT, STYLE, SIZE, OR COLOR.

FOR PLASTIC FILM FOR INDUSTRIAL AND COMMERCIAL USE (U.S. CLS. 1, 5, 12, 13, 35 AND 50).

FIRST USE 10-15-1998; IN COMMERCE 10-15-1998.

KATHERINE STOIDES, EXAMINING ATTORNEY

SN 76-620,325. MSM INDUSTRIES, SMYRNA, TN. FILED 11-12-2004.

SOFT-WALK

THE MARK CONSISTS OF STANDARD CHARACTERS WITHOUT CLAIM TO ANY PARTICULAR FONT, STYLE, SIZE, OR COLOR.

FOR SOUND ABSORBING FLOORING UNDERLAYMENT (U.S. CLS. 1, 5, 12, 13, 35 AND 50).

FIRST USE 10-15-2002; IN COMMERCE 1-1-2003.

NANCY CLARKE, EXAMINING ATTORNEY

CLASS 17—(Continued).

SN 76-626,052. ABOUNADER, PAULETTE, BUFFALO, NY.
FILED 12-27-2004.

TAPEGROUPUSA

SEC. 2(F).

FOR ADHESIVE TRANSFER TAPE FOR INDUSTRIAL AND COMMERCIAL USE THAT IS USED BY FINISHING COMPANIES OF BUSINESS FORMS, TAGS AND LABELS AND OTHER GOODS, BINDING COMPANIES, ENVELOPE COMPANIES AND PRINTING COMPANIES (U.S. CLS. 1, 5, 12, 13, 35 AND 50).

FIRST USE 3-24-1997; IN COMMERCE 3-24-1997.

TANYA AMOS, EXAMINING ATTORNEY

SN 76-627,142. METL-SPAN I, LTD., LEWISVILLE, TX.
FILED 1-7-2005.

THERMALSAFE

THE MARK CONSISTS OF STANDARD CHARACTERS WITHOUT CLAIM TO ANY PARTICULAR FONT, STYLE, SIZE, OR COLOR.

FOR METAL INSULATED CONSTRUCTION PANEL CONTAINING A NON-COMBUSTIBLE STRUCTURAL MINERAL WOOL CORE AND EXTERIOR AND INTERIOR LIGHT GAUGE METAL FACINGS FOR USE IN FIRE RESISTIVE EXTERIOR AND INTERIOR WALLS (U.S. CLS. 1, 5, 12, 13, 35 AND 50).

FIRST USE 8-31-2004; IN COMMERCE 8-31-2004.

DEBRA LEE, EXAMINING ATTORNEY

SN 78-207,561. BARREL ACCESSORIES & SUPPLIES CO., INC., UNIVERSITY PARK, IL. FILED 1-27-2003.

RIGHT SEAL

NO CLAIM IS MADE TO THE EXCLUSIVE RIGHT TO USE "SEAL", APART FROM THE MARK AS SHOWN.

FOR NON-METAL SEALING RINGS AND GASKETS (U.S. CLS. 1, 5, 12, 13, 35 AND 50).

FIRST USE 12-1-2002; IN COMMERCE 12-1-2002.

REBECCA SMITH, EXAMINING ATTORNEY

SN 78-280,347. POLYMER SEALING SOLUTIONS, INC., FORT WAYNE, IN. FILED 7-29-2003.

STEPSEAL

OWNER OF U.S. REG. NO. 1,500,522.

FOR NON-METAL, NON-MECHANICAL MULTI-ELEMENT SEALS FOR USE IN FOR USE IN HYDRAULIC EQUIPMENT AND MACHINERY (U.S. CLS. 1, 5, 12, 13, 35 AND 50).

FIRST USE 2-28-1975; IN COMMERCE 2-28-1975.

JOHN SCHUYLER YARD, EXAMINING ATTORNEY

CLASS 17—(Continued).

SN 78-305,913. TOZEN CORPORATION, YOSHIKAWA, SAITAMA, JAPAN, FILED 9-26-2003.

PIPEGUARD

FOR RUBBER PIPE JOINTS (U.S. CLS. 1, 5, 12, 13, 35 AND 50).
PAULA MAYS, EXAMINING ATTORNEY

CLASS 17—(Continued).

SN 78-358,718. INDUSTRIAL NANOTECH, INC., CHEYENNE, WY. FILED 1-28-2004.

NANSULATE

SN 78-351,156. THE GATES CORPORATION, DENVER, CO. FILED 1-13-2004.

CONNECTED

THE MARK CONSISTS OF STANDARD CHARACTERS WITHOUT CLAIM TO ANY PARTICULAR FONT, STYLE, SIZE, OR COLOR.
FOR RUBBER HYDRAULIC HOSE, RUBBER FUEL HOSE, RUBBER HOSE AND NON-METALLIC RIGID TUBING, ALL AFORESAID GOODS FOR USE IN LAND VEHICLES. (U.S. CLS. 1, 5, 12, 13, 35 AND 50).
TONI HICKEY, EXAMINING ATTORNEY

THE MARK CONSISTS OF STANDARD CHARACTERS WITHOUT CLAIM TO ANY PARTICULAR FONT, STYLE, SIZE, OR COLOR.
FOR COMPOSITION FOR FORMING THERMAL INSULATION COATING, NAMELY INSULATING PAINT FOR INDUSTRIAL USE (U.S. CLS. 1, 5, 12, 13, 35 AND 50).
JAMES A. RAUEN, EXAMINING ATTORNEY

SN 78-353,929. NETAFIM (A.C.S.) LTD, TEL AVIV, ISRAEL, FILED 1-20-2004.

SN 78-417,338. RIDABOCK, HARRY WINTON, II, NORTHAMPTON, MA. FILED 5-12-2004.

DRIPNET PC

THE MARK CONSISTS OF STANDARD CHARACTERS WITHOUT CLAIM TO ANY PARTICULAR FONT, STYLE, SIZE, OR COLOR.
PRIORITY CLAIMED UNDER SEC. 44(D) ON ISRAEL APPLICATION NO. 167596, FILED 10-29-2003, REG. NO. 167596, DATED 10-29-2003, EXPIRES 10-29-2013.
NO CLAIM IS MADE TO THE EXCLUSIVE RIGHT TO USE "PC", APART FROM THE MARK AS SHOWN.
FOR DRIPPER LINES FOR IRRIGATION; PLASTIC CONDUIT FOR IRRIGATION; PARTS AND FITTINGS FOR ALL THE AFOREMENTIONED GOODS (U.S. CLS. 1, 5, 12, 13, 35 AND 50).
JANICE L. MCMORROW, EXAMINING ATTORNEY



THE STIPPLING IS FOR SHADING PURPOSES ONLY.
THE MARK CONSISTS OF A GEOMETRIC DESIGN OF 12 BARS AND THE WORD "SILENT" IN BLOCK TYPE WITH THE OVERLAPPING WORD "SOURCE" IN SCRIPT.
FOR ACOUSTICAL PANELS FOR BUILDINGS (U.S. CLS. 1, 5, 12, 13, 35 AND 50).
FIRST USE 4-2-1993; IN COMMERCE 4-2-1993.
PAULA MAYS, EXAMINING ATTORNEY

CLASS 17—(Continued).

SN 78-418,880. PORTER, RICHARD A., KNOXVILLE, TN.
FILED 5-14-2004.

**BLACK
FLAM**
Masonry Foam Insulation

NO CLAIM IS MADE TO THE EXCLUSIVE RIGHT TO USE "MASONRY FOAM INSULATION", APART FROM THE MARK AS SHOWN.

FOR FOAM-IN PLACE INSULATION KIT FOR USE IN BUILDING AND CONSTRUCTION CONSISTING OF A SPRAY-DRIED POLYMERIC RESIN, A FOAMING CATALYST CONCENTRATE, AND INSTRUCTIONS FOR COMBINING WITH WATER AND COMPRESSED AIR IN SPECIALIZED EQUIPMENT FOLLOWED BY INJECTION OF THE SAME INTO THE HOLLOW CORES OF EXISTING CONCRETE MASONRY UNIT WALL STRUCTURES TO IMPART THERMAL AND/OR ACOUSTICAL INSULATIVE PROPERTIES (U.S. CLS. 1, 5, 12, 13, 35 AND 50).

MARC LEIPZIG, EXAMINING ATTORNEY

CLASS 17—(Continued).

SN 78-460,621. KURIYAMA OF AMERICA, INC., SCHAM-
BURG, IL. FILED 8-2-2004.

BEACON

THE MARK CONSISTS OF STANDARD CHARACTERS WITHOUT CLAIM TO ANY PARTICULAR FONT, STYLE, SIZE, OR COLOR.

FOR NON-METAL HOSES FOR USE IN CLEANING SEWER LINES (U.S. CLS. 1, 5, 12, 13, 35 AND 50).

ROBERT LAVACHE, EXAMINING ATTORNEY

SN 78-513,577. DYNAMIC CONTROL OF NORTH AMER-
ICA, INC., HAMILTON, OH. FILED 11-9-2004.

DYNALINER

SN 78-422,830. US GREENFIBER, LLC, CHARLOTTE, NC.
FILED 5-21-2004.

NATURE GUARD

THE MARK CONSISTS OF STANDARD CHARACTERS WITHOUT CLAIM TO ANY PARTICULAR FONT, STYLE, SIZE, OR COLOR.

FOR BUILDING INSULATION (U.S. CLS. 1, 5, 12, 13, 35 AND 50).

TANYA AMOS, EXAMINING ATTORNEY

THE MARK CONSISTS OF STANDARD CHARACTERS WITHOUT CLAIM TO ANY PARTICULAR FONT, STYLE, SIZE, OR COLOR.

FOR POLYETHER, URETHANE BASED, THERMO-ACOUSTIC FOAM FOR SOUND DEADENING AND VIBRATION DAMPING FOR USE WITH AUDIO AND SOUND SYSTEMS (U.S. CLS. 1, 5, 12, 13, 35 AND 50).

FIRST USE 11-1-1994; IN COMMERCE 3-31-1995.

JOHN SCHUYLER YARD, EXAMINING ATTORNEY

CLASS 17—(Continued).

SN 78-515,314. FEDERAL-MOGUL POWERTRAIN, INC., SOUTHFIELD, MI. FILED 11-11-2004.

CLASS 17—(Continued).

SN 78-521,211. CT GASKET & POLYMER CO., INC., HOUSTON, TX. FILED 11-22-2004.

PROGARD

ENERGIZER

THE MARK CONSISTS OF STANDARD CHARACTERS WITHOUT CLAIM TO ANY PARTICULAR FONT, STYLE, SIZE, OR COLOR.

OWNER OF U.S. REG. NO. 2,502,225.

FOR ABRASION RESISTANT PROTECTIVE SLEEVING OF WOVEN POLYMERIC MATERIAL FOR PROTECTION OF HOSES, CABLES, WIRES AND ROPES (U.S. CLS. 1, 5, 12, 13, 35 AND 50).

FIRST USE 6-6-2000; IN COMMERCE 6-6-2000.

CHRISTOPHER ADKINS, EXAMINING ATTORNEY

THE MARK CONSISTS OF STANDARD CHARACTERS WITHOUT CLAIM TO ANY PARTICULAR FONT, STYLE, SIZE, OR COLOR.

FOR GASKETS FOR USE IN FORMING SEALS BETWEEN PIPING SEGMENTS (U.S. CLS. 1, 5, 12, 13, 35 AND 50).

FIRST USE 12-31-1990; IN COMMERCE 12-31-1990.

KATHRYN COWARD, EXAMINING ATTORNEY

SN 78-517,445. R-BLOX SOUND CONTROL, INC., CORRY, PA. FILED 11-16-2004.

SN 78-524,524. HONEYWELL INTERNATIONAL INC., MORRISTOWN, NY. FILED 11-30-2004.

R-BLOX

CAP-SHIELD

THE MARK CONSISTS OF STANDARD CHARACTERS WITHOUT CLAIM TO ANY PARTICULAR FONT, STYLE, SIZE, OR COLOR.

FOR SOLID RUBBER BASED MATERIAL FOR ABSORBING OR DAMPENING SOUNDS AND/OR VIBRATIONS FOR AUDIO EQUIPMENT IN VEHICLES (U.S. CLS. 1, 5, 12, 13, 35 AND 50).

FIRST USE 9-25-2004; IN COMMERCE 9-25-2004.

CAROLINE WOOD, EXAMINING ATTORNEY

THE MARK CONSISTS OF STANDARD CHARACTERS WITHOUT CLAIM TO ANY PARTICULAR FONT, STYLE, SIZE, OR COLOR.

FOR PLASTIC FILM FOR USE IN FOOD PACKAGING (U.S. CLS. 1, 5, 12, 13, 35 AND 50).

BRENDAN REGAN, EXAMINING ATTORNEY

CLASS 17—(Continued).

SN 78-533,217. SEKISUI TA INDUSTRIES, INC., BREA, CA. FILED 12-15-2004.



NO CLAIM IS MADE TO THE EXCLUSIVE RIGHT TO USE "CARTON SEALING TAPE", APART FROM THE MARK AS SHOWN.

THE MARK CONSISTS OF STYLIZED WORD SUPREME OVER BOX CONTAINING PLAIN TEXT OF CARTON SEALING TAPE.

SEC. 2(F).
FOR ADHESIVE TAPE FOR SEALING CARTONS FOR INDUSTRIAL OR COMMERCIAL USE (U.S. CLS. 1, 5, 12, 13, 35 AND 50).

FIRST USE 12-31-1985; IN COMMERCE 12-31-1985.
BARBARA A. GOLD, EXAMINING ATTORNEY

SN 78-536,413. GREAT LAKES COATING AND LAMINATING, INC., WHITE BEAR LAKE, MN. FILED 12-21-2004.

BAYFIELD

THE MARK CONSISTS OF STANDARD CHARACTERS WITHOUT CLAIM TO ANY PARTICULAR FONT, STYLE, SIZE, OR COLOR.

FOR ADHESIVE-COATED SUBSTRATES, NAMELY TAPES, TRANSFER FILMS AND LABEL STOCKS, NOT BEING PAPER (U.S. CLS. 1, 5, 12, 13, 35 AND 50).

ALICE BENMAMAN, EXAMINING ATTORNEY

CLASS 17—(Continued).

SN 78-543,780. TRIM-TEX, INC., LINCOLNWOOD, IL. FILED 1-7-2005.

TRIM-TEX

THE MARK CONSISTS OF STANDARD CHARACTERS WITHOUT CLAIM TO ANY PARTICULAR FONT, STYLE, SIZE, OR COLOR.

OWNER OF U.S. REG. NOS. 1,923,669, 2,290,084 AND 2,712,905.

FOR ADHESIVE SEALANTS AND CAULKING COMPOUNDS, ALL FOR USE IN BUILDING CONSTRUCTION, IN BUILDING REMODELING, AND IN INSTALLATION OF DRYWALL-TRIMMING ACCESSORIES (U.S. CLS. 1, 5, 12, 13, 35 AND 50).

FIRST USE 6-0-2005; IN COMMERCE 6-0-2005.
WON TEAK OH, EXAMINING ATTORNEY

SN 78-546,826. TRU VUE, INC., MCCOOK, IL. FILED 1-13-2005.

OPTIUM

THE MARK CONSISTS OF STANDARD CHARACTERS WITHOUT CLAIM TO ANY PARTICULAR FONT, STYLE, SIZE, OR COLOR.

FOR ACRYLIC SHEETS FOR PICTURE FRAMES AND DISPLAY CASES (U.S. CLS. 1, 5, 12, 13, 35 AND 50).

FIRST USE 7-20-2004; IN COMMERCE 7-20-2004.
MARY BOAGNI, EXAMINING ATTORNEY

CLASS 18—LEATHER GOODS

SN 76-543,340. PEI LICENSING, INC., MIAMI, FL. FILED 9-8-2003.

AXIS

FOR LEATHER GOODS AND IMITATION LEATHER GOODS, NAMELY, WALLETS, HANDBAGS, COSMETIC BAGS SOLD EMPTY, GROOMING BAGS SOLD EMPTY, AGENDA AND PORTFOLIO CASES, KEY CASES, CALENDAR COVERS, ADDRESS BOOK COVERS, AND PASSPORT CASES (U.S. CLS. 1, 2, 3, 22 AND 41).
TRACY FLETCHER, EXAMINING ATTORNEY

SN 76-599,407. A&A BODY WORSHIP, INC., NEW YORK, NY, AND RHONE, SYLVIA, NEW YORK, NY. FILED 6-24-2004.

INDEPENDENT BODIES

THE MARK CONSISTS OF STANDARD CHARACTERS WITHOUT CLAIM TO ANY PARTICULAR FONT, STYLE, SIZE, OR COLOR.

FOR ALL-PURPOSE SPORTS AND ATHLETIC BAGS, FANNY PACKS, BACKPACKS, KNAPSACKS, SPORTS PACKS, WAIST PACKS, GYM BAGS, DUFFEL BAGS, TOTE BAGS, BOOK BAGS, HAND BAGS, PURSES, CLUTCH PURSES, CHANGE PURSES, SHOULDER BAGS, CARRY-ON BAGS, TRAVEL BAGS, GARMENT BAGS FOR TRAVEL, LEATHER SHOPPING BAGS, BEACH BAGS, SATCHELS, LUGGAGE, LUGGAGE TAGS, TRUNKS, SUITCASES, COSMETIC CASES SOLD EMPTY, TOILETRY CASES SOLD EMPTY, VANITY CASES SOLD EMPTY, COSMETIC BAGS SOLD EMPTY, TOOL BAGS SOLD EMPTY, ATTACHE CASES, BRIEFCASES, BRIEFCASE-TYPE PORTFOLIOS, MEN'S CLUTCHES, BUSINESS CASES, BUSINESS CARD CASES, CREDIT CARD CASES, CALLING CARD CASES, PASSPORT CASES, KEY CASES, LEATHER KEY CHAINS, COIN POUCHES, WALLETS, BILLFOLDS, UMBRELLAS AND PARASOLS (U.S. CLS. 1, 2, 3, 22 AND 41).
CAROLYN CATALDO, EXAMINING ATTORNEY

SN 76-603,513. PERFECT WORLD LUGGAGE, INC., SAN ANTONIO, TX. FILED 7-19-2004.

GÖZ

THE MARK CONSISTS OF STANDARD CHARACTERS WITHOUT CLAIM TO ANY PARTICULAR FONT, STYLE, SIZE, OR COLOR.

FOR LUGGAGE AND TRAVELING BAGS (U.S. CLS. 1, 2, 3, 22 AND 41).
MAUREEN DALL, EXAMINING ATTORNEY

CLASS 18—(Continued).

SN 76-606,252. AMARU ENTERTAINMENT, INC., WEST HOLLYWOOD, CA. FILED 8-9-2004.

MADAMEVELI

THE MARK CONSISTS OF STANDARD CHARACTERS WITHOUT CLAIM TO ANY PARTICULAR FONT, STYLE, SIZE, OR COLOR.

MADAME VELI DOES NOT IDENTIFY A PARTICULAR LIVING INDIVIDUAL.

FOR HANDBAGS; LUGGAGE; LEATHER KEYCHAIN; AND LEATHER GOODS, NAMELY, LEATHER BACKPACKS, LEATHER CASES, LEATHER BAGS, LEATHER PURSES, LEATHER KEY CASES, AND LEATHER BRIEFCASES (U.S. CLS. 1, 2, 3, 22 AND 41).
GRETTA YAO, EXAMINING ATTORNEY

SN 76-613,785. AREA 51 INC., LEDQEWOOD, NJ. FILED 9-28-2004.

51

THE MARK CONSISTS OF STANDARD CHARACTERS WITHOUT CLAIM TO ANY PARTICULAR FONT, STYLE, SIZE, OR COLOR.

FOR HANDBAGS (U.S. CLS. 1, 2, 3, 22 AND 41).
FIRST USE 1-0-2002; IN COMMERCE 1-0-2002.
SALLY SHIH, EXAMINING ATTORNEY

SN 76-618,658. THE HOLLYWOOD COMPANY, LLC, LOS ANGELES, CA. FILED 11-1-2004.

HOT IN HOLLYWOOD

THE MARK CONSISTS OF STANDARD CHARACTERS WITHOUT CLAIM TO ANY PARTICULAR FONT, STYLE, SIZE, OR COLOR.

NO CLAIM IS MADE TO THE EXCLUSIVE RIGHT TO USE HOLLYWOOD, APART FROM THE MARK AS SHOWN.

FOR HANDBAGS, TOTE BAGS, SHOULDER BAGS AND BRIDAL BAGS (U.S. CLS. 1, 2, 3, 22 AND 41).
FIRST USE 3-23-2003; IN COMMERCE 3-23-2003.
JACQUELINE A. LAVINE, EXAMINING ATTORNEY

CLASS 18—(Continued).

SN 76-621,230. GUCCI AMERICA, INC., NEW YORK, NY. FILED 11-17-2004.



OWNER OF U.S. REG. NO. 1,158,170.
FOR WALLETS, PURSES, HANDBAGS, TOTE BAGS, BUSINESS CARD CASES, CREDIT CARD CASES AND KEY CASES, PARTLY OR WHOLLY OF LEATHER (U.S. CLS. 1, 2, 3, 22 AND 41).
FIRST USE 9-0-2002; IN COMMERCE 9-0-2002.
AMOS T. MATTHEWS, JR., EXAMINING ATTORNEY

SN 76-621,963. KOOL PAK, INC., HOLLYWOOD, FL. FILED 11-23-2004.

KOOL PAK

THE MARK CONSISTS OF STANDARD CHARACTERS WITHOUT CLAIM TO ANY PARTICULAR FONT, STYLE, SIZE, OR COLOR.

OWNER OF U.S. REG. NOS. 1,319,429 AND 1,841,697.
FOR ALL PURPOSE SPORT BAGS, ALL PURPOSE ATHLETIC BAGS, ALL PURPOSE CARRYING BAGS, ATHLETIC BAGS, BARREL BAGS, BEACH BAGS, BOOK BAGS, CARRY-ALL BAGS, DUFFEL BAGS, FLEXIBLE BAGS FOR GARMENTS, GARMEN T BAGS FOR TRAVEL, GYM BAGS, MESH SHOPPING BAGS, OVER-NIGHT BAGS, ROLL BAGS, SCHOOL BAGS, SHOULDER BAGS, SUIT BAGS, TOTE BAGS, TRAVEL BAGS (U.S. CLS. 1, 2, 3, 22 AND 41).
FIRST USE 0-0-1989; IN COMMERCE 0-0-1989.
LINDA M. KING, EXAMINING ATTORNEY

SN 76-622,276. CREA, INC., LOS ANGELES, CA. FILED 11-23-2004.



FOR HANDBAGS, WALLETS, LUGGAGE, TRAVELING BAGS, BACKPACKS AND ALL PURPOSE OF SPORTS BAG (U.S. CLS. 1, 2, 3, 22 AND 41).
LESLEY LAMOTHE, EXAMINING ATTORNEY

CLASS 18—(Continued).

SN 76-622,526. FALLEN ANGELS PRODUCTIONS, INC., LOS ANGELES, CA. FILED 11-30-2004.

FINOLA HUGHES

THE MARK CONSISTS OF STANDARD CHARACTERS WITHOUT CLAIM TO ANY PARTICULAR FONT, STYLE, SIZE, OR COLOR.

THE NAME SHOWN IN THE MARK IDENTIFIES FINOLA HUGHES, WHOSE CONSENT TO REGISTER IS MADE OF RECORD.

FOR LEATHER BAGS, CHANGE PURSES, CLUTCH PURSES, COIN PURSES, LEATHER PURSES, SMALL CLUTCH PURSES, WRIST MOUNTED PURSES, HANDBAGS, EVENING HANDBAGS, LEATHER HANDBAGS, STRAPS FOR HANDBAGS, HANDBAGS FOR MEN, ALL PURPOSE SPORTS BAGS, ALL PURPOSE ATHLETIC BAGS, ALL PURPOSE CARRYING BAGS, ATHLETIC BAGS, BABY CARRYING BAGS, BOOK-BAGS, BEACH BAGS, BOSTON BAGS, CARRY ALL BAGS, CLUTCH BAGS, COSMETIC BAGS SOLD EMPTY, DIAPER BAGS, DUFFEL BAGS, GARMEN T BAGS FOR TRAVEL, GYM BAGS, KEY BAGS, LEATHER AND LEATHER IMITATION BAGS, SUITCASES, WALLETS, BILLFOLDS, SCHOOL BAGS, SHOULDER BAGS, TOTE BAGS, WAIST BAGS (U.S. CLS. 1, 2, 3, 22 AND 41).

CYNTHIA SLOAN, EXAMINING ATTORNEY

SN 78-261,252. STARBOARD CRUISE SERVICES, INC., MIAMI, FL. FILED 6-11-2003.

COTE D'AZUR

THE FOREIGN WORDING IN THE MARK TRANSLATES INTO ENGLISH AS "BLUE COAST".

FOR EVENING BAGS MADE OF SEQUINS AND BEADS; COSMETIC BAGS SOLD EMPTY. (U.S. CLS. 1, 2, 3, 22 AND 41).

DEBRA LEE, EXAMINING ATTORNEY

SN 78-275,073. NIKE, INC., BEAVERTON, OR. FILED 7-16-2003.

KING JAMES

FOR ALL-PURPOSE SPORTS BAGS, BACKPACKS, WAISTPACKS AND SHOE BAGS FOR TRAVEL (U.S. CLS. 1, 2, 3, 22 AND 41).

JILL C. ALT, EXAMINING ATTORNEY

CLASS 18—(Continued).

SN 78-318,191. PADRES L.P., SAN DIEGO, CA. FILED 10-24-2003.



FOR ATHLETIC BAGS, OVERNIGHT BAGS, BACK-PACKS, DUFFEL BAGS, TOTE BAGS, BEACH BAGS, KNAPSACKS, ATTACHE CASES, BRIEFCASES, PURSES, HANDBAGS, WALLETS, BILLFOLDS, FANNY PACKS, WAIST PACKS, COSMETIC CASES SOLD EMPTY, TOILETRY CASES SOLD EMPTY, KEY CASES, LUGGAGE, LUGGAGE TAGS, SUITCASES, GARMENT BAGS FOR TRAVEL, TRUNKS FOR TRAVELING, UMBRELLAS, CANES, BUSINESS CARD CASES, DOG COLLARS AND DOG LEASHES (U.S. CLS. 1, 2, 3, 22 AND 41).
BRIDGETT SMITH, EXAMINING ATTORNEY

CLASS 18—(Continued).

SN 78-391,440. MACARO, TRACI, FAIRHOPE, AL. FILED 3-26-2004.

Ooh La La

THE MARK CONSISTS OF STANDARD CHARACTERS WITHOUT CLAIM TO ANY PARTICULAR FONT, STYLE, SIZE, OR COLOR.
FOR PURSE AND HANDBAGS (U.S. CLS. 1, 2, 3, 22 AND 41).
FIRST USE 9-13-2002; IN COMMERCE 9-13-2002.
MAUREEN DALL, EXAMINING ATTORNEY

SN 78-389,489. BLACK IRON WEST. INC., ELIZABETH, CO. FILED 3-23-2004.

KATE'S

THE MARK CONSISTS OF STANDARD CHARACTERS WITHOUT CLAIM TO ANY PARTICULAR FONT, STYLE, SIZE, OR COLOR.
FOR SADDLES AND EQUINE RELATED GOODS, NAMELY, BRIDLES, HORSE BLANKETS, TACK, HARNESSSES (U.S. CLS. 1, 2, 3, 22 AND 41).
FIRST USE 8-0-2002; IN COMMERCE 8-0-2002.
MARY ROSSMAN, EXAMINING ATTORNEY

SN 78-394,374. DC SHOES, INC., VISTA, CA. FILED 3-31-2004.

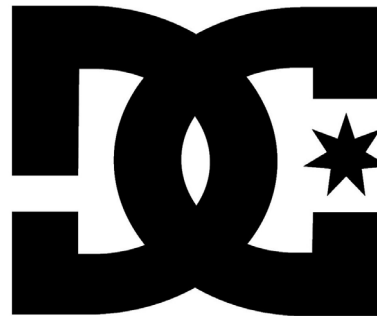

OWNER OF U.S. REG. NOS. 2,317,622 AND 2,427,124.
THE MARK CONSISTS OF THE LETTERS "DC" AND A STAR IN A STYLIZED DESIGN.
FOR BACKPACKS, DUFFEL BAGS, ATHLETIC-STYLE BAGS, ALL-PURPOSE SPORTS BAGS, GYM BAGS, KNAPSACKS AND FANNY PACKS (U.S. CLS. 1, 2, 3, 22 AND 41).
FIRST USE 3-1-1998; IN COMMERCE 3-1-1998.
ALICE SUE CARRUTHERS, EXAMINING ATTORNEY

CLASS 18—(Continued).

SN 78-394,667. DC SHOES, INC., VISTA, CA. FILED 4-1-2004.

DCSHOECOUSA

THE MARK CONSISTS OF STANDARD CHARACTERS WITHOUT CLAIM TO ANY PARTICULAR FONT, STYLE, SIZE, OR COLOR.

OWNER OF U.S. REG. NOS. 234,004, 2,074,045 AND 2,449,069.

FOR LUGGAGE, BACKPACKS, DUFFEL BAGS, WALLETTS, ALL-PURPOSE ATHLETIC BAGS, ALL-PURPOSE SPORTS BAGS, TRAVEL BAGS, BOOK BAGS, GYM BAGS, SCHOOL BAGS, TOTE BAGS, HANDBAGS, CARRYON BAGS, KNAPSACKS, AND FANNY PACKS (U.S. CLS. 1, 2, 3, 22 AND 41).

FIRST USE 3-1-1998; IN COMMERCE 3-1-1998.

ALICE SUE CARRUTHERS, EXAMINING ATTORNEY

CLASS 18—(Continued).

SN 78-412,660. THE NORTH FACE APPAREL CORP., WILMINGTON, DE. FILED 5-4-2004.

**MOUNTAIN GUIDE
FLEX**

THE MARK CONSISTS OF STANDARD CHARACTERS WITHOUT CLAIM TO ANY PARTICULAR FONT, STYLE, SIZE, OR COLOR.

NO CLAIM IS MADE TO THE EXCLUSIVE RIGHT TO USE "FLEX", APART FROM THE MARK AS SHOWN.

FOR BACKPACKS (U.S. CLS. 1, 2, 3, 22 AND 41).

ZACHARY BELLO, EXAMINING ATTORNEY

SN 78-410,447. S.F. DELUXE PRODUCTIONS, INC., SAN FRANCISCO, CA. FILED 4-29-2004.

ANTIHERO

THE MARK CONSISTS OF STANDARD CHARACTERS WITHOUT CLAIM TO ANY PARTICULAR FONT, STYLE, SIZE, OR COLOR.

OWNER OF U.S. REG. NO. 2,093,493.

FOR LEATHER GOODS AND CARRYING BAGS, NAMELY, ALL-PURPOSE SPORTING GOODS BAGS, GYM BAGS AND ALL-PURPOSE SPORTING GEAR CARRYING BAGS; BACKPACKS; SHOULDER BAGS; WALLETS (U.S. CLS. 1, 2, 3, 22 AND 41).

LA TONIA FISHER, EXAMINING ATTORNEY

SN 78-420,483. VIACOM INTERNATIONAL INC., NEW YORK, NY. FILED 5-18-2004.

ROARR E. SAURUS

THE MARK CONSISTS OF STANDARD CHARACTERS WITHOUT CLAIM TO ANY PARTICULAR FONT, STYLE, SIZE, OR COLOR.

THE NAME(S), PORTRAIT(S), AND/OR SIGNATURE(S) SHOWN IN THE MARK DOES NOT IDENTIFY A PARTICULAR LIVING INDIVIDUAL.

FOR UMBRELLAS, LUGGAGE, LUGGAGE TAGS, TOTE BAGS, BACKPACKS, FANNY PACKS, MESSENGER BAGS, HANDBAGS, WALLETS AND PURSES, ATHLETIC BAGS, GARMENT BAGS FOR TRAVEL, KNAPSACKS, CHANGE PURSES, DUFFLE BAGS, BEACH BAGS (U.S. CLS. 1, 2, 3, 22 AND 41).

LANA PHAM, EXAMINING ATTORNEY

CLASS 18—(Continued).

SN 78-429,240. MIDWEST TROPHY MFG. CO., INC., DEL CITY, OK. FILED 6-3-2004.

CLASS 18—(Continued).

SN 78-433,472. MARK HATHAWAY AND CATRINKA MARVIS, HERMOSA BEACH, CA. FILED 6-10-2004.

PENELOPE PORTER

Montreux

THE MARK CONSISTS OF STANDARD CHARACTERS WITHOUT CLAIM TO ANY PARTICULAR FONT, STYLE, SIZE, OR COLOR.

OWNER OF U.S. REG. NO. 1.629.083.
FOR LUGGAGE SOLD THROUGH MAIL ORDER CATALOGS, DIRECT-MAIL CATALOGS, AND IN-PERSON SALES CALLS; ALL ONLY TO BUSINESSES FOR IN-HOUSE PROMOTIONAL AND AWARDS PURPOSES (U.S. CLS. 1, 2, 3, 22 AND 41).

FIRST USE 12-31-2002; IN COMMERCE 12-31-2002.
ELISSA GARBER KON, EXAMINING ATTORNEY

THE MARK CONSISTS OF STANDARD CHARACTERS WITHOUT CLAIM TO ANY PARTICULAR FONT, STYLE, SIZE, OR COLOR.

"PENELOPE PORTER" DOES NOT IDENTIFY A LIVING INDIVIDUAL.

FOR HANDBAGS, TOTE BAGS, SHOPPING BAGS OF WOVEN TEXTILES, AND CARRIERS WITH HANDLES FOR ROLLED MATS AND TOWELS (U.S. CLS. 1, 2, 3, 22 AND 41).

BRIAN NEVILLE, EXAMINING ATTORNEY

SN 78-480,495. MAIN YI INTERNATIONAL, INC., SAN FRANCISCO, CA. FILED 9-8-2004.

SN 78-430,902. MISHA GELLER & ZIGGY DESIGNS, INC., CHICAGO, IL. FILED 6-7-2004.

LE CHEE

MISHA GELLER

THE MARK CONSISTS OF STANDARD CHARACTERS WITHOUT CLAIM TO ANY PARTICULAR FONT, STYLE, SIZE, OR COLOR.

THE NAME(S), PORTRAIT(S), AND/OR SIGNATURE(S) SHOWN IN THE MARK IDENTIFIES MISHA GELLER, WHOSE CONSENT(S) TO REGISTER IS SUBMITTED.

FOR PURSES; HANDBAGS; LUGGAGE; ALL-PURPOSE CARRYING BAGS; TOTE BAGS; TRAVELLING BAGS; SHOULDER BAGS; BACKPACKS; WALLETS, COSMETIC BAGS AND VANITY CASES SOLD EMPTY; LEATHER KEY CHAINS; PET COLLARS; ANIMAL CARRIERS (U.S. CLS. 1, 2, 3, 22 AND 41).

WINSTON FOLMAR, EXAMINING ATTORNEY

THE MARK CONSISTS OF STANDARD CHARACTERS WITHOUT CLAIM TO ANY PARTICULAR FONT, STYLE, SIZE, OR COLOR.

THE WORDS "LE CHEE" IS THE LITERAL PRONUNCIATION OF THE CANTONESE DIALECT OF THE FRUIT LITCHI.

FOR HAND BAGS, TRUNKS, PURSES, TRAVELLING BAGS AND OTHER BAGS MADE OF LEATHER AND IMITATIONS OF LEATHER (U.S. CLS. 1, 2, 3, 22 AND 41).

DANIEL CAPSHAW, EXAMINING ATTORNEY

CLASS 18—(Continued).

SN 78-489,326. WORLD TRIATHLON CORPORATION, TARPON SPRINGS, FL. FILED 9-24-2004.



NO CLAIM IS MADE TO THE EXCLUSIVE RIGHT TO USE "GIRL", APART FROM THE MARK AS SHOWN.

FOR ALL PURPOSE SPORT BAGS, BACK PACKS, TOTE BAGS, ALL PURPOSE CARRYING BAGS, AND FANNY PACKS (U.S. CLS. 1, 2, 3, 22 AND 41).

FIRST USE 9-12-2004; IN COMMERCE 9-12-2004.
ATTIYA MALIK, EXAMINING ATTORNEY

SN 78-489,924. MADDEN, WALTER G., CHESTERFIELD, MI. FILED 9-27-2004.

THE KITTY KOMBER

THE MARK CONSISTS OF STANDARD CHARACTERS WITHOUT CLAIM TO ANY PARTICULAR FONT, STYLE, SIZE, OR COLOR.

FOR CAT SCRATCHING POSTS (U.S. CLS. 1, 2, 3, 22 AND 41).

FIRST USE 8-2-2004; IN COMMERCE 8-2-2004.
ALEXANDER L. POWERS, EXAMINING ATTORNEY

SN 78-491,580. KAREN MARKETING, SKOKIE, IL. FILED 9-29-2004.



NO CLAIM IS MADE TO THE EXCLUSIVE RIGHT TO USE "SHADE", APART FROM THE MARK AS SHOWN.

THE MARK CONSISTS OF TWO WORDS PLUS A REPRESENTATION OF AN UMBRELLA WITH THE LETTER "T" INCORPORATED IN TO IT.

FOR UMBRELLAS AND THEIR PARTS (U.S. CLS. 1, 2, 3, 22 AND 41).
CARRIE ACHEN, EXAMINING ATTORNEY

CLASS 18—(Continued).

SN 78-498,050. MERCHANDISE SERVICES ONLINE, INC., MIAMI BEACH, FL. FILED 10-11-2004.

VITALIO VERA

THE MARK CONSISTS OF STANDARD CHARACTERS WITHOUT CLAIM TO ANY PARTICULAR FONT, STYLE, SIZE, OR COLOR.

THE NAME "VITALIO VERA" DOES NOT IDENTIFY A LIVING INDIVIDUAL.

FOR HANDBAGS, WALLET, BACKPACKS, TRAVEL BAGS, BRIEFCASES, BRIEFCASE-TYPE PORTFOLIOS (U.S. CLS. 1, 2, 3, 22 AND 41).

FIRST USE 8-19-2004; IN COMMERCE 8-19-2004.
WARREN L. OLANDRIA, EXAMINING ATTORNEY

SN 78-500,585. DEUTSCHE TELEKOM AG, BONN, FED REP GERMANY, FILED 10-15-2004.



PRIORITY CLAIMED UNDER SEC. 44(D) ON FED REP GERMANY APPLICATION NO. 30421576.735, FILED 4-15-2004, REG. NO. 30421576, DATED 9-9-2004, EXPIRES 4-30-2014.

OWNER OF U.S. REG. NO. 2,282,432.
THE COLORS MAGENTA AND GREY ARE CLAIMED AS A FEATURE OF THE MARK.

THE COLOR MAGENTA APPEARS IN THE LETTER "T" AND THE COLOR GREY APPEARS IN THE WORD "MOBILE" AND THE SQUARES.

FOR UMBRELLAS, PARASOLS; GOODS MADE OF LEATHER AND IMITATIONS OF LEATHERS, NAMELY, WALLET, VALISES, CARRYING CASES FOR CREDIT CARDS, TICKETS IN PARTICULAR, AIR TRAVEL TICKETS, PURSES, WRITING CASES, NAMELY, BRIEFCASE-TYPE PORTFOLIOS, SUITCASES, TRAVELING BAGS, AND BRIEFCASES; TRUNKS FOR TRAVEL AND TRAVEL BAGS (U.S. CLS. 1, 2, 3, 22 AND 41).

ROBERT C. CLARK JR., EXAMINING ATTORNEY

CLASS 18—(Continued).

SN 78-501,850. MACTAVISH & COMPANY, INCORPORATED, SAINT CHARLES, IL. FILED 10-19-2004.

NuBreed Pet Apparel

THE MARK CONSISTS OF STANDARD CHARACTERS WITHOUT CLAIM TO ANY PARTICULAR FONT, STYLE, SIZE, OR COLOR.

NO CLAIM IS MADE TO THE EXCLUSIVE RIGHT TO USE "PET APPAREL", APART FROM THE MARK AS SHOWN.

FOR PET APPAREL (U.S. CLS. 1, 2, 3, 22 AND 41).
FIRST USE 11-1-1993; IN COMMERCE 4-1-1994.
MARIA-VICTORIA SUAREZ, EXAMINING ATTORNEY

SN 78-509,379. ARTVENTURE, LLC, MIAMI BEACH, FL. FILED 11-1-2004.

SCHOOLFOLIO

THE MARK CONSISTS OF STANDARD CHARACTERS WITHOUT CLAIM TO ANY PARTICULAR FONT, STYLE, SIZE, OR COLOR.

FOR CHILDREN'S POLYPROPYLENE ART CASES SOLD EMPTY (U.S. CLS. 1, 2, 3, 22 AND 41).
FIRST USE 6-1-2002; IN COMMERCE 6-1-2002.

AISHA CLARKE, EXAMINING ATTORNEY

SN 78-514,241. IRONI, EMILY, LOS ANGELES, CA. FILED 11-10-2004.

ALEXIS HUDSON

THE MARK CONSISTS OF STANDARD CHARACTERS WITHOUT CLAIM TO ANY PARTICULAR FONT, STYLE, SIZE, OR COLOR.

THE NAME(S), PORTRAIT(S), AND/OR SIGNATURE(S) SHOWN IN THE MARK DOES NOT IDENTIFY A PARTICULAR LIVING INDIVIDUAL.

FOR HANDBAGS, PURSES, DIAPER BAGS (U.S. CLS. 1, 2, 3, 22 AND 41).
GEORGIA CARTY, EXAMINING ATTORNEY

CLASS 18—(Continued).

SN 78-518,040. CHEVRON CORPORATION, SAN RAMON, CA. FILED 11-16-2004.



FOR BAGS FOR TRAVEL; ATHLETIC BAGS; FANNY PACKS; BRIEF CASES; BRIEF CASE-TYPE PORTFOLIOS; LUGGAGE TAGS AND GARMENT BAGS FOR TRAVEL (U.S. CLS. 1, 2, 3, 22 AND 41).

FIRST USE 7-1-1969; IN COMMERCE 7-1-1969.
ZACHARY BELLO, EXAMINING ATTORNEY

SN 78-518,573. QUIROS DESIGNS, LLC, ANAHEIM HILLS, CA. FILED 11-17-2004.

WitchEye

THE MARK CONSISTS OF STANDARD CHARACTERS WITHOUT CLAIM TO ANY PARTICULAR FONT, STYLE, SIZE, OR COLOR.

FOR SPORTS-TYPE GYM BAG (U.S. CLS. 1, 2, 3, 22 AND 41).

FIRST USE 8-14-2004; IN COMMERCE 10-8-2004.
CIMMERIAN COLEMAN, EXAMINING ATTORNEY

CLASS 18—(Continued).

SN 78-519,439. GIACOMO DESIGN LTD, NEW YORK, NY. FILED 11-18-2004.



THE MARK CONSISTS OF VARIOUS SHAPES AND FORMS OF MUSHROOMS.

FOR HANDBAGS, POCKETBOOKS, PURSES, WALLETS, TRAVELING BAGS, ZIPPERED AND DRAW-STRING POUCHES, AND SHOULDER BAGS (U.S. CLS. 1, 2, 3, 22 AND 41).

JOSETTE BEVERLY, EXAMINING ATTORNEY

CLASS 18—(Continued).

SN 78-520,029. DEXAS INTERNATIONAL, LTD., CARROLLTON, TX. FILED 11-19-2004.

TRI-FOLIO

THE MARK CONSISTS OF STANDARD CHARACTERS WITHOUT CLAIM TO ANY PARTICULAR FONT, STYLE, SIZE, OR COLOR.

FOR DOCUMENT CASES (U.S. CLS. 1, 2, 3, 22 AND 41).

FIRST USE 12-11-2002; IN COMMERCE 12-11-2002.
SONYA STEPHENS, EXAMINING ATTORNEY

SN 78-519,468. PAYLESS SHOESOURCE WORLDWIDE, INC., TOPEKA, KS. FILED 11-18-2004.

P-TEK

THE MARK CONSISTS OF STANDARD CHARACTERS WITHOUT CLAIM TO ANY PARTICULAR FONT, STYLE, SIZE, OR COLOR.

FOR HANDBAGS, SHOULDER BAGS, PURSES, WALLETS, TOTE BAGS, BACKPACKS, AND MESSENGER BAGS (U.S. CLS. 1, 2, 3, 22 AND 41).

FIRST USE 6-1-2004; IN COMMERCE 6-1-2004.
ANDREW BENZMILLER, EXAMINING ATTORNEY

SN 78-520,088. STYLEMARK, INC., ORMOND BEACH, FL. FILED 11-19-2004.

STYLEMARK

THE MARK CONSISTS OF STANDARD CHARACTERS WITHOUT CLAIM TO ANY PARTICULAR FONT, STYLE, SIZE, OR COLOR.

FOR WALLETS, HANDBAGS, BACKPACKS, UMBRELLAS, ROLLING TRAVELING BAGS, ALL-PURPOSE SPORT BAGS, DUFFEL BAGS, TOTE BAGS, BEACH BAGS, GENERAL UTILITY TOTE BAGS, FANNY PACKS, GARMENT BAGS FOR TRAVEL, WALKING STICKS, LUGGAGE, ATHLETIC BAGS, TRAVEL BAGS, CLUTCH BAGS, ATTACHÉ CASES, BILLFOLDS, BOOK BAGS, BRIEFCASE-TYPE PORTFOLIOS; LEATHER KEY CHAINS; OVERNIGHT BAGS; POCKETBOOKS; PURSES; SCHOOL BAGS; AND SUITCASES (U.S. CLS. 1, 2, 3, 22 AND 41).

JASON TURNER, EXAMINING ATTORNEY

CLASS 18—(Continued).

SN 78-521,876. TERRENCE, JERRY, LOS ANGELES, CA. FILED 11-23-2004.

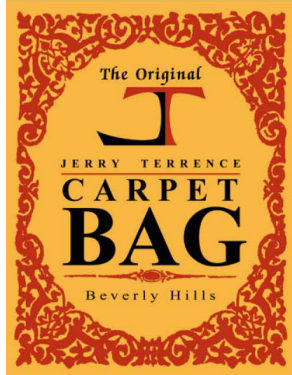

NO CLAIM IS MADE TO THE EXCLUSIVE RIGHT TO USE "ORIGINAL", "CARPET BAG" AND "BEVERLY HILLS", APART FROM THE MARK AS SHOWN.

THE COLORS MUSTARD YELLOW, DARK ORANGE, AND BLACK ARE CLAIMED AS A FEATURE OF THE MARK.

THE MARK CONSISTS OF MUSTARD YELLOW BACKGROUND, UPON WHICH IS A DARK ORANGE DESIGN, AND IN WHICH THE WORDS "THE ORIGINAL JERRY TERRENCE CARPET BAG" ARE PRINTED IN BLACK; AND THE LETTERS "J", IN BLACK AND "T", IN ORANGE ARE NESTED TOGETHER.

FOR BAGS MADE PREDOMINANTLY OF CARPETING MATERIALS; NAMELY, HANDBAGS, SHOULDER BAGS, BRIEFCASES, DUFFLE BAGS, TOTE BAGS, CLUTCH BAGS, ATTACHE-CASES, SUITCASES, GARMENT BAGS, RUCKSACKS, TRUNKS, TRAVELING BAGS, WALLETS, PURSES, BACKPACKS, SCHOOL BAGS, BUSINESS CARD CASES, CREDIT CARD CASES, KEY CASES, COSMETIC BAGS SOLD EMPTY, UMBRELLA BAGS (U.S. CLS. 1, 2, 3, 22 AND 41).

FIRST USE 3-1-1965; IN COMMERCE 3-1-1965.
DAWN HAN, EXAMINING ATTORNEY

SN 78-522,552. BUSHWACKER BACKPACK & SUPPLY CO., INC., DBA COUNTER ASSAULT, KALISPELL, MT. FILED 11-24-2004.

GRIZZLY GRIP

THE MARK CONSISTS OF STANDARD CHARACTERS WITHOUT CLAIM TO ANY PARTICULAR FONT, STYLE, SIZE, OR COLOR.

FOR BRACKET FOR ATTACHMENT OF PEPPER SPRAY OR BEAR DETERRENT TO A WALKING OR HIKING STICK OR POLE (U.S. CLS. 1, 2, 3, 22 AND 41).

FIRST USE 10-1-2000; IN COMMERCE 10-1-2000.
DAWN FELDMAN, EXAMINING ATTORNEY

CLASS 18—(Continued).

SN 78-522,560. TIBA, INC., CHARLOTTE, NC. FILED 11-24-2004.

TIBA

THE MARK CONSISTS OF STANDARD CHARACTERS WITHOUT CLAIM TO ANY PARTICULAR FONT, STYLE, SIZE, OR COLOR.

FOR HANDBAGS, DIAPER BAGS, COSMETIC BAGS, AND LUGGAGE TAGS (U.S. CLS. 1, 2, 3, 22 AND 41).

FIRST USE 7-20-2004; IN COMMERCE 7-20-2004.
DAWN FELDMAN, EXAMINING ATTORNEY

SN 78-523,568. N'GAI...LLC, NEW YORK, NY. FILED 11-29-2004.

n'gai...

THE ENGLISH TRANSLATION OF N'GAI IS CHOSEN ONE.

FOR HANDBAGS, SHOULDER BAGS, TOTE BAGS, SUITCASES, CHANGE PURSES, BRIEFCASE TYPE PORTFOLIOS, BRIEFCASES, COSMETIC BAGS SOLD EMPTY, BUSINESS CARD CASES, GYM BAGS, BACKPACKS, BOOK BAGS, POCKETBOOKS, PURSES, BAG AND PURSE CLUTCHES, AND WALLETS (U.S. CLS. 1, 2, 3, 22 AND 41).

CHRISIE B. KING, EXAMINING ATTORNEY

CLASS 18—(Continued).

SN 78-524,973. ERTI-ALVARO, MICHELLE, CANANDAI-GUA, NY. FILED 12-1-2004.

Pursex

THE MARK CONSISTS OF STANDARD CHARACTERS WITHOUT CLAIM TO ANY PARTICULAR FONT, STYLE, SIZE, OR COLOR.

FOR HANDBAGS (U.S. CLS. 1, 2, 3, 22 AND 41).
ANGELA M. MICHELI, EXAMINING ATTORNEY

SN 78-528,155. KOLLER ENTERPRISES, INC., FENTON, MO. FILED 12-7-2004.

KREATURE KINGDOM

THE MARK CONSISTS OF STANDARD CHARACTERS WITHOUT CLAIM TO ANY PARTICULAR FONT, STYLE, SIZE, OR COLOR.

FOR CONTAINERS FOR TRANSPORTING FISH, RODENTS AND SIMILAR SMALL ANIMAL PETS (U.S. CLS. 1, 2, 3, 22 AND 41).
KATRINA EDGE, EXAMINING ATTORNEY

SN 78-539,793. CMP MEDIA LLC, MANHASSET, NY. FILED 12-29-2004.

**CSI COMPUTER
SECURITY INSTITUTE**

THE MARK CONSISTS OF STANDARD CHARACTERS WITHOUT CLAIM TO ANY PARTICULAR FONT, STYLE, SIZE, OR COLOR.

FOR ATTACHE CASES (U.S. CLS. 1, 2, 3, 22 AND 41).
FIRST USE 6-30-2004; IN COMMERCE 6-30-2004.
WENDY GOODMAN, EXAMINING ATTORNEY

CLASS 18—(Continued).

SN 78-539,865. SIGNATURES NETWORK, INC., SAN FRANCISCO, CA. FILED 12-29-2004.

WINTERLAND

THE MARK CONSISTS OF STANDARD CHARACTERS WITHOUT CLAIM TO ANY PARTICULAR FONT, STYLE, SIZE, OR COLOR.

OWNER OF U.S. REG. NOS. 1,452,076, 2,368,379 AND OTHERS.

FOR BACKPACKS, PURSES, HANDBAGS, AND WALLET(S) (U.S. CLS. 1, 2, 3, 22 AND 41).

ELIZABETH HUGHITT, EXAMINING ATTORNEY

SN 78-543,159. FASHION KINGDOM TRADING, INC., N RICHLAND HILLS, TX. FILED 1-6-2005.

LE STILE

THE MARK CONSISTS OF STANDARD CHARACTERS WITHOUT CLAIM TO ANY PARTICULAR FONT, STYLE, SIZE, OR COLOR.

FOR HAND BAG FOR MAN AND WOMAN (U.S. CLS. 1, 2, 3, 22 AND 41).

FIRST USE 10-10-2003; IN COMMERCE 12-12-2004.
TEJBIR SINGH, EXAMINING ATTORNEY

CLASS 18—(Continued).

SN 78-548,047. CIELO CREATIONS INC, COMMERCE, CA. FILED 1-14-2005.

CLASS 18—(Continued).

SN 78-555,258. INTEC CORPORATION, CLIFFWOOD BEACH, NJ. FILED 1-27-2005.



Comfort Flow

FOR HANDBAGS, TOTE BAGS, LUGGAGE, PURSES, WALLETS AND BACKPACKS (U.S. CLS. 1, 2, 3, 22 AND 41).
FIRST USE 12-6-2004; IN COMMERCE 12-6-2004.
CHERYL STEPLIGHT, EXAMINING ATTORNEY

THE MARK CONSISTS OF STANDARD CHARACTERS WITHOUT CLAIM TO ANY PARTICULAR FONT, STYLE, SIZE, OR COLOR.
FOR PADS FOR HORSE SADDLES (U.S. CLS. 1, 2, 3, 22 AND 41).
CIMMERIAN COLEMAN, EXAMINING ATTORNEY

SN 78-554,734. ADELMAN, GREGORY, MARC, BOULDER, CO. FILED 1-27-2005.

SN 78-556,014. STRICTLY PUPPER CRUST, LLC, LAWRENCEVILLE, NJ. FILED 1-28-2005.

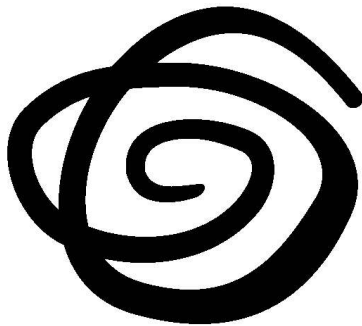

Let Me

THE MARK CONSISTS OF A SPIRAL PATTERN WITH THICK LINES THAT VARY SOME IN THICKNESS. THE PATTERN LOOKS LIKE IT WAS WRITTEN FREEHAND AND HAS THE APPEARANCE OF A SCRIBBLE.
FOR LUGGAGE AND BACKPACKS (U.S. CLS. 1, 2, 3, 22 AND 41).
KARLA PERKINS, EXAMINING ATTORNEY

THE MARK CONSISTS OF STANDARD CHARACTERS WITHOUT CLAIM TO ANY PARTICULAR FONT, STYLE, SIZE, OR COLOR.
FOR PET ACCESSORIES, NAMELY COLLARS AND LEASHES (U.S. CLS. 1, 2, 3, 22 AND 41).
MARIA-VICTORIA SUAREZ, EXAMINING ATTORNEY

CLASS 18—(Continued).

SN 78-556,200. MEEJEE CORP., BUCHON-CITY, REPUBLIC OF KOREA, FILED 1-28-2005.

OZIC

THE MARK CONSISTS OF STANDARD CHARACTERS WITHOUT CLAIM TO ANY PARTICULAR FONT, STYLE, SIZE, OR COLOR.

FOR BRIEFCASES, BRIEFCASE-TYPE PORTFOLIOS, SUITCASES, ATTACH CASES, BACKPACKS, TOTE BAGS, BOSTON BAGS, CARRY-ON BAGS, DUFFEL BAGS, HANDBAGS, PURSES, CLUTCHES, LUGGAGE, LEATHER SHOPPING BAGS, MESH SHOPPING BAGS, LEATHER POUCHES AND TRAVELING BAGS (U.S. CLS. 1, 2, 3, 22 AND 41).

DOMINIC J. FERRAIUOLO, EXAMINING ATTORNEY

SN 78-559,767. DCF ENTERPRISES, SCHENECTADY, NY. FILED 2-3-2005.

Ready Tote

THE MARK CONSISTS OF STANDARD CHARACTERS WITHOUT CLAIM TO ANY PARTICULAR FONT, STYLE, SIZE, OR COLOR.

NO CLAIM IS MADE TO THE EXCLUSIVE RIGHT TO USE TOTE, APART FROM THE MARK AS SHOWN.

FOR SMALL TOTE BAGS, SMALL TRAVEL TOTE BAGS, TOTE BAGS FOR MEDICAL PRODUCTS AND MEDICINES (U.S. CLS. 1, 2, 3, 22 AND 41).

STEVEN R. FINE, EXAMINING ATTORNEY

CLASS 18—(Continued).

SN 78-626,636. PANAMA JACK INTERNATIONAL, INC., ORLANDO, FL. FILED 5-10-2005.

PANAMA JACK BEACH CLUB

THE MARK CONSISTS OF STANDARD CHARACTERS WITHOUT CLAIM TO ANY PARTICULAR FONT, STYLE, SIZE, OR COLOR.

OWNER OF U.S. REG. NOS. 1,328,519, 2,942,960 AND OTHERS.

FOR WALLETS, HANDBAGS, LUGGAGE TAGS, TRUNKS, BACKPACKS, LEATHER KEY CHAINS, UMBRELLAS, ROLL BAGS, ALL-PURPOSE SPORT BAGS, DUFFEL BAGS, TOTE BAGS, BEACH BAGS, FANNY PACKS, COSMETIC BAGS SOLD EMPTY, GARMENT BAGS FOR TRAVEL, WALKING STICKS, LUGGAGE, ATHLETIC BAGS, TRAVEL BAGS, CLUTCH BAGS, ATTACHE CASES, BILLFOLDS, BOOK BAGS, BRIEFCASE-TYPE PORTFOLIOS; BUSINESS CARD CASES; CANES, CHANGE PURSES, FOOTLOCKERS; OVERNIGHT BAGS, POCKETBOOKS; PURSES; SCHOOL BAGS; AND SUITCASES (U.S. CLS. 1, 2, 3, 22 AND 41).

CAROLINE WOOD, EXAMINING ATTORNEY

CLASS 19—NON-METALLIC BUILDING MATERIALS

SN 75-385,218. HEARTLAND BUILDING PRODUCTS, INC., BOONEVILLE, MS. FILED 11-5-1997.

HEARTLAND

OWNER OF U.S. REG. NOS. 1,738,648 AND 1,741,719. FOR WINDOWS, VINYL DECKING, VINYL FENCING, PATIO DOORS AND ACCESSORIES AND RELATED PRODUCTS THERETO (U.S. CLS. 1, 12, 33 AND 50).

FIRST USE 7-0-2003; IN COMMERCE 7-0-2003.

RAUL CORDOVA, EXAMINING ATTORNEY

SN 76-349,713. VINYL BILT WINDOW SYSTEMS INC., CONCORD, ONTARIO, CANADA, FILED 12-19-2001.

SIMPLY-CLEAN

PRIORITY CLAIMED UNDER SEC. 44(D) ON CANADA APPLICATION NO. 1125494, FILED 12-17-2001, REG. NO. TMA633,242, DATED 2-21-2005, EXPIRES 2-21-2020.

FOR PERMANENT CLEAR WINDOW COATINGS SOLD AS A COMPONENT OF WINDOW GLASS (U.S. CLS. 1, 12, 33 AND 50).

JOHN E. MICHOS, EXAMINING ATTORNEY

CLASS 19—(Continued).

SN 76-454,179. SHIELDCRETE LIMITED, EDMONTON, ALBERTA, T5J 3W8, CANADA, FILED 10-1-2002.

SHIELDCRETE

PRIORITY CLAIMED UNDER SEC. 44(D) ON CANADA APPLICATION NO. 1,140,845, FILED 5-14-2002, REG. NO. TMA641449, DATED 6-6-2005, EXPIRES 6-6-2020.
FOR CEMENTITIOUS SHOTCRETE MIX (U.S. CLS. 1, 12, 33 AND 50).
DAVID H. STINE, EXAMINING ATTORNEY

SN 76-526,594. WELL MADE FLOOR COVERINGS INTERNATIONAL, INC., WILSONVILLE, OR. FILED 6-19-2003.

WELLMADE

SEC. 2(F).
FOR WOODEN, BAMBOO, PLYWOOD AND STONE FLOORING (U.S. CLS. 1, 12, 33 AND 50).
FIRST USE 12-1-1991; IN COMMERCE 12-1-1991.
STEVEN JACKSON, EXAMINING ATTORNEY

SN 76-554,138. OVERHEAD DOOR CORPORATION, FARMERS BRANCH, TX. FILED 10-22-2003.

WEATHER SENTRY

FOR SEAL FOR USE AS A STRUCTURAL PART OF LOADING DOCKS AND SHELTERS CONSISTING PRIMARILY OF PADS OF FOAM AND VINYL, FOAM, STEEL TUBING, FIBERGLASS, ALUMINUM TRIM, RUBBER TARP STRAPS AND WOOD (U.S. CLS. 1, 12, 33 AND 50).
ANN E. SAPPENFIELD, EXAMINING ATTORNEY

SN 76-562,835. DISTINCTIVE PAVING BRICK, INC., COMSTOCK PARK, MI. FILED 12-3-2003.

BRICK GRIP

NO CLAIM IS MADE TO THE EXCLUSIVE RIGHT TO USE "BRICK", APART FROM THE MARK AS SHOWN.
FOR DECORATIVE PAVING BRICKS FOR INSTALLATION IN WALKWAYS, PATIOS, POOL AREAS, STEPS, DRIVEWAYS AND RETAINING WALL UNITS (U.S. CLS. 1, 12, 33 AND 50).
FIRST USE 6-0-2003; IN COMMERCE 6-0-2003.
DOMINICK J. SALEMI, EXAMINING ATTORNEY

CLASS 19—(Continued).

SN 76-574,096. CUSTOM PLASTICS, INC., ELK GROVE VILLAGE, IL. FILED 2-4-2004.

HANDIWALL

THE MARK CONSISTS OF STANDARD CHARACTERS WITHOUT CLAIM TO ANY PARTICULAR FONT, STYLE, SIZE, OR COLOR.
FOR WALL PANELS, NOT OF METAL, FOR HANGING, ORGANIZING AND STORING ITEMS FOR INDOOR USAGE (U.S. CLS. 1, 12, 33 AND 50).
FIRST USE 8-0-2003; IN COMMERCE 8-0-2003.
SAMUEL E. SHARPER JR., EXAMINING ATTORNEY

SN 76-582,023. BLUE HERON ENTERPRISES, L.L.C., CALIFON, NJ. FILED 3-16-2004.

ANY TIME IS DECK TIME

THE MARK CONSISTS OF STANDARD CHARACTERS WITHOUT CLAIM TO ANY PARTICULAR FONT, STYLE, SIZE, OR COLOR.
FOR CONSTRUCTION ELEMENTS NOT MADE OF METAL, NAMELY, ANCHORS AND BRACKETS, FOR USE IN CONSTRUCTION OF OUTDOOR WOODEN DECKS (U.S. CLS. 1, 12, 33 AND 50).
FIRST USE 3-15-2004; IN COMMERCE 3-15-2004.
ERNEST SHOSHO, EXAMINING ATTORNEY

SN 76-585,595. CHAMPION WINDOW MANUFACTURING AND SUPPLY CO., CINCINNATI, OH. FILED 4-5-2004.

COMFORT 365

FOR INSULATED GLASS SOLD AS AN INTEGRAL COMPONENT OF NON-METAL DOORS, WINDOWS AND PATIO ENCLOSURES (U.S. CLS. 1, 12, 33 AND 50).
FIRST USE 2-23-2004; IN COMMERCE 2-23-2004.
LESLEY LAMOTHE, EXAMINING ATTORNEY

CLASS 19—(Continued).

SN 76-588,857. VESTAL ASPHALT INC., VESTAL, NY. FILED 4-23-2004.



NO CLAIM IS MADE TO THE EXCLUSIVE RIGHT TO USE "ASPHALT, INC.", APART FROM THE MARK AS SHOWN.

THE COLOR(S) YELLOW, GRAY AND BLACK IS/ARE CLAIMED AS A FEATURE OF THE MARK.

THE COLOR YELLOW APPEARS IN A DIAMOND-SHAPE RECTANGLE, THE COLOR GRAY APPEARS IN A TRIANGLE AND THE TERM ASPHALT, AND THE COLOR BLACK APPEARS IN A TRIANGLE AND THE TERMS "VESTAL" AND "INC."

FOR BITUMINOUS ASPHALT, NAMELY ASPHALT CEMENT (U.S. CLS. 1, 12, 33 AND 50).

FIRST USE 0-0-2002; IN COMMERCE 0-0-2002.

SALLY SHIH, EXAMINING ATTORNEY

CLASS 19—(Continued).

SN 76-597,765. ROOFING SUPPLY LIMITED, HOUSTON, TX. FILED 6-11-2004.

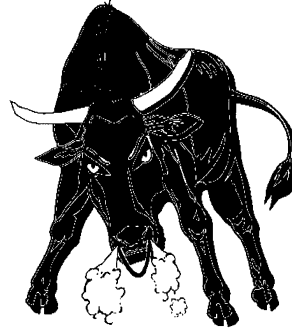

THE STIPPLING IS A FEATURE OF THE MARK.

FOR ROOF COATINGS, NAMELY, ASPHALT-BASED AND NON-ASPHALT-BASED COATINGS APPLIED TO A ROOF TO PROVIDE A WATER-PROOF BARRIER AND PROTECTION FROM UV-LIGHT; ROOF CEMENTS, NAMELY, COLD PROCESS CEMENT, ELASTOMERIC PATCHING CEMENT, FLASHING CEMENT AND PLASTIC ROOF CEMENT; ASPHALT ROOF PRIMER; ROOFING MEMBRANES; ROOFING SLATES; ROOFING UNDERLAYMENT; TAR-BASED ROOFING SEALANT, BITUMEN-BASED ROOFING SEALANT; ROOFING FABRICS; GYPSUM; AND VINYL SIDING (U.S. CLS. 1, 12, 33 AND 50).

FIRST USE 6-0-1992; IN COMMERCE 6-0-1992.

DORITT L. CARROLL, EXAMINING ATTORNEY

SN 76-591,847. INNOVATIVE BRICK SYSTEMS, LLC, BROOMFIELD, CO. FILED 5-12-2004.

VERSA LINER

THE MARK CONSISTS OF STANDARD CHARACTERS WITHOUT CLAIM TO ANY PARTICULAR FONT, STYLE, SIZE, OR COLOR.

NO CLAIM IS MADE TO THE EXCLUSIVE RIGHT TO USE "LINER", APART FROM THE MARK AS SHOWN.

FOR NON METAL LINER FOR HOLDING OBJECTS, SUCH AS BRICK AND STONE PAYERS, IN PLACE DURING THE FORMATION OF A POURED WALL (U.S. CLS. 1, 12, 33 AND 50).

FIRST USE 8-18-1998; IN COMMERCE 8-18-1998.

CHERYL CLAYTON, EXAMINING ATTORNEY

SN 76-608,254. CABANA VILLAGE, LLC, WILMINGTON, DE. FILED 8-23-2004.

Cabana Village

THE MARK CONSISTS OF STANDARD CHARACTERS WITHOUT CLAIM TO ANY PARTICULAR FONT, STYLE, SIZE, OR COLOR.

NO CLAIM IS MADE TO THE EXCLUSIVE RIGHT TO USE "CABANA", APART FROM THE MARK AS SHOWN.

FOR PRE-FABRICATED NON-METAL HOUSING MADE PRIMARILY OF WOOD, NAMELY CABANAS, POOL HOUSES, POOL CABANAS, SPA ENCLOSURES, CABINS AND COTTAGES; NON-METAL STORAGE SHEDS AND GARDEN SHEDS (U.S. CLS. 1, 12, 33 AND 50).

FIRST USE 1-15-2004; IN COMMERCE 2-15-2004.

ELLEN PERKINS, EXAMINING ATTORNEY

CLASS 19—(Continued).

SN 76-613,733. PALMER ASPHALT COMPANY, BAYONNE, NJ. FILED 9-27-2004.

DUREX

THE MARK CONSISTS OF STANDARD CHARACTERS WITHOUT CLAIM TO ANY PARTICULAR FONT, STYLE, SIZE, OR COLOR.
FOR ROOFING MATERIALS, NAMELY, ASPHALT AND ELASTOMERIC ROOF COVERINGS (U.S. CLS. 1, 12, 33 AND 50).
FIRST USE 0-0-1932; IN COMMERCE 0-0-1932.
SHAUNIA WALLACE, EXAMINING ATTORNEY

CLASS 19—(Continued).

SN 76-621,867. INDUSTRIAL FABRICS, INC., BATON ROUGE, LA. FILED 11-23-2004.

GreenSolutions

THE MARK CONSISTS OF STANDARD CHARACTERS WITHOUT CLAIM TO ANY PARTICULAR FONT, STYLE, SIZE, OR COLOR.
FOR EROSION CONTROL BLANKET MADE FROM STRAW AND/OR COCONUT FIBERS (U.S. CLS. 1, 12, 33 AND 50).
REBECCA HAN, EXAMINING ATTORNEY

SN 76-620,888. MD ENTERPRISES, INC., ONTARIO, CA. FILED 11-17-2004.

Build a Better Barn

THE MARK CONSISTS OF STANDARD CHARACTERS WITHOUT CLAIM TO ANY PARTICULAR FONT, STYLE, SIZE, OR COLOR.
NO CLAIM IS MADE TO THE EXCLUSIVE RIGHT TO USE "BARN", APART FROM THE MARK AS SHOWN.
FOR MODULAR BUILDINGS, NAMELY, BARNS (U.S. CLS. 1, 12, 33 AND 50).
FIRST USE 1-1-2001; IN COMMERCE 1-1-2001.
MITCHELL FRONT, EXAMINING ATTORNEY

SN 76-622,703. PALM HARBOR HOMES, INC., ADDISON, TX. FILED 12-1-2004.

KEYPOINT
CUSTOM HOMES

NO CLAIM IS MADE TO THE EXCLUSIVE RIGHT TO USE CUSTOM HOMES, APART FROM THE MARK AS SHOWN.
FOR MODULAR HOMES (U.S. CLS. 1, 12, 33 AND 50).
KEVIN DINALLO, EXAMINING ATTORNEY

SN 76-621,570. NEW CENTURY BUILDINGS, LLC, PORTLAND, OR. FILED 11-22-2004.

MODULUBE

THE MARK CONSISTS OF STANDARD CHARACTERS WITHOUT CLAIM TO ANY PARTICULAR FONT, STYLE, SIZE, OR COLOR.
FOR MODULAR BUILDING UNITS FOR USE IN VEHICLE REPAIR AND MAINTENANCE (U.S. CLS. 1, 12, 33 AND 50).
FIRST USE 11-16-2004; IN COMMERCE 11-16-2004.
YONG KIM, EXAMINING ATTORNEY

SN 76-624,911. OBERFIELD'S, INC., DELAWARE, OH. FILED 12-16-2004.

BELHAVEN

THE MARK CONSISTS OF STANDARD CHARACTERS WITHOUT CLAIM TO ANY PARTICULAR FONT, STYLE, SIZE, OR COLOR.
FOR COMBINATION OF SMALL AND LARGE CONCRETE PAVERS WITH A DIMPLED TEXTURE APPEARANCE (U.S. CLS. 1, 12, 33 AND 50).
ADA HAN, EXAMINING ATTORNEY

CLASS 19—(Continued).

SN 76-626,803. W.M. TINDER, INC., MANASSAS, VA. FILED 1-4-2005.

CORNER-IT

THE MARK CONSISTS OF STANDARD CHARACTERS WITHOUT CLAIM TO ANY PARTICULAR FONT, STYLE, SIZE, OR COLOR.

FOR BUILDING PRODUCTS NAMELY EXTERIOR TRIM MADE OF PLASTIC (U.S. CLS. 1, 12, 33 AND 50).
EVELYN BRADLEY, EXAMINING ATTORNEY

SN 76-628,361. PAWLING CORPORATION, PAWLING, NY. FILED 1-19-2005.

FLIP-IT

THE MARK CONSISTS OF STANDARD CHARACTERS WITHOUT CLAIM TO ANY PARTICULAR FONT, STYLE, SIZE, OR COLOR.

FOR FLEXIBLE FLOORING TILES (U.S. CLS. 1, 12, 33 AND 50).

FIRST USE 1-31-1984; IN COMMERCE 1-31-1984.
TRACY FLETCHER, EXAMINING ATTORNEY

SN 78-119,003. ELDORADO STONE OPERATIONS LLC, CARNATION, WA. FILED 4-2-2002.

CLIFFSTONE

FOR BUILDING PRODUCTS, NAMELY MANUFACTURED STONE VENEERS FOR EXTERIOR OR INTERIOR VERTICAL SURFACES OF WALLS AND BUILDINGS (U.S. CLS. 1, 12, 33 AND 50).

FIRST USE 6-30-2001; IN COMMERCE 6-30-2001.
JOHN LINCOSKI, EXAMINING ATTORNEY

CLASS 19—(Continued).

SN 78-295,020. PAVER SYSTEMS, LLC, WEST PALM BEACH, FL. FILED 9-2-2003.

MINI HOLLAND

THE MARK CONSISTS OF STANDARD CHARACTERS WITHOUT CLAIM TO ANY PARTICULAR FONT, STYLE, SIZE, OR COLOR.

FOR CONCRETE CONSTRUCTION MATERIALS IN THE NATURE OF FABRICATED PAVING BLOCKS AND STONES; FABRICATED PAVING BLOCKS AND STONES; STONES AND CONCRETE BLOCK PAVING STONES FOR BUILDING AND CONSTRUCTION (U.S. CLS. 1, 12, 33 AND 50).

FIRST USE 1-1-1995; IN COMMERCE 1-1-1995.
BRIDGETT SMITH, EXAMINING ATTORNEY

SN 78-341,427. STONECRAFT, INC., DENVER, CO. FILED 12-16-2003.

GRANITE TO GO

THE MARK CONSISTS OF STANDARD CHARACTERS WITHOUT CLAIM TO ANY PARTICULAR FONT, STYLE, SIZE, OR COLOR.

NO CLAIM IS MADE TO THE EXCLUSIVE RIGHT TO USE "GRANITE", APART FROM THE MARK AS SHOWN.

FOR PREMANUFACTURED GRANITE SLABS (U.S. CLS. 1, 12, 33 AND 50).

TINA L. SNAPP, EXAMINING ATTORNEY

SN 78-344,140. BAERGEN INNOVATIONS GROUP, GODFREY, CANADA, FILED 12-22-2003.

AQUAZEBO

THE MARK CONSISTS OF STANDARD CHARACTERS WITHOUT CLAIM TO ANY PARTICULAR FONT, STYLE, SIZE, OR COLOR.

PRIORITY CLAIMED UNDER SEC. 44(D) ON CANADA APPLICATION NO. 1199934, FILED 12-19-2003, REG. NO. TMA641652, DATED 6-8-2005, EXPIRES 6-8-2020.

FOR NON-METAL FLOATING DOCKS WITH ATTACHED GAZEBO (U.S. CLS. 1, 12, 33 AND 50).
ANDREA SAUNDERS, EXAMINING ATTORNEY

CLASS 19—(Continued).

SN 78-389,391. GOLDEN GLOBAL MANUFACTURING, INC., FT. MYERS, FL. FILED 3-23-2004.

CLASS 19—(Continued).

SN 78-409,756. LESTER BUILDING SYSTEMS, LLC, LESTER PRAIRIE, MN. FILED 4-28-2004.

TIKI IN A BOX

THE MARK CONSISTS OF STANDARD CHARACTERS WITHOUT CLAIM TO ANY PARTICULAR FONT, STYLE, SIZE, OR COLOR.

FOR PRIMARILY NON-METAL MANUFACTURED TIKI HUTS, CHIKEE HUTS, AND TIKI BARS, PRIMARILY NON-METAL PRE-FABRICATED BUILDING KITS FOR ASSEMBLING TIKI HUTS, TIKI BARS, AND CHIKEE HUTS (U.S. CLS. 1, 12, 33 AND 50).

JOSETTE BEVERLY, EXAMINING ATTORNEY

LESTER BUILDINGS

THE MARK CONSISTS OF STANDARD CHARACTERS WITHOUT CLAIM TO ANY PARTICULAR FONT, STYLE, SIZE, OR COLOR.

OWNER OF U.S. REG. NOS. 862,254, 1,708,692 AND OTHERS.

NO CLAIM IS MADE TO THE EXCLUSIVE RIGHT TO USE "BUILDINGS", APART FROM THE MARK AS SHOWN.

FOR PREFABRICATED WOOD FRAME BUILDINGS, NAMELY, HOG HOUSES, DAIRY BARNs, POULTRY HOUSES, MACHINE AND UTILITY SHEDS, CATTLE SHEDS, HORSE STABLES, SHEEP BUILDINGS, AGRICULTURAL BUILDINGS AND COMMERCIAL/INDUSTRIAL BUILDINGS, AND STRUCTURAL PARTS THEREOF (U.S. CLS. 1, 12, 33 AND 50).

FIRST USE 2-0-2004; IN COMMERCE 2-0-2004.

SAMUEL E. SHARPER JR., EXAMINING ATTORNEY

SN 78-408,450. PANTIM WOOD PRODUCTS, INC., PORTLAND, ME. FILED 4-27-2004.

SN 78-414,544. ELK PREMIUM BUILDING PRODUCTS, INC., DALLAS, TX. FILED 5-6-2004.

TIMBERMILL

THE MARK CONSISTS OF STANDARD CHARACTERS WITHOUT CLAIM TO ANY PARTICULAR FONT, STYLE, SIZE, OR COLOR.

FOR HARDWOOD FLOORING (U.S. CLS. 1, 12, 33 AND 50).

FIRST USE 6-0-2004; IN COMMERCE 6-0-2004.

DAWN HAN, EXAMINING ATTORNEY

BALSAM FOREST

THE MARK CONSISTS OF STANDARD CHARACTERS WITHOUT CLAIM TO ANY PARTICULAR FONT, STYLE, SIZE, OR COLOR.

FOR NON-METALLIC ROOFING SHINGLES (U.S. CLS. 1, 12, 33 AND 50).

FIRST USE 6-0-2001; IN COMMERCE 6-0-2001.

GENE MACIOL, EXAMINING ATTORNEY

CLASS 19—(Continued).

SN 78-418,420. ASSOCIATED MATERIALS, INCORPORATED, DBA ALSIDE, CUYAHOGA FALLS, OH. FILED 5-13-2004.

FRICTION FIT

THE MARK CONSISTS OF STANDARD CHARACTERS WITHOUT CLAIM TO ANY PARTICULAR FONT, STYLE, SIZE, OR COLOR.

FOR BUILDING MATERIALS, NAMELY, STACK LOCKING MECHANISM THAT ENABLES CONTOURED POLYSTYRENE FOAM TO BE MECHANICALLY FASTENED TO THE VINYL SIDING PANEL AND TO ALSO ENABLE PANELS TO INTERLOCK IN A TONGUE AND GROOVE MANNER (U.S. CLS. 1, 12, 33 AND 50).

BARBARA A. GOLD, EXAMINING ATTORNEY



SN 78-437,679. GEMINI DESIGNS INC., NORTH YORK, ONTARIO, CANADA, FILED 6-18-2004.

GEMFLOOR

THE MARK CONSISTS OF STANDARD CHARACTERS WITHOUT CLAIM TO ANY PARTICULAR FONT, STYLE, SIZE, OR COLOR.

PRIORITY CLAIMED UNDER SEC. 44(D) ON CANADA APPLICATION NO. 1202546, FILED 12-31-2003, REG. NO. TMA638680, DATED 4-29-2005, EXPIRES 4-29-2020.

FOR HARDWOOD FLOORING (U.S. CLS. 1, 12, 33 AND 50).

KARLA PERKINS, EXAMINING ATTORNEY

CLASS 19—(Continued).

SN 78-446,876. CEBALLOS-GODEFROY, RICARDO, COL. DEL VALLE, MEXICO, AND NEUMANN-DURAN, HERMAN, FEDERICO, COL. DEL VALLE, MEXICO, FILED 7-7-2004.

QUICK COUNTER

THE MARK CONSISTS OF STANDARD CHARACTERS WITHOUT CLAIM TO ANY PARTICULAR FONT, STYLE, SIZE, OR COLOR.

NO CLAIM IS MADE TO THE EXCLUSIVE RIGHT TO USE "COUNTER", APART FROM THE MARK AS SHOWN.

FOR NON-METAL TRADE SHOW BOOTHS (U.S. CLS. 1, 12, 33 AND 50).

AMY HELLA, EXAMINING ATTORNEY



SN 78-456,054. COASTAL INNOVATIVE PRODUCTS, IRVINE, CA. FILED 7-23-2004.



NO CLAIM IS MADE TO THE EXCLUSIVE RIGHT TO USE "DOORS", APART FROM THE MARK AS SHOWN.

THE COLORS WHITE, BLUE AND GREEN ARE CLAIMED AS A FEATURE OF THE MARK.

THE MARK CONSISTS OF A BI-FOLDING DOOR IN THE COLOR WHITE WITH GREEN FLOWERS ON THE SIDE OF THE DOOR WITH A BLUE BACKGROUND. THE WORDING LANAI BRINGING THE OUTDOORS IN IN BLUE AND THE WORDING DOORS IN GREEN.

FOR NON-METAL BIFOLDING DOORS AND WINDOWS (U.S. CLS. 1, 12, 33 AND 50).

FIRST USE 7-21-2004; IN COMMERCE 7-21-2004.

KEVON CHISOLM, EXAMINING ATTORNEY

CLASS 19—(Continued).

SN 78-459,752. COLUMBIA FOREST PRODUCTS, INC., PORTLAND, OR. FILED 7-30-2004.



THE MARK CONSISTS OF THE WORD "FIRSTSTEP" IN STYLIZED LOWER CASE LETTERS, WITH THE UPPER ARM OF THE LOWERCASE LETTER "F" CONSISTING OF THREE VERTICAL PARALLEL LINES, WHICH ALSO SERVE AS WHAT WOULD OTHERWISE BE THE DOT ABOVE THE LOWER CASE "I", AND WITH THE LOWER ARM OF THE LOWERCASE LETTER "F" CONNECTED TO THE TOP PORTION OF THE LOWERCASE "I".

FOR PREPRIMED PLYWOOD PANELS (U.S. CLS. 1, 12, 33 AND 50).
HEATHER THOMPSON, EXAMINING ATTORNEY

CLASS 19—(Continued).

SN 78-501,578. INTER-CONTINENTAL HARDWOODS, CURRIE, NC. FILED 10-18-2004.

FOUR DIAMOND FLOORS

THE MARK CONSISTS OF STANDARD CHARACTERS WITHOUT CLAIM TO ANY PARTICULAR FONT, STYLE, SIZE, OR COLOR.

NO CLAIM IS MADE TO THE EXCLUSIVE RIGHT TO USE "FLOORS", APART FROM THE MARK AS SHOWN.

FOR PREFINISHED AND UNFINISHED SOLID WOOD FLOORING (U.S. CLS. 1, 12, 33 AND 50).

FIRST USE 6-5-2004; IN COMMERCE 9-25-2004.
CHRISTOPHER BUONGIORNO, EXAMINING ATTORNEY

SN 78-478,962. MELLOW FLOORING GROUP CO., LTD., CHAOYANG DISTRICT, BEIJING, CHINA, FILED 9-4-2004.



韦仑嘉禾地板

NO CLAIM IS MADE TO THE EXCLUSIVE RIGHT TO USE DIBAN, APART FROM THE MARK AS SHOWN.

THE COLOR(S) GREEN, WHITE, GRAY AND BLACK IS/ ARE CLAIMED AS A FEATURE OF THE MARK.

THE MARK CONSISTS OF WHITE ENGLISH WORD MELLOW WITH GRAY BACKGROUND, SIX CHINESE CHARACTERS IN BLACK AND DEVICE IN GREEN AND WHITE.

THE FIRST FOUR CHINESE CHARACTERS IS THE APPLICANT'S CHINESE TRADE NAME WITH TRANSLITERATION OF WEILUN-JIAHE, WHICH HAS NO MEANING IN CHINESE OR IN OTHER LANGUAGES. THE LAST TWO CHINESE CHARACTERS TRANSLITERATE DIBAN, WHICH MEANS FLOORING IN CHINESE.

FOR WOODEN FLOORING; ENGINEERED WOODEN FLOORING; BUILDING MATERIALS, NAMELY, FLOOR BOARDS OF WOOD, SLATE, MARBLE, NON-METAL TILE FLOORING, NON-METAL GATES, NON-METAL WINDOWS, NON-METAL FLOORS, CERAMIC TILES FOR LINING, LUMBER, PREFABRICATED NON-METAL CABANAS, BALUSTRADES, PORTABLE NON-METAL BUILDINGS, LUMINOUS PAVING STONES (U.S. CLS. 1, 12, 33 AND 50).

MATTHEW KLINE, EXAMINING ATTORNEY

SN 78-504,181. VEKA AKTIENGESELLSCHAFT AKA VEKA AG, SENDENHORST, FED REP GERMANY, FILED 10-22-2004.

VEKARANCH

THE MARK CONSISTS OF STANDARD CHARACTERS WITHOUT CLAIM TO ANY PARTICULAR FONT, STYLE, SIZE, OR COLOR.

OWNER OF U.S. REG. NOS. 1,772,978, 2,736,625 AND OTHERS.

FOR PLASTIC FENCES, NAMELY FENCE POSTS AND RAILS AND CONNECTION PARTS AND FITTINGS THEREFOR (U.S. CLS. 1, 12, 33 AND 50).

AMY GEARIN, EXAMINING ATTORNEY

CLASS 19—(Continued).

SN 78-509,009. AEOLIAN ENTERPRISES, INCORPORATED, LOYALHANNA, PA. FILED 11-1-2004.

BreezeWood

THE MARK CONSISTS OF STANDARD CHARACTERS WITHOUT CLAIM TO ANY PARTICULAR FONT, STYLE, SIZE, OR COLOR.

FOR BUILDING PRODUCTS, NAMELY, PLASTIC LUMBER EXTRUSIONS (U.S. CLS. 1, 12, 33 AND 50).
TONI HICKEY, EXAMINING ATTORNEY

SN 78-512,107. BURNS, MORRIS & STEWART LIMITED PARTNERSHIP, NACOGDOCHES, TX. FILED 11-5-2004.

SILL FRAMESAVER

THE MARK CONSISTS OF STANDARD CHARACTERS WITHOUT CLAIM TO ANY PARTICULAR FONT, STYLE, SIZE, OR COLOR.

OWNER OF U.S. REG. NO. 2,279,907.
NO CLAIM IS MADE TO THE EXCLUSIVE RIGHT TO USE "SILL", APART FROM THE MARK AS SHOWN.
FOR NON-METAL WINDOW FRAMES (U.S. CLS. 1, 12, 33 AND 50).
SUNG IN, EXAMINING ATTORNEY

CLASS 19—(Continued).

SN 78-512,112. BURNS, MORRIS & STEWART LIMITED PARTNERSHIP, NACOGDOCHES, TX. FILED 11-5-2004.

GARAGE DOOR FRAMESAVER

THE MARK CONSISTS OF STANDARD CHARACTERS WITHOUT CLAIM TO ANY PARTICULAR FONT, STYLE, SIZE, OR COLOR.

OWNER OF U.S. REG. NO. 2,279,907.
NO CLAIM IS MADE TO THE EXCLUSIVE RIGHT TO USE "GARAGE DOOR", APART FROM THE MARK AS SHOWN.
FOR NON-METAL DOOR FRAMES (U.S. CLS. 1, 12, 33 AND 50).
SUNG IN, EXAMINING ATTORNEY

SN 78-512,117. BURNS, MORRIS & STEWART LIMITED PARTNERSHIP, NACOGDOCHES, TX. FILED 11-5-2004.

FRAMESAVER DOOR SYSTEMS

THE MARK CONSISTS OF STANDARD CHARACTERS WITHOUT CLAIM TO ANY PARTICULAR FONT, STYLE, SIZE, OR COLOR.

OWNER OF U.S. REG. NO. 2,279,907.
NO CLAIM IS MADE TO THE EXCLUSIVE RIGHT TO USE "DOOR SYSTEMS", APART FROM THE MARK AS SHOWN.
FOR NON-METAL DOOR FRAMES (U.S. CLS. 1, 12, 33 AND 50).
SUNG IN, EXAMINING ATTORNEY

SN 78-512,676. MODERN BUILDERS SUPPLY, INC., TOLEDO, OH. FILED 11-7-2004.

MASTERTECH

THE MARK CONSISTS OF STANDARD CHARACTERS WITHOUT CLAIM TO ANY PARTICULAR FONT, STYLE, SIZE, OR COLOR.

FOR NON-METAL WINDOWS AND DOORS (U.S. CLS. 1, 12, 33 AND 50).
FIRST USE 6-1-2001; IN COMMERCE 6-1-2001.
DAVID TAYLOR, EXAMINING ATTORNEY

CLASS 19—(Continued).

SN 78-515,090. CORRECT BUILDING PRODUCTS, LLC, BIDDEFORD, ME. FILED 11-11-2004.

CLASS 19—(Continued).

SN 78-519,168. HARBISON-WALKER REFRACTORIES COMPANY, MOON TOWNSHIP, OH. FILED 11-18-2004.

GOOD FOR LIFE

THE MARK CONSISTS OF STANDARD CHARACTERS WITHOUT CLAIM TO ANY PARTICULAR FONT, STYLE, SIZE, OR COLOR.

FOR BUILDING MATERIALS FOR DECKS, PLAY-GROUNDS, AND BOARDWALKS, NAMELY, NON-METAL PLANKS, COLUMNS, RAILS, POSTS, STAIRS, STAIR TREADS, BEAMS AND JOISTS; NON-METAL DOOR JAMBS; NON-METAL WINDOW AND DOOR SILLS; VINYL AND WOOD SIDINGS; AND NON-METAL ROOFING PANELS (U.S. CLS. 1, 12, 33 AND 50).

MICHAEL SOUDERS, EXAMINING ATTORNEY

VEGA

THE MARK CONSISTS OF STANDARD CHARACTERS WITHOUT CLAIM TO ANY PARTICULAR FONT, STYLE, SIZE, OR COLOR.

OWNER OF U.S. REG. NOS. 415,351 AND 619,299. FOR REFRACTORY BRICK (U.S. CLS. 1, 12, 33 AND 50).

MICHAEL SOUDERS, EXAMINING ATTORNEY

SN 78-518,429. SIGNATURE SYSTEMS, LLC, NEW YORK, NY. FILED 11-17-2004.

SN 78-520,731. HARBISON-WALKER REFRACTORIES COMPANY, MOON TOWNSHIP, PA. FILED 11-22-2004.

HexaDeck

THE MARK CONSISTS OF STANDARD CHARACTERS WITHOUT CLAIM TO ANY PARTICULAR FONT, STYLE, SIZE, OR COLOR.

FOR OUTDOOR TEMPORARY HEAVY DUTY INTER-LOCKING PLASTIC FLOORING SECTIONS (U.S. CLS. 1, 12, 33 AND 50).

FIRST USE 5-30-2004; IN COMMERCE 5-30-2004. DAWN FELDMAN, EXAMINING ATTORNEY

KORUNDAL

THE MARK CONSISTS OF STANDARD CHARACTERS WITHOUT CLAIM TO ANY PARTICULAR FONT, STYLE, SIZE, OR COLOR.

OWNER OF U.S. REG. NOS. 795,874, 795,875 AND 1,982,525.

FOR REFRACTORY MATERIALS, NAMELY, REFRACTORY BRICK, REFRACTORY MIXES, REFRACTORY GUNNING MIXES, REFRACTORY MORTAR AND REFRACTORY BONDING MIXES (U.S. CLS. 1, 12, 33 AND 50).

KIMBERLY PERRY, EXAMINING ATTORNEY

CLASS 19—(Continued).

SN 78-521,245. YANKEE BARN HOMES, INC., GRANTHAM, NH. FILED 11-22-2004.

CLASS 19—(Continued).

SN 78-524,399. SURVIVOR TECHNOLOGIES, INC., HILLSIDE, NJ. FILED 11-30-2004.

WEDGELOC

THE MARK CONSISTS OF STANDARD CHARACTERS WITHOUT CLAIM TO ANY PARTICULAR FONT, STYLE, SIZE, OR COLOR.

FOR NON-METAL ROOF PANEL JOINTS USED TO ASSEMBLE ADJACENT ROOF PANELS TOGETHER (U.S. CLS. 1, 12, 33 AND 50).

GINNY ISAACSON, EXAMINING ATTORNEY

IMAGINATION IS A BEAUTIFUL THING

THE MARK CONSISTS OF STANDARD CHARACTERS WITHOUT CLAIM TO ANY PARTICULAR FONT, STYLE, SIZE, OR COLOR.

FOR VINYL DOORS AND WINDOWS (U.S. CLS. 1, 12, 33 AND 50).

KIMBERLY FRYE, EXAMINING ATTORNEY

SN 78-522,053. KEYSTONE RETAINING WALL SYSTEMS, INC., MINNEAPOLIS, MN. FILED 11-23-2004.

RETAINING EXCELLENCE

THE MARK CONSISTS OF STANDARD CHARACTERS WITHOUT CLAIM TO ANY PARTICULAR FONT, STYLE, SIZE, OR COLOR.

FOR MODULAR CONCRETE BLOCKS USED TO CONSTRUCT EARTH RETAINING WALLS (U.S. CLS. 1, 12, 33 AND 50).

FIRST USE 12-31-2003; IN COMMERCE 12-31-2003.

LINDA MICKLEBURGH, EXAMINING ATTORNEY

SN 78-524,413. SURVIVOR TECHNOLOGIES, INC., HILLSIDE, NJ. FILED 11-30-2004.

THE ONLY THING MISSING FROM OUR VINYL WINDOWS AND DOORS IS YOUR HOME

SN 78-524,057. ROYAL HERITAGE MILLWORK, INC., MINNEAPOLIS, MN. FILED 11-29-2004.

ROYAL HERITAGE

THE MARK CONSISTS OF STANDARD CHARACTERS WITHOUT CLAIM TO ANY PARTICULAR FONT, STYLE, SIZE, OR COLOR.

FOR NON-METAL WINDOWS AND DOORS (U.S. CLS. 1, 12, 33 AND 50).

DAVID C. REIHNER, EXAMINING ATTORNEY

THE MARK CONSISTS OF STANDARD CHARACTERS WITHOUT CLAIM TO ANY PARTICULAR FONT, STYLE, SIZE, OR COLOR.

FOR VINYL DOORS AND WINDOWS (U.S. CLS. 1, 12, 33 AND 50).

KIMBERLY FRYE, EXAMINING ATTORNEY

CLASS 19—(Continued).

SN 78-527,028. LOUISIANA-PACIFIC CORPORATION, PORTLAND, OR. FILED 12-3-2004.

CLASS 19—(Continued).

SN 78-543,659. DEPARTMENT OF THE ARMY, ARLINGTON, VA. FILED 1-7-2005.

LP ABT

SACON

THE MARK CONSISTS OF STANDARD CHARACTERS WITHOUT CLAIM TO ANY PARTICULAR FONT, STYLE, SIZE, OR COLOR.
FOR NON-METAL BUILDING MATERIALS, NAMELY, HARDBOARD SIDING (U.S. CLS. 1, 12, 33 AND 50).
STEPHANIE DAVIS, EXAMINING ATTORNEY

THE MARK CONSISTS OF STANDARD CHARACTERS WITHOUT CLAIM TO ANY PARTICULAR FONT, STYLE, SIZE, OR COLOR.
OWNER OF U.S. REG. NO. 2,536,581.
FOR FIBER-REINFORCED CONCRETE (U.S. CLS. 1, 12, 33 AND 50).
FIRST USE 10-0-1984; IN COMMERCE 5-9-2001.
MICHAEL KAZAZIAN, EXAMINING ATTORNEY

SN 78-545,909. FACINGS OF AMERICA, INC, PHOENIX, AZ. FILED 1-11-2005.

SN 78-539,076. DENISON-CANNON COMPANY, NORTH BILLERICA, MA. FILED 12-28-2004.

HEXSTONE

TRUEPRIME

THE MARK CONSISTS OF STANDARD CHARACTERS WITHOUT CLAIM TO ANY PARTICULAR FONT, STYLE, SIZE, OR COLOR.
FOR BUILDING MATERIALS, NAMELY WOOD BOARDS (U.S. CLS. 1, 12, 33 AND 50).
PAUL F. GAST, EXAMINING ATTORNEY

THE MARK CONSISTS OF STANDARD CHARACTERS WITHOUT CLAIM TO ANY PARTICULAR FONT, STYLE, SIZE, OR COLOR.
FOR BUILDING AND FLOORING STONE IN THE NATURE OF MARBLE, GRANITE, SLATE, ONYX, LIMESTONE, SOAPSTONE, DECORATED STONE, CANTERRA STONE, ADOQUINE, STONE MOLDINGS, QUARTZITE, PRECAST STONE, AGGLOMERATE STONE, BASALT, AND SERPENTINE STONE, AND CERAMIC TILES, GLASS TILES, AND STONE MOSAICS USED IN CONSTRUCTION FOR FLOORING AND HOME FURNISHING AS ARCHITECTURAL ELEMENTS AND FEATURES (U.S. CLS. 1, 12, 33 AND 50).
FIRST USE 11-27-2004; IN COMMERCE 1-11-2005.
TRACY FLETCHER, EXAMINING ATTORNEY

CLASS 19—(Continued).

SN 78-546,675. COLUMBIA FOREST PRODUCTS, INC., PORTLAND, OR. FILED 1-12-2005.

IT'S ALL ABOUT THE FLOOR

THE MARK CONSISTS OF STANDARD CHARACTERS WITHOUT CLAIM TO ANY PARTICULAR FONT, STYLE, SIZE, OR COLOR.

FOR WOOD AND LAMINATE FLOORING (U.S. CLS. 1, 12, 33 AND 50).

CYNTHIA SLOAN, EXAMINING ATTORNEY

SN 78-547,354. TONGER INDUSTRIES CORP., FT. LAUDERDALE, FL. FILED 1-13-2005.

STEPCO

THE MARK CONSISTS OF STANDARD CHARACTERS WITHOUT CLAIM TO ANY PARTICULAR FONT, STYLE, SIZE, OR COLOR.

FOR HARDWOOD FLOORING (U.S. CLS. 1, 12, 33 AND 50).

FIRST USE 6-30-2004; IN COMMERCE 6-30-2004.
WENDY GOODMAN, EXAMINING ATTORNEY

SN 78-555,780. MULTI-REACH, INC., LONDON, ONTARIO, CANADA, FILED 1-28-2005.

SHADE IN-A-BOX

THE MARK CONSISTS OF STANDARD CHARACTERS WITHOUT CLAIM TO ANY PARTICULAR FONT, STYLE, SIZE, OR COLOR.

FOR NON-METAL EXTERIOR WINDOW BLINDS (U.S. CLS. 1, 12, 33 AND 50).

CHERYL CLAYTON, EXAMINING ATTORNEY

CLASS 19—(Continued).

SN 78-609,370. RUSSELL WADE, INC., APOPKA, FL. FILED 4-14-2005.

infoamation

THE MARK CONSISTS OF STANDARD CHARACTERS WITHOUT CLAIM TO ANY PARTICULAR FONT, STYLE, SIZE, OR COLOR.

FOR NON-LUMINOUS, NON-MECHANICAL SIGN NOT OF METAL, NAMELY, A FOAM AND PLASTIC DISPLAY BOARD FOR USE AS AN ANNOUNCEMENT SIGN OR MESSAGE BOARD (U.S. CLS. 1, 12, 33 AND 50).

JASON ROTH, EXAMINING ATTORNEY

SN 79-004,306. HAUSER, STEPHAN, D-63225 LANGEN, FED REP GERMANY, FILED 4-8-2004.

DUCON

THE MARK CONSISTS OF STANDARD CHARACTERS WITHOUT CLAIM TO ANY PARTICULAR FONT, STYLE, SIZE, OR COLOR.

OWNER OF INTERNATIONAL REGISTRATION 0830394 DATED 4-8-2004, EXPIRES 4-8-2014.

FOR CONCRETE, WIRE MESH CONCRETE; CONCRETE BUILDING MATERIALS, NAMELY BLOCKS, BRICKS, POSTS, SLABS, PANELS; NON-METALLIC REINFORCEMENTS FOR CONSTRUCTION PURPOSES (U.S. CLS. 1, 12, 33 AND 50).

DOMINIC J. FERRAIUOLO, EXAMINING ATTORNEY

SN 79-005,809. SYSTEM S.P.A., ITALY, FILED 5-21-2004.

SYNTERFLEX

THE MARK CONSISTS OF STANDARD CHARACTERS WITHOUT CLAIM TO ANY PARTICULAR FONT, STYLE, SIZE, OR COLOR.

OWNER OF INTERNATIONAL REGISTRATION 0834576 DATED 5-21-2004, EXPIRES 5-21-2014.

THE MARK CONSISTS OF THE WORDING SYNTERFLEX WHICH CAN BE REPRODUCED IN ANY CHARACTERS.

FOR NON-METALLIC BUILDING MATERIALS, NAMELY, CERAMIC SLABS, SHEETS AND TILE, PORCELAIN SLABS, SHEETS AND TILE, CERAMIC AND PORCELAIN BUILDING MATERIALS IN THE FORM OF SLABS, SHEETS AND TILES MADE OF CLAY AND FELDSPATHIC ROCKS (U.S. CLS. 1, 12, 33 AND 50).

DARRYL SPRUILL, EXAMINING ATTORNEY

CLASS 20—FURNITURE AND ARTICLES NOT OTHERWISE CLASSIFIED

SN 76-563,459. TALON SYSTEMS INC., MISSISSAUGA, ONTARIO NL5R 3Y9, CANADA, FILED 12-5-2003.

TALON

THE MARK CONSISTS OF STANDARD CHARACTERS WITHOUT CLAIM TO ANY PARTICULAR FONT, STYLE, SIZE, OR COLOR.

PRIORITY CLAIMED UNDER SEC. 44(D) ON CANADA APPLICATION NO. 1,197,297, FILED 11-24-2003, REG. NO. TMA629,155, DATED 12-23-2004, EXPIRES 12-23-2019.

FOR FURNITURE (U.S. CLS. 2, 13, 22, 25, 32 AND 50). FIRST USE 0-0-1993; IN COMMERCE 0-0-1993. DAVID MURRAY, EXAMINING ATTORNEY

SN 76-581,702. PRECISION DYNAMICS CORPORATION, SAN FERNANDO, CA. FILED 3-18-2004.

AGEBAND

THE MARK CONSISTS OF STANDARD CHARACTERS WITHOUT CLAIM TO ANY PARTICULAR FONT, STYLE, SIZE, OR COLOR.

FOR NON-METALLIC IDENTIFICATION WRISTBANDS FOR USE IN CROWD CONTROL, SCREENING, AND ADMISSIONS (U.S. CLS. 2, 13, 22, 25, 32 AND 50).

FIRST USE 3-9-2004; IN COMMERCE 3-9-2004. RAMONA ORTIGA, EXAMINING ATTORNEY

SN 76-584,043. BECKER DESIGNED, INC., CHANTILLY, VA. FILED 3-30-2004.

VISTA

THE MARK CONSISTS OF STANDARD CHARACTERS WITHOUT CLAIM TO ANY PARTICULAR FONT, STYLE, SIZE, OR COLOR.

FOR FURNITURE (U.S. CLS. 2, 13, 22, 25, 32 AND 50). FIRST USE 9-0-2002; IN COMMERCE 9-0-2002. JOHN DALIER, EXAMINING ATTORNEY

CLASS 20—(Continued).

SN 76-587,760. SOLID TERRAIN MODELING, INC., FILLMORE, CA. FILED 4-21-2004.

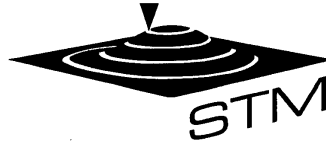

OWNER OF U.S. REG. NO. 2,886,939. FOR THREE-DIMENSIONAL PHYSICAL GEOGRAPHIC MODEL (U.S. CLS. 2, 13, 22, 25, 32 AND 50). FIRST USE 8-22-2002; IN COMMERCE 8-22-2002. CIMMERIAN COLEMAN, EXAMINING ATTORNEY

SN 76-589,419. AMERICAN SIGNATURE, INC., COLUMBUS, OH. FILED 4-29-2004.

UNI-STEEL

THE MARK CONSISTS OF STANDARD CHARACTERS WITHOUT CLAIM TO ANY PARTICULAR FONT, STYLE, SIZE, OR COLOR.

FOR FURNITURE AND FURNITURE COMPONENTS, NAMELY STRUCTURAL PARTS THEREFOR (U.S. CLS. 2, 13, 22, 25, 32 AND 50).

FIRST USE 6-15-2004; IN COMMERCE 6-15-2004. SAMUEL E. SHARPER JR., EXAMINING ATTORNEY

SN 76-593,523. ALTEX DECORATION LTEE, TERREBONNE, QUEBEC, CANADA, FILED 5-21-2004.

TEXSCREEN

THE MARK CONSISTS OF STANDARD CHARACTERS WITHOUT CLAIM TO ANY PARTICULAR FONT, STYLE, SIZE, OR COLOR.

OWNER OF CANADA REG. NO. 600804, DATED 1-28-2004, EXPIRES 1-28-2019.

FOR WINDOW BLINDS, VENETIAN BLINDS, HORIZONTAL BLINDS, VERTICAL BLINDS, BLINDS MADE OF PAPER, BLINDS MADE OF PLASTIC, BLINDS MADE OF VINYL, BLINDS MADE OF CANVAS, BLINDS MADE OF CLOTH, CUSTOM-FIT BLINDS, BLINDS MADE OF BAMBOO, ROLLER BLINDS AND SHADES; HARDWARE AND ACCESSORIES FOR BLINDS, SHADES AND CURTAINS, NAMELY, BRACKETS, FASTENERS, PULLS, FRINGES, ROLLERS AND VALANCES; CURTAIN RODS (U.S. CLS. 2, 13, 22, 25, 32 AND 50).

MICHAEL KEATING, EXAMINING ATTORNEY

CLASS 20—(Continued).

SN 76-601,878. STUDIO RTA, INC., PICO RIVERA, CA. FILED 7-12-2004.

ARIEL

THE MARK CONSISTS OF STANDARD CHARACTERS WITHOUT CLAIM TO ANY PARTICULAR FONT, STYLE, SIZE, OR COLOR.

FOR OFFICE FURNITURE, NAMELY, DESKS, FILE CABINETS, BOOKCASES, TABLES (U.S. CLS. 2, 13, 22, 25, 32 AND 50).

GIANCARLO CASTRO, EXAMINING ATTORNEY

SN 76-609,574. MARÉ-PACKARD, JEANNETTE, TUCSON, AZ. FILED 8-23-2004.

BEN'S BELL

THE MARK CONSISTS OF STANDARD CHARACTERS WITHOUT CLAIM TO ANY PARTICULAR FONT, STYLE, SIZE, OR COLOR.

NO CLAIM IS MADE TO THE EXCLUSIVE RIGHT TO USE "BELL", APART FROM THE MARK AS SHOWN.

FOR WIND CHIMES (U.S. CLS. 2, 13, 22, 25, 32 AND 50).

FIRST USE 3-29-2003; IN COMMERCE 3-29-2003.
ROBERT LORENZO, EXAMINING ATTORNEY

SN 76-617,712. STILSON, LLC, SANDY, UT. FILED 10-25-2004.

NATURE SLEEP

NO CLAIM IS MADE TO THE EXCLUSIVE RIGHT TO USE "SLEEP", APART FROM THE MARK AS SHOWN.

FOR ANATOMICALLY CORRECT MATTRESSES AND SLEEP SURFACES (U.S. CLS. 2, 13, 22, 25, 32 AND 50).

FIRST USE 10-31-1994; IN COMMERCE 10-31-1994.
INGA ERVIN, EXAMINING ATTORNEY

CLASS 20—(Continued).

SN 76-617,997. I-BED CO., LTD., TAIPEI, TAIWAN, FILED 10-27-2004.



PRIORITY CLAIMED UNDER SEC. 44(D) ON TAIWAN APPLICATION NO. 93035747, FILED 8-3-2004, REG. NO. 1151490, DATED 5-1-2005, EXPIRES 4-30-2015.

NO CLAIM IS MADE TO THE EXCLUSIVE RIGHT TO USE BED, APART FROM THE MARK AS SHOWN.

FOR BEDS, MATTRESSES, SPRING MATTRESSES, BOX SPRINGS, PILLOWS, CUSHIONS, NECK SUPPORT CUSHIONS, HEADBOARDS FOR BEDS, BED FRAMES (U.S. CLS. 2, 13, 22, 25, 32 AND 50).

CAROLINE WEIMER, EXAMINING ATTORNEY

SN 76-618,714. WINTERS, ROSE, NAPLES, FL. FILED 10-29-2004.

Tansy the conscious life style

THE MARK CONSISTS OF STANDARD CHARACTERS WITHOUT CLAIM TO ANY PARTICULAR FONT, STYLE, SIZE, OR COLOR.

FOR ENVIRONMENTALLY FRIENDLY FURNITURE (U.S. CLS. 2, 13, 22, 25, 32 AND 50).

REBECCA SMITH, EXAMINING ATTORNEY

SN 76-619,880. W.Y. TEXTILE, INC., TUSTIN, CA. FILED 11-9-2004.

MicroPlush

THE MARK CONSISTS OF THE WORD "MICROPLUSH" IN STYLIZED FONT.

FOR PET BEDS AND CUSHIONS (U.S. CLS. 2, 13, 22, 25, 32 AND 50).

FIRST USE 8-1-2004; IN COMMERCE 8-1-2004.
ESTHER A. BORSUK, EXAMINING ATTORNEY

CLASS 20—(Continued).

SN 76-623,443. DERON, JULIE, CHICAGO, IL. FILED 12-6-2004.

FLASHIN FANNYE.

THE MARK CONSISTS OF STANDARD CHARACTERS WITHOUT CLAIM TO ANY PARTICULAR FONT, STYLE, SIZE, OR COLOR.

FOR FABRIC HAND FANS (U.S. CLS. 2, 13, 22, 25, 32 AND 50).

KRISTINA KLOIBER, EXAMINING ATTORNEY

SN 76-623,670. AMERICAN WOODMARK CORPORATION, WINCHESTER, VA. FILED 12-8-2004.

YELLOWSTONE

THE MARK CONSISTS OF STANDARD CHARACTERS WITHOUT CLAIM TO ANY PARTICULAR FONT, STYLE, SIZE, OR COLOR.

OWNER OF U.S. REG. NO. 2,207,684.

FOR KITCHEN CABINETS AND BATHROOM CABINETS (U.S. CLS. 2, 13, 22, 25, 32 AND 50).

DANIEL BRODY, EXAMINING ATTORNEY

SN 76-625,590. SYROCO, INC., BALDWINVILLE, NY. FILED 12-21-2004.



OWNER OF U.S. REG. NOS. 422,195, 426,532 AND 1,021,553.

FOR FURNITURE, INCLUDING GARDEN AND OUTDOOR FURNITURE, MIRRORS AND PLAQUES MADE OF PLASTIC (U.S. CLS. 2, 13, 22, 25, 32 AND 50).

BILL DAWE, EXAMINING ATTORNEY

CLASS 20—(Continued).

SN 76-638,201. POLY-AMERICA, L.P., GRAND PRAIRIE, TX. FILED 5-6-2005.

HUSKY

THE MARK CONSISTS OF STANDARD CHARACTERS WITHOUT CLAIM TO ANY PARTICULAR FONT, STYLE, SIZE, OR COLOR.

OWNER OF U.S. REG. NOS. 1,300,604, 1,322,172 AND 2,924,814.

FOR NON-METAL LAWN EDGING (U.S. CLS. 2, 13, 22, 25, 32 AND 50).

FIRST USE 3-0-1992; IN COMMERCE 3-0-1992.

MELISSA SHELLA, EXAMINING ATTORNEY

SN 78-245,709. MAX PROTECTION, KENT, WA. FILED 5-5-2003.

MAX PROTECTION

FOR PLASTIC STORAGE CONTAINERS TO DISPLAY AND STORE COLLECTIBLES, TOYS, SPORTS MEMORABILIA AND TRADING CARDS (U.S. CLS. 2, 13, 22, 25, 32 AND 50).

DAVID TAYLOR, EXAMINING ATTORNEY

SN 78-257,851. SOURCE WINDOW COVERINGS, INC., WOODINVILLE, WA. FILED 6-3-2003.



FOR WINDOW TREATMENTS, NAMELY, INTERIOR WINDOW BLINDS, SHADES, AND INTERIOR WINDOW SHUTTERS (U.S. CLS. 2, 13, 22, 25, 32 AND 50).

FIRST USE 12-31-1983; IN COMMERCE 12-31-1983.

DORITT L. CARROLL, EXAMINING ATTORNEY

SN 78-260,439. PACIFIC COAST FEATHER COMPANY, SEATTLE, WA. FILED 6-10-2003.

ALLERX

FOR PILLOWS (U.S. CLS. 2, 13, 22, 25, 32 AND 50).

GLENN CLARK, EXAMINING ATTORNEY

CLASS 20—(Continued).

SN 78-324,825. JOFCO, INC., JASPER, IN. FILED 11-7-2003.

COLLECTIVE

THE MARK CONSISTS OF STANDARD CHARACTERS WITHOUT CLAIM TO ANY PARTICULAR FONT, STYLE, SIZE, OR COLOR.

FOR FURNITURE, PARTICULARLY OFFICE FURNITURE, NAMELY, DESKS, CREDENZAS, STORAGE CABINETS, TABLES, BRIDGES, OVERHEAD CABINETS, FILE CABINETS, WARDROBES, DESK PEDESTALS, OVERHEAD SCREENS, SPINE WALL ELEMENTS FOR MODULAR FURNITURE ARRANGEMENTS, STORAGE TOWERS, CORPORATE STYLE LOUNGE SEATING SUCH AS CHAIRS, SOFAS, END TABLES, COFFEE TABLES AND CONSOLE TABLES, AND ACCESSORIES AND COMPONENTS THEREFOR (U.S. CLS. 2, 13, 22, 25, 32 AND 50).

FIRST USE 6-16-2003; IN COMMERCE 6-16-2003.
AMY GEARIN, EXAMINING ATTORNEY

SN 78-363,163. RICHARDS-WILCOX, INC., AURORA, IL. FILED 2-5-2004.

AURORA

THE MARK CONSISTS OF STANDARD CHARACTERS WITHOUT CLAIM TO ANY PARTICULAR FONT, STYLE, SIZE, OR COLOR.

FOR STEEL SHELVING AND MOBILE STEEL SHELVING UNITS COMPRISING SHELVING ATTACHED TO CARRIAGES (U.S. CLS. 2, 13, 22, 25, 32 AND 50).

FIRST USE 12-31-1952; IN COMMERCE 12-31-1952.
RONALD MCMORROW, EXAMINING ATTORNEY

CLASS 20—(Continued).

SN 78-381,485. NU-TECH, INC., MIAMI, FL. FILED 3-10-2004.



THE MARK CONSISTS OF STYLIZED BLACK LETTERING AROUND A DARKENED IN CIRCLE WITH A STYLIZED WHITE PELICAN INSIDE THE CIRCLE.

FOR FURNITURE (U.S. CLS. 2, 13, 22, 25, 32 AND 50).
FIRST USE 3-15-1996; IN COMMERCE 3-15-1996.
IRA J. GOODSaid, EXAMINING ATTORNEY

SN 78-387,198. WALKER, BRIAN B, BIG LAKE, MN. FILED 3-19-2004.

forefront

THE MARK CONSISTS OF TYPE DEPICTING A MOVING "F" REPRESENTING PRODUCTS MOVING ON A RETAIL SHELF.

FOR AUTOMATED RETAIL DISPLAY CASES FOR MERCHANDISE TO IMPROVE SPACE UTILIZATION AND PRODUCT PRESENTATION WHILE REDUCING NEEDED LABOR (U.S. CLS. 2, 13, 22, 25, 32 AND 50).

FIRST USE 9-10-2003; IN COMMERCE 9-28-2003.
JASON TURNER, EXAMINING ATTORNEY

SN 78-388,983. GRIFFITHS, ROBERT PHILLIP, MASCOT, NSW, AUSTRALIA, FILED 3-23-2004.

LOUVER MATE

THE MARK CONSISTS OF STANDARD CHARACTERS WITHOUT CLAIM TO ANY PARTICULAR FONT, STYLE, SIZE, OR COLOR.

NO CLAIM IS MADE TO THE EXCLUSIVE RIGHT TO USE "LOUVER", APART FROM THE MARK AS SHOWN.

FOR INTERIOR WINDOW LOUVERS AND SHUTTERS OF MATERIALS OTHER THAN METALS; SHUTTER ASSEMBLIES FOR WINDOWS, NAMELY, OPENING AND CLOSING MECHANISMS NOT MADE OF METAL (U.S. CLS. 2, 13, 22, 25, 32 AND 50).

SEAN DWYER, EXAMINING ATTORNEY

CLASS 20—(Continued).

SN 78-407,292. EL DORADO FURNITURE CORPORATION,
MIAMI, FL. FILED 4-23-2004.

**CHRISTOPHER
CASABLANCA**

THE MARK CONSISTS OF STANDARD CHARACTERS
WITHOUT CLAIM TO ANY PARTICULAR FONT, STYLE,
SIZE, OR COLOR.

THE NAME(S), PORTRAIT(S), AND/OR SIGNATURE(S)
SHOWN IN THE MARK DOES NOT IDENTIFY A PARTI-
CULAR LIVING INDIVIDUAL.

FOR FURNITURE, NAMELY CHAIRS, SOFAS, TA-
BLES, DESKS, SECTIONALS, BOOKCASES, CHESTS,
CHESTS OF DRAWERS, CABINETS, AND BEDS (U.S.
CLS. 2, 13, 22, 25, 32 AND 50).

FIRST USE 2-4-2004; IN COMMERCE 2-4-2004.
CAROLINE WOOD, EXAMINING ATTORNEY

SN 78-412,613. FLEXSTEEL INDUSTRIES, INC., DUBUQUE,
IA. FILED 5-4-2004.

DUALflex
SPRING SYSTEM

NO CLAIM IS MADE TO THE EXCLUSIVE RIGHT TO
USE "SPRING SYSTEM", APART FROM THE MARK AS
SHOWN.

THE MARK CONSISTS OF THE WORDS DUALFLEX
SPRING SYSTEM IN SPECIAL FORM.

FOR FURNITURE (U.S. CLS. 2, 13, 22, 25, 32 AND 50).
FIRST USE 1-2-2004; IN COMMERCE 1-2-2004.
DAVID MURRAY, EXAMINING ATTORNEY

SN 78-414,446. DEALER CONCEPTS, LLC, CLARKSTON, MI.
FILED 5-6-2004.

PUNCH A DEAL

THE MARK CONSISTS OF STANDARD CHARACTERS
WITHOUT CLAIM TO ANY PARTICULAR FONT, STYLE,
SIZE, OR COLOR.

FOR PLASTIC KEY TAGS, PLASTIC KEY CHAIN
TAGS HAVING PRINTED MATERIAL DISPLAYED
THEREON (U.S. CLS. 2, 13, 22, 25, 32 AND 50).

FIRST USE 11-28-2001; IN COMMERCE 12-17-2001.
GEORGIA CARTY, EXAMINING ATTORNEY

CLASS 20—(Continued).

SN 78-418,589. HOUSE OF MIRRORS INC., MARLTON, NJ.
FILED 5-13-2004.

House of Mirrors

THE MARK CONSISTS OF STANDARD CHARACTERS
WITHOUT CLAIM TO ANY PARTICULAR FONT, STYLE,
SIZE, OR COLOR.

NO CLAIM IS MADE TO THE EXCLUSIVE RIGHT TO
USE MIRRORS, APART FROM THE MARK AS SHOWN.
FOR MIRRORS (U.S. CLS. 2, 13, 22, 25, 32 AND 50).
FIRST USE 2-1-1991; IN COMMERCE 2-1-1991.
MARY CRAWFORD, EXAMINING ATTORNEY

SN 78-420,326. MIKRON INDUSTRIES, INC., KENT, WA.
FILED 5-17-2004.



NO CLAIM IS MADE TO THE EXCLUSIVE RIGHT TO
USE "LOCK", APART FROM THE MARK AS SHOWN.

FOR WINDOW LOCKS AND SLIDING GLASS DOOR
LOCKS COMPRISED PREDOMINANTLY OF NON-ME-
TALLIC MATERIALS, INCLUDING PLASTIC COMPO-
SITE MATERIALS (U.S. CLS. 2, 13, 22, 25, 32 AND 50).

FIRST USE 8-1-2002; IN COMMERCE 8-1-2002.
THEODORE MCBRIDE, EXAMINING ATTORNEY

CLASS 20—(Continued).

SN 78-421,407. JORDI MASRAMON PLA, MANRESA (BARCELONA), SPAIN, FILED 5-19-2004.



FOR FURNITURE AND MIRRORS FOR BATHROOMS, NAMELY BATHROOM STORAGE CONTAINERS MADE OF WOOD, BATHROOM SHELVES, BATHROOM COUNTERTOPS, AND BATHROOM CABINETS (U.S. CLS. 2, 13, 22, 25, 32 AND 50).

DEZMONA MIZELLE, EXAMINING ATTORNEY

CLASS 20—(Continued).

SN 78-436,712. OWENS-ILLINOIS CLOSURE INC., TOLEDO, OH. FILED 6-17-2004.

REGAL

THE MARK CONSISTS OF STANDARD CHARACTERS WITHOUT CLAIM TO ANY PARTICULAR FONT, STYLE, SIZE, OR COLOR.

FOR NON-METALLIC CLOSURES, NAMELY, CLOSURES FOR BOTTLE, JARS, JUGS AND CONTAINERS (U.S. CLS. 2, 13, 22, 25, 32 AND 50).

BARNEY CHARLON, EXAMINING ATTORNEY

SN 78-422,124. HOMECREST INDUSTRIES INCORPORATED, WADENA, MN. FILED 5-20-2004.

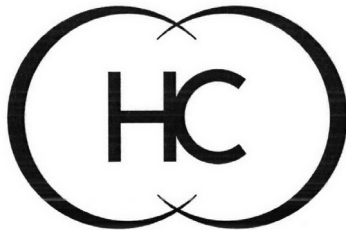

FOR CASUAL AND OUTDOOR FURNITURE (U.S. CLS. 2, 13, 22, 25, 32 AND 50).

WINSTON FOLMAR, EXAMINING ATTORNEY

SN 78-446,069. ID RESULT B.V., TERHEIJDEN, NETHERLANDS, FILED 7-6-2004.



SN 78-435,881. WEAVER SALES & SERVICES, INC., RAINBOW CITY, AL. FILED 6-16-2004.

**SUTTON BRIDGE
FURNITURE**

THE MARK CONSISTS OF STANDARD CHARACTERS WITHOUT CLAIM TO ANY PARTICULAR FONT, STYLE, SIZE, OR COLOR.

NO CLAIM IS MADE TO THE EXCLUSIVE RIGHT TO USE "FURNITURE", APART FROM THE MARK AS SHOWN.

FOR FURNITURE (U.S. CLS. 2, 13, 22, 25, 32 AND 50).
LOURDES AYALA, EXAMINING ATTORNEY

NO CLAIM IS MADE TO THE EXCLUSIVE RIGHT TO USE "SIPPER", APART FROM THE MARK AS SHOWN.

FOR PLASTIC CAPS AND CLOSURES FOR BOTTLES AND CONTAINERS; PLASTIC CAPS AND CLOSURES FOR BEVERAGE-BOTTLES; BOTTLE CLOSURES NOT OF METAL; DEVICE FOR SIPPING DRINKS FROM VARIOUS BOTTLES, BEVERAGE-BOTTLES AND CONTAINERS, COMPRISING, DRINKING STRAW AND PLASTIC BOTTLE CLOSURES (U.S. CLS. 2, 13, 22, 25, 32 AND 50).

GEOFFREY FOSDICK, EXAMINING ATTORNEY

CLASS 20—(Continued).

SN 78-459,442. KENYATTA DESIGN CORPORATION, LITHONIA, GA. FILED 7-30-2004.

CLASS 20—(Continued).

SN 78-471,793. KRAUS, PHILIP, SAN FERNANDO, CA. FILED 8-23-2004.



EURO SENSE

THE COLOR(S) GOLD COLOR IDENTIFIED AS PMS NUMBER 139 IS/ARE CLAIMED AS A FEATURE OF THE MARK.

THE COLORS GOLD AND IVORY ARE CLAIMED AS A FEATURE OF THE MARK. THE MARK CONSISTS OF THE LETTERS KDC WITH THE HEIGHT OF THE K BEING TWICE THE SIZE OF THE D AND C. THE KDC ARE THE A CLASSIC LAID BARONIAL IVORY COLOR AND THE ENCLOSED RECTANGULAR SHAPE WITH ROUNDED CORNERS IS A GOLD COLOR.

FOR FURNITURE (U.S. CLS. 2, 13, 22, 25, 32 AND 50). WILLIAM BRECKENFELD, EXAMINING ATTORNEY

THE MARK CONSISTS OF STANDARD CHARACTERS WITHOUT CLAIM TO ANY PARTICULAR FONT, STYLE, SIZE, OR COLOR.

NO CLAIM IS MADE TO THE EXCLUSIVE RIGHT TO USE "EURO", APART FROM THE MARK AS SHOWN.

FOR MATTRESSES, MATTRESS FOUNDATIONS, BEDS, AND ADJUSTABLE BEDS (U.S. CLS. 2, 13, 22, 25, 32 AND 50).

FIRST USE 8-20-2004; IN COMMERCE 8-20-2004. CYNTHIA SLOAN, EXAMINING ATTORNEY

SN 78-462,914. VENETIAN CASINO RESORT, LLC, LAS VEGAS, NV. FILED 8-5-2004.

SN 78-476,279. G.C. HUDSON INDUSTRIES, INC., RICHMOND, VA. FILED 8-31-2004.

VENETIAN PALAZZO

SCIENCE OF SLEEP

THE MARK CONSISTS OF STANDARD CHARACTERS WITHOUT CLAIM TO ANY PARTICULAR FONT, STYLE, SIZE, OR COLOR.

FOR NON-METAL AND NON-LEATHER KEY CHAINS; PICTURE FRAMES; MIRRORS; PLASTIC NOVELTY LICENSE PLATES (U.S. CLS. 2, 13, 22, 25, 32 AND 50).

ANDREW RHIM, EXAMINING ATTORNEY

THE MARK CONSISTS OF STANDARD CHARACTERS WITHOUT CLAIM TO ANY PARTICULAR FONT, STYLE, SIZE, OR COLOR.

OWNER OF U.S. REG. NO. 1,588,907. NO CLAIM IS MADE TO THE EXCLUSIVE RIGHT TO USE "SLEEP", APART FROM THE MARK AS SHOWN.

FOR PILLOWS (U.S. CLS. 2, 13, 22, 25, 32 AND 50). FIRST USE 10-24-1986; IN COMMERCE 10-24-1986.

WON TEAK OH, EXAMINING ATTORNEY

CLASS 20—(Continued).

SN 78-487,231. JOMAR GREETINGS, INC., OAKLAND, NJ.
FILED 9-21-2004.

**Ultra Sleeve
Transplanting
Made Easy**

THE MARK CONSISTS OF STANDARD CHARACTERS WITHOUT CLAIM TO ANY PARTICULAR FONT, STYLE, SIZE, OR COLOR.

NO CLAIM IS MADE TO THE EXCLUSIVE RIGHT TO USE "SLEEVE TRANSPLANTING", APART FROM THE MARK AS SHOWN.

FOR PLASTIC INSERTS FOR USE AS CONTAINER LINERS, NAMELY, REMOVABLE LINER FOR PLANT SEEDLING STARTING CONTAINER (U.S. CLS. 2, 13, 22, 25, 32 AND 50).

FIRST USE 9-21-2004; IN COMMERCE 9-21-2004.
ROBERT LAVACHE, EXAMINING ATTORNEY

CLASS 20—(Continued).

SN 78-505,121. J.L. CLARK, INC., ROCKFORD, IL. FILED 10-25-2004.

FLIP-N-RIP

THE MARK CONSISTS OF STANDARD CHARACTERS WITHOUT CLAIM TO ANY PARTICULAR FONT, STYLE, SIZE, OR COLOR.

FOR PLASTIC STORAGE CONTAINERS AND PLASTIC STORAGE CONTAINER LIDS (U.S. CLS. 2, 13, 22, 25, 32 AND 50).

JANICE L. MCMORROW, EXAMINING ATTORNEY

SN 78-506,224. PILLOWSAYS, INC., WILMETTE, IL. FILED 10-26-2004.

PillowSays

SN 78-504,598. BROYHILL FURNITURE INDUSTRIES, INC., LENOIR, NC. FILED 10-22-2004.

URBAN VIEW

THE MARK CONSISTS OF STANDARD CHARACTERS WITHOUT CLAIM TO ANY PARTICULAR FONT, STYLE, SIZE, OR COLOR.

FOR FURNITURE (U.S. CLS. 2, 13, 22, 25, 32 AND 50).
FIRST USE 9-7-2004; IN COMMERCE 9-7-2004.
ANDREA K. NADELMAN, EXAMINING ATTORNEY

THE MARK CONSISTS OF STANDARD CHARACTERS WITHOUT CLAIM TO ANY PARTICULAR FONT, STYLE, SIZE, OR COLOR.

FOR PILLOWS AND RELATED PRODUCTS, NAMELY PILLOWFORMS, THAT INCLUDE EXTERIOR PICTURES AND/OR INTERNAL VOICE MEMORY CHIPS (U.S. CLS. 2, 13, 22, 25, 32 AND 50).

FIRST USE 10-8-2004; IN COMMERCE 10-8-2004.
KRISTINA KLOIBER, EXAMINING ATTORNEY

CLASS 20—(Continued).

SN 78-509,372. TRION INDUSTRIES, INC., WILKES-BARRE, PA. FILED 11-1-2004.

WONDER BAR

THE MARK CONSISTS OF STANDARD CHARACTERS WITHOUT CLAIM TO ANY PARTICULAR FONT, STYLE, SIZE, OR COLOR.

NO CLAIM IS MADE TO THE EXCLUSIVE RIGHT TO USE "BAR", APART FROM THE MARK AS SHOWN.

FOR DISPLAY RACKS FOR DISPLAYING MERCHANDISE IN STORES (U.S. CLS. 2, 13, 22, 25, 32 AND 50).

WINSTON FOLMAR, EXAMINING ATTORNEY

CLASS 20—(Continued).

SN 78-515,738. BNK INDUSTRIES, COLORADO SPRINGS, CO. FILED 11-12-2004.



NO CLAIM IS MADE TO THE EXCLUSIVE RIGHT TO USE WOOD SCRIPT, APART FROM THE MARK AS SHOWN.

THE MARK CONSISTS OF A STYLIZED LETTER "W" FOLLOWED BY "OOD", AND A SYLIZED LETTER "S" FOLLOWED BY "CRIPT".

FOR WOOD CARVINGS, NAMELY DESIGN AND WORDS CUT INTO WOOD CREATING A 3-DIMENSIONAL EFFECT (U.S. CLS. 2, 13, 22, 25, 32 AND 50).

FIRST USE 3-29-2004; IN COMMERCE 11-11-2004.
LINDA POWELL, EXAMINING ATTORNEY

SN 78-514,365. WENGER CORPORATION, OWATONNA, MN. FILED 11-10-2004.

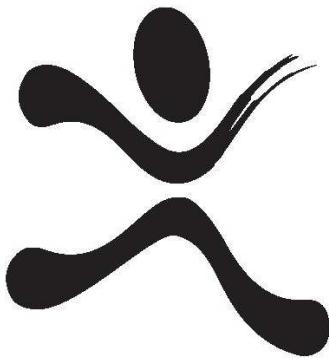

CozyCushy

FOR FURNITURE FOR CLASSROOMS, TABLES, CHAIRS, DESKS, CABINETS, BEDS, ACTIVITY CENTERS COMPRISED OF FURNITURE, NON-METAL COAT HOOKS, WORKSTATIONS HAVING MULTI-USE WORK SURFACES FOR USE IN A VARIETY OF FIELDS, WARDROBES (U.S. CLS. 2, 13, 22, 25, 32 AND 50).

STACY WAHLBERG, EXAMINING ATTORNEY

SN 78-516,414. NORCOTT, MARGARET L, ALPHARETTA, GA. FILED 11-12-2004.

THE MARK CONSISTS OF STANDARD CHARACTERS WITHOUT CLAIM TO ANY PARTICULAR FONT, STYLE, SIZE, OR COLOR.

FOR NURSING PILLOW FOR BREAST FEEDING MOTHERS (U.S. CLS. 2, 13, 22, 25, 32 AND 50).

ADA HAN, EXAMINING ATTORNEY

CLASS 20—(Continued).

SN 78-516,574. GRASSI, RALPH, WILDWOOD, NJ. FILED 11-14-2004.

DARKRIDE

THE MARK CONSISTS OF STANDARD CHARACTERS WITHOUT CLAIM TO ANY PARTICULAR FONT, STYLE, SIZE, OR COLOR.

FOR COLLECTIBLE STATUE OF WOOD AND PLASTER (U.S. CLS. 2, 13, 22, 25, 32 AND 50).

FIRST USE 11-1-2004; IN COMMERCE 11-1-2004.
ANNE E. GUSTASON, EXAMINING ATTORNEY

CLASS 20—(Continued).

SN 78-518,763. DOGSTERS, LLC, MILFORD, CT. FILED 11-17-2004.

CATSTERS

THE MARK CONSISTS OF STANDARD CHARACTERS WITHOUT CLAIM TO ANY PARTICULAR FONT, STYLE, SIZE, OR COLOR.

OWNER OF U.S. REG. NO. 2,921,591.

FOR FURNITURE, CHAIR PADS, DOG BEDS, HOLIDAY ORNAMENTS OF PLASTIC, PILLOWS AND CUSHIONS, PLASTIC KEY RINGS AND TAGS, PLAY HOUSES FOR PETS, PORTABLE BEDS FOR DOGS (U.S. CLS. 2, 13, 22, 25, 32 AND 50).

TEJBIR SINGH, EXAMINING ATTORNEY

SN 78-518,388. RAIES, CLAUDIO, HIGH POINT, NC. FILED 11-17-2004.

SAFENOSE

THE MARK CONSISTS OF STANDARD CHARACTERS WITHOUT CLAIM TO ANY PARTICULAR FONT, STYLE, SIZE, OR COLOR.

FOR BED FRAMES, BEDS (U.S. CLS. 2, 13, 22, 25, 32 AND 50).

FIRST USE 2-15-2003; IN COMMERCE 5-19-2004.
IRA J. GOODSaid, EXAMINING ATTORNEY

SN 78-518,815. KING KOIL LICENSING COMPANY, INC., HINSDALE, IL. FILED 11-17-2004.



OWNER OF U.S. REG. NOS. 2,519,613, 2,751,179 AND 2,818,040.

THE LINING IS A FEATURE OF THE MARK AND DOES NOT INDICATE COLOR.

FOR BEDS, MATTRESSES AND BOX SPRINGS (U.S. CLS. 2, 13, 22, 25, 32 AND 50).

FIRST USE 2-0-2002; IN COMMERCE 5-0-2002.
KAREN BRACEY, EXAMINING ATTORNEY

CLASS 20—(Continued).

SN 78-519,256. DANZE, ALEX, CORONA, CA. FILED 11-18-2004.

CLASS 20—(Continued).

SN 78-520,223. LOVELAND PRODUCTS, INC., GREELEY, CO. FILED 11-19-2004.

Pro Cap Stool

DYNABOX

THE MARK CONSISTS OF STANDARD CHARACTERS WITHOUT CLAIM TO ANY PARTICULAR FONT, STYLE, SIZE, OR COLOR.

NO CLAIM IS MADE TO THE EXCLUSIVE RIGHT TO USE "CAP STOOL", APART FROM THE MARK AS SHOWN, FOR FURNITURE FOR HOUSE, OFFICE, GARDEN, AND CAMPING; PORTABLE STOOL, NAMELY STOOL, CHAIR, DECK CHAIRS, SEATS, AND FOLDING CHAIRS (U.S. CLS. 2, 13, 22, 25, 32 AND 50).

EUGENIA MARTIN, EXAMINING ATTORNEY

THE MARK CONSISTS OF STANDARD CHARACTERS WITHOUT CLAIM TO ANY PARTICULAR FONT, STYLE, SIZE, OR COLOR.

FOR HARD-SIDED PLASTIC CONTAINERS FOR COMMERCIAL USE, NAMELY FOR SHIPPING AGRICULTURAL SEEDS (U.S. CLS. 2, 13, 22, 25, 32 AND 50).

BARBARA RUTLAND, EXAMINING ATTORNEY

SN 78-519,373. TWENTIETH CENTURY FOX FILM CORPORATION, LOS ANGELES, CA. FILED 11-18-2004.

SN 78-520,346. SIEGEL, SHERRY, SANTA FE, NM. FILED 11-19-2004.

AMERICAN DAD

COWGIRL DUST

THE MARK CONSISTS OF STANDARD CHARACTERS WITHOUT CLAIM TO ANY PARTICULAR FONT, STYLE, SIZE, OR COLOR.

FOR PLASTIC KEY CHAINS AND TAGS (U.S. CLS. 2, 13, 22, 25, 32 AND 50).

TRACY FLETCHER, EXAMINING ATTORNEY

THE MARK CONSISTS OF STANDARD CHARACTERS WITHOUT CLAIM TO ANY PARTICULAR FONT, STYLE, SIZE, OR COLOR.

FOR NOVELTY GIFT ITEM, NAMELY POUCH OR PENDANT CONTAINING SHIMMERING GLITTER (U.S. CLS. 2, 13, 22, 25, 32 AND 50).

FIRST USE 10-0-2004; IN COMMERCE 10-0-2004.

BARBARA BROWN, EXAMINING ATTORNEY

CLASS 20—(Continued).

SN 78-520,701. STEAMROOM USA, INC., ALPHARETTA, GA. FILED 11-21-2004.

CLASS 20—(Continued).

SN 78-523,147. ENDICK, MITCHELL, ATHENS, OH. FILED 11-26-2004.

AQUALAIR

Ache Less

THE MARK CONSISTS OF STANDARD CHARACTERS WITHOUT CLAIM TO ANY PARTICULAR FONT, STYLE, SIZE, OR COLOR.

FOR VANITIES THAT INCLUDE COUNTER TOPS, MIRRORS, SHELVES AND CABINETS (U.S. CLS. 2, 13, 22, 25, 32 AND 50).

CHERYL CLAYTON, EXAMINING ATTORNEY

THE MARK CONSISTS OF STANDARD CHARACTERS WITHOUT CLAIM TO ANY PARTICULAR FONT, STYLE, SIZE, OR COLOR.

FOR MATTRESSES AND FUTONS (U.S. CLS. 2, 13, 22, 25, 32 AND 50).

FIRST USE 11-1-2004; IN COMMERCE 11-15-2004.

LAURA KOVAISKY, EXAMINING ATTORNEY

SN 78-524,388. ZINUS, INC., PLEASANTON, CA. FILED 11-30-2004.

SN 78-522,085. INTERNATIONAL OUTSOURCING SERVICES, LLC, BLOOMINGTON, IN. FILED 11-23-2004.

GRAND RIVER

Ultima

THE MARK CONSISTS OF STANDARD CHARACTERS WITHOUT CLAIM TO ANY PARTICULAR FONT, STYLE, SIZE, OR COLOR.

FOR FURNITURE (U.S. CLS. 2, 13, 22, 25, 32 AND 50).
LINDA POWELL, EXAMINING ATTORNEY

THE MARK CONSISTS OF STANDARD CHARACTERS WITHOUT CLAIM TO ANY PARTICULAR FONT, STYLE, SIZE, OR COLOR.

FOR PILLOWS, SEAT CUSHIONS, MATTRESS TOPPERS, MATTRESSES (U.S. CLS. 2, 13, 22, 25, 32 AND 50).
KIMBERLY FRYE, EXAMINING ATTORNEY

CLASS 20—(Continued).

SN 78-525,074. WINDSHIP AVIATION LTD., EDMONTON, CANADA, FILED 12-1-2004.

CLASS 20—(Continued).

SN 78-536,121. KHVALIN, OLEG, ROCHESTER, NY. FILED 12-21-2004.

WALKABOUT

Comeback Kid

THE MARK CONSISTS OF STANDARD CHARACTERS WITHOUT CLAIM TO ANY PARTICULAR FONT, STYLE, SIZE, OR COLOR.

FOR ADVERTISING BALLOONS NAMELY; HEAVY NYLON BALLOONS FILLED WITH FORCED COLD OR HOT AIR (U.S. CLS. 2, 13, 22, 25, 32 AND 50).
SCOTT BALDWIN, EXAMINING ATTORNEY

THE MARK CONSISTS OF STANDARD CHARACTERS WITHOUT CLAIM TO ANY PARTICULAR FONT, STYLE, SIZE, OR COLOR.

FOR NON-METAL TROPHIES (U.S. CLS. 2, 13, 22, 25, 32 AND 50).
LAURA KOVAISKY, EXAMINING ATTORNEY

SN 78-526,691. HAWORTH, INC., HOLLAND, MI. FILED 12-3-2004.

SN 78-538,600. INDUSTRIAL RUBBER AND SUPPLY, INC., FIFE, WA. FILED 12-27-2004.

HAWORTH LETS YOU
DESIGN GREAT SPACES
THAT BEST ADAPT TO
CHANGE

A Refreshing
Change From
Springs

THE MARK CONSISTS OF STANDARD CHARACTERS WITHOUT CLAIM TO ANY PARTICULAR FONT, STYLE, SIZE, OR COLOR.

OWNER OF U.S. REG. NOS. 296,273, 1,864,740 AND OTHERS.
FOR FURNITURE (U.S. CLS. 2, 13, 22, 25, 32 AND 50).
LINDA ESTRADA, EXAMINING ATTORNEY

THE MARK CONSISTS OF STANDARD CHARACTERS WITHOUT CLAIM TO ANY PARTICULAR FONT, STYLE, SIZE, OR COLOR.

FOR ADJUSTABLE BED BASES, VISCO ELASTIC FOAM MATTRESSES, PILLOWS AND BED TOPPERS; LATEX FOAM MATTRESSES, PILLOWS AND BED TOPPERS (U.S. CLS. 2, 13, 22, 25, 32 AND 50).
BARBARA RUTLAND, EXAMINING ATTORNEY

CLASS 20—(Continued).

SN 78-539,895. STANLEY FURNITURE COMPANY, INC., STANLEYTOWN, VA. FILED 12-29-2004.

CLASS 20—(Continued).

SN 78-540,153. STAPLES THE OFFICE SUPERSTORE, LLC, FRAMINGHAM, MA. FILED 12-30-2004.

BARBADOS

EASYFLEX

THE MARK CONSISTS OF STANDARD CHARACTERS WITHOUT CLAIM TO ANY PARTICULAR FONT, STYLE, SIZE, OR COLOR.
FOR WOODEN HOUSEHOLD AND OFFICE FURNITURE (U.S. CLS. 2, 13, 22, 25, 32 AND 50).
JENNIFER WILLISTON, EXAMINING ATTORNEY

THE MARK CONSISTS OF STANDARD CHARACTERS WITHOUT CLAIM TO ANY PARTICULAR FONT, STYLE, SIZE, OR COLOR.
FOR OFFICE FURNITURE (U.S. CLS. 2, 13, 22, 25, 32 AND 50).
CYNTHIA SLOAN, EXAMINING ATTORNEY

SN 78-539,963. WORLD FACTORY, INC., SOUTHLAKE, TX. FILED 12-30-2004.

SN 78-543,956. HSN LP, ST. PETERSBURG, FL. FILED 1-7-2005.

YUKON

**CONCIERGE
COLLECTION**

THE MARK CONSISTS OF STANDARD CHARACTERS WITHOUT CLAIM TO ANY PARTICULAR FONT, STYLE, SIZE, OR COLOR.
FOR NON-METAL GOODS, NAMELY, EXTENSION LADDERS, STEP LADDERS, AND STEP STOOLS (U.S. CLS. 2, 13, 22, 25, 32 AND 50).
BRENDAN MCCAULEY, EXAMINING ATTORNEY

THE MARK CONSISTS OF STANDARD CHARACTERS WITHOUT CLAIM TO ANY PARTICULAR FONT, STYLE, SIZE, OR COLOR.
NO CLAIM IS MADE TO THE EXCLUSIVE RIGHT TO USE "COLLECTION", APART FROM THE MARK AS SHOWN.
FOR FURNITURE (U.S. CLS. 2, 13, 22, 25, 32 AND 50).
PAUL F. GAST, EXAMINING ATTORNEY

CLASS 20—(Continued).

SN 78-544,729. ZINUS INC., PLEASANTON, CA. FILED 1-10-2005.

Loftex

THE MARK CONSISTS OF STANDARD CHARACTERS WITHOUT CLAIM TO ANY PARTICULAR FONT, STYLE, SIZE, OR COLOR.

FOR LATEX-LIKE PILLOWS, MATTRESSES, MATTRESS TOPPERS, SEAT CUSHIONS, FURNITURE (U.S. CLS. 2, 13, 22, 25, 32 AND 50).

DAVID C. REIHNER, EXAMINING ATTORNEY

CLASS 20—(Continued).

SN 78-590,500. DOGSTERS, LLC, MILFORD, CT. FILED 3-18-2005.



FOR FURNITURE, CHAIR PADS, DOG BEDS, HOLIDAY ORNAMENTS OF PLASTIC, PILLOWS AND CUSHIONS, PLASTIC KEY RINGS AND TAGS, PLAY HOUSES FOR PETS, PORTABLE BEDS FOR DOGS (U.S. CLS. 2, 13, 22, 25, 32 AND 50).

JIM RINGLE, EXAMINING ATTORNEY

SN 78-599,414. SHARP, DAVID R., NORTH SALT LAKE, UT. FILED 3-31-2005.

SHOW IT ALL

SN 78-544,779. ACP, LLC, ALABASTER, AL. FILED 1-10-2005.

THE MARK CONSISTS OF STANDARD CHARACTERS WITHOUT CLAIM TO ANY PARTICULAR FONT, STYLE, SIZE, OR COLOR.

FOR FRAMES FOR DISPLAY OF THREE DIMENSIONAL ITEMS (U.S. CLS. 2, 13, 22, 25, 32 AND 50).

FIRST USE 2-20-2005; IN COMMERCE 2-20-2005.
MELVIN AXILBUND, EXAMINING ATTORNEY

FUZZY FEET

SN 79-005,184. SPROG LIMITED, UNITED KINGDOM, FILED 5-12-2004.

BABY POD

THE MARK CONSISTS OF STANDARD CHARACTERS WITHOUT CLAIM TO ANY PARTICULAR FONT, STYLE, SIZE, OR COLOR.

OWNER OF INTERNATIONAL REGISTRATION 0832894 DATED 5-12-2004, EXPIRES 5-12-2014.

NO CLAIM IS MADE TO THE EXCLUSIVE RIGHT TO USE "BABY", APART FROM THE MARK AS SHOWN.

FOR FURNITURE, SEATS, BEDS, COTS, MATTRESSES, NAMELY, FOR CHILDREN AND BABIES (U.S. CLS. 2, 13, 22, 25, 32 AND 50).

ELLEN PERKINS, EXAMINING ATTORNEY

THE MARK CONSISTS OF STANDARD CHARACTERS WITHOUT CLAIM TO ANY PARTICULAR FONT, STYLE, SIZE, OR COLOR.

FOR FURNITURE PARTS, NAMELY GLIDES FOR ATTACHMENT TO FEET ON THE ENDS OF FURNITURE LEGS (U.S. CLS. 2, 13, 22, 25, 32 AND 50).

DAVID C. REIHNER, EXAMINING ATTORNEY

CLASS 20—(Continued).

SN 79-008,063. "BLACK RED WHITE" SPÓLKA AKCYJNA, PL-23-400 BILGORAJ, POLAND, FILED 12-13-2004.



OWNER OF INTERNATIONAL REGISTRATION 0786428 DATED 2-28-2002, EXPIRES 2-28-2012.

THE COLOR(S) BLACK, RED AND WHITE IS/ARE CLAIMED AS A FEATURE OF THE MARK.

THE COLOR WHITE APPEARS IN THE SQUARE INSIDE THE LARGER SQUARE AND IN THE WORD "WHITE". THE COLOR RED APPEARS IN THE WORD "RED" AND ALSO TO THE RIGHT OF THE WHITE SQUARE IN THE FORM OF AN INVERSE LETTER "L". THE COLOR BLACK APPEARS IN THE WORD "BLACK", IN THE OUTSIDE LINING OF THE WORD "WHITE", IN THE LEFT-HAND SIDE OF THE WHITE SQUARE THAT FORMS A LARGER SQUARE AROUND THE WHITE AND RED PORTIONS, AND IN THE UNDERLINING OF THE LARGE SQUARE.

FOR FURNITURE; OFFICE FURNITURE; SCHOOL FURNITURE; FURNITURE OF METAL; FURNITURE SHELVES; DESKS, FURNITURE PARTITIONS OF WOOD; DOORS FOR FURNITURE; ARMCHAIRS; SHOWCASES; SETTEES; FURNITURE PARTS, NAMELY, STAVES OF WOOD AND SLIVERED GLASS; PLAYPENS FOR BABIES; CHESTS OF DRAWERS; SIDEBARDS; CHAIRS; FLOWER-STANDS AND PEDESTALS; BEDS; DECK CHAIRS; MIRRORS; BENCHES; MATTRESSES; WALL PLAQUES, NOT OF TEXTILE; COAT AND MAGAZINE RACKS; LECTERNS; PICTURE FRAMES; POLES, NOT OF METAL; TABLES; CUPBOARDS; LOCKERS; FOOTSTOOLS; STANDS FOR WASHBASINS; HOOKS, NOT OF METAL, FOR CLOTHES RAILS; HINGES, NOT OF METAL; OUTDOOR FURNITURE; COUNTERTOPS; BUFFETS; BOOKCASES; WOODEN BEDS; WOODEN COUCHES; WOODEN OFFICE ARMCHAIRS; RODS FOR BEDS; COUCHES; OFFICE ARMCHAIRS; CURTAIN RODS; SCREENS; TABLES (U.S. CLS. 2, 13, 22, 25, 32 AND 50).

MICHELLE DUBOIS, EXAMINING ATTORNEY

CLASS 21—HOUSEWARES AND GLASS

SN 76-532,261. GAINEX INTERNATIONAL LIMITED, NEW TERRITORIES, HONG KONG, FILED 7-15-2003.



FOR NONELECTRIC COFFEE AND TEA POTS, NOT OF PRECIOUS METAL (U.S. CLS. 2, 13, 23, 29, 30, 33, 40 AND 50).

FIRST USE 5-31-2001; IN COMMERCE 5-31-2001.
ALICE SUE CARRUTHERS, EXAMINING ATTORNEY

CLASS 21—(Continued).

SN 76-589,068. COOL GEAR INTERNATIONAL, INC., PLYMOUTH, MA. FILED 4-28-2004.

EZ HEAT

THE MARK CONSISTS OF STANDARD CHARACTERS WITHOUT CLAIM TO ANY PARTICULAR FONT, STYLE, SIZE, OR COLOR.

NO CLAIM IS MADE TO THE EXCLUSIVE RIGHT TO USE "HEAT", APART FROM THE MARK AS SHOWN.

FOR PLASTIC CONTAINERS CONTAINING HEATABLE GEL FOR HOUSEHOLD USE AS THERMAL INSULATED FOOD STORAGE CONTAINERS (U.S. CLS. 2, 13, 23, 29, 30, 33, 40 AND 50).

DANIEL BRODY, EXAMINING ATTORNEY

SN 76-590,168. SPC RESOURCES, INC., HARTSVILLE, SC. FILED 5-3-2004.

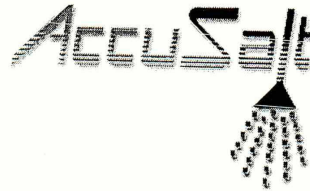

FOR PLASTIC SALT SHAKERS FOR FOOD SERVICE ESTABLISHMENTS AND HOLDERS THEREFORE (U.S. CLS. 2, 13, 23, 29, 30, 33, 40 AND 50).

NAAKWAMA ANKRAH, EXAMINING ATTORNEY

SN 76-596,153. STEAMWAY CORP., SCOTTSBURG, IN. FILED 6-8-2004.



OWNER OF U.S. REG. NO. 2,506,219.

NO CLAIM IS MADE TO THE EXCLUSIVE RIGHT TO USE TECHNOLOGIES, APART FROM THE MARK AS SHOWN.

FOR PLASTIC MICROWAVABLE FOOD CONTAINERS AND TRAYS (U.S. CLS. 2, 13, 23, 29, 30, 33, 40 AND 50).

FIRST USE 9-9-2003; IN COMMERCE 9-9-2003.
ASMAT KHAN, EXAMINING ATTORNEY

CLASS 21—(Continued).

SN 76-601,421. DFL TRADING COMPANY, SOUTH EL MONTE, CA. FILED 7-6-2004.

TRIMART-USA

THE MARK CONSISTS OF STANDARD CHARACTERS WITHOUT CLAIM TO ANY PARTICULAR FONT, STYLE, SIZE, OR COLOR.

FOR COSMETIC BRUSHES AND BRUSHES FOR USE IN PUTTING ON COSMETICS, NAMELY, MAKE-UP BRUSH, POWDER BRUSH, FAN BRUSH, BLUSH BRUSH, CONTOUR BRUSH, EYE SHADOW BRUSH, ANGLE SHADOW BRUSH, COMB/BROW BRUSH, MAS-CARA BRUSH, EYELINER BRUSH, RETRACTABLE POWDER BRUSH, RETRACTABLE LIP BRUSH, AC-RYLIC NAIL BRUSH, NAIL BRUSH, FOUNDATION BRUSH, KABUKI BRUSH, EYEBROW BRUSH, CON-CEALER BRUSH, NECK BRUSH, AND WET AND DRY BRUSH (U.S. CLS. 2, 13, 23, 29, 30, 33, 40 AND 50).

FIRST USE 7-28-2003; IN COMMERCE 7-28-2003.
BRENDAN MCCAULEY, EXAMINING ATTORNEY

CLASS 21—(Continued).

SN 76-619,252. JACK GUTTMAN, INC., WEST CHESTER, OH. FILED 11-4-2004.

TREAT TREE

THE MARK CONSISTS OF STANDARD CHARACTERS WITHOUT CLAIM TO ANY PARTICULAR FONT, STYLE, SIZE, OR COLOR.

NO CLAIM IS MADE TO THE EXCLUSIVE RIGHT TO USE "TREE", APART FROM THE MARK AS SHOWN.

FOR CUPCAKE STANDS (U.S. CLS. 2, 13, 23, 29, 30, 33, 40 AND 50).

FIRST USE 9-10-2004; IN COMMERCE 9-10-2004.
MARK SPARACINO, EXAMINING ATTORNEY

SN 76-617,629. KULL, CHERYL R. P., DULUTH, GA. FILED 10-26-2004.

LATEA

THE MARK CONSISTS OF STANDARD CHARACTERS WITHOUT CLAIM TO ANY PARTICULAR FONT, STYLE, SIZE, OR COLOR.

FOR TEAPOTS NOT OF PRECIOUS METAL (U.S. CLS. 2, 13, 23, 29, 30, 33, 40 AND 50).

ELLEN B. AWRICH, EXAMINING ATTORNEY

SN 76-621,212. PDF, ORANGE, CA. FILED 11-18-2004.

DISPOSAFLASK

THE MARK CONSISTS OF STANDARD CHARACTERS WITHOUT CLAIM TO ANY PARTICULAR FONT, STYLE, SIZE, OR COLOR.

FOR DISPOSABLE PLASTIC FLASKS (U.S. CLS. 2, 13, 23, 29, 30, 33, 40 AND 50).

JASON TURNER, EXAMINING ATTORNEY

SN 76-618,993. HOLIDAY HOUSEWARES, INC., LEOMIN-STER, MA. FILED 11-1-2004.

SHEER VIEW

THE MARK CONSISTS OF STANDARD CHARACTERS WITHOUT CLAIM TO ANY PARTICULAR FONT, STYLE, SIZE, OR COLOR.

FOR PLASTIC STORAGE CONTAINERS FOR HOUSE-HOLD AND KITCHEN USE (U.S. CLS. 2, 13, 23, 29, 30, 33, 40 AND 50).

FIRST USE 3-4-2004; IN COMMERCE 3-4-2004.
JOHN GARTNER, EXAMINING ATTORNEY

SN 76-621,890. WIDE-EYED DESIGNS, LLC, ST. LOUIS, MO. FILED 11-23-2004.

YOU'RE THE STAR

THE MARK CONSISTS OF STANDARD CHARACTERS WITHOUT CLAIM TO ANY PARTICULAR FONT, STYLE, SIZE, OR COLOR.

FOR CERAMIC DECORATIVE PLATES FOR USE AS GIFTS (U.S. CLS. 2, 13, 23, 29, 30, 33, 40 AND 50).

TANYA AMOS, EXAMINING ATTORNEY

CLASS 21—(Continued).

SN 76-623,259. VANI CREATIONS, LLC, DEERFIELD, IL. FILED 12-6-2004.

SNIFFY THE BEAR

THE MARK CONSISTS OF STANDARD CHARACTERS WITHOUT CLAIM TO ANY PARTICULAR FONT, STYLE, SIZE, OR COLOR.

NO CLAIM IS MADE TO THE EXCLUSIVE RIGHT TO USE BEAR, APART FROM THE MARK AS SHOWN.

FOR TISSUE DISPENSER IN THE FORM OF A PUPPET (U.S. CLS. 2, 13, 23, 29, 30, 33, 40 AND 50).
ANN LINNEHAN, EXAMINING ATTORNEY

CLASS 21—(Continued).

SN 76-626,267. PWP INDUSTRIES, VERNON, CA. FILED 12-30-2004.

TAMPER-EVIDENT

THE MARK CONSISTS OF STANDARD CHARACTERS WITHOUT CLAIM TO ANY PARTICULAR FONT, STYLE, SIZE, OR COLOR.

FOR SEE-THROUGH PLASTIC FOOD CONTAINER (U.S. CLS. 2, 13, 23, 29, 30, 33, 40 AND 50).

BARBARA BROWN, EXAMINING ATTORNEY

SN 76-623,284. VANI CREATIONS, LLC, DEERFIELD, IL. FILED 12-6-2004.

SNEEZY THE DUCK

THE MARK CONSISTS OF STANDARD CHARACTERS WITHOUT CLAIM TO ANY PARTICULAR FONT, STYLE, SIZE, OR COLOR.

NO CLAIM IS MADE TO THE EXCLUSIVE RIGHT TO USE "DUCK", APART FROM THE MARK AS SHOWN.

FOR TISSUE DISPENSER IN THE FORM OF A PUPPET (U.S. CLS. 2, 13, 23, 29, 30, 33, 40 AND 50).
MATTHEW KLINE, EXAMINING ATTORNEY

SN 76-626,268. PWP INDUSTRIES, VERNON, CA. FILED 12-30-2004.

TAMPER-EVIDENCE

THE MARK CONSISTS OF STANDARD CHARACTERS WITHOUT CLAIM TO ANY PARTICULAR FONT, STYLE, SIZE, OR COLOR.

FOR SEE-THROUGH PLASTIC FOOD CONTAINER (U.S. CLS. 2, 13, 23, 29, 30, 33, 40 AND 50).

BARBARA BROWN, EXAMINING ATTORNEY

SN 76-624,100. ARMALY SPONGE COMPANY, WALLED LAKE, MI. FILED 12-9-2004.

BUGSTER

THE MARK CONSISTS OF STANDARD CHARACTERS WITHOUT CLAIM TO ANY PARTICULAR FONT, STYLE, SIZE, OR COLOR.

FOR PAD FOR REMOVING BUGS FROM VEHICULAR GRILLES, BUMPERS AND WINDOWS (U.S. CLS. 2, 13, 23, 29, 30, 33, 40 AND 50).

GEORGIA CARTY, EXAMINING ATTORNEY

SN 76-626,548. KAAS, RANDY, PHOENIX, AZ. FILED 12-30-2004.

POURFECT BOWL

THE MARK CONSISTS OF STANDARD CHARACTERS WITHOUT CLAIM TO ANY PARTICULAR FONT, STYLE, SIZE, OR COLOR.

NO CLAIM IS MADE TO THE EXCLUSIVE RIGHT TO USE BOWL, APART FROM THE MARK AS SHOWN.

FOR MIXING BOWLS (U.S. CLS. 2, 13, 23, 29, 30, 33, 40 AND 50).

FIRST USE 12-15-2004; IN COMMERCE 12-15-2004.

LINDA MICKLEBURGH, EXAMINING ATTORNEY

CLASS 21—(Continued).

SN 78-235,415. THE ECHO DESIGN GROUP, INC., NEW YORK, NY. FILED 4-8-2003.

ECHO

OWNER OF U.S. REG. NOS. 246,934, 2,646,159 AND OTHERS.

FOR BEVERAGE GLASSWARE; BUCKETS OF WOVEN FABRIC; NON-ELECTRIC CANDELABRAS, CANDLE HOLDERS, AND CANDLESTICKS NOT OF PRECIOUS METAL; CHAMPAGNE BUCKETS; EARTHENWARE, CHINA, CRYSTAL, PORCELAIN AND GLASS ORNAMENTS; CONTAINERS FOR HOUSEHOLD OR KITCHEN USE NOT OF PRECIOUS METAL; COOLING BUCKETS FOR WINE; CHIP AND DIP SERVERS; CRUET STANDS FOR OIL OR VINEGAR NOT OF PRECIOUS METAL; CRUETS NOT OF PRECIOUS METAL; CUPS; NON-METAL DECORATIVE BOXES; DECORATIVE PLATES; DINNERWARE; DISHES; EGG CUPS; FLOWER POTS; GARBAGE CANS; GLASS ETCHED BY ACID; GOBLETS; GRAVY BOATS; FLOWER POT HOLDERS; SHAPED IRONING BOARD COVERS; PORCELAIN, CERAMIC AND GLASS KNOBS; GLASS, PORCELAIN AND EARTHENWARE MUGS; NAPKIN RINGS NOT OF PRECIOUS METALS; PAPER CUPS; PAPER PLATES; PITCHERS; PLATES; SAUCERS; SERVING PLATTERS; TOILET PAPER HOLDERS; TOOTHPICK HOLDERS; TOOTHBRUSH HOLDERS; TOWEL HOLDERS; TRIVETS; VASES; WASTEPAPER BASKETS; SOUP TUREENS; COOKIE JARS; CHINA, CRYSTAL, EARTHENWARE, GLASS, PORCELAIN AND TERRA COTTA FIGURINES (U.S. CLS. 2, 13, 23, 29, 30, 33, 40 AND 50).

WILLIAM BRECKENFELD, EXAMINING ATTORNEY

SN 78-283,452. GATE FIVE GROUP LLC, SAUSALITO, CA. FILED 8-5-2003.

ROOST

FOR HOUSEWARES, NAMELY, BEVERAGE GLASSWARE; DINNERWARE, NAMELY, PLATES, SAUCERS, CUPS, SERVING TRAYS, MEAL TRAYS, PLATTERS, PITCHERS, CASSEROLE DISHES, VASES, AND BOWLS; COOKWARE, NAMELY, POTS, PANS, SKILLETS, STREAMERS, BOILERS, GRIDDLES, WOKS, DUTCH OVENS, NON-ELECTRIC KETTLES, TEA KETTLES, COFFEE POTS NOT OF PRECIOUS METAL, CARVING BOARDS, AND WOOD CHOPPING BLOCKS; BAKEWARE, NAMELY, CANDY MOLDS, COOKIE SHEETS, PIE TINS, LOAF PANS, CAKE PANS, PIZZA PANS, AND MUFFIN PANS; BEVERAGE WARE; HOUSEHOLD UTENSILS, NAMELY, POT AND PAN SCRAPER, ROLLING PINS, SPATULAS, TURNERS, WHISKS, COOKING SPOONS, COOKING FORKS, CORKSCREWS, BLENDERS, BEATERS, STRAINERS, COLANDERS, MASHERS, GRATERS, COFFEE GRINDERS, FOOD STORAGE CONTAINERS, CHOPPERS, LADLES, MIXING, SERVING AND SLOTTED SPOONS, PIE AND CAKE SERVERS, COOKIE CUTTERS, ICE CUBE MOLDS, CUTTING BOARDS, PASTRY AND BASTING BRUSHES, ICE CREAM SCOOPS, BOTTLE OPENERS, SALAD SPINNERS, MIXING BOWLS, SALT AND PEPPER GRINDERS, GARLIC PRESSES, STIRRERS, DECANTERS, COASTERS NOT OF PAPER AND NOT BEING TABLE LINEN, AND PLASTIC COASTERS (U.S. CLS. 2, 13, 23, 29, 30, 33, 40 AND 50).

ROBERT C. CLARK JR., EXAMINING ATTORNEY

CLASS 21—(Continued).

SN 78-335,681. DISNEY ENTERPRISES, INC., BURBANK, CA. FILED 12-3-2003.

DISNEY CUTIES

THE MARK CONSISTS OF STANDARD CHARACTERS WITHOUT CLAIM TO ANY PARTICULAR FONT, STYLE, SIZE, OR COLOR.

OWNER OF U.S. REG. NOS. 1,162,727, 2,412,749 AND OTHERS.

FOR DINNERWARE; GLASS BEVERAGEWARE; PLASTIC COASTERS; REMOVABLE INSULATORS FOR DRINK CANS AND BOTTLES; LUNCH KITS CONSISTING OF LUNCH BOXES AND THERMAL INSULATED CONTAINERS FOR FOOD AND BEVERAGE; SERVING TRAYS NOT MADE OF PRECIOUS METAL; HAIR BRUSHES; HAIR COMBS; NON-ELECTRIC TOOTHBRUSHES; FIGURINES MADE OF CHINA, CRYSTAL, EARTHENWARE, GLASS, PORCELAIN, TERRA COTTA, CERAMIC OR STAINED GLASS; PLASTIC CUPS, COOKIE JARS; PAPER CUPS; PAPER PLATES (U.S. CLS. 2, 13, 23, 29, 30, 33, 40 AND 50).

LINDA MICKLEBURGH, EXAMINING ATTORNEY

SN 78-371,248. COBRA PRODUCTS, INC., BRIDGEPORT, NJ. FILED 2-20-2004.

PLUNG-IT

THE MARK CONSISTS OF STANDARD CHARACTERS WITHOUT CLAIM TO ANY PARTICULAR FONT, STYLE, SIZE, OR COLOR.

FOR AIR PRESSURE ASSISTED MANUAL PLUNGER TO CLEAR CLOGGED DRAINS (U.S. CLS. 2, 13, 23, 29, 30, 33, 40 AND 50).

FIRST USE 6-0-2004; IN COMMERCE 6-0-2004.

PRISCILLA MILTON, EXAMINING ATTORNEY

CLASS 21—(Continued).

SN 78-381,921. WILTON INDUSTRIES, INC., WOODRIDGE, IL. FILED 3-10-2004.

INCREDIBLE ICE CREAM SCOOP

THE MARK CONSISTS OF STANDARD CHARACTERS WITHOUT CLAIM TO ANY PARTICULAR FONT, STYLE, SIZE, OR COLOR.

NO CLAIM IS MADE TO THE EXCLUSIVE RIGHT TO USE "ICE CREAM SCOOP", APART FROM THE MARK AS SHOWN.

FOR ICE CREAM SCOOP (U.S. CLS. 2, 13, 23, 29, 30, 33, 40 AND 50).

TONJA GASKINS, EXAMINING ATTORNEY

SN 78-416,142. TIENSHAN, INC., SOUTH NORWALK, CT. FILED 5-10-2004.



FOR CHINA AND STONEWARE, NAMELY, PLATES, BOWLS, MUGS, CANISTERS, SALT AND PEPPER SHAKERS, SERVING DISHES (U.S. CLS. 2, 13, 23, 29, 30, 33, 40 AND 50).

FIRST USE 6-0-1988; IN COMMERCE 6-0-1988.

MICHAEL ENGEL, EXAMINING ATTORNEY

SN 78-417,892. ST. JAMES WINERY, INC., ST. JAMES, MO. FILED 5-13-2004.

ST. JAMES WINERY

THE MARK CONSISTS OF STANDARD CHARACTERS WITHOUT CLAIM TO ANY PARTICULAR FONT, STYLE, SIZE, OR COLOR.

OWNER OF U.S. REG. NO. 2,951,837.

SEC. 2(F) IN PART, AS TO ST. JAMES.

FOR BEVERAGE GLASSWARE, DINNERWARE, MUGS, WINE CHARMS NOT OF METAL USED FOR IDENTIFICATION PURPOSES, SUN CATCHERS, CORK SCREWS, DISHES AND COASTERS NOT OF PAPER AND NOT BEING TABLE LINEN (U.S. CLS. 2, 13, 23, 29, 30, 33, 40 AND 50).

FIRST USE 12-31-1993; IN COMMERCE 12-31-1993.

PAULA MAHONEY, EXAMINING ATTORNEY

CLASS 21—(Continued).

SN 78-419,918. U.S. SIGO INC., MIAMI, FL. FILED 5-17-2004.

NEW WORLD DESIGNS

THE MARK CONSISTS OF STANDARD CHARACTERS WITHOUT CLAIM TO ANY PARTICULAR FONT, STYLE, SIZE, OR COLOR.

NO CLAIM IS MADE TO THE EXCLUSIVE RIGHT TO USE "DESIGNS", APART FROM THE MARK AS SHOWN.

FOR HOUSEWARES, NAMELY, PORCELAIN AND EARTHENWARE PLACE SETTINGS, NAMELY, PLATES, CUPS AND BOWLS; KITCHEN UTENSILS, NAMELY, BOTTLE OPENERS, SPATULAS, FRYING PANS, POTS, HAND-OPERATED GRINDERS, AND SEALABLE AND NON-SEALABLE PLASTIC FOOD CONTAINERS (U.S. CLS. 2, 13, 23, 29, 30, 33, 40 AND 50).

SOPHIA S. KIM, EXAMINING ATTORNEY

SN 78-419,923. ST. JAMES WINERY, INC., ST. JAMES, MO. FILED 5-17-2004.



OWNER OF U.S. REG. NOS. 2,951,837, 2,959,894 AND 2,959,899.

SEC. 2(F).

FOR BEVERAGE GLASSWARE, DINNERWARE, MUGS, WINE CHARMS NOT OF METAL USED FOR IDENTIFICATION PURPOSES, SUN CATCHERS, CORK SCREWS, DISHES AND COASTERS NOT OF PAPER AND NOT BEING TABLE LINEN (U.S. CLS. 2, 13, 23, 29, 30, 33, 40 AND 50).

FIRST USE 5-31-1996; IN COMMERCE 5-31-1996.

WINSTON FOLMAR, EXAMINING ATTORNEY

SN 78-420,114. ST. JAMES WINERY, INC., ST. JAMES, MO. FILED 5-17-2004.



FOR BEVERAGE GLASSWARE, DINNERWARE, MUGS, WINE CHARMS NOT OF METAL USED FOR IDENTIFICATION PURPOSES, SUN CATCHERS, CORK SCREWS, DISHES AND COASTERS NOT OF PAPER AND NOT BEING TABLE LINEN (U.S. CLS. 2, 13, 23, 29, 30, 33, 40 AND 50).

FIRST USE 5-31-1996; IN COMMERCE 5-31-1996.

TARAH HARDY, EXAMINING ATTORNEY

CLASS 21—(Continued).

SN 78-422,371. INNOVATION IP HOLDING CO., DAVENPORT, IA. FILED 5-20-2004.

KITCHEN SELECT

THE MARK CONSISTS OF STANDARD CHARACTERS WITHOUT CLAIM TO ANY PARTICULAR FONT, STYLE, SIZE, OR COLOR.

NO CLAIM IS MADE TO THE EXCLUSIVE RIGHT TO USE "KITCHEN", APART FROM THE MARK AS SHOWN.

FOR POTS, PANS, NON-ELECTRIC GRILLS, NON-ELECTRIC FRYING PANS, BOWLS, SAUTÉ PANS, MULTI-USE POTS, CLAM POTS, PANS WITH FLARED SIDES, PIE PLATES, LASAGNA PANS, PAELLA PANS, TEAKETTLES, GRIDDLES, STOCKPOTS, ROASTERS, SAUCEPANS, DUTCH OVENS, DOUBLE BOILERS, OMELET PANS, CASSEROLE PANS AND DISHES, STEAMERS, MIXING BOWLS, SOUFLÉ PANS, RAMEKINS, NON-ELECTRIC CHICKEN FRYERS, NON-ELECTRIC PRESSURE COOKERS, AND TRIVETS (U.S. CLS. 2, 13, 23, 29, 30, 33, 40 AND 50).

FIRST USE 7-14-2004; IN COMMERCE 7-14-2004.
VERNA BETH RIRIE, EXAMINING ATTORNEY

SN 78-429,432. WIEGNER, THOMAS F., ST. CHARLES, IL. FILED 6-3-2004.

LÄTTI

THE MARK CONSISTS OF STANDARD CHARACTERS WITHOUT CLAIM TO ANY PARTICULAR FONT, STYLE, SIZE, OR COLOR.

THE ENGLISH TRANSLATION OF LATTI IS MILK.

FOR PORTABLE BEVERAGE CONTAINERS, NAMELY, COFFEE DISPENSERS; AND CONTAINERS FOR HOUSEHOLD AND KITCHEN USE, NAMELY COFFEE STORAGE CONTAINERS (U.S. CLS. 2, 13, 23, 29, 30, 33, 40 AND 50).

FIRST USE 6-1-2004; IN COMMERCE 6-1-2004.
NICHOLAS ALTREE, EXAMINING ATTORNEY

CLASS 21—(Continued).

SN 78-433,456. LAITNER BRUSH COMPANY, TRAVERSE CITY, MI. FILED 6-10-2004.



NO CLAIM IS MADE TO THE EXCLUSIVE RIGHT TO USE "SWEEP", APART FROM THE MARK AS SHOWN.

THE MARK CONSISTS OF THE TERMS GREEN SWEEP WITH AN OVERSIZED LETTER S INSIDE AN OVAL WITH TIRE MARKS AND LEAVES IN THE BACKGROUND.

FOR BROOMS MADE FROM MATERIAL USING RECYCLED TIRES AND PLASTICS (U.S. CLS. 2, 13, 23, 29, 30, 33, 40 AND 50).

REBECCA SMITH, EXAMINING ATTORNEY

SN 78-441,429. MIDWEST TROPHY MFG. CO., INC., DEL CITY, OK. FILED 6-25-2004.

Montreux

THE MARK CONSISTS OF STANDARD CHARACTERS WITHOUT CLAIM TO ANY PARTICULAR FONT, STYLE, SIZE, OR COLOR.

OWNER OF U.S. REG. NO. 1,629,083.

FOR CRYSTAL DESKTOP DECORATIVE BOWLS, SOLD THROUGH MAIL ORDER CATALOGS, DIRECT-MAIL CATALOGS, AND IN-PERSON SALES CALLS; ALL ONLY TO BUSINESSES FOR IN-HOUSE PROMOTIONAL AND AWARDS PURPOSES (U.S. CLS. 2, 13, 23, 29, 30, 33, 40 AND 50).

FIRST USE 5-1-2004; IN COMMERCE 5-1-2004.

ELISSA GARBER KON, EXAMINING ATTORNEY

CLASS 21—(Continued).

SN 78-446,174. NORSIG ENTERPRISES, LLC, NEW YORK, NY. FILED 7-6-2004.

**CHRISTINA NORSIG
NEW YORK**

THE MARK CONSISTS OF STANDARD CHARACTERS WITHOUT CLAIM TO ANY PARTICULAR FONT, STYLE, SIZE, OR COLOR.

NO CLAIM IS MADE TO THE EXCLUSIVE RIGHT TO USE "NEW YORK", APART FROM THE MARK AS SHOWN.

THE NAME SHOWN IN THE MARK IDENTIFIES CHRISTINA NORSIG, WHOSE CONSENT IS OF RECORD.

FOR HOUSEHOLD AND KITCHEN CONTAINERS NOT OF PRECIOUS METAL; HOUSEHOLD AND KITCHEN UTENSILS, NAMELY, POT AND PAN SCRAPERS, ROLLING PINS, SPATULAS, LADLES; BEVERAGE GLASSWARE; PORCELAIN JARS FOR JAMS AND JELLIES; PORCELAIN MUG; AND EARTHENWARE BASINS AND MUGS (U.S. CLS. 2, 13, 23, 29, 30, 33, 40 AND 50).

NELSON SNYDER, EXAMINING ATTORNEY

CLASS 21—(Continued).

SN 78-449,830. VAN RENSSELAER, ALEX T., HOBE SOUND, FL. FILED 7-13-2004.

Wine Requestor

THE MARK CONSISTS OF STANDARD CHARACTERS WITHOUT CLAIM TO ANY PARTICULAR FONT, STYLE, SIZE, OR COLOR.

NO CLAIM IS MADE TO THE EXCLUSIVE RIGHT TO USE "WINE", APART FROM THE MARK AS SHOWN.

FOR WINE ACCESSORIES, NAMELY, RACKS, BUCKETS AND STRAINERS (U.S. CLS. 2, 13, 23, 29, 30, 33, 40 AND 50).

LAURA KOVAISKY, EXAMINING ATTORNEY

SN 78-451,914. SWELLCO HOLDINGS, L.L.C., NEW YORK, NY. FILED 7-16-2004.

**SWELL BY CYNTHIA
ROWLEY & ILENE
ROSENZWEIG**

SN 78-448,327. QUICKIE MANUFACTURING CORPORATION, CINNAMINSON, NJ. FILED 7-9-2004.

SUPER SQUEEZE

THE MARK CONSISTS OF STANDARD CHARACTERS WITHOUT CLAIM TO ANY PARTICULAR FONT, STYLE, SIZE, OR COLOR.

NO CLAIM IS MADE TO THE EXCLUSIVE RIGHT TO USE "SQUEEZE", APART FROM THE MARK AS SHOWN.

FOR MOPS (U.S. CLS. 2, 13, 23, 29, 30, 33, 40 AND 50).
NICHOLAS ALTREE, EXAMINING ATTORNEY

THE MARK CONSISTS OF STANDARD CHARACTERS WITHOUT CLAIM TO ANY PARTICULAR FONT, STYLE, SIZE, OR COLOR.

OWNER OF U.S. REG. NO. 2,861,168.

THE NAMES "CYNTHIA ROWLEY" AND "ILENE ROSENZWEIG" IDENTIFY LIVING INDIVIDUALS WHOSE CONSENT IS OF RECORD.

FOR CLEANING SUPPLIES, NAMELY BROOMS; DUSTERS; DUSTPAN SETS; SQUEEGEES FOR HOUSEHOLD USE; MOPS; SWEEP SET COMPRISED OF BROOMS AND DUST PANS; SCRUBBING SPONGES; CLEANING SPONGES; DISHWASHING BRUSHES; CLEANING GLOVES; CLEANING SUPPLY CADDIES; BUCKETS AND REPLACEMENT MOP HEADS (U.S. CLS. 2, 13, 23, 29, 30, 33, 40 AND 50).

REBECCA GILBERT, EXAMINING ATTORNEY

CLASS 21—(Continued).

SN 78-452,011. INTERGLOBAL MARKETING GROUP CORP., ENCINO, CA. FILED 7-16-2004.

TUFFERMADE

THE MARK CONSISTS OF STANDARD CHARACTERS WITHOUT CLAIM TO ANY PARTICULAR FONT, STYLE, SIZE, OR COLOR.

FOR HOUSEWARES, NAMELY BOWLS, PITCHERS, MUGS, HOUSEHOLD CONTAINERS FOR FOOD STORAGE, CUPS, BOTTLES SOLD EMPTY, MUGS THAT ARE FROZEN IN ORDER TO SERVE BEVERAGES WITHOUT ICE, KITCHEN UTENSILS, NAMELY GRATERS, SPATULAS, TURNERS, WHISKS, SIEVES, STRAINERS, WATER JUGS, ICE CUBE TRAYS, PLASTIC WATER BOTTLES SOLD EMPTY, COLANDERS, NON-ELECTRIC JUICERS, CUTTING BOARDS, BABY BATH TUBS, PORTABLE BEVERAGE COOLERS, WASTE BASKETS, PLASTIC BASKETS FOR LAUNDRY, CANISTER SETS, DUST PANS, MOPS, LUNCH BOXES, PAILS, MONEY BANKS, NAMELY NON-METAL PIGGY BANKS, BUCKETS, CAKE PLATES WITH COVERS, VACUUM FLASKS (U.S. CLS. 2, 13, 23, 29, 30, 33, 40 AND 50).

FIRST USE 1-15-2002; IN COMMERCE 1-15-2002.
SONYA STEPHENS, EXAMINING ATTORNEY

SN 78-462,669. H-D MICHIGAN, INC., ANN ARBOR, MI. FILED 8-5-2004.



FOR MUGS, BEVERAGE GLASSWARE (U.S. CLS. 2, 13, 23, 29, 30, 33, 40 AND 50).
FIRST USE 1-0-2002; IN COMMERCE 1-0-2002.
LEIGH LOWRY, EXAMINING ATTORNEY

CLASS 21—(Continued).

SN 78-469,018. PRESCOTT, DANIEL C, TUSTIN, CA. FILED 8-17-2004.



FOR INSULATING SLEEVE HOLDERS FOR BEVERAGE CONTAINERS (U.S. CLS. 2, 13, 23, 29, 30, 33, 40 AND 50).

MARIA-VICTORIA SUAREZ, EXAMINING ATTORNEY

SN 78-473,045. NICHOLS, MARK, STUART, FL. FILED 8-25-2004.

SIMPLE SUCKERS

THE MARK CONSISTS OF STANDARD CHARACTERS WITHOUT CLAIM TO ANY PARTICULAR FONT, STYLE, SIZE, OR COLOR.

FOR HOUSEHOLD BATHROOM ACCESSORIES, NAMELY, NON-METAL TOWEL HANGERS AND TOWEL HOOKS (U.S. CLS. 2, 13, 23, 29, 30, 33, 40 AND 50).
CHRISTOPHER ADKINS, EXAMINING ATTORNEY

SN 78-473,395. SPEEDWAY SUPERAMERICA LLC, ENON, OH. FILED 8-25-2004.



OWNER OF U.S. REG. NOS. 2,448,690 AND 2,807,422.
NO CLAIM IS MADE TO THE EXCLUSIVE RIGHT TO USE "COFFEE", APART FROM THE MARK AS SHOWN.
FOR MUGS (U.S. CLS. 2, 13, 23, 29, 30, 33, 40 AND 50).
FIRST USE 9-5-1997; IN COMMERCE 9-5-1997.
MICHAEL SOUDERS, EXAMINING ATTORNEY

CLASS 21—(Continued).

SN 78-481,169. ONE PASS, LLC, SEASIDE, CA. FILED 9-9-2004.

SUPERFLEX

THE MARK CONSISTS OF STANDARD CHARACTERS WITHOUT CLAIM TO ANY PARTICULAR FONT, STYLE, SIZE, OR COLOR.

FOR DEVICE FOR REMOVING WATER FROM CURVED AND FLAT SURFACES, NAMELY, WATER-BLADES IN THE NATURE OF HANDLED BLADES EDGED WITH SILICONE OR RUBBER FOR REMOVING WATER FROM WINDOWS AND FROM CURVED AND FLAT SURFACES (U.S. CLS. 2, 13, 23, 29, 30, 33, 40 AND 50).

NANCY CLARKE, EXAMINING ATTORNEY

SN 78-501,051. COX, BRETT, LINDEN, MI. FILED 10-17-2004.

CoolGripper

THE MARK CONSISTS OF STANDARD CHARACTERS WITHOUT CLAIM TO ANY PARTICULAR FONT, STYLE, SIZE, OR COLOR.

FOR THERMAL INSULATED CONTAINERS FOR BEVERAGE WITH UNIQUE, SPORTS-THEMED SHAPE (U.S. CLS. 2, 13, 23, 29, 30, 33, 40 AND 50).

FIRST USE 1-1-2004; IN COMMERCE 1-1-2004.
MICHAEL ENGEL, EXAMINING ATTORNEY

CLASS 21—(Continued).

SN 78-509,950. GILLETTE CANADA COMPANY, DBA ORAL-B LABORATORIES, MISSISSAUGA, ONTARIO, CANADA, FILED 11-2-2004.

ORAL-B TRIUMPH

THE MARK CONSISTS OF STANDARD CHARACTERS WITHOUT CLAIM TO ANY PARTICULAR FONT, STYLE, SIZE, OR COLOR.

FOR TOOTHBRUSHES (U.S. CLS. 2, 13, 23, 29, 30, 33, 40 AND 50).

JULIE GUTTADAURO, EXAMINING ATTORNEY

SN 78-515,838. GILLETTE CANADA COMPANY, DBA ORAL-B LABORATORIES, MISSISSAUGA, ONTARIO, CANADA, FILED 11-12-2004.

**CROSSACTION POWER
MAX**

THE MARK CONSISTS OF STANDARD CHARACTERS WITHOUT CLAIM TO ANY PARTICULAR FONT, STYLE, SIZE, OR COLOR.

NO CLAIM IS MADE TO THE EXCLUSIVE RIGHT TO USE POWER, APART FROM THE MARK AS SHOWN.

FOR TOOTHBRUSHES AND REPLACEMENT BRUSH-HEADS FOR TOOTHBRUSHES (U.S. CLS. 2, 13, 23, 29, 30, 33, 40 AND 50).

FIRST USE 5-31-2004; IN COMMERCE 5-31-2004.
ALINA MORRIS, EXAMINING ATTORNEY

SN 78-518,488. PROCTER & GAMBLE COMPANY, THE, CINCINNATI, OH. FILED 11-17-2004.

**MR. CLEAN MAGIC
ERASER**

THE MARK CONSISTS OF STANDARD CHARACTERS WITHOUT CLAIM TO ANY PARTICULAR FONT, STYLE, SIZE, OR COLOR.

OWNER OF U.S. REG. NOS. 658,915, 2,583,814 AND OTHERS.

FOR HOUSEHOLD CLEANING TOOLS, NAMELY MOPS AND REPLACEMENT MOP HEADS (U.S. CLS. 2, 13, 23, 29, 30, 33, 40 AND 50).

ANDREW BENZMILLER, EXAMINING ATTORNEY

CLASS 21—(Continued).

SN 78-518,675. THE BOARD OF REGENTS OF THE UNIVERSITY OF OKLAHOMA, NORMAN, OK. FILED 11-17-2004.

OU

THE MARK CONSISTS OF STANDARD CHARACTERS WITHOUT CLAIM TO ANY PARTICULAR FONT, STYLE, SIZE, OR COLOR.

OWNER OF U.S. REG. NOS. 1,336,001, 1,366,736 AND OTHERS.

FOR HOUSEWARES AND GLASSES, NAMELY, DRINKING GLASSES, MUGS, CUPS, GLASS COASTERS, PLASTIC WATER BOTTLES SOLD EMPTY, BOTTLE OPENERS AND TRASH CANS (U.S. CLS. 2, 13, 23, 29, 30, 33, 40 AND 50).

FIRST USE 9-1-1966; IN COMMERCE 9-1-1966.
LAURA KOVAISKY, EXAMINING ATTORNEY

CLASS 21—(Continued).

SN 78-518,705. THE BOARD OF REGENTS OF THE UNIVERSITY OF OKLAHOMA, NORMAN, OK. FILED 11-17-2004.



OWNER OF U.S. REG. NOS. 1,336,001, 1,366,736 AND OTHERS.

THE MARK CONSISTS OF THE LETTERS "OU" IN AN INTERLOCKING DESIGN.

FOR HOUSEWARES AND GLASSES, NAMELY, DRINKING GLASSES, MUGS, CUPS, GLASS COASTERS, PLASTIC WATER BOTTLES SOLD EMPTY, BOTTLE OPENERS AND TRASH CANS (U.S. CLS. 2, 13, 23, 29, 30, 33, 40 AND 50).

FIRST USE 2-15-1979; IN COMMERCE 2-15-1979.
LAURA KOVAISKY, EXAMINING ATTORNEY

SN 78-518,768. DOGSTERS, LLC, MILFORD, CT. FILED 11-17-2004.

CATSTERS

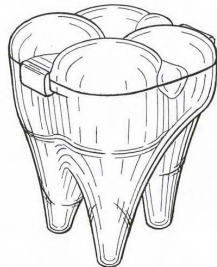

THE MARK CONSISTS OF A THREE-DIMENSIONAL CONFIGURATION OF A CONTAINER.

FOR DENTAL FLOSS (U.S. CLS. 2, 13, 23, 29, 30, 33, 40 AND 50).

FIRST USE 0-0-1990; IN COMMERCE 0-0-1990.
ALICE BENMAMAN, EXAMINING ATTORNEY

THE MARK CONSISTS OF STANDARD CHARACTERS WITHOUT CLAIM TO ANY PARTICULAR FONT, STYLE, SIZE, OR COLOR.

OWNER OF U.S. REG. NO. 2,921,591.

FOR BRUSHES FOR PETS; BASKETS MADE OF WICKER, STRAW AND WOOD CLOTH, BEER MUGS, BEVERAGE GLASSWARE, BEVERAGE WARE, BOWLS, CAKE MOLDS, CAKE SERVERS, CAKE STANDS, CERAMIC FIGURINES, COFFEE CUPS, CONTAINER FOR FOOD, COOKIE JARS, CUPS, DECORATIVE PLATES, DISHES, FLOWER BASKETS, HOLIDAY ORNAMENTS OF CERAMIC, HOLIDAY ORNAMENTS OF PORCELAIN, PAPER CUPS, PAPER PLATES, PET FEEDING DISHES AND PLASTIC CUPS, PORTABLE BEVERAGE COOLERS (U.S. CLS. 2, 13, 23, 29, 30, 33, 40 AND 50).

TEJBIR SINGH, EXAMINING ATTORNEY

CLASS 21—(Continued).

SN 78-519,096. PROCTER & GAMBLE COMPANY, THE, CINCINNATI, OH. FILED 11-18-2004.

CLASS 21—(Continued).

SN 78-519,404. G. G. MARCK & ASSOCIATES, INC., TOLEDO, OH. FILED 11-18-2004.

**MR. CLEAN MAGIC
ERASER MOP**

3476

THE MARK CONSISTS OF STANDARD CHARACTERS WITHOUT CLAIM TO ANY PARTICULAR FONT, STYLE, SIZE, OR COLOR.

OWNER OF U.S. REG. NOS. 658,915, 2,583,814 AND OTHERS.

NO CLAIM IS MADE TO THE EXCLUSIVE RIGHT TO USE MOP, APART FROM THE MARK AS SHOWN.

FOR HOUSEHOLD CLEANING TOOLS, NAMELY MOPS AND REPLACEMENT MOP HEADS (U.S. CLS. 2, 13, 23, 29, 30, 33, 40 AND 50).

ANDREW BENZMILLER, EXAMINING ATTORNEY

THE MARK CONSISTS OF STANDARD CHARACTERS WITHOUT CLAIM TO ANY PARTICULAR FONT, STYLE, SIZE, OR COLOR.

FOR BEVERAGeware (U.S. CLS. 2, 13, 23, 29, 30, 33, 40 AND 50).

FIRST USE 6-0-2000; IN COMMERCE 7-13-2000.

JACQUELINE A. LAVINE, EXAMINING ATTORNEY

SN 78-519,254. ORAL FIXATION, LLC, HOPEWELL, NJ. FILED 11-18-2004.

SN 78-519,827. HALPERN IMPORT COMPANY, INC., ATLANTA, GA. FILED 11-19-2004.

Oral Fixation

BUSY BEE

THE MARK CONSISTS OF STANDARD CHARACTERS WITHOUT CLAIM TO ANY PARTICULAR FONT, STYLE, SIZE, OR COLOR.

OWNER OF U.S. REG. NO. 2,832,902. FOR TOOTHPICKS (U.S. CLS. 2, 13, 23, 29, 30, 33, 40 AND 50).

FIRST USE 11-1-2004; IN COMMERCE 11-1-2004.

BRENDAN MCCAULEY, EXAMINING ATTORNEY

THE MARK CONSISTS OF STANDARD CHARACTERS WITHOUT CLAIM TO ANY PARTICULAR FONT, STYLE, SIZE, OR COLOR.

FOR GARDENING GLOVES (U.S. CLS. 2, 13, 23, 29, 30, 33, 40 AND 50).

FIRST USE 2-0-1998; IN COMMERCE 2-0-1998.

DOMINIC J. FERRAIUOLO, EXAMINING ATTORNEY

CLASS 21—(Continued).

SN 78-521,659. INTEX DIY, INC., VILLA RICA, GA. FILED 11-23-2004.

CLASS 21—(Continued).

SN 78-524,124. PROCESS 4, CHAGRIN FALLS, OH. FILED 11-30-2004.

ABRA-CADABRA

THE MARK CONSISTS OF STANDARD CHARACTERS WITHOUT CLAIM TO ANY PARTICULAR FONT, STYLE, SIZE, OR COLOR.

FOR CLEANING SPONGES (U.S. CLS. 2, 13, 23, 29, 30, 33, 40 AND 50).
BRIAN PINO, EXAMINING ATTORNEY

GRUNGE SPONGE

THE MARK CONSISTS OF STANDARD CHARACTERS WITHOUT CLAIM TO ANY PARTICULAR FONT, STYLE, SIZE, OR COLOR.

NO CLAIM IS MADE TO THE EXCLUSIVE RIGHT TO USE "SPONGE", APART FROM THE MARK AS SHOWN.
FOR FLUID ABSORBING AND ODOR MASKING PADS FOR TRASH RECEPTACLES (U.S. CLS. 2, 13, 23, 29, 30, 33, 40 AND 50).
SAMUEL E. SHARPER JR., EXAMINING ATTORNEY

SN 78-522,415. REDCATS USA, L.P., INDIANAPOLIS, IN. FILED 11-24-2004.

HOLIDAY BELLES

THE MARK CONSISTS OF STANDARD CHARACTERS WITHOUT CLAIM TO ANY PARTICULAR FONT, STYLE, SIZE, OR COLOR.

FOR DRINKING GLASSES, WINE GLASSES, DECANTERS, CARAFES, SERVING PLATTERS, AND PUNCH BOWL SETS COMPRISED OF BOWL AND CUPS (U.S. CLS. 2, 13, 23, 29, 30, 33, 40 AND 50).
G. MAYERSCHOFF, EXAMINING ATTORNEY

SN 78-532,902. GOOD IDEAS INTERNATIONAL, LLC, SARASOTA, FL. FILED 12-15-2004.

SN 78-522,800. S. C. JOHNSON & SON, INC., RACINE, WI. FILED 11-24-2004.

AQUA FOAMER

CORAL GLIMMER

THE MARK CONSISTS OF STANDARD CHARACTERS WITHOUT CLAIM TO ANY PARTICULAR FONT, STYLE, SIZE, OR COLOR.

FOR CANDLE HOLDERS NOT OF PRECIOUS METAL (U.S. CLS. 2, 13, 23, 29, 30, 33, 40 AND 50).
JOHN DALIER, EXAMINING ATTORNEY

THE MARK CONSISTS OF STANDARD CHARACTERS WITHOUT CLAIM TO ANY PARTICULAR FONT, STYLE, SIZE, OR COLOR.

NO CLAIM IS MADE TO THE EXCLUSIVE RIGHT TO USE "FOAMER", APART FROM THE MARK AS SHOWN.
FOR DISPENSERS FOR LIQUID SOAP (U.S. CLS. 2, 13, 23, 29, 30, 33, 40 AND 50).
FIRST USE 11-13-2004; IN COMMERCE 11-13-2004.
JOHN GARTNER, EXAMINING ATTORNEY

CLASS 21—(Continued).

SN 78-538,182. ERRERARICHARD B., RONKONKOMA, NY.
FILED 12-23-2004.

"Gourmet
Impressions
Stamper"

THE MARK CONSISTS OF STANDARD CHARACTERS
WITHOUT CLAIM TO ANY PARTICULAR FONT, STYLE,
SIZE, OR COLOR.

OWNER OF U.S. REG. NOS. 2,811,811 AND 2,826,203.
NO CLAIM IS MADE TO THE EXCLUSIVE RIGHT TO
USE "STAMPER", APART FROM THE MARK AS SHOWN.
FOR HAND-OPERATED FOOD EMBOSsing AND
IMPRINTING TOOL FOR RESTAURANTS, FOOD SER-
VICE, AND HOME USE (U.S. CLS. 2, 13, 23, 29, 30, 33, 40
AND 50).

MICHAEL HALL, EXAMINING ATTORNEY

CLASS 21—(Continued).

SN 78-541,245. MCI PRODUCTS GROUP, INC., PLAINVIEW,
NY. FILED 1-3-2005.

Quick-Top

THE MARK CONSISTS OF STANDARD CHARACTERS
WITHOUT CLAIM TO ANY PARTICULAR FONT, STYLE,
SIZE, OR COLOR.

FOR WASTEBASKET (U.S. CLS. 2, 13, 23, 29, 30, 33, 40
AND 50).

FIRST USE 9-1-2004; IN COMMERCE 9-15-2004.

ALEXANDER L. POWERS, EXAMINING ATTORNEY

SN 78-539,810. CMP MEDIA LLC, MANHASSET, NY. FILED
12-29-2004.

CSI COMPUTER
SECURITY INSTITUTE

THE MARK CONSISTS OF STANDARD CHARACTERS
WITHOUT CLAIM TO ANY PARTICULAR FONT, STYLE,
SIZE, OR COLOR.

FOR MUGS AND CUPS (U.S. CLS. 2, 13, 23, 29, 30, 33,
40 AND 50).

FIRST USE 6-30-2004; IN COMMERCE 6-30-2004.

WENDY GOODMAN, EXAMINING ATTORNEY

SN 78-552,158. NOUR TRADING HOUSE INC., WATERLOO,
ONTARIO, CANADA, FILED 1-22-2005.

NOURFLEX

THE MARK CONSISTS OF STANDARD CHARACTERS
WITHOUT CLAIM TO ANY PARTICULAR FONT, STYLE,
SIZE, OR COLOR.

FOR PROCESSED FILAMENTS FOR MAKING
BRUSHES (U.S. CLS. 2, 13, 23, 29, 30, 33, 40 AND 50).

JANICE L. MCMORROW, EXAMINING ATTORNEY

CLASS 21—(Continued).

SN 78-590,502. DOGSTERS, LLC, MILFORD, CT. FILED 3-18-2005.



FOR BRUSHES FOR PETS; BASKETS MADE OF WICKER, STRAW, WOOD, AND CLOTH; BEER MUGS, BEVERAGE GLASSWARE, BEVERAGE WARE, BOWLS, CAKE MOLDS, CAKE SERVERS, CAKE STANDS, CERAMIC FIGURINES, COFFEE CUPS, HOUSEHOLD CONTAINERS FOR FOOD, COOKIE JARS, CUPS, DECORATIVE PLATES, DISHES, FLOWER BASKETS, HOLIDAY ORNAMENTS OF CERAMIC, HOLIDAY ORNAMENTS OF PORCELAIN, PAPER CUPS, PAPER PLATES, PET FEEDING DISHES AND PLASTIC CUPS, PORTABLE BEVERAGE COOLERS (U.S. CLS. 2, 13, 23, 29, 30, 33, 40 AND 50).

JIM RINGLE, EXAMINING ATTORNEY

SN 79-002,617. NINGBO LISI PLASTIC AND RUBBER; CO., LTD., ZHEJIANG 315171, CHINA, FILED 4-20-2004.



OWNER OF INTERNATIONAL REGISTRATION 0784709 DATED 7-22-2002, EXPIRES 7-22-2012.

FOR COOKING STRAINERS NOT OF PRECIOUS METAL; CONTAINERS NOT OF PRECIOUS METAL FOR HOUSEHOLD OR KITCHEN USE; KITCHEN UTENSILS, NOT OF PRECIOUS METAL, NAMELY, STAINLESS TURNERS, SALT AND PEPPER SHAKERS, GRATERS, FOLDING SPICE RACKS, FOLDING TOWEL RACKS AND FOLDING DISH DRYING RACKS; ENAMELWARE AND PLASTIC UTENSILS FOR HOUSEHOLD PURPOSES, NAMELY, BASINS, BOWLS, DISHES, POTS AND CUPS; WATERING CANS; TRASH CANS; FLOOR BRUSHES; VACUUM BOTTLES; BASKETS FOR WASTE PAPER LITTERING; NON-ELECTRIC FRUIT PRESSES FOR HOUSEHOLD PURPOSES (U.S. CLS. 2, 13, 23, 29, 30, 33, 40 AND 50).

DAWN HAN, EXAMINING ATTORNEY

CLASS 21—(Continued).

SN 79-005,061. BEIJING BEIXIONG TEC. & IND. CO., LTD.; (BEIJING BEIXIONG KEJI SHIYE; YOUXIAN GONGSI), CHINA, FILED 5-18-2004.



OWNER OF INTERNATIONAL REGISTRATION 0832443 DATED 5-18-2004, EXPIRES 5-18-2014.

THE MARK CONSISTS OF BBX.

FOR BEVERAGE GLASSWARE FOR DAILY USE; WORKS OF GLASS, NAMELY, GLASS FIGURINES, GLASS BUSTS, GLASS STATUES; GLASS RECEPTACLES, NAMELY, DRINKING GLASSES, HOLDERS FOR FLOWERS; JUGS NOT OF PRECIOUS METAL; POLISHED PLATE GLASS; INSULATED VACUUM BOTTLES; PERFUME SPRAYERS SOLD EMPTY; IMITATION OF PORCELAIN WARE, NAMELY, PORCELAIN STATUES, PORCELAIN FLOWER POTS; HOUSEHOLD ENAMEL AND PLASTIC UTENSILS FOR DAILY USE, NAMELY, POT AND PAN SCRAPERS, ROLLING PINS, SPATULAS, TURNERS, WHISKS (U.S. CLS. 2, 13, 23, 29, 30, 33, 40 AND 50).

ANN LINNEHAN, EXAMINING ATTORNEY

CLASS 22—CORDAGE AND FIBERS

SN 76-590,429. SCARPATI, LAWRENCE, DBA UNDERCOVER AUTO, BROOKLYN, NY. FILED 5-4-2004.

UNDERCOVER AUTO

THE MARK CONSISTS OF STANDARD CHARACTERS WITHOUT CLAIM TO ANY PARTICULAR FONT, STYLE, SIZE, OR COLOR.

NO CLAIM IS MADE TO THE EXCLUSIVE RIGHT TO USE "AUTO", APART FROM THE MARK AS SHOWN.

FOR UNFITTED VEHICLE COVERS AND ACCESSORIES THEREFOR, NAMELY UNFITTED VEHICLE COVER FOLDING BOARDS TO AID IN THE FOLDING OF UNFITTED VEHICLE COVERS FOR STORAGE PURPOSES WHEN NOT IN USE (U.S. CLS. 1, 2, 7, 19, 22, 42 AND 50).

FIRST USE 1-0-2004; IN COMMERCE 1-0-2004.

ANDREA SAUNDERS, EXAMINING ATTORNEY

CLASS 22—(Continued).

SN 76-592,927. RAINBOW POLYBAG CO., INC., BROOKLYN, NY. FILED 5-19-2004.

DUAL SECURITY TRANSPORTER

THE MARK CONSISTS OF STANDARD CHARACTERS WITHOUT CLAIM TO ANY PARTICULAR FONT, STYLE, SIZE, OR COLOR.

NO CLAIM IS MADE TO THE EXCLUSIVE RIGHT TO USE SECURITY, APART FROM THE MARK AS SHOWN.

FOR TAMPER EVIDENT SECURITY BAGS MADE OF THIN GAUGE POLY VINYL CHLORIDE PLASTIC FOR USE IN MAKING BANK DEPOSITS (U.S. CLS. 1, 2, 7, 19, 22, 42 AND 50).

FIRST USE 11-21-2003; IN COMMERCE 11-21-2003.
IRENE D. WILLIAMS, EXAMINING ATTORNEY

CLASS 22—(Continued).

SN 78-527,652. BEAULIEU GROUP, LLC, DALTON, GA. FILED 12-6-2004.

AVALAR

SN 76-622,117. OUTBACK CHAIR CO., INC., VIRGINIA BEACH, VA. FILED 11-26-2004.

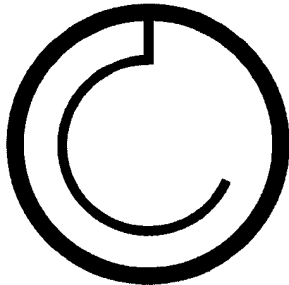

THE MARK CONSISTS OF STANDARD CHARACTERS WITHOUT CLAIM TO ANY PARTICULAR FONT, STYLE, SIZE, OR COLOR.

THE ENGLISH TRANSLATION OF AVALAR IS "TO ENDORSE".

FOR TEXTILE FIBERS (U.S. CLS. 1, 2, 7, 19, 22, 42 AND 50).

REBECCA GILBERT, EXAMINING ATTORNEY

FOR HAMMOCKS (U.S. CLS. 1, 2, 7, 19, 22, 42 AND 50).
FIRST USE 6-30-2003; IN COMMERCE 6-30-2003.
STEVEN PEREZ, EXAMINING ATTORNEY

SN 78-477,411. PINEDA, GERARDO, SILVER SPRING, MD. FILED 9-1-2004.

NecktiLanyards

THE MARK CONSISTS OF STANDARD CHARACTERS WITHOUT CLAIM TO ANY PARTICULAR FONT, STYLE, SIZE, OR COLOR.

FOR LANYARD TO PUBLICLY DISPLAY INDIVIDUAL IDENTIFICATION CARDS AND BADGES ON NECKTIES (U.S. CLS. 1, 2, 7, 19, 22, 42 AND 50).

DAWN FELDMAN, EXAMINING ATTORNEY

SN 79-002,489. TEUFELBERGER GESELLSCHAFT M.B.H., AUSTRIA, FILED 4-20-2004.

OLYMPUS

THE MARK CONSISTS OF STANDARD CHARACTERS WITHOUT CLAIM TO ANY PARTICULAR FONT, STYLE, SIZE, OR COLOR.

PRIORITY DATE OF 10-27-2003 IS CLAIMED.

OWNER OF INTERNATIONAL REGISTRATION 0824537 DATED 4-20-2004, EXPIRES 4-20-2014.

FOR ROPES, STRING, ROPES OF TEXTILE OR SYNTHETIC MATERIAL (U.S. CLS. 1, 2, 7, 19, 22, 42 AND 50).

DAWN HAN, EXAMINING ATTORNEY

CLASS 23—YARNS AND THREADS

SN 76-591,960. LI PENG ENTERPRISE CO., LTD., TAIPEI, TAIWAN, FILED 5-13-2004.

LIBOLON

THE MARK CONSISTS OF STANDARD CHARACTERS WITHOUT CLAIM TO ANY PARTICULAR FONT, STYLE, SIZE, OR COLOR.

THE ENGLISH TRANSLATION OF "LI BO LON" IS "FORCE PRECIOUS DRAGON".

FOR YARNS AND THREADS, FOR TEXTILE USE (U.S. CL. 43).

FIRST USE 5-19-1999; IN COMMERCE 5-19-1999.
BARBARA GAYNOR, EXAMINING ATTORNEY

CLASS 23—(Continued).

SN 78-512,980. J. & P. COATS, LIMITED, GLASGOW, SCOTLAND, FILED 11-8-2004.

CATANIA

THE MARK CONSISTS OF STANDARD CHARACTERS WITHOUT CLAIM TO ANY PARTICULAR FONT, STYLE, SIZE, OR COLOR.

FOR HANDKNITTING YARNS (U.S. CL. 43).
FIRST USE 8-31-2000; IN COMMERCE 8-31-2000.
DANIEL CAPSHAW, EXAMINING ATTORNEY

SN 78-373,620. CARPET CRAFTS, INC., DALTON, GA. FILED 2-25-2004.

MIRA-TWIST...THE MIRACLE FIBER

THE MARK CONSISTS OF STANDARD CHARACTERS WITHOUT CLAIM TO ANY PARTICULAR FONT, STYLE, SIZE, OR COLOR.

NO CLAIM IS MADE TO THE EXCLUSIVE RIGHT TO USE FIBER, APART FROM THE MARK AS SHOWN.

FOR YARN FIBER MADE FROM SOLUTION DYED FILAMENT POLYETHYLENE TEREPHTHALATE (PET) (U.S. CL. 43).

FIRST USE 2-25-2004; IN COMMERCE 2-25-2004.
ANDREW BENZMILLER, EXAMINING ATTORNEY

SN 78-512,983. J. & P. COATS, LIMITED, GLASGOW, SCOTLAND, FILED 11-8-2004.

SN 78-512,971. J. & P. COATS, LIMITED, GLASGOW, SCOTLAND, FILED 11-8-2004.

GIGANTE

THE MARK CONSISTS OF STANDARD CHARACTERS WITHOUT CLAIM TO ANY PARTICULAR FONT, STYLE, SIZE, OR COLOR.

OWNER OF U.S. REG. NO. 2,738,122.

THE ENGLISH TRANSLATION OF GIGANTE IS GIANT.

FOR HANDKNITTING YARNS (U.S. CL. 43).

FIRST USE 7-31-2000; IN COMMERCE 7-31-2000.
ANDREA SAUNDERS, EXAMINING ATTORNEY

LIPOMO

THE MARK CONSISTS OF STANDARD CHARACTERS WITHOUT CLAIM TO ANY PARTICULAR FONT, STYLE, SIZE, OR COLOR.

FOR HANDKNITTING YARNS (U.S. CL. 43).

FIRST USE 12-31-2003; IN COMMERCE 12-31-2003.
KHANH LE, EXAMINING ATTORNEY

CLASS 23—(Continued).

SN 78-521,128. SOUTHPORT HOLDINGS, LLC, SPARTANBURG, SC. FILED 11-22-2004.

CLASS 23—(Continued).

SN 78-521,533. J. & P. COATS, LIMITED, GLASGOW, SCOTLAND, UNITED KINGDOM, FILED 11-23-2004.

Hilosol

OPULENZ

THE MARK CONSISTS OF STANDARD CHARACTERS WITHOUT CLAIM TO ANY PARTICULAR FONT, STYLE, SIZE, OR COLOR.
FOR FILAMENT ACRYLIC YARN FOR TEXTILE USE (U.S. CL. 43).
SOPHIA S. KIM, EXAMINING ATTORNEY

THE MARK CONSISTS OF STANDARD CHARACTERS WITHOUT CLAIM TO ANY PARTICULAR FONT, STYLE, SIZE, OR COLOR.
FOR HANDKNITTING YARNS (U.S. CL. 43).
FLORENTINA BLANDU, EXAMINING ATTORNEY

SN 78-521,531. J. & P. COATS, LIMITED, GLASGOW, SCOTLAND, UNITED KINGDOM, FILED 11-23-2004.

SN 78-538,944. J. & P. COATS, LIMITED, GLASGOW, SCOTLAND, FILED 12-28-2004.

SHANINA

WHIRLY

THE MARK CONSISTS OF STANDARD CHARACTERS WITHOUT CLAIM TO ANY PARTICULAR FONT, STYLE, SIZE, OR COLOR.
FOR HANDKNITTING YARNS (U.S. CL. 43).
FLORENTINA BLANDU, EXAMINING ATTORNEY

THE MARK CONSISTS OF STANDARD CHARACTERS WITHOUT CLAIM TO ANY PARTICULAR FONT, STYLE, SIZE, OR COLOR.
FOR HANDKNITTING YARNS (U.S. CL. 43).
BRENDAN MCCAULEY, EXAMINING ATTORNEY

CLASS 23—(Continued).

SN 78-549,149. GRECO, KATHLEEN A., SOUTHAMPTON, PA. FILED 1-18-2005.

Yummy Yarns

THE MARK CONSISTS OF STANDARD CHARACTERS WITHOUT CLAIM TO ANY PARTICULAR FONT, STYLE, SIZE, OR COLOR.

NO CLAIM IS MADE TO THE EXCLUSIVE RIGHT TO USE "YARNS", APART FROM THE MARK AS SHOWN. FOR KNITTING AND CROCHET YARNS (U.S. CL. 43). FIRST USE 12-15-2004; IN COMMERCE 1-10-2005. ANGELA M. MICHELI, EXAMINING ATTORNEY

CLASS 24—(Continued).

SN 76-579,402. STYLE ARCHITECTS, LLC, DALLAS, TX. FILED 3-4-2004.

JACOB + JACOB

THE MARK CONSISTS OF STANDARD CHARACTERS WITHOUT CLAIM TO ANY PARTICULAR FONT, STYLE, SIZE, OR COLOR.

FOR BED, BATH AND HOUSEHOLD LINENS (U.S. CLS. 42 AND 50). JANICE L. MCMORROW, EXAMINING ATTORNEY

CLASS 24—FABRICS

SN 76-579,400. STYLE ARCHITECTS, LLC, DALLAS, TX. FILED 3-4-2004.

FASHION ARCHITECTS

THE MARK CONSISTS OF STANDARD CHARACTERS WITHOUT CLAIM TO ANY PARTICULAR FONT, STYLE, SIZE, OR COLOR.

FOR BED, BATH AND HOUSEHOLD LINENS (U.S. CLS. 42 AND 50). JANICE L. MCMORROW, EXAMINING ATTORNEY

SN 76-580,033. PLENTY, BOBBIE JEAN, DBA MY TOWELS TALK, LLC, DALE CITY, UNITED STATES, FILED 3-9-2004.

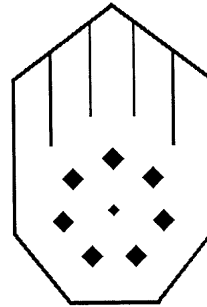

THE MARK CONSISTS OF A STYLIZED REPRESENTATION OF A HAND HAVING SEVEN LARGE FILLED-IN DIAMONDS SURROUNDING A SINGLE SMALLER FILLED-IN DIAMOND.

FOR TOWELS WITH EMBROIDERED INSPIRING AND UPLIFTING INSCRIPTIONS (U.S. CLS. 42 AND 50). FIRST USE 3-9-2004; IN COMMERCE 3-9-2004. ZHALEH DELANEY, EXAMINING ATTORNEY

SN 76-579,401. STYLE ARCHITECTS, LLC, DALLAS, TX. FILED 3-4-2004.

ARCHITECTS OF FASHION

THE MARK CONSISTS OF STANDARD CHARACTERS WITHOUT CLAIM TO ANY PARTICULAR FONT, STYLE, SIZE, OR COLOR.

FOR BED, BATH AND HOUSEHOLD LINENS (U.S. CLS. 42 AND 50). JANICE L. MCMORROW, EXAMINING ATTORNEY

SN 76-586,961. COLOR ME BABY, LLC, NEW YORK, NY. FILED 4-15-2004.

COLOR ME BABY

THE MARK CONSISTS OF STANDARD CHARACTERS WITHOUT CLAIM TO ANY PARTICULAR FONT, STYLE, SIZE, OR COLOR.

NO CLAIM IS MADE TO THE EXCLUSIVE RIGHT TO USE "BABY", APART FROM THE MARK AS SHOWN. FOR PERSONALIZED BABY GIFTS, NAMELY, BURP CLOTHS, TOWELS AND BLANKETS (U.S. CLS. 42 AND 50).

FIRST USE 10-1-2003; IN COMMERCE 10-1-2003. ALICIA COLLINS, EXAMINING ATTORNEY

CLASS 24—(Continued).

SN 76-587,944. DISNEY ENTERPRISES, INC., BURBANK, CA. FILED 4-19-2004.

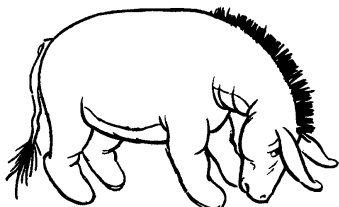

OWNER OF U.S. REG. NO. 2,704,886.
FOR TEXTILE ARTICLES, NAMELY, CURTAINS, NAPKINS, TABLE CLOTHS, HANDKERCHIEFS; BATH LINEN; TABLE LINEN; BED LINEN; HOUSEHOLD LINEN; KITCHEN LINEN; TOWELS; KITCHEN TOWELS; WASHCLOTHS; BEDDING, NAMELY, BED BLANKETS, BED SHEETS, BED SKIRTS, BED SPREADS, CRIB BUMPERS, COMFORTERS, QUILTS, PILLOW CASES AND UNFITTED FABRIC FURNITURE COVERS (U.S. CLS. 42 AND 50).
DEBRA LEE, EXAMINING ATTORNEY

SN 76-591,962. LI PENG ENTERPRISE CO., LTD., TAIPEI, TAIWAN, FILED 5-13-2004.

LIBOLON

THE MARK CONSISTS OF STANDARD CHARACTERS WITHOUT CLAIM TO ANY PARTICULAR FONT, STYLE, SIZE, OR COLOR.

THE ENGLISH TRANSLATION OF "LI BO LON" IS "FORCE PRECIOUS DRAGON".

FOR TEXTILES AND TEXTILE GOODS, NAMELY, SAIL CLOTH, FLAX CLOTH, WOOLEN CLOTH, SILK CLOTH, BED SHEETS, BEDSPREADS, BED BLANKETS, TABLE CLOTHS NOT OF PAPER, AND TEXTILE WALL HANGINGS (U.S. CLS. 42 AND 50).

FIRST USE 5-19-1999; IN COMMERCE 5-19-1999.
BARBARA GAYNOR, EXAMINING ATTORNEY

CLASS 24—(Continued).

SN 76-594,915. AMERICO GROUP, INC., NEW YORK, NY. FILED 5-28-2004.

DRI-MOTION

THE MARK CONSISTS OF STANDARD CHARACTERS WITHOUT CLAIM TO ANY PARTICULAR FONT, STYLE, SIZE, OR COLOR.

FOR BATH LINEN, BATH TOWELS, BED BLANKETS, BED LINEN, BED SHEETS, BED SPREADS, COMFORTERS, KITCHEN TOWELS, LINEN, PILLOW CASES, PILLOW COVERS, PILLOW SHAMS, SHAMS, TOWELS, AND OTHER FABRICS, NAMELY, COTTON, COTTON-POLYESTER, POLYESTER AND SYNTHETIC FIBER FABRICS (U.S. CLS. 42 AND 50).

AMY HELLA, EXAMINING ATTORNEY

SN 76-596,049. GRAVITEX INTERNATIONAL, LLC, LOS ANGELES, CA. FILED 6-7-2004.

BEANBAG PICNIC TABLECLOTH

THE MARK CONSISTS OF STANDARD CHARACTERS WITHOUT CLAIM TO ANY PARTICULAR FONT, STYLE, SIZE, OR COLOR.

NO CLAIM IS MADE TO THE EXCLUSIVE RIGHT TO USE PICNIC TABLECLOTH, APART FROM THE MARK AS SHOWN.

FOR TABLE CLOTHS NOT OF PAPER AND TABLE LINENS (U.S. CLS. 42 AND 50).

FIRST USE 1-1-2003; IN COMMERCE 2-1-2003.

BILL DAWE, EXAMINING ATTORNEY

SN 76-598,511. MITCHELLACE, INC., PORTSMOUTH, OH. FILED 6-18-2004.



FOR FABRIC, NAMELY, NYLON COTTON, POLYESTER AND PLASTIC NETTING (U.S. CLS. 42 AND 50).

FIRST USE 0-0-1920; IN COMMERCE 0-0-1920.
RON FAIRBANKS, EXAMINING ATTORNEY

CLASS 24—(Continued).

SN 76-603,804. TORAY KABUSHIKI KAISHA (TORAY INDUSTRIES, INC.), CHUO-KU, TOKYO, JAPAN, FILED 7-26-2004.

LIGHTYGRAM

THE MARK CONSISTS OF STANDARD CHARACTERS WITHOUT CLAIM TO ANY PARTICULAR FONT, STYLE, SIZE, OR COLOR.

FOR TEXTILE PIECE GOODS INCLUDING WOVEN, NON-WOVEN, KNITTED AND NETTED FABRICS MADE WHOLLY OR PARTIALLY OF SYNTHETIC FIBERS FOR USE IN THE MANUFACTURE OF CLOTHING (U.S. CLS. 42 AND 50).

ROBERT C. CLARK JR., EXAMINING ATTORNEY

SN 76-615,375. KREISNER, INC., CARROLLTON, TX. FILED 10-6-2004.

TOASTY COMFORTER

THE MARK CONSISTS OF STANDARD CHARACTERS WITHOUT CLAIM TO ANY PARTICULAR FONT, STYLE, SIZE, OR COLOR.

OWNER OF U.S. REG. NO. 2,852,841.

NO CLAIM IS MADE TO THE EXCLUSIVE RIGHT TO USE "COMFORTER", APART FROM THE MARK AS SHOWN.

FOR BED BLANKETS (U.S. CLS. 42 AND 50).

LOURDES AYALA, EXAMINING ATTORNEY

SN 76-621,087. KRAVET CONTRACT SALES, INC., DBA PORTFOLIO TEXTILES INC., BETHPAGE, NY. FILED 11-17-2004.

CABANA CLUB

THE MARK CONSISTS OF STANDARD CHARACTERS WITHOUT CLAIM TO ANY PARTICULAR FONT, STYLE, SIZE, OR COLOR.

FOR FABRICS AND TEXTILES FOR USE IN THE MANUFACTURE OF HOME FURNISHINGS, NAMELY, UPHOLSTERY, DRAPERIES, WALL COVERINGS, LINENS, CURTAINS, PILLOWS, BEDSHEETS, QUILTS (U.S. CLS. 42 AND 50).

FIRST USE 7-0-2004; IN COMMERCE 9-0-2004.

SCOTT OSLICK, EXAMINING ATTORNEY

CLASS 24—(Continued).

SN 76-622,198. INTERFACE FABRICS, INC., ATLANTA, GA. FILED 11-26-2004.

BLOCKAIDE

THE MARK CONSISTS OF STANDARD CHARACTERS WITHOUT CLAIM TO ANY PARTICULAR FONT, STYLE, SIZE, OR COLOR.

FOR FABRICS INCORPORATING STAIN-RESISTANT, SOIL-RESISTANT AND MOISTURE-RESISTANT AGENTS, FOR USE IN CONNECTION WITH THE FURTHER MANUFACTURE OF UPHOLSTERY AND WALLCOVERINGS (U.S. CLS. 42 AND 50).

FIRST USE 1-31-2001; IN COMMERCE 1-31-2001.

NICHOLAS ALTREE, EXAMINING ATTORNEY

SN 76-623,793. AMERICAN HOMES & TEXTILES, INC., METUCHEN, NJ. FILED 12-9-2004.

BLEEKER STREET

THE MARK CONSISTS OF STANDARD CHARACTERS WITHOUT CLAIM TO ANY PARTICULAR FONT, STYLE, SIZE, OR COLOR.

FOR TEXTILE GOODS MADE OF COTTON OR POLYESTER, NAMELY, BED LINENS, SHEET SETS CONSISTING OF BED SHEETS AND PILLOW CASES, BED BLANKETS, BEDSPREADS, DUVETS, SHAMS, COMFORTERS AND PILLOW COVERS, AND WINDOW TREATMENTS, NAMELY, PUFFS, POUFS, SWAGS, CURTAINS, DRAPES, AND FABRIC VALANCES (U.S. CLS. 42 AND 50).

AMY GEARIN, EXAMINING ATTORNEY

SN 76-624,830. BENNAN, INC., VIRGINIA BEACH, VA. FILED 12-16-2004.

TAG RELIEF

THE MARK CONSISTS OF STANDARD CHARACTERS WITHOUT CLAIM TO ANY PARTICULAR FONT, STYLE, SIZE, OR COLOR.

NO CLAIM IS MADE TO THE EXCLUSIVE RIGHT TO USE "TAG", APART FROM THE MARK AS SHOWN.

FOR ADHESIVE ATTACHED FABRIC OVERLAYS FOR TAGS OR LABELS ATTACHED TO CLOTHING ARTICLES (U.S. CLS. 42 AND 50).

RUDY R. SINGLETON, EXAMINING ATTORNEY

CLASS 24—(Continued).

SN 76-626,304. WILLIAM CARTER COMPANY, THE, ATLANTA, GA. FILED 12-30-2004.

WHO'S INSIDE

THE MARK CONSISTS OF STANDARD CHARACTERS WITHOUT CLAIM TO ANY PARTICULAR FONT, STYLE, SIZE, OR COLOR.

FOR CHILDREN'S TOWELS (U.S. CLS. 42 AND 50).
SALLY SHIH, EXAMINING ATTORNEY

CLASS 24—(Continued).

SN 78-419,935. U.S. SIGO INC., MIAMI, FL. FILED 5-17-2004.

NEW WORLD DESIGNS

SN 78-304,208. 3TEX, INC., CARY, NC. FILED 9-23-2003.

3WEAVE

OWNER OF U.S. REG. NO. 2,391,748.
FOR WOVEN, KNITTED AND BRAIDED FABRICS USED FOR PREFORMS AND REINFORCEMENT FOR COMPOSITE MATERIALS AND STRUCTURES HAVING APPLICATIONS IN PROTECTIVE WEAR AND MATERIALS, INFRASTRUCTURE, AUTOMOTIVE, AEROSPACE AND AIRCRAFT MATERIALS, MARINE, BIOMEDICAL, GENERAL INDUSTRIAL USE; ALSO, FABRICS MADE WITH MULTI-DIMENSIONAL FIBER ENGINEERING AND TECHNOLOGY FOR THE MANUFACTURE OF FABRIC PREFORMS AND RESIN INFUSED COMPOSITES FOR COMMERCIAL AND INDUSTRIAL USE (U.S. CLS. 42 AND 50).

FIRST USE 10-22-2001; IN COMMERCE 10-22-2001.
DAWN HAN, EXAMINING ATTORNEY

THE MARK CONSISTS OF STANDARD CHARACTERS WITHOUT CLAIM TO ANY PARTICULAR FONT, STYLE, SIZE, OR COLOR.

NO CLAIM IS MADE TO THE EXCLUSIVE RIGHT TO USE "DESIGNS", APART FROM THE MARK AS SHOWN.

FOR BED LINENS; BATH LINENS; DINING LINENS; HOUSEHOLD LINENS; KITCHEN LINENS (U.S. CLS. 42 AND 50).

SOPHIA S. KIM, EXAMINING ATTORNEY

SN 78-420,482. VIACOM INTERNATIONAL INC., NEW YORK, NY. FILED 5-18-2004.

SN 78-419,910. U.S. SIGO INC., MIAMI, FL. FILED 5-17-2004.

ROARR E. SAURUS**NWD**

THE MARK CONSISTS OF STANDARD CHARACTERS WITHOUT CLAIM TO ANY PARTICULAR FONT, STYLE, SIZE, OR COLOR.

FOR BED LINENS; BATH LINENS; DINING LINENS; HOUSEHOLD LINENS; KITCHEN LINENS (U.S. CLS. 42 AND 50).

SOPHIA S. KIM, EXAMINING ATTORNEY

THE MARK CONSISTS OF STANDARD CHARACTERS WITHOUT CLAIM TO ANY PARTICULAR FONT, STYLE, SIZE, OR COLOR.

THE NAME(S), PORTRAIT(S), AND/OR SIGNATURE(S) SHOWN IN THE MARK DOES NOT IDENTIFY A PARTICULAR LIVING INDIVIDUAL.

FOR BED LINEN, BATH LINEN, HOUSEHOLD LINEN, TABLE LINEN; TABLECLOTHS NOT OF PAPER; BEACH TOWELS; CURTAINS, SHOWER CURTAINS; TEXTILE WALL HANGINGS AND CLOTH BANNERS (U.S. CLS. 42 AND 50).

LANA PHAM, EXAMINING ATTORNEY

CLASS 24—(Continued).

SN 78-420,703. INTERNATIONAL TRADE ASSOCIATES, INC., ST. AUGUSTINE, FL. FILED 5-18-2004.

ARTISOL

THE MARK CONSISTS OF STANDARD CHARACTERS WITHOUT CLAIM TO ANY PARTICULAR FONT, STYLE, SIZE, OR COLOR.

FOR DECORATIVE FABRICS, NAMELY, POLYESTERS, ACRYLICS, VINYL COATED POLYESTERS, WOVEN FIBERGLASS AND TEXTILES FOR USE IN CONNECTION WITH WINDOW COVERINGS AND TREATMENTS, NAMELY, BLINDS, ROMAN BLINDS, SHADES, AND ROMAN SHADES (U.S. CLS. 42 AND 50).

GINA HAYES, EXAMINING ATTORNEY

CLASS 24—(Continued).

SN 78-469,530. CMW, LLC, MONTROSE, CO. FILED 8-18-2004.

VANISH

THE MARK CONSISTS OF STANDARD CHARACTERS WITHOUT CLAIM TO ANY PARTICULAR FONT, STYLE, SIZE, OR COLOR.

FOR FABRICS, NAMELY, COTTON AND POLYESTER FABRIC, AND FABRIC FOR THE MANUFACTURE OF COATS AND JACKETS, HUNTING VESTS, BIB OVERALLS, SHIRTS, PANTS, BED SHEETS, BED COVERS, PILLOW CASES AND BEDSPREADS (U.S. CLS. 42 AND 50).

CARRIE ACHEN, EXAMINING ATTORNEY

SN 78-445,550. COOKSEY, THOMAS CLAYTON, TALLAHASSEE, FL. FILED 7-2-2004.



NO CLAIM IS MADE TO THE EXCLUSIVE RIGHT TO USE CAMOUFLAGE, APART FROM THE MARK AS SHOWN.

THE COLOR(S) GREY, GREEN, BURGUNDY IS/ARE CLAIMED AS A FEATURE OF THE MARK.

THE WORDS THE ART OF HIDING, CAMOUFLAGE, AND THE DEPICTION OF A FOOT ARE GREY. THE WORD BIG IS GREEN. THE WORD FOOT IS BURGUNDY.

THE MARK CONSISTS IN PART OF A REPRESENTATION OF A HUMAN FOOT.

FOR COTTON, WOOL, AND SYNTHETIC FABRICS HAVING CAMOUFLAGE PATTERNS (U.S. CLS. 42 AND 50).

G. MAYERSCHOFF, EXAMINING ATTORNEY

SN 78-489,402. THORTEL FIREPROOF FABRICS, INC., ALLENWOOD, NJ. FILED 9-24-2004.

INTERSPEC

THE MARK CONSISTS OF STANDARD CHARACTERS WITHOUT CLAIM TO ANY PARTICULAR FONT, STYLE, SIZE, OR COLOR.

FOR FLAME RETARDANT FABRICS (U.S. CLS. 42 AND 50).

FIRST USE 6-16-1981; IN COMMERCE 6-16-1981.

TINA L. SNAPP, EXAMINING ATTORNEY

CLASS 24—(Continued).

SN 78-513,452. TWENTIETH CENTURY FOX FILM CORPORATION, LOS ANGELES, CA. FILED 11-8-2004.

AMERICAN DAD

THE MARK CONSISTS OF STANDARD CHARACTERS WITHOUT CLAIM TO ANY PARTICULAR FONT, STYLE, SIZE, OR COLOR.

FOR FABRIC FLAGS; FABRIC PENNANTS; PILLOW CASES; BED SKIRTS; BEDSPREADS; QUILT COVERS; BED BLANKETS; CURTAINS; SHOWER CURTAINS; PLASTIC PLACEMATS; TEXTILE PLACEMATS; TOWELS (U.S. CLS. 42 AND 50).

TRACY FLETCHER, EXAMINING ATTORNEY

SN 78-517,938. FUNIKA U.S., SAN DIEGO, CA. FILED 11-16-2004.

Cecilia

THE MARK CONSISTS OF STANDARD CHARACTERS WITHOUT CLAIM TO ANY PARTICULAR FONT, STYLE, SIZE, OR COLOR.

FOR TEXTILES AND TEXTILE GOODS, NAMELY BATH TOWELS, HAND TOWELS, FACE TOWELS, KITCHEN TOWELS, BEACH TOWELS, TEA TOWELS, CLEANING TOWELS, GOLF TOWELS, HOODED TOWELS, WORK TOWELS, SPORTS TOWELS, BEAUTY SUPPLY TOWELS, PET GROOMER TOWELS (U.S. CLS. 42 AND 50).

FIRST USE 4-10-2002; IN COMMERCE 4-20-2003.
MITCHELL FRONT, EXAMINING ATTORNEY

CLASS 24—(Continued).

SN 78-519,220. NATIONAL ALLERGY SUPPLY, INC., DULUTH, GA. FILED 11-18-2004.

SATINSOFT

THE MARK CONSISTS OF STANDARD CHARACTERS WITHOUT CLAIM TO ANY PARTICULAR FONT, STYLE, SIZE, OR COLOR.

FOR HYPO-ALLERGENIC BEDDING PRODUCTS, NAMELY, MATTRESS ENCASINGS CONSISTING OF MATTRESS COVERS, BOXSPRING ENCASINGS CONSISTING OF BOXSPRING COVERS, PILLOW COVERS, AND COMFORTER COVERS (U.S. CLS. 42 AND 50).

FIRST USE 6-0-1995; IN COMMERCE 6-0-1995.
ASMAT KHAN, EXAMINING ATTORNEY

SN 78-519,935. ANNIN & CO., INC., ROSELAND, NJ. FILED 11-19-2004.



NO CLAIM IS MADE TO THE EXCLUSIVE RIGHT TO USE SERIES, APART FROM THE MARK AS SHOWN.

FOR FLAGS, PENNANTS AND BANNERS MADE OF TEXTILE MATERIALS (U.S. CLS. 42 AND 50).

FIRST USE 3-5-2004; IN COMMERCE 3-5-2004.
JOHN HWANG, EXAMINING ATTORNEY

SN 78-550,046. BWW CT, INC., GREENSBORO, NC. FILED 1-19-2005.

CLEYN TINKER

THE MARK CONSISTS OF STANDARD CHARACTERS WITHOUT CLAIM TO ANY PARTICULAR FONT, STYLE, SIZE, OR COLOR.

FOR FABRICS FOR USE IN THE MANUFACTURE OF CLOTHING AND UNIFORMS (U.S. CLS. 42 AND 50).

FIRST USE 12-31-1962; IN COMMERCE 12-31-1962.
KATHRYN COWARD, EXAMINING ATTORNEY

CLASS 24—(Continued).

SN 78-556,759. WOODARD, LLC, CHICAGO, IL. FILED 1-31-2005.

Summer Solutions

THE MARK CONSISTS OF STANDARD CHARACTERS WITHOUT CLAIM TO ANY PARTICULAR FONT, STYLE, SIZE, OR COLOR.

FOR COVERS FOR CUSHIONS USED ON OUTDOOR FURNITURE (U.S. CLS. 42 AND 50).

KAREN BRACEY, EXAMINING ATTORNEY

SN 79-007,530. IZWOOL INTERNATIONAL PTY LTD, AUSTRALIA, FILED 7-13-2004.

i-merino

THE MARK CONSISTS OF STANDARD CHARACTERS WITHOUT CLAIM TO ANY PARTICULAR FONT, STYLE, SIZE, OR COLOR.

PRIORITY DATE OF 2-19-2004 IS CLAIMED.

OWNER OF INTERNATIONAL REGISTRATION 0839516 DATED 7-13-2004, EXPIRES 7-13-2014.

FOR FABRICS OF FINE GAUGE KNITTED AND WOVEN MERINO WOOL (U.S. CLS. 42 AND 50).

SHAUNIA WALLACE, EXAMINING ATTORNEY

CLASS 25—CLOTHING

SN 76-190,820. STRING CHEESE INCIDENT, INC., THE, BOULDER, CO. FILED 1-8-2001.

SCI

SEC. 2(F).

FOR CLOTHING MERCHANDISE, NAMELY T-SHIRTS, SWEATSHIRTS, JACKETS AND HEADWEAR (U.S. CLS. 22 AND 39).

FIRST USE 9-1-1996; IN COMMERCE 9-1-1996.

TRICIA THOMPSON, EXAMINING ATTORNEY

CLASS 25—(Continued).

SN 76-268,756. T. H. Y. & ASSOCIATES, INC., KEAAU, HI. FILED 6-6-2001.

Locals

FOR FOOTWEAR, NAMELY SLIPPERS AND SANDALS (U.S. CLS. 22 AND 39).

FIRST USE 11-26-1986; IN COMMERCE 11-26-1986.

ROBERT C. CLARK JR., EXAMINING ATTORNEY

SN 76-292,676. ALLY USA, FOREST HILLS, NY. FILED 8-2-2001.

FENNIX

FOR BELTS IMPORTED FROM ITALY (U.S. CLS. 22 AND 39).

FIRST USE 11-25-1998; IN COMMERCE 3-16-1999.

KIM SAITO, EXAMINING ATTORNEY

SN 76-406,019. INTELLECTUAL RESERVE, INC., SALT LAKE CITY, UT. FILED 5-10-2002.

BEEHIVE CLOTHING

NO CLAIM IS MADE TO THE EXCLUSIVE RIGHT TO USE "CLOTHING", APART FROM THE MARK AS SHOWN. FOR CLOTHING, NAMELY, SLIPS, DRESSES, UNDERGARMENTS, SLIPPERS, HATS, ROBES, APRONS (U.S. CLS. 22 AND 39).

FIRST USE 0-0-1970; IN COMMERCE 0-0-1970.

SONYA STEPHENS, EXAMINING ATTORNEY

SN 76-442,977. ASHLAND LICENSING AND INTELLECTUAL PROPERTY LLC, DUBLIN, OH. FILED 8-21-2002.

EAGLE ONE

OWNER OF U.S. REG. NOS. 1,467,894, 2,368,393 AND OTHERS.

FOR CLOTHING, NAMELY, T-SHIRTS, SWEAT SHIRTS, SWEAT PANTS, SHIRTS, JACKETS, SWEATERS, SHORTS, VISORS, HATS AND CAPS (U.S. CLS. 22 AND 39).

FIRST USE 1-0-1980; IN COMMERCE 1-0-1980.

BILL DAWE, EXAMINING ATTORNEY

CLASS 25—(Continued).

SN 76-444,286. NINA FOOTWEAR CORP., NEW YORK, NY.
FILED 8-26-2002.

MOBILITY

OWNER OF U.S. REG. NO. 2,230,733.
FOR CHILDREN'S FOOTWEAR (U.S. CLS. 22 AND 39).
FIRST USE 6-0-2003; IN COMMERCE 6-0-2003.
SCOTT OSCLICK, EXAMINING ATTORNEY

SN 76-461,683. HONEY LADY UTAMA LTD., JAKARTA,
INDONESIA, FILED 10-25-2002.

LADY'S SECRET

PRIORITY CLAIMED UNDER SEC. 44(D) ON INDONE-
SIA APPLICATION NO. D00.2002.085, FILED 5-1-2002, REG.
NO. 537478, DATED 5-23-2003, EXPIRES 5-2-2012.

FOR UNDERWEAR FOR WOMEN, MEN AND CHIL-
DREN; NAMELY, BRA, UNDERPANTS, PANTS, SLEEP-
ING DRESS, T-SHIRT, JACKET, DRESS, BLOUSE (U.S.
CLS. 22 AND 39).

RUSS HERMAN, EXAMINING ATTORNEY

SN 76-471,113. RADIANT DEVELOPMENT LIMITED, SAN
PO KONG, KOWLOON, HONG KONG, FILED 11-25-2002.

DIOSA

THE ENGLISH TRANSLATION OF DIOSA IS GODDESS.
FOR CLOTHING; NAMELY, TEE SHIRTS, SHIRTS,
SWEATERS, SKIRTS, JACKETS, PANTS, JEANS,
DRESSES, HATS, TRACKSUITS, TIES, COATS, SUITS
AND FOOTWEAR (U.S. CLS. 22 AND 39).

JULIE WATSON, EXAMINING ATTORNEY

SN 76-490,721. SK VENTURES, LLC, CHATSWORTH, CA.
FILED 2-21-2003.

dance
kinetics

NO CLAIM IS MADE TO THE EXCLUSIVE RIGHT TO
USE "DANCE", APART FROM THE MARK AS SHOWN.
FOR FOOTWEAR (U.S. CLS. 22 AND 39).
VIVIAN MICZNIK FIRST, EXAMINING ATTORNEY

CLASS 25—(Continued).

SN 76-503,058. MACKLIN, ORLANDO, RICHMOND, VA.
FILED 3-28-2003.



NO CLAIM IS MADE TO THE EXCLUSIVE RIGHT TO
USE "JEANS", APART FROM THE MARK AS SHOWN.

THE NAME "JAQUAN ELLIS" DOES NOT IDENTIFY A
LIVING INDIVIDUAL.

FOR MEN'S, WOMEN'S AND CHILDREN'S URBAN
FASHION DESIGN APPAREL, NAMELY LEATHER-
WEAR IN THE NATURE OF LEATHER PANTS,
LEATHER JACKETS AND LEATHER COATS, FOOT-
WEAR, KNITWEAR IN THE NATURE OF CARDIGANS,
SWEATERS AND JACKETS, WOVENWEAR IN THE
NATURE OF JACKETS, SHIRTS, PANTS AND JEANS,
OUTERWEAR IN THE NATURE OF COATS, JACKETS
AND GLOVES, BELTS FOR CLOTHING, SHIRTS, TANK
TOPS, SWEATERS, T-SHIRTS, POLO SHIRTS, COL-
LARED SHIRTS, SHORTS, SKIRTS, JACKETS, UNDER-
WEAR, UNDERGARMENTS, STOCKINGS, SOCKS,
WRISTBANDS, PAJAMAS, SLEEPWEAR, HATS, HEAD-
BANDS, VISORS, CAPS, BANDANAS, RAINWEAR,
COATS, SNEAKERS, AND BOOTS (U.S. CLS. 22 AND 39).
FIRST USE 7-0-1997; IN COMMERCE 7-0-1997.

STEVEN JACKSON, EXAMINING ATTORNEY

SN 76-516,356. KABUSHIKI KAISHA ONWARD KASHIYA-
MA, CHUO-KU, TOKYO, JAPAN, FILED 5-22-2003.

ONWARD

OWNER OF JAPAN REG. NO. 4747959, DATED 2-20-2004,
EXPIRES 2-20-2014.

OWNER OF U.S. REG. NOS. 2,391,540, 2,666,971 AND
2,666,980.

FOR CLOTHING, NAMELY, SUITS, COATS, JACKETS,
SHIRTS, T-SHIRTS, DRESSES, SKIRTS, BLOUSES,
TROUSERS, PANTS, SHORTS, JUMPERS, SWEATERS,
CARDIGANS, VESTS; CLOTHING, NAMELY, UNDER-
CLOTHING, PAJAMAS, BATH ROBES, SWIMSUITS,
GOLF WEAR, NAMELY, GOLF SHIRTS, GOLF PANTS,
GOLF SHOES, GOLF SWEATERS, GOLF JACKETS,
GOLF VESTS, AND GOLF SHORTS, SKI WEAR, ANOR-
AKS, UNIFORMS, WRISTBANDS; SHOES, BOOTS, SLIP-
PERS, SANDALS, RAIN SHOES, SPORT SHOES,
SNEAKERS, WOODEN SHOES, SOCKS, STOCKINGS;
HATS CAPS, BATH CAPS, BATHING CAPS; SCARVES,
MUFFS, NECKERCHIEFS, GLOVES FOR KEEPING
WARM AND FOR CLOTHING, NECKTIES, BELTS FOR
CLOTHING, APRONS, SUSPENDERS (U.S. CLS. 22 AND
39).

FIRST USE 9-1-1988; IN COMMERCE 10-1-1995.
GINA FINK, EXAMINING ATTORNEY

CLASS 25—(Continued).

SN 76-520,470. J.E.M. INTERNATIONAL, INC., NEW YORK, NY. FILED 5-28-2003.

GIRL THING

NO CLAIM IS MADE TO THE EXCLUSIVE RIGHT TO USE "GIRL", APART FROM THE MARK AS SHOWN.

FOR FOOTWEAR, PAJAMAS, ROBES AND NIGHT-GOWNS; SPORTSWEAR, NAMELY, TOPS, SHORTS AND PANTS; UNDERWEAR, HOSIERY AND SOCKS (U.S. CLS. 22 AND 39).

FIRST USE 0-0-2000; IN COMMERCE 0-0-2000.
TRACY FLETCHER, EXAMINING ATTORNEY

SN 76-544,069. DOUBLESTAR GROUP CO., LTD, QINGDAO, CHINA, FILED 9-11-2003.



THE MARK CONSISTS OF STYLIZED DESIGN INCLUDING THE WORDS 'DOUBLE' AND 'STAR'; TWO OVERLAPPING 3-D STARS RESTING ON A CIRCULAR RIM WITH THE WORDS 'DOUBLE STAR' CURVED ABOVE THE RIM.

THE FOREIGN WORDING IN THE MARK TRANSLATES INTO ENGLISH AS DOUBLE STAR.

THE NON-LATIN CHARACTER(S) IN THE MARK TRANSLITERATES INTO SHUANG XING, AND THIS MEANS DOUBLE STAR IN ENGLISH.

FOR CLOTHING, NAMELY SHIRTS, PANTS, DRESSES, HATS, SOCKS, SHOES, AND BELTS (U.S. CLS. 22 AND 39).

FIRST USE 4-15-1993; IN COMMERCE 4-15-1993.
PAUL F. GAST, EXAMINING ATTORNEY

SN 76-545,837. HOSEA, ELSIE, MONTGOMERY, AL. FILED 9-22-2003.

GUMP CITY 334 334

THE MARK CONSISTS OF STANDARD CHARACTERS WITHOUT CLAIM TO ANY PARTICULAR FONT, STYLE, SIZE, OR COLOR.

FOR CLOTHING NAMELY T-SHIRTS, SWEATSHIRTS, HATS, AND CAPS (U.S. CLS. 22 AND 39).

FIRST USE 6-8-2001; IN COMMERCE 6-8-2001.
DEZMONA MIZELLE, EXAMINING ATTORNEY

CLASS 25—(Continued).

SN 76-556,129. CONCEPT FOOTWEAR LTDA, NOVO HAMBURGO - RS, BRAZIL, FILED 11-3-2003.

CONCEPT FOOTWEAR

THE MARK CONSISTS OF STANDARD CHARACTERS WITHOUT CLAIM TO ANY PARTICULAR FONT, STYLE, SIZE, OR COLOR.

NO CLAIM IS MADE TO THE EXCLUSIVE RIGHT TO USE "FOOTWEAR", APART FROM THE MARK AS SHOWN.

FOR MEN'S, WOMEN'S AND CHILDREN'S FOOTWEAR, NAMELY, SHOES (U.S. CLS. 22 AND 39).

ALICE SUE CARRUTHERS, EXAMINING ATTORNEY

SN 76-557,952. CAPRICE SCHUHPRODUKTION GMBH & CO. KG, PIRMASSENS, FED REP GERMANY, FILED 10-20-2003.



OWNER OF FED REP GERMANY REG. NO. 30336073, DATED 9-25-2003, EXPIRES 7-31-2013.

FOR SHOES AND FOOTWEAR AS WELL AS PARTS OF SHOES, NAMELY SOLES, HEELS AND BOOT UPPERS (U.S. CLS. 22 AND 39).

KELLEY WELLS, EXAMINING ATTORNEY

SN 76-560,753. PINEAPPLE TRADEMARKS (PTY) LTD., BURLEIGH HEAD, QUEENSLAND, AUSTRALIA, FILED 11-17-2003.

SPARE

THE MARK CONSISTS OF STANDARD CHARACTERS WITHOUT CLAIM TO ANY PARTICULAR FONT, STYLE, SIZE, OR COLOR.

FOR CLOTHING, NAMELY JACKETS, SHIRTS, TOPS, T-SHIRTS, SWEAT SHIRTS, SWEAT PANTS, PANTS, SHORTS, SWIM WEAR; HATS, CAPS AND BEANIES (U.S. CLS. 22 AND 39).

FIRST USE 8-1-1992; IN COMMERCE 9-1-1992.
ESTHER BELENKER, EXAMINING ATTORNEY

CLASS 25—(Continued).

SN 76-562,045. JAMES, JESSE, LONG BEACH, CA. FILED 11-26-2003.

VANILLA GORILLA

THE MARK CONSISTS OF STANDARD CHARACTERS WITHOUT CLAIM TO ANY PARTICULAR FONT, STYLE, SIZE, OR COLOR.

FOR CLOTHING, NAMELY; SHIRTS, T-SHIRTS; HATS; CAPS; HEADBANDS; SCARVES, GLOVES, UNDERWEAR, TANK TOPS, SOCKS; BELTS, RAINWEAR, SWIMWEAR, JACKETS, SWEATSHIRTS, SWEATPANTS, SHORTS AND PANTS, SHOES AND BOOTS (U.S. CLS. 22 AND 39).

TONI HICKEY, EXAMINING ATTORNEY

CLASS 25—(Continued).

SN 76-577,047. NEW ERA DESIGN, L.L.C., NEW YORK, NY. FILED 2-23-2004.

X RAY

THE MARK CONSISTS OF STANDARD CHARACTERS WITHOUT CLAIM TO ANY PARTICULAR FONT, STYLE, SIZE, OR COLOR.

FOR CLOTHING, NAMELY, JEANS, SHIRTS, COATS, JACKETS, RAINCOATS, SWEATERS, PANTS, SHORTS, SOCKS, SHOES, HATS, GLOVES, AND SCARVES (U.S. CLS. 22 AND 39).

CHRIS WELLS, EXAMINING ATTORNEY

SN 76-562,173. WAL-MART STORES, INC., BENTONVILLE, AR. FILED 11-14-2003.

nobo

FOR CLOTHING, NAMELY, BLOUSES, SHIRTS, TOPS, PANTS, SLACKS, JEANS, SKIRTS, SHORTS, JACKETS, DRESSES, HOSIERY, SOCKS, GLOVES, HATS, SCARVES, HATS, BELTS, SLEEPWEAR, LINGERIE AND SHOES (U.S. CLS. 22 AND 39).

FIRST USE 12-15-2003; IN COMMERCE 12-15-2003.

HENRY S. ZAK, EXAMINING ATTORNEY

SN 76-583,377. GEYER, HOPE, SANTA BARBARA, CA. FILED 3-26-2004.



THE MARK CONSISTS OF A STYLIZED VERSION OF THE WORD 'SERAPHIM', WITH THE 'S' HAVING WINGS AND A HALO.

FOR PANTS, SKIRTS, TOPS, WRAPS, BELTS (U.S. CLS. 22 AND 39).

FIRST USE 2-14-2004; IN COMMERCE 2-14-2004.

JENNIFER CHICOSKI, EXAMINING ATTORNEY

SN 76-573,287. TOSHI'S TERIYAKI, INC., MEDINA, WA. FILED 2-2-2004.



OWNER OF U.S. REG. NO. 1,763,453.
NO CLAIM IS MADE TO THE EXCLUSIVE RIGHT TO USE "THE ORIGINAL", APART FROM THE MARK AS SHOWN.

FOR APPAREL; NAMELY, APRONS AND T-SHIRTS (U.S. CLS. 22 AND 39).

FIRST USE 4-1-1990; IN COMMERCE 4-1-1990.

STEVEN JACKSON, EXAMINING ATTORNEY

SN 76-584,175. CORSELLO, BRIAN C., WESTLAKE, OH. FILED 3-31-2004.



THE FOREIGN WORDING IN THE MARK TRANSLATES INTO ENGLISH AS OF LIFE.

FOR CLOTHING, NAMELY, HATS, CAPS, PANTS, JEANS, SHIRTS, AND T-SHIRTS (U.S. CLS. 22 AND 39).

FIRST USE 7-27-2003; IN COMMERCE 7-27-2003.

H. M. FISHER, EXAMINING ATTORNEY

CLASS 25—(Continued).

SN 76-585,886. JOHNSON, DANA, COLUMBUS, OH. FILED 4-9-2004.

HOOZ NEXST

THE MARK CONSISTS OF STANDARD CHARACTERS WITHOUT CLAIM TO ANY PARTICULAR FONT, STYLE, SIZE, OR COLOR.

FOR CLOTHING, NAMELY, POLO JACKETS, HEADWEAR, PANTS, SHORTS, SWEAT SHIRTS, SWEAT PANTS, HATS, JACKETS, SOCKS, SWIM WEAR, RAIN WEAR, DRESSES, FOOTWEAR, SCARVES, HEADBANDS, PAJAMAS AND SLEEP WEAR, BANDANNAS, BELTS, VESTS, WRISTBANDS, JEANS, SUITS, SLACKS, TANK TOPS, UNDERWEAR, SPORTS SHIRTS, T-SHIRTS, AND COATS (U.S. CLS. 22 AND 39).

VERNA BETH RIRIE, EXAMINING ATTORNEY

SN 76-587,317. DISNEY ENTERPRISES, INC., BURBANK, CA. FILED 4-19-2004.



OWNER OF U.S. REG. NO. 2,700,620.

FOR CLOTHING, NAMELY, SWEATERS; DRESSES; SKIRTS; COATS; JACKETS; PANTS; SWEAT PANTS; SWEAT SHIRTS; SHIRTS; SHORTS; SLEEPERS; T-SHIRTS; TANK TOPS; VESTS; JERSEYS; ROBES; PAJAMAS; NIGHT SHIRTS; NIGHT GOWNS; BEACHWEAR; SWIM WEAR; BATHING SUITS; UNDERWEAR; HEAD BANDS; WRIST BANDS; BIBS, NAMELY, CHILDREN'S AND INFANTS' CLOTH BIBS AND BABY BIBS NOT OF PAPER; MITTENS; GLOVES; SCARVES; NECKTIES; BELTS; LEOTARDS; LEG WARMERS; HOSIERY; SOCKS; STOCKINGS; PANTYHOSE; TIGHTS; RAINWEAR; FOOTWEAR; HEADWEAR; HALLOWEEN AND MASQUERADE COSTUMES (U.S. CLS. 22 AND 39).

MARLENE BELL, EXAMINING ATTORNEY

CLASS 25—(Continued).

SN 76-588,159. DISNEY ENTERPRISES, INC., BURBANK, CA. FILED 4-19-2004.



FOR CLOTHING, NAMELY, SWEATERS; DRESSES; SKIRTS; COATS; JACKETS; PANTS; SWEAT PANTS; SWEAT SHIRTS; SHIRTS; SHORTS; SLEEPERS; T-SHIRTS; TANKTOPS; VESTS; JERSEYS; ROBES; PAJAMAS; NIGHT SHIRTS; NIGHT GOWNS; BEACHWEAR; SWIM WEAR; BATHING SUITS; UNDERWEAR; HEAD BANDS; WRISTBANDS; BIBS; MITTENS; GLOVES; SCARVES; NECKTIES; BELTS; LEOTARDS; LEG WARMERS; HOSIERY; SOCKS; STOCKINGS; PANTYHOSE; TIGHTS; RAINWEAR; FOOTWEAR; HEADWEAR; HALLOWEEN AND MASQUERADE COSTUMES (U.S. CLS. 22 AND 39).

GINA HAYES, EXAMINING ATTORNEY

SN 76-588,224. BENSUSAN RESTAURANT CORPORATION, NEW YORK, NY. FILED 4-23-2004.

BLUE NOTE

OWNER OF U.S. REG. NOS. 2,158,939, 2,209,141 AND OTHERS.

NO CLAIM IS MADE TO THE EXCLUSIVE RIGHT TO USE "BLUE", APART FROM THE MARK AS SHOWN.

FOR CLOTHING, NAMELY, BASEBALL CAPS, T-SHIRTS, SWEATSHIRTS (U.S. CLS. 22 AND 39).

FIRST USE 8-0-1984; IN COMMERCE 8-0-1984.

BERYL GARDNER, EXAMINING ATTORNEY

SN 76-588,661. PATTERSON, DANIEL, TILLSON, NY. FILED 4-26-2004.

DINOTEEZ

THE MARK CONSISTS OF STANDARD CHARACTERS WITHOUT CLAIM TO ANY PARTICULAR FONT, STYLE, SIZE, OR COLOR.

FOR CLOTHING, NAMELY T-SHIRTS (U.S. CLS. 22 AND 39).

FIRST USE 5-30-1996; IN COMMERCE 4-1-2001.

MARTHA FROMM, EXAMINING ATTORNEY

CLASS 25—(Continued).

SN 76-588,701. THE INTERTEX GROUP, INC., DALLAS, TX.
FILED 4-26-2004.

COTTON IN ACTION

OWNER OF U.S. REG. NO. 1,873,914.
NO CLAIM IS MADE TO THE EXCLUSIVE RIGHT TO
USE "COTTON", APART FROM THE MARK AS SHOWN.
FOR KNITWEAR AND ACTIVE WEAR MADE IN
WHOLE OR IN SIGNIFICANT PART OF COTTON,
NAMELY POLO SHIRTS, T-SHIRTS AND FLEECE
SHIRTS (U.S. CLS. 22 AND 39).
FIRST USE 1-31-1993; IN COMMERCE 1-31-1993.
LESLEY LAMOTHE, EXAMINING ATTORNEY

SN 76-589,681. MISSISSIPPI UNIVERSITY FOR WOMEN,
COLUMBUS, MS. FILED 4-23-2004.



NO CLAIM IS MADE TO THE EXCLUSIVE RIGHT TO
USE 1884 OR UNIVERSITY, APART FROM THE MARK AS
SHOWN.
SEC. 2(F).
FOR CLOTHING, NAMELY T-SHIRTS, JERSEYS,
CAPS, SHORTS, JACKETS, SWEAT SHIRTS, SWEATERS,
PANTS, SHIRTS AND COATS (U.S. CLS. 22 AND 39).
HENRY S. ZAK, EXAMINING ATTORNEY

SN 76-590,535. YOUNGONE CORP, NORTH AMERICAN
LIASON OFFICE, SEATTLE, WA. FILED 5-5-2004.

BROAD PEAK

THE MARK CONSISTS OF STANDARD CHARACTERS
WITHOUT CLAIM TO ANY PARTICULAR FONT, STYLE,
SIZE, OR COLOR.

OWNER OF U.S. REG. NO. 2,942,467.
FOR CLOTHING, NAMELY, JACKETS, PARKAS,
PULLOVERS, ANORAKS, PANTS, SHORTS, SWEAT
SUITS, SKI BIBS AND WINTER AND SUMMER COATS
(U.S. CLS. 22 AND 39).
FIRST USE 11-1-2001; IN COMMERCE 1-1-2002.
MELISSA SHELLA, EXAMINING ATTORNEY

CLASS 25—(Continued).

SN 76-590,744. CALHOUN, GEORGE, SAN ANTONIO, TX.
FILED 5-6-2004.

WADE AID

THE MARK CONSISTS OF STANDARD CHARACTERS
WITHOUT CLAIM TO ANY PARTICULAR FONT, STYLE,
SIZE, OR COLOR.
SEC. 2(F).
FOR FISHING ACCESSORIES, NAMELY, A WADE
FISHERMAN'S ACCESSORY BELT (U.S. CLS. 22 AND
39).
FIRST USE 7-0-1995; IN COMMERCE 7-0-1995.
RONALD MCMORROW, EXAMINING ATTORNEY

SN 76-590,745. WITTELS, KYLE E, SUNNY ISLES BEACH,
FL. FILED 5-6-2004.

SUNDAY

FOR MEN'S AND WOMEN'S CLOTHING, NAMELY,
JACKETS, COATS, PARKAS, BLOUSONS, SUITS,
SKIRTS, PANTS, TROUSERS, BREECHES, COATS,
SWEATERS, VESTS, CARDIGANS, TEE-SHIRTS,
SKIRTS, BLOUSES, DRESSES FOR WOMEN, CAMI-
SOLES, LEOTARDS, WARM UP SUITS, SWEAT PANTS,
SWEAT SHIRTS, SPATS, UNIFORMS, CLOTHING OF
LEATHER, NAMELY, PANTS, SHIRTS, JACKETS AND
COATS; BODICES, SWEAT SHIRTS, APRONS, BABY'S
PANTS, BATHROBES, PAJAMAS, BATHING CAPS,
BATHING DRAWERS, BATHING SUITS, BANDANAS,
SOCKS, GLOVES, SCARVES, SHAWLS, BOAS, MUF-
FLERS, NECKTIES, EAR MUFFS, BELTS, HEAD WEAR,
SHOES, SANDALS, BOOTS, FUR COATS AND FUR
JACKETS (U.S. CLS. 22 AND 39).
FIRST USE 1-15-2003; IN COMMERCE 2-1-2003.
RONALD MCMORROW, EXAMINING ATTORNEY

CLASS 25—(Continued).

SN 76-592,411. POG UNLIMITED, LOS ANGELES, CA. FILED 5-14-2004.

POG

THE MARK CONSISTS OF STANDARD CHARACTERS WITHOUT CLAIM TO ANY PARTICULAR FONT, STYLE, SIZE, OR COLOR.

FOR CLOTHING, NAMELY, T-SHIRTS, SHORTS, PANTS, SWEATSHIRTS, SWEATPANTS, BANDANNAS, SCARVES, APRONS, JACKETS, JEAN JACKETS, TANK TOPS, VESTS, NECKTIES, HOCKEY JERSEYS, SOCCER JERSEYS, FASHION KNIT SHIRTS, BUTTON-DOWN SHIRTS, BASKETBALL JERSEYS, LONG SLEEVE T-SHIRTS, SWEATERS, BASEBALL JERSEYS, BABY DOLL T-SHIRTS, POLO SHIRTS, WIND RESISTANT JACKETS, MUSCLE T-SHIRTS, BABY ROMPERS, TODDLER T-SHIRTS, ALLOVERS, MOCK TURTLE NECKS, TRACK PANTS, PONCHOS, AND HOODED SHIRTS; HEADWEAR; AND FOOTWEAR (U.S. CLS. 22 AND 39).

DAVID ELTON, EXAMINING ATTORNEY

SN 76-592,573. ADRIENNE VICTORIA DESIGNS, INC., NEW YORK, NY. FILED 5-17-2004.

MARY.L

THE MARK CONSISTS OF STANDARD CHARACTERS WITHOUT CLAIM TO ANY PARTICULAR FONT, STYLE, SIZE, OR COLOR.

THE NAME MARY L DOES NOT IDENTIFY A LIVING INDIVIDUAL.

FOR CLOTHING FOR WOMEN, NAMELY JEANS, SLACKS, PANTS, SKIRTS, BLOUSES, T-SHIRTS, SUITS, DRESSES, GOWNS, SHORTS, TANKTOPS, VESTS, SWEATPANTS, SWEATSHIRTS, SWEATERS, COATS, JACKETS, PARKAS, STOLES, SHAWLS, CAPES, APRONS, CAPS, HATS, SLIPPERS, MITTENS, GLOVES, MITTS; BELTS, BOOTS, SHOES, ROBES, PAJAMAS, UNDERPANTS, BRASSIERES, NIGHTGOWNS; BEACHWEAR INCLUDING BATHING SUITS, BODYWRAPS, AND SARONGS (U.S. CLS. 22 AND 39).

RONALD MCMORROW, EXAMINING ATTORNEY

CLASS 25—(Continued).

SN 76-593,723. MR. HAWAII, INC., GARDENA, CA. FILED 5-24-2004.

DOUBLE OR NOTHING

THE MARK CONSISTS OF STANDARD CHARACTERS WITHOUT CLAIM TO ANY PARTICULAR FONT, STYLE, SIZE, OR COLOR.

FOR CASUAL WEAR; NAMELY, TEE SHIRTS, SWEATSHIRTS, WOVEN SHIRTS, KNIT SHIRTS, WALK SHORTS AND CARGO SHORTS, BASEBALL CAPS AND CAPS, WOVEN BLOUSES, AND LEISURE WEAR; NAMELY, WOVEN SHIRTS, KNIT SHIRTS, GOLF SHIRTS, WALK SHORTS AND CARGO SHORTS, JACKETS, SKORTS, AND WOVEN BLOUSES (U.S. CLS. 22 AND 39).

MARK SPARACINO, EXAMINING ATTORNEY

SN 76-596,297. GOLDINGER, STEVEN, LOS ANGELES, CA. FILED 6-7-2004.

STEVEN GOLDINGER

THE MARK CONSISTS OF STANDARD CHARACTERS WITHOUT CLAIM TO ANY PARTICULAR FONT, STYLE, SIZE, OR COLOR.

FOR MEN'S, WOMEN'S AND CHILDREN'S CLOTHING, NAMELY, TOPS, BOTTOMS, HEADWEAR, FOOTWEAR, JACKETS, COATS, BELTS, SHIRTS, SLEEPWEAR, SWEAT SHIRTS, SWEAT PANTS, SWEAT SUITS, SHORTS, PANTS, BODYSUITS, BLOUSES, UNDERWEAR, LINGERIE, SWEATERS, HOSIERY, SOCKS, SKIRTS, OVERALLS, PLAYSUITS, TIES, SWIMWEAR, VESTS, UNIFORMS, SCARVES, ROBES, GLOVES AND CAMISOLES. (U.S. CLS. 22 AND 39).

JOHN GARTNER, EXAMINING ATTORNEY

SN 76-596,418. ASICS CORPORATION, KOBE 650-8555, JAPAN, FILED 6-8-2004.

KAYANO

THE MARK CONSISTS OF STANDARD CHARACTERS WITHOUT CLAIM TO ANY PARTICULAR FONT, STYLE, SIZE, OR COLOR.

OWNER OF U.S. REG. NOS. 2,228,545 AND 2,468,343. SEC. 2(F).
FOR APPAREL, NAMELY SOCKS, SINGLETS, SHORTS, SHIRTS, JERSEYS (U.S. CLS. 22 AND 39).
FIRST USE 5-1-2002; IN COMMERCE 5-1-2002.
NELSON SNYDER, EXAMINING ATTORNEY

CLASS 25—(Continued).

SN 76-597,444. LANDAU UNIFORMS, INCORPORATED,
OLIVE BRANCH, MS. FILED 6-15-2004.



OWNER OF U.S. REG. NOS. 1,345,902, 2,587,572 AND
2,608,522.

FOR CLOTHING FOR NURSES AND OTHER
HEALTHCARE PROFESSIONALS, NAMELY, PANTS,
TOPS, JACKETS, VESTS AND TEE SHIRTS (U.S. CLS.
22 AND 39).

FIRST USE 4-15-2004; IN COMMERCE 4-15-2004.
ASMAT KHAN, EXAMINING ATTORNEY

SN 76-597,445. LANDAU UNIFORMS, INCORPORATED,
OLIVE BRANCH, MS. FILED 6-15-2004.



OWNER OF U.S. REG. NOS. 1,345,902, 2,587,572 AND
2,608,522.

FOR CLOTHING FOR NURSES AND OTHER
HEALTHCARE PROFESSIONALS, NAMELY, PANTS,
TOPS, JACKETS, VESTS AND TEE SHIRTS (U.S. CLS.
22 AND 39).

FIRST USE 4-15-2004; IN COMMERCE 4-15-2004.
ASMAT KHAN, EXAMINING ATTORNEY

CLASS 25—(Continued).

SN 76-597,483. BROWN, KEVIN ANDRE YAHSIM, II,
VALLEJO, CA. FILED 6-14-2004.

KAY 1 APPAREL

THE MARK CONSISTS OF STANDARD CHARACTERS
WITHOUT CLAIM TO ANY PARTICULAR FONT, STYLE,
SIZE, OR COLOR.

NO CLAIM IS MADE TO THE EXCLUSIVE RIGHT TO
USE "APPAREL", APART FROM THE MARK AS SHOWN.

FOR CLOTHING, NAMELY, SWEATSHIRTS, HATS,
CAPS, SOCKS, PANTS, JEANS, T-SHIRTS, BOXER
SHORTS, UNDERWEAR, DRESSES, SCARVES, VESTS,
SWEATERS, SWIMSUITS, PANTIES, BELTS, PAJAMAS,
SHIRTS, GLOVES, BANDANAS, SKIRTS, HEADBANDS,
TIES, COATS, JACKETS, HEADWEAR, SHOES, STOCK-
INGS, AND SHORTS (U.S. CLS. 22 AND 39).

FIRST USE 10-27-2003; IN COMMERCE 10-27-2003.

ALICE SUE CARRUTHERS, EXAMINING ATTORNEY

SN 76-599,406. A&A BODY WORSHIP, INC., NEW YORK,
NY, AND RHONE, SYLVIA, NEW YORK, NY. FILED 6-24-
2004.

INDEPENDENT BODIES

THE MARK CONSISTS OF STANDARD CHARACTERS
WITHOUT CLAIM TO ANY PARTICULAR FONT, STYLE,
SIZE, OR COLOR.

FOR CLOTHING, NAMELY, SHIRTS, T-SHIRTS, UN-
DER SHIRTS, NIGHT SHIRTS, RUGBY SHIRTS, POLO
SHIRTS, CARDIGANS, JERSEYS, UNIFORMS, PANTS,
TROUSERS, SLACKS, JEANS, DENIM JEANS, OVER-
ALLS, COVERALLS, JUMPERS, JUMP SUITS, SHORTS,
BOXER SHORTS, TOPS, CROP TOPS, TANK TOPS,
HALTER TOPS, SWEAT SHIRTS, SWEAT SHORTS,
SWEAT PANTS, WRAPS, WARM-UP SUITS, JOGGING
SUITS, TRACK SUITS, BLOUSES, SKIRTS, DRESSES,
GOWNS, SWEATERS, VESTS, PULLOVERS, SNOW
SUITS, PARKAS, CAPES, ANORAKS, PONCHOS, JACK-
ETS, REVERSIBLE JACKETS, COATS, BLAZERS, SUITS,
TURTLENECKS, CLOTH SKI BIBS, SWIMWEAR,
BEACHWEAR, TENNIS WEAR, SURF WEAR, SKI
WEAR, INFANTWEAR, BABY BIBS NOT OF PAPER,
CLOTH DIAPERS, CAPS, SWIM CAPS, BERETS, BEA-
NIES, HATS, VISORS, HEADBANDS, WRIST BANDS,
SWEAT BANDS, HEADWEAR, EAR MUFFS, APRONS,
SCARVES, BANDANAS, BELTS, SUSPENDERS, NECK-
WEAR, TIES, NECKERCHIEFS, ASCOTS, UNDERWEAR,
BRIEFS, SWIM AND BATHING TRUNKS, BRAS,
SPORTS BRAS, BRASSIERES, BUSTIERS, CORSETS,
PANTIES, GARTERS AND GARTER BELTS, TEDDIES,
GIRDLES, FOUNDATION GARMENTS, SINGLETS,
SOCKS, LOUNGEWEAR, ROBES, UNDERCLOTHES, PA-
JAMAS, SLEEPWEAR, NIGHT GOWNS, LINGERIE, CA-
MISOLE, NEGLIGEE, CHEMISES, CHEMISSETTES,
SLIPS, SARONGS, LEG WARMERS, HOSIERY, PANTY-
HOSE, BODY STOCKINGS, KNEE HIGHS, LEGGINGS,
TIGHTS, LEOTARDS, BODY SUITS, UNITARDS, BODY
SHAPERS, GLOVES, MITTENS, FOOTWEAR, SHOES,
SNEAKERS, BOOTS, GALOSHES, SANDALS, FLIP-
FLOPS, SLIPPERS AND RAINWEAR (U.S. CLS. 22 AND
39).

CAROLYN CATALDO, EXAMINING ATTORNEY

CLASS 25—(Continued).

SN 76-599,732. OLSEN, TROY, TUCSON, AZ. FILED 6-29-2004.

TROY OLSEN

THE MARK CONSISTS OF STANDARD CHARACTERS WITHOUT CLAIM TO ANY PARTICULAR FONT, STYLE, SIZE, OR COLOR.

THE NAME(S), PORTRAIT(S), AND/OR SIGNATURE(S) SHOWN IN THE MARK IDENTIFIES TROY OLSEN, WHOSE CONSENT(S) TO REGISTER IS SUBMITTED.

FOR CLOTHING; NAMELY, BASEBALL CAPS, HATS, T-SHIRTS AND SWEATSHIRTS (U.S. CLS. 22 AND 39).

FIRST USE 6-1-1998; IN COMMERCE 6-1-1998.
REBECCA GILBERT, EXAMINING ATTORNEY

SN 76-600,484. RAFI MUHAMMAD, ONEIDA L., WALNUT COVE, NC. FILED 7-2-2004.

JUMPSUITS

FOR CLOTHING AND HEADGEAR, NAMELY, COATS, JACKETS, HATS, BASEBALL CAPS, BERETS, SCARVES, JUMPSUITS, SHIRTS, PANTS, JOGGING SUITS, SWEAT PANTS, SWEAT SHIRTS, T-SHIRTS, BOXERS, OVERALLS, AND COVERALLS (U.S. CLS. 22 AND 39).

FIRST USE 1-23-2002; IN COMMERCE 1-23-2002.
ANGELA M. MICHELI, EXAMINING ATTORNEY

SN 76-600,986. GEORGE M. SIMONTON, LTD, NEW YORK, NY. FILED 7-6-2004.

MICHAEL DE GRAY BY GEORGE SIMONTON

THE MARK CONSISTS OF STANDARD CHARACTERS WITHOUT CLAIM TO ANY PARTICULAR FONT, STYLE, SIZE, OR COLOR.

OWNER OF U.S. REG. NO. 2,343,789.

THE NAME MICHAEL DE GRAY DOES NOT IDENTIFY A LIVING INDIVIDUAL; THE NAME GEORGE SIMONTON IDENTIFIES A LIVING INDIVIDUAL WHOSE CONSENT IS OF RECORD.

FOR WOMEN'S APPAREL, NAMELY, DRESSES, SUITS, PANTS, SHIRTS, BLOUSES, SWEATSUITS, T-SHIRTS, JEANS, COATS, JACKETS AND HATS (U.S. CLS. 22 AND 39).

FIRST USE 7-0-2003; IN COMMERCE 7-0-2003.
STEVEN JACKSON, EXAMINING ATTORNEY

CLASS 25—(Continued).

SN 76-605,670. HILTS, DAVE, MURRIETA, CA. FILED 8-5-2004.



NO CLAIM IS MADE TO THE EXCLUSIVE RIGHT TO USE "PADDLEWEAR", APART FROM THE MARK AS SHOWN.

THE MARK CONSISTS OF AN ELLIPSE CROSSED IN ITS LOWER RIGHT-HAND CORNER BY THE TAIL END OF A FANCIFUL SURFBOARD, WHERE, INSIDE THE ELLIPSE, THE SURFBOARD NOSE BECOMES THE BOTTOM OF A FANCIFUL WAVE, WITH THREE SHOOTS OF SPRAY CASCADING OVER THE LITERAL ELEMENT OF THE MARK, NAMELY THE WORD IN LARGE LETTERS "PADDLEAIR", WITH THE WORDS "POWER PADDLEWEAR" IN SMALLER SIZE LETTERS UNDERNEATH THE WORD "PADDLEAIR".

FOR WATER SURFING GARMENTS, NAMELY SHIRTS, WETSUITS, AND SHORTS (U.S. CLS. 22 AND 39).

FIRST USE 3-1-2004; IN COMMERCE 4-4-2004.
JANICE L. MCMORROW, EXAMINING ATTORNEY

SN 76-607,737. STEIN MART BUYING CORPORATION, JACKSONVILLE, FL. FILED 8-19-2004.

CLEARWATER OUTFITTERS

THE MARK CONSISTS OF STANDARD CHARACTERS WITHOUT CLAIM TO ANY PARTICULAR FONT, STYLE, SIZE, OR COLOR.

NO CLAIM IS MADE TO THE EXCLUSIVE RIGHT TO USE "OUTFITTERS", APART FROM THE MARK AS SHOWN.

FOR MEN'S CLOTHING, NAMELY, SHIRTS, T-SHIRTS, JACKETS, VESTS, ANORAKS, SWEATERS, PANTS, SHORTS, JEANS, AND HATS (U.S. CLS. 22 AND 39).

FIRST USE 3-0-2004; IN COMMERCE 3-0-2004.
TONI HICKEY, EXAMINING ATTORNEY

SN 76-608,032. MODUS VIVENDI & COMPANY, LLC, LOS ANGELES, CA. FILED 8-18-2004.

SOPHIE TYLER

THE MARK CONSISTS OF STANDARD CHARACTERS WITHOUT CLAIM TO ANY PARTICULAR FONT, STYLE, SIZE, OR COLOR.

THE NAME "SOPHIE TYLER" DOES NOT IDENTIFY A LIVING INDIVIDUAL.

FOR CLOTHING NAMELY, SWEATERS, WOYEN SHIRTS, TOPS, CARDIGANS, TANK TOPS, AND VESTS (U.S. CLS. 22 AND 39).

FIRST USE 4-0-2003; IN COMMERCE 4-0-2003.
ERNEST SHOSHO, EXAMINING ATTORNEY

CLASS 25—(Continued).

SN 76-610,147. LEHIGH SAFETY SHOE CO. LLC, VESTAL, NY. FILED 9-1-2004.



THE LINING IS A FEATURE OF THE MARK AND DOES NOT INDICATE COLOR.

THE COLOR(S) YELLOW, BLACK AND WHITE ARE CLAIMED AS A FEATURE OF THE MARK.

THE COLOR BLACK APPEARS IN THE CENTER RECTANGLES ENCOMPASSING THE CENTER DIAMOND AND THE CENTER DIAMOND SHAPE ITSELF. THE COLOR YELLOW APPEARS IN THE BORDER SURROUNDING THE OUTSIDE EDGE OF THE DESIGN AND IN THE CENTER RECTANGLE PORTIONS OF THE LETTER L. THE COLOR WHITE ALTERNATES WITH THE COLOR BLACK IN THE CENTER DIAMOND PORTION AND APPEARS IN THE LINING THAT CONNECTS TO THE OUTER EDGE OF THE DESIGN, AS WELL AS THE OUTSIDE EDGE OF THE RECTANGLES THAT COMPRISE THE LETTER L.

FOR FOOTWEAR (U.S. CLS. 22 AND 39).
FIRST USE 1-1-2001; IN COMMERCE 1-1-2001.
BRIAN PINO, EXAMINING ATTORNEY

CLASS 25—(Continued).

SN 76-612,025. HOKE, WAYNE R., HARRISON, NJ. FILED 9-20-2004.



THE MARK CONSISTS OF THE STYLIZED LETTER "G" SUPERIMPOSED OVER A STYLIZED CADUCEUS.

FOR CLOTHING, WOVENS AND KNITS, NAMELY, T-SHIRTS, TANK TOPS, JEANS, SHIRTS, PANTS, SHORTS, SKIRTS, BUTTON DOWN SHIRTS, POLO SHIRTS, CARDIGANS, SWEATERS, HATS, JACKETS, COATS, ATHLETIC FOOTWEAR, SHOES, SOCKS, UNDERGARMENTS, BRAS, PANTIES, UNDERWEAR, BOXER SHORTS (U.S. CLS. 22 AND 39).

FIRST USE 8-28-2004; IN COMMERCE 8-28-2004.
TRICIA SONNEBORN, EXAMINING ATTORNEY

SN 76-610,787. SIMON, BARBARA, BEVERLY HILLS, CA. FILED 9-10-2004.



NO CLAIM IS MADE TO THE EXCLUSIVE RIGHT TO USE "TOLTEC YOGA", APART FROM THE MARK AS SHOWN.

THE STIPLING IS FOR SHADING PURPOSES.

THE LIKENESS (OR, "PORTRAIT") IN THE MARK IDENTIFIES A LIVING INDIVIDUAL WHOSE CONSENT IS OF RECORD.

FOR CLOTHING, FOOTWEAR AND HEADGEAR, NAMELY, PANTS, SHORTS, SKIRTS, T-SHIRTS, DRESSES, SPORT SHIRTS, BLOUSES, JACKETS, SWEAT PANTS, SWEAT SHIRTS, VESTS, SWEATERS, HATS, HEADBANDS AND SOCKS (U.S. CLS. 22 AND 39).

DAVID MURRAY, EXAMINING ATTORNEY

SN 76-615,365. SYKZILLA, LLC, MADISON, CT. FILED 10-6-2004.

SYKZILLA

THE MARK CONSISTS OF STANDARD CHARACTERS WITHOUT CLAIM TO ANY PARTICULAR FONT, STYLE, SIZE, OR COLOR.

FOR CLOTHING NAMELY, SHORTS, T-SHIRTS, LONG SLEEVE T-SHIRTS, RASHGUARDS, HALTER TOPS, TANK TOPS, SWEAT SHIRTS, SWEAT PANTS, DRESSES, SKIRTS, JACKETS, HATS, VISORS, FOOTWEAR, FLIP FLOPS, SANDALS, BATHING SUITS, SPORTSWEAR, NAMELY, POLO SHIRTS, BEANIES (U.S. CLS. 22 AND 39).

RONALD AIKENS, EXAMINING ATTORNEY

CLASS 25—(Continued).

SN 76-615,535. ENADEGHE, EFOSA KENNETH, SILVER SPRING, MD. FILED 10-4-2004.



FOR APPAREL, NAMELY, PANTS, SHIRTS, JACKETS, SHOES, CAPS, FOOTWEAR, HEADWEAR, DRESSES, COATS, SHORTS, PANTS, JEANS, SWEATERS, SUITS, TUXEDOS, T-SHIRTS, BLOUSES, KNIT TOPS, HALTER TOPS, SMOCK TOPS, VESTS, WIND RESISTANT JACKETS, JOGGING SUITS, SWEAT SHIRTS, SWEAT PANTS, SKIING JACKETS, MUFFLERS, HEADBANDS, BELTS, GLOVES, SCARVES, PONCHOS, STOCKINGS, HOSIERY, SOCKS, TIGHTS, LEGGINGS, PAJAMAS, ROBES, NIGHTGOWNS, PANTIES, BRAS, UNDERWEAR, UNDERSHIRTS, RAIN COATS, SWIMWEAR, LINGERIE AND TIES (U.S. CLS. 22 AND 39).

RUDY R. SINGLETON, EXAMINING ATTORNEY

SN 76-616,192. MCKINNEY, JUSTON L., ENCINO, NY. FILED 10-12-2004.

SUCK IT UP

THE MARK CONSISTS OF STANDARD CHARACTERS WITHOUT CLAIM TO ANY PARTICULAR FONT, STYLE, SIZE, OR COLOR.

FOR CLOTHING, NAMELY, T-SHIRTS, SWEATSHIRTS, TANK TOPS, SHORTS, BOXER SHORTS, SPORTS BRAS, JACKETS, SWEATPANTS; FOOTWEAR; HEADWEAR, NAMELY, BASEBALL CAPS (U.S. CLS. 22 AND 39).

FIRST USE 1-31-1997; IN COMMERCE 1-31-1997.
INGA ERVIN, EXAMINING ATTORNEY

SN 76-616,576. OFFICIAL BUGLE BOY, LLC, COLUMBUS, OH. FILED 10-18-2004.

765

THE MARK CONSISTS OF STANDARD CHARACTERS WITHOUT CLAIM TO ANY PARTICULAR FONT, STYLE, SIZE, OR COLOR.

OWNER OF U.S. REG. NO. 2,186,869.
FOR CLOTHING, NAMELY, PANTS, JEANS, AND SHORTS (U.S. CLS. 22 AND 39).

ALICE BENMAMAN, EXAMINING ATTORNEY

CLASS 25—(Continued).

SN 76-616,959. BRAGEL INTERNATIONAL INC., POMONA, CA. FILED 10-20-2004.

NuBra Aphrodite

THE MARK CONSISTS OF STANDARD CHARACTERS WITHOUT CLAIM TO ANY PARTICULAR FONT, STYLE, SIZE, OR COLOR.

OWNER OF U.S. REG. NO. 2,794,831.
FOR LINGERIE; LINGERIE ACCESSORIES, NAMELY BRASSIERES, ADHESIVE BRAS, STRAPLESS BRAS; AND PANTIES (U.S. CLS. 22 AND 39).
FIRST USE 9-4-2004; IN COMMERCE 9-4-2004.
MATTHEW PAPPAS, EXAMINING ATTORNEY

SN 76-616,960. BRAGEL INTERNATIONAL INC., POMONA, CA. FILED 10-20-2004.

NuBra Ultra-Lite

THE MARK CONSISTS OF STANDARD CHARACTERS WITHOUT CLAIM TO ANY PARTICULAR FONT, STYLE, SIZE, OR COLOR.

OWNER OF U.S. REG. NO. 2,794,831.
NO CLAIM IS MADE TO THE EXCLUSIVE RIGHT TO USE "LIGHT", APART FROM THE MARK AS SHOWN.
FOR LINGERIE; LINGERIE ACCESSORIES, NAMELY BRASSIERES, ADHESIVE BRAS, STRAPLESS BRAS, AND PANTIES (U.S. CLS. 22 AND 39).
FIRST USE 7-1-2004; IN COMMERCE 7-1-2004.
MATTHEW PAPPAS, EXAMINING ATTORNEY

SN 76-616,961. BRAGEL INTERNATIONAL INC., POMONA, CA. FILED 10-20-2004.

NuBra Trinity

THE MARK CONSISTS OF STANDARD CHARACTERS WITHOUT CLAIM TO ANY PARTICULAR FONT, STYLE, SIZE, OR COLOR.

OWNER OF U.S. REG. NO. 2,794,831.
FOR LINGERIE; LINGERIE ACCESSORIES, NAMELY BRASSIERES, ADHESIVE BRAS, STRAPLESS BRAS; AND PANTIES (U.S. CLS. 22 AND 39).

MATTHEW PAPPAS, EXAMINING ATTORNEY

CLASS 25—(Continued).

SN 76-618,138. CACHET INDUSTRIES, INC., NEW YORK, NY. FILED 10-25-2004.

CACHET

THE MARK CONSISTS OF STANDARD CHARACTERS WITHOUT CLAIM TO ANY PARTICULAR FONT, STYLE, SIZE, OR COLOR.

FOR WOMEN'S GARMENTS NAMELY, PANTS, SKIRTS, SHORTS, BLOUSES, DRESSES, JACKETS AND COATS (U.S. CLS. 22 AND 39).

FIRST USE 8-0-1980; IN COMMERCE 0-0-1980.
AMY HELLA, EXAMINING ATTORNEY

SN 76-618,203. QVC, INC., WEST CHESTER, PA. FILED 10-28-2004.

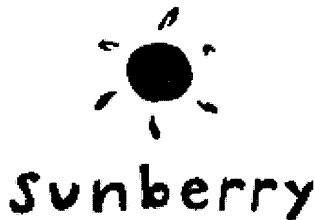

FOR WOMEN'S APPAREL, NAMELY, T-SHIRTS, SWEATSHIRTS, SHORTS, DRESSES, SKIRTS, TOPS, PANTS, JACKETS, TANK TOPS AND BLOUSES (U.S. CLS. 22 AND 39).

KEVIN DINALLO, EXAMINING ATTORNEY

SN 76-619,610. I'M ALL IN WEAR, INC., NORTH LAS VEGAS, NV. FILED 11-8-2004.

IAI

THE MARK CONSISTS OF STANDARD CHARACTERS WITHOUT CLAIM TO ANY PARTICULAR FONT, STYLE, SIZE, OR COLOR.

FOR MEN'S AND WOMEN'S CLOTHING, NAMELY, SHIRTS, SHORT-SLEEVED AND LONG-SLEEVED T-SHIRTS, TANK TOPS, SWEATSHIRTS, SWEATERS, FLEECE PULLOVERS, HOODED SWEATSHIRTS AND HOODED SHIRTS (U.S. CLS. 22 AND 39).

FIRST USE 10-5-2004; IN COMMERCE 10-13-2004.
JENNIFER KRISP, EXAMINING ATTORNEY

CLASS 25—(Continued).

SN 76-619,954. NYC KNITWEAR INC., NEW YORK, NY. FILED 11-10-2004.

SUGAR KNITS

THE MARK CONSISTS OF STANDARD CHARACTERS WITHOUT CLAIM TO ANY PARTICULAR FONT, STYLE, SIZE, OR COLOR.

NO CLAIM IS MADE TO THE EXCLUSIVE RIGHT TO USE "KNITS", APART FROM THE MARK AS SHOWN.

FOR V-NECK SWEATERS, CARDIGANS, WRAP-AROUNDS, CROP TOPS, HALTER TOPS, MOCK TURTLE-NECK SWEATERS, PONCHOS, PULLOVERS, SHAWLS, SWEATERS, TANK TOPS (U.S. CLS. 22 AND 39).

FIRST USE 8-1-2004; IN COMMERCE 8-1-2004.
RONALD MCMORROW, EXAMINING ATTORNEY

SN 76-620,109. LAGO, AHMED, BROOKLYN, NY. FILED 11-12-2004.

SPIT 16

THE MARK CONSISTS OF STANDARD CHARACTERS WITHOUT CLAIM TO ANY PARTICULAR FONT, STYLE, SIZE, OR COLOR.

FOR CLOTHING, NAMELY, T-SHIRTS, HATS, SNEAKERS AND BOOTS (U.S. CLS. 22 AND 39).

FIRST USE 9-3-2004; IN COMMERCE 9-3-2004.
ADA HAN, EXAMINING ATTORNEY

SN 76-620,130. GLOVER, TINA L., CHICAGO, IL. FILED 11-12-2004.



NO CLAIM IS MADE TO THE EXCLUSIVE RIGHT TO USE HAT COUTURE, APART FROM THE MARK AS SHOWN.

FOR HATS, HEADWEAR, PANTS, SHIRTS, JACKETS (U.S. CLS. 22 AND 39).

PAULA MAHONEY, EXAMINING ATTORNEY

CLASS 25—(Continued).

SN 76-620,550. POWELL, TERI V., RAPID CITY, SD. FILED 11-15-2004.

Jammy Hats

THE MARK CONSISTS OF STANDARD CHARACTERS WITHOUT CLAIM TO ANY PARTICULAR FONT, STYLE, SIZE, OR COLOR.

NO CLAIM IS MADE TO THE EXCLUSIVE RIGHT TO USE HATS, APART FROM THE MARK AS SHOWN.

FOR CLOTHING, NAMELY, HATS (U.S. CLS. 22 AND 39).

FIRST USE 12-1-2003; IN COMMERCE 3-18-2004.
JOHN E. MICHOS, EXAMINING ATTORNEY

SN 76-620,611. A FINE GAUGE, INC., NEW YORK, NY. FILED 11-12-2004.

24 hundred

THE MARK CONSISTS OF STANDARD CHARACTERS WITHOUT CLAIM TO ANY PARTICULAR FONT, STYLE, SIZE, OR COLOR.

FOR CLOTHING, NAMELY SWEATERS, BLOUSES, SHIRTS, PANTS, SKIRTS, DRESSES, SHORTS, SCARVES, SHAWLS, HATS, GLOVES, SOCKS, COATS, JACKETS, T-SHIRTS, BODY SUITS, AND PONCHOS (U.S. CLS. 22 AND 39).

FIRST USE 9-10-2004; IN COMMERCE 9-10-2004.
JOHN DWYER, EXAMINING ATTORNEY

SN 76-620,698. LUCKY & WEALTHY CO., LTD., BANGKOK 10320, THAILAND, FILED 11-15-2004.



OWNER OF THAILAND REG. NO. KHOR122754, DATED 5-20-1999, EXPIRES 5-19-2009.

FOR CLOTHING, NAMELY, T-SHIRTS, SHIRTS, DRESSES, PANTS, SWEATERS, JACKETS, SUITS, SOCKS, HATS, CAPS, LINGERIE, SPANDEX HEADBAND AND WRISTBAND, AND GLOVES (U.S. CLS. 22 AND 39).

WILLIAM VERHOSEK, EXAMINING ATTORNEY

CLASS 25—(Continued).

SN 76-621,079. DUNHAM'S ATHLEISURE CORPORATION, WATERFORD, MI. FILED 11-17-2004.

AEROLINE

THE MARK CONSISTS OF STANDARD CHARACTERS WITHOUT CLAIM TO ANY PARTICULAR FONT, STYLE, SIZE, OR COLOR.

FOR CLOTHING, NAMELY, PANTS, SHIRTS, SHORTS, TOPS, SOCKS, UNDERGARMENTS (U.S. CLS. 22 AND 39).

FIRST USE 1-1-2003; IN COMMERCE 1-1-2003.
JUDITH HELFMAN, EXAMINING ATTORNEY

SN 76-621,229. GUCCI AMERICA, INC., NEW YORK, NY. FILED 11-17-2004.



OWNER OF U.S. REG. NO. 1,158,170.
FOR FOOTWEAR AND BELTS (U.S. CLS. 22 AND 39).
FIRST USE 9-0-2002; IN COMMERCE 9-0-2002.
AMOS T. MATTHEWS, JR., EXAMINING ATTORNEY

SN 76-621,320. AW CHANG CORPORATION, NEW YORK, NY. FILED 11-18-2004.

COBB SALAD DESIGN

THE MARK CONSISTS OF STANDARD CHARACTERS WITHOUT CLAIM TO ANY PARTICULAR FONT, STYLE, SIZE, OR COLOR.

NO CLAIM IS MADE TO THE EXCLUSIVE RIGHT TO USE "DESIGN", APART FROM THE MARK AS SHOWN.

FOR CLOTHING, NAMELY SHIRTS, VESTS, SWEATERS, SHOES, CAPS, BANDANNAS, SHORTS, SWEAT SHIRTS, PANTS, BELTS FOR CLOTHING, SOCKS, SWIMWEAR, JACKETS, RAINWEAR, BLOUSES, DRESSES, FOOTWEAR, HOSIERY, SCARVES, HATS, HEAD BANDS, PAJAMAS AND SLEEPWEAR (U.S. CLS. 22 AND 39).

LAURA KOVAISKY, EXAMINING ATTORNEY

CLASS 25—(Continued).

SN 76-621,323. LAMBERT, JUDI, LOS ANGELES, CA. FILED 11-18-2004.

JOYSTICK

THE MARK CONSISTS OF STANDARD CHARACTERS WITHOUT CLAIM TO ANY PARTICULAR FONT, STYLE, SIZE, OR COLOR.

FOR CLOTHING, NAMELY, JACKETS, COATS, CAPES, PANTS, SHIRTS, SKIRTS, DRESSES, T-SHIRTS, SWEATERS, VESTS, SHORTS, BLOUSES, NECKWEAR, BELTS, UNDERWEAR, LINGERIE, PAJAMAS, ROBES, SWIMWEAR, SWEATPANTS, SWEATSHIRTS AND WRISTBANDS; HEADWEAR, NAMELY, SCARVES (U.S. CLS. 22 AND 39).

FIRST USE 2-12-2004; IN COMMERCE 2-12-2004.
CHERYL CLAYTON, EXAMINING ATTORNEY

CLASS 25—(Continued).

SN 76-621,761. SKUDERA, GEORGE F., FARMINGDALE, NJ. FILED 11-22-2004.



FOR BATHING SUITS; BEACHWEAR; BELTS; CLOTH BIBS FOR BABIES AND INFANTS; UNDERWEAR; SWEATERS; HALLOWEEN COSTUMES; DRESSES; GLOVES; HATS; CAPS; HOSIERY; INFANT WEAR; JACKETS; MITTENS; PAJAMAS; PANTS; SWEAT PANTS; SWEAT SHIRTS; SHIRTS; SHOES; SHORTS; SLEEPERS; SOCKS; T-SHIRTS; TANK TOPS; TIGHTS; VESTS; JERSEYS; SCARVES; NECKTIES; ROBES; NIGHT SHIRTS; NIGHT GOWNS; HEAD BANDS; WRIST BANDS; SKIRTS; COATS; LEOTARDS; LEG WARMERS; STOCKINGS; PANTY HOSE; ATHLETIC SHOES; SLIPPERS; BOOTS; SANDALS; RAINWEAR (U.S. CLS. 22 AND 39).

NICHOLAS ALTREE, EXAMINING ATTORNEY

SN 76-621,797. KRIZIA S.P.A., 20121 MILAN, ITALY, FILED 11-22-2004.

KRIZIA

THE MARK CONSISTS OF STANDARD CHARACTERS WITHOUT CLAIM TO ANY PARTICULAR FONT, STYLE, SIZE, OR COLOR.

OWNER OF U.S. REG. NO. 998,746.

FOR CLOTHING FOR MEN, WOMEN AND CHILDREN NAMELY, SHIRTS, BLOUSES, SKIRTS, JACKETS, TROUSERS, SHORTS, SWEATERS, T-SHIRTS, PAJAMAS, SHOES, STOCKINGS, TANK-TOPS, UNDERPANTS, PETTICOATS, SLIPPERS, FOOTWEAR, HATS, SCARVES, NECKERCHIEVES, TIES, RAINCOATS, OVERCOATS, BATHING SUITS, SWEAT SUITS, WIND-JACKETS, SKI PANTS, BELTS, GIRDLES, GARTER BELTS; LEATHER CLOTHING, NAMELY, LEATHER COATS, LEATHER HEADWEAR, LEATHER JACKETS, LEATHER PANTS, LEATHER SHOES, LEATHER SLIPPERS, SUITS OF LEATHER, TROUSERS OF LEATHER (U.S. CLS. 22 AND 39).

FIRST USE 1-13-1954; IN COMMERCE 9-10-1973.
CAROLINE WOOD, EXAMINING ATTORNEY

SN 76-621,465. MAIER, RICHARD L., LILBURN, GA. FILED 11-19-2004.

THE SLOW PITCH STRIKER

THE MARK CONSISTS OF STANDARD CHARACTERS WITHOUT CLAIM TO ANY PARTICULAR FONT, STYLE, SIZE, OR COLOR.

FOR CLOTHING, NAMELY, T-SHIRTS, CAPS AND HATS (U.S. CLS. 22 AND 39).

ELIZABETH J. WINTER, EXAMINING ATTORNEY

CLASS 25—(Continued).

SN 76-621,974. SILBER, JERE, SILVER SPRING, MD. FILED 11-23-2004.

UNITED FRONT OUTERWEAR

THE MARK CONSISTS OF STANDARD CHARACTERS WITHOUT CLAIM TO ANY PARTICULAR FONT, STYLE, SIZE, OR COLOR.

NO CLAIM IS MADE TO THE EXCLUSIVE RIGHT TO USE OUTERWEAR, APART FROM THE MARK AS SHOWN.

FOR CLOTHING FOR MEN AND WOMEN; NAMELY, SHIRTS, HATS, PANTS, JACKETS, SWEATPANTS AND SWEAT SHIRTS (U.S. CLS. 22 AND 39).

FIRST USE 6-0-1992; IN COMMERCE 6-0-1992.
DANIEL CAPSHAW, EXAMINING ATTORNEY

CLASS 25—(Continued).

SN 76-622,652. NEW CONCEPT TRADING CORP., NEW YORK, NY. FILED 11-30-2004.



FOR WOMEN'S DRESSES, PANTS, TOPS, BLOUSES, JACKETS, SUITS AND SWEATERS (U.S. CLS. 22 AND 39).

MONTIA G. PRESSEY, EXAMINING ATTORNEY

SN 76-622,296. GRAND CENTRAL DISCOVERY, CORP., BRIDGEHAMPTON, NY. FILED 11-29-2004.

Scharfe`

FOR WOMEN'S OR GIRLS' SCARVES, NAMELY A COMBINATION OF A SCARF AND A SHAWL COVERLET (U.S. CLS. 22 AND 39).

JOHN WILKE, EXAMINING ATTORNEY

SN 76-623,003. SIMONE, ROBERT D., DOYLESTOWN, PA. FILED 12-3-2004.

BONEFISH BOB

THE MARK CONSISTS OF STANDARD CHARACTERS WITHOUT CLAIM TO ANY PARTICULAR FONT, STYLE, SIZE, OR COLOR.

FOR GOLF AND FISHING CLOTHING, NAMELY SHIRTS, SLACKS, JACKETS, HATS, GLOVES, SHORTS, AND SOCKS (U.S. CLS. 22 AND 39).

BARBARA BROWN, EXAMINING ATTORNEY

SN 76-622,413. OUYANG, DAVIDIAN, DUARTE, CA. FILED 11-29-2004.

Coffee Talk

THE MARK CONSISTS OF STANDARD CHARACTERS WITHOUT CLAIM TO ANY PARTICULAR FONT, STYLE, SIZE, OR COLOR.

FOR LADIES' AND CHILDREN'S UNDERWEAR, SLEEPWEAR AND LOUNGEWEAR (U.S. CLS. 22 AND 39).

FIRST USE 2-25-2004; IN COMMERCE 2-25-2004.
LINDA M. KING, EXAMINING ATTORNEY

SN 76-623,220. BOHRT, HUMBERTO, LA PAZ, BOLIVIA, FILED 12-6-2004.

CASHLLAMA

THE MARK CONSISTS OF STANDARD CHARACTERS WITHOUT CLAIM TO ANY PARTICULAR FONT, STYLE, SIZE, OR COLOR.

FOR SWEATERS, PONCHOS, SCARVES, HATS AND GLOVES (U.S. CLS. 22 AND 39).

ANN LINNEHAN, EXAMINING ATTORNEY

CLASS 25—(Continued).

SN 76-623,596. U.O.D., INC., WILMINGTON, DE. FILED 12-7-2004.

LOST SOLES

THE MARK CONSISTS OF STANDARD CHARACTERS WITHOUT CLAIM TO ANY PARTICULAR FONT, STYLE, SIZE, OR COLOR.

NO CLAIM IS MADE TO THE EXCLUSIVE RIGHT TO USE SOLES, APART FROM THE MARK AS SHOWN. FOR FOOTWEAR (U.S. CLS. 22 AND 39). ALICE BENMAMAN, EXAMINING ATTORNEY

CLASS 25—(Continued).

SN 76-624,047. THE GIFT WRAPPED BABY, INC., SANTEE, CA. FILED 12-13-2004.

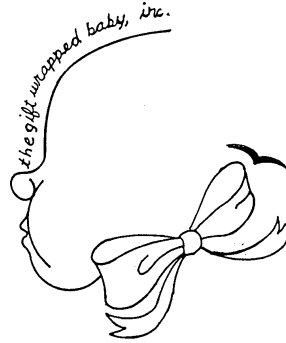

NO CLAIM IS MADE TO THE EXCLUSIVE RIGHT TO USE "BABY" OR "INC.", APART FROM THE MARK AS SHOWN.

FOR THEMED INFANT WRAPS MADE OF FABRIC (U.S. CLS. 22 AND 39). FIRST USE 11-5-2004; IN COMMERCE 11-5-2004. HENRY S. ZAK, EXAMINING ATTORNEY

SN 76-623,735. DANCE MAGIC, INC., ESSEXVILLE, MI. FILED 12-7-2004.

STARMAKER

THE MARK CONSISTS OF STANDARD CHARACTERS WITHOUT CLAIM TO ANY PARTICULAR FONT, STYLE, SIZE, OR COLOR.

FOR DANCEWEAR CLOTHING, NAMELY, LEOTARDS, BLOUSES, TIGHTS, DRESSES, BODY SUITS, TUTUS, PANTS, BLOOMERS, JACKETS, SHIRTS, CAPES, VESTS, LEG-WARMERS, LEGGINGS, BOAS, BELTS, BERETS, SCARVES, GLOVES, CUMMERBUNDS AND BOW TIES (U.S. CLS. 22 AND 39).

FIRST USE 11-30-1993; IN COMMERCE 11-30-1993. ANNE MADDEN, EXAMINING ATTORNEY

SN 76-624,110. WONDERLUST INDUSTRIES, INC., NEW YORK, NY. FILED 12-9-2004.

WONDERLUST

THE MARK CONSISTS OF STANDARD CHARACTERS WITHOUT CLAIM TO ANY PARTICULAR FONT, STYLE, SIZE, OR COLOR.

FOR CLOTHING, NAMELY BLOUSES, BOXER SHORTS, BRAS, CAMISOLES, COATS, COVERALLS, DRESSES, HALTER TOPS, JACKETS, JEANS, KIMONOS, NIGHTSHIRTS, OVERALLS, PANTS, PULLOVERS, RAINWEAR, ROBES, SARONGS, SHAWLS, SHIRTS, SHORTS, SKIRTS, SLEEPWEAR, SUITS, SWEAT PANTS, SWEAT SHIRTS, SWEAT SUITS, SWEATERS, TANK TOPS, T-SHIRTS, TUNICS, UNDERWEAR, VESTS; SANDALS, SHOES, SLIPPERS, SOCKS; BANDANNAS, BELTS, GLOVES, HATS, HEADBANDS, HEADWEAR, KERCHIEFS, MITTENS, SCARVES, SWEATBANDS (U.S. CLS. 22 AND 39).

AMY GEARIN, EXAMINING ATTORNEY

CLASS 25—(Continued).

SN 76-625,778. MACIAS, SEAN E., LOS ANGELES, CA. FILED 12-22-2004.

Street Millions

THE MARK CONSISTS OF STANDARD CHARACTERS WITHOUT CLAIM TO ANY PARTICULAR FONT, STYLE, SIZE, OR COLOR.

FOR CLOTHING AND HEADGEAR, NAMELY SHIRTS, T-SHIRTS, SWEATSHIRTS, SINGLETS, TANK TOPS, SWEATERS, PULLOVERS, SWEAT PANTS, SHORTS, BEACH WEAR, SWIMWEAR, BELTS, HATS, CAPS AND VISORS (U.S. CLS. 22 AND 39).
SUSAN HAYASH, EXAMINING ATTORNEY

CLASS 25—(Continued).

SN 76-626,521. BOOT ROYALTY COMPANY, L.P., FORT WORTH, TX. FILED 12-30-2004.

THIS AIN'T OUR FIRST RODEO

THE MARK CONSISTS OF STANDARD CHARACTERS WITHOUT CLAIM TO ANY PARTICULAR FONT, STYLE, SIZE, OR COLOR.

FOR FOOTWEAR, NAMELY, BOOTS (U.S. CLS. 22 AND 39).
VERNA BETH RIRIE, EXAMINING ATTORNEY

SN 76-625,779. MACIAS, SEAN E., LOS ANGELES, CA. FILED 12-22-2004.



FOR CLOTHING AND HEADGEAR, NAMELY SHIRTS, T-SHIRTS, SWEATSHIRTS, SINGLETS, TANK TOPS, SWEATERS, PULLOVERS, SWEAT PANTS, SHORTS, BEACH WEAR, SWIMWEAR, BELTS, HATS, CAPS AND VISORS (U.S. CLS. 22 AND 39).
SUSAN HAYASH, EXAMINING ATTORNEY

SN 76-626,550. THE WILLIAM CARTER COMPANY, ATLANTA, GA. FILED 12-30-2004.

WRAP-ME-UP

THE MARK CONSISTS OF STANDARD CHARACTERS WITHOUT CLAIM TO ANY PARTICULAR FONT, STYLE, SIZE, OR COLOR.

FOR BATHROBES (U.S. CLS. 22 AND 39).
SAMUEL E. SHARPER JR., EXAMINING ATTORNEY

SN 76-626,520. BOOT ROYALTY COMPANY, L.P., FORT WORTH, TARRANT COUNTY, TX. FILED 12-30-2004.



FOR FOOTWEAR, NAMELY, BOOTS (U.S. CLS. 22 AND 39).
VERNA BETH RIRIE, EXAMINING ATTORNEY

SN 76-626,569. THE WILLIAM CARTER COMPANY, ATLANTA, GA. FILED 12-30-2004.

SLEEPLIKELY

THE MARK CONSISTS OF STANDARD CHARACTERS WITHOUT CLAIM TO ANY PARTICULAR FONT, STYLE, SIZE, OR COLOR.

FOR INFANTS' AND CHILDREN'S CLOTHING, NAMELY, SLEEPWEAR, NIGHTGOWNS, PAJAMAS, SLEEPERS, AND SLEEPING SUITS (U.S. CLS. 22 AND 39).
LINDA M. KING, EXAMINING ATTORNEY

CLASS 25—(Continued).

SN 76-626,598. MILANO MANHATTAN, LLC, NEW YORK, NY. FILED 12-30-2004.

LLOYD WILLIAMS

THE MARK CONSISTS OF STANDARD CHARACTERS WITHOUT CLAIM TO ANY PARTICULAR FONT, STYLE, SIZE, OR COLOR.

LLOYD WILLIAMS IS A LIVING INDIVIDUAL WHOSE CONSENT IS OF RECORD.

FOR WOMEN'S APPAREL, NAMELY, SUITS, JACKETS, COATS, SCARVES, SOCKS, BELTS, GLOVES, HATS, UNDERGARMENTS, SHIRTS, BLOUSES, SWEATERS, VESTS, DRESSES, SKIRTS, PANTS, TROUSERS, SHORTS AND SHOES (U.S. CLS. 22 AND 39).

LINDA M. KING, EXAMINING ATTORNEY

SN 76-626,686. SPRING FLOWERS, INCORPORATED, NEW YORK, NY. FILED 1-3-2005.



FOR BABIES CLOTHING, NAMELY, UNDERWEAR, GOWNS, SLEEPWEAR, JUMPSUITS, PANTS, SWEATERS, JACKETS, SNOWSUITS, DRESSES, OVERALLS, JUMPERS, RAINCOATS, BABY SHOES, SOCKS, HATS, SCARVES, MITTENS, CLOTH BIBS AND TIGHTS; BOYS CLOTHING, NAMELY, SHIRTS, PANTS, SHORTS, T-SHIRTS, JACKETS, COATS, SOCKS, SWEATERS, CARDIGANS, VESTS, TIES, UNDERWEAR, SLEEPWEAR, RAINCOATS, SHOES, BOOTS, HATS, SCARVES, MITTENS AND GLOVES; GIRLS' CLOTHING, NAMELY, DRESSES, SKIRTS, BLOUSES, PANTS, SHORTS, SKORTS, NAMELY SKIRT AND SHORTS COMBINATIONS, T-SHIRTS, JACKETS, COATS, SOCKS, TIGHTS, SWEATERS, CARDIGANS, VESTS, UNDERWEAR, SLEEPWEAR, RAINCOATS, SHOES, BOOTS, HATS, SCARVES, MITTENS AND GLOVES (U.S. CLS. 22 AND 39).

FIRST USE 8-0-1983; IN COMMERCE 9-0-1983.

PATRICIA EVANKO, EXAMINING ATTORNEY

SN 76-626,762. C.S.F. CORP., WILMINGTON, DE. FILED 1-3-2005.

DELUXE L.A. BLUES

THE MARK CONSISTS OF STANDARD CHARACTERS WITHOUT CLAIM TO ANY PARTICULAR FONT, STYLE, SIZE, OR COLOR.

OWNER OF U.S. REG. NO. 1,585,808.

FOR WOMEN'S APPAREL, NAMELY, BASEBALL CAPS, CAPRI PANTS, DENIM JACKETS, DRESSES, JACKETS, JEANS, SHIRTS, SHORTS, SKIRTS AND TOPS (U.S. CLS. 22 AND 39).

GINNY ISAACSON, EXAMINING ATTORNEY

CLASS 25—(Continued).

SN 76-627,548. XTREME CYCLES OF SARASOTA, LLC, SARASOTA, FL. FILED 1-10-2005.

LIVE NUDE CHOPPERS

THE MARK CONSISTS OF STANDARD CHARACTERS WITHOUT CLAIM TO ANY PARTICULAR FONT, STYLE, SIZE, OR COLOR.

FOR MEN'S, WOMEN'S AND CHILDREN'S CLOTHING, NAMELY BASEBALL CAPS, BATHING SUITS, BATHROBES, BEACH COVERUPS, BELTS, BIKINIS, BODY SUITS, BOOTS, BOXER SHORTS, BRAS, BRIEFS, CAPS, COATS, FOOTWEAR, GLOVES, HALTER TOPS, HATS, HEADWEAR, INFANT WEAR, JACKETS, JEANS, JUMPSUITS, PAJAMAS, PANTIES, PANTS, ROBES, SHORTS, SHIRTS, SOCKS, SWEAT SUITS, SWIMWEAR, TANK TOPS, T-SHIRTS, UNDERWEAR AND VISORS (U.S. CLS. 22 AND 39).

FIRST USE 11-20-2004; IN COMMERCE 11-20-2004.

JEFFERY COWARD, EXAMINING ATTORNEY

SN 76-628,092. STEEVES, KAREN, AUSTIN, TX. FILED 1-18-2005.

BLESSED AND GRATEFUL

THE MARK CONSISTS OF STANDARD CHARACTERS WITHOUT CLAIM TO ANY PARTICULAR FONT, STYLE, SIZE, OR COLOR.

FOR CLOTHING, NAMELY SHIRTS AND HATS (U.S. CLS. 22 AND 39).

BILL DAWE, EXAMINING ATTORNEY

SN 76-629,212. GUCCI AMERICA, INC., NEW YORK, NY. FILED 1-28-2005.



OWNER OF U.S. REG. NOS. 1,106,722, 1,107,259 AND 1,107,311.

THE STIPPLING IN THE DRAWING IS TO SHOW INDENTATION OF THE MARK.

FOR NECKTIES, BELTS, FOOTWEAR AND SCARVES (U.S. CLS. 22 AND 39).

FIRST USE 7-0-2004; IN COMMERCE 7-0-2004.

AMOS T. MATTHEWS, JR., EXAMINING ATTORNEY

CLASS 25—(Continued).

SN 78-125,238. PARAMOUNT PICTURES CORPORATION, LOS ANGELES, CA. FILED 4-30-2002.

SAVE THE LAST DANCE

FOR T-SHIRTS, SWEATSHIRTS, HATS, JACKETS, PAJAMAS, TANK TOPS, FOOTWEAR, SWEATPANTS, SHORTS (U.S. CLS. 22 AND 39).
DORITT L. CARROLL, EXAMINING ATTORNEY

SN 78-157,684. NEVADA APPAREL CORP., NEW YORK, NY. FILED 8-26-2002.

SHINE NEW YORK

NO CLAIM IS MADE TO THE EXCLUSIVE RIGHT TO USE "NEW YORK", APART FROM THE MARK AS SHOWN. FOR LADIES' CLOTHING, NAMELY, T-SHIRTS, SHIRTS, DRESSES, PANTS, SKIRTS, JACKETS AND SWEATERS (U.S. CLS. 22 AND 39).
FIRST USE 12-0-1999; IN COMMERCE 12-0-1999.
BILL DAWE, EXAMINING ATTORNEY

SN 78-183,951. TORQUAY ENTERPRISES LIMITED, AUCKLAND, NEW ZEALAND, FILED 11-12-2002.



PRIORITY CLAIMED UNDER SEC. 44(D) ON NEW ZEALAND APPLICATION NO. 667521, FILED 10-29-2002, REG. NO. 667521, DATED 5-1-2003, EXPIRES 5-1-2010.
OWNER OF U.S. REG. NO. 2,375,503.

NO CLAIM IS MADE TO THE EXCLUSIVE RIGHT TO USE "EST. 1990", APART FROM THE MARK AS SHOWN.

THE MARK CONSISTS OF A STYLIZED DEPICTION OF A PUMPKIN UNDER THE WORDS PUMPKIN PATCH EST. 1990, ALL WITHIN A CIRCLE.

FOR CLOTHING, NAMELY, HEAD WEAR; FOOTWEAR; NECKWEAR; CHILDREN'S AND BABY'S CLOTHING, NAMELY, T-SHIRTS, SHORTS, ROMPERS, BIKE PANTS AND LEGGINGS, PANTS AND JEANS, DRESSES, CLOTH BIBS, OVERALLS, SHIRTS AND BLOUSES, KNIT SHIRTS AND OTHER TOPS, SKIRTS, SWEATSHIRTS, TRACKSUITS, UNDERWEAR, JACKETS, BODY SUITS AND DRESSES, SLEEP WEAR, SWIM WEAR, SOCKS; MATERNITY CLOTHING, NAMELY, MATERNITY DRESSES, BODYSUITS, JACKETS, KNIT SHIRTS AND OTHER TOPS, SKIRTS, SWEATSHIRTS, TRACKSUITS, UNDERWEAR, JACKETS, BODY SUITS AND DRESSES, SLEEP WEAR; SWIMWEAR, SOCKS; OUTERWEAR, NAMELY, JACKETS; AND UNDERWEAR (U.S. CLS. 22 AND 39).

ELISSA GARBER KON, EXAMINING ATTORNEY

CLASS 25—(Continued).

SN 78-225,881. STEVE DAHL & COMPANY, INC., LINCOLNSHIRE, IL. FILED 3-14-2003.

DEADBEAT DADS

FOR CLOTHING, NAMELY HEADWEAR, HATS, CAPS, SHIRTS, T-SHIRTS (U.S. CLS. 22 AND 39).
JOHN DWYER, EXAMINING ATTORNEY

SN 78-235,427. APSARA DESIGNS LIMITED, LONDON, UNITED KINGDOM, FILED 4-8-2003.



PRIORITY CLAIMED UNDER SEC. 44(D) ON ERP CMNTY TM OFC APPLICATION NO. E00003037C, FILED 4-3-2003.

FOR LADIES DAYTIME AND EVENING DRESSES; CAPTAN DRESSES; SKIRTS; LADIES' TOPS; SARONG AND PAREO WRAPS; PANTS AND SHORTS; AND MENS' SHIRTS; HEAD SCARVES AND BANDANAS; SHOES, SANDALS AND BELTS (U.S. CLS. 22 AND 39).

FIRST USE 5-30-2002; IN COMMERCE 3-15-2003.
JOHN GARTNER, EXAMINING ATTORNEY

SN 78-245,437. MCCARTNEY, MIYUKI Y., DBA INTERNEKO, AUSTIN, TX. FILED 5-4-2003.

INTERNEKO

FOR T-SHIRTS (U.S. CLS. 22 AND 39).
FIRST USE 4-22-2003; IN COMMERCE 5-1-2003.
SCOTT BALDWIN, EXAMINING ATTORNEY

SN 78-246,989. ALOHA BABY CLOTHING COMPANY, EL CAJON, CA. FILED 5-7-2003.

ALOHA BABY

NO CLAIM IS MADE TO THE EXCLUSIVE RIGHT TO USE BABY, APART FROM THE MARK AS SHOWN.

FOR CLOTHING FOR INFANTS AND CHILDREN, NAMELY, T-SHIRTS, BODY SUITS, SWEATSHIRTS, SHORTS, PANTS, DRESS SHIRTS, DRESSES AND JACKETS, FOOTWEAR AND HEADWEAR (U.S. CLS. 22 AND 39).

FIRST USE 4-15-2003; IN COMMERCE 4-20-2003.
CIMMERIAN COLEMAN, EXAMINING ATTORNEY

CLASS 25—(Continued).

SN 78-253,904. AWESOME KIDS, L.L.C., WHEATON, IL. FILED 5-23-2003.

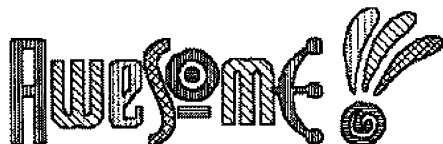

OWNER OF U.S. REG. NOS. 2,192,460 AND 2,338,400. THE STIPPLING IS A FEATURE OF THE MARK.

THE LETTER "A" IS RED, THE LETTER "W" IS GREEN, THE FIRST LETTER "E" IS PURPLE, THE LETTER "O" IS RED, THE CENTER AND LINE UNDER THE "O" IS BLUE, THE LETTER "M" IS GREEN, THE SECOND LETTER "E" IS RED, THE LINES IN THE EXCLAMATION POINT ARE COLORED PURPLE, GREEN AND ORANGE, AND THE POINT OF THE EXCLAMATION POINT IS BLUE.

THE APPLIED-FOR MARK COMPRISES THE STYLIZED WORD AWESOME AND A STYLIZED EXCLAMATION POINT

FOR CLOTHING FOR CHILDREN, INFANTS AND TODDLERS, BUT EXCLUDING WOMEN'S AND ATHLETIC CLOTHING OF ANY KIND, NAMELY, SHIRTS, TANK TOPS, BLOUSES, PULLOVERS, TOPS, SUITS, JACKETS, PARKAS, COATS, WIND RESISTANT JACKETS, SWEATERS, VESTS, PANTS, SLACKS, JEANS, OVERALLS, SHORTS, BOTTOMS, SKIRTS, DRESSES, GOWNS, CLOTH BABY BIBS, CLOTH DIAPERS, UNDERGARMENTS, UNDERWEAR, NAMELY, BOXER SHORTS, UNDERSHORTS, UNDERPANTS, SOCKS, BOOTIES, HOSIERY, STOCKINGS, GLOVES, MITTENS, SWIMWEAR, RAINWEAR; BEACHWEAR, LEOTARDS, LEGGINGS, TIGHTS, PAJAMAS, ROBES, SLEEPWEAR, LOUNGEWEAR, BELTS; HALLOWEEN COSTUMES, MASQUERADE COSTUMES; FOOTWEAR FOR CHILDREN, INFANTS AND TODDLERS, BUT EXCLUDING WOMEN'S AND ATHLETIC FOOTWEAR OF ANY KIND, NAMELY, SHOES, BOOTS, SANDALS AND SLIPPERS (U.S. CLS. 22 AND 39).

KELLY BOULTON, EXAMINING ATTORNEY

SN 78-266,458. STUDIO GROUP HOLDINGS LIMITED, LONDON, UNITED KINGDOM, FILED 6-24-2003.

PIED A TERRE

OWNER OF UNITED KINGDOM REG. NO. 1580326, DATED 8-4-1995, EXPIRES 8-2-2011.

THE ENGLISH TRANSLATION OF PIED A TERRE IS "FOOT ON THE GROUND".

FOR COATS; JACKETS; TROUSERS; SKIRTS; DRESSES; JUMPERS; SHIRTS; T-SHIRTS; SWEATERS; SOCKS; STOCKINGS; SCARVES; UNDERWEAR; SHORTS; CARDIGANS; BELTS; FOOTWEAR; HATS; AND CAPS (U.S. CLS. 22 AND 39).

TINA L. SNAPP, EXAMINING ATTORNEY

CLASS 25—(Continued).

SN 78-274,740. PARTNERSHIP OF SANTORO, LUCIO AND SANTORO, MEERA, THE, LONDON, UNITED KINGDOM, FILED 7-16-2003.

SANTORO

OWNER OF U.S. REG. NO. 2,724,216.

SEC. 2(F).

FOR CLOTHING, NAMELY, T-SHIRTS, SWEAT-SHIRTS, SWEATPANTS, TANK TOPS, APRONS, BLOUSES, COATS, DRESSES, JACKETS, JERSEYS, JOGGING SUITS, GYM SHORTS, JUMPERS, NIGHTSHIRTS, PAJAMAS, PONCHOS, ROBES, SHIRTS, SHORTS, SKIRTS, SWEATERS, SWEAT SUITS, JEANS, PANTS, VESTS, TOPS, TURTLENECKS, SOCKS, CAMISOLES, KNIT SHIRTS, SWEAT BANDS, WRIST BANDS, FLEECE TOPS AND BOTTOMS, GOLF SHIRTS, RAINCOATS, POLO SHIRTS, SLEEVELESS SHIRTS, BEACHWEAR, SWIM WEAR, BATHING SUITS, BATHROBES, LEOTARDS, LEGGINGS, SLACKS, UNDERWEAR AND UNDERGARMENTS, NAMELY, BOXER SHORTS, PANTS, BRAS, PANTIES, SLIPS, HOSIERY, PANTYHOSE AND TIGHTS, ACCESSORIES, NAMELY, NECKWEAR, BELTS, GLOVES, TIES, SCARVES, EAR MUFFS, MITTENS, BABY'S CLOTHING, NAMELY, BIBS NOT OF PAPER, CLOTH BIBS, ROMPER SUITS; HEADGEAR, NAMELY HATS, CAPS, BASEBALL CAPS, KNITTED HEADWEAR, KNIT HATS AND CAPS, HEADBANDS, BANDANAS, SUN VISORS AND VISORS, FOOTWEAR, NAMELY, BOOTS, SHOES, SNEAKERS AND ATHLETIC SHOES, SANDALS, SLIPPERS, FLIP-FLOP SANDALS (U.S. CLS. 22 AND 39).

FIRST USE 12-0-2002; IN COMMERCE 2-0-2003.

ANDREW BENZMILLER, EXAMINING ATTORNEY

SN 78-283,631. ZHEJIANG SAINA GROUP CO., LTD., ZHEJIANG PROVINCE, CHINA, FILED 8-6-2003.



FOR CHILDREN'S WEAR, NAMELY, SWIMSUITS, GLOVES, NECKTIES, SCARVES, HOSIERY, SOCKS, JACKETS, CHEMISETTES, OVERALLS, FROCKS, UNDERCLOTHING, UNIFORMS, SPORTS JERSEYS AND SHIRTS; FOOTWEAR, NAMELY FOOTBALL SHOES; SHOES; HEADGEAR, NAMELY HATS AND CAPS (U.S. CLS. 22 AND 39).

FIRST USE 5-1-1997; IN COMMERCE 9-1-2000.

HOWARD SMIGA, EXAMINING ATTORNEY

SN 78-289,057. ROCK JEAN, INC., DBA DENIM ROCK, LOS ANGELES, CA. FILED 8-19-2003.

ROCK JEAN

NO CLAIM IS MADE TO THE EXCLUSIVE RIGHT TO USE "JEAN", APART FROM THE MARK AS SHOWN.

FOR DENIM CLOTHING, NAMELY, LONG PANTS, CAPRI PANTS, SHORTS, SKIRTS, JACKETS, TOPS, SHIRTS AND DRESSES (U.S. CLS. 22 AND 39).

REBECCA SMITH, EXAMINING ATTORNEY

CLASS 25—(Continued).

SN 78-296,926. STEPHEN, HARPER, AGOURA HILLS, CA. FILED 9-5-2003.

MALIBU PIER

FOR CLOTHING, NAMELY, HATS, CAPS, VISORS, HEADWEAR, SHIRTS, T-SHIRTS, TANK TOPS, HAWAIIAN SHIRTS, ALOHA SHIRTS, SURF SHIRTS, ATHLETIC JERSEYS, TEAM JERSEYS, SWEATERS, JUMPERS, PULLOVERS, JACKETS, VESTS, PONCHOS, PARKAS, SWEAT SHIRTS, SWEAT PANTS, TROUSERS, COVERALLS, OVERALLS, PANTS, SHORTS, JEANS, FOOTWEAR, SOCKS, ROBES, PAJAMAS, NIGHT-SHIRTS, NIGHTGOWNS, UNDERWEAR, APRONS, WETSUITS, SURFING SUITS, SWIM SUITS, BATHING SUITS, SKIRTS, DRESSES, SUNDRESSES, BEACH WRAPS, AND MITTENS (U.S. CLS. 22 AND 39).
SHAUNIA WALLACE, EXAMINING ATTORNEY

SN 78-318,568. COHEN, STEPHANIE BROOKE, WOODLAND HILLS, CA. AND HORNSBY, TODD, WOODLAND HILLS, CA. FILED 10-24-2003.

PHASHO

FOR WOMENS AND MENS- T-SHIRTS, SHIRTS, JACKETS; TANK TOPS; SHORTS, SWEATPANTS; SUITS, PANTS; SWEATSHIRTS, SKIRTS, SHOES, JUMPSUITS, HATS, DRESSES, BELTS, JEANS, PAJAMAS, BOXERS, PANTIES, LINGERIE; SOCKS (U.S. CLS. 22 AND 39).
KELLEY WELLS, EXAMINING ATTORNEY

SN 78-340,332. THE OAKLAND RAIDERS, ALAMEDA, CA. FILED 12-12-2003.

THE BLACK HOLE

THE MARK CONSISTS OF STANDARD CHARACTERS WITHOUT CLAIM TO ANY PARTICULAR FONT, STYLE, SIZE, OR COLOR.

OWNER OF U.S. REG. NO. 2,806,550.
FOR CLOTHING, NAMELY, SHIRTS, T-SHIRTS, TANKTOPS (U.S. CLS. 22 AND 39).
FIRST USE 7-1-1995; IN COMMERCE 7-1-1995.
STACY WAHLBERG, EXAMINING ATTORNEY

CLASS 25—(Continued).

SN 78-347,253. GHAOYANG WINWOLF INDUSTRIAL LIMITED, GUANGDONG, CHINA, FILED 1-2-2004.

WinBeauty

FOR CLOTHING, NAMELY, FOLK COSTUMES, DRESS SUITS, GYM SUITS, HEAD WEAR, INFANTWEAR, JEANS, LAIDES' UNDERWEAR, LEOTARDS AND TIGHTS FOR WOMEN, MEN AND CHILDREN OF NYLON, COTTON OR OTHER TEXTILE FIBERS, LINGERIE, LONG SLEEVED VESTS (U.S. CLS. 22 AND 39).

JEFF DEFORD, EXAMINING ATTORNEY

SN 78-353,193. SCHOFIELD PRINTING, INC., PAWTUCKET, RI. FILED 1-16-2004.

PHAT FANNIE

THE MARK CONSISTS OF STANDARD CHARACTERS WITHOUT CLAIM TO ANY PARTICULAR FONT, STYLE, SIZE, OR COLOR.

FOR MENS, WOMENS AND CHILDRENS APPAREL, NAMELY, HATS, SHIRTS, BLOUSES, SKIRTS, SLACKS, PANTS, BELTS, OUTERWEAR, NAMELY, JACKETS AND COATS, UNDER GARMENTS, SOCKS AND T-SHIRTS (U.S. CLS. 22 AND 39).

FIRST USE 1-14-2004; IN COMMERCE 1-14-2004.
BARBARA GAYNOR, EXAMINING ATTORNEY

CLASS 25—(Continued).

SN 78-359,477. SCARLET MODA EUROPA, S.A. DE C.V., ESTADO DE MEXICO, MEXICO, FILED 1-29-2004.

MARINGO

THE MARK CONSISTS OF STANDARD CHARACTERS WITHOUT CLAIM TO ANY PARTICULAR FONT, STYLE, SIZE, OR COLOR.

FOR CLOTHING, NAMELY, T-SHIRTS AND SWEATSHIRTS, FOOTWEAR AND HATS (U.S. CLS. 22 AND 39). FIRST USE 1-1-2001; IN COMMERCE 1-1-2001. NANCY CLARKE, EXAMINING ATTORNEY

SN 78-359,958. BIRTHDAY WEAR, INC., COLUMBIA, MD. FILED 1-30-2004.



NO CLAIM IS MADE TO THE EXCLUSIVE RIGHT TO USE WEAR, APART FROM THE MARK AS SHOWN.

FOR WEARABLE TEXTILE CLOTHING, NAMELY T-SHIRTS, SWEATSHIRTS, DRESS SHIRTS, GOLF SHIRTS, PANTS, SOCKS, BLOUSES, HATS, HEADBANDS, JACKETS, SCARF'S, AND JERSEYS (U.S. CLS. 22 AND 39).

SUE LAWRENCE, EXAMINING ATTORNEY

CLASS 25—(Continued).

SN 78-360,412. KORUPT KLOTHING, INC., TEMPE, AZ. FILED 1-30-2004.

KORUPT KLOTHING

THE MARK CONSISTS OF STANDARD CHARACTERS WITHOUT CLAIM TO ANY PARTICULAR FONT, STYLE, SIZE, OR COLOR.

OWNER OF U.S. REG. NO. 2,048,470. NO CLAIM IS MADE TO THE EXCLUSIVE RIGHT TO USE "CLOTHING", APART FROM THE MARK AS SHOWN. FOR SHIRTS, HATS, SHORTS, SWEATSHIRTS, JACKETS (U.S. CLS. 22 AND 39).

FIRST USE 7-5-1995; IN COMMERCE 8-1-1995. NORA BUCHANAN WILL, EXAMINING ATTORNEY

SN 78-365,739. DUNKERBECK, BJORN, PAIA, HI. FILED 2-10-2004.



THE COLOR(S) DARK BLUE, LIGHT BLUE, AND WHITE IS/ARE CLAIMED AS A FEATURE OF THE MARK.

THE MARK CONSISTS OF THE WORDS "JAWS MAUI". THE WORD "JAWS" IS LINED FOR THE COLORS WHITE (REPRESENTING FOAM OR SWELL CAUSED BY A WAVE NEAR THE TOP OF EACH OF THE LETTERS "JAWS"), DARK BLUE AND TWO SHADES OF LIGHTER BLUE. ONE SHADE OF LIGHT BLUE APPEARS AT THE TOP OF THE LETTERS "JAW" WHICH REPRESENTS THE SKY. A SECOND SHADE OF LIGHT BLUE APPEARS IN THE MIDDLE OF THE LETTERS "W" AND "S" SO AS TO REPRESENT WHITER WATER BEHIND THE DEPICTION OF THE SURFER RIDING THE WAVE APPEARING ON THE LETTER "W". THE LOWER PORTION OF THE LETTERS "JAWS" IS DARK BLUE. THE WORD MAUI IS LIGHT BLUE.

THE MARK CONSISTS OF STYLIZED LETTERS JAWS WITH WAVES PERMEATING EACH LETTER AND A SURFER OR A WAVE WITHIN ONE OF THE LETTERS; STYLIZED LETTERS MAUI.

FOR CLOTHING, NAMELY, T-SHIRTS, HATS AND LONG SHIRTS, WHERE SAID CLOTHING IS NOT RELATED IN ANY MANNER TO SHARKS, MOTION PICTURES CONCERNING SHARKS OR SHARK ATTACKS, OR SHARK-RELATED THEME PARK ATTRACTIONS (U.S. CLS. 22 AND 39).

LINDA M. KING, EXAMINING ATTORNEY

CLASS 25—(Continued).

SN 78-365,752. DUNKERBECK, BJORN, PAIA, HI. FILED 2-10-2004.

JAWS MAUI

THE MARK CONSISTS OF STANDARD CHARACTERS WITHOUT CLAIM TO ANY PARTICULAR FONT, STYLE, SIZE, OR COLOR.

FOR CLOTHING, NAMELY, T-SHIRTS, HATS AND LONG SHIRTS, WHERE SAID CLOTHING IS NOT RELATED IN ANY MANNER TO SHARKS, MOTION PICTURES CONCERNING SHARKS OR SHARK ATTACKS, OR SHARK-RELATED THEME PARK ATTRACTIONS (U.S. CLS. 22 AND 39).

LINDA M. KING, EXAMINING ATTORNEY

SN 78-370,235. LEWIS, DAVID R., DANVILLE, CA. FILED 2-18-2004.



THE COLORS BLACK, WHITE, RED, GRAY ARE CLAIMED AS A FEATURE OF THE MARK.

THE COLOR BLACK APPEARS IN THE WORDING FIVE HOLE HOCKEY, IN THE OUTLINE OF THE OUTER AND INNER CIRCLES, IN THE OUTLINE OF THE GOALIE STICK, IN THE OUTLINE OF THE GOALIE BLOCKER, IN THE OUTLINE OF THE GOALIE MASK, IN FIVE SECTIONS OF THE GOALIE STICK ALTERNATING WITH THE COLOR WHITE, IN THE NECK PORTION OF THE JERSEY, IN THE WRIST CUFFS OF THE GOALIE JERSEY AND IN THE OUTLINE OF THE SHOULDERS OF THE BODY OF THE GOALIE; THE COLOR RED APPEARS IN THE NUMBER 5, IN THE INNER PORTION OF THE GOALIE MASK THAT OUTLINES THE FACE, IN THE BRACKET THAT APPEARS ON THE RIGHT SIDE THE CIRCLES BETWEEN THE WORDS HOLE AND HOCKEY AND IN THE BRACKET THAT APPEARS ON THE LEFT SIDE OF THE CIRCLES BETWEEN THE WORDS FIVE AND HOCKEY; THE COLOR WHITE APPEARS AS BACKGROUND

CLASS 25—(Continued).

FOR THE OUTER AND INNER CIRCLES, IN SIX SECTIONS OF THE GOALIE STICK ALTERNATING WITH THE COLOR BLACK, IN TWO SECTIONS OF THE RIGHT SIDE OF THE GOALIE GLOVE AND IN THE UPPER AND LOWER PORTION OF THE GOALIE MASK; AND THE COLOR GRAY APPEARS IN THE FACE PORTION OF THE GOALIE MASK, IN THE GOALIE BLOCKER, IN THE LEFT SIDE OF THE GOALIE GLOVE AND BETWEEN THE TWO SECTIONS OF WHITE ON THE RIGHT SIDE OF THE GOALIE GLOVE, AND IN THE LEG PADS.

FOR T-SHIRTS, HATS (U.S. CLS. 22 AND 39).
BILL DAWE, EXAMINING ATTORNEY

SN 78-370,348. ABOUD, BENSION, S. PLAINFIELD, NJ. FILED 2-19-2004.

aygay

THE MARK CONSISTS OF STANDARD CHARACTERS WITHOUT CLAIM TO ANY PARTICULAR FONT, STYLE, SIZE, OR COLOR.

FOR ARTICLES OF CLOTHING, NAMELY, SUITS, JACKETS, TROUSERS, OVERCOATS, SOCKS, HOSIERY, SLEEPWEAR, RAINWEAR, SHORTS, SHIRTS, FROCKS, DRESSES, BLOUSES, JERSEYS, PARKAS, SWEATERS, SKIRTS, HEADWEAR, GLOVES, FOOTWEAR, T-SHIRTS, SWEATSHIRTS, SCARVES, TIES, CLOTHING BELTS, CRAVATS, SHAWLS, BATH ROBES, SWIMWEAR, JEANS AND TUXEDOS (U.S. CLS. 22 AND 39).

MICHAEL HALL, EXAMINING ATTORNEY

CLASS 25—(Continued).

SN 78-377,147. SHERWOOD, SCOTT, SAN MARCOS, CA. AND PENTALA, HARRY, SAN MARCOS, CA. FILED 3-2-2004.

EZERA

THE MARK CONSISTS OF STANDARD CHARACTERS WITHOUT CLAIM TO ANY PARTICULAR FONT, STYLE, SIZE, OR COLOR.

SEC. 2(F).
FOR CLOTHING, NAMELY, T-SHIRTS, HATS, SHORTS, JACKETS, SHIRTS AND SWIMWEAR (U.S. CLS. 22 AND 39).

FIRST USE 8-1-1994; IN COMMERCE 1-26-1996.
SONYA STEPHENS, EXAMINING ATTORNEY

SN 78-377,979. JAYMAR-RUBY, INC., MICHIGAN CITY, IN. FILED 3-3-2004.

**COMFORT CASUAL BY
SANSABELT**

THE MARK CONSISTS OF STANDARD CHARACTERS WITHOUT CLAIM TO ANY PARTICULAR FONT, STYLE, SIZE, OR COLOR.

OWNER OF U.S. REG. NO. 1,331,010.
NO CLAIM IS MADE TO THE EXCLUSIVE RIGHT TO USE "COMFORT CASUAL", APART FROM THE MARK AS SHOWN.

FOR CLOTHING, NAMELY MEN'S SUITS, SPORT-COATS, SLACKS, TROUSERS, SHIRTS, SWEATERS, JACKETS AND COATS (U.S. CLS. 22 AND 39).
APRIL L. RADEMACHER, EXAMINING ATTORNEY

SN 78-386,816. MUSCLETECH RESEARCH AND DEVELOPMENT, INC., MISSISSAUGA, ONTARIO, CANADA, FILED 3-18-2004.

Supplements That Work!

FOR CLOTHING, NAMELY, SHIRTS, T-SHIRTS (U.S. CLS. 22 AND 39).
FIRST USE 1-0-2004; IN COMMERCE 1-0-2004.
NELSON SNYDER, EXAMINING ATTORNEY

CLASS 25—(Continued).

SN 78-394,669. LOOMSTATE, LLC, NEW YORK, NY. FILED 4-1-2004.

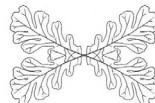

*Nature
Calls*

THE MARK CONSISTS OF THE WORDS NATURE CALLS WITH A LEAF.

FOR PANTS, SHIRTS AND FOOTWEAR (U.S. CLS. 22 AND 39).

FIRST USE 1-15-2004; IN COMMERCE 1-15-2004.
BRIAN NEVILLE, EXAMINING ATTORNEY

SN 78-395,721. CHECKERBOARD, HERALD, CA. FILED 4-2-2004.



THE MARK CONSISTS OF THE WORD "IXENO" IN STYLIZED LETTERS, SUPERIMPOSED OVER AN ELONGATED DARK OVAL PLACED HORIZONTALLY, WITH DOUBLE WHITE STRIPES AT EACH END OF THE OVAL, SAID OVAL SUPERIMPOSED OVER A BLACK CIRCLE

FOR T-SHIRTS (U.S. CLS. 22 AND 39).
FIRST USE 3-22-2004; IN COMMERCE 3-22-2004.
MARLENE BELL, EXAMINING ATTORNEY

CLASS 25—(Continued).

SN 78-397,552. FACETS LTD. LLC, GRAFTON, WI. FILED 4-7-2004.

CLASS 25—(Continued).

SN 78-397,574. SARA LEE CORPORATION, WINSTON-SALEM, NC. FILED 4-7-2004.

JMS ACTIVE

Facets

THE MARK CONSISTS OF STANDARD CHARACTERS WITHOUT CLAIM TO ANY PARTICULAR FONT, STYLE, SIZE, OR COLOR.

OWNER OF U.S. REG. NOS. 2,733,376 AND 2,817,823.

NO CLAIM IS MADE TO THE EXCLUSIVE RIGHT TO USE "ACTIVE", APART FROM THE MARK AS SHOWN.

FOR BRAS; PANTIES; CASUALWEAR, NAMELY TOPS AND BOTTOMS; HOSIERY AND SLEEPWEAR, NAMELY GOWNS, PAJAMAS AND ROBES (U.S. CLS. 22 AND 39).

RENEE MCCRAY, EXAMINING ATTORNEY

SN 78-397,579. SARA LEE CORPORATION, WINSTON-SALEM, NC. FILED 4-7-2004.

THE MARK CONSISTS OF STANDARD CHARACTERS WITHOUT CLAIM TO ANY PARTICULAR FONT, STYLE, SIZE, OR COLOR.

FOR CLOTHING, NAMELY, ASCOTS; BANDANAS; BED JACKETS; BELTS FOR GARMENTS; BELTS FOR CLOTHING, BELTS OF TEXTILE; BLAZERS; BLOUSES; BLOUSONS; BOLEROS; CAFTANS; CAMISOLES; CAPES; CAPRI PANTS; CAPRIS; CARDIGANS; CHEMISES; COATS; COATS OF DENIM; DENIM JACKETS; DRESSES; DUSTERS; EVENING DRESSES; EVENING GOWNS; FABRIC BELTS; GOWNS; HEAD SCARVES; HOODED SWEATSHIRTS; JACKETS; JUMPERS; KERICHIERS; KIMONOS; KNIT SHIRTS; LADIES' SUITS; LEGGINGS; LONG JACKETS; LONG SLEEVED VESTS; LOUNGEWEAR; MEN AND WOMEN JACKETS, COATS, TROUSERS, VESTS; MINISKIRTS; MOCK TURTLE-NECK SWEATERS; MUFFLERS; NECKERCHIEFS; NECKWEAR; OPEN-NECKED SHIRTS; PANTS; PANTSUITS; PAREOS; PONCHOS; PULLOVERS; QUILTED VESTS; SARONGS; SASHES; SCARVES; SHAWLS; SHAWLS AND HEADSCARVES; SHAWLS AND STOLEES; SHIRTS; SHIRTS FOR SUITS; SHORT-SLEEVED OR LONG-SLEEVED T-SHIRTS; SHORT-SLEEVED T-SHIRTS; SHOULDER SCARVES; SHOULDER WRAPS; SHRUGS; SILK SCARVES; SKIRT SUITS; SKIRTS; SKIRTS AND DRESSES; SLACKS; SLEEVED OR SLEEVELESS JACKETS; STOLEES; SUIT COATS; SUITS; SWEATERS; TANK TOPS; TAP PANTS; TIES; TOPS; TROUSERS; TUNICS; TURTLENECK SWEATERS; TURTLENECKS; T-SHIRTS; VESTS; V-NECK SWEATERS; AND WRAPS (U.S. CLS. 22 AND 39).

CHARLES JOYNER, EXAMINING ATTORNEY

JMS FIT EXPERT

THE MARK CONSISTS OF STANDARD CHARACTERS WITHOUT CLAIM TO ANY PARTICULAR FONT, STYLE, SIZE, OR COLOR.

OWNER OF U.S. REG. NOS. 2,733,376 AND 2,817,823.

NO CLAIM IS MADE TO THE EXCLUSIVE RIGHT TO USE "FIT EXPERT", APART FROM THE MARK AS SHOWN.

FOR BRAS AND PANTIES (U.S. CLS. 22 AND 39).
MONTIA G. PRESSEY, EXAMINING ATTORNEY

CLASS 25—(Continued).

SN 78-399,124. NOMOR URBAN DESIGN APPAREL INC.,
LAVAL, QUÉBEC, CANADA, FILED 4-9-2004.

SAVED 2 SERVE
Christian Clothing Line

NO CLAIM IS MADE TO THE EXCLUSIVE RIGHT TO USE "CHRISTIAN CLOTHING LINE", APART FROM THE MARK AS SHOWN.

FOR CLOTHING AND ACCESSORIES FOR WOMEN, MEN AND CHILDREN, NAMELY, PANTS, DENIM JEANS, OVERALLS, CASUAL PANTS, SHORTS, SHIRTS, SPORT SHIRTS, T-SHIRTS, POLO SHIRTS, CAMISOLES, SLIPOVERS, COATS, SKIRTS, DRESSES, BLOUSES, BLOUSONS, PULLOVERS, SWEATERS, V-NECK SWEATERS, SWEAT PANTS, SWEAT BANDS, SWEAT SHIRTS, SWEAT SHORTS, SWEAT SUITS, JUMPSUITS, UNDERWEAR, UNDERPANTS, UNDERSHIRTS, VESTS, VESTED SUITS, CASUAL COATS, LEATHER COATS, BLAZERS, LEATHER JACKETS, JACKETS, DENIM JACKETS, HATS, PEAK CAPS, TOQUES, HEADBANDS AND WRISTBANDS AGAINST SWEATING, ATHLETIC UNIFORMS, GLOVES, SOCKS, NECKTIES, BELTS, SCARVES, RUNNING SHOES, BOOTS, AND SANDALS (U.S. CLS. 22 AND 39).

WINSTON FOLMAR, EXAMINING ATTORNEY

CLASS 25—(Continued).

SN 78-404,087. NAGYAR GROUP INC, NEW YORK, NY.
FILED 4-19-2004.

SCKOON

THE MARK CONSISTS OF STANDARD CHARACTERS WITHOUT CLAIM TO ANY PARTICULAR FONT, STYLE, SIZE, OR COLOR.

THE ENGLISH TRANSLATION FOR THE WORD SCKOON IS STILLNESS.

FOR CLOTHING, NAMELY, SHIRTS, SKIRTS, PANTS, SLEEPWEAR, AND DRESSES (U.S. CLS. 22 AND 39).

SALLY SHIH, EXAMINING ATTORNEY

SN 78-402,203. RICHELIEU, ROBERT W., BELLA VISTA, CA.
FILED 4-15-2004.

JUSTRITE

THE MARK CONSISTS OF STANDARD CHARACTERS WITHOUT CLAIM TO ANY PARTICULAR FONT, STYLE, SIZE, OR COLOR.

FOR CLOTHING CONTAINING A HEATING OR COOLING APPARATUS OR A THERMAL PACK, NAMELY, HEADBANDS AND WRAPS FOR USE ON WRISTS, KNEES, ANKLES AND ABDOMINAL AREA (U.S. CLS. 22 AND 39).

VERNA BETH RIRIE, EXAMINING ATTORNEY

SN 78-404,929. PHILLIPS-VAN HEUSEN CORPORATION,
NEW YORK, NY. FILED 4-20-2004.

IZOD G GOLF

THE MARK CONSISTS OF STANDARD CHARACTERS WITHOUT CLAIM TO ANY PARTICULAR FONT, STYLE, SIZE, OR COLOR.

OWNER OF U.S. REG. NOS. 840,548, 2,692,600 AND OTHERS.

NO CLAIM IS MADE TO THE EXCLUSIVE RIGHT TO USE "GOLF", APART FROM THE MARK AS SHOWN.

FOR MEN'S AND WOMEN'S GOLF APPAREL, NAMELY, POLO SHIRTS, SWEATERS, SWEATER SETS; OUTERWEAR IN THE NATURE OF JACKETS, FLEECE PULLOVERS AND WINDSHIRTS; PANTS, SHORTS, SKORTS, SKIRTS, CAPS, VISORS, T-SHIRTS, SWEATSHIRTS, SOCKS AND SHOES (U.S. CLS. 22 AND 39).

BRIDGETT SMITH, EXAMINING ATTORNEY

CLASS 25—(Continued).

SN 78-404,943. GOODY'S MS, LP, KNOXVILLE, TN. FILED 4-20-2004.

**DUCK HEAD JEANS
CO.**

THE MARK CONSISTS OF STANDARD CHARACTERS WITHOUT CLAIM TO ANY PARTICULAR FONT, STYLE, SIZE, OR COLOR.

OWNER OF U.S. REG. NOS. 817,443, 1,949,457 AND OTHERS.

NO CLAIM IS MADE TO THE EXCLUSIVE RIGHT TO USE JEANS CO., APART FROM THE MARK AS SHOWN.

FOR CLOTHING, NAMELY SHIRTS AND PANTS (U.S. CLS. 22 AND 39).

NELSON SNYDER, EXAMINING ATTORNEY

CLASS 25—(Continued).

SN 78-410,673. ARMSTRONG, JIM, SOLANA BEACH, CA. FILED 4-29-2004.



SN 78-405,490. YAKIRA, LLC, SOUTH RIVER, NJ. FILED 4-21-2004.

**Ecko
Function**

THE FOREIGN WORDING IN THE MARK TRANSLATES INTO ENGLISH AS OF THE SEA.

FOR CLOTHING, NAMELY, T-SHIRTS, SHIRTS, TOPS, SHORTS, SWEATSHIRTS, AND PULLOVERS (U.S. CLS. 22 AND 39).

FIRST USE 1-0-2004; IN COMMERCE 1-0-2004.

DEZMONA MIZELLE, EXAMINING ATTORNEY

OWNER OF U.S. REG. NOS. 2,262,749 AND 2,729,329. THE MARK CONSISTS OF FRONT HALF OF A RHINO WITH A BORDER DESIGN.

FOR CLOTHING, NAMELY, TRENCH COATS, PONCHOS AND RAIN SLICKERS, NAMELY, RAIN-COATS (U.S. CLS. 22 AND 39).

KELLY CHOE, EXAMINING ATTORNEY

SN 78-411,292. ELVIS PRESLEY ENTERPRISES, INC., MEMPHIS, TN. FILED 4-30-2004.

**TAKING CARE OF
BUSINESS**

SN 78-410,667. PALMER, DONALD C., THOUSAND OAKS, CA. FILED 4-29-2004.

BOOMERSONLY

THE MARK CONSISTS OF STANDARD CHARACTERS WITHOUT CLAIM TO ANY PARTICULAR FONT, STYLE, SIZE, OR COLOR.

FOR JACKETS, T-SHIRTS, CAPS (U.S. CLS. 22 AND 39).

ESTHER BELENKER, EXAMINING ATTORNEY

THE MARK CONSISTS OF STANDARD CHARACTERS WITHOUT CLAIM TO ANY PARTICULAR FONT, STYLE, SIZE, OR COLOR.

FOR CLOTHING, NAMELY T-SHIRTS, SWEATSHIRTS AND HATS (U.S. CLS. 22 AND 39).

FIRST USE 10-1-1987; IN COMMERCE 10-1-1987.

CHRISTOPHER BUONGIORNO, EXAMINING ATTORNEY

CLASS 25—(Continued).

SN 78-411,485. EBLEN, EDMUND L., CANYON COUNTRY, CA. AND RUTHERFORD, LYNN K., SIMI VALLEY, CA. FILED 4-30-2004.

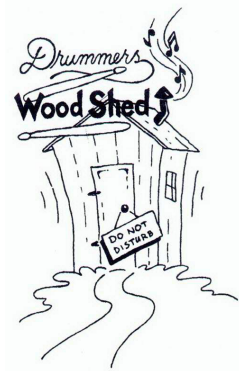

NO CLAIM IS MADE TO THE EXCLUSIVE RIGHT TO USE "DRUMMERS", APART FROM THE MARK AS SHOWN.

THE STIPPLING IS A FEATURE OF THE MARK. FOR DRUMMING BUSINESS CLOTHING, FOOTWEAR, AND HEADGEAR, NAMELY- T-SHIRTS, HATS, CAPS, SHORTS, SWEATERS, JACKETS, JERSEYS, SWEAT TOPS, BELTS, SHOES, AND SOCKS (U.S. CLS. 22 AND 39).

RON FAIRBANKS, EXAMINING ATTORNEY

CLASS 25—(Continued).

SN 78-417,900. ST. JAMES WINERY, INC., ST. JAMES, MO. FILED 5-13-2004.

ST. JAMES WINERY

THE MARK CONSISTS OF STANDARD CHARACTERS WITHOUT CLAIM TO ANY PARTICULAR FONT, STYLE, SIZE, OR COLOR.

OWNER OF U.S. REG. NO. 2,951,837.

SEC. 2(F) AS TO ST. JAMES.

FOR T-SHIRTS, SWEATSHIRTS, JACKETS, HATS, SHIRTS (U.S. CLS. 22 AND 39).

FIRST USE 12-31-1998; IN COMMERCE 12-31-1998.

PAULA MAHONEY, EXAMINING ATTORNEY

SN 78-419,477. MOTOART, LLC, TORRANCE, CA. FILED 5-15-2004.



Blessing House

SN 78-414,219. MORRISON, BARBARA J, CROSBY, TX. FILED 5-6-2004.

THE MARK CONSISTS OF STANDARD CHARACTERS WITHOUT CLAIM TO ANY PARTICULAR FONT, STYLE, SIZE, OR COLOR.

FOR INFANTWEAR (U.S. CLS. 22 AND 39).

JAMES A. RAUEN, EXAMINING ATTORNEY

THE MARK CONSISTS OF AN AIRPLANE AND THE WORD "MOTO" UNDER THE LEFT WING OF THE AIRPLANE AND THE WORD "ART" UNDER THE RIGHT WING OF THE AIRPLANE.

FOR CLOTHING, NAMELY, SHIRTS, T-SHIRTS, TANK TOPS, CAMISOLES, TOPS, BLOUSES, SWEATERS, VESTS, PANTS, SLACKS, JEANS, SHORTS, BOTTOMS, SWEAT PANTS, SWEAT SHIRTS, SWEAT SUITS, JOGGING PANTS, JOGGING SUITS, SKIRTS, DRESSES, JACKETS, COATS, SLEEPWEAR, UNDERWEAR, LOUNGEWEAR, ROBES, TIES, SOCKS, BELTS, APRONS, BELTS; HEADGEAR, NAMELY, HATS, CAPS, VISORS; AND FOOTWEAR (U.S. CLS. 22 AND 39).

KELLY CHOE, EXAMINING ATTORNEY

CLASS 25—(Continued).

SN 78-419,543. ANDERSON-HOEHN, KAREN, TOWSON, MD. FILED 5-16-2004.

CLASS 25—(Continued).

SN 78-421,003. RAMIN, TOVFIGH RAFII, CP 5009 - CORDOBA, ARGENTINA, FILED 5-18-2004.

LaxMom

VITNIK

OWNER OF ARGENTINA REG. NO. 1,977,753, DATED 4-14-2004, EXPIRES 4-14-2014.
FOR CLOTHING, NAMELY, PANTS, TROUSERS, SHORTS, TIGHTS, FITNESS PANTS, T-SHIRTS, SHIRTS, TOPS, SWEATSHIRTS, PULLOVERS, SWEATERS, VESTS, SUITS, JACKETS, SOCKS, STOCKINGS; FOOTWEAR; HEADWEAR (U.S. CLS. 22 AND 39).
HENRY S. ZAK, EXAMINING ATTORNEY

THE MARK CONSISTS OF STANDARD CHARACTERS WITHOUT CLAIM TO ANY PARTICULAR FONT, STYLE, SIZE, OR COLOR.
FOR CLOTHING, NAMELY SHIRTS, HATS, AND JACKETS (U.S. CLS. 22 AND 39).
SCOTT OSCLICK, EXAMINING ATTORNEY

SN 78-422,744. COFFEE BEAN (MIAMI), INC., MIAMI, FL. FILED 5-21-2004.

SN 78-420,225. JESSIE STEELE, INC., SAN JOSE, CA. FILED 5-17-2004.

Picture Me

Jessie Steele

THE MARK CONSISTS OF STANDARD CHARACTERS WITHOUT CLAIM TO ANY PARTICULAR FONT, STYLE, SIZE, OR COLOR.
FOR CLOTHING, NAMELY, BELTS, CAPRI PANTS, CAPS, SHORT SETS, TOPS, PANTS, DRESSES, SHOES, FOOTWEAR, HEADGEAR, NAMELY, HATS, CAPS AND VISORS (U.S. CLS. 22 AND 39).
FIRST USE 1-1-2004; IN COMMERCE 1-1-2004.
RONALD AIKENS, EXAMINING ATTORNEY

THE NAME(S), PORTRAIT(S), AND/OR SIGNATURE(S) SHOWN IN THE MARK DOES NOT IDENTIFY A PARTICULAR LIVING INDIVIDUAL.
FOR FINE HOSTESS APRONS (U.S. CLS. 22 AND 39).
FIRST USE 10-2-2003; IN COMMERCE 10-2-2003.
RUSS HERMAN, EXAMINING ATTORNEY

CLASS 25—(Continued).

SN 78-425,727. HALF ORANGE PRODUCTIONS, LLC, SANTA BARBARA, CA. FILED 5-26-2004.

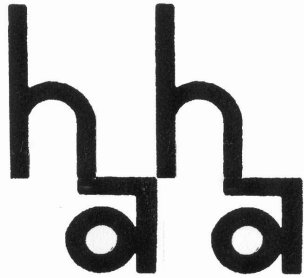

THE MARK CONSISTS OF TWO STYLIZED LOWERCASE LETTERS "H" AND H" AND TWO CIRCLES FOR FOOTWEAR (U.S. CLS. 22 AND 39).
KATHY DE JONGE, EXAMINING ATTORNEY

SN 78-427,270. 3BN, INC., LOS ANGELES, CA. FILED 5-28-2004.

TRES BIEN

THE MARK CONSISTS OF STANDARD CHARACTERS WITHOUT CLAIM TO ANY PARTICULAR FONT, STYLE, SIZE, OR COLOR.

THE FOREIGN WORDING IN THE MARK TRANSLATES INTO ENGLISH AS VERY WELL.

FOR BATHING SUIT, BEACHWEAR, BELTS, BLAZERS, BLOUSES, CAPS, DRESSES, FOOTWEAR, JACKETS, JEANS, NECKTIES, PAJAMAS, PANTS, SHIRTS, SKIRTS, SHORTS, SPORT COATS, SPORTS SHIRTS, T-SHIRTS, AND UNDERWEAR (U.S. CLS. 22 AND 39).

STEVEN JACKSON, EXAMINING ATTORNEY

CLASS 25—(Continued).

SN 78-427,707. FOOTSTAR CORPORATION, MAHWAH, NJ. FILED 6-1-2004.

XRTS

THE MARK CONSISTS OF STANDARD CHARACTERS WITHOUT CLAIM TO ANY PARTICULAR FONT, STYLE, SIZE, OR COLOR.

FOR FOOTWEAR AND FOOTWEAR COMPONENT SYSTEM COMPRISED OF AN OUTSOLE, INSOLE, AND CUSHION INSERTS PRIMARILY FOR NON-ORTHOPEDIC PURPOSES (U.S. CLS. 22 AND 39).

MICHAEL TANNER, EXAMINING ATTORNEY

SN 78-430,160. BALLET MAKERS, INC., TOTOWA, NJ. FILED 6-4-2004.

**POWER POINTE
CONSTRUCTION**

THE MARK CONSISTS OF STANDARD CHARACTERS WITHOUT CLAIM TO ANY PARTICULAR FONT, STYLE, SIZE, OR COLOR.

NO CLAIM IS MADE TO THE EXCLUSIVE RIGHT TO USE POINTE, APART FROM THE MARK AS SHOWN. FOR FOOTWEAR (U.S. CLS. 22 AND 39).

CYNTHIA SLOAN, EXAMINING ATTORNEY

CLASS 25—(Continued).

SN 78-430,229. THOROUGHbred LEGENDS, LLC, ATLANTA, GA. FILED 6-4-2004.

KELSO

THE MARK CONSISTS OF STANDARD CHARACTERS WITHOUT CLAIM TO ANY PARTICULAR FONT, STYLE, SIZE, OR COLOR.

FOR CLOTHING, NAMELY, HATS, CAPS, VISORS, APRONS, SHIRTS, T-SHIRTS, JACKETS, VESTS, SWEATSHIRTS, SWEATPANTS, PANTS, AND SHORTS (U.S. CLS. 22 AND 39).

DARRYL SPRUILL, EXAMINING ATTORNEY

SN 78-433,111. CATHERINE FULMER COMPANY, LLC, NEW YORK, NY. FILED 6-10-2004.

CATHERINE FULMER

THE MARK CONSISTS OF STANDARD CHARACTERS WITHOUT CLAIM TO ANY PARTICULAR FONT, STYLE, SIZE, OR COLOR.

THE NAME(S), PORTRAIT(S), AND/OR SIGNATURE(S) SHOWN IN THE MARK IDENTIFIES A LIVING INDIVIDUAL, WHOSE CONSENT(S) TO REGISTER IS SUBMITTED.

FOR DRESSES, INCLUDING PLEATED DRESSES, WRAP DRESSES, STRAPLESS FITTED DRESSES, SPAGHETTI STRAP SUMMER DRESSES, HALTER TOP DRESSES, SILK TUBE DRESSES, BLACK TIE LONG SILK DRESSES, COUTURE BLACK TIE GOWNS, PENCIL DRESSES IN COTTON SATEEN, BIAS CUT SILK DRESSES, VELVET TRIMMED DRESSES, RUFFLED DRESSES, PRINT DRESSES, GRAFFITI DRESSES, VINTAGE TRIMMED DRESSES; SKIRTS, INCLUDING PENCIL SKIRTS, WRAP COTTON SKIRTS, DENIM SKIRTS, PLEATED SKIRTS, RUFFLED SKIRTS AND LEATHER PENCIL SKIRTS; PANTS, INCLUDING MEN'S TROUSERS, LEGGINGS, PANTS WITH SIDE ZIPPERS, DENIM JEANS, WOMEN'S WOOL TROUSERS, WOMEN'S LINEN TROUSERS, WOOL AND COTTON KNICKERS, LEATHER PANTS, VINTAGE TRIMMED PANTS AND

CLASS 25—(Continued).

CROPPED PANTS; JACKETS, INCLUDING CROPPED JACKETS, DENIM JACKETS, JACKETS WITH ZIPPERS, LEATHER BOMBER JACKETS; BLAZERS, INCLUDING SILK BLAZERS, MEN'S BLAZERS, VELVET BLAZERS; COATS, INCLUDING SATIN TRENCH COATS, BRUSHED COTTON TRENCH COATS; TOPS, INCLUDING COTTON TUBE TOPS, LONG-SLEEVED TOPS, T-SHIRTS, HALTER TOPS, VINTAGE TRIMMED TOPS, INCLUDING TUBE, SHORT SLEEVE, AND LONG SLEEVE, COLLARED FITTED SHIRTS, BRAIDED SILK TOPS, TURTLENECK BLOUSES, PRINT TOPS; SUITS, INCLUDING MEN'S SUITS INCLUDING SUITS CONSISTING OF BLAZERS AND PANTS, BLACK JUMPSUITS, CAT SUITS, WOMEN'S SUITS CONSISTING OF TWEED SKIRTS AND JACKETS; SWEATERS, INCLUDING CASHMERE CARDIGANS; SCARVES, INCLUDING LINEN SCARVES, WOOL SCARVES; UNDERGARMENTS, INCLUDING UNDERWEAR, BRAS, SLIPS, INCLUDING SILK SLIPS AND SATEEN SLIPS; BATHING SUITS; SHOES; SUSPENDERS; SOCKS; AND VESTS, INCLUDING CORDUROY VESTS (U.S. CLS. 22 AND 39).
ROBERT C. CLARK JR., EXAMINING ATTORNEY

SN 78-434,951. DEHLINGER, DOUGLAS M., CERRITOS, CA. AND QUARLES, JOSEPH N., CERRITOS, CA. AND QUARLES, SHAWN L., CERRITOS, CA. FILED 6-14-2004.

Howie Rolle

THE MARK CONSISTS OF STANDARD CHARACTERS WITHOUT CLAIM TO ANY PARTICULAR FONT, STYLE, SIZE, OR COLOR.

THE MARK "HOWIE ROLLE" DOES NOT IDENTIFY A LIVING INDIVIDUAL.

FOR CLOTHING NAMELY SOCKS, PANTS, JEANS, SHORTS, T-SHIRTS, SHIRTS, UNDERWEAR, TIES, JACKETS, COATS, SKIRTS, BLOUSES, HATS, BELTS, SWEATSHIRTS, SWEATPANTS, VESTS, SWEAT SUITS, SHOES, BOOTS, SNEAKERS, VISORS, SWEATBANDS AND HATS, NAMELY BEANIES (U.S. CLS. 22 AND 39).
FIRST USE 1-1-2004; IN COMMERCE 4-1-2004.
JAMES GRIFFIN, EXAMINING ATTORNEY

CLASS 25—(Continued).

SN 78-435,969. DAVIS, HORACE I., ALBION, MI. FILED 6-16-2004.

DETROIT ROCK CITY

THE MARK CONSISTS OF STANDARD CHARACTERS WITHOUT CLAIM TO ANY PARTICULAR FONT, STYLE, SIZE, OR COLOR.

FOR CLOTHING, NAMELY SHIRTS, SWEATERS, SHOES, CAPS, BANDANAS, SHORTS, SWEAT SHIRTS, PANTS, JACKETS, HATS, HEAD BANDS, SOCKS, BLOUSES, SCARVES, DRESSES, AND HOSIERY (U.S. CLS. 22 AND 39).

FIRST USE 11-1-2002; IN COMMERCE 11-2-2002.
MICHAEL KEATING, EXAMINING ATTORNEY

SN 78-436,723. BARBER, DEWEY W., ODUM, GA. FILED 6-17-2004.

**All American
Outfitters**

THE MARK CONSISTS OF STANDARD CHARACTERS WITHOUT CLAIM TO ANY PARTICULAR FONT, STYLE, SIZE, OR COLOR.

NO CLAIM IS MADE TO THE EXCLUSIVE RIGHT TO USE "OUTFITTERS", APART FROM THE MARK AS SHOWN.

FOR APRONS, BASEBALL CAPS, CAP VISORS, CHILDREN'S HEADWEAR, GOLF SHIRTS, SHIRTS, SEAT PANTS, SWEAT SHIRTS, SWEAT SHORTS, SWEATSUITS, T-SHIRTS (U.S. CLS. 22 AND 39).

FIRST USE 1-1-2003; IN COMMERCE 1-1-2003.
ERNEST SHOSHO, EXAMINING ATTORNEY

CLASS 25—(Continued).

SN 78-436,777. COUNCIL OF IVY GROUP PRESIDENTS, PRINCETON, NJ. FILED 6-17-2004.

IVYGOLF

THE MARK CONSISTS OF STANDARD CHARACTERS WITHOUT CLAIM TO ANY PARTICULAR FONT, STYLE, SIZE, OR COLOR.

OWNER OF U.S. REG. NOS. 2,096,273, 2,364,793 AND 2,592,274.

FOR CLOTHING, NAMELY, SHIRTS, T-SHIRTS, JACKETS, COATS, SWEATERS, SWEATSHIRTS, SHORTS, SKIRTS, PANTS, AND SOCKS; HEADWEAR; FOOTWEAR (U.S. CLS. 22 AND 39).

JOHN SCHUYLER YARD, EXAMINING ATTORNEY

SN 78-438,147. BAMBELLA, INC., CANTON, GA. FILED 6-19-2004.

BAM*bean*

THE COLOR(S) BLACK AND GARNET-RED IS/ARE CLAIMED AS A FEATURE OF THE MARK.

THE MARK CONSISTS OF STYLIZED "BAM" IN BLACK AND STYLIZED "BEAU" IN GARNET-RED.

FOR MENS SHIRTS, PANTS AND TIES (U.S. CLS. 22 AND 39).

JOHN E. MICHOS, EXAMINING ATTORNEY

CLASS 25—(Continued).

SN 78-439,572. TYCOON TUTTI, INC., MIAMI, FL. FILED 6-22-2004.

**BAL HARBOUR SPORTS
CLUB**

THE MARK CONSISTS OF STANDARD CHARACTERS WITHOUT CLAIM TO ANY PARTICULAR FONT, STYLE, SIZE, OR COLOR.

NO CLAIM IS MADE TO THE EXCLUSIVE RIGHT TO USE "BAL HARBOUR", APART FROM THE MARK AS SHOWN.

FOR CLOTHING FOR MEN, WOMEN, AND CHILDREN, NAMELY, BEACHWEAR, BLAZERS, CAPRIS, CAPS, COATS, COVERALLS, COVER-UPS, DUNGAREES, GOLF SHIRTS, HATS, JACKETS, ONE PIECE GARMENTS FOR INFANTS AND TODDLERS, PAJAMAS, PANTS, POLO SHIRTS, PONCHOS, RAINCOATS, ROBES, ROMPERS, SHIRTS, SHOES, SKIRTS, SKORTS, SOCKS, SWEAT PANTS, SWEAT SHIRTS, SWEAT SHORTS, SWEATERS, SWIMWEAR, TANK TOPS, TIES, TOPS, AND VESTS (U.S. CLS. 22 AND 39).

DAVID MURRAY, EXAMINING ATTORNEY

SN 78-442,455. MCGRUFF, MARLON E., BROOKLYN, NY. FILED 6-28-2004.



THE MARK CONSISTS OF THE STYLIZED LETTER "S" ABOVE SIKAMO IN STYLIZED LETTERS.

FOR CLOTHING, NAMELY, JACKETS, SHIRTS, T-SHIRTS, SWEATSHIRTS, TOPS, SWEATERS, JERSEYS, SLACKS, JEANS, SHORTS, SWIMWEAR, UNDERWEAR AND HEADWEAR (U.S. CLS. 22 AND 39).

JULIE WATSON, EXAMINING ATTORNEY

CLASS 25—(Continued).

SN 78-443,432. SHRIVASTAV INTERNATIONAL INC, DBA GINGERBLU, NEWYORK, NY. FILED 6-29-2004.

GingerBlu

THE COLOR(S) ORANGE IS/ARE CLAIMED AS A FEATURE OF THE MARK.

THE COLOR ORANGE APPEARS IN THE WORDING IN THE MARK.

FOR (BASED ON USE IN COMMERCE) CLOTHING LINE FOR WOMEN, NAMELY, T-SHIRTS AND SKIRTS (BASED ON INTENT TO USE) CLOTHING LINE FOR WOMEN, NAMELY, BATHING SUITS, DRESSES, BLOUSES, PANTS, SHORTS, LINGERIE, SCARFS, COATS, JACKETS AND SWEATERS (U.S. CLS. 22 AND 39).

FIRST USE 2-24-2003; IN COMMERCE 11-30-2003.

NAKWAMA ANKRAH, EXAMINING ATTORNEY

SN 78-445,823. TYLER, CHRISTOPHER MILTON, NORTH AUGUSTA, SC. FILED 7-4-2004.

ONE WHEEL DRIVE

THE MARK CONSISTS OF STANDARD CHARACTERS WITHOUT CLAIM TO ANY PARTICULAR FONT, STYLE, SIZE, OR COLOR.

FOR MOTORCYCLE APPAREL, NAMELY, HATS, SHIRTS, T-SHIRTS, SWEATSHIRTS, TANK TOPS, JACKETS, PANTS AND UNDERWEAR (U.S. CLS. 22 AND 39).

SUSAN HAYASH, EXAMINING ATTORNEY

CLASS 25—(Continued).

SN 78-445,837. JWG3 HOLDING INC., CHICAGO, IL. FILED 7-4-2004.



THE COLOR(S) RED IS/ARE CLAIMED AS A FEATURE OF THE MARK.
 THE COLOR RED APPEARS IN THE ENTIRE MARK FOR CLOTHING, NAMELY JEANS (U.S. CLS. 22 AND 39).

SUSAN HAYASH, EXAMINING ATTORNEY

CLASS 25—(Continued).

SN 78-449,787. MT POCKETS RACING, ALOHA, OR. FILED 7-13-2004.

NITE RIDES

THE MARK CONSISTS OF STANDARD CHARACTERS WITHOUT CLAIM TO ANY PARTICULAR FONT, STYLE, SIZE, OR COLOR.

FOR APPAREL FOR OFF-ROAD, ALL-TERRAIN VEHICLE AND MOTORCYCLE USE, NAMELY, HATS, BEANIES, VISORS, BANDANAS, T-SHIRTS, JACKETS, SWEATSHIRTS, VESTS, COATS, CHAPS, BOOTS, AND GLOVES; AND LEATHERS, NAMELY, JACKETS, PANTS, HEADWEAR, CHAPS, BOOTS, AND GLOVES (U.S. CLS. 22 AND 39).

MARK SPARACINO, EXAMINING ATTORNEY

SN 78-449,316. NEUF, PARIS, FRANCE, FILED 7-12-2004.



SN 78-453,179. TONILYNN LLC, GARDINER, NY. FILED 7-20-2004.

STUPID SPORTSWEAR

FOR CLOTHING FOR MEN, WOMEN AND CHILDREN, NAMELY, HATS, CAPS AND HEADWEAR, GLOVES, JACKETS, COATS, PANTS, DRESSES, SKIRTS, SHIRTS, T-SHIRTS, PULL-OVERS, KNITWEAR, NAMELY, KNITTED JACKETS, CLOTHING OF LEATHER, NAMELY, LEATHER PANTS AND LEATHER JACKETS, SWIMSUITS, GOWNS, TIES, SCARVES, SOCKS, BELTS, BOXER SHORTS, SHOES, SLIPPERS (U.S. CLS. 22 AND 39).

FIRST USE 0-0-1997; IN COMMERCE 0-0-1997.
 JULIE WATSON, EXAMINING ATTORNEY

THE MARK CONSISTS OF STANDARD CHARACTERS WITHOUT CLAIM TO ANY PARTICULAR FONT, STYLE, SIZE, OR COLOR.

NO CLAIM IS MADE TO THE EXCLUSIVE RIGHT TO USE "SPORTSWEAR", APART FROM THE MARK AS SHOWN.

FOR APPAREL NAMELY JEANS SWEATERS SKIRTS TOPS AND PANTS (U.S. CLS. 22 AND 39).
 FIRST USE 7-1-2004; IN COMMERCE 7-1-2004.
 DAWN FELDMAN, EXAMINING ATTORNEY

CLASS 25—(Continued).

SN 78-454,259. SLEEPING FOX, INC., FORT MYERS, FL. FILED 7-21-2004.

Sleeping Fox

THE MARK CONSISTS OF STANDARD CHARACTERS WITHOUT CLAIM TO ANY PARTICULAR FONT, STYLE, SIZE, OR COLOR.

FOR CLOTHING, NAMELY, JACKETS, PANTS, T-SHIRTS, SHIRTS, HATS, CAPS, UNDERWEAR, SCARVES, SKIRTS, SHORTS, HEAD BANDS, SWEAT SHIRTS, SWEAT PANTS, SWEAT SHORTS, SWEATERS, SOCKS AND COATS (U.S. CLS. 22 AND 39).

AMY HELLA, EXAMINING ATTORNEY

CLASS 25—(Continued).

SN 78-455,074. HAGER, MARK, BROOKLYN, NY. AND DANZER, JEFF, NEW YORK, NY. FILED 7-22-2004.

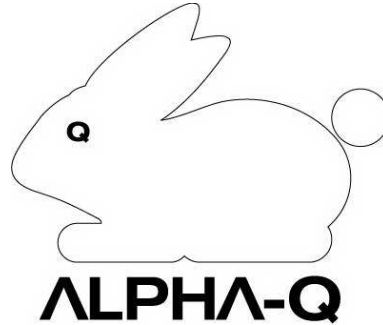

FOR CLOTHING: NAMELY, JEANS, TROUSERS, SLACKS, PANTS, SHORTS, OVERALLS, JUMPSUITS, SHIRTS, DRESS SHIRTS, T-SHIRTS, SWEATSHIRTS, SWEATSHORTS, SWEATPANTS, SWEATSUITS, JOGGING SUITS, VESTS, JACKETS, SWEATERS, UNDERWEAR BRIEFS, UNDERWEAR TOPS, BOXER SHORTS, HATS, SHOES, SNEAKERS, SOCKS, GLOVES, SCARVES, BODY SUITS, SWIMSUITS, ROBES, SKIRTS, BLOUSES, DRESSES, HOSE, SLIPS, CAMISOLES, LEGGINGS, HALTERS, PANTYHOSE, TIGHTS, STOCKINGS, SOCKS, LEOTARDS, SLEEPWEAR, BIKINIS, BELTS (U.S. CLS. 22 AND 39).

KATRINA EDGE, EXAMINING ATTORNEY

SN 78-454,804. BLAIR D. BEATTY, WILMINGTON, NC. FILED 7-22-2004.



FOR CLOTHING, NAMELY, TRUCKER HATS, MESH HATS, VISORS, FITTED HATS, COWBOY HATS, FOAM HATS, BEANIES, T-SHIRTS, POLO SHIRTS, TANK TOPS, SLACKS, JEANS, SHORTS, DRESSES, SKIRTS, PANTS, UNDERGARMENTS, BRIEFS, BOXERS, BRAS, PANTIES, SOCKS, SHOES, SANDALS (U.S. CLS. 22 AND 39).

CATHERINE CAIN, EXAMINING ATTORNEY

SN 78-459,838. QUAN, STEVE, ALHAMBRA, CA. FILED 7-30-2004.



THE COLOR RED IS CLAIMED AS A FEATURE OF THE MARK.

THE MARK CONSISTS OF "HK ARMY," WITH THE LETTERS "HK" OVERLAPPING IN A STYLIZED DESIGN. THE RIGHT PART OF THE LETTER "K" IS RED.

FOR CLOTHING, NAMELY, JACKETS, PANTS, T-SHIRTS, SHIRTS, HATS, AND GLOVES (U.S. CLS. 22 AND 39).

ALICE SUE CARRUTHERS, EXAMINING ATTORNEY

CLASS 25—(Continued).

SN 78-462,957. PINEL CORREA, CARLOS EMILIO, WOODBRIDGE, NJ. FILED 8-5-2004.

Pinel

THE MARK CONSISTS OF THE WORD PINEL IN STYLIZED LETTERS. THE LETTER P IS A CAPITAL LETTER WHEREAS THE REST OF THE LETTERS, NAMELY, INEL, APPEAR IN LOWER CASE.

FOR CLOTHING FOR MEN, WOMEN AND CHILDREN, NAMELY, DRESSES, SHIRTS, BLOUSES, JACKETS, COATS, VESTS, PANTS, JEANS, SKIRTS, SOCKS, GABARDINES, RAINCOATS, TIES, SCARVES, SHAWLS, APRONS, BELTS, SUSPENDERS, GLOVES AND HATS; SPORTSWEAR, NAMELY SHORTS, T-SHIRTS AND SWEATSHIRTS; SLEEPWEAR, NAMELY, DRESSING GOWNS; BATHING SUITS; UNDERWEAR; FOOTWEAR, NAMELY, BOOTS, SHOES, SNEAKERS, SANDALS, SLIPPERS, TENNIS SHOES; FOOTWEAR ACCESSORIES, NAMELY, TOECAPS, HEELS, SOLES (U.S. CLS. 22 AND 39).

FIRST USE 8-8-1998; IN COMMERCE 8-8-1998.
SANI KHOURI, EXAMINING ATTORNEY

CLASS 25—(Continued).

SN 78-463,020. RIP SQUEAK, INC., SAN LUIS OBISPO, CA. FILED 8-5-2004.

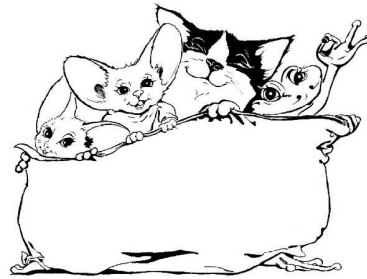

SN 78-462,982. MIZUNO CORPORATION, OSAKA, 541-8538, JAPAN, FILED 8-5-2004.

WAVE INSPIRE

THE MARK CONSISTS OF STANDARD CHARACTERS WITHOUT CLAIM TO ANY PARTICULAR FONT, STYLE, SIZE, OR COLOR.

OWNER OF U.S. REG. NOS. 2,453,908, 2,690,092 AND OTHERS.

FOR FOOTWEAR (U.S. CLS. 22 AND 39).
FIRST USE 6-16-2004; IN COMMERCE 6-16-2004.
LAURA KOVAISKY, EXAMINING ATTORNEY

FOR T-SHIRTS, BASEBALL CAPS, PAJAMAS, SWEATSHIRTS, TRACK SUITS, SLEEPWEAR, CLOTH BIBS, UNDERWEAR, STOCKINGS, TIGHTS, SOCKS, TIES, BOW TIES, SHOES, SWIMSUITS, UNIFORMS, APRONS, BATHING SUITS, FOOTWEAR, HEADWEAR, SLIPPERS, CHARACTER COSTUMES, HATS, SHIRTS, TROUSERS, OVERALLS, PANTS, SHORTS, DRESSES, SKIRTS, PULLOVERS, CARDIGANS, COATS, JACKETS, BATHROBES, BELTS, WAISTBANDS, WAISTCOATS, HEADBANDS, MITTENS, SCARVES AND GLOVES; INFANTWEAR, NAMELY, TEXTILE DIAPERS, PANTS, CAPS, HATS, SUITS, T-SHIRTS, LONG-SLEEVED T-SHIRTS, OVERALLS, PULLOVERS, BONNETS, BOOTIES, SOCKS AND BUNTING; SPORTS APPAREL, NAMELY, JERSEYS, SHORTS, WIND-RESISTANT JACKETS, SINGLETS, PANTS, LEOTARDS AND SPORT SHOES; WATER-PROOF CLOTHING, NAMELY, RAINCOATS, PONCHOS, RAIN HATS, BOOTS AND GALOSHES (U.S. CLS. 22 AND 39).

ALICE SUE CARRUTHERS, EXAMINING ATTORNEY

CLASS 25—(Continued).

SN 78-463,795. GLOBAL LEGENDS, INC., LAGUNA HILLS, CA. FILED 8-6-2004.

*Babes Gear*

NO CLAIM IS MADE TO THE EXCLUSIVE RIGHT TO USE "GEAR", APART FROM THE MARK AS SHOWN.

THE COLOR(S) YELLOW AND BLUE IS/ARE CLAIMED AS A FEATURE OF THE MARK.

THE MARK CONSISTS OF A WOMAN OUTLINED IN THE COLOR BLUE, WEARING YELLOW AND BLUE CHECKERED SHORTS; A YELLOW MIDRIF SHIRT WITH A YELLOW AND BLUE CHECKERED BOTTOM THEREOF; A YELLOW NECKLACE; AND HAVING YELLOW HIGH-LIGHTS IN HER BLUE HAIR AND THE WORDING BABES GEAR IN THE COLOR BLUE.

FOR ANKLETS, BASEBALL CAPS, BLOUSES, BUSTIERS, CAPS, GOLF SHIRTS, GYM SUITS, GYM SHORTS, HALTER TOPS, HATS, HEAD WEAR, JACKETS, JEANS, JERSEYS, LINGERIE, MINISKIRTS, NIGHT SHIRTS, PANTS, SWEATPANTS, POLO SHIRTS, SHIRTS, SHORTS, SWEAT SHORTS, BERMUDA SHORTS, SOCKS, SPORT SHIRTS, SWEATSHIRTS, SWEAT BANDS, SWEATERS, SWIM WEAR, T-SHIRTS, TANK TOPS, UNDERGARMENTS, VISORS, AND SUN VISORS (U.S. CLS. 22 AND 39).

LINDA ESTRADA, EXAMINING ATTORNEY

SN 78-464,841. ROBINSON, LISA J., HOUSTON, TX. FILED 8-10-2004.

THE COLORS BLACK, PINK, GOLD AND SILVER ARE CLAIMED AS A FEATURE OF THE MARK.

THE MARK CONSISTS OF BLACK LETTERS WITH PINK POLKA DOTS, WITH THE EXCEPTION THAT EACH LETTER O IN THE TERM GLAMOROUS IS GOLD AND APPEARS AS A DIAMOND RING. THE LETTER I IN THE WORD LIFE HAS A REPRESENTATION OF A DIAMOND ABOVE THE LETTER I.

FOR RHINESTONE JEANS AND JACKETS; RHINESTONE T-SHIRTS AND BLOUSES; RHINESTONE BABY CLOTHES, NAMELY, ONE PIECE GARMENT FOR INFANTS AND TODDLERS, T-SHIRTS, JEANS, JACKETS, DRESSES, AND SHORTS; RHINESTONE DANCEWEAR, NAMELY, LEOTARDS, SHORTS, SWEAT PANTS, T-SHIRTS AND TIGHTS; RHINESTONE LEATHER BELTS, CORSETS AND LINGERIE (U.S. CLS. 22 AND 39).

TONI HICKEY, EXAMINING ATTORNEY

CLASS 25—(Continued).

SN 78-466,103. KOUKLA, LLC, GUILFORD, CT. FILED 8-11-2004.

Koukla

THE MARK CONSISTS OF STANDARD CHARACTERS WITHOUT CLAIM TO ANY PARTICULAR FONT, STYLE, SIZE, OR COLOR.

OWNER OF U.S. REG. NO. 2,711,468.

THE ENGLISH TRANSLATION OF THE GREEK WORDING "KOUKLA" IS "DOLL."

FOR WOMEN'S CLOTHING, NAMELY, SHIRTS, SWEAT SHIRTS, SWEAT PANTS, PANTS, LINGERIE, SHORTS, HATS, DRESSES, SHOES, SKIRTS (U.S. CLS. 22 AND 39).

MICHELLE DUBOIS, EXAMINING ATTORNEY

SN 78-468,589. BRUERE, CAROLE J., ALBUQUERQUE, NM. FILED 8-17-2004.

GIMME LUV

THE MARK CONSISTS OF STANDARD CHARACTERS WITHOUT CLAIM TO ANY PARTICULAR FONT, STYLE, SIZE, OR COLOR.

FOR CLOTHING, NAMELY, SHIRTS, BLOUSES, T-SHIRTS, TANK TOPS, SHORTS, PANTS, UNDERWEAR, SOCKS, HATS, CAPS, CAP VISORS, COATS, AND JACKETS (U.S. CLS. 22 AND 39).

MONTIA G. PRESSEY, EXAMINING ATTORNEY

CLASS 25—(Continued).

SN 78-469,946. GRAY, MICHAEL, STAMFORD, CT. FILED 8-19-2004.



THE COLORS RED, WHITE, AND BLUE ARE CLAIMED AS A FEATURE OF THE MARK.

THE WATER IN THE FOREGROUND AND SKY IN THE BACKGROUND OF THE MARK APPEAR IN BLUE. THE WORM ON THE HOOK APPEARS IN RED. THE HOOK AND TEXT APPEAR IN WHITE.

THE MARK CONSISTS OF THE WORDS EAT MY WORM WITH A WORM WEARING SUNGLASSES CURLED AROUND A FISHING HOOK WITH WAVES IN THE BACKGROUND.

FOR CLOTHING, NAMELY, SHIRTS, PANTS, TOPS, SOCKS, T-SHIRTS, SHORTS, UNDERWEAR, BOXER SHORTS, SWEATSHIRTS, SWEATERS, JACKETS, HEADWEAR (U.S. CLS. 22 AND 39).

JERI J. FICKES, EXAMINING ATTORNEY

SN 78-470,366. LAMSON, DENNIS R, CENTRAL POINT, OR. AND LAMSON, SHEILA R, CENTRAL POINT, OR. FILED 8-19-2004.

**Wear The World At
90 Degrees**

THE MARK CONSISTS OF STANDARD CHARACTERS WITHOUT CLAIM TO ANY PARTICULAR FONT, STYLE, SIZE, OR COLOR.

FOR CLOTHING, NAMELY, SHIRTS, PANTS, TIES, SHORTS; HEADGEAR, NAMELY, HATS, HEADBANDS, BANDANAS; FOOTWEAR, NAMELY, SHOES, SOCKS (U.S. CLS. 22 AND 39).

JASON LOTT, EXAMINING ATTORNEY

CLASS 25—(Continued).

SN 78-473,801. COLUMBIA INSURANCE COMPANY, OMAHA, NE. FILED 8-26-2004.

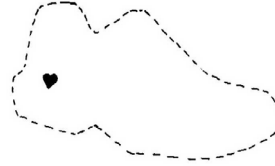

OWNER OF U.S. REG. NOS. 1,259,487 AND 1,708,339. THE MARK CONSISTS OF A HEART DESIGN PLACED SPECIFICALLY ON THE OUTSIDE OF SHOE UPPER BACK PORTION OF THE SHOE.

FOR FOOTWEAR (U.S. CLS. 22 AND 39). FIRST USE 6-0-2003; IN COMMERCE 6-0-2003.

JOHN DALIER, EXAMINING ATTORNEY

SN 78-473,841. COLUMBIA INSURANCE COMPANY, OMAHA, NE. FILED 8-26-2004.

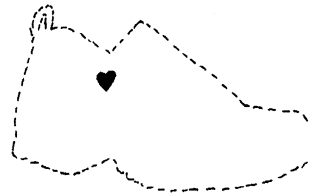

OWNER OF U.S. REG. NOS. 1,259,487 AND 1,708,339. THE MARK CONSISTS OF A HEART DESIGN PLACED SPECIFICALLY ON THE OUTSIDE OF SHOE UPPER MIDDLE PORTION OF THE SHOE.

FOR FOOTWEAR (U.S. CLS. 22 AND 39). FIRST USE 6-0-2003; IN COMMERCE 6-0-2003.

JOHN DALIER, EXAMINING ATTORNEY

SN 78-475,567. PRETTY BOY U.S.A., INC., MILWAUKEE, WI. FILED 8-30-2004.

Prettyboy U.S.A.

THE MARK CONSISTS OF STANDARD CHARACTERS WITHOUT CLAIM TO ANY PARTICULAR FONT, STYLE, SIZE, OR COLOR.

NO CLAIM IS MADE TO THE EXCLUSIVE RIGHT TO USE "U.S.A.", APART FROM THE MARK AS SHOWN.

FOR CLOTHING; NAMELY, POLO SHIRTS, T-SHIRTS, OXFORD SHIRTS, KNIT SWEATERS, DENIM PANTS, KHAKI PANTS, SWEATSHIRTS, BLOUSES, AND LEATHER, NYLON, AND CLOTH JACKETS (U.S. CLS. 22 AND 39).

FIRST USE 8-29-1998; IN COMMERCE 10-15-1998.

BRIAN PINO, EXAMINING ATTORNEY

CLASS 25—(Continued).

SN 78-476,776. CALCADOS FERRACINI LTDA., FRANCA / SP, BRAZIL, FILED 8-31-2004.

FOR FOOTWEAR, SHOES, SANDALS, BELTS, CLOTHING, NAMELY, SHIRTS, T-SHIRTS, PANTS, SOCKS, BERMUDA SHORTS. (U.S. CLS. 22 AND 39).

NORA BUCHANAN WILL, EXAMINING ATTORNEY

SN 78-480,253. ERIKA I. IKELER, MILWAUKEE, WI. FILED 9-8-2004.

FASHION NINJA

THE MARK CONSISTS OF STANDARD CHARACTERS WITHOUT CLAIM TO ANY PARTICULAR FONT, STYLE, SIZE, OR COLOR.

NO CLAIM IS MADE TO THE EXCLUSIVE RIGHT TO USE "FASHION", APART FROM THE MARK AS SHOWN.

FOR CLOTHING, NAMELY, SHIRTS, BLOUSES, PONCHOS, SKIRTS, PANTS, SUITS, SHORTS, DRESSES, SWEATERS, BLAZERS, STRAPLESS SHIRTS, CAMISOLES, AND LADIES UNDERWEAR (U.S. CLS. 22 AND 39).

DAYNA BROWNE, EXAMINING ATTORNEY

CLASS 25—(Continued).

SN 78-482,210. NOGA, SHLEZINGER, ALFI MENAHSE, ISRAEL, FILED 9-13-2004.

Petit Bouchon

THE MARK CONSISTS OF STANDARD CHARACTERS WITHOUT CLAIM TO ANY PARTICULAR FONT, STYLE, SIZE, OR COLOR.

THE ENGLISH TRANSLATION OF THE WORD PETIT BOUCHON IN THE MARK IS SMALL CORK OR SMALL PLUG.

FOR CLOTHING FOR INFANTS AND KIDS, NAMELY, SHIRTS, TROUSERS, TOPS, BATHING SUITS, SUITS, SOCKS, BLAZEERS, JUMP SUITS, WARM-UP SUITS, SWEAT SUITS, SWEAT PANTS AND SWEATSHIRTS, BODY SUITS, LEOTARDS, TIGHTS, LEG WARMERS, LEGGINGS, BATHING SUITS, SUITS, TUXEDOS, SLACKS, TROUSERS, PANTS, JEANS, SHORTS, SWEAT SHORTS, GYM SHORTS, TOPS, COATS, SPORT COATS, SHIRTS, AND SPORT SHIRTS; T-SHIRTS, KNIT SHIRTS, POLO SHIRTS, PULLOVERS, SWEATERS, VESTS, TANK TOPS, BLAZERS, JUMPSUITS, PLAYSUITS, JACKETS, OVERCOATS, PARKAS, WIND RESISTANT JACKETS, LEATHER JACKETS, SKIRTS, DRESSES; FOOTWEAR, NAMELY, SHOES, BOOTS, SANDALS AND SLIPPERS; HEADWEAR, NAMELY, HATS, HOODS, CAPS, VISORS, NECKERCHIEFS, SCARVES, BANDANNAS, SLEEPWEAR, ROBES, PAJAMAS, NIGHTSHIRTS, RAINCOATS, GLOVES, MITTENS, GALOSHES AND RAINBOOTS, LOUNGEWEAR, UNDERWEAR, BRIEFS, UNDERPANTS, BOXER SHORTS, UNDERSHIRTS, SUSPENDERS, HOSIERY, SOCKS, AND APRONS (U.S. CLS. 22 AND 39).

FIRST USE 7-8-1997; IN COMMERCE 7-8-1997.
KEVON CHISOLM, EXAMINING ATTORNEY

SN 78-485,424. CLAYTON, KENNETH WAYNE, JR., KNOXVILLE, TN. FILED 9-17-2004.



THE MARK CONSISTS OF A STYLIZED CHOPPER-SLED HAVING THE APPEARANCE OF A MOTORCYCLE AT THE FRONT AND THE APPEARANCE OF A SLED AT THE REAR.

FOR CLOTHING, NAMELY, T-SHIRTS, TANK TOPS, CROP TOPS, SWEATSHIRTS, FLEECE TOPS, POLO/ GOLF SHIRTS, ATHLETIC JERSEYS, JACKETS, COATS, VESTS, GLOVES, WOMEN'S BLOUSES AND TOPS, NECKTIES, SOCKS, PANTS, SWEAT PANTS, FLEECE PANTS, UNDERWEAR, LINGERIE, PAJAMAS, NIGHT GOWNS, BELTS, SCARVES, DENIM JEANS AND JACKETS, SWIMSUITS AND COVER-UPS; HEADGEAR, NAMELY, HATS, CAPS, KNIT CAPS, HEADBANDS, BEANIES AND BANDANAS (U.S. CLS. 22 AND 39).

MATTHEW PAPPAS, EXAMINING ATTORNEY

CLASS 25—(Continued).

SN 78-485,973. COURTNEY, JOHN, T, YONKERS, NY.
FILED 9-20-2004.

no licky no sticky

THE MARK CONSISTS OF STANDARD CHARACTERS
WITHOUT CLAIM TO ANY PARTICULAR FONT, STYLE,
SIZE, OR COLOR.

FOR T-SHIRTS (U.S. CLS. 22 AND 39).
ROBERT LORENZO, EXAMINING ATTORNEY

SN 78-485,974. COURTNEY, JOHN, T, YONKERS, NY.
FILED 9-20-2004.

99% angel 1% slut

THE MARK CONSISTS OF STANDARD CHARACTERS
WITHOUT CLAIM TO ANY PARTICULAR FONT, STYLE,
SIZE, OR COLOR.

FOR T-SHIRTS (U.S. CLS. 22 AND 39).
ROBERT LORENZO, EXAMINING ATTORNEY

SN 78-485,975. COURTNEY, JOHN, T, YONKERS, NY.
FILED 9-20-2004.

my other
boyfriend/girlfriend
is a model

THE MARK CONSISTS OF STANDARD CHARACTERS
WITHOUT CLAIM TO ANY PARTICULAR FONT, STYLE,
SIZE, OR COLOR.

FOR T-SHIRTS (U.S. CLS. 22 AND 39).
ROBERT LORENZO, EXAMINING ATTORNEY

CLASS 25—(Continued).

SN 78-486,835. MEDINA, RICHARD V., CARROLLTON, TX.
FILED 9-21-2004.

CO2K

THE MARK CONSISTS OF STANDARD CHARACTERS
WITHOUT CLAIM TO ANY PARTICULAR FONT, STYLE,
SIZE, OR COLOR.

FOR HEADWEAR, NAMELY HATS (U.S. CLS. 22 AND
39).

FIRST USE 5-0-2005; IN COMMERCE 5-0-2005.
HENRY S. ZAK, EXAMINING ATTORNEY

SN 78-490,243. ARMADILLO TRADING COMPANY, AUS-
TIN, TX. FILED 9-27-2004.

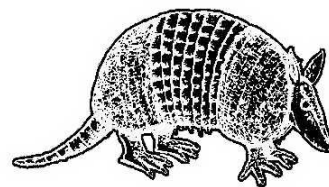

THE LINING AND/OR STIPPLING SHOWN IN THE
MARK ON THE DRAWING IS FOR SHADING PURPOSES
ONLY, AND DOES NOT FORM COLOR.

THE MARK CONSISTS OF A FANCIFUL REPRESENTA-
TION OF THE PROFILE OF AN ARMADILLO ANIMAL
WITH THE HEAD OF THE ANIMAL FACING THE VIEW-
ER'S RIGHT.

FOR CLOTHING, NAMELY, MEN'S, WOMEN'S AND
CHILDREN'S DRESS AND CASUAL SHIRTS, T-SHIRTS,
PANTS, SHORTS, CAPS, HATS, TIES, AND BELTS (U.S.
CLS. 22 AND 39).

FIRST USE 6-1-2004; IN COMMERCE 7-14-2004.
ANNE FARRELL, EXAMINING ATTORNEY

CLASS 25—(Continued).

SN 78-494,068. PAVLISH, JOHN E., CLEVELAND HTS., OH.
FILED 10-4-2004.

CLASS 25—(Continued).

SN 78-494,688. KING, DAN, SCOTTSDALE, AZ. FILED 10-5-2004.

Life is On

SinFuel

THE MARK CONSISTS OF STANDARD CHARACTERS WITHOUT CLAIM TO ANY PARTICULAR FONT, STYLE, SIZE, OR COLOR.

FOR CLOTHING, NAMELY SWEATSHIRTS, T-SHIRTS, HATS, SHORTS AND JACKETS (U.S. CLS. 22 AND 39).

JOHN WILKE, EXAMINING ATTORNEY

THE MARK CONSISTS OF STANDARD CHARACTERS WITHOUT CLAIM TO ANY PARTICULAR FONT, STYLE, SIZE, OR COLOR.

FOR CLOTHING FOR ACTIVE WEAR, ATHLETIC WEAR, ADULTS CASUAL WEAR, RACING TYPE CLOTHING, YOUTH CLOTHING, AUTOMOBILE TYPE CLOTHING, AND GOLF TYPE CLOTHING, NAMELY, T-SHIRTS, TOPS, HATS, CAPS, BEANIES, SWEATERS, JACKETS, HOODED SWEATSHIRTS AND POLO SHIRTS (U.S. CLS. 22 AND 39).

FIRST USE 6-5-2003; IN COMMERCE 9-6-2004.
TINA L. SNAPP, EXAMINING ATTORNEY

SN 78-494,511. STEVENS CLOGGING SUPPLIES, INC.,
MERCER, PA. FILED 10-5-2004.

SN 78-496,073. BROWN SHOE COMPANY, INC., ST. LOUIS,
MO. FILED 10-7-2004.

BUCK TAPS

ENERGY DISC MATRIX

THE MARK CONSISTS OF STANDARD CHARACTERS WITHOUT CLAIM TO ANY PARTICULAR FONT, STYLE, SIZE, OR COLOR.

NO CLAIM IS MADE TO THE EXCLUSIVE RIGHT TO USE TAPS, APART FROM THE MARK AS SHOWN.
SEC. 2(F).

FOR DANCING TAPS ATTACHABLE TO THE SHOES (U.S. CLS. 22 AND 39).

FIRST USE 2-4-1987; IN COMMERCE 2-4-1987.
JOHN HWANG, EXAMINING ATTORNEY

THE MARK CONSISTS OF STANDARD CHARACTERS WITHOUT CLAIM TO ANY PARTICULAR FONT, STYLE, SIZE, OR COLOR.

OWNER OF U.S. REG. NO. 2,931,919.
FOR FOOTWEAR (U.S. CLS. 22 AND 39).
JILL C. ALT, EXAMINING ATTORNEY

CLASS 25—(Continued).

SN 78-496,956. RIAZI, SHIRIN, WEST HILLS, CA. FILED 10-8-2004.

RUN FREE

THE MARK CONSISTS OF STANDARD CHARACTERS WITHOUT CLAIM TO ANY PARTICULAR FONT, STYLE, SIZE, OR COLOR.

NO CLAIM IS MADE TO THE EXCLUSIVE RIGHT TO USE "RUN", APART FROM THE MARK AS SHOWN.

FOR FOOT COVERING PLACED ON THE FOOT PRIOR TO PUTTING ON SOCKS OR HOSE (U.S. CLS. 22 AND 39).

KATHLEEN M. VANSTON, EXAMINING ATTORNEY

CLASS 25—(Continued).

SN 78-498,622. SEXY SHOP, INC., MIAMI BEACH, FL. FILED 10-12-2004.



NO CLAIM IS MADE TO THE EXCLUSIVE RIGHT TO USE SEXY SHOP, APART FROM THE MARK AS SHOWN. THE COLORS WHITE, PINK, RED, GRAY AND BLACK ARE CLAIMED AS A FEATURE OF THE MARK.

THE MARK CONSISTS OF A STYLIZED LETTER S WITH THE WORDING SEXY SHOP SUPERIMPOSED OVER THE MIDDLE OF THE S. THE TOP OF THE LETTER S IS WRAPPED AROUND THE HEAD OF A WOMAN. THE WOMEN'S HEAD HAS A BLACK HAIR NET, BLACK EYES AND EYELASHES, AND RED LIPS. THE STYLIZED LETTER S IS WHITE TO THE RIGHT OF THE WOMEN'S FACE, WITH THE REMAINDER OF THE LETTER IN PINK. THE STYLIZED S HAS A GRAY SHADOW OUTLINE. THE WORDING SEXY SHOP APPEARS IN BLACK.

FOR INTIMATE ADULT APPAREL, NAMELY, SEXY LINGERIE, UNDERWEAR, COSTUMES FOR USE IN ROLE-PLAYING GAMES (U.S. CLS. 22 AND 39).

FIRST USE 9-28-2003; IN COMMERCE 10-4-2003.

PAULA MAHONEY, EXAMINING ATTORNEY

SN 78-497,823. ZILLA HARDWARE, PORTLAND, OR. FILED 10-11-2004.



FOR SHIRTS, PANTS, SHORTS, SHOES, JACKETS, HATS (U.S. CLS. 22 AND 39).

INGRID C. EULIN, EXAMINING ATTORNEY

SN 78-500,558. THE GOLF WAREHOUSE, INC., WICHITA, KS. FILED 10-15-2004.

17TH GREEN

THE MARK CONSISTS OF STANDARD CHARACTERS WITHOUT CLAIM TO ANY PARTICULAR FONT, STYLE, SIZE, OR COLOR.

FOR CLOTHING, NAMELY, PANTS, SHORTS, SHIRTS, COATS, GLOVES, SOCKS, FOOTWEAR, HEADWEAR, RAINWEAR, AND JACKETS (U.S. CLS. 22 AND 39).

JENNIFER WILLISTON, EXAMINING ATTORNEY

CLASS 25—(Continued).

SN 78-502,297. COBIAN, FRANK JR., ANAHEIM, CA. FILED 10-19-2004.



THE MARK CONSISTS OF A PICTURE OF A BABY INSIDE A CIRCLE WITH SNEAKER.
FOR CLOTHING NAMELY, T-SHIRTS, AND SWEATERS (U.S. CLS. 22 AND 39).
ANNE E. GUSTASON, EXAMINING ATTORNEY

CLASS 25—(Continued).

SN 78-504,357. LAM, MUK SANG, MONTEREY PARK, CA. FILED 10-22-2004.



NO CLAIM IS MADE TO THE EXCLUSIVE RIGHT TO USE "THE TAILOR", APART FROM THE MARK AS SHOWN.

"REGENT THE TAILOR" DOES NOT IDENTIFY A LIVING INDIVIDUAL.

THE COLOR(S) RED AND BLACK IS/ARE CLAIMED AS A FEATURE OF THE MARK.

THE LETTER "R" APPEARS IN THE COLOR RED. THE WORDING "REGENT THE TAILOR" APPEARS IN THE COLOR BLACK.

FOR CUSTOM TAILORED CLOTHING FOR MEN AND WOMEN, NAMELY, TUXEDOS, COATS, SUITS, SHIRTS, BLOUSES, VESTS, PANTS AND BLAZERS (U.S. CLS. 22 AND 39).

FRED MANDIR, EXAMINING ATTORNEY

SN 78-503,200. WHITTAKER, EVELYN, SAN JOSE, CA. FILED 10-20-2004.



SN 78-505,348. THE CHENILLE KRAFT COMPANY, GURNEE, IL. FILED 10-25-2004.

LITTLE PRETENDERS

NO CLAIM IS MADE TO THE EXCLUSIVE RIGHT TO USE "TOTS", APART FROM THE MARK AS SHOWN.

FOR CLOTHING LINE FOR INFANTS AND TODDLERS, NAMELY, T-SHIRTS, ONE PIECE GARMENTS FOR INFANTS AND TODDLERS, ROMPERS, AND BUCKET HATS (U.S. CLS. 22 AND 39).

FIRST USE 7-15-2004; IN COMMERCE 10-12-2004.

INGA ERVIN, EXAMINING ATTORNEY

THE MARK CONSISTS OF STANDARD CHARACTERS WITHOUT CLAIM TO ANY PARTICULAR FONT, STYLE, SIZE, OR COLOR.

FOR COSTUMES FOR USE IN ROLE-PLAYING (U.S. CLS. 22 AND 39).

BRIAN NEVILLE, EXAMINING ATTORNEY

CLASS 25—(Continued).

SN 78-505,582. PUNCH FITNESS, INC., MIAMI BEACH, FL.
FILED 10-25-2004.

GKA
Girls Kick Ass

FOR CLOTHING, NAMELY, T-SHIRTS (U.S. CLS. 22 AND 39).

FIRST USE 3-0-2004; IN COMMERCE 3-0-2004.
DARRYL SPRUILL, EXAMINING ATTORNEY

SN 78-507,637. B.B. DAKOTA, INC., SANTA ANA HEIGHTS,
CA. FILED 10-28-2004.

B.B.'S CLOSET

THE MARK CONSISTS OF STANDARD CHARACTERS WITHOUT CLAIM TO ANY PARTICULAR FONT, STYLE, SIZE, OR COLOR.

FOR WEARING APPAREL NAMELY, T-SHIRTS, SHIRTS, SHORTS, PANTS, SWEATSHIRTS, SWEATPANTS, HATS, VISORS, SHOES, SANDALS AND BELTS (U.S. CLS. 22 AND 39).

SHAUNIA WALLACE, EXAMINING ATTORNEY

SN 78-508,241. NAF NAF DISTRIBUTION BV, 1062 HH
AMSTERDAM, NETHERLANDS, FILED 10-29-2004.

CHE BY CHEVIGNON

THE MARK CONSISTS OF STANDARD CHARACTERS WITHOUT CLAIM TO ANY PARTICULAR FONT, STYLE, SIZE, OR COLOR.

OWNER OF U.S. REG. NOS. 1,536,460 AND 2,330,714.
FOR CLOTHING, NAMELY JEANS, SHORTS, BERMUDA SHORTS, TROUSERS, DUNGAREES, COMBINATIONS, OVERALLS, SHIRTS, JACKETS, WIND RESISTANT JACKETS, PULLOVERS, TEE-SHIRTS, SWEATSHIRTS, SUITS, VESTS, PARKAS, COATS, RAINCOATS, PETTICOATS, DRESSES, UNDERWEAR, BATHING SUITS, STOCKINGS, TIGHTS, SOCKS, DRESSING GOWNS, BATHROBES, LINGERIE, LAYETTES, BELTS, TIES, GLOVES, STOLES, SCARVES, SASHES FOR WEAR, SHAWLS; SHOES, BOOTS, SLIPPERS; HEADWEAR, HATS, CAPS, BERETS, BONNETS (U.S. CLS. 22 AND 39).

PAULA MAHONEY, EXAMINING ATTORNEY

CLASS 25—(Continued).

SN 78-509,718. THE BASKETBALL CLUB OF SEATTLE, LLC,
SEATTLE, WA. FILED 11-2-2004.

**SEATTLE SUPER
SONICS**

THE MARK CONSISTS OF STANDARD CHARACTERS WITHOUT CLAIM TO ANY PARTICULAR FONT, STYLE, SIZE, OR COLOR.

OWNER OF U.S. REG. NOS. 1,084,317 AND 1,831,387.
SEC. 2(F) AS TO "SEATTLE".

FOR CLOTHING, NAMELY HOSIERY, FOOTWEAR, BASKETBALL SHOES, BASKETBALL SNEAKERS, T-SHIRTS, SHIRTS, POLO SHIRTS, SWEATSHIRTS, SWEATPANTS, PANTS, TANK TOPS, JERSEYS, SHORTS, PAJAMAS, SPORT SHIRTS, RUGBY SHIRTS, SWEATERS, BELTS, TIES, NIGHTSHIRTS, HATS, CAPS, VISORS, WARM-UP SUITS, WARM-UP PANTS, WARM-UP TOPS/SHOOTING SHIRTS, JACKETS, WIND RESISTANT JACKETS, PARKAS, COATS, BABY BIBS NOT OF PAPER, HEAD BANDS, WRIST BANDS, APRONS, UNDERGARMENTS, BOXER SHORTS, SLACKS, CAPS, EAR MUFFS, GLOVES, MITTENS, SCARVES, WOVEN AND KNIT SHIRTS, JERSEY DRESSES, DRESSES, CHEERLEADING DRESSES AND UNIFORMS, SWIM WEAR, BATHING SUITS, SWIMSUITS, BIKINIS, TANKINIS, SWIM TRUNKS, BATHING TRUNKS, BOARD SHORTS, WET SUITS, BEACH COVER-UPS, BATHING SUIT COVER-UPS, BATHING SUIT WRAPS, SANDALS, BEACH SANDALS, BEACH HATS, SUN VISORS, SWIM CAPS, BATHING CAPS, NOVELTY HEADWEAR WITH WIGS (U.S. CLS. 22 AND 39).

FIRST USE 11-30-1975; IN COMMERCE 11-30-1975.
DEZMONA MIZELLE, EXAMINING ATTORNEY

SN 78-511,776. SEPHUS, INC., NEW ORLEANS, LA. FILED 11-5-2004.

SEAFUSS

THE MARK CONSISTS OF STANDARD CHARACTERS WITHOUT CLAIM TO ANY PARTICULAR FONT, STYLE, SIZE, OR COLOR.

FOR SHIRTS, PANTS, AND SHOES (U.S. CLS. 22 AND 39).

FIRST USE 0-0-2003; IN COMMERCE 1-0-2004.
TRICIA SONNEBORN, EXAMINING ATTORNEY

CLASS 25—(Continued).

SN 78-512,027. ROBINSON, DAMON A., LOS ANGELES, CA. FILED 11-5-2004.

CLASS 25—(Continued).

SN 78-512,454. CALLAWAY GOLF COMPANY, CARLSBAD, CA. FILED 11-5-2004.

Praise The Lowered



THE MARK CONSISTS OF STANDARD CHARACTERS WITHOUT CLAIM TO ANY PARTICULAR FONT, STYLE, SIZE, OR COLOR.

OWNER OF U.S. REG. NO. 2,920,209. FOR PRINTED T-SHIRTS, PRINTED SWEATSHIRTS, PANTS, UNDERGARMENTS, AND HATS (U.S. CLS. 22 AND 39).

FIRST USE 3-1-2003; IN COMMERCE 5-1-2003. SANI KHOURI, EXAMINING ATTORNEY

FOR SHIRTS, BLOUSES, T-SHIRTS, SLACKS, SHORTS, SWEATERS, SWEATS, JACKETS, WIND-RESISTANT JACKETS, WIND-RESISTANT PANTS, VESTS, SKIRTS, DRESSES, GLOVES, TANK TOPS, HATS, CAPS, VISORS, BELTS, TIES, HOSIERY AND FOOTWEAR (U.S. CLS. 22 AND 39).

FIRST USE 8-13-2001; IN COMMERCE 8-13-2001. JASON TURNER, EXAMINING ATTORNEY

SN 78-512,408. THE BOARD OF REGENTS OF THE UNIVERSITY OF OKLAHOMA, NORMAN, OK. FILED 11-5-2004.

SN 78-512,816. TQRO TEQUIERO, INCORPORATED, PHILADELPHIA, PA. FILED 11-8-2004.

SOONERS



THE MARK CONSISTS OF STANDARD CHARACTERS WITHOUT CLAIM TO ANY PARTICULAR FONT, STYLE, SIZE, OR COLOR.

OWNER OF U.S. REG. NOS. 1,374,838, 1,402,237 AND OTHERS.

FOR CLOTHING AND SPORTS CLOTHING APPAREL AND OUTERWEAR, NAMELY T-SHIRTS, SHIRTS, SWEATERS, VESTS, SWEAT SHIRTS, JACKETS, PANTS, SWEATPANTS, SHORTS, HATS, CAPS, VISORS AND FOOTWEAR (U.S. CLS. 22 AND 39).

FIRST USE 1-1-1950; IN COMMERCE 1-1-1950. DARRYL SPRUILL, EXAMINING ATTORNEY

THE COLOR RED IS CLAIMED AS A FEATURE OF THE MARK.

THE ENTIRE MARK IS RED.

THE ENGLISH TRANSLATION OF TE QUIERO IS "I WANT YOU".

FOR LEG WARMERS, PONCHOS, JEANS, T-SHIRTS, BLAZERS, LINGERIE, PANTS, SHIRTS, SKIRTS, PANT SUITS, DRESSES, SKIRT SUITS (U.S. CLS. 22 AND 39).

FIRST USE 7-1-2004; IN COMMERCE 10-5-2004. TRICIA SONNEBORN, EXAMINING ATTORNEY

CLASS 25—(Continued).

SN 78-513,013. GARDNER, SEAN, WOODBURY, NJ. FILED 11-8-2004.

We're Going!

THE MARK CONSISTS OF STANDARD CHARACTERS WITHOUT CLAIM TO ANY PARTICULAR FONT, STYLE, SIZE, OR COLOR.

FOR T-SHIRTS AND SWEATSHIRTS PRINTED WITH SPORTS INFORMATION WORN IN CONJUNCTION WITH SUPPORTING AN AREA SPORTS TEAM (U.S. CLS. 22 AND 39).

MARGERY A. TIERNEY, EXAMINING ATTORNEY

SN 78-513,460. TWENTIETH CENTURY FOX FILM CORPORATION, LOS ANGELES, CA. FILED 11-8-2004.

AMERICAN DAD

THE MARK CONSISTS OF STANDARD CHARACTERS WITHOUT CLAIM TO ANY PARTICULAR FONT, STYLE, SIZE, OR COLOR.

FOR HATS; CAPS; T-SHIRTS; SHIRTS; PANTS; SWEATSHIRTS; SWEATPANTS; SWEATERS; UNDERWEAR; UNDERSHIRTS; BOXER SHORTS; PAJAMAS; NIGHTGOWNS; NIGHTSHIRTS; SLIPPERS; ROBES; RAIN COATS; RAIN BOOTS; GLOVES; TIES; SOCKS; BELTS; COATS; JACKETS; HALLOWEEN AND MASQUERADE COSTUMES AND MASKS SOLD IN CONNECTION THEREWITH (U.S. CLS. 22 AND 39).

TRACY FLETCHER, EXAMINING ATTORNEY

CLASS 25—(Continued).

SN 78-513,474. THE TRUSTEES OF THE MUHAMMAD ALI FAMILY TRUST, BERRIEN SPRINGS, MI. FILED 11-8-2004.



FOR CLOTHING, NAMELY, SHIRTS, VESTS, SWEATERS, SHOES, CAPS, BANDANNAS, SHORTS, SWEATSHIRTS, PANTS, BELTS FOR CLOTHING, SOCKS, SWIMWEAR, JACKETS, RAINWEAR, BLOUSES, DRESSES, FOOTWEAR, HOSIERY, SCARVES, HATS, HEADBANDS, PAJAMAS AND SLEEPWEAR (U.S. CLS. 22 AND 39).

GINA FINK, EXAMINING ATTORNEY

SN 78-513,744. REAL DEAL, LOS ANGELES, CA. FILED 11-9-2004.



THE MARK CONSISTS OF STYLIZED LETTERS R AND D WITH SURROUNDING DESIGN.

FOR SHIRTS, TANK TOPS, HATS, BEANIES, HEADBANDS (U.S. CLS. 22 AND 39).

FIRST USE 12-13-2001; IN COMMERCE 12-13-2001.

TEJBIR SINGH, EXAMINING ATTORNEY

CLASS 25—(Continued).

SN 78-514,712. JESSE MCCARTNEY LLC, LOS ANGELES, CA. FILED 11-10-2004.

JESSE MCCARTNEY

THE MARK CONSISTS OF STANDARD CHARACTERS WITHOUT CLAIM TO ANY PARTICULAR FONT, STYLE, SIZE, OR COLOR.

JESSE MCCARTNEY IDENTIFIES A LIVING INDIVIDUAL WHOSE CONSENT IS OF RECORD.

FOR CLOTHING, NAMELY, SHIRTS, UNDER SHIRTS, NIGHT SHIRTS, RUGBY SHIRTS, POLO SHIRTS, T-SHIRTS, COORDINATED SHIRTS AND PANTS, JERSEYS, UNIFORMS, ATHLETIC UNIFORMS, PANTS, TROUSERS, SLACKS, JEANS, DENIM JEANS, OVERALLS, COVERALLS, JUMPERS, JUMP SUITS, SHORTS, BOXER SHORTS, TOPS, CROP TOPS, TANK TOPS, HALTER TOPS, SWEAT SHIRTS, SWEAT SHORTS, SWEAT PANTS, WRAPS, WARM-UP SUITS, JOGGING SUITS, BLOUSES, SKIRTS, DRESSES, SWEATERS, VESTS, FLEECE VESTS, PULLOVERS, FLEECE PULLOVERS, SNOW SUITS, PARKAS, ANORAKS, PONCHOS, JACKETS, DINNER JACKETS, SPORTS JACKETS, GOLF AND SKI JACKETS, REVERSIBLE JACKETS, COATS, BLAZERS, SUITS, TURTLENECKS, SWIMWEAR, BEACHWEAR, CAPS, BERETS, HATS, HEADBANDS, WRISTBANDS, SWEAT BANDS, HEADWEAR, EAR MUFFS, APRONS, SCARVES, BANDANAS, BELTS, SUSPENDERS, NECKWEAR, NECKTIES, TIES, UNDERWEAR, BRIEFS, TRUNKS, BRAS, SPORTS BRAS, SINGLETs, SOCKS, LOUNGEWEAR, ROBES, BATHROBES, UNDERCLOTHES, PAJAMAS, THERMAL UNDERWEAR, SLEEPWEAR, NIGHT GOWNS, LINGERIE, CAMISOLES, HOSIERY, SLIPS, LEG WARMERS, BODYSUITS, LEGGINGS, TIGHTS, LEOTARDS, UNITARDS, GLOVES, MITTENS, FOOTWEAR, SHOES, TENNIS SHOES, SNEAKERS, BOOTS, GALOSHES, SANDALS, ZORI, SLIPPERS AND RAINWEAR (U.S. CLS. 22 AND 39).

JIM RINGLE, EXAMINING ATTORNEY

SN 78-515,371. ZHEJIANG DON DRAGON IMPORT & EXPORT CO., LTD., SHAOXING, ZHEJIANG, CHINA, FILED 11-11-2004.



FOR TIES, SHIRTS, PANTS, T-SHIRTS, VESTS, UNDERWEAR, SOCKS, GLOVES, JACKETS, COATS, CAPS, HATS, SPORTS SHOES, LEATHER SHOES, AND SLIPPERS (U.S. CLS. 22 AND 39).

FIRST USE 0-0-2000; IN COMMERCE 0-0-2000.
ELLEN PERKINS, EXAMINING ATTORNEY

CLASS 25—(Continued).

SN 78-515,519. THE SHOE FACTORY, INC., BRONX, NY. FILED 11-11-2004.

LESANADENG

THE MARK CONSISTS OF STANDARD CHARACTERS WITHOUT CLAIM TO ANY PARTICULAR FONT, STYLE, SIZE, OR COLOR.

THE NAME(S), PORTRAIT(S), AND/OR SIGNATURE(S) SHOWN IN THE MARK DOES NOT IDENTIFY A PARTICULAR LIVING INDIVIDUAL.

FOR WOMEN'S FINE FOOTWEAR (U.S. CLS. 22 AND 39).

FIRST USE 11-10-2004; IN COMMERCE 11-10-2004.
TANYA AMOS, EXAMINING ATTORNEY

SN 78-516,037. INTERNATIONAL NEWS, INC., KENT, WA. FILED 11-12-2004.



THE MARK CONSISTS OF LETTER M DESIGN WITH PARTIAL STAR AT BOTTOM LEFT FORMING A LEG OF THE M.

FOR FOOTWEAR (U.S. CLS. 22 AND 39).
FIRST USE 12-1-1998; IN COMMERCE 12-1-1998.
VIVIAN MICZNIK FIRST, EXAMINING ATTORNEY

CLASS 25—(Continued).

SN 78-516,653. ROBLES, CARLOS ALBERTO, LOS ANGELES, CA. FILED 11-15-2004.

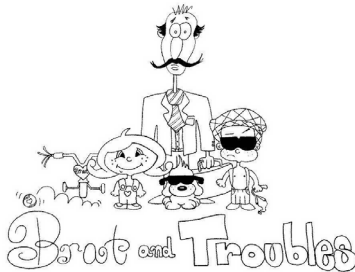

THE MARK CONSISTS OF FOUR CARTOON FIGURES, A BICYCLE, BOUNCING BALL AND STYLIZED LETTERS BRAT AND TROUBLES.

FOR MEN'S, BOY'S, WOMEN'S, GIRL'S, AND CHILDREN'S, SHORTS, DRESSES, JUMPERS, SHIRTS, BLOUSES, JACKETS, COATS, T-SHIRTS, SWEATPANTS, SWEATSHORTS, UNDERWEAR, PANTS, SWEAT SHIRTS, SLEEPWEAR, LOUNGEWEAR, SWIMWEAR, WET SUITS, OVERALLS, COVERALLS, VESTS, SWEATERS, NECKWEAR, WRISTBANDS, FOOTWEAR AND HEADWEAR (U.S. CLS. 22 AND 39).

CAROLYN GRAY, EXAMINING ATTORNEY

CLASS 25—(Continued).

SN 78-517,039. OXLER, STEVEN J., MOORESTOWN, NJ. FILED 11-15-2004.

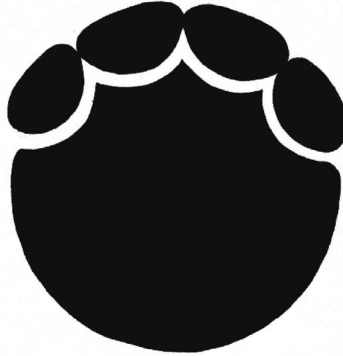

THE MARK CONSISTS OF AN ELEPHANT FOOTPRINT. FOR CLOTHING AND ACCESSORIES, NAMELY HATS, HOODS, CAPS, VISORS, HEADWEAR, BANDANAS, SWEATERS, SWEATSHIRTS, TOPS, SHIRTS, T-SHIRTS, BLAZERS, TURTLENECKS, CROP TOPS, TANK TOPS, BLOUSES, GOLF SHIRTS, SHORTS, JEANS, PANTS, SWEATPANTS, OVERALLS, PONCHOS, PARKAS, FOOTWEAR, SOCKS, JACKETS, COATS, WRAPS, MANTLES, MUFFLERS, SCARVES, EAR MUFFS, GLOVES, MITTENS, SHIRTS, TIES, BEACHWEAR, LOUNGEWEAR, PAJAMAS, RAINWEAR, HEADBANDS, WRISTBANDS, TRACKSUITS, JOGGING SUITS, SUSPENDERS, BELTS (U.S. CLS. 22 AND 39).

YONG KIM, EXAMINING ATTORNEY

SN 78-516,692. CASLER, JEFFREY, BOSTON, MA. FILED 11-15-2004.

BLUE STATE OF MIND

THE MARK CONSISTS OF STANDARD CHARACTERS WITHOUT CLAIM TO ANY PARTICULAR FONT, STYLE, SIZE, OR COLOR.

FOR BASEBALL CAPS, BOXER SHORTS, CAPS, VISORS, CLOTH BIBS, GOLF SHIRTS, GYM SHORTS, HATS, HEAD BANDS, SCARVES, JACKETS, NECK TIES, SINGLET, SWEAT SHIRTS, T-SHIRTS, TANK TOPS AND WRIST BANDS (U.S. CLS. 22 AND 39).

CARRIE ACHEN, EXAMINING ATTORNEY

SN 78-517,447. KRIZIA S.P.A., MILAN, ITALY, FILED 11-16-2004.



OWNER OF U.S. REG. NO. 1,302,712.

THE ENGLISH TRANSLATION OF THE WORD POI IN THE MARK IS THEN:

FOR CLOTHING, NAMELY, SHIRTS AND CHEMISES, BLOUSES, SKIRTS, COATS, TROUSERS, SHORTS, VESTS, JERSEYS, SOCKS AND STOCKINGS, SINGLET, HATS, SCARFS, RAINCOATS, OVERCOATS, GREATCOATS, BELTS (U.S. CLS. 22 AND 39).

FIRST USE 2-1-2000; IN COMMERCE 2-1-2000.

CAROLINE WOOD, EXAMINING ATTORNEY

CLASS 25—(Continued).

SN 78-517,452. ET-A-KIT, LLC, NEW YORK, NY. FILED 11-16-2004.

CLASS 25—(Continued).

SN 78-518,452. MULTI-VIZE HEADWEAR, LLC, CROSS LANES, WV. FILED 11-17-2004.

2Pink

MULTI-VIZE
HEADWEAR

THE MARK CONSISTS OF STANDARD CHARACTERS WITHOUT CLAIM TO ANY PARTICULAR FONT, STYLE, SIZE, OR COLOR.
FOR T-SHIRTS, TOPS, SWEATERS, JEANS, PANTS (U.S. CLS. 22 AND 39).
FIRST USE 9-1-2003; IN COMMERCE 9-1-2003.
CAROLINE WOOD, EXAMINING ATTORNEY

THE MARK CONSISTS OF STANDARD CHARACTERS WITHOUT CLAIM TO ANY PARTICULAR FONT, STYLE, SIZE, OR COLOR.
NO CLAIM IS MADE TO THE EXCLUSIVE RIGHT TO USE HEADWEAR, APART FROM THE MARK AS SHOWN. FOR HEADGEAR NAMELY VISORS (U.S. CLS. 22 AND 39).
FIRST USE 10-27-2004; IN COMMERCE 11-2-2004.
TRICIA SONNEBORN, EXAMINING ATTORNEY

SN 78-517,940. TENNESSEE WALKING HORSE BREEDERS' & EXHIBITORS' ASSOCIATION, LEWISBURG, TN. FILED 11-16-2004.

SN 78-518,588. BALLET MAKERS, INC., TOTOWA, NJ. FILED 11-17-2004.



TELE TONE JR.

NO CLAIM IS MADE TO THE EXCLUSIVE RIGHT TO USE "TENNESSEE WALKING HORSE", APART FROM THE MARK AS SHOWN.
FOR PULLOVER SHIRTS, T-SHIRTS, CAPS (U.S. CLS. 22 AND 39).
FIRST USE 11-0-2004; IN COMMERCE 11-9-2004.
ANDREA K. NADELMAN, EXAMINING ATTORNEY

THE MARK CONSISTS OF STANDARD CHARACTERS WITHOUT CLAIM TO ANY PARTICULAR FONT, STYLE, SIZE, OR COLOR.
OWNER OF U.S. REG. NOS. 1,122,872, 2,210,600 AND 2,266,965.
FOR FOOTWEAR (U.S. CLS. 22 AND 39).
FIRST USE 1-1-2005; IN COMMERCE 1-1-2005.
JEFF DEFORD, EXAMINING ATTORNEY

CLASS 25—(Continued).

SN 78-518,604. MIZRAHI SPORT INTERNATIONAL INC.,
NEW YORK, NY. FILED 11-17-2004.

KING GEORGE JEANS

THE MARK CONSISTS OF STANDARD CHARACTERS
WITHOUT CLAIM TO ANY PARTICULAR FONT, STYLE,
SIZE, OR COLOR.

NO CLAIM IS MADE TO THE EXCLUSIVE RIGHT TO
USE "JEANS", APART FROM THE MARK AS SHOWN.

FOR CLOTHING, NAMELY JEANS, PANTS, SHORTS,
TROUSERS, OVERALLS, SHIRTS, T-SHIRTS, POLO
SHIRTS, SPORT SHIRTS, KNIT SHIRTS, CAPS, JACK-
ETS, SPORT COATS, OVERCOATS, SUITS, SOCKS,
SWEATERS, SWIMWEAR, HEADWEAR, FOOTWEAR,
UNDERWEAR, HOSIERY, SOCKS, NECKTIES,
SCARVES, BELTS, AND GLOVES (U.S. CLS. 22 AND 39).

FIRST USE 1-1-1997; IN COMMERCE 1-1-1997.
MICHELE SWAIN, EXAMINING ATTORNEY

SN 78-518,728. SMARTWOOL CORP., STEAMBOAT
SPRINGS, CO. FILED 11-17-2004.

**ANYWHERE
ANYWEATHER**

THE MARK CONSISTS OF STANDARD CHARACTERS
WITHOUT CLAIM TO ANY PARTICULAR FONT, STYLE,
SIZE, OR COLOR.

FOR HOSIERY; SOCKS; THERMAL UNDERWEAR;
UNDERGARMENTS; UNDERWEAR; PANTS; SHIRTS;
JACKETS; SWEATERS; NECK GAITERS; TIGHTS;
VESTS; SWEAT SHIRTS; LEG WARMERS; ARM WAR-
MERS; HATS; GLOVES; AND MITTENS (U.S. CLS. 22
AND 39).

ANDREW BENZMILLER, EXAMINING ATTORNEY

CLASS 25—(Continued).

SN 78-518,771. DOGSTERS, LLC, MILFORD, CT. FILED 11-
17-2004.

CATSTERS

THE MARK CONSISTS OF STANDARD CHARACTERS
WITHOUT CLAIM TO ANY PARTICULAR FONT, STYLE,
SIZE, OR COLOR.

OWNER OF U.S. REG. NO. 2,921,591.

FOR APRONS, BANDANAS, BASEBALL CAPS, CHIL-
DREN'S EATING BIBS MADE OF CLOTH; CLOTHING,
NAMELY, SHIRTS, T-SHIRTS, HATS, JACKETS, COAT,
FLEECE PULLOVERS, HATS, INFANT WEAR; JERSEYS,
JEANS, NECK BANDS, NECKERCHIEFS, NECKTIES;
NECKWEAR, PAJAMAS, RAINWEAR, GLOVES, SWEA-
TERS, TENNIS WEAR, SOCKS, TROUSERS AND UN-
DERGARMENTS (U.S. CLS. 22 AND 39).

TEJBIR SINGH, EXAMINING ATTORNEY

SN 78-519,048. ERATO, ROBERT, PALM CITY, FL. FILED 11-
18-2004.

**DIVINE
INTERVENTION**

THE MARK CONSISTS OF STANDARD CHARACTERS
WITHOUT CLAIM TO ANY PARTICULAR FONT, STYLE,
SIZE, OR COLOR.

FOR LINGERIE AND UNDERGARMENTS, NAMELY
BRAS, BUSTIERS, CAMISOLES, GARTER BELTS, GIR-
DLES, NIGHT GOWNS, NIGHT SHIRTS, PAJAMAS,
PANTIES, PANTYHOSE, TEDDIES (U.S. CLS. 22 AND
39).

WON TEAK OH, EXAMINING ATTORNEY

CLASS 25—(Continued).

SN 78-519,062. SARA LEE CORPORATION, WINSTON-SALEM, NC. FILED 11-18-2004.

CLASS 25—(Continued).

SN 78-519,079. SARA LEE CORPORATION, WINSTON-SALEM, NC. FILED 11-18-2004.

SNOWBOUND

THE MARK CONSISTS OF STANDARD CHARACTERS WITHOUT CLAIM TO ANY PARTICULAR FONT, STYLE, SIZE, OR COLOR.
FOR UNDERWEAR, SHORTS, SHIRTS, T-SHIRTS, SOCKS AND PANTS (U.S. CLS. 22 AND 39).
WON TEAK OH, EXAMINING ATTORNEY

SN 78-519,063. ERATO, ROBERT, PALM CITY, FL. FILED 11-18-2004.

BETTER THAN A MIRACLE...ONLY GOD WILL KNOW THE TRUTH

THE MARK CONSISTS OF STANDARD CHARACTERS WITHOUT CLAIM TO ANY PARTICULAR FONT, STYLE, SIZE, OR COLOR.
FOR LINGERIE AND UNDERGARMENTS, NAMELY BRAS, BUSTIERS, CAMISOLES, GARTER BELTS, GIRDLES, NIGHT GOWNS, NIGHT SHIRTS, PAJAMAS, PANTIES, PANTYHOSE, TEDDIES (U.S. CLS. 22 AND 39).
WON TEAK OH, EXAMINING ATTORNEY

BALI LIFESTYLE COLLECTIONS

THE MARK CONSISTS OF STANDARD CHARACTERS WITHOUT CLAIM TO ANY PARTICULAR FONT, STYLE, SIZE, OR COLOR.
OWNER OF U.S. REG. NOS. 1,832,787, 2,807,373 AND OTHERS.
NO CLAIM IS MADE TO THE EXCLUSIVE RIGHT TO USE "COLLECTIONS", APART FROM THE MARK AS SHOWN.
FOR BRAS, PANTIES, CAMISOLES, TANK TOPS AND GARMENTS THAT SHAPE THE BODY, NAMELY BRIEFS, BODY BRIEFERS, THIGH SHAPERS, WAIST SHAPERS AND SHAPING TOPS (U.S. CLS. 22 AND 39).
MARLENE BELL, EXAMINING ATTORNEY

SN 78-519,246. PROPET USA, INC., KENT, WA. FILED 11-18-2004.

SEALTEX

THE MARK CONSISTS OF STANDARD CHARACTERS WITHOUT CLAIM TO ANY PARTICULAR FONT, STYLE, SIZE, OR COLOR.
FOR SHOES (U.S. CLS. 22 AND 39).
MICHAEL KAZAZIAN, EXAMINING ATTORNEY

CLASS 25—(Continued).

SN 78-519,259. CAPPELLO FOR YOU, L.L.C., FENTON, MO.
FILED 11-18-2004.

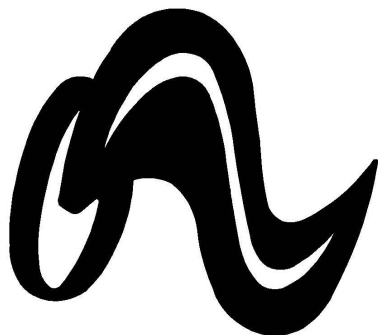

FOR CAPS, HATS, AND T-SHIRTS (U.S. CLS. 22 AND 39).
EUGENIA MARTIN, EXAMINING ATTORNEY

SN 78-519,389. O'NEAL, JERMAINE, SAN FRANCISCO, CA.
FILED 11-18-2004.

J70

THE MARK CONSISTS OF STANDARD CHARACTERS WITHOUT CLAIM TO ANY PARTICULAR FONT, STYLE, SIZE, OR COLOR.

FOR CLOTHING, NAMELY PANTS, SHIRTS, SUITS, COATS, JACKETS, SWEATERS, BODY SUITS, SWEAT-SHIRTS, SWEATSUITS, SHORTS, TOPS, BOTTOMS, SLEEPWEAR, UNDERWEAR, SWIMWEAR, BEACH COVERUPS, SOCKS, GLOVES, NECKTIES, SCARVES, HEADWEAR, HATS, SUN VISORS, SANDALS, SHOES, AND FOOTWEAR (U.S. CLS. 22 AND 39).

BARBARA BROWN, EXAMINING ATTORNEY

CLASS 25—(Continued).

SN 78-519,463. R&B ENTERPRISES, LLC, BOSTON, MA.
FILED 11-18-2004.

Life is a Highway

THE MARK CONSISTS OF STANDARD CHARACTERS WITHOUT CLAIM TO ANY PARTICULAR FONT, STYLE, SIZE, OR COLOR.

FOR SHIRTS, HATS, SHOES, AND PANTS (U.S. CLS. 22 AND 39).

TANYA AMOS, EXAMINING ATTORNEY

SN 78-519,739. BYE-BYE INC., BOWIE, MD. FILED 11-18-2004.

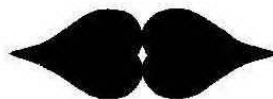

FOR WOMEN'S SHIRTS (U.S. CLS. 22 AND 39).
GINA HAYES, EXAMINING ATTORNEY

SN 78-519,871. WRANGLER APPAREL CORP., WILMINGTON, DE. FILED 11-19-2004.

ULTRA GUARD

THE MARK CONSISTS OF STANDARD CHARACTERS WITHOUT CLAIM TO ANY PARTICULAR FONT, STYLE, SIZE, OR COLOR.

FOR JEANS, CASUAL PANTS, TROUSERS, SHORTS, SWEAT PANTS, SWEAT SHORTS, SKIRTS, SHIRTS, BLOUSES, T-SHIRTS, PULL-OVER TOPS, SWEAT SHIRTS, SWEATERS, VESTS, JACKETS, SWEAT JACKETS, COATS, OVERALLS, COVERALLS, BELTS, SUSPENDERS, GLOVES, SCARVES, BANDANAS, HATS, CAPS, SOCKS, TIGHTS, HOSIERY, SHOES, SLIPPERS, BOOTS (U.S. CLS. 22 AND 39).

FLORENTINA BLANDU, EXAMINING ATTORNEY

CLASS 25—(Continued).

SN 78-520,107. GIZZY POP DESIGNS, HOUSTON, TX. FILED 11-19-2004.

CLASS 25—(Continued).

SN 78-520,189. KEENER, CAGLE, G., LAGUNA NIGUEL, CA. FILED 11-19-2004.

BallerinaGirl



THE MARK CONSISTS OF STANDARD CHARACTERS WITHOUT CLAIM TO ANY PARTICULAR FONT, STYLE, SIZE, OR COLOR.

FOR CLOTHING, NAMELY, SHIRTS AND TOPS FOR WOMEN AND GIRLS (U.S. CLS. 22 AND 39).
MICHAEL SOUDERS, EXAMINING ATTORNEY

THE COLOR(S) GRAY, DARK GREEN, LIGHT GREEN, YELLOW, ORANGE, RED, PURPLE, DARK BLUE, AND LIGHT BLUE IS/ARE CLAIMED AS A FEATURE OF THE MARK.

THE COLOR DARK GREEN APPEARS IN THE FAR-LEFT PETAL OF THE FLOWER/PINWHEEL DESIGN, AND OTHER COLORS APPEAR IN THE PETALS IN A CLOCKWISE MANNER IN THE FOLLOWING ORDER: LIGHT GREEN, YELLOW, ORANGE, RED, PURPLE, DARK BLUE, AND LIGHT BLUE. THE COLOR GRAY APPEARS IN THE WORD KEENBEAN.

FOR CLOTHING AND APPAREL, NAMELY, T-SHIRTS, HATS, JACKETS, SANDALS, JEANS, SKIRTS, SHORTS, PANTS, CLOTH BIBS, BEANIES (U.S. CLS. 22 AND 39).

SUNG IN, EXAMINING ATTORNEY

SN 78-520,120. STYLEMARK INC., ORMOND BEACH, FL. FILED 11-19-2004.

SN 78-520,386. LAKESHIRTS, INC., DETROIT LAKES, MN. FILED 11-19-2004.

STYLEMARK

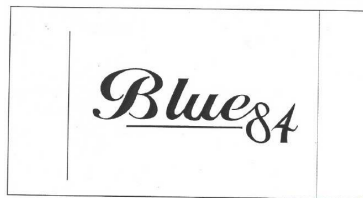

THE MARK CONSISTS OF STANDARD CHARACTERS WITHOUT CLAIM TO ANY PARTICULAR FONT, STYLE, SIZE, OR COLOR.

FOR HATS AND BELTS (U.S. CLS. 22 AND 39).
NORA BUCHANAN WILL, EXAMINING ATTORNEY

THE MARK CONSISTS OF STYLIZED WORD "BLUE 84" UNDERLINED AND PRINTED WITHIN A RECTANGULAR SHAPED GEOMETRIC DRAWING CONTAINING VERTICAL LINES NEAR EACH END OF THE RECTANGLE.

FOR OUTER CLOTHING, NAMELY SHIRTS, PANTS AND CAPS (U.S. CLS. 22 AND 39).

RUSS HERMAN, EXAMINING ATTORNEY

CLASS 25—(Continued).

SN 78-520,453. SAEZ, ENGLE E., SEATTLE, WA. FILED 11-19-2004.

CLASS 25—(Continued).

SN 78-520,816. NYP HOLDINGS, INC., NEW YORK, NY. FILED 11-22-2004.

ZOVO

PAGE SIX

THE MARK CONSISTS OF STANDARD CHARACTERS WITHOUT CLAIM TO ANY PARTICULAR FONT, STYLE, SIZE, OR COLOR.
FOR LINGERIE (U.S. CLS. 22 AND 39).
REBECCA GAN, EXAMINING ATTORNEY

THE MARK CONSISTS OF STANDARD CHARACTERS WITHOUT CLAIM TO ANY PARTICULAR FONT, STYLE, SIZE, OR COLOR.
OWNER OF U.S. REG. NOS. 1,678,509, 2,871,688 AND OTHERS.
FOR T-SHIRTS, SWEATSHIRTS, HATS, CAPS, JACKETS, SOCKS, BAR APRONS, BOXER SHORTS, HEADBANDS, PAJAMAS, ROBES, SCARVES, SUN VISORS, TIES, FASHION TOPS AND UNDERWEAR (U.S. CLS. 22 AND 39).
RON FAIRBANKS, EXAMINING ATTORNEY

SN 78-520,594. SUNSHINE PUBLICATIONS, INC., BONITA SPRINGS, FL. FILED 11-20-2004.

SN 78-521,227. MUDD (USA) LLC, NEW YORK, NY. FILED 11-22-2004.

Let's Do Lunch

RED MUKK

THE MARK CONSISTS OF STANDARD CHARACTERS WITHOUT CLAIM TO ANY PARTICULAR FONT, STYLE, SIZE, OR COLOR.
OWNER OF U.S. REG. NO. 2,820,513.
FOR T-SHIRTS, TANK TOPS, SWEAT SHIRTS, SHORTS, HATS, VISORS AND APRONS (U.S. CLS. 22 AND 39).
RONALD MCMORROW, EXAMINING ATTORNEY

THE MARK CONSISTS OF STANDARD CHARACTERS WITHOUT CLAIM TO ANY PARTICULAR FONT, STYLE, SIZE, OR COLOR.
FOR JEANS, PANTS, TOPS, SKIRTS, SHORTS, JACKETS, COATS, SWEATERS, SHIRTS AND FOOTWEAR (U.S. CLS. 22 AND 39).
ELIZABETH PIGNATELLO, EXAMINING ATTORNEY

CLASS 25—(Continued).

SN 78-521,280. BLUARROW AVIATION LIMITED, HALESOWEN, WEST MIDLANDS, UNITED KINGDOM, FILED 11-22-2004.



THE MARK CONSISTS OF THE TERM "FLYWHO" IN LOWER CASE LETTERING WITH A BUTTERFLY POSITIONED ABOVE AND TO THE RIGHT OF THE LETTER "O".

FOR CLOTHING, NAMELY, HEADWEAR, BEACHWEAR, FOOTWEAR, LOUNGEWEAR, SLEEPWEAR, INFANTWEAR, NECKTIES, SHIRTS, SOCKS, SWEATSHIRTS, T-SHIRTS, AND BASEBALL CAPS (U.S. CLS. 22 AND 39).

WENDY GOODMAN, EXAMINING ATTORNEY

SN 78-521,290. PANDELCO, INC., LOS ANGELES, CA. FILED 11-22-2004.

BE PRECIOUS

THE MARK CONSISTS OF STANDARD CHARACTERS WITHOUT CLAIM TO ANY PARTICULAR FONT, STYLE, SIZE, OR COLOR.

FOR CLOTHING, NAMELY TOPS AND BOTTOMS (U.S. CLS. 22 AND 39).

WENDY GOODMAN, EXAMINING ATTORNEY

CLASS 25—(Continued).

SN 78-521,329. GOLDLUCK INTERNATIONAL USA CORP., NEW YORK, NY. FILED 11-22-2004.

GIN MARLIER

THE NAME GIN MARLIER DOES NOT IDENTIFY A LIVING INDIVIDUAL.

THE MARK CONSISTS OF THE WORDS "GIN MARLIER" STYLIZED.

FOR CLOTHING, NAMELY, SHIRTS, BLOUSES, TIES, SWEATSHIRTS, SWEATERS, T-SHIRTS, VESTS, PANTS, CAPS, HATS, JACKETS, SPORT COATS, DRESSES, SOCKS, SHOES, HOSIERY, GLOVES, SUITS, SCARVES, BEANIES, LINGERIE, UNDERWEAR, LAYETTES, RAINCOATS, AND OUTERWEAR—NAMELY, COATS, JACKETS, AND BELTS (U.S. CLS. 22 AND 39).

FIRST USE 11-22-2004; IN COMMERCE 11-22-2004.

JOANNA DUKOVIC, EXAMINING ATTORNEY

SN 78-521,522. AMF BOWLING WORLDWIDE, INC., MECHANICSVILLE, VA. FILED 11-23-2004.



OWNER OF U.S. REG. NOS. 1,807,077, 2,703,766 AND OTHERS.

FOR BOWLING SHOES (U.S. CLS. 22 AND 39).

FIRST USE 5-31-1957; IN COMMERCE 5-31-1957.

DAVID C. REIHNER, EXAMINING ATTORNEY

SN 78-521,685. SECOND STRENGTH LLC, LEXINGTON, MA. FILED 11-23-2004.

SECOND STRENGTH

THE MARK CONSISTS OF STANDARD CHARACTERS WITHOUT CLAIM TO ANY PARTICULAR FONT, STYLE, SIZE, OR COLOR.

FOR FITNESS APPAREL, NAMELY, JACKETS, SWEATSHIRTS, SWEAT PANTS, T-SHIRTS, SHIRTS, TANK TOPS, CAPS, SHORTS, PANTS AND BANDANAS (U.S. CLS. 22 AND 39).

CHARLES L. JENKINS, EXAMINING ATTORNEY

CLASS 25—(Continued).

SN 78-521,820. UNDER ARMOUR, INC., BALTIMORE, MD.
FILED 11-23-2004.

UNDENIABLE

THE MARK CONSISTS OF STANDARD CHARACTERS
WITHOUT CLAIM TO ANY PARTICULAR FONT, STYLE,
SIZE, OR COLOR.

FOR CLOTHING, NAMELY SHIRTS AND T-SHIRTS
(U.S. CLS. 22 AND 39).

FIRST USE 10-19-2002; IN COMMERCE 10-19-2002.

DAVID H. STINE, EXAMINING ATTORNEY

SN 78-521,856. DYER, ANA DEBASA, TUJUNGA, CA. FILED
11-23-2004.

RECYCLED TEASE

THE MARK CONSISTS OF STANDARD CHARACTERS
WITHOUT CLAIM TO ANY PARTICULAR FONT, STYLE,
SIZE, OR COLOR.

NO CLAIM IS MADE TO THE EXCLUSIVE RIGHT TO
USE "RECYCLED", APART FROM THE MARK AS SHOWN.

FOR CLOTHING, NAMELY, PANTS, SHORTS,
SWEATPANTS, OVERALLS, SHIRTS, TEE-SHIRTS, JER-
SEY STYLE SHIRTS, SWEATSHIRTS, BLOUSES, JACK-
ETS, VESTS, COATS, RAINWEAR, SHOES, LINGERIE,
SLEEPWEAR, LOUNGEWEAR, SWIMWEAR, GLOVES,
SOCKS, HOISERY, BELTS, SCARVES, HATS, BASEBALL
STYLE CAPS, SKI CAPS, TIES, SLIPPERS (U.S. CLS. 22
AND 39).

FIRST USE 2-26-2004; IN COMMERCE 4-1-2004.

MICHAEL KEATING, EXAMINING ATTORNEY

CLASS 25—(Continued).

SN 78-521,959. AVIREX LTD., NEW YORK, NY. FILED 11-23-
2004.

THE COCKPIT

THE MARK CONSISTS OF STANDARD CHARACTERS
WITHOUT CLAIM TO ANY PARTICULAR FONT, STYLE,
SIZE, OR COLOR.

FOR CLOTHING, NAMELY SHIRTS, BLOUSES, T-
SHIRTS, SWEATERS, SWIMSUITS, SCARVES, NECK-
TIES, BELTS, SUSPENDERS, GLOVES, LINGERIE, UN-
DERGARMENTS, PAJAMAS, NIGHTGOWNS, HOISERY,
SOCKS, LEG WARMERS AND TIGHTS; FOOTWEAR,
NAMELY SHOES, BOOTS, SANDALS, ATHLETIC
SHOES, SNEAKERS AND SLIPPERS; HEADGEAR,
NAMELY HATS, CAPS, HEAD WEAR AND HEAD
BANDS (U.S. CLS. 22 AND 39).

FIRST USE 6-1-1980; IN COMMERCE 6-1-1980.

BARBARA BROWN, EXAMINING ATTORNEY

SN 78-521,968. BYER CALIFORNIA, SAN FRANCISCO, CA.
FILED 11-23-2004.

AMY WEAR

THE MARK CONSISTS OF STANDARD CHARACTERS
WITHOUT CLAIM TO ANY PARTICULAR FONT, STYLE,
SIZE, OR COLOR.

NO CLAIM IS MADE TO THE EXCLUSIVE RIGHT TO
USE "WEAR", APART FROM THE MARK AS SHOWN.

FOR CLOTHING, NAMELY, DRESSES, SKIRTS,
BLOUSES, SKORTS, SHORTS, SHIRTS, PANTS, JACK-
ETS, SWEATERS, VESTS AND JUMPSUITS (U.S. CLS. 22
AND 39).

BARBARA BROWN, EXAMINING ATTORNEY

CLASS 25—(Continued).

SN 78-522,220. AEROPOSTALE WEST, INC., WAYNE, NJ.
FILED 11-23-2004.

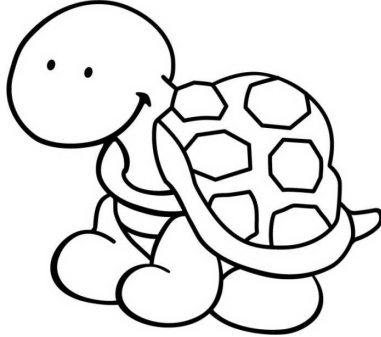

THE MARK CONSISTS OF A GRAPHIC IMAGE OF A TURTLE.

FOR CLOTHING, NAMELY, SHIRTS, T-SHIRTS, PANTS, SHORTS, SLEEPWEAR, UNDERWEAR, UNDERPANTS, AND SHOES, NAMELY, FLIP FLOPS AND SLIPPERS (U.S. CLS. 22 AND 39).

FIRST USE 3-7-2004; IN COMMERCE 3-7-2004.
LAURA KOVAISKY, EXAMINING ATTORNEY

CLASS 25—(Continued).

SN 78-522,426. STOP KILLING DOGS, INC., BALTIMORE, MD. FILED 11-24-2004.



FOR CLOTHING NAMELY SHIRTS, SHORTS AND SOCKS (U.S. CLS. 22 AND 39).

ANNE MADDEN, EXAMINING ATTORNEY

SN 78-522,410. NAVY EXCHANGE SERVICE COMMAND ("NEXCOM"), VIRGINIA BEACH, VA. FILED 11-24-2004.

SN 78-522,489. MEGAWEAR TRADING INC., NEW YORK, NY. FILED 11-24-2004.

Modern Images

THE MARK CONSISTS OF STANDARD CHARACTERS WITHOUT CLAIM TO ANY PARTICULAR FONT, STYLE, SIZE, OR COLOR.

OWNER OF U.S. REG. NO. 2,647,207.

FOR WOMEN'S, MEN'S, AND CHILDREN'S CLOTHING, NAMELY SPORTS WEAR IN THE NATURE OF SWEATERS, SWEATS SUITS, SHIRTS, JEANS, PANTS, DRESSES; OUTER WEAR IN THE NATURE OF JACKETS, OVERCOATS, HATS, SCARVES AND GLOVES; ACTIVE WEAR IN THE NATURE OF SWEATSHIRTS, T-SHIRTS, AND SNEAKERS; INTIMATE APPAREL IN THE NATURE SLEEPERS, BRAS, PANTIES, LOUNGE WEAR AND HOSIERY; ACCESSORIES IN THE NATURE OF SCARVES AND BELTS; SHOES; MEN'S SPORTSWEAR IN THE NATURE OF SWEATERS, SWEAT SUITS, SHIRTS, JEANS, AND PANTS; OUTER WEAR IN THE NATURE OF PAJAMAS, UNDERWEAR, AND HOSIERY; CHILDREN'S CLOTHING IN THE NATURE OF SLEEPERS, UNDERWEAR, AND OUTER WEAR, NAMELY, SNOW SUITS, JACKETS, AND SHOES (U.S. CLS. 22 AND 39).

FIRST USE 12-1-2000; IN COMMERCE 12-1-2000.
KATHRYN COWARD, EXAMINING ATTORNEY

MUGATU

THE MARK CONSISTS OF STANDARD CHARACTERS WITHOUT CLAIM TO ANY PARTICULAR FONT, STYLE, SIZE, OR COLOR.

FOR ARTICLES OF CLOTHING, NAMELY— SHIRTS, JUMPERS, SKIRTS, BLOUSES, COATS, JACKETS, WIND RESISTANT JACKETS, TRACKSUITS, SLACKS, TROUSERS, SHORTS, OVERALLS, DUNGAREES, SWEATERS, T-SHIRTS, SWEATSHIRTS, BLOUSONS, HOSIERY, TIGHTS, JEANS (U.S. CLS. 22 AND 39).

STEVEN R. FOSTER, EXAMINING ATTORNEY

CLASS 25—(Continued).

SN 78-522,598. NEW CONCEPT TRADING CORP., NEW YORK, NY. FILED 11-24-2004.

COUNTRY CONCEPT

THE MARK CONSISTS OF STANDARD CHARACTERS WITHOUT CLAIM TO ANY PARTICULAR FONT, STYLE, SIZE, OR COLOR.

NO CLAIM IS MADE TO THE EXCLUSIVE RIGHT TO USE "COUNTRY", APART FROM THE MARK AS SHOWN. FOR WOMEN'S DRESSES, PANTS, TOPS, BLOUSES, JACKETS, SUITS AND SWEATERS (U.S. CLS. 22 AND 39).

FIRST USE 2-0-2005; IN COMMERCE 2-0-2005.
LAURIE MAYES, EXAMINING ATTORNEY

SN 78-522,754. DFUNCT LLC, SAN FRANCISCO, CA. FILED 11-24-2004.

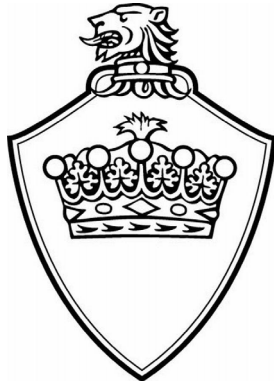

THE MARK CONSISTS OF A SHIELD WITH A CROWN IN THE MIDDLE AND AN ANIMAL HEAD ON TOP.

FOR CLOTHING, NAMELY, SHIRTS, SWEATSHIRTS, SWEATERS, PANTS, SHORTS, JACKETS, FOOTWEAR, CAPS AND HATS (U.S. CLS. 22 AND 39).

FIRST USE 3-31-2000; IN COMMERCE 11-30-2001.
LANA PHAM, EXAMINING ATTORNEY

SN 78-522,761. WINTER, CHRISTOPHER B., SMITHTOWN, NY. FILED 11-24-2004.



FOR AUDIOHAT, NAMELY, A FLEECE HAT WITH COMPARTMENTS FOR AUDIO SPEAKERS (U.S. CLS. 22 AND 39).

ANNE FARRELL, EXAMINING ATTORNEY

CLASS 25—(Continued).

SN 78-522,881. JOHNSON, WILLIAM A., LOS ANGELES, CA. FILED 11-24-2004.

KILLER SHREWS

THE MARK CONSISTS OF STANDARD CHARACTERS WITHOUT CLAIM TO ANY PARTICULAR FONT, STYLE, SIZE, OR COLOR.

FOR CLOTHING, NAMELY, FOOTWEAR, ATHLETIC FOOTWEAR, ATHLETIC SHOES, SHOES, BOOTS, SLIPPERS, BASKETBALL SHOES, CASUAL FOOTWEAR, SANDALS; APRONS, BANDANNAS, HEADBANDS, SWEATBANDS, WRISTBANDS, BATHING CAPS, BATHING SUITS AND TRUNKS, BEACHWEAR, SWIMWEAR, BEACH AND BATHING COVERUPS, BIKINIS, CLOTHING BELTS, BERMUDA SHORTS, BLAZERS, BLOUSES, COATS, HALLOWEEN AND MASQUERADE COSTUMES, FOUL WEATHER GEAR, GLOVES, GYM SHORTS, LEATHER COATS AND JACKETS, PANTS, PARKAS, PLAY SUITS, POLO SHIRTS, PONCHOS, PULLOVERS, RAIN COATS, SHIRTS, SKIRTS, SLACKS, SWEATPANTS, SWEATSHIRTS, SWEATSHORTS, SWEATERS, T-SHIRTS, TANK TOPS, TOPS, WET SUITS, JACKETS, JEANS, SUITS AND JOGGING SUITS, WARM UP SUITS, JOGGING SUITS, SWEAT SUITS, BODY-SUITS, LEOTARDS, LEG WARMERS, SKI SUITS, SKI PANTS, SKI BIBS, SKI JACKETS, SUITS, TUXEDOS, TROUSERS, SHORTS, COATS, SPORT COATS, KNIT SHIRTS, VESTS, JUMPSUITS, OVERCOATS, WIND RESISTANT JACKETS; HEADWEAR, NAMELY, HATS, NECKTIES, NECKERCHIEVES, SCARVES; SLEEPWEAR, NAMELY, NIGHTGOWNS, ROBES, PAJAMAS, NIGHT-SHIRTS; RAINWEAR, NAMELY, GLOVES, MITTENS, GALOSHES; LINGERIE, PANTIES, UNDERCLOTHES, LOUNGEWEAR, UNDERWEAR, BRIEFS, UNDERPANTS, BOXER SHORTS, UNDERSHIRTS, SUSPENDERS, HOSIERY, SOCKS (U.S. CLS. 22 AND 39).

EDWARD NELSON, EXAMINING ATTORNEY

SN 78-523,300. TOPDOWN INTERNATIONAL INC., EDMONTON, ALBERTA, CANADA, FILED 11-27-2004.



THE MARK CONSISTS OF A SIMPLE DRAWING OF BUTTERFLY ON TOP OF THE WORD "WAY" OF THE "RITEWAY".

FOR CLOTHING, NAMELY, COATS, OVERCOATS, SUITS, SHIRTS, TROUSERS, SKIRTS, SWEATERS, T-SHIRTS, PAJAMAS, UNDERWEAR; FEATHER CLOTHING, NAMELY, FEATHER COATS, FEATHER SCARVES, FEATHER JACKETS, FEATHER GLOVES, FEATHER PANTS, FEATHER VESTS; LEATHER CLOTHING, NAMELY, LEATHER COATS, LEATHER OVERCOATS, LEATHER JACKETS; SHOES, HATS, GLOVES AND NECKTIES (U.S. CLS. 22 AND 39).

SUSAN HAYASH, EXAMINING ATTORNEY

CLASS 25—(Continued).

SN 78-523,527. FREEMAN INTERNATIONAL, INC., MONTVALE, NJ. FILED 11-29-2004.

ULTRA SHIELD

THE MARK CONSISTS OF STANDARD CHARACTERS WITHOUT CLAIM TO ANY PARTICULAR FONT, STYLE, SIZE, OR COLOR.

FOR FOOTWEAR (U.S. CLS. 22 AND 39).
ANNE FARRELL, EXAMINING ATTORNEY

SN 78-523,570. N'GAI...LLC, NEW YORK, NY. FILED 11-29-2004.

n'gai...

THE ENGLISH TRANSLATION OF N'GAI IS CHOSEN ONE.

FOR CLOTHING, NAMELY, SHIRTS, T-SHIRTS, SWEATSHIRTS, DRESS SHIRTS, TANK TOPS, JERSEYS, BANDANAS, SWIMWEAR, UNDERWEAR, UNDERSHIRTS, LOUNGEWEAR, SLEEPWEAR, ROBES, WARM-UP SUITS, TRACK SUITS, SWEATERS, TURTLENECKS, BLOUSES, SHORTS, PANTS, CAPRI PANTS, JEANS, DRESSES, GOWNS, SUITS, SOCKS, FOOTWEAR, SCARVES, WRAPS, GLOVES, TIES, HATS, CAPS, COATS, JACKETS, FLEECE PULLOVERS, BLAZERS, VESTS, BELTS AND HOSIERY (U.S. CLS. 22 AND 39).
CHRISIE B. KING, EXAMINING ATTORNEY

SN 78-523,608. OREGON GLOVE COMPANY, SALEM, OR. FILED 11-29-2004.

CANE TRAINER

THE MARK CONSISTS OF STANDARD CHARACTERS WITHOUT CLAIM TO ANY PARTICULAR FONT, STYLE, SIZE, OR COLOR.

FOR GLOVES- NAMELY LEATHER PALM AND BACK WITH GAUNTLET CUFF (U.S. CLS. 22 AND 39).
FIRST USE 5-1-1999; IN COMMERCE 5-1-1999.
BARBARA BROWN, EXAMINING ATTORNEY

CLASS 25—(Continued).

SN 78-523,670. KOVAC MANUFACTURING INC., WEST MONTREAL, QUEBEC, CANADA, FILED 11-29-2004.

Touche

THE MARK CONSISTS OF STANDARD CHARACTERS WITHOUT CLAIM TO ANY PARTICULAR FONT, STYLE, SIZE, OR COLOR.

OWNER OF U.S. REG. NO. 2,682,249.
FOR INTIMATE APPAREL, NAMELY, BRAS, PANTIES, TEDDIES; COVER UPS; PAJAMAS; SLEEP SHIRTS; ROBES; GOWNS; SWIM WEAR, NAMELY, ONE PIECE BATHING SUITS; BIKINIS; SHORTS (U.S. CLS. 22 AND 39).
EVELYN BRADLEY, EXAMINING ATTORNEY

SN 78-523,689. ORIGINALES LEPE'S S.A DE C.V, ZAPOTLAN DEL REY, MEXICO, FILED 11-29-2004.

Only 4U Girls

FOR EXCLUSIVELY PANTS AND JEANS (U.S. CLS. 22 AND 39).
GINNY ISAACSON, EXAMINING ATTORNEY

CLASS 25—(Continued).

SN 78-523,736. MECHALY, FRANK, LOS ANGELES, CA.
FILED 11-29-2004.

CLASS 25—(Continued).

SN 78-524,072. MARENCO, PEDRO ALBERTO FUENTES, LA
LIBERTAD, EL SALVADOR, FILED 11-29-2004.

575

WANAKO

THE MARK CONSISTS OF STANDARD CHARACTERS
WITHOUT CLAIM TO ANY PARTICULAR FONT, STYLE,
SIZE, OR COLOR.

FOR JACKETS, SKIRTS AND PANTS (U.S. CLS. 22
AND 39).

SEAN DWYER, EXAMINING ATTORNEY

THE MARK CONSISTS OF STANDARD CHARACTERS
WITHOUT CLAIM TO ANY PARTICULAR FONT, STYLE,
SIZE, OR COLOR.

FOR SHIRTS AND T-SHIRTS FOR MEN, LADIES
BLOUSES, UNISEX PANTS, SWEAT SHIRTS, JACKETS,
COATS, CAPS, HATS, SOCKS, STOCKINGS, MEN AND
WOMENS UNDERWEAR (U.S. CLS. 22 AND 39).

DOMINICK J. SALEMI, EXAMINING ATTORNEY

SN 78-524,044. FREDRICO, SAN MARINO, CA. FILED 11-29-
2004.

SN 78-524,530. VANITY FAIR, INC., WILMINGTON, DE.
FILED 11-30-2004.

TRUTHSEEKER

INVISIBLY SMOOTH

THE MARK CONSISTS OF STANDARD CHARACTERS
WITHOUT CLAIM TO ANY PARTICULAR FONT, STYLE,
SIZE, OR COLOR.

FOR CLOTHING, NAMELY, T-SHIRTS, SHIRTS,
SWEATERS, SWEATSHIRTS, JACKETS, SLACKS,
JEANS, SHORTS, SKIRTS, SOCKS, UNDERWEAR, AND
HEADWEAR SUCH AS HATS AND CAPS (U.S. CLS. 22
AND 39).

FIRST USE 9-13-1999; IN COMMERCE 9-13-1999.
DANIEL BRODY, EXAMINING ATTORNEY

THE MARK CONSISTS OF STANDARD CHARACTERS
WITHOUT CLAIM TO ANY PARTICULAR FONT, STYLE,
SIZE, OR COLOR.

FOR LINGERIE, SLEEPWEAR AND HOSIERY (U.S.
CLS. 22 AND 39).

ELLEN BURNS, EXAMINING ATTORNEY

CLASS 25—(Continued).

SN 78-524,825. FRAGE, THOMAS G., STEWARTSVILLE, NJ. FILED 11-30-2004.

CLASS 25—(Continued).

SN 78-524,859. NINA FOOTWEAR CORP., NEW YORK, NY. FILED 11-30-2004.

DOLLS BY NINA

Style Pointz

THE MARK CONSISTS OF STANDARD CHARACTERS WITHOUT CLAIM TO ANY PARTICULAR FONT, STYLE, SIZE, OR COLOR.
OWNER OF U.S. REG. NOS. 681,187, 2,719,730 AND OTHERS.
FOR FOOTWEAR (U.S. CLS. 22 AND 39).
INGRID C. EULIN, EXAMINING ATTORNEY

THE MARK CONSISTS OF STANDARD CHARACTERS WITHOUT CLAIM TO ANY PARTICULAR FONT, STYLE, SIZE, OR COLOR.
FOR CLOTHING FOR PEOPLE, NAMELY, SHIRTS, PANTS, SHORTS, T-SHIRTS, HATS, GLOVES, SOCKS AND SHOES (U.S. CLS. 22 AND 39).
JOSETTE BEVERLY, EXAMINING ATTORNEY

SN 78-525,250. C.T. COMPAGNIE, AUTUN, FRANCE, FILED 12-1-2004.

SN 78-524,828. KILI SPORTS INTERNATIONAL, INC., PHOENIX, AZ. FILED 11-30-2004.

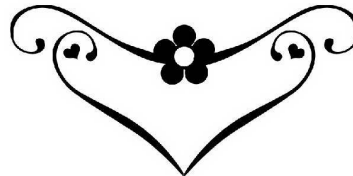

FOR BRAS AND PANTIES (U.S. CLS. 22 AND 39).
JENNIFER KRISP, EXAMINING ATTORNEY



SN 78-525,259. C.T. COMPAGNIE, AUTUN, FRANCE, FILED 12-1-2004.

THE MARK CONSISTS OF STYLIZED "K" - AN "I" AND A "C" CONNECTED - WITH "KILI" INSIDE THE "C".
THE ENGLISH TRANSLATION OF KILI IS AWESOME.
FOR FOOTWEAR; HEADWEAR; APPAREL, NAMELY, SWEATPANTS, SWEATSHIRTS, SHIRTS, SHORTS, SWEATERS, SLACKS, SOCKS, JACKETS, SWEAT SUITS, ROMPERS, JUMPSUITS, WARM-UP SUITS, SHOOTING SHIRTS, FLEECE TOPS, TANK TOPS, POLO SHIRTS, PANTS, UNITARDS, LEOTARDS, ATHLETIC BRAS, LEGGINGS, SKIRTS, RAIN SUITS, TURTLENECKS, BATHING SUITS, VESTS, PARKAS, BRA TOPS, TIGHTS, DRESSES, ATHLETIC UNIFORMS, GLOVES, THERMAL UNDERWEAR, INFANT WEAR, COVERALLS, RUNNING SUITS, BABY BIBS NOT OF PAPER, AND PAJAMAS (U.S. CLS. 22 AND 39).
DAVID ELTON, EXAMINING ATTORNEY

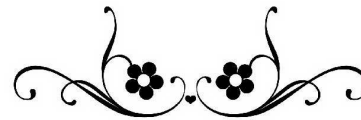

FOR BRAS AND PANTIES (U.S. CLS. 22 AND 39).
RONALD MCMORROW, EXAMINING ATTORNEY

CLASS 25—(Continued).

SN 78-525,277. L'S WEAR NY, INC., CENTERPORT, NY.
FILED 12-1-2004.

CLASS 25—(Continued).

SN 78-526,324. CRISTAL, DEAN V., SANTA BARBARA, CA.
FILED 12-2-2004.

STAPP

C 2 G

THE MARK CONSISTS OF STANDARD CHARACTERS WITHOUT CLAIM TO ANY PARTICULAR FONT, STYLE, SIZE, OR COLOR.

FOR CLOTHING, NAMELY, T-SHIRTS, SHORTS, PANTS, SHIRTS, SKIRTS, JACKETS, SLEEPWEAR, SWIMWEAR, NECKWEAR, HEADWEAR, UNDERWEAR, SOCKS, HOSIERY, JACKETS, HATS, AND CAPS (U.S. CLS. 22 AND 39).

JACQUELINE A. LAVINE, EXAMINING ATTORNEY

THE MARK CONSISTS OF STANDARD CHARACTERS WITHOUT CLAIM TO ANY PARTICULAR FONT, STYLE, SIZE, OR COLOR.

FOR SHIRTS, PANTS, SHORTS, JACKETS, SHOES, HATS, SWEATSHIRTS, SOCKS (U.S. CLS. 22 AND 39).

CATHERINE CAIN, EXAMINING ATTORNEY

SN 78-525,838. THE CUSTOM HOUSE, INC., NEWARK, NJ.
FILED 12-2-2004.

SN 78-526,335. CRISTAL, DEAN V., SANTA BARBARA, CA.
FILED 12-2-2004.

The Custom House

WHAT WOULD GOD SAY

NO CLAIM IS MADE TO THE EXCLUSIVE RIGHT TO USE "CUSTOM", APART FROM THE MARK AS SHOWN.

FOR CLOTHING ITEMS, NAMELY, SUITS, SHIRTS, PANTS, JACKETS, VESTS, AND NECK TIES (U.S. CLS. 22 AND 39).

FIRST USE 7-1-2003; IN COMMERCE 11-1-2003.
WENDY GOODMAN, EXAMINING ATTORNEY

THE MARK CONSISTS OF STANDARD CHARACTERS WITHOUT CLAIM TO ANY PARTICULAR FONT, STYLE, SIZE, OR COLOR.

FOR SHIRTS, PANTS, SHORTS, JACKETS, SHOES, HATS, SWEATSHIRTS, SOCKS (U.S. CLS. 22 AND 39).

GEOFFREY FOSDICK, EXAMINING ATTORNEY

CLASS 25—(Continued).

SN 78-526,340. CHRISTAL, DEAN V., SANTA BARBARA, CA.
FILED 12-2-2004.

CLASS 25—(Continued).

SN 78-527,178. SUPER LUCKY CAT, INC., LOS ANGELES,
CA. FILED 12-4-2004.

WWGS

bourgeois cat

THE MARK CONSISTS OF STANDARD CHARACTERS
WITHOUT CLAIM TO ANY PARTICULAR FONT, STYLE,
SIZE, OR COLOR.

FOR SHIRTS, PANTS, SHORTS, JACKETS, SHOES,
HATS, SWEATSHIRTS, SOCKS (U.S. CLS. 22 AND 39).
GEOFFREY FOSDICK, EXAMINING ATTORNEY

THE MARK CONSISTS OF STANDARD CHARACTERS
WITHOUT CLAIM TO ANY PARTICULAR FONT, STYLE,
SIZE, OR COLOR.

FOR CLOTHING, NAMELY, SHIRTS, PANTS, SKIRTS,
DRESSES, COATS, HATS, BELTS, TIES, MEN'S AND
WOMEN'S SHIRTS IN THE FORM OF BAGS (U.S. CLS.
22 AND 39).
MICHELLE DUBOIS, EXAMINING ATTORNEY

SN 78-526,341. LUDWICK, HENRY L. III, GLENSHAW, PA.
FILED 12-2-2004.

SN 78-527,273. TRIPLE T ENTERPRISES, INC., BOISE, ID.
FILED 12-5-2004.

**TERRORISM IS A
DISEASE**

SMOKY MOUNTAIN

THE MARK CONSISTS OF STANDARD CHARACTERS
WITHOUT CLAIM TO ANY PARTICULAR FONT, STYLE,
SIZE, OR COLOR.

FOR CLOTHING APPAREL, NAMELY SHIRTS,
SWEATSHIRTS, HOODED SWEATSHIRTS, HATS, VI-
SORS, JACKETS, AND PULLOVER JACKETS (U.S. CLS.
22 AND 39).
GEOFFREY FOSDICK, EXAMINING ATTORNEY

THE MARK CONSISTS OF STANDARD CHARACTERS
WITHOUT CLAIM TO ANY PARTICULAR FONT, STYLE,
SIZE, OR COLOR.

OWNER OF U.S. REG. NOS. 2,841,465, 2,879,077 AND
OTHERS.
FOR CLOTHING, NAMELY T-SHIRTS AND HATS
(U.S. CLS. 22 AND 39).
ROBIN CHOSID, EXAMINING ATTORNEY

CLASS 25—(Continued).

SN 78-527,480. PSYCHWORLD, INC., GAINESVILLE, FL.
FILED 12-6-2004.

Go Positive

THE MARK CONSISTS OF STANDARD CHARACTERS
WITHOUT CLAIM TO ANY PARTICULAR FONT, STYLE,
SIZE, OR COLOR.

FOR CLOTHING, NAMELY, SHIRTS, SWEATSHIRTS,
JACKETS, PANTS, SHOES, SKIRTS, AND HATS (U.S.
CLS. 22 AND 39).

KATRINA EDGE, EXAMINING ATTORNEY

SN 78-528,691. TAPIA, FERNANDO, DBA GAMEFACE-
GEAR, MORENO VALLEY, CA. FILED 12-7-2004.

GAMEFACEGEAR

THE MARK CONSISTS OF STANDARD CHARACTERS
WITHOUT CLAIM TO ANY PARTICULAR FONT, STYLE,
SIZE, OR COLOR.

FOR CLOTHING, NAMELY, FOOTWEAR AND HEAD
WEAR (U.S. CLS. 22 AND 39).

JIM RINGLE, EXAMINING ATTORNEY

SN 78-529,111. VANDERMOLEN, JON, RICHLAND, MI.
FILED 12-8-2004.

WHO HAS MORE FUN

THE MARK CONSISTS OF STANDARD CHARACTERS
WITHOUT CLAIM TO ANY PARTICULAR FONT, STYLE,
SIZE, OR COLOR.

FOR CLOTHING NAMELY, HATS, CAPS, VISORS,
SHIRTS, T-SHIRTS, SWEATSHIRTS, JACKETS, SHORTS,
CREW VESTS (U.S. CLS. 22 AND 39).

CAROLYN CATALDO, EXAMINING ATTORNEY

CLASS 25—(Continued).

SN 78-529,126. ACI INTERNATIONAL, LOS ANGELES, CA.
FILED 12-8-2004.

TRI AIR

THE MARK CONSISTS OF STANDARD CHARACTERS
WITHOUT CLAIM TO ANY PARTICULAR FONT, STYLE,
SIZE, OR COLOR.

FOR FOOTWEAR (U.S. CLS. 22 AND 39).

LINDA E. BLOHM, EXAMINING ATTORNEY

SN 78-530,052. FEDRICK, KEVIN, OLIVETTE, MO. FILED
12-9-2004.

FED KEV

THE MARK CONSISTS OF STANDARD CHARACTERS
WITHOUT CLAIM TO ANY PARTICULAR FONT, STYLE,
SIZE, OR COLOR.

FOR CLOTHING NAMELY JEANS, HATS, SHORTS, T-
SHIRTS, SHIRTS (U.S. CLS. 22 AND 39).

REBECCA SMITH, EXAMINING ATTORNEY

CLASS 25—(Continued).

SN 78-530,384. KROSLAK, JENNIFER, SCOTTSDALE, AZ. FILED 12-10-2004.

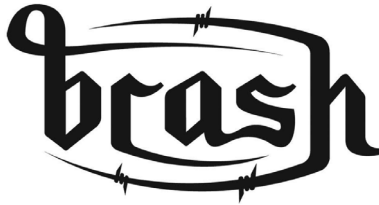

FOR MEN'S, BOY'S, WOMEN'S, GIRL'S AND CHILDREN'S SHIRTS, BLOUSES, JACKETS, COATS, T-SHIRTS, VESTS, SWEATERS, DENIM JACKETS, NECKWEAR, BELTS, BABY BIBS NOT OF PAPER, HEADWEAR AND HATS (U.S. CLS. 22 AND 39).

KARANENDRA S. CHHINA, EXAMINING ATTORNEY

SN 78-530,857. PREMKUMAR, SAKHRANI N, LOS ANGELES, CA. FILED 12-10-2004.

WEST COAST KIDS

THE MARK CONSISTS OF STANDARD CHARACTERS WITHOUT CLAIM TO ANY PARTICULAR FONT, STYLE, SIZE, OR COLOR.

FOR MEN'S, LADIES' AND CHILDREN'S CLOTHING, NAMELY, DRESSES, BLOUSES, SHORTS, BOXER SHORTS, CARGO SHORTS, BERMUDA SHORTS, JEANS, PANTS, SLACKS, JOGGING SUITS, BLAZERS, SHIRTS, T-SHIRTS, SKIRTS, 2 PIECE SKIRT SETS, 3 PIECE SKIRT SETS, TANK TOPS, HALTER TOPS, JACKETS, SWEAT SHIRTS, SWEAT SHORTS, SWEAT SUITS, SWEAT PANTS, SWEATERS, BRAS, BUSTIERS, PANTIES, GIRDLES, UNDERPANTS, UNDERSHIRTS, UNDERWEAR, VESTS, TIGHTS, BIKINIS, BATHING SUITS, SWIMWEAR, SWIMSUITS, BEACHWEAR, LINGERIE, CAMISOLES, BEACH COVER-UPS, LEOTARDS, PANTYHOSE, STOCKINGS, SOCKS, TIGHTS, SCARVES, KNIT SHIRTS, WOVEN SHIRTS, KNIT TOPS, WOVEN TOPS, SUITS, 2 PIECE SUIT SETS, 3 PIECE SUIT SETS, SLEEP WEAR, GOWNS, NIGHT GOWNS, 1 PIECE NIGHT DRESSES, 2 PIECE NIGHT DRESS SETS, 3 PIECE NIGHT DRESS SETS, BATHROBES, TEDDIES, TIES, 1 PIECE DRESS SETS, 2 PIECE DRESS SETS, 3 PIECE DRESS SETS, BELTS, SUSPENDERS, HATS, GLOVES, HEADBANDS, VISORS, CAPS, COATS AND RAIN COATS (U.S. CLS. 22 AND 39).

ALLISON SCHRODY, EXAMINING ATTORNEY

CLASS 25—(Continued).

SN 78-530,894. HOT TOPIC, INC., CITY OF INDUSTRY, CA. FILED 12-10-2004.

MUSIC = LIFE

THE MARK CONSISTS OF STANDARD CHARACTERS WITHOUT CLAIM TO ANY PARTICULAR FONT, STYLE, SIZE, OR COLOR.

FOR CLOTHING, NAMELY, MEN'S, WOMEN'S AND CHILDREN'S WEARING APPAREL NAMELY, JEANS, SHIRTS; OUTERWEAR NAMELY, JACKETS, COATS, VESTS, SPORTS JACKETS; PANTS, TROUSERS, SWEATERS, SWEATPANTS, SWEATSHIRTS, SWEAT SUITS, JUMPSUITS, SHORTS, OVERALLS, SHORTALLS, DRESSES, SKIRTS, BLOUSES, T-SHIRTS, KNIT SHIRTS, RAINWEAR, RAINCOATS, TANK TOPS, BATHING SUITS, SUITS, ROBES, PAJAMAS, LOUNGEWEAR, SLIPS, BELTS, BRIEFS, LEOTARDS, TIGHTS, HOSIERY, SOCKS, GLOVES, ARM WARMERS, PANTYHOSE, SCARVES, SHAWLS, PONCHOS, SUN VISORS, BLAZERS, BRAS, NIGHTGOWNS, UNDERGARMENTS, PANTIES, PERFORMANCE WEAR, NAMELY, JERSEYS, BICYCLE PANTS, GYMNASTIC SUITS; SPORTSWEAR, NAMELY PRINTED T-SHIRTS, SWIMWEAR, BEACH AND SWIMSUIT COVER-UPS; FOOTWEAR, NAMELY SHOES, SANDALS, BOOTS, RUBBER BOOTS, AND SLIPPERS; AND HEADGEAR, NAMELY, HATS, CAPS AND VISORS (U.S. CLS. 22 AND 39).

MARLENE BELL, EXAMINING ATTORNEY

SN 78-538,478. EASY LUCK CO., INC., MIAMI, FL. FILED 12-27-2004.

NEW STEP

THE MARK CONSISTS OF STANDARD CHARACTERS WITHOUT CLAIM TO ANY PARTICULAR FONT, STYLE, SIZE, OR COLOR.

FOR FOOTWEAR, NAMELY MEN, LADIES' AND CHILDREN'S SHOES, ATHLETIC SHOES, SANDALS, AND SLIPPERS (U.S. CLS. 22 AND 39).

FIRST USE 8-20-2002; IN COMMERCE 8-20-2002.
BARBARA RUTLAND, EXAMINING ATTORNEY

CLASS 25—(Continued).

SN 78-538,774. ALL FOR ONE, LLC, BERGENFIELD, NJ.
FILED 12-27-2004.



THE COLOR(S) WHITE, BLUE, LIGHT BLUE, SILVER AND BLACK IS/ARE CLAIMED AS A FEATURE OF THE MARK.

THE MARK CONSISTS OF CONCENTRIC CIRCLES OF WHITE, BLUE AND SILVER. INSIDE THE CIRCLES ARE THE LETTERS "AFO" IN BLUE AND INSIDE THE LETTER "O" IS THE NUMBER "5" IN LIGHT BLUE. TWO SMALL BLACK TRIANGLES SIT ON EACH SIDE OF THE LETTER "F".

FOR SHIRTS, PANTS, HATS, WRIST BANDS, ARM BANDS, HEAD BANDS AND FOOTWEAR (U.S. CLS. 22 AND 39).

FIRST USE 3-19-2004; IN COMMERCE 9-1-2004.
KEVIN DINALLO, EXAMINING ATTORNEY

SN 78-538,926. RUEGSEGGER, SHELLY, SAN DIEGO, CA.
FILED 12-28-2004.

GROPE

THE MARK CONSISTS OF STANDARD CHARACTERS WITHOUT CLAIM TO ANY PARTICULAR FONT, STYLE, SIZE, OR COLOR.

FOR CLOTHING, NAMELY, HATS, T-SHIRTS, SWEATSHIRTS, SWEATPANTS, TANK TOPS, BEANIES (U.S. CLS. 22 AND 39).

JANICE L. MCMORROW, EXAMINING ATTORNEY

CLASS 25—(Continued).

SN 78-539,064. BURT, MONTEZ DION, COPPERAS COVE, TX. FILED 12-28-2004.

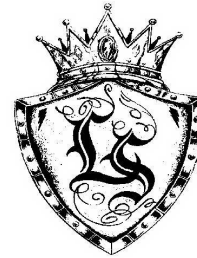

L.STREETS

FOR WOMEN'S AND MEN'S CLOTHING ITEMS, NAMELY, JEANS, SHIRTS, T-SHIRTS, SHOES, HATS, JACKETS, AND SWEATERS (U.S. CLS. 22 AND 39).
NAAKWAMA ANKRAH, EXAMINING ATTORNEY

SN 78-539,110. ZANJAN INC., LOS ANGELES, CA. FILED 12-28-2004.

LOGIN

THE MARK CONSISTS OF STANDARD CHARACTERS WITHOUT CLAIM TO ANY PARTICULAR FONT, STYLE, SIZE, OR COLOR.

FOR MEN'S CLOTHING, NAMELY, SHIRTS, T-SHIRTS, SWEATERS, PANTS AND JACKETS (U.S. CLS. 22 AND 39).

ELIZABETH PIGNATELLO, EXAMINING ATTORNEY

CLASS 25—(Continued).

SN 78-539,504. ADIDAS-SALOMON AG, D-91074 HERZOGENAUACH, FED REP GERMANY, FILED 12-29-2004.

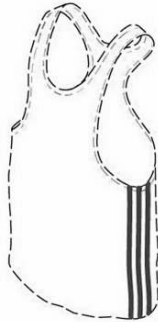

THE MARK CONSISTS OF THREE PARALLEL STRIPES RUNNING ALONG THE SLEEVE OF A SHIRT, T-SHIRT, SWEATSHIRT, VEST, JACKET OR COAT. THE DOTTED OUTLINE OF THE GARMENT IS NOT CLAIMED AS PART OF THE MARK AND IS INTENDED ONLY TO SHOW THE POSITION OF THE MARK.

SEC. 2(F).

FOR CLOTHING, NAMELY, SHIRTS, T-SHIRTS, SWEATSHIRTS, VESTS, JACKETS AND COATS (U.S. CLS. 22 AND 39).

FIRST USE 2-3-1967; IN COMMERCE 8-3-1967.
HOWARD SMIGA, EXAMINING ATTORNEY

SN 78-539,729. CMP MEDIA LLC, MANHASSET, NY. FILED 12-29-2004.

**CSI COMPUTER
SECURITY INSTITUTE**

THE MARK CONSISTS OF STANDARD CHARACTERS WITHOUT CLAIM TO ANY PARTICULAR FONT, STYLE, SIZE, OR COLOR.

FOR CLOTHING, NAMELY, SHIRTS, HATS AND CAPS (U.S. CLS. 22 AND 39).

FIRST USE 6-30-2004; IN COMMERCE 6-30-2004.
WENDY GOODMAN, EXAMINING ATTORNEY

CLASS 25—(Continued).

SN 78-539,894. KUHLMAN, BRUCE F, SAN RAFAEL, CA. FILED 12-29-2004.

Rock & Roll Mojo

THE MARK CONSISTS OF STANDARD CHARACTERS WITHOUT CLAIM TO ANY PARTICULAR FONT, STYLE, SIZE, OR COLOR.

FOR SHOES, HATS, SHIRTS, PANTS (U.S. CLS. 22 AND 39).

JENNIFER WILLISTON, EXAMINING ATTORNEY

SN 78-539,897. TORRES, DEBRA ROSA, NEW YORK, NY. FILED 12-29-2004.

Debra Torres

THE MARK CONSISTS OF STANDARD CHARACTERS WITHOUT CLAIM TO ANY PARTICULAR FONT, STYLE, SIZE, OR COLOR.

THE NAME(S), PORTRAIT(S), AND/OR SIGNATURE(S) SHOWN IN THE MARK IDENTIFIES DEBRA TORRES, WHOSE CONSENT(S) TO REGISTER IS SUBMITTED.

FOR CLOTHING, NAMELY, JACKETS, SHIRTS, PANTS, DRESSES, SKIRTS, SHORTS AND COATS (U.S. CLS. 22 AND 39).

JENNIFER WILLISTON, EXAMINING ATTORNEY

SN 78-539,958. MOST HIGH CLOTHING LINE, INC., DAUPHIN, PA. FILED 12-30-2004.

MOST HIGH CLOTHING

THE MARK CONSISTS OF STANDARD CHARACTERS WITHOUT CLAIM TO ANY PARTICULAR FONT, STYLE, SIZE, OR COLOR.

NO CLAIM IS MADE TO THE EXCLUSIVE RIGHT TO USE "CLOTHING", APART FROM THE MARK AS SHOWN. FOR CLOTHING, NAMELY HATS, CAPS, SHIRTS AND PANTS (U.S. CLS. 22 AND 39).

FIRST USE 6-20-2003; IN COMMERCE 9-15-2004.
JOHN DWYER, EXAMINING ATTORNEY

CLASS 25—(Continued).

SN 78-541,405. ROYAL BLUNTS, INC.; CORONA, CA. FILED 1-3-2005.

GOT BLUNTS?

THE MARK CONSISTS OF STANDARD CHARACTERS WITHOUT CLAIM TO ANY PARTICULAR FONT, STYLE, SIZE, OR COLOR.

OWNER OF U.S. REG. NO. 2,185,513.

FOR CLOTHING NAMELY, T-SHIRTS, DRESS SHIRTS, SHORT SLEEVE SHIRTS, PANTS, JACKETS, SHOES, BOOTS, COATS, SWEATSHIRTS, SWEATPANTS, BELTS, SOCKS AND HATS, WOMEN'S CLOTHING NAMELY, TANK TOPS, BLOUSES, BRAS AND PANTIES (U.S. CLS. 22 AND 39).

FIRST USE 9-1-2004; IN COMMERCE 9-1-2004.

WON TEAK OH, EXAMINING ATTORNEY

CLASS 25—(Continued).

SN 78-543,241. REDCATS USA, L.P., INDIANAPOLIS, IN. FILED 1-6-2005.

OUTDOOR ELEMENTS

THE MARK CONSISTS OF STANDARD CHARACTERS WITHOUT CLAIM TO ANY PARTICULAR FONT, STYLE, SIZE, OR COLOR.

NO CLAIM IS MADE TO THE EXCLUSIVE RIGHT TO USE "OUTDOOR", APART FROM THE MARK AS SHOWN. FOR WOMEN'S FASHION CLOTHING, NAMELY, WEATHER-RESISTANT COATS AND JACKETS (U.S. CLS. 22 AND 39).

APRIL L. RADEMACHER, EXAMINING ATTORNEY

SN 78-544,740. DASHAMERICA, INC., BROOMFIELD, CO. FILED 1-10-2005.

SYNCROGUIDE

THE MARK CONSISTS OF STANDARD CHARACTERS WITHOUT CLAIM TO ANY PARTICULAR FONT, STYLE, SIZE, OR COLOR.

FOR FOOTWEAR (U.S. CLS. 22 AND 39).

MARK T. MULLEN, EXAMINING ATTORNEY

SN 78-544,751. DASHAMERICA, INC., BROOMFIELD, CO. FILED 1-10-2005.

Tan Girl**SYNCROFLOAT**

THE MARK CONSISTS OF STANDARD CHARACTERS WITHOUT CLAIM TO ANY PARTICULAR FONT, STYLE, SIZE, OR COLOR.

FOR T-SHIRTS (U.S. CLS. 22 AND 39).

DOMINIC J. FERRAIUOLO, EXAMINING ATTORNEY

THE MARK CONSISTS OF STANDARD CHARACTERS WITHOUT CLAIM TO ANY PARTICULAR FONT, STYLE, SIZE, OR COLOR.

FOR FOOTWEAR (U.S. CLS. 22 AND 39).

MARK T. MULLEN, EXAMINING ATTORNEY

CLASS 25—(Continued).

SN 78-544,794. DASHAMERICA, INC., BROOMFIELD, CO. FILED 1-10-2005.

CLASS 25—(Continued).

SN 78-545,006. THE NORTH FACE APPAREL CORP., WIL-MINGTON, DE. FILED 1-10-2005.

SYNCROSEEK

STEEP TECH

THE MARK CONSISTS OF STANDARD CHARACTERS WITHOUT CLAIM TO ANY PARTICULAR FONT, STYLE, SIZE, OR COLOR.
FOR FOOTWEAR (U.S. CLS. 22 AND 39).
MARK T. MULLEN, EXAMINING ATTORNEY

THE MARK CONSISTS OF STANDARD CHARACTERS WITHOUT CLAIM TO ANY PARTICULAR FONT, STYLE, SIZE, OR COLOR.
FOR FOOTWEAR (U.S. CLS. 22 AND 39).
SONYA STEPHENS, EXAMINING ATTORNEY

SN 78-544,961. MARTIN STUART, LTD., NEW YORK, NY. FILED 1-10-2005.

SN 78-545,078. EL, ANTWAAN RANDLE, UNIONDALE, NY. FILED 1-10-2005.

N.Y.L. JEANS

AMAZING EL

THE MARK CONSISTS OF STANDARD CHARACTERS WITHOUT CLAIM TO ANY PARTICULAR FONT, STYLE, SIZE, OR COLOR.
OWNER OF U.S. REG. NO. 2,243,108.
NO CLAIM IS MADE TO THE EXCLUSIVE RIGHT TO USE "JEANS", APART FROM THE MARK AS SHOWN.
FOR CLOTHING FOR MISSY, JUNIOR, WOMAN, AND PETITE SIZES, NAMELY, SHIRTS, T-SHIRTS, SWEATSHIRTS, JACKETS, TANK TOPS, WORKOUT BRAS, PANTS, JODHPURS, CLAMDIGGERS, SHORTS, OVERALLS, SHORTALLS, SKIRTS, SWEATERS, JEANS, AND DRESSES; GIRLS' AND BOYS' WEAR, NAMELY, SHIRTS, T-SHIRTS, SWEATSHIRTS, JACKETS, TANK TOPS, PANTS, JODHPURS, CLAMDIGGERS, SHORTS, OVERALLS, SHORTALLS, SKIRTS, SWEATERS, JEANS, AND DRESSES; AND MEN'S WEAR, NAMELY, SHIRTS, T-SHIRTS, SWEATSHIRTS, JACKETS, TANK TOPS, PANTS, SHORTS, OVERALLS, SWEATERS, AND JEANS (U.S. CLS. 22 AND 39).
JOHN GARTNER, EXAMINING ATTORNEY

THE MARK CONSISTS OF STANDARD CHARACTERS WITHOUT CLAIM TO ANY PARTICULAR FONT, STYLE, SIZE, OR COLOR.
FOR MEN'S, WOMEN'S AND CHILDREN'S CLOTHING, NAMELY, FLEECE TOPS AND BOTTOMS, CAPS, HEADWEAR, T-SHIRTS, SWEATSHIRTS, SHORTS, TANK TOPS, SWEATERS, PANTS, JACKETS, TURTLE-NECKS, GOLF SHIRTS, WOVEN SHIRTS, KNIT SHIRTS, JERSEYS, WRISTBANDS, WARM UP SUITS, SWIMWEAR, WIND RESISTANT JACKETS, RAINCOATS, PARKAS, PONCHOS, GLOVES, TIES, SUSPENDERS, CLOTH BIBS, SLEEPWEAR, NAMELY, ROBES, NIGHT SHIRTS AND PAJAMAS, MITTENS, KNIT HATS AND CAPS, SCARVES, APRONS, HEADBANDS, EAR MUFFS, UNDERWEAR, SOCKS, SHOES, ATHLETIC SHOES, BOOTS, SNEAKERS AND SLIPPERS (U.S. CLS. 22 AND 39).
VIVIAN MICZNIK FIRST, EXAMINING ATTORNEY

CLASS 25—(Continued).

SN 78-545,493. FORTUNE FASHIONS INDUSTRIES, LLC, VERNON, CA. FILED 1-11-2005.

Nowheresville

THE MARK CONSISTS OF STANDARD CHARACTERS WITHOUT CLAIM TO ANY PARTICULAR FONT, STYLE, SIZE, OR COLOR.

FOR CLOTHING, NAMELY SHIRTS, T-SHIRTS, SWEATSHIRTS, TANK TOPS, BLOUSES, JACKETS, COATS, PANTS, SWEATPANTS, LEGGINGS, SKIRTS, SWIMWEAR, UNDERWEAR, LOUNGEWEAR, SLEEPWEAR, SCARVES, BELTS; HEADGEAR, NAMELY, BASEBALL CAPS, VISORS AND FOOTWEAR (U.S. CLS. 22 AND 39).

ANN LINNEHAN, EXAMINING ATTORNEY

CLASS 25—(Continued).

SN 78-545,536. IMPULSE WEAR, INC., BLACKLICK, OH. FILED 1-11-2005.

COUNTRY BOY

THE MARK CONSISTS OF STANDARD CHARACTERS WITHOUT CLAIM TO ANY PARTICULAR FONT, STYLE, SIZE, OR COLOR.

FOR SPORTSWEAR AND CASUAL CLOTHING, NAMELY, PANTS, SLACKS, SKIRTS, DRESSES, JUMPERS, BLOUSES, SHIRTS, TEE-SHIRTS, SOCKS, SHORTS, JACKETS, HOSIERY, TIGHTS, SCARVES, SASHES, HATS, CAPS, SHOES, SANDALS, SLIPPERS, SNEAKERS, ATHLETIC SHOES, TIES, CRAVATS, ASCOTS, SWIM TRUNKS, SWEATSHIRTS AND SWEAT SUITS (U.S. CLS. 22 AND 39).

FIRST USE 2-15-2004; IN COMMERCE 2-15-2004.

MARGERY A. TIERNEY, EXAMINING ATTORNEY

SN 78-545,515. IMPULSE WEAR, INC., BLACKLICK, OH. FILED 1-11-2005.

COUNTRY GIRL

THE MARK CONSISTS OF STANDARD CHARACTERS WITHOUT CLAIM TO ANY PARTICULAR FONT, STYLE, SIZE, OR COLOR.

FOR SPORTSWEAR AND CASUAL CLOTHING, NAMELY, PANTS, SLACKS, SKIRTS, DRESSES, JUMPERS, BLOUSES, SHIRTS, TEE-SHIRTS, SOCKS, SHORTS, JACKETS, HOSIERY, TIGHTS, SCARVES, SASHES, HATS, CAPS, SHOES, SANDALS, SLIPPERS, SNEAKERS, ATHLETIC SHOES, TIES, CRAVATS, ASCOTS, SWIM TRUNKS, SWEATSHIRTS AND SWEAT SUITS (U.S. CLS. 22 AND 39).

FIRST USE 2-15-2004; IN COMMERCE 2-15-2004.

MARGERY A. TIERNEY, EXAMINING ATTORNEY

SN 78-545,706. GUBIN, KARIN, MEMPHIS, TN. FILED 1-11-2005.

SO LAST YEAR

THE MARK CONSISTS OF STANDARD CHARACTERS WITHOUT CLAIM TO ANY PARTICULAR FONT, STYLE, SIZE, OR COLOR.

FOR CLOTHING, NAMELY, T-SHIRTS, SHIRTS, DRESSES, PANTS, JACKETS, COATS AND SHORTS (U.S. CLS. 22 AND 39).

DORITT L. CARROLL, EXAMINING ATTORNEY

CLASS 25—(Continued).

SN 78-545,732. MORAVEC, DANIEL, G., ROWLAND HEIGHTS, CA. FILED 1-11-2005.

CLASS 25—(Continued).

SN 78-546,005. SACRED TEEZ INC, KIHEI, HI. FILED 1-12-2005.



FOR T-SHIRTS (U.S. CLS. 22 AND 39).
WILLIAM VERHOSEK, EXAMINING ATTORNEY

Sacred Teez

THE MARK CONSISTS OF STANDARD CHARACTERS WITHOUT CLAIM TO ANY PARTICULAR FONT, STYLE, SIZE, OR COLOR.

NO CLAIM IS MADE TO THE EXCLUSIVE RIGHT TO USE "TEES", APART FROM THE MARK AS SHOWN.

FOR CLOTHING, NAMELY: SHORTS, PANTS, SHIRTS, TANK TOPS, JERSEYS, SWEATERS, JACKETS, COATS, WINDSUITS, WARM-UP SUITS, PAJAMAS, SLEEP WEAR, BATH ROBES, SOCKS, UNDERWEAR, BOXER SHORTS, HEADWEAR, HATS, CAPS, BEANIES, VISORS, HEADBANDS, GLOVES, UNITARDS, LEGGINGS, BRA TOPS, NECKTIES, BANDANNAS, SWIMWEAR (U.S. CLS. 22 AND 39).

FIRST USE 1-19-2005; IN COMMERCE 1-21-2005.
CHRISIE B. KING, EXAMINING ATTORNEY

SN 78-545,761. MACDONALD, CAMERON, DUXBURY, MA. FILED 1-11-2005.

SN 78-546,555. BYER CALIFORNIA, SAN FRANCISCO, CA. FILED 1-12-2005.

UNDERPOCKETS

BYER GIRL

THE MARK CONSISTS OF STANDARD CHARACTERS WITHOUT CLAIM TO ANY PARTICULAR FONT, STYLE, SIZE, OR COLOR.

FOR UNDERGARMENTS (U.S. CLS. 22 AND 39).
RONALD MCMORROW, EXAMINING ATTORNEY

THE MARK CONSISTS OF STANDARD CHARACTERS WITHOUT CLAIM TO ANY PARTICULAR FONT, STYLE, SIZE, OR COLOR.

NO CLAIM IS MADE TO THE EXCLUSIVE RIGHT TO USE "GIRL", APART FROM THE MARK AS SHOWN.

FOR CLOTHING, NAMELY, DRESSES, SKIRTS, BLOUSES, SKORTS, SHORTS, SHIRTS, PANTS, JACKETS, SWEATERS, VESTS AND JUMPSUITS (U.S. CLS. 22 AND 39).

FIRST USE 9-30-2004; IN COMMERCE 9-30-2004.
JUDITH HELFMAN, EXAMINING ATTORNEY

CLASS 25—(Continued).

SN 78-546,730. ALDANA, RICARDO MEYER, LEON, GTO., MEXICO, FILED 1-12-2005.



FOR TENNIS SHOES, SOCCER FOOTBALL SHOES, BASE BALL SHOES, ATHLETIC SHOES, CYCLING SHOES, ALPINISM SHOES, CASUAL SHOES, BOOTS AND SANDALS, PANTS, T SHIERTS, JERSEYS, SHORTS, JACKETS, CAPS (U.S. CLS. 22 AND 39).
FIRST USE 0-0-1999; IN COMMERCE 0-0-1999.
WON TEAK OH, EXAMINING ATTORNEY

SN 78-546,994. WATERBURY GARMENT CORP., WATERBURY, CT. FILED 1-13-2005.

WGC BOYZ

THE MARK CONSISTS OF STANDARD CHARACTERS WITHOUT CLAIM TO ANY PARTICULAR FONT, STYLE, SIZE, OR COLOR.

NO CLAIM IS MADE TO THE EXCLUSIVE RIGHT TO USE "BOYS", APART FROM THE MARK AS SHOWN.

FOR CHILDREN'S, TODDLER'S AND INFANTS' CLOTHING, NAMELY, UNDERWEAR, PAJAMAS, SLEEPWEAR, ROBES AND SLIPPERS (U.S. CLS. 22 AND 39).

FIRST USE 1-1-2004; IN COMMERCE 6-11-2004.
ANNE E. GUSTASON, EXAMINING ATTORNEY

SN 78-548,816. AMERIDIAN GROUP, INC., SAN DIEGO, CA. FILED 1-17-2005.

MABLE

FOR CLOTHING, NAMELY, SWEATERS (U.S. CLS. 22 AND 39).

FIRST USE 12-2-2004; IN COMMERCE 12-2-2004.
GEORGE LORENZO, EXAMINING ATTORNEY

CLASS 25—(Continued).

SN 78-550,999. HEADBLADE COMPANY, LLC, VENICE, CA. FILED 1-20-2005.

AGAINST THE GRAIN

THE MARK CONSISTS OF STANDARD CHARACTERS WITHOUT CLAIM TO ANY PARTICULAR FONT, STYLE, SIZE, OR COLOR.

FOR CAPS, HATS, T-SHIRTS (U.S. CLS. 22 AND 39).
FIRST USE 7-0-2004; IN COMMERCE 7-0-2004.
VIVIAN MICZNIK FIRST, EXAMINING ATTORNEY

SN 78-552,194. PÉ DE FERRO CALÇADOS E ARTEFATOS DE COURO LTDA., FRANCA, SAO PAULO, BRAZIL, FILED 1-22-2005.

PÉ DE FERRO

THE MARK CONSISTS OF STANDARD CHARACTERS WITHOUT CLAIM TO ANY PARTICULAR FONT, STYLE, SIZE, OR COLOR.

THE FOREIGN WORDING IN THE MARK TRANSLATES INTO ENGLISH AS IRON FOOT.

FOR FOOTWEAR FOR MEN, WOMEN AND CHILDREN, NAMELY, MEN'S SHOES, LADIES' SHOES AND CHILDREN'S SHOES, TENNIS SHOES, SANDALS, SLIPPERS, BOOTS AND SCUFFS (U.S. CLS. 22 AND 39).

JEFF DEFORD, EXAMINING ATTORNEY

SN 78-553,405. E. S. ORIGINALS, INC., NEW YORK, NY. FILED 1-25-2005.

MARRAKESH

THE MARK CONSISTS OF STANDARD CHARACTERS WITHOUT CLAIM TO ANY PARTICULAR FONT, STYLE, SIZE, OR COLOR.

FOR FOOTWEAR (U.S. CLS. 22 AND 39).
ATTIYA MALIK, EXAMINING ATTORNEY

CLASS 25—(Continued).

SN 78-553,490. VANITY FAIR, INC., WILMINGTON, DE.
FILED 1-25-2005.

BOUNCE MINIMIZER

THE MARK CONSISTS OF STANDARD CHARACTERS
WITHOUT CLAIM TO ANY PARTICULAR FONT, STYLE,
SIZE, OR COLOR.

FOR LINGERIE, SLEEPWEAR AND HOSIERY (U.S.
CLS. 22 AND 39).

AMY GEARIN, EXAMINING ATTORNEY

SN 78-553,642. PINK INC., DALLAS, TX. FILED 1-25-2005.

PINK!

THE MARK CONSISTS OF STANDARD CHARACTERS
WITHOUT CLAIM TO ANY PARTICULAR FONT, STYLE,
SIZE, OR COLOR.

FOR CLOTHING AND APPAREL, NAMELY, PAJAMA-
MAS, LOUNGEWEAR, UNDERWEAR, SLIPPERS,
SHIRTS, PANTS, SKIRTS, TOPS, HATS, VISORS, AND
SWEAT SUITS (U.S. CLS. 22 AND 39).

AMY HELLA, EXAMINING ATTORNEY

SN 78-555,530. RENTSCHLER, MICHAEL A., SHERMAN
OAKS, CA. FILED 1-28-2005.

Kiss My Flag

THE MARK CONSISTS OF STANDARD CHARACTERS
WITHOUT CLAIM TO ANY PARTICULAR FONT, STYLE,
SIZE, OR COLOR.

FOR SHORT-SLEEVED OR LONG-SLEEVED T-
SHIRTS, SWEAT SHIRTS, SWEAT PANTS, TANK-TOPS,
HATS, JACKETS, TIES, UNDERWEAR, SHOES, BOOTS,
SHORTS, SWEAT SHORTS, SWEAT BANDS, SUSPEN-
DERS, SUN VISORS, SWEAT BANDS, SWEAT SOCKS,
SWEATERS (U.S. CLS. 22 AND 39).

KEVON CHISOLM, EXAMINING ATTORNEY

CLASS 25—(Continued).

SN 78-556,184. NIKE, INC., BEAVERTON, OR. FILED 1-28-
2005.

DISKI

THE MARK CONSISTS OF STANDARD CHARACTERS
WITHOUT CLAIM TO ANY PARTICULAR FONT, STYLE,
SIZE, OR COLOR.

FOR FOOTWEAR; APPAREL, NAMELY T-SHIRTS,
SWEATSHIRTS, JACKETS, ANORAKS, PANTS, SKIRTS,
TANK TOPS, HEADWEAR, DRESSES, SHIRTS, WARM-
UP SUITS, SHORTS, VISORS, SOCKS, SPORTS BRAS,
SWEATBANDS, AND SWEATERS (U.S. CLS. 22 AND 39).

DOMINIC J. FERRAIUOLO, EXAMINING ATTORNEY

SN 78-556,193. REVISE CLOTHING, INC., TETERBORO, NJ.
FILED 1-28-2005.

VANILLA TWIST

THE MARK CONSISTS OF STANDARD CHARACTERS
WITHOUT CLAIM TO ANY PARTICULAR FONT, STYLE,
SIZE, OR COLOR.

OWNER OF U.S. REG. NO. 2,762,901.

FOR CLOTHING, NAMELY, SHIRTS, PANTS, JACK-
ETS AND JEANS FOR MEN, WOMAN AND CHILDREN
(U.S. CLS. 22 AND 39).

DOMINIC J. FERRAIUOLO, EXAMINING ATTORNEY

SN 78-558,155. CUTHBERT, DAVID L., WOODINVILLE, WA.
FILED 2-1-2005.

Nucomfort Bra

NO CLAIM IS MADE TO THE EXCLUSIVE RIGHT TO
USE "BRA", APART FROM THE MARK AS SHOWN.

FOR BRAS FOR WOMEN (U.S. CLS. 22 AND 39).

JEAN IM, EXAMINING ATTORNEY

CLASS 25—(Continued).

SN 78-558,299. CUTHBERT, DAVID L., WOODINVILLE, WA. FILED 2-1-2005.

Nucomfort *Ultra Light Bra*

NO CLAIM IS MADE TO THE EXCLUSIVE RIGHT TO USE "ULTRA LIGHT BRA", APART FROM THE MARK AS SHOWN.

FOR BRAS FOR WOMEN (U.S. CLS. 22 AND 39).
JEAN IM, EXAMINING ATTORNEY

CLASS 25—(Continued).

SN 78-572,058. WARNACO U.S., INC., MILFORD, CT. FILED 2-22-2005.

OLGA, THE FIGURE SOLUTIONS SPECIALIST

SN 78-560,096. HEPBURN II, JAMES H., OKLAHOMA CITY, OK. FILED 2-3-2005.



THE MARK CONSISTS OF THE LETTER "R" ON TOP OF THE LETTER "B" IN AN INTERLOCKING FASHION, AND A SUN WITHIN THE "B".

FOR CASUAL CLOTHING, NAMELY, SHIRTS, HATS, JACKETS, SHOES, SWEATS AND UNDERGARMENTS (U.S. CLS. 22 AND 39).

GIANCARLO CASTRO, EXAMINING ATTORNEY

THE MARK CONSISTS OF STANDARD CHARACTERS WITHOUT CLAIM TO ANY PARTICULAR FONT, STYLE, SIZE, OR COLOR.

OWNER OF U.S. REG. NOS. 780,385, 2,169,796 AND OTHERS.

NO CLAIM IS MADE TO THE EXCLUSIVE RIGHT TO USE "FIGURE" AND "SPECIALIST", APART FROM THE MARK AS SHOWN.

FOR INTIMATE APPAREL AND FIGURE ENHANCING GARMENTS, NAMELY, BRAS, PANTIES, UNDERWEAR, UNDERPANTS, UNDERGARMENTS, UNDERCLOTHES, TEDDIES, SLIPS, SARONGS, NEGLIGEEES, LINGERIE, FOUNDATION GARMENTS, GIRDLES, CORSETS, CAMISOLES, BODY SLIPS AND BODY SUITS, SLEEPWEAR AND NIGHTGOWNS (U.S. CLS. 22 AND 39).

CHARLES JOYNER, EXAMINING ATTORNEY

SN 78-565,544. GAP (APPAREL), LLC, SAN FRANCISCO, CA. FILED 2-11-2005.

GAP SELECT

THE MARK CONSISTS OF STANDARD CHARACTERS WITHOUT CLAIM TO ANY PARTICULAR FONT, STYLE, SIZE, OR COLOR.

FOR CLOTHING, NAMELY, PANTS, SHORTS, SWEATPANTS, OVERALLS, SHIRTS, TEE-SHIRTS, SWEATSHIRTS, BLOUSES, SKIRTS, DRESSES, JACKETS, VESTS, COATS, RAINWEAR, SHOES, LINGERIE, SLEEPWEAR, LOUNGEWEAR, UNDERWEAR, GLOVES, SOCKS, HOSIERY, BELTS, SCARVES, HATS, TIES, SLIPPERS (U.S. CLS. 22 AND 39).

ELLEN PERKINS, EXAMINING ATTORNEY

SN 78-575,528. EMERSON, ERNEST R., TORRANCE, CA. AND EMERSON, MARY, TORRANCE, CA. FILED 2-25-2005.

CQC

THE MARK CONSISTS OF STANDARD CHARACTERS WITHOUT CLAIM TO ANY PARTICULAR FONT, STYLE, SIZE, OR COLOR.

FOR CLOTHING, NAMELY T-SHIRTS, HATS, CAPS, JACKETS, SWEATSUITS, SWEATSHIRTS, PULLOVERS, LONG PANTS, SHORTS, LONG AND SHORT SLEEVED SHIRTS, VESTS, COATS (U.S. CLS. 22 AND 39).

SANJEEV VOHRA, EXAMINING ATTORNEY

CLASS 25—(Continued).

SN 78-581,817. LEGACY HOCKEY, LLC, PHOENIX, AZ. FILED 3-7-2005.



FOR CLOTHING, NAMELY, BEACH COVER-UPS, BELTS, BODY SUITS, BOXER SHORTS, CAPS, CLOTH BIBS, COATS, DRESSES, FOOTWEAR, EAR MUFFS, GLOVES, HATS, HEADBANDS, HOSIERY, HOUSECOATS, JACKETS, JERSEYS, MITTENS, NIGHTSHIRTS, PAJAMAS, PANTS, RAIN COATS, RAIN WEAR, ROBES, SCARVES, SHORTS, SKIRTS, SOCKS, SUITS, SUN VISORS, SUSPENDERS, SWEATERS, SWEATPANTS, SWEATSHIRTS, SWIMSUITS, SWIM TRUNKS, T-SHIRTS, POLO SHIRTS, TIES, UNDERWEAR, VESTS, WARM-UP SUITS AND WRISTBANDS (U.S. CLS. 22 AND 39).

CHERYL CLAYTON, EXAMINING ATTORNEY

CLASS 25—(Continued).

SN 78-581,829. LEGACY HOCKEY, LLC, PHOENIX, AZ. FILED 3-7-2005.



FOR CLOTHING, NAMELY, BEACH COVER-UPS, BELTS, BODY SUITS, BOXER SHORTS, CAPS, CLOTH BIBS, COATS, DRESSES, FOOTWEAR, EAR MUFFS, GLOVES, HATS, HEADBANDS, HOSIERY, HOUSECOATS, JACKETS, JERSEYS, MITTENS, NIGHTSHIRTS, PAJAMAS, PANTS, RAIN COATS, RAIN WEAR, ROBES, SCARVES, SHORTS, SKIRTS, SOCKS, SUITS, SUN VISORS, SUSPENDERS, SWEATERS, SWEATPANTS, SWEATSHIRTS, SWIMSUITS, SWIM TRUNKS, T-SHIRTS, POLO SHIRTS, TIES, UNDERWEAR, VESTS, WARM-UP SUITS AND WRISTBANDS (U.S. CLS. 22 AND 39).

CHERYL CLAYTON, EXAMINING ATTORNEY

SN 78-581,823. LEGACY HOCKEY, LLC, PHOENIX, AZ. FILED 3-7-2005.



THE COLOR(S) YELLOW, BLUE, BLACK AND WHITE IS/ ARE CLAIMED AS A FEATURE OF THE MARK.

THE COLOR YELLOW APPEARS IN THE LETTERS PHX. THE LETTERS ARE OUTLINED IN BLACK. THE COLORS BLUE, BLACK AND WHITE APPEAR AT THE ENDS OF THE HOCKEY STICKS.

THE MARK CONSISTS OF THE LETTERS PHX. THE LETTER X IS COMPRISED OF TWO UPSIDE DOWN HOCKEY STICKS.

FOR CLOTHING, NAMELY, BEACH COVER-UPS, BELTS, BODY SUITS, BOXER SHORTS, CAPS, CLOTH BIBS, COATS, DRESSES, FOOTWEAR, EAR MUFFS, GLOVES, HATS, HEADBANDS, HOSIERY, HOUSECOATS, JACKETS, JERSEYS, MITTENS, NIGHTSHIRTS, PAJAMAS, PANTS, RAIN COATS, RAIN WEAR, ROBES, SCARVES, SHORTS, SKIRTS, SOCKS, SUITS, SUN VISORS, SUSPENDERS, SWEATERS, SWEATPANTS, SWEATSHIRTS, SWIMSUITS, SWIM TRUNKS, T-SHIRTS, POLO SHIRTS, TIES, UNDERWEAR, VESTS, WARM-UP SUITS AND WRISTBANDS (U.S. CLS. 22 AND 39).

CHERYL CLAYTON, EXAMINING ATTORNEY

SN 78-590,504. DOGSTERS, LLC, MILFORD, CT. FILED 3-18-2005.



FOR APRONS, BANDANAS, BASEBALL CAPS, CHILDREN'S EATING BIBS MADE OF CLOTH; CLOTHING, NAMELY, SHIRTS, T-SHIRTS, HATS, JACKETS, COAT, FLEECE PULLOVERS, HATS, INFANT WEAR; JERSEYS, JEANS, NECK BANDS, NECKERCHIEFS, NECKTIES; NECKWEAR, PAJAMAS, RAINWEAR, GLOVES, SWEATERS, TENNIS WEAR, SOCKS, TROUSERS AND UNDERGARMENTS (U.S. CLS. 22 AND 39).

JIM RINGLE, EXAMINING ATTORNEY

CLASS 25—(Continued).

SN 78-624,827. THE TJX COMPANIES, INC., FRAMINGHAM, MA. FILED 5-6-2005.

OUR PETITE APPROACH

THE MARK CONSISTS OF STANDARD CHARACTERS WITHOUT CLAIM TO ANY PARTICULAR FONT, STYLE, SIZE, OR COLOR.

FOR CLOTHING, NAMELY, SWEATERS, TOPS, BOTTOMS, SKIRTS, JACKETS, COATS AND DRESSES (U.S. CLS. 22 AND 39).

SANJEEV VOHRA, EXAMINING ATTORNEY

SN 78-624,835. THE TJX COMPANIES, INC., FRAMINGHAM, MA. FILED 5-6-2005.

PETITE BY DESIGN

THE MARK CONSISTS OF STANDARD CHARACTERS WITHOUT CLAIM TO ANY PARTICULAR FONT, STYLE, SIZE, OR COLOR.

FOR CLOTHING, NAMELY, SWEATERS, TOPS, BOTTOMS, SKIRTS, JACKETS, COATS AND DRESSES (U.S. CLS. 22 AND 39).

SANJEEV VOHRA, EXAMINING ATTORNEY

SN 78-626,663. PANAMA JACK INTERNATIONAL, INC., ORLANDO, FL. FILED 5-10-2005.

PANAMA JACK BEACH CLUB

THE MARK CONSISTS OF STANDARD CHARACTERS WITHOUT CLAIM TO ANY PARTICULAR FONT, STYLE, SIZE, OR COLOR.

OWNER OF U.S. REG. NOS. 1,667,691, 2,802,252 AND OTHERS.

FOR CLOTHING, NAMELY, FOOTWEAR, SHOES, ATHLETIC SHOES, SANDALS, SLIPPERS, AQUA SHOES, SPORT SANDALS, CANVAS SHOES, SOCCER SHOES, DRESS SANDALS, BOAT SHOES, SLIPPERS, T-SHIRTS, SHIRTS, JERSEYS, BASEBALL SHIRTS, SWEAT SHIRTS, SWEAT PANTS, SWIM WEAR, DRESSES, JACKETS, COATS, HEADBANDS, PANTS, NIGHT SHIRTS, SKIRTS, ROBES, CAPS, HATS, VISORS, BELTS, PAJAMAS, SHORTS, SOCKS, LINGERIE, UNDERWEAR, BANDANNAS, JOGGING SUITS, NECKTIES, CAMP SHIRTS, LEG WARMERS, YOGA OR EXERCISE PANTS AND LOUNGEWEAR (U.S. CLS. 22 AND 39).

CAROLINE WOOD, EXAMINING ATTORNEY

CLASS 25—(Continued).

SN 78-645,153. DR PEPPER/SEVEN UP, INC., PLANO, TX. FILED 6-7-2005.

DR PEPPER

THE MARK CONSISTS OF STANDARD CHARACTERS WITHOUT CLAIM TO ANY PARTICULAR FONT, STYLE, SIZE, OR COLOR.

OWNER OF U.S. REG. NOS. 561,181, 2,230,689 AND OTHERS.

FOR CLOTHING, NAMELY TOPS, T-SHIRTS, PANTS AND LOUNGEWEAR, HEADWEAR, JACKETS AND FOOTWEAR (U.S. CLS. 22 AND 39).

FIRST USE 8-31-2004; IN COMMERCE 8-31-2004.

APRIL L. RADEMACHER, EXAMINING ATTORNEY

SN 78-975,830. SPOONER, JOSEPH LAWSON, BROOKLYN, NY. FILED 7-22-2003.

AFRO-PUNK

FOR T-SHIRTS, JACKETS, PANTS, SHIRTS, COATS, BANDANNAS, SWEATSHIRTS, FOOTWEAR, HEADWEAR AND FASHION ACCESSORIES, NAMELY, BELTS, TIES, GLOVES, SCARVES, SOCKS, HOSIERY, UNDERWEAR, BOXER SHORTS, DRESSES AND WOMEN'S LINGERIE (U.S. CLS. 22 AND 39).

FIRST USE 5-29-2001; IN COMMERCE 5-29-2001.

GLENN CLARK, EXAMINING ATTORNEY

SN 79-001,666. ZETEX B.V., NETHERLANDS, FILED 2-27-2004.

PASTUNETTE

THE MARK CONSISTS OF STANDARD CHARACTERS WITHOUT CLAIM TO ANY PARTICULAR FONT, STYLE, SIZE, OR COLOR.

OWNER OF INTERNATIONAL REGISTRATION 0487474 DATED 7-25-1984, EXPIRES 7-25-2014.

FOR CLOTHING, NAMELY, UNDERWEAR, LINGERIE, NIGHT CLOTHES; HOME-WEAR, NAMELY, BATHROBES, HOUSECOATS, T-SHIRTS, SWEATERS AND TRACKSUITS; BOOTS, SHOES AND SLIPPERS (U.S. CLS. 22 AND 39).

STEVEN JACKSON, EXAMINING ATTORNEY

CLASS 25—(Continued).

SN 79-003,111. MUSTO LIMITED, UNITED KINGDOM,
FILED 5-11-2004.

MUSTO

THE MARK CONSISTS OF STANDARD CHARACTERS WITHOUT CLAIM TO ANY PARTICULAR FONT, STYLE, SIZE, OR COLOR.

OWNER OF INTERNATIONAL REGISTRATION 0826625 DATED 5-11-2004, EXPIRES 5-11-2014.

OWNER OF U.S. REG. NOS. 2,088,581 AND 2,626,040.
SEC. 2(F).

FOR ARTICLES OF CLOTHING, NAMELY, T-SHIRTS, POLO SHIRTS, TURTLENECKS, SWEATSHIRTS, SMOCKS, GILETS, SHORTS, SKIRTS, PANTS, TROUSERS, OVER-TROUSERS, BREEKS, WAISTCOATS, JACKETS, SMOCKS, ONE-PIECE SUITS, SALOPETTES, COATS, JERSEYS, WATER PROOF JACKETS, VESTS, BLOUSONS, GLOVES; HEADWEAR AND FOOTWEAR BEING FOR CASUAL WEAR, BEING LEISURE WEAR, BEING SAILING WEAR OR BEING WATERPROOF; UNDERGARMENTS, SOCKS (U.S. CLS. 22 AND 39).
BRENDAN REGAN, EXAMINING ATTORNEY

SN 79-004,595. DARKMEN TEKSTIL; SANAYI VE TICARET LIMITED SIRKETI, TURKEY, FILED 4-16-2004.



OWNER OF INTERNATIONAL REGISTRATION 0831191 DATED 4-16-2004, EXPIRES 4-16-2014.

FOR TROUSERS, JACKETS, SHIRTS, SKIRTS, TEE-SHIRTS, OVERCOATS, DRESSING GOWNS, SOCKS, NECKTIES, BLOUSES, CARDIGANS, SWEATERS, WAISTCOATS, SWIMSUITS, NIGHTGOWNS, SHORTS, PETTICOATS, UNDERPANTS, PAJAMAS, TRACKSUITS, SHAWLS, HATS, BATHROBES, VESTS, BRASSIERES, GLOVES, PULLOVERS, GARTERS, SCARVES (U.S. CLS. 22 AND 39).

JOHN LINCOSKI, EXAMINING ATTORNEY

CLASS 25—(Continued).

SN 79-005,222. KABUSHIKI KAISHA WANHANDOREDDO-KURABU, JAPAN, FILED 8-6-2004.

HELLCATPUNKS

THE MARK CONSISTS OF STANDARD CHARACTERS WITHOUT CLAIM TO ANY PARTICULAR FONT, STYLE, SIZE, OR COLOR.

OWNER OF INTERNATIONAL REGISTRATION 0833065 DATED 8-6-2004, EXPIRES 8-6-2014.

FOR CLOTHING, NAMELY, JACKETS, SKIRTS, TROUSERS, CARDIGANS, SWEATERS, VESTS, WAISTCOATS, OPEN-NECKED SHIRTS, BLOUSES, POLO SHIRTS, CAMISOLES, SOCKS, STOCKINGS, GLOVES, MITTENS, BANDANAS, MUFFLERS, TROUSER STRAPS, BELTS, AND FOOTWEAR (U.S. CLS. 22 AND 39).

KEVIN DINALLO, EXAMINING ATTORNEY

SN 79-005,238. MAGLIFICIO CHIEMAR S.R.L., ITALY,
FILED 6-25-2004.

ANNE CLAIRE

OWNER OF INTERNATIONAL REGISTRATION 0833108 DATED 6-25-2004, EXPIRES 6-25-2014.

THE NAME ANNE CLAIRE DOES NOT IDENTIFY A LIVING INDIVIDUAL.

THE MARK CONSISTS OF THE UNDERLINED WORDING ANNE CLAIRE ON A LIGHT BACKGROUND.

FOR KNITTED ARTICLES OF CLOTHING, NAMELY, JERSEYS, SWEATERS, SHIRTS, BLOUSES, UNDER-SHIRTS, SKIRTS, SHORTS, PANTS, JACKETS, CARDIGANS, OVERCOATS (U.S. CLS. 22 AND 39).

TIMOTHY FINNEGAN, EXAMINING ATTORNEY

SN 79-005,886. 313 BULLROT, SARL, FRANCE, FILED 4-5-2004.



BULLROT

OWNER OF INTERNATIONAL REGISTRATION 0767914A DATED 9-3-2001, EXPIRES 9-3-2011.

FOR CLOTHING, NAMELY, SCARVES, GOWNS, BATHING CAPS, BATHING TRUNKS, BATHING SUITS, UNDERWEAR, SOCKS, TIES, BANDANAS, SHAWLS, SHIRTS, GLOVES, WAISTCOATS, JACKETS, TROUSERS, SKIRTS, COATS, OVERCOATS, PARKAS, PULLOVERS, T-SHIRTS, SWEATSHIRTS, PAJAMAS, CLOTHING BELTS; FOOTWEAR, NAMELY, SHOES, BOOTS, SLIPPERS, SANDALS, HEEL PIECES FOR SHOES, ESPADRILLES; HATS, BERETS, BONNETS, CAPS, VISORS (U.S. CLS. 22 AND 39).

ROBERT C. CLARK JR., EXAMINING ATTORNEY

CLASS 25—(Continued).

SN 79-006,379. BRAMA SPORTSWEAR SRL, (MASSA CARARA), ITALY, FILED 6-16-2004.

RLTES

THE MARK CONSISTS OF STANDARD CHARACTERS WITHOUT CLAIM TO ANY PARTICULAR FONT, STYLE, SIZE, OR COLOR.

OWNER OF INTERNATIONAL REGISTRATION 0836230 DATED 6-16-2004, EXPIRES 6-16-2014.

FOR PULLOVERS; CARDIGANS; JERSEYS; NECKWEAR; SWEATERS; SOCKS; STOCKINGS; TIGHTS; TROUSERS; LEGGINGS; SKIRTS; JACKETS; JERKINS; SHIRTS; VESTS; WAISTCOATS; JUMPERS; TRACK SUITS; BLOUSES; BLOUSONS; JEANS; SWEAT PANTS; GYM SUITS; KNICKERS; PANTS; SHORTS; T-SHIRTS; SWEATSHIRTS; SHAWLS; SUITS AND DRESSES; WIND RESISTANT JACKETS; OVERCOATS; ANORAKS; COATS; RAINCOATS; BELTS; SUSPENDERS; GLOVES; LOUNGEWEAR; UNDERWEAR; BEACHWEAR; SLEEPWEAR; FOOTWEAR; HEADWEAR (U.S. CLS. 22 AND 39).

SUSAN LESLIE DUBOIS, EXAMINING ATTORNEY

SN 79-007,414. HONGQINGTING GROUP CO., LTD., YONGJIA; ZHEJIANG PROVINCE 325100, CHINA, FILED 8-4-2004.

JORO

OWNER OF INTERNATIONAL REGISTRATION 0839194 DATED 8-4-2004, EXPIRES 8-4-2014.

FOR SHOES; TRACK SHOES; CLOTHING, NAMELY TROUSERS, SHORTS, KNIT SHIRTS, SWEATERS, SHIRTS, COATS, SPORTS SHIRTS, VESTS, T-SHIRTS, DUST COATS, OVERCOATS, JACKETS, SKIRTS, DRESSES, SUITS, UNDERWEAR, SLEEPWEAR, UNDERPANTS, HATS; HOSIERY; SWIMSUITS; NECKTIES; LEATHER BELTS; LAYETTES; WATERPROOF CLOTHING, NAMELY, RAIN JACKETS (U.S. CLS. 22 AND 39).

KIMBERLY PERRY, EXAMINING ATTORNEY

CLASS 25—(Continued).

SN 79-007,425. J.B.A., FRANCE, FILED 8-12-2004.

PAUL BRIAL

THE MARK CONSISTS OF STANDARD CHARACTERS WITHOUT CLAIM TO ANY PARTICULAR FONT, STYLE, SIZE, OR COLOR.

PRIORITY DATE OF 2-25-2004 IS CLAIMED.

OWNER OF INTERNATIONAL REGISTRATION 0839219 DATED 8-12-2004, EXPIRES 8-12-2014.

THE NAME PAUL BRIAL DOES NOT IDENTIFY A LIVING INDIVIDUAL.

FOR UNDERWEAR; FOOTWEAR; HEADWEAR; BELTS AND GLOVES FOR DRESSING; CLOTHING, NAMELY, OVERALLS, GABARDINES, PARKAS, COATS, OVERCOATS, RAINCOATS, JACKETS, SUITS, WAISTCOATS, SWEATERS, BLOUSES, SHIRTS, TEE-SHIRTS, JUMPERS, SLIPOVER TOPS, PULLOVERS, TROUSERS, SHORTS, SKIRTS, DRESSES, FROCKS, PETTICOATS, NECKTIES, POCKET SQUARES, SCARVES, COLLARS, SHAWLS, SASHES, STOLE, PYJAMAS, SOCKS, SUSPENDERS, DRESSING GOWNS, BATHING SUITS, BATHROBES, BATHING TRUNKS, SWIMSUITS (U.S. CLS. 22 AND 39).

GENE MACIOL, EXAMINING ATTORNEY

CLASS 26—FANCY GOODS

SN 76-575,305. MITCHELLACE, INC., PORTSMOUTH, OH. FILED 2-12-2004.

BUNGEE LACES

NO CLAIM IS MADE TO THE EXCLUSIVE RIGHT TO USE "LACES", APART FROM THE MARK AS SHOWN.

FOR SHOE LACES (U.S. CLS. 37, 39, 40, 42 AND 50).

FIRST USE 12-1-1993; IN COMMERCE 12-1-1993.

INGA ERVIN, EXAMINING ATTORNEY

SN 76-589,915. DOLLAR TREE STORES, INC., CHESAPEAKE, VA. FILED 4-12-2004.

DECORATOR'S CHOICE

THE MARK CONSISTS OF STANDARD CHARACTERS WITHOUT CLAIM TO ANY PARTICULAR FONT, STYLE, SIZE, OR COLOR.

NO CLAIM IS MADE TO THE EXCLUSIVE RIGHT TO USE "DECORATOR'S", APART FROM THE MARK AS SHOWN.

FOR ARTIFICIAL FRUIT, ARTIFICIAL VEGETABLES AND ARTIFICIAL FLOWERS IN THE NATURE OF WREATHS (U.S. CLS. 37, 39, 40, 42 AND 50).

FIRST USE 3-20-2002; IN COMMERCE 3-20-2002.

ELLEN B. AWRICH, EXAMINING ATTORNEY

CLASS 26—(Continued).

SN 76-620,173. ACA CORPORATION, SAIPAN, MP, N. MARIANA ISLAND, FILED 11-12-2004.

I 
SAIPAN

NO CLAIM IS MADE TO THE EXCLUSIVE RIGHT TO USE "SAIPAN", APART FROM THE MARK AS SHOWN.

FOR FANCY GOODS, NAMELY, ARTIFICIAL FLOWERS, NOVELTY BUTTONS MADE OF TEXTILES, ORNAMENTAL NOVELTY PINS MADE OF PLASTIC, ORNAMENTAL RIBBONS MADE OF TEXTILES, HAIR ORNAMENTS MADE OF TEXTILES, PINS MADE OF PLASTIC FOR HAIR, ARTIFICIAL PLANTS, PRIZE RIBBONS, WIGS, WOOLEN LACES, AND ARTIFICIAL WREATHS (U.S. CLS. 37, 39, 40, 42 AND 50).

FIRST USE 9-10-2004; IN COMMERCE 9-10-2004.
MAUREEN DALL, EXAMINING ATTORNEY

CLASS 26—(Continued).

SN 78-385,025. POMCHIES LLC, PHOENIX, AZ. FILED 3-16-2004.

Pomsnap

THE MARK CONSISTS OF STANDARD CHARACTERS WITHOUT CLAIM TO ANY PARTICULAR FONT, STYLE, SIZE, OR COLOR.

FOR HAIR FASHION AND DECORATIVE ACCESSORIES, NAMELY, SNAP CLIPS (U.S. CLS. 37, 39, 40, 42 AND 50).

FIRST USE 1-16-2004; IN COMMERCE 2-23-2004.
GIANCARLO CASTRO, EXAMINING ATTORNEY

SN 78-377,638. COUNTY OF LOS ANGELES SHERIFF'S DEPARTMENT, MONTEREY PARK, CA. FILED 3-3-2004.

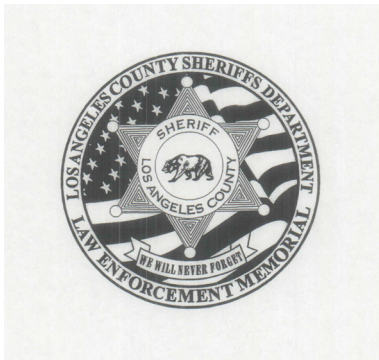

NO CLAIM IS MADE TO THE EXCLUSIVE RIGHT TO USE LOS ANGELES COUNTY, APART FROM THE MARK AS SHOWN.

FOR ORNAMENTAL CLOTH PATCHES FOR CLOTHING (U.S. CLS. 37, 39, 40, 42 AND 50).
FIRST USE 2-10-2004; IN COMMERCE 2-10-2004.
BRIDGETT SMITH, EXAMINING ATTORNEY

SN 78-480,312. EIC STEALTH, INC., AKRON, OH. FILED 9-8-2004.

KRT GLOBAL, INC.

THE MARK CONSISTS OF STANDARD CHARACTERS WITHOUT CLAIM TO ANY PARTICULAR FONT, STYLE, SIZE, OR COLOR.

NO CLAIM IS MADE TO THE EXCLUSIVE RIGHT TO USE "INC.", APART FROM THE MARK AS SHOWN.

FOR ARTIFICIAL TREES FOR USE WHEN HIDING COMMUNICATIONS TOWERS (U.S. CLS. 37, 39, 40, 42 AND 50).

RENEE MCCRAY, EXAMINING ATTORNEY

CLASS 26—(Continued).

SN 78-509,479. HOLY GROUND CHRISTIAN FELLOWSHIP, BUENA PARK, CA. FILED 11-1-2004.



THE COLOR(S) TAN, BLACK, BROWN, RED, WHITE IS/ ARE CLAIMED AS A FEATURE OF THE MARK.

THE MARK CONSISTS OF BLACK LETTERING ON TAN BACKGROUND WITH A BROWN CROSS THAT STATES INRI IN WHITE LETTERING, WITH A POOL OF RED BLOOD AT THE BASE OF THE CROSS WITH A WHITE TEAR DROP HITTING THE POOL OF BLOOD, WITH A BROWN CROWN OF THORNS AND A RED SLASH MARK BETWEEN THE LETTERS M/M.

FOR CLOTH PATCHES FOR CLOTHING (U.S. CLS. 37, 39, 40, 42 AND 50). MITCHELL FRONT, EXAMINING ATTORNEY

CLASS 26—(Continued).

SN 78-520,821. BRAZABRA CORPORATION, LEE, MA. FILED 11-22-2004.

UPSIE DAISIES

THE MARK CONSISTS OF STANDARD CHARACTERS WITHOUT CLAIM TO ANY PARTICULAR FONT, STYLE, SIZE, OR COLOR.

FOR BODY AND CLOTHING TAPE, NAMELY, ADHESIVE TAPE DESIGNED TO HOLD UP FORMAL WEAR STRAPLESS GOWNS (U.S. CLS. 37, 39, 40, 42 AND 50).

DOUGLAS LEE, EXAMINING ATTORNEY

SN 78-539,869. SIGNATURES NETWORK, INC., SAN FRANCISCO, CA. FILED 12-29-2004.

SN 78-517,511. ANGEL WREATHS, INC., BIRMINGHAM, AL. FILED 11-16-2004.

ANGEL WREATHS

THE MARK CONSISTS OF STANDARD CHARACTERS WITHOUT CLAIM TO ANY PARTICULAR FONT, STYLE, SIZE, OR COLOR.

OWNER OF U.S. REG. NOS. 2,914,254 AND 2,935,743. NO CLAIM IS MADE TO THE EXCLUSIVE RIGHT TO USE "WREATHS", APART FROM THE MARK AS SHOWN. FOR ARTIFICIAL WREATHS, NAMELY WREATHS MADE OF FEATHERS (U.S. CLS. 37, 39, 40, 42 AND 50). FIRST USE 6-3-2003; IN COMMERCE 6-3-2003. GISELLE AGOSTO, EXAMINING ATTORNEY

WINTERLAND

THE MARK CONSISTS OF STANDARD CHARACTERS WITHOUT CLAIM TO ANY PARTICULAR FONT, STYLE, SIZE, OR COLOR.

OWNER OF U.S. REG. NOS. 1,452,076, 2,368,379 AND OTHERS.

FOR BELT BUCKLES NOT OF PRECIOUS METAL (U.S. CLS. 37, 39, 40, 42 AND 50).

ELIZABETH HUGHITT, EXAMINING ATTORNEY

CLASS 26—(Continued).

SN 78-552,716. L'OREAL USA CREATIVE, INC., NEW YORK, NY. FILED 1-24-2005.

VISICOLOR

THE MARK CONSISTS OF STANDARD CHARACTERS WITHOUT CLAIM TO ANY PARTICULAR FONT, STYLE, SIZE, OR COLOR.

FOR TRANSLUCENT SHEETS FOR USE IN HAIR COLORING AND HAIR HIGHLIGHTING (U.S. CLS. 37, 39, 40, 42 AND 50).

MICHELLE DUBOIS, EXAMINING ATTORNEY

CLASS 27—(Continued).

SN 78-372,555. BETTER LIFE TECHNOLOGY LLC, LENEXA, KS. FILED 2-23-2004.



NO CLAIM IS MADE TO THE EXCLUSIVE RIGHT TO USE TECHNOLOGY L.L.C., APART FROM THE MARK AS SHOWN.

FOR FLOORING PRODUCTS, NAMELY FLEXIBLE PROTECTIVE FLOOR COVERINGS AND FLOOR MATS FOR COVERING EXISTING FLOORS (U.S. CLS. 19, 20, 37, 42 AND 50).

FIRST USE 2-1-2000; IN COMMERCE 2-1-2000.

BILL DAWE, EXAMINING ATTORNEY

SN 78-432,562. MEDICI888 LLC, VIRGINIA BEACH, VA. FILED 6-9-2004.

CLASS 27—FLOOR COVERINGS

SN 76-622,101. DE WITTE, JAMES, KORTRIJK, BELGIUM, FILED 11-26-2004.

2TEC2

THE MARK CONSISTS OF STANDARD CHARACTERS WITHOUT CLAIM TO ANY PARTICULAR FONT, STYLE, SIZE, OR COLOR.

FOR NON-TEXTILE WALL COVERINGS, NON-TEXTILE WALL HANGINGS, TAPESTRY STYLE WALL HANGINGS, NOT OF TEXTILE; CARPETS; FLOOR COVERINGS (U.S. CLS. 19, 20, 37, 42 AND 50).

SUSAN HAYASH, EXAMINING ATTORNEY

DOORMATES

THE MARK CONSISTS OF STANDARD CHARACTERS WITHOUT CLAIM TO ANY PARTICULAR FONT, STYLE, SIZE, OR COLOR.

FOR DOOR MATS; DOOR MATS OF INDIA RUBBER; DOOR MATS OF INDIA RUBBER OR TEXTILE; DOOR MATS OF TEXTILE (U.S. CLS. 19, 20, 37, 42 AND 50).

STANLEY I. OSBORNE, EXAMINING ATTORNEY

CLASS 27—(Continued).

SN 78-443,310. COLUMBIA INSURANCE COMPANY, OMAHA, NE. FILED 6-29-2004.



NO CLAIM IS MADE TO THE EXCLUSIVE RIGHT TO USE "EPA PRESIDENTIAL GREEN CHEMISTRY AWARD WINNER ENVIRONMENTALLY PREFERABLE PRODUCT", APART FROM THE MARK AS SHOWN.
FOR CARPETING (U.S. CLS. 19, 20, 37, 42 AND 50).
FIRST USE 2-29-2004; IN COMMERCE 2-29-2004.
MARLENE BELL, EXAMINING ATTORNEY

SN 78-492,221. TARKETT INC., FARNHAM, CANADA, FILED 9-30-2004.

MOTION

THE MARK CONSISTS OF STANDARD CHARACTERS WITHOUT CLAIM TO ANY PARTICULAR FONT, STYLE, SIZE, OR COLOR.
FOR FLOOR COVERINGS, NAMELY SYNTHETIC RESIN (VINYL) FLOOR COVERINGS (U.S. CLS. 19, 20, 37, 42 AND 50).
TINA L. SNAPP, EXAMINING ATTORNEY

CLASS 27—(Continued).

SN 78-502,839. BRITON ENGINEERING DEVELOPMENTS LTD, HOLMFIRTH, UNITED KINGDOM, FILED 10-20-2004.

SNOWFLEX

THE MARK CONSISTS OF STANDARD CHARACTERS WITHOUT CLAIM TO ANY PARTICULAR FONT, STYLE, SIZE, OR COLOR.

OWNER OF UNITED KINGDOM REG. NO. 2176655, DATED 9-5-1998, EXPIRES 9-5-2008.

FOR ARTIFICIAL CARPET-LIKE SNOW SPORTS SURFACE FOR ALL-WEATHER YEAR-ROUND USE FOR SKIING AND SNOWBOARDING CONSISTING OF A POLYMER COMPOSITE MATERIAL WITH A MONOFILAMENT FIBER AND IMPREGNATED CARRIER LAYER WITH A SHOCK LAYER (U.S. CLS. 19, 20, 37, 42 AND 50).

MARK T. MULLEN, EXAMINING ATTORNEY

SN 78-510,420. SHAW INDUSTRIES GROUP, INC., DALTON, GA. FILED 11-3-2004.

NO RULES

THE MARK CONSISTS OF STANDARD CHARACTERS WITHOUT CLAIM TO ANY PARTICULAR FONT, STYLE, SIZE, OR COLOR.

FOR CARPETING (U.S. CLS. 19, 20, 37, 42 AND 50).
FIRST USE 5-31-2004; IN COMMERCE 5-31-2004.
JULIE GUTTADAURO, EXAMINING ATTORNEY

CLASS 27—(Continued).

SN 78-546,561. SHAW INDUSTRIES GROUP, INC., DALTON, GA. FILED 1-12-2005.

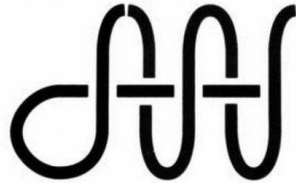

THE MARK CONSISTS OF A LOOPED WEAVE DESIGN. FOR CARPETING (U.S. CLS. 19, 20, 37, 42 AND 50). FIRST USE 12-11-2003; IN COMMERCE 12-11-2003. DAHLIA GEORGE, EXAMINING ATTORNEY

CLASS 28—(Continued).

SN 76-466,022. TOMY CORPORATION, NEWPORT BEACH, CA. FILED 11-4-2002.

SNOT

FOR TOYS AND GAMES, NAMELY, MOVABLE FIGURINES CONFIGURED AS ANIMALS FEATURING VOICE RESPONSE CAPABILITY (U.S. CLS. 22, 23, 38 AND 50). FIRST USE 9-18-2002; IN COMMERCE 9-18-2002. BARBARA A. LOUGHRAN, EXAMINING ATTORNEY

CLASS 28—TOYS AND SPORTING GOODS

SN 76-155,298. LUCAS, RONN, SHERMAN OAKS, CA. FILED 10-30-2000.

SCORCH

FOR STUFFED DOLLS (U.S. CLS. 22, 23, 38 AND 50). FIRST USE 7-12-1999; IN COMMERCE 7-12-1999. YONG KIM, EXAMINING ATTORNEY

SN 76-481,379. OFFICIALS' FLAGS 'N BAGS, USA INC., SARASOTA, FL. FILED 1-10-2003.

SN 76-426,600. AMERICAN AIRLINES, INC., DFW AIRPORT, TX. FILED 7-1-2002.

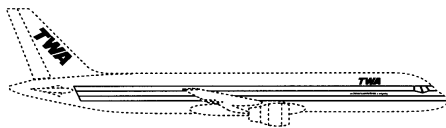

THE PLANE IS SILVER. THE STRIPES ARE BLUE, WHITE AND RED. THE LETTERING ON THE PLANE IS RED.

THE BODY, WINGS AND ENGINE OF THE PLANE ARE SILVER. THERE ARE THREE (3) STRIPES PLACED HORIZONTALLY ALONG THE PLANE. THE STRIPES ARE BLUE, WHITE AND RED IN DESCENDING ORDER. THE LETTERS "T-W-A" ARE RED OUTLINED IN WHITE.

FOR SCALE MODEL AIRPLANES (U.S. CLS. 22, 23, 38 AND 50).

FIRST USE 12-2-2001; IN COMMERCE 12-2-2001. JASON TURNER, EXAMINING ATTORNEY

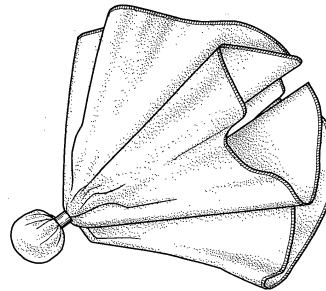

THE LINING SHOWN IN THE MARK ON THE DRAWING IS A FEATURE OF THE MARK AND DOES NOT INDICATE COLOR. THE STIPPLING SHOWN IN THE MARK ON THE DRAWING IS FOR SHADING PURPOSES ONLY.

THE MARK CONSISTS OF THE CONFIGURATION OF A PENALTY FLAG.

SEC. 2(F). FOR PENALTY FLAGS FOR FOOTBALL OFFICIALS (U.S. CLS. 22, 23, 38 AND 50).

FIRST USE 8-0-1986; IN COMMERCE 8-0-1986. DEZMONA MIZELLE, EXAMINING ATTORNEY

CLASS 28—(Continued).

SN 76-496,635. MICKI LEKSAKER AB, 360 32 GEMLA, SWEDEN, FILED 3-11-2003.

MICKI

PRIORITY CLAIMED UNDER SEC. 44(D) ON SWEDEN APPLICATION NO. 2002/08214, FILED 12-13-2002, REG. NO. 362179, DATED 7-18-2003, EXPIRES 7-18-2013.

FOR COMPLETE LINE OF WOODEN GAMES AND PLAYTHINGS; TOY MINIATURES OF FURNITURE, TOY SET OF CARPENTER'S TOOLS DOLL'S PRAMS, DOLL'S BEDS, TOY BENCHES, WITH KNOCK COMPONENTS, BUILDING RODS, BUILDING BLOCKS, WEAVING LOOMS AND WEAVING FRAMES, MINIATURE FARMS AND MINIATURE CASTLES, PLAYHOUSES, TRAINS AND EQUIPMENT AND FITTINGS TO TRAINS AND RAILWAYS, PUZZLES; KITCHEN PLAYTHINGS, NAMELY MINIATURE KITCHEN FURNITURE AND FIXTURES AND KITCHEN UTENSILS AND KITCHEN EQUIPMENT AND FITTINGS; CHINAWARE; TOY HOUSES, DOLL'S HOUSES AND ACCESSORIES, NAMELY FITTINGS AND INTERIOR DECORATIONS THEREFOR IN THE FORM OF TOY MINIATURES OF FURNITURE, CARPETS, CURTAINS, STAIRCASES, LADDERS, BATHROOM AND KITCHEN EQUIPMENT AND FITTINGS, ELECTRICAL AND LIGHTING FITTINGS AND EQUIPMENT, LAMPS, SPORTS APPLIANCES, PLAY TOOLS, GARDEN FURNITURE, GARDENS AND GARDEN INSTALLATIONS (U.S. CLS. 22, 23, 38 AND 50).

ESTHER A. BORSUK, EXAMINING ATTORNEY

SN 76-496,636. MICKI LEKSAKER AB, 360 32 GEMLA, SWEDEN, FILED 3-11-2003.



PRIORITY CLAIMED UNDER SEC. 44(D) ON SWEDEN APPLICATION NO. 2002/08213, FILED 12-13-2002, REG. NO. 362178, DATED 7-18-2003, EXPIRES 7-18-2013.

FOR COMPLETE LINE OF WOODEN GAMES AND PLAYTHINGS; TOY MINIATURES OF FURNITURE, TOY SETS OF CARPENTER'S TOOLS DOLL'S PRAMS, DOLL'S BEDS, TOY BENCHES WITH KNOCKOUT COMPONENTS, BUILDING RODS, BUILDING BLOCKS, WEAVING LOOMS AND WEAVING FRAMES, MINIATURE FARMS AND MINIATURE CASTLES, PLAYHOUSES, TRAINS AND EQUIPMENT AND FITTINGS TO TRAINS AND RAILWAYS, PUZZLES; KITCHEN PLAYTHINGS, NAMELY MINIATURE KITCHEN FURNITURE AND FIXTURES AND KITCHEN UTENSILS AND KITCHEN EQUIPMENT AND FITTINGS; CHINAWARE; OUTDOOR PLAYTHINGS; TOY HOUSES, DOLL'S HOUSES AND ACCESSORIES, NAMELY FITTINGS AND INTERIOR DECORATIONS THEREFOR IN THE FORM OF TOY MINIATURES OF FURNITURE, CARPETS, CURTAINS, STAIRCASES, LADDERS, BATHROOM AND KITCHEN EQUIPMENT AND FITTINGS, ELECTRICAL AND LIGHTING FITTINGS AND EQUIPMENT, LAMPS, SPORTS APPLIANCES, PLAY TOOLS, GARDEN FURNITURE, GARDENS AND GARDEN INSTALLATIONS (U.S. CLS. 22, 23, 38 AND 50).

ESTHER A. BORSUK, EXAMINING ATTORNEY

CLASS 28—(Continued).

SN 76-519,954. WOODY O'TIME COMPANY LIMITED, NEW TERRITORIES, HONG KONG, FILED 5-23-2003.



PRIORITY CLAIMED UNDER SEC. 44(D) ON CHINA APPLICATION NO. 3433743, FILED 1-13-2003, REG. NO. 3433743, DATED 9-28-2004, EXPIRES 9-27-2014.

FOR BABY PRODUCTS AND TOYS, NAMELY, MECHANICAL TOYS, DOLLS, INFLATABLE TOYS, LEARNING TOYS, NAMELY, ELECTRONIC EDUCATIONAL GAME MACHINES FOR CHILDREN, MUSICAL TOYS, SOFT TOYS, NAMELY, PLUSH TOYS AND STUFFED TOYS, GAMES AND TOYS, NAMELY, PARLOR GAMES, CARD GAMES AND CHESS GAMES, TOY CLOCKS (U.S. CLS. 22, 23, 38 AND 50).

MARY ROSSMAN, EXAMINING ATTORNEY

SN 76-536,159. ALLEGHENY VALLEY SCHOOL, CORAOPOLIS, PA. FILED 7-28-2003.

MYRON COPE'S OFFICIAL

The
**terrible
towel**

OWNER OF U.S. REG. NOS. 2,123,428, 2,128,165 AND 2,386,205.

NO CLAIM IS MADE TO THE EXCLUSIVE RIGHT TO USE OFFICIAL, APART FROM THE MARK AS SHOWN.

THE NAME MYRON COPE IDENTIFIES A LIVING INDIVIDUAL WHOSE CONSENT IS OF RECORD.

FOR FOOTBALLS (U.S. CLS. 22, 23, 38 AND 50). FIRST USE 11-14-2003; IN COMMERCE 11-14-2003.

NANCY CLARKE, EXAMINING ATTORNEY

CLASS 28—(Continued).

SN 76-537,085. CARL WALTHER GMBH, 89073 ULM, FED REP GERMANY, FILED 8-11-2003.



OWNER OF ERPN CMNTY TM OFC REG. NO. 003167863, DATED 12-7-2004, EXPIRES 5-15-2013.

FOR TOY WEAPONS, NAMELY, TOY REPLICAS OF WEAPONS AND DECORATIVE TOY WEAPONS; TOY MODEL HOBBYCRAFT KITS, NAMELY, TOY MODEL KIT WEAPONS (U.S. CLS. 22, 23, 38 AND 50).
ALINA MORRIS, EXAMINING ATTORNEY

CLASS 28—(Continued).

SN 76-549,551. MARTIN MAGNUSSON & CO AB, 330 27 HESTRA, SWEDEN, FILED 10-7-2003.

BERG LAND

FOR GLOVES FOR OUTDOOR SPORTS AND OUTDOOR ACTIVITIES, NAMELY, GLOVES FOR ALPINE AND CROSS COUNTRY SKIING, SNOWBOARDING, SKATING, BIKING, MOTORBIKING, HIKING, CANOEING AND FOR GENERAL PURPOSE OUTDOOR ACTIVITY WEAR (U.S. CLS. 22, 23, 38 AND 50).
SUSAN HAYASH, EXAMINING ATTORNEY

SN 76-561,315. INTERNATIONAL GAMCO, INC., OMAHA, NE. FILED 11-12-2003.

HORSE RACE

THE MARK CONSISTS OF STANDARD CHARACTERS WITHOUT CLAIM TO ANY PARTICULAR FONT, STYLE, SIZE, OR COLOR.

FOR DISPOSABLE TICKET SETS FOR PLAYING A GAME OF CHANCE (U.S. CLS. 22, 23, 38 AND 50).

FIRST USE 2-26-2003; IN COMMERCE 2-26-2003.
RENEE MCCRAY, EXAMINING ATTORNEY

SN 76-547,160. FOCUS GOLF SYSTEMS, INC., GREENVILLE, SC. FILED 9-26-2003.

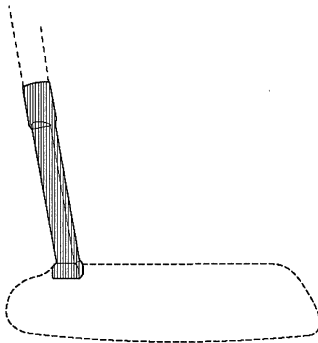

OWNER OF U.S. REG. NO. 2,942,706.

THE DRAWING IS LINED FOR THE COLOR RED. THE MARK CONSISTS OF THE COLOR RED REPRESENTED IN THE DRAWING BY THE SHADING TO SHOW THE COLOR CONTRAST OF THE HOSEL WITH THE SHAFT. THE COLOR OF THE SHAFT MAY NOT INCLUDE THE COLOR BLACK, TO THE EXTENT THAT THE HOSEL DESIGN ABUTS, FADES INTO OR OTHERWISE TOUCHES THE COLOR BLACK. THE DOTTED LINES IN THE DRAWING SERVE TO INDICATE THE POSITION OF THE MARK IN REFERENCE TO THE SHAFT AND GOLF CLUB HEAD AND DO NOT FORM PART OF THE MARK. THE COLOR RED IS CLAIMED AS A FEATURE OF THE MARK AND THE COLOR RED APPEARS ON THE HOSEL AT THE CLUB HEAD END OF A GOLF CLUB.

SEC. 2(F).

FOR GOLF CLUBS AND GOLF CLUB PARTS, NAMELY HOSELS FOR GOLF CLUBS (U.S. CLS. 22, 23, 38 AND 50).

FIRST USE 10-31-2003; IN COMMERCE 10-31-2003.

JENNIFER CHICOSKI, EXAMINING ATTORNEY

SN 76-563,540. TAIWAN POWCO LTD., TAIPEI, TAIWAN, FILED 11-28-2003.

TEAM POWER

THE MARK CONSISTS OF STANDARD CHARACTERS WITHOUT CLAIM TO ANY PARTICULAR FONT, STYLE, SIZE, OR COLOR.

FOR BOYS' TOYS, NAMELY TOY BINOCULARS; SPORT BALLS AND NOVELTY BALLS; TOY TOOLS; TOY CONSTRUCTION SETS; TOY PHONES; PUZZLES; TOY INTERACTIVE NOVELTY DRINKING CUPS; BATTERY-OPERATED RADIO-CONTROL VEHICLES; TOY PULL-BACK VEHICLES; TOY VEHICLES, NAMELY, CARS, TRUCKS, BIKES, BOATS, TRAINS, HELICOPTERS, AND PLANES; PUMP-ACTION ROCKETS AND LAUNCHERS AND ACCESSORIES THEREFOR; WATER GUNS; SMALL TOYS ATTACHED TO KEYCHAINS; DISC SHOOTERS; TARGET GAME SETS; TOY ROBOTS; ROLE-PLAYING TOY DRESS-UP SETS AND ACCESSORIES THEREFOR; TOY SPACE-RELATED VEHICLES; SPORT-RELATED TABLETOP GAMES AND NOVELTY TABLETOP GAMES; PINBALL GAMES; CARD GAMES; MAGNETIC TARGET, CAPTURE, AND BOARD GAMES; DART GAMES; AND ELECTRONIC TABLE-TOP, HAND-HELD, AND FREE-STANDING GAMES; MARBLES; JACKS AND BALLS FOR USE THEREWITH; TOY BUILDING BLOCKS; SLING SHOTS; TOY BOWS AND ARROWS; STACKING-TOY OBJECTS; YO-YOS; TOY WHISTLES; AND INTERACTIVE TOY-RELATED WRIST WATCHES (U.S. CLS. 22, 23, 38 AND 50).

BRENDAN REGAN, EXAMINING ATTORNEY

CLASS 28—(Continued).

SN 76-571,481. CIESUIN, PAUL M., MANHATTAN, IL.
FILED 1-21-2004.

DARK LEGION

THE MARK CONSISTS OF STANDARD CHARACTERS WITHOUT CLAIM TO ANY PARTICULAR FONT, STYLE, SIZE, OR COLOR.

FOR EQUIPMENT FOR CONDUCTING A GAME OF NIGHT PAINTBALL, NAMELY, GLOW IN THE DARK PAINTBALLS (U.S. CLS. 22, 23, 38 AND 50).

FIRST USE 4-1-2003; IN COMMERCE 4-1-2003.

AMY HELLA, EXAMINING ATTORNEY

SN 76-576,068. O'SULLIVAN, BRENDON, MELBOURNE, AUSTRALIA, FILED 2-11-2004.

PHATYO

THE MARK CONSISTS OF STANDARD CHARACTERS WITHOUT CLAIM TO ANY PARTICULAR FONT, STYLE, SIZE, OR COLOR.

PRIORITY CLAIMED UNDER SEC. 44(D) ON AUSTRALIA APPLICATION NO. 982399, FILED 12-16-2003, REG. NO. 982399, DATED 12-17-2003, EXPIRES 12-17-2013.

FOR YO-YOS AND YO-YO ACCESSORIES, NAMELY, YO-YO AXLES, YO-YO BEARINGS, YO-YO BEARING SLEEVES, YO-YO AXEL SPACERS, YO-YO FRICTION PADS, YO-YO HALVES, YO-YO STRINGS, YO-YO DECORATIVE CAPS, NAMELY PARTS OF A SIDE OF A YO-YO FEATURING WORDS AND DESIGNS, AND POGS, NAMELY DIE CAST PARTS THAT POP IN AND OUT OF THE SIDE OF A YO-YO (U.S. CLS. 22, 23, 38 AND 50).

ANN LINNEHAN, EXAMINING ATTORNEY

SN 76-581,139. IGO, MATTHEW, BOISE, ID. FILED 3-15-2004.

IGO 360°

THE MARK CONSISTS OF STANDARD CHARACTERS WITHOUT CLAIM TO ANY PARTICULAR FONT, STYLE, SIZE, OR COLOR.

NO CLAIM IS MADE TO THE EXCLUSIVE RIGHT TO USE "360", APART FROM THE MARK AS SHOWN.

FOR WATERFOWL HUNTING DECOYS, NAMELY DUCK DECOYS (U.S. CLS. 22, 23, 38 AND 50).

FIRST USE 2-12-2003; IN COMMERCE 2-12-2003.

BARBARA A. LOUGHRAN, EXAMINING ATTORNEY

CLASS 28—(Continued).

SN 76-592,815. APPLEHEAD FACTORY INC., MORTON, PA.
FILED 5-14-2004.

ABNORMAL CYRUS

THE MARK CONSISTS OF STANDARD CHARACTERS WITHOUT CLAIM TO ANY PARTICULAR FONT, STYLE, SIZE, OR COLOR.

FOR STUFFED TOY ANIMALS (U.S. CLS. 22, 23, 38 AND 50).

FIRST USE 10-31-2003; IN COMMERCE 10-31-2003.

DAVID TAYLOR, EXAMINING ATTORNEY

SN 76-595,586. HASBRO, INC., PAWTUCKET, RI. FILED 6-4-2004.

BRIGHT NIGHT

THE MARK CONSISTS OF STANDARD CHARACTERS WITHOUT CLAIM TO ANY PARTICULAR FONT, STYLE, SIZE, OR COLOR.

FOR TOY PONIES AND ACCESSORIES FOR USE THEREWITH (U.S. CLS. 22, 23, 38 AND 50).

HENRY S. ZAK, EXAMINING ATTORNEY

SN 76-596,045. REGENT SPORTS CORPORATION, HAUPAUGE, NY. FILED 6-7-2004.

MAX-GUARD

THE MARK CONSISTS OF STANDARD CHARACTERS WITHOUT CLAIM TO ANY PARTICULAR FONT, STYLE, SIZE, OR COLOR.

FOR BASEBALL BATTING GLOVES, BASEBALL GLOVES, FOOTBALL GLOVES, FOOTBALL PROTECTIVE EQUIPMENT, NAMELY, SHOULDER PADS, GIRDLES, KNEE PADS AND ELBOW PADS; SOCCER SHIN GUARDS AND BASKETBALL PROTECTIVE EQUIPMENT, NAMELY, KNEE PADS AND ELBOW PADS (U.S. CLS. 22, 23, 38 AND 50).

BILL DAWE, EXAMINING ATTORNEY

CLASS 28—(Continued).

SN 76-599,545. LAKAI, LTD., TORRANCE, CA. FILED 6-28-2004.

LAKAI

THE MARK CONSISTS OF STANDARD CHARACTERS WITHOUT CLAIM TO ANY PARTICULAR FONT, STYLE, SIZE, OR COLOR.

FOR SPORTING GOODS AND EQUIPMENT, NAMELY, SKATEBOARDS, SKATEBOARD WHEELS, SKATEBOARD BEARINGS, SKATEBOARD GRIP TAPE, SKATEBOARD TRUCKS; AND SKATEBOARD PROTECTIVE GEAR, NAMELY, KNEE GUARDS, ELBOW GUARDS AND WRIST GUARDS; SNOWBOARD BINDINGS; SNOWBOARDS (U.S. CLS. 22, 23, 38 AND 50).

MARK T. MULLEN, EXAMINING ATTORNEY

SN 76-600,728. PATE, DWIGHT, DBA PATE INTERNATIONAL, SAN FRANCISCO, CA. FILED 7-6-2004.

GOLF TRACK

THE MARK CONSISTS OF STANDARD CHARACTERS WITHOUT CLAIM TO ANY PARTICULAR FONT, STYLE, SIZE, OR COLOR.

NO CLAIM IS MADE TO THE EXCLUSIVE RIGHT TO USE "GOLF", APART FROM THE MARK AS SHOWN.

FOR GOLF EQUIPMENT, NAMELY, GOLF BALLS, GOLF ACCESSORY POUCHES, GOLF BAGS, GOLF BAG COVERS, GOLF BAG TAGS, GOLF BALL MARKERS, GOLF BALL RETRIEVERS, NON-MOTORIZED GOLF CARTS, GOLF CLUBS, GOLF CLUB HEADS, SHAFTS OR INSERTS, GOLF CLUB HAND GRIPS, GRIP TAPES, OR HEAD COVERS, GOLF FLAGS, GOLF GLOVES, AND GOLF TEE MARKERS (U.S. CLS. 22, 23, 38 AND 50).

KIMBERLY PERRY, EXAMINING ATTORNEY

SN 76-602,382. YONEX KABUSHIKI KAISHA, TOKYO, JAPAN, FILED 7-15-2004.

NANOSPEED

THE MARK CONSISTS OF STANDARD CHARACTERS WITHOUT CLAIM TO ANY PARTICULAR FONT, STYLE, SIZE, OR COLOR.

FOR TENNIS RACKETS, BADMINTON RACKETS, AND GOLF CLUBS (U.S. CLS. 22, 23, 38 AND 50).

KELLY CHOE, EXAMINING ATTORNEY

CLASS 28—(Continued).

SN 76-608,125. BOLAÑOS, ROBERTO GOMEZ, COYOACÁN, MEXICO D.F. 04310, MEXICO, FILED 8-18-2004.



El Chapulin Colorado

THE FOREIGN WORDING IN THE MARK TRANSLATES INTO ENGLISH AS THE RED CRICKET.

FOR TOYS, NAMELY, CARD AND BOARD GAMES, STUFFED PLUSH TOYS, BABY MULTIPLE ACTIVITY TOYS, BATH TOYS, MOBILES FOR CHILDREN, TOY MOBILES, TOY SCOOTERS, DOLLS, MUSICAL TOYS, DIDACTIC TOYS, NAMELY, BLOCKS, LETTERS, NUMBERS, SHAPES, RINGS, TOKENS, DICE, CARDS AND PUZZLES THAT MAY OR MAY NOT REQUIRE A BOARD, KITES, JIGSAW PUZZLES, TOY BUILDING BLOCKS, TOY CONSTRUCTION TOYS; SPORTING GOODS, NAMELY, BASKETBALLS, FOOTBALLS, HANDBALLS, RUBBER BALLS, SPORT BALLS, SKATEBOARDS (U.S. CLS. 22, 23, 38 AND 50).

JOANNA DUKOVIC, EXAMINING ATTORNEY

SN 76-614,210. MUKDAPRAKOM, LISA, BURBANK, CA. AND HUSSAKHOON, POLCHAI, BURBANK, CA. FILED 10-1-2004.

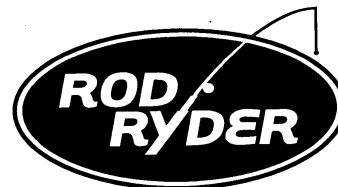

FOR TOYS AND SPORTING GOODS, NAMELY FISHING ROD HOLDERS (U.S. CLS. 22, 23, 38 AND 50).

TEJBIR SINGH, EXAMINING ATTORNEY

CLASS 28—(Continued).

SN 76-614,270. HASBRO, INC., PAWTUCKET, RI. FILED 10-1-2004.

ROBOT REBELLION

THE MARK CONSISTS OF STANDARD CHARACTERS WITHOUT CLAIM TO ANY PARTICULAR FONT, STYLE, SIZE, OR COLOR.

NO CLAIM IS MADE TO THE EXCLUSIVE RIGHT TO USE ROBOT, APART FROM THE MARK AS SHOWN.

FOR TOY ACTION FIGURES AND ACCESSORIES FOR USE THEREWITH; TOY VEHICLES AND ACCESSORIES FOR USE THEREWITH; TOY PLAYSETS FOR USE WITH TOY ACTION FIGURES AND TOY VEHICLES; DOLLS, DOLL CLOTHING AND DOLL ACCESSORIES; CHILDREN'S MULTIPLE ACTIVITY TOYS; PLUSH TOYS; STUFFED TOYS; BEAN BAG TOYS; TOY MODELING COMPOUNDS; TOY MOLDS AND TOY EXTRUDERS FOR USE WITH TOY MODELING COMPOUNDS; PLASTIC AND VINYL TOY CHARACTERS AND TOY ANIMALS; RIDE-ON TOYS; PULL TOYS; PUSH TOYS; RADIO CONTROLLED TOY VEHICLES; TOY ROBOTS CONVERTIBLE INTO OTHER VISUAL TOY FORMS; MECHANICAL TOYS; TOY CONSTRUCTION SETS, BUILDING TOYS; WIND-UP TOYS; WATER SQUIRTING TOYS; INFLATABLE TOYS; ROLE-PLAYING TOYS; TOY BALL AND DART SHOOTERS AND FOAM TOY BALLS AND DARTS FOR USE THEREWITH; BOARD GAMES; PARLOR GAMES; SKILL AND ACTION GAMES; CARD GAMES; PLAYING CARDS; TRADING CARD GAMES; ELECTRONIC HAND-HELD GAMES; JIGSAW PUZZLES; CHRISTMAS TREE DECORATIONS (U.S. CLS. 22, 23, 38 AND 50).

JANICE L. MCMORROW, EXAMINING ATTORNEY

SN 76-614,273. HASBRO, INC., PAWTUCKET, RI. FILED 10-1-2004.

TONKA ULTIMATE TRUCK DIVISION

THE MARK CONSISTS OF STANDARD CHARACTERS WITHOUT CLAIM TO ANY PARTICULAR FONT, STYLE, SIZE, OR COLOR.

OWNER OF U.S. REG. NOS. 1,102,272, 1,699,230 AND OTHERS.

NO CLAIM IS MADE TO THE EXCLUSIVE RIGHT TO USE ULTIMATE TRUCK, APART FROM THE MARK AS SHOWN.

FOR TOY VEHICLES (U.S. CLS. 22, 23, 38 AND 50).

JANICE L. MCMORROW, EXAMINING ATTORNEY

SN 76-614,274. HASBRO, INC., PAWTUCKET, RI. FILED 10-1-2004.

FUZZY PET PARLOR

THE MARK CONSISTS OF STANDARD CHARACTERS WITHOUT CLAIM TO ANY PARTICULAR FONT, STYLE, SIZE, OR COLOR.

NO CLAIM IS MADE TO THE EXCLUSIVE RIGHT TO USE PET PARLOR, APART FROM THE MARK AS SHOWN.

FOR TOY PLAYSET FOR USE WITH TOY MODELING COMPOUNDS (U.S. CLS. 22, 23, 38 AND 50).

JANICE L. MCMORROW, EXAMINING ATTORNEY

CLASS 28—(Continued).

SN 76-615,201. HASBRO, INC., PAWTUCKET, RI. FILED 10-12-2004.

LENNY LIFTER

THE MARK CONSISTS OF STANDARD CHARACTERS WITHOUT CLAIM TO ANY PARTICULAR FONT, STYLE, SIZE, OR COLOR.

NO CLAIM IS MADE TO THE EXCLUSIVE RIGHT TO USE "LIFTER", APART FROM THE MARK AS SHOWN.

FOR TOY VEHICLES AND ACCESSORIES FOR USE THEREWITH (U.S. CLS. 22, 23, 38 AND 50).

RON FAIRBANKS, EXAMINING ATTORNEY

SN 76-615,203. HASBRO, INC., PAWTUCKET, RI. FILED 10-12-2004.

CHASER CHUCK

THE MARK CONSISTS OF STANDARD CHARACTERS WITHOUT CLAIM TO ANY PARTICULAR FONT, STYLE, SIZE, OR COLOR.

OWNER OF U.S. REG. NOS. 2,254,448, 2,450,003 AND OTHERS.

FOR TOY VEHICLES AND ACCESSORIES FOR USE THEREWITH (U.S. CLS. 22, 23, 38 AND 50).

RON FAIRBANKS, EXAMINING ATTORNEY

SN 76-617,061. STRAVINA OPERATING COMPANY, LLC, CHATSWORTH, CA. FILED 10-18-2004.

KAMPIN' KRITTERS

THE MARK CONSISTS OF STANDARD CHARACTERS WITHOUT CLAIM TO ANY PARTICULAR FONT, STYLE, SIZE, OR COLOR.

FOR NOVELTY ITEMS, NAMELY, PLUSH ANIMALS AND PLUSH ANIMALS SOLD AS UNIT THAT MAY BE WORN OR CLIPPED TO CLOTHING, BELTS, HANDBAGS, BACKPACKS OR OTHER OBJECTS (U.S. CLS. 22, 23, 38 AND 50).

LINDA MICKLEBURGH, EXAMINING ATTORNEY

CLASS 28—(Continued).

SN 76-619,045. TWANE, INC., LAS VEGAS, NV. FILED 11-1-2004.

TAYLOR WANE' S

THE MARK CONSISTS OF STANDARD CHARACTERS WITHOUT CLAIM TO ANY PARTICULAR FONT, STYLE, SIZE, OR COLOR.

"TAYLOR WANE" IDENTIFIES A LIVING INDIVIDUAL WHOSE CONSENT IS OF RECORD.

FOR ACTION FIGURES; ACTION FIGURES AND ACCESSORIES THEREFOR; TOY MODEL KITS; TOYS FOR ADULTS, NAMELY, NOVELTY SEX TOYS MADE OF RUBBER, PLASTIC, PVC, RESIN, OR VINYL (U.S. CLS. 22, 23, 38 AND 50).

FIRST USE 5-1-2003; IN COMMERCE 5-1-2003.
DAVID ELTON, EXAMINING ATTORNEY

SN 76-619,514. KABUSHIKI KAISHA SHUEISHA, TA SHUEISHA INC., TOKYO 101-8050, JAPAN, FILED 11-5-2004.

ANDROID 17

THE MARK CONSISTS OF STANDARD CHARACTERS WITHOUT CLAIM TO ANY PARTICULAR FONT, STYLE, SIZE, OR COLOR.

FOR GAMES, PLAYTHINGS AND SPORTING GOODS, NAMELY, TOY ACTION FIGURES (U.S. CLS. 22, 23, 38 AND 50).

FIRST USE 5-0-2001; IN COMMERCE 5-0-2001.
LA TONIA FISHER, EXAMINING ATTORNEY

SN 76-619,846. LAWTON, LINDA A., TORONTO, ONTARIO, CANADA, FILED 11-10-2004.



OWNER OF CANADA REG. NO. TMA467,693, DATED 12-16-1996, EXPIRES 12-16-2011.

NO CLAIM IS MADE TO THE EXCLUSIVE RIGHT TO USE PLANKTON PETS, APART FROM THE MARK AS SHOWN.

THE MARK CONSISTS OF WAVY LINE (LIKE WAVES) AND PLANKTON PETS IN CAPITAL LETTERS.

FOR PLUSH TOYS RESEMBLING MICROSCOPIC PLANTS AND ANIMALS, COLLECTIVELY CALLED PLANKTON (U.S. CLS. 22, 23, 38 AND 50).

ESTHER A. BORSUK, EXAMINING ATTORNEY

CLASS 28—(Continued).

SN 76-619,942. ATLAS O, LLC, HILLSIDE, NJ. FILED 11-9-2004.

ADJUST-A-COUPLER

THE MARK CONSISTS OF STANDARD CHARACTERS WITHOUT CLAIM TO ANY PARTICULAR FONT, STYLE, SIZE, OR COLOR.

FOR TOY MODEL TRAINS AND ACCESSORIES, NAMELY, RAILROAD TRACK, LOCOMOTIVES, FREIGHT CARS, AND STRUCTURES IN THE NATURE OF BRIDGES, STATIONS, PIERS, AND TUNNELS, AND KITS FOR MAKING TRACKSIDE BUILDINGS (U.S. CLS. 22, 23, 38 AND 50).

FIRST USE 7-19-1983, FIRST USE: JUL 19, 1983.; IN COMMERCE 7-19-1983, FIRST USE IN COMMERCE: JUL 19, 1983..

GIANCARLO CASTRO, EXAMINING ATTORNEY

SN 76-620,731. BRUNSWICK BOWLING & BILLIARDS CORPORATION, LAKE FOREST, IL. FILED 11-15-2004.

HERITAGE

THE MARK CONSISTS OF STANDARD CHARACTERS WITHOUT CLAIM TO ANY PARTICULAR FONT, STYLE, SIZE, OR COLOR.

FOR BILLIARD EQUIPMENT, NAMELY BILLIARD BALLS, CUES, AND RACKS (U.S. CLS. 22, 23, 38 AND 50).

FIRST USE 10-0-1999; IN COMMERCE 10-0-1999.
ROBIN CHOSID, EXAMINING ATTORNEY

SN 76-620,817. BRUNSWICK BOWLING & BILLIARDS CORPORATION, LAKE FOREST, IL. FILED 11-16-2004.

INFERNO

THE MARK CONSISTS OF STANDARD CHARACTERS WITHOUT CLAIM TO ANY PARTICULAR FONT, STYLE, SIZE, OR COLOR.

FOR BOWLING BALLS (U.S. CLS. 22, 23, 38 AND 50).
FIRST USE 1-0-2003; IN COMMERCE 1-0-2003.

GIANCARLO CASTRO, EXAMINING ATTORNEY

CLASS 28—(Continued).

SN 76-620,819. FREMANTLE MEDIA OPERATIONS B.V.,
1217 GP HILVERSUM, NETHERLANDS, FILED 11-16-
2004.

SHOWCASE SHOWDOWN

THE MARK CONSISTS OF STANDARD CHARACTERS
WITHOUT CLAIM TO ANY PARTICULAR FONT, STYLE,
SIZE, OR COLOR.

FOR LOTTERY TICKETS (U.S. CLS. 22, 23, 38 AND 50).
FIRST USE 9-15-2003; IN COMMERCE 9-15-2003.
GIANCARLO CASTRO, EXAMINING ATTORNEY

SN 76-620,953. A&E TELEVISION NETWORKS, NEW YORK,
NY. FILED 11-17-2004.

THE HISTORY CHANNEL

THE MARK CONSISTS OF STANDARD CHARACTERS
WITHOUT CLAIM TO ANY PARTICULAR FONT, STYLE,
SIZE, OR COLOR.

OWNER OF U.S. REG. NOS. 1,794,538, 2,888,721 AND
OTHERS.

FOR DIE-CAST MODELS OF AUTOMOBILES,
TRUCKS AND MOTOR VEHICLES (U.S. CLS. 22, 23, 38
AND 50).

FIRST USE 10-4-2004; IN COMMERCE 10-4-2004.
NORA BUCHANAN WILL, EXAMINING ATTORNEY

SN 76-620,974. BIG DADDY INTERNATIONAL INC., MAL-
VERN, PA. FILED 11-17-2004.

BIG DADDY

THE MARK CONSISTS OF STANDARD CHARACTERS
WITHOUT CLAIM TO ANY PARTICULAR FONT, STYLE,
SIZE, OR COLOR.

OWNER OF U.S. REG. NOS. 1,986,812 AND 2,484,206.

FOR GOLF CLUBS (U.S. CLS. 22, 23, 38 AND 50).

FIRST USE 7-8-2004; IN COMMERCE 7-8-2004.

SUSAN STIGLITZ, EXAMINING ATTORNEY

CLASS 28—(Continued).

SN 76-622,264. TOSTAL TOYS, INC., MIAMI, FL. FILED 11-
26-2004.



THE MARK CONSISTS OF THE STYLIZED WORD
SNAPTO INSIDE A RECTANGULAR FRAME IN SUCH A
WAY AS TO APPEAR TO BE VIEWED FROM ONE SIDE OF
THE FRAME.

FOR MECHANICAL ACTION TOYS (U.S. CLS. 22, 23,
38 AND 50).

DOMINIC J. FERRAIUOLO, EXAMINING ATTORNEY

SN 76-622,981. IMPERIAL TOY CORPORATION, LOS AN-
GELES, CA. FILED 12-2-2004.

AFTERMARKET

THE MARK CONSISTS OF STANDARD CHARACTERS
WITHOUT CLAIM TO ANY PARTICULAR FONT, STYLE,
SIZE, OR COLOR.

FOR TOYS, NAMELY DIE CAST, PRESSED STEEL
AND PLASTIC CARS (U.S. CLS. 22, 23, 38 AND 50).

MIDGE BUTLER, EXAMINING ATTORNEY

SN 76-623,999. GROSSMAN, KENNETH, CLEARWATER, FL.
FILED 12-7-2004.

JACK EM

THE MARK CONSISTS OF STANDARD CHARACTERS
WITHOUT CLAIM TO ANY PARTICULAR FONT, STYLE,
SIZE, OR COLOR.

FOR CARD GAME THAT IS A COMBINATION OF
BLACK JACK AND POKER (U.S. CLS. 22, 23, 38 AND 50).

MITCHELL FRONT, EXAMINING ATTORNEY

CLASS 28—(Continued).

SN 76-626,203. CLEVERKITS, LLC, STAMFORD, CT. FILED 12-23-2004.



THE COLOR(S) BLACK AND YELLOW IS/ARE CLAIMED AS A FEATURE OF THE MARK.

THE MARK CONSISTS OF A BLACK OUTLINE OF A LIGHT BULB WITH THE WORDS CLEVERKITS IN BLACK UNDERNEATH. THE COLOR YELLOW RADIATES OUTWARD FROM THE LIGHT BULB.

FOR CHILDREN'S MULTIPLE ACTIVITY TOYS COMPRISING FINGER PUPPETS AND AUDIO CD WITH MUSIC AND DIRECTIONS FOR CHILDREN TO FOLLOW ALONG INTERACTIVELY ALL SOLD AS A UNIT (U.S. CLS. 22, 23, 38 AND 50).

TARAH HARDY, EXAMINING ATTORNEY

SN 76-627,405. ROLBECK, KATHI, PLACERVILLE, CA. AND ROLBECK, MICHAEL, PLACERVILLE, CA. FILED 1-10-2005.

YESTERYEAR'S TREASURES

FOR CLOTHING FOR DOLLS AND TEDDY BEARS (U.S. CLS. 22, 23, 38 AND 50).

FIRST USE 4-0-2002; IN COMMERCE 6-0-2003.

GRETTA YAO, EXAMINING ATTORNEY

SN 76-627,867. RYAN, JAMES P., SANTA ROSA BEACH, FL. AND BARKER, PAT, FREEPORT, FL. FILED 1-11-2005.

GRIMP

THE MARK CONSISTS OF STANDARD CHARACTERS WITHOUT CLAIM TO ANY PARTICULAR FONT, STYLE, SIZE, OR COLOR.

FOR FISHING LURES (U.S. CLS. 22, 23, 38 AND 50).

LEIGH CAROLINE CASE, EXAMINING ATTORNEY

CLASS 28—(Continued).

SN 76-627,989. WATSON, LARRY, GULFPORT, MS. FILED 1-14-2005.

BUCKCHASER

THE MARK CONSISTS OF STANDARD CHARACTERS WITHOUT CLAIM TO ANY PARTICULAR FONT, STYLE, SIZE, OR COLOR.

FOR DEER STAND (U.S. CLS. 22, 23, 38 AND 50).

JENNIFER MARTIN, EXAMINING ATTORNEY

SN 76-629,507. ADVANCE MAGAZINE PUBLISHERS INC., NEW YORK, NY. FILED 1-27-2005.

GOLF DIGEST

THE MARK CONSISTS OF STANDARD CHARACTERS WITHOUT CLAIM TO ANY PARTICULAR FONT, STYLE, SIZE, OR COLOR.

OWNER OF U.S. REG. NO. 2,365,347.

FOR PLAYING CARDS AND PLAYING CARD CASES; TOY WOOD PEGBOARDS (U.S. CLS. 22, 23, 38 AND 50).

ANNE FARRELL, EXAMINING ATTORNEY

SN 78-142,627. BUTTERCUP DESIGNS, INC., RED BANK, NJ. FILED 7-10-2002.

BUTTERCUP DESIGNS

NO CLAIM IS MADE TO THE EXCLUSIVE RIGHT TO USE "DESIGNS", APART FROM THE MARK AS SHOWN.

FOR CLOTHES, FURNITURE AND ACCESSORIES FOR DOLLS (U.S. CLS. 22, 23, 38 AND 50).

KATHY DE JONGE, EXAMINING ATTORNEY

SN 78-164,961. BURROWS GOLF, INC., VALENCIA, CA. FILED 9-17-2002.

POWER SOURCE

FOR GOLF CLUBS AND COMPONENT PARTS THEREOF, NAMELY, HEADS, SHAFTS AND GRIPS (U.S. CLS. 22, 23, 38 AND 50).

CHERYL CLAYTON, EXAMINING ATTORNEY

CLASS 28—(Continued).

SN 78-268,662. PLANET ECLIPSE LIMITED, TRAFFORD PARK, UNITED KINGDOM, FILED 6-30-2003.

NEXUS

FOR PAINTBALL EQUIPMENT, NAMELY, PAINTBALL MARKERS, PAINTBALLS, AND PAINTBALL MARKER PARTS, NAMELY, CONTAINERS, FILL ADAPTERS, REGULATORS, BARRELS, OPEN SIGHTS, NON-TELESCOPIC SIGHTS, TRIGGER ASSEMBLIES, TURBULENCE BOLTS, EXPANSION CHAMBERS, GRIP FRAMES, FRAME COVERS, AND MARKER BAGS (U.S. CLS. 22, 23, 38 AND 50).

FIRST USE 6-4-2003; IN COMMERCE 6-4-2003.
JOHN SCHUYLER YARD, EXAMINING ATTORNEY

CLASS 28—(Continued).

SN 78-309,032. LUCKYBUG LLC, DURHAM, NC. FILED 10-3-2003.



SN 78-285,547. MICHANDER COMPANY, LELAND, MI. FILED 8-11-2003.



NO CLAIM IS MADE TO THE EXCLUSIVE RIGHT TO USE "A GOLF GAME", APART FROM THE MARK AS SHOWN.

THE MARK CONSISTS OF THE WORDS "WHOOPS A GOLF GAME," IN STYLIZED LETTERS, WITH A SWOOSH ABOVE THE "H" AND UNDER "OPS", WITH AN EXPLANATION MARK WITH A GOLF FLAG ATTACHED.

FOR CARD GAMES, NAMELY CARD GAMES THAT ARE PLAYED IN CONNECTION WITH A GAME OF GOLF OR A GOLF CONTEST, WHEREBY CARDS WITH DESIGNATED SYMBOLS ON THEM ARE AWARDED TO GOLF PLAYERS WHO ACCOMPLISH A PARTICULAR RESULT AT A PARTICULAR TIME (U.S. CLS. 22, 23, 38 AND 50).

FIRST USE 8-6-2003; IN COMMERCE 8-6-2003.
TONJA GASKINS, EXAMINING ATTORNEY

NO CLAIM IS MADE TO THE EXCLUSIVE RIGHT TO USE "KEEPSAKE KIT", APART FROM THE MARK AS SHOWN.

THE LIKENESS (OR, "PORTRAIT") IN THE MARK DOES NOT IDENTIFY A LIVING INDIVIDUAL.

THE COLOR(S) MAGENTA (PMS 213C), AND LIME GREEN (PMS 375C) IS/ARE CLAIMED AS A FEATURE OF THE MARK.

THE MARK CONSISTS OF STYLIZED WORDS "CRAFTY GIRLS KEEPSAKE KIT" IN GIGI FONT. OUTER MAGENTA (PMS 213C) CIRCLE WITH THREE GIRLS INSIDE. GIRL ON LEFT SIDE HAS LIGHT BROWN SKIN, DARK BROWN LIPS, PINK HAIR, BLACK GLASSES, GIRL IN MIDDLE HAS BLACK HAIR, BLACK GLASSES, VERY LIGHT BROWN SKIN, AND RED LIPS, GIRL ON RIGHT HAS RED HAIR, DARK BROWN SKIN, AND BLACK LIPS. GIRLS CLOTHING IS LIME GREEN (PMS 375C). COMPANY NAME, LUCKYBUG LLC, APPEARS WITHIN CLOTHING IN MAGENTA WITH GIGI FONT. BUG WITHIN CLOTHES IS GREEN, WITH MAGENTA SHAMROCKS ON ITS BACK. RIGHT HAND GIRL IS HOLDING PAINTING PALATTE WITH SPOTS OF LIME GREEN AND BLUE.

THE MARK CONSISTS OF STYLIZED WORDS "CRAFTY GIRLS KEEPSAKE KIT" IN GIGI FONT. OUTER MAGENTA (PMS 213C) CIRCLE WITH THREE GIRLS INSIDE. GIRL ON LEFT SIDE HAS LIGHT BROWN SKIN, DARK BROWN LIPS, PINK HAIR, BLACK GLASSES, GIRL IN MIDDLE HAS BLACK HAIR, BLACK GLASSES, VERY LIGHT BROWN SKIN, AND RED LIPS, GIRL ON RIGHT HAS RED HAIR, DARK BROWN SKIN, AND BLACK LIPS. GIRLS CLOTHING IS LIME GREEN (PMS 375C). COMPANY NAME, LUCKYBUG LLC, APPEARS WITHIN CLOTHING IN MAGENTA WITH GIGI FONT. BUG WITHIN CLOTHES IS GREEN, WITH MAGENTA SHAMROCKS ON ITS BACK. RIGHT HAND GIRL IS HOLDING PAINTING PALATTE WITH SPOTS OF LIME GREEN AND BLUE.

FOR CRAFT KIT COMPRISING BURP CLOTHS, BABY BODYSUITS, HANDTOWELS, AND TOOLS, NAMELY, GLUE, PAINT, STENCILS FOR USE IN MAKING KEEPSAKE GIFTS FOR PERSONAL USE (U.S. CLS. 22, 23, 38 AND 50).

GINA HAYES, EXAMINING ATTORNEY

CLASS 28—(Continued).

SN 78-326,504. PAROMON CO, INDIANAPOLIS, IN. FILED 11-11-2003.

CLASS 28—(Continued).

SN 78-335,376. MATTEL, INC., EL SEGUNDO, CA. FILED 12-2-2003.

Quokker

**ROYAL KINGDOM
CARRIAGE**

THE MARK CONSISTS OF STANDARD CHARACTERS WITHOUT CLAIM TO ANY PARTICULAR FONT, STYLE, SIZE, OR COLOR.

FOR CARD GAMES; EQUIPMENT SOLD AS A UNIT FOR PLAYING CARD GAMES; BOARD GAMES; EQUIPMENT SOLD AS A UNIT FOR PLAYING BOARD GAMES; DICE GAMES; EQUIPMENT SOLD AS A UNIT FOR PLAYING DICE GAMES; DOMINO GAMES; EQUIPMENT SOLD AS A UNIT FOR PLAYING DOMINO GAMES; CUBE GAMES; EQUIPMENT SOLD AS A UNIT FOR PLAYING CUBE GAMES; AND PUZZLES (U.S. CLS. 22, 23, 38 AND 50).

FIRST USE 12-19-2000; IN COMMERCE 8-12-2004.
AMY GEARIN, EXAMINING ATTORNEY

THE MARK CONSISTS OF STANDARD CHARACTERS WITHOUT CLAIM TO ANY PARTICULAR FONT, STYLE, SIZE, OR COLOR.

NO CLAIM IS MADE TO THE EXCLUSIVE RIGHT TO USE "CARRIAGE", APART FROM THE MARK AS SHOWN. FOR TOYS, GAMES AND PLAYTHINGS, NAMELY, HORSE-DRAWN TOY VEHICLES AND ACCESSORIES THEREFOR (U.S. CLS. 22, 23, 38 AND 50).

STEVEN JACKSON, EXAMINING ATTORNEY

SN 78-329,921. MATTEL, INC., EL SEGUNDO, CA. FILED 11-19-2003.

SN 78-335,379. MATTEL, INC., EL SEGUNDO, CA. FILED 12-2-2003.

PINK LABEL

ROYAL MUSIC PALACE

THE MARK CONSISTS OF STANDARD CHARACTERS WITHOUT CLAIM TO ANY PARTICULAR FONT, STYLE, SIZE, OR COLOR.

FOR TOYS, GAMES AND PLAYTHINGS, NAMELY, DOLLS, DOLL CLOTHING AND DOLL ACCESSORIES (U.S. CLS. 22, 23, 38 AND 50).

BERYL GARDNER, EXAMINING ATTORNEY

THE MARK CONSISTS OF STANDARD CHARACTERS WITHOUT CLAIM TO ANY PARTICULAR FONT, STYLE, SIZE, OR COLOR.

NO CLAIM IS MADE TO THE EXCLUSIVE RIGHT TO USE "PALACE", APART FROM THE MARK AS SHOWN. FOR TOYS, GAMES AND PLAYTHINGS, NAMELY, DOLL HOUSES AND ACCESSORIES THEREFOR (U.S. CLS. 22, 23, 38 AND 50).

STEVEN JACKSON, EXAMINING ATTORNEY

CLASS 28—(Continued).

SN 78-336,995. DISNEY ENTERPRISES, INC., BURBANK, CA. FILED 12-5-2003.

CLASS 28—(Continued).

SN 78-359,805. JAKKS PACIFIC, INC., MALIBU, CA. FILED 1-29-2004.

SUNSHINE MONSTER NOODLE

MR. HUPH

THE MARK CONSISTS OF STANDARD CHARACTERS WITHOUT CLAIM TO ANY PARTICULAR FONT, STYLE, SIZE, OR COLOR.

FOR TOYS, GAMES, PLAYTHINGS AND SPORTING GOODS, NAMELY, FLEXIBLE FOAM CONSTRUCTION TOYS, TOY FOAM FIGURES, FOAM BATH TOYS, SOFT SCULPTURE FOAM TOYS, FOAM FLOATS FOR RECREATIONAL USE AND FOAM TOY GLIDER (U.S. CLS. 22, 23, 38 AND 50).

JOSETTE BEVERLY, EXAMINING ATTORNEY

SN 78-366,134. TANGLE, INC., SOUTH SAN FRANCISCO, CA. FILED 2-11-2004.

THE MARK CONSISTS OF STANDARD CHARACTERS WITHOUT CLAIM TO ANY PARTICULAR FONT, STYLE, SIZE, OR COLOR.

MR. HUPH DOES NOT IDENTIFY A LIVING INDIVIDUAL.

FOR RUBBER ACTION BALLS; ACTION FIGURES AND ACCESSORIES THEREFORE; ACTION SKILL GAMES; BEAN BAG DOLLS; PLUSH TOYS; BALLOONS; GOLF BALLS; TENNIS BALLS; BATH TOYS; CHRISTMAS TREE ORNAMENTS; SNOW GLOBES; BOARD GAMES; TOY BUILDING BLOCKS; EQUIPMENT SOLD AS A UNIT FOR PLAYING CARD GAMES; PLAYING CARDS; DOLLS AND DOLL CLOTHING; DOLL PLAYSETS; CHILDREN'S PLAY COSMETICS; CRIB TOYS; ELECTRIC ACTION TOYS; MANIPULATIVE GAMES; GOLF GLOVES; GOLF BALL MARKERS; JIGSAW PUZZLES; KITES; CRIB AND TOY MOBILES; MUSIC BOX TOYS; PARTY FAVORS IN THE NATURE OF SMALL TOYS; INFLATABLE POOL TOYS; BABY AND CHILDREN'S MULTIPLE ACTIVITY TOYS; WIND-UP TOYS; TARGET GAMES; DISC-TYPE TOSS TOYS; TOY BOWS AND ARROWS; TOY VEHICLES; MODEL TOY CARS; MODEL TOY TRUCKS; TOY BUCKET AND SHOVEL SETS; ROLLER SKATES; TOY MODEL HOBBYCRAFT KITS; TOY ROCKETS; TOY GUNS; TOY HOLSTERS; MUSICAL TOYS; TOY BADMINTON SETS; BUBBLE MAKING WANDS AND SOLUTION SETS; MODELED PLASTIC TOY FIGURINES; TOY BANKS; PUPPETS; YO-YOS; SKATEBOARDS; TOY SCOOTERS; FACE MASKS; HAND-HELD UNIT FOR PLAYING ELECTRONIC GAMES; TALKING TOYS; TOY MODEL WALKIE-TALKIES; TOY MODEL ELECTRONIC VOICE RECORDERS (U.S. CLS. 22, 23, 38 AND 50).

RENEE MCCRAY, EXAMINING ATTORNEY

Super Stunters

THE MARK CONSISTS OF STANDARD CHARACTERS WITHOUT CLAIM TO ANY PARTICULAR FONT, STYLE, SIZE, OR COLOR.

FOR ACTION TOYS IN THE NATURE OF KINETIC SCULPTURES AND PLASTIC CHARACTER TOYS (U.S. CLS. 22, 23, 38 AND 50).

FIRST USE 2-8-2005; IN COMMERCE 2-8-2005.

JENNIFER MARTIN, EXAMINING ATTORNEY

CLASS 28—(Continued).

SN 78-370,255. CHILDLIFE PRODUCTS, INC., MINNETONKA, MN. FILED 2-18-2004.

CLASS 28—(Continued).

SN 78-381,960. DREAMSHIP, INC., SEBASTOPOL, CA. FILED 3-10-2004.

KIDSMART

TRIAZZLE

THE MARK CONSISTS OF STANDARD CHARACTERS WITHOUT CLAIM TO ANY PARTICULAR FONT, STYLE, SIZE, OR COLOR.

OWNER OF U.S. REG. NOS. 2,919,838 AND 2,921,595.
FOR TOYS, NAMELY, BABY MULTIPLE ACTIVITY TOYS, CHILDREN'S MULTIPLE ACTIVITY TOYS; ACTION FIGURES; BOARD GAMES; CARD GAMES; DOLLS; DOLL COSTUMES; INFANT ACTION CRIB TOYS; CRIB MOBILES; DOLL ACCESSORIES; DOG TOYS (U.S. CLS. 22, 23, 38 AND 50).
JEAN IM, EXAMINING ATTORNEY

THE MARK CONSISTS OF STANDARD CHARACTERS WITHOUT CLAIM TO ANY PARTICULAR FONT, STYLE, SIZE, OR COLOR.

OWNER OF U.S. REG. NO. 2,042,984.
FOR PUZZLES (U.S. CLS. 22, 23, 38 AND 50).
FIRST USE 5-11-1995; IN COMMERCE 5-11-1995.
BRIAN BROWN, EXAMINING ATTORNEY

SN 78-380,721. MATTEL, INC., EL SEGUNDO, CA. FILED 3-9-2004.

SN 78-382,294. NICE IDEAS, LLC, WAUKESHA, WI. FILED 3-11-2004.

BEBE DO

DOIN' D.C.

THE MARK CONSISTS OF STANDARD CHARACTERS WITHOUT CLAIM TO ANY PARTICULAR FONT, STYLE, SIZE, OR COLOR.

NO CLAIM IS MADE TO THE EXCLUSIVE RIGHT TO USE "BEBE", APART FROM THE MARK AS SHOWN.
THE FOREIGN WORDING IN THE MARK TRANSLATES INTO ENGLISH AS BABY.
FOR TOYS, GAMES AND PLAYTHINGS, NAMELY, DOLLS, DOLL CLOTHING AND DOLL ACCESSORIES (U.S. CLS. 22, 23, 38 AND 50).
DAVID ELTON, EXAMINING ATTORNEY

THE MARK CONSISTS OF STANDARD CHARACTERS WITHOUT CLAIM TO ANY PARTICULAR FONT, STYLE, SIZE, OR COLOR.

FOR BOARD GAMES (U.S. CLS. 22, 23, 38 AND 50).
TONJA GASKINS, EXAMINING ATTORNEY

CLASS 28—(Continued).

SN 78-383,844. AVI ARAD & ASSOCIATES, LLC, WESTPORT, CT. FILED 3-12-2004.

RESCUE KITTY

THE MARK CONSISTS OF STANDARD CHARACTERS WITHOUT CLAIM TO ANY PARTICULAR FONT, STYLE, SIZE, OR COLOR.

NO CLAIM IS MADE TO THE EXCLUSIVE RIGHT TO USE KITTY, APART FROM THE MARK AS SHOWN.

FOR REMOTE CONTROLS FOR TOYS; TOYS AND PLAYTHINGS, NAMELY, PLUSH TOYS AND CLOTHING, COSTUMES, FURNITURE, HOUSES, CASES, AND ACCESSORIES THEREFOR; STUFFED TOYS AND CLOTHING, COSTUMES, FURNITURE, HOUSES, CASES, AND ACCESSORIES THEREFOR; DOLLS AND DOLL CLOTHING, COSTUMES, FURNITURE, HOUSES, CASES AND ACCESSORIES THEREFOR; ACTION FIGURES AND ACCESSORIES THEREFOR; CARD GAMES; CASES FOR PLAY ACCESSORIES, TOY STRUCTURES AND TOY VEHICLES; INFLATABLE TOYS AND INFLATABLE POOL TOYS; COLLECTIBLE TOY FIGURES; DART BOARDS; MUSICAL TOYS; PARTY FAVORS IN THE NATURE OF SMALL TOYS; PARTY GAMES; PLAYING CARDS; PULL AND PUSH TOYS; PUNCHING BAGS; PUPPETS; PUZZLES; KITES; SAND TOYS; SNOW TOYS, NAMELY, SNOW SLEDS FOR RECREATIONAL USE, AND TOY SNOW SHOVELS, RAKES, TROWELS, SCOOPS, FORKS, SPADES AND HOES; SKATEBOARDS; WIND-UP TOYS; YO-YOS; AMUSEMENT PARK RIDES; PLAY EQUIPMENT IN THE NATURE OF JUNGLE GYMS; CRIB MOBILES AND TOYS; CHRISTMAS TREE ORNAMENTS [EXCLUDING CONFECTIONERY OR ILLUMINATION ORNAMENTS]; AND PET TOYS (U.S. CLS. 22, 23, 38 AND 50).

TONI HICKEY, EXAMINING ATTORNEY

SN 78-400,140. LEARNING RESOURCES, INC., VERNON HILLS, IL. FILED 4-12-2004.

LEARNING MATH IS A SNAP!

THE MARK CONSISTS OF STANDARD CHARACTERS WITHOUT CLAIM TO ANY PARTICULAR FONT, STYLE, SIZE, OR COLOR.

OWNER OF U.S. REG. NO. 2,637,194.
FOR MANIPULATIVES USED FOR TEACHING MATHEMATICS (U.S. CLS. 22, 23, 38 AND 50).
FIRST USE 3-24-2004; IN COMMERCE 3-24-2004.
SAMUEL E. SHARPER JR., EXAMINING ATTORNEY

CLASS 28—(Continued).

SN 78-404,886. BONSEN, JOOST PAUL, CAMBRIDGE, MA. AND GRIFFITH, SAUL, CAMBRIDGE, MA. FILED 4-20-2004.

HOWTOONS

THE MARK CONSISTS OF STANDARD CHARACTERS WITHOUT CLAIM TO ANY PARTICULAR FONT, STYLE, SIZE, OR COLOR.

FOR GAMES, NAMELY, BOARD GAMES, ROLE-PLAYING GAMES, CARD GAMES, PARLOR GAMES; TOYS, NAMELY, ACTION FIGURES AND ACCESSORIES THEREFOR, ARCADE GAMES, SELF-ASSEMBLY PROJECTS, BUILDING BLOCKS, BUILDING SETS, TOY MODEL KITS, CONSTRUCTION TOYS, DRAWING TOYS, MECHANICAL AND ELECTRICAL ACTION TOYS, TOY CONSTRUCTION BLOCKS (U.S. CLS. 22, 23, 38 AND 50).

RON FAIRBANKS, EXAMINING ATTORNEY

SN 78-406,536. SPRI PRODUCTS, INC., LIBERTYVILLE, IL. FILED 4-22-2004.

XERSLIM

THE MARK CONSISTS OF STANDARD CHARACTERS WITHOUT CLAIM TO ANY PARTICULAR FONT, STYLE, SIZE, OR COLOR.

FOR EXERCISE EQUIPMENT KITS COMPRISED OF EXERCISE BALLS AND PUMPS THEREFOR, MANUAL UPPER AND LOWER BODY RESISTANCE EXERCISE DEVICES, DUMBBELLS, EXERCISE MATS, PRE-RECORDED VIDEOTAPES AND DVDS FEATURING EXERCISE INSTRUCTION SOLD THEREWITH, AND EXERCISE INSTRUCTION SHEETS SOLD THEREWITH (U.S. CLS. 22, 23, 38 AND 50).

WINSTON FOLMAR, EXAMINING ATTORNEY

CLASS 28—(Continued).

SN 78-406,763. STEINBERG, ELLIOTT, FREMONT, CA. FILED 4-22-2004.

GOOOOLF

THE MARK CONSISTS OF STANDARD CHARACTERS WITHOUT CLAIM TO ANY PARTICULAR FONT, STYLE, SIZE, OR COLOR.

NO CLAIM IS MADE TO THE EXCLUSIVE RIGHT TO USE GOLF, APART FROM THE MARK AS SHOWN.

FOR EQUIPMENT SOLD AS A UNIT FOR PLAYING ACTION SKILL GAMES (U.S. CLS. 22, 23, 38 AND 50).

BILL DAWE, EXAMINING ATTORNEY

SN 78-406,816. AQUA-LEISURE INDUSTRIES, INC., AVON, MA. FILED 4-22-2004.

DRENCHERS

THE MARK CONSISTS OF STANDARD CHARACTERS WITHOUT CLAIM TO ANY PARTICULAR FONT, STYLE, SIZE, OR COLOR.

FOR RECREATIONAL GOODS, NAMELY, PLUSH TOYS FOR USE IN AND AROUND THE WATER (U.S. CLS. 22, 23, 38 AND 50).

FIRST USE 10-1-1999; IN COMMERCE 10-1-1999.

STEVEN JACKSON, EXAMINING ATTORNEY

CLASS 28—(Continued).

SN 78-411,361. NORMARK CORPORATION, MINNETONKA, MN. FILED 4-30-2004.

WILLIAMSON LURES

THE MARK CONSISTS OF STANDARD CHARACTERS WITHOUT CLAIM TO ANY PARTICULAR FONT, STYLE, SIZE, OR COLOR.

NO CLAIM IS MADE TO THE EXCLUSIVE RIGHT TO USE "LURES", APART FROM THE MARK AS SHOWN.

SEC. 2(F) AS TO "WILLIAMSON".

FOR FISHING LURES AND FISHING TACKLE; FISHING KITS COMPRISING THE AFOREMENTIONED ITEMS (U.S. CLS. 22, 23, 38 AND 50).

FIRST USE 12-31-1988; IN COMMERCE 12-31-1988.

SONYA STEPHENS, EXAMINING ATTORNEY

SN 78-413,432. MATTEL, INC., EL SEGUNDO, AR. FILED 5-5-2004.

BARBIE MILLICENT ROBERTS

THE MARK CONSISTS OF STANDARD CHARACTERS WITHOUT CLAIM TO ANY PARTICULAR FONT, STYLE, SIZE, OR COLOR.

THE NAME(S), PORTRAIT(S), AND/OR SIGNATURE(S) SHOWN IN THE MARK DOES NOT IDENTIFY A PARTICULAR LIVING INDIVIDUAL.

FOR TOYS, GAMES AND PLAYTHINGS, NAMELY, DOLLS, DOLL CLOTHING AND DOLL ACCESSORIES (U.S. CLS. 22, 23, 38 AND 50).

PAM WILLIS, EXAMINING ATTORNEY

SN 78-417,233. MOOSE MOUNTAIN TOYMAKERS LTD., KOWLOON, HONG KONG, FILED 5-12-2004.

TRUTH OR DARE

THE MARK CONSISTS OF STANDARD CHARACTERS WITHOUT CLAIM TO ANY PARTICULAR FONT, STYLE, SIZE, OR COLOR.

FOR CHILDREN'S DANCING GAME COMPOSED OF A STEP-ON ELECTRONIC FLOORMAT AND AN ELECTRONIC CONTROL MODULE, SOLD THEREWITH AS A UNIT, FOR PROVIDING USER INTERACTION WITH THE FLOORMAT (U.S. CLS. 22, 23, 38 AND 50).

TINA L. SNAPP, EXAMINING ATTORNEY

CLASS 28—(Continued).

SN 78-421,067. MIZUNO USA, INC., NORCROSS, GA. FILED 5-18-2004.

KABUKI

THE MARK CONSISTS OF STANDARD CHARACTERS WITHOUT CLAIM TO ANY PARTICULAR FONT, STYLE, SIZE, OR COLOR.

FOR GOLF BAGS (U.S. CLS. 22, 23, 38 AND 50).
FIRST USE 8-0-2003; IN COMMERCE 8-0-2004.
EUGENIA MARTIN, EXAMINING ATTORNEY

SN 78-423,716. SPRI PRODUCTS, INC., LIBERTYVILLE, IL.
FILED 5-24-2004.

EXERGYM

THE MARK CONSISTS OF STANDARD CHARACTERS WITHOUT CLAIM TO ANY PARTICULAR FONT, STYLE, SIZE, OR COLOR.

OWNER OF U.S. REG. NO. 2,064,862.
FOR EXERCISE DEVICES, NAMELY, EXERCISE MACHINES AND MANUALLY-OPERATED EXERCISE EQUIPMENT (U.S. CLS. 22, 23, 38 AND 50).
LANA PHAM, EXAMINING ATTORNEY

CLASS 28—(Continued).

SN 78-426,352. CENTRAL PARK MEDIA CORPORATION, NEW YORK, NY. FILED 5-27-2004.

DOGGY POO

THE MARK CONSISTS OF STANDARD CHARACTERS WITHOUT CLAIM TO ANY PARTICULAR FONT, STYLE, SIZE, OR COLOR.

FOR TOYS, GAMES AND PLAYTHINGS, NAMELY, STUFFED TOYS; PLUSH TOYS; BATH AND POOL TOYS, FLOATING PLASTIC TOYS, PULL STRING TOYS, TOY FIGURES, PLUSH TOYS WITH ELECTRONIC COMPONENTS, DOLLS, DOLL CLOTHING, DOLL ACCESSORIES, ACTION FIGURES; JIGSAW PUZZLES; INFANTS' RATTLES; MUSICAL TOYS; BOARD GAMES; TOY BUILDING BLOCKS; BALLOONS; AND PLAYGROUND BALLS (U.S. CLS. 22, 23, 38 AND 50).
KATHY DE JONGE, EXAMINING ATTORNEY

SN 78-427,732. TUPPER, SHARON D., SEDONA, AZ. FILED 6-1-2004.

RACECAR Lap Dogs

THE MARK CONSISTS OF STANDARD CHARACTERS WITHOUT CLAIM TO ANY PARTICULAR FONT, STYLE, SIZE, OR COLOR.

FOR PLUSH TOYS IN THE COMBINED SHAPE OF RACE CARS AND DOGS (U.S. CLS. 22, 23, 38 AND 50).
DOMINIC J. FERRAIUOLO, EXAMINING ATTORNEY

CLASS 28—(Continued).

SN 78-427,897. MANHATTAN GROUP, LLC, MINNEAPOLIS, MN. FILED 6-1-2004.

DREAMTASTIC BY GROOVY GIRLS

THE MARK CONSISTS OF STANDARD CHARACTERS WITHOUT CLAIM TO ANY PARTICULAR FONT, STYLE, SIZE, OR COLOR.

OWNER OF U.S. REG. NOS. 2,344,957, 2,609,848 AND OTHERS.

FOR TOYS, NAMELY, DOLLS, PAPER DOLLS, STUFFED DOLLS, DOLL CLOTHING, DOLL COSTUMES, DOLL ACCESSORIES, DOLL CASES, DOLL FURNITURE, DOLL HOUSE FURNISHINGS, DOLL HOUSES, DOLL PLAYSETS, STUFFED TOY ANIMALS FOR USE WITH DOLLS, POSITIONABLE TOY FIGURES, COLLECTABLE TOY FIGURES, STUFFED AND PLUSH TOYS, CHILDREN'S MULTIPLE ACTIVITY TOYS, BATH TOYS, INFANT TOYS, TOY PURSES; GAMES, NAMELY, PARLOR GAMES, BOARD GAMES AND ACTIVITY GAMES; HOBBY CRAFT KITS COMPRISING KITS TO DECORATE AND CREATE DOLLS AND DOLL ACCESSORIES USING PAPER AND FABRIC; HOBBY CRAFT KITS TO CREATE HAIR ORNAMENTS, JEWELRY AND OTHER PERSONAL ACCESSORIES FOR CHILDREN AND DOLLS; PUZZLES; PARTY FAVORS IN THE NATURE OF NOISEMAKERS AND SMALL TOYS (U.S. CLS. 22, 23, 38 AND 50).

GRETTA YAO, EXAMINING ATTORNEY

SN 78-431,999. INNOVATIVE PRODUCT DEVELOPMENT, INC, BLAINE, WA. FILED 6-8-2004.

THE YEAR OF THE DOG

THE MARK CONSISTS OF STANDARD CHARACTERS WITHOUT CLAIM TO ANY PARTICULAR FONT, STYLE, SIZE, OR COLOR.

FOR PLUSH TOYS, NAMELY STUFFED ANIMALS MADE FROM TEXTILES, AND ANIMALS SHAPES MADE FROM PLASTIC(S) (U.S. CLS. 22, 23, 38 AND 50). FIRST USE 1-14-2005; IN COMMERCE 1-14-2005.
JOHN DALIER, EXAMINING ATTORNEY

CLASS 28—(Continued).

SN 78-432,812. G STUDIOS, LLC, NEWPORT BEACH, CA. FILED 6-10-2004.

EARTH 2 JANE

THE MARK CONSISTS OF STANDARD CHARACTERS WITHOUT CLAIM TO ANY PARTICULAR FONT, STYLE, SIZE, OR COLOR.

FOR GAMES, TOYS AND SPORTING GOODS, NAMELY, DOLLS, DOLL CLOTHING AND DOLL ACCESSORIES, COLLECTABLE TOY FIGURINES, TOY PLAYSETS FOR DOLLS, SOFT SCULPTURE DOLLS, CHILDREN'S MULTIPLE ACTIVITY TOYS, CHARACTER TOY FIGURINES, PLUSH TOYS, TALKING TOYS, SOFT SCULPTURE PLUSH TOYS; BOARD GAMES AND PARTY GAMES, JIGSAW PUZZLES, JUMP ROPES, KITES, MUSIC TOY BOXES, AND SPORTING GOODS, NAMELY BALLS; ELECTRONIC ACTION TOYS, ELECTRONIC GAMES, NAMELY, HAND HELD UNITS FOR PLAYING ELECTRONIC GAMES AND ARCADE-TYPE ELECTRONIC VIDEO GAMES, SURFBOARDS, AND WAKEBOARDS (U.S. CLS. 22, 23, 38 AND 50).

REBECCA SMITH, EXAMINING ATTORNEY

SN 78-432,813. G STUDIOS, LLC, NEWPORT BEACH, CA. FILED 6-10-2004.

FOR GIVING SOULS

THE MARK CONSISTS OF STANDARD CHARACTERS WITHOUT CLAIM TO ANY PARTICULAR FONT, STYLE, SIZE, OR COLOR.

FOR GAMES, TOYS AND SPORTING GOODS, NAMELY, DOLLS, DOLL CLOTHING AND DOLL ACCESSORIES, COLLECTABLE TOY FIGURINES, TOY PLAYSETS FOR DOLLS, SOFT SCULPTURE DOLLS, CHILDREN'S MULTIPLE ACTIVITY TOYS, CHARACTER TOY FIGURINES, PLUSH TOYS, TALKING TOYS, SOFT SCULPTURE PLUSH TOYS; BOARD GAMES AND PARTY GAMES, JIGSAW PUZZLES, JUMP ROPES, KITES, MUSIC TOY BOXES, AND SPORTING GOODS, NAMELY BALLS; ELECTRONIC ACTION TOYS, ELECTRONIC GAMES, NAMELY, HAND HELD UNITS FOR PLAYING ELECTRONIC GAMES AND ARCADE-TYPE ELECTRONIC VIDEO GAMES, SURFBOARDS, AND WAKEBOARDS (U.S. CLS. 22, 23, 38 AND 50).

REBECCA SMITH, EXAMINING ATTORNEY

CLASS 28—(Continued).

SN 78-432,815. G STUDIOS, LLC, NEWPORT BEACH, CA.
FILED 6-10-2004.

TALL HATS

THE MARK CONSISTS OF STANDARD CHARACTERS WITHOUT CLAIM TO ANY PARTICULAR FONT, STYLE, SIZE, OR COLOR.

FOR GAMES, TOYS AND SPORTING GOODS, NAMELY, DOLLS, DOLL CLOTHING AND DOLL ACCESSORIES, COLLECTABLE TOY FIGURINES, TOY PLAYSETS FOR DOLLS, SOFT SCULPTURE DOLLS, CHILDREN'S MULTIPLE ACTIVITY TOYS, CHARACTER TOY FIGURINES, PLUSH TOYS, TALKING TOYS, SOFT SCULPTURE PLUSH TOYS; BOARD GAMES AND PARTY GAMES, JIGSAW PUZZLES, JUMP ROPES, KITES, MUSIC TOY BOXES, AND SPORTING GOODS, NAMELY BALLS; ELECTRONIC ACTION TOYS, ELECTRONIC GAMES, NAMELY, HAND HELD UNITS FOR PLAYING ELECTRONIC GAMES AND ARCADE-TYPE ELECTRONIC VIDEO GAMES, SURFBOARDS, AND WAKEBOARDS (U.S. CLS. 22, 23, 38 AND 50).

REBECCA SMITH, EXAMINING ATTORNEY

SN 78-432,816. G STUDIOS, LLC, NEWPORT BEACH, CA.
FILED 6-10-2004.

**THE LAND OF MILK
AND HONEY**

THE MARK CONSISTS OF STANDARD CHARACTERS WITHOUT CLAIM TO ANY PARTICULAR FONT, STYLE, SIZE, OR COLOR.

FOR GAMES, TOYS AND SPORTING GOODS, NAMELY, DOLLS, DOLL CLOTHING AND DOLL ACCESSORIES, COLLECTABLE TOY FIGURINES, TOY PLAYSETS FOR DOLLS, SOFT SCULPTURE DOLLS, CHILDREN'S MULTIPLE ACTIVITY TOYS, CHARACTER TOY FIGURINES, PLUSH TOYS, TALKING TOYS, SOFT SCULPTURE PLUSH TOYS; BOARD GAMES AND PARTY GAMES, JIGSAW PUZZLES, JUMP ROPES, KITES, MUSIC TOY BOXES, AND SPORTING GOODS, NAMELY BALLS; ELECTRONIC ACTION TOYS, ELECTRONIC GAMES, NAMELY, HAND HELD UNITS FOR PLAYING ELECTRONIC GAMES AND ARCADE-TYPE ELECTRONIC VIDEO GAMES, SURFBOARDS, AND WAKEBOARDS (U.S. CLS. 22, 23, 38 AND 50).

REBECCA SMITH, EXAMINING ATTORNEY

CLASS 28—(Continued).

SN 78-437,373. MATTEL, INC., EL SEGUNDO, CA. FILED 6-17-2004.

HOTT DAWG

THE MARK CONSISTS OF STANDARD CHARACTERS WITHOUT CLAIM TO ANY PARTICULAR FONT, STYLE, SIZE, OR COLOR.

FOR TOYS, GAMES AND PLAYTHINGS, NAMELY, ACTION SKILL GAMES, TOY FIGURES AND ACCESSORIES THEREFOR (U.S. CLS. 22, 23, 38 AND 50).

CIMMERIAN COLEMAN, EXAMINING ATTORNEY

SN 78-437,388. MATTEL, INC., EL SEGUNDO, CA. FILED 6-17-2004.

PASSION TOO

THE MARK CONSISTS OF STANDARD CHARACTERS WITHOUT CLAIM TO ANY PARTICULAR FONT, STYLE, SIZE, OR COLOR.

FOR TOYS, GAMES AND PLAYTHINGS, NAMELY, TOY VEHICLES AND ACCESSORIES THEREFOR (U.S. CLS. 22, 23, 38 AND 50).

CHRISIE B. KING, EXAMINING ATTORNEY

SN 78-437,389. MATTEL, INC., EL SEGUNDO, CA. FILED 6-17-2004.

PIRANHA FRENZY

THE MARK CONSISTS OF STANDARD CHARACTERS WITHOUT CLAIM TO ANY PARTICULAR FONT, STYLE, SIZE, OR COLOR.

FOR TOYS, GAMES AND PLAYTHINGS, NAMELY, TOY ACTION FIGURES AND ACCESSORIES THEREFOR (U.S. CLS. 22, 23, 38 AND 50).

CHRISIE B. KING, EXAMINING ATTORNEY

CLASS 28—(Continued).

SN 78-437,390. MATTEL, INC., EL SEGUNDO, CA. FILED 6-17-2004.

**PRINCESS OF
IMPERIAL RUSSIA**

THE MARK CONSISTS OF STANDARD CHARACTERS WITHOUT CLAIM TO ANY PARTICULAR FONT, STYLE, SIZE, OR COLOR.

FOR TOYS, GAMES AND PLAYTHINGS, NAMELY, DOLLS, DOLL CLOTHING AND DOLL ACCESSORIES (U.S. CLS. 22, 23, 38 AND 50).

CHRISIE B. KING, EXAMINING ATTORNEY

CLASS 28—(Continued).

SN 78-442,014. G STUDIOS LLC, NEWPORT BEACH, CA. FILED 6-27-2004.

CHOSEN GIRLS

THE MARK CONSISTS OF STANDARD CHARACTERS WITHOUT CLAIM TO ANY PARTICULAR FONT, STYLE, SIZE, OR COLOR.

FOR GAMES, TOYS AND SPORTING GOODS, NAMELY, DOLLS, DOLL CLOTHING AND DOLL ACCESSORIES, COLLECTABLE TOY FIGURINES, TOY PLAYSETS FOR DOLLS, SOFT SCULPTURE DOLLS, CHILDREN'S MULTIPLE ACTIVITY TOYS, CHARACTER TOY FIGURINES, PLUSH TOYS, TALKING TOYS, SOFT SCULPTURE PLUSH TOYS; BOARD GAMES AND PARTY GAMES, JIGSAW PUZZLES, JUMP ROPES, KITES, MUSIC TOY BOXES, AND SPORTING GOODS, NAMELY BALLS; ELECTRONIC ACTION TOYS, ELECTRONIC GAMES, NAMELY, HAND HELD UNITS FOR PLAYING ELECTRONIC GAMES AND ARCADE-TYPE ELECTRONIC VIDEO GAMES, SURFBOARDS, AND WAKEBOARDS (U.S. CLS. 22, 23, 38 AND 50).

REBECCA SMITH, EXAMINING ATTORNEY

SN 78-440,660. BURLISON, BARRY, BRUSH PRAIRIE, WA. FILED 6-24-2004.

ROCKET SCIENCE

THE MARK CONSISTS OF STANDARD CHARACTERS WITHOUT CLAIM TO ANY PARTICULAR FONT, STYLE, SIZE, OR COLOR.

FOR TOYS, GAMES AND PLAYTHINGS, NAMELY, REMOTE CONTROL TOYS, TOY BIRD FEEDERS, TOY BINOCULARS, TOY CHOCOCHINO MACHINES, TOY ARTIFACTS, TOY FOSSILS, AND ACTION FIGURES (U.S. CLS. 22, 23, 38 AND 50).

JEFF DEFORD, EXAMINING ATTORNEY

SN 78-442,333. DER-TEX CORPORATION, SACO, ME. FILED 6-28-2004.

FRELONIC

THE MARK CONSISTS OF STANDARD CHARACTERS WITHOUT CLAIM TO ANY PARTICULAR FONT, STYLE, SIZE, OR COLOR.

OWNER OF U.S. REG. NOS. 1,673,518 AND 1,762,981, FOR PERSONAL EXERCISE MATS (U.S. CLS. 22, 23, 38 AND 50).

FIRST USE 9-30-1997; IN COMMERCE 9-30-1997.
JASON TURNER, EXAMINING ATTORNEY

CLASS 28—(Continued).

SN 78-442,382. MATTEL, INC., EL SEGUNDO, CA. FILED 6-28-2004.

CALIFORNIA GIRL

THE MARK CONSISTS OF STANDARD CHARACTERS WITHOUT CLAIM TO ANY PARTICULAR FONT, STYLE, SIZE, OR COLOR.

NO CLAIM IS MADE TO THE EXCLUSIVE RIGHT TO USE GIRL, APART FROM THE MARK AS SHOWN.

FOR DOLLS, DOLL CLOTHING AND DOLL ACCESSORIES (U.S. CLS. 22, 23, 38 AND 50).

STEPHANIE DAVIS, EXAMINING ATTORNEY

SN 78-446,019. ZAG SKIS USA LLC, NEW YORK, NY. FILED 7-6-2004.

ZAG

THE MARK CONSISTS OF STANDARD CHARACTERS WITHOUT CLAIM TO ANY PARTICULAR FONT, STYLE, SIZE, OR COLOR.

FOR SPORTING GOODS, NAMELY SKIS AND SNOW BOARDS (U.S. CLS. 22, 23, 38 AND 50).

DOMINICK J. SALEMI, EXAMINING ATTORNEY

SN 78-446,559. MATTEL, INC., EL SEGUNDO, CA. FILED 7-6-2004.

ROLLIN' THUNDER

THE MARK CONSISTS OF STANDARD CHARACTERS WITHOUT CLAIM TO ANY PARTICULAR FONT, STYLE, SIZE, OR COLOR.

FOR TOYS, GAMES AND PLAYTHINGS, NAMELY, TOY VEHICLES AND ACCESSORIES THEREFOR (U.S. CLS. 22, 23, 38 AND 50).

MIDGE BUTLER, EXAMINING ATTORNEY

CLASS 28—(Continued).

SN 78-450,558. MACK TRUCKS, INC., ALLENTOWN, PA. FILED 7-14-2004.

BULLDOG TOUGH

THE MARK CONSISTS OF STANDARD CHARACTERS WITHOUT CLAIM TO ANY PARTICULAR FONT, STYLE, SIZE, OR COLOR.

OWNER OF U.S. REG. NOS. 232,268, 1,307,678 AND OTHERS.

FOR TOY VEHICLES, NAMELY DIE CAST TRUCK REPLICAS AND PLUSH TOYS, NAMELY TRUCKS (U.S. CLS. 22, 23, 38 AND 50).

FIRST USE 12-31-2000; IN COMMERCE 12-31-2000.

SONYA STEPHENS, EXAMINING ATTORNEY

SN 78-456,760. GODU, INC., ATLANTA, GA. FILED 7-26-2004.

FRONT SEAT ANGEL

THE MARK CONSISTS OF STANDARD CHARACTERS WITHOUT CLAIM TO ANY PARTICULAR FONT, STYLE, SIZE, OR COLOR.

NO CLAIM IS MADE TO THE EXCLUSIVE RIGHT TO USE "ANGEL", APART FROM THE MARK AS SHOWN.

FOR DOLLS AND DOLL ACCESSORIES (U.S. CLS. 22, 23, 38 AND 50).

DAWN FELDMAN, EXAMINING ATTORNEY

SN 78-457,588. LIFE VERSES INC., FALLBROOK, CA. FILED 7-27-2004.

Scripture Buddies

THE MARK CONSISTS OF STANDARD CHARACTERS WITHOUT CLAIM TO ANY PARTICULAR FONT, STYLE, SIZE, OR COLOR.

NO CLAIM IS MADE TO THE EXCLUSIVE RIGHT TO USE "SCRIPTURE", APART FROM THE MARK AS SHOWN.

FOR STUFFED TOY ANIMALS (U.S. CLS. 22, 23, 38 AND 50).

MATTHEW PAPPAS, EXAMINING ATTORNEY

CLASS 28—(Continued).

SN 78-457,750. DALSING, MARY LOU, HAZEL GREEN, WI. AND DALSING, RICHARD, HAZEL GREEN, WI. FILED 7-28-2004.

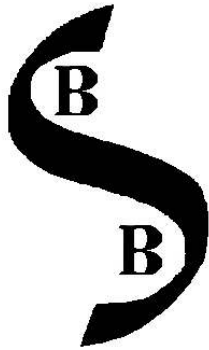

THE MARK CONSISTS OF A LARGE STYLIZED LETTER S WITH A SMALLER STYLIZED LETTER B DIRECTLY UNDER THE TOP CURVING PORTION OF THE LETTER S AND ANOTHER LETTER B DIRECTLY ABOVE THE BOTTOM CURVING PORTION OF THE LETTER S.

FOR COMPACT, EXTENDABLE AND RETRACTABLE GOLF ACCESSORY DEVICE, NAMELY, A GOLF BALL GRIPPER AND PICKUP USEFUL TO AID A GOLFER IN PICKING-UP A BALL FROM THE GOLF COURSE. (U.S. CLS. 22, 23, 38 AND 50).

NAKWAMA ANKRAH, EXAMINING ATTORNEY

CLASS 28—(Continued).

SN 78-465,522. JOHNSON, LANNY L., OKEMOS, MI. FILED 8-11-2004.

JUST WHAT THE DOCTOR ORDERED

THE MARK CONSISTS OF STANDARD CHARACTERS WITHOUT CLAIM TO ANY PARTICULAR FONT, STYLE, SIZE, OR COLOR.

FOR GOLF CLUBS AND RELATED GOLFING EQUIPMENT NAMELY, GOLF BAG TAGS, GOLF BALL MARKERS, GOLF GLOVES, GOLF CLUB GRIPS, GOLF BALL RETRIEVERS, DIVOT REPAIR TOOLS, GOLF CLUB INSERTS, GOLF BALLS, GOLF CLUB BAGS, GOLF CLUB HEAD COVERS AND GOLF TEES (U.S. CLS. 22, 23, 38 AND 50).

CIMMERIAN COLEMAN, EXAMINING ATTORNEY

SN 78-458,274. BATTAT INCORPORATED, PLATTSBURGH, NY. FILED 7-28-2004.



OWNER OF U.S. REG. NO. 1,387,626.

NO CLAIM IS MADE TO THE EXCLUSIVE RIGHT TO USE "SPORTS", APART FROM THE MARK AS SHOWN.

FOR TOYS, NAMELY, SPORTING GOODS, NAMELY, BASEBALL SETS, NAMELY, BASEBALL, BAT, GLOVE, AND BASES, INCLUDING HOME PLATE; BASKETBALL SETS, NAMELY, BASKETBALL, RIM, NET, AND BACKBOARD; FOOTBALL SETS, NAMELY, FOOTBALL, KICKING TEE, AND HELMET; HOCKEY SETS, NAMELY, PUCK, GOAL, AND STICK; TENNIS SETS, NAMELY, A RACQUET AND TENNIS BALLS, AND A NET WITH STANCHIONS; SOCCER SETS, NAMELY A SOCCER BALL, A GOAL AND SHIN GUARDS; AND GOLF SETS, NAMELY, GOLF BALLS, CLUBS, WOODS, IRONS, AND PUTTER, TEES, MINIATURE PUTTING GREEN, HOLE FLAG, AND GOLF BAG; ACTIVITY AND SPORTS BALLS, INCLUDING, JUMPING BALL, GRAB FOOTBALL; GRAB BUMPY BALL; GRAB BASKETBALL; RING TOSS MATERIALS, HOOK AND LOOP BALL AND CATCHING GLOVE, AND BOCCIE BALL GAME AND MATERIALS (U.S. CLS. 22, 23, 38 AND 50).

JOHN HWANG, EXAMINING ATTORNEY

SN 78-466,582. PURSUIT MARKETING, INC., DES PLAINES, IL. FILED 8-12-2004.

BULLET PAQ

THE MARK CONSISTS OF STANDARD CHARACTERS WITHOUT CLAIM TO ANY PARTICULAR FONT, STYLE, SIZE, OR COLOR.

NO CLAIM IS MADE TO THE EXCLUSIVE RIGHT TO USE PAQ, APART FROM THE MARK AS SHOWN.

SEC. 2(F).

FOR PAINTBALL EQUIPMENT FOR HOLDING PAINTBALLS, NAMELY, PAINTBALL TUBES, PAINTBALL CONTAINERS, PAINTBALL PODS, POD PACKS AND HARNESSSES (U.S. CLS. 22, 23, 38 AND 50).

FIRST USE 6-1-1999; IN COMMERCE 6-1-1999.

ASMAT KHAN, EXAMINING ATTORNEY

CLASS 28—(Continued).

SN 78-472,061. XTRA FIELDER, LLC, CALIFON, NJ. FILED 8-23-2004.



THE MARK CONSISTS OF A BASEBALL DIAMOND ON THE LEFT SIDE, WITH AN OVERSIZED X AS PART OF THE WORD MARK "XTRA". THE IS A NET DESIGN FOLLOWING THE WORD ELEMENT "NET FACTOR".

FOR TOYS, NAMELY, A FIELD GAME FOR TWO OR MORE PARTICIPANTS, CONSISTING OF NETS AND SUPPORTS THEREFORE (U.S. CLS. 22, 23, 38 AND 50).
GINA FINK, EXAMINING ATTORNEY

CLASS 28—(Continued).

SN 78-474,032. ROSE, PATRICK, LEBANON, OH. FILED 8-26-2004.

Cornholeo

THE MARK CONSISTS OF STANDARD CHARACTERS WITHOUT CLAIM TO ANY PARTICULAR FONT, STYLE, SIZE, OR COLOR.

FOR OUTDOOR RECREATION EQUIPMENT, NAMELY, CORN HOLE GAMES CONSISTING OF CORN FILLED BEAN BAGS, AND CORN TOSS CADDIES (U.S. CLS. 22, 23, 38 AND 50).

FIRST USE 7-1-2003; IN COMMERCE 7-1-2004.

PAULA MAHONEY, EXAMINING ATTORNEY

SN 78-474,122. BROWNSTONE BABIES, BROOKLYN, NY. FILED 8-26-2004.

Brownstone Babies

SN 78-472,784. SIMON, STANLEY, SYRACUSE, NY. FILED 8-24-2004.



NO CLAIM IS MADE TO THE EXCLUSIVE RIGHT TO USE "THE GAME OF TWISTING BALLS", APART FROM THE MARK AS SHOWN.

FOR OUTDOOR LAWN ACTIVITY GAME FEATURING TETHERED GOLF BALLS (U.S. CLS. 22, 23, 38 AND 50).

STEVEN JACKSON, EXAMINING ATTORNEY

THE MARK CONSISTS OF STANDARD CHARACTERS WITHOUT CLAIM TO ANY PARTICULAR FONT, STYLE, SIZE, OR COLOR.

NO CLAIM IS MADE TO THE EXCLUSIVE RIGHT TO USE "BABIES", APART FROM THE MARK AS SHOWN.

FOR TOYS, NAMELY, DOLLS, DOLL ACCESSORIES INCLUDING DOLL SPORTING EQUIPMENT, CHILDREN'S MULTIPLE ACTIVITY TOYS, BATH TOYS, PULL TOYS, PLUSH TOYS, MECHANICAL TOYS, PUZZLES, CRIB TOYS, COLLECTIBLE TOY FIGURES, MECHANICAL ACTION TOYS, POP UP TOYS, WIND-UP TOYS, RIDING TOYS, TOY MUSICAL INSTRUMENTS, TOY HOUSES, TOY FURNITURE, TOY BUILDING TOOLS, BATTERY-OPERATED ACTION TOYS, INFANT DEVELOPMENT TOYS, TOY CONSTRUCTION SETS, TOY BUILDING BLOCKS, TOY COOKING UTENSILS AND TOY FOOD, TOY ABACUS, TOY RULERS, TOY PROTRACTORS, TOY WHEEL CHAIR, AND TOY SCIENCE APPARATUS, NAMELY INSECT COLLECTION TOYS, TOY GARDENING TOOLS, TOY WEATHER MONITORING SETS, TOY ARCHEOLOGY TOOLS, TOY ASTRONOMY TOOLS, TOY MEDICAL INSTRUMENTS, AND TOY VETERINARIAN INSTRUMENTS (U.S. CLS. 22, 23, 38 AND 50).

DAYNA BROWNE, EXAMINING ATTORNEY

CLASS 28—(Continued).

SN 78-476,109. CAITEC CORPORATION, BALTIMORE, MD.
FILED 8-31-2004.



THE LINING IS A FEATURE OF THE MARK AND DOES NOT INDICATE COLOR.

THE MARK CONSISTS OF THE STYLIZED WORD "PARADISE" POSITIONED ABOVE A LOGO OF A BIRD WITH FEATHERS AND A PORTION OF A BIRD CAGE TO THE RIGHT SIDE OF THE BIRD.

FOR TOYS FOR PET BIRDS (U.S. CLS. 22, 23, 38 AND 50).

FIRST USE 12-15-2000; IN COMMERCE 12-15-2000.
BRIAN PINO, EXAMINING ATTORNEY

CLASS 28—(Continued).

SN 78-487,156. J.J LA LUNA, EAST HANOVER, NJ. FILED 9-21-2004.

It's The Pits

THE MARK CONSISTS OF STANDARD CHARACTERS WITHOUT CLAIM TO ANY PARTICULAR FONT, STYLE, SIZE, OR COLOR.

FOR PLUSH ANIMALS WITH ATTACHED PACKS OF AROMATHERAPY IN THE NATURE OF POTPOURRI (U.S. CLS. 22, 23, 38 AND 50).

DAVID C. REIHNER, EXAMINING ATTORNEY

SN 78-484,075. HANYOUNG KANGAROO CO., LTD, SEOUL, REPUBLIC OF KOREA, FILED 9-15-2004.



THE COLOR(S) RED AND WHITE IS/ARE CLAIMED AS A FEATURE OF THE MARK.

THE MARK CONSISTS OF THE WORD GRIPBITE. THE LETTERS G,R,I,P,I,T,E ARE IN WHITE COLOR AND THE LETTER B IS IN RED COLOR. THE FIRST LETTER "G" AND THE FIFTH LETTER "B" IN THE LETTER GRIPBITE ARE CAPITALIZED AND THE REST LETTERS ARE IN LOWER CASE.

FOR GOLF GLOVES (U.S. CLS. 22, 23, 38 AND 50).
FIRST USE 8-26-2004; IN COMMERCE 9-8-2004.
WON TEAK OH, EXAMINING ATTORNEY

SN 78-488,774. APRICOT BROWN LLC., NY, NY. FILED 9-23-2004.

APRICOT BROWN

THE MARK CONSISTS OF STANDARD CHARACTERS WITHOUT CLAIM TO ANY PARTICULAR FONT, STYLE, SIZE, OR COLOR.

FOR ACTION FIGURES, BALLOONS, BEAN BAG DOLLS, COLLECTABLE TOY FIGURES, CLOTHES FOR EUROPEAN DOLLS, DOLLS, DOLL CLOTHING, DOLL ACCESSORIES, DOLLS FOR PLAYING, EUROPEAN STYLE DOLLS, GIRLS' FESTIVAL DOLLS AND THEIR FITTINGS, RAG DOLLS, STUFFED DOLLS AND ANIMALS, TOY ACTION FIGURES, TOY FIGURES (U.S. CLS. 22, 23, 38 AND 50).

REBECCA GAN, EXAMINING ATTORNEY

CLASS 28—(Continued).

SN 78-490,124. SLAZENGERS LIMITED, BUCKINGHAMSHIRE, UNITED KINGDOM, FILED 9-27-2004.

SLAZENGER MONEY

THE MARK CONSISTS OF STANDARD CHARACTERS WITHOUT CLAIM TO ANY PARTICULAR FONT, STYLE, SIZE, OR COLOR.

PRIORITY CLAIMED UNDER SEC. 44(D) ON UNITED KINGDOM APPLICATION NO. 2371219, FILED 8-20-2004, REG. NO. 2371219A, DATED 8-20-2004, EXPIRES 8-20-2014.

FOR GAMES AND PLAYTHINGS, NAMELY, BOARD GAMES; GYMNAS TIC AND SPORTING ARTICLES AND APPARATUS, NAMELY, PERSONAL EXERCISE MATS, BASEBALL BATS, BASKET BALL HOOPS, GOLF CLUBS AND BASEBALL GLOVES; BALLS FOR USE IN SPORTS AND GAMES, NAMELY, BASEBALLS, FOOTBALLS, BASKET BALLS, AND SOCCER BALLS; GOLF BALLS; BAGS SPECIFICALLY ADAPTED FOR SPORTS EQUIPMENT (U.S. CLS. 22, 23, 38 AND 50).

DAWN FELDMAN, EXAMINING ATTORNEY

CLASS 28—(Continued).

SN 78-497,571. CANO, LARRY, R, NEWPORT BEACH, CA. FILED 10-11-2004.

RALLY LION

THE MARK CONSISTS OF STANDARD CHARACTERS WITHOUT CLAIM TO ANY PARTICULAR FONT, STYLE, SIZE, OR COLOR.

NO CLAIM IS MADE TO THE EXCLUSIVE RIGHT TO USE "LION", APART FROM THE MARK AS SHOWN.

FOR TOYS, IN THE NATURE OF STUFFED ANIMALS (U.S. CLS. 22, 23, 38 AND 50).

GEORGIA CARTY, EXAMINING ATTORNEY

SN 78-490,550. BASS BOYS, LLC, CUMMING, GA. FILED 9-28-2004.

BASS BOYS

THE MARK CONSISTS OF STANDARD CHARACTERS WITHOUT CLAIM TO ANY PARTICULAR FONT, STYLE, SIZE, OR COLOR.

NO CLAIM IS MADE TO THE EXCLUSIVE RIGHT TO USE "BASS", APART FROM THE MARK AS SHOWN.

FOR FISHING TACKLE: FISHING EQUIPMENT, NAMELY LURES, LURE RETRIEVERS, RODS AND REELS, ARTIFICIAL BAIT, FLOATS, FISHING BUOYS, SINKERS, FISHING WEIGHTS, LINE WEIGHTS AND HOOKS (U.S. CLS. 22, 23, 38 AND 50).

FIRST USE 3-12-2003; IN COMMERCE 3-21-2003.
JAMES GRIFFIN, EXAMINING ATTORNEY

SN 78-500,141. PLAYTONIUM LABS, LLC, ORANGE, CA. FILED 10-14-2004.

The C.E.O.

THE MARK CONSISTS OF STANDARD CHARACTERS WITHOUT CLAIM TO ANY PARTICULAR FONT, STYLE, SIZE, OR COLOR.

FOR DOLLS AND DOLL TOY KEY CHAINS WITH ELECTRONIC CHIPS THAT IMITATE TALKING (U.S. CLS. 22, 23, 38 AND 50).

STEVEN JACKSON, EXAMINING ATTORNEY

CLASS 28—(Continued).

SN 78-503,418. PRINCIOTTA, JOSEPH, ADELPHIA, NJ.
FILED 10-21-2004.

CLASS 28—(Continued).

SN 78-507,548. KOLPIN OUTDOORS, INC., FOX LAKE, WI.
FILED 10-28-2004.

WHO'S THE DON?

THE MARK CONSISTS OF STANDARD CHARACTERS
WITHOUT CLAIM TO ANY PARTICULAR FONT, STYLE,
SIZE, OR COLOR.

FOR TOYS, NAMELY BOARD GAME EQUIPMENT
SOLD AS A UNIT (U.S. CLS. 22, 23, 38 AND 50).
FLORENTINA BLANDU, EXAMINING ATTORNEY

ELIMINATOR

THE MARK CONSISTS OF STANDARD CHARACTERS
WITHOUT CLAIM TO ANY PARTICULAR FONT, STYLE,
SIZE, OR COLOR.

OWNER OF U.S. REG. NO. 2,438,371.
FOR HUNTING DECOYS (U.S. CLS. 22, 23, 38 AND 50).
KELLY BOULTON, EXAMINING ATTORNEY

SN 78-504,166. CARRUTH STUDIO, INC., WATERVILLE,
OH. FILED 10-22-2004.

ODD WHEELS

THE MARK CONSISTS OF STANDARD CHARACTERS
WITHOUT CLAIM TO ANY PARTICULAR FONT, STYLE,
SIZE, OR COLOR.

NO CLAIM IS MADE TO THE EXCLUSIVE RIGHT TO
USE "WHEELS", APART FROM THE MARK AS SHOWN.

FOR TOYS, NAMELY TOY FIGURES AND TOY CARS
(U.S. CLS. 22, 23, 38 AND 50).
CURTIS FRENCH, EXAMINING ATTORNEY

SN 78-509,980. BRINE, INC., MILFORD, MA. FILED 11-2-
2004.

FRESH MESH

SN 78-506,021. PUNCH FITNESS, INC., MIAMI BEACH, FL.
FILED 10-26-2004.

GKA
Girls Kick Ass

FOR BOXING EQUIPMENT, NAMELY, BOXING
GLOVES AND HAND WRAPS (U.S. CLS. 22, 23, 38 AND
50).

FIRST USE 12-31-2003; IN COMMERCE 12-31-2003.
DARRYL SPRUILL, EXAMINING ATTORNEY

THE MARK CONSISTS OF STANDARD CHARACTERS
WITHOUT CLAIM TO ANY PARTICULAR FONT, STYLE,
SIZE, OR COLOR.

NO CLAIM IS MADE TO THE EXCLUSIVE RIGHT TO
USE "MESH", APART FROM THE MARK AS SHOWN.

FOR MESH USED FOR LACROSSE STICK HEADS;
MESH AS SOLD AS A COMPONENT OF KITS USED
FOR REPAIR AND REPLACEMENT OF LACROSSE
STICK HEADS; MESH SOLD AS A COMPONENT OF
LACROSSE STICK HEADS; MESH SOLD AS A COMPO-
NENT OF LACROSSE STICKS (U.S. CLS. 22, 23, 38 AND
50).

SALLY SHIH, EXAMINING ATTORNEY

CLASS 28—(Continued).

SN 78-510,005. BERGER, MARILYN OLIN, NEW YORK, NY. FILED 11-2-2004.

CLASS 28—(Continued).

SN 78-512,251. ERDEK, DAVID S., ATLANTA, GA. FILED 11-5-2004.

Jiggledy Piggledy

RALLY DRUM

THE MARK CONSISTS OF STANDARD CHARACTERS WITHOUT CLAIM TO ANY PARTICULAR FONT, STYLE, SIZE, OR COLOR.

FOR BOARD GAMES CONSISTING OF PLAYING PIECES, EQUIPMENT, AND RELATED ACCESSORIES ALL OF WHICH ARE SOLD AS A UNIT (U.S. CLS. 22, 23, 38 AND 50).

LANA PHAM, EXAMINING ATTORNEY

THE MARK CONSISTS OF STANDARD CHARACTERS WITHOUT CLAIM TO ANY PARTICULAR FONT, STYLE, SIZE, OR COLOR.

NO CLAIM IS MADE TO THE EXCLUSIVE RIGHT TO USE "DRUM", APART FROM THE MARK AS SHOWN, FOR TOY NOISEMAKER FOR USE BY FANS AT ATHLETIC OR SPORTING EVENTS (U.S. CLS. 22, 23, 38 AND 50).

DOUGLAS LEE, EXAMINING ATTORNEY

SN 78-511,112. TAMISIN, WINSTON D., ALPHARETTA, GA. FILED 11-4-2004.

SN 78-513,168. RAPID DISPLAYS, INC., CHICAGO, IL. FILED 11-8-2004.

SMAK-Stiks

KNICK-KNACK PADDYWHACK

THE MARK CONSISTS OF STANDARD CHARACTERS WITHOUT CLAIM TO ANY PARTICULAR FONT, STYLE, SIZE, OR COLOR.

FOR PADDED SPARRING STICK USED IN MARTIAL ARTS TRAINING (U.S. CLS. 22, 23, 38 AND 50).

MATTHEW PAPPAS, EXAMINING ATTORNEY

THE MARK CONSISTS OF STANDARD CHARACTERS WITHOUT CLAIM TO ANY PARTICULAR FONT, STYLE, SIZE, OR COLOR.

FOR CARD GAMES (U.S. CLS. 22, 23, 38 AND 50).

GEORGIA CARTY, EXAMINING ATTORNEY

CLASS 28—(Continued).

SN 78-513,451. NELCO (INDIA) PRIVATE LIMITED, MEERUT (U.P.), INDIA, FILED 11-8-2004.

Nelco

THE MARK CONSISTS OF THE WORD NELCO IN A STYLIZED BOLD FONT.

FOR SPORTING EQUIPMENT, NAMELY, TRACK AND FIELD EQUIPMENT, NAMELY DISCUS, SHOTS, HAMMERS, HAMMER ACCESSORIES, JAVELINS, RACKS FOR DISCUS, HAMMERS, JAVELINS AND SHOTS, STARTING BLOCKS, STARTER ROSTRUMS, HURDLES, RACKS AND SCORE BOARDS, HIGH JUMP STANDARDS, POLE VAULT STANDS AND POLES, CAGES FOR DISCUS, SHOT PUT, JAVELIN, HIGH JUMP STANDS, CROSS BARS AND PITS, TOE BOARDS FOR SHOT PUT AND LONG JUMP TAKE-OFF, JAVELIN ARCS, DISCUS-SHOT HAMMER CIRCLES, RELAY BATONS, LANE MARKER BOXES, MARKING FLAGS, POWER LIFTER BELTS, WEIGHT LIFTING SETS, CHEST PULLS, HAND GRIPS, ANKLE AND WRITS WEIGHTS, DUMBBELLS, WEIGHT LIFTING AND SIT-UP BENCHES, ROWING MACHINES, PUSH-UP STANDS, JUMP ROPES, NAUTILUS EQUIPMENT, STEPPERS, MOUTH GUARDS, REFEREE WHISTLES, BASKET BALL HOOPS, MARKING CONES, SWIMMING BRICKS, SEAT STICKS (U.S. CLS. 22, 23, 38 AND 50).

FIRST USE 0-0-1971; IN COMMERCE 0-0-1971.
DARRYL SPRUILL, EXAMINING ATTORNEY

SN 78-513,900. CLASSIC MEDIA, INC., NEW YORK, NY. FILED 11-9-2004.

**GERALD MCBOING
BOING**

THE MARK CONSISTS OF STANDARD CHARACTERS WITHOUT CLAIM TO ANY PARTICULAR FONT, STYLE, SIZE, OR COLOR.

FOR PUZZLES (U.S. CLS. 22, 23, 38 AND 50).
FIRST USE 6-1-2002; IN COMMERCE 6-1-2002.
ASMAT KHAN, EXAMINING ATTORNEY

CLASS 28—(Continued).

SN 78-514,486. MATTEL, INC., EL SEGUNDO, CA. FILED 11-10-2004.

**PRINCESS OF THE
PACIFIC ISLANDS**

THE MARK CONSISTS OF STANDARD CHARACTERS WITHOUT CLAIM TO ANY PARTICULAR FONT, STYLE, SIZE, OR COLOR.

FOR TOYS, GAMES AND PLAYTHINGS, NAMELY, DOLLS, DOLL CLOTHING AND DOLL ACCESSORIES (U.S. CLS. 22, 23, 38 AND 50).

CHRISIE B. KING, EXAMINING ATTORNEY

SN 78-514,967. BARROWS, STACY ANN, MANHATTAN BEACH, CA. AND BARROWS, MATTHEW DANIEL, MANHATTAN BEACH, CA. FILED 11-10-2004.

SMARTROLLER

THE MARK CONSISTS OF STANDARD CHARACTERS WITHOUT CLAIM TO ANY PARTICULAR FONT, STYLE, SIZE, OR COLOR.

FOR MANUALLY-OPERATED EXERCISE EQUIPMENT (U.S. CLS. 22, 23, 38 AND 50).
MICHAEL TANNER, EXAMINING ATTORNEY

CLASS 28—(Continued).

SN 78-515,994. EASTMAN LAUBACH KREATIONS, INC.,
GARDINER, MT. FILED 11-12-2004.

CLASS 28—(Continued).

SN 78-518,594. NEW ADVENTURES CORPORATION, WEST
ORANGE, NJ. FILED 11-17-2004.

YOTE HOWLER

THE MARK CONSISTS OF STANDARD CHARACTERS
WITHOUT CLAIM TO ANY PARTICULAR FONT, STYLE,
SIZE, OR COLOR.

FOR WILD GAME CALL (U.S. CLS. 22, 23, 38 AND 50).
FIRST USE 6-8-2004; IN COMMERCE 6-8-2004.
ZACHARY BELLO, EXAMINING ATTORNEY

BABY PUFFS

THE MARK CONSISTS OF STANDARD CHARACTERS
WITHOUT CLAIM TO ANY PARTICULAR FONT, STYLE,
SIZE, OR COLOR.

NO CLAIM IS MADE TO THE EXCLUSIVE RIGHT TO
USE BABY, APART FROM THE MARK AS SHOWN.
FOR DOLLS, DOLL ACCESSORIES AND PLUSH TOYS
(U.S. CLS. 22, 23, 38 AND 50).

JEFF DEFORD, EXAMINING ATTORNEY

SN 78-518,836. SHOOT THE MOON PRODUCTS II, LLC,
PLEASANTON, CA. FILED 11-17-2004.

LITTLE SMOOCHERS

THE MARK CONSISTS OF STANDARD CHARACTERS
WITHOUT CLAIM TO ANY PARTICULAR FONT, STYLE,
SIZE, OR COLOR.

FOR PLUSH ANIMALS (U.S. CLS. 22, 23, 38 AND 50).
ELLEN B. AWRICH, EXAMINING ATTORNEY

SN 78-517,580. NIKE, INC., BEAVERTON, OR. FILED 11-16-
2004.

SN 78-519,092. BATTAT INCORPORATED, PLATTSBURGH,
NY. FILED 11-18-2004.

SASQUATCH

THE MARK CONSISTS OF STANDARD CHARACTERS
WITHOUT CLAIM TO ANY PARTICULAR FONT, STYLE,
SIZE, OR COLOR.

FOR GOLF CLUBS, GOLF BALLS, GOLF GLOVES,
GOLF CLUB GRIPS, GOLF BAGS, GOLF TEES, HEAD
COVERS FOR GOLF CLUBS, GOLF BALL MARKERS
(U.S. CLS. 22, 23, 38 AND 50).

SANI KHOURI, EXAMINING ATTORNEY

HUGGABALOO

THE MARK CONSISTS OF STANDARD CHARACTERS
WITHOUT CLAIM TO ANY PARTICULAR FONT, STYLE,
SIZE, OR COLOR.

OWNER OF U.S. REG. NO. 2,904,369.

FOR TOYS, NAMELY, TOY RATTLES; CHILDREN'S
AND BABY'S MULTIPLE ACTIVITY TOYS, NAMELY,
INFANT HAND MANIPULATIVES OF PLUSH AND/OR
PLASTIC COMPONENTS, BABY ACTIVITY MATS;
PLUSH AND SOFT SCULPTED TOYS; PLUSH TOY
RATTLES INCORPORATING HOLDING AND TEE-
THING RINGS (U.S. CLS. 22, 23, 38 AND 50).

JENNIFER WILLISTON, EXAMINING ATTORNEY

CLASS 28—(Continued).

SN 78-519,146. WINNING MOVES INC., DANVERS, MA.
FILED 11-18-2004.

CLASS 28—(Continued).

SN 78-520,479. MCCAFFERTY, JAMES R., SANTA ANA, CA.
FILED 11-19-2004.

RUMMY 10

THE MARK CONSISTS OF STANDARD CHARACTERS WITHOUT CLAIM TO ANY PARTICULAR FONT, STYLE, SIZE, OR COLOR.

OWNER OF U.S. REG. NO. 2,512,197.

NO CLAIM IS MADE TO THE EXCLUSIVE RIGHT TO USE "RUMMY", APART FROM THE MARK AS SHOWN.

FOR BOARD GAMES, CARD GAMES AND PUZZLES (U.S. CLS. 22, 23, 38 AND 50).

JULIE GUTTADAURO, EXAMINING ATTORNEY

COGMEN

SN 78-519,572. YASUI & CO., TOKYO, JAPAN, FILED 11-18-2004.

ULTIMA

THE MARK CONSISTS OF STANDARD CHARACTERS WITHOUT CLAIM TO ANY PARTICULAR FONT, STYLE, SIZE, OR COLOR.

FOR ARCHERY EQUIPMENT, NAMELY, NON-TELESCOPIC BOW SIGHTS (U.S. CLS. 22, 23, 38 AND 50).

CHRISIE B. KING, EXAMINING ATTORNEY

THE MARK CONSISTS OF STANDARD CHARACTERS WITHOUT CLAIM TO ANY PARTICULAR FONT, STYLE, SIZE, OR COLOR.

FOR GAMES AND PLAYTHINGS, NAMELY, MANIPULATIVE GAMES; TOY FIGURES; PLAY FIGURES; FANTASY CHARACTER TOYS; TOY ACTION FIGURES AND ACCESSORIES THEREFORE; TOY VEHICLES; TOY FIGURES, ACCESSORIES AND VEHICLES FOR PLAY IN WATER; MECHANICAL TOYS; PARTY FAVORS IN THE NATURE OF SMALL TOYS; PLUSH TOYS; MANIPULATIVE PUZZLES; COLLECTIBLE TOY FIGURES; SAND TOYS; ELECTRONIC AND MECHANICALLY OPERATED EDUCATIONAL AND ENTERTAINMENT TOYS, NAMELY, HANDHELD UNITS FOR PLAYING ELECTRONIC GAMES, MECHANICAL TOYS, TOY VEHICLES, AND ACTION FIGURES (U.S. CLS. 22, 23, 38 AND 50).

AMY HELLA, EXAMINING ATTORNEY

CLASS 28—(Continued).

SN 78-520,855. BASEBALL EXPOS, L.P., MONTREAL, QUEBEC, CANADA, FILED 11-22-2004.

WASHINGTON
NATIONALS

THE MARK CONSISTS OF STANDARD CHARACTERS WITHOUT CLAIM TO ANY PARTICULAR FONT, STYLE, SIZE, OR COLOR.

NO CLAIM IS MADE TO THE EXCLUSIVE RIGHT TO USE "WASHINGTON", APART FROM THE MARK AS SHOWN.

FOR TOYS AND SPORTING GOODS, NAMELY KALEIDOSCOPES, STUFFED TOYS, PLUSH TOYS, BEAN BAG TOYS, SOFT SCULPTURE FOAM TOYS, PUPPETS; BALLOONS, MARBLES, DICE, CHECKER SETS, CHESS SETS, BOARD GAMES, CARD GAMES, PLAYING CARDS, DART BOARDS AND DART BOARD ACCESSORIES, NAMELY, DARTS, DART SHAFTS AND DART FLIGHTS, TOY CARS AND TRUCKS, TOY MOBILES, JIGSAW AND MANIPULATIVE PUZZLES, YO-YO'S, TOY BANKS, TOY FIGURES, TOY VEHICLES, TOY AIRPLANES, DOLLS AND DOLL ACCESSORIES, BOBBING HEAD DOLLS, INFLATABLE BASEBALL BATS, DECORATIVE WIND SOCKS, FLYING DISCS, MINIATURE BASEBALL BATS, MINI BATTING HELMET REPLICAS, TOY NECKLACES, MINIATURE TOY BASEBALLS, COIN-OPERATED PINBALL MACHINES, BASEBALLS, HOLDERS FOR BASEBALLS, AUTOGRAPHED BASEBALLS, FOOTBALLS, SOFTBALLS, PLAYGROUND BALLS, RUBBER ACTION BALLS, GOLF BALLS, GOLF CLUB HEAD COVERS, GOLF CLUB BAGS, GOLF PUTTERS, BILLIARD ACCESSORIES, NAMELY, CUES, BILLIARD BALLS AND CUE CASES, BOWLING BALLS, BOWLING BAGS, BASEBALL BASES, PITCHER'S PLATES, BASEBALL BATS, CATCHER'S MASKS, GRIP TAPE FOR BASEBALL BATS, BASEBALL BATTING TEES, PINE TAR BAGS FOR BASEBALL, ROSIN BAGS FOR BASEBALL, BASEBALL GLOVE OIL, BATTING GLOVES, BASEBALL GLOVES, BASEBALL MITTS, UMPIRE'S PROTECTIVE EQUIPMENT, CHEST PROTECTORS FOR SPORTS, ATHLETIC SUPPORTERS, BASEBALL PITCHING MACHINES, INFLATABLE TOYS, SWIM FLOATS FOR RECREATIONAL USE; HAND HELD VIDEO AND ELECTRONIC GAMES; PARTY FAVORS IN THE NATURE OF NOISE MAKERS; COSTUME MASKS; AND, CHRISTMAS TREE ORNAMENTS, EXCLUDING CONFECTIONERY AND ILLUMINATION ARTICLES (U.S. CLS. 22, 23, 38 AND 50).

KATHY DE JONGE, EXAMINING ATTORNEY

CLASS 28—(Continued).

SN 78-520,872. BASEBALL EXPOS, L.P., MONTREAL, QUEBEC, CANADA, FILED 11-22-2004.



THE MARK CONSISTS OF THE LETTERS "DC" IN STYLIZED FORM.

FOR TOYS AND SPORTING GOODS, NAMELY KALEIDOSCOPES, STUFFED TOYS, PLUSH TOYS, BEAN BAG TOYS, SOFT SCULPTURE FOAM TOYS, PUPPETS; BALLOONS, MARBLES, DICE, CHECKER SETS, CHESS SETS, BOARD GAMES, CARD GAMES, PLAYING CARDS, DART BOARDS AND DART BOARD ACCESSORIES, NAMELY, DARTS, DART SHAFTS AND DART FLIGHTS, TOY CARS AND TRUCKS, TOY MOBILES, JIGSAW AND MANIPULATIVE PUZZLES, YO-YO'S, TOY BANKS, TOY FIGURES, TOY VEHICLES, TOY AIRPLANES, DOLLS AND DOLL ACCESSORIES, BOBBING HEAD DOLLS, INFLATABLE BASEBALL BATS, DECORATIVE WIND SOCKS, FLYING DISCS, MINIATURE BASEBALL BATS, MINI BATTING HELMET REPLICAS, TOY NECKLACES, MINIATURE TOY BASEBALLS, COIN-OPERATED PINBALL MACHINES, BASEBALLS, HOLDERS FOR BASEBALLS, AUTOGRAPHED BASEBALLS, FOOTBALLS, SOFTBALLS, PLAYGROUND BALLS, RUBBER ACTION BALLS, GOLF BALLS, GOLF CLUB HEAD COVERS, GOLF CLUB BAGS, GOLF PUTTERS, BILLIARD ACCESSORIES, NAMELY, CUES, BILLIARD BALLS AND CUE CASES, BOWLING BALLS, BOWLING BAGS, BASEBALL BASES, PITCHER'S PLATES, BASEBALL BATS, CATCHER'S MASKS, GRIP TAPE FOR BASEBALL BATS, BASEBALL BATTING TEES, PINE TAR BAGS FOR BASEBALL, ROSIN BAGS FOR BASEBALL, BASEBALL GLOVE OIL, BATTING GLOVES, BASEBALL GLOVES, BASEBALL MITTS, UMPIRE'S PROTECTIVE EQUIPMENT, CHEST PROTECTORS FOR SPORTS, ATHLETIC SUPPORTERS, BASEBALL PITCHING MACHINES, INFLATABLE TOYS, SWIM FLOATS FOR RECREATIONAL USE; HAND HELD VIDEO AND ELECTRONIC GAMES; PARTY FAVORS IN THE NATURE OF NOISE MAKERS; COSTUME MASKS; AND, CHRISTMAS TREE ORNAMENTS, EXCLUDING CONFECTIONERY AND ILLUMINATION ARTICLES (U.S. CLS. 22, 23, 38 AND 50).

MICHELLE DUBOIS, EXAMINING ATTORNEY

CLASS 28—(Continued).

SN 78-520,931. FITNESS DESIGN & DEVELOPMENT, LOGAN, UT. FILED 11-22-2004.

CLASS 28—(Continued).

SN 78-521,444. MILK AND HONEY PRINTING PRESS, LLC, NEW ORLEANS, LA. FILED 11-22-2004.

GLADIATOR FITNESS

THE MARK CONSISTS OF STANDARD CHARACTERS WITHOUT CLAIM TO ANY PARTICULAR FONT, STYLE, SIZE, OR COLOR.

NO CLAIM IS MADE TO THE EXCLUSIVE RIGHT TO USE "FITNESS", APART FROM THE MARK AS SHOWN.

FOR EXERCISE MACHINES FOR STRENGTH TRAINING (U.S. CLS. 22, 23, 38 AND 50).

DAVID C. REIHNER, EXAMINING ATTORNEY

Be Healed

SN 78-521,220. ETHE, JANE, NEW YORK, NY. AND LEMPERT, CATHY, NEW YORK, NY. FILED 11-22-2004.

THE MARK CONSISTS OF STANDARD CHARACTERS WITHOUT CLAIM TO ANY PARTICULAR FONT, STYLE, SIZE, OR COLOR.

FOR STUFFED TOY ANIMALS (U.S. CLS. 22, 23, 38 AND 50).

FIRST USE 2-2-2003; IN COMMERCE 2-2-2003.

WILLIAM VERHOSEK, EXAMINING ATTORNEY

SIGNOSAURUS

THE MARK CONSISTS OF STANDARD CHARACTERS WITHOUT CLAIM TO ANY PARTICULAR FONT, STYLE, SIZE, OR COLOR.

FOR TOY STUFFED ANIMAL (U.S. CLS. 22, 23, 38 AND 50).

ELIZABETH PIGNATELLO, EXAMINING ATTORNEY

SN 78-521,626. WILSON SPORTING GOODS CO., CHICAGO, IL. FILED 11-23-2004.

SN 78-521,443. MILK AND HONEY PRINTING PRESS, LLC, NEW ORLEANS, LA. FILED 11-22-2004.

JET

Celibacy

THE MARK CONSISTS OF STANDARD CHARACTERS WITHOUT CLAIM TO ANY PARTICULAR FONT, STYLE, SIZE, OR COLOR.

FOR STUFFED TOY ANIMALS (U.S. CLS. 22, 23, 38 AND 50).

FIRST USE 6-1-2003; IN COMMERCE 6-1-2003.

WILLIAM VERHOSEK, EXAMINING ATTORNEY

THE MARK CONSISTS OF STANDARD CHARACTERS WITHOUT CLAIM TO ANY PARTICULAR FONT, STYLE, SIZE, OR COLOR.

OWNER OF U.S. REG. NOS. 575,624 AND 1,865,346. FOR INFLATED BALLS, NAMELY, BASKETBALLS, FOOTBALLS, VOLLEYBALLS, AND SOCCERBALLS (U.S. CLS. 22, 23, 38 AND 50).

FIRST USE 6-2-1952; IN COMMERCE 6-2-1952.

JOANNA DUKOVIC, EXAMINING ATTORNEY

CLASS 28—(Continued).

SN 78-521,926. WILSON SPORTING GOODS CO., CHICAGO, IL. FILED 11-23-2004.



THE MARK CONSISTS OF IMAGE OF A KEYHOLE. FOR RACKETS FOR TENNIS, RACKETBALL, SQUASH, BADMINTON, PLATFORM TENNIS, AND PADDLEBALL (U.S. CLS. 22, 23, 38 AND 50). FIRST USE 4-24-2004; IN COMMERCE 4-24-2004. NICHOLAS ALTREE, EXAMINING ATTORNEY

CLASS 28—(Continued).

SN 78-522,395. ELECTRIC RED CORPORATION, WELLESLEY, MA. FILED 11-24-2004.

ELECTRIC RED

THE MARK CONSISTS OF STANDARD CHARACTERS WITHOUT CLAIM TO ANY PARTICULAR FONT, STYLE, SIZE, OR COLOR.

NO CLAIM IS MADE TO THE EXCLUSIVE RIGHT TO USE "ELECTRIC", APART FROM THE MARK AS SHOWN. FOR GAMES, NAMELY, HAND-HELD UNIT FOR PLAYING ELECTRONIC GAMES (U.S. CLS. 22, 23, 38 AND 50).

LAURIE MAYES, EXAMINING ATTORNEY

SN 78-522,510. MINDWALK INC, HIALEAH, FL. FILED 11-24-2004.

SN 78-522,077. OSMENT MODELS, INC., DBA WOODLAND SCENICS, LINN CREEK, MO. FILED 11-23-2004.

SCENIC DETAILS

THE MARK CONSISTS OF STANDARD CHARACTERS WITHOUT CLAIM TO ANY PARTICULAR FONT, STYLE, SIZE, OR COLOR.

OWNER OF U.S. REG. NO. 1,227,126. SEC. 2(F).

FOR HOBBY CRAFT KITS FOR CONSTRUCTING MINIATURE REPLICAS OF NATURAL AND MAN MADE OBJECTS (U.S. CLS. 22, 23, 38 AND 50).

FIRST USE 10-3-1980; IN COMMERCE 10-3-1980. SHAUNIA WALLACE, EXAMINING ATTORNEY

Subbies

THE MARK CONSISTS OF STANDARD CHARACTERS WITHOUT CLAIM TO ANY PARTICULAR FONT, STYLE, SIZE, OR COLOR.

FOR POOL AND BATH TOY CARICATURES THAT USE UNBALANCED MOTORS FOR LOCOMOTION (U.S. CLS. 22, 23, 38 AND 50).

FIRST USE 0-0-2002; IN COMMERCE 0-0-2002.

APRIL L. RADEMACHER, EXAMINING ATTORNEY

CLASS 28—(Continued).

SN 78-522,885. JOHNSON, WILLIAM A., LOS ANGELES, CA.
FILED 11-24-2004.

KILLER SHREWS

THE MARK CONSISTS OF STANDARD CHARACTERS WITHOUT CLAIM TO ANY PARTICULAR FONT, STYLE, SIZE, OR COLOR.

FOR TOYS, GAMES, PLAYTHINGS AND SPORTING GOODS; NAMELY, ACTION FIGURES AND ACCESSORIES THEREFOR, STUFFED TOY ANIMALS; BABY'S MULTIPLE ACTIVITY TOYS; TOY BAKEWARE AND COOKWARE; BALLOONS; TOY BANKS; BATH TOYS, BATHTUB TOYS, INFLATABLE BATH TOYS; EQUIPMENT SOLD AS A UNIT FOR PLAYING CARD GAMES; TOY CARS; DOLLS, BEANBAG DOLLS, PAPER DOLLS, RAG DOLLS, SOFT SCULPTURE DOLLS, DOLLS' ACCESSORIES AND PLAYSETS THEREFOR, INCLUDING DOLL CASES, DOLL CLOTHING, DOLL HOUSE FURNISHINGS, DOLL COSTUMES; STUFFED TOYS; CHECKER SETS; CHESS SETS; CHILDREN'S PLAY COSMETICS; CHILD'S MULTIPLE ACTIVITY TOYS, TOY CONSTRUCTION BLOCKS; INFANT'S ACTION CRIB TOYS; FLYING DISCS, ELECTRONIC HAND HELD GAME UNITS; ELECTRONIC GAME EQUIPMENT WITH A WATCH FUNCTION; ELECTRONICALLY OPERATED TOY MOTOR VEHICLES; BOARD GAMES AND GAME EQUIPMENT SOLD AS A UNIT FOR PLAYING BOARD GAMES, CARD GAMES, MANIPULATIVE GAMES, PARLOUR GAMES, ROLE-PLAYING GAMES AND DRESS UP SETS, ACTION TYPE TARGET GAMES; COIN OR NON-COIN OPERATED VIDEO OUTPUT STAND ALONE GAME MACHINES; ROCKING HORSES; JIGSAW PUZZLES; KITES; MANIPULATIVE PUZZLES; PAPER FACE MASKS; TOY MODEL TRAIN SETS; TOY MODEL VEHICLES AND RELATED ACCESSORIES SOLD AS A UNIT; ELECTRONIC BATTERY OPERATED TOYS; TOY TRICK NOISE-MAKERS; TOY WHISTLES; PARTY FAVORS IN THE NATURE OF SMALL TOYS; TOY CAP PISTOLS; PLUSH TOYS; SOFT SCULPTURE PLUSH TOYS; THREE DIMENSIONAL CUBE TYPE PUZZLES; TOY RECORD PLAYER FOR PLAYING TUNES AND CASSETTES AND DISCS THEREFOR; SKATEBOARDS; ICE SKATES; TOY ROLLER SKATES; TOY IN-LINE SKATES AND SKATING KNEE, WRIST AND ELBOW PADS; WATER SQUIRTING TOYS; TEDDY BEARS; WIND UP WALKING TOYS; WIND UP TOYS; NON-MOTORIZED NON-ELECTRIC MOBILE SELF-PROPELLED RIDING TOYS; TOY TRUCKS; TWIRLING BATONS; TOY ZIP GUNS; GYMNAS TIC APPARATUS; BALLS, NAMELY, PLAYGROUND BALLS, SOCCER BALLS, SPORTBALLS, BASEBALLS, BASKETBALLS, FOAM BALLS; BASEBALL GLOVES; SWIMMING FLOATS FOR RECREATIONAL USE; HEADCOVERS FOR GOLF CLUBS; GOLF BALLS; GOLF CLUBS; INFLATABLE SWIMMING POOLS FOR RECREATIONAL USE; FLOATATION KICKBOARDS; GYMNAS TIC PARALLEL BARS; WATER SKIS, SNOW SKIS; SNOWBOARDS; SKIPPING ROPES, JUMP ROPES; SNOW SLEDS FOR RECREATIONAL USE; SURF FINS; SURFBOARDS; SWIM BOARDS FOR RECREATIONAL USE; BODYBOARDS; SWIM FINS; INFLATABLE AND BUOYANT BATH, SWIMMING AND RIDE-ON TOYS; MUSICAL TOYS, LATEX SQUEEZE TOYS; EXERCISE EQUIPMENT, NAMELY, STATIONARY BIKES, TREADMILLS, STAIR STEPPING MACHINES, WEIGHT MACHINES, FREE WEIGHTS; CHRISTMAS TREE ORNAMENTS (U.S. CLS. 22, 23, 38 AND 50).
EDWARD NELSON, EXAMINING ATTORNEY

CLASS 28—(Continued).

SN 78-523,337. DELLHEIM, JEFFREY I., NEW YORK, NY.
FILED 11-28-2004.

Run-A-Round

THE MARK CONSISTS OF STANDARD CHARACTERS WITHOUT CLAIM TO ANY PARTICULAR FONT, STYLE, SIZE, OR COLOR.

FOR EQUIPMENT SOLD AS A UNIT FOR PLAYING A PARLOR GAME; BOARD GAME; MECHANICAL TOY; COIN-OPERATED VIDEO GAME; HAND-HELD UNIT FOR PLAYING VIDEO GAMES (U.S. CLS. 22, 23, 38 AND 50).

DAVID MURRAY, EXAMINING ATTORNEY

SN 78-523,359. BLACK BOX, INC., VISTA, CA. FILED 11-28-2004.

ZERO

THE MARK CONSISTS OF STANDARD CHARACTERS WITHOUT CLAIM TO ANY PARTICULAR FONT, STYLE, SIZE, OR COLOR.

OWNER OF U.S. REG. NO. 2,593,557.

FOR SKATEBOARDS, SKATEBOARD WHEELS AND SKATEBOARD ACCESSORIES NAMELY CURB WAX, RISER PADS, BEARINGS, GRIP TAPE AND HARDWARE AND PARTS THEREFORE AND SPORTING OBSTACLES USED IN CONNECTION WITH SKATEBOARDING (U.S. CLS. 22, 23, 38 AND 50).

FIRST USE 1-5-1996; IN COMMERCE 1-5-1996.

CAROLYN GRAY, EXAMINING ATTORNEY

CLASS 28—(Continued).

SN 78-523,362. THE ORVIS COMPANY, INC., MANCHESTER, VT. FILED 11-28-2004.

HY-FLOTE

THE MARK CONSISTS OF STANDARD CHARACTERS WITHOUT CLAIM TO ANY PARTICULAR FONT, STYLE, SIZE, OR COLOR.

FOR FISHING TACKLE, FLY FISHING LINE, FLY FISHING LINE AND FLY FLOATANT (U.S. CLS. 22, 23, 38 AND 50).

FIRST USE 0-0-1983; IN COMMERCE 0-0-1983.
CAROLYN GRAY, EXAMINING ATTORNEY

SN 78-524,227. FRANKLIN SPORTS, INC., STOUGHTON, MA. FILED 11-30-2004.

INSTA-FIT

THE MARK CONSISTS OF STANDARD CHARACTERS WITHOUT CLAIM TO ANY PARTICULAR FONT, STYLE, SIZE, OR COLOR.

FOR SPORTS MOUTH GUARDS (U.S. CLS. 22, 23, 38 AND 50).

ALICE BENMAMAN, EXAMINING ATTORNEY

CLASS 28—(Continued).

SN 78-524,322. ROBINSON, KITTY, LAYTONVILLE, CA. FILED 11-30-2004.

SNUGGLE ME

THE MARK CONSISTS OF STANDARD CHARACTERS WITHOUT CLAIM TO ANY PARTICULAR FONT, STYLE, SIZE, OR COLOR.

FOR STUFFED TOYS INCORPORATING AN ALARM CLOCK (U.S. CLS. 22, 23, 38 AND 50).

ALEXANDER L. POWERS, EXAMINING ATTORNEY

SN 78-524,997. LERNELL CO, LLC, DBA LERNELL/MASS, LLC, BROOKLYN, NY. AND MASS MARKET IDEAS, LLC, DBA LERNELL/MASS, LLC, BROOKLYN, NY. FILED 12-1-2004.

CHOOSE TO FUSE

THE MARK CONSISTS OF STANDARD CHARACTERS WITHOUT CLAIM TO ANY PARTICULAR FONT, STYLE, SIZE, OR COLOR.

FOR TOYS AND GAMES, NAMELY, HAND HELD UNIT FOR PLAYING ELECTRONIC GAMES, PLAYSETS FOR ACTION FIGURES, TOY VEHICLES AND TOY ACTION FIGURES (U.S. CLS. 22, 23, 38 AND 50).

ZACHARY BELLO, EXAMINING ATTORNEY

SN 78-525,001. LERNELL CO, LLC, DBA LERNELL/MASS, LLC, BROOKLYN, NY. AND MASS MARKET IDEAS, LLC, DBA LERNELL/MASS, LLC, BROOKLYN, NY. FILED 12-1-2004.

JOIN THE FORCE

THE MARK CONSISTS OF STANDARD CHARACTERS WITHOUT CLAIM TO ANY PARTICULAR FONT, STYLE, SIZE, OR COLOR.

FOR TOYS AND GAMES, NAMELY, HAND HELD UNIT FOR PLAYING ELECTRONIC GAMES, PLAYSETS FOR ACTION FIGURES, TOY VEHICLES AND TOY ACTION FIGURES (U.S. CLS. 22, 23, 38 AND 50).

ZACHARY BELLO, EXAMINING ATTORNEY

CLASS 28—(Continued).

SN 78-525,003. LERNELL CO, LLC, DBA LERNELL/MASS, LLC, BROOKLYN, NY. AND MASS MARKET IDEAS, LLC, DBA LERNELL/MASS, LLC, BROOKLYN, NY. FILED 12-1-2004.

CLASS 28—(Continued).

SN 78-526,407. WOW WEE LIMITED, TSIM SHA TSUI EAST, KOWLOON, HONG KONG, FILED 12-2-2004.

UNITED WE STAND

THE MARK CONSISTS OF STANDARD CHARACTERS WITHOUT CLAIM TO ANY PARTICULAR FONT, STYLE, SIZE, OR COLOR.

FOR TOYS AND GAMES, NAMELY, HAND HELD UNIT FOR PLAYING ELECTRONIC GAMES, PLAYSETS FOR ACTION FIGURES, TOY VEHICLES AND TOY ACTION FIGURES (U.S. CLS. 22, 23, 38 AND 50).
MONTIA G. PRESSEY, EXAMINING ATTORNEY

ROBORAPTOR

THE MARK CONSISTS OF STANDARD CHARACTERS WITHOUT CLAIM TO ANY PARTICULAR FONT, STYLE, SIZE, OR COLOR.

FOR TOY ANIMALS AND ACCESSORIES THEREFORE (U.S. CLS. 22, 23, 38 AND 50).
JEAN IM, EXAMINING ATTORNEY

SN 78-525,190. TAIYO KOGYO CO., LTD., TOKYO, JAPAN, FILED 12-1-2004.

SKYSHOOTER

THE MARK CONSISTS OF STANDARD CHARACTERS WITHOUT CLAIM TO ANY PARTICULAR FONT, STYLE, SIZE, OR COLOR.

FOR TOYS, NAMELY, LAUNCHERS FOR TOY AIRPLANES (U.S. CLS. 22, 23, 38 AND 50).
DAWN HAN, EXAMINING ATTORNEY

SN 78-526,696. OUZIEL, RICK GORDON, LOS ANGELES, CA. FILED 12-3-2004.

SN 78-525,571. FUNMASTERS, INC., LAS VEGAS, NV. FILED 12-1-2004.

CYA

FUNMASTERS

THE MARK CONSISTS OF STANDARD CHARACTERS WITHOUT CLAIM TO ANY PARTICULAR FONT, STYLE, SIZE, OR COLOR.

FOR EDUCATIONAL TOY KITS COMPRISED OF JUGGLING EQUIPMENT, MAGIC TRICKS, PRACTICAL JOKES AND GAG PROPS ACCOMPANIED BY AN INSTRUCTIONAL DVD ON SUCH SUBJECTS (U.S. CLS. 22, 23, 38 AND 50).
JENNIFER CHICOSKI, EXAMINING ATTORNEY

THE MARK CONSISTS OF STANDARD CHARACTERS WITHOUT CLAIM TO ANY PARTICULAR FONT, STYLE, SIZE, OR COLOR.

FOR SKIMBOARDS, FIBERGLASS SKIMBOARDS, CARBON FIBER SKIMBOARDS, SURFBOARDS, SAILBOARDS, WAKE BOARDS, BODY BOARDS, SURFBOARD FINS, SURFBOARD LEASHES AND WAX, SURF FINS, FINS FOR BODY BOARDS, LEASHES USED IN CONJUNCTION WITH SURFING, KITE SURFING BOARDS, AND PADDLE BOARDS (U.S. CLS. 22, 23, 38 AND 50).
MICHELLE S. WISEMAN, EXAMINING ATTORNEY

CLASS 28—(Continued).

SN 78-526,732. BARRETT, ALAN J., WHITE LAKE, MI.
FILED 12-3-2004.

SnakeRod

THE MARK CONSISTS OF STANDARD CHARACTERS
WITHOUT CLAIM TO ANY PARTICULAR FONT, STYLE,
SIZE, OR COLOR.

FOR FISHING ROD WITH A FLEXIBLE HANDLE
THAT CAN BE SHAPED INTO A NEAR C-FORM OR
OTHER MULTIPLE SHAPES TO ASSIST IN GRIPPING
THE FISHING ROD (U.S. CLS. 22, 23, 38 AND 50).
BRENDAN REGAN, EXAMINING ATTORNEY

SN 78-527,007. THE ORVIS COMPANY, INC., MANCHE-
STER, VT. FILED 12-3-2004.

ZERO GRAVITY

THE MARK CONSISTS OF STANDARD CHARACTERS
WITHOUT CLAIM TO ANY PARTICULAR FONT, STYLE,
SIZE, OR COLOR.

FOR FISHING TACKLE, FISHING RODS (U.S. CLS. 22,
23, 38 AND 50).
MICHAEL KEATING, EXAMINING ATTORNEY

CLASS 28—(Continued).

SN 78-531,755. LAMAR HEALTH, FITNESS & SPORTS LLC,
BOULDER, CO. FILED 12-13-2004.

HIKER

THE MARK CONSISTS OF STANDARD CHARACTERS
WITHOUT CLAIM TO ANY PARTICULAR FONT, STYLE,
SIZE, OR COLOR.

FOR EXERCISE EQUIPMENT, NAMELY TREAD-
MILLS (U.S. CLS. 22, 23, 38 AND 50).
FIRST USE 12-2-2004; IN COMMERCE 12-2-2004.
ROBERT C. CLARK JR., EXAMINING ATTORNEY

SN 78-531,866. STAMINA PRODUCTS, INC., SPRINGFIELD,
MO. FILED 12-13-2004.

CARDIOBOARD

THE MARK CONSISTS OF STANDARD CHARACTERS
WITHOUT CLAIM TO ANY PARTICULAR FONT, STYLE,
SIZE, OR COLOR.

FOR MANUALLY OPERATED EXERCISE EQUIP-
MENT (U.S. CLS. 22, 23, 38 AND 50).
JAMES A. RAUEN, EXAMINING ATTORNEY

SN 78-536,394. ORIGINAL DIAMOND DESIGNS, INC.,
SARASOTA, FL. FILED 12-21-2004.

ITS A BALL PLAYER

THE MARK CONSISTS OF STANDARD CHARACTERS
WITHOUT CLAIM TO ANY PARTICULAR FONT, STYLE,
SIZE, OR COLOR.

FOR MANUALLY OPERATED EXERCISE EQUIP-
MENT USED FOR IMPROVING BALANCE (U.S. CLS.
22, 23, 38 AND 50).
DAWN HAN, EXAMINING ATTORNEY

CLASS 28—(Continued).

SN 78-537,786. COLEMAN, KENDALL E., ARVADA, CO. FILED 12-23-2004.

CLASS 28—(Continued).

SN 78-538,201. HIGGINBOTHAM, HUGH, R, NORTH PALM BEACH, FL. FILED 12-24-2004.

Big Buster

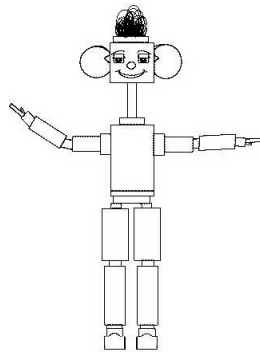

THE MARK CONSISTS OF STANDARD CHARACTERS WITHOUT CLAIM TO ANY PARTICULAR FONT, STYLE, SIZE, OR COLOR.

FOR PERSONAL EXERCISE MACHINES FOR PECTORAL CHEST MUSCLES (U.S. CLS. 22, 23, 38 AND 50).
JASON ROTH, EXAMINING ATTORNEY

SN 78-538,221. CAMPBELL, SUSAN, ROCKPORT, MA. FILED 12-24-2004.

THE MARK CONSISTS OF MALE CHARACTER WITH CURLY HAIR.

FOR ACTION FIGURES AND ACCESSORIES THEREFORE; ACTION SKILL GAMES; BEAN BAG DOLLS; PLUSH TOYS; BALLOONS; GOLF BALLS; TENNIS BALLS; BATH TOYS; CHRISTMAS TREE ORNAMENTS; BOARD GAMES; TOY BUILDING BLOCKS; EQUIPMENT SOLD AS A UNIT FOR PLAYING CARD GAMES; PLAYING CARDS; DOLLS; DOLL PLAYSETS; CHILDREN'S PLAY COSMETICS; CRIB TOYS; ELECTRIC ACTION TOYS; MANIPULATIVE GAMES; JIGSAW PUZZLES; KITES; CRIB AND TOY MOBILES; MUSIC BOX TOYS; PARTY FAVORS IN THE NATURE OF SMALL TOYS; INFLATABLE POOL TOYS; BABY AND CHILDREN'S MULTIPLE ACTIVITY TOYS; WIND-UP TOYS; TARGET GAMES; DISC-TYPE TOSS TOYS; TOY BOWS AND ARROWS; TOY VEHICLES; MODEL TOY CARS; MODEL TOY TRUCKS; TOY BUCKET AND SHOVEL SETS; ROLLER SKATES; TOY MODEL HOBBYCRAFT KITS; TOY ROCKETTS; TOY GUNS; TOY HOLSTERS; MUSICAL TOYS; TOY BADMINTON SETS; BUBBLE MAKING WANDS AND SOLUTION SETS; MODELED PLASTIC TOY FIGURINES; TOY BANKS; PUPPETS; YO-YOS; SKATEBOARDS; TOY SCOOTERS; FACE MASKS; HAND-HELD UNIT FOR PLAYING ELECTRONIC GAMES; TALKING TOYS; TOY MODEL WALKIE-TALKIES; TOY MODEL ELECTRONIC VOICE RECORDERS (U.S. CLS. 22, 23, 38 AND 50).
MICHAEL SOUDERS, EXAMINING ATTORNEY

Schoolhouse Studio

THE MARK CONSISTS OF STANDARD CHARACTERS WITHOUT CLAIM TO ANY PARTICULAR FONT, STYLE, SIZE, OR COLOR.

FOR FULL LINE OF PET TOYS (U.S. CLS. 22, 23, 38 AND 50).
ZHALEH DELANEY, EXAMINING ATTORNEY

CLASS 28—(Continued).

SN 78-539,188. PACIFIC CYCLE, LLC, MADISON, WI. FILED 12-28-2004.

MONGOOSE

THE MARK CONSISTS OF STANDARD CHARACTERS WITHOUT CLAIM TO ANY PARTICULAR FONT, STYLE, SIZE, OR COLOR.
OWNER OF U.S. REG. NOS. 2,358,569, 2,358,586 AND OTHERS.

FOR FOAM SNOW SLIDERS, SNOW TUBES, SNOW DISCS AND SNOW SLEDS FOR RECREATIONAL USE (U.S. CLS. 22, 23, 38 AND 50).
CYNTHIA SLOAN, EXAMINING ATTORNEY

CLASS 28—(Continued).

SN 78-540,366. WOW WEE LIMITED, TSIM SHA TSUI EAST, KOWLOON, HONG KONG, FILED 12-30-2004.

ROBONETICS

THE MARK CONSISTS OF STANDARD CHARACTERS WITHOUT CLAIM TO ANY PARTICULAR FONT, STYLE, SIZE, OR COLOR.

FOR TOY ANIMALS AND ACCESSORIES THEREFORE (U.S. CLS. 22, 23, 38 AND 50).
JEAN IM, EXAMINING ATTORNEY

SN 78-540,716. CAMPBELL, SUSAN, ROCKPORT, MA. FILED 1-1-2005.

Four Legged Angels

SN 78-539,409. KASTALON, INC., ALSIP, IL. FILED 12-29-2004.

THE MARK CONSISTS OF STANDARD CHARACTERS WITHOUT CLAIM TO ANY PARTICULAR FONT, STYLE, SIZE, OR COLOR.

FOR FULL LINE OF PET TOYS (U.S. CLS. 22, 23, 38 AND 50).
CURTIS FRENCH, EXAMINING ATTORNEY

SN 78-540,734. CAMPBELL, SUSAN, ROCKPORT, MA. FILED 1-1-2005.

Koat-A-Wheel

THE MARK CONSISTS OF STANDARD CHARACTERS WITHOUT CLAIM TO ANY PARTICULAR FONT, STYLE, SIZE, OR COLOR.

FOR SNAP-ON POLYURETHANE SKATE WHEEL TIRE (U.S. CLS. 22, 23, 38 AND 50).
FIRST USE 11-10-1998; IN COMMERCE 11-10-1998.
DOMINICK J. SALEMI, EXAMINING ATTORNEY

THE MARK CONSISTS OF STANDARD CHARACTERS WITHOUT CLAIM TO ANY PARTICULAR FONT, STYLE, SIZE, OR COLOR.

FOR FULL LINE OF PET TOYS (U.S. CLS. 22, 23, 38 AND 50).
CURTIS FRENCH, EXAMINING ATTORNEY

4 Legged Angels

CLASS 28—(Continued).

SN 78-542,022. WILD PLANET TOYS, INC., SAN FRANCISCO, CA. FILED 1-4-2005.

CLASS 28—(Continued).

SN 78-545,740. MATTEL, INC., EL SEGUNDO, CA. FILED 1-11-2005.

DIGGOR

THE MARK CONSISTS OF STANDARD CHARACTERS WITHOUT CLAIM TO ANY PARTICULAR FONT, STYLE, SIZE, OR COLOR.

FOR TOYS, NAMELY INSECT SHAPED PLASTIC TOYS EMPLOYING A FRICTION MOTOR TO PROPEL THEM IN IMAGINARY CONFLICT AND STRENGTH GAMES WITH ACCESSORY PARTS AND WHEELS TO CUSTOMIZE THE TOY (U.S. CLS. 22, 23, 38 AND 50).
JILL PRATER, EXAMINING ATTORNEY

SN 78-542,076. D.O. COLLABORATIVE LLC, NEWPORT, KY. FILED 1-4-2005.

Wild Turkey Opoly

THE MARK CONSISTS OF STANDARD CHARACTERS WITHOUT CLAIM TO ANY PARTICULAR FONT, STYLE, SIZE, OR COLOR.

NO CLAIM IS MADE TO THE EXCLUSIVE RIGHT TO USE "WILD TURKEY", APART FROM THE MARK AS SHOWN.

FOR BOARD GAME FEATURING WILD TURKEY HUNTING (U.S. CLS. 22, 23, 38 AND 50).
BARNEY CHARLON, EXAMINING ATTORNEY

BARBIE & ME

THE MARK CONSISTS OF STANDARD CHARACTERS WITHOUT CLAIM TO ANY PARTICULAR FONT, STYLE, SIZE, OR COLOR.

OWNER OF U.S. REG. NOS. 689,055, 2,837,174 AND OTHERS.

FOR TOYS, GAMES AND PLAYTHINGS; NAMELY DOLLS, DOLL CLOTHING AND DOLL ACCESSORIES; PLUSH TOYS AND ACCESSORIES THEREFOR (U.S. CLS. 22, 23, 38 AND 50).

JIM RINGLE, EXAMINING ATTORNEY

SN 78-545,908. SMITH, ERIK R, DBA ON THE LINE GAME COMPANY, SAN FRANCISCO, CA. FILED 1-11-2005.

Pizza Box Football

THE MARK CONSISTS OF STANDARD CHARACTERS WITHOUT CLAIM TO ANY PARTICULAR FONT, STYLE, SIZE, OR COLOR.

NO CLAIM IS MADE TO THE EXCLUSIVE RIGHT TO USE "FOOTBALL", APART FROM THE MARK AS SHOWN.

FOR TOYS, PLAYTHINGS AND GAMES, NAMELY, BOARD GAMES AND COMPONENT PIECES THEREOF FOR USE AS A SET (U.S. CLS. 22, 23, 38 AND 50).
DAVID ELTON, EXAMINING ATTORNEY

CLASS 28—(Continued).

SN 78-548,163. WHITNEY, DANIEL D., SANFORD, FL.
FILED 1-14-2005.

GIT-R-DONE

THE MARK CONSISTS OF STANDARD CHARACTERS
WITHOUT CLAIM TO ANY PARTICULAR FONT, STYLE,
SIZE, OR COLOR.

FOR DOLLS (U.S. CLS. 22, 23, 38 AND 50).
FIRST USE 5-11-2005; IN COMMERCE 5-11-2005.
ANDREW BENZMILLER, EXAMINING ATTORNEY

SN 78-548,974. IVORY, JOYCE, DETROIT, MI. FILED 1-18-
2005.



NO CLAIM IS MADE TO THE EXCLUSIVE RIGHT TO
USE COLORED, APART FROM THE MARK AS SHOWN.

THE COLORS WHITE, RED, BROWN, BLUE, PINK,
PURPLE, ORANGE, AND GREEN ARE CLAIMED AS A
FEATURE OF THE MARK.

THE MARK CONSISTS OF THE STYLIZED VERSION OF
WORDING COLORED KIDS; THE "C" IS WHITE, THE
FIRST "O" IS RED, THE "L" IS MEDIUM BROWN, THE
SECOND "O" IS BLUE, THE "R" IS DARK BROWN, THE "E"
IS LIGHT PINK, THE "D" IS WHITE, THE "K" IS PURPLE,
THE "I" IS WHITE, THE "D" IS ORANGE, AND THE "S" IS
LIGHT GREEN.

FOR DOLLS IN A VARIETY OF DIFFERENT COLORS
AND ACCESSORIES THEREFORE, AND DOLL CLOTH-
ING (U.S. CLS. 22, 23, 38 AND 50).

SUE LAWRENCE, EXAMINING ATTORNEY

CLASS 28—(Continued).

SN 78-549,398. EBSCO INDUSTRIES, INC., BIRMINGHAM,
AL. FILED 1-18-2005.

MEGASAMPSON

THE MARK CONSISTS OF STANDARD CHARACTERS
WITHOUT CLAIM TO ANY PARTICULAR FONT, STYLE,
SIZE, OR COLOR.

FOR SPORTING GOODS, NAMELY, TREESTANDS
AND TREESTAND LADDERS FOR HUNTING, AND
PARTS AND ATTACHMENTS THEREFOR (U.S. CLS.
22, 23, 38 AND 50).

FIRST USE 1-1-2004; IN COMMERCE 1-1-2004.
MARC LEIPZIG, EXAMINING ATTORNEY

SN 78-549,442. EBSCO INDUSTRIES, INC., BIRMINGHAM,
AL. FILED 1-18-2005.

BULLET BACKPACKER

THE MARK CONSISTS OF STANDARD CHARACTERS
WITHOUT CLAIM TO ANY PARTICULAR FONT, STYLE,
SIZE, OR COLOR.

NO CLAIM IS MADE TO THE EXCLUSIVE RIGHT TO
USE "BACKPACKER", APART FROM THE MARK AS
SHOWN.

FOR SPORTING GOODS, NAMELY, TREESTANDS
FOR HUNTING AND PARTS THEREFOR (U.S. CLS. 22,
23, 38 AND 50).

FIRST USE 1-1-2003; IN COMMERCE 1-1-2003.
NAAKWAMA ANKRAH, EXAMINING ATTORNEY

SN 78-550,196. FUJIKURA COMPOSITES AMERICA, INC.,
VISTA, CA. FILED 1-19-2005.



FOR GOLF CLUB SHAFTS (U.S. CLS. 22, 23, 38 AND
50).

FIRST USE 0-0-2000; IN COMMERCE 0-0-2000.
LAURIE MAYES, EXAMINING ATTORNEY

CLASS 28—(Continued).

SN 78-552,283. CYBEX INTERNATIONAL, INC., MEDWAY, MA. FILED 1-23-2005.

CLASS 28—(Continued).

SN 78-557,966. COOPER, JOHN, CARLSBAD, CA. FILED 2-1-2005.

**MOVE. MEASURE.
MOTIVATE.**

Zip Stix

THE MARK CONSISTS OF STANDARD CHARACTERS WITHOUT CLAIM TO ANY PARTICULAR FONT, STYLE, SIZE, OR COLOR.

FOR EXERCISE AND FITNESS EQUIPMENT, NAMELY, UPPER AND LOWER BODY CARDIOVASCULAR CONDITIONING MACHINES; EXTREMITY TESTING MACHINES; WEIGHT LIFTING MACHINES AND ACCESSORIES; AND A FLOOR MAT WITH SENSORS AND ASSOCIATED COMPUTER HARDWARE AND SOFTWARE, SOLD AS A UNIT, FOR FUNCTIONAL ASSESSMENT OF THE PHYSICAL BALANCE, STABILITY, WEIGHT BEARING CAPACITIES, REACTION TIME AND OTHER STRENGTH AND MOVEMENT SKILLS OF A SUBJECT (U.S. CLS. 22, 23, 38 AND 50).
KIMBERLY PERRY, EXAMINING ATTORNEY

THE MARK CONSISTS OF STANDARD CHARACTERS WITHOUT CLAIM TO ANY PARTICULAR FONT, STYLE, SIZE, OR COLOR.

NO CLAIM IS MADE TO THE EXCLUSIVE RIGHT TO USE STICKS, APART FROM THE MARK AS SHOWN.
FOR CHILDREN'S HAND-HELD MULTIPLE ACTIVITY TOY (U.S. CLS. 22, 23, 38 AND 50).
TARAH HARDY, EXAMINING ATTORNEY

SN 78-555,887. DEOLA, JAMES A., VINELAND, NJ. FILED 1-28-2005.

SN 78-558,831. MARCY S. TOSCHER, ENCINO, CA. FILED 2-2-2005.

HIDEAWAY

BUDDHA BEAR

THE MARK CONSISTS OF STANDARD CHARACTERS WITHOUT CLAIM TO ANY PARTICULAR FONT, STYLE, SIZE, OR COLOR.

FOR MANUALLY OPERATED HOME GYM MACHINES AND EQUIPMENT (U.S. CLS. 22, 23, 38 AND 50).
JAMES A. RAUEN, EXAMINING ATTORNEY

THE MARK CONSISTS OF STANDARD CHARACTERS WITHOUT CLAIM TO ANY PARTICULAR FONT, STYLE, SIZE, OR COLOR.

NO CLAIM IS MADE TO THE EXCLUSIVE RIGHT TO USE "BEAR", APART FROM THE MARK AS SHOWN.
FOR PLUSH TOYS (U.S. CLS. 22, 23, 38 AND 50).
ALLISON HOLTZ, EXAMINING ATTORNEY

CLASS 28—(Continued).

SN 78-566,481. INTERNATIONAL TRUCK INTELLECTUAL PROPERTY COMPANY, LLC, WARRENVILLE, IL. FILED 2-14-2005.

CXT

THE MARK CONSISTS OF STANDARD CHARACTERS WITHOUT CLAIM TO ANY PARTICULAR FONT, STYLE, SIZE, OR COLOR.

FOR TOY TRUCKS (U.S. CLS. 22, 23, 38 AND 50).
FIRST USE 10-24-2004; IN COMMERCE 10-24-2004.
MICHAEL WEBSTER, EXAMINING ATTORNEY

SN 78-590,505. DOGSTERS, LLC, MILFORD, CT. FILED 3-18-2005.



FOR ACTION FIGURINES AND ACCESSORIES THEREFOR, AMUSEMENT GAME MACHINES, AMUSEMENT PARK RIDES, BABY MULTIPLE ACTIVITY TOYS, BALLOONS, BATH TOYS, BEACH BALLS, BENDABLE TOYS, BOARD GAMES, CHRISTMAS STOCKINGS; CHRISTMAS TREE DECORATIONS, CHRISTMAS TREE SKIRTS, COLLECTABLE TOY FIGURES, CRAFT SETS FOR DECORATING BALLOONS, CRIB MOBILES AND CRIB TOYS, DOG AND CAT TOYS, EASTER EGG COLORING KITS, INFLATABLE TOYS, KITES, MECHANICAL TOYS, MUSICAL TOYS, PAPER DOLLS, PARLOR GAMES, PLAYING CARDS, PLUSH TOYS, PET TOYS, NAMELY, PET TOYS CONTAINING CATNIP, PET TOYS MADE OF ROPE, RAG DOLLS, STUFFED TOY ANIMALS; STUFFED TOYS, TENNIS BALLS, TOSSING DISC TOYS, TOY ACTION FIGURES AND ACCESSORIES THEREFOR, TOY BANKS, TOY BOXES, TOY FIGURES, TOYS, NAMELY, BATTERY-POWERED COMPUTER GAMES WITH LCD SCREEN WHICH FEATURE ANIMATION AND SOUND EFFECTS (U.S. CLS. 22, 23, 38 AND 50).
JIM RINGLE, EXAMINING ATTORNEY

CLASS 28—(Continued).

SN 78-637,897. THE BOARD OF REGENTS OF THE UNIVERSITY OF OKLAHOMA, NORMAN, OK. FILED 5-26-2005.

OU

THE MARK CONSISTS OF STANDARD CHARACTERS WITHOUT CLAIM TO ANY PARTICULAR FONT, STYLE, SIZE, OR COLOR.

OWNER OF U.S. REG. NOS. 1,336,001, 1,378,171 AND OTHERS.

FOR SPORTING GOODS, NAMELY FOOTBALLS, BASKETBALLS, SOCCER BALLS, BASEBALLS, GOLF BALLS, GOLF TEES, GOLF GLOVES, GOLF CLUB HEAD COVERS; STUFFED TOY ANIMALS AND PUZZLES (U.S. CLS. 22, 23, 38 AND 50).

FIRST USE 12-31-1979; IN COMMERCE 12-31-1979.
LAURA KOVAISKY, EXAMINING ATTORNEY

SN 78-638,313. THE BOARD OF REGENTS OF THE UNIVERSITY OF OKLAHOMA, NORMAN, OK. FILED 5-26-2005.



OWNER OF U.S. REG. NOS. 1,336,002, 1,378,171 AND OTHERS.

THE MARK CONSISTS OF THE LETTERS OU STYLIZED IN AN INTERLOCKING DESIGN.

FOR SPORTING GOODS, NAMELY FOOTBALLS, BASKETBALLS, SOCCER BALLS, BASEBALLS, GOLF BALLS, GOLF TEES, GOLF GLOVES, GOLF CLUB HEAD COVERS; STUFFED TOY ANIMALS AND PUZZLES (U.S. CLS. 22, 23, 38 AND 50).

FIRST USE 9-19-1953; IN COMMERCE 9-19-1953.
LAURA KOVAISKY, EXAMINING ATTORNEY

CLASS 28—(Continued).

SN 79-001,576. ARISTOCRAT TECHNOLOGIES AUSTRALIA PTY LTD, AUSTRALIA, FILED 2-18-2004.

GOLDEN GOALS

THE MARK CONSISTS OF STANDARD CHARACTERS WITHOUT CLAIM TO ANY PARTICULAR FONT, STYLE, SIZE, OR COLOR.

PRIORITY DATE OF 8-18-2003 IS CLAIMED.

OWNER OF INTERNATIONAL REGISTRATION 0821298 DATED 2-18-2004, EXPIRES 2-18-2014.

FOR GAMING MACHINES INCLUDING POKER MACHINES FEATURING GAMES OF CHANCE OR GAMES OF MIXED CHANCE AND SKILL OR PSEUDO SKILL; GAMING MACHINES INCLUDING POKER MACHINES COMPRISING OF SOFTWARE MODULES AND COMPONENTS INCLUDING GAME SYMBOLS, MATHEMATICS, SOUND EFFECTS AND OTHER CONFIGURABLE ITEMS EMBEDDED IN ERASABLE PROGRAMMABLE READ-ONLY MEMORY (EPROM) CHIPS OR OTHER SUCH MEDIA; GAMING MACHINE REPLACEMENT PARTS (U.S. CLS. 22, 23, 38 AND 50).
GINA FINK, EXAMINING ATTORNEY

CLASS 28—(Continued).

SN 79-004,294. HYDRO SPORTZ PTY LIMITED, AUSTRALIA, FILED 4-8-2004.

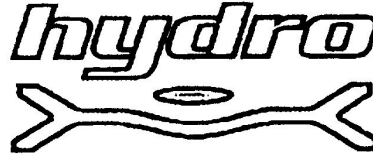

OWNER OF INTERNATIONAL REGISTRATION 0830371 DATED 4-8-2004, EXPIRES 4-8-2014.

FOR SWIMMING, DIVING AND SURFING APPARATUS AND EQUIPMENT, NAMELY, SWIMMING FLIPPERS, SWIMMING FINS, SWIM FIN RETAINERS AND LEASHES, SWIMMING BOARDS, SWIMMING BOARD RETAINERS, LEASHES AND PLUGS, SURFING BODY BOARDS, SURFING BODY BOARD RETAINERS, LEASHES AND PLUGS, SURFBOARDS, SURFBOARD RETAINERS, LEASHES AND PLUGS, SURFING WEBS, KICK BOARDS, KICK BOARD RETAINERS, LEASHES AND PLUGS, POOL BOARDS, POOL BOARD RETAINERS, LEASHES AND PLUGS, SWIMMING HARNESS, SWIMMING HAND PADDLES, BODY SURFING HAND BOARDS (U.S. CLS. 22, 23, 38 AND 50).
DOMINIC J. FERRAIUOLO, EXAMINING ATTORNEY

SN 79-005,325. SHIMANO INC., JAPAN, FILED 8-10-2004.

RAPID FIRE

PRIORITY DATE OF 7-13-2004 IS CLAIMED.

OWNER OF INTERNATIONAL REGISTRATION 0833328 DATED 8-10-2004, EXPIRES 8-10-2014.

FOR FISHING TACKLE, NAMELY, REELS, RODS, LINES, LINE GUIDES, HOOKS, LURES, ARTIFICIAL BAITS, FLOATS, SINKERS, LANDING NETS FOR ANGLERS, FISHING BAGS, FISHING GLOVES, FISHING ROD CASES AND FISHING TACKLE CONTAINERS (U.S. CLS. 22, 23, 38 AND 50).
EDWARD NELSON, EXAMINING ATTORNEY

SN 79-001,658. VÖLKL (INTERNATIONAL) GMBH, SWITZERLAND, FILED 3-9-2004.

SUPERSPEED

THE MARK CONSISTS OF STANDARD CHARACTERS WITHOUT CLAIM TO ANY PARTICULAR FONT, STYLE, SIZE, OR COLOR.

PRIORITY DATE OF 10-23-2003 IS CLAIMED.

OWNER OF INTERNATIONAL REGISTRATION 0821703 DATED 3-9-2004, EXPIRES 3-9-2014.

FOR SPORTING ARTICLES AND APPARATUS, NAMELY, TENNIS RACQUETS, SQUASH RACQUETS, RACQUETBALL RACQUETS, BADMINTON RACQUETS, SKIS, SNOWBOARDS, SKI POLES, SKI BINDINGS AND SNOWBOARD BINDINGS; PARTS AND ACCESSORIES OF SPORTING ARTICLES, NAMELY, GRIP BANDS AND STRINGS FOR RACQUETS AND COVERS FOR RACQUETS, SKIS AND SNOWBOARDS (U.S. CLS. 22, 23, 38 AND 50).
PRISCILLA MILTON, EXAMINING ATTORNEY

SN 79-005,386. FRANZ SCHNEIDER GMBH & CO KG, FED REP GERMANY, FILED 7-20-2004.

ROLLY

THE MARK CONSISTS OF STANDARD CHARACTERS WITHOUT CLAIM TO ANY PARTICULAR FONT, STYLE, SIZE, OR COLOR.

OWNER OF INTERNATIONAL REGISTRATION 0833507 DATED 7-20-2004, EXPIRES 7-20-2014.

OWNER OF U.S. REG. NOS. 1,969,845, 2,864,946 AND 2,886,235.

FOR TOY PEDAL VEHICLES FOR CHILDREN; TOY MOTOR VEHICLES FOR CHILDREN; SNOW SPORT APPARATUS, NAMELY, SLIDES, BOBSLEDS, SNOWBOARDS; TOYS, NAMELY ROCKING AND WHEELED RIDING TOY ANIMALS AND DOLLS; ACTION AND BOARD GAMES (U.S. CLS. 22, 23, 38 AND 50).
LAURA KOVAISKY, EXAMINING ATTORNEY

CLASS 29—MEATS AND PROCESSED FOODS

SN 75-646,008. WALTENSPIEL, RONALD E., DBA TIMBER CREST FARMS, HEALDSBURG, CA. FILED 2-22-1999.

APPLE-TEASERS

FOR CARAMELIZED DRIED APPLES (U.S. CL. 46).
YSA DEJESUS, EXAMINING ATTORNEY

SN 76-194,158. FLEMING COMPANIES, INC., OKLAHOMA CITY, OK. FILED 1-12-2001.

TULARE MISSION

FOR CANNED AND JARRED OLIVES AND JALAPEÑO PEPPERS; PROCESSED OLIVES AND PEPPERS (U.S. CL. 46).
TRACY WHITAKER-BOWN, EXAMINING ATTORNEY

SN 76-232,807. SAVE-A-LOT FOOD STORES, LTD., EARTH CITY, MO. FILED 3-29-2001.

FRUIT FLIPS

OWNER OF U.S. REG. NO. 2,261,645.
NO CLAIM IS MADE TO THE EXCLUSIVE RIGHT TO USE "FRUIT", APART FROM THE MARK AS SHOWN.
FOR DEHYDRATED FRUIT SNACKS (U.S. CL. 46).
YSA DEJESUS, EXAMINING ATTORNEY

SN 76-337,176. MASTERTASTE PURCHASING COMPANY, AKA. CRYSTALS INTERNATIONAL, PLANT CITY, FL. FILED 11-13-2001.

CRYSTAL CAPS

OWNER OF U.S. REG. NO. 1,664,307.
SEC. 2(F).
FOR FREEZE-DRIED FRUIT AND VEGETABLE POWDERS (U.S. CL. 46).
FIRST USE 11-6-1996; IN COMMERCE 11-6-1996.
ROBERT LORENZO, EXAMINING ATTORNEY

SN 76-476,191. CORDOLIVA, SOCIEDAD COOPERATIVA ANDALUZA, 14710 VILLARRUBIA CORDOBA, SPAIN, FILED 12-16-2002.

CORDOLIVA

OWNER OF SPAIN REG. NO. M0546929, DATED 11-3-1967, EXPIRES 11-3-2007.
FOR OLIVE OIL (U.S. CL. 46).
SUSAN LESLIE DUBOIS, EXAMINING ATTORNEY

CLASS 29—(Continued).

SN 76-551,468. COOPERATIVA DE PRODUCTORES DE LECHE DOS PINOS, R.L., ALAJUELA, COSTA RICA, FILED 9-25-2003.



OWNER OF U.S. REG. NO. 2,894,462.
NO CLAIM IS MADE TO THE EXCLUSIVE RIGHT TO USE BEBIDA DE LECHE SEMIDESCREMADA CON CAFE AND ENRIQUECIDA CON VITAMINA A, ACIDO FOLICO Y HIERRO, APART FROM THE MARK AS SHOWN.

THE COLORS GREEN, BROWN, BEIGE, RED AND WHITE IS/ARE CLAIMED AS A FEATURE OF THE MARK.

THE WORDS DOS AND PINOS AND THE PINE TREES IN A CIRCLE ARE GREEN WITH WHITE OUTLINING; THE WORD KAPUCCI IS WHITE WITH DARK BROWN OUTLINING; THE WORDS BEBIDA DE LECHE SEMIDESCREMADA CON CAFE ARE WHITE WITH DARK BROWN OUTLINING. THE WORDS ENRIQUECIDA CON VITAMINA A, ACIDO FOLICO Y HIERRO ARE WHITE ON A RED RECTANGULAR BACKGROUND; THE PITCHERS AND THE GLASS AND OVERALL BACKGROUND ARE BEIGE; THE LIQUIDS BEING Poured ARE BROWN AND WHITE.

THE ENGLISH TRANSLATION OF THE WORDING DOS PINOS IN THE MARK IS TWO PINES, BEBIDA DE LECHE IS MILK DRINK, SEMIDESCREMADA CON CAFE IS LOW FAT WITH COFFEE, AND "ENRIQUECIDA CON VITAMINA A, ACIDO FOLICO Y HIERRO" IS "ENRICHED WITH VITAMIN A, FOLIC ACID AND IRON".

FOR MILK, POWDERED MILK, YOGURT, CHEESE, SOUR CREAM, BUTTER AND DRINKS WITH A MILK BASE (U.S. CL. 46).

JOHN WILKE, EXAMINING ATTORNEY

SN 76-590,813. CEREALITY OPERATORS, INC., CHICAGO, IL. FILED 5-3-2004.

SLURREALITIES

THE MARK CONSISTS OF STANDARD CHARACTERS WITHOUT CLAIM TO ANY PARTICULAR FONT, STYLE, SIZE, OR COLOR.

FOR DAIRY-BASED BEVERAGES CONSISTING PRIMARILY OF A BLEND OF FRUIT JUICE, BREAKFAST CEREALS, FRUIT, NUTS AND/OR SYRUP TOPPING, ICE, YOGURT AND/OR MILK, INCLUDING SOY MILK (U.S. CL. 46).

FIRST USE 8-25-2003; IN COMMERCE 8-25-2003.
PRISCILLA MILTON, EXAMINING ATTORNEY

CLASS 29—(Continued).

SN 76-606,110. NITTANY CORPORATION, WILMINGTON, DE. FILED 8-6-2004.

AUNT KITTY'S

THE MARK CONSISTS OF STANDARD CHARACTERS WITHOUT CLAIM TO ANY PARTICULAR FONT, STYLE, SIZE, OR COLOR.

THE NAME AUNT KITTY DOES NOT IDENTIFY A LIVING INDIVIDUAL.

FOR POTATO CHIPS (U.S. CL. 46).
FIRST USE 9-0-2004; IN COMMERCE 9-0-2004.
MARCIE MILONE, EXAMINING ATTORNEY

SN 76-607,162. SHELTON'S POULTRY, INC., POMONA, CA. FILED 8-16-2004.

Shelton's
Premium Poultry Since 1924

NO CLAIM IS MADE TO THE EXCLUSIVE RIGHT TO USE "PREMIUM POULTRY SINCE 1924", APART FROM THE MARK AS SHOWN.

FOR WHOLE CHICKENS, CHICKEN PARTS, GROUND CHICKEN, CHICKEN SAUSAGES, WHOLE TURKEYS, TURKEY PARTS, GROUND TURKEY, TURKEY SAUSAGES, DUCKS, GEESE, PHEASANTS, GAME HENS, CAPONS, STEW HENS, RABBITS, CHICKEN EGGS, CHICKEN SOUPS, SAUSAGE LINKS, SAUSAGE PATTIES, TURKEY BURGERS, TURKEY FRANKS, CHICKEN FRANKS, TURKEY BREAKFAST STRIPS, CHICKEN BOLOGNA, TURKEY BOLOGNA, TURKEY JERKY, TURKEY CHILI, CHICKEN CHILI, TURKEY MEATLOAF, SLICED TURKEY, SHREDDED TURKEY, CHICKEN BROTH, AND FROZEN ENTREES CONSISTING PRIMARILY OF CHICKEN AND NOODLES (U.S. CL. 46).

FIRST USE 1-0-1987, FIRST USE IN ANOTHER FORM IN JANUARY 1983.; IN COMMERCE 1-0-1987, FIRST USE IN INTERSTATE COMMERCE IN ANOTHER FORM IN JANUARY 1983..

KATHRYN COWARD, EXAMINING ATTORNEY

SN 76-607,163. SHELTON'S POULTRY, INC., POMONA, CA. FILED 8-16-2004.

OUR CHICKENS DON'T DO DRUGS

THE MARK CONSISTS OF STANDARD CHARACTERS WITHOUT CLAIM TO ANY PARTICULAR FONT, STYLE, SIZE, OR COLOR.

FOR WHOLE CHICKENS, CHICKEN PARTS, GROUND CHICKEN, CHICKEN SAUSAGES, CHICKEN SOUPS, CHICKEN FRANKS, CHICKEN BOLOGNA, CHICKEN CHILI, CHICKEN BROTH, CHICKEN EGGS, AND FROZEN ENTREES CONSISTING PRIMARILY OF CHICKEN AND NOODLES (U.S. CL. 46).

FIRST USE 1-0-1987; IN COMMERCE 1-0-1987.
KATHRYN COWARD, EXAMINING ATTORNEY

CLASS 29—(Continued).

SN 76-610,839. FRICK'S QUALITY MEATS, INC., WASHINGTON, MO. FILED 9-7-2004.

FRICK'S

THE MARK CONSISTS OF STANDARD CHARACTERS WITHOUT CLAIM TO ANY PARTICULAR FONT, STYLE, SIZE, OR COLOR.

SEC. 2(F).

FOR BOLOGNA, BRAUNSCHWEIGER, SAUSAGES, FRANKS, SALAMI, HAM HOCKS, BACON, BONELESS, BONE-IN AND SLICED HAMS (U.S. CL. 46).
FIRST USE 0-0-1896; IN COMMERCE 0-0-1896.

RONALD MCMORROW, EXAMINING ATTORNEY

SN 76-615,464. SUPERIOR SEAFOODS, L.L.C., LOS ANGELES, CA. FILED 10-7-2004.

LOUIS KEMP

THE MARK CONSISTS OF STANDARD CHARACTERS WITHOUT CLAIM TO ANY PARTICULAR FONT, STYLE, SIZE, OR COLOR.

THE NAME LOUIS KEMP IDENTIFIES A LIVING INDIVIDUAL WHOSE CONSENT IS OF RECORD.

FOR PRESERVED, DRIED, AND COOKED FRUITS AND VEGETABLES; JELLIES; JAMS; AND EGGS (U.S. CL. 46).

PATRICIA EVANKO, EXAMINING ATTORNEY

CLASS 29—(Continued).

SN 76-615,911. MARTIN INTERNATIONAL CORPORATION, BOSTON, MA. FILED 10-13-2004.



OWNER OF U.S. REG. NOS. 2,221,109 AND 2,433,486. NO CLAIM IS MADE TO THE EXCLUSIVE RIGHT TO USE SUSTAINABLE FISHERY, RENEWABLE RESOURCE AND ECO FRIENDLY, APART FROM THE MARK AS SHOWN.

FOR WILD SALMON, HALIBUT, SABLE AND STRIPED BASS (U.S. CL. 46).
ZHALEH DELANEY, EXAMINING ATTORNEY

SN 76-618,347. LION ROCK HOLDINGS L.L.C., GRAND RAPIDS, MI. FILED 10-26-2004.

CHEFS SELECT

THE MARK CONSISTS OF STANDARD CHARACTERS WITHOUT CLAIM TO ANY PARTICULAR FONT, STYLE, SIZE, OR COLOR.

NO CLAIM IS MADE TO THE EXCLUSIVE RIGHT TO USE "SELECT", APART FROM THE MARK AS SHOWN. FOR BUTTER AND MARGARINE (U.S. CL. 46).
RICHARD WHITE, EXAMINING ATTORNEY

SN 76-619,508. PALOMAR, JUAN M., DAYTON, OH. FILED 11-5-2004.

SIERRA SOL

THE MARK CONSISTS OF STANDARD CHARACTERS WITHOUT CLAIM TO ANY PARTICULAR FONT, STYLE, SIZE, OR COLOR.

THE ENGLISH TRANSLATION OF "SOL" IS "SUN". FOR GOURMET FOODS, NAMELY OLIVE OILS (U.S. CL. 46).

FIRST USE 12-18-2003; IN COMMERCE 12-18-2003.
NORA BUCHANAN WILL, EXAMINING ATTORNEY

CLASS 29—(Continued).

SN 76-619,993. LIEN HOA FOOD CORPORATION, CHICAGO, IL. FILED 11-10-2004.

LIEN HOA BRAND

THE MARK CONSISTS OF STANDARD CHARACTERS WITHOUT CLAIM TO ANY PARTICULAR FONT, STYLE, SIZE, OR COLOR.

OWNER OF U.S. REG. NO. 2,046,924.

NO CLAIM IS MADE TO THE EXCLUSIVE RIGHT TO USE "BRAND", APART FROM THE MARK AS SHOWN.

THE ENGLISH TRANSLATION OF "LIEN" IS "UNITED" AND "HOA" IS "CHINESE".

SEC. 2(F).

FOR CANNED, DRIED AND PRESERVED FRUITS, VEGETABLES, MEATS, FISH AND POULTRY AND FOOD FLAVORING ENHANCERS USED AS EDIBLE OILS AND FATS (U.S. CL. 46).

FIRST USE 7-6-1988; IN COMMERCE 7-6-1988.

LAURA KOVAISKY, EXAMINING ATTORNEY

SN 76-620,467. TOWNSENDS, INC., WILMINGTON, DE. FILED 11-15-2004.

**SAUTÉ
SENSATIONS**

THE MARK CONSISTS OF STANDARD CHARACTERS WITHOUT CLAIM TO ANY PARTICULAR FONT, STYLE, SIZE, OR COLOR.

NO CLAIM IS MADE TO THE EXCLUSIVE RIGHT TO USE "SAUTÉ", APART FROM THE MARK AS SHOWN.

FOR MEAT PRODUCTS, NAMELY, FRESH POULTRY, PREPARED POULTRY, PREPARED ENTREES CONSISTING PRIMARILY OF POULTRY, AND PREPARED MEALS CONSISTING PRIMARILY OF POULTRY (U.S. CL. 46).

FIRST USE 3-0-2004; IN COMMERCE 5-0-2004.

DORITT L. CARROLL, EXAMINING ATTORNEY

SN 76-621,555. KOCH FOODS INCORPORATED, PARK RIDGE, IL. FILED 11-22-2004.

SMARTPRESS

THE MARK CONSISTS OF STANDARD CHARACTERS WITHOUT CLAIM TO ANY PARTICULAR FONT, STYLE, SIZE, OR COLOR.

FOR CHICKEN PRODUCTS, NAMELY FLATTENED CHICKEN BREASTS (U.S. CL. 46).

FIRST USE 8-1-1999; IN COMMERCE 8-1-1999.

SUSAN HAYASH, EXAMINING ATTORNEY

CLASS 29—(Continued).

SN 76-621,600. GIUSEPPE CITTERIO S.P.A., 20017 RHO, MILANO, ITALY, FILED 11-22-2004.

CITTERIO RUSTICO

THE MARK CONSISTS OF STANDARD CHARACTERS WITHOUT CLAIM TO ANY PARTICULAR FONT, STYLE, SIZE, OR COLOR.

OWNER OF U.S. REG. NOS. 988,024, 2,886,119 AND OTHERS.

THE ENGLISH TRANSLATION OF THE ITALIAN TERM "RUSTICO" IS "FOLKSY" OR "PLOUGHMAN" (COUNTRY-MAN).

FOR DELI MEATS (U.S. CL. 46).
FIRST USE 6-0-2004; IN COMMERCE 6-0-2004.
GEORGE LORENZO, EXAMINING ATTORNEY

CLASS 29—(Continued).

SN 76-627,418. VIENNA BEEF LTD., CHICAGO, IL. FILED 1-10-2005.



NO CLAIM IS MADE TO THE EXCLUSIVE RIGHT TO USE "DELI", APART FROM THE MARK AS SHOWN.

THE COLOR(S) BEIGE, BROWN AND BLACK IS/ARE CLAIMED AS A FEATURE OF THE MARK.

THE MARK CONSISTS OF THE WORDS MAXWELL STREET DELI IN BLACK, SUPERIMPOSED ON A BEIGE RIBBON DESIGN, BELOW A VINTAGE STREET SCENE IN BLACK, ALL OF WHICH IS OUTLINED IN BEIGE.

FOR LUNCHEON MEATS (U.S. CL. 46).
FIRST USE 4-0-1996; IN COMMERCE 4-0-1996.
JENNIFER MARTIN, EXAMINING ATTORNEY

SN 76-621,865. VIENNA BEEF LTD., CHICAGO, IL. FILED 11-23-2004.



THE COLOR(S) YELLOW, BLUE, RED IS/ARE CLAIMED AS A FEATURE OF THE MARK.

THE MARK CONSISTS OF A LARGE BLUE "K" INSIDE OF WHICH IS SUPERIMPOSED THE DESIGN OF A HOT DOG AND FORK, IN THE COLOR RED, ALL OF WHICH IS PLACED WITHIN A YELLOW SQUARE DEFINED BY A BLUE BORDER.

FOR HOT DOGS (U.S. CL. 46).
FIRST USE 6-0-2004; IN COMMERCE 6-0-2004.
MICHELE SWAIN, EXAMINING ATTORNEY

SN 76-627,419. VIENNA BEEF LTD., CHICAGO, IL. FILED 1-10-2005.



NO CLAIM IS MADE TO THE EXCLUSIVE RIGHT TO USE "MARKET", APART FROM THE MARK AS SHOWN.

THE COLOR(S) GOLD, BROWN, GREEN, BLACK AND WHITE IS/ARE CLAIMED AS A FEATURE OF THE MARK.

THE MARK CONSISTS OF THE WORDS MAXWELL STREET IN WHITE PRINTED ON A GREEN RECTANGULAR "STREET" SIGN, SURROUNDED BY A BROWN BORDER, WITH THE WORD MARKET IN BLACK ON A GOLD RIBBON DESIGN BENEATH THE "STREET" SIGN, AND A BROWN ANTIQUE LAMPPOST ABOVE AND BEHIND THE "STREET" SIGN.

FOR SAUSAGE (U.S. CL. 46).
FIRST USE 1-0-1997; IN COMMERCE 1-0-1997.
JENNIFER MARTIN, EXAMINING ATTORNEY

CLASS 29—(Continued).

SN 76-627,551. EUPHRATES, INC., JOHNSTOWN, NY.
FILED 1-10-2005.

BERIVAN

THE MARK CONSISTS OF STANDARD CHARACTERS WITHOUT CLAIM TO ANY PARTICULAR FONT, STYLE, SIZE, OR COLOR.

THE ENGLISH TRANSLATION OF THE WORD "BERIVAN" IN THE MARK IS "SHEPERD GIRL." FOR CHEESE (U.S. CL. 46).
FIRST USE 12-0-2003; IN COMMERCE 12-0-2003.
CHARLES L. JENKINS, EXAMINING ATTORNEY

SN 78-151,509. EDIBLE ARRANGEMENTS, LLC., HAMDEN, CT. FILED 8-6-2002.



THE MARK CONSISTS OF THE OVERALL BOUQUET DESIGN, INCLUDING THE SHAPED FRUIT, THE UNCUT FRUIT TO THE EXTENT THAT IT MAKES UP THE OVERALL BOUQUET DESIGN, AND THE BASKET.

SEC. 2(F).

FOR SCULPTED FRESH FRUIT, FRESH STRAWBERRIES AND CHOCOLATE DIPPED STRAWBERRIES ARRANGEMENTS IN A BASKET (U.S. CL. 46).

FIRST USE 10-30-1999; IN COMMERCE 10-30-1999.

DOMINIC J. FERRAIUOLO, EXAMINING ATTORNEY

SN 78-232,539. ARCADIA INTERNACIONAL, S.A., 08272 SANT FRUITOS DE BAGES (BARCELONA), SPAIN, FILED 4-1-2003.

SLIMBURGER

PRIORITY CLAIMED UNDER SEC. 44(D) ON ERPNCMNTY TM OFC APPLICATION NO. 3094877, FILED 3-13-2003, REG. NO. 003094877, DATED 1-3-2005, EXPIRES 3-13-2013.

FOR MEAT, FISH, POULTRY AND GAME; MEAT EXTRACT; PRESERVED, DRIED AND COOKED FRUITS AND VEGETABLES; JELLIES, JAMS, APPLE SAUCE; EGGS, MILK, AND MILK PRODUCTS, NAMELY, DAIRY PRODUCTS EXCLUDING ICE CREAM, ICE MILK AND FROZEN YOGURT; EDIBLE OILS AND FATS (U.S. CL. 46).

JOHN GARTNER, EXAMINING ATTORNEY

CLASS 29—(Continued).

SN 78-247,573. MINH HAI EXPORT FROZEN SEAFOOD PROCESSING JOINT-STOCK COMPANY (MINH HAI JOSTOCO), CA MAU CITY, CA MAU PROVINCE, VIETNAM, FILED 5-8-2003.



PRIORITY CLAIMED UNDER SEC. 44(D) ON VIETNAM APPLICATION NO. 4-2003-03268, FILED 5-8-2003, REG. NO. 61669, DATED 4-7-2005, EXPIRES 5-8-2013.
FOR PROCESSED SEAFOOD, NAMELY, SHRIMP, FISH, CUTTLE-FISH (U.S. CL. 46).
JOHN KELLY, EXAMINING ATTORNEY

SN 78-277,461. BUFFALO WILD WINGS, INC., MINNEAPOLIS, MN. FILED 7-22-2003.

BUFFALO LEGS

NO CLAIM IS MADE TO THE EXCLUSIVE RIGHT TO USE "LEGS", APART FROM THE MARK AS SHOWN.

SEC. 2(F).

FOR CHICKEN LEGS SOLD IN RESTAURANTS (U.S. CL. 46).

FIRST USE 9-15-1995; IN COMMERCE 9-15-1995.

CHERYL STEPLIGHT, EXAMINING ATTORNEY

CLASS 29—(Continued).

SN 78-337,734. RYOO, YOUNG DONG, ANDONG, REPUBLIC OF KOREA, FILED 12-8-2003.



NO CLAIM IS MADE TO THE EXCLUSIVE RIGHT TO USE "SALTED MACKEREL" AND THE NON-LATIN CHARACTERS THAT TRANSLATE IN ENGLISH TO "SALTED MACKEREL", APART FROM THE MARK AS SHOWN.

THE NAME(S), PORTRAIT(S), AND/OR SIGNATURE(S) SHOWN IN THE MARK IDENTIFIES MR. DONG SAM LEE, WHOSE CONSENT(S) TO REGISTER IS SUBMITTED.

THE COLOR(S) BLACK, RED, YELLOW, WHITE, AND SILVERY GRAY IS/ARE CLAIMED AS A FEATURE OF THE MARK.

THE MARK CONSISTS OF A DRAWING OF AN OUTLINE OF A MACKEREL IN BLACK; KOREAN CHARACTERS IN BLACK; THE DESCRIPTIVE WORDING "ANDONG SALTED MACKEREL" IN BLACK; A SQUARE DRAWING BETWEEN THE KOREAN CHARACTERS IN RED AND WHITE; A PHOTOGRAPHIC IMAGE OF AN ASIAN MAN WITH BLACK HAIR WEARING A YELLOW STRAW HAT WITH A WHITE HEADBAND, WHITE CLOTHING, AND HOLDING SILVERY-GRAY SALTED MACKERELS IN FRONT OF A BACKGROUND THAT HAS COLORS OF BLACK, WHITE AND YELLOW; AND AN AUTOGRAPH SIGNATURE IN BLACK.

THE FOREIGN WORDING IN THE MARK TRANSLATES INTO ENGLISH AS ANDONG SALTED MACKEREL.

THE NON-LATIN CHARACTER(S) IN THE MARK TRANSLITERATES INTO ANDONG KAN GODUNGA, AND THIS MEANS ANDONG SALTED MACKEREL IN ENGLISH.

SEC. 2(F) AS TO "ANDONG SALTED MACKEREL".

FOR SALTED MACKEREL (U.S. CL. 46).

FIRST USE 3-17-1999; IN COMMERCE 9-16-1999.

PRISCILLA MILTON, EXAMINING ATTORNEY

CLASS 29—(Continued).

SN 78-374,375. UPSTATE FARMS COOPERATIVE, INC., BUFFALO, NY. FILED 2-26-2004.

CRÈMDORÉ

THE MARK CONSISTS OF STANDARD CHARACTERS WITHOUT CLAIM TO ANY PARTICULAR FONT, STYLE, SIZE, OR COLOR.

FOR DAIRY PRODUCTS NAMELY BUTTER (U.S. CL. 46).

FIRST USE 10-0-2004; IN COMMERCE 10-0-2004.
PAULA MAYS, EXAMINING ATTORNEY

SN 78-401,127. SEA GOLD SEAFOOD PRODUCTS, INC., NEW BEDFORD, MA. FILED 4-13-2004.

CHEESE A PEÑO

THE MARK CONSISTS OF STANDARD CHARACTERS WITHOUT CLAIM TO ANY PARTICULAR FONT, STYLE, SIZE, OR COLOR.

NO CLAIM IS MADE TO THE EXCLUSIVE RIGHT TO USE "CHEESE", APART FROM THE MARK AS SHOWN.

FOR DIPS AND SPREADS FEATURING BLENDED CHEESE AND JALAPENOS (U.S. CL. 46).

STEVEN JACKSON, EXAMINING ATTORNEY

SN 78-403,247. TYSON FOODS, INC., SPRINGDALE, AR. FILED 4-16-2004.

BATTER GOLD

THE MARK CONSISTS OF STANDARD CHARACTERS WITHOUT CLAIM TO ANY PARTICULAR FONT, STYLE, SIZE, OR COLOR.

FOR POULTRY (U.S. CL. 46).

FIRST USE 9-2-1996; IN COMMERCE 9-2-1996.

SEAN DWYER, EXAMINING ATTORNEY

CLASS 29—(Continued).

SN 78-405,929. POLIFRUTA INDUSTRIA E COMERCIO DE PRODUTOS ALIMENTICIOS LTDA., ESTADO DE BAHIA, BRAZIL, FILED 4-21-2004.

POLIFRUTA

THE MARK CONSISTS OF STANDARD CHARACTERS WITHOUT CLAIM TO ANY PARTICULAR FONT, STYLE, SIZE, OR COLOR.

THE ENGLISH TRANSLATION OF POLI IS "MANY" AND THE ENGLISH TRANSLATION OF "FRUITA" IS FRUIT.

FOR FRUIT PULP; CRYSTALLIZED FRUIT; FRUIT JAMS AND JELLIES; CANNED FRUITS; STEWED FRUITS; DRIED FRUITS; COOKED FRUITS; FRUIT MARMALADES; FRUIT SALADS; FRUIT PRESERVES; DRIED AND COOKED FRUIT SLICES (U.S. CL. 46).
MICHELLE S. WISEMAN, EXAMINING ATTORNEY

CLASS 29—(Continued).

SN 78-417,903. ST. JAMES WINERY, INC., ST. JAMES, MO. FILED 5-13-2004.

ST. JAMES WINERY

THE MARK CONSISTS OF STANDARD CHARACTERS WITHOUT CLAIM TO ANY PARTICULAR FONT, STYLE, SIZE, OR COLOR.

OWNER OF U.S. REG. NOS. 2,959,894 AND 2,959,899. SEC. 2(F) ST. JAMES.

FOR FRUIT PRESERVES, JELLY, PROCESSED VEGETABLES, MARINATED VEGETABLES, BUTTER, CHEESE, SOUP, SOUP MIX, SAUSAGE, PROCESSED NUTS, SHELLED NUTS, ROASTED NUTS, PROCESSED PECAN NUTS, SNACK MIX CONSISTING PRIMARILY OF PROCESSED FRUITS, PROCESSED VEGETABLES, PROCESSED NUTS AND/OR RAISINS (U.S. CL. 46).
FIRST USE 6-13-2001; IN COMMERCE 6-13-2001.

PAULA MAHONEY, EXAMINING ATTORNEY

SN 78-415,034. THE PLITT COMPANY OF CHICAGO, CHICAGO, IL. FILED 5-7-2004.

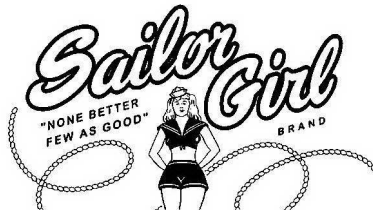

NO CLAIM IS MADE TO THE EXCLUSIVE RIGHT TO USE "BRAND", APART FROM THE MARK AS SHOWN. FOR SEAFOOD (U.S. CL. 46).
FIRST USE 0-0-1950; IN COMMERCE 0-0-1950.
MICHAEL ENGEL, EXAMINING ATTORNEY

SN 78-422,932. SMILING GOAT CHEESE COMPANY, HARRISON, NY. FILED 5-21-2004.

SMILING GOAT

THE MARK CONSISTS OF STANDARD CHARACTERS WITHOUT CLAIM TO ANY PARTICULAR FONT, STYLE, SIZE, OR COLOR.

NO CLAIM IS MADE TO THE EXCLUSIVE RIGHT TO USE "GOAT", APART FROM THE MARK AS SHOWN. FOR CHEESES (U.S. CL. 46).

FRED MANDIR, EXAMINING ATTORNEY

CLASS 29—(Continued).

SN 78-426,645. FREEDMAN MEATS, INC., HOUSTON, TX.
FILED 5-27-2004.

CLASS 29—(Continued).

SN 78-434,903. GOYA FOODS, INC., SECAUCUS, NJ. FILED
6-14-2004.



CASERITA

NO CLAIM IS MADE TO THE EXCLUSIVE RIGHT TO
USE "MEAT", APART FROM THE MARK AS SHOWN.
SEC. 2(F) AS TO TEXAS MEAT PURVEYORS.
FOR MEAT, POULTRY AND FISH (U.S. CL. 46).
FIRST USE 1-31-1992; IN COMMERCE 1-31-1992.
WILLIAM P. SHANAHAN, EXAMINING ATTORNEY

THE MARK CONSISTS OF STANDARD CHARACTERS
WITHOUT CLAIM TO ANY PARTICULAR FONT, STYLE,
SIZE, OR COLOR.
FOR CHICKEN CROQUETTES (U.S. CL. 46).
FIRST USE 10-19-1972; IN COMMERCE 10-19-1972.
JOANNA DUKOVIC, EXAMINING ATTORNEY

SN 78-426,649. FREEDMAN MEATS, INC., HOUSTON, TX.
FILED 5-27-2004.

SN 78-437,826. BOJANGLES' INTERNATIONAL LLC, CHAR-
LOTTE, NC. FILED 6-18-2004.

TEXAS MEAT
PURVEYORS

GOTTAWANNANEEDAGET
TAHAVA

THE MARK CONSISTS OF STANDARD CHARACTERS
WITHOUT CLAIM TO ANY PARTICULAR FONT, STYLE,
SIZE, OR COLOR.
NO CLAIM IS MADE TO THE EXCLUSIVE RIGHT TO
USE "MEAT", APART FROM THE MARK AS SHOWN.
SEC. 2(F).
FOR MEAT, POULTRY AND FISH (U.S. CL. 46).
FIRST USE 1-31-1992; IN COMMERCE 1-31-1992.
G. MAYERSCHOFF, EXAMINING ATTORNEY

THE MARK CONSISTS OF STANDARD CHARACTERS
WITHOUT CLAIM TO ANY PARTICULAR FONT, STYLE,
SIZE, OR COLOR.
FOR CHICKEN FOR CONSUMPTION ON OR OFF
THE PREMISES (U.S. CL. 46).
FIRST USE 9-29-2003; IN COMMERCE 9-29-2003.
NORA BUCHANAN WILL, EXAMINING ATTORNEY

CLASS 29—(Continued).

SN 78-439,381. CHEF JAY'S FOOD PRODUCTS, LAS VEGAS, NV. FILED 6-22-2004.



NO CLAIM IS MADE TO THE EXCLUSIVE RIGHT TO USE "FOOD PRODUCTS", APART FROM THE MARK AS SHOWN.

CHEF JAY IDENTIFIES A LIVING INDIVIDUAL WHOSE CONSENT IS OF RECORD.

FOR PROTEIN BASED, NUTRIENT-DENSE SNACK BARS (U.S. CL. 46).

FIRST USE 10-0-2002; IN COMMERCE 10-0-2002.
INGRID C. EULIN, EXAMINING ATTORNEY

CLASS 29—(Continued).

SN 78-445,106. LEEANN CHIN, INC., BLOOMINGTON, MN. FILED 7-2-2004.



OWNER OF U.S. REG. NOS. 1,402,617, 2,279,502 AND OTHERS.

NO CLAIM IS MADE TO THE EXCLUSIVE RIGHT TO USE "CHINESE CUISINE", APART FROM THE MARK AS SHOWN.

THE NAME LEEANN CHIN IDENTIFIES A LIVING INDIVIDUAL WHOSE CONSENT IS OF RECORD.

THE MARK CONSISTS IN PART OF A CHINESE FOOD TAKE-OUT BOX WITH A CHINESE CHARACTER ON IT.

THE NON-LATIN CHARACTERS IN THE MARK TRANSLITERATE TO CHIN.

FOR ORIENTAL FOODS, NAMELY, PREPARED ENTREES, APPETIZERS AND MEALS CONSISTING PRIMARILY OF MEAT, POULTRY, FISH AND/OR VEGETABLES (U.S. CL. 46).

KIMBERLY FRYE, EXAMINING ATTORNEY

SN 78-445,321. GRUPO CORPORATIVO TEYPE, SL, MADRID, SPAIN, FILED 7-2-2004.

SN 78-443,372. GLACIER FISH COMPANY LLC, SEATTLE, WA. FILED 6-29-2004.



NO CLAIM IS MADE TO THE EXCLUSIVE RIGHT TO USE "FISH COMPANY", APART FROM THE MARK AS SHOWN.

FOR FROZEN FISH (U.S. CL. 46).
FIRST USE 2-22-1984; IN COMMERCE 2-22-1984.
ANNE FARRELL, EXAMINING ATTORNEY



NO CLAIM IS MADE TO THE EXCLUSIVE RIGHT TO USE "SOY", APART FROM THE MARK AS SHOWN.

THE COLORS RED, WHITE AND GREEN ARE CLAIMED AS A FEATURE OF THE MARK.

THE MARK CONSISTS OF THE WORD PASCUAL IN WHITE STYLIZED LETTERING WITH A RED STYLIZED RECTANGLE BACKGROUND. THE WORD SOY IS IN GREEN STYLIZED LETTERING. AT THE BOTTOM OF THE LETTER Y THERE IS A LEAF SHAPE DESIGN.

FOR MILK AND MILK PRODUCTS, NAMELY, MILK AND HALF-AND-HALF MILK, CREAM MIXTURES, CALCIUM MILK, CREAM, BUTTER, MARGARINE, SOUR CREAM AND YOGURT (U.S. CL. 46).

JULIE WATSON, EXAMINING ATTORNEY

CLASS 29—(Continued).

SN 78-477,414. E. & J. GALLO WINERY, MODESTO, CA.
FILED 9-1-2004.

CLASS 29—(Continued).

SN 78-481,313. FUN ENERGY FOODS INC., MARKHAM,
CANADA, FILED 9-9-2004.

GALLO FAMILY

Alertz Energy

THE MARK CONSISTS OF STANDARD CHARACTERS
WITHOUT CLAIM TO ANY PARTICULAR FONT, STYLE,
SIZE, OR COLOR.
OWNER OF U.S. REG. NO. 2,618,424.
SEC. 2(F).
FOR OLIVE OIL (U.S. CL. 46).
CARRIE ACHEN, EXAMINING ATTORNEY

THE MARK CONSISTS OF STANDARD CHARACTERS
WITHOUT CLAIM TO ANY PARTICULAR FONT, STYLE,
SIZE, OR COLOR.
NO CLAIM IS MADE TO THE EXCLUSIVE RIGHT TO
USE "ENERGY", APART FROM THE MARK AS SHOWN.
FOR PROTEIN BASED NUTRIENT DENSE ENERGY
SNACK BARS; SOY BASED ENERGY FOOD BARS. (U.S.
CL. 46).
JANICE L. MCMORROW, EXAMINING ATTORNEY

SN 78-480,607. INTERNATIONAL BUSINESS ENTERPRISE,
S. DE R.L. DE C.V., DURANGO, MEXICO, FILED 9-8-2004.

SN 78-481,971. BUENAVIDA INC., CALGARY, ALBERTA,
CANADA, FILED 9-10-2004.

EL YOGHURT DE BUENA LECHE

Topper's Light Whipped Cream

THE MARK CONSISTS OF STANDARD CHARACTERS
WITHOUT CLAIM TO ANY PARTICULAR FONT, STYLE,
SIZE, OR COLOR.
NO CLAIM IS MADE TO THE EXCLUSIVE RIGHT TO
USE "YOGHURT" AND "LECHE", APART FROM THE
MARK AS SHOWN.
THE ENGLISH TRANSLATION OF EL YOGHURT DE
BUENA LECHE IS "THE YOGURT MADE FROM QUALITY
MILK".
FOR MILK AND MILK PRODUCTS, NAMELY, UL-
TRA-PASTUERIZED MILK, SKIM MILK, WHOLE MILK,
FLAVORED MILK, DE-LACTOSE MILK AND LOW FAT
MILK, NATURAL AND FLAVORED YOGHURTS, COT-
TAGE CHEESE, RICOTTA CHEESE, CREAM CHEESE,
PASTEURIZED CREAM (U.S. CL. 46).
MICHAEL TANNER, EXAMINING ATTORNEY

THE MARK CONSISTS OF STANDARD CHARACTERS
WITHOUT CLAIM TO ANY PARTICULAR FONT, STYLE,
SIZE, OR COLOR.
NO CLAIM IS MADE TO THE EXCLUSIVE RIGHT TO
USE LIGHT WHIPPED CREAM, APART FROM THE MARK
AS SHOWN.
FOR WHIPPED CREAM IN AN AEROSOL CAN (U.S.
CL. 46).
FIRST USE 6-1-2000; IN COMMERCE 1-15-2003.
ALICE BENMAMAN, EXAMINING ATTORNEY

CLASS 29—(Continued).

SN 78-486,534. BURGER JOINTS LLC, SEATTLE, WA. FILED 9-20-2004.

Bamboozle Burger

THE MARK CONSISTS OF STANDARD CHARACTERS WITHOUT CLAIM TO ANY PARTICULAR FONT, STYLE, SIZE, OR COLOR.

NO CLAIM IS MADE TO THE EXCLUSIVE RIGHT TO USE "BURGER", APART FROM THE MARK AS SHOWN. FOR VEGGIE BURGER PATTIES (U.S. CL. 46). FIRST USE 9-1-2003; IN COMMERCE 9-20-2003. WILLIAM VERHOSEK, EXAMINING ATTORNEY

SN 78-489,317. BBI, INC., WILMINGTON, DE. FILED 9-24-2004.

**LOOKS LIKE
HOMEMADE. TASTES
LIKE HOMEMADE.**

THE MARK CONSISTS OF STANDARD CHARACTERS WITHOUT CLAIM TO ANY PARTICULAR FONT, STYLE, SIZE, OR COLOR.

FOR CHILI (U.S. CL. 46). FIRST USE 9-14-2004; IN COMMERCE 9-14-2004. MARK T. MULLEN, EXAMINING ATTORNEY

SN 78-491,909. THOMAS M. SAENZ, FULLERTON, CA. FILED 9-30-2004.

TRADICION MEXICANA

THE MARK CONSISTS OF STANDARD CHARACTERS WITHOUT CLAIM TO ANY PARTICULAR FONT, STYLE, SIZE, OR COLOR.

NO CLAIM IS MADE TO THE EXCLUSIVE RIGHT TO USE "MEXICANA", APART FROM THE MARK AS SHOWN. THE ENGLISH TRANSLATION OF THE MARK IS MEXICAN TRADITION.

FOR NON-ALCOHOLIC MILK BASED CHOCOLATE BEVERAGES (U.S. CL. 46). DANIEL CAPSHAW, EXAMINING ATTORNEY

CLASS 29—(Continued).

SN 78-501,422. GFA BRANDS, INC., CRESSKILL, NJ. FILED 10-18-2004.

CANOLA BALANCE

THE MARK CONSISTS OF STANDARD CHARACTERS WITHOUT CLAIM TO ANY PARTICULAR FONT, STYLE, SIZE, OR COLOR.

NO CLAIM IS MADE TO THE EXCLUSIVE RIGHT TO USE "CANOLA", APART FROM THE MARK AS SHOWN. FOR COOKING OIL, CHEESE, SHORTENING, COOKING SPRAY, BUTTER SUBSTITUTES AND MARGARINE. (U.S. CL. 46).

FIRST USE 3-0-1999; IN COMMERCE 3-0-1999. KEVON CHISOLM, EXAMINING ATTORNEY

SN 78-508,560. PEELED INC, NEW YORK, NY. FILED 10-29-2004.

peeled^{leaf}
SNACKS

NO CLAIM IS MADE TO THE EXCLUSIVE RIGHT TO USE "PEELED AND SNACKS", APART FROM THE MARK AS SHOWN.

FOR SNACK MIX CONSISTING PRIMARILY OF PROCESSED FRUITS, PROCESSED NUTS AND/OR RAISINS (U.S. CL. 46).

FIRST USE 6-2-2004; IN COMMERCE 10-14-2004. DANIEL CAPSHAW, EXAMINING ATTORNEY

SN 78-511,154. COPELAND, AL C., METAIRIE, LA. FILED 11-4-2004.

FLATFOOT

THE MARK CONSISTS OF STANDARD CHARACTERS WITHOUT CLAIM TO ANY PARTICULAR FONT, STYLE, SIZE, OR COLOR.

FOR PREPARED CHICKEN (U.S. CL. 46). KELLY CHOE, EXAMINING ATTORNEY

CLASS 29—(Continued).

SN 78-514,288. ALLIANT FOODSERVICE, INC., COLUMBIA, MD. FILED 11-10-2004.



OWNER OF U.S. REG. NOS. 2,089,864, 2,767,675 AND OTHERS.

FOR CHEESE, BUTTER, MARGARINE, MILK, POWDERED MILK, CANNED MILK, CREAM, WHIPPING CREAM, NON-DAIRY CREAMER, COTTAGE CHEESE, CREAM CHEESE, SOUR CREAM, EGGS, POWDERED EGGS, EGG SUBSTITUTE, YOGURT (U.S. CL. 46).

FIRST USE 2-13-1997; IN COMMERCE 2-13-1997.

CAROLINE WOOD, EXAMINING ATTORNEY

SN 78-515,674. VAN RYN, JONATHAN, VISALIA, CA. FILED 11-11-2004.



NO CLAIM IS MADE TO THE EXCLUSIVE RIGHT TO USE "VINTAGE CHEESE COMPANY", APART FROM THE MARK AS SHOWN.

THE COLOR(S) ORANGE, YELLOW AND RED IS/ARE CLAIMED AS A FEATURE OF THE MARK.

THE COLOR ORANGE APPEARS IN THE CHEESE, THE COLOR RED APPEARS IN THE OUTSIDE OF THE CHEESE, THE COLOR YELLOW APPEARS IN THE WORDING CHEESE COMPANY, THE COLOR GRAY APPEARS IN THE WORD VINTAGE, AND THE COLOR BLACK IN THE SEMI-CIRCLE UNDER THE CHEESE.

FOR CHEESE AND DAIRY PRODUCTS EXCLUDING ICE CREAM, ICE MILK AND FROZEN YOGURT (U.S. CL. 46).

ANNE E. GUSTASON, EXAMINING ATTORNEY

CLASS 29—(Continued).

SN 78-518,695. GEORG GAVRILOVIC, HR-10000 ZAGREB, CROATIA, FILED 11-17-2004.



OWNER OF U.S. REG. NO. 1,957,115.

NO CLAIM IS MADE TO THE EXCLUSIVE RIGHT TO USE JETRENA PASTETA PORK LIVER PATE, APART FROM THE MARK AS SHOWN.

THE COLOR(S) ORANGE, RED, WHITE, BLUE, YELLOW, PINK, BLACK, AND BROWN IS/ARE CLAIMED AS A FEATURE OF THE MARK.

THE MARK CONSISTS OF A ROUND LABEL WITH ORANGE BACKGROUND. THE LABEL SHOWS A FACE OF A GIRL IN PINK, BLACK, WHITE, BLUE, AND BROWN COLORS, IN A CROATIAN REGIONAL BONNET IN WHITE, RED, BLUE, BLACK, AND YELLOW COLORS. THE NAME GAVRILOVIC IS WRITTEN IN RED AND WHITE BELOW THE DRAWING OF THE GIRL. THE WORDS PORK LIVER PATE AND JETRENA PASTETA ARE WRITTEN IN WHITE ON THE RED AND BLUE OVALS.

THE ENGLISH TRANSLATION OF THE FOREIGN WORDING "JETRENA PASTETA" IS "LIVER PATE".

FOR LIVER PATE (U.S. CL. 46).

TEJBIR SINGH, EXAMINING ATTORNEY

SN 78-519,190. RIVIANA FOODS INC., HOUSTON, TX. FILED 11-18-2004.

RIVIANA

THE MARK CONSISTS OF STANDARD CHARACTERS WITHOUT CLAIM TO ANY PARTICULAR FONT, STYLE, SIZE, OR COLOR.

OWNER OF U.S. REG. NO. 834,849.

FOR EDIBLE OILS (U.S. CL. 46).

CHRISIE B. KING, EXAMINING ATTORNEY

CLASS 29—(Continued).

SN 78-519,205. RIVIANA FOODS INC., HOUSTON, TX.
FILED 11-18-2004.

RIZIANA

THE MARK CONSISTS OF STANDARD CHARACTERS
WITHOUT CLAIM TO ANY PARTICULAR FONT, STYLE,
SIZE, OR COLOR.

OWNER OF U.S. REG. NO. 834,849.
FOR EDIBLE OILS (U.S. CL. 46).
CHRISIE B. KING, EXAMINING ATTORNEY

SN 78-519,511. MIA PURE LLC, MIAMI BEACH, FL. FILED
11-18-2004.

LEAN BROWNIE

THE MARK CONSISTS OF STANDARD CHARACTERS
WITHOUT CLAIM TO ANY PARTICULAR FONT, STYLE,
SIZE, OR COLOR.

NO CLAIM IS MADE TO THE EXCLUSIVE RIGHT TO
USE BROWNIE, APART FROM THE MARK AS SHOWN.
FOR PROTEIN BASED, NUTRIENT-DENSE SNACK
BARS (U.S. CL. 46).
CHERYL STEPLIGHT, EXAMINING ATTORNEY

CLASS 29—(Continued).

SN 78-520,964. CARGILL, INCORPORATED, WAYZATA,
MN. FILED 11-22-2004.

SKILLET FRITTATAS

THE MARK CONSISTS OF STANDARD CHARACTERS
WITHOUT CLAIM TO ANY PARTICULAR FONT, STYLE,
SIZE, OR COLOR.

OWNER OF U.S. REG. NOS. 1,760,832 AND 2,778,060.
NO CLAIM IS MADE TO THE EXCLUSIVE RIGHT TO
USE "FRITTATAS", APART FROM THE MARK AS SHOWN.
SEC. 2(F) AS TO "SKILLET".
FOR OMELETS (U.S. CL. 46).
KATHY DE JONGE, EXAMINING ATTORNEY

SN 78-521,295. AMERICA'S DRIVE-IN CORP., WICHITA, KS.
FILED 11-22-2004.

**GARDEN GROWN
FRESHNESS IN EVERY
BITE.**

THE MARK CONSISTS OF STANDARD CHARACTERS
WITHOUT CLAIM TO ANY PARTICULAR FONT, STYLE,
SIZE, OR COLOR.

FOR PRE-CUT VEGETABLE SALADS FOR CONSUMP-
TION ON OR OFF THE PREMISES (U.S. CL. 46).
FIRST USE 9-1-2004; IN COMMERCE 9-1-2004.
WENDY GOODMAN, EXAMINING ATTORNEY

SN 78-522,111. SAINT HELEN'S GOURMETS, S.L., MADRID,
SPAIN, FILED 11-23-2004.

GOURMOLIV

THE MARK CONSISTS OF STANDARD CHARACTERS
WITHOUT CLAIM TO ANY PARTICULAR FONT, STYLE,
SIZE, OR COLOR.

FOR EDIBLE OILS (U.S. CL. 46).
STEVEN JACKSON, EXAMINING ATTORNEY

CLASS 29—(Continued).

SN 78-522,824. ACEITUNAS SEVILLANAS, S.A., SEVILLA, SPAIN, FILED 11-24-2004.

CLASS 29—(Continued).

SN 78-524,403. VERDEOROUSA INC., HILLSIDE, NJ. FILED 11-30-2004.

AMELIA

Virgin Gold

THE MARK CONSISTS OF STANDARD CHARACTERS WITHOUT CLAIM TO ANY PARTICULAR FONT, STYLE, SIZE, OR COLOR.

FOR PRESERVED OLIVES; MEAT PRESERVES; FRUIT PRESERVES; FISH PRESERVES; VEGETABLE PRESERVES; PRESERVED PULSES; EDIBLE FATS AND OILS; EDIBLE CRUSTACEANS AND SHELLFISH (NOT LIVE) (U.S. CL. 46).

ERNEST SHOSHO, EXAMINING ATTORNEY

THE MARK CONSISTS OF STANDARD CHARACTERS WITHOUT CLAIM TO ANY PARTICULAR FONT, STYLE, SIZE, OR COLOR.

FOR FOOD OIL (U.S. CL. 46).

KIMBERLY FRYE, EXAMINING ATTORNEY

SN 78-525,741. AMERICAN SEAFOODS GROUP LLC, SEATTLE, WA. FILED 12-2-2004.

SN 78-523,732. FRANKLIN FOODS, INC., ENOSBURG FALLS, VT. FILED 11-29-2004.

HEAVENLY PLAIN

Clear Lakes
Catfish

THE MARK CONSISTS OF STANDARD CHARACTERS WITHOUT CLAIM TO ANY PARTICULAR FONT, STYLE, SIZE, OR COLOR.

NO CLAIM IS MADE TO THE EXCLUSIVE RIGHT TO USE "PLAIN", APART FROM THE MARK AS SHOWN.

FOR MIXTURES OF YOGURT AND CREAM CHEESE (U.S. CL. 46).

FIRST USE 6-30-2004; IN COMMERCE 6-30-2004.
LAURA KOVAISKY, EXAMINING ATTORNEY

THE MARK CONSISTS OF STANDARD CHARACTERS WITHOUT CLAIM TO ANY PARTICULAR FONT, STYLE, SIZE, OR COLOR.

NO CLAIM IS MADE TO THE EXCLUSIVE RIGHT TO USE "CATFISH", APART FROM THE MARK AS SHOWN.

FOR CATFISH, NAMELY FILLETS BOTH BREADED AND PLAIN, WHOLE FISH BOTH BREADED AND PLAIN, SMOKED, STUFFED, SEASONED, AND BREADED NUGGETS (U.S. CL. 46).

ALICIA COLLINS, EXAMINING ATTORNEY

CLASS 29—(Continued).

SN 78-536,949. KRAFT FOODS HOLDINGS, INC., NORTH-FIELD, IL. FILED 12-22-2004.

CLASS 29—(Continued).

SN 78-538,933. FISHERY PRODUCTS INTERNATIONAL LIMITED, ST. JOHN'S, NEWFOUNDLAND, CANADA, FILED 12-28-2004.

LOVERS

THE MARK CONSISTS OF STANDARD CHARACTERS WITHOUT CLAIM TO ANY PARTICULAR FONT, STYLE, SIZE, OR COLOR.
FOR PROCESSED NUTS (U.S. CL. 46).
SHAUNIA WALLACE, EXAMINING ATTORNEY

THE MARK CONSISTS OF STANDARD CHARACTERS WITHOUT CLAIM TO ANY PARTICULAR FONT, STYLE, SIZE, OR COLOR.
FOR FROZEN BREADED AND BATTERED SEAFOOD (U.S. CL. 46).
JANICE L. MCMORROW, EXAMINING ATTORNEY

SN 78-543,047. PRESTAGE FOODS, INC., CLINTON, NC. FILED 1-6-2005.

PRESTAGE FOODS

SN 78-538,604. G-UP CORPORATION, SAN JOSE, CA. FILED 12-27-2004.

THE MARK CONSISTS OF STANDARD CHARACTERS WITHOUT CLAIM TO ANY PARTICULAR FONT, STYLE, SIZE, OR COLOR.
NO CLAIM IS MADE TO THE EXCLUSIVE RIGHT TO USE FOODS, APART FROM THE MARK AS SHOWN.
FOR TURKEY; PORK; PROCESSED FOODS, NAMELY TURKEY AND PORK (U.S. CL. 46).
STANLEY I. OSBORNE, EXAMINING ATTORNEY

PACIFIC PIER

SN 78-543,051. READY PAC PRODUCE, INC., IRWINDALE, CA. FILED 1-6-2005.

SIMPLY LETTUCE

THE MARK CONSISTS OF STANDARD CHARACTERS WITHOUT CLAIM TO ANY PARTICULAR FONT, STYLE, SIZE, OR COLOR.
NO CLAIM IS MADE TO THE EXCLUSIVE RIGHT TO USE "PACIFIC", APART FROM THE MARK AS SHOWN.
FOR CANNED TUNA FISH, CRAB, AND SHRIMPS; PRE-PACKAGED DINNERS CONSISTING PRIMARILY OF CRAB EGG ROLL; PRE-PACKAGED DINNERS CONSISTING PRIMARILY OF SEAFOOD SERVED WITH PASTA; FROZEN SEAFOOD, SHRIMPS, CRAB LEGS AND SURIMI-BASED SEAFOODS (U.S. CL. 46).
BARBARA RUTLAND, EXAMINING ATTORNEY

THE MARK CONSISTS OF STANDARD CHARACTERS WITHOUT CLAIM TO ANY PARTICULAR FONT, STYLE, SIZE, OR COLOR.
NO CLAIM IS MADE TO THE EXCLUSIVE RIGHT TO USE LETTUCE, APART FROM THE MARK AS SHOWN.
FOR PROCESSED VEGETABLES (U.S. CL. 46).
STANLEY I. OSBORNE, EXAMINING ATTORNEY

CLASS 29—(Continued).

SN 78-543,390. ARMANINO FOODS OF DISTINCTION, INC., HAYWARD, CA. FILED 1-6-2005.

ITALIAN HOLIDAY

THE MARK CONSISTS OF STANDARD CHARACTERS WITHOUT CLAIM TO ANY PARTICULAR FONT, STYLE, SIZE, OR COLOR.

OWNER OF U.S. REG. NO. 1,929,922.
NO CLAIM IS MADE TO THE EXCLUSIVE RIGHT TO USE "ITALIAN", APART FROM THE MARK AS SHOWN.
FOR FROZEN MEATBALLS (U.S. CL. 46).
FIRST USE 12-7-2004; IN COMMERCE 12-7-2004.
RUSS HERMAN, EXAMINING ATTORNEY

SN 78-544,884. P.T. KEONG NUSANTARA ABADI, BANDAR LAMPUNG, INDONESIA, FILED 1-10-2005.

龍情

THE MARK CONSISTS OF TWO CHINESE CHARACTERS.

THE FOREIGN WORDING IN THE MARK TRANSLATES INTO ENGLISH AS DRAGON'S AFFECTION.

THE NON-LATIN CHARACTER(S) IN THE MARK TRANSLITERATES INTO LUNG CHING, AND THIS MEANS DRAGON'S AFFECTION IN ENGLISH.

FOR EDIBLE BIRD'S NESTS; PROCESSED BEE POLLEN FOR FOOD PURPOSES; PROCESSED GINSENG FOR USE AS A VEGETABLE; DAIRY-BASED FOOD BEVERAGES; LACTIC ACID DRINKS; CANNED OR BOTTLED FRUITS; DRIED FRUIT MIXES; AND PROCESSED MUSHROOMS (U.S. CL. 46).
ODESSA BIBBINS, EXAMINING ATTORNEY

CLASS 29—(Continued).

SN 78-544,927. BUFFETT, JIMMY, KEY WEST, FL. FILED 1-10-2005.

LAST MANGO

THE MARK CONSISTS OF STANDARD CHARACTERS WITHOUT CLAIM TO ANY PARTICULAR FONT, STYLE, SIZE, OR COLOR.

OWNER OF U.S. REG. NO. 2,324,655.
FOR FROZEN PREPARED POULTRY, MEAT, AND SEAFOOD; FROZEN APPETIZERS CONSISTING PRIMARILY OF VEGETABLES, MEAT, POULTRY, SEAFOOD, AND/OR CHEESE; FROZEN APPETIZERS, NAMELY BREADED AND COATED VEGETABLES, MEAT, POULTRY, SEAFOOD, AND/OR CHEESE COMBINATIONS; SNACK DIPS; AND DAIRY-BASED DIPS (U.S. CL. 46).
WILLIAM VERHOSEK, EXAMINING ATTORNEY

SN 78-557,784. PATCUD INVESTMENTS, INC., WILMINGTON, DE. FILED 2-1-2005.

LOVE WHAT YOU EAT!

THE MARK CONSISTS OF STANDARD CHARACTERS WITHOUT CLAIM TO ANY PARTICULAR FONT, STYLE, SIZE, OR COLOR.

FOR MEAT (U.S. CL. 46).
CHERYL CLAYTON, EXAMINING ATTORNEY

SN 78-608,790. ALL-ONE-GOD-FAITH, INC., ESCONDIDO, CA. FILED 4-14-2005.

ALPSNACK

THE MARK CONSISTS OF STANDARD CHARACTERS WITHOUT CLAIM TO ANY PARTICULAR FONT, STYLE, SIZE, OR COLOR.

FOR FOOD SNACKS, NAMELY SNACK BARS CONSISTING PRIMARILY OF NUTS AND FRUITS AND SOMETIMES ALSO CHOCOLATE (U.S. CL. 46).

FIRST USE 8-31-2003; IN COMMERCE 8-31-2003.
JILL PRATER, EXAMINING ATTORNEY

CLASS 29—(Continued).

SN 78-608,816. ALL-ONE-GOD-FAITH, INC., ESCONDIDO, CA. FILED 4-14-2005.

GERTRUDE & BRONNER'S MAGIC
ALPSNACK

THE MARK CONSISTS OF STANDARD CHARACTERS WITHOUT CLAIM TO ANY PARTICULAR FONT, STYLE, SIZE, OR COLOR.

FOR FOOD SNACKS, NAMELY SNACK BARS CONSISTING PRIMARILY OF NUTS AND FRUITS AND SOMETIMES ALSO CHOCOLATE (U.S. CL. 46).

FIRST USE 8-31-2003; IN COMMERCE 8-31-2003.
JILL PRATER, EXAMINING ATTORNEY

SN 79-006,000. AKRYON (S.A.R.L.), FRANCE, FILED 8-31-2004.

GLISODIN

THE MARK CONSISTS OF STANDARD CHARACTERS WITHOUT CLAIM TO ANY PARTICULAR FONT, STYLE, SIZE, OR COLOR.

PRIORITY DATE OF 3-5-2004 IS CLAIMED.

OWNER OF INTERNATIONAL REGISTRATION 0835105 DATED 8-31-2004, EXPIRES 8-31-2014.

OWNER OF U.S. REG. NOS. 2,723,572 AND 2,889,867.

FOR DIETETIC FOODSTUFFS FOR NON-MEDICAL USE COMPRISING FRUIT AND/OR VEGETABLE EXTRACTS; DIETETIC FOODSTUFFS FOR NON-MEDICAL USE COMPRISING MEAT, FISH, POULTRY AND GAME, EGGS, MILK (U.S. CL. 46).

KEVON CHISOLM, EXAMINING ATTORNEY

CLASS 30—STAPLE FOODS

SN 76-150,768. NISSIN SHOKUHIN KABUSHIKI KAISHA, DBA NISSIN FOOD PRODUCTS CO., LTD., YODOGAWA-KU, OSAKA, JAPAN, FILED 10-20-2000.

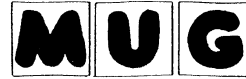

OWNER OF JAPAN REG. NO. 3349643, DATED 10-3-1997, EXPIRES 10-3-2007.

OWNER OF U.S. REG. NOS. 1,941,419 AND 2,063,578.

FOR INSTANT COOKING NOODLES; NOODLES; CORNFLAKES; UNCOOKED UDON, NAMELY, JAPANESE NOODLES OF WHEAT FLOUR; OATFLAKES; OATMEAL; BOILED AND DRIED RICE; ENRICHED RICE; COATINGS OF DUMPLINGS STUFFED WITH MINCED PORK; ARTIFICIAL RICE; SPAGHETTI; UNCOOKED SOMEN, NAMELY, JAPANESE VERY THIN NOODLES OF WHEAT FLOUR; INSTANT OR PRECOOKED UDON; INSTANT OR PRECOOKED SOBA, NAMELY, JAPANESE NOODLES OF BUCKWHEAT FLOUR; INSTANT OR PRECOOKED CHINESE NOODLES; UNCOOKED SOBA; UNCOOKED CHINESE NOODLES; FENTIAO, NAMELY, CHINESE TRANSLUCENT NOODLES MADE FROM STARCH; BREAD CRUMBS; MIFEN, NAMELY, CHINESE RICE NOODLES; FU, NAMELY, JAPANESE FLUFFY GLUTEN BREAD; CANNED BOILED RICE; MACARONI; MOCHI, NAMELY, JAPANESE POUND RICE CAKE; COFFEE; COCOA; COFFEE BEANS; TEA; SALAD DRESSINGS; STARCH SYRUP; SALT; CHEMICAL SEASONINGS; SPICES; PROCESSED GRAINS; SANDWICHES; SUSHI; PIZZAS; BOX LUNCHES CONTAINING PRIMARILY SANDWICHES, PASTA AND/OR RICE; MEAT PIES; RAVIOLI; CONFECTIONERY, NAMELY CANDY; ICE CANDIES; ICE CREAMS; WAFERS; CASTELLA CAKES; SHIP BISCUITS; CARAMELS; CANDIES; COOKIES; CRACKERS; ICE-CREAM CONES; SHERBETS; CREAM PUFFS; SPONGE CAKES; TOFFEE; CHEWING GUMS; CHOCOLATES; DOUGHNUTS; CANDY DROPS; NOUGAT; PIES; BISCUITS; FROZEN YOGURT; BALL CAKES; PANCAKES; POPPED POPCORN; MARSHMALLOWS; CANDY COATED APPLES; RUSKS; WAFFLES; BREAD; BUNS; PREMIXES FOR CAKES; PREMIXES FOR ICE CREAM; ALMOND PASTE; BAKING POWDER; ICE; BINDING AGENTS FOR ICE CREAM; SAKE LEES, NAMELY, EDIBLE SOFT CAKE MADE FROM RICE WINE (U.S. CL. 46).

ROBERT LORENZO, EXAMINING ATTORNEY

SN 76-302,541. MARS, INCORPORATED, MCLEAN, VA. FILED 8-21-2001.



OWNER OF MEXICO REG. NO. 145234, DATED 11-10-2000, EXPIRES 11-10-2010.

FOR CANDY (U.S. CL. 46).

FIRST USE 11-22-1999; IN COMMERCE 11-22-1999.

SUSAN LESLIE DUBOIS, EXAMINING ATTORNEY

CLASS 30—(Continued).

SN 76-364,416. GRUPO BIMBO S.A. DE C.V., DELEGACION ALVARO OBREGON, MEXICO, FILED 1-28-2002.

DIPPERS

FOR FRIED CORN SNACKS (U.S. CL. 46).
YSA DEJESUS, EXAMINING ATTORNEY

SN 76-492,390. OLE MEXICAN FOODS, INC., NORCROSS, GA. FILED 2-24-2003.

MEXICAN MEAL SOLUTIONS

NO CLAIM IS MADE TO THE EXCLUSIVE RIGHT TO USE "MEXICAN MEAL", APART FROM THE MARK AS SHOWN.

FOR MEAL KITS FOR CREATING TORTILLAS, BURRITOS AND QUESADILLAS CONSISTING PRIMARILY OF FLOUR TORTILLAS, RICE, MOLE, CHEESE, SALSA, AND PROCESSED AND REFRIED BEANS (U.S. CL. 46).
ESTHER BELENKER, EXAMINING ATTORNEY

SN 76-527,810. KETO, L.L.C., NEPTUNE, NJ. FILED 6-18-2003.

KETO COCOA CRISP

NO CLAIM IS MADE TO THE EXCLUSIVE RIGHT TO USE "COCOA", APART FROM THE MARK AS SHOWN.

FOR BREAKFAST CEREAL (U.S. CL. 46).
FIRST USE 7-31-2001; IN COMMERCE 7-31-2001.
H. M. FISHER, EXAMINING ATTORNEY

CLASS 30—(Continued).

SN 76-541,819. LI, KAR YEE KELLY, NEW TERRITORIES, HONG KONG, FILED 8-21-2003.



BAO ZHI LIN IS NOT THE NAME OF A KNOWN LIVING INDIVIDUAL.

THE ENGLISH TRANSLATION OF THE CHINESE CHARACTERS IN THE MARK IS, FROM LEFT TO RIGHT, "PRECIOUS, RARE, VALUABLE, TREASURE", "FUNGUS WITH PURPLISH STALK INDICATING LONG LIFE AND PROSPERITY", AND "FOREST, GROVE". THE COMBINATION OF THE CHINESE CHARACTERS IN THE MARK, TAKEN TOGETHER, HAVE NO ENGLISH TRANSLATION OR MEANING.

THE TRANSLITERATION OF THE CHINESE CHARACTERS IN THE MARK IS, FROM LEFT TO RIGHT, "BAO", "ZHI", AND "LIN".

FOR COFFEE, COCOA, RICE, TAPIOCA, HONEY, FLOUR AND PREPARATIONS MADE FROM CEREALS, NAMELY, CEREAL BASED SNACK FOODS AND BREAKFAST CEREALS; BREAD AND PASTRIES; TEA, HERBAL TEA; CANDY, JELLY CANDY, HERBAL CANDY, SPICE CANDY, FRUIT CANDY, LIQUORICE; NON-MEDICATED LOZENGES; CHEWING GUM; CONFECTIONERY FOR FOOD PURPOSES IN JELLY FORM; GRANOLA-BASED SNACK BARS; NON-ALCOHOLIC BEVERAGES NAMELY, COFFEE, TEA, HERBAL TEA; MILK-BASED, ICE CREAM BASED, YOGURT BASED, SHERBET BASED, AND SORBET BASED SHAKES, FLAVORED ICES AND FROZEN CONFECTIONS (U.S. CL. 46).

DAWN FELDMAN, EXAMINING ATTORNEY

SN 76-560,767. LEO ARRETIN, INC., WALNUT, CA. FILED 11-17-2003.

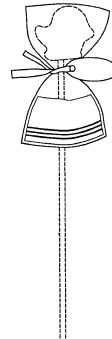

THE MARK CONSISTS OF PACKAGING FOR A LOLLIPOP, NAMELY, TRANSPARENT WRAP CONTAINING A RECTANGULAR DESIGN HAVING A SERIES OF THREE

CLASS 30—(Continued).

ESSENTIALLY PARALLEL STRIPES EXTENDING ACROSS THE BOTTOM PORTION THEREOF, AND AN OVAL SHAPED TAG ATTACHED TO THE TRANSPARENT WRAP WITH A TWIST-TIE FORMING A BOW TIE SHAPE. THE MATTER SHOWN IN DOTTED LINES CONSISTS OF A SUCKER, WHICH IS SHOWN IN THE SHAPE OF A DUCK, SUPPORTED ON A LONG STEM, AND THIS MATTER IS NOT PART OF THE MARK, AND SERVES ONLY TO SHOW THE POSITION OF THE PACKAGING RELATIVE TO THE LOLLIPOP.

SEC. 2(F).

FOR LOLLIPOPS (U.S. CL. 46).

FIRST USE 4-1-2002; IN COMMERCE 4-1-2002.

ESTHER BELENKER, EXAMINING ATTORNEY

SN 76-562,808. SUSIE'S SOUTH FORTY CONFECTIONS, INC., MIDLAND, TX. FILED 11-17-2003.

Texas Trash

THE MARK CONSISTS OF STANDARD CHARACTERS WITHOUT CLAIM TO ANY PARTICULAR FONT, STYLE, SIZE, OR COLOR.

NO CLAIM IS MADE TO THE EXCLUSIVE RIGHT TO USE TEXAS, APART FROM THE MARK AS SHOWN.

FOR CANDY (U.S. CL. 46).

FIRST USE 7-1-2003; IN COMMERCE 7-1-2003.

SHARON MEIER, EXAMINING ATTORNEY

SN 76-562,810. SUSIE'S SOUTH FORTY CONFECTIONS, INC., MIDLAND, TX. FILED 11-17-2003.

You Can't Bite a Better Bark

THE MARK CONSISTS OF STANDARD CHARACTERS WITHOUT CLAIM TO ANY PARTICULAR FONT, STYLE, SIZE, OR COLOR.

FOR CANDY (U.S. CL. 46).

FIRST USE 7-1-2003; IN COMMERCE 7-1-2003.

SHARON MEIER, EXAMINING ATTORNEY

SN 76-565,008. MRS. SULLIVAN'S INC., MARTINSVILLE, NJ. FILED 12-12-2003.

MRS. SULLIVAN'S SOUTHWESTERN

OWNER OF U.S. REG. NO. 1,682,166.

NO CLAIM IS MADE TO THE EXCLUSIVE RIGHT TO USE "SOUTHWESTERN", APART FROM THE MARK AS SHOWN.

THE DESIGNATION "MRS. SULLIVAN" DOES NOT IDENTIFY A LIVING INDIVIDUAL.

FOR PIES (U.S. CL. 46).

FIRST USE 10-5-2002; IN COMMERCE 10-5-2002.

BERYL GARDNER, EXAMINING ATTORNEY

CLASS 30—(Continued).

SN 76-574,778. TIPPY ROSA LLC, OVERLAND PARK, KS. FILED 2-9-2004.



THE NAME(S), PORTRAIT(S), AND/OR SIGNATURE(S) SHOWN IN THE MARK IDENTIFIES TAYLOR ROSE KING, WHOSE CONSENT(S) TO REGISTER IS SUBMITTED.

FOR MEXICAN FOOD PRODUCTS, NAMELY, TACO SHELLS, TOSTADA SHELLS AND TACO SEASONING (U.S. CL. 46).

BRIDGETT SMITH, EXAMINING ATTORNEY

SN 76-578,908. R. SEELIG & HILLE OHG, 40549 DUESSELDORF, FED REP GERMANY, FILED 3-3-2004.

POMPADOUR

PRIORITY CLAIMED UNDER SEC. 44(D) ON FED REP GERMANY APPLICATION NO. 30361136.7/3, FILED 11-25-2003, REG. NO. 30361136, DATED 11-25-2003, EXPIRES 11-30-2013.

OWNER OF U.S. REG. NO. 767,926.

FOR TEA; HERBAL TEA FOR FOOD PURPOSES; HERBAL INFUSIONS; FRUIT TEAS; TEA SUBSTITUTES; INSTANT TEA; ICED TEA; FLAVORED TEA; INSTANT OR FLAVORED HERBAL INFUSIONS; INSTANT OR FLAVORED FRUIT TEAS; INSTANT OF FLAVORED TEA SUBSTITUTES (U.S. CL. 46).

BRIDGETT SMITH, EXAMINING ATTORNEY

SN 76-581,163. MARS, INCORPORATED, MCLEAN, VA. FILED 3-16-2004.

MY MESSAGE

THE MARK CONSISTS OF STANDARD CHARACTERS WITHOUT CLAIM TO ANY PARTICULAR FONT, STYLE, SIZE, OR COLOR.

NO CLAIM IS MADE TO THE EXCLUSIVE RIGHT TO USE "MESSAGE", APART FROM THE MARK AS SHOWN.

FOR CONFECTIONERY, NAMELY, CANDY (U.S. CL. 46).

HEATHER THOMPSON, EXAMINING ATTORNEY

CLASS 30—(Continued).

SN 76-586,224. BARSOUMIAN, HAGOP, CHATSWORTH, CA. AND BARSOUMIAN, MARAL, CHATSWORTH, CA. FILED 4-12-2004.

VANILLA CAVIAR

THE MARK CONSISTS OF STANDARD CHARACTERS WITHOUT CLAIM TO ANY PARTICULAR FONT, STYLE, SIZE, OR COLOR.

NO CLAIM IS MADE TO THE EXCLUSIVE RIGHT TO USE VANILLA, APART FROM THE MARK AS SHOWN. FOR VANILLA PASTE (U.S. CL. 46). FIRST USE 3-29-2004; IN COMMERCE 3-29-2004. ERNEST SHOSHO, EXAMINING ATTORNEY

SN 76-587,689. LACAS COFFEE CORPORATION, PENNSAUKEN, NJ. FILED 4-16-2004.

RITTENHOUSE FINE COFFEE

THE MARK CONSISTS OF STANDARD CHARACTERS WITHOUT CLAIM TO ANY PARTICULAR FONT, STYLE, SIZE, OR COLOR.

NO CLAIM IS MADE TO THE EXCLUSIVE RIGHT TO USE "FINE COFFEE", APART FROM THE MARK AS SHOWN. SEC. 2(F). FOR COFFEE (U.S. CL. 46). FIRST USE 11-0-1999; IN COMMERCE 11-0-1999. STEVEN JACKSON, EXAMINING ATTORNEY

SN 76-590,756. SOKOL CHIAPAS COFFEE COMPANY, L.L.C., HINSDALE, IL. FILED 5-6-2004.

SOKOL

THE MARK CONSISTS OF STANDARD CHARACTERS WITHOUT CLAIM TO ANY PARTICULAR FONT, STYLE, SIZE, OR COLOR.

THE ENGLISH TRANSLATION OF SOKOL IS FALCON. FOR ROASTED AND GROUND COFFEE (U.S. CL. 46). FIRST USE 7-1-2002; IN COMMERCE 7-1-2002. MARY CRAWFORD, EXAMINING ATTORNEY

CLASS 30—(Continued).

SN 76-590,800. CEREAILITY OPERATORS, INC., CHICAGO, IL. FILED 5-3-2004.

YOUR CEREAL. YOUR WAY.

THE MARK CONSISTS OF STANDARD CHARACTERS WITHOUT CLAIM TO ANY PARTICULAR FONT, STYLE, SIZE, OR COLOR.

NO CLAIM IS MADE TO THE EXCLUSIVE RIGHT TO USE "CEREAL", APART FROM THE MARK AS SHOWN.

FOR PREPARED MENU ITEMS CONSISTING PRIMARILY OF A BLEND OF BRANDED BREAKFAST CEREALS, AND FRUIT, NUT AND/OR SYRUP TOPPINGS AND MILK, INCLUDING SOY MILK (U.S. CL. 46).

FIRST USE 8-25-2003; IN COMMERCE 8-25-2003. PRISCILLA MILTON, EXAMINING ATTORNEY

SN 76-590,801. CEREAILITY OPERATORS, INC., CHICAGO, IL. FILED 5-3-2004.

YOUR CEREAL. OUR WAY.

THE MARK CONSISTS OF STANDARD CHARACTERS WITHOUT CLAIM TO ANY PARTICULAR FONT, STYLE, SIZE, OR COLOR.

NO CLAIM IS MADE TO THE EXCLUSIVE RIGHT TO USE "CEREAL", APART FROM THE MARK AS SHOWN.

FOR PREPARED MENU ITEMS CONSISTING PRIMARILY OF A BLEND OF BRANDED BREAKFAST CEREALS, AND FRUIT, NUT AND/OR SYRUP TOPPINGS AND MILK, INCLUDING SOY MILK (U.S. CL. 46).

FIRST USE 8-25-2003; IN COMMERCE 8-25-2003. PRISCILLA MILTON, EXAMINING ATTORNEY

SN 76-590,803. CEREAILITY OPERATORS, INC., CHICAGO, IL. FILED 5-3-2004.

MY CEREAL. MY WAY.

THE MARK CONSISTS OF STANDARD CHARACTERS WITHOUT CLAIM TO ANY PARTICULAR FONT, STYLE, SIZE, OR COLOR.

NO CLAIM IS MADE TO THE EXCLUSIVE RIGHT TO USE "CEREAL", APART FROM THE MARK AS SHOWN.

FOR PREPARED MENU ITEMS CONSISTING PRIMARILY OF A BLEND OF BRANDED BREAKFAST CEREALS, AND FRUIT, NUT AND/OR SYRUP TOPPINGS AND MILK, INCLUDING SOY MILK (U.S. CL. 46).

FIRST USE 8-25-2003; IN COMMERCE 8-25-2003. PRISCILLA MILTON, EXAMINING ATTORNEY

CLASS 30—(Continued).

SN 76-590,806. CEREALITY OPERATORS, INC., CHICAGO, IL. FILED 5-3-2004.

DEVIL MADE ME DO IT

THE MARK CONSISTS OF STANDARD CHARACTERS WITHOUT CLAIM TO ANY PARTICULAR FONT, STYLE, SIZE, OR COLOR.

FOR PREPARED MENU ITEM CONSISTING PRIMARILY OF A BLEND OF BRANDED BREAKFAST CEREALS, AND FRUIT, NUT AND/OR SYRUP TOPPING AND MILK, INCLUDING SOY MILK (U.S. CL. 46).

FIRST USE 8-25-2003; IN COMMERCE 8-25-2003.
PRISCILLA MILTON, EXAMINING ATTORNEY

SN 76-590,807. CEREALITY OPERATORS, INC., CHICAGO, IL. FILED 5-3-2004.

LIFE EXPERIENCE

THE MARK CONSISTS OF STANDARD CHARACTERS WITHOUT CLAIM TO ANY PARTICULAR FONT, STYLE, SIZE, OR COLOR.

FOR PREPARED MENU ITEM CONSISTING PRIMARILY OF A BLEND OF BRANDED BREAKFAST CEREALS, AND FRUIT, NUT AND/OR SYRUP TOPPING AND MILK, INCLUDING SOY MILK (U.S. CL. 46).

FIRST USE 8-25-2003; IN COMMERCE 8-25-2003.
PRISCILLA MILTON, EXAMINING ATTORNEY

SN 76-590,809. CEREALITY OPERATORS, INC., CHICAGO, IL. FILED 5-3-2004.

HEALTH KICK

THE MARK CONSISTS OF STANDARD CHARACTERS WITHOUT CLAIM TO ANY PARTICULAR FONT, STYLE, SIZE, OR COLOR.

FOR PREPARED MENU ITEM CONSISTING PRIMARILY OF A BLEND OF BRANDED BREAKFAST CEREALS, AND FRUIT, NUT AND/OR SYRUP TOPPING AND MILK, INCLUDING SOY MILK (U.S. CL. 46).

FIRST USE 8-25-2003; IN COMMERCE 8-25-2003.
PRISCILLA MILTON, EXAMINING ATTORNEY

CLASS 30—(Continued).

SN 76-590,819. CEREALITY OPERATORS, INC., CHICAGO, IL. FILED 5-3-2004.

ALTERED CEREALITIES

THE MARK CONSISTS OF STANDARD CHARACTERS WITHOUT CLAIM TO ANY PARTICULAR FONT, STYLE, SIZE, OR COLOR.

OWNER OF U.S. REG. NO. 2,836,818.

FOR CEREAL BASED SNACK FOOD (U.S. CL. 46).

FIRST USE 8-25-2003; IN COMMERCE 8-25-2003.
PRISCILLA MILTON, EXAMINING ATTORNEY

SN 76-590,823. CEREALITY OPERATORS, INC., CHICAGO, IL. FILED 5-3-2004.

PARFAITS YOUR WAY

THE MARK CONSISTS OF STANDARD CHARACTERS WITHOUT CLAIM TO ANY PARTICULAR FONT, STYLE, SIZE, OR COLOR.

NO CLAIM IS MADE TO THE EXCLUSIVE RIGHT TO USE "PARFAITS", APART FROM THE MARK AS SHOWN.

FOR CEREAL BASED PARFAIT, FEATURING YOGURT, FRUIT, NUT, AND/OR SYRUP TOPPING (U.S. CL. 46).

FIRST USE 8-25-2003; IN COMMERCE 8-25-2003.
PRISCILLA MILTON, EXAMINING ATTORNEY

SN 76-590,826. CEREALITY OPERATORS, INC., CHICAGO, IL. FILED 5-3-2004.

INVENT-A-BLEND

THE MARK CONSISTS OF STANDARD CHARACTERS WITHOUT CLAIM TO ANY PARTICULAR FONT, STYLE, SIZE, OR COLOR.

FOR PREPARED MENU ITEMS CONSISTING PRIMARILY OF A BLEND OF BRANDED BREAKFAST CEREALS, AND FRUIT, NUT AND/OR SYRUP TOPPING AND MILK, INCLUDING SOY MILK. (U.S. CL. 46).

FIRST USE 8-25-2003; IN COMMERCE 8-25-2003.
PRISCILLA MILTON, EXAMINING ATTORNEY

CLASS 30—(Continued).

SN 76-593,199. PROSCIUTTIFICIO SAN FRANCESCO S.P.A., MODENA, ITALY, FILED 5-20-2004.



NO CLAIM IS MADE TO THE EXCLUSIVE RIGHT TO USE "ACETO BALSAMICO DI MODENA", APART FROM THE MARK AS SHOWN.

THE TERM "SAN FRANCESCO" TRANSLATES AS SAINT FRANCIS. THE TERM ACETO BALSAMICO DI MODENA TRANSLATES AS BALSAMIC VINEGAR OF MODENA. FOR BALSAMIC VINEGAR (U.S. CL. 46).

KATHLEEN M. VANSTON, EXAMINING ATTORNEY

SN 76-593,715. PEDA INC., LAS VEGAS, NV. FILED 5-24-2004.

KUTTIN' CARBS KEEPIN' FLAVOR

THE MARK CONSISTS OF STANDARD CHARACTERS WITHOUT CLAIM TO ANY PARTICULAR FONT, STYLE, SIZE, OR COLOR.

FOR BREADS, ROLLS, TORTILLAS, BAGELS, PIZZA CRUSTS, PITA BREADS AND CONFECTIONERIES, NAMELY, BAKERY GOODS (U.S. CL. 46).

ERNEST SHOSHO, EXAMINING ATTORNEY

SN 76-597,180. NELSON, CRAIG W., WEST CHESTERFIELD, NH. FILED 6-10-2004.

GOURICÉ

THE MARK CONSISTS OF STANDARD CHARACTERS WITHOUT CLAIM TO ANY PARTICULAR FONT, STYLE, SIZE, OR COLOR.

FOR ICE CUBES (U.S. CL. 46).

DOUGLAS LEE, EXAMINING ATTORNEY

CLASS 30—(Continued).

SN 76-597,688. JANA'S CLASSICS, INC., TUALATIN, OR. FILED 6-16-2004.

JANA'S CLASSICS, INC.

THE MARK CONSISTS OF STANDARD CHARACTERS WITHOUT CLAIM TO ANY PARTICULAR FONT, STYLE, SIZE, OR COLOR.

OWNER OF U.S. REG. NOS. 1,432,124, 2,840,224 AND OTHERS.

NO CLAIM IS MADE TO THE EXCLUSIVE RIGHT TO USE CLASSICS, INC., APART FROM THE MARK AS SHOWN.

FOR COOKIES, COOKIE DOUGH, AND COOKIE PIECES AND COOKIE DOUGH PIECES FOR MIXING INTO ICE CREAM (U.S. CL. 46).

ELLEN B. AWRICH, EXAMINING ATTORNEY

SN 76-600,874. LEELIN, MARIA TERESA, SANTA FE SPRINGS, CA. FILED 7-7-2004.

SIP THE POWER FEEL THE ENERGY

THE MARK CONSISTS OF STANDARD CHARACTERS WITHOUT CLAIM TO ANY PARTICULAR FONT, STYLE, SIZE, OR COLOR.

FOR BASES FOR MAKING MILK SHAKES; CAPPUCINO; CHICORY BASED COFFEE SUBSTITUTE; CHOCOLATE; CHOCOLATE FOOD BEVERAGES NOT BEING DAIRY-BASED OR VEGETABLE BASED; CHOCOLATE POWDER; CHOCOLATE SYRUP; COCOA; COCOA MIXES; COFFEE; COFFEE BEANS; COFFEE SUBSTITUTE; COFFEE-BASED BEVERAGE; COFFEE-BASED BEVERAGE CONTAINING MILK; ESPRESSO; EXTRACTS USED AS FLAVORING WHICH ARE NOT ESSENTIAL OILS; FOOD FLAVORING MADE OF NON-ESSENTIAL OILS; FLAVORED ICES; FRUIT ICE; FLAVORING ADDITIVES FOR NON-NUTRITIONAL PURPOSES; FLAVORING SYRUP; HERBAL TEA FOR FOOD PURPOSES; HERBAL FOOD BEVERAGES; HERBAL INFUSIONS; HOT CHOCOLATE; ICE CREAM; ICE CREAM DRINKS; ICE CREAM SUBSTITUTE; ICE MILK; ICED TEA; MILK SHAKES; SHAKES; TEA; TEA FOR INFUSIONS; TEA-BASED BEVERAGES; GRAIN-BASED BEVERAGES; AND, GRAIN-BASED FOOD BEVERAGES (U.S. CL. 46).

FIRST USE 1-0-2001; IN COMMERCE 1-0-2004.

TRICIA SONNEBORN, EXAMINING ATTORNEY

SN 76-602,479. STARWAY, INC, BROOKLYN, NY. FILED 7-14-2004.

THOUSAND SWALLOW

THE MARK CONSISTS OF STANDARD CHARACTERS WITHOUT CLAIM TO ANY PARTICULAR FONT, STYLE, SIZE, OR COLOR.

FOR CHINESE NOODLES, NAMELY UNCOOKED NOODLES (U.S. CL. 46).

FIRST USE 5-25-2004; IN COMMERCE 5-25-2004.

TIMOTHY FINNEGAN, EXAMINING ATTORNEY

CLASS 30—(Continued).

SN 76-608,377. GUAYAKI SUSTAINABLE RAINFOREST PRODUCTS, INC., SAN LUIS OBISPO, CA. FILED 8-19-2004.

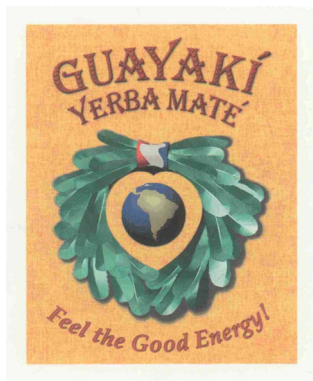

OWNER OF U.S. REG. NO. 2,185,036.
NO CLAIM IS MADE TO THE EXCLUSIVE RIGHT TO USE YERBA MATE, APART FROM THE MARK AS SHOWN.

RED, GREEN, WHITE, BLUE, YELLOW
THE MARK CONSISTS OF THE WORDS GUAYAKI YERBA MATE IN RED STYLIZED LETTERING, BELOW WHICH IS A GREEN WREATH OF LEAVES BOUND BY A RED, WHITE AND BLUE BAND; THE INSIDE OF THE WREATH IS HEART-SHAPED, WITHIN WHICH IS A BLUE AND GREEN GLOBE DEPICTING THE EARTH; BELOW THE WREATH ARE THE WORDS "FEEL THE GOOD ENERGY!" IN RED STYLIZED LETTERS; ALL OF WHICH ARE DEPICTED AGAINST A YELLOW BACKGROUND WITH A WOVEN APPEARANCE.

FOR HERBAL TEA IN LOOSE AND TEA BAG FORM (U.S. CL. 46).

FIRST USE 6-26-2003; IN COMMERCE 6-26-2003.
ANN LINNEHAN, EXAMINING ATTORNEY

SN 76-616,870. LAWLOR, ANNE F., QUINCY, MA. FILED 10-21-2004.

INTERNATIONAL BROWNIE

THE MARK CONSISTS OF STANDARD CHARACTERS WITHOUT CLAIM TO ANY PARTICULAR FONT, STYLE, SIZE, OR COLOR.

NO CLAIM IS MADE TO THE EXCLUSIVE RIGHT TO USE "BROWNIE", APART FROM THE MARK AS SHOWN. SEC. 2(F).

FOR STAPLE FOODS, NAMELY, GOURMET BROWNIES (U.S. CL. 46).

FIRST USE 11-11-1994; IN COMMERCE 12-15-1994.
EUGENIA MARTIN, EXAMINING ATTORNEY

CLASS 30—(Continued).

SN 76-617,315. LIC MANUFACTURING, LLC, OWINGS MILLS, MD. FILED 10-20-2004.



NO CLAIM IS MADE TO THE EXCLUSIVE RIGHT TO USE "ICE CREAM" AND "SINCE 1979", APART FROM THE MARK AS SHOWN.

FOR ICE CREAM, ICE CREAM SANDWICHES, ICE CREAM CONES, ICE CREAM CAKES, ICE CREAM PIES, ICE CREAM COOKIES AND FROZEN CONFECTIONS, ALL FOR CONSUMPTION ON OR OFF THE PREMISES (U.S. CL. 46).

FIRST USE 1-0-2004; IN COMMERCE 1-0-2004.
STEVEN JACKSON, EXAMINING ATTORNEY

SN 76-619,702. EXPORTADORA MERCANTIL AGRO-INDUSTRIAL, S.A., A SAN JOSE PINULA, GUATEMALA, FILED 11-1-2004.

GAMA

THE MARK CONSISTS OF STANDARD CHARACTERS WITHOUT CLAIM TO ANY PARTICULAR FONT, STYLE, SIZE, OR COLOR.

OWNER OF GUATEMALA REG. NO. 36,980, DATED 5-22-1979, EXPIRES 5-21-2009.

THE ENGLISH TRANSLATION OF THE WORD GAMA IN THE MARK IS SPECTRUM.

FOR COOKIES (U.S. CL. 46).
LINDA ESTRADA, EXAMINING ATTORNEY

SN 76-620,798. EXPORT TRADE OF AMERICA, INC., NEW YORK, NY. FILED 11-16-2004.

SUPER-BEE AMERICAN HONEY

THE MARK CONSISTS OF STANDARD CHARACTERS WITHOUT CLAIM TO ANY PARTICULAR FONT, STYLE, SIZE, OR COLOR.

NO CLAIM IS MADE TO THE EXCLUSIVE RIGHT TO USE "AMERICAN HONEY", APART FROM THE MARK AS SHOWN.

FOR "HONEY" (U.S. CL. 46).
FIRST USE 12-21-1994; IN COMMERCE 12-21-1994.
JUDITH HELFMAN, EXAMINING ATTORNEY

CLASS 30—(Continued).

SN 76-621,128. SAN CRISTOBAL MULTIMERCADOS, INC.,
DBA SAN CRISTOBAL COFFEE IMPORTERS, KIRK-
LAND, WA. FILED 11-16-2004.

BEIJA FLOR

THE MARK CONSISTS OF STANDARD CHARACTERS
WITHOUT CLAIM TO ANY PARTICULAR FONT, STYLE,
SIZE, OR COLOR.
THE TRANSLATION OF THE MARK "BEIJA FLOR" IS
"HUMMING BIRD".
FOR COFFEE BEANS, COFFEE, COFFEE BY THE
WEIGHT (U.S. CL. 46).
FIRST USE 3-23-2001; IN COMMERCE 4-1-2001.
GISELLE AGOSTO, EXAMINING ATTORNEY

SN 76-621,338. THANKSGIVING COFFEE, FORT BRAGG,
CA. FILED 11-22-2004.

COFFEE WITH A FACE

THE MARK CONSISTS OF STANDARD CHARACTERS
WITHOUT CLAIM TO ANY PARTICULAR FONT, STYLE,
SIZE, OR COLOR.
NO CLAIM IS MADE TO THE EXCLUSIVE RIGHT TO
USE "COFFEE", APART FROM THE MARK AS SHOWN.
FOR COFFEE, COFFEE PACKETS (U.S. CL. 46).
FIRST USE 10-1-2004; IN COMMERCE 10-1-2004.
CHERYL CLAYTON, EXAMINING ATTORNEY

SN 76-621,339. JENSEN, KIM, WHITTIR, CA. FILED 11-22-
2004.

KIM'S CANDIES

THE MARK CONSISTS OF STANDARD CHARACTERS
WITHOUT CLAIM TO ANY PARTICULAR FONT, STYLE,
SIZE, OR COLOR.
NO CLAIM IS MADE TO THE EXCLUSIVE RIGHT TO
USE "CANDIES", APART FROM THE MARK AS SHOWN.
FOR CANDY (U.S. CL. 46).
FIRST USE 12-3-2003; IN COMMERCE 8-18-2004.
CHERYL CLAYTON, EXAMINING ATTORNEY

CLASS 30—(Continued).

SN 76-621,485. INTERBAKE FOODS INC., RICHMOND, VA.
FILED 11-19-2004.

THANKS-A-LOT

THE MARK CONSISTS OF STANDARD CHARACTERS
WITHOUT CLAIM TO ANY PARTICULAR FONT, STYLE,
SIZE, OR COLOR.
FOR COOKIES (U.S. CL. 46).
MELISSA SHELLA, EXAMINING ATTORNEY

SN 76-621,670. AN ORIGINAL SOFT PRETZEL FACTORY
INC., PHILADELPHIA, PA. FILED 11-22-2004.

PHILLY SOFT PRETZEL FACTORY

THE MARK CONSISTS OF STANDARD CHARACTERS
WITHOUT CLAIM TO ANY PARTICULAR FONT, STYLE,
SIZE, OR COLOR.
OWNER OF U.S. REG. NOS. 2,885,994 AND 2,894,758.
NO CLAIM IS MADE TO THE EXCLUSIVE RIGHT TO
USE PHILLY SOFT PRETZEL, APART FROM THE MARK
AS SHOWN.
SEC. 2(F).
FOR SOFT PRETZELS (U.S. CL. 46).
FIRST USE 10-12-1999; IN COMMERCE 10-12-1999.
TONI HICKEY, EXAMINING ATTORNEY

SN 76-623,345. TREVINO, LEOBARDO, HIDALGO, TX.
FILED 12-6-2004.

LITO

THE MARK CONSISTS OF STANDARD CHARACTERS
WITHOUT CLAIM TO ANY PARTICULAR FONT, STYLE,
SIZE, OR COLOR.
FOR CANDIES (U.S. CL. 46).
ALEX KEAM, EXAMINING ATTORNEY

CLASS 30—(Continued).

SN 76-623,348. TREVINO, LEOBARDO, HIDALGO, TX.
FILED 12-6-2004.

COOL KETCHUP

THE MARK CONSISTS OF STANDARD CHARACTERS WITHOUT CLAIM TO ANY PARTICULAR FONT, STYLE, SIZE, OR COLOR.

NO CLAIM IS MADE TO THE EXCLUSIVE RIGHT TO USE "KETCHUP", APART FROM THE MARK AS SHOWN. FOR KETCHUP (U.S. CL. 46).
ALEX KEAM, EXAMINING ATTORNEY

CLASS 30—(Continued).

SN 76-627,666. ARABAN COFFEE CO. INC., HINGHAM, MA.
FILED 1-12-2005.

COCOA ISLAND

THE MARK CONSISTS OF STANDARD CHARACTERS WITHOUT CLAIM TO ANY PARTICULAR FONT, STYLE, SIZE, OR COLOR.

NO CLAIM IS MADE TO THE EXCLUSIVE RIGHT TO USE "COCOA", APART FROM THE MARK AS SHOWN.

FOR READY TO MIX BASE FOR COCOA BEVERAGES (U.S. CL. 46).

FIRST USE 3-0-2000; IN COMMERCE 3-0-2000.
KATHY DE JONGE, EXAMINING ATTORNEY

SN 76-624,175. URTH CAFFE CORPORATION, LOS ANGELES, CA. FILED 12-10-2004.

MOUNTAIN GORILLA

THE MARK CONSISTS OF STANDARD CHARACTERS WITHOUT CLAIM TO ANY PARTICULAR FONT, STYLE, SIZE, OR COLOR.

FOR WHOLE BEAN AND GROUND COFFEE (U.S. CL. 46).

KARANENDRA S. CHHINA, EXAMINING ATTORNEY

SN 78-247,470. CAMINO REAL FOOD, INC., CYPRESS, CA.
FILED 5-8-2003.



NO CLAIM IS MADE TO THE EXCLUSIVE RIGHT TO USE "TEXAS", APART FROM THE MARK AS SHOWN.

THE MARK CONSISTS OF THE WORDS "TEXAS" AND "OUTLAND" WITH SURROUNDING SILHOUTTES DEPICTING FLAMES.

FOR FROZEN MEXICAN FOODS; NAMELY BURRITOS, TAQUITOS, CHIMICHANGAS, ENCHILADAS, QUESADILLAS, TACOS, TAMALES, AND FLAUTAS (U.S. CL. 46).

BARBARA RUTLAND, EXAMINING ATTORNEY

SN 76-624,349. JUST BORN, INC., BETHLEHEM, PA. FILED 12-13-2004.

HOT TAMALES FIRE

THE MARK CONSISTS OF STANDARD CHARACTERS WITHOUT CLAIM TO ANY PARTICULAR FONT, STYLE, SIZE, OR COLOR.

OWNER OF U.S. REG. NOS. 759,781 AND 2,280,110. FOR CINNAMON FLAVORED CANDIES (U.S. CL. 46). FIRST USE 10-16-2004; IN COMMERCE 10-16-2004.
EDWARD NELSON, EXAMINING ATTORNEY

SN 78-252,881. JOYCO COLOMBINA S.A., ZARZAL VALLE, COLOMBIA, FILED 5-21-2003.

SQUIRT

PRIORITY CLAIMED UNDER SEC. 44(D) ON COLOMBIA APPLICATION NO. 03037123, FILED 5-5-2003, REG. NO. 290049, DATED 12-23-2003, EXPIRES 12-23-2013.

FOR GUMS AND CONFECTIONERY, NAMELY, BUBBLE GUM, WITH AND WITHOUT FILLING, CHEWING GUMS AND CANDY (U.S. CL. 46).

IRA J. GOODSaid, EXAMINING ATTORNEY

CLASS 30—(Continued).

SN 78-256,072. ZHONGSHAN JUXIANGYUAN FOOD CO. LTD., GUANGDONG, CHINA, FILED 5-30-2003.

THE FOREIGN WORDING IN THE MARK TRANSLATES INTO ENGLISH AS CHEW FRAGRANCE GARDEN. THE NON-LATIN CHARACTER(S) IN THE MARK TRANSLITERATES INTO JUE XIANG YUAN, AND THIS MEANS CHEW FRAGRANCE GARDEN IN ENGLISH.

FOR CAKES, NAMELY MOON CAKES, RICE CAKES; EGG ROLL; BISCUITS, NAMELY COOKIES, CRACKERS, WAFFLES, BISCUITS WITH ALMOND FLAVOR; BREAD; GLAZED POPCORN; POPPED POPCORN; PROCESSED POPCORN; SNACK FOODS PREPARED FROM POTATO FLOUR; FLOUR BASED CHIPS; CEREAL BASED SNACK FOOD (U.S. CL. 46).

FIRST USE 1-1-1918; IN COMMERCE 9-21-1990.
ROBIN CHOSID, EXAMINING ATTORNEY

SN 78-257,240. HEWITT, PETER LINCOLN, ACTON, MA. FILED 6-2-2003.

NO CLAIM IS MADE TO THE EXCLUSIVE RIGHT TO USE "TEA", APART FROM THE MARK AS SHOWN.

THE MARK CONSISTS OF THE MARK CONSISTS OF THE WORDS TEA FORTE WITH THE T IN UPPER CASE LETTERING AND ALL OTHER LETTERS IN LOWER CASE LETTERING, AND WITH ALL LETTERS HAVING BLACK OUTLINES AND WHITE INTERIORS. THERE IS AN ACCENT MARK OVER THE FINAL E IN FORTE.

FOR TEA, TEA BAGS, TEA FOR INFUSIONS (U.S. CL. 46).

FIRST USE 10-31-2003; IN COMMERCE 10-31-2003.
LAURA KOVAISKY, EXAMINING ATTORNEY

SN 78-298,590. CARGILL, INCORPORATED, WAYZATA, MN. FILED 9-10-2003.



NO CLAIM IS MADE TO THE EXCLUSIVE RIGHT TO USE "HEART HEALTHY" AND "BREAD PREMIX", APART FROM THE MARK AS SHOWN.

FOR MIXES FOR MAKING BAKERY GOODS FOR USE BY COMMERCIAL BAKERS AND MANUFACTURERS FOR FURTHER PROCESSING (U.S. CL. 46).

FIRST USE 7-31-2003; IN COMMERCE 7-31-2003.
AISHA CLARKE, EXAMINING ATTORNEY

CLASS 30—(Continued).

SN 78-311,344. COMPAGNIA DEL CAFFE' S.R.L., 65010 MOSCUFO, PESCARA, ITALY, FILED 10-9-2003.



NO CLAIM IS MADE TO THE EXCLUSIVE RIGHT TO USE CAFFÈ, APART FROM THE MARK AS SHOWN.

THE MARK CONSISTS OF THE WORDS UNIVERSAL CAFFÈ' IN SPECIAL FORM WITH AN ARBITRARY DESIGN WITHIN AN OVAL DESIGN.

THE ENGLISH WORD FOR CAFFÈ IN THE MARK IS CAFE.

FOR COFFEE (U.S. CL. 46).

FIRST USE 7-17-1987; IN COMMERCE 9-18-1989.
BARNEY CHARLON, EXAMINING ATTORNEY

SN 78-311,630. CHO, SUNG-MIN, SEOUL, REPUBLIC OF KOREA, FILED 10-9-2003.



NO CLAIM IS MADE TO THE EXCLUSIVE RIGHT TO USE JONGRO AND TTOK BANG, APART FROM THE MARK AS SHOWN.

THE WORD "JONGRO" IN THE TRADEMARK IDENTIFIES THE NAME OF A STREET IN SEOUL LOCATED NEAR KYONGBOK PALACE WHERE THE KINGS OF LEE DYNASTY LIVED. THE WORD "BOK" (THE FIRST THREE LETTERS OF THE SECOND WORD) MEANS "FORTUNE" OR "LUCK". THE WORD "TTOK" (THE MIDDLE THREE LETTERS OF THE SECOND WORD) MEANS "RICE CAKE" AND THE WORD "BANG" (THE LAST FOUR LETTERS OF THE SECOND WORD) MEANS "SHOP" OR "STORE". THESE ROMAN CHARACTERS OF THE TRADEMARK ARE THE TRANSLATION OF THE KOREAN CHARACTERS MEANS "JONGRO STREET" AND KOREAN CHARACTERS MEANS "RICE CAKE SHOP" AND THE CHINESE CHARACTER (II MEANS "FORTUNE" OR "LUCK").

FOR RICE CAKE; CAKE MADE OF GLUTINOUS RICE, OIL AND HONEY PASTRY WITH SESAME; PATTERNED SAVORY CAKE; FRIED CAKE MADE OF RICE, HONEY, AND OIL; UNCLEANSED RICE FLOUR FOR FOOD; AND RICE FLOUR FOR FOOD (U.S. CL. 46).

TINA L. SNAPP, EXAMINING ATTORNEY

CLASS 30—(Continued).

SN 78-365,129. SOCIETE DES PRODUITS NESTLE S.A., 1800 VEVEY, SWITZERLAND, FILED 2-9-2004.

ZOÉGAS

THE MARK CONSISTS OF STANDARD CHARACTERS WITHOUT CLAIM TO ANY PARTICULAR FONT, STYLE, SIZE, OR COLOR.

OWNER OF U.S. REG. NO. 1,313,702.
FOR COFFEE (U.S. CL. 46).
FIRST USE 6-1-1983; IN COMMERCE 6-1-1983.
MARY BOAGNI, EXAMINING ATTORNEY

CLASS 30—(Continued).

SN 78-378,469. MITSUI NORIN CO., LTD., TOKYO, JAPAN, FILED 3-4-2004.

MITSUI GREEN TEA

THE MARK CONSISTS OF STANDARD CHARACTERS WITHOUT CLAIM TO ANY PARTICULAR FONT, STYLE, SIZE, OR COLOR.

PRIORITY CLAIMED UNDER SEC. 44(D) ON JAPAN APPLICATION NO. 2003-97482, FILED 11-5-2003.
NO CLAIM IS MADE TO THE EXCLUSIVE RIGHT TO USE "GREEN TEA", APART FROM THE MARK AS SHOWN.
FOR TEA, COFFEE, COCOA (U.S. CL. 46).
RON FAIRBANKS, EXAMINING ATTORNEY

SN 78-369,626. GIVE AND GO PREPARED FOODS CORP., TORONTO ONTARIO M9W 5Y6, CANADA, FILED 2-18-2004.

SN 78-389,260. 7-ELEVEN, INC., DALLAS, TX. FILED 3-23-2004.



CHOCOLATE AND CREAM CAKEWICH

PRIORITY CLAIMED UNDER SEC. 44(D) ON CANADA APPLICATION NO. 1205743, FILED 2-9-2004, REG. NO. TMA632534, DATED 2-10-2005, EXPIRES 2-10-2020.

OWNER OF U.S. REG. NO. 2,766,189.
NO CLAIM IS MADE TO THE EXCLUSIVE RIGHT TO USE "BROWNIES", APART FROM THE MARK AS SHOWN.
FOR BAKED GOODS, NAMELY BROWNIES (U.S. CL. 46).
JEFF DEFORD, EXAMINING ATTORNEY

THE MARK CONSISTS OF STANDARD CHARACTERS WITHOUT CLAIM TO ANY PARTICULAR FONT, STYLE, SIZE, OR COLOR.

NO CLAIM IS MADE TO THE EXCLUSIVE RIGHT TO USE CHOCOLATE AND CREAM, APART FROM THE MARK AS SHOWN.
FOR BAKERY PRODUCTS FOR CONSUMPTION ON OR OFF THE PREMISES (U.S. CL. 46).
FIRST USE 3-22-2004; IN COMMERCE 3-22-2004.
MARY ROSSMAN, EXAMINING ATTORNEY

CLASS 30—(Continued).

SN 78-390,635. NOTHIN' NUTTY LLC, PORT CHESTER, NY. FILED 3-25-2004.

CLASS 30—(Continued).

SN 78-407,730. STILLWELL, JEFFREY G., NILES, IL. FILED 4-26-2004.

BRITES

CARLO CARBIANO

THE MARK CONSISTS OF STANDARD CHARACTERS WITHOUT CLAIM TO ANY PARTICULAR FONT, STYLE, SIZE, OR COLOR.

FOR CHOCOLATE, CANDY, CHOCOLATE CHIPS, CHOCOLATE TOPPING, CONFECTIONERY CHIPS, MIXES FOR BAKERY GOODS, CONFECTIONERY CHIPS FOR BAKING, SNACK MIX CONSISTING PRIMARILY OF CHOCOLATE CHIPS, PRETZELS, MARSHMALLOWS, AND GRANOLA; CANDY CAKE DECORATIONS (U.S. CL. 46).

FIRST USE 1-1-2004; IN COMMERCE 1-1-2004.
YSA DEJESUS, EXAMINING ATTORNEY

THE MARK CONSISTS OF STANDARD CHARACTERS WITHOUT CLAIM TO ANY PARTICULAR FONT, STYLE, SIZE, OR COLOR.

THE NAME(S), PORTRAIT(S), AND/OR SIGNATURE(S) SHOWN IN THE MARK DOES NOT IDENTIFY A PARTICULAR LIVING INDIVIDUAL.

FOR PIZZA, FROZEN PIZZA, READY MADE PIZZA CRUST AND PIZZA CRUST MIX (U.S. CL. 46).
LANA PHAM, EXAMINING ATTORNEY

SN 78-399,197. KIKKOMAN FOODS, INC., WALWORTH, WI. FILED 4-9-2004.

SN 78-415,948. THE AMERICAN GUM COMPANY, YPSILANTI, MI. FILED 5-10-2004.



Breathless

NO CLAIM IS MADE TO THE EXCLUSIVE RIGHT TO USE "RESTAURANT SERIES", APART FROM THE MARK AS SHOWN.

THE ENGLISH TRANSLATION OF KIKKOMAN IS "TEN THOUSAND WITHIN HEXAGON".

FOR SAUCES FOR USE IN FOOD PREPARATION, SEASONING, AND SERVING (U.S. CL. 46).

FIRST USE 6-30-2003; IN COMMERCE 6-30-2003.
ASMAT KHAN, EXAMINING ATTORNEY

THE MARK CONSISTS OF STANDARD CHARACTERS WITHOUT CLAIM TO ANY PARTICULAR FONT, STYLE, SIZE, OR COLOR.

FOR CHEWING GUM ONLY (U.S. CL. 46).
FIRST USE 1-1-2004; IN COMMERCE 3-1-2004.
CHRIS WELLS, EXAMINING ATTORNEY

CLASS 30—(Continued).

SN 78-421,285. MAYFAIR SALES, INC., BUFFALO, NY.
FILED 5-19-2004.

CLASS 30—(Continued).

SN 78-423,056. GIFFORD'S DAIRY, INC., SKOWHEGAN,
ME. FILED 5-21-2004.

Basket Stuffers

THE MARK CONSISTS OF STANDARD CHARACTERS
WITHOUT CLAIM TO ANY PARTICULAR FONT, STYLE,
SIZE, OR COLOR.

FOR CANDY AND CHEWING GUM (U.S. CL. 46).
FIRST USE 2-0-2004; IN COMMERCE 2-0-2004.
SKYE YOUNG, EXAMINING ATTORNEY

NET 2

THE MARK CONSISTS OF STANDARD CHARACTERS
WITHOUT CLAIM TO ANY PARTICULAR FONT, STYLE,
SIZE, OR COLOR.

FOR FROZEN CONFECTIONS, NAMELY, ICE CREAM
(U.S. CL. 46).
PAM WILLIS, EXAMINING ATTORNEY

SN 78-421,858. EMPRESAS CAROZZI S.A., SAN BERNARDO,
CHILE, FILED 5-19-2004.

SN 78-424,606. KILLIAN KORN, INC., OTHELLO, WA.
FILED 5-25-2004.

COSTA GRETEL

THE MARK CONSISTS OF STANDARD CHARACTERS
WITHOUT CLAIM TO ANY PARTICULAR FONT, STYLE,
SIZE, OR COLOR.

THE FOREIGN WORDING IN THE MARK TRANSLATES
INTO ENGLISH AS COAST GRETEL.

FOR CRACKERS, BISCUITS AND COOKIES (U.S. CL.
46).

ROBIN CHOSID, EXAMINING ATTORNEY

NO CLAIM IS MADE TO THE EXCLUSIVE RIGHT TO
USE "CORN", APART FROM THE MARK AS SHOWN.

THE MARK CONSISTS OF TWO FARMERS – A HUS-
BAND AND WIFE – WITH APRONS STANDING BETWEEN
TWO STALKS OF CORN WITH A BANNER SCROLLED
BELOW THE IMAGE THAT READS: "KILLIAN KORN".

FOR POPCORN CONFECTION PRODUCTS, NAMELY,
CARAMEL POPCORN, WHITE CHOCOLATE POPCORN,
AND PEANUT AND PECAN BRITTLE (U.S. CL. 46).

FIRST USE 1-1-1986; IN COMMERCE 1-1-1986.

WILLIAM BRECKENFELD, EXAMINING ATTORNEY

CLASS 30—(Continued).

SN 78-425,443. TREBOR BASSETT LIMITED, LONDON, UNITED KINGDOM, FILED 5-26-2004.

BASSETT'S

THE MARK CONSISTS OF STANDARD CHARACTERS WITHOUT CLAIM TO ANY PARTICULAR FONT, STYLE, SIZE, OR COLOR.

OWNER OF U.S. REG. NO. 854,750.
SEC. 2(F).
FOR CONFECTIONERY, NAMELY CANDY (U.S. CL. 46).
FIRST USE 12-31-1858; IN COMMERCE 12-31-1858.
GINA FINK, EXAMINING ATTORNEY

SN 78-427,473. RAYNIES INC., LOS ALTOS, CA. FILED 5-30-2004.



FOR PACKAGED TEA (U.S. CL. 46).
ESTHER A. BORSUK, EXAMINING ATTORNEY

SN 78-427,540. FUHGEDDABOUTIT FAMILY BRANDS, LLC, LIVERPOOL, NY. FILED 5-31-2004.

BROOKLYN'S BEST

THE MARK CONSISTS OF STANDARD CHARACTERS WITHOUT CLAIM TO ANY PARTICULAR FONT, STYLE, SIZE, OR COLOR.

NO CLAIM IS MADE TO THE EXCLUSIVE RIGHT TO USE "BEST", APART FROM THE MARK AS SHOWN.
FOR PASTA SAUCE (U.S. CL. 46).
WARREN L. OLANDRIA, EXAMINING ATTORNEY

CLASS 30—(Continued).

SN 78-429,951. SCHWAN'S IP, LLC, MARSHALL, MN. FILED 6-4-2004.

RISTORANTE

THE MARK CONSISTS OF STANDARD CHARACTERS WITHOUT CLAIM TO ANY PARTICULAR FONT, STYLE, SIZE, OR COLOR.

THE FOREIGN WORDING IN THE MARK TRANSLATES INTO ENGLISH AS RESTAURANT.

FOR FROZEN PIZZA: HAND-HELD SANDWICHES CONSISTING OF ENROBED DOUGH FILLED WITH MEAT, CHEESE, WITH OR WITHOUT SAUCE AND WITH OR WITHOUT VEGETABLES; APPETIZERS CONSISTING OF ENROBED DOUGH FILLED WITH MEAT, CHEESE, WITH OR WITHOUT SAUCE AND WITH OR WITHOUT VEGETABLES (U.S. CL. 46).

DORITT L. CARROLL, EXAMINING ATTORNEY

SN 78-430,393. THE CABO COFFEE COMPANY, CABO SAN LUCAS, MEXICO, FILED 6-4-2004.



OWNER OF MEXICO REG. NO. 805646, DATED 2-25-2003, EXPIRES 2-25-2013.

NO CLAIM IS MADE TO THE EXCLUSIVE RIGHT TO USE "COFFEE CO.", APART FROM THE MARK AS SHOWN.

THE COLORS RED, YELLOW AND BLUE ARE CLAIMED AS A FEATURE OF THE MARK.

THE OUTER CIRCLE IS RED WITH A YELLOW BORDER AND YELLOW FLOWERS. THE MOUNTAIN AND ARCH INSIDE THE CIRCLE ARE YELLOW AND SKY AND WATER ARE BLUE.

THE MARK CONSISTS OF BURGUNDY CIRCLE WITH GOLD BORDER CONTAINING THE WORDS THE CABO COFFEE COMPANY (WHITE) AND TWO GOLD LEAVES AND AN INNER CIRCLE WITH A GOLD BORDER AND A DIGITAL REPRESENTATION OF LAND'S END.

THE ENGLISH TRANSLATION OF THE WORD "CABO" IN THE MARK IS "CAPE".

FOR COFFEE (U.S. CL. 46).

FIRST USE 8-1-2003; IN COMMERCE 8-1-2003.

DAVID MURRAY, EXAMINING ATTORNEY

CLASS 30—(Continued).

SN 78-433,744. FUHGEDDABOUDIT FAMILY BRANDS, LLC, LIVERPOOL, NY. FILED 6-11-2004.

BROOKLYN'S BEST

THE MARK CONSISTS OF STANDARD CHARACTERS WITHOUT CLAIM TO ANY PARTICULAR FONT, STYLE, SIZE, OR COLOR.

NO CLAIM IS MADE TO THE EXCLUSIVE RIGHT TO USE "BEST", APART FROM THE MARK AS SHOWN.

FOR FROZEN PREPARED MEALS, NAMELY, FROZEN PIZZA AND FROZEN ITALIAN DINNERS CONTAINING PASTA AND SAUCE (U.S. CL. 46).

WARREN L. OLANDRIA, EXAMINING ATTORNEY

CLASS 30—(Continued).

SN 78-447,880. Q.F.C. USA, INC., WALNUT, CA. FILED 7-8-2004.



NO CLAIM IS MADE TO THE EXCLUSIVE RIGHT TO USE "ICE CREAM", APART FROM THE MARK AS SHOWN. THE COLORS LIGHT BLUE, DARK BLUE, RED, WHITE AND YELLOW ARE CLAIMED AS A FEATURE OF THE MARK.

THE WORD "ROYAL" APPEARS IN RED TEXT OUTLINED IN YELLOW. THE CROWN APPEARS IN RED AND IS OUTLINED IN YELLOW. THE WORD "ICE CREAM" APPEARS IN DARK BLUE LETTERS THAT ARE "SNOW-CAPPED" IN WHITE. THE BACKGROUND OF THE MARK IS LIGHT BLUE.

FOR ICE CREAM (U.S. CL. 46).
FRED MANDIR, EXAMINING ATTORNEY

SN 78-435,753. LOCO VENTURES, INC., DBA LOARD'S ICE CREAM & CANDY, SAN LEANDRO, CA. FILED 6-15-2004.

LOARD'S ICE CREAM

THE MARK CONSISTS OF STANDARD CHARACTERS WITHOUT CLAIM TO ANY PARTICULAR FONT, STYLE, SIZE, OR COLOR.

NO CLAIM IS MADE TO THE EXCLUSIVE RIGHT TO USE "ICE CREAM", APART FROM THE MARK AS SHOWN. SEC. 2(F).

FOR ICE CREAM AND CANDY (U.S. CL. 46).
FIRST USE 5-0-1950; IN COMMERCE 5-0-1950.
MELISSA SHELLA, EXAMINING ATTORNEY

SN 78-448,249. JOSHKO, INC., TULSA, OK. FILED 7-9-2004.

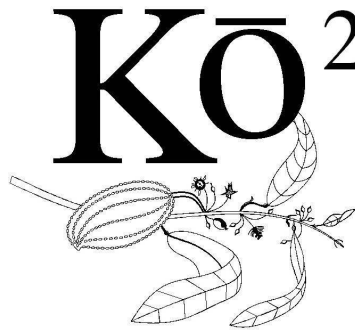

FOR CHOCOLATE CONFECTIONS, BAKED GOODS, NAMELY TRUFFLES AND MADELEINES; FROZEN GELATO DESSERTS; CHOCOLATE DRINKS, NAMELY, HOT CHOCOLATE DRINKS AND CHOCOLATE GELATO; COFFEE DRINKS, NAMELY COFFEE AND CAPPUCCINO; ROASTED WHOLE BEAN COFFEE; PACKAGED BAKING MIXES FOR SCONES; PACKAGED DRINK MIXES FOR HOT CHOCOLATE DRINKS; DESSERT SAUCES; SYRUPS FOR COFFEE BEVERAGES; ALL SOLD VIA RETAIL, WEBSITE AND MAIL ORDER SHIPMENT SALES (U.S. CL. 46).

FIRST USE 12-7-2003; IN COMMERCE 12-7-2003.
JEFF DEFORD, EXAMINING ATTORNEY

CLASS 30—(Continued).

SN 78-453,103. US CALLALATE GLOBAL, INC., SAN GABRIEL, CA. FILED 7-19-2004.

COCOFUL

THE MARK CONSISTS OF STANDARD CHARACTERS WITHOUT CLAIM TO ANY PARTICULAR FONT, STYLE, SIZE, OR COLOR.

FOR CANDY, CHOCOLATE CANDIES (U.S. CL. 46).
FIRST USE 3-20-2004; IN COMMERCE 3-20-2004.
WINSTON FOLMAR, EXAMINING ATTORNEY

CLASS 30—(Continued).

SN 78-457,408. GRISWOLD, DAVID, PORTLAND, OR. FILED 7-27-2004.

**SUSTAINABLE
HARVEST**

THE MARK CONSISTS OF STANDARD CHARACTERS WITHOUT CLAIM TO ANY PARTICULAR FONT, STYLE, SIZE, OR COLOR.

NO CLAIM IS MADE TO THE EXCLUSIVE RIGHT TO USE SUSTAINABLE, APART FROM THE MARK AS SHOWN.

FOR GOODS: COFFEE,TEA,COCOA AND VANILLA (U.S. CL. 46).

FIRST USE 4-25-1995; IN COMMERCE 4-25-1995.
PRISCILLA MILTON, EXAMINING ATTORNEY

SN 78-457,133. GRUPO BIMBO, S.A. DE C.V., MEXICO CITY, MEXICO, FILED 7-27-2004.

SMART BITES

THE MARK CONSISTS OF STANDARD CHARACTERS WITHOUT CLAIM TO ANY PARTICULAR FONT, STYLE, SIZE, OR COLOR.

NO CLAIM IS MADE TO THE EXCLUSIVE RIGHT TO USE BITES, APART FROM THE MARK AS SHOWN.
FOR SWEET BAKERY GOODS (U.S. CL. 46).
AMY HELLA, EXAMINING ATTORNEY

SN 78-458,458. QUANTUM AND ILLIASTER INC., ST MARYS, PA. FILED 7-28-2004.

Goblin Chocolates

THE MARK CONSISTS OF STANDARD CHARACTERS WITHOUT CLAIM TO ANY PARTICULAR FONT, STYLE, SIZE, OR COLOR.

NO CLAIM IS MADE TO THE EXCLUSIVE RIGHT TO USE "CHOCOLATES", APART FROM THE MARK AS SHOWN.

FOR CANDY, CHOCOLATES, FROZEN CONFECTIONS, ICE CREAM (U.S. CL. 46).
FIRST USE 6-9-2004; IN COMMERCE 6-9-2004.
WENDY GOODMAN, EXAMINING ATTORNEY

CLASS 30—(Continued).

SN 78-459,600. QUANTUM AND ILLIASTER INC., ST MARYS, PA. FILED 7-30-2004.



NO CLAIM IS MADE TO THE EXCLUSIVE RIGHT TO USE "CHOCOLATE", APART FROM THE MARK AS SHOWN.

THE MARK CONSISTS OF A STYLIZED GOBLIN PEEKING OVER AND TO THE RIGHT SIDE OF THE HORIZONTALLY PRESENTED WORD GOBLIN- AND THE WORD GOBLIN LIES ON TOP OF AND SLIGHTLY SINISTER OF THE HORIZONTAL WORD CHOCOLATES.

FOR CANDY, CHOCOLATES, FROZEN CONFECTIONS, ICE CREAM (U.S. CL. 46).

FIRST USE 6-9-2004; IN COMMERCE 6-9-2004.
WENDY GOODMAN, EXAMINING ATTORNEY

SN 78-459,996. KAL WEST INC., COSTA MESA, CA. FILED 7-31-2004.

NATA'LE COFFEE

THE MARK CONSISTS OF STANDARD CHARACTERS WITHOUT CLAIM TO ANY PARTICULAR FONT, STYLE, SIZE, OR COLOR.

NO CLAIM IS MADE TO THE EXCLUSIVE RIGHT TO USE "COFFEE", APART FROM THE MARK AS SHOWN.

THE FOREIGN WORDING IN THE MARK TRANSLATES INTO ENGLISH AS NEW BORN/CHRISTMAS.

FOR ROASTED AND PACKAGED COFFEE (U.S. CL. 46).

FIRST USE 1-1-1985; IN COMMERCE 1-1-1985.
ANNE FARRELL, EXAMINING ATTORNEY

SN 78-460,040. HELADOS LA MEXICANA, FRESNO, CA. FILED 7-31-2004.

Bulldog Bars

THE MARK CONSISTS OF STANDARD CHARACTERS WITHOUT CLAIM TO ANY PARTICULAR FONT, STYLE, SIZE, OR COLOR.

NO CLAIM IS MADE TO THE EXCLUSIVE RIGHT TO USE "BARS", APART FROM THE MARK AS SHOWN.

FOR ICE CREAM BARS (U.S. CL. 46).
GEORGIA CARTY, EXAMINING ATTORNEY

CLASS 30—(Continued).

SN 78-461,000. NELSON, JAMES A., HOMER, AK. FILED 8-3-2004.

BIBLE MINT

THE MARK CONSISTS OF STANDARD CHARACTERS WITHOUT CLAIM TO ANY PARTICULAR FONT, STYLE, SIZE, OR COLOR.

NO CLAIM IS MADE TO THE EXCLUSIVE RIGHT TO USE "MINT", APART FROM THE MARK AS SHOWN.

FOR MINT CANDY (U.S. CL. 46).
TRACY CROSS, EXAMINING ATTORNEY

SN 78-463,912. DRAB, FRANCIS P., RYDAL, PA. FILED 8-8-2004.

BUMBLE GUM

THE MARK CONSISTS OF STANDARD CHARACTERS WITHOUT CLAIM TO ANY PARTICULAR FONT, STYLE, SIZE, OR COLOR.

NO CLAIM IS MADE TO THE EXCLUSIVE RIGHT TO USE "GUM", APART FROM THE MARK AS SHOWN.

FOR CHEWING GUM AND BUBBLE GUM (U.S. CL. 46).

SUNG IN, EXAMINING ATTORNEY

SN 78-464,408. MCILHENNY COMPANY, AVERY ISLAND, LA. FILED 8-9-2004.



OWNER OF U.S. REG. NOS. 805,671, 2,703,927 AND OTHERS.

FOR CONDIMENTS, NAMELY, PEPPER SAUCES; SNACKS, NAMELY, FLAVORED POPPED POPCORN (U.S. CL. 46).

FIRST USE 5-24-2004; IN COMMERCE 5-24-2004.
MARK RADEMACHER, EXAMINING ATTORNEY

CLASS 30—(Continued).

SN 78-468,876. NATURE'S PATH FOODS INC., RICHMOND, BRITISH COLUMBIA, CANADA, FILED 8-17-2004.

REBOUND

THE MARK CONSISTS OF STANDARD CHARACTERS WITHOUT CLAIM TO ANY PARTICULAR FONT, STYLE, SIZE, OR COLOR.

PRIORITY CLAIMED UNDER SEC. 44(D) ON CANADA APPLICATION NO. 1227095, FILED 8-16-2004.

FOR PROCESSED CEREALS, BREAKFAST CEREALS, WAFFLES, FOOD BARS, HOT OATMEAL MIXES, BREAD, PASTRIES, BISCUITS, MUFFINS, COOKIES, CRACKERS, PANCAKE MIXES, WAFFLE MIXES, BAGELS (U.S. CL. 46).

GINA HAYES, EXAMINING ATTORNEY

SN 78-471,215. FEFFER, BRUCE MASON, NEW YORK, NY. FILED 8-20-2004.

Take A Bao

THE MARK CONSISTS OF STANDARD CHARACTERS WITHOUT CLAIM TO ANY PARTICULAR FONT, STYLE, SIZE, OR COLOR.

NO CLAIM IS MADE TO THE EXCLUSIVE RIGHT TO USE "BAO", APART FROM THE MARK AS SHOWN.

THE FOREIGN WORDING IN THE MARK TRANSLATES INTO ENGLISH AS BUNS.

FOR ASIAN STYLE FOOD-FILLED BUNS FILLED WITH ANY OF THE FOLLOWING SEPARATELY OR IN COMBINATION TOGETHER— PORK, BEEF, CHICKEN, VEGETABLE, CUSTARD, BEAN PASTE, SHRIMP, CRAB, LOBSTER, CHEESE (U.S. CL. 46).

DARRYL SPRUILL, EXAMINING ATTORNEY

CLASS 30—(Continued).

SN 78-472,941. IMAGINE-GLOBAL LLC, LARGO, FL. FILED 8-24-2004.



NO CLAIM IS MADE TO THE EXCLUSIVE RIGHT TO USE "MALLOW", APART FROM THE MARK AS SHOWN.

THE COLOR(S) YELLOW, BLUE, MAGENTA AND WHITE IS/ARE CLAIMED AS A FEATURE OF THE MARK.

THE MARK CONTAINS A YELLOW RECTANGLE BACKGROUND OUTLINED IN BLUE WITH THE WORD "YUMMY" IN BLUE LETTERS OUTLINED IN WHITE AND THE WORD "MALLOW" IN MAGENTA OUTLINED IN WHITE.

FOR SOFT MARSHMALLOW CANDY (U.S. CL. 46).

FIRST USE 5-3-2004; IN COMMERCE 7-5-2004.

DANIEL CAPSHAW, EXAMINING ATTORNEY

SN 78-474,069. BURNS & RICKER, INC., NEW BRUNSWICK, NJ. FILED 8-26-2004.



OWNER OF U.S. REG. NOS. 1,515,619 AND 2,634,213. NO CLAIM IS MADE TO THE EXCLUSIVE RIGHT TO USE "BAKERY" AND "BRAND", APART FROM THE MARK AS SHOWN.

THE LINING IS A FEATURE OF THE MARK. THE MARK CONSISTS OF A DEPICTION OF A SKYLINE WITH THE SUN SETTING BEHIND THE BUILDINGS AND A BANNER DIRECTLY BELOW THE BUILDINGS WITH THE WORDS NEW YORK STYLE BRAND CONTAINED THEREIN.

SEC. 2(F) AS TO "NEW YORK STYLE". FOR (USE IN COMMERCE) BAGEL CHIPS, PITA CHIPS, FLATBREADS, SNACK TOASTS AND BISCOTTI; (INTENT TO USE) BREADSTICKS AND PASTRIES (U.S. CL. 46).

FIRST USE 3-1-1984; IN COMMERCE 3-1-1984.

MATTHEW PAPPAS, EXAMINING ATTORNEY

CLASS 30—(Continued).

SN 78-484,042. HERSHEY CHOCOLATE & CONFECTIONERY CORPORATION, WHEAT RIDGE, CO. FILED 9-15-2004.

TWIZTED TRIPLE BERRY

THE MARK CONSISTS OF STANDARD CHARACTERS WITHOUT CLAIM TO ANY PARTICULAR FONT, STYLE, SIZE, OR COLOR.

OWNER OF U.S. REG. NOS. 680,105 AND 1,889,412.
NO CLAIM IS MADE TO THE EXCLUSIVE RIGHT TO USE "TWISTED" AND "BERRY", APART FROM THE MARK AS SHOWN.
FOR CANDY (U.S. CL. 46).
SHARON MEIER, EXAMINING ATTORNEY

CLASS 30—(Continued).

SN 78-504,058. MONOGRAM INTERNATIONAL, INC., PINELLAS PARK, FL. FILED 10-21-2004.

Lip Licker Mini Roller Candy

THE MARK CONSISTS OF STANDARD CHARACTERS WITHOUT CLAIM TO ANY PARTICULAR FONT, STYLE, SIZE, OR COLOR.

NO CLAIM IS MADE TO THE EXCLUSIVE RIGHT TO USE "MINI ROLLER CANDY", APART FROM THE MARK AS SHOWN.
FOR CONFECTIONS NAMELY LIQUID CANDY (U.S. CL. 46).
FIRST USE 6-15-2004; IN COMMERCE 10-18-2004.
EUGENIA MARTIN, EXAMINING ATTORNEY

SN 78-490,044. WELLS' DAIRY, INC., LE MARS, IA. FILED 9-27-2004.

PECAN PASSION

THE MARK CONSISTS OF STANDARD CHARACTERS WITHOUT CLAIM TO ANY PARTICULAR FONT, STYLE, SIZE, OR COLOR.

NO CLAIM IS MADE TO THE EXCLUSIVE RIGHT TO USE "PECAN", APART FROM THE MARK AS SHOWN.
FOR FROZEN CONFECTIONS (U.S. CL. 46).
FIRST USE 9-17-2002; IN COMMERCE 9-17-2002.
GRETTA YAO, EXAMINING ATTORNEY

SN 78-510,412. PROCTER & GAMBLE COMPANY, THE, CINCINNATI, OH. FILED 11-3-2004.



OWNER OF U.S. REG. NOS. 1,422,170, 2,684,202 AND OTHERS.

THE MARK CONSISTS OF A STYLIZED DESIGN OF THE WORD MILLSTONE WITH A BLACK CURVED LINE UNDERNEATH THE WORD MILLSTONE EXISTING WITH A COFFEE HOUSE DESIGN OVERLAY IN THE CENTER OF THE CURVED LINE.

FOR COFFEE (U.S. CL. 46).
FIRST USE 7-31-2002; IN COMMERCE 7-31-2002.
JULIE GUTTADAURO, EXAMINING ATTORNEY

CLASS 30—(Continued).

SN 78-510,695. HEB GROCERY COMPANY, LP, SAN ANTONIO, TX. FILED 11-3-2004.

BLAZING HOT

THE MARK CONSISTS OF STANDARD CHARACTERS WITHOUT CLAIM TO ANY PARTICULAR FONT, STYLE, SIZE, OR COLOR.

NO CLAIM IS MADE TO THE EXCLUSIVE RIGHT TO USE "HOT", APART FROM THE MARK AS SHOWN. FOR CORN CHIPS (U.S. CL. 46).
GRETTA YAO, EXAMINING ATTORNEY

SN 78-511,150. CHERRYBROOK KITCHEN, INC., LAWRENCE, MA. FILED 11-4-2004.

Cherrybrook Kitchen

THE MARK CONSISTS OF STANDARD CHARACTERS WITHOUT CLAIM TO ANY PARTICULAR FONT, STYLE, SIZE, OR COLOR.

NO CLAIM IS MADE TO THE EXCLUSIVE RIGHT TO USE "KITCHEN", APART FROM THE MARK AS SHOWN. FOR CAKE, COOKIE AND FROSTING MIXES (U.S. CL. 46).
KELLY CHOE, EXAMINING ATTORNEY

SN 78-516,107. MALACOLEAF AKTIEBOLAG, MALMO, SWEDEN, FILED 11-12-2004.

SWEDISH FISH AQUALIFE

THE MARK CONSISTS OF STANDARD CHARACTERS WITHOUT CLAIM TO ANY PARTICULAR FONT, STYLE, SIZE, OR COLOR.

OWNER OF U.S. REG. NO. 1,273,762. SEC. 2(F) AS TO "SWEDISH FISH". FOR CANDY (U.S. CL. 46).
LEIGH LOWRY, EXAMINING ATTORNEY

CLASS 30—(Continued).

SN 78-516,126. MALACOLEAF AKTIEBOLAG, MALMO, SWEDEN, FILED 11-12-2004.

SWEDISH FISH DOUBLE UPS

THE MARK CONSISTS OF STANDARD CHARACTERS WITHOUT CLAIM TO ANY PARTICULAR FONT, STYLE, SIZE, OR COLOR.

OWNER OF U.S. REG. NO. 1,273,762. SEC. 2(F) AS TO "SWEDISH FISH". FOR CANDY (U.S. CL. 46).
LEIGH LOWRY, EXAMINING ATTORNEY

SN 78-516,632. RICHARD K. GEORGES, STURGEON BAY, WI. FILED 11-14-2004.

Aspen Ideas

THE MARK CONSISTS OF STANDARD CHARACTERS WITHOUT CLAIM TO ANY PARTICULAR FONT, STYLE, SIZE, OR COLOR.

FOR GOURMET FOODS, NAMELY, COFFEE (U.S. CL. 46).
FIRST USE 6-29-1999; IN COMMERCE 6-1-2003.
LAURIE MAYES, EXAMINING ATTORNEY

SN 78-516,789. LESAFFRE YEAST CORPORATION, MILWAUKEE, WI. FILED 11-15-2004.

RED STAR TER

THE MARK CONSISTS OF STANDARD CHARACTERS WITHOUT CLAIM TO ANY PARTICULAR FONT, STYLE, SIZE, OR COLOR.

FOR YEAST (U.S. CL. 46).
HOWARD B. LEVINE, EXAMINING ATTORNEY

CLASS 30—(Continued).

SN 78-517,184. SCHLOSSBERG, LEE, BUELLTON, CA.
FILED 11-15-2004.

BAHAMA BEACH

THE MARK CONSISTS OF STANDARD CHARACTERS WITHOUT CLAIM TO ANY PARTICULAR FONT, STYLE, SIZE, OR COLOR.
FOR COOKING SAUCES, NAMELY BBQ SAUCES (U.S. CL. 46).
FIRST USE 1-15-2003; IN COMMERCE 1-15-2003.
PAUL F. GAST, EXAMINING ATTORNEY

CLASS 30—(Continued).

SN 78-517,935. RALCORP HOLDINGS, INC., ST. LOUIS, MO.
FILED 11-16-2004.



THE COLOR(S) RED IS/ARE CLAIMED AS A FEATURE OF THE MARK.
THE MARK CONSISTS OF RECTANGLE SHAPE WITH RED SHADING AND TWO CONCAVE SECTIONS ON OPPOSING SIDES.
FOR BREAKFAST CEREAL (U.S. CL. 46).
MITCHELL FRONT, EXAMINING ATTORNEY

SN 78-517,670. FOOD SCIENCE INNOVATIONS, INC., NEW YORK, NY. FILED 11-16-2004.

**THE SMART
INDULGENCE**

THE MARK CONSISTS OF STANDARD CHARACTERS WITHOUT CLAIM TO ANY PARTICULAR FONT, STYLE, SIZE, OR COLOR.
FOR ICE CREAM, ICE CREAM NOVELTIES, NAMELY, FROZEN CONFECTIONS; ICE CREAM MIXES (U.S. CL. 46).
FIRST USE 8-13-2004; IN COMMERCE 11-11-2004.
BRENDAN MCCAULEY, EXAMINING ATTORNEY

SN 78-518,261. PODHEAD.COM, LLC, NARRAGANSETT, RI.
FILED 11-17-2004.

Sensation

THE MARK CONSISTS OF STANDARD CHARACTERS WITHOUT CLAIM TO ANY PARTICULAR FONT, STYLE, SIZE, OR COLOR.
FOR SINGLE SERVE INDIVIDUALLY PACKED COFFEE PODS (U.S. CL. 46).
FIRST USE 4-24-2004; IN COMMERCE 8-30-2004.
APRIL L. RADEMACHER, EXAMINING ATTORNEY

CLASS 30—(Continued).

SN 78-518,423. STEPHEN'S INTERNATIONAL, LLC, PROVO, UT. FILED 11-17-2004.

CLASS 30—(Continued).

SN 78-519,678. IMPACT CONFECTIONS, INC., COLORADO SPRINGS, CO. FILED 11-18-2004.

Sweet Insights

BUBBALOHA!

THE MARK CONSISTS OF STANDARD CHARACTERS WITHOUT CLAIM TO ANY PARTICULAR FONT, STYLE, SIZE, OR COLOR.
FOR CHEWING GUM (U.S. CL. 46).
JENNIFER DIXON, EXAMINING ATTORNEY

THE MARK CONSISTS OF STANDARD CHARACTERS WITHOUT CLAIM TO ANY PARTICULAR FONT, STYLE, SIZE, OR COLOR.
NO CLAIM IS MADE TO THE EXCLUSIVE RIGHT TO USE "SWEET", APART FROM THE MARK AS SHOWN.
FOR COCOA, COCOA MIXES, PREPARED COCOA AND COCOA-BASED BEVERAGES (U.S. CL. 46).
FIRST USE 11-10-2004; IN COMMERCE 11-10-2004.
KATRINA EDGE, EXAMINING ATTORNEY

SN 78-519,688. IMPACT CONFECTIONS, INC., COLORADO SPRINGS, CO. FILED 11-18-2004.

CHAMPION CHEW

SN 78-519,009. NICHOLSON, KELLIE R., SHERMAN OAKS, CA. FILED 11-18-2004.

THE MARK CONSISTS OF STANDARD CHARACTERS WITHOUT CLAIM TO ANY PARTICULAR FONT, STYLE, SIZE, OR COLOR.
NO CLAIM IS MADE TO THE EXCLUSIVE RIGHT TO USE "CHEW", APART FROM THE MARK AS SHOWN.
FOR CHEWING GUM (U.S. CL. 46).
ELLEN PERKINS, EXAMINING ATTORNEY

SN 78-519,789. MY FAVORITE COMPANY, INC., LOS ANGELES, CA. FILED 11-19-2004.

Grandma Gillie's Gourmet Goodies

Tummy Treats

THE MARK CONSISTS OF STANDARD CHARACTERS WITHOUT CLAIM TO ANY PARTICULAR FONT, STYLE, SIZE, OR COLOR.
FOR PASTRIES, COOKIES AND BAKERY DESSERTS (U.S. CL. 46).
FIRST USE 1-30-2004; IN COMMERCE 2-10-2004.
MARGERY A. TIERNEY, EXAMINING ATTORNEY

THE MARK CONSISTS OF STANDARD CHARACTERS WITHOUT CLAIM TO ANY PARTICULAR FONT, STYLE, SIZE, OR COLOR.
NO CLAIM IS MADE TO THE EXCLUSIVE RIGHT TO USE "TREATS", APART FROM THE MARK AS SHOWN.
FOR CANDY (U.S. CL. 46).
VERNA BETH RIRIE, EXAMINING ATTORNEY

CLASS 30—(Continued).

SN 78-519,925. WM. WRIGLEY JR. COMPANY, CHICAGO, IL. FILED 11-19-2004.

DOUBLEMINT TWINS

THE MARK CONSISTS OF STANDARD CHARACTERS WITHOUT CLAIM TO ANY PARTICULAR FONT, STYLE, SIZE, OR COLOR.

OWNER OF U.S. REG. NOS. 102,011 AND 2,782,923. FOR CONFECTIONERY, NAMELY, CHEWING GUM, BUBBLE GUM, CANDY AND MINTS (U.S. CL. 46). JOHN HWANG, EXAMINING ATTORNEY

SN 78-519,940. CULINARY DEVELOPMENT GROUP, INC., AKRON, OH. FILED 11-19-2004.

**DEMI-GLACE DE VEAU
GOLD**

THE MARK CONSISTS OF STANDARD CHARACTERS WITHOUT CLAIM TO ANY PARTICULAR FONT, STYLE, SIZE, OR COLOR.

OWNER OF U.S. REG. NOS. 2,147,723 AND 2,147,725. NO CLAIM IS MADE TO THE EXCLUSIVE RIGHT TO USE "DEMI-GLACE DE VEAU", APART FROM THE MARK AS SHOWN.

THE FOREIGN WORDING IN THE MARK TRANSLATES INTO ENGLISH AS VEAL.

FOR SAUCES (U.S. CL. 46). FIRST USE 1-13-2004; IN COMMERCE 1-13-2004. JOHN HWANG, EXAMINING ATTORNEY

CLASS 30—(Continued).

SN 78-520,160. SAFARIAN S.A., BELGIUM, BELGIUM, FILED 11-19-2004.

GRAND-PLACE

THE MARK CONSISTS OF STANDARD CHARACTERS WITHOUT CLAIM TO ANY PARTICULAR FONT, STYLE, SIZE, OR COLOR.

OWNER OF BENELUX REG. NO. 0711520, DATED 12-11-2001, EXPIRES 12-11-2011.

THE ENGLISH TRANSLATION OF THE WORD GRAND-PLACE IN THE MARK IS BIG PLACE OR LARGE PLACE.

FOR COFFEE, TEA, COCOA, COFFEE SUBSTITUTES, NAMELY ARTIFICIAL COFFEE, PASTERIES AND CANDY, CHOCOLATE AND CHOCOLATE BARS, CHOCOLATE CHIPS, CHOCOLATE PASTES, CHOCOLATE POWDER, CHOCOLATE SYRUP, COUVERTURE CHOCOLATE, WAFFLES AND COOKIES; COFFEE, TEA, COCOA, COFFEE SUBSTITUTES, NAMELY ARTIFICIAL COFFEE, PASTRIES AND CANDY, CHOCOLATE AND CHOCOLATE BARS, CHOCOLATE CHIPS, CHOCOLATE PASTES, CHOCOLATE POWDER, CHOCOLATE SYRUP, COUVERTURE CHOCOLATE, WAFFLES AND COOKIES (U.S. CL. 46).

DORITT L. CARROLL, EXAMINING ATTORNEY

SN 78-520,243. AMT GROUP, LLC, SKOKIE, IL. FILED 11-19-2004.

***T*z**

THE MARK CONSISTS OF STANDARD CHARACTERS WITHOUT CLAIM TO ANY PARTICULAR FONT, STYLE, SIZE, OR COLOR.

FOR LOOSE TEA, BAGGED TEA AND READY-TO-DRINK TEA BEVERAGES (U.S. CL. 46).

IRA J. GOODSaid, EXAMINING ATTORNEY

CLASS 30—(Continued).

SN 78-520,568. ALLORTO, INC., WOODBURY, MN. FILED 11-20-2004.

CLASS 30—(Continued).

SN 78-520,810. KNORR-NAEHRMITTEL AKTIENGESELLSCHAFT, THAYNGEN, SWITZERLAND, FILED 11-22-2004.

Slo-Jo

THE MARK CONSISTS OF STANDARD CHARACTERS WITHOUT CLAIM TO ANY PARTICULAR FONT, STYLE, SIZE, OR COLOR.

FOR COFFEE AND CHOCOLATE- BASED POWDERED BEVERAGES (U.S. CL. 46).
CHERYL CLAYTON, EXAMINING ATTORNEY

UN MUNDO DE SABOR

THE MARK CONSISTS OF STANDARD CHARACTERS WITHOUT CLAIM TO ANY PARTICULAR FONT, STYLE, SIZE, OR COLOR.

THE FOREIGN WORDING IN THE MARK TRANSLATES INTO ENGLISH AS A WORLD OF FLAVOR.

FOR SAUCES(EXCLUDING APPLE AND CRANBERRY), GRAVIES, SEASONINGS, AND MIXES FOR MAKING THE SAME (U.S. CL. 46).

CHARLES L. JENKINS, EXAMINING ATTORNEY

SN 78-521,030. CHARDOGS USA, INC., PADUCAH, KY. FILED 11-22-2004.

SN 78-520,770. STILES, MELISSA, K, SHORELINE, WA. FILED 11-22-2004.

baking woopie



NO CLAIM IS MADE TO THE EXCLUSIVE RIGHT TO USE "REAL CHOCOLATE; REAL PEANUT BUTTER" AND "BARS", APART FROM THE MARK AS SHOWN.

THE COLOR(S) YELLOW, BLUE, AND SHADES OF BROWN IS/ARE CLAIMED AS A FEATURE OF THE MARK.

A YELLOW BACKGROUND WITH BLUE BORDER AND THE PHRASES "REAL CHOCOLATE REAL PEANUT BUTTER" AND "A REVOLUTION IN FROZEN BANANAS!" IN BROWN ON TOP AND BOTTOM, AND THE STYLIZED PHRASE "JUNGLE BARS" COLORED IN A FADING YELLOW GRADIENT, ALL OVERLAYED AND DIVIDED IN THE MIDDLE BY A SMILING, CHOCOLATE- AND PEANUT BUTTER-COVERED BANANA, DEPICTED IN SHADES OF BROWN, ON A STICK.

FOR FROZEN CONFECTIONS (U.S. CL. 46).

NORA BUCHANAN WILL, EXAMINING ATTORNEY

THE MARK CONSISTS OF STANDARD CHARACTERS WITHOUT CLAIM TO ANY PARTICULAR FONT, STYLE, SIZE, OR COLOR.

NO CLAIM IS MADE TO THE EXCLUSIVE RIGHT TO USE "BAKING", APART FROM THE MARK AS SHOWN. FOR BAKED CHOCOLATE CREAM FILLED DESERTS (U.S. CL. 46).

FIRST USE 4-17-2004; IN COMMERCE 4-17-2004.

MICHELE SWAIN, EXAMINING ATTORNEY

CLASS 30—(Continued).

SN 78-521,732. GREEN MOUNTAIN COFFEE ROASTERS, INC., WATERBURY, VT. FILED 11-23-2004.

GREAT COFFEE MADE EASY

THE MARK CONSISTS OF STANDARD CHARACTERS WITHOUT CLAIM TO ANY PARTICULAR FONT, STYLE, SIZE, OR COLOR.

OWNER OF U.S. REG. NO. 2,821,736.

NO CLAIM IS MADE TO THE EXCLUSIVE RIGHT TO USE "GREAT" OR "COFFEE", APART FROM THE MARK AS SHOWN.

FOR GROUND ROASTED COFFEE PACKAGED FOR MACHINE BREWING OF SINGLE CUP SERVINGS (U.S. CL. 46).

FIRST USE 10-31-2002; IN COMMERCE 10-31-2002.
NAAKWAMA ANKRAH, EXAMINING ATTORNEY

CLASS 30—(Continued).

SN 78-522,082. CADBURY ADAMS USA LLC, PARSIPPANY, NJ. FILED 11-23-2004.

OBSESSED WITH YOUR SMILE

THE MARK CONSISTS OF STANDARD CHARACTERS WITHOUT CLAIM TO ANY PARTICULAR FONT, STYLE, SIZE, OR COLOR.

FOR CONFECTIONERY, NAMELY CHEWING GUM (U.S. CL. 46).

LINDA POWELL, EXAMINING ATTORNEY

SN 78-522,813. AUGUST STORCK KG, BERLIN, FED REP GERMANY, FILED 11-24-2004.

SN 78-522,054. DIN DON FOODS CORP., CITY OF INDUSTRY, CA. FILED 11-23-2004.



THE COLOR(S) PINK, BLUE, YELLOW, ORANGE, RED, WHITE AND BLACK IS/ARE CLAIMED AS A FEATURE OF THE MARK.

THE COLOR PINK APPEARS IN THE BOW ON THE FEMALE CHARACTER; THE COLOR BLUE APPEARS ON THE HAT OF THE MALE CHARACTER, THE BODY OF THE MALE CHARACTER AND IN THE EYES OF BOTH CHARACTERS; THE COLOR YELLOW APPEARS ON THE BODY OF THE FEMALE CHARACTER, THE UPPER PART OF THE WORDS DIN DON AND ON THE INNER PART OF THE STAR DESIGNS; THE COLOR ORANGE APPEARS ON THE NOSES OF BOTH CHARACTERS, THE COLOR RED APPEARS ON THE LOWER PART OF THE WORDS DIN DON, THE OUTER PART OF THE STAR DESIGNS AND THE TONGUES OF THE CHARACTERS; THE COLOR WHITE APPEARS IN THE EYES OF THE CHARACTERS AND THE WHITE CIRCLE IN THE CENTER OF BOTH CHARACTERS; THE COLOR BLACK APPEARS ON THE EYELASHES OF THE FEMALE CHARACTER AND THE OUTLINE OF THE EYES OF BOTH CHARACTERS.

FOR PUDDING, FLAVORED AND SWEETENED GELATIN, EDIBLE WAFERS, CANDY AND MARSHMALLOWS (U.S. CL. 46).

FIRST USE 6-1-2002; IN COMMERCE 6-1-2003.
MARGERY A. TIERNEY, EXAMINING ATTORNEY

MILKMICE

THE MARK CONSISTS OF STANDARD CHARACTERS WITHOUT CLAIM TO ANY PARTICULAR FONT, STYLE, SIZE, OR COLOR.

FOR CANDY (U.S. CL. 46).

DAWN HAN, EXAMINING ATTORNEY

SN 78-523,373. KERR PACIFIC CORP., PORTLAND, OR. FILED 11-28-2004.

BAKERS CRAFT

THE MARK CONSISTS OF STANDARD CHARACTERS WITHOUT CLAIM TO ANY PARTICULAR FONT, STYLE, SIZE, OR COLOR.

FOR WHOLESALE BLEACHED AND UNBLEACHED FLOUR (U.S. CL. 46).

FIRST USE 1-1-1966; IN COMMERCE 1-1-1966.
NORA BUCHANAN WILL, EXAMINING ATTORNEY

CLASS 30—(Continued).

SN 78-523,907. KELLOGG NORTH AMERICA COMPANY, BATTLE CREEK, MI. FILED 11-29-2004.

CLASS 30—(Continued).

SN 78-524,913. TROPAUER, EILEEN, ATLANTA, GA. FILED 12-1-2004.

RIP 'N' TIP PACKS

THE MARK CONSISTS OF STANDARD CHARACTERS WITHOUT CLAIM TO ANY PARTICULAR FONT, STYLE, SIZE, OR COLOR.
NO CLAIM IS MADE TO THE EXCLUSIVE RIGHT TO USE "PACKS", APART FROM THE MARK AS SHOWN.
FOR COOKIES AND CRACKERS (U.S. CL. 46).
INGRID C. EULIN, EXAMINING ATTORNEY

SHPRINDLE

THE MARK CONSISTS OF STANDARD CHARACTERS WITHOUT CLAIM TO ANY PARTICULAR FONT, STYLE, SIZE, OR COLOR.
FOR BAKERY GOODS; COOKIES (U.S. CL. 46).
RICHARD WHITE, EXAMINING ATTORNEY

SN 78-525,015. GIRAUD, ELLIOTT, NORTH MIAMI, FL. FILED 12-1-2004.

snow white sugar

SN 78-524,142. ADRIA ALIMENTOS DO BRASIL LTDA, SAO CAETANO DO SUL-SP, BRAZIL, FILED 11-30-2004.

THE MARK CONSISTS OF STANDARD CHARACTERS WITHOUT CLAIM TO ANY PARTICULAR FONT, STYLE, SIZE, OR COLOR.
NO CLAIM IS MADE TO THE EXCLUSIVE RIGHT TO USE "SUGAR", APART FROM THE MARK AS SHOWN.
FOR SUGAR (U.S. CL. 46).
AISHA CLARKE, EXAMINING ATTORNEY

SN 78-525,114. CUMBERLAND PACKING CORP., BROOKLYN, NY. FILED 12-1-2004.



HONEY ON THE RAW

THE COLOR(S) RED, BLACK AND WHITE ARE CLAIMED AS A FEATURE OF THE MARK.
THE MARK CONSISTS OF A RED BANNER WITH BLACK SHADOWING ON TWO SIDES. THE BANNER CONTAINS THE WORD ZABET IN WHITE WITH BLACK SHADOWING.
FOR MACAROONS, PASTRY, COOKIES, BISCUITS, PETIT-BUERRE BISCUITS, CRACKERS, RUSKS, MALT BISCUITS AND WAFFLES (U.S. CL. 46).
TARAH HARDY, EXAMINING ATTORNEY

THE MARK CONSISTS OF STANDARD CHARACTERS WITHOUT CLAIM TO ANY PARTICULAR FONT, STYLE, SIZE, OR COLOR.
OWNER OF U.S. REG. NO. 2,643,110.
NO CLAIM IS MADE TO THE EXCLUSIVE RIGHT TO USE "HONEY", APART FROM THE MARK AS SHOWN.
FOR GRANULATED PRODUCT CONSISTING OF HONEY AND SUGAR (U.S. CL. 46).
DAWN FELDMAN, EXAMINING ATTORNEY

CLASS 30—(Continued).

SN 78-525,303. AMERICAN DAIRY QUEEN CORPORATION, EDINA, MN. FILED 12-1-2004.

CLASS 30—(Continued).

SN 78-529,154. MALACOLEAF AKTIEBOLAG, MALMO, SWEDEN, FILED 12-8-2004.

CHILLABRATION

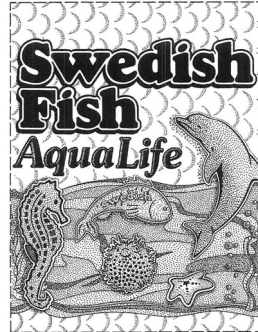

THE MARK CONSISTS OF STANDARD CHARACTERS WITHOUT CLAIM TO ANY PARTICULAR FONT, STYLE, SIZE, OR COLOR.

FOR FROZEN CONFECTIONS; ICE CREAM DESERTS; AND ICE CREAM NOVELTIES, NAMELY ICE CREAM BARS, CAKES AND CUPCAKES (U.S. CL. 46).
JOHN SCHUYLER YARD, EXAMINING ATTORNEY

OWNER OF U.S. REG. NO. 1,273,762.

THE STIPPLING IS FOR SHADING PURPOSES ONLY. THE MARK CONSISTS OF A DESIGN FEATURING A WATER-LIFE SCENE WITH SEA CREATURES SUPERIMPOSED ON A BACKGROUND OF SCALE DESIGNS WITH THE WORDING SWEDISH FISH AQUALIFE ON THE PACKAGING FOR THE GOODS; THE BROKEN LINES ARE INTENDED TO SHOW PLACEMENT ON THE PACKAGE AND ARE NOT PART OF THE MARK.

SEC. 2(F) AS TO "SWEDISH FISH" .

FOR CANDY (U.S. CL. 46).

LEIGH LOWRY, EXAMINING ATTORNEY

SN 78-526,591. MJ BEVERAGE LLC, FAIRFAX, VA. FILED 12-3-2004.

SN 78-529,628. DEL MAR NUTRITION, LLC, DEL MAR, CA. FILED 12-9-2004.



It's What Your Heart Craves.

NO CLAIM IS MADE TO THE EXCLUSIVE RIGHT TO USE "TEAS & HERBS", APART FROM THE MARK AS SHOWN.

THE MARK CONSISTS OF THE WORDS "TENZSING TEAS & HERBS" A STYLIZED RECTANGLE.

FOR TEA (U.S. CL. 46).

BARBARA GAYNOR, EXAMINING ATTORNEY

THE MARK CONSISTS OF STANDARD CHARACTERS WITHOUT CLAIM TO ANY PARTICULAR FONT, STYLE, SIZE, OR COLOR.

FOR READY TO EAT, CEREAL DERIVED FOOD BARS (U.S. CL. 46).

ANDREA K. NADELMAN, EXAMINING ATTORNEY

CLASS 30—(Continued).

SN 78-532,905. CADBURY ADAMS CANADA INC., TORONTO, ONTARIO, CANADA, FILED 12-15-2004.

SOUR PATCH KID PARTS

THE MARK CONSISTS OF STANDARD CHARACTERS WITHOUT CLAIM TO ANY PARTICULAR FONT, STYLE, SIZE, OR COLOR.

OWNER OF U.S. REG. NOS. 2,304,261 AND 2,595,207.
NO CLAIM IS MADE TO THE EXCLUSIVE RIGHT TO USE "SOUR", APART FROM THE MARK AS SHOWN.
FOR CONFECTIONERY, NAMELY CANDY (U.S. CL. 46).

MITCHELL FRONT, EXAMINING ATTORNEY

SN 78-532,977. CADBURY ADAMS CANADA INC., TORONTO, ONTARIO, CANADA, FILED 12-15-2004.

SOUR PATCH EXTREME

THE MARK CONSISTS OF STANDARD CHARACTERS WITHOUT CLAIM TO ANY PARTICULAR FONT, STYLE, SIZE, OR COLOR.

OWNER OF U.S. REG. NOS. 2,304,261 AND 2,595,207.
NO CLAIM IS MADE TO THE EXCLUSIVE RIGHT TO USE "SOUR", APART FROM THE MARK AS SHOWN.
FOR CONFECTIONERY, NAMELY CANDY (U.S. CL. 46).

MITCHELL FRONT, EXAMINING ATTORNEY

SN 78-533,956. MATT & RACHEL, LLC, CARMEL, IN. FILED 12-16-2004.

NOT SO UGLY

THE MARK CONSISTS OF STANDARD CHARACTERS WITHOUT CLAIM TO ANY PARTICULAR FONT, STYLE, SIZE, OR COLOR.

FOR HAMBURGER SANDWICHES (U.S. CL. 46).
FIRST USE 2-5-2003; IN COMMERCE 2-5-2003.
MARTHA FROMM, EXAMINING ATTORNEY

CLASS 30—(Continued).

SN 78-535,691. SUPERIOR BAKERY, INC., NORTH GROSVENORDALE, CT. FILED 12-20-2004.

KASANOF'S SELECTS

THE MARK CONSISTS OF STANDARD CHARACTERS WITHOUT CLAIM TO ANY PARTICULAR FONT, STYLE, SIZE, OR COLOR.

OWNER OF U.S. REG. NOS. 2,290,177, 2,345,671 AND 2,836,749.

NO CLAIM IS MADE TO THE EXCLUSIVE RIGHT TO USE "SELECTS", APART FROM THE MARK AS SHOWN.
FOR BAKERY PRODUCTS (U.S. CL. 46).

GEOFFREY FOSDICK, EXAMINING ATTORNEY

SN 78-536,262. SUPHERB FARMS, TURLOCK, CA. FILED 12-21-2004.

FLAV-R-FLOW

THE MARK CONSISTS OF STANDARD CHARACTERS WITHOUT CLAIM TO ANY PARTICULAR FONT, STYLE, SIZE, OR COLOR.

FOR BLENDS OF SOME OR ALL OF PROCESSED HERBS, SALT, PEPPER, SEASONINGS, FLAVORING ADDITIVES FOR NON-NUTRITIONAL PURPOSES, SPICES, AND NATURAL SWEETENERS, USED TO FLAVOR FOODS (U.S. CL. 46).

ALLISON HOLTZ, EXAMINING ATTORNEY

CLASS 30—(Continued).

SN 78-536,273. SARA LEE/DE N.V., 3532 AD UTRECHT, NETHERLANDS, FILED 12-21-2004.

CLASS 30—(Continued).

SN 78-537,767. INTERNATIONAL TRADE & IMPORTS, LTD., SAN DIEGO, CA. FILED 12-23-2004.

BLEND 1753

appetizer

THE MARK CONSISTS OF STANDARD CHARACTERS WITHOUT CLAIM TO ANY PARTICULAR FONT, STYLE, SIZE, OR COLOR.
NO CLAIM IS MADE TO THE EXCLUSIVE RIGHT TO USE BLEND, APART FROM THE MARK AS SHOWN.
FOR COFFEE (U.S. CL. 46).
JOHN E. MICHOS, EXAMINING ATTORNEY

THE MARK CONSISTS OF STANDARD CHARACTERS WITHOUT CLAIM TO ANY PARTICULAR FONT, STYLE, SIZE, OR COLOR.
FOR FLAVORINGS, COATINGS AND SEASONINGS FOR PET FOOD (U.S. CL. 46).
KEVIN DINALLO, EXAMINING ATTORNEY

SN 78-536,338. PURA VIDA COFFEE, LC, SEATTLE, WA. FILED 12-21-2004.

SN 78-539,257. SNAK KING CORP, CITY OF INDUSTRY, CA. FILED 12-28-2004.

NEW BEGINNINGS

FRIGHT BITES

THE MARK CONSISTS OF STANDARD CHARACTERS WITHOUT CLAIM TO ANY PARTICULAR FONT, STYLE, SIZE, OR COLOR.
FOR COFFEE BEANS; GROUND COFFEE; COFFEE BEVERAGES; COFFEE CONCENTRATES; COFFEE POWDERS (U.S. CL. 46).
CIMMERIAN COLEMAN, EXAMINING ATTORNEY

THE MARK CONSISTS OF STANDARD CHARACTERS WITHOUT CLAIM TO ANY PARTICULAR FONT, STYLE, SIZE, OR COLOR.
NO CLAIM IS MADE TO THE EXCLUSIVE RIGHT TO USE BITES, APART FROM THE MARK AS SHOWN.
FOR RICE PUFFS, CORN PUFFS, CORN CURLS, CORN CHIPS, GRAIN-BASED CHIP, TACO CHIPS, TORTILLA CHIPS AND FLOUR-BASED CHIPS (U.S. CL. 46).
ALICE BENMAMAN, EXAMINING ATTORNEY

CLASS 30—(Continued).

SN 78-539,505. HERSHEY CHOCOLATE & CONFECTIONERY CORPORATION, WHEAT RIDGE, CO. FILED 12-29-2004.

KISSORTMENT

THE MARK CONSISTS OF STANDARD CHARACTERS WITHOUT CLAIM TO ANY PARTICULAR FONT, STYLE, SIZE, OR COLOR.

FOR CANDY (U.S. CL. 46).
HOWARD SMIGA, EXAMINING ATTORNEY

SN 78-542,011. COLE & PARKS, LLC, FISHERS, NY. FILED 1-4-2005.

DOUGH EGGS

THE MARK CONSISTS OF STANDARD CHARACTERS WITHOUT CLAIM TO ANY PARTICULAR FONT, STYLE, SIZE, OR COLOR.

NO CLAIM IS MADE TO THE EXCLUSIVE RIGHT TO USE DOUGH, APART FROM THE MARK AS SHOWN.

FOR COOKIE DOUGH AND COOKIE MIX (U.S. CL. 46).

FIRST USE 11-14-2003; IN COMMERCE 12-20-2003.
ROBIN CHOSID, EXAMINING ATTORNEY

SN 78-542,802. COMPANIA ALIMENTICIA DEL NORTE, S.A. DE C.V., SAN NICOLAS DE LOS GARZA, N.L., MEXICO, FILED 1-5-2005.

**LOS AUTENTICOS
COMPADRES**

THE MARK CONSISTS OF STANDARD CHARACTERS WITHOUT CLAIM TO ANY PARTICULAR FONT, STYLE, SIZE, OR COLOR.

THE FOREIGN WORDING IN THE MARK TRANSLATES INTO ENGLISH AS THE AUTHENTIC FRIENDS.

FOR SALSA, SAUCES, SALAD DRESSING, AND SPICES (U.S. CL. 46).

ALLISON SCHRODY, EXAMINING ATTORNEY

CLASS 30—(Continued).

SN 78-544,399. LAURA CID, CHICAGO, IL. FILED 1-8-2005.



NO CLAIM IS MADE TO THE EXCLUSIVE RIGHT TO USE "BOMBON", APART FROM THE MARK AS SHOWN.

THE COLOR(S) GREEN AND BLUE IS/ARE CLAIMED AS A FEATURE OF THE MARK.

THE MARK CONSISTS OF STYLIZED LETTERS IN BLUE FOR "BOMBON" WITH A BACKGROUND USING 2 SHADES OF GREEN.

THE ENGLISH TRANSLATION OF THE WORD BOMBON IN THE MARK IS "CHOCOLATE".

FOR PASTRIES, CAKES, BAKERY DESSERTS, BREADS, COOKIES, CANDY (U.S. CL. 46).

FIRST USE 5-1-2001; IN COMMERCE 5-1-2001.

ELISSA GARBER KON, EXAMINING ATTORNEY

SN 78-545,012. WM. WRIGLEY JR. COMPANY, CHICAGO, IL. FILED 1-10-2005.

**A DAZZLING SMILE
NO MATTER WHAT**

THE MARK CONSISTS OF STANDARD CHARACTERS WITHOUT CLAIM TO ANY PARTICULAR FONT, STYLE, SIZE, OR COLOR.

FOR CONFECTIONERY, NAMELY, CHEWING GUM, BUBBLE GUM, CANDY AND MINTS (U.S. CL. 46).

SONYA STEPHENS, EXAMINING ATTORNEY

CLASS 30—(Continued).

SN 78-545,249. CAJOHNS FIREY FOODS COMPANY, COLUMBUS, OH. FILED 1-11-2005.

CABOOM!

THE MARK CONSISTS OF STANDARD CHARACTERS WITHOUT CLAIM TO ANY PARTICULAR FONT, STYLE, SIZE, OR COLOR.

OWNER OF U.S. REG. NO. 2,614,790.
FOR SAUCES, NAMELY, SALSA, PICANTE SAUCE, HOT SAUCE, BARBEQUE SAUCE, AND MUSTARD (U.S. CL. 46).

FIRST USE 11-30-1997; IN COMMERCE 3-31-1998.
DAVID C. REIHNER, EXAMINING ATTORNEY

CLASS 30—(Continued).

SN 78-546,084. THE RAYMOND-HADLEY CORP., SPENCER, NY. FILED 1-12-2005.

SNOW WHITE

THE MARK CONSISTS OF STANDARD CHARACTERS WITHOUT CLAIM TO ANY PARTICULAR FONT, STYLE, SIZE, OR COLOR.

FOR FOOD PRODUCTS, NAMELY, FLOUR (U.S. CL. 46).

FIRST USE 12-31-1965; IN COMMERCE 12-31-1965.
ZACHARY BELLO, EXAMINING ATTORNEY

SN 78-546,705. BODY WISE INTERNATIONAL, LLC, TUSTIN, CA. FILED 1-12-2005.

BODY WISE

THE MARK CONSISTS OF STANDARD CHARACTERS WITHOUT CLAIM TO ANY PARTICULAR FONT, STYLE, SIZE, OR COLOR.

OWNER OF U.S. REG. NOS. 1,999,998, 2,364,413 AND 2,410,251.

FOR TEAS (U.S. CL. 46).
WON TEAK OH, EXAMINING ATTORNEY

SN 78-546,072. THE RAYMOND-HADLEY CORP., SPENCER, NY. FILED 1-12-2005.

DIAMOND WHITE

THE MARK CONSISTS OF STANDARD CHARACTERS WITHOUT CLAIM TO ANY PARTICULAR FONT, STYLE, SIZE, OR COLOR.

NO CLAIM IS MADE TO THE EXCLUSIVE RIGHT TO USE WHITE, APART FROM THE MARK AS SHOWN.
FOR FOOD PRODUCTS, NAMELY, GRITS (U.S. CL. 46).

FIRST USE 12-31-1965; IN COMMERCE 12-31-1965.
PAUL E. FAHRENKOPF, EXAMINING ATTORNEY

SN 78-547,847. UNCLE WALLY'S LLC, SHIRLEY, NY. FILED 1-14-2005.

SMART PORTIONS

THE MARK CONSISTS OF STANDARD CHARACTERS WITHOUT CLAIM TO ANY PARTICULAR FONT, STYLE, SIZE, OR COLOR.

FOR MUFFINS (U.S. CL. 46).
TEJBIR SINGH, EXAMINING ATTORNEY

CLASS 30—(Continued).

SN 78-548,227. NATURE'S PATH FOODS INC., RICHMOND, CANADA, FILED 1-14-2005.

OPTIMUM REBOUND

THE MARK CONSISTS OF STANDARD CHARACTERS WITHOUT CLAIM TO ANY PARTICULAR FONT, STYLE, SIZE, OR COLOR.

PRIORITY CLAIMED UNDER SEC. 44(D) ON CANADA APPLICATION NO. 1243023, FILED 1-10-2005.

OWNER OF U.S. REG. NO. 2,836,884.

FOR PROCESSED CEREALS, BREAKFAST CEREALS, WAFFLES, FOOD BARS, HOT OATMEAL MIXES, BREAD, PASTRIES, BISCUITS, MUFFINS, COOKIES, CRACKERS, PANCAKE MIXES, WAFFLE MIXES, BAGELS (U.S. CL. 46).

GINA HAYES, EXAMINING ATTORNEY

CLASS 30—(Continued).

SN 78-548,253. MULTIFOODS BRANDS, INC., MINNETONKA, MN. FILED 1-15-2005.



**Robin Hood
Page**

OWNER OF U.S. REG. NOS. 132,001, 1,250,616 AND OTHERS.

FOR FLOUR (U.S. CL. 46).

FIRST USE 11-17-2004; IN COMMERCE 11-17-2004.

THEODORE MCBRIDE, EXAMINING ATTORNEY

SN 78-548,252. MULTIFOODS BRANDS, INC., MINNETONKA, MN. FILED 1-15-2005.



**Robin Hood
Yeomen**

OWNER OF U.S. REG. NOS. 132,001, 1,250,616 AND OTHERS.

FOR FLOUR (U.S. CL. 46).

FIRST USE 11-17-2004; IN COMMERCE 11-17-2004.

THEODORE MCBRIDE, EXAMINING ATTORNEY

SN 78-548,254. MULTIFOODS BRANDS, INC., MINNETONKA, MN. FILED 1-15-2005.



**Robin Hood
Squire**

OWNER OF U.S. REG. NOS. 132,001, 1,250,616 AND OTHERS.

FOR FLOUR (U.S. CL. 46).

FIRST USE 11-17-2004; IN COMMERCE 11-17-2004.

THEODORE MCBRIDE, EXAMINING ATTORNEY

CLASS 30—(Continued).

SN 78-548,255. MULTIFOODS BRANDS, INC., MINNETONKA, MN. FILED 1-15-2005.

CLASS 30—(Continued).

SN 78-548,720. MIKES RESTAURANTS INC. LES RESTAURANTS MIKES INC., MONTREAL, QUEBEC, CANADA, FILED 1-17-2005.

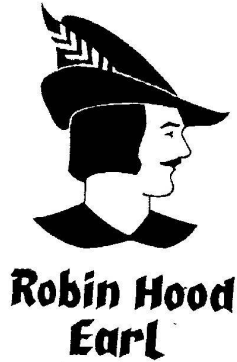

CELEBRITY

OWNER OF U.S. REG. NOS. 132,001, 1,250,616 AND OTHERS.
FOR FLOUR (U.S. CL. 46).
FIRST USE 11-17-2004; IN COMMERCE 11-17-2004.
THEODORE MCBRIDE, EXAMINING ATTORNEY

THE MARK CONSISTS OF STANDARD CHARACTERS WITHOUT CLAIM TO ANY PARTICULAR FONT, STYLE, SIZE, OR COLOR.
FOR SANDWICHES (U.S. CL. 46).
FIRST USE 8-3-2004; IN COMMERCE 8-3-2004.
MICHAEL ENGEL, EXAMINING ATTORNEY

SN 78-548,436. WITTMAN SPECIALTY FOODS LLC, WEST HARTFORD, CT. FILED 1-16-2005.

SN 78-550,355. MELZY ENTERPRISES INC., PENNGROVE, CA. FILED 1-19-2005.

NIP 'N TANG

FIGAMAJIGS

THE MARK CONSISTS OF STANDARD CHARACTERS WITHOUT CLAIM TO ANY PARTICULAR FONT, STYLE, SIZE, OR COLOR.
FOR SAUCES (U.S. CL. 46).
FIRST USE 0-0-1986; IN COMMERCE 0-0-1986.
ADA HAN, EXAMINING ATTORNEY

THE MARK CONSISTS OF STANDARD CHARACTERS WITHOUT CLAIM TO ANY PARTICULAR FONT, STYLE, SIZE, OR COLOR.
FOR CANDY (U.S. CL. 46).
FIRST USE 11-15-2004; IN COMMERCE 11-15-2004.
WON TEAK OH, EXAMINING ATTORNEY

CLASS 30—(Continued).

SN 78-620,073. ATKINS NUTRITIONALS, INC., RONKONKOMA, NY. FILED 4-29-2005.

ATKINS ENDULGE

THE MARK CONSISTS OF STANDARD CHARACTERS WITHOUT CLAIM TO ANY PARTICULAR FONT, STYLE, SIZE, OR COLOR.

OWNER OF U.S. REG. NOS. 2,689,974 AND 2,828,890.
FOR CHOCOLATE BASED READY TO EAT FOOD BARS; CHOCOLATE; CHOCOLATE BARS; CANDY; CANDY BARS; NUTRITIONAL CANDY BARS; PEANUT BUTTER CUPS; CHOCOLATE COVERED NUTS; CARAMEL NUT CLUSTERS; CHOCOLATE MINT PATTIES; ICE CREAM; AND COOKIES (U.S. CL. 46).

FIRST USE 3-9-2001; IN COMMERCE 3-9-2001.
REBECCA GAN, EXAMINING ATTORNEY

SN 79-000,666. RIENSCH & HELD (GMBH & CO.), FED REP GERMANY, FILED 11-22-2003.

TEAGIRL

THE MARK CONSISTS OF STANDARD CHARACTERS WITHOUT CLAIM TO ANY PARTICULAR FONT, STYLE, SIZE, OR COLOR.

OWNER OF INTERNATIONAL REGISTRATION 0801255 DATED 11-28-2002, EXPIRES 11-28-2012.

FOR TEA, HERBAL TEA FOR FOOD PURPOSES, ICED TEA, JAPANESE GREEN TEA, LIME TEA, CHINESE TEA, SAGE TEA, TEA SUBSTITUTES, TEA-BASED BEVERAGES WITH FRUIT FLAVORING, THEME-FREE TEA SWEETENED WITH SWEETENERS, FRUIT TEAS, BEVERAGES MADE OF TEA, TEA FOR INFUSIONS (U.S. CL. 46).

DEZMONA MIZELLE, EXAMINING ATTORNEY

SN 79-002,060. SONNENTOR KRÄUTERHANDELS; GESELLSCHAFT M.B.H., AUSTRIA, FILED 4-5-2004.



OWNER OF INTERNATIONAL REGISTRATION 0823038 DATED 4-5-2004, EXPIRES 4-5-2014.

THE ENGLISH TRANSLATION OF THE GERMAN WORD "SONNENTOR" IN THE MARK IS "SUN GATE."
FOR TEA, ARTIFICIAL COFFEE, PREPARATIONS MADE FROM CEREALS, CEREAL-BASED CHIPS, BREAD, PASTRY, HONEY, VINEGAR, SPICES (U.S. CL. 46).

MARK RADEMACHER, EXAMINING ATTORNEY

CLASS 30—(Continued).

SN 79-002,295. HARIBO GMBH & CO. KG, FED REP GERMANY, FILED 2-2-2004.

Goldbären

THE MARK CONSISTS OF STANDARD CHARACTERS WITHOUT CLAIM TO ANY PARTICULAR FONT, STYLE, SIZE, OR COLOR.

OWNER OF INTERNATIONAL REGISTRATION 0823911 DATED 2-2-2004, EXPIRES 2-2-2014.

OWNER OF U.S. REG. NOS. 1,346,555, 1,671,952 AND 2,173,149.

THE ENGLISH TRANSLATION OF "GOLDBAREN" IS "GOLDBEARS".

FOR CONFECTIONERY, NAMELY, GUMMY CANDY (U.S. CL. 46).

LOURDES AYALA, EXAMINING ATTORNEY

SN 79-004,287. AUGUST STORCK KG, FED REP GERMANY, FILED 4-2-2004.

OZZ

THE MARK CONSISTS OF STANDARD CHARACTERS WITHOUT CLAIM TO ANY PARTICULAR FONT, STYLE, SIZE, OR COLOR.

PRIORITY DATE OF 12-16-2003 IS CLAIMED.

OWNER OF INTERNATIONAL REGISTRATION 0830333 DATED 4-2-2004, EXPIRES 4-2-2014.

FOR CONFECTIONERY, CHOCOLATE, CHOCOLATE BARS, CHOCOLATE CANDIES, CHOCOLATE SYRUP AND PASTRIES (U.S. CL. 46).

MICHELLE S. WISEMAN, EXAMINING ATTORNEY

CLASS 30—(Continued).

SN 79-004,525. ZAKŁADY PRZEMYSŁU CUKIERNICZEGO; MIESZKO SPÓŁKA AKCYJNA, POLAND, FILED 5-21-2004.



OWNER OF INTERNATIONAL REGISTRATION 0831006 DATED 5-21-2004, EXPIRES 5-21-2014.

THE COLOR(S) YELLOW, RED, BLACK, WHITE, BLUE, VIOLET, ORANGE AND PURPLE IS/ARE CLAIMED AS A FEATURE OF THE MARK.

THE TRADEMARK CONSISTS OF A FIGURE WHICH HAS A LARGE YELLOW HEAD SHAPED SIMILAR TO A CIRCLE WITH A RED AND BLACK SMILING MOUTH, WHITE TEETH AND RED TONGUE, WHITE AND BLACK EYES WITH ORANGE EYELIDS, BLUE SPIRALS SYMBOLIZING HAIR, PURPLE HANDS WITH HUGE PALMS, VIOLET AND BLUE LEGS, AN ORANGE BODY COVERED BY BLUE OVERALLS WITH TWO PURPLE BUTTONS AND A RED MARKING BETWEEN THE BUTTONS.

FOR COFFEE, TEA, COCOA, RICE, TAPIOCA, SAGO, FLOUR, AND CEREAL PREPARATIONS, NAMELY, BREAKFAST CEREALS, CEREAL SNACK FOODS, AND PROCESSED CEREALS; BREAD, CONFECTIONERY AND SWEETS, NAMELY, BISCUITS, BROWNIES, BUTTER BISCUITS, COOKIES, BONBONS, BUBBLE GUM, CANDIES, CHOCOLATE BARS, CANDY MINTS, CARAMEL CANDIES, COCOA CANDIES, CANDIED CAKE DECORATIONS, CHOCOLATES AND CHOCOLATE CANDIES, AND FRUIT JELLIES; AND ICE CREAMS, HONEY, TREACLE, YEAST, BAKING-POWDER, SALT, MUSTARD, VINEGAR, SAUCES, SPICES, AND ICE (U.S. CL. 46).

WARREN L. OLANDRIA, EXAMINING ATTORNEY

SN 79-008,368. MOKA EFTI S.P.A., ITALY, FILED 11-17-2004.

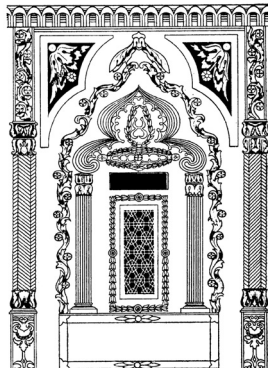

OWNER OF INTERNATIONAL REGISTRATION 0233407 DATED 7-8-1960, EXPIRES 7-8-2010.

FOR COFFEE (U.S. CL. 46).

NORA BUCHANAN WILL, EXAMINING ATTORNEY

CLASS 31—NATURAL AGRICULTURAL PRODUCTS

SN 76-059,030. A.E. MCKENZIE CO. INC., BRANDON, MANITOBA, CANADA, FILED 5-30-2000.



PRIORITY CLAIMED UNDER SEC. 44(D) ON CANADA APPLICATION NO. 1052746, FILED 3-29-2000, REG. NO. TMA597719, DATED 12-16-2003, EXPIRES 12-16-2018.

NO CLAIM IS MADE TO THE EXCLUSIVE RIGHT TO USE "SEEDS, SEMENCES, SEMILLAS, SAMEN, AND BASILICO, BASIL, BASILIC, ALBALBACA, BASILIKUM, A FOGLIA DI LATTUGA" AND "GUSTO ITALIA", APART FROM THE MARK AS SHOWN.

THE CIRCLE IN THE DESIGN CONTAINS A DEPICTION OF A MAN WITH A MOUSTACHE WEARING A CHEF'S JACKET AND HAT

THE ENGLISH TRANSLATION OF GUSTO ITALIA IS TASTE ITALY. THE ENGLISH TRANSLATION OF "SEMENCES", "SEMILLAS" AND "SAMEN" IS "SEED." THE ENGLISH TRANSLATION OF "BASILICO", "BASILIC", "ALBAHACA" AND "BASILKUM" IS "BASIL." THE ENGLISH TRANSLATION OF "A FOGLIA DI LATTUGA" IS "LEAF LETTUCE."

FOR SEEDS OF VEGETABLES AND HERBS TYPICAL TO ITALIAN-STYLE COOKING FOR USE IN PLANTING IN GARDENS (U.S. CLS. 1 AND 46).

MARCIE MILONE, EXAMINING ATTORNEY

SN 76-552,132. BLUE STAR HOLDING, LLC, AVENTURA, FL. FILED 9-26-2003.

EUCALYPTUS GOLD

NO CLAIM IS MADE TO THE EXCLUSIVE RIGHT TO USE "EUCALYPTUS", APART FROM THE MARK AS SHOWN.

FOR MULCH AND WOOD CHIPS FOR USE AS GROUND COVERING (U.S. CLS. 1 AND 46).

LESLEY LAMOTHE, EXAMINING ATTORNEY

CLASS 31—(Continued).

SN 76-584,244. SELECTA KLEMM GMBH & CO. KG, STUTTGART, FED REP GERMANY, FILED 3-31-2004.

SERENGETI

THE MARK CONSISTS OF STANDARD CHARACTERS WITHOUT CLAIM TO ANY PARTICULAR FONT, STYLE, SIZE, OR COLOR.

FOR PROPAGATION MATERIAL FOR PLANTS; LIVING PLANTS AND NATURAL FLOWERS, NAMELY, ORNAMENTAL PLANTS (U.S. CLS. 1 AND 46).

AMOS T. MATTHEWS, JR., EXAMINING ATTORNEY

CLASS 31—(Continued).

SN 76-590,628. MIDWESTERN PET FOODS, INC., EVANSVILLE, IN. FILED 5-3-2004.

NUT 'R' NIPZ

FOR PET FOOD; EDIBLE PET TREATS (U.S. CLS. 1 AND 46).

FIRST USE 10-12-2004; IN COMMERCE 10-12-2004.

RON FAIRBANKS, EXAMINING ATTORNEY

SN 76-585,822. PRO KENNEL'S CHOICE, LLC, JIM FALLS, WI. FILED 4-8-2004.

WOODY'S

HI-FAT
LO-PRO
22/16
Performance
Dog Food

NO CLAIM IS MADE TO THE EXCLUSIVE RIGHT TO USE "HI-FAT" AND "DOG FOOD" AND "THE PICTORIAL REPRESENTATION OF A DOG", APART FROM THE MARK AS SHOWN.

FOR DOG FOOD (U.S. CLS. 1 AND 46).

FIRST USE 2-1-2001; IN COMMERCE 2-1-2001.

CHRISTOPHER ADKINS, EXAMINING ATTORNEY

SN 76-597,316. THE CHRISTIAN CHURCH COMMUNITY TRUST, WESTLAND, NEW ZEALAND, FILED 6-15-2004.

ANGEL MOSS

NO CLAIM IS MADE TO THE EXCLUSIVE RIGHT TO USE "MOSS", APART FROM THE MARK AS SHOWN.

FOR MOSS; SPHAGNUM MOSS; PEAT MOSS; MOSS LINERS FOR HANGING PLANT BASKETS; SEEDS FOR HORTICULTURAL PURPOSES; LIVE PLANTS AND FLOWERS (U.S. CLS. 1 AND 46).

FIRST USE 1-20-2004; IN COMMERCE 1-20-2004.

H. M. FISHER, EXAMINING ATTORNEY

SN 76-590,243. CAROLINA WREATH AND FARM, INC., ROCKY MOUNT, NC. FILED 5-3-2004.

CAROLINA WREATH

THE MARK CONSISTS OF STANDARD CHARACTERS WITHOUT CLAIM TO ANY PARTICULAR FONT, STYLE, SIZE, OR COLOR.

NO CLAIM IS MADE TO THE EXCLUSIVE RIGHT TO USE "WREATH", APART FROM THE MARK AS SHOWN.

SEC. 2(F).

FOR FRESH CUT WREATHS (U.S. CLS. 1 AND 46).

FIRST USE 4-0-1999; IN COMMERCE 4-0-1999.

TRICIA SONNEBORN, EXAMINING ATTORNEY



SN 76-598,878. JAMES E. COOLEY PEACH FARMS, INC., CHESNEE, SC. FILED 6-23-2004.

FOR FRESH STRAWBERRIES (U.S. CLS. 1 AND 46).

FIRST USE 0-0-1956; IN COMMERCE 0-0-1956.

MARC LEIPZIG, EXAMINING ATTORNEY

CLASS 31—(Continued).

SN 76-600,347. VEDALIFE, INC., LANCASTER, NY. FILED 7-1-2004.

VEDA PET

THE MARK CONSISTS OF STANDARD CHARACTERS WITHOUT CLAIM TO ANY PARTICULAR FONT, STYLE, SIZE, OR COLOR.

NO CLAIM IS MADE TO THE EXCLUSIVE RIGHT TO USE "PET", APART FROM THE MARK AS SHOWN.

FOR NATURAL ENERGY POTASSIUM DRINK FOR ANIMALS (U.S. CLS. 1 AND 46).

JASON TURNER, EXAMINING ATTORNEY

CLASS 31—(Continued).

SN 76-619,452. ALL STAR SEED, EL CENTRO, CA. FILED 11-5-2004.

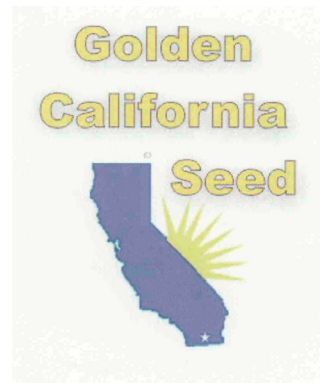

NO CLAIM IS MADE TO THE EXCLUSIVE RIGHT TO USE CALIFORNIA SEED, APART FROM THE MARK AS SHOWN.

THE COLORS GOLD AND BLUE ARE CLAIMED AS FEATURES OF THE MARK.

THE COLOR GOLD APPEARS WITHIN THE TERMS "GOLDEN CALIFORNIA SEED," WITHIN THE SUN RAYS PROTRUDING FROM THE IMAGE OF THE STATE OF CALIFORNIA AND WITHIN THE FIVE POINT STAR AT THE BASE OF THE IMAGE OF THE STATE OF CALIFORNIA. THE COLOR BLUE APPEARS WITHIN THE IMAGE OF THE STATE OF CALIFORNIA.

FOR GRASS SEED; FORAGE PRODUCTS, NAMELY ALFALFA; WHEAT SEED (U.S. CLS. 1 AND 46).

STEPHANIE DAVIS, EXAMINING ATTORNEY

SN 76-605,040. AGRELIANT GENETICS, LLC, WESTFIELD, IN. FILED 7-30-2004.

STACK ATTACK

FOR AGRICULTURAL PRODUCTS, NAMELY SOY-BEAN, CORN AND ALFALFA SEED FOR PLANTING (U.S. CLS. 1 AND 46).

FIRST USE 6-0-2004; IN COMMERCE 6-0-2004.

CIMMERIAN COLEMAN, EXAMINING ATTORNEY

SN 76-619,910. FRIONA INDUSTRIES, L.P., AMARILLO, TX. FILED 11-9-2004.

NATURAL CALF

SN 76-619,451. ALL STAR SEED, EL CENTRO, CA. FILED 11-5-2004.

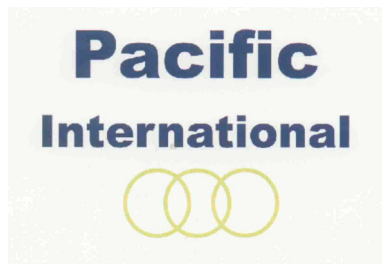

NO CLAIM IS MADE TO THE EXCLUSIVE RIGHT TO USE INTERNATIONAL, APART FROM THE MARK AS SHOWN.

THE COLOR(S) GOLD IS/ARE CLAIMED AS A FEATURE OF THE MARK.

THE COLOR GOLD APPEARS IN THE FORM OF THREE INTERTWINED RINGS.

FOR GRASS SEED; FORAGE PRODUCTS, NAMELY ALFALFA; WHEAT SEED (U.S. CLS. 1 AND 46).

STEPHANIE DAVIS, EXAMINING ATTORNEY

THE MARK CONSISTS OF STANDARD CHARACTERS WITHOUT CLAIM TO ANY PARTICULAR FONT, STYLE, SIZE, OR COLOR.

NO CLAIM IS MADE TO THE EXCLUSIVE RIGHT TO USE CALF, APART FROM THE MARK AS SHOWN.

FOR ANIMAL FEED, NAMELY, MILK REPLACER FOR CALVES (U.S. CLS. 1 AND 46).

FIRST USE 10-1-2004; IN COMMERCE 10-1-2004.

PRISCILLA MILTON, EXAMINING ATTORNEY

CLASS 31—(Continued).

SN 76-620,377. OOH PET PRODUCTS LLC., NEW YORK, NY.
FILED 11-10-2004.

PUP CUPS

THE MARK CONSISTS OF STANDARD CHARACTERS WITHOUT CLAIM TO ANY PARTICULAR FONT, STYLE, SIZE, OR COLOR.

FOR FOODSTUFFS FOR DOGS, NAMELY WATER FOR DOGS, DOG FOOD AND TREATS FOR DOGS (U.S. CLS. 1 AND 46).

FIRST USE 1-15-2005; IN COMMERCE 1-15-2005.
RAUL CORDOVA, EXAMINING ATTORNEY

SN 76-621,355. SANTA ROSA TROPICALS, SANTA ROSA, CA. FILED 11-19-2004.



THE STIPPLING IS A FEATURE OF THE MARK. FOR LIVE PLANTS, NAMELY FERNS (U.S. CLS. 1 AND 46).

FIRST USE 9-30-2003; IN COMMERCE 9-30-2003.
AMY GEARIN, EXAMINING ATTORNEY

SN 76-622,291. PET CENTER, INC., LOS ANGELES, CA.
FILED 11-26-2004.

MUNCHIE HUT

THE MARK CONSISTS OF STANDARD CHARACTERS WITHOUT CLAIM TO ANY PARTICULAR FONT, STYLE, SIZE, OR COLOR.

FOR PET FOOD (U.S. CLS. 1 AND 46).
PAUL E. FAHRENKOPF, EXAMINING ATTORNEY

CLASS 31—(Continued).

SN 76-624,250. NORTHEASTERN PRODUCTS CORP., WARRENSBURG, NY. FILED 12-13-2004.

ABSORBDRI

THE MARK CONSISTS OF STANDARD CHARACTERS WITHOUT CLAIM TO ANY PARTICULAR FONT, STYLE, SIZE, OR COLOR.

FOR PROCESSED WOOD SHAVINGS AND CHIPS AND GROUND CORN COB FOR USE AS ANIMAL BEDDING AND ANIMAL LITTER (U.S. CLS. 1 AND 46).
INGRID C. EULIN, EXAMINING ATTORNEY

SN 76-626,250. FRIEDA'S, INC., LOS ALAMITOS, CA. FILED 12-30-2004.

COLOR BLAST

THE MARK CONSISTS OF STANDARD CHARACTERS WITHOUT CLAIM TO ANY PARTICULAR FONT, STYLE, SIZE, OR COLOR.

FOR FRESH WHOLE POTATOES (U.S. CLS. 1 AND 46).
SALLY SHIH, EXAMINING ATTORNEY

SN 76-627,309. LOTRIDGE, JOANNA, RICHARDSON, TX.
FILED 1-7-2005.

Barn
Buddy
Biscuits

THE MARK IS NOT IN COLOR. THE COLOR GRAY IS INTENDED TO INDICATE SHADING ONLY.

FOR FOODSTUFFS FOR ANIMALS, NAMELY TREATS FOR DOGS AND HORSES (U.S. CLS. 1 AND 46).
FIRST USE 12-17-2004; IN COMMERCE 12-17-2004.
ADA HAN, EXAMINING ATTORNEY

CLASS 31—(Continued).

SN 78-251,564. SALEM ORGANIC SOILS, INC., WINGDALE, NY. FILED 5-19-2003.



OWNER OF U.S. REG. NO. 2,087,562.
NO CLAIM IS MADE TO THE EXCLUSIVE RIGHT TO USE "100% ORGANIC", APART FROM THE MARK AS SHOWN.
SEC. 2(F) BEST MULCH ON EARTH.
FOR MULCH FOR AGRICULTURE USE (U.S. CLS. 1 AND 46).
FIRST USE 12-23-2004; IN COMMERCE 12-23-2004.
ZHALEH DELANEY, EXAMINING ATTORNEY

SN 78-266,798. BLUE SEAL FEEDS, INC., LONDONDERRY, NH. FILED 6-25-2003.

FURRY FRIENDS

FOR SMALL ANIMAL FEED AND PET FOOD (U.S. CLS. 1 AND 46).
FIRST USE 10-2-2003; IN COMMERCE 10-10-2003.
KATHLEEN M. VANSTON, EXAMINING ATTORNEY

SN 78-327,059. TEAM SANTA ROSA AGRIBUSINESS COMMITTEE, MILTON, FL. FILED S.R. 11-12-2003; AM. P.R. 6-9-2005.



NO CLAIM IS MADE TO THE EXCLUSIVE RIGHT TO USE "SANTA ROSA FRESH", APART FROM THE MARK AS SHOWN.
FOR FRESH PRODUCE, NAMELY, FRESH VEGETABLES, RAW VEGETABLES AND UNPROCESSED VEGETABLES (U.S. CLS. 1 AND 46).
FIRST USE 2-1-2003; IN COMMERCE 5-6-2003.
DAVID MURRAY, EXAMINING ATTORNEY

CLASS 31—(Continued).

SN 78-411,682. KNIGHT HOLLOW NURSERY, INC., MIDDLETON, WI. FILED 4-30-2004.

Chickadee's Rose

THE MARK CONSISTS OF STANDARD CHARACTERS WITHOUT CLAIM TO ANY PARTICULAR FONT, STYLE, SIZE, OR COLOR.

NO CLAIM IS MADE TO THE EXCLUSIVE RIGHT TO USE "ROSE", APART FROM THE MARK AS SHOWN.
FOR ORNAMENTAL SHRUB ROSES (U.S. CLS. 1 AND 46).

FIRST USE 4-13-2004; IN COMMERCE 4-13-2004.
ROBIN CHOSID, EXAMINING ATTORNEY

SN 78-414,106. WEST CENTRAL PRODUCE INC., LOS ANGELES, CA, CA. FILED 5-6-2004.

**WEST CENTRAL
PRODUCE**

THE MARK CONSISTS OF STANDARD CHARACTERS WITHOUT CLAIM TO ANY PARTICULAR FONT, STYLE, SIZE, OR COLOR.

NO CLAIM IS MADE TO THE EXCLUSIVE RIGHT TO USE "PRODUCE", APART FROM THE MARK AS SHOWN.
SEC. 2(F).

FOR FRESH FRUITS, FRESH VEGETABLES (U.S. CLS. 1 AND 46).
FIRST USE 1-1-1975; IN COMMERCE 1-1-1975.
CHARLES JOYNER, EXAMINING ATTORNEY

SN 78-420,599. STOKES SEEDS, LIMITED, THOROLD ONTARIO L2V 5B6, CANADA, FILED 5-18-2004.



PRIORITY CLAIMED UNDER SEC. 44(D) ON CANADA APPLICATION NO. 1215449, FILED 4-30-2004, REG. NO. TMA635029, DATED 3-11-2005, EXPIRES 3-11-2020.

SEC. 2(F).
FOR VEGETABLE SEEDS AND FLOWER SEEDS (U.S. CLS. 1 AND 46).
FIRST USE 0-0-1965; IN COMMERCE 0-0-1965.
GEORGE LORENZO, EXAMINING ATTORNEY

CLASS 31—(Continued).

SN 78-439,695. CAMELOT NURSERIES, INC., DBA MOUNTAIN STATES WHOLESALE NURSERY, LITCHFIELD PARK, AZ. FILED 6-22-2004.

CLASS 31—(Continued).

SN 78-439,704. CAMELOT NURSERIES, INC., DBA MOUNTAIN STATES WHOLESALE NURSERY, LITCHFIELD PARK, AZ. FILED 6-22-2004.

VALENTINE

DESERT CARPET

THE MARK CONSISTS OF STANDARD CHARACTERS WITHOUT CLAIM TO ANY PARTICULAR FONT, STYLE, SIZE, OR COLOR.
SEC. 2(F).
FOR LIVE SHRUBS (U.S. CLS. 1 AND 46).
FIRST USE 4-11-1996; IN COMMERCE 4-11-1996.
STEVEN R. FINE, EXAMINING ATTORNEY

THE MARK CONSISTS OF STANDARD CHARACTERS WITHOUT CLAIM TO ANY PARTICULAR FONT, STYLE, SIZE, OR COLOR.
SEC. 2(F).
FOR LIVE SHRUBS (U.S. CLS. 1 AND 46).
FIRST USE 6-1-1998; IN COMMERCE 6-1-1998.
CAROLINE WOOD, EXAMINING ATTORNEY

SN 78-439,697. CAMELOT NURSERIES, INC., DBA MOUNTAIN STATES WHOLESALE NURSERY, LITCHFIELD PARK, AZ. FILED 6-22-2004.

SN 78-442,044. WEST CENTRAL PRODUCE INC., LOS ANGELES, CA. FILED 6-27-2004.

REGAL MIST

**westcentralproduce
.com**

THE MARK CONSISTS OF STANDARD CHARACTERS WITHOUT CLAIM TO ANY PARTICULAR FONT, STYLE, SIZE, OR COLOR.
SEC. 2(F).
FOR LIVE SHRUBS (U.S. CLS. 1 AND 46).
FIRST USE 1-10-1992; IN COMMERCE 1-1-1992.
STEVEN R. FINE, EXAMINING ATTORNEY

THE MARK CONSISTS OF STANDARD CHARACTERS WITHOUT CLAIM TO ANY PARTICULAR FONT, STYLE, SIZE, OR COLOR.
SEC. 2(F).
FOR FRESH FRUITS, FRESH VEGETABLES (U.S. CLS. 1 AND 46).
FIRST USE 12-24-1999; IN COMMERCE 12-24-1999.
CHARLES JOYNER, EXAMINING ATTORNEY

CLASS 31—(Continued).

SN 78-454,992. SYNGENTA PARTICIPATIONS AG, BASEL, SWITZERLAND, FILED 7-22-2004.

CLASS 31—(Continued).

SN 78-489,060. GRO ALLIANCE LLC, CUBA CITY, WI. FILED 9-24-2004.

BELLAGIO

GRO ALLIANCE

THE MARK CONSISTS OF STANDARD CHARACTERS WITHOUT CLAIM TO ANY PARTICULAR FONT, STYLE, SIZE, OR COLOR.

FOR SEEDS FOR AGRICULTURAL, HORTICULTURAL AND FORESTRY PURPOSES; PLANT SEEDS, SPECIFICALLY EXCLUDING TOMATO SEEDS; LIVE PLANTS, LIVE PLANT SEEDLINGS, LIVE PLANT CUTTINGS, PLANT SEEDS, LIVE PLANT TRANSPLANTS, YOUNG LIVE PLANTS AND OTHER PARTS OF LIVING PLANTS AND YOUNG LIVING PLANTS SUITABLE FOR PROPAGATION, SPECIFICALLY EXCLUDING TOMATO PLANTS, ALL FOR AGRICULTURAL PURPOSES (U.S. CLS. 1 AND 46).

SUNG IN, EXAMINING ATTORNEY

THE MARK CONSISTS OF STANDARD CHARACTERS WITHOUT CLAIM TO ANY PARTICULAR FONT, STYLE, SIZE, OR COLOR.

FOR AGRICULTURAL SEEDS (U.S. CLS. 1 AND 46).
JOHN WILKE, EXAMINING ATTORNEY

SN 78-478,494. SEAPODS, LLC, SEATTLE, WA. FILED 9-3-2004.

SN 78-489,395. ARBOR ACRES FARM, INC., GLASTONBURY, CT. FILED 9-24-2004.

Seapods

Nicholas

THE MARK CONSISTS OF STANDARD CHARACTERS WITHOUT CLAIM TO ANY PARTICULAR FONT, STYLE, SIZE, OR COLOR.

FOR UNPROCESSED LIVE MICROSCOPIC AND MACROSCOPIC ZOOPLANKTON FOR USE AS FOOD FOR LIVE FISH, CORAL, CLAMS, SPONGES, AND OTHER AQUARIUM AND AQUACULTURED DWELLING CREATURES (U.S. CLS. 1 AND 46).

WINSTON FOLMAR, EXAMINING ATTORNEY

OWNER OF U.S. REG. NO. 2,228,992.

FOR LIVE POULTRY; LIVE TURKEYS AND CHICKS; LIVE HATCHING EGGS; LIVE POULTRY FOR BREEDING AND GROWING (U.S. CLS. 1 AND 46).

FIRST USE 4-27-1998; IN COMMERCE 4-27-1998.

INGRID C. EULIN, EXAMINING ATTORNEY

CLASS 31—(Continued).

SN 78-498,017. CHEYNE, JAMES C., KLAMATH FALLS, OR.
FILED 10-11-2004.



NO CLAIM IS MADE TO THE EXCLUSIVE RIGHT TO USE "SHASTA", APART FROM THE MARK AS SHOWN.

THE COLORS WHITE, LIGHT BLUE AND DARK BLUE ARE CLAIMED AS A FEATURE OF THE MARK.

THE MARK CONSISTS OF THE WORD "SHASTA" BELOW THE IMAGE OF A MOUNTAIN. THE LOWER HALF OF THE MARK CONSISTS OF A DARK BLUE RECTANGLE WITH THE WORD SHASTA IN WHITE. THE UPPER HALF OF THE MARK CONSISTS OF AN OUTLINE OF A MOUNTAIN RANGE IN WHITE AGAINST A LIGHT BLUE BACKGROUND.

FOR FRESH POTATOES (U.S. CLS. 1 AND 46).

FIRST USE 9-1-2004; IN COMMERCE 9-1-2004.

PAULA MAHONEY, EXAMINING ATTORNEY

CLASS 31—(Continued).

SN 78-505,058. BALL HORTICULTURAL COMPANY, WEST CHICAGO, IL. FILED 10-25-2004.

STARSTRUCK

THE MARK CONSISTS OF STANDARD CHARACTERS WITHOUT CLAIM TO ANY PARTICULAR FONT, STYLE, SIZE, OR COLOR.

FOR LIVE PLANTS, NAMELY, PELARGONIUMS (U.S. CLS. 1 AND 46).

DAWN HAN, EXAMINING ATTORNEY

SN 78-513,415. BOOTH RANCHES, ORANGE COVE, CA.
FILED 11-8-2004.

SN 78-504,178. THE CHEF'S GARDEN, INC., HURON, OH.
FILED 10-22-2004.

OTIS RANCHES**TASTY T'AISINS**

THE MARK CONSISTS OF STANDARD CHARACTERS WITHOUT CLAIM TO ANY PARTICULAR FONT, STYLE, SIZE, OR COLOR.

FOR FRESH TOMATOES (U.S. CLS. 1 AND 46).

FIRST USE 10-14-2004; IN COMMERCE 10-15-2004.

AMY GEARIN, EXAMINING ATTORNEY

THE MARK CONSISTS OF STANDARD CHARACTERS WITHOUT CLAIM TO ANY PARTICULAR FONT, STYLE, SIZE, OR COLOR.

OWNER OF U.S. REG. NO. 2,921,247.

NO CLAIM IS MADE TO THE EXCLUSIVE RIGHT TO USE "RANCHES", APART FROM THE MARK AS SHOWN.

FOR FRESH ORANGES AND OTHER FRESH CITRUS PRODUCTS, NAMELY FRESH TANGERINES, TANGELOS, AND GRAPEFRUITS (U.S. CLS. 1 AND 46).

JOHN DWYER, EXAMINING ATTORNEY

CLASS 31—(Continued).

SN 78-516,446. TRES TOROS LLC, WESTLAKE VILLAGE, CA. FILED 11-13-2004.

CLASS 31—(Continued).

SN 78-517,220. BENTOLI, INC., HOMESTEAD, FL. FILED 11-15-2004.

SAM'S YAMS

Aqua Savor

THE MARK CONSISTS OF STANDARD CHARACTERS WITHOUT CLAIM TO ANY PARTICULAR FONT, STYLE, SIZE, OR COLOR.

FOR EDIBLE CHEWS FOR ANIMALS (U.S. CLS. 1 AND 46).

FIRST USE 5-0-2004; IN COMMERCE 5-0-2004.
KIMBERLY PERRY, EXAMINING ATTORNEY

THE MARK CONSISTS OF STANDARD CHARACTERS WITHOUT CLAIM TO ANY PARTICULAR FONT, STYLE, SIZE, OR COLOR.

NO CLAIM IS MADE TO THE EXCLUSIVE RIGHT TO USE AQUA, APART FROM THE MARK AS SHOWN.

FOR AQUATIC FEED ADDITIVES, NAMELY, ATTRACTANTS AND STIMULANTS (U.S. CLS. 1 AND 46).
JULIE WATSON, EXAMINING ATTORNEY

SN 78-516,453. TRES TOROS LLC, WESTLAKE VILLAGE, CA. FILED 11-13-2004.

SN 78-518,387. CARGILL, INCORPORATED, WAYZATA, MN. FILED 11-17-2004.

BIG BOYZ

SAFE & SOUND

THE MARK CONSISTS OF STANDARD CHARACTERS WITHOUT CLAIM TO ANY PARTICULAR FONT, STYLE, SIZE, OR COLOR.

FOR EDIBLE CHEWS FOR ANIMALS (U.S. CLS. 1 AND 46).

FIRST USE 8-0-2003; IN COMMERCE 8-0-2003.
KIMBERLY PERRY, EXAMINING ATTORNEY

THE MARK CONSISTS OF STANDARD CHARACTERS WITHOUT CLAIM TO ANY PARTICULAR FONT, STYLE, SIZE, OR COLOR.

FOR ANIMAL FOODSTUFFS (U.S. CLS. 1 AND 46).
FIRST USE 3-18-2004; IN COMMERCE 3-18-2004.

IRA J. GOODSaid, EXAMINING ATTORNEY

CLASS 31—(Continued).

SN 78-519,534. MORARI SPECIALTIES, INC., MIAMI, FL.
FILED 11-18-2004.

CLASS 31—(Continued).

SN 78-519,698. CENZONE TECH, INC., SAN MARCOS, CA.
FILED 11-18-2004.



FOR FRESH PRODUCE, NAMELY, FRUITS AND
VEGETABLES (U.S. CLS. 1 AND 46).
FIRST USE 10-0-2004; IN COMMERCE 10-0-2004.
GEORGE LORENZO, EXAMINING ATTORNEY

MICROBOND

THE MARK CONSISTS OF STANDARD CHARACTERS
WITHOUT CLAIM TO ANY PARTICULAR FONT, STYLE,
SIZE, OR COLOR.
FOR NON-MEDICATED ALL NATURAL ANIMAL
FEED ADDITIVE WHICH PROMOTES GROWTH AND
PRODUCTION (U.S. CLS. 1 AND 46).
FIRST USE 1-0-2001; IN COMMERCE 1-0-2001.
ALICE BENMAMAN, EXAMINING ATTORNEY

SN 78-520,042. CENZONE TECH, INC., SAN MARCOS, CA.
FILED 11-19-2004.

SN 78-519,606. MURAD, JULIE WEISS, DENVER, CO. FILED
11-18-2004.

GREENFEATHER GOODIES

BIOTURE

THE MARK CONSISTS OF STANDARD CHARACTERS
WITHOUT CLAIM TO ANY PARTICULAR FONT, STYLE,
SIZE, OR COLOR.
FOR BEAN MIXES, SPROUT MIXES AND GORP
MIXES FOR BIRDS (U.S. CLS. 1 AND 46).
WILLIAM BRECKENFELD, EXAMINING ATTORNEY

THE MARK CONSISTS OF STANDARD CHARACTERS
WITHOUT CLAIM TO ANY PARTICULAR FONT, STYLE,
SIZE, OR COLOR.
FOR NON-MEDICATED ALL NATURAL ANIMAL
FEED ADDITIVE WHICH PROMOTES GROWTH AND
PRODUCTION (U.S. CLS. 1 AND 46).
FIRST USE 1-0-2002; IN COMMERCE 1-0-2002.
LEIGH LOWRY, EXAMINING ATTORNEY

CLASS 31—(Continued).

SN 78-520,996. THE IAMS COMPANY, DAYTON, OH. FILED 11-22-2004.

CLASS 31—(Continued).

SN 78-522,748. SCHELL & KAMPETER, INC., META, MO. FILED 11-24-2004.

IAMS SMART PUPPY

CHECKUPS

THE MARK CONSISTS OF STANDARD CHARACTERS WITHOUT CLAIM TO ANY PARTICULAR FONT, STYLE, SIZE, OR COLOR.

OWNER OF U.S. REG. NOS. 1,317,225, 1,980,228 AND OTHERS.

NO CLAIM IS MADE TO THE EXCLUSIVE RIGHT TO USE "PUPPY", APART FROM THE MARK AS SHOWN.

FOR FOODSTUFFS FOR DOGS (U.S. CLS. 1 AND 46).
DAWN HAN, EXAMINING ATTORNEY

THE MARK CONSISTS OF STANDARD CHARACTERS WITHOUT CLAIM TO ANY PARTICULAR FONT, STYLE, SIZE, OR COLOR.

FOR EDIBLE CAT AND DOG TREATS (U.S. CLS. 1 AND 46).

CHRIS WELLS, EXAMINING ATTORNEY

SN 78-521,036. LUSK, ALBERT G., WILMINGTON, DE. FILED 11-22-2004.

SN 78-525,071. SOCIETE DES PRODUITS NESTLE S. A., VEVEY, SWITZERLAND, FILED 12-1-2004.

RawDawg

WHOLE MOUTH CLEAN

THE MARK CONSISTS OF STANDARD CHARACTERS WITHOUT CLAIM TO ANY PARTICULAR FONT, STYLE, SIZE, OR COLOR.

FOR DOG AND CAT FOOD (U.S. CLS. 1 AND 46).
STEVEN R. FINE, EXAMINING ATTORNEY

THE MARK CONSISTS OF STANDARD CHARACTERS WITHOUT CLAIM TO ANY PARTICULAR FONT, STYLE, SIZE, OR COLOR.

FOR PET FOOD AND PET TREATS (U.S. CLS. 1 AND 46).

DAVID C. REIHNER, EXAMINING ATTORNEY

CLASS 31—(Continued).

SN 78-525,265. WEISMANTEL, CHERYL A., FERNDAL, WA. FILED 12-1-2004.

CLASS 31—(Continued).

SN 78-526,318. BIALLA, PAUL H., WINDSOR, CA. FILED 12-2-2004.

BIALLA VINEYARDS

Bit o' Luv

THE MARK CONSISTS OF STANDARD CHARACTERS WITHOUT CLAIM TO ANY PARTICULAR FONT, STYLE, SIZE, OR COLOR.

NO CLAIM IS MADE TO THE EXCLUSIVE RIGHT TO USE "VINEYARDS", APART FROM THE MARK AS SHOWN.

FOR FRESH WINE GRAPES (U.S. CLS. 1 AND 46).
FIRST USE 10-1-1995; IN COMMERCE 10-1-1995.
THEODORE MCBRIDE, EXAMINING ATTORNEY

THE MARK CONSISTS OF STANDARD CHARACTERS WITHOUT CLAIM TO ANY PARTICULAR FONT, STYLE, SIZE, OR COLOR.

FOR EDIBLE TREATS FOR CATS AND DOGS, NAMELY, DEHYDRATED BEEF AND CHICKEN LIVER TREATS (U.S. CLS. 1 AND 46).

RONALD MCMORROW, EXAMINING ATTORNEY

SN 78-529,142. PETRA PET, INC., DBA PETRAPPORT, CARLSTADT, NJ. FILED 12-8-2004.

SN 78-525,319. PENNINGTON SEED, INC., MADISON, GA. FILED 12-1-2004.

PORKEEZ

TALL FESCUE PLUS

THE MARK CONSISTS OF STANDARD CHARACTERS WITHOUT CLAIM TO ANY PARTICULAR FONT, STYLE, SIZE, OR COLOR.

NO CLAIM IS MADE TO THE EXCLUSIVE RIGHT TO USE TALL FESCUE, APART FROM THE MARK AS SHOWN.

FOR GRASS SEED (U.S. CLS. 1 AND 46).
STEVEN R. FINE, EXAMINING ATTORNEY

THE MARK CONSISTS OF STANDARD CHARACTERS WITHOUT CLAIM TO ANY PARTICULAR FONT, STYLE, SIZE, OR COLOR.

FOR PET FOOD, PET TREATS, AND PET CHEWS (U.S. CLS. 1 AND 46).

TEJBIR SINGH, EXAMINING ATTORNEY

CLASS 31—(Continued).

SN 78-530,057. S&M NUTEC, LLC, NORTH KASAS CITY, MO. FILED 12-9-2004.

CLASS 31—(Continued).

SN 78-535,393. CASTLEVERDE CORPORATION, EL PASO, TX. FILED 12-20-2004.

HIP CHIPS

THE MARK CONSISTS OF STANDARD CHARACTERS WITHOUT CLAIM TO ANY PARTICULAR FONT, STYLE, SIZE, OR COLOR.

NO CLAIM IS MADE TO THE EXCLUSIVE RIGHT TO USE "CHIPS", APART FROM THE MARK AS SHOWN.

FOR PET FOOD AND EDIBLE PET TREATS (U.S. CLS. 1 AND 46).

FIRST USE 11-1-2004; IN COMMERCE 11-1-2004.
JENNIFER MARTIN, EXAMINING ATTORNEY

CASTLEVERDE

THE MARK CONSISTS OF STANDARD CHARACTERS WITHOUT CLAIM TO ANY PARTICULAR FONT, STYLE, SIZE, OR COLOR.

FOR FRESH ORGANIC VEGETABLES (U.S. CLS. 1 AND 46).

LEIGH CAROLINE CASE, EXAMINING ATTORNEY

SN 78-538,870. OLD MOTHER HUBBARD, INC., LOWELL, MA. FILED 12-28-2004.

SN 78-533,642. NU MAIZE LLC, BOALSBURG, PA. FILED 12-16-2004.

PLANTRITE

THE MARK CONSISTS OF STANDARD CHARACTERS WITHOUT CLAIM TO ANY PARTICULAR FONT, STYLE, SIZE, OR COLOR.

FOR AGRICULTURAL SEEDS (U.S. CLS. 1 AND 46).
GINNY ISAACSON, EXAMINING ATTORNEY



THE LINING AND/OR STIPPLING SHOWN IN THE MARK IS FOR SHADING PURPOSES ONLY, AND IS NOT A FEATURE OF THE MARK NOR AN INDICATION OF COLOR.

THE MARK CONSISTS OF A DOG IN CLOTHING THAT DEPICTS A MOUNTAIN CLIMBER.

FOR DOG FOOD (U.S. CLS. 1 AND 46).
JENNIFER MARTIN, EXAMINING ATTORNEY

CLASS 31—(Continued).

SN 78-540,837. CICCONI, TERESE A., FORT PIERCE, FL.
FILED 1-2-2005.

CLASS 31—(Continued).

SN 78-551,399. ELLIS, GEORGE, POMPANO BEACH, FL.
FILED 1-21-2005.

PUPPALICIOUS

THE MARK CONSISTS OF STANDARD CHARACTERS
WITHOUT CLAIM TO ANY PARTICULAR FONT, STYLE,
SIZE, OR COLOR.
FOR DOG TREATS (U.S. CLS. 1 AND 46).
JASON ROTH, EXAMINING ATTORNEY

THE WORLD OF FRESH HARVEST INTERNATIONAL USA

SN 78-546,323. DEL MONTE CORPORATION, PITTSBURGH,
PA. FILED 1-12-2005.

THE MARK CONSISTS OF STANDARD CHARACTERS
WITHOUT CLAIM TO ANY PARTICULAR FONT, STYLE,
SIZE, OR COLOR.
NO CLAIM IS MADE TO THE EXCLUSIVE RIGHT TO
USE FRESH AND INTERNATIONAL USA, APART FROM
THE MARK AS SHOWN.
FOR FRESH FRUIT AND VEGETABLES (U.S. CLS. 1
AND 46).
STANLEY I. OSBORNE, EXAMINING ATTORNEY

BIG BITS

THE MARK CONSISTS OF STANDARD CHARACTERS
WITHOUT CLAIM TO ANY PARTICULAR FONT, STYLE,
SIZE, OR COLOR.
FOR PET FOOD (U.S. CLS. 1 AND 46).
NANCY CLARKE, EXAMINING ATTORNEY

SN 78-555,048. KENT FEEDS, INC., MUSCATINE, IA. FILED
1-27-2005.

SN 78-548,179. UP RIGHT TRADING CORP., EL MONTE,
CA. FILED 1-14-2005.

Hang Time

AQUA DELITE

THE MARK CONSISTS OF STANDARD CHARACTERS
WITHOUT CLAIM TO ANY PARTICULAR FONT, STYLE,
SIZE, OR COLOR.
FOR FISH FOOD (U.S. CLS. 1 AND 46).
FIRST USE 3-31-1998; IN COMMERCE 3-31-1998.
MIDGE BUTLER, EXAMINING ATTORNEY

THE MARK CONSISTS OF STANDARD CHARACTERS
WITHOUT CLAIM TO ANY PARTICULAR FONT, STYLE,
SIZE, OR COLOR.
FOR LIVESTOCK FEEDS (U.S. CLS. 1 AND 46).
CAROLYN CATALDO, EXAMINING ATTORNEY

CLASS 31—(Continued).

SN 78-555,052. MACKENZIE, DAVID, SPRING LAKE, MI.
FILED 1-27-2005.

LiveRoof

THE MARK CONSISTS OF STANDARD CHARACTERS
WITHOUT CLAIM TO ANY PARTICULAR FONT, STYLE,
SIZE, OR COLOR.

FOR LIVE PLANTS USED FOR ROOF COVERING
(U.S. CLS. 1 AND 46).

CAROLYN CATALDO, EXAMINING ATTORNEY

SN 78-556,107. SOCIETE DES PRODUITS NESTLE, S. A.,
VEVEY, SWITZERLAND, FILED 1-28-2005.

ULTIMATE CHEW

THE MARK CONSISTS OF STANDARD CHARACTERS
WITHOUT CLAIM TO ANY PARTICULAR FONT, STYLE,
SIZE, OR COLOR.

NO CLAIM IS MADE TO THE EXCLUSIVE RIGHT TO
USE CHEW, APART FROM THE MARK AS SHOWN.
FOR PET TREATS (U.S. CLS. 1 AND 46).

ANDREW BENZMILLER, EXAMINING ATTORNEY

SN 78-558,900. LAFEVER, TED, BATAVIA, IL. FILED 2-2-
2005.

WORK 'N CHEW

THE MARK CONSISTS OF STANDARD CHARACTERS
WITHOUT CLAIM TO ANY PARTICULAR FONT, STYLE,
SIZE, OR COLOR.

FOR PET FOOD (U.S. CLS. 1 AND 46).

MONTIA G. PRESSEY, EXAMINING ATTORNEY

CLASS 31—(Continued).

SN 78-590,506. DOGSTERS, LLC, MILFORD, CT. FILED 3-18-
2005.



OWNER OF U.S. REG. NO. 2,921,591.
FOR ANIMAL FOODSTUFFS, PET FOOD, NAMELY,
BEVERAGES FOR ANIMALS, PET BISCUITS, EDIBLE
PET TREATS AND FOOD FOR ANIMALS; LIVE ANI-
MALS (U.S. CLS. 1 AND 46).

JIM RINGLE, EXAMINING ATTORNEY

SN 79-003,434. FLORIMEX INTERNATIONAL B.V., NETH-
ERLANDS, FILED 4-29-2004.

Florimex

OWNER OF INTERNATIONAL REGISTRATION 0544624
DATED 11-10-1989, EXPIRES 11-10-2009.

FOR LIVING PLANTS, CUT FLOWERS (U.S. CLS. 1
AND 46).

KATHLEEN M. VANSTON, EXAMINING ATTORNEY

CLASS 31—(Continued).

SN 79-006,861. EVIALIS SA, FRANCE, FILED 8-23-2004.



OWNER OF INTERNATIONAL REGISTRATION 0837533 DATED 8-23-2004, EXPIRES 8-23-2014.

NO CLAIM IS MADE TO THE EXCLUSIVE RIGHT TO USE "AQUACULTURE", APART FROM THE MARK AS SHOWN.

THE COLOR(S) BLUE AND GREEN IS/ARE CLAIMED AS A FEATURE OF THE MARK.

IN THE TOP HALF, A CIRCLE IS DIVIDED IN TWO EQUAL PARTS, BLUE ON THE LEFT WITH A WHITE SHRIMP, THE OTHER IS GREEN WITH A WHITE FISH. IN THE BOTTOM HALF, THE NAME OCIALIS APPEARS IN BLUE WITH THE DOTS OF THE 'S' IN GREEN.

FOR LIVE ANIMALS, ANIMAL FOODSTUFFS, AQUATIC PLANTS (U.S. CLS. 1 AND 46).

MICHAEL WEBSTER, EXAMINING ATTORNEY

CLASS 32—(Continued).

SN 76-572,199. KAGOME CO., LTD., NAKA-KU, NAGOYA, JAPAN, FILED 1-23-2004.



THE COLOR(S) PURPLE, RED, ORANGE, WHITE, AND GREEN IS/ARE CLAIMED AS A FEATURE OF THE MARK.

THE OUTER RING OF THE MARK IS TAN; THE CURVED SHAPES IN THE INNER CIRCLE OF THE MARK ARE PURPLE, RED, ORANGE, WHITE, AND GREEN; AND THE LETTERING IN THE MARK IS BROWN.

THE MARK CONSISTS OF A COLORED SPIRAL WITH A JAPANESE CHARACTER IN THE CENTER OF THE MARK. FOR FRUIT AND VEGETABLE JUICES (U.S. CLS. 45, 46 AND 48).

JOHN WILKE, EXAMINING ATTORNEY

SN 76-583,677. FRESH ISLAND BEVERAGE COMPANY, WHEELING, IL. FILED 3-29-2004.

FRESH ISLAND**CLASS 32—LIGHT BEVERAGES**

SN 76-558,643. CHARLES WELLS LIMITED, BEDFORD, MK40 4LU, UNITED KINGDOM, FILED 11-10-2003.

JOHN BULL

THE MARK CONSISTS OF STANDARD CHARACTERS WITHOUT CLAIM TO ANY PARTICULAR FONT, STYLE, SIZE, OR COLOR.

OWNER OF UNITED KINGDOM REG. NO. 571,575, DATED 9-15-1936, EXPIRES 9-15-2006.

JOHN BULL DOES NOT IDENTIFY A PARTICULAR LIVING INDIVIDUAL.

FOR BEER PRODUCTS, NAMELY, BEER; ALE; LAGER (U.S. CLS. 45, 46 AND 48).

FRED MANDIR, EXAMINING ATTORNEY

THE MARK CONSISTS OF STANDARD CHARACTERS WITHOUT CLAIM TO ANY PARTICULAR FONT, STYLE, SIZE, OR COLOR.

FOR NON-ALCOHOLIC MIXERS USED IN THE PREPARATION OF BEVERAGES (U.S. CLS. 45, 46 AND 48).

FIRST USE 3-1-2004; IN COMMERCE 3-1-2004.

SONYA STEPHENS, EXAMINING ATTORNEY

SN 76-587,092. CALYPSO WHOLESALE DISTRIBUTORS LLC, BROOKLYN, NY. FILED 4-9-2004.

Rejuvenate

THE MARK CONSISTS OF STANDARD CHARACTERS WITHOUT CLAIM TO ANY PARTICULAR FONT, STYLE, SIZE, OR COLOR.

FOR SPRING WATER (U.S. CLS. 45, 46 AND 48).

MARY CRAWFORD, EXAMINING ATTORNEY

CLASS 32—(Continued).

SN 76-587,852. COTT CORPORATION, TORONTO, ONTARIO, CANADA, FILED 4-21-2004.

AQUENCHIALS

THE MARK CONSISTS OF STANDARD CHARACTERS WITHOUT CLAIM TO ANY PARTICULAR FONT, STYLE, SIZE, OR COLOR.

FOR NON-ALCOHOLIC BEVERAGES, NAMELY, CARBONATED AND NON-CARBONATED SOFT DRINKS, FRUIT DRINKS; WATER BEVERAGES, NAMELY, SPRING WATER, FLAVORED DRINKING WATER, WATER AND FLAVORED WATER ENHANCED WITH VITAMINS; PURIFIED DRINKING WATER AND FILTERED DRINKING WATER (U.S. CLS. 45, 46 AND 48).

VERNA BETH RIRIE, EXAMINING ATTORNEY

SN 76-587,854. COTT CORPORATION, TORONTO, ONTARIO, CANADA, FILED 4-21-2004.

PLAY MAKER

THE MARK CONSISTS OF STANDARD CHARACTERS WITHOUT CLAIM TO ANY PARTICULAR FONT, STYLE, SIZE, OR COLOR.

FOR NON-ALCOHOLIC BEVERAGES, NAMELY, CARBONATED AND NON-CARBONATED SOFT DRINKS, SPORTS DRINKS, FRUIT DRINKS (U.S. CLS. 45, 46 AND 48).

VERNA BETH RIRIE, EXAMINING ATTORNEY

SN 76-595,846. MEHRAN BOTTLERS (PRIVATE) LIMITED, KARACHI, PAKISTAN, FILED 6-7-2004.



FOR MINERAL AND AERATED WATER; SOFT DRINKS, NAMELY CARBONATED SOFT DRINKS AND NON-CARBONATED SOFT DRINKS; AND SYRUPS FOR MAKING CARBONATED AND NON-CARBONATED SOFT DRINKS (U.S. CLS. 45, 46 AND 48).

FIRST USE 1-1-1951; IN COMMERCE 1-1-2001.

BARBARA A. LOUGHRAN, EXAMINING ATTORNEY

CLASS 32—(Continued).

SN 76-603,195. ADVANCED FLUID TECHNOLOGIES INC., SAINT-LAURENT (QUEBEC) H4R 2K9, CANADA, FILED 7-20-2004.

AQUA BOOST OXYGENATED SPRING WATER

THE MARK CONSISTS OF STANDARD CHARACTERS WITHOUT CLAIM TO ANY PARTICULAR FONT, STYLE, SIZE, OR COLOR.

NO CLAIM IS MADE TO THE EXCLUSIVE RIGHT TO USE "AQUA" AND "OXYGENATED SPRING WATER", APART FROM THE MARK AS SHOWN.

FOR OXYGENATED SPRING WATER (U.S. CLS. 45, 46 AND 48).

FIRST USE 6-10-2004; IN COMMERCE 6-10-2004.

EVELYN BRADLEY, EXAMINING ATTORNEY

SN 76-615,463. SUPERIOR SEAFOODS, L.L.C., LOS ANGELES, CA. FILED 10-7-2004.

LOUIS KEMP

THE MARK CONSISTS OF STANDARD CHARACTERS WITHOUT CLAIM TO ANY PARTICULAR FONT, STYLE, SIZE, OR COLOR.

FOR BEERS, MINERAL AND AERATED WATERS AND OTHER NONALCOHOLIC DRINKS, NAMELY SOY BASED DRINKS NOT BEING MILK SUBSTITUTES (U.S. CLS. 45, 46 AND 48).

PATRICIA EVANKO, EXAMINING ATTORNEY

SN 76-615,727. PAN AMERICAN GRAIN MFG. CO., INC., GUAYNABO, PUERTO RICO, FILED 10-14-2004.



OWNER OF U.S. REG. NO. 2,476,004 AND OTHERS. THE ENGLISH TRANSLATION OF THE WORDING MAMI IN THE MARK IS MOMMY.

FOR FRUIT DRINKS, FRUIT JUICES, AERATED WATER, DRINKING WATER, MINERAL WATER, SELTZER WATER, SODA WATER AND SPRING WATER (U.S. CLS. 45, 46 AND 48).

CAROLYN CATALDO, EXAMINING ATTORNEY

CLASS 32—(Continued).

SN 76-619,284. CRYSTAL GEYSER WATER COMPANY, SAN FRANCISCO, CA. FILED 11-4-2004.

AMINA

THE MARK CONSISTS OF STANDARD CHARACTERS WITHOUT CLAIM TO ANY PARTICULAR FONT, STYLE, SIZE, OR COLOR.

FOR FRUIT FLAVORED DRINKS CONTAINING AMINOS; SPORTS DRINKS CONTAINING AMINOS (U.S. CLS. 45, 46 AND 48).

TERESA M. RUPP, EXAMINING ATTORNEY

CLASS 32—(Continued).

SN 76-619,907. EMPRESAS LA FAMOSA, INC., TOA BAJA, PR, PUERTO RICO, FILED 11-9-2004.



OWNER OF U.S. REG. NO. 1,113,759.
PARROT LIKE FIGURE WITH ITS HAT RESEMBLING A COCONUT AND WITH A DRINK IN ITS LEFT WING AND POINTING ITS RIGHT WING.

FOR CREAM OF COCONUT AND COCONUT DERIVED SYRUPS AND BASES PRIMARILY FOR MAKING SOFT DRINKS AND ALCOHOLIC MIXED DRINKS (U.S. CLS. 45, 46 AND 48).

FIRST USE 10-22-1994; IN COMMERCE 10-22-1994.
PRISCILLA MILTON, EXAMINING ATTORNEY

SN 76-619,679. EMPRESAS LA FAMOSA, INC., TOA BAJA, PUERTO RICO, FILED 11-8-2004.

Coco López

OWNER OF U.S. REG. NO. 1,026,342.
NO CLAIM IS MADE TO THE EXCLUSIVE RIGHT TO USE "COCO", APART FROM THE MARK AS SHOWN.
THE NAME COCO LOPEZ DOES NOT IDENTIFY A LIVING INDIVIDUAL.

THE SPANISH WORD "COCO" MEANS "COCONUT".
FOR CREAM OF COCONUT AND COCONUT DERIVED SYRUPS AND BASES PRIMARILY FOR MAKING SOFT DRINKS AND ALCOHOLIC MIXED DRINKS (U.S. CLS. 45, 46 AND 48).

FIRST USE 0-0-1949; IN COMMERCE 10-22-1994.
MELVIN AXILBUND, EXAMINING ATTORNEY

SN 76-619,995. LIEN HOA FOOD CORPORATION, CHICAGO, IL. FILED 11-10-2004.



OWNER OF U.S. REG. NOS. 1,918,169 AND 2,588,246.
THE LINING SHOWN IN THE MARK IS A FEATURE OF THE MARK AND DOES NOT INDICATE COLOR OR SHADING.

THE USE OF A PERSON IN THE PORTRAIT SHOWN IN THE MARK IS NOT INTENDED TO REPRESENT A PARTICULAR LIVING INDIVIDUAL.

THE MARK CONSISTS OF AN ASIAN MAN SITTING IN THE MIDDLE, WITH A DRAGON'S HEAD TO HIS RIGHT AND THE DRAGON'S TAIL TO HIS LEFT, A FISH RESTING ON HIS SHOULDERS WITH THE HEAD OF THE FISH ON HIS RIGHT SHOULDER, THE FINS ON HIS LEFT SHOULDER, AND FLOWERS IN THE BACKGROUND.

SEC. 2(F).
FOR NON-ALCOHOLIC, NON-CARBONATED SPORTS ENERGY DRINK (U.S. CLS. 45, 46 AND 48).
FIRST USE 5-24-2004; IN COMMERCE 5-24-2004.
LAURA KOVAISKY, EXAMINING ATTORNEY

CLASS 32—(Continued).

SN 76-623,494. JAQUEZ, RAMON E., BRENTWOOD, NY.
FILED 12-6-2004.



NO CLAIM IS MADE TO THE EXCLUSIVE RIGHT TO USE MULTI-VITAMIN ENHANCED WATER, APART FROM THE MARK AS SHOWN.

FOR BOTTLED DRINKING WATER (U.S. CLS. 45, 46 AND 48).

FIRST USE 11-15-2004; IN COMMERCE 11-15-2004.
DOMINICK J. SALEMI, EXAMINING ATTORNEY

SN 76-627,717. SALES USA, INC., SALADO, TX. FILED 1-5-2005.

POCO RICO

THE MARK CONSISTS OF STANDARD CHARACTERS WITHOUT CLAIM TO ANY PARTICULAR FONT, STYLE, SIZE, OR COLOR.

THE ENGLISH TRANSLATION OF THE TERM "POCO RICO" IS "LITTLE RICH".

FOR NON-ALCOHOLIC BEVERAGES, NAMELY FRUIT DRINKS AND FRUIT JUICES (U.S. CLS. 45, 46 AND 48).

LEIGH CAROLINE CASE, EXAMINING ATTORNEY

SN 78-237,477. UNITED BRANDS COMPANY, INC., LOS ANGELES, CA. FILED 4-14-2003.

SIZE DOES MATTER

FOR FRUIT JUICE; CARBONATED AND NON-CARBONATED ENERGY SOFT DRINKS, SPORT DRINKS ENHANCED WITH VITAMINS, MINERALS, CAFFEINE, NUTRIENT, AMINO ACIDS, OR HERBS (U.S. CLS. 45, 46 AND 48).

WILLIAM VERHOSEK, EXAMINING ATTORNEY

CLASS 32—(Continued).

SN 78-291,748. SUNNY DELIGHT BEVERAGES CO., CINCINNATI, OH. FILED 8-25-2003.

SUNNY D INTENSE SPORT

OWNER OF U.S. REG. NOS. 1,343,111, 1,734,136 AND 2,164,130.

NO CLAIM IS MADE TO THE EXCLUSIVE RIGHT TO USE "SPORT", APART FROM THE MARK AS SHOWN.

FOR FRUIT JUICE DRINKS CONTAINING WATER (U.S. CLS. 45, 46 AND 48).

NORA BUCHANAN WILL, EXAMINING ATTORNEY

SN 78-333,768. JAMBA JUICE COMPANY, SAN FRANCISCO, CA. FILED 11-26-2003.

BLENDER LITES

THE MARK CONSISTS OF STANDARD CHARACTERS WITHOUT CLAIM TO ANY PARTICULAR FONT, STYLE, SIZE, OR COLOR.

NO CLAIM IS MADE TO THE EXCLUSIVE RIGHT TO USE LITES, APART FROM THE MARK AS SHOWN.

FOR FRUIT AND VEGETABLE JUICES; SMOOTHIES (U.S. CLS. 45, 46 AND 48).

BARBARA GAYNOR, EXAMINING ATTORNEY

SN 78-343,154. AMERICAN LIQUID PACKAGING SYSTEMS, INC., REDWOOD CITY, CA. FILED 12-18-2003.



THE MARK CONSISTS OF A TEAR SHAPED DROP OF WATER INSIDE THE CIRCULAR CENTER OF AN EIGHT-POINTED STAR.

FOR BOTTLED DRINKING WATER, MINERAL WATER AND SPRING WATER (U.S. CLS. 45, 46 AND 48).

FIRST USE 6-1-1998; IN COMMERCE 6-15-1998.
JOHN GARTNER, EXAMINING ATTORNEY

CLASS 32—(Continued).

SN 78-348,184. SHREWSBERRY, JOHN A., EDWARDS, MS. FILED 1-6-2004.



NO CLAIM IS MADE TO THE EXCLUSIVE RIGHT TO USE "WATER" AND "MINERAL AND TRACE MINERAL ENHANCED WATER", APART FROM THE MARK AS SHOWN.

THE COLOR(S) BLUE RED IS/ARE CLAIMED AS A FEATURE OF THE MARK.

THE COLOR(S) BLUE RED IS/ARE APART OF THE MARK.

THE MARK CONSISTS OF PRO HAS BLUE FADING COLOR WATER HAS RED FADING COLOR.

FOR BOTTLED MINERAL WATER FOR CONSUMER CONSUMPTION (U.S. CLS. 45, 46 AND 48).

KAREN BRACEY, EXAMINING ATTORNEY

CLASS 32—(Continued).

SN 78-349,801. A&W CONCENTRATE COMPANY, WHITE PLAINS, NY. FILED 1-9-2004.



NO CLAIM IS MADE TO THE EXCLUSIVE RIGHT TO USE "BARREL-AGED AND BOLD TASTE", APART FROM THE MARK AS SHOWN.

THE LINING IN THE DRAWING IS A FEATURE OF THE MARK AND NOT INTENDED TO INDICATE COLOR.

THE MARK CONSISTS OF A BARREL FOR CARBONATED SOFT DRINKS (U.S. CLS. 45, 46 AND 48).

FIRST USE 2-1-1996; IN COMMERCE 2-1-1996.

DEZMONA MIZELLE, EXAMINING ATTORNEY

SN 78-350,000. CRUNK LLC, CARLSBAD, CA. FILED 1-9-2004.

DRAWING PAGE



SN 78-348,425. MEHANA BREWING COMPANY, INC., HILO, HI. FILED 1-6-2004.



OWNER OF U.S. REG. NO. 2,775,595. THE MARK CONSISTS OF CENTER OF LETTERS HAS GRADIENT FILL.

THE FOREIGN WORDING IN THE MARK TRANSLATES INTO ENGLISH AS WARMTH.

FOR MALT BASED BEER (U.S. CLS. 45, 46 AND 48).

FIRST USE 12-5-1996; IN COMMERCE 12-5-1996.

GINA HAYES, EXAMINING ATTORNEY

THE STIPPLING IS A FEATURE OF THE MARK. THE COLORS GRAY, ORANGE AND BLACK ARE CLAIMED AS FEATURES OF THE MARK.

THE STAR DESIGN AND SOME OF THE DOTS IN THE MARK ARE GRAY. THE BACKGROUND OF THE MARK IS ORANGE. THE LETTERING IS BLACK. THE EDGES OF THE LETTERING ARE GRAY.

FOR NON-ALCOHOLIC BEVERAGES, NAMELY, SOFT DRINKS, SPORTS DRINKS, ENERGY DRINKS, ISOTONIC DRINKS, HYPERTONIC DRINKS AND HYPOTONIC DRINKS; NON-ALCOHOLIC COCKTAILS AND DRINKS IN THE NATURE OF SOFT DRINKS, NON-ALCOHOLIC BEER, NON-ALCOHOLIC PUNCHES, NON-ALCOHOLIC COCKTAIL MIXES, NON-ALCOHOLIC MALT-COOLERS, NON-ALCOHOLIC WINE, NON-ALCOHOLIC WINE COCKTAILS, NON-ALCOHOLIC LIQUEURS AND NON-ALCOHOLIC MIXED COCKTAILS (U.S. CLS. 45, 46 AND 48).

FIRST USE 11-0-2003; IN COMMERCE 11-0-2003.

AISHA CLARKE, EXAMINING ATTORNEY

CLASS 32—(Continued).

SN 78-362,975. HOLSTEIN-BRAUEREI AG, D 22765 HAMBURG, FED REP GERMANY, FILED 2-5-2004.

DUCKSTEIN

THE MARK CONSISTS OF STANDARD CHARACTERS WITHOUT CLAIM TO ANY PARTICULAR FONT, STYLE, SIZE, OR COLOR.

OWNER OF FED REP GERMANY REG. NO. 1111540, DATED 9-17-1987, EXPIRES 1-31-2007.

FOR BEERS (U.S. CLS. 45, 46 AND 48).

CHERYL STEPLIGHT, EXAMINING ATTORNEY

SN 78-378,410. MITSUI NORIN CO., LTD., TOKYO, JAPAN, FILED 3-4-2004.

mitsui tea

THE MARK CONSISTS OF STANDARD CHARACTERS WITHOUT CLAIM TO ANY PARTICULAR FONT, STYLE, SIZE, OR COLOR.

PRIORITY CLAIMED UNDER SEC. 44(D) ON JAPAN APPLICATION NO. 2003-115122, FILED 12-25-2003.

NO CLAIM IS MADE TO THE EXCLUSIVE RIGHT TO USE "TEA", APART FROM THE MARK AS SHOWN.

FOR WATERS, NAMELY, DRINKING WATER, MINERAL WATER, SPRING WATER; NON-ALCOHOLIC BEVERAGES, NAMELY, NON-ALCOHOLIC CARBONATED BEVERAGES, NON-ALCOHOLIC BEVERAGES WITH TEA FLAVOR; NON-ALCOHOLIC FRUIT JUICE BEVERAGES; WHEY BEVERAGES; VEGETABLE JUICES. (U.S. CLS. 45, 46 AND 48).

RON FAIRBANKS, EXAMINING ATTORNEY

CLASS 32—(Continued).

SN 78-387,676. DONAGHY, RYAN, FRESNO, CA. FILED 3-19-2004.



ORGANICA

NO CLAIM IS MADE TO THE EXCLUSIVE RIGHT TO USE "ORGANICA", APART FROM THE MARK AS SHOWN.

THE MARK CONSISTS OF THE WORD ORGANICA BELOW A MUG OF BEER WITH A WHEAT STEM BEHIND AND OVER THE BEER MUG.

THE FOREIGN WORDING IN THE MARK TRANSLATES INTO ENGLISH AS ORGANIC.

FOR ORGANIC BEER (U.S. CLS. 45, 46 AND 48).

STEVEN JACKSON, EXAMINING ATTORNEY

SN 78-413,940. ANHEUSER-BUSCH, INCORPORATED, ST. LOUIS, MO. FILED 5-6-2004.

ANHEUSER

THE MARK CONSISTS OF STANDARD CHARACTERS WITHOUT CLAIM TO ANY PARTICULAR FONT, STYLE, SIZE, OR COLOR.

OWNER OF U.S. REG. NOS. 1,499,106, 2,844,072 AND OTHERS.

SEC. 2(F).

FOR BEER (U.S. CLS. 45, 46 AND 48).

FIRST USE 5-26-2003; IN COMMERCE 5-26-2003.

DAWN FELDMAN, EXAMINING ATTORNEY

CLASS 32—(Continued).

SN 78-422,731. CREEKSIDE SPRINGS, LLC, AMBRIDGE, PA.
FILED 5-21-2004.

CLASS 32—(Continued).

SN 78-446,473. SCHWEPPES INTERNATIONAL LIMITED,
LONDON, UNITED KINGDOM, FILED 7-6-2004.

HYPERPURE WATER

MIX WITH THE BEST

THE MARK CONSISTS OF STANDARD CHARACTERS
WITHOUT CLAIM TO ANY PARTICULAR FONT, STYLE,
SIZE, OR COLOR.

NO CLAIM IS MADE TO THE EXCLUSIVE RIGHT TO
USE "WATER", APART FROM THE MARK AS SHOWN.
FOR BOTTLED DRINKING WATER (U.S. CLS. 45, 46
AND 48).

FIRST USE 1-8-2004; IN COMMERCE 1-8-2004.
CHRISIE B. KING, EXAMINING ATTORNEY

THE MARK CONSISTS OF STANDARD CHARACTERS
WITHOUT CLAIM TO ANY PARTICULAR FONT, STYLE,
SIZE, OR COLOR.

FOR TONIC WATER, CLUB SODA, SELTZER WATER,
FLAVORED SELTZER WATER, SPARKLING WATER,
NON ALCOHOLIC BITTER LEMON COCKTAIL MIX,
NON ALCOHOLIC COLLINS COCKTAIL MIX, NON
ALCOHOLIC SOUR COCKTAIL MIX, GINGER ALE,
FLAVORED GINGER ALE, SOFT DRINKS, SYRUPS
AND CONCENTRATES FOR MAKING SOFT DRINKS,
FRUIT JUICES AND FRUIT JUICE DRINKS (U.S. CLS.
45, 46 AND 48).

LOURDES AYALA, EXAMINING ATTORNEY

SN 78-446,319. LIQUID SALVATION, INC., RENO, NV.
FILED 7-6-2004.

SN 78-449,789. MEDION CORPORATION, TORONTO, ON-
TARIO, CANADA, FILED 7-13-2004.

GET LIQ'D

EMEND

THE MARK CONSISTS OF STANDARD CHARACTERS
WITHOUT CLAIM TO ANY PARTICULAR FONT, STYLE,
SIZE, OR COLOR.

FOR PURE SPRING BOTTLED WATER (U.S. CLS. 45,
46 AND 48).

FIRST USE 4-24-2003; IN COMMERCE 4-24-2003.
JENNIFER CHICOSKI, EXAMINING ATTORNEY

THE MARK CONSISTS OF STANDARD CHARACTERS
WITHOUT CLAIM TO ANY PARTICULAR FONT, STYLE,
SIZE, OR COLOR.

PRIORITY CLAIMED UNDER SEC. 44(D) ON CANADA
APPLICATION NO. 1223290, FILED 7-13-2004, REG. NO.
TMA639511, DATED 5-10-2005, EXPIRES 5-10-2020.

FOR SPORTS DRINK (U.S. CLS. 45, 46 AND 48).
MARK SPARACINO, EXAMINING ATTORNEY

CLASS 32—(Continued).

SN 78-470,212. THE COCA-COLA COMPANY, ATLANTA, GA. FILED 8-19-2004.

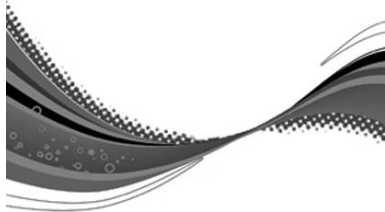

OWNER OF U.S. REG. NOS. 1,057,885 AND 2,793,129. THE STIPLING IS A FEATURE OF THE MARK. THE MARK CONSISTS OF THE COCA-COLA C2 MODIFIED DYNAMIC RIBBON.

FOR NON-ALCOHOLIC BEVERAGES, NAMELY SOFT DRINKS; SYRUPS AND CONCENTRATES FOR MAKING BEVERAGES, NAMELY SOFT DRINKS (U.S. CLS. 45, 46 AND 48).

FIRST USE 5-25-2004; IN COMMERCE 6-11-2004. BARBARA BROWN, EXAMINING ATTORNEY

SN 78-470,293. THE COCA-COLA COMPANY, ATLANTA, GA. FILED 8-19-2004.



OWNER OF U.S. REG. NOS. 1,057,885 AND 2,793,129. THE STIPLING IS A FEATURE OF THE MARK. THE MARK CONSISTS OF THE MODIFIED DYNAMIC RIBBON FOR DIET COKE WITH LEMON/LIME.

FOR NON-ALCOHOLIC BEVERAGES, NAMELY SOFT DRINKS; SYRUPS AND CONCENTRATES FOR MAKING BEVERAGES, NAMELY SOFT DRINKS (U.S. CLS. 45, 46 AND 48).

FIRST USE 2-1-2004; IN COMMERCE 2-1-2004. KATRINA EDGE, EXAMINING ATTORNEY

SN 78-476,097. ACQUA FRESCA DISTRIBUTORS, LLC, WESTERLY, RI. FILED 8-30-2004.



NO CLAIM IS MADE TO THE EXCLUSIVE RIGHT TO USE "ACQUA FRESCA NATURAL SPRING WATER", APART FROM THE MARK AS SHOWN.

THE COLOR(S) BLUE, ACQUA BLUE, WHITE IS/ARE CLAIMED AS A FEATURE OF THE MARK.

THE MARK CONSISTS OF THE WORDS ACQUA FRESCA ARE A DEEP BLUE WITH A WHITE SHADED BORDER.

CLASS 32—(Continued).

THE WORDS NATURAL SPRING WATER ARE WHITE WITH A BLACK SHADOW BORDER. THE Q IS SIGNIFICANTLY LARGER THAN ANY OTHER LETTER IN THE TRADEMARK AND ALSO CONTAINS A 5 GALLON BOTTLE INSIDE OF THE LETTER Q. THE Q IS CAPITALIZED. THERE IS A WHITE KNOCKOUT BACKGROUND BETWEEN THE INSIDE OF THE Q AND THE OUTSIDE OF THE 5 GALLON BOTTLE. THE WORDS ACQUA FRESCA NATURAL SPRING WATER ARE ON A LIGHT BLUE BACKDROP.

FOR BOTTLED SPRING WATER IN VARIOUS SIZES (U.S. CLS. 45, 46 AND 48).

FIRST USE 2-1-2001; IN COMMERCE 2-1-2001. KEVON CHISOLM, EXAMINING ATTORNEY

SN 78-477,524. RIVER WEST BRANDS LLC, CHICAGO, IL. FILED 9-1-2004.

SOHO NATURAL

THE MARK CONSISTS OF STANDARD CHARACTERS WITHOUT CLAIM TO ANY PARTICULAR FONT, STYLE, SIZE, OR COLOR.

NO CLAIM IS MADE TO THE EXCLUSIVE RIGHT TO USE "NATURAL", APART FROM THE MARK AS SHOWN.

FOR NON-ALCOHOLIC BEVERAGES, NAMELY, CARBONATED BEVERAGES AND SYRUP FOR MAKING THE SAME; FRUIT JUICES (U.S. CLS. 45, 46 AND 48).

REBECCA GILBERT, EXAMINING ATTORNEY

SN 78-478,530. TALKING RAIN BEVERAGE CO. INC., PRESTON, WA. FILED 9-3-2004.



FOR BOTTLED FLAVORED WATER (U.S. CLS. 45, 46 AND 48).

ESTHER BELENKER, EXAMINING ATTORNEY

CLASS 32—(Continued).

SN 78-480,273. SANAQUA INC., CHADDS FORD, PA. FILED 9-8-2004.

SAN AQUA

THE MARK CONSISTS OF STANDARD CHARACTERS WITHOUT CLAIM TO ANY PARTICULAR FONT, STYLE, SIZE, OR COLOR.
NO CLAIM IS MADE TO THE EXCLUSIVE RIGHT TO USE "AQUA", APART FROM THE MARK AS SHOWN.
FOR BOTTLED DRINKING WATER (U.S. CLS. 45, 46 AND 48).
GIANCARLO CASTRO, EXAMINING ATTORNEY

SN 78-483,013. BREAKTHRU PRODUCTS, LLC, NEW YORK, NY. FILED 9-14-2004.



OWNER OF U.S. REG. NO. 2,911,579.
THE MARK CONSISTS OF THE DESIGN OF A LIGHTNING BOLT/BURST OF FIRE WITH THE WORD BREAKTHRU IN THE CENTER.
FOR SPORTS DRINKS (U.S. CLS. 45, 46 AND 48).
FIRST USE 6-23-2004; IN COMMERCE 6-30-2004.
JOHN HWANG, EXAMINING ATTORNEY

CLASS 32—(Continued).

SN 78-486,816. FISVARG ARGENTINA S.A., MENDOZA, ARGENTINA, FILED 9-21-2004.

GREEN GOLIATH

THE MARK CONSISTS OF STANDARD CHARACTERS WITHOUT CLAIM TO ANY PARTICULAR FONT, STYLE, SIZE, OR COLOR.
OWNER OF U.S. REG. NO. 2,788,410.
NO CLAIM IS MADE TO THE EXCLUSIVE RIGHT TO USE GREEN, APART FROM THE MARK AS SHOWN.
FOR SOFT DRINKS AND FRUIT AND VEGETABLE JUICES (U.S. CLS. 45, 46 AND 48).
TRACY WHITAKER-BOWN, EXAMINING ATTORNEY

SN 78-492,912. AMERICAN DAIRY QUEEN CORPORATION, EDINA, MN. FILED 10-1-2004.

ARCTIC RUSH

THE MARK CONSISTS OF STANDARD CHARACTERS WITHOUT CLAIM TO ANY PARTICULAR FONT, STYLE, SIZE, OR COLOR.
FOR FLAVORED SEMI-FROZEN SLUSH TYPE SOFT DRINKS; NON-CARBONATED SOFT DRINKS (U.S. CLS. 45, 46 AND 48).
FIRST USE 4-24-2005; IN COMMERCE 4-24-2005.
JOHN WILKE, EXAMINING ATTORNEY

SN 78-503,584. PEPSICO, INC., PURCHASE, NY. FILED 10-21-2004.



OWNER OF U.S. REG. NOS. 811,787, 2,654,546 AND OTHERS.
FOR SOFT DRINKS, AND SYRUPS AND CONCENTRATES FOR MAKING THE SAME (U.S. CLS. 45, 46 AND 48).
ESTHER BELENKER, EXAMINING ATTORNEY

CLASS 32—(Continued).

SN 78-507,309. OTSUKA SYOKUHUIN KABUSHIKI KAISHA, DBA OTSUKA FOODS CO., LTD., CHUO-KU, OSAKA, JAPAN, FILED 10-28-2004.

SINVINO SPARKLING

THE MARK CONSISTS OF STANDARD CHARACTERS WITHOUT CLAIM TO ANY PARTICULAR FONT, STYLE, SIZE, OR COLOR.

NO CLAIM IS MADE TO THE EXCLUSIVE RIGHT TO USE "SPARKLING", APART FROM THE MARK AS SHOWN.

FOR NON-ALCOHOLIC BEVERAGES, NAMELY, CARBONATED DRINKS; NON-ALCOHOLIC FRUIT JUICE BEVERAGES (U.S. CLS. 45, 46 AND 48).

DORITT L. CARROLL, EXAMINING ATTORNEY

SN 78-510,523. 7-ELEVEN, INC., DALLAS, TX. FILED 11-3-2004.

BIG GULP ICE CREAM FLOAT

THE MARK CONSISTS OF STANDARD CHARACTERS WITHOUT CLAIM TO ANY PARTICULAR FONT, STYLE, SIZE, OR COLOR.

OWNER OF U.S. REG. NOS. 1,110,172, 2,749,708 AND OTHERS.

NO CLAIM IS MADE TO THE EXCLUSIVE RIGHT TO USE "ICE CREAM SODA FLOAT", APART FROM THE MARK AS SHOWN.

FOR SOFT DRINKS CONTAINING ICE CREAM FOR CONSUMPTION ON OR OFF THE PREMISES (U.S. CLS. 45, 46 AND 48).

INGRID C. EULIN, EXAMINING ATTORNEY

CLASS 32—(Continued).

SN 78-513,002. CADBURY BEVERAGES INC., RYE BROOK, NY. FILED 11-8-2004.

CHELMSFORD

THE MARK CONSISTS OF STANDARD CHARACTERS WITHOUT CLAIM TO ANY PARTICULAR FONT, STYLE, SIZE, OR COLOR.

OWNER OF U.S. REG. NO. 202,201.

FOR NON-ALCOHOLIC BEVERAGES, NAMELY, SOFT DRINKS AND SYRUPS FOR THE PREPARATION OF SAME (U.S. CLS. 45, 46 AND 48).

FIRST USE 1-20-1925; IN COMMERCE 1-20-1925.

MARGERY A. TIERNEY, EXAMINING ATTORNEY

SN 78-514,651. MILLER PRODUCTS COMPANY, MILWAUKEE, WI. FILED 11-10-2004.



NO CLAIM IS MADE TO THE EXCLUSIVE RIGHT TO USE "ESTABLISHED 1895", "FINEST QUALITY" AND "INGREDIENTS", APART FROM THE MARK AS SHOWN.

FOR BEER (U.S. CLS. 45, 46 AND 48).

FIRST USE 7-19-2004; IN COMMERCE 7-19-2004.

ANN LINNEHAN, EXAMINING ATTORNEY

SN 78-518,750. SUNNY DELIGHT BEVERAGES CO., CINCINNATI, OH. FILED 11-17-2004.



OWNER OF U.S. REG. NOS. 1,343,111, 1,916,700 AND OTHERS.

NO CLAIM IS MADE TO THE EXCLUSIVE RIGHT TO USE "BEVERAGES CO.", APART FROM THE MARK AS SHOWN.

FOR FRUIT JUICE DRINKS CONTAINING WATER (U.S. CLS. 45, 46 AND 48).

GRETTA YAO, EXAMINING ATTORNEY

CLASS 32—(Continued).

SN 78-518,874. OLD EUROPEAN BREWERY COMPANY, SAN DIEGO, CA. FILED 11-17-2004.

CLASS 32—(Continued).

SN 78-520,509. KIM, JOHN JUNGMIN, REDONDO BEACH, CA. FILED 11-19-2004.

SIMPLE SELTZER

THE MARK CONSISTS OF STANDARD CHARACTERS WITHOUT CLAIM TO ANY PARTICULAR FONT, STYLE, SIZE, OR COLOR.

NO CLAIM IS MADE TO THE EXCLUSIVE RIGHT TO USE "SELTZER", APART FROM THE MARK AS SHOWN.

FOR SOFT DRINKS, NAMELY CARBONATED SOFT DRINKS, LOW CALORIE SOFT DRINKS, NON-CARBONATED SOFT DRINKS (U.S. CLS. 45, 46 AND 48).

TINA L. SNAPP, EXAMINING ATTORNEY

Qi Water

THE MARK CONSISTS OF STANDARD CHARACTERS WITHOUT CLAIM TO ANY PARTICULAR FONT, STYLE, SIZE, OR COLOR.

NO CLAIM IS MADE TO THE EXCLUSIVE RIGHT TO USE "WATER", APART FROM THE MARK AS SHOWN.

THE ENGLISH TRANSLATION OF THE WORD QI IN THE MARK IS "ENERGY" OR "LIFE FORCE".

FOR DRINKING WATER, NATURAL WATER, SPRING WATER, AND PURIFIED WATER (U.S. CLS. 45, 46 AND 48).

ATTIYA MALIK, EXAMINING ATTORNEY

SN 78-519,197. PEPSICO, INC., PURCHASE, NY. FILED 11-18-2004.

LET IT FLOW

THE MARK CONSISTS OF STANDARD CHARACTERS WITHOUT CLAIM TO ANY PARTICULAR FONT, STYLE, SIZE, OR COLOR.

FOR SOFT DRINKS (U.S. CLS. 45, 46 AND 48).

WARREN L. OLANDRIA, EXAMINING ATTORNEY

SN 78-521,099. PEPSICO, INC., PURCHASE, NY. FILED 11-22-2004.

SPORTS PASS

SN 78-520,149. BOONRAWD BREWERY CO., LTD., BANGKOK, THAILAND, FILED 11-19-2004.

THE LION OF ASIA

THE MARK CONSISTS OF STANDARD CHARACTERS WITHOUT CLAIM TO ANY PARTICULAR FONT, STYLE, SIZE, OR COLOR.

FOR BEER AND MALT LIQUOR (U.S. CLS. 45, 46 AND 48).

WILLIAM P. SHANAHAN, EXAMINING ATTORNEY

THE MARK CONSISTS OF STANDARD CHARACTERS WITHOUT CLAIM TO ANY PARTICULAR FONT, STYLE, SIZE, OR COLOR.

FOR SOFT DRINKS (U.S. CLS. 45, 46 AND 48).

MONTIA G. PRESSEY, EXAMINING ATTORNEY

CLASS 32—(Continued).

SN 78-522,472. THE DANNON COMPANY, INC., WHITE PLAINS, NY. FILED 11-24-2004.

DANNON FRUSION

THE MARK CONSISTS OF STANDARD CHARACTERS WITHOUT CLAIM TO ANY PARTICULAR FONT, STYLE, SIZE, OR COLOR.

OWNER OF U.S. REG. NO. 2,651,045.
FOR FRUIT JUICES AND FRUIT DRINKS; FRUIT-BASED BEVERAGES WITH YOGURT; SMOOTHIES (U.S. CLS. 45, 46 AND 48).

FIRST USE 1-16-2001; IN COMMERCE 1-16-2001.
MARK T. MULLEN, EXAMINING ATTORNEY

SN 78-523,622. WIDMER BROTHERS BREWING COMPANY, PORTLAND, OR. FILED 11-29-2004.

W'07

THE MARK CONSISTS OF STANDARD CHARACTERS WITHOUT CLAIM TO ANY PARTICULAR FONT, STYLE, SIZE, OR COLOR.

FOR BEER (U.S. CLS. 45, 46 AND 48).
PAM WILLIS, EXAMINING ATTORNEY

SN 78-527,050. TWENTIETH CENTURY FOX FILM CORPORATION, LOS ANGELES, CA. FILED 12-3-2004.

DUFF

THE MARK CONSISTS OF STANDARD CHARACTERS WITHOUT CLAIM TO ANY PARTICULAR FONT, STYLE, SIZE, OR COLOR.

FOR CARBONATED AND NON-CARBONATED SOFT DRINKS, FRUIT DRINKS, FRUIT JUICES, MINERAL AND AERATED WATER, SYRUPS AND POWDERS FOR MAKING SOFT DRINKS AND OTHER BEVERAGES, NAMELY SOFT DRINKS, FRUIT DRINKS AND TEA (U.S. CLS. 45, 46 AND 48).

MARC LEIPZIG, EXAMINING ATTORNEY

CLASS 32—(Continued).

SN 78-529,291. AMT GROUP, LLC, SKOKIE, IL. FILED 12-8-2004.

NIGHT LIGHT

THE MARK CONSISTS OF STANDARD CHARACTERS WITHOUT CLAIM TO ANY PARTICULAR FONT, STYLE, SIZE, OR COLOR.

FOR ENERGY-PROVIDING BEVERAGES (U.S. CLS. 45, 46 AND 48).

CAROLINE WOOD, EXAMINING ATTORNEY

SN 78-529,494. 1952, LLC, NAPLES, FL. FILED 12-8-2004.

SYNÀ

Natural Artesian Spring Water

THE MARK CONSISTS OF STANDARD CHARACTERS WITHOUT CLAIM TO ANY PARTICULAR FONT, STYLE, SIZE, OR COLOR.

NO CLAIM IS MADE TO THE EXCLUSIVE RIGHT TO USE "NATURAL ARTESIAN SPRING WATER", APART FROM THE MARK AS SHOWN.

SYNÀ IS A BRAZILIAN RAINFOREST TRIBAL WORD WHICH REFERS TO WATER.

FOR MINERAL WATER, SPRING WATER, FLAVORED WATER, BOTTLED WATER; DRINKING WATER, NAMELY VITAMIN AND MINERAL WATERS AND HERBAL WATERS (U.S. CLS. 45, 46 AND 48).

LAURA KOVAISKY, EXAMINING ATTORNEY

CLASS 32—(Continued).

SN 78-546,643. NITROUS OXIDE SYSTEMS, INC., CYPRESS, CA. FILED 1-12-2005.

NOS

THE MARK CONSISTS OF STANDARD CHARACTERS WITHOUT CLAIM TO ANY PARTICULAR FONT, STYLE, SIZE, OR COLOR.

OWNER OF U.S. REG. NOS. 1,725,069, 1,738,011 AND 1,895,895.

FOR ENERGY DRINKS (U.S. CLS. 45, 46 AND 48).
WILLIAM VERHOSEK, EXAMINING ATTORNEY

CLASS 32—(Continued).

SN 78-568,358. NORTON, JOSEPH J., BRIGHTON, MI. FILED 2-16-2005.

BUG

THE MARK CONSISTS OF STANDARD CHARACTERS WITHOUT CLAIM TO ANY PARTICULAR FONT, STYLE, SIZE, OR COLOR.

FOR FRUIT FLAVORED BEVERAGES (U.S. CLS. 45, 46 AND 48).

HEATHER THOMPSON, EXAMINING ATTORNEY

SN 78-587,690. NORTON, JOSEPH J., BRIGHTON, MI. FILED 3-15-2005.

SN 78-546,710. SALES CHILDREN INTERNATIONAL INC., ROCKVILLE, MD. FILED 1-12-2005.

DRINKBUGJUICE.COM



THE MARK CONSISTS OF STANDARD CHARACTERS WITHOUT CLAIM TO ANY PARTICULAR FONT, STYLE, SIZE, OR COLOR.

FOR FRUIT FLAVORED BEVERAGES (U.S. CLS. 45, 46 AND 48).

FIRST USE 1-3-1997; IN COMMERCE 1-3-1997.

HEATHER THOMPSON, EXAMINING ATTORNEY

SN 78-609,212. PABST BREWING COMPANY, SAN ANTONIO, TX. FILED 4-14-2005.

ANDEKER

NO CLAIM IS MADE TO THE EXCLUSIVE RIGHT TO USE "ENERGY DRINK FORTIFIED WITH VITAMINS", APART FROM THE MARK AS SHOWN.

THE MARK CONSISTS OF A STYLIZED IMAGE OF A TYRANNOSAURUS REX HOLDING THE WORDS "T-REX" IN HIS CLAWS WITH FLYING PTERODACTYLS CIRCLING IN THE BACKGROUND.

FOR NON-ALCOHOLIC FRUIT JUICE BASED BEVERAGES; ENERGY DRINKS (U.S. CLS. 45, 46 AND 48).

RICHARD A. STRASER, EXAMINING ATTORNEY

THE MARK CONSISTS OF STANDARD CHARACTERS WITHOUT CLAIM TO ANY PARTICULAR FONT, STYLE, SIZE, OR COLOR.

OWNER OF U.S. REG. NO. 363,733.

FOR BEER (U.S. CLS. 45, 46 AND 48).

JASON ROTH, EXAMINING ATTORNEY

CLASS 32—(Continued).

SN 78-620,676. THE COCA-COLA COMPANY, ATLANTA, GA. FILED 5-2-2005.

DASANI

THE MARK CONSISTS OF STANDARD CHARACTERS WITHOUT CLAIM TO ANY PARTICULAR FONT, STYLE, SIZE, OR COLOR.

OWNER OF U.S. REG. NOS. 2,315,899 AND 2,738,003.

FOR NON-ALCOHOLIC BEVERAGES, NAMELY, SOFT DRINKS AND FLAVORED WATERS; SYRUPS, POWDERS AND CONCENTRATES FOR MAKING NON-ALCOHOLIC BEVERAGES, NAMELY, SOFT DRINKS AND FLAVORED WATERS (U.S. CLS. 45, 46 AND 48).

FIRST USE 6-15-2004; IN COMMERCE 6-15-2004.

JIM RINGLE, EXAMINING ATTORNEY

CLASS 32—(Continued).

SN 79-006,734. BOSK SERVICE S.R.L., ITALY, FILED 5-25-2004.



OWNER OF INTERNATIONAL REGISTRATION 0837176 DATED 5-25-2004, EXPIRES 5-25-2014.

NO CLAIM IS MADE TO THE EXCLUSIVE RIGHT TO USE FRUIT OR SUCCHI, APART FROM THE MARK AS SHOWN.

THE COLORS WHITE, YELLOW, RED, ORANGE, GREEN, BROWN, PINK AND BLUE ARE CLAIMED AS FEATURES OF THE MARK.

THE COLOR WHITE APPEARS IN AN OVAL THE CENTER OF THE ARRANGEMENT OF FRUIT AND IN THE WORDING SUCCHI A BASE DI VITA, THE COLOR GREEN OUTLINES THE WORD BOSK AND APPEARS IN A GREEN LEAF, THE COLOR BLUE APPEARS IN THE BACKGROUND, AND VARIOUS SHADES OF THE COLORS YELLOW, RED, ORANGE, GREEN AND BROWN APPEAR THROUGHOUT THE FRUIT ARRANGEMENT.

THE ENGLISH TRANSLATION OF SUCCHI A BASE DI VITA IS LIFE BASED JUICES.

FOR FRUIT DRINKS; FRUIT JUICES; SYRUPS AND OTHER PREPARATIONS FOR MAKING FRUIT DRINKS (U.S. CLS. 45, 46 AND 48).

JOHN KELLY, EXAMINING ATTORNEY

CLASS 33—WINES AND SPIRITS

SN 76-349,853. ARCUS AS, OSLO, NORWAY, FILED 12-17-2001.

SN 79-005,398. NEUMARKTER LAMMSBRÄU; GEBR. EHRNSPERGER E.K., FED REP GERMANY, FILED 8-19-2004.

Lammsbräu

OWNER OF INTERNATIONAL REGISTRATION 0579147 DATED 11-9-1991, EXPIRES 11-9-2011.

THE FOREIGN WORDING IN THE MARK TRANSLATES INTO ENGLISH AS LAMB BREW.

FOR BEERS, MINERAL WATERS, LEMONADES, FRUIT JUICES, FRUIT NECTARS (U.S. CLS. 45, 46 AND 48).

DORITT L. CARROLL, EXAMINING ATTORNEY

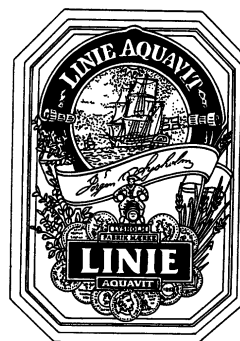

OWNER OF U.S. REG. NO. 1,986,531.

NO CLAIM IS MADE TO THE EXCLUSIVE RIGHT TO USE "AQUAVIT" AND "FABRIK MARKE", APART FROM THE MARK AS SHOWN.

THE ENGLISH TRANSLATION OF "FABRIK MARKE" MEANS "TRADEMARK". THE ENGLISH TRANSLATION OF "LINIE" MEANS "EQUATOR".

FOR ALCOHOLIC BEVERAGES, NAMELY, AQUAVIT, RUM, VODKA, GIN AND WHISKY (U.S. CLS. 47 AND 49).

FIRST USE 12-31-1954; IN COMMERCE 12-31-1954.

CRAIG D. TAYLOR, EXAMINING ATTORNEY

CLASS 33—(Continued).

SN 76-522,784. CAVAS VAMER, S.A. DE C.V., STATE OF JALISCO, MEXICO, FILED 6-9-2003.

IMPALA

OWNER OF MEXICO REG. NO. 748682, DATED 1-16-2002, EXPIRES 1-16-2012.
FOR TEQUILA (U.S. CLS. 47 AND 49).
LEIGH CAROLINE CASE, EXAMINING ATTORNEY

CLASS 33—(Continued).

SN 76-559,886. LOGSTOR ENTERPRISES LIMITED, NICOSIA, CYPRUS, FILED 11-14-2003.



SN 76-542,786. HEPPLER, RICHARD U., PHOENIXVILLE, PA. FILED 9-4-2003.

PANDA

FOR ALCOHOL BEVERAGES OTHER THAN BEER, NAMELY, WINE (U.S. CLS. 47 AND 49).
LINDA E. BLOHM, EXAMINING ATTORNEY

OWNER OF RUSSIAN FED. REG. NO. 221889, DATED 9-22-2002, EXPIRES 11-23-2011.

NO CLAIM IS MADE TO THE EXCLUSIVE RIGHT TO USE "VODKA", APART FROM THE MARK AS SHOWN.

THE LINING IS A FEATURE OF THE MARK AND DOES NOT INDICATE COLOR.

THE MARK CONSISTS OF THE WORDS "VODKA" AND "PEHOTNAYA" WITH A FANCIFUL REPRESENTATION OF A RUSSIAN ARMY BADGE. THE CENTER OF THE BADGE IS A RUSSIAN "N" SUGGESTING THAT THIS BADGE IS FROM THE REIGN OF CZAR NICHOLAS I.

APPLICANT RESPECTFULLY STATES THAT THE ENGLISH TRANSLATION OF "PEHOTA" IS INFANTRY AND THAT "PEHOTNAYA" IS AN ADJECTIVE FORM OF "PEHOTA".

FOR SPRITS AND BEVERAGES, NAMELY APERITIFS, BRANDY, GIN, BITTERS, VODKA, WHISKEY (U.S. CLS. 47 AND 49).

INGA ERVIN, EXAMINING ATTORNEY

SN 76-564,570. TEMPLE FAMILY VINEYARDS, LLC, ST. HELENA, CA. FILED 12-10-2003.

TEMPLE FAMILY VINEYARDS

SN 76-554,954. SIGNATORY VINTAGE SCOTCH WHISKY COMPANY LIMITED, EH6 5PY EDINBURGH, UNITED KINGDOM, FILED 10-23-2003.

BALLECHIN

OWNER OF UNITED KINGDOM REG. NO. 2329726, DATED 11-14-2003, EXPIRES 4-16-2013.
FOR SCOTCH WHISKY (U.S. CLS. 47 AND 49).
KATHY DE JONGE, EXAMINING ATTORNEY

THE MARK CONSISTS OF STANDARD CHARACTERS WITHOUT CLAIM TO ANY PARTICULAR FONT, STYLE, SIZE, OR COLOR.

NO CLAIM IS MADE TO THE EXCLUSIVE RIGHT TO USE "VINEYARDS", APART FROM THE MARK AS SHOWN.

SEC. 2(F) AS TO "TEMPLE".

FOR WINE (U.S. CLS. 47 AND 49).

FIRST USE 12-1-1992; IN COMMERCE 12-1-1992.

MELVIN AXILBUND, EXAMINING ATTORNEY

CLASS 33—(Continued).

SN 76-589,388. STONINGTON VINEYARDS, INC., STONINGTON, CT. FILED 4-29-2004.

STONINGTON VINEYARDS



NO CLAIM IS MADE TO THE EXCLUSIVE RIGHT TO USE VINEYARDS, APART FROM THE MARK AS SHOWN. SEC. 2(F) AS TO STONINGTON.
FOR WINES (U.S. CLS. 47 AND 49).
FIRST USE 10-15-1987; IN COMMERCE 10-15-1987.
LINDA ESTRADA, EXAMINING ATTORNEY

SN 76-590,994. SOCIEDADE DOS VINHOS BORGES, S.A., 4435 RIO TINTO, PORTUGAL, FILED 5-7-2004.



OWNER OF U.S. REG. NO. 963,045.
NO CLAIM IS MADE TO THE EXCLUSIVE RIGHT TO USE "PORTO", APART FROM THE MARK AS SHOWN.
THE ENGLISH TRANSLATION OF THE WORD PORTO IN THE MARK IS PORT
FOR PORT WINE (U.S. CLS. 47 AND 49).
FIRST USE 3-31-1996; IN COMMERCE 3-31-1996.
MARLENE BELL, EXAMINING ATTORNEY

SN 76-591,307. A. V. IMPORTS, INC., COLUMBIA, MD. FILED 5-7-2004.

PAZZA LUPO

THE MARK CONSISTS OF STANDARD CHARACTERS WITHOUT CLAIM TO ANY PARTICULAR FONT, STYLE, SIZE, OR COLOR.
THE ENGLISH TRANSLATION OF THE WORD PAZZA LUPO IN THE MARK IS CRAZY WOLF.
FOR WINES (U.S. CLS. 47 AND 49).
MIDGE BUTLER, EXAMINING ATTORNEY

CLASS 33—(Continued).

SN 76-592,174. SAINT BRENDAN'S IRISH CREAM LIQUEUR CO. LTD., DERRY, NORTHERN IRELAND, FILED 5-14-2004.

SAINT BRENDAN'S SUPERIOR IRISH CREAM LIQUEUR TREATS

THE MARK CONSISTS OF STANDARD CHARACTERS WITHOUT CLAIM TO ANY PARTICULAR FONT, STYLE, SIZE, OR COLOR.

OWNER OF U.S. REG. NOS. 1,359,610, 2,122,955 AND 2,124,931.

NO CLAIM IS MADE TO THE EXCLUSIVE RIGHT TO USE "SUPERIOR IRISH CREAM LIQUEUR", APART FROM THE MARK AS SHOWN.

FOR LIQUEURS (U.S. CLS. 47 AND 49).
RAMONA ORTIGA, EXAMINING ATTORNEY

SN 76-593,358. BAQUEDANO, JUAN IGNACIO VELASCO, S/ N 31230 VIANA, NAVARRA, SPAIN, FILED 5-20-2004.

LLAMA

PRIORITY CLAIMED UNDER SEC. 44(D) ON SPAIN APPLICATION NO. 2568114, FILED 11-20-2003, REG. NO. 2568114, DATED 4-20-2004, EXPIRES 11-20-2013.

FOR ALCOHOLIC BEVERAGES NAMELY, WINES (U.S. CLS. 47 AND 49).

CAROLYN GRAY, EXAMINING ATTORNEY

SN 76-593,990. WESTERN WINES LIMITED, SHROPSHIRE, UNITED KINGDOM, FILED 5-26-2004.

CARANCHO

THE MARK CONSISTS OF STANDARD CHARACTERS WITHOUT CLAIM TO ANY PARTICULAR FONT, STYLE, SIZE, OR COLOR.

PRIORITY CLAIMED UNDER SEC. 44(D) ON UNITED KINGDOM APPLICATION NO. 2357510, FILED 3-4-2004, REG. NO. 2357510, DATED 8-13-2004, EXPIRES 3-4-2014.

FOR WINE; TABLE WINE (U.S. CLS. 47 AND 49).
G. MAYERSCHOFF, EXAMINING ATTORNEY

CLASS 33—(Continued).

SN 76-595,791. L & J WINES, LLC, NAPA, CA. FILED 6-7-2004.

JOCELYN

THE MARK CONSISTS OF STANDARD CHARACTERS WITHOUT CLAIM TO ANY PARTICULAR FONT, STYLE, SIZE, OR COLOR.

FOR WINE (U.S. CLS. 47 AND 49).
FIRST USE 4-0-2002; IN COMMERCE 6-0-2002.
MARK RADEMACHER, EXAMINING ATTORNEY

SN 76-598,791. CNS ENTERPRISES INC., SO. EL MONTE, CA.
FILED 6-21-2004.



NO CLAIM IS MADE TO THE EXCLUSIVE RIGHT TO USE "BRAND", APART FROM THE MARK AS SHOWN.

THE MARK CONSISTS OF THE WORDS "CHENG BRAND," THE TWO CHINESE CHARACTERS " " WHICH TRANSLITERATE IN MANDARIN TO "CHENG PAI," AND WHICH TRANSLATES TO "FORT BRAND;" AND THE DISTINCTIVE LOGO OF AN ORIENTAL FORT.

FOR WINES, COOKING WINES, AND DISTILLED LIQUORS (U.S. CLS. 47 AND 49).

FIRST USE 5-1-1990; IN COMMERCE 5-1-1990.
TIMOTHY FINNEGAN, EXAMINING ATTORNEY

SN 76-600,372. VINA VENTISQUERO LIMITADA, SECTOR PUNTA DE CORTES, RANCAGUA, CHILE, FILED 6-30-2004.

BALADA

THE MARK CONSISTS OF STANDARD CHARACTERS WITHOUT CLAIM TO ANY PARTICULAR FONT, STYLE, SIZE, OR COLOR.

THE ENGLISH TRANSLATION OF "BALADA" IS "BAL-LAD".

FOR ALCOHOLIC BEVERAGES, NAMELY, WINE AND DISTILLED SPIRITS (U.S. CLS. 47 AND 49).

KELLY BOULTON, EXAMINING ATTORNEY

CLASS 33—(Continued).

SN 76-603,377. MEY ALKOLLU ICKILER SANAYII VE TICARET ANONIM SIRKETI, 1 MASLAK ISTANBUL, TURKEY, FILED 7-22-2004.

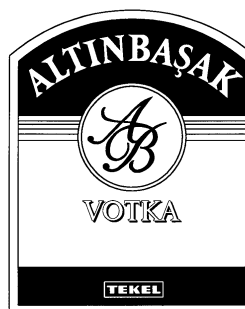

OWNER OF TURKEY REG. NO. 200007582, DATED 4-25-2000, EXPIRES 4-25-2010.

NO CLAIM IS MADE TO THE EXCLUSIVE RIGHT TO USE "VOTKA", APART FROM THE MARK AS SHOWN. THE ENGLISH TRANSLATION OF "VOTKA" IS "VODKA".

FOR VODKA (U.S. CLS. 47 AND 49).
C. DIONNE CLYBURN, EXAMINING ATTORNEY

SN 76-605,328. MUDHOUSE WINE CO. LIMITED, RENWICK, MARLBOROUGH, NEW ZEALAND, FILED 8-3-2004.



NO CLAIM IS MADE TO THE EXCLUSIVE RIGHT TO USE "MARLBOROUGH WINES NEW ZEALAND", APART FROM THE MARK AS SHOWN.

FOR ALCOHOLIC BEVERAGES, NAMELY WINES (U.S. CLS. 47 AND 49).

FIRST USE 2-2-2000; IN COMMERCE 2-2-2000.
C. DIONNE CLYBURN, EXAMINING ATTORNEY

CLASS 33—(Continued).

SN 76-619,561. CASA VINICOLA ZONIN S.P.A., 36053 GAMBELLARA (VICENZA), ITALY, FILED 11-5-2004.

VILLA ROGOLE

THE MARK CONSISTS OF STANDARD CHARACTERS WITHOUT CLAIM TO ANY PARTICULAR FONT, STYLE, SIZE, OR COLOR.

FOR WINES AND SPARKLING WINES (U.S. CLS. 47 AND 49).

BARBARA GAYNOR, EXAMINING ATTORNEY

SN 76-619,921. STEVEN ALTSCHULER, LLC, CLIFFSIDE PARK, NJ, FILED 11-9-2004.

MR. A

THE MARK CONSISTS OF STANDARD CHARACTERS WITHOUT CLAIM TO ANY PARTICULAR FONT, STYLE, SIZE, OR COLOR.

"MR. A" IDENTIFIES A LIVING INDIVIDUAL WHOSE CONSENT IS OF RECORD.

FOR WINE AND DISTILLED SPIRITS (U.S. CLS. 47 AND 49).

LINDA POWELL, EXAMINING ATTORNEY

SN 76-620,134. ZAKRYITOYE AKSIONERNOYE OBSHCHESTVO "REGION-AM", MOSCOW, RUSSIAN FED., FILED 11-12-2004.

CHAYKA

THE MARK CONSISTS OF STANDARD CHARACTERS WITHOUT CLAIM TO ANY PARTICULAR FONT, STYLE, SIZE, OR COLOR.

FOR VODKA (U.S. CLS. 47 AND 49).

PAULA MAHONEY, EXAMINING ATTORNEY

CLASS 33—(Continued).

SN 76-620,465. BRONCO WINE COMPANY, CERES, CA, FILED 11-15-2004.

QUAIL CREEK

THE MARK CONSISTS OF STANDARD CHARACTERS WITHOUT CLAIM TO ANY PARTICULAR FONT, STYLE, SIZE, OR COLOR.

FOR WINES (U.S. CLS. 47 AND 49).

FIRST USE 10-6-2003; IN COMMERCE 10-6-2003.

GEORGE LORENZO, EXAMINING ATTORNEY

SN 76-620,477. HENRY'S DRIVE VIGNERONS PTY LTD, PADTHAWAY, SOUTH AUSTRALIA, AUSTRALIA, FILED 11-15-2004.

HENRY'S DRIVE

THE MARK CONSISTS OF STANDARD CHARACTERS WITHOUT CLAIM TO ANY PARTICULAR FONT, STYLE, SIZE, OR COLOR.

FOR WINES (U.S. CLS. 47 AND 49).

FIRST USE 12-0-1999; IN COMMERCE 12-0-1999.

MARIAM MAHMOUDI, EXAMINING ATTORNEY

SN 76-621,178. CEDAR KNOLL VINEYARDS, INC., NAPA, CA, FILED 11-18-2004.



FOR ALCOHOLIC BEVERAGES, NAMELY, WINES (U.S. CLS. 47 AND 49).

FIRST USE 8-11-2003; IN COMMERCE 8-11-2003.

DOMINIC J. FERRAIUOLO, EXAMINING ATTORNEY

CLASS 33—(Continued).

SN 76-621,203. BODEGAS OTTO BESTUE, S.L., 22312 ENATE (HUESCA), SPAIN, FILED 11-15-2004.

BESTUÉ DE OTTO BESTUÉ

THE MARK CONSISTS OF STANDARD CHARACTERS WITHOUT CLAIM TO ANY PARTICULAR FONT, STYLE, SIZE, OR COLOR.

THE ENGLISH TRANSLATION OF THE WORD "DE" IN THE MARK IS "OF".

FOR WINES (U.S. CLS. 47 AND 49).

FIRST USE 0-0-2002; IN COMMERCE 0-0-2003.

DAWN HAN, EXAMINING ATTORNEY

SN 76-623,303. VIÑAS ARGENTINAS S.A., COQUIMBITO MAIPU MENDOZA, ARGENTINA, FILED 12-6-2004.

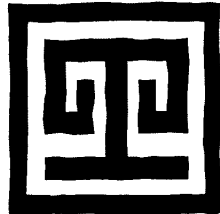
TELTECA**WINERY**

NO CLAIM IS MADE TO THE EXCLUSIVE RIGHT TO USE "WINERY", APART FROM THE MARK AS SHOWN.
FOR WINES (U.S. CLS. 47 AND 49).
RONALD MCMORROW, EXAMINING ATTORNEY

SN 76-623,304. VIÑAS ARGENTINA S.A., COQUIMBITO MAIPU MENDOZA, ARGENTINA, FILED 12-6-2004.

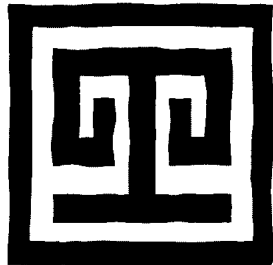

FOR WINES (U.S. CLS. 47 AND 49).
RONALD MCMORROW, EXAMINING ATTORNEY

CLASS 33—(Continued).

SN 76-625,303. RUTHERGLEN ESTATES PTY LTD, RUTHERGLEN VIC 3685, AUSTRALIA, FILED 12-21-2004.



OWNER OF AUSTRALIA REG. NO. 924158, DATED 8-22-2002, EXPIRES 8-22-2012.

NO CLAIM IS MADE TO THE EXCLUSIVE RIGHT TO USE "RUTHERGLEN ESTATES", APART FROM THE MARK AS SHOWN.

FOR WINES (U.S. CLS. 47 AND 49).

DAVID MURRAY, EXAMINING ATTORNEY

SN 76-626,155. ZIMMERMAN, MARC H., LAKE HAVASU CITY, AZ. FILED 12-28-2004.

Divine Wine Imports International

THE MARK CONSISTS OF STANDARD CHARACTERS WITHOUT CLAIM TO ANY PARTICULAR FONT, STYLE, SIZE, OR COLOR.

NO CLAIM IS MADE TO THE EXCLUSIVE RIGHT TO USE WINE IMPORTS INTERNATIONAL, APART FROM THE MARK AS SHOWN.

FOR DISTILLED SPIRITS, WINE, AND ALCOHOLIC BEVERAGES PRODUCED FROM A BREWED MALT BASE WITH NATURAL FLAVORS (U.S. CLS. 47 AND 49).

LINDA POWELL, EXAMINING ATTORNEY

SN 76-627,210. COLUMBIA RIVER WINERY, INC., HOOD RIVER, OR. FILED 1-6-2005.

**Cathedral Ridge
Winery**

THE MARK CONSISTS OF STANDARD CHARACTERS WITHOUT CLAIM TO ANY PARTICULAR FONT, STYLE, SIZE, OR COLOR.

NO CLAIM IS MADE TO THE EXCLUSIVE RIGHT TO USE WINERY, APART FROM THE MARK AS SHOWN.

FOR WINES (U.S. CLS. 47 AND 49).

FIRST USE 5-5-2004; IN COMMERCE 6-24-2004.

VIVIAN MICZNIK FIRST, EXAMINING ATTORNEY

SN 78-054,205. E. & J. GALLO WINERY, MODESTO, CA. FILED 3-21-2001.

WILD BULL

OWNER OF U.S. REG. NO. 2,921,387.

FOR WINES (U.S. CLS. 47 AND 49).

ELISSA GARBER KON, EXAMINING ATTORNEY

CLASS 33—(Continued).

SN 78-197,729. TEQUILA CUERVO LA ROJENA, S.A. DE C.V., CODIGO 45070, MEXICO, FILED 12-24-2002.



THE LINING IS A FEATURE OF THE MARK AND IS NOT INTENDED TO INDICATE COLOR.

THE MARK CONSISTS OF THE SHAPE OF A BOTTLE CONSISTING OF A OVAL BASE AND A TAPERED NECK. THE FRONT OF THE BOTTLE CONTAINS A FLAT RECTANGULAR SURFACE. RIDGES RUN VERTICALLY DOWN THE SIDES OF THE BOTTLE.

FOR ALCOHOLIC BEVERAGES, NAMELY, TEQUILA (U.S. CLS. 47 AND 49).

SHARI SHEFFIELD, EXAMINING ATTORNEY

CLASS 33—(Continued).

SN 78-350,023. LYLES, COSMOS M S, NEW YORK, NY. FILED 1-9-2004.

FRUIT-O-HOL

THE MARK CONSISTS OF STANDARD CHARACTERS WITHOUT CLAIM TO ANY PARTICULAR FONT, STYLE, SIZE, OR COLOR.

FOR ALCOHOLIC BEVERAGES, NAMELY, RUM, GIN, TEQUILA, WHISKEY, COGNAC, VODKA AND DISTILLED SPIRITS MIXED WITH FRUIT JUICE (U.S. CLS. 47 AND 49).

FIRST USE 11-1-2002; IN COMMERCE 11-1-2002.

ZACHARY BELLO, EXAMINING ATTORNEY

SN 78-288,820. DEHESA DE LOS LLANOS, S.L., ALBACETE, SPAIN, FILED 8-18-2003.

MEDWHITE

FOR WINES (U.S. CLS. 47 AND 49).
SOPHIA S. KIM, EXAMINING ATTORNEY

SN 78-385,426. VIÑA TARAPACÁ EX ZAVALA S.A., SANTIAGO, CHILE, FILED 3-16-2004.

TEMMA

SN 78-317,242. DIAGEO BRANDS B.V., AMSTERDAM, NETHERLANDS, FILED 10-22-2003.

GILBEY'S

SEC. 2(F).
FOR VODKA AND GIN; SPIRITS (U.S. CLS. 47 AND 49).
FIRST USE 0-0-1857; IN COMMERCE 0-0-1857.
SAMUEL E. SHARPER JR., EXAMINING ATTORNEY

SN 78-319,437. ZUCCARDI, JOSE ALBERTO, MAIPÚ, PROVINCIA DE MENDOZA, ARGENTINA, FILED 10-28-2003.

MALAMADO

OWNER OF ARGENTINA REG. NO. 1912627, DATED 2-7-2003, EXPIRES 2-7-2013.

FOR WINES AND DISTILLED SPIRIT OF GRAPES AND FRUITS (U.S. CLS. 47 AND 49).

YONG KIM, EXAMINING ATTORNEY

THE MARK CONSISTS OF STANDARD CHARACTERS WITHOUT CLAIM TO ANY PARTICULAR FONT, STYLE, SIZE, OR COLOR.

PRIORITY CLAIMED UNDER SEC. 44(D) ON CHILE APPLICATION NO. 640.106, FILED 3-12-2004, REG. NO. 702.453, DATED 9-3-2000, EXPIRES 9-3-2010.

FOR WINES AND SPARKLING WINES (U.S. CLS. 47 AND 49).

JANICE L. MCMORROW, EXAMINING ATTORNEY

CLASS 33—(Continued).

SN 78-386,867. INDEPENDENT LIQUOR (NZ) LIMITED, PAKAKURA, AUCKLAND, NEW ZEALAND, FILED 3-18-2004.

FX

THE MARK CONSISTS OF STANDARD CHARACTERS WITHOUT CLAIM TO ANY PARTICULAR FONT, STYLE, SIZE, OR COLOR.

FOR PREPARED ALCOHOLIC COCKTAILS AND VODKA-BASED COOLERS (U.S. CLS. 47 AND 49).
TONI HICKEY, EXAMINING ATTORNEY

SN 78-401,547. FATTORIE AZZOLINO S.R.L., 90043 CAMPORALE (PA), ITALY, FILED 4-14-2004.

FATTORIE AZZOLINO

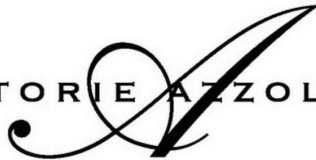

OWNER OF ERPN CMNTY TM OFC REG. NO. 002768869, DATED 9-22-2003, EXPIRES 7-8-2012.

NO CLAIM IS MADE TO THE EXCLUSIVE RIGHT TO USE "FATTORIE", APART FROM THE MARK AS SHOWN. THE FOREIGN WORDING IN THE MARK TRANSLATES INTO ENGLISH AS AZZOLINO FARMS.

FOR WINES (U.S. CLS. 47 AND 49).
ASMAT KHAN, EXAMINING ATTORNEY

SN 78-407,156. CHATAM INTERNATIONAL INCORPORATED, WILMINGTON, DE. FILED 4-23-2004.



NO CLAIM IS MADE TO THE EXCLUSIVE RIGHT TO USE "WINE OF WESTERN CAPE" "SOUTH AFRICA", APART FROM THE MARK AS SHOWN.

THE STIPPLING IS A FEATURE OF THE MARK.
FOR WINE (U.S. CLS. 47 AND 49).
STEVEN JACKSON, EXAMINING ATTORNEY

CLASS 33—(Continued).

SN 78-412,368. CHALONE WINE GROUP, LTD., THE, NAPA, CA. FILED 5-3-2004.

TERRA IGNEUS

THE MARK CONSISTS OF STANDARD CHARACTERS WITHOUT CLAIM TO ANY PARTICULAR FONT, STYLE, SIZE, OR COLOR.

THE FOREIGN WORDING IN THE MARK TRANSLATES INTO ENGLISH AS BURNING EARTH.
FOR WINE (U.S. CLS. 47 AND 49).
JOHN WILKE, EXAMINING ATTORNEY

SN 78-415,664. TITTARELLI VITIVINICOLA Y OLIVICOLA SOCIEDAD ANONIMA, BUENOS AIRES, CAPITAL FEDERAL, ARGENTINA, FILED 5-10-2004.

TITTARELLI

THE MARK CONSISTS OF STANDARD CHARACTERS WITHOUT CLAIM TO ANY PARTICULAR FONT, STYLE, SIZE, OR COLOR.

SEC. 2(F).
FOR WINES (U.S. CLS. 47 AND 49).
FIRST USE 12-30-1915; IN COMMERCE 12-11-1996.
LANA PHAM, EXAMINING ATTORNEY

CLASS 33—(Continued).

SN 78-417,809. AVELINO VEGAS, S.A., SANTIUSTE DE SAN JUAN BAUTISTA, SPAIN, FILED 5-13-2004.

CLASS 33—(Continued).

SN 78-420,033. LOPEZ LORENZO, AUGUSTO RAMON, MIAMI, FL. AND LOPEZ LORENZO, EVA MARIA, MIAMI, FL. FILED 5-17-2004.

CASA LA LUNA

CUBANACAN

THE MARK CONSISTS OF STANDARD CHARACTERS WITHOUT CLAIM TO ANY PARTICULAR FONT, STYLE, SIZE, OR COLOR.

OWNER OF SPAIN REG. NO. 2415969, DATED 5-20-2002, EXPIRES 7-19-2011.

THE FOREIGN WORDING IN THE MARK TRANSLATES INTO ENGLISH AS HOUSE OF THE MOON.

FOR ALCOHOLIC BEVERAGES, NAMELY WINE. (U.S. CLS. 47 AND 49).

JAMES GRIFFIN, EXAMINING ATTORNEY

THE MARK CONSISTS OF STANDARD CHARACTERS WITHOUT CLAIM TO ANY PARTICULAR FONT, STYLE, SIZE, OR COLOR.

FOR ALCOHOLIC BEVERAGES, NAMELY RUM, RUM WITH FRUIT FLAVORS, AND LIQUEURS (U.S. CLS. 47 AND 49).

DAVID C. REIHNER, EXAMINING ATTORNEY

SN 78-417,811. BODEGAS FUENTESPINA, S.L., FUENTESPINA, SPAIN, FILED 5-13-2004.

SN 78-421,076. RIVER ROAD VINEYARDS, SEBASTOPOL, CA. FILED 5-18-2004.



RIVER ROAD

OWNER OF SPAIN REG. NO. 2260414, DATED 10-20-2000, EXPIRES 9-29-2009.

NO CLAIM IS MADE TO THE EXCLUSIVE RIGHT TO USE "BODEGAS", APART FROM THE MARK AS SHOWN.

THE FOREIGN WORDING IN THE MARK TRANSLATES INTO ENGLISH AS WINE CELLAR.

FOR ALCOHOLIC BEVERAGES, NAMELY WINE. (U.S. CLS. 47 AND 49).

JAMES GRIFFIN, EXAMINING ATTORNEY

THE MARK CONSISTS OF STANDARD CHARACTERS WITHOUT CLAIM TO ANY PARTICULAR FONT, STYLE, SIZE, OR COLOR.

FOR WINES (U.S. CLS. 47 AND 49).
FIRST USE 0-0-1979; IN COMMERCE 0-0-1979.
ANN LINNEHAN, EXAMINING ATTORNEY

CLASS 33—(Continued).

SN 78-424,551. ACCADEMIA DEI RACEMI S.R.L., 74024 MANDURIA (TA), ITALY, FILED 5-25-2004.

CLASS 33—(Continued).

SN 78-435,583. SOL DIOS TEQUILA CO. LLC, NEW YORK, NY, FILED 6-15-2004.

TRULLARI

DON BERNARDO G

THE MARK CONSISTS OF STANDARD CHARACTERS WITHOUT CLAIM TO ANY PARTICULAR FONT, STYLE, SIZE, OR COLOR.

PRIORITY CLAIMED UNDER SEC. 44(D) ON ITALY APPLICATION NO. FE2004C0001, FILED 4-22-2004, REG. NO. 970168, DATED 6-23-2005, EXPIRES 4-22-2014.

FOR WINES (U.S. CLS. 47 AND 49).
CHRISTOPHER ADKINS, EXAMINING ATTORNEY

THE MARK CONSISTS OF STANDARD CHARACTERS WITHOUT CLAIM TO ANY PARTICULAR FONT, STYLE, SIZE, OR COLOR.

THE NAME(S), PORTRAIT(S), AND/OR SIGNATURE(S) SHOWN IN THE MARK DOES NOT IDENTIFY A PARTICULAR LIVING INDIVIDUAL.

FOR DISTILLED ALCOHOLIC BEVERAGES, NAMELY DISTILLED LIQUOR (U.S. CLS. 47 AND 49).
MARK SPARACINO, EXAMINING ATTORNEY

SN 78-440,375. CRYSTAL CRUISES, INC., LOS ANGELES, CA. FILED 6-23-2004.

SN 78-434,825. SAZERAC COMPANY, INC., NEW ORLEANS, LA. FILED 6-14-2004.

**THE EXPERIMENTAL
COLLECTION**

C RESERVE

THE MARK CONSISTS OF STANDARD CHARACTERS WITHOUT CLAIM TO ANY PARTICULAR FONT, STYLE, SIZE, OR COLOR.

NO CLAIM IS MADE TO THE EXCLUSIVE RIGHT TO USE "COLLECTION", APART FROM THE MARK AS SHOWN.

FOR ALCOHOLIC BEVERAGES, NAMELY, WHISKIES (U.S. CLS. 47 AND 49).
WARREN L. OLANDRIA, EXAMINING ATTORNEY

THE MARK CONSISTS OF STANDARD CHARACTERS WITHOUT CLAIM TO ANY PARTICULAR FONT, STYLE, SIZE, OR COLOR.

NO CLAIM IS MADE TO THE EXCLUSIVE RIGHT TO USE "RESERVE", APART FROM THE MARK AS SHOWN.

FOR ALCOHOLIC BEVERAGES, NAMELY WINE (U.S. CLS. 47 AND 49).
MARK SPARACINO, EXAMINING ATTORNEY

CLASS 33—(Continued).

SN 78-443,093. LATIQ SPIRITS, LLC, NEW MILFORD, NJ.
FILED 6-29-2004.

LATIQQ

THE MARK CONSISTS OF STANDARD CHARACTERS
WITHOUT CLAIM TO ANY PARTICULAR FONT, STYLE,
SIZE, OR COLOR.

FOR ALCOHOLIC BEVERAGES, NAMELY, DIS-
TILLED SPIRITS AND LIQUORS (U.S. CLS. 47 AND 49).
DOMINICK J. SALEMI, EXAMINING ATTORNEY

CLASS 33—(Continued).

SN 78-446,321. SACRED HILL WINES LIMITED, HASTINGS,
NEW ZEALAND, FILED 7-6-2004.

GUNN ESTATE

THE MARK CONSISTS OF STANDARD CHARACTERS
WITHOUT CLAIM TO ANY PARTICULAR FONT, STYLE,
SIZE, OR COLOR.

NO CLAIM IS MADE TO THE EXCLUSIVE RIGHT TO
USE "ESTATE", APART FROM THE MARK AS SHOWN.

FOR WINE AND WINE BASED BEVERAGES (U.S.
CLS. 47 AND 49).

SHAUNIA WALLACE, EXAMINING ATTORNEY

SN 78-443,844. BIURKO GORRI, S.A.L., BARGOTA, NAVAR-
RA, SPAIN, FILED 6-30-2004.

BIURKO

THE MARK CONSISTS OF STANDARD CHARACTERS
WITHOUT CLAIM TO ANY PARTICULAR FONT, STYLE,
SIZE, OR COLOR.

FOR ALCOHOLIC BEVERAGES, NAMELY, WINES
(U.S. CLS. 47 AND 49).

FIRST USE 11-8-2001; IN COMMERCE 9-0-2002.
ANNE FARRELL, EXAMINING ATTORNEY

SN 78-450,930. CLOVELY ESTATE LIMITED, BRISBANE,
AUSTRALIA, FILED 7-14-2004.

THE LABEL REALLY
JUMPS OUT AT YOU

THE MARK CONSISTS OF STANDARD CHARACTERS
WITHOUT CLAIM TO ANY PARTICULAR FONT, STYLE,
SIZE, OR COLOR.

PRIORITY CLAIMED UNDER SEC. 44(D) ON AUSTRALIA
APPLICATION NO. PFN65115, FILED 7-12-2004, REG.
NO. 1010345, DATED 7-12-2004, EXPIRES 7-12-2014.

FOR WINE (U.S. CLS. 47 AND 49).

GENE MACIOL, EXAMINING ATTORNEY

CLASS 33—(Continued).

SN 78-450,933. CLOVELY ESTATE LIMITED, BRISBANE, AUSTRALIA, FILED 7-14-2004.

IT WON'T IMPROVE
YOUR SEX LIFE BUT
YOU'LL SEE A
COCKATOO

THE MARK CONSISTS OF STANDARD CHARACTERS WITHOUT CLAIM TO ANY PARTICULAR FONT, STYLE, SIZE, OR COLOR.
PRIORITY CLAIMED UNDER SEC. 44(D) ON AUSTRALIA APPLICATION NO. PFN65114, FILED 7-12-2004, REG. NO. 1010488, DATED 7-12-2004, EXPIRES 7-12-2014.
FOR WINE (U.S. CLS. 47 AND 49).
GENE MACIOL, EXAMINING ATTORNEY

SN 78-450,975. BOULDER IMPORTS, LLC, SAN ANTONIO, TX. FILED 7-15-2004.

DEL RAZO

THE MARK CONSISTS OF STANDARD CHARACTERS WITHOUT CLAIM TO ANY PARTICULAR FONT, STYLE, SIZE, OR COLOR.
FOR ALCOHOLIC BEVERAGES CONTAINING PULQUE (U.S. CLS. 47 AND 49).
ROBERT LORENZO, EXAMINING ATTORNEY

CLASS 33—(Continued).

SN 78-450,981. BOULDER IMPORTS, LLC, SAN ANTONIO, TX. FILED 7-15-2004.

DEL RAZO PULQUE

THE MARK CONSISTS OF STANDARD CHARACTERS WITHOUT CLAIM TO ANY PARTICULAR FONT, STYLE, SIZE, OR COLOR.
NO CLAIM IS MADE TO THE EXCLUSIVE RIGHT TO USE "PULQUE", APART FROM THE MARK AS SHOWN.
FOR ALCOHOLIC BEVERAGES CONTAINING PULQUE (U.S. CLS. 47 AND 49).
ROBERT LORENZO, EXAMINING ATTORNEY

SN 78-450,982. BOULDER IMPORTS, LLC, SAN ANTONIO, TX. FILED 7-15-2004.

NECTAR DEL RAZO

THE MARK CONSISTS OF STANDARD CHARACTERS WITHOUT CLAIM TO ANY PARTICULAR FONT, STYLE, SIZE, OR COLOR.
NO CLAIM IS MADE TO THE EXCLUSIVE RIGHT TO USE "NECTAR", APART FROM THE MARK AS SHOWN.
FOR ALCOHOLIC BEVERAGES CONTAINING PULQUE (U.S. CLS. 47 AND 49).
ROBERT LORENZO, EXAMINING ATTORNEY

SN 78-450,983. BOULDER IMPORTS, LLC, SAN ANTONIO, TX. FILED 7-15-2004.

**NECTAR DEL RAZO
PULQUE**

THE MARK CONSISTS OF STANDARD CHARACTERS WITHOUT CLAIM TO ANY PARTICULAR FONT, STYLE, SIZE, OR COLOR.
NO CLAIM IS MADE TO THE EXCLUSIVE RIGHT TO USE "NECTAR" AND "PULQUE", APART FROM THE MARK AS SHOWN.
FOR ALCOHOLIC BEVERAGES CONTAINING PULQUE (U.S. CLS. 47 AND 49).
ROBERT LORENZO, EXAMINING ATTORNEY

CLASS 33—(Continued).

SN 78-455,565. FLAG HILL ENTERPRISES, LTD., LEE, NH.
FILED 7-23-2004.

CLASS 33—(Continued).

SN 78-476,879. FRATELLO INTERNATIONAL, LLC, OR-
LANDO, FL. FILED 8-31-2004.

GENERAL JOHN STARK

THE MARK CONSISTS OF STANDARD CHARACTERS
WITHOUT CLAIM TO ANY PARTICULAR FONT, STYLE,
SIZE, OR COLOR.

THE NAME(S), PORTRAIT(S), AND/OR SIGNATURE(S)
SHOWN IN THE MARK DOES NOT IDENTIFY A PARTI-
CULAR LIVING INDIVIDUAL.

FOR ALCOHOLIC BEVERAGES, NAMELY DISTILLED
LIQUOR (U.S. CLS. 47 AND 49).

BRIAN NEVILLE, EXAMINING ATTORNEY



FOR VODKA (U.S. CLS. 47 AND 49).
GEORGIA CARTY, EXAMINING ATTORNEY

SN 78-461,062. INDEPENDENT LIQUOR (NZ) LIMITED,
PAPAKURA, AUCKLAND, NEW ZEALAND, FILED 8-3-
2004.

HOODOO MAJIC

THE MARK CONSISTS OF STANDARD CHARACTERS
WITHOUT CLAIM TO ANY PARTICULAR FONT, STYLE,
SIZE, OR COLOR.

FOR ALCOHOLIC BEVERAGES, NAMELY, MIX-
TURES OF ALCOHOL FROM BREWED OR SPIRIT
BASE, WITH FLAVORED SOFT DRINK (U.S. CLS. 47
AND 49).

STEPHANIE DAVIS, EXAMINING ATTORNEY

SN 78-481,823. DRAPER & ESQUIN WINE & SPIRITS, LLC,
POINT RICHMOND, CA. FILED 9-10-2004.

SN 78-464,053. THE COUNTRY VINTNER, MAIDENS, VA.
FILED 8-9-2004.

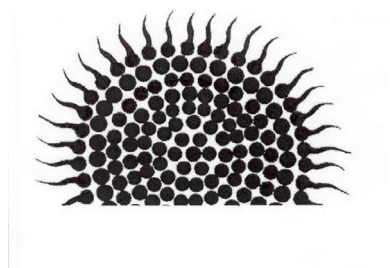

FOR WINE (U.S. CLS. 47 AND 49).
FIRST USE 7-21-2004; IN COMMERCE 7-21-2004.
ANNE E. GUSTASON, EXAMINING ATTORNEY

VINETOU

THE MARK CONSISTS OF STANDARD CHARACTERS
WITHOUT CLAIM TO ANY PARTICULAR FONT, STYLE,
SIZE, OR COLOR.

FOR WINE (U.S. CLS. 47 AND 49).
FIRST USE 8-13-2004; IN COMMERCE 9-14-2004.
BILL DAWE, EXAMINING ATTORNEY

CLASS 33—(Continued).

SN 78-485,326. DILLIGAB, LLC, HONOLULU, HI. FILED 9-17-2004.

CLASS 33—(Continued).

SN 78-490,056. CAB 4 TEN, LLC, SALT LAKE CITY, UT. FILED 9-27-2004.

CF

CAB.4.TEN

THE MARK CONSISTS OF STANDARD CHARACTERS WITHOUT CLAIM TO ANY PARTICULAR FONT, STYLE, SIZE, OR COLOR.
FOR WINE AND DISTILLED SPIRITS (U.S. CLS. 47 AND 49).
KELLY BOULTON, EXAMINING ATTORNEY

THE MARK CONSISTS OF STANDARD CHARACTERS WITHOUT CLAIM TO ANY PARTICULAR FONT, STYLE, SIZE, OR COLOR.
FOR WINES (U.S. CLS. 47 AND 49).
FIRST USE 7-0-2004; IN COMMERCE 7-0-2004.
JUDITH HELFMAN, EXAMINING ATTORNEY

SN 78-490,682. ALLIED LOMAR, INC., BURLINGAME, CA. FILED 9-28-2004.

ACQUA

SN 78-488,205. MACDONALD & MUIR LIMITED, BROXBURN, WEST LOTHIAN, UNITED KINGDOM, FILED 9-23-2004.

THE MARK CONSISTS OF STANDARD CHARACTERS WITHOUT CLAIM TO ANY PARTICULAR FONT, STYLE, SIZE, OR COLOR.
FOR DISTILLED SPIRITS (U.S. CLS. 47 AND 49).
FIRST USE 4-13-2004; IN COMMERCE 4-13-2004.
LINDA MICKLEBURGH, EXAMINING ATTORNEY

SN 78-492,887. PRODUCTOS FINOS DE AGAVE, SA DE C.V., JALISCO, MEXICO, FILED 10-1-2004.

GLEN MORAY

DON ALEJANDRO

THE MARK CONSISTS OF STANDARD CHARACTERS WITHOUT CLAIM TO ANY PARTICULAR FONT, STYLE, SIZE, OR COLOR.
OWNER OF UNITED KINGDOM REG. NO. 1059369, DATED 2-25-1976, EXPIRES 2-25-2007.
OWNER OF U.S. REG. NO. 1,875,495.
THE NAME GLEN MORAY DOES NOT IDENTIFY A LIVING INDIVIDUAL.
SEC. 2(F).
FOR SCOTCH WHISKY (U.S. CLS. 47 AND 49).
FIRST USE 0-0-1933; IN COMMERCE 0-0-1933.
ELISSA GARBER KON, EXAMINING ATTORNEY

THE MARK CONSISTS OF STANDARD CHARACTERS WITHOUT CLAIM TO ANY PARTICULAR FONT, STYLE, SIZE, OR COLOR.
THE NAME DON ALEJANDRO DOES NOT IDENTIFY A LIVING INDIVIDUAL.
THE ENGLISH TRANSLATION OF DON ALEJANDRO IS MR. ALEJANDRO.
FOR ALCOHOL, NAMELY TEQUILA (U.S. CLS. 47 AND 49).
FIRST USE 0-0-2004; IN COMMERCE 0-0-2004.
ANDREA SAUNDERS, EXAMINING ATTORNEY

CLASS 33—(Continued).

SN 78-501,255. CAB 4 TEN, LLC, SALT LAKE CITY, UT. FILED 10-18-2004.

CLASS 33—(Continued).

SN 78-508,072. ALLIED DOMEQ SPIRITS & WINE LIMITED, BRISTOL, UNITED KINGDOM, FILED 10-29-2004.

CAB 4 10

LEMON HART

THE MARK CONSISTS OF STANDARD CHARACTERS WITHOUT CLAIM TO ANY PARTICULAR FONT, STYLE, SIZE, OR COLOR.
FOR WINE AND DISTILLED SPIRITS (U.S. CLS. 47 AND 49).
KELLY BOULTON, EXAMINING ATTORNEY

THE MARK CONSISTS OF STANDARD CHARACTERS WITHOUT CLAIM TO ANY PARTICULAR FONT, STYLE, SIZE, OR COLOR.
OWNER OF U.S. REG. NO. 597,462.
FOR RUM (U.S. CLS. 47 AND 49).
FIRST USE 0-0-1804; IN COMMERCE 8-29-1933.
JOANNA DUKOVIC, EXAMINING ATTORNEY

SN 78-506,117. DIAGEO NORTH AMERICA, INC., NORWALK, CT. FILED 10-26-2004.

SN 78-509,491. CAB 4 TEN, LLC, SALT LAKE CITY, UT. FILED 11-1-2004.

QED

CAB FOR TEN

THE MARK CONSISTS OF STANDARD CHARACTERS WITHOUT CLAIM TO ANY PARTICULAR FONT, STYLE, SIZE, OR COLOR.
FOR ALCOHOLIC BEVERAGES, NAMELY WINE AND WINE-BASED BEVERAGES (U.S. CLS. 47 AND 49).
JOHN DWYER, EXAMINING ATTORNEY

THE MARK CONSISTS OF STANDARD CHARACTERS WITHOUT CLAIM TO ANY PARTICULAR FONT, STYLE, SIZE, OR COLOR.
FOR WINE AND DISTILLED SPIRITS (U.S. CLS. 47 AND 49).
KELLY BOULTON, EXAMINING ATTORNEY

CLASS 33—(Continued).

SN 78-512,750. THE RAVENVALE GROUP PTY LTD, NOOSA HEADS, QUEENSLAND, AUSTRALIA, FILED 11-7-2004.



NO CLAIM IS MADE TO THE EXCLUSIVE RIGHT TO USE "PRODUCT OF AUSTRALIA", APART FROM THE MARK AS SHOWN.

FOR WINE (U.S. CLS. 47 AND 49).
BARBARA RUTLAND, EXAMINING ATTORNEY

CLASS 33—(Continued).

SN 78-513,332. ALLIED LOMAR, INC., BURLINGAME, CA. FILED 11-8-2004.

DAKOTA

THE MARK CONSISTS OF STANDARD CHARACTERS WITHOUT CLAIM TO ANY PARTICULAR FONT, STYLE, SIZE, OR COLOR.

FOR DISTILLED SPIRITS (U.S. CLS. 47 AND 49).
FIRST USE 11-5-2001; IN COMMERCE 11-5-2001.
LINDA MICKLEBURGH, EXAMINING ATTORNEY

SN 78-513,616. DIAGEO NORTH AMERICA, INC., NORWALK, CT. FILED 11-9-2004.

Q.E.D.

SN 78-513,326. HAMADASHUZO CO., LTD., HIOKI-GUN, KAGOSHIMA-KEN, JAPAN, FILED 11-8-2004.



THE MARK CONSISTS OF STANDARD CHARACTERS WITHOUT CLAIM TO ANY PARTICULAR FONT, STYLE, SIZE, OR COLOR.

FOR ALCOHOLIC BEVERAGES, NAMELY WINE AND WINE-BASED BEVERAGES. (U.S. CLS. 47 AND 49).
JOHN DWYER, EXAMINING ATTORNEY

SN 78-515,323. WINERY EXCHANGE, INC., NOVATO, CA. FILED 11-11-2004.

MANIÑA

NO CLAIM IS MADE TO THE EXCLUSIVE RIGHT TO USE "SOJU OR SHOUCHU", APART FROM THE MARK AS SHOWN.

THE MARK CONSISTS OF THE KOREAN WORDING SOJU AND THE JAPANESE WORDING SHOUCHU KAKUSHIGURA ABOVE THE DRAWING OF TWO JAPANESE CHARACTERS. THE BLURRED EDGES OF THE JAPANESE CHARACTERS REPRESENT BRUSH STROKES AND ARE INTENDED AS A FEATURE OF THE MARK.

THE TRANSLATION OF THE KOREAN WORD SOJU IS "DISTILLED SPIRITS." THE TRANSLATION OF THE JAPANESE WORDS SHOUCHU AND KAKUSHIGURA ARE "DISTILLED SPIRITS" AND "HIDDEN STOREHOUSE" RESPECTIVELY.

THE NON-LATIN CHARACTER(S) IN THE MARK TRANSLITERATES INTO KAKUSHIGURA, AND THIS MEANS "HIDDEN STOREHOUSE" IN ENGLISH.

FOR DISTILLED SPIRITS (U.S. CLS. 47 AND 49).
FIRST USE 4-0-2004; IN COMMERCE 5-10-2004.
KARANENDRA S. CHHINA, EXAMINING ATTORNEY

THE MARK CONSISTS OF STANDARD CHARACTERS WITHOUT CLAIM TO ANY PARTICULAR FONT, STYLE, SIZE, OR COLOR.

FOR WINE (U.S. CLS. 47 AND 49).
GEORGE LORENZO, EXAMINING ATTORNEY

CLASS 33—(Continued).

SN 78-516,566. MILLER WINE WORKS, LLC, NAPA, CA. FILED 11-14-2004.



THE MARK CONSISTS OF M FOR MILLER, W FOR WINE, W FOR WORKS, SUPERIMPOSED OVER EACH OTHER.
FOR WINE (U.S. CLS. 47 AND 49).
FIRST USE 9-3-2003; IN COMMERCE 9-3-2003.
GEORGE LORENZO, EXAMINING ATTORNEY

CLASS 33—(Continued).

SN 78-520,145. FIR CREST VINEYARDS LLC, CARLTON, OR. FILED 11-19-2004.

TWELVE

THE MARK CONSISTS OF STANDARD CHARACTERS WITHOUT CLAIM TO ANY PARTICULAR FONT, STYLE, SIZE, OR COLOR.
FOR WINE (U.S. CLS. 47 AND 49).
KEVIN DINALLO, EXAMINING ATTORNEY

SN 78-520,742. JMB IMPORTS LLC, DALLAS, TX. FILED 11-22-2004.

SN 78-519,275. GAMARRA, RICHARD D., LONG BEACH, CA. FILED 11-18-2004.



THE COLOR(S) LIME GREEN, BLACK AND YELLOW IS/ ARE CLAIMED AS A FEATURE OF THE MARK.
THE MARK CONSISTS OF SCRIPTED CAPITAL A & R IN LIME GREEN WITH BLACK BORDER, AND SOM & ITA IN BLACK WITH YELLOW BORDER.
FOR DISTILLED SPIRITS (U.S. CLS. 47 AND 49).
GENE MACIOL, EXAMINING ATTORNEY

VANYAK

THE MARK CONSISTS OF STANDARD CHARACTERS WITHOUT CLAIM TO ANY PARTICULAR FONT, STYLE, SIZE, OR COLOR.
FOR COGNAC WITH VANILLA FLAVOR; ALCOHOLIC COFFEE, TEA, AND JUICE-BASED BEVERAGES (U.S. CLS. 47 AND 49).
TARAH HARDY, EXAMINING ATTORNEY

CLASS 33—(Continued).

SN 78-521,200. VIÑA VENTISQUERO LIMITADA, RANCA-GUA, CHILE, FILED 11-22-2004.

CLASS 33—(Continued).

SN 78-521,795. WINEHAVEN, INC., CHISAGO CITY, MN. FILED 11-23-2004.

CHILOTE

LAKESIDE

THE MARK CONSISTS OF STANDARD CHARACTERS WITHOUT CLAIM TO ANY PARTICULAR FONT, STYLE, SIZE, OR COLOR.
FOR ALCOHOLIC BEVERAGES, NAMELY, WINE (U.S. CLS. 47 AND 49).
WENDY GOODMAN, EXAMINING ATTORNEY

THE MARK CONSISTS OF STANDARD CHARACTERS WITHOUT CLAIM TO ANY PARTICULAR FONT, STYLE, SIZE, OR COLOR.
FOR WINE (U.S. CLS. 47 AND 49).
FIRST USE 4-20-2004; IN COMMERCE 4-29-2004.
JILL C. ALT, EXAMINING ATTORNEY

SN 78-521,300. ARTISTE MANAGEMENT COMPANY, LLC, SANTA YNEZ, CA. FILED 11-22-2004.

SN 78-521,829. VIÑA VENTISQUERO LIMITADA, RANCA-GUA, CHILE, FILED 11-23-2004.

IMPRESSIONIST

CHILCANO

THE MARK CONSISTS OF STANDARD CHARACTERS WITHOUT CLAIM TO ANY PARTICULAR FONT, STYLE, SIZE, OR COLOR.
FOR WINE (U.S. CLS. 47 AND 49).
FIRST USE 7-1-2002; IN COMMERCE 7-1-2002.
STEVEN PEREZ, EXAMINING ATTORNEY

THE MARK CONSISTS OF STANDARD CHARACTERS WITHOUT CLAIM TO ANY PARTICULAR FONT, STYLE, SIZE, OR COLOR.
FOR ALCOHOLIC BEVERAGES, NAMELY, WINE (U.S. CLS. 47 AND 49).
WENDY GOODMAN, EXAMINING ATTORNEY

CLASS 33—(Continued).

SN 78-523,516. BODEGAS DEL MEDIEVO, S.L., LA RIOJA, SPAIN, FILED 11-29-2004.

CLASS 33—(Continued).

SN 78-524,038. SHOUP, ALLEN C., SEATTLE, WA. FILED 11-29-2004.

MEDIEVO

SEQUEL

THE MARK CONSISTS OF STANDARD CHARACTERS WITHOUT CLAIM TO ANY PARTICULAR FONT, STYLE, SIZE, OR COLOR.

THE FOREIGN WORDING IN THE MARK TRANSLATES INTO ENGLISH AS MIDDLE AGES.

FOR WINES (U.S. CLS. 47 AND 49).

FIRST USE 10-4-2001; IN COMMERCE 9-22-2004.

DAVID C. REIHNER, EXAMINING ATTORNEY

THE MARK CONSISTS OF STANDARD CHARACTERS WITHOUT CLAIM TO ANY PARTICULAR FONT, STYLE, SIZE, OR COLOR.

FOR WINE (U.S. CLS. 47 AND 49).

KATRINA EDGE, EXAMINING ATTORNEY

SN 78-524,093. BEVERAGE BRANDS, INC., PITTSBURGH, PA. FILED 11-29-2004.

SN 78-523,802. LEXIM, INC., SEATTLE, WA. FILED 11-29-2004.

Tierra Del Sol

Blue Crystal

THE MARK CONSISTS OF STANDARD CHARACTERS WITHOUT CLAIM TO ANY PARTICULAR FONT, STYLE, SIZE, OR COLOR.

THE FOREIGN WORDING IN THE MARK TRANSLATES INTO ENGLISH AS LAND OF THE SUN.

FOR WINES, RED AND WHITE TABLE WINES (U.S. CLS. 47 AND 49).

CHERYL CLAYTON, EXAMINING ATTORNEY

THE MARK CONSISTS OF STANDARD CHARACTERS WITHOUT CLAIM TO ANY PARTICULAR FONT, STYLE, SIZE, OR COLOR.

NO CLAIM IS MADE TO THE EXCLUSIVE RIGHT TO USE "BLUE", APART FROM THE MARK AS SHOWN.

FOR FLAVORED VODKA (U.S. CLS. 47 AND 49).

ROBIN CHOSID, EXAMINING ATTORNEY

CLASS 33—(Continued).

SN 78-524,988. SIDNEY FRANK IMPORTING CO., INC.,
NEW ROCHELLE, NY. FILED 12-1-2004.

MICHAEL COLLINS

THE MARK CONSISTS OF STANDARD CHARACTERS
WITHOUT CLAIM TO ANY PARTICULAR FONT, STYLE,
SIZE, OR COLOR.

THE NAME MICHAEL COLLINS DOES NOT IDENTIFY A
LIVING INDIVIDUAL.

FOR IRISH WHISKEY (U.S. CLS. 47 AND 49).
KATRINA EDGE, EXAMINING ATTORNEY

SN 78-527,487. FETZER VINEYARDS, HOPLAND, CA.
FILED 12-6-2004.



THE MARK CONSISTS OF A FANCIFUL BLACK AND
WHITE PICTURE OF A WALKING WOMAN HOLDING A
VINE WITH LEAVES ATTACHED. IN THE UPPER POR-
TION OF THE PICTURE ARE A CRESCENT MOON, STARS,
AND FLOWER. IN THE LOWER LEFT AND RIGHT
PORTIONS OF THE PICTURE ARE LEAVES, FLOWERS,
AND RIVERS FLOWING DOWN TO THE SEA FROM THE
HILLSIDE.

FOR ALCOHOLIC BEVERAGES, NAMELY, WINE
(U.S. CLS. 47 AND 49).

MARK SPARACINO, EXAMINING ATTORNEY

SN 78-528,197. FETZER VINEYARDS, HOPLAND, CA.
FILED 12-7-2004.



THE MARK CONSISTS OF A WOMAN RUNNING
THROUGH WATER AND JUGGLING FIVE SEMI-SPHERI-
CAL SHAPES. BEHIND THE WOMAN IS A PARTIAL
IMAGE OF THE SUN. IN THE RIGHT PORTION OF THE
MARK ARE STARS AND A RIVER.

FOR ALCOHOLIC BEVERAGES, NAMELY, WINE
(U.S. CLS. 47 AND 49).

BRENDAN MCCAULEY, EXAMINING ATTORNEY

CLASS 33—(Continued).

SN 78-529,732. BERINGER BLOSS WINE ESTATES LIMITED,
SOUTHBANK, VICTORIA 3006, AUSTRALIA, FILED 12-9-
2004.

YELLOWGLEN YELLOW

THE MARK CONSISTS OF STANDARD CHARACTERS
WITHOUT CLAIM TO ANY PARTICULAR FONT, STYLE,
SIZE, OR COLOR.

OWNER OF U.S. REG. NO. 1,567,449.

FOR WINES (U.S. CLS. 47 AND 49).

DAWN FELDMAN, EXAMINING ATTORNEY

SN 78-531,184. DFM S.R.L., 20100 MILANO, ITALY, FILED
12-13-2004.

JUDICA

THE MARK CONSISTS OF STANDARD CHARACTERS
WITHOUT CLAIM TO ANY PARTICULAR FONT, STYLE,
SIZE, OR COLOR.

FOR ALCOHOLIC BEVERAGES NAMELY, WINES,
SPARKLING WINES, DISTILLED SPIRITS, GRAPPA
AND LIQUEURS (U.S. CLS. 47 AND 49).

LINDA POWELL, EXAMINING ATTORNEY

SN 78-537,030. QUAKING ASPEN DISTILLERS, LLC, PARK
CITY, UT. FILED 12-22-2004.

Spirit of the West

THE MARK CONSISTS OF STANDARD CHARACTERS
WITHOUT CLAIM TO ANY PARTICULAR FONT, STYLE,
SIZE, OR COLOR.

NO CLAIM IS MADE TO THE EXCLUSIVE RIGHT TO
USE "SPIRIT", APART FROM THE MARK AS SHOWN.

FOR DISTILLED SPIRITS, NAMELY, WHISKEY (U.S.
CLS. 47 AND 49).

TIMOTHY FINNEGAN, EXAMINING ATTORNEY

CLASS 33—(Continued).

SN 78-539,289. OPERA LLC, NEW YORK, NY. FILED 12-28-2004.

SETENA

THE MARK CONSISTS OF STANDARD CHARACTERS WITHOUT CLAIM TO ANY PARTICULAR FONT, STYLE, SIZE, OR COLOR.

FOR WINE (U.S. CLS. 47 AND 49).
TINA L. SNAPP, EXAMINING ATTORNEY

SN 78-539,731. WILSON CREEK WINERY & VINEYARDS, L.L.C., TEMECULA, CA. FILED 12-29-2004.

WILSON CREEK GOLDEN JUBILEE

THE MARK CONSISTS OF STANDARD CHARACTERS WITHOUT CLAIM TO ANY PARTICULAR FONT, STYLE, SIZE, OR COLOR.

FOR WINE AND CHAMPAGNE (U.S. CLS. 47 AND 49).
ALINA MORRIS, EXAMINING ATTORNEY

SN 78-540,068. WILSON CREEK WINERY & VINEYARDS, L.L.C., TEMECULA, CA. FILED 12-30-2004.

OH MY GOSH

THE MARK CONSISTS OF STANDARD CHARACTERS WITHOUT CLAIM TO ANY PARTICULAR FONT, STYLE, SIZE, OR COLOR.

FOR WINE AND CHAMPAGNE (U.S. CLS. 47 AND 49).
WON TEAK OH, EXAMINING ATTORNEY

CLASS 33—(Continued).

SN 78-543,128. PACIFIC INTERNATIONAL LIQUORS, INC., VERNON, CA. FILED 1-6-2005.

MERRICK RIDGE

THE MARK CONSISTS OF STANDARD CHARACTERS WITHOUT CLAIM TO ANY PARTICULAR FONT, STYLE, SIZE, OR COLOR.

FOR WINE (U.S. CLS. 47 AND 49).
FIRST USE 1-1-2002; IN COMMERCE 6-1-2002.
LOURDES AYALA, EXAMINING ATTORNEY

SN 78-544,936. BUFFETT, JIMMY, KEY WEST, FL. FILED 1-10-2005.

LAST MANGO

THE MARK CONSISTS OF STANDARD CHARACTERS WITHOUT CLAIM TO ANY PARTICULAR FONT, STYLE, SIZE, OR COLOR.

OWNER OF U.S. REG. NO. 2,324,655.
FOR TEQUILA, FLAVORED TEQUILA, RUM, FLAVORED RUM, GIN, FLAVORED GIN, VODKA, FLAVORED VODKA, LIQUEURS, PREPARED ALCOHOLIC COCKTAILS, PREPARED WINE COCKTAILS, WINE COOLERS AND WINE (U.S. CLS. 47 AND 49).
WILLIAM VERHOSEK, EXAMINING ATTORNEY

CLASS 33—(Continued).

SN 78-545,115. OLOTOA, LA'AULI J., BALDWIN PARK, CA. AND OLOTOA, TERESA, BALDWIN PARK, CA. AND CONDE, TINESA, BALDWIN PARK, CA. AND OLOTOA, LANA, BALDWIN PARK, CA. FILED 1-10-2005.

CLASS 33—(Continued).

SN 78-545,432. GREENFIELD WINE COMPANY, AMERICAN CANYON, CA. FILED 1-11-2005.

JackUp

RABID RED

THE MARK CONSISTS OF STANDARD CHARACTERS WITHOUT CLAIM TO ANY PARTICULAR FONT, STYLE, SIZE, OR COLOR.

FOR ALCOHOLIC BEVERAGE, NAMELY, A BLENDING OF LIQUORS TO MAKE A MIX DRINK (U.S. CLS. 47 AND 49).

ELLEN B. AWRICH, EXAMINING ATTORNEY

THE MARK CONSISTS OF STANDARD CHARACTERS WITHOUT CLAIM TO ANY PARTICULAR FONT, STYLE, SIZE, OR COLOR.

NO CLAIM IS MADE TO THE EXCLUSIVE RIGHT TO USE "RED", APART FROM THE MARK AS SHOWN.

FOR WINE (U.S. CLS. 47 AND 49).

FIRST USE 4-26-2005; IN COMMERCE 4-26-2005.

KATRINA EDGE, EXAMINING ATTORNEY

SN 78-545,401. BLAYLOCK, MICHAEL A., MADERA, CA. FILED 1-11-2005.

SN 78-548,258. MELKA WINES, LLC, ST. HELENA, CA. FILED 1-15-2005.

The Dude

METISSE

THE MARK CONSISTS OF STANDARD CHARACTERS WITHOUT CLAIM TO ANY PARTICULAR FONT, STYLE, SIZE, OR COLOR.

FOR WINE (U.S. CLS. 47 AND 49).

FIRST USE 12-1-2000; IN COMMERCE 8-9-2004.

GEORGE LORENZO, EXAMINING ATTORNEY

THE MARK CONSISTS OF STANDARD CHARACTERS WITHOUT CLAIM TO ANY PARTICULAR FONT, STYLE, SIZE, OR COLOR.

FOR WINE (U.S. CLS. 47 AND 49).

FIRST USE 3-17-1999; IN COMMERCE 4-1-1999.

GEORGE LORENZO, EXAMINING ATTORNEY

CLASS 33—(Continued).

SN 78-548,370. COMEX CONSULTING, S.L., CARTAGENA, SPAIN, FILED 1-16-2005.

VERTVS

THE MARK CONSISTS OF STANDARD CHARACTERS WITHOUT CLAIM TO ANY PARTICULAR FONT, STYLE, SIZE, OR COLOR.

FOR WINE (U.S. CLS. 47 AND 49).
FIRST USE 0-0-2002; IN COMMERCE 0-0-2002.
ALICE BENMAMAN, EXAMINING ATTORNEY

SN 78-555,037. COOPERATIVA AGRICOLA VITIVINICOLA DE CAUQUENES LTDA., CAUQUENES, CHILE, FILED 1-27-2005.

HEART OF LAS LOMAS

THE MARK CONSISTS OF STANDARD CHARACTERS WITHOUT CLAIM TO ANY PARTICULAR FONT, STYLE, SIZE, OR COLOR.

OWNER OF U.S. REG. NO. 2,592,168.
THE TERM LAS LOMAS IS TRANSLATED INTO ENGLISH AS "THE HILLS".
FOR WINES (U.S. CLS. 47 AND 49).
STEVEN R. FINE, EXAMINING ATTORNEY

SN 78-558,547. BUENA VISTA WINERY, INC., SONOMA, CA, FILED 2-2-2005.

RAMAL ROAD

THE MARK CONSISTS OF STANDARD CHARACTERS WITHOUT CLAIM TO ANY PARTICULAR FONT, STYLE, SIZE, OR COLOR.

FOR WINES (U.S. CLS. 47 AND 49).
MARGERY A. TIERNEY, EXAMINING ATTORNEY

CLASS 33—(Continued).

SN 79-001,642. LAURENT-PERRIER, F-51150 TOURS-SUR-MARNE, FRANCE, FILED 3-2-2004.



OWNER OF INTERNATIONAL REGISTRATION 0821603 DATED 3-2-2004, EXPIRES 3-2-2014.

OWNER OF U.S. REG. NOS. 745,935, 2,871,535 AND OTHERS.

NO CLAIM IS MADE TO THE EXCLUSIVE RIGHT TO USE "CHAMPAGNE", "DEMI-SEC" AND "DEPUIS SINCE 1812", APART FROM THE MARK AS SHOWN.

THE NAME SHOWN IN THE MARK LAURENT PERRIER DOES NOT IDENTIFY A PARTICULAR LIVING INDIVIDUAL.

THE COLORS BLACK, VERY LIGHT YELLOW, GREY, GOLDEN ARE CLAIMED AS A FEATURE OF THE MARK.

WORDS LAURENT-PERRIER, DEMI-SEC AND CHAMPAGNE IN BLACK LETTERS ON A VERY LIGHT YELLOW BACKGROUND; GREY BORDER ENCLOSING ANOTHER GOLD BORDER; SCROLLS AND WORDS DEPUIS 1812 SINCE ALSO GOLD.

THE WORDS "DEPUIS 1812" MEAN "SINCE 1812" IN ENGLISH.

FOR WINES WITH CHAMPAGNE PROTECTED LABEL OF ORIGIN (U.S. CLS. 47 AND 49).

JULIA HARDY COFIELD, EXAMINING ATTORNEY

SN 79-002,772. BODEGAS ROMERO DE AVILA SALCEDO, S.L., SPAIN, FILED 4-6-2004.

FRODO

THE MARK CONSISTS OF STANDARD CHARACTERS WITHOUT CLAIM TO ANY PARTICULAR FONT, STYLE, SIZE, OR COLOR.

OWNER OF INTERNATIONAL REGISTRATION 0825579 DATED 4-6-2004, EXPIRES 4-6-2014.

FOR ALCOHOLIC BEVERAGES, NAMELY, WINES, EXCEPT FOR BEER (U.S. CLS. 47 AND 49).

STEVEN JACKSON, EXAMINING ATTORNEY

SN 79-003,386. VINAESSENCE PTY LTD, AUSTRALIA, FILED 6-18-2004.

ESSENCE OF THE VINE

THE MARK CONSISTS OF STANDARD CHARACTERS WITHOUT CLAIM TO ANY PARTICULAR FONT, STYLE, SIZE, OR COLOR.

PRIORITY DATE OF 12-19-2003 IS CLAIMED.

OWNER OF INTERNATIONAL REGISTRATION 0827543 DATED 6-18-2004, EXPIRES 6-18-2014.

FOR WINES, INCLUDING PORT WINES AND LIQUEURS (U.S. CLS. 47 AND 49).

LEIGH LOWRY, EXAMINING ATTORNEY

CLASS 33—(Continued).

SN 79-003,980. "CANTINA LA VIS E VALLE DI CEMBRA; SOCIETA' COOPERATIVA A RESPONSABILITA' LIMITATA"; IN SIGLA "CANTINA LA VIS S.C.A.R.L."; "C.S.L.S.S. S.C.A.R.L." - "C.S.L. S.C.A.R.L." -; "CANLAV S.C.A.R.L.", "CIELLE S.C.A.R.L.", ITALY, FILED 4-23-2004.

RITRATTI

THE MARK CONSISTS OF STANDARD CHARACTERS WITHOUT CLAIM TO ANY PARTICULAR FONT, STYLE, SIZE, OR COLOR.

OWNER OF INTERNATIONAL REGISTRATION 0829350 DATED 4-23-2004, EXPIRES 4-23-2014.

THE MARK IS COMPRISED OF THE WORDING "RITRATTI" PRINTED IN ANY WAY.

THE ENGLISH TRANSLATION OF THE WORD RITRATTI IN THE MARK IS "PORTRAITS".

FOR WINE, DISTILLED SPIRITS, LIQUEURS (U.S. CLS. 47 AND 49).

SAMUEL E. SHARPER JR., EXAMINING ATTORNEY

SN 79-004,088. EURO-NEGOCE, FRANCE, FILED 5-14-2004.

La Force Divine d'un Grand COGNAC

PRIORITY DATE OF 12-8-2003 IS CLAIMED.

OWNER OF INTERNATIONAL REGISTRATION 0829640 DATED 5-14-2004, EXPIRES 5-14-2014.

THE ENGLISH TRANSLATION OF THE WORD "LA FORCE DIVINE D'UN GRAND COGNAC" IN THE MARK IS DIVINE FORCE OF A GRAND COGNAC.

FOR COGNAC, NAMELY FRENCH BRANDY (U.S. CLS. 47 AND 49).

KELLY BOULTON, EXAMINING ATTORNEY

SN 79-004,996. EURO-NEGOCE, F-16130 JUILLAC LE COQ, FRANCE, FILED 6-25-2004.

BONNE MAISON

PRIORITY DATE OF 1-20-2004 IS CLAIMED.

OWNER OF INTERNATIONAL REGISTRATION 0832326 DATED 6-25-2004, EXPIRES 6-25-2014.

THE ENGLISH TRANSLATION OF BONNE MAISON IS FINE HOUSE.

FOR COGNAC (U.S. CLS. 47 AND 49).

MARK T. MULLEN, EXAMINING ATTORNEY

SN 79-005,098. DOMINIO DE ARANLEON, S.L., SPAIN, FILED 5-27-2004.

ARANLEON

THE MARK CONSISTS OF STANDARD CHARACTERS WITHOUT CLAIM TO ANY PARTICULAR FONT, STYLE, SIZE, OR COLOR.

OWNER OF INTERNATIONAL REGISTRATION 0832550 DATED 5-27-2004, EXPIRES 5-27-2014.

FOR ALCOHOLIC BEVERAGES EXCLUDING BEER, NAMELY, WINE (U.S. CLS. 47 AND 49).

KELLY BOULTON, EXAMINING ATTORNEY

CLASS 33—(Continued).

SN 79-005,319. FIRMA "SOYUZ-VICTAN" LTD; (TOVARISTVO Z OBMEZHENOYU; VIDPOVIDAL'NIST'U), UKRAINE, FILED 7-22-2004.

SV – Luxe

OWNER OF INTERNATIONAL REGISTRATION 0833302 DATED 7-22-2004, EXPIRES 7-22-2014.

THE FOREIGN WORDING IN THE MARK TRANSLATES INTO ENGLISH AS LUXURY.

FOR VODKA; ALCOHOLIC BITTERS; GORILKA, A UKRANIAN ALCOHOLIC BEVERAGE (U.S. CLS. 47 AND 49).

DANIEL BRODY, EXAMINING ATTORNEY

SN 79-005,661. COMPAÑIA VITIVINICOLA TANDEM, S.A., E-31620 GORRAIZ - NAVARRA, SPAIN, FILED 5-17-2004.

"ARSNOVA"

THE MARK CONSISTS OF STANDARD CHARACTERS WITHOUT CLAIM TO ANY PARTICULAR FONT, STYLE, SIZE, OR COLOR.

OWNER OF INTERNATIONAL REGISTRATION 0815171 DATED 11-7-2003, EXPIRES 11-7-2013.

FOR WINES AND SPIRITS (U.S. CLS. 47 AND 49).

ANDREA SAUNDERS, EXAMINING ATTORNEY

SN 79-006,337. VINORICA S.L., SPAIN, FILED 9-21-2004.

STAIRWAY TO HEAVEN

THE MARK CONSISTS OF STANDARD CHARACTERS WITHOUT CLAIM TO ANY PARTICULAR FONT, STYLE, SIZE, OR COLOR.

PRIORITY DATE OF 7-2-2004 IS CLAIMED.

OWNER OF INTERNATIONAL REGISTRATION 0836067 DATED 9-21-2004, EXPIRES 9-21-2014.

FOR ALCOHOLIC BEVERAGES, NAMELY, WINES, RUM, WHISKEY, COGNAC, GRAPPA, BRANDY, LIQUEURS, HARD CIDER, GIN, VODKA, ARAK, PERRY, APERITIFS, AND ALCOHOLIC BEVERAGES OF FRUIT (U.S. CLS. 47 AND 49).

LAURA KOVAISKY, EXAMINING ATTORNEY

SN 79-006,598. GERARDO CESARI S.P.A.; IN SIGLA G.C. S.P.A., ITALY, FILED 8-23-2004.

VALPERGA

OWNER OF INTERNATIONAL REGISTRATION 0576902 DATED 10-18-1991, EXPIRES 10-18-2011.

FOR WINES (U.S. CLS. 47 AND 49).

MICHAEL WEBSTER, EXAMINING ATTORNEY

CLASS 33—(Continued).

SN 79-007,157. T K WINES PTY LTD; ACN 108 907 517, AUSTRALIA, FILED 8-11-2004.



T K

PRIORITY DATE OF 5-12-2004 IS CLAIMED.
OWNER OF INTERNATIONAL REGISTRATION 0834713
DATED 8-11-2004, EXPIRES 8-11-2014.
FOR WINE; POTABLE SPIRITS (U.S. CLS. 47 AND 49).
BARNEY CHARLON, EXAMINING ATTORNEY

SN 79-007,800. PETER RUMBALL WINES PTY LTD, AUSTRALIA, FILED 12-30-2004.

RUMBALL

THE MARK CONSISTS OF STANDARD CHARACTERS WITHOUT CLAIM TO ANY PARTICULAR FONT, STYLE, SIZE, OR COLOR.
PRIORITY DATE OF 12-21-2004 IS CLAIMED.
OWNER OF INTERNATIONAL REGISTRATION 0840220
DATED 12-30-2004, EXPIRES 12-30-2014.
FOR WINE AND WINE BASED LIQUEURS (U.S. CLS. 47 AND 49).
STEVEN PEREZ, EXAMINING ATTORNEY

SN 79-007,991. SIMON GILBERT WINES LIMITED, AUSTRALIA, FILED 11-9-2004.

EIGHTY LINKS

THE MARK CONSISTS OF STANDARD CHARACTERS WITHOUT CLAIM TO ANY PARTICULAR FONT, STYLE, SIZE, OR COLOR.
PRIORITY DATE OF 8-24-2004 IS CLAIMED.
OWNER OF INTERNATIONAL REGISTRATION 0840635
DATED 11-9-2004, EXPIRES 11-9-2014.
FOR WINE (U.S. CLS. 47 AND 49).
ESTHER A. BORSUK, EXAMINING ATTORNEY

CLASS 33—(Continued).

SN 79-009,256. FANTINEL SPA, ITALY, FILED 8-3-2004.

FANTINEL

THE MARK CONSISTS OF STANDARD CHARACTERS WITHOUT CLAIM TO ANY PARTICULAR FONT, STYLE, SIZE, OR COLOR.

PRIORITY DATE OF 5-12-2004 IS CLAIMED.
OWNER OF INTERNATIONAL REGISTRATION 0844378
DATED 8-3-2004, EXPIRES 8-3-2014.

CONSISTS OF THE WORD "FANTINEL" WRITTEN IN ANY TYPE SIZE, PROPORTION AND COLOUR.

FOR ALCOHOLIC BEVERAGES, NAMELY, BITTERS, COCKTAILS, ALCOHOLIC PUNCH, ALCOHOLIC ESSENCES, ALCOHOLIC EXTRACTS, APERITIFS, ALCOHOLIC BEVERAGES CONTAINING FRUIT, ALCOHOLIC BITTERS, BRANDY, PREPARED ALCOHOLIC COCKTAILS, LIQUEURS, POTABLE SPIRITS, DISTILLED SPIRITS, NAMELY GRAPPA, ALCOHOLIC FRUIT EXTRACTS, GIN, KIRSCH, PEPPERMINT LIQUEURS, PIQUETTE, RICE ALCOHOL, RUM, SAKE, VODKA, WHISKY, AND WINE (U.S. CLS. 47 AND 49).
BARBARA A. GOLD, EXAMINING ATTORNEY

SN 79-009,783. REMY-PANNIER, FRANCE, FILED 11-26-2004.

TASTEWORLD

OWNER OF INTERNATIONAL REGISTRATION 0846047
DATED 11-26-2004, EXPIRES 11-26-2014.
FOR RED, WHITE AND ROSE STILL WINES, SPARKLING WINES (U.S. CLS. 47 AND 49).
NANCY CLARKE, EXAMINING ATTORNEY

CLASS 34—SMOKERS' ARTICLES

SN 76-265,185. DUNHILL TOBACCO OF LONDON LIMITED, LONDON, ENGLAND, UNITED KINGDOM, FILED 5-29-2001.

**DUNHILL THREE YEARS
MATURED**

OWNER OF U.S. REG. NOS. 541,949, 2,155,097 AND OTHERS.
NO CLAIM IS MADE TO THE EXCLUSIVE RIGHT TO USE "THREE YEARS MATURED", APART FROM THE MARK AS SHOWN.
FOR PIPE TOBACCO (U.S. CLS. 2, 8, 9 AND 17).
BRIDGETT SMITH, EXAMINING ATTORNEY

CLASS 34—(Continued).

SN 76-380,298. GMB, INC., KING, NC. FILED 3-7-2002.

TWIST

FOR CIGARETTES (U.S. CLS. 2, 8, 9 AND 17).
FIRST USE 11-1-1999; IN COMMERCE 11-1-1999.
MIDGE BUTLER, EXAMINING ATTORNEY

SN 76-523,789. REPUBLIC TOBACCO, L.P., GLENVIEW, IL.
FILED 6-9-2003.

TRIBAL

FOR CIGARETTE PAPER (U.S. CLS. 2, 8, 9 AND 17).
FIRST USE 7-0-2001; IN COMMERCE 7-0-2001.
LAURA KOVAISKY, EXAMINING ATTORNEY

SN 78-281,740. JOHN GIBSON ENTERPRISES INC., LOS
OSOS, CA. FILED 7-31-2003.

MEGA MATCH

FOR BARBECUE LIGHTER (U.S. CLS. 2, 8, 9 AND 17).
FIRST USE 1-1-2003; IN COMMERCE 2-1-2003.
AMOS T. MATTHEWS, JR., EXAMINING ATTORNEY

SN 78-449,855. SKOOKUM CREEK TOBACCO INC, SHEL-
TON, WA. FILED 7-13-2004.

WINTHROPS

THE MARK CONSISTS OF STANDARD CHARACTERS
WITHOUT CLAIM TO ANY PARTICULAR FONT, STYLE,
SIZE, OR COLOR.
FOR CIGARETTES, CIGARS, PIPE TOBACCO, CHEW-
ING TOBACCO (U.S. CLS. 2, 8, 9 AND 17).
ARETHA SOMERVILLE, EXAMINING ATTORNEY

CLASS 34—(Continued).

SN 78-515,765. SIRIUS INNOVATIONS INCORPORATED,
GREENSBORO, NC. FILED 11-12-2004.

TRAVELER BRAND

THE MARK CONSISTS OF STANDARD CHARACTERS
WITHOUT CLAIM TO ANY PARTICULAR FONT, STYLE,
SIZE, OR COLOR.
NO CLAIM IS MADE TO THE EXCLUSIVE RIGHT TO
USE BRAND, APART FROM THE MARK AS SHOWN.
FOR CIGARETTES (U.S. CLS. 2, 8, 9 AND 17).
PRISCILLA MILTON, EXAMINING ATTORNEY

SN 78-520,722. KING EDWARD TECHNOLOGY, INC., WIL-
MINGTON, DE. FILED 11-22-2004.

TRADICION VIEJA

THE MARK CONSISTS OF STANDARD CHARACTERS
WITHOUT CLAIM TO ANY PARTICULAR FONT, STYLE,
SIZE, OR COLOR.
THE WORDS TRADICION VIEJA ARE TRANSLATED
INTO ENGLISH AS "OLD TRADITION".
FOR CIGARS (U.S. CLS. 2, 8, 9 AND 17).
STEVEN R. FINE, EXAMINING ATTORNEY

SN 78-538,315. PRAKASH, ROHIT, COPLEY, OH. FILED 12-
25-2004.

TREAT

THE MARK CONSISTS OF STANDARD CHARACTERS
WITHOUT CLAIM TO ANY PARTICULAR FONT, STYLE,
SIZE, OR COLOR.
FOR FILTER-TIPPED CIGARETTES (U.S. CLS. 2, 8, 9
AND 17).
ELISSA GARBER KON, EXAMINING ATTORNEY

CLASS 34—(Continued).

SN 78-539,281. DHANRAJ IMPORTS, INC., RIVERSIDE, CA.
FILED 12-28-2004.

CLASS 34—(Continued).

SN 78-559,768. EVE HOLDINGS INC., WILMINGTON, DE.
FILED 2-3-2005.

ROMANCE

FLAGSTAFF

THE MARK CONSISTS OF STANDARD CHARACTERS
WITHOUT CLAIM TO ANY PARTICULAR FONT, STYLE,
SIZE, OR COLOR.
FOR CIGARETTES (U.S. CLS. 2, 8, 9 AND 17).
G. MAYERSCHOFF, EXAMINING ATTORNEY

THE MARK CONSISTS OF STANDARD CHARACTERS
WITHOUT CLAIM TO ANY PARTICULAR FONT, STYLE,
SIZE, OR COLOR.
FOR CIGARETTES (U.S. CLS. 2, 8, 9 AND 17).
STEVEN R. FINE, EXAMINING ATTORNEY

SN 78-559,754. EVE HOLDINGS INC., WILMINGTON, DE.
FILED 2-3-2005.

SN 78-560,180. EVE HOLDINGS INC., WILMINGTON, DE.
FILED 2-3-2005.

DRAFT

SANDSTONE

THE MARK CONSISTS OF STANDARD CHARACTERS
WITHOUT CLAIM TO ANY PARTICULAR FONT, STYLE,
SIZE, OR COLOR.
FOR CIGARETTES (U.S. CLS. 2, 8, 9 AND 17).
PAUL E. FAHRENKOPF, EXAMINING ATTORNEY

THE MARK CONSISTS OF STANDARD CHARACTERS
WITHOUT CLAIM TO ANY PARTICULAR FONT, STYLE,
SIZE, OR COLOR.
FOR CIGARETTES (U.S. CLS. 2, 8, 9 AND 17).
GEORGE LORENZO, EXAMINING ATTORNEY

CLASS 35—(Continued).

CLASS 35—(Continued).

SN 75-832,825. FLEET WHOLESALE SUPPLY CO., INC., APPLETON, WI. FILED 10-26-1999.

SERVICE MARKS

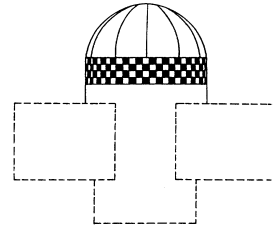

CLASS 35—ADVERTISING AND BUSINESS

SN 75-558,905. HR AMERICA, INC., FORT WAYNE, IN. FILED 9-25-1998.

HR AMERICA

THE MARK CONSISTS OF A DOME-LIKE STRUCTURE, WITH A ROTUND BASE, WHICH PEOPLE GENERALLY IDENTIFY AS A "SILO," FEATURING A CHECKERBOARD PATTERN ENCIRCLING THE BASE AT ITS INTERSECTION WITH THE DOME. THE SILO IS PART OF THE STORE FRONT FOR THE APPLICANT AND THE DOTTED LINES MERELY REPRESENT THE PORTIONS OF THE BUILDING WHICH INTERSECT WITH THE SILO AS PART OF THE STORE FRONT.

SEC. 2(F).

FOR RETAIL STORES FEATURING HARDWARE, HOUSEWARES, PLUMBING, SPORTING GOODS, FARM ITEMS, GARDEN ITEMS, AUTOMOTIVE ITEMS, SHOES, WEARING APPAREL, ELECTRONIC GOODS AND PHOTOGRAPHIC EQUIPMENT (U.S. CLS. 100, 101 AND 102).

FIRST USE 2-28-2000; IN COMMERCE 2-28-2000.

JERI J. FICKES, EXAMINING ATTORNEY

NO CLAIM IS MADE TO THE EXCLUSIVE RIGHT TO USE "HR", APART FROM THE MARK AS SHOWN. SEC. 2(F).

FOR EMPLOYEE LEASING AND HUMAN RESOURCE CONSULTING SERVICES (U.S. CLS. 100, 101 AND 102).

FIRST USE 7-1-1991; IN COMMERCE 7-1-1991.

JOANNA DUKOVIC, EXAMINING ATTORNEY

SN 75-918,725. LAITE, JOSEPH M., NEWBURYPORT, MA. FILED 2-14-2000.

adeptsearch

the sales placement experts

NO CLAIM IS MADE TO THE EXCLUSIVE RIGHT TO USE "THE SALES PLACEMENT EXPERTS", APART FROM THE MARK AS SHOWN.

FOR PERSONNEL PLACEMENT AND RECRUITMENT (U.S. CLS. 100, 101 AND 102).

FIRST USE 1-3-2000; IN COMMERCE 1-3-2000.

TRACY CROSS, EXAMINING ATTORNEY

SN 75-637,749. E-DIALOG, INC., LEXINGTON, MA. FILED 2-10-1999.

E-DIALOG

SN 76-012,699. AUTOFAIR INVESTORS, LP, MANCHESTER, NH. FILED 3-29-2000.

AUTOFAIR

SEC. 2(F).

FOR AUTOMOBILE DEALERSHIP SERVICES FEATURING NEW AND NEARLY NEW AUTOMOBILES, BUT EXCLUDING THE OFFERING FOR SALE OR EXHIBITION OF CUSTOM, COLLECTOR OR SPECIALTY CARS OR TRUCKS (U.S. CLS. 100, 101 AND 102).

FIRST USE 2-5-1991; IN COMMERCE 2-5-1991.

ZHALEH DELANEY, EXAMINING ATTORNEY

SEC. 2(F).
FOR ELECTRONIC DIRECT-RESPONSE MARKETING SERVICES VIA AN ON-LINE GLOBAL COMPUTER NETWORK (U.S. CLS. 100, 101 AND 102).

FIRST USE 10-11-1996; IN COMMERCE 5-0-1997.

IRENE D. WILLIAMS, EXAMINING ATTORNEY

CLASS 35—(Continued).

SN 76-397,860. PROPHET BRAND STRATEGY, SAN FRANCISCO, CA. FILED 4-18-2002.

PROPHET

OWNER OF U.S. REG. NOS. 2,048,718 AND 2,397,453.
FOR STRATEGIC BUSINESS PLANNING; BUSINESS
MARKETING; CORPORATE IDENTITY MARKETING;
AND MARKET RESEARCH CONSULTING SERVICES
(U.S. CLS. 100, 101 AND 102).

FIRST USE 6-30-1992; IN COMMERCE 6-30-1992.
SCOTT OSICK, EXAMINING ATTORNEY

SN 76-440,430. ARCHERY TRADE ASSOCIATION, INC.,
VIENNA, VA. FILED 8-5-2002.



NO CLAIM IS MADE TO THE EXCLUSIVE RIGHT TO
USE ARCHERY TRADE ASSOCIATION, APART FROM
THE MARK AS SHOWN.

FOR ASSOCIATION SERVICES, NAMELY, PROMOTING
THE INTERESTS OF MANUFACTURERS, DISTRIBUTORS,
RETAILERS, DEALERS, SALES REPRESENTATIVES
AND OTHERS FROM THE SPORTING AND OUTDOOR
INDUSTRIES WHO MAKE, DISTRIBUTE AND SELL
SPORTING AND HUNTING EQUIPMENT (U.S. CLS.
100, 101 AND 102).

FIRST USE 8-5-2002; IN COMMERCE 8-5-2002.
LESLEY LAMOTHE, EXAMINING ATTORNEY

SN 76-448,056. PANTRY, INC., THE, SANFORD, NC. FILED
9-9-2002.

THE CHILL ZONE

NO CLAIM IS MADE TO THE EXCLUSIVE RIGHT TO
USE "CHILL", APART FROM THE MARK AS SHOWN.

FOR RETAIL CONVENIENCE STORE SERVICES
FEATURING SELF-SERVE BEVERAGE STATIONS FOR
DISPENSING OF CHILLED AND FROZEN SOFT
DRINKS (U.S. CLS. 100, 101 AND 102).

FIRST USE 5-14-2002; IN COMMERCE 5-14-2002.
TRICIA THOMPCKINS, EXAMINING ATTORNEY

CLASS 35—(Continued).

SN 76-454,689. THE BELO COMPANY, A DELAWARE
BUSINESS TRUST, THE TRUSTEES COMPRISING MARK
T. RYAN, SANDRA J. RADCLIFFE, JULIAN H. BAUMANN,
JR., ALL U.S. CITIZENS, WILMINGTON, DE.
FILED 10-2-2002.



NO CLAIM IS MADE TO THE EXCLUSIVE RIGHT TO
USE "DIRECT", APART FROM THE MARK AS SHOWN.

THE STIPPLING IS FOR SHADING PURPOSES.
FOR ADVERTISING SERVICES, NAMELY, PROVIDING
EXCLUSIVE DISCOUNTS, SPECIAL OFFERS AND
PRIVATE ANNOUNCEMENTS FROM ADVERTISERS
TO OTHERS VIA ELECTRONIC MAIL (U.S. CLS. 100,
101 AND 102).

FIRST USE 8-24-2001; IN COMMERCE 8-24-2001.
TRICIA THOMPCKINS, EXAMINING ATTORNEY

SN 76-462,621. BEST BUY ENTERPRISE SERVICES, INC.,
RICHFIELD, MN. FILED 10-28-2002.

THE FANATICAL TV MONTH

NO CLAIM IS MADE TO THE EXCLUSIVE RIGHT TO
USE "TV MONTH", APART FROM THE MARK AS SHOWN.

FOR RETAILER SERVICES IN THE FIELD OF MAJOR
HOUSEHOLD APPLIANCES, PHOTOGRAPHIC EQUIP-
MENT, TELECOMMUNICATION EQUIPMENT, VIDEO
EQUIPMENT, AUDIO EQUIPMENT, PERSONAL COM-
PUTERS AND OTHER HOME OFFICE PRODUCTS AND
ENTERTAINMENT SOFTWARE, INCLUDING COM-
PACT DISCS, PRE-RECORDED AUDIO AND VIDEO
CASSETTES AND COMPUTER SOFTWARE, AND RE-
LATED MERCHANDISE (U.S. CLS. 100, 101 AND 102).

FIRST USE 1-6-2002; IN COMMERCE 1-6-2002.
ZACHARY BELLO, EXAMINING ATTORNEY

SN 76-492,551. PARTSEARCH TECHNOLOGIES, INC., NEW
YORK, NY. FILED 2-26-2003.



NO CLAIM IS MADE TO THE EXCLUSIVE RIGHT TO
USE "PARTSEARCH TECHNOLOGIES", APART FROM
THE MARK AS SHOWN.

FOR ELECTRONIC CATALOG AND ORDER FUL-
FILLMENT FROM CATALOG ORDERS FEATURING
REPLACEMENT PARTS AND ACCESSORIES FOR CON-
SUMER ELECTRONICS, MAJOR APPLIANCES, CELLU-
LAR TELEPHONES, LAWN AND GARDEN
EQUIPMENT, AND COMPUTERS (U.S. CLS. 100, 101
AND 102).

FIRST USE 3-5-2001; IN COMMERCE 3-5-2001.
CURTIS FRENCH, EXAMINING ATTORNEY

CLASS 35—(Continued).

SN 76-514,801. ACCOUNTING WORLD CPA'S INTERNATIONAL, L.L.C., SCOTTSDALE, AZ. FILED 5-16-2003.



Accounting World CPA'S, P.L.C.
A Certified Public Accounting Firm

NO CLAIM IS MADE TO THE EXCLUSIVE RIGHT TO USE ACCOUNTING, CPA'S, P.L.C., A CERTIFIED PUBLIC ACCOUNTING FIRM, APART FROM THE MARK AS SHOWN.

FOR INCOME TAX PREPARATION AND CONSULTATION AND ACCOUNTING SERVICES (U.S. CLS. 100, 101 AND 102).

FIRST USE 12-24-1998; IN COMMERCE 12-24-1998.
KELLY BOULTON, EXAMINING ATTORNEY

SN 76-522,108. ROMAX, INC., SEATTLE, WA. FILED 6-11-2003.

ROMAX

FOR RETAIL STORE SERVICES, AVAILABLE THROUGH COMPUTER COMMUNICATIONS AND INTERACTIVE TELEVISION, FEATURING FOOTWEAR, FOOTWEAR ACCESSORIES, SHOE CARE PRODUCTS, CLOTHING, HATS, JEWELRY, HANDBAGS AND EYEWEAR (U.S. CLS. 100, 101 AND 102).

FIRST USE 5-0-2000; IN COMMERCE 5-0-2000.
GIANCARLO CASTRO, EXAMINING ATTORNEY

SN 76-558,651. BAGGED AND BOARDED, LLC, BENSALEM, PA. FILED 11-10-2003.

BAGGED AND BOARDED

FOR RETAIL STORE SERVICES IN THE AREA OF COLLECTIBLES, NAMELY, COMIC BOOKS, RELATED COLLECTIBLES AND SUPPLIES, NON-SPORTS-RELATED TRADING CARDS AND GAMES, LIMITED EDITION LITHOGRAPHS AND FIGURINES, ACTION FIGURES, POSTERS, BOBBLE-HEAD DOLLS, COLLECTOR PLATE AND COMIC BOOK RELATED LICENSED APPAREL (U.S. CLS. 100, 101 AND 102).

FIRST USE 9-29-2003; IN COMMERCE 9-29-2003.
ANNE MADDEN, EXAMINING ATTORNEY

CLASS 35—(Continued).

SN 76-558,718. HEALTHSTAR COMMUNICATIONS, INC., WOODBRIDGE, NJ. FILED 10-27-2003.

SMARTPORT

FOR MARKETING CONSULTING SERVICES, NAMELY, PROVIDING CUSTOMIZED DATA COLLECTION AND MARKET PLANNING INFORMATION VIA THE INTERNET TO THE PHARMACEUTICAL AND HEALTHCARE INDUSTRIES (U.S. CLS. 100, 101 AND 102).

FIRST USE 7-18-2003; IN COMMERCE 7-18-2003.
KATHERINE STOIDES, EXAMINING ATTORNEY

SN 76-561,658. SRA FOODS, INC., BIRMINGHAM, AL. FILED 11-10-2003.



NO CLAIM IS MADE TO THE EXCLUSIVE RIGHT TO USE "FOODS, INC.", APART FROM THE MARK AS SHOWN.

FOR WHOLESALE DISTRIBUTORSHIP FEATURING MEAT (U.S. CLS. 100, 101 AND 102).

SUE LAWRENCE, EXAMINING ATTORNEY

SN 76-566,241. WAL-MART STORES, INC., BENTONVILLE, AR. FILED 12-18-2003.

FAX 'N' PULL

THE MARK CONSISTS OF STANDARD CHARACTERS WITHOUT CLAIM TO ANY PARTICULAR FONT, STYLE, SIZE, OR COLOR.

OWNER OF U.S. REG. NO. 2,804,435.

FOR FAX ORDERING SERVICES FEATURING WHOLESALE AND RETAIL DISTRIBUTION OF GENERAL MERCHANDISE; PROVIDING SHOPPING SERVICES VIA FACSIMILE FEATURING GENERAL MERCHANDISE; ORDERING SERVICES FEATURING GENERAL MERCHANDISE VIA FACSIMILE (U.S. CLS. 100, 101 AND 102).

FIRST USE 3-0-1995; IN COMMERCE 3-0-1995.
MARY ROSSMAN, EXAMINING ATTORNEY

CLASS 35—(Continued).

SN 76-566,722. THE WHITE HOUSE COMMISSION ON THE NATIONAL MOMENT OF REMEMBRANCE, WASHINGTON, DC. FILED 12-23-2003.

WHITE HOUSE COMMISSION ON REMEMBRANCE

THE MARK CONSISTS OF STANDARD CHARACTERS WITHOUT CLAIM TO ANY PARTICULAR FONT, STYLE, SIZE, OR COLOR.

SEC. 2(F).
FOR PROMOTING PUBLIC AWARENESS OF THE RELEVANCE AND LEGACY OF MEMORIAL DAY; PROMOTING PUBLIC AWARENESS OF THE NEED TO HONOR AND SUPPORT THE MEN AND WOMEN WHO DIED WHILE IN SERVICE TO THEIR COUNTRY, VETERANS OF THE ARMED SERVICES, AND THOSE WHO CONTINUE TO SERVE; PROMOTING AWARENESS IN CHILDREN ABOUT PATRIOTISM AND THE AMERICAN SPIRIT (U.S. CLS. 100, 101 AND 102).

FIRST USE 5-0-2002; IN COMMERCE 5-0-2002.
JOHN LINCOSKI, EXAMINING ATTORNEY

SN 76-571,402. THAIGEM GLOBAL MARKETING LIMITED CORPORATION, BANGRAK, BANGKOK, 10500, THAILAND. FILED 1-22-2004.

THAIGEM.COM

NO CLAIM IS MADE TO THE EXCLUSIVE RIGHT TO USE THAIGEM.COM, APART FROM THE MARK AS SHOWN.

FOR ON-LINE RETAIL STORE SERVICES, FEATURING PRECIOUS STONES, AND JEWELRY OF OTHERS (U.S. CLS. 100, 101 AND 102).

FIRST USE 9-15-1998; IN COMMERCE 9-15-1998.
MICHAEL ENGEL, EXAMINING ATTORNEY

SN 76-572,782. VERITY PARTNERS, LLC, ATLANTA, GA. FILED 1-28-2004.

VERITY PARTNERS

THE MARK CONSISTS OF STANDARD CHARACTERS WITHOUT CLAIM TO ANY PARTICULAR FONT, STYLE, SIZE, OR COLOR.

NO CLAIM IS MADE TO THE EXCLUSIVE RIGHT TO USE "PARTNERS", APART FROM THE MARK AS SHOWN.

FOR CONSULTANCY SERVICES REGARDING BUSINESS STRATEGIES IN RELATION TO CORPORATE MERGERS AND ACQUISITIONS PLANNING AND EXECUTION, CORPORATE AND TAX RESTRUCTURING, BUSINESS SYSTEMS PLANNING AND IMPLEMENTATION, AND BUSINESS PROCESS DESIGN AND IMPLEMENTATION (U.S. CLS. 100, 101 AND 102).

GEOFFREY FOSDICK, EXAMINING ATTORNEY

CLASS 35—(Continued).

SN 76-575,168. SHENOA & CO. LTD, DBA GLOBAL BARGAIN HUNTERS, NEW YORK, NY. FILED 2-10-2004.

GLOBAL BARGAIN HUNTERS

THE MARK CONSISTS OF STANDARD CHARACTERS WITHOUT CLAIM TO ANY PARTICULAR FONT, STYLE, SIZE, OR COLOR.

NO CLAIM IS MADE TO THE EXCLUSIVE RIGHT TO USE "GLOBAL", APART FROM THE MARK AS SHOWN.

FOR ELECTRONIC RETAILING IN THE FIELD OF JEWELRY AT LOW PRICES VIA A GLOBAL COMPUTER NETWORK (U.S. CLS. 100, 101 AND 102).

FIRST USE 9-1-2003; IN COMMERCE 9-1-2003.
VIVIAN MICZNIK FIRST, EXAMINING ATTORNEY

SN 76-575,457. SCHOOLS INTEROPERABILITY FRAMEWORK ASSOCIATION, WASHINGTON, DC. FILED 2-17-2004.

SIF

THE MARK CONSISTS OF STANDARD CHARACTERS WITHOUT CLAIM TO ANY PARTICULAR FONT, STYLE, SIZE, OR COLOR.

SEC. 2(F).
FOR ASSOCIATION SERVICES, NAMELY, PROMOTING INTEROPERABILITY BETWEEN EDUCATIONAL SOFTWARE APPLICATIONS (U.S. CLS. 100, 101 AND 102).

FIRST USE 2-2-1999; IN COMMERCE 2-2-1999.
ELIZABETH J. WINTER, EXAMINING ATTORNEY

SN 76-578,509. TAIWAN EXTERNAL TRADE DEVELOPMENT COUNCIL, TAIPEI, TAIWAN, FILED 2-25-2004.

TAITRA

OWNER OF U.S. REG. NOS. 1,899,443 AND 2,784,890.
FOR MARKET ANALYSIS AND PROMOTION SERVICES FOR THE GOODS AND SERVICES MADE OR RENDERED IN TAIWAN BY OTHERS; ARRANGING AND CONDUCTING TRADE SHOWS AND EXHIBITS FEATURING GOODS AND SERVICES MADE OR RENDERED IN TAIWAN BY OTHERS (U.S. CLS. 100, 101 AND 102).

CHRISTOPHER BUONGIORNO, EXAMINING ATTORNEY

CLASS 35—(Continued).

SN 76-584,259. TAYLOR, RONALD LEE, STUART, FL.
FILED 3-29-2004.



OWNER OF U.S. REG. NO. 2,335,414.
NO CLAIM IS MADE TO THE EXCLUSIVE RIGHT TO USE "PROFESSIONAL AIR TRAFFIC CONTROLLERS ORGANIZATION", APART FROM THE MARK AS SHOWN.
THE MARK CONSISTS OF A SPECIAL CHARACTER DRAWING, WHICH CONSISTS OF THE LETTERS PATCO, WITH A JET STREAM THROUGH THE CENTER OF THE LETTERS, "PATC" AND A JET AIRCRAFT IN THE CENTER OF THE LETTER "O", WITH THE WORDS, "PROFESSIONAL AIR TRAFFIC CONTROLLERS ORGANIZATION" UNDERNEATH THE DESIGN.

FOR ASSOCIATION SERVICES, NAMELY, PROMOTING THE INTERESTS OF FORMER AIR TRAFFIC CONTROLLERS AND OTHER PERSONS INTERESTED IN THE AIR TRAFFIC CONTROL INDUSTRY (U.S. CLS. 100, 101 AND 102).

FIRST USE 1-1-1996; IN COMMERCE 1-1-1996.
ODESSA BIBBINS, EXAMINING ATTORNEY

SN 76-588,039. E.A. DION, INC., ATTLEBORO, MA. FILED 4-22-2004.

JEWELRY SOLUTIONS

THE MARK CONSISTS OF STANDARD CHARACTERS WITHOUT CLAIM TO ANY PARTICULAR FONT, STYLE, SIZE, OR COLOR.

NO CLAIM IS MADE TO THE EXCLUSIVE RIGHT TO USE JEWELRY, APART FROM THE MARK AS SHOWN.

FOR BUSINESS SERVICES, NAMELY, PROVIDING RECOGNITION, PROMOTION AND MOTIVATION JEWELRY REWARDS, FEATURING EMBLEMATIC JEWELRY, AS AN INCENTIVE FOR IMPROVED WORK AND SALES PERFORMANCE (U.S. CLS. 100, 101 AND 102).

WILLIAM VERHOSEK, EXAMINING ATTORNEY

SN 76-589,138. HOSS, INC., FAIRFIELD, CT. FILED 4-28-2004.

HOSS

THE MARK CONSISTS OF STANDARD CHARACTERS WITHOUT CLAIM TO ANY PARTICULAR FONT, STYLE, SIZE, OR COLOR.

FOR ADVERTISING SERVICES (U.S. CLS. 100, 101 AND 102).

FIRST USE 4-1-2003; IN COMMERCE 4-1-2003.
ANNE E. GUSTASON, EXAMINING ATTORNEY

CLASS 35—(Continued).

SN 76-589,414. DECISION ANALYST, INC., ARLINGTON, TX. FILED 4-29-2004.

TECHNOLOGY ADVISORY BOARD

THE MARK CONSISTS OF STANDARD CHARACTERS WITHOUT CLAIM TO ANY PARTICULAR FONT, STYLE, SIZE, OR COLOR.

OWNER OF U.S. REG. NO. 2,572,404.

NO CLAIM IS MADE TO THE EXCLUSIVE RIGHT TO USE BOARD, APART FROM THE MARK AS SHOWN.
SEC. 2(F).

FOR CONDUCTING MARKETING RESEARCH VIA THE INTERNET (U.S. CLS. 100, 101 AND 102).

FIRST USE 4-27-1999; IN COMMERCE 4-27-1999.

NAAKWAMA ANKRAH, EXAMINING ATTORNEY

SN 76-589,842. PHIBRO ANIMAL HEALTH CORPORATION, FORT LEE, NJ. FILED 4-30-2004.

PHIBROCARE

THE MARK CONSISTS OF STANDARD CHARACTERS WITHOUT CLAIM TO ANY PARTICULAR FONT, STYLE, SIZE, OR COLOR.

FOR DISTRIBUTORSHIP SERVICES IN THE FIELD OF CHEMICAL INGREDIENTS AND SPECIALTY CHEMICALS FOR USE IN FORMULATION OF PERSONAL CARE PRODUCTS (U.S. CLS. 100, 101 AND 102).

FIRST USE 4-16-2004; IN COMMERCE 4-16-2004.

KATHERINE STOIDES, EXAMINING ATTORNEY

SN 76-589,925. DOLLAR TREE STORES, INC., CHESAPEAKE, VA. FILED 4-12-2004.



NO CLAIM IS MADE TO THE EXCLUSIVE RIGHT TO USE "EVERYTHING'S \$1", APART FROM THE MARK AS SHOWN.

THE COLOR(S) YELLOW, WHITE, GREEN AND BLACK IS/ARE CLAIMED AS A FEATURE OF THE MARK.

THE MARK CONSISTS OF AN ARABIC DOLLAR SIGN AND NUMBER ONE IN BLACK, SUPERIMPOSED OVER

CLASS 35—(Continued).

FIVE CONCENTRIC CIRCLES, THE INNER CIRCLE OF ALTERNATING STRIPES OF YELLOW (PMS #116) AND WHITE, ENCOMPASSED BY A NARROW CIRCLE OF GREEN (PMS #355), WHICH IS ENCOMPASSED BY A NARROW CIRCLE OF GREEN (PMS #360), WHICH IS ENCOMPASSED BY A WIDER WHITE CIRCLE WHICH IS ENCOMPASSED BY A VERY NARROW BLACK CIRCLE, WITHIN THE WIDER WHITE CIRCLE IS THE WORD EVERYTHING'S IN GREEN (PMS#360) WITH A BLACK OUTLINE.

FOR RETAIL STORE SERVICES FEATURING GENERAL CONSUMER MERCHANDISE (U.S. CLS. 100, 101 AND 102).

FIRST USE 3-28-2003; IN COMMERCE 3-28-2003.
KATHRYN COWARD, EXAMINING ATTORNEY

SN 76-591,731. ECONOMIC DEVELOPMENT CENTER OF ST. CHARLES COUNTY, ST. CHARLES, MO. FILED 5-11-2004.



*A Great Place to Grow
Your Business & Your Life*

NO CLAIM IS MADE TO THE EXCLUSIVE RIGHT TO USE "ST CHARLES COUNTY MISSOURI", APART FROM THE MARK AS SHOWN.

FOR PROMOTING BUSINESS AND ECONOMIC DEVELOPMENT IN ST. CHARLES COUNTY, MISSOURI (U.S. CLS. 100, 101 AND 102).

FIRST USE 9-26-2003; IN COMMERCE 9-26-2003.
TONI HICKEY, EXAMINING ATTORNEY

SN 76-592,750. MEN/WOMEN N.Y. MODEL MANAGEMENT, INC., NEW YORK, NY. FILED 5-7-2004.

WOMEN MANAGEMENT

SEC. 2(F).
FOR MODEL AGENCY SERVICES (U.S. CLS. 100, 101 AND 102).

FIRST USE 12-31-1980; IN COMMERCE 12-31-1980.
GINA HAYES, EXAMINING ATTORNEY

CLASS 35—(Continued).

SN 76-593,008. AJANI INVESTMENTS, INC., DULUTH, GA. FILED 5-19-2004.



NO CLAIM IS MADE TO THE EXCLUSIVE RIGHT TO USE JAVA, APART FROM THE MARK AS SHOWN.

FOR WHOLESALE SUPPLY, RETAIL OUTLETS AND MAIL ORDER SERVICES FEATURING GROUND AND WHOLE BEAN COFFEE, TEA, COCOA, COFFEE AND ESPRESSO BEVERAGES AND BEVERAGES MADE WITH A BASE OF COFFEE, ESPRESSO, AND/OR MILK, POWDERED FLAVORINGS, FLAVORING SYRUPS, BAKED GOODS, INCLUDING MUFFINS, SCONES, BISCUITS, COOKIES, PASTRIES, CAKES AND BREADS, AND READY-TO-MAKE MIXES OF THE SAME, PACKAGED FOODS, SANDWICHES AND PREPARED FOODS, CHOCOLATE AND CONFECTIONERY ITEMS, GRANOLA, DRIED FRUITS, SPREADS, JUICES, SOFT DRINKS, ELECTRIC APPLIANCES, NAMELY, KETTLES, COFFEE MAKERS, ESPRESSO MAKERS AND COFFEE GRINDERS, HOUSEWARES, NON-ELECTRIC APPLIANCES AND RELATED ITEMS, NAMELY, HAND OPERATED COFFEE GRINDERS AND COFFEE MILLS, INSULATED COFFEE AND BEVERAGE CUPS (MADE OF PLASTICS AND/OR CERAMICS), COLLAPSIBLE CUP CARRIERS AND CADDIES, NON-PAPER COASTERS, INSULATED VACUUM BOTTLES, COFFEE CUPS, TEA CUPS AND MUGS, GLASSWARE, DISHES, PLATES AND BOWLS, TRIVETS, STORAGE CANISTERS, NON-ELECTRIC DRIP COFFEE MAKERS AND NON-ELECTRIC PLUNGER-STYLE COFFEE MAKERS, PAPER AND NON PAPER COFFEE FILTERS, FURNITURE, CLOCKS, TOYS, BOOKS, MUSICAL RECORDINGS, T-SHIRTS, CAPS, SWEATSHIRTS, JACKETS, APRONS AND OTHER CLOTHING ITEMS, AND FOR RESTAURANT, CAFE AND COFFEE HOUSE SERVICES (U.S. CLS. 100, 101 AND 102).

FIRST USE 5-7-2004; IN COMMERCE 5-7-2004.
ANN LINNEHAN, EXAMINING ATTORNEY

SN 76-593,368. WORLD FINDS, INC., DOWNERS GROVE, IL. FILED 5-20-2004.



NO CLAIM IS MADE TO THE EXCLUSIVE RIGHT TO USE HANDMADE FAIR TRADE, APART FROM THE MARK AS SHOWN.

FOR IMPORTATION AGENCIES AND DISTRIBUTORSHIPS IN THE FIELD OF WOMEN'S ACCESSORIES, NAMELY, PURSES AND HANDBAGS, SILVER JEWELRY, ETHNIC HOME ACCESSORIES, HANDMADE PAPER ITEMS, CLOVE PRODUCTS AND HOLIDAY ITEMS (U.S. CLS. 100, 101 AND 102).

FIRST USE 6-0-2003; IN COMMERCE 6-0-2003.
ANDREA SAUNDERS, EXAMINING ATTORNEY

CLASS 35—(Continued).

SN 76-593,369. WORLD FINDS, INC., WESTERN SPRINGS, IL. FILED 5-20-2004.

WORLD FINDS

THE MARK CONSISTS OF STANDARD CHARACTERS WITHOUT CLAIM TO ANY PARTICULAR FONT, STYLE, SIZE, OR COLOR.

FOR IMPORTATION AND WHOLESALE DISTRIBUTORSHIP OF WOMEN'S ACCESSORIES, NAMELY, PURSES AND HANDBAGS, SILVER JEWELRY, ETHNIC HOME ACCESSORIES, HANDMADE PAPER ITEMS, CLOVE PRODUCTS, AND HOLIDAY ITEMS (U.S. CLS. 100, 101 AND 102).

FIRST USE 11-0-1999; IN COMMERCE 11-0-1999.
MICHAEL KEATING, EXAMINING ATTORNEY

SN 76-594,836. ENOVATEIT, LLC, MURFREESBORO, TN. FILED 6-1-2004.

ENOVATEIT

THE MARK CONSISTS OF STANDARD CHARACTERS WITHOUT CLAIM TO ANY PARTICULAR FONT, STYLE, SIZE, OR COLOR.

FOR MARKETING IN THE FIELD OF SYSTEM INTEGRATION AND PRODUCT INTEGRATION OF MOBILE WIRELESS COMPUTING SYSTEMS IN THE HEALTH CARE FIELD AND OTHER SIMILAR MARKETS (U.S. CLS. 100, 101 AND 102).

FIRST USE 2-15-2003; IN COMMERCE 2-15-2003.
SUSAN HAYASH, EXAMINING ATTORNEY

SN 76-595,001. JACKSON, DENNIS A., BURBANK, CA. AND JACKSON, JENNIFER A., BURBANK, CA. FILED 6-1-2004.

URATE AUTO

THE MARK CONSISTS OF STANDARD CHARACTERS WITHOUT CLAIM TO ANY PARTICULAR FONT, STYLE, SIZE, OR COLOR.

NO CLAIM IS MADE TO THE EXCLUSIVE RIGHT TO USE AUTO, APART FROM THE MARK AS SHOWN.

FOR GATHERING INFORMATION, INCLUDING PROVIDING SURVEYS, AND DISSEMINATING SAID INFORMATION AND SURVEYS, CONCERNING QUALITY OF MOTOR VEHICLE REPAIR AND MAINTENANCE FACILITIES (U.S. CLS. 100, 101 AND 102).

FIRST USE 1-15-2000; IN COMMERCE 1-15-2000.
BRIAN NEVILLE, EXAMINING ATTORNEY

CLASS 35—(Continued).

SN 76-595,699. GREENE, TWEED OF DELAWARE, INC., WILMINGTON, DE. FILED 6-4-2004.

NOVAGISTICS

THE MARK CONSISTS OF STANDARD CHARACTERS WITHOUT CLAIM TO ANY PARTICULAR FONT, STYLE, SIZE, OR COLOR.

FOR SUPPLY CHAIN MANAGEMENT SERVICES; AND BUSINESS CONSULTATION IN THE FIELDS OF LOGISTICS AND SUPPLY CHAIN MANAGEMENT (U.S. CLS. 100, 101 AND 102).

CIMMERIAN COLEMAN, EXAMINING ATTORNEY

SN 76-596,038. CHOI, MYUNG BOK, LOS ANGELES, CA. FILED 6-7-2004.

POPLOOKS

FOR WHOLESALE STORE SERVICES FEATURING T-SHIRTS; JACKETS AND JEANS (U.S. CLS. 100, 101 AND 102).

FIRST USE 4-15-2004; IN COMMERCE 4-15-2004.
WILLIAM P. SHANAHAN, EXAMINING ATTORNEY

SN 76-596,405. LAURA GUIDO-CLARK DESIGN, LLC, BERKLEY, CA. FILED 6-8-2004.

CLIMATOLOGY

THE MARK CONSISTS OF STANDARD CHARACTERS WITHOUT CLAIM TO ANY PARTICULAR FONT, STYLE, SIZE, OR COLOR.

FOR ADVISORY AND CONSULTANCY SERVICES RELATING TO BRAND DEVELOPMENT AND BRAND ESTABLISHMENT AND IMAGE, PROVIDED TO CULTURAL AND BUSINESS INSTITUTIONS (U.S. CLS. 100, 101 AND 102).

SONYA STEPHENS, EXAMINING ATTORNEY

SN 76-596,851. WASHINGTON NATIONAL OPERA, WASHINGTON, DC. FILED 6-10-2004.

WASHINGTON NATIONAL OPERA

THE MARK CONSISTS OF STANDARD CHARACTERS WITHOUT CLAIM TO ANY PARTICULAR FONT, STYLE, SIZE, OR COLOR.

NO CLAIM IS MADE TO THE EXCLUSIVE RIGHT TO USE "WASHINGTON", APART FROM THE MARK AS SHOWN.

FOR RETAIL STORE SERVICES, COMPUTERIZED ON-LINE RETAIL SERVICES, TELEPHONE SHOP-AT-HOME SERVICES, AND MAIL-ORDER CATALOGUE SERVICES FEATURING CLOTHING, HEADWEAR, ACCESSORIES, GIFTS, JEWELRY, MUSIC BOXES, TRAVEL GOODS, CARRYING BAGS, GLASSWARE, PORCELAIN, CERAMICS, CHRISTMAS DECORATIONS AND ORNAMENTS (U.S. CLS. 100, 101 AND 102).

MIDGE BUTLER, EXAMINING ATTORNEY

CLASS 35—(Continued).

SN 76-596,868. MALONEY, JOHN CAMPBELL, ARLINGTON, VA. FILED 6-10-2004.

BLUEUNDERGROUND

FOR ADVERTISING AND ADVERTISEMENT SERVICES, NAMELY, DEVELOPMENT OF MARKETING STRATEGIES, MARKETING COMMUNICATIONS, TECHNOLOGY STRATEGIES, LOGOS, BANNER ADS, E-COMMERCE ADVERTISING SOLUTIONS, AND ADVERTISING NETWORK UTILIZATION; ADVERTISING SERVICES, NAMELY, ONLINE MARKETING CAMPAIGNS; ADVERTISING SERVICES, NAMELY, CREATING CORPORATE AND BRAND IDENTITY FOR OTHERS, CREATION OF REPORTS, PUBLICATIONS, BROCHURES, CORPORATE EVENT COMMUNICATIONS, CD PACKAGES AND ADVERTISING; CREATING AND CONDUCTING TRADE SHOW EXHIBITIONS BASED UPON THE SPECIFICATIONS OF OTHERS; PROMOTION, ADVERTISING AND MARKETING OF ONLINE WEBSITES (U.S. CLS. 100, 101 AND 102).

FIRST USE 11-0-1999; IN COMMERCE 11-0-1999.
JILL C. ALT, EXAMINING ATTORNEY

SN 76-597,074. CARPEDIA INTERNATIONAL LTD., OAKVILLE, ONTARIO, CANADA, FILED 6-10-2004.

CARPEDIA

THE MARK CONSISTS OF STANDARD CHARACTERS WITHOUT CLAIM TO ANY PARTICULAR FONT, STYLE, SIZE, OR COLOR.

FOR BUSINESS CONSULTING SERVICES IN RELATION TO PHYSICALLY IMPLEMENTING PRODUCT, PROCESS, MANAGEMENT SYSTEM AND ORGANIZATIONAL BEHAVIOR CHANGES IN ORGANIZATIONS THAT RESULT IN POSITIVE FINANCIAL IMPROVEMENT (U.S. CLS. 100, 101 AND 102).

FIRST USE 3-31-1994; IN COMMERCE 3-31-1994.
BARBARA BROWN, EXAMINING ATTORNEY

SN 76-597,764. ROOFING SUPPLY LIMITED, HOUSTON, TX. FILED 6-11-2004.



NO CLAIM IS MADE TO THE EXCLUSIVE RIGHT TO USE "ROOFING SUPPLY GROUP", APART FROM THE MARK AS SHOWN.

FOR DISTRIBUTORSHIP, RETAIL AND WHOLESALE STORE SERVICES FEATURING ROOFING SUPPLIES (U.S. CLS. 100, 101 AND 102).

FIRST USE 2-0-2000; IN COMMERCE 2-0-2000.
SHAUNIA WALLACE, EXAMINING ATTORNEY

CLASS 35—(Continued).

SN 76-598,256. HALDEX AB, SE10388 STOCKHOLM, SWEDEN, FILED 6-21-2004.



OWNER OF U.S. REG. NOS. 1,455,157 AND 2,420,384.
THE COLOR(S) BLUE IS/ARE CLAIMED AS A FEATURE OF THE MARK.

THE RECTANGULAR BACKGROUND AROUND THE WORDING APPEARS IN THE COLOR BLUE.

FOR ADVERTISING AND MARKETING SERVICES; BUSINESS MANAGEMENT; BUSINESS ADMINISTRATION; OFFICE FUNCTIONS; RETAIL STORE AND ONLINE RETAIL STORE SERVICES FEATURING PARTS FOR LAND VEHICLES AND RELATED COMPUTER SOFTWARE, DISTRIBUTORSHIP SERVICES IN THE FIELD OF AUTOMOTIVE PARTS AND ACCESSORIES, COMPUTERIZED ONLINE RETAIL STORE SERVICES IN THE FIELD OF AUTOMOTIVE PARTS AND ACCESSORIES (U.S. CLS. 100, 101 AND 102).

FIRST USE 12-0-2001; IN COMMERCE 12-0-2001.
SAMUEL E. SHARPER JR., EXAMINING ATTORNEY

SN 76-598,900. SUNGARD DEVELOPMENT CORPORATION, WILMINGTON, DE. FILED 6-23-2004.

SUNGARD SUMMIT

THE MARK CONSISTS OF STANDARD CHARACTERS WITHOUT CLAIM TO ANY PARTICULAR FONT, STYLE, SIZE, OR COLOR.

OWNER OF U.S. REG. NOS. 1,682,725, 2,433,644 AND OTHERS.

FOR CONDUCTING A TRADE SHOW IN THE FIELD OF COMPUTER SOFTWARE, AND COMPUTER SOFTWARE PROGRAMMING AND DEVELOPMENT ALL IN THE FIELD OF HIGHER EDUCATION (U.S. CLS. 100, 101 AND 102).

SUE LAWRENCE, EXAMINING ATTORNEY

SN 76-599,346. KINGSLEY, TODD, STATEN ISLAND, NY. FILED 6-25-2004.

SUNJUICE

THE MARK CONSISTS OF STANDARD CHARACTERS WITHOUT CLAIM TO ANY PARTICULAR FONT, STYLE, SIZE, OR COLOR.

FOR RETAIL STORE SERVICES OF RENEWABLE FORMS OF ENERGY FEATURING SOLAR EQUIPMENT ITEMS THAT CREATE ENERGY FROM THE SUN AND OTHER WIND AND HYDRO ENERGY SYSTEMS, GENERATORS, POWER STORAGE AND BATTERIES THAT RUN ON ELECTRICITY (U.S. CLS. 100, 101 AND 102).

RAMONA ORTIGA, EXAMINING ATTORNEY

CLASS 35—(Continued).

SN 76-599,538. ANDERSON, HOWARD J., HOPEWELL, NJ. AND FICARRA, MARK C., HOPEWELL, NJ. FILED 6-28-2004.

THE MAGAZINE THAT PAYS TO READ

THE MARK CONSISTS OF STANDARD CHARACTERS WITHOUT CLAIM TO ANY PARTICULAR FONT, STYLE, SIZE, OR COLOR.

NO CLAIM IS MADE TO THE EXCLUSIVE RIGHT TO USE MAGAZINE, APART FROM THE MARK AS SHOWN. FOR ADVERTISING SERVICES CONSISTING OF A DIRECT MAIL BOOKLET WITH DISCOUNT COUPONS (U.S. CLS. 100, 101 AND 102).

FIRST USE 12-24-2003; IN COMMERCE 3-3-2004.
KIMBERLY PERRY, EXAMINING ATTORNEY

SN 76-600,595. WAL-MART STORES, INC., BENTONVILLE, AR. FILED 7-2-2004.

FITS YOUR FAMILY. YOUR BUDGET. YOUR LIFE.

THE MARK CONSISTS OF STANDARD CHARACTERS WITHOUT CLAIM TO ANY PARTICULAR FONT, STYLE, SIZE, OR COLOR.

FOR ON-LINE RETAIL DEPARTMENT STORE SERVICES (U.S. CLS. 100, 101 AND 102).

MARGERY A. TIERNEY, EXAMINING ATTORNEY

SN 76-600,985. COLEE HAMMOCK TRADING COMPANY, INC., FORT LAUDERDALE, FL. FILED 7-6-2004.

COLEE HAMMOCK HOME

THE MARK CONSISTS OF STANDARD CHARACTERS WITHOUT CLAIM TO ANY PARTICULAR FONT, STYLE, SIZE, OR COLOR.

NO CLAIM IS MADE TO THE EXCLUSIVE RIGHT TO USE "HOME", APART FROM THE MARK AS SHOWN.

FOR RETAIL STORE SERVICES AND MAIL ORDER CATALOG SERVICES FEATURING HOUSEWARES, GLASSWARE, TABLEWARE, FLATWARE, INDOOR FURNITURE, PILLOWS, SLIPCOVERS, RUGS, LAMPS AND LIGHTING FIXTURES, CURTAINS, CURTAIN RODS, TABLE LINENS, BED LINENS, BATH LINENS, BATH OILS, SKIN CARE LOTIONS AND OILS, FRAGRANCE OILS, POTPOURRI, CANDLE HOLDERS, PICTURE FRAMES, MIRRORS, VASES, BASKETS MADE OF WICKER, INTERIOR DECORATING BOOKS, INTERIOR WALL AND FURNITURE PAINT, WALL COVERINGS, WINDOW COVERING, WINDOW SHADES, FABRIC NAMELY CURTAIN FABRIC, UPHOLSTERY FABRIC, FABRIC MADE OF COTTON AND FABRIC MADE OF GAUZE, EXCLUDING HAMMOCKS (U.S. CLS. 100, 101 AND 102).

STEVEN JACKSON, EXAMINING ATTORNEY

CLASS 35—(Continued).

SN 76-601,373. MUSIC EDUCATORS NATIONAL CONFERENCE (MENC), RESTON, VA. FILED 7-8-2004.



NO CLAIM IS MADE TO THE EXCLUSIVE RIGHT TO USE "THE NATIONAL ANTHEM PROJECT", APART FROM THE MARK AS SHOWN.

FOR CONDUCTING A PUBLIC AWARENESS CAMPAIGN TO EDUCATE THE PUBLIC ABOUT THE IMPORTANCE OF THE NATIONAL ANTHEM AND ITS HISTORY (U.S. CLS. 100, 101 AND 102).

FIRST USE 3-1-2004; IN COMMERCE 3-1-2004.
DAVID H. STINE, EXAMINING ATTORNEY

SN 76-601,843. SA SA OVERSEAS LIMITED, TORTOLA, BR. VIRGIN ISLANDS, FILED 7-9-2004.

OWNER OF HONG KONG REG. NO. 200403204, DATED 3-9-2004, EXPIRES 3-9-2011.

OWNER OF U.S. REG. NOS. 2,446,341 AND 2,857,114.

THE CHINESE CHARACTERS CAN BE TRANSLITERATED TO SA SA (IN CANTONESE) AND SHA SHA (IN MANDARIN). THE CHINESE CHARACTERS HAVE NO MEANING OF ANY WORD IN THE CHINESE LANGUAGE.

FOR WHOLESALE DISTRIBUTORSHIP, RETAIL STORES, AND DISTRIBUTORSHIP SERVICES RELATING TO COSMETICS, CREAMS, MILKS, LOTIONS, GELS AND POWDERS FOR THE FACE, THE BODY AND THE HANDS, LIPSTICKS, MASCARAS, TONERS, MAKE-UP, MAKE-UP PREPARATIONS, MAKE-UP REMOVING PREPARATIONS, COSMETIC PREPARATIONS FOR SLIMMING PURPOSES, SUNTAN PREPARATIONS, COSMETIC PENCILS, NAIL CARE PREPARATIONS, NAIL CARE VARNISH, NAIL POLISH, FALSE NAILS, COTTON STICKS AND WOOL FOR COSMETIC PURPOSES, SHAVING PREPARATIONS, SHAMPOOS, HAIR CONDITIONER, GELS, SPRAYS, MOUSSES AND BALMS FOR HAIR STYLING AND HAIR CARE, HAIR LACQUERS, HAIR COLORING AND HAIR DE-COLORANT PREPARATIONS, HAIR PERMANENT WAVING AND CURLING PREPARATIONS, PREPARATIONS AND SUBSTANCES FOR SKIN CARE AND HAIR CARE, BEAUTY MASKS, TOILETRIES, MINERAL WATER SPRAYS FOR COSMETIC PURPOSES, SHOWER GELS, BODY WASHES, BODY CARE PREPARATIONS, MANICURE PREPARATIONS, TANNING AND AFTER-SUN MILKS, GELS AND OILS, BODY DEODORANTS, PERFUMERY, TOILET WATER, ESSENTIAL OILS, SOAPS, ANTI-PERSPIRANTS, TOOTHPASTES, TOOTH CARE PREPARATIONS, TOOTH CLEANING PREPARATIONS, DENTIFRICES, COSMETICS FOR USE ON THE SKIN, PUMICE STONE, PHARMACEUTICAL AND MEDICAL PREPARATIONS AND SUBSTANCES FOR SKIN CARE AND HAIR CARE, PHARMACEUTICAL PREPARATIONS FOR TREATING DANDRUFF, PHARMACEUTICAL AND SANITARY PREPARATIONS, PRODUCTS AND APPLICATIONS, MEDICAL PREPARATIONS FOR

CLASS 35—(Continued).

SLIMMING PURPOSES, DIETETIC SUBSTANCES ADAPTED FOR MEDICAL USE, MEDICINAL SUPPLEMENT FOOD FOR BABIES, DISINFECTANTS, FUNGICIDES, MEDICATED SOAPS, MEDICATED HAIR REMEDIES, MEDICATED BATH PREPARATIONS, MEDICATED SKIN CARE COSMETICS, HEALTH FOOD SUPPLEMENTS, HERBAL EXTRACTS, SUNBURN OINTMENTS FOR PHARMACEUTICAL PURPOSES, SUNBURN PREPARATIONS FOR PHARMACEUTICAL PURPOSES, MEDICINES FOR DENTAL PURPOSES, BOTTLES, BRUSHES, COMB CASES, COMBS, COMBS FOR THE HAIR, COSMETIC UTENSILS, DEODORIZING APPARATUS FOR PERSONAL USE, EYEBROW BRUSHES, APPLIANCES FOR REMOVING MAKE-UP, NAIL BRUSHES, PADS FOR CLEANING PURPOSES; PERFUME SPRAYERS, PERFUME VAPORIZERS, POWDER COMPACTS NOT OF PRECIOUS METAL, POWDER PUFFS, SCRUBBING BRUSHES, SPONGES FOR COSMETIC PURPOSES, PUFF FOR FACE, SPONGES FOR FACE, BRUSHES INCORPORATING A PUMICE STONE, CLOTHING ACCESSORIES, BELTS, PINS, WATCHES, JEWELRY, SUNGLASSES, EARRINGS, BRACELETS, NECKLACES, HAIR BOWS, HAIR CLIPS, HAIR WRAPS, HAIR STICKS, CUFF LINKS, TIE RACKS, LIGHTERS, PENS, INK PENS, BAGS, LIPSTICK HOLDERS, COSMETIC BAGS, CLOTHING, FOOTWEAR, HEADGEAR; BUSINESS MANAGEMENT AND CONSULTANCY SERVICES; ADVERTISING AND PUBLICITY SERVICES; ACCOUNTING AND SALES PROMOTION SERVICES THROUGH THE DISTRIBUTION AND ADMINISTRATION OF PRIVILEGED USER CARDS, SPONSORING OF TV AND RADIO PROGRAMS AND CONDUCTING VARIOUS EVENTS AND COMPETITIONS; BUSINESS MARKETING SERVICES; RENTAL OF ADVERTISING SPACE; PROVISION OF INFORMATION RELATING TO TRADE DEVELOPMENT AND BUSINESS OPPORTUNITY; PROVISION OF ALL OF THE ABOVE SERVICES VIA CABLE TELEVISION, MOBILE PHONES, AND THE INTERNET (U.S. CLS. 100, 101 AND 102).

JAMES A. RAUEN, EXAMINING ATTORNEY

CLASS 35—(Continued).

SN 76-604,034. PARKER, RICHARD H., MODESTO, CA. FILED 7-21-2004.

1 BIGSIN

THE MARK CONSISTS OF STANDARD CHARACTERS WITHOUT CLAIM TO ANY PARTICULAR FONT, STYLE, SIZE, OR COLOR.

FOR ADVERTISING THE GOODS AND SERVICES OF OTHERS THROUGH ALL PRINT, AUDIO, AND VISUAL PUBLIC COMMUNICATIONS MEANS; ADVERTISING AGENCY (U.S. CLS. 100, 101 AND 102).

FIRST USE 6-7-2004; IN COMMERCE 6-7-2004.

MELISSA SHELLA, EXAMINING ATTORNEY

SN 76-604,319. HDVE, LLC, IRVING, TX. FILED 7-28-2004.

SN 76-603,999. O2 HOLDINGS, LLC, NEW YORK, NY. FILED 7-26-2004.

WOMEN'S WATCH

THE MARK CONSISTS OF STANDARD CHARACTERS WITHOUT CLAIM TO ANY PARTICULAR FONT, STYLE, SIZE, OR COLOR.

NO CLAIM IS MADE TO THE EXCLUSIVE RIGHT TO USE "WOMEN'S", APART FROM THE MARK AS SHOWN.

FOR CONDUCTING MARKET RESEARCH SURVEYS, MARKET RESEARCH FOCUS GROUPS AND PUBLIC OPINION POLLING ON TOPICS CONCERNING CURRENT EVENTS, ATTITUDES, PROFILES AND LIFESTYLE ISSUES INCLUDING HEALTH, FITNESS, MEDICINE, BEAUTY, FAMILY, BUSINESS, MEDIA AND POLITICS (U.S. CLS. 100, 101 AND 102).

MELISSA SHELLA, EXAMINING ATTORNEY

TRUE COMPATIBILITY

THE MARK CONSISTS OF STANDARD CHARACTERS WITHOUT CLAIM TO ANY PARTICULAR FONT, STYLE, SIZE, OR COLOR.

NO CLAIM IS MADE TO THE EXCLUSIVE RIGHT TO USE "COMPATIBILITY", APART FROM THE MARK AS SHOWN.

FOR CAREER NETWORKING SERVICES, NAMELY, PROVIDING CAREER INFORMATION IN THE NATURE OF AN INDEX OF POTENTIAL EMPLOYEES BY MEANS OF GLOBAL COMPUTER-NETWORKS; PERSONNEL PLACEMENT AND RECRUITMENT SERVICES, NAMELY, SCREENING AND SOURCING OF POTENTIAL JOB CANDIDATES FOR POTENTIAL EMPLOYERS VIA A GLOBAL COMPUTER NETWORK; EMPLOYMENT AGENT AND COUNSELING SERVICES, NAMELY EMPLOYMENT RECRUITMENT SERVICES, CAREER DEVELOPMENT COUNSELING AND JOB PLACEMENT; REFERRAL SERVICES IN THE NATURE OF PROVIDING ROOMMATE MATCHING SERVICES FOR OTHERS (U.S. CLS. 100, 101 AND 102).

SUSAN LESLIE DUBOIS, EXAMINING ATTORNEY

CLASS 35—(Continued).

SN 76-606,637. HDVE, LLC, IRVING, TX. FILED 8-12-2004.

TRUE (IN)VISIBILITY

THE MARK CONSISTS OF STANDARD CHARACTERS WITHOUT CLAIM TO ANY PARTICULAR FONT, STYLE, SIZE, OR COLOR.

FOR CAREER NETWORKING SERVICES, NAMELY, PROVIDING CAREER INFORMATION IN THE NATURE OF AN INDEX OF POTENTIAL EMPLOYEES BY MEANS OF GLOBAL COMPUTER-NETWORKS; PERSONNEL PLACEMENT AND RECRUITMENT SERVICES, NAMELY, SCREENING AND SOURCING OF POTENTIAL JOB CANDIDATES FOR POTENTIAL EMPLOYERS VIA GLOBAL COMPUTER NETWORK; EMPLOYMENT AGENT AND COUNSELING SERVICES, NAMELY, EMPLOYMENT RECRUITMENT SERVICES, CAREER DEVELOPMENT COUNSELING AND JOB PLACEMENT; REFERRAL SERVICES IN THE NATURE OF PROVIDING ROOMMATE MATCHING SERVICES FOR OTHERS; ADMINISTRATION OF A DISCOUNT PROGRAM FOR ENABLING PARTICIPANTS TO OBTAIN DISCOUNTS AND COMPLIMENTARY AWARDS ON GOODS AND SERVICES THROUGH USE OF A DISCOUNT MEMBERSHIP CARD (U.S. CLS. 100, 101 AND 102).

SUSAN LESLIE DUBOIS, EXAMINING ATTORNEY

SN 76-606,712. QUISQUEYANA, INC., NEW YORK, NY. FILED 8-12-2004.

CLUB Q

THE MARK CONSISTS OF STANDARD CHARACTERS WITHOUT CLAIM TO ANY PARTICULAR FONT, STYLE, SIZE, OR COLOR.

NO CLAIM IS MADE TO THE EXCLUSIVE RIGHT TO USE "CLUB", APART FROM THE MARK AS SHOWN.

FOR CUSTOMER LOYALTY SERVICES AND CUSTOMER CLUB SERVICES, FOR COMMERCIAL, PROMOTIONAL AND/OR ADVERTISING PURPOSES (U.S. CLS. 100, 101 AND 102).

STEVEN JACKSON, EXAMINING ATTORNEY

SN 76-606,843. THELADDERS.COM, INC., NEW YORK, NY. FILED 8-13-2004.

RECRUIT LADDER

NO CLAIM IS MADE TO THE EXCLUSIVE RIGHT TO USE "RECRUIT", APART FROM THE MARK AS SHOWN.

FOR PROVIDING CAREER INFORMATION AND JOB LISTINGS VIA A GLOBAL COMPUTER NETWORK (U.S. CLS. 100, 101 AND 102).

FIRST USE 5-14-2004; IN COMMERCE 5-14-2004.
CHERYL CLAYTON, EXAMINING ATTORNEY**CLASS 35—(Continued).**

SN 76-607,799. LUNDY, ALBERT L., NORMAL, IL. FILED 8-19-2004.

Adspecially Yours

THE MARK CONSISTS OF STANDARD CHARACTERS WITHOUT CLAIM TO ANY PARTICULAR FONT, STYLE, SIZE, OR COLOR.

FOR RETAIL SERVICES BY DIRECT PERSONAL SOLICITATION TO BUSINESSES FEATURING PROMOTIONAL ADVERTISING PRODUCTS, NAMELY, PENS, GLASSWARE/CERAMICS, OFFICE SUPPLIES, CLOTHING/WEARABLES, BAGS, CALENDARS, GAMES, TOYS, PLAYING CARDS, INFLATABLES, TROPHIES JEWELRY, CLOCKS, WATCHES, PLAQUES, CERTIFICATES, PICNIC/PARTY PRODUCTS, CAMPING EQUIPMENT, BARBEQUE EQUIPMENT, COMPUTER ACCESSORIES, AND MAGNETS WITH THE CUSTOMER'S BUSINESS NAME AND LOGO PRINTED THEREON (U.S. CLS. 100, 101 AND 102).

FIRST USE 8-9-2004; IN COMMERCE 8-9-2004.
CARRIE ACHEN, EXAMINING ATTORNEY

SN 76-608,863. VANDEWALLE, KRISTIN OLSON, BOZEMAN, MT. AND METZGER, HAROLD F., JR., ELMHURST, IL. FILED 8-24-2004.

ZTRA

THE MARK CONSISTS OF STANDARD CHARACTERS WITHOUT CLAIM TO ANY PARTICULAR FONT, STYLE, SIZE, OR COLOR.

FOR ONLINE RETAIL STORE SERVICES AND RETAIL STORE SERVICES, FEATURING KITS FOR MAKING A BOUND BOOK OR ALBUM (U.S. CLS. 100, 101 AND 102).

FIRST USE 5-5-2004; IN COMMERCE 5-5-2004.
ANNE FARRELL, EXAMINING ATTORNEY

SN 76-609,297. PAULSONS' SUPER VALU, INC., DBA DOLLAR CENTS, DULUTH, MN. FILED 8-30-2004.

**Dollar
Cents**

FOR RETAIL DEPARTMENT STORES; AND DISCOUNT DEPARTMENT STORES FEATURING MEN'S CLOTHING, WOMEN'S CLOTHING, SPORTING GOODS, HARDWARE, COSMETICS, PERSONAL CARE PRODUCTS, HOUSEWARES, FOOD, GREETING CARDS AND CLEANING PRODUCTS (U.S. CLS. 100, 101 AND 102).

IRA J. GOODSaid, EXAMINING ATTORNEY

CLASS 35—(Continued).

SN 76-609,355. HDVE, LLC, IRVING, TX. FILED 8-30-2004.

TRUE REWARDS

THE MARK CONSISTS OF STANDARD CHARACTERS WITHOUT CLAIM TO ANY PARTICULAR FONT, STYLE, SIZE, OR COLOR.

FOR CAREER NETWORKING SERVICES, NAMELY, PROVIDING CAREER INFORMATION IN THE NATURE OF AN INDEX OF POTENTIAL EMPLOYEES BY MEANS OF GLOBAL COMPUTER-NETWORKS; PERSONNEL PLACEMENT AND RECRUITMENT SERVICES, NAMELY, SCREENING AND SOURCING OF POTENTIAL JOB CANDIDATES FOR POTENTIAL EMPLOYERS VIA A GLOBAL COMPUTER NETWORK; EMPLOYMENT AGENT AND COUNSELING SERVICES, NAMELY, EMPLOYMENT RECRUITMENT SERVICES, CAREER DEVELOPMENT COUNSELING AND JOB PLACEMENT; REFERRAL SERVICES IN THE NATURE OF PROVIDING ROOMMATE MATCHING SERVICES FOR OTHERS; ADMINISTRATION OF A DISCOUNT PROGRAM FOR ENABLING PARTICIPANTS TO OBTAIN DISCOUNTS AND COMPLIMENTARY AWARDS ON GOODS AND SERVICES THROUGH USE OF A DISCOUNT MEMBERSHIP CARD (U.S. CLS. 100, 101 AND 102).

SUSAN LESLIE DUBOIS, EXAMINING ATTORNEY

SN 76-609,648. VISTA SERV CORPORATION, SARASOTA, FL. FILED 9-1-2004.



**Wanna see how *fast*
our SERVICE is ?**

Wanna see it again ??

NO CLAIM IS MADE TO THE EXCLUSIVE RIGHT TO USE SERVICE, APART FROM THE MARK AS SHOWN.

FOR WHOLESALE DISTRIBUTORSHIPS AND STORES FEATURING COMMERCIAL CHEMICALS FOR THE FOOD SERVICE, HOSPITALITY AND INSTITUTIONAL MARKETS (U.S. CLS. 100, 101 AND 102).

FIRST USE 5-3-2004; IN COMMERCE 5-3-2004.
CAROLYN GRAY, EXAMINING ATTORNEY

CLASS 35—(Continued).

SN 76-611,550. KITTEL, MAX, NASHVILLE, TN. FILED 9-10-2004.

WINE WIZARDS OF OZ

THE MARK CONSISTS OF STANDARD CHARACTERS WITHOUT CLAIM TO ANY PARTICULAR FONT, STYLE, SIZE, OR COLOR.

NO CLAIM IS MADE TO THE EXCLUSIVE RIGHT TO USE "WINE", APART FROM THE MARK AS SHOWN.

FOR RETAIL STORE SERVICES AND WHOLESALE DISTRIBUTORSHIP SERVICES FEATURING WINES FROM AUSTRALIA; PROMOTING THE GOODS AND SERVICES OF OTHERS IN THE NATURE OF WINES FROM AUSTRALIA AND FOOD AND WINE TASTING EVENTS (U.S. CLS. 100, 101 AND 102).

BRIDGETT SMITH, EXAMINING ATTORNEY

SN 76-613,556. GENTE CORPORATION, READING, MA. FILED 9-24-2004.

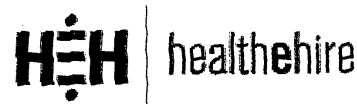

FOR PROVIDING INFORMATION IN THE FIELD OF EMPLOYMENT HIRING, RECRUITING, PLACEMENT AND STAFFING FOR HEALTH CARE PROFESSIONALS, INCLUDING JOB AND PERSONNEL PLACEMENT FOR EMPLOYMENT AND CAREER OPPORTUNITIES IN HEALTH CARE FIELDS, VIA WEBSITES ON THE INTERNET (U.S. CLS. 100, 101 AND 102).

FIRST USE 7-1-2004; IN COMMERCE 7-1-2004.
JOHN GARTNER, EXAMINING ATTORNEY

SN 76-615,131. PENNWELL CORPORATION, TULSA, OK. FILED 10-8-2004.



THE DESIGN PORTION OF THE MARK CONSISTS OF A CIRCLE CONTAINING SQUARES.

FOR ARRANGING AND CONDUCTING BUSINESS CONFERENCES AND EXHIBITIONS IN THE FIELD OF SEMICONDUCTOR FABRICATION (U.S. CLS. 100, 101 AND 102).

FIRST USE 8-16-2004; IN COMMERCE 8-16-2004.
REBECCA SMITH, EXAMINING ATTORNEY

CLASS 35—(Continued).

SN 76-615,174. VIRTUAL FREIGHT SYSTEMS, INC., MENO-
MONEE FALLS, WI. FILED 10-7-2004.

VFI

THE MARK CONSISTS OF STANDARD CHARACTERS
WITHOUT CLAIM TO ANY PARTICULAR FONT, STYLE,
SIZE, OR COLOR.

FOR REFERRALS IN THE FIELD OF FREIGHT
INSPECTIONS (U.S. CLS. 100, 101 AND 102).
FIRST USE 7-26-2004; IN COMMERCE 7-26-2004.
KIMBERLY PERY, EXAMINING ATTORNEY

SN 76-615,192. CAMILLI ECONOMICS, LLC, NEW YORK,
NY. FILED 10-12-2004.

CAPITALISM WAITS FOR NO ONE

THE MARK CONSISTS OF STANDARD CHARACTERS
WITHOUT CLAIM TO ANY PARTICULAR FONT, STYLE,
SIZE, OR COLOR.

FOR CONSULTANCY SERVICES REGARDING BUSI-
NESS STRATEGIES BASED UPON TIMELY ECONOMIC
ANALYSIS FOR ORGANIZATIONS AND INDIVIDUALS
(U.S. CLS. 100, 101 AND 102).
ALEXANDER L. POWERS, EXAMINING ATTORNEY

SN 76-615,373. TRACTOR SUPPLY COMPANY, BRENT-
WOOD, TN. FILED 10-6-2004.

TRACTOR SUPPLY CO.

NO CLAIM IS MADE TO THE EXCLUSIVE RIGHT TO
USE "CO.", APART FROM THE MARK AS SHOWN.
SEC. 2(F).

FOR RETAIL STORE SERVICES IN THE FIELD OF
ANIMAL CARE, HOME IMPROVEMENT, RECREA-
TION, AND APPAREL; RETAIL STORE SERVICES IN
THE FIELD OF AUTOMOTIVE ACCESSORIES,
NAMESLY BATTERIES, LUBRICANTS, TARPS, TRUCK
TOOLBOXES, TRAILERS, TOWING PARTS, AND FUEL
TANKS; RETAIL STORE SERVICES IN THE FIELD OF
MAINTENANCE EQUIPMENT, NAMESLY AIR COM-
PRESSORS, WELDERS, GENERATORS, PUMPS, ELEC-
TRICAL PRODUCTS, PLUMBING, AND PAINT; RETAIL
STORE SERVICES IN THE FIELD OF LAWN AND
GARDEN PRODUCTS, NAMESLY SEED AND BULBS,
FERTILIZER, WINDMILLS, AND YARD ACCESSORIES
(U.S. CLS. 100, 101 AND 102).

FIRST USE 0-0-1938; IN COMMERCE 0-0-1938.
GIANCARLO CASTRO, EXAMINING ATTORNEY

CLASS 35—(Continued).

SN 76-615,735. ROSEMARIE CORONA INC., DBA BIG
HORSE FEED, TEMECULA, CA. FILED 10-14-2004.

IF YOU CAN'T RUN WITH THE BIG HORSES STAY IN THE BARN

THE MARK CONSISTS OF STANDARD CHARACTERS
WITHOUT CLAIM TO ANY PARTICULAR FONT, STYLE,
SIZE, OR COLOR.

FOR RETAIL AND ONLINE STORE SERVICES FEAT-
URING FEED, SADDLE AND TACK, NUTRITIONAL
PRODUCTS FOR HORSES, CHILDREN'S CLOTHING
AND BOOKS, AND JEWELRY (U.S. CLS. 100, 101 AND
102).

FIRST USE 8-0-2000; IN COMMERCE 8-0-2000.
MARK T. MULLEN, EXAMINING ATTORNEY

SN 76-616,704. MODELL ASSOCIATES, INC., BASALT, CO.
FILED 10-20-2004.

THE SUN VALLEY CATALOGUE

THE MARK CONSISTS OF STANDARD CHARACTERS
WITHOUT CLAIM TO ANY PARTICULAR FONT, STYLE,
SIZE, OR COLOR.

OWNER OF U.S. REG. NOS. 1,697,934, 2,469,343 AND
OTHERS.

NO CLAIM IS MADE TO THE EXCLUSIVE RIGHT TO
USE CATALOGUE, APART FROM THE MARK AS SHOWN.
SEC. 2(F).

FOR PROMOTING THE GOODS AND SERVICES OF
OTHERS THROUGH THE PUBLICATION AND DISTRI-
BUTION OF RETAIL SHOPPING GUIDES (U.S. CLS. 100,
101 AND 102).

FIRST USE 11-0-1995; IN COMMERCE 12-10-1997.
CARRIE ACHEN, EXAMINING ATTORNEY

SN 76-617,037. LILLIAN VERNON CORPORATION, WHITE
PLAINS, NY. FILED 10-18-2004.

**PERSONAL STYLE
BY LILLIAN VERNON**

THE MARK CONSISTS OF STANDARD CHARACTERS
WITHOUT CLAIM TO ANY PARTICULAR FONT, STYLE,
SIZE, OR COLOR.

OWNER OF U.S. REG. NOS. 1,108,270, 1,285,663 AND
OTHERS.

LILLIAN VERNON IDENTIFIES A LIVING INDIVIDUAL
WHOSE CONSENT IS OF RECORD.

FOR MAIL ORDER CATALOG SERVICES FEATUR-
ING HANDBAGS, SMALL LEATHER GOODS, SCARVES,
JEWELRY AND FASHION ACCESSORIES (U.S. CLS. 100,
101 AND 102).

NAAKWAMA ANKRAH, EXAMINING ATTORNEY

CLASS 35—(Continued).

SN 76-617,494. PARADISE PEN COMPANY, DENVER, CO. FILED 10-25-2004.

PARADISE PEN

NO CLAIM IS MADE TO THE EXCLUSIVE RIGHT TO USE PEN, APART FROM THE MARK AS SHOWN.

FOR "RETAIL STORE SERVICES, ONLINE INTERACTIVE RETAIL STORE SERVICES AND MAIL ORDER CATALOG SERVICES, ALL FEATURING WRITING INSTRUMENTS, NAMELY PENS; WATCHES AND CLOCKS; DESK ACCESSORIES, NAMELY INKS, DESKTOP BUSINESS CARD HOLDERS, WRITING PADS, PENHOLDERS; BRIEFCASES, DOCUMENT AND STATIONERY PORTFOLIOS, WALLETS AND PHOTO ALBUMS" (U.S. CLS. 100, 101 AND 102).

FIRST USE 2-28-2001; IN COMMERCE 2-28-2001.
JILL C. ALT, EXAMINING ATTORNEY

SN 76-618,080. GLM GLOBAL SERVICE AGENCY, INC., EAST BRUNSWICK, NJ. FILED 10-27-2004.

GLM

THE MARK CONSISTS OF STANDARD CHARACTERS WITHOUT CLAIM TO ANY PARTICULAR FONT, STYLE, SIZE, OR COLOR.

FOR WHOLESALE DISTRIBUTORSHIPS FEATURING AUTO PARTS (U.S. CLS. 100, 101 AND 102).
FIRST USE 5-1-1999; IN COMMERCE 5-1-1999.
GEORGE LORENZO, EXAMINING ATTORNEY

SN 76-618,554. SUN SPLASH, INC., SAN DIEGO, CA. FILED 10-28-2004.

SUN SPLASH

THE MARK CONSISTS OF STANDARD CHARACTERS WITHOUT CLAIM TO ANY PARTICULAR FONT, STYLE, SIZE, OR COLOR.

FOR WHOLESALE, RETAIL AND ONLINE RETAIL STORE SERVICES FEATURING MEN'S, WOMEN'S, AND CHILDREN'S CLOTHING, AND ACCESSORIES, SWIMWEAR, OUTDOOR APPAREL, FOOTWEAR, HATS, CAPS, VISORS, AND BEACH BAGS (U.S. CLS. 100, 101 AND 102).

FIRST USE 3-0-2004; IN COMMERCE 3-0-2004.
SANJEEV VOHRA, EXAMINING ATTORNEY

CLASS 35—(Continued).

SN 76-619,026. VERSATILE CONCEPTS, LLC, KANSAS CITY, MO. FILED 11-3-2004.

VERSATILE CONCEPTS

THE MARK CONSISTS OF STANDARD CHARACTERS WITHOUT CLAIM TO ANY PARTICULAR FONT, STYLE, SIZE, OR COLOR.

FOR WHOLESALE DISTRIBUTORSHIPS FEATURING TOOLS (U.S. CLS. 100, 101 AND 102).

CATHERINE CAIN, EXAMINING ATTORNEY

SN 76-619,356. PROGRESSIVE SOFTWARE COMPUTING INC., WILMINGTON, DE. FILED 11-4-2004.

PSCI

THE MARK CONSISTS OF STANDARD CHARACTERS WITHOUT CLAIM TO ANY PARTICULAR FONT, STYLE, SIZE, OR COLOR.

FOR EMPLOYMENT HIRING, RECRUITING, PLACEMENT, STAFFING AND CAREER NETWORKING SERVICES (U.S. CLS. 100, 101 AND 102).

FIRST USE 1-0-1993; IN COMMERCE 1-0-1993.
JULIE WATSON, EXAMINING ATTORNEY

SN 76-619,690. ROBERT H. SCHAFFER & ASSOCIATES, LLC, STAMFORD, CT. FILED 11-8-2004.

RAPID-RESULTS, EXPANDING CAPACITY

THE MARK CONSISTS OF STANDARD CHARACTERS WITHOUT CLAIM TO ANY PARTICULAR FONT, STYLE, SIZE, OR COLOR.

FOR BUSINESS MANAGEMENT CONSULTING SERVICES RELATED TO ACQUISITION INTEGRATION, PERFORMANCE IMPROVEMENT, LEADERSHIP DEVELOPMENT, PERFORMANCE IMPROVEMENT IN AREAS OF STRATEGIC AND TACTICAL FOCUS, LARGE-SCALE CHANGE, STRATEGIC TRANSFORMATION, CONSULTING EFFECTIVENESS AND STRATEGY EXECUTION (U.S. CLS. 100, 101 AND 102).

FIRST USE 7-20-2000; IN COMMERCE 7-20-2000.
ROBIN CHOSID, EXAMINING ATTORNEY

CLASS 35—(Continued).

SN 76-619,692. ELWOOD STAFFING SERVICES, INC., COLUMBUS, IN. FILED 11-8-2004.

ELWOOD STAFFING

THE MARK CONSISTS OF STANDARD CHARACTERS WITHOUT CLAIM TO ANY PARTICULAR FONT, STYLE, SIZE, OR COLOR.

NO CLAIM IS MADE TO THE EXCLUSIVE RIGHT TO USE "STAFFING", APART FROM THE MARK AS SHOWN. FOR TEMPORARY AND PERMANENT EMPLOYMENT PLACEMENT AND STAFFING SERVICES, EMPLOYMENT AGENCY SERVICES, PAYROLL PREPARATION AND EMPLOYEE ASSESSMENT SERVICES (U.S. CLS. 100, 101 AND 102).

FIRST USE 1-1-1997; IN COMMERCE 1-1-1997.
ROBIN CHOSID, EXAMINING ATTORNEY

CLASS 35—(Continued).

SN 76-619,845. AMERICAN HOCKEY LEAGUE, INC., SPRINGFIELD, MA. FILED 11-8-2004.



OWNER OF U.S. REG. NOS. 2,549,840 AND 2,803,241.
NO CLAIM IS MADE TO THE EXCLUSIVE RIGHT TO USE "HOCKEY LEAGUE", APART FROM THE MARK AS SHOWN.

SEC. 2(F) AS TO "AMERICAN".
FOR ASSOCIATION SERVICES OF A PROFESSIONAL HOCKEY LEAGUE, NAMELY, PROMOTING THE INTERESTS OF MEMBER TEAMS, PROMOTING AND SCHEDULING HOCKEY GAMES, AND GENERALLY PROMOTING INTEREST IN THE GAME OF HOCKEY (U.S. CLS. 100, 101 AND 102).

FIRST USE 12-0-1971; IN COMMERCE 12-0-1971.
ROBERT LORENZO, EXAMINING ATTORNEY

SN 76-619,736. BOOKS & CRANNIES, LLC, VIENNA, VA. FILED 11-8-2004.



FOR RETAIL STORE SERVICES IN THE FIELDS OF PUBLICATIONS, FOOD AND DRINK (U.S. CLS. 100, 101 AND 102).

MICHAEL SOUDERS, EXAMINING ATTORNEY

SN 76-619,999. ATLANTIC PLANT MAINTENANCE, INC., PASADENA, TX. FILED 11-10-2004.

SN 76-619,797. AON CONSULTING, INC., CHICAGO, IL. FILED 11-8-2004.

OWN YOUR FINANCIAL FUTURE

THE MARK CONSISTS OF STANDARD CHARACTERS WITHOUT CLAIM TO ANY PARTICULAR FONT, STYLE, SIZE, OR COLOR.

FOR FACILITATING THE EXCHANGE OF INFORMATION FOR DEFERRED COMPENSATION ACCOUNTS VIA THE INTERNET (U.S. CLS. 100, 101 AND 102).

FIRST USE 9-8-2004; IN COMMERCE 9-8-2004.
REBECCA GAN, EXAMINING ATTORNEY



FOR EMPLOYMENT AGENCY SERVICES IN THE NATURE OF PROVIDING INDUSTRIAL PLANT CONSTRUCTION AND MAINTENANCE EMPLOYEES FOR OTHERS (U.S. CLS. 100, 101 AND 102).

FIRST USE 1-0-1989; IN COMMERCE 1-0-1989.
LAURA KOVAISKY, EXAMINING ATTORNEY

CLASS 35—(Continued).

SN 76-620,080. COMPASS SETTINGS, LTD., AUSTIN, TX. FILED 11-9-2004.

COMPASS SETTINGS

THE MARK CONSISTS OF STANDARD CHARACTERS WITHOUT CLAIM TO ANY PARTICULAR FONT, STYLE, SIZE, OR COLOR.

FOR PERSONNEL MANAGEMENT CONSULTATION SERVICES; PROVIDING BUSINESS MANAGEMENT INFORMATION IN THE FIELD OF HUMAN PERFORMANCE CRITERIA BY MEANS OF A GLOBAL COMPUTER INFORMATION NETWORK (U.S. CLS. 100, 101 AND 102).

FIRST USE 12-0-2003; IN COMMERCE 3-0-2004.
DEZMONA MIZELLE, EXAMINING ATTORNEY

CLASS 35—(Continued).

SN 76-620,300. BENTON OIL SERVICES, INC., CHATTANOOGA, TN. FILED 11-12-2004.

BURN THE MIDNITE OIL

THE MARK CONSISTS OF STANDARD CHARACTERS WITHOUT CLAIM TO ANY PARTICULAR FONT, STYLE, SIZE, OR COLOR.

FOR RETAIL STORE SERVICES FEATURING CONVENIENCE STORE ITEMS AND GASOLINE (U.S. CLS. 100, 101 AND 102).

FIRST USE 7-1-2004; IN COMMERCE 7-1-2004.
GENE MACIOL, EXAMINING ATTORNEY

SN 76-620,099. AMERICAN COUNCIL ON THE TEACHING OF FOREIGN LANGUAGES, ALEXANDRIA, VA. FILED 11-10-2004.

ACTFL

THE MARK CONSISTS OF STANDARD CHARACTERS WITHOUT CLAIM TO ANY PARTICULAR FONT, STYLE, SIZE, OR COLOR.

FOR ASSOCIATION SERVICES, NAMELY PROMOTING THE INTERESTS OF FOREIGN LANGUAGE EDUCATORS AND ADMINISTRATORS AND PROMOTING PUBLIC AWARENESS OF THE NEED FOR FOREIGN LANGUAGE TEACHING AND LEARNING (U.S. CLS. 100, 101 AND 102).

FIRST USE 2-1-1977; IN COMMERCE 2-1-1977.
MARIAM MAHMOUDI, EXAMINING ATTORNEY

SN 76-620,187. NON STOP SALES & SERVICE, INC., BELLINGHAM, MA. FILED 11-12-2004.



FOR DISTRIBUTORSHIPS IN THE FIELD OF VEHICLE WASHING MACHINES AND PARTS THEREFOR (U.S. CLS. 100, 101 AND 102).

BARBARA A. GOLD, EXAMINING ATTORNEY

SN 76-620,405. TECTON MANAGEMENT SERVICES COMPANY, LLC, MIAMI, FL. FILED 11-15-2004.

TECTON HOSPITALITY

THE MARK CONSISTS OF STANDARD CHARACTERS WITHOUT CLAIM TO ANY PARTICULAR FONT, STYLE, SIZE, OR COLOR.

NO CLAIM IS MADE TO THE EXCLUSIVE RIGHT TO USE "HOSPITALITY", APART FROM THE MARK AS SHOWN.

FOR HOTEL HOSPITALITY MANAGEMENT FOR OTHERS (U.S. CLS. 100, 101 AND 102).

FIRST USE 1-30-1997; IN COMMERCE 1-30-1997.
LOURDES AYALA, EXAMINING ATTORNEY

SN 76-620,538. HARBOR TO HOME INC., ELLICOTT CITY, MD. FILED 11-15-2004.



FOR WHOLESALE DISTRIBUTORSHIP SERVICES FEATURING FURNITURE, FIXTURES, APPLIANCES, ELECTRONIC GOODS AND ENTERTAINMENT CENTERS (U.S. CLS. 100, 101 AND 102).

H. M. FISHER, EXAMINING ATTORNEY

CLASS 35—(Continued).

SN 76-620,790. GOPOSTER LLC, NEW YORK, NY. FILED 11-16-2004.

WILDPPOSTING

THE MARK CONSISTS OF STANDARD CHARACTERS WITHOUT CLAIM TO ANY PARTICULAR FONT, STYLE, SIZE, OR COLOR.

FOR ADVERTISING SERVICES (U.S. CLS. 100, 101 AND 102).

FIRST USE 3-0-2001; IN COMMERCE 3-0-2001.
EDWARD NELSON, EXAMINING ATTORNEY

SN 76-620,791. GOPOSTER LLC, NEW YORK, NY. FILED 11-16-2004.

GoPOSTER

THE MARK CONSISTS OF STANDARD CHARACTERS WITHOUT CLAIM TO ANY PARTICULAR FONT, STYLE, SIZE, OR COLOR.

FOR ADVERTISING SERVICES (U.S. CLS. 100, 101 AND 102).

FIRST USE 3-0-2001; IN COMMERCE 3-0-2001.
EDWARD NELSON, EXAMINING ATTORNEY

SN 76-620,830. MERVIS DIAMOND CORP., ROCKVILLE, MD. FILED 11-16-2004.

MERVIS

THE MARK CONSISTS OF STANDARD CHARACTERS WITHOUT CLAIM TO ANY PARTICULAR FONT, STYLE, SIZE, OR COLOR.

FOR RETAIL OUTLET SERVICES IN THE FIELD OF JEWELRY AND DIAMONDS (U.S. CLS. 100, 101 AND 102).

FIRST USE 12-31-1980; IN COMMERCE 12-31-1980.
DAWN HAN, EXAMINING ATTORNEY

CLASS 35—(Continued).

SN 76-620,846. FUTON ASSOCIATION OF NORTH AMERICA, INC., ORLANDO, FL. FILED 11-16-2004.

FUTON EXPO AND SPECIALTY SLEEP SHOW

THE MARK CONSISTS OF STANDARD CHARACTERS WITHOUT CLAIM TO ANY PARTICULAR FONT, STYLE, SIZE, OR COLOR.

OWNER OF U.S. REG. NO. 2,768,361.

NO CLAIM IS MADE TO THE EXCLUSIVE RIGHT TO USE FUTON EXPO AND SHOW, APART FROM THE MARK AS SHOWN.

SEC. 2(F).

FOR ARRANGING AND CONDUCTING TRADE CONFERENCES IN THE FIELD OF FURNITURE (U.S. CLS. 100, 101 AND 102).

FIRST USE 4-0-1999; IN COMMERCE 4-0-1999.

LINDA POWELL, EXAMINING ATTORNEY

SN 76-620,903. PARABLE GROUP, INC., THE, SAN LUIS OBISPO, CA. FILED 11-17-2004.

TRIUNISON

THE MARK CONSISTS OF STANDARD CHARACTERS WITHOUT CLAIM TO ANY PARTICULAR FONT, STYLE, SIZE, OR COLOR.

FOR INVENTORY CONTROL SERVICES IN THE RETAIL FIELD; INVENTORY CONTROL, INVENTORY TRACKING AND REPLENISHMENT SERVICES; BUSINESS CONSULTING SERVICES WITH RELATION TO SALES, MARKETING AND PRODUCT MANAGEMENT SERVICES (U.S. CLS. 100, 101 AND 102).

MARIA-VICTORIA SUAREZ, EXAMINING ATTORNEY

SN 76-620,990. FUTURESENSE, INC., SAN RAFAEL, CA. FILED 11-18-2004.

FUTURESENSE

THE MARK CONSISTS OF STANDARD CHARACTERS WITHOUT CLAIM TO ANY PARTICULAR FONT, STYLE, SIZE, OR COLOR.

FOR BUSINESS MANAGEMENT CONSULTATION (U.S. CLS. 100, 101 AND 102).

FIRST USE 9-30-1993; IN COMMERCE 9-30-1993.

LAURIE MAYES, EXAMINING ATTORNEY

CLASS 35—(Continued).

SN 76-620,991. FUTURESENSE, INC., SAN RAFAEL, CA.
FILED 11-18-2004.

VALUESENSE

THE MARK CONSISTS OF STANDARD CHARACTERS WITHOUT CLAIM TO ANY PARTICULAR FONT, STYLE, SIZE, OR COLOR.

FOR CONSULTING SERVICES IN THE FIELD OF HUMAN CAPITAL MANAGEMENT (U.S. CLS. 100, 101 AND 102).

FIRST USE 8-1-2003; IN COMMERCE 8-1-2003.
JOHN DALIER, EXAMINING ATTORNEY

CLASS 35—(Continued).

SN 76-621,277. SUREHEALTH, LLC, WILMINGTON, DE.
FILED 11-19-2004.

SUREHEALTH PHARMACY

THE MARK CONSISTS OF STANDARD CHARACTERS WITHOUT CLAIM TO ANY PARTICULAR FONT, STYLE, SIZE, OR COLOR.

NO CLAIM IS MADE TO THE EXCLUSIVE RIGHT TO USE PHARMACY, APART FROM THE MARK AS SHOWN.

FOR RETAIL PHARMACY SERVICES AND PROVIDING RETAIL PHARMACY SERVICES TO LONG-TERM HEALTH CARE FACILITIES (U.S. CLS. 100, 101 AND 102).

PAULA MAHONEY, EXAMINING ATTORNEY

SN 76-621,115. @RADICAL.MEDIA, INC., NEW YORK, NY.
FILED 11-18-2004.

CHEFSTUDIO

THE MARK CONSISTS OF STANDARD CHARACTERS WITHOUT CLAIM TO ANY PARTICULAR FONT, STYLE, SIZE, OR COLOR.

FOR RETAIL STORES FEATURING FOOD AND COOKING PRODUCTS; RETAIL STORES FEATURING WINE AND WINE PRODUCTS (U.S. CLS. 100, 101 AND 102).

MATTHEW KLINE, EXAMINING ATTORNEY

SN 76-621,398. COSMIC COLORS, INC., LEXINGTON, KY.
FILED 11-19-2004.

COSMIC ROCKS

THE MARK CONSISTS OF STANDARD CHARACTERS WITHOUT CLAIM TO ANY PARTICULAR FONT, STYLE, SIZE, OR COLOR.

FOR COMPUTERIZED ONLINE ORDERING FEATURING CLOTHING, NAMELY, T-SHIRTS, HATS, SWEATSHIRTS, AND ACCESSORIES (U.S. CLS. 100, 101 AND 102).

FIRST USE 7-0-2004; IN COMMERCE 7-0-2004.
PAULA MAHONEY, EXAMINING ATTORNEY

SN 76-621,184. PROFITEC, INC., WALLINGFORD, CT.
FILED 11-18-2004.

OMNISCRUB

THE MARK CONSISTS OF STANDARD CHARACTERS WITHOUT CLAIM TO ANY PARTICULAR FONT, STYLE, SIZE, OR COLOR.

FOR BILLING SERVICES FOR THE TELECOMMUNICATIONS INDUSTRY (U.S. CLS. 100, 101 AND 102).

FIRST USE 1-1-2004; IN COMMERCE 1-1-2004.
VIVIAN MICZNIK FIRST, EXAMINING ATTORNEY

SN 76-621,449. TRANS UNION SETTLEMENT SOLUTIONS, INC., WILMINGTON, DE. FILED 11-22-2004.

CORDANCE TECHNOLOGIES

THE MARK CONSISTS OF STANDARD CHARACTERS WITHOUT CLAIM TO ANY PARTICULAR FONT, STYLE, SIZE, OR COLOR.

NO CLAIM IS MADE TO THE EXCLUSIVE RIGHT TO USE "TECHNOLOGIES", APART FROM THE MARK AS SHOWN.

FOR PROVIDING A WEBSITE PORTAL THAT ALLOWS CUSTOMERS TO SINGLE-SOURCE THEIR VENDORS THEN RECEIVE THE ORDER BACK IN A STANDARDIZED FORM (U.S. CLS. 100, 101 AND 102).

MARGERY A. TIERNEY, EXAMINING ATTORNEY

CLASS 35—(Continued).

SN 76-621,514. BENTON OIL SERVICES, INC., CHATTANOOGA, TN. FILED 11-19-2004.



THE SERVICE MARK CONSISTS OF THE WORD "MIDNITE" ABOVE THE WORD "OIL", WITH AN OIL DROP TO THE LEFT OF THE WORDS "MIDNITE" AND "OIL" AND WITH A HORIZONTAL BAR RUNNING FROM THE OIL DROP TO THE CENTER OF THE "O" IN THE WORD "OIL".

FOR RETAIL STORE SERVICES FEATURING CONVENIENCE STORE ITEMS AND GASOLINE (U.S. CLS. 100, 101 AND 102).

FIRST USE 7-1-2004; IN COMMERCE 7-1-2004.
GENE MACIOL, EXAMINING ATTORNEY

SN 76-621,645. VICTORY INTANGIBLES, L.P., DALLAS, TX. FILED 11-23-2004.

THE MARKET AT VICTORY

THE MARK CONSISTS OF STANDARD CHARACTERS WITHOUT CLAIM TO ANY PARTICULAR FONT, STYLE, SIZE, OR COLOR.

OWNER OF U.S. REG. NOS. 2,463,173, 2,786,811 AND OTHERS.

NO CLAIM IS MADE TO THE EXCLUSIVE RIGHT TO USE "MARKET", APART FROM THE MARK AS SHOWN.

FOR RETAIL GOURMET GROCERY STORE SERVICES (U.S. CLS. 100, 101 AND 102).

EVELYN BRADLEY, EXAMINING ATTORNEY

SN 76-621,856. ANGELES, JERRY L., SPRINGFIELD, MO. FILED 11-23-2004.

RENTPIX

THE MARK CONSISTS OF STANDARD CHARACTERS WITHOUT CLAIM TO ANY PARTICULAR FONT, STYLE, SIZE, OR COLOR.

FOR ONLINE RESOURCE PROVIDING RELOCATION INFORMATION AND ADVERTISING SPACE FOR RESIDENTIAL, VACATION, AND/OR TRAVEL-LODGING RENTAL PROPERTIES (U.S. CLS. 100, 101 AND 102).

FIRST USE 11-22-2004; IN COMMERCE 11-22-2004.
INGRID C. EULIN, EXAMINING ATTORNEY

CLASS 35—(Continued).

SN 76-621,904. CHANNING BETE COMPANY, INC., SOUTH DEERFIELD, MA. FILED 11-23-2004.



OWNER OF U.S. REG. NOS. 1,948,348, 2,918,225 AND 2,918,231.

NO CLAIM IS MADE TO THE EXCLUSIVE RIGHT TO USE "COMPANY", APART FROM THE MARK AS SHOWN.

THE NAME CHANNING BETE DOES NOT IDENTIFY A LIVING INDIVIDUAL.

FOR DISTRIBUTORSHIP SERVICES FEATURING MEDICAL PRODUCTS (U.S. CLS. 100, 101 AND 102).

FIRST USE 1-5-2002; IN COMMERCE 1-5-2002.

KATHRYN COWARD, EXAMINING ATTORNEY

SN 76-621,907. BEVAN MANUFACTURING CORPORATION, BURLINGTON, NJ. FILED 11-23-2004.

DANCESPIRATIONS

THE MARK CONSISTS OF STANDARD CHARACTERS WITHOUT CLAIM TO ANY PARTICULAR FONT, STYLE, SIZE, OR COLOR.

FOR RETAIL STORE SERVICES, WHOLESALE DISTRIBUTORSHIP SERVICES, MAIL ORDER AND CATALOG SERVICES, AND ONLINE RETAIL STORE SERVICES FEATURING JEWELRY, DECORATIVE ACCESSORIES FOR CLOTHING, EMBROIDERED PATCHES FOR CLOTHING, ORNAMENTAL CLOTH PATCHES, FABRIC APPLIQUES, SCARVES, FLAGS, TAMBOURINES, DANCE COSTUMES, PRAISE DANCE COSTUMES, LITURGICAL DANCE COSTUMES, WORSHIP DANCE COSTUMES, SPORTS UNIFORMS, CLOTHING FOR GYMNASTICS, BODY SUITS, CAMISOLES, GLOVES, HATS, HEADBANDS, JERSEYS, LEGGINGS, LEG WARMERS, LEOTARDS, PANTS, SHIRTS, SHORTS, SKIRTS, SOCKS, STOCKINGS, SWEATBANDS, SWEATPANTS, SWEATSHIRTS, TIGHTS, UNITARDS, WARM-UP JACKETS, AND WARM-UP PANTS (U.S. CLS. 100, 101 AND 102).

FIRST USE 11-1-2004; IN COMMERCE 11-1-2004.

LINDA M. KING, EXAMINING ATTORNEY

CLASS 35—(Continued).

SN 76-621,909. BEVAN MANUFACTURING CORPORATION, BURLINGTON, NJ. FILED 11-23-2004.



FOR RETAIL STORE SERVICES, WHOLESALE DISTRIBUTORSHIP SERVICES, MAIL ORDER AND CATALOG SERVICES, AND ONLINE RETAIL STORE SERVICES FEATURING JEWELRY, DECORATIVE ACCESSORIES FOR CLOTHING, EMBROIDERED PATCHES FOR CLOTHING, ORNAMENTAL CLOTH PATCHES, FABRIC APPLIQUES, SCARVES, FLAGS, TAMBOURINES, DANCE COSTUMES, PRAISE DANCE COSTUMES, LITURGICAL DANCE COSTUMES, WORSHIP DANCE COSTUMES, SPORTS UNIFORMS, CLOTHING FOR GYMNASTICS, BODY SUITS, CAMISOLES, GLOVES, HATS, HEADBANDS, JERSEYS, LEGGINGS, LEG WARMERS, LEOTARDS, PANTS, SHIRTS, SHORTS, SKIRTS, SOCKS, STOCKINGS, SWEATBANDS, SWEATPANTS, SWEATSHIRTS, TIGHTS, UNITARDS, WARM-UP JACKETS, AND WARM-UP PANTS (U.S. CLS. 100, 101 AND 102).

FIRST USE 11-1-2004; IN COMMERCE 11-1-2004.
LINDA M. KING, EXAMINING ATTORNEY

SN 76-621,946. CHANNING BETE COMPANY, INC., SOUTH DEERFIELD, MA. FILED 11-24-2004.

CHANNING BETE COMPANY

THE MARK CONSISTS OF STANDARD CHARACTERS WITHOUT CLAIM TO ANY PARTICULAR FONT, STYLE, SIZE, OR COLOR.

OWNER OF U.S. REG. NOS. 1,948,348, 2,918,225 AND 2,918,231.

NO CLAIM IS MADE TO THE EXCLUSIVE RIGHT TO USE "COMPANY", APART FROM THE MARK AS SHOWN.

THE NAME CHANNING BETE DOES NOT IDENTIFY A LIVING INDIVIDUAL.

FOR DISTRIBUTORSHIP SERVICES FEATURING MEDICAL PRODUCTS (U.S. CLS. 100, 101 AND 102).

FIRST USE 1-5-2002; IN COMMERCE 1-5-2002.
KATHRYN COWARD, EXAMINING ATTORNEY

CLASS 35—(Continued).

SN 76-621,947. CHANNING BETE COMPANY, INC., SOUTH DEERFIELD, MA. FILED 11-24-2004.



OWNER OF U.S. REG. NOS. 2,918,230 AND 2,918,231.
THE MARK CONSISTS OF A FANCIFUL DEPICTION OF A PERSON RUNNING.

FOR DISTRIBUTORSHIP SERVICES FEATURING MEDICAL PRODUCTS (U.S. CLS. 100, 101 AND 102).

FIRST USE 1-5-2002; IN COMMERCE 1-5-2002.
BARBARA RUTLAND, EXAMINING ATTORNEY

SN 76-622,241. NATIONAL TELECOMMUNICATIONS CO-OPERATIVE ASSOCIATION, ARLINGTON, VA. FILED 11-29-2004.

VoIPossibilities

THE MARK CONSISTS OF STANDARD CHARACTERS WITHOUT CLAIM TO ANY PARTICULAR FONT, STYLE, SIZE, OR COLOR.

FOR ARRANGING AND CONDUCTING BUSINESS CONFERENCES, ARRANGING AND CONDUCTING TRADE SHOWS, EXHIBITIONS AND DEMONSTRATIONS IN THE FIELD OF COMMUNICATIONS; BUSINESS CONSULTING SERVICES IN THE FIELD OF COMMUNICATIONS; PROVIDING TRADE INFORMATION ABOUT THE COMMUNICATIONS INDUSTRY (U.S. CLS. 100, 101 AND 102).

FIRST USE 11-1-2003; IN COMMERCE 11-1-2003.
JOHN HWANG, EXAMINING ATTORNEY

SN 76-622,262. THATIPALLY, SRINIVAS, HYDERABAD, AP-500080, INDIA, FILED 11-26-2004.



FOR SHOPPING SERVICE, NAMELY PROVIDING SHOPPERS WITH PRODUCT AND PRICE INFORMATION VIA GLOBAL COMPUTER NETWORKS (U.S. CLS. 100, 101 AND 102).

FIRST USE 11-18-2002; IN COMMERCE 11-18-2002.
DOMINIC J. FERRAIUOLO, EXAMINING ATTORNEY

CLASS 35—(Continued).

SN 76-622,263. THATIPALLY, SRINIVAS, HYDERABAD, AP-500080, INDIA, FILED 11-26-2004.

DEALS2BUY

THE MARK CONSISTS OF STANDARD CHARACTERS WITHOUT CLAIM TO ANY PARTICULAR FONT, STYLE, SIZE, OR COLOR.

FOR SHOPPING SERVICE, NAMELY PROVIDING SHOPPERS WITH PRODUCT AND PRICE INFORMATION VIA GLOBAL COMPUTER NETWORKS (U.S. CLS. 100, 101 AND 102).

FIRST USE 11-18-2002; IN COMMERCE 11-18-2002.

DOMINIC J. FERRAIUOLO, EXAMINING ATTORNEY

SN 76-622,308. ETHEL M CHOCOLATES, INC., HENDERSON, NV. FILED 11-26-2004.



THE MARK CONSISTS OF THE WORD MARK "ETHEL'S" IN STYLIZED LETTERS.

FOR RETAIL STORE SERVICES IN THE FIELD OF CANDY PRODUCTS, FRUIT AND BEVERAGES (U.S. CLS. 100, 101 AND 102).

DANIEL CAPSHAW, EXAMINING ATTORNEY

SN 76-622,362. WOODMOOR GROUP, INC., MONUMENT, CO. FILED 11-26-2004.

WOODMOOR GROUP

THE MARK CONSISTS OF STANDARD CHARACTERS WITHOUT CLAIM TO ANY PARTICULAR FONT, STYLE, SIZE, OR COLOR.

NO CLAIM IS MADE TO THE EXCLUSIVE RIGHT TO USE "GROUP", APART FROM THE MARK AS SHOWN.

FOR EXECUTIVE SEARCH AND PLACEMENT SERVICES (U.S. CLS. 100, 101 AND 102).

FIRST USE 3-19-1994; IN COMMERCE 3-19-1994.

JENNIFER MARTIN, EXAMINING ATTORNEY

CLASS 35—(Continued).

SN 76-622,442. GRUGGEN BUCKLEY, INC., MINNEAPOLIS, MN. FILED 11-22-2004.

SPEEDPROOF

THE MARK CONSISTS OF STANDARD CHARACTERS WITHOUT CLAIM TO ANY PARTICULAR FONT, STYLE, SIZE, OR COLOR.

FOR PROVIDING AN ONLINE PROPRIETARY DATABASE THAT ALLOWS ADVERTISING AGENCY CLIENTS TO ACCESS, REVIEW AND PROVIDE FEEDBACK REGARDING ADDING CREATIVE PROJECTS (U.S. CLS. 100, 101 AND 102).

FIRST USE 7-21-2004; IN COMMERCE 7-21-2004.

DEZMONA MIZELLE, EXAMINING ATTORNEY

SN 76-622,525. INCHORD COMMUNICATIONS, INC., WESTERVILLE, OH. FILED 11-30-2004.

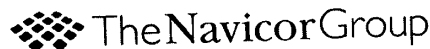

FOR ADVERTISING, MARKETING AND STRATEGIC BUSINESS CONSULTING FOR COMPANIES IN THE HEALTHCARE INDUSTRY (U.S. CLS. 100, 101 AND 102).

MARY CRAWFORD, EXAMINING ATTORNEY

SN 76-622,704. PALM HARBOR HOMES, INC., ADDISON, TX. FILED 12-1-2004.



NO CLAIM IS MADE TO THE EXCLUSIVE RIGHT TO USE CUSTOM HOMES, APART FROM THE MARK AS SHOWN.

FOR RETAIL OUTLETS FEATURING MODULAR HOUSING (U.S. CLS. 100, 101 AND 102).

KEVIN DINALLO, EXAMINING ATTORNEY

CLASS 35—(Continued).

SN 76-622,716. MANHEIM AUCTIONS, INC., ATLANTA, GA. FILED 12-1-2004.

MANHEIM MEDALLION CLUB

THE MARK CONSISTS OF STANDARD CHARACTERS WITHOUT CLAIM TO ANY PARTICULAR FONT, STYLE, SIZE, OR COLOR.

NO CLAIM IS MADE TO THE EXCLUSIVE RIGHT TO USE "CLUB", APART FROM THE MARK AS SHOWN.

FOR PROMOTING THE LOYALTY AND RETENTION OF CUSTOMERS THROUGH THE ADMINISTRATION OF INCENTIVE AWARDS PROGRAMS AS A FEATURE OF AUTOMOBILE AUCTION SERVICES (U.S. CLS. 100, 101 AND 102).

DOMINICK J. SALEMI, EXAMINING ATTORNEY

SN 76-622,998. TBH MARKS, INC., WILMINGTON, DE. FILED 12-2-2004.

BEAUTY BY TOVA

THE MARK CONSISTS OF STANDARD CHARACTERS WITHOUT CLAIM TO ANY PARTICULAR FONT, STYLE, SIZE, OR COLOR.

OWNER OF U.S. REG. NOS. 2,309,061, 2,374,425 AND OTHERS.

NO CLAIM IS MADE TO THE EXCLUSIVE RIGHT TO USE "BEAUTY", APART FROM THE MARK AS SHOWN.

FOR HOME SHOPPING SERVICES IN THE FIELD OF COSMETICS, FRAGRANCES AND SKIN CARE PRODUCTS BY MEANS OF TELEVISION, TELEPHONE AND THE INTERNET (U.S. CLS. 100, 101 AND 102).

FIRST USE 2-20-2003; IN COMMERCE 2-20-2003.
KIMBERLY PERRY, EXAMINING ATTORNEY

SN 76-623,404. WILSON, CHRISTOPHER S., OKLAHOMA CITY, OK. FILED 12-6-2004.

WILSON RESEARCH STRATEGIES

THE MARK CONSISTS OF STANDARD CHARACTERS WITHOUT CLAIM TO ANY PARTICULAR FONT, STYLE, SIZE, OR COLOR.

NO CLAIM IS MADE TO THE EXCLUSIVE RIGHT TO USE "RESEARCH STRATEGIES", APART FROM THE MARK AS SHOWN.
SEC. 2(F).

FOR MARKET RESEARCH SERVICES FOR OTHERS, NAMELY, CONDUCTING MARKET RESEARCH STUDIES ON VARIOUS POLITICAL, SOCIAL, ECONOMIC AND BUSINESS ISSUES (U.S. CLS. 100, 101 AND 102).

FIRST USE 9-7-1998; IN COMMERCE 9-7-1998.
ELISSA GARBER KON, EXAMINING ATTORNEY

CLASS 35—(Continued).

SN 76-623,660. COOLSAVINGS, INC., CHICAGO, IL. FILED 12-8-2004.

COOLTRAVEL

THE MARK CONSISTS OF STANDARD CHARACTERS WITHOUT CLAIM TO ANY PARTICULAR FONT, STYLE, SIZE, OR COLOR.

OWNER OF U.S. REG. NO. 2,209,627.

FOR ADVERTISING AND MARKETING SERVICES FOR OTHERS, NAMELY, DIRECT MAIL ADVERTISING, DIRECT EMAIL ADVERTISING AND ADVERTISING FOR OTHERS VIA THE WORLD WIDE WEB (U.S. CLS. 100, 101 AND 102).

AMY GEARIN, EXAMINING ATTORNEY

SN 76-623,957. POARCH BAND OF CREEK INDIANS, ATMORE, AL. FILED 12-8-2004.



NO CLAIM IS MADE TO THE EXCLUSIVE RIGHT TO USE "POARCH CREEK INDIANS", APART FROM THE MARK AS SHOWN.

A CIRCLE WITH A CROSS; FEATHER HANGING FROM BOTH SIDES OF CROSS; WORDS POARCH CREEK INDIANS

FOR ASSOCIATION SERVICES, NAMELY PROMOTING THE INTERESTS OF THE MEMBERS OF THE POARCH BAND OF CREEK INDIANS (U.S. CLS. 100, 101 AND 102).

FIRST USE 1-23-1988; IN COMMERCE 1-23-1988.
KATHY DE JONGE, EXAMINING ATTORNEY

CLASS 35—(Continued).

SN 76-624,534. ETHEL M CHOCOLATES, INC., HENDERSON, NV. FILED 12-14-2004.

CLASS 35—(Continued).

SN 76-624,568. CONDOPEDIA, INC., JAMAICA PLAIN, MA. FILED 12-15-2004.

CONDOPEDIA



FOR RETAIL STORE SERVICES IN THE FIELD OF CANDY PRODUCTS, FRUIT AND BEVERAGES (U.S. CLS. 100, 101 AND 102).
DANIEL CAPSHAW, EXAMINING ATTORNEY

THE MARK CONSISTS OF STANDARD CHARACTERS WITHOUT CLAIM TO ANY PARTICULAR FONT, STYLE, SIZE, OR COLOR.

FOR COMPUTER SERVICES, NAMELY, PROVIDING ONLINE BUSINESS MANAGEMENT INFORMATION FOR CONDOMINIUM MANAGERS AND CONDOMINIUM ASSOCIATIONS; MARKETING SERVICES, NAMELY, PROVIDING QUALIFIED SALES LEADS TO OTHERS; ONLINE REFERRAL SERVICES TO SERVICE PROVIDERS FOR THE CONDOMINIUM MANAGEMENT AND CONDOMINIUM ASSOCIATION INDUSTRY; COMPUTER SERVICES, NAMELY, PROVIDING A SEARCHABLE DIRECTORY OF INFORMATION FOR OBTAINING DATA AND INFORMATION FROM OTHERS VIA THE INTERNET FOR THE CONDOMINIUM MANAGEMENT AND CONDOMINIUM ASSOCIATION INDUSTRY; ADVERTISING SERVICES, NAMELY, PROVIDING ONLINE MARKETING SERVICES IN THE NATURE OF BANNER ADVERTISING, DISPLAY ADVERTISING, LINK EXCHANGES AND SEARCH ENGINE PLACEMENT SERVICES FOR THE CONDOMINIUM MANAGEMENT AND CONDOMINIUM ASSOCIATION INDUSTRY (U.S. CLS. 100, 101 AND 102).

CYNTHIA SLOAN, EXAMINING ATTORNEY

SN 76-624,535. ETHEL M CHOCOLATES, INC., HENDERSON, NV. FILED 12-14-2004.

SN 76-624,775. CATENATE, LLC, MANLIUS, NY. FILED 12-17-2004.



FOR RETAIL STORE SERVICES IN THE FIELD OF CANDY PRODUCTS, FRUIT AND BEVERAGES (U.S. CLS. 100, 101 AND 102).
DANIEL CAPSHAW, EXAMINING ATTORNEY

FOR BUSINESS AND MARKET RESEARCH AND ANALYSIS SERVICES; BUSINESS MARKETING CONSULTING SERVICES; PROVISION OF MARKETING INFORMATION, DEMOGRAPHIC INFORMATION, GEOGRAPHIC TRADING AREA INFORMATION, AND ANALYSIS FOR ALL OF THE FOREGOING SERVICES (U.S. CLS. 100, 101 AND 102).

CAROLYN GRAY, EXAMINING ATTORNEY

CLASS 35—(Continued).

SN 76-625,776. LIGGETT VECTOR BRANDS INC., RESEARCH TRIANGLE PARK, NC. FILED 12-22-2004.

PARTNER BRANDS

THE MARK CONSISTS OF STANDARD CHARACTERS WITHOUT CLAIM TO ANY PARTICULAR FONT, STYLE, SIZE, OR COLOR.

NO CLAIM IS MADE TO THE EXCLUSIVE RIGHT TO USE "BRANDS", APART FROM THE MARK AS SHOWN.

FOR MARKETING, ADVERTISING, AND PROMOTIONAL SERVICES IN THE NATURE OF COMMERCIALIZATION OF CIGARETTES DEVELOPED EXCLUSIVELY FOR WHOLESALE AND RETAIL CUSTOMERS (U.S. CLS. 100, 101 AND 102).

SUSAN HAYASH, EXAMINING ATTORNEY

SN 76-626,374. BOJANOVA, DINKA, LOS ANGELES, CA. FILED 12-28-2004.

ILLEGAL

THE MARK CONSISTS OF STANDARD CHARACTERS WITHOUT CLAIM TO ANY PARTICULAR FONT, STYLE, SIZE, OR COLOR.

FOR CUSTOMER AND CLIENT RECOGNITION PROGRAMS IN THE NATURE OF AN INCENTIVE CARD FOR USE IN HOTEL, CASINO AND RESORT FACILITIES (U.S. CLS. 100, 101 AND 102).

TRACY FLETCHER, EXAMINING ATTORNEY

SN 76-626,575. JAXARA GROUP, LLC, BETHESDA, MD. FILED 12-30-2004.

JAXARA

THE MARK CONSISTS OF STANDARD CHARACTERS WITHOUT CLAIM TO ANY PARTICULAR FONT, STYLE, SIZE, OR COLOR.

FOR BUSINESS CONSULTATION SERVICES ON THE SUBJECTS OF BUSINESS REENGINEERING AND ON-LINE COMMERCE; PROVIDING INFORMATION OVER GLOBAL, LOCAL AND INTERNAL COMPUTER NETWORKS ON THE SUBJECTS OF BUSINESS PLANNING, BUSINESS REENGINEERING, ON-LINE COMMERCE AND E-COMMERCE; AND PROVIDING BUSINESS INFORMATION VIA THE INTERNET ON THE SUBJECTS OF BUSINESS RE-ENGINEERING AND ON-LINE COMMERCE (U.S. CLS. 100, 101 AND 102).

FIRST USE 3-0-2003; IN COMMERCE 3-0-2003.

STEVEN PEREZ, EXAMINING ATTORNEY

CLASS 35—(Continued).

SN 76-626,706. ETERNAL LIFE PUBLISHING COMPANY, BARDSTOWN, KY. FILED 1-3-2005.

ETERNAL LIFE

THE MARK CONSISTS OF STANDARD CHARACTERS WITHOUT CLAIM TO ANY PARTICULAR FONT, STYLE, SIZE, OR COLOR.

FOR WHOLESALE STORES, MAIL ORDER SERVICES, DISTRIBUTORSHIPS, RETAIL STORE SERVICES, AND ON-LINE RETAIL STORE SERVICES ALL FEATURING AUDIO TAPES, VIDEOS, CD'S, PRAY CARDS, POSTERS, PAMPHLETS, CALENDARS, BOOKS, GIFTS, CARDS, AND MEMORIAL ITEMS (U.S. CLS. 100, 101 AND 102).

FIRST USE 6-0-1986; IN COMMERCE 6-0-1986.

DAHLIA GEORGE, EXAMINING ATTORNEY

SN 76-626,909. GS & G INC USA, BAY HARBOR ISLAND, FL. FILED 1-4-2005.

ADDICT

THE MARK CONSISTS OF STANDARD CHARACTERS WITHOUT CLAIM TO ANY PARTICULAR FONT, STYLE, SIZE, OR COLOR.

FOR RETAIL STORE SERVICES FEATURING CLOTHING (U.S. CLS. 100, 101 AND 102).

FIRST USE 8-12-2004; IN COMMERCE 8-12-2004.

ALICE BENMAMAN, EXAMINING ATTORNEY

SN 76-627,251. PRIME VET LLC, PARIS, MO. FILED 1-7-2005.

PETSNMORE

THE MARK CONSISTS OF STANDARD CHARACTERS WITHOUT CLAIM TO ANY PARTICULAR FONT, STYLE, SIZE, OR COLOR.

FOR ON-LINE RETAIL STORE SERVICES FEATURING PET SUPPLIES (U.S. CLS. 100, 101 AND 102).

FIRST USE 11-19-2003; IN COMMERCE 11-19-2003.

ALICE BENMAMAN, EXAMINING ATTORNEY

CLASS 35—(Continued).

SN 76-627,821. TOP WEDDING SITES, INC., WAYNE, NJ. FILED 1-13-2005.

TEAMWEDDING.COM

FOR PROMOTING THE GOODS AND SERVICES OF OTHERS BY PROVIDING HYPERTEXT LINKS TO THE WEB SITES OF OTHERS THAT FEATURE WEDDING INFORMATION AND SERVICES (U.S. CLS. 100, 101 AND 102).

INGA ERVIN, EXAMINING ATTORNEY



SN 76-627,878. CLUBCORP USA, INC., DALLAS, TX. FILED 1-13-2005.

BUILDING RELATIONSHIPS & ENRICHING LIVES

THE MARK CONSISTS OF STANDARD CHARACTERS WITHOUT CLAIM TO ANY PARTICULAR FONT, STYLE, SIZE, OR COLOR.

FOR PROMOTION, ADVERTISING, AND MARKETING OF SERVICES (U.S. CLS. 100, 101 AND 102).

RICHARD WHITE, EXAMINING ATTORNEY



SN 76-977,291. VOLKSWAGEN OF AMERICA, INC., AUBURN HILLS, MI. FILED 11-18-2003.

AGARRA CALLE

THE MARK CONSISTS OF STANDARD CHARACTERS WITHOUT CLAIM TO ANY PARTICULAR FONT, STYLE, SIZE, OR COLOR.

THE MARK TRANSLATES FROM SPANISH INTO ENGLISH AS "IT TAKES HOLD OF THE STREET."

FOR ADVERTISING SERVICES, NAMELY, PROMOTING THE SALE AND SERVICING OF AUTOMOBILES FOR OTHERS BY DISTRIBUTING ADVERTISING MATERIALS THROUGH A VARIETY OF METHODS (U.S. CLS. 100, 101 AND 102).

FIRST USE 5-0-2002; IN COMMERCE 5-0-2002.
RICHARD WHITE, EXAMINING ATTORNEY

CLASS 35—(Continued).

SN 78-013,733. LOUISIANA ONLINE, INC., BATON ROUGE, LA. FILED 6-21-2000.

ALUMNI WAREHOUSE

THE MARK CONSISTS OF STANDARD CHARACTERS WITHOUT CLAIM TO ANY PARTICULAR FONT, STYLE, SIZE, OR COLOR.

NO CLAIM IS MADE TO THE EXCLUSIVE RIGHT TO USE WAREHOUSE, APART FROM THE MARK AS SHOWN.

FOR COMPUTERIZED ON-LINE AND MAIL ORDER RETAIL SERVICES IN THE FIELD OF COLLEGE, ACADEMIC, OR SPORTS THEMED ITEMS, NAMELY, CLOTHING, FLAGS, UMBRELLAS, POSTERS, JEWELRY, ELECTRONICS, HOUSEWARES, SUNGLASSES, VIDEOS, BACKPACKS, BAGS, AND MUSIC. (U.S. CLS. 100, 101 AND 102).

ANDREW BENZMILLER, EXAMINING ATTORNEY



SN 78-138,775. TEACHERSPARADISE.COM, INC., MIAMI, FL. FILED 6-25-2002.



NO CLAIM IS MADE TO THE EXCLUSIVE RIGHT TO USE TEACHERS, APART FROM THE MARK AS SHOWN.

FOR RETAIL STORE SERVICES IN THE FIELD OF SCHOOL SUPPLIES, TEACHER AND EDUCATIONAL MATERIALS, NAMELY, EDUCATIONAL TOYS, BOOKS, MAGAZINES, COMPACT DISCS, AUDIO AND VIDEO-CASSETTES, DIGITAL VIDEO DISCS AND POSTERS; COMPUTERIZED ON-LINE ORDERING SERVICES IN THE FIELD OF SCHOOL SUPPLIES, TEACHER AND EDUCATIONAL MATERIALS, NAMELY, EDUCATIONAL TOYS, BOOKS, MAGAZINES, COMPACT DISCS, AUDIO AND VIDEO CASSETTES, DIGITAL VIDEO DISCS AND POSTERS; ON-LINE RETAIL STORE SERVICES FEATURING SCHOOL SUPPLIES, TEACHER AND EDUCATIONAL MATERIALS, NAMELY, EDUCATIONAL TOYS, BOOKS, MAGAZINES, COMPACT DISCS, AUDIO AND VIDEO CASSETTES, DIGITAL VIDEO DISCS AND POSTERS; ON-LINE MAIL ORDER CATALOG SERVICES FEATURING SCHOOL SUPPLIES, TEACHER AND EDUCATIONAL MATERIALS, NAMELY, EDUCATIONAL TOYS, BOOKS, MAGAZINES, COMPACT DISCS, AUDIO AND VIDEO CASSETTES, DIGITAL VIDEO DISCS AND POSTERS; ON-LINE RETAIL STORE SERVICES FEATURING SCHOOL SUPPLIES, TEACHER AND EDUCATIONAL MATERIALS, SPORTS EQUIPMENT, PHYSICAL EDUCATION

CLASS 35—(Continued).

TRAINING MATERIALS AND EQUIPMENT, CLASSROOM FURNITURE, DAYCARE FURNITURE, AUDIO-VISUAL EQUIPMENT, GENERAL OFFICE SUPPLIES, ARTS AND CRAFTS, NAMELY, TEACHING BOOKS, STICKERS, BULLETIN BOARD SETS, EDUCATIONAL PUBLISHING, AND POSTERS; RETAIL STORE AND CATALOG ORDERING SERVICES FEATURING SCHOOL AND CLASSROOM GOODS AND SUPPLIES; RETAIL STORE AND CATALOG ORDERING SERVICES FEATURING OF SCHOOL AND CLASSROOM GOODS AND SUPPLIES BY MAIL ORDER AND BY MEANS OF A GLOBAL COMPUTER NETWORK; MAIL ORDER CATALOG SERVICES AND ON-LINE ORDERING SERVICES, ALL FEATURING EDUCATIONAL MATERIALS FOR ELEMENTARY AND SECONDARY SCHOOLS; RETAIL STORE AND MAIL ORDER SERVICES IN THE FIELD OF SCHOOL AND OFFICE SUPPLIES, OFFICE AND SCHOOL FURNITURE AND AUDIO VISUAL EQUIPMENT; RETAIL, CATALOG, MAIL ORDER AND ON-LINE SERVICES RELATING TO EDUCATIONAL MATERIALS (U.S. CLS. 100, 101 AND 102).

FIRST USE 12-10-2000; IN COMMERCE 12-10-2000.
HOWARD SMIGA, EXAMINING ATTORNEY

SN 78-212,354. MISSION SEARCH CORPORATION, TAMPA, FL. FILED 2-7-2003.



MISSIONSEARCH

FOR PERSONNEL PLACEMENT AND RECRUITMENT SERVICES INCLUDING, EXECUTIVE SEARCH AND PLACEMENT SERVICES, EMPLOYMENT HIRING, RECRUITING, PLACEMENT, STAFFING AND CAREER NETWORKING SERVICES, AND TEMPORARY EMPLOYMENT AGENCIES (U.S. CLS. 100, 101 AND 102).

FIRST USE 10-1-2002; IN COMMERCE 10-1-2002.
ALICIA COLLINS, EXAMINING ATTORNEY

SN 78-219,225. OUTSIDE-THE-BOX, INC., CHARLOTTE, NC. FILED 2-26-2003.

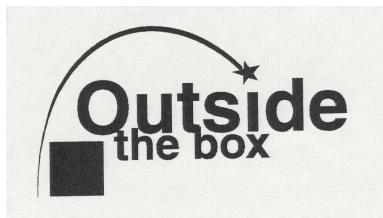

THE MARK CONSISTS OF THE WORD "OUTSIDE" APPEARING OVER THE WORDING "IN THE BOX" HAVING THE GRAPHIC REPRESENTATION OF A SQUARE UNDER THE "O" IN THE WORD "OUTSIDE" AND THE GRAPHIC REPRESENTATION OF A SHOOTING STAR ARCHING FROM THE LOWER LEFT-HAND CORNER AND ENDING WITH THE STAR AS THE DOT IN THE "I" IN THE WORD "OUTSIDE".

FOR BUSINESS CONSULTING SERVICES IN THE FIELD OF PRODUCT DEVELOPMENT AND MARKETING (U.S. CLS. 100, 101 AND 102).

FIRST USE 2-0-2002; IN COMMERCE 2-0-2002.
ALLISON HOLTZ, EXAMINING ATTORNEY

CLASS 35—(Continued).

SN 78-223,808. DECIMA RESEARCH INC., OTTAWA, ONTARIO, CANADA, FILED 3-10-2003.

SIGNIFICANTLY DIFFERENT

PRIORITY CLAIMED UNDER SEC. 44(D) ON CANADA APPLICATION NO. 1152197, FILED 9-10-2002, REG. NO. TMA640422, DATED 5-25-2005, EXPIRES 5-25-2019.

FOR PUBLIC OPINION AND MARKET RESEARCH SERVICES (U.S. CLS. 100, 101 AND 102).

TERESA M. RUPP, EXAMINING ATTORNEY

SN 78-230,553. LIVING SPACES FURNITURE, LLC, RANCHO CUCAMONGA, CA. FILED 3-27-2003.

LIVING SPACES

FOR RETAIL FURNITURE STORE (U.S. CLS. 100, 101 AND 102).

BARBARA A. LOUGHRAN, EXAMINING ATTORNEY

SN 78-292,567. JOHN M. FLOYD & ASSOCIATES, INC., BAYTOWN, TX. FILED 8-26-2003.

**JOHN M. FLOYD &
ASSOCIATES "NEW
CUSTOMER" ACCOUNT
ACQUISITION PROGRAM**

NO CLAIM IS MADE TO THE EXCLUSIVE RIGHT TO USE "ASSOCIATES NEW CUSTOMER ACCOUNT ACQUISITION PROGRAM", APART FROM THE MARK AS SHOWN.

THE NAME(S), PORTRAIT(S), AND/OR SIGNATURE(S) SHOWN IN THE MARK IDENTIFIES JOHN M. FLOYD, WHOSE CONSENT(S) TO REGISTER IS SUBMITTED.

FOR BUSINESS AND ADVERTISING SERVICES, NAMELY, DIRECT MAIL PROGRAMS FOR BANKS TO MARKET CHECKING ACCOUNT SERVICES TO CONSUMERS (U.S. CLS. 100, 101 AND 102).

FIRST USE 8-18-2003; IN COMMERCE 8-18-2003.
YONG KIM, EXAMINING ATTORNEY

CLASS 35—(Continued).

SN 78-292,573. JOHN M. FLOYD & ASSOCIATES, INC.,
BAYTOWN, TX. FILED 8-26-2003.

**JOHN M. FLOYD &
ASSOCIATES "NEW
MEMBER" ACCOUNT
ACQUISITION PROGRAM**

NO CLAIM IS MADE TO THE EXCLUSIVE RIGHT TO USE "ASSOCIATES NEW MEMBER ACCOUNT ACQUISITION PROGRAM", APART FROM THE MARK AS SHOWN. THE NAME(S), PORTRAIT(S), AND/OR SIGNATURE(S) SHOWN IN THE MARK IDENTIFIES JOHN M. FLOYD, WHOSE CONSENT(S) TO REGISTER IS SUBMITTED.

FOR BUSINESS AND ADVERTISING SERVICES, NAMELY, DIRECT MAIL PROGRAMS FOR CREDIT UNIONS TO MARKET SHARE DRAFT SERVICES TO CONSUMERS (U.S. CLS. 100, 101 AND 102).

FIRST USE 8-18-2003; IN COMMERCE 8-18-2003.
YONG KIM, EXAMINING ATTORNEY

SN 78-293,570. GLOBAL AUTO SYSTEMS INC., GROSSE
POINTE WOODS, MI. FILED 8-28-2003.

GLOBAL AUTO SYSTEMS

NO CLAIM IS MADE TO THE EXCLUSIVE RIGHT TO USE "AUTO", APART FROM THE MARK AS SHOWN.

FOR BUSINESS CONSULTATION AND BUSINESS RESEARCH SERVICES; PROVIDING BUSINESS INFORMATION RELATING TO THE AUTO INDUSTRY VIA A WEB SITE ON THE INTERNET (U.S. CLS. 100, 101 AND 102).

FIRST USE 7-0-2000; IN COMMERCE 7-0-2000.
SCOTT OSCLICK, EXAMINING ATTORNEY

SN 78-296,832. AIDA-AMERICA CORPORATION, DAYTON,
OH. FILED 9-5-2003.

AIDA CPR

FOR BUSINESS CONSULTATION, BUSINESS PROJECT MANAGEMENT AND LOGISTICS MANAGEMENT IN THE FIELD OF METAL-FORMING PRESSES; TRANSPORTATION LOGISTICS SERVICES, NAMELY, ARRANGING THE TRANSPORTATION OF GOODS FOR OTHERS IN THE METAL-FORMING PRESS INDUSTRY. (U.S. CLS. 100, 101 AND 102).

JOHN GARTNER, EXAMINING ATTORNEY

CLASS 35—(Continued).

SN 78-309,068. PRISMA ENERGY INTERNATIONAL, INC.,
FORT STREET, GEORGE TOWN, CAYMAN ISLANDS,
FILED 10-3-2003.

PrismaEnergy

FOR BUSINESS CONSULTING AND MANAGEMENT SERVICES RELATED TO DEVELOPING, OWNING AND OPERATING NATURAL GAS PIPELINES, NATURAL GAS GATHERING FACILITIES, GAS PROCESSING FACILITIES, GAS AND HYDROCARBON LIQUIDS TRANSPORTATION, STORAGE, AND DISTRIBUTION FACILITIES, POWER GENERATING FACILITIES, AND ELECTRICITY DISTRIBUTION COMPANIES (U.S. CLS. 100, 101 AND 102).

FIRST USE 8-0-2003; IN COMMERCE 8-0-2003.

JENNIFER CHICOSKI, EXAMINING ATTORNEY

SN 78-315,072. EVENTSCAPE, INC., BARRINGTON, IL,
FILED 10-17-2003.

EVENTSCAPE

FOR PUBLIC RELATIONS; ADVERTISING SERVICES, NAMELY, PROMOTING THE SERVICES OF NOT-FOR PROFIT ORGANIZATIONS THROUGH THE DISTRIBUTION OF PRINTED AND AUDIO PROMOTIONAL MATERIALS AND BY RENDERING SALES PROMOTION ADVICE; DEVELOPING PROMOTIONAL CAMPAIGNS FOR BUSINESS; PREPARING PROMOTIONAL AND MERCHANDISING MATERIALS FOR OTHERS (U.S. CLS. 100, 101 AND 102).

FIRST USE 8-15-2001; IN COMMERCE 8-15-2001.

TEJBIR SINGH, EXAMINING ATTORNEY

SN 78-315,282. FIRST CHOICE ARMOR & EQUIPMENT,
INC., BROCKTON, MA. FILED 10-17-2003.

**FIRST CHOICE
ARMOR**
With you. For life.

OWNER OF U.S. REG. NOS. 2,721,285 AND 2,871,750.
NO CLAIM IS MADE TO THE EXCLUSIVE RIGHT TO USE ARMOR, APART FROM THE MARK AS SHOWN.

THE COLORS, BLUE AND GREY, ARE CLAIMED AS FEATURES OF THE MARK.

THE MARK CONSISTS OF FIRST CHOICE ARMOR IS IN BLUE. WITH YOU. FOR LIFE IS IN GREY. THE BULLET IS ALSO IN GREY.

FOR RETAIL DISTRIBUTORSHIP IN THE FIELD OF SAFETY EQUIPMENT, NAMELY HELMETS, SHIELDS, POUCHES, BAGS, CLUBS, AND BLANKETS, AND SAFETY APPAREL, NAMELY BULLET PROOF VESTS AND BODY ARMOR (U.S. CLS. 100, 101 AND 102).

RICHARD A. STRASER, EXAMINING ATTORNEY

CLASS 35—(Continued).

SN 78-319,352. WORLD WIDE PARTS AND ACCESSORIES CORPORATION, NEWARK, CA. FILED 10-28-2003.

WORLD WIDE PARTS AND ACCESSORIES CORPORATION

NO CLAIM IS MADE TO THE EXCLUSIVE RIGHT TO USE "PARTS AND ACCESSORIES CORPORATION", APART FROM THE MARK AS SHOWN.

SEC. 2(F).

FOR DISTRIBUTORSHIP SERVICES IN THE FIELD OF AUTOMOTIVE PARTS AND ACCESSORIES (U.S. CLS. 100, 101 AND 102).

FIRST USE 0-0-1995; IN COMMERCE 0-0-1995.

SAMUEL E. SHARPER JR., EXAMINING ATTORNEY

CLASS 35—(Continued).

SN 78-329,016. FISHER SCIENTIFIC COMPANY, L.L.C., HAMPTON, NH. FILED 11-17-2003.

ASSET

THE MARK CONSISTS OF STANDARD CHARACTERS WITHOUT CLAIM TO ANY PARTICULAR FONT, STYLE, SIZE, OR COLOR.

FOR DISTRIBUTORSHIP SERVICES IN THE FIELD OF PERSONAL PROTECTION PRODUCTS, LABORATORY INSTRUMENTS, APPLIANCES, EQUIPMENT, APPAREL, CHEMICAL AND DIAGNOSTIC PRODUCTS, FOR THE SCIENTIFIC INDUSTRY AND THE CLINICAL LABORATORY INDUSTRY (U.S. CLS. 100, 101 AND 102).
BRIAN PINO, EXAMINING ATTORNEY

SN 78-334,569. BELL SOUTH INTELLECTUAL PROPERTY CORPORATION, WILMINGTON, DE. FILED 12-1-2003.

SN 78-323,409. COYNE, JOHN, E, BROOKLYN PARK, MN. FILED 11-5-2003.

BERRYSPI

Parade of Gifts

THE MARK CONSISTS OF STANDARD CHARACTERS WITHOUT CLAIM TO ANY PARTICULAR FONT, STYLE, SIZE, OR COLOR.

NO CLAIM IS MADE TO THE EXCLUSIVE RIGHT TO USE "GIFTS", APART FROM THE MARK AS SHOWN.

FOR RETAIL STORE SERVICES FEATURING GIFTWARE CATALOGS TO GIFTWARE RETAILERS (U.S. CLS. 100, 101 AND 102).

FIRST USE 8-14-1982; IN COMMERCE 8-14-1982.

EVELYN BRADLEY, EXAMINING ATTORNEY

THE MARK CONSISTS OF STANDARD CHARACTERS WITHOUT CLAIM TO ANY PARTICULAR FONT, STYLE, SIZE, OR COLOR.

OWNER OF U.S. REG. NOS. 1,605,880, 2,066,298 AND OTHERS.

FOR TELEPHONE DIRECTORY SERVICES, NAMELY, PREPARATION AND PLACEMENT OF ADVERTISEMENTS IN CLASSIFIED DIRECTORIES FOR OTHERS; ADVERTISING SERVICES, NAMELY, PLACING ADVERTISEMENTS FOR OTHERS; MEDIA PLANNING SERVICES, NAMELY, ADVISING BUSINESSES AS TO WHAT DIRECTORY MEDIA TO PROMOTE THEMSELVES IN AND ACQUIRING ADVERTISING SPACE IN THE RECOMMENDED MEDIA; AND MARKETING SERVICES, NAMELY, CONDUCTING MARKET RESEARCH AND FORECASTING STUDIES; MARKET RESEARCH SERVICES (U.S. CLS. 100, 101 AND 102).

FIRST USE 3-15-2003; IN COMMERCE 10-1-2003.

WILLIAM VERHOSEK, EXAMINING ATTORNEY

CLASS 35—(Continued).

SN 78-340,581. BUMPDRAFT MOTORSPORTS INC., TEGA CAY, SC. FILED 12-14-2003.

CLASS 35—(Continued).

SN 78-348,275. MINC SYSTEMS, LLC, WOOSTER, OH. FILED 1-6-2004.

BUMPDRAFT

MAINTENANCE, INC.

THE MARK CONSISTS OF STANDARD CHARACTERS WITHOUT CLAIM TO ANY PARTICULAR FONT, STYLE, SIZE, OR COLOR.

FOR MAIL ORDER SERVICES IN THE FIELD OF AUTOMOBILE PARTS (U.S. CLS. 100, 101 AND 102).

FIRST USE 1-1-2003; IN COMMERCE 1-1-2003.
LESLEY LAMOTHE, EXAMINING ATTORNEY

THE MARK CONSISTS OF STANDARD CHARACTERS WITHOUT CLAIM TO ANY PARTICULAR FONT, STYLE, SIZE, OR COLOR.

NO CLAIM IS MADE TO THE EXCLUSIVE RIGHT TO USE "INC", APART FROM THE MARK AS SHOWN.

SEC. 2(F).

FOR RETAIL STORE SERVICES FEATURING BITUMINOUS AND OTHER MATERIALS FOR WATER-PROOFING, DAMP-PROOFING AND SEALING OF ASPHALT AND CONCRETE, SPECIFICALLY DRIVEWAYS, PAVEMENT AND SPORTS SURFACES (U.S. CLS. 100, 101 AND 102).

FIRST USE 5-15-1940; IN COMMERCE 6-22-1940.
KIMBERLY PERRY, EXAMINING ATTORNEY

SN 78-340,846. CHIROTOOLS, INC., INCLINE VILLAGE, NV. FILED 12-15-2003.

SN 78-349,211. BUILD-A-BEAR RETAIL MANAGEMENT, INC., ST. LOUIS, MO. FILED 1-8-2004.

CHIROTOOLS

WHERE BEST FRIENDS PARTY

THE MARK CONSISTS OF STANDARD CHARACTERS WITHOUT CLAIM TO ANY PARTICULAR FONT, STYLE, SIZE, OR COLOR.

FOR DIRECT MARKETING ADVERTISING FOR OTHERS, NAMELY, DISTRIBUTING ADVERTISING FOR MEDICAL PRACTITIONERS BY MESSAGE TEXTING TO TELEPHONES (U.S. CLS. 100, 101 AND 102).

FIRST USE 3-17-2003; IN COMMERCE 3-17-2003.
BARNEY CHARLON, EXAMINING ATTORNEY

THE MARK CONSISTS OF STANDARD CHARACTERS WITHOUT CLAIM TO ANY PARTICULAR FONT, STYLE, SIZE, OR COLOR.

OWNER OF U.S. REG. NOS. 2,602,016, 2,722,224 AND OTHERS.

FOR RETAIL STORE SERVICES IN THE FIELD OF STUFFED AND PLUSH TOY ANIMALS, DOLLS AND ACCESSORIES THEREFOR (U.S. CLS. 100, 101 AND 102).

LANA PHAM, EXAMINING ATTORNEY

CLASS 35—(Continued).

SN 78-354,511. KRAVITZ, STEVEN, D, NEW YORK, NY. FILED 1-20-2004.

1-800- I WANT A MORTGAGE

THE MARK CONSISTS OF STANDARD CHARACTERS WITHOUT CLAIM TO ANY PARTICULAR FONT, STYLE, SIZE, OR COLOR.

NO CLAIM IS MADE TO THE EXCLUSIVE RIGHT TO USE "1-800" AND "MORTGAGE", APART FROM THE MARK AS SHOWN.

FOR MORTGAGE BROKERAGE AND LENDING, NAMELY TELEMARKETING AND LEAD GENERATING SERVICES FOR LENDING INDUSTRY (U.S. CLS. 100, 101 AND 102).

NAAKWAMA ANKRAH, EXAMINING ATTORNEY



SN 78-356,086. TIME DOLLAR INSTITUTE, WASHINGTON, DC. FILED 1-23-2004.

Time Banks International

THE MARK CONSISTS OF STANDARD CHARACTERS WITHOUT CLAIM TO ANY PARTICULAR FONT, STYLE, SIZE, OR COLOR.

NO CLAIM IS MADE TO THE EXCLUSIVE RIGHT TO USE BANKS INTERNATIONAL, APART FROM THE MARK AS SHOWN.

FOR ADMINISTERING A TIME CREDIT EXCHANGE REWARDS PROGRAM WHEREBY PARTICIPANTS WHO PARTICIPATE IN VOLUNTEER AND COMMUNITY SERVICE INITIATIVES CAN ACCUMULATE CREDIT THAT CAN BE USED TO PURCHASE MERCHANDISE ITEMS AND SERVICES PROVIDED BY OTHER MEMBERS (U.S. CLS. 100, 101 AND 102).

PRISCILLA MILTON, EXAMINING ATTORNEY

CLASS 35—(Continued).

SN 78-356,765. WUSC EDUCATION AND DEVELOPMENT CORPORATION, OTTAWA, ONTARIO, CANADA, FILED 1-23-2004.

ÉTUDIANTS SANS FRONTIÈRES

THE MARK CONSISTS OF STANDARD CHARACTERS WITHOUT CLAIM TO ANY PARTICULAR FONT, STYLE, SIZE, OR COLOR.

NO CLAIM IS MADE TO THE EXCLUSIVE RIGHT TO USE "ÉTUDIANTS", APART FROM THE MARK AS SHOWN.

THE FOREIGN WORDING IN THE MARK TRANSLATES INTO ENGLISH AS STUDENTS WITHOUT BORDERS.

FOR PROVIDING INFORMATION ON THE TOPIC OF PROMOTING EDUCATION VIA A GLOBAL COMPUTER NETWORK; PROMOTING THE EXCHANGE OF INFORMATION ABOUT EDUCATION VIA A GLOBAL COMPUTER NETWORK; PROMOTING PUBLIC AWARENESS OF THE BENEFITS OF EXCHANGING INFORMATION ABOUT EDUCATION VIA A GLOBAL COMPUTER NETWORK (U.S. CLS. 100, 101 AND 102).

LOURDES AYALA, EXAMINING ATTORNEY



SN 78-357,714. VIDEO ADVENTURE, INC., DUBUQUE, IA. FILED 1-26-2004.

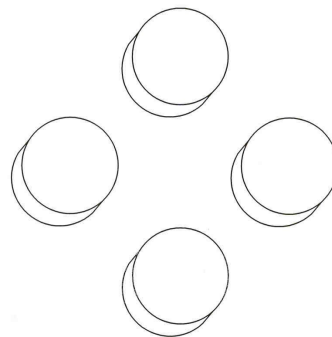

THE MARK CONSISTS OF FOUR THREE-DIMENSIONAL BUTTONS.

FOR ONLINE AND RETAIL STORE SERVICES FEATURING HOME ENTERTAINMENT ELECTRONIC PRODUCTS, SYSTEMS AND ACCESSORIES, NAMELY, DVD MOVIES, COMPUTER GAMES, VIDEO GAMES, AND UNITS FOR PLAYING THE GAMES (U.S. CLS. 100, 101 AND 102).

FIRST USE 7-1-2003; IN COMMERCE 7-1-2003. PAULA MAYS, EXAMINING ATTORNEY

CLASS 35—(Continued).

SN 78-368,380. THE FRUIT FACTORY, INC., CHICAGO, IL.
FILED 2-15-2004.

CLASS 35—(Continued).

SN 78-373,501. REPLY! INC., ALAMO, CA. FILED 2-24-2004.

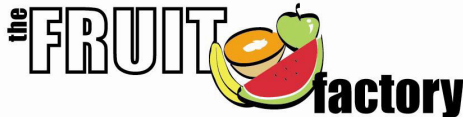

REPLY.COM

NO CLAIM IS MADE TO THE EXCLUSIVE RIGHT TO USE "THE FRUIT" AND "FACTORY", APART FROM THE MARK AS SHOWN.

THE COLORS RED, GREEN, YELLOW, ORANGE, TAN (LIGHT BROWN) AND BLACK ARE CLAIMED AS A FEATURE OF THE MARK.

THE MARK CONSISTS OF THE FOLLOWING ELEMENTS: "THE" IS IN LOWER CASE, COMPLETELY BLACK IN COLOR, AND PLACED HORIZONTALLY ON THE LEFT OF "FRUIT." "FRUIT" IS IN UPPER CASE AND WHITE IN COLOR WITH THE OUTLINE BLACK IN COLOR. THE BANANA IS YELLOW IN COLOR WITH BLACK OUTLINE. THE CANTALOUPE HAS THE FOLLOWING FOUR COLORS, TAN (LIGHT BROWN) FOR THE SKIN, BLACK FOR THE RIM OF THE FRUIT, AND ORANGE AND WHITE FOR THE INTERIOR OF THE FRUIT. THE APPLE IS LIGHT GREEN IN COLOR WITH WHITE SHINY SPOT ON THE TOP RIGHT CORNER AND THE OUTLINE IS BLACK IN COLOR. THE WATERMELON HAS THE FOLLOWING FOUR MAIN COLORS, GREEN SKIN WITH BLACK OUTLINE, RED INTERIOR WITH BLACK SEEDS AND A WHITE SPACE BETWEEN THE INTERIOR AND THE GREEN SKIN, AND THE TERM "FACTORY" IS IN LOWER CASE AND COMPLETELY BLACK IN COLOR.

FOR RETAIL STORE SERVICES FEATURING FRESH FRUIT CUPS AND SALADS AND FRESH FRUIT PLATTERS (U.S. CLS. 100, 101 AND 102).

TONI HICKEY, EXAMINING ATTORNEY

THE MARK CONSISTS OF STANDARD CHARACTERS WITHOUT CLAIM TO ANY PARTICULAR FONT, STYLE, SIZE, OR COLOR.

FOR PROVIDING REFERRALS AND BUSINESS LEADS TO REAL ESTATE AGENTS, HOME IMPROVEMENT CONTRACTORS, VEHICLE DEALERS, LENDERS, INSURANCE PROVIDERS AND HOME MOVERS; PROVIDING A WEB SITE AT WHICH USERS CAN OFFER GOODS FOR SALE AND BUY GOODS OFFERED BY OTHERS; PROVIDING CONSUMER INFORMATION ABOUT AUTOMOBILES AND HOMES FOR SALE BY MEANS OF THE INTERNET; PROMOTION OF REAL ESTATE SERVICES OR HOME MOVING SERVICES OF OTHERS; PROVIDING CONSUMER INFORMATION AND PROMOTING RETAIL SERVICES OF OTHERS ONLINE IN THE AUTOMOTIVE FIELD FEATURING INFORMATION ABOUT SALES, HISTORY, MODEL, VALUE, AND PERFORMANCE CONCERNING THE AUTOMOTIVE INDUSTRY, MOTOR VEHICLES AND MOTOR VEHICLE SALES, PRICES AND RATINGS; PROMOTING RETAIL SERVICES OF OTHERS ONLINE IN THE FIELDS OF HOME IMPROVEMENT, HOME CONTRACTING, INTERIOR AND EXTERIOR HOME DESIGN, FINANCING, INSURANCE, REAL ESTATE AND HOME MOVING; PROVIDING RATINGS AND REFERENCES FOR CONTRACTORS AND BUILDERS ONLINE; PROMOTING RETAIL SERVICES ONLINE IN THE AUTOMOTIVE FIELD CONCERNING MOTOR VEHICLE MAINTENANCE; PROVIDING CONSUMER INFORMATION ONLINE IN THE FIELDS OF FINANCING, INSURANCE, AND REAL ESTATE; PROVIDING CONSUMER INFORMATION ONLINE IN THE FIELDS OF HOME IMPROVEMENT, AND MOTOR VEHICLE MAINTENANCE (U.S. CLS. 100, 101 AND 102).

ANDREW BENZMILLER, EXAMINING ATTORNEY

CLASS 35—(Continued).

SN 78-374,940. STB CREATIONS, MCALLEN, TX. FILED 2-26-2004.

HAIR PREMIERE

THE MARK CONSISTS OF STANDARD CHARACTERS WITHOUT CLAIM TO ANY PARTICULAR FONT, STYLE, SIZE, OR COLOR.

NO CLAIM IS MADE TO THE EXCLUSIVE RIGHT TO USE "HAIR", APART FROM THE MARK AS SHOWN.

FOR INTERNET AND PHYSICAL RETAIL STORE SERVICES FEATURING, NATURAL FUSION HAIR EXTENSIONS, COLOR SWATCH RINGS, CREAM HAIR EXTENSION REMOVER AND DEMONSTRATIONAL VIDEOS (U.S. CLS. 100, 101 AND 102).

FIRST USE 10-27-2003; IN COMMERCE 10-27-2003.

JEAN IM, EXAMINING ATTORNEY

CLASS 35—(Continued).

SN 78-381,959. CORE INTEGRATION PARTNERS, INC., DENVER, CO. FILED 3-10-2004.

NANOHOUSING

THE MARK CONSISTS OF STANDARD CHARACTERS WITHOUT CLAIM TO ANY PARTICULAR FONT, STYLE, SIZE, OR COLOR.

FOR BUSINESS MANAGEMENT CONSULTANCY AS WELL AS DEVELOPMENT OF PROCESSES FOR THE ANALYSIS AND THE IMPLEMENTATION OF STRATEGY PLANS AND MANAGEMENT PROJECTS (U.S. CLS. 100, 101 AND 102).

MICHAEL HALL, EXAMINING ATTORNEY

SN 78-377,757. YCONCEPT, INC., BOCA RATON, FL. FILED 3-3-2004.

**Corporate-
Insiders.com**

THE MARK CONSISTS OF STANDARD CHARACTERS WITHOUT CLAIM TO ANY PARTICULAR FONT, STYLE, SIZE, OR COLOR.

FOR BUSINESS SERVICES, NAMELY, PREPARING AND FILING SECURITIES AND EXCHANGE COMMISSION REPORTS OVER THE INTERNET (U.S. CLS. 100, 101 AND 102).

FIRST USE 2-1-2004; IN COMMERCE 2-1-2004.

JOHN DALIER, EXAMINING ATTORNEY

SN 78-383,633. HARLEY'S HOUSE OF HARLEYS, OCEANSIDE, CA. FILED 3-12-2004.

Biggs

FOR RETAIL STORE SERVICES FEATURING MOTORCYCLES AND MOTORCYCLE ACCESSORIES (U.S. CLS. 100, 101 AND 102).

FIRST USE 8-22-2003; IN COMMERCE 8-22-2003.

AISHA CLARKE, EXAMINING ATTORNEY

CLASS 35—(Continued).

SN 78-386,064. AUTOMOTIVE RENTALS, INC., MT. LAUREL, NJ. FILED 3-17-2004.

FLEET TRAK

THE MARK CONSISTS OF STANDARD CHARACTERS WITHOUT CLAIM TO ANY PARTICULAR FONT, STYLE, SIZE, OR COLOR.

FOR FLEET VEHICLE MANAGEMENT SERVICES, NAMELY, PROVIDING MANAGEMENT SERVICES TO OWNERS OF CARS AND TRUCKS, RELATING TO THE DOCUMENTATION OF TITLE, LICENSING, INSURANCE, MAINTENANCE AND FUEL COSTS (U.S. CLS. 100, 101 AND 102).

FIRST USE 1-0-2002; IN COMMERCE 1-0-2002.
FLORENTINA BLANDU, EXAMINING ATTORNEY

CLASS 35—(Continued).

SN 78-390,135. MEREDITH CORPORATION, DES MOINES, IA. FILED 3-24-2004.

AMERICAN BABY SAMPLER

THE MARK CONSISTS OF STANDARD CHARACTERS WITHOUT CLAIM TO ANY PARTICULAR FONT, STYLE, SIZE, OR COLOR.

OWNER OF U.S. REG. NOS. 1,496,741 AND 1,893,287.
NO CLAIM IS MADE TO THE EXCLUSIVE RIGHT TO USE "SAMPLER", APART FROM THE MARK AS SHOWN. SEC. 2(F).

FOR PROMOTING THE GOODS AND SERVICES OF OTHERS THROUGH THE DISTRIBUTION OF PRODUCT SAMPLES OF INTEREST TO PARENTS OF INFANTS OR EXPECTANT PARENTS (U.S. CLS. 100, 101 AND 102).

TIMOTHY FINNEGAN, EXAMINING ATTORNEY

SN 78-387,220. TERRY MCCLAUGHERTY, MONTGOMERY, TX. FILED 3-19-2004.

AHUGEDEAL

THE MARK CONSISTS OF STANDARD CHARACTERS WITHOUT CLAIM TO ANY PARTICULAR FONT, STYLE, SIZE, OR COLOR.

FOR ADVERTISING SERVICES, NAMELY, PROMOTING THE SALE OF ARTICLES AND SERVICES FOR THIRD PARTIES BY THE TRANSMISSION OF ADVERTISING MATERIAL, NAMELY, COUPONS, VIA THE GLOBAL COMPUTER NETWORK (U.S. CLS. 100, 101 AND 102).

FIRST USE 9-1-2000; IN COMMERCE 9-1-2000.
KEVON CHISOLM, EXAMINING ATTORNEY

SN 78-390,760. SEYMOUR, MATTHEW R., DOWNTOWN, PA. FILED 3-25-2004.

MIND'S EYE MARKETING

THE MARK CONSISTS OF STANDARD CHARACTERS WITHOUT CLAIM TO ANY PARTICULAR FONT, STYLE, SIZE, OR COLOR.

NO CLAIM IS MADE TO THE EXCLUSIVE RIGHT TO USE "MARKETING", APART FROM THE MARK AS SHOWN.

FOR HEALTHCARE MARKETING SERVICES SPECIALIZING IN PATIENT MOTIVATION (U.S. CLS. 100, 101 AND 102).

GIANCARLO CASTRO, EXAMINING ATTORNEY

CLASS 35—(Continued).

SN 78-392,760. AX CET HR SOLUTIONS, INC., LENEXA, KS.
FILED 3-29-2004.

CLASS 35—(Continued).

SN 78-394,913. INTERGLOBAL INTERNATIONAL LIMITED,
MARLOW, BUCKINGHAMSHIRE, ENGLAND, FILED 4-
1-2004.

Outsource | One Source | Resource

THE MARK CONSISTS OF STANDARD CHARACTERS WITHOUT CLAIM TO ANY PARTICULAR FONT, STYLE, SIZE, OR COLOR.

NO CLAIM IS MADE TO THE EXCLUSIVE RIGHT TO USE "OUTSOURCE", APART FROM THE MARK AS SHOWN.

FOR PROFESSIONAL EMPLOYER ORGANIZATION SERVICES, NAMELY, PROVIDING CO-EMPLOYMENT SERVICES IN THE NATURE OF PROVIDING HUMAN RESOURCE MANAGEMENT FOR OTHERS (U.S. CLS. 100, 101 AND 102).

FIRST USE 2-19-2004; IN COMMERCE 2-19-2004.
SCOTT OSCLICK, EXAMINING ATTORNEY

INTERGLOBAL

SN 78-393,962. ETA SOLUTIONS LAB., INC., LARKSPUR,
CA. FILED 3-31-2004.

ETA SOLUTIONS LAB

THE MARK CONSISTS OF STANDARD CHARACTERS WITHOUT CLAIM TO ANY PARTICULAR FONT, STYLE, SIZE, OR COLOR.

NO CLAIM IS MADE TO THE EXCLUSIVE RIGHT TO USE "SOLUTIONS", APART FROM THE MARK AS SHOWN.

FOR BUSINESS CONSULTATION IN THE FIELD OF SUPPLY CHAIN MANAGEMENT AND ENTERPRISE ASSET LIFECYCLE MANAGEMENT (U.S. CLS. 100, 101 AND 102).

FIRST USE 2-1-2004; IN COMMERCE 2-1-2004.
CIMMERIAN COLEMAN, EXAMINING ATTORNEY

THE MARK CONSISTS OF STANDARD CHARACTERS WITHOUT CLAIM TO ANY PARTICULAR FONT, STYLE, SIZE, OR COLOR.

FOR ADVERTISING; BUSINESS MANAGEMENT; BUSINESS ADMINISTRATION; OFFICE FUNCTIONS NAMELY RECORDING, TRANSCRIPTION, TRANSFORMATION, COMPOSITION, COMPILATION AND SYSTEMIZATION OF INFORMATION USED IN ELECTRONIC TRANSMISSIONS; MARKETING CONSULTING; PRODUCT MARKETING FOR OTHERS; PROMOTIONAL MARKETING FOR OTHERS; BUSINESS MARKETING; BUSINESS ADVICE RELATING TO MARKETING; DEMONSTRATION OF GOODS; ADVERTISING, INCLUDING PROMOTION RELATING TO THE SALE OF ARTICLES AND SERVICES FOR THIRD PARTIES BY THE TRANSMISSION OF ADVERTISING MATERIAL AND THE DISSEMINATION OF ADVERTISING MESSAGES ON COMPUTER NETWORKS; CLERICAL SERVICES FOR THE TAKING OF SALES ORDERS; BUSINESS ACCOUNT MANAGEMENT, FINANCIAL STATEMENT PREPARATION AND ANALYSIS FOR BUSINESSES; PROCURING OF CONTRACTS FOR THE PURCHASE AND SALE OF GOODS; PRODUCTION OF TELEVISION COMMERCIALS AND INFOMERCIALS; PUBLICATION OF PUBLICITY TEXTS; COMPILATION AND SYSTEMIZATION OF INFORMATION INTO COMPUTER DATABASES; INFORMATION, ADVISORY AND CONSULTANCY SERVICES RELATING TO BUSINESS AND MANAGEMENT OR BUSINESS ADMINISTRATION (U.S. CLS. 100, 101 AND 102).

FIRST USE 2-28-2001; IN COMMERCE 2-28-2001.
WARREN L. OLANDRIA, EXAMINING ATTORNEY

CLASS 35—(Continued).

SN 78-396,148. ACTIVE MOBILITY, INC., SYLVANIA, OH. FILED 4-5-2004.



NO CLAIM IS MADE TO THE EXCLUSIVE RIGHT TO USE "MOBILITY INC.", APART FROM THE MARK AS SHOWN.

THE COLOR(S) BLUE AND GRAY IS/ARE CLAIMED AS A FEATURE OF THE MARK.

THE COLOR BLUE APPEARS IN THE STYLIZED LETTER A IN THE FORM OF A CHEVRON AND LINES DEPICTING SPEED ATTACHED TO THE CHEVRON. THE REMAINING WHEEL DESIGN AND LETTERING APPEAR IN THE COLOR GRAY.

THE MARK CONSISTS OF A STYLIZED LETTER "A" ABOVE A WHEEL.

FOR RETAIL STORES IN THE FIELD OF MOBILITY PRODUCTS FOR THE AGED AND INFIRM (U.S. CLS. 100, 101 AND 102).

FIRST USE 3-4-2004; IN COMMERCE 3-4-2004.
SAMUEL E. SHARPER JR., EXAMINING ATTORNEY

CLASS 35—(Continued).

SN 78-399,202. R. MICHAEL DONOVAN, INC., FRAMINGHAM, MA. FILED 4-9-2004.

Lean Manufacturing Certification

THE MARK CONSISTS OF STANDARD CHARACTERS WITHOUT CLAIM TO ANY PARTICULAR FONT, STYLE, SIZE, OR COLOR.

NO CLAIM IS MADE TO THE EXCLUSIVE RIGHT TO USE "LEAN MANUFACTURING", APART FROM THE MARK AS SHOWN.

SEC. 2(F).
FOR BUSINESS CONSULTATION SERVICES, NAMELY, PROVIDING CONSULTATION ON SUPPLY CHAIN ACCELERATOR AND PERFORMANCE IMPROVEMENT IN PRODUCT MANUFACTURING (U.S. CLS. 100, 101 AND 102).

FIRST USE 1-1-2000; IN COMMERCE 1-1-2000.
RAMONA ORTIGA, EXAMINING ATTORNEY

SN 78-398,256. WOMB-TO-GROW, LAWRENCEVILLE, GA. FILED 4-7-2004.



NO CLAIM IS MADE TO THE EXCLUSIVE RIGHT TO USE "INC.", APART FROM THE MARK AS SHOWN.

THE LINING SHOWN IN THE DRAWING IS A FEATURE OF THE MARK.

FOR ON-LINE RETAIL STORE SERVICES FEATURING PRENATAL AND BABY ITEMS VIA THE INTERNET (U.S. CLS. 100, 101 AND 102).

FIRST USE 3-1-2004; IN COMMERCE 10-18-2004.
CATHERINE FAINT, EXAMINING ATTORNEY

SN 78-400,298. THE FLORIDA PETROLEUM MARKETERS AND CONVENIENCE STORE ASSOCIATION, INC., TALLAHASSEE, FL. FILED 4-12-2004.



NO CLAIM IS MADE TO THE EXCLUSIVE RIGHT TO USE "FLORIDA" "INDEPENDENT GASOLINE RETAILER" AND "PETROLEUM MARKETERS AND CONVENIENCE STORE ASSOCIATION", APART FROM THE MARK AS SHOWN.

THE COLOR(S) RED, YELLOW, AND BLACK IS/ARE CLAIMED AS A FEATURE OF THE MARK IS/ARE CLAIMED AS A FEATURE OF THE MARK.

THE MARK CONSISTS OF A RED GASOLINE PUMP WITH A YELLOW SCREEN WITH THE BLACK STYLIZED LETTERS "FPMA" INSIDE THE BOX. ON THE RED GASOLINE PUMP ARE ALSO THE WORDS "YOUR" IN YELLOW AND "FLORIDA INDEPENDENT GASOLINE RETAILER" IN WHITE. IN THE UPPER RIGHT HAND TOP CORNER OF THE MARK ARE THE WORDS "NEIGHBORS" IN BLACK, "SERVING" IN RED LETTERS AND "NEIGHBORS" IN BLACK. BEHIND THE WORDS "NEIGHBORS SERVING NEIGHBORS" IN THE RIGHT HAND TOP CORNER IS A YELLOW SUNBURST. BELOW THE SUNBURST IN THE LOWER RIGHT HAND CORNER ARE THREE DRAWINGS OF HOUSES: THE FIRST ONE IS BLACK WITH A WHITE DOOR AND YELLOW WINDOW; THE SECOND ONE IS

CLASS 35—(Continued).

RED WITH TWO YELLOW WINDOW, TWO WHITE WINDOWS AND A WHITE DOOR; THE THIRD IS A GREY HOUSE WITH TWO YELLOW WINDOWS, THREE WHITE WINDOWS AND A WHITE DOOR. ALONG THE BOTTOM OF THE MARK IS YELLOW BOX WITH THE WORDS "FLORIDA PETROLEUM MARKETERS AND CONVENIENCE STORE ASSOCIATION". THE MARK IS OUTLINED IN A RED BOX COVERING ALL FOUR SIDES OF THE MARK AND A BLACK SHADOW LINE COVERING THE RIGHT HAND SIDE AND BOTTOM OF THE MARK.

FOR RETAIL CONVENIENCE STORES FEATURING CONVENIENCE STORE ITEMS AND GASOLINE (U.S. CLS. 100, 101 AND 102).

FIRST USE 1-31-2000; IN COMMERCE 1-31-2000.
JENNIFER KRISP, EXAMINING ATTORNEY

CLASS 35—(Continued).

SN 78-402,981. AUCTION GATEWAY LP, RICHARDSON, TX. FILED 4-16-2004.

auctiongateway.com

SN 78-400,642. INSIDE OUTFITTERS, DUBLIN, OH. FILED 4-13-2004.

INSIDE OUTFITTERS

THE MARK CONSISTS OF STANDARD CHARACTERS WITHOUT CLAIM TO ANY PARTICULAR FONT, STYLE, SIZE, OR COLOR.

NO CLAIM IS MADE TO THE EXCLUSIVE RIGHT TO USE "OUTFITTERS", APART FROM THE MARK AS SHOWN.

FOR DISTRIBUTORSHIPS IN THE FIELD OF WINDOW TREATMENTS, WINDOW SHADES, WINDOW BLINDS, DRAPERIES, TOP TREATMENTS, BEDSPREADS AND CUSTOM TREATMENTS, NAMELY STAGE DRAPERIES, ACOUSTICAL FABRICS, BANNERS, CHAIR BACK COVERS, WALL COVERINGS AND AWNINGS (U.S. CLS. 100, 101 AND 102).

FIRST USE 10-31-1979; IN COMMERCE 10-31-1979.
DOMINICK J. SALEMI, EXAMINING ATTORNEY

THE MARK CONSISTS OF STANDARD CHARACTERS WITHOUT CLAIM TO ANY PARTICULAR FONT, STYLE, SIZE, OR COLOR.

FOR LISTING OF CONSIGNED ITEMS FOR ON-LINE AUCTIONS, NAMELY, PROVIDING INFORMATION ABOUT THE GOODS OF OTHERS AVAILABLE VIA ON-LINE AUCTIONS (U.S. CLS. 100, 101 AND 102).

FIRST USE 2-12-2004; IN COMMERCE 2-27-2004.
RAUL CORDOVA, EXAMINING ATTORNEY

SN 78-401,210. SOFTWARE SPECTRUM, INC., GARLAND, TX. FILED 4-13-2004.

PLUS HARDWARE

THE MARK CONSISTS OF STANDARD CHARACTERS WITHOUT CLAIM TO ANY PARTICULAR FONT, STYLE, SIZE, OR COLOR.

NO CLAIM IS MADE TO THE EXCLUSIVE RIGHT TO USE HARDWARE, APART FROM THE MARK AS SHOWN.

FOR ONLINE RETAIL STORE SERVICES FEATURING COMPUTER EQUIPMENT AND RELATED MATERIAL (U.S. CLS. 100, 101 AND 102).

FIRST USE 4-26-2004; IN COMMERCE 4-26-2004.
CHERYL STEPLIGHT, EXAMINING ATTORNEY

SN 78-403,078. VALUEVISION MEDIA, INC., EDEN PRAIRIE, MN. FILED 4-16-2004.

18 KARAT ELEGANCE

THE MARK CONSISTS OF STANDARD CHARACTERS WITHOUT CLAIM TO ANY PARTICULAR FONT, STYLE, SIZE, OR COLOR.

NO CLAIM IS MADE TO THE EXCLUSIVE RIGHT TO USE "18 KARAT", APART FROM THE MARK AS SHOWN.

FOR PROVIDING HOME SHOPPING SERVICES FEATURING JEWELRY BY MEANS OF TELEVISION AND VIA A GLOBAL COMPUTER NETWORK (U.S. CLS. 100, 101 AND 102).

FIRST USE 5-22-1999; IN COMMERCE 5-22-1999.
AMOS T. MATTHEWS, JR., EXAMINING ATTORNEY

CLASS 35—(Continued).

SN 78-403,116. SMARTMAIL, LLC, WESTON, FL. FILED 4-16-2004.

SMARTLINK

THE MARK CONSISTS OF STANDARD CHARACTERS WITHOUT CLAIM TO ANY PARTICULAR FONT, STYLE, SIZE, OR COLOR.

OWNER OF U.S. REG. NOS. 2,137,266 AND 2,819,549.
FOR COMPUTERIZED TRACKING AND TRACING OF PACKAGES IN TRANSIT; INFORMATION MANAGEMENT SERVICES, NAMELY, SHIPMENT PROCESSING, PREPARING SHIPPING DOCUMENTS AND INVOICES, TRACKING DOCUMENTS, PACKAGES AND FREIGHT OVER COMPUTER NETWORKS, INTRANET AND INTERNETS; MONITORING AND TRACKING OF PACKAGE SHIPMENTS (U.S. CLS. 100, 101 AND 102).

FIRST USE 1-1-2002; IN COMMERCE 1-1-2002.
DAVID ELTON, EXAMINING ATTORNEY

SN 78-404,229. TOOTIT LLC, ATLANTA, GA. FILED 4-19-2004.

Tootit

THE MARK CONSISTS OF STANDARD CHARACTERS WITHOUT CLAIM TO ANY PARTICULAR FONT, STYLE, SIZE, OR COLOR.

FOR PROVIDING AN ON-LINE COMMERCIAL INFORMATION DIRECTORY ON THE INTERNET (U.S. CLS. 100, 101 AND 102).

FIRST USE 11-21-2003; IN COMMERCE 12-21-2003.
CHRISTOPHER BUONGIORNO, EXAMINING ATTORNEY

CLASS 35—(Continued).

SN 78-406,201. NEW ENGLAND FORESTRY CONSULTANTS, INC., WARNER, NH. FILED 4-22-2004.

**New England
Forestry Consultants**

THE MARK CONSISTS OF STANDARD CHARACTERS WITHOUT CLAIM TO ANY PARTICULAR FONT, STYLE, SIZE, OR COLOR.

NO CLAIM IS MADE TO THE EXCLUSIVE RIGHT TO USE "FORESTRY CONSULTANTS", APART FROM THE MARK AS SHOWN.

SEC. 2(F).
FOR FORESTRY MANAGEMENT CONSULTING SERVICES (U.S. CLS. 100, 101 AND 102).

FIRST USE 6-25-1994; IN COMMERCE 6-25-1994.
WARREN L. OLANDRIA, EXAMINING ATTORNEY

SN 78-406,891. BULLDOG NEW YORK, LLC, NEW YORK, NY. FILED 4-23-2004.

BULLDOG

THE MARK CONSISTS OF STANDARD CHARACTERS WITHOUT CLAIM TO ANY PARTICULAR FONT, STYLE, SIZE, OR COLOR.

FOR MARKETING CONSULTING AND CONSULTING SERVICES CONSISTING OF THE DEVELOPMENT OF BUSINESS PROCESS MODELS; GENERAL STRATEGIC MARKETING CONSULTING SERVICES; DEVELOPMENT OF OVERALL STRATEGIC AND TACTICAL MARKETING AND COMMUNICATION PLANS; DEVELOPMENT OF STRATEGIC AND TACTICAL MARKETING AND COMMUNICATION PLANS FOR SPECIFIC CLIENT PRODUCTS, BUSINESS LINES, AND INITIATIVES; AND WRITING ADVERTISING COPY FOR OTHERS FOR ALL TYPES OF MEDIA (U.S. CLS. 100, 101 AND 102).

DAVID C. REIHNER, EXAMINING ATTORNEY

CLASS 35—(Continued).

SN 78-406,927. YUGMA, INC, EDEN PRAIRIE, MN. FILED 4-23-2004.

**When Face-to-Face
is Next to
Impossible**

THE MARK CONSISTS OF STANDARD CHARACTERS WITHOUT CLAIM TO ANY PARTICULAR FONT, STYLE, SIZE, OR COLOR.

FOR ADVERTISING AND BUSINESS MANAGEMENT CONSULTANCY IN THE FIELD OF COMPUTER SOFTWARE (U.S. CLS. 100, 101 AND 102).

STEVEN JACKSON, EXAMINING ATTORNEY

CLASS 35—(Continued).

SN 78-408,036. GRAN RESERVE CORP., MIAMI LAKES, FL. FILED 4-26-2004.

**CIGARS AROUND THE
WORLD**

THE MARK CONSISTS OF STANDARD CHARACTERS WITHOUT CLAIM TO ANY PARTICULAR FONT, STYLE, SIZE, OR COLOR.

SEC. 2(F).

FOR ON-LINE RETAIL STORE SERVICES FEATURING CIGARS AND RELATED GIFTS AND ACCESSORIES (U.S. CLS. 100, 101 AND 102).

FIRST USE 1-30-1998; IN COMMERCE 1-30-1998.

TRACY CROSS, EXAMINING ATTORNEY

SN 78-408,824. R.A. INTERNATIONAL, INC., BURLINGTON, VT. FILED 4-27-2004.

SN 78-407,631. METRY, CATHERINE, STERLING HEIGHTS, MI. FILED 4-25-2004.



NO CLAIM IS MADE TO THE EXCLUSIVE RIGHT TO USE "AD AND PROMOTIONAL ADVERTISING & MARKETING, INC.", APART FROM THE MARK AS SHOWN.

FOR ADVERTISING AND MARKETING (U.S. CLS. 100, 101 AND 102).

FIRST USE 10-22-1990; IN COMMERCE 10-22-1990.

BARNEY CHARLON, EXAMINING ATTORNEY



NO CLAIM IS MADE TO THE EXCLUSIVE RIGHT TO USE "HOME", APART FROM THE MARK AS SHOWN.

THE COLOR(S) GREEN, SALMON AND BURNT SIENNA ARE CLAIMED AS A FEATURE OF THE MARK.

THE ELEMENTS COMPRISING THE FIRST VERTICAL BAR FROM THE LEFT, THE LETTERING COMPRISING THE WORDS HOME LIFE AND THE SHADED CIRCLE DESIGN AT THE TOP OF THE LETTER "L" ARE DISPLAYED IN GREEN. THE DESIGN ELEMENTS COMPRISING THE TWO HORIZONTAL BARS ARE DISPLAYED IN BURNT SIENNA ON TOP AND SALMON ON THE BOTTOM.

FOR RETAIL STORE SERVICES IN THE FIELD OF FURNITURE, FURNITURE ACCESSORIES AND HOME FURNISHINGS (U.S. CLS. 100, 101 AND 102).

TRACY CROSS, EXAMINING ATTORNEY

CLASS 35—(Continued).

SN 78-409,045. ECOST.COM, INC., TORRANCE, CA. FILED 4-27-2004.

ECOST.COM

THE MARK CONSISTS OF STANDARD CHARACTERS WITHOUT CLAIM TO ANY PARTICULAR FONT, STYLE, SIZE, OR COLOR.

OWNER OF U.S. REG. NOS. 2,588,881 AND 2,762,044.

FOR TELEPHONE, MAIL ORDER AND ONLINE RETAIL SERVICES FEATURING CLOTHING, BOOKS, GIFTS, PRERECORDED AND BLANK CDS, CD-ROMS, AUDIO CASSETTES AND FLOPPY DISCS, SPORTING GOODS, TRAVEL GOODS, PRINTED MATTERS, PHOTOGRAPHS, RECORDED MUSIC, TOYS, PHOTOGRAPHY INSTRUMENTS, MUSICAL INSTRUMENTS AND FITTINGS THEREFOR, PHOTOGRAPHS, STATIONERY, HOROLOGICAL INSTRUMENTS AND PARTS THEREFOR, MANUAL AND POWER TOOLS, SOAPS, PERFUMERY, COSMETICS, LEATHER, IMITATION LEATHER, BAGS, UMBRELLAS, WALKING STICKS, SADDLERY, FURNITURE, FABRIC, INDOOR ORNAMENTS OF TEXTILE, SMOKERS ARTICLES AND GARDEN ITEMS (U.S. CLS. 100, 101 AND 102).

MELISSA SHELLA, EXAMINING ATTORNEY

CLASS 35—(Continued).

SN 78-410,625. STUDENT & YOUTH TRAVEL ASSOCIATION OF NORTH AMERICA, CLARKSTON, MI. FILED 4-29-2004.

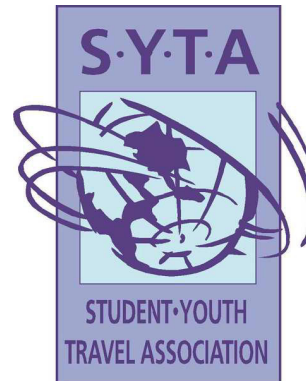

NO CLAIM IS MADE TO THE EXCLUSIVE RIGHT TO USE "STUDENT YOUTH TRAVEL ASSOCIATION", APART FROM THE MARK AS SHOWN.

THE COLORS LIGHT BLUE, BLUE, AND DARK BLUE ARE CLAIMED AS A FEATURE OF THE MARK.

THE COLOR LIGHT BLUE APPEARS WITHIN THE INNER RECTANGLE DESIGN OF THE MARK, THE COLOR BLUE APPEARS WITHIN THE OUTER RECTANGLE DESIGN, AND THE COLOR DARK BLUE APPEARS IN THE STYLIZED GLOBE DESIGN AND IN THE WORDING SYTA STUDENT YOUTH TRAVEL ASSOCIATION OF THE MARK.

FOR TRADE ASSOCIATION SERVICES, NAMELY, PROMOTING THE INTERESTS OF ENTITIES INVOLVED IN THE FIELD OF STUDENT AND YOUTH TRAVEL, INCLUDING TOUR OPERATORS, TRAVEL AGENCIES, AND SUPPLIER ORGANIZATIONS (U.S. CLS. 100, 101 AND 102).

FIRST USE 7-31-1997; IN COMMERCE 7-31-1997.

ANDREW RHIM, EXAMINING ATTORNEY

SN 78-410,806. GINLACK, SAA TAMBA, KAPAA, HI. FILED 4-29-2004.

TAMBA SURF CO

THE MARK CONSISTS OF STANDARD CHARACTERS WITHOUT CLAIM TO ANY PARTICULAR FONT, STYLE, SIZE, OR COLOR.

NO CLAIM IS MADE TO THE EXCLUSIVE RIGHT TO USE "SURF CO.", APART FROM THE MARK AS SHOWN.

THE FOREIGN WORDING IN THE MARK TRANSLATES INTO ENGLISH AS SECOND BORN SON.

SEC. 2(F).

FOR RETAIL STORE SERVICES FEATURING CLOTHING, SURF GEAR AND SURFING ACCESSORIES (U.S. CLS. 100, 101 AND 102).

FIRST USE 10-10-1998; IN COMMERCE 10-10-1998.

TRICIA SONNEBORN, EXAMINING ATTORNEY

CLASS 35—(Continued).

SN 78-411,622. CROWE, JESSE, COSTA MESA, CA. FILED 4-30-2004.

Resonation Communications

THE MARK CONSISTS OF STANDARD CHARACTERS WITHOUT CLAIM TO ANY PARTICULAR FONT, STYLE, SIZE, OR COLOR.

NO CLAIM IS MADE TO THE EXCLUSIVE RIGHT TO USE "COMMUNICATIONS", APART FROM THE MARK AS SHOWN.

FOR BUSINESS MARKETING CONSULTING SERVICES; DIRECT MARKETING SERVICES; DIRECT MARKETING ADVERTISING FOR OTHERS (U.S. CLS. 100, 101 AND 102).

WANDA KAY PRICE, EXAMINING ATTORNEY

CLASS 35—(Continued).

SN 78-412,978. SOCIETY FOR THE PRESERVATION OF NEW ENGLAND ANTIQUITIES, BOSTON, MA. FILED 5-4-2004.



FOR PROMOTING PUBLIC AWARENESS OF THE HISTORY OF NEW ENGLAND LIFE AND PROMOTING PUBLIC AWARENESS OF THE PRESERVATION AND RESTORATION OF HISTORICAL PROPERTIES, ART AND ANTIQUES OF NEW ENGLAND (U.S. CLS. 100, 101 AND 102).

FIRST USE 6-0-1996; IN COMMERCE 6-0-1996.

DAVID MURRAY, EXAMINING ATTORNEY

SN 78-412,655. AMSPIRIT HOLDING COMPANY, BLACK-LICK, OH. FILED 5-4-2004.

AmSpirit

THE MARK CONSISTS OF STANDARD CHARACTERS WITHOUT CLAIM TO ANY PARTICULAR FONT, STYLE, SIZE, OR COLOR.

FOR BUSINESS CONSULTING RELATED TO BUSINESS NETWORKING SERVICES (U.S. CLS. 100, 101 AND 102).

FIRST USE 3-1-2002; IN COMMERCE 3-1-2002.

MICHAEL KEATING, EXAMINING ATTORNEY

SN 78-413,391. DONNELLY, KAREN, LADY LAKE, FL. FILED 5-5-2004.



NO CLAIM IS MADE TO THE EXCLUSIVE RIGHT TO USE "VILLAGES GUIDE", APART FROM THE MARK AS SHOWN.

THE MARK CONSISTS OF THE WORDING THE VILLAGES GUIDE.COM AND A MAGNIFYING GLASS AND RECTANGLE.

FOR ON-LINE BUSINESS DIRECTORY SERVING THE VILLAGES, LAKE COUNTY, SUMTER COUNTY, AND MARION COUNTY IN FLORIDA FEATURING COUPONS, DIRECTIONS, E-MAIL AND WEBSITE LINKS, PHOTOGRAPHS, LOGOS, CONTACT INFORMATION, BUSINESS AND SERVICE DESCRIPTIONS (U.S. CLS. 100, 101 AND 102).

FIRST USE 1-26-2004; IN COMMERCE 2-1-2004.

KEVON CHISOLM, EXAMINING ATTORNEY

CLASS 35—(Continued).

SN 78-413,840. CHAVEZ, EDGAR M., PEORIA, AZ. FILED 5-6-2004.

CRUISERLAND

THE MARK CONSISTS OF STANDARD CHARACTERS WITHOUT CLAIM TO ANY PARTICULAR FONT, STYLE, SIZE, OR COLOR.

FOR PROMOTING THE GOODS AND SERVICES OF OTHERS THROUGH ON-LINE ORDERING AND CATALOGING OF THOSE GOODS AND SERVICES; PROVIDING INFORMATION ABOUT THE GOODS AND SERVICES OF OTHERS VIA THE GLOBAL COMPUTER NETWORK (U.S. CLS. 100, 101 AND 102).

FIRST USE 1-25-2000; IN COMMERCE 1-25-2000.
BILL DAWE, EXAMINING ATTORNEY

CLASS 35—(Continued).

SN 78-414,272. PERIDOT, LTD., ATLANTA, GA. FILED 5-6-2004.

PERIDOT

THE MARK CONSISTS OF STANDARD CHARACTERS WITHOUT CLAIM TO ANY PARTICULAR FONT, STYLE, SIZE, OR COLOR.

SEC. 2(F).

FOR RETAIL STORE SERVICES AND MAIL ORDER CATALOG SERVICES FEATURING, NAMELY, FURNITURE, GENERAL HOUSE WARES, GIFTWARE, DECORATIVE FURNISHINGS AND ACCESSORIES, PAPER PRODUCTS, BEDDING AND BED LINENS, CLOCKS, LAMPS, PICTURE FRAMES, ARTWORK, CRAFTS, BATHROOM FURNISHINGS AND LINENS, SEASONAL ITEMS, DINNERWARE, GLASSWARE, KITCHEN WARE AND UTENSILS (U.S. CLS. 100, 101 AND 102).

FIRST USE 7-0-1989; IN COMMERCE 7-0-1989.
MICHELE SWAIN, EXAMINING ATTORNEY

SN 78-414,225. PERIDOT, LTD., ATLANTA, GA. FILED 5-6-2004.

SN 78-414,631. BRIGHT GUY INC., BROADVIEW HEIGHTS, OH. FILED 5-6-2004.

**BRIGHTGUY**

SEC. 2(F) AS TO "PERIDOT".

FOR RETAIL STORE SERVICES AND MAIL ORDER CATALOG SERVICES FEATURING, NAMELY, FURNITURE, GENERAL HOUSE WARES, GIFTWARE, DECORATIVE FURNISHINGS AND ACCESSORIES, PAPER PRODUCTS, BEDDING AND BED LINENS, CLOCKS, LAMPS, PICTURE FRAMES, ARTWORK, CRAFTS, BATHROOM FURNISHINGS AND LINENS, SEASONAL ITEMS, DINNERWARE, GLASSWARE, KITCHEN WARE AND UTENSILS (U.S. CLS. 100, 101 AND 102).

FIRST USE 7-0-1989; IN COMMERCE 7-0-1989.
MICHELE SWAIN, EXAMINING ATTORNEY

THE MARK CONSISTS OF STANDARD CHARACTERS WITHOUT CLAIM TO ANY PARTICULAR FONT, STYLE, SIZE, OR COLOR.

FOR RETAIL STORE AND ONLINE RETAIL STORE SERVICES FEATURING FLASHLIGHTS, LANTERNS, DIVE LIGHTS, EMERGENCY LIGHTS, TASK LIGHTS, BULBS, BATTERIES, STORAGE CASES, COMPUTER CASES, CASES WITH WHEELS, ATTACHE CASES, MICRO STORAGE CASES, AND OTHER ELECTRICAL AND HARDWARE PRODUCTS (U.S. CLS. 100, 101 AND 102).

FIRST USE 4-30-1998; IN COMMERCE 4-30-1998.
CATHERINE CAIN, EXAMINING ATTORNEY

CLASS 35—(Continued).

SN 78-415,899. INSTANT MEDIA INC., ALISO VIEJO, CA.
FILED 5-10-2004.

I'M

THE MARK CONSISTS OF STANDARD CHARACTERS WITHOUT CLAIM TO ANY PARTICULAR FONT, STYLE, SIZE, OR COLOR.

FOR ELECTRONIC RETAILING SERVICES VIA THE INTERNET AND OTHER ELECTRONIC COMMUNICATIONS NETWORKS, FEATURING GENERAL CONSUMER MERCHANDISE, ELECTRONIC DEVICES, MUSIC, MOVIES, VIDEO GAMES AND RELATED MERCHANDISE; DEVELOPING ON-LINE PROMOTIONAL CAMPAIGNS FOR OTHERS IN THE FIELD OF ENTERTAINMENT (U.S. CLS. 100, 101 AND 102).

MICHAEL TANNER, EXAMINING ATTORNEY

SN 78-416,005. TRUE VALUE COMPANY, CHICAGO, IL.
FILED 5-10-2004.

COLOR PROMISE

THE MARK CONSISTS OF STANDARD CHARACTERS WITHOUT CLAIM TO ANY PARTICULAR FONT, STYLE, SIZE, OR COLOR.

NO CLAIM IS MADE TO THE EXCLUSIVE RIGHT TO USE "COLOR", APART FROM THE MARK AS SHOWN.

FOR RETAIL HARDWARE STORE SERVICES (U.S. CLS. 100, 101 AND 102).

FIRST USE 10-23-2003; IN COMMERCE 10-23-2003.

FRED MANDIR, EXAMINING ATTORNEY

CLASS 35—(Continued).

SN 78-417,172. DISNEY ENTERPRISES, INC., BURBANK, CA. FILED 5-12-2004.

MOVIENATION

THE MARK CONSISTS OF STANDARD CHARACTERS WITHOUT CLAIM TO ANY PARTICULAR FONT, STYLE, SIZE, OR COLOR.

FOR PUBLIC OPINION SURVEYS (U.S. CLS. 100, 101 AND 102).

FIRST USE 5-10-2004; IN COMMERCE 5-10-2004.

ARETHA SOMERVILLE, EXAMINING ATTORNEY

SN 78-418,424. BREAKDOWN SERVICES, LTD., LOS ANGELES, CA. FILED 5-13-2004.

ACTOR SLATE

THE MARK CONSISTS OF STANDARD CHARACTERS WITHOUT CLAIM TO ANY PARTICULAR FONT, STYLE, SIZE, OR COLOR.

NO CLAIM IS MADE TO THE EXCLUSIVE RIGHT TO USE "ACTOR", APART FROM THE MARK AS SHOWN.

FOR DEVELOPMENT, CREATION, AND DISTRIBUTION OF ELECTRONIC INFORMATION ABOUT ACTORS, NAMELY, DIGITIZED VIDEO RESUMES AND CASTING REELS, TO THE ENTERTAINMENT INDUSTRY, NAMELY, TO CASTING DIRECTORS, PRODUCERS, AND DIRECTORS (U.S. CLS. 100, 101 AND 102).

FIRST USE 5-7-2004; IN COMMERCE 5-7-2004.

ARETHA SOMERVILLE, EXAMINING ATTORNEY

CLASS 35—(Continued).

SN 78-419,082. MMI AFFILIATES CORPORATION, PANAMA CITY, FL. FILED 5-14-2004.



NO CLAIM IS MADE TO THE EXCLUSIVE RIGHT TO USE "TV", APART FROM THE MARK AS SHOWN.

THE COLOR(S) BLUE, GREEN, YELLOW AND RED IS/ARE CLAIMED AS A FEATURE OF THE MARK.

THE COLOR(S) BLUE, YELLOW AND GREEN APPEAR IN THE RECTANGULAR BOX DESIGN; THE COLOR GREEN IS DEPICTED IN THE WORD "SCATTER"; THE COLOR YELLOW IS DEPICTED IN THE LETTERS "TV" AND THE COLOR RED IS DEPICTED IN THE SMALL SQUARE BOX.

FOR INTERNET SERVICES, NAMELY OPERATING ON-LINE MARKETPLACES FOR SELLERS OF SERVICES, NAMELY, COMMERCIAL TELEVISION ADVERTISING ANNOUNCEMENTS (U.S. CLS. 100, 101 AND 102).

STANLEY I. OSBORNE, EXAMINING ATTORNEY

SN 78-419,126. LEADERSHIP FOR QUALITY EDUCATION, CHICAGO, IL. FILED 5-14-2004.



FOR OFFERING TECHNICAL ASSISTANCE IN THE ESTABLISHMENT OF CHARTER PUBLIC SCHOOLS; PROMOTING PUBLIC AWARENESS OF THE NEED FOR CHARTER AND CONTRACT SCHOOL SYSTEMS, AND FOR REFORMS AND IMPROVEMENTS IN TRADITIONAL PUBLIC SCHOOLS; ASSOCIATION SERVICES, NAMELY PROMOTING THE INTERESTS OF TRADITIONAL AND CHARTER PUBLIC SCHOOLS (U.S. CLS. 100, 101 AND 102).

FIRST USE 5-1-2001; IN COMMERCE 5-1-2001.

ESTHER BELENKER, EXAMINING ATTORNEY

CLASS 35—(Continued).

SN 78-419,189. RMC OF ILLINOIS, INC., PHILADELPHIA, PA. FILED 5-14-2004.



OWNER OF U.S. REG. NOS. 2,320,263, 2,840,895 AND OTHERS.

FOR HUMAN RESOURCE CONSULTING AND CAREER TRANSITION SERVICES, NAMELY, PROVIDING OUTPLACEMENT ASSISTANCE ON BEHALF OF EMPLOYERS FOR DEPARTING AND/OR DEPARTED EMPLOYEES; AND, ORGANIZATIONAL CONSULTING SERVICES FOR LEADERSHIP DEVELOPMENT/TALENT MANAGEMENT/ORGANIZATIONAL PERFORMANCE, NAMELY, ASSISTING EXECUTIVES AND COMPANIES WITH THE PROFESSIONAL GROWTH AND DEVELOPMENT OF THEIR PEOPLE (U.S. CLS. 100, 101 AND 102).

FIRST USE 12-0-1993; IN COMMERCE 12-0-1993.

TRICIA SONNEBORN, EXAMINING ATTORNEY

SN 78-419,278. DISNEY ENTERPRISES, INC., BURBANK, CA. FILED 5-14-2004.

WALT DISNEY COLLECTORS SOCIETY

THE MARK CONSISTS OF STANDARD CHARACTERS WITHOUT CLAIM TO ANY PARTICULAR FONT, STYLE, SIZE, OR COLOR.

OWNER OF U.S. REG. NOS. 1,141,312 AND 1,267,000.

NO CLAIM IS MADE TO THE EXCLUSIVE RIGHT TO USE "COLLECTORS SOCIETY", APART FROM THE MARK AS SHOWN.

THE NAME WALT DISNEY DOES NOT IDENTIFY A LIVING INDIVIDUAL.

FOR RETAIL STORE SERVICES IN THE FIELD OF FIGURINES AND ARTWORK (U.S. CLS. 100, 101 AND 102).

MATTHEW PAPPAS, EXAMINING ATTORNEY

SN 78-419,450. SHARPLEFT, INCORPORATED, NEW YORK, NY. FILED 5-15-2004.



NO CLAIM IS MADE TO THE EXCLUSIVE RIGHT TO USE "MARKETING", APART FROM THE MARK AS SHOWN.

THE COLORS YELLOW, ORANGE, BLACK AND GREY ARE CLAIMED AS A FEATURE OF THE MARK.

THE MARK CONSIST OF A YELLOW AND ORANGE 3-DIMENSIONAL LOOKING ROAD SIGN WITH A FLOAT-

CLASS 35—(Continued).

ING GREY DROP SHADOW BENEATH IT. INSIDE THE BORDERS OF THE SIGN ARE A HIGHLY STYLIZED BLACK ARROW POINTING LEFT. THE WORDS TO THE RIGHT OF THE SIGN ARE "SHARPLEFT" AND ARE ALL CAPITAL LETTERS, REVERSED ITALICS, WITH THE WORD "SHARP" IN BLACK, AND THE WORD "LEFT" IN GREY. BELOW THE WORD "SHARPLEFT" ARE THE WORDS "HIGH PERFORMANCE MARKETING" IN ALL LOWERCASE LETTERS, REVERSED ITALICS, AND USING THE "INTERTATE" FONT IN GREY COLOR.

FOR CREATIVE ADVERTISING SERVICES (U.S. CLS. 100, 101 AND 102).
FIRST USE 4-19-1999; IN COMMERCE 4-19-1999.
GEOFFREY FOSDICK, EXAMINING ATTORNEY

SN 78-420,199. SUMMERS, MELANIE, NEW YORK, NY.
FILED 5-17-2004.

SAME STRAIGHT ALLIANCE FOR MARRIAGE EQUALITY SAME

THE MARK CONSISTS OF STANDARD CHARACTERS WITHOUT CLAIM TO ANY PARTICULAR FONT, STYLE, SIZE, OR COLOR.

FOR PROMOTING PUBLIC AWARENESS OF THE NEED FOR MARRIAGE EQUALITY (U.S. CLS. 100, 101 AND 102).
FIRST USE 5-11-2004; IN COMMERCE 5-11-2004.
SCOTT OSCLICK, EXAMINING ATTORNEY

SN 78-421,287. SARA LEE FOODS, INC., CINCINNATI, OH.
FILED 5-19-2004.

GRATITUDE
PREFERRED
CUSTOMER PROGRAM

THE MARK CONSISTS OF STANDARD CHARACTERS WITHOUT CLAIM TO ANY PARTICULAR FONT, STYLE, SIZE, OR COLOR.

NO CLAIM IS MADE TO THE EXCLUSIVE RIGHT TO USE "PREFERRED CUSTOMER PROGRAM", APART FROM THE MARK AS SHOWN.

FOR ADMINISTRATION OF A CUSTOMER REWARD DISCOUNT PROGRAM FOR DISCOUNT SAVINGS AND REBATES ON CONSUMER MERCHANDISE. (U.S. CLS. 100, 101 AND 102).

FIRST USE 5-31-2003; IN COMMERCE 5-31-2003.
SKYE YOUNG, EXAMINING ATTORNEY

CLASS 35—(Continued).

SN 78-422,255. INTERNATIONAL SUBSIDIARY DEVELOPMENT INC., CAMBRIDGE, MA. FILED 5-20-2004.



FOR BUSINESS MARKETING, MANAGEMENT, AND CONSULTING SERVICES IN THE FIELD OF ESTABLISHING SUBSIDIARY, BRANCH OR REGIONAL OFFICES FOR INTERNATIONAL BUSINESSES (U.S. CLS. 100, 101 AND 102).

FIRST USE 1-7-2004; IN COMMERCE 1-7-2004.
KAREN BRACEY, EXAMINING ATTORNEY

SN 78-423,404. DAVID E. OSHESKIE, DBA LOOSE DIAMONDS, SEATTLE, WA. FILED 5-22-2004.

Loose Diamonds

THE MARK CONSISTS OF STANDARD CHARACTERS WITHOUT CLAIM TO ANY PARTICULAR FONT, STYLE, SIZE, OR COLOR.

FOR ADVERTISING AGENCIES (U.S. CLS. 100, 101 AND 102).

FIRST USE 6-15-2004; IN COMMERCE 6-15-2004.
LINDA MICKLEBURGH, EXAMINING ATTORNEY

CLASS 35—(Continued).

SN 78-424,323. WINDHOLZ, DANA, PAHRUMP, NV. FILED 5-25-2004.

LAS VEGAS, THE
CITY OF THE WORLD

THE MARK CONSISTS OF STANDARD CHARACTERS WITHOUT CLAIM TO ANY PARTICULAR FONT, STYLE, SIZE, OR COLOR.

NO CLAIM IS MADE TO THE EXCLUSIVE RIGHT TO USE "LAS VEGAS", APART FROM THE MARK AS SHOWN. FOR BUSINESS, NAMELY, RETAIL GIFT SHOPS FOR SOUVENIRS, MUGS, CARD DECKS, SHIRTS, HATS (U.S. CLS. 100, 101 AND 102).

DORITT L. CARROLL, EXAMINING ATTORNEY

SN 78-424,416. ANHEUSER-BUSCH, INCORPORATED, ST. LOUIS, MO. FILED 5-25-2004.



NO CLAIM IS MADE TO THE EXCLUSIVE RIGHT TO USE "DRAUGHT EXCELLENCE", APART FROM THE MARK AS SHOWN.

THE MARK CONSISTS OF AN OVAL DESIGN CONTAINING A GLASS OF BEER ABOVE A RIBBON DESIGN CONTAINING THE WORDS "DRAUGHT EXCELLENCE" SUPERIMPOSED UPON A WREATH OF HOPS AND WHEAT.

FOR CONDUCTING AN INCENTIVE AWARD PROGRAM FOR OTHERS TO PROMOTE THE SALE OF GOODS AND SERVICES OF RETAILERS THAT MAINTAIN AND ADHERE TO SPECIFIC QUALITY STANDARDS FOR SERVING DRAUGHT BEER (U.S. CLS. 100, 101 AND 102).

FIRST USE 7-15-2003; IN COMMERCE 7-15-2003.
CHRISTOPHER ADKINS, EXAMINING ATTORNEY

CLASS 35—(Continued).

SN 78-424,655. EMAJO INC., WHITE PLAINS, NY. FILED 5-25-2004.



THE MARK CONSISTS OF A STYLIZED GEOMETRIC DESIGN WITH NO CLAIM TO COLOR.

FOR PROMOTING PUBLIC AWARENESS OF THE NEED FOR AND BENEFITS OF HIRING SKILLED CONSTRUCTION WORKERS AND TRADES PEOPLE, INCLUDING PEOPLE FROM MINORITY BACKGROUNDS, THROUGH VARIOUS FORMS OF MEDIA (U.S. CLS. 100, 101 AND 102).

FIRST USE 3-30-2004; IN COMMERCE 3-30-2004.
ESTHER BELENKER, EXAMINING ATTORNEY

SN 78-426,045. WESTERN BINGO SUPPLIES, INC., ST. CATHARINES ONTARIO, CANADA, FILED 5-27-2004.

BK POINTS

THE MARK CONSISTS OF STANDARD CHARACTERS WITHOUT CLAIM TO ANY PARTICULAR FONT, STYLE, SIZE, OR COLOR.

NO CLAIM IS MADE TO THE EXCLUSIVE RIGHT TO USE "POINTS", APART FROM THE MARK AS SHOWN.

FOR PROMOTING THE SALE OF BINGO CONSUMABLE PRODUCTS AND PAPER PRODUCTS USED IN GAMES OF CHANCE THROUGH THE ADMINISTRATION OF INCENTIVE AWARD PROGRAMS (U.S. CLS. 100, 101 AND 102).

STEVEN R. FINE, EXAMINING ATTORNEY

CLASS 35—(Continued).

SN 78-428,951. ACCOMMODATION MOLLEN, INC., PHILADELPHIA, PA. FILED 6-2-2004.



NO CLAIM IS MADE TO THE EXCLUSIVE RIGHT TO USE "CLEANER'S", APART FROM THE MARK AS SHOWN. FOR RETAIL STORES FEATURING CLEANING, CUSTODIAL AND MAINTENANCE SUPPLIES AND EQUIPMENT (U.S. CLS. 100, 101 AND 102).
BRIAN NEVILLE, EXAMINING ATTORNEY

SN 78-431,075. DIRECT RESPONSE FORUM, BROOKFIELD, WI. FILED 6-7-2004.



NO CLAIM IS MADE TO THE EXCLUSIVE RIGHT TO USE "DIRECT RESPONSE FORUM, INC.", APART FROM THE MARK AS SHOWN.
THE MARK CONSISTS OF THE WORDING DIRECT RESPONSE FORUM, INC. TO THE LEFT AND TOP OF A DESIGN OF DIAGONAL RAYS EMANATING FROM THE TOP RIGHT OF A SQUARE TOWARDS A SINGLE LINE CORNER.
FOR ASSOCIATION SERVICES, NAMELY, A TRADE ASSOCIATION PROMOTING THE INTEREST OF DIRECT MARKETERS AND NON-FACE-TO-FACE MERCHANTS (U.S. CLS. 100, 101 AND 102).
FIRST USE 7-31-2002; IN COMMERCE 7-31-2002.
JASON TURNER, EXAMINING ATTORNEY

SN 78-432,101. MASTERPLANNING GROUP, INTERNATIONAL, LAKE MARY, FL. FILED 6-9-2004.



"BOBB BIEHL" IDENTIFIES A LIVING INDIVIDUAL WHOSE CONSENT IS OF RECORD.
FOR ORGANIZATIONAL DEVELOPMENT CONSULTING SERVICES (U.S. CLS. 100, 101 AND 102).
SCOTT OSCLICK, EXAMINING ATTORNEY

CLASS 35—(Continued).

SN 78-432,698. HAHN, RANDY A., ANCHORAGE, AK. AND HIRSCH, MARK F., ANCHORAGE, AK. FILED 6-9-2004.

GOOD2GO AUTO SALES

THE MARK CONSISTS OF STANDARD CHARACTERS WITHOUT CLAIM TO ANY PARTICULAR FONT, STYLE, SIZE, OR COLOR.
NO CLAIM IS MADE TO THE EXCLUSIVE RIGHT TO USE "AUTO SALES", APART FROM THE MARK AS SHOWN.
FOR AUTOMOBILE DEALERSHIP SERVICES, NAMELY, PROVIDING RENT-TO-OWN PROGRAMS AS MEANS TO PURCHASE USED AUTOMOBILES (U.S. CLS. 100, 101 AND 102).
FIRST USE 3-1-2003; IN COMMERCE 3-1-2003.
WINSTON FOLMAR, EXAMINING ATTORNEY

SN 78-433,882. MEMEC GROUP LIMITED, THAME, OXON, UNITED KINGDOM, FILED 6-11-2004.

MEMEC IMPACT

THE MARK CONSISTS OF STANDARD CHARACTERS WITHOUT CLAIM TO ANY PARTICULAR FONT, STYLE, SIZE, OR COLOR.
OWNER OF U.S. REG. NOS. 2,561,905, 2,597,954 AND OTHERS.
FOR DISTRIBUTORSHIPS IN THE FIELD OF ELECTRONIC PARTS AND COMPONENTS (U.S. CLS. 100, 101 AND 102).
TRICIA SONNEBORN, EXAMINING ATTORNEY

SN 78-433,952. MEMEC GROUP LIMITED, THAME, OXON, UNITED KINGDOM, FILED 6-11-2004.

MEMEC UNITED

THE MARK CONSISTS OF STANDARD CHARACTERS WITHOUT CLAIM TO ANY PARTICULAR FONT, STYLE, SIZE, OR COLOR.
OWNER OF U.S. REG. NOS. 2,561,905, 2,597,954 AND OTHERS.
FOR DISTRIBUTORSHIPS IN THE FIELD OF ELECTRONIC PARTS AND COMPONENTS (U.S. CLS. 100, 101 AND 102).
TRICIA SONNEBORN, EXAMINING ATTORNEY

CLASS 35—(Continued).

SN 78-439,006. GYM-MARK, INC., SAN FRANCISCO, CA. FILED 6-22-2004.

CLASS 35—(Continued).

SN 78-440,040. THE MARSHALL RETAIL GROUP, LLC, LAS VEGAS, NV. FILED 6-23-2004.

CHEZ JANE



THE MARK CONSISTS OF STANDARD CHARACTERS WITHOUT CLAIM TO ANY PARTICULAR FONT, STYLE, SIZE, OR COLOR.

FOR ONLINE RETAIL STORE SERVICES AND RETAIL STORE SERVICES IN THE FIELDS OF HOME DECOR AND BED AND BATH (U.S. CLS. 100, 101 AND 102).

DANIEL BRODY, EXAMINING ATTORNEY

THE COLOR(S) BLACK AND RED IS/ARE CLAIMED AS A FEATURE OF THE MARK.

THE MARK CONSISTS OF THE WORD MISURA OVER THE WORD PER ME IN BLACK; THE I IN THE WORD MISURA HAS A RED DOT WITH A BLACK LINE TO THE RIGHT.

THE FOREIGN WORDING IN THE MARK TRANSLATES INTO ENGLISH AS MEASURE FOR ME.

FOR RETAIL STORE SERVICES FEATURING MEN'S APPAREL, SHOES AND ACCESSORIES (U.S. CLS. 100, 101 AND 102).

FIRST USE 7-0-2003; IN COMMERCE 7-0-2003.

LAURA KOVAISKY, EXAMINING ATTORNEY

SN 78-439,011. GYM-MARK, INC., SAN FRANCISCO, CA. FILED 6-22-2004.

SN 78-440,068. DISNEY ENTERPRISES, INC., BURBANK, CA. FILED 6-23-2004.

CHEZ JANEVILLE

DISNEY'S PHOTOPASS

THE MARK CONSISTS OF STANDARD CHARACTERS WITHOUT CLAIM TO ANY PARTICULAR FONT, STYLE, SIZE, OR COLOR.

FOR ONLINE RETAIL STORE SERVICES AND RETAIL STORE SERVICES IN THE FIELDS OF HOME DECOR AND BED AND BATH (U.S. CLS. 100, 101 AND 102).

DANIEL BRODY, EXAMINING ATTORNEY

THE MARK CONSISTS OF STANDARD CHARACTERS WITHOUT CLAIM TO ANY PARTICULAR FONT, STYLE, SIZE, OR COLOR.

FOR RETAIL STORE SERVICES IN THE FIELD OF PHOTOGRAPHS; ON-LINE RETAIL STORE SERVICES IN THE FIELD OF PHOTOGRAPHS VIA THE INTERNET; STAND-ALONE RETAIL KIOSK SERVICES IN THE FIELD OF PHOTOGRAPHS (U.S. CLS. 100, 101 AND 102).

MATTHEW PAPPAS, EXAMINING ATTORNEY

CLASS 35—(Continued).

SN 78-440,433. SPELLMAN, NELSON, BROOKLYN, NY.
FILED 6-24-2004.

CLASS 35—(Continued).

SN 78-442,055. CHRISTOPHER D. LEE, NORTH YAR-
MOUTH, ME. FILED 6-28-2004.

CLAPPA

THE MARK CONSISTS OF STANDARD CHARACTERS WITHOUT CLAIM TO ANY PARTICULAR FONT, STYLE, SIZE, OR COLOR.

FOR PROMOTING THE GOODS AND SERVICES OF OTHERS BY PROVIDING HYPERTEXT LINKS TO THE WEBS SITES OF OTHERS (U.S. CLS. 100, 101 AND 102).
MARK SPARACINO, EXAMINING ATTORNEY

THE MARK CONSISTS OF STANDARD CHARACTERS WITHOUT CLAIM TO ANY PARTICULAR FONT, STYLE, SIZE, OR COLOR.

FOR BUSINESS MANAGEMENT CONSULTING SERVICES IN THE FIELD OF ORGANIZATIONAL DEVELOPMENT AND PERFORMANCE MANAGEMENT (U.S. CLS. 100, 101 AND 102).

FIRST USE 4-12-2004; IN COMMERCE 4-12-2004.
DAWN FELDMAN, EXAMINING ATTORNEY

SN 78-440,495. INKIE'S CARTRIDGE REFILL EXCHANGE, LLC, WICHITA, KS. FILED 6-24-2004.



NO CLAIM IS MADE TO THE EXCLUSIVE RIGHT TO USE "CARTRIDGE REFILL EXCHANGE", APART FROM THE MARK AS SHOWN.

THE COLOR(S) RED, BLUE, GREEN AND YELLOW IS/ARE CLAIMED AS A FEATURE OF THE MARK.

THE MARK CONSISTS OF AN INK CARTRIDGE WITH A RED BODY, YELLOW SOCKS AND INK DROPS COLORED RED, GREEN, BLUE AND YELLOW, STYLIZED BLUE AND GREEN LETTERS FORMING THE WORDS CARTRIDGE AND EXCHANGE, STYLIZED RED LETTERS FORMING THE WORD REFILL, AND STYLIZED YELLOW LETTERS FORMING THE WORD INKIE'S ALL ON A YELLOW BACKGROUND.

FOR RETAIL AND WHOLESALE STORE SERVICES AND INTERNET RETAIL AND WHOLESALE SERVICES FEATURING PRINTER INK FOR INKJET PRINTERS, AND TONER FOR LASER PRINTERS, INK, DUPLICATING INK, PRINTER INK RIBBONS, FAX ROLLS, OFFICE MACHINE RIBBONS, INK PRINTER CARTRIDGES, TONER PRINTER CARTRIDGES, SOLID INKS FOR PRINTERS, PHOTOCOPIER CARTRIDGES, AND PAPER (U.S. CLS. 100, 101 AND 102).

GEOFFREY FOSDICK, EXAMINING ATTORNEY

SN 78-442,474. EMERGENT MEDICAL STAFFING, INC., MILBANK, SD. FILED 6-28-2004.



NO CLAIM IS MADE TO THE EXCLUSIVE RIGHT TO USE THE CADUCEUS SYMBOL AND "SPECIALTY NURSES, INC.", APART FROM THE MARK AS SHOWN.

THE MARK CONSISTS, IN PART, OF A CADUCEUS. FOR EMPLOYMENT SERVICES, NAMELY, NURSE STAFFING FOR HOSPITALS, CLINICS AND NURSING HOMES (U.S. CLS. 100, 101 AND 102).

FIRST USE 5-1-1999; IN COMMERCE 5-1-1999.
LINDA E. BLOHM, EXAMINING ATTORNEY

CLASS 35—(Continued).

SN 78-442,826. HUNT, LEO T., ATLANTA, GA. FILED 6-29-2004.

CLASS 35—(Continued).

SN 78-444,470. THE SPRING AIR COMPANY, ELK GROVE VILLAGE, IL. FILED 7-1-2004.

Tax First

**SPRING AIR
MATTRESS DIRECT**

THE MARK CONSISTS OF STANDARD CHARACTERS WITHOUT CLAIM TO ANY PARTICULAR FONT, STYLE, SIZE, OR COLOR.

NO CLAIM IS MADE TO THE EXCLUSIVE RIGHT TO USE TAX, APART FROM THE MARK AS SHOWN.

FOR INCOME TAX PREPARATION FOR INDIVIDUALS AND BUSINESSES (U.S. CLS. 100, 101 AND 102).

FIRST USE 1-1-2001; IN COMMERCE 1-1-2001.

JASON TURNER, EXAMINING ATTORNEY

THE MARK CONSISTS OF STANDARD CHARACTERS WITHOUT CLAIM TO ANY PARTICULAR FONT, STYLE, SIZE, OR COLOR.

OWNER OF U.S. REG. NOS. 1,059,300, 2,725,614 AND OTHERS.

NO CLAIM IS MADE TO THE EXCLUSIVE RIGHT TO USE "MATTRESS DIRECT", APART FROM THE MARK AS SHOWN.

FOR RETAIL STORE SERVICES FEATURING MATTRESSES, BOX SPRINGS, BEDS AND RELATED PRODUCTS (U.S. CLS. 100, 101 AND 102).

JOHN DWYER, EXAMINING ATTORNEY

SN 78-443,822. PEMRO DISTRIBUTION LLC, CLEVELAND, OH. FILED 6-30-2004.

SN 78-445,314. CARGILL, INCORPORATED, WAYZATA, MN. FILED 7-2-2004.

PEMRO

Grainsense

THE MARK CONSISTS OF STANDARD CHARACTERS WITHOUT CLAIM TO ANY PARTICULAR FONT, STYLE, SIZE, OR COLOR.

FOR DISTRIBUTORSHIP SERVICES IN THE FIELD OF COMPUTER PARTS AND ELECTRONIC PARTS FOR USE IN MANUFACTURING COMPUTERS AND ELECTRONICS (U.S. CLS. 100, 101 AND 102).

FIRST USE 2-1-2004; IN COMMERCE 2-1-2004.

RAMONA ORTIGA, EXAMINING ATTORNEY

THE MARK CONSISTS OF STANDARD CHARACTERS WITHOUT CLAIM TO ANY PARTICULAR FONT, STYLE, SIZE, OR COLOR.

FOR DEVELOPING INDIVIDUALIZED CROP MARKETING PLANS FOR FARMERS (U.S. CLS. 100, 101 AND 102).

MIDGE BUTLER, EXAMINING ATTORNEY

CLASS 35—(Continued).

SN 78-445,759. CLYDE EAST AND NICHOLAS EAST PARTNERSHIP, THE, SAN JUAN CAPISTRANO, CA. FILED 7-3-2004.

CLASS 35—(Continued).

SN 78-447,391. VELARDE, JENNIFER, CHICAGO, IL. FILED 7-8-2004.

FreeBay

1154 LILL

THE MARK CONSISTS OF STANDARD CHARACTERS WITHOUT CLAIM TO ANY PARTICULAR FONT, STYLE, SIZE, OR COLOR.

FOR PROMOTING THE GOODS AND SERVICES OF OTHERS THROUGH THE DISTRIBUTION OF COUPONS REDEEMABLE FOR FREE PRODUCTS AND/OR SERVICES OF OTHERS BY MEANS OF ADVERTISEMENTS AND MESSAGES DISSEMINATED ON A GLOBAL COMPUTER NETWORK (U.S. CLS. 100, 101 AND 102).
YSA DEJESUS, EXAMINING ATTORNEY

THE MARK CONSISTS OF STANDARD CHARACTERS WITHOUT CLAIM TO ANY PARTICULAR FONT, STYLE, SIZE, OR COLOR.

OWNER OF U.S. REG. NOS. 2,656,058 AND 2,891,182.
FOR RETAIL STORE SERVICES FEATURING HAND BAGS (U.S. CLS. 100, 101 AND 102).
FIRST USE 8-1-1999; IN COMMERCE 8-1-1999.
CHRISTOPHER ADKINS, EXAMINING ATTORNEY

SN 78-446,967. CIGNA INTELLECTUAL PROPERTY, INC., CLAYMONT, DE. FILED 7-7-2004.

SN 78-447,773. AUTOMATION ALLEY, PONTIAC, MI. FILED 7-8-2004.

CIGNA CARE FAIRS

AUTOMATION ALLEY

THE MARK CONSISTS OF STANDARD CHARACTERS WITHOUT CLAIM TO ANY PARTICULAR FONT, STYLE, SIZE, OR COLOR.

NO CLAIM IS MADE TO THE EXCLUSIVE RIGHT TO USE "CARE FAIRS", APART FROM THE MARK AS SHOWN.

FOR ORGANIZING AND CONDUCTING FAIRS AND EXHIBITIONS FOR BUSINESS AND ADVERTISING PURPOSES THAT PROVIDE INFORMATION CONCERNING EMPLOYER AND EMPLOYEE HEALTH ISSUES (U.S. CLS. 100, 101 AND 102).
GLENN CLARK, EXAMINING ATTORNEY

THE MARK CONSISTS OF STANDARD CHARACTERS WITHOUT CLAIM TO ANY PARTICULAR FONT, STYLE, SIZE, OR COLOR.

SEC. 2(F).
FOR PROMOTIONAL SERVICES IN THE FIELD OF TECHNOLOGICAL, ECONOMIC AND BUSINESS GROWTH AND DEVELOPMENT (U.S. CLS. 100, 101 AND 102).

FIRST USE 10-1-1998; IN COMMERCE 1-1-1999.
MELVIN AXILBUND, EXAMINING ATTORNEY

CLASS 35—(Continued).

SN 78-449,788. EDWARDS MEDICAL SUPPLY, INC., BO-LINGBROOK, IL. FILED 7-13-2004.

MYEDWARDS

THE MARK CONSISTS OF STANDARD CHARACTERS WITHOUT CLAIM TO ANY PARTICULAR FONT, STYLE, SIZE, OR COLOR.

FOR ELECTRONIC CATALOG SERVICES FEATURING MEDICAL SUPPLIES AND EQUIPMENT; COMPUTERIZED ON-LINE ORDERING SERVICES IN THE FIELD OF MEDICAL SUPPLIES AND EQUIPMENT (U.S. CLS. 100, 101 AND 102).

FIRST USE 6-15-2005; IN COMMERCE 6-15-2005.
MARK SPARACINO, EXAMINING ATTORNEY

CLASS 35—(Continued).

SN 78-451,935. SUNNY REALTY, LLC, MIAMI, FL. FILED 7-16-2004.

RENT EXPRESS

THE MARK CONSISTS OF STANDARD CHARACTERS WITHOUT CLAIM TO ANY PARTICULAR FONT, STYLE, SIZE, OR COLOR.

NO CLAIM IS MADE TO THE EXCLUSIVE RIGHT TO USE "RENT", APART FROM THE MARK AS SHOWN.

FOR RETAIL STORE SERVICES FEATURING, HOME FURNITURE, HOME FURNISHINGS, APPLIANCES AND CONSUMER ELECTRONICS THAT MAY BE LEASED, RENTED, LEASED-TO-OWN, AND RENTED-TO-OWN (U.S. CLS. 100, 101 AND 102).

CHARLES JOYNER, EXAMINING ATTORNEY

SN 78-453,265. ADVANCE MERCHANDISING COMPANY, INC., ROANOKE, VA. FILED 7-20-2004.

SN 78-450,968. LAND ROVER, WARWICKSHIRE, UNITED KINGDOM, FILED 7-15-2004.

ADVENTURE QUOTIENT

THE MARK CONSISTS OF STANDARD CHARACTERS WITHOUT CLAIM TO ANY PARTICULAR FONT, STYLE, SIZE, OR COLOR.

FOR ADVERTISING AND PROMOTION SERVICES, BUSINESS CONSULTATION SERVICES; CONDUCTING ONLINE PUBLIC OPINION AND BUSINESS SURVEYS AND QUESTIONNAIRES; PROMOTING THE SALE OF GOODS AND SERVICES OF OTHERS BY DISSEMINATION OF PROMOTIONAL MATERIALS AND PRODUCT INFORMATION VIA TELEVISION AND RADIO BROADCASTS, PRINTED MATERIALS, AND INTERNET WEBSITES (U.S. CLS. 100, 101 AND 102).

ROBERT LORENZO, EXAMINING ATTORNEY

APPLICATION AND ANY RESULTING REGISTRATION IS LIMITED TO THE ENTIRE UNITED STATES EXCEPT FOR JEFFERSON COUNTY, KENTUCKY, PURSUANT TO THE DECREE OF THE UNITED STATES COURT OF APPEALS FOR THE SIXTH CIRCUIT, ADVANCE STORES CO. V. REFINISHING SPECIALTIES, 188 F.3D 608 (6TH CIR. 1999), CONCURRENT REGISTRATION WITH REFINISHING SPECIALTIES, INC., 4101 TAYLOR BOULEVARD, LOUISVILLE, KENTUCKY 40215, USING ITS MARK IN CONNECTION WITH RETAIL AUTO PARTS STORE SERVICES IN JEFFERSON COUNTY, KENTUCKY, SINCE 1974.

OWNER OF U.S. REG. NOS. 1,484,796, 1,815,267 AND 1,847,137.

NO CLAIM IS MADE TO THE EXCLUSIVE RIGHT TO USE "AUTO PARTS", APART FROM THE MARK AS SHOWN.

THE COLOR(S) YELLOW, RED, BLACK AND WHITE IS/ARE CLAIMED AS A FEATURE OF THE MARK.

THE MARK CONSISTS OF STYLIZED WORDS ADVANCE AUTO PARTS IN SINGLE LINE FORMAT COLORED YELLOW, FOLLOWED BY YELLOW FLAGPOLE AND BLACK AND WHITE CHECKERED FLAG, ALL ON RED BACKGROUND.

FOR RETAIL AUTO PARTS STORE SERVICES (U.S. CLS. 100, 101 AND 102).

FIRST USE 3-0-2002; IN COMMERCE 3-0-2002.
JENNIFER KRISP, EXAMINING ATTORNEY



CLASS 35—(Continued).

SN 78-454,080. HERITAGE PRESERVATION CORPORATION, SPARTANBURG, SC. FILED 7-21-2004.

DataSelect

THE MARK CONSISTS OF STANDARD CHARACTERS WITHOUT CLAIM TO ANY PARTICULAR FONT, STYLE, SIZE, OR COLOR.

FOR COMPUTER DATABASE MANAGEMENT SERVICES, NAMELY, PROVIDING A PREMEDIA DATABASE PUBLISHING SERVICE THAT ENABLES CUSTOMERS TO CENTRALLY MANAGE, COORDINATE, STORE, AND SEGMENT THEIR CORPORATE INFORMATION FOR OUTPUT TO UNIQUE AND VARIABLE VERSIONS IN ELECTRONIC AND PRINT FORMATS (U.S. CLS. 100, 101 AND 102).

MATTHEW KLINE, EXAMINING ATTORNEY

CLASS 35—(Continued).

SN 78-455,433. THE FLESH COMPANY, ST. LOUIS, MO. FILED 7-23-2004.

CONCENTRIC SOURCING

THE MARK CONSISTS OF STANDARD CHARACTERS WITHOUT CLAIM TO ANY PARTICULAR FONT, STYLE, SIZE, OR COLOR.

NO CLAIM IS MADE TO THE EXCLUSIVE RIGHT TO USE "SOURCING", APART FROM THE MARK AS SHOWN.

FOR PROCUREMENT, NAMELY PURCHASING OF OFFICE SUPPLIES, PRINTED BUSINESS FORMS, CORPORATE PROMOTIONAL PRODUCTS AND APPAREL, JANITORIAL SUPPLIES AND OFFICE FURNITURE FOR OTHERS; PROVIDING A CUSTOMIZED ONLINE COMMERCIAL DIRECTORY OF INFORMATION FOR OTHER BUSINESSES FOR THE PURCHASING OF OFFICE SUPPLIES, PRINTED BUSINESS FORMS, CORPORATE PROMOTIONAL PRODUCTS AND APPAREL, JANITORIAL SUPPLIES AND OFFICE FURNITURE (U.S. CLS. 100, 101 AND 102).

FIRST USE 10-1-2004; IN COMMERCE 10-1-2004.
ELLEN PERKINS, EXAMINING ATTORNEY

SN 78-455,342. INNOLABS CORP., SANCHUNG CITY, TAIWAN, FILED 7-23-2004.



OWNER OF U.S. REG. NO. 2,697,728.
FOR EXPORT AND IMPORT AGENCIES SERVICES (U.S. CLS. 100, 101 AND 102).
FIRST USE 8-17-2001; IN COMMERCE 9-11-2001.
ROBERT LORENZO, EXAMINING ATTORNEY

SN 78-456,815. ANDERSON, SAMUEL, MANTECA, CA. FILED 7-26-2004.

The World's Simplest Business

THE MARK CONSISTS OF STANDARD CHARACTERS WITHOUT CLAIM TO ANY PARTICULAR FONT, STYLE, SIZE, OR COLOR.

FOR BUSINESS NETWORKING, OPERATING ONLINE MARKETPLACES FOR SELLERS OF GOODS AND/OR SERVICES, PROMOTING THE GOODS AND SERVICES OF OTHERS BY MEANS OF A PREFERRED CUSTOMER PROGRAM FEATURING AN ONLINE WEB REFERRAL SYSTEM AND TRACKING AND VIDEO PRESENTATION (U.S. CLS. 100, 101 AND 102).

FIRST USE 8-5-2003; IN COMMERCE 8-5-2003.
ANGELA M. MICHELI, EXAMINING ATTORNEY

CLASS 35—(Continued).

SN 78-458,481. QUILTED HEART LLC, PULLMAN, WA. FILED 7-28-2004.

Quilted Heart

THE MARK CONSISTS OF STANDARD CHARACTERS WITHOUT CLAIM TO ANY PARTICULAR FONT, STYLE, SIZE, OR COLOR.

FOR RETAIL STORE AND COMPUTERIZED ON-LINE RETAIL STORE SERVICES FEATURING FABRICS, NOTIONS, BOOKS, QUILTS, PATTERNS, SOFTWARE, STATIONARY, BATTING, AND PRODUCTS RELATED TO THE QUILTING HOBBY AS WELL AS INSTRUCTION ON USING THE LISTED PRODUCTS (U.S. CLS. 100, 101 AND 102).

FIRST USE 7-0-1993; IN COMMERCE 7-0-1993.
NAAKWAMA ANKRAH, EXAMINING ATTORNEY

CLASS 35—(Continued).

SN 78-460,447. MITCHAM INDUSTRIES INC., HUNTSVILLE, TX. FILED 8-2-2004.

**THE EXPLORATION
EQUIPMENT SUPPLIER**

THE MARK CONSISTS OF STANDARD CHARACTERS WITHOUT CLAIM TO ANY PARTICULAR FONT, STYLE, SIZE, OR COLOR.

NO CLAIM IS MADE TO THE EXCLUSIVE RIGHT TO USE "EQUIPMENT SUPPLIER", APART FROM THE MARK AS SHOWN.

FOR WHOLESALE DISTRIBUTORSHIPS FEATURING ELECTRONIC EQUIPMENT (U.S. CLS. 100, 101 AND 102).

STANLEY I. OSBORNE, EXAMINING ATTORNEY

SN 78-460,804. JARQUE, ARMANDO E., MEXICO CITY D.F. 11850, MEXICO, FILED 8-2-2004.

SN 78-459,372. GET A GRIP CYCLES, LLC, CHICAGO, IL. FILED 7-30-2004.

GET A GRIP CYCLES

THE MARK CONSISTS OF STANDARD CHARACTERS WITHOUT CLAIM TO ANY PARTICULAR FONT, STYLE, SIZE, OR COLOR.

NO CLAIM IS MADE TO THE EXCLUSIVE RIGHT TO USE "CYCLES", APART FROM THE MARK AS SHOWN.

FOR RETAIL BICYCLE STORE (U.S. CLS. 100, 101 AND 102).

FIRST USE 12-19-2003; IN COMMERCE 12-19-2003.
ELLEN BURNS, EXAMINING ATTORNEY



THE COLOR(S) GREEN, BLACK, GOLD, RED AND WHITE IS/ARE CLAIMED AS A FEATURE OF THE MARK.

THE MARK CONSISTS OF A GREEN HORIZONTAL OVAL WITH "COMPRAHOGAR" WRITTEN IN BLACK, A DOLLAR SYMBOL IN GOLD INSIDE THE "C" AND A HOME IN WHITE WITH RED ROOF BEHIND THE "H".

FOR MAIL ORDER CATALOG SERVICES FEATURING FURNITURE, HOME ELECTRONIC GOODS AND HOUSEHOLD APPLIANCES (U.S. CLS. 100, 101 AND 102).

FIRST USE 10-20-2003; IN COMMERCE 1-20-2004.
ALICE BENMAMAN, EXAMINING ATTORNEY

CLASS 35—(Continued).

SN 78-461,880. AUCTION MILLS, INC., MCKINNEY, TX. FILED 8-4-2004.



NO CLAIM IS MADE TO THE EXCLUSIVE RIGHT TO USE AUCTION, APART FROM THE MARK AS SHOWN.

THE COLOR(S) ORANGE AND GREEN IS/ARE CLAIMED AS A FEATURE OF THE MARK.

THE COLOR(S) ORANGE AND GREEN IS/ARE APART OF THE MARK.

THE MARK CONSISTS OF STYLIZED LETTERING WITH THE WORD "AUCTION" APPEARING PRIMARILY IN GREEN WITH THE LETTER "O" IN ORANGE RESEMBLING A MILL WHEEL WITH ORANGE ASTERISKS DOTTING THE "I" AND APPEARING UNDER THE LETTER "U" IN THE WORD "AUCTION." THE WORD "MILLS" APPEARS IN WHITE WITHIN A SLIGHTLY ROUNDED ORANGE RECTANGLE WITH GREEN DOTS ON EACH SIDE OF THE WORD..

FOR ARRANGING AND CONDUCTING AUCTION SALES VIA THE INTERNET (U.S. CLS. 100, 101 AND 102).

ZHALEH DELANEY, EXAMINING ATTORNEY

SN 78-463,994. MANN, ANDRE, MEREDITH, NH. FILED 8-9-2004.

XIFOX

THE MARK CONSISTS OF STANDARD CHARACTERS WITHOUT CLAIM TO ANY PARTICULAR FONT, STYLE, SIZE, OR COLOR.

FOR INFORMATION SERVICES RELATING TO BUSINESS MATTERS, NAMELY, THE PLANNING, CAPTURE AND INTERPRETATION OF MARKET LEADERSHIP INDICATORS, NEWS FLOW, AND CUSTOM SURVEYS FOR COMPANY EXECUTIVES (U.S. CLS. 100, 101 AND 102).

HEATHER THOMPSON, EXAMINING ATTORNEY

CLASS 35—(Continued).

SN 78-469,895. BROWN, LILIA, VAN NUYS, CA. FILED 8-19-2004.



THE MARK CONSISTS OF A BROWN DOG WITH IT'S TONGUE STICKING OUT, COMING OUT OF A STYLIZED LETTER B. BELOW THE DOG AND STYLIZED LETTER B IS THE LITERAL ELEMENT.

FOR ON-LINE RETAIL STORE FEATURING DOG SUPPLIES (U.S. CLS. 100, 101 AND 102).

STEVEN JACKSON, EXAMINING ATTORNEY

SN 78-471,175. ENTERTAINMENT AND SHOPPING NETWORKS, LAKE OSWEGO, OR. FILED 8-20-2004.



THE COLOR(S) REFLEX BLUE IS/ARE CLAIMED AS A FEATURE OF THE MARK.

THE MARK CONSISTS OF WHITE STYLIZED LETTERS E,S AND N IN A CIRCLE FILLED IN REFLEX BLUE.

FOR COMPUTERIZED ON-LINE AND INTERACTIVE TELEVISION RETAIL SERVICES FEATURING THE GOODS AND SERVICES OF OTHERS IN THE FIELD OF GENERAL CONSUMER GOODS, HEALTH AND BEAUTY PRODUCTS. (U.S. CLS. 100, 101 AND 102).

TONI HICKEY, EXAMINING ATTORNEY

CLASS 35—(Continued).

SN 78-471,385. BIG ON STYLE, INC., CAPITOLA, CA. FILED 8-20-2004.



NO CLAIM IS MADE TO THE EXCLUSIVE RIGHT TO USE "GENEROUSLY SIZED FASHIONS", APART FROM THE MARK AS SHOWN.

FOR RETAIL STORE SERVICES AND ONLINE RETAIL STORE SERVICES FEATURING CLOTHING AND RELATED ACCESSORIES (U.S. CLS. 100, 101 AND 102).
FIRST USE 3-1-2003; IN COMMERCE 11-30-2003.
KIMBERLY FRYE, EXAMINING ATTORNEY

CLASS 35—(Continued).

SN 78-472,861. WESLEY E. ANKNEY, DBA THE YARD SALE SHOPPE, FAYETTEVILLE, PA. FILED 8-24-2004.

The Yard Sale
Shoppe

THE MARK CONSISTS OF STANDARD CHARACTERS WITHOUT CLAIM TO ANY PARTICULAR FONT, STYLE, SIZE, OR COLOR.

NO CLAIM IS MADE TO THE EXCLUSIVE RIGHT TO USE "SHOP", APART FROM THE MARK AS SHOWN.
FOR RETAIL VARIETY STORES (U.S. CLS. 100, 101 AND 102).
ANN LINNEHAN, EXAMINING ATTORNEY

SN 78-471,941. NEW MEXICO OPTICS INDUSTRY ASSOCIATION, ALBUQUERQUE, NM. FILED 8-23-2004.



CHEERS BEVERAGE
CONFERENCE

THE MARK CONSISTS OF A STYLIZED REPRESENTATION OF A HUMAN HOLDING A REPRESENTATION OF A PORTION OF THE SUN BETWEEN HIS/HER OUT-STRETCHED ARMS.

FOR ASSOCIATION SERVICES, NAMELY, PROMOTING THE ECONOMIC DEVELOPMENT OF THE OPTICS AND PHOTONICS INDUSTRY (U.S. CLS. 100, 101 AND 102).

FIRST USE 1-31-2002; IN COMMERCE 1-31-2002.
WILLIAM VERHOSEK, EXAMINING ATTORNEY

THE MARK CONSISTS OF STANDARD CHARACTERS WITHOUT CLAIM TO ANY PARTICULAR FONT, STYLE, SIZE, OR COLOR.

OWNER OF U.S. REG. NO. 2,214,696.
NO CLAIM IS MADE TO THE EXCLUSIVE RIGHT TO USE "BEVERAGE CONFERENCE", APART FROM THE MARK AS SHOWN.

FOR ARRANGING AND CONDUCTING TRADE SHOWS AND BUSINESS CONFERENCES IN THE BEVERAGE INDUSTRY (U.S. CLS. 100, 101 AND 102).

FIRST USE 4-15-2002; IN COMMERCE 4-15-2002.
MARGERY A. TIERNEY, EXAMINING ATTORNEY

CLASS 35—(Continued).

SN 78-473,941. KANSAS CITY AREA DEVELOPMENT COUNCIL, KANSAS CITY, MO. FILED 8-26-2004.



NO CLAIM IS MADE TO THE EXCLUSIVE RIGHT TO USE KC, APART FROM THE MARK AS SHOWN.

THE MARK CONSISTS OF "A BALL WITH KC ENCLOSED IN THE BALL AND THE BALL FORMS THE O FOR ONE".

FOR PROMOTING THE ECONOMIC DEVELOPMENT OF AND ATTRACTING TOURISTS TO THE GREATER KANSAS CITY AREA OF MISSOURI AND KANSAS (U.S. CLS. 100, 101 AND 102).

FIRST USE 1-0-2004; IN COMMERCE 1-0-2004.
HOWARD SMIGA, EXAMINING ATTORNEY

SN 78-474,634. KNOTRUB, INC., OMAHA, NE. FILED 8-27-2004.

TOBACCO HOUSE

THE MARK CONSISTS OF STANDARD CHARACTERS WITHOUT CLAIM TO ANY PARTICULAR FONT, STYLE, SIZE, OR COLOR.

NO CLAIM IS MADE TO THE EXCLUSIVE RIGHT TO USE "TOBACCO", APART FROM THE MARK AS SHOWN.

FOR RETAIL STORE SERVICES FEATURING CONVENIENCE STORE ITEMS AND GASOLINE (U.S. CLS. 100, 101 AND 102).

KIMBERLY FRYE, EXAMINING ATTORNEY

SN 78-475,005. DENIS, ISRAEL, MIAMI, FL. FILED 8-27-2004.

ARISMA GROUP

THE MARK CONSISTS OF STANDARD CHARACTERS WITHOUT CLAIM TO ANY PARTICULAR FONT, STYLE, SIZE, OR COLOR.

NO CLAIM IS MADE TO THE EXCLUSIVE RIGHT TO USE GROUP, APART FROM THE MARK AS SHOWN.

FOR CONSULTING SERVICES RELATING TO BUSINESS MANAGEMENT AND/OR THE USE OF INFORMATION PROCESSING SYSTEMS. (U.S. CLS. 100, 101 AND 102).

KAREN K. BUSH, EXAMINING ATTORNEY

CLASS 35—(Continued).

SN 78-476,149. CITY PUBLICATIONS FRANCHISE GROUP, INC., ATLANTA, GA. FILED 8-31-2004.



NO CLAIM IS MADE TO THE EXCLUSIVE RIGHT TO USE "PUBLICATIONS", APART FROM THE MARK AS SHOWN.

THE DESIGN PORTION OF THE MARK CONSISTS OF A DEPICTION OF A CITY SKYLINE.

FOR MARKETING, DIRECT MAIL CONSULTING AND DIRECT MAIL ADVERTISING (U.S. CLS. 100, 101 AND 102).

FIRST USE 4-15-2004; IN COMMERCE 4-15-2004.
EVELYN BRADLEY, EXAMINING ATTORNEY

SN 78-477,447. SILVER CRESCENT, COLUMBIA, SC. FILED 9-1-2004.

SILVER CRESCENT

THE MARK CONSISTS OF STANDARD CHARACTERS WITHOUT CLAIM TO ANY PARTICULAR FONT, STYLE, SIZE, OR COLOR.

FOR LOBBYING SERVICES, NAMELY PROMOTING THE INTERESTS OF TRADE ASSOCIATIONS AND BUSINESSES IN THE FIELD OF STATE AND FEDERAL GOVERNMENT LEGISLATION, ADMINISTRATION AND REGULATION; PUBLIC RELATIONS (U.S. CLS. 100, 101 AND 102).

FIRST USE 10-28-2003; IN COMMERCE 10-28-2003.
ADA HAN, EXAMINING ATTORNEY

CLASS 35—(Continued).

SN 78-477,455. THE GRAVY FACTORY, ROSEVILLE, CA.
FILED 9-1-2004.



FOR RETAIL STORE SERVICES AND ONLINE RETAIL STORE SERVICES FEATURING CLOTHING, INCLUDING HATS, T-SHIRTS, SWEATSHIRTS, ATHLETIC WEAR, WALLETS, PURSES, HANDBAGS, SHOES, CUT AND SEW APPAREL INCLUDING JEANS, JEAN SHIRTS, BUTTON DOWN SHIRTS, COMPUTER ACCESSORIES INCLUDING BACKPACKS, MOUSE PADS, COMPUTER BAGS AND LUGGAGE (U.S. CLS. 100, 101 AND 102).

FIRST USE 5-10-2004; IN COMMERCE 5-10-2004.
STEVEN PEREZ, EXAMINING ATTORNEY

CLASS 35—(Continued).

SN 78-481,423. UDP, INC., SAN ANTONIO, TX. FILED 9-10-2004.

COMET EXPLORER

THE MARK CONSISTS OF STANDARD CHARACTERS WITHOUT CLAIM TO ANY PARTICULAR FONT, STYLE, SIZE, OR COLOR.

OWNER OF U.S. REG. NO. 2,893,254.

FOR COMPUTERIZED BILLING, REPORTING AND DATA ARCHIVING AND RETRIEVAL SERVICES, NAMELY, COMPUTERIZED BILLING RECORD PROCESSING, BILLING RECORD REPORTING, BILLING SERVICES, AND PREPARING BUSINESS REPORTS, ALL FOR SERVICE PROVIDERS IN THE TELECOMMUNICATIONS INDUSTRY. (U.S. CLS. 100, 101 AND 102).
KELLY BOULTON, EXAMINING ATTORNEY

SN 78-481,164. EARWOOD LOGISTIC SERVICES, INC., WEST DES MOINES, IA. FILED 9-9-2004.



NO CLAIM IS MADE TO THE EXCLUSIVE RIGHT TO USE "E-SHIPPING DELIVERY SOLUTIONS FOR BUSINESS", APART FROM THE MARK AS SHOWN.

FOR BUSINESS CONSULTING SERVICES IN THE AREA OF CONSOLIDATING AND RESELLING SERVICES FOR TRANSPORTATION OF PACKAGES, FREIGHTS AND PARCELS (U.S. CLS. 100, 101 AND 102).

FIRST USE 8-1-2004; IN COMMERCE 8-1-2004.
ELLEN BURNS, EXAMINING ATTORNEY

SN 78-481,515. HOT STUFF FOODS, LLC, SIOUX FALLS, SD.
FILED 9-10-2004.

HOT STUFF FOOD SOLUTIONS

SN 78-481,298. OF THE NET, INC, RUTHERFORD, NJ.
FILED 9-9-2004.



NO CLAIM IS MADE TO THE EXCLUSIVE RIGHT TO USE "INC", APART FROM THE MARK AS SHOWN.

FOR COMPUTERIZED ON-LINE RETAIL STORE SERVICES IN THE FIELD OF JEWELRY AND JEWELRY ACCESSORIES FOR MEN AND WOMEN, NAMELY RINGS, EARRINGS, BRACELETS AND NECKLACES (U.S. CLS. 100, 101 AND 102).

KIMBERLY PERRY, EXAMINING ATTORNEY

THE MARK CONSISTS OF STANDARD CHARACTERS WITHOUT CLAIM TO ANY PARTICULAR FONT, STYLE, SIZE, OR COLOR.

NO CLAIM IS MADE TO THE EXCLUSIVE RIGHT TO USE "FOOD SOLUTIONS", APART FROM THE MARK AS SHOWN.

FOR FRANCHISING SERVICES, NAMELY OFFERING TECHNICAL ASSISTANCE IN THE ESTABLISHMENT AND OPERATION OF RESTAURANT, FOOD MARKETS AND CARRY-OUT FOOD SHOPS. (U.S. CLS. 100, 101 AND 102).

LA TONIA FISHER, EXAMINING ATTORNEY

CLASS 35—(Continued).

SN 78-482,522. CAMPUS LOFT COMPANY, LLC, WHITTIER, CA. FILED 9-13-2004.

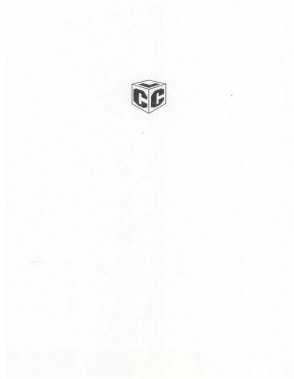

FOR PROCUREMENT, NAMELY, PURCHASE OF FURNITURE FOR EDUCATIONAL AND RECREATIONAL INSTITUTIONS (U.S. CLS. 100, 101 AND 102).
FIRST USE 10-3-2003; IN COMMERCE 10-3-2002.
MICHAEL ENGEL, EXAMINING ATTORNEY

SN 78-485,570. CONCEPT ATTRACTIONS OF WISCONSIN, INC., JACKSON, WY. FILED 9-17-2004.

GNOME DEPOT

THE MARK CONSISTS OF STANDARD CHARACTERS WITHOUT CLAIM TO ANY PARTICULAR FONT, STYLE, SIZE, OR COLOR.
NO CLAIM IS MADE TO THE EXCLUSIVE RIGHT TO USE GNOME, APART FROM THE MARK AS SHOWN.
FOR RETAIL GIFT SHOP SERVICES (U.S. CLS. 100, 101 AND 102).
FIRST USE 7-0-2004; IN COMMERCE 7-0-2004.
PATRICIA EVANKO, EXAMINING ATTORNEY

CLASS 35—(Continued).

SN 78-486,069. SPLURGE, INC., INDIANAPOLIS, IN. FILED 9-20-2004.

splurge

THE MARK CONSISTS OF THE WORD "SPLURGE" IN CONTINUUM LIGHT FONT.
FOR RETAIL STORE SERVICES, NAMELY, RETAIL AND ON-LINE STORE SERVICES FEATURING MEN'S AND WOMEN'S CLOTHING AND ACCESSORIES (U.S. CLS. 100, 101 AND 102).
FIRST USE 4-28-2003; IN COMMERCE 4-28-2003.
JOSETTE BEVERLY, EXAMINING ATTORNEY

SN 78-486,324. INTERNATIONAL COPPER ASSOCIATION LTD, NEW YORK, NY. FILED 9-20-2004.

Cuprion

FOR ASSOCIATION SERVICES, NAMELY, PROMOTING THE USE OF COPPER ALLOYS AS A CONTRIBUTOR TO A HIGHER STANDARD OF LIVING AND RAISING AWARENESS OF THE ANTIMICROBIAL PROPERTIES OF COPPER ALLOYS FOR USE IN PRODUCT DESIGN AND BUILDING CONSTRUCTION (U.S. CLS. 100, 101 AND 102).
KATHLEEN M. VANSTON, EXAMINING ATTORNEY

SN 78-487,743. GLOBE TAX SERVICES INCORPORATED, NEW YORK, NY. FILED 9-22-2004.

GLOBETAX

THE MARK CONSISTS OF STANDARD CHARACTERS WITHOUT CLAIM TO ANY PARTICULAR FONT, STYLE, SIZE, OR COLOR.
FOR TAX INFORMATION, PREPARATION, FILING, AND CONSULTANCY SERVICES SPECIALIZING IN INTERNATIONAL TAX RECLAMATION (U.S. CLS. 100, 101 AND 102).
FIRST USE 7-1-2004; IN COMMERCE 8-1-2004.
BARBARA BROWN, EXAMINING ATTORNEY

CLASS 35—(Continued).

SN 78-489,943. NATIONAL ALLIANCE FOR YOUTH SPORTS, WEST PALM BEACH, FL. FILED 9-27-2004.



OWNER OF U.S. REG. NO. 2,103,212.
NO CLAIM IS MADE TO THE EXCLUSIVE RIGHT TO USE "PARENTS ASSOCIATION FOR YOUTH SPORTS", APART FROM THE MARK AS SHOWN.

FOR ASSOCIATION SERVICES PROMOTING THE INTEREST OF YOUTH SPORTS (U.S. CLS. 100, 101 AND 102).

FIRST USE 10-7-1997; IN COMMERCE 10-10-1997.
TEJBIR SINGH, EXAMINING ATTORNEY

CLASS 35—(Continued).

SN 78-491,466. FIRST MEDIA, INC., LOS ANGELES, CA. FILED 9-29-2004.

NOT SO NIMBLE

THE MARK CONSISTS OF STANDARD CHARACTERS WITHOUT CLAIM TO ANY PARTICULAR FONT, STYLE, SIZE, OR COLOR.

FOR RETAIL STORE AND WHOLESALE STORE SERVICES FEATURING GOODS FOR SLIGHTLY HANDICAPPED PEOPLE, NAMELY, TOOLS, UTENSILS, CLOTHING, VIDEOS AND DVDS, CRAFTS, EXERCISE EQUIPMENT, AND BOOKS; ON-LINE RETAIL STORE SERVICES FEATURING GOODS FOR SLIGHTLY HANDICAPPED PEOPLE, NAMELY, TOOLS, UTENSILS, CLOTHING, VIDEOS AND DVDS, CRAFTS, EXERCISE EQUIPMENT, AND BOOKS AND WHICH PROVIDES LINKS TO THE RETAIL WEBSITES OF OTHERS OFFERING GOODS AND SERVICES TO THE HANDICAPPED (U.S. CLS. 100, 101 AND 102).

MARY CRAWFORD, EXAMINING ATTORNEY

SN 78-491,335. STERN, KENNETH F., SIMSBURY, CT. FILED 9-29-2004.

SYNXRONOS

THE MARK CONSISTS OF STANDARD CHARACTERS WITHOUT CLAIM TO ANY PARTICULAR FONT, STYLE, SIZE, OR COLOR.

FOR BUSINESS MANAGEMENT CONSULTING SERVICES IN THE FIELDS OF MERGERS AND ACQUISITIONS, STRATEGIC PLANNING, CORPORATE DEVELOPMENT, MARKET FORECASTING, AND COMPETITIVE ANALYSIS (U.S. CLS. 100, 101 AND 102).

FIRST USE 9-28-2004; IN COMMERCE 9-28-2004.
BARBARA A. GOLD, EXAMINING ATTORNEY

SN 78-492,911. TRAVIS INDUSTRIES, INC., MUKILTEO, WA. FILED 10-1-2004.

HOUSE OF FIRE

THE MARK CONSISTS OF STANDARD CHARACTERS WITHOUT CLAIM TO ANY PARTICULAR FONT, STYLE, SIZE, OR COLOR.

FOR WHOLESALE STORE, RETAIL STORE AND WHOLESALE DISTRIBUTORSHIP SERVICES IN THE FIELD OF HEARTH-RELATED PRODUCTS, NAMELY WOOD, GAS, AND PELLET BURNING STOVES, FIREPLACES, FIREPLACE INSERTS IN THE NATURE OF HEAT EXCHANGERS, SOLID AND GAS FUEL BURNERS AND REPLACEMENT PARTS THEREFORE (U.S. CLS. 100, 101 AND 102).

JOHN WILKE, EXAMINING ATTORNEY

CLASS 35—(Continued).

SN 78-493,040. KENSAKU, INC., ORLANDO, FL. FILED 10-1-2004.

KAMI SPEED

THE MARK CONSISTS OF STANDARD CHARACTERS WITHOUT CLAIM TO ANY PARTICULAR FONT, STYLE, SIZE, OR COLOR.

FOR ON-LINE RETAIL STORE SERVICES FEATURING PARTS AND ACCESSORIES FOR MOTOR VEHICLES (U.S. CLS. 100, 101 AND 102).

FIRST USE 10-1-2004; IN COMMERCE 10-1-2004.

DAWN HAN, EXAMINING ATTORNEY

CLASS 35—(Continued).

SN 78-493,070. DEUTSCHE TELEKOM AG, BONN, FED REP GERMANY, FILED 10-1-2004.

**T-Mobile Sound
Alert**

THE MARK CONSISTS OF STANDARD CHARACTERS WITHOUT CLAIM TO ANY PARTICULAR FONT, STYLE, SIZE, OR COLOR.

PRIORITY CLAIMED UNDER SEC. 44(D) ON FED REP GERMANY APPLICATION NO. 30418516738, FILED 4-2-2004, REG. NO. 30418516, DATED 4-22-2004, EXPIRES 4-30-2014.

OWNER OF U.S. REG. NOS. 2,282,432, 2,959,646 AND OTHERS.

FOR TELEPHONE DIRECTORY ASSISTANCE SERVICES; ADVERTISING SERVICES, NAMELY, PREPARING AND PLACING ADVERTISEMENTS FOR OTHERS PROMOTING THE GOODS AND SERVICES OF OTHERS THROUGH PRINTED ADVERTISING, PRINTED DIRECTORIES, THROUGH ENCODED MEDIA, THROUGH THE DISSEMINATION OF PROMOTIONAL MATERIALS, THROUGH DIRECT MAIL ADVERTISING, THROUGH ELECTRONIC BILLBOARD ADVERTISING, PREPARING AUDIO-VISUAL PRESENTATIONS FOR USE IN ADVERTISING; BUSINESS MANAGEMENT SERVICES, NAMELY, BUSINESS APPRAISALS, BUSINESS AUDITING, PROVIDING BUSINESS INFORMATION, NAMELY, PREPARING BUSINESS REPORTS AND CONDUCTING BUSINESS RESEARCH, ANALYSIS AND SURVEYS, BUSINESS MANAGEMENT PLANNING, BUSINESS MANAGEMENT CONSULTATION, BUSINESS MANAGEMENT SUPERVISION, CONDUCTING BUSINESS NETWORKING FOR OTHERS; BUSINESS MANAGEMENT AND CONSULTING SERVICES, EXCLUDING AGRICULTURAL BUSINESS MANAGEMENT AND CONSULTING SERVICES; PROVIDING INFORMATION VIA THE TELEPHONE AND THE GLOBAL COMMUNICATION NETWORKS IN THE FIELD OF ADVERTISING AND BUSINESS MARKETING; PROFESSIONAL CONSULTANCY IN THE FIELD OF DATA PROCESSING; RENTAL OF AUTOMATIC VENDING MACHINES; RENTAL OF DATA PROCESSING EQUIPMENT; ORGANIZING JOB FAIRS (U.S. CLS. 100, 101 AND 102).

INGRID C. EULIN, EXAMINING ATTORNEY

SN 78-493,813. SEARS BRANDS, LLC, HOFFMAN ESTATES, IL. FILED 10-4-2004.

**GOOD LIFE. GREAT
PRICE.**

THE MARK CONSISTS OF STANDARD CHARACTERS WITHOUT CLAIM TO ANY PARTICULAR FONT, STYLE, SIZE, OR COLOR.

FOR RETAIL DEPARTMENT STORE SERVICES (U.S. CLS. 100, 101 AND 102).

FIRST USE 5-4-2003; IN COMMERCE 5-4-2003.

MARGERY A. TIERNEY, EXAMINING ATTORNEY

CLASS 35—(Continued).

SN 78-495,698. JACKSON, JIM, DURANGO, CO. FILED 10-6-2004.

CLASS 35—(Continued).

SN 78-498,338. SMITH, JEFFERSON, PORTLAND, OR. FILED 10-12-2004.

TIME FLIES WHEN
YOU ARE HAVING
RUM

TRICK-OR-VOTE

THE MARK CONSISTS OF STANDARD CHARACTERS WITHOUT CLAIM TO ANY PARTICULAR FONT, STYLE, SIZE, OR COLOR.
FOR PROMOTING PUBLIC AWARENESS OF THE NEED FOR PARTICIPATION IN THE POLITICAL PROCESS (U.S. CLS. 100, 101 AND 102).
FIRST USE 10-0-2002; IN COMMERCE 10-0-2002.
MAUREEN DALL, EXAMINING ATTORNEY

THE MARK CONSISTS OF STANDARD CHARACTERS WITHOUT CLAIM TO ANY PARTICULAR FONT, STYLE, SIZE, OR COLOR.
FOR ADVERTISING SERVICES, FOR THIRD PARTIES, IN CONNECTION WITH THE COMMERCIALIZATION AND SALE OF ALCOHOLIC BEVERAGES, NAMELY, RUM (U.S. CLS. 100, 101 AND 102).
JILL C. ALT, EXAMINING ATTORNEY

SN 78-498,846. LAB COMPANIES, INC., THE, JERSEY CITY, NJ. FILED 10-13-2004.

SN 78-498,175. PHOENIX INTANGIBLES HOLDING COMPANY, GREENVILLE, DE. FILED 10-12-2004.

The Lab

GIANT EAGLE MARKET
DISTRICT

THE MARK CONSISTS OF STANDARD CHARACTERS WITHOUT CLAIM TO ANY PARTICULAR FONT, STYLE, SIZE, OR COLOR.
OWNER OF U.S. REG. NO. 2,640,976.
NO CLAIM IS MADE TO THE EXCLUSIVE RIGHT TO USE "MARKET", APART FROM THE MARK AS SHOWN.
FOR RETAIL SUPERMARKET SERVICES (U.S. CLS. 100, 101 AND 102).
RUDY R. SINGLETON, EXAMINING ATTORNEY

THE MARK CONSISTS OF STANDARD CHARACTERS WITHOUT CLAIM TO ANY PARTICULAR FONT, STYLE, SIZE, OR COLOR.
FOR BUSINESS CONSULTATION SERVICES; BUSINESS CONSULTATION IN THE FIELD OF BUSINESS OPERATIONS; BUSINESS MANAGEMENT CONSULTATION (U.S. CLS. 100, 101 AND 102).
FIRST USE 0-0-1993; IN COMMERCE 0-0-1993.
ALICE BENMAMAN, EXAMINING ATTORNEY

CLASS 35—(Continued).

SN 78-498,967. PPC MARKETING, LTD., PITTSBURGH, TX. FILED 10-13-2004.



NO CLAIM IS MADE TO THE EXCLUSIVE RIGHT TO USE DISTRIBUTION, APART FROM THE MARK AS SHOWN.

FOR DISTRIBUTORSHIP IN THE FIELD OF FOOD (U.S. CLS. 100, 101 AND 102).

FIRST USE 8-25-2004; IN COMMERCE 8-25-2004.
JOHN HWANG, EXAMINING ATTORNEY

SN 78-499,459. GRAND, ALEXANDER, CARMICHAEL, CA. AND PEDRAM, BABAK, MISSISSAUGA, ONTARIO, CANADA, FILED 10-13-2004.

CLASS 35—(Continued).

SN 78-500,740. HALL FINANCIAL GROUP HALL FINANCIAL GROUP GP, INC., FRISCO, TX. FILED 10-15-2004.



NO CLAIM IS MADE TO THE EXCLUSIVE RIGHT TO USE "FINANCIAL GROUP", APART FROM THE MARK AS SHOWN.

FOR ADVERTISING AND BUSINESS SERVICES, NAMELY, PROMOTING THE SERVICES OF OFFICE BUILDINGS, APARTMENTS, AND MULTI-FAMILY PROPERTIES THROUGH THE DISTRIBUTION OF PRINTED MATERIALS AND VIA THE INTERNET; BUSINESS MANAGEMENT SERVICES FOR OFFICE BUILDINGS, APARTMENTS AND MULTIFAMILY PROPERTIES (U.S. CLS. 100, 101 AND 102).

FIRST USE 8-1-1991; IN COMMERCE 8-1-1991.
DAWN FELDMAN, EXAMINING ATTORNEY

SN 78-501,572. KOHL'S ILLINOIS, INC., AURORA, IL. FILED 10-18-2004.

Music Tidbit

THE MARK CONSISTS OF STANDARD CHARACTERS WITHOUT CLAIM TO ANY PARTICULAR FONT, STYLE, SIZE, OR COLOR.

NO CLAIM IS MADE TO THE EXCLUSIVE RIGHT TO USE "MUSIC", APART FROM THE MARK AS SHOWN.

FOR PROVIDING EMPLOYMENT HIRING INFORMATION IN THE FIELD OF MUSIC, NAMELY POSTING PERSONAL PROFILES VIA THE INTERNET AND PROVIDING EMPLOYMENT CONTRACTS VIA THE INTERNET (U.S. CLS. 100, 101 AND 102).

NORA BUCHANAN WILL, EXAMINING ATTORNEY

EXPECT GREAT THINGS

THE MARK CONSISTS OF STANDARD CHARACTERS WITHOUT CLAIM TO ANY PARTICULAR FONT, STYLE, SIZE, OR COLOR.

FOR RETAIL DEPARTMENT STORE SERVICES (U.S. CLS. 100, 101 AND 102).

CHRISTOPHER BUONGIORNO, EXAMINING ATTORNEY

CLASS 35—(Continued).

SN 78-503,130. TIDYMAN'S MANAGEMENT SERVICES, INC., SPOKANE, WA. FILED 10-20-2004.

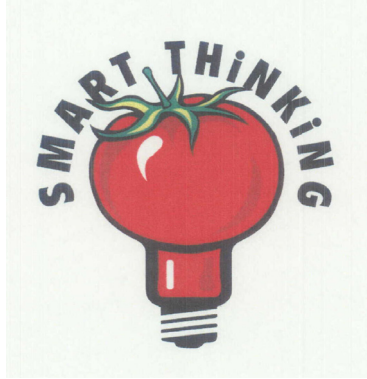

THE COLOR(S) RED, GREEN, BLACK, WHITE AND YELLOW IS/ARE CLAIMED AS A FEATURE OF THE MARK.

THE LIGHT BULB/TOMATO IS RED WITH WHITE HIGHLIGHTS AND BLACK OUTLINING. THE BOTTOM OF THE LIGHT BULB IS BLACK AND WHITE. THE WORDING IS BLACK. THE STEM AND LEAVES OF THE TOMATO ARE GREEN AND YELLOW.

THE MARK CONSISTS OF A DESIGN OF A TOMATO WHICH IS SHAPED LIKE A LIGHT BULB.

FOR SUPERMARKET SERVICES (U.S. CLS. 100, 101 AND 102).

FIRST USE 9-29-2004; IN COMMERCE 9-29-2004.
WENDY GOODMAN, EXAMINING ATTORNEY

SN 78-504,726. THE UPPER DECK COMPANY, NORTH LAS VEGAS, NV. FILED 10-22-2004.

COLLECT THE BEST

THE MARK CONSISTS OF STANDARD CHARACTERS WITHOUT CLAIM TO ANY PARTICULAR FONT, STYLE, SIZE, OR COLOR.

FOR ADVERTISING AND MARKETING SERVICES NAMELY THE PROMOTION OF TRADING CARDS, COLLECTABLE CARD GAMES, COLLECTIBLES, SPORTS AND ENTERTAINMENT, AND MEMORABILIA FOR OTHERS (U.S. CLS. 100, 101 AND 102).

FIRST USE 4-1-2002; IN COMMERCE 4-1-2002.
TIMOTHY FINNEGAN, EXAMINING ATTORNEY

CLASS 35—(Continued).

SN 78-506,717. QUILL LINCOLNSHIRE, INC., LINCOLNSHIRE, IL. FILED 10-27-2004.



OWNER OF U.S. REG. NOS. 2,538,243, 2,934,015 AND OTHERS.

NO CLAIM IS MADE TO THE EXCLUSIVE RIGHT TO USE "REWARDS", APART FROM THE MARK AS SHOWN. FOR MAIL ORDER CATALOG SERVICES AND ON-LINE RETAIL STORE SERVICES, FEATURING OFFICE SUPPLIES, OFFICE EQUIPMENT AND OFFICE FURNITURE; AND PROVIDING A CUSTOMER LOYALTY INCENTIVE PROGRAM WHEREBY PARTICIPANTS ACCUMULATE VALUE FROM PURCHASES WHICH CAN BE REDEEMED AGAINST FUTURE PURCHASES (U.S. CLS. 100, 101 AND 102).

FIRST USE 2-0-2004; IN COMMERCE 2-0-2004.
WINSTON FOLMAR, EXAMINING ATTORNEY

SN 78-507,209. RENTBLURB, LLC, LAKE MONROE, FL. FILED 10-28-2004.



NO CLAIM IS MADE TO THE EXCLUSIVE RIGHT TO USE "RENT", APART FROM THE MARK AS SHOWN.

THE COLORS LIME GREEN, SILVER, AND BLACK ARE CLAIMED AS A FEATURE OF THE MARK.

THE COLOR LIME GREEN APPEARS ON THE DEPICTION OF THE WORD RENT; THE COLOR SILVER APPEARS ON THE DEPICTION OF THE WORD BLURB; THE COLOR BLACK APPEARS ON THE DEPICTION OF THE WORD .COM.

FOR PROVIDING A WEB SITE WHICH FEATURES ADVERTISEMENTS FOR THE GOODS AND SERVICES OF OTHERS ON A GLOBAL COMPUTER NETWORK (U.S. CLS. 100, 101 AND 102).

MICHAEL TANNER, EXAMINING ATTORNEY

CLASS 35—(Continued).

SN 78-507,247. CRAFT & HOBBY ASSOCIATION, ELMWOOD PARK, NJ. FILED 10-28-2004.

CLASS 35—(Continued).

SN 78-508,891. HOOSE, JOHN W., HOWELL, MI. FILED 10-31-2004.



Craft & Hobby Association

Auction-it TODAY

NO CLAIM IS MADE TO THE EXCLUSIVE RIGHT TO USE "CRAFT & HOBBY ASSOCIATION", APART FROM THE MARK AS SHOWN.

THE MARK CONSISTS OF THE LETTERS CHA IN A STYLIZED VERSION.

FOR ASSOCIATION SERVICES, NAMELY PROMOTING THE INTERESTS OF THE CRAFT AND HOBBY INDUSTRY (U.S. CLS. 100, 101 AND 102).

FIRST USE 6-1-2004; IN COMMERCE 6-1-2004.
KELLY CHOE, EXAMINING ATTORNEY

THE MARK CONSISTS OF STANDARD CHARACTERS WITHOUT CLAIM TO ANY PARTICULAR FONT, STYLE, SIZE, OR COLOR.

FOR CONDUCTING AUCTION SALES; CONSULTING SERVICES IN THE FIELD OF INTERNET AUCTIONS AS RELATED TO PHOTOGRAPHY AND DISPLAY ENHANCEMENT, MERCHANDISE LISTING, INVENTORY STORAGE, CONSIGNMENT INTERNET SALES, PAYMENT RECONCILIATION, AND SHIPPING AND HANDLING ALL FOR USE IN INTERNET AUCTION SERVICES (U.S. CLS. 100, 101 AND 102).

FIRST USE 12-15-2003; IN COMMERCE 12-15-2003.
ANDREA SAUNDERS, EXAMINING ATTORNEY

SN 78-507,287. THE PRINCESS SOCIETY, LLC, TAMPA, FL. FILED 10-28-2004.

SN 78-508,934. RAISING CANE RUM COMPANY, INC., CHARLESTON, SC. FILED 11-1-2004.

**THE PRINCESS
SOCIETY**

**Raising Cane Rum
Company, Inc.**

THE MARK CONSISTS OF STANDARD CHARACTERS WITHOUT CLAIM TO ANY PARTICULAR FONT, STYLE, SIZE, OR COLOR.

NO CLAIM IS MADE TO THE EXCLUSIVE RIGHT TO USE "SOCIETY", APART FROM THE MARK AS SHOWN.

FOR ASSOCIATION SERVICES, NAMELY, PROMOTING THE INTERESTS OF WOMEN (U.S. CLS. 100, 101 AND 102).

FIRST USE 10-10-2004; IN COMMERCE 10-10-2004.
HOWARD SMIGA, EXAMINING ATTORNEY

THE MARK CONSISTS OF STANDARD CHARACTERS WITHOUT CLAIM TO ANY PARTICULAR FONT, STYLE, SIZE, OR COLOR.

NO CLAIM IS MADE TO THE EXCLUSIVE RIGHT TO USE RUM COMPANY, INC., APART FROM THE MARK AS SHOWN.

FOR COOPERATIVE ADVERTISING AND MARKETING (U.S. CLS. 100, 101 AND 102).

ANDREA SAUNDERS, EXAMINING ATTORNEY

CLASS 35—(Continued).

SN 78-509,143. E ELEMENT LLC, CHICAGO, IL. FILED 11-1-2004.



NO CLAIM IS MADE TO THE EXCLUSIVE RIGHT TO USE "EADVERTISER", APART FROM THE MARK AS SHOWN.

FOR ADVERTISING SERVICES, NAMELY, INTERNATIONAL ELECTRONIC ADVERTISING THROUGH ECOMMERCE TECHNOLOGIES (U.S. CLS. 100, 101 AND 102).

FIRST USE 5-1-2004; IN COMMERCE 5-1-2004.
DOMINIC J. FERRAIUOLO, EXAMINING ATTORNEY

SN 78-509,209. ANICHINI, INC., TUNBRIDGE, VT. FILED 11-1-2004.

ANICHINI

THE MARK CONSISTS OF STANDARD CHARACTERS WITHOUT CLAIM TO ANY PARTICULAR FONT, STYLE, SIZE, OR COLOR.

OWNER OF U.S. REG. NOS. 2,199,712, 2,271,073 AND OTHERS.

FOR RETAIL STORE AND ONLINE RETAIL STORE SERVICES FEATURING TEXTILE PRODUCTS, FURNITURE, HOUSEHOLD PRODUCTS, CLOTHING, BED LINENS, TABLE LINENS, BATH LINENS AND FABRICS (U.S. CLS. 100, 101 AND 102).

FIRST USE 0-0-1999; IN COMMERCE 0-0-1999.
ERNEST SHOSHO, EXAMINING ATTORNEY

CLASS 35—(Continued).

SN 78-509,796. THE INTERNATIONAL ASSOCIATION OF CHIEFS OF POLICE, ALEXANDRIA, VA. FILED 11-2-2004.



NO CLAIM IS MADE TO THE EXCLUSIVE RIGHT TO USE "VOLUNTEERS IN POLICE SERVICE", APART FROM THE MARK AS SHOWN.

FOR PROMOTING PUBLIC AWARENESS OF THE NEED FOR VOLUNTEERS IN LAW ENFORCEMENT (U.S. CLS. 100, 101 AND 102).

FIRST USE 5-30-2002; IN COMMERCE 5-30-2002.
EDWARD NELSON, EXAMINING ATTORNEY

SN 78-510,167. THE INTERPUBLIC GROUP OF COMPANIES, INC., NEW YORK, NY. FILED 11-2-2004.



OWNER OF U.S. REG. NOS. 2,485,994 AND 2,618,403. THE MARK CONSISTS OF A STYLIZED RENDERING OF THE PHRASE "MCCANN ERICKSON TAG IDEATION".

FOR ADVERTISING AGENCIES; ADVERTISING AND MARKETING (U.S. CLS. 100, 101 AND 102).
FIRST USE 8-0-2003; IN COMMERCE 8-0-2003.
KIMBERLY FRYE, EXAMINING ATTORNEY

CLASS 35—(Continued).

SN 78-511,353. LEISSNER, WILLIAM E., PORTLAND, OR.
FILED 11-4-2004.

CLASS 35—(Continued).

SN 78-511,362. PLANITAX, INC., EMERYVILLE, CA. FILED
11-4-2004.

FleaCycle

THE MARK CONSISTS OF STANDARD CHARACTERS WITHOUT CLAIM TO ANY PARTICULAR FONT, STYLE, SIZE, OR COLOR.

NO CLAIM IS MADE TO THE EXCLUSIVE RIGHT TO USE CORPORATE TAX, APART FROM THE MARK AS SHOWN.

FOR TAX SERVICES ON A GLOBAL COMPUTER NETWORK TO TRACK AND MANAGE FINANCIAL DATA TO FACILITATE AUDIT MANAGEMENT AND TAX PREPARATION (U.S. CLS. 100, 101 AND 102).

FIRST USE 8-1-2004; IN COMMERCE 8-1-2004.
BRIAN NEVILLE, EXAMINING ATTORNEY

SN 78-511,566. CALIFORNIA ACRYLIC INDUSTRIES, POMONA, CA. FILED 11-4-2004.

THE MARK CONSISTS OF STANDARD CHARACTERS WITHOUT CLAIM TO ANY PARTICULAR FONT, STYLE, SIZE, OR COLOR.

FOR ONLINE COMPUTER SERVICES, NAMELY, PROVIDING A WEB SITE AT WHICH USERS CAN OFFER GOODS FOR SALE AND BUY GOODS OFFERED BY OTHERS; CHARITABLE SERVICES, NAMELY, ORGANIZING AND CONDUCTING VOLUNTEER PROGRAMS AND COMMUNITY SERVICE PROJECTS; PROVIDING CONSUMER PRODUCT INFORMATION VIA THE INTERNET; PROVIDING SPACE AT A WEB SITE FOR THE ADVERTISEMENT OF THE GOODS AND SERVICES OF OTHERS; PROVIDING ON-LINE DIRECTORY INFORMATION SERVICES, ALSO FEATURING HYPERLINKS TO OTHER WEB SITES; PROVIDING INFORMATION ABOUT AND MAKING REFERRALS IN THE FIELD OF CONSUMER PRODUCTS AND SERVICES FOR RETAIL SERVICES CONCERNING PRODUCTS, SERVICES, EVENTS, ACTIVITIES, ATTRACTIONS AND FACILITIES IN PARTICULAR GEOGRAPHIC LOCATIONS; PROVIDING INFORMATION ABOUT COMMERCIAL BUSINESS AND COMMERCIAL INFORMATION VIA THE GLOBAL COMPUTER NETWORK; PROVIDING INFORMATION ABOUT THE GOODS AND SERVICES OF OTHERS VIA THE GLOBAL COMPUTER NETWORK; PROMOTING THE GOODS AND SERVICES OF OTHERS BY PROVIDING HYPERTEXT LINKS TO THE WEB SITES OF OTHERS (U.S. CLS. 100, 101 AND 102).

FIRST USE 6-29-2004; IN COMMERCE 6-29-2004.
ALICE SUE CARRUTHERS, EXAMINING ATTORNEY

**LEISURE WORLD HOME
RESORT PRODUCTS**

THE MARK CONSISTS OF STANDARD CHARACTERS WITHOUT CLAIM TO ANY PARTICULAR FONT, STYLE, SIZE, OR COLOR.

NO CLAIM IS MADE TO THE EXCLUSIVE RIGHT TO USE HOME RESORT PRODUCTS, APART FROM THE MARK AS SHOWN.

FOR RETAIL STORES FEATURING SPAS, GAZEBOS, BARS, SAUNAS, BARBECUE GRILLS AND CUSTOMIZABLE SURROUNDING ISLANDS, BARBECUE CARTS AND RELATED ACCESSORIES (U.S. CLS. 100, 101 AND 102).

FIRST USE 3-25-2002; IN COMMERCE 3-25-2002.
CHRISTOPHER ADKINS, EXAMINING ATTORNEY

CLASS 35—(Continued).

SN 78-513,372. PETAL, CYNTHIA, NORTHFIELD CENTER TWP., OH. FILED 11-8-2004.

CLASS 35—(Continued).

SN 78-513,557. LUCKY BRAND DUNGAREES, INC., VERNON, CA. FILED 11-9-2004.

Adventures in Stamping

LUCKY BRAND JEANS

THE MARK CONSISTS OF STANDARD CHARACTERS WITHOUT CLAIM TO ANY PARTICULAR FONT, STYLE, SIZE, OR COLOR.

NO CLAIM IS MADE TO THE EXCLUSIVE RIGHT TO USE "STAMPING", APART FROM THE MARK AS SHOWN, FOR ARRANGING AND CONDUCTING TRADE SHOW EXHIBITIONS IN THE FIELD OF ART AND CRAFTS, SPECIFICALLY ARTISTIC RUBBER STAMPS AND RELATED PRODUCTS AND SUPPLIES (U.S. CLS. 100, 101 AND 102).

FIRST USE 5-12-1993; IN COMMERCE 7-1-1994.
JIM RINGLE, EXAMINING ATTORNEY

THE MARK CONSISTS OF STANDARD CHARACTERS WITHOUT CLAIM TO ANY PARTICULAR FONT, STYLE, SIZE, OR COLOR.

OWNER OF U.S. REG. NOS. 2,655,004, 2,857,464 AND OTHERS.

NO CLAIM IS MADE TO THE EXCLUSIVE RIGHT TO USE "BRAND JEANS", APART FROM THE MARK AS SHOWN.

FOR RETAIL STORE SERVICES FEATURING A VARIETY OF GOODS INCLUDING CLOTHING, CLOTHING ACCESSORIES, HEADGEAR, FOOTWEAR, GENERAL MERCHANDISE, GIFT ITEMS, JEWELRY, HANDBAGS, WALLETS, SUNGLASSES, FRAGRANCES, PERSONAL CARE PRODUCTS AND TOYS (U.S. CLS. 100, 101 AND 102).

FIRST USE 12-0-1996; IN COMMERCE 12-0-1996.
JUDITH HELFMAN, EXAMINING ATTORNEY

SN 78-513,434. APRIANT, INC., DENVER, CO. FILED 11-8-2004.

SN 78-513,607. PROFESSIONAL ADVANTAGE, INC., EDINA, MN. FILED 11-9-2004.

APRIANT

THE PROFESSIONAL ADVANTAGE

THE MARK CONSISTS OF STANDARD CHARACTERS WITHOUT CLAIM TO ANY PARTICULAR FONT, STYLE, SIZE, OR COLOR.

FOR BUSINESS MANAGEMENT AND CONSULTING SERVICES IN THE FIELDS OF BUSINESS PLANNING, BUSINESS OPERATIONS, BUSINESS STRATEGY, AND THE PROVISION OF INFORMATION RELATED THERETO (U.S. CLS. 100, 101 AND 102).

FIRST USE 8-17-2004; IN COMMERCE 9-1-2004.
RENEE MCCRAY, EXAMINING ATTORNEY

THE MARK CONSISTS OF STANDARD CHARACTERS WITHOUT CLAIM TO ANY PARTICULAR FONT, STYLE, SIZE, OR COLOR.

FOR BUSINESS CONSULTATION, NAMELY, PROVIDING BUSINESS ADVICE IN THE FIELDS OF EXECUTIVE COACHING, TEAM BUILDING, SELF-EMPOWERMENT, TEAM EMPOWERMENT AND CONFLICT MANAGEMENT (U.S. CLS. 100, 101 AND 102).

CHARLES L. JENKINS, EXAMINING ATTORNEY

CLASS 35—(Continued).

SN 78-513,778. CONVERGYS CMG UTAH INC., SOUTH JORDAN, UT. FILED 11-9-2004.

GLOBAL WORKFORCE INTEGRATOR

THE MARK CONSISTS OF STANDARD CHARACTERS WITHOUT CLAIM TO ANY PARTICULAR FONT, STYLE, SIZE, OR COLOR.

NO CLAIM IS MADE TO THE EXCLUSIVE RIGHT TO USE "GLOBAL AND INTEGRATOR", APART FROM THE MARK AS SHOWN.

FOR BUSINESS SERVICES, NAMELY DATA PROCESSING SERVICES IN THE FIELD OF PAYROLL SYSTEMS, EMPLOYEE BENEFITS, AND EMPLOYEE TIME AND ATTENDANCE; BUSINESS CONSULTING SERVICES IN THE FIELDS OF PAYROLL PROCESSING, EMPLOYEE BENEFITS, AND EMPLOYEE TIME AND ATTENDANCE; PAYROLL PROCESSING SERVICES; PAYROLL PREPARATION SERVICES (U.S. CLS. 100, 101 AND 102).

JENNIFER DIXON, EXAMINING ATTORNEY

SN 78-514,239. SPECIALTY MERCHANDISE CORPORATION, CHATSWORTH, CA. FILED 11-9-2004.

SMC

THE MARK CONSISTS OF STANDARD CHARACTERS WITHOUT CLAIM TO ANY PARTICULAR FONT, STYLE, SIZE, OR COLOR.

FOR BUSINESS INFORMATION SERVICES IN THE NATURE OF PROVIDING INFORMATION ON BUSINESS OPPORTUNITIES (U.S. CLS. 100, 101 AND 102).

FIRST USE 7-5-1967; IN COMMERCE 7-5-1967.

MIDGE BUTLER, EXAMINING ATTORNEY

CLASS 35—(Continued).

SN 78-514,410. RAMFJELD AND COMPANY, INC., CHATHAM, NJ. FILED 11-10-2004.

RAMFJELD & COMPANY, INC.

THE MARK CONSISTS OF STANDARD CHARACTERS WITHOUT CLAIM TO ANY PARTICULAR FONT, STYLE, SIZE, OR COLOR.

NO CLAIM IS MADE TO THE EXCLUSIVE RIGHT TO USE "& COMPANY, INC"., APART FROM THE MARK AS SHOWN.

FOR WHOLESALE DISTRIBUTORSHIPS FEATURING CANNED FOODS AND GROCERY ITEMS (U.S. CLS. 100, 101 AND 102).

FIRST USE 0-0-1945; IN COMMERCE 0-0-1945.

KATRINA EDGE, EXAMINING ATTORNEY

SN 78-514,857. TRUST TEMPORARY SERVICES, INC., DBA HELPMATES STAFFING SERVICES, IRVINE, CA. FILED 11-10-2004.

CATCH'EM DOING SOMETHING SAFE

THE MARK CONSISTS OF STANDARD CHARACTERS WITHOUT CLAIM TO ANY PARTICULAR FONT, STYLE, SIZE, OR COLOR.

FOR CONDUCTING EMPLOYEE INCENTIVE AWARDS PROGRAMS TO PROMOTE ON THE JOB SAFETY (U.S. CLS. 100, 101 AND 102).

FIRST USE 1-1-2000; IN COMMERCE 5-1-2004.

BARBARA BROWN, EXAMINING ATTORNEY

SN 78-515,186. PROFESSIONAL PHOTOGRAPHERS OF AMERICA, INC., ATLANTA, GA. FILED 11-11-2004.

IMAGING USA

THE MARK CONSISTS OF STANDARD CHARACTERS WITHOUT CLAIM TO ANY PARTICULAR FONT, STYLE, SIZE, OR COLOR.

OWNER OF U.S. REG. NO. 2,336,859.

SEC. 2(F).

FOR ADVERTISING SERVICES, NAMELY, TRADE SHOWS IN THE FIELD OF PROFESSIONAL PHOTOGRAPHY (U.S. CLS. 100, 101 AND 102).

FIRST USE 8-0-1999; IN COMMERCE 8-0-1999.

HENRY S. ZAK, EXAMINING ATTORNEY

CLASS 35—(Continued).

SN 78-515,217. XATA CORPORATION, BURNSVILLE, MN.
FILED 11-11-2004.

CLASS 35—(Continued).

SN 78-515,522. INFOKOREA, INC., LOS ANGELES, CA.
FILED 11-11-2004.

KOREANYELLOWPAGE

XATA

THE MARK CONSISTS OF STANDARD CHARACTERS WITHOUT CLAIM TO ANY PARTICULAR FONT, STYLE, SIZE, OR COLOR.

SEC. 2(F).

FOR PROVIDING AN ONLINE COMMERCIAL INFORMATION DIRECTORY ON THE INTERNET, FEATURING LISTINGS OF BUSINESSES, PROFESSIONALS, AND SERVICES OF INTEREST TO KOREANS AND KOREAN-AMERICANS, AND KOREAN SPEAKING USERS (U.S. CLS. 100, 101 AND 102).

FIRST USE 10-0-1999; IN COMMERCE 10-0-1999.

TANYA AMOS, EXAMINING ATTORNEY

THE MARK CONSISTS OF STANDARD CHARACTERS WITHOUT CLAIM TO ANY PARTICULAR FONT, STYLE, SIZE, OR COLOR.

FOR CONSULTING SERVICES IN CONNECTION WITH FLEET MANAGEMENT (U.S. CLS. 100, 101 AND 102).

FIRST USE 12-13-1986; IN COMMERCE 12-13-1986.

GINA HAYES, EXAMINING ATTORNEY

SN 78-515,698. SOLBERG/ADAMS LLC, BEAVERTON, OR.
FILED 11-11-2004.

SN 78-515,393. THE J. JILL GROUP, INC., QUINCY, MA.
FILED 11-11-2004.

VTB

PURE JILL

THE MARK CONSISTS OF STANDARD CHARACTERS WITHOUT CLAIM TO ANY PARTICULAR FONT, STYLE, SIZE, OR COLOR.

FOR RETAIL OUTLETS, MAIL-ORDER CATALOGUE AND ON-LINE CATALOGUE SERVICES FEATURING CLOTHING AND ACCESSORIES (U.S. CLS. 100, 101 AND 102).

MATTHEW PAPPAS, EXAMINING ATTORNEY

THE MARK CONSISTS OF STANDARD CHARACTERS WITHOUT CLAIM TO ANY PARTICULAR FONT, STYLE, SIZE, OR COLOR.

FOR TELECOM INVOICE OUTSOURCING SERVICES, NAMELY OUTSOURCING IN THE FIELD OF INVOICE ACCOUNTING, INVOICE BILLING AND INVOICE PAYMENT PROCESSING (U.S. CLS. 100, 101 AND 102).

FIRST USE 8-1-2000; IN COMMERCE 8-1-2000.

ELLEN PERKINS, EXAMINING ATTORNEY

CLASS 35—(Continued).

SN 78-516,093. ADVERTISER PERCEPTIONS, INC., DANVILLE, CA. FILED 11-12-2004.

CLASS 35—(Continued).

SN 78-516,253. TIGHE INDUSTRIES, INC., YORK, PA. FILED 11-12-2004.

CURTAIN CALL FOR CLASS

Power Metrics

THE MARK CONSISTS OF STANDARD CHARACTERS WITHOUT CLAIM TO ANY PARTICULAR FONT, STYLE, SIZE, OR COLOR.

FOR MARKET RESEARCH FOR THE MEDIA INDUSTRY (U.S. CLS. 100, 101 AND 102).

FIRST USE 2-12-2004; IN COMMERCE 2-22-2004.
NANCY CLARKE, EXAMINING ATTORNEY

THE MARK CONSISTS OF STANDARD CHARACTERS WITHOUT CLAIM TO ANY PARTICULAR FONT, STYLE, SIZE, OR COLOR.

NO CLAIM IS MADE TO THE EXCLUSIVE RIGHT TO USE "FOR CLASS", APART FROM THE MARK AS SHOWN.

FOR ONLINE RETAIL STORE SERVICES FEATURING DANCE CLASS APPAREL; WHOLESALE DISTRIBUTORSHIPS FEATURING DANCE CLASS APPAREL; ELECTRONIC CATALOG SERVICES FEATURING DANCE CLASS APPAREL; MAIL ORDER CATALOG SERVICES FEATURING DANCE CLASS APPAREL (U.S. CLS. 100, 101 AND 102).

FIRST USE 8-0-2003; IN COMMERCE 8-0-2003.
SUSAN STIGLITZ, EXAMINING ATTORNEY

SN 78-516,138. WADDLE TO TODDLE, INC., BILLINGS, MT. FILED 11-12-2004.

SN 78-516,305. CALLA DESIGNS, INC., MENLO PARK, CA. FILED 11-12-2004.

WADDLE TO TODDLE

PINK WASABI

THE MARK CONSISTS OF STANDARD CHARACTERS WITHOUT CLAIM TO ANY PARTICULAR FONT, STYLE, SIZE, OR COLOR.

FOR COMPUTERIZED ON-LINE AND RETAIL STORE SERVICES IN THE FIELD OF WOMEN'S MATERNITY CLOTHING AND ACCESSORIES AND INFANT CLOTHING AND ACCESSORIES (U.S. CLS. 100, 101 AND 102).

FIRST USE 5-1-2004; IN COMMERCE 6-7-2004.
GLENN CLARK, EXAMINING ATTORNEY

THE MARK CONSISTS OF STANDARD CHARACTERS WITHOUT CLAIM TO ANY PARTICULAR FONT, STYLE, SIZE, OR COLOR.

FOR RETAIL CLOTHING STORES (U.S. CLS. 100, 101 AND 102).

FIRST USE 9-1-2002; IN COMMERCE 9-1-2002.
JOHN GARTNER, EXAMINING ATTORNEY

CLASS 35—(Continued).

SN 78-516,343. CALLA DESIGNS, INC., MENLO PARK, CA.
FILED 11-12-2004.



FOR RETAIL CLOTHING STORES (U.S. CLS. 100, 101
AND 102).

FIRST USE 9-1-2002; IN COMMERCE 9-1-2002.
JOHN GARTNER, EXAMINING ATTORNEY

SN 78-516,388. CEONEX, INC., NORTH ADAMS, MA. FILED
11-12-2004.

Quantemo

THE MARK CONSISTS OF STANDARD CHARACTERS
WITHOUT CLAIM TO ANY PARTICULAR FONT, STYLE,
SIZE, OR COLOR.

FOR MARKET MANIPULATION, RESEARCH AND
ANALYSIS, WHETHER OR NOT VIA THE INTERNET
(U.S. CLS. 100, 101 AND 102).

FIRST USE 10-20-2004; IN COMMERCE 10-20-2004.
DARRYL SPRUILL, EXAMINING ATTORNEY

CLASS 35—(Continued).

SN 78-516,395. NEW PAGE CONSULTING, INC., DEL MAR,
CA. FILED 11-12-2004.



Ethical Wisdom

NO CLAIM IS MADE TO THE EXCLUSIVE RIGHT TO
USE "ETHICAL", APART FROM THE MARK AS SHOWN.

FOR BUSINESS ORGANIZATION, MANAGEMENT
CONSULTING, AND LEADERSHIP DEVELOPMENT
SERVICES (U.S. CLS. 100, 101 AND 102).

FIRST USE 11-4-2004; IN COMMERCE 11-4-2004.
JEAN IM, EXAMINING ATTORNEY

SN 78-516,448. TRES TOROS LLC, WESTLAKE VILLAGE,
CA. FILED 11-13-2004.

FRONT PORCH PETS

THE MARK CONSISTS OF STANDARD CHARACTERS
WITHOUT CLAIM TO ANY PARTICULAR FONT, STYLE,
SIZE, OR COLOR.

NO CLAIM IS MADE TO THE EXCLUSIVE RIGHT TO
USE "PETS", APART FROM THE MARK AS SHOWN.

FOR ONLINE RETAIL STORE SERVICES IN THE
FIELD OF PET TREATS AND PET FOODS (U.S. CLS.
100, 101 AND 102).

FIRST USE 6-6-2003; IN COMMERCE 6-6-2003.
KIMBERLY PERRY, EXAMINING ATTORNEY

SN 78-516,537. DORFMAN, MARGOT, EASTON, MD. FILED
11-13-2004.

Pipeline to the Presidency

THE MARK CONSISTS OF STANDARD CHARACTERS
WITHOUT CLAIM TO ANY PARTICULAR FONT, STYLE,
SIZE, OR COLOR.

FOR ASSOCIATION SERVICES, NAMELY, PROMOTING
THE INTEREST OF WOMEN THROUGH SPONSORING
AND CONDUCTING DISCUSSION GROUPS AND
FORUMS FOR IDENTIFICATION AND CONSIDERATION
OF WOMEN'S NEEDS, PRIORITY ISSUES, AND
GOALS (U.S. CLS. 100, 101 AND 102).

FIRST USE 11-10-2004; IN COMMERCE 11-13-2004.
ADA HAN, EXAMINING ATTORNEY

CLASS 35—(Continued).

SN 78-516,661. SUPERVALU INC., EDEN PRAIRIE, MN.
FILED 11-15-2004.

CLASS 35—(Continued).

SN 78-516,849. KRIPPENDORFF, KAIHAN P., MIAMI
BEACH, FL. FILED 11-15-2004.

**MAKE OUR BRANDS,
YOUR BRANDS!**

THE MARK CONSISTS OF STANDARD CHARACTERS
WITHOUT CLAIM TO ANY PARTICULAR FONT, STYLE,
SIZE, OR COLOR.
FOR GROCERY STORE SERVICES (U.S. CLS. 100, 101
AND 102).
FIRST USE 8-9-2004; IN COMMERCE 8-9-2004.
G. MAYERSCHOFF, EXAMINING ATTORNEY

**Outthink the
competition**

SN 78-516,678. DRIVETIME SALES AND FINANCE COR-
PORATION, PHOENIX, AZ. FILED 11-15-2004.

THE MARK CONSISTS OF STANDARD CHARACTERS
WITHOUT CLAIM TO ANY PARTICULAR FONT, STYLE,
SIZE, OR COLOR.
FOR BUSINESS MANAGEMENT CONSULTING (U.S.
CLS. 100, 101 AND 102).
BARBARA BROWN, EXAMINING ATTORNEY

1.866.DT.LETS.GO

THE MARK CONSISTS OF STANDARD CHARACTERS
WITHOUT CLAIM TO ANY PARTICULAR FONT, STYLE,
SIZE, OR COLOR.
FOR AUTOMOBILE DEALERSHIP SERVICES (U.S.
CLS. 100, 101 AND 102).
FIRST USE 1-10-2005; IN COMMERCE 1-10-2005.
KARLA PERKINS, EXAMINING ATTORNEY

SN 78-516,851. BELL SOUTH INTELLECTUAL PROPERTY
CORPORATION, WILMINGTON, DE. FILED 11-15-2004.

SN 78-516,693. DRIVETIME SALES AND FINANCE COR-
PORATION, PHOENIX, AZ. FILED 11-15-2004.

DELIVERS MORE

GET IN. LET'S GO.

THE MARK CONSISTS OF STANDARD CHARACTERS
WITHOUT CLAIM TO ANY PARTICULAR FONT, STYLE,
SIZE, OR COLOR.
FOR AUTOMOBILE DEALERSHIP SERVICES (U.S.
CLS. 100, 101 AND 102).
FIRST USE 7-15-2004; IN COMMERCE 7-15-2004.
SANI KHOURI, EXAMINING ATTORNEY

THE MARK CONSISTS OF STANDARD CHARACTERS
WITHOUT CLAIM TO ANY PARTICULAR FONT, STYLE,
SIZE, OR COLOR.
FOR DIRECT MARKETING SERVICES; NAMELY,
PROMOTING THE GOODS AND SERVICES OF OTHERS
THROUGH THE PACKAGING AND DISTRIBUTION OF
PRINTED PROMOTIONAL MATERIALS, ADVERTISE-
MENTS, CATALOGUES, COUPONS AND PRODUCT
SAMPLES (U.S. CLS. 100, 101 AND 102).
FIRST USE 10-1-1998; IN COMMERCE 10-1-1998.
BARBARA BROWN, EXAMINING ATTORNEY

CLASS 35—(Continued).

SN 78-516,879. HOLLYWOOD MANAGEMENT COMPANY,
WILSONVILLE, OR. FILED 11-15-2004.

CLASS 35—(Continued).

SN 78-517,154. SUSTAIN THE GAIN, LLC, SHALIMAR, FL.
FILED 11-15-2004.

WE UNDERSTAND.

THE MARK CONSISTS OF STANDARD CHARACTERS
WITHOUT CLAIM TO ANY PARTICULAR FONT, STYLE,
SIZE, OR COLOR.

FOR RETAIL STORE SERVICES FEATURING VIDEO
AND COMPUTER GAMES AND ASSOCIATED EQUIP-
MENT AND ACCESSORIES, PRE-RECORDED ENTERTAINMENT
MEDIA AND ASSOCIATED EQUIPMENT AND ACCESSORIES,
MUSIC AND RELATED HOME ENTERTAINMENT EQUIPMENT
AND ACCESSORIES, GAMES, PRINTED PUBLICATIONS,
FOODSTUFFS, CLOTHING, TOYS, AND COMPUTER SOFTWARE
AND HARDWARE, ALL PROVIDED VIA PHYSICAL
ESTABLISHMENTS AND VIA A GLOBAL COMMUNI-
CATION NETWORK (U.S. CLS. 100, 101 AND 102).

FIRST USE 8-10-2004; IN COMMERCE 8-10-2004.
STEVEN R. FINE, EXAMINING ATTORNEY

THE MARK CONSISTS OF STANDARD CHARACTERS
WITHOUT CLAIM TO ANY PARTICULAR FONT, STYLE,
SIZE, OR COLOR.

FOR BUSINESS INFORMATION FOR BUSINESS
MANAGEMENT AND ORGANIZATIONAL CONSULTAN-
CY, NAMELY THE OBJECTIVE ANALYSIS OF
BUSINESS AND FINANCIAL RESULTS TO ASSIST
MANAGEMENT IN THEIR STRATEGIC PLANNING
(U.S. CLS. 100, 101 AND 102).

FIRST USE 10-8-2004; IN COMMERCE 10-20-2004.
JANICE L. MCMORROW, EXAMINING ATTORNEY

SN 78-517,155. ST. LOUIS CONVENTION AND VISITORS
COMMISSION, ST. LOUIS, MO. FILED 11-15-2004.

**KEEP YOUR MEETINGS
AT HOME**

THE MARK CONSISTS OF STANDARD CHARACTERS
WITHOUT CLAIM TO ANY PARTICULAR FONT, STYLE,
SIZE, OR COLOR.

FOR CONVENTION COMMISSION SERVICES,
NAMELY, PROMOTING BUSINESS IN THE SAINT
LOUIS REGION (U.S. CLS. 100, 101 AND 102).

FIRST USE 0-0-2001; IN COMMERCE 0-0-2001.
JANICE L. MCMORROW, EXAMINING ATTORNEY

SN 78-517,040. PUBLIC AGENDA FOUNDATION INC., NEW
YORK, NY. FILED 11-15-2004.

PUBLIC AGENDA

SN 78-517,566. MARKOVICH VENTURES, INC., PITTS-
BURGH, PA. FILED 11-16-2004.



THE MARK CONSISTS OF STANDARD CHARACTERS
WITHOUT CLAIM TO ANY PARTICULAR FONT, STYLE,
SIZE, OR COLOR.

OWNER OF U.S. REG. NOS. 1,975,975 AND 2,282,849.
FOR PROVIDING ON-LINE PUBLIC POLICY RE-
PORTS (U.S. CLS. 100, 101 AND 102).

FIRST USE 11-22-1996; IN COMMERCE 3-0-1997.
YONG KIM, EXAMINING ATTORNEY

NO CLAIM IS MADE TO THE EXCLUSIVE RIGHT TO
USE "VITAMIN DISCOUNT WAREHOUSE" AND "VITA-
MIN DISCOUNT WAREHOUSE.COM", APART FROM THE
MARK AS SHOWN.

FOR ONLINE E-COMMERCE SERVICES, NAMELY,
ONLINE RETAIL SHOP SERVICES FEATURING VITA-
MINS AND SUPPLEMENTS (U.S. CLS. 100, 101 AND 102).

FIRST USE 10-1-2003; IN COMMERCE 10-1-2003.
PAUL F. GAST, EXAMINING ATTORNEY

CLASS 35—(Continued).

SN 78-517,626. SWAGELOK COMPANY, SOLON, OH. FILED 11-16-2004.



FOR PROVIDING COMPUTERIZED ON-LINE ORDERING OF PRODUCTS UTILIZED IN THE BIOPHARMACEUTICAL, CHEMICAL, PETROCHEMICAL, FOOD, BEVERAGE, DAIRY, OIL AND GAS, POWER, PULP AND PAPER, SEMI-CONDUCTOR AND SHIP BUILDING FIELDS; PROVIDING COMPUTERIZED ON-LINE ORDERING OF ANALYTICAL AND PROCESS INSTRUMENTATION PRODUCTS UTILIZED IN THE BIOPHARMACEUTICAL, CHEMICAL, PETROCHEMICAL, FOOD, BEVERAGE, DAIRY, OIL AND GAS, POWER, PULP AND PAPER, SEMI-CONDUCTOR AND SHIP BUILDING FIELDS (U.S. CLS. 100, 101 AND 102).
FIRST USE 11-1-2004; IN COMMERCE 11-1-2004.
MICHELE SWAIN, EXAMINING ATTORNEY

SN 78-517,641. CALIFORNIA SERVICE CORPS, SACRAMENTO, CA. FILED 11-16-2004.



THE COLOR(S) BROWN, BLACK, BLUE, RED, YELLOW AND GREEN IS/ARE CLAIMED AS A FEATURE OF THE MARK.

THE COLOR BROWN APPEARS IN THE BEAR. THE COLOR BLACK APPEARS IN THE BEAR'S NOSE AND THE OUTLINE OF THE BEAR, FLOWER AND DUMBBELL. THE COLOR BLUE APPEARS IN THE DUMBBELL AND THE BACKPACK BELT BUCKLE. THE COLOR RED APPEARS IN THE BACKPACK. THE COLOR YELLOW APPEARS IN THE FLOWER AND OUTLINE OF THE BACKPACK AS WELL AS THE BUTTON AND THE SHAPE OF THE STATE OF CALIFORNIA ON THE BACKPACK. THE COLOR GREEN APPEARS IN THE STEM AND LEAVES OF THE FLOWER AND IN THE BEAR'S EYES.

THE MARK CONSISTS OF A BROWN BEAR WITH A RED BACKPACK WITH A YELLOW OUTLINE OF THE STATE OF CALIFORNIA ON THE BACKPACK. THE BEAR IS HOLDING A YELLOW FLOWER WITH ONE HAND AND A BLUE DUMBBELL WITH THE OTHER HAND. THE IMAGE IS SET AGAINST A BLUE BACKGROUND.

FOR PROMOTING PUBLIC AWARENESS OF THE NEED FOR VOLUNTEERS THROUGH ENCOURAGING, FACILITATING AND RECOGNIZING VOLUNTEER EFFORTS (U.S. CLS. 100, 101 AND 102).

FIRST USE 8-25-2004; IN COMMERCE 8-25-2004.
CHRISIE B. KING, EXAMINING ATTORNEY

CLASS 35—(Continued).

SN 78-517,644. INTERO HOLDINGS, INC., DENVER, CO. FILED 11-16-2004.



OWNER OF U.S. REG. NOS. 2,764,317 AND 2,926,453.
NO CLAIM IS MADE TO THE EXCLUSIVE RIGHT TO USE "REAL ESTATE SERVICES", APART FROM THE MARK AS SHOWN.

THE MARK CONSISTS OF A 3-DIMENSIONAL DESIGN OF A COLUMN AND COLUMN CAP PRECEDING THE WORDS INTERO REAL ESTATE SERVICES. THE WORD INTERO IS ALL CAPITALIZED AND IN SERIF FONT, AND THE WORDS REAL ESTATE SERVICES ARE LOCATED DIRECTLY BELOW THE WORD INTERO, IN A SMALL SIZE ARIAL FONT.

THE ENGLISH TRANSLATION OF THE WORD INTERO IN THE MARK IS ENTIRE.

FOR REAL ESTATE BROKERAGE FRANCHISING SERVICES, NAMELY, RENDERING TECHNICAL ASSISTANCE TO OTHERS IN THE ESTABLISHMENT AND/OR OPERATION OF REAL ESTATE BROKERAGE BUSINESSES (U.S. CLS. 100, 101 AND 102).

MICHAEL TANNER, EXAMINING ATTORNEY

SN 78-517,667. CALIFORNIA SERVICE CORPS, SACRAMENTO, CA. FILED 11-16-2004.



THE COLORS BROWN, BLACK, BLUE, RED, YELLOW AND GREEN ARE CLAIMED AS A FEATURE OF THE MARK.

THE COLOR BROWN APPEARS IN THE BEAR. THE COLOR BLACK APPEARS IN THE BEAR'S NOSE AND THE OUTLINE OF THE BEAR, FLOWER AND DUMBBELL. THE COLOR BLUE APPEARS IN THE DUMBBELL, THE BACKPACK BELT BUCKLE, ALL THE WORDS AND THE BANDS/LINES ABOVE AND BELOW THE MARK. THE COLOR RED APPEARS IN THE BACKPACK. THE COLOR YELLOW APPEARS IN THE FLOWER, THE OUTLINE OF THE BACKPACK AS WELL AS THE BUTTON AND THE SHAPE OF THE STATE OF CALIFORNIA ON THE BACKPACK AND THE INSIDE PORTION OF THE LETTERS BEAR RESPONSIBILITY. THE COLOR GREEN APPEARS IN THE STEM AND LEAVES OF THE FLOWER AND IN THE BEAR'S EYES.

THE MARK CONSISTS OF A BROWN BEAR WITH A RED BACKPACK WITH A YELLOW OUTLINE OF THE STATE OF CALIFORNIA ON THE BACKPACK. THE BEAR IS HOLDING A YELLOW FLOWER WITH ONE HAND AND A BLUE DUMBBELL WITH THE OTHER HAND. THE IMAGE IS SET AGAINST A BLUE BACKGROUND, AND THE TEXTUAL ELEMENTS OF THE MARK SURROUND THE IMAGE.

FOR PROMOTING PUBLIC AWARENESS OF THE NEED FOR VOLUNTEERS THROUGH ENCOURAGING, FACILITATING, AND RECOGNIZING VOLUNTEER EFFORTS (U.S. CLS. 100, 101 AND 102).

FIRST USE 8-25-2004; IN COMMERCE 8-25-2004.
CHRISIE B. KING, EXAMINING ATTORNEY

CLASS 35—(Continued).

SN 78-517,773. THE TRUSTEES OF THE SHEET METAL INDUSTRY LABOR MANAGEMENT COOPERATION FUND, A DISTRICT OF COLUMBIA TRUST, THE TRUSTEES COMPRISING CHARLES D. CORBETT, RICHARD CRAMER SR., MICHAEL J. SULLIVAN AND THOMAS J. KELLY, ALL US CITIZENS, CHANTILLY, VA. FILED 11-16-2004.



FOR ASSOCIATION SERVICES, NAMELY PROMOTING LABOR AND MANAGEMENT INTERESTS OF THE SHEET METAL AND AIR CONDITIONING INDUSTRY (U.S. CLS. 100, 101 AND 102).

FIRST USE 9-22-2004; IN COMMERCE 9-22-2004.
JOHN HWANG, EXAMINING ATTORNEY

SN 78-518,026. PROFESSIONAL LIABILITY UNDERWRITING SOCIETY, MINNEAPOLIS, MN. FILED 11-16-2004.

THE QUINTESSENTIAL
SOURCE OF
INFORMATION AND
EDUCATION ON
PROFESSIONAL
LIABILITY

THE MARK CONSISTS OF STANDARD CHARACTERS WITHOUT CLAIM TO ANY PARTICULAR FONT, STYLE, SIZE, OR COLOR.

OWNER OF U.S. REG. NO. 2,523,680.
SEC. 2(F).

FOR ASSOCIATION SERVICES, NAMELY, PROMOTING THE INTERESTS OF PROFESSIONAL LIABILITY UNDERWRITERS (U.S. CLS. 100, 101 AND 102).

FIRST USE 1-0-1999; IN COMMERCE 1-0-1999.
ROBERT C. CLARK JR., EXAMINING ATTORNEY

CLASS 35—(Continued).

SN 78-518,459. WORLD WIDE INVESTMENTS, LAS VEGAS, NV. FILED 11-17-2004.



NO CLAIM IS MADE TO THE EXCLUSIVE RIGHT TO USE THE REPRESENTATION OF THE UNITED STATES AND "U.S. PROPERTY FOR SALE BY OWNER", APART FROM THE MARK AS SHOWN.

FOR ADVERTISING SERVICES, NAMELY PROMOTING PROPERTIES FOR SALE BY OWNER VIA THE INTERNET (U.S. CLS. 100, 101 AND 102).

FIRST USE 1-1-1988; IN COMMERCE 1-1-1988.
TRICIA SONNEBORN, EXAMINING ATTORNEY

SN 78-518,681. BLUEWATER AGENCY, LTD, ANNAPOLIS, MD. FILED 11-17-2004.

THE BEST IDEAS
COME OUT OF THE
BLUE

THE MARK CONSISTS OF STANDARD CHARACTERS WITHOUT CLAIM TO ANY PARTICULAR FONT, STYLE, SIZE, OR COLOR.

FOR STRATEGIC MARKETING AND ADVERTISING AGENCY SERVICES (U.S. CLS. 100, 101 AND 102).
LINDA M. KING, EXAMINING ATTORNEY

SN 78-518,898. GOODIES GALORE, INC., NASHUA, NH. FILED 11-17-2004.

Goodies Galore

FOR RETAIL STORE FEATURING JEWELRY, HANDBAGS, GLASSWARE, CANDLES, CANDLE HOLDERS, CARDS, PERSONAL HYGIENE, PAIN RELIEF, HOUSEWARE, GIFTWARE, STICKERS, TOYS, NOVELTIES, STONWARE, AND AN ASSORTMENT OF DOLLAR GOOD ITEMS (U.S. CLS. 100, 101 AND 102).

JENNIFER MARTIN, EXAMINING ATTORNEY

CLASS 35—(Continued).

SN 78-518,902. INFINITE PLACEMENTS, INC., BRENTWOOD, CA. FILED 11-17-2004.

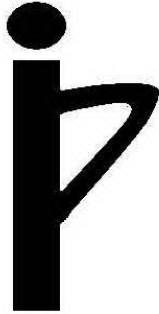

INFINITE PLACEMENTS

NO CLAIM IS MADE TO THE EXCLUSIVE RIGHT TO USE "PLACEMENTS", APART FROM THE MARK AS SHOWN.

FOR EMPLOYMENT RECRUITING, PLACEMENT AND STAFFING SERVICES FOR THE INSURANCE AND FINANCIAL INDUSTRY (U.S. CLS. 100, 101 AND 102).

FIRST USE 2-1-2004; IN COMMERCE 2-1-2004.
CHRISIE B. KING, EXAMINING ATTORNEY

CLASS 35—(Continued).

SN 78-519,114. PSYCHOGUYS, LLC, PITTSBURGH, PA. FILED 11-18-2004.

PSYCHOGUYS

THE MARK CONSISTS OF STANDARD CHARACTERS WITHOUT CLAIM TO ANY PARTICULAR FONT, STYLE, SIZE, OR COLOR.

FOR BUSINESS CONSULTING SERVICES, NAMELY, CONSULTING RELATING TO BUSINESS ORGANIZATION, BUSINESS CULTURE, MANAGEMENT, LEADERSHIP, HIRING, AND DEVELOPMENT; INDIVIDUAL AND GROUP EMPLOYMENT CONSULTING AND COUNSELING SERVICES; EMPLOYMENT CONSULTING SERVICES (U.S. CLS. 100, 101 AND 102).

DAWN HAN, EXAMINING ATTORNEY

SN 78-519,111. POSTREL, RICHARD, MIAMI BEACH, FL. FILED 11-18-2004.

POINTPOWER

THE MARK CONSISTS OF STANDARD CHARACTERS WITHOUT CLAIM TO ANY PARTICULAR FONT, STYLE, SIZE, OR COLOR.

FOR CUSTOMER LOYALTY SERVICES AND CUSTOMER CLUB SERVICES, FOR COMMERCIAL, PROMOTIONAL AND/OR ADVERTISING PURPOSES (U.S. CLS. 100, 101 AND 102).

DAWN HAN, EXAMINING ATTORNEY

SN 78-519,546. MARKETING SUPPORT, INCORPORATED, CHICAGO, IL. FILED 11-18-2004.

INSIGHT ACCESS

THE MARK CONSISTS OF STANDARD CHARACTERS WITHOUT CLAIM TO ANY PARTICULAR FONT, STYLE, SIZE, OR COLOR.

FOR MARKET RESEARCH SERVICES (U.S. CLS. 100, 101 AND 102).

SALLY SHIH, EXAMINING ATTORNEY

CLASS 35—(Continued).

SN 78-519,697. MCMACKIN, JULIE S., NEWPORT BEACH, CA. AND MCMACKIN, B. C., NEWPORT BEACH, CA. FILED 11-18-2004.

MOLLY BROWN'S

THE MARK CONSISTS OF STANDARD CHARACTERS WITHOUT CLAIM TO ANY PARTICULAR FONT, STYLE, SIZE, OR COLOR.

THE MARK DOES NOT IDENTIFY A LIVING INDIVIDUAL.

FOR RETAIL STORE SERVICES AND ONLINE RETAIL STORE SERVICES FEATURING SWIMWEAR (U.S. CLS. 100, 101 AND 102).

FIRST USE 7-12-1976; IN COMMERCE 7-12-1976.
MONTIA G. PRESSEY, EXAMINING ATTORNEY

CLASS 35—(Continued).

SN 78-519,821. USA FINANCIAL MARKETING CORPORATION, ADA, MI. FILED 11-19-2004.

**9 LITTLE KNOWN
MONEY TRAPS THAT
ROUTINELY COST
MANY RETIREES
THOUSANDS**

THE MARK CONSISTS OF STANDARD CHARACTERS WITHOUT CLAIM TO ANY PARTICULAR FONT, STYLE, SIZE, OR COLOR.

FOR BUSINESS MARKETING SERVICES, AND ORGANIZING MEETINGS, NAMELY, BUSINESS MEETING PLANNING FOR OTHERS (U.S. CLS. 100, 101 AND 102).

FIRST USE 2-5-2002; IN COMMERCE 2-5-2002.
GEOFFREY FOSDICK, EXAMINING ATTORNEY

SN 78-519,823. BID4ASSETS, INC., SILVER SPRING, MD. FILED 11-19-2004.

SN 78-519,711. MENARD, INC., EAU CLAIRE, WI. FILED 11-18-2004.

SHADES OF SUMMER

THE MARK CONSISTS OF STANDARD CHARACTERS WITHOUT CLAIM TO ANY PARTICULAR FONT, STYLE, SIZE, OR COLOR.

FOR RETAIL STORE SERVICES IN THE FIELDS OF LAWN FURNITURE, DECK CHAIRS, PLASTIC PICNIC DINNERWARE, CUPS, PLATES, CANDLES, PLAQUES, VASES, PLANTING POTS, BIRD HOUSES, AND STATUARY (U.S. CLS. 100, 101 AND 102).

ALICE SUE CARRUTHERS, EXAMINING ATTORNEY

LienPro

THE MARK CONSISTS OF STANDARD CHARACTERS WITHOUT CLAIM TO ANY PARTICULAR FONT, STYLE, SIZE, OR COLOR.

FOR PROVIDING INFORMATION REGARDING REAL ESTATE AUCTIONS VIA THE INTERNET (U.S. CLS. 100, 101 AND 102).

FIRST USE 11-15-2004; IN COMMERCE 11-15-2004.
APRIL L. RADEMACHER, EXAMINING ATTORNEY

CLASS 35—(Continued).

SN 78-519,938. MODERNISTA LTD., BOSTON, MA. FILED 11-19-2004.

CLASS 35—(Continued).

SN 78-520,015. REHABWORKS, LLC, HUNT VALLEY, MD. FILED 11-19-2004.

YOU DRIVE US

REHABPLUS

THE MARK CONSISTS OF STANDARD CHARACTERS WITHOUT CLAIM TO ANY PARTICULAR FONT, STYLE, SIZE, OR COLOR.

FOR ADVERTISING, INCLUDING PROMOTION RELATING TO THE SALE AND SERVICE OF MOTOR VEHICLES FOR THIRD PARTIES BY THE DISSEMINATION OF PRINTED ADVERTISING MATERIAL AND THE DISSEMINATION OF ADVERTISING MESSAGES ON TELEVISION, RADIO AND COMPUTER NETWORKS (U.S. CLS. 100, 101 AND 102).
JOHN HWANG, EXAMINING ATTORNEY

THE MARK CONSISTS OF STANDARD CHARACTERS WITHOUT CLAIM TO ANY PARTICULAR FONT, STYLE, SIZE, OR COLOR.

FOR CONSULTATION IN THE FIELD OF MANAGING HOSPITALS AND HEALTH CARE FACILITIES (U.S. CLS. 100, 101 AND 102).
FIRST USE 12-1-2000; IN COMMERCE 12-1-2000.
CHERYL CLAYTON, EXAMINING ATTORNEY

SN 78-520,070. OFFICE OF THE CHAIRMAN, IRVINE, CA. FILED 11-19-2004.

SN 78-519,997. REPLY! INC., ALAMO, CA. FILED 11-19-2004.

ROUND TABLE OF SUCCESS
IN THE BOARDROOM, ALL DIRECTORS ARE CREATED EQUAL

REALTYNOW.COM

THE MARK CONSISTS OF STANDARD CHARACTERS WITHOUT CLAIM TO ANY PARTICULAR FONT, STYLE, SIZE, OR COLOR.

FOR ONLINE REFERRAL SERVICES TO REAL ESTATE AGENTS; PROVIDING REFERRALS AND BUSINESS LEADS TO REAL ESTATE AGENTS (U.S. CLS. 100, 101 AND 102).
FIRST USE 11-1-2002; IN COMMERCE 11-1-2002.
VERNA BETH RIRIE, EXAMINING ATTORNEY

THE MARK CONSISTS OF STANDARD CHARACTERS WITHOUT CLAIM TO ANY PARTICULAR FONT, STYLE, SIZE, OR COLOR.

FOR BUSINESS CONSULTING AND EVALUATION FOR CORPORATE BOARDROOM MEMBERS AND BOARDROOM BUSINESS ACTIVITIES IN THE NATURE OF PROVIDING ONE ON ONE OR GROUP CONSULTING AND EVALUATION OF CORPORATE GOVERNANCE, BOARD LEADERSHIP AND DIRECTOR BUSINESS ROADMAPS FOR IMPROVING CORPORATE, BOARDROOM AND BUSINESS LEADERSHIP AND FUNCTIONALITY (U.S. CLS. 100, 101 AND 102).
CHRISTOPHER ADKINS, EXAMINING ATTORNEY

CLASS 35—(Continued).

SN 78-520,802. LSN, INC., ATLANTA, GA. FILED 11-22-2004.

TXT2SAVE

THE MARK CONSISTS OF STANDARD CHARACTERS WITHOUT CLAIM TO ANY PARTICULAR FONT, STYLE, SIZE, OR COLOR.

OWNER OF U.S. REG. NO. 2,924,400.

FOR ADVERTISING SERVICES, NAMELY, PROMOTING THE GOODS AND SERVICES OF OTHERS THROUGH THE WIRELESS DISTRIBUTION OF DISCOUNT COUPONS AND OFFERS (U.S. CLS. 100, 101 AND 102).

JEFF DEFORD, EXAMINING ATTORNEY

CLASS 35—(Continued).

SN 78-520,974. PHILACTOS ORIENTAL RUGS INC., DBA PAYLESS RUGS, MAMARONECK, NY. FILED 11-22-2004.

PAYLESS RUGS

THE MARK CONSISTS OF STANDARD CHARACTERS WITHOUT CLAIM TO ANY PARTICULAR FONT, STYLE, SIZE, OR COLOR.

NO CLAIM IS MADE TO THE EXCLUSIVE RIGHT TO USE "RUGS", APART FROM THE MARK AS SHOWN.

FOR RETAIL STORE SERVICES AND ONLINE RETAIL STORE SERVICES, FEATURING PAINTINGS, PILLOWS, RUGS, RUG PADS, STAIR RODS, WALL HANGER KITS AND WALL TAPESTRIES (U.S. CLS. 100, 101 AND 102).

FIRST USE 2-28-2002; IN COMMERCE 2-28-2002.

MARIA-VICTORIA SUAREZ, EXAMINING ATTORNEY

SN 78-521,008. BOURGEOIS, RANDALL, ALISO VIEJO, CA. AND BURNSIDE, TRACEY, ALISO VIEJO, CA. FILED 11-22-2004.

WHAT WOULD YOU DO WITH YOURS?

THE MARK CONSISTS OF STANDARD CHARACTERS WITHOUT CLAIM TO ANY PARTICULAR FONT, STYLE, SIZE, OR COLOR.

FOR ADVERTISING AND MARKETING SERVICES FOR CONSUMER PRODUCTS AND SERVICES (U.S. CLS. 100, 101 AND 102).

ESTHER BELENKER, EXAMINING ATTORNEY

SN 78-520,945. CIGNA INTELLECTUAL PROPERTY, INC., CLAYMONT, DE. FILED 11-22-2004.

BENEFITS ACCESS

THE MARK CONSISTS OF STANDARD CHARACTERS WITHOUT CLAIM TO ANY PARTICULAR FONT, STYLE, SIZE, OR COLOR.

OWNER OF U.S. REG. NO. 2,215,932.

NO CLAIM IS MADE TO THE EXCLUSIVE RIGHT TO USE BENEFITS, APART FROM THE MARK AS SHOWN.

FOR MEDICAL REFERRAL SERVICES; BUSINESS MANAGEMENT CONSULTATION SERVICES FOR THE INSURANCE INDUSTRY (U.S. CLS. 100, 101 AND 102).

BRIDGETT SMITH, EXAMINING ATTORNEY

SN 78-521,031. SMZ ENTERPRISES, DBA BAGEL CHATEAU, WESTFIELD, NJ. FILED 11-22-2004.



FOR RETAIL STORE SERVICES FEATURING BAGELS (U.S. CLS. 100, 101 AND 102).

FIRST USE 9-1-1990; IN COMMERCE 9-1-1990.

MICHELLE DUBOIS, EXAMINING ATTORNEY

CLASS 35—(Continued).

SN 78-521,071. ZONE INVESTMENT GROUP, INC., LAWRENCEVILLE, GA. FILED 11-22-2004.

POPTOP

THE MARK CONSISTS OF STANDARD CHARACTERS WITHOUT CLAIM TO ANY PARTICULAR FONT, STYLE, SIZE, OR COLOR.

FOR RETAIL STORE SERVICES FEATURING CONVENIENCE STORE ITEMS AND GASOLINE (U.S. CLS. 100, 101 AND 102).

BRIAN PINO, EXAMINING ATTORNEY

CLASS 35—(Continued).

SN 78-521,332. WINDOWLOGY FRANCHISE CORP., PLEASANTON, CA. FILED 11-22-2004.



OWNER OF U.S. REG. NO. 1,861,456.
THE STIPPLING IS FOR SHADING PURPOSES ONLY.
FOR FRANCHISED SALES REPRESENTATIVES IN THE FIELD OF WINDOW BLINDS AND WINDOW SHADES (U.S. CLS. 100, 101 AND 102).
FIRST USE 10-19-1991; IN COMMERCE 10-19-1991.
JOANNA DUKOVIC, EXAMINING ATTORNEY

SN 78-521,341. BURWELL INDUSTRIES, INC., LITTLETON, CO. FILED 11-22-2004.

LIFE LIBRARY

FLEETFLO

THE MARK CONSISTS OF STANDARD CHARACTERS WITHOUT CLAIM TO ANY PARTICULAR FONT, STYLE, SIZE, OR COLOR.

FOR AUTOMOBILE DISTRIBUTORSHIP SERVICES (U.S. CLS. 100, 101 AND 102).

CAROLYN CATALDO, EXAMINING ATTORNEY

THE MARK CONSISTS OF STANDARD CHARACTERS WITHOUT CLAIM TO ANY PARTICULAR FONT, STYLE, SIZE, OR COLOR.

FOR WHOLESALE AND RETAIL STORE, MAIL ORDER, AND COMPUTER ON-LINE ORDERING SERVICES FEATURING PERFUME, SACHETS, WARDROBE BOXES FOR HOLDING SACHETS, PICTURE FRAMES, INCENSE, CANDLES, BUBBLE BATH, HAND AND BODY LOTION, BODY POWDER, BEDDING, PAJAMAS, HAND BAGS, BOOTS AND STATIONARY (U.S. CLS. 100, 101 AND 102).

DAVID MURRAY, EXAMINING ATTORNEY

CLASS 35—(Continued).

SN 78-521,558. PERSHING INVESTMENTS LLC, NEWARK, DE. FILED 11-23-2004.

CLASS 35—(Continued).

SN 78-521,792. LAURA J. HAMER, PROSPECT, ME. FILED 11-23-2004.

Arf! and Running



THE MARK CONSISTS OF STANDARD CHARACTERS WITHOUT CLAIM TO ANY PARTICULAR FONT, STYLE, SIZE, OR COLOR.
FOR ON-LINE RETAIL STORE SERVICES FEATURING DOG AGILITY EQUIPMENT FOR TRAINING AND COMPETITION PURPOSES (U.S. CLS. 100, 101 AND 102).
FIRST USE 12-30-2002; IN COMMERCE 12-30-2002.
KEVIN DINALLO, EXAMINING ATTORNEY

THE STIPLING IN THE DRAWING IS FOR SHADING PURPOSES ONLY.
FOR BUSINESS RESEARCH AND CONSULTATION SERVICES, NAMELY MONITORING, TRACKING, EVALUATING AND DISPLAYING IN GRAPH FORM QUALITY CONTROL ASPECTS OF BUSINESS OPERATIONS TO MEASURE ENTERPRISE PERFORMANCE FUNCTIONS (U.S. CLS. 100, 101 AND 102).
SCOTT OSLICK, EXAMINING ATTORNEY

SN 78-521,827. BUILD-A-BEAR RETAIL MANAGEMENT, INC., ST. LOUIS, MO. FILED 11-23-2004.

BEARY CHARMING

THE MARK CONSISTS OF STANDARD CHARACTERS WITHOUT CLAIM TO ANY PARTICULAR FONT, STYLE, SIZE, OR COLOR.
FOR RETAIL STORE SERVICES IN THE FIELD OF JEWELRY AND TOY JEWELRY (U.S. CLS. 100, 101 AND 102).
JASON LOTT, EXAMINING ATTORNEY

SN 78-521,782. LDM GROUP, LLC, ST. LOUIS, MO. FILED 11-23-2004.

SN 78-521,870. LINDA ANGEL INVESTMENTS, LLC, DBA KIDOODLES, NORMAN, OK. FILED 11-23-2004.

ScriptGuide

KIDOODLES

THE MARK CONSISTS OF STANDARD CHARACTERS WITHOUT CLAIM TO ANY PARTICULAR FONT, STYLE, SIZE, OR COLOR.
FOR ADVERTISING RELATING TO PHARMACEUTICAL AND OVER-THE-COUNTER PRODUCTS IN A HEALTHCARE PROVIDER'S OFFICE OR FACILITY FOR PATIENT EDUCATIONAL AND INFORMATIONAL PURPOSES (U.S. CLS. 100, 101 AND 102).
GINA HAYES, EXAMINING ATTORNEY

THE MARK CONSISTS OF STANDARD CHARACTERS WITHOUT CLAIM TO ANY PARTICULAR FONT, STYLE, SIZE, OR COLOR.
FOR RETAIL STORE SERVICES PROVIDING CHILDREN'S EDUCATIONAL AND DEVELOPMENTAL TOYS, CRAFTS, GAMES, AND BOOKS (U.S. CLS. 100, 101 AND 102).
FIRST USE 11-1-1985; IN COMMERCE 11-1-1985.
DAWN HAN, EXAMINING ATTORNEY

CLASS 35—(Continued).

SN 78-521,879. REED ELSEVIER PROPERTIES INC., WILMINGTON, DE. FILED 11-23-2004.

CLASS 35—(Continued).

SN 78-522,012. INSTITUTE OF ENTREPRENURIAL THINKING, CINCINNATI, OH. FILED 11-23-2004.

QUALITY EXPO

THE MARK CONSISTS OF STANDARD CHARACTERS WITHOUT CLAIM TO ANY PARTICULAR FONT, STYLE, SIZE, OR COLOR.

OWNER OF U.S. REG. NO. 2,816,593.

NO CLAIM IS MADE TO THE EXCLUSIVE RIGHT TO USE "EXPO", APART FROM THE MARK AS SHOWN.

SEC. 2(F).

FOR ARRANGING, PROMOTING AND CONDUCTING TRADESHOWS, EXHIBITIONS, EXPOSITIONS AND FAIRS RELATING TO INNOVATIONS IN BUSINESS PROCESSES, MANAGEMENT AND MANUFACTURING; PROMOTING THE GOODS AND SERVICES OF OTHERS BY MEANS OF TRADESHOWS, EXHIBITIONS, EXPOSITIONS AND FAIRS (U.S. CLS. 100, 101 AND 102).

FIRST USE 4-0-1992; IN COMMERCE 4-0-1992.

DAWN HAN, EXAMINING ATTORNEY

COMSDA

THE MARK CONSISTS OF STANDARD CHARACTERS WITHOUT CLAIM TO ANY PARTICULAR FONT, STYLE, SIZE, OR COLOR.

FOR BUSINESS MANAGEMENT CONSULTING SERVICES (U.S. CLS. 100, 101 AND 102).

FIRST USE 9-1-2004; IN COMMERCE 9-1-2004.

MICHAEL KAZAZIAN, EXAMINING ATTORNEY

SN 78-521,880. MEMORIAL CITY PERSONNEL, LTD., HOUSTON, TX. FILED 11-23-2004.

SN 78-522,094. SPAINIT, LLC, EDINA, MN. FILED 11-23-2004.

MURRAY RESOURCES

THE MARK CONSISTS OF STANDARD CHARACTERS WITHOUT CLAIM TO ANY PARTICULAR FONT, STYLE, SIZE, OR COLOR.

NO CLAIM IS MADE TO THE EXCLUSIVE RIGHT TO USE "RESOURCES", APART FROM THE MARK AS SHOWN.

FOR EMPLOYMENT HIRING, STAFFING AND CAREER NETWORKING SERVICES; EMPLOYMENT COUNSELING AND RECRUITING SERVICES; EXECUTIVE SEARCH AND PLACEMENT SERVICES; CAREER PLACEMENT SERVICES; RESUME PREPARATION SERVICES; HUMAN RESOURCES CONSULTATION, NAMELY, PERFORMING EMPLOYEE ASSESSMENTS, BEHAVIORAL ASSESSMENTS, EMPLOYEE BACKGROUND CHECKS AND EMPLOYEE CRIMINAL CHECKS (U.S. CLS. 100, 101 AND 102).

FIRST USE 11-1-2000; IN COMMERCE 11-1-2000.

DAWN HAN, EXAMINING ATTORNEY

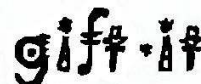

THE MARK CONSISTS OF THE WORDS IN FANCIFUL LETTERING.

FOR ON-LINE RETAIL STORE FEATURING CERAMIC SERVING PLATTERS, CERAMIC DISHES AND PLATES, BEVERAGE GLASSWARE AND BARWARE (U.S. CLS. 100, 101 AND 102).

FIRST USE 10-9-2004; IN COMMERCE 10-9-2004.

MATTHEW KLINE, EXAMINING ATTORNEY

CLASS 35—(Continued).

SN 78-522,160. PERFORMANCE MANAGEMENT CONSULTING, L.L.C., SLIDELL, LA. FILED 11-23-2004.



NO CLAIM IS MADE TO THE EXCLUSIVE RIGHT TO USE MANAGEMENT CONSULTING, LLC, APART FROM THE MARK AS SHOWN.

THE COLORS WHITE, BLUE AND GREEN ARE CLAIMED AS A FEATURE OF THE MARK.

THE COLOR WHITE APPEARS IN THE STYLIZED RUNNING PERSON; THE COLOR BLUE APPEARS IN THE CENTER RECTANGLE AND ALL THE WORDING; AND THE COLOR GREEN APPEARS IN THE TWO OUTSIDE RECTANGLES.

THE MARK CONSISTS OF "P" AND "E" OF THE WORK "PERFORMANCE" ENLARGED. THE MARK CONSISTS, IN PART, OF A STYLIZED RUNNING PERSON IN FRONT OF THREE RECTANGLES.

FOR BUSINESS MANAGEMENT AND CONSULTING, AND HELP IN THE MANAGEMENT OF BUSINESS AFFAIRS OR COMMERCIAL FUNCTIONS OF AN INDUSTRIAL OR COMMERCIAL ENTERPRISE (U.S. CLS. 100, 101 AND 102).

FIRST USE 4-1-2004; IN COMMERCE 4-1-2004.
WILLIAM VERHOSEK, EXAMINING ATTORNEY

CLASS 35—(Continued).

SN 78-522,702. BUSCH'S, INC., ANN ARBOR, MI. FILED 11-24-2004.

**FRESH. FOOD.
IDEAS.**

THE MARK CONSISTS OF STANDARD CHARACTERS WITHOUT CLAIM TO ANY PARTICULAR FONT, STYLE, SIZE, OR COLOR.

NO CLAIM IS MADE TO THE EXCLUSIVE RIGHT TO USE "FRESH. FOOD.", APART FROM THE MARK AS SHOWN.

FOR RETAIL GROCERY STORE SERVICES (U.S. CLS. 100, 101 AND 102).

FIRST USE 9-15-2004; IN COMMERCE 9-15-2004.
ESTHER BELENKER, EXAMINING ATTORNEY

SN 78-522,391. BUILDERS ASSOCIATION OF THE TWIN CITIES, ROSEVILLE, MN. FILED 11-24-2004.

**WHERE DREAM HOMES
COME TRUE**

THE MARK CONSISTS OF STANDARD CHARACTERS WITHOUT CLAIM TO ANY PARTICULAR FONT, STYLE, SIZE, OR COLOR.

FOR PROMOTING THE GOODS AND SERVICES OF MEMBERS OF THE HOME BUILDING CONSTRUCTION INDUSTRY THROUGH THE PRESENTATION OF NEW AND REMODELED HOMES TO THE PUBLIC; AND PROMOTING THE SERVICES OF BUILDERS BY ORGANIZING AND ARRANGING HOME TOURS (U.S. CLS. 100, 101 AND 102).

FIRST USE 12-31-1995; IN COMMERCE 12-31-1995.
ZACHARY BELLO, EXAMINING ATTORNEY

SN 78-522,811. RKS DESIGN INTERNATIONAL, INC., THOUSAND OAKS, CA. FILED 11-24-2004.

ON 2 SALES

THE MARK CONSISTS OF STANDARD CHARACTERS WITHOUT CLAIM TO ANY PARTICULAR FONT, STYLE, SIZE, OR COLOR.

NO CLAIM IS MADE TO THE EXCLUSIVE RIGHT TO USE "SALES", APART FROM THE MARK AS SHOWN.

FOR PRODUCT MERCHANDISING (U.S. CLS. 100, 101 AND 102).

DAWN HAN, EXAMINING ATTORNEY

CLASS 35—(Continued).

SN 78-522,851. CROWN VALLEY WINERY INC., STE. GENEVIEVE, MO. FILED 11-24-2004.

**Crown Valley
Winery**

THE MARK CONSISTS OF STANDARD CHARACTERS WITHOUT CLAIM TO ANY PARTICULAR FONT, STYLE, SIZE, OR COLOR.

NO CLAIM IS MADE TO THE EXCLUSIVE RIGHT TO USE "WINERY", APART FROM THE MARK AS SHOWN.

FOR WINERY SERVICES, NAMELY WINERY RETAIL STORE SERVICES FEATURING WINE (U.S. CLS. 100, 101 AND 102).

FIRST USE 4-1-1999; IN COMMERCE 4-1-1999.

MARK RADEMACHER, EXAMINING ATTORNEY

SN 78-522,896. PIZZERIA UNO CORPORATION, WILMINGTON, DE. FILED 11-24-2004.

CLUB UNO

THE MARK CONSISTS OF STANDARD CHARACTERS WITHOUT CLAIM TO ANY PARTICULAR FONT, STYLE, SIZE, OR COLOR.

OWNER OF U.S. REG. NOS. 1,089,458, 1,329,014 AND OTHERS.

NO CLAIM IS MADE TO THE EXCLUSIVE RIGHT TO USE "CLUB", APART FROM THE MARK AS SHOWN.

THE ENGLISH TRANSLATION OF THE WORD "UNO" IN THE MARK IS "ONE."

FOR CUSTOMER LOYALTY SERVICES FOR RESTAURANT CUSTOMERS FOR COMMERCIAL, PROMOTIONAL AND ADVERTISING PURPOSES PROVIDED VIA E-MAIL, THE INTERNET AND OTHER MEANS OF COMMUNICATION (U.S. CLS. 100, 101 AND 102).

MARCIE MILONE, EXAMINING ATTORNEY

CLASS 35—(Continued).

SN 78-523,138. KERBECK MOTORS, INC., PLEASANTVILLE, NJ. FILED 11-26-2004.

KERBECK

THE MARK CONSISTS OF STANDARD CHARACTERS WITHOUT CLAIM TO ANY PARTICULAR FONT, STYLE, SIZE, OR COLOR.

SEC. 2(F).

FOR AUTOMOBILE DEALERSHIPS (U.S. CLS. 100, 101 AND 102).

FIRST USE 0-0-1902; IN COMMERCE 0-0-1902.

LAURA KOVAISKY, EXAMINING ATTORNEY

SN 78-523,217. U-SPY, LLC, ORLANDO, FL. FILED 11-27-2004.

U-SPY

THE MARK CONSISTS OF STANDARD CHARACTERS WITHOUT CLAIM TO ANY PARTICULAR FONT, STYLE, SIZE, OR COLOR.

OWNER OF U.S. REG. NO. 1,877,219.

FOR RETAIL STORE SERVICES, MAIL ORDER CATALOG SERVICES, ONLINE RETAIL SERVICES, WHOLESALE DISTRIBUTION SERVICES, ALL SERVICES IN THE FIELD OF SECURITY, SURVEILLANCE AND PROTECTION (U.S. CLS. 100, 101 AND 102).

FIRST USE 9-0-1993; IN COMMERCE 10-0-1993.

WILLIAM P. SHANAHAN, EXAMINING ATTORNEY

CLASS 35—(Continued).

SN 78-523,218. U-SPY, LLC, ORLANDO, FL. FILED 11-27-2004.

CLASS 35—(Continued).

SN 78-523,633. BELMONT, JUDITH, ALLENTOWN, PA. FILED 11-29-2004.

U-SPY STORE

THE MARK CONSISTS OF STANDARD CHARACTERS WITHOUT CLAIM TO ANY PARTICULAR FONT, STYLE, SIZE, OR COLOR.

OWNER OF U.S. REG. NO. 1,877,219.

NO CLAIM IS MADE TO THE EXCLUSIVE RIGHT TO USE "STORE", APART FROM THE MARK AS SHOWN.

FOR RETAIL STORE SERVICES, MAIL ORDER CATALOG SERVICES, ONLINE RETAIL SERVICES, WHOLESALE DISTRIBUTION SERVICES, ALL SERVICES IN THE FIELD OF SECURITY, SURVEILLANCE AND PROTECTION (U.S. CLS. 100, 101 AND 102).

FIRST USE 9-0-1993; IN COMMERCE 10-0-1993.

WILLIAM P. SHANAHAN, EXAMINING ATTORNEY

WORKSITE INSIGHTS

THE MARK CONSISTS OF STANDARD CHARACTERS WITHOUT CLAIM TO ANY PARTICULAR FONT, STYLE, SIZE, OR COLOR.

FOR BUSINESS CONSULTATION FOR EMPLOYEE DEVELOPMENT AND PERFORMANCE (U.S. CLS. 100, 101 AND 102).

JOHN E. MICHOS, EXAMINING ATTORNEY

SN 78-523,741. MW COACHING AND CONSULTING, INC., LITTLETON, CO. AND POSITIVE IMPACT, LLC, POINT RICHMOND, CA. FILED 11-29-2004.

SN 78-523,301. SAMUEL LINDSAY & COMPANY LLC, ATHENS, GA. FILED 11-27-2004.

Set Your Table

THE MARK CONSISTS OF STANDARD CHARACTERS WITHOUT CLAIM TO ANY PARTICULAR FONT, STYLE, SIZE, OR COLOR.

FOR RETAIL STORE SERVICES FEATURING FLATWARE, SILVERWARE AND CUTLERY WITH ACCESSORIES FOR FINE DINING (U.S. CLS. 100, 101 AND 102).

SUSAN HAYASH, EXAMINING ATTORNEY

Integral Intelligence

THE MARK CONSISTS OF STANDARD CHARACTERS WITHOUT CLAIM TO ANY PARTICULAR FONT, STYLE, SIZE, OR COLOR.

FOR BUSINESS MANAGEMENT CONSULTATION IN THE FIELD OF EXECUTIVE AND LEADERSHIP DEVELOPMENT (U.S. CLS. 100, 101 AND 102).

SEAN DWYER, EXAMINING ATTORNEY

CLASS 35—(Continued).

SN 78-523,774. BEHAVIOR MANAGEMENT ASSOCIATES, INC., CLEVELAND, OH. FILED 11-29-2004.

Organizational MRI

THE MARK CONSISTS OF STANDARD CHARACTERS WITHOUT CLAIM TO ANY PARTICULAR FONT, STYLE, SIZE, OR COLOR.

NO CLAIM IS MADE TO THE EXCLUSIVE RIGHT TO USE "ORGANIZATIONAL", APART FROM THE MARK AS SHOWN.

FOR TESTING, ASSESSMENT, SCORING AND REPORTING SERVICES RELATING TO BUSINESS ORGANIZATION AND PERSONNEL RESOURCES; CONSULTATION SERVICES IN THE FIELD OF BUSINESS ORGANIZATION, MANAGEMENT AND PERSONNEL RESOURCES, AND BEHAVIORAL HEALTHCARE (U.S. CLS. 100, 101 AND 102).

NAAKWAMA ANKRAH, EXAMINING ATTORNEY

SN 78-523,919. SOUTHWEST MEDICAL EXAMINATION SERVICES, INC., DALLAS, TX. FILED 11-29-2004.



OWNER OF U.S. REG. NO. 1,902,933.

NO CLAIM IS MADE TO THE EXCLUSIVE RIGHT TO USE "SOUTHWEST MEDICAL EXAMINATION SERVICES" AND THE CADUCEUS SYMBOL, APART FROM THE MARK AS SHOWN.

FOR NON-MEDICAL BUSINESS AND BUSINESS OFFICE MANAGEMENT, BOOKKEEPING AND ACCOUNTING SERVICES RENDERED TO INDEPENDENTLY CONTRACTING MEDICAL EVALUATIVE PHYSICIANS; PROVIDING FACILITIES FOR USE BY INDEPENDENTLY CONTRACTING MEDICAL EVALUATIVE PHYSICIANS OF OFFICE EQUIPMENT AND MACHINERY; AND REPORT AND RECORD TRANSCRIPTION SERVICES RENDERED TO INDEPENDENTLY CONTRACTING MEDICAL EVALUATIVE PHYSICIANS (U.S. CLS. 100, 101 AND 102).

FIRST USE 10-25-2001; IN COMMERCE 10-25-2001.

ANNE E. GUSTASON, EXAMINING ATTORNEY

CLASS 35—(Continued).

SN 78-524,226. QUARTER CORNER, INC., WEST PALM BEACH, FL. FILED 11-30-2004.

QUARTER CORNER

THE MARK CONSISTS OF STANDARD CHARACTERS WITHOUT CLAIM TO ANY PARTICULAR FONT, STYLE, SIZE, OR COLOR.

FOR RETAIL DEPARTMENT STORE SERVICES (U.S. CLS. 100, 101 AND 102).

ALICE BENMAMAN, EXAMINING ATTORNEY

SN 78-524,306. MIKE, CECIL ANTHONY, NEW YORK, NY. FILED 11-30-2004.

BedChamber

THE MARK CONSISTS OF STANDARD CHARACTERS WITHOUT CLAIM TO ANY PARTICULAR FONT, STYLE, SIZE, OR COLOR.

FOR RETAIL STORE, MAIL ORDER AND COMPUTER ON-LINE RETAIL SERVICES FEATURING AND IN THE FIELDS OF LINEN PRODUCTS, HOME FURNISHINGS, TOYS, BOOKS, HOME FURNITURE, HOUSEWARES, HOUSE PLANTS, KITCHEN APPLIANCES, OFFICE SUPPLIES, KNAPSACKS, LUGGAGE, LAMPS, SOAPS, LOTIONS, WALL DECOR, WINDOW DECOR, CRIBS, TODDLER BEDS, BABY WALKERS, BABY BOUNCERS, BABY CARE PRODUCTS, TOOTHBRUSHES, KITCHEN ACCESSORIES, BATHROOM ACCESSORIES, AND OTHER HOUSEHOLD ACCESSORIES, NOVELTY ITEMS, PICTURE FRAMES, CANDLES, AROMATHERAPY PRODUCTS, POTPOURRI, DESKTOP ELECTRONICS, UMBRELLAS, APPAREL, FABRICS, YARNS, RUGS, SHEETS, TOWELS, BLANKETS, PILLOWS, TABLECLOTHS, COMFORTERS, CURTAINS, DRAPERIES AND DRAPERY HARDWARE, NOTIONS, PATTERNS, MATTRESSES, BEDSPREADS AND SHOWER CURTAINS (U.S. CLS. 100, 101 AND 102).

TARAH HARDY, EXAMINING ATTORNEY

CLASS 35—(Continued).

SN 78-525,083. GRAB, MARTIN, ALBANY, NY. FILED 12-1-2004.

CLASS 35—(Continued).

SN 78-525,506. DANIEL J. HORABURDA, MIDDLEVILLE, MI. FILED 12-1-2004.

FLITE

PRAYING TWICE

THE MARK CONSISTS OF STANDARD CHARACTERS WITHOUT CLAIM TO ANY PARTICULAR FONT, STYLE, SIZE, OR COLOR.

FOR ON-LINE RETAIL STORE SERVICES FEATURING DOWNLOADABLE PRE-RECORDED RELIGIOUS MUSIC (U.S. CLS. 100, 101 AND 102).

SCOTT OSLICK, EXAMINING ATTORNEY

THE MARK CONSISTS OF STANDARD CHARACTERS WITHOUT CLAIM TO ANY PARTICULAR FONT, STYLE, SIZE, OR COLOR.

FOR BUSINESS CONSULTATION IN THE FIELD OF BUSINESS SOLUTIONS AND BUSINESS TECHNOLOGY (U.S. CLS. 100, 101 AND 102).

KATRINA EDGE, EXAMINING ATTORNEY

SN 78-525,720. AMERICAN SEAFOODS GROUP LLC, SEATTLE, WA. FILED 12-2-2004.

SN 78-525,274. CATTELL, DIERDRE, BEAUMONT, TX. FILED 12-1-2004.

**Clear Lakes
Aquaculture**

myopenhouse.com

THE MARK CONSISTS OF STANDARD CHARACTERS WITHOUT CLAIM TO ANY PARTICULAR FONT, STYLE, SIZE, OR COLOR.

NO CLAIM IS MADE TO THE EXCLUSIVE RIGHT TO USE "AQUACULTURE", APART FROM THE MARK AS SHOWN.

FOR WHOLESALE DISTRIBUTORSHIP FEATURING PROCESSED AND UNPROCESSED FISH AND FISH PRODUCTS (U.S. CLS. 100, 101 AND 102).

RUSS HERMAN, EXAMINING ATTORNEY

THE MARK CONSISTS OF STANDARD CHARACTERS WITHOUT CLAIM TO ANY PARTICULAR FONT, STYLE, SIZE, OR COLOR.

FOR REAL ESTATE ADVERTISING SERVICES (U.S. CLS. 100, 101 AND 102).

JEAN IM, EXAMINING ATTORNEY

CLASS 35—(Continued).

SN 78-525,770. BEST LISTING BID, LLC, ST. LOUIS, MO. FILED 12-2-2004.

HUNGRYAGENT.COM

THE MARK CONSISTS OF STANDARD CHARACTERS WITHOUT CLAIM TO ANY PARTICULAR FONT, STYLE, SIZE, OR COLOR.

FOR BUSINESS SERVICES, NAMELY, MATCHING CONSUMERS WITH REAL ESTATE PROFESSIONALS IN THE FIELD OF REAL ESTATE SERVICES VIA A GLOBAL COMPUTER NETWORK (U.S. CLS. 100, 101 AND 102).

ELIZABETH PIGNATELLO, EXAMINING ATTORNEY

SN 78-526,012. DEUTSCHE TELEKOM AG, BONN, FED REP GERMANY, FILED 12-2-2004.

**T-Mobile Data
Connect**

THE MARK CONSISTS OF STANDARD CHARACTERS WITHOUT CLAIM TO ANY PARTICULAR FONT, STYLE, SIZE, OR COLOR.

OWNER OF FED REP GERMANY REG. NO. 30433157, DATED 7-20-2004, EXPIRES 6-30-2014.

OWNER OF U.S. REG. NOS. 2,282,432 AND 2,889,632. NO CLAIM IS MADE TO THE EXCLUSIVE RIGHT TO USE "DATA", APART FROM THE MARK AS SHOWN.

FOR ADVERTISING SERVICES, NAMELY, PREPARING AND PLACING ADVERTISEMENTS FOR OTHERS PROMOTING THE GOODS AND SERVICES OF OTHERS THROUGH PRINTED ADVERTISING, PRINTED DIRECTORIES, THROUGH ENCODED MEDIA, THROUGH THE DISSEMINATION OF PROMOTIONAL MATERIALS, THROUGH DIRECT MAIL ADVERTISING, THROUGH ELECTRONIC BILLBOARD ADVERTISING, PREPARING AUDIO-VISUAL PRESENTATIONS FOR USE IN ADVERTISING; BUSINESS MANAGEMENT SERVICES, NAMELY, BUSINESS APPRAISALS, BUSINESS AUDITING, PROVIDING BUSINESS INFORMATION, NAMELY, PREPARING BUSINESS REPORTS AND CONDUCTING BUSINESS RESEARCH, ANALYSIS AND SURVEYS, BUSINESS MANAGEMENT PLANNING, BUSINESS MANAGEMENT CONSULTATION, BUSINESS MANAGEMENT SUPERVISION, CONDUCTING BUSINESS NETWORKING FOR OTHERS; BUSINESS MANAGEMENT AND CONSULTING SERVICES, EXCLUDING AGRICULTURAL BUSINESS MANAGEMENT AND CONSULTING SERVICES; PROVIDING INFORMATION VIA THE TELEPHONE AND THE GLOBAL COMMUNICATION NETWORKS IN THE FIELD OF ADVERTISING AND BUSINESS MARKETING; PROFESSIONAL CONSULTANCY IN THE FIELD OF DATA PROCESSING (U.S. CLS. 100, 101 AND 102).

LAURIE MAYES, EXAMINING ATTORNEY

CLASS 35—(Continued).

SN 78-526,299. SPECIALTY MERCHANDISE CORPORATION, CHATSWORTH, CA. FILED 12-2-2004.

**SUMMERFIELD
TERRACE**

THE MARK CONSISTS OF STANDARD CHARACTERS WITHOUT CLAIM TO ANY PARTICULAR FONT, STYLE, SIZE, OR COLOR.

FOR MAIL ORDER CATALOG SERVICES FEATURING GIFTWARE, NOVELTIES, COLLECTIBLES, HOUSEWARES, DOLLS, TOYS, GAMES, AND SPORTING GOODS; FOUNTAINS; SCULPTURES; LANTERNS; GARDEN ITEMS; GARDEN PLAQUES; FURNITURE; CHERUBS; PLANTERS; SUNCATCHERS; WIND-CHIMES; WEATHER VANES; BIRDHOUSES; BIRDBATHS; BIRDFEEDERS; HAMMOCKS; PATRIOTIC ITEMS; INCENSE ITEMS; METAL SCULPTURES; THERMOMETERS; CLOCKS; WALL DECOR; VASES; BOWLS; PLATES; CURTAINS; PILLOWS; TABLE CLOTHS; THROWS; SHELVES; TABLES; SCULPTURES; DESK ACCESSORIES; BOOKENDS; BENCHES; PORCELAIN ITEMS; TEA ACCESSORIES; CORK ITEMS; SCREENS; WINE RACKS; WALL PLAQUES; PLANTSTANDS; COAT HANGERS; SCREENS; CABINETS; MAGAZINE RACKS; POTPOURRI; NAUTICAL ITEMS; LIGHTHOUSES; CHICKEN AND ROOSTERS DECORATIVE ITEMS; KITCHEN ITEMS; COOKWARE; TOOLS; LUGGAGE; MASSAGERS; CAMPING PRODUCTS; ALL FOCUSED ON HOME AND GARDEN DECOR (U.S. CLS. 100, 101 AND 102).

FLORENTINA BLANDU, EXAMINING ATTORNEY

SN 78-526,300. SPECIALTY MERCHANDISE CORPORATION, CHATSWORTH, CA. FILED 12-2-2004.

SUNRISE CREEK

THE MARK CONSISTS OF STANDARD CHARACTERS WITHOUT CLAIM TO ANY PARTICULAR FONT, STYLE, SIZE, OR COLOR.

FOR MAIL ORDER CATALOG SERVICES FEATURING PERSONAL CARE, BATH AND BODY PRODUCTS; GIFTWARE; SPA-RELATED ITEMS; HOUSEWARES; HOME DECOR PRODUCTS; GARDEN WARES; JEWELRY (U.S. CLS. 100, 101 AND 102).

FLORENTINA BLANDU, EXAMINING ATTORNEY

CLASS 35—(Continued).

SN 78-526,805. SARA LEE CORPORATION, WINSTON-SALEM, NC. FILED 12-3-2004.

CLASS 35—(Continued).

SN 78-528,176. PLASTIC POINTS, L.P., ARLINGTON, TX. FILED 12-7-2004.

VISR

THE MARK CONSISTS OF STANDARD CHARACTERS WITHOUT CLAIM TO ANY PARTICULAR FONT, STYLE, SIZE, OR COLOR.

FOR ON-LINE RETAIL STORE SERVICES FEATURING APPAREL AND ACCESSORIES, PERSONAL CARE PRODUCTS, AND HOME FURNISHINGS (U.S. CLS. 100, 101 AND 102).

LANA PHAM, EXAMINING ATTORNEY

PLASTIC POINTS

THE MARK CONSISTS OF STANDARD CHARACTERS WITHOUT CLAIM TO ANY PARTICULAR FONT, STYLE, SIZE, OR COLOR.

NO CLAIM IS MADE TO THE EXCLUSIVE RIGHT TO USE "POINTS", APART FROM THE MARK AS SHOWN.

FOR PROMOTING THE USE OF CREDIT CARD ACCOUNTS BY ADMINISTERING INCENTIVE AWARD PROGRAMS (U.S. CLS. 100, 101 AND 102).

DAVID MURRAY, EXAMINING ATTORNEY

SN 78-528,267. SPARKS INDUSTRIES, ROCHESTER, MI. FILED 12-7-2004.

SN 78-526,817. MOSTER & WYNNE P.C., AUSTIN, TX. FILED 12-3-2004.

COUNSEL SELECT

THE MARK CONSISTS OF STANDARD CHARACTERS WITHOUT CLAIM TO ANY PARTICULAR FONT, STYLE, SIZE, OR COLOR.

FOR BUSINESS MANAGEMENT AND CONSULTING SERVICES, NAMELY, PROVIDING CUSTOMIZED OR STANDARDIZED DOCUMENTS, FORMS, PROCEDURES, PLANS, INTELLECTUAL PROPERTY, PERSONNEL, AND BUSINESS ADVICE TO ASSIST CLIENTS WITH THE ESTABLISHMENT OF PROFESSIONAL SERVICE OFFICES SUCH AS LAW OFFICES, ACCOUNTING OFFICES AND THE LIKE (U.S. CLS. 100, 101 AND 102).

GIANCARLO CASTRO, EXAMINING ATTORNEY

FacilityMax

THE MARK CONSISTS OF STANDARD CHARACTERS WITHOUT CLAIM TO ANY PARTICULAR FONT, STYLE, SIZE, OR COLOR.

FOR ON-LINE ORDERING SERVICES FEATURING COMMERCIAL OFFICE REPLACEMENT HARDWARE AND EQUIPMENT (U.S. CLS. 100, 101 AND 102).

TEJBIR SINGH, EXAMINING ATTORNEY

CLASS 35—(Continued).

SN 78-529,663. BRAND ALCHEMY, INC., PHOENIXVILLE, PA. FILED 12-9-2004.

Brand Alchemy

THE MARK CONSISTS OF STANDARD CHARACTERS WITHOUT CLAIM TO ANY PARTICULAR FONT, STYLE, SIZE, OR COLOR.

NO CLAIM IS MADE TO THE EXCLUSIVE RIGHT TO USE "BRAND", APART FROM THE MARK AS SHOWN.

FOR BUSINESS MARKETING CONSULTING SERVICES, NAMELY, BRAND STRATEGY AND MARKET RESEARCH (U.S. CLS. 100, 101 AND 102).
RICHARD A. STRASER, EXAMINING ATTORNEY

CLASS 35—(Continued).

SN 78-530,413. OFF-PRICE SPECIALIST CENTER, MILWAUKEE, WI. FILED 12-10-2004.



OWNER OF U.S. REG. NOS. 2,359,597, 2,359,601 AND 2,370,258.

NO CLAIM IS MADE TO THE EXCLUSIVE RIGHT TO USE "OFF PRICE SPECIALIST SHOW HOME GOODS", APART FROM THE MARK AS SHOWN.

THE MARK CONSISTS OF THE WORDS WITH A PICTURE OF A PENNY ABOVE THE "I" IN THE WORD PRICE.

FOR ARRANGING AND CONDUCTING TRADE SHOW EXHIBITIONS IN THE FIELD OF DISCOUNT MERCHANDISE AND HOME GOODS (U.S. CLS. 100, 101 AND 102).

FIRST USE 11-20-2003; IN COMMERCE 11-20-2003.
ELLEN BURNS, EXAMINING ATTORNEY

SN 78-530,422. OFF-PRICE SPECIALIST CENTER, BROOKFIELD, WI. FILED 12-10-2004.

SN 78-530,312. DOE ANDERSON INC., LOUISVILLE, KY. FILED 12-10-2004.



FOR ADVERTISING RESEARCH INVOLVING CONSUMER BEHAVIORAL MAPPING (U.S. CLS. 100, 101 AND 102).
KARANENDRA S. CHHINA, EXAMINING ATTORNEY



OWNER OF U.S. REG. NOS. 2,359,597, 2,359,601 AND 2,370,258.

NO CLAIM IS MADE TO THE EXCLUSIVE RIGHT TO USE "OFF PRICE SPECIALIST SHOW", APART FROM THE MARK AS SHOWN.

THE MARK CONSISTS OF THE WORDS WITH A PICTURE OF A PENNY ABOVE THE "I" IN PRICE.

FOR ARRANGING AND CONDUCTING TRADE SHOW EXHIBITIONS IN THE FIELD OF DISCOUNT MERCHANDISE AND APPAREL (U.S. CLS. 100, 101 AND 102).

FIRST USE 11-20-2003; IN COMMERCE 11-20-2003.
ELLEN BURNS, EXAMINING ATTORNEY

CLASS 35—(Continued).

SN 78-530,474. BUSSEY, BARBARA, FAIR OAKS, CA. FILED 12-10-2004.



NO CLAIM IS MADE TO THE EXCLUSIVE RIGHT TO USE "AUDIO MARKETING", APART FROM THE MARK AS SHOWN.

THE COLOR(S) BLACK, RED AND GREY IS/ARE CLAIMED AS A FEATURE OF THE MARK.

THE COLOR RED APPEARS IN THE LETTERING PERFORMANCE; THE COLOR BLACK APPEARS IN THE LETTERING AUDIO MARKETING, AN UNDERLINE UNDER THE LETTERING PERFORMANCE, AND THE DESIGN OF A MICROPHONE; AND THE COLOR GRAY APPEARS INSIDE THE DESIGN OF THE MICROPHONE.

THE MARK CONSISTS OF A DESIGN OF A MICROPHONE, THE STYLIZED LETTERING PERFORMANCE AUDIO MARKETING, AND A LINE BETWEEN THE LETTERING PERFORMANCE AND AUDIO MARKETING.

FOR CREATING PROMOTIONAL TELEPHONE MESSAGES FOR ORGANIZATIONS, EXCLUDING ORGANIZATIONS IN THE FIELD OF AGRICULTURAL GRAIN, THAT PLAY WHILE CUSTOMERS WAIT ON HOLD (U.S. CLS. 100, 101 AND 102).

FIRST USE 10-20-2004; IN COMMERCE 10-20-2004.

ANDREA K. NADELMAN, EXAMINING ATTORNEY

SN 78-531,195. CARFAX, INC., FAIRFAX, VA. FILED 12-13-2004.

CARFAX Hot Listings

OWNER OF U.S. REG. NOS. 1,589,438, 2,463,326 AND 2,515,290.

NO CLAIM IS MADE TO THE EXCLUSIVE RIGHT TO USE "LISTINGS", APART FROM THE MARK AS SHOWN.

THE MARK CONSISTS OF THE WORD CARFAX IN CAPITALS, THE WORD HOT ENGULFED IN FLAMES WITH ONLY THE H CAPITALIZED AND THE WORD LISTINGS WITH ONLY THE L CAPITALIZED.

FOR PROVIDING INFORMATION TO CONSUMERS ABOUT AUTOMOBILES FOR SALE BY MEANS OF THE INTERNET AND VIA E-MAIL (U.S. CLS. 100, 101 AND 102).

FIRST USE 6-1-2004; IN COMMERCE 6-1-2004.

JULIE WATSON, EXAMINING ATTORNEY

CLASS 35—(Continued).

SN 78-531,387. STRATEGIC CAREERS.COM CORP., HOUSTON, TX. FILED 12-13-2004.

STRATEGIC CAREERS

THE MARK CONSISTS OF STANDARD CHARACTERS WITHOUT CLAIM TO ANY PARTICULAR FONT, STYLE, SIZE, OR COLOR.

NO CLAIM IS MADE TO THE EXCLUSIVE RIGHT TO USE "CAREERS", APART FROM THE MARK AS SHOWN. SEC. 2(F).

FOR EMPLOYMENT HIRING, RECRUITING, PLACEMENT, STAFFING, CAREER NETWORKING SERVICES, AND HUMAN RESOURCES CONSULTATION AND MANAGEMENT (U.S. CLS. 100, 101 AND 102).

FIRST USE 1-1-2000; IN COMMERCE 1-1-2000.

ANDREA SAUNDERS, EXAMINING ATTORNEY

SN 78-533,597. HIRSCH, MARK F., ANCHORAGE, AK. AND HAHN, RANDY A., ANCHORAGE, AK. FILED 12-16-2004.

GOOD2GO AUTO YOUR RENT TO OWN DEALER

THE MARK CONSISTS OF STANDARD CHARACTERS WITHOUT CLAIM TO ANY PARTICULAR FONT, STYLE, SIZE, OR COLOR.

NO CLAIM IS MADE TO THE EXCLUSIVE RIGHT TO USE "AUTO", APART FROM THE MARK AS SHOWN.

FOR AUTOMOBILE DEALERSHIP SERVICES, NAMELY, PROVIDING RENT-TO-OWN PROGRAMS AS MEANS TO PURCHASE USED AUTOMOBILES (U.S. CLS. 100, 101 AND 102).

FIRST USE 1-1-2004; IN COMMERCE 1-1-2004.

WINSTON FOLMAR, EXAMINING ATTORNEY

SN 78-533,776. CASTLE MOUNTAIN GROUP LLC, CHICAGO, IL. FILED 12-16-2004.

BARTERADS

THE MARK CONSISTS OF STANDARD CHARACTERS WITHOUT CLAIM TO ANY PARTICULAR FONT, STYLE, SIZE, OR COLOR.

FOR OBTAINING AND ARRANGING FOR THE PLACEMENT OF ADVERTISING MEDIA SPACE AND TIME FOR OTHERS (U.S. CLS. 100, 101 AND 102).

DAVID TAYLOR, EXAMINING ATTORNEY

CLASS 35—(Continued).

SN 78-534,320. ALBRIGHT, SHARON, MYERSTOWN, PA.
FILED 12-17-2004.

CLASS 35—(Continued).

SN 78-536,584. FAULKNER, ROBERT, FERGUSON, MO.
AND STEINMAN, STEPHANIE, FERGUSON, MO. FILED
12-21-2004.

OF CORSETS FUN

THE MARK CONSISTS OF STANDARD CHARACTERS
WITHOUT CLAIM TO ANY PARTICULAR FONT, STYLE,
SIZE, OR COLOR.

OWNER OF U.S. REG. NO. 2,953,677.
FOR RETAIL STORE SERVICES FEATURING CLOTH-
ING AND LINGERIE (U.S. CLS. 100, 101 AND 102).
FIRST USE 11-28-2003; IN COMMERCE 11-28-2003.
SONYA STEPHENS, EXAMINING ATTORNEY

SN 78-535,310. HANLEY-WOOD, LLC, WASHINGTON, DC.
FILED 12-20-2004.

PLANSCONNECT

THE MARK CONSISTS OF STANDARD CHARACTERS
WITHOUT CLAIM TO ANY PARTICULAR FONT, STYLE,
SIZE, OR COLOR.

FOR ADVERTISING SERVICES (U.S. CLS. 100, 101
AND 102).
KATHLEEN M. VANSTON, EXAMINING ATTORNEY

SN 78-535,969. MEADWESTVACO CORPORATION, STAM-
FORD, CT. FILED 12-21-2004.

MEAD MONEY MADNESS

THE MARK CONSISTS OF STANDARD CHARACTERS
WITHOUT CLAIM TO ANY PARTICULAR FONT, STYLE,
SIZE, OR COLOR.

OWNER OF U.S. REG. NOS. 1,072,214, 2,402,213 AND
OTHERS.
FOR INCENTIVE AWARD PROGRAMS TO PROMOTE
THE SALE OF SCHOOL AND OFFICE PRODUCTS (U.S.
CLS. 100, 101 AND 102).
STEPHANIE DAVIS, EXAMINING ATTORNEY

Boomer Bonus

THE MARK CONSISTS OF STANDARD CHARACTERS
WITHOUT CLAIM TO ANY PARTICULAR FONT, STYLE,
SIZE, OR COLOR.

FOR THE ADMINISTRATION OF A DISCOUNT PRO-
GRAM FOR ELIGIBLE SENIOR CITIZENS TO OBTAIN
DISCOUNTS FOR GOODS AND SERVICES (U.S. CLS.
100, 101 AND 102).
KEVIN DINALLO, EXAMINING ATTORNEY

SN 78-537,429. SHOKO AMERICA, INC., COLORADO
SPRINGS, CO. FILED 12-22-2004.

SHOKO

THE MARK CONSISTS OF STANDARD CHARACTERS
WITHOUT CLAIM TO ANY PARTICULAR FONT, STYLE,
SIZE, OR COLOR.

FOR MAIL ORDER AND WHOLESALE DISTRIBU-
TORSHIPS FEATURING SCIENTIFIC APPARATUS AND
INSTRUMENTS (U.S. CLS. 100, 101 AND 102).
LINDA POWELL, EXAMINING ATTORNEY

CLASS 35—(Continued).

SN 78-537,717. FOR FLOORS INC, CHICAGO, IL. FILED 12-23-2004.



NO CLAIM IS MADE TO THE EXCLUSIVE RIGHT TO USE "FOR FLOORS", APART FROM THE MARK AS SHOWN.

FOR RETAIL AND WHOLESALE STORE SERVICES, ONLINE RETAIL AND WHOLESALE STORE SERVICES, COMPUTER ONLINE RETAIL AND WHOLESALE ORDERING SERVICES, RETAIL AND WHOLESALE TELEPHONE ORDERING SERVICES, ALL FEATURING PRODUCTS USED IN THE INSTALLATION, FINISHING AND MAINTENANCE OF HARDWOOD FLOORS (U.S. CLS. 100, 101 AND 102).

PAUL F. GAST, EXAMINING ATTORNEY

CLASS 35—(Continued).

SN 78-537,876. BLIND EXPRESS FRANCHISING, INC., ALPHARETTA, GA. FILED 12-23-2004.

AVIEW BLINDS & SHUTTERS

THE MARK CONSISTS OF STANDARD CHARACTERS WITHOUT CLAIM TO ANY PARTICULAR FONT, STYLE, SIZE, OR COLOR.

NO CLAIM IS MADE TO THE EXCLUSIVE RIGHT TO USE "BLINDS" AND "SHUTTERS", APART FROM THE MARK AS SHOWN.

FOR RETAIL STORE SERVICES IN THE FIELD OF WINDOW COVERINGS, NAMELY BLINDS, SHUTTERS, SHADES AND DRAPERIES (U.S. CLS. 100, 101 AND 102).

JOHN WILKE, EXAMINING ATTORNEY

SN 78-537,830. BLIND EXPRESS FRANCHISING, INC., ALPHARETTA, GA. FILED 12-23-2004.

**DISTINCTIVE VIEWS
BLINDS &
SHUTTERS**

THE MARK CONSISTS OF STANDARD CHARACTERS WITHOUT CLAIM TO ANY PARTICULAR FONT, STYLE, SIZE, OR COLOR.

NO CLAIM IS MADE TO THE EXCLUSIVE RIGHT TO USE "BLINDS" AND "SHUTTERS", APART FROM THE MARK AS SHOWN.

FOR RETAIL STORE SERVICES IN THE FIELD OF WINDOW COVERINGS, NAMELY BLINDS, SHUTTERS, SHADES AND DRAPERIES (U.S. CLS. 100, 101 AND 102).

JOHN WILKE, EXAMINING ATTORNEY

SN 78-537,879. BLIND EXPRESS FRANCHISING, INC., ALPHARETTA, GA. FILED 12-23-2004.

**ABX DISTINCTIVE
VIEWS BLINDS &
SHUTTERS**

THE MARK CONSISTS OF STANDARD CHARACTERS WITHOUT CLAIM TO ANY PARTICULAR FONT, STYLE, SIZE, OR COLOR.

NO CLAIM IS MADE TO THE EXCLUSIVE RIGHT TO USE "BLINDS" AND "SHUTTERS", APART FROM THE MARK AS SHOWN.

FOR RETAIL STORE SERVICES IN THE FIELD OF WINDOW COVERINGS, NAMELY BLINDS, SHUTTERS, SHADES AND DRAPERIES (U.S. CLS. 100, 101 AND 102).

JOHN WILKE, EXAMINING ATTORNEY

CLASS 35—(Continued).

SN 78-538,272. QUASH, CASSANDRA J., MITCHELLVILLE, MD. FILED 12-24-2004.

CLASS 35—(Continued).

SN 78-539,305. VANTEC HOLDINGS CORP., YOKOHAMA-SHI, KANAGAWA-KEN, JAPAN, FILED 12-28-2004.

Cuddly Couture

THE MARK CONSISTS OF STANDARD CHARACTERS WITHOUT CLAIM TO ANY PARTICULAR FONT, STYLE, SIZE, OR COLOR.

FOR BABY RETAIL CLOTHING BOUTIQUES (U.S. CLS. 100, 101 AND 102).
CYNTHIA SLOAN, EXAMINING ATTORNEY

VANTEC

THE MARK CONSISTS OF STANDARD CHARACTERS WITHOUT CLAIM TO ANY PARTICULAR FONT, STYLE, SIZE, OR COLOR.

FOR IMPORT-EXPORT AGENCY SERVICES; PROVISION OF ASSISTANCE FOR CUSTOMS CLEARANCE OF CARGO (U.S. CLS. 100, 101 AND 102).
ALINA MORRIS, EXAMINING ATTORNEY

SN 78-538,847. DUN & BRADSTREET, INC., SHORT HILLS, NJ. FILED 12-28-2004.

DECIDERIGHT

THE MARK CONSISTS OF STANDARD CHARACTERS WITHOUT CLAIM TO ANY PARTICULAR FONT, STYLE, SIZE, OR COLOR.

FOR BUSINESS MANAGEMENT CONSULTING SERVICES AND BUSINESS OUTSOURCING SERVICES IN THE FIELD OF BUSINESS DATA ANALYTICS (U.S. CLS. 100, 101 AND 102).
CYNTHIA SLOAN, EXAMINING ATTORNEY

SN 78-539,475. NATIONAL FEATHER CRAFT CO., INC., ST. LOUIS, MO. FILED 12-29-2004.

FEATHER-CRAFT

SN 78-538,855. DUN & BRADSTREET, INC., SHORT HILLS, NJ. FILED 12-28-2004.

DECIDE**Right**

FOR BUSINESS MANAGEMENT CONSULTING SERVICES AND BUSINESS OUTSOURCING SERVICES IN THE FIELD OF BUSINESS DATA ANALYTICS (U.S. CLS. 100, 101 AND 102).
CYNTHIA SLOAN, EXAMINING ATTORNEY

THE MARK CONSISTS OF STANDARD CHARACTERS WITHOUT CLAIM TO ANY PARTICULAR FONT, STYLE, SIZE, OR COLOR.

FOR RETAIL FISHING EQUIPMENT STORE SERVICES AND RETAIL MAIL ORDER SERVICES IN THE FIELD OF FISHING EQUIPMENT (U.S. CLS. 100, 101 AND 102).

FIRST USE 7-22-1975; IN COMMERCE 7-22-1975.
LINDA MICKLEBURGH, EXAMINING ATTORNEY

CLASS 35—(Continued).

SN 78-539,755. CAREGROUP MEDICAL SERVICE ORGANIZATION, LLC, BOSTON, MA. FILED 12-29-2004.

MEDVENTIVE

THE MARK CONSISTS OF STANDARD CHARACTERS WITHOUT CLAIM TO ANY PARTICULAR FONT, STYLE, SIZE, OR COLOR.

FOR BUSINESS CONSULTING SERVICES IN THE MEDICAL AND PHARMACEUTICAL FIELDS; PHARMACEUTICAL COST MANAGEMENT SERVICES AND DRUG UTILIZATION REVIEW SERVICES (U.S. CLS. 100, 101 AND 102).

ANNE E. GUSTASON, EXAMINING ATTORNEY

CLASS 35—(Continued).

AND PERMANENT PERSONNEL; HUMAN RESOURCES CONSULTING ON RECRUITING, TRAINING AND TESTING OF EMPLOYEES; CONTRACT AND PERMANENT STAFFING AGENCY SERVICES FEATURING STAFF PROFESSIONALS IN FINANCE, INFORMATION TECHNOLOGY, ENGINEERING, SCIENTIFIC AND TECHNICAL PERSONNEL, AS WELL AS OFFICE ADMINISTRATIVE STAFF, FACTORY STAFF, INDUSTRIAL STAFF AND CALL CENTER STAFF; EMPLOYMENT OUTPLACEMENT SERVICES; EMPLOYMENT COUNSELING; PROVIDING CAREER INFORMATION VIA A WEBSITE ON A GLOBAL INFORMATION NETWORK; PROVIDING INFORMATION ON JOBS VIA A WEBSITE ON A GLOBAL INFORMATION NETWORK; PROVIDING AN ON-LINE COMPUTER DATABASE IN THE FIELDS OF CONTRACT AND PERMANENT PERSONNEL STAFFING; PROVIDING OFFICE FUNCTIONS TO OTHERS, NAMELY, ACCOUNTING, ADMINISTRATION AND BOOKKEEPING SERVICES; BUSINESS CONSULTING (U.S. CLS. 100, 101 AND 102).

FIRST USE 1-15-2001; IN COMMERCE 7-26-2001.
ROBIN CHOSID, EXAMINING ATTORNEY

SN 78-540,764. SPYGLASS STAFFING, INC., CENTENNIAL, CO. FILED 1-2-2005.

Spyglass Staffing

THE MARK CONSISTS OF STANDARD CHARACTERS WITHOUT CLAIM TO ANY PARTICULAR FONT, STYLE, SIZE, OR COLOR.

NO CLAIM IS MADE TO THE EXCLUSIVE RIGHT TO USE "STAFFING", APART FROM THE MARK AS SHOWN.

FOR EMPLOYMENT AGENCY SERVICES; TEMPORARY AND PERMANENT EMPLOYMENT AGENCY SERVICES; EMPLOYEE LEASING; EMPLOYMENT RELATED SERVICES, NAMELY PROVIDING JOB PLACEMENT, EMPLOYMENT RECRUITMENT, AND GENERAL EMPLOYMENT INFORMATION TO OTHERS; SUPPLYING TO OTHERS ON A TEMPORARY AND PERMANENT BASIS ENGINEERS, COMPUTER PROGRAMMERS, ACCOUNTANTS, ADMINISTRATIVE ASSISTANTS, SALES PROFESSIONALS, MARKETING PROFESSIONALS, FINANCE PROFESSIONALS, AND SKILLED TECHNICAL PERSONNEL; PROVIDING AND MANAGING CONTRACT PERSONNEL PROGRAMS; ANALYZING AND CONSULTING ON PERSONNEL NEEDS; PROVIDING CONTRACT, TEMPORARY, AND PERMANENT PERSONNEL STAFFING SERVICES; ARRANGING FOR AND MANAGING THE PROVISION OF TEMPORARY CONTRACT PERSONNEL; PERSONNEL MANAGEMENT AND CONSULTANCY SERVICES ON THE PROCUREMENT OF TEMPORARY, CONTRACT,

SN 78-541,005. GAMEMASTERS, INC., QUINCY, IL. FILED 1-3-2005.

GameMasters

THE MARK CONSISTS OF STANDARD CHARACTERS WITHOUT CLAIM TO ANY PARTICULAR FONT, STYLE, SIZE, OR COLOR.

FOR RETAIL STORES IN THE FIELD OF HUNTING, FISHING, OUTDOOR GEAR AND SPORTING GOODS (U.S. CLS. 100, 101 AND 102).

FIRST USE 10-1-2003; IN COMMERCE 10-1-2003.
JOHN GARTNER, EXAMINING ATTORNEY

CLASS 35—(Continued).

SN 78-541,257. STAPLES THE OFFICE SUPERSTORE, LLC, FRAMINGHAM, MA. FILED 1-3-2005.



THE MARK CONSISTS OF A LOWERCASE, STYLIZED LETTER E INSIDE A SQUARE BACKGROUND.

FOR RETAIL STORE SERVICES, MAIL ORDER CATALOG SERVICES, AND COMPUTERIZED ONLINE RETAIL STORE SERVICES FEATURING OFFICE SUPPLIES, OFFICE EQUIPMENT, INCLUDING COMPUTER HARDWARE, COPIERS AND TELEPHONES, AND OFFICE FURNITURE (U.S. CLS. 100, 101 AND 102).

ADA HAN, EXAMINING ATTORNEY

CLASS 35—(Continued).

SN 78-541,916. WORLD GOLD COUNCIL, GENEVE 2, SWITZERLAND, FILED 1-4-2005.

MAY IS GOLD MONTH

THE MARK CONSISTS OF STANDARD CHARACTERS WITHOUT CLAIM TO ANY PARTICULAR FONT, STYLE, SIZE, OR COLOR.

NO CLAIM IS MADE TO THE EXCLUSIVE RIGHT TO USE "GOLD", APART FROM THE MARK AS SHOWN.

FOR ADVERTISING AND PROMOTING THE USE OF GOLD JEWELRY (U.S. CLS. 100, 101 AND 102).

FIRST USE 4-15-2005; IN COMMERCE 4-15-2005.

TEJBIR SINGH, EXAMINING ATTORNEY

SN 78-541,282. DEPARTMENT OF DEFENSE, ARLINGTON, VA. FILED 1-3-2005.

JAMRS

THE MARK CONSISTS OF STANDARD CHARACTERS WITHOUT CLAIM TO ANY PARTICULAR FONT, STYLE, SIZE, OR COLOR.

FOR ADVERTISING, NAMELY, PROVIDING ADVERTISING FOR MILITARY RECRUITING AND CAREERS (U.S. CLS. 100, 101 AND 102).

FIRST USE 1-2-2004; IN COMMERCE 1-8-2004.

PAUL E. FAHRENKOPF, EXAMINING ATTORNEY

SN 78-541,979. OBSERVATORY GROUP, INC., CINCINNATI, OH. FILED 1-4-2005.

**The A-Team Every
Time**

THE MARK CONSISTS OF STANDARD CHARACTERS WITHOUT CLAIM TO ANY PARTICULAR FONT, STYLE, SIZE, OR COLOR.

NO CLAIM IS MADE TO THE EXCLUSIVE RIGHT TO USE "THE A-TEAM", APART FROM THE MARK AS SHOWN.

FOR BUSINESS CONSULTATION SERVICES IN THE FIELD OF BRANDING AND BUSINESS STRATEGY FEATURING A TEAM WHOSE MEMBERS HAVE THE EXACT SKILLS TO EXCEL IN THE REQUIREMENTS OF THE ASSIGNMENT (U.S. CLS. 100, 101 AND 102).

FIRST USE 10-1-2002; IN COMMERCE 10-1-2002.

GISELLE AGOSTO, EXAMINING ATTORNEY

CLASS 35—(Continued).

SN 78-543,053. ORR, TIM, SPOKANE, WA. FILED 1-6-2005.



THE COLOR(S) RED AND BLUE IS/ARE CLAIMED AS A FEATURE OF THE MARK.

THE COLOR(S) BLUE APPEARS IN THE LETTERING IN THE MARK AND THE COLOR(S) RED APPEARS IN THE CIRCLES IN THE MARK.

FOR RETAIL AND WHOLESALE STORE SERVICES, INTERNET RETAIL AND WHOLESALE SERVICES, CATALOG, AND MAIL ORDER SERVICE IN THE FIELD OF PRINTER AND PHOTOCOPIER CONSUMABLES IN THE NATURE OF DUPLICATING INKS, INKS, INK ROLLERS FOR OFFICE MACHINES, FAX ROLLS, PAPER, PRINTER INK FOR INKJET AND LASER PRINTERS, PRINTER CARTRIDGES AND TONER, AND PHOTOCOPIER CARTRIDGES AND TONER (U.S. CLS. 100, 101 AND 102).

STANLEY I. OSBORNE, EXAMINING ATTORNEY

SN 78-543,397. AMERICAN ACADEMY OF PHYSICAL MEDICINE AND REHABILITATION, CHICAGO, IL. FILED 1-6-2005.

**AMERICAN ACADEMY
OF PHYSICAL MEDICINE
AND REHABILITATION**

THE MARK CONSISTS OF STANDARD CHARACTERS WITHOUT CLAIM TO ANY PARTICULAR FONT, STYLE, SIZE, OR COLOR.

NO CLAIM IS MADE TO THE EXCLUSIVE RIGHT TO USE ACADEMY OF PHYSICAL MEDICINE AND REHABILITATION, APART FROM THE MARK AS SHOWN.

SEC. 2(F).

FOR ASSOCIATION SERVICES, NAMELY PROMOTING THE INTERESTS OF PHYSIATRISTS, THE PRACTICE OF PHYSIATRY, AND THE PERSONS PROVIDING RELATED MEDICAL SERVICES (U.S. CLS. 100, 101 AND 102).

FIRST USE 0-0-1955; IN COMMERCE 0-0-1955.

RUSS HERMAN, EXAMINING ATTORNEY

CLASS 35—(Continued).

SN 78-543,555. BLOOM ORGANICS, INC., SARASOTA, FL. FILED 1-6-2005.

BLOOM ORGANICS

THE MARK CONSISTS OF STANDARD CHARACTERS WITHOUT CLAIM TO ANY PARTICULAR FONT, STYLE, SIZE, OR COLOR.

NO CLAIM IS MADE TO THE EXCLUSIVE RIGHT TO USE "ORGANICS", APART FROM THE MARK AS SHOWN. FOR RETAIL STORE SERVICES FEATURING ORGANIC SKIN, BODY AND PERSONAL CARE PRODUCTS (U.S. CLS. 100, 101 AND 102).

FIRST USE 11-26-2004; IN COMMERCE 11-26-2004.

ZHALEH DELANEY, EXAMINING ATTORNEY

SN 78-543,829. DEUTSCHE TELEKOM AG, BONN, FED REP GERMANY, FILED 1-7-2005.

T-Mobile Thanx

THE MARK CONSISTS OF STANDARD CHARACTERS WITHOUT CLAIM TO ANY PARTICULAR FONT, STYLE, SIZE, OR COLOR.

OWNER OF FED REP GERMANY REG. NO. 30441826, DATED 8-16-2004, EXPIRES 7-31-2014.

OWNER OF U.S. REG. NOS. 2,282,432, 2,908,563 AND OTHERS.

FOR ADVERTISING SERVICES, NAMELY, PREPARING AND PLACING ADVERTISEMENTS FOR OTHERS PROMOTING THE GOODS AND SERVICES OF OTHERS THROUGH PRINTED ADVERTISING, PRINTED DIRECTORIES, THROUGH ENCODED MEDIA, THROUGH THE DISSEMINATION OF PROMOTIONAL MATERIALS, THROUGH DIRECT MAIL ADVERTISING, THROUGH ELECTRONIC BILLBOARD ADVERTISING, PREPARING AUDIO-VISUAL PRESENTATIONS FOR USE IN ADVERTISING; BUSINESS MANAGEMENT SERVICES, NAMELY, BUSINESS APPRAISALS, BUSINESS AUDITING, PROVIDING BUSINESS INFORMATION, NAMELY, PREPARING BUSINESS REPORTS AND CONDUCTING BUSINESS RESEARCH, ANALYSIS AND SURVEYS, BUSINESS MANAGEMENT PLANNING, BUSINESS MANAGEMENT CONSULTATION, BUSINESS MANAGEMENT SUPERVISION, CONDUCTING BUSINESS NETWORKING FOR OTHERS; BUSINESS MANAGEMENT AND CONSULTING SERVICES, EXCLUDING AGRICULTURAL BUSINESS MANAGEMENT AND CONSULTING SERVICES; PROVIDING INFORMATION VIA THE TELEPHONE AND THE GLOBAL COMMUNICATION NETWORKS IN THE FIELD OF ADVERTISING AND BUSINESS MARKETING; PROFESSIONAL CONSULTANCY IN THE FIELD OF DATA PROCESSING (U.S. CLS. 100, 101 AND 102).

Laurie Mayes, Examining Attorney

CLASS 35—(Continued).

SN 78-544,589. FITTING GROUP, INC., PITTSBURGH, PA. FILED 1-10-2005.

CLASS 35—(Continued).

SN 78-545,056. XPAYS, INC., SAN FRANCISCO, CA. FILED 1-10-2005.

BRAND SPANKING

THE MARK CONSISTS OF STANDARD CHARACTERS WITHOUT CLAIM TO ANY PARTICULAR FONT, STYLE, SIZE, OR COLOR.

FOR BUSINESS MARKETING CONSULTING SERVICES; PUBLIC RELATIONS; AND ADVERTISING SERVICES, NAMELY CREATING CORPORATE AND BRAND IDENTITY FOR OTHERS (U.S. CLS. 100, 101 AND 102).

RICHARD WHITE, EXAMINING ATTORNEY

GOT JOINS?

THE MARK CONSISTS OF STANDARD CHARACTERS WITHOUT CLAIM TO ANY PARTICULAR FONT, STYLE, SIZE, OR COLOR.

FOR DISSEMINATION OF ADVERTISING OF THE GOODS AND SERVICES OF OTHERS VIA A GLOBAL COMPUTER NETWORK (U.S. CLS. 100, 101 AND 102).

FIRST USE 8-23-2000; IN COMMERCE 8-23-2000.
BARBARA RUTLAND, EXAMINING ATTORNEY

SN 78-544,856. TRANS WORLD NEW YORK, LLC, ALBANY, NY. FILED 1-10-2005.

SN 78-545,083. BRADGATE LLC, SAN DIEGO, CA. FILED 1-10-2005.

FYE BACKSTAGE PASS

THE MARK CONSISTS OF STANDARD CHARACTERS WITHOUT CLAIM TO ANY PARTICULAR FONT, STYLE, SIZE, OR COLOR.

OWNER OF U.S. REG. NOS. 1,870,180, 1,880,186 AND OTHERS.

FOR PROMOTING THE GOODS OF OTHERS IN CONNECTION WITH RETAIL STORE SERVICES BY AWARDED DISCOUNTS AND GIFT INCENTIVES TO FREQUENT PURCHASERS OF PRERECORDED MUSIC AND VIDEO PRODUCTS, INCLUDING RECORDS, VIDEOS, TAPES, CD'S, AND INTERACTIVE GAMES (U.S. CLS. 100, 101 AND 102).

LINDA ORNDORFF, EXAMINING ATTORNEY

**PHOENIX DIRECT
MAIL**

THE MARK CONSISTS OF STANDARD CHARACTERS WITHOUT CLAIM TO ANY PARTICULAR FONT, STYLE, SIZE, OR COLOR.

NO CLAIM IS MADE TO THE EXCLUSIVE RIGHT TO USE "DIRECT MAIL", APART FROM THE MARK AS SHOWN.

FOR DIRECT MAIL ADVERTISING AND MARKETING SERVICES; DIRECT MARKETING ADVERTISING FOR OTHERS (U.S. CLS. 100, 101 AND 102).

FIRST USE 12-31-1983; IN COMMERCE 12-31-1983.
TEJBIR SINGH, EXAMINING ATTORNEY

CLASS 35—(Continued).

SN 78-545,494. DEUTSCHE TELEKOM AG, BONN, FED REP GERMANY, FILED 1-11-2005.

T-Mobile Dial a Smile

THE MARK CONSISTS OF STANDARD CHARACTERS WITHOUT CLAIM TO ANY PARTICULAR FONT, STYLE, SIZE, OR COLOR.

PRIORITY CLAIMED UNDER SEC. 44(D) ON FED REP GERMANY APPLICATION NO. 30441824238, FILED 7-21-2004, REG. NO. 30441824, DATED 8-31-2004, EXPIRES 7-31-2014.

OWNER OF U.S. REG. NOS. 2,282,432, 2,908,563 AND OTHERS.

FOR ADVERTISING SERVICES, NAMELY, PREPARING AND PLACING ADVERTISEMENTS FOR OTHERS PROMOTING THE GOODS AND SERVICES OF OTHERS THROUGH PRINTED ADVERTISING, PRINTED DIRECTORIES, THROUGH ENCODED MEDIA, THROUGH THE DISSEMINATION OF PROMOTIONAL MATERIALS, THROUGH DIRECT MAIL ADVERTISING, THROUGH ELECTRONIC BILLBOARD ADVERTISING, PREPARING AUDIO-VISUAL PRESENTATIONS FOR USE IN ADVERTISING; BUSINESS MANAGEMENT SERVICES, NAMELY, BUSINESS APPRAISALS, BUSINESS AUDITING, PROVIDING BUSINESS INFORMATION, NAMELY, PREPARING BUSINESS REPORTS AND CONDUCTING BUSINESS RESEARCH, ANALYSIS AND SURVEYS, BUSINESS MANAGEMENT PLANNING, BUSINESS MANAGEMENT CONSULTATION, BUSINESS MANAGEMENT SUPERVISION, CONDUCTING BUSINESS NETWORKING FOR OTHERS; BUSINESS MANAGEMENT AND CONSULTING SERVICES, EXCLUDING AGRICULTURAL BUSINESS MANAGEMENT AND CONSULTING SERVICES; PROVIDING INFORMATION VIA THE TELEPHONE AND THE GLOBAL COMMUNICATION NETWORKS IN THE FIELD OF ADVERTISING AND BUSINESS MARKETING; PROFESSIONAL CONSULTANCY IN THE FIELD OF DATA PROCESSING (U.S. CLS. 100, 101 AND 102).

LAURIE MAYES, EXAMINING ATTORNEY

CLASS 35—(Continued).

SN 78-545,675. DEUTSCHE TELEKOM AG, BONN, FED REP GERMANY, FILED 1-11-2005.

T-Mobile Thrills

THE MARK CONSISTS OF STANDARD CHARACTERS WITHOUT CLAIM TO ANY PARTICULAR FONT, STYLE, SIZE, OR COLOR.

PRIORITY CLAIMED UNDER SEC. 44(D) ON FED REP GERMANY APPLICATION NO. 30441825038, FILED 7-21-2004, REG. NO. 30441825, DATED 8-16-2004, EXPIRES 7-31-2014.

OWNER OF U.S. REG. NOS. 2,282,432, 2,908,563 AND OTHERS.

FOR ADVERTISING SERVICES, NAMELY, PREPARING AND PLACING ADVERTISEMENTS FOR OTHERS PROMOTING THE GOODS AND SERVICES OF OTHERS THROUGH PRINTED ADVERTISING, PRINTED DIRECTORIES, THROUGH ENCODED MEDIA, THROUGH THE DISSEMINATION OF PROMOTIONAL MATERIALS, THROUGH DIRECT MAIL ADVERTISING, THROUGH ELECTRONIC BILLBOARD ADVERTISING, PREPARING AUDIO-VISUAL PRESENTATIONS FOR USE IN ADVERTISING; BUSINESS MANAGEMENT SERVICES, NAMELY, BUSINESS APPRAISALS, BUSINESS AUDITING, PROVIDING BUSINESS INFORMATION, NAMELY, PREPARING BUSINESS REPORTS AND CONDUCTING BUSINESS RESEARCH, ANALYSIS AND SURVEYS, BUSINESS MANAGEMENT PLANNING, BUSINESS MANAGEMENT CONSULTATION, BUSINESS MANAGEMENT SUPERVISION, CONDUCTING BUSINESS NETWORKING FOR OTHERS; BUSINESS MANAGEMENT AND CONSULTING SERVICES, EXCLUDING AGRICULTURAL BUSINESS MANAGEMENT AND CONSULTING SERVICES; PROVIDING INFORMATION VIA THE TELEPHONE AND THE GLOBAL COMMUNICATION NETWORKS IN THE FIELD OF ADVERTISING AND BUSINESS MARKETING; PROFESSIONAL CONSULTANCY IN THE FIELD OF DATA PROCESSING (U.S. CLS. 100, 101 AND 102).

LAURIE MAYES, EXAMINING ATTORNEY

SN 78-546,134. KNOWLES, ERIC, FAYETTEVILLE, AR. FILED 1-12-2005.

OMEGA CHANGE

THE MARK CONSISTS OF STANDARD CHARACTERS WITHOUT CLAIM TO ANY PARTICULAR FONT, STYLE, SIZE, OR COLOR.

FOR PROVIDING INFORMATION FOR IDENTIFYING CONFLICTS AND REMOVING OBSTRUCTIONS WITHIN BUSINESS TRANSACTIONS (U.S. CLS. 100, 101 AND 102).

FIRST USE 8-5-2003; IN COMMERCE 8-5-2003.

NORA BUCHANAN WILL, EXAMINING ATTORNEY

CLASS 35—(Continued).

SN 78-546,556. LOGO-MOTION LLC, GREEN BAY, WI.
FILED 1-12-2005.

LOGOMOTION

THE MARK CONSISTS OF STANDARD CHARACTERS WITHOUT CLAIM TO ANY PARTICULAR FONT, STYLE, SIZE, OR COLOR.

FOR ADVERTISING SERVICES, NAMELY, PROVIDING PHYSICALLY MOBILE BILLBOARD ADVERTISING (U.S. CLS. 100, 101 AND 102).

FIRST USE 12-0-2004; IN COMMERCE 12-0-2004.
JUDITH HELFMAN, EXAMINING ATTORNEY

SN 78-546,742. CYNTHIA M. TORRES, DBA SINCERE MOMENTS.COM, MONTGOMERY, NY. FILED 1-12-2005.

Sincere Moments.com
Gift Baskets

NO CLAIM IS MADE TO THE EXCLUSIVE RIGHT TO USE "GIFT BASKETS", APART FROM THE MARK AS SHOWN.

THE COLOR(S) RED, GREEN, PURPLE AND BLACK IS/ ARE CLAIMED AS A FEATURE OF THE MARK.

THE COLOR(S) RED AND GREEN APPEAR IN THE DESIGN OF A RED TULIP WITH A GREEN STEM AND TWO LEAVES. THE COLOR PURPLE APPEARS IN THE DEPICTION OF A BUTTERFLY NEXT TO THE TULIP. THE COLOR BLACK APPEARS IN THE WORDING "SINCERE," "MOMENTS.COM" AND "GIFT BASKETS."

FOR ON-LINE ORDERING SERVICES FEATURING GIFT BASKETS (U.S. CLS. 100, 101 AND 102).
KATRINA EDGE, EXAMINING ATTORNEY

CLASS 35—(Continued).

SN 78-546,871. HEALTHTRUST PURCHASING GROUP, LP, BRENTWOOD, TN. FILED 1-13-2005.

HPG

THE MARK CONSISTS OF STANDARD CHARACTERS WITHOUT CLAIM TO ANY PARTICULAR FONT, STYLE, SIZE, OR COLOR.

OWNER OF U.S. REG. NOS. 2,437,507 AND 2,552,023.

FOR GROUP PURCHASING ORGANIZATION SERVICES, NAMELY, (A) THE COORDINATION AND NEGOTIATION OF CONTRACTS WITH SUPPLIERS THROUGH WHICH MEMBERS OF THE ORGANIZATION CAN PURCHASE EQUIPMENT, PRODUCTS, SUPPLIES AND SERVICES FOR THE MEDICAL AND HEALTHCARE FIELDS, AND (B) THE PROVISION OF RELATED ADMINISTRATIVE SERVICES (U.S. CLS. 100, 101 AND 102).

FIRST USE 5-1-1999; IN COMMERCE 5-1-1999.
ANNE FARRELL, EXAMINING ATTORNEY

SN 78-546,894. SELECT TEMPORARIES, INC., SANTA BARBARA, CA. FILED 1-13-2005.



THE MARK CONSISTS OF A STYLIZED REPRESENTATION OF A PERSON WITHIN AN OVAL FRAME.

FOR TEMPORARY AND PERMANENT EMPLOYMENT PLACEMENT SERVICES (U.S. CLS. 100, 101 AND 102).

DEZMONA MIZELLE, EXAMINING ATTORNEY

CLASS 35—(Continued).

SN 78-547,256. BREAKDOWN SERVICES, LTD., LOS ANGELES, CA. FILED 1-13-2005.

REALITY ACCESS

THE MARK CONSISTS OF STANDARD CHARACTERS WITHOUT CLAIM TO ANY PARTICULAR FONT, STYLE, SIZE, OR COLOR.

FOR BUSINESS SERVICES, NAMELY, PROVIDING A WEBSITE FOR PEOPLE SEEKING TO SUBMIT THEMSELVES FOR ROLES IN REALITY TELEVISION PRODUCTIONS (U.S. CLS. 100, 101 AND 102).

FIRST USE 4-0-2004; IN COMMERCE 4-0-2004.
ANGELA M. MICHELI, EXAMINING ATTORNEY

SN 78-547,278. KITES, TAILS & TOYS, INC., NEW ORLEANS, LA. FILED 1-13-2005.



NO CLAIM IS MADE TO THE EXCLUSIVE RIGHT TO USE "KITES" AND "TOYS", APART FROM THE MARK AS SHOWN.

FOR RETAIL STORE SERVICES AND ONLINE RETAIL STORE SERVICES FOR KITES AND TOYS (U.S. CLS. 100, 101 AND 102).

FIRST USE 2-19-1998; IN COMMERCE 2-19-1998.
JUDITH HELFMAN, EXAMINING ATTORNEY

SN 78-547,837. NATIONAL SHOOTING SPORTS FOUNDATION, INC., NEWTOWN, CT. FILED 1-14-2005.

VOTE YOUR SPORT

THE MARK CONSISTS OF STANDARD CHARACTERS WITHOUT CLAIM TO ANY PARTICULAR FONT, STYLE, SIZE, OR COLOR.

FOR PROVIDING INFORMATION REGARDING POLITICAL ISSUES, KNOWING HOW TO VOTE AND KNOWING HOW TO REGISTER TO VOTE (U.S. CLS. 100, 101 AND 102).

FIRST USE 10-0-1999; IN COMMERCE 10-0-1999.
SKYE YOUNG, EXAMINING ATTORNEY

CLASS 35—(Continued).

SN 78-548,732. CHEVRON CORPORATION, SAN RAMON, CA. FILED 1-17-2005.



FOR RETAIL OUTLET SERVICES, NAMELY CONVENIENCE STORES (U.S. CLS. 100, 101 AND 102).
FIRST USE 6-30-1999; IN COMMERCE 6-30-1999.
SUE LAWRENCE, EXAMINING ATTORNEY

SN 78-549,564. 3D CLONE INCORPORATION, REDWOOD CITY, CA. FILED 1-18-2005.

3D CLONE

THE MARK CONSISTS OF STANDARD CHARACTERS WITHOUT CLAIM TO ANY PARTICULAR FONT, STYLE, SIZE, OR COLOR.

NO CLAIM IS MADE TO THE EXCLUSIVE RIGHT TO USE "3D", APART FROM THE MARK AS SHOWN.
FOR RETAIL STORE SERVICES FEATURING DOLLS AND FIGURINES (U.S. CLS. 100, 101 AND 102).

FIRST USE 11-8-2002; IN COMMERCE 7-19-2004.
JOHN SCHUYLER YARD, EXAMINING ATTORNEY

CLASS 35—(Continued).

SN 78-549,701. SPECIAL DATA PROCESSING CORPORATION, CLEARWATER, FL. FILED 1-19-2005.

MOVERADVANTAGE

THE MARK CONSISTS OF STANDARD CHARACTERS WITHOUT CLAIM TO ANY PARTICULAR FONT, STYLE, SIZE, OR COLOR.

FOR ADDRESS CHANGE NOTIFICATION SERVICES IN THE NATURE OF POSTING NOTIFICATIONS OF CHANGES OF ADDRESS (U.S. CLS. 100, 101 AND 102).
ANGELA M. MICHELI, EXAMINING ATTORNEY

SN 78-549,707. SPECIAL DATA PROCESSING CORPORATION, CLEARWATER, FL. FILED 1-19-2005.

MOVER ADVANTAGE

THE MARK CONSISTS OF STANDARD CHARACTERS WITHOUT CLAIM TO ANY PARTICULAR FONT, STYLE, SIZE, OR COLOR.

FOR ADDRESS CHANGE NOTIFICATION SERVICES IN THE NATURE OF POSTING NOTIFICATIONS OF CHANGES OF ADDRESS (U.S. CLS. 100, 101 AND 102).
ANGELA M. MICHELI, EXAMINING ATTORNEY

CLASS 35—(Continued).

SN 78-551,088. SPOGGER, INC., REDWOOD CITY, CA. FILED 1-20-2005.

SPOGGER

THE MARK CONSISTS OF STANDARD CHARACTERS WITHOUT CLAIM TO ANY PARTICULAR FONT, STYLE, SIZE, OR COLOR.

FOR GENERAL BUSINESS NETWORKING REFERRAL SERVICES, NAMELY, PROMOTING THE GOODS AND SERVICES OF OTHERS BY PASSING BUSINESS LEADS AND REFERRALS AMONG GROUP MEMBERS VIA ELECTRONIC MEDIA, SPECIFICALLY THE INTERNET; ADVERTISING AND COMMERCIAL INFORMATION SERVICES VIA ELECTRONIC MEDIA, SPECIFICALLY THE INTERNET; DISSEMINATION AND DISPLAYING OF ADVERTISING FOR OTHERS VIA AN ONLINE COMMUNICATIONS NETWORK ON THE INTERNET; AND ON-LINE TRADING SERVICES IN WHICH SELLER POSTS PRODUCTS TO BE AUCTIONED AND BIDDING IS DONE VIA THE INTERNET (U.S. CLS. 100, 101 AND 102).

FIRST USE 2-17-2004; IN COMMERCE 2-17-2004.
CURTIS FRENCH, EXAMINING ATTORNEY

SN 78-552,775. GREENSPRING MEDIA GROUP, INC, MINNEAPOLIS, MN. FILED 1-24-2005.

**LOFT/CONDO LIVING
TOUR**

THE MARK CONSISTS OF STANDARD CHARACTERS WITHOUT CLAIM TO ANY PARTICULAR FONT, STYLE, SIZE, OR COLOR.

NO CLAIM IS MADE TO THE EXCLUSIVE RIGHT TO USE "LOFT/CONDO" AND "TOUR", APART FROM THE MARK AS SHOWN.

FOR PROMOTING THE SERVICES OF BUILDERS, ARCHITECTS, INTERIOR DECORATORS AND FURNITURE SUPPLIERS BY ORGANIZING AND ARRANGING HOME TOURS (U.S. CLS. 100, 101 AND 102).

MICHELLE DUBOIS, EXAMINING ATTORNEY

CLASS 35—(Continued).

SN 78-553,428. BLAKER'S SENIOR CONSULTANT'S, LLC, MESA, AZ. FILED 1-25-2005.

CLASS 35—(Continued).

SN 78-556,669. ARTIST IN MIND, INC., SHERMAN OAKS, CA. FILED 1-31-2005.



ARTIST IN MIND

NO CLAIM IS MADE TO THE EXCLUSIVE RIGHT TO USE "ENSURING SENIORS TAKE ADVANTAGE OF TAX ELIMINATION", APART FROM THE MARK AS SHOWN.

FOR BUSINESS CONSULTING SERVICES FOR FINANCIAL PLANNERS AND ADVISORS (U.S. CLS. 100, 101 AND 102).

ESTHER BELENKER, EXAMINING ATTORNEY

THE MARK CONSISTS OF STANDARD CHARACTERS WITHOUT CLAIM TO ANY PARTICULAR FONT, STYLE, SIZE, OR COLOR.

NO CLAIM IS MADE TO THE EXCLUSIVE RIGHT TO USE ARTIST, APART FROM THE MARK AS SHOWN.

FOR ARTIST MANAGEMENT SERVICES (U.S. CLS. 100, 101 AND 102).

DANIEL CAPSHAW, EXAMINING ATTORNEY

SN 78-554,591. HERBA ENTERPRISE, INC., SAN FRANCISCO, CA. FILED 1-26-2005.

SN 78-557,485. CHILDREN'S ORCHARD, INC., ANN ARBOR, MI. FILED 2-1-2005.

WAH TUO

**Find a treasure.
Save a fortune.**

THE MARK CONSISTS OF STANDARD CHARACTERS WITHOUT CLAIM TO ANY PARTICULAR FONT, STYLE, SIZE, OR COLOR.

OWNER OF U.S. REG. NO. 2,742,843.

FOR WHOLESALE STORES FEATURING CHINESE CONSUMER PRODUCTS; WHOLESALE ORDERING SERVICES IN THE FIELD OF CHINESE CONSUMER PRODUCTS; IMPORT AND EXPORT AGENCIES FOR CHINESE CONSUMER PRODUCTS, AND ONLINE RETAIL STORE SERVICES FEATURING CHINESE CONSUMER PRODUCTS (U.S. CLS. 100, 101 AND 102).

NANCY CLARKE, EXAMINING ATTORNEY

THE MARK CONSISTS OF STANDARD CHARACTERS WITHOUT CLAIM TO ANY PARTICULAR FONT, STYLE, SIZE, OR COLOR.

FOR RETAIL STORE SERVICES FEATURING CHILDREN'S CLOTHING, FURNITURE AND TOYS (U.S. CLS. 100, 101 AND 102).

ELLEN PERKINS, EXAMINING ATTORNEY

CLASS 35—(Continued).

SN 78-558,219. ATTUNE INCORPORATED, MINNEAPOLIS, MN. FILED 2-1-2005.

CLASS 35—(Continued).

SN 78-582,896. DEUTSCHE TELEKOM AG, BONN, FED REP GERMANY, FILED 3-8-2005.

T-Systems Enterprise Services

THE MARK CONSISTS OF STANDARD CHARACTERS WITHOUT CLAIM TO ANY PARTICULAR FONT, STYLE, SIZE, OR COLOR.

PRIORITY CLAIMED UNDER SEC. 44(D) ON FED REP GERMANY APPLICATION NO. 30452358542, FILED 9-9-2004, REG. NO. 30452358, DATED 11-15-2004, EXPIRES 9-30-2014.

OWNER OF U.S. REG. NOS. 2,448,571 AND 2,880,613.

NO CLAIM IS MADE TO THE EXCLUSIVE RIGHT TO USE "ENTERPRISE SERVICES", APART FROM THE MARK AS SHOWN.

FOR ADVERTISING SERVICES, NAMELY, PREPARING AND PLACING ADVERTISEMENTS FOR OTHERS PROMOTING THE GOODS AND SERVICES OF OTHERS THROUGH PRINTED ADVERTISING, PRINTED DIRECTORIES, THROUGH ENCODED MEDIA, THROUGH THE DISSEMINATION OF PROMOTIONAL MATERIALS, THROUGH DIRECT MAIL ADVERTISING, THROUGH ELECTRONIC BILLBOARD ADVERTISING, PREPARING AUDIO-VISUAL PRESENTATIONS FOR USE IN ADVERTISING; BUSINESS MANAGEMENT SERVICES, NAMELY, BUSINESS APPRAISALS, BUSINESS AUDITING, PROVIDING BUSINESS INFORMATION, NAMELY, PREPARING BUSINESS REPORTS AND CONDUCTING BUSINESS RESEARCH, ANALYSIS AND SURVEYS, BUSINESS MANAGEMENT PLANNING, BUSINESS MANAGEMENT CONSULTATION, BUSINESS MANAGEMENT SUPERVISION, CONDUCTING BUSINESS NETWORKING FOR OTHERS; BUSINESS MANAGEMENT AND CONSULTING SERVICES, EXCLUDING AGRICULTURAL BUSINESS MANAGEMENT AND CONSULTING SERVICES; PROVIDING INFORMATION VIA THE TELEPHONE AND THE GLOBAL COMMUNICATION NETWORKS IN THE FIELD OF ADVERTISING AND BUSINESS MARKETING; PROFESSIONAL CONSULTANCY IN THE FIELD OF DATA PROCESSING (U.S. CLS. 100, 101 AND 102).

LAURIE MAYES, EXAMINING ATTORNEY

ATTUNE

SN 78-590,513. DOGSTERS, LLC, MILFORD, CT. FILED 3-18-2005.



THE MARK CONSISTS OF STANDARD CHARACTERS WITHOUT CLAIM TO ANY PARTICULAR FONT, STYLE, SIZE, OR COLOR.

FOR CONSULTING SERVICES IN THE FIELD OF BUSINESS DEVELOPMENT, MARKETING AND SALES (U.S. CLS. 100, 101 AND 102).

INGRID C. EULIN, EXAMINING ATTORNEY

FOR ADVERTISING SERVICES, NAMELY, PROMOTING THE ADVANTAGES OF DISTRIBUTING AND SELLING PET FOOD AND PET ACCESSORIES (U.S. CLS. 100, 101 AND 102).

JIM RINGLE, EXAMINING ATTORNEY

CLASS 35—(Continued).

SN 78-598,511. DAVARTA, INC., PORTLAND, OR. FILED 3-30-2005.

CLASS 35—(Continued).

SN 78-598,539. GH GLOBAL HEALTH DIRECT LLC, BROOKFIELD, WI. FILED 3-30-2005.

DAVARTA

QUESTRIC PRO

THE MARK CONSISTS OF STANDARD CHARACTERS WITHOUT CLAIM TO ANY PARTICULAR FONT, STYLE, SIZE, OR COLOR.

FOR DIRECT MARKETING AND ADVERTISING SERVICES; PROVIDING MARKETING INFORMATION (U.S. CLS. 100, 101 AND 102).

JASON ROTH, EXAMINING ATTORNEY

THE MARK CONSISTS OF STANDARD CHARACTERS WITHOUT CLAIM TO ANY PARTICULAR FONT, STYLE, SIZE, OR COLOR.

FOR OPERATING ON-LINE MARKETPLACES FOR SELLERS OF HEALTHCARE PRODUCTS AND SERVICES DIRECTED TO CONSUMERS AND HEALTHCARE PROFESSIONALS (U.S. CLS. 100, 101 AND 102).

JASON ROTH, EXAMINING ATTORNEY

SN 78-598,534. GH GLOBAL HEALTH DIRECT LLC, BROOKFIELD, WI. FILED 3-30-2005.

SN 78-605,092. KEYCORP, CLEVELAND, OH. FILED 4-8-2005.

QUESTRIC

KEY TOTAL SALES

THE MARK CONSISTS OF STANDARD CHARACTERS WITHOUT CLAIM TO ANY PARTICULAR FONT, STYLE, SIZE, OR COLOR.

FOR OPERATING ON-LINE MARKETPLACES FOR SELLERS OF HEALTHCARE PRODUCTS AND SERVICES DIRECTED TO CONSUMERS AND HEALTHCARE PROFESSIONALS (U.S. CLS. 100, 101 AND 102).

JASON ROTH, EXAMINING ATTORNEY

THE MARK CONSISTS OF STANDARD CHARACTERS WITHOUT CLAIM TO ANY PARTICULAR FONT, STYLE, SIZE, OR COLOR.

OWNER OF U.S. REG. NOS. 1,722,378, 1,956,625 AND 1,998,350.

NO CLAIM IS MADE TO THE EXCLUSIVE RIGHT TO USE "SALES", APART FROM THE MARK AS SHOWN.

FOR BUSINESS MARKETING CONSULTING SERVICES (U.S. CLS. 100, 101 AND 102).

FIRST USE 2-28-2005; IN COMMERCE 2-28-2005.

CHERYL CLAYTON, EXAMINING ATTORNEY

CLASS 35—(Continued).

SN 78-605,131. KEYCORP, CLEVELAND, OH. FILED 4-8-2005.

KEY TOTAL WORKFORCE

THE MARK CONSISTS OF STANDARD CHARACTERS WITHOUT CLAIM TO ANY PARTICULAR FONT, STYLE, SIZE, OR COLOR.

OWNER OF U.S. REG. NOS. 1,722,378, 1,956,625 AND 1,998,350.

NO CLAIM IS MADE TO THE EXCLUSIVE RIGHT TO USE "WORKFORCE", APART FROM THE MARK AS SHOWN.

FOR BUSINESS MANAGEMENT AND CONSULTATION REGARDING EMPLOYMENT AND HUMAN RESOURCES MANAGEMENT, PLANNING AND SUPERVISION (U.S. CLS. 100, 101 AND 102).

FIRST USE 2-28-2005; IN COMMERCE 2-28-2005.
CHERYL CLAYTON, EXAMINING ATTORNEY

SN 78-605,164. KEYCORP, CLEVELAND, OH. FILED 4-8-2005.

KEYCONSULT

THE MARK CONSISTS OF STANDARD CHARACTERS WITHOUT CLAIM TO ANY PARTICULAR FONT, STYLE, SIZE, OR COLOR.

OWNER OF U.S. REG. NOS. 1,722,378, 1,956,625 AND 1,998,350.

FOR BUSINESS CONSULTING SERVICES, NAMELY, ASSISTANCE, ADVISORY SERVICES AND CONSULTANCY WITH REGARD TO BUSINESS PLANNING, BUSINESS ANALYSIS, BUSINESS MANAGEMENT AND BUSINESS ORGANIZATION (U.S. CLS. 100, 101 AND 102).

FIRST USE 2-28-2005; IN COMMERCE 2-28-2005.
CHERYL CLAYTON, EXAMINING ATTORNEY

CLASS 35—(Continued).

SN 78-623,438. GENERAL MOTORS ACCEPTANCE CORPORATION, DETROIT, MI. FILED 5-5-2005.

SMART REPLACEMENT

THE MARK CONSISTS OF STANDARD CHARACTERS WITHOUT CLAIM TO ANY PARTICULAR FONT, STYLE, SIZE, OR COLOR.

NO CLAIM IS MADE TO THE EXCLUSIVE RIGHT TO USE "REPLACEMENT", APART FROM THE MARK AS SHOWN.

FOR SERVICES OFFERED TO INSURANCE CUSTOMERS, NAMELY PROVIDING ASSISTANCE TO TOTAL LOSS PARTICIPANTS IN LOCATING A REPLACEMENT VEHICLE. (U.S. CLS. 100, 101 AND 102).

APRIL L. RADEMACHER, EXAMINING ATTORNEY

SN 78-648,627. PIZZERIA UNO CORPORATION, WILMINGTON, DE. FILED 6-10-2005.



OWNER OF U.S. REG. NOS. 1,089,458, 1,329,014 AND OTHERS.

NO CLAIM IS MADE TO THE EXCLUSIVE RIGHT TO USE "INSIDER'S CLUB", APART FROM THE MARK AS SHOWN.

THE ENGLISH TRANSLATION OF THE WORD UNO IN THE MARK IS "ONE."

FOR CUSTOMER LOYALTY SERVICES FOR RESTAURANT CUSTOMERS FOR COMMERCIAL, PROMOTIONAL AND ADVERTISING PURPOSES PROVIDED VIA E-MAIL, THE INTERNET AND OTHER MEANS OF COMMUNICATION (U.S. CLS. 100, 101 AND 102).

MARCIE MILONE, EXAMINING ATTORNEY

CLASS 36—INSURANCE AND FINANCIAL

SN 74-610,563. ARKANSAS BLUE CROSS AND BLUE SHIELD, LITTLE ROCK, AR. FILED 12-13-1994.



OWNER OF U.S. REG. NOS. 1,473,493, 1,850,423 AND OTHERS.

NO CLAIM IS MADE TO THE EXCLUSIVE RIGHT TO USE "ARKANSAS" AND "PRIMARY CARE NETWORK POINT OF SERVICE", APART FROM THE MARK AS SHOWN.

FOR ADMINISTERING SELF-INSURED EMPLOYEE BENEFIT ACCOUNTS AND HEALTH INSURANCE UNDERWRITING OFFERED THROUGH A PREFERRED PROVIDER ORGANIZATION FOR PREPAID HEALTH CARE SERVICES (U.S. CLS. 100, 101 AND 102).
JULIE WATSON, EXAMINING ATTORNEY

CLASS 36—(Continued).

SN 76-146,888. PROMISTAR FINANCIAL CORPORATION, JOHNSTOWN, PA. FILED 10-16-2000.



NO CLAIM IS MADE TO THE EXCLUSIVE RIGHT TO USE "COMMUNITY DEVELOPMENT CORPORATION", APART FROM THE MARK AS SHOWN.

FOR FINANCING HOUSING FOR LOW TO MODERATE INCOME CITIZENS (U.S. CLS. 100, 101 AND 102).
TANYA AMOS, EXAMINING ATTORNEY

SN 76-209,994. ANDREWS, DUANE, VALLEJO, CA. FILED 2-8-2001.



SN 75-504,473. MUTUAL BENEFIT GROUP, HUNTINGDON, PA. FILED 6-16-1998.

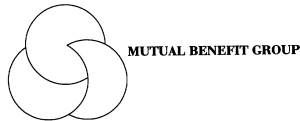

NO CLAIM IS MADE TO THE EXCLUSIVE RIGHT TO USE "REO NETWORK", APART FROM THE MARK AS SHOWN.

FOR REAL ESTATE MANAGEMENT SERVICES AND REAL ESTATE BROKERAGE SERVICES (U.S. CLS. 100, 101 AND 102).

FIRST USE 1-31-2001; IN COMMERCE 1-31-2001.
KELLEY WELLS, EXAMINING ATTORNEY

NO CLAIM IS MADE TO THE EXCLUSIVE RIGHT TO USE "GROUP", APART FROM THE MARK AS SHOWN.

FOR INSURANCE UNDERWRITING IN THE FIELD OF PROPERTY AND CASUALTY INSURANCE (U.S. CLS. 100, 101 AND 102).

FIRST USE 7-0-1998; IN COMMERCE 7-0-1998.
JENNIFER WILLISTON, EXAMINING ATTORNEY

SN 76-232,716. QUANTUM CAPITAL CORP., SUWANEE, GA. FILED 3-29-2001.

SN 75-821,083. DECIDE.COM, INC., SAN JOSE, CA. FILED 10-11-1999.

WIRELESS TEST DRIVE



QUANTUM
NATIONAL BANK

NO CLAIM IS MADE TO THE EXCLUSIVE RIGHT TO USE "WIRELESS", APART FROM THE MARK AS SHOWN.

FOR BROKERAGE SERVICES IN THE FIELD OF INTERNET SERVICE PROVIDERS AND UTILITY PROVIDERS, OFFERED VIA A GLOBAL COMPUTER NETWORK (U.S. CLS. 100, 101 AND 102).

STACY WAHLBERG, EXAMINING ATTORNEY

NO CLAIM IS MADE TO THE EXCLUSIVE RIGHT TO USE "NATIONAL BANK", APART FROM THE MARK AS SHOWN.

FOR BANKING (U.S. CLS. 100, 101 AND 102).
FIRST USE 12-27-1995; IN COMMERCE 12-27-1995.
BILL DAWE, EXAMINING ATTORNEY

CLASS 36—(Continued).

SN 76-278,610. OXFORD HEALTH PLANS LLC, TRUMBULL, CT. FILED 6-29-2001.

OXFORD USA

CONCURRENT USE PROCEEDING NO. 1104, OXFORD HEALTH PLANS, INC. V. OXFORD HEALTHCARE CORP. (FINDING IN FAVOR OF CONCURRENT USE REGISTRATIONS), PURSUANT TO SECTION 2.42, APPLICANT STATES THAT THE GEOGRAPHIC AREA OF APPLICANT'S USE SHALL BE AS FOLLOWS: ALL STATES AND TERRITORIES OF THE UNITED STATES, EXCEPT FOR THE STATES OF CALIFORNIA, KANSAS, OKLAHOMA, ARKANSAS, MISSOURI, MISSISSIPPI, LOUISIANA, ALABAMA, AND TENNESSEE.

NO CLAIM IS MADE TO THE EXCLUSIVE RIGHT TO USE "USA", APART FROM THE MARK AS SHOWN.

FOR INDEMNITY HEALTH INSURANCE UNDERWRITING, CLAIMS PROCESSING, AND ADMINISTRATION FOR MEMBERS OF MANAGED HEALTH CARE PLANS (U.S. CLS. 100, 101 AND 102).

FIRST USE 7-1-2001; IN COMMERCE 7-1-2001.
SAMUEL E. SHARPER JR., EXAMINING ATTORNEY

CLASS 36—(Continued).

SN 76-435,434. ST. CROIX MORTGAGE, INC., MINNEAPOLIS, MN. FILED 7-29-2002.



NO CLAIM IS MADE TO THE EXCLUSIVE RIGHT TO USE "ST. CROIX MORTGAGE", APART FROM THE MARK AS SHOWN.

THE LINING IS A FEATURE OF THE MARK AND DOES NOT INDICATE COLOR.

FOR PROVIDING SERVICES TO PERSONS WHO ARE SEEKING LOANS OR REFINANCING, NAMELY MORTGAGE LOANS, HOME EQUITY LOANS, DEBT CONSOLIDATION LOANS, COMMERCIAL LOANS AND CONSTRUCTION LOANS (U.S. CLS. 100, 101 AND 102).

FIRST USE 5-31-2001; IN COMMERCE 5-31-2001.
BARBARA RUTLAND, EXAMINING ATTORNEY

SN 76-320,254. PRIME THERAPEUTICS, INC., EAGAN, MN. FILED 10-1-2001.

PRIMEREPORTER

FOR PROVIDING HEALTH INFORMATION, NAMELY, PROVIDING INSURANCE CLAIM INFORMATION FOR DRUGS (U.S. CLS. 100, 101 AND 102).

KIM SAITO, EXAMINING ATTORNEY

SN 76-461,622. DUNDEE CORPORATION, TORONTO, ONTARIO, CANADA, FILED 10-23-2002.



PRIORITY CLAIMED UNDER SEC. 44(D) ON CANADA APPLICATION NO. 1152415, FILED 9-16-2002, REG. NO. TMA638035, DATED 4-21-2005, EXPIRES 4-21-2020.

FOR TRUST SERVICES, NAMELY, INVESTMENT AND TRUST COMPANY SERVICES (U.S. CLS. 100, 101 AND 102).

BILL DAWE, EXAMINING ATTORNEY

SN 76-386,816. D & G ADVISORY GROUP, L.L.C., MENOMINEE, MI. FILED 3-22-2002.



NO CLAIM IS MADE TO THE EXCLUSIVE RIGHT TO USE "ADVISORY GROUP", APART FROM THE MARK AS SHOWN.

FOR FINANCIAL SERVICES IN THE NATURE OF AN INVESTMENT SECURITY (U.S. CLS. 100, 101 AND 102).

FIRST USE 12-1-2001; IN COMMERCE 12-1-2001.
ANGELA M. MICHELI, EXAMINING ATTORNEY

SN 76-489,846. THE OHIO CASUALTY INSURANCE COMPANY, FAIRFIELD, OH. FILED 2-12-2003.



THE STIPLING IN THE DRAWING IS TO INDICATE SHADING AND DOES NOT COMPOSE PART OF THE MARK.

FOR PROPRIETARY ADMINISTRATION OF PROPERTY AND CASUALTY INSURANCE POLICIES FOR AUTHORIZED INDEPENDENT INSURANCE AGENTS THROUGH PRIVATE ACCESS OVER A GLOBAL COMMUNICATION SYSTEM (U.S. CLS. 100, 101 AND 102).

ASMAT KHAN, EXAMINING ATTORNEY

SN 76-409,205. 7-ELEVEN, INC., DALLAS, TX. FILED 5-16-2002.

7-ELEVEN SPEAK OUT

FOR TELEPHONE CALLING CARD SERVICES; TELEPHONE CALLING CARD SERVICES FOR CONNECTION TO THE INTERNET THROUGH USE OF A PRE-PAID CD-ROM (U.S. CLS. 100, 101 AND 102).

BERYL GARDNER, EXAMINING ATTORNEY

CLASS 36—(Continued).

SN 76-547,313. IBERIABANK CORPORATION, LAFAYETTE, LA. FILED 9-26-2003.

IBERIABANK

SEC. 2(F).

FOR BANKING SERVICES; ONLINE BANKING SERVICES; INVESTMENT BANKING SERVICES; MORTGAGE BANKING SERVICES; FINANCIAL SERVICES, NAMELY MONEY LENDING, INVESTMENT FUND TRANSFER AND TRANSACTION SERVICES, FINANCIAL PLANNING SERVICES; BANKING SERVICES, NAMELY, CHECKING ACCOUNTS, COMPOUND INTEREST ACCOUNTS, SAVINGS ACCOUNTS, LOAN FINANCING AND MONEY LENDING SERVICES, CREDIT AND LOAN SERVICES, SAVINGS AND OTHER INTEREST ACCOUNT SERVICES, FOREIGN EXCHANGE, SAFE DEPOSIT BOX SERVICES, ISSUING LETTERS OF CREDIT AND TRAVELERS' CHECKS, ELECTRONIC FUNDS TRANSFER, COMMERCIAL SAVINGS, AND FIDUCIARY AND TRUST DEPARTMENT SERVICES; ELECTRONIC BANKING, NAMELY AUTOMATED TELLER MACHINE SERVICES; ONLINE BANKING SERVICES; INVESTMENT BANKING SERVICES; INVESTMENT BANKING SERVICES INVOLVING BUSINESS, PROFESSIONAL AND INDIVIDUAL RETIREMENT PLANS, PENSIONS AND OTHER INVESTMENTS; MORTGAGE BANKING SERVICES; STOCK BROKERAGE SERVICES; INSURANCE AGENCY SERVICES IN THE FIELDS OF AUTO AND VEHICLE INSURANCE, HOME INSURANCE, LIFE INSURANCE, MEDICAL INSURANCE, AND DISABILITY INSURANCE; CREDIT CARD SERVICES (U.S. CLS. 100, 101 AND 102).

FIRST USE 12-3-1997; IN COMMERCE 12-3-1997.
TRACY WHITAKER-BOWN, EXAMINING ATTORNEY

SN 76-552,781. NATIONSRX, INC., MURRIETA, CA. FILED 10-20-2003.

NATIONSRX

FOR PHARMACY BENEFITS MANAGEMENT SERVICES, NAMELY, BENEFIT-PLAN ADMINISTRATION (U.S. CLS. 100, 101 AND 102).

FIRST USE 3-30-2003; IN COMMERCE 3-30-2003.
WON TEAK OH, EXAMINING ATTORNEY

SN 76-553,904. THE MOSAIC TILE COMPANY OF VIRGINIA, INC., SPRINGFIELD, VA. FILED 10-24-2003.

MOSAIC TILE COMPANY

NO CLAIM IS MADE TO THE EXCLUSIVE RIGHT TO USE COMPANY, APART FROM THE MARK AS SHOWN.
FOR FINANCIAL SERVICES NAMELY CREDIT LINES (U.S. CLS. 100, 101 AND 102).

FIRST USE 8-12-1972; IN COMMERCE 8-12-1972.
GEORGE LORENZO, EXAMINING ATTORNEY

CLASS 36—(Continued).

SN 76-554,092. THE MOSAIC TILE COMPANY OF VIRGINIA, INC., SPRINGFIELD, VA. FILED 10-24-2003.

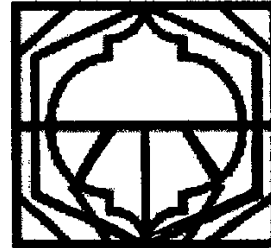

FOR FINANCIAL SERVICES NAMELY CREDIT LINES (U.S. CLS. 100, 101 AND 102).

FIRST USE 9-17-2001; IN COMMERCE 9-17-2001.
GIANCARLO CASTRO, EXAMINING ATTORNEY

SN 76-564,026. GORDON BROTHERS GROUP, LLC, BOSTON, MA. FILED 12-8-2003.

GB FIXED ASSET SOLUTIONS

THE MARK CONSISTS OF STANDARD CHARACTERS WITHOUT CLAIM TO ANY PARTICULAR FONT, STYLE, SIZE, OR COLOR.

OWNER OF U.S. REG. NOS. 2,842,235 AND 2,842,236.

NO CLAIM IS MADE TO THE EXCLUSIVE RIGHT TO USE "FIXED ASSET SOLUTIONS", APART FROM THE MARK AS SHOWN.

FOR BUSINESS LIQUIDATION, ASSET DISPOSITION AND REDEPLOYMENT SERVICES FOR THE CONSUMER PRODUCTS AND RETAILING INDUSTRIES (U.S. CLS. 100, 101 AND 102).

FIRST USE 1-1-2003; IN COMMERCE 1-1-2003.
SCOTT OSCLICK, EXAMINING ATTORNEY

SN 76-567,834. 200 KELSEY ASSOCIATES, LLC, NEW ROCHELLE, NJ. FILED 12-31-2003.

BOWERY SAVINGS BANK

THE MARK CONSISTS OF STANDARD CHARACTERS WITHOUT CLAIM TO ANY PARTICULAR FONT, STYLE, SIZE, OR COLOR.

NO CLAIM IS MADE TO THE EXCLUSIVE RIGHT TO USE "SAVINGS BANK", APART FROM THE MARK AS SHOWN.

FOR BANKING SERVICES; FINANCIAL SERVICES, NAMELY, FINANCIAL ANALYSIS AND CONSULTATION, FINANCIAL SERVICES IN THE FIELD OF MONEY LENDING, MONEY LENDING, INVESTMENT FUND TRANSFER AND TRANSACTION SERVICES (U.S. CLS. 100, 101 AND 102).

DORITT L. CARROLL, EXAMINING ATTORNEY

CLASS 36—(Continued).

SN 76-568,942. SECURITY PACIFIC HOME LOANS, INC., PASADENA, CA. FILED 1-6-2004.

SECURITY PACIFIC HOME LOANS

THE MARK CONSISTS OF STANDARD CHARACTERS WITHOUT CLAIM TO ANY PARTICULAR FONT, STYLE, SIZE, OR COLOR.

NO CLAIM IS MADE TO THE EXCLUSIVE RIGHT TO USE HOME LOANS, APART FROM THE MARK AS SHOWN.

FOR FINANCIAL SERVICES, NAMELY MORTGAGE LENDING AND MORTGAGE BANKING (U.S. CLS. 100, 101 AND 102).

FIRST USE 6-0-2004; IN COMMERCE 6-0-2004.

ANDREW BENZMILLER, EXAMINING ATTORNEY

SN 76-569,298. NET PROFIT, INC., GREENVILLE, SC. FILED 1-12-2004.

WIZARD

THE MARK CONSISTS OF STANDARD CHARACTERS WITHOUT CLAIM TO ANY PARTICULAR FONT, STYLE, SIZE, OR COLOR.

FOR TAX CONSULTATION AND PREPARATION SERVICES, NAMELY IDENTIFYING, CALCULATING AND ADMINISTERING TAX CREDITS AND INCENTIVE PROGRAMS (U.S. CLS. 100, 101 AND 102).

FIRST USE 10-0-2003; IN COMMERCE 10-0-2003.

BRIDGETT SMITH, EXAMINING ATTORNEY

SN 76-572,726. CITY OF HOPE, DUARTE, CA. FILED 1-29-2004.

THE CAMPAIGN FOR HOPE

THE MARK CONSISTS OF STANDARD CHARACTERS WITHOUT CLAIM TO ANY PARTICULAR FONT, STYLE, SIZE, OR COLOR.

NO CLAIM IS MADE TO THE EXCLUSIVE RIGHT TO USE "CAMPAIGN", APART FROM THE MARK AS SHOWN.

FOR CHARITABLE FUNDRAISING SERVICES (U.S. CLS. 100, 101 AND 102).

MARTHA FROMM, EXAMINING ATTORNEY

CLASS 36—(Continued).

SN 76-575,864. CUENCA, FRANK A., SAN DIEGO, CA. FILED 2-12-2004.

THE RETIREMENT GROUP

THE MARK CONSISTS OF STANDARD CHARACTERS WITHOUT CLAIM TO ANY PARTICULAR FONT, STYLE, SIZE, OR COLOR.

OWNER OF U.S. REG. NO. 2,138,009.

NO CLAIM IS MADE TO THE EXCLUSIVE RIGHT TO USE GROUP, APART FROM THE MARK AS SHOWN.

SEC. 2(F).

FOR INVESTMENT ADVICE AND FINANCIAL PLANNING ADVISORY SERVICES (U.S. CLS. 100, 101 AND 102).

FIRST USE 8-1-1993; IN COMMERCE 8-1-1993.

H. M. FISHER, EXAMINING ATTORNEY

SN 76-575,990. DEUTSCHE TELEKOM AG, BONN, 53113, FED REP GERMANY, FILED 2-17-2004.

T-M3

THE MARK CONSISTS OF STANDARD CHARACTERS WITHOUT CLAIM TO ANY PARTICULAR FONT, STYLE, SIZE, OR COLOR.

OWNER OF FED REP GERMANY REG. NO. 30341456, DATED 9-22-2003, EXPIRES 8-31-2013.

FOR INSURANCE SERVICES, NAMELY, INSURANCE BROKERAGE AND INSURANCE CLAIMS PROCESSING; FINANCIAL SPONSORSHIP OF SPORTS TEAMS AND SPORTING EVENTS, EDUCATIONAL LECTURES AND TRAINING COURSES, MUSICAL CONCERTS, BALLET AND THEATRE PROGRAMS; MONETARY EXCHANGE; CREDIT CARD SERVICES; TELEPHONE CALLING CARD SERVICES; ELECTRONIC COMMERCE SERVICES, NAMELY, ELECTRONIC DEBIT AND CREDIT CARD TRANSACTION PROCESSING SERVICES, FUNDS TRANSFER AND BILL PAYMENT-PROCESSING SERVICES; CUSTOM BROKERAGE FOR THIRD PARTIES IN THE FIELD OF INSURANCE; REAL ESTATE SERVICES, NAMELY, BROKERAGE, MANAGEMENT, LEASING, AND APPRAISAL OF REAL PROPERTY (U.S. CLS. 100, 101 AND 102).

JEFFERY COWARD, EXAMINING ATTORNEY

SN 76-586,031. SAMBA FINANCIAL GROUP, RIYADH, SAUDI ARABIA, FILED 4-8-2004.

samba financial group  مجموعة سامبا المالية

NO CLAIM IS MADE TO THE EXCLUSIVE RIGHT TO USE "FINANCIAL GROUP" AND THE NON-LATIN CHARACTERS THAT REPRESENT THE WORDING FINANCIAL GROUP, APART FROM THE MARK AS SHOWN.

THE NON-LATIN CHARACTER(S) IN THE MARK TRANSLITERATES INTO MAJMU'AT SAMBA AL MALIYAH, AND THIS MEANS SAMBA FINANCIAL GROUP IN ENGLISH.

FOR BANKING AND FINANCIAL SERVICES (U.S. CLS. 100, 101 AND 102).

CURTIS FRENCH, EXAMINING ATTORNEY

CLASS 36—(Continued).

SN 76-586,717. DISCOVERY COLLEGIATE ADVISORS, INC., TOMS RIVER, NJ. FILED 4-14-2004.



THE MARK CONSISTS OF THE STYLIZED LETTERS "DCA" WITH A PICTURE OF A GRADUATION CAP THAT LIES ON TOP OF THE LETTER "C."

FOR CONSULTING SERVICES, NAMELY CONSULTING IN THE FIELD OF FUNDING AND SAVING FOR SECONDARY EDUCATION EXPENSES AND FINANCIAL AID FOR SECONDARY EDUCATION (U.S. CLS. 100, 101 AND 102).

FIRST USE 1-0-1997; IN COMMERCE 1-0-1997.
CAROLINE WOOD, EXAMINING ATTORNEY

CLASS 36—(Continued).

SN 76-591,873. KANSAS CITY AVIATION DEPARTMENT, KANSAS CITY, MO. FILED 5-12-2004.



THE MARK CONSISTS OF THE MARK CONSISTS OF THE LETTERS KCI OVER THE WORD QUICKTAG, WITH THREE ROWS OF DOTS APPEARING ON A DIAGONAL AND ONE DOT THAT APPEARS TO BE TRAVELING IN MOTION BETWEEN THE SECOND AND THIRD ROWS OF DOTS. THE STIPPLING IS INTENDED TO INDICATE THE MOTION OF THE TRAVELING DOT.

FOR ELECTRONIC PAYMENT COLLECTION SERVICES, NAMELY, COLLECTION OF PARKING FEES THROUGH USE OF AN ELECTRONIC SYSTEM TO IDENTIFY VEHICLES AND AUTOMATICALLY CHARGE PARKING FEES TO THE VEHICLE OWNER'S ACCOUNT (U.S. CLS. 100, 101 AND 102).

FIRST USE 11-4-2004; IN COMMERCE 11-4-2004.
MICHAEL SOUDERS, EXAMINING ATTORNEY

SN 76-591,984. HBW INSURANCE & FINANCIAL SERVICES, INC., SIMI VALLEY, CA. FILED 5-13-2004.

HBW

SN 76-588,629. RESULTS HOMEBUYERS, INC., BURNSVILLE, MN. FILED 4-26-2004.

1-800-SELL-NOW

THE MARK CONSISTS OF STANDARD CHARACTERS WITHOUT CLAIM TO ANY PARTICULAR FONT, STYLE, SIZE, OR COLOR.

FOR REAL ESTATE BROKERAGE AND ACQUISITION SERVICES (U.S. CLS. 100, 101 AND 102).

FIRST USE 9-21-2003; IN COMMERCE 11-10-2003.
KATHRYN COWARD, EXAMINING ATTORNEY

THE MARK CONSISTS OF STANDARD CHARACTERS WITHOUT CLAIM TO ANY PARTICULAR FONT, STYLE, SIZE, OR COLOR.

FOR FINANCIAL SERVICES, NAMELY, BROKERAGE OF TERM AND UNIVERSAL LIFE INSURANCE POLICIES; BROKERAGE OF MUTUAL FUND, ANNUITIES, AND OTHER SECURITIES; FINANCIAL PLANNING AND INVESTMENT ADVISING (U.S. CLS. 100, 101 AND 102).

FIRST USE 10-0-1991; IN COMMERCE 10-0-1991.
ANN E. SAPPENFIELD, EXAMINING ATTORNEY

CLASS 36—(Continued).

SN 76-592,321. IMAGINENATIONS GROUP, INC., PASADENA, MD. FILED 5-14-2004.

IMAGINENATIONS

THE MARK CONSISTS OF STANDARD CHARACTERS WITHOUT CLAIM TO ANY PARTICULAR FONT, STYLE, SIZE, OR COLOR.

FOR CHARITABLE FUNDRAISING SERVICES; CHARITABLE FUND RAISING SERVICES FOR LOAN FINANCING AND GRANTS TO INDIVIDUALS IN DEVELOPING COUNTRIES FOR MICRO-ECONOMIC DEVELOPMENT; PROVIDING LOANS AND GRANTS TO INDIVIDUALS IN DEVELOPING COUNTRIES FOR MICRO-ECONOMIC DEVELOPMENT; DISSEMINATION OF FINANCIAL INFORMATION; DISSEMINATION OF FINANCIAL INFORMATION REGARDING CHARITABLE FUND RAISING SERVICES AND LOAN FINANCING AND GRANTS FOR INDIVIDUALS IN DEVELOPING COUNTRIES FOR MICRO-ECONOMIC DEVELOPMENT; CONSULTATION SERVICES RELATING TO CHARITABLE FUND RAISING SERVICES AND LOAN FINANCING AND GRANTS FOR INDIVIDUALS IN DEVELOPING COUNTRIES FOR MICRO-ECONOMIC DEVELOPMENT; ADMINISTRATION OF PROGRAMS PROVIDING LOAN FINANCING AND GRANTS TO INDIVIDUALS IN DEVELOPING COUNTRIES FOR MICRO-ECONOMIC DEVELOPMENT (U.S. CLS. 100, 101 AND 102).

ELIZABETH J. WINTER, EXAMINING ATTORNEY

SN 76-592,407. USA FOOTBALL, VIENNA, VA. FILED 5-14-2004.

TACKLE READING

THE MARK CONSISTS OF STANDARD CHARACTERS WITHOUT CLAIM TO ANY PARTICULAR FONT, STYLE, SIZE, OR COLOR.

NO CLAIM IS MADE TO THE EXCLUSIVE RIGHT TO USE "READING", APART FROM THE MARK AS SHOWN.

FOR CHARITABLE SERVICES IN SUPPORT OF READING DEVELOPMENT AND DESIGNED TO MOTIVATE READING, NAMELY, CHARITABLE FUND RAISING AND ACCEPTING AND ADMINISTERING MONETARY CHARITABLE CONTRIBUTIONS (U.S. CLS. 100, 101 AND 102).

DAVID ELTON, EXAMINING ATTORNEY

CLASS 36—(Continued).

SN 76-592,551. NEW SOUTH MORTGAGE CORPORATION, CHARLESTON, SC. FILED 5-17-2004.

THE ZERO LOAN

THE MARK CONSISTS OF STANDARD CHARACTERS WITHOUT CLAIM TO ANY PARTICULAR FONT, STYLE, SIZE, OR COLOR.

NO CLAIM IS MADE TO THE EXCLUSIVE RIGHT TO USE "LOAN", APART FROM THE MARK AS SHOWN.

FOR MORTGAGE BROKERAGE (U.S. CLS. 100, 101 AND 102).

FIRST USE 0-0-2004; IN COMMERCE 0-0-2004.

SKYE YOUNG, EXAMINING ATTORNEY

SN 76-592,567. OCEAN FRONT PROPERTIES, INC., POTOMAC, MD. FILED 5-17-2004.

OCEANFRONTPROPERTIES.COM

THE MARK CONSISTS OF STANDARD CHARACTERS WITHOUT CLAIM TO ANY PARTICULAR FONT, STYLE, SIZE, OR COLOR.

SEC. 2(F).

FOR PROVIDING INFORMATION IN THE NATURE OF REAL ESTATE LISTING FOR BUYERS, SELLERS AND RENTERS BY MEANS OF A GLOBAL COMPUTER NETWORK (U.S. CLS. 100, 101 AND 102).

FIRST USE 3-2-1997; IN COMMERCE 3-2-1997.

LAURA KOVAISKY, EXAMINING ATTORNEY

SN 76-595,008. MARATHON FINANCIAL GROUP, LTD., GARDEN CITY, NY. FILED 6-1-2004.



NO CLAIM IS MADE TO THE EXCLUSIVE RIGHT TO USE "PAYROLL SERVICES", APART FROM THE MARK AS SHOWN.

FOR PROVIDING COMPUTING, DATA, AND PROFESSIONAL SERVICES TO EMPLOYERS, NAMELY, BENEFITS ADMINISTRATION, PENSION RECORD KEEPING, AND UNEMPLOYMENT COMPENSATION MANAGEMENT SERVICES (U.S. CLS. 100, 101 AND 102).

FIRST USE 1-4-2003; IN COMMERCE 1-4-2003.

BRIAN NEVILLE, EXAMINING ATTORNEY

CLASS 36—(Continued).

SN 76-596,400. DELTA DENTAL PLAN OF MINNESOTA, EAGAN, MN. FILED 6-7-2004.

SINGULAR DENTAL

THE MARK CONSISTS OF STANDARD CHARACTERS WITHOUT CLAIM TO ANY PARTICULAR FONT, STYLE, SIZE, OR COLOR.

NO CLAIM IS MADE TO THE EXCLUSIVE RIGHT TO USE DENTAL, APART FROM THE MARK AS SHOWN.

FOR ADMINISTRATION OF CUSTOM DENTAL PLANS FOR OTHERS; DENTAL INSURANCE CLAIMS PROCESSING (U.S. CLS. 100, 101 AND 102).

FIRST USE 11-14-2003; IN COMMERCE 11-14-2003.
LEIGH CAROLINE CASE, EXAMINING ATTORNEY



SN 76-597,069. FAMIGHETTE, MATTHEW C., LINDENHURST, NY. FILED 6-14-2004.

MY LOAN 1ST

THE MARK CONSISTS OF STANDARD CHARACTERS WITHOUT CLAIM TO ANY PARTICULAR FONT, STYLE, SIZE, OR COLOR.

NO CLAIM IS MADE TO THE EXCLUSIVE RIGHT TO USE "LOAN", APART FROM THE MARK AS SHOWN.

FOR SERVICE OF MORTGAGE BROKERING (U.S. CLS. 100, 101 AND 102).

SUSAN LESLIE DUBOIS, EXAMINING ATTORNEY



SN 76-597,171. PROPERTY ASSESSMENT ADVISORS, INC., CHICAGO, IL. FILED 6-10-2004.

TRA

THE MARK CONSISTS OF STANDARD CHARACTERS WITHOUT CLAIM TO ANY PARTICULAR FONT, STYLE, SIZE, OR COLOR.

FOR FINANCIAL AND REAL ESTATE SERVICES, NAMELY, EVALUATING THE CREDIT WORTHINESS AND CREDIT RATING OF EXISTING OR PROSPECTIVE TENANTS, AND PROVIDING REPORTS FOR CREDIT RISK MANAGEMENT IN CONNECTION WITH THE LEASING OF REAL ESTATE, FOR BUSINESSES AND INDIVIDUALS (U.S. CLS. 100, 101 AND 102).

FIRST USE 3-0-2003; IN COMMERCE 3-0-2003.
DOUGLAS LEE, EXAMINING ATTORNEY

CLASS 36—(Continued).

SN 76-597,261. GMAC MORTGAGE CORPORATION, HORSHAM, PA. FILED 6-14-2004.

GO FAST

THE MARK CONSISTS OF STANDARD CHARACTERS WITHOUT CLAIM TO ANY PARTICULAR FONT, STYLE, SIZE, OR COLOR.

FOR REAL ESTATE MORTGAGE BANKING AND LENDING SERVICES (U.S. CLS. 100, 101 AND 102).

KELLEY WELLS, EXAMINING ATTORNEY



SN 76-598,701. ARGENT MORTGAGE COMPANY, LLC, IRVINE, CA. FILED 6-23-2004.

ARGENT CREDIT ADVANTAGE

THE MARK CONSISTS OF STANDARD CHARACTERS WITHOUT CLAIM TO ANY PARTICULAR FONT, STYLE, SIZE, OR COLOR.

OWNER OF U.S. REG. NOS. 2,765,045, 2,898,968 AND OTHERS.

NO CLAIM IS MADE TO THE EXCLUSIVE RIGHT TO USE "CREDIT ADVANTAGE", APART FROM THE MARK AS SHOWN.

FOR MORTGAGE LENDING; MORTGAGE BANKING; BROKER SERVICES, NAMELY, MORTGAGE BROKERAGE; MORTGAGE LENDING AND FINANCIAL SERVICES, NAMELY, LOAN PROCESSING, LOAN COLLECTIONS, AND MORTGAGE BROKERAGE; AND WHOLESALE AND RETAIL MORTGAGE SERVICES, NAMELY PURCHASING MORTGAGE LOANS FROM REAL ESTATE AND MORTGAGE BROKERS AND CORRESPONDENT LENDERS FOR OTHERS, BROKERING THE SALE AND SERVICING OF MORTGAGE LOANS TO SECONDARY MORTGAGE LENDERS, MAINTENANCE OF MORTGAGE ESCROW ACCOUNTS, AND PURCHASING MORTGAGE LOANS FROM REAL ESTATE AND MORTGAGE BROKERS AND CORRESPONDENT LENDERS; AND MORTGAGE LENDING, MORTGAGE BANKING AND MORTGAGE BROKERAGE SERVICES OVER THE GLOBAL COMPUTER NETWORK (U.S. CLS. 100, 101 AND 102).

FIRST USE 3-0-2004; IN COMMERCE 3-0-2004.
CATHERINE CAIN, EXAMINING ATTORNEY



SN 76-598,702. NATIONWIDE CARD SERVICES, INCORPORATED, BARTLETT, TN. FILED 6-23-2004.

PUTTING LENDERS A CLICK AWAY

THE MARK CONSISTS OF STANDARD CHARACTERS WITHOUT CLAIM TO ANY PARTICULAR FONT, STYLE, SIZE, OR COLOR.

FOR COMPUTER SERVICES, NAMELY, PROVIDING AN INTERACTIVE, SEARCHABLE DATABASE FEATURING BORROWER PROFILES USED FOR MATCHING BORROWERS WITH POTENTIAL LENDERS IN THE FIELD OF MORTGAGE LENDING VIA A GLOBAL COMPUTER NETWORK (U.S. CLS. 100, 101 AND 102).

FIRST USE 1-30-2003; IN COMMERCE 1-30-2003.
CATHERINE CAIN, EXAMINING ATTORNEY

CLASS 36—(Continued).

SN 76-598,703. NATIONWIDE CARD SERVICES, INCORPORATED, BARTLETT, TN. FILED 6-23-2004.

SERVICE 1 MORTGAGE

THE MARK CONSISTS OF STANDARD CHARACTERS WITHOUT CLAIM TO ANY PARTICULAR FONT, STYLE, SIZE, OR COLOR.

NO CLAIM IS MADE TO THE EXCLUSIVE RIGHT TO USE "MORTGAGE", APART FROM THE MARK AS SHOWN.

FOR COMPUTER SERVICES, NAMELY, PROVIDING AN INTERACTIVE, SEARCHABLE DATABASE FEATURING BORROWER PROFILES USED FOR MATCHING BORROWERS WITH POTENTIAL LENDERS IN THE FIELD OF MORTGAGE LENDING VIA A GLOBAL COMPUTER NETWORK (U.S. CLS. 100, 101 AND 102).

FIRST USE 1-30-2003; IN COMMERCE 1-30-2003.
CATHERINE CAIN, EXAMINING ATTORNEY

SN 76-600,311. AMSOUTH BANCORPORATION, BIRMINGHAM, AL. FILED 7-1-2004.

BUENAS RELACIONES

THE MARK CONSISTS OF STANDARD CHARACTERS WITHOUT CLAIM TO ANY PARTICULAR FONT, STYLE, SIZE, OR COLOR.

THE ENGLISH TRANSLATION OF THE MARK IS GOOD RELATIONS.

FOR BANKING SERVICES, NAMELY CHECKING ACCOUNT SERVICES, OVERDRAFT CHECKING ACCOUNT SERVICES, ELECTRONIC BANKING SERVICES, ELECTRONIC BILL PAYMENT SERVICES AND ELECTRONIC TRANSFER OF FUNDS ON BEHALF OF OTHERS; INTERNET BANKING, TELEPHONE BANKING, ATM AND DEBIT CARD SERVICES, MONEY TRANSFERS IN THE NATURE OF WIRING OF FUNDS, MORTGAGE LENDING SERVICES, MORTGAGE BANKING SERVICES, SAVINGS ACCOUNT SERVICES, COMMERCIAL AND CONSUMER LENDING SERVICES, AND CREDIT CARD SERVICES (U.S. CLS. 100, 101 AND 102).

SONYA STEPHENS, EXAMINING ATTORNEY

SN 76-600,337. UPAID SYSTEMS, LTD., 75010 PARIS, FRANCE, FILED 7-2-2004.

TEXT CHECK

THE MARK CONSISTS OF STANDARD CHARACTERS WITHOUT CLAIM TO ANY PARTICULAR FONT, STYLE, SIZE, OR COLOR.

NO CLAIM IS MADE TO THE EXCLUSIVE RIGHT TO USE "TEXT", APART FROM THE MARK AS SHOWN.

FOR ELECTRONIC COMMERCE PAYMENT SERVICES, NAMELY, PROVIDING ELECTRONIC BILL PAYMENT SERVICES VIA ELECTRONIC MEDIA INCLUDING THE INTERNET AND MOBILE TELECOMMUNICATIONS (U.S. CLS. 100, 101 AND 102).

ESTHER BELENKER, EXAMINING ATTORNEY

CLASS 36—(Continued).

SN 76-601,946. EASTMAN CREDIT UNION, KINGSPORT, TN. FILED 7-12-2004.

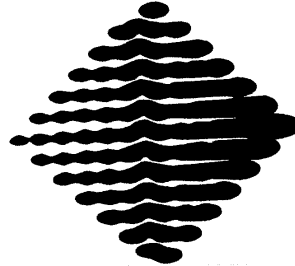

FOR FINANCIAL SERVICES, NAMELY CREDIT UNIONS (U.S. CLS. 100, 101 AND 102).

FIRST USE 2-1-2003; IN COMMERCE 2-1-2003.
MARK RADEMACHER, EXAMINING ATTORNEY

SN 76-601,947. EASTMAN CREDIT UNION, KINGSPORT, TN. FILED 7-12-2004.

EASTMAN CREDIT UNION

THE MARK CONSISTS OF STANDARD CHARACTERS WITHOUT CLAIM TO ANY PARTICULAR FONT, STYLE, SIZE, OR COLOR.

NO CLAIM IS MADE TO THE EXCLUSIVE RIGHT TO USE "CREDIT UNION", APART FROM THE MARK AS SHOWN.

SEC. 2(F).

FOR FINANCIAL SERVICES, NAMELY CREDIT UNIONS (U.S. CLS. 100, 101 AND 102).

FIRST USE 9-1-1934; IN COMMERCE 3-1-1986.

MARK RADEMACHER, EXAMINING ATTORNEY

SN 76-607,483. ALPINE MORTGAGE CORPORATION, WARREN, MI. FILED 8-18-2004.

HOME OF THE NO PROOF LOAN

THE MARK CONSISTS OF STANDARD CHARACTERS WITHOUT CLAIM TO ANY PARTICULAR FONT, STYLE, SIZE, OR COLOR.

FOR FINANCIAL SERVICES; NAMELY, MORTGAGE BROKERAGE, MORTGAGE CONSULTING SERVICES, AND LOAN FINANCING SERVICES (U.S. CLS. 100, 101 AND 102).

FIRST USE 11-1-2003; IN COMMERCE 11-1-2003.

VERNA BETH RIRIE, EXAMINING ATTORNEY

CLASS 36—(Continued).

SN 76-608,562. RINET COMPANY LLC, BOSTON, MA.
FILED 8-20-2004.



RINET COMPANY

NO CLAIM IS MADE TO THE EXCLUSIVE RIGHT TO USE "COMPANY", APART FROM THE MARK AS SHOWN. THE MARK CONSISTS OF THE CAPITALIZED WORDS RINET COMPANY, IN STYLIZED TYPE, WITH RINET APPEARING LARGER THAN COMPANY, WITH THREE OVERLAPPING ARCHES SITUATED ABOVE THE WORD COMPANY.

FOR FINANCIAL SERVICES, NAMELY ESTATE TRUST ADMINISTRATION SERVICES, INVESTMENT AND ASSET MANAGEMENT SERVICES, AND FINANCIAL PLANNING SERVICES. (U.S. CLS. 100, 101 AND 102).

JENNIFER MARTIN, EXAMINING ATTORNEY

SN 76-608,563. RINET COMPANY LLC, BOSTON, MA.
FILED 8-20-2004.



RINET COMPANY

INTEGRATED WEALTH MANAGEMENT

NO CLAIM IS MADE TO THE EXCLUSIVE RIGHT TO USE "COMPANY" AND "INTEGRATED WEALTH MANAGEMENT", APART FROM THE MARK AS SHOWN.

THE MARK CONSISTS OF THE CAPITALIZED WORDS RINET COMPANY, IN STYLIZED TYPE, WITH RINET APPEARING LARGER THAN COMPANY, WITH THREE OVERLAPPING ARCHES SITUATED ABOVE THE WORD COMPANY. BENEATH RINET COMPANY APPEAR THE CAPITALIZED WORDS INTEGRATED WEALTH MANAGEMENT IN SMALLER TYPE.

FOR FINANCIAL SERVICES, NAMELY ESTATE TRUST ADMINISTRATION SERVICES, INVESTMENT AND ASSET MANAGEMENT, AND FINANCIAL PLANNING (U.S. CLS. 100, 101 AND 102).

JENNIFER MARTIN, EXAMINING ATTORNEY

SN 76-610,352. UNITED SERVICES AUTOMOBILE ASSOCIATION, SAN ANTONIO, TX. FILED 9-7-2004.

USAA TOTAL RETURN STRATEGY FUND

THE MARK CONSISTS OF STANDARD CHARACTERS WITHOUT CLAIM TO ANY PARTICULAR FONT, STYLE, SIZE, OR COLOR.

OWNER OF U.S. REG. NOS. 1,590,157, 1,951,916 AND OTHERS.

NO CLAIM IS MADE TO THE EXCLUSIVE RIGHT TO USE TOTAL RETURN STRATEGY FUND, APART FROM THE MARK AS SHOWN.

FOR MUTUAL FUND INVESTMENT SERVICES (U.S. CLS. 100, 101 AND 102).

KELLY BOULTON, EXAMINING ATTORNEY

CLASS 36—(Continued).

SN 76-610,518. AGQUEST FINANCIAL SERVICES, INC., MORGAN, MN. FILED 8-27-2004.



Companion

THE MARK CONSISTS OF STANDARD CHARACTERS WITHOUT CLAIM TO ANY PARTICULAR FONT, STYLE, SIZE, OR COLOR.

FOR AGRICULTURAL LENDING SERVICES (U.S. CLS. 100, 101 AND 102).

FIRST USE 1-1-2001; IN COMMERCE 1-1-2001.

JOHN LINCOSKI, EXAMINING ATTORNEY

SN 76-610,942. TIMCOR EXCHANGE CORPORATION, CULVER CITY, CA. FILED 9-3-2004.



TIMCOR EXCHANGE CORPORATION

NO CLAIM IS MADE TO THE EXCLUSIVE RIGHT TO USE "EXCHANGE CORPORATION" AND "1031", APART FROM THE MARK AS SHOWN.

FOR FINANCIAL CONSULTATION AND MANAGEMENT SERVICES RELATING TO IRS § 1031 TAX DEFERRED PROPERTY EXCHANGE TRANSACTIONS, INCLUDING SERVICES AS A QUALIFIED INTERMEDIARY, AND/OR ACCOMMODATE, AND/OR TRUSTEE IN SUCH TRANSACTIONS (U.S. CLS. 100, 101 AND 102).

FIRST USE 0-0-2004; IN COMMERCE 0-0-2004.

KHANH LE, EXAMINING ATTORNEY

SN 76-611,680. EASTERN CORPORATE FEDERAL CREDIT UNION, WOBURN, MA. FILED 9-9-2004.

1909 FINANCIAL ADVISORS

THE MARK CONSISTS OF STANDARD CHARACTERS WITHOUT CLAIM TO ANY PARTICULAR FONT, STYLE, SIZE, OR COLOR.

NO CLAIM IS MADE TO THE EXCLUSIVE RIGHT TO USE "FINANCIAL ADVISORS", APART FROM THE MARK AS SHOWN.

FOR FINANCIAL RISK ANALYSIS, RISK MANAGEMENT, FINANCIAL STRATEGIC PLANNING AND FINANCIAL CONSULTING SERVICES FOR OTHERS (U.S. CLS. 100, 101 AND 102).

FIRST USE 1-0-2004; IN COMMERCE 4-0-2004.

DANIEL BRODY, EXAMINING ATTORNEY

CLASS 36—(Continued).

SN 76-611,935. MARSHALL & ILSLEY CORPORATION, MILWAUKEE, WI. FILED 9-20-2004.

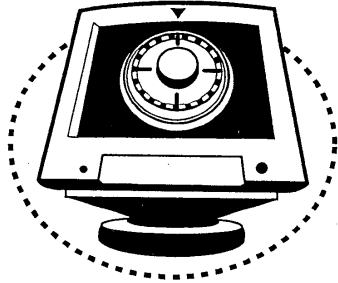

FOR ONLINE BANKING SERVICES (U.S. CLS. 100, 101 AND 102).
FIRST USE 7-0-2004; IN COMMERCE 7-0-2004.
MICHAEL KAZAZIAN, EXAMINING ATTORNEY

SN 76-614,805. TRANS UNION L.L.C., CHICAGO, IL. FILED 10-7-2004.

STREAMLOAN TITLE

THE MARK CONSISTS OF STANDARD CHARACTERS WITHOUT CLAIM TO ANY PARTICULAR FONT, STYLE, SIZE, OR COLOR.

OWNER OF U.S. REG. NO. 2,795,822.
NO CLAIM IS MADE TO THE EXCLUSIVE RIGHT TO USE "TITLE", APART FROM THE MARK AS SHOWN.

FOR PROVIDING TITLE INSURANCE TO HOME EQUITY LENDERS TO ENSURE COLLATERAL PROTECTION (U.S. CLS. 100, 101 AND 102).
ELLEN B. AWRICH, EXAMINING ATTORNEY

SN 76-615,514. FIRST HORIZON NATIONAL CORPORATION, MEMPHIS, TN. FILED 10-6-2004.



OWNER OF U.S. REG. NOS. 2,331,541, 2,348,125 AND OTHERS.

THE COLOR(S) RED, WHITE AND BLUE IS/ARE CLAIMED AS A FEATURE OF THE MARK.

THE COLOR RED APPEARS IN THE UPPER PORTION OF THE BISECTED SQUARE, THE COLOR BLUE APPEARS IN THE LOWER PORTION OF THE BISECTED SQUARE AND IN THE WORDING OF THE MARK, AND THE COLOR WHITE APPEARS IN THE STAR AND THE BISECTING STRIPE IN THE SQUARE.

SEC. 2(F).
FOR BANKING SERVICES AND A HOUSE MARK FOR A FULL LINE OF MORTGAGE SERVICES, SECURITIES, BROKERAGE SERVICES, INVESTMENT BANKING SERVICES, FINANCIAL SERVICES AND INSURANCE SERVICES (U.S. CLS. 100, 101 AND 102).
FIRST USE 8-4-1998; IN COMMERCE 8-4-1998.

JOHN SCHUYLER YARD, EXAMINING ATTORNEY

CLASS 36—(Continued).

SN 76-615,844. O'BRIEN COMMERCIAL REAL ESTATE, GREENVILLE, SC. FILED 10-7-2004.



FOR REAL ESTATE AGENCY SERVICES; COMMERCIAL REAL ESTATE BROKERAGE, LISTING, AND MANAGEMENT (U.S. CLS. 100, 101 AND 102).
FIRST USE 8-0-2000; IN COMMERCE 8-0-2000.
TINA L. SNAPP, EXAMINING ATTORNEY

SN 76-617,428. LIBERTY HOME MORTGAGE, LLC, WEST CALDWELL, NJ. FILED 10-25-2004.



NO CLAIM IS MADE TO THE EXCLUSIVE RIGHT TO USE "HOME MORTGAGE", APART FROM THE MARK AS SHOWN.

FOR MORTGAGE BANKING SERVICES (U.S. CLS. 100, 101 AND 102).

FIRST USE 4-1-2000; IN COMMERCE 4-1-2000.
ANN LINNEHAN, EXAMINING ATTORNEY

SN 76-617,587. YONAN JOHN M., III, TRACY, CA. FILED 10-26-2004.

SMART SAVINGS

THE MARK CONSISTS OF STANDARD CHARACTERS WITHOUT CLAIM TO ANY PARTICULAR FONT, STYLE, SIZE, OR COLOR.

NO CLAIM IS MADE TO THE EXCLUSIVE RIGHT TO USE "SAVINGS", APART FROM THE MARK AS SHOWN.

FOR REAL ESTATE AGENCIES AND BROKERAGES (U.S. CLS. 100, 101 AND 102).

TIMOTHY FINNEGAN, EXAMINING ATTORNEY

CLASS 36—(Continued).

SN 76-618,874. NEXT ESTATE COMMUNICATIONS, INC., MONROVIA, CA. FILED 11-1-2004.

DECLINE GUARD

THE MARK CONSISTS OF STANDARD CHARACTERS WITHOUT CLAIM TO ANY PARTICULAR FONT, STYLE, SIZE, OR COLOR.
FOR PREPAID DEBIT-CARD SERVICES (U.S. CLS. 100, 101 AND 102).
JOHN DALIER, EXAMINING ATTORNEY

SN 76-620,457. SHENANDOAH LIFE INSURANCE COMPANY, ROANOKE, VA. FILED 11-15-2004.

SAFE SOLUTION

THE MARK CONSISTS OF STANDARD CHARACTERS WITHOUT CLAIM TO ANY PARTICULAR FONT, STYLE, SIZE, OR COLOR.
OWNER OF U.S. REG. NO. 2,289,644.
FOR ANNUITY UNDERWRITING SERVICES (U.S. CLS. 100, 101 AND 102).
FIRST USE 3-4-2005; IN COMMERCE 3-4-2005.
BRIAN PINO, EXAMINING ATTORNEY

SN 76-620,506. JELD-WEN, INC., KLAMATH FALLS, OR. FILED 11-15-2004.

THE JELD-WEN FOUNDATION

OWNER OF U.S. REG. NOS. 1,388,339 AND 2,705,030.
NO CLAIM IS MADE TO THE EXCLUSIVE RIGHT TO USE "FOUNDATION", APART FROM THE MARK AS SHOWN.
FOR PROVIDING GRANTS TO ORGANIZATIONS INVOLVED IN SOCIAL WELFARE ACTIVITIES, EDUCATIONAL ACTIVITIES, HEALTHCARE ACTIVITIES, YOUTH ACTIVITIES, ARTS AND CULTURAL ACTIVITIES, AND/OR FREE-MARKET AND FREE ENTERPRISE ORIENTED ACTIVITIES; PROVIDING COLLEGE SCHOLARSHIPS; ADMINISTERING MONETARY CHARITABLE CONTRIBUTIONS (U.S. CLS. 100, 101 AND 102).
JOHN GARTNER, EXAMINING ATTORNEY

CLASS 36—(Continued).

SN 76-620,893. PROVIDENT BANCORP, INC., DBA PROVIDENT BANK, SUFFERN (VILLAGE OF MONTEBELLO), NY. FILED 11-17-2004.

Connecting People with Opportunities

THE MARK CONSISTS OF STANDARD CHARACTERS WITHOUT CLAIM TO ANY PARTICULAR FONT, STYLE, SIZE, OR COLOR.
FOR BANK SERVICES (U.S. CLS. 100, 101 AND 102).
FIRST USE 10-6-2004; IN COMMERCE 10-6-2004.
LAURIE MAYES, EXAMINING ATTORNEY

SN 76-620,988. COMMUNITY HOSPICE FOUNDATION, FAYETTEVILLE, NC. FILED 11-18-2004.

REACHING OUT AND SHARING THE JOURNEY.

THE MARK CONSISTS OF STANDARD CHARACTERS WITHOUT CLAIM TO ANY PARTICULAR FONT, STYLE, SIZE, OR COLOR.
FOR NON-PROFIT CHARITABLE ACTIVITIES, NAMELY, FUND-RAISING FOR END-OF-LIFE CARE (U.S. CLS. 100, 101 AND 102).
FIRST USE 10-0-2001; IN COMMERCE 10-0-2001.
LAURIE MAYES, EXAMINING ATTORNEY

SN 76-621,274. THE BEAR STEARNS COMPANIES INC., NEW YORK, NY. FILED 11-19-2004.

WEALTHSET

THE MARK CONSISTS OF STANDARD CHARACTERS WITHOUT CLAIM TO ANY PARTICULAR FONT, STYLE, SIZE, OR COLOR.
FOR FINANCIAL SERVICES, NAMELY FINANCIAL PLANNING AND RISK MANAGEMENT (U.S. CLS. 100, 101 AND 102).
FIRST USE 11-12-2004; IN COMMERCE 11-12-2004.
PAULA MAHONEY, EXAMINING ATTORNEY

SN 76-621,434. FIRSTMERIT CORPORATION, AKRON, OH. FILED 11-22-2004.

CHANGE FOR THE BETTER. CHANGE FOR GOOD.

THE MARK CONSISTS OF STANDARD CHARACTERS WITHOUT CLAIM TO ANY PARTICULAR FONT, STYLE, SIZE, OR COLOR.
FOR BANKING SERVICES (U.S. CLS. 100, 101 AND 102).
FIRST USE 8-9-2004; IN COMMERCE 8-9-2004.
JEFFERY COWARD, EXAMINING ATTORNEY

CLASS 36—(Continued).

SN 76-621,582. SANCHEZ RETIREMENT PLANNING GROUP, INC., STATELINE, NV. FILED 11-22-2004.

JON SANCHEZ, YOUR PERSONAL WEALTH COACH

THE MARK CONSISTS OF STANDARD CHARACTERS WITHOUT CLAIM TO ANY PARTICULAR FONT, STYLE, SIZE, OR COLOR.

NO CLAIM IS MADE TO THE EXCLUSIVE RIGHT TO USE PERSONAL WEALTH COACH, APART FROM THE MARK AS SHOWN.

FOR INVESTMENT BROKERAGE; FINANCIAL PLANNING; REAL ESTATE INVESTMENT; ESTATE PLANNING; ASSET INVESTMENT SERVICES; ADVISE RELATING TO INVESTMENTS; DISCOUNT BROKERAGE SERVICES; FINANCIAL ANALYSIS AND CONSULTATION; PERSONAL WEALTH MANAGEMENT (U.S. CLS. 100, 101 AND 102).

YONG KIM, EXAMINING ATTORNEY

SN 76-621,599. HORACE MANN LIFE INSURANCE COMPANY, SPRINGFIELD, IL. FILED 11-19-2004.

CAPITAL SECURITY 5

THE MARK CONSISTS OF STANDARD CHARACTERS WITHOUT CLAIM TO ANY PARTICULAR FONT, STYLE, SIZE, OR COLOR.

NO CLAIM IS MADE TO THE EXCLUSIVE RIGHT TO USE "CAPITAL SECURITY", APART FROM THE MARK AS SHOWN.

FOR FINANCIAL PLANNING SERVICES, NAMELY, UNDERWRITING OF ANNUITIES (U.S. CLS. 100, 101 AND 102).

WILLIAM P. SHANAHAN, EXAMINING ATTORNEY

SN 76-621,814. VESTPOINTE WEALTH MANAGEMENT LLC, SCOTTSDALE, AZ. FILED 11-22-2004.

VESTPOINTE

THE MARK CONSISTS OF STANDARD CHARACTERS WITHOUT CLAIM TO ANY PARTICULAR FONT, STYLE, SIZE, OR COLOR.

FOR ACCOUNTING AND INVESTMENT SERVICES, NAMELY WEALTH MANAGEMENT IN THE FORM OF PROVIDING INVESTMENT ADVICE, TAX AND ESTATE PLANNING AND PREPARATION, PERSONAL FINANCIAL PLANNING AND INVESTMENT MANAGEMENT (U.S. CLS. 100, 101 AND 102).

FIRST USE 11-10-2004; IN COMMERCE 11-10-2004.

SEAN DWYER, EXAMINING ATTORNEY

CLASS 36—(Continued).

SN 76-621,817. INFORMATION DEVELOPMENT CONSULTANTS, INC., CHICAGO, IL. FILED 11-22-2004.

REAL SOLUTIONS FROM A TRUSTED PARTNER

THE MARK CONSISTS OF STANDARD CHARACTERS WITHOUT CLAIM TO ANY PARTICULAR FONT, STYLE, SIZE, OR COLOR.

FOR FINANCIAL MANAGEMENT CONSULTATION SERVICES FOR NATIONAL, STATE AND LOCAL GOVERNMENTS (U.S. CLS. 100, 101 AND 102).

FIRST USE 10-1-2004; IN COMMERCE 10-1-2004.

BRENDAN MCCAULEY, EXAMINING ATTORNEY

SN 76-621,864. MAKE-A-WISH FOUNDATION^(P) OF CENTRAL AND WESTERN NORTH CAROLINA, INC., CHARLOTTE, NC. FILED 11-23-2004.

CELEBRATION OF HOPE

THE MARK CONSISTS OF STANDARD CHARACTERS WITHOUT CLAIM TO ANY PARTICULAR FONT, STYLE, SIZE, OR COLOR.

FOR CHARITABLE FUNDRAISING FOR CHILDREN WITH LIFE-THREATENING MEDICAL CONDITIONS (U.S. CLS. 100, 101 AND 102).

FIRST USE 11-0-2003; IN COMMERCE 11-0-2003.

MICHELE SWAIN, EXAMINING ATTORNEY

SN 76-622,297. REALTY GOLD, INC., HOLLYWOOD, CA. FILED 11-29-2004.



NO CLAIM IS MADE TO THE EXCLUSIVE RIGHT TO USE "REALTY", APART FROM THE MARK AS SHOWN.

FOR REAL ESTATE AGENCIES AND LEASING OF REAL ESTATE, NAMELY, OF HOMES, APARTMENT BUILDINGS, COMMERCIAL AND INDUSTRIAL BUILDINGS, LANDS, AND BUSINESSES, AND LOAN FINANCING (U.S. CLS. 100, 101 AND 102).

FIRST USE 10-17-2004; IN COMMERCE 10-17-2004.

JOHN WILKE, EXAMINING ATTORNEY

CLASS 36—(Continued).

SN 76-622,540. GALA RESOURCES LLC, NEW YORK, NY. FILED 11-29-2004.

**WHEN OPPORTUNITY STRIKES, AND
TIMING IS EVERYTHING WE CLOSE!**

THE MARK CONSISTS OF STANDARD CHARACTERS WITHOUT CLAIM TO ANY PARTICULAR FONT, STYLE, SIZE, OR COLOR.

FOR MORTGAGE LENDING AND MORTGAGE BROKERAGE SERVICES (U.S. CLS. 100, 101 AND 102). FIRST USE 7-0-2003; IN COMMERCE 7-0-2003. MARIA-VICTORIA SUAREZ, EXAMINING ATTORNEY

SN 76-623,426. COMBINED INSURANCE COMPANY OF AMERICA, CHICAGO, IL. FILED 12-6-2004.

YOUR GOALS, OUR COMMITMENT

THE MARK CONSISTS OF STANDARD CHARACTERS WITHOUT CLAIM TO ANY PARTICULAR FONT, STYLE, SIZE, OR COLOR.

FOR INSURANCE SERVICES, NAMELY PROVIDING SUPPLEMENTAL ACCIDENT AND HEALTH INSURANCE DIRECTLY TO INDIVIDUALS AT HOME AND IN THE WORKPLACE (U.S. CLS. 100, 101 AND 102). FIRST USE 8-30-2004; IN COMMERCE 8-30-2004. SALLY SHIH, EXAMINING ATTORNEY

SN 76-626,351. EXCESS SPACE RETAIL SERVICES, INC., LAKE SUCCESS, NY. FILED 12-28-2004.

EXCESS SPACE RETAIL SERVICES, INC.

THE MARK CONSISTS OF STANDARD CHARACTERS WITHOUT CLAIM TO ANY PARTICULAR FONT, STYLE, SIZE, OR COLOR.

OWNER OF U.S. REG. NO. 2,907,719. NO CLAIM IS MADE TO THE EXCLUSIVE RIGHT TO USE RETAIL SERVICES, INC., APART FROM THE MARK AS SHOWN.

SEC. 2(F) AS TO EXCESS SPACE. FOR REAL ESTATE BROKERAGE AND LEASING (U.S. CLS. 100, 101 AND 102). FIRST USE 6-9-2004; IN COMMERCE 6-9-2004. AMY GEARIN, EXAMINING ATTORNEY

CLASS 36—(Continued).

SN 76-626,841. INTERMEDIARY INSURANCE SERVICES, INC., SAN FRANCISCO, CA. FILED 1-4-2005.



FOR INSURANCE UNDERWRITING AND BROKERAGE IN THE FIELDS OF EXCESS LOSS AND LIFE; INSURANCE CLAIM PROCESSING, ADMINISTRATION AND ADJUSTMENT (U.S. CLS. 100, 101 AND 102). FIRST USE 12-30-1997; IN COMMERCE 12-30-1997. IRA J. GOODSaid, EXAMINING ATTORNEY

SN 76-627,277. SIGETY, C. BIRGE, TAMPA, FL. FILED 1-7-2005.

CONVERGENT BANK

THE MARK CONSISTS OF STANDARD CHARACTERS WITHOUT CLAIM TO ANY PARTICULAR FONT, STYLE, SIZE, OR COLOR.

NO CLAIM IS MADE TO THE EXCLUSIVE RIGHT TO USE BANK, APART FROM THE MARK AS SHOWN. FOR BANKING SERVICES (U.S. CLS. 100, 101 AND 102).

ALICE BENMAMAN, EXAMINING ATTORNEY

SN 76-627,353. AMERICAN INTERNATIONAL GROUP, INC., NEW YORK, NY. FILED 1-10-2005.

AIG ALTARIS HEALTH PARTNERS

THE MARK CONSISTS OF STANDARD CHARACTERS WITHOUT CLAIM TO ANY PARTICULAR FONT, STYLE, SIZE, OR COLOR.

OWNER OF U.S. REG. NOS. 1,151,229, 2,980,015 AND OTHERS.

NO CLAIM IS MADE TO THE EXCLUSIVE RIGHT TO USE "HEALTH PARTNERS", APART FROM THE MARK AS SHOWN.

FOR INVESTMENT CONSULTATION; INVESTMENT MANAGEMENT; INVESTMENT ADVISORY SERVICES; MANAGEMENT OF PRIVATE EQUITY FUNDS AND PRINCIPAL INVESTING SERVICES (U.S. CLS. 100, 101 AND 102).

FIRST USE 4-23-2005; IN COMMERCE 4-23-2005. TANYA AMOS, EXAMINING ATTORNEY

CLASS 36—(Continued).

SN 76-627,354. AMERICAN INTERNATIONAL GROUP, INC., NEW YORK, NY. FILED 1-10-2005.

AIG ALTARIS

THE MARK CONSISTS OF STANDARD CHARACTERS WITHOUT CLAIM TO ANY PARTICULAR FONT, STYLE, SIZE, OR COLOR.

OWNER OF U.S. REG. NOS. 1,151,229, 2,980,015 AND OTHERS.

FOR INVESTMENT CONSULTATION; INVESTMENT MANAGEMENT; INVESTMENT ADVISORY SERVICES; MANAGEMENT OF PRIVATE EQUITY FUNDS AND PRINCIPAL INVESTING SERVICES (U.S. CLS. 100, 101 AND 102).

TANYA AMOS, EXAMINING ATTORNEY

SN 76-627,355. AMERICAN INTERNATIONAL GROUP, INC., NEW YORK, NY. FILED 1-10-2005.

ALTARIS

THE MARK CONSISTS OF STANDARD CHARACTERS WITHOUT CLAIM TO ANY PARTICULAR FONT, STYLE, SIZE, OR COLOR.

OWNER OF U.S. REG. NO. 2,581,365.

FOR INVESTMENT CONSULTATION; INVESTMENT MANAGEMENT; INVESTMENT ADVISORY SERVICES; MANAGEMENT OF PRIVATE EQUITY FUNDS AND PRINCIPAL INVESTING SERVICES (U.S. CLS. 100, 101 AND 102).

FIRST USE 4-23-2005; IN COMMERCE 4-23-2005.
TANYA AMOS, EXAMINING ATTORNEY

SN 76-627,356. AMERICAN INTERNATIONAL GROUP, INC., NEW YORK, NY. FILED 1-10-2005.

ALTARIS HEALTH PARTNERS

THE MARK CONSISTS OF STANDARD CHARACTERS WITHOUT CLAIM TO ANY PARTICULAR FONT, STYLE, SIZE, OR COLOR.

OWNER OF U.S. REG. NO. 2,581,365.

NO CLAIM IS MADE TO THE EXCLUSIVE RIGHT TO USE "HEALTH PARTNERS", APART FROM THE MARK AS SHOWN.

FOR INVESTMENT CONSULTATION; INVESTMENT MANAGEMENT; INVESTMENT ADVISORY SERVICES; MANAGEMENT OF PRIVATE EQUITY FUNDS AND PRINCIPAL INVESTING SERVICES (U.S. CLS. 100, 101 AND 102).

TANYA AMOS, EXAMINING ATTORNEY

CLASS 36—(Continued).

SN 76-627,741. PORTLAND TEACHERS CREDIT UNION, PORTLAND, OR. FILED 1-12-2005.

FLEX ADVANTAGE

THE MARK CONSISTS OF STANDARD CHARACTERS WITHOUT CLAIM TO ANY PARTICULAR FONT, STYLE, SIZE, OR COLOR.

FOR FINANCIAL SERVICES FOR CREDIT UNION MEMBERS, NAMELY LOAN SERVICES (U.S. CLS. 100, 101 AND 102).

JILL C. ALT, EXAMINING ATTORNEY

SN 76-627,771. GMAC RESIDENTIAL HOLDING CORPORATION, HORSHAM, PA. FILED 1-13-2005.



NO CLAIM IS MADE TO THE EXCLUSIVE RIGHT TO USE SERVICE, APART FROM THE MARK AS SHOWN.

FOR REAL ESTATE MORTGAGE BANKING AND LENDING SERVICES; LOAN ORIGINATION AND FINANCING VIA A GLOBAL COMMUNICATIONS NETWORK (U.S. CLS. 100, 101 AND 102).

FIRST USE 7-1-2002; IN COMMERCE 7-1-2002.
MICHELE SWAIN, EXAMINING ATTORNEY

SN 76-631,353. BUSINESS FUNDING SOLUTIONS, INC., LAS VEGAS, NV. FILED 2-15-2005.



NO CLAIM IS MADE TO THE EXCLUSIVE RIGHT TO USE BUSINESS FUNDING SOLUTIONS, APART FROM THE MARK AS SHOWN.

THE COLORS BLUE, LIGHT BLUE, DARK BLUE, BLACK, AND WHITE ARE CLAIMED AS A FEATURE OF THE MARK.

BUSINESS FUNDING SOLUTIONS IS IN BLUE WITH BLACK UNDERLINING; CHANGING THE WORLD OF BUSINESS FINANCE IS IN BLACK; THE BUILDING IS IN LIGHT BLUE, WHITE, AND DARK BLUE. THE BUILDING IS ENCIRCLED WITH LIGHT TO DARK BLUE.

FOR FINANCIAL SERVICES, NAMELY, FINANCIAL CONSULTATION AND MATCHING OF COMPANIES' FINANCIAL NEEDS WITH THE APPROPRIATE FUNDING SOURCE (U.S. CLS. 100, 101 AND 102).

FIRST USE 9-23-2004; IN COMMERCE 9-23-2004.
PAUL E. FAHRENKOPF, EXAMINING ATTORNEY

CLASS 36—(Continued).

SN 78-200,012. HIGH PERFORMANCE AIRCRAFT, INC., EL CAJON, CA. FILED 1-3-2003.

HIGH PERFORMANCE AIRCRAFT

NO CLAIM IS MADE TO THE EXCLUSIVE RIGHT TO USE AIRCRAFT, APART FROM THE MARK AS SHOWN. SEC. 2(F).

FOR BROKERAGE SERVICES IN THE FIELD OF AIRCRAFT (U.S. CLS. 100, 101 AND 102).

FIRST USE 12-5-1989; IN COMMERCE 12-5-1989.
TARAH HARDY, EXAMINING ATTORNEY

SN 78-227,337. MA - RUSSIA WHARF, L.L.C., CHICAGO, IL. FILED 3-19-2003.

RUSSIA WHARF

THE MARK CONSISTS OF STANDARD CHARACTERS WITHOUT CLAIM TO ANY PARTICULAR FONT, STYLE, SIZE, OR COLOR.

SEC. 2(F).

FOR REAL ESTATE SERVICES, NAMELY, LEASING AND MANAGING COMMERCIAL AND RETAIL PROPERTY (U.S. CLS. 100, 101 AND 102).

FIRST USE 0-0-1982; IN COMMERCE 0-0-1982.
RON FAIRBANKS, EXAMINING ATTORNEY

SN 78-243,249. GNS DEVELOPMENT CORPORATION, NORWALK, CA. FILED 4-29-2003.



CHECK CASHING \$ PAYDAY & TITLE LOANS

NO CLAIM IS MADE TO THE EXCLUSIVE RIGHT TO USE "CHECK CASHING, PAYDAY AND TITLE LOANS", APART FROM THE MARK AS SHOWN.

FOR FINANCIAL SERVICES, NAMELY, CHECK CASHING SERVICES, LOANS, ACCEPTANCE OF UTILITY PAYMENTS, MONEY TRANSFERS AND ISSUING MONEY ORDERS (U.S. CLS. 100, 101 AND 102).

FIRST USE 3-7-2003; IN COMMERCE 3-7-2003.
MIDGE BUTLER, EXAMINING ATTORNEY

SN 78-265,062. SHARECRAZY.COM LTD., BRIGHTON, UNITED KINGDOM, FILED 6-20-2003.

SHARECRAZY

OWNER OF UNITED KINGDOM REG. NO. 2220946, DATED 1-12-2001, EXPIRES 1-12-2011.

FOR FINANCIAL SERVICES, NAMELY PROVIDING INFORMATION ABOUT INVESTING FUNDS IN STOCK MARKETS, TRADING STOCKS, AND TRACKING INVESTMENTS ALL PROVIDED BY ELECTRONIC MEANS; FINANCIAL SERVICES, NAMELY PROVIDING ON-LINE STOCK TRADING (U.S. CLS. 100, 101 AND 102).

DORITT L. CARROLL, EXAMINING ATTORNEY

CLASS 36—(Continued).

SN 78-275,335. CPI QUALIFIED PLAN CONSULTANTS, INC., GREAT BEND, KS. FILED 7-17-2003.

The 401(k) Professional TIMELY. PROVEN. ACCURATE.

NO CLAIM IS MADE TO THE EXCLUSIVE RIGHT TO USE "401(K)", APART FROM THE MARK AS SHOWN.

FOR ADMINISTRATION OF EMPLOYEE PENSION PLANS (U.S. CLS. 100, 101 AND 102).

FIRST USE 3-28-2003; IN COMMERCE 3-28-2003.
AISHA CLARKE, EXAMINING ATTORNEY

SN 78-311,349. LUMP SUM CAPITAL, LLC, BETHESDA, MD. FILED 10-9-2003.



NO CLAIM IS MADE TO THE EXCLUSIVE RIGHT TO USE "LUMP SUM CAPITAL", APART FROM THE MARK AS SHOWN.

FOR FINANCIAL SERVICES, NAMELY THE PURCHASE OF FUTURE PAYMENTS OF LOTTERY AND CONTEST WINNINGS AND STRUCTURED SETTLEMENTS (U.S. CLS. 100, 101 AND 102).

FIRST USE 10-24-2003; IN COMMERCE 10-24-2003.
CHARLES JOYNER, EXAMINING ATTORNEY

SN 78-319,154. THORNBURG, GARRETT H., SANTA FE, NM. FILED 10-27-2003.

THORNBURG

SEC. 2(F).

FOR FINANCIAL MANAGEMENT SERVICES, NAMELY INVESTMENT ADVISORY, SUPERVISORY, AND MANAGEMENT SERVICES TO INDIVIDUAL AND INSTITUTIONAL INVESTORS; PROVIDING ADMINISTRATION AND SHAREHOLDER SERVICES TO MUTUAL FUNDS, NAMELY ACCOUNT INFORMATION, DATA, MARKET DATA, SHARE PRICE MOVEMENT AND SECURITIES REPORTING, AND ACCOUNT RECORD KEEPING; FUND ADVISORY AND INVESTMENT SERVICES, NAMELY INDIVIDUAL BOND AND EQUITY SECURITIES, AND MUNICIPAL, BOND, MONEY MARKET, INCOME, VALUE, GROWTH, AND STOCK EQUITY MUTUAL FUNDS; PROVIDING SEPARATE INVESTMENT BROKERAGE AND RETIREMENT ACCOUNTS, NAMELY TRADING, MAINTENANCE, AND MANAGEMENT OF FINANCIAL SECURITIES, STOCKS, BONDS, AND OTHER INVESTMENTS; MORTGAGE BANKING SERVICES, MORTGAGE LENDING

CLASS 36—(Continued).

AND FINANCIAL SERVICES, NAMELY LOAN PROCESSING, COLLECTIONS, UNDERWRITING, FUNDING, ISSUANCE OF MORTGAGE-BACKED SECURITIES, INVESTMENT IN MORTGAGE-BACKED SECURITIES, SERVICING OF MORTGAGE LOANS, MAINTENANCE OF MORTGAGE ESCROW ACCOUNTS AND PROVIDING INFORMATION ON FINANCIAL AND MORTGAGE SERVICES; PROVIDING MORTGAGE BANKING SERVICES AND MORTGAGE LENDING SERVICES OVER THE GLOBAL COMPUTER NETWORK, NAMELY PROVIDING FINANCIAL INFORMATION IN THE NATURE OF MORTGAGE RATES, AND FINANCIAL PLANNING; PROVIDING FINANCIAL SERVICES OVER THE GLOBAL COMPUTER NETWORK, NAMELY EQUITY AND BOND MUTUAL FUND INVESTMENT DATA, SHAREHOLDER ACCOUNT INFORMATION, MARKET COMMENTARY AND FINANCIAL PLANNING; CHARITABLE FUND RAISING AND ELEEMOSYNARY SERVICES IN THE NATURE OF FINANCIAL CONTRIBUTIONS FOR NOT-FOR-PROFIT ORGANIZATIONS (U.S. CLS. 100, 101 AND 102).

FIRST USE 7-27-1982; IN COMMERCE 4-18-1984.
ANDREA K. NADELMAN, EXAMINING ATTORNEY

SN 78-319,808. DEUTSCHE TELEKOM AG, BONN 53113, FED REP GERMANY, FILED 10-28-2003.

TM³

PRIORITY CLAIMED UNDER SEC. 44(D) ON FED REP GERMANY APPLICATION NO. 30321682.4/3, FILED 4-29-2003, REG. NO. 30321682, DATED 10-31-2003, EXPIRES 4-30-2013.

FOR INSURANCE SERVICES, NAMELY, INSURANCE BROKERAGE AND INSURANCE CLAIMS PROCESSING; FINANCIAL SPONSORSHIP OF SPORTING EVENTS, EDUCATIONAL PROGRAMS, MUSICAL CONCERTS, GYMNASIAC, DANCE, AND BALLET PERFORMANCES; REAL ESTATE SERVICES, NAMELY BROKERAGE, MANAGEMENT, LEASING, APPRAISAL OF REAL PROPERTY; CUSTOMS BROKERAGE FOR THIRD PARTIES; MONETARY EXCHANGE; CREDIT CARD SERVICES; TELEPHONE CALLING CARD SERVICES; ELECTRONIC COMMERCE SERVICES, NAMELY, ELECTRONIC DEBIT AND CREDIT CARD PROCESSING SERVICES, AND FUNDS TRANSFER AND PAYMENT PROCESSING SERVICES (U.S. CLS. 100, 101 AND 102).

JEFFERY COWARD, EXAMINING ATTORNEY

CLASS 36—(Continued).

SN 78-325,073. THORNBURG, GARRETT H., SANTA FE, NM. FILED 11-7-2003.

THORNBURG FUNDS

THE MARK CONSISTS OF STANDARD CHARACTERS WITHOUT CLAIM TO ANY PARTICULAR FONT, STYLE, SIZE, OR COLOR.

NO CLAIM IS MADE TO THE EXCLUSIVE RIGHT TO USE "FUNDS", APART FROM THE MARK AS SHOWN.

SEC. 2(F).

FOR FINANCIAL MANAGEMENT SERVICES, NAMELY INVESTMENT ADVISORY, SUPERVISORY, AND MANAGEMENT SERVICES TO INDIVIDUAL AND INSTITUTIONAL INVESTORS; PROVIDING ADMINISTRATION AND SHAREHOLDER SERVICES TO MUTUAL FUNDS, NAMELY ACCOUNT INFORMATION, DATA, MARKET DATA, SHARE PRICE MOVEMENT AND SECURITIES REPORTING, AND ACCOUNT RECORD KEEPING; FUND ADVISORY AND INVESTMENT SERVICES, NAMELY INDIVIDUAL BOND AND EQUITY SECURITIES, AND MUNICIPAL, BOND, MONEY MARKET, INCOME, VALUE, GROWTH, AND STOCK EQUITY MUTUAL FUNDS; PROVIDING SEPARATE INVESTMENT BROKERAGE AND RETIREMENT ACCOUNTS, NAMELY TRADING, MAINTENANCE, AND MANAGEMENT OF FINANCIAL SECURITIES, STOCKS, BONDS, AND OTHER INVESTMENTS (U.S. CLS. 100, 101 AND 102).

FIRST USE 2-0-1995; IN COMMERCE 2-0-1995.

ANDREA K. NADELMAN, EXAMINING ATTORNEY

SN 78-329,238. BRINES, LORRAINE ANN, GIG HARBOR, WA. FILED 11-17-2003.

Hassle-Free Home Selling

THE MARK CONSISTS OF STANDARD CHARACTERS WITHOUT CLAIM TO ANY PARTICULAR FONT, STYLE, SIZE, OR COLOR.

NO CLAIM IS MADE TO THE EXCLUSIVE RIGHT TO USE HOME SELLING, APART FROM THE MARK AS SHOWN.

FOR REAL ESTATE AGENCY SERVICES (U.S. CLS. 100, 101 AND 102).

LESLEY LAMOTHE, EXAMINING ATTORNEY

CLASS 36—(Continued).

SN 78-329,936. CREDO CAPITAL MANAGEMENT, L.L.C., DALLAS, TX. FILED 11-19-2003.

CLASS 36—(Continued).

SN 78-358,155. AMERICAN CASH ADVANCE, INC., KANSAS CITY, MO. FILED 1-27-2004.

CREDO

THE MARK CONSISTS OF STANDARD CHARACTERS WITHOUT CLAIM TO ANY PARTICULAR FONT, STYLE, SIZE, OR COLOR.

FOR FINANCIAL SERVICES, NAMELY, INVESTMENT ADVISORY SERVICES, INVESTMENT MANAGEMENT SERVICES, INVESTMENT OF FUNDS FOR OTHERS (U.S. CLS. 100, 101 AND 102).
MICHAEL HALL, EXAMINING ATTORNEY



NO CLAIM IS MADE TO THE EXCLUSIVE RIGHT TO USE "AMERICAN CASH ADVANCE FINANCIAL SERVICES", APART FROM THE MARK AS SHOWN.

FOR FINANCIAL SERVICES, NAMELY, CHECK CASHING, DEFERRED PRESENTMENT OF PAYDAY LOANS, WIRING OF FUNDS, BILL PAYMENT, AND CONSUMER LOANS (U.S. CLS. 100, 101 AND 102).

FIRST USE 12-30-2003; IN COMMERCE 1-8-2004.
AMOS T. MATTHEWS, JR., EXAMINING ATTORNEY

SN 78-361,002. THE NATIONAL BANK OF INDIANAPOLIS CORPORATION, INDIANAPOLIS, IN. FILED 2-2-2004.

SN 78-341,015. TUSCANY REALTY, INC., SAN JOSE, CA. FILED 12-15-2003.



TUSCANY
Real Estate Services

NO CLAIM IS MADE TO THE EXCLUSIVE RIGHT TO USE "REAL ESTATE SERVICES", APART FROM THE MARK AS SHOWN.

FOR RESIDENTIAL BROKERAGE REAL ESTATE SERVICES AND MORTGAGE SERVICES, NAMELY, BUYER PRE-QUALIFICATION OF MORTGAGES FOR MORTGAGE BROKERS AND BANKS (U.S. CLS. 100, 101 AND 102).

FIRST USE 10-8-2003; IN COMMERCE 10-8-2003.
DAWN HAN, EXAMINING ATTORNEY

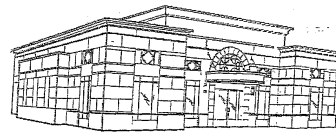

THE MARK CONSISTS OF A THREE-DIMENSIONAL CONFIGURATION OF A BUILDING AND THE TRADE DRESS OF A BUILDING DESCRIBED AS NEOCLASSICAL WITH ART DECO INFLUENCE, AND CONSISTS OF PRIMARY AND SECONDARY CORNICES CREATING A TWO-TIERED EFFECT, AN EXAGGERATED ARCH, SCORED EXTERIOR BUILDING MATERIALS CREATING A STUCCO-LIKE APPEARANCE A NEUTRAL COLOR SCHEME, AND DIAMOND ACCENTS.

SEC. 2(F).
FOR BANKING SERVICES (U.S. CLS. 100, 101 AND 102).

FIRST USE 3-31-1995; IN COMMERCE 3-31-1995.
LINDA E. BLOHM, EXAMINING ATTORNEY

CLASS 36—(Continued).

SN 78-367,645. THE DREAM INSTITUTE, TULSA, OK. FILED 2-13-2004.



NO CLAIM IS MADE TO THE EXCLUSIVE RIGHT TO USE "INSTITUTE" AND "DISABILITY RESOURCES EDUCATIONAL ADVOCACY MOTIVATION", APART FROM THE MARK AS SHOWN.

FOR PROVIDING EDUCATIONAL SCHOLARSHIPS AND GRANTS AND ASSISTANCE IN SECURING FINANCING FOR EDUCATION FOR STUDENTS WITH DISABILITIES (U.S. CLS. 100, 101 AND 102).

FIRST USE 5-31-2002; IN COMMERCE 10-31-2003.
BARBARA BROWN, EXAMINING ATTORNEY

SN 78-375,380. TOWER FINANCIAL CORPORATION, FORT WAYNE, IN. FILED 2-27-2004.

Something Perfect

THE MARK CONSISTS OF STANDARD CHARACTERS WITHOUT CLAIM TO ANY PARTICULAR FONT, STYLE, SIZE, OR COLOR.

FOR BANKING SERVICES (U.S. CLS. 100, 101 AND 102).

FIRST USE 1-11-2004; IN COMMERCE 1-11-2004.
HENRY S. ZAK, EXAMINING ATTORNEY

CLASS 36—(Continued).

SN 78-376,689. HARTFORD FIRE INSURANCE COMPANY, HARTFORD, CT. FILED 3-2-2004.

HARTFORD SELECT LEADERS

THE MARK CONSISTS OF STANDARD CHARACTERS WITHOUT CLAIM TO ANY PARTICULAR FONT, STYLE, SIZE, OR COLOR.

OWNER OF U.S. REG. NOS. 2,564,511, 2,646,842 AND OTHERS.

SEC. 2(F) AS TO HARTFORD.

FOR ANNUITY AND INSURANCE UNDERWRITING SERVICES (U.S. CLS. 100, 101 AND 102).

FIRST USE 7-24-2000; IN COMMERCE 7-24-2000.
SUELLEN HICKEY, EXAMINING ATTORNEY

SN 78-377,513. ALEXANDER, DAVID-MICHAEL, DOVER, DE. FILED 3-3-2004.

WANTED



David Alexander

Delaware's

Most Wanted

Real Estate

Agent

NO CLAIM IS MADE TO THE EXCLUSIVE RIGHT TO USE "DELAWARE'S MOST WANTED REAL ESTATE AGENT", APART FROM THE MARK AS SHOWN.

THE NAME(S), PORTRAIT(S), AND/OR SIGNATURE(S) SHOWN IN THE MARK IDENTIFIES DAVID-MICHAEL ALEXANDER, WHOSE CONSENT(S) TO REGISTER IS SUBMITTED.

THE MARK CONSISTS OF ME IN A PRISON SUIT HOLDING MY CELL NUMBER WITH THE WORDS AS ATTACHED ALL IN BLACK AND WHITE.

FOR REAL ESTATE SERVICES, NAMELY, BUYING AND SELLING OF REAL ESTATE FOR OTHERS (U.S. CLS. 100, 101 AND 102).

FIRST USE 1-1-2003; IN COMMERCE 1-1-2003.

REGINA DRUMMOND, EXAMINING ATTORNEY

CLASS 36—(Continued).

SN 78-381,407. INTERNATIONAL MEDICAL GROUP, INC., INDIANAPOLIS, IN. FILED 3-10-2004.

CLASS 36—(Continued).

SN 78-386,014. GO APPLY, INC., ALISO VIEJO, CA. FILED 3-17-2004.

HEADSTART

GOAPPLY.COM

THE MARK CONSISTS OF STANDARD CHARACTERS WITHOUT CLAIM TO ANY PARTICULAR FONT, STYLE, SIZE, OR COLOR.

FOR INSURANCE PLAN ADMINISTRATION AND UNDERWRITING SERVICES IN THE FIELDS OF LIFE, HEALTH, DISABILITY, MEDICAL AND TRAVEL INSURANCE (U.S. CLS. 100, 101 AND 102).
TONI HICKEY, EXAMINING ATTORNEY

THE MARK CONSISTS OF STANDARD CHARACTERS WITHOUT CLAIM TO ANY PARTICULAR FONT, STYLE, SIZE, OR COLOR.

FOR PROVIDING INFORMATION ABOUT LOANS BY MEANS OF THE INTERNET (U.S. CLS. 100, 101 AND 102).
FIRST USE 6-11-2003; IN COMMERCE 6-11-2003.
MICHELE SWAIN, EXAMINING ATTORNEY

SN 78-385,753. WILSHIRE QUINN CAPITAL, LLC, BEVERLY HILLS, CA. FILED 3-17-2004.

SN 78-387,324. FLEXPOINT FUNDING CORPORATION, IRVINE, CA. FILED 3-19-2004.

**Stop Guessing.
Start Knowing**

FlexPoint
FUNDING

THE MARK CONSISTS OF STANDARD CHARACTERS WITHOUT CLAIM TO ANY PARTICULAR FONT, STYLE, SIZE, OR COLOR.

FOR FULL SERVICE FUTURES AND COMMODITIES BROKERAGE FIRM SPECIALIZING IN BONDS, CURRENCIES, STOCK INDEX FUTURES, METALS, AGRICULTURALS, AND DERIVATIVES (U.S. CLS. 100, 101 AND 102).
SUSAN STIGLITZ, EXAMINING ATTORNEY

NO CLAIM IS MADE TO THE EXCLUSIVE RIGHT TO USE "FUNDING", APART FROM THE MARK AS SHOWN.

THE MARK CONSISTS OF SYLIZED WORDS CONSISTING OF A LETTER "I" IN LIGHTER COLOR AND THE WORD "FUNDING" APPEARING IN WHITE WITHIN A COLORED RECTANGULAR BLOCK.

FOR MORTGAGE BANKING SERVICES; BROKER SERVICES, NAMELY, MORTGAGE BROKERAGE; MORTGAGE LENDING AND FINANCIAL SERVICES, NAMELY, LOAN PROCESSING, AND MORTGAGE BROKERAGE; RETAIL MORTGAGE SERVICES, NAMELY BROKERING OF MORTGAGE LOANS TO SECONDARY MORTGAGE LENDERS; CONSUMER MORTGAGE BANKING AND LOAN FINANCING SERVICES. (U.S. CLS. 100, 101 AND 102).
KATHERINE STOIDES, EXAMINING ATTORNEY

CLASS 36—(Continued).

SN 78-392,213. NATIONAL TRUST FOR HISTORIC PRESERVATION IN THE UNITED STATES, WASHINGTON, DC. FILED 3-29-2004.

**INSURANCE
SOLUTIONS FOR
HISTORIC AMERICA**

THE MARK CONSISTS OF STANDARD CHARACTERS WITHOUT CLAIM TO ANY PARTICULAR FONT, STYLE, SIZE, OR COLOR.

OWNER OF U.S. REG. NO. 1,967,735.

NO CLAIM IS MADE TO THE EXCLUSIVE RIGHT TO USE "INSURANCE", APART FROM THE MARK AS SHOWN.

FOR ADMINISTERING INSURANCE PROGRAMS FOR HISTORIC PROPERTIES (U.S. CLS. 100, 101 AND 102).

FIRST USE 2-12-2004; IN COMMERCE 2-12-2004.
GINA HAYES, EXAMINING ATTORNEY

SN 78-399,541. THE SAN DIEGO FOUNDATION, SAN DIEGO, CA. FILED 4-9-2004.

ENDOW SAN DIEGO

THE MARK CONSISTS OF STANDARD CHARACTERS WITHOUT CLAIM TO ANY PARTICULAR FONT, STYLE, SIZE, OR COLOR.

NO CLAIM IS MADE TO THE EXCLUSIVE RIGHT TO USE SAN DIEGO, APART FROM THE MARK AS SHOWN.

FOR CHARITABLE SERVICES, NAMELY, PROVIDING INFORMATION ABOUT MONETARY CHARITABLE CONTRIBUTIONS AND COMMUNITY NEEDS RELATED THERETO; PHILANTHROPIC PLANNING SERVICES CONCERNING MONETARY DONATIONS (U.S. CLS. 100, 101 AND 102).

RON FAIRBANKS, EXAMINING ATTORNEY

CLASS 36—(Continued).

SN 78-400,731. PIPER JAFFRAY & CO., MINNEAPOLIS, MN. FILED 4-13-2004.

**PIPER JAFFRAY
ADVISOR**

THE MARK CONSISTS OF STANDARD CHARACTERS WITHOUT CLAIM TO ANY PARTICULAR FONT, STYLE, SIZE, OR COLOR.

OWNER OF U.S. REG. NOS. 2,098,959 AND 2,889,370.

NO CLAIM IS MADE TO THE EXCLUSIVE RIGHT TO USE "ADVISOR", APART FROM THE MARK AS SHOWN.

FOR INVESTMENT BANKING SERVICES; SECURITIES BROKERAGE AND DEALER SERVICES; FINANCIAL RESEARCH, ANALYSIS, CONSULTATION, AND ADVISORY SERVICES; INVESTMENT MANAGEMENT SERVICES; FUNDS INVESTMENT SERVICES; INVESTMENT ADVISORY SERVICES; INVESTMENT CONSULTATION SERVICES; AND INVESTMENT OF FUNDS FOR OTHERS (U.S. CLS. 100, 101 AND 102).

FIRST USE 5-0-1999; IN COMMERCE 5-0-1999.
WILLIAM VERHOSEK, EXAMINING ATTORNEY

SN 78-403,838. CAPITAL ONE FINANCIAL CORPORATION, RICHMOND, VA. FILED 4-19-2004.

**CAPITAL ONE SLAM
DUNK SWEEPSTAKES**

THE MARK CONSISTS OF STANDARD CHARACTERS WITHOUT CLAIM TO ANY PARTICULAR FONT, STYLE, SIZE, OR COLOR.

OWNER OF U.S. REG. NOS. 2,853,604, 2,877,448 AND OTHERS.

NO CLAIM IS MADE TO THE EXCLUSIVE RIGHT TO USE "SWEEPSTAKES", APART FROM THE MARK AS SHOWN.

FOR FINANCIAL SERVICES, NAMELY CREDIT CARD SERVICES; FINANCIAL SPONSORSHIP OF A COLLEGE BASKETBALL CHAMPIONSHIP GAME; FINANCIAL SPONSORSHIP OF A COLLEGE BASKETBALL SWEEPSTAKES (U.S. CLS. 100, 101 AND 102).

FIRST USE 2-9-2004; IN COMMERCE 2-9-2004.
CAROL SPILS, EXAMINING ATTORNEY

CLASS 36—(Continued).

SN 78-404,046. FDG-WATERLOO, LTD., WATERLOO, IA. FILED 4-19-2004.



FINANCIAL DECISIONS GROUP

NO CLAIM IS MADE TO THE EXCLUSIVE RIGHT TO USE "FINANCIAL DECISIONS GROUP", APART FROM THE MARK AS SHOWN.

FOR INVESTMENT MANAGEMENT OF AND DISTRIBUTION OF VARIABLE ANNUITIES; FINANCIAL PLANNING; ESTATE PLANNING; INSURANCE AGENCIES IN THE FIELD OF LIFE, HEALTH AND ACCIDENT (U.S. CLS. 100, 101 AND 102).

FIRST USE 1-1-2003; IN COMMERCE 1-1-2003. MARIA-VICTORIA SUAREZ, EXAMINING ATTORNEY

SN 78-404,248. SENECA ONE FINANCE, INC., BETHESDA, MD. FILED 4-19-2004.

INSTANT LOAN

THE MARK CONSISTS OF STANDARD CHARACTERS WITHOUT CLAIM TO ANY PARTICULAR FONT, STYLE, SIZE, OR COLOR.

NO CLAIM IS MADE TO THE EXCLUSIVE RIGHT TO USE "LOAN", APART FROM THE MARK AS SHOWN.

FOR PROVIDING FINANCIAL SERVICES, NAMELY, LOAN FINANCING (U.S. CLS. 100, 101 AND 102).

JOHN DALIER, EXAMINING ATTORNEY

SN 78-405,233. CREDIT SUISSE FIRST BOSTON LLC, NEW YORK, NY. FILED 4-20-2004.

CSFB CMBS INDEX

THE MARK CONSISTS OF STANDARD CHARACTERS WITHOUT CLAIM TO ANY PARTICULAR FONT, STYLE, SIZE, OR COLOR.

NO CLAIM IS MADE TO THE EXCLUSIVE RIGHT TO USE "CMBS INDEX", APART FROM THE MARK AS SHOWN.

FOR FINANCIAL SERVICES IN THE NATURE OF PROVIDING AND UPDATING AN INDEX COMPRISED OF MORTGAGE BACKED SECURITIES (U.S. CLS. 100, 101 AND 102).

FIRST USE 3-8-2004; IN COMMERCE 3-8-2004. KIMBERLY FRYE, EXAMINING ATTORNEY

CLASS 36—(Continued).

SN 78-406,171. POLARIS RISK MANAGERS, WEST CAWELL, NJ. FILED 4-22-2004.

POLARISK MANAGERS

THE MARK CONSISTS OF STANDARD CHARACTERS WITHOUT CLAIM TO ANY PARTICULAR FONT, STYLE, SIZE, OR COLOR.

NO CLAIM IS MADE TO THE EXCLUSIVE RIGHT TO USE MANAGERS, APART FROM THE MARK AS SHOWN.

FOR INSURANCE CONSULTING SERVICES FOR PROPERTY AND CASUALTY INSURANCE (U.S. CLS. 100, 101 AND 102).

FIRST USE 9-1-2003; IN COMMERCE 9-1-2003. ANDREA SAUNDERS, EXAMINING ATTORNEY

SN 78-408,281. CLK MANAGEMENT, LLC, OVERLAND PARK, KS. FILED 4-26-2004.

POCKETLOAN

THE MARK CONSISTS OF STANDARD CHARACTERS WITHOUT CLAIM TO ANY PARTICULAR FONT, STYLE, SIZE, OR COLOR.

FOR FINANCIAL SERVICES, NAMELY, MONEY LENDING IN THE FIELD OF SHORT TERM LOANS PROVIDED AS PAYDAY LOAN ADVANCES (U.S. CLS. 100, 101 AND 102).

LA TONIA FISHER, EXAMINING ATTORNEY

SN 78-408,729. ONLINE BROKERAGE SERVICES, INC., WATERVILLE, OH. FILED 4-27-2004.



NO CLAIM IS MADE TO THE EXCLUSIVE RIGHT TO USE "TRUST", APART FROM THE MARK AS SHOWN.

FOR TRUST AND INVESTMENT BROKERAGE SERVICES; INVESTMENT MANAGEMENT SERVICES; PROVIDING TRUST AND INVESTMENT INFORMATION VIA THE INTERNET (U.S. CLS. 100, 101 AND 102).

FIRST USE 12-1-2003; IN COMMERCE 12-1-2003. MICHAEL HALL, EXAMINING ATTORNEY

CLASS 36—(Continued).

SN 78-411,266. STRUCTURED FINANCIAL ASSOCIATES, INC., BALTIMORE, MD. FILED 4-30-2004.

STRUCTURED FINANCIAL ASSOCIATES



OWNER OF U.S. REG. NOS. 1,422,379 AND 2,161,320.
THE MARK CONSISTS OF THE WORDS STRUCTURED FINANCIAL ASSOCIATES AND A STYLIZED DESIGN OF A CIRCLE WITH THE LETTERS SFA.

SEC. 2(F) AS TO "STRUCTURED FINANCIAL ASSOCIATES".

FOR FINANCIAL SERVICES, NAMELY, CONSULTING SERVICES FOR STRUCTURING FINANCIAL SETTLEMENTS (U.S. CLS. 100, 101 AND 102).

FIRST USE 1-15-1999; IN COMMERCE 1-15-1999.

DAVID MURRAY, EXAMINING ATTORNEY

CLASS 36—(Continued).

SN 78-416,391. CAPITAL ONE FINANCIAL CORPORATION, RICHMOND, VA. FILED 5-11-2004.

CAPITAL ONE
MORTGAGE AND HOME
EQUITY

THE MARK CONSISTS OF STANDARD CHARACTERS WITHOUT CLAIM TO ANY PARTICULAR FONT, STYLE, SIZE, OR COLOR.

OWNER OF U.S. REG. NOS. 1,992,626, 2,893,370 AND OTHERS.

NO CLAIM IS MADE TO THE EXCLUSIVE RIGHT TO USE "MORTGAGE AND HOME EQUITY", APART FROM THE MARK AS SHOWN.

FOR FINANCIAL SERVICES, NAMELY MORTGAGE BANKING AND LENDING; HOME EQUITY LOANS (U.S. CLS. 100, 101 AND 102).

FIRST USE 5-3-2004; IN COMMERCE 5-3-2004.

CHERYL STEPLIGHT, EXAMINING ATTORNEY

SN 78-412,482. OREGON NATURAL RESOURCES COUNCIL FUND, DBA OREGON NATURAL RESOURCES COUNCIL, AND DBA ONRC, PORTLAND, OR. FILED 5-3-2004.

OREGON WILD

THE MARK CONSISTS OF STANDARD CHARACTERS WITHOUT CLAIM TO ANY PARTICULAR FONT, STYLE, SIZE, OR COLOR.

NO CLAIM IS MADE TO THE EXCLUSIVE RIGHT TO USE "OREGON", APART FROM THE MARK AS SHOWN.

FOR CHARITABLE FUND RAISING (U.S. CLS. 100, 101 AND 102).

FIRST USE 12-0-1997; IN COMMERCE 12-0-1997.

JOHN HWANG, EXAMINING ATTORNEY

SN 78-417,949. CONQUER CREDIT MANAGEMENT, INC., VAN NUYS, CA. FILED 5-13-2004.



Your Personal Credit Experts!

NO CLAIM IS MADE TO THE EXCLUSIVE RIGHT TO USE "CREDIT MANAGEMENT" AND "PERSONAL CREDIT EXPERT", APART FROM THE MARK AS SHOWN.

THE COLOR(S) BLUE, AND GREEN IS/ARE CLAIMED AS A FEATURE OF THE MARK.

THE COLOR(S) THE OUTER STYLIZED "C." THE WORD "CONQUER" AND "YOUR PERSONAL CREDIT EXPERTS" ARE ALL IN THE COLOR BLUE, THE INNER STYLIZED "C" AND THE WORDS "CREDIT MANAGEMENT" ARE IN GREEN IS/ARE CLAIMED AS A FEATURE OF THE MARK.

THE MARK CONSISTS OF TWO STYLIZED DRAWINGS OF THE LETTER "C" SITTING WITHIN ONE ANOTHER WITH THE LITERAL ELEMENTS OF THE MARK PARTIALLY WITHIN THE STYLIZED "C".

FOR CREDIT MANAGEMENT AND RESTORATIONS SERVICES (U.S. CLS. 100, 101 AND 102).

FIRST USE 11-1-2001; IN COMMERCE 11-1-2001.

C. DIONNE CLYBURN, EXAMINING ATTORNEY

CLASS 36—(Continued).

SN 78-420,013. CONTINENTAL-NATIONAL SERVICES CORPORATION, TAMPA, FL. FILED 5-17-2004.

THE STRENGTH OF
EXPERIENCE

THE MARK CONSISTS OF STANDARD CHARACTERS WITHOUT CLAIM TO ANY PARTICULAR FONT, STYLE, SIZE, OR COLOR.

FOR INSURANCE BROKERAGE SERVICES IN THE FIELDS OF EXTENDED SERVICE CONTRACTS FOR AUTOMOTIVE VEHICLES AND CREDIT INSURANCE (U.S. CLS. 100, 101 AND 102).

FIRST USE 1-1-1993; IN COMMERCE 1-1-1993.
DAVID H. STINE, EXAMINING ATTORNEY

SN 78-421,116. VAN ALSTYNE FINANCIAL CORPORATION, VAN ALSTYNE, TX. FILED 5-18-2004.



NO CLAIM IS MADE TO THE EXCLUSIVE RIGHT TO USE "TEXAS" AND "BANK", APART FROM THE MARK AS SHOWN.

THE LINING IS A FEATURE OF THE MARK AND DOES NOT INDICATE COLOR.

THE MARK CONSISTS OF THE WORDS TEXAS STAR APPEAR IN AN ARC, WRAPPED OVER A STAR WHICH OVERLAYS FOUR ROUNDED BANDS, TWO OF WHICH SEEM TO FORM AT THE TOP IN A HORSESHOE FASHION; THE WORD BANK APPEARS AT THE BOTTOM OF THE FOUR BANDS BELOW THE STAR.

FOR BANKING SERVICES (U.S. CLS. 100, 101 AND 102).

FIRST USE 10-1-2003; IN COMMERCE 10-1-2003.
CATHERINE FAINT, EXAMINING ATTORNEY

CLASS 36—(Continued).

SN 78-421,715. AMERICAN INTERNATIONAL GROUP, INC., NEW YORK, NY. FILED 5-19-2004.

CONTINUL

THE MARK CONSISTS OF STANDARD CHARACTERS WITHOUT CLAIM TO ANY PARTICULAR FONT, STYLE, SIZE, OR COLOR.

FOR INSURANCE UNDERWRITING SERVICES, NAMELY UNIVERSAL LIFE INSURANCE (U.S. CLS. 100, 101 AND 102).

FIRST USE 6-15-2004; IN COMMERCE 6-15-2004.
CHERYL CLAYTON, EXAMINING ATTORNEY

SN 78-422,809. TRI-SOURCE TITLE AGENCY, INC., CLEVELAND, OH. FILED 5-21-2004.



TRI * SOURCE

THE COLOR(S) STEEL BLUE AND LIGHT STEEL BLUE IS/ARE CLAIMED AS A FEATURE OF THE MARK.

THE COLOR STEEL BLUE APPEARS IN ON THE BUILDINGS AND THE COLOR LIGHT STEEL BLUE APPEARS AROUND THE OUTSIDE OF THE BUILDINGS.

FOR REAL ESTATE ESCROW SERVICES; REAL ESTATE TITLE INSURANCE AGENCY SERVICES (U.S. CLS. 100, 101 AND 102).

FIRST USE 8-1-2001; IN COMMERCE 8-1-2001.
MARCIE MILONE, EXAMINING ATTORNEY

CLASS 36—(Continued).

SN 78-423,705. TEAM ORTHO FOUNDATION, INC., MINNEAPOLIS, MN. FILED 5-24-2004.

TEAM ORTHO

THE MARK CONSISTS OF STANDARD CHARACTERS WITHOUT CLAIM TO ANY PARTICULAR FONT, STYLE, SIZE, OR COLOR.

NO CLAIM IS MADE TO THE EXCLUSIVE RIGHT TO USE "TEAM", APART FROM THE MARK AS SHOWN.

FOR CHARITABLE FUNDRAISING SERVICES FOR PROMOTING RESEARCH, EDUCATION AND PATIENT CARE RELATING TO ORTHOPEDIC CONDITIONS, NAMELY ARTHRITIS, TRAUMA, JOINT REPLACEMENT, COMPLEX FRACTURES AND WOUND INFECTION (U.S. CLS. 100, 101 AND 102).

FIRST USE 1-15-2003; IN COMMERCE 1-15-2003.
GINA FINK, EXAMINING ATTORNEY

SN 78-423,755. LYONS DIRECT, INC., DEERFIELD BEACH, FL. FILED 5-24-2004.

1STREACH

THE MARK CONSISTS OF STANDARD CHARACTERS WITHOUT CLAIM TO ANY PARTICULAR FONT, STYLE, SIZE, OR COLOR.

FOR COLLECTION AGENCY SERVICES THAT UTILIZE UNMANNED TELEPHONY AND MESSAGING TECHNOLOGY TO REMIND CUSTOMERS, MEMBERS OR POLICYHOLDERS THAT THEIR ACCOUNTS ARE PAST DUE AND ALLOWS FOR THE ARRANGEMENT FOR THE PAYMENT OF OPEN BILLS ELECTRONICALLY OR OVER THE TELEPHONE (U.S. CLS. 100, 101 AND 102).

FIRST USE 4-1-2004; IN COMMERCE 4-1-2004.
JULIE WATSON, EXAMINING ATTORNEY

CLASS 36—(Continued).

SN 78-424,524. ENCORE CREDIT CORP., IRVINE, CA. FILED 5-25-2004.

BRAVO CREDIT

THE MARK CONSISTS OF STANDARD CHARACTERS WITHOUT CLAIM TO ANY PARTICULAR FONT, STYLE, SIZE, OR COLOR.

NO CLAIM IS MADE TO THE EXCLUSIVE RIGHT TO USE "CREDIT", APART FROM THE MARK AS SHOWN.

FOR RETAIL CONSUMER FINANCIAL SERVICES, NAMELY, AUTO LOANS, CREDIT CARDS AND SERVICING OF CREDIT CARD RECEIVABLES, UNSECURED CONSUMER LOAN FINANCING SERVICES, LOAN PROCESSING, LOAN COLLECTIONS, BILL PAYMENT SERVICES, MONEY ORDER SERVICES, DEBIT AND STORED VALUE CARD SERVICES AND DIRECT DEPOSIT OF FUNDS INTO CUSTOMER BANK ACCOUNTS; MORTGAGE LENDING SERVICES, MORTGAGE BANKING AND MORTGAGE BROKERAGE SERVICES, NAMELY PURCHASING MORTGAGE LOANS FROM REAL ESTATE AND MORTGAGE BROKERS AND CORRESPONDENT LENDERS, SALE OF MORTGAGE LOANS TO SECONDARY MORTGAGE LENDERS, SERVICING MORTGAGE LOANS; HOME EQUITY LOANS (U.S. CLS. 100, 101 AND 102).

RONALD AIKENS, EXAMINING ATTORNEY

SN 78-427,155. ADVANCE FINANCIAL FEDERAL CREDIT UNION, SCHERERVILLE, IN. FILED 5-28-2004.



NO CLAIM IS MADE TO THE EXCLUSIVE RIGHT TO USE "FINANCIAL FEDERAL CREDIT UNION", APART FROM THE MARK AS SHOWN.

FOR CREDIT UNION SERVICES, FINANCIAL AND LENDING SERVICES (U.S. CLS. 100, 101 AND 102).

AISHA CLARKE, EXAMINING ATTORNEY

CLASS 36—(Continued).

SN 78-428,511. CAPITAL ONE FINANCIAL CORPORATION, RICHMOND, VA. FILED 6-2-2004.

CLASS 36—(Continued).

SN 78-429,652. PREMIER BLUE CROSS, SEATTLE, WA. FILED 6-3-2004.



EM-POWER

OWNER OF U.S. REG. NOS. 2,065,991, 2,727,453 AND OTHERS.

NO CLAIM IS MADE TO THE EXCLUSIVE RIGHT TO USE "SAVINGS", APART FROM THE MARK AS SHOWN.

THE MARK CONSISTS OF THE WORDS "CAPITAL ONE SAVINGS" IN A STYLIZED FORMAT, WITH THE WORDS CAPITAL ONE AND SAVINGS SEPARATED BY A HORIZONTAL LINE.

SEC. 2(F) AS TO "CAPITAL ONE".

FOR FINANCIAL SERVICES, NAMELY SAVINGS AND LOAN SERVICES (U.S. CLS. 100, 101 AND 102).

FIRST USE 4-25-2004; IN COMMERCE 4-25-2004.

BRENDAN REGAN, EXAMINING ATTORNEY

THE MARK CONSISTS OF STANDARD CHARACTERS WITHOUT CLAIM TO ANY PARTICULAR FONT, STYLE, SIZE, OR COLOR.

FOR HEALTH, MEDICAL, DENTAL, HOSPITAL, PHARMACEUTICAL, AND PRESCRIPTION DRUG INSURANCE UNDERWRITING; ADMINISTRATION AND ORGANIZING OF PREPAID OR PREFERRED PROVIDER HEALTH, MEDICAL, DENTAL, HOSPITAL, PHARMACEUTICAL, PRESCRIPTION DRUG PLANS, AND RELATED HEALTHCARE PLANS AND NETWORKS; INTERNET ACCESS BASED SYSTEMS ACCESSIBLE BY CLIENTS, HEALTHCARE PROVIDERS, INSURANCE UNDERWRITING ADMINISTRATORS, AND OTHERS FOR ADMINISTERING AND UNDERWRITING HEALTH CARE COVERAGE THROUGH CONTRACTED RELATIONSHIPS WITH SUBSCRIBERS AND PROFESSIONAL CLINICAL, HOSPITAL, NURSING HOME, AND OTHER HEALTH CARE PROVIDERS (U.S. CLS. 100, 101 AND 102).

H. M. FISHER, EXAMINING ATTORNEY

SN 78-428,530. CAPITAL ONE FINANCIAL CORPORATION, RICHMOND, VA. FILED 6-2-2004.

SN 78-432,852. DEPARTMENT OF THE TREASURY, FINANCIAL MANAGEMENT SERVICE, WASHINGTON, DC. FILED 6-10-2004.



TT&L Plus

NO CLAIM IS MADE TO THE EXCLUSIVE RIGHT TO USE "SAVINGS", APART FROM THE MARK AS SHOWN.

THE MARK CONSISTS OF THE MARK CONSISTS OF THE WORDS "SAVINGS" IN A STYLIZED FORMAT. THE V IN THE WORD SAVINGS IS TEAL BLUE.

FOR FINANCIAL SERVICES, NAMELY SAVINGS AND LOAN SERVICES (U.S. CLS. 100, 101 AND 102).

FIRST USE 5-6-2004; IN COMMERCE 5-6-2004.

BRENDAN REGAN, EXAMINING ATTORNEY

THE MARK CONSISTS OF STANDARD CHARACTERS WITHOUT CLAIM TO ANY PARTICULAR FONT, STYLE, SIZE, OR COLOR.

FOR FINANCIAL SERVICES, NAMELY, THE PROCESSING OF FEDERAL TAX DEPOSIT COUPONS AND INVESTMENT OF EXCESS U.S.; TREASURY OPERATING BALANCES (U.S. CLS. 100, 101 AND 102).

ODESSA BIBBINS, EXAMINING ATTORNEY

CLASS 36—(Continued).

SN 78-434,677. LINCOLN GENERAL INSURANCE COMPANY, YORK, PA. FILED 6-14-2004.



NO CLAIM IS MADE TO THE EXCLUSIVE RIGHT TO USE "GENERAL INSURANCE COMPANY", APART FROM THE MARK AS SHOWN.

THE COLOR(S) RED AND BLUE IS/ARE CLAIMED AS A FEATURE OF THE MARK.

RED AND BLUE STRIPES, WITH BLUE LETTERS.

THE MARK CONSISTS OF LINCOLN GENERAL INSURANCE IN STYLIZED BLUE LETTERS. RED AND BLUE STRIPES. THE LETTERS LG IN A DIAMOND.

FOR INSURANCE UNDERWRITING, CLAIMS ADJUSTMENT AND ADMINISTRATION FOR COMMERCIAL AND PERSONAL VEHICLES, PROPERTY COVERAGES, SURETY SERVICES, AND BAIL BONDING (U.S. CLS. 100, 101 AND 102).

FIRST USE 3-17-1977; IN COMMERCE 3-17-1977.

RONALD MCMORROW, EXAMINING ATTORNEY

SN 78-435,936. CAPITAL ONE FINANCIAL CORPORATION, RICHMOND, VA. FILED 6-16-2004.

U-TURN REFI

THE MARK CONSISTS OF STANDARD CHARACTERS WITHOUT CLAIM TO ANY PARTICULAR FONT, STYLE, SIZE, OR COLOR.

NO CLAIM IS MADE TO THE EXCLUSIVE RIGHT TO USE "REFI", APART FROM THE MARK AS SHOWN.

FOR FINANCIAL SERVICES, NAMELY AUTOMOBILE FINANCING AND RE-FINANCING SERVICES (U.S. CLS. 100, 101 AND 102).

JENNIFER KRISP, EXAMINING ATTORNEY

CLASS 36—(Continued).

SN 78-437,261. COASTAL FEDERAL BANK, MYRTLE BEACH, SC. FILED 6-17-2004.

PENNY PAVILION

THE MARK CONSISTS OF STANDARD CHARACTERS WITHOUT CLAIM TO ANY PARTICULAR FONT, STYLE, SIZE, OR COLOR.

NO CLAIM IS MADE TO THE EXCLUSIVE RIGHT TO USE "PENNY", APART FROM THE MARK AS SHOWN.

FOR AUTOMATED COIN COUNTING, SORTING AND CONVERTING SERVICES (U.S. CLS. 100, 101 AND 102).

BRIDGETT SMITH, EXAMINING ATTORNEY

SN 78-439,766. WHITTICOM, JONATHAN R., NEW YORK, NY. FILED 6-23-2004.



NO CLAIM IS MADE TO THE EXCLUSIVE RIGHT TO USE "BID", APART FROM THE MARK AS SHOWN.

THE COLORS BLUE, RED AND BLACK ARE CLAIMED AS A FEATURE OF THE MARK.

THE MARK CONSISTS OF A BLUE MAN WITH A RED HEART STANDING IN FRONT OF THE OUTLINE OF A BLACK GLOBE WITH THE RED LETTERING "BID TO GIVE" PLACED ABOVE THE GLOBE.

FOR CHARITABLE FUND RAISING SERVICES, NAMELY, CONDUCTING AUCTIONS TO RAISE FUNDS FOR CHARITIES (U.S. CLS. 100, 101 AND 102).

JIM RINGLE, EXAMINING ATTORNEY

CLASS 36—(Continued).

SN 78-439,847. WARD, CARLOS, MIDDLETOWN, PA. FILED 6-23-2004.

CLASS 36—(Continued).

SN 78-441,804. NELNET, INC., LINCOLN, NE. FILED 6-25-2004.

ROLL IRA

**Expect
extraordinary**

THE MARK CONSISTS OF STANDARD CHARACTERS WITHOUT CLAIM TO ANY PARTICULAR FONT, STYLE, SIZE, OR COLOR.

NO CLAIM IS MADE TO THE EXCLUSIVE RIGHT TO USE "IRA", APART FROM THE MARK AS SHOWN.

FOR FINANCIAL SERVICES, NAMELY, FINANCIAL PLANNING FOR RETIREMENT AND MANAGEMENT OF RETIREMENT ASSETS (U.S. CLS. 100, 101 AND 102).

FIRST USE 6-1-2004; IN COMMERCE 6-1-2004.

DOMINICK J. SALEMI, EXAMINING ATTORNEY

THE MARK CONSISTS OF STANDARD CHARACTERS WITHOUT CLAIM TO ANY PARTICULAR FONT, STYLE, SIZE, OR COLOR.

FOR FINANCIAL SERVICES, NAMELY, MONEY LENDING; PROVIDING EDUCATION LOANS; PROVIDING MANAGEMENT OF EDUCATION LOANS; PROVIDING FINANCIAL AID CONSULTATION TO SCHOOLS AND UNIVERSITIES (U.S. CLS. 100, 101 AND 102).

FIRST USE 10-1-2003; IN COMMERCE 10-1-2003.

JASON LOTT, EXAMINING ATTORNEY

SN 78-441,240. DEFINITY HEALTH CORPORATION, ST. LOUIS PARK, MN. FILED 6-25-2004.

SN 78-443,685. RBS LYNK INCORPORATED, ATLANTA, GA. FILED 6-30-2004.

**CREATING
HEALTHCARE
CONSUMERS**

GIFTVANTAGE

THE MARK CONSISTS OF STANDARD CHARACTERS WITHOUT CLAIM TO ANY PARTICULAR FONT, STYLE, SIZE, OR COLOR.

FOR ADMINISTERING HEALTH CARE PLANS AND MANAGING MEDICAL SPENDING ACCOUNTS FOR INDIVIDUALS AND EMPLOYERS; PROVIDING INFORMATION VIA THE INTERNET IN THE FIELD OF HEALTH CARE, NAMELY, DESCRIPTIONS OF HEALTH CARE PLANS AND BENEFITS, AND INFORMATION ON HEALTH BENEFITS ACCOUNTS (U.S. CLS. 100, 101 AND 102).

FIRST USE 2-28-2001; IN COMMERCE 2-28-2001.

KHANH LE, EXAMINING ATTORNEY

THE MARK CONSISTS OF STANDARD CHARACTERS WITHOUT CLAIM TO ANY PARTICULAR FONT, STYLE, SIZE, OR COLOR.

FOR FINANCIAL SERVICES, IN THE NATURE OF GIFT CARD SERVICES, NAMELY, PROCESSING ELECTRONIC PAYMENTS MADE THROUGH PREPAID GIFT CARDS (U.S. CLS. 100, 101 AND 102).

PRISCILLA MILTON, EXAMINING ATTORNEY

CLASS 36—(Continued).

SN 78-444,571. EPIC FINANCIAL, INC., MIAMI, FL. FILED 7-1-2004.



FOR THIRD PARTY PAYMENT SERVICE, NAMELY COLLECTING BI-WEEKLY PAYMENTS FROM CUSTOMERS AND PROVIDING THE COLLECTED PAYMENTS TO LENDERS TO SATISFY CUSTOMER OBLIGATIONS TO THE LENDER FOR THE CUSTOMER ACCOUNT. (U.S. CLS. 100, 101 AND 102).
BARBARA GAYNOR, EXAMINING ATTORNEY

CLASS 36—(Continued).

SN 78-448,647. GUARANTEED FUNDING, LLC, BETHESDA, MD. FILED 7-9-2004.

GET THE GUARANTEED ADVANTAGE

THE MARK CONSISTS OF STANDARD CHARACTERS WITHOUT CLAIM TO ANY PARTICULAR FONT, STYLE, SIZE, OR COLOR.
FOR FINANCIAL SERVICES, NAMELY THE PURCHASE OF FUTURE PAYMENTS OF LOTTERY AND CONTEST WINNINGS, STRUCTURED SETTLEMENTS, AND SECURED INSURANCE SETTLEMENTS (U.S. CLS. 100, 101 AND 102).
ANN E. SAPPENFIELD, EXAMINING ATTORNEY

SN 78-446,580. VALUED SERVICES INTELLECTUAL PROPERTY MANAGEMENT, INC. II, LAS VEGAS, NV. FILED 7-6-2004.

PURPOSE CONNEXTION

THE MARK CONSISTS OF STANDARD CHARACTERS WITHOUT CLAIM TO ANY PARTICULAR FONT, STYLE, SIZE, OR COLOR.
FOR CASH CARD, STORED VALUE CARD, CREDIT CARD, AND DEBIT CARD SERVICES (U.S. CLS. 100, 101 AND 102).
STEVEN JACKSON, EXAMINING ATTORNEY

SN 78-462,424. ANDERSON & ASSOCIATES, INC., DBA FRANCHISE FINANCE, LITTLE ROCK, AR. FILED 8-5-2004.

SN 78-447,655. SPECIALIZED LOAN SERVICING, LLC, HIGHLANDS RANCH, CO. FILED 7-8-2004.



NO CLAIM IS MADE TO THE EXCLUSIVE RIGHT TO USE "SPECIALIZED LOAN SERVICING, LLC", APART FROM THE MARK AS SHOWN.
FOR MORTGAGE LOAN SERVICING AND MANAGEMENT SERVICES, NAMELY, COLLECTING MONTHLY HOME LOAN PAYMENTS AND MAINTAINING MORTGAGE ESCROW ACCOUNTS (U.S. CLS. 100, 101 AND 102).
FIRST USE 1-1-2004; IN COMMERCE 1-1-2004.
ELIZABETH PIGNATELLO, EXAMINING ATTORNEY

NO CLAIM IS MADE TO THE EXCLUSIVE RIGHT TO USE "FRANCHISE FINANCE", APART FROM THE MARK AS SHOWN.
FOR FINANCIAL SERVICES, NAMELY MONEY LENDING SERVICES FOR FRANCHISEES AND FRANCHISORS (U.S. CLS. 100, 101 AND 102).
FIRST USE 1-31-1998; IN COMMERCE 1-31-1998.
ANNE E. GUSTASON, EXAMINING ATTORNEY

CLASS 36—(Continued).

SN 78-465,188. LEPAGE, JACQUES, LONDON, UNITED KINGDOM, FILED 8-10-2004.

CLASS 36—(Continued).

SN 78-466,406. JAGUAR CARS LIMITED, COVENTRY, UNITED KINGDOM, FILED 8-12-2004.

NORAMPTCO

JAGUAR

THE MARK CONSISTS OF STANDARD CHARACTERS WITHOUT CLAIM TO ANY PARTICULAR FONT, STYLE, SIZE, OR COLOR.

FOR FINANCIAL STATEMENT PREPARATION AND ANALYSIS FOR BUSINESSES; FINANCIAL TRUST OPERATIONS; FINANCIAL ANALYSIS AND CONSULTATION; FINANCIAL PLANNING; FINANCIAL BROKERAGE IN THE FIELD OF ART, INSURANCE, STOCKS, COMMODITIES; INVESTMENT SERVICES, NAMELY ASSET ACQUISITIONS, CONSULTATION, DEVELOPMENT AND MANAGEMENT SERVICES IN COMMERCIAL ENTERPRISES AND COMPANIES FOR OTHERS; CAPITAL INVESTMENT CONSULTATION; FUNDS INVESTMENT. (U.S. CLS. 100, 101 AND 102).
TIMOTHY FINNEGAN, EXAMINING ATTORNEY

THE MARK CONSISTS OF STANDARD CHARACTERS WITHOUT CLAIM TO ANY PARTICULAR FONT, STYLE, SIZE, OR COLOR.

FOR INSURANCE SERVICES, NAMELY, UNDERWRITING EXTENDED WARRANTY CONTRACTS IN THE FIELD OF MOTOR VEHICLES; INSURANCE SERVICES FOR MOTOR VEHICLES, NAMELY, INSURANCE UNDERWRITING AND INSURANCE BROKERAGE (U.S. CLS. 100, 101 AND 102).
INGA ERVIN, EXAMINING ATTORNEY

SN 78-470,199. AQUASUN REALTY LLC, CORAL GABLES, FL. FILED 8-19-2004.

SN 78-466,144. FINANCIAL INVESTMENT MANAGEMENT GROUP, LTD., TRAVERSE CITY, MI. FILED 8-12-2004.

UTOPIA FUNDS

AQUASUN

THE MARK CONSISTS OF STANDARD CHARACTERS WITHOUT CLAIM TO ANY PARTICULAR FONT, STYLE, SIZE, OR COLOR.

NO CLAIM IS MADE TO THE EXCLUSIVE RIGHT TO USE "FUNDS", APART FROM THE MARK AS SHOWN.
FOR MUTUAL FUND INVESTMENT SERVICES (U.S. CLS. 100, 101 AND 102).
DARRYL SPRUILL, EXAMINING ATTORNEY

THE MARK CONSISTS OF STANDARD CHARACTERS WITHOUT CLAIM TO ANY PARTICULAR FONT, STYLE, SIZE, OR COLOR.

FOR REAL ESTATE AGENCY SERVICES (U.S. CLS. 100, 101 AND 102).
FIRST USE 10-24-2003; IN COMMERCE 10-24-2003.
DAVID MURRAY, EXAMINING ATTORNEY

CLASS 36—(Continued).

SN 78-471,970. THE AMERICAN ACADEMY OF NEUROLOGY, ST. PAUL, MN. FILED 8-23-2004.



OWNER OF U.S. REG. NOS. 1,625,320 AND 2,571,380.
NO CLAIM IS MADE TO THE EXCLUSIVE RIGHT TO USE "FOUNDATION", APART FROM THE MARK AS SHOWN.

THE MARK CONSISTS OF THE WORDING AMERICAN ACADEMY OF NEUROLOGY IN STANDARD CHARACTER FONT IN ALL CAPS WITH THE WORD FOUNDATION IN A STYLIZED CURSIVE FONT UNDERNEATH AND A DESIGN OF A BRAIN NEURON TO THE LEFT OF THE WRITING.

SEC. 2(F) AS TO "AMERICAN ACADEMY OF NEUROLOGY".

FOR FOUNDATION SERVICES, NAMELY CHARITABLE FUNDRAISING TO SUPPORT APPLICANT'S MISSION TO BROADEN THE BASE OF SUPPORT, PUBLIC EDUCATION AND RESEARCH, FUNDING RESEARCH, AND PROVIDING PATIENT EDUCATION, ALL OF THE FOREGOING IN THE FIELD OF NEUROLOGY (U.S. CLS. 100, 101 AND 102).

FIRST USE 6-0-2004; IN COMMERCE 6-0-2004.
WINSTON FOLMAR, EXAMINING ATTORNEY

SN 78-471,987. AMERICAN ACADEMY OF NEUROLOGY, THE, ST. PAUL, MN. FILED 8-23-2004.

AMERICAN ACADEMY
OF NEUROLOGY
FOUNDATION

THE MARK CONSISTS OF STANDARD CHARACTERS WITHOUT CLAIM TO ANY PARTICULAR FONT, STYLE, SIZE, OR COLOR.

OWNER OF U.S. REG. NOS. 1,625,320 AND 2,571,380.
NO CLAIM IS MADE TO THE EXCLUSIVE RIGHT TO USE "FOUNDATION", APART FROM THE MARK AS SHOWN.

SEC. 2(F) AS TO "AMERICAN ACADEMY OF NEUROLOGY".

FOR FOUNDATION SERVICES, NAMELY CHARITABLE FUNDRAISING TO SUPPORT APPLICANT'S MISSION TO BROADEN THE BASE OF SUPPORT, PUBLIC EDUCATION AND RESEARCH, FUNDING RESEARCH, AND PROVIDING PATIENT EDUCATION, ALL OF THE FOREGOING IN THE FIELD OF NEUROLOGY (U.S. CLS. 100, 101 AND 102).

FIRST USE 11-1-2002; IN COMMERCE 11-1-2002.
WINSTON FOLMAR, EXAMINING ATTORNEY

CLASS 36—(Continued).

SN 78-479,240. CAPVENT AG, ZURICH, SWITZERLAND, FILED 9-7-2004.

CAPVENT

THE MARK CONSISTS OF STANDARD CHARACTERS WITHOUT CLAIM TO ANY PARTICULAR FONT, STYLE, SIZE, OR COLOR.

OWNER OF SWITZERLAND REG. NO. 500773, DATED 1-16-2002, EXPIRES 1-16-2012.

FOR FINANCIAL ANALYSIS AND CONSULTATION; FINANCIAL INVESTMENT IN THE FIELD OF PRIVATE EQUITY, VENTURE CAPITAL, SECURITIES, HEDGE FUNDS; FINANCIAL MANAGEMENT; FINANCIAL PLANNING; FINANCIAL PORTFOLIO MANAGEMENT; FINANCIAL RESEARCH; FINANCIAL SERVICES IN THE NATURE OF AN INVESTMENT SECURITY; FUND INVESTMENT CONSULTATION; INVESTMENT ADVICE; INVESTMENT CONSULTATION; INVESTMENT MANAGEMENT (U.S. CLS. 100, 101 AND 102).

JILL C. ALT, EXAMINING ATTORNEY

SN 78-483,260. WLS, LC, DBA NAI MIAMI, MIAMI, FL. FILED 9-14-2004.

GLOBAL KNOWLEDGE. LOCAL EXPERTISE.

THE MARK CONSISTS OF STANDARD CHARACTERS WITHOUT CLAIM TO ANY PARTICULAR FONT, STYLE, SIZE, OR COLOR.

FOR REAL ESTATE AGENCY AND BROKERAGE SERVICES; FINANCIAL INVESTMENT IN THE FIELD OF REAL ESTATE; FINANCIAL VALUATION OF REAL ESTATE; LEASING OF REAL ESTATE; PROVIDING INFORMATION IN THE FIELD OF REAL ESTATE BY MEANS OF LINKING THE WEB SITE TO OTHER WEB SITES FEATURING REAL ESTATE INFORMATION; REAL ESTATE ACQUISITION; REAL ESTATE EQUITY SHARING, NAMELY, MANAGING AND ARRANGING FOR CO-OWNERSHIP OF REAL ESTATE; REAL ESTATE MANAGEMENT; AND COMMERCIAL MORTGAGE BROKERAGE (U.S. CLS. 100, 101 AND 102).

FIRST USE 12-5-2001; IN COMMERCE 12-5-2001.
REBECCA GILBERT, EXAMINING ATTORNEY

CLASS 36—(Continued).

SN 78-483,942. ESCROW.COM, INC., IRVINE, CA. FILED 9-15-2004.

CLASS 36—(Continued).

SN 78-490,447. ERIE INSURANCE EXCHANGE, ERIE, PA. FILED 9-28-2004.



**WE ARE THE
COMPETITION**

NO CLAIM IS MADE TO THE EXCLUSIVE RIGHT TO USE "ESCROW.COM", APART FROM THE MARK AS SHOWN.

THE STIPPLING IS FOR SHADING PURPOSES ONLY. THE MARK CONSISTS OF A STYLIZED "E" FOLLOWED BY THE TEXT "ESCROW.COM".

FOR FINANCIAL SERVICES, NAMELY, PERSONAL PROPERTY ESCROW SERVICES AND LOAN FINANCING SERVICES (U.S. CLS. 100, 101 AND 102).

FIRST USE 3-0-2000; IN COMMERCE 3-0-2000.
KHANH LE, EXAMINING ATTORNEY

THE MARK CONSISTS OF STANDARD CHARACTERS WITHOUT CLAIM TO ANY PARTICULAR FONT, STYLE, SIZE, OR COLOR.

FOR ANNUITY UNDERWRITING, AND AUTOMOBILE, HOME, PROPERTY, CASUALTY AND LIFE INSURANCE UNDERWRITING FOR INDIVIDUAL AND BUSINESS CUSTOMERS (U.S. CLS. 100, 101 AND 102).

FIRST USE 7-30-1990; IN COMMERCE 7-30-1990.
SKYE YOUNG, EXAMINING ATTORNEY

SN 78-490,621. SIX400 PARTNERS, LLC, HOUSTON, TX. FILED 9-28-2004.

SN 78-485,252. STARKEY LABORATORIES, INC., EDEN PRAIRIE, MN. FILED 9-17-2004.

Bank Advantage

SOUNDCHOICE

THE MARK CONSISTS OF STANDARD CHARACTERS WITHOUT CLAIM TO ANY PARTICULAR FONT, STYLE, SIZE, OR COLOR.

FOR CONSUMER CREDIT CARD SERVICES, IN THE FIELD OF HEARING CARE (U.S. CLS. 100, 101 AND 102).

FIRST USE 9-1-2003; IN COMMERCE 9-1-2003.
YONG KIM, EXAMINING ATTORNEY

THE MARK CONSISTS OF STANDARD CHARACTERS WITHOUT CLAIM TO ANY PARTICULAR FONT, STYLE, SIZE, OR COLOR.

NO CLAIM IS MADE TO THE EXCLUSIVE RIGHT TO USE "BANK", APART FROM THE MARK AS SHOWN.

FOR INSURANCE AND FINANCIAL SERVICES, NAMELY, PROCESSING FINANCIAL TRANSACTIONS, SPECIFICALLY EXPEDITING THE COLLECTION OF NON-SUFFICIENT FUND CHECKS AND UNPAID INVOICES FOR COMMERCIAL DEPOSITORS THROUGH THE USE OF COLLECTION LETTERS AND COLLECTION AGENCIES (U.S. CLS. 100, 101 AND 102).

FIRST USE 5-30-2003; IN COMMERCE 5-30-2003.
ROBIN CHOSID, EXAMINING ATTORNEY

CLASS 36—(Continued).

SN 78-492,373. MICHIGAN CONSTRUCTION INDUSTRY MUTUAL INSURANCE COMPANY, LANSING, MI. FILED 9-30-2004.



SEC. 2(F).
FOR INSURANCE CONSULTATION AND UNDERWRITING IN THE FIELD OF WORKERS' COMPENSATION INSURANCE (U.S. CLS. 100, 101 AND 102).
FIRST USE 1-1-2000; IN COMMERCE 1-1-2000.
JOHN DALIER, EXAMINING ATTORNEY

SN 78-492,615. EAGLE LEGACY CREDIT UNION, ARVADA, CO. FILED 9-30-2004.



OWNER OF U.S. REG. NO. 2,767,927.
NO CLAIM IS MADE TO THE EXCLUSIVE RIGHT TO USE "CREDIT UNION", APART FROM THE MARK AS SHOWN.
FOR CREDIT UNION SERVICES (U.S. CLS. 100, 101 AND 102).
FIRST USE 1-1-2003; IN COMMERCE 1-1-2003.
ANNE MADDEN, EXAMINING ATTORNEY

CLASS 36—(Continued).

SN 78-493,073. DEUTSCHE TELEKOM AG, BONN, FED REP GERMANY, FILED 10-1-2004.

T-Mobile Sound Alert

THE MARK CONSISTS OF STANDARD CHARACTERS WITHOUT CLAIM TO ANY PARTICULAR FONT, STYLE, SIZE, OR COLOR.

PRIORITY CLAIMED UNDER SEC. 44(D) ON FED REP GERMANY APPLICATION NO. 30418516738, FILED 4-2-2004, REG. NO. 30418516, DATED 4-22-2004, EXPIRES 4-30-2014.

OWNER OF U.S. REG. NOS. 2,282,432, 2,959,646 AND OTHERS.

FOR INSURANCE SERVICES, NAMELY, INSURANCE BROKERAGE, INSURANCE CLAIMS PROCESSING; FINANCIAL SERVICES, NAMELY, CLEARING OF SECURE FINANCIAL TRANSACTIONS THROUGH ONLINE SERVICES; FINANCIAL ANALYSIS AND CONSULTATION; FINANCIAL INFORMATION PROVIDED BY ELECTRONIC MEANS; FINANCIAL INFORMATION PROCESSING; FINANCIAL PORTFOLIO MANAGEMENT; FINANCIAL SERVICES, NAMELY, SECURITIES CONSULTING AND SAFE KEEPING; FINANCIAL SPONSORSHIP OF SPORTS, EDUCATIONAL AND ENTERTAINMENT PROGRAMS AND EVENTS; COMMERCIAL LENDING SERVICES; MONETARY EXCHANGE; CREDIT CARD SERVICES; TELEPHONE CALLING CARD SERVICES; ELECTRONIC COMMERCE SERVICES, NAMELY, ELECTRONIC DEBIT AND CREDIT CARD TRANSACTION PROCESSING SERVICES, FUNDS TRANSFER AND BILL PAYMENT-PROCESSING SERVICES; DISCOUNT BROKERAGE SERVICES; SECURITY BROKERAGE; BROKERAGE IN THE FIELD OF INSURANCE, STOCKS, COMMODITIES; CUSTOM BROKERAGE FOR THIRD PARTIES IN THE FIELD OF INSURANCE, STOCKS, COMMODITIES; BROKERAGE OF SHARES AND VENTURE CAPITAL FUNDING SERVICES TO START-UP COMPANIES; BROKERAGE OF FUND SHARES; BROKERAGE OF PRODUCTIVE INVESTMENT OF FUNDS; REAL ESTATE SERVICES, NAMELY, BROKERAGE, MANAGEMENT, LEASING, AND APPRAISAL OF REAL PROPERTY; CONSULTING SERVICES RELATING TO INSURANCE SERVICES, NAMELY, PROVIDING INFORMATION AND BROKERAGE OF INSURANCES IN THE FIELD OF HOME INSURANCE, ACCIDENT INSURANCE AND HEALTH INSURANCE; CONSULTING SERVICES RELATING TO BANK SERVICES; PROVIDING INFORMATION VIA THE TELEPHONE AND THE GLOBAL COMMUNICATION NETWORKS IN THE FIELD OF FINANCE (U.S. CLS. 100, 101 AND 102).
INGRID C. EULIN, EXAMINING ATTORNEY

CLASS 36—(Continued).

SN 78-494,099. BANK OF DENVER, DENVER, CO. FILED 10-4-2004.

CLASS 36—(Continued).

SN 78-494,797. SANDLER O'NEILL & PARTNERS, L.P., NEW YORK, NY. FILED 10-5-2004.

Fast Draw

THE MARK CONSISTS OF STANDARD CHARACTERS WITHOUT CLAIM TO ANY PARTICULAR FONT, STYLE, SIZE, OR COLOR.

SEC. 2(F).
FOR FINANCIAL SERVICES, NAMELY, A LINE OF CREDIT TIED TO CHECKING ACCOUNT (U.S. CLS. 100, 101 AND 102).

FIRST USE 0-0-1970; IN COMMERCE 0-0-1970.
CATHERINE FAINT, EXAMINING ATTORNEY

N-CHIPPS

THE MARK CONSISTS OF STANDARD CHARACTERS WITHOUT CLAIM TO ANY PARTICULAR FONT, STYLE, SIZE, OR COLOR.

FOR FINANCIAL SERVICES, NAMELY, FACILITATING THE ISSUANCE OF NON-CUMULATIVE PERPETUAL PREFERRED STOCK OF BANKS, THRIFTS AND OTHER DEPOSITORY INSTITUTIONS AND HOLDING COMPANIES OF BANKS, THRIFTS AND OTHER DEPOSITORY INSTITUTIONS (U.S. CLS. 100, 101 AND 102).
LOURDES AYALA, EXAMINING ATTORNEY

SN 78-495,322. THE ANURADHA FOUNDATION, LOS ALTOS, CA. FILED 10-6-2004.

SN 78-494,308. THE INVESTLINC GROUP, LLC, HOFFMAN ESTATES, IL. FILED 10-4-2004.

**INVESTLINC/GK
PROPERTIES**

THE MARK CONSISTS OF STANDARD CHARACTERS WITHOUT CLAIM TO ANY PARTICULAR FONT, STYLE, SIZE, OR COLOR.

NO CLAIM IS MADE TO THE EXCLUSIVE RIGHT TO USE "PROPERTIES", APART FROM THE MARK AS SHOWN.

FOR REAL ESTATE INVESTMENT (U.S. CLS. 100, 101 AND 102).

FIRST USE 1-10-2001; IN COMMERCE 1-10-2001.
DOMINIC J. FERRAIUOLO, EXAMINING ATTORNEY

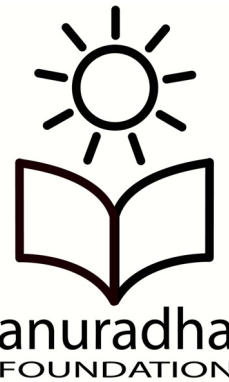

NO CLAIM IS MADE TO THE EXCLUSIVE RIGHT TO USE FOUNDATION, APART FROM THE MARK AS SHOWN.

THE COLOR(S) YELLOW, GREEN AND BROWN IS/ARE CLAIMED AS A FEATURE OF THE MARK.

THE COLOR(S) YELLOW SUN OVER A GREEN BOOK AND BROWN LETTERS.

THE MARK CONSISTS OF SUN OVER A BOOK AND THE WORDS ANURADHA FOUNDATION.

FOR CHARITABLE SERVICES, NAMELY, PROVIDING FUNDS FOR EDUCATIONAL AND MENTAL HEALTH SERVICES (U.S. CLS. 100, 101 AND 102).

FIRST USE 1-1-2004; IN COMMERCE 1-1-2004.
KARANENDRA S. CHHINA, EXAMINING ATTORNEY

CLASS 36—(Continued).

SN 78-496,118. ALLIED HOME MORTGAGE CORPORATION, HOUSTON, TX. FILED 10-7-2004.



NO CLAIM IS MADE TO THE EXCLUSIVE RIGHT TO USE HOME MORTGAGE CAPITAL CORPORATION, APART FROM THE MARK AS SHOWN.

FOR FINANCIAL SERVICES, NAMELY, MORTGAGES SERVICES, NAMELY, BUYER PRE-QUALIFICATION OF MORTGAGES FOR MORTGAGE BROKERS AND BANKS, LOAN FINANCING REGARDING MORTGAGE LOANS, MORTGAGE BROKERING, MAINTAINING MORTGAGE ESCROW ACCOUNTS, MORTGAGE BANKING, MORTGAGE LENDING, MORTGAGE PROCUREMENT FOR OTHERS; REAL ESTATE AGENCIES; REAL ESTATE APPRAISAL; REAL ESTATE BROKERAGE; REAL ESTATE INVESTMENT; REAL ESTATE ESCROW SERVICES; REAL ESTATE MANAGEMENT; REAL ESTATE SYNDICATION; REAL ESTATE PROCUREMENT FOR OTHERS (U.S. CLS. 100, 101 AND 102).
FIRST USE 2-25-2002; IN COMMERCE 2-25-2002.
CHRISTOPHER ADKINS, EXAMINING ATTORNEY

SN 78-496,715. PROGRESSIVE CASUALTY INSURANCE COMPANY, MAYFIELD VILLAGE, OH. FILED 10-8-2004.

LET'S GO. LET'S DRIVE.

THE MARK CONSISTS OF STANDARD CHARACTERS WITHOUT CLAIM TO ANY PARTICULAR FONT, STYLE, SIZE, OR COLOR.

FOR PRIVATE PASSENGER AND COMMERCIAL AUTOMOBILE, MOTORCYCLE, PERSONAL MOBILITY DEVICES, ALL TERRAIN VEHICLE, SNOWMOBILE, RECREATION VEHICLE, AND WATERCRAFT PROPERTY AND CASUALTY INSURANCE UNDERWRITING AND ADMINISTRATION SERVICES, NAMELY, INSURANCE PREMIUM QUOTING, TAKING AND PROCESSING INSURANCE APPLICATIONS, AND POLICY ISSUANCE AND SERVICING; PROVIDING CONSUMER INFORMATION VIA A GLOBAL COMPUTER INFORMATION NETWORK REGARDING INSURANCE UNDERWRITING AND SERVICING IN THE FIELDS OF PRIVATE PASSENGER AND COMMERCIAL AUTOMOBILE, MOTORCYCLE, PERSONAL MOBILITY DEVICES, ALL TERRAIN VEHICLE, SNOWMOBILE, RECREATION VEHICLE, AND WATERCRAFT PROPERTY AND CASUALTY INSURANCE (U.S. CLS. 100, 101 AND 102).
FIRST USE 12-10-2004; IN COMMERCE 12-10-2004.
DAYNA BROWNE, EXAMINING ATTORNEY

CLASS 36—(Continued).

SN 78-497,699. EAGLE MOUNTAIN INTERNATIONAL CHURCH, INC., FORT WORTH, TX. FILED 10-11-2004.



THE MARK CONSISTS OF THE PHRASE, CHEKTEL, WITHIN A CIRCLE WITH THE LETTER "K" DESIGNED TO LOOK LIKE A CHECK MARK.

FOR FINANCIAL SERVICE, NAMELY ELECTRONIC AND TELEPHONE CHECK ACCEPTANCE SERVICES (U.S. CLS. 100, 101 AND 102).
FIRST USE 4-15-2004; IN COMMERCE 4-15-2004.
BRIAN PINO, EXAMINING ATTORNEY

SN 78-497,870. YOUNG GUNS REALTY, INC., SCOTTSDALE, AZ. FILED 10-11-2004.



NO CLAIM IS MADE TO THE EXCLUSIVE RIGHT TO USE "REALTY, INC", APART FROM THE MARK AS SHOWN.

FOR REAL ESTATE SERVICES, NAMELY REAL ESTATE AGENCIES AND REAL ESTATE BROKERAGE SERVICES (U.S. CLS. 100, 101 AND 102).
FIRST USE 2-24-2004; IN COMMERCE 8-8-2004.
NANCY CLARKE, EXAMINING ATTORNEY

SN 78-501,526. HARTFORD FIRE INSURANCE COMPANY, HARTFORD, CT. FILED 10-18-2004.

THE HARTFORD CLAIMPLUS TEAM

THE MARK CONSISTS OF STANDARD CHARACTERS WITHOUT CLAIM TO ANY PARTICULAR FONT, STYLE, SIZE, OR COLOR.

NO CLAIM IS MADE TO THE EXCLUSIVE RIGHT TO USE "TEAM", APART FROM THE MARK AS SHOWN. SEC. 2(F) AS TO "HARTFORD".
FOR INSURANCE UNDERWRITING SERVICES FOR ALL TYPES OF INSURANCE; INSURANCE SERVICES, NAMELY, INSURANCE CLAIMS ADMINISTRATION, INSURANCE CLAIM ASSESSMENT, AND INSURANCE CLAIMS PROCESSING. (U.S. CLS. 100, 101 AND 102).
STANLEY I. OSBORNE, EXAMINING ATTORNEY

CLASS 36—(Continued).

SN 78-504,584. AMERICAN INTERNATIONAL GROUP, INC., NEW YORK, NY. FILED 10-22-2004.

AIG FAST TRACK

THE MARK CONSISTS OF STANDARD CHARACTERS WITHOUT CLAIM TO ANY PARTICULAR FONT, STYLE, SIZE, OR COLOR.

OWNER OF U.S. REG. NOS. 1,151,229, 2,840,342 AND 2,893,413.

FOR INSURANCE UNDERWRITING SERVICES, NAMELY, MANAGEMENT LIABILITY INSURANCE WHICH INCLUDES DIRECTORS AND OFFICERS, EMPLOYMENT PRACTICES LIABILITY, PENSION, FIDELITY, ERRORS AND OMISSIONS COVERAGE, FINANCIAL INSTITUTIONS COVERAGE, EXCESS/UMBRELLA COVERAGE, AND ACCIDENT AND HEALTH INSURANCE (U.S. CLS. 100, 101 AND 102).
GLENN CLARK, EXAMINING ATTORNEY

SN 78-505,566. MICHAILEDIS, JOHN A., CHICAGO, IL. FILED 10-25-2004.

Chicago Building Exchange

THE MARK CONSISTS OF STANDARD CHARACTERS WITHOUT CLAIM TO ANY PARTICULAR FONT, STYLE, SIZE, OR COLOR.

NO CLAIM IS MADE TO THE EXCLUSIVE RIGHT TO USE "CHICAGO BUILDING", APART FROM THE MARK AS SHOWN.

FOR REAL ESTATE BROKERAGE SERVICES OF MULTI-UNIT AND MIXED-USE BUILDINGS (U.S. CLS. 100, 101 AND 102).

FIRST USE 5-0-2003; IN COMMERCE 8-0-2003.
ALINA MORRIS, EXAMINING ATTORNEY

CLASS 36—(Continued).

SN 78-507,089. THE CENTRAL VALLEY FOUNDATION, SACRAMENTO, CA. FILED 10-27-2004.

Central Valley Foundation

THE MARK CONSISTS OF STANDARD CHARACTERS WITHOUT CLAIM TO ANY PARTICULAR FONT, STYLE, SIZE, OR COLOR.

NO CLAIM IS MADE TO THE EXCLUSIVE RIGHT TO USE "FOUNDATION", APART FROM THE MARK AS SHOWN.

SEC. 2(F).

FOR ACCEPTING AND ADMINISTERING MONETARY CHARITABLE CONTRIBUTIONS (U.S. CLS. 100, 101 AND 102).

FIRST USE 9-1-1992; IN COMMERCE 9-1-1992.

TRICIA SONNEBORN, EXAMINING ATTORNEY

SN 78-507,585. MEDICAL JUSTICE CORP., GREENSBORO, NC. FILED 10-28-2004.



OWNER OF U.S. REG. NOS. 2,592,074 AND 2,635,903.

NO CLAIM IS MADE TO THE EXCLUSIVE RIGHT TO USE MEDICAL, APART FROM THE MARK AS SHOWN.

THE COLOR(S) BLUE AND WHITE IS/ARE CLAIMED AS A FEATURE OF THE MARK.

THE TERM MEDICAL APPEARS IN BLUE LETTERING ON A WHITE BACKGROUND. THE TERM JUSTICE APPEARS IN WHITE LETTERING AND THE SCALES OF JUSTICE INTERTWINED WITH THE PARTIAL CADUCEUS SYMBOL APPEARS IN WHITE, BOTH ON A BLUE BACKGROUND. THE MARK IS ENCLOSED IN A BLUE RECTANGULAR FRAME.

THE MARK CONSISTS, IN PART, OF A DESIGN OF THE SCALES OF JUSTICE COMBINED AND INTERTWINED WITH A PORTION OF THE CADUCEUS SYMBOL.

FOR INSURANCE SERVICES, NAMELY, LEGAL EXPENSE INSURANCE PROVIDER (U.S. CLS. 100, 101 AND 102).

FIRST USE 10-1-2004; IN COMMERCE 10-1-2004.
ZHALEH DELANEY, EXAMINING ATTORNEY

CLASS 36—(Continued).

SN 78-508,877. FRAZIER, SCOTT W., ALPINE, UT. FILED 10-31-2004.

UtahAngels

THE MARK CONSISTS OF STANDARD CHARACTERS WITHOUT CLAIM TO ANY PARTICULAR FONT, STYLE, SIZE, OR COLOR.
FOR INVESTMENT CLUBS (U.S. CLS. 100, 101 AND 102).

FIRST USE 5-30-1998; IN COMMERCE 5-30-1998.
KATHRYN COWARD, EXAMINING ATTORNEY

SN 78-509,088. NEW CENTURY MORTGAGE CORPORATION, IRVINE, CA. FILED 11-1-2004.

Home123

OWNER OF U.S. REG. NOS. 2,250,525, 2,559,001 AND 2,631,907.

FOR MORTGAGE BANKING AND MORTGAGE LENDING SERVICES (U.S. CLS. 100, 101 AND 102).
FIRST USE 11-1-2004; IN COMMERCE 11-1-2004.
WILLIAM VERHOSEK, EXAMINING ATTORNEY

SN 78-509,849. DAGSTANI, TAREK, LEESBURG, VA. FILED 11-2-2004.

RENTOCMD

THE MARK CONSISTS OF STANDARD CHARACTERS WITHOUT CLAIM TO ANY PARTICULAR FONT, STYLE, SIZE, OR COLOR.

FOR REAL ESTATE PROPERTY MANAGEMENT, REAL ESTATE RENTAL PROPERTY MANAGEMENT (U.S. CLS. 100, 101 AND 102).

MICHAEL TANNER, EXAMINING ATTORNEY

CLASS 36—(Continued).

SN 78-510,442. SUNTRUST BANKS, INC., ORLANDO, FL. FILED 11-3-2004.

CARSWELL
Insurance Services
An Affiliate of SunTrust Banks, Inc.

OWNER OF U.S. REG. NOS. 1,513,026 AND 2,634,807.

NO CLAIM IS MADE TO THE EXCLUSIVE RIGHT TO USE "INSURANCE SERVICES AFFILIATE AND BANKS, INC.", APART FROM THE MARK AS SHOWN.

THE COLOR(S) GRAY AND BLUE IS/ARE CLAIMED AS A FEATURE OF THE MARK.

THE MARK CONSISTS OF STYLIZED LETTERING IN GRAY AND THE LINE IS BLUE.

FOR INSURANCE SERVICES, NAMELY, INSURANCE BROKERAGE AND INSURANCE AGENCIES IN THE FIELD OF PROPERTY AND CASUALTY INSURANCE (U.S. CLS. 100, 101 AND 102).

SANI KHOURI, EXAMINING ATTORNEY

SN 78-510,753. THE ZOHOURI GROUP, LLC, ATLANTA, GA. FILED 11-3-2004.

TODAY'S AMERICAN HOME REAL ESTATE

THE MARK CONSISTS OF STANDARD CHARACTERS WITHOUT CLAIM TO ANY PARTICULAR FONT, STYLE, SIZE, OR COLOR.

NO CLAIM IS MADE TO THE EXCLUSIVE RIGHT TO USE "AMERICAN HOME REAL ESTATE", APART FROM THE MARK AS SHOWN.

FOR REAL ESTATE AGENCY AND BROKERAGE SERVICES (U.S. CLS. 100, 101 AND 102).

MICHAEL WEBSTER, EXAMINING ATTORNEY

CLASS 36—(Continued).

SN 78-511,544. CAPITAL ONE FINANCIAL CORPORATION, RICHMOND, VA. FILED 11-4-2004.

CLASS 36—(Continued).

SN 78-512,341. WYDLER, HANS L, BETHESDA, MD. AND WYDLER, STEVEN C, MCLEAN, VA. FILED 11-5-2004.



NO CLAIM IS MADE TO THE EXCLUSIVE RIGHT TO USE "PURCHASE PROGRAM", APART FROM THE MARK AS SHOWN.

THE COLOR(S) BLUE AND RED IS/ARE CLAIMED AS A FEATURE OF THE MARK.

THE MARK COLOR STATEMENT CONSISTS OF THE WORDS NO HASSLE PURCHASE PROGRAM IN BLUE. TO THE RIGHT OF THE WORDS IS A BLUE CIRCLE WITH A RED CHECK MARK IN IT.

FOR FINANCIAL SERVICES, NAMELY CREDIT CARD SERVICES (U.S. CLS. 100, 101 AND 102).

FIRST USE 7-21-2004; IN COMMERCE 7-21-2004. CHERYL CLAYTON, EXAMINING ATTORNEY

WYDLER BROTHERS

THE MARK CONSISTS OF STANDARD CHARACTERS WITHOUT CLAIM TO ANY PARTICULAR FONT, STYLE, SIZE, OR COLOR.

FOR REAL ESTATE SERVICES FOR OTHERS, NAMELY, REAL ESTATE LISTING AND REPRESENTING BUYERS AND SELLERS IN PURCHASING AND SELLING REAL ESTATE (U.S. CLS. 100, 101 AND 102).

FIRST USE 1-1-2004; IN COMMERCE 1-1-2004. GEORGIA CARTY, EXAMINING ATTORNEY

SN 78-513,262. MUNICIPAL MORTGAGE & EQUITY, LLC, BALTIMORE, MD. FILED 11-8-2004.

SN 78-512,249. SEABURY & SMITH, INC., NEW YORK, NY. FILED 11-5-2004.

PRODESIGN

THE MARK CONSISTS OF STANDARD CHARACTERS WITHOUT CLAIM TO ANY PARTICULAR FONT, STYLE, SIZE, OR COLOR.

FOR UNDERWRITING AND ADMINISTRATION OF PROFESSIONAL LIABILITY INSURANCE FOR DESIGN AND TECHNOLOGY PROFESSIONALS, ENGINEERS, AND ARCHITECTS (U.S. CLS. 100, 101 AND 102).

FIRST USE 2-0-2004; IN COMMERCE 2-0-2004. DOUGLAS LEE, EXAMINING ATTORNEY

MUNIMAE

THE MARK CONSISTS OF STANDARD CHARACTERS WITHOUT CLAIM TO ANY PARTICULAR FONT, STYLE, SIZE, OR COLOR.

FOR REAL ESTATE DEBT INVESTMENTS AND EQUITY ARRANGEMENTS, NAMELY, MANAGING AND ARRANGING FOR LOANS TO AND OWNERSHIP OF REAL ESTATE FOR OTHERS, NAMELY, RESIDENTIAL AND COMMERCIAL REAL ESTATE, RETIREMENT COMMUNITIES, LIFE CARE, ASSISTED LIVING, AND OTHER FACILITIES FOR THE ELDERLY; REAL ESTATE INVESTMENTS FOR OTHERS; LOANS, INCLUDING TAX EXEMPT BOND LOANS, FOR RESIDENTIAL AND COMMERCIAL REAL ESTATE, RETIREMENT COMMUNITIES, LIFE CARE, ASSISTED LIVING AND OTHER FACILITIES FOR THE ELDERLY; AND CONSULTATION IN CONNECTION THEREWITH; ALL SERVICES ARE FOR THE BENEFIT OF OTHERS (U.S. CLS. 100, 101 AND 102).

FIRST USE 6-1-1996; IN COMMERCE 6-1-1996. ESTHER A. BORSUK, EXAMINING ATTORNEY

CLASS 36—(Continued).

SN 78-513,393. GIFTCO, INC., VERNON HILLS, IL. FILED 11-8-2004.

PRIZE PLANET

THE MARK CONSISTS OF STANDARD CHARACTERS WITHOUT CLAIM TO ANY PARTICULAR FONT, STYLE, SIZE, OR COLOR.
OWNER OF U.S. REG. NOS. 204,878, 2,504,882 AND OTHERS.

NO CLAIM IS MADE TO THE EXCLUSIVE RIGHT TO USE "PRIZE", APART FROM THE MARK AS SHOWN.

FOR FUND-RAISING FOR SCHOOLS THROUGH THE SALE OF MERCHANDISE, NAMELY, PROVIDING INCENTIVE TO PARTICIPANTS WHO SELL MERCHANDISE THROUGH ISSUANCE OF AWARDS IN THE FORM OF TROPHIES, PLAQUES, PRIZES, SCHOLARSHIPS AND CONSUMER GOODS (U.S. CLS. 100, 101 AND 102).

FIRST USE 1-0-1996; IN COMMERCE 1-0-1996.
BILL DAWE, EXAMINING ATTORNEY

SN 78-513,399. GIFTCO, INC., VERNON HILLS, IL. FILED 11-8-2004.

PRIZE DIMENSION

THE MARK CONSISTS OF STANDARD CHARACTERS WITHOUT CLAIM TO ANY PARTICULAR FONT, STYLE, SIZE, OR COLOR.

NO CLAIM IS MADE TO THE EXCLUSIVE RIGHT TO USE "PRIZE", APART FROM THE MARK AS SHOWN.

FOR FUND-RAISING FOR SCHOOLS THROUGH THE SALE OF MERCHANDISE, NAMELY, PROVIDING INCENTIVE TO PARTICIPANTS WHO SELL MERCHANDISE THROUGH ISSUANCE OF AWARDS IN THE FORM OF TROPHIES, PLAQUES, PRIZES, SCHOLARSHIPS AND CONSUMER GOODS (U.S. CLS. 100, 101 AND 102).

FIRST USE 1-0-1998; IN COMMERCE 1-0-1998.
BILL DAWE, EXAMINING ATTORNEY

CLASS 36—(Continued).

SN 78-513,433. BPN CORPORATION, CHINO, CA. FILED 11-8-2004.

CLASSICPLAN

THE MARK CONSISTS OF STANDARD CHARACTERS WITHOUT CLAIM TO ANY PARTICULAR FONT, STYLE, SIZE, OR COLOR.

FOR INSURANCE PREMIUM FINANCING SERVICES (U.S. CLS. 100, 101 AND 102).

FIRST USE 11-1-1984; IN COMMERCE 11-1-1984.
RENEE MCCRAY, EXAMINING ATTORNEY

SN 78-513,480. POST ROAD CAPITAL MANAGEMENT, LLC, NORWALK, CT. FILED 11-8-2004.

POST ROAD CAPITAL

NO CLAIM IS MADE TO THE EXCLUSIVE RIGHT TO USE "CAPITAL", APART FROM THE MARK AS SHOWN.

THE MARK CONSISTS OF POST ROAD CAPITAL IN STYLIZED LETTERS WITH A HEAVY LINE BELOW AND ABOVE.

FOR FINANCIAL SERVICES, NAMELY, CAPITAL INVESTMENT FUNDS MANAGEMENT (U.S. CLS. 100, 101 AND 102).

FIRST USE 9-1-2004; IN COMMERCE 9-1-2004.
GINA FINK, EXAMINING ATTORNEY

SN 78-513,660. MID-ATLANTIC FINANCIAL SERVICES, INC., ATLANTA, GA. FILED 11-9-2004.



NO CLAIM IS MADE TO THE EXCLUSIVE RIGHT TO USE MID-ATLANTIC FINANCIAL SERVICES, INC., APART FROM THE MARK AS SHOWN.

THE MARK CONSISTS OF THE WORDS MID-ATLANTIC FINANCIAL SERVICES, INC. WITH A ROOF AND CHIMNEY OVER THE LETTER M.

FOR MORTGAGE BANKING AND LENDING (U.S. CLS. 100, 101 AND 102).

FIRST USE 3-1-1996; IN COMMERCE 3-1-1996.
MICHAEL KAZAZIAN, EXAMINING ATTORNEY

CLASS 36—(Continued).

SN 78-514,065. CALIFORNIA BANK & TRUST, SAN DIEGO, CA. FILED 11-9-2004.

**CALIFORNIA BANK &
TRUST**

THE MARK CONSISTS OF STANDARD CHARACTERS WITHOUT CLAIM TO ANY PARTICULAR FONT, STYLE, SIZE, OR COLOR.

OWNER OF U.S. REG. NOS. 2,315,073, 2,655,377 AND OTHERS.

NO CLAIM IS MADE TO THE EXCLUSIVE RIGHT TO USE "BANK & TRUST", APART FROM THE MARK AS SHOWN.

SEC. 2(F).
FOR BANKING SERVICES (U.S. CLS. 100, 101 AND 102).

FIRST USE 10-1-1998; IN COMMERCE 10-1-1998.
MIDGE BUTLER, EXAMINING ATTORNEY

CLASS 36—(Continued).

SN 78-514,480. POPULAR, INC., SAN JUAN, PUERTO RICO, FILED 11-10-2004.

POPULAR L/C ONLINE

THE MARK CONSISTS OF STANDARD CHARACTERS WITHOUT CLAIM TO ANY PARTICULAR FONT, STYLE, SIZE, OR COLOR.

OWNER OF U.S. REG. NOS. 1,882,478, 2,858,774 AND OTHERS.

NO CLAIM IS MADE TO THE EXCLUSIVE RIGHT TO USE L/C OR ONLINE, APART FROM THE MARK AS SHOWN.

FOR ONLINE BANKING SERVICES, NAMELY ELECTRONIC PROCESSING AND TRANSMISSION OF LETTER OF CREDIT APPLICATIONS (U.S. CLS. 100, 101 AND 102).

FIRST USE 6-1-2001; IN COMMERCE 6-1-2001.
DEBRA LEE, EXAMINING ATTORNEY

SN 78-515,363. NEW SOUTH FEDERAL SAVINGS BANK, BIRMINGHAM, AL. FILED 11-11-2004.

SN 78-514,254. HARALD O. SCHWARZ AND DONALD H. JUDGE, JR., THE, OAKLAND PARK, FL. FILED 11-10-2004.

**"Providing the
keys to open the
doors of your
dreams"**

THE MARK CONSISTS OF STANDARD CHARACTERS WITHOUT CLAIM TO ANY PARTICULAR FONT, STYLE, SIZE, OR COLOR.

FOR REAL ESTATE LISTING SERVICES (U.S. CLS. 100, 101 AND 102).

FIRST USE 10-0-2004; IN COMMERCE 10-0-2004.
REBECCA GILBERT, EXAMINING ATTORNEY

**UMBRELLA FEDERAL
SAVINGS BANK**

THE MARK CONSISTS OF STANDARD CHARACTERS WITHOUT CLAIM TO ANY PARTICULAR FONT, STYLE, SIZE, OR COLOR.

OWNER OF U.S. REG. NOS. 2,564,254, 2,886,800 AND OTHERS.

NO CLAIM IS MADE TO THE EXCLUSIVE RIGHT TO USE "FEDERAL SAVINGS BANK", APART FROM THE MARK AS SHOWN.

FOR FINANCIAL SERVICES, NAMELY, BANKING, PERSONAL AND COMMERCIAL LENDING, FINANCIAL PLANNING, FINANCIAL MANAGEMENT, BILL PAYMENT, AUTOMATIC TELLER MACHINE SERVICES, MORTGAGE BROKERAGE, MORTGAGE LENDING, CREDIT CARD SERVICES, INSURANCE BROKERAGE SERVICES, AND INVESTMENT ADVISORY AND BROKERAGE SERVICES OFFERED AND RENDERED THROUGH GLOBAL COMMUNICATIONS NETWORKS (U.S. CLS. 100, 101 AND 102).

MARC LEIPZIG, EXAMINING ATTORNEY

CLASS 36—(Continued).

SN 78-515,566. NET WORTH STRATEGIES, INC., BEND, OR. FILED 11-11-2004.

CLASS 36—(Continued).

SN 78-515,848. WEB CD EXCHANGE, INC., MIAMI, FL. FILED 11-12-2004.

Forfeit Value

STAY Deposit

THE MARK CONSISTS OF STANDARD CHARACTERS WITHOUT CLAIM TO ANY PARTICULAR FONT, STYLE, SIZE, OR COLOR.
FOR FINANCIAL PLANNING (U.S. CLS. 100, 101 AND 102).
FIRST USE 5-19-2004; IN COMMERCE 5-19-2004.
MATTHEW PAPPAS, EXAMINING ATTORNEY

THE MARK CONSISTS OF STANDARD CHARACTERS WITHOUT CLAIM TO ANY PARTICULAR FONT, STYLE, SIZE, OR COLOR.
NO CLAIM IS MADE TO THE EXCLUSIVE RIGHT TO USE "DEPOSIT", APART FROM THE MARK AS SHOWN.
FOR FINANCIAL MANAGEMENT SERVICES, NAMELY, ISSUANCE AND MANAGEMENT OF DEPOSITS WITH FDIC INSURED BANKS WHICH ARE SUBSEQUENTLY MANAGED TO INSURE THE LEVEL OF DEPOSITS IN ANY PARTICULAR BANK (U.S. CLS. 100, 101 AND 102).
FIRST USE 11-9-2004; IN COMMERCE 11-9-2004.
ANDREW RHIM, EXAMINING ATTORNEY

SN 78-515,800. KIDS TO LOVE FOUNDATION, HUNTSVILLE, AL. FILED 11-12-2004.

SN 78-516,189. EMO CORPORATION, AUSTIN, TX. FILED 11-12-2004.

KIDS TO LOVE

EMO

THE MARK CONSISTS OF STANDARD CHARACTERS WITHOUT CLAIM TO ANY PARTICULAR FONT, STYLE, SIZE, OR COLOR.
FOR FUNDRAISING SERVICES IN THE FIELD OF PROVIDING RESOURCES AND SUPPORT TO FOSTER CHILDREN AND THEIR FOSTER FAMILIES (U.S. CLS. 100, 101 AND 102).
FIRST USE 11-30-2000; IN COMMERCE 11-30-2000.
SHAUNIA WALLACE, EXAMINING ATTORNEY

THE MARK CONSISTS OF STANDARD CHARACTERS WITHOUT CLAIM TO ANY PARTICULAR FONT, STYLE, SIZE, OR COLOR.
FOR FINANCIAL SERVICES, NAMELY PROVIDING ON-LINE STORED VALUE ACCOUNTS AND ELECTRONIC FUNDS DISBURSEMENT SERVICES; DISBURSING REBATES FOR OTHERS VIA A GLOBAL COMPUTER NETWORK (U.S. CLS. 100, 101 AND 102).
FIRST USE 4-0-2002; IN COMMERCE 4-0-2002.
DEBRA LEE, EXAMINING ATTORNEY

CLASS 36—(Continued).

SN 78-516,374. ON THE HOUSE HOMES AND LOANS, INC., WOODLAND HILLS, CA. FILED 11-12-2004.



NO CLAIM IS MADE TO THE EXCLUSIVE RIGHT TO USE "HOMES", APART FROM THE MARK AS SHOWN.

FOR REAL ESTATE ACQUISITION SERVICES, REAL ESTATE AGENCIES, REAL ESTATE BROKERAGE, REAL ESTATE PROCUREMENT FOR OTHERS (U.S. CLS. 100, 101 AND 102).

FIRST USE 12-1-2003; IN COMMERCE 1-1-2004.
DAHLIA GEORGE, EXAMINING ATTORNEY

SN 78-516,923. NEW SOUTH FEDERAL SAVINGS BANK, BIRMINGHAM, AL. FILED 11-15-2004.

THE POINT OF GREAT RETURN

THE MARK CONSISTS OF STANDARD CHARACTERS WITHOUT CLAIM TO ANY PARTICULAR FONT, STYLE, SIZE, OR COLOR.

FOR FINANCIAL SERVICES, NAMELY, CERTIFICATE OF DEPOSIT ACCOUNT SERVICES; PROVIDING FINANCIAL INFORMATION RELATING TO YIELDS OF CERTIFICATES OF DEPOSIT BY TELEPHONE AND VIA A GLOBAL COMPUTER NETWORK (U.S. CLS. 100, 101 AND 102).

FIRST USE 3-20-2003; IN COMMERCE 3-20-2003.
IRA J. GOODSAD, EXAMINING ATTORNEY

SN 78-516,930. TRI COUNTIES BANK, A CALIFORNIA BANKING CORPORATION, CHICO, CA. FILED 11-15-2004.

YOUR LIFE IMPROVEMENT BANK

THE MARK CONSISTS OF STANDARD CHARACTERS WITHOUT CLAIM TO ANY PARTICULAR FONT, STYLE, SIZE, OR COLOR.

NO CLAIM IS MADE TO THE EXCLUSIVE RIGHT TO USE "BANK", APART FROM THE MARK AS SHOWN. FOR BANKING SERVICES (U.S. CLS. 100, 101 AND 102).

FIRST USE 1-1-2003; IN COMMERCE 1-1-2003.
IRA J. GOODSAD, EXAMINING ATTORNEY

CLASS 36—(Continued).

SN 78-516,988. THE TORONTO-DOMINION BANK, TORONTO, ONTARIO, CANADA, FILED 11-15-2004.



PRIORITY CLAIMED UNDER SEC. 44(D) ON CANADA APPLICATION NO. 1216785, FILED 5-13-2004.

OWNER OF U.S. REG. NOS. 1,640,759, 1,649,009 AND 2,750,706.

THE COLOR(S) GREEN AND WHITE IS/ARE CLAIMED AS A FEATURE OF THE MARK.

THE COLOR GREEN APPEARS AS A BACKGROUND FOR THE LETTERS "TD" DEPICTED IN WHITE.

FOR SECURITIES BROKERAGE SERVICES; MUTUAL FUND BROKERAGE SERVICES; BANKING SERVICES (U.S. CLS. 100, 101 AND 102).

FIRST USE 3-0-1969; IN COMMERCE 6-0-1999.
DAVID H. STINE, EXAMINING ATTORNEY

SN 78-517,240. BANK OF THE WEST, SAN FRANCISCO, CA. FILED 11-15-2004.



NO CLAIM IS MADE TO THE EXCLUSIVE RIGHT TO USE "BANK", APART FROM THE MARK AS SHOWN.

FOR BANKING SERVICES (U.S. CLS. 100, 101 AND 102).

FIRST USE 8-0-1989; IN COMMERCE 8-0-1989.
MATTHEW KLINE, EXAMINING ATTORNEY

CLASS 36—(Continued).

SN 78-517,372. WAITS, RONALD, HAMPTON, GA. FILED 11-16-2004.



NO CLAIM IS MADE TO THE EXCLUSIVE RIGHT TO USE "REALTY", APART FROM THE MARK AS SHOWN. FOR REAL ESTATE BROKERAGE SERVICES (U.S. CLS. 100, 101 AND 102).

FIRST USE 11-1-2004; IN COMMERCE 11-1-2004.
MARGERY A. TIERNEY, EXAMINING ATTORNEY

CLASS 36—(Continued).

SN 78-517,719. ANCORA CAPITAL, INC., BEACHWOOD, OH. FILED 11-16-2004.

ANCORA

SN 78-517,662. THE PNC FINANCIAL SERVICES GROUP, INC., PITTSBURGH, PA. FILED 11-16-2004.

**BECAUSE YOUR TIME
FLIES**

THE MARK CONSISTS OF STANDARD CHARACTERS WITHOUT CLAIM TO ANY PARTICULAR FONT, STYLE, SIZE, OR COLOR.

FOR FINANCIAL SERVICES, NAMELY, OFFERING LOANS RELATED TO, OR LEASES FOR, AIRCRAFT (U.S. CLS. 100, 101 AND 102).

FIRST USE 8-31-1998; IN COMMERCE 8-31-1998.
ANNE E. GUSTASON, EXAMINING ATTORNEY

THE MARK CONSISTS OF STANDARD CHARACTERS WITHOUT CLAIM TO ANY PARTICULAR FONT, STYLE, SIZE, OR COLOR.

THE FOREIGN WORDING IN THE MARK TRANSLATES INTO ENGLISH AS "ANCHOR". THE MARK CAN ALSO MEAN "AGAIN", "STILL" OR "YET" WHEN TRANSLATED FROM ITALIAN TO ENGLISH.

FOR FINANCIAL SERVICES, NAMELY, PORTFOLIO AND MONEY MANAGEMENT FOR HIGH NET WORTH CLIENTS AND INSTITUTIONAL INVESTORS CONSISTING OF MUTUAL FUNDS, EQUITY INVESTMENTS, FIXED INCOME INVESTMENTS, OPTIONS AND ASSET ALLOCATION STRATEGIES; INVESTMENT ADVICE FOR INDIVIDUALS AND NON-CHARITABLE INSTITUTIONS; INVESTMENT ADVICE FOR MUTUAL FUND MANAGERS; PRIVATE ASSET MANAGEMENT; MUTUAL FUND BROKERAGE, MANAGEMENT, INVESTMENT AND DEALER SERVICES; STOCK AND SECURITY BROKERAGE SERVICES; BACK OFFICE BROKER/DEALER SERVICES; INSTITUTIONAL BROKERAGE SERVICES FOR BROKER/DEALERS, INVESTMENT ADVISORS, MUTUAL FUNDS AND HEDGE FUNDS; INSURANCE SERVICES FOR INDIVIDUALS AND INSTITUTIONS, NAMELY IN THE FIELD OF LONG TERM CARE POLICIES, LIFE INSURANCE POLICIES, DISABILITY POLICIES AND ANNUITIES (U.S. CLS. 100, 101 AND 102).

FIRST USE 1-31-2002; IN COMMERCE 1-31-2002.
CHRIS WELLS, EXAMINING ATTORNEY

CLASS 36—(Continued).

SN 78-517,788. HEDGE FUND RESEARCH, INC., CHICAGO, IL. FILED 11-16-2004.

CLASS 36—(Continued).

SN 78-518,018. KIEFT, GERALD N., PALM CITY, FL. FILED 11-16-2004.



HFRX

THE MARK CONSISTS OF STANDARD CHARACTERS WITHOUT CLAIM TO ANY PARTICULAR FONT, STYLE, SIZE, OR COLOR.

OWNER OF U.S. REG. NOS. 2,395,301 AND 2,442,400. FOR FINANCIAL SERVICES IN THE FIELD OF HEDGE FUNDS AND ALTERNATIVE INVESTMENTS (U.S. CLS. 100, 101 AND 102).

FIRST USE 6-0-2003; IN COMMERCE 6-0-2003. JOHN HWANG, EXAMINING ATTORNEY

NO CLAIM IS MADE TO THE EXCLUSIVE RIGHT TO USE "WALL ST. RESOURCES", APART FROM THE MARK AS SHOWN.

THE COLOR(S) GREEN, WHITE, AND BLACK IS/ARE CLAIMED AS A FEATURE OF THE MARK.

THE COLOR GREEN APPEARS IN THE RECTANGULAR BACKGROUND OF THE WORDING WALL ST.; THE WORDING WALL ST. AND THE LINES ABOVE AND BELOW IT ARE WHITE; THE MISCELLANEOUS DIAMOND SHAPES, THE WORDING RESOURCES AND THE LINES ABOVE AND BELOW IT ARE BLACK.

FOR PROVIDING STOCK/SECURITIES MARKET INFORMATION (U.S. CLS. 100, 101 AND 102).

FIRST USE 10-31-2003; IN COMMERCE 11-3-2003. JEAN IM, EXAMINING ATTORNEY

SN 78-517,820. TOTAL SYSTEM SERVICES, INC., COLUMBUS, GA. FILED 11-16-2004.

TSYS PREPAID

THE MARK CONSISTS OF STANDARD CHARACTERS WITHOUT CLAIM TO ANY PARTICULAR FONT, STYLE, SIZE, OR COLOR.

OWNER OF U.S. REG. NOS. 2,329,548, 2,460,399 AND 2,599,320.

NO CLAIM IS MADE TO THE EXCLUSIVE RIGHT TO USE "PREPAID", APART FROM THE MARK AS SHOWN.

FOR ELECTRONIC PAYMENTS ADMINISTRATION AND PROCESSING SERVICES; STORE-VALUE DEBIT CARD ADMINISTRATION AND PROCESSING SERVICES (U.S. CLS. 100, 101 AND 102).

FIRST USE 8-2-2004; IN COMMERCE 8-2-2004. SANJEEV VOHRA, EXAMINING ATTORNEY

SN 78-518,084. MAYFLOWER FINANCIAL GROUP, INC., LAS VEGAS, NV. FILED 11-16-2004.

MAYFLOWER FINANCIAL GROUP

THE MARK CONSISTS OF STANDARD CHARACTERS WITHOUT CLAIM TO ANY PARTICULAR FONT, STYLE, SIZE, OR COLOR.

NO CLAIM IS MADE TO THE EXCLUSIVE RIGHT TO USE "FINANCIAL GROUP", APART FROM THE MARK AS SHOWN.

FOR FINANCIAL SERVICES IN THE NATURE OF AN INVESTMENT SECURITY (U.S. CLS. 100, 101 AND 102).

FIRST USE 7-0-2001; IN COMMERCE 11-10-2004. JEAN IM, EXAMINING ATTORNEY

CLASS 36—(Continued).

SN 78-518,690. MY ROCK, LLC, WINSTON-SALEM, NC. FILED 11-17-2004.

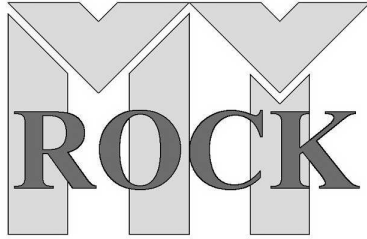

THE MARK IS NOT IN COLOR.
FOR REAL ESTATE BROKERAGE, REAL ESTATE INVESTMENT, REAL ESTATE MANAGEMENT (U.S. CLS. 100, 101 AND 102).
FIRST USE 6-1-2003; IN COMMERCE 6-1-2003.
LINDA M. KING, EXAMINING ATTORNEY

SN 78-518,809. SOUTHERN HERITAGE BANK, CLEVELAND, TN. FILED 11-17-2004.



OWNER OF U.S. REG. NO. 2,300,948.
NO CLAIM IS MADE TO THE EXCLUSIVE RIGHT TO USE "EST 1998" AND "BANK", APART FROM THE MARK AS SHOWN.
THE MARK CONSISTS OF A DARK CIRCLE WITH A GAZEBO IN THE CENTER.
FOR BANKING SERVICES (U.S. CLS. 100, 101 AND 102).
FIRST USE 4-12-1999; IN COMMERCE 4-12-1999.
CYNTHIA SLOAN, EXAMINING ATTORNEY

SN 78-518,891. SOUTHERN HERITAGE BANK, CLEVELAND, TN. FILED 11-17-2004.



OWNER OF U.S. REG. NO. 2,300,948.
NO CLAIM IS MADE TO THE EXCLUSIVE RIGHT TO USE "BANK", APART FROM THE MARK AS SHOWN.
FOR BANKING SERVICES (U.S. CLS. 100, 101 AND 102).
FIRST USE 4-1-2001; IN COMMERCE 4-1-2001.
CYNTHIA SLOAN, EXAMINING ATTORNEY

CLASS 36—(Continued).

SN 78-519,148. MIDDLESEX MUTUAL ASSURANCE COMPANY, MIDDLETOWN, CT. FILED 11-18-2004.



OWNER OF U.S. REG. NOS. 2,587,925 AND 2,617,211.
NO CLAIM IS MADE TO THE EXCLUSIVE RIGHT TO USE "MUTUAL ASSURANCE", APART FROM THE MARK AS SHOWN.

THE MARK CONSISTS OF OVAL WITH MIDDLESEX MUTUAL ASSURANCE.
FOR UNDERWRITING PROPERTY AND CASUALTY INSURANCE (U.S. CLS. 100, 101 AND 102).
FIRST USE 7-26-1999; IN COMMERCE 7-26-1999.
JULIE GUTTADAURO, EXAMINING ATTORNEY

SN 78-519,408. HEALTH INSURANCE PLAN OF GREATER NEW YORK, NEW YORK, NY. FILED 11-18-2004.

NOW THAT'S HIP

THE MARK CONSISTS OF STANDARD CHARACTERS WITHOUT CLAIM TO ANY PARTICULAR FONT, STYLE, SIZE, OR COLOR.
OWNER OF U.S. REG. NO. 1,751,547.
FOR UNDERWRITING AND ADMINISTRATION OF INSURANCE FOR HEALTH MAINTENANCE ORGANIZATIONS (U.S. CLS. 100, 101 AND 102).
FIRST USE 9-0-2002; IN COMMERCE 9-0-2002.
JACQUELINE A. LAVINE, EXAMINING ATTORNEY

SN 78-519,410. AUL CORP., NAPA, CA. FILED 11-18-2004.

ANY YEAR ANY MILEAGE

THE MARK CONSISTS OF STANDARD CHARACTERS WITHOUT CLAIM TO ANY PARTICULAR FONT, STYLE, SIZE, OR COLOR.
OWNER OF U.S. REG. NO. 1,902,997.
FOR ADMINISTERING VEHICLE SERVICE CONTRACTS FOR USED VEHICLES (U.S. CLS. 100, 101 AND 102).
FIRST USE 8-1-1990; IN COMMERCE 8-1-1990.
JOHN DALIER, EXAMINING ATTORNEY

CLASS 36—(Continued).

SN 78-519,567. CRESTMARK BANCORP, INC., TROY, MI. FILED 11-18-2004.

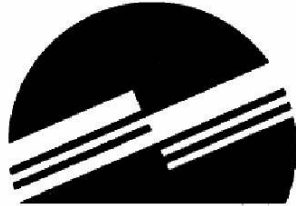

THE MARK CONSISTS OF A MISCELLANEOUS DESIGN. FOR FINANCING SERVICES, NAMELY, FACTORING, LOAN FINANCING, ASSET-BASED LENDING, RECEIVABLES FINANCING, REAL ESTATE LENDING, AND ISSUING CERTIFICATES OF DEPOSIT (U.S. CLS. 100, 101 AND 102).
FIRST USE 10-1-1996; IN COMMERCE 10-1-1996.
RICHARD WHITE, EXAMINING ATTORNEY

CLASS 36—(Continued).

SN 78-519,814. CORK STREET INVESTORS, L.L.C., KALAMAZOO, MI. FILED 11-19-2004.

CREATING INDUSTRY
AND MARKET
CONNECTIONS

THE MARK CONSISTS OF STANDARD CHARACTERS WITHOUT CLAIM TO ANY PARTICULAR FONT, STYLE, SIZE, OR COLOR.
FOR INDUSTRIAL AND COMMERCIAL REAL ESTATE INVESTMENT SERVICES (U.S. CLS. 100, 101 AND 102).
FIRST USE 2-28-2003; IN COMMERCE 2-28-2003.
APRIL L. RADEMACHER, EXAMINING ATTORNEY

SN 78-519,686. USAA FEDERAL CREDIT UNION, SAN ANTONIO, TX. FILED 11-18-2004.

UNITED SA

THE MARK CONSISTS OF STANDARD CHARACTERS WITHOUT CLAIM TO ANY PARTICULAR FONT, STYLE, SIZE, OR COLOR.
FOR CREDIT UNION SERVICES AND CONSUMER AND COMMERCIAL LENDING SERVICES (U.S. CLS. 100, 101 AND 102).
ELLEN PERKINS, EXAMINING ATTORNEY

SN 78-519,816. CORK STREET INVESTORS, L.L.C., KALAMAZOO, MI. FILED 11-19-2004.

AN EXTRAORDINARY
PLACE WITH
EXTRAORDINARY
SPACE

THE MARK CONSISTS OF STANDARD CHARACTERS WITHOUT CLAIM TO ANY PARTICULAR FONT, STYLE, SIZE, OR COLOR.
FOR INDUSTRIAL AND COMMERCIAL REAL ESTATE INVESTMENT SERVICES (U.S. CLS. 100, 101 AND 102).
FIRST USE 1-31-2004; IN COMMERCE 1-31-2004.
APRIL L. RADEMACHER, EXAMINING ATTORNEY

CLASS 36—(Continued).

SN 78-520,005. IDT NETHERLANDS, B.V. (PUERTO RICO BRANCH), SAN JUAN, OTHER, PUERTO RICO, FILED 11-19-2004.

UNION FLORIDA

THE MARK CONSISTS OF STANDARD CHARACTERS WITHOUT CLAIM TO ANY PARTICULAR FONT, STYLE, SIZE, OR COLOR.

OWNER OF U.S. REG. NO. 2,843,006.

NO CLAIM IS MADE TO THE EXCLUSIVE RIGHT TO USE "FLORIDA", APART FROM THE MARK AS SHOWN.

FOR PREPAID TELEPHONE CALLING CARD AND TELEPHONE DEBIT CARD SERVICES (U.S. CLS. 100, 101 AND 102).

FIRST USE 6-14-2001; IN COMMERCE 6-14-2001.

H. M. FISHER, EXAMINING ATTORNEY

SN 78-520,048. OAK STREET MORTGAGE, LLC, CARMEL, IN. FILED 11-19-2004.

**OAK STREET
FINANCIAL SERVICES**

THE MARK CONSISTS OF STANDARD CHARACTERS WITHOUT CLAIM TO ANY PARTICULAR FONT, STYLE, SIZE, OR COLOR.

OWNER OF U.S. REG. NOS. 2,827,872, 2,929,595 AND 2,931,583.

NO CLAIM IS MADE TO THE EXCLUSIVE RIGHT TO USE "FINANCIAL SERVICES", APART FROM THE MARK AS SHOWN.

FOR ACCOUNTS PAYABLE DEBITING SERVICES; ACCOUNTS RECEIVABLES FINANCING SERVICES; ADMINISTRATION OF SAVINGS ACCOUNTS SERVICES; AUTOMATED TELLER MACHINE SERVICES; BANKING SERVICES; BILL CONSOLIDATION SERVICES; BILL PAYMENT SERVICES; BROKERAGE HOUSES IN THE FIELD OF STOCKS, COMMODITIES, AND FUTURES; BROKERAGE IN THE FIELD OF INSURANCE, STOCKS, AND COMMODITIES; BUSINESS FINANCE PROCUREMENT SERVICES; CASH MANAGEMENT SERVICES; CHECK CASHING SERVICES; CHECK PROCESSING SERVICES; CHECK VERIFICATION SERVICES; CHECKING ACCOUNT SERVICES; COLLECTION AGENCY SERVICES; COMMERCIAL LENDING SERVICES; COMMODITIES EXCHANGE SERVICES; COMMODITIES BROKERAGE SERVICES; COMMODITY INVESTMENT ADVICE SERVICES; COMMODITY QUOTATIONS SERVICES; CONSUMER LENDING SERVICES; CREDIT CARD SERVICES; CREDIT CARD TRANSACTION PROCESSING SERVICES; CREDIT RECOVERY AND COLLECTION SERVICES; CURRENCY EXCHANGE AND ADVICE SERVICES; DEBIT CARD SERVICES; DEBT COUNSELING SERVICES; DEBT RECOVERY AND COLLECTION AGENCY SERVICES; ELECTRONIC CASH TRANSACTIONS SERVICES; ELECTRONIC CREDIT CARD TRANSACTIONS SERVICES; ELECTRONIC DEBIT TRANSACTIONS SERVICES; ELECTRONIC FUNDS TRANSFER SERVICES; ELECTRONIC PAYMENT, NAMELY, ELECTRONIC PROCESSING AND TRANSMISSION OF BILL PAYMENT DATA; EQUIPMENT FINANCING SERVICES; FACILITATING AND ARRAN-

CLASS 36—(Continued).

GING FOR THE FINANCING OF BUSINESSES, HOMES, AUTOMOBILES, PERSONAL PROPERTY AND REAL PROPERTY; FIDUCIARY REPRESENTATIVES SERVICES; FINANCIAL ANALYSIS AND CONSULTATION SERVICES; FINANCIAL GUARANTEE AND SURETY SERVICES; FINANCIAL SERVICES IN THE NATURE OF AN INVESTMENT SECURITY; FINANCIAL SERVICES IN THE FIELD OF MONEY LENDING; FINANCIAL SERVICES, NAMELY, INVESTMENT FUND TRANSFER AND TRANSACTION SERVICES; FINANCIAL VALUATION OF PERSONAL PROPERTY AND REAL ESTATE SERVICES; FINANCING SERVICES; HOME APPRAISAL SERVICES; HOME EQUITY LOANS SERVICES; INSTALLMENT LOANS SERVICES; INSURANCE AGENCY SERVICES; LOAN FINANCING SERVICES; MAINTAINING MORTGAGE ESCROW ACCOUNTS SERVICES; MONEY ORDER PAYMENT GUARANTEE SERVICES; MONEY ORDER SERVICES; MORTGAGE BANKING SERVICES; MORTGAGE BROKERAGE SERVICES; MORTGAGE LENDING SERVICES; MORTGAGE PROCUREMENT FOR OTHERS; MUTUAL FUND BROKERAGE SERVICES; ON-LINE BANKING SERVICES; PROVIDING BANK ACCOUNT INFORMATION BY TELEPHONE; PROVIDING INFORMATION IN THE FIELD OF REAL ESTATE BY MEANS OF LINKING THE WEBSITE TO OTHER WEBSITES FEATURING REAL ESTATE INFORMATION; PROVIDING LOANS SECURED BY COMMERCIAL PAPER SERVICES; PROVIDING STUDENT LOAN INFORMATION SERVICES; PROVIDING TEMPORARY LOANS SERVICES; SAFE DEPOSIT BOX SERVICES; SAFETY DEPOSIT BOX SERVICES; SAVINGS ACCOUNT SERVICES; SAVINGS AND LOAN ASSOCIATIONS SERVICES; SAVINGS AND LOAN SERVICES; SAVINGS BANK SERVICES; SECURITY BROKERAGE SERVICES; STUDENT LOANS SERVICES; SECURITY SERVICES, NAMELY, GUARANTEEING LOANS; STOCK BROKERAGE SERVICES; STOCK EXCHANGE PRICE QUOTATION SERVICES; TAX PAYMENT PROCESSING SERVICES; TEMPORARY LOANS SERVICES; AND TRAVELERS' CHECK ISSUANCE SERVICES (U.S. CLS. 100, 101 AND 102).

LEIGH LOWRY, EXAMINING ATTORNEY

SN 78-520,064. SUN ELECTRONIC PAYMENT SERVICES, INC., CAMDEN, NJ. FILED 11-19-2004.

MEX-CASH

THE MARK CONSISTS OF STANDARD CHARACTERS WITHOUT CLAIM TO ANY PARTICULAR FONT, STYLE, SIZE, OR COLOR.

FOR FINANCIAL SERVICES, NAMELY, ELECTRONIC FUNDS TRANSFER, INCLUDING ELECTRONIC DEBIT TRANSACTIONS (U.S. CLS. 100, 101 AND 102).

FIRST USE 1-1-2004; IN COMMERCE 1-1-2004.

JEFFERY COWARD, EXAMINING ATTORNEY

CLASS 36—(Continued).

SN 78-520,144. UNITED STATES LIABILITY INSURANCE COMPANY AND ITS AFFILIATES, WAYNE, PA. FILED 11-19-2004.

CLUB SELECT

THE MARK CONSISTS OF STANDARD CHARACTERS WITHOUT CLAIM TO ANY PARTICULAR FONT, STYLE, SIZE, OR COLOR.

FOR INSURANCE UNDERWRITING IN THE FIELD OF LIQUOR AND GENERAL LIABILITY (U.S. CLS. 100, 101 AND 102).

KEVIN DINALLO, EXAMINING ATTORNEY



SN 78-520,630. COPELAND, DECHONTELLE, PFLUGERVILLE, TX. FILED 11-21-2004.

knowledge is money

THE MARK CONSISTS OF STANDARD CHARACTERS WITHOUT CLAIM TO ANY PARTICULAR FONT, STYLE, SIZE, OR COLOR.

FOR REAL ESTATE BROKERAGE, REAL ESTATE CONSULTANCY, FINANCIAL INVESTMENT IN THE FIELD OF REAL ESTATE, FINANCIAL VALUATION OF PERSONAL PROPERTY AND REAL ESTATE, LAND ACQUISITION, NAMELY, REAL ESTATE BROKERAGE, LEASING OF REAL ESTATE, OPERATING MARKETPLACES FOR SELLERS OF GOODS AND/OR SERVICES REAL ESTATE, APPRAISAL OF REAL ESTATE, APPRAISALS FOR INSURANCE CLAIMS OF REAL ESTATE, PROVIDING INFORMATION IN THE FIELD OF REAL ESTATE BY MEANS OF LINKING THE WEB SITE TO OTHER WEB SITES FEATURING REAL ESTATE INFORMATION, REAL ESTATE ACQUISITION SERVICES, ASSESSMENT AND MANAGEMENT OF REAL ESTATE, REAL ESTATE CONSULTATION, REAL ESTATE AGENCIES, REAL ESTATE APPRAISAL, REAL ESTATE MANAGEMENT, REAL ESTATE LISTING, REAL ESTATE INVESTMENT, REAL ESTATE VALUATION SERVICES, REAL ESTATE VALUATIONS, VACATION REAL ESTATE TIME-SHARING, REAL ESTATE TRUSTEE SERVICES, REAL ESTATE SYNDICATION, REAL ESTATE TIME-SHARING, REAL ESTATE ESCROW SERVICES, REAL ESTATE EQUITY SHARING, NAMELY, MANAGING AND ARRANGING FOR CO-OWNERSHIP OF REAL ESTATE (U.S. CLS. 100, 101 AND 102).

ERNEST SHOSHO, EXAMINING ATTORNEY

CLASS 36—(Continued).

SN 78-520,744. STUDENT LOAN XPRESS, INC., SAN DIEGO, CA. FILED 11-22-2004.

HEALTH XPRESS

THE MARK CONSISTS OF STANDARD CHARACTERS WITHOUT CLAIM TO ANY PARTICULAR FONT, STYLE, SIZE, OR COLOR.

OWNER OF U.S. REG. NOS. 2,571,644, 2,692,905 AND OTHERS.

NO CLAIM IS MADE TO THE EXCLUSIVE RIGHT TO USE HEALTH, APART FROM THE MARK AS SHOWN.

FOR LOAN FINANCING SERVICES, PROVIDING LOANS TO STUDENTS (U.S. CLS. 100, 101 AND 102).

TARAH HARDY, EXAMINING ATTORNEY



SN 78-520,902. IDT NETHERLANDS, B.V. (PUERTO RICO BRANCH), SAN JUAN, OTHER, PUERTO RICO, FILED 11-22-2004.

UNION NEW ENGLAND

THE MARK CONSISTS OF STANDARD CHARACTERS WITHOUT CLAIM TO ANY PARTICULAR FONT, STYLE, SIZE, OR COLOR.

OWNER OF U.S. REG. NOS. 2,831,964, 2,871,453 AND OTHERS.

NO CLAIM IS MADE TO THE EXCLUSIVE RIGHT TO USE "NEW ENGLAND", APART FROM THE MARK AS SHOWN.

FOR PREPAID TELEPHONE CALLING CARD AND TELEPHONE DEBIT CARD SERVICES (U.S. CLS. 100, 101 AND 102).

FIRST USE 8-7-2002; IN COMMERCE 8-7-2002.

H. M. FISHER, EXAMINING ATTORNEY

CLASS 36—(Continued).

SN 78-520,908. IDT NETHERLANDS, B.V. (PUERTO RICO BRANCH), SAN JUAN, OTHER, PUERTO RICO, FILED 11-22-2004.

CLASS 36—(Continued).

SN 78-521,080. WALSER SPECIALIZED SERVICES, LLC, HOPKINS, MN. FILED 11-22-2004.

UNION CAROLINAS

FLEETFLO

THE MARK CONSISTS OF STANDARD CHARACTERS WITHOUT CLAIM TO ANY PARTICULAR FONT, STYLE, SIZE, OR COLOR.

OWNER OF U.S. REG. NOS. 2,831,964, 2,871,453 AND OTHERS.

NO CLAIM IS MADE TO THE EXCLUSIVE RIGHT TO USE "CAROLINAS", APART FROM THE MARK AS SHOWN.

FOR PREPAID TELEPHONE CALLING CARD AND TELEPHONE DEBIT CARD SERVICES (U.S. CLS. 100, 101 AND 102).

FIRST USE 11-14-2002; IN COMMERCE 11-14-2002.

H. M. FISHER, EXAMINING ATTORNEY

THE MARK CONSISTS OF STANDARD CHARACTERS WITHOUT CLAIM TO ANY PARTICULAR FONT, STYLE, SIZE, OR COLOR.

FOR VEHICLE LEASE-PURCHASE FINANCING (U.S. CLS. 100, 101 AND 102).

CAROLYN CATALDO, EXAMINING ATTORNEY

SN 78-521,171. SALLIE MAE INC., RESTON, VA. FILED 11-22-2004.

SN 78-520,992. CHEROKEE STATE BANK, ST. PAUL, MN. FILED 11-22-2004.

collegeanswer.com

BANKCHEROKEE

THE MARK CONSISTS OF STANDARD CHARACTERS WITHOUT CLAIM TO ANY PARTICULAR FONT, STYLE, SIZE, OR COLOR.

FOR BANKING SERVICES (U.S. CLS. 100, 101 AND 102).

DAWN HAN, EXAMINING ATTORNEY

THE MARK CONSISTS OF STANDARD CHARACTERS WITHOUT CLAIM TO ANY PARTICULAR FONT, STYLE, SIZE, OR COLOR.

FOR PROVIDING A WEB SITE FEATURING INFORMATION ON COLLEGE COSTS, FINANCIAL AID AND SCHOLARSHIPS FOR COLLEGE; PROVIDING AN ON-LINE INTERACTIVE COMPUTER DATABASE FOR ANALYZING COLLEGE COSTS AND COMPARING FINANCIAL AID PACKAGES; PROVIDING AN ON-LINE COMPUTER DATABASE IN THE FIELD OF HIGHER EDUCATION FINANCIAL AID LOANS, LENDERS AND SCHOLARSHIPS (U.S. CLS. 100, 101 AND 102).

FIRST USE 9-1-2004; IN COMMERCE 9-1-2004.

IRA J. GOODSaid, EXAMINING ATTORNEY

CLASS 36—(Continued).

SN 78-521,184. SALLIE MAE, INC., RESTON, VA. FILED 11-22-2004.

**Sallie Mae
Mortgage**

THE MARK CONSISTS OF STANDARD CHARACTERS WITHOUT CLAIM TO ANY PARTICULAR FONT, STYLE, SIZE, OR COLOR.

OWNER OF U.S. REG. NO. 1,646,267.
NO CLAIM IS MADE TO THE EXCLUSIVE RIGHT TO USE "MORTGAGE", APART FROM THE MARK AS SHOWN.

FOR FINANCIAL SERVICES, NAMELY, MORTGAGE LOANS (U.S. CLS. 100, 101 AND 102).
FIRST USE 11-11-2004; IN COMMERCE 11-15-2004.
MATTHEW KLINE, EXAMINING ATTORNEY

CLASS 36—(Continued).

SN 78-521,286. CUSTOM HOUSE CURRENCY EXCHANGE LTD., VICTORIA, BRITISH COLUMBIA V8W 1E7, CANADA, FILED 11-22-2004.

CUSTOM HOUSE

THE MARK CONSISTS OF STANDARD CHARACTERS WITHOUT CLAIM TO ANY PARTICULAR FONT, STYLE, SIZE, OR COLOR.

NO CLAIM IS MADE TO THE EXCLUSIVE RIGHT TO USE "HOUSE", APART FROM THE MARK AS SHOWN.
FOR FOREIGN EXCHANGE BROKERAGE SERVICES (U.S. CLS. 100, 101 AND 102).

FIRST USE 5-1-1995; IN COMMERCE 5-1-1995.
WENDY GOODMAN, EXAMINING ATTORNEY

SN 78-521,194. SALLIE MAE, INC., RESTON, VA. FILED 11-22-2004.

**Sallie Mae
Financial**

THE MARK CONSISTS OF STANDARD CHARACTERS WITHOUT CLAIM TO ANY PARTICULAR FONT, STYLE, SIZE, OR COLOR.

OWNER OF U.S. REG. NO. 1,646,267.
NO CLAIM IS MADE TO THE EXCLUSIVE RIGHT TO USE FINANCIAL, APART FROM THE MARK AS SHOWN.
FOR FINANCIAL SERVICES, NAMELY, EDUCATIONAL AND HOME LOANS (U.S. CLS. 100, 101 AND 102).

FIRST USE 11-11-2004; IN COMMERCE 11-15-2004.
ALICE BENMAMAN, EXAMINING ATTORNEY

SN 78-521,291. GULF STATES MORTGAGE CORPORATION, HOUSTON, TX. FILED 11-22-2004.

**you do the
mortgage**

THE MARK CONSISTS OF STANDARD CHARACTERS WITHOUT CLAIM TO ANY PARTICULAR FONT, STYLE, SIZE, OR COLOR.

FOR PROVIDING A WEBSITE ON WHICH CONSUMERS CAN ACQUIRE AND MANAGE THEIR OWN RESIDENTIAL MORTGAGES (U.S. CLS. 100, 101 AND 102).

WENDY GOODMAN, EXAMINING ATTORNEY

CLASS 36—(Continued).

SN 78-521,392. HARVEY, CHRIS, ST PETE BEACH, FL.
FILED 11-22-2004.

SQUAREMOUTH

THE MARK CONSISTS OF STANDARD CHARACTERS WITHOUT CLAIM TO ANY PARTICULAR FONT, STYLE, SIZE, OR COLOR.

FOR INSURANCE BROKERAGE SERVICES PROVIDED VIA GLOBAL COMPUTER NETWORK (U.S. CLS. 100, 101 AND 102).

ELLEN PERKINS, EXAMINING ATTORNEY

CLASS 36—(Continued).

SN 78-521,868. THINK-PLACE, INC., SEATTLE, WA. FILED
11-23-2004.

THINK SPOT

THE MARK CONSISTS OF STANDARD CHARACTERS WITHOUT CLAIM TO ANY PARTICULAR FONT, STYLE, SIZE, OR COLOR.

FOR MEETING SPACE RENTAL & LEASING FOR CORPORATE AND INDIVIDUAL CUSTOMERS (U.S. CLS. 100, 101 AND 102).

FIRST USE 9-9-2004; IN COMMERCE 11-15-2004.

ELISSA GARBER KON, EXAMINING ATTORNEY

SN 78-521,470. ATHOME, INC., DBA ATHOME, CHICAGO,
IL. FILED 11-22-2004.



THE MARK CONSISTS OF THE FOLLOWING TWO COMPONENTS: THE FIRST PART OF THE MARK CONSISTS OF AN UPPER-CASE LETTER "A". THE RIGHT SIDE OF THE LETTER "A" EXTENDS AND WRAPS (COUNTER-CLOCKWISE) INTO ALMOST A COMPLETE CIRCLE. THIS PART OF THE MARK IS AN ABSTRACT REFERENCE TO THE "@" SYMBOL. PLEASE NOTE THAT THE MAIN DISTINCTION BETWEEN THE "@" SYMBOL AND THIS COMPONENT OF THE MARK IS THAT THE "@" SYMBOL USES A LOWER-CASE LETTER "a" AND THIS COMPONENT OF THE MARK USES AN UPPER-CASE LETTER "A". THIS COMPONENT OF THE MARK IS A VISUAL REPRESENTATION OF THE FIRST PART OF THE COMPANY NAME (ATHOME). THE SECOND COMPONENT OF THE MARK CONSISTS OF THE FOLLOWING: THE UPPER-CASE LETTER "A" AS DESCRIBED ABOVE IS OUTLINED BY WHAT APPEARS TO BE THE OUTLINE OF A HOUSE. THE RIGHT SIDE OF THE HOUSE EXTENDS AND WRAPS (COUNTER-CLOCKWISE) INTO ALMOST A COMPLETE CIRCLE. THE HOUSE ALSO HAS A ROOFLINE WITH A CHIMNEY. THIS SECOND COMPONENT OF THE MARK IS A VISUAL REPRESENTATION OF THE SECOND PART OF THE COMPANY NAME (ATHOME). PLEASE NOTE THAT NO CLAIM TO COLOR IS BEING MADE AS A FEATURE OF THE MARK.

FOR REAL ESTATE BROKERAGE (U.S. CLS. 100, 101 AND 102).

FIRST USE 2-1-2004; IN COMMERCE 2-1-2004.

HOWARD B. LEVINE, EXAMINING ATTORNEY

SN 78-521,986. AVISTA MANAGEMENT, INC., ORLANDO,
FL. FILED 11-23-2004.

AVISTA RESORTS

THE MARK CONSISTS OF STANDARD CHARACTERS WITHOUT CLAIM TO ANY PARTICULAR FONT, STYLE, SIZE, OR COLOR.

NO CLAIM IS MADE TO THE EXCLUSIVE RIGHT TO USE "RESORTS", APART FROM THE MARK AS SHOWN.

FOR REAL ESTATE INVESTMENTS; REAL ESTATE EQUITY SHARING, NAMELY, MANAGING AND ARRANGING FOR CO-OWNERSHIP OF REAL ESTATE; REAL ESTATE MANAGEMENT OF RESORT PROPERTIES (U.S. CLS. 100, 101 AND 102).

RENEE MCCRAY, EXAMINING ATTORNEY

CLASS 36—(Continued).

SN 78-521,995. IDT NETHERLANDS, B.V. (PUERTO RICO BRANCH), SAN JUAN, OTHER, PUERTO RICO, FILED 11-23-2004.

CLASS 36—(Continued).

SN 78-522,533. CLK MANAGMENT, LLC, OVERLAND PARK, KS. FILED 11-24-2004.

UNION MIDWEST

THE MARK CONSISTS OF STANDARD CHARACTERS WITHOUT CLAIM TO ANY PARTICULAR FONT, STYLE, SIZE, OR COLOR.

OWNER OF U.S. REG. NOS. 2,831,964, 2,871,453 AND OTHERS.

NO CLAIM IS MADE TO THE EXCLUSIVE RIGHT TO USE "MIDWEST", APART FROM THE MARK AS SHOWN.

FOR PREPAID TELEPHONE CALLING CARD AND TELEPHONE DEBIT CARD SERVICES (U.S. CLS. 100, 101 AND 102).

FIRST USE 2-12-2004; IN COMMERCE 2-12-2004.

H. M. FISHER, EXAMINING ATTORNEY

**CHANGING THE WAY
AMERICA GETS A
LOAN!**

THE MARK CONSISTS OF STANDARD CHARACTERS WITHOUT CLAIM TO ANY PARTICULAR FONT, STYLE, SIZE, OR COLOR.

FOR FINANCIAL SERVICES IN THE FIELD OF SHORT TERM LOANS PROVIDED AS PAYDAY LOAN ADVANCES (U.S. CLS. 100, 101 AND 102).

FIRST USE 1-0-2003; IN COMMERCE 1-0-2003.

TONI HICKEY, EXAMINING ATTORNEY

SN 78-522,269. ARTHUR AND ELENA COURT NATURE WATCH CONSERVANCY, BRISBANE, CA. FILED 11-23-2004.

SN 78-522,641. CLK MANAGMENT, LLC, OVERLAND PARK, KS. FILED 11-24-2004.

**ARTHUR AND ELENA
COURT NATURE
WATCH
CONSERVANCY**

**WHERE AMERICA GETS
A LOAN!**

THE MARK CONSISTS OF STANDARD CHARACTERS WITHOUT CLAIM TO ANY PARTICULAR FONT, STYLE, SIZE, OR COLOR.

NO CLAIM IS MADE TO THE EXCLUSIVE RIGHT TO USE "NATURE WATCH CONSERVANCY", APART FROM THE MARK AS SHOWN.

THE NAME(S), PORTRAIT(S), AND/OR SIGNATURE(S) SHOWN IN THE MARK IDENTIFIES ARTHUR COURT, ELENA COURT, WHOSE CONSENT(S) TO REGISTER IS SUBMITTED.

FOR CHARITABLE FUND RAISING FOR NATURE AND WILDLIFE PRESERVATION AND PROTECTION (U.S. CLS. 100, 101 AND 102).

FIRST USE 7-1-1990; IN COMMERCE 5-1-1991.

ELLEN BURNS, EXAMINING ATTORNEY

THE MARK CONSISTS OF STANDARD CHARACTERS WITHOUT CLAIM TO ANY PARTICULAR FONT, STYLE, SIZE, OR COLOR.

FOR FINANCIAL SERVICES IN THE FIELD OF SHORT TERM LOANS PROVIDED AS PAYDAY LOAN ADVANCES (U.S. CLS. 100, 101 AND 102).

FIRST USE 2-0-2004; IN COMMERCE 2-0-2004.

TONI HICKEY, EXAMINING ATTORNEY

CLASS 36—(Continued).

SN 78-522,654. CONWAY, ADRIAN, SAN DIEGO, CA. FILED 11-24-2004.

Fiji for Free

THE MARK CONSISTS OF STANDARD CHARACTERS WITHOUT CLAIM TO ANY PARTICULAR FONT, STYLE, SIZE, OR COLOR.

FOR REAL ESTATE BROKERAGE (U.S. CLS. 100, 101 AND 102).

CHRISIE B. KING, EXAMINING ATTORNEY

CLASS 36—(Continued).

SN 78-524,207. UNIVERSITY FEDERAL CREDIT UNION, AUSTIN, TX. FILED 11-30-2004.

CONSUMER CONNECTION

THE MARK CONSISTS OF STANDARD CHARACTERS WITHOUT CLAIM TO ANY PARTICULAR FONT, STYLE, SIZE, OR COLOR.

FOR CREDIT UNION SERVICES (U.S. CLS. 100, 101 AND 102).

CATHERINE CAIN, EXAMINING ATTORNEY

SN 78-522,768. MONTANA HIGHER EDUCATION STUDENT ASSISTANCE CORPORATION, HELENA, MT. FILED 11-24-2004.

MHESAC

THE MARK CONSISTS OF STANDARD CHARACTERS WITHOUT CLAIM TO ANY PARTICULAR FONT, STYLE, SIZE, OR COLOR.

FOR ORIGINATING, PURCHASING AND CONSOLIDATING FEDERALLY GUARANTEED EDUCATIONAL LOANS (U.S. CLS. 100, 101 AND 102).

FIRST USE 6-30-1993; IN COMMERCE 6-30-1993.

LESLEY LAMOTHE, EXAMINING ATTORNEY

SN 78-524,247. THE NATURE CONSERVANCY, ARLINGTON, VA. FILED 11-30-2004.

OASIS

THE MARK CONSISTS OF STANDARD CHARACTERS WITHOUT CLAIM TO ANY PARTICULAR FONT, STYLE, SIZE, OR COLOR.

FOR CHARITABLE FUND RAISING SERVICES IN THE FIELD OF CONSERVATION OF NATURAL RESOURCES AND PRESERVATION OF ENDANGERED SPECIES (U.S. CLS. 100, 101 AND 102).

DORITT L. CARROLL, EXAMINING ATTORNEY

CLASS 36—(Continued).

SN 78-524,376. SCHAEFFER, JILL, WAYNE, PA. FILED 11-30-2004.

CLASS 36—(Continued).

SN 78-524,921. DEUTSCHE TELEKOM AG, BONN, FED REP GERMANY, FILED 12-1-2004.

Map & Go

Deal Me In

THE MARK CONSISTS OF STANDARD CHARACTERS WITHOUT CLAIM TO ANY PARTICULAR FONT, STYLE, SIZE, OR COLOR.

PRIORITY CLAIMED UNDER SEC. 44(D) ON FED REP GERMANY APPLICATION NO. 30431984838, FILED 6-2-2004, REG. NO. 30431984, DATED 9-14-2004, EXPIRES 6-30-2014.

FOR FINANCIAL SERVICES, NAMELY, CLEARING OF SECURE FINANCIAL TRANSACTIONS THROUGH ONLINE SERVICES; FINANCIAL ANALYSIS AND CONSULTATION, PROVIDING FINANCIAL INFORMATION, ISSUANCE OF SECURITIES, COMMERCIAL LENDING SERVICES, FINANCIAL PORTFOLIO MANAGEMENT, DISCOUNT BROKERAGE SERVICES, STOCK BROKERAGE, SECURITY BROKERAGE, BUSINESS BROKERAGE, BUSINESS VENTURE SERVICES IN THE NATURE OF VENTURE CAPITAL FUNDING SERVICES TO EMERGING AND START-UP COMPANIES, SECURITIES CONSULTING AND SAFE KEEPING, BROKERAGE OF PRODUCTIVE INVESTMENTS AND FUNDS; FINANCIAL SPONSORSHIP OF SPORTS, EDUCATIONAL AND ENTERTAINMENT PROGRAMS AND EVENTS; REAL ESTATE SERVICES, NAMELY BROKERAGE, MANAGEMENT, LEASING, APPRAISAL OF REAL PROPERTY; CUSTOMS BROKERAGE FOR THIRD PARTIES; MONETARY EXCHANGE; CREDIT CARD SERVICES; TELEPHONE CALLING CARD SERVICES; ELECTRONIC COMMERCE SERVICES, NAMELY, ELECTRONIC DEBIT AND CREDIT CARD PROCESSING SERVICES, FUNDS TRANSFER AND PAYMENT PROCESSING SERVICES; PROVIDING INFORMATION VIA THE TELEPHONE AND THE GLOBAL COMMUNICATIONS INFORMATION NETWORK IN THE FIELD OF FINANCE (U.S. CLS. 100, 101 AND 102).

FLORENTINA BLANDU, EXAMINING ATTORNEY

THE MARK CONSISTS OF STANDARD CHARACTERS WITHOUT CLAIM TO ANY PARTICULAR FONT, STYLE, SIZE, OR COLOR.

FOR CHARITABLE FUNDRAISING, MAINLY HOSTING SOCIAL EVENTS AND POKER TOURNAMENTS (U.S. CLS. 100, 101 AND 102).

ALEXANDER L. POWERS, EXAMINING ATTORNEY

CLASS 36—(Continued).

SN 78-525,954. DOUGLAS C. LANE & ASSOCIATES, INC., NEW YORK, NY. FILED 12-2-2004.

DCLA

THE MARK CONSISTS OF STANDARD CHARACTERS WITHOUT CLAIM TO ANY PARTICULAR FONT, STYLE, SIZE, OR COLOR.

FOR FINANCIAL SERVICES, NAMELY, INVESTMENT ADVISORY SERVICES, ASSET AND WEALTH MANAGEMENT, FINANCIAL PLANNING (U.S. CLS. 100, 101 AND 102).

DAWN HAN, EXAMINING ATTORNEY

SN 78-526,022. DEUTSCHE TELEKOM AG, BONN, FED REP GERMANY, FILED 12-2-2004.

**T-Mobile Data
Connect**

THE MARK CONSISTS OF STANDARD CHARACTERS WITHOUT CLAIM TO ANY PARTICULAR FONT, STYLE, SIZE, OR COLOR.

OWNER OF FED REP GERMANY REG. NO. 30433157, DATED 7-20-2004, EXPIRES 6-30-2014.

OWNER OF U.S. REG. NOS. 2,282,432 AND 2,889,632.

NO CLAIM IS MADE TO THE EXCLUSIVE RIGHT TO USE "DATA", APART FROM THE MARK AS SHOWN.

FOR INSURANCE SERVICES, NAMELY, INSURANCE BROKERAGE, INSURANCE CLAIMS PROCESSING; FINANCIAL SERVICES, NAMELY, CLEARING OF SECURE FINANCIAL TRANSACTIONS THROUGH ONLINE SERVICES; FINANCIAL ANALYSIS AND CONSULTATION; FINANCIAL INFORMATION PROVIDED BY ELECTRONIC MEANS; FINANCIAL INFORMATION PROCESSING; FINANCIAL PORTFOLIO MANAGEMENT; FINANCIAL SERVICES, NAMELY, SECURITIES CONSULTING AND SAFE KEEPING; FINANCIAL SPONSORSHIP OF SPORTS, EDUCATIONAL AND ENTERTAINMENT PROGRAMS AND EVENTS; COMMERCIAL LENDING SERVICES; MONETARY EXCHANGE; CREDIT CARD SERVICES; TELEPHONE CALLING CARD SERVICES; ELECTRONIC COMMERCE SERVICES, NAMELY, ELECTRONIC DEBIT AND CREDIT CARD TRANSACTION PROCESSING SERVICES,

CLASS 36—(Continued).

FUNDS TRANSFER AND BILL PAYMENT-PROCESSING SERVICES; DISCOUNT BROKERAGE SERVICES; SECURITY BROKERAGE; BROKERAGE IN THE FIELD OF INSURANCE, STOCKS, COMMODITIES; CUSTOM BROKERAGE FOR THIRD PARTIES IN THE FIELD OF INSURANCE, STOCKS, COMMODITIES; BROKERAGE OF SHARES AND VENTURE CAPITAL FUNDING SERVICES TO START-UP COMPANIES; BROKERAGE OF FUND SHARES; BROKERAGE OF PRODUCTIVE INVESTMENT OF FUNDS; REAL ESTATE SERVICES, NAMELY, BROKERAGE, MANAGEMENT, LEASING, AND APPRAISAL OF REAL PROPERTY; CONSULTING SERVICES RELATING TO INSURANCE SERVICES, NAMELY, PROVIDING INFORMATION AND BROKERAGE OF INSURANCES IN THE FIELD OF HOME INSURANCE, ACCIDENT INSURANCE AND HEALTH INSURANCE; CONSULTING SERVICES RELATING TO BANK SERVICES; PROVIDING INFORMATION VIA THE TELEPHONE AND THE GLOBAL COMMUNICATION NETWORKS IN THE FIELD OF FINANCE (U.S. CLS. 100, 101 AND 102).

Laurie Mayes, Examining Attorney

SN 78-526,178. OAK STREET MORTGAGE, LLC, CARMEL, IN. FILED 12-2-2004.

OAK STREET FUNDING

THE MARK CONSISTS OF STANDARD CHARACTERS WITHOUT CLAIM TO ANY PARTICULAR FONT, STYLE, SIZE, OR COLOR.

OWNER OF U.S. REG. NOS. 2,827,872, 2,929,595 AND 2,931,583.

NO CLAIM IS MADE TO THE EXCLUSIVE RIGHT TO USE "FUNDING", APART FROM THE MARK AS SHOWN.

FOR BILL CONSOLIDATION SERVICES; CONSUMER LENDING SERVICES; FACILITATING AND ARRANGING FOR THE FINANCING OF BUSINESSES, HOMES, AUTOMOBILES, AND PERSONAL PROPERTY; FINANCIAL SERVICES IN THE FIELD OF MONEY LENDING; FINANCING SERVICES; HOME EQUITY LOAN SERVICES; LOAN FINANCING SERVICES; MAINTAINING MORTGAGE ESCROW ACCOUNTS SERVICES; MORTGAGE BANKING SERVICES; MORTGAGE BROKERAGE SERVICES; MORTGAGE LENDING SERVICES; AND MORTGAGE PROCUREMENT FOR OTHERS (U.S. CLS. 100, 101 AND 102).

FIRST USE 11-28-2003; IN COMMERCE 11-28-2003.

Leigh Lowry, Examining Attorney

CLASS 36—(Continued).

SN 78-529,064. CITICORP, NEW YORK, NY. FILED 12-8-2004.

TREASURYVISION

THE MARK CONSISTS OF STANDARD CHARACTERS WITHOUT CLAIM TO ANY PARTICULAR FONT, STYLE, SIZE, OR COLOR.

FOR FINANCIAL SERVICES, NAMELY, BANK ACCOUNT DATA AGGREGATION SERVICES, NAMELY, AGGREGATION OF FINANCIAL DATA FROM BANK AND INVESTMENT ACCOUNTS FOR CORPORATE CLIENTS WITH MULTIPLE ACCOUNTS; PROVIDING AN ONLINE INTERACTIVE WEBSITE FEATURING INFORMATION FOR DETERMINING CASH POSITION ANALYTICS AND TREASURY RELATED REPORTING WHEREBY CLIENTS CAN PERFORM FINANCIAL TREND ANALYSES, VIEW CASH POSITIONS, PERFORM CASH FLOW FORECASTING, REVIEW INVESTMENT ACTIVITIES, MONITOR REQUEST AND APPROVAL PROCESSES RELATING TO GLOBAL LIQUIDITY MANAGEMENT, ANALYZE FOREIGN CURRENCY RISK, AND MONITOR INTRA-COMPANY FOREIGN CURRENCY POSITIONS, LOANS AND DEPOSITS (U.S. CLS. 100, 101 AND 102).

MICHAEL TANNER, EXAMINING ATTORNEY

CLASS 36—(Continued).

SN 78-530,841. GLOBAL CAPITAL GROUP, INC., SAN DIEGO, CA. FILED 12-10-2004.



NO CLAIM IS MADE TO THE EXCLUSIVE RIGHT TO USE "GLOBAL CAPITAL GROUP", APART FROM THE MARK AS SHOWN.

FOR MORTGAGE BANKING (U.S. CLS. 100, 101 AND 102).

FIRST USE 12-7-1998; IN COMMERCE 12-7-1998.
SUSAN STIGLITZ, EXAMINING ATTORNEY

SN 78-533,092. IRWIN HOME EQUITY CORPORATION, SAN RAMON, CA. FILED 12-15-2004.

SN 78-530,263. SCP PRIVATE EQUITY MANAGEMENT COMPANY, LLC, WAYNE, PA. FILED 12-10-2004.

SCP PARTNERS

THE MARK CONSISTS OF STANDARD CHARACTERS WITHOUT CLAIM TO ANY PARTICULAR FONT, STYLE, SIZE, OR COLOR.

NO CLAIM IS MADE TO THE EXCLUSIVE RIGHT TO USE "PARTNERS", APART FROM THE MARK AS SHOWN.

FOR INVESTMENT MANAGEMENT AND FINANCING SERVICES IN THE FIELD OF VENTURE CAPITAL (U.S. CLS. 100, 101 AND 102).

KELLEY WELLS, EXAMINING ATTORNEY

IRESULTS

THE MARK CONSISTS OF STANDARD CHARACTERS WITHOUT CLAIM TO ANY PARTICULAR FONT, STYLE, SIZE, OR COLOR.

FOR FINANCIAL SERVICES, NAMELY, HOME EQUITY LENDING SERVICES (U.S. CLS. 100, 101 AND 102).

LESLEY LAMOTHE, EXAMINING ATTORNEY

CLASS 36—(Continued).

SN 78-535,658. HEDGE FUND RESEARCH, INC., CHICAGO, IL. FILED 12-20-2004.

HFRI

THE MARK CONSISTS OF STANDARD CHARACTERS WITHOUT CLAIM TO ANY PARTICULAR FONT, STYLE, SIZE, OR COLOR.

OWNER OF U.S. REG. NOS. 2,395,301 AND 2,442,400.
FOR FINANCIAL SERVICES IN THE FIELDS OF HEDGE FUNDS, ALTERNATIVE INVESTMENTS, AND FUND INDICES (U.S. CLS. 100, 101 AND 102).
FIRST USE 12-0-1993; IN COMMERCE 12-0-1993.
JOHN HWANG, EXAMINING ATTORNEY

CLASS 36—(Continued).

SN 78-539,937. CAPITAL ONE FINANCIAL CORPORATION, RICHMOND, VA. FILED 12-30-2004.

CLARITY CARD FROM CAPITAL ONE

THE MARK CONSISTS OF STANDARD CHARACTERS WITHOUT CLAIM TO ANY PARTICULAR FONT, STYLE, SIZE, OR COLOR.

OWNER OF U.S. REG. NOS. 1,992,626, 2,075,171 AND OTHERS.

NO CLAIM IS MADE TO THE EXCLUSIVE RIGHT TO USE "CARD", APART FROM THE MARK AS SHOWN.

FOR FINANCIAL SERVICES, NAMELY CREDIT CARD SERVICES (U.S. CLS. 100, 101 AND 102).
JEAN IM, EXAMINING ATTORNEY

SN 78-539,073. NEW CENTURY MORTGAGE CORPORATION, IRVINE, CA. FILED 12-28-2004.

Casa123

THE MARK CONSISTS OF STANDARD CHARACTERS WITHOUT CLAIM TO ANY PARTICULAR FONT, STYLE, SIZE, OR COLOR.

OWNER OF U.S. REG. NOS. 2,250,525, 2,559,001 AND 2,631,907.

THE FOREIGN WORDING IN THE MARK TRANSLATES INTO ENGLISH AS HOME.

FOR MORTGAGE LENDING SERVICES (U.S. CLS. 100, 101 AND 102).
KRISTINA KLOIBER, EXAMINING ATTORNEY

SN 78-539,940. CAPITAL ONE FINANCIAL CORPORATION, RICHMOND, VA. FILED 12-30-2004.

CLARITY CARD

THE MARK CONSISTS OF STANDARD CHARACTERS WITHOUT CLAIM TO ANY PARTICULAR FONT, STYLE, SIZE, OR COLOR.

NO CLAIM IS MADE TO THE EXCLUSIVE RIGHT TO USE "CARD", APART FROM THE MARK AS SHOWN.

FOR FINANCIAL SERVICES, NAMELY CREDIT CARD SERVICES (U.S. CLS. 100, 101 AND 102).
JEAN IM, EXAMINING ATTORNEY

CLASS 36—(Continued).

SN 78-539,941. CAPITAL ONE FINANCIAL CORPORATION, RICHMOND, VA. FILED 12-30-2004.

CLASS 36—(Continued).

SN 78-540,214. IXI CORPORATION, MCLEAN, VA. FILED 12-30-2004.

CLARITY

DSI

THE MARK CONSISTS OF STANDARD CHARACTERS WITHOUT CLAIM TO ANY PARTICULAR FONT, STYLE, SIZE, OR COLOR.

FOR FINANCIAL SERVICES, NAMELY CREDIT CARD SERVICES (U.S. CLS. 100, 101 AND 102).
JEAN IM, EXAMINING ATTORNEY

THE MARK CONSISTS OF STANDARD CHARACTERS WITHOUT CLAIM TO ANY PARTICULAR FONT, STYLE, SIZE, OR COLOR.

FOR PROVIDING DATABASES IN THE FIELD OF WEALTH AND AFFLUENCE CLASSIFICATION (U.S. CLS. 100, 101 AND 102).
CYNTHIA SLOAN, EXAMINING ATTORNEY

SN 78-540,150. NILES & ASSOCIATES, INC., BATTLE CREEK, MI. FILED 12-30-2004.

SN 78-541,668. SECOND HELPINGS, INC., INDIANAPOLIS, IN. FILED 1-4-2005.

fundgineer

HARVEST

THE MARK CONSISTS OF STANDARD CHARACTERS WITHOUT CLAIM TO ANY PARTICULAR FONT, STYLE, SIZE, OR COLOR.

FOR CHARITABLE FUND RAISING SERVICES WHEREBY FUNDS ARE RAISED BY SELLING REUSABLE PLASTIC PREPAID CARDS THAT OFFER DISCOUNTS NATIONWIDE FOR RESTAURANTS, ENTERTAINMENT CENTERS, AUTOMOTIVE SERVICES, AND TO OTHER GENERAL PRODUCTS AND SERVICES (U.S. CLS. 100, 101 AND 102).
ANN LINNEHAN, EXAMINING ATTORNEY

THE MARK CONSISTS OF STANDARD CHARACTERS WITHOUT CLAIM TO ANY PARTICULAR FONT, STYLE, SIZE, OR COLOR.

FOR FUNDRAISING SERVICES FOR A CHARITABLE ORGANIZATION PROVIDING CULINARY TRAINING, AND RETRIEVING UNUSED FOOD AND PREPARING SUCH FOOD TO FEED THE NEEDY (U.S. CLS. 100, 101 AND 102).
FIRST USE 10-15-2004; IN COMMERCE 10-15-2004.
DAYNA BROWNE, EXAMINING ATTORNEY

CLASS 36—(Continued).

SN 78-541,775. REFINANCEYOURCAR.COM, AUSTIN, TX. FILED 1-4-2005.

reficarguys.com

THE MARK CONSISTS OF STANDARD CHARACTERS WITHOUT CLAIM TO ANY PARTICULAR FONT, STYLE, SIZE, OR COLOR.

FOR INSURANCE SERVICES, NAMELY, UNDERWRITING EXTENDED WARRANTY CONTRACTS IN THE FIELD OF AUTOMOBILES; INSURANCE UNDERWRITING IN THE FIELDS OF LIFE, HEALTH AND ACCIDENT; INSTALLMENT LOAN BROKERAGE SERVICES (U.S. CLS. 100, 101 AND 102).

FIRST USE 8-1-2003; IN COMMERCE 8-1-2003.
JASON ROTH, EXAMINING ATTORNEY

SN 78-542,985. ASSET RECOVERY GROUP, LLC, THE, BOWIE, MD. FILED 1-6-2005.

We Get Money.

THE MARK CONSISTS OF STANDARD CHARACTERS WITHOUT CLAIM TO ANY PARTICULAR FONT, STYLE, SIZE, OR COLOR.

FOR COLLECTION OF DEBTS (U.S. CLS. 100, 101 AND 102).
FIRST USE 12-27-2004; IN COMMERCE 1-1-2005.
KIM SAITO, EXAMINING ATTORNEY

CLASS 36—(Continued).

SN 78-543,007. BOARD OF PENSIONS OF THE EVANGELICAL LUTHERAN CHURCH IN AMERICA, MINNEAPOLIS, MN. FILED 1-6-2005.

ELCA 40E BALANCED FUND

THE MARK CONSISTS OF STANDARD CHARACTERS WITHOUT CLAIM TO ANY PARTICULAR FONT, STYLE, SIZE, OR COLOR.

NO CLAIM IS MADE TO THE EXCLUSIVE RIGHT TO USE BALANCED FUND, APART FROM THE MARK AS SHOWN.

FOR FINANCIAL SERVICES, NAMELY, FUNDS INVESTMENT SERVICES (U.S. CLS. 100, 101 AND 102).

FIRST USE 1-0-2003; IN COMMERCE 1-0-2003.
HOWARD SMIGA, EXAMINING ATTORNEY

SN 78-543,012. BOARD OF PENSIONS OF THE EVANGELICAL LUTHERAN CHURCH IN AMERICA, MINNEAPOLIS, MN. FILED 1-6-2005.

ELCA 40E SOCIAL PURPOSE BALANCED FUND

THE MARK CONSISTS OF STANDARD CHARACTERS WITHOUT CLAIM TO ANY PARTICULAR FONT, STYLE, SIZE, OR COLOR.

NO CLAIM IS MADE TO THE EXCLUSIVE RIGHT TO USE BALANCED FUND, APART FROM THE MARK AS SHOWN.

FOR FINANCIAL SERVICES, NAMELY, FUNDS INVESTMENT SERVICES (U.S. CLS. 100, 101 AND 102).
FIRST USE 1-0-2003; IN COMMERCE 1-0-2003.
HOWARD SMIGA, EXAMINING ATTORNEY

CLASS 36—(Continued).

SN 78-543,015. BOARD OF PENSIONS OF THE EVANGELICAL LUTHERAN CHURCH IN AMERICA, MINNEAPOLIS, MN. FILED 1-6-2005.

ELCA 60E BALANCED FUND

THE MARK CONSISTS OF STANDARD CHARACTERS WITHOUT CLAIM TO ANY PARTICULAR FONT, STYLE, SIZE, OR COLOR.
NO CLAIM IS MADE TO THE EXCLUSIVE RIGHT TO USE BALANCED FUND, APART FROM THE MARK AS SHOWN.
FOR FINANCIAL SERVICES, NAMELY, FUNDS INVESTMENT SERVICES (U.S. CLS. 100, 101 AND 102).
FIRST USE 1-0-2003; IN COMMERCE 1-0-2003.
HOWARD SMIGA, EXAMINING ATTORNEY

SN 78-543,022. BOARD OF PENSIONS OF THE EVANGELICAL LUTHERAN CHURCH IN AMERICA, MINNEAPOLIS, MN. FILED 1-6-2005.

ELCA 80E BALANCED FUND

THE MARK CONSISTS OF STANDARD CHARACTERS WITHOUT CLAIM TO ANY PARTICULAR FONT, STYLE, SIZE, OR COLOR.
NO CLAIM IS MADE TO THE EXCLUSIVE RIGHT TO USE BALANCED FUND, APART FROM THE MARK AS SHOWN.
FOR FINANCIAL SERVICES, NAMELY, FUNDS INVESTMENT SERVICES (U.S. CLS. 100, 101 AND 102).
FIRST USE 1-0-2003; IN COMMERCE 1-0-2003.
HOWARD SMIGA, EXAMINING ATTORNEY

CLASS 36—(Continued).

SN 78-543,603. BOARD OF PENSIONS OF THE EVANGELICAL LUTHERAN CHURCH IN AMERICA, MINNEAPOLIS, MN. FILED 1-6-2005.

ELCA 60E SOCIAL PURPOSE BALANCED FUND

THE MARK CONSISTS OF STANDARD CHARACTERS WITHOUT CLAIM TO ANY PARTICULAR FONT, STYLE, SIZE, OR COLOR.
NO CLAIM IS MADE TO THE EXCLUSIVE RIGHT TO USE BALANCED FUND, APART FROM THE MARK AS SHOWN.
FOR FINANCIAL SERVICES, NAMELY, FUNDS INVESTMENT SERVICES (U.S. CLS. 100, 101 AND 102).
FIRST USE 1-0-2003; IN COMMERCE 1-0-2003.
HOWARD SMIGA, EXAMINING ATTORNEY

SN 78-543,605. BOARD OF PENSIONS OF THE EVANGELICAL LUTHERAN CHURCH IN AMERICA, MINNEAPOLIS, MN. FILED 1-7-2005.

ELCA 80E SOCIAL PURPOSE BALANCED FUND

THE MARK CONSISTS OF STANDARD CHARACTERS WITHOUT CLAIM TO ANY PARTICULAR FONT, STYLE, SIZE, OR COLOR.
NO CLAIM IS MADE TO THE EXCLUSIVE RIGHT TO USE BALANCED FUND, APART FROM THE MARK AS SHOWN.
FOR FINANCIAL SERVICES, NAMELY, FUNDS INVESTMENT SERVICES (U.S. CLS. 100, 101 AND 102).
FIRST USE 1-0-2003; IN COMMERCE 1-0-2003.
HOWARD SMIGA, EXAMINING ATTORNEY

CLASS 36—(Continued).

SN 78-543,832. DEUTSCHE TELEKOM AG, BONN, FED REP GERMANY, FILED 1-7-2005.

T-Mobile Thanx

THE MARK CONSISTS OF STANDARD CHARACTERS WITHOUT CLAIM TO ANY PARTICULAR FONT, STYLE, SIZE, OR COLOR.

PRIORITY CLAIMED UNDER SEC. 44(D) ON FED REP GERMANY APPLICATION NO. 30441826938, FILED 7-21-2004, REG. NO. 30441826, DATED 8-16-2004, EXPIRES 7-31-2014.

OWNER OF U.S. REG. NOS. 2,282,432, 2,908,563 AND OTHERS.

FOR INSURANCE SERVICES, NAMELY, INSURANCE BROKERAGE, INSURANCE CLAIMS PROCESSING; FINANCIAL SERVICES, NAMELY, CLEARING OF SECURE FINANCIAL TRANSACTIONS THROUGH ONLINE SERVICES; FINANCIAL ANALYSIS AND CONSULTATION; FINANCIAL INFORMATION PROVIDED BY ELECTRONIC MEANS; FINANCIAL INFORMATION PROCESSING; FINANCIAL PORTFOLIO MANAGEMENT; FINANCIAL SERVICES, NAMELY, SECURITIES CONSULTING AND SAFE KEEPING; FINANCIAL SPONSORSHIP OF SPORTS, EDUCATIONAL AND ENTERTAINMENT PROGRAMS AND EVENTS; COMMERCIAL LENDING SERVICES; MONETARY EXCHANGE; CREDIT CARD SERVICES; TELEPHONE CALLING CARD SERVICES; ELECTRONIC COMMERCE SERVICES, NAMELY, ELECTRONIC DEBIT AND CREDIT CARD TRANSACTION PROCESSING SERVICES, FUNDS TRANSFER AND BILL PAYMENT-PROCESSING SERVICES; DISCOUNT BROKERAGE SERVICES; SECURITY BROKERAGE; BROKERAGE IN THE FIELD OF INSURANCE, STOCKS, COMMODITIES; CUSTOM BROKERAGE FOR THIRD PARTIES IN THE FIELD OF INSURANCE, STOCKS, COMMODITIES; BROKERAGE OF SHARES AND VENTURE CAPITAL FUNDING SERVICES TO START-UP COMPANIES; BROKERAGE OF FUND SHARES; BROKERAGE OF PRODUCTIVE INVESTMENT OF FUNDS; REAL ESTATE SERVICES, NAMELY, BROKERAGE, MANAGEMENT, LEASING, AND APPRAISAL OF REAL PROPERTY; CONSULTING SERVICES RELATING TO INSURANCE SERVICES, NAMELY, PROVIDING INFORMATION AND BROKERAGE OF INSURANCES IN THE FIELD OF HOME INSURANCE, ACCIDENT INSURANCE AND HEALTH INSURANCE; CONSULTING SERVICES RELATING TO BANK SERVICES; PROVIDING INFORMATION VIA THE TELEPHONE AND THE GLOBAL COMMUNICATION NETWORKS IN THE FIELD OF FINANCE (U.S. CLS. 100, 101 AND 102).

Laurie Mayes, Examining Attorney

CLASS 36—(Continued).

SN 78-545,498. DEUTSCHE TELEKOM AG, BONN, FED REP GERMANY, FILED 1-11-2005.

T-Mobile Dial a Smile

THE MARK CONSISTS OF STANDARD CHARACTERS WITHOUT CLAIM TO ANY PARTICULAR FONT, STYLE, SIZE, OR COLOR.

PRIORITY CLAIMED UNDER SEC. 44(D) ON FED REP GERMANY APPLICATION NO. 30441824238, FILED 7-21-2004, REG. NO. 30441824, DATED 7-31-2004, EXPIRES 7-31-2014.

OWNER OF U.S. REG. NOS. 2,282,432, 2,908,563 AND OTHERS.

FOR INSURANCE SERVICES, NAMELY, INSURANCE BROKERAGE, INSURANCE CLAIMS PROCESSING; FINANCIAL SERVICES, NAMELY, CLEARING OF SECURE FINANCIAL TRANSACTIONS THROUGH ONLINE SERVICES; FINANCIAL ANALYSIS AND CONSULTATION; FINANCIAL INFORMATION PROVIDED BY ELECTRONIC MEANS; FINANCIAL INFORMATION PROCESSING; FINANCIAL PORTFOLIO MANAGEMENT; FINANCIAL SERVICES, NAMELY, SECURITIES CONSULTING AND SAFE KEEPING; FINANCIAL SPONSORSHIP OF SPORTS, EDUCATIONAL AND ENTERTAINMENT PROGRAMS AND EVENTS; COMMERCIAL LENDING SERVICES; MONETARY EXCHANGE; CREDIT CARD SERVICES; TELEPHONE CALLING CARD SERVICES; ELECTRONIC COMMERCE SERVICES, NAMELY, ELECTRONIC DEBIT AND CREDIT CARD TRANSACTION PROCESSING SERVICES, FUNDS TRANSFER AND BILL PAYMENT-PROCESSING SERVICES; DISCOUNT BROKERAGE SERVICES; SECURITY BROKERAGE; BROKERAGE IN THE FIELD OF INSURANCE, STOCKS, COMMODITIES; CUSTOM BROKERAGE FOR THIRD PARTIES IN THE FIELD OF INSURANCE, STOCKS, COMMODITIES; BROKERAGE OF SHARES AND VENTURE CAPITAL FUNDING SERVICES TO START-UP COMPANIES; BROKERAGE OF FUND SHARES; BROKERAGE OF PRODUCTIVE INVESTMENT OF FUNDS; REAL ESTATE SERVICES, NAMELY, BROKERAGE, MANAGEMENT, LEASING, AND APPRAISAL OF REAL PROPERTY; CONSULTING SERVICES RELATING TO INSURANCE SERVICES, NAMELY, PROVIDING INFORMATION AND BROKERAGE OF INSURANCES IN THE FIELD OF HOME INSURANCE, ACCIDENT INSURANCE AND HEALTH INSURANCE; CONSULTING SERVICES RELATING TO BANK SERVICES; PROVIDING INFORMATION VIA THE TELEPHONE AND THE GLOBAL COMMUNICATION NETWORKS IN THE FIELD OF FINANCE (U.S. CLS. 100, 101 AND 102).

Laurie Mayes, Examining Attorney

CLASS 36—(Continued).

SN 78-545,668. BANK OF AMERICA CORPORATION,
CHARLOTTE, NC. FILED 1-11-2005.

INDEX CYCLES

THE MARK CONSISTS OF STANDARD CHARACTERS
WITHOUT CLAIM TO ANY PARTICULAR FONT, STYLE,
SIZE, OR COLOR.

NO CLAIM IS MADE TO THE EXCLUSIVE RIGHT TO
USE "INDEX", APART FROM THE MARK AS SHOWN.

FOR FINANCIAL AND INVESTMENT SERVICES,
NAMELY, ISSUING, BROKERING AND UNDERWRIT-
ING UNSECURED SENIOR DEBT SECURITIES AND
EQUITY DERIVATIVE SECURITIES (U.S. CLS. 100, 101
AND 102).

FIRST USE 11-1-2004; IN COMMERCE 11-1-2004,
MELVIN AXILBUND, EXAMINING ATTORNEY

SN 78-545,681. DEUTSCHE TELEKOM AG, BONN, FED REP
GERMANY, FILED 1-11-2005.

T-Mobile Thrills

THE MARK CONSISTS OF STANDARD CHARACTERS
WITHOUT CLAIM TO ANY PARTICULAR FONT, STYLE,
SIZE, OR COLOR.

PRIORITY CLAIMED UNDER SEC. 44(D) ON FED REP
GERMANY APPLICATION NO. 30441825038, FILED 7-21-
2004, REG. NO. 30441825, DATED 8-16-2004, EXPIRES 7-31-
2014.

OWNER OF U.S. REG. NOS. 2,282,432, 2,908,563 AND
OTHERS.

FOR INSURANCE SERVICES, NAMELY, INSURANCE
BROKERAGE, INSURANCE CLAIMS PROCESSING; FI-
NANCIAL SERVICES, NAMELY, CLEARING OF SE-
CURE FINANCIAL TRANSACTIONS THROUGH
ONLINE SERVICES; FINANCIAL ANALYSIS AND CON-
SULTATION; FINANCIAL INFORMATION PROVIDED
BY ELECTRONIC MEANS; FINANCIAL INFORMATION
PROCESSING; FINANCIAL PORTFOLIO MANAGE-
MENT; FINANCIAL SERVICES, NAMELY, SECURITIES
CONSULTING AND SAFE KEEPING; FINANCIAL
SPONSORSHIP OF SPORTS, EDUCATIONAL AND EN-
TERTAINMENT PROGRAMS AND EVENTS; COMMERCIAL
LENDING SERVICES; MONETARY EXCHANGE;
CREDIT CARD SERVICES; TELEPHONE CALLING
CARD SERVICES; ELECTRONIC COMMERCE SER-
VICES, NAMELY, ELECTRONIC DEBIT AND CREDIT
CARD TRANSACTION PROCESSING SERVICES,

CLASS 36—(Continued).

FUNDS TRANSFER AND BILL PAYMENT-PROCES-
SING SERVICES; DISCOUNT BROKERAGE SERVICES;
SECURITY BROKERAGE; BROKERAGE IN THE FIELD
OF INSURANCE, STOCKS, COMMODITIES; CUSTOM
BROKERAGE FOR THIRD PARTIES IN THE FIELD OF
INSURANCE, STOCKS, COMMODITIES; BROKERAGE
OF SHARES AND VENTURE CAPITAL FUNDING
SERVICES TO START-UP COMPANIES; BROKERAGE
OF FUND SHARES; BROKERAGE OF PRODUCTIVE
INVESTMENT OF FUNDS; REAL ESTATE SERVICES,
NAMELY, BROKERAGE, MANAGEMENT, LEASING,
AND APPRAISAL OF REAL PROPERTY; CONSULTING
SERVICES RELATING TO INSURANCE SERVICES,
NAMELY, PROVIDING INFORMATION AND BROKER-
AGE OF INSURANCES IN THE FIELD OF HOME
INSURANCE, ACCIDENT INSURANCE AND HEALTH
INSURANCE; CONSULTING SERVICES RELATING TO
BANK SERVICES; PROVIDING INFORMATION VIA
THE TELEPHONE AND THE GLOBAL COMMUNICA-
TION NETWORKS IN THE FIELD OF FINANCE (U.S.
CLS. 100, 101 AND 102).

LAURIE MAYES, EXAMINING ATTORNEY

SN 78-545,789. REDMOND NATIONAL BANK, REDMOND,
WA. FILED 1-11-2005.

RED CANOE

THE MARK CONSISTS OF STANDARD CHARACTERS
WITHOUT CLAIM TO ANY PARTICULAR FONT, STYLE,
SIZE, OR COLOR.

FOR BANKING; ON-LINE BANKING SERVICES;
MORTGAGE BANKING SERVICES (U.S. CLS. 100, 101
AND 102).

KARANENDRA S. CHHINA, EXAMINING ATTORNEY

SN 78-545,889. FOCUS REDEVELOPMENT, TEMPE, AZ.
FILED 1-11-2005.



NO CLAIM IS MADE TO THE EXCLUSIVE RIGHT TO
USE FORECLOSURES FOR INVESTORS, APART FROM
THE MARK AS SHOWN.

FOR REAL ESTATE INVESTMENT ADVICE (U.S. CLS.
100, 101 AND 102).

FIRST USE 1-1-2005; IN COMMERCE 1-1-2005,
LINDA POWELL, EXAMINING ATTORNEY

CLASS 36—(Continued).

SN 78-546,288. REAL SOFT COMMERCIAL CONNECTION, LLC, STAMFORD, CT. FILED 1-12-2005.



THE STIPPLING IS FOR SHADING PURPOSES. THE MARK CONSISTS OF A DESIGN OF A PLANAR SURFACE SUPPORTING THREE DIFFERENT SIZE BLOCKS IN A PERSPECTIVE VIEW.

FOR PROVIDING COMMERCIAL REAL ESTATE LISTING INFORMATION VIA A GLOBAL COMMUNICATION NETWORK; PROVIDING AN ON-LINE COMPUTER DATABASE OF CURRENT AND HISTORICAL REAL ESTATE MANAGEMENT AND TRANSACTION INFORMATION FEATURING CONFIRMED SALES TRANSACTION DATA, PHOTOGRAPHS, MAPS, AND NEWS STORIES RELATING TO THE COMMERCIAL, INDUSTRIAL, RETAIL AND HOSPITALITY-ORIENTED REAL ESTATE INDUSTRY; PROVIDING REAL ESTATE INFORMATION SERVICES, NAMELY, SEARCHING, ANALYZING, TRACKING, MANAGING, AND REPORTING OF CURRENT AND HISTORICAL REAL ESTATE DATA, NAMELY SALES AND TRANSACTIONAL DATA, AS WELL AS PHOTOGRAPHS, MAPS, AND NEWS STORIES RELATING TO THE COMMERCIAL, INDUSTRIAL, RETAIL AND HOSPITALITY-ORIENTED REAL ESTATE INDUSTRY; PROVIDING INFORMATION REGARDING COMMERCIAL, INDUSTRIAL, RETAIL AND HOSPITALITY-ORIENTED REAL ESTATE PROPERTIES; PROVIDING LISTS OF TENANTS OF COMMERCIAL, INDUSTRIAL, RETAIL AND HOSPITALITY-ORIENTED REAL ESTATE PROPERTIES (U.S. CLS. 100, 101 AND 102).

FIRST USE 9-20-2004; IN COMMERCE 9-20-2004. JENNIFER CHICOSKI, EXAMINING ATTORNEY

SN 78-546,330. MEDIA/PROFESSIONAL INSURANCE. A DIVISION OF FINANCIAL & PROFESSIONAL RISK SOLUTIONS, INC., KANSAS CITY, MO. FILED 1-12-2005.

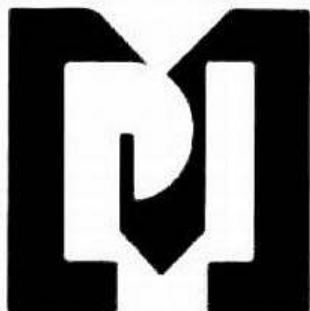

THE MARK CONSISTS OF THE LETTERS MPI THAT FORM A SQUARE DESIGN.

FOR INSURANCE BROKERAGE SERVICES (U.S. CLS. 100, 101 AND 102).

FIRST USE 10-21-1988; IN COMMERCE 10-21-1988. ANDREW RHIM, EXAMINING ATTORNEY

CLASS 36—(Continued).

SN 78-547,557. BEECHER CARLSON HOLDINGS, INC., ATLANTA, GA. FILED 1-14-2005.

BEECHER CARLSON

THE MARK CONSISTS OF STANDARD CHARACTERS WITHOUT CLAIM TO ANY PARTICULAR FONT, STYLE, SIZE, OR COLOR.

OWNER OF U.S. REG. NO. 2,380,283.

FOR DESIGN AND MANAGEMENT OF CAPTIVE INSURANCE PROGRAMS; INSURANCE BROKERAGE SERVICES; CONSULTING IN THE FIELD OF RISK MANAGEMENT; CONSULTING REGARDING THE ESTABLISHMENT OF CAPTIVE INSURANCE PROGRAMS; AND CONSULTING REGARDING DESIGN AND MANAGEMENT OF EXTENDED WARRANTY PROGRAMS (U.S. CLS. 100, 101 AND 102).

FIRST USE 8-1-2004; IN COMMERCE 8-1-2004. BRENDAN REGAN, EXAMINING ATTORNEY

SN 78-547,561. BEECHER CARLSON HOLDINGS, INC., ATLANTA, GA. FILED 1-14-2005.



OWNER OF U.S. REG. NO. 2,380,283.

FOR DESIGN AND MANAGEMENT OF CAPTIVE INSURANCE PROGRAMS; INSURANCE BROKERAGE SERVICES; CONSULTING IN THE FIELD OF RISK MANAGEMENT; CONSULTING REGARDING THE ESTABLISHMENT OF CAPTIVE INSURANCE PROGRAMS; AND CONSULTING REGARDING DESIGN AND MANAGEMENT OF EXTENDED WARRANTY PROGRAMS (U.S. CLS. 100, 101 AND 102).

FIRST USE 8-1-2004; IN COMMERCE 8-1-2004. BRENDAN REGAN, EXAMINING ATTORNEY

CLASS 36—(Continued).

SN 78-547,997. SEABURY & SMITH, INC., NEW YORK, NY. FILED 1-14-2005.

CLASS 36—(Continued).

SN 78-549,538. HEALTHTRAN, LLC, GREENWOOD VILLAGE, CO. FILED 1-18-2005.

TECHARMOUR

HEALTHTRANS

THE MARK CONSISTS OF STANDARD CHARACTERS WITHOUT CLAIM TO ANY PARTICULAR FONT, STYLE, SIZE, OR COLOR.

FOR ADMINISTRATION, UNDERWRITING AND CONSULTING IN THE FIELD OF PROFESSIONAL LIABILITY INSURANCE FOR NETWORK SECURITY, INFORMATION TECHNOLOGY, INTERNET CONTENT, TECHNOLOGY ERRORS AND OMISSIONS AND INTELLECTUAL PROPERTY (U.S. CLS. 100, 101 AND 102).

FIRST USE 1-14-2005; IN COMMERCE 1-14-2005.
DANIEL BRODY, EXAMINING ATTORNEY

THE MARK CONSISTS OF STANDARD CHARACTERS WITHOUT CLAIM TO ANY PARTICULAR FONT, STYLE, SIZE, OR COLOR.

FOR PHARMACY BENEFIT MANAGEMENT SERVICES, NAMELY, DESIGN AND ADMINISTRATION OF PHARMACY BENEFIT PLANS; PROVIDING ELECTRONIC PROCESSING AND TRANSMISSION OF BILL PAYMENT DATA FOR THE HEALTHCARE INDUSTRY AND ELECTRONIC PROCESSING OF INSURANCE CLAIMS AND PAYMENT DATA AND ONLINE REPORTING OF ELECTRONIC HEALTH BENEFITS CLAIMS; PRESCRIPTION DRUG INSURANCE CLAIMS PROCESSING SERVICES; INSURANCE CLAIMS ADMINISTRATION THAT INCLUDE PRESCRIPTION DRUG FORMULARY MANAGEMENT SERVICES (U.S. CLS. 100, 101 AND 102).

FIRST USE 1-1-2000; IN COMMERCE 1-1-2000.
ELISSA GARBER KON, EXAMINING ATTORNEY

SN 78-549,144. VIGILAR, INC., ATLANTA, GA. FILED 1-18-2005.

SN 78-549,700. BUREAU OF THE PUBLIC DEBT, WASHINGTON, DC. FILED 1-19-2005.

OPTISECURE

TREASURY HUNT

THE MARK CONSISTS OF STANDARD CHARACTERS WITHOUT CLAIM TO ANY PARTICULAR FONT, STYLE, SIZE, OR COLOR.

FOR RISK MANAGEMENT SERVICES USING SECURITY METHODOLOGY AND ACCREDITATION STANDARD BASED UPON INDUSTRY STANDARDS WITH RESPECT TO COMPUTER NETWORKS, NETWORK COMMUNICATIONS AND CONNECTIVITY, ELECTRONIC DATA STORAGE, AND NETWORK AND DATA STORAGE SECURITY SOLUTIONS (U.S. CLS. 100, 101 AND 102).

FIRST USE 3-21-2005; IN COMMERCE 3-21-2005.
ANGELA M. MICHELI, EXAMINING ATTORNEY

THE MARK CONSISTS OF STANDARD CHARACTERS WITHOUT CLAIM TO ANY PARTICULAR FONT, STYLE, SIZE, OR COLOR.

FOR SECURITIES SERVICES, NAMELY PROVIDING A WEB-BASED APPLICATION THAT CONSUMERS CAN USE TO SEARCH FOR MATURED SAVINGS BONDS, MATURED DEFINITIVE REGISTERED SECURITIES, UNDELIVERABLE BONDS OR INTEREST PAYMENTS OR OTHER TREASURY OBLIGATIONS BEING HELD BY THE BUREAU OF THE PUBLIC DEBT (U.S. CLS. 100, 101 AND 102).

FIRST USE 5-1-2000; IN COMMERCE 2-5-2001.
ANGELA M. MICHELI, EXAMINING ATTORNEY

CLASS 36—(Continued).

SN 78-549,705. BUREAU OF THE PUBLIC DEBT, WASHINGTON, DC. FILED 1-19-2005.

TREASURYHUNT

THE MARK CONSISTS OF STANDARD CHARACTERS WITHOUT CLAIM TO ANY PARTICULAR FONT, STYLE, SIZE, OR COLOR.

FOR SECURITIES SERVICES, NAMELY PROVIDING A WEB-BASED APPLICATION THAT CONSUMERS CAN USE TO SEARCH FOR MATURED SAVINGS BONDS, MATURED DEFINITIVE REGISTERED SECURITIES, UNDELIVERABLE BONDS OR INTEREST PAYMENTS OR OTHER TREASURY OBLIGATIONS BEING HELD BY THE BUREAU OF THE PUBLIC DEBT (U.S. CLS. 100, 101 AND 102).

FIRST USE 5-1-2000; IN COMMERCE 2-5-2001.
ANGELA M. MICHELI, EXAMINING ATTORNEY

CLASS 36—(Continued).

SN 78-554,444. KAGAN, ANDREW T., FORT MYERS, FL. FILED 1-26-2005.

**Complication
Insurance**

THE MARK CONSISTS OF STANDARD CHARACTERS WITHOUT CLAIM TO ANY PARTICULAR FONT, STYLE, SIZE, OR COLOR.

NO CLAIM IS MADE TO THE EXCLUSIVE RIGHT TO USE "INSURANCE", APART FROM THE MARK AS SHOWN.

FOR CONSUMER PURCHASED INSURANCE IN THE MEDICAL FIELD (U.S. CLS. 100, 101 AND 102).
CHRISTOPHER BUONGIORNO, EXAMINING ATTORNEY

SN 78-549,972. NORTH ISLAND CREDIT UNION, FORMERLY NORTH ISLAND FEDERAL CREDIT UNION, CHULA VISTA, CA. FILED 1-19-2005.

NiftiPhone

THE MARK CONSISTS OF STANDARD CHARACTERS WITHOUT CLAIM TO ANY PARTICULAR FONT, STYLE, SIZE, OR COLOR.

OWNER OF U.S. REG. NO. 2,211,251.
FOR BANKING SERVICES PROVIDED VIA TELEPHONE (U.S. CLS. 100, 101 AND 102).
FIRST USE 6-21-2001; IN COMMERCE 6-21-2001.
NANCY CLARKE, EXAMINING ATTORNEY

SN 78-558,222. HUMPCO, INC., ATLANTA, GA. FILED 2-1-2005.

EQUITAX

THE MARK CONSISTS OF STANDARD CHARACTERS WITHOUT CLAIM TO ANY PARTICULAR FONT, STYLE, SIZE, OR COLOR.

FOR PROPERTY TAX EQUALIZATION SERVICES (U.S. CLS. 100, 101 AND 102).
INGRID C. EULIN, EXAMINING ATTORNEY

CLASS 36—(Continued).

SN 78-569,697. INTRUST FINANCIAL CORPORATION, WICHITA, KS. FILED 2-17-2005.

Nestegg Fund 2010

THE MARK CONSISTS OF STANDARD CHARACTERS WITHOUT CLAIM TO ANY PARTICULAR FONT, STYLE, SIZE, OR COLOR.

NO CLAIM IS MADE TO THE EXCLUSIVE RIGHT TO USE "FUND 2010", APART FROM THE MARK AS SHOWN. FOR MUTUAL FUNDS INVESTMENT SERVICES (U.S. CLS. 100, 101 AND 102).

FIRST USE 1-4-1999; IN COMMERCE 1-4-1999.
PAULA MAHONEY, EXAMINING ATTORNEY

SN 78-570,905. AMERICAN INTERNATIONAL GROUP, INC., NEW YORK, NY. FILED 2-18-2005.

IDL MAX

THE MARK CONSISTS OF STANDARD CHARACTERS WITHOUT CLAIM TO ANY PARTICULAR FONT, STYLE, SIZE, OR COLOR.

OWNER OF U.S. REG. NO. 2,761,858.

NO CLAIM IS MADE TO THE EXCLUSIVE RIGHT TO USE "IDL", APART FROM THE MARK AS SHOWN.

FOR INSURANCE UNDERWRITING SERVICES, NAMELY, LIABILITY INSURANCE FOR INDEPENDENT CORPORATE BOARD DIRECTORS (U.S. CLS. 100, 101 AND 102).

FIRST USE 2-16-2005; IN COMMERCE 2-16-2005.
SANJEEV VOHRA, EXAMINING ATTORNEY

CLASS 36—(Continued).

SN 78-576,698. THE TORONTO-DOMINION BANK, TORONTO, ONTARIO, CANADA, FILED 2-28-2005.

TD

THE MARK CONSISTS OF STANDARD CHARACTERS WITHOUT CLAIM TO ANY PARTICULAR FONT, STYLE, SIZE, OR COLOR.

OWNER OF U.S. REG. NOS. 1,640,759, 1,649,009 AND 2,750,706.

FOR SECURITIES BROKERAGE SERVICES; MUTUAL FUND BROKERAGE SERVICES; BANKING SERVICES (U.S. CLS. 100, 101 AND 102).

FIRST USE 3-0-1969; IN COMMERCE 6-0-1999.
DAVID H. STINE, EXAMINING ATTORNEY

SN 78-582,901. DEUTSCHE TELEKOM AG, BONN, FED REP GERMANY, FILED 3-8-2005.

T-Systems
Enterprise Services

THE MARK CONSISTS OF STANDARD CHARACTERS WITHOUT CLAIM TO ANY PARTICULAR FONT, STYLE, SIZE, OR COLOR.

PRIORITY CLAIMED UNDER SEC. 44(D) ON FED REP GERMANY APPLICATION NO. 30452358542, FILED 9-9-2004, REG. NO. 30452358, DATED 11-15-2004, EXPIRES 9-30-2014.

OWNER OF U.S. REG. NOS. 2,448,571 AND 2,880,613.

NO CLAIM IS MADE TO THE EXCLUSIVE RIGHT TO USE "ENTERPRISE SERVICES", APART FROM THE MARK AS SHOWN.

FOR INSURANCE SERVICES, NAMELY, INSURANCE BROKERAGE, INSURANCE CLAIMS PROCESSING; FINANCIAL SERVICES, NAMELY, CLEARING OF SECURE FINANCIAL TRANSACTIONS THROUGH ONLINE SERVICES; FINANCIAL ANALYSIS AND CONSULTATION; FINANCIAL INFORMATION PROVIDED BY ELECTRONIC MEANS; FINANCIAL INFORMATION PROCESSING; FINANCIAL PORTFOLIO MANAGEMENT; FINANCIAL SERVICES, NAMELY, SECURITIES CONSULTING AND SAFE KEEPING; FINANCIAL SPONSORSHIP OF SPORTS, EDUCATIONAL AND ENTERTAINMENT PROGRAMS AND EVENTS; COMMERCIAL LENDING SERVICES; MONETARY EXCHANGE; CREDIT CARD SERVICES; TELEPHONE CALLING CARD SERVICES; ELECTRONIC COMMERCE SERVICES, NAMELY, ELECTRONIC DEBIT AND CREDIT CARD TRANSACTION PROCESSING SERVICES,

CLASS 36—(Continued).

FUNDS TRANSFER AND BILL PAYMENT-PROCESSING SERVICES; DISCOUNT BROKERAGE SERVICES; SECURITY BROKERAGE; BROKERAGE IN THE FIELD OF INSURANCE, STOCKS, COMMODITIES; CUSTOM BROKERAGE FOR THIRD PARTIES IN THE FIELD OF INSURANCE, STOCKS, COMMODITIES; BROKERAGE OF SHARES AND VENTURE CAPITAL FUNDING SERVICES TO START-UP COMPANIES; BROKERAGE OF FUND SHARES; BROKERAGE OF PRODUCTIVE INVESTMENT OF FUNDS; REAL ESTATE SERVICES, NAMELY, BROKERAGE, MANAGEMENT, LEASING, AND APPRAISAL OF REAL PROPERTY; CONSULTING SERVICES RELATING TO INSURANCE SERVICES, NAMELY, PROVIDING INFORMATION AND BROKERAGE OF INSURANCES IN THE FIELD OF HOME INSURANCE, ACCIDENT INSURANCE AND HEALTH INSURANCE; CONSULTING SERVICES RELATING TO BANK SERVICES; PROVIDING INFORMATION VIA THE TELEPHONE AND THE GLOBAL COMMUNICATION NETWORKS IN THE FIELD OF FINANCE (U.S. CLS. 100, 101 AND 102).

Laurie Mayes, Examining Attorney

SN 78-583,610. MATTEL, INC., EL SEGUNDO, CA. FILED 3-9-2005.

MATTEL

THE MARK CONSISTS OF STANDARD CHARACTERS WITHOUT CLAIM TO ANY PARTICULAR FONT, STYLE, SIZE, OR COLOR.

OWNER OF U.S. REG. NOS. 753,681, 898,209 AND OTHERS.

FOR CHARITABLE FUNDRAISING SERVICES (U.S. CLS. 100, 101 AND 102).

FIRST USE 8-22-1978; IN COMMERCE 8-22-1978.
Brendan Regan, Examining Attorney

SN 78-605,840. CHEROKEE STATE BANK, ST. PAUL, MN. FILED 4-11-2005.



FOR BANKING SERVICES (U.S. CLS. 100, 101 AND 102).

FIRST USE 12-6-2004; IN COMMERCE 1-3-2005.
Dawn Han, Examining Attorney

CLASS 36—(Continued).

SN 78-610,129. USAA FEDERAL CREDIT UNION, SAN ANTONIO, TX. FILED 4-15-2005.



FOR CREDIT UNION SERVICES AND CONSUMER AND COMMERCIAL LENDING SERVICES (U.S. CLS. 100, 101 AND 102).

FIRST USE 5-30-1986; IN COMMERCE 5-30-1986.
Ellen Perkins, Examining Attorney

SN 78-637,912. MEDCO HEALTH SOLUTIONS, INC., FRANKLIN LAKES, NJ. FILED 5-26-2005.

MEDCO ADVANTAGE RETAIL

THE MARK CONSISTS OF STANDARD CHARACTERS WITHOUT CLAIM TO ANY PARTICULAR FONT, STYLE, SIZE, OR COLOR.

OWNER OF U.S. REG. NOS. 2,744,576, 2,894,558 AND OTHERS.

NO CLAIM IS MADE TO THE EXCLUSIVE RIGHT TO USE "RETAIL", APART FROM THE MARK AS SHOWN.

FOR ADMINISTERING MULTIPLE PRESCRIPTION DRUG REFILL PRESCRIPTION BENEFIT PROGRAM DIRECTED TO RETAIL PHARMACIES (U.S. CLS. 100, 101 AND 102).

Ginny Isaacson, Examining Attorney

CLASS 36—(Continued).

SN 78-646,498. MEDCO HEALTH SOLUTIONS, INC.,
FRANKLIN LAKES, NJ. FILED 6-8-2005.

MEDCO PRESCRIPTION SAVINGS
PLAN

THE MARK CONSISTS OF STANDARD CHARACTERS
WITHOUT CLAIM TO ANY PARTICULAR FONT, STYLE,
SIZE, OR COLOR.

OWNER OF U.S. REG. NOS. 2,744,576, 2,894,558 AND
OTHERS.

NO CLAIM IS MADE TO THE EXCLUSIVE RIGHT TO
USE "PRESCRIPTION SAVINGS PLAN", APART FROM
THE MARK AS SHOWN.

FOR ADMINISTERING AND UNDERWRITING OF A
MEDICARE PRESCRIPTION DRUG BENEFIT PLAN
(U.S. CLS. 100, 101 AND 102).

GINNY ISAACSON, EXAMINING ATTORNEY

CLASS 36—(Continued).

SN 79-003,194. INTERNATIONAL INDEX COMPANY LIM-
ITED, UNITED KINGDOM, FILED 5-6-2004.



OWNER OF INTERNATIONAL REGISTRATION 0798911
DATED 8-14-2002, EXPIRES 8-14-2012.

OWNER OF U.S. REG. NO. 2,728,723.

NO CLAIM IS MADE TO THE EXCLUSIVE RIGHT TO
USE "INDICES", APART FROM THE MARK AS SHOWN.

THE STIPPLING IS A FEATURE OF THE MARK.

THE COLOR(S) RED, WHITE, BLUE IS/ARE CLAIMED AS
A FEATURE OF THE MARK.

THE COLOURS ARE RED FOR THE WORD IBOXX AND
THE SMALL SQUARE IN THE UPPER RIGHT CORNER
AND BLUE FOR THE WORD INDICES AND THE LARGE
SQUARE.

FOR FINANCIAL INFORMATION SERVICES,
NAMELY, DETERMINING AND CALCULATING FIXED
INCOME PRICES, INDEXES, AND RELATED INFOR-
MATION AND PROVIDING FIXED INCOME PRICES,
INDEXES AND RELATED INFORMATION (U.S. CLS.
100, 101 AND 102).

CHARLES JOYNER, EXAMINING ATTORNEY

CLASS 37—CONSTRUCTION AND REPAIR

SN 76-335,010. PIERCEY, TODD, GLENDALE, AZ. FILED 11-
7-2001.



FOR CUSTOM REBUILDING OF EXISTING AUTO-
MOBILES (U.S. CLS. 100, 103 AND 106).

FIRST USE 8-11-2001; IN COMMERCE 8-11-2001.

KIM SAITO, EXAMINING ATTORNEY

GENERICS FIRST

THE MARK CONSISTS OF STANDARD CHARACTERS
WITHOUT CLAIM TO ANY PARTICULAR FONT, STYLE,
SIZE, OR COLOR.

OWNER OF U.S. REG. NOS. 2,624,827 AND 2,638,136.

NO CLAIM IS MADE TO THE EXCLUSIVE RIGHT TO
USE "GENERICS", APART FROM THE MARK AS SHOWN.

FOR PHARMACEUTICAL AND PRESCRIPTION
DRUG INSURANCE UNDERWRITING; ADMINISTRA-
TION AND ORGANIZING OF PHARMACEUTICAL AND
PRESCRIPTION DRUG PLANS (U.S. CLS. 100, 101 AND
102).

LAURIE MAYES, EXAMINING ATTORNEY

SN 76-553,903. THE MOSAIC TILE COMPANY OF VIRGI-
NIA, INC., SPRINGFIELD, VA. FILED 10-24-2003.

MOSAIC TILE COMPANY

NO CLAIM IS MADE TO THE EXCLUSIVE RIGHT TO
USE COMPANY, APART FROM THE MARK AS SHOWN.
SEC. 2(F).

FOR PROVIDING ADVICE IN THE NATURE OF
INSTALLING TILING AND STONE VIA A WEBSITE
AND ONLINE (U.S. CLS. 100, 103 AND 106).

FIRST USE 8-12-1972; IN COMMERCE 8-12-1972.

GEORGE LORENZO, EXAMINING ATTORNEY

CLASS 37—(Continued).

SN 76-593,474. LEVITT CORPORATION, FORT LAUDERDALE, FL. FILED 5-21-2004.



OWNER OF U.S. REG. NOS. 697,913, 2,512,207 AND 2,873,986.

SEC. 2(F).

FOR CONSTRUCTION SERVICES, NAMELY, PLANNING, LAYING OUT AND CUSTOM CONSTRUCTION OF RESIDENTIAL AND COMMERCIAL COMMUNITIES (U.S. CLS. 100, 103 AND 106).

FIRST USE 1-0-2003; IN COMMERCE 1-0-2003.

SAMUEL E. SHARPER JR., EXAMINING ATTORNEY

SN 76-593,912. PROSOURCE ROOFING, DALLAS, TX. FILED 5-14-2004.



NO CLAIM IS MADE TO THE EXCLUSIVE RIGHT TO USE "ROOFING", APART FROM THE MARK AS SHOWN.

THE COLOR(S) RED, WHITE AND BLUE IS/ARE CLAIMED AS A FEATURE OF THE MARK.

THE MARK CONSISTS OF A BLUE PYRAMID WITH THE NAME OF PROSOURCE SUPERIMPOSED ON THE PYRAMID AND A RED RECTANGLE WITH THE WORD ROOFING. THE WORD PROSOURCE IS OUTLINED IN RED.

FOR ROOFING INSTALLATION AND REPAIRS (U.S. CLS. 100, 103 AND 106).

FIRST USE 3-26-2001; IN COMMERCE 3-26-2001.

SHARON MEIER, EXAMINING ATTORNEY

SN 76-596,718. TOWER CLEANING SYSTEMS, INC., NORRISTOWN, PA. FILED 6-9-2004.

US MAINTENANCE

THE MARK CONSISTS OF STANDARD CHARACTERS WITHOUT CLAIM TO ANY PARTICULAR FONT, STYLE, SIZE, OR COLOR.

NO CLAIM IS MADE TO THE EXCLUSIVE RIGHT TO USE MAINTENANCE, APART FROM THE MARK AS SHOWN.

SEC. 2(F).

FOR JANITORIAL SERVICES, NAMELY, CLEANING OF BUSINESS PREMISES, AND MAINTENANCE AND/OR REPAIR OF BUSINESS PREMISES, AND MAINTENANCE AND/OR REPAIR OF FLOORING SYSTEMS (U.S. CLS. 100, 103 AND 106).

FIRST USE 1-1-1998; IN COMMERCE 1-1-1998.

STANLEY I. OSBORNE, EXAMINING ATTORNEY

CLASS 37—(Continued).

SN 76-596,720. TOWER CLEANING SYSTEMS, INC., NORRISTOWN, PA. FILED 6-9-2004.



NO CLAIM IS MADE TO THE EXCLUSIVE RIGHT TO USE MAINTENANCE, APART FROM THE MARK AS SHOWN.

SEC. 2(F).

FOR JANITORIAL SERVICES, NAMELY, CLEANING OF BUSINESS PREMISES, AND MAINTENANCE AND/OR REPAIR OF BUSINESS PREMISES, AND MAINTENANCE AND/OR REPAIR OF FLOORING SYSTEMS (U.S. CLS. 100, 103 AND 106).

FIRST USE 1-1-1998; IN COMMERCE 1-1-1998.

STANLEY I. OSBORNE, EXAMINING ATTORNEY

SN 76-599,036. FRAMATOME ANP, INC., LYNCHBURG, VA. FILED 6-24-2004.

STEARNS ROGER

THE MARK CONSISTS OF STANDARD CHARACTERS WITHOUT CLAIM TO ANY PARTICULAR FONT, STYLE, SIZE, OR COLOR.

FOR REPAIR OR MAINTENANCE OF NUCLEAR POWER PLANTS IN THE NATURE OF REFUELING REACTORS AND PROVIDING UPGRADES TO CONTROL SYSTEMS (U.S. CLS. 100, 103 AND 106).

FIRST USE 6-14-2004; IN COMMERCE 6-16-2004.

TARAH HARDY, EXAMINING ATTORNEY

SN 76-600,156. GES EXPOSITION SERVICES, INC., LAS VEGAS, NV. FILED 7-1-2004.

TRADE SHOW RIGGING TSR

THE MARK CONSISTS OF STANDARD CHARACTERS WITHOUT CLAIM TO ANY PARTICULAR FONT, STYLE, SIZE, OR COLOR.

NO CLAIM IS MADE TO THE EXCLUSIVE RIGHT TO USE TRADE SHOW, APART FROM THE MARK AS SHOWN.

FOR PROVIDING ELECTRICAL CONTRACTOR AND LIGHTING CONTRACTOR SERVICES AT TRADE SHOWS, EXHIBITIONS, CONCERTS, EXPOSITIONS, AND SPECIAL EVENTS (U.S. CLS. 100, 103 AND 106).

ERNEST SHOSHO, EXAMINING ATTORNEY

CLASS 37—(Continued).

SN 76-604,141. VENVEST, INC., ST. LOUIS, MO. FILED 7-27-2004.

THE PRINCE OF PLUMBING

THE MARK CONSISTS OF STANDARD CHARACTERS WITHOUT CLAIM TO ANY PARTICULAR FONT, STYLE, SIZE, OR COLOR.

OWNER OF U.S. REG. NO. 2,896,187.

NO CLAIM IS MADE TO THE EXCLUSIVE RIGHT TO USE PLUMBING, APART FROM THE MARK AS SHOWN.

FOR REPAIR, MAINTENANCE, AND INSTALLATION SERVICES IN THE FIELD OF PLUMBING, HEATING, VENTILATION, AND AIR CONDITIONING; ELECTRICAL REPAIR, MAINTENANCE, AND INSTALLATION OF ELECTRICAL WIRING, OUTLETS, LIGHT FIXTURES, AND ELECTRICAL PANELS (U.S. CLS. 100, 103 AND 106).

FIRST USE 5-0-2003; IN COMMERCE 12-0-2003.
REBECCA SMITH, EXAMINING ATTORNEY

SN 76-607,502. BONADIO, KAREN, LOS ANGELES, CA. FILED 8-18-2004.

WALLPAPERGURU

THE MARK CONSISTS OF STANDARD CHARACTERS WITHOUT CLAIM TO ANY PARTICULAR FONT, STYLE, SIZE, OR COLOR.

FOR CONSULTING IN THE FIELD OF WALLPAPER INSTALLATION AND RESTORATION; INSTALLATION AND RESTORATIONS OF CUSTOM AND HISTORIC WALL COVERINGS AND MURALS (U.S. CLS. 100, 103 AND 106).

FIRST USE 6-0-2001; IN COMMERCE 6-0-2001.
HOWARD B. LEVINE, EXAMINING ATTORNEY

SN 76-615,212. DELAGRANGE HOMES, INC., FORT WAYNE, IN. FILED 10-12-2004.

DELAGRANGE HOMES

THE MARK CONSISTS OF STANDARD CHARACTERS WITHOUT CLAIM TO ANY PARTICULAR FONT, STYLE, SIZE, OR COLOR.

SEC. 2(F).

FOR COMMERCIAL AND RESIDENTIAL REAL ESTATE DEVELOPMENT SERVICES; CONSTRUCTION SERVICES, NAMELY, PLANNING, LAYING OUT AND CONSTRUCTION OF COMMERCIAL AND RESIDENTIAL COMMUNITIES AND BUILDINGS, INCLUDING SINGLE FAMILY HOMES, APARTMENTS, CONDOMINIUMS AND VILLAMINIUMS (U.S. CLS. 100, 103 AND 106).

FIRST USE 0-0-1961; IN COMMERCE 0-0-1961.
HEATHER THOMPSON, EXAMINING ATTORNEY

CLASS 37—(Continued).

SN 76-617,898. ROGERS CORPORATION, INC., WILMINGTON, NC. FILED 10-25-2004.

ADVANCED MAINTENANCE ON-SITE VEHICLE SERVICES

THE MARK CONSISTS OF STANDARD CHARACTERS WITHOUT CLAIM TO ANY PARTICULAR FONT, STYLE, SIZE, OR COLOR.

NO CLAIM IS MADE TO THE EXCLUSIVE RIGHT TO USE "MAINTENANCE ON-SITE VEHICLE SERVICES", APART FROM THE MARK AS SHOWN.

SEC. 2(F).

FOR CAR AND TRUCK MOBILE REPAIR AND MAINTENANCE SERVICES (U.S. CLS. 100, 103 AND 106).

FIRST USE 4-1-1999; IN COMMERCE 4-1-1999.

ELISSA GARBER KON, EXAMINING ATTORNEY

SN 76-620,404. SELECTIVE SEAMLESS SIDING COMPANY, NAPERVILLE, IL. FILED 11-15-2004.

MELT ICE AND SNOW IN A SNAP WITH HEATER CAP

THE MARK CONSISTS OF STANDARD CHARACTERS WITHOUT CLAIM TO ANY PARTICULAR FONT, STYLE, SIZE, OR COLOR.

FOR PROVIDING WINTER GUTTER PROTECTION (U.S. CLS. 100, 103 AND 106).

FIRST USE 10-0-2002; IN COMMERCE 10-0-2002.

JEAN IM, EXAMINING ATTORNEY

SN 76-621,594. NOBLE HOUSE LLC, AVENTURA, FL. FILED 11-19-2004.

NOBLEHOUSE

THE MARK CONSISTS OF STANDARD CHARACTERS WITHOUT CLAIM TO ANY PARTICULAR FONT, STYLE, SIZE, OR COLOR.

FOR REAL ESTATE DEVELOPMENT (U.S. CLS. 100, 103 AND 106).

FIRST USE 10-10-2004; IN COMMERCE 10-13-2004.

JEFFERY COWARD, EXAMINING ATTORNEY

CLASS 37—(Continued).

SN 76-621,618. TCG INTERNATIONAL INC., BRITISH COLUMBIA V5H 4M2, CANADA, FILED 11-22-2004.

SPEEDY

THE MARK CONSISTS OF STANDARD CHARACTERS WITHOUT CLAIM TO ANY PARTICULAR FONT, STYLE, SIZE, OR COLOR.

OWNER OF U.S. REG. NOS. 1,502,513, 2,801,219 AND OTHERS.

FOR INSTALLATION OF GLASS IN AUTOMOBILES, RESIDENCES AND COMMERCIAL ESTABLISHMENTS (U.S. CLS. 100, 103 AND 106).

FIRST USE 10-1-1984; IN COMMERCE 10-1-1984.
ZHALEH DELANEY, EXAMINING ATTORNEY

SN 76-621,790. CITTA, LLC, CHICAGO, IL, FILED 11-22-2004.

HAVE YOU HAD IT LATELY?

THE MARK CONSISTS OF STANDARD CHARACTERS WITHOUT CLAIM TO ANY PARTICULAR FONT, STYLE, SIZE, OR COLOR.

FOR REAL ESTATE DEVELOPMENT (U.S. CLS. 100, 103 AND 106).

FIRST USE 0-0-1996; IN COMMERCE 0-0-1996.
NICHOLAS ALTREE, EXAMINING ATTORNEY

SN 76-622,467. CORPORATE ROTABLE & SUPPLY, INC., FORT LAUDERDALE, FL, FILED 11-29-2004.

THRUST-TECH AVIATION

THE MARK CONSISTS OF STANDARD CHARACTERS WITHOUT CLAIM TO ANY PARTICULAR FONT, STYLE, SIZE, OR COLOR.

NO CLAIM IS MADE TO THE EXCLUSIVE RIGHT TO USE "AVIATION", APART FROM THE MARK AS SHOWN.

FOR FAA CERTIFIED REPAIR STATIONS WHICH ENGAGE IN THE BUSINESS OF REPAIR AND REFURBISHMENT OF JET PARTS (U.S. CLS. 100, 103 AND 106).

FIRST USE 5-13-1985; IN COMMERCE 5-13-1985.
CHERYL CLAYTON, EXAMINING ATTORNEY

CLASS 37—(Continued).

SN 76-625,315. APOTHECARY STEAM CLEANING & RESTORATION, INC., RICHFIELD, MN, FILED 12-21-2004.

APOTHECARY

THE MARK CONSISTS OF STANDARD CHARACTERS WITHOUT CLAIM TO ANY PARTICULAR FONT, STYLE, SIZE, OR COLOR.

FOR COMMERCIAL AND RESIDENTIAL BUILDING CLEANING, REPAIR AND RESTORATION SERVICES, AND GENERAL CONTRACTING THEREFOR (U.S. CLS. 100, 103 AND 106).

FIRST USE 10-0-2004; IN COMMERCE 10-0-2004.
JULIE GUTTADAURO, EXAMINING ATTORNEY

SN 76-625,843. SAVE MACHINE CO., LTD., FUJISAWA CITY, KANAGAWA, JAPAN, FILED 12-27-2004.

PARABOLA SYSTEM

OWNER OF JAPAN REG. NO. 4780050, DATED 6-18-2004, EXPIRES 6-18-2014.

NO CLAIM IS MADE TO THE EXCLUSIVE RIGHT TO USE SYSTEM, APART FROM THE MARK AS SHOWN.

FOR CONSTRUCTION, GENERAL BUILDING CONSTRUCTION WORKS, DREDGING, GENERAL CIVIL ENGINEERING WORKS, ROAD PAVING, MASONRY, GLAZING (GLASSWORK), STEEL STRUCTURE CONSTRUCTION WORKS, PLASTERING, CARPENTRY, TILE LAYING, BRICKLAYING OR BLOCK LAYING, JOINERY, BUILDING REINFORCING, PAINTING, SCAFFOLDING, EARTHWORKS OR CONCRETE CONSTRUCTIONS, UPHOLSTERING, METAL PLATING, BUILDING DAMP-PROOFING AND ROOFING SERVICES (U.S. CLS. 100, 103 AND 106).

CAROLINE WEIMER, EXAMINING ATTORNEY

SN 76-626,875. VENVEST, INC., ST. LOUIS, MO, FILED 1-4-2005.

GOOD GUYS HVAC SERVICE

THE MARK CONSISTS OF STANDARD CHARACTERS WITHOUT CLAIM TO ANY PARTICULAR FONT, STYLE, SIZE, OR COLOR.

OWNER OF U.S. REG. NO. 2,666,894.

NO CLAIM IS MADE TO THE EXCLUSIVE RIGHT TO USE "HVAC SERVICE", APART FROM THE MARK AS SHOWN.

FOR REPAIR, MAINTENANCE AND INSTALLATION SERVICES IN THE FIELD OF PLUMBING, HEATING, VENTILATION AND AIR CONDITIONING (U.S. CLS. 100, 103 AND 106).

TRACY WHITAKER-BOWN, EXAMINING ATTORNEY

CLASS 37—(Continued).

SN 78-311,751. MARC MCGUIRE, SAN MARCOS, CA. FILED 10-9-2003.



THE COLOR(S) GREEN AND BLACK IS/ARE CLAIMED AS A FEATURE OF THE MARK.

THE COLORS GREEN AND BLACK ARE CLAIMED AS DISTINCTIVE FEATURES OF THE MARK, WITH THE COLOR GREEN APPEARING IN THE CLOVERLEAF DESIGN, AND THE COLOR BLACK APPEARING IN THE LETTERS "IS".

FOR CERAMIC TILE AND STONE FLOORING INSTALLATION SERVICES (U.S. CLS. 100, 103 AND 106).

FIRST USE 2-15-1985; IN COMMERCE 2-15-1985.
RON FAIRBANKS, EXAMINING ATTORNEY

SN 78-321,626. DUNSHEA HOLDINGS INC, ESCONDIDO, CA. FILED 10-31-2003.

MASTERGLASS WINDSHIELD REPAIR AND REPLACEMENT

NO CLAIM IS MADE TO THE EXCLUSIVE RIGHT TO USE "WINDSHIELD REPAIR AND REPLACEMENT", APART FROM THE MARK AS SHOWN.

FOR AUTO GLASS REPAIR AND REPLACEMENT SERVICES (U.S. CLS. 100, 103 AND 106).
MARTHA FROMM, EXAMINING ATTORNEY

SN 78-333,176. MURPHY, PETER, OCEANSIDE, CA. FILED 11-25-2003.



NO CLAIM IS MADE TO THE EXCLUSIVE RIGHT TO USE "WALLPAPER REMOVAL", APART FROM THE MARK AS SHOWN.

FOR WALLPAPER REMOVAL, STRIPPING, AND STEAMING SERVICES FOR COMMERCIAL AND RESIDENTIAL CUSTOMERS (U.S. CLS. 100, 103 AND 106).

FIRST USE 11-1-2003; IN COMMERCE 11-1-2003.
LANA PHAM, EXAMINING ATTORNEY

CLASS 37—(Continued).

SN 78-356,858. CAPTAIN CLEAN, INC., SHERIDAN, WY. FILED 1-23-2004.



NO CLAIM IS MADE TO THE EXCLUSIVE RIGHT TO USE "CLEAN", APART FROM THE MARK AS SHOWN.

THE COLOR(S) DARK BLUE IS/ARE CLAIMED AS A FEATURE OF THE MARK.

THE MARK CONSISTS OF A DESIGN CONSISTING OF A SAILOR AND BOAT ON WATER WITH A BORDER AND WORDS "CAPTAIN CLEAN". THE COLOR DARK BLUE APPEARS ON THE BORDER, THE WATER, THE BOTTOM OF THE BOAT, THE SAILOR'S SUIT AND BRIM OF THE SAILOR'S CAP.

FOR PROFESSIONAL CLEANING SERVICES IN THE NATURE OF JANITORIAL SERVICES; NAMELY, CARPET CLEANING, FURNITURE CLEANING, CHIMNEY CLEANING, FURNACE AND DUCT CLEANING, FIRE AND WATER DAMAGE CLEANING, DRYING AND RESTORATION IN THE NATURE OF BUILDING CLEANUP AND REPAIR; INTERIOR, EXTERIOR BUILDING CLEANING, AND NEW CONSTRUCTION CLEANING, SPECIFICALLY INTERNAL AND EXTERNAL SURFACES OF BUILDINGS, INDUSTRIAL PREMISES, RESIDENTIAL HOUSES, NAMELY CEILING CLEANING, WALL CLEANING, AND FLOOR CLEANING (U.S. CLS. 100, 103 AND 106).

FIRST USE 0-0-1973; IN COMMERCE 0-0-1973.
PRISCILLA MILTON, EXAMINING ATTORNEY

SN 78-370,270. ALTIMA HOMES, INC, SOUTH BARRINGTON, IL. FILED S.R. 2-18-2004; AM. P.R. 10-15-2004.

BUILDING A BETTER AMERICA ONE DREAM AT A TIME

THE MARK CONSISTS OF STANDARD CHARACTERS WITHOUT CLAIM TO ANY PARTICULAR FONT, STYLE, SIZE, OR COLOR.

FOR REAL ESTATE DEVELOPMENT (U.S. CLS. 100, 103 AND 106).

FIRST USE 2-16-2001; IN COMMERCE 2-16-2001.
KAREN K. BUSH, EXAMINING ATTORNEY

CLASS 37—(Continued).

SN 78-376,038. EDA GULF PROPERTIES, LLC, SANIBEL ISLAND, FL. FILED 2-29-2004.

Gulf Hideaway

THE MARK CONSISTS OF STANDARD CHARACTERS WITHOUT CLAIM TO ANY PARTICULAR FONT, STYLE, SIZE, OR COLOR.

FOR REAL ESTATE DEVELOPMENT (U.S. CLS. 100, 103 AND 106).

FIRST USE 6-27-2002; IN COMMERCE 6-27-2002.
HOWARD SMIGA, EXAMINING ATTORNEY

SN 78-385,827. WALLSTREETMAN, INC, LOS ANGELES, CA. FILED 3-17-2004.

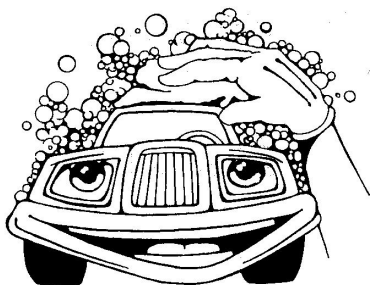

FOR CAR WASHING SERVICES; CAR WASHING SERVICES BY HAND; AUTOMOBILE DETAILING SERVICES (U.S. CLS. 100, 103 AND 106).

FIRST USE 11-1-2000; IN COMMERCE 11-1-2000.
MICHAEL ENGEL, EXAMINING ATTORNEY

SN 78-400,250. EASE E-WASTE INC., SANTA ANA, CA. FILED 4-12-2004.



NO CLAIM IS MADE TO THE EXCLUSIVE RIGHT TO USE INC., APART FROM THE MARK AS SHOWN.

FOR ENVIRONMENTAL REMEDIATION SERVICES, NAMELY, ENVIRONMENTALLY RESPONSIBLE WASTE DISPOSAL OF OBSOLETE CONSUMER ELECTRONICS EQUIPMENT FROM COMPANIES WITH THIS NEED (U.S. CLS. 100, 103 AND 106).

FIRST USE 9-10-2003; IN COMMERCE 9-10-2003.
SAMUEL E. SHARPER JR., EXAMINING ATTORNEY

CLASS 37—(Continued).

SN 78-400,408. A & W HOLDINGS, INC., MERIDIAN, MS. FILED 4-12-2004.

OLDE TOWNE CLEANERS

THE MARK CONSISTS OF STANDARD CHARACTERS WITHOUT CLAIM TO ANY PARTICULAR FONT, STYLE, SIZE, OR COLOR.

NO CLAIM IS MADE TO THE EXCLUSIVE RIGHT TO USE "CLEANERS", APART FROM THE MARK AS SHOWN.

FOR LAUNDRY AND DRYCLEANING FOR CLOTHING, CLOTHING, FABRIC AND LINENS (U.S. CLS. 100, 103 AND 106).

REBECCA GILBERT, EXAMINING ATTORNEY

SN 78-402,001. NATURALLY MAID, KOKOMO, IN. FILED 4-14-2004.

NATURALLY MAID

THE MARK CONSISTS OF STANDARD CHARACTERS WITHOUT CLAIM TO ANY PARTICULAR FONT, STYLE, SIZE, OR COLOR.

NO CLAIM IS MADE TO THE EXCLUSIVE RIGHT TO USE MAID, APART FROM THE MARK AS SHOWN.

FOR RESIDENTIAL AND COMMERCIAL CLEANING SERVICES (U.S. CLS. 100, 103 AND 106).

FIRST USE 11-21-2003; IN COMMERCE 11-21-2003.
ROBERT C. CLARK JR., EXAMINING ATTORNEY

CLASS 37—(Continued).

SN 78-409,465. PLAYERS TURF INTERNATIONAL, CHILLICOTHE, IL. FILED 4-28-2004.

CLASS 37—(Continued).

SN 78-409,764. LESTER BUILDING SYSTEMS, LLC, LESTER PRAIRIE, MN. FILED 4-28-2004.

PLAYERS TURF



THE MARK CONSISTS OF STANDARD CHARACTERS WITHOUT CLAIM TO ANY PARTICULAR FONT, STYLE, SIZE, OR COLOR.

NO CLAIM IS MADE TO THE EXCLUSIVE RIGHT TO USE "TURF", APART FROM THE MARK AS SHOWN.

FOR INSTALLATION OF SYNTHETIC SURFACES, NAMELY, GOLF GREENS, TEE BOXES, DRIVING RANGE TEE LINE, FAIRWAY TURF, SOCCER FIELDS, TENNIS COURTS, FIELD HOCKEY, LACROSSE, FOOTBALL FIELDS, BASEBALL FIELDS, RECREATIONAL SURFACES, HOME LANDSCAPING (U.S. CLS. 100, 103 AND 106).

FIRST USE 0-0-2000; IN COMMERCE 0-0-2000.
JEFF DEFORD, EXAMINING ATTORNEY

OWNER OF U.S. REG. NOS. 862,254, 1,708,692 AND OTHERS.

NO CLAIM IS MADE TO THE EXCLUSIVE RIGHT TO USE "BUILDINGS", APART FROM THE MARK AS SHOWN.

FOR CUSTOM CONSTRUCTION AND CONSTRUCTION PLANNING OF PREFABRICATED WOOD FRAME BUILDINGS, NAMELY, HOG HOUSES, DAIRY BARNs, POULTRY HOUSES, MACHINE AND UTILITY SHEDS, CATTLE SHEDS, HORSE STABLES, SHEEP BUILDINGS, AGRICULTURAL BUILDINGS AND COMMERCIAL/INDUSTRIAL BUILDINGS (U.S. CLS. 100, 103 AND 106).

FIRST USE 1-0-2004; IN COMMERCE 1-0-2004.
SAMUEL E. SHARPER JR., EXAMINING ATTORNEY

SN 78-409,471. PLAYERS TURF INTERNATIONAL, CHILLICOTHE, IL. FILED 4-28-2004.

SN 78-410,394. WHITECOTTON, JASON P., LONG BEACH, CA. FILED 4-29-2004.



PIPEDREAM PLUMBING

NO CLAIM IS MADE TO THE EXCLUSIVE RIGHT TO USE "TURF", APART FROM THE MARK AS SHOWN.

FOR INSTALLATION OF SYNTHETIC SURFACES, NAMELY, GOLF GREENS, TEE BOXES, DRIVING RANGE TEE LINE, FAIRWAY TURF, SOCCER FIELDS, TENNIS COURTS, FIELD HOCKEY, LACROSSE, FOOTBALL FIELDS, BASEBALL FIELDS, RECREATIONAL SURFACES, HOME LANDSCAPING (U.S. CLS. 100, 103 AND 106).

FIRST USE 0-0-2000; IN COMMERCE 0-0-2000.
JEFF DEFORD, EXAMINING ATTORNEY

THE MARK CONSISTS OF STANDARD CHARACTERS WITHOUT CLAIM TO ANY PARTICULAR FONT, STYLE, SIZE, OR COLOR.

NO CLAIM IS MADE TO THE EXCLUSIVE RIGHT TO USE "PLUMBING", APART FROM THE MARK AS SHOWN, FOR PLUMBING SERVICES (U.S. CLS. 100, 103 AND 106).

FIRST USE 11-1-2003; IN COMMERCE 11-1-2003.
WON TEAK OH, EXAMINING ATTORNEY

CLASS 37—(Continued).

SN 78-423,188. ANDONIAN, MICHAEL, KIRKLAND, WA.
FILED 5-21-2004.

ANDONIAN

THE MARK CONSISTS OF STANDARD CHARACTERS WITHOUT CLAIM TO ANY PARTICULAR FONT, STYLE, SIZE, OR COLOR.

SEC. 2(F).

FOR CARPET AND RUG INSTALLATION, CLEANING, RESTORATION AND REPAIR (U.S. CLS. 100, 103 AND 106).

FIRST USE 1-31-1995; IN COMMERCE 1-31-1995.

CHRISTOPHER BUONGIORNO, EXAMINING ATTORNEY

CLASS 37—(Continued).

SN 78-438,746. GAMBLIN, JEFFREY E, BRIGHTON, IL.
FILED 6-21-2004.

MY TECHNICIANS ARE
CLEAN-CUT, DRUG-
FREE AND
BACKGROUND
CHECKED! WHAT
OTHER COMPANY CAN
MAKE THIS BOLD
STATEMENT?

THE MARK CONSISTS OF STANDARD CHARACTERS WITHOUT CLAIM TO ANY PARTICULAR FONT, STYLE, SIZE, OR COLOR.

FOR RESIDENTIAL AND COMMERCIAL PLUMBING SERVICES; HEATING, AIR CONDITIONING AND DUCT WORK REPAIR AND INSTALLATION SERVICES (U.S. CLS. 100, 103 AND 106).

STACY WAHLBERG, EXAMINING ATTORNEY

SN 78-431,533. MCGUCKIN DRILLING INCORPORATED,
PHOENIX, AZ. FILED 6-8-2004.

TORRENT RESOURCES

THE MARK CONSISTS OF STANDARD CHARACTERS WITHOUT CLAIM TO ANY PARTICULAR FONT, STYLE, SIZE, OR COLOR.

NO CLAIM IS MADE TO THE EXCLUSIVE RIGHT TO USE "RESOURCES", APART FROM THE MARK AS SHOWN.

FOR INSTALLATION OF DRYWELL DRAINAGE SYSTEMS, SEWAGE DISPOSAL SYSTEMS, AND RECHARGING WELLS FOR ENVIRONMENTAL REMEDIATION AND MUNICIPAL RECHARGE (U.S. CLS. 100, 103 AND 106).

ANN E. SAPPENFIELD, EXAMINING ATTORNEY

SN 78-456,654. KRIEGL, JEFFREY W., DOWNINGTOWN,
PA. FILED 7-26-2004.

Marsh Creek Maids

THE MARK CONSISTS OF STANDARD CHARACTERS WITHOUT CLAIM TO ANY PARTICULAR FONT, STYLE, SIZE, OR COLOR.

NO CLAIM IS MADE TO THE EXCLUSIVE RIGHT TO USE "MAIDS", APART FROM THE MARK AS SHOWN.

FOR CLEANING OF RESIDENTIAL HOUSES (U.S. CLS. 100, 103 AND 106).

CIMMERIAN COLEMAN, EXAMINING ATTORNEY

CLASS 37—(Continued).

SN 78-466,812. MIKIT CALIFORNIA, INC., ENCINO, CA. FILED 8-12-2004.

CLASS 37—(Continued).

SN 78-467,951. LONG, JOHN M., RIDGELAND, MS. FILED 8-16-2004.

**When Things Go
Wrong...Call Long**

**Where there's a
will, there's a way**

THE MARK CONSISTS OF STANDARD CHARACTERS WITHOUT CLAIM TO ANY PARTICULAR FONT, STYLE, SIZE, OR COLOR.

FOR ELECTRICAL CONTRACTOR SERVICES AND REPAIR OF ELECTRIC GENERATORS, ELECTRIC MOTORS FOR MACHINES, COVERS FOR ELECTRIC OUTLETS, DUCTING FOR ELECTRIC CABLES, ELECTRIC CABLES, ELECTRIC CAPACITORS, ELECTRIC CONNECTORS, ELECTRIC CONTROL PANELS, ELECTRIC CORDS, ELECTRIC CURRENT SWITCHES, ELECTRIC DOOR BELLS, ELECTRIC DOOR CHIMES, ELECTRIC FUSE BOXES, ELECTRIC JUNCTION BOXES, ELECTRIC LIGHT DIMMERS, ELECTRIC LIGHT SWITCHES, ELECTRIC LUMINESCENT DISPLAY PANELS, ELECTRIC OR ELECTRONIC PROXIMITY SENSORS, ELECTRIC PLUGS, ELECTRIC RELAYS, ELECTRIC SIGNS, ELECTRIC SOCKETS, ELECTRIC SWITCH PLATES, ELECTRIC SWITCHES, ELECTRIC TRANSFORMERS, ELECTRIC WIRES AND CABLES, FLUORESCENT LAMP BALLAST FOR ELECTRIC LIGHTS, FUSES FOR ELECTRIC CURRENT, ELECTRICAL CANDELABRAS, ELECTRIC COOKING OVENS, ELECTRIC COOKTOPS, ELECTRIC FANS, ELECTRIC LIGHT BULBS, ELECTRIC LIGHTING FIXTURES, ELECTRIC LUMINARIES, ELECTRIC NIGHT LIGHTS, ELECTRIC SPACE HEATERS, ELECTRIC STOVES, ELECTRIC TRACK LIGHTING UNITS, FLUORESCENT ELECTRIC LIGHT BULBS, SOCKETS FOR ELECTRIC LIGHTS, ELECTRIC LIGHTING APPARATUS, AND ELECTRIC MOTORS (U.S. CLS. 100, 103 AND 106).

FIRST USE 6-15-1997; IN COMMERCE 6-15-1997.
LANA PHAM, EXAMINING ATTORNEY

THE MARK CONSISTS OF STANDARD CHARACTERS WITHOUT CLAIM TO ANY PARTICULAR FONT, STYLE, SIZE, OR COLOR.

FOR CONSTRUCTION SERVICES, NAMELY, CUSTOM CONSTRUCTION OF RESIDENTIAL HOUSES (U.S. CLS. 100, 103 AND 106).

ALICE BENMAMAN, EXAMINING ATTORNEY

CLASS 37—(Continued).

SN 78-472,470. ANDRADE, VERONICA, AURORA, IL.
FILED 8-24-2004.

CLASS 37—(Continued).

SN 78-483,152. MARSH, PETER R., BEAVERTON, OR. FILED
9-14-2004.



EASYFLOW

THE MARK CONSISTS OF STANDARD CHARACTERS WITHOUT CLAIM TO ANY PARTICULAR FONT, STYLE, SIZE, OR COLOR.

FOR HEATING, AIR CONDITIONING, AND VENTILATION AIR DUCT CLEANING AND SANITIZING; DRYER VENT CLEANING (U.S. CLS. 100, 103 AND 106).
DARRYL SPRUILL, EXAMINING ATTORNEY

NO CLAIM IS MADE TO THE EXCLUSIVE RIGHT TO USE "HOMES", APART FROM THE MARK AS SHOWN.

FOR RESIDENTIAL AND COMMERCIAL BUILDING, LAYOUT AND CONSTRUCTION; HOME BUILDING SERVICES AND PLANNING; GENERAL CONTRACTOR SERVICES IN THE FIELD OF BUILDING CONSTRUCTION AND DEVELOPMENT, AND REPAIR, NAMELY CARPENTRY, REMODELING/RENOVATION, CARPETING/FLOORING, CAULKING/GLAZING, GRAFFITI REMOVAL, PAINTING, PARKING LOT STRIPING, SANDBLASTING, WATER-BLASTING/PRESSURE WASHING, AND WALL-COVERING (U.S. CLS. 100, 103 AND 106).

FIRST USE 1-1-1969; IN COMMERCE 1-1-1969.
MARK RADEMACHER, EXAMINING ATTORNEY

SN 78-475,204. MINTIE CORPORATION, LOS ANGELES, CA.
FILED 8-27-2004.

SN 78-484,683. COPPERLEAF, HELENA, MT. FILED 9-16-
2004.

THE MARK CONSISTS OF THE WORD "MINTIE" AND THREE VERTICAL LINES ABOVE THE WORD FORMING THE STYLIZED LETTER "M".

FOR SERVICES OF SPECIALIZED CLEANING, MAINTENANCE AND REHABILITATION OF MACHINES, ENCLOSURES, HEATING, VENTILATING AND AIR CONDITIONING EQUIPMENT AND LIGHTING EQUIPMENT (U.S. CLS. 100, 103 AND 106).

ANGELA M. MICHELI, EXAMINING ATTORNEY

SOPHISTICATED SURFACE FINISHES

THE MARK CONSISTS OF STANDARD CHARACTERS WITHOUT CLAIM TO ANY PARTICULAR FONT, STYLE, SIZE, OR COLOR.

NO CLAIM IS MADE TO THE EXCLUSIVE RIGHT TO USE "SURFACE FINISHES", APART FROM THE MARK AS SHOWN.

FOR PAINTING CONTRACTOR SERVICES FEATURING DECORATIVE PAINTING, WALL TREATMENT, CUSTOM EMBOSSMENT AND STENCILING; AND PLASTERING CONTRACTOR SERVICES FEATURING PLASTERING AND WALL GLAZING (U.S. CLS. 100, 103 AND 106).

FIRST USE 1-0-2002; IN COMMERCE 3-0-2002.
CHARLES L. JENKINS, EXAMINING ATTORNEY

CLASS 37—(Continued).

SN 78-496,556. SANDLIN HOMES INC., FT. WORTH, TX. FILED 10-7-2004.

SANDLIN CUSTOM HOMES

THE MARK CONSISTS OF STANDARD CHARACTERS WITHOUT CLAIM TO ANY PARTICULAR FONT, STYLE, SIZE, OR COLOR.

NO CLAIM IS MADE TO THE EXCLUSIVE RIGHT TO USE "CUSTOM HOMES", APART FROM THE MARK AS SHOWN.

SEC. 2(F).
FOR NEW RESIDENTIAL CUSTOM CONSTRUCTION OF HOMES (U.S. CLS. 100, 103 AND 106).
FIRST USE 1-1-1995; IN COMMERCE 1-1-1995.
ODESSA BIBBINS, EXAMINING ATTORNEY

CLASS 37—(Continued).

SN 78-504,440. CLEAR IMAGE AUTO GLASS, INC., GRAND RAPIDS, MI. FILED 10-22-2004.

CLEAR IMAGE

THE MARK CONSISTS OF STANDARD CHARACTERS WITHOUT CLAIM TO ANY PARTICULAR FONT, STYLE, SIZE, OR COLOR.

FOR VEHICLE GLASS REPAIR AND REPLACEMENT SERVICES (U.S. CLS. 100, 103 AND 106).

FIRST USE 5-2-2003; IN COMMERCE 5-2-2003.
RONALD MCMORROW, EXAMINING ATTORNEY

SN 78-507,716. SUN MICROSYSTEMS, INC., SANTA CLARA, CA. FILED 10-28-2004.



FOR COMPUTER SERVICES, NAMELY, INSTALLATION AND REPAIR OF COMPUTERS, COMPUTER HARDWARE, COMPUTER PERIPHERALS, COMPUTER SYSTEMS, COMPUTER NETWORKS AND COMPUTER-RELATED EQUIPMENT (U.S. CLS. 100, 103 AND 106).
DAVID MURRAY, EXAMINING ATTORNEY

SN 78-502,292. KLEEN SEAL FRANCHISE SYSTEMS, LLC, METUCHEN, NJ. FILED 10-19-2004.



NO CLAIM IS MADE TO THE EXCLUSIVE RIGHT TO USE "PREMIUM DRIVEWAY PROTECTION" AND "DRIVEWAY SEALING", APART FROM THE MARK AS SHOWN.

THE MARK CONSISTS OF THE WORDS "KLEENSEAL DRIVEWAY SEALING PREMIUM DRIVEWAY PROTECTION" AND A LOGO INCLUDING A SEAL HOLDING A TOOL.

FOR ASPHALT DRIVEWAY SEALING SERVICES (U.S. CLS. 100, 103 AND 106).
FIRST USE 3-31-2003; IN COMMERCE 3-31-2003.
RICHARD WHITE, EXAMINING ATTORNEY

SN 78-508,063. COLBERT, JAMES, NORWOOD, PA. FILED 10-29-2004.

**ALWAYS ON TIME,
ALWAYS FIXED FINE**

THE MARK CONSISTS OF STANDARD CHARACTERS WITHOUT CLAIM TO ANY PARTICULAR FONT, STYLE, SIZE, OR COLOR.

FOR REPAIR, MAINTENANCE AND INSTALLATION SERVICES IN THE FIELD OF AIR CONDITIONING, VENTILATION, HEATING AND PLUMBING (U.S. CLS. 100, 103 AND 106).

FIRST USE 2-28-1997; IN COMMERCE 2-0-2004.
JOANNA DUKOVIC, EXAMINING ATTORNEY

CLASS 37—(Continued).

SN 78-510,062. SHADDOCK BUILDERS & DEVELOPERS, INC., DBA SOTHERBY HOMES, PLANO, TX. FILED 11-2-2004.



FOR CUSTOM CONSTRUCTION OF HOMES (U.S. CLS. 100, 103 AND 106).
FIRST USE 4-0-1995; IN COMMERCE 4-0-1995.
ELIZABETH J. WINTER, EXAMINING ATTORNEY

CLASS 37—(Continued).

SN 78-513,087. STARCHOICE, LLC, WEST COVINA, CA. FILED 11-8-2004.

STARCHOICE

THE MARK CONSISTS OF STANDARD CHARACTERS WITHOUT CLAIM TO ANY PARTICULAR FONT, STYLE, SIZE, OR COLOR.

FOR CARPET AND UPHOLSTERY CLEANING; WATER DAMAGE REPAIR AND WATER DAMAGE RESTORATION SERVICES (U.S. CLS. 100, 103 AND 106).
FIRST USE 9-30-2004; IN COMMERCE 11-8-2004.
MICHELLE DUBOIS, EXAMINING ATTORNEY

SN 78-512,243. KING, DONALD, NAPERVILLE, IL. FILED 11-5-2004.



NO CLAIM IS MADE TO THE EXCLUSIVE RIGHT TO USE "DOOR REPAIR.COM", APART FROM THE MARK AS SHOWN.

FOR MAINTENANCE AND/OR REPAIR OF DOORS (U.S. CLS. 100, 103 AND 106).
FIRST USE 3-1-2001; IN COMMERCE 3-1-2001.
AMY ALFIERI, EXAMINING ATTORNEY

SN 78-514,226. LUIGI SQUEEGEE, LLC, FAIRFIELD, CT. FILED 11-9-2004.



FOR WINDOW CLEANING (U.S. CLS. 100, 103 AND 106).

FIRST USE 7-8-2004; IN COMMERCE 7-8-2004.
GEORGIA CARTY, EXAMINING ATTORNEY

SN 78-512,848. NEW TOWN BUILDERS LLC, HIGHLANDS RANCH, CO. FILED 11-8-2004.

**THINKING OUTSIDE
THE BEIGE BOX**

THE MARK CONSISTS OF STANDARD CHARACTERS WITHOUT CLAIM TO ANY PARTICULAR FONT, STYLE, SIZE, OR COLOR.

FOR HOME BUILDING (U.S. CLS. 100, 103 AND 106).
FIRST USE 2-1-2004; IN COMMERCE 2-1-2004.
DANIEL CAPSHAW, EXAMINING ATTORNEY

SN 78-514,972. GENERAL PEST CONTROL, INC., DURANGO, CO. FILED 11-10-2004.



General Pest Control

NO CLAIM IS MADE TO THE EXCLUSIVE RIGHT TO USE GENERAL PEST CONTROL, APART FROM THE MARK AS SHOWN.

FOR COMPREHENSIVE PEST CONTROL SERVICES (U.S. CLS. 100, 103 AND 106).
FIRST USE 3-1-1949; IN COMMERCE 3-1-1949.
KAREN K. BUSH, EXAMINING ATTORNEY

CLASS 37—(Continued).

SN 78-515,032. ENTRYPOINT, LLC, ZEELAND, MI. FILED 11-11-2004.

ENTRYPOINT

THE MARK CONSISTS OF STANDARD CHARACTERS WITHOUT CLAIM TO ANY PARTICULAR FONT, STYLE, SIZE, OR COLOR.

OWNER OF U.S. REG. NO. 2,406,942.
FOR INSTALLATION AND REPLACEMENT OF DOOR GLASS (U.S. CLS. 100, 103 AND 106).
FIRST USE 9-1-2000; IN COMMERCE 9-1-2000.
GISELLE AGOSTO, EXAMINING ATTORNEY

SN 78-515,033. ENTRYPOINT, LLC, ZEELAND, MI. FILED 11-11-2004.

**YOUR DOOR - OUR
GLASS**

THE MARK CONSISTS OF STANDARD CHARACTERS WITHOUT CLAIM TO ANY PARTICULAR FONT, STYLE, SIZE, OR COLOR.

FOR INSTALLATION AND REPLACEMENT OF DOOR GLASS (U.S. CLS. 100, 103 AND 106).
FIRST USE 9-13-2004; IN COMMERCE 9-13-2004.
GISELLE AGOSTO, EXAMINING ATTORNEY

SN 78-517,374. DORTRONIC SERVICE INC., BROOKLYN HEIGHTS, OH. FILED 11-16-2004.

DOOR DOCTOR

THE MARK CONSISTS OF STANDARD CHARACTERS WITHOUT CLAIM TO ANY PARTICULAR FONT, STYLE, SIZE, OR COLOR.

NO CLAIM IS MADE TO THE EXCLUSIVE RIGHT TO USE DOOR, APART FROM THE MARK AS SHOWN.
FOR INSTALLATION, MAINTENANCE AND REPAIR OF OVERHEAD GARAGE DOORS AND OPERATORS (U.S. CLS. 100, 103 AND 106).
FIRST USE 2-24-1976; IN COMMERCE 2-24-1976.
MARGERY A. TIERNEY, EXAMINING ATTORNEY

CLASS 37—(Continued).

SN 78-517,390. THE GREEN CLUB, LLC, EDGARTOWN, MA. FILED 11-16-2004.

THE GREEN CLUB

THE MARK CONSISTS OF STANDARD CHARACTERS WITHOUT CLAIM TO ANY PARTICULAR FONT, STYLE, SIZE, OR COLOR.

NO CLAIM IS MADE TO THE EXCLUSIVE RIGHT TO USE "GREEN", APART FROM THE MARK AS SHOWN.

FOR REAL ESTATE DEVELOPMENT, NAMELY, DEVELOPING REAL ESTATE PROJECTS THAT HAVE AN ENVIRONMENTALLY-FRIENDLY "GREEN" PHILOSOPHY EITHER BY DEBT OR EQUITY INVESTMENTS IN COMPANIES INVOLVED IN SUCH PROJECTS OR BY UNDERTAKING SUCH PROJECTS DIRECTLY (U.S. CLS. 100, 103 AND 106).

ROBIN CHOSID, EXAMINING ATTORNEY

SN 78-517,749. DECKER CAR WASH, INC., NORTH CHARLESTON, SC. FILED 11-16-2004.



OWNER OF U.S. REG. NO. 2,171,643.
NO CLAIM IS MADE TO THE EXCLUSIVE RIGHT TO USE "CAR WASH", APART FROM THE MARK AS SHOWN.

THE MARK CONSISTS OF DESIGN OF A CACTUS WITH THE WORDS CACTUS CAR WASH.

FOR AUTOMOBILE AND VEHICLE WASHING SERVICES (U.S. CLS. 100, 103 AND 106).

FIRST USE 3-21-1996; IN COMMERCE 3-21-1996.
JULIE GUTTADAURO, EXAMINING ATTORNEY

SN 78-518,473. LONG FENCE COMPANY, INC., CAPITOL HEIGHTS, MD. FILED 11-17-2004.



OWNER OF U.S. REG. NOS. 900,585, 2,015,168 AND OTHERS.

NO CLAIM IS MADE TO THE EXCLUSIVE RIGHT TO USE "IRON", APART FROM THE MARK AS SHOWN.

FOR INSTALLATION OF IRON GATES, FENCES, WINDOW GUARDS AND SECURITY DOORS (U.S. CLS. 100, 103 AND 106).

FIRST USE 4-17-2003; IN COMMERCE 4-17-2003.
JEAN IM, EXAMINING ATTORNEY

CLASS 37—(Continued).

SN 78-518,787. OCP CONTRACTORS, INC., HOLLAND, OH. FILED 11-17-2004.

THE CONTRACTOR OF CHOICE

THE MARK CONSISTS OF STANDARD CHARACTERS WITHOUT CLAIM TO ANY PARTICULAR FONT, STYLE, SIZE, OR COLOR.

OWNER OF U.S. REG. NO. 2,254,613. NO CLAIM IS MADE TO THE EXCLUSIVE RIGHT TO USE "CONTRACTOR", APART FROM THE MARK AS SHOWN.

SEC. 2(F). FOR BUILDING CONSTRUCTION AND REPAIR SERVICES (U.S. CLS. 100, 103 AND 106). FIRST USE 2-0-1996; IN COMMERCE 2-0-1996. EVELYN BRADLEY, EXAMINING ATTORNEY

SN 78-519,053. LONG FENCE COMPANY, INC., CAPITOL HEIGHTS, MD. FILED 11-18-2004.

LONG VINYL

OWNER OF U.S. REG. NOS. 2,638,445, 2,638,447 AND OTHERS.

NO CLAIM IS MADE TO THE EXCLUSIVE RIGHT TO USE "VINYL", APART FROM THE MARK AS SHOWN. FOR INSTALLATION OF VINYL SIDING (U.S. CLS. 100, 103 AND 106).

FIRST USE 8-21-2002; IN COMMERCE 8-28-2002. JEAN IM, EXAMINING ATTORNEY

SN 78-519,056. LONG FENCE COMPANY, INC., CAPITOL HEIGHTS, MD. FILED 11-18-2004.

LONG PAVERS

OWNER OF U.S. REG. NOS. 2,638,445, 2,638,447 AND OTHERS.

NO CLAIM IS MADE TO THE EXCLUSIVE RIGHT TO USE "PAVERS", APART FROM THE MARK AS SHOWN. FOR INSTALLATION OF PAVERS (U.S. CLS. 100, 103 AND 106).

FIRST USE 4-2-2002; IN COMMERCE 4-11-2002. JEAN IM, EXAMINING ATTORNEY

CLASS 37—(Continued).

SN 78-519,060. LONG FENCE COMPANY, INC., CAPITOL HEIGHTS, MD. FILED 11-18-2004.

LONG DECKS

OWNER OF U.S. REG. NOS. 2,638,445, 2,638,447 AND OTHERS.

NO CLAIM IS MADE TO THE EXCLUSIVE RIGHT TO USE "DECKS", APART FROM THE MARK AS SHOWN. FOR INSTALLATION OF DECKS (U.S. CLS. 100, 103 AND 106).

FIRST USE 4-2-2002; IN COMMERCE 4-11-2002. JEAN IM, EXAMINING ATTORNEY

SN 78-519,098. LONG FENCE COMPANY, INC., CAPITOL HEIGHTS, MD. FILED 11-18-2004.

LONG PATIO ROOMS

OWNER OF U.S. REG. NOS. 2,638,445, 2,638,447 AND OTHERS.

NO CLAIM IS MADE TO THE EXCLUSIVE RIGHT TO USE "PATIO ROOMS", APART FROM THE MARK AS SHOWN.

FOR CONSTRUCTION AND INSTALLATION OF PATIO ROOMS (U.S. CLS. 100, 103 AND 106).

FIRST USE 3-23-2002; IN COMMERCE 3-23-2002. JEAN IM, EXAMINING ATTORNEY

SN 78-519,323. LONG FENCE COMPANY, INC., CAPITOL HEIGHTS, MD. FILED 11-18-2004.

LONG AWNINGS

OWNER OF U.S. REG. NOS. 2,638,445, 2,638,447 AND OTHERS.

NO CLAIM IS MADE TO THE EXCLUSIVE RIGHT TO USE "AWNINGS", APART FROM THE MARK AS SHOWN. FOR INSTALLATION OF AWNINGS (U.S. CLS. 100, 103 AND 106).

FIRST USE 6-11-2004; IN COMMERCE 6-23-2004. JEAN IM, EXAMINING ATTORNEY

CLASS 37—(Continued).

SN 78-520,411. NETWORK DESIGN AND SECURITY, LLC, WEST CHESTER, PA. FILED 11-19-2004.

CLASS 37—(Continued).

SN 78-522,362. PICI, GERARDO, CLEARWATER, FL. FILED 11-24-2004.

Clean A Scene

For the look and
quality that's just
peachy!

THE MARK CONSISTS OF STANDARD CHARACTERS WITHOUT CLAIM TO ANY PARTICULAR FONT, STYLE, SIZE, OR COLOR.

FOR CLEANING SERVICES, NAMELY, CLEANING OF BIOHAZARDOUS WASTE AND HUMAN OR ANIMAL REMAINS AS A RESULT OF HOMICIDE, SUICIDE, OR NATURAL DECOMPOSITION, AND URINE AND FECES FROM COMMERCIAL, RESIDENTIAL, GOVERNMENT, OR PUBLIC PROPERTY; AND THE CLEANUP OF A VARIETY OF CHEMICALS INCLUDING EXPLOSIVES, SOLVENTS, METALS, SALTS, AND CORROSIVES FOUND AT CLANDESTINE METHAMPHETAMINE MANUFACTURING LABORATORIES SET UP AT RENTAL HOMES, APARTMENTS, MOTEL ROOMS, GARAGES, STORAGE SHEDS, CARS, CAMPGROUNDS AND OTHER VARIOUS OUTBUILDINGS (U.S. CLS. 100, 103 AND 106).

BARNEY CHARLON, EXAMINING ATTORNEY

THE MARK CONSISTS OF STANDARD CHARACTERS WITHOUT CLAIM TO ANY PARTICULAR FONT, STYLE, SIZE, OR COLOR.

FOR CUSTOM CONSTRUCTION OF HOMES (U.S. CLS. 100, 103 AND 106).

AMY HELLA, EXAMINING ATTORNEY

SN 78-521,399. SERVICE PRO PAINTERS INC., CLERMONT, FL. FILED 11-22-2004.

SN 78-523,170. INFINITY HOME IMPROVEMENT, INC., WYOMING, MI. FILED 11-26-2004.



HIDDEN HEAT

NO CLAIM IS MADE TO THE EXCLUSIVE RIGHT TO USE "PAINTERS", APART FROM THE MARK AS SHOWN. FOR PAINTING SERVICES; NAMELY, PAINTING RESIDENTIAL AND COMMERCIAL BUILDINGS (U.S. CLS. 100, 103 AND 106).

FIRST USE 7-1-2004; IN COMMERCE 8-15-2004.
LAURA KOVAISKY, EXAMINING ATTORNEY

THE MARK CONSISTS OF STANDARD CHARACTERS WITHOUT CLAIM TO ANY PARTICULAR FONT, STYLE, SIZE, OR COLOR.

FOR BUILDING CONSTRUCTION NAMELY EXTERIOR HOME BUILDING REPAIR SERVICES (U.S. CLS. 100, 103 AND 106).

MARC LEIPZIG, EXAMINING ATTORNEY

CLASS 37—(Continued).

SN 78-523,264. FERRELLGAS, L.P., LIBERTY, MO. FILED 11-27-2004.

RHINO POWER

THE MARK CONSISTS OF STANDARD CHARACTERS WITHOUT CLAIM TO ANY PARTICULAR FONT, STYLE, SIZE, OR COLOR.

OWNER OF U.S. REG. NOS. 1,898,501 AND 2,912,949. FOR CYLINDER EXCHANGE SERVICES, NAMELY, REFURBISHMENT AND EXCHANGE OF CO* CYLINDERS; AND CONSULTATION AND TECHNICAL SUPPORT SERVICES FOR THE MAINTENANCE AND REPAIR OF CO* CYLINDERS (U.S. CLS. 100, 103 AND 106). ANNE FARRELL, EXAMINING ATTORNEY

SN 78-530,060. FARMER, JAMES W., MINNEAPOLIS, MN. FILED 12-9-2004.

Iron Creek Camp

THE MARK CONSISTS OF STANDARD CHARACTERS WITHOUT CLAIM TO ANY PARTICULAR FONT, STYLE, SIZE, OR COLOR.

FOR LAND DEVELOPMENT SERVICES, NAMELY, PLANNING AND LAYING OUT OF RESIDENTIAL AND/OR COMMERCIAL COMMUNITIES (U.S. CLS. 100, 103 AND 106). INGRID C. EULIN, EXAMINING ATTORNEY

CLASS 37—(Continued).

SN 78-531,183. STREET FORCE INCORPORATED, ST-LAURENT, QUEBEC, CANADA, FILED 12-13-2004.

STREETFORCE

THE MARK CONSISTS OF STANDARD CHARACTERS WITHOUT CLAIM TO ANY PARTICULAR FONT, STYLE, SIZE, OR COLOR.

FOR AUTOMOBILE DETAILING OF CARS INTERIORS AND EXTERIORS (U.S. CLS. 100, 103 AND 106). LINDA POWELL, EXAMINING ATTORNEY

SN 78-537,031. DOMINION HOMES, INC., DUBLIN, OH. FILED 12-22-2004.

DOMINION HOMES

THE MARK CONSISTS OF STANDARD CHARACTERS WITHOUT CLAIM TO ANY PARTICULAR FONT, STYLE, SIZE, OR COLOR.

OWNER OF U.S. REG. NOS. 2,190,283, 2,718,066 AND OTHERS. NO CLAIM IS MADE TO THE EXCLUSIVE RIGHT TO USE "HOMES", APART FROM THE MARK AS SHOWN. FOR HOME CONSTRUCTION SERVICES (U.S. CLS. 100, 103 AND 106). FIRST USE 7-1-1989; IN COMMERCE 7-1-1989. MICHAEL WEBSTER, EXAMINING ATTORNEY

SN 78-538,939. GENERAL BINDING CORPORATION, NORTHBROOK, IL. FILED 12-28-2004.

FULL CIRCLE SERVICE

THE MARK CONSISTS OF STANDARD CHARACTERS WITHOUT CLAIM TO ANY PARTICULAR FONT, STYLE, SIZE, OR COLOR.

NO CLAIM IS MADE TO THE EXCLUSIVE RIGHT TO USE SERVICE, APART FROM THE MARK AS SHOWN. FOR MAINTENANCE AND REPAIR OF OFFICE EQUIPMENT (U.S. CLS. 100, 103 AND 106). JANICE L. MCMORROW, EXAMINING ATTORNEY

CLASS 37—(Continued).

SN 78-539,201. J.R. MCDADE COMPANY, INC., SCOTTS-DALE, AZ. FILED 12-28-2004.

CLASS 37—(Continued).

SN 78-547,264. SIDEFX, LLC, ZIONSVILLE, IN. FILED 1-13-2005.

DINE & DESIGN

THE MARK CONSISTS OF STANDARD CHARACTERS WITHOUT CLAIM TO ANY PARTICULAR FONT, STYLE, SIZE, OR COLOR.

FOR CONSTRUCTION SERVICES, NAMELY, PLANNING, LAYING OUT AND CUSTOM CONSTRUCTION OF RESIDENTIAL AND COMMERCIAL STRUCTURES; CONSTRUCTION AND RENOVATION OF RESIDENTIAL AND COMMERCIAL STRUCTURES; CUSTOM CONSTRUCTION OF COMMERCIAL AND RESIDENTIAL KITCHENS (U.S. CLS. 100, 103 AND 106).
ANDREW BENZMILLER, EXAMINING ATTORNEY

SIDEFX

THE MARK CONSISTS OF STANDARD CHARACTERS WITHOUT CLAIM TO ANY PARTICULAR FONT, STYLE, SIZE, OR COLOR.

FOR SIDING CONTRACTOR SERVICES (U.S. CLS. 100, 103 AND 106).
FIRST USE 1-0-2002; IN COMMERCE 1-0-2002.
GEORGE LORENZO, EXAMINING ATTORNEY

SN 78-545,509. PACIFIC COAST INDUSTRIAL LIGHTING, LLC, WOODINVILLE, WA. FILED 1-11-2005.

LIGHT DOCTOR

THE MARK CONSISTS OF STANDARD CHARACTERS WITHOUT CLAIM TO ANY PARTICULAR FONT, STYLE, SIZE, OR COLOR.

NO CLAIM IS MADE TO THE EXCLUSIVE RIGHT TO USE "LIGHT", APART FROM THE MARK AS SHOWN.
FOR LIGHTING AND ELECTRICAL MAINTENANCE AND REPAIR SERVICES; LIGHTING RETROFIT SERVICES AND CONSULTING SERVICES IN CONNECTION THEREWITH (U.S. CLS. 100, 103 AND 106).
FIRST USE 12-31-1996; IN COMMERCE 12-31-1996.
MARGERY A. TIERNEY, EXAMINING ATTORNEY

SN 78-548,937. NRE ACQUISITION CO., LLC, PADUCAH, KY. FILED 1-18-2005.

VMV PADUCAHBILT

SN 78-545,976. RESIDENTIAL ELECTRICAL SERVICES, INC., WOODLAND PARK, CO. FILED 1-11-2005.

THE HOME OWNER'S SOURCE FOR PROFESSIONAL ELECTRICAL SERVICES

THE MARK CONSISTS OF STANDARD CHARACTERS WITHOUT CLAIM TO ANY PARTICULAR FONT, STYLE, SIZE, OR COLOR.

FOR ELECTRICAL REMODELING AND REPAIR SERVICES PROVIDED FOR HOME OWNER'S NEEDS AT THEIR LOCATIONS (U.S. CLS. 100, 103 AND 106).
FIRST USE 0-0-2001; IN COMMERCE 5-31-2002.
CHRISTOPHER ADKINS, EXAMINING ATTORNEY

THE MARK CONSISTS OF STANDARD CHARACTERS WITHOUT CLAIM TO ANY PARTICULAR FONT, STYLE, SIZE, OR COLOR.

FOR REBUILDING, PAINTING, MAINTENANCE AND REPAIR SERVICES FOR LOCOMOTIVES AND LOCOMOTIVE SUB-ASSEMBLIES; AND DIESEL ENGINE REMANUFACTURE (U.S. CLS. 100, 103 AND 106).
FIRST USE 8-0-1986; IN COMMERCE 8-0-1986.
JOHN HWANG, EXAMINING ATTORNEY

CLASS 37—(Continued).

SN 78-549,224. DEANGELIS DIAMOND CONSTRUCTION, INC., NAPLES, FL. FILED 1-18-2005.

DEANGELIS DIAMOND CONSTRUCTION

THE MARK CONSISTS OF STANDARD CHARACTERS WITHOUT CLAIM TO ANY PARTICULAR FONT, STYLE, SIZE, OR COLOR.

NO CLAIM IS MADE TO THE EXCLUSIVE RIGHT TO USE "CONSTRUCTION", APART FROM THE MARK AS SHOWN.

FOR LAND DEVELOPMENT SERVICES, NAMELY, PLANNING AND LAYOUT OF COMMERCIAL AND/OR RESIDENTIAL REAL ESTATE DEVELOPMENTS AND/OR COMMUNITIES; CONSTRUCTION SERVICES, NAMELY, PLANNING, LAYING OUT AND CUSTOM CONSTRUCTION OF RESIDENTIAL AND/OR COMMERCIAL COMMUNITIES; COMMERCIAL AND RESIDENTIAL BUILDING, CONSTRUCTION AND REPAIR; DEVELOPMENT OF COMMERCIAL AND RESIDENTIAL BUILDINGS; CONSTRUCTION, MAINTENANCE AND RENOVATION OF PROPERTY; CUSTOM CONSTRUCTION AND BUILDING RENOVATION; RENOVATION IN THE FIELD OF COMMERCIAL AND/OR RESIDENTIAL BUILDINGS; REMODELING OF COMMERCIAL AND/OR RESIDENTIAL BUILDINGS; CONSTRUCTION GENERAL CONTRACTOR; AND INFORMATION SERVICES FOR ALL OF THE FOREGOING PROVIDED VIA GLOBAL COMPUTER NETWORKS (U.S. CLS. 100, 103 AND 106).

FIRST USE 5-6-1996; IN COMMERCE 5-6-1996.
SALLY SHIH, EXAMINING ATTORNEY

SN 78-549,267. DEANGELIS DIAMOND CONSTRUCTION, INC., NAPLES, FL. FILED 1-18-2005.

THE HONOR TO BUILD

THE MARK CONSISTS OF STANDARD CHARACTERS WITHOUT CLAIM TO ANY PARTICULAR FONT, STYLE, SIZE, OR COLOR.

FOR LAND DEVELOPMENT SERVICES, NAMELY, PLANNING AND LAYOUT OF COMMERCIAL AND/OR RESIDENTIAL REAL ESTATE DEVELOPMENTS AND/OR COMMUNITIES; CONSTRUCTION SERVICES, NAMELY, PLANNING, LAYING OUT AND CUSTOM CONSTRUCTION OF RESIDENTIAL AND/OR COMMERCIAL COMMUNITIES; COMMERCIAL AND RESIDENTIAL BUILDING, CONSTRUCTION AND REPAIR; DEVELOPMENT OF COMMERCIAL AND RESIDENTIAL BUILDINGS; CONSTRUCTION, MAINTENANCE AND RENOVATION OF PROPERTY; CUSTOM CONSTRUCTION AND BUILDING RENOVATION; RENOVATION IN THE FIELD OF COMMERCIAL AND/OR RESIDENTIAL BUILDINGS; REMODELING OF COMMERCIAL AND/OR RESIDENTIAL BUILDINGS; CONSTRUCTION GENERAL CONTRACTOR; AND INFORMATION SERVICES FOR ALL OF THE FOREGOING PROVIDED VIA GLOBAL COMPUTER NETWORKS (U.S. CLS. 100, 103 AND 106).

FIRST USE 1-0-2001; IN COMMERCE 1-0-2001.
MARK RADEMACHER, EXAMINING ATTORNEY

CLASS 37—(Continued).

SN 78-550,567. CLOPAY SERVICE COMPANY, INC., MASON, OH. FILED 1-20-2005.

RIGHT FROM THE START

THE MARK CONSISTS OF STANDARD CHARACTERS WITHOUT CLAIM TO ANY PARTICULAR FONT, STYLE, SIZE, OR COLOR.

FOR BUILDING CONSTRUCTION AND REPAIR (U.S. CLS. 100, 103 AND 106).

FIRST USE 10-31-2004; IN COMMERCE 10-31-2004.
JENNIFER CHICOSKI, EXAMINING ATTORNEY

SN 78-553,026. VIRBIUS VENTURES LLC, LOS ANGELES, CA. FILED 1-24-2005.

Virbius Ventures LLC

THE MARK CONSISTS OF STANDARD CHARACTERS WITHOUT CLAIM TO ANY PARTICULAR FONT, STYLE, SIZE, OR COLOR.

NO CLAIM IS MADE TO THE EXCLUSIVE RIGHT TO USE VENTURES LLC, APART FROM THE MARK AS SHOWN.

FOR REAL ESTATE DEVELOPMENT (U.S. CLS. 100, 103 AND 106).
KIM SAITO, EXAMINING ATTORNEY

SN 78-557,094. LONG FENCE COMPANY, INC., CAPITOL HEIGHTS, MD. FILED 1-31-2005.

LONG GUTTERS

OWNER OF U.S. REG. NOS. 900,585, 2,638,446 AND OTHERS.

NO CLAIM IS MADE TO THE EXCLUSIVE RIGHT TO USE "GUTTERS", APART FROM THE MARK AS SHOWN, FOR INSTALLATION OF GUTTERS AND GUTTER COVERS (U.S. CLS. 100, 103 AND 106).

FIRST USE 10-8-2004; IN COMMERCE 10-22-2004.
JEAN IM, EXAMINING ATTORNEY

CLASS 37—(Continued).

SN 78-610,125. LONG FENCE COMPANY, INC., CAPITOL HEIGHTS, MD. FILED 4-15-2005.

OWNER OF U.S. REG. NOS. 900,585, 2,688,028 AND OTHERS.

NO CLAIM IS MADE TO THE EXCLUSIVE RIGHT TO USE "KENNELS", APART FROM THE MARK AS SHOWN, FOR CONSTRUCTION AND INSTALLATION OF KENNELS (U.S. CLS. 100, 103 AND 106).

FIRST USE 11-30-2004; IN COMMERCE 12-6-2004.
JEAN IM, EXAMINING ATTORNEY

CLASS 38—(Continued).

SN 76-567,358. TEXTERITY, INC., SOUTHBOROUGH, MA. FILED 12-18-2003.

THE MARK CONSISTS OF STANDARD CHARACTERS WITHOUT CLAIM TO ANY PARTICULAR FONT, STYLE, SIZE, OR COLOR.

FOR DELIVERY OF DOCUMENTS VIA THE GLOBAL COMPUTER NETWORK (U.S. CLS. 100, 101 AND 104).

FIRST USE 6-8-1999; IN COMMERCE 6-8-1999.
KIMBERLY FRYE, EXAMINING ATTORNEY

SN 78-639,060. LONG FENCE COMPANY, INC., RIVERDALE, MD. FILED 5-27-2005.

THE MARK CONSISTS OF STANDARD CHARACTERS WITHOUT CLAIM TO ANY PARTICULAR FONT, STYLE, SIZE, OR COLOR.

OWNER OF U.S. REG. NOS. 900,585, 2,688,028 AND OTHERS.

FOR INSTALLATION OF PAVERS (U.S. CLS. 100, 103 AND 106).

FIRST USE 8-0-1999; IN COMMERCE 8-0-1999.
JEAN IM, EXAMINING ATTORNEY

SN 76-594,231. THQ WIRELESS INC., CALABASAS HILLS, CA. FILED 5-21-2004.

OWNER OF U.S. REG. NOS. 1,744,660, 2,614,259 AND OTHERS.

NO CLAIM IS MADE TO THE EXCLUSIVE RIGHT TO USE "WIRELESS", APART FROM THE MARK AS SHOWN.

THE MARK CONSISTS OF THE LETTERS THQ IN STYLIZED TYPE APPEARING ON A PARALLELOGRAM BACKGROUND. THE STYLIZED LETTERS THQ ARE UNDERLINED BY A LINE ON THE PARALLELOGRAM BACKGROUND. BELOW, THE LETTERS WIRELESS IN STYLIZED TYPE APPEAR PARTIALLY SURROUNDED BY A CRESCENT SHAPE.

FOR COMMUNICATIONS SERVICES, NAMELY, HIGH SPEED TRANSMISSION OF VOICE, DATA, GAMES, IMAGES, VIDEO, AUDIO AND INFORMATION VIA A GLOBAL COMPUTER NETWORK, COMPUTERS AND WIRELESS DEVICES; AND PROVIDING MULTIPLE USER ACCESS TO A GLOBAL COMPUTER NETWORK (U.S. CLS. 100, 101 AND 104).

KELLY BOULTON, EXAMINING ATTORNEY

CLASS 38—COMMUNICATION

SN 76-251,875. CINEMANOW, INC., SANTA MONICA, CA. FILED 5-4-2001.

SEC. 2(F).
FOR ON-DEMAND TRANSMISSION OF PRE-RECORDED AUDIO AND VIDEO ENTERTAINMENT MATERIAL OVER THE INTERNET PROTOCOL BASED NETWORKS (U.S. CLS. 100, 101 AND 104).

FIRST USE 2-0-2001; IN COMMERCE 2-0-2001.
CURTIS FRENCH, EXAMINING ATTORNEY

SN 76-610,649. PAGER PRAYER, INC., MCDONOUGH, GA. FILED 9-2-2004.

THE MARK CONSISTS OF STANDARD CHARACTERS WITHOUT CLAIM TO ANY PARTICULAR FONT, STYLE, SIZE, OR COLOR.

NO CLAIM IS MADE TO THE EXCLUSIVE RIGHT TO USE "PAGER", APART FROM THE MARK AS SHOWN.

FOR PAGING SERVICES (U.S. CLS. 100, 101 AND 104).
HEATHER THOMPSON, EXAMINING ATTORNEY

CLASS 38—(Continued).

SN 76-621,833. CITADEL BROADCASTING COMPANY, LAS VEGAS, NV. FILED 11-22-2004.

100 FM THE PIKE

THE MARK CONSISTS OF STANDARD CHARACTERS WITHOUT CLAIM TO ANY PARTICULAR FONT, STYLE, SIZE, OR COLOR.

NO CLAIM IS MADE TO THE EXCLUSIVE RIGHT TO USE 100 FM, APART FROM THE MARK AS SHOWN.

FOR RADIO BROADCASTING SERVICES (U.S. CLS. 100, 101 AND 104).

FIRST USE 10-7-2004; IN COMMERCE 10-7-2004.
ANGELA M. MICHELI, EXAMINING ATTORNEY

SN 76-623,102. DRIVERTV LLC, NEW YORK, NY. FILED 12-3-2004.

DRIVERTV

THE MARK CONSISTS OF STANDARD CHARACTERS WITHOUT CLAIM TO ANY PARTICULAR FONT, STYLE, SIZE, OR COLOR.

FOR TELEVISION BROADCASTING SERVICES; VIDEO-ON-DEMAND, DIGITAL TELEVISION, CABLE TELEVISION, SATELLITE TELEVISION, AND BROADBAND TRANSMISSION AND BROADCASTING SERVICES FEATURING INFORMATION ABOUT THE ATTRIBUTES, FEATURES AND SPECIFICATIONS OF MODEL AUTOMOBILES FROM ALL MAJOR MANUFACTURERS AS WELL AS OTHER INFORMATION AND ADVERTISING THAT WILL HELP CONSUMERS MAKE INFORMED PURCHASING DECISIONS REGARDING AUTOMOBILES AND ANCILLARY AUTOMOTIVE PRODUCTS (U.S. CLS. 100, 101 AND 104).

MONTIA G. PRESSEY, EXAMINING ATTORNEY

SN 76-625,580. SUNCOM WIRELESS OPERATING COMPANY, L.L.C., BERWYN, PA. FILED 12-21-2004.

TRUTH IN WIRELESS

THE MARK CONSISTS OF STANDARD CHARACTERS WITHOUT CLAIM TO ANY PARTICULAR FONT, STYLE, SIZE, OR COLOR.

NO CLAIM IS MADE TO THE EXCLUSIVE RIGHT TO USE "WIRELESS", APART FROM THE MARK AS SHOWN.

FOR WIRELESS TELECOMMUNICATIONS SERVICES, NAMELY, TRANSMISSION OF VOICE, DATA AND INFORMATION BY ELECTRONIC MEANS (U.S. CLS. 100, 101 AND 104).

ESTHER A. BORSUK, EXAMINING ATTORNEY

CLASS 38—(Continued).

SN 78-163,408. JAENICKE, RICHARD, KETCHUM, ID. FILED 9-12-2002.

CORPORATENEWS

OWNER OF U.S. REG. NO. 2,076,601.

THE MARK CONSISTS OF CORPORATENEWS. SEC. 2(F).

FOR TELECOMMUNICATION SERVICES, NAMELY, PROVIDING ELECTRONIC TRANSMISSION OF CUSTOMER MESSAGES AND DATA ON COMPANIES AND COMPANY PRODUCTS (U.S. CLS. 100, 101 AND 104).

FIRST USE 6-11-1996; IN COMMERCE 6-11-1996.
BRIAN NEVILLE, EXAMINING ATTORNEY

SN 78-302,235. SBC KNOWLEDGE VENTURES, L.P., AUSTIN, TX. FILED 9-18-2003.

JUSTCALL

FOR LONG DISTANCE TELEPHONE COMMUNICATION SERVICES (U.S. CLS. 100, 101 AND 104).

FIRST USE 9-22-2003; IN COMMERCE 9-22-2003.
KAREN BRACEY, EXAMINING ATTORNEY

SN 78-322,602. RAILINC CORP., CARY, NC. FILED 11-4-2003.

NEXTPATH

THE MARK CONSISTS OF STANDARD CHARACTERS WITHOUT CLAIM TO ANY PARTICULAR FONT, STYLE, SIZE, OR COLOR.

FOR CONNECTIVITY OPTIONS AMONG CUSTOMERS, SERVICE PROVIDERS AND TRADING PARTNERS, IN THE NATURE OF DATA EXCHANGE SERVICES, NAMELY, ELECTRONIC STORE-AND-FORWARD MESSAGING AND MESSAGE VIEWING (U.S. CLS. 100, 101 AND 104).

SUSAN HAYASH, EXAMINING ATTORNEY

CLASS 38—(Continued).

SN 78-408,464. MEMBER'S EDGE, LLC, HACKENSACK, NJ. FILED 4-27-2004.

CLASS 38—(Continued).

SN 78-414,791. SOUTHERN COMMUNICATION SERVICES, INC., ATLANTA, GA. FILED 5-7-2004.

Family Discount
Network

LINCAROUND

THE MARK CONSISTS OF STANDARD CHARACTERS WITHOUT CLAIM TO ANY PARTICULAR FONT, STYLE, SIZE, OR COLOR.

NO CLAIM IS MADE TO THE EXCLUSIVE RIGHT TO USE "DISCOUNT", APART FROM THE MARK AS SHOWN. FOR ELECTRONIC MAIL SERVICES (U.S. CLS. 100, 101 AND 104).

FIRST USE 4-9-2004; IN COMMERCE 4-9-2004.
C. DIONNE CLYBURN, EXAMINING ATTORNEY

THE MARK CONSISTS OF STANDARD CHARACTERS WITHOUT CLAIM TO ANY PARTICULAR FONT, STYLE, SIZE, OR COLOR.

FOR TELECOMMUNICATION SERVICES IN THE FIELD OF PROVIDING CELLULAR TELEPHONE COMMUNICATION AND TWO-WAY RADIOS, NAMELY, PROVIDING OFF-NETWORK TWO-WAY PRIVATE AND GROUP COMMUNICATION (U.S. CLS. 100, 101 AND 104).

FIRST USE 6-30-2004; IN COMMERCE 7-1-2004.
WINSTON FOLMAR, EXAMINING ATTORNEY

SN 78-410,519. ASSOCIATED NETWORK PARTNERS, INC., SPRINGFIELD, IL. FILED 4-29-2004.

SN 78-415,699. VIACOM INTERNATIONAL INC., NEW YORK, NY. FILED 5-10-2004.

NO BOUNDARIES

NICK

THE MARK CONSISTS OF STANDARD CHARACTERS WITHOUT CLAIM TO ANY PARTICULAR FONT, STYLE, SIZE, OR COLOR.

FOR INTERNET TELEPHONY COMMUNICATIONS SERVICES, NAMELY PROVIDING VOICE COMMUNICATIONS SERVICES OVER THE INTERNET (U.S. CLS. 100, 101 AND 104).

EUGENIA MARTIN, EXAMINING ATTORNEY

OWNER OF U.S. REG. NOS. 1,390,284 AND 1,578,189. FOR TELEVISION BROADCASTING SERVICES VIA CABLE, SATELLITE AND OTHER MEANS (U.S. CLS. 100, 101 AND 104).

FIRST USE 12-31-1983; IN COMMERCE 12-31-1983.
RON FAIRBANKS, EXAMINING ATTORNEY

CLASS 38—(Continued).

SN 78-427,423. ULOCATE COMMUNICATIONS, INC., FRAMINGHAM, MA. FILED 5-29-2004.

uLocate

THE MARK CONSISTS OF STANDARD CHARACTERS WITHOUT CLAIM TO ANY PARTICULAR FONT, STYLE, SIZE, OR COLOR.

FOR SATELLITE COMMUNICATION SERVICES, NAMELY, IDENTIFYING THE GEOGRAPHIC POSITION OF PERSONS, PLACES OR OBJECTS USING LOCATION DETERMINATION TECHNOLOGY INCLUDING SATELLITES AND COMPUTER SOFTWARE AND DISPLAYING THE LOCATION OF SUCH PERSONS, PLACES OR OBJECTS ON A MAP VIA THE INTERNET OR THROUGH OTHER MEANS (U.S. CLS. 100, 101 AND 104).

FIRST USE 2-13-2003; IN COMMERCE 2-13-2003.
CHRIS WELLS, EXAMINING ATTORNEY

SN 78-445,066. BIERMANN PRODUCTIONS LLC, WICHITA, KS. FILED 7-2-2004.

CONCERTCENTRAL HD

THE MARK CONSISTS OF STANDARD CHARACTERS WITHOUT CLAIM TO ANY PARTICULAR FONT, STYLE, SIZE, OR COLOR.

NO CLAIM IS MADE TO THE EXCLUSIVE RIGHT TO USE "HD", APART FROM THE MARK AS SHOWN.

FOR TELEVISION BROADCASTING, RADIO BROADCASTING, AUDIO BROADCASTING, VIDEO BROADCASTING, AND BROADCASTING PROGRAMS VIA A GLOBAL COMPUTER NETWORK (U.S. CLS. 100, 101 AND 104).

AISHA CLARKE, EXAMINING ATTORNEY

CLASS 38—(Continued).

SN 78-492,876. TP CORPORATION, BOSTON, MA. FILED 10-1-2004.

g8wave

THE MARK CONSISTS OF STANDARD CHARACTERS WITHOUT CLAIM TO ANY PARTICULAR FONT, STYLE, SIZE, OR COLOR.

FOR TELECOMMUNICATIONS GATEWAY SERVICES FOR DELIVERING TEXT, PHOTO, VIDEO AND MUSIC FILES AND SPECIFIED RING TONES TO MOBILE PHONES AND PERSONAL DIGITAL ASSISTANTS (PDAS) THROUGH SHORT MESSAGE SERVICE (SMS) GATEWAYS (U.S. CLS. 100, 101 AND 104).

FIRST USE 2-28-2003; IN COMMERCE 2-28-2003.
SUSAN STIGLITZ, EXAMINING ATTORNEY

SN 78-493,077. DEUTSCHE TELEKOM AG, BONN, FED REP GERMANY, FILED 10-1-2004.

T-Mobile Sound
Alert

THE MARK CONSISTS OF STANDARD CHARACTERS WITHOUT CLAIM TO ANY PARTICULAR FONT, STYLE, SIZE, OR COLOR.

PRIORITY CLAIMED UNDER SEC. 44(D) ON FED REP GERMANY APPLICATION NO. 30418516738, FILED 4-2-2004, REG. NO. 30418516, DATED 4-22-2004, EXPIRES 4-30-2014.

OWNER OF U.S. REG. NOS. 2,282,432, 2,959,646 AND OTHERS.

FOR TELECOMMUNICATION AND INFORMATION TECHNOLOGY SERVICES, NAMELY, ELECTRIC, DIGITAL, CELLULAR AND WIRELESS TRANSMISSION OF VOICE, DATA, INFORMATION IMAGES, SIGNALS AND MESSAGES AND TRANSMISSION OF VOICE, DATA, IMAGES, AUDIO, VIDEO AND INFORMATION VIA TELEPHONE, TELEVISION AND GLOBAL COMMUNICATION NETWORKS; PROVIDING TELECOMMUNICATIONS CONNECTIONS OVER A GLOBAL COMMUNICATIONS NETWORK, ELECTRONIC MAIL, VOICE MAIL AND MESSAGING SERVICES, NAMELY, THE RECORDING AND SUBSEQUENT TRANSMISSION OF VOICE MESSAGES BY TELEPHONE; RENTAL OF TELECOMMUNICATIONS EQUIPMENT, NAMELY, EQUIPMENT FOR ELECTRONIC ACCESS TO GLOBAL TELECOMMUNICATIONS NETWORK, EQUIPMENT FOR TRANSMITTING, RECEIVING, RECORDING AND

CLASS 38—(Continued).

MONITORING VOICE, DATA, INFORMATION IMAGES, SIGNALS, MESSAGES COMPRISED OF DATA AND WORD PROCESSORS, AND TELECOMMUNICATIONS HARDWARE COMPONENTS AND PERIPHERALS THEREOF FOR USE IN THE TELECOMMUNICATIONS INDUSTRY, AND RENTAL OF EQUIPMENT FOR TRANSMITTING, RECEIVING, RECORDING AND MONITORING COMPUTER PROGRAMS FOR USE IN OPERATING AND ACCESSING TELECOMMUNICATIONS SYSTEMS; AUDIO AND VIDEO BROADCASTING; PROVIDING MULTIPLE-USER DIAL-UP AND DEDICATED ACCESS TO THE INTERNET; PERSONAL COMMUNICATIONS SERVICES; PAGER SERVICES; TRANSMISSION AND BROADCAST OF AUDIO AND VIDEO PROGRAMMING; LEASING OF TELECOMMUNICATIONS EQUIPMENT, COMPONENTS AND SYSTEMS; PROVIDING INFORMATION VIA THE TELEPHONE AND THE GLOBAL COMMUNICATION NETWORKS IN THE FIELD OF TELECOMMUNICATIONS; CONSULTING IN THE FIELD OF TELECOMMUNICATIONS (U.S. CLS. 100, 101 AND 104).

INGRID C. EULIN, EXAMINING ATTORNEY

CLASS 38—(Continued).

SN 78-500,096. TRANSNEXUS, INC., ATLANTA, GA. FILED 10-14-2004.

PeeringHouse

THE MARK CONSISTS OF STANDARD CHARACTERS WITHOUT CLAIM TO ANY PARTICULAR FONT, STYLE, SIZE, OR COLOR.

FOR TELECOMMUNICATIONS ROUTING AND JUNCTION SERVICES, GATEWAY SERVICES, AND TELECOMMUNICATION ACCESS SERVICES (U.S. CLS. 100, 101 AND 104).

LOURDES AYALA, EXAMINING ATTORNEY

SN 78-497,017. KINGDOM TELEPHONE COMPANY, AUX-VASEE, MO. FILED 10-8-2004.

SN 78-507,613. TELCEL COMMUNICATIONS, INC., LAKE-LAND, FL. FILED 10-28-2004.

AIRWIRE



OWNER OF U.S. REG. NO. 2,932,137.

NO CLAIM IS MADE TO THE EXCLUSIVE RIGHT TO USE MIX NETWORKS, APART FROM THE MARK AS SHOWN.

THE COLOR(S) BLUE AND GREEN IS/ARE CLAIMED AS A FEATURE OF THE MARK.

THE COLOR BLUE APPEARS IN THE LETTERS "M" AND "X" AND IN THE LOWER AND LEFT PORTION OF THE SWIRL DESIGN ABOVE THE LETTER "I". THE COLOR GREEN APPEARS IN THE LETTER "I" AND IN THE UPPER AND RIGHT PORTION OF THE SWIRL DESIGN ABOVE THE LETTER "I".

THE MARK CONSISTS OF THE WORD "MIX" IN STYLIZED FONT WITH THE DOT OVER THE LETTER "I" CONSISTING OF A SWIRL DESIGN. THE WORD "NETWORKS" IN PLAIN LOWER CASE LETTERING APPEARS BELOW THE WORD "MIX".

FOR INTERNET TELEPHONY SERVICES (U.S. CLS. 100, 101 AND 104).

FIRST USE 11-1-2003; IN COMMERCE 1-10-2004.

ASMAT KHAN, EXAMINING ATTORNEY

THE MARK CONSISTS OF STANDARD CHARACTERS WITHOUT CLAIM TO ANY PARTICULAR FONT, STYLE, SIZE, OR COLOR.

FOR WIRELESS BROADBAND COMMUNICATIONS SERVICES AND SATELLITE TRANSMISSION SERVICES FEATURING THE TRANSMISSION OF DATA, VOICE AND VIDEO (U.S. CLS. 100, 101 AND 104).

ELISSA GARBER KON, EXAMINING ATTORNEY

CLASS 38—(Continued).

SN 78-512,402. UTAH TELECOMMUNICATION OPEN INFRASTRUCTURE AGENCY, MURRAY, UT. FILED 11-5-2004.



NO CLAIM IS MADE TO THE EXCLUSIVE RIGHT TO USE COMMUNITY, APART FROM THE MARK AS SHOWN.

THE COLOR(S) GREY, WHITE AND ORANGE IS/ARE CLAIMED AS A FEATURE OF THE MARK.

THE MARK CONSISTS OF WHITE STYLIZED "UTOPIA" ON GREY BACKGROUND NEXT TO WHITE STYLIZED "COMMUNITY METRONET" ON ORANGE BACKGROUND.

FOR TELECOMMUNICATIONS SERVICES, NAMELY PROVIDING FIBER OPTIC NETWORK SERVICES (U.S. CLS. 100, 101 AND 104).

FIRST USE 11-1-2004; IN COMMERCE 11-5-2004.
AMY GEARIN, EXAMINING ATTORNEY

CLASS 38—(Continued).

SN 78-513,719. HD CINEMA 10 COMPANY LLC, BETHPAGE, NY. FILED 11-9-2004.



NO CLAIM IS MADE TO THE EXCLUSIVE RIGHT TO USE HD, APART FROM THE MARK AS SHOWN.

THE COLORS GRAY, BLACK AND WHITE ARE CLAIMED AS A FEATURE OF THE MARK.

THE LETTERS "HD" ARE IN BLACK. THE WORD "VICE" IS IN GRAY AND WHITE IN THE PATTERN OF A FINGERPRINT.

FOR SATELLITE TELEVISION BROADCASTING SERVICES; PAY-PER-VIEW TELEVISION TRANSMISSION SERVICES; VIDEO BROADCASTING SERVICES; VIDEO-ON-DEMAND TRANSMISSION SERVICES (U.S. CLS. 100, 101 AND 104).

MICHAEL SOUDERS, EXAMINING ATTORNEY

SN 78-512,452. NORTH AMERICAN BROADCASTING COMPANY, INC., COLUMBUS, OH. FILED 11-5-2004.

TED FM

THE MARK CONSISTS OF STANDARD CHARACTERS WITHOUT CLAIM TO ANY PARTICULAR FONT, STYLE, SIZE, OR COLOR.

NO CLAIM IS MADE TO THE EXCLUSIVE RIGHT TO USE "FM", APART FROM THE MARK AS SHOWN.

THE NAME TED DOES NOT IDENTIFY A LIVING INDIVIDUAL.

FOR RADIO BROADCASTING (U.S. CLS. 100, 101 AND 104).

FIRST USE 11-5-2004; IN COMMERCE 11-5-2004.
JASON TURNER, EXAMINING ATTORNEY

SN 78-516,237. ALLEN, MARCIA, SAN DIEGO, CA. FILED 11-12-2004.

SCIENTIST SOLUTIONS

THE MARK CONSISTS OF STANDARD CHARACTERS WITHOUT CLAIM TO ANY PARTICULAR FONT, STYLE, SIZE, OR COLOR.

NO CLAIM IS MADE TO THE EXCLUSIVE RIGHT TO USE "SCIENTIST", APART FROM THE MARK AS SHOWN.

FOR PROVIDING AN ON-LINE ELECTRONIC DISCUSSION BOARD FOR TRANSMISSION OF MESSAGES AMONG SCIENTISTS (U.S. CLS. 100, 101 AND 104).

FIRST USE 10-14-2004; IN COMMERCE 10-14-2004.
JASON LOTT, EXAMINING ATTORNEY

CLASS 38—(Continued).

SN 78-517,558. IBASIS, INC., BURLINGTON, MA. FILED 11-16-2004.

CLASS 38—(Continued).

SN 78-520,470. METNET COMMUNICATIONS, INC., SAN FRANCISCO, CA. FILED 11-19-2004.

**The last calling
card you'll ever
need!**

THE MARK CONSISTS OF STANDARD CHARACTERS WITHOUT CLAIM TO ANY PARTICULAR FONT, STYLE, SIZE, OR COLOR.

FOR PREPAID INTERNATIONAL COMMUNICATIONS SERVICE THAT ENABLES CONSUMERS TO PURCHASE CALLING TIME MINUTES VIA CREDIT CARD USING A WEB SITE INTERFACE (U.S. CLS. 100, 101 AND 104).

FIRST USE 9-14-2004; IN COMMERCE 9-14-2004.
CIMMERIAN COLEMAN, EXAMINING ATTORNEY

METNET MAN

THE MARK CONSISTS OF STANDARD CHARACTERS WITHOUT CLAIM TO ANY PARTICULAR FONT, STYLE, SIZE, OR COLOR.

NO CLAIM IS MADE TO THE EXCLUSIVE RIGHT TO USE MAN, APART FROM THE MARK AS SHOWN.

FOR PROVIDING FIBER OPTIC NETWORK SERVICES; ELECTRONIC TRANSMISSION OF DATA; PROVIDING CONNECTIVITY AMONG COMPUTER NETWORKS OVER WIDE AREA NETWORKS; PROVIDING VIRTUAL PRIVATE LAN SERVICE (VPLS); PROVIDING CONNECTIVITY BETWEEN PRIVATE COMPUTER NETWORKS AND PUBLIC COMPUTER NETWORKS, INCLUDING THE INTERNET; PROVIDING MULTIPLE-USER ACCESS TO THE INTERNET AND OTHER GLOBAL COMPUTER NETWORKS (U.S. CLS. 100, 101 AND 104).

AMY HELLA, EXAMINING ATTORNEY

SN 78-520,472. METNET COMMUNICATIONS, INC., SAN FRANCISCO, CA. FILED 11-19-2004.

SN 78-518,592. LSN, INC., ATLANTA, GA. FILED 11-17-2004.

METNET NET

TXT4SPORTS

THE MARK CONSISTS OF STANDARD CHARACTERS WITHOUT CLAIM TO ANY PARTICULAR FONT, STYLE, SIZE, OR COLOR.

OWNER OF U.S. REG. NO. 2,924,400.
FOR TRANSMISSION OF INFORMATION, NAMELY SPORTS NEWS TO WIRELESS DEVICES (U.S. CLS. 100, 101 AND 104).

JEFF DEFORD, EXAMINING ATTORNEY

THE MARK CONSISTS OF STANDARD CHARACTERS WITHOUT CLAIM TO ANY PARTICULAR FONT, STYLE, SIZE, OR COLOR.

NO CLAIM IS MADE TO THE EXCLUSIVE RIGHT TO USE NET, APART FROM THE MARK AS SHOWN.

FOR PROVIDING FIBER OPTIC NETWORK SERVICES; ELECTRONIC TRANSMISSION OF DATA; PROVIDING CONNECTIVITY AMONG COMPUTER NETWORKS OVER WIDE AREA NETWORKS; PROVIDING VIRTUAL PRIVATE LAN SERVICE (VPLS); PROVIDING CONNECTIVITY BETWEEN PRIVATE COMPUTER NETWORKS AND PUBLIC COMPUTER NETWORKS, INCLUDING THE INTERNET; PROVIDING MULTIPLE-USER ACCESS TO THE INTERNET AND OTHER GLOBAL COMPUTER NETWORKS (U.S. CLS. 100, 101 AND 104).

AMY HELLA, EXAMINING ATTORNEY

CLASS 38—(Continued).

SN 78-520,475. METNET COMMUNICATIONS, INC., SAN FRANCISCO, CA. FILED 11-19-2004.

METNET WAN

THE MARK CONSISTS OF STANDARD CHARACTERS WITHOUT CLAIM TO ANY PARTICULAR FONT, STYLE, SIZE, OR COLOR.

NO CLAIM IS MADE TO THE EXCLUSIVE RIGHT TO USE WAN, APART FROM THE MARK AS SHOWN.

FOR PROVIDING FIBER OPTIC NETWORK SERVICES; ELECTRONIC TRANSMISSION OF DATA; PROVIDING CONNECTIVITY AMONG COMPUTER NETWORKS OVER WIDE AREA NETWORKS; PROVIDING VIRTUAL PRIVATE LAN SERVICE (VPLS); PROVIDING CONNECTIVITY BETWEEN PRIVATE COMPUTER NETWORKS AND PUBLIC COMPUTER NETWORKS, INCLUDING THE INTERNET; PROVIDING MULTIPLE-USER ACCESS TO THE INTERNET AND OTHER GLOBAL COMPUTER NETWORKS (U.S. CLS. 100, 101 AND 104).

AMY HELLA, EXAMINING ATTORNEY

CLASS 38—(Continued).

SN 78-521,787. MINUTE SYSTEMS, INC., SOLANA BEACH, CA. FILED 11-23-2004.

TELEFIESTA

THE MARK CONSISTS OF STANDARD CHARACTERS WITHOUT CLAIM TO ANY PARTICULAR FONT, STYLE, SIZE, OR COLOR.

FOR TELEPHONE TELECOMMUNICATIONS SERVICES PROVIDED VIA PREPAID TELEPHONE CALLING CARDS (U.S. CLS. 100, 101 AND 104).

FIRST USE 2-14-2005; IN COMMERCE 2-14-2005.

KEVIN DINALLO, EXAMINING ATTORNEY

SN 78-520,838. GLOBAL CROSSING HOLDINGS LIMITED, HAMILTON HM12, BERMUDA, FILED 11-22-2004.

CC-1

THE MARK CONSISTS OF STANDARD CHARACTERS WITHOUT CLAIM TO ANY PARTICULAR FONT, STYLE, SIZE, OR COLOR.

FOR PROVIDING COMMUNICATIONS CONNECTIONS AND TRANSFER OF DATA, VOICE, VIDEO AND OTHER INFORMATION VIA A FIBER-OPTIC BASED NETWORK (U.S. CLS. 100, 101 AND 104).

HENRY S. ZAK, EXAMINING ATTORNEY

SN 78-525,900. BANDTEL, LLC, LOS ANGELES, CA. FILED 12-2-2004.

Bandtel

THE MARK CONSISTS OF STANDARD CHARACTERS WITHOUT CLAIM TO ANY PARTICULAR FONT, STYLE, SIZE, OR COLOR.

FOR VOICE OVER INTERNET PROTOCOL (U.S. CLS. 100, 101 AND 104).

BRIDGETT SMITH, EXAMINING ATTORNEY

CLASS 38—(Continued).

SN 78-526,031. DEUTSCHE TELEKOM AG, BONN, FED REP GERMANY, FILED 12-2-2004.

CLASS 38—(Continued).

SN 78-526,933. DEUTSCHE TELEKOM AG, BONN, FED REP GERMANY, FILED 12-3-2004.

T-Mobile Data Connect

THE MARK CONSISTS OF STANDARD CHARACTERS WITHOUT CLAIM TO ANY PARTICULAR FONT, STYLE, SIZE, OR COLOR.

OWNER OF FED REP GERMANY REG. NO. 30433157, DATED 7-20-2004, EXPIRES 6-30-2014.

OWNER OF U.S. REG. NOS. 2,282,432 AND 2,889,632.

NO CLAIM IS MADE TO THE EXCLUSIVE RIGHT TO USE "DATA CONNECT", APART FROM THE MARK AS SHOWN.

FOR TELECOMMUNICATION SERVICES, NAMELY, ELECTRIC, DIGITAL, CELLULAR AND WIRELESS TRANSMISSION OF VOICE, DATA, INFORMATION IMAGES, SIGNALS AND MESSAGES AND TRANSMISSION OF VOICE, DATA, IMAGES, AUDIO, VIDEO AND INFORMATION VIA TELEPHONE, TELEVISION AND GLOBAL COMMUNICATION NETWORKS; PROVIDING TELECOMMUNICATIONS CONNECTIONS TO A GLOBAL COMMUNICATIONS NETWORK, ELECTRONIC MAIL, VOICE MAIL AND MESSAGING SERVICES, NAMELY, THE RECORDING AND SUBSEQUENT TRANSMISSION OF VOICE MESSAGES BY TELEPHONE; RENTAL OF TELECOMMUNICATIONS EQUIPMENT, NAMELY, EQUIPMENT FOR ELECTRONIC ACCESS TO GLOBAL TELECOMMUNICATIONS NETWORK; RENTAL OF TELECOMMUNICATIONS HARDWARE COMPONENTS AND PERIPHERALS THEREOF FOR USE IN THE TELECOMMUNICATIONS INDUSTRY, AND RENTAL OF EQUIPMENT FOR TRANSMITTING, RECEIVING, RECORDING AND MONITORING COMPUTER PROGRAMS FOR USE IN OPERATING AND ACCESSING TELECOMMUNICATIONS SYSTEMS; AUDIO AND VIDEO BROADCASTING; PROVIDING MULTIPLE-USER DIAL-UP AND DEDICATED ACCESS TO THE INTERNET; PERSONAL COMMUNICATIONS SERVICES; PAGER SERVICES; BROADCAST OF AUDIO AND VIDEO PROGRAMMING; LEASING OF TELECOMMUNICATIONS EQUIPMENT; CONSULTING IN THE FIELD OF TELECOMMUNICATIONS (U.S. CLS. 100, 101 AND 104).

LAURIE MAYES, EXAMINING ATTORNEY

T-Mobile M2M Connect

THE MARK CONSISTS OF STANDARD CHARACTERS WITHOUT CLAIM TO ANY PARTICULAR FONT, STYLE, SIZE, OR COLOR.

PRIORITY CLAIMED UNDER SEC. 44(D) ON FED REP GERMANY APPLICATION NO. 30433156238, FILED 6-7-2004, REG. NO. 30433156, DATED 7-20-2004, EXPIRES 6-30-2014.

OWNER OF U.S. REG. NOS. 2,282,432 AND 2,889,632.

NO CLAIM IS MADE TO THE EXCLUSIVE RIGHT TO USE "M2M CONNECT", APART FROM THE MARK AS SHOWN.

FOR TELECOMMUNICATION SERVICES, NAMELY, ELECTRIC, DIGITAL, CELLULAR AND WIRELESS TRANSMISSION OF VOICE, DATA, INFORMATION IMAGES, SIGNALS AND MESSAGES AND TRANSMISSION OF VOICE, DATA, IMAGES, AUDIO, VIDEO AND INFORMATION VIA TELEPHONE, TELEVISION AND GLOBAL COMMUNICATION NETWORKS; PROVIDING TELECOMMUNICATIONS CONNECTIONS TO A GLOBAL COMMUNICATIONS NETWORK, ELECTRONIC MAIL, VOICE MAIL AND MESSAGING SERVICES, NAMELY, THE RECORDING AND SUBSEQUENT TRANSMISSION OF VOICE MESSAGES BY TELEPHONE; RENTAL OF TELECOMMUNICATIONS EQUIPMENT, NAMELY, EQUIPMENT FOR ELECTRONIC ACCESS TO GLOBAL TELECOMMUNICATIONS NETWORK; RENTAL OF TELECOMMUNICATIONS HARDWARE COMPONENTS AND PERIPHERALS THEREOF FOR USE IN THE TELECOMMUNICATIONS INDUSTRY, AND RENTAL OF EQUIPMENT FOR TRANSMITTING, RECEIVING, RECORDING AND MONITORING COMPUTER PROGRAMS FOR USE IN OPERATING AND ACCESSING TELECOMMUNICATIONS SYSTEMS; AUDIO AND VIDEO BROADCASTING; PROVIDING MULTIPLE-USER DIAL-UP AND DEDICATED ACCESS TO THE INTERNET; PERSONAL COMMUNICATIONS SERVICES; PAGER SERVICES; BROADCAST OF AUDIO AND VIDEO PROGRAMMING; LEASING OF TELECOMMUNICATIONS EQUIPMENT; CONSULTING IN THE FIELD OF TELECOMMUNICATIONS (U.S. CLS. 100, 101 AND 104).

LAURIE MAYES, EXAMINING ATTORNEY

CLASS 38—(Continued).

SN 78-533,315. PERSONAL SATELLITE NETWORK, INC., MANASSAS, VA. FILED 12-15-2004.

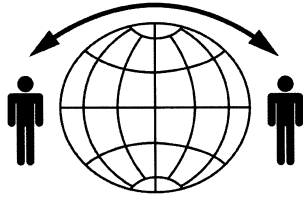

THE MARK CONSISTS OF A GLOBE WITH TWO PERSONS, ONE ON EITHER SIDE WITH A DOUBLE-ARROW ON THE TOP OF THE GLOBE POINTING TO EACH PERSON INDICATING COMMUNICATIONS.

FOR SATELLITE COMMUNICATION SERVICES (U.S. CLS. 100, 101 AND 104).

FIRST USE 1-1-1995; IN COMMERCE 1-1-1996.
JOHN DALIER, EXAMINING ATTORNEY

CLASS 38—(Continued).

SN 78-537,730. MOBIV, INC., BERKELEY, CA. FILED 12-23-2004.

MO

THE MARK CONSISTS OF STANDARD CHARACTERS WITHOUT CLAIM TO ANY PARTICULAR FONT, STYLE, SIZE, OR COLOR.

OWNER OF U.S. REG. NOS. 2,920,088 AND 2,941,660.

FOR BROADCASTING SERVICES, NAMELY, DELIVERING LIVE STREAMING INTERACTIVE AND NON-INTERACTIVE TELEVISION, MEDIA, DATA STREAMS, AND PRERECORDED VIDEO AND AUDIO PROGRAMMING IN REAL-TIME TO WIRELESS RECEIVERS, WIRELESS HANDSETS, AND CELLULAR TELEPHONES (U.S. CLS. 100, 101 AND 104).

ELLEN BURNS, EXAMINING ATTORNEY

SN 78-534,514. MERRIMACK SERVICES CORPORATION, MERRIMACK, NH. FILED 12-17-2004.

SN 78-539,710. IP CARRIER CONSULTING GROUP, PIPERSVILLE, PA. FILED 12-29-2004.

yourONLYphone

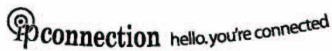

FOR TELECOMMUNICATIONS SERVICES, NAMELY, PROVIDING TRANSMISSION OF VOICE VIA GLOBAL COMPUTER NETWORK (U.S. CLS. 100, 101 AND 104).

FIRST USE 9-7-2004; IN COMMERCE 9-7-2004.
DARRYL SPRUILL, EXAMINING ATTORNEY

THE MARK CONSISTS OF STANDARD CHARACTERS WITHOUT CLAIM TO ANY PARTICULAR FONT, STYLE, SIZE, OR COLOR.

FOR TELECOMMUNICATIONS SERVICES, NAMELY SUBSCRIPTION-BASED TELEPHONE SERVICE FOR VOICE OVER INTERNET PROTOCOL COMMUNICATIONS DELIVERED AND RECEIVED VIA A GLOBAL COMPUTER NETWORK (U.S. CLS. 100, 101 AND 104).

AMY GEARIN, EXAMINING ATTORNEY

CLASS 38—(Continued).

SN 78-543,836. DEUTSCHE TELEKOM AG, BONN, FED REP GERMANY, FILED 1-7-2005.

CLASS 38—(Continued).

SN 78-545,259. KRUSE, DEREK, RICHFIELD, MN. FILED 1-11-2005.

Fusion City

T-Mobile Thanx

THE MARK CONSISTS OF STANDARD CHARACTERS WITHOUT CLAIM TO ANY PARTICULAR FONT, STYLE, SIZE, OR COLOR.

FOR PROVIDING ONLINE CHAT ROOMS FOR THE TRANSMISSION OF MESSAGES AMONG COMPUTER USERS CONCERNING A VARIETY OF SUBJECTS OF GENERAL INTEREST (U.S. CLS. 100, 101 AND 104).

FIRST USE 3-15-2002; IN COMMERCE 9-30-2004.
LESLEY LAMOTHE, EXAMINING ATTORNEY

SN 78-545,503. DEUTSCHE TELEKOM AG, BONN, FED REP GERMANY, FILED 1-11-2005.

THE MARK CONSISTS OF STANDARD CHARACTERS WITHOUT CLAIM TO ANY PARTICULAR FONT, STYLE, SIZE, OR COLOR.

OWNER OF FED REP GERMANY REG. NO. 30441826, DATED 8-16-2004, EXPIRES 7-31-2014.

OWNER OF U.S. REG. NOS. 2,282,432, 2,908,563 AND OTHERS.

FOR TELECOMMUNICATION SERVICES, NAMELY, ELECTRIC, DIGITAL, CELLULAR AND WIRELESS TRANSMISSION OF VOICE, DATA, INFORMATION IMAGES, SIGNALS AND MESSAGES AND TRANSMISSION OF VOICE, DATA, IMAGES, AUDIO, VIDEO AND INFORMATION VIA TELEPHONE, TELEVISION AND GLOBAL COMMUNICATION NETWORKS; PROVIDING TELECOMMUNICATIONS CONNECTIONS TO A GLOBAL COMMUNICATIONS NETWORK, ELECTRONIC MAIL, VOICE MAIL AND MESSAGING SERVICES, NAMELY, THE RECORDING AND SUBSEQUENT TRANSMISSION OF VOICE MESSAGES BY TELEPHONE; RENTAL OF TELECOMMUNICATIONS EQUIPMENT, NAMELY, EQUIPMENT FOR ELECTRONIC ACCESS TO GLOBAL TELECOMMUNICATIONS NETWORK; RENTAL OF TELECOMMUNICATIONS HARDWARE COMPONENTS AND PERIPHERALS THEREOF FOR USE IN THE TELECOMMUNICATIONS INDUSTRY, AND RENTAL OF EQUIPMENT FOR TRANSMITTING, RECEIVING, RECORDING AND MONITORING COMPUTER PROGRAMS FOR USE IN OPERATING AND ACCESSING TELECOMMUNICATIONS SYSTEMS; AUDIO AND VIDEO BROADCASTING; PROVIDING MULTIPLE-USER DIAL-UP AND DEDICATED ACCESS TO THE INTERNET; PERSONAL COMMUNICATIONS SERVICES; PAGER SERVICES; BROADCAST OF AUDIO AND VIDEO PROGRAMMING; LEASING OF TELECOMMUNICATIONS EQUIPMENT; CONSULTING IN THE FIELD OF TELECOMMUNICATIONS (U.S. CLS. 100, 101 AND 104).

LAURIE MAYES, EXAMINING ATTORNEY

T-Mobile Dial a Smile

THE MARK CONSISTS OF STANDARD CHARACTERS WITHOUT CLAIM TO ANY PARTICULAR FONT, STYLE, SIZE, OR COLOR.

PRIORITY CLAIMED UNDER SEC. 44(D) ON FED REP GERMANY APPLICATION NO. 30441824238, FILED 7-21-2004, REG. NO. 30441824, DATED 8-31-2004, EXPIRES 7-31-2014.

OWNER OF U.S. REG. NOS. 2,282,432, 2,908,563 AND OTHERS.

FOR TELECOMMUNICATION AND INFORMATION TECHNOLOGY SERVICES, NAMELY, ELECTRIC, DIGITAL, CELLULAR AND WIRELESS TRANSMISSION OF VOICE, DATA, INFORMATION IMAGES, SIGNALS AND MESSAGES AND TRANSMISSION OF VOICE, DATA, IMAGES, AUDIO, VIDEO AND INFORMATION VIA TELEPHONE, TELEVISION AND GLOBAL COMMUNICATION NETWORKS; PROVIDING TELECOMMUNICATIONS CONNECTIONS OVER A GLOBAL COMMUNICATIONS NETWORK, ELECTRONIC MAIL, VOICE MAIL AND MESSAGING SERVICES, NAMELY, THE RECORDING AND SUBSEQUENT TRANSMISSION OF VOICE MESSAGES BY TELEPHONE; RENTAL OF TELECOMMUNICATIONS EQUIPMENT, NAMELY, EQUIPMENT FOR ELECTRONIC ACCESS TO GLOBAL TELECOMMUNICATIONS NETWORK, EQUIPMENT FOR TRANSMITTING, RECEIVING, RECORDING AND

CLASS 38—(Continued).

MONITORING VOICE, DATA, INFORMATION IMAGES, SIGNALS, MESSAGES COMPRISED OF DATA AND WORD PROCESSORS, AND TELECOMMUNICATIONS HARDWARE COMPONENTS AND PERIPHERALS THEREOF FOR USE IN THE TELECOMMUNICATIONS INDUSTRY, AND RENTAL OF EQUIPMENT FOR TRANSMITTING, RECEIVING, RECORDING AND MONITORING COMPUTER PROGRAMS FOR USE IN OPERATING AND ACCESSING TELECOMMUNICATIONS SYSTEMS; AUDIO AND VIDEO BROADCASTING; PROVIDING MULTIPLE-USER DIAL-UP AND DEDICATED ACCESS TO THE INTERNET; PERSONAL COMMUNICATIONS SERVICES; PAGER SERVICES; TRANSMISSION AND BROADCAST OF AUDIO AND VIDEO PROGRAMMING; LEASING OF TELECOMMUNICATIONS EQUIPMENT, COMPONENTS AND SYSTEMS; PROVIDING INFORMATION VIA THE TELEPHONE AND THE GLOBAL COMMUNICATION NETWORKS IN THE FIELD OF TELECOMMUNICATIONS; CONSULTING IN THE FIELD OF TELECOMMUNICATIONS (U.S. CLS. 100, 101 AND 104).
 LAURIE MAYES, EXAMINING ATTORNEY

CLASS 38—(Continued).

MONITORING VOICE, DATA, INFORMATION IMAGES, SIGNALS, MESSAGES COMPRISED OF DATA AND WORD PROCESSORS, AND TELECOMMUNICATIONS HARDWARE COMPONENTS AND PERIPHERALS THEREOF FOR USE IN THE TELECOMMUNICATIONS INDUSTRY, AND RENTAL OF EQUIPMENT FOR TRANSMITTING, RECEIVING, RECORDING AND MONITORING COMPUTER PROGRAMS FOR USE IN OPERATING AND ACCESSING TELECOMMUNICATIONS SYSTEMS; AUDIO AND VIDEO BROADCASTING; PROVIDING MULTIPLE-USER DIAL-UP AND DEDICATED ACCESS TO THE INTERNET; PERSONAL COMMUNICATIONS SERVICES; PAGER SERVICES; TRANSMISSION AND BROADCAST OF AUDIO AND VIDEO PROGRAMMING; LEASING OF TELECOMMUNICATIONS EQUIPMENT, COMPONENTS AND SYSTEMS; PROVIDING INFORMATION VIA THE TELEPHONE AND THE GLOBAL COMMUNICATION NETWORKS IN THE FIELD OF TELECOMMUNICATIONS; CONSULTING IN THE FIELD OF TELECOMMUNICATIONS (U.S. CLS. 100, 101 AND 104).
 LAURIE MAYES, EXAMINING ATTORNEY

SN 78-545,686. DEUTSCHE TELEKOM AG, BONN, FED REP GERMANY, FILED 1-11-2005.

T-Mobile Thrills

THE MARK CONSISTS OF STANDARD CHARACTERS WITHOUT CLAIM TO ANY PARTICULAR FONT, STYLE, SIZE, OR COLOR.
 PRIORITY CLAIMED UNDER SEC. 44(D) ON FED REP GERMANY APPLICATION NO. 30441825038, FILED 7-21-2004, REG. NO. 30441825, DATED 8-16-2004, EXPIRES 7-31-2014.
 OWNER OF U.S. REG. NOS. 2,282,432, 2,908,563 AND OTHERS.
 FOR TELECOMMUNICATION AND INFORMATION TECHNOLOGY SERVICES, NAMELY, ELECTRIC, DIGITAL, CELLULAR AND WIRELESS TRANSMISSION OF VOICE, DATA, INFORMATION IMAGES, SIGNALS AND MESSAGES AND TRANSMISSION OF VOICE, DATA, IMAGES, AUDIO, VIDEO AND INFORMATION VIA TELEPHONE, TELEVISION AND GLOBAL COMMUNICATION NETWORKS; PROVIDING TELECOMMUNICATIONS CONNECTIONS OVER A GLOBAL COMMUNICATIONS NETWORK, ELECTRONIC MAIL, VOICE MAIL AND MESSAGING SERVICES, NAMELY, THE RECORDING AND SUBSEQUENT TRANSMISSION OF VOICE MESSAGES BY TELEPHONE; RENTAL OF TELECOMMUNICATIONS EQUIPMENT, NAMELY, EQUIPMENT FOR ELECTRONIC ACCESS TO GLOBAL TELECOMMUNICATIONS NETWORK, EQUIPMENT FOR TRANSMITTING, RECEIVING, RECORDING AND

SN 78-545,874. MILLENNIUM CENTRAL NEW JERSEY ASSET HOLDCO. LLC, TRENTON, NJ. FILED 1-11-2005.

SOJO 104.9

THE MARK CONSISTS OF STANDARD CHARACTERS WITHOUT CLAIM TO ANY PARTICULAR FONT, STYLE, SIZE, OR COLOR.
 NO CLAIM IS MADE TO THE EXCLUSIVE RIGHT TO USE 104.9, APART FROM THE MARK AS SHOWN.
 FOR RADIO BROADCASTING SERVICES, NAMELY BROADCASTING NEWS AND TRAFFIC INFORMATION (U.S. CLS. 100, 101 AND 104).
 FIRST USE 11-5-2004; IN COMMERCE 11-5-2004.
 WILLIAM VERHOSEK, EXAMINING ATTORNEY

SN 78-545,879. MILLENNIUM CENTRAL NEW JERSEY ASSET HOLDCO. LLC, TRENTON, NJ. FILED 1-11-2005.

SOJO

THE MARK CONSISTS OF STANDARD CHARACTERS WITHOUT CLAIM TO ANY PARTICULAR FONT, STYLE, SIZE, OR COLOR.
 FOR RADIO BROADCASTING SERVICES, NAMELY BROADCASTING NEWS AND TRAFFIC INFORMATION (U.S. CLS. 100, 101 AND 104).
 FIRST USE 11-5-2004; IN COMMERCE 11-5-2004.
 WILLIAM VERHOSEK, EXAMINING ATTORNEY

CLASS 38—(Continued).

SN 78-550,313. BRILLIANT CITIES, MINNEAPOLIS, MN. FILED 1-19-2005.



FOR TRANSMISSION OF SOUND, VIDEO, AND INFORMATION OVER FIBER-OPTIC NETWORK; VIDEO BROADCASTING; VIDEO-ON-DEMAND TRANSMISSION SERVICES; INTERNET TELEPHONY SERVICES (U.S. CLS. 100, 101 AND 104).

SCOTT BALDWIN, EXAMINING ATTORNEY

CLASS 38—(Continued).

SN 78-570,845. CLEVELAND UNLIMITED, INC., INDEPENDENCE, OH. FILED 2-18-2005.

SN 78-551,073. SPOGGER, INC., REDWOOD CITY, CA. FILED 1-20-2005.

SPOGGER



THE MARK CONSISTS OF STANDARD CHARACTERS WITHOUT CLAIM TO ANY PARTICULAR FONT, STYLE, SIZE, OR COLOR.

FOR COMMUNICATION SERVICES, NAMELY, ELECTRONIC AND DIGITAL TRANSMISSION AND RECEPTION OF DATA, DOCUMENTS, IMAGES, VOICES AND INFORMATION BY MEANS OF MOBILE PHONES, ELECTRONIC MAIL, SATELLITES, AND MULTINATIONAL TELECOMMUNICATION NETWORKS; PROVIDING PRIVATE AND SECURE REAL TIME ELECTRONIC COMMUNICATION OVER A COMPUTER NETWORK, NAMELY ON-LINE CHAT ROOMS AND ELECTRONIC BULLETIN BOARDS FOR TRANSMISSION OF MESSAGES AMONG USERS IN THE FIELD OF GENERAL INTEREST; TRANSMISSION OF DATA, INFORMATION, MESSAGES, IMAGES, PHOTOGRAPHS, SOUND AND VIDEO VIA NATIONAL AND INTERNATIONAL NETWORKS AND ELECTRONIC MEDIA; ELECTRONIC, ELECTRIC, AND DIGITAL TRANSMISSION OF VOICE, DATA, IMAGES, SIGNALS, AND MESSAGES; AND ELECTRONIC MAIL SERVICES, NAMELY DELIVERY OF IMAGES AND PHOTOGRAPHS VIA A GLOBAL COMPUTER NETWORK, EXCHANGE OF DATA STORED IN DATABASES ACCESSIBLE VIA TELECOMMUNICATION NETWORKS, AND ELECTRONIC STORE-AND-FORWARD MESSAGING (U.S. CLS. 100, 101 AND 104).

FIRST USE 2-17-2004; IN COMMERCE 2-17-2004.
WILLIAM P. SHANAHAN, EXAMINING ATTORNEY

FOR CELLULAR TELEPHONE SERVICES (U.S. CLS. 100, 101 AND 104).

ANN E. SAPPENFIELD, EXAMINING ATTORNEY

CLASS 38—(Continued).

SN 78-582,907. DEUTSCHE TELEKOM AG, BONN, FED REP GERMANY, FILED 3-8-2005.

T-Systems Enterprise Services

THE MARK CONSISTS OF STANDARD CHARACTERS WITHOUT CLAIM TO ANY PARTICULAR FONT, STYLE, SIZE, OR COLOR.

PRIORITY CLAIMED UNDER SEC. 44(D) ON FED REP GERMANY APPLICATION NO. 30452358542, FILED 9-9-2004, REG. NO. 30452358, DATED 11-15-2004, EXPIRES 9-30-2014.

OWNER OF U.S. REG. NOS. 2,448,571 AND 2,880,613. NO CLAIM IS MADE TO THE EXCLUSIVE RIGHT TO USE "ENTERPRISE SERVICES", APART FROM THE MARK AS SHOWN.

FOR TELECOMMUNICATION SERVICES, NAMELY, ELECTRIC, DIGITAL, CELLULAR AND WIRELESS TRANSMISSION OF VOICE, DATA, INFORMATION IMAGES, SIGNALS AND MESSAGES AND TRANSMISSION OF VOICE, DATA, IMAGES, AUDIO, VIDEO AND INFORMATION VIA TELEPHONE, TELEVISION AND GLOBAL COMMUNICATION NETWORKS; PROVIDING TELECOMMUNICATIONS CONNECTIONS TO A GLOBAL COMMUNICATIONS NETWORK, ELECTRONIC MAIL, VOICE MAIL AND MESSAGING SERVICES, NAMELY, THE RECORDING AND SUBSEQUENT TRANSMISSION OF VOICE MESSAGES BY TELEPHONE; RENTAL OF TELECOMMUNICATIONS EQUIPMENT, NAMELY, EQUIPMENT FOR ELECTRONIC ACCESS TO GLOBAL TELECOMMUNICATIONS NETWORK; RENTAL OF TELECOMMUNICATIONS HARDWARE COMPONENTS AND PERIPHERALS THEREOF FOR USE IN THE TELECOMMUNICATIONS INDUSTRY, AND RENTAL OF EQUIPMENT FOR TRANSMITTING, RECEIVING, RECORDING AND MONITORING COMPUTER PROGRAMS FOR USE IN OPERATING AND ACCESSING TELECOMMUNICATIONS SYSTEMS; AUDIO AND VIDEO BROADCASTING; PROVIDING MULTIPLE-USER DIAL-UP AND DEDICATED ACCESS TO THE INTERNET; PERSONAL COMMUNICATIONS SERVICES; PAGER SERVICES; BROADCAST OF AUDIO AND VIDEO PROGRAMMING; LEASING OF TELECOMMUNICATIONS EQUIPMENT; CONSULTING IN THE FIELD OF TELECOMMUNICATIONS (U.S. CLS. 100, 101 AND 104).

Laurie Mayes, Examining Attorney

CLASS 38—(Continued).

SN 79-003,404. S.I.T. HOLDING S.A., LUXEMBOURG, FILED 5-26-2004.



PRIORITY DATE OF 12-18-2003 IS CLAIMED. OWNER OF INTERNATIONAL REGISTRATION 0827599 DATED 5-26-2004, EXPIRES 5-26-2014.

THE MARK CONSISTS, IN PART, OF THE NAME, LEONARDO, THE DESIGN OF A SOUND WAVE, AND DESIGN

FOR TELECOMMUNICATIONS SERVICES, NAMELY, SATELLITE TELEVISION BROADCASTING, CABLE TELEVISION BROADCASTING, TELEVISION PROGRAM BROADCASTING VIA CABLE, AND BROADCASTING PROGRAMS VIA A GLOBAL COMPUTER NETWORK (U.S. CLS. 100, 101 AND 104).

Barbara A. Gold, Examining Attorney

CLASS 39—TRANSPORTATION AND STORAGE

SN 76-398,877. METRO NEWS, TORONTO, ONTARIO MIL 4N1, CANADA, FILED 4-22-2002.

PROLOGIX

PRIORITY CLAIMED UNDER SEC. 44(D) ON CANADA APPLICATION NO. 1119392, FILED 10-24-2001, REG. NO. TMA624000, DATED 10-29-2004, EXPIRES 10-29-2019.

FOR PHYSICAL DELIVERY OF PERIODICALS, MAGAZINES AND BOOKS VIA TRUCKS (U.S. CLS. 100 AND 105).

Brendan McCauley, Examining Attorney

SN 76-549,035. BELLINGHAM/WHATCOM COUNTY CONVENTION & VISITORS BUREAU, BELLINGHAM, WA. FILED 10-6-2003.

GIRLFRIENDS ROADTRIP

FOR TOURIST INFORMATION SERVICES (U.S. CLS. 100 AND 105).

First Use 11-15-2002; In Commerce 11-15-2002.
Lesley Lamothe, Examining Attorney

CLASS 39—(Continued).

SN 76-558,876. PHILADELPHIA CONVENTION & VISITORS BUREAU, PHILADELPHIA, PA. FILED 11-10-2003.



NO CLAIM IS MADE TO THE EXCLUSIVE RIGHT TO USE "PHILADELPHIA", APART FROM THE MARK AS SHOWN.

THE STIPLING IS FOR SHADING PURPOSES ONLY. FOR PROVIDING AN INTERACTIVE WEB-BASED COMPUTER DATABASE IN THE FIELD OF TOURISM FOR THE CREATION OF ITINERARIES FOR USE IN THE TOURISM INDUSTRY (U.S. CLS. 100 AND 105).
JENNIFER CHICOSKI, EXAMINING ATTORNEY

SN 76-560,442. WA GOLF COMPANY, L.L.C., NEWTON, MA. FILED 11-17-2003.

LIBERTY NATIONAL

THE MARK CONSISTS OF STANDARD CHARACTERS WITHOUT CLAIM TO ANY PARTICULAR FONT, STYLE, SIZE, OR COLOR.

NO CLAIM IS MADE TO THE EXCLUSIVE RIGHT TO USE "NATIONAL", APART FROM THE MARK AS SHOWN. FOR TRANSPORT OF PASSENGERS AND GOLF EQUIPMENT BY GOLF CART (U.S. CLS. 100 AND 105).
NICHOLAS ALTREE, EXAMINING ATTORNEY

SN 76-589,205. CARSON HELICOPTERS INC., PERKASIE, PA. FILED 4-27-2004.

CARSON HELICOPTERS

THE MARK CONSISTS OF STANDARD CHARACTERS WITHOUT CLAIM TO ANY PARTICULAR FONT, STYLE, SIZE, OR COLOR.

NO CLAIM IS MADE TO THE EXCLUSIVE RIGHT TO USE HELICOPTERS, APART FROM THE MARK AS SHOWN.

SEC. 2(F).
FOR HELICOPTER AIRLIFT AND TRANSPORTATION SERVICES (U.S. CLS. 100 AND 105).
FIRST USE 0-0-1963; IN COMMERCE 0-0-1963.
MARK RADEMACHER, EXAMINING ATTORNEY

CLASS 39—(Continued).

SN 76-591,398. BULLDOG MOVERS, INC., SMYRNA, GA. FILED 5-7-2004.



NO CLAIM IS MADE TO THE EXCLUSIVE RIGHT TO USE MOVERS, APART FROM THE MARK AS SHOWN.

THE COLOR(S) GOLD, YELLOW, GREY, AND BLACK IS/ ARE CLAIMED AS A FEATURE OF THE MARK.

THE MARK CONSISTS OF A DRAWING OF A "YELLOW JACKET" STYLE STINGING, FLYING, INSECT, OVER A YELLOW TRIANGLE, WITH THE WORD "YELLOW JACKET" ABOVE AND THE WORD "MOVERS" BELOW. THE MARK PRESENTS A HOLLOW GOLD CIRCLE DOUBLE-OUTLINED IN BLACK, IN THE CENTER OF WHICH IS A WINGED CARICATURED BEE IN YELLOW AND BLACK WITH GREY WINGS CARRYING A GOLD PACKAGE, WITH THE WHITE WORDS YELLOW JACKET CURVED ABOVE THE CIRCLE AND THE WORD MOVERS DISPLAYED HORIZONTALLY BELOW THE CIRCLE, EACH SHADOWED BY BLACK.

FOR MOVING, STORING, AND TRANSPORTING OF GOODS AND PERSONAL PROPERTY FROM ONE LOCATION TO ANOTHER FOR RESIDENTIAL AND COMMERCIAL CUSTOMERS (U.S. CLS. 100 AND 105).

FIRST USE 1-30-2004; IN COMMERCE 1-30-2004.
MICHELE SWAIN, EXAMINING ATTORNEY

CLASS 39—(Continued).

SN 76-591,525. BULLDOG MOVERS, INC., SMYRNA, GA. FILED 5-7-2004.



NO CLAIM IS MADE TO THE EXCLUSIVE RIGHT TO USE "MOVERS", APART FROM THE MARK AS SHOWN. THE COLOR(S) RED, WHITE, AND BLACK IS/ARE CLAIMED AS A FEATURE OF THE MARK.

THE MARK CONSISTS OF A DRAWING OF A BULLDOG RUNNING, OVER A RED TRIANGLE, WITH THE WORD "BULLDOG" ABOVE AND THE WORD "MOVERS" BELOW. THE MARK PRESENTS A RED TRIANGLE DOUBLE-OUTLINED IN BLACK ON TOP OF WHICH IS OVERLAID A WHITE BULLDOG OUTLINED IN BLACK WITH THE WHITE WORD BULLDOG CURVED ABOVE THE DOG AND THE WORD MOVERS DISPLAYED HORIZONTALLY BELOW THE DOG, EACH OUTLINED IN BLACK.

FOR MOVING, STORING, AND TRANSPORTING OF GOODS AND PERSONAL PROPERTY FROM ONE LOCATION TO ANOTHER FOR RESIDENTIAL AND COMMERCIAL CUSTOMERS (U.S. CLS. 100 AND 105).

FIRST USE 1-30-1993; IN COMMERCE 1-30-1993.
MICHELE SWAIN, EXAMINING ATTORNEY

SN 76-592,112. GUARDIAN MOVING AND STORAGE, INC., INDIANAPOLIS, IN. FILED 5-13-2004.



FOR MOVING AND STORAGE SERVICES, NAMELY, MOVING AND STORAGE OF COMMERCIAL AND RESIDENTIAL PROPERTY OF OTHERS VIA MOTOR VEHICLE AND CONSULTING AND PLANNING SERVICES PROVIDED THEREWITH (U.S. CLS. 100 AND 105).

STEPHANIE DAVIS, EXAMINING ATTORNEY

CLASS 39—(Continued).

SN 76-593,133. NATIONAL LEISURE GROUP, INC., WOBURN, MA. FILED 5-18-2004.



OWNER OF U.S. REG. NOS. 1,519,447, 2,208,328 AND 2,623,736.

SEC. 2(F).

FOR TRAVEL AGENCY SERVICES, NAMELY, MAKING RESERVATIONS AND BOOKINGS FOR TRANSPORTATION (U.S. CLS. 100 AND 105).

FIRST USE 1-1-2000; IN COMMERCE 1-1-2000.
PAM WILLIS, EXAMINING ATTORNEY

SN 76-618,333. CHESAPEAKE HOLDING COMPANY, LLC, MCLEAN, VA. FILED 10-28-2004.

EUROPEAN ESCAPES

THE MARK CONSISTS OF STANDARD CHARACTERS WITHOUT CLAIM TO ANY PARTICULAR FONT, STYLE, SIZE, OR COLOR.

NO CLAIM IS MADE TO THE EXCLUSIVE RIGHT TO USE "EUROPEAN", APART FROM THE MARK AS SHOWN. FOR ARRANGING TRAVEL TOURS, AND TRAVEL AGENCY SERVICES, NAMELY, MAKING RESERVATIONS AND BOOKINGS FOR TRANSPORTATION (U.S. CLS. 100 AND 105).

FIRST USE 10-11-2004; IN COMMERCE 10-11-2004.
ANNE FARRELL, EXAMINING ATTORNEY

SN 76-618,650. THE BEKINS COMPANY, HILLSIDE, IL. FILED 11-1-2004.



OWNER OF U.S. REG. NO. 2,584,285.

NO CLAIM IS MADE TO THE EXCLUSIVE RIGHT TO USE "HOME DIRECT" AND "USA", APART FROM THE MARK AS SHOWN.

FOR TRANSPORTATION AND DELIVERY OF GOODS TO THE HOME BY MEANS OF AIR, TRUCK, RAIL AND BOAT (U.S. CLS. 100 AND 105).

FIRST USE 12-15-2003; IN COMMERCE 12-15-2003.
ALEX KEAM, EXAMINING ATTORNEY

CLASS 39—(Continued).

SN 76-619,404. ELECTRONIC DATA CARRIERS, INC., DBA EDC MOVING SYSTEMS, HOUSTON, TX. FILED 11-4-2004.

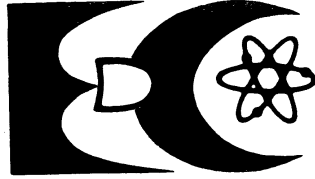

FOR FREIGHT TRANSPORTATION BY TRUCK; PACKAGING ARTICLES FOR TRANSPORTATION; PACKAGING ARTICLES TO THE ORDER AND SPECIFICATION OF OTHERS; WAREHOUSING OF GOODS FOR OTHERS (U.S. CLS. 100 AND 105).
FIRST USE 10-2-1989; IN COMMERCE 10-2-1989.
HENRY S. ZAK, EXAMINING ATTORNEY

SN 76-619,978. BEAVEX INCORPORATED, NORTH HAVEN, CT. FILED 11-10-2004.

BEAVEX

THE MARK CONSISTS OF STANDARD CHARACTERS WITHOUT CLAIM TO ANY PARTICULAR FONT, STYLE, SIZE, OR COLOR.
OWNER OF U.S. REG. NO. 2,417,417.
FOR PROVIDING PICK UP AND DELIVERY OF GOODS, PARCELS AND DOCUMENTS BY AUTOMOBILE, TRUCK, AIR AND RAIL, AND WAREHOUSE STORAGE AND PROVIDING PICK UP AND DELIVERY OF GOODS, PARCELS AND DOCUMENTS FROM SUCH FACILITIES BY AUTOMOBILE, TRUCK, AIR AND RAIL (U.S. CLS. 100 AND 105).
FIRST USE 12-9-1999; IN COMMERCE 12-9-1999.
BRIDGETT SMITH, EXAMINING ATTORNEY

SN 76-620,856. ABERCROMBIE & KENT GROUP HOLDINGS, S.A., FL-9490 VADUZ, LIECHTENSTEIN, FILED 11-15-2004.

DESIGN YOUR DAY

THE MARK CONSISTS OF STANDARD CHARACTERS WITHOUT CLAIM TO ANY PARTICULAR FONT, STYLE, SIZE, OR COLOR.
FOR ARRANGING AND PROVIDING TRAVEL TOURS (U.S. CLS. 100 AND 105).
FIRST USE 10-13-2004; IN COMMERCE 10-13-2004.
IRENE D. WILLIAMS, EXAMINING ATTORNEY

CLASS 39—(Continued).

SN 76-622,196. THE NUTRITION FACTOR, LLC, NASHVILLE, TN. FILED 11-26-2004.

NUTRITION FACTOR

THE MARK CONSISTS OF STANDARD CHARACTERS WITHOUT CLAIM TO ANY PARTICULAR FONT, STYLE, SIZE, OR COLOR.
FOR MEAL DELIVERY SERVICES (U.S. CLS. 100 AND 105).
WINSTON FOLMAR, EXAMINING ATTORNEY

SN 76-627,684. BNSF RAILWAY COMPANY, FORT WORTH, TX. FILED 1-11-2005.



OWNER OF U.S. REG. NOS. 2,712,344, 2,808,880 AND OTHERS.
NO CLAIM IS MADE TO THE EXCLUSIVE RIGHT TO USE RAILWAY, APART FROM THE MARK AS SHOWN.
FOR RAILROAD TRANSPORTATION SERVICES (U.S. CLS. 100 AND 105).
FIRST USE 1-25-2005; IN COMMERCE 1-25-2005.
IRA J. GOODSaid, EXAMINING ATTORNEY

SN 76-627,685. BNSF RAILWAY COMPANY, FORT WORTH, TX. FILED 1-11-2005.



OWNER OF U.S. REG. NOS. 2,712,344, 2,808,880 AND OTHERS.
FOR RAILROAD TRANSPORTATION SERVICES (U.S. CLS. 100 AND 105).
FIRST USE 5-27-2005; IN COMMERCE 5-27-2005.
IRA J. GOODSaid, EXAMINING ATTORNEY

CLASS 39—(Continued).

SN 76-627,686. BNSF RAILWAY COMPANY, FORT WORTH, TX. FILED 1-11-2005.



OWNER OF U.S. REG. NOS. 2,712,344, 2,808,880 AND OTHERS.

NO CLAIM IS MADE TO THE EXCLUSIVE RIGHT TO USE "RAILWAY", APART FROM THE MARK AS SHOWN. THE COLORS BLACK AND ORANGE ARE CLAIMED AS A FEATURE OF THE MARK.

THE LETTERS "BNSF" ARE ORANGE. THE REST OF THE MARK IS BLACK.

THE MARK CONSISTS OF THE LETTERS "BNSF" IN CAPITALIZED BLOCK FORM IN THE COLOR ORANGE ON TOP OF A BLACK TRIANGLE THAT IS THICKEST UNDER THE "B" AND BECOMES PROGRESSIVELY THINNER AS IT MOVES TOWARDS THE "F" WITH THE WORD "RAILWAY" WRITTEN IN BLACK CAPITALIZED BLOCK FORM UNDER THE THIN PART OF THE TRIANGLE UNDER THE LETTERS "SF".

FOR RAILROAD TRANSPORTATION SERVICES (U.S. CLS. 100 AND 105).

FIRST USE 1-25-2005; IN COMMERCE 1-25-2005.
IRA J. GOODSAD, EXAMINING ATTORNEY

SN 76-627,687. BNSF RAILWAY COMPANY, FORT WORTH, TX. FILED 1-11-2005.



OWNER OF U.S. REG. NOS. 2,712,344, 2,808,880 AND OTHERS.

THE COLORS BLACK AND ORANGE ARE CLAIMED AS A FEATURE OF THE MARK.

THE LETTERS "BNSF" ARE ORANGE. THE REST OF THE MARK IS BLACK.

THE MARK CONSISTS OF THE LETTERS "BNSF" IN CAPITALIZED BLOCK FORM IN THE COLOR ORANGE ON TOP OF A BLACK TRIANGLE THAT IS THICKEST UNDER THE "B" AND BECOMES PROGRESSIVELY THINNER AS IT MOVES TOWARDS THE "F".

FOR RAILROAD TRANSPORTATION SERVICES (U.S. CLS. 100 AND 105).

FIRST USE 6-9-2005; IN COMMERCE 6-9-2005.
IRA J. GOODSAD, EXAMINING ATTORNEY

SN 78-311,490. CLOUGH, WAYNE, P, FLUSHING, NY. FILED 10-9-2003.

4SAMEDAYDELIVERY

FOR SAME DAY NATIONWIDE MESSENGER AND COURIER DELIVERY SERVICES BY AIR AND BY GROUND (U.S. CLS. 100 AND 105).

KELLEY WELLS, EXAMINING ATTORNEY

CLASS 39—(Continued).

SN 78-387,835. AVIV RENT A CAR, INC., LOS ANGELES, CA. FILED 3-19-2004.



NO CLAIM IS MADE TO THE EXCLUSIVE RIGHT TO USE "RENT A CAR", APART FROM THE MARK AS SHOWN.

THE COLOR(S) GREEN, BLACK AND ORANGE IS/ARE CLAIMED AS A FEATURE OF THE MARK.

THE COLOR GREEN APPEARS IN THE LEAF REPRESENTING THE DOT OVER THE "I" IN THE WORD, AVIV. THE WORDS, "AVIV RENT A CAR" APPEAR IN THE COLOR BLACK, AND THE BACKGROUND OF THE RECTANGLE APPEARS IN THE COLOR ORANGE, IN THE MARK.

THE FOREIGN WORDING IN THE MARK TRANSLATES INTO ENGLISH AS SPRING.

FOR AUTOMOBILE AND TRUCK RENTAL AND LEASING, FEATURING PRIVATE AND COMMERCIAL, PASSENGER AND COMMERCIAL VEHICLES, OF ALL MAKES, MODELS AND SIZES (U.S. CLS. 100 AND 105).

FIRST USE 0-0-2000; IN COMMERCE 0-0-2000.
ODESSA BIBBINS, EXAMINING ATTORNEY

SN 78-410,586. PIONEER ORGANICS, INCORPORATED, SEATTLE, WA. FILED 4-29-2004.



NO CLAIM IS MADE TO THE EXCLUSIVE RIGHT TO USE "ORGANICS AND HOME DELIVERY", APART FROM THE MARK AS SHOWN.

FOR HOME DELIVERY AND OFFICE DELIVERY BY GROUND TRANSPORTATION OF ORGANICALLY GROWN PRODUCE (U.S. CLS. 100 AND 105).

FIRST USE 2-2-2004; IN COMMERCE 2-2-2004.
DAWN HAN, EXAMINING ATTORNEY

CLASS 39—(Continued).

SN 78-412,072. SPECIALTY SHIPPING, INC., ODESSA, FL.
FILED 5-3-2004.

BOATSEXPRESS

THE MARK CONSISTS OF STANDARD CHARACTERS WITHOUT CLAIM TO ANY PARTICULAR FONT, STYLE, SIZE, OR COLOR.

FOR VESSEL TRANSPORT, NAMELY, TRANSPORTATION OF BOATS ACROSS LAND BY TRUCKS (U.S. CLS. 100 AND 105).

FIRST USE 6-0-1992; IN COMMERCE 6-0-1992.
DAVID MURRAY, EXAMINING ATTORNEY

SN 78-414,666. NORTON INTERNATIONAL MARKETING GROUP, INC., KAPALUA, HI. FILED 5-7-2004.

**FISH & CHIPS
SPORTING
ADVENTURES**

THE MARK CONSISTS OF STANDARD CHARACTERS WITHOUT CLAIM TO ANY PARTICULAR FONT, STYLE, SIZE, OR COLOR.

NO CLAIM IS MADE TO THE EXCLUSIVE RIGHT TO USE "SPORTING ADVENTURES", APART FROM THE MARK AS SHOWN.

FOR ARRANGING TRAVEL TOURS; TRAVEL BOOKING AGENCIES; TRAVEL GUIDE SERVICES; TRAVEL INFORMATION SERVICES (U.S. CLS. 100 AND 105).

FIRST USE 5-1-2004; IN COMMERCE 5-1-2004.
TIMOTHY FINNEGAN, EXAMINING ATTORNEY

CLASS 39—(Continued).

SN 78-421,709. PENSKE SYSTEM, INC., WILMINGTON, DE.
FILED 5-19-2004.

**PENSKE PRECISION
LEASE**

THE MARK CONSISTS OF STANDARD CHARACTERS WITHOUT CLAIM TO ANY PARTICULAR FONT, STYLE, SIZE, OR COLOR.

OWNER OF U.S. REG. NOS. 1,795,304 AND 2,132,515.

NO CLAIM IS MADE TO THE EXCLUSIVE RIGHT TO USE "LEASE", APART FROM THE MARK AS SHOWN.

FOR FULL-SERVICE TRUCK LEASING SERVICES WHICH INCLUDE LEASING VEHICLES EQUIPPED WITH GLOBAL POSITIONING SYSTEMS THAT TRACK LOCATION OF VEHICLES; FULL SERVICE TRUCK LEASING SERVICES WHICH INCLUDE LEASING VEHICLES EQUIPPED WITH ON-BOARD COMPUTERS WHICH TRACK VEHICLE PERFORMANCE AND DRIVER HABITS (U.S. CLS. 100 AND 105).

FIRST USE 1-12-2004; IN COMMERCE 1-12-2004.
AMY GEARIN, EXAMINING ATTORNEY

SN 78-430,838. GLACIER BAY SEA KAYAKS, INC., GUSTAVUS, AK. FILED 6-7-2004.



THE MARK CONSISTS OF A STYLIZED PICTURE OF TWO PEOPLE IN A BLACK KAYAK. THE ENDS OF THE KAYAK CONNECT TO THE TAILS OF TWO BLACK AND WHITE ORCAS THAT MEET AT THEIR NOSES TO CREATE A CIRCLE.

FOR RENTAL OF BOATS, NAMELY KAYAKS; TRAVEL BOOKING AGENCY (U.S. CLS. 100 AND 105).

FIRST USE 6-1-1986; IN COMMERCE 6-1-1986.
DOMINIC J. FERRAIUOLO, EXAMINING ATTORNEY

CLASS 39—(Continued).

SN 78-445,612. LONDON FLEET LIMITED INC., CHICAGO, IL. FILED 7-2-2004.

CLASS 39—(Continued).

SN 78-479,422. HEB GROCERY COMPANY, L.P., SAN ANTONIO, TX. FILED 9-7-2004.

ELEGANT,
ACCESSIBLE, UNIQUE

PARKWAY
MANUFACTURING &
TRADING COMPANY

THE MARK CONSISTS OF STANDARD CHARACTERS WITHOUT CLAIM TO ANY PARTICULAR FONT, STYLE, SIZE, OR COLOR.

FOR TRANSPORTATION AND LIVERY SERVICES, NAMELY TAXI AND LIMOUSINE SERVICES (U.S. CLS. 100 AND 105).

JANICE L. MCMORROW, EXAMINING ATTORNEY

THE MARK CONSISTS OF STANDARD CHARACTERS WITHOUT CLAIM TO ANY PARTICULAR FONT, STYLE, SIZE, OR COLOR.

NO CLAIM IS MADE TO THE EXCLUSIVE RIGHT TO USE "MANUFACTURING & TRADING COMPANY", APART FROM THE MARK AS SHOWN.

FOR PROVIDING WAREHOUSING AND TRANSPORT SERVICES BY ALL AVAILABLE MEANS FOR FOOD AND BEVERAGES (U.S. CLS. 100 AND 105).

LEIGH LOWRY, EXAMINING ATTORNEY

SN 78-451,143. TIS EXELL, INC., MANHATTAN BEACH, CA. FILED 7-15-2004.

SN 78-493,713. MOUSESAVERS, INC., CASCADE, CO. FILED 10-4-2004.

Experience the
Best

MouseSavers.com

THE MARK CONSISTS OF STANDARD CHARACTERS WITHOUT CLAIM TO ANY PARTICULAR FONT, STYLE, SIZE, OR COLOR.

FOR ARRANGING TRAVEL TOURS IN THE FIELD OF SPORTS TOURS PACKAGES FOR TEAMS AND SPORTS ORGANIZATIONS (U.S. CLS. 100 AND 105).

TINA L. SNAPP, EXAMINING ATTORNEY

THE MARK CONSISTS OF STANDARD CHARACTERS WITHOUT CLAIM TO ANY PARTICULAR FONT, STYLE, SIZE, OR COLOR.

FOR PROVIDING ONLINE INFORMATION REGARDING TRAVEL AND REGARDING DISCOUNTS, COUPONS AND SPECIAL OFFERS FOR THE TRAVEL RELATED GOODS AND SERVICES OF OTHERS (U.S. CLS. 100 AND 105).

FIRST USE 4-29-2001; IN COMMERCE 4-29-2001.

LINDA MICKLEBURGH, EXAMINING ATTORNEY

CLASS 39—(Continued).

SN 78-501,234. KLLM, INC., RICHLAND, MS. FILED 10-18-2004.



OWNER OF U.S. REG. NOS. 1,456,863 AND 2,150,158. NO CLAIM IS MADE TO THE EXCLUSIVE RIGHT TO USE "TRANSPORT SERVICES", APART FROM THE MARK AS SHOWN.

FOR TRANSPORTATION SERVICES, NAMELY, SURFACE TRANSPORTATION OF THE FREIGHT AND GOODS OF OTHERS BY TRUCK (U.S. CLS. 100 AND 105).

FIRST USE 9-1-2004; IN COMMERCE 9-1-2004. JOHN DWYER, EXAMINING ATTORNEY

CLASS 39—(Continued).

SN 78-512,800. JANET MORGAN, PORT ORANGE, FL. FILED 11-8-2004.

**Planning
Vacations...
Delivering Dreams**

THE MARK CONSISTS OF STANDARD CHARACTERS WITHOUT CLAIM TO ANY PARTICULAR FONT, STYLE, SIZE, OR COLOR.

FOR TRAVEL AGENCY SERVICE, NAMELY, MAKING RESERVATIONS AND BOOKINGS FOR TRANSPORTATION, TOURS, CRUISES, AND TRANSPORTATION AND TOUR TICKET RESERVATIONS FOR VACATIONERS (U.S. CLS. 100 AND 105).

FIRST USE 10-18-2004; IN COMMERCE 10-18-2004. ANN LINNEHAN, EXAMINING ATTORNEY

SN 78-507,464. THE BEKINS COMPANY, HILLSIDE, IL. FILED 10-28-2004.

**TRUST GOES A LONG
WAY**

THE MARK CONSISTS OF STANDARD CHARACTERS WITHOUT CLAIM TO ANY PARTICULAR FONT, STYLE, SIZE, OR COLOR.

FOR TRANSPORTATION SERVICES, NAMELY, TRANSPORTATION AND COORDINATION OF THE TRANSPORTATION OF USED HOUSEHOLD GOODS TO AND FROM PERSONAL RESIDENCES BY MEANS OF TRUCK AND RAIL (U.S. CLS. 100 AND 105).

LOURDES AYALA, EXAMINING ATTORNEY

SN 78-515,802. JK MOVING & STORAGE, INC., STERLING, VA. FILED 11-12-2004.

**MAKE THE MOVE OF
YOUR LIFE**

SN 78-511,561. ELITE LAND TOURS, INC., PALM SPRINGS, CA. FILED 11-4-2004.

**DISCOVERY THROUGH
EXPLORATION**

THE MARK CONSISTS OF STANDARD CHARACTERS WITHOUT CLAIM TO ANY PARTICULAR FONT, STYLE, SIZE, OR COLOR.

FOR TOUR GUIDE SERVICES AND CONDUCTING SIGHTSEEING TOURS FOR OTHERS, NAMELY GUIDED SIGHTSEEING TOURS TO REMOTE AREAS (U.S. CLS. 100 AND 105).

FIRST USE 9-1-2004; IN COMMERCE 9-1-2004. PRISCILLA MILTON, EXAMINING ATTORNEY

THE MARK CONSISTS OF STANDARD CHARACTERS WITHOUT CLAIM TO ANY PARTICULAR FONT, STYLE, SIZE, OR COLOR.

FOR TRANSPORT, PACKAGING AND STORAGE OF GOODS (U.S. CLS. 100 AND 105).

FIRST USE 6-1-2003; IN COMMERCE 6-1-2003. KAREN BRACEY, EXAMINING ATTORNEY

CLASS 39—(Continued).

SN 78-515,817. JK MOVING & STORAGE, INC., STERLING, VA. FILED 11-12-2004.

CLASS 39—(Continued).

SN 78-516,443. DEBOER TRANSPORTATION, INC., BLENNER, WI. FILED 11-13-2004.

**This Move is Your
Future. It's ours
too.**

DEBOER

THE MARK CONSISTS OF STANDARD CHARACTERS WITHOUT CLAIM TO ANY PARTICULAR FONT, STYLE, SIZE, OR COLOR.

FOR TRANSPORT AND STORAGE OF GOODS; PACKAGING ARTICLES FOR TRANSPORTATION (U.S. CLS. 100 AND 105).

FIRST USE 6-1-2003; IN COMMERCE 6-1-2003.
DAWN HAN, EXAMINING ATTORNEY

THE MARK CONSISTS OF STANDARD CHARACTERS WITHOUT CLAIM TO ANY PARTICULAR FONT, STYLE, SIZE, OR COLOR.

SEC. 2(F).
FOR TRANSPORTATION SERVICES, NAMELY, TRANSPORTATION AND SHIPPING OF GOODS BY TRUCK; INTERMODAL SERVICES, NAMELY, INTERMODAL SERVICES INVOLVING THE TRANSPORTATION AND SHIPPING OF FREIGHT, CARGO AUTOMOTIVE VEHICLES, AND CARGO CONTAINER BY TRUCK OR TRAIN (U.S. CLS. 100 AND 105).

FIRST USE 0-0-1967; IN COMMERCE 0-0-1967.
ESTHER A. BORSUK, EXAMINING ATTORNEY

SN 78-516,436. SOUTHFORK DEVELOPMENT GROUP, EL DORADO HILLS, CA. FILED 11-13-2004.

SN 78-516,444. DEBOER TRANSPORTATION, INC., BLENNER, WI. FILED 11-13-2004.

Gold Key



THE MARK CONSISTS OF STANDARD CHARACTERS WITHOUT CLAIM TO ANY PARTICULAR FONT, STYLE, SIZE, OR COLOR.

FOR SELF-STORAGE SERVICES; STORAGE SERVICES FOR RECREATIONAL VEHICLES, BOATS AND WINE (U.S. CLS. 100 AND 105).

FIRST USE 5-1-2004; IN COMMERCE 6-1-2004.
BRIAN NEVILLE, EXAMINING ATTORNEY

FOR TRANSPORTATION SERVICES, NAMELY, TRANSPORTATION AND SHIPPING OF GOODS BY TRUCK; INTERMODAL SERVICES, NAMELY, INTERMODAL SERVICES INVOLVING THE TRANSPORTATION AND SHIPPING OF FREIGHT, CARGO AUTOMOTIVE VEHICLES, AND CARGO CONTAINER BY TRUCK OR TRAIN (U.S. CLS. 100 AND 105).

FIRST USE 0-0-1967; IN COMMERCE 0-0-1967.
JEAN IM, EXAMINING ATTORNEY

CLASS 39—(Continued).

SN 78-517,840. ACADEMY BUS, L.L.C., HOBOKEN, NJ.
FILED 11-16-2004.

CLASS 39—(Continued).

SN 78-517,914. SOUTHWEST AIRLINES CO., DALLAS, TX.
FILED 11-16-2004.

**CELEBREMOS TU
HERENCIA**

ACADEMY

THE MARK CONSISTS OF STANDARD CHARACTERS WITHOUT CLAIM TO ANY PARTICULAR FONT, STYLE, SIZE, OR COLOR.

THE FOREIGN WORDING IN THE MARK TRANSLATES INTO ENGLISH AS LET'S CELEBRATE YOUR HERITAGE. FOR TRANSPORTATION SERVICES, NAMELY TRANSPORTING PASSENGERS AND CARGO BY AIR (U.S. CLS. 100 AND 105).

FIRST USE 9-1-2001; IN COMMERCE 9-1-2001.
ANNE E. GUSTASON, EXAMINING ATTORNEY

THE MARK CONSISTS OF STANDARD CHARACTERS WITHOUT CLAIM TO ANY PARTICULAR FONT, STYLE, SIZE, OR COLOR.

FOR BUS TRANSPORTATION SERVICES (U.S. CLS. 100 AND 105).

FIRST USE 0-0-1983; IN COMMERCE 0-0-1983.
JEAN IM, EXAMINING ATTORNEY

SN 78-518,017. ACADEMY BUS, L.L.C., HOBOKEN, NJ.
FILED 11-16-2004.



FOR BUS TRANSPORTATION SERVICES (U.S. CLS. 100 AND 105).

FIRST USE 0-0-1983; IN COMMERCE 0-0-1983.
JEAN IM, EXAMINING ATTORNEY

SN 78-517,873. ACADEMY BUS, L.L.C., HOBOKEN, NJ.
FILED 11-16-2004.

SN 78-518,165. ACADEMY BUS, L.L.C., HOBOKEN, NJ.
FILED 11-17-2004.



QUIKPASS

THE MARK CONSISTS OF STANDARD CHARACTERS WITHOUT CLAIM TO ANY PARTICULAR FONT, STYLE, SIZE, OR COLOR.

FOR BUS TRANSPORTATION SERVICES (U.S. CLS. 100 AND 105).

FIRST USE 12-0-2002; IN COMMERCE 12-0-2002.
KEVIN DINALLO, EXAMINING ATTORNEY

FOR BUS TRANSPORTATION SERVICES (U.S. CLS. 100 AND 105).

FIRST USE 0-0-1983; IN COMMERCE 0-0-1983.
JEAN IM, EXAMINING ATTORNEY

CLASS 39—(Continued).

SN 78-521,082. WALSER SPECIALIZED SERVICES, LLC, HOPKINS, MN. FILED 11-22-2004.

FLEETFLO

THE MARK CONSISTS OF STANDARD CHARACTERS WITHOUT CLAIM TO ANY PARTICULAR FONT, STYLE, SIZE, OR COLOR.
FOR VEHICLE LEASING SERVICES (U.S. CLS. 100 AND 105).
CAROLYN CATALDO, EXAMINING ATTORNEY

CLASS 39—(Continued).

SN 78-524,028. CYCLE OREGON, INC., PORTLAND, OR. FILED 11-29-2004.

CYCLE OREGON

THE MARK CONSISTS OF STANDARD CHARACTERS WITHOUT CLAIM TO ANY PARTICULAR FONT, STYLE, SIZE, OR COLOR.
NO CLAIM IS MADE TO THE EXCLUSIVE RIGHT TO USE "CYCLE", APART FROM THE MARK AS SHOWN.
SEC. 2(F).
FOR ARRANGING AND CONDUCTING BICYCLE RIDES AND TOURS (U.S. CLS. 100 AND 105).
FIRST USE 0-0-1988; IN COMMERCE 0-0-1988.
ROBIN CHOSID, EXAMINING ATTORNEY

SN 78-524,035. CYCLE OREGON, INC., PORTLAND, OR. FILED 11-29-2004.



NO CLAIM IS MADE TO THE EXCLUSIVE RIGHT TO USE "CYCLE", APART FROM THE MARK AS SHOWN.
SEC. 2(F) AS TO CYCLE OREGON.
FOR ARRANGING AND CONDUCTING BICYCLE RIDES AND TOURS (U.S. CLS. 100 AND 105).
FIRST USE 1-0-2003. THE MARK WAS FIRST USED ANYWHERE IN A DIFFERENT FORM OTHER THAN THAT SOUGHT TO BE REGISTERED ON 00/00/1988.; IN COMMERCE 1-0-2003. THE MARK WAS FIRST USED IN COMMERCE IN A DIFFERENT FORM OTHER THAN THAT SOUGHT TO BE REGISTERED ON 00/00/1988..
ROBIN CHOSID, EXAMINING ATTORNEY

SN 78-521,282. BLUARROW AVIATION LIMITED, HALESOWEN, WEST MIDLANDS, UNITED KINGDOM, FILED 11-22-2004.



THE MARK CONSISTS OF THE TERM "FLYWHO" IN LOWER CASE LETTERING WITH A BUTTERFLY POSITIONED ABOVE AND TO THE RIGHT OF THE LETTER "O".
FOR TRANSPORTATION OF PASSENGERS, PARCELS, FREIGHT AND CARGO BY AIR; PROVIDING INFORMATION ABOUT AIR TRANSPORTATION VIA A WEBSITE ON A GLOBAL COMPUTER NETWORK; TRAVEL AGENCY SERVICES, NAMELY, MAKING RESERVATIONS AND BOOKINGS FOR TRANSPORTATION; AIRLINE PASSENGER SERVICES IN THE NATURE OF A FREQUENT FLYER PROGRAM (U.S. CLS. 100 AND 105).
WENDY GOODMAN, EXAMINING ATTORNEY

CLASS 39—(Continued).

SN 78-527,274. TRIPLE T ENTERPRISES, INC., BOISE, ID. FILED 12-5-2004.

CLASS 39—(Continued).

SN 78-541,511. SIMPLY SOUTHERN, LLC, COCOA, FL. FILED 1-3-2005.

SMOKY MOUNTAIN

FloraGram

THE MARK CONSISTS OF STANDARD CHARACTERS WITHOUT CLAIM TO ANY PARTICULAR FONT, STYLE, SIZE, OR COLOR.

OWNER OF U.S. REG. NOS. 2,841,465, 2,879,077 AND OTHERS.

FOR DELIVERY OF FOOD, NAMELY GRILLED FOOD, PIZZA, PASTA AND SANDWICHES (U.S. CLS. 100 AND 105).

ROBIN CHOSID, EXAMINING ATTORNEY

THE MARK CONSISTS OF STANDARD CHARACTERS WITHOUT CLAIM TO ANY PARTICULAR FONT, STYLE, SIZE, OR COLOR.

FOR DELIVERY OF FLORALS, WREATHS, CANDY, WITH GIFT AND MESSAGE (U.S. CLS. 100 AND 105). DOMINIC J. FERRAIUOLO, EXAMINING ATTORNEY

SN 78-541,330. WORLDPASS TRAVEL GROUP, LLC, EL DORADO HILLS, CA. FILED 1-3-2005.

SN 78-545,057. NORTHSTAR TRAVEL MEDIA, LLC, SECAUCUS, NJ. FILED 1-10-2005.

USA EXECUTIVE SERVICES

in the know on where to go

THE MARK CONSISTS OF STANDARD CHARACTERS WITHOUT CLAIM TO ANY PARTICULAR FONT, STYLE, SIZE, OR COLOR.

OWNER OF U.S. REG. NO. 2,226,908.

NO CLAIM IS MADE TO THE EXCLUSIVE RIGHT TO USE "SERVICES", APART FROM THE MARK AS SHOWN. SEC. 2(F).

FOR ARRANGING TRAVEL TOURS (U.S. CLS. 100 AND 105).

FIRST USE 11-1-1997; IN COMMERCE 11-1-1997.

CHRISTOPHER BUONGIORNO, EXAMINING ATTORNEY

THE MARK CONSISTS OF STANDARD CHARACTERS WITHOUT CLAIM TO ANY PARTICULAR FONT, STYLE, SIZE, OR COLOR.

FOR PROVISION OF ONLINE INFORMATION RELATED TO TRAVEL (U.S. CLS. 100 AND 105).

CYNTHIA SLOAN, EXAMINING ATTORNEY

CLASS 39—(Continued).

SN 78-547,735. WADSWORTH, NADINE, TREASURE ISLAND, FL. FILED 1-14-2005.

CLASS 39—(Continued).

SN 78-556,691. DESTINY MARKETING GROUP, INC., SAN CLEMENTE, CA. FILED 1-31-2005.

DOGGY SOD

THE MARK CONSISTS OF STANDARD CHARACTERS WITHOUT CLAIM TO ANY PARTICULAR FONT, STYLE, SIZE, OR COLOR.

NO CLAIM IS MADE TO THE EXCLUSIVE RIGHT TO USE "SOD", APART FROM THE MARK AS SHOWN.

FOR SERVICE TO HOMES OF DOG OWNERS, NAMELY, PROVIDING A SERVICE TO DELIVER AND PICK UP TRAYS OF SOD WHICH DOGS HAVE DONE THEIR BUSINESS IN (U.S. CLS. 100 AND 105).

FIRST USE 1-2-2005; IN COMMERCE 1-4-2005.
DAVID ELTON, EXAMINING ATTORNEY

TRIP N' TEA

THE MARK CONSISTS OF STANDARD CHARACTERS WITHOUT CLAIM TO ANY PARTICULAR FONT, STYLE, SIZE, OR COLOR.

FOR TRAVEL AGENCY SERVICES, NAMELY, MAKING RESERVATIONS AND BOOKINGS FOR TRANSPORTATION (U.S. CLS. 100 AND 105).

C. DIONNE CLYBURN, EXAMINING ATTORNEY

SN 78-555,079. DESTINY MARKETING GROUP, INC., SAN CLEMENTE, CA. FILED 1-27-2005.

SN 78-556,768. VALDA, EDUARDO, ALBUQUERQUE, NM. FILED 1-31-2005.

FUN IN MOTION

THE MARK CONSISTS OF STANDARD CHARACTERS WITHOUT CLAIM TO ANY PARTICULAR FONT, STYLE, SIZE, OR COLOR.

FOR TRAVEL AGENCY SERVICES, NAMELY, MAKING RESERVATIONS AND BOOKINGS FOR TRANSPORTATION (U.S. CLS. 100 AND 105).

HEATHER THOMPSON, EXAMINING ATTORNEY

France at a Glance

THE MARK CONSISTS OF STANDARD CHARACTERS WITHOUT CLAIM TO ANY PARTICULAR FONT, STYLE, SIZE, OR COLOR.

NO CLAIM IS MADE TO THE EXCLUSIVE RIGHT TO USE "FRANCE", APART FROM THE MARK AS SHOWN.

FOR CONDUCTING SIGHTSEEING TOURS FOR OTHERS (U.S. CLS. 100 AND 105).

KATHY DE JONGE, EXAMINING ATTORNEY

CLASS 39—(Continued).

SN 79-007,235. IBERIA.; LINEAS AEREAS DE ESPAÑA, S.A., SPAIN, FILED 7-21-2004.



PRIORITY DATE OF 1-21-2004 IS CLAIMED.
OWNER OF INTERNATIONAL REGISTRATION 0838713
DATED 7-21-2004, EXPIRES 7-21-2014.
OWNER OF U.S. REG. NOS. 830,010, 2,351,172 AND
OTHERS.

FOR AIR TRANSPORT; TRANSPORTATION SERVICES VIA AIR; PACKING ARTICLES FOR TRANSPORTATION; WAREHOUSING SERVICES, NAMELY, STORAGE, DISTRIBUTION, PICK-UP AND PACKING FOR SHIPMENT OF DOCUMENTS, PACKAGES, RAW MATERIALS AND OTHER FREIGHT FOR OTHERS; WAREHOUSE STORAGE SERVICES; ARRANGING OF TRAVEL TOURS; BOOKING TRANSPORTATION FOR TRAVEL; AND RENTAL CAR RESERVATION SERVICES (U.S. CLS. 100 AND 105).

JEAN IM, EXAMINING ATTORNEY

CLASS 40—MATERIAL TREATMENT

SN 75-525,647. CONTROL FIRE SYSTEMS LTD., TORONTO, ONTARIO, CANADA, FILED 7-27-1998.



PRIORITY CLAIMED UNDER SEC. 44(D) ON CANADA APPLICATION NO. 882,479, FILED 6-24-1998, REG. NO. TMA533178, DATED 9-22-2000, EXPIRES 9-22-2015.

PRIORITY CLAIMED UNDER SEC. 44(D) ON CANADA APPLICATION NO. 873,944, FILED 4-1-1998, REG. NO. TMA522365, DATED 1-27-2000, EXPIRES 1-27-2015.

NO CLAIM IS MADE TO THE EXCLUSIVE RIGHT TO USE "FIRE SYSTEMS LTD.", APART FROM THE MARK AS SHOWN.

THE LINING AND STIPPLING SHOWN IN THE DRAWING ARE FEATURES OF THE MARK AND ARE NOT MEANT TO INDICATE COLOR.

FOR RECYCLING OF HALON (U.S. CLS. 100, 103 AND 106).

ARETHA SOMERVILLE, EXAMINING ATTORNEY

CLASS 40—(Continued).

SN 76-593,514. WILLIAMSON PRINTING CORPORATION, DALLAS, TX, FILED 5-21-2004.

WILLIAMSON MAILER MAGIC

THE MARK CONSISTS OF STANDARD CHARACTERS WITHOUT CLAIM TO ANY PARTICULAR FONT, STYLE, SIZE, OR COLOR.

NO CLAIM IS MADE TO THE EXCLUSIVE RIGHT TO USE "MAILER", APART FROM THE MARK AS SHOWN.

FOR PRINTING SERVICES; CONVERTING PAPER INTO MAILING ENVELOPES AND OTHER MAILERS (U.S. CLS. 100, 103 AND 106).

LINDA E. BLOHM, EXAMINING ATTORNEY

SN 76-607,620. CONSTRUCTIVE COPY, LLC, LATHAM, NY, FILED 8-16-2004.

CONSTRUCTIVE COPY

THE MARK CONSISTS OF STANDARD CHARACTERS WITHOUT CLAIM TO ANY PARTICULAR FONT, STYLE, SIZE, OR COLOR.

NO CLAIM IS MADE TO THE EXCLUSIVE RIGHT TO USE "COPY", APART FROM THE MARK AS SHOWN.

FOR PRINTING OF DOCUMENTS; PHOTOGRAPHIC REPRODUCTION; ELECTRONIC IMAGING AND SCANNING OF PHOTOGRAPHIC IMAGES; DUPLICATION OF AUDIO TAPES, VIDEO TAPES, TAPE RECORDINGS, VIDEO CASSETTES, CD-ROM'S AND DVDS (U.S. CLS. 100, 103 AND 106).

FIRST USE 8-1-2003; IN COMMERCE 10-17-2003.

CHRISIE B. KING, EXAMINING ATTORNEY

SN 76-612,841. POLYMICRO TECHNOLOGIES, LLC, PHOENIX, AZ, FILED 9-27-2004.

EXPLORE OUR CAPABILITIES

THE MARK CONSISTS OF STANDARD CHARACTERS WITHOUT CLAIM TO ANY PARTICULAR FONT, STYLE, SIZE, OR COLOR.

FOR CONTRACT MANUFACTURING IN THE FOLLOWING FIELDS— MULTIMODE, STEPINDEX FUSED SILICA OPTICAL FIBERS WITH POLYIMIDE, ACRYLATE, SILICONE AND ALUMINUM BUFFERS; SOLARIZATION RESISTANT OPTICAL FIBERS; HOLLOW SILICA WAVEGUIDES; FIBER OPTIC CABLES AND ASSEMBLIES; HIGH STRENGTH, HIGH TEMPERATURE FLEXIBLE FUSED SILICA CAPILLARIES; SQUARE CAPILLARIES; LIGHT GUIDING CAPILLARIES; CUSTOM PRECISION SILICA AND QUARTZ ROD AND TUBING PIECES; CUSTOM SHAPED ROD AND TUBING; MULTILUMEN TUBING; AND TELECOM FERRULES AND SLEEVES (U.S. CLS. 100, 103 AND 106).

FIRST USE 5-0-2002; IN COMMERCE 5-0-2002.

ELLEN B. AWRICH, EXAMINING ATTORNEY

CLASS 40—(Continued).

SN 76-613,296. ANCHOR LAMINA AMERICA, INC., OAK PARK, MI. FILED 9-22-2004.

LAMGLIDE

THE MARK CONSISTS OF STANDARD CHARACTERS WITHOUT CLAIM TO ANY PARTICULAR FONT, STYLE, SIZE, OR COLOR.

FOR MANUFACTURE OF MACHINE PARTS TO THE ORDER AND SPECIFICATION OF OTHERS (U.S. CLS. 100, 103 AND 106).

FIRST USE 2-23-2001; IN COMMERCE 3-22-2002.
TONI HICKEY, EXAMINING ATTORNEY

SN 76-616,035. NORTHSTAR CHEMICALS, INC., CARTERSVILLE, GA. FILED 10-15-2004.



NO CLAIM IS MADE TO THE EXCLUSIVE RIGHT TO USE CHEMICALS INC, APART FROM THE MARK AS SHOWN.

FOR PRODUCTION SERVICES IN THE CHEMICAL INDUSTRY, NAMELY, CUSTOM MANUFACTURE OF AEROSOL AND LIQUID ADHESIVE PRODUCTS (U.S. CLS. 100, 103 AND 106).

FIRST USE 8-18-1994; IN COMMERCE 8-18-1994.
NICHOLAS ALTREE, EXAMINING ATTORNEY

SN 76-623,577. ASTRO MODEL DEVELOPMENT CORP., EASTLAKE, OH. FILED 12-7-2004.

ASTRO MANUFACTURING & DESIGN

THE MARK CONSISTS OF STANDARD CHARACTERS WITHOUT CLAIM TO ANY PARTICULAR FONT, STYLE, SIZE, OR COLOR.

OWNER OF U.S. REG. NO. 2,153,720.

NO CLAIM IS MADE TO THE EXCLUSIVE RIGHT TO USE "MANUFACTURING & DESIGN", APART FROM THE MARK AS SHOWN.

FOR CUSTOM MANUFACTURING OF PARTS, MACHINES AND PROTOTYPES BASED ON THE SPECIFICATIONS OF OTHERS USING MILLING, BORING, TURNING, GRINDING, LASER CUTTING TECHNOLOGIES AND LAMINATED OBJECT MANUFACTURING IN THE FIELD OF MEDICAL, ELECTRICAL, AUTOMOTIVE AND TECHNOLOGY RELATED INDUSTRIES (U.S. CLS. 100, 103 AND 106).

BILL DAWE, EXAMINING ATTORNEY

CLASS 40—(Continued).

SN 78-248,793. AMTECH CORPORATION, YELM, WA. FILED 5-12-2003.

AMTECH CORPORATION

OWNER OF U.S. REG. NO. 2,903,223.

NO CLAIM IS MADE TO THE EXCLUSIVE RIGHT TO USE "CORPORATION", APART FROM THE MARK AS SHOWN.

FOR CUSTOM FABRICATION AND MANUFACTURE OF PORTABLE NON-METAL BUILDING UNITS FOR COMMERCIAL, RECREATIONAL, AND RESIDENTIAL USE; BATHROOM MODULES; CUSTOMIZABLE MODULAR BATHROOM CONSISTING OF AT LEAST ONE OF TOILETS, BATHTUBS, SINKS AND SHOWERS; PORTABLE TOILETS; PREFABRICATED GREENHOUSES; HOT TUBS; SPAS; FITTED COVERS FOR VEHICLES; HARDTOPS FOR MILITARY AND UTILITY VEHICLES AND TRAILERS FOR HAULING CARGO AND EQUIPMENT; PARTS AND COMPONENTS THEREOF, USING FIBERGLASS, PLASTIC, EPOXY AND/OR URETHANE (U.S. CLS. 100, 103 AND 106).

FIRST USE 7-13-1987; IN COMMERCE 7-13-1987.
NANCY CLARKE, EXAMINING ATTORNEY

SN 78-281,136. REEL REVIVAL, LLC, WOODLAND HILLS, CA. FILED 7-30-2003.

REEL REVIVAL

NO CLAIM IS MADE TO THE EXCLUSIVE RIGHT TO USE "REEL", APART FROM THE MARK AS SHOWN.

FOR FORMAT CONVERSION SERVICES FROM ONE MEDIA FORMAT TO ANOTHER, NAMELY, FORMAT CONVERSION OF MOTION PICTURES, FILMS, TELEVISION PROGRAMS, HDTV PROGRAMS, VIDEOS, OR BROADCAST MATERIAL TO ANOTHER MEDIA FORMAT; FORMAT CONVERSION OF NTSC VIDEO FORMAT, PAL VIDEO FORMAT, MOTION PICTURE FORMAT, OR TELEVISION FORMAT TO AN HDTV FORMAT (U.S. CLS. 100, 103 AND 106).

FIRST USE 12-31-2002; IN COMMERCE 12-31-2002.
REBECCA SMITH, EXAMINING ATTORNEY

SN 78-400,251. PRINTPACK, ILLINOIS, INC., ELGIN, IL. FILED 4-12-2004.

Packaging Better Ideas

THE MARK CONSISTS OF STANDARD CHARACTERS WITHOUT CLAIM TO ANY PARTICULAR FONT, STYLE, SIZE, OR COLOR.

FOR CUSTOM MANUFACTURE OF PACKAGING MATERIALS FOR CONSUMER GOODS COMPANIES (U.S. CLS. 100, 103 AND 106).

FIRST USE 12-0-2002; IN COMMERCE 12-0-2002.
REBECCA SMITH, EXAMINING ATTORNEY

CLASS 40—(Continued).

SN 78-401,789. KAINDL, ROBERT W., DBA ART GLASS PRODUCTION, REDMOND, WA. FILED 4-14-2004.

YOUR VISION. OUR
TALENT.

THE MARK CONSISTS OF STANDARD CHARACTERS WITHOUT CLAIM TO ANY PARTICULAR FONT, STYLE, SIZE, OR COLOR.

FOR CUSTOM CREATION OF ART FOR OTHERS (U.S. CLS. 100, 103 AND 106).

FIRST USE 0-0-2002; IN COMMERCE 0-0-2002.

ANNE FARRELL, EXAMINING ATTORNEY

SN 78-418,217. CHEMCENTRIC, L.P., HOUSTON, TX. FILED 5-13-2004.

ChemSolver

THE MARK CONSISTS OF STANDARD CHARACTERS WITHOUT CLAIM TO ANY PARTICULAR FONT, STYLE, SIZE, OR COLOR.

FOR INTERNET-BASED WATER TREATMENT CONSULTATION SERVICES FOR SELECTING TREATMENT OR CORROSION AND SCALE INHIBITION CHEMICALS FOR INDUSTRIAL AND COMMERCIAL AQUEOUS COOLING, HEATING, AND CONDENSATE SYSTEMS, FOR BOILER FEEDWATER, AND FOR RAW AND WASTEWATER CLARIFICATION SYSTEMS (U.S. CLS. 100, 103 AND 106).

FIRST USE 8-1-2001; IN COMMERCE 3-19-2003.

DARRYL SPRUILL, EXAMINING ATTORNEY

CLASS 40—(Continued).

SN 78-418,932. ST. JAMES WINERY, INC., ST. JAMES, MO. FILED 5-14-2004.

ST. JAMES WINERY

THE MARK CONSISTS OF STANDARD CHARACTERS WITHOUT CLAIM TO ANY PARTICULAR FONT, STYLE, SIZE, OR COLOR.

OWNER OF U.S. REG. NO. 2,951,837.

SEC. 2(F) AS TO "ST. JAMES".

FOR PROVIDING INFORMATION ABOUT WINE-MAKING (U.S. CLS. 100, 103 AND 106).

FIRST USE 12-31-1970; IN COMMERCE 12-31-1970.

PAULA MAHONEY, EXAMINING ATTORNEY

SN 78-426,129. MIMEO.COM, INC., NEW YORK, NY. FILED 5-27-2004.



OWNER OF U.S. REG. NOS. 2,505,979, 2,607,935 AND OTHERS.

THE COLOR(S) BLUE AND PALE GREEN. IS/ARE CLAIMED AS A FEATURE OF THE MARK.

THE MARK CONSISTS OF A CIRCLE DESIGN HALF IN BLUE AND HALF IN PALE GREEN.

FOR ON-LINE PRINTING SERVICES (U.S. CLS. 100, 103 AND 106).

FIRST USE 6-1-2001; IN COMMERCE 6-1-2001.

VERNA BETH RIRIE, EXAMINING ATTORNEY

SN 78-448,754. POWELL PRODUCTS INC., COLORADO SPRINGS, CO. FILED 7-9-2004.



NO CLAIM IS MADE TO THE EXCLUSIVE RIGHT TO USE "PRODUCTS, INC.", APART FROM THE MARK AS SHOWN.

THE MARK CONSISTS OF POWELL PRODUCTS INC TO THE RIGHT OF THREE CRESCENT SHAPES.

FOR MANUFACTURE OF APPLICATORS AND SUBSTANCE TRANSFER AND FLOW-THROUGH DEVICES FOR CLEANROOM, MEDICAL, DENTAL, PHARMACEUTICAL, COSMETIC AND FOOD-TESTING APPLICATIONS TO THE ORDER AND SPECIFICATION OF OTHERS (U.S. CLS. 100, 103 AND 106).

FIRST USE 11-30-2003; IN COMMERCE 11-30-2003.

YONG KIM, EXAMINING ATTORNEY

CLASS 40—(Continued).

SN 78-502,222. SEARS BRANDS, LLC, HOFFMAN ESTATES, IL. FILED 10-19-2004.

CLASS 40—(Continued).

SN 78-505,924. STAR COPY PRINTING & PROMOTION CENTER, INC., NAPERVILLE, IL. FILED 10-26-2004.

PICTURES TO GO

**If it's not
breathing, Star
can print on it!**

THE MARK CONSISTS OF STANDARD CHARACTERS WITHOUT CLAIM TO ANY PARTICULAR FONT, STYLE, SIZE, OR COLOR.

NO CLAIM IS MADE TO THE EXCLUSIVE RIGHT TO USE "PICTURES", APART FROM THE MARK AS SHOWN.

FOR PHOTOGRAPHIC FINISHING, PHOTOGRAPHIC DEVELOPING AND PHOTOGRAPHIC PRINTING SERVICES (U.S. CLS. 100, 103 AND 106).

ANNE E. GUSTASON, EXAMINING ATTORNEY

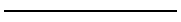

SN 78-505,645. STAR COPY PRINTING & PROMOTION CENTER, INC., NAPERVILLE, IL. FILED 10-25-2004.

THE MARK CONSISTS OF STANDARD CHARACTERS WITHOUT CLAIM TO ANY PARTICULAR FONT, STYLE, SIZE, OR COLOR.

FOR PRINTING SERVICES, NAMELY, CUSTOMIZED PRINTING OF COMPANY LOGOS OR CORPORATE IMAGES FOR PROMOTIONAL AND ADVERTISING PURPOSES ON THE GOODS OF OTHERS, NAMELY, ON PROMOTIONAL AND TRADE SHOW ITEMS (U.S. CLS. 100, 103 AND 106).

FIRST USE 1-20-2004; IN COMMERCE 9-1-2004.
STEVEN PEREZ, EXAMINING ATTORNEY

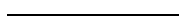

SN 78-506,113. MANNKRAFT CORPORATION, NEWARK, NJ. FILED 10-26-2004.

**If it's not
breathing, we
can print on it!**

RETAILERS LOVE US!

THE MARK CONSISTS OF STANDARD CHARACTERS WITHOUT CLAIM TO ANY PARTICULAR FONT, STYLE, SIZE, OR COLOR.

FOR PRINTING SERVICES, NAMELY, PRINTING COMPANY LOGOS OR CORPORATE IMAGES ON PROMOTIONAL AND TRADE SHOW ITEMS (U.S. CLS. 100, 103 AND 106).

FIRST USE 1-10-2004; IN COMMERCE 9-20-2004.
MARGERY A. TIERNEY, EXAMINING ATTORNEY

THE MARK CONSISTS OF STANDARD CHARACTERS WITHOUT CLAIM TO ANY PARTICULAR FONT, STYLE, SIZE, OR COLOR.

FOR CUSTOM MANUFACTURE OF POP-UP ADVERTISING DISPLAYS FOR THIRD PARTIES (U.S. CLS. 100, 103 AND 106).

FIRST USE 8-15-2004; IN COMMERCE 8-15-2004.
EDWARD NELSON, EXAMINING ATTORNEY

CLASS 40—(Continued).

SN 78-513,950. JLC TECHNOLOGIES, L.L.C., TYLER, TX. FILED 11-9-2004.

**JLC TECHNOLOGIES
GROUP**

THE MARK CONSISTS OF STANDARD CHARACTERS WITHOUT CLAIM TO ANY PARTICULAR FONT, STYLE, SIZE, OR COLOR.

NO CLAIM IS MADE TO THE EXCLUSIVE RIGHT TO USE "TECHNOLOGIES GROUP", APART FROM THE MARK AS SHOWN.

FOR FLUID TREATMENT AND PROCESSING SERVICES FOR WATER, OIL, GAS, HYDROCARBON, LUBE OILS, AROMATICS, WATER, WASTE WATER, OIL AND GAS WELL DRILLING FLUIDS AND SLURRIES, PRODUCTION AND WASTE FLUIDS; FLUID RECLAMATION SERVICES FOR WATER, OIL, GAS, HYDROCARBON, LUBE OILS, AROMATICS, WATER, WASTE WATER, OIL AND GAS WELL DRILLING FLUIDS AND SLURRIES, PRODUCTION AND WASTE FLUIDS (U.S. CLS. 100, 103 AND 106).

CARRIE ACHEN, EXAMINING ATTORNEY

CLASS 40—(Continued).

SN 78-517,203. THE GAGE CORPORATION, INT., SPARTA, WI. FILED 11-15-2004.

GAGEMETAL

THE MARK CONSISTS OF STANDARD CHARACTERS WITHOUT CLAIM TO ANY PARTICULAR FONT, STYLE, SIZE, OR COLOR.

FOR CUSTOM MANUFACTURE FOR OTHERS OF ARCHITECTURAL AND DECORATIVE BUILDING COMPONENTS, NAMELY TILES, PANELS, SHEETS, AND CLADDING FOR USE ON SURFACES OF BUILDING INTERIORS, BUILDING EXTERIORS, AND BUILDING COMPONENTS (U.S. CLS. 100, 103 AND 106).

FIRST USE 2-25-2004; IN COMMERCE 2-25-2004.
JENNIFER MARTIN, EXAMINING ATTORNEY

SN 78-514,526. KENNEL KOMFORTS, INC., EUREKA, MT. FILED 11-10-2004.

KENNEL KOMFORTS

THE MARK CONSISTS OF STANDARD CHARACTERS WITHOUT CLAIM TO ANY PARTICULAR FONT, STYLE, SIZE, OR COLOR.

NO CLAIM IS MADE TO THE EXCLUSIVE RIGHT TO USE "KENNEL", APART FROM THE MARK AS SHOWN.

FOR CUSTOM MANUFACTURE OF DOG PRODUCTS, SPECIFICALLY, CLOTHING, BEDS, TOYS, CARRIERS, LEADS, AND ACCESSORIES (U.S. CLS. 100, 103 AND 106).

FIRST USE 5-19-1998; IN COMMERCE 5-19-1998.
ARETHA SOMERVILLE, EXAMINING ATTORNEY

SN 78-520,542. BELL, LAWRENCE R., GEORGETOWN, TX. FILED 11-20-2004.

**FROM YOUR HARD-
DRIVE TO YOUR WALL**

THE MARK CONSISTS OF STANDARD CHARACTERS WITHOUT CLAIM TO ANY PARTICULAR FONT, STYLE, SIZE, OR COLOR.

FOR PRINTING AND FRAMING OF ART REPRODUCTIONS AND PHOTOGRAPHS (U.S. CLS. 100, 103 AND 106).

FIRST USE 3-1-2004; IN COMMERCE 3-1-2004.
DOMINICK J. SALEMI, EXAMINING ATTORNEY

CLASS 40—(Continued).

SN 78-520,595. SUNSHINE PUBLICATIONS, INC., BONITA SPRINGS, FL. FILED 11-20-2004.

Let's Do Lunch

THE MARK CONSISTS OF STANDARD CHARACTERS WITHOUT CLAIM TO ANY PARTICULAR FONT, STYLE, SIZE, OR COLOR.

OWNER OF U.S. REG. NO. 2,820,513.
FOR IMPRINTING MESSAGES ON T-SHIRTS; EMBROIDERING (U.S. CLS. 100, 103 AND 106).
RONALD MCMORROW, EXAMINING ATTORNEY

SN 78-520,732. WRANGLER APPAREL CORP., WILMINGTON, DE. FILED 11-22-2004.

ULTRA GUARD

THE MARK CONSISTS OF STANDARD CHARACTERS WITHOUT CLAIM TO ANY PARTICULAR FONT, STYLE, SIZE, OR COLOR.

FOR TREATMENT OF CLOTHING MATERIALS TO RESIST ABRASION, WEAR AND LOSS OF COLOR (U.S. CLS. 100, 103 AND 106).
FLORENTINA BLANDU, EXAMINING ATTORNEY

CLASS 40—(Continued).

SN 78-539,164. MICROBE GUARD FRANCHISING, INC., PLYMOUTH, MN. FILED 12-28-2004.

DON'T BUILD WITHOUT IT!

THE MARK CONSISTS OF STANDARD CHARACTERS WITHOUT CLAIM TO ANY PARTICULAR FONT, STYLE, SIZE, OR COLOR.

FOR APPLICATION OF ANTIMICROBIAL COATINGS IN THE BUILDING MATERIALS AND CONSTRUCTION INDUSTRIES (U.S. CLS. 100, 103 AND 106).

FIRST USE 6-10-2004; IN COMMERCE 6-16-2004.
WILLIAM P. SHANAHAN, EXAMINING ATTORNEY

SN 78-542,984. SOLAR ECLIPSE GLASS TINTING, INC., WOODBRIDGE, VA. FILED 1-6-2005.



THE COLOR(S) BLACK AND YELLOW IS/ARE CLAIMED AS A FEATURE OF THE MARK.

THE MARK CONSISTS OF THE PHRASE "SOLAR ECLIPSE" WITH THE "O" BLACKED OUT AS THE MOON ECLIPSES THE SUN WITH THE "O" AND A PLANETARY ORBIT OUTLINED IN YELLOW.

FOR GLASS TINTING SERVICE (U.S. CLS. 100, 103 AND 106).

FIRST USE 4-1-1999; IN COMMERCE 4-1-1999.
KIM SAITO, EXAMINING ATTORNEY

SN 78-543,054. PRESTAGE FOODS, INC., CLINTON, NC. FILED 1-6-2005.

PRESTAGE FOODS

THE MARK CONSISTS OF STANDARD CHARACTERS WITHOUT CLAIM TO ANY PARTICULAR FONT, STYLE, SIZE, OR COLOR.

NO CLAIM IS MADE TO THE EXCLUSIVE RIGHT TO USE FOODS, APART FROM THE MARK AS SHOWN.

FOR FOOD PROCESSING (U.S. CLS. 100, 103 AND 106).

STANLEY I. OSBORNE, EXAMINING ATTORNEY

CLASS 40—(Continued).

SN 78-544,764. PRECISION PRESS, INC., NORTH MANKATO, MN. FILED 1-10-2005.

QUADRIS MEDICAL

THE MARK CONSISTS OF STANDARD CHARACTERS WITHOUT CLAIM TO ANY PARTICULAR FONT, STYLE, SIZE, OR COLOR.

NO CLAIM IS MADE TO THE EXCLUSIVE RIGHT TO USE "MEDICAL", APART FROM THE MARK AS SHOWN. FOR MANUFACTURE AND ASSEMBLY OF MEDICAL DEVICES TO THE ORDER AND SPECIFICATION OF OTHERS (U.S. CLS. 100, 103 AND 106).

CHRISTOPHER BUONGIORNO, EXAMINING ATTORNEY

CLASS 41—(Continued).

SN 76-070,738. ANDERSON, KENT, BISMARCK, ND. FILED 6-13-2000.

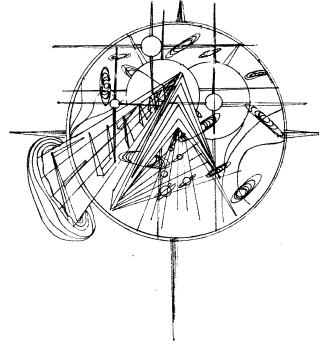

FOR COUNTRY CLUBS, NOT INCLUDING GOLF CLUB SERVICES; NIGHT CLUBS, YACHT CLUBS, FAN CLUB SERVICES; HEALTH CLUB SERVICES NAMELY, PROVIDING INSTRUCTION AND EQUIPMENT IN THE FIELD OF PHYSICAL EXERCISE, WRESTLING CLUBS, SPORTS CLUBS FOR FOOTBALL, BASKETBALL, RACING, BASEBALL, AND BOXING; PROVIDING VARIOUS FACILITIES FOR AN ARRAY OF ATHLETIC EVENTS NOT INCLUDING GOLF; SPECIAL INTEREST CLUBS IN THE FIELD OF AUTOMOBILES, AIRCRAFT, AND LAND CRAFT, ENTERTAINMENT, FINANCE, TRANSPORTATION, EDUCATION, INVENTIONS, BUSINESS OPERATIONS, GOING TO RESTAURANTS; MUSIC ENTERTAINMENT CLUBS FOR AMATEUR MUSICIANS (U.S. CLS. 100, 101 AND 107).

ESTHER BELENKER, EXAMINING ATTORNEY

CLASS 41—EDUCATION AND ENTERTAINMENT

SN 76-070,551. NATIONAL BOSTON VIDEO CENTER, INC., BROOKLINE, MA. FILED 6-15-2000.

NATIONAL BOSTON

NO CLAIM IS MADE TO THE EXCLUSIVE RIGHT TO USE BOSTON, APART FROM THE MARK AS SHOWN.

FOR MOTION PICTURE FILM PRODUCTION; AUDIO RECORDING AND PRODUCTION, VIDEO RECORDING AND PRODUCTION AND PRODUCTION OF AUDIO AND VIDEO DISCS AND TAPES FOR OTHERS (U.S. CLS. 100, 101 AND 107).

FIRST USE 5-0-1990; IN COMMERCE 5-0-1990. AMY GEARIN, EXAMINING ATTORNEY

SN 76-123,585. RADIANT SYSTEMS, INC., SOUTH PLAINFIELD, NJ. FILED 9-5-2000.

RADIANT

FOR EDUCATIONAL SERVICES IN THE FIELD OF COMPUTERS, NAMELY TRAINING IN COMPUTER PROGRAMMING, ADMINISTRATION OF COMPUTER SYSTEMS, DATABASE MANAGEMENT SYSTEMS, PROGRAMMING LANGUAGES, DESK-TOP APPLICATIONS, CLIENT/SERVER TECHNOLOGY, RAPID APPLICATION DEVELOPMENT TOOLS (U.S. CLS. 100, 101 AND 107).

FIRST USE 12-4-1995; IN COMMERCE 5-1-1996. HENRY S. ZAK, EXAMINING ATTORNEY

CLASS 41—(Continued).

SN 76-430,785. CLAYTON COLLEGE OF NATURAL HEALTH, INC., BIRMINGHAM, AL. FILED 7-15-2002.

PRACTICE WHAT WE TEACH

OWNER OF U.S. REG. NOS. 2,396,997, 2,533,696 AND OTHERS.

FOR CONDUCTING EDUCATIONAL SERVICES, NAMELY, CONDUCTING DISTANCE LEARNING COURSES, IN THE FIELDS OF NATUROPATHY, NATURAL HEALTH, HOLISTIC NUTRITION, BIOLOGY, ANATOMY, PHYSIOLOGY, TOXICOLOGY, PHARMACOLOGY, STRESS REDUCTION, WEIGHT MANAGEMENT, HOLISTIC HEALTH CONSULTING, AND HOMEOPATHY, TOGETHER WITH TESTING OF STUDENTS IN THE AFOREMENTIONED FIELDS, AND DISTRIBUTING COURSE MATERIALS IN CONNECTION THEREWITH (U.S. CLS. 100, 101 AND 107).

CURTIS FRENCH, EXAMINING ATTORNEY

SN 76-440,429. ARCHERY TRADE ASSOCIATION, INC., VIENNA, VA. FILED 8-5-2002.



NO CLAIM IS MADE TO THE EXCLUSIVE RIGHT TO USE ARCHERY TRADE ASSOCIATION, APART FROM THE MARK AS SHOWN.

FOR EDUCATIONAL SERVICES, NAMELY, CONDUCTING PROGRAMS, CLASSES, SEMINARS, CONFERENCES AND WORKSHOPS AND EXHIBITIONS, DISPLAYS AND INTERACTIVE EXHIBITS ON SPORTING AND HUNTING AND WILDLIFE CONSERVATION AND PUBLISHING SERVICES, NAMELY, PUBLICATION OF TEXT AND GRAPHIC WORKS OF OTHERS IN MAGAZINES, BOOKS, MANUALS, TARGETS, RULE BOOKS, TEXT BOOKS AND ARTICLES FEATURING INTEREST TO THOSE WITH INTEREST IN SPORTING AND HUNTING (U.S. CLS. 100, 101 AND 107).

FIRST USE 8-5-2002; IN COMMERCE 8-5-2002.
LESLEY LAMOTHE, EXAMINING ATTORNEY

SN 76-447,013. CANSOURCE MARKETING CORP., TORONTO, ONTARIO, CANADA, FILED 9-4-2002.

HORSE RACING IS REAL RACING

THE MARK CONSISTS OF STANDARD CHARACTERS WITHOUT CLAIM TO ANY PARTICULAR FONT, STYLE, SIZE, OR COLOR.

PRIORITY CLAIMED UNDER SEC. 44(D) ON CANADA APPLICATION NO. 1,132,611, FILED 3-5-2002, REG. NO. 1132611, DATED 4-1-2005, EXPIRES 4-1-2020.

FOR DISSEMINATION OF INFORMATION RELATING TO HORSE RACING (U.S. CLS. 100, 101 AND 107).
CHARLES L. JENKINS, EXAMINING ATTORNEY

CLASS 41—(Continued).

SN 76-482,786. WARNER BROS. ENTERTAINMENT INC., BURBANK, CA. FILED 1-16-2003.

THE WB'S EASY VIEW

OWNER OF U.S. REG. NOS. 1,971,247 AND 2,626,658.
FOR ENTERTAINMENT SERVICES IN THE NATURE OF LIVE-ACTION, COMEDY, DRAMA AND ANIMATED TELEVISION SERIES; PRODUCTION OF LIVE-ACTION, COMEDY, DRAMA AND ANIMATED TELEVISION SERIES; DISTRIBUTION AND DISPLAY OF LIVE-ACTION, COMEDY, DRAMA AND ANIMATED MOTION PICTURE THEATRICAL FILMS; PRODUCTION OF LIVE-ACTION, COMEDY, DRAMA AND ANIMATED MOTION PICTURE THEATRICAL FILMS; THEATRICAL PERFORMANCES BOTH ANIMATED AND LIVE ACTION; INTERNET SERVICES PROVIDING INFORMATION VIA AN ELECTRONIC GLOBAL COMPUTER NETWORK IN THE FIELD OF ENTERTAINMENT RELATING SPECIFICALLY TO MUSIC, MOVIES, AND TELEVISION; PROVIDING GENERAL INTEREST NEWS, ENTERTAINMENT, AND EDUCATIONAL INFORMATION VIA A GLOBAL COMPUTER NETWORK; AND PROVIDING INFORMATION FOR AND ACTUAL ENTERTAINMENT VIA ELECTRONIC GLOBAL COMMUNICATIONS NETWORK IN THE NATURE OF LIVE-ACTION, COMEDY, DRAMA AND ANIMATED PROGRAMS AND PRODUCTION OF LIVE-ACTION COMEDY, ACTION AND ANIMATED MOTION FILMS FOR DISTRIBUTION VIA A GLOBAL COMPUTER NETWORK (U.S. CLS. 100, 101 AND 107).

FIRST USE 8-27-2002; IN COMMERCE 8-27-2002.
RICHARD WHITE, EXAMINING ATTORNEY

SN 76-510,759. KINOSTAR, LLC, DEDHAM, MA. FILED 4-30-2003.

KINOSTAR

FOR MOVIE THEATRE SERVICES AND PROVIDING FACILITIES FOR LIVE ENTERTAINMENT (U.S. CLS. 100, 101 AND 107).

GENE MACIOL, EXAMINING ATTORNEY

SN 76-514,278. AMC, INC., ATLANTA, GA. FILED 5-15-2003.

AMERICASMART SCRAPBOOK UNIVERSITY

NO CLAIM IS MADE TO THE EXCLUSIVE RIGHT TO USE SCRAPBOOK, APART FROM THE MARK AS SHOWN.
FOR EDUCATIONAL SERVICES, NAMELY, CONDUCTING CLASSES, AND SEMINARS TO TEACH HOW TO CREATE, SELL AND MARKET MEMORY BOOKS (U.S. CLS. 100, 101 AND 107).

MARY CRAWFORD, EXAMINING ATTORNEY

CLASS 41—(Continued).

SN 76-514,503. MICHIGAN BUSINESS AND PROFESSIONAL ASSOCIATION, DBA MICHIGAN BUSINESS AND PROFESSIONAL ASSOCIATION, WARREN, MI. FILED 5-14-2003.

101 BEST AND BRIGHTEST COMPANIES TO WORK FOR

SEC. 2(F).
FOR PROVIDING RECOGNITION AND INCENTIVES BY THE WAY OF AWARDS TO DEMONSTRATE EXCELLENCE IN THE FIELD OF HUMAN RESOURCES (U.S. CLS. 100, 101 AND 107).
FIRST USE 3-0-2000; IN COMMERCE 3-0-2000.
DAVID TAYLOR, EXAMINING ATTORNEY

SN 76-518,769. MING, YAO, WALNUT CREEK, CA. FILED 5-12-2003.

YAO MING

THE NAME YAO MING IDENTIFIES A LIVING INDIVIDUAL WHOSE CONSENT IS OF RECORD.
FOR ENTERTAINMENT IN THE NATURE OF LIVE COMPETITIONS IN THE FIELD OF ATHLETICS; ENTERTAINMENT SERVICES, NAMELY PERSONAL APPEARANCES BY A SPORTS CELEBRITY (U.S. CLS. 100, 101 AND 107).
FIRST USE 12-1-2000; IN COMMERCE 12-1-2000.
SCOTT BALDWIN, EXAMINING ATTORNEY

SN 76-521,719. GRACIE, CARISON, JR., CHICAGO, IL. FILED 6-10-2003.



THE COLOR(S) GRAY, BLACK, WHITE, AND RED IS/ ARE CLAIMED AS A FEATURE OF THE MARK.

THE TWO BULLDOGS ARE THE COLOR GRAY. THE BULLDOGS ARE BOTH WEARING A BLACK DOG COLLAR WITH WHITE SPIKES. THE MOUTH AREA AND LARGE TEETH OF THE BULLDOG ARE WHITE. THE BULLDOGS SHOW RED IN THE GUM-AREA OF THE MOUTH, AND THERE ARE RED DROPS FALLING OUT OF THE BULLDOGS MOUTH. THE EYES (PUPIL) OF THE BULLDOG ARE RED. THE MARK CONSISTS OF: TWO FEROCIOUS BULLDOGS FACING EACH OTHER. THERE ARE BLACK HORIZONTAL LINES BEHIND EACH BULLDOG REPRESENTING SWIFT MOTION TOWARDS EACH OTHER.

FOR EDUCATIONAL INSTRUCTION AND TRAINING IN MARTIAL ARTS FORM KNOWN AS BRAZILIAN JIU-JITSU; ORGANIZING COMPETITIVE EVENTS IN THE MARTIAL ARTS FORM KNOWN AS BRAZILIAN JIU-JITSU (U.S. CLS. 100, 101 AND 107).

FIRST USE 1-1-1992; IN COMMERCE 8-1-1996.
HENRY S. ZAK, EXAMINING ATTORNEY

CLASS 41—(Continued).

SN 76-528,115. LIFE PACIFIC COLLEGE, SAN DIMAS, CA. FILED 7-7-2003.

LIFE PACIFIC COLLEGE

NO CLAIM IS MADE TO THE EXCLUSIVE RIGHT TO USE "COLLEGE", APART FROM THE MARK AS SHOWN, FOR RELIGIOUS INSTRUCTION (U.S. CLS. 100, 101 AND 107).
FIRST USE 3-13-2002; IN COMMERCE 4-9-2002.
ANDREA SAUNDERS, EXAMINING ATTORNEY

SN 76-533,622. TRADEV SYSTEMS, INC., TAMPA, FL. FILED 7-30-2003.



NO CLAIM IS MADE TO THE EXCLUSIVE RIGHT TO USE "SYSTEMS" AND "TRAINING & DEVELOPMENT SYSTEMS", APART FROM THE MARK AS SHOWN.

FOR EDUCATIONAL SERVICES, NAMELY CONDUCTING SEMINARS AND WORKSHOPS IN THE FIELD OF BUSINESS MANAGEMENT (U.S. CLS. 100, 101 AND 107).

FIRST USE 5-28-2003; IN COMMERCE 5-28-2003.
REBECCA GILBERT, EXAMINING ATTORNEY

SN 76-555,516. THE WRIGHT BUILDERS, INC., ASHEVILLE, NC. FILED 10-31-2003.



FOR EDUCATIONAL SEMINARS, NAMELY, CONDUCTING SEMINARS IN THE FIELD OF CREATING PROSPERITY (U.S. CLS. 100, 101 AND 107).

FIRST USE 2-8-2003; IN COMMERCE 2-8-2003.
GIANCARLO CASTRO, EXAMINING ATTORNEY

CLASS 41—(Continued).

SN 76-558,837. KVIP, INC., NEW YORK, NY. FILED 11-10-2003.

Cinder Fella

THE MARK CONSISTS OF STANDARD CHARACTERS WITHOUT CLAIM TO ANY PARTICULAR FONT, STYLE, SIZE, OR COLOR.

FOR ENTERTAINMENT SERVICES, NAMELY THE PRODUCTION AND DISTRIBUTION OF FEATURE FILMS AND MOTION PICTURES (U.S. CLS. 100, 101 AND 107).

CHERYL STEPLIGHT, EXAMINING ATTORNEY

SN 76-563,002. JUST IN TIME MUSIC, INC., BIRMINGHAM, AL. FILED 11-10-2003.

DRUM LINE LIVE

THE MARK CONSISTS OF STANDARD CHARACTERS WITHOUT CLAIM TO ANY PARTICULAR FONT, STYLE, SIZE, OR COLOR.

NO CLAIM IS MADE TO THE EXCLUSIVE RIGHT TO USE "LIVE", APART FROM THE MARK AS SHOWN.

FOR ENTERTAINMENT SERVICES, NAMELY, ORGANIZING AND STAGING MUSICAL BAND CONCERTS (U.S. CLS. 100, 101 AND 107).

ALICIA COLLINS, EXAMINING ATTORNEY

SN 76-567,638. GANZ, WOODBRIDGE, ONTARIO L4L 3T2, CANADA, FILED 12-29-2003.

WEBKINZ WONDERWORLD

THE MARK CONSISTS OF STANDARD CHARACTERS WITHOUT CLAIM TO ANY PARTICULAR FONT, STYLE, SIZE, OR COLOR.

FOR ENTERTAINMENT SERVICES, NAMELY, PROVIDING ON-LINE COMPUTER GAMES IN SINGLE OR MULTI-USER FORMATS, FEATURING FICTIONAL CHARACTERS (U.S. CLS. 100, 101 AND 107).

TARAH HARDY, EXAMINING ATTORNEY

SN 76-570,943. MATTEL, INC., EL SEGUNDO, CA. FILED 1-15-2004.

BARBIE  COLLECTOR.COM

OWNER OF U.S. REG. NOS. 2,151,952 AND 2,316,907.
FOR PROVIDING EDUCATIONAL AND ENTERTAINMENT SERVICES VIA A GLOBAL COMPUTER NETWORK WEB SITE FEATURING GAMES, PRODUCT TRIVIA AND ACTIVITIES INTENDED FOR CONSUMERS OF ALL AGES (U.S. CLS. 100, 101 AND 107).

JOHN DALIER, EXAMINING ATTORNEY

CLASS 41—(Continued).

SN 76-571,500. YAHOO! INC., SUNNYVALE, CA. FILED 1-21-2004.

YAHOO!

THE MARK CONSISTS OF STANDARD CHARACTERS WITHOUT CLAIM TO ANY PARTICULAR FONT, STYLE, SIZE, OR COLOR.

OWNER OF U.S. REG. NOS. 2,040,222, 2,559,219 AND OTHERS.

FOR ENTERTAINMENT AND EDUCATION SERVICES, NAMELY, PROVIDING ONLINE COMPUTER GAMES AND CONTESTS; ONLINE COMPUTER SERVICES TO ENABLE PEOPLE TO LOCATE OTHER GAME PLAYERS AND PLAY GAMES OVER COMMUNICATIONS NETWORKS; ONGOING ENTERTAINMENT PROGRAMS BROADCAST VIA RADIO, CELLULAR, AND WIRELESS COMMUNICATION, THE INTERNET, ELECTRONIC COMMUNICATIONS NETWORKS, AND COMPUTER NETWORKS IN THE FIELDS OF NEWS, WEATHER, SPORTS, TRAVEL, CURRENT EVENTS, REFERENCE INFORMATION, CAREER INFORMATION, COMPUTING, TECHNOLOGY, SHOPPING, AUCTIONS, MOVIES, THEATER, MUSIC, HEALTH, EDUCATION, SCIENCE, FINANCE, AND INVESTING; PROVIDING SPORTS INFORMATION VIA TELEPHONE, CELLULAR TELEPHONE, WIRELESS COMMUNICATION DEVICES, AND THE INTERNET; PROVIDING INFORMATION IN THE FIELD OF SPORTS, SPORTS SCORES, SPORTS STATISTICS, PLAYER STATISTICS, PLAY-BY-PLAY SPORTS COMMENTARY, AND SPORTS EDITORIAL COMMENTARY VIA THE INTERNET; CONDUCTING CLASSES TO TRAIN EMPLOYMENT RECRUITERS AND PERSONNEL MANAGERS HOW TO OPTIMIZE THE HIRING PROCESS; PROVIDING INFORMATION AND NEWS ONLINE IN THE FIELDS OF EMPLOYMENT TRAINING; MOVIE SCHEDULE AND LOCATION INFORMATION SERVICES; PROVIDING A WEBSITE FEATURING INFORMATION, LISTINGS, AND NEWS REGARDING TELEVISION PROGRAMMING AND ENTERTAINMENT; PROVIDING INFORMATION IN THE FIELDS OF NEWS AND ENTERTAINMENT, NAMELY, MOVIES, TELEVISION, MUSIC, SPORTS, AND CELEBRITY PERSONALITIES VIA COMPUTER NETWORKS; ENTERTAINMENT SERVICES IN THE FORM OF A CONTINUING NEWS SHOW DISTRIBUTED OVER COMPUTER NETWORKS; ORGANIZING AND CONDUCTING FANTASY SPORTS CONTESTS AND LEAGUES; PROVIDING ONLINE FANTASY SPORTS NEWS INFORMATION; PROVIDING HOROSCOPE INFORMATION AND ENTERTAINMENT VIA COMPUTER NETWORKS; PROVIDING INFORMATION RELATING TO ELECTRONIC AND COMPUTER GAMES; PRODUCTION OF MUSIC VIDEO PROGRAMS FOR BROADCAST ON COMPUTER NETWORKS; ENTERTAINMENT SERVICES, NAMELY, PROVIDING A WEB SITE FEATURING MUSICAL PERFORMANCES, MUSICAL VIDEOS, FILM CLIPS, CELEBRITY INTERVIEWS, TALK SHOWS, TELEVISION SHOW PREVIEWS, PHOTOGRAPHS, AND OTHER MULTIMEDIA MATERIALS; PROVIDING PRERECORDED MUSIC, INFORMATION IN THE FIELD OF MUSIC, AND COMMENTARY AND ARTICLES ABOUT MUSIC, ALL VIA COMPUTER NETWORKS; PROVIDING INFORMATION REGARDING PHOTOGRAPHY (U.S. CLS. 100, 101 AND 107).

FIRST USE 8-9-1995; IN COMMERCE 8-9-1995.

ANDREW BENZMILLER, EXAMINING ATTORNEY

CLASS 41—(Continued).

SN 76-578,068. SIGNIFICANT EDUCATION, LLC, PHOENIX, AZ. FILED 2-27-2004.

GRAND CANYON UNIVERSITY

THE MARK CONSISTS OF STANDARD CHARACTERS WITHOUT CLAIM TO ANY PARTICULAR FONT, STYLE, SIZE, OR COLOR.

NO CLAIM IS MADE TO THE EXCLUSIVE RIGHT TO USE "UNIVERSITY", APART FROM THE MARK AS SHOWN.

SEC. 2(F).

FOR EDUCATIONAL SERVICES, NAMELY, PROVIDING COURSES OF INSTRUCTION AND SEMINARS AT THE UNDERGRADUATE, GRADUATE, POST-GRADUATE, AND PROFESSIONAL LEVELS; ARRANGING AND CONDUCTING EDUCATIONAL CONFERENCES; EDUCATIONAL RESEARCH; LIBRARIES; PROVIDING COLLEGE, GRADUATE, POST-GRADUATE, AND PROFESSIONAL LEVEL COURSES OF INSTRUCTION AND SEMINARS VIA DISTANCE LEARNING COMMUNICATIONS MEDIA AND THE INTERNET, AND DISTRIBUTION OF COURSE MATERIALS IN CONNECTION THEREWITH; PROVIDING AN ON-LINE ELECTRONIC LIBRARY; ENTERTAINMENT SERVICES, NAMELY, PRESENTATION OF SPORTING AND ATHLETIC EVENTS, LECTURES, CONCERTS, FINE ART EXHIBITIONS, AND DRAMATIC PRODUCTIONS (U.S. CLS. 100, 101 AND 107).

FIRST USE 10-25-1989; IN COMMERCE 10-25-1989.
KATHRYN COWARD, EXAMINING ATTORNEY

SN 76-579,589. GORMAN, ANNE MARIE, BERRYVILLE, VA. FILED 3-8-2004.

CHEER ERUPTION

THE MARK CONSISTS OF STANDARD CHARACTERS WITHOUT CLAIM TO ANY PARTICULAR FONT, STYLE, SIZE, OR COLOR.

FOR GYMNASTIC AND CHEERLEADING TRAINING SERVICES (U.S. CLS. 100, 101 AND 107).

FIRST USE 2-0-2003; IN COMMERCE 2-0-2003.

DOMINICK J. SALEMI, EXAMINING ATTORNEY

CLASS 41—(Continued).

SN 76-579,605. R & L VIDEO, LLC, DBA IMAGERY MARKETING CONSULTANTS, ST. LOUIS, MO. FILED 3-8-2004.



FOR PRODUCING IN-STORE VIDEO AND DVD PRODUCTS TO THE CUSTOM ORDER OF RENT-TO-PURCHASE DEALERS AND RETAILERS FOR THE PURPOSE OF PROMOTING THE BENEFITS OF THEIR PRODUCTS AND SERVICES (U.S. CLS. 100, 101 AND 107).

DOMINICK J. SALEMI, EXAMINING ATTORNEY

SN 76-581,290. ISOTHERMAL COMMUNITY COLLEGE, SPINDALE, NC. FILED 3-15-2004.

Frank on Friday

THE MARK CONSISTS OF STANDARD CHARACTERS WITHOUT CLAIM TO ANY PARTICULAR FONT, STYLE, SIZE, OR COLOR.

FOR ENTERTAINMENT, NAMELY A CONTINUING MUSIC SHOW BROADCAST OVER RADIO (U.S. CLS. 100, 101 AND 107).

FIRST USE 1-1-1991; IN COMMERCE 1-1-1991.

HOWARD B. LEVINE, EXAMINING ATTORNEY

SN 76-585,853. ALTSCHULER, STUART, LOS ANGELES, CA. FILED 4-5-2004.

TELL THE TRUTH FASTER

THE MARK CONSISTS OF STANDARD CHARACTERS WITHOUT CLAIM TO ANY PARTICULAR FONT, STYLE, SIZE, OR COLOR.

FOR ENTERTAINMENT SERVICES, NAMELY, A RADIO TALK SHOW IN THE FIELD OF MENTAL HEALTH AND SELF-DEVELOPMENT; ENTERTAINMENT AND EDUCATIONAL SERVICES, NAMELY PUBLIC SPEAKING APPEARANCES AND TELEVISED APPEARANCES BY A LICENSED PSYCHOTHERAPIST, EDUCATOR OR RADIO PERSONALITY (U.S. CLS. 100, 101 AND 107).

FIRST USE 8-0-2001; IN COMMERCE 8-0-2001.

STEVEN JACKSON, EXAMINING ATTORNEY

CLASS 41—(Continued).

SN 76-587,964. AMERICAN HEART ASSOCIATION, INC., DALLAS, TX. FILED 4-22-2004.

Stroke Science OnDemand

THE MARK CONSISTS OF STANDARD CHARACTERS WITHOUT CLAIM TO ANY PARTICULAR FONT, STYLE, SIZE, OR COLOR.

NO CLAIM IS MADE TO THE EXCLUSIVE RIGHT TO USE "STROKE SCIENCE", APART FROM THE MARK AS SHOWN.

FOR PUBLICATION OF SCIENCE PRESENTATIONS AND SUPPORTING SCIENCE DOCUMENTATION DELIVERED AT SCIENTIFIC CONFERENCES, AND RELATED CONFERENCE MATERIALS VIA THE GLOBAL COMPUTER NETWORK (U.S. CLS. 100, 101 AND 107).

SAMUEL E. SHARPER JR., EXAMINING ATTORNEY

CLASS 41—(Continued).

SN 76-589,804. MICHAEL, MICHAEL W., CENTRAL ISLIP, NY. FILED 4-30-2004.



SN 76-588,239. TD INTERNATIONAL, LLC, MIAMI, FL. FILED 4-22-2004.

PSYCHONUTRITIONIST

THE MARK CONSISTS OF STANDARD CHARACTERS WITHOUT CLAIM TO ANY PARTICULAR FONT, STYLE, SIZE, OR COLOR.

SEC. 2(F).

FOR EDUCATIONAL SERVICES, NAMELY PROVIDING EATING PROGRAMS DESIGNED TO IMPROVE PHYSICAL, MENTAL AND EMOTIONAL HEALTH AND DISTRIBUTING PRINTED COURSE MATERIALS IN CONNECTION THEREWITH IN THE FORM OF RELATED ARTICLES AND NEWSLETTERS ON PHYSICAL, MENTAL AND EMOTIONAL HEALTH (U.S. CLS. 100, 101 AND 107).

FIRST USE 0-0-1985; IN COMMERCE 0-0-1985.

DANIEL BRODY, EXAMINING ATTORNEY

FOR ENTERTAINMENT SERVICES IN THE NATURE OF LIVE PERFORMANCES BY A MUSICAL GROUP (U.S. CLS. 100, 101 AND 107).

FIRST USE 11-0-1999; IN COMMERCE 11-0-1999.

SONYA STEPHENS, EXAMINING ATTORNEY

SN 76-589,541. SILENT PARTNER ENTERTAINMENT, LLC, WATERTOWN, MA. FILED 4-30-2004.

SILENT PARTNER ENTERTAINMENT

THE MARK CONSISTS OF STANDARD CHARACTERS WITHOUT CLAIM TO ANY PARTICULAR FONT, STYLE, SIZE, OR COLOR.

NO CLAIM IS MADE TO THE EXCLUSIVE RIGHT TO USE ENTERTAINMENT, APART FROM THE MARK AS SHOWN.

FOR PRODUCTION AND DISTRIBUTION FOR OTHERS OF MOTION PICTURES; PRODUCTION FOR OTHERS OF COMEDY, MUSICAL AND DRAMATIC TELEVISION SERIES, DOCUMENTARIES, SPORTING EVENTS RENDERED THROUGH THE MEDIA OF TELEVISION, CABLE, AND SATELLITE SYSTEMS, AND/OR VIA THE INTERNET; DISTRIBUTION FOR OTHERS OF COMEDY, MUSICAL AND DRAMATIC TELEVISION SERIES THROUGH THE MEDIA OF TELEVISION, CABLE, AND SATELLITE SYSTEMS, AND/OR VIA THE INTERNET (U.S. CLS. 100, 101 AND 107).

FIRST USE 1-1-2004; IN COMMERCE 1-15-2004.

TRACY WHITAKER-BOWN, EXAMINING ATTORNEY

SN 76-590,001. KURSHALS, RAYMOND, SANTA FE, NM. FILED S.R. 5-3-2004; AM. P.R. 6-27-2005.

PILATES SANTA FE

THE MARK CONSISTS OF STANDARD CHARACTERS WITHOUT CLAIM TO ANY PARTICULAR FONT, STYLE, SIZE, OR COLOR.

NO CLAIM IS MADE TO THE EXCLUSIVE RIGHT TO USE "PILATES", APART FROM THE MARK AS SHOWN.

SEC. 2(F).

FOR PROVIDING FITNESS TRAINING PILATES INSTRUCTION (U.S. CLS. 100, 101 AND 107).

FIRST USE 8-0-1996; IN COMMERCE 8-0-1996.

RAUL CORDOVA, EXAMINING ATTORNEY

CLASS 41—(Continued).

SN 76-591,561. NORSK HØSTFEST ASSOCIATION, MINOT, ND. FILED 5-10-2004.



*North America's
Largest Scandinavian Festival*

NO CLAIM IS MADE TO THE EXCLUSIVE RIGHT TO USE "NORSK HØSTFEST NORTH AMERICA'S LARGEST SCANDINAVIAN FESTIVAL", APART FROM THE MARK AS SHOWN.

THE COLORS RED AND BLUE ARE CLAIMED AS A FEATURE OF THE MARK.

THE COLOR RED APPEARS IN THE WORDS NORSK HØSTFEST IN SKYLARK FONT. THE COLOR BLUE APPEARS IN ROSEMALING ABOVE THE WORDS NORTH AMERICA'S LARGEST SCANDINAVIAN FESTIVAL (ALSO IN BLUE).

THE ENGLISH TRANSLATION OF THE WORD "NORSK" IN THE MARK IS "SCANDINAVIAN". THE ENGLISH TRANSLATION OF THE WORD "HØSTFEST" IN THE MARK IS "FESTIVAL."

FOR ENTERTAINMENT IN THE NATURE OF A SCANDINAVIAN ETHNIC/CULTURAL FESTIVAL (U.S. CLS. 100, 101 AND 107).

FIRST USE 11-1-1977; IN COMMERCE 11-1-1977.
INGRID C. EULIN, EXAMINING ATTORNEY

SN 76-592,379. AMERICAN INDIAN GENOCIDE MUSEUM, HOUSTON, TX. FILED 5-14-2004.

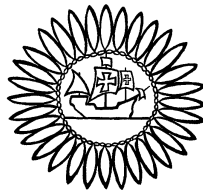

American Indian Genocide Museum

NO CLAIM IS MADE TO THE EXCLUSIVE RIGHT TO USE "AMERICAN INDIAN GENOCIDE MUSEUM", APART FROM THE MARK AS SHOWN.

FOR MUSEUM AND EDUCATIONAL SERVICES, NAMELY, ORGANIZING AND CONDUCTING EXHIBITIONS AND DISPLAYS USING ART, FILM, SCULPTURE, HISTORICAL DISPLAYS, BOOKS, TEXTS, OTHER HISTORICAL ITEMS, MICROFILM, INTERACTIVE DISPLAYS, AND GUIDES THAT CONVEY INFORMATION ABOUT EVENTS THAT HAVE TRANSPIRED IN THE NEAR EXTERMINATION AND, IN SOME CASES, THE TOTAL EXTERMINATION OF NATIVE TRIBES AND CULTURES, AND ISSUES OF RACISM, DISCRIMINATION, GENOCIDE AND INJUSTICE BOTH IN THE PAST AND IN THE PRESENT (U.S. CLS. 100, 101 AND 107).

ELIZABETH J. WINTER, EXAMINING ATTORNEY

CLASS 41—(Continued).

SN 76-592,406. USA FOOTBALL, VIENNA, VA. FILED 5-14-2004.

TACKLE READING

THE MARK CONSISTS OF STANDARD CHARACTERS WITHOUT CLAIM TO ANY PARTICULAR FONT, STYLE, SIZE, OR COLOR.

NO CLAIM IS MADE TO THE EXCLUSIVE RIGHT TO USE "READING", APART FROM THE MARK AS SHOWN.

FOR EDUCATIONAL SERVICES, NAMELY, CONDUCTING PROGRAMS, CLASSES, SEMINARS, CONFERENCES AND WORKSHOPS DESIGNED TO MOTIVATE READING BY ADULTS AND CHILDREN; TRAINING EDUCATORS, PARENTS AND CAREGIVERS IN SUPPORTING READING DEVELOPMENT IN CONJUNCTION WITH SUCH EDUCATIONAL SERVICES AND DISTRIBUTING COURSE MATERIALS IN CONJUNCTION WITH SUCH EDUCATIONAL SERVICES; PUBLISHING OF BOOKS AND MAGAZINES; CHARITABLE SERVICES, NAMELY, PROVIDING RESOURCE LIBRARY SERVICES TO THOSE IN NEED AND PROVIDING BOOKS AND READING MENTORING TO THOSE IN NEED (U.S. CLS. 100, 101 AND 107).

DAVID ELTON, EXAMINING ATTORNEY

SN 76-593,086. BURROUGHS & CHAPIN COMPANY, INC., MYRTLE BEACH, SC. FILED 5-19-2004.

**ADVENTURE IN
HISTORY! SCIENCE! NATURE!**

THE MARK CONSISTS OF STANDARD CHARACTERS WITHOUT CLAIM TO ANY PARTICULAR FONT, STYLE, SIZE, OR COLOR.

NO CLAIM IS MADE TO THE EXCLUSIVE RIGHT TO USE HISTORY, SCIENCE AND NATURE, APART FROM THE MARK AS SHOWN.

FOR ENTERTAINMENT SERVICES, NAMELY, AMUSEMENT PARK SERVICES WITH AN HISTORICAL, SCIENTIFIC AND NATURE THEME (U.S. CLS. 100, 101 AND 107).

MATTHEW KLINE, EXAMINING ATTORNEY

SN 76-593,359. ENGENDERHEALTH, INC., NEW YORK, NY. FILED 5-20-2004.

ENGENDERHEALTH

THE MARK CONSISTS OF STANDARD CHARACTERS WITHOUT CLAIM TO ANY PARTICULAR FONT, STYLE, SIZE, OR COLOR.

FOR EDUCATIONAL SERVICES, NAMELY, PROVIDING COURSES AND TRAINING IN THE FIELD OF REPRODUCTIVE HEALTH (U.S. CLS. 100, 101 AND 107).

FIRST USE 3-0-1999; IN COMMERCE 3-0-1999.

REBECCA SMITH, EXAMINING ATTORNEY

CLASS 41—(Continued).

SN 76-594,264. GIULIANI, RUDOLPH W., NEW YORK, NY.
FILED 5-21-2004.

GIULIANI PARTNERS

THE MARK CONSISTS OF STANDARD CHARACTERS WITHOUT CLAIM TO ANY PARTICULAR FONT, STYLE, SIZE, OR COLOR.

NO CLAIM IS MADE TO THE EXCLUSIVE RIGHT TO USE PARTNERS, APART FROM THE MARK AS SHOWN.

FOR CONDUCTING SEMINARS IN THE FIELDS OF BUSINESS MANAGEMENT, GOVERNMENT AND SAFETY AND SECURITY (U.S. CLS. 100, 101 AND 107).

FIRST USE 6-0-2002; IN COMMERCE 6-0-2002.

CHERYL STEPLIGHT, EXAMINING ATTORNEY

SN 76-594,515. DIVADON RECORDS, LLC, NEW YORK, NY.
FILED 5-27-2004.



NO CLAIM IS MADE TO THE EXCLUSIVE RIGHT TO USE "RECORDS", APART FROM THE MARK AS SHOWN.
THE MARK IS DESCRIBED AS A MEDAL WITH A BOW IN WHICH THE WORDS "DIVADON RECORDS" ARE CENTERED.

FOR RECORD MASTER PRODUCTION; MUSIC PRODUCTION; AUDIO RECORDING AND PRODUCTION; VIDEOTAPE PRODUCTION; MOTION PICTURE FILM PRODUCTION; PRODUCTION OF VIDEO DISCS FOR OTHERS; RECORDING STUDIOS; ENTERTAINMENT SERVICES, NAMELY, PRODUCTION OF AUDIO AND VIDEO RECORDINGS; MUSIC COMPOSITION FOR OTHERS; SONG WRITING SERVICES; MUSIC PUBLISHING SERVICES; ENTERTAINMENT IN THE NATURE OF LIVE PERFORMANCES BY A MUSICAL PERFORMER, MUSICAL BAND OR MUSICAL GROUP; ENTERTAINMENT IN THE NATURE OF LIVE PERFORMANCES BY A MUSICAL ARTIST, MUSICAL GROUP OR MUSICAL BAND; ENTERTAINMENT IN THE NATURE OF VISUAL AND AUDIO PERFORMANCES BY A MUSICAL ARTIST, MUSICAL GROUP AND MUSICAL BAND; ENTERTAINMENT, NAMELY, LIVE MUSIC CONCERTS; ENTERTAINMENT, NAMELY, PERSONAL APPEARANCES BY A MUSICIAN, MUSICAL GROUP OR MUSICAL BAND; ENTERTAINMENT, NAMELY PROVIDING A WEB SITE FEATURING MUSICAL PERFORMANCES, MUSICAL VIDEOS, RELATED FILM CLIPS, PHOTOGRAPHS, AND OTHER MULTIMEDIA MATERIALS; ENTERTAINMENT SERVICES, NAMELY, PROVIDING PRERECORDED MUSIC, INFORMATION IN THE FIELD OF MUSIC, COMMENTARY AND ARTICLES ABOUT MU-

CLASS 41—(Continued).

SIC, ALL ONLINE VIA THE INTERNET; TELEVISION PRODUCTION; TELEVISION SHOW PRODUCTION; CABLE TELEVISION SHOW PRODUCTION; RADIO ENTERTAINMENT PRODUCTION; MOTION PICTURE FILM PRODUCTION AND DISTRIBUTION; ENTERTAINMENT IN THE NATURE OF ON-GOING TELEVISION AND RADIO, PROGRAMS FEATURING A WIDE VARIETY OF PERFORMANCES INCLUDING BUT NOT LIMITED TO MUSICAL, DANCE, COMEDIC AND DRAMATIC ACTS AMONG OTHER TYPES OF PERFORMANCES; TELEVISION PROGRAMS FEATURING A WIDE VARIETY OF SUBJECT MATTER INCLUDING BUT NOT LIMITED TO ANIMATION MUSIC, DANCE, DRAMA AND COMEDY; PROVIDING A CONTINUING VARIETY SHOW BROADCAST OVER TELEVISION, RADIO, SATELLITE, AUDIO AND VIDEO MEDIA; THEATRE PRODUCTIONS; ENTERTAINMENT IN THE NATURE OF TRAVELING TOURS FEATURING A WIDE VARIETY OF SUBJECT MATTERS INCLUDING BUT NOT LIMITED TO MUSIC, DANCE, DRAMA AND COMEDY (U.S. CLS. 100, 101 AND 107).

JIM RINGLE, EXAMINING ATTORNEY

SN 76-594,518. DIVADON RECORDS, LLC, NEW YORK, NY.
FILED 5-27-2004.

DIVADON RECORDS

THE MARK CONSISTS OF STANDARD CHARACTERS WITHOUT CLAIM TO ANY PARTICULAR FONT, STYLE, SIZE, OR COLOR.

NO CLAIM IS MADE TO THE EXCLUSIVE RIGHT TO USE "RECORDS", APART FROM THE MARK AS SHOWN.

FOR RECORD MASTER PRODUCTION; MUSIC PRODUCTION; AUDIO RECORDING AND PRODUCTION; VIDEOTAPE PRODUCTION; MOTION PICTURE FILM PRODUCTION; PRODUCTION OF VIDEO DISCS FOR OTHERS; RECORDING STUDIOS; ENTERTAINMENT SERVICES, NAMELY, PRODUCTION OF AUDIO AND VIDEO RECORDINGS; MUSIC COMPOSITION FOR OTHERS; SONG WRITING SERVICES; MUSIC PUBLISHING SERVICES; ENTERTAINMENT IN THE NATURE OF LIVE PERFORMANCES BY A MUSICAL PERFORMER, MUSICAL BAND OR MUSICAL GROUP; ENTERTAINMENT IN THE NATURE OF LIVE PERFORMANCES BY A MUSICAL ARTIST, MUSICAL GROUP OR MUSICAL BAND; ENTERTAINMENT IN THE NATURE OF VISUAL AND AUDIO PERFORMANCES BY A MUSICAL ARTIST, MUSICAL GROUP AND MUSICAL BAND; ENTERTAINMENT, NAMELY, LIVE MUSIC CONCERTS; ENTERTAINMENT, NAMELY, PERSONAL APPEARANCES BY A MUSICIAN, MUSICAL GROUP OR MUSICAL BAND; ENTERTAINMENT, NAMELY PROVIDING A WEB SITE FEATURING MUSICAL PERFORMANCES, MUSICAL VIDEOS, RELATED FILM CLIPS, PHOTOGRAPHS, AND OTHER MULTIMEDIA MATERIALS; ENTERTAINMENT SERVICES, NAMELY, PROVIDING PRERECORDED MUSIC, INFORMATION IN THE FIELD OF MUSIC, COMMENTARY AND ARTICLES ABOUT MU-

CLASS 41—(Continued).

SIC, ALL ONLINE VIA THE INTERNET; TELEVISION PRODUCTION; TELEVISION SHOW PRODUCTION; CABLE TELEVISION SHOW PRODUCTION; RADIO ENTERTAINMENT PRODUCTION; MOTION PICTURE FILM PRODUCTION AND DISTRIBUTION; ENTERTAINMENT IN THE NATURE OF ON-GOING TELEVISION AND RADIO, PROGRAMS FEATURING A WIDE VARIETY OF PERFORMANCES INCLUDING BUT NOT LIMITED TO MUSICAL, DANCE, COMEDIC AND DRAMATIC ACTS AMONG OTHER TYPES OF PERFORMANCES; TELEVISION PROGRAMS FEATURING A WIDE VARIETY OF SUBJECT MATTER INCLUDING BUT NOT LIMITED TO ANIMATION MUSIC, DANCE, DRAMA AND COMEDY; PROVIDING A CONTINUING VARIETY SHOW BROADCAST OVER TELEVISION, RADIO, SATELLITE, AUDIO AND VIDEO MEDIA; THEATRE PRODUCTIONS ENTERTAINMENT IN THE NATURE OF TRAVELING TOURS FEATURING A WIDE VARIETY OF SUBJECT MATTERS INCLUDING BUT NOT LIMITED TO MUSIC, DANCE, DRAMA AND COMEDY (U.S. CLS. 100, 101 AND 107).

MICHAEL ENGEL, EXAMINING ATTORNEY

SN 76-595,355. DOOLEY, LEE, PORTSMOUTH, RI. AND DOOLEY, KRISTA, PORTSMOUTH, RI. FILED 6-3-2004.

CLUBSPROUTS

THE MARK CONSISTS OF STANDARD CHARACTERS WITHOUT CLAIM TO ANY PARTICULAR FONT, STYLE, SIZE, OR COLOR.

FOR PROVIDING EDUCATIONAL SERVICES, NAMELY CONDUCTING PROGRAMS AND CLASSES FOR FOSTERING GROWTH DEVELOPMENT, LEARNING, AND SOCIAL SKILLS DEVELOPMENT, FOR INFANTS AND/OR CHILDREN, NAMELY ENRICHMENT AND DEVELOPMENT PROGRAMS, OPEN PLAY SESSIONS, SUPERVISED PLAY EVENTS, PHYSICAL FITNESS INSTRUCTION AND PROGRAMS, SPORTS FITNESS INSTRUCTION AND PROGRAMS; PROVIDING EDUCATIONAL SERVICES, NAMELY CONDUCTING PROGRAMS AND CLASSES FOR PARENTS RELATED TO PARENTING SKILLS, CHILDCARE AND WELL-BEING DEVELOPMENT, NAMELY, PARENTING SUPPORT AND SKILL DEVELOPMENT PROGRAMS AND INSTRUCTION RELATED TO CARING FOR THEMSELVES AND FOR THEIR CHILDREN, MOTHERHOOD AND FATHERHOOD PROGRAMS, NUTRITIONAL PROGRAMS, PARENTING AND CHILDCARE NETWORKING PROGRAMS, AND HEALTH AND PHYSICAL FITNESS EDUCATION AND PROGRAMS, CARDIOPULMONARY RESUSCITATION, CPR, AND FIRST AID PROGRAMS, AND HOME SAFETY AND CHILD-PROOFING INSTRUCTION; ENTERTAINMENT SERVICES, NAMELY, ORGANIZING AND CONDUCTING INFANT AND CHILDREN PLAY ACTIVITIES, ORGANIZING AND CONDUCTING BIRTHDAY PARTIES FOR INFANTS AND CHILDREN AND OTHER CHILDREN'S ENTERTAINMENT EVENTS AND ACTIVITIES. (U.S. CLS. 100, 101 AND 107).

MARLENE BELL, EXAMINING ATTORNEY

CLASS 41—(Continued).

SN 76-596,355. KOVAR'S, INC., CARMICHAEL, CA. FILED 6-4-2004.

PROFITS WITH A PURPOSE

THE MARK CONSISTS OF STANDARD CHARACTERS WITHOUT CLAIM TO ANY PARTICULAR FONT, STYLE, SIZE, OR COLOR.

FOR EDUCATIONAL SERVICES, NAMELY CONDUCTING SEMINARS IN THE FIELD OF MARTIAL ART (U.S. CLS. 100, 101 AND 107).

LESLEY LAMOTHE, EXAMINING ATTORNEY

SN 76-596,506. TRUSTEES OF THE ESTATE OF BERNICE PAUAAHI BISHOP, DBA KAMEHAMEHA SCHOOLS, HONOLULU, HI. FILED 6-10-2004.



A CONTINUING COMMITMENT

THE NAME(S), PORTRAIT(S), AND/OR SIGNATURE(S) SHOWN IN THE MARK DOES NOT IDENTIFY A PARTICULAR LIVING INDIVIDUAL.

THE DESIGN OF THE MARK IS DESCRIBED AS TWO RECTANGULAR BOXES ORIENTED SIDE BY SIDE; WITHIN THE LEFT BOX IS THE FACE OF BERNICE PAUAAHI BISHOP AND IMMEDIATELY TO THE RIGHT OF HER FACE THE WORD "PAUAAHI'S" IS WRITTEN IN SCRIPT LETTERS; THE RIGHT BOX CONTAINS A BROAD LEAF DESIGN IN THE BACKGROUND AND THE WORDS "LEGACY LIVES" WRITTEN IN SCRIPT LETTERS IN THE FOREGROUND; DIRECTLY UNDER THE TWO BOXES ARE THE WORDS "A CONTINUING COMMITMENT" WRITTEN IN CAPITAL BLOCK LETTERS.

FOR EDUCATIONAL SERVICES, NAMELY, PROVIDING COURSES OF INSTRUCTION AT THE PRE-SCHOOL, KINDERGARTEN, PRIMARY, AND SECONDARY LEVELS (U.S. CLS. 100, 101 AND 107).

FIRST USE 1-0-2001; IN COMMERCE 1-0-2001.

MATTHEW KLINE, EXAMINING ATTORNEY

SN 76-597,323. PACER INTERNATIONAL, INC., CONCORD, CA. FILED 6-15-2004.

STACK FACTS

THE MARK CONSISTS OF STANDARD CHARACTERS WITHOUT CLAIM TO ANY PARTICULAR FONT, STYLE, SIZE, OR COLOR.

NO CLAIM IS MADE TO THE EXCLUSIVE RIGHT TO USE "FACTS", APART FROM THE MARK AS SHOWN.

FOR PROVIDING NEWSLETTERS IN THE FIELD OF INTERMODAL RAIL TRANSPORTATION, TRANSPORTATION LOGISTICS, FREIGHT FORWARDING, FREIGHT TRANSPORTATION, CARGO TRANSPORTATION, AIR FREIGHT SERVICES AND LOGISTICS MANAGEMENT AND SERVICES FOR CUSTOMERS WITH NATIONAL AND INTERNATIONAL SHIPPING REQUIREMENTS VIA E-MAIL (U.S. CLS. 100, 101 AND 107).

FIRST USE 5-0-1999; IN COMMERCE 5-0-1999.

HOWARD SMIGA, EXAMINING ATTORNEY

CLASS 41—(Continued).

SN 76-597,571. BELLO, GILBERTO, BUDD LAKE, NJ. FILED 6-14-2004.

GILBERTO BELLO

THE MARK CONSISTS OF STANDARD CHARACTERS WITHOUT CLAIM TO ANY PARTICULAR FONT, STYLE, SIZE, OR COLOR.

FOR EDUCATIONAL SERVICES NAMELY, CONDUCTING SELF-AWARENESS SEMINARS, AND ADULT EDUCATION PROGRAMS IN THE FIELDS OF PERSONAL AND PROFESSIONAL GROWTH, AND DISTRIBUTION OF EDUCATIONAL TAPES, BOOKS, AND OTHER INSTRUCTIONAL MATERIALS IN CONNECTION THEREWITH (U.S. CLS. 100, 101 AND 107).

DAVID H. STINE, EXAMINING ATTORNEY

SN 76-598,553. ALL-PRO 3, INC., ALBANY, GA. FILED 6-21-2004.



FOR TRAINING SERVICES, NAMELY CONDUCTING WORKSHOPS AND CLINICS IN THE FIELD OF CHEERLEADING AND DANCE; SPORTS CAMPS, NAMELY, DANCE AND CHEERLEADING CAMPS; ARRANGING AND CONDUCTING ATHLETIC COMPETITIONS; AND ENTERTAINMENT SERVICES, NAMELY PROVIDING DANCE AND CHEERLEADING CHOREOGRAPHY (U.S. CLS. 100, 101 AND 107).

FIRST USE 9-0-2003; IN COMMERCE 9-0-2003.

TIMOTHY FINNEGAN, EXAMINING ATTORNEY

CLASS 41—(Continued).

SN 76-598,792. PILOT BOY PRODUCTIONS, INC., LOS ANGELES, CA. FILED 6-21-2004.

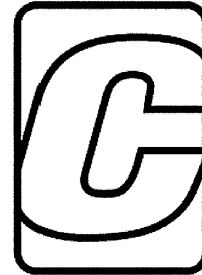

FOR ENTERTAINMENT SERVICES, NAMELY, LIVE COMEDY PERFORMANCES, PRODUCTION OF MOTION PICTURES, TELEVISION AND RADIO/AUDIO PROGRAMS IN THE FIELDS OF COMEDY AND DRAMATIC ENTERTAINMENT, PRODUCTION OF INTERACTIVE ENTERTAINMENT CONTENT IN THE FIELDS OF COMEDY AND DRAMA FOR DELIVERY OVER WIRELESS COMMUNICATIONS NETWORKS AND THE INTERNET. (U.S. CLS. 100, 101 AND 107).

TIMOTHY FINNEGAN, EXAMINING ATTORNEY

SN 76-599,513. LINDBERG, TAMMY, STANCHFIELD, MN. FILED 6-28-2004.

NO PRIDE

THE MARK CONSISTS OF STANDARD CHARACTERS WITHOUT CLAIM TO ANY PARTICULAR FONT, STYLE, SIZE, OR COLOR.

FOR LIVE PERFORMANCES BY A MUSICAL GROUP (U.S. CLS. 100, 101 AND 107).

FIRST USE 6-1-2001; IN COMMERCE 6-30-2001.

NANCY CLARKE, EXAMINING ATTORNEY

SN 76-599,614. NEWMAN, CANDACE J., NAPLES, FL. AND NEWMAN, JOHN, NAPLES, FL. FILED 6-28-2004.

TOUCH WITH OILS

FOR EDUCATIONAL SERVICES IN THE NATURE OF PROVIDING COURSES OF INSTRUCTION THROUGH CLASSES, SEMINARS AND WORKSHOPS IN THE FIELD OF AROMATHERAPY, NAMELY USING OILS FOR THERAPEUTIC AND COSMETIC APPLICATIONS AND PERFORMING AROMATHERAPY MASSAGES; AND PROVIDING EDUCATIONAL DEMONSTRATIONS AND DISTRIBUTING COURSE MATERIALS IN CONNECTION THEREWITH (U.S. CLS. 100, 101 AND 107).

FIRST USE 1-31-1994; IN COMMERCE 1-31-1994.

MICHAEL WEBSTER, EXAMINING ATTORNEY

CLASS 41—(Continued).

SN 76-599,672. OLSEN, TROY, TUCSON, AZ. FILED 6-29-2004.

TROY OLSEN

THE MARK CONSISTS OF STANDARD CHARACTERS WITHOUT CLAIM TO ANY PARTICULAR FONT, STYLE, SIZE, OR COLOR.

THE NAME(S), PORTRAIT(S), AND/OR SIGNATURE(S) SHOWN IN THE MARK IDENTIFIES TROY OLSEN, WHOSE CONSENT(S) TO REGISTER IS SUBMITTED.

FOR ENTERTAINMENT SERVICES, NAMELY, LIVE MUSICAL PERFORMANCES BY AN INDIVIDUAL (U.S. CLS. 100, 101 AND 107).

FIRST USE 6-1-1997; IN COMMERCE 6-1-1997.

REBECCA GILBERT, EXAMINING ATTORNEY

SN 76-601,727. LAWRENCE, REVEREND ODEAN P., LANCASTER, CA. FILED 7-12-2004.

SHILOAH - KERYGMA

THE MARK CONSISTS OF STANDARD CHARACTERS WITHOUT CLAIM TO ANY PARTICULAR FONT, STYLE, SIZE, OR COLOR.

FOR RELIGIOUS NON-PROFIT INSTRUCTIONAL SERVICES (U.S. CLS. 100, 101 AND 107).

FIRST USE 6-1-2002; IN COMMERCE 6-1-2002.

AMY GEARIN, EXAMINING ATTORNEY

SN 76-601,808. KINGS WAY GOLF CLUB, INC., YARMOUTH PORT, MA. FILED 7-9-2004.



NO CLAIM IS MADE TO THE EXCLUSIVE RIGHT TO USE "GOLF CLUB", APART FROM THE MARK AS SHOWN.

FOR GOLF COURSES; GOLF CLUB SERVICES FEATURING A CLUBHOUSE, LOCKER ROOM, PUBLIC LOBBY AREAS AND PRIVATE MEETING ROOMS; PROVIDING GOLF INSTRUCTION SERVICES; CONDUCTING GOLF TOURNAMENTS AND EXHIBITIONS (U.S. CLS. 100, 101 AND 107).

FIRST USE 12-31-2001; IN COMMERCE 12-31-2001.

ANDREW RHIM, EXAMINING ATTORNEY

CLASS 41—(Continued).

SN 76-601,965. CALDWELL, ANNE, PHOENIX, AZ. FILED 7-12-2004.

HR BASICS FOR SMALL BUSINESSES

THE MARK CONSISTS OF STANDARD CHARACTERS WITHOUT CLAIM TO ANY PARTICULAR FONT, STYLE, SIZE, OR COLOR.

SEC. 2(F).

FOR EDUCATIONAL SERVICES, NAMELY CONDUCTING WORKSHOPS IN THE FIELD OF HUMAN RESOURCES AND DISTRIBUTING COURSE MATERIALS IN CONNECTION THEREWITH (U.S. CLS. 100, 101 AND 107).

FIRST USE 2-0-1999; IN COMMERCE 2-0-1999.

MARK RADEMACHER, EXAMINING ATTORNEY

SN 76-602,763. AMERICAN WOODMARK CORPORATION, WINCHESTER, VA. FILED 7-19-2004.

INDUSTRY INSIGHTS

THE MARK CONSISTS OF STANDARD CHARACTERS WITHOUT CLAIM TO ANY PARTICULAR FONT, STYLE, SIZE, OR COLOR.

NO CLAIM IS MADE TO THE EXCLUSIVE RIGHT TO USE "INDUSTRY", APART FROM THE MARK AS SHOWN.

FOR PROVIDING AN ONLINE NEWSLETTER FEATURING INFORMATION ON KITCHEN AND BATHROOM CABINETS, ACCESSED THROUGH A GLOBAL COMPUTER NETWORK (U.S. CLS. 100, 101 AND 107).

FIRST USE 5-26-2004; IN COMMERCE 5-26-2004.

TONJA GASKINS, EXAMINING ATTORNEY

SN 76-604,320. HDVE, LLC, IRVING, TX. FILED 7-28-2004.

TRUE COMPATIBILITY

THE MARK CONSISTS OF STANDARD CHARACTERS WITHOUT CLAIM TO ANY PARTICULAR FONT, STYLE, SIZE, OR COLOR.

NO CLAIM IS MADE TO THE EXCLUSIVE RIGHT TO USE "COMPATIBILITY", APART FROM THE MARK AS SHOWN.

FOR CAREER COUNSELING; PERSONAL COACHING SERVICES IN THE FIELDS OF DATING, COMPATIBILITY, SOCIAL RELATIONSHIPS, PERSONAL IMPROVEMENT, SELF-DEVELOPMENT AND SELF AWARENESS; EDUCATIONAL AND TRAINING SERVICES, NAMELY, CONDUCTING CLASSES, SEMINARS, CONFERENCES AND WORKSHOPS IN THE FIELDS OF DATING, COMPATIBILITY, SOCIAL RELATIONSHIPS, AND EFFECTIVE COMMUNICATIONS; INSTRUCTION ON THE SUBJECTS OF MOTIVATION AND PERSONAL DEVELOPMENT TO ACHIEVE INDIVIDUAL AND PROFESSIONAL SUCCESS; AND COURSE MATERIALS DISTRIBUTED IN CONNECTION THEREWITH (U.S. CLS. 100, 101 AND 107).

ANN LINNEHAN, EXAMINING ATTORNEY

CLASS 41—(Continued).

SN 76-604,654. HEALING OUR VILLAGE, SPRINGFIELD, VA. FILED 7-29-2004.

HEALING OUR VILLAGE

THE MARK CONSISTS OF STANDARD CHARACTERS WITHOUT CLAIM TO ANY PARTICULAR FONT, STYLE, SIZE, OR COLOR.

FOR EDUCATIONAL SERVICES, NAMELY, PROVIDING CLASSES FOR CONSUMERS AND HEALTH CARE PROFESSIONALS IN THE FIELDS OF HOW TO TREAT AND LIVE WITH CHRONIC DISEASES, NAMELY, DIABETES, HEART DISEASE, HIV/AIDS, ASTHMA, CANCER, DEPRESSION, ANXIETY, AND OBESITY (U.S. CLS. 100, 101 AND 107).

FIRST USE 3-1-2004; IN COMMERCE 3-1-2004.
SUSAN HAYASH, EXAMINING ATTORNEY

SN 76-606,636. HDVE, LLC, IRVING, TX. FILED 8-12-2004.

TRUE (IN)VISIBILITY

THE MARK CONSISTS OF STANDARD CHARACTERS WITHOUT CLAIM TO ANY PARTICULAR FONT, STYLE, SIZE, OR COLOR.

FOR CAREER COUNSELING; PERSONAL COACHING SERVICES IN THE FIELDS OF DATING, COMPATIBILITY, SOCIAL RELATIONSHIPS, PERSONAL IMPROVEMENT, SELF-DEVELOPMENT AND SELF AWARENESS; EDUCATIONAL AND TRAINING SERVICES, NAMELY, CONDUCTING CLASSES, SEMINARS, CONFERENCES AND WORKSHOPS IN THE FIELDS OF DATING, COMPATIBILITY, SOCIAL RELATIONSHIPS, AND EFFECTIVE COMMUNICATIONS; INSTRUCTION ON THE SUBJECTS OF MOTIVATION AND PERSONAL DEVELOPMENT TO ACHIEVE INDIVIDUAL AND PROFESSIONAL SUCCESS; AND COURSE MATERIALS DISTRIBUTED IN CONNECTION WITH ALL OF THE FOREGOING SERVICES (U.S. CLS. 100, 101 AND 107).

SUSAN LESLIE DUBOIS, EXAMINING ATTORNEY

SN 76-606,842. THELADDERS.COM, INC., NEW YORK, NY. FILED 8-13-2004.

RECRUIT LADDER

NO CLAIM IS MADE TO THE EXCLUSIVE RIGHT TO USE "RECRUIT", APART FROM THE MARK AS SHOWN.

FOR CAREER COUNSELING AND ADVICE; PROVIDING NEWSLETTERS IN THE FIELDS OF CAREER COUNSELING AND ADVICE VIA E-MAIL (U.S. CLS. 100, 101 AND 107).

FIRST USE 5-14-2004; IN COMMERCE 5-14-2004.
CHERYL CLAYTON, EXAMINING ATTORNEY

CLASS 41—(Continued).

SN 76-607,220. WINGS, INC., BOISE, ID. FILED 8-9-2004.



NO CLAIM IS MADE TO THE EXCLUSIVE RIGHT TO USE "GYMNASTICS", APART FROM THE MARK AS SHOWN.

THE MARK CONSISTS OF DIAMOND BACKGROUND, WITH WINGS GYMNASTICS LETTERS, A SET OF RINGS, FOR PROVIDING CLASSES, LESSONS, CAMPS, CLINICS AND COMPETITIONS IN GYMNASTICS (U.S. CLS. 100, 101 AND 107).

FIRST USE 1-1-1990; IN COMMERCE 1-1-1990.
JOHN E. MICHOS, EXAMINING ATTORNEY

SN 76-607,221. WINGS, INC., BOISE, ID. FILED 8-9-2004.



NO CLAIM IS MADE TO THE EXCLUSIVE RIGHT TO USE "GYMNASTICS FOR AGES 1 TO 7", APART FROM THE MARK AS SHOWN.

THE MARK CONSISTS OF DIAMOND BACKGROUND, WITH SMALL STARS LETTERS, AND 4 STARS, WITH OTHER SMALLER LETTERS.

FOR EDUCATIONAL SERVICES NAMELY CONDUCTING CLASSES FOR MOTOR DEVELOPMENT AND GYMNASTICS FOR YOUNG CHILDREN (U.S. CLS. 100, 101 AND 107).

FIRST USE 1-1-1990; IN COMMERCE 1-1-1990.
JOHN E. MICHOS, EXAMINING ATTORNEY

CLASS 41—(Continued).

SN 76-607,222. WINGS, INC., BOISE, ID. FILED 8-9-2004.



NO CLAIM IS MADE TO THE EXCLUSIVE RIGHT TO USE "INFLATABLES", APART FROM THE MARK AS SHOWN.

THE MARK CONSISTS OF: DIAMOND BACKGROUND, WITH INCREDIBLE INFLATABLES LETTERS, WITH AN INFLATABLE PLAY UNIT.

FOR RENTAL OF INFLATABLE PLAY EQUIPMENT FOR PARTIES AND OTHER EVENTS (U.S. CLS. 100, 101 AND 107).

FIRST USE 1-1-1995; IN COMMERCE 1-1-1995.
JOHN E. MICHOS, EXAMINING ATTORNEY

SN 76-607,224. WINGS, INC., BOISE, ID. FILED 8-9-2004.

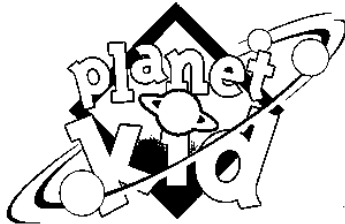

THE MARK CONSISTS OF: DIAMOND BACKGROUND, WITH PLANET KID LETTERS, WITH A RING WITH CIRCLING BALLS.

FOR PROVISION OF RECREATIONAL FACILITIES IN THE NATURE OF CHILDREN'S SOFT PADDED PLAY AREAS (U.S. CLS. 100, 101 AND 107).

FIRST USE 1-1-1993; IN COMMERCE 1-1-1993.
JOHN E. MICHOS, EXAMINING ATTORNEY

SN 76-607,268. BOYD GAMING CORPORATION, LAS VEGAS, NV. FILED 8-9-2004.

PRIME HOT SEAT

THE MARK CONSISTS OF STANDARD CHARACTERS WITHOUT CLAIM TO ANY PARTICULAR FONT, STYLE, SIZE, OR COLOR.

FOR CASINO SERVICES, NAMELY A BONUS INCENTIVE PROGRAM FOR PLAYERS (U.S. CLS. 100, 101 AND 107).

FIRST USE 11-1-2003; IN COMMERCE 11-1-2003.
YSA DEJESUS, EXAMINING ATTORNEY

CLASS 41—(Continued).

SN 76-609,222. MILLENNIUM THOROUGHBREDS, INC., AUSTIN, TX. FILED 8-26-2004.

MILLENNIUM FARMS

THE MARK CONSISTS OF STANDARD CHARACTERS WITHOUT CLAIM TO ANY PARTICULAR FONT, STYLE, SIZE, OR COLOR.

OWNER OF U.S. REG. NO. 2,933,882.

NO CLAIM IS MADE TO THE EXCLUSIVE RIGHT TO USE "FARMS", APART FROM THE MARK AS SHOWN.

FOR ENTERTAINMENT SERVICES, NAMELY, CONDUCTING HORSE RACES; RACING OF HORSES FOR OTHERS (U.S. CLS. 100, 101 AND 107).

DARRYL SPRUILL, EXAMINING ATTORNEY

SN 76-609,354. HDVE, LLC, IRVING, TX. FILED 8-30-2004.

TRUE REWARDS

THE MARK CONSISTS OF STANDARD CHARACTERS WITHOUT CLAIM TO ANY PARTICULAR FONT, STYLE, SIZE, OR COLOR.

FOR CAREER COUNSELING; PERSONAL COACHING SERVICES IN THE FIELDS OF DATING, COMPATIBILITY, SOCIAL RELATIONSHIPS, PERSONAL IMPROVEMENT, SELF DEVELOPMENT AND SELF AWARENESS; EDUCATIONAL AND TRAINING SERVICES, NAMELY, CONDUCTING CLASSES, SEMINARS, CONFERENCES AND WORKSHOPS IN THE FIELDS OF DATING, COMPATIBILITY, SOCIAL RELATIONSHIPS, AND EFFECTIVE COMMUNICATIONS; INSTRUCTION ON THE SUBJECTS OF MOTIVATION AND PERSONAL DEVELOPMENT TO ACHIEVE INDIVIDUAL AND PROFESSIONAL SUCCESS; AND COURSE MATERIALS DISTRIBUTED IN CONNECTION WITH ALL OF THE FOREGOING SERVICES (U.S. CLS. 100, 101 AND 107).

SUSAN LESLIE DUBOIS, EXAMINING ATTORNEY

SN 76-610,824. SIMON, BARBARA, BEVERLY HILLS, CA. FILED 9-10-2004.



NO CLAIM IS MADE TO THE EXCLUSIVE RIGHT TO USE "TOLTEC YOGA", APART FROM THE MARK AS SHOWN.

THE STIPPLING IS FOR SHADING PURPOSES.

THE LIKENESS (OR, "PORTRAIT") IN THE MARK IDENTIFIES A LIVING INDIVIDUAL WHOSE CONSENT IS OF RECORD.

FOR YOGA INSTRUCTION (U.S. CLS. 100, 101 AND 107).

FIRST USE 6-1-2004; IN COMMERCE 6-1-2004.
DAVID MURRAY, EXAMINING ATTORNEY

CLASS 41—(Continued).

SN 76-611,372. KING'S HAWAIIAN HOLDING COMPANY, INC., TORRANCE, CA. FILED 9-7-2004.



OWNER OF U.S. REG. NOS. 1,228,641, 2,823,976 AND OTHERS.

NO CLAIM IS MADE TO THE EXCLUSIVE RIGHT TO USE "HAWAIIAN", "GRILL HAWAIIAN STYLE" AND "SWEEPSTAKES", APART FROM THE MARK AS SHOWN.

THE COLOR(S) RED, OLIVE GOLD, BLUE, WHITE, DARK BROWN AND LIGHT TAN IS/ARE CLAIMED AS A FEATURE OF THE MARK.

THE FOLLOWING DESIGNATED COLORS ARE A FEATURE OF THE MARK: (I) THE OUTER THICK BORDERLINES OF THE OVAL DESIGN ARE IN WHITE; (II) THE INNER THIN BORDERLINES OF THE OVAL DESIGN ARE IN DARK BROWN (PANTONE 476); (III) THE WORDS "KING'S HAWAIIAN" ARE IN WARM RED (PANTONE WARM RED); (IV) THE CROWN DESIGN, THE SHADOW LINES OF THE WORDS "KING'S HAWAIIAN" AND THE UNDERLINE BENEATH THE WORDS "KING'S HAWAIIAN" ARE ALL IN OLIVE GOLD (PANTONE 871); (V) THE WORDS "GRILL HAWAIIAN STYLE" ARE IN BLUE (PANTONE PROCESS BLUE); (VI) THE SHADOW LINES OF THE WORDS "GRILL HAWAIIAN STYLE" ARE PARTIALLY IN WHITE AND PARTIALLY IN DARK BROWN (PANTONE 476); (VII) THE WORD "SWEEPSTAKES" ARE IN DARK BROWN (PANTONE 476); (VIII) THE WAVE LINES IN THE BACKGROUND ARE IN TAN (PANTONE 467); AND (IX) THE SPACE IN BETWEEN THE WAVE LINES IS IN LIGHT TAN (PANTONE 468).

FOR ENTERTAINMENT SERVICES IN THE NATURE OF CONDUCTING SWEEPSTAKES GAMES (U.S. CLS. 100, 101 AND 107).

FIRST USE 5-1-2004; IN COMMERCE 5-1-2004.
SKYE YOUNG, EXAMINING ATTORNEY

SN 76-612,575. SCHON, NEAL, EMERALD HILLS, CA. FILED 9-23-2004.

GUITAR ZOO

THE MARK CONSISTS OF STANDARD CHARACTERS WITHOUT CLAIM TO ANY PARTICULAR FONT, STYLE, SIZE, OR COLOR.

FOR ENTERTAINMENT IN THE NATURE OF ARRANGING AND CONDUCTING LIVE ROCK CONCERT FESTIVALS FEATURING MULTIPLE MUSICAL GROUPS AND BANDS (U.S. CLS. 100, 101 AND 107).

RENEE MCCRAY, EXAMINING ATTORNEY

CLASS 41—(Continued).

SN 76-614,271. HASBRO, INC., PAWTUCKET, RI. FILED 10-1-2004.

ROBOT REBELLION

THE MARK CONSISTS OF STANDARD CHARACTERS WITHOUT CLAIM TO ANY PARTICULAR FONT, STYLE, SIZE, OR COLOR.

NO CLAIM IS MADE TO THE EXCLUSIVE RIGHT TO USE ROBOT, APART FROM THE MARK AS SHOWN.

FOR ENTERTAINMENT SERVICES, NAMELY, PRODUCTION AND DISTRIBUTION OF MOTION PICTURES, TELEVISION PROGRAMS, TELEVISION GAMES SHOWS AND CARTOON SERIES; ON-GOING TELEVISION PROGRAMS IN THE NATURE OF CHILDREN'S GAME SHOWS AND ANIMATED TELEVISION CARTOON SERIES; PROVIDING INTERACTIVE COMPUTER GAMES BY MEANS OF A GLOBAL COMPUTER NETWORK (U.S. CLS. 100, 101 AND 107).

JANICE L. MCMORROW, EXAMINING ATTORNEY

SN 76-614,575. BUILDING CHAMPIONS, INC., LAKE OSWEGO, OR. FILED 10-5-2004.



BUILDING CHAMPIONS

COACHING BUSINESS AND LIFE | ON PURPOSE

OWNER OF U.S. REG. NOS. 2,622,915 AND 2,719,671.

NO CLAIM IS MADE TO THE EXCLUSIVE RIGHT TO USE "COACHING BUSINESS AND LIFE", APART FROM THE MARK AS SHOWN.

FOR EDUCATIONAL SERVICES, NAMELY, CONDUCTING INDIVIDUAL AND GROUP TRAINING, TEACHING AND MENTORING SESSIONS BY TELEPHONE, EMAIL AND PERSONAL APPEARANCES IN THE FIELD OF SELF-IMPROVEMENT AND JOB PERFORMANCE, INCLUDING THE DISTRIBUTION OF COURSE MATERIALS IN CONNECTION THEREWITH (U.S. CLS. 100, 101 AND 107).

FIRST USE 6-22-2004; IN COMMERCE 7-15-2004.
WON TEAK OH, EXAMINING ATTORNEY

SN 76-614,869. THE H.W. WILSON COMPANY, BRONX, NY. FILED 10-4-2004.

WILSONLINK

THE MARK CONSISTS OF STANDARD CHARACTERS WITHOUT CLAIM TO ANY PARTICULAR FONT, STYLE, SIZE, OR COLOR.

OWNER OF U.S. REG. NOS. 1,320,037, 2,288,671 AND OTHERS.

SEC. 2(F) AS TO "WILSON".

FOR PROVIDING LINKS VIA A GLOBAL COMPUTER NETWORK TO WEB SITES OF OTHERS FEATURING PERIODICALS OF INTEREST TO ACADEMIC RESEARCHERS (U.S. CLS. 100, 101 AND 107).

FIRST USE 1-0-2003; IN COMMERCE 1-0-2003.
BRENDAN REGAN, EXAMINING ATTORNEY

CLASS 41—(Continued).

SN 76-615,937. THE PAINTERS AND ALLIED TRADES LABOR MANAGEMENT COOPERATION INITIATIVE, WASHINGTON, DC. FILED 10-14-2004.



NO CLAIM IS MADE TO THE EXCLUSIVE RIGHT TO USE "SAFETY TRAINING AWARDS RECOGNITION", APART FROM THE MARK AS SHOWN.

THE MARK CONSISTS OF A RECTANGULAR DESIGN WHICH INCLUDES THE STYLIZED WORD "STAR" WITHIN THE RECTANGLE. THE LETTER "A" IN THE WORD "STAR" IS DEPICTED BY A DESIGN OF A STAR. UNDER THE RECTANGLE ARE THE WORDS "SAFETY TRAINING AWARDS RECOGNITION".

FOR PROVIDING RECOGNITION AND INCENTIVES BY THE WAY OF AWARDS TO DEMONSTRATE EXCELLENCE IN THE FIELD OF WORKPLACE SAFETY TO PAINTERS AND TRADE WORKERS WHO COMPLETE SAFETY COURSES IN ENVIRONMENTAL AND HEALTH SAFETY AND WHO WORK A CERTAIN NUMBER OF HOURS WITHOUT JOB-RELATED ACCIDENTS OR JOB RELATED ILLNESSES (U.S. CLS. 100, 101 AND 107).

DANIEL BRODY, EXAMINING ATTORNEY

SN 76-618,098. MADAVOR MEDIA, LLC, BOSTON, MA. FILED 10-28-2004.



FOR PUBLICATION OF PRINT MEDIA, NAMELY PUBLICATION OF BOOKS, MAGAZINES AND NEWSLETTERS; PUBLICATION OF BOOKS, MAGAZINES AND NEWSLETTERS ON-LINE; ENTERTAINMENT SERVICES, NAMELY, PROVIDING INFORMATION IN THE FIELD OF ENTERTAINMENT, BOOKS AND MAGAZINES ON A GLOBAL COMPUTER NETWORK (U.S. CLS. 100, 101 AND 107).

JULIE GUTTADAURO, EXAMINING ATTORNEY

CLASS 41—(Continued).

SN 76-619,190. CCF PRODUCTIONS, INC., LOS ANGELES, CA. FILED 11-3-2004.

JOAN AND MELISSA LIVE FROM THE RED CARPET

THE MARK CONSISTS OF STANDARD CHARACTERS WITHOUT CLAIM TO ANY PARTICULAR FONT, STYLE, SIZE, OR COLOR.

OWNER OF U.S. REG. NO. 2,914,196.

THE NAME(S), PORTRAIT(S), AND/OR SIGNATURE(S) SHOWN IN THE MARK IDENTIFIES, WHOSE CONSENT(S) TO REGISTER IS SUBMITTED.

SEC. 2(F) "LIVE FROM THE RED CARPET".

FOR ENTERTAINMENT SERVICES, NAMELY, TELEVISION PROGRAMS IN THE FIELD OF ENTERTAINMENT AWARD SHOWS AND CELEBRITY INTERVIEWS BROADCAST OVER THE MEDIA OF TELEVISION, CABLE AND SATELLITE; AND PROVIDING INFORMATION IN THE FIELD OF ENTERTAINMENT AWARD SHOWS AND CELEBRITY INTERVIEWS ON GLOBAL COMPUTER NETWORKS (U.S. CLS. 100, 101 AND 107).

LINDA M. KING, EXAMINING ATTORNEY

SN 76-619,248. CCF PRODUCTIONS, INC., LOS ANGELES, CA. FILED 11-3-2004.

JOAN AND MELISSA ARE THE RED CARPET

THE MARK CONSISTS OF STANDARD CHARACTERS WITHOUT CLAIM TO ANY PARTICULAR FONT, STYLE, SIZE, OR COLOR.

OWNER OF U.S. REG. NO. 2,914,196.

THE NAME(S), PORTRAIT(S), AND/OR SIGNATURE(S) SHOWN IN THE MARK IDENTIFIES, WHOSE CONSENT(S) TO REGISTER IS SUBMITTED.

FOR ENTERTAINMENT SERVICES, NAMELY, TELEVISION PROGRAMS IN THE FIELD OF ENTERTAINMENT AWARD SHOWS AND CELEBRITY INTERVIEWS BROADCAST OVER THE MEDIA OF TELEVISION, CABLE AND SATELLITE; AND PROVIDING INFORMATION IN THE FIELD OF ENTERTAINMENT AWARD SHOWS AND CELEBRITY INTERVIEWS ON GLOBAL COMPUTER NETWORKS (U.S. CLS. 100, 101 AND 107).

LINDA M. KING, EXAMINING ATTORNEY

SN 76-619,461. SAVOCA, TOM, PHOENIX, AZ. AND BOAEN, ROB, PHOENIX, AZ. FILED 11-5-2004.

BALL SAC RACING

THE MARK CONSISTS OF STANDARD CHARACTERS WITHOUT CLAIM TO ANY PARTICULAR FONT, STYLE, SIZE, OR COLOR.

NO CLAIM IS MADE TO THE EXCLUSIVE RIGHT TO USE "RACING", APART FROM THE MARK AS SHOWN.

FOR ENTERTAINMENT SERVICES IN THE NATURE OF CLOSED-COURSE MOTORCYCLE RACING BY A MOTORCYCLE RACING TEAM (U.S. CLS. 100, 101 AND 107).

FIRST USE 2-0-2004; IN COMMERCE 4-30-2004.

DOUGLAS LEE, EXAMINING ATTORNEY

CLASS 41—(Continued).

SN 76-619,836. MARKET MAKERS USA, INC., MARINA DEL REY, CA. FILED 11-8-2004.

SLEEPING MILLIONAIRE

THE MARK CONSISTS OF STANDARD CHARACTERS WITHOUT CLAIM TO ANY PARTICULAR FONT, STYLE, SIZE, OR COLOR.

FOR EDUCATIONAL SERVICES, NAMELY, CONDUCTING STUDY PROGRAMS, SEMINARS AND CLASSES RELATING TO FINANCES AND INVESTMENTS (U.S. CLS. 100, 101 AND 107).

ROBERT LORENZO, EXAMINING ATTORNEY

CLASS 41—(Continued).

SN 76-620,461. GRAYDON HEAD & RITCHEY LLP, CINCINNATI, OH. FILED 11-15-2004.

DIRT TO DOLLARS

THE MARK CONSISTS OF STANDARD CHARACTERS WITHOUT CLAIM TO ANY PARTICULAR FONT, STYLE, SIZE, OR COLOR.

FOR EDUCATIONAL SERVICES, NAMELY, CONDUCTING SEMINARS AND WORKSHOPS ON REAL ESTATE MATTERS (U.S. CLS. 100, 101 AND 107).

FIRST USE 1-2-2003; IN COMMERCE 1-2-2003.
STEVEN JACKSON, EXAMINING ATTORNEY

SN 76-620,136. FISCHER PRODUCTIONS, LLC, FAIRFIELD, CT. FILED 11-12-2004.

GOURMET GALLEY

THE MARK CONSISTS OF STANDARD CHARACTERS WITHOUT CLAIM TO ANY PARTICULAR FONT, STYLE, SIZE, OR COLOR.

FOR PRODUCING AND DISTRIBUTION TELEVISION SHOWS (U.S. CLS. 100, 101 AND 107).

PAULA MAHONEY, EXAMINING ATTORNEY

SN 76-620,762. PERFECT IMAGE FILM & VIDEO PRODUCTION, INC., MIAMI, FL. FILED 11-16-2004.

LA FAMILIA PERFECTA

THE MARK CONSISTS OF STANDARD CHARACTERS WITHOUT CLAIM TO ANY PARTICULAR FONT, STYLE, SIZE, OR COLOR.

THE ENGLISH TRANSLATION OF "LA FAMILIA PERFECTA" IS "THE PERFECT FAMILY".

FOR ENTERTAINMENT SERVICES, NAMELY, PRESENTATION OF LIVE AND PRERECORDED MUSICAL PERFORMANCES VIA A TELEVISION SHOW (U.S. CLS. 100, 101 AND 107).

ALICIA COLLINS, EXAMINING ATTORNEY

SN 76-620,316. MC DONALD, CARL, YONKERS, NY. FILED 11-12-2004.



FOR RENTAL OF MUSICAL INSTRUMENTS (U.S. CLS. 100, 101 AND 107).

GINA HAYES, EXAMINING ATTORNEY

SN 76-620,787. SUPPER THYME USA FRANCHISE SERVICE L.L.C., OMAHA, NE. FILED 11-16-2004.



NO CLAIM IS MADE TO THE EXCLUSIVE RIGHT TO USE "USA", APART FROM THE MARK AS SHOWN.

FOR SOCIAL AND INSTRUCTIONAL CLASSES IN WHICH MEALS ARE PREPARED FOR CONSUMPTION LATER (U.S. CLS. 100, 101 AND 107).

FIRST USE 4-0-2003; IN COMMERCE 4-0-2003.
JUDITH HELFMAN, EXAMINING ATTORNEY

CLASS 41—(Continued).

SN 76-621,002. ARENA FOOTBALL LEAGUE, LLC, CHICAGO, IL. FILED 11-18-2004.

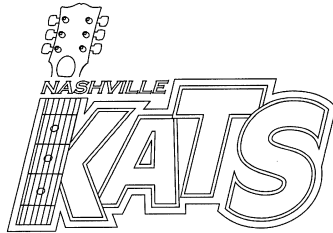

OWNER OF U.S. REG. NOS. 2,089,857, 2,591,115 AND OTHERS.

NO CLAIM IS MADE TO THE EXCLUSIVE RIGHT TO USE NASHVILLE, APART FROM THE MARK AS SHOWN. THE MARK CONSISTS, IN PART, OF A THE LETTER "K" STYLIZED SO AS TO RESEMBLE A GUITAR.

FOR ENTERTAINMENT SERVICES, NAMELY ORGANIZING AND PRESENTING FOOTBALL GAMES BEFORE LIVE AUDIENCES AND ON TELEVISION, RADIO, FOR GLOBAL COMPUTER NETWORK DISPLAY AND OTHER MEDIA (U.S. CLS. 100, 101 AND 107).
KIMBERLY PERRY, EXAMINING ATTORNEY

SN 76-621,003. ARENA FOOTBALL LEAGUE, LLC, CHICAGO, IL. FILED 11-18-2004.

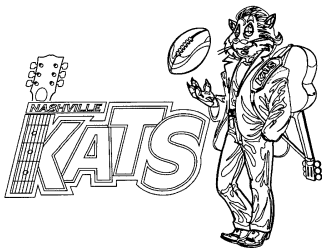

OWNER OF U.S. REG. NOS. 2,089,857, 2,591,115 AND OTHERS.

NO CLAIM IS MADE TO THE EXCLUSIVE RIGHT TO USE NASHVILLE, APART FROM THE MARK AS SHOWN. THE MARK CONSISTS, IN PART, OF A THE LETTER "K" STYLIZED SO AS TO RESEMBLE A GUITAR AND A CAT TOSSING A FOOTBALL.

FOR ENTERTAINMENT SERVICES, NAMELY ORGANIZING AND PRESENTING FOOTBALL GAMES BEFORE LIVE AUDIENCES AND ON TELEVISION, RADIO, FOR GLOBAL COMPUTER NETWORK DISPLAY AND OTHER MEDIA (U.S. CLS. 100, 101 AND 107).
KIMBERLY PERRY, EXAMINING ATTORNEY

CLASS 41—(Continued).

SN 76-621,095. LD COACH, LLC, MARIETTA, GA. FILED 11-17-2004.



NO CLAIM IS MADE TO THE EXCLUSIVE RIGHT TO USE "LD COACH", APART FROM THE MARK AS SHOWN. THE STYLIZED WORDS "LD COACH" ACCOMPANIED BY A PERSON READING A BOOK WITH AN EIGHT-POINTED STAR SHAPE OVER THE PERSON'S HEAD WITH DESIGN.

FOR EDUCATION SERVICES, NAMELY, PROVIDING LITERACY INSTRUCTION (U.S. CLS. 100, 101 AND 107).
MELISSA VALLILLO, EXAMINING ATTORNEY

SN 76-621,458. MOVIE GALLERY ASSET MANAGEMENT, INC., WILMINGTON, DE. FILED 11-19-2004.

PLAY ON PROMISE

THE MARK CONSISTS OF STANDARD CHARACTERS WITHOUT CLAIM TO ANY PARTICULAR FONT, STYLE, SIZE, OR COLOR.

FOR ENTERTAINMENT SERVICES, NAMELY, RENTAL OF VIDEOCASSETTES, DVDS, AND VIDEO GAMES (U.S. CLS. 100, 101 AND 107).

FIRST USE 7-5-2004; IN COMMERCE 7-5-2004.
ELIZABETH J. WINTER, EXAMINING ATTORNEY

SN 76-621,536. MIKOHN GAMING CORPORATION, LAS VEGAS, NV. FILED 11-22-2004.

COMMUNITY JACKPOT

THE MARK CONSISTS OF STANDARD CHARACTERS WITHOUT CLAIM TO ANY PARTICULAR FONT, STYLE, SIZE, OR COLOR.

NO CLAIM IS MADE TO THE EXCLUSIVE RIGHT TO USE "JACKPOT", APART FROM THE MARK AS SHOWN. FOR CASINO GAMING SERVICES, NAMELY, PROVIDING CARD GAMES AND WAGERING EVENTS (U.S. CLS. 100, 101 AND 107).

FIRST USE 4-12-2005; IN COMMERCE 4-12-2005.
TRACY WHITAKER-BOWN, EXAMINING ATTORNEY

CLASS 41—(Continued).

SN 76-621,712. ADVANCE MAGAZINE PUBLISHERS INC.,
NEW YORK, NY. FILED 11-22-2004.

GOLF DIGEST MOBILE

THE MARK CONSISTS OF STANDARD CHARACTERS WITHOUT CLAIM TO ANY PARTICULAR FONT, STYLE, SIZE, OR COLOR.

OWNER OF U.S. REG. NOS. 781,433, 2,310,354 AND OTHERS.

NO CLAIM IS MADE TO THE EXCLUSIVE RIGHT TO USE "MOBILE", APART FROM THE MARK AS SHOWN. SEC. 2(F) AS TO GOLF DIGEST.

FOR ELECTRONIC PUBLICATION SERVICES, NAMELY, PUBLICATION OF TEXT AND GRAPHIC WORKS RECORDED ON ELECTRONIC MEDIA, NAMELY CD, DVD AND ONLINE, AS WELL AS WIRELESS TECHNOLOGY AND COMMUNICATION DEVICES, MOBILE PHONES, CELL PHONES, WIRELESS LAPTOP COMPUTERS, PDAS AND PAGERS IN THE FIELD OF THE SPORT OF GOLF (U.S. CLS. 100, 101 AND 107).

ANNE FARRELL, EXAMINING ATTORNEY

SN 76-621,714. ADVANCE MAGAZINE PUBLISHERS INC.,
NEW YORK, NY. FILED 11-22-2004.

GOLF DIGEST SWING SEQUENCES

THE MARK CONSISTS OF STANDARD CHARACTERS WITHOUT CLAIM TO ANY PARTICULAR FONT, STYLE, SIZE, OR COLOR.

OWNER OF U.S. REG. NOS. 781,433, 2,310,354 AND OTHERS.

NO CLAIM IS MADE TO THE EXCLUSIVE RIGHT TO USE "SWING SEQUENCES", APART FROM THE MARK AS SHOWN.

SEC. 2(F) AS TO GOLF DIGEST.

FOR ELECTRONIC PUBLICATION SERVICES, NAMELY, PUBLICATION OF TEXT AND GRAPHIC WORKS RECORDED ON ELECTRONIC MEDIA, NAMELY CD, DVD AND ONLINE, AS WELL AS WIRELESS TECHNOLOGY AND COMMUNICATION DEVICES, MOBILE PHONES, CELL PHONES, WIRELESS LAPTOP COMPUTERS, PDAS AND PAGERS IN THE FIELD OF THE SPORT OF GOLF (U.S. CLS. 100, 101 AND 107).

ANNE FARRELL, EXAMINING ATTORNEY

CLASS 41—(Continued).

SN 76-621,825. BROOKLYN KINGS BASKETBALL CLUB,
LLC, THE, BROOKLYN, NY. FILED 11-23-2004.



NO CLAIM IS MADE TO THE EXCLUSIVE RIGHT TO USE "BROOKLYN" AND "BASKETBALL", APART FROM THE MARK AS SHOWN.

FOR ENTERTAINMENT SERVICES IN THE NATURE OF LIVE BASKETBALL GAMES AND BASKETBALL EXHIBITIONS AND THE PRODUCTION AND DISTRIBUTION OF RADIO AND TELEVISION BROADCASTS OF BASKETBALL GAMES AND EXHIBITIONS (U.S. CLS. 100, 101 AND 107).

FIRST USE 4-30-1999; IN COMMERCE 4-30-1999.

CHRISIE B. KING, EXAMINING ATTORNEY

SN 76-621,827. WANG CENTER FOR THE PERFORMING
ARTS, INC., BOSTON, MA. FILED 11-23-2004.

COMMONWEALTH SHAKESPEARE COMPANY

THE MARK CONSISTS OF STANDARD CHARACTERS WITHOUT CLAIM TO ANY PARTICULAR FONT, STYLE, SIZE, OR COLOR.

NO CLAIM IS MADE TO THE EXCLUSIVE RIGHT TO USE "SHAKESPEARE COMPANY", APART FROM THE MARK AS SHOWN.

FOR ENTERTAINMENT SERVICES, NAMELY THEATRICAL PERFORMANCES; EDUCATIONAL SERVICES, NAMELY PROVIDING EDUCATIONAL AND TRAINING PROGRAMS IN THE FIELD OF THEATRE AND SHAKESPEARE (U.S. CLS. 100, 101 AND 107).

FIRST USE 3-0-1996; IN COMMERCE 3-0-1996.

DAVID C. REIHNER, EXAMINING ATTORNEY

CLASS 41—(Continued).

SN 76-621,855. CCF PRODUCTIONS, INC., LOS ANGELES, CA. FILED 11-23-2004.

JOAN AND MELISSA LIVE AT THE RED CARPET

THE MARK CONSISTS OF STANDARD CHARACTERS WITHOUT CLAIM TO ANY PARTICULAR FONT, STYLE, SIZE, OR COLOR.

OWNER OF U.S. REG. NO. 2,914,196.

THE NAME(S), PORTRAIT(S), AND/OR SIGNATURE(S) SHOWN IN THE MARK IDENTIFIES JOAN ROSENBERG AND MELISSA RIVERS, WHOSE CONSENT(S) TO REGISTER IS SUBMITTED.

SEC. 2(F) AS TO "LIVE AT THE RED CARPET".

FOR ENTERTAINMENT SERVICES, NAMELY, TELEVISION PROGRAMS IN THE FIELD OF ENTERTAINMENT AWARD SHOWS AND CELEBRITY INTERVIEWS BROADCAST OVER THE MEDIA OF TELEVISION, CABLE AND SATELLITE; AND PROVIDING INFORMATION IN THE FIELD OF ENTERTAINMENT AWARD SHOWS AND CELEBRITY INTERVIEWS ON GLOBAL COMPUTER NETWORKS (U.S. CLS. 100, 101 AND 107).

LINDA M. KING, EXAMINING ATTORNEY

SN 76-622,190. BARONE, JOHN E., SANIBEL, FL. FILED 11-26-2004.

MEAT AND POTATOES WORKOUT

THE MARK CONSISTS OF STANDARD CHARACTERS WITHOUT CLAIM TO ANY PARTICULAR FONT, STYLE, SIZE, OR COLOR.

NO CLAIM IS MADE TO THE EXCLUSIVE RIGHT TO USE "WORKOUT", APART FROM THE MARK AS SHOWN.

FOR PERSONAL TRAINING SERVICES, NAMELY, STRENGTH AND CONDITIONING TRAINING (U.S. CLS. 100, 101 AND 107).

JOANNA DUKOVIC, EXAMINING ATTORNEY

SN 76-622,380. EARL MILLER PHOTOGRAPHY, INC., CHATSWORTH, CA. FILED 11-29-2004.

EARLMILLER.COM

THE MARK CONSISTS OF STANDARD CHARACTERS WITHOUT CLAIM TO ANY PARTICULAR FONT, STYLE, SIZE, OR COLOR.

OWNER OF U.S. REG. NO. 2,615,074 AND OTHERS.

THE NAME "EARL MILLER" IDENTIFIES A LIVING INDIVIDUAL WHOSE CONSENT IS OF RECORD.

FOR ONLINE ENTERTAINMENT SERVICES, NAMELY, PROVIDING ADULT-THEMED PHOTOS AND VIDEOS VIA THE INTERNET (U.S. CLS. 100, 101 AND 107).

FIRST USE 2-19-1998; IN COMMERCE 2-19-1998.

MICHELLE DUBOIS, EXAMINING ATTORNEY

CLASS 41—(Continued).

SN 76-622,381. EARL MILLER PHOTOGRAPHY, INC., CHATSWORTH, CA. FILED 11-29-2004.

PREMIUM PORN FOR PURE PLEASURE

THE MARK CONSISTS OF STANDARD CHARACTERS WITHOUT CLAIM TO ANY PARTICULAR FONT, STYLE, SIZE, OR COLOR.

NO CLAIM IS MADE TO THE EXCLUSIVE RIGHT TO USE "PORN", APART FROM THE MARK AS SHOWN.

FOR ONLINE ENTERTAINMENT SERVICES, NAMELY, PROVIDING ADULT-THEMED PHOTOS AND VIDEOS VIA THE INTERNET (U.S. CLS. 100, 101 AND 107).

FIRST USE 11-8-2004; IN COMMERCE 11-8-2004.

CHERYL CLAYTON, EXAMINING ATTORNEY

SN 76-622,430. GOLDEN OPPORTUNITY, INC., ROCKVILLE, MD. FILED 11-26-2004.

GOLDEN OPPORTUNITY, INC.

THE MARK CONSISTS OF STANDARD CHARACTERS WITHOUT CLAIM TO ANY PARTICULAR FONT, STYLE, SIZE, OR COLOR.

NO CLAIM IS MADE TO THE EXCLUSIVE RIGHT TO USE "INC.", APART FROM THE MARK AS SHOWN.

FOR TECHNOLOGY TRAINING AND COACHING IN THE FIELD OF WEB SITE DEVELOPMENT AND DESKTOP SOFTWARE DEVELOPMENT; PROVIDING MOTIVATIONAL SPEAKERS; CONDUCTING WORKSHOPS FOR ADULTS AND CHILDREN IN THE FIELD OF PUBLIC SPEAKING AND PRESENTATION SKILLS (U.S. CLS. 100, 101 AND 107).

KATHY DE JONGE, EXAMINING ATTORNEY

SN 76-622,433. SIX SIGMA STUDIOS, INC., WARRENTON, VA. FILED 11-26-2004.

School's Out.

THE MARK CONSISTS OF STANDARD CHARACTERS WITHOUT CLAIM TO ANY PARTICULAR FONT, STYLE, SIZE, OR COLOR.

FOR VIDEO YEARBOOK PRODUCTION SERVICES (U.S. CLS. 100, 101 AND 107).

JOHN WILKE, EXAMINING ATTORNEY

CLASS 41—(Continued).

SN 76-622,656. CONNECTIONS ACADEMY, LLC, BALTIMORE, MD. FILED 11-30-2004.

LONGITUDINAL EVALUATION OF ACADEMIC PROGRESS

THE MARK CONSISTS OF STANDARD CHARACTERS WITHOUT CLAIM TO ANY PARTICULAR FONT, STYLE, SIZE, OR COLOR.

NO CLAIM IS MADE TO THE EXCLUSIVE RIGHT TO USE EVALUATION OF ACADEMIC PROGRESS, APART FROM THE MARK AS SHOWN.

FOR EDUCATIONAL SERVICES, NAMELY, PROVIDING WEB-BASED EDUCATIONAL LEVEL ASSESSMENT SERVICES, LESSONS, AND ACTIVITIES FOR STUDENTS AND CHILDREN; PROVIDING CUSTOMIZED EDUCATIONAL PROGRAMS TO AID IN THE INSTRUCTING OF STUDENTS AND CHILDREN IN CONNECTION WITH CORE SCHOLASTIC SUBJECTS SUCH AS READING, WRITING AND MATH; PROVIDING AND ADMINISTERING EDUCATIONAL ASSESSMENT TESTS AND ONLINE EDUCATIONAL ASSESSMENT TESTS TO STUDENTS AND CHILDREN (U.S. CLS. 100, 101 AND 107).

DAWN HAN, EXAMINING ATTORNEY

SN 76-623,101. DRIVERTV LLC, NEW YORK, NY. FILED 12-3-2004.

DRIVERTV

THE MARK CONSISTS OF STANDARD CHARACTERS WITHOUT CLAIM TO ANY PARTICULAR FONT, STYLE, SIZE, OR COLOR.

FOR ENTERTAINMENT AND EDUCATIONAL SERVICES, NAMELY, PRODUCTION OF VIDEO PROGRAMMING FEATURING INFORMATION ABOUT THE ATTRIBUTES, FEATURES AND SPECIFICATIONS OF MODEL AUTOMOBILES FROM ALL MAJOR MANUFACTURERS AS WELL AS OTHER INFORMATION THAT WILL HELP CONSUMERS MAKE INFORMED PURCHASING DECISIONS REGARDING AUTOMOBILES AND ANCILLARY AUTOMOTIVE PRODUCTS, WHICH IS DISTRIBUTED TO VIDEO-ON-DEMAND TELEVISION CHANNELS, WEB SITES, IN-ROOM HOTEL NETWORKS, ON-DEMAND SATELLITE CHANNELS, ON-DEMAND TELEPHONE COMPANY VIDEO SERVICES AND WIRELESS NETWORKS (U.S. CLS. 100, 101 AND 107).

MONTIA G. PRESSEY, EXAMINING ATTORNEY

CLASS 41—(Continued).

SN 76-623,578. ALICEA, JOSE, NEW YORK, NY. FILED 12-7-2004.

HIDDEN HAND ENTERPRISES

THE MARK CONSISTS OF STANDARD CHARACTERS WITHOUT CLAIM TO ANY PARTICULAR FONT, STYLE, SIZE, OR COLOR.

NO CLAIM IS MADE TO THE EXCLUSIVE RIGHT TO USE "ENTERPRISES", APART FROM THE MARK AS SHOWN.

FOR MUSIC PRODUCTION SERVICES (U.S. CLS. 100, 101 AND 107).

BILL DAWE, EXAMINING ATTORNEY

SN 76-624,033. ABREU, CARLOS, BEVERLY HILLS, CA. FILED 12-13-2004.

HOLLYWOOD FILM FESTIVAL

THE MARK CONSISTS OF STANDARD CHARACTERS WITHOUT CLAIM TO ANY PARTICULAR FONT, STYLE, SIZE, OR COLOR.

OWNER OF U.S. REG. NOS. 2,200,740, 2,422,376 AND OTHERS.

NO CLAIM IS MADE TO THE EXCLUSIVE RIGHT TO USE "FILM FESTIVAL", APART FROM THE MARK AS SHOWN.

SEC. 2(F).

FOR MOVIE THEATRE SERVICES; EDUCATIONAL SERVICES IN THE NATURE OF CONFERENCES AND SEMINARS IN THE FIELD OF SCREEN WRITING AND FILM MAKING; ENTERTAINMENT SERVICES, NAMELY, ORGANIZING AND CONDUCTING AWARDS PROGRAMS TO RECOGNIZE ACHIEVEMENTS IN THE FIELDS OF MOTION PICTURES, TELEVISION, AND NEW MEDIA (U.S. CLS. 100, 101 AND 107).

FIRST USE 4-0-1997; IN COMMERCE 5-0-1997.

BRIDGETT SMITH, EXAMINING ATTORNEY

SN 76-624,316. ASSOCIATION OF SCHOOL BUSINESS OFFICIALS INTERNATIONAL, RESTON, VA. FILED 12-9-2004.

EAGLE AWARDS

THE MARK CONSISTS OF STANDARD CHARACTERS WITHOUT CLAIM TO ANY PARTICULAR FONT, STYLE, SIZE, OR COLOR.

NO CLAIM IS MADE TO THE EXCLUSIVE RIGHT TO USE "AWARDS", APART FROM THE MARK AS SHOWN.

FOR EDUCATIONAL SERVICES, NAMELY, PROVIDING INCENTIVES TO SCHOOL BUSINESS OFFICIALS TO DEMONSTRATE EXCELLENCE IN THE FIELD OF COMMUNITY SERVICE, JOB PERFORMANCE AND PROFESSIONALISM THROUGH THE ISSUANCE OF AWARDS (U.S. CLS. 100, 101 AND 107).

FIRST USE 7-1-1997; IN COMMERCE 7-1-1997.

ALICE SUE CARRUTHERS, EXAMINING ATTORNEY

CLASS 41—(Continued).

SN 76-624,495. WHEELER, SEAN PATRICK, PALM SPRINGS, CA. FILED 12-14-2004.

THROW RAG

THE MARK CONSISTS OF STANDARD CHARACTERS WITHOUT CLAIM TO ANY PARTICULAR FONT, STYLE, SIZE, OR COLOR.

FOR ENTERTAINMENT SERVICES; NAMELY, LIVE PERFORMANCES BY A VOCAL AND INSTRUMENTAL GROUP (U.S. CLS. 100, 101 AND 107).

FIRST USE 3-12-1994; IN COMMERCE 3-12-1994.

ANN E. SAPPENFIELD, EXAMINING ATTORNEY

SN 76-625,280. CELEBRATIONZ, INC., WEST PALM BEACH, FL. FILED 12-20-2004.



NO CLAIM IS MADE TO THE EXCLUSIVE RIGHT TO USE "CELEBRATIONS", APART FROM THE MARK AS SHOWN.

FOR PROVIDING FACILITIES FOR CHILDREN'S PARTIES; ENTERTAINMENT SERVICES, NAMELY, CONDUCTING CHILDREN'S PARTIES (U.S. CLS. 100, 101 AND 107).

ESTHER A. BORSUK, EXAMINING ATTORNEY

CLASS 41—(Continued).

SN 76-626,030. MAJOR LEAGUE LACROSSE LLC, BRIGHTON, MA. FILED 12-27-2004.



OWNER OF U.S. REG. NOS. 2,764,955 AND 2,769,741. NO CLAIM IS MADE TO THE EXCLUSIVE RIGHT TO USE PHILADELPHIA, APART FROM THE MARK AS SHOWN.

FOR ENTERTAINMENT IN THE NATURE OF LACROSSE GAMES, COMPETITIONS AND TOURNAMENTS; ENTERTAINMENT, NAMELY, PARTICIPATION IN LACROSSE GAMES AND COMPETITIONS; CONDUCTING ENTERTAINMENT EXHIBITIONS IN THE NATURE OF LACROSSE GAMES AND COMPETITIONS; ORGANIZING EXHIBITIONS FOR THE SPORT OF LACROSSE; PROVIDING FACILITIES FOR LACROSSE TOURNAMENTS; ARRANGING AND CONDUCTING ATHLETIC COMPETITIONS; ENTERTAINMENT IN THE NATURE ON-GOING TELEVISION PROGRAMS IN THE FIELD OF SPORTING EVENTS; ENTERTAINMENT, NAMELY, A CONTINUING SPORTS EVENT SHOW DISTRIBUTED OVER TELEVISION, SATELLITE, AUDIO AND VIDEO MEDIA; ENTERTAINMENT SERVICES, NAMELY, PROVIDING A TELEVISION PROGRAM FEATURING SPORTING EVENTS VIA A GLOBAL COMPUTER NETWORK; PROVIDING AN ON-LINE COMPUTER DATABASE IN THE FIELD OF LACROSSE; ENTERTAINMENT SERVICES, NAMELY, PROVIDING A WEB SITE FEATURING INFORMATION PERTAINING TO LACROSSE GOODS AND SERVICES (U.S. CLS. 100, 101 AND 107).

DAVID ELTON, EXAMINING ATTORNEY

SN 76-626,344. GUITARSTRING PRODUCTIONS, INC., FORT WORTH, TX. FILED 12-30-2004.

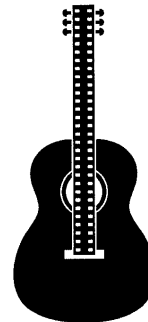

FOR DEVELOPMENT AND PRODUCTION OF MOTION PICTURES (U.S. CLS. 100, 101 AND 107).

JENNIFER MARTIN, EXAMINING ATTORNEY

CLASS 41—(Continued).

SN 76-626,345. GUITARSTRING PRODUCTIONS, INC.,
FORT WORTH, TX. FILED 12-30-2004.

GUITARSTRING PRODUCTIONS

THE MARK CONSISTS OF STANDARD CHARACTERS
WITHOUT CLAIM TO ANY PARTICULAR FONT, STYLE,
SIZE, OR COLOR.

NO CLAIM IS MADE TO THE EXCLUSIVE RIGHT TO
USE "PRODUCTIONS", APART FROM THE MARK AS
SHOWN.

FOR DEVELOPMENT AND PRODUCTION OF MO-
TION PICTURES (U.S. CLS. 100, 101 AND 107).
JENNIFER MARTIN, EXAMINING ATTORNEY

SN 76-627,288. SIGMA BREAKTHROUGH TECHNOLOGIES,
INC., SAN MARCOS, TX. FILED 1-7-2005.

PatientSIM

THE MARK CONSISTS OF STANDARD CHARACTERS
WITHOUT CLAIM TO ANY PARTICULAR FONT, STYLE,
SIZE, OR COLOR.

FOR EDUCATIONAL SERVICES, NAMELY, CON-
DUCTING CLASSES AND SEMINARS IN THE PROCESS
IMPROVEMENT OF HOSPITALS AND THE IDENTIFI-
CATION AND ELIMINATION OF WASTE IN THE
SERVICE DELIVERY SYSTEMS OF HOSPITALS (U.S.
CLS. 100, 101 AND 107).

FIRST USE 1-2-2004; IN COMMERCE 1-2-2004.
JEFFERY COWARD, EXAMINING ATTORNEY

SN 76-627,290. SIGMA BREAKTHROUGH TECHNOLOGIES,
INC., SAN MARCOS, TX. FILED 1-7-2005.

K-Sigma

THE MARK CONSISTS OF STANDARD CHARACTERS
WITHOUT CLAIM TO ANY PARTICULAR FONT, STYLE,
SIZE, OR COLOR.

FOR EDUCATIONAL SERVICES, NAMELY, CON-
DUCTING CLASSES AND SEMINARS IN THE PROCESS
IMPROVEMENT OF CORPORATE STRUCTURES AND
THE IDENTIFICATION AND ELIMINATION OF WASTE
IN THE PRODUCTION OR SERVICE DELIVERY SYS-
TEMS OF CORPORATIONS (U.S. CLS. 100, 101 AND 107).

FIRST USE 1-2-2004; IN COMMERCE 1-2-2004.
LEIGH CAROLINE CASE, EXAMINING ATTORNEY

CLASS 41—(Continued).

SN 76-627,335. PURSELL TECHNOLOGIES, INC., SYLACAU-
GA, AL. FILED 1-10-2005.

FARMLINKS AT PURSELL FARMS

THE MARK CONSISTS OF STANDARD CHARACTERS
WITHOUT CLAIM TO ANY PARTICULAR FONT, STYLE,
SIZE, OR COLOR.

FOR RESEARCH AND DEMONSTRATION GOLF
COURSE (U.S. CLS. 100, 101 AND 107).

FIRST USE 6-0-2003; IN COMMERCE 6-0-2003.
BARBARA BROWN, EXAMINING ATTORNEY

SN 76-627,336. PURSELL TECHNOLOGIES, INC., SYLACAU-
GA, AL. FILED 1-10-2005.

FARMLINKS GOLF CLUB

THE MARK CONSISTS OF STANDARD CHARACTERS
WITHOUT CLAIM TO ANY PARTICULAR FONT, STYLE,
SIZE, OR COLOR.

NO CLAIM IS MADE TO THE EXCLUSIVE RIGHT TO
USE "GOLF CLUB", APART FROM THE MARK AS
SHOWN.

FOR RESEARCH AND DEMONSTRATION GOLF
COURSE (U.S. CLS. 100, 101 AND 107).

FIRST USE 6-0-2003; IN COMMERCE 6-0-2003.
BARBARA BROWN, EXAMINING ATTORNEY

SN 76-627,339. PURSELL TECHNOLOGIES, INC., SYLACAU-
GA, AL. FILED 1-10-2005.

THE EXPERIENCE AT FARMLINKS

THE MARK CONSISTS OF STANDARD CHARACTERS
WITHOUT CLAIM TO ANY PARTICULAR FONT, STYLE,
SIZE, OR COLOR.

FOR RESEARCH AND DEMONSTRATION GOLF
COURSE (U.S. CLS. 100, 101 AND 107).

FIRST USE 6-0-2003; IN COMMERCE 6-0-2003.
BARBARA BROWN, EXAMINING ATTORNEY

CLASS 41—(Continued).

SN 76-627,782. BEST FITNESS CORP., SCHENECTADY, NY.
FILED 1-12-2005.

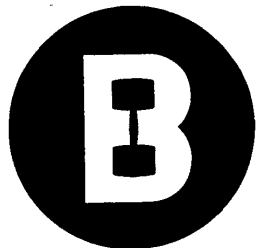

OWNER OF U.S. REG. NO. 2,935,396.
THE MARK CONSISTS OF A STYLIZED LETTER "B" IN
A SHADED CIRCLE WITH A DUMBBELL FORMING THE
INNER PORTION OF THE LETTER.
FOR HEALTH CLUB SERVICES, NAMELY PROVID-
ING INSTRUCTION AND EQUIPMENT IN THE FIELD
OF PHYSICAL EXERCISE (U.S. CLS. 100, 101 AND 107).
FIRST USE 9-1-2003; IN COMMERCE 9-1-2003.
CURTIS FRENCH, EXAMINING ATTORNEY

SN 76-627,783. BEST FITNESS CORP., SCHENECTADY, NY.
FILED 1-12-2005.



BEST FITNESS

OWNER OF U.S. REG. NO. 2,935,396.
NO CLAIM IS MADE TO THE EXCLUSIVE RIGHT TO
USE "BEST FITNESS", APART FROM THE MARK AS
SHOWN.
THE MARK CONSISTS OF A STYLIZED LETTER "B" IN
A SHADED CIRCLE WITH A DUMBBELL FORMING THE
INNER PORTION OF THE LETTER. THE MARK IN-
CLUDES THE WORDING BEST FITNESS.
FOR HEALTH CLUB SERVICES, NAMELY PROVID-
ING INSTRUCTION AND EQUIPMENT IN THE FIELD
OF PHYSICAL EXERCISE (U.S. CLS. 100, 101 AND 107).
FIRST USE 9-1-2003; IN COMMERCE 9-1-2003.
CURTIS FRENCH, EXAMINING ATTORNEY

CLASS 41—(Continued).

SN 76-628,056. PINNACLE ENTERTAINMENT, INC., LAS
VEGAS, NV. FILED 1-18-2005.

MIDNIGHT MADNESS

THE MARK CONSISTS OF STANDARD CHARACTERS
WITHOUT CLAIM TO ANY PARTICULAR FONT, STYLE,
SIZE, OR COLOR.
FOR CASINO AND GAMING SERVICES; ENTER-
TAINMENT SERVICES IN THE NATURE OF ARRAN-
GING AND CONDUCTING SPECIAL EVENTS
FEATURING CONTESTS AND TOURNAMENTS (U.S.
CLS. 100, 101 AND 107).
CHERYL CLAYTON, EXAMINING ATTORNEY

SN 76-634,068. AMERICAN COUNCIL ON THE TEACHING
OF FOREIGN LANGUAGES, ALEXANDRIA, VA. FILED
3-22-2005.

ACTFL OPI

THE MARK CONSISTS OF STANDARD CHARACTERS
WITHOUT CLAIM TO ANY PARTICULAR FONT, STYLE,
SIZE, OR COLOR.
FOR EDUCATIONAL SERVICES, NAMELY ARRAN-
GING AND CONDUCTING ORAL EXAMINATIONS
FOR ASSESSING SPOKEN LANGUAGE PROFICIENCY
(U.S. CLS. 100, 101 AND 107).
FIRST USE 5-1-1982; IN COMMERCE 5-1-1982.
MARIAM MAHMOUDI, EXAMINING ATTORNEY

SN 78-043,294. INTERNATIONAL DATA GROUP, INC.,
FRAMINGHAM, MA. FILED 1-16-2001.

NETSMART

OWNER OF U.S. REG. NO. 2,490,992.
SEC. 2(F).
FOR PROVIDING A WEBSITE FEATURING INFOR-
MATION RELATING TO EDUCATIONAL TRAINING IN
THE FIELD OF INFORMATION TECHNOLOGY (U.S.
CLS. 100, 101 AND 107).
FIRST USE 3-1-2000; IN COMMERCE 3-1-2000.
TARAH HARDY, EXAMINING ATTORNEY

CLASS 41—(Continued).

SN 78-129,900. BELL MANAGEMENT GROUP, INC., INDIAN LANTIC, FL. FILED 5-20-2002.



NO CLAIM IS MADE TO THE EXCLUSIVE RIGHT TO USE "SPORTBOOK", APART FROM THE MARK AS SHOWN.

FOR ONLINE PARI-MUTUEL BETTING AND WAGERING SERVICES; ONLINE SPORT BETTING AND WAGERING SERVICES; ONLINE CASINO SERVICES (U.S. CLS. 100, 101 AND 107).

FIRST USE 7-1-2001; IN COMMERCE 7-1-2001.
JOHN KELLY, EXAMINING ATTORNEY

SN 78-171,612. CSI ENTERTAINMENT, INC., STATEN ISLAND, NY. FILED 10-7-2002.

FIGHT SPORTS NETWORK

NO CLAIM IS MADE TO THE EXCLUSIVE RIGHT TO USE "NETWORK", APART FROM THE MARK AS SHOWN. SEC. 2(F).

FOR PRODUCTION OF TELEVISION PROGRAMMING IN THE FIELD OF CONTACT SPORTS; DISTRIBUTION OF TELEVISION PROGRAMMING IN THE FIELD OF CONTACT SPORTS TO TELEVISION SYSTEMS; DISTRIBUTION OF TELEVISION PROGRAMS FOR OTHERS (U.S. CLS. 100, 101 AND 107).

FIRST USE 9-2-2004; IN COMMERCE 9-2-2004.
DORITT L. CARROLL, EXAMINING ATTORNEY

SN 78-180,815. ODYSSEY ADVENTURE RACING, INC., VIRGINIA BEACH, VA. FILED 11-1-2002.



NO CLAIM IS MADE TO THE EXCLUSIVE RIGHT TO USE "OFF-ROAD" AND "TRIATHLON", APART FROM THE MARK AS SHOWN.

FOR ORGANIZING, PLANNING AND PRODUCING MULTI-SPORT EVENTS, RACES AND RELATED ACTIVITY; SEMINARS AND CLINICS IN THE NATURE OF INSTRUCTION RELATED TO RAPPELLING, CLIMBING, BICYCLING, CANOEING, KAYAKING, PADDLING, NAVIGATING, ORIENTEERING, ADVENTURE RACES AND MULTI-SPORTS EVENTS AND ACTIVITIES (U.S. CLS. 100, 101 AND 107).

PAUL F. GAST, EXAMINING ATTORNEY

CLASS 41—(Continued).

SN 78-220,582. LUGO, JOHN R., LOXAHATCHEE, FL. FILED 3-1-2003.

MRS. U. S. CONTINENTAL PAGEANT

NO CLAIM IS MADE TO THE EXCLUSIVE RIGHT TO USE "US CONTINENTAL PAGEANT", APART FROM THE MARK AS SHOWN.

FOR ENTERTAINMENT IN THE NATURE OF BEAUTY PAGEANTS; TELEVISION SHOW PRODUCTION IN THE NATURE OF BEAUTY PAGEANTS (U.S. CLS. 100, 101 AND 107).

FIRST USE 8-12-1994; IN COMMERCE 8-12-1994.
ALLISON HOLTZ, EXAMINING ATTORNEY

SN 78-254,148. SMITH, ROGER D., OVIEDO, FL. FILED 5-25-2003.

MILITARY SIMULATION TECHNIQUES AND TECHNOLOGY

NO CLAIM IS MADE TO THE EXCLUSIVE RIGHT TO USE "MILITARY SIMULATION", APART FROM THE MARK AS SHOWN.

SEC. 2(F).
FOR EDUCATIONAL SERVICES, NAMELY, CONDUCTING CLASSES IN THE FIELD OF MILITARY MODELING, SIMULATION, AND VIRTUAL WORLD CREATION, AND DISTRIBUTING COURSE MATERIALS IN CONNECTION THEREWITH (U.S. CLS. 100, 101 AND 107).

FIRST USE 12-0-1997; IN COMMERCE 1-0-1998.
TINA L. SNAPP, EXAMINING ATTORNEY

SN 78-290,896. HARRAH'S LICENSE COMPANY, LLC, LAS VEGAS, NV. FILED 8-22-2003.



OWNER OF U.S. REG. NOS. 1,237,716, 2,209,160 AND OTHERS.

THE LINING AND STIPPLING IN THE DRAWING ARE FEATURES OF THE MARK AND DO NOT INDICATE COLOR.

THE MARK CONSISTS OF THE WORD MORE IN A STYLIZED FONT WITH THREE PLAYER IDENTIFICATION CARDS LOCATED INSIDE OF THE "O."

FOR CASINO ENTERTAINMENT SERVICES (U.S. CLS. 100, 101 AND 107).

FIRST USE 6-1-2003; IN COMMERCE 6-17-2003.
DEZMONA MIZELLE, EXAMINING ATTORNEY

CLASS 41—(Continued).

SN 78-292,050. MICHAEL MASON, DOWNERS GROVE, IL. AND JEFF PINDELSKI, ORLAND PARK, IL. FILED 8-26-2003.

R.I.C.O. RAPID INTERVENTION COMPANY OPERATIONS

SEC. 2(F) AS TO "RAPID INTERVENTION COMPANY OPERATIONS"

FOR EDUCATIONAL SERVICES, NAMELY CONDUCTING SEMINARS AND TRAINING COURSES FOR FIREFIGHTERS REGARDING THE RESCUE OF DOWNED FIREFIGHTERS (U.S. CLS. 100, 101 AND 107). FIRST USE 2-25-1999; IN COMMERCE 2-25-1999. YONG KIM, EXAMINING ATTORNEY

SN 78-305,577. WASHINGTON MUTUAL, INC., SEATTLE, WA. FILED 9-25-2003.

WAMUSIC

FOR ORGANIZING AND CONDUCTING MUSICAL CONCERTS AND LIVE MUSICAL PERFORMANCES BY SOLOISTS AND GROUPS TO RAISE MONEY FOR AFFORDABLE HOUSING FOR TEACHERS AND EDUCATORS, TEACHER RECRUITMENT AND TEACHER RETENTION; ORGANIZING AND CONDUCTING COMMUNITY FESTIVALS FEATURING LIVE MUSICAL PERFORMANCES, LIVE THEATRICAL PERFORMANCES, ART EXHIBITIONS, LIVE DANCE PERFORMANCES AND ARTS AND CRAFTS FOR CHARITABLE PURPOSES; ORGANIZING AND CONDUCTING COMMUNITY TALENT COMPETITIONS AND SHOWS FOR CHARITABLE PURPOSES; LIVE MUSICAL PERFORMANCES BY SOLOISTS AND GROUPS AND MUSICAL CONCERTS; CONCERT BOOKING; EDUCATIONAL SERVICES, NAMELY, ORGANIZING AND CONDUCTING CONFERENCES, CLASSES, SEMINARS AND WORKSHOPS ON THE FOLLOWING SUBJECTS—TEACHING SKILLS AND TECHNIQUES, TEACHING PROFESSIONALS HOW TO TEACH CHILDREN ABOUT THE IMPORTANT ASPECTS OF A PARTICULAR PROFESSION, CAREER EXPLORATION, PROFESSIONAL DEVELOPMENT, VOCATIONAL GUIDANCE AND PREPARATION FOR TRAINING IN VARIOUS PROFESSIONS; CAREER COUNSELING (U.S. CLS. 100, 101 AND 107).

SAMUEL E. SHARPER JR., EXAMINING ATTORNEY

CLASS 41—(Continued).

SN 78-305,588. WASHINGTON MUTUAL, INC., SEATTLE, WA. FILED 9-25-2003.

WAMUSICA

FOR ORGANIZING AND CONDUCTING MUSICAL CONCERTS AND LIVE MUSICAL PERFORMANCES BY SOLOISTS AND GROUPS TO RAISE MONEY FOR AFFORDABLE HOUSING FOR TEACHERS AND EDUCATORS, TEACHER RECRUITMENT AND TEACHER RETENTION; ORGANIZING AND CONDUCTING COMMUNITY FESTIVALS FEATURING LIVE MUSICAL PERFORMANCES, LIVE THEATRICAL PERFORMANCES, ART EXHIBITIONS, LIVE DANCE PERFORMANCES AND ARTS AND CRAFTS FOR CHARITABLE PURPOSES; ORGANIZING AND CONDUCTING COMMUNITY TALENT COMPETITIONS AND SHOWS FOR CHARITABLE PURPOSES; LIVE MUSICAL PERFORMANCES BY SOLOISTS AND GROUPS AND MUSICAL CONCERTS; CONCERT BOOKING; EDUCATIONAL SERVICES, NAMELY, ORGANIZING AND CONDUCTING CONFERENCES, CLASSES, SEMINARS AND WORKSHOPS ON THE FOLLOWING SUBJECTS—TEACHING SKILLS AND TECHNIQUES, TEACHING PROFESSIONALS HOW TO TEACH CHILDREN ABOUT THE IMPORTANT ASPECTS OF A PARTICULAR PROFESSION, CAREER EXPLORATION, PROFESSIONAL DEVELOPMENT, VOCATIONAL GUIDANCE AND PREPARATION FOR TRAINING IN VARIOUS PROFESSIONS; CAREER COUNSELING (U.S. CLS. 100, 101 AND 107).

SAMUEL E. SHARPER JR., EXAMINING ATTORNEY

SN 78-311,486. LOYOLA COLLEGE IN MARYLAND, INC., BALTIMORE, MD. FILED 10-9-2003.



THE COLOR(S) BLACK, GOLD, GREEN, RED, WHITE, AND GRAY IS/ARE CLAIMED AS A FEATURE OF THE MARK.

THE MARK CONSISTS OF A SHIELD CONSISTING OF A BLACK BORDER ABOVE OF A GOLD CROSS THAT DIVIDES THE FACE OF SAID SHIELD INTO FOUR QUADRANTS, WHICH DEPICT (CLOCKWISE FROM UPPER RIGHT QUADRANT) A GREEN EVERGREEN TREE, GOLD AND RED DIAGONAL STRIPES, GRAY ANIMALS OVER A BLACK KETTLE, AND A GOLD AND BLACK DIAGONAL CHECKERED PATTERN.

FOR EDUCATIONAL SERVICES, NAMELY, CONDUCTING LECTURE, COURSES OF STUDY, WORKSHOPS, SEMINARS AND EDUCATIONAL CONFERENCES AT THE UNDERGRADUATE AND GRADUATE LEVELS (U.S. CLS. 100, 101 AND 107).

FIRST USE 1-1-2001; IN COMMERCE 1-1-2001.

JENNIFER KRISP, EXAMINING ATTORNEY

CLASS 41—(Continued).

SN 78-319,920. DISNEY ENTERPRISES, INC., BURBANK, CA. FILED 10-28-2003.

JETIX

FOR ENTERTAINMENT SERVICES, NAMELY, PROVIDING A WEB SITE FEATURING ANIMATED ENTERTAINMENT, FILM CLIPS, TV SHOW SCHEDULES, ARTWORK, CONTESTS, GAMES, ON-LINE TRADING CARDS, SPORTS INFORMATION AND OTHER MULTIMEDIA MATERIALS (U.S. CLS. 100, 101 AND 107).

FIRST USE 2-1-2004; IN COMMERCE 2-1-2004.
JEFFERY COWARD, EXAMINING ATTORNEY

CLASS 41—(Continued).

SN 78-336,347. ARMENTA, WILLIAM J., MONTEBELLO, CA. AND ARMENTA, MANUEL JR., EL MONTE, CA. FILED 12-4-2003.

**The Armenta
Brothers**

SN 78-320,381. ACQUIENT LLC, VIENNA, VA. FILED 10-29-2003.

SALES CPR

NO CLAIM IS MADE TO THE EXCLUSIVE RIGHT TO USE "SALES", APART FROM THE MARK AS SHOWN.

FOR SALES TRAINING OF OTHERS (U.S. CLS. 100, 101 AND 107).

FIRST USE 8-1-2000; IN COMMERCE 8-1-2000.
KELLY BOULTON, EXAMINING ATTORNEY

THE MARK CONSISTS OF STANDARD CHARACTERS WITHOUT CLAIM TO ANY PARTICULAR FONT, STYLE, SIZE, OR COLOR.

FOR ENTERTAINMENT IN THE NATURE OF VISUAL AND AUDIO PERFORMANCES, NAMELY, MUSICAL BAND, ROCK GROUP (U.S. CLS. 100, 101 AND 107).

FIRST USE 1-1-1945; IN COMMERCE 1-1-1945.
STANLEY I. OSBORNE, EXAMINING ATTORNEY

SN 78-327,929. R2 MUSIC PUBLISHING, INC., BARRINGTON, RI. FILED 11-14-2003.



THE STIPLING IS FOR SHADING PURPOSES.
FOR MUSIC PUBLISHING SERVICES (U.S. CLS. 100, 101 AND 107).

KATHERINE STOIDES, EXAMINING ATTORNEY

SN 78-337,633. QWEST COMMUNICATIONS INTERNATIONAL INC., DENVER, CO. FILED 12-8-2003.

**VERTICAL
DESTINATION**

THE MARK CONSISTS OF STANDARD CHARACTERS WITHOUT CLAIM TO ANY PARTICULAR FONT, STYLE, SIZE, OR COLOR.

FOR CONDUCTING ENTERTAINMENT EXHIBITIONS IN THE NATURE OF EXTREME SPORTS, NAMELY, SKATEBOARDING, INLINE SKATING, AND BMX RACING (U.S. CLS. 100, 101 AND 107).

FIRST USE 11-0-2003; IN COMMERCE 11-0-2003.
JASON TURNER, EXAMINING ATTORNEY

CLASS 41—(Continued).

SN 78-338,887. GRAHAM, DEBBIE, OLATHE, KS. FILED 12-10-2003.

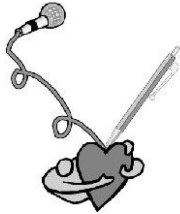
Heart Hugs International

NO CLAIM IS MADE TO THE EXCLUSIVE RIGHT TO USE "INTERNATIONAL", APART FROM THE MARK AS SHOWN.

THE COLOR(S) GRAY IS/ARE CLAIMED AS A FEATURE OF THE MARK.

THE COLOR GRAY IS A FEATURE OF THE MARK; IT APPEARS ON THE MOUTH PIECE OF THE MICROPHONE, IT APPEARS ON THE CORD OF THE MICROPHONE, IT APPEARS ON THE BODY OF THE PEN, IT APPEARS ON THE INTERIOR OF THE HEART, IT APPEARS ON THE BODIES AND HEADS OF THE HUMAN FIGURES IN THE DRAWINGS.

FOR EDUCATIONAL SERVICES IN THE NATURE OF SPEAKING ENGAGEMENTS DEALING WITH SPIRITUAL GROWTH (U.S. CLS. 100, 101 AND 107).

ALICE SUE CARRUTHERS, EXAMINING ATTORNEY

CLASS 41—(Continued).

SN 78-341,161. MY EPHIT.COM, LLC, SALT LAKE CITY, UT. FILED 12-15-2003.

ECOACH

THE MARK CONSISTS OF STANDARD CHARACTERS WITHOUT CLAIM TO ANY PARTICULAR FONT, STYLE, SIZE, OR COLOR.

FOR EDUCATIONAL SERVICES, NAMELY, CONDUCTING AN ON-LINE HEALTH EDUCATION PROGRAM FOR PROMOTING AN INDIVIDUAL'S OVERALL PHYSICAL, MENTAL, EMOTIONAL, AND SPIRITUAL WELL-BEING AND PROVIDING INCENTIVES TO EMPLOYEES OF EMPLOYER GROUPS AND MEMBERS OF HEALTH PLANS TO DEMONSTRATE EXCELLENCE IN THE FIELD OF ACHIEVING A HIGH PHYSICAL, MENTAL, EMOTIONAL, AND/OR SPIRITUAL WELL-BEING (U.S. CLS. 100, 101 AND 107).

STEVEN JACKSON, EXAMINING ATTORNEY

SN 78-339,542. MILLENNIUM MARKETING GROUP, LLC, HOUSTON, TX. FILED 12-11-2003.

**MILLENNIUM
UNIVERSITY**

THE MARK CONSISTS OF STANDARD CHARACTERS WITHOUT CLAIM TO ANY PARTICULAR FONT, STYLE, SIZE, OR COLOR.

NO CLAIM IS MADE TO THE EXCLUSIVE RIGHT TO USE UNIVERSITY, APART FROM THE MARK AS SHOWN.

FOR EDUCATION AND TRAINING SERVICES, NAMELY, PROVIDING COURSES OF INSTRUCTION, SEMINARS AND WORKSHOPS FEATURING EMPLOYER AND EMPLOYEE BENEFITS (U.S. CLS. 100, 101 AND 107).

FIRST USE 11-0-2002; IN COMMERCE 11-0-2002.
PATRICIA EVANKO, EXAMINING ATTORNEY

SN 78-341,396. KFX-FOREX, LLC, WILMINGTON, DE. FILED 12-16-2003.

KNOVAMIND

THE MARK CONSISTS OF STANDARD CHARACTERS WITHOUT CLAIM TO ANY PARTICULAR FONT, STYLE, SIZE, OR COLOR.

FOR EDUCATIONAL SERVICES, NAMELY, PROVIDING CLASSES IN THE FIELD OF FINANCIAL MARKET TRADING; PROVIDING ONLINE INTERACTIVE ELECTRONIC NEWSLETTERS IN THE FIELD OF FINANCIAL MARKET TRADING (U.S. CLS. 100, 101 AND 107).

FIRST USE 6-5-2003; IN COMMERCE 6-5-2003.
ALICIA COLLINS, EXAMINING ATTORNEY

CLASS 41—(Continued).

SN 78-342,382. QWEST COMMUNICATIONS INTERNATIONAL INC., DENVER, CO. FILED 12-17-2003.

JUST ONE DESTINATION

THE MARK CONSISTS OF STANDARD CHARACTERS WITHOUT CLAIM TO ANY PARTICULAR FONT, STYLE, SIZE, OR COLOR.

FOR ENTERTAINMENT SERVICES, IN THE NATURE OF SPORTS CONTESTS AND SWEEPSTAKES CONTESTS; PROVIDING A WEBSITE FEATURING SPORTS AND SWEEPSTAKES (U.S. CLS. 100, 101 AND 107).

FIRST USE 12-11-2003; IN COMMERCE 12-11-2003.
ROBERT C. CLARK JR., EXAMINING ATTORNEY

CLASS 41—(Continued).

SN 78-353,688. BUTLER, M. WARREN, MOBILE, AL. FILED 1-19-2004.

WHAT YOU NEVER LEARNED IN LAW SCHOOL: HOW TO BE A LITIGATION LAWYER

THE MARK CONSISTS OF STANDARD CHARACTERS WITHOUT CLAIM TO ANY PARTICULAR FONT, STYLE, SIZE, OR COLOR.

FOR LEGAL SEMINAR (U.S. CLS. 100, 101 AND 107).

FIRST USE 7-22-2003; IN COMMERCE 7-22-2003.
STANLEY I. OSBORNE, EXAMINING ATTORNEY

SN 78-342,442. PACIFIC INSTITUTE FOR IMPLANT DENTISTRY INC., VANCOUVER, BRITISH COLUMBIA, CANADA, FILED 12-17-2003.

PACIFIC IMPLANT INSTITUTE

THE MARK CONSISTS OF STANDARD CHARACTERS WITHOUT CLAIM TO ANY PARTICULAR FONT, STYLE, SIZE, OR COLOR.

PRIORITY CLAIMED UNDER SEC. 44(D) ON CANADA APPLICATION NO. 1196888, FILED 11-19-2003, REG. NO. TMA639420, DATED 5-10-2005, EXPIRES 5-10-2020.

NO CLAIM IS MADE TO THE EXCLUSIVE RIGHT TO USE "IMPLANT INSTITUTE", APART FROM THE MARK AS SHOWN.

FOR EDUCATIONAL SERVICES, NAMELY, LECTURES AND EDUCATIONAL PROGRAMS IN RELATION TO IMPLANT DENTISTRY (U.S. CLS. 100, 101 AND 107).

FIRST USE 4-1-1996; IN COMMERCE 4-1-1996.
YONG KIM, EXAMINING ATTORNEY

SN 78-361,454. IVISTRA LIMITED, AUCKLAND, NEW ZEALAND, FILED 2-3-2004.



PRIORITY CLAIMED UNDER SEC. 44(D) ON NEW ZEALAND APPLICATION NO. 684276, FILED 8-6-2003, REG. NO. 684276, DATED 2-9-2004, EXPIRES 8-6-2010.

NO CLAIM IS MADE TO THE EXCLUSIVE RIGHT TO USE "VIRTUAL", APART FROM THE MARK AS SHOWN.

THE COLOR(S) GREEN AND GRAY IS/ARE CLAIMED AS A FEATURE OF THE MARK.

THE MARK CONSISTS OF A GREEN LETTER G OVERLAPPING A GRAY V SEPARATED BY A GRAY VIRGULE FROM THE WORDS GO IN GREEN AND VIRTUAL IN GRAY. THE ENSEMBLE IS ON A LIGHT GREEN FIELD.

FOR SPORTS RELATED SPECIAL EFFECTS AND ANIMATION SERVICES FOR EDUCATION AND ENTERTAINMENT SERVICES, NAMELY, PRODUCTION, RENTAL, AND DISTRIBUTION OF FILMS, VIDEOS, MULTIMEDIA, AND RADIO AND TELEVISION PROGRAMS AND PROGRAMS THAT MAY BE VIEWED VIA THE GLOBAL COMPUTER NETWORK; PROVIDING A WEB SITE FEATURING FILMS, VIDEOS, PHOTOGRAPHS, IMAGES, ANIMATION, AND OTHER MULTIMEDIA MATERIALS FOR SPORTS RELATED EDUCATION AND ENTERTAINMENT (U.S. CLS. 100, 101 AND 107).

RONALD MCMORROW, EXAMINING ATTORNEY

CLASS 41—(Continued).

SN 78-364,761. DBLS HOLDINGS, LTD., NEWTON, MA. FILED 2-9-2004.

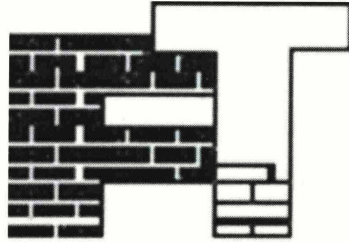

FOR EDUCATIONAL SERVICES IN THE FIELD OF SALES, NAMELY, CONDUCTING SEMINARS AND WORKSHOPS IN THE FIELDS OF MEDICINE, BIOTECHNOLOGY AND PHARMACEUTICAL SALES AND DISTRIBUTING COURSE MATERIALS THEREWITH; TRAINING IN THE FIELD OF MEDICINE, BIOTECHNOLOGY AND PHARMACEUTICALS SALES, USING COMPUTER SOFTWARE PROGRAMS, SEMINARS, WORKSHOPS AND DISTRIBUTING COURSE MATERIALS THEREWITH (U.S. CLS. 100, 101 AND 107).
FIRST USE 12-31-2001; IN COMMERCE 12-31-2001.
ANGELA M. MICHELI, EXAMINING ATTORNEY

CLASS 41—(Continued).

SN 78-364,773. DBLS HOLDINGS, LTD., NEWTON, MA. FILED 2-9-2004.

WHOLE SYSTEMS

THE MARK CONSISTS OF STANDARD CHARACTERS WITHOUT CLAIM TO ANY PARTICULAR FONT, STYLE, SIZE, OR COLOR.
NO CLAIM IS MADE TO THE EXCLUSIVE RIGHT TO USE "SYSTEMS", APART FROM THE MARK AS SHOWN.
FOR EDUCATION AND TRAINING SERVICES IN THE NATURE OF CONDUCTING TRAINING WORKSHOPS AND SEMINARS AND COURSES IN THE FIELDS OF SALES IN THE MEDICAL, BIOTECHNOLOGICAL AND PHARMACEUTICALS INDUSTRIES; MEDICINE; BIOTECHNOLOGY; AND PHARMACEUTICALS; AND THE DISTRIBUTION COURSE MATERIALS IN CONNECTION THEREWITH (U.S. CLS. 100, 101 AND 107).
FIRST USE 1-15-1997; IN COMMERCE 1-15-1997.
DAYNA BROWNE, EXAMINING ATTORNEY

SN 78-365,452. DOCUMENT MANAGEMENT INDUSTRIES ASSOCIATION, INC., ALEXANDRIA, VA. FILED 2-10-2004.



NO CLAIM IS MADE TO THE EXCLUSIVE RIGHT TO USE "PRINT EDUCATION & RESEARCH FOUNDATION", APART FROM THE MARK AS SHOWN.
THE MARK CONSISTS OF THE LETTERS AND WORDS IN ADDITION TO FOUR CIRCLES WITHIN CIRCLES SHADOWING THE LETTERS P E R F.
FOR EDUCATIONAL SERVICES, NAMELY, CONDUCTING CLASSES, SEMINARS, CONFERENCES AND WORKSHOPS IN THE FIELDS OF BUSINESS PRINTING AND DOCUMENT MANAGEMENT (U.S. CLS. 100, 101 AND 107).
FIRST USE 7-1-2003; IN COMMERCE 12-16-2003.
YONG KIM, EXAMINING ATTORNEY

SN 78-364,768. DBLS HOLDINGS, LTD., NEWTON, MA. FILED 2-9-2004.



OWNER OF U.S. REG. NO. 2,248,900.
THE MARK CONSISTS OF THE WORD PHARMASELL WITHIN A TWO-TONED RECTANGULAR DESIGN.
FOR EDUCATIONAL SERVICES, NAMELY, CONDUCTING SEMINARS, TRAINING SESSIONS, AND WORKSHOPS IN THE FIELD OF SALES USING COMPUTER SOFTWARE AND MULTI-MEDIA PRESENTATIONS AND DISTRIBUTING WORKBOOKS, TEXTBOOKS, AND WRITTEN MATERIALS THEREWITH (U.S. CLS. 100, 101 AND 107).
FIRST USE 5-1-1997; IN COMMERCE 5-1-1997.
ANGELA M. MICHELI, EXAMINING ATTORNEY

SN 78-365,517. TGC, INC., ORLANDO, FL. FILED 2-10-2004.



NO CLAIM IS MADE TO THE EXCLUSIVE RIGHT TO USE GAME TRACKER, APART FROM THE MARK AS SHOWN.
FOR ONLINE INFORMATION RELATED TO GOLF AND GOLFING (U.S. CLS. 100, 101 AND 107).
FIRST USE 1-0-2002; IN COMMERCE 1-0-2002.
DANIEL CAPSHAW, EXAMINING ATTORNEY

CLASS 41—(Continued).

SN 78-366,625. NEW BIRTH MISSIONARY BAPTIST CHURCH, LITHONIA, GA. FILED 2-11-2004.



NO CLAIM IS MADE TO THE EXCLUSIVE RIGHT TO USE "HEALTH AND FITNESS CENTER", APART FROM THE MARK AS SHOWN.

FOR PROVIDING FITNESS AND EXERCISE FACILITIES (U.S. CLS. 100, 101 AND 107).

FIRST USE 6-1-2003; IN COMMERCE 6-1-2003.
DAVID MURRAY, EXAMINING ATTORNEY

SN 78-369,038. BERARD, STEPHANIE, SANTA CRUZ, CA. FILED 2-17-2004.

Chi Kinetics

THE MARK CONSISTS OF STANDARD CHARACTERS WITHOUT CLAIM TO ANY PARTICULAR FONT, STYLE, SIZE, OR COLOR.

NO CLAIM IS MADE TO THE EXCLUSIVE RIGHT TO USE "KINETICS", APART FROM THE MARK AS SHOWN.

THE FOREIGN WORDING CHI TRANSLATES INTO ENGLISH AS "ENERGY".

FOR PHYSICAL FITNESS INSTRUCTION FEATURING AN EXERCISE PROGRAM THAT COMBINES TECHNIQUES OF TAI CHI, PILATES, AND YOGA (U.S. CLS. 100, 101 AND 107).

LEIGH LOWRY, EXAMINING ATTORNEY

CLASS 41—(Continued).

SN 78-388,332. THE TRIZETTO GROUP, INC., NEWPORT BEACH, CA. FILED 3-22-2004.

ONE POWERFUL SOURCE

THE MARK CONSISTS OF STANDARD CHARACTERS WITHOUT CLAIM TO ANY PARTICULAR FONT, STYLE, SIZE, OR COLOR.

OWNER OF U.S. REG. NO. 2,482,774.

FOR PROVIDING TRAINING IN THE USE AND OPERATION OF COMPUTER SYSTEMS, PERIPHERALS AND SOFTWARE; PROVIDING COURSES OF INSTRUCTION IN THE FIELD OF COMPUTER PROGRAMMING AND THE SCHEDULING OF COMPUTER PROGRAMS ON THE INTERNET; EDUCATIONAL SERVICES, NAMELY, CONDUCTING INSTRUCTOR LED CLASSES, REGIONAL WORKSHOPS, PROGRAMS, TRAINING SESSIONS AND ONLINE EXHIBITIONS AND DISPLAYS, AND INTERACTIVE EXHIBITS FOR HEALTHCARE ORGANIZATIONS, PROVIDERS AND PAYERS; AND ASSISTING HEALTHCARE ORGANIZATIONS, PROVIDERS AND PAYERS BY PROVIDING COURSES, LECTURES, AND SEMINARS IN LEARNING HOW TO BECOME COMPLIANT WITH THE HEALTH INSURANCE PORTABILITY AND ACCOUNTABILITY ACT OF 1996 (HIPAA) LEGISLATION; AND IN ASSISTING IN LEARNING HIPAA COMPLIANCE FOR USE IN THE ADMINISTRATION OF EMPLOYEE VOLUNTARY BENEFIT INSURANCE PLANS, BUT EXCLUDING THE PROVISION OF TRAINING RELATING TO VOLUNTARY BENEFIT NEEDS FOR ADMINISTRATION OF EMPLOYEE BENEFIT INSURANCE PLANS (U.S. CLS. 100, 101 AND 107).

FIRST USE 1-31-2001; IN COMMERCE 1-31-2001.
DARRYL SPRUILL, EXAMINING ATTORNEY

SN 78-392,847. M-PHISIS, INCORPORATED, DENVER, CO. FILED 3-29-2004.

WILD BLUE YONDER

THE MARK CONSISTS OF STANDARD CHARACTERS WITHOUT CLAIM TO ANY PARTICULAR FONT, STYLE, SIZE, OR COLOR.

FOR PRODUCTION AND PROGRAMMING OF DIGITAL CONTENT ON THE INTERNET, FEATURING INDEPENDENT SHORT FILMS, VIDEO NEWS RELEASES, FASHION SHOWS, ARTIST PROFILES, MUSIC VIDEOS TARGETED TO AN AFFLUENT, TRAVELER LIFESTYLE (U.S. CLS. 100, 101 AND 107).

TEJBIR SINGH, EXAMINING ATTORNEY

CLASS 41—(Continued).

SN 78-393,966. TASTE THIS PRODUCTION, MERRICK, NY. FILED 3-31-2004.

TASTE THIS T.V.

THE MARK CONSISTS OF STANDARD CHARACTERS WITHOUT CLAIM TO ANY PARTICULAR FONT, STYLE, SIZE, OR COLOR.

FOR TELEVISION SHOW PRODUCTION SERVICES (U.S. CLS. 100, 101 AND 107).

FIRST USE 9-10-2003; IN COMMERCE 9-10-2003.
WINSTON FOLMAR, EXAMINING ATTORNEY

CLASS 41—(Continued).

SN 78-396,826. PUMPHREY, CHRISTOPHER J., PALM BEACH GARDENS, FL. FILED 4-6-2004.

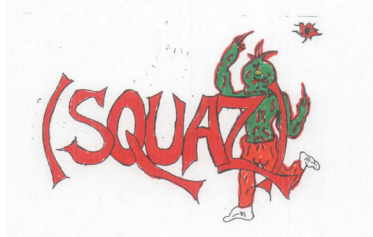

THE COLOR(S) RED, ORANGE, GREEN, BLACK, AND YELLOW IS/ARE CLAIMED AS A FEATURE OF THE MARK.

THE MARK CONSISTS OF THE SQUAZ MONSTER WITH A SUN TO THE UPPER RIGHT AND THE WORD "(SQUAZ)" ENCLOSED IN PARENTHESES. THE SQUAZ MONSTER'S HEAD AND UPPER BODY ARE GREEN WITH RED OUTLINES. THE LOWER BODY IS ORANGE WITH RED OUTLINES. THE SHOES ARE WHITE WITH BLACK OUTLINES. IN THE CENTER OF SQUAZ MONSTER'S FACE IS A YELLOW SMILEY FACE WITH BLACK OUTLINES. THE SUN IS RED WITH A GREEN CENTER. THE CHARACTERS IN "(SQUAZ)" ARE RED WITH BLACK OUTLINES.

FOR LIVE MUSICAL PERFORMANCES BY A BAND (U.S. CLS. 100, 101 AND 107).

SCOTT OSLICK, EXAMINING ATTORNEY

SN 78-398,606. IMPRESARIO ARTS, LLC, NEW YORK, NY. FILED 4-8-2004.



NO CLAIM IS MADE TO THE EXCLUSIVE RIGHT TO USE "TUSCAN" AND "FESTIVAL", APART FROM THE MARK AS SHOWN.

THE COLORS YELLOW, WHITE AND BLUE ARE CLAIMED AS FEATURES OF THE MARK.

THE COLOR WHITE APPEARS IN THE CRESCENT SHAPED DESIGN APPEARING IN THE CENTER OF THE SUN OR SUNFLOWER DESIGN. EXCEPT FOR THE CRESCENT IN THE CENTER OF THE SUN OR SUNFLOWER DESIGN, THE COLOR YELLOW APPEARS IN THE ENTIRETY OF THE SUN OR SUNFLOWER DESIGN. THE COLOR BLUE APPEARS IN THE LETTERS COMPRISING THE WORDS "TUSCAN SUN FESTIVAL".

THE MARK FEATURES THE COLORS YELLOW, WHITE AND BLUE, AND CONSISTS OF THE WORDS "TUSCAN SUN FESTIVAL", TOGETHER WITH A DESIGN OF SMILING SUN OR SUNFLOWER, HAVING SEVENTEEN RAYS OR PETALS EXTENDING THEREFROM AND HAVING A CRESCENT DESIGN IN THE MIDDLE.

FOR ORGANIZING AND CONDUCTING A PERFORMING ARTS FESTIVAL OFFERING MUSIC, LITERATURE, CUISINE, CINEMA, ART, AND WELLNESS (U.S. CLS. 100, 101 AND 107).

FIRST USE 12-1-2002; IN COMMERCE 4-1-2003.

BARBARA A. LOUGHRAN, EXAMINING ATTORNEY

SN 78-396,656. BIOTECH PRIMER, INC., BALTIMORE, MD. FILED 4-5-2004.



NO CLAIM IS MADE TO THE EXCLUSIVE RIGHT TO USE BIOTECH AND INC., APART FROM THE MARK AS SHOWN.

THE COLOR(S) BLUE, BLACK, WHITE IS/ARE CLAIMED AS A FEATURE OF THE MARK.

THE COLOR WHITE APPEARS ON THE WORD BIOTECH AND THE COLOR BLUE APPEARS ON THE WORD PRIMER. FURTHER THE "I" IN THE WORD PRIMER IS IN THE IMAGE OF A TEST TUBE AND ABOVE THAT TEST TUBE ARE DNA AND CHROMOSOME FIGURES. THE COLOR BLUE APPEARS ON THE WORD INC.

FOR EDUCATIONAL SERVICES, NAMELY PROVIDING BOTH SEMINARS AND CLASSES IN THE FIELD OF LIFE SCIENCE AND BIOTECHNOLOGY FOR NON-SCIENCE PROFESSIONALS (U.S. CLS. 100, 101 AND 107).

FIRST USE 10-0-2000; IN COMMERCE 12-0-2000.

JEFF DEFORD, EXAMINING ATTORNEY

CLASS 41—(Continued).

SN 78-401,805. CAMPBELL, GREG A., KNOXVILLE, TN.
FILED 4-14-2004.

Knoxville Knights

THE MARK CONSISTS OF STANDARD CHARACTERS WITHOUT CLAIM TO ANY PARTICULAR FONT, STYLE, SIZE, OR COLOR.

NO CLAIM IS MADE TO THE EXCLUSIVE RIGHT TO USE "KNOXVILLE", APART FROM THE MARK AS SHOWN.

FOR ENTERTAINMENT IN THE NATURE OF FOOTBALL GAMES (U.S. CLS. 100, 101 AND 107).

FIRST USE 1-1-2004; IN COMMERCE 1-15-2004.
WON TEAK OH, EXAMINING ATTORNEY

SN 78-403,578. COCHRANE, CHARLENE M., ORLANDO, FL.
AND CROUCH, MOLLY K., ORLANDO, FL. FILED 4-16-2004.

Muffy Rout

THE MARK CONSISTS OF STANDARD CHARACTERS WITHOUT CLAIM TO ANY PARTICULAR FONT, STYLE, SIZE, OR COLOR.

FOR ENTERTAINMENT, NAMELY PUBLISHING IN THE FORM OF AN ON-LINE WEB SITE FEATURING A CARTOON CHARACTER, DIRECTED TOWARDS LIFESTYLE SPECIFIC, STORIES, ARTICLES, INFORMATION, AND RELATED MERCHANDISE (U.S. CLS. 100, 101 AND 107).

NAAKWAMA ANKRAH, EXAMINING ATTORNEY

CLASS 41—(Continued).

SN 78-407,299. NETWORK ENTERPRISES INC., NEW YORK, NY. FILED 4-23-2004.

THE PAZZINIS

THE MARK CONSISTS OF STANDARD CHARACTERS WITHOUT CLAIM TO ANY PARTICULAR FONT, STYLE, SIZE, OR COLOR.

FOR ENTERTAINMENT SERVICES IN THE NATURE OF AN ON-GOING TELEVISION SERIES FEATURING ANIMATION, COMEDY AND DRAMA; PROVIDING INFORMATION IN THE FIELD OF ENTERTAINMENT RELATED TO TELEVISION PROGRAMS IN THE FIELDS OF ANIMATION, COMEDY AND DRAMA BY MEANS OF A GLOBAL COMPUTER NETWORK (U.S. CLS. 100, 101 AND 107).

CAROLINE WOOD, EXAMINING ATTORNEY

SN 78-407,761. CARLOW UNIVERSITY, PITTSBURGH, PA.
FILED 4-26-2004.

DAUGHTERS AND SONS OF ABRAHAM

THE MARK CONSISTS OF STANDARD CHARACTERS WITHOUT CLAIM TO ANY PARTICULAR FONT, STYLE, SIZE, OR COLOR.

SEC. 2(F).

FOR ARRANGING WORKSHOPS, SEMINARS AND CONFERENCES IN THE FIELD OF RELIGION FOR THE PURPOSE OF NURTURING UNDERSTANDING AND FOSTERING GOODWILL AMONG CHRISTIANS, JEWS, AND MUSLIMS (U.S. CLS. 100, 101 AND 107).

FIRST USE 6-30-1996; IN COMMERCE 6-30-1996.
TONI HICKEY, EXAMINING ATTORNEY

CLASS 41—(Continued).

SN 78-408,336. KING, HEATHER, MENLO PARK, CA. FILED 4-26-2004.

CLASS 41—(Continued).

SN 78-408,435. AWARDS WITH CHARACTER, LLC, COLORADO SPRINGS, CO. FILED 4-27-2004.

Every Child Is A Star

OCEANS 360

THE MARK CONSISTS OF STANDARD CHARACTERS WITHOUT CLAIM TO ANY PARTICULAR FONT, STYLE, SIZE, OR COLOR.

FOR PROVIDING RECOGNITION AND INCENTIVES BY THE WAY OF AWARDS AND TROPHIES TO DEMONSTRATE EXCELLENCE AND ACHIEVEMENT IN THE FIELD OF ATHLETICS AND EDUCATION (U.S. CLS. 100, 101 AND 107).

FIRST USE 4-1-2004; IN COMMERCE 4-1-2004.
LANA PHAM, EXAMINING ATTORNEY

THE MARK CONSISTS OF STANDARD CHARACTERS WITHOUT CLAIM TO ANY PARTICULAR FONT, STYLE, SIZE, OR COLOR.

NO CLAIM IS MADE TO THE EXCLUSIVE RIGHT TO USE "OCEANS", APART FROM THE MARK AS SHOWN.

FOR ENTERTAINMENT SERVICES, NAMELY, PRODUCTION OF EDUCATIONAL PROGRAMS, NAMELY, PRODUCTION OF FILMS, TELEVISION PROGRAMS AND RADIO PROGRAMS FEATURING ISSUES RELATED TO EARTH ENVIRONMENT, NATURE, OCEANS AND HUMANITY; DISTRIBUTION OF EDUCATIONAL PROGRAMS FOR OTHERS, NAMELY, FILMS, TELEVISION PROGRAMS AND RADIO PROGRAMS FEATURING ISSUES RELATED TO EARTH ENVIRONMENT, NATURE, OCEANS AND HUMANITY; PRODUCTION OF TELEVISION PROGRAMS; DISTRIBUTION OF TELEVISION PROGRAMS FOR OTHERS; PRODUCTION AND DISTRIBUTION OF DOCUMENTARY FILMS AND SLIDE SHOWS FEATURING ISSUES RELATED TO EARTH ENVIRONMENT, NATURE, OCEANS AND HUMANITY; PRODUCTION AND DISTRIBUTION OF PHOTOGRAPHIC COMMENTARIES FOR OTHERS, NAMELY, FILMS AND TELEVISION PROGRAMS FEATURING COMMENTARIES ON ISSUES RELATED TO EARTH ENVIRONMENT, NATURE, OCEANS AND HUMANITY; PUBLISHING AND DISTRIBUTION OF PRINTED MATERIALS FEATURING ISSUES RELATED TO EARTH ENVIRONMENT, OCEANS AND HUMANITY; ARRANGING AND CONDUCTING EDUCATIONAL EXHIBITIONS FEATURING PHOTOGRAPHS REGARDING ISSUES RELATED TO EARTH ENVIRONMENT, OCEANS AND HUMANITY; PRODUCTION OF VIDEOTAPES AND VIDEO DISKS FOR OTHERS; PROVIDING ON-LINE SUPPLEMENTAL INFORMATION VIA THE INTERNET ON SUBJECTS PRESENTED IN EDUCATIONAL PROGRAMS, TELEVISION PROGRAMS, DOCUMENTARY FILMS, SLIDE SHOWS, BOOKS, PHOTOGRAPHIC COMMENTARIES, PHOTOGRAPHIC EXHIBITIONS, ASSOCIATED PRINTED MATERIALS AND PRE-RECORDED VIDEO PRODUCTS CONTAINING OR FEATURING ISSUES RELATED TO EARTH ENVIRONMENT, NATURE, OCEANS AND HUMANITY (U.S. CLS. 100, 101 AND 107).

LA TONIA FISHER, EXAMINING ATTORNEY

SN 78-408,437. AWARDS WITH CHARACTER, LLC, COLORADO SPRINGS, CO. FILED 4-27-2004.

Every Child Is A Champ

THE MARK CONSISTS OF STANDARD CHARACTERS WITHOUT CLAIM TO ANY PARTICULAR FONT, STYLE, SIZE, OR COLOR.

FOR PROVIDING RECOGNITION AND INCENTIVES BY THE WAY OF AWARDS AND TROPHIES TO DEMONSTRATE EXCELLENCE AND ACHIEVEMENT IN THE FIELD OF ATHLETICS AND EDUCATION (U.S. CLS. 100, 101 AND 107).

FIRST USE 4-1-2004; IN COMMERCE 4-1-2004.
LANA PHAM, EXAMINING ATTORNEY

CLASS 41—(Continued).

SN 78-412,843. BALLET TECH FOUNDATION, INC., NEW YORK, NY. FILED 5-4-2004.

MANDANCE

THE MARK CONSISTS OF STANDARD CHARACTERS WITHOUT CLAIM TO ANY PARTICULAR FONT, STYLE, SIZE, OR COLOR.

FOR ENTERTAINMENT SERVICES, NAMELY, LIVE DANCE PERFORMANCES (U.S. CLS. 100, 101 AND 107).
ASMAT KHAN, EXAMINING ATTORNEY

SN 78-413,750. AMERICAN BROADCASTING COMPANIES, INC., BURBANK, CA. FILED 5-5-2004.

ABC FAMILY

THE MARK CONSISTS OF STANDARD CHARACTERS WITHOUT CLAIM TO ANY PARTICULAR FONT, STYLE, SIZE, OR COLOR.

NO CLAIM IS MADE TO THE EXCLUSIVE RIGHT TO USE "FAMILY", APART FROM THE MARK AS SHOWN.

FOR ENTERTAINMENT SERVICES IN THE NATURE OF PRODUCTION AND DISTRIBUTION OF MOTION PICTURE FILMS AND TELEVISION SHOW PROGRAMS FEATURING ANIMATED SERIES, VARIETY SHOWS, ACTION-ADVENTURE SERIES, LIVE-ACTION SERIES, COMEDIES, MUSICALS, DRAMATIC SERIES, DOCUMENTARIES, AND SPORTING EVENTS BY MEANS OF AND FOR CABLE TELEVISION, SATELLITE-DELIVERED AND TELEVISION BROADCASTING; ENTERTAINMENT SERVICES, NAMELY, COMPUTER ON-LINE SERVICES OFFERED OVER A WORLDWIDE COMMUNICATION NETWORK FEATURING INFORMATION AND ENTERTAINMENT RELATING TO MOTION PICTURE FILMS, TELEVISION SHOW PROGRAMS, CONTESTS AND FAMILY ENTERTAINMENT VIA A GLOBAL COMMUNICATIONS NETWORK (U.S. CLS. 100, 101 AND 107).

FIRST USE 12-19-2001; IN COMMERCE 12-19-2001.
JOHN DALIER, EXAMINING ATTORNEY

CLASS 41—(Continued).

SN 78-414,600. EXOTICA GOURMET, INC., SAN DIEGO, CA. FILED 5-6-2004.

EXOTICA GOURMET

THE MARK CONSISTS OF STANDARD CHARACTERS WITHOUT CLAIM TO ANY PARTICULAR FONT, STYLE, SIZE, OR COLOR.

NO CLAIM IS MADE TO THE EXCLUSIVE RIGHT TO USE "GOURMET", APART FROM THE MARK AS SHOWN. FOR EDUCATIONAL SERVICES, NAMELY, PROVIDING INDIVIDUAL AND TEAM INSTRUCTION IN THE FIELDS OF FOOD PREPARATION, PRESENTATION AND CATERING (U.S. CLS. 100, 101 AND 107).

FIRST USE 7-0-2003; IN COMMERCE 7-0-2003.
JEFFERY COWARD, EXAMINING ATTORNEY

SN 78-415,414. JOHNSON, APOLLO RAY, SANTA CLARA, CA. FILED 5-7-2004.

Elimi-Freak
THE MATING GAME

NO CLAIM IS MADE TO THE EXCLUSIVE RIGHT TO USE THE MATING GAME, APART FROM THE MARK AS SHOWN.

THE MARK CONSISTS OF STYLIZED LETTERING FOR THE MARK.

FOR ENTERTAINMENT SERVICES IN THE NATURE OF AN ON-GOING REALITY-BASED DATING GAME TELEVISION PROGRAM VIA TELEVISION, CABLE, INTERNET, AND LIVE SHOWS DIRECTED PRIMARILY TO BLACK AMERICANS; PRODUCTION AND DISTRIBUTION OF LIVE-ACTION, COMEDY, DRAMA, AND ANIMATED TELEVISION PROGRAMS FOR OTHERS, DIRECTED PRIMARILY TO BLACK AMERICANS (U.S. CLS. 100, 101 AND 107).

PRISCILLA MILTON, EXAMINING ATTORNEY

CLASS 41—(Continued).

SN 78-415,565. JAMIEL, DYANNA, DAVIE, FL. FILED 5-9-2004.



THE COLOR(S) GOLD, YELLOW & BLACK IS/ARE CLAIMED AS A FEATURE OF THE MARK.

THE COLOR GOLD APPEARS AS THE PRIMARY FILL COLOR OF EACH LETTER IN THE MARK. THE COLOR YELLOW APPEARS GRADIENT HIGHLIGHT IN EACH LETTER OF THE MARK. THE COLOR BLACK APPEARS AS A BORDER AND SHADOW AROUND EACH LETTER OF THE MARK.

FOR EDUCATIONAL SERVICES, NAMELY CONDUCTING SEMINARS, CLASSES AND WORKSHOPS IN THE FIELD OF PHYSICAL FITNESS AND NUTRITION (U.S. CLS. 100, 101 AND 107).

FIRST USE 6-30-1995; IN COMMERCE 6-30-1995.
PRISCILLA MILTON, EXAMINING ATTORNEY

CLASS 41—(Continued).

SN 78-416,174. BOSON SOFTWARE, INC., TAMPA, FL. FILED 5-10-2004.

BOSON EDUCATION BY SIMULATION

THE MARK CONSISTS OF STANDARD CHARACTERS WITHOUT CLAIM TO ANY PARTICULAR FONT, STYLE, SIZE, OR COLOR.

OWNER OF U.S. REG. NOS. 2,675,662, 2,788,883 AND OTHERS.

NO CLAIM IS MADE TO THE EXCLUSIVE RIGHT TO USE "EDUCATION BY SIMULATION", APART FROM THE MARK AS SHOWN.

FOR EDUCATIONAL SERVICES, NAMELY, INSTRUCTOR-LED TRAINING AND COURSES TO FACILITATE INFORMATION TECHNOLOGY EDUCATION AND TEST PREPARATION (U.S. CLS. 100, 101 AND 107).

FIRST USE 1-16-2004; IN COMMERCE 1-16-2004.
HENRY S. ZAK, EXAMINING ATTORNEY

SN 78-415,735. ARTS4ALL, LTD., NEW YORK, NY. FILED 5-10-2004.

ARTSPASS

THE MARK CONSISTS OF STANDARD CHARACTERS WITHOUT CLAIM TO ANY PARTICULAR FONT, STYLE, SIZE, OR COLOR.

FOR PROVIDING ARTS RELATED INFORMATION AND EDUCATIONAL SERVICES, NAMELY, CONDUCTING INFORMATIVE AUDIO-VISUAL PROGRAMS IN THE FIELD OF THE ARTS OVER A GLOBAL COMPUTER NETWORK (U.S. CLS. 100, 101 AND 107).

FIRST USE 1-1-2004; IN COMMERCE 1-1-2004.
SCOTT BALDWIN, EXAMINING ATTORNEY

SN 78-419,165. THE FANTASY FOOTBALL TIMES.COM, LLC, BURLINGTON, MA. FILED 5-14-2004.



NO CLAIM IS MADE TO THE EXCLUSIVE RIGHT TO USE "WWW.THE FANTASY FOOTBALL.COM", APART FROM THE MARK AS SHOWN.

THE MARK CONSISTS OF COMPANY FONT IN OLD ENGLISH TEXT. TAG LINE ACCOMPANYING COMPANY FONT.

FOR PROVIDING INFORMATION VIA A GLOBAL COMPUTER NETWORK ON THE SUBJECT OF FANTASY FOOTBALL (U.S. CLS. 100, 101 AND 107).

FIRST USE 5-1-2003; IN COMMERCE 5-1-2003.
ERNEST SHOSHO, EXAMINING ATTORNEY

CLASS 41—(Continued).

SN 78-420,222. TWENTIETH CENTURY FOX FILM CORPORATION, LOS ANGELES, CA. FILED 5-17-2004.



NO CLAIM IS MADE TO THE EXCLUSIVE RIGHT TO USE SPORTS; RACE THE PROS, APART FROM THE MARK AS SHOWN.

FOR ENTERTAINMENT SERVICES IN THE NATURE OF AN ONLINE COMPUTER GAME (U.S. CLS. 100, 101 AND 107).

FIRST USE 2-13-2004; IN COMMERCE 2-13-2004.
RUSS HERMAN, EXAMINING ATTORNEY

CLASS 41—(Continued).

SN 78-420,500. SNEED, DAVID, FLIPPIN, AR. FILED 5-18-2004.

WHEELS THAT WON THE WEST

THE MARK CONSISTS OF STANDARD CHARACTERS WITHOUT CLAIM TO ANY PARTICULAR FONT, STYLE, SIZE, OR COLOR.

FOR ENTERTAINMENT SERVICES IN THE NATURE OF AN ON-GOING TELEVISION PROGRAM FEATURING EARLY AMERICAN TRANSPORTATION (U.S. CLS. 100, 101 AND 107).

MARC LEIPZIG, EXAMINING ATTORNEY

SN 78-420,457. A&E TELEVISION NETWORKS, NEW YORK, NY. FILED 5-18-2004.

**HARDCOVER HISTORY:
THE HISTORY
CHANNEL BOOK CLUB**

THE MARK CONSISTS OF STANDARD CHARACTERS WITHOUT CLAIM TO ANY PARTICULAR FONT, STYLE, SIZE, OR COLOR.

OWNER OF U.S. REG. NOS. 2,191,590, 2,890,170 AND OTHERS.

NO CLAIM IS MADE TO THE EXCLUSIVE RIGHT TO USE BOOK CLUB, APART FROM THE MARK AS SHOWN. SEC. 2(F) THE HISTORY CHANNEL.

FOR ENTERTAINMENT SERVICES, NAMELY, PRODUCTION OF AN ON-GOING CABLE TELEVISION SHOW FEATURING REVIEWS AND DISCUSSIONS OF BOOKS, ATLASES AND LIBRARIES FEATURING HISTORY AND HISTORICAL TOPICS (U.S. CLS. 100, 101 AND 107).

FIRST USE 10-15-2002; IN COMMERCE 10-15-2002.
MATTHEW KLINE, EXAMINING ATTORNEY

SN 78-421,459. REGAN, ROLAND J., JR., MARBLEHEAD, MA. FILED 5-19-2004.

N.C.O.F.

THE MARK CONSISTS OF STANDARD CHARACTERS WITHOUT CLAIM TO ANY PARTICULAR FONT, STYLE, SIZE, OR COLOR.

FOR CREATING, DEVELOPING AND CONDUCTING HEALTH EDUCATION PROGRAMS, TRAINING SESSIONS AND EDUCATIONAL EVENTS IN THE FIELD OF NUTRITION AND PHYSICAL ACTIVITY (U.S. CLS. 100, 101 AND 107).

FIRST USE 6-1-2004; IN COMMERCE 6-1-2004.
LA TONIA FISHER, EXAMINING ATTORNEY

CLASS 41—(Continued).

SN 78-421,695. JIM MCLEAN ENTERPRISES, MIAMI, FL.
FILED 5-19-2004.

SCORING SCHOOL

THE MARK CONSISTS OF STANDARD CHARACTERS WITHOUT CLAIM TO ANY PARTICULAR FONT, STYLE, SIZE, OR COLOR.

OWNER OF U.S. REG. NO. 2,246,767.

NO CLAIM IS MADE TO THE EXCLUSIVE RIGHT TO USE "SCHOOL", APART FROM THE MARK AS SHOWN.

FOR EDUCATIONAL SERVICES, NAMELY, PROVIDING INSTRUCTION, TRAINING AND COURSES IN THE FIELD OF GOLF (U.S. CLS. 100, 101 AND 107).

FIRST USE 12-0-1996; IN COMMERCE 12-0-1996.

CHERYL CLAYTON, EXAMINING ATTORNEY

SN 78-422,164. ROBINSON, ARVEE, CLAREMONT, CA.
FILED 5-20-2004.

**Instant Pro
Speaker**

THE MARK CONSISTS OF STANDARD CHARACTERS WITHOUT CLAIM TO ANY PARTICULAR FONT, STYLE, SIZE, OR COLOR.

NO CLAIM IS MADE TO THE EXCLUSIVE RIGHT TO USE PRO SPEAKER, APART FROM THE MARK AS SHOWN.

FOR EDUCATIONAL SERVICES, NAMELY CONDUCTING TRAINING SEMINARS AND PROGRAMS IN THE FIELD OF BUSINESS PRESENTATION AND COMMUNICATION SKILLS (U.S. CLS. 100, 101 AND 107).

FIRST USE 12-29-2003; IN COMMERCE 12-29-2003.

ANDREA SAUNDERS, EXAMINING ATTORNEY

CLASS 41—(Continued).

SN 78-422,680. DAVIS, JOHN, SEATTLE, WA. FILED 5-21-2004.



NO CLAIM IS MADE TO THE EXCLUSIVE RIGHT TO USE "MEDIA", APART FROM THE MARK AS SHOWN.

THE MARK CONSISTS OF THE TERM "GRITZ MEDIA" IN STYLIZED LETTERING AND THE FIGURE OF A MAN HOLDING A MICROPHONE STAND AND A LIGHTNING BOLT.

FOR MOTION PICTURE FILM AND MUSIC VIDEO PRODUCTION SERVICES; AUDIO AND STAGE PRODUCTION SERVICES FOR THE LIVE MUSICAL PERFORMANCES OF OTHERS; PUBLISHING AND PRODUCTION OF MUSICAL RECORDINGS; PREPARATION OF MULTIMEDIA PRESENTATIONS FOR OTHERS FEATURING GRAPHICS, VIDEO, ANIMATION AND SOUND, IN THE NATURE OF LIVE SHOW AND MUSICAL PERFORMANCES; PHOTOGRAPHY, VIDEOGRAPHY, AND CINEMATOGRAPHY SERVICES (U.S. CLS. 100, 101 AND 107).

FIRST USE 3-0-2004; IN COMMERCE 3-0-2004.

LAURA KOVAISKY, EXAMINING ATTORNEY

SN 78-424,408. 1185 COMEDY INC., NEW YORK, NY. FILED 5-25-2004.



NO CLAIM IS MADE TO THE EXCLUSIVE RIGHT TO USE "NEW YORK COMEDY FESTIVAL", APART FROM THE MARK AS SHOWN.

THE MARK CONSISTS OF THE WORDS NEW YORK COMEDY FESTIVAL AND AN IMAGE OF THE STATUE OF LIBERTY HOLDING A MICROPHONE.

FOR ENTERTAINMENT SERVICES IN THE NATURE OF LIVE COMEDIC PERFORMANCES; ENTERTAINMENT SERVICES IN THE NATURE OF ON-GOING TELEVISION PROGRAMS AND MOVIES IN THE FIELD OF COMEDY SHOWS (U.S. CLS. 100, 101 AND 107).

FIRST USE 1-31-2004; IN COMMERCE 1-31-2004.

MATTHEW KLINE, EXAMINING ATTORNEY

CLASS 41—(Continued).

SN 78-426,368. HEARTLAND PAYMENT SYSTEMS, INC., SCOTTSDALE, AZ. FILED 5-27-2004.

hLearning

THE MARK CONSISTS OF STANDARD CHARACTERS WITHOUT CLAIM TO ANY PARTICULAR FONT, STYLE, SIZE, OR COLOR.

FOR EDUCATIONAL SERVICES, NAMELY, CONDUCTING ONLINE CLASSES, WORKSHOPS AND COURSES, TO MERCHANTS TO FURTHER THEIR UNDERSTANDING OF CREDIT CARD PROCESSING SERVICES AND CHARGES. (U.S. CLS. 100, 101 AND 107).

DOUGLAS LEE, EXAMINING ATTORNEY

SN 78-426,756. COUNCIL FOR A BETTER LOUISIANA, BATON ROUGE, LA. FILED 5-28-2004.

LEADERSHIP LOUISIANA

THE MARK CONSISTS OF STANDARD CHARACTERS WITHOUT CLAIM TO ANY PARTICULAR FONT, STYLE, SIZE, OR COLOR.

NO CLAIM IS MADE TO THE EXCLUSIVE RIGHT TO USE "LOUISIANA", APART FROM THE MARK AS SHOWN. FOR PROVIDING SEMINARS FOCUSING ON STATE AND COMMUNITY ISSUES, AND LEADERSHIP DEVELOPMENT (U.S. CLS. 100, 101 AND 107).

FIRST USE 1-31-1989; IN COMMERCE 1-31-1989.
DAWN FELDMAN, EXAMINING ATTORNEY

CLASS 41—(Continued).

SN 78-426,895. ULTRA HD COMPANY LLC, BETHPAGE, NY. FILED 5-28-2004.

FASHION AVENUE

THE MARK CONSISTS OF STANDARD CHARACTERS WITHOUT CLAIM TO ANY PARTICULAR FONT, STYLE, SIZE, OR COLOR.

NO CLAIM IS MADE TO THE EXCLUSIVE RIGHT TO USE FASHION, APART FROM THE MARK AS SHOWN.

FOR ENTERTAINMENT SERVICES, NAMELY, AN ON-GOING TELEVISION SHOW IN THE FIELD OF FASHION (U.S. CLS. 100, 101 AND 107).

STEVEN JACKSON, EXAMINING ATTORNEY

SN 78-427,022. JOHNSTON, FREDERICK WILLIAM, NEW YORK, NY. FILED 5-28-2004.

THE ALGONQUIN AWARD

THE MARK CONSISTS OF STANDARD CHARACTERS WITHOUT CLAIM TO ANY PARTICULAR FONT, STYLE, SIZE, OR COLOR.

NO CLAIM IS MADE TO THE EXCLUSIVE RIGHT TO USE AWARD, APART FROM THE MARK AS SHOWN.

FOR PROVIDING RECOGNITION AND INCENTIVES BY THE WAY OF AWARDS TO DEMONSTRATE EXCELLENCE IN THE LITERARY FIELD (U.S. CLS. 100, 101 AND 107).

ANDREA SAUNDERS, EXAMINING ATTORNEY

SN 78-427,024. BRADLEY PHARMACEUTICALS, INC., FAIRFIELD, NJ. FILED 5-28-2004.

THE FIRST SEMINAR

THE MARK CONSISTS OF STANDARD CHARACTERS WITHOUT CLAIM TO ANY PARTICULAR FONT, STYLE, SIZE, OR COLOR.

NO CLAIM IS MADE TO THE EXCLUSIVE RIGHT TO USE "SEMINAR", APART FROM THE MARK AS SHOWN.

FOR EDUCATIONAL SERVICES, NAMELY, ORGANIZING MEDICAL EDUCATION SEMINARS FOR PHYSICIANS, PHARMACISTS AND OTHER HEALTH CARE PROFESSIONALS (U.S. CLS. 100, 101 AND 107).

MARY BOAGNI, EXAMINING ATTORNEY

CLASS 41—(Continued).

SN 78-427,692. THE PAXEN GROUP, INC., MELBOURNE, FL. FILED 6-1-2004.



FOR EDUCATIONAL SERVICES NAMELY A YOUTH INTERVENTION PROGRAM ENCOMPASSING JOB TRAINING, WORK EXPERIENCE, WORK READINESS TRAINING AND ACADEMIC CREDENTIAL ATTAINMENT (U.S. CLS. 100, 101 AND 107).

FIRST USE 10-23-2003; IN COMMERCE 10-23-2003.

DOMINIC J. FERRAIUOLO, EXAMINING ATTORNEY

SN 78-428,137. DELTA WATERFOWL FOUNDATION, BISMARCK, ND. FILED 6-1-2004.

CANVASBACK CLUB

THE MARK CONSISTS OF STANDARD CHARACTERS WITHOUT CLAIM TO ANY PARTICULAR FONT, STYLE, SIZE, OR COLOR.

NO CLAIM IS MADE TO THE EXCLUSIVE RIGHT TO USE "CLUB", APART FROM THE MARK AS SHOWN.

FOR YOUTH CLUB SERVICES, NAMELY, PROVIDING INSTRUCTIONS AND PARTICIPATION IN THE FIELD OF WATERFOWL CONSERVATION AND WATERFOWL HUNTING (U.S. CLS. 100, 101 AND 107).

DAWN FELDMAN, EXAMINING ATTORNEY

SN 78-430,961. CMP INFORMATION, INC., NEW YORK, NY. FILED 6-7-2004.

EQ

THE MARK CONSISTS OF STANDARD CHARACTERS WITHOUT CLAIM TO ANY PARTICULAR FONT, STYLE, SIZE, OR COLOR.

FOR PROVIDING AN ONLINE MAGAZINE FOR THE RECORDING INDUSTRY ABOUT MUSIC AND AUDIO RECORDING AND THE RECORDING INDUSTRY (U.S. CLS. 100, 101 AND 107).

FIRST USE 3-31-1997; IN COMMERCE 3-31-1997.

JOHN SCHUYLER YARD, EXAMINING ATTORNEY

CLASS 41—(Continued).

SN 78-431,198. PRO FASTPITCH LTD., ORLAND PARK, IL. FILED 6-7-2004.



NO CLAIM IS MADE TO THE EXCLUSIVE RIGHT TO USE "NEW YORK" AND "NEW JERSEY", APART FROM THE MARK AS SHOWN.

THE MARK CONSISTS OF THE WORD "JUGGERNAUT" IN A SCRIPT FONT, ABOVE WHICH, IN SMALLER TYPE APPEAR THE WORDS "NEW YORK" AND "NEW JERSEY," BETWEEN WHICH APPEARS A STYLIZED SLASH FORMED FROM THE LETTERS "NY" AND "NJ".

FOR ARRANGING AND CONDUCTING ATHLETIC COMPETITIONS; ENTERTAINMENT IN THE NATURE OF SOFTBALL GAMES (U.S. CLS. 100, 101 AND 107).

FIRST USE 6-1-2004; IN COMMERCE 6-1-2004.

TRACY CROSS, EXAMINING ATTORNEY

SN 78-432,820. G STUDIOS, LLC, NEWPORT BEACH, CA. FILED 6-10-2004.

TALL HATS

THE MARK CONSISTS OF STANDARD CHARACTERS WITHOUT CLAIM TO ANY PARTICULAR FONT, STYLE, SIZE, OR COLOR.

FOR ENTERTAINMENT IN THE NATURE OF A SERIES OF TELEVISION PROGRAMS IN THE FIELDS OF ACTION, ADVENTURE, ANIMATION AND VARIETY; ENTERTAINMENT IN THE NATURE OF FASHION SHOWS; ENTERTAINMENT SERVICES, NAMELY, PROVIDING AN INTERNET WEBSITE FEATURING MUSICAL PERFORMANCES, MUSICAL VIDEOS, FILM CLIPS, PHOTOGRAPHS, AND ANIMATED SHOWS; FAN CLUBS; PRODUCTION AND DISTRIBUTION OF MOTION PICTURES; PRODUCTION OF RADIO AND TELEVISION PROGRAMS; PRODUCTION OF CABLE TELEVISION PROGRAMS; AND PROVIDING ON-LINE COMPUTER GAMES THAT MAY BE ACCESSED NETWORK-WIDE BY NETWORK USERS (U.S. CLS. 100, 101 AND 107).

REBECCA SMITH, EXAMINING ATTORNEY

CLASS 41—(Continued).

SN 78-432,821. G STUDIOS, LLC, NEWPORT BEACH, CA. FILED 6-10-2004.

FOR GIVING SOULS

THE MARK CONSISTS OF STANDARD CHARACTERS WITHOUT CLAIM TO ANY PARTICULAR FONT, STYLE, SIZE, OR COLOR.

FOR ENTERTAINMENT IN THE NATURE OF A SERIES OF TELEVISION PROGRAMS IN THE FIELDS OF ACTION, ADVENTURE, ANIMATION AND VARIETY; ENTERTAINMENT IN THE NATURE OF FASHION SHOWS; ENTERTAINMENT SERVICES, NAMELY, PROVIDING AN INTERNET WEBSITE FEATURING MUSICAL PERFORMANCES, MUSICAL VIDEOS, FILM CLIPS, PHOTOGRAPHS, AND ANIMATED SHOWS; FAN CLUBS; PRODUCTION AND DISTRIBUTION OF MOTION PICTURES; PRODUCTION OF RADIO AND TELEVISION PROGRAMS; PRODUCTION OF CABLE TELEVISION PROGRAMS; AND PROVIDING ON-LINE COMPUTER GAMES THAT MAY BE ACCESSED NETWORK-WIDE BY NETWORK USERS (U.S. CLS. 100, 101 AND 107).

DAVID C. REIHNER, EXAMINING ATTORNEY

CLASS 41—(Continued).

SN 78-437,240. PSI TECH INCORPORATED, HANA, HI. FILED 6-17-2004.

FIGHT TECH

THE MARK CONSISTS OF STANDARD CHARACTERS WITHOUT CLAIM TO ANY PARTICULAR FONT, STYLE, SIZE, OR COLOR.

NO CLAIM IS MADE TO THE EXCLUSIVE RIGHT TO USE "FIGHT", APART FROM THE MARK AS SHOWN. FOR MARTIAL ARTS INSTRUCTION (U.S. CLS. 100, 101 AND 107).

FIRST USE 5-26-2004; IN COMMERCE 5-26-2004. KIMBERLY FRYE, EXAMINING ATTORNEY

SN 78-436,405. THE COMPASSIONATE LISTENING PROJECT, INDIANOLA, WA. FILED 6-16-2004.

**Compassionate
Listening**

THE MARK CONSISTS OF STANDARD CHARACTERS WITHOUT CLAIM TO ANY PARTICULAR FONT, STYLE, SIZE, OR COLOR.

SEC. 2(F). FOR EDUCATIONAL SERVICES, NAMELY, CONDUCTING WORKSHOPS, SEMINARS, AND INTERNATIONAL EDUCATIONAL STUDY TOURS IN THE FIELD OF CONFLICT RESOLUTION AND PEACEMAKING, AND DISTRIBUTING COURSE MATERIALS IN CONNECTION THEREWITH; DEVELOPMENT AND DISSEMINATION OF EDUCATIONAL MATERIALS OF OTHERS IN THE FIELD OF CONFLICT RESOLUTION AND PEACEMAKING, UTILIZING A VARIETY OF MEDIA INCLUDING PRINT AND VIDEO (U.S. CLS. 100, 101 AND 107).

FIRST USE 8-1-1996; IN COMMERCE 8-1-1996. ANDREW RHIM, EXAMINING ATTORNEY

SN 78-440,654. AMERICAN ACADEMY OF NURSING, WASHINGTON, DC. FILED 6-24-2004.



NO CLAIM IS MADE TO THE EXCLUSIVE RIGHT TO USE "INSTITUTE FOR NURSING LEADERSHIP", APART FROM THE MARK AS SHOWN.

FOR CONDUCT EDUCATIONAL RESEARCH REGARDING IMPLEMENTATION OF NURSING LEADERSHIP PROGRAMS; DEVELOP EDUCATIONAL MANUALS, PROGRAMS AND MODULES TO BE USED FOR IMPLEMENTATION OF NURSING LEADERSHIP PROGRAMS; ARRANGE AND CONDUCT EDUCATIONAL CONFERENCES AND SEMINARS REGARDING NURSING LEADERSHIP PROGRAMS; PROVIDE INSTRUCTION AND TEACHING REGARDING NURSING LEADERSHIP (U.S. CLS. 100, 101 AND 107).

FIRST USE 12-31-1998; IN COMMERCE 12-31-1998. SCOTT OSLICK, EXAMINING ATTORNEY

CLASS 41—(Continued).

SN 78-442,492. VIACOM INTERNATIONAL INC., NEW YORK, NY. FILED 6-28-2004.

CLASSIC Q&A

THE MARK CONSISTS OF STANDARD CHARACTERS WITHOUT CLAIM TO ANY PARTICULAR FONT, STYLE, SIZE, OR COLOR.

NO CLAIM IS MADE TO THE EXCLUSIVE RIGHT TO USE "Q&A", APART FROM THE MARK AS SHOWN.

FOR ENTERTAINMENT SERVICES IN THE NATURE OF A TELEVISION SERIES FEATURING LIVE ACTION, TRIVIA, COMEDY AND DRAMA (U.S. CLS. 100, 101 AND 107).

DANIEL CAPSHAW, EXAMINING ATTORNEY

CLASS 41—(Continued).

SN 78-445,190. ROBERT MORRIS UNIVERSITY, PITTSBURGH, PA. FILED 7-2-2004.

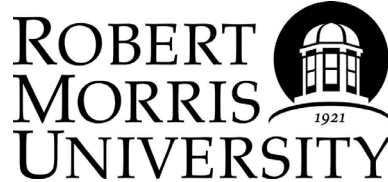

OWNER OF U.S. REG. NO. 2,660,432.
NO CLAIM IS MADE TO THE EXCLUSIVE RIGHT TO USE 1921 AND UNIVERSITY, APART FROM THE MARK AS SHOWN.

THE NAME ROBERT MORRIS DOES NOT IDENTIFY A LIVING INDIVIDUAL.

THE MARK CONSISTS OF A CUPOLA TOWER WITH THE NUMBER "1921" AND THE WORDS "ROBERT MORRIS UNIVERSITY".

FOR EDUCATIONAL SERVICES IN THE NATURE OF COURSES AT THE UNIVERSITY LEVEL (U.S. CLS. 100, 101 AND 107).

FIRST USE 1-14-2002; IN COMMERCE 1-14-2002.
BILL DAWE, EXAMINING ATTORNEY

SN 78-443,965. HOWARD UNIVERSITY MIDDLE SCHOOL OF MATHEMATICS AND SCIENCE, WASHINGTON, DC. FILED 6-30-2004.

(MS)²

FOR EDUCATIONAL SERVICES, NAMELY, PROVIDING COURSES OF INSTRUCTION AT THE SECONDARY LEVEL AND DISTRIBUTING COURSE MATERIAL IN CONNECTION THEREWITH (U.S. CLS. 100, 101 AND 107).

GINA HAYES, EXAMINING ATTORNEY

SN 78-445,621. INTERNATIONAL INSTITUTE OF MODERN LETTERS, LAS VEGAS, NV. FILED 7-2-2004.

BLACK MOUNTAIN COLLEGE

THE MARK CONSISTS OF STANDARD CHARACTERS WITHOUT CLAIM TO ANY PARTICULAR FONT, STYLE, SIZE, OR COLOR.

NO CLAIM IS MADE TO THE EXCLUSIVE RIGHT TO USE "COLLEGE", APART FROM THE MARK AS SHOWN.

FOR EDUCATIONAL SERVICES, NAMELY, PROVIDING COURSES OF INSTRUCTION AT THE COLLEGE LEVEL (U.S. CLS. 100, 101 AND 107).

JANICE L. MCMORROW, EXAMINING ATTORNEY

CLASS 41—(Continued).

SN 78-448,053. SCHINDEL, P. GREGORY, WILLITS, CA.
FILED 7-8-2004.



NO CLAIM IS MADE TO THE EXCLUSIVE RIGHT TO USE "SINGER", APART FROM THE MARK AS SHOWN.

THE COLOR GOLD IS CLAIMED AS A FEATURE OF THE MARK.

THE COLOR GOLD APPEARS IN THE LETTERING AND TRACK DESIGN ELEMENT OF THE MARK.

THE MARK CONSISTS OF BRASS LETTERS "TRAIN SINGER", AS ON A TRAIN CONDUCTOR'S HAT.

SEC. 2(F).
FOR ENTERTAINMENT IN THE NATURE OF LIVE MUSICAL PERFORMANCES (U.S. CLS. 100, 101 AND 107).

FIRST USE 1-1-1990; IN COMMERCE 1-1-1990.
NICHOLAS ALTREE, EXAMINING ATTORNEY

CLASS 41—(Continued).

SN 78-454,353. ERNST & YOUNG U.S. LLP, NEW YORK, NY.
FILED 7-21-2004.

EXPLORATIONS

THE MARK CONSISTS OF STANDARD CHARACTERS WITHOUT CLAIM TO ANY PARTICULAR FONT, STYLE, SIZE, OR COLOR.

FOR CONFERENCES, SEMINARS AND EDUCATIONAL PROGRAMS IN THE ENERGY, CHEMICAL AND UTILITY INDUSTRIES (U.S. CLS. 100, 101 AND 107).

ANDREW BENZMILLER, EXAMINING ATTORNEY

SN 78-455,687. VARONA, LEIGH CODY, HUNTINGTON BEACH, CA. FILED 7-23-2004.

REBELS DE ROYALE

THE MARK CONSISTS OF STANDARD CHARACTERS WITHOUT CLAIM TO ANY PARTICULAR FONT, STYLE, SIZE, OR COLOR.

FOR ENTERTAINMENT SERVICES; NAMELY PARTY PLANNING (U.S. CLS. 100, 101 AND 107).

TRACY CROSS, EXAMINING ATTORNEY

SN 78-455,973. EARLY ADVANTAGE, LLC, FAIRFIELD, CT.
FILED 7-23-2004.

Captain Eat Right

THE MARK CONSISTS OF STANDARD CHARACTERS WITHOUT CLAIM TO ANY PARTICULAR FONT, STYLE, SIZE, OR COLOR.

FOR EDUCATIONAL SERVICES, NAMELY, CONDUCTING CLASSES, SCHOOL ASSEMBLIES, CONFERENCES, AND WORKSHOPS IN THE FIELD OF CHILDREN REGARDING HEALTH ISSUES, AND DISTRIBUTING COURSE MATERIALS IN CONNECTION THEREWITH, PAMPHLETS, BOOKLETS, WORKSHEETS AND FLYERS; ENTERTAINMENT IN THE NATURE OF LIVE PERFORMANCES ON THE TOPIC OF HEALTH ISSUES RELATED TO CHILDREN (U.S. CLS. 100, 101 AND 107).

RONALD AIKENS, EXAMINING ATTORNEY

**GREAT BOOKS SUMMER
READING PROGRAMS**

THE MARK CONSISTS OF STANDARD CHARACTERS WITHOUT CLAIM TO ANY PARTICULAR FONT, STYLE, SIZE, OR COLOR.

NO CLAIM IS MADE TO THE EXCLUSIVE RIGHT TO USE "SUMMER READING PROGRAMS", APART FROM THE MARK AS SHOWN.

FOR EDUCATIONAL SERVICES, NAMELY READING CAMPS AND ONLINE AND AT HOME READING PROGRAMS IN LITERATURE AND HISTORY (U.S. CLS. 100, 101 AND 107).

FIRST USE 11-0-2001; IN COMMERCE 5-0-2002.
KEVON CHISOLM, EXAMINING ATTORNEY

CLASS 41—(Continued).

SN 78-457,313. AVILA, ENRIQUE, HOLLYWOOD, CA. FILED 7-27-2004.

ZAFADOS MUSICAL

THE MARK CONSISTS OF STANDARD CHARACTERS WITHOUT CLAIM TO ANY PARTICULAR FONT, STYLE, SIZE, OR COLOR.

NO CLAIM IS MADE TO THE EXCLUSIVE RIGHT TO USE "MUSICAL", APART FROM THE MARK AS SHOWN.

THE ENGLISH TRANSLATION OF THE WORD "ZAFADOS" IN THE MARK IS "KOOKS".

FOR ENTERTAINMENT SERVICES, NAMELY LIVE PERFORMANCES BY A MUSICAL GROUP (U.S. CLS. 100, 101 AND 107).

MICHAEL ENGEL, EXAMINING ATTORNEY

CLASS 41—(Continued).

SN 78-462,174. GRAND SLAM CLUB/OVIS, BIRMINGHAM, AL. FILED 8-4-2004.

CAPRA WORLD SLAM

THE MARK CONSISTS OF STANDARD CHARACTERS WITHOUT CLAIM TO ANY PARTICULAR FONT, STYLE, SIZE, OR COLOR.

NO CLAIM IS MADE TO THE EXCLUSIVE RIGHT TO USE "CAPRA", APART FROM THE MARK AS SHOWN.

FOR ORGANIZING CONFERENCES, ORGANIZING EVENTS FOR AWARDING PRIZES, ORGANIZING EDUCATIONAL AND OUTREACH PROGRAMS, PROVIDING RECOGNITION AND INCENTIVES BY THE WAY OF AWARDS TO DEMONSTRATE EXCELLENCE, ALL IN THE FIELD OF WILD SHEEP HUNTING (U.S. CLS. 100, 101 AND 107).

MICHELE SWAIN, EXAMINING ATTORNEY

SN 78-457,936. AWANA CLUBS INTERNATIONAL, STREAMWOOD, IL. FILED 7-28-2004.



NO CLAIM IS MADE TO THE EXCLUSIVE RIGHT TO USE "414 FORUM", APART FROM THE MARK AS SHOWN.

THE COLOR(S) GOLD (PMS 137) AND CYAN (PMS 2995) AND MAGENTA (PMS 248) IS/ARE CLAIMED AS A FEATURE OF THE MARK.

THE MARK CONSISTS OF A RECTANGLE WHERE THE LEFT ONE-THIRD IS GOLD AND CONTAINS A WHITE NUMBER 4 AND THE UPPER HALF OF THE RIGHT TWO-THIRDS OF THE RECTANGLE IS CYAN AND THE LOWER HALF OF THE RIGHT TWO-THIRDS OF THE RECTANGLE IS MAGENTA AND CONTAINS A WHITE NUMBER 14. BELOW THE RECTANGLE ARE THE LETTERS FOR "FORUM" AND THE F AND R ARE MAGENTA AND THE O AND M ARE CYAN AND THE U IS GOLD.

FOR EDUCATIONAL SERVICES, NAMELY, PROVIDING RELIGIOUS MISSIONS TRAINING TO CHURCHES, YOUTH WORKERS, DENOMINATIONS, AGENCIES AND THE DISTRIBUTION OF RELATED MATERIALS THEREWITH (U.S. CLS. 100, 101 AND 107).

FIRST USE 2-0-2004; IN COMMERCE 2-0-2004.
CYNTHIA SLOAN, EXAMINING ATTORNEY

SN 78-463,028. CITY OF FORT WORTH, FORT WORTH, TX. FILED 8-5-2004.



THE MARK CONSISTS OF AN ANIMATED BLOB OF MOTOR OIL.

FOR EDUCATIONAL SERVICES, NAMELY, CONDUCTING PROGRAMS FOR PROMOTING ENVIRONMENTAL AWARENESS AND RECYCLING ISSUES AND PROGRAMS IN THE FIELD OF ENVIRONMENTAL COLLECTION SERVICES DIRECTED TO SECONDARY SCHOOLS (U.S. CLS. 100, 101 AND 107).

FIRST USE 4-0-1998; IN COMMERCE 4-0-1998.
EUGENIA MARTIN, EXAMINING ATTORNEY

CLASS 41—(Continued).

SN 78-463,036. CITY OF FORT WORTH, FORT WORTH, TX.
FILED 8-5-2004.

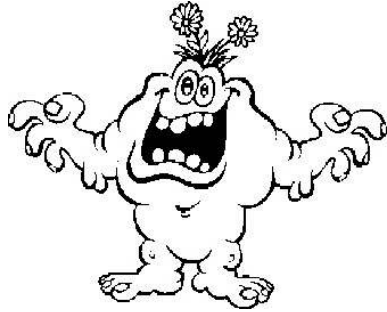

THE MARK CONSISTS OF AN ANIMATED FERTILIZER CREATURE.

FOR EDUCATIONAL SERVICES, NAMELY, CONDUCTING PROGRAMS FOR PROMOTING ENVIRONMENTAL AWARENESS AND RECYCLING ISSUES AND PROGRAMS IN THE FIELD OF ENVIRONMENTAL COLLECTION SERVICES DIRECTED TO SECONDARY SCHOOLS (U.S. CLS. 100, 101 AND 107).

FIRST USE 4-0-1998; IN COMMERCE 4-0-1998.
EUGENIA MARTIN, EXAMINING ATTORNEY

CLASS 41—(Continued).

SN 78-463,693. TECHNOLOGY CLE, LLC, MAGALIA, CA.
FILED 8-6-2004.



NO CLAIM IS MADE TO THE EXCLUSIVE RIGHT TO USE "CLE", APART FROM THE MARK AS SHOWN.

FOR EDUCATIONAL SERVICES, NAMELY ARRANGING AND CONDUCTING CLASSES, ON-LINE CLASSES, SEMINARS, CONFERENCES, WORKSHOPS, CONTINUING EDUCATION, IN-SERVICE TRAINING, AND INDIVIDUAL INSTRUCTION IN THE LEGAL FIELD AND DISTRIBUTING COURSE MATERIALS IN CONNECTION THEREWITH (U.S. CLS. 100, 101 AND 107).

RON FAIRBANKS, EXAMINING ATTORNEY

SN 78-463,043. CITY OF FORT WORTH, FORT WORTH, TX.
FILED 8-5-2004.



THE MARK CONSISTS OF AN ANIMATED BLOB OF DETERGENT.

FOR EDUCATIONAL SERVICES, NAMELY, CONDUCTING PROGRAMS FOR PROMOTING ENVIRONMENTAL AWARENESS AND RECYCLING ISSUES AND PROGRAMS IN THE FIELD OF ENVIRONMENTAL COLLECTION SERVICES DIRECTED TO SECONDARY SCHOOLS (U.S. CLS. 100, 101 AND 107).

FIRST USE 5-0-2001; IN COMMERCE 5-0-2001.
EUGENIA MARTIN, EXAMINING ATTORNEY

SN 78-466,873. CICALÉ/CANNATA, THERESA ANN, EMERSON, NJ. FILED 8-13-2004.

Beauty & The Grease

THE MARK CONSISTS OF STANDARD CHARACTERS WITHOUT CLAIM TO ANY PARTICULAR FONT, STYLE, SIZE, OR COLOR.

FOR ENTERTAINMENT SERVICES IN THE NATURE OF LIVE PERFORMANCES BY A MUSICAL GROUP (U.S. CLS. 100, 101 AND 107).

FIRST USE 11-0-1994; IN COMMERCE 11-0-1994.
JENNIFER CHICOSKI, EXAMINING ATTORNEY

CLASS 41—(Continued).

SN 78-469,606. MECKLENBURG COUNTY GOVERNMENT, PARK & RECREATION DEPARTMENT, CHARLOTTE, NC. FILED 8-18-2004.



THE COLOR(S) BLUE AND GREEN IS/ARE CLAIMED AS A FEATURE OF THE MARK.

THE MARK CONSISTS OF THREE GREEN WAVY LINES TO THE LEFT OF AND ABOVE THREE BLUE WAVY LINES WITH AN OVERALL IMPRESSION OF OPEN WATER WAVES.

FOR RECREATIONAL PARK SERVICES (U.S. CLS. 100, 101 AND 107).

FIRST USE 8-13-2004; IN COMMERCE 8-13-2004. WINSTON FOLMAR, EXAMINING ATTORNEY

CLASS 41—(Continued).

SN 78-472,564. BOSTONREED.COM, ST. HELENA, CA. FILED 8-24-2004.

BOSTON REED

THE MARK CONSISTS OF STANDARD CHARACTERS WITHOUT CLAIM TO ANY PARTICULAR FONT, STYLE, SIZE, OR COLOR.

THE NAME BOSTON REED DOES NOT IDENTIFY A LIVING INDIVIDUAL

FOR EDUCATIONAL SERVICES, NAMELY, ADULT VOCATIONAL AND PROFESSIONAL DEGREE AND NON-DEGREE CAREER TRAINING PROGRAMS IN THE FIELD OF HEALTH CARE; ARRANGING AND CONDUCTING ONLINE EDUCATIONAL COURSES IN THE FIELD OF HEALTH CARE AND DISTRIBUTING COURSE MATERIALS IN CONNECTION THEREWITH (U.S. CLS. 100, 101 AND 107).

FIRST USE 12-7-1991; IN COMMERCE 12-7-1991. JEFF DEFORD, EXAMINING ATTORNEY

SN 78-472,273. UNITED STATES POWER SQUADRONS, RALEIGH, NC. FILED 8-24-2004.



OWNER OF U.S. REG. NOS. 271,254, 1,737,334 AND OTHERS.

THE MARK CONSISTS OF A CARTOON-LIKE DEPICTION OF A GULL WEARING A LIFE VEST AND A CAP UPON WHICH THE LETTERS USPS APPEAR ALONG WITH A FLAG EMBLEM, WHILE HOLDING A PENNANT CONTAINING THE FLAG EMBLEM AND THE LETTERS USPS4KIDS.ORG.

FOR EDUCATIONAL SERVICES, PARTICULARLY FOR CHILDREN, NAMELY, CONDUCTING COURSES OF INSTRUCTION IN BOATING SAFETY AND DISTRIBUTING INSTRUCTIONAL COURSE MATERIALS IN CONNECTION THEREWITH (U.S. CLS. 100, 101 AND 107).

FIRST USE 1-0-2004; IN COMMERCE 1-0-2004. JEFFERY COWARD, EXAMINING ATTORNEY

SN 78-472,965. TANZER, JOSHUA M., HOBOKEN, NJ. FILED 8-25-2004.

Offoffoff

THE MARK CONSISTS OF STANDARD CHARACTERS WITHOUT CLAIM TO ANY PARTICULAR FONT, STYLE, SIZE, OR COLOR.

FOR PUBLICATION OF ONLINE COLUMNS IN THE FIELDS OF REVIEWS, NEWS, INTERVIEWS, OPINIONS, AND LISTINGS RELATED TO ARTS, ENTERTAINMENT, BOOKS, ACADEMIC RESEARCH, NEWS AND CULTURE; PROVIDING A WEB SITE THAT CONTAINS INTERACTIVE FEATURES RELATED TO ARTS, ENTERTAINMENT, BOOKS, NEWS AND CULTURE (U.S. CLS. 100, 101 AND 107).

FIRST USE 10-1-1999; IN COMMERCE 10-1-1999. KIMBERLY FRYE, EXAMINING ATTORNEY

CLASS 41—(Continued).

SN 78-474,795. IFDA, INC., FALLS CHURCH, VA. FILED 8-27-2004.



NO CLAIM IS MADE TO THE EXCLUSIVE RIGHT TO USE "FOOD INDUSTRY TRUCK DRIVING CHAMPIONSHIP", APART FROM THE MARK AS SHOWN.

THE COLOR(S) BLACK, WHITE AND RED IS/ARE CLAIMED AS A FEATURE OF THE MARK.

THE COLOR(S) BLACK APPLIED TO "FOOD INDUSTRY TRUCK DRIVING CHAMPIONSHIP", AND WHITE APPLIED TO THE STYLIZED TRUCK DESIGN, AND RED APPLIED TO THE ARC AND THE GENERALLY OVAL BACKGROUND.

THE MARK CONSISTS OF AN ARC, AND A STYLIZED TRUCK ON A GENERALLY OVAL BACKGROUND.

FOR ORGANIZING, ARRANGING AND CONDUCTING COMPETITIONS IN THE FIELD OF FOODSERVICE DISTRIBUTORS TRUCK DRIVING (U.S. CLS. 100, 101 AND 107).

FIRST USE 7-0-2003; IN COMMERCE 7-0-2003.
BARBARA BROWN, EXAMINING ATTORNEY

CLASS 41—(Continued).

SN 78-478,797. BUGARIN, EDWARD U., HONOLULU, HI. FILED 9-3-2004.

STREND

THE MARK CONSISTS OF STANDARD CHARACTERS WITHOUT CLAIM TO ANY PARTICULAR FONT, STYLE, SIZE, OR COLOR.

FOR ORGANIZING COMMUNITY SPORTING EVENTS THAT REQUIRE STRENGTH TRAINING AND RUNNING; PHYSICAL FITNESS INSTRUCTION THAT REQUIRES STRENGTH TRAINING AND RUNNING (U.S. CLS. 100, 101 AND 107).

FIRST USE 1-1-1992; IN COMMERCE 3-2-1992.
AMY ALFIERI, EXAMINING ATTORNEY

SN 78-477,690. SECURITIES TRAINING CORPORATION, NEW YORK, NY. FILED 9-2-2004.



OWNER OF U.S. REG. NOS. 1,805,574, 2,582,661 AND OTHERS.

FOR EDUCATIONAL SERVICES; NAMELY, PROVIDING EXAMINATION PREPARATION AND REVIEW COURSES FOR PROFESSIONAL LICENSING EXAMS IN THE FIELD OF STOCKS, BONDS, COMMODITIES, INSURANCE AND THE FINANCIAL AND INVESTMENT INDUSTRIES (U.S. CLS. 100, 101 AND 107).

NORA BUCHANAN WILL, EXAMINING ATTORNEY

SN 78-479,498. FLORIDA MEDIA INC, ALTAMONTE SPRINGS, FL. FILED 9-7-2004.

Florida Travel and Life

THE MARK CONSISTS OF STANDARD CHARACTERS WITHOUT CLAIM TO ANY PARTICULAR FONT, STYLE, SIZE, OR COLOR.

SEC. 2(F).
FOR ONLINE PERIODICAL MAGAZINE DEALING WITH SUBJECTS OF INTEREST TO RESIDENTS OF AND VISITORS TO FLORIDA (U.S. CLS. 100, 101 AND 107).

FIRST USE 1-31-2000; IN COMMERCE 1-31-2000.
BRENDAN MCCAULEY, EXAMINING ATTORNEY

CLASS 41—(Continued).

SN 78-480,396. SHARP MARKETING, LLC, SANTA MONICA, CA. FILED 9-8-2004.

Salud con Sabor

THE MARK CONSISTS OF STANDARD CHARACTERS WITHOUT CLAIM TO ANY PARTICULAR FONT, STYLE, SIZE, OR COLOR.

THE FOREIGN WORDING IN THE MARK TRANSLATES INTO ENGLISH AS HEALTH WITH FLAVOR, TASTE AND STYLE.

FOR ORGANIZING LATINO INTERACTIVE HEALTHY LIFESTYLE FESTIVALS FEATURING A VARIETY OF ACTIVITIES INCLUDING HEALTHY CHOICES FOR TRADITIONAL RECIPES, PARTICIPATORY EVENTS SHOWING KIDS AND ADULTS HOW TO INCORPORATE HEALTHY PHYSICAL ACTIVITY INTO THEIR DAY AND THE LIKE (U.S. CLS. 100, 101 AND 107).

JAMES A. RAUEN, EXAMINING ATTORNEY

CLASS 41—(Continued).

SN 78-481,593. STARK, DANNY L. OLATHE, KS. FILED 9-10-2004.

GraceTime

THE MARK CONSISTS OF STANDARD CHARACTERS WITHOUT CLAIM TO ANY PARTICULAR FONT, STYLE, SIZE, OR COLOR.

FOR ENTERTAINMENT AND EDUCATIONAL SERVICES FEATURING INTERVIEWS WITH INDIVIDUALS CONCERNING THEIR PERSONAL VIEWS OF THEIR LIVES AND THE EVENTS IN THEIR LIVES, PROVIDING AN INTIMATE, REVEALING, PERMANENT RECORD OF THEIR PERSONALITIES AND BELIEFS FOR THEIR DESCENDANTS AND OTHERS THROUGH STORAGE AND RETRIEVAL OF THEIR STORIES VIA ELECTRONIC MULTI-MEDIA AND VIA A WEBSITE (U.S. CLS. 100, 101 AND 107).

JILL C. ALT, EXAMINING ATTORNEY

SN 78-480,405. BERKLEY, DANIEL H., WOODCLIFF LAKE, NJ. FILED 9-8-2004.

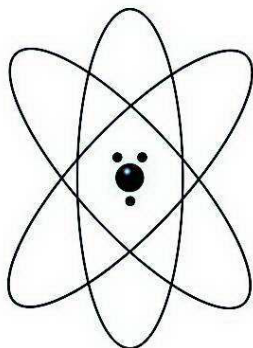

THE MARK CONSISTS OF THREE OVERLAPPING OVALS WITH FOUR CIRCLES IN THE INTERIOR SECTION DEPICTING TWO EYES, A NOSE AND A MOUTH.

FOR ENTERTAINMENT SERVICES IN THE NATURE OF CLOWN PERFORMANCES (U.S. CLS. 100, 101 AND 107).

RONALD AIKENS, EXAMINING ATTORNEY

SN 78-482,184. PETERSON, KAREN ANNE, PAIA, HI. FILED 9-12-2004.

Giving Back

THE MARK CONSISTS OF STANDARD CHARACTERS WITHOUT CLAIM TO ANY PARTICULAR FONT, STYLE, SIZE, OR COLOR.

FOR CHARITABLE SERVICES, NAMELY, ACADEMIC MENTORING OF SCHOOL AGE CHILDREN (U.S. CLS. 100, 101 AND 107).

FIRST USE 7-5-2000; IN COMMERCE 7-5-2000.

KIMBERLY PERRY, EXAMINING ATTORNEY

CLASS 41—(Continued).

SN 78-483,058. KIM, IN MOOK, SAN ANTONIO, TX. FILED 9-14-2004.



NO CLAIM IS MADE TO THE EXCLUSIVE RIGHT TO USE "ACADEMY OF TAE KWON DO" AND THE NON-LATIN CHARACTERS THAT MEAN "TAE KWON DO", APART FROM THE MARK AS SHOWN.

THE NON-LATIN CHARACTER(S) IN THE MARK TRANSLITERATES INTO TAE KWON DO , AND THIS MEANS FOOT AND FIST WAY IN ENGLISH.

FOR INSTRUCTION AND TRAINING IN THE MARTIAL ARTS INCLUDING THE INSTRUCTION OF TAE KWON-DO AND INSTRUCTION IN THE TOURNAMENT RULES AND PROCEDURES FOR, AND CONDUCT OF, THE SPORT OF TAE KWON-DO (U.S. CLS. 100, 101 AND 107).

FIRST USE 9-15-1970; IN COMMERCE 5-12-1971.
VERNA BETH RIRIE, EXAMINING ATTORNEY

SN 78-483,359. WIKIMEDIA FOUNDATION, INC., ST. PETERSBURG, FL. FILED 9-14-2004.

Wikipedia

THE MARK CONSISTS OF STANDARD CHARACTERS WITHOUT CLAIM TO ANY PARTICULAR FONT, STYLE, SIZE, OR COLOR.

FOR PROVIDING INFORMATION IN THE FIELD OF GENERAL ENCYCLOPEDIA KNOWLEDGE VIA THE INTERNET (U.S. CLS. 100, 101 AND 107).

FIRST USE 1-11-2001; IN COMMERCE 1-13-2001.
ADA HAN, EXAMINING ATTORNEY

CLASS 41—(Continued).

SN 78-484,470. SPACE ASPIRATIONS, INC., BEDFORD HILLS, NY. FILED 9-16-2004.

YouthTruth

THE MARK CONSISTS OF STANDARD CHARACTERS WITHOUT CLAIM TO ANY PARTICULAR FONT, STYLE, SIZE, OR COLOR.

FOR EDUCATIONAL SERVICES, NAMELY, CONDUCTING CLASSES, SEMINARS, CONFERENCES, AND WORKSHOPS IN THE FIELD OF UNIVERSAL AND COSMIC ENERGIES (U.S. CLS. 100, 101 AND 107).

FIRST USE 9-9-2002; IN COMMERCE 9-9-2002.
STANLEY I. OSBORNE, EXAMINING ATTORNEY

SN 78-484,942. KIM, GINA, WAILUKU, HI. FILED S.R. 9-16-2004; AM. P.R. 8-4-2005.

Cellular Regeneration Technique

THE MARK CONSISTS OF STANDARD CHARACTERS WITHOUT CLAIM TO ANY PARTICULAR FONT, STYLE, SIZE, OR COLOR.

NO CLAIM IS MADE TO THE EXCLUSIVE RIGHT TO USE CELLULAR REGENERATION, APART FROM THE MARK AS SHOWN.

SEC. 2(F).
FOR PROVIDING EDUCATIONAL SEMINARS WITH ACCOMPANYING MANUALS THEREWITH IN THE FIELD OF NATURAL HEALTH CARE TECHNIQUES (U.S. CLS. 100, 101 AND 107).

FIRST USE 8-1-1998; IN COMMERCE 8-1-1998.
JOHN HWANG, EXAMINING ATTORNEY

CLASS 41—(Continued).

SN 78-485,517. TOYOTA JIDOSHA KABUSHIKI KAISHA, TA TOYOTA MOTOR CORPORATION, TOYOTA-SHI, AICHI-KEN, JAPAN, FILED 9-17-2004.

CLASS 41—(Continued).

SN 78-486,848. BARCLAY, LAUREL, NEW YORK, NY. AND KATZ-BOHEN, MATTHEW, NEW YORK, NY. FILED 9-21-2004.

**LEXUS FINANCIAL
SERVICES SALES
SOLUTIONS**

Daddy

THE MARK CONSISTS OF STANDARD CHARACTERS WITHOUT CLAIM TO ANY PARTICULAR FONT, STYLE, SIZE, OR COLOR.

OWNER OF U.S. REG. NOS. 1,574,718, 1,675,339 AND 2,884,937.

NO CLAIM IS MADE TO THE EXCLUSIVE RIGHT TO USE "FINANCIAL SERVICES SALES SOLUTIONS", APART FROM THE MARK AS SHOWN.

FOR PROVIDING TRAINING PROGRAMS IN THE FIELD OF FINANCE AND INSURANCE FOR AUTOMOBILE DEALERSHIPS AND THEIR PERSONNEL (U.S. CLS. 100, 101 AND 107).

ELLEN BURNS, EXAMINING ATTORNEY

THE MARK CONSISTS OF STANDARD CHARACTERS WITHOUT CLAIM TO ANY PARTICULAR FONT, STYLE, SIZE, OR COLOR.

FOR ENTERTAINMENT, NAMELY, LIVE PERFORMANCES BY A MUSICAL BAND (U.S. CLS. 100, 101 AND 107).

FIRST USE 10-15-1998; IN COMMERCE 5-1-1999.
ASMAT KHAN, EXAMINING ATTORNEY

SN 78-485,699. LEAPFROG ENTERPRISES, INC., EMERYVILLE, CA. FILED 9-17-2004.

SN 78-487,329. KNIGHT, THOMAS MARK, AUSTIN, TX. FILED 9-21-2004.

LEAPFROG

The Window Channel

THE MARK CONSISTS OF STANDARD CHARACTERS WITHOUT CLAIM TO ANY PARTICULAR FONT, STYLE, SIZE, OR COLOR.

OWNER OF U.S. REG. NOS. 2,745,425, 2,890,005 AND OTHERS.

FOR EDUCATING AT THE PRE-K THROUGH 12TH GRADE LEVELS (U.S. CLS. 100, 101 AND 107).

TEJBIR SINGH, EXAMINING ATTORNEY

THE MARK CONSISTS OF STANDARD CHARACTERS WITHOUT CLAIM TO ANY PARTICULAR FONT, STYLE, SIZE, OR COLOR.

NO CLAIM IS MADE TO THE EXCLUSIVE RIGHT TO USE "CHANNEL", APART FROM THE MARK AS SHOWN.

FOR ENTERTAINMENT SERVICES IN THE NATURE OF A TELEVISION PROGRAM FEATURING NON-NARRATIVE, AMBIENT, SCENIC VIDEOS (U.S. CLS. 100, 101 AND 107).

MARY BOAGNI, EXAMINING ATTORNEY

CLASS 41—(Continued).

SN 78-489,198. SOUTHERN CALIFORNIA PUBLIC RADIO, PASADENA, CA. FILED 9-24-2004.

PM

THE MARK CONSISTS OF STANDARD CHARACTERS WITHOUT CLAIM TO ANY PARTICULAR FONT, STYLE, SIZE, OR COLOR.

FOR ENTERTAINMENT SERVICES, NAMELY, PROVIDING AN ONGOING RADIO PROGRAM IN THE NATURE OF A TALK SHOW IN THE FIELDS OF CURRENT EVENTS, LOCAL AND NATIONAL ISSUES, CULTURAL TRENDS, ENTERTAINMENT, SCIENCE, CONVERSATION, NEWS, POLITICS AND THE ARTS; AND ENTERTAINMENT SERVICES, NAMELY, PROVIDING RADIO PROGRAMMING AND INFORMATION VIA A GLOBAL COMPUTER NETWORK IN THE FIELDS OF CURRENT EVENTS, NEWS REGARDING LOCAL AND NATIONAL ISSUES, ENTERTAINMENT IN THE NATURE OF MUSIC, AND UPCOMING PERFORMING ARTS EVENTS (U.S. CLS. 100, 101 AND 107).

FIRST USE 10-18-2004; IN COMMERCE 10-18-2004.
KHANH LE, EXAMINING ATTORNEY

SN 78-493,842. CLAUDER, MARGARET, ARLINGTON, TX. FILED 10-4-2004.

MAGGIE THE MAGICAL
CLOWN

THE MARK CONSISTS OF STANDARD CHARACTERS WITHOUT CLAIM TO ANY PARTICULAR FONT, STYLE, SIZE, OR COLOR.

NO CLAIM IS MADE TO THE EXCLUSIVE RIGHT TO USE "CLOWN", APART FROM THE MARK AS SHOWN.

FOR ENTERTAINMENT SERVICES IN THE NATURE OF LIVE CLOWN PERFORMANCES AND LIVE PERFORMANCES BY A FICTIONAL CHARACTER (U.S. CLS. 100, 101 AND 107).

FIRST USE 0-0-1991; IN COMMERCE 0-0-1991.
SONYA STEPHENS, EXAMINING ATTORNEY

CLASS 41—(Continued).

SN 78-494,222. LARSEN, ELAINE, JOLEEN, HAINES CITY, FL. AND LARSEN, CHRISTOPHER, ROBERT, HAINES CITY, FL. FILED 10-4-2004.

MISS TA FIRE

THE MARK CONSISTS OF STANDARD CHARACTERS WITHOUT CLAIM TO ANY PARTICULAR FONT, STYLE, SIZE, OR COLOR.

FOR ENTERTAINMENT SERVICES, NAMELY, PARTICIPATION IN JET DRAGSTER RACES (U.S. CLS. 100, 101 AND 107).

SCOTT BALDWIN, EXAMINING ATTORNEY

SN 78-494,753. ALGARIO COMMUNICATIONS INC., OAKVILLE, ONTARIO, CANADA, FILED 10-5-2004.

KNOWLEDGE POWERS
RESULTS

THE MARK CONSISTS OF STANDARD CHARACTERS WITHOUT CLAIM TO ANY PARTICULAR FONT, STYLE, SIZE, OR COLOR.

FOR EDUCATIONAL SERVICES NAMELY DEVELOPING AND PROVIDING ONLINE TRAINING AND TESTING PROGRAMS IN THE FIELD OF SALES, MARKETING, CUSTOMER SERVICE, BUSINESS OPERATIONS, AND MANAGEMENT (U.S. CLS. 100, 101 AND 107).

FIRST USE 1-1-2001; IN COMMERCE 1-1-2001.
MICHELLE DUBOIS, EXAMINING ATTORNEY

CLASS 41—(Continued).

SN 78-498,033. SBTN, INC, GARDEN GROVE, CA. FILED 10-11-2004.



NO CLAIM IS MADE TO THE EXCLUSIVE RIGHT TO USE "SAIGON BROADCASTING TELEVISION NETWORK", APART FROM THE MARK AS SHOWN.

THE MARK CONSISTS OF A MYTHICAL VIETNAMESE BIRD KNOWN AS LAC VIET, WITH A LONG BEAK, FLYING IN AN S.

SEC. 2(F).

FOR ENTERTAINMENT SERVICES, NAMELY, PROVIDING A TELEVISION PROGRAM IN THE FIELD OF VIETNAMESE HISTORY, CULTURE, ECONOMICS, TALK SHOW, SITCOM, GAMES SHOW; PRODUCTION OF RADIO AND TELEVISION PROGRAMS IN VIETNAMESE (U.S. CLS. 100, 101 AND 107).

FIRST USE 5-1-2003; IN COMMERCE 5-1-2003.
ZACHARY BELLO, EXAMINING ATTORNEY

CLASS 41—(Continued).

SN 78-499,626. CE UNIVERSITY, INC., OLD SAYBROOK, CT. FILED 10-14-2004.

**Get courses. Get
credits. Get back
to business.**

THE MARK CONSISTS OF STANDARD CHARACTERS WITHOUT CLAIM TO ANY PARTICULAR FONT, STYLE, SIZE, OR COLOR.

FOR EDUCATIONAL SERVICES, NAMELY PROVIDING ONLINE COURSES FOR CONTINUING EDUCATION IN THE FIELD OF INSURANCE AND CLAIM ADJUSTERS (U.S. CLS. 100, 101 AND 107).

ADA HAN, EXAMINING ATTORNEY

SN 78-499,450. ESPINDLE LEARNING, SEBASTOPOL, CA. FILED 10-13-2004.



THE COLOR(S) BLUE AND ORANGE/YELLOW IS/ARE CLAIMED AS A FEATURE OF THE MARK.

THE COLOR BLUE APPEARS IN THE LETTER "E" IN BOTH LOCATIONS, AND IN THE WORDING "PINDLE," WHICH IS PART OF THE WORDING "ESPINDLE," AND THE COLORS YELLOW AND ORANGE APPEAR IN THE SPINDLE (SPIRAL) DESIGN AND IN THE "S" IN THE WORDING, "ESPINDLE."

FOR EDUCATIONAL SERVICES, NAMELY, PROVIDING ONLINE TUTORING IN THE FIELDS OF SPELLING, VOCABULARY, VARIOUS LANGUAGES, GEOGRAPHY, MATH, HISTORY AND A RANGE OF DIFFERENT, MEMORY-BASED LEARNING SUBJECTS (U.S. CLS. 100, 101 AND 107).

FIRST USE 6-10-2004; IN COMMERCE 10-5-2004.
WANDA KAY PRICE, EXAMINING ATTORNEY

SN 78-501,021. BURNING CICADA, LTD., DEKALB, IL. FILED 10-16-2004.

BURNING CICADA

THE MARK CONSISTS OF STANDARD CHARACTERS WITHOUT CLAIM TO ANY PARTICULAR FONT, STYLE, SIZE, OR COLOR.

FOR ENTERTAINMENT SERVICES, NAMELY LIVE MUSIC CONCERTS; AUDIO RECORDING AND PRODUCTION; MUSIC PRODUCTION SERVICES; RECORD, COMPACT DISC, CASSETTE TAPE, AND DIGITAL MUSIC PRODUCTION; VIDEOTAPE AND DIGITAL VIDEO DISK PRODUCTION; AND MULTIMEDIA ENTERTAINMENT SOFTWARE PRODUCTION SERVICES (U.S. CLS. 100, 101 AND 107).

FIRST USE 10-6-2004; IN COMMERCE 10-6-2004.
GENE MACIOL, EXAMINING ATTORNEY

CLASS 41—(Continued).

SN 78-501,508. THE GEORGIA REPTILE AND AMPHIBIAN RESCUE EFFORT, LAWRENCEVILLE, GA. FILED 10-18-2004.

Creepy Critters

THE MARK CONSISTS OF STANDARD CHARACTERS WITHOUT CLAIM TO ANY PARTICULAR FONT, STYLE, SIZE, OR COLOR.

FOR EDUCATIONAL AND ENTERTAINMENT SERVICES, NAMELY, PROVIDING EDUCATIONAL PROGRAMS UTILIZING LIVE ANIMALS AND PERSONALIZED INSTRUCTION TO TEACH AND ENTERTAIN (U.S. CLS. 100, 101 AND 107).

FIRST USE 5-0-1998; IN COMMERCE 5-0-1998.

JULIE GUTTADAURO, EXAMINING ATTORNEY

SN 78-501,632. B.A.S.S. (IP), LLC, BRISTOL, CT. FILED 10-18-2004.

BASSCENTER

THE MARK CONSISTS OF STANDARD CHARACTERS WITHOUT CLAIM TO ANY PARTICULAR FONT, STYLE, SIZE, OR COLOR.

FOR ENTERTAINMENT SERVICES, NAMELY, AN ONGOING TELEVISION PROGRAM IN THE FIELD OF FISHING; ENTERTAINMENT SERVICES VIA A GLOBAL COMPUTER NETWORK IN THE FIELD OF FISHING, NAMELY, PROVIDING FISHING INFORMATION AND INSTRUCTION, PROVIDING INFORMATION ABOUT AN ONGOING TELEVISION PROGRAM IN THE FIELD OF FISHING; PROVIDING FISHING INFORMATION VIA WIRELESS AND MOBILE DEVICES (U.S. CLS. 100, 101 AND 107).

KIMBERLY FRYE, EXAMINING ATTORNEY

CLASS 41—(Continued).

SN 78-502,354. PEREZ BETANCOURT, ANGEL L., SAN JUAN, PUERTO RICO, FILED 10-19-2004.

KARIS(NAME),EL PODER DEL SWING,LA COREOGRAFIA CON SWING(SLOGAN)

THE MARK CONSISTS OF STANDARD CHARACTERS WITHOUT CLAIM TO ANY PARTICULAR FONT, STYLE, SIZE, OR COLOR.

THE ENGLISH TRANSLATION OF THE WORDING EL PODER DEL SWING LA COREOGRAFIA CON SWING IN THE MARK IS THE POWER OF SWING THE CHOREOGRAPHY WITH SWING.

FOR ENTERTAINMENT, NAMELY, LIVE PERFORMANCES BY A MUSICAL BAND (U.S. CLS. 100, 101 AND 107).

DAVID MURRAY, EXAMINING ATTORNEY

SN 78-503,060. JUPITERMEDIA CORPORATION, DARIEN, CT. FILED 10-20-2004.

Liquid Treat

THE MARK CONSISTS OF STANDARD CHARACTERS WITHOUT CLAIM TO ANY PARTICULAR FONT, STYLE, SIZE, OR COLOR.

FOR PROVIDING ONLINE PUBLICATIONS IN THE NATURE OF A WEEKLY EMAIL BULLETIN FEATURING INFORMATION IN THE FIELD OF PRODUCT DESIGN (U.S. CLS. 100, 101 AND 107).

FIRST USE 4-11-2003; IN COMMERCE 4-11-2003.

DAVID H. STINE, EXAMINING ATTORNEY

CLASS 41—(Continued).

SN 78-503,284. STARZ ENTERTAINMENT GROUP LLC, ENGLEWOOD, CO. FILED 10-20-2004.

CLASS 41—(Continued).

SN 78-504,822. L.A. CONSULTING, INC., MILWAUKEE, WI. FILED 10-23-2004.

ENCORE ACTION

SYNTHESIS

THE MARK CONSISTS OF STANDARD CHARACTERS WITHOUT CLAIM TO ANY PARTICULAR FONT, STYLE, SIZE, OR COLOR.
OWNER OF U.S. REG. NOS. 2,048,058, 2,604,003 AND OTHERS.

NO CLAIM IS MADE TO THE EXCLUSIVE RIGHT TO USE ACTION, APART FROM THE MARK AS SHOWN.

FOR ENTERTAINMENT SERVICES IN THE NATURE OF PROGRAMMING AND PRODUCTION OF MOTION PICTURES AND TELEVISION PROGRAMS FOR CABLE AND SATELLITE TELEVISION BROADCASTING; DISTRIBUTION OF MOTION PICTURES AND AUDIO AND VIDEO PROGRAMMING FOR TRANSMISSION VIA A GLOBAL COMMUNICATIONS NETWORK (U.S. CLS. 100, 101 AND 107).

JENNIFER WILLISTON, EXAMINING ATTORNEY

THE MARK CONSISTS OF STANDARD CHARACTERS WITHOUT CLAIM TO ANY PARTICULAR FONT, STYLE, SIZE, OR COLOR.

FOR EDUCATIONAL TRAINING IN THE FIELDS OF MEDITATION, BODY, MIND AND SPIRIT INTEGRATION, INTERFAITH MINISTRY, AND SCIENCE OF THE SOUL (U.S. CLS. 100, 101 AND 107).

TRACY CROSS, EXAMINING ATTORNEY

SN 78-505,564. JAY DELP PRODUCTIONS, HARLEYSVILLE, PA. FILED 10-25-2004.

SN 78-503,594. DEPLANCHE GROUP, BIRMINGHAM, MI. FILED 10-21-2004.

ON-TRACK SPEAKING

SHOW AND TELL

THE MARK CONSISTS OF STANDARD CHARACTERS WITHOUT CLAIM TO ANY PARTICULAR FONT, STYLE, SIZE, OR COLOR.

NO CLAIM IS MADE TO THE EXCLUSIVE RIGHT TO USE "SPEAKING", APART FROM THE MARK AS SHOWN.

THE MARK CONSISTS OF ON-TRACK SPEAKING IS IN COPPERPLATE GOTHIC FONT.

FOR TRAINING AND COACHING IN THE FIELDS OF PERSONAL GROWTH, INTEGRITY AND LEADERSHIP; PROVIDING EDUCATIONAL AND MOTIVATIONAL SPEAKERS IN THE FIELDS OF PERSONAL GROWTH, INTEGRITY AND LEADERSHIP (U.S. CLS. 100, 101 AND 107).

CAROLYN GRAY, EXAMINING ATTORNEY

THE MARK CONSISTS OF STANDARD CHARACTERS WITHOUT CLAIM TO ANY PARTICULAR FONT, STYLE, SIZE, OR COLOR.

FOR WORKSHOPS AND SEMINARS FOR FAITH-BASED ORGANIZATIONS IN THE FIELD OF VIDEO AND MEDIA TECHNOLOGY (U.S. CLS. 100, 101 AND 107).

MICHELLE DUBOIS, EXAMINING ATTORNEY

CLASS 41—(Continued).

SN 78-506,649. DUE PROCESS GOLF & HORSE STABLES, LLC, DBA DUE PROCESS STABLE, COLTS NECK, NJ. FILED 10-27-2004.

DUE PROCESS STABLE

THE MARK CONSISTS OF STANDARD CHARACTERS WITHOUT CLAIM TO ANY PARTICULAR FONT, STYLE, SIZE, OR COLOR.

NO CLAIM IS MADE TO THE EXCLUSIVE RIGHT TO USE "STABLE", APART FROM THE MARK AS SHOWN.

FOR GOLF CLUB AND COUNTRY CLUB SERVICES; RECREATIONAL SERVICES IN THE NATURE OF HORSEBACK RIDING AND HORSEBACK RIDING LESSONS (U.S. CLS. 100, 101 AND 107).

FIRST USE 3-0-1995; IN COMMERCE 3-0-1995.
REBECCA SMITH, EXAMINING ATTORNEY

SN 78-508,153. SOUTH DAKOTA SCHOOL FOR THE DEAF, SIOUX FALLS, SD. FILED 10-29-2004.

**SOUTH DAKOTA
SCHOOL FOR THE DEAF**

THE MARK CONSISTS OF STANDARD CHARACTERS WITHOUT CLAIM TO ANY PARTICULAR FONT, STYLE, SIZE, OR COLOR.

SEC. 2(F).
FOR EDUCATIONAL SERVICES, NAMELY, CONDUCTING CLASSES AT THE PRE-SCHOOL THROUGH HIGH SCHOOL LEVELS FOR STUDENTS WHO ARE DEAF, HARD OF HEARING, AND/OR RECIPIENTS OF COCHLEAR IMPLANTS (U.S. CLS. 100, 101 AND 107).

FIRST USE 0-0-1968; IN COMMERCE 0-0-1990.
KEVON CHISOLM, EXAMINING ATTORNEY

CLASS 41—(Continued).

SN 78-508,991. CENTRO NUEVA CREACION, PHILADELPHIA, PA. FILED 11-1-2004.

GOODLANDS

THE MARK CONSISTS OF STANDARD CHARACTERS WITHOUT CLAIM TO ANY PARTICULAR FONT, STYLE, SIZE, OR COLOR.

FOR ENTERTAINMENT SERVICES, NAMELY ART EXHIBITIONS; EDUCATIONAL SERVICES, NAMELY OFFERING CLASSES AND INSTRUCTION IN THE FIELDS OF ARTS AND PHOTOGRAPHY (U.S. CLS. 100, 101 AND 107).

FIRST USE 8-3-2001; IN COMMERCE 8-3-2001.
RON FAIRBANKS, EXAMINING ATTORNEY

SN 78-509,238. NATIONAL CONFERENCE OF STANDARDS LABORATORIES, BOULDER, CO. FILED 11-1-2004.

NCSL INTERNATIONAL

THE MARK CONSISTS OF STANDARD CHARACTERS WITHOUT CLAIM TO ANY PARTICULAR FONT, STYLE, SIZE, OR COLOR.

NO CLAIM IS MADE TO THE EXCLUSIVE RIGHT TO USE "INTERNATIONAL", APART FROM THE MARK AS SHOWN.

FOR EDUCATION SERVICES, NAMELY, EDUCATIONAL AND TRAINING SEMINARS AND INSTRUCTION THROUGH COURSES, PROGRAMS AND WORKSHOPS RELATING TO METROLOGY AND CALIBRATION (U.S. CLS. 100, 101 AND 107).

FIRST USE 5-30-2000; IN COMMERCE 5-30-2000.
CIMMERIAN COLEMAN, EXAMINING ATTORNEY

CLASS 41—(Continued).

SN 78-509,549. MARQUIS ENTERTAINMENT, LLC, VIENNA, VA. FILED 11-2-2004.

CLASS 41—(Continued).

SN 78-511,773. DIRECTV, INC., EL SEGUNDO, CA. FILED 11-5-2004.

MODEL MADNESS

THE MARK CONSISTS OF STANDARD CHARACTERS WITHOUT CLAIM TO ANY PARTICULAR FONT, STYLE, SIZE, OR COLOR.

NO CLAIM IS MADE TO THE EXCLUSIVE RIGHT TO USE "MODEL", APART FROM THE MARK AS SHOWN.

FOR ARRANGING AND CONDUCTING ENTERTAINMENT EVENTS IN THE NATURE OF A FASHION AND MODELING CONTEST WHERE CONTESTANTS MAY ALSO SING (U.S. CLS. 100, 101 AND 107).

FIRST USE 10-1-2004; IN COMMERCE 10-1-2004.
AMY GEARIN, EXAMINING ATTORNEY

WORLDDIRECT

THE MARK CONSISTS OF STANDARD CHARACTERS WITHOUT CLAIM TO ANY PARTICULAR FONT, STYLE, SIZE, OR COLOR.

FOR TELEVISION PROGRAMMING AND PRODUCTION SERVICES; DISTRIBUTION OF TELEVISION PROGRAMS FOR OTHERS (U.S. CLS. 100, 101 AND 107).

FIRST USE 12-3-2004; IN COMMERCE 12-3-2004.
JOHN DWYER, EXAMINING ATTORNEY

SN 78-511,016. NEW PARADIGM ENTERPRISES, INC., NAPERVILLE, IL. FILED 11-3-2004.

SN 78-512,263. JNE PUBLISHING, INC, HUNTSVILLE, AL. FILED 11-5-2004.

8 Track Playback

THE MARK CONSISTS OF STANDARD CHARACTERS WITHOUT CLAIM TO ANY PARTICULAR FONT, STYLE, SIZE, OR COLOR.

FOR ENTERTAINMENT IN THE NATURE OF ONGOING RADIO PROGRAMS AND RADIO FEATURES IN THE FIELD OF MUSIC (U.S. CLS. 100, 101 AND 107).

FIRST USE 10-25-2004; IN COMMERCE 10-25-2004.
MARIA-VICTORIA SUAREZ, EXAMINING ATTORNEY

PREDATOR & PREY

THE MARK CONSISTS OF STANDARD CHARACTERS WITHOUT CLAIM TO ANY PARTICULAR FONT, STYLE, SIZE, OR COLOR.

FOR PROVIDING INFORMATION IN THE FIELD OF HUNTING AND OUTDOOR ACTIVITY (U.S. CLS. 100, 101 AND 107).

FIRST USE 8-1-2005; IN COMMERCE 8-1-2005.
JAMES A. RAUEN, EXAMINING ATTORNEY

CLASS 41—(Continued).

SN 78-512,565. 14 DAY PRODUCTIONS, TORRANCE, CA.
FILED 11-5-2004.



NO CLAIM IS MADE TO THE EXCLUSIVE RIGHT TO USE "PRODUCTIONS", APART FROM THE MARK AS SHOWN.

FOR ENTERTAINMENT SERVICES, NAMELY, MOTION PICTURE FILM PRODUCTION (U.S. CLS. 100, 101 AND 107).

FIRST USE 8-9-2004; IN COMMERCE 9-15-2004.
MARIAM MAHMOUDI, EXAMINING ATTORNEY

SN 78-512,866. HOWSTUFFWORKS, INC., ATLANTA, GA.
FILED 11-8-2004.

STUFFO

THE MARK CONSISTS OF STANDARD CHARACTERS WITHOUT CLAIM TO ANY PARTICULAR FONT, STYLE, SIZE, OR COLOR.

FOR INFORMATION SERVICES, NAMELY, PROVIDING A WIDE RANGE OF INFORMATION IN THE FIELD OF ENTERTAINMENT NEWS, MOVIE PRODUCTS, VIDEO GAMES, ENTERTAINMENT PUBLICATIONS AND INTERVIEWS, AND PROVIDING LINKS TO ENTERTAINMENT WEBSITES OF OTHERS VIA A GLOBAL COMPUTER NETWORK, CABLE TELEVISION, BROADCAST TELEVISION, BROADCAST RADIO, COMPACT DISCS AND DVDS (U.S. CLS. 100, 101 AND 107).

FIRST USE 10-14-2004; IN COMMERCE 11-7-2004.
GINNY ISAACSON, EXAMINING ATTORNEY

CLASS 41—(Continued).

SN 78-513,680. PERCY, BERNARD, LOS ANGELES, CA.
FILED 11-9-2004.

Foundations of Brilliance

THE MARK CONSISTS OF STANDARD CHARACTERS WITHOUT CLAIM TO ANY PARTICULAR FONT, STYLE, SIZE, OR COLOR.

FOR EDUCATIONAL SEMINARS AND CONSULTING RELATING TO CAREER COUNSELING AND CAREER AND VOCATIONAL GUIDANCE (U.S. CLS. 100, 101 AND 107).

FIRST USE 8-6-2004; IN COMMERCE 8-6-2004.
MICHAEL KAZAZIAN, EXAMINING ATTORNEY

SN 78-514,041. FEED THEIR DREAMS CHILDREN'S FOUNDATION, INC., PROVIDENCE, RI. FILED 11-9-2004.

Feed Their Dreams

THE MARK CONSISTS OF STANDARD CHARACTERS WITHOUT CLAIM TO ANY PARTICULAR FONT, STYLE, SIZE, OR COLOR.

FOR EDUCATIONAL SERVICES, NAMELY, CONDUCTING PROGRAMS IN THE FIELD OF HEALTHY CHOICES IN RESTAURANT FOODS (U.S. CLS. 100, 101 AND 107).

FIRST USE 9-15-2004; IN COMMERCE 9-15-2004.
IRA J. GOODSaid, EXAMINING ATTORNEY

CLASS 41—(Continued).

SN 78-514,295. JOHNSON, LANNY L., OKEMOS, MI. FILED 11-10-2004.

**ALTERNATIVE
MEDICINE FOR
PUTTING**

THE MARK CONSISTS OF STANDARD CHARACTERS WITHOUT CLAIM TO ANY PARTICULAR FONT, STYLE, SIZE, OR COLOR.

FOR GOLF INSTRUCTION AND EDUCATIONAL SERVICES, NAMELY, CONDUCTING CLASSES, SEMINARS, CONFERENCES, WORKSHOPS IN THE FIELD OF GOLF (U.S. CLS. 100, 101 AND 107).

APRIL L. RADEMACHER, EXAMINING ATTORNEY

SN 78-514,352. RHODES, DYNELLE, 64331 WEITERSTADT, FED REP GERMANY, FILED 11-10-2004.

THE WEATHER GIRLS

THE MARK CONSISTS OF STANDARD CHARACTERS WITHOUT CLAIM TO ANY PARTICULAR FONT, STYLE, SIZE, OR COLOR.

NO CLAIM IS MADE TO THE EXCLUSIVE RIGHT TO USE "GIRLS", APART FROM THE MARK AS SHOWN.

FOR ENTERTAINMENT SERVICES IN THE NATURE OF LIVE PERFORMANCES BY A MUSICAL AND SINGING GROUP OR INDIVIDUAL (U.S. CLS. 100, 101 AND 107).

MONTIA G. PRESSEY, EXAMINING ATTORNEY

CLASS 41—(Continued).

SN 78-514,405. ALEXANDER GRAND, BABAK PEDRAM, GENERAL PARTNERS, DBA TIDBIT NETWORKS, CARMICHAEL, CA. FILED 11-10-2004.



NO CLAIM IS MADE TO THE EXCLUSIVE RIGHT TO USE "NETWORKS", APART FROM THE MARK AS SHOWN.

THE COLORS BLUE, GRAY, AND BLACK ARE CLAIMED AS A FEATURE OF THE MARK.

THE WORDING "TIDBIT" IN THE MARK APPEARS IN THE COLOR GRAY. THE WORDING "NETWORKS" IS BLACK IN COLOR, AND THE CIRCLES IN THE BACKGROUND ARE BLUE AND GRAY.

FOR PROVIDING WEB SITES FEATURING INFORMATION ON FASHION, MUSIC, MOVIES, AND ARTIST'S PROFILES (U.S. CLS. 100, 101 AND 107).

TINA L. SNAPP, EXAMINING ATTORNEY

SN 78-514,441. ALEXANDER GRAND AND BABAK PEDRAM PARTNERSHIP, THE, CARMICHAEL, CA. FILED 11-10-2004.



NO CLAIM IS MADE TO THE EXCLUSIVE RIGHT TO USE "MOVIE", APART FROM THE MARK AS SHOWN.

THE COLORS BLUE, BLACK AND WHITE ARE CLAIMED AS A FEATURE OF THE MARK.

THE COLOR BLUE APPEARS IN THE BACKGROUND OF THE CIRCLE DESIGN; THE COLOR BLACK APPEARS AS THE BORDER OF THE CIRCLE DESIGN, IN THE DESIGN OF THE DOG, AS THE BORDER OF THE BANNER DESIGN, AND IN THE WORDING "MOVIE TIDBIT"; AND THE COLOR WHITE APPEARS IN THE BACKGROUND OF THE BANNER DESIGN.

FOR PROVIDING INFORMATION ABOUT ACTING AND MOVIES VIA AN INTERNET WEB SITE (U.S. CLS. 100, 101 AND 107).

CARRIE ACHEN, EXAMINING ATTORNEY

CLASS 41—(Continued).

SN 78-514,932. GRAND, ALEXANDER, CARMICHAEL, CA.
FILED 11-10-2004.

Network Into the Spotlight One TidbiT at a Time

THE MARK CONSISTS OF STANDARD CHARACTERS WITHOUT CLAIM TO ANY PARTICULAR FONT, STYLE, SIZE, OR COLOR.

FOR WEB SITE FEATURING INFORMATION ON FASHION, MUSIC, MOVIES, AND ARTIST'S PROFILES (U.S. CLS. 100, 101 AND 107).

CHRISTOPHER BUONGIORNO, EXAMINING ATTORNEY

SN 78-515,262. WARNER BROS. ENTERTAINMENT INC.,
BURBANK, CA. FILED 11-11-2004.

WELCOME TO THE OC BITCH

THE MARK CONSISTS OF STANDARD CHARACTERS WITHOUT CLAIM TO ANY PARTICULAR FONT, STYLE, SIZE, OR COLOR.

FOR ENTERTAINMENT SERVICES IN THE NATURE OF LIVE-ACTION, COMEDY, DRAMA AND ANIMATED TELEVISION SERIES; PRODUCTION OF LIVE-ACTION, COMEDY, DRAMA AND ANIMATED TELEVISION SERIES; DISTRIBUTION AND DISPLAY OF LIVE-ACTION, COMEDY, DRAMA AND ANIMATED MOTION PICTURE THEATRICAL FILMS; PRODUCTION OF LIVE-ACTION, COMEDY, DRAMA AND ANIMATED MOTION PICTURE THEATRICAL FILMS; THEATRICAL PERFORMANCES BOTH ANIMATED AND LIVE ACTION; INTERNET SERVICES PROVIDING INFORMATION VIA AN ELECTRONIC GLOBAL COMPUTER NETWORK IN THE FIELD OF ENTERTAINMENT RELATING SPECIFICALLY TO MUSIC, MOVIES, AND TELEVISION; PROVIDING GENERAL INTEREST NEWS, ENTERTAINMENT, AND EDUCATIONAL INFORMATION VIA A GLOBAL COMPUTER NETWORK; AND PROVIDING INFORMATION FOR AND ACTUAL ENTERTAINMENT VIA ELECTRONIC GLOBAL COMMUNICATIONS NETWORK IN THE NATURE OF LIVE-ACTION, COMEDY, DRAMA AND ANIMATED PROGRAMS AND PRODUCTION OF LIVE-ACTION COMEDY, ACTION AND ANIMATED MOTION FILMS FOR DISTRIBUTION VIA A GLOBAL COMPUTER NETWORK (U.S. CLS. 100, 101 AND 107).

BARNEY CHARLON, EXAMINING ATTORNEY

CLASS 41—(Continued).

SN 78-515,471. ALZLIFE, LLC, DBA MEMORY CONCEPTS,
PORT WASHINGTON, NY. FILED 11-11-2004.

MY MEMORY SPARKS

THE MARK CONSISTS OF STANDARD CHARACTERS WITHOUT CLAIM TO ANY PARTICULAR FONT, STYLE, SIZE, OR COLOR.

FOR TRAINING SERVICES IN THE FIELD OF COGNITION UTILIZING TRAINING EXERCISES DESIGNED TO OPTIMIZE MEMORY FUNCTIONING AND OTHER COGNITIVE SKILLS IN INDIVIDUALS WITH MEMORY LOSS AND TO INDIVIDUALS CONCERNED ABOUT MEMORY LOSS AND THE CAUSES RELATED THERE-TO (U.S. CLS. 100, 101 AND 107).

FIRST USE 7-0-2004; IN COMMERCE 7-0-2004.
SALLY SHIH, EXAMINING ATTORNEY

SN 78-515,732. DONNELSON, MARK K., COUNCIL BLUFFS,
IA. FILED 11-12-2004.



FOR ENTERTAINMENT SERVICES, NAMELY, LIVE PERFORMANCES BY A MUSICAL GROUP (U.S. CLS. 100, 101 AND 107).

ROBIN CHOSID, EXAMINING ATTORNEY

CLASS 41—(Continued).

SN 78-515,734. VILLALOBOS, XAVIER, LOS ANGELES, CA. FILED 11-12-2004.



JDUBS DOES NOT IDENTIFY A LIVING INDIVIDUAL. THE MARK IS COMPRISED OF THE WORDING "JDUBS" IN STYLIZED FONT. FOR VIDEO AND MUSIC PRODUCTION SERVICES AND VIDEO EDITING SERVICES FOR OTHERS (U.S. CLS. 100, 101 AND 107). FIRST USE 1-1-1996; IN COMMERCE 1-1-1996. LINDA POWELL, EXAMINING ATTORNEY

CLASS 41—(Continued).

SN 78-516,011. MERCK & CO., INC., WHITEHOUSE STATION, NJ. FILED 11-12-2004.

STAR MANAGEMENT

THE MARK CONSISTS OF STANDARD CHARACTERS WITHOUT CLAIM TO ANY PARTICULAR FONT, STYLE, SIZE, OR COLOR. NO CLAIM IS MADE TO THE EXCLUSIVE RIGHT TO USE "MANAGEMENT", APART FROM THE MARK AS SHOWN. FOR EDUCATIONAL SERVICES, NAMELY, PROVIDING COURSES ON THE PREVENTION AND MANAGEMENT OF INFECTIOUS DISEASES AND CONDITIONS, AND COURSE MATERIALS DISTRIBUTED IN CONNECTION THEREWITH (U.S. CLS. 100, 101 AND 107). FIRST USE 2-12-2004; IN COMMERCE 2-12-2004. JIM RINGLE, EXAMINING ATTORNEY

SN 78-515,945. AMERICAN EXPRESS COMPANY, NEW YORK, NY. FILED 11-12-2004.

THE CHAIRLIFT CHALLENGE

THE MARK CONSISTS OF STANDARD CHARACTERS WITHOUT CLAIM TO ANY PARTICULAR FONT, STYLE, SIZE, OR COLOR. FOR ON-LINE SWEEPSTAKES (U.S. CLS. 100, 101 AND 107). FIRST USE 11-1-2004; IN COMMERCE 11-1-2004. KATRINA EDGE, EXAMINING ATTORNEY

SN 78-516,075. BRADFORD CAPITAL PARTNERS, PITTSBURGH, PA. FILED 11-12-2004.



FOR VOCATIONAL EDUCATION IN THE FIELD OF VETERINARY MEDICINE (U.S. CLS. 100, 101 AND 107). FIRST USE 1-7-2005; IN COMMERCE 1-7-2005. STACY WAHLBERG, EXAMINING ATTORNEY

CLASS 41—(Continued).

SN 78-516,123. RATHER, KEVIN, OCONOMOWOC, WI.
FILED 11-12-2004.

CLASS 41—(Continued).

SN 78-516,339. E! ENTERTAINMENT TELEVISION, INC.,
LOS ANGELES, CA. FILED 11-12-2004.

FREEDOM TRAINING CENTERS

DR. 90210

THE MARK CONSISTS OF STANDARD CHARACTERS
WITHOUT CLAIM TO ANY PARTICULAR FONT, STYLE,
SIZE, OR COLOR.

NO CLAIM IS MADE TO THE EXCLUSIVE RIGHT TO
USE "TRAINING CENTERS", APART FROM THE MARK
AS SHOWN.

FOR PROVIDING FACILITIES FOR EDUCATIONAL
TRAINING; AND EDUCATIONAL SERVICES, NAMELY
CONDUCTING WORKSHOPS AND SEMINARS IN THE
FIELD OF BUSINESS (U.S. CLS. 100, 101 AND 107).

FIRST USE 2-1-2004; IN COMMERCE 2-1-2004.
KHANH LE, EXAMINING ATTORNEY

THE MARK CONSISTS OF STANDARD CHARACTERS
WITHOUT CLAIM TO ANY PARTICULAR FONT, STYLE,
SIZE, OR COLOR.

FOR ENTERTAINMENT SERVICES; NAMELY AN
ONGOING REALITY TELEVISION SERIES FEATURING
DOCTORS AND THEIR PATIENTS, AND INFORMA-
TION RELATED TO SUCH SERIES DISSEMINATED
THROUGH GLOBAL COMPUTER NETWORKS (U.S.
CLS. 100, 101 AND 107).

FIRST USE 4-11-2004; IN COMMERCE 4-11-2004.
EDWARD NELSON, EXAMINING ATTORNEY

SN 78-516,141. SUPER STECK, LLC, HENDERSON, NV.
FILED 11-12-2004.

SN 78-516,341. E! ENTERTAINMENT TELEVISION, INC.,
LOS ANGELES, CA. FILED 11-12-2004.

AUSSIE ANGELS-THE WONDERS FROM DOWN UNDER

how do i look?

THE MARK CONSISTS OF STANDARD CHARACTERS
WITHOUT CLAIM TO ANY PARTICULAR FONT, STYLE,
SIZE, OR COLOR.

FOR ENTERTAINMENT SERVICES, NAMELY MUSI-
CALS AND DANCE PERFORMANCES, LIVE STAGE
SHOWS AND PRESENTATION OF PRE-RECORDED
STAGE SHOWS BEFORE A LIVE AUDIENCE, MUSICAL
REVIEWS AND THEATRICAL PRODUCTIONS (U.S.
CLS. 100, 101 AND 107).

FIRST USE 10-25-2004; IN COMMERCE 10-25-2004.
MICHAEL HALL, EXAMINING ATTORNEY

THE MARK CONSISTS OF STANDARD CHARACTERS
WITHOUT CLAIM TO ANY PARTICULAR FONT, STYLE,
SIZE, OR COLOR.

FOR ENTERTAINMENT SERVICES; NAMELY AN
ONGOING TELEVISION SERIES FEATURING PERSONAL
MAKEOVERS, AND INFORMATION RELATED TO
SUCH SERIES DISSEMINATED THROUGH GLOBAL
COMPUTER NETWORKS (U.S. CLS. 100, 101 AND 107).

FIRST USE 12-22-2003; IN COMMERCE 12-22-2003.
JOHN GARTNER, EXAMINING ATTORNEY

CLASS 41—(Continued).

SN 78-516,405. ALETA ENTERPRISES, INC., DBA VISIONS UNLIMITED, ARLINGTON, VA. FILED 11-12-2004.

CLASS 41—(Continued).

SN 78-517,100. EHRICH, JOANNE L., SAN MATEO, CA. FILED 11-15-2004.

Extraordinary
People



THE MARK CONSISTS OF STANDARD CHARACTERS WITHOUT CLAIM TO ANY PARTICULAR FONT, STYLE, SIZE, OR COLOR.

OWNER OF U.S. REG. NO. 2,729,184.
FOR ENTERTAINMENT SERVICES RENDERED THROUGH THE MEDIUM OF TELEVISION IN THE NATURE OF A TALK SHOW SERIES AND COMPUTER SERVICES, NAMELY, PROVIDING ENTERTAINMENT INFORMATION VIA AN INTERNET WEB SITE FEATURING INFORMATION ON A TELEVISION TALK SHOW AND GUESTS FEATURED THEREON (U.S. CLS. 100, 101 AND 107).

FIRST USE 11-8-2004; IN COMMERCE 11-8-2004.
GIANCARLO CASTRO, EXAMINING ATTORNEY

NO CLAIM IS MADE TO THE EXCLUSIVE RIGHT TO USE PUBLISHING, APART FROM THE MARK AS SHOWN. THE NAME KOALA JO DOES NOT IDENTIFY A LIVING INDIVIDUAL.

FOR PUBLISHING OF COFFEE TABLE AND GIFT BOOKS (U.S. CLS. 100, 101 AND 107).
ANDREW BENZMILLER, EXAMINING ATTORNEY

SN 78-516,670. KURTAIN, WILLIAM, YARDLEY, PA. FILED 11-15-2004.

SN 78-517,381. MAYNOV PRODUCTIONS L.L.C., LONG ISLAND CITY, NY. FILED 11-16-2004.

Winning Touch
Tennis

Do you cook?

THE MARK CONSISTS OF STANDARD CHARACTERS WITHOUT CLAIM TO ANY PARTICULAR FONT, STYLE, SIZE, OR COLOR.

NO CLAIM IS MADE TO THE EXCLUSIVE RIGHT TO USE "TENNIS", APART FROM THE MARK AS SHOWN.

FOR TENNIS PROGRAM FEATURING TENNIS INSTRUCTION AND LEAGUE COMPETITION; PROVIDING OPEN COURTS FOR PLAYING TENNIS (U.S. CLS. 100, 101 AND 107).

YONG KIM, EXAMINING ATTORNEY

THE MARK CONSISTS OF STANDARD CHARACTERS WITHOUT CLAIM TO ANY PARTICULAR FONT, STYLE, SIZE, OR COLOR.

FOR ENTERTAINMENT IN THE NATURE OF AN ONGOING TELEVISION SERIES IN THE FIELD OF COOKING AND FOOD (U.S. CLS. 100, 101 AND 107).

KAREN BRACEY, EXAMINING ATTORNEY

CLASS 41—(Continued).

SN 78-517,793. CENTER FOR TEACHER FORMATION,
BAINBRIDGE ISLAND, WA. FILED 11-16-2004.

CLASS 41—(Continued).

SN 78-518,162. JERRY GARCIA ESTATE LLC, SAUSALITO,
CA. FILED 11-16-2004.

**CIRCLES OF TRUST**

THE MARK CONSISTS OF STANDARD CHARACTERS WITHOUT CLAIM TO ANY PARTICULAR FONT, STYLE, SIZE, OR COLOR.

FOR CONDUCTING EDUCATIONAL WORKSHOPS AND RETREATS IN THE FIELD OF SELF AWARENESS AND VOCATIONAL IDENTITY AND INTEGRITY FOR TEACHERS AND LEADERS IN OTHER SERVING PROFESSIONS (U.S. CLS. 100, 101 AND 107).

FIRST USE 10-1-2004; IN COMMERCE 10-1-2004.
JOHN HWANG, EXAMINING ATTORNEY

OWNER OF U.S. REG. NOS. 2,298,506, 2,302,439 AND 2,363,464.

THE NAME(S), PORTRAIT(S), AND/OR SIGNATURE(S) SHOWN IN THE MARK DOES NOT IDENTIFY A PARTICULAR LIVING INDIVIDUAL.

THE MARK CONSISTS OF DECEASED MUSICIAN AND ARTIST JERRY GARCIA'S OWN INDIVIDUAL HAND-PRINT WITH A MISSING MIDDLE FINGER AND SHOWING GARCIA'S DISTINCTIVE FINGER PRINTS, PALM PRINT AND LIFE LINES, AND JERRY GARCIA'S SIGNATURE, "J. GARCIA," SIGNED ACROSS THE PALM, ALL WITHIN A CIRCLE.

FOR ENTERTAINMENT SERVICES, NAMELY, MUSICAL SOUND RECORDING PRODUCTION SERVICES AND AUDIOVISUAL RECORDING PRODUCTION SERVICES; MUSIC PUBLISHING SERVICES; MUSIC FAN CLUB SERVICES; PROVIDING AN ON-LINE COMPUTER DATABASE VIA A GLOBAL COMPUTER NETWORK FEATURING PRERECORDED MUSIC, MUSICAL PERFORMANCES, MUSIC VIDEOS, MUSIC VIDEO CLIPS, MUSIC FILMS, AND MULTIMEDIA MATERIALS IN CONNECTION WITH A RECORD LABEL, MUSICAL GROUPS AND SOLO RECORDING ARTISTS; PROVIDING AN ON-LINE COMPUTER DATABASE VIA A GLOBAL COMPUTER NETWORK FEATURING GRAPHICS, INFORMATION, DATA, NEWS, REVIEWS, PHOTOGRAPHS, SCHEDULES OF TOURS, SCHEDULES OF TRAVEL, SCHEDULES OF LIVE AND PRERECORDED MUSICAL PERFORMANCES, SCHEDULES OF RELEASES OF SOUND RECORDINGS, SCHEDULES OF RELEASES OF VIDEO RECORDINGS, SCHEDULES OF RELEASES OF LASER AND DIGITAL RECORDINGS, SCHEDULES OF RELEASES OF MULTIMEDIA SOFTWARE, SCHEDULES OF RELEASES OF COLLECTIBLE GOODS AND PRINTED MATTER MERCHANDISE; BOOK PUBLISHING (U.S. CLS. 100, 101 AND 107).

FIRST USE 4-8-2004; IN COMMERCE 4-8-2004.
ALLISON HOLTZ, EXAMINING ATTORNEY

CLASS 41—(Continued).

SN 78-518,168. MOUSE CLUB USA, INC., MANSFIELD, TX.
FILED 11-17-2004.

FLOPPY'S MOUSE CLUB

THE MARK CONSISTS OF STANDARD CHARACTERS WITHOUT CLAIM TO ANY PARTICULAR FONT, STYLE, SIZE, OR COLOR.

FOR EDUCATIONAL SERVICES, NAMELY, CLASSES AND WORKSHOPS IN THE FIELD OF TEACHING COMPUTER SKILLS TO PRE-SCHOOL AGE CHILDREN (U.S. CLS. 100, 101 AND 107).

FIRST USE 3-0-2004; IN COMMERCE 3-0-2004.

THEODORE MCBRIDE, EXAMINING ATTORNEY

SN 78-518,542. TECHNICAL TRADES INSTITUTE, INC.,
DBA INTELLITEC COLLEGES, DENVER, CO. FILED 11-17-2004.



The logo for Intellitec features a stylized 'i' icon on the left, composed of a vertical bar with a diagonal line through it, followed by the word 'ntellitec' in a lowercase, sans-serif font.

FOR EDUCATIONAL SERVICES IN THE NATURE OF POST-SECONDARY VOCATIONAL AND TECHNICAL SCHOOLS (U.S. CLS. 100, 101 AND 107).

FIRST USE 5-31-2000; IN COMMERCE 5-31-2000.

ALINA MORRIS, EXAMINING ATTORNEY

SN 78-518,547. DELTA LEADERSHIP GROUP, INC.,
SCOTTSDALE, AZ. FILED 11-17-2004.

RELATIONSHIP EDGE

THE MARK CONSISTS OF STANDARD CHARACTERS WITHOUT CLAIM TO ANY PARTICULAR FONT, STYLE, SIZE, OR COLOR.

FOR TRAINING COURSES RELATING TO SALES, PROMOTION, MARKETING, AND BUSINESS (U.S. CLS. 100, 101 AND 107).

FIRST USE 8-26-2004; IN COMMERCE 8-26-2004.

ALINA MORRIS, EXAMINING ATTORNEY

CLASS 41—(Continued).

SN 78-518,772. MEREDITH CORPORATION, DES MOINES,
IA. FILED 11-17-2004.

CAMP DIRT

THE MARK CONSISTS OF STANDARD CHARACTERS WITHOUT CLAIM TO ANY PARTICULAR FONT, STYLE, SIZE, OR COLOR.

NO CLAIM IS MADE TO THE EXCLUSIVE RIGHT TO USE "CAMP", APART FROM THE MARK AS SHOWN.

FOR RECREATIONAL AND SPORT CAMPS (U.S. CLS. 100, 101 AND 107).

TEJBIR SINGH, EXAMINING ATTORNEY

SN 78-518,866. DIAMOND, KARTAR, CULVER CITY, CA.
FILED 11-17-2004.

Four Pillars Publishing

THE MARK CONSISTS OF STANDARD CHARACTERS WITHOUT CLAIM TO ANY PARTICULAR FONT, STYLE, SIZE, OR COLOR.

NO CLAIM IS MADE TO THE EXCLUSIVE RIGHT TO USE "PUBLISHING", APART FROM THE MARK AS SHOWN.

FOR PUBLISHING OF BOOKS, MAGAZINES (U.S. CLS. 100, 101 AND 107).

FIRST USE 10-1-2003; IN COMMERCE 10-1-2003.

NELSON SNYDER, EXAMINING ATTORNEY

CLASS 41—(Continued).

SN 78-519,238. NATIONAL ALLERGY SUPPLY, INC., DULUTH, GA. FILED 11-18-2004.

NATIONAL ALLERGY SUPPLY

THE MARK CONSISTS OF STANDARD CHARACTERS WITHOUT CLAIM TO ANY PARTICULAR FONT, STYLE, SIZE, OR COLOR.

FOR EDUCATION IN THE FIELD OF ALLERGEN AVOIDANCE (U.S. CLS. 100, 101 AND 107).
FIRST USE 1-1-1989; IN COMMERCE 1-1-1989.
CHERYL CLAYTON, EXAMINING ATTORNEY

CLASS 41—(Continued).

SN 78-519,387. COLUMBIA PICTURES INDUSTRIES, INC., CULVER CITY, CA. FILED 11-18-2004.

A LEAGUE OF THEIR OWN

THE MARK CONSISTS OF STANDARD CHARACTERS WITHOUT CLAIM TO ANY PARTICULAR FONT, STYLE, SIZE, OR COLOR.

FOR ENTERTAINMENT SERVICES, NAMELY, A TELEVISION COMEDY SERIES (U.S. CLS. 100, 101 AND 107).
SHARON MEIER, EXAMINING ATTORNEY

SN 78-519,270. ROI MEDIA GROUP CORP, MORRISVILLE, PA. FILED 11-18-2004.

SN 78-519,400. OUTDOOR LIFE NETWORK, L.L.C., STAMFORD, CT. FILED 11-18-2004.

IntelliTopics

THE MARK CONSISTS OF STANDARD CHARACTERS WITHOUT CLAIM TO ANY PARTICULAR FONT, STYLE, SIZE, OR COLOR.

FOR EDUCATIONAL SERVICES, NAMELY, COURSES CONDUCTED VIA TELECONFERENCE, SATELLITE BROADCAST AND WEBCAST-BASED COMMUNICATION SYSTEM FOR EDUCATING HEALTHCARE PROFESSIONALS IN CURRENT MEDICAL AND SCIENTIFIC TOPICS (U.S. CLS. 100, 101 AND 107).
FIRST USE 3-1-2004; IN COMMERCE 3-1-2004.
WENDY GOODMAN, EXAMINING ATTORNEY

GRAVITY GAMES

THE MARK CONSISTS OF STANDARD CHARACTERS WITHOUT CLAIM TO ANY PARTICULAR FONT, STYLE, SIZE, OR COLOR.

OWNER OF U.S. REG. NOS. 2,464,289, 2,872,255 AND OTHERS.

NO CLAIM IS MADE TO THE EXCLUSIVE RIGHT TO USE GAMES, APART FROM THE MARK AS SHOWN.

FOR ENTERTAINMENT SERVICES IN THE NATURE OF ON-GOING TELEVISION PROGRAMS IN THE FIELD OF EXTREME SPORTS EXHIBITIONS AND COMPETITIONS; PRODUCTION AND DISTRIBUTION OF SAME TELEVISION PROGRAMS; PROVIDING INFORMATION AND ENTERTAINMENT VIA A GLOBAL COMPUTER NETWORK, NAMELY, SCHEDULES, SYNOPSIS, PHOTOGRAPHS, VIDEO CLIPS AND INTERVIEWS, ALL RELATED TO SAME TELEVISION PROGRAMS (U.S. CLS. 100, 101 AND 107).

FIRST USE 5-0-1999; IN COMMERCE 5-0-1999.
GISELLE AGOSTO, EXAMINING ATTORNEY

CLASS 41—(Continued).

SN 78-519,418. MOVES, A DANCE AND FITNESS STUDIO, INC., WEST CHICAGO, IL. FILED 11-18-2004.

**BRINGING DANCERS
TO THE NEXT STAGE**

THE MARK CONSISTS OF STANDARD CHARACTERS WITHOUT CLAIM TO ANY PARTICULAR FONT, STYLE, SIZE, OR COLOR.

FOR EDUCATIONAL SERVICES, NAMELY CONDUCTING CLASSES AND WORKSHOPS IN THE FIELD OF PERFORMING ARTS AND DISTRIBUTING COURSE MATERIALS IN CONJUNCTION THEREWITH (U.S. CLS. 100, 101 AND 107).

FIRST USE 10-1-2004; IN COMMERCE 10-1-2004.
MICHELLE DUBOIS, EXAMINING ATTORNEY

SN 78-519,425. OUTDOOR LIFE NETWORK, L.L.C., STAMFORD, CT. FILED 11-18-2004.

**WINTER GRAVITY
GAMES**

THE MARK CONSISTS OF STANDARD CHARACTERS WITHOUT CLAIM TO ANY PARTICULAR FONT, STYLE, SIZE, OR COLOR.

OWNER OF U.S. REG. NOS. 2,464,289, 2,872,255 AND OTHERS.

NO CLAIM IS MADE TO THE EXCLUSIVE RIGHT TO USE WINTER AND GAMES, APART FROM THE MARK AS SHOWN.

FOR ENTERTAINMENT SERVICES IN THE NATURE OF ON-GOING TELEVISION PROGRAMS IN THE FIELD OF EXTREME SPORTS EXHIBITIONS AND COMPETITIONS; PRODUCTION AND DISTRIBUTION OF SAME TELEVISION PROGRAMS; PROVIDING INFORMATION AND ENTERTAINMENT VIA A GLOBAL COMPUTER NETWORK, NAMELY, SCHEDULES, SYNOPSIS, PHOTOGRAPHS, VIDEO CLIPS AND INTERVIEWS, ALL RELATED TO SAME TELEVISION PROGRAMS (U.S. CLS. 100, 101 AND 107).

FIRST USE 5-0-1999; IN COMMERCE 5-0-1999.
GISELLE AGOSTO, EXAMINING ATTORNEY

CLASS 41—(Continued).

SN 78-519,574. CAPITOL RACQUET SPORTS, INC., DBA COURTHOUSE ATHLETIC CLUB, SALEM, OR. FILED 11-18-2004.



THE MARK CONSISTS OF A STYLIZED C ENCLOSED IN AN OVAL.

FOR HEALTH CLUB SERVICES, NAMELY PROVIDING INSTRUCTION AND EQUIPMENT IN THE FIELD OF PHYSICAL EXERCISE; PERSONAL TRAINING SERVICES, NAMELY, STRENGTH AND CONDITIONING TRAINING; PHYSICAL FITNESS CONSULTATION; PHYSICAL FITNESS INSTRUCTION; PROVIDING TENNIS COURT FACILITIES; TENNIS INSTRUCTION; SPORTS CAMPS; SWIMMING INSTRUCTION; KARATE, JUDO, AND MARTIAL ARTS INSTRUCTION; PROVIDING BASKETBALL AND RACQUETBALL COURT FACILITIES (U.S. CLS. 100, 101 AND 107).

FIRST USE 5-1-2000; IN COMMERCE 5-1-2000.
ELLEN BURNS, EXAMINING ATTORNEY

SN 78-519,763. BYRKIT, DOUG, OVERLAND, MO. FILED 11-18-2004.

The Breakers

THE MARK CONSISTS OF STANDARD CHARACTERS WITHOUT CLAIM TO ANY PARTICULAR FONT, STYLE, SIZE, OR COLOR.

FOR ENTERTAINMENT, NAMELY, LIVE PERFORMANCES BY A MUSICAL GROUP (U.S. CLS. 100, 101 AND 107).

ZACHARY BELLO, EXAMINING ATTORNEY

CLASS 41—(Continued).

SN 78-520,234. VIACOM INTERNATIONAL INC., NEW YORK, NY. FILED 11-19-2004.

CELEBREALITY

THE MARK CONSISTS OF STANDARD CHARACTERS WITHOUT CLAIM TO ANY PARTICULAR FONT, STYLE, SIZE, OR COLOR.

FOR ENTERTAINMENT SERVICES IN THE NATURE OF TELEVISION PROGRAMMING FEATURING LIVE ACTION, COMEDY, DRAMA, ANIMATION, VIDEO GAMES AND MUSIC; PROVIDING INFORMATION IN THE FIELD OF ENTERTAINMENT FEATURING LIVE ACTION, COMEDY, DRAMA, ANIMATION, VIDEO GAMES AND MUSIC VIA A GLOBAL COMPUTER NETWORK (U.S. CLS. 100, 101 AND 107).

FIRST USE 12-5-2004; IN COMMERCE 12-5-2004.
LINDA MICKLEBURGH, EXAMINING ATTORNEY

SN 78-520,650. REILLY, TRACY L., CHICAGO, IL. FILED 11-21-2004.

NO SMALL TALK

THE MARK CONSISTS OF STANDARD CHARACTERS WITHOUT CLAIM TO ANY PARTICULAR FONT, STYLE, SIZE, OR COLOR.

FOR EDUCATIONAL SERVICES, NAMELY, ORGANIZING AND CONDUCTING TRAINING CLASSES, SEMINARS AND WORKSHOPS IN THE FIELDS OF LEGAL CAREER COUNSELING, DEVELOPMENT OF CLIENT RELATIONSHIPS, WRITING, GRAMMAR, SPEAKING, PERSONAL DEVELOPMENT, MOTIVATION, INTERPERSONAL GROWTH AND LEADERSHIP SKILLS (U.S. CLS. 100, 101 AND 107).

JENNIFER WILLISTON, EXAMINING ATTORNEY

CLASS 41—(Continued).

SN 78-520,712. GLOBAL GAMING LEAGUE, INC., SANTA MONICA, CA. FILED 11-22-2004.

STOP PLAYING WITH YOURSELF

THE MARK CONSISTS OF STANDARD CHARACTERS WITHOUT CLAIM TO ANY PARTICULAR FONT, STYLE, SIZE, OR COLOR.

FOR ENTERTAINMENT SERVICES, NAMELY, PROVIDING COMPETITIVE MULTI-PLAYER VIDEO GAMING VIA THE INTERNET, LIVE ON-THE-GROUND EVENTS, TELEVISION AND RADIO (U.S. CLS. 100, 101 AND 107).

DEZMONA MIZELLE, EXAMINING ATTORNEY

SN 78-520,747. CEU.COM, OLD SAYBROOK, CT. FILED 11-22-2004.



NO CLAIM IS MADE TO THE EXCLUSIVE RIGHT TO USE "CEU.COM", APART FROM THE MARK AS SHOWN.

THE COLOR(S) BLUE AND NAVY IS/ARE CLAIMED AS A FEATURE OF THE MARK.

THE LETTERS CEU AND THE LEFT HALF OF THE OPEN BOOK DESIGN IS IN NAVY, THE LETTERS .COM AND THE RIGHT HALF OF THE OPEN BOOK DESIGN ARE IN THE COLOR BLUE.

FOR EDUCATIONAL SERVICES, NAMELY, PROVIDING ONLINE COURSES OF INSTRUCTION IN THE FIELD OF INSURANCE (U.S. CLS. 100, 101 AND 107).

FIRST USE 1-1-1999; IN COMMERCE 1-1-1999.

TARAH HARDY, EXAMINING ATTORNEY

SN 78-521,056. CANTOR CONSULTING, ASHLAND, MA. FILED 11-22-2004.

DREAM FACTORY

THE MARK CONSISTS OF STANDARD CHARACTERS WITHOUT CLAIM TO ANY PARTICULAR FONT, STYLE, SIZE, OR COLOR.

FOR EDUCATIONAL SERVICES NAMELY CONDUCTING PROGRAMS IN THE FIELD OF COMMUNITY-BASED ENTREPRENEURIALISM (U.S. CLS. 100, 101 AND 107).

FIRST USE 11-22-2004; IN COMMERCE 11-22-2004.

TARAH HARDY, EXAMINING ATTORNEY

CLASS 41—(Continued).

SN 78-521,098. SEATTLE AUDUBON SOCIETY, SEATTLE, WA. FILED 11-22-2004.

BIRDNOTE

THE MARK CONSISTS OF STANDARD CHARACTERS WITHOUT CLAIM TO ANY PARTICULAR FONT, STYLE, SIZE, OR COLOR.

FOR ENTERTAINMENT SERVICES, NAMELY, PROVIDING A RADIO PROGRAM ABOUT BIRDS (U.S. CLS. 100, 101 AND 107).

JULIE WATSON, EXAMINING ATTORNEY

CLASS 41—(Continued).

SN 78-521,442. DALE, VALERIA, GREENSBORO, NC. FILED 11-22-2004.



La Escuelita Móvil

THE MARK CONSISTS OF A SMALL SCHOOLHOUSE ON WHEELS MOVING TO THE RIGHT WITH EXHAUST TO THE LEFT AND A FLAG ON THE ROOF. THE FRONT OF THE SCHOOL HAS TWO WINDOWS, ONE DOOR, AND ONE LITTLE BELL.

THE FOREIGN WORDING IN THE MARK TRANSLATES INTO ENGLISH AS THE MOBILE SMALL SCHOOL.

FOR EARLY CHILDHOOD SPANISH EDUCATION; SPANISH CLASSES OFFERED IN DIFFERENT CHILD CARE CENTERS (U.S. CLS. 100, 101 AND 107).

FIRST USE 10-1-2003; IN COMMERCE 10-1-2003.
HOWARD B. LEVINE, EXAMINING ATTORNEY

SN 78-521,352. GOLDWATER, JARED, NEW YORK, NY. FILED 11-22-2004.

DIRICULOUS

THE MARK CONSISTS OF STANDARD CHARACTERS WITHOUT CLAIM TO ANY PARTICULAR FONT, STYLE, SIZE, OR COLOR.

FOR ENTERTAINMENT IN THE NATURE OF AN ONGOING TELEVISION PROGRAM IN THE FIELD OF COMEDY (U.S. CLS. 100, 101 AND 107).

CHARLES L. JENKINS, EXAMINING ATTORNEY

SN 78-521,520. TIME INC., NEW YORK, NY. FILED 11-23-2004.

PICKS & PANS

THE MARK CONSISTS OF STANDARD CHARACTERS WITHOUT CLAIM TO ANY PARTICULAR FONT, STYLE, SIZE, OR COLOR.

OWNER OF U.S. REG. NO. 1,678,513.
SEC. 2(F).

FOR ENTERTAINMENT SERVICES, NAMELY, AN ONGOING TELEVISION PROGRAM FEATURING INFORMATION ABOUT TELEVISION, MUSIC, LITERATURE, MOVIES, STAGE PERFORMANCES AND OTHER ENTERTAINMENT MEDIA (U.S. CLS. 100, 101 AND 107).

ANNE MADDEN, EXAMINING ATTORNEY

CLASS 41—(Continued).

SN 78-521,642. TRAINING & DEVELOPMENT SYSTEMS, INC., HOUSTON, TX. FILED 11-23-2004.



THE COLOR(S) BLUE, GREY AND WHITE IS/ARE CLAIMED AS A FEATURE OF THE MARK.

THE MARK CONSISTS OF A BLUE "TDS" WITH A WHITE AND GREY TELEPHONE DIAL.

FOR BUSINESS TRAINING (U.S. CLS. 100, 101 AND 107).

FIRST USE 3-1-1995; IN COMMERCE 3-1-1995.

APRIL L. RADEMACHER, EXAMINING ATTORNEY

SN 78-522,106. THE CONSERVATION FOUNDATION, NAPERVILLE, IL. FILED 11-23-2004.



NO CLAIM IS MADE TO THE EXCLUSIVE RIGHT TO USE "CONSERVATION@HOME", APART FROM THE MARK AS SHOWN.

FOR EDUCATIONAL SERVICES NAMELY CONDUCTING PROGRAMS IN THE FIELD OF ENVIRONMENTAL PROTECTION AND PRESERVATION (U.S. CLS. 100, 101 AND 107).

REBECCA SMITH, EXAMINING ATTORNEY

SN 78-522,443. ADVANSTAR COMMUNICATIONS INC., DULUTH, MN. FILED 11-24-2004.

**WHAT ARE YOU
RIDING?**

THE MARK CONSISTS OF STANDARD CHARACTERS WITHOUT CLAIM TO ANY PARTICULAR FONT, STYLE, SIZE, OR COLOR.

FOR ORGANIZING, ARRANGING AND CONDUCTING EXPOSITIONS FEATURING MOTORCYCLES AND RELATED PRODUCTS AND ACCESSORIES (U.S. CLS. 100, 101 AND 107).

FIRST USE 8-0-2003; IN COMMERCE 11-7-2003.

KELLY BOULTON, EXAMINING ATTORNEY

CLASS 41—(Continued).

SN 78-522,452. CEC ENTERTAINMENT CONCEPTS, L.P., IRVING, TX. FILED 11-24-2004.

**WHERE A KID CAN BE
A KID**

THE MARK CONSISTS OF STANDARD CHARACTERS WITHOUT CLAIM TO ANY PARTICULAR FONT, STYLE, SIZE, OR COLOR.

OWNER OF U.S. REG. NO. 1,506,573.

FOR ENTERTAINMENT SERVICES, NAMELY, PROVISION OF CHILDREN'S PLAY AREAS AT RESTAURANTS, PROVISION OF ARCADE GAMES, AMUSEMENT ARCADES AND AMUSEMENT ARCADE RIDES; PROVIDING VIDEO AND COIN OPERATED GAMES; AND LIVE THEATRICAL PERFORMANCES FEATURING LIVE AND ELECTRONICALLY ANIMATED CHARACTERS (U.S. CLS. 100, 101 AND 107).

FIRST USE 1-1-1986; IN COMMERCE 1-1-1986.

SCOTT OSLICK, EXAMINING ATTORNEY

SN 78-522,752. BUILD-A-BEAR RETAIL MANAGEMENT, INC., ST. LOUIS, MO. FILED 11-24-2004.

**2DAY'S HOTTEST
NEWS 4 THE COOLEST
GIRLS**

THE MARK CONSISTS OF STANDARD CHARACTERS WITHOUT CLAIM TO ANY PARTICULAR FONT, STYLE, SIZE, OR COLOR.

FOR NEWSLETTERS RELATING TO DOLLS, STUFFED AND PLUSH DOLLS AND ACCESSORIES THEREFOR PROVIDED VIA EMAIL (U.S. CLS. 100, 101 AND 107).

CHERYL CLAYTON, EXAMINING ATTORNEY

CLASS 41—(Continued).

SN 78-522,867. BELLE VUE SUNSHINE TOURING, INC., WOODLAND HILLS, CA. FILED 11-24-2004.

MOTÖRHEAD

THE MARK CONSISTS OF STANDARD CHARACTERS WITHOUT CLAIM TO ANY PARTICULAR FONT, STYLE, SIZE, OR COLOR.

FOR ENTERTAINMENT SERVICES, NAMELY, LIVE PERFORMANCES BY A MUSICAL GROUP (U.S. CLS. 100, 101 AND 107).

FIRST USE 7-20-1975; IN COMMERCE 4-19-1981.
MARK RADEMACHER, EXAMINING ATTORNEY

SN 78-523,261. DIGIART LLC, CENTENNIAL, CO. FILED 11-27-2004.

DIGIART

THE MARK CONSISTS OF STANDARD CHARACTERS WITHOUT CLAIM TO ANY PARTICULAR FONT, STYLE, SIZE, OR COLOR.

FOR ELECTRONIC PUBLISHING SERVICES, NAMELY, PUBLICATION OF GRAPHIC, TEXT AND AUDIO WORKS ON DIGITAL VIDEO DISKS FEATURING EDUCATIONAL AND ENTERTAINMENT MATERIAL (U.S. CLS. 100, 101 AND 107).

ANNE FARRELL, EXAMINING ATTORNEY

CLASS 41—(Continued).

SN 78-523,371. DAY, VENUS MARIA, PORT ORANGE, FL. FILED 11-28-2004.

**Universe
International and
World
Ambassador**

THE MARK CONSISTS OF STANDARD CHARACTERS WITHOUT CLAIM TO ANY PARTICULAR FONT, STYLE, SIZE, OR COLOR.

NO CLAIM IS MADE TO THE EXCLUSIVE RIGHT TO USE "INTERNATIONAL AND WORLD AMBASSADOR", APART FROM THE MARK AS SHOWN.

FOR PROVIDING RECOGNITION BY THE WAY OF AN AWARD TO DEMONSTRATE EXCELLENCE IN THE FIELDS OF EDUCATION, ARTS, HUMANITIES, BUSINESS, TECHNOLOGY, HEALTH AND SCIENCE, AND ESPECIALLY IN THE AREA OF COMMUNITY SERVICE, PRESENTED TO A RECIPIENT CHOSEN BASED UPON THEIR RESUME, CHARACTER, PAST AWARDS, AND HIS/HER CONTINUOUS ACTIVE PURSUIT IN MAKING THE WORLD A BETTER PLACE FOR TOMORROW (U.S. CLS. 100, 101 AND 107).

NORA BUCHANAN WILL, EXAMINING ATTORNEY

SN 78-523,517. THE BARTER FOUNDATION, INCORPORATED, ABINGDON, VA. FILED 11-29-2004.

BARTER

THE MARK CONSISTS OF STANDARD CHARACTERS WITHOUT CLAIM TO ANY PARTICULAR FONT, STYLE, SIZE, OR COLOR.

FOR ENTERTAINMENT SERVICES IN THE NATURE OF LIVE THEATRICAL PERFORMANCES (U.S. CLS. 100, 101 AND 107).

FIRST USE 12-31-1932; IN COMMERCE 12-31-1932.
ZHALEH DELANEY, EXAMINING ATTORNEY

CLASS 41—(Continued).

SN 78-523,529. THE BARTER FOUNDATION, INCORPORATED, ABINGDON, VA. FILED 11-29-2004.

BARTER THEATRE

THE MARK CONSISTS OF STANDARD CHARACTERS WITHOUT CLAIM TO ANY PARTICULAR FONT, STYLE, SIZE, OR COLOR.

NO CLAIM IS MADE TO THE EXCLUSIVE RIGHT TO USE THEATRE, APART FROM THE MARK AS SHOWN.

FOR ENTERTAINMENT SERVICES IN THE NATURE OF LIVE THEATRICAL PERFORMANCES (U.S. CLS. 100, 101 AND 107).

FIRST USE 12-31-1932; IN COMMERCE 12-31-1932.
ZHALEH DELANEY, EXAMINING ATTORNEY

SN 78-523,538. THE BARTER FOUNDATION, INCORPORATED, ABINGDON, VA. FILED 11-29-2004.



NO CLAIM IS MADE TO THE EXCLUSIVE RIGHT TO USE PLAYERS, APART FROM THE MARK AS SHOWN.

THE MARK CONSISTS OF A BLACK AND WHITE IMAGE OF A BOY IN A STRIPED SHIRT WITH A TOP HAT NEXT TO THE WORDS "THE BARTER PLAYERS".

FOR ENTERTAINMENT SERVICES IN THE NATURE OF LIVE THEATRICAL PERFORMANCES (U.S. CLS. 100, 101 AND 107).

FIRST USE 12-31-1967; IN COMMERCE 12-31-1967.
ZHALEH DELANEY, EXAMINING ATTORNEY

CLASS 41—(Continued).

SN 78-523,587. THE NEMOURS FOUNDATION, JACKSONVILLE, FL. FILED 11-29-2004.



OWNER OF U.S. REG. NOS. 2,777,708, 2,777,710 AND OTHERS.

THE COLOR(S) BLUE AND RED IS/ARE CLAIMED AS A FEATURE OF THE MARK.

THE MARK CONSISTS OF THE WORD "NEMOURS", WHICH APPEARS IN BLUE, ABOVE A HORIZONTAL BRUSH STROKE, WHICH APPEARS IN RED.

FOR EDUCATIONAL SERVICES, NAMELY, ARRANGING AND CONDUCTING EDUCATIONAL CONFERENCES, CLASSES, SEMINARS, WORKSHOPS, AND INDIVIDUALIZED INSTRUCTION IN THE FIELDS OF HEALTH CARE, MEDICINE, AND HUMAN WELFARE; DEVELOPMENT AND DISSEMINATION OF EDUCATIONAL MATERIALS IN THE FIELDS OF HEALTH CARE, MEDICINE, AND HUMAN WELFARE (U.S. CLS. 100, 101 AND 107).

FIRST USE 1-0-2004. THE MARK WAS FIRST USED ANYWHERE IN A DIFFERENT FORM OTHER THAN THAT SOUGHT TO BE REGISTERED ON 00/00/1949.; IN COMMERCE 1-0-2004. THE MARK WAS FIRST USED IN COMMERCE IN A DIFFERENT FORM OTHER THAN THAT SOUGHT TO BE REGISTERED ON 00/00/1949..

ESTHER BELENKER, EXAMINING ATTORNEY

SN 78-523,641. KICKDOE ENTERTAINMENT, ELLENWOOD, GA. FILED 11-29-2004.

**Kickdoo
Entertainment**

THE MARK CONSISTS OF STANDARD CHARACTERS WITHOUT CLAIM TO ANY PARTICULAR FONT, STYLE, SIZE, OR COLOR.

NO CLAIM IS MADE TO THE EXCLUSIVE RIGHT TO USE ENTERTAINMENT, APART FROM THE MARK AS SHOWN.

FOR ENTERTAINMENT SERVICES, NAMELY, MUSIC PRODUCTION SERVICES (U.S. CLS. 100, 101 AND 107).

JOHN E. MICHOS, EXAMINING ATTORNEY

CLASS 41—(Continued).

SN 78-523,648. TOUGH MEDIA, INC., HUNTINGTON PARK, CA. FILED 11-29-2004.

CLASS 41—(Continued).

SN 78-523,984. WORLD WRESTLING ENTERTAINMENT, INC., STAMFORD, CT. FILED 11-29-2004.

FIGHT ZONE

THE MASTERPIECE

THE MARK CONSISTS OF STANDARD CHARACTERS WITHOUT CLAIM TO ANY PARTICULAR FONT, STYLE, SIZE, OR COLOR.

NO CLAIM IS MADE TO THE EXCLUSIVE RIGHT TO USE "FIGHT", APART FROM THE MARK AS SHOWN.

FOR ENTERTAINMENT SERVICES IN THE NATURE OF NEWS AND SPORTS PROGRAMMING DISTRIBUTED VIA BROADCAST TELEVISION, CABLE TELEVISION, NEWS REPORTS AND PAY-PER-VIEW MEDIA IN THE FIELDS OF FIGHT BOUTS, SPORTING EVENTS AND FIGHT NEWS, FEATURING MARTIAL ARTS, WRESTLING AND MIXED MARTIAL ARTS (U.S. CLS. 100, 101 AND 107).

JENNIFER DIXON, EXAMINING ATTORNEY

THE MARK CONSISTS OF STANDARD CHARACTERS WITHOUT CLAIM TO ANY PARTICULAR FONT, STYLE, SIZE, OR COLOR.

FOR ENTERTAINMENT SERVICES, NAMELY, LIVE WRESTLING EXHIBITIONS AND PERFORMANCES BY A PROFESSIONAL WRESTLER/ENTERTAINER AND PROVIDING WRESTLING NEWS AND INFORMATION VIA A GLOBAL COMPUTER NETWORK (U.S. CLS. 100, 101 AND 107).

IRA J. GOODSaid, EXAMINING ATTORNEY

SN 78-524,095. THE FERRARI GROUP, LLC, LEXINGTON, KY. FILED 11-29-2004.

SN 78-523,862. NEW YORK COLLEGE OF HEALTH PROFESSIONS, SYOSSET, NY. FILED 11-29-2004.

ETTA MAY

FOR THE CHANGE OF A LIFETIME

THE MARK CONSISTS OF STANDARD CHARACTERS WITHOUT CLAIM TO ANY PARTICULAR FONT, STYLE, SIZE, OR COLOR.

FOR EDUCATIONAL SERVICES, NAMELY PROVIDING COURSES AT THE COLLEGE LEVEL AND DISTRIBUTING COURSE, ADVERTISING, AND PROMOTIONAL MATERIAL IN CONNECTION THEREWITH (U.S. CLS. 100, 101 AND 107).

JOHN WILKE, EXAMINING ATTORNEY

THE MARK CONSISTS OF STANDARD CHARACTERS WITHOUT CLAIM TO ANY PARTICULAR FONT, STYLE, SIZE, OR COLOR.

THE NAME ETTA MAY IDENTIFIES THE STAGE NAME OF BRENDA FERRARI, WHOSE CONSENT TO REGISTER IS SUBMITTED.

FOR ENTERTAINMENT SERVICES IN THE NATURE OF COMEDY PRESENTATIONS, NAMELY, LIVE PERFORMANCES BY COMEDIANS; AND PROVIDING A WEB SITE FEATURING COMEDY ENTERTAINMENT AND COMEDY INFORMATION ON A GLOBAL COMPUTER NETWORK (U.S. CLS. 100, 101 AND 107).

FIRST USE 11-25-1985; IN COMMERCE 11-25-1985.

TANYA AMOS, EXAMINING ATTORNEY

CLASS 41—(Continued).

SN 78-524,103. THE FERRARI GROUP, LLC, LEXINGTON, KY. FILED 11-29-2004.

ETTA MAY AND THE SOUTHERN FRIED CHICKS

THE MARK CONSISTS OF STANDARD CHARACTERS WITHOUT CLAIM TO ANY PARTICULAR FONT, STYLE, SIZE, OR COLOR.

THE NAME ETTA MAY SHOWN IN THE MARK IDENTIFIES THE STAGE NAME OF BRENDA FERRARI, WHOSE CONSENT TO REGISTER IS SUBMITTED.

FOR ENTERTAINMENT SERVICES IN THE NATURE OF COMEDY PRESENTATIONS, NAMELY, LIVE PERFORMANCES BY COMEDIANS (U.S. CLS. 100, 101 AND 107).

FIRST USE 12-14-2003; IN COMMERCE 12-14-2003.
TANYA AMOS, EXAMINING ATTORNEY

SN 78-524,164. CROSTOWN PICTURES, INC., NEW YORK, NY. FILED 11-30-2004.

**Crosstown
Pictures, Inc.**

THE MARK CONSISTS OF STANDARD CHARACTERS WITHOUT CLAIM TO ANY PARTICULAR FONT, STYLE, SIZE, OR COLOR.

NO CLAIM IS MADE TO THE EXCLUSIVE RIGHT TO USE "PICTURES, INC", APART FROM THE MARK AS SHOWN.

FOR MOTION PICTURE FILM PRODUCTION, TELEVISION PRODUCTION, FILM DISTRIBUTION, AND DISTRIBUTION OF TELEVISION PROGRAMS FOR OTHERS (U.S. CLS. 100, 101 AND 107).

MELISSA SHELLA, EXAMINING ATTORNEY

CLASS 41—(Continued).

SN 78-524,555. MAGNA ENTERTAINMENT CORP., AURORA, CANADA, FILED 11-30-2004.

GYPSY ROSE

THE MARK CONSISTS OF STANDARD CHARACTERS WITHOUT CLAIM TO ANY PARTICULAR FONT, STYLE, SIZE, OR COLOR.

FOR HORSE RACE BETTING SERVICES DELIVERED ON-LINE OR THROUGH A COMPUTERIZED BETTING SYSTEM AND SERVICES OF PROVIDING HANDICAPPING ADVICE TO BETTORS DELIVERED ON-LINE OR THROUGH A COMPUTERIZED BETTING SYSTEM (U.S. CLS. 100, 101 AND 107).

MATTHEW PAPPAS, EXAMINING ATTORNEY

SN 78-525,550. CARVILLE, MIKE, NEVADA CITY, CA. FILED 12-1-2004.

Monster Gym

THE MARK CONSISTS OF STANDARD CHARACTERS WITHOUT CLAIM TO ANY PARTICULAR FONT, STYLE, SIZE, OR COLOR.

NO CLAIM IS MADE TO THE EXCLUSIVE RIGHT TO USE "GYM", APART FROM THE MARK AS SHOWN.

FOR HEALTH CLUB SERVICES, NAMELY, PROVIDING EXERCISE INSTRUCTION (U.S. CLS. 100, 101 AND 107).

FIRST USE 9-12-2004; IN COMMERCE 10-24-2004.
MELISSA VALLILLO, EXAMINING ATTORNEY

CLASS 41—(Continued).

SN 78-526,421. STEED HOLT, INC., SAN DIEGO, CA. FILED 12-3-2004.

STEED HOLT

THE MARK CONSISTS OF STANDARD CHARACTERS WITHOUT CLAIM TO ANY PARTICULAR FONT, STYLE, SIZE, OR COLOR.

THE NAME STEED HOLT DOES NOT IDENTIFY A LIVING INDIVIDUAL.

FOR ENTERTAINMENT SERVICES, NAMELY, MOTION PICTURE FILM ACTING (U.S. CLS. 100, 101 AND 107).

TARAH HARDY, EXAMINING ATTORNEY

CLASS 41—(Continued).

SN 78-528,713. TWENTIETH CENTURY FOX FILM CORPORATION, LOS ANGELES, CA. FILED 12-7-2004.



NO CLAIM IS MADE TO THE EXCLUSIVE RIGHT TO USE "FOOTBALL FRIDAY", APART FROM THE MARK AS SHOWN.

FOR ENTERTAINMENT SERVICES IN THE NATURE OF AN ON-GOING TELEVISION PROGRAM FEATURING SPORTS (U.S. CLS. 100, 101 AND 107).

FIRST USE 8-6-2004; IN COMMERCE 8-6-2004.

YSA DEJESUS, EXAMINING ATTORNEY

SN 78-529,619. HOME GROWN INDUSTRIES OF GEORGIA, INC., ATLANTA, GA. FILED 12-9-2004.

SN 78-528,030. AMERICAN PUBLIC POWER ASSOCIATION, WASHINGTON, DC. FILED 12-6-2004.



THE CUBE

THE MARK CONSISTS OF STANDARD CHARACTERS WITHOUT CLAIM TO ANY PARTICULAR FONT, STYLE, SIZE, OR COLOR.

FOR ENTERTAINMENT SERVICES, NAMELY, LIVE MUSIC PERFORMANCES (U.S. CLS. 100, 101 AND 107).

ANDREA K. NADELMAN, EXAMINING ATTORNEY

THE STIPPLING IS FOR SHADING ONLY AND DOES NOT REPRESENT ANY COLOR.

THE MARK CONSISTS OF THE LETTERS R AND P AND THE ARABIC NUMERAL 3 BELOW THE LETTER P WITH STIPPLING IN THE LETTERS AND NUMBER AND WITH A EIGHT PRONGED STAR EMANATING FROM THE CENTER OF THE LETTER P ON A BLACK SQUARE BACKGROUND.

FOR AWARDS PROGRAM FOR MEMBERS ATTAINING IDENTIFIED LEVELS OF PROFICIENCY IN THE AREAS OF ELECTRIC ENERGY RELIABILITY, SAFETY, TRAINING AND SYSTEM IMPROVEMENT OR RESEARCH AND DEVELOPMENT (U.S. CLS. 100, 101 AND 107).

RUSS HERMAN, EXAMINING ATTORNEY

SN 78-531,481. CAMPBELL, VEX X., PHILADELPHIA, PA. FILED 12-13-2004.



FOR ENTERTAINMENT, NAMELY LIVE PERFORMANCES BY A MUSICAL BAND (U.S. CLS. 100, 101 AND 107).

FIRST USE 2-1-2003; IN COMMERCE 2-1-2004.

ADA HAN, EXAMINING ATTORNEY

CLASS 41—(Continued).

SN 78-535,513. CHOHAN, HARJINDER K., FREMONT, CA. FILED 12-20-2004.

MRS. SOUTH ASIA

THE MARK CONSISTS OF STANDARD CHARACTERS WITHOUT CLAIM TO ANY PARTICULAR FONT, STYLE, SIZE, OR COLOR.

NO CLAIM IS MADE TO THE EXCLUSIVE RIGHT TO USE "SOUTH ASIA", APART FROM THE MARK AS SHOWN.

FOR ENTERTAINMENT IN THE NATURE OF BEAUTY PAGEANTS (U.S. CLS. 100, 101 AND 107).
JIM RINGLE, EXAMINING ATTORNEY

CLASS 41—(Continued).

SN 78-536,161. HALL, PATRICE E., LOS ANGELES, CA. FILED 12-21-2004.

Warrior Priestess

THE MARK CONSISTS OF STANDARD CHARACTERS WITHOUT CLAIM TO ANY PARTICULAR FONT, STYLE, SIZE, OR COLOR.

FOR ENTERTAINMENT - PRODUCTION OF TELEVISION PROGRAMS (U.S. CLS. 100, 101 AND 107).
CATHERINE FAINT, EXAMINING ATTORNEY

SN 78-537,661. BENEFIT COSMETICS LLC, SAN FRANCISCO, CA. FILED 12-23-2004.

benefitBASH!
it's a...BLAST•

OWNER OF U.S. REG. NOS. 1,582,141, 2,799,579 AND OTHERS.

FOR EDUCATIONAL SERVICES, NAMELY, CONDUCTING WORKSHOPS IN THE FIELD OF MAKEUP SELECTION AND APPLICATION (U.S. CLS. 100, 101 AND 107).

PAUL F. GAST, EXAMINING ATTORNEY

SN 78-535,881. GREGORY S. WOOD AND ALICE KUN-REAUTHER JOINT VENTURE, THE, ALISO VIEJO, CA. FILED 12-20-2004.



THE COLOR(S) ORANGE AND BLUE IS/ARE CLAIMED AS A FEATURE OF THE MARK.

THE WORDS "PROVIDING", "FOR" AND "SUCCESS" ARE IN BLUE. THE WORD "DIRECTION" IS IN ORANGE. THE IMAGE OF THE ROAD IS OUTLINED WITH BLUE LINES WITH THE LANE MARKERS IN ORANGE. THE ROAD LEADS TOWARD THE WORD "HIRE".

THE MARK CONSISTS OF THE WORDS THEHIREROAD, PROVIDING DIRECTION FOR SUCCESS. THE WORDS "THE" AND "ROAD" ARE BLUE. THE WORD "HIRE" HAS THE "H" AND "R" AND "E" IN ORANGE. THE "I" IS AN ABSTRACT IMAGE OF A PERSON IN BLUE, WITH THE HEAD, OR DOT OF THE "I", IN ORANGE. THE WORDS "PROVIDING", "FOR" AND "SUCCESS" ARE IN BLUE. THE WORD "DIRECTION" IS IN ORANGE. THE IMAGE OF THE ROAD IS OUTLINED WITH BLUE LINES WITH THE LANE MARKERS IN ORANGE. THE ROAD LEADS TOWARD THE WORD "HIRE".

FOR EDUCATIONAL SEMINARS IN THE FIELD OF JOB SEARCH (U.S. CLS. 100, 101 AND 107).

NAAKWAMA ANKRAH, EXAMINING ATTORNEY

SN 78-537,732. DIAMOND LANE, SAN JOSE, CA. FILED 12-23-2004.

DIAMOND LANE

THE MARK CONSISTS OF STANDARD CHARACTERS WITHOUT CLAIM TO ANY PARTICULAR FONT, STYLE, SIZE, OR COLOR.

FOR ENTERTAINMENT SERVICES, NAMELY, LIVE MUSICAL PERFORMANCES AND PUBLIC APPEARANCES BY A MUSICAL AND VOCAL GROUP (U.S. CLS. 100, 101 AND 107).

ELLEN BURNS, EXAMINING ATTORNEY

CLASS 41—(Continued).

SN 78-538,757. MCQUEEN, DEBORAH, LIVERMORE, CA. FILED 12-27-2004.

VOICESMARTS

THE MARK CONSISTS OF STANDARD CHARACTERS WITHOUT CLAIM TO ANY PARTICULAR FONT, STYLE, SIZE, OR COLOR.

OWNER OF U.S. REG. NO. 2,717,456.
FOR EDUCATIONAL SERVICES, NAMELY, CONDUCTING CLASSES, SEMINARS AND WORKSHOPS AT THE PRIMARY LEVEL IN THE FIELD OF OPERA, MUSIC AND LITERATURE (U.S. CLS. 100, 101 AND 107).
CARRIE ACHEN, EXAMINING ATTORNEY

SN 78-538,761. MCQUEEN, DEBORAH, LIVERMORE, CA. FILED 12-27-2004.

VOCALSMARTS

THE MARK CONSISTS OF STANDARD CHARACTERS WITHOUT CLAIM TO ANY PARTICULAR FONT, STYLE, SIZE, OR COLOR.

OWNER OF U.S. REG. NO. 2,717,456.
FOR EDUCATIONAL SERVICES, NAMELY, CONDUCTING CLASSES, SEMINARS, AND WORKSHOPS AT THE PRIMARY LEVEL IN THE FIELD OF OPERA, MUSIC, AND LITERATURE (U.S. CLS. 100, 101 AND 107).
CARRIE ACHEN, EXAMINING ATTORNEY

SN 78-538,904. CHARLES WINTHROPE & SONS, LTD., NILES, IL. FILED 12-28-2004.

CHARLES WINTHROPE & SONS

THE MARK CONSISTS OF STANDARD CHARACTERS WITHOUT CLAIM TO ANY PARTICULAR FONT, STYLE, SIZE, OR COLOR.

THE NAME CHARLES WINTHROPE DOES NOT IDENTIFY A LIVING INDIVIDUAL.
FOR BOOK PUBLISHING SERVICES (U.S. CLS. 100, 101 AND 107).
MARK T. MULLEN, EXAMINING ATTORNEY

CLASS 41—(Continued).

SN 78-541,123. LAFFITTE, TYLER L., MOBILE, AL. FILED 1-3-2005.

RISE-N-GRIND RECORDS

THE MARK CONSISTS OF STANDARD CHARACTERS WITHOUT CLAIM TO ANY PARTICULAR FONT, STYLE, SIZE, OR COLOR.

NO CLAIM IS MADE TO THE EXCLUSIVE RIGHT TO USE "RECORDS", APART FROM THE MARK AS SHOWN.
FOR AUDIO RECORDING AND PRODUCTION; MUSIC PRODUCTION SERVICES (U.S. CLS. 100, 101 AND 107).
CURTIS FRENCH, EXAMINING ATTORNEY

SN 78-541,234. DELLARIA, JOHN, NEW YORK, NY. FILED 1-3-2005.

Pyrametrics

THE MARK CONSISTS OF STANDARD CHARACTERS WITHOUT CLAIM TO ANY PARTICULAR FONT, STYLE, SIZE, OR COLOR.

FOR TRAINING ON A TECHNICAL SYSTEM FOR CUTTING HAIR (U.S. CLS. 100, 101 AND 107).
KATHRYN COWARD, EXAMINING ATTORNEY

CLASS 41—(Continued).

SN 78-541,784. SCALLIWAGS, LLC, PEMBROKE, MA. FILED 1-4-2005.

SCALLIWAGS

THE MARK CONSISTS OF STANDARD CHARACTERS WITHOUT CLAIM TO ANY PARTICULAR FONT, STYLE, SIZE, OR COLOR.

FOR CHILDREN'S ENTERTAINMENT AND AMUSEMENT SERVICES, NAMELY INTERACTIVE PLAY AREAS AND PARTY FACILITIES (U.S. CLS. 100, 101 AND 107).

FIRST USE 8-15-2003; IN COMMERCE 11-28-2003.
LAURIE MAYES, EXAMINING ATTORNEY

CLASS 41—(Continued).

SN 78-542,221. AHMADI, HAMID, CONCORD, CA. FILED 1-5-2005.

ICC

THE MARK CONSISTS OF STANDARD CHARACTERS WITHOUT CLAIM TO ANY PARTICULAR FONT, STYLE, SIZE, OR COLOR.

FOR ENTERTAINMENT IN THE NATURE OF ONGOING TELEVISION PROGRAMS IN THE FIELD OF FOREIGN FILMS; ENTERTAINMENT SERVICES IN THE NATURE OF CABLE AND SATELLITE TELEVISION PROGRAMMING; DISTRIBUTION OF TELEVISION PROGRAMMING TO CABLE TELEVISION SYSTEMS AND DISTRIBUTION OF TELEVISION PROGRAMS FOR OTHERS (U.S. CLS. 100, 101 AND 107).

FIRST USE 9-5-2003; IN COMMERCE 9-5-2003.
SEAN DWYER, EXAMINING ATTORNEY

SN 78-541,989. PEARCE, CHRIS, HONOLULU, HI. FILED 1-4-2005.

THE JOY OF SAKE

THE MARK CONSISTS OF STANDARD CHARACTERS WITHOUT CLAIM TO ANY PARTICULAR FONT, STYLE, SIZE, OR COLOR.

NO CLAIM IS MADE TO THE EXCLUSIVE RIGHT TO USE SAKE, APART FROM THE MARK AS SHOWN.

FOR ENTERTAINMENT SERVICES, NAMELY, CONDUCTING A CULTURAL EVENT DESIGNED TO PROMOTE AWARENESS AND APPRECIATION OF SAKE (U.S. CLS. 100, 101 AND 107).

FIRST USE 8-1-2001; IN COMMERCE 8-1-2001.
CAROLINE WEIMER, EXAMINING ATTORNEY

SN 78-543,444. INSTITUTE FOR MEDICAL EDUCATION & RESEARCH, INC., NORTH MIAMI, FL. FILED 1-6-2005.



THE MARK CONSISTS OF FLOWER HAVING A STEM MADE FROM A RIBBON AND FIVE PETALS EACH FORMED BY A RESPECTIVE RIBBON SURROUNDING A CENTRAL CIRCLE.

FOR PROVIDING CONTINUING MEDICAL EDUCATION COURSES, NAMELY, IN THE FIELD OF ONCOLOGY (U.S. CLS. 100, 101 AND 107).

FIRST USE 4-30-2002; IN COMMERCE 4-30-2002.
BRENDAN REGAN, EXAMINING ATTORNEY

CLASS 41—(Continued).

SN 78-543,840. DEUTSCHE TELEKOM AG, BONN, FED REP GERMANY, FILED 1-7-2005.

CLASS 41—(Continued).

SN 78-544,947. PEAK STRENGTH & CONDITIONING, LLC, TREXLERTOWN, PA. FILED 1-10-2005.

T-Mobile Thanx

THE MARK CONSISTS OF STANDARD CHARACTERS WITHOUT CLAIM TO ANY PARTICULAR FONT, STYLE, SIZE, OR COLOR.

OWNER OF FED REP GERMANY REG. NO. 30441826, DATED 8-16-2004, EXPIRES 7-31-2014.

OWNER OF U.S. REG. NOS. 2,282,432, 2,908,563 AND OTHERS.

FOR EDUCATION AND INSTRUCTION, NAMELY, EDUCATIONAL SERVICES IN THE NATURE OF CLASSES AND SEMINARS IN THE FIELDS OF BUSINESS, TELECOMMUNICATIONS AND COMPUTERS, AND THE DISTRIBUTION OF COURSE MATERIALS THEREWITH; ENTERTAINMENT IN THE NATURE OF VISUAL AND AUDIO PERFORMANCES, NAMELY, MUSICAL BANDS, GYMNASTIC, DANCE, AND BALLET PERFORMANCES; ENTERTAINMENT SERVICES, NAMELY, PROVIDING MUSICAL, VARIETY, NEWS AND COMEDY SHOWS VIA A GLOBAL COMPUTER INFORMATION NETWORK; PROVIDING ENTERTAINMENT INFORMATION AT THE SPECIFIC REQUEST OF END-USERS BY MEANS OF TELEPHONE OR GLOBAL COMMUNICATIONS NETWORKS; ENTERTAINMENT SERVICES, NAMELY, PROVIDING ON-LINE COMPUTER GAMES FOR CHILDREN AND ADULTS; ORGANIZING COMMUNITY SPORTING AND CULTURAL EVENTS; PUBLICATION OF BOOKS, MAGAZINES, JOURNALS, MANUALS, BROCHURES AND LEAFLETS ON THE SUBJECT OF TELECOMMUNICATIONS; ELECTRONIC PUBLISHING SERVICES, NAMELY, PUBLICATION OF TEXT AND GRAPHIC WORKS OF OTHERS ON TELECOMMUNICATIONS RECORDED ON ELECTRONIC MEDIA, NAMELY, CD, DVD AND ONLINE; ORGANIZING FAIRS AND EXHIBITIONS IN THE FIELD OF VISUAL AND AUDIO PERFORMANCES, NAMELY, ROCK GROUP, GYMNASTIC, DANCE, AND BALLET PERFORMANCES (U.S. CLS. 100, 101 AND 107).

LAURIE MAYES, EXAMINING ATTORNEY

WeddingShape

SN 78-544,854. FUEL TV, INC., LOS ANGELES, CA. FILED 1-10-2005.

CUT MASTERS

THE MARK CONSISTS OF STANDARD CHARACTERS WITHOUT CLAIM TO ANY PARTICULAR FONT, STYLE, SIZE, OR COLOR.

FOR ENTERTAINMENT SERVICES IN THE NATURE OF A TELEVISION SERIES IN THE REALITY GENRE (U.S. CLS. 100, 101 AND 107).

SHAUNIA WALLACE, EXAMINING ATTORNEY

THE MARK CONSISTS OF STANDARD CHARACTERS WITHOUT CLAIM TO ANY PARTICULAR FONT, STYLE, SIZE, OR COLOR.

FOR PHYSICAL FITNESS STRENGTH AND CONDITIONING CONSULTATION; TRAINING FOR INDIVIDUALS AND ENTITIES IN THE FIELD OF PHYSICAL FITNESS STRENGTH AND CONDITIONING; PUBLICATION OF BOOKS, MANUALS, BROCHURES, MAGAZINES, AND JOURNALS IN THE FIELD OF PHYSICAL FITNESS STRENGTH AND CONDITIONING; EDUCATIONAL SERVICES, NAMELY PROVIDING ON-LINE, INTERACTIVE PROGRAMS IN THE FIELD OF PHYSICAL FITNESS (U.S. CLS. 100, 101 AND 107).

FIRST USE 1-9-2005; IN COMMERCE 1-9-2005.

ALICE BENMAMAN, EXAMINING ATTORNEY

CLASS 41—(Continued).

SN 78-545,505. DEUTSCHE TELEKOM AG, BONN, FED REP GERMANY, FILED 1-11-2005.

CLASS 41—(Continued).

SN 78-545,549. ID PARTS, INC, GREENSBURGH, PA. FILED 1-11-2005.

**T-Mobile Dial a
Smile**

**Magic Tools
Adventures**

THE MARK CONSISTS OF STANDARD CHARACTERS WITHOUT CLAIM TO ANY PARTICULAR FONT, STYLE, SIZE, OR COLOR.

PRIORITY CLAIMED UNDER SEC. 44(D) ON FED REP GERMANY APPLICATION NO. 30441824238, FILED 7-21-2004, REG. NO. 30441824, DATED 8-31-2004, EXPIRES 7-31-2014.

OWNER OF U.S. REG. NOS. 2,282,432, 2,908,563 AND OTHERS.

FOR EDUCATION AND INSTRUCTION, NAMELY, EDUCATIONAL SERVICES IN THE NATURE OF CLASSES AND SEMINARS IN THE FIELDS OF BUSINESS, TELECOMMUNICATIONS AND COMPUTERS, AND THE DISTRIBUTION OF COURSE MATERIALS THEREWITH; ENTERTAINMENT IN THE NATURE OF VISUAL AND AUDIO PERFORMANCES, NAMELY, MUSICAL BANDS, GYMNASTIC, DANCE, AND BALLET PERFORMANCES; ENTERTAINMENT SERVICES, NAMELY, PROVIDING MUSICAL, VARIETY, NEWS AND COMEDY SHOWS VIA A GLOBAL COMPUTER INFORMATION NETWORK; PROVIDING ENTERTAINMENT INFORMATION AT THE SPECIFIC REQUEST OF END-USERS BY MEANS OF TELEPHONE OR GLOBAL COMMUNICATIONS NETWORKS; ENTERTAINMENT SERVICES, NAMELY, PROVIDING ON-LINE COMPUTER GAMES FOR CHILDREN AND ADULTS; ORGANIZING COMMUNITY SPORTING AND CULTURAL EVENTS; PUBLICATION OF BOOKS, MAGAZINES, JOURNALS, MANUALS, BROCHURES AND LEAFLETS ON THE SUBJECT OF TELECOMMUNICATIONS; ELECTRONIC PUBLISHING SERVICES, NAMELY, PUBLICATION OF TEXT AND GRAPHIC WORKS OF OTHERS ON TELECOMMUNICATIONS RECORDED ON ELECTRONIC MEDIA, NAMELY, CD, DVD AND ONLINE; ORGANIZING FAIRS AND EXHIBITIONS IN THE FIELD OF VISUAL AND AUDIO PERFORMANCES, NAMELY, ROCK GROUP, GYMNASTIC, DANCE, AND BALLET PERFORMANCES (U.S. CLS. 100, 101 AND 107).
LAURIE MAYES, EXAMINING ATTORNEY

THE MARK CONSISTS OF STANDARD CHARACTERS WITHOUT CLAIM TO ANY PARTICULAR FONT, STYLE, SIZE, OR COLOR.

FOR MOTION PICTURE FILM PRODUCTION (U.S. CLS. 100, 101 AND 107).

KAREN BRACEY, EXAMINING ATTORNEY

CLASS 41—(Continued).

SN 78-545,691. DEUTSCHE TELEKOM AG, BONN, FED REP GERMANY, FILED 1-11-2005.

CLASS 41—(Continued).

SN 78-546,250. HARD WATER HOCKEY LLC, MCKINNEY, TX. FILED 1-12-2005.

T-Mobile Thrills



NO CLAIM IS MADE TO THE EXCLUSIVE RIGHT TO USE "TEAM", "TEXAS" OR "ALL - STARS", APART FROM THE MARK AS SHOWN.

FOR EDUCATIONAL SERVICES, NAMELY PROVIDING CLINICS AND CLASSES IN THE SPORT OF ICE HOCKEY (U.S. CLS. 100, 101 AND 107).

FIRST USE 6-1-2004; IN COMMERCE 12-22-2004.

JACQUELINE A. LAVINE, EXAMINING ATTORNEY

THE MARK CONSISTS OF STANDARD CHARACTERS WITHOUT CLAIM TO ANY PARTICULAR FONT, STYLE, SIZE, OR COLOR.

PRIORITY CLAIMED UNDER SEC. 44(D) ON FED REP GERMANY APPLICATION NO. 30441825038, FILED 7-21-2004, REG. NO. 30441825, DATED 8-16-2004, EXPIRES 7-31-2014.

OWNER OF U.S. REG. NOS. 2,282,432, 2,908,563 AND OTHERS.

FOR EDUCATION AND INSTRUCTION, NAMELY, EDUCATIONAL SERVICES IN THE NATURE OF CLASSES AND SEMINARS IN THE FIELDS OF BUSINESS, TELECOMMUNICATIONS AND COMPUTERS, AND THE DISTRIBUTION OF COURSE MATERIALS THEREWITH; ENTERTAINMENT IN THE NATURE OF VISUAL AND AUDIO PERFORMANCES, NAMELY, MUSICAL BANDS, GYMNASTIC, DANCE, AND BALLET PERFORMANCES; ENTERTAINMENT SERVICES, NAMELY, PROVIDING MUSICAL, VARIETY, NEWS AND COMEDY SHOWS VIA A GLOBAL COMPUTER INFORMATION NETWORK; PROVIDING ENTERTAINMENT INFORMATION AT THE SPECIFIC REQUEST OF END-USERS BY MEANS OF TELEPHONE OR GLOBAL COMMUNICATIONS NETWORKS; ENTERTAINMENT SERVICES, NAMELY, PROVIDING ON-LINE COMPUTER GAMES FOR CHILDREN AND ADULTS; ORGANIZING COMMUNITY SPORTING AND CULTURAL EVENTS; PUBLICATION OF BOOKS, MAGAZINES, JOURNALS, MANUALS, BROCHURES AND LEAFLETS ON THE SUBJECT OF TELECOMMUNICATIONS; ELECTRONIC PUBLISHING SERVICES, NAMELY, PUBLICATION OF TEXT AND GRAPHIC WORKS OF OTHERS ON TELECOMMUNICATIONS RECORDED ON ELECTRONIC MEDIA, NAMELY, CD, DVD AND ONLINE; ORGANIZING FAIRS AND EXHIBITIONS IN THE FIELD OF VISUAL AND AUDIO PERFORMANCES, NAMELY, ROCK GROUP, GYMNASTIC, DANCE, AND BALLET PERFORMANCES (U.S. CLS. 100, 101 AND 107).

Laurie Mayes, Examining Attorney

SN 78-546,633. FEATHER ROCK BOOKS, INC., ORONO, MN. FILED 1-12-2005.

FEATHER ROCK BOOKS

THE MARK CONSISTS OF STANDARD CHARACTERS WITHOUT CLAIM TO ANY PARTICULAR FONT, STYLE, SIZE, OR COLOR.

NO CLAIM IS MADE TO THE EXCLUSIVE RIGHT TO USE "BOOKS", APART FROM THE MARK AS SHOWN.

FOR BOOK PUBLISHING SERVICES (U.S. CLS. 100, 101 AND 107).

William Verhosek, Examining Attorney

CLASS 41—(Continued).

SN 78-547,007. SPORT AND HEALTH, INC., VIENNA, VA.
FILED 1-13-2005.

EXPLOSIVE PERFORMANCE

THE MARK CONSISTS OF STANDARD CHARACTERS WITHOUT CLAIM TO ANY PARTICULAR FONT, STYLE, SIZE, OR COLOR.

NO CLAIM IS MADE TO THE EXCLUSIVE RIGHT TO USE "PERFORMANCE", APART FROM THE MARK AS SHOWN.

FOR HEALTH CLUB SERVICES, NAMELY PROVIDING INSTRUCTION AND EQUIPMENT IN THE FIELD OF PHYSICAL EXERCISE; AND PERSONAL TRAINING, NAMELY, STRENGTH AND CONDITIONING TRAINING (U.S. CLS. 100, 101 AND 107).

FIRST USE 4-1-1995; IN COMMERCE 4-1-1995.
CHRISIE B. KING, EXAMINING ATTORNEY

SN 78-547,262. RAINTREE ESSIX INC., WILMINGTON, DE.
FILED 1-13-2005.

MTM

THE MARK CONSISTS OF STANDARD CHARACTERS WITHOUT CLAIM TO ANY PARTICULAR FONT, STYLE, SIZE, OR COLOR.

FOR CONDUCTING SEMINARS, WORKSHOPS, LECTURES, COURSES, EDUCATIONAL CONFERENCES IN THE FIELD OF DENTISTRY, PARTICULARLY ORTHODONTICS, THE OPERATION OF ORTHODONTIC LABORATORIES, ORTHODONTIC TECHNIQUES AND PROCEDURES, AND ORTHODONTIC EQUIPMENT AND TECHNOLOGY (U.S. CLS. 100, 101 AND 107).

FIRST USE 1-15-2004; IN COMMERCE 1-15-2004.
JUDITH HELFMAN, EXAMINING ATTORNEY

CLASS 41—(Continued).

SN 78-548,345. SOUND DEFIANCE, ASTORIA, NY. FILED 1-16-2005.

Distinguish Yourself

THE MARK CONSISTS OF STANDARD CHARACTERS WITHOUT CLAIM TO ANY PARTICULAR FONT, STYLE, SIZE, OR COLOR.

FOR MUSIC COMPOSITION AND PRODUCTION SERVICES FOR OTHERS (U.S. CLS. 100, 101 AND 107).

FIRST USE 11-30-2004; IN COMMERCE 12-12-2004.
LANA PHAM, EXAMINING ATTORNEY

SN 78-550,208. MINNESOTA PUBLIC RADIO, ST. PAUL, MN.
FILED 1-19-2005.

THE GRAPES OF LAUGH

THE MARK CONSISTS OF STANDARD CHARACTERS WITHOUT CLAIM TO ANY PARTICULAR FONT, STYLE, SIZE, OR COLOR.

FOR ENTERTAINMENT SERVICES IN THE NATURE OF WINE TASTINGS; ENTERTAINMENT SERVICES IN THE NATURE OF MUSICAL, DRAMATIC AND COMEDIC PERFORMANCES (U.S. CLS. 100, 101 AND 107).

FIRST USE 8-6-2005; IN COMMERCE 8-6-2005.
MATTHEW KLINE, EXAMINING ATTORNEY

CLASS 41—(Continued).

SN 78-551,028. SPOGGER, INC., REDWOOD CITY, CA. FILED 1-20-2005.

SPOGGER

THE MARK CONSISTS OF STANDARD CHARACTERS WITHOUT CLAIM TO ANY PARTICULAR FONT, STYLE, SIZE, OR COLOR.

FOR ON-LINE LIBRARY SERVICES, NAMELY, PROVIDING ELECTRONIC LIBRARY SERVICES WHICH FEATURE NEWSPAPERS, MAGAZINES, PHOTOGRAPHS, REVIEWS, IMAGES, CATALOGS, AND JOURNALS VIA AN ON-LINE COMPUTER NETWORK; ENTERTAINMENT SERVICES, NAMELY, PROVIDING ON-LINE REVIEWS OF SUBJECT MATTERS OF GENERAL PUBLIC INTEREST; PUBLICATION OF ELECTRONIC JOURNALS, REVIEWS, EDITORIALS, CATALOGS AND BROCHURES ACCESSIBLE VIA A GLOBAL COMPUTER NETWORK; AND PUBLICATION OF THE EDITORIAL CONTENT OF SITES ACCESSIBLE VIA A GLOBAL COMPUTER NETWORK (U.S. CLS. 100, 101 AND 107).

FIRST USE 2-17-2004; IN COMMERCE 2-17-2004.
WILLIAM P. SHANAHAN, EXAMINING ATTORNEY

SN 78-551,812. SAN ANTONIO LIVESTOCK EXPOSITION, INC., SAN ANTONIO, TX. FILED 1-21-2005.

MORE THAN AN 8 SECOND RIDE

THE MARK CONSISTS OF STANDARD CHARACTERS WITHOUT CLAIM TO ANY PARTICULAR FONT, STYLE, SIZE, OR COLOR.

FOR ENTERTAINMENT SERVICES, NAMELY, ORGANIZING, CONDUCTING, PROVIDING AND OPERATING LIVESTOCK SHOWS, LIVESTOCK EXHIBITS, RODEOS, LIVE PERFORMANCE BY A MUSICAL BAND, LIVE PERFORMANCES BY RODEO BULLFIGHTERS, EDUCATIONAL SERVICES, NAMELY, TRAINING IN THE FIELD OF LIVESTOCK (U.S. CLS. 100, 101 AND 107).

JOSETTE BEVERLY, EXAMINING ATTORNEY

CLASS 41—(Continued).

SN 78-552,280. CARRILLO, JAIME ROBERT, WASHINGTON, DC. AND PRICE, MICHAEL SCOTT, NEW YORK, NY. FILED 1-23-2005.

Next Renaissance

THE MARK CONSISTS OF STANDARD CHARACTERS WITHOUT CLAIM TO ANY PARTICULAR FONT, STYLE, SIZE, OR COLOR.

FOR ENTERTAINMENT IN THE NATURE OF THEATER PRODUCTIONS (U.S. CLS. 100, 101 AND 107).
KIMBERLY PERRY, EXAMINING ATTORNEY

SN 78-556,661. DETROIT RIVERFRONT CONSERVANCY, INC., DETROIT, MI. FILED 1-31-2005.

WALK THE WATER'S EDGE

THE MARK CONSISTS OF STANDARD CHARACTERS WITHOUT CLAIM TO ANY PARTICULAR FONT, STYLE, SIZE, OR COLOR.

FOR RECREATIONAL PARK SERVICES (U.S. CLS. 100, 101 AND 107).
JEFFERY COWARD, EXAMINING ATTORNEY

SN 78-557,726. LEGACY HOCKEY, LLC, PHOENIX, AZ. FILED 2-1-2005.

PHOENIX ROADRUNNERS

THE MARK CONSISTS OF STANDARD CHARACTERS WITHOUT CLAIM TO ANY PARTICULAR FONT, STYLE, SIZE, OR COLOR.

NO CLAIM IS MADE TO THE EXCLUSIVE RIGHT TO USE "PHOENIX", APART FROM THE MARK AS SHOWN.
FOR ENTERTAINMENT SERVICES, NAMELY, PROFESSIONAL ICE HOCKEY GAMES, EXHIBITIONS AND COMPETITIONS (U.S. CLS. 100, 101 AND 107).

CHERYL CLAYTON, EXAMINING ATTORNEY

CLASS 41—(Continued).

SN 78-558,958. VIACOM INTERNATIONAL INC., NEW YORK, NY. FILED 2-2-2005.

**MILK IT AND WIN
INSTANT WIN**

THE MARK CONSISTS OF STANDARD CHARACTERS WITHOUT CLAIM TO ANY PARTICULAR FONT, STYLE, SIZE, OR COLOR.

FOR ENTERTAINMENT SERVICES IN THE NATURE OF CONDUCTING A SWEEPSTAKES GAME (U.S. CLS. 100, 101 AND 107).

JACQUELINE A. LAVINE, EXAMINING ATTORNEY

SN 78-559,748. ROME RENEGADES, L.L.C., ROME, GA. FILED 2-3-2005.

**CATCH THE BALL.
HIT THE WALL. THE
NEXT GENERATION
OF FOOTBALL.**

THE MARK CONSISTS OF STANDARD CHARACTERS WITHOUT CLAIM TO ANY PARTICULAR FONT, STYLE, SIZE, OR COLOR.

FOR ENTERTAINMENT IN THE NATURE OF FOOTBALL GAMES (U.S. CLS. 100, 101 AND 107).

MICHAEL KEATING, EXAMINING ATTORNEY

SN 78-580,087. LEGACY HOCKEY, LLC, PHOENIX, AZ. FILED 3-4-2005.



FOR ENTERTAINMENT SERVICES, NAMELY, PROFESSIONAL ICE HOCKEY GAMES, EXHIBITIONS AND COMPETITIONS (U.S. CLS. 100, 101 AND 107).

CHERYL CLAYTON, EXAMINING ATTORNEY

CLASS 41—(Continued).

SN 78-580,089. LEGACY HOCKEY, LLC, PHOENIX, AZ. FILED 3-4-2005.



THE COLOR(S) YELLOW, BLUE, BLACK AND WHITE IS/ ARE CLAIMED AS A FEATURE OF THE MARK.

THE COLOR YELLOW APPEARS IN THE LETTERS PH. THE LETTERS ARE OUTLINED IN BLACK. THE COLORS BLUE, BLACK AND WHITE APPEAR AT THE ENDS OF THE HOCKEY STICKS.

THE MARK CONSISTS OF THE LETTERS PH. THE LETTER X IS COMPRISED OF TWO UPSIDE DOWN HOCKEY STICKS.

FOR ENTERTAINMENT SERVICES, NAMELY, PROFESSIONAL ICE HOCKEY GAMES, EXHIBITIONS AND COMPETITIONS (U.S. CLS. 100, 101 AND 107).

CHERYL CLAYTON, EXAMINING ATTORNEY

SN 78-580,094. LEGACY HOCKEY, LLC, PHOENIX, AZ. FILED 3-4-2005.



FOR ENTERTAINMENT SERVICES, NAMELY, PROFESSIONAL ICE HOCKEY GAMES, EXHIBITIONS AND COMPETITIONS (U.S. CLS. 100, 101 AND 107).

CHERYL CLAYTON, EXAMINING ATTORNEY

SN 78-641,271. THE BOARD OF REGENTS OF THE UNIVERSITY OF OKLAHOMA, NORMAN, OK. FILED 6-1-2005.

SOONERSPORTS.COM

THE MARK CONSISTS OF STANDARD CHARACTERS WITHOUT CLAIM TO ANY PARTICULAR FONT, STYLE, SIZE, OR COLOR.

FOR PROVIDING ON-LINE INFORMATION AND NEWS IN THE FIELD OF COLLEGE SPORTS (U.S. CLS. 100, 101 AND 107).

FIRST USE 1-3-2000; IN COMMERCE 1-3-2000.

DARRYL SPRUILL, EXAMINING ATTORNEY

CLASS 41—(Continued).

SN 78-975,683. PFIZER INC., NEW YORK, NY. FILED 8-27-2003.

SIRBO

FOR EDUCATIONAL SERVICES, NAMELY CONDUCTING SEMINARS IN THE FIELD OF CLINICAL RESEARCH (U.S. CLS. 100, 101 AND 107).
FIRST USE 6-24-2003; IN COMMERCE 6-24-2003.
KATHRYN COWARD, EXAMINING ATTORNEY

SN 78-976,011. P-1 MUSIC, INC., CHICAGO, IL. FILED 2-29-2004.

P-1

THE MARK CONSISTS OF STANDARD CHARACTERS WITHOUT CLAIM TO ANY PARTICULAR FONT, STYLE, SIZE, OR COLOR.

FOR ENTERTAINMENT, NAMELY, LIVE MUSIC CONCERTS AND PERFORMANCES BY A MUSICAL GROUP, AND A PERFORMANCE WEBSITE ON A GLOBAL COMPUTER NETWORK FEATURING INFORMATION ON A MUSICAL GROUP AND ITS MUSICAL PERFORMANCES, TOURS, BIOGRAPHIES, SOUND AND VIDEO RECORDINGS, AND APPEARANCES (U.S. CLS. 100, 101 AND 107).

FIRST USE 4-1-2002; IN COMMERCE 7-1-2002.
MARY BOAGNI, EXAMINING ATTORNEY

SN 79-001,634. THOMAS KOERFER FILM AG, CH-8038 ZÜRICH, SWITZERLAND, FILED 3-4-2004.

VENUS HOTTENTOT

THE MARK CONSISTS OF STANDARD CHARACTERS WITHOUT CLAIM TO ANY PARTICULAR FONT, STYLE, SIZE, OR COLOR.

PRIORITY DATE OF 11-14-2003 IS CLAIMED.
OWNER OF INTERNATIONAL REGISTRATION 0821590 DATED 3-4-2004, EXPIRES 3-4-2014.

THE NAME IN THE MARK DOES NOT IDENTIFY A LIVING INDIVIDUAL.

FOR MOTION PICTURE FILM PRODUCTION (U.S. CLS. 100, 101 AND 107).

TONJA GASKINS, EXAMINING ATTORNEY

CLASS 41—(Continued).

SN 79-004,885. DÖLCOM ÖZEL EGITIM HİZMETLERİ; ANONİM ŞİRKETİ, TURKEY, FILED 5-18-2004.



PRIORITY DATE OF 4-2-2004 IS CLAIMED.
OWNER OF INTERNATIONAL REGISTRATION 0832011 DATED 5-18-2004, EXPIRES 5-18-2014.

NO CLAIM IS MADE TO THE EXCLUSIVE RIGHT TO USE "INTERNATIONAL", APART FROM THE MARK AS SHOWN.

THE COLOR(S) BLUE AND GRAY IS/ARE CLAIMED AS A FEATURE OF THE MARK.

THE COLOR BLUE APPEARS IN THE LETTERING AND IN THE DESIGN PORTION OF THE MARK, THE COLOR GRAY APPEARS IN THE BACKGROUND.

THE WORDING "D DEULCOM INTERNATIONAL" HAS NO MEANING OTHER THAN TRADEMARK SIGNIFICANCE.

FOR EDUCATIONAL SERVICES, NAMELY PROVIDING COURSES OF INSTRUCTION FOR ALL AGE LEVELS, INCLUDING COURSES OF INSTRUCTION THROUGH KINDERGARTENS, BOARDING SCHOOLS, PRIVATE SCHOOLS AND ACADEMIES; EDUCATIONAL SERVICES, NAMELY PROVIDING CONFERENCES, CLASSES, SEMINARS, WORKSHOPS, TRAINING AND COURSES IN FOREIGN LANGUAGES, CAREER PLACEMENT AND ADVANCEMENT, AND PREPARATION FOR TAKING TECHNICAL, ACADEMIC AND CAREER ORIENTED EXAMINATIONS; EDUCATIONAL SERVICES, NAMELY PROVIDING TRAINING IN CAREER ADVANCEMENT AND PLACEMENT FOR HOSTESS CANDIDATES, TICKETING PERSONNEL AND COMPUTER AND IT TECHNICIANS, OPERATORS AND PROGRAMMERS; EDUCATIONAL SERVICES, NAMELY PROVIDING COURSES OF INSTRUCTION TO ASSESS STUDENT SKILLS AND ABILITIES WITH REGARD TO EXAMINATION TAKING AND TO ASSIST STUDENTS OF ALL AGE AND EDUCATION LEVELS TO PREPARE FOR TAKING EXAMINATIONS; EDUCATIONAL SERVICES, NAMELY PROVIDING SEMINARS, CLASSES AND COURSES ABOUT CULTURE, SCIENCE, ART, SPORTS, TOURISM, FOREIGN LANGUAGES, EXPOSITIONS AND COMPUTER SERVICES; TRANSLATION; PUBLICATION OF BOOKS, MAGAZINES AND NEWSPAPERS; LENDING LIBRARIES (U.S. CLS. 100, 101 AND 107).

ANNE E. GUSTASON, EXAMINING ATTORNEY

CLASS 42—SCIENTIFIC, COMPUTER AND LEGAL SERVICES

SN 75-662,999. HONDA GIKEN KOGYO KABUSHIKI KAISHA (HONDA MOTOR CO., LTD.), MINATO-KU, TOKYO 107, JAPAN, FILED 3-18-1999.

HONDA HOMECOMING

OWNER OF U.S. REG. NOS. 826,779, 2,229,290 AND OTHERS.

NO CLAIM IS MADE TO THE EXCLUSIVE RIGHT TO USE "HOMECOMING", APART FROM THE MARK AS SHOWN.

FOR CATERING AND HOSTING AN ANNUAL EVENT, NAMELY A REUNION AND SOCIAL GATHERING OF MOTORCYCLE OWNERS (U.S. CLS. 100 AND 101).

FIRST USE 1-0-1989; IN COMMERCE 1-0-1989.
JULIE WATSON, EXAMINING ATTORNEY

SN 76-424,465. WIRESPEED NETWORKS, INC., IRVINE, CA. FILED 6-24-2002.



NO CLAIM IS MADE TO THE EXCLUSIVE RIGHT TO USE "NETWORKS", APART FROM THE MARK AS SHOWN.

FOR PROFESSIONAL COMPUTER CONSULTING SERVICES (U.S. CLS. 100 AND 101).

FIRST USE 1-24-2001; IN COMMERCE 1-24-2001.
MICHAEL ENGEL, EXAMINING ATTORNEY

SN 76-541,353. RESOLUTION COUNSEL, LLP, CINCINNATI, OH. FILED 8-25-2003.

RESOLUTION COUNSEL

NO CLAIM IS MADE TO THE EXCLUSIVE RIGHT TO USE COUNSEL, APART FROM THE MARK AS SHOWN.

FOR LEGAL SERVICES EXCLUDING CONSULTATION SERVICES IN MATTERS OF FAMILY LAW (U.S. CLS. 100 AND 101).

FIRST USE 4-11-2002; IN COMMERCE 4-11-2002.
SHAUNIA WALLACE, EXAMINING ATTORNEY

SN 76-541,544. RESOLUTION COUNSEL LLP, CINCINNATI, OH. FILED 8-25-2003.

RESOLUTION COUNSEL

NO CLAIM IS MADE TO THE EXCLUSIVE RIGHT TO USE COUNSEL, APART FROM THE MARK AS SHOWN.

FOR LEGAL SERVICES EXCLUDING CONSULTATION SERVICES IN MATTERS OF FAMILY LAW (U.S. CLS. 100 AND 101).

FIRST USE 4-11-2002; IN COMMERCE 4-11-2002.
SHAUNIA WALLACE, EXAMINING ATTORNEY

CLASS 42—(Continued).

SN 76-545,819. COMPLEX SETTLEMENTS, P.C., ST. PAUL, MN. FILED 9-22-2003.

COMPLEX SETTLEMENTS

THE MARK CONSISTS OF STANDARD CHARACTERS WITHOUT CLAIM TO ANY PARTICULAR FONT, STYLE, SIZE, OR COLOR.

NO CLAIM IS MADE TO THE EXCLUSIVE RIGHT TO USE "SETTLEMENTS", APART FROM THE MARK AS SHOWN.

FOR LEGAL SERVICES (U.S. CLS. 100 AND 101).
FIRST USE 6-25-2003; IN COMMERCE 8-21-2003.
ALEXANDER L. POWERS, EXAMINING ATTORNEY

SN 76-548,313. NOVAURORA, INC., PITTSBURGH, PA. FILED 10-1-2003.



OWNER OF U.S. REG. NO. 2,737,583.

THE MARK CONSISTS OF THE WORD NOVAURORA AND A FANCIFUL DESIGN OF TWO STYLIZED TRIANGLES.

FOR WEBSITE DEVELOPMENT AND PROGRAMMING SERVICES FOR OTHERS, NAMELY, DIGITAL DESIGN SERVICES, MULTIMEDIA DESIGN, WEB DESIGN AND GRAPHIC DESIGN SERVICES; WEBSITE HOSTING SERVICES (U.S. CLS. 100 AND 101).

FIRST USE 2-27-2002; IN COMMERCE 2-27-2002.
BRIAN PINO, EXAMINING ATTORNEY

SN 76-549,077. BECHTEL, SYLVIA, LAFAYETTE, IN. FILED 10-6-2003.

AVENCAP

FOR CONSULTING SERVICES IN THE FIELD OF INTELLECTUAL PROPERTY LICENSING (U.S. CLS. 100 AND 101).

FIRST USE 8-28-2003; IN COMMERCE 8-28-2003.
LESLEY LAMOTHE, EXAMINING ATTORNEY

CLASS 42—(Continued).

SN 76-554,093. THE MOSAIC TILE COMPANY OF VIRGINIA, INC., SPRINGFIELD, VA. FILED 10-24-2003.



NO CLAIM IS MADE TO THE EXCLUSIVE RIGHT TO USE "MOSAIC TILE COMPANY", APART FROM THE MARK AS SHOWN.

SEC. 2(F).
FOR DESIGN CONSULTATION FEATURING TILING AND STONE (U.S. CLS. 100 AND 101).

FIRST USE 9-17-2001; IN COMMERCE 9-17-2001.
GIANCARLO CASTRO, EXAMINING ATTORNEY

SN 76-570,130. DEKRA E.V., D-70565 STUTTGART, FED REP GERMANY, FILED 1-14-2004.



THE COLOR(S) GREEN IS/ARE CLAIMED AS A FEATURE OF THE MARK.

THE MARK CONSISTS OF THE WORD DEKRA AND A STYLIZED, TRIANGULAR D-SHAPED DESIGN, BOTH IN THE COLOR GREEN. THE COLOR GREEN APPEARS THROUGHOUT EVERY PORTION OF THE MARK.

FOR TESTING, ANALYSIS, EVALUATION AND INSPECTION OF THE GOODS AND SERVICES OF OTHERS IN THE FIELD OF AUTOMOTIVE MANUFACTURING AND THE AUTOMOTIVE AFTERMARKET FOR THE PURPOSE OF CERTIFICATION; TECHNICAL CONSULTATION IN THE FIELDS OF AUTOMOTIVE MANUFACTURING AND THE AUTOMOTIVE AFTERMARKET (U.S. CLS. 100 AND 101).

TONI HICKEY, EXAMINING ATTORNEY

SN 76-573,389. RYOSAN COMPANY LIMITED, CHIYODAKU, TOKYO, JAPAN, FILED 2-3-2004.

centrAct

THE MARK CONSISTS OF STANDARD CHARACTERS WITHOUT CLAIM TO ANY PARTICULAR FONT, STYLE, SIZE, OR COLOR.

PRIORITY CLAIMED UNDER SEC. 44(D) ON JAPAN APPLICATION NO. 2003-107274, FILED 12-3-2003, REG. NO. 4788121, DATED 7-16-2004, EXPIRES 7-16-2014.

FOR COMPUTER SOFTWARE DESIGN FOR OTHERS; MAINTENANCE OF COMPUTER SOFTWARE; DATABASE DEVELOPMENT SERVICES; AND RENTAL OF COMPUTERS (U.S. CLS. 100 AND 101).

DORITT L. CARROLL, EXAMINING ATTORNEY

CLASS 42—(Continued).

SN 76-585,566. DEACERO, S.A. DE CV., GARZA GARCIA, NL, MEXICO, FILED 4-5-2004.

IDEA SOLUTIONS

THE MARK CONSISTS OF STANDARD CHARACTERS WITHOUT CLAIM TO ANY PARTICULAR FONT, STYLE, SIZE, OR COLOR.

PRIORITY CLAIMED UNDER SEC. 44(D) ON MEXICO APPLICATION NO. 648914, FILED 3-26-2004, REG. NO. 795733, DATED 3-26-2004, EXPIRES 3-26-2014.

NO CLAIM IS MADE TO THE EXCLUSIVE RIGHT TO USE "SOLUTIONS", APART FROM THE MARK AS SHOWN.

FOR DESIGN AND DEVELOPMENT OF COMPUTER PROGRAMS AND SOFTWARE FOR USE IN THE FIELD OF INDUSTRIAL RESEARCH, INDUSTRIAL EQUIPMENT AND LEGAL SERVICES (U.S. CLS. 100 AND 101).
TARAH HARDY, EXAMINING ATTORNEY

SN 76-585,989. ACS MARKETING, L.P., DALLAS, TX. FILED 4-9-2004.

ACSNET

THE MARK CONSISTS OF STANDARD CHARACTERS WITHOUT CLAIM TO ANY PARTICULAR FONT, STYLE, SIZE, OR COLOR.

OWNER OF U.S. REG. NOS. 2,150,183 AND 2,153,370.
FOR INTEGRATION OF COMPUTER NETWORKS THAT PROVIDE VOICE AND DATA COMMUNICATIONS FOR CUSTOMERS IN PRIVATE AND VIRTUAL PRIVATE NETWORKS (U.S. CLS. 100 AND 101).

VERNA BETH RIRIE, EXAMINING ATTORNEY

SN 76-589,262. ADVANCED TECHNOLOGY SYSTEMS, INC., PITTSBURGH, PA. FILED 4-29-2004.

SOLVING TOMORROW'S PROBLEMS TODAY

THE MARK CONSISTS OF STANDARD CHARACTERS WITHOUT CLAIM TO ANY PARTICULAR FONT, STYLE, SIZE, OR COLOR.

FOR ENGINEERING SERVICES (U.S. CLS. 100 AND 101).

FIRST USE 1-0-2004; IN COMMERCE 1-0-2004.
CATHERINE CAIN, EXAMINING ATTORNEY

CLASS 42—(Continued).

SN 76-591,624. ADVANCED TECHNOLOGY SYSTEMS, INC., PITTSBURGH, PA. FILED 5-11-2004.

CHESTER ENGINEERS

THE MARK CONSISTS OF STANDARD CHARACTERS WITHOUT CLAIM TO ANY PARTICULAR FONT, STYLE, SIZE, OR COLOR.

NO CLAIM IS MADE TO THE EXCLUSIVE RIGHT TO USE "ENGINEERS", APART FROM THE MARK AS SHOWN.

FOR ENGINEERING SERVICES (U.S. CLS. 100 AND 101).

FIRST USE 0-0-1910; IN COMMERCE 0-0-1910.
ALICE BENMAMAN, EXAMINING ATTORNEY

SN 76-591,890. BUILDING RESEARCH SYSTEMS, INC., EDMOND, OK. FILED 5-12-2004.

ROLLLOK

THE MARK CONSISTS OF STANDARD CHARACTERS WITHOUT CLAIM TO ANY PARTICULAR FONT, STYLE, SIZE, OR COLOR.

FOR LICENSING OF INTELLECTUAL PROPERTY TO THE METAL BUILDING CONSTRUCTION INDUSTRY (U.S. CLS. 100 AND 101).

FIRST USE 1-27-1999; IN COMMERCE 1-27-1999.
ELLEN PERKINS, EXAMINING ATTORNEY

SN 76-591,929. DATAWATCH SYSTEMS, INC., BETHESDA, MD. FILED 5-13-2004.

ENERGYWATCH

THE MARK CONSISTS OF STANDARD CHARACTERS WITHOUT CLAIM TO ANY PARTICULAR FONT, STYLE, SIZE, OR COLOR.

FOR REMOTE ACTIVATION SERVICES FOR BUILDING AIR CONDITIONING AND HEATING SYSTEMS FOR AFTER HOURS ACCESS (U.S. CLS. 100 AND 101).

BRENDAN REGAN, EXAMINING ATTORNEY

CLASS 42—(Continued).

SN 76-594,250. THQ WIRELESS INC., CALABASAS HILLS, CA. FILED 5-21-2004.



NO CLAIM IS MADE TO THE EXCLUSIVE RIGHT TO USE "WIRELESS", APART FROM THE MARK AS SHOWN.

THE MARK CONSISTS OF THE LETTERS THQ IN STYLIZED TYPE APPEARING ON A PARALLELOGRAM BACKGROUND. THE STYLIZED LETTERS THQ ARE UNDERLINED BY A LINE ON THE PARALLELOGRAM BACKGROUND. BELOW, THE LETTERS WIRELESS IN STYLIZED TYPE APPEAR PARTIALLY SURROUNDED BY A CRESCENT SHAPE.

FOR APPLICATION SERVICE PROVIDER, NAMELY, HOSTING WIRELESS SOFTWARE APPLICATIONS OF OTHERS, NAMELY, WIRELESS GAMES AND ENTERTAINMENT APPLICATIONS FOR MULTIPLE CARRIERS; DEVELOPMENT OF WIRELESS GAME AND ENTERTAINMENT SOFTWARE FOR USE ACROSS MULTIPLE MOBILE HANDSETS, CARRIERS AND GATEWAYS, FOR OTHERS (U.S. CLS. 100 AND 101).

FIRST USE 4-23-2004; IN COMMERCE 4-23-2004.
RONALD AIKENS, EXAMINING ATTORNEY

SN 76-598,248. COMPETENTMED, INC., DOUGLASVILLE, PA. FILED 6-21-2004.

COMPETENTMED

THE MARK CONSISTS OF STANDARD CHARACTERS WITHOUT CLAIM TO ANY PARTICULAR FONT, STYLE, SIZE, OR COLOR.

FOR PROVIDING TEMPORARY USE OF ON-LINE EDUCATIONAL SOFTWARE FOR TEACHING MEDICAL STUDENTS BY ENABLING STUDENTS TO ASK QUESTIONS TO A COMPUTERIZED SIMULATED PATIENT AND REACH A DIAGNOSIS BASED ON THE RESPONSE. (U.S. CLS. 100 AND 101).

MICHELE SWAIN, EXAMINING ATTORNEY

CLASS 42—(Continued).

SN 76-598,249. COMPETENTMED, INC., DOUGLASVILLE, PA. FILED 6-21-2004.

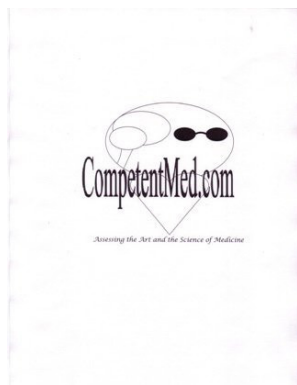

NO CLAIM IS MADE TO THE EXCLUSIVE RIGHT TO USE "MEDICINE", APART FROM THE MARK AS SHOWN. THE MARK CONSISTS OF A DRAWING OF A HEAD WITH GLASSES, AND PARTS OF THE BRAIN; A HEART IS UNDERNEATH THE HEAD.

FOR PROVIDING TEMPORARY USE OF ON-LINE EDUCATIONAL SOFTWARE FOR TEACHING MEDICAL STUDENTS BY ENABLING STUDENTS TO ASK QUESTIONS TO A COMPUTERIZED SIMULATED PATIENT AND REACH A DIAGNOSIS BASED ON THE RESPONSE. (U.S. CLS. 100 AND 101).

MICHELE SWAIN, EXAMINING ATTORNEY

SN 76-599,547. ARGENT CONSULTING SERVICES, INC., HOUSTON, TX. FILED 6-28-2004.

PERPETUAL COMPLIANCE ASSURANCE

THE MARK CONSISTS OF STANDARD CHARACTERS WITHOUT CLAIM TO ANY PARTICULAR FONT, STYLE, SIZE, OR COLOR.

NO CLAIM IS MADE TO THE EXCLUSIVE RIGHT TO USE "PERPETUAL COMPLIANCE", APART FROM THE MARK AS SHOWN.

FOR PROVIDING TEMPORARY USE OF ON-LINE NON-DOWNLOADABLE SOFTWARE FOR USE IN FACILITATING COMPLIANCE WITH STATUTES, LAWS, RULES, REGULATIONS, CODES AND EMPLOYEE MANUAL REGULATIONS (U.S. CLS. 100 AND 101).

FIRST USE 1-1-2004; IN COMMERCE 1-1-2004.
RENEE MCCRAY, EXAMINING ATTORNEY

CLASS 42—(Continued).

SN 76-600,067. SUNGARD FINANCIAL SYSTEMS INC., HOPKINS, MN. FILED 7-1-2004.

FITRAC

THE MARK CONSISTS OF STANDARD CHARACTERS WITHOUT CLAIM TO ANY PARTICULAR FONT, STYLE, SIZE, OR COLOR.

FOR COMPUTER SERVICES, NAMELY PROVIDING ON-LINE NON-DOWNLOADABLE SOFTWARE THROUGH WHICH FINANCIAL INSTITUTIONS REPORT FINANCIAL INSTRUMENT TRADING, TRADE CLEARANCE AND SETTLEMENT ASSOCIATED WITH SECURITIES TRADING TO FINANCIAL CLEARING-HOUSES (U.S. CLS. 100 AND 101).

DARRYL SPRUILL, EXAMINING ATTORNEY

SN 76-603,263. EPICHEM PTY LTD, WESTERN AUSTRALIA, 6150, AUSTRALIA, FILED 7-21-2004.

EPICHEM

THE MARK CONSISTS OF STANDARD CHARACTERS WITHOUT CLAIM TO ANY PARTICULAR FONT, STYLE, SIZE, OR COLOR.

PRIORITY CLAIMED UNDER SEC. 44(D) ON AUSTRALIA APPLICATION NO. 990668, FILED 2-25-2004, REG. NO. 990668, DATED 2-25-2004, EXPIRES 2-25-2014.

FOR SCIENTIFIC RESEARCH; SCIENTIFIC RESEARCH AND DEVELOPMENT; SCIENTIFIC INVESTIGATIONS FOR MEDICAL PURPOSES; DEVELOPMENT OF NEW TECHNOLOGY FOR OTHERS IN THE FIELDS OF CHEMISTRY, BIOTECHNOLOGY, AND BIOLOGY; DEVELOPMENT OF NEW TECHNOLOGY FOR OTHERS IN THE VETERINARY, PHARMACEUTICAL, DRUG DISCOVERY, SYNTHETIC AND MEDICINAL CHEMISTRY FIELDS; TECHNOLOGY CONSULTATION IN THE FIELDS OF CHEMISTRY, BIOTECHNOLOGY, AND BIOLOGY; TECHNOLOGY CONSULTATION IN THE VETERINARY, PHARMACEUTICAL, DRUG DISCOVERY, SYNTHETIC AND MEDICINAL CHEMISTRY FIELDS; CHEMICAL RESEARCH; CHEMICAL, BIOCHEMICAL, BIOLOGICAL AND BACTERIOLOGICAL RESEARCH AND ANALYSIS; INFORMATION ON THE SUBJECT OF SCIENTIFIC RESEARCH IN THE FIELDS OF CHEMISTRY, BIOTECHNOLOGY, AND BIOLOGY; INFORMATION ON THE SUBJECT OF SCIENTIFIC RESEARCH IN THE VETERINARY, PHARMACEUTICAL, DRUG DISCOVERY, SYNTHETIC AND MEDICINAL CHEMISTRY FIELDS; LABORATORY RESEARCH IN THE FIELDS OF CHEMISTRY, BIOTECHNOLOGY, AND BIOLOGY; LABORATORY RESEARCH IN THE VETERINARY, PHARMACEUTICAL, DRUG DISCOVERY, SYNTHETIC AND MEDICINAL CHEMISTRY FIELDS; PHARMACEUTICAL RESEARCH AND DEVELOPMENT.

CLASS 42—(Continued).

OPMENT; PHARMACEUTICAL RESEARCH SERVICES; PRODUCT RESEARCH; PRODUCT RESEARCH AND DEVELOPMENT; RESEARCH AND DEVELOPMENT FOR NEW PRODUCTS FOR OTHERS; RESEARCH AND DEVELOPMENT OF VACCINES AND MEDICINES; RESEARCH IN THE FIELD OF CHEMISTRY; RESEARCH ON THE SUBJECT OF PHARMACEUTICALS; RESEARCH AND DESIGN OF CHEMICALS FOR USE IN THE FIELDS OF BIOTECHNOLOGY AND BIOLOGY; RESEARCH AND DESIGN OF CHEMICALS FOR USE IN THE VETERINARY AND PHARMACEUTICAL FIELDS; PHARMACEUTICAL DRUG DEVELOPMENT SERVICES; CHEMISTRY CONSULTATION; SYNTHETIC AND MEDICINAL CHEMISTRY CONSULTATION; CONSULTING SERVICES IN THE FIELDS OF CHEMISTRY, BIOTECHNOLOGY, AND BIOLOGY; CONSULTING SERVICES IN THE VETERINARY, PHARMACEUTICAL, DRUG DISCOVERY, SYNTHETIC AND MEDICINAL CHEMISTRY FIELDS; LABORATORY RESEARCH IN THE FIELDS OF CHEMISTRY, BIOTECHNOLOGY, AND BIOLOGY (U.S. CLS. 100 AND 101).

LINDA E. BLOHM, EXAMINING ATTORNEY

SN 76-613,662. CARPENTER & KULAS, LLP, PALO ALTO, CA. FILED 9-20-2004.

MAKING THE MOST OF IDEAS

THE MARK CONSISTS OF STANDARD CHARACTERS WITHOUT CLAIM TO ANY PARTICULAR FONT, STYLE, SIZE, OR COLOR.

FOR LEGAL SERVICES (U.S. CLS. 100 AND 101).

FIRST USE 4-0-2003; IN COMMERCE 4-0-2003.

ALEXANDER L. POWERS, EXAMINING ATTORNEY

SN 76-614,520. ASF-KEYSTONE, INC., GRANITE CITY, IL. FILED 10-1-2004.

BLUE-WAVE

THE MARK CONSISTS OF STANDARD CHARACTERS WITHOUT CLAIM TO ANY PARTICULAR FONT, STYLE, SIZE, OR COLOR.

FOR PROVIDING QUALITY CONTROL FOR OTHERS FOR THE MANUFACTURE OF RAILWAY FREIGHT CAR CASTINGS (U.S. CLS. 100 AND 101).

FIRST USE 9-15-2004; IN COMMERCE 9-15-2004.

AISHA CLARKE, EXAMINING ATTORNEY

CLASS 42—(Continued).

SN 76-614,521. ASF-KEYSTONE, INC., GRANITE CITY, IL. FILED 10-1-2004.

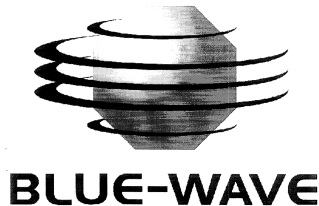

FOR PROVIDING QUALITY CONTROL FOR OTHERS FOR THE MANUFACTURE OF RAILWAY FREIGHT CAR CASTINGS (U.S. CLS. 100 AND 101).
FIRST USE 9-15-2004; IN COMMERCE 9-15-2004.
AISHA CLARKE, EXAMINING ATTORNEY

SN 76-619,357. PROGRESSIVE SOFTWARE COMPUTING INC., WILMINGTON, DE. FILED 11-4-2004.

PSCI

THE MARK CONSISTS OF STANDARD CHARACTERS WITHOUT CLAIM TO ANY PARTICULAR FONT, STYLE, SIZE, OR COLOR.

FOR CONSULTING SERVICES IN THE FIELD OF DESIGN, SELECTION, IMPLEMENTATION AND USE OF COMPUTER HARDWARE AND SOFTWARE SYSTEMS FOR OTHERS (U.S. CLS. 100 AND 101).

FIRST USE 1-0-1997; IN COMMERCE 1-0-1997.

JULIE WATSON, EXAMINING ATTORNEY

SN 76-619,377. SARAH A. FONTINEL DESIGNS, LLC, AUSTIN, TX. FILED 11-5-2004.

PAINTING WITH TILE

THE MARK CONSISTS OF STANDARD CHARACTERS WITHOUT CLAIM TO ANY PARTICULAR FONT, STYLE, SIZE, OR COLOR.

FOR ARTISTIC DESIGN SERVICES IN THE FIELD OF MOSAICS AND WARM GLASS (U.S. CLS. 100 AND 101).

FIRST USE 12-1-2002; IN COMMERCE 12-1-2002.

JOSETTE BEVERLY, EXAMINING ATTORNEY

CLASS 42—(Continued).

SN 76-619,588. MYCOM GROUP, INC., CINCINNATI, OH.
FILED 11-8-2004.

MAILMAX

THE MARK CONSISTS OF STANDARD CHARACTERS WITHOUT CLAIM TO ANY PARTICULAR FONT, STYLE, SIZE, OR COLOR.

FOR COMPUTER SERVICES, NAMELY, SCANNING, FILTERING, AND HANDLING OF INBOUND AND OUTBOUND E-MAILS CONTAINING SPAM, VIRUSES, PORNOGRAPHY, INAPPROPRIATE CONTENT AND LANGUAGE, AND UNACCEPTABLE SIZE, AND ISSUING REPORTS ASSOCIATED THEREWITH (U.S. CLS. 100 AND 101).

FIRST USE 1-1-1999; IN COMMERCE 7-26-1999.
JEFFERY COWARD, EXAMINING ATTORNEY

SN 76-619,599. WIND ENGINEERING COMPANY, KIRKWOOD, MO. FILED 11-8-2004.



NO CLAIM IS MADE TO THE EXCLUSIVE RIGHT TO USE "ENGINEERING COMPANY", APART FROM THE MARK AS SHOWN.

FOR ENGINEERING SERVICES (U.S. CLS. 100 AND 101).

FIRST USE 7-0-2000; IN COMMERCE 7-0-2000.
LA TONIA FISHER, EXAMINING ATTORNEY

SN 76-620,855. THE CIA GROUP, LLC, FOUNTAIN INN, SC.
FILED 11-15-2004.

HYPERHEALTHY

THE MARK CONSISTS OF STANDARD CHARACTERS WITHOUT CLAIM TO ANY PARTICULAR FONT, STYLE, SIZE, OR COLOR.

FOR INDOOR AIR QUALITY ANALYSIS AND RESEARCH, TESTING, AND CONSULTATION IN THE FIELD OF INDOOR AIRBORNE POLLUTANT PREVENTION (U.S. CLS. 100 AND 101).

FIRST USE 9-1-2004; IN COMMERCE 9-1-2004.
DAHLIA GEORGE, EXAMINING ATTORNEY

CLASS 42—(Continued).

SN 76-620,959. LS3P ASSOCIATES, LTD., CHARLESTON, SC.
FILED 11-17-2004.

**SOLUTIONS through LISTENING
SERVICE by DESIGN
SUCCESS from EXPERIENCE**

THE MARK CONSISTS OF STANDARD CHARACTERS WITHOUT CLAIM TO ANY PARTICULAR FONT, STYLE, SIZE, OR COLOR.

FOR ARCHITECTURAL SERVICES, NAMELY, DESIGN OF BUILDINGS (U.S. CLS. 100 AND 101).

FIRST USE 0-0-2003; IN COMMERCE 0-0-2003.
NORA BUCHANAN WILL, EXAMINING ATTORNEY

SN 76-621,426. PIXELFORCE, LLC, LACONIA, NH. FILED 11-22-2004.

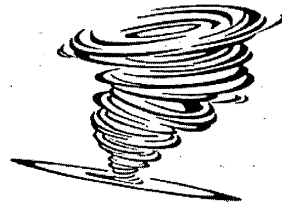

FOR MULTI-MEDIUM GRAPHIC DESIGN SERVICES (U.S. CLS. 100 AND 101).

FIRST USE 9-28-2004; IN COMMERCE 9-28-2004.
GIANCARLO CASTRO, EXAMINING ATTORNEY

SN 76-621,900. REPROMEDIX CORPORATION, WOBURN, MA. FILED 11-23-2004.

REPROMEDIX

THE MARK CONSISTS OF STANDARD CHARACTERS WITHOUT CLAIM TO ANY PARTICULAR FONT, STYLE, SIZE, OR COLOR.

FOR LABORATORY TESTING AND RESEARCH IN THE FIELD OF REPRODUCTIVE HEALTH AND MEDICINE AND PROVIDING INFORMATION ON THE SUBJECT OF SCIENTIFIC RESEARCH IN THE FIELD OF REPRODUCTIVE HEALTH (U.S. CLS. 100 AND 101).

FIRST USE 11-0-1994; IN COMMERCE 11-0-1994.
CARRIE ACHEN, EXAMINING ATTORNEY

CLASS 42—(Continued).

SN 76-622,342. ASICS CORPORATION, CHUO-KU, KOBE 650-8555, JAPAN, FILED 11-26-2004.

ATOMIC WASH

THE MARK CONSISTS OF STANDARD CHARACTERS WITHOUT CLAIM TO ANY PARTICULAR FONT, STYLE, SIZE, OR COLOR.

FOR ACCREDITATION SERVICES, NAMELY, DEVELOPING, EVALUATING AND TESTING STANDARDS FOR ATHLETIC APPAREL FOR THE PURPOSE OF ACCREDITATION (U.S. CLS. 100 AND 101).

FIRST USE 5-2-2002; IN COMMERCE 5-2-2002.
KIMBERLY PERRY, EXAMINING ATTORNEY

CLASS 42—(Continued).

SN 76-626,441. HEARTLAND HYBRIDS, INC., DASSEL, MN. FILED 12-28-2004.

CS³

FOR PROPRIETARY GRAPHIC INFORMATION AND MAPPING SERVICE UTILIZING A SUBSCRIBER-BASED GLOBAL ACCESS COMPUTER SYSTEM WHICH ACCESSES AND INTEGRATES GOVERNMENT AND PRIVATE PARTY SATELLITE AND AERIAL PHOTOGRAPHS, GEOGRAPHIC AND INFORMATIONAL MAPS AND OTHER DATA SOURCES TO CREATE CUSTOM MAPS AND IMAGES OF INTEREST TO FARMERS AND OTHER AGRICULTURAL CUSTOMERS ILLUSTRATING HISTORIC SOIL CONDITIONS, CROP GROWTH AND OTHER RELEVANT INFORMATION (U.S. CLS. 100 AND 101).

FIRST USE 7-31-2004; IN COMMERCE 9-30-2004.
TEJBIR SINGH, EXAMINING ATTORNEY

SN 76-626,577. JAXARA GROUP, LLC, BETHESDA, MD. FILED 12-30-2004.

JAXARA

THE MARK CONSISTS OF STANDARD CHARACTERS WITHOUT CLAIM TO ANY PARTICULAR FONT, STYLE, SIZE, OR COLOR.

FOR CONSULTING SERVICES IN THE FIELD OF DESIGN, SELECTION, IMPLEMENTATION AND USE OF COMPUTER HARDWARE AND SOFTWARE SYSTEMS FOR OTHERS; COMPUTER CONSULTING SERVICES FOR PLANNING, DESIGN, AND ANALYSIS OF INFORMATION PROCESSES, SYSTEMS, AND BUSINESS REENGINEERING; ANALYSIS AND DESIGN OF COMPUTER SYSTEMS, SOFTWARE AND INFORMATION SYSTEMS FOR OTHERS; DESIGN FOR OTHERS OF WEB SITES AND SOFTWARE APPLICATIONS THEREFORE ON LOCAL AND INTERNAL COMPUTER NETWORKS AND THE INTERNET; PROVIDING DESIGN, DEVELOPMENT, MAINTENANCE, AND HOST SERVICES FOR OTHERS' INTERNET WEB SITES AND COMPUTER NETWORKS; INFORMATION TECHNOLOGY CONSULTATION SERVICES; COMPUTER CONSULTATION ON THE COMPUTER-RELATED ASPECTS OF E-COMMERCE AND INFORMATION TECHNOLOGY SECURITY; PROVIDING INFORMATION OVER LOCAL AND INTERNAL COMPUTER NETWORKS AND THE INTERNET ON THE SUBJECTS OF COMPUTER ANALYSIS, COMPUTER SYSTEMS DESIGN SERVICES, AND SOFTWARE AND SOFTWARE DEVELOPMENT; AND PROVIDING INFORMATION VIA THE INTERNET ON THE SUBJECTS OF SOFTWARE DESIGN (U.S. CLS. 100 AND 101).

FIRST USE 3-0-2003; IN COMMERCE 3-0-2003.
STEVEN PEREZ, EXAMINING ATTORNEY

SN 76-623,989. EBB & FLOW PRODUCTIONS, INC., LOS ANGELES, CA. FILED 12-7-2004.

**notaryON
DEMAND**



NO CLAIM IS MADE TO THE EXCLUSIVE RIGHT TO USE NOTARY, APART FROM THE MARK AS SHOWN.

THE MARK CONSISTS OF: "A RUNNING MAN WHOSE HEAD IS THE 'O' OF THE WORD 'ON' IN THE COMPANY NAME 'NOTARY ON DEMAND'".

FOR MOBILE NOTARY PUBLIC SERVICES (U.S. CLS. 100 AND 101).

FIRST USE 6-19-2003; IN COMMERCE 6-19-2003.
WILLIAM VERHOSEK, EXAMINING ATTORNEY

CLASS 42—(Continued).

SN 76-626,579. JAXARA GROUP, LLC, BETHESDA, MD.
FILED 12-30-2004.

JAXARA GROUP

THE MARK CONSISTS OF STANDARD CHARACTERS WITHOUT CLAIM TO ANY PARTICULAR FONT, STYLE, SIZE, OR COLOR.

NO CLAIM IS MADE TO THE EXCLUSIVE RIGHT TO USE "GROUP", APART FROM THE MARK AS SHOWN.

FOR CONSULTING SERVICES IN THE FIELD OF DESIGN, SELECTION, IMPLEMENTATION AND USE OF COMPUTER HARDWARE AND SOFTWARE SYSTEMS FOR OTHERS; COMPUTER CONSULTING SERVICES FOR PLANNING, DESIGN, AND ANALYSIS OF INFORMATION PROCESSES, SYSTEMS, AND BUSINESS REENGINEERING; ANALYSIS AND DESIGN OF COMPUTER SYSTEMS, SOFTWARE AND INFORMATION SYSTEMS FOR OTHERS; DESIGN FOR OTHERS OF WEB SITES AND SOFTWARE APPLICATIONS THEREFORE ON LOCAL AND INTERNAL COMPUTER NETWORKS AND THE INTERNET; PROVIDING DESIGN, DEVELOPMENT, MAINTENANCE, AND HOST SERVICES FOR OTHERS' INTERNET WEB SITES AND COMPUTER NETWORKS; INFORMATION TECHNOLOGY CONSULTATION SERVICES; COMPUTER CONSULTATION ON THE COMPUTER-RELATED ASPECTS OF E-COMMERCE AND INFORMATION TECHNOLOGY SECURITY; PROVIDING INFORMATION OVER LOCAL AND INTERNAL COMPUTER NETWORKS AND THE INTERNET ON THE SUBJECTS OF COMPUTER ANALYSIS, COMPUTER SYSTEMS DESIGN SERVICES, AND SOFTWARE AND SOFTWARE DEVELOPMENT; AND PROVIDING INFORMATION VIA THE INTERNET ON THE SUBJECTS OF SOFTWARE DESIGN (U.S. CLS. 100 AND 101).

FIRST USE 3-0-2003; IN COMMERCE 3-0-2003.
STEVEN PEREZ, EXAMINING ATTORNEY

SN 76-626,712. METROPOLITAN - LIGHTNING, LLC, GARDINER, NY. FILED 1-3-2005.

LUNACHICS

FOR LICENSING SERVICES, NAMELY THE LICENSING OF INTELLECTUAL PROPERTY (U.S. CLS. 100 AND 101).

ALINA MORRIS, EXAMINING ATTORNEY

CLASS 42—(Continued).

SN 76-626,970. THE GEEK PATROL INC., CALGARY, ALBERTA, CANADA, FILED 1-5-2005.

RING A GEEK

THE MARK CONSISTS OF STANDARD CHARACTERS WITHOUT CLAIM TO ANY PARTICULAR FONT, STYLE, SIZE, OR COLOR.

FOR COMPUTER DIAGNOSTIC SERVICES INVOLVING INSTALLATION, REPAIR, MAINTENANCE, UPDATING AND TROUBLESHOOTING OF INFORMATION TECHNOLOGY SYSTEMS; COMPUTER NETWORK DESIGN AND ADMINISTRATION INCLUDING ANALYSIS OF INFORMATION TECHNOLOGY SYSTEMS, WEBSITE DESIGN AND DATABASE DESIGN; INFORMATION TECHNOLOGY SERVICES, NAMELY VIRUS REMOVAL AND PROTECTION, COMPUTER SOFTWARE AND HARDWARE INSTALLATION AND TRAINING, SYNCHRONIZATION AND CONSOLIDATION OF SYSTEM FUNCTIONS, AND NETWORK AND COMPUTER OPTIMIZATION (U.S. CLS. 100 AND 101).

FIRST USE 12-20-2004; IN COMMERCE 12-20-2004.
ANNE FARRELL, EXAMINING ATTORNEY

SN 76-630,713. LILBRO SOFTWARE, LLC, NEW YORK, NY.
FILED 2-8-2005.

THE WEDDING WIZARD

THE MARK CONSISTS OF STANDARD CHARACTERS WITHOUT CLAIM TO ANY PARTICULAR FONT, STYLE, SIZE, OR COLOR.

OWNER OF U.S. REG. NO. 2,676,053.

SEC. 2(F).

FOR PROVIDING ONLINE NON-DOWNLOADABLE SOFTWARE FOR WEDDING PLANNING (U.S. CLS. 100 AND 101).

FIRST USE 1-15-1996; IN COMMERCE 1-15-1996.
BRIDGETT SMITH, EXAMINING ATTORNEY

SN 78-171,149. MEMBERS MORTGAGE COMPANY, INC., WOBURN, MA. FILED 10-4-2002.

MORTGAGECLICK

FOR PROVIDING TEMPORARY USE OF NON-DOWNLOADABLE SOFTWARE FOR USE IN APPLYING FOR AND OBTAINING MORTGAGES AND PROVIDING MORTGAGE INFORMATION; DESIGNING WEBPAGES THAT PROVIDE INFORMATION RELATED TO MORTGAGES AND OTHER FINANCIAL SERVICES AND PROVIDE THE ABILITY TO APPLY FOR AND OBTAIN MORTGAGES AND MORTGAGE INFORMATION USING COMPUTER SOFTWARE (U.S. CLS. 100 AND 101).

FIRST USE 10-4-2002; IN COMMERCE 10-4-2002.
CIMMERIAN COLEMAN, EXAMINING ATTORNEY

CLASS 42—(Continued).

SN 78-180,167. H2F MEDIA, INC., LAKE OSWEGO, OR.
FILED 10-30-2002.

ADAPTIVE MEDIA PACKAGE

NO CLAIM IS MADE TO THE EXCLUSIVE RIGHT TO USE "MEDIA PACKAGE", APART FROM THE MARK AS SHOWN.

FOR PROVIDING TEMPORARY USE OF ON-LINE, NON-DOWNLOADABLE SOFTWARE THAT ALLOWS ASSEMBLY OF TEXT, HTML, AUDIO, VIDEO, OR OTHER MULTIMEDIA CONTENT INTO ELECTRONIC MAIL MESSAGES (U.S. CLS. 100 AND 101).

FIRST USE 6-1-2002; IN COMMERCE 6-1-2002.

M. L. HERSHKOWITZ, EXAMINING ATTORNEY

SN 78-223,304. MCAFEE, SAM, M. SAN FRANCISCO, CA.
AND GRAB, ANGELINA, K, SAN FRANCISCO, CA.
FILED 3-8-2003.

RADICALFUSION

THE MARK CONSISTS OF STANDARD CHARACTERS WITHOUT CLAIM TO ANY PARTICULAR FONT, STYLE, SIZE, OR COLOR.

FOR WEBSITE DESIGN AND DEVELOPMENT (U.S. CLS. 100 AND 101).

FIRST USE 2-1-2001; IN COMMERCE 6-1-2002.

SONYA STEPHENS, EXAMINING ATTORNEY

SN 78-287,743. HOYNG, FRANCISCO, TUJUNGA, CA.
FILED 8-14-2003.

MAXLEGAL

FOR LEGAL SERVICES; ATTORNEY SERVICES; LEGAL REPRESENTATION; LEGAL RESEARCH; PARALEGAL SERVICES; LEGAL DOCUMENT PREPARATION AND FILING ASSISTANCE (U.S. CLS. 100 AND 101).

MATTHEW KLINE, EXAMINING ATTORNEY

SN 78-303,080. CODECORRECT, YAKIMA, WA. FILED 9-19-2003.

CODECORRECT COACH

OWNER OF U.S. REG. NO. 2,337,928.

NO CLAIM IS MADE TO THE EXCLUSIVE RIGHT TO USE "CODECORRECT", APART FROM THE MARK AS SHOWN.

FOR PROVIDING TEMPORARY USE OF ON-LINE, NON-DOWNLOADABLE SOFTWARE, WHICH IS USED TO RESEARCH MEDICAL CODING INFORMATION FOR MEDICAL PROFESSIONALS IN MEDICAL OFFICES AND HOSPITALS (U.S. CLS. 100 AND 101).

FIRST USE 7-1-2003; IN COMMERCE 7-1-2003.

WON TEAK OH, EXAMINING ATTORNEY

CLASS 42—(Continued).

SN 78-311,782. KKLC MORTGAGE LOAN PROCESSING, LLC, SAN DIEGO, CA. FILED 10-9-2003.

NOTARIZE THIS!

NO CLAIM IS MADE TO THE EXCLUSIVE RIGHT TO USE NOTARIZE, APART FROM THE MARK AS SHOWN.

FOR NOTARY PUBLIC SERVICES (U.S. CLS. 100 AND 101).

FIRST USE 9-1-2000; IN COMMERCE 9-1-2000.

CHERYL STEPLIGHT, EXAMINING ATTORNEY

SN 78-312,321. DEUTSCHE TELEKOM AG, BONN, FED REP GERMANY, FILED 10-10-2003.

CompanyConnect

PRIORITY CLAIMED UNDER SEC. 44(D) ON FED REP GERMANY APPLICATION NO. 30318778.638, FILED 4-11-2003, REG. NO. 30318778, DATED 10-13-2003, EXPIRES 4-30-2013.

FOR COMPUTER PROGRAMMING SERVICES FOR OTHERS; RENTAL OF COMPUTER SOFTWARE AND HARDWARE FOR ONLINE ACCESS; COMPUTER SERVICES NAMELY, CREATING INDEXES OF INFORMATION AVAILABLE ON COMPUTER NETWORKS (U.S. CLS. 100 AND 101).

LINDA POWELL, EXAMINING ATTORNEY

SN 78-316,184. VISITECH AS, DRAMMEN N3003, NORWAY, FILED 10-21-2003.

LUXBEAM
BY VISITECH

PRIORITY CLAIMED UNDER SEC. 44(D) ON NORWAY APPLICATION NO. 200309522, FILED 10-14-2003, REG. NO. 223873, DATED 7-15-2004, EXPIRES 7-15-2014.

FOR ENGINEERING; TECHNICAL CONSULTATION AND RESEARCH IN THE FIELD OF ELECTRONICS (U.S. CLS. 100 AND 101).

MICHAEL KEATING, EXAMINING ATTORNEY

CLASS 42—(Continued).

SN 78-337,279. QWEST COMMUNICATIONS INTERNATIONAL INC., DENVER, CO. FILED 12-5-2003.

QWEST WEB CONTACT CENTER

THE MARK CONSISTS OF STANDARD CHARACTERS WITHOUT CLAIM TO ANY PARTICULAR FONT, STYLE, SIZE, OR COLOR.

OWNER OF U.S. REG. NOS. 2,669,737, 2,794,685 AND OTHERS.

NO CLAIM IS MADE TO THE EXCLUSIVE RIGHT TO USE "WEB CONTACT CENTER", APART FROM THE MARK AS SHOWN.

FOR PROVIDING TEMPORARY USE OF ON-LINE NON-DOWNLOADABLE COMPUTER SOFTWARE FOR DEVELOPING, CUSTOMIZING, MANAGING AND MAINTAINING SOFTWARE SYSTEMS USED IN A TELEPHONE CALL CENTER (U.S. CLS. 100 AND 101).

FIRST USE 8-0-2001; IN COMMERCE 8-0-2001.
SONYA STEPHENS, EXAMINING ATTORNEY

CLASS 42—(Continued).

SN 78-350,579. ASC INCORPORATED, SOUTHGATE, MI. FILED 1-12-2004.

AMERICAN SPECIALTY CARS

THE MARK CONSISTS OF STANDARD CHARACTERS WITHOUT CLAIM TO ANY PARTICULAR FONT, STYLE, SIZE, OR COLOR.

NO CLAIM IS MADE TO THE EXCLUSIVE RIGHT TO USE SPECIALTY CARS, APART FROM THE MARK AS SHOWN.

FOR DESIGNING, STYLING AND ENGINEERING OF AUTOMOTIVE VEHICLES, CUSTOMIZED VEHICLES, SHOW VEHICLES, AUTOMOTIVE VEHICLE BODIES, ROOF SYSTEMS, CONVERTIBLE ROOFS, SUNROOFS, MOON ROOFS, POP TOP SUNROOFS, VENTING SUNROOFS, T-TOP ROOFS, VINYL TOPS, AUTOMOTIVE VEHICLE TONNEAU AND BOOT COVERS, TRUNK DECK LIDS, RUNNING BOARDS, AUTOMOTIVE VEHICLE INTERIOR TRIM AND AUTOMOTIVE VEHICLE EXTERIOR TRIM (U.S. CLS. 100 AND 101).

FIRST USE 1-4-2004; IN COMMERCE 1-4-2004.
CAROLINE WEIMER, EXAMINING ATTORNEY

SN 78-338,750. ISPI OF LINCOLN, INC., LINCOLN, NE. FILED 12-10-2003.

SOCS

THE MARK CONSISTS OF STANDARD CHARACTERS WITHOUT CLAIM TO ANY PARTICULAR FONT, STYLE, SIZE, OR COLOR.

FOR PROVIDING BUSINESS SERVICES TO SCHOOLS THROUGH THE TEMPORARY USE OF ON-LINE NON-DOWNLOADABLE SOFTWARE THAT CAN BE USED TO PROVIDE SCHOOL NEWS, ANNOUNCEMENTS, ARTICLES, INTERACTIVE POLLS AND E-MAILS, PUBLIC EVENTS CALENDARS, LUNCH MENUS, AND PHOTOGRAPHS, THROUGH WEB SITES MAINTAINED BY THE SCHOOLS (U.S. CLS. 100 AND 101).

FIRST USE 3-1-2002; IN COMMERCE 5-14-2002.
INGA ERVIN, EXAMINING ATTORNEY

SN 78-353,823. NEVADA GEOLOGICAL SURVEY, GLENBROOK, NV. FILED 1-19-2004.

Nevada Geological Survey

THE MARK CONSISTS OF STANDARD CHARACTERS WITHOUT CLAIM TO ANY PARTICULAR FONT, STYLE, SIZE, OR COLOR.

NO CLAIM IS MADE TO THE EXCLUSIVE RIGHT TO USE "GEOLOGICAL SURVEY", APART FROM THE MARK AS SHOWN.

SEC. 2(F).
FOR TECHNICAL CONSULTATION AND RESEARCH IN THE FIELD OF GEOLOGY (U.S. CLS. 100 AND 101).
FIRST USE 9-7-1995; IN COMMERCE 9-8-1995.
BARBARA A. LOUGHRAN, EXAMINING ATTORNEY

CLASS 42—(Continued).

SN 78-359,792. INFONE LLC, BEAVERTON, OR. FILED 1-29-2004.

IMAGINE YOUR LIFE
WITH A PERSONAL
ASSISTANT

THE MARK CONSISTS OF STANDARD CHARACTERS WITHOUT CLAIM TO ANY PARTICULAR FONT, STYLE, SIZE, OR COLOR.

FOR PROVIDING INFORMATION ABOUT WEATHER CONDITIONS, SKI CONDITIONS AND ROAD CLOSURES DUE TO WEATHER CONDITIONS; PROVIDING INFORMATION AT THE SPECIFIC REQUEST OF END-USERS BY MEANS OF TELEPHONE (U.S. CLS. 100 AND 101).

FIRST USE 1-30-2004; IN COMMERCE 1-30-2004.
JOSETTE BEVERLY, EXAMINING ATTORNEY

SN 78-387,353. REACTION CORP., LITTLETON, CO. FILED 3-19-2004.

Reaction Web

THE MARK CONSISTS OF STANDARD CHARACTERS WITHOUT CLAIM TO ANY PARTICULAR FONT, STYLE, SIZE, OR COLOR.

NO CLAIM IS MADE TO THE EXCLUSIVE RIGHT TO USE "WEB", APART FROM THE MARK AS SHOWN.

FOR COMPUTER SERVICES, NAMELY, WEB SITE DEVELOPMENT AND DESIGN; AND SOFTWARE-BASED MULTIMEDIA DEVELOPMENT AND DESIGN (U.S. CLS. 100 AND 101).

FIRST USE 1-0-1997; IN COMMERCE 1-0-1997.
TONJA GASKINS, EXAMINING ATTORNEY

CLASS 42—(Continued).

SN 78-402,603. DIGIDYNE INCORPORATED, MOBILE, AL. FILED 4-15-2004.

DOCENROLL

THE MARK CONSISTS OF STANDARD CHARACTERS WITHOUT CLAIM TO ANY PARTICULAR FONT, STYLE, SIZE, OR COLOR.

FOR PROVIDING TEMPORARY USE OF ONLINE NON-DOWNLOADABLE SOFTWARE BY SUBSCRIPTION SERVICE THAT PROVIDES ACCESS TO FORMS AND APPLICATIONS FOR PAYMENT OF MEDICAL CLAIMS, RECORD MANAGEMENT, INFORMATION MANAGEMENT, BILLING, POSTING AND SECONDARY BILLING, DOCUMENT IMAGING, ELECTRONIC DATA INTERCHANGE AND ELECTRONIC MESSAGING FOR HEALTHCARE PROVIDERS, PAYERS AND CLEARINGHOUSE VENDORS IN THE HEALTHCARE INDUSTRY (U.S. CLS. 100 AND 101).

FIRST USE 5-18-2003; IN COMMERCE 5-18-2003.
JEFF DEFORD, EXAMINING ATTORNEY

SN 78-402,790. MAINSPRING TECHNOLOGIES, INC., CHAGRIN FALLS, OH. FILED 4-15-2004.

DIGITAL DEPOT

THE MARK CONSISTS OF STANDARD CHARACTERS WITHOUT CLAIM TO ANY PARTICULAR FONT, STYLE, SIZE, OR COLOR.

NO CLAIM IS MADE TO THE EXCLUSIVE RIGHT TO USE "DIGITAL", APART FROM THE MARK AS SHOWN.

FOR PROVIDING TEMPORARY USE OF ON-LINE, NON-DOWNLOADABLE SOFTWARE FOR MANAGEMENT, SEARCHING, EDITING, AND TRANSMITTING OF DIGITAL FILES (U.S. CLS. 100 AND 101).

JASON LOTT, EXAMINING ATTORNEY

CLASS 42—(Continued).

SN 78-408,308. UNISONE CORPORATION, NEW CASTLE, DE. FILED 4-26-2004.

CLASS 42—(Continued).

SN 78-415,805. TIEBRIDGE, INC, FALLS CHURCH, VA. FILED 5-10-2004.

UNISONE

We get IT.

THE MARK CONSISTS OF STANDARD CHARACTERS WITHOUT CLAIM TO ANY PARTICULAR FONT, STYLE, SIZE, OR COLOR.

FOR COMPUTER SERVICES, NAMELY, DEVELOPMENT OF SPECIALIZED SOFTWARE FOR OTHERS FOR APPLICATION AND DATABASE INTEGRATION, NOT INCLUDING FOR COMPUTER TELECOMMUNICATION CALL CENTERS (U.S. CLS. 100 AND 101).
CHRISTOPHER ADKINS, EXAMINING ATTORNEY

THE MARK CONSISTS OF STANDARD CHARACTERS WITHOUT CLAIM TO ANY PARTICULAR FONT, STYLE, SIZE, OR COLOR.

FOR TECHNICAL CONSULTATION SERVICE IN THE FIELD OF INFORMATION TECHNOLOGY (U.S. CLS. 100 AND 101).
FIRST USE 4-1-2004; IN COMMERCE 5-1-2004.
MIDGE BUTLER, EXAMINING ATTORNEY

SN 78-410,195. BIONANOMATRIX, LLC, PRINCETON, NJ. FILED 4-29-2004.

SN 78-418,739. BTU SOURCE, INC., ATLANTA, GA. FILED 5-14-2004.

NANOARCHIVER

BTU SOURCE

THE MARK CONSISTS OF STANDARD CHARACTERS WITHOUT CLAIM TO ANY PARTICULAR FONT, STYLE, SIZE, OR COLOR.

FOR MEDICAL, SCIENTIFIC AND INDUSTRIAL LABORATORY SERVICES, NAMELY PRESERVING AND STORING BIOLOGICAL AND GENETIC MATERIALS (U.S. CLS. 100 AND 101).
JOHN WILKE, EXAMINING ATTORNEY

THE MARK CONSISTS OF STANDARD CHARACTERS WITHOUT CLAIM TO ANY PARTICULAR FONT, STYLE, SIZE, OR COLOR.

NO CLAIM IS MADE TO THE EXCLUSIVE RIGHT TO USE "BTU", APART FROM THE MARK AS SHOWN.
FOR REMOTE MONITORING AND MEASURING SERVICES REGARDING THE PERFORMANCE OF HEAT TRANSFER AND THERMAL PROCESSING EQUIPMENT AND PROVIDING SUCH MEASUREMENTS VIA GLOBAL COMPUTER NETWORKS (U.S. CLS. 100 AND 101).
FIRST USE 11-1-2001; IN COMMERCE 11-1-2001.
BRENDAN MCCAULEY, EXAMINING ATTORNEY

CLASS 42—(Continued).

SN 78-419,214. PRIMEREVENUE, INC., ATLANTA, GA.
FILED 5-14-2004.



FOR APPLICATION SERVICE PROVIDER FOR HOSTING COMPUTER SOFTWARE FOR MANAGING THE FINANCIAL SUPPLY CHAIN AND PROVIDING A COLLABORATIVE APPROACH TO WORKING CAPITAL MANAGEMENT BETWEEN BUYERS, SUPPLIERS AND FINANCIAL INSTITUTIONS (U.S. CLS. 100 AND 101).
FIRST USE 1-1-2004; IN COMMERCE 2-1-2004.
MICHAEL KEATING, EXAMINING ATTORNEY

CLASS 42—(Continued).

SN 78-429,265. WELLINGHOFF, LORI N., CINCINNATI, OH.
FILED 6-3-2004.



THE MARK CONSISTS OF STANDARD CHARACTERS WITHOUT CLAIM TO ANY PARTICULAR FONT, STYLE, SIZE, OR COLOR.

FOR DESIGN FOR OTHERS, NAMELY INTERIOR AND EXTERIOR ARCHITECTURAL DESIGN SERVICES (U.S. CLS. 100 AND 101).

BARBARA GAYNOR, EXAMINING ATTORNEY

SN 78-420,063. MULTI SERVICE CORPORATION, OVERLAND PARK, KS. FILED 5-17-2004.



THE MARK CONSISTS OF STANDARD CHARACTERS WITHOUT CLAIM TO ANY PARTICULAR FONT, STYLE, SIZE, OR COLOR.

FOR APPLICATION SERVICE PROVIDER, NAMELY, HOSTING COMPUTER SOFTWARE APPLICATIONS OF OTHERS IN THE FIELD OF POINT-OF-SALE CREDIT CARD TRANSACTIONS (U.S. CLS. 100 AND 101).

STEVEN R. FINE, EXAMINING ATTORNEY

SN 78-432,736. DIRECT DIMENSIONS, INC., OWINGS MILLS, MD. FILED 6-9-2004.



THE MARK CONSISTS OF STANDARD CHARACTERS WITHOUT CLAIM TO ANY PARTICULAR FONT, STYLE, SIZE, OR COLOR.

NO CLAIM IS MADE TO THE EXCLUSIVE RIGHT TO USE DIMENSIONS, APART FROM THE MARK AS SHOWN.

FOR COMPUTERIZED ENGINEERING SERVICES NAMELY, THREE-DIMENSIONAL MEASURING, ANALYZING, DIGITIZING, SCANNING, DIGITAL MODELING AND REVERSE ENGINEERING; INTEGRATION OF COMPUTER HARDWARE AND SOFTWARE FOR PURPOSES OF INDUSTRIAL DESIGN, HISTORIC PRESERVATION, MANUFACTURING AND REPLICATION; PRODUCT RESEARCH AND DEVELOPMENT IN THE AREA OF THREE-DIMENSIONAL MEASURING, ANALYZING, DIGITIZING, SCANNING, DIGITAL MODELING AND REVERSE ENGINEERING (U.S. CLS. 100 AND 101).

FIRST USE 4-7-1995; IN COMMERCE 4-7-1995.

SHARON MEIER, EXAMINING ATTORNEY

CLASS 42—(Continued).

SN 78-432,741. DIRECT DIMENSIONS, INC., OWINGS MILLS, MD. FILED 6-9-2004.

Rapid Solutions to 3D Problems

THE MARK CONSISTS OF STANDARD CHARACTERS WITHOUT CLAIM TO ANY PARTICULAR FONT, STYLE, SIZE, OR COLOR.

FOR COMPUTERIZED ENGINEERING SERVICES, NAMELY THREE-DIMENSIONAL MEASURING, ANALYZING, DIGITIZING, SCANNING, DIGITAL MODELING AND REVERSE ENGINEERING; INTEGRATION OF COMPUTER HARDWARE AND SOFTWARE FOR PURPOSES OF PRODUCT DEVELOPMENT, INDUSTRIAL DESIGN, HISTORIC PRESERVATION, MANUFACTURING AND REPLICATION; PRODUCT RESEARCH AND DEVELOPMENT IN THE AREA OF THREE-DIMENSIONAL MEASURING, ANALYZING, DIGITIZING, SCANNING, DIGITAL MODELING AND REVERSE ENGINEERING (U.S. CLS. 100 AND 101).

FIRST USE 4-7-1995; IN COMMERCE 4-7-1995.
SHARON MEIER, EXAMINING ATTORNEY

SN 78-435,903. BERNSTEIN LITOWITZ BERGER & GROSSMANN LLP, NEW YORK, NY. FILED 6-16-2004.

People, Resources, Excellence...**Results**

THE COLOR(S) RED IS/ARE CLAIMED AS A FEATURE OF THE MARK.

THE COLOR RED APPEARS IN THE WORD RESULTS. FOR LEGAL SERVICES (U.S. CLS. 100 AND 101).
FIRST USE 6-1-2001; IN COMMERCE 6-1-2001.
ELLEN B. AWRICH, EXAMINING ATTORNEY

SN 78-436,580. EXELA PHARM SCI PRIVATE LIMITED, BILEKAHALLI, BANGALORE, INDIA, FILED 6-16-2004.

EXELA PHARMSCI

THE MARK CONSISTS OF STANDARD CHARACTERS WITHOUT CLAIM TO ANY PARTICULAR FONT, STYLE, SIZE, OR COLOR.

FOR PRODUCT DEVELOPMENT, NAMELY DEVELOPING PHARMACEUTICAL PRODUCTS IN SPECIALIZED DOSAGE FORMS, NAMELY, CONTROLLED DRUG-RELEASING FORMULATIONS, STERILE PRODUCTS, INHALATION PRODUCTS, TOPICAL PRODUCTS; AND ATTENDANT ANALYTICAL SERVICES (U.S. CLS. 100 AND 101).

DEZMONA MIZELLE, EXAMINING ATTORNEY

CLASS 42—(Continued).

SN 78-438,107. PATEL, NIRALI H., LENEXA, KS. FILED 6-19-2004.

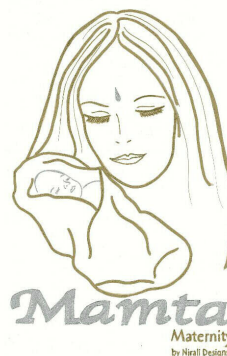

NO CLAIM IS MADE TO THE EXCLUSIVE RIGHT TO USE "MATERNITY" AND "DESIGNS", APART FROM THE MARK AS SHOWN.

THE COLOR(S) GOLD AND SILVER IS/ARE CLAIMED AS A FEATURE OF THE MARK.

THE MARK CONSISTS OF A STYLIZED WORD "MAMTA" ALL IN SILVER. ALSO THE WORDS "MATERNITY BY NIRALI DESIGNS" IN GOLD BUT STANDARD CHARACTER. ALSO THERE IS AN IMAGE OF A WOMAN OUTLINED IN GOLD WITH A SILVER DOT LIKE OBJECT ON HER FOREHEAD. THE WOMAN IS HOLDING A CHILD WRAPPED IN A BLANKET WHICH HAS A GOLD LINING BUT THE CHILD IS OUTLINED IN SILVER.

THE FOREIGN WORDING IN THE MARK TRANSLATES INTO ENGLISH AS MOTHERLY FEELINGS.

FOR DRESS DESIGN (U.S. CLS. 100 AND 101).
DOMINICK J. SALEMI, EXAMINING ATTORNEY

SN 78-442,017. THE HOUSE OF BUCKNER LLC, AUXVASSE, MO. FILED 6-27-2004.

The Wave Game

THE MARK CONSISTS OF STANDARD CHARACTERS WITHOUT CLAIM TO ANY PARTICULAR FONT, STYLE, SIZE, OR COLOR.

FOR DESIGN AND TESTING OF NEW PRODUCTS FOR OTHERS (U.S. CLS. 100 AND 101).

ALLISON SCHRODY, EXAMINING ATTORNEY

CLASS 42—(Continued).

SN 78-449,871. REESE-SHERILL, MARY KATHRYN, DALLAS, TX. FILED 7-13-2004.

EINSTEIN HOUSE

THE MARK CONSISTS OF STANDARD CHARACTERS WITHOUT CLAIM TO ANY PARTICULAR FONT, STYLE, SIZE, OR COLOR.

NO CLAIM IS MADE TO THE EXCLUSIVE RIGHT TO USE "HOUSE", APART FROM THE MARK AS SHOWN.

FOR DESIGN AND ENGINEERING OF HOME AUTOMATION SYSTEMS; INTEGRATION OF COMPUTER SYSTEMS AND NETWORKS FOR HOME AUTOMATION; CONSULTING REGARDING HOME AUTOMATION (U.S. CLS. 100 AND 101).

SUE LAWRENCE, EXAMINING ATTORNEY

SN 78-452,436. SCHULTZ, YOUNG & ASSOCIATES, LLC, REDWOOD CITY, CA. FILED 7-18-2004.

SY&A SCHULTZ, YOUNG & ASSOCIATES

THE MARK CONSISTS OF STANDARD CHARACTERS WITHOUT CLAIM TO ANY PARTICULAR FONT, STYLE, SIZE, OR COLOR.

NO CLAIM IS MADE TO THE EXCLUSIVE RIGHT TO USE ASSOCIATES, APART FROM THE MARK AS SHOWN.

FOR CONSULTATION SERVICES IN THE FIELD OF INFORMATION TECHNOLOGY SYSTEMS, INCLUDING INTRANETS AND INTERNETS (U.S. CLS. 100 AND 101).

KARLA PERKINS, EXAMINING ATTORNEY

SN 78-455,421. VOLT INFORMATION SCIENCES, INC., ORANGE, CA. FILED 7-23-2004.

NETS

THE MARK CONSISTS OF STANDARD CHARACTERS WITHOUT CLAIM TO ANY PARTICULAR FONT, STYLE, SIZE, OR COLOR.

FOR COMPUTER SERVICES, NAMELY, ACTING AS AN APPLICATION SERVICE PROVIDER FOR OTHERS BY HOSTING AND MAINTAINING A WEB-BASED APPLICATION SERVICE FOR REGISTERING AND TRACKING NON-EMPLOYEE PERSONNEL AND CONTRACTORS (U.S. CLS. 100 AND 101).

JEFF DEFORD, EXAMINING ATTORNEY

CLASS 42—(Continued).

SN 78-457,371. BROWN, JANICE, SAN DIEGO, CA. FILED 7-27-2004.

LAW GROUP
brown

NO CLAIM IS MADE TO THE EXCLUSIVE RIGHT TO USE LAW GROUP, APART FROM THE MARK AS SHOWN. FOR LEGAL SERVICES (U.S. CLS. 100 AND 101).

FIRST USE 9-10-2003; IN COMMERCE 9-10-2003.
MICHAEL ENGEL, EXAMINING ATTORNEY

SN 78-463,374. BAKER & DANIELS, INDIANAPOLIS, IN. FILED 8-6-2004.

**BAKER & DANIELS
LLP**

THE MARK CONSISTS OF STANDARD CHARACTERS WITHOUT CLAIM TO ANY PARTICULAR FONT, STYLE, SIZE, OR COLOR.

OWNER OF U.S. REG. NO. 1,635,100.

NO CLAIM IS MADE TO THE EXCLUSIVE RIGHT TO USE "LLP", APART FROM THE MARK AS SHOWN.

FOR LEGAL SERVICES (U.S. CLS. 100 AND 101).

SANJEEV VOHRA, EXAMINING ATTORNEY

CLASS 42—(Continued).

SN 78-473,535. SALTMINE, INC., SEATTLE, WA. FILED 8-25-2004.

SALTMINE

THE MARK CONSISTS OF STANDARD CHARACTERS WITHOUT CLAIM TO ANY PARTICULAR FONT, STYLE, SIZE, OR COLOR.

FOR COMPUTER CONSULTATION SERVICES; CUSTOM COMPUTER SOFTWARE DESIGN AND DEVELOPMENT SERVICES FOR OTHERS; WEBSITE DESIGN AND DEVELOPMENT SERVICES FOR OTHERS; PROVIDING CONSULTATION ON THE USE, INTEGRATION AND OPERATION OF COMPUTER SOFTWARE PROGRAMS AND THE UPDATING OF COMPUTER SOFTWARE PROGRAMS SERVICES (U.S. CLS. 100 AND 101). FIRST USE 4-15-1995; IN COMMERCE 4-15-1995. MARGERY A. TIERNEY, EXAMINING ATTORNEY

SN 78-474,215. VIASTAR ENERGY, LLC, INDIANAPOLIS, IN. FILED 8-26-2004.

**INTEGRATED METER
READER**

THE MARK CONSISTS OF STANDARD CHARACTERS WITHOUT CLAIM TO ANY PARTICULAR FONT, STYLE, SIZE, OR COLOR.

NO CLAIM IS MADE TO THE EXCLUSIVE RIGHT TO USE "METER READER", APART FROM THE MARK AS SHOWN.

FOR UTILITY METER READING SERVICES (U.S. CLS. 100 AND 101). BRENDAN MCCAULEY, EXAMINING ATTORNEY

CLASS 42—(Continued).

SN 78-476,374. HINCKLEY, ALLEN & SNYDER LLP, PROVIDENCE, RI. FILED 8-31-2004.

**PRACTICING LAW
WITH OUR SLEEVES
ROLLED UP**

THE MARK CONSISTS OF STANDARD CHARACTERS WITHOUT CLAIM TO ANY PARTICULAR FONT, STYLE, SIZE, OR COLOR.

FOR LEGAL SERVICES (U.S. CLS. 100 AND 101). FIRST USE 9-22-2004; IN COMMERCE 9-22-2004. WON TEAK OH, EXAMINING ATTORNEY

SN 78-481,268. SNAPBUILD COMMUNICATIONS, LLC, VANCOUVER, WA. FILED 9-9-2004.

SnapGuard

THE MARK CONSISTS OF STANDARD CHARACTERS WITHOUT CLAIM TO ANY PARTICULAR FONT, STYLE, SIZE, OR COLOR.

FOR HOSTING OF DIGITAL CONTENT ON THE INTERNET (U.S. CLS. 100 AND 101). MICHAEL KAZAZIAN, EXAMINING ATTORNEY

SN 78-485,566. CRANEL INCORPORATED, COLUMBUS, OH. FILED 9-17-2004.

ISOdx

THE MARK CONSISTS OF STANDARD CHARACTERS WITHOUT CLAIM TO ANY PARTICULAR FONT, STYLE, SIZE, OR COLOR.

FOR MANAGEMENT OF COMPUTER NETWORKS FOR THIRD PARTIES (U.S. CLS. 100 AND 101). FIRST USE 9-10-2004; IN COMMERCE 9-10-2004. ANNE E. GUSTASON, EXAMINING ATTORNEY

CLASS 42—(Continued).

SN 78-493,113. DEUTSCHE TELEKOM AG, BONN, FED REP GERMANY, FILED 10-1-2004.

CLASS 42—(Continued).

SN 78-493,597. IMAGINOLOGY, LLC, PHOENIX, AZ. FILED 10-2-2004.

Imaginology

T-Mobile Jukebox

THE MARK CONSISTS OF STANDARD CHARACTERS WITHOUT CLAIM TO ANY PARTICULAR FONT, STYLE, SIZE, OR COLOR.

FOR DESIGN AND DEVELOPMENT OF MULTIMEDIA PRODUCTS (U.S. CLS. 100 AND 101).

FIRST USE 4-13-1997; IN COMMERCE 10-1-1998.
ELLEN B. AWRICH, EXAMINING ATTORNEY

THE MARK CONSISTS OF STANDARD CHARACTERS WITHOUT CLAIM TO ANY PARTICULAR FONT, STYLE, SIZE, OR COLOR.

PRIORITY CLAIMED UNDER SEC. 44(D) ON FED REP GERMANY APPLICATION NO. 30418467538, FILED 4-2-2004, REG. NO. 30418467, DATED 5-10-2004, EXPIRES 4-30-2014.

OWNER OF U.S. REG. NOS. 2,282,432, 2,959,646 AND OTHERS.

NO CLAIM IS MADE TO THE EXCLUSIVE RIGHT TO USE "JUKEBOX", APART FROM THE MARK AS SHOWN.

FOR COMPUTER PROGRAMMING SERVICES FOR OTHERS; RENTAL OF COMPUTER SOFTWARE AND HARDWARE FOR ONLINE ACCESS; DATA ENCRYPTION SERVICES, NAMELY, ADMINISTRATION OF DIGITAL KEYS AND DIGITAL CERTIFICATES; APPLICATION SERVICE PROVIDER, NAMELY, HOSTING COMPUTER SOFTWARE APPLICATIONS FOR OTHERS, HOSTING OF DIGITAL CONTENT FOR OTHERS ON THE INTERNET; HOSTING THE WEBSITES OF OTHERS ON A COMPUTER SERVER FOR A GLOBAL COMPUTER NETWORK; COMPUTER SERVICES, NAMELY, CREATING INDEXES OF INFORMATION AVAILABLE ON COMPUTER NETWORKS; PROVIDING INFORMATION VIA THE TELEPHONE AND THE GLOBAL COMMUNICATION NETWORKS IN THE FIELD OF INFORMATION TECHNOLOGY; CONSULTING SERVICES IN THE FIELD OF DESIGN, SELECTION, IMPLEMENTATION AND USE OF COMPUTER HARDWARE AND SOFTWARE SYSTEMS FOR OTHERS; INSTALLATION, MAINTENANCE AND REPAIR OF COMPUTER SOFTWARE; TECHNICAL CONSULTATION REGARDING THE PROJECT PLANNING FOR THE PRODUCTION OF TELECOMMUNICATIONS EQUIPMENT; PROVIDING GENERAL INFORMATION AT THE SPECIFIC REQUEST OF END-USERS BY MEANS OF TELEPHONE OR GLOBAL COMMUNICATIONS NETWORKS; PROVIDING TEMPORARY USE OF ONLINE NON-DOWNLOADABLE TELECOMMUNICATIONS SOFTWARE FOR PROVIDING MULTIPLE USER ACCESS TO THE GLOBAL COMPUTER NETWORK (U.S. CLS. 100 AND 101).

EUGENIA MARTIN, EXAMINING ATTORNEY

SN 78-493,746. DEGNER, RICHARD A., HOUSTON, TX. FILED 10-4-2004.



NO CLAIM IS MADE TO THE EXCLUSIVE RIGHT TO USE "GLOBAL GEOPHYSICAL SERVICES", APART FROM THE MARK AS SHOWN.

THE MARK CONSISTS OF A PARTIAL GLOBE WITH MEDITIANS OF LONGITUDE AND LATITUDE WITH A SUPER-IMPOSED SEISMIC PULSE WAVE FORM.

FOR GEOPHYSICAL SERVICES FOR OIL AND GAS EXPLORATION, NAMELY, SEISMIC DATA ACQUISITION AND PROCESSING, NAMELY, RESEARCHING AND COMPILING SEISMIC DATA (U.S. CLS. 100 AND 101).

FIRST USE 6-1-2004; IN COMMERCE 9-1-2004.
ALEX KEAM, EXAMINING ATTORNEY

CLASS 42—(Continued).

SN 78-493,843. URANGATANG WEB DESIGN, LLC, TINTON FALLS, NJ. FILED 10-4-2004.

CLASS 42—(Continued).

SN 78-500,465. ONERAIN INCORPORATED, LONGMONT, CO. FILED 10-15-2004.

Web Design That Shines

THE MARK CONSISTS OF STANDARD CHARACTERS WITHOUT CLAIM TO ANY PARTICULAR FONT, STYLE, SIZE, OR COLOR.

FOR COMPUTER SERVICES, NAMELY, CREATING AND MAINTAINING WEB SITES FOR OTHERS (U.S. CLS. 100 AND 101).

FIRST USE 3-1-2003; IN COMMERCE 3-1-2003.
KIM SAITO, EXAMINING ATTORNEY

Contrail

THE MARK CONSISTS OF STANDARD CHARACTERS WITHOUT CLAIM TO ANY PARTICULAR FONT, STYLE, SIZE, OR COLOR.

FOR PROVIDING ONLINE NON-DOWNLOADABLE COMPUTER SOFTWARE FOR, AND INFORMATION SERVICES CONCERNING, THE COLLECTING, ANALYZING, DISSEMINATING AND DISPLAYING OF WEATHER AND ENVIRONMENTAL DATA (U.S. CLS. 100 AND 101).

BRENDAN REGAN, EXAMINING ATTORNEY

SN 78-496,803. PNEUMADYNE, INC., PLYMOUTH, MN. FILED 10-8-2004.

MAKE-A-MANIFOLD

THE MARK CONSISTS OF STANDARD CHARACTERS WITHOUT CLAIM TO ANY PARTICULAR FONT, STYLE, SIZE, OR COLOR.

FOR PROVIDING AN INTERACTIVE COMPUTER DATABASE CONCERNING ENGINEERING AND DESIGN IN THE FIELD OF PNEUMATIC MANIFOLDS (U.S. CLS. 100 AND 101).

DAHLIA GEORGE, EXAMINING ATTORNEY

SN 78-501,905. WISPI.NET, INC., ATLANTA, GA. FILED 10-19-2004.

WISPI.NET

SN 78-496,838. POWELL GOLDSTEIN LLP, ATLANTA, GA. FILED 10-8-2004.

POWELL GOLDSTEIN LLP

THE MARK CONSISTS OF STANDARD CHARACTERS WITHOUT CLAIM TO ANY PARTICULAR FONT, STYLE, SIZE, OR COLOR.

OWNER OF U.S. REG. NOS. 2,536,480 AND 2,536,482. NO CLAIM IS MADE TO THE EXCLUSIVE RIGHT TO USE "LLP", APART FROM THE MARK AS SHOWN.

THE NAME POWELL GOLDSTEIN DOES NOT IDENTIFY A LIVING INDIVIDUAL.

FOR LEGAL SERVICES (U.S. CLS. 100 AND 101).
FIRST USE 9-1-2004; IN COMMERCE 9-1-2004.
NICHOLAS ALTREE, EXAMINING ATTORNEY

THE MARK CONSISTS OF STANDARD CHARACTERS WITHOUT CLAIM TO ANY PARTICULAR FONT, STYLE, SIZE, OR COLOR.

FOR DESIGN SERVICES FOR OTHERS, NAMELY, PROVIDING DESIGN, APPLICATIONS AND PROTOTYPING OF WIRELESS SENSOR PRODUCTS ARRAYED IN APPLICATION-SPECIFIC, INTELLIGENT NETWORKS THAT REQUIRE MACHINE-TO-MACHINE (M2M) COMMUNICATIONS, FOR CUSTOMERS WITH WIRELESS PRODUCTS, NETWORKS, AND COMMUNICATIONS REQUIREMENTS (U.S. CLS. 100 AND 101).

PRISCILLA MILTON, EXAMINING ATTORNEY

CLASS 42—(Continued).

SN 78-502,312. CHEMOCENTRYX, INC., MOUNTAIN VIEW, CA. FILED 10-19-2004.

**CYTOTRAFFIC
BARCODE**

THE MARK CONSISTS OF STANDARD CHARACTERS WITHOUT CLAIM TO ANY PARTICULAR FONT, STYLE, SIZE, OR COLOR.

OWNER OF U.S. REG. NO. 2,932,905.
NO CLAIM IS MADE TO THE EXCLUSIVE RIGHT TO USE BARCODE, APART FROM THE MARK AS SHOWN, FOR DRUG DEVELOPMENT AND DISCOVERY SERVICES, INCLUDING DETERMINING THE EFFECT OF CHEMOKINES ON CELL MIGRATION FOR MULTIPLE CELL TYPES (U.S. CLS. 100 AND 101).
AMY GEARIN, EXAMINING ATTORNEY

SN 78-504,320. ENVISION TECHNICAL SERVICES, RESTON, VA. FILED 10-22-2004.



NO CLAIM IS MADE TO THE EXCLUSIVE RIGHT TO USE "TECHNICAL SERVICES" AND "TECHNOLOGY", APART FROM THE MARK AS SHOWN.

FOR COMPUTER CONSULTATION IN THE FIELD OF COMPUTER SOFTWARE AND COMPUTER SYSTEMS IN THE FIELD OF INFORMATION TECHNOLOGY; DESIGN OF COMPUTERS AND COMPUTER SOFTWARE, BOTH IN THE FIELD OF INFORMATION TECHNOLOGY, FOR OTHERS; TECHNICAL SUPPORT SERVICES, NAMELY, TROUBLESHOOTING OF COMPUTER SYSTEMS AND COMPUTER SOFTWARE PROBLEMS FOR OTHERS, IN THE FIELD OF INFORMATION TECHNOLOGY; DESIGN AND TESTING OF NEW PRODUCTS FOR OTHERS, NAMELY COMPUTER SYSTEMS AND COMPUTER SOFTWARE IN THE FIELD OF INFORMATION TECHNOLOGY; MAINTENANCE OF COMPUTER SOFTWARE FOR OTHERS IN THE FIELD OF INFORMATION TECHNOLOGY; CONSULTING SERVICES IN THE FIELD OF DESIGN, SELECTION, IMPLEMENTATION AND USE OF COMPUTER HARDWARE AND SOFTWARE SYSTEMS FOR OTHERS, IN THE FIELD OF INFORMATION TECHNOLOGY (U.S. CLS. 100 AND 101).
MICHAEL HALL, EXAMINING ATTORNEY

CLASS 42—(Continued).

SN 78-504,838. JUDICIAL INTELLIGENCE AGENCY CORP, EDMONDS, WA. FILED 10-23-2004.

CREEKRAT

THE MARK CONSISTS OF STANDARD CHARACTERS WITHOUT CLAIM TO ANY PARTICULAR FONT, STYLE, SIZE, OR COLOR.

FOR SERVICES IN COMMERCIAL ART DESIGN, GRAPHIC ART DESIGN, GRAPHIC ILLUSTRATION, ANIMATION AND SPECIAL-EFFECTS DESIGN FOR OTHERS (U.S. CLS. 100 AND 101).
FIRST USE 10-1-1977; IN COMMERCE 10-1-1980.
TANYA AMOS, EXAMINING ATTORNEY

SN 78-508,597. MAYO FOUNDATION FOR MEDICAL EDUCATION AND RESEARCH, ROCHESTER, MN. FILED 10-29-2004.

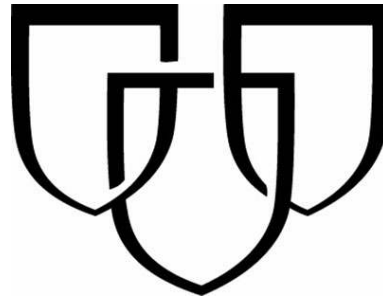

OWNER OF U.S. REG. NOS. 1,613,827, 2,875,340 AND OTHERS.
FOR BIOMEDICAL AND CLINICAL RESEARCH (U.S. CLS. 100 AND 101).
FIRST USE 10-31-2001; IN COMMERCE 10-31-2001.
DEZMONA MIZELLE, EXAMINING ATTORNEY

CLASS 42—(Continued).

SN 78-510,023. SIEMENS ENERGY & AUTOMATION, INC., ALPHARETTA, GA. FILED 11-2-2004.

CLASS 42—(Continued).

SN 78-510,128. CHILDREN'S CHOICE LEARNING CENTERS, INC., PLANO, TX. FILED 11-2-2004.

INSTRUWATCH



THE MARK CONSISTS OF STANDARD CHARACTERS WITHOUT CLAIM TO ANY PARTICULAR FONT, STYLE, SIZE, OR COLOR.

FOR REMOTE MONITORING AND READING OF DATA AND INFORMATION GENERATED BY INDUSTRIAL EQUIPMENT AND INSTRUMENTS; COMPUTER SERVICES, NAMELY, PROVIDING AND MAINTAINING AN INTERACTIVE COMPUTER DATABASE AND DATA MANAGEMENT SYSTEM FOR OTHERS VIA A GLOBAL COMPUTER NETWORK FOR THE PURPOSE OF MONITORING INDUSTRIAL EQUIPMENT AND INSTRUMENTS (U.S. CLS. 100 AND 101).

FIRST USE 3-0-2002; IN COMMERCE 3-0-2002.
ELIZABETH J. WINTER, EXAMINING ATTORNEY

NO CLAIM IS MADE TO THE EXCLUSIVE RIGHT TO USE "TRACKING", APART FROM THE MARK AS SHOWN.

FOR COMPUTER SERVICES, NAMELY, PROVIDING TEMPORARY USE OF ON-LINE NON-DOWNLOADABLE SOFTWARE FOR THE MANAGEMENT OF SINGLE AND MULTIPLE LOCATION CHILDCARE CENTERS (U.S. CLS. 100 AND 101).

FIRST USE 7-1-2000; IN COMMERCE 7-1-2000.
CHRISTOPHER BUONGIORNO, EXAMINING ATTORNEY

SN 78-510,118. CHILDREN'S CHOICE LEARNING CENTERS, INC., PLANO, TX. FILED 11-2-2004.

SN 78-510,371. MARISSA INC., NEW YORK, NY. FILED 11-3-2004.

Choice Tracking



THE MARK CONSISTS OF STANDARD CHARACTERS WITHOUT CLAIM TO ANY PARTICULAR FONT, STYLE, SIZE, OR COLOR.

NO CLAIM IS MADE TO THE EXCLUSIVE RIGHT TO USE "TRACKING", APART FROM THE MARK AS SHOWN. FOR COMPUTER SERVICES, NAMELY, PROVIDING TEMPORARY USE OF ON-LINE NON-DOWNLOADABLE SOFTWARE FOR THE MANAGEMENT OF SINGLE AND MULTIPLE LOCATION CHILDCARE CENTERS (U.S. CLS. 100 AND 101).

FIRST USE 7-1-2000; IN COMMERCE 7-1-2000.
CHRISTOPHER BUONGIORNO, EXAMINING ATTORNEY

FOR DESIGN CONSULTING IN CONNECTION WITH CORPORATE IDENTITY, PACKAGING AND PRODUCTS; MULTI-MEDIA DESIGN SERVICES IN CONNECTION WITH DEVELOPING ADVERTISING FOR CORPORATE BRANDS AND COMMERCIAL PRODUCTS ON TELEVISION, INTERNET AND PRINT (U.S. CLS. 100 AND 101).

FIRST USE 6-0-2004; IN COMMERCE 6-0-2004.
HENRY S. ZAK, EXAMINING ATTORNEY

CLASS 42—(Continued).

SN 78-510,419. GGD, INC., CAMBRIDGE, MA. FILED 11-3-2004.

GUAVA GIRL

THE MARK CONSISTS OF STANDARD CHARACTERS WITHOUT CLAIM TO ANY PARTICULAR FONT, STYLE, SIZE, OR COLOR.

FOR CUSTOM DESIGN AND ENGINEERING OF WEB SITES AND RELATED COMPUTER GRAPHICS DESIGN (U.S. CLS. 100 AND 101).

FIRST USE 3-1-2003; IN COMMERCE 3-1-2003.

JULIE GUTTADAURO, EXAMINING ATTORNEY

SN 78-510,461. AMPLIMED CORPORATION, TUCSON, AZ. FILED 11-3-2004.

AMPLIMED

THE MARK CONSISTS OF STANDARD CHARACTERS WITHOUT CLAIM TO ANY PARTICULAR FONT, STYLE, SIZE, OR COLOR.

FOR SCIENTIFIC AND MEDICAL RESEARCH AND PHARMACEUTICAL DRUG DEVELOPMENT SERVICES (U.S. CLS. 100 AND 101).

FIRST USE 1-11-1989; IN COMMERCE 1-11-1989.

MICHAEL HALL, EXAMINING ATTORNEY

CLASS 42—(Continued).

SN 78-511,172. KEYSER MASON BALL, LLP, MISSISSAUGA, CANADA, FILED 11-4-2004.

**A RESOLVE FOR
BUSINESS**

THE MARK CONSISTS OF STANDARD CHARACTERS WITHOUT CLAIM TO ANY PARTICULAR FONT, STYLE, SIZE, OR COLOR.

FOR PROVISION OF LEGAL SERVICES; LEGAL AGENCIES, NAMELY PROVISION OF TRADE-MARK AGENCY SERVICES; OPERATION OF A WEB SITE FOR THE PURPOSE OF DISSEMINATION OF LEGAL INFORMATION AND BUSINESS LAW INFORMATION (U.S. CLS. 100 AND 101).

KAREN BRACEY, EXAMINING ATTORNEY

SN 78-511,297. BECOME, INC., MOUNTAIN VIEW, CA. FILED 11-4-2004.

BECOME

THE MARK CONSISTS OF STANDARD CHARACTERS WITHOUT CLAIM TO ANY PARTICULAR FONT, STYLE, SIZE, OR COLOR.

FOR COMPUTER SERVICES, NAMELY, PROVIDING SPECIFIC INFORMATION AS REQUESTED BY CUSTOMERS FROM SEARCHABLE INDEXES AND DATABASES OF INFORMATION, INCLUDING TEXT, ELECTRONIC DOCUMENTS, DATABASES, GRAPHICS AND AUDIO VISUAL INFORMATION, BY MEANS OF A GLOBAL COMPUTER INFORMATION NETWORK; CUSTOMIZED SEARCHING SERVICES IN THE NATURE OF PROVIDING SPECIFIC INFORMATION REGARDING PRODUCTS OR SERVICES OR PRODUCT OR SERVICE PRICES AS REQUESTED BY CUSTOMERS FROM INDEXES OF INFORMATION, INDEXES OF WEB SITES AND INDEXES OF OTHER INFORMATION SOURCES VIA THE INTERNET; PROVIDING SOFTWARE INTERFACES AVAILABLE OVER A NETWORK IN ORDER TO CREATE PERSONALIZED ON-LINE INFORMATION SERVICES (U.S. CLS. 100 AND 101).

TEJBIR SINGH, EXAMINING ATTORNEY

CLASS 42—(Continued).

SN 78-511,346. SCHULTE ROTH & ZABEL LLP, NEW YORK, NY. FILED 11-4-2004.

CLASS 42—(Continued).

SN 78-513,450. FAN, JULIA Y., SAN RAMON, CA. FILED 11-8-2004.

GET TO THE POINT

THE MARK CONSISTS OF STANDARD CHARACTERS WITHOUT CLAIM TO ANY PARTICULAR FONT, STYLE, SIZE, OR COLOR.

FOR LEGAL SERVICES (U.S. CLS. 100 AND 101).
FIRST USE 7-1-2003; IN COMMERCE 7-1-2003.
HENRY S. ZAK, EXAMINING ATTORNEY



SN 78-511,745. IDEAL COUNSEL, A PROFESSIONAL LAW CORPORATION, PALO ALTO, CA. FILED 11-5-2004.

IDEAL COUNSEL

THE MARK CONSISTS OF STANDARD CHARACTERS WITHOUT CLAIM TO ANY PARTICULAR FONT, STYLE, SIZE, OR COLOR.

NO CLAIM IS MADE TO THE EXCLUSIVE RIGHT TO USE "COUNSEL", APART FROM THE MARK AS SHOWN.
FOR LEGAL SERVICES (U.S. CLS. 100 AND 101).
FIRST USE 11-1-2004; IN COMMERCE 11-1-2004.
INGRID C. EULIN, EXAMINING ATTORNEY



SN 78-513,118. TECTONIX STEEL, INC., MESA, AZ. FILED 11-8-2004.

TECTONIX STEEL

THE MARK CONSISTS OF STANDARD CHARACTERS WITHOUT CLAIM TO ANY PARTICULAR FONT, STYLE, SIZE, OR COLOR.

NO CLAIM IS MADE TO THE EXCLUSIVE RIGHT TO USE STEEL, APART FROM THE MARK AS SHOWN.
FOR DRAFTING SERVICES FOR THE STEEL CONSTRUCTION INDUSTRY (U.S. CLS. 100 AND 101).
FIRST USE 6-1-2003; IN COMMERCE 6-1-2003.
DANIEL CAPSHAW, EXAMINING ATTORNEY

INDIVI LIFE

THE MARK CONSISTS OF STANDARD CHARACTERS WITHOUT CLAIM TO ANY PARTICULAR FONT, STYLE, SIZE, OR COLOR.

FOR CONSULTATION SERVICES IN THE FIELD OF INTERIOR DESIGN (U.S. CLS. 100 AND 101).
SHAUNIA WALLACE, EXAMINING ATTORNEY



SN 78-514,312. DEPARTMENT OF THE ARMY, ARLINGTON, VA. FILED 11-10-2004.

PARTNERING FOR SUCCESS

THE MARK CONSISTS OF STANDARD CHARACTERS WITHOUT CLAIM TO ANY PARTICULAR FONT, STYLE, SIZE, OR COLOR.

FOR ALTERNATIVE DISPUTE RESOLUTION SERVICES (U.S. CLS. 100 AND 101).
FIRST USE 4-0-1997; IN COMMERCE 4-0-1997.
ALICE SUE CARRUTHERS, EXAMINING ATTORNEY



SN 78-515,280. LAW OFFICE OF STEVEN B. LEAVITT, LLP, ROWLETT, TX. FILED 11-11-2004.

YOU INVENT IT

THE MARK CONSISTS OF STANDARD CHARACTERS WITHOUT CLAIM TO ANY PARTICULAR FONT, STYLE, SIZE, OR COLOR.

FOR LEGAL SERVICES AND CONSULTING IN THE FIELD OF PATENTS, TRADEMARKS, DESIGNS, COPYRIGHTS AND/OR LICENSING OF INTELLECTUAL PROPERTY; PROVIDING INFORMATION IN THE FIELD OF PATENTS, TRADEMARKS, AND COPYRIGHTS (U.S. CLS. 100 AND 101).
MICHAEL ENGEL, EXAMINING ATTORNEY

CLASS 42—(Continued).

SN 78-515,468. MITCHELL, ROBERT, FAIRFAX, CA. FILED 11-11-2004.

APPLIED HOME PERFORMANCE

THE MARK CONSISTS OF STANDARD CHARACTERS WITHOUT CLAIM TO ANY PARTICULAR FONT, STYLE, SIZE, OR COLOR.

NO CLAIM IS MADE TO THE EXCLUSIVE RIGHT TO USE "HOME", APART FROM THE MARK AS SHOWN.

FOR INSPECTIONS OF HOMES AND COMMERCIAL REAL ESTATE FOR THE EXISTENCE OF MOLD, AIR QUALITY, INTEGRITY OF CONSTRUCTION AND SYSTEMS OPERATION (U.S. CLS. 100 AND 101).

INGA ERVIN, EXAMINING ATTORNEY

SN 78-516,207. MOTLEY RICE LLC, MT. PLEASANT, SC. FILED 11-12-2004.

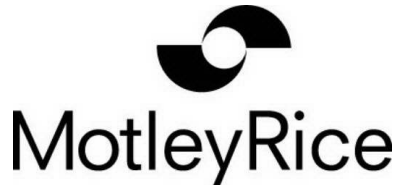

THE MARK CONSISTS OF THE WORDING "MOTLEYRICE" WITH A DESIGN OF A HURRICANE PLACED ABOVE IT.

FOR LEGAL SERVICES (U.S. CLS. 100 AND 101).

FIRST USE 10-22-2004; IN COMMERCE 10-22-2004.

JAMES A. RAUEN, EXAMINING ATTORNEY

SN 78-516,269. M&A DESIGN GROUP, INC., CHICAGO, IL. FILED 11-12-2004.

15 LETTERS INC.

THE MARK CONSISTS OF STANDARD CHARACTERS WITHOUT CLAIM TO ANY PARTICULAR FONT, STYLE, SIZE, OR COLOR.

NO CLAIM IS MADE TO THE EXCLUSIVE RIGHT TO USE "INC.", APART FROM THE MARK AS SHOWN.

FOR CREATIVE GRAPHIC DESIGN AND PROGRAMMING OF INTERACTIVE WEBSITES (U.S. CLS. 100 AND 101).

FIRST USE 10-13-2004; IN COMMERCE 10-13-2004.

JAMES A. RAUEN, EXAMINING ATTORNEY

CLASS 42—(Continued).

SN 78-516,650. SIMONE, JOSEPH M., HAWTHORNE, CA. FILED 11-15-2004.

Menace Studios

THE MARK CONSISTS OF STANDARD CHARACTERS WITHOUT CLAIM TO ANY PARTICULAR FONT, STYLE, SIZE, OR COLOR.

NO CLAIM IS MADE TO THE EXCLUSIVE RIGHT TO USE "STUDIOS", APART FROM THE MARK AS SHOWN.

FOR DESIGN AND DEVELOPMENT OF MULTIMEDIA PRODUCTS; ANIMATION AND SPECIAL-EFFECTS DESIGN FOR OTHERS; GRAPHIC ILLUSTRATION SERVICES FOR OTHERS; GRAPHIC ART DESIGN; AND COMPUTER SERVICES, NAMELY, CREATING AND MAINTAINING WEB SITES FOR OTHERS (U.S. CLS. 100 AND 101).

FIRST USE 6-5-2003; IN COMMERCE 6-5-2003.

PAM WILLIS, EXAMINING ATTORNEY

SN 78-517,428. ANDRX PHARMACEUTICALS, LLC, DAVIE, FL. FILED 11-16-2004.

MACS

THE MARK CONSISTS OF STANDARD CHARACTERS WITHOUT CLAIM TO ANY PARTICULAR FONT, STYLE, SIZE, OR COLOR.

FOR DEVELOPMENT AND PREPARATION OF PHARMACEUTICAL FORMULATION TECHNOLOGIES FOR CONTROLLED RELEASE OR DELIVERY OF PHARMACEUTICAL SUBSTANCES (U.S. CLS. 100 AND 101).

GINA HAYES, EXAMINING ATTORNEY

CLASS 42—(Continued).

SN 78-517,683. TZOLKIN CORP., PEPPERELL, MA. FILED 11-16-2004.

TZO

THE MARK CONSISTS OF STANDARD CHARACTERS WITHOUT CLAIM TO ANY PARTICULAR FONT, STYLE, SIZE, OR COLOR.

FOR COMPUTER SERVICES, NAMELY, REGISTRATION OF DOMAIN NAMES FOR IDENTIFICATION OF USERS ON A GLOBAL COMPUTER NETWORK, HOSTING WEB SITES AND EMAIL FOR OTHERS, ENABLING OTHERS TO HOST THEIR OWN WEB SITES AND EMAIL (U.S. CLS. 100 AND 101).

FIRST USE 11-25-1997; IN COMMERCE 11-25-1997.
VIVIAN MICZNIK FIRST, EXAMINING ATTORNEY

SN 78-517,854. GLASER, JAMES B., SHARON, MA. FILED 11-16-2004.

DIAL-A-LAWYER

THE MARK CONSISTS OF STANDARD CHARACTERS WITHOUT CLAIM TO ANY PARTICULAR FONT, STYLE, SIZE, OR COLOR.

OWNER OF U.S. REG. NO. 2,280,193. SEC. 2(F).
FOR LEGAL SERVICES (U.S. CLS. 100 AND 101).
FIRST USE 1-20-1999; IN COMMERCE 1-20-1999.
ANN LINNEHAN, EXAMINING ATTORNEY

CLASS 42—(Continued).

SN 78-517,876. TARI, TOLGA, JACKSONVILLE, FL. FILED 11-16-2004.

SELLMOREAUTOS

THE MARK CONSISTS OF STANDARD CHARACTERS WITHOUT CLAIM TO ANY PARTICULAR FONT, STYLE, SIZE, OR COLOR.

FOR DESIGN, CREATE, HOST, AND MAINTAIN WEBSITES FOR OTHERS IN THE FIELD OF AUTOMOBILES (U.S. CLS. 100 AND 101).

FIRST USE 11-18-2001; IN COMMERCE 1-24-2002.
TANYA AMOS, EXAMINING ATTORNEY

SN 78-518,405. LAN-TECH, INC., MARIETTA, GA. FILED 11-17-2004.

STOP THE PAPER CHASE!

THE MARK CONSISTS OF STANDARD CHARACTERS WITHOUT CLAIM TO ANY PARTICULAR FONT, STYLE, SIZE, OR COLOR.

FOR COMPUTER CONSULTATION SERVICES; NAMELY THE DESIGN AND IMPLEMENTATION OF DOCUMENT MANAGEMENT SYSTEMS FOR COMPUTERS (U.S. CLS. 100 AND 101).

FIRST USE 5-31-2004; IN COMMERCE 5-31-2004.
KAREN K. BUSH, EXAMINING ATTORNEY

SN 78-518,636. ZIOLKOWSKI PATENT SOLUTIONS GROUP, LLC, MEQUON, WI. FILED 11-17-2004.

IMAGINE INVENT PROTECT

THE MARK CONSISTS OF STANDARD CHARACTERS WITHOUT CLAIM TO ANY PARTICULAR FONT, STYLE, SIZE, OR COLOR.

FOR PROVIDING LEGAL SERVICES IN THE AREA OF INTELLECTUAL PROPERTY LAW, INCLUDING PATENTS, TRADEMARKS, COPYRIGHTS, AND TRADE SECRETS (U.S. CLS. 100 AND 101).

FIRST USE 11-1-2004; IN COMMERCE 11-1-2004.
MONTIA G. PRESSEY, EXAMINING ATTORNEY

CLASS 42—(Continued).

SN 78-519,317. CORTEK, INC., DEDHAM, MA. FILED 11-18-2004.

SOTEIRA

THE MARK CONSISTS OF STANDARD CHARACTERS WITHOUT CLAIM TO ANY PARTICULAR FONT, STYLE, SIZE, OR COLOR.

FOR DEVELOPMENT OF MEDICAL AND SURGICAL INSTRUMENTS FOR THE TREATMENT OF SPINAL DISORDERS (U.S. CLS. 100 AND 101).

GENE MACIOL, EXAMINING ATTORNEY

CLASS 42—(Continued).

SN 78-519,536. LLOYD D. COHEN ATTORNEY, L.L.C., COLUMBUS, OH. FILED 11-18-2004.



THE MARK CONSISTS OF A HUMAN HAND REACHING OUT OF A STACK OF FINANCE RELATED DOCUMENTS. FOR LEGAL SERVICES FOR CLIENTS REQUIRING ASSISTANCE IN BANKRUPTCY LAW AND RELATED LEGAL MATTERS (U.S. CLS. 100 AND 101).

FIRST USE 1-31-2000; IN COMMERCE 11-30-2003.

GISELLE AGOSTO, EXAMINING ATTORNEY

SN 78-519,637. CEMINES, INC., GOLDEN, CO. FILED 11-18-2004.

SN 78-519,495. MANTALINE CORPORATION, AURORA, OH. FILED 11-18-2004.

MANTALINE

THE MARK CONSISTS OF STANDARD CHARACTERS WITHOUT CLAIM TO ANY PARTICULAR FONT, STYLE, SIZE, OR COLOR.

FOR ENGINEERING SERVICES RELATED TO THE DESIGN AND MANUFACTURING OF MOLDED OR EXTRUDED NON-METAL SEALS AND GASKETS (U.S. CLS. 100 AND 101).

FIRST USE 9-1-1996; IN COMMERCE 9-1-1996.
ZACHARY BELLO, EXAMINING ATTORNEY

CEMINING

THE MARK CONSISTS OF STANDARD CHARACTERS WITHOUT CLAIM TO ANY PARTICULAR FONT, STYLE, SIZE, OR COLOR.

FOR PROVIDING TEMPORARY USE OF ON-LINE INTERACTIVE NON-DOWNLOADABLE SOFTWARE IN THE FIELD OF BIO-INFORMATICS FOR USE IN ANALYSIS OF DIAGNOSTIC TEST RESULTS TO DETERMINE MEDICAL DIAGNOSES AND THERAPEUTIC MODALITIES (U.S. CLS. 100 AND 101).

ROBERT LAVACHE, EXAMINING ATTORNEY

CLASS 42—(Continued).

SN 78-520,427. LOEFFLER TUGGEY PAUERSTEIN ROSENTHAL LLP, SAN ANTONIO, TX. FILED 11-19-2004.

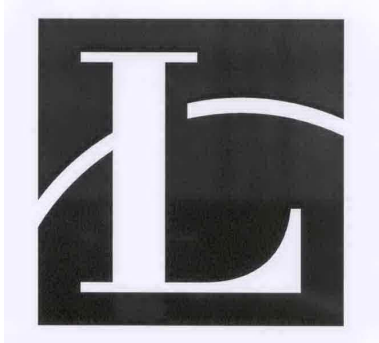

FOR LEGAL SERVICES (U.S. CLS. 100 AND 101).
REBECCA GAN, EXAMINING ATTORNEY

CLASS 42—(Continued).

SN 78-521,122. BULLHORN, INC., BOSTON, MA. FILED 11-22-2004.

**THE LAST SOFTWARE
YOU'LL EVER NEED**

THE MARK CONSISTS OF STANDARD CHARACTERS WITHOUT CLAIM TO ANY PARTICULAR FONT, STYLE, SIZE, OR COLOR.

FOR PROVIDING TEMPORARY USE OF NON-DOWNLOADABLE WEB-BASED SOFTWARE USED TO MANAGE HUMAN RESOURCE FUNCTIONS AND FEATURING ON-LINE MANAGEMENT OF RESUMES, EMAIL, JOB TASKS, CALENDARS, JOB ORDERS, PERSONNEL PLACEMENT AND TIMECARDS; COMPUTER SOFTWARE DESIGN, DEVELOPMENT AND CUSTOMIZATION FOR OTHERS; INSTALLATION, MAINTENANCE AND UPDATE OF COMPUTER SOFTWARE; AND TECHNICAL SUPPORT SERVICES, NAMELY, TROUBLESHOOTING OF SOFTWARE PROBLEMS (U.S. CLS. 100 AND 101).

JULIE WATSON, EXAMINING ATTORNEY

SN 78-521,441. IN2NET NETWORK INC., BURNABY BC V5G 4W9, CANADA, FILED 11-22-2004.

IN2NET

WE KNOW NEVADA

THE MARK CONSISTS OF STANDARD CHARACTERS WITHOUT CLAIM TO ANY PARTICULAR FONT, STYLE, SIZE, OR COLOR.

FOR LEGAL SERVICES; PROVIDING INFORMATION IN THE FIELD OF LAW REGARDING COMMERCIAL LITIGATION, GAMING REGULATIONS, COMMERCIAL TRANSACTIONS, INTELLECTUAL PROPERTY, INTERNET GAMING, TAX LAW, LABOR LAW, ENVIRONMENTAL LAW, INTERNET SWEEPSTAKES AND RELATED TOPICS (U.S. CLS. 100 AND 101).
JOHN WILKE, EXAMINING ATTORNEY

THE MARK CONSISTS OF STANDARD CHARACTERS WITHOUT CLAIM TO ANY PARTICULAR FONT, STYLE, SIZE, OR COLOR.

FOR COMPUTER SERVICES, NAMELY, DESIGNING, CREATING, MAINTAINING, IMPLEMENTING AND HOSTING WEBSITES FOR OTHERS ON A GLOBAL COMPUTER NETWORK; COMPUTER SOFTWARE APPLICATIONS DEPLOYMENT FOR OTHERS ON A GLOBAL COMPUTER NETWORK; COMPUTER CONSULTING SERVICES, NAMELY, PROVIDING TECHNICAL CUSTOMER SERVICE SUPPORT FOR COMPUTER SOFTWARE AND GLOBAL COMPUTER NETWORK USERS, NAMELY TROUBLESHOOTING OF COMPUTER HARDWARE AND SOFTWARE PROBLEMS, BY TELEPHONE AND ON-LINE VIA A GLOBAL COMPUTER NETWORK; COMPUTER CONSULTING SERVICES IN CONNECTION WITH COMPUTERS AND ELECTRONIC COMMERCE (U.S. CLS. 100 AND 101).
FIRST USE 9-1-1996; IN COMMERCE 9-1-1996.

HOWARD B. LEVINE, EXAMINING ATTORNEY

CLASS 42—(Continued).

SN 78-521,500. KEITH S. WINN ASSOCIATES, INC., PLANTATION, FL. FILED 11-23-2004.



NO CLAIM IS MADE TO THE EXCLUSIVE RIGHT TO USE "LOAN SYSTEM", APART FROM THE MARK AS SHOWN.

THE COLOR(S) NAVY BLUE AND CYAN IS/ARE CLAIMED AS A FEATURE OF THE MARK.

THE MARK CONSISTS OF STYLIZED LETTERS FOR WORRY IN NAVY BLUE; STYLIZED LETTERS FOR FREE IN CYAN; STYLIZED LETTERS FOR LOAN SYSTEM IN CYAN. FOUR STYLIZED PEOPLE FIGURES IN NAVY BLUE AND CYAN SURROUNDED BY A RING CONSISTING OF TWO CRESCENT SHAPES MADE UP OF GRADIENT NAVY BLUE AND A CYAN SHADOW.

FOR PROVIDING TEMPORARY USE OF NON-DOWNLOADABLE COMPUTER SOFTWARE FOR OFFERING AND CROSS-SELLING LENDING INSURANCE PRODUCTS (U.S. CLS. 100 AND 101).

JOHN WILKE, EXAMINING ATTORNEY

SN 78-521,535. FRANK BRUNCKHORST CO., L.L.C., BROOKLYN, NY. FILED 11-23-2004.

DELIVIZ.COM

THE MARK CONSISTS OF STANDARD CHARACTERS WITHOUT CLAIM TO ANY PARTICULAR FONT, STYLE, SIZE, OR COLOR.

FOR ONLINE DESIGN AND LAYOUT OF DELICATESSENS FOR OTHERS (U.S. CLS. 100 AND 101).

FLORENTINA BLANDU, EXAMINING ATTORNEY

CLASS 42—(Continued).

SN 78-522,292. ETHNIC HOME LIFESTYLE CORPORATION, EDINA, MN. FILED 11-23-2004.

ETHNICHOME

THE MARK CONSISTS OF STANDARD CHARACTERS WITHOUT CLAIM TO ANY PARTICULAR FONT, STYLE, SIZE, OR COLOR.

FOR INTERIOR DECORATING; PROVIDING INFORMATION ON INTERIOR DECORATING AND RELATED MATTERS THEREOF VIA A GLOBAL COMPUTER NETWORK (U.S. CLS. 100 AND 101).

FIRST USE 12-15-1999; IN COMMERCE 12-15-1999.
KATHERINE STOIDES, EXAMINING ATTORNEY

SN 78-523,574. GRAVES, DOUGHERTY, HEARON & MOODY, P.C., AUSTIN, TX. FILED 11-29-2004.



GRAVES DOUGHERTY HEARON & MOODY

OWNER OF U.S. REG. NOS. 2,544,583 AND 2,759,549.
FOR LEGAL SERVICES (U.S. CLS. 100 AND 101).
FIRST USE 8-20-2003; IN COMMERCE 8-20-2003.
DANIEL BRODY, EXAMINING ATTORNEY

SN 78-523,601. THE NEMOURS FOUNDATION, JACKSONVILLE, FL. FILED 11-29-2004.

OWNER OF U.S. REG. NOS. 2,777,708, 2,777,710 AND OTHERS.

THE COLOR(S) BLUE AND RED IS/ARE CLAIMED AS A FEATURE OF THE MARK.

THE MARK CONSISTS OF THE WORD "NEMOURS", WHICH APPEARS IN BLUE, ABOVE A HORIZONTAL BRUSH STROKE, WHICH APPEARS IN RED.

FOR CONDUCTING MEDICAL AND SCIENTIFIC RESEARCH (U.S. CLS. 100 AND 101).

FIRST USE 1-0-2004. THE MARK WAS FIRST USED ANYWHERE IN A DIFFERENT FORM OTHER THAN THAT SOUGHT TO BE REGISTERED ON 10/00/1940.; IN COMMERCE 1-0-2004. THE MARK WAS FIRST USED IN COMMERCE IN A DIFFERENT FORM OTHER THAN THAT SOUGHT TO BE REGISTERED ON 10/00/1940..

MONTIA G. PRESSEY, EXAMINING ATTORNEY

CLASS 42—(Continued).

SN 78-524,172. GOODWIN PROCTER LLP, BOSTON, MA. FILED 11-30-2004.

CLASS 42—(Continued).

SN 78-527,297. APPLIED FOOD TECHNOLOGIES, LLC, BLACKSBURG, VA. FILED 12-6-2004.

**HOW BUSINESS
THINKS**

THE MARK CONSISTS OF STANDARD CHARACTERS WITHOUT CLAIM TO ANY PARTICULAR FONT, STYLE, SIZE, OR COLOR.

FOR LEGAL SERVICES; PROVIDING INFORMATION IN THE FIELD OF LEGAL SERVICES (U.S. CLS. 100 AND 101).

DOUGLAS LEE, EXAMINING ATTORNEY

AUTHENTI-KIT

THE MARK CONSISTS OF STANDARD CHARACTERS WITHOUT CLAIM TO ANY PARTICULAR FONT, STYLE, SIZE, OR COLOR.

FOR SCIENTIFIC RESEARCH AND DEVELOPMENT, NAMELY THE DEVELOPMENT OF ANTIBODIES AND SUBSTANCES FOR USE IN DIAGNOSTIC KITS FOR USE IN THE FOOD INDUSTRY, INCLUDING THE SEAFOOD INDUSTRY (U.S. CLS. 100 AND 101).

REBECCA SMITH, EXAMINING ATTORNEY

SN 78-527,376. TEL-E-ATRICS, INC., WEST HENRIETTA, NY. FILED 12-6-2004.

TEL-E-ATRICS

SN 78-525,577. IDELL, RICHARD J., SAN FRANCISCO, CA. FILED 12-1-2004.

THE MARK CONSISTS OF STANDARD CHARACTERS WITHOUT CLAIM TO ANY PARTICULAR FONT, STYLE, SIZE, OR COLOR.

FOR CONSULTING SERVICES IN THE FIELD OF DESIGN, SELECTION, IMPLEMENTATION AND USE OF COMPUTER HARDWARE AND SOFTWARE SYSTEMS FOR OTHERS TO ENABLE THE PRACTICE OF TELEMEDICINE (U.S. CLS. 100 AND 101).

TEJBIR SINGH, EXAMINING ATTORNEY

**at the
intersection of
entertainment
and technology**

SN 78-528,071. SCHWARTZ, KENNETH L., NEW YORK, NY. FILED 12-7-2004.

**latinprivateequity.
com**

THE MARK CONSISTS OF STANDARD CHARACTERS WITHOUT CLAIM TO ANY PARTICULAR FONT, STYLE, SIZE, OR COLOR.

FOR LEGAL SERVICES (U.S. CLS. 100 AND 101).

G. MAYERSCHOFF, EXAMINING ATTORNEY

THE MARK CONSISTS OF STANDARD CHARACTERS WITHOUT CLAIM TO ANY PARTICULAR FONT, STYLE, SIZE, OR COLOR.

FOR LEGAL SERVICES (U.S. CLS. 100 AND 101).

LINDA POWELL, EXAMINING ATTORNEY

CLASS 42—(Continued).

SN 78-528,330. C-CHIP TECHNOLOGIES CORPORATION, MONTREAL (QUEBEC), CANADA, FILED 12-7-2004.

C-CHIP

THE MARK CONSISTS OF STANDARD CHARACTERS WITHOUT CLAIM TO ANY PARTICULAR FONT, STYLE, SIZE, OR COLOR.

FOR SERVICES OF DESIGN AND ENGINEERING OF COMPUTER CHIPS (U.S. CLS. 100 AND 101).
BARBARA GAYNOR, EXAMINING ATTORNEY

SN 78-539,170. J.R. MCDADE COMPANY, INC., SCOTTS-DALE, AZ. FILED 12-28-2004.

DINE & DESIGN

THE MARK CONSISTS OF STANDARD CHARACTERS WITHOUT CLAIM TO ANY PARTICULAR FONT, STYLE, SIZE, OR COLOR.

FOR ARCHITECTURAL DESIGN SERVICES; INTERIOR DESIGN SERVICES FOR OTHERS (U.S. CLS. 100 AND 101).

ANDREW BENZMILLER, EXAMINING ATTORNEY

CLASS 42—(Continued).

SN 78-541,882. NORTH CENTRAL ASSOCIATION COMMISSION ON ACCREDITATION AND SCHOOL IMPROVEMENT, TEMPE, AZ. FILED 1-4-2005.

Transitions

THE MARK CONSISTS OF STANDARD CHARACTERS WITHOUT CLAIM TO ANY PARTICULAR FONT, STYLE, SIZE, OR COLOR.

SEC. 2(F).
FOR ACCREDITATION SERVICES, NAMELY, DEVELOPING, EVALUATING, AND TESTING STANDARDS FOR EDUCATION FOR THE PURPOSES OF ACCREDITATION (U.S. CLS. 100 AND 101).

FIRST USE 7-1-1995; IN COMMERCE 7-1-1995.
LINDA M. KING, EXAMINING ATTORNEY

SN 78-541,987. QUALITY INNOVATIVE SOLUTIONS, INC., OXNARD, CA. FILED 1-4-2005.

QI-Solutions

THE MARK CONSISTS OF STANDARD CHARACTERS WITHOUT CLAIM TO ANY PARTICULAR FONT, STYLE, SIZE, OR COLOR.

FOR TECHNOLOGY CONSULTATIONS AND RESEARCH IN THE FIELD OF SYSTEMS ENGINEERING (U.S. CLS. 100 AND 101).

FIRST USE 8-1-2004; IN COMMERCE 8-1-2004.
MARY CRAWFORD, EXAMINING ATTORNEY

CLASS 42—(Continued).

SN 78-545,510. DOUG SNIDER, BOHEMIA, NY. FILED 1-11-2005.

CLASS 42—(Continued).

SN 78-545,511. DEUTSCHE TELEKOM AG, BONN, FED REP GERMANY, FILED 1-11-2005.

T-Mobile Dial a
Smile

MapToons

THE MARK CONSISTS OF STANDARD CHARACTERS WITHOUT CLAIM TO ANY PARTICULAR FONT, STYLE, SIZE, OR COLOR.

PRIORITY CLAIMED UNDER SEC. 44(D) ON FED REP GERMANY APPLICATION NO. 30441824238, FILED 7-21-2004, REG. NO. 30441824, DATED 8-31-2004, EXPIRES 7-31-2014.

OWNER OF U.S. REG. NOS. 2,282,432, 2,908,563 AND OTHERS.

FOR COMPUTER PROGRAMMING SERVICES FOR OTHERS; RENTAL OF COMPUTER SOFTWARE AND HARDWARE FOR ONLINE ACCESS; DATA ENCRYPTION SERVICES, NAMELY, ADMINISTRATION OF DIGITAL KEYS AND DIGITAL CERTIFICATES; APPLICATION SERVICE PROVIDER, NAMELY, HOSTING COMPUTER SOFTWARE APPLICATIONS FOR OTHERS, HOSTING OF DIGITAL CONTENT ON THE INTERNET; HOSTING THE WEB SITES OF OTHERS ON A COMPUTER SERVER FOR A GLOBAL COMPUTER NETWORK; COMPUTER SERVICES, NAMELY, CREATING INDEXES OF INFORMATION AVAILABLE ON COMPUTER NETWORKS; PROVIDING INFORMATION VIA THE TELEPHONE AND THE GLOBAL COMMUNICATION NETWORKS IN THE FIELD OF INFORMATION TECHNOLOGY; CONSULTING SERVICES IN THE FIELD OF DESIGN, SELECTION, IMPLEMENTATION AND USE OF COMPUTER HARDWARE AND SOFTWARE SYSTEMS FOR OTHERS; INSTALLATION, MAINTENANCE AND REPAIR OF COMPUTER SOFTWARE; TECHNICAL PROJECT PLANNING SERVICES RELATED TO TELECOMMUNICATIONS EQUIPMENT; PROVIDING INFORMATION AT THE SPECIFIC REQUEST OF END-USERS BY MEANS OF TELEPHONE OR GLOBAL COMMUNICATIONS NETWORKS; PROVIDING TEMPORARY USE OF ONLINE NON-DOWNLOADABLE TELECOMMUNICATIONS SOFTWARE FOR PROVIDING MULTIPLE USER ACCESS TO THE GLOBAL COMPUTER NETWORK (U.S. CLS. 100 AND 101).

Laurie Mayes, Examining Attorney

THE MARK CONSISTS OF STANDARD CHARACTERS WITHOUT CLAIM TO ANY PARTICULAR FONT, STYLE, SIZE, OR COLOR.

NO CLAIM IS MADE TO THE EXCLUSIVE RIGHT TO USE "MAP", APART FROM THE MARK AS SHOWN.

FOR CARTOGRAPHY - CARTOON MAP MAKING (U.S. CLS. 100 AND 101).

FIRST USE 9-1-2003; IN COMMERCE 9-1-2003.

Margery A. Tierney, Examining Attorney

CLASS 42—(Continued).

SN 78-545,738. TRUVEON CORPORATION, DURHAM, NC. FILED 1-11-2005.

Truveon

THE MARK CONSISTS OF STANDARD CHARACTERS WITHOUT CLAIM TO ANY PARTICULAR FONT, STYLE, SIZE, OR COLOR.

FOR PRODUCT RESEARCH, DEVELOPMENT AND COMPUTER-AIDED ENGINEERING OF CLIMATE CONTROL SYSTEM HARDWARE, SOFTWARE, DATABASES, USER INTERFACES, AND RELATED TECHNICAL SUPPORT SERVICES, NAMELY TROUBLESHOOTING OF COMPUTER HARDWARE AND SOFTWARE PROBLEMS, MONITORING OF NETWORK SYSTEMS, AND PROVIDING BACK-UP COMPUTER PROGRAMS AND FACILITIES (U.S. CLS. 100 AND 101).

WILLIAM VERHOSEK, EXAMINING ATTORNEY

SN 78-546,432. MENDEN & FREIMAN, LLP, ATLANTA, GA. FILED 1-12-2005.

YOUR FUTURE IS
HERE

THE MARK CONSISTS OF STANDARD CHARACTERS WITHOUT CLAIM TO ANY PARTICULAR FONT, STYLE, SIZE, OR COLOR.

FOR LEGAL SERVICES (U.S. CLS. 100 AND 101). FIRST USE 12-28-2004; IN COMMERCE 12-28-2004. WON TEAK OH, EXAMINING ATTORNEY

CLASS 42—(Continued).

SN 78-546,864. AMERISPEC, INC., MEMPHIS, TN. FILED 1-13-2005.

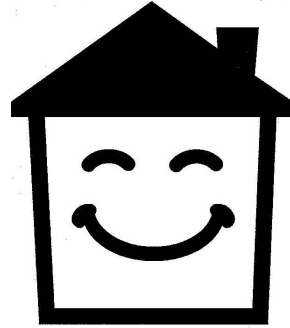

THE MARK CONSISTS OF A DRAWING OF A HOUSE WITH A SMILEY FACE IN THE MIDDLE.

FOR HOME INSPECTION SERVICES (U.S. CLS. 100 AND 101).

FIRST USE 11-1-2004; IN COMMERCE 11-1-2004.

IRA J. GOODSaid, EXAMINING ATTORNEY

SN 78-547,209. INTERNET SYSTEMS DEFENSE CORPORATION, HARRISBURG, PA. FILED 1-13-2005.



THE MARK CONSISTS OF STYLIZED HUMAN FIGURE IN WHICH THE BODY IS AN UPWARDLY OPEN V, THE SHOULDERS ARE A CIRCLE TRANSVERSE TO THE PLANE OF THE V, AND THE HEAD IS A SMALLER CIRCLE COPLANAR WITH THE V.

FOR CONSULTATION IN THE FIELD OF COMPUTER SECURITY; COMPUTER SECURITY SERVICE, NAMELY, RESTRICTING ACCESS TO AND BY COMPUTER NETWORKS TO AND OF UNDESIRED WEB SITES, MEDIA AND INDIVIDUALS AND FACILITIES (U.S. CLS. 100 AND 101).

FIRST USE 11-1-2004; IN COMMERCE 11-1-2004.

CHRISIE B. KING, EXAMINING ATTORNEY

CLASS 42—(Continued).

SN 78-547,220. INTERNET SYSTEMS DEFENSE CORPORATION, HARRISBURG, PA. FILED 1-13-2005.

THE THREAT IS
ALWAYS THERE. SO
ARE WE.

THE MARK CONSISTS OF STANDARD CHARACTERS WITHOUT CLAIM TO ANY PARTICULAR FONT, STYLE, SIZE, OR COLOR.

FOR CONSULTATION IN THE FIELD OF COMPUTER SECURITY; COMPUTER SECURITY SERVICE, NAMELY, RESTRICTING ACCESS TO AND BY COMPUTER NETWORKS TO AND OF UNDESIRE WEB SITES, MEDIA AND INDIVIDUALS AND FACILITIES (U.S. CLS. 100 AND 101).

FIRST USE 11-1-2004; IN COMMERCE 11-1-2004.
GEORGE LORENZO, EXAMINING ATTORNEY

CLASS 42—(Continued).

SN 78-548,628. COWAN, GERALD L., INDIANAPOLIS, IN. FILED 1-17-2005.

Probate Without
Probate

THE MARK CONSISTS OF STANDARD CHARACTERS WITHOUT CLAIM TO ANY PARTICULAR FONT, STYLE, SIZE, OR COLOR.

NO CLAIM IS MADE TO THE EXCLUSIVE RIGHT TO USE "PROBATE", APART FROM THE MARK AS SHOWN.

FOR LEGAL SERVICES (U.S. CLS. 100 AND 101).
FIRST USE 1-10-2004; IN COMMERCE 1-10-2004.
NAAKWAMA ANKRAH, EXAMINING ATTORNEY

SN 78-549,634. USHER, JAMES P., TOMBALL, TX. FILED 1-18-2005.

SN 78-547,467. NETSOURCED IT LLC, CENTENNIAL, CO. FILED 1-13-2005.

ALANYSIS

THE COLOR(S) BLUE AND ORANGE IS/ARE CLAIMED AS A FEATURE OF THE MARK.

THE FIRST A AND YSIS APPEAR IN THE COLOR BLUE. THE LETTERS LAN APPEAR IN THE COLOR ORANGE.

FOR CONSULTING SERVICES IN THE FIELD OF OFFICE AND WORKPLACE AUTOMATION (U.S. CLS. 100 AND 101).

FIRST USE 12-17-2004; IN COMMERCE 12-17-2004.
CHRISIE B. KING, EXAMINING ATTORNEY

Deeptrek

THE MARK CONSISTS OF STANDARD CHARACTERS WITHOUT CLAIM TO ANY PARTICULAR FONT, STYLE, SIZE, OR COLOR.

FOR UNDERWATER EXPLORATION (U.S. CLS. 100 AND 101).

FIRST USE 1-1-2001; IN COMMERCE 1-15-2001.
HOWARD B. LEVINE, EXAMINING ATTORNEY

SN 78-549,651. IT'S YOUR STUFF, LLC, KIRKWOOD, MO. FILED 1-19-2005.

"It's Your Stuff!"
LLC

NO CLAIM IS MADE TO THE EXCLUSIVE RIGHT TO USE "LLC", APART FROM THE MARK AS SHOWN. FOR INTERIOR DECORATING (U.S. CLS. 100 AND 101).

FIRST USE 12-0-2000; IN COMMERCE 4-0-2001.
DEBRA LEE, EXAMINING ATTORNEY

CLASS 42—(Continued).

SN 78-549,759. HEMO GENIX, INC., COLORADO SPRINGS, CO. FILED 1-19-2005.

CLASS 42—(Continued).

SN 78-551,052. SPOGGER, INC., REDWOOD CITY, CA. FILED 1-20-2005.

HEMOGENIX

THE MARK CONSISTS OF STANDARD CHARACTERS WITHOUT CLAIM TO ANY PARTICULAR FONT, STYLE, SIZE, OR COLOR.

FOR RESEARCH AND TESTING OF DRUGS AND COMPOUNDS FOR THEIR EFFECTS ON THE BLOOD SYSTEM (U.S. CLS. 100 AND 101).

FIRST USE 3-1-2000; IN COMMERCE 3-1-2000.
NORA BUCHANAN WILL, EXAMINING ATTORNEY

SPOGGER

SN 78-550,326. BRILLIANT CITIES, MINNEAPOLIS, MN. FILED 1-19-2005.



FOR CUSTOM DESIGN AND ENGINEERING OF TELEPHONY, CABLE, INFORMATION SYSTEMS AND FIBER OPTICS (U.S. CLS. 100 AND 101).

SCOTT BALDWIN, EXAMINING ATTORNEY

THE MARK CONSISTS OF STANDARD CHARACTERS WITHOUT CLAIM TO ANY PARTICULAR FONT, STYLE, SIZE, OR COLOR.

FOR CREATION, DESIGN, HOSTING, AND MAINTENANCE OF WEB PAGES AND COMPUTER SITES TO AND FOR THIRD PARTIES; COMPUTER SERVICES, NAMELY, PROVIDING SEARCH ENGINES FOR OBTAINING DATA ON A GLOBAL COMPUTER NETWORK AND CREATING INDEXES OF INFORMATION, SITES AND OTHER RESOURCES AVAILABLE ON COMPUTER NETWORKS; PROVIDING CUSTOMIZED ON-LINE WEB PAGES FEATURING USER-DEFINED INFORMATION, WHICH INCLUDES SEARCH ENGINES AND ON-LINE WEB LINKS TO OTHER WEB SITES AND PROVIDING SPECIFIC INFORMATION AS REQUESTED BY CUSTOMERS VIA THE INTERNET; STOCK PHOTOGRAPHY SERVICES, NAMELY, LEASING REPRODUCTION RIGHTS OF PHOTOGRAPHS AND TRANSPARENCIES TO OTHERS; COMPUTER TIME-SHARING SERVICES; DATA ENCRYPTION SERVICES AND DATA WAREHOUSING; CUSTOMIZATION, DESIGN AND DEVELOPMENT OF WEBSITES FOR ADVERTISING PURPOSES; CUSTOMIZATION, DESIGN AND DEVELOPMENT OF COMPUTER HARDWARE, SOFTWARE AND MULTIMEDIA PRODUCTS; DEVELOPMENT, MAINTENANCE AND UPDATING OF A TELECOMMUNICATION NETWORK SEARCH ENGINE; AND DISPLAYING THE WEB SITES AND IMAGES OF OTHERS ON A COMPUTER SERVER (U.S. CLS. 100 AND 101).

FIRST USE 2-17-2004; IN COMMERCE 2-17-2004.
WILLIAM P. SHANAHAN, EXAMINING ATTORNEY

CLASS 42—(Continued).

SN 78-555,567. VISIONPACE, INC., INDEPENDENCE, MO. FILED 1-28-2005.

VISIONPACE

THE MARK CONSISTS OF STANDARD CHARACTERS WITHOUT CLAIM TO ANY PARTICULAR FONT, STYLE, SIZE, OR COLOR.

FOR COMPUTER CONSULTING SERVICES AND SOFTWARE DEVELOPMENT SERVICES (U.S. CLS. 100 AND 101).

LESLEY LAMOTHE, EXAMINING ATTORNEY

SN 78-559,297. SIEBEL SYSTEMS, INC., SAN MATEO, CA. FILED 2-2-2005.

IT'S ALL ABOUT THE CUSTOMER

THE MARK CONSISTS OF STANDARD CHARACTERS WITHOUT CLAIM TO ANY PARTICULAR FONT, STYLE, SIZE, OR COLOR.

FOR PROVIDING TEMPORARY USE OF ONLINE NON-DOWNLOADABLE SOFTWARE FOR ORGANIZING, MANAGING, STORING, TRACKING, ANALYZING AND CREATING REPORTS ON INFORMATION RELATED TO RELATIONSHIP MANAGEMENT, SALES, PROMOTION AND MARKETING; COMPUTER SERVICES, NAMELY DESIGNING, DEVELOPING, IMPLEMENTING, INSTALLING, MAINTAINING, UPGRADING, SUPPORTING AND CONFIGURING COMPUTER SOFTWARE AND CONSULTING RELATED THERETO; PROVIDING ONLINE INFORMATION REGARDING COMPUTER SOFTWARE AND THE FOREGOING COMPUTER SERVICES (U.S. CLS. 100 AND 101).

ROBIN CHOSID, EXAMINING ATTORNEY

CLASS 42—(Continued).

SN 78-610,977. KEYCORP, CLEVELAND, OH. FILED 4-18-2005.

KEY TOTAL COMMERCE

THE MARK CONSISTS OF STANDARD CHARACTERS WITHOUT CLAIM TO ANY PARTICULAR FONT, STYLE, SIZE, OR COLOR.

OWNER OF U.S. REG. NOS. 1,722,378, 1,956,625 AND 1,998,350.

FOR CREATION AND MAINTENANCE OF WEB SITES FOR OTHERS (U.S. CLS. 100 AND 101).

FIRST USE 2-28-2005; IN COMMERCE 2-28-2005.
CHERYL CLAYTON, EXAMINING ATTORNEY

SN 79-003,325. MOMO DESIGN S.R.L., ITALY, FILED 5-12-2004.

MOMO DESIGN

THE MARK CONSISTS OF STANDARD CHARACTERS WITHOUT CLAIM TO ANY PARTICULAR FONT, STYLE, SIZE, OR COLOR.

PRIORITY DATE OF 2-20-2004 IS CLAIMED.

OWNER OF INTERNATIONAL REGISTRATION 0827356 DATED 5-12-2004, EXPIRES 5-12-2014.

OWNER OF U.S. REG. NOS. 2,576,528, 2,721,335 AND OTHERS.

NO CLAIM IS MADE TO THE EXCLUSIVE RIGHT TO USE "DESIGN", APART FROM THE MARK AS SHOWN.

FOR INDUSTRIAL DESIGN; PRODUCT AND PACKAGING DESIGN FOR OTHERS; DESIGN OF OUTLET INTERIORS AND EXHIBITION PLACES; HOME INTERIOR DESIGN; SHOP INTERIOR DESIGN; DRESS DESIGNING; AND ENGINEERING. (U.S. CLS. 100 AND 101).

TINA L. SNAPP, EXAMINING ATTORNEY

SN 79-004,325. GIVAUDAN S.A., SWITZERLAND, FILED 7-15-2004.

TRENDTREK

THE MARK CONSISTS OF STANDARD CHARACTERS WITHOUT CLAIM TO ANY PARTICULAR FONT, STYLE, SIZE, OR COLOR.

PRIORITY DATE OF 3-26-2004 IS CLAIMED.

OWNER OF INTERNATIONAL REGISTRATION 0830448 DATED 7-15-2004, EXPIRES 7-15-2014.

OWNER OF U.S. REG. NO. 2,485,769.

FOR RESEARCH AND DEVELOPMENT OF NEW PRODUCTS FOR OTHERS (U.S. CLS. 100 AND 101).

MARTHA FROMM, EXAMINING ATTORNEY

CLASS 42—(Continued).

SN 79-006,671. MARGIT SJÖROOS, FINLAND, FILED 6-15-2004.

STRESSFREE AREA

THE MARK CONSISTS OF STANDARD CHARACTERS WITHOUT CLAIM TO ANY PARTICULAR FONT, STYLE, SIZE, OR COLOR.

PRIORITY DATE OF 12-15-2003 IS CLAIMED.
OWNER OF INTERNATIONAL REGISTRATION 0837012 DATED 6-15-2004, EXPIRES 6-15-2014.

FOR ARCHITECTURAL DESIGN SERVICES, ARCHITECTURAL CONSULTATION SERVICES, COMPUTER SOFTWARE DESIGN, COMPUTER SYSTEM DESIGN, INDUSTRIAL DESIGN, INTERIOR DESIGN SERVICES (U.S. CLS. 100 AND 101).

DAWN FELDMAN, EXAMINING ATTORNEY

SN 79-008,557. SANA-EXPRESS S.R.L., ITALY, FILED 8-3-2004.

GLOBAR

THE MARK CONSISTS OF STANDARD CHARACTERS WITHOUT CLAIM TO ANY PARTICULAR FONT, STYLE, SIZE, OR COLOR.

PRIORITY DATE OF 4-21-2004 IS CLAIMED.
OWNER OF INTERNATIONAL REGISTRATION 0842319 DATED 8-3-2004, EXPIRES 8-3-2014.

THE TRADEMARK IS COMPOSED BY THE FANCY NAME "GLOBAR" WHICH COULD BE REPRODUCED IN ANY CHARACTER, COLOR OR COMBINATION OF COLORS.

FOR TESTING, ANALYSIS AND EVALUATION OF THE GOODS AND SERVICES OF OTHERS FOR THE PURPOSE OF CERTIFICATION AND QUALITY CONTROL SERVICES FOR OTHERS (U.S. CLS. 100 AND 101).

RICHARD WHITE, EXAMINING ATTORNEY

CLASS 43—HOTEL AND RESTAURANT SERVICES

SN 76-412,800. ZENITH CORPORATION, BROOKLYN, NY, FILED 5-24-2002.

TRAILER PARK LOUNGE

THE MARK CONSISTS OF STANDARD CHARACTERS WITHOUT CLAIM TO ANY PARTICULAR FONT, STYLE, SIZE, OR COLOR.

NO CLAIM IS MADE TO THE EXCLUSIVE RIGHT TO USE "LOUNGE", APART FROM THE MARK AS SHOWN.
FOR RESTAURANT SERVICES (U.S. CLS. 100 AND 101).

FIRST USE 5-2-2002; IN COMMERCE 5-2-2002.
LOURDES AYALA, EXAMINING ATTORNEY

CLASS 43—(Continued).

SN 76-527,016. GARFINCKEL'S LIMITED PARTNERSHIP, WASHINGTON, DC. FILED 6-26-2003.

BUTTERFIELD 9

FOR RESTAURANT SERVICES (U.S. CLS. 100 AND 101).

FIRST USE 10-0-1999; IN COMMERCE 10-0-1999.
JERI J. FICKES, EXAMINING ATTORNEY

SN 76-583,187. THE BARBERSHOP CAFE LLC, HILLSBORO, NM. FILED 3-22-2004.



NO CLAIM IS MADE TO THE EXCLUSIVE RIGHT TO USE "HILLSBORO, NEW MEXICO" AND "SHOP CAFE", APART FROM THE MARK AS SHOWN.

FOR RESTAURANT SERVICES (U.S. CLS. 100 AND 101).

FIRST USE 10-0-1999; IN COMMERCE 5-5-2000.
ALICE BENMAMAN, EXAMINING ATTORNEY

SN 76-584,740. THREE FINGERS, INC., MOBILE, AL. FILED 4-5-2004.

foosackly's
CHICKEN FINGERS

NO CLAIM IS MADE TO THE EXCLUSIVE RIGHT TO USE "CHICKEN FINGERS", APART FROM THE MARK AS SHOWN.

FOR RESTAURANT SERVICES (U.S. CLS. 100 AND 101).

FIRST USE 4-28-2000; IN COMMERCE 4-28-2000.
ANDREW RHIM, EXAMINING ATTORNEY

CLASS 43—(Continued).

SN 76-587,826. GPH PARTNERS, LLC, NEW YORK, NY.
FILED 4-21-2004.

GRAMERCY PARK HOTEL

THE MARK CONSISTS OF STANDARD CHARACTERS
WITHOUT CLAIM TO ANY PARTICULAR FONT, STYLE,
SIZE, OR COLOR.

NO CLAIM IS MADE TO THE EXCLUSIVE RIGHT TO
USE HOTEL, APART FROM THE MARK AS SHOWN.

SEC. 2(F).

FOR HOTEL SERVICES (U.S. CLS. 100 AND 101).

FIRST USE 0-0-1925; IN COMMERCE 0-0-1925.

PAULA MAHONEY, EXAMINING ATTORNEY

CLASS 43—(Continued).

SN 76-590,833. CEREALITY OPERATORS, INC., CHICAGO,
IL. FILED 5-3-2004.

UNITED FLAKES OF AMERICA

THE MARK CONSISTS OF STANDARD CHARACTERS
WITHOUT CLAIM TO ANY PARTICULAR FONT, STYLE,
SIZE, OR COLOR.

FOR RESTAURANT, SNACK BAR AND TAKE OUT
SERVICES (U.S. CLS. 100 AND 101).

FIRST USE 8-25-2003; IN COMMERCE 8-25-2003.

PRISCILLA MILTON, EXAMINING ATTORNEY

SN 76-591,193. CHOCOLATE ELEGANCE, LLC, APPLETON,
WI. FILED 5-10-2004.

CHOCOLATE ELEGANCE

THE MARK CONSISTS OF STANDARD CHARACTERS
WITHOUT CLAIM TO ANY PARTICULAR FONT, STYLE,
SIZE, OR COLOR.

NO CLAIM IS MADE TO THE EXCLUSIVE RIGHT TO
USE CHOCOLATE, APART FROM THE MARK AS SHOWN.

FOR RENTAL OF FOOD SERVICE EQUIPMENT,
NAMESLY, FOUNTAINS (U.S. CLS. 100 AND 101).

FIRST USE 7-0-2003; IN COMMERCE 7-0-2003.

GEORGE LORENZO, EXAMINING ATTORNEY

SN 76-590,804. CEREALITY OPERATORS, INC., CHICAGO,
IL. FILED 5-3-2004.

CEREALITY ON THE GO

THE MARK CONSISTS OF STANDARD CHARACTERS
WITHOUT CLAIM TO ANY PARTICULAR FONT, STYLE,
SIZE, OR COLOR.

OWNER OF U.S. REG. NO. 2,836,818.
FOR TAKE OUT SERVICES FOR CEREAL BASED
FOOD (U.S. CLS. 100 AND 101).

FIRST USE 8-25-2003; IN COMMERCE 8-25-2003.

PRISCILLA MILTON, EXAMINING ATTORNEY

SN 76-594,555. HANNAH'S HOME, WILLOWICK, OH. FILED
5-28-2004.

SN 76-590,832. CEREALITY OPERATORS, INC., CHICAGO,
IL. FILED 5-3-2004.

THE WHOLE GRAIN TRUTH

THE MARK CONSISTS OF STANDARD CHARACTERS
WITHOUT CLAIM TO ANY PARTICULAR FONT, STYLE,
SIZE, OR COLOR.

FOR RESTAURANT, SNACK BAR AND TAKE OUT
SERVICES (U.S. CLS. 100 AND 101).

FIRST USE 8-25-2003; IN COMMERCE 8-25-2003.

PRISCILLA MILTON, EXAMINING ATTORNEY

OWNER OF U.S. REG. NOS. 2,590,850, 2,590,852 AND
OTHERS.

NO CLAIM IS MADE TO THE EXCLUSIVE RIGHT TO
USE HOME, APART FROM THE MARK AS SHOWN.

FOR MATERNITY HOME SERVICES, NAMESLY, PRO-
VIDING TEMPORARY HOUSING ACCOMMODATION
AND FOOD FOR WOMEN IN CRISIS PREGNANCIES
(U.S. CLS. 100 AND 101).

FIRST USE 3-0-2004; IN COMMERCE 3-0-2004.

RON FAIRBANKS, EXAMINING ATTORNEY



CLASS 43—(Continued).

SN 76-595,231. PEABODY MANAGEMENT, INC., MEMPHIS, TN. FILED 6-3-2004.

CAPRICCIO GRILL

THE MARK CONSISTS OF STANDARD CHARACTERS WITHOUT CLAIM TO ANY PARTICULAR FONT, STYLE, SIZE, OR COLOR.

OWNER OF U.S. REG. NO. 2,839,473.

NO CLAIM IS MADE TO THE EXCLUSIVE RIGHT TO USE "GRILL", APART FROM THE MARK AS SHOWN.

THE ENGLISH TRANSLATION OF "CAPRICCIO" IS "CAPRICE".

FOR RESTAURANT SERVICES (U.S. CLS. 100 AND 101).

FIRST USE 10-6-2003; IN COMMERCE 10-6-2003.

WILLIAM VERHOSEK, EXAMINING ATTORNEY

SN 76-598,906. MCLEMORE ENTERPRISES, INC., CHESAPEAKE, VA. FILED 6-23-2004.



FOR RESTAURANT SERVICES (U.S. CLS. 100 AND 101).

FIRST USE 9-1-2003; IN COMMERCE 9-1-2003.

SUE LAWRENCE, EXAMINING ATTORNEY

SN 76-600,586. CYBER TOWN, L.P., SAN ANTONIO, TX. FILED 7-2-2004.

CYBER TOWN

THE MARK CONSISTS OF STANDARD CHARACTERS WITHOUT CLAIM TO ANY PARTICULAR FONT, STYLE, SIZE, OR COLOR.

FOR PROVIDING RESTAURANT, PUB, BAR, AND TAVERN SERVICES (U.S. CLS. 100 AND 101).

MARGERY A. TIERNEY, EXAMINING ATTORNEY

CLASS 43—(Continued).

SN 76-600,786. DREAM DINNERS, INC., SNOHOMISH, WA. FILED 7-6-2004.



OWNER OF U.S. REG. NO. 2,816,395.

NO CLAIM IS MADE TO THE EXCLUSIVE RIGHT TO USE DINNERS, APART FROM THE MARK AS SHOWN.

THE COLORS BLUE, WHITE AND BLACK ARE CLAIMED AS A FEATURE OF THE MARK.

THE COLOR BLUE APPEARS IN THE BACKGROUND, THE COLOR WHITE APPEARS IN THE DINNER PLATE DESIGN AND THE COLOR BLACK APPEARS IN THE WORDING "DREAM DINNERS" AND THE LINING ON THE DINNER PLATE.

FOR PERSONALIZED MENU AND FOOD PREPARATION AND FOOD CATERING FOR THE GENERAL PUBLIC (U.S. CLS. 100 AND 101).

FIRST USE 6-1-2002; IN COMMERCE 6-1-2002.

DAVID H. STINE, EXAMINING ATTORNEY

SN 76-603,921. PURPLE POTATO, LLC, CLARKSVILLE, MD. FILED 7-26-2004.

Great Sage
Global Green Cuisine

NO CLAIM IS MADE TO THE EXCLUSIVE RIGHT TO USE "GLOBAL GREEN CUISINE", APART FROM THE MARK AS SHOWN.

FOR RESTAURANT SERVICES (U.S. CLS. 100 AND 101).

FIRST USE 6-22-2004; IN COMMERCE 6-23-2004.

DAWN HAN, EXAMINING ATTORNEY

SN 76-604,702. SHARE THE DAY, RENO, NV. FILED 7-30-2004.

SHARE THE DAY

THE MARK CONSISTS OF STANDARD CHARACTERS WITHOUT CLAIM TO ANY PARTICULAR FONT, STYLE, SIZE, OR COLOR.

FOR ADULT DAY CARE FOR CLIENTS TWENTY ONE YEARS AND OLDER WITH COGNITIVE IMPAIRMENTS THAT WILL BENEFIT FROM THE ACTIVITIES AND SOCIALIZATION THAT A SUPERVISED ADULT DAY CENTER CAN PROVIDE (U.S. CLS. 100 AND 101).

FIRST USE 3-1-2004; IN COMMERCE 3-1-2004.

BRIAN NEVILLE, EXAMINING ATTORNEY

CLASS 43—(Continued).

SN 76-605,291. HALL, BRIAN, IDAHO FALLS, ID. FILED 7-26-2004.



NO CLAIM IS MADE TO THE EXCLUSIVE RIGHT TO USE "AUSSIE EATS", APART FROM THE MARK AS SHOWN.

DARK GREEN, BURGUNDY, BROWN
 APPLICANT CLAIMS THE COLORS DARK GREEN FOR THE WORDING AUSSIE EATS, ASSOCIATED WITH A BURGUNDY KANGAROO SUPERIMPOSED UPON A BROWN AND MARKED BOOMERANG.

FOR RESTAURANT SERVICES (U.S. CLS. 100 AND 101).

FIRST USE 5-1-2004; IN COMMERCE 5-1-2004.
 DORITT L. CARROLL, EXAMINING ATTORNEY

SN 76-605,635. TCWD LIDO REST INC., DBA OLIVE OIL'S, POINT LOOKOUT, NY. FILED 8-4-2004.

YOUR HOME AWAY FROM ROME

THE MARK CONSISTS OF STANDARD CHARACTERS WITHOUT CLAIM TO ANY PARTICULAR FONT, STYLE, SIZE, OR COLOR.

FOR RESTAURANT SERVICES (U.S. CLS. 100 AND 101).

ELLEN BURNS, EXAMINING ATTORNEY

SN 76-609,851. TIME FOR GOOD FOOD, INC., ALEXANDRIA, VA. FILED 9-2-2004.

COMFORT FOOD WITH A SOUTHERN ACCENT

FOR RESTAURANT SERVICES (U.S. CLS. 100 AND 101).

FIRST USE 6-1-2004; IN COMMERCE 6-1-2004.
 PAULA MAHONEY, EXAMINING ATTORNEY

CLASS 43—(Continued).

SN 76-609,890. C.O. JONES LLC, NEW HAVEN, CT. FILED 9-2-2004.

c.o.jones
 Bally Mexican Cuisine

NO CLAIM IS MADE TO THE EXCLUSIVE RIGHT TO USE "MEXICAN CUISINE", APART FROM THE MARK AS SHOWN.

THE NAME C.O.JONES DOES NOT IDENTIFY A LIVING INDIVIDUAL.

FOR RESTAURANT SERVICES (U.S. CLS. 100 AND 101).

FIRST USE 4-0-1999; IN COMMERCE 4-0-1999.
 DAWN HAN, EXAMINING ATTORNEY

SN 76-611,321. EL TACO TOTE TRADEMARK COMPANY, L.L.C., EL PASO, TX. FILED 9-14-2004.



OWNER OF U.S. REG. NOS. 2,833,865 AND 2,842,429.
 NO CLAIM IS MADE TO THE EXCLUSIVE RIGHT TO USE "EL TACO", APART FROM THE MARK AS SHOWN.

THE COLOR(S) BLACK, GREEN, RED, AND YELLOW IS/ ARE CLAIMED AS A FEATURE OF THE MARK.

THE MARK CONSIST OF THREE OVAL RINGS ENCLOSING THE WORDS EL TACO TOTE. THE OUTERMOST RING IS SHADED IN THE COLOR BLACK (PANTONE 0-0-0), THE CENTER RING IS SHADED IN THE COLOR GREEN (PANTONE 31-181-59) AND THE INNERMOST RING IS SHADED IN THE COLOR RED (PANTONE 255-0-0). THE INTERIOR OF THE OVAL IS SHADED IN THE COLOR YELLOW (PANTONE 548-227-21) AND THE WORDS "EL TACO TOTE" ARE IN GREEN (PANTONE 31-181-59) BUBBLE LETTERS.

THE FOREIGN WORD "EL" IN THE MARK TRANSLATES INTO ENGLISH AS "THE".

FOR RESTAURANTS SERVICES (U.S. CLS. 100 AND 101).

FIRST USE 10-1-1988; IN COMMERCE 9-14-1994.
 CAROLINE WOOD, EXAMINING ATTORNEY

CLASS 43—(Continued).

SN 76-612,987. KILOHANA, INC., DUBLIN, CA. FILED 9-20-2004.



NO CLAIM IS MADE TO THE EXCLUSIVE RIGHT TO USE "GRILL", APART FROM THE MARK AS SHOWN. THE ENGLISH TRANSLATION FOR "KILOHANA" IS "BEST".

FOR RESTAURANTS (U.S. CLS. 100 AND 101).
FIRST USE 12-1-2002; IN COMMERCE 12-1-2002.
DAWN HAN, EXAMINING ATTORNEY

SN 76-616,909. SABOR LATINO FAMILIAR, INC., SPRING VALLEY, NY. FILED 10-20-2004.



NO CLAIM IS MADE TO THE EXCLUSIVE RIGHT TO USE "LATINO RESTAURANT", APART FROM THE MARK AS SHOWN.

THE FOREIGN WORDING IN THE MARK TRANSLATES INTO ENGLISH AS LATIN FLAVOR.

FOR RESTAURANT AND BAR SERVICES (U.S. CLS. 100 AND 101).

TARAH HARDY, EXAMINING ATTORNEY

SN 76-617,314. PEABODY MANAGEMENT, INC., MEMPHIS, TN. FILED 10-20-2004.

CAPRICCIO GRILL
ITALIAN STEAKHOUSE

OWNER OF U.S. REG. NO. 2,839,473.

NO CLAIM IS MADE TO THE EXCLUSIVE RIGHT TO USE "GRILL" AND "ITALIAN STEAKHOUSE", APART FROM THE MARK AS SHOWN.

FOR RESTAURANT SERVICES (U.S. CLS. 100 AND 101).

FIRST USE 5-10-2004; IN COMMERCE 5-10-2004.
STEVEN JACKSON, EXAMINING ATTORNEY

CLASS 43—(Continued).

SN 76-617,595. AGAKHANYAN, ARARAT, BURBANK, CA. FILED 10-26-2004.

**BIG MAMA'S & PAPA'S
PIZZERIA**



"Home of the World's Largest Pizza"
Restaurant food in a box

NO CLAIM IS MADE TO THE EXCLUSIVE RIGHT TO USE PIZZERIA "HOME OF THE WORLD'S LARGEST PIZZA" AND RESTAURANT FOOD IN A BOX, APART FROM THE MARK AS SHOWN.

FOR RESTAURANT SERVICES FEATURING HOME DELIVERY, DINE IN AND TAKE OUT (U.S. CLS. 100 AND 101).

SCOTT OSCLICK, EXAMINING ATTORNEY

SN 76-617,596. WDM, INC., MT. CARMEL, IL. FILED 10-26-2004.



NO CLAIM IS MADE TO THE EXCLUSIVE RIGHT TO USE TACO, APART FROM THE MARK AS SHOWN.

THE ENGLISH TRANSLATION OF THE WORD "TERRA" IN THE MARK IS "LAND".

FOR RESTAURANT SERVICES (U.S. CLS. 100 AND 101).

FIRST USE 8-6-1977; IN COMMERCE 8-6-1977.
SCOTT OSCLICK, EXAMINING ATTORNEY

SN 76-617,686. EGG VENTURES, INC., PAWLEYS ISLAND, SC. FILED 10-22-2004.

EGGS UP GRILL

THE MARK CONSISTS OF STANDARD CHARACTERS WITHOUT CLAIM TO ANY PARTICULAR FONT, STYLE, SIZE, OR COLOR.

NO CLAIM IS MADE TO THE EXCLUSIVE RIGHT TO USE "EGGS" OR "GRILL", APART FROM THE MARK AS SHOWN.

FOR RESTAURANT SERVICES (U.S. CLS. 100 AND 101).

FIRST USE 10-0-1997; IN COMMERCE 10-0-1997.
TINA L. SNAPP, EXAMINING ATTORNEY

CLASS 43—(Continued).

SN 76-620,792. AMELIA'S NEIGHBORHOOD RESTAURANT LLC, JERSEY CITY, NJ. FILED 11-16-2004.



NO CLAIM IS MADE TO THE EXCLUSIVE RIGHT TO USE BISTRO, APART FROM THE MARK AS SHOWN. FOR RESTAURANTS SERVICES (U.S. CLS. 100 AND 101). FIRST USE 11-9-2004; IN COMMERCE 11-9-2004. WINSTON FOLMAR, EXAMINING ATTORNEY

SN 76-621,213. THE WEST END, LLC, NASHVILLE, TN. FILED 11-18-2004.

JOHNNY BROWN'S

THE MARK CONSISTS OF STANDARD CHARACTERS WITHOUT CLAIM TO ANY PARTICULAR FONT, STYLE, SIZE, OR COLOR. THE MARK DOES NOT IDENTIFY A PARTICULAR LIVING INDIVIDUAL. FOR RESTAURANT SERVICES (U.S. CLS. 100 AND 101). JASON TURNER, EXAMINING ATTORNEY

SN 76-621,410. BROOCKS, WILLIAM RICE, NASHVILLE, TN. FILED 11-19-2004.

WHERE THE WORLD CONNECTS

THE MARK CONSISTS OF STANDARD CHARACTERS WITHOUT CLAIM TO ANY PARTICULAR FONT, STYLE, SIZE, OR COLOR. FOR RESTAURANT, CAFÉ AND TAKE-OUT FOOD SERVICES (U.S. CLS. 100 AND 101). DANIEL CAPSHAW, EXAMINING ATTORNEY

CLASS 43—(Continued).

SN 76-622,847. HAVANA USA, INC., RICHMOND, VA. FILED 12-2-2004.

TEAS ME

THE MARK CONSISTS OF STANDARD CHARACTERS WITHOUT CLAIM TO ANY PARTICULAR FONT, STYLE, SIZE, OR COLOR. FOR RESTAURANT AND CATERING SERVICES (U.S. CLS. 100 AND 101). BARBARA A. GOLD, EXAMINING ATTORNEY

SN 76-622,863. GOSH ENTERPRISES, INC., COLUMBUS, OH. FILED 12-2-2004.

CHARLEY'S PHILLY GRILL

THE MARK CONSISTS OF STANDARD CHARACTERS WITHOUT CLAIM TO ANY PARTICULAR FONT, STYLE, SIZE, OR COLOR. NO CLAIM IS MADE TO THE EXCLUSIVE RIGHT TO USE "PHILLY GRILL", APART FROM THE MARK AS SHOWN. FOR RESTAURANT SERVICES (U.S. CLS. 100 AND 101). MIDGE BUTLER, EXAMINING ATTORNEY

SN 76-623,447. GOLDEN FLAME HOT WINGS, INC., AURORA, CO. FILED 12-6-2004.

GOLDEN FLAME

THE MARK CONSISTS OF STANDARD CHARACTERS WITHOUT CLAIM TO ANY PARTICULAR FONT, STYLE, SIZE, OR COLOR. FOR RESTAURANT SERVICES (U.S. CLS. 100 AND 101). KRISTINA KLOIBER, EXAMINING ATTORNEY

CLASS 43—(Continued).

SN 76-623,943. UNIVERSAL CITY STUDIOS LLLP, UNIVERSAL CITY, CA. FILED 12-10-2004.

GALAXY BAR

THE MARK CONSISTS OF STANDARD CHARACTERS WITHOUT CLAIM TO ANY PARTICULAR FONT, STYLE, SIZE, OR COLOR.

NO CLAIM IS MADE TO THE EXCLUSIVE RIGHT TO USE "BAR", APART FROM THE MARK AS SHOWN. FOR RESTAURANT SERVICES (U.S. CLS. 100 AND 101).

FIRST USE 7-0-2001; IN COMMERCE 7-0-2001.
JOHN DALIER, EXAMINING ATTORNEY

CLASS 43—(Continued).

SN 76-624,907. DONATONE, THOMAS, WILMINGTON, NC. FILED 12-16-2004.

PUPS PLAY & STAY

THE MARK CONSISTS OF STANDARD CHARACTERS WITHOUT CLAIM TO ANY PARTICULAR FONT, STYLE, SIZE, OR COLOR.

NO CLAIM IS MADE TO THE EXCLUSIVE RIGHT TO USE PUPS, APART FROM THE MARK AS SHOWN. FOR PET SERVICES, NAMELY PET BOARDING AND DAYCARE (U.S. CLS. 100 AND 101).

LEIGH CAROLINE CASE, EXAMINING ATTORNEY

SN 76-624,108. CELLA, TODD, NEW YORK, NY. FILED 12-9-2004.



THE STIPPLING IS FOR SHADING PURPOSES. FOR RESTAURANT SERVICES (U.S. CLS. 100 AND 101).

AMY GEARIN, EXAMINING ATTORNEY

SN 76-624,214. J.L.G. CAFES, INC., PONCE INLET, FL. FILED 12-9-2004.

GENOVESE'S ITALIAN CAFE

THE MARK CONSISTS OF STANDARD CHARACTERS WITHOUT CLAIM TO ANY PARTICULAR FONT, STYLE, SIZE, OR COLOR.

NO CLAIM IS MADE TO THE EXCLUSIVE RIGHT TO USE "ITALIAN CAFE", APART FROM THE MARK AS SHOWN.

FOR RESTAURANT SERVICES (U.S. CLS. 100 AND 101).

FIRST USE 3-3-1983; IN COMMERCE 3-3-1983.
DANIEL BRODY, EXAMINING ATTORNEY

SN 76-626,343. BALOT, STEVEN, LIVINGSTON, NJ. FILED 12-30-2004.

BUNNY HOP

THE MARK CONSISTS OF STANDARD CHARACTERS WITHOUT CLAIM TO ANY PARTICULAR FONT, STYLE, SIZE, OR COLOR.

FOR RESTAURANT AND TAVERN SERVICES (U.S. CLS. 100 AND 101).

JENNIFER MARTIN, EXAMINING ATTORNEY

SN 76-626,433. ANDREWS, CHRISTOPHER, NEW YORK, NY. FILED 12-28-2004.

BAO 111

THE MARK CONSISTS OF STANDARD CHARACTERS WITHOUT CLAIM TO ANY PARTICULAR FONT, STYLE, SIZE, OR COLOR.

"BAO" IS THE VIETNAMESE WORD FOR "BAG" OR "SACK".

FOR RESTAURANT, CARRY-OUT FOOD RESTAURANT AND BAR SERVICES (U.S. CLS. 100 AND 101).

FIRST USE 12-11-2002; IN COMMERCE 12-11-2002.
TANYA AMOS, EXAMINING ATTORNEY

CLASS 43—(Continued).

SN 76-628,164. BOB EVANS RESTAURANTS OF MICHIGAN, INC., ANN ARBOR, MI. FILED 1-19-2005.

SMART CHOICES

THE MARK CONSISTS OF STANDARD CHARACTERS WITHOUT CLAIM TO ANY PARTICULAR FONT, STYLE, SIZE, OR COLOR.

FOR RESTAURANT SERVICES FEATURING A CUSTOMER RELATIONS PROGRAM (U.S. CLS. 100 AND 101).

FIRST USE 8-0-2004; IN COMMERCE 8-0-2004.
MICHAEL SOUDERS, EXAMINING ATTORNEY

CLASS 43—(Continued).

SN 78-292,894. EL GAUCHO SEATTLE, LLC, SEATTLE, WA. FILED 8-27-2003.

EL GAUCHO

THE ENGLISH TRANSLATION OF THE SPANISH WORDING "EL GAUCHO" IS "THE COWBOY".

FOR RESTAURANT SERVICES (U.S. CLS. 100 AND 101).

FIRST USE 12-16-1996; IN COMMERCE 12-16-1996.
BARBARA A. GOLD, EXAMINING ATTORNEY

SN 76-628,299. SAWMILL TAVERN, INC., HOUSTON, TX. FILED 1-19-2005.

FRONT PORCH PUB

THE MARK CONSISTS OF STANDARD CHARACTERS WITHOUT CLAIM TO ANY PARTICULAR FONT, STYLE, SIZE, OR COLOR.

NO CLAIM IS MADE TO THE EXCLUSIVE RIGHT TO USE PUB, APART FROM THE MARK AS SHOWN.

FOR RESTAURANT AND BAR SERVICES (U.S. CLS. 100 AND 101).

FIRST USE 12-21-2000; IN COMMERCE 12-21-2000.
JEFF DEFORD, EXAMINING ATTORNEY

SN 78-309,389. SLOW FOODS, LLC, WALLA WALLA, WA. FILED 10-3-2003.

26BRIX

FOR RESTAURANT SERVICES (U.S. CLS. 100 AND 101).

FIRST USE 6-20-2004; IN COMMERCE 6-20-2004.
SHARON MEIER, EXAMINING ATTORNEY

SN 78-168,790. BURRITO BEACH, LLC, CHICAGO, IL. FILED 9-27-2002.



OWNER OF U.S. REG. NOS. 2,095,659 AND 2,127,616.
NO CLAIM IS MADE TO THE EXCLUSIVE RIGHT TO USE "BURRITO" AND "BURRITOS", APART FROM THE MARK AS SHOWN.

THE MARK CONSISTS OF THE WORDING BURRITO BEACH IN A SHADED RECTANGLE DESIGN ABOVE THE WORDING CELEBRITY CHEF BURRITOS WITH A DESIGN OF A SOMBRERO WEARING A CHEF'S HAT TO THE LEFT OF THE WORDING.

FOR RESTAURANT SERVICES (U.S. CLS. 100 AND 101).
CYNTHIA SLOAN, EXAMINING ATTORNEY

SN 78-312,337. MERUELO, HOMERO, MIAMI BEACH, FL. FILED 10-10-2003.

Beach Paradise Hotel

NO CLAIM IS MADE TO THE EXCLUSIVE RIGHT TO USE HOTEL, APART FROM THE MARK AS SHOWN.

FOR HOTELS (U.S. CLS. 100 AND 101).
FIRST USE 4-1-1999; IN COMMERCE 4-1-1999.
KATHERINE STOIDES, EXAMINING ATTORNEY

CLASS 43—(Continued).

SN 78-357,989. A BARBECUE EXPERIENCE LLC, DBA THE SMOKED JOINT: A BARBECUE EXPERIENCE, PHILADELPHIA, PA. FILED 1-27-2004.

CLASS 43—(Continued).

SN 78-371,241. WONG, PHILIP JASON, NEW YORK, NY. FILED 2-20-2004.

THE GRILL-THAT-THRILLS

RED BAMBOO

THE MARK CONSISTS OF STANDARD CHARACTERS WITHOUT CLAIM TO ANY PARTICULAR FONT, STYLE, SIZE, OR COLOR.

FOR RESTAURANT AND CATERING SERVICES (U.S. CLS. 100 AND 101).
RON FAIRBANKS, EXAMINING ATTORNEY

THE MARK CONSISTS OF STANDARD CHARACTERS WITHOUT CLAIM TO ANY PARTICULAR FONT, STYLE, SIZE, OR COLOR.

FOR RESTAURANT SERVICES, CARRY-OUT SERVICES AND CATERING (U.S. CLS. 100 AND 101).
FIRST USE 1-4-2001; IN COMMERCE 2-15-2001.
PRISCILLA MILTON, EXAMINING ATTORNEY

SN 78-362,051. JMN FOOD SERVICES, INC., VENICE, CA. FILED 2-3-2004.

SN 78-371,391. DHR RESTAURANT CO. LLC, NEW YORK, NY. FILED 2-20-2004.

JJ Chill



THE MARK CONSISTS OF STANDARD CHARACTERS WITHOUT CLAIM TO ANY PARTICULAR FONT, STYLE, SIZE, OR COLOR.

APPLICANT'S MARK DOES NOT IDENTIFY A LIVING INDIVIDUAL.
FOR RESTAURANT SERVICES, PREPARATION OF FOOD AND BEVERAGES, SERVING FOOD AND BEVERAGES (U.S. CLS. 100 AND 101).
SHAUNIA WALLACE, EXAMINING ATTORNEY

NO CLAIM IS MADE TO THE EXCLUSIVE RIGHT TO USE "BAR & GRILL", APART FROM THE MARK AS SHOWN.

THE STIPPLING IS FOR SHADING PURPOSES ONLY.
FOR RESTAURANT AND BAR SERVICES (U.S. CLS. 100 AND 101).
FIRST USE 3-15-2003; IN COMMERCE 3-15-2003.
TRICIA SONNEBORN, EXAMINING ATTORNEY

CLASS 43—(Continued).

SN 78-384,590. VON SINGH CORPORATION, NEW YORK, NY. FILED 3-15-2004.

Von Singh's

THE MARK CONSISTS OF STANDARD CHARACTERS WITHOUT CLAIM TO ANY PARTICULAR FONT, STYLE, SIZE, OR COLOR.

VON SINGH DOES NOT IDENTIFY A PARTICULAR LIVING INDIVIDUAL OF WHICH THE APPLICANT IS AWARE.

FOR RESTAURANT SERVICES (U.S. CLS. 100 AND 101).

TONI HICKEY, EXAMINING ATTORNEY

SN 78-397,160. CANAD CORPORATION OF MANITOBA LTD., WINNIPEG, CANADA, FILED 4-6-2004.

TAVERN UNITED

THE MARK CONSISTS OF STANDARD CHARACTERS WITHOUT CLAIM TO ANY PARTICULAR FONT, STYLE, SIZE, OR COLOR.

NO CLAIM IS MADE TO THE EXCLUSIVE RIGHT TO USE TAVERN, APART FROM THE MARK AS SHOWN.

FOR RESTAURANT AND BAR SERVICES (U.S. CLS. 100 AND 101).

MICHAEL ENGEL, EXAMINING ATTORNEY

CLASS 43—(Continued).

SN 78-408,188. EAT'N PARK HOSPITALITY GROUP, INC., HOMESTEAD, PA. FILED 4-26-2004.



OWNER OF U.S. REG. NO. 2,349,924.
NO CLAIM IS MADE TO THE EXCLUSIVE RIGHT TO USE HOSPITALITY, APART FROM THE MARK AS SHOWN.

THE MARK CONSISTS OF THE WORDS CURA HOSPITALITY OVER A PINEAPPLE.

FOR CONTRACT FOOD SERVICES, NAMELY, PROVIDING DINING SERVICES FOR RESIDENTS OF HEALTHCARE FACILITIES (U.S. CLS. 100 AND 101).

DOMINICK J. SALEMI, EXAMINING ATTORNEY

SN 78-409,775. ACCESSIBLE SPACE, INC., ST. PAUL, MN. FILED 4-28-2004.

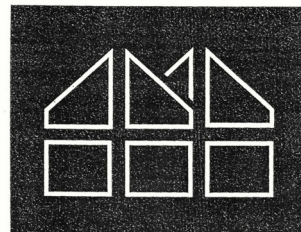

OWNER OF U.S. REG. NO. 1,775,593.

THE MARK CONSISTS OF DESIGN OF TWO HOUSES. FOR PROVIDING ACCESSIBLE, AFFORDABLE, INDEPENDENT AND SUPPORTIVE ASSISTED LIVING FACILITIES TO PERSONS WITH DISABILITIES, AND BRAIN INJURIES, AS WELL AS SENIOR CITIZENS (U.S. CLS. 100 AND 101).

FIRST USE 9-0-2001; IN COMMERCE 9-0-2001.

CHARLES L. JENKINS, EXAMINING ATTORNEY

CLASS 43—(Continued).

SN 78-409,817. BAKER, MATTHEW, W., SCOTTSDALE, AZ.
FILED 4-28-2004.

Bare Back Grill

THE MARK CONSISTS OF STANDARD CHARACTERS WITHOUT CLAIM TO ANY PARTICULAR FONT, STYLE, SIZE, OR COLOR.

NO CLAIM IS MADE TO THE EXCLUSIVE RIGHT TO USE "GRILL", APART FROM THE MARK AS SHOWN.

FOR RESTAURANT SERVICES; TAKE OUT RESTAURANT SERVICES (U.S. CLS. 100 AND 101).

BARBARA RUTLAND, EXAMINING ATTORNEY

CLASS 43—(Continued).

SN 78-414,402. WICKED WINGS LLC, LITTLETON, CO.
FILED 5-6-2004.

WICKED WINGS

THE MARK CONSISTS OF STANDARD CHARACTERS WITHOUT CLAIM TO ANY PARTICULAR FONT, STYLE, SIZE, OR COLOR.

NO CLAIM IS MADE TO THE EXCLUSIVE RIGHT TO USE WINGS, APART FROM THE MARK AS SHOWN.

FOR RESTAURANT SERVICES (U.S. CLS. 100 AND 101).

CAROLINE WOOD, EXAMINING ATTORNEY

SN 78-410,246. PLATINUM DEVELOPMENT, BEVERLY HILLS, CA. FILED 4-29-2004.

7 DIAMOND

THE MARK CONSISTS OF STANDARD CHARACTERS WITHOUT CLAIM TO ANY PARTICULAR FONT, STYLE, SIZE, OR COLOR.

FOR RESORT HOTELS; HOTEL SERVICES (U.S. CLS. 100 AND 101).

NORA BUCHANAN WILL, EXAMINING ATTORNEY

SN 78-416,879. PRIVATE ESCAPES, LLC, FORT COLLINS, CO. FILED 5-11-2004.

PRIVATE ESCAPES

THE MARK CONSISTS OF STANDARD CHARACTERS WITHOUT CLAIM TO ANY PARTICULAR FONT, STYLE, SIZE, OR COLOR.

FOR ARRANGING TEMPORARY RESORT ACCOMMODATIONS (U.S. CLS. 100 AND 101).

FIRST USE 10-14-2003; IN COMMERCE 12-8-2003.

ANGELA M. MICHELI, EXAMINING ATTORNEY

SN 78-410,351. PLATINUM DEVELOPMENT, LLC, BEVERLY HILLS, CA. FILED 4-29-2004.

BEVERLY SPRINGS

THE MARK CONSISTS OF STANDARD CHARACTERS WITHOUT CLAIM TO ANY PARTICULAR FONT, STYLE, SIZE, OR COLOR.

FOR RESORT LODGINGS AND HOTEL SERVICES (U.S. CLS. 100 AND 101).

LESLEY LAMOTHE, EXAMINING ATTORNEY

SN 78-421,982. E-BRANDS ACQUISITION, LLC, ORLANDO, FL. FILED 5-20-2004.



NO CLAIM IS MADE TO THE EXCLUSIVE RIGHT TO USE "RESTAURANTS", APART FROM THE MARK AS SHOWN.

THE MARK INCLUDES THE LETTER "E" IN STYLIZED FORM.

FOR RESTAURANT SERVICES, BAR SERVICES, CATERING SERVICES (U.S. CLS. 100 AND 101).

MATTHEW PAPPAS, EXAMINING ATTORNEY

CLASS 43—(Continued).

SN 78-427,956. FOSSILS, L.L.C., BATON ROUGE, LA. FILED 6-1-2004.

CLASS 43—(Continued).

SN 78-431,548. ZIEGLER RESTAURANT INC., SCOTTSDALE, AZ. FILED 6-8-2004.

ZIEGLER'S NEW YORK
PIZZA DEPT

Fossils

THE MARK CONSISTS OF STANDARD CHARACTERS WITHOUT CLAIM TO ANY PARTICULAR FONT, STYLE, SIZE, OR COLOR.

NO CLAIM IS MADE TO THE EXCLUSIVE RIGHT TO USE "NEW YORK PIZZA", APART FROM THE MARK AS SHOWN.

FOR RESTAURANT SERVICES (U.S. CLS. 100 AND 101).

FIRST USE 11-1-1996; IN COMMERCE 11-1-1996.
CAROL SPILS, EXAMINING ATTORNEY

THE MARK CONSISTS OF STANDARD CHARACTERS WITHOUT CLAIM TO ANY PARTICULAR FONT, STYLE, SIZE, OR COLOR.

FOR RESTAURANT AND CONTRACT FOOD SERVICES (U.S. CLS. 100 AND 101).

TIMOTHY FINNEGAN, EXAMINING ATTORNEY

SN 78-435,076. VICTORY OUTREACH INTERNATIONAL, SAN DIMAS, CA. FILED 6-14-2004.

SN 78-429,470. RAISING CANE'S USA, L.L.C., BATON ROUGE, VA. FILED 6-3-2004.

Victory
International
Conference
Center

GET FRIED!

THE MARK CONSISTS OF STANDARD CHARACTERS WITHOUT CLAIM TO ANY PARTICULAR FONT, STYLE, SIZE, OR COLOR.

NO CLAIM IS MADE TO THE EXCLUSIVE RIGHT TO USE "INTERNATIONAL CONFERENCE CENTER", APART FROM THE MARK AS SHOWN.

FOR PROVISION OF CONFERENCE FACILITIES (U.S. CLS. 100 AND 101).

GRETTA YAO, EXAMINING ATTORNEY

THE MARK CONSISTS OF STANDARD CHARACTERS WITHOUT CLAIM TO ANY PARTICULAR FONT, STYLE, SIZE, OR COLOR.

FOR RESTAURANT SERVICES (U.S. CLS. 100 AND 101).

MATTHEW KLINE, EXAMINING ATTORNEY

CLASS 43—(Continued).

SN 78-441,901. HAPPY HOUNDS DOG DAY CARE, LLC, PLYMOUTH, MI. FILED 6-26-2004.



NO CLAIM IS MADE TO THE EXCLUSIVE RIGHT TO USE "HOUNDS" OR "DOG DAY CARE", APART FROM THE MARK AS SHOWN.
 FOR DOG DAY CARE (U.S. CLS. 100 AND 101).
 FIRST USE 6-14-2004; IN COMMERCE 6-14-2004.
 MICHAEL WEBSTER, EXAMINING ATTORNEY

SN 78-458,833. TRINITY CHILDREN AND FAMILY SERVICES, COLTON, CA. FILED 7-29-2004.

**TRINITY CHILDREN &
 FAMILY SERVICES**

THE MARK CONSISTS OF STANDARD CHARACTERS WITHOUT CLAIM TO ANY PARTICULAR FONT, STYLE, SIZE, OR COLOR.
 NO CLAIM IS MADE TO THE EXCLUSIVE RIGHT TO USE "CHILDREN & FAMILY SERVICES", APART FROM THE MARK AS SHOWN.
 FOR DELINQUENCY TREATMENT, NAMELY PROVIDING JUVENILE CORRECTIONS SERVICES, SPECIFICALLY, SHORT- AND LONG-TERM RESIDENTIAL SERVICES TO HELP COURT-ORDERED YOUTHS (U.S. CLS. 100 AND 101).
 FIRST USE 10-20-1998; IN COMMERCE 10-20-1998.
 ANNE MADDEN, EXAMINING ATTORNEY

CLASS 43—(Continued).

SN 78-470,351. MORRISSEY HOSPITALITY COMPANIES, INC., ST. PAUL, MN. FILED 8-19-2004.



NO CLAIM IS MADE TO THE EXCLUSIVE RIGHT TO USE "CONSULTING", APART FROM THE MARK AS SHOWN.
 THE COLOR(S) GRAY IS/ARE CLAIMED AS A FEATURE OF THE MARK.
 THE COLOR GRAY APPEARS IN THE "MHC" WHICH APPEARS BEHIND THE WORD "CONSULTING".
 FOR CONSULTING SERVICES IN THE FIELD OF HOSPITALITY (U.S. CLS. 100 AND 101).
 FIRST USE 5-30-1995; IN COMMERCE 5-30-1995.
 DAVID C. REIHNER, EXAMINING ATTORNEY

SN 78-476,113. ANGELIA CHOU, BROOKLYN, NY. FILED 8-31-2004.

Thai 101

THE MARK CONSISTS OF STANDARD CHARACTERS WITHOUT CLAIM TO ANY PARTICULAR FONT, STYLE, SIZE, OR COLOR.
 NO CLAIM IS MADE TO THE EXCLUSIVE RIGHT TO USE "THAI", APART FROM THE MARK AS SHOWN.
 FOR THAI RESTAURANT SERVICES (U.S. CLS. 100 AND 101).
 FIRST USE 1-1-2003; IN COMMERCE 1-1-2003.
 BRENDAN MCCAULEY, EXAMINING ATTORNEY

CLASS 43—(Continued).

SN 78-479,423. PRIVATE ESCAPES, LLC, FORT COLLINS, CO. FILED 9-7-2004.

**PRIVATE ESCAPES**

THE COLOR BURGUNDY IS CLAIMED AS A FEATURE OF THE MARK.

THE BURGUNDY APPEARS IN THE OVAL CARRIER, THE COLOR WHITE APPEARS IN THE LETTERS PE FOUND IN THE OVAL, AND THE COLOR BLACK APPEARS IN THE WORDS PRIVATE ESCAPES.

THE MARK CONSISTS OF THE STYLIZED LETTERS "P" AND "E" ON AN OVAL CARRIER POSITIONED AT A 45 DEGREE ANGLE TO THE RIGHT FROM VERTICAL, BENEATH WHICH ARE THE WORDS "PRIVATE ESCAPES" IN STYLIZED LETTERS.

FOR ARRANGING TEMPORARY RESORT ACCOMMODATIONS (U.S. CLS. 100 AND 101).

FIRST USE 12-8-2003; IN COMMERCE 12-8-2003.
ANGELA M. MICHELI, EXAMINING ATTORNEY

SN 78-485,361. SALTLIK RESTAURANTS LTD., NORTH VANCOUVER, BRITISH COLUMBIA, CANADA, FILED 9-17-2004.

SALTLIK

THE MARK CONSISTS OF STANDARD CHARACTERS WITHOUT CLAIM TO ANY PARTICULAR FONT, STYLE, SIZE, OR COLOR.

OWNER OF CANADA REG. NO. TMA580435, DATED 5-1-2003, EXPIRES 5-1-2018.

FOR RESTAURANT AND BAR SERVICES (U.S. CLS. 100 AND 101).

YONG KIM, EXAMINING ATTORNEY

CLASS 43—(Continued).

SN 78-485,445. WILLIAMS, EVA, CHATTANOOGA, TN. FILED 9-17-2004.

MOJO BURRITO

THE MARK CONSISTS OF STANDARD CHARACTERS WITHOUT CLAIM TO ANY PARTICULAR FONT, STYLE, SIZE, OR COLOR.

NO CLAIM IS MADE TO THE EXCLUSIVE RIGHT TO USE "BURRITO", APART FROM THE MARK AS SHOWN.

FOR RESTAURANT SERVICES (U.S. CLS. 100 AND 101).

FIRST USE 6-6-2002; IN COMMERCE 6-6-2002.

MATTHEW PAPPAS, EXAMINING ATTORNEY

SN 78-485,467. HOULIHAN'S RESTAURANTS, INC., LEAWOOD, KS. FILED 9-17-2004.



OWNER OF U.S. REG. NO. 2,274,633.

THE MARK CONSISTS OF THE LETTER H, IN MYRIAD PRO-BOLD FONT STYLE, TILTED AT APPROXIMATELY A 45° ANGLE.

FOR RESTAURANT SERVICES, BAR SERVICES, TAKE-OUT RESTAURANT SERVICES (U.S. CLS. 100 AND 101).

FIRST USE 6-6-2005; IN COMMERCE 6-6-2005.

ELLEN BURNS, EXAMINING ATTORNEY

SN 78-488,596. BUSCH, JAMES, APPLETON, WI. FILED 9-23-2004.

CHEEKY WADSWORTH

THE MARK CONSISTS OF STANDARD CHARACTERS WITHOUT CLAIM TO ANY PARTICULAR FONT, STYLE, SIZE, OR COLOR.

CHEEKY WADSWORTH DOES NOT IDENTIFY A LIVING INDIVIDUAL.

FOR RESTAURANT AND LIQUOR BAR SERVICES (U.S. CLS. 100 AND 101).

GINA HAYES, EXAMINING ATTORNEY

CLASS 43—(Continued).

SN 78-492,070. LETTUCE ENTERTAIN YOU ENTERPRISES, INC, CHICAGO, IL. FILED 9-30-2004.

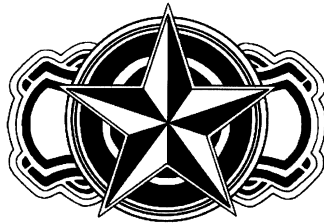

FOR RESTAURANT SERVICES (U.S. CLS. 100 AND 101).
MICHAEL TANNER, EXAMINING ATTORNEY

CLASS 43—(Continued).

SN 78-494,539. SICILY PIZZA & PASTA INC., STAFFORD, TX. FILED 10-5-2004.

SICILY PIZZA & PASTA

THE MARK CONSISTS OF STANDARD CHARACTERS WITHOUT CLAIM TO ANY PARTICULAR FONT, STYLE, SIZE, OR COLOR.

NO CLAIM IS MADE TO THE EXCLUSIVE RIGHT TO USE "PIZZA & PASTA", APART FROM THE MARK AS SHOWN.

SEC. 2(F).
FOR RESTAURANT SERVICES AND FOOD CATERING, CARRY-OUT RESTAURANT SERVICES; AND RESTAURANTS FEATURING HOME DELIVERY SERVICES (U.S. CLS. 100 AND 101).

FIRST USE 8-0-1998; IN COMMERCE 8-0-1998.
MICHELLE DUBOIS, EXAMINING ATTORNEY

SN 78-506,762. TAHOE JOE'S, INC., FRESNO, CA. FILED 10-27-2004.



OWNER OF U.S. REG. NO. 2,114,109.
FOR RESTAURANT SERVICES (U.S. CLS. 100 AND 101).

FIRST USE 9-1-2004; IN COMMERCE 9-1-2004.
REBECCA GILBERT, EXAMINING ATTORNEY

SN 78-494,061. EMPIRE CRABHOUSE, LLC, BOULDER, CO. FILED 10-4-2004.



SN 78-509,380. U DOG, LLC, SANTA ROSA, CA. FILED 11-1-2004.

Professor Weiner

NO CLAIM IS MADE TO THE EXCLUSIVE RIGHT TO USE "RESTAURANT GROUP", APART FROM THE MARK AS SHOWN.

THE COLORS RED AND BLACK ARE CLAIMED AS A FEATURE OF THE MARK.

THE MARK CONSISTS OF A STYLIZED LETTER "F" IN RED AND IS FOLLOWED BY THE WORDING BIG RED F RESTAURANT GROUP IN BLACK.

FOR RESTAURANT SERVICES (U.S. CLS. 100 AND 101).
FIRST USE 1-1-2003; IN COMMERCE 1-1-2003.
KATHY DE JONGE, EXAMINING ATTORNEY

THE MARK CONSISTS OF STANDARD CHARACTERS WITHOUT CLAIM TO ANY PARTICULAR FONT, STYLE, SIZE, OR COLOR.

FOR RESTAURANT SERVICES (U.S. CLS. 100 AND 101).
FIRST USE 9-21-2004; IN COMMERCE 9-21-2004.
AISHA CLARKE, EXAMINING ATTORNEY

CLASS 43—(Continued).

SN 78-511,363. U DOG, LLC, SANTA ROSA, CA. FILED 11-4-2004.



THE MARK CONSISTS OF AN ANIMATED HOT DOG WITH A MONOCLE AND NECK TIE WITH THE WORDS "PROFESSOR WEINER" IN STYLIZED SCRIPT. FOR RESTAURANT SERVICES (U.S. CLS. 100 AND 101).
FIRST USE 9-21-2004; IN COMMERCE 9-21-2004.
AISHA CLARKE, EXAMINING ATTORNEY

CLASS 43—(Continued).

SN 78-515,490. ROSENTHAL LICENSING, INC., DOVER, OH. FILED 11-11-2004.

Hog Heaven Open Flame BBQ

THE MARK CONSISTS OF STANDARD CHARACTERS WITHOUT CLAIM TO ANY PARTICULAR FONT, STYLE, SIZE, OR COLOR.
NO CLAIM IS MADE TO THE EXCLUSIVE RIGHT TO USE OPEN FLAME BBQ, APART FROM THE MARK AS SHOWN.
FOR SERVICES FOR PROVIDING FOOD AND DRINK, NAMELY RESTAURANTS AND TAVERNS (U.S. CLS. 100 AND 101).
FIRST USE 11-21-2001; IN COMMERCE 11-21-2001.
REBECCA GILBERT, EXAMINING ATTORNEY

SN 78-513,829. HOWELL, STEPHEN M., KETTERING, OH. FILED 11-9-2004.

La Pergola

THE MARK CONSISTS OF STANDARD CHARACTERS WITHOUT CLAIM TO ANY PARTICULAR FONT, STYLE, SIZE, OR COLOR.
FOR RESTAURANT (U.S. CLS. 100 AND 101).
FIRST USE 1-1-2004; IN COMMERCE 1-1-2004.
EVELYN BRADLEY, EXAMINING ATTORNEY

SN 78-515,552. ROSENTHAL LICENSING, INC., DOVER, OH. FILED 11-11-2004.



NO CLAIM IS MADE TO THE EXCLUSIVE RIGHT TO USE OPEN FLAME BBQ EST. 2000, APART FROM THE MARK AS SHOWN.
THE MARK CONSISTS OF THE PROFILE OF A BOAR'S HEAD AND THE WORDS "HOG HEAVEN OPEN FLAME BBQ" OVER THE WORDS "EST. 2000" WITHIN A STYLIZED FLAME DESIGN.
FOR SERVICES FOR PROVIDING FOOD AND DRINK, NAMELY RESTAURANTS AND TAVERNS (U.S. CLS. 100 AND 101).
FIRST USE 11-21-2001; IN COMMERCE 11-21-2001.
REBECCA GILBERT, EXAMINING ATTORNEY

CLASS 43—(Continued).

SN 78-517,108. ROCCOVINO II, INC., ELK GROVE VIL-
LAGE, IL. FILED 11-15-2004.

CLASS 43—(Continued).

SN 78-519,322. CHOPCHOP RICE CO., L.P., AMARILLO, TX.
FILED 11-18-2004.

ROCCOVINO'S

THE MARK CONSISTS OF STANDARD CHARACTERS
WITHOUT CLAIM TO ANY PARTICULAR FONT, STYLE,
SIZE, OR COLOR.

FOR RESTAURANT SERVICES (U.S. CLS. 100 AND
101).

FIRST USE 10-21-2003; IN COMMERCE 10-21-2003.
AISHA CLARKE, EXAMINING ATTORNEY

Big Italy's

THE MARK CONSISTS OF STANDARD CHARACTERS
WITHOUT CLAIM TO ANY PARTICULAR FONT, STYLE,
SIZE, OR COLOR.

FOR RESTAURANTS (U.S. CLS. 100 AND 101).
MONTIA G. PRESSEY, EXAMINING ATTORNEY

SN 78-518,080. FOHL, LES, HAYWARD, CA. FILED 11-16-
2004.



FOR RESTAURANTS FEATURING TACOS (U.S. CLS.
100 AND 101).
ODESSA BIBBINS, EXAMINING ATTORNEY

SN 78-519,564. JACK IN THE BOX INC., SAN DIEGO, CA.
FILED 11-18-2004.

SN 78-518,841. PRIMROSE MANAGEMENT, LLC, ABERD-
EEN, SD. FILED 11-17-2004.

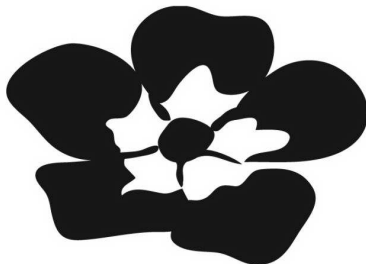

THE MARK CONSISTS OF A FLOWER.
FOR PROVIDING CONGREGATE, INDEPENDENT,
AND ASSISTED LIVING FACILITIES (U.S. CLS. 100
AND 101).
FIRST USE 6-0-2003; IN COMMERCE 6-0-2003.
ALLISON SCHRODY, EXAMINING ATTORNEY



NO CLAIM IS MADE TO THE EXCLUSIVE RIGHT TO
USE "GRILL", APART FROM THE MARK AS SHOWN.
THE MARK CONSISTS OF THE STYLIZED LETTERS JBX
ABOVE THE STYLIZED WORD GRILL.
FOR RESTAURANT SERVICES (U.S. CLS. 100 AND
101).
KEVIN DINALLO, EXAMINING ATTORNEY

CLASS 43—(Continued).

SN 78-521,162. AMERICAN YOUTH HOSTELS, INC., SILVER SPRING, MD. FILED 11-22-2004.

CLASS 43—(Continued).

SN 78-521,918. NATIONAL CITY CORPORATION, CLEVELAND, OH. FILED 11-23-2004.

CRAVINGS A LA CARTE

FreeNites & More

THE MARK CONSISTS OF STANDARD CHARACTERS WITHOUT CLAIM TO ANY PARTICULAR FONT, STYLE, SIZE, OR COLOR.

NO CLAIM IS MADE TO THE EXCLUSIVE RIGHT TO USE "A LA CARTE", APART FROM THE MARK AS SHOWN.

FOR CAFETERIA AND CATERING SERVICES (U.S. CLS. 100 AND 101).

MELISSA VALLILLO, EXAMINING ATTORNEY

THE MARK CONSISTS OF STANDARD CHARACTERS WITHOUT CLAIM TO ANY PARTICULAR FONT, STYLE, SIZE, OR COLOR.

FOR PROVIDING TEMPORARY ACCOMMODATION FEATURING A FREQUENT GUEST BONUS PROGRAM (U.S. CLS. 100 AND 101).

FIRST USE 1-15-2003; IN COMMERCE 1-15-2003.
IRA J. GOODSID, EXAMINING ATTORNEY

SN 78-522,314. HARMON, LAURA ALTO, WEST HOLLYWOOD, CA. FILED 11-24-2004.

BEST OF THE BUNCH

THE MARK CONSISTS OF STANDARD CHARACTERS WITHOUT CLAIM TO ANY PARTICULAR FONT, STYLE, SIZE, OR COLOR.

FOR CATERING (U.S. CLS. 100 AND 101).
PAUL F. GAST, EXAMINING ATTORNEY

SN 78-521,668. BARRAJA, INC., NEW YORK, NY. FILED 11-23-2004.

SN 78-522,886. BELLAGIO, LLC, LAS VEGAS, NV. FILED 11-24-2004.

THALIA

JASMINE

THE MARK CONSISTS OF STANDARD CHARACTERS WITHOUT CLAIM TO ANY PARTICULAR FONT, STYLE, SIZE, OR COLOR.

FOR RESTAURANT SERVICES (U.S. CLS. 100 AND 101).

FIRST USE 10-31-1999; IN COMMERCE 10-31-1999.
TRICIA SONNEBORN, EXAMINING ATTORNEY

THE MARK CONSISTS OF STANDARD CHARACTERS WITHOUT CLAIM TO ANY PARTICULAR FONT, STYLE, SIZE, OR COLOR.

FOR RESTAURANT, BAR AND COCKTAIL LOUNGE SERVICES (U.S. CLS. 100 AND 101).

FIRST USE 10-15-1998; IN COMMERCE 10-15-1998.
DEBRA LEE, EXAMINING ATTORNEY

CLASS 43—(Continued).

SN 78-523,173. OREGON BREWING COMPANY, NEWPORT, OR. FILED 11-26-2004.

CLASS 43—(Continued).

SN 78-523,801. MY THAI RESTAURANT, LLC, FAIRFAX, VA. FILED 11-29-2004.

ROGUE

I LOVE THAI

THE MARK CONSISTS OF STANDARD CHARACTERS WITHOUT CLAIM TO ANY PARTICULAR FONT, STYLE, SIZE, OR COLOR.

OWNER OF U.S. REG. NOS. 1,625,132, 2,484,994 AND OTHERS.

FOR RESTAURANT, PUB AND CATERING SERVICES (U.S. CLS. 100 AND 101).

FIRST USE 0-0-1989; IN COMMERCE 0-0-1989.
STEVEN R. FINE, EXAMINING ATTORNEY

THE MARK CONSISTS OF STANDARD CHARACTERS WITHOUT CLAIM TO ANY PARTICULAR FONT, STYLE, SIZE, OR COLOR.

NO CLAIM IS MADE TO THE EXCLUSIVE RIGHT TO USE "THAI", APART FROM THE MARK AS SHOWN, FOR RESTAURANT SERVICES (U.S. CLS. 100 AND 101).

NAAKWAMA ANKRAH, EXAMINING ATTORNEY

SN 78-523,714. ANTOINE'S NAME AND RECIPES, LLC, NEW ORLEANS, LA. FILED 11-29-2004.

SN 78-525,816. CHILORIO I, LLC, PHILADELPHIA, PA. FILED 12-2-2004.

Antoine's

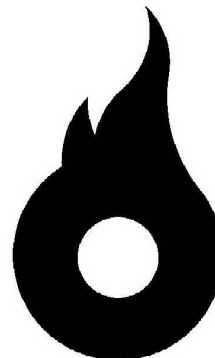

THE MARK CONSISTS OF STANDARD CHARACTERS WITHOUT CLAIM TO ANY PARTICULAR FONT, STYLE, SIZE, OR COLOR.

FOR RESTAURANT, BAR AND CATERING SERVICES (U.S. CLS. 100 AND 101).

FIRST USE 12-31-1840; IN COMMERCE 12-31-1840.
KATHY DE JONGE, EXAMINING ATTORNEY

THE MARK CONSISTS OF A STYLIZED FLAME DESIGN, FOR RESTAURANT SERVICES (U.S. CLS. 100 AND 101).

DOUGLAS LEE, EXAMINING ATTORNEY

CLASS 43—(Continued).

SN 78-528,489. ROGERS, DOUGLAS J, GASTONIA, NC. FILED 12-7-2004.

CLASS 43—(Continued).

SN 78-529,939. PIZZA EXPRESS INC., BLOOMINGTON, IN. FILED 12-9-2004.



PIZZA X

NO CLAIM IS MADE TO THE EXCLUSIVE RIGHT TO USE "PIZZA" AND "WATERING HOLE", APART FROM THE MARK AS SHOWN.

THE NAME JOHNNY B DOES NOT IDENTIFY A PARTICULAR LIVING INDIVIDUAL.

THE COLOR(S) RED, GREEN, BLUE, YELLOW, ORANGE, & BLACK IS/ARE CLAIMED AS A FEATURE OF THE MARK.

THE COLORS ORANGE, YELLOW AND BLACK APPEAR IN THE SURFBOARD; THE COLOR GREEN APPEARS IN THE FROG; THE COLORS BLUE AND RED APPEAR IN THE SHORTS; THE COLOR LIGHT BLUE APPEARS IN THE CIRCLE; THE COLOR RED APPEARS IN THE WORDS JOHNNY B'S AND THE CIRCLE BORDER.

FOR RESTAURANT (U.S. CLS. 100 AND 101).
MIDGE BUTLER, EXAMINING ATTORNEY

THE MARK CONSISTS OF STANDARD CHARACTERS WITHOUT CLAIM TO ANY PARTICULAR FONT, STYLE, SIZE, OR COLOR.

NO CLAIM IS MADE TO THE EXCLUSIVE RIGHT TO USE "PIZZA", APART FROM THE MARK AS SHOWN.

FOR RESTAURANT SERVICES (U.S. CLS. 100 AND 101).

MICHAEL TANNER, EXAMINING ATTORNEY

SN 78-533,391. KELLEY, SEAN, GRAY, ME. FILED 12-16-2004.

SN 78-529,574. COMPASS GROUP USA, INC., CHARLOTTE, NC. FILED 12-9-2004.

BEFORE YOU FLY



THE MARK CONSISTS OF STANDARD CHARACTERS WITHOUT CLAIM TO ANY PARTICULAR FONT, STYLE, SIZE, OR COLOR.

FOR RESTAURANT SERVICES (U.S. CLS. 100 AND 101).

PAUL F. GAST, EXAMINING ATTORNEY

OWNER OF U.S. REG. NO. 2,765,730.
NO CLAIM IS MADE TO THE EXCLUSIVE RIGHT TO USE BOARDING FOR YOUR PET, APART FROM THE MARK AS SHOWN.

FOR KENNEL SERVICES (U.S. CLS. 100 AND 101).

FIRST USE 11-10-2000; IN COMMERCE 4-30-2001.

GISELLE AGOSTO, EXAMINING ATTORNEY

CLASS 43—(Continued).

SN 78-534,439. CAPERS INC., STONEHAM, MA. FILED 12-17-2004.



THE MARK CONSISTS OF DESIGN OF STYLIZED CAPER.
FOR CATERING SERVICES (U.S. CLS. 100 AND 101).
FIRST USE 10-31-1993; IN COMMERCE 10-31-1993.
JENNIFER MARTIN, EXAMINING ATTORNEY

CLASS 43—(Continued).

SN 78-539,860. SODEXHO OPERATIONS, LLC, GAITHERSBURG, MD. FILED 12-29-2004.

THE SET

THE MARK CONSISTS OF STANDARD CHARACTERS WITHOUT CLAIM TO ANY PARTICULAR FONT, STYLE, SIZE, OR COLOR.
FOR PREPARING AND SERVING FOODS (U.S. CLS. 100 AND 101).
DAYNA BROWNE, EXAMINING ATTORNEY

SN 78-541,726. STAPLETON, TRACY J., PORT JEFFERSON, NY. FILED 1-4-2005.

NAPPER TANDY'S

THE MARK CONSISTS OF STANDARD CHARACTERS WITHOUT CLAIM TO ANY PARTICULAR FONT, STYLE, SIZE, OR COLOR.
FOR IRISH PUB/RESTAURANT (U.S. CLS. 100 AND 101).
FIRST USE 3-15-1991; IN COMMERCE 3-15-1991.
JENNIFER WILLISTON, EXAMINING ATTORNEY

SN 78-536,260. HILTON HOSPITALITY, INC., BEVERLY HILLS, CA. FILED 12-21-2004.

HAMPTON'S ON THE RUN

SN 78-545,487. ARIAS & MARTINEZ INC, NEW YORK, NY. FILED 1-11-2005.

THE MARK CONSISTS OF STANDARD CHARACTERS WITHOUT CLAIM TO ANY PARTICULAR FONT, STYLE, SIZE, OR COLOR.
FOR HOTEL AND MOTEL SERVICES, NAMELY PROVIDING CARRY OUT MEALS FOR HOTEL GUESTS; RESTAURANT SERVICES (U.S. CLS. 100 AND 101).
ALLISON HOLTZ, EXAMINING ATTORNEY



FOR BISTRO RESTAURANT SERVICES (U.S. CLS. 100 AND 101).
FIRST USE 11-0-2004; IN COMMERCE 11-0-2004.
ANDREA K. NADELMAN, EXAMINING ATTORNEY

CLASS 43—(Continued).

SN 78-545,838. 3-D HOLDING LLC, CARNATION, WA.
FILED 1-11-2005.

CLASS 43—(Continued).

SN 78-546,898. K & K MANAGEMENT SERVICES, INC.,
FARGO, ND. FILED 1-13-2005.

REMLINGER FARMS

THE MARK CONSISTS OF STANDARD CHARACTERS
WITHOUT CLAIM TO ANY PARTICULAR FONT, STYLE,
SIZE, OR COLOR.
OWNER OF U.S. REG. NOS. 2,817,349, 2,823,346 AND
OTHERS.

SEC. 2(F).
FOR CATERING SERVICES, NAMELY, PROVIDING
FOOD FOR PARTIES, PRIVATE PICNICS AND CORPO-
RATE PICNICS (U.S. CLS. 100 AND 101).
FIRST USE 0-0-1992; IN COMMERCE 0-0-1992.
MICHELLE S. WISEMAN, EXAMINING ATTORNEY

SN 78-546,417. DOUGHERTY, FRANK, MARGATE CITY,
NJ. FILED 1-12-2005.

Knife & Fork Inn

THE MARK CONSISTS OF STANDARD CHARACTERS
WITHOUT CLAIM TO ANY PARTICULAR FONT, STYLE,
SIZE, OR COLOR.

NO CLAIM IS MADE TO THE EXCLUSIVE RIGHT TO
USE "INN", APART FROM THE MARK AS SHOWN.
FOR RESTAURANT, BAR AND CATERING SERVICES
(U.S. CLS. 100 AND 101).
FIRST USE 0-0-1912; IN COMMERCE 0-0-1912.
BARBARA A. GOLD, EXAMINING ATTORNEY

SN 78-546,868. TJF USA, LLC, MAITLAND, FL. FILED 1-13-
2005.

**HOT IS THE NEW
COOL**

THE MARK CONSISTS OF STANDARD CHARACTERS
WITHOUT CLAIM TO ANY PARTICULAR FONT, STYLE,
SIZE, OR COLOR.

FOR RESTAURANT SERVICES SERVING FOOD AND
DRINK, INCLUDING TAKE OUT (U.S. CLS. 100 AND
101).
FIRST USE 10-4-2004; IN COMMERCE 10-4-2004.
ANNE FARRELL, EXAMINING ATTORNEY

**Fryn' Pan Family
Restaurant**

THE MARK CONSISTS OF STANDARD CHARACTERS
WITHOUT CLAIM TO ANY PARTICULAR FONT, STYLE,
SIZE, OR COLOR.

OWNER OF U.S. REG. NO. 1,322,680.
NO CLAIM IS MADE TO THE EXCLUSIVE RIGHT TO
USE FAMILY RESTAURANT, APART FROM THE MARK
AS SHOWN.
FOR RESTAURANT SERVICES (U.S. CLS. 100 AND
101).

FIRST USE 4-23-1981; IN COMMERCE 5-5-1981.
ALICE BENMAMAN, EXAMINING ATTORNEY

SN 78-546,911. TJF USA, LLC, MAITLAND, FL. FILED 1-13-
2005.

GIVE HEAT A CHANCE

THE MARK CONSISTS OF STANDARD CHARACTERS
WITHOUT CLAIM TO ANY PARTICULAR FONT, STYLE,
SIZE, OR COLOR.

OWNER OF U.S. REG. NO. 2,731,322.
FOR RESTAURANT SERVICES (U.S. CLS. 100 AND
101).
FIRST USE 11-1-1995; IN COMMERCE 11-1-1995.
KATHRYN COWARD, EXAMINING ATTORNEY

CLASS 43—(Continued).

SN 78-547,310. BANNER BUFFETS, LLC, JONESBORO, AR. FILED 1-13-2005.



THE COLOR(S) RED AND SILVER IS/ARE CLAIMED AS A FEATURE OF THE MARK.

THE MARK CONSISTS OF THE WORDS "WHISTLE JUNCTION", WHICH APPEAR IN RED, AND A STYLIZED IMAGE OF A WHISTLE, WHICH APPEARS IN SILVER, IN THE PLACE OF THE LETTER "I" IN THE WORD "WHISTLE".

FOR RESTAURANT SERVICES (U.S. CLS. 100 AND 101).

FIRST USE 3-22-2004; IN COMMERCE 3-22-2004.
JOHN LINCOSKI, EXAMINING ATTORNEY

SN 78-547,903. RED ROBIN INTERNATIONAL, INC., GREENWOOD VILLAGE, CO. FILED 1-14-2005.

SHAREABLE STARTERS

THE MARK CONSISTS OF STANDARD CHARACTERS WITHOUT CLAIM TO ANY PARTICULAR FONT, STYLE, SIZE, OR COLOR.

NO CLAIM IS MADE TO THE EXCLUSIVE RIGHT TO USE "STARTERS", APART FROM THE MARK AS SHOWN. FOR RESTAURANT SERVICES (U.S. CLS. 100 AND 101).

FIRST USE 7-0-2004; IN COMMERCE 7-0-2004.
G. MAYERSCHOFF, EXAMINING ATTORNEY

SN 78-550,619. RJR, INC., TAMPA, FL. FILED 1-20-2005.

BUILDING BETTER SANDWICHES

THE MARK CONSISTS OF STANDARD CHARACTERS WITHOUT CLAIM TO ANY PARTICULAR FONT, STYLE, SIZE, OR COLOR.

FOR RESTAURANT SERVICES (U.S. CLS. 100 AND 101).

FIRST USE 8-23-2004; IN COMMERCE 8-23-2004.
ANGELA M. MICHELI, EXAMINING ATTORNEY

CLASS 43—(Continued).

SN 78-553,417. ARBY'S IP HOLDER TRUST, FT. LAUDERDALE, FL. FILED 1-25-2005.

I'M THINKING ARBY'S

THE MARK CONSISTS OF STANDARD CHARACTERS WITHOUT CLAIM TO ANY PARTICULAR FONT, STYLE, SIZE, OR COLOR.

OWNER OF U.S. REG. NOS. 890,565, 2,815,992 AND OTHERS.

FOR RESTAURANT SERVICES (U.S. CLS. 100 AND 101).

MARC LEIPZIG, EXAMINING ATTORNEY

SN 78-608,593. NOGA, JOSEPH P., CHATSWORTH, CA. FILED 4-14-2005.

Q. T. O.

THE MARK CONSISTS OF STANDARD CHARACTERS WITHOUT CLAIM TO ANY PARTICULAR FONT, STYLE, SIZE, OR COLOR.

FOR RESTAURANT SERVICES (U.S. CLS. 100 AND 101).

KIMBERLY PERRY, EXAMINING ATTORNEY

CLASS 43—(Continued).

SN 78-627,174. L & L FRANCHISE, INC., HONOLULU, HI.
FILED 5-10-2005.



OWNER OF U.S. REG. NOS. 2,371,282, 2,395,661 AND 2,490,665.

NO CLAIM IS MADE TO THE EXCLUSIVE RIGHT TO USE "BARBECUE AND SINCE 1976", APART FROM THE MARK AS SHOWN.

THE COLORS RED AND YELLOW ARE CLAIMED AS A FEATURE OF THE MARK.

THE MARK CONSISTS OF THE LETTERS "L&L" IN RED ABOVE A DRAWING OF A SURFBOARD COLORED RED, BELOW WHICH ARE THE WORDS "HAWAIIAN BARBECUE SINCE 1976" IN RED FOLLOWED BY THE WORD "HAWAII", ALL FRAMED IN RED WITH A YELLOW STIPPLED BACKGROUND.

SEC. 2(F) AS TO "HAWAIIAN" AND "HAWAII".

FOR RESTAURANTS AND RESTAURANT SERVICES, NAMELY FAST FOOD, SELF-SERVICE AND TAKE OUT RESTAURANTS AND RESTAURANT SERVICES (U.S. CLS. 100 AND 101).

FIRST USE 11-30-1999; IN COMMERCE 11-30-1999.

JUDITH HELFMAN, EXAMINING ATTORNEY

SN 78-642,257. NCL CORPORATION LTD., MIAMI, FL.
FILED 6-2-2005.

FREESTYLE DINING

THE MARK CONSISTS OF STANDARD CHARACTERS WITHOUT CLAIM TO ANY PARTICULAR FONT, STYLE, SIZE, OR COLOR.

OWNER OF U.S. REG. NOS. 2,568,445, 2,938,444 AND OTHERS.

NO CLAIM IS MADE TO THE EXCLUSIVE RIGHT TO USE "DINING", APART FROM THE MARK AS SHOWN.

FOR RESTAURANT SERVICES RENDERED ON BOARD OCEAN CRUISE SHIPS (U.S. CLS. 100 AND 101).

FIRST USE 7-1-2000; IN COMMERCE 7-1-2000.

CHERYL CLAYTON, EXAMINING ATTORNEY

CLASS 44—MEDICAL, BEAUTY AND AGRICULTURAL SERVICES

SN 76-538,890. INFINITE POTENTIAL PROGRAM, INC., CRANSTON, RI. FILED 8-20-2003.

INFINITE POTENTIAL PROGRAM

NO CLAIM IS MADE TO THE EXCLUSIVE RIGHT TO USE "PROGRAM", APART FROM THE MARK AS SHOWN.

FOR MEDICAL SERVICES, NAMELY, MEDICAL PROGRAM THAT ASSESSES, DIAGNOSES AND TREATS VARIOUS DEVELOPMENTAL DISABILITIES AND DEVELOPS AN INDIVIDUALIZED PROGRAM COMBINING COGNITIVE AND PHYSICAL APPROACHES DESIGNED TO ADDRESS A PERSON'S DISTINCTIVE NEEDS (U.S. CLS. 100 AND 101).

FIRST USE 3-14-2002; IN COMMERCE 3-14-2002.

INGRID C. EULIN, EXAMINING ATTORNEY

SN 76-557,759. CHERNEY, GREGORY A., LAGUNA HILLS, CA. FILED 10-20-2003.



NO CLAIM IS MADE TO THE EXCLUSIVE RIGHT TO USE "HEALING AND WELLNESS", APART FROM THE MARK AS SHOWN.

THE COLORS BLUE AND BLUE-GREEN ARE CLAIMED AS A FEATURE OF THE MARK.

THE COLOR BLUE APPEARS IN THE WORDS "HEALING AND WELLNESS". THE LETTER "M", AND IN THE TOP PORTION OF "OMENTUM" THAT IS ABOVE THE WAVE; THE COLOR BLUE-GREEN APPEARS IN THE WAVE IN "OMENTUM".

FOR CHIROPRACTIC SERVICES (U.S. CLS. 100 AND 101).

FIRST USE 5-1-2003; IN COMMERCE 5-1-2003.

MICHAEL HALL, EXAMINING ATTORNEY

SN 76-576,085. BITTER, PATRICK H., JR., LOS GATOS, CA.
FILED 2-9-2004.

FOTOLIFT

THE MARK CONSISTS OF STANDARD CHARACTERS WITHOUT CLAIM TO ANY PARTICULAR FONT, STYLE, SIZE, OR COLOR.

OWNER OF U.S. REG. NOS. 2,515,007 AND 2,637,526.

FOR SKIN AND BODY CARE SERVICES, NAMELY, NON-INVASIVE SKIN REJUVENATION AND SKIN SMOOTHING TREATMENT SERVICES (U.S. CLS. 100 AND 101).

LINDA MICKLEBURGH, EXAMINING ATTORNEY

CLASS 44—(Continued).

SN 76-587,272. GEISINGER COMMUNITY HEALTH SERVICES, DANVILLE, PA. FILED 4-19-2004.

YOUR HEALTH YOUR HOME YOUR CHOICE

THE MARK CONSISTS OF STANDARD CHARACTERS WITHOUT CLAIM TO ANY PARTICULAR FONT, STYLE, SIZE, OR COLOR.

FOR MEDICAL AND HEALTH CARE SERVICES IN THE NATURE OF HOME CARE SERVICES, HOSPICE SERVICES (U.S. CLS. 100 AND 101).

FIRST USE 10-4-2002; IN COMMERCE 10-4-2002.
MAUREEN DALL, EXAMINING ATTORNEY

CLASS 44—(Continued).

SN 76-603,467. MEDICAL DOCTORS+DESIGNERS USA, INC., WESTFIELD, NJ. FILED 7-22-2004.



THE MARK CONSISTS OF THE WORDING "STAYING CONNECTED" IN STYLIZED LETTERS, WITH A LINE EXTENDING FROM THE "G" IN "STAYING" AND BORDERING THE RIGHT HAND SIDE OF THE MARK, AND ENDING WITH A FANCIFUL REPRESENTATION OF TWO INDIVIDUALS.

FOR PROVIDING HEALTHCARE INFORMATION FOR PATIENTS AND MEDICAL PERSONNEL (U.S. CLS. 100 AND 101).

SUSAN LESLIE DUBOIS, EXAMINING ATTORNEY

SN 76-593,250. BRAID IT UP!, WASHINGTON, DC. FILED 5-17-2004.

BRAID IT UP

THE MARK CONSISTS OF STANDARD CHARACTERS WITHOUT CLAIM TO ANY PARTICULAR FONT, STYLE, SIZE, OR COLOR.

FOR BEAUTY SALON SERVICES (U.S. CLS. 100 AND 101).

FIRST USE 5-18-2002; IN COMMERCE 5-18-2002.
JENNIFER CHICOSKI, EXAMINING ATTORNEY

SN 76-609,376. S. IYABO TINUBU-KARCH, MD PLLC, SEATTLE, WA. FILED 8-30-2004.



FOR MEDICAL SERVICES, NAMELY, PLASTIC OR COSMETIC SURGERY SERVICES; NUTRITION COUNSELING SERVICES; HEALTH AND PSYCHOLOGICAL COUNSELING (U.S. CLS. 100 AND 101).

FIRST USE 8-1-2003; IN COMMERCE 8-1-2003.
DAWN FELDMAN, EXAMINING ATTORNEY

SN 76-594,223. CAPITAL REGION WELLNESS CENTER, ALBANY, NY. FILED 5-24-2004.



NO CLAIM IS MADE TO THE EXCLUSIVE RIGHT TO USE "REGION WELLNESS CENTER", APART FROM THE MARK AS SHOWN.

FOR PROVIDING HOLISTIC TREATMENT SERVICES, NAMELY, MASSAGE THERAPY, ACUPUNCTURE, HYPNOTHERAPY, REIKI, OPTION METHODS AND ENERGY MEDICINE (U.S. CLS. 100 AND 101).

FIRST USE 6-27-2003; IN COMMERCE 6-27-2003.
MARGERY A. TIERNEY, EXAMINING ATTORNEY

SN 76-610,893. UHS OF DELAWARE, INC., KING OF PRUSSIA, PA. FILED 9-7-2004.



at Wellington Regional Medical Center

NO CLAIM IS MADE TO THE EXCLUSIVE RIGHT TO USE "THE SLEEP CENTER AT WELLINGTON REGIONAL MEDICAL CENTER", APART FROM THE MARK AS SHOWN.

FOR MEDICAL, HEALTHCARE, AND HOSPITAL SERVICES (U.S. CLS. 100 AND 101).

SEAN DWYER, EXAMINING ATTORNEY

CLASS 44—(Continued).

SN 76-611,686. BYNOE, GLORIA, BROOKLYN, NY. FILED 9-10-2004.

NEW MOTHER, FATHER AND BABY RESOURCE.

THE MARK CONSISTS OF STANDARD CHARACTERS WITHOUT CLAIM TO ANY PARTICULAR FONT, STYLE, SIZE, OR COLOR.

SEC. 2(F).

FOR HEALTH CARE AND PROVIDING HEALTH INFORMATION RELATING TO PARENTING (U.S. CLS. 100 AND 101).

FIRST USE 1-1-1993; IN COMMERCE 1-1-1993.
JOHN HWANG, EXAMINING ATTORNEY

SN 76-612,215. CARROLTON HOME CARE, INC., DBA COMMUNITY HOME CARE & HOSPICE, ROCKY MOUNT, NC. FILED 9-15-2004.

every patient we care for stays in our hearts

THE MARK CONSISTS OF STANDARD CHARACTERS WITHOUT CLAIM TO ANY PARTICULAR FONT, STYLE, SIZE, OR COLOR.

FOR HOSPICE AND HOME HEALTH CARE SERVICES (U.S. CLS. 100 AND 101).

FIRST USE 1-0-2003; IN COMMERCE 1-0-2003.
GEOFFREY FOSDICK, EXAMINING ATTORNEY

SN 76-614,514. FOR ALL SEASONS TREE SERVICE INC., LOGANVILLE, GA. FILED 10-1-2004.



NO CLAIM IS MADE TO THE EXCLUSIVE RIGHT TO USE "TREE SERVICE", APART FROM THE MARK AS SHOWN.

FOR SERVICE TREE REMOVAL (U.S. CLS. 100 AND 101).

FIRST USE 2-1-2004; IN COMMERCE 2-1-2004.
JUDITH HELFMAN, EXAMINING ATTORNEY

CLASS 44—(Continued).

SN 76-614,920. GREG J. PERENTIS, DDS, PLLC, DURHAM, NC. FILED 10-6-2004.

CAROUSEL DENTISTRY

THE MARK CONSISTS OF STANDARD CHARACTERS WITHOUT CLAIM TO ANY PARTICULAR FONT, STYLE, SIZE, OR COLOR.

NO CLAIM IS MADE TO THE EXCLUSIVE RIGHT TO USE "DENTISTRY", APART FROM THE MARK AS SHOWN.

FOR DENTISTRY AND DENTIST SERVICES (U.S. CLS. 100 AND 101).

FIRST USE 9-17-2001; IN COMMERCE 9-17-2001.
JAMES A. RAUEN, EXAMINING ATTORNEY

SN 76-615,121. CARING HANDS ANIMAL HOSPITAL, INC., CENTREVILLE, VA. FILED 10-6-2004.

CARING HANDS ANIMAL HOSPITAL

THE MARK CONSISTS OF STANDARD CHARACTERS WITHOUT CLAIM TO ANY PARTICULAR FONT, STYLE, SIZE, OR COLOR.

NO CLAIM IS MADE TO THE EXCLUSIVE RIGHT TO USE "ANIMAL HOSPITAL", APART FROM THE MARK AS SHOWN.

FOR VETERINARY SERVICES (U.S. CLS. 100 AND 101).

FIRST USE 3-0-1997; IN COMMERCE 3-0-1997.
ADA HAN, EXAMINING ATTORNEY

SN 76-619,419. MANDARIN ORIENTAL SERVICES B.V., 1077 VX AMSTERDAM, NETHERLANDS, FILED 11-4-2004.

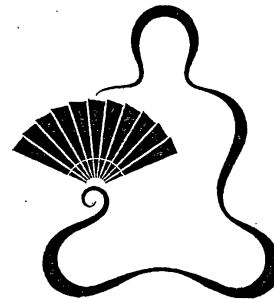

OWNER OF U.S. REG. NOS. 1,568,258, 2,385,157 AND OTHERS.

FOR HAIRDRESSING SERVICES; BEAUTY SALONS; PROVIDING TURKISH BATHS, SAUNAS AND MASSAGE PARLORS; HEALTH SPA SERVICES (U.S. CLS. 100 AND 101).

FIRST USE 12-0-2003; IN COMMERCE 12-0-2003.
JENNIFER DIXON, EXAMINING ATTORNEY

CLASS 44—(Continued).

SN 76-619,547. LIFELINE CRYOGENICS, LLC, STAMFORD, CT. FILED 11-5-2004.

PRESERVE YOUR FUTURE

THE MARK CONSISTS OF STANDARD CHARACTERS WITHOUT CLAIM TO ANY PARTICULAR FONT, STYLE, SIZE, OR COLOR.

FOR PRESERVATION, FREEZING AND STORAGE OF REPRODUCTIVE TISSUES AND BLOOD (U.S. CLS. 100 AND 101).

FIRST USE 12-31-1999; IN COMMERCE 12-31-1999.
CHARLES JOYNER, EXAMINING ATTORNEY

SN 76-620,613. BAYLOR HEALTH CARE SYSTEM, DALLAS, TX. FILED 11-12-2004.

OUR FLAME BURNS BRIGHT

THE MARK CONSISTS OF STANDARD CHARACTERS WITHOUT CLAIM TO ANY PARTICULAR FONT, STYLE, SIZE, OR COLOR.

FOR HEALTH CARE AND HOSPITAL SERVICES (U.S. CLS. 100 AND 101).

FIRST USE 5-0-2004; IN COMMERCE 5-0-2004.
JOHN DWYER, EXAMINING ATTORNEY

SN 76-621,058. HALLOWELL ADVANCE LLC, SUDBURY, MA. FILED 11-17-2004.



NO CLAIM IS MADE TO THE EXCLUSIVE RIGHT TO USE "CENTER", APART FROM THE MARK AS SHOWN.

FOR MULTIDISCIPLINARY PSYCHOTHERAPY PRACTICE; PROVIDING PSYCHOLOGICAL ASSESSMENTS, THERAPY AND COUNSELING SERVICES; THERAPY SERVICES, NAMELY, DIAGNOSIS AND MANAGEMENT SERVICES OF PERSONS WITH ATTENTION DEFICIT HYPERACTIVITY DISORDER (ADHD), LEARNING DISABILITIES, DEPRESSION AND ANXIETY DISORDERS (U.S. CLS. 100 AND 101).

FIRST USE 10-25-2004; IN COMMERCE 10-25-2004.
ALICE SUE CARRUTHERS, EXAMINING ATTORNEY

SN 76-621,252. ITEX COMPANY, LINCOLNWOOD, IL. FILED 11-19-2004.

THE CARE YOU NEED. THE LUXURY YOU EXPECT.

THE MARK CONSISTS OF STANDARD CHARACTERS WITHOUT CLAIM TO ANY PARTICULAR FONT, STYLE, SIZE, OR COLOR.

FOR NURSING HOMES (U.S. CLS. 100 AND 101).
BARBARA A. GOLD, EXAMINING ATTORNEY

CLASS 44—(Continued).

SN 76-621,729. WELCOME BACK INC., PHILADELPHIA, PA. FILED 11-22-2004.

MORE PRESSURE, LESS STRESS

THE MARK CONSISTS OF STANDARD CHARACTERS WITHOUT CLAIM TO ANY PARTICULAR FONT, STYLE, SIZE, OR COLOR.

FOR MASSAGE SERVICES (U.S. CLS. 100 AND 101).
FIRST USE 9-9-2004; IN COMMERCE 9-9-2004.
MICHAEL SOUDERS, EXAMINING ATTORNEY

SN 76-622,038. THE TRUSTEES OF THE UNIVERSITY OF PENNSYLVANIA, PHILADELPHIA, PA. FILED 11-24-2004.

PENN E-LERT

THE MARK CONSISTS OF STANDARD CHARACTERS WITHOUT CLAIM TO ANY PARTICULAR FONT, STYLE, SIZE, OR COLOR.

OWNER OF U.S. REG. NOS. 1,773,257, 2,744,279 AND OTHERS.

SEC. 2(F) AS TO "PENN".
FOR MEDICAL SERVICES (U.S. CLS. 100 AND 101).
REBECCA GAN, EXAMINING ATTORNEY

SN 76-622,077. ACADEMIC NETWORK, LLC, PORTLAND, OR. FILED 11-24-2004.



FOR PROVIDING AN ON-LINE COMPUTER DATABASE CONCERNING THE PROBLEM OF CHILDHOOD INACTIVITY AND OBESITY AND SURVEYING PROGRAMS IN THE UNITED STATES TO ADDRESS THIS PROBLEM (U.S. CLS. 100 AND 101).

FIRST USE 4-30-2004; IN COMMERCE 4-30-2004.
ALICE SUE CARRUTHERS, EXAMINING ATTORNEY

CLASS 44—(Continued).

SN 76-622,644. ODC THERAPY, INC., DALLAS, TX. FILED 12-1-2004.

ODC THERAPY

THE MARK CONSISTS OF STANDARD CHARACTERS WITHOUT CLAIM TO ANY PARTICULAR FONT, STYLE, SIZE, OR COLOR.

NO CLAIM IS MADE TO THE EXCLUSIVE RIGHT TO USE "THERAPY", APART FROM THE MARK AS SHOWN. FOR MEDICAL SERVICES, NAMELY CANCER IMMUNOTHERAPY (U.S. CLS. 100 AND 101).

JASON TURNER, EXAMINING ATTORNEY

SN 76-623,497. PROFESSIONAL MANAGEMENT SERVICES, LLC, ATLANTA, GA. FILED 12-6-2004.



THE COLOR GRAY IS INTENDED FOR SHADING PURPOSES ONLY. THE MARK IS NOT IN COLOR.

FOR INPATIENT AND OUTPATIENT CARE FOR THE TERMINALLY ILL (U.S. CLS. 100 AND 101).

FIRST USE 12-28-2000; IN COMMERCE 12-28-2000.
DOMINICK J. SALEMI, EXAMINING ATTORNEY

SN 76-623,749. L A WEIGHT LOSS CENTERS, INC., HORSHAM, PA. FILED 12-8-2004.

CHANGING LIVES, FULFILLING DREAMS

THE MARK CONSISTS OF STANDARD CHARACTERS WITHOUT CLAIM TO ANY PARTICULAR FONT, STYLE, SIZE, OR COLOR.

FOR WEIGHT LOSS SERVICES (U.S. CLS. 100 AND 101).

INGRID C. EULIN, EXAMINING ATTORNEY

CLASS 44—(Continued).

SN 76-624,198. ALLAN, BRENT R., PARADISE VALLEY, AZ. FILED 12-10-2004.



NO CLAIM IS MADE TO THE EXCLUSIVE RIGHT TO USE "SCOTTSDALE DIET", APART FROM THE MARK AS SHOWN.

FOR WEIGHT REDUCTION DIET PLANNING AND SUPERVISION, NAMELY, A MULTI-MONTH DIET PROGRAM SPECIFIC FOR DISEASE MANAGEMENT, ADULT OBESITY, MIGRAINE, HA, HPT, HYPERLIPIDEMIA, DM, ARTHRITIS, LONGEVITY, HEALTHY WOMEN, PEDIATRICS, ADOLESCENT OBESITY, HEART DISEASE, FOOD ALLERGIES, AND POST OBESITY SURGERY (U.S. CLS. 100 AND 101).

FIRST USE 8-15-2004; IN COMMERCE 8-15-2004.
SHAUNIA WALLACE, EXAMINING ATTORNEY

SN 76-625,652. ALDEN MANAGEMENT SERVICES, INC., CHICAGO, IL. FILED 12-20-2004.

ALDEN CareLink[^]

THE MARK CONSISTS OF STANDARD CHARACTERS WITHOUT CLAIM TO ANY PARTICULAR FONT, STYLE, SIZE, OR COLOR.

FOR TREATMENT OF SUB-ACUTE AND POST-ACUTE INDIVIDUALS AT VARIOUS REHABILITATION AND HEALTH CARE CENTERS (U.S. CLS. 100 AND 101).

FIRST USE 9-10-1995; IN COMMERCE 9-10-1995.
MATTHEW KLINE, EXAMINING ATTORNEY

SN 76-626,365. BOJANOVA, DINKA, LOS ANGELES, CA. FILED 12-28-2004.

ILLEGAL

THE MARK CONSISTS OF STANDARD CHARACTERS WITHOUT CLAIM TO ANY PARTICULAR FONT, STYLE, SIZE, OR COLOR.

FOR SPA SERVICES, NAMELY, MASSAGE, REFLEXOLOGY, BODY TREATMENTS, FACIAL TREATMENTS; AND BEAUTY SALON SERVICES, NAMELY, HAIRCUTS, BLOW DRY HAIRSTYLING, HAIR COLORING, HAIR GLOSSING, HAIR HIGHLIGHTING, HAIR PERMING, HAIR RELAXING, HAIR FOILING, MAKE UP APPLICATION, EYEBROW GROOMING, MANICURES AND PEDICURES (U.S. CLS. 100 AND 101).

TRACY FLETCHER, EXAMINING ATTORNEY

CLASS 44—(Continued).

SN 78-182,416. JEFFREY K GARNER, DDS, PA, LITTLE ROCK, AR. FILED 11-6-2002.

THE SMILE DOCTOR

FOR DENTAL SERVICES, NAMELY, COSMETIC DENTISTRY SERVICES PROVIDED TO PATIENTS IN A DENTAL OFFICE SETTING (U.S. CLS. 100 AND 101).
FIRST USE 9-30-2001; IN COMMERCE 9-30-2001.
DOMINIC J. FERRAIUOLO, EXAMINING ATTORNEY

CLASS 44—(Continued).

SN 78-343,395. TAP PHARMACEUTICAL PRODUCTS, INC., LAKE FOREST, IL. FILED 12-19-2003.

ENDOKNOW

SN 78-322,371. HCA SQUARED, LLC, NASHVILLE, TN. FILED 11-3-2003.

CENTENNIAL MEDICAL CENTER

THE MARK CONSISTS OF STANDARD CHARACTERS WITHOUT CLAIM TO ANY PARTICULAR FONT, STYLE, SIZE, OR COLOR.

NO CLAIM IS MADE TO THE EXCLUSIVE RIGHT TO USE "MEDICAL CENTER", APART FROM THE MARK AS SHOWN.

FOR MEDICAL AND HEALTHCARE SERVICES; HOSPITAL SERVICES (U.S. CLS. 100 AND 101).

FIRST USE 1-22-1990; IN COMMERCE 1-22-1990.
GEORGE LORENZO, EXAMINING ATTORNEY

THE MARK CONSISTS OF STANDARD CHARACTERS WITHOUT CLAIM TO ANY PARTICULAR FONT, STYLE, SIZE, OR COLOR.

FOR PROVIDING AN INTERNET WEBSITE FEATURING INFORMATION CONCERNING MEDICAL CONDITIONS (U.S. CLS. 100 AND 101).

FIRST USE 10-20-2003; IN COMMERCE 10-20-2003.
STACY WAHLBERG, EXAMINING ATTORNEY

SN 78-345,840. LEE, MOON FREE, FLUSHING, NY. FILED 12-28-2003.

SN 78-336,691. SKIN SOLUTIONS PLUS, INC., COMMACK, NY. FILED 12-4-2003.



NO CLAIM IS MADE TO THE EXCLUSIVE RIGHT TO USE SKIN CARE SKIN CARE WITH YOUR HEALTH IN MIND, APART FROM THE MARK AS SHOWN.

FOR SKIN CARE SERVICES, NAMELY, PROVIDING FACIALS, COSMETIC LASER TREATMENTS, NAMELY, LASER HAIR REMOVAL, LASER SKIN RESURFACING, LASER VEIN THERAPY (U.S. CLS. 100 AND 101).

FIRST USE 3-1-2003; IN COMMERCE 3-1-2003.
JACQUELINE A. LAVINE, EXAMINING ATTORNEY



NO CLAIM IS MADE TO THE EXCLUSIVE RIGHT TO USE QUEENS BEAUTY CORP AND THE NON-LATIN CHARACTERS WHICH TRANSLITERATE TO SHI XIAN TI MEI RON ZHON XIN, APART FROM THE MARK AS SHOWN.

THE COLOR(S) BLACK AND GOLD IS/ARE CLAIMED AS A FEATURE OF THE MARK.

THE COLOR GOLD APPEARS IN THE WORDS ROYAL QUEENS BEAUTY CORP AND THE NON-LATIN CHARACTERS; THE COLOR BLACK APPEARS THE DESIGN OF THE WOMAN AND LARGE NON-LATIN CHARACTERS AS WELL AS THE OVAL BORDER.

THE NON-LATIN CHARACTER IN THE MARK TRANSLITERATE TO "HUANG SHI XIAN TI MEI RON ZHON XIN" AND THIS MEANS "ROYAL QUEENS BEAUTY CORP" IN ENGLISH.

FOR PROVIDING BEAUTY SALON AND SKIN CARE SERVICES (U.S. CLS. 100 AND 101).

FIRST USE 9-1-2003; IN COMMERCE 9-1-2003.

MARGERY A. TIERNEY, EXAMINING ATTORNEY

CLASS 44—(Continued).

SN 78-349,584. BRIGGS MEDICAL SERVICE COMPANY, DBA BRIGGS CORPORATION, WEST DES MOINES, IA. FILED 1-8-2004.



THE MARK CONSISTS OF A BESPECTACLED OWL WITH WINGS PARTIALLY OUTSTRETCHED STANDING ON THREE CLOSED BOOKS.

FOR PROVIDING INFORMATION VIA THE INTERNET IN THE FIELD OF MEDICAL RECORD COMPLETION TECHNIQUES THAT ARE USED IN THE DIAGNOSIS, TREATMENT, AND OBSERVATION OF PATIENTS; PROVIDING AN INTERACTIVE INTERNET WEB BASED DATABASE FOR USE BY MEDICAL, NURSING AND RELATED PERSONNEL IN COMPLETING MEDICAL RECORDS THAT ARE USED IN THE DIAGNOSIS, TREATMENT, AND OBSERVATION OF PATIENTS (U.S. CLS. 100 AND 101).

FIRST USE 9-1-2003; IN COMMERCE 9-1-2003.
TONI HICKEY, EXAMINING ATTORNEY

CLASS 44—(Continued).

SN 78-361,216. ROTECH HEALTHCARE INC., ORLANDO, FL. FILED 2-2-2004.

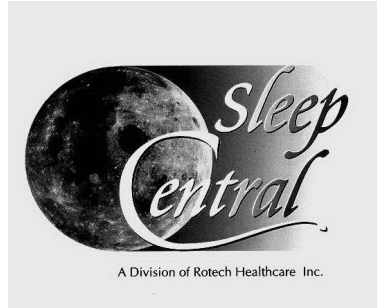

NO CLAIM IS MADE TO THE EXCLUSIVE RIGHT TO USE "SLEEP", "A DIVISION OF" AND "HEALTHCARE INC.", APART FROM THE MARK AS SHOWN.

THE GRAY IS FOR SHADING PURPOSES ONLY.
FOR MEDICAL SERVICES AND MEDICAL CONSULTING SERVICES FOR THE TREATMENT OF SLEEP AND RELATED DISORDERS (U.S. CLS. 100 AND 101).

FIRST USE 5-0-2001; IN COMMERCE 5-0-2001.
CYNTHIA SLOAN, EXAMINING ATTORNEY

SN 78-353,411. CLINICAL IQ, LLC, FLORHAM PARK, NJ. FILED 1-17-2004.

**Clinical IQ,
Compounding
Quality Systems**

THE MARK CONSISTS OF STANDARD CHARACTERS WITHOUT CLAIM TO ANY PARTICULAR FONT, STYLE, SIZE, OR COLOR.

NO CLAIM IS MADE TO THE EXCLUSIVE RIGHT TO USE "CLINICAL", APART FROM THE MARK AS SHOWN.
FOR HEALTH CARE CONSULTATION SERVICES (U.S. CLS. 100 AND 101).

VERNA BETH RIRIE, EXAMINING ATTORNEY

SN 78-364,653. THE MOUNT SINAI HOSPITAL, NEW YORK, NY. FILED 2-9-2004.

**It's Great To Be A
Loser!**

THE MARK CONSISTS OF STANDARD CHARACTERS WITHOUT CLAIM TO ANY PARTICULAR FONT, STYLE, SIZE, OR COLOR.

FOR WEIGHT REDUCTION DIET PLANNING AND SUPERVISION (U.S. CLS. 100 AND 101).

FIRST USE 1-1-2002; IN COMMERCE 1-1-2002.
TEJBIR SINGH, EXAMINING ATTORNEY

CLASS 44—(Continued).

SN 78-375,081. VISTA, SPS, LLC, COLLEGE POINT, NY. FILED 2-27-2004.



NO CLAIM IS MADE TO THE EXCLUSIVE RIGHT TO USE "CHRONIC CARE", APART FROM THE MARK AS SHOWN.

FOR HEALTH CARE SERVICES, NAMELY, CHRONIC DISEASE CASE MANAGEMENT FOR PERSONS WITH HEMOPHILIA, HEPATITIS C, RHEUMATOID ARTHRITIS, MULTIPLE SCLEROSIS, GAUCHER'S DISEASE, RESPIRATORY SYNCYTIAL VIRUS PREVENTION, PRIMARY IMMUNE DEFICIENCIES AND GROWTH HORMONE DEFICIENCIES; PROVIDING MEDICAL INFORMATION VIA THE TELEPHONE, HOME HEALTH CARE NURSING SERVICES (U.S. CLS. 100 AND 101).

PAULA MAHONEY, EXAMINING ATTORNEY

SN 78-389,264. ST. MARY'S HEALTH SYSTEM, INC., DBA ST. MARY'S MEDICAL CENTER, INC., KNOXVILLE, TN. FILED 3-23-2004.



OWNER OF U.S. REG. NO. 1,484,755.
NO CLAIM IS MADE TO THE EXCLUSIVE RIGHT TO USE "HEALTH", APART FROM THE MARK AS SHOWN.

FOR HEALTH PROGRAM WHICH PROMOTES HEALTH THROUGH TEAM COMPETITION AND SUPPORT, HEALTH EDUCATION, MOTIVATIONAL PROGRAMS AND INCENTIVES (U.S. CLS. 100 AND 101).

FIRST USE 5-1-2003; IN COMMERCE 5-1-2003.
CAROLYN GRAY, EXAMINING ATTORNEY

CLASS 44—(Continued).

SN 78-403,004. WATSON, BEN GERVAIS, LODI, CA. FILED 4-16-2004.



NO CLAIM IS MADE TO THE EXCLUSIVE RIGHT TO USE "OCCUPATIONAL HEALTH SERVICES", APART FROM THE MARK AS SHOWN.

THE COLOR(S) MAROON IS/ARE CLAIMED AS A FEATURE OF THE MARK.

THE MARK CONSISTS OF THE LETTERS OHS IN A STYLIZED FORMAT WITH A HARD HAT PERCHED ON THE "O" AND A CROSS MARK ON THE HAT. THIS DESIGN IS ABOVE THE LEGEND OCCUPATIONAL HEALTH SERVICES IN A BACKGROUND OF GREY OR RED, FADING TO WHITE FURTHER UP ON THE DESIGN. THE CROSS WILL NOT BE FILLED WITH ANY SHADE OF RED.

THE MARK CONSISTS OF STYLIZED LETTERS OHS, A HARD HAT WITH A GRAY COLOR CROSS ATOP THE O, THE WORDS OCCUPATIONAL HEALTH SERVICE EMBEDDED IN A FIELD OF MAROON SHADING, WHICH FADES TOWARD THE UPPER PORTIONS OF THE OHS FIGURE.

FOR COMPREHENSIVE MEDICAL SERVICES, NAMELY, WORK-RELATED INJURY AND ILLNESS TREATMENT, POST JOB PHYSICALS, DOT PHYSICALS, WORKSITE MEDICAL TESTING AND DRUG TESTING FOR SUBSTANCE ABUSE AND WORK CONDITIONING (U.S. CLS. 100 AND 101).

FIRST USE 4-12-2004; IN COMMERCE 4-15-2004.
AISHA CLARKE, EXAMINING ATTORNEY

SN 78-408,208. CAROLINA CARE PLAN, INC., COLUMBIA, SC. FILED 4-26-2004.

CAROLINA PATHWAYS

THE MARK CONSISTS OF STANDARD CHARACTERS WITHOUT CLAIM TO ANY PARTICULAR FONT, STYLE, SIZE, OR COLOR.

NO CLAIM IS MADE TO THE EXCLUSIVE RIGHT TO USE "CAROLINA", APART FROM THE MARK AS SHOWN.

FOR PATIENT CARE MANAGEMENT AND WELLNESS PROGRAMS, NAMELY PROGRAMS TO ASSIST PATIENTS IN MANAGING CONDITIONS SUCH AS ASTHMA, DIABETES, CARDIOVASCULAR CONDITIONS, PREGNANCY, HYPERTENSION AND HIGH CHOLESTEROL (U.S. CLS. 100 AND 101).

DOMINICK J. SALEMI, EXAMINING ATTORNEY

CLASS 44—(Continued).

SN 78-412,694. C/HCA, INC., NASHVILLE, TN. FILED 5-4-2004.



THE MARK CONSISTS OF M WITH FLAME.
FOR MEDICAL AND HEALTHCARE SERVICES (U.S.
CLS. 100 AND 101).
FIRST USE 8-3-2003; IN COMMERCE 8-3-2003.
TANYA AMOS, EXAMINING ATTORNEY

CLASS 44—(Continued).

SN 78-421,521. IMARX THERAPEUTICS, INC., TUCSON, AZ.
FILED 5-19-2004.

SONOLYSIS

THE MARK CONSISTS OF STANDARD CHARACTERS
WITHOUT CLAIM TO ANY PARTICULAR FONT, STYLE,
SIZE, OR COLOR.
FOR SURGERY ACCOMPANIED BY THE USE OF
ULTRASOUND TO ELIMINATE BLOOD CLOTS (U.S.
CLS. 100 AND 101).
TONI HICKEY, EXAMINING ATTORNEY

SN 78-414,478. DATAI, INC., LAS VEGAS, NV. FILED 5-6-2004.

limelight

THE MARK CONSISTS OF STANDARD CHARACTERS
WITHOUT CLAIM TO ANY PARTICULAR FONT, STYLE,
SIZE, OR COLOR.
FOR BEAUTY SALONS (U.S. CLS. 100 AND 101).
FIRST USE 1-2-2004; IN COMMERCE 1-2-2004.
SKYE YOUNG, EXAMINING ATTORNEY

SN 78-426,412. PATHGROUP, INC., BRENTWOOD, TN.
FILED 5-27-2004.

PathConnect

THE MARK CONSISTS OF STANDARD CHARACTERS
WITHOUT CLAIM TO ANY PARTICULAR FONT, STYLE,
SIZE, OR COLOR.
FOR COMPUTERIZED MEDICAL INFORMATION
SERVICES FOR PHYSICIANS' OFFICES, NAMELY,
PROVIDING MEDICAL TEST RESULTS OF CLINICAL
AND ANATOMIC PATHOLOGY TESTS BY MEANS OF A
COMPUTERIZED ONLINE ORDERING AND RETRIE-
VAL SERVICE (U.S. CLS. 100 AND 101).
FIRST USE 7-30-2004; IN COMMERCE 7-30-2004.
THEODORE MCBRIDE, EXAMINING ATTORNEY

CLASS 44—(Continued).

SN 78-438,513. ADVANCE CARE PLANNING, INC., BAY VILLAGE, OH. FILED 6-21-2004.



NO CLAIM IS MADE TO THE EXCLUSIVE RIGHT TO USE "ADVANCE DIRECTIVES", "THE LIVING WILL", "POWER OF ATTORNEY" AND "THE ADVANCE CARE PLAN", APART FROM THE MARK AS SHOWN.

THE COLORS RED, BLUE AND BLACK ARE CLAIMED AS A FEATURE OF THE MARK.

THE COLOR RED APPEARS IN THE TRIANGLE DESIGN, THE COLOR BLUE APPEARS IN THE WORDING THE TRIAD OF ADVANCE DIRECTIVES, AND THE COLOR BLACK APPEARS IN THE WORDING THE LIVING WILL, POWER OF ATTORNEY, THE ADVANCE CARE PLAN OF THE MARK.

FOR PROVIDING HEALTH CARE INFORMATION, NAMELY, PROVIDING INFORMATION REGARDING DOCUMENTING ADVANCE CARE PLANS AND PREPARING ADVANCED CARE PLANS, ADVANCED CARE PLAN FORMS, PROVIDING INFORMATION TO POTENTIAL NURSING HOME RESIDENTS IN THE PREPARATION OF ADVANCED CARE PLANS, AND PROVIDING INFORMATION TO POTENTIAL LONG TERM CARE FACILITY RESIDENTS IN THE PREPARATION OF ADVANCED CARE PLANS (U.S. CLS. 100 AND 101).

ANDREW RHIM, EXAMINING ATTORNEY

SN 78-444,938. HATTEN, JOHN H., ODESSA, TX. FILED 7-1-2004.

ENJOY THE
EXPERIENCE
EXPERIENCE THE
ENJOYMENT

THE MARK CONSISTS OF STANDARD CHARACTERS WITHOUT CLAIM TO ANY PARTICULAR FONT, STYLE, SIZE, OR COLOR.

FOR DENTIST SERVICES (U.S. CLS. 100 AND 101). FIRST USE 5-0-1999; IN COMMERCE 10-0-1999. YSA DEJESUS, EXAMINING ATTORNEY

CLASS 44—(Continued).

SN 78-453,592. PERFORMANCE PHYSICAL THERAPY, FRANKFORT, IL. FILED 7-20-2004.



NO CLAIM IS MADE TO THE EXCLUSIVE RIGHT TO USE PHYSICAL THERAPY, APART FROM THE MARK AS SHOWN.

FOR PHYSICAL THERAPY (U.S. CLS. 100 AND 101). FIRST USE 3-1-2004; IN COMMERCE 3-1-2004. ANN LINNEHAN, EXAMINING ATTORNEY

SN 78-463,933. LAYMAN, WILLIAM D, CLEARWATER, FL. FILED 8-8-2004.



NO CLAIM IS MADE TO THE EXCLUSIVE RIGHT TO USE "ORTHODONTICS", APART FROM THE MARK AS SHOWN.

THE COLOR(S) RED AND BLACK IS/ARE CLAIMED AS A FEATURE OF THE MARK.

THE MARK CONSISTS OF A RED FACE JAW LINE WITH A SMILE; ORTHODONTICS AND SUORTHO.COM IS IN RED THE WORD STRAIGHTEN UP IS IN BLACK.

FOR ORTHODONTIC SERVICES (U.S. CLS. 100 AND 101). SUNG IN, EXAMINING ATTORNEY

CLASS 44—(Continued).

SN 78-481,126. MOSELEY, THOMAS M., POTOMAC, MD.
FILED 9-9-2004.

**CLASS 44—(Continued).**

SN 78-483,616. BUCHANAN, G. GLENN, SEATTLE, WA.
FILED 9-14-2004.

**REFLECTIONS DENTAL
CENTRE-Reflecting the
needs of our community.**

OWNER OF U.S. REG. NO. 1,351,092.

NO CLAIM IS MADE TO THE EXCLUSIVE RIGHT TO USE "MARYLAND GARDENS TREE & SHRUB FARM", APART FROM THE MARK AS SHOWN.

THE COLORS WHITE, LIGHT GREEN AND DARK GREEN ARE CLAIMED AS A FEATURE OF THE MARK.

THE COLOR WHITE APPEARS IN THE WORDING "MARYLAND GARDENS TREE & SHRUB FARM". THE COLOR LIGHT GREEN APPEARS IN THE SHOVEL DESIGN AND IN THE BORDER SURROUNDING THE RECTANGULAR DESIGN OF THE MARK, AND THE COLOR DARK GREEN APPEARS IN THE BACKGROUND OF THE RECTANGULAR DESIGN OF THE MARK.

FOR NURSERY SERVICES, NAMELY, TREE AND SHRUB NURSERIES (U.S. CLS. 100 AND 101).

FIRST USE 7-10-1978; IN COMMERCE 7-10-1978.

ANDREW RHIM, EXAMINING ATTORNEY

THE MARK CONSISTS OF STANDARD CHARACTERS WITHOUT CLAIM TO ANY PARTICULAR FONT, STYLE, SIZE, OR COLOR.

NO CLAIM IS MADE TO THE EXCLUSIVE RIGHT TO USE "DENTAL CENTRE", APART FROM THE MARK AS SHOWN.

FOR DENTIST SERVICES (U.S. CLS. 100 AND 101).

TEJBIR SINGH, EXAMINING ATTORNEY

SN 78-481,521. NORTHEAST ARKANSAS HEALTH SYSTEM,
LLC, JONESBORO, AR. FILED 9-10-2004.



NO CLAIM IS MADE TO THE EXCLUSIVE RIGHT TO USE "MEDICAL CENTER", APART FROM THE MARK AS SHOWN.

THE MARK CONSISTS OF THE WORDS NEA MEDICAL CENTER WITH A FLOATING SCRIPT LETTER "N" IN THE BACKGROUND.

FOR HEALTH CARE SERVICES; HOSPITAL SERVICES; MEDICAL SERVICES; PHYSICIAN SERVICES; PHYSICIAN MANAGED HEALTH CARE SERVICES; WELLNESS SERVICES, NAMELY, PHYSICAL THERAPY, PSYCHOLOGICAL COUNSELING, DIETARY AND NUTRITIONAL COUNSELING, PROVIDING HEALTH INFORMATION, HEALTH SCREENING AND RISK ASSESSMENT AND WELLNESS PROFILES; COUNSELING IN THE FIELD OF HEALTH; NURSING CARE SERVICES; MEDICAL DIAGNOSTIC AND TREATMENT SERVICES; INPATIENT, OUTPATIENT AND EMERGENCY MEDICAL SERVICES; AND SURGICAL SERVICES (U.S. CLS. 100 AND 101).

DANIEL BRODY, EXAMINING ATTORNEY

SN 78-484,817. THE MOUNT SINAI HOSPITAL, NEW YORK,
NY. FILED 9-16-2004.

Winning By Losing

THE MARK CONSISTS OF STANDARD CHARACTERS WITHOUT CLAIM TO ANY PARTICULAR FONT, STYLE, SIZE, OR COLOR.

FOR WEIGHT REDUCTION DIET PLANNING AND SUPERVISION (U.S. CLS. 100 AND 101).

FIRST USE 1-1-2002; IN COMMERCE 1-1-2002.

CAROLYN GRAY, EXAMINING ATTORNEY

CLASS 44—(Continued).

SN 78-493,236. MARIO DIANA, M.D., P.A., SAN ANTONIO, TX. FILED 10-1-2004.

complementing your
beauty within

THE MARK CONSISTS OF STANDARD CHARACTERS WITHOUT CLAIM TO ANY PARTICULAR FONT, STYLE, SIZE, OR COLOR.

FOR COSMETIC SURGERY AND HEALTH AND WELLNESS SERVICES CONSISTING OF HEALTH ASSESSMENTS AND SPA TREATMENTS (U.S. CLS. 100 AND 101).

FIRST USE 9-1-2004; IN COMMERCE 9-1-2004.
DAWN FELDMAN, EXAMINING ATTORNEY

SN 78-494,641. GERSH, TAMMY, CARROLLTON, TX. FILED 10-5-2004.

Oceanna

THE MARK CONSISTS OF STANDARD CHARACTERS WITHOUT CLAIM TO ANY PARTICULAR FONT, STYLE, SIZE, OR COLOR.

FOR HEALTH SPA SERVICES FOR HEALTH AND WELLNESS OF BODY, MIND, AND SPIRIT (U.S. CLS. 100 AND 101).

FIRST USE 2-1-2004; IN COMMERCE 2-1-2004.
CHRIS WELLS, EXAMINING ATTORNEY

CLASS 44—(Continued).

SN 78-498,555. HELIXYS, LLC, GLENDALE, AZ. FILED 10-12-2004.

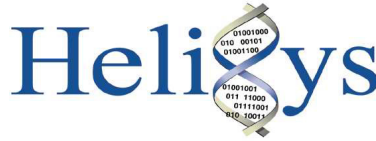

THE COLOR(S) BLUE, TAN AND BLACK IS/ARE CLAIMED AS A FEATURE OF THE MARK.

THE MARK CONSIST OF THE FOLLOWING LETTERS IN BLUE- H, E, L, I, Y, AND S. THE DOUBLE HELIX IN THE CENTER OF THE MARK IS BLUE AND TAN, WITH BLACK NUMBERS.

FOR COMPUTER SERVICES, NAMELY, PROVIDING MEDICAL IMAGES VIA GLOBAL COMPUTER INFORMATION NETWORKS; AND PROVIDING A WEBSITE ON GLOBAL COMPUTER INFORMATION NETWORKS FEATURING MEDICAL IMAGES AND INFORMATION (U.S. CLS. 100 AND 101).

GWEN STOKOLS, EXAMINING ATTORNEY

SN 78-500,994. VALKLEIN, INC., DBA WHILE YOUR AWAY, LADERA RANCH, CA. FILED 10-16-2004.

WHILE YOUR AWAY

THE MARK CONSISTS OF STANDARD CHARACTERS WITHOUT CLAIM TO ANY PARTICULAR FONT, STYLE, SIZE, OR COLOR.

FOR PET SITTING SERVICES AND PET WALKING SERVICES (U.S. CLS. 100 AND 101).

FIRST USE 1-20-2001; IN COMMERCE 1-20-2001.
LINDA M. KING, EXAMINING ATTORNEY

SN 78-506,932. REHABWORKS, LLC, HUNT VALLEY, MD. FILED 10-27-2004.

REHAB WITH RESULTS!

THE MARK CONSISTS OF STANDARD CHARACTERS WITHOUT CLAIM TO ANY PARTICULAR FONT, STYLE, SIZE, OR COLOR.

FOR PHYSICAL THERAPY, OCCUPATIONAL THERAPY, AND PHYSICAL REHABILITATION SERVICES (U.S. CLS. 100 AND 101).

FIRST USE 2-1-2002; IN COMMERCE 2-1-2002.
WARREN L. OLANDRIA, EXAMINING ATTORNEY

CLASS 44—(Continued).

SN 78-507,579. CHC COMMUNITY CARE, LLC, PLANO, TX. FILED 10-28-2004.



NO CLAIM IS MADE TO THE EXCLUSIVE RIGHT TO USE "HOSPITAL OF SOUTHEAST TEXAS", APART FROM THE MARK AS SHOWN.
THE MARK CONSISTS OF CIRCULAR ARROW DESIGN. FOR HOSPITAL AND HEALTH CARE SERVICES (U.S. CLS. 100 AND 101).
FIRST USE 9-28-2004; IN COMMERCE 9-28-2004.
JACQUELINE A. LAVINE, EXAMINING ATTORNEY

SN 78-510,014. REHABWORKS, LLC, HUNT VALLEY, MD. FILED 11-2-2004.

THE RIGHT RESULTS

THE MARK CONSISTS OF STANDARD CHARACTERS WITHOUT CLAIM TO ANY PARTICULAR FONT, STYLE, SIZE, OR COLOR.
FOR PHYSICAL THERAPY, OCCUPATIONAL THERAPY AND PHYSICAL REHABILITATION SERVICES (U.S. CLS. 100 AND 101).
FIRST USE 3-1-2003; IN COMMERCE 3-1-2003.
ATTIYA MALIK, EXAMINING ATTORNEY

SN 78-510,015. REHABWORKS, LLC, HUNT VALLEY, MD. FILED 11-2-2004.

**PASSIONATE PEOPLE
PROVIDING
POWERFUL
PROGRAMS**

THE MARK CONSISTS OF STANDARD CHARACTERS WITHOUT CLAIM TO ANY PARTICULAR FONT, STYLE, SIZE, OR COLOR.
FOR PHYSICAL THERAPY, OCCUPATIONAL THERAPY AND PHYSICAL REHABILITATION SERVICES (U.S. CLS. 100 AND 101).
FIRST USE 3-1-2003; IN COMMERCE 3-1-2003.
ATTIYA MALIK, EXAMINING ATTORNEY

CLASS 44—(Continued).

SN 78-511,714. SCHNEIDER, M.D., JOHN H., BILLINGS, MT. FILED 11-4-2004.



NO CLAIM IS MADE TO THE EXCLUSIVE RIGHT TO USE "NORTHERN ROCKIES BRAIN & SPINE CENTER", APART FROM THE MARK AS SHOWN.
FOR THE EVALUATION, DIAGNOSIS AND SURGICAL MANAGEMENT OF DISEASES AFFECTING THE BRAIN AND SPINAL CORD (U.S. CLS. 100 AND 101).
FIRST USE 11-1-2002; IN COMMERCE 11-1-2002.
MARIAM MAHMOUDI, EXAMINING ATTORNEY

SN 78-512,037. KALANGES, LAURI, RENO, NV. FILED 11-5-2004.



NO CLAIM IS MADE TO THE EXCLUSIVE RIGHT TO USE CENTER FOR ACTIVE AGING & HEALTHY LIVING, APART FROM THE MARK AS SHOWN.
FOR HEALTH CARE (U.S. CLS. 100 AND 101).
FIRST USE 10-16-2004; IN COMMERCE 10-20-2004.
TARAH HARDY, EXAMINING ATTORNEY

SN 78-512,149. PARTNERS HEALTHCARE SYSTEM, INC., BOSTON, MA. FILED 11-5-2004.

**PARTNERS COMMUNITY
HEALTHCARE, INC.**

THE MARK CONSISTS OF STANDARD CHARACTERS WITHOUT CLAIM TO ANY PARTICULAR FONT, STYLE, SIZE, OR COLOR.
OWNER OF U.S. REG. NO. 2,375,555.
NO CLAIM IS MADE TO THE EXCLUSIVE RIGHT TO USE "COMMUNITY HEALTHCARE, INC"., APART FROM THE MARK AS SHOWN.
FOR HEALTH CARE (U.S. CLS. 100 AND 101).
FIRST USE 0-0-1994; IN COMMERCE 0-0-1994.
JULIE WATSON, EXAMINING ATTORNEY

CLASS 44—(Continued).

SN 78-512,871. RODRIGUEZ, RAUL P., DALLAS, TX. FILED 11-8-2004.

THINJECTION

THE MARK CONSISTS OF STANDARD CHARACTERS WITHOUT CLAIM TO ANY PARTICULAR FONT, STYLE, SIZE, OR COLOR.

FOR MEDICAL SERVICES, NAMELY, ADMINISTERING INJECTIONS, NUTRITIONAL SUPPLEMENTS AND PHARMACEUTICAL PREPARATIONS FOR USE IN LOCALIZED FAT AND CELLULITE REDUCTION (U.S. CLS. 100 AND 101).

JULIE GUTTADAURO, EXAMINING ATTORNEY

SN 78-513,261. ELLIOT HEALTH SYSTEM, MANCHESTER, NH. FILED 11-8-2004.

Save a Sister

THE MARK CONSISTS OF STANDARD CHARACTERS WITHOUT CLAIM TO ANY PARTICULAR FONT, STYLE, SIZE, OR COLOR.

FOR MEDICAL SERVICES FOR BREASTS (U.S. CLS. 100 AND 101).

FIRST USE 1-1-2003; IN COMMERCE 1-1-2003.

SHAUNIA WALLACE, EXAMINING ATTORNEY

CLASS 44—(Continued).

SN 78-513,838. TRS BEHAVIORAL CARE, INC., HOUSTON, TX. FILED 11-9-2004.

The Right Step

THE MARK CONSISTS OF STANDARD CHARACTERS WITHOUT CLAIM TO ANY PARTICULAR FONT, STYLE, SIZE, OR COLOR.

FOR ADDICTION TREATMENT SERVICES AND REHABILITATION OF DRUG, ALCOHOL, NARCOTIC AND SUBSTANCE ADDICTED PATIENTS, AND COUNSELING AND REHABILITATION SERVICES FOR ALCOHOL AND OTHER DRUG-DEPENDENT PATIENTS (U.S. CLS. 100 AND 101).

FIRST USE 0-0-1990; IN COMMERCE 0-0-1990.

MARIA-VICTORIA SUAREZ, EXAMINING ATTORNEY

SN 78-516,700. SCOTT R. FIRESTONE, MELVILLE, NY. FILED 11-15-2004.

**DENTISTRY WITH
DISTINCTION**

THE MARK CONSISTS OF STANDARD CHARACTERS WITHOUT CLAIM TO ANY PARTICULAR FONT, STYLE, SIZE, OR COLOR.

NO CLAIM IS MADE TO THE EXCLUSIVE RIGHT TO USE "DENTISTRY", APART FROM THE MARK AS SHOWN.

FOR DENTAL SERVICES (U.S. CLS. 100 AND 101).

FIRST USE 11-15-2004; IN COMMERCE 11-15-2004.

BRENDAN MCCAULEY, EXAMINING ATTORNEY

CLASS 44—(Continued).

SN 78-516,812. TRS BEHAVIORAL CARE, INC., HOUSTON, TX. FILED 11-15-2004.



FOR ADDICTION TREATMENT SERVICES AND REHABILITATION OF DRUG, ALCOHOL, NARCOTIC AND SUBSTANCE ADDICTED PATIENTS, AND COUNSELING AND REHABILITATION SERVICES FOR ALCOHOL AND OTHER DRUG-DEPENDENT PATIENTS (U.S. CLS. 100 AND 101).

FIRST USE 0-0-1990; IN COMMERCE 0-0-1990.
MARIA-VICTORIA SUAREZ, EXAMINING ATTORNEY

SN 78-517,500. PHOENIX SLEEP, L.L.C., SCOTTSDALE, AZ. FILED 11-16-2004.

YOUR DAYS ARE ONLY
AS GOOD AS YOUR
NIGHTS

THE MARK CONSISTS OF STANDARD CHARACTERS WITHOUT CLAIM TO ANY PARTICULAR FONT, STYLE, SIZE, OR COLOR.

FOR MEDICAL SERVICES, NAMELY, SLEEP DISORDER CONSULTATION, DIAGNOSIS, TREATMENT, AND ASSISTANCE SERVICES (U.S. CLS. 100 AND 101).
FIRST USE 12-15-2003; IN COMMERCE 12-15-2003.
DAVID C. REIHNER, EXAMINING ATTORNEY

CLASS 44—(Continued).

SN 78-520,725. UNIVERSAL COMPANIES, INC., ABINGDON, VA. FILED 11-22-2004.

SPASRIPTIVE

THE MARK CONSISTS OF STANDARD CHARACTERS WITHOUT CLAIM TO ANY PARTICULAR FONT, STYLE, SIZE, OR COLOR.

FOR HEALTH SPA SERVICES, NAMELY, COSMETIC AND HEALTH BODY CARE SERVICES (U.S. CLS. 100 AND 101).

FIRST USE 12-1-2003; IN COMMERCE 12-1-2003.
MIDGE BUTLER, EXAMINING ATTORNEY

SN 78-521,041. SERVICE DISABLED VETERAN ENTERPRISES, INC., NAPERVILLE, IL. FILED 11-22-2004.

WINGS OF EAGLES

THE MARK CONSISTS OF STANDARD CHARACTERS WITHOUT CLAIM TO ANY PARTICULAR FONT, STYLE, SIZE, OR COLOR.

FOR HEALTH EMERGENCY MEDICAL INFORMATION SERVICES (U.S. CLS. 100 AND 101).
STEVEN R. FINE, EXAMINING ATTORNEY

SN 78-521,173. TRANSIMMUNE CORPORATION, WESTPORT, CT. FILED 11-22-2004.

TRANSIMMUNIZATION

THE MARK CONSISTS OF STANDARD CHARACTERS WITHOUT CLAIM TO ANY PARTICULAR FONT, STYLE, SIZE, OR COLOR.

FOR MEDICAL SERVICE IN THE NATURE OF A THERAPEUTIC TREATMENT FOR INDUCING A PATIENT'S IMMUNE SYSTEM TO ELIMINATE CANCER CELLS WITHIN THE BODY (U.S. CLS. 100 AND 101).

FIRST USE 4-0-1999; IN COMMERCE 5-0-1999.
IRA J. GOODSaid, EXAMINING ATTORNEY

CLASS 44—(Continued).

SN 78-521,177. MINUTECLINIC, INC., MINNEAPOLIS, MN. FILED 11-22-2004.

THE PRESCRIPTION
FOR YOUR BUSY
LIFE

THE MARK CONSISTS OF STANDARD CHARACTERS WITHOUT CLAIM TO ANY PARTICULAR FONT, STYLE, SIZE, OR COLOR.

FOR DROP-IN MEDICAL CLINIC FEATURING NON-EMERGENCY MEDICAL DIAGNOSTIC SERVICES IN CONVENIENT LOCATIONS (U.S. CLS. 100 AND 101).
MICHAEL SOUDERS, EXAMINING ATTORNEY

SN 78-521,748. BERENZVEIG, DOV, NEW YORK, NY. FILED 11-23-2004.

DOV

THE MARK CONSISTS OF STANDARD CHARACTERS WITHOUT CLAIM TO ANY PARTICULAR FONT, STYLE, SIZE, OR COLOR.

FOR HAIR STYLING AND BEAUTY SALON SERVICES (U.S. CLS. 100 AND 101).
FIRST USE 0-0-1995; IN COMMERCE 0-0-1995.
STEVEN PEREZ, EXAMINING ATTORNEY

CLASS 44—(Continued).

SN 78-523,609. THE NEMOURS FOUNDATION, JACKSONVILLE, FL. FILED 11-29-2004.

Nemours

OWNER OF U.S. REG. NOS. 2,777,708, 2,777,710 AND OTHERS.

THE COLOR(S) BLUE AND RED IS/ARE CLAIMED AS A FEATURE OF THE MARK.

THE MARK CONSISTS OF THE WORD "NEMOURS", WHICH APPEARS IN BLUE, ABOVE A HORIZONTAL BRUSH STROKE, WHICH APPEARS IN RED.

FOR MEDICAL SERVICES; HEALTH CARE SERVICES; HOSPITAL SERVICES; OPERATION OF MEDICAL CLINICS; MEDICAL TRAUMA CENTER SERVICES; CHARITABLE SERVICES, NAMELY, PROVIDING MEDICAL SERVICES TO PERSONS IN NEED (U.S. CLS. 100 AND 101).

FIRST USE 1-0-2004; IN COMMERCE 1-0-2004.
BARBARA BROWN, EXAMINING ATTORNEY

SN 78-530,862. PROMEDX, KNOXVILLE, TN. FILED 12-10-2004.

OxyC

THE MARK CONSISTS OF STANDARD CHARACTERS WITHOUT CLAIM TO ANY PARTICULAR FONT, STYLE, SIZE, OR COLOR.

FOR DRUG TESTING FOR SUBSTANCE ABUSE (U.S. CLS. 100 AND 101).
MATTHEW PAPPAS, EXAMINING ATTORNEY

CLASS 44—(Continued).

SN 78-535,155. OPTION CARE, INC., BUFFALO GROVE, IL. FILED 12-19-2004.

CLASS 44—(Continued).

SN 78-538,602. EPIC TELERADIOLOGY, LLC, LEESBURG, FL. FILED 12-27-2004.

FACTOR APE

Epic Teleradiology

THE MARK CONSISTS OF STANDARD CHARACTERS WITHOUT CLAIM TO ANY PARTICULAR FONT, STYLE, SIZE, OR COLOR.

FOR BLEEDING DISORDER THERAPY; PROVIDING EDUCATIONAL INFORMATION ONLINE IN THE AREA OF BLEEDING DISORDERS AND BLEEDING DISORDER THERAPY (U.S. CLS. 100 AND 101).

FIRST USE 7-1-2001; IN COMMERCE 7-1-2001.
WINSTON FOLMAR, EXAMINING ATTORNEY

THE MARK CONSISTS OF STANDARD CHARACTERS WITHOUT CLAIM TO ANY PARTICULAR FONT, STYLE, SIZE, OR COLOR.

NO CLAIM IS MADE TO THE EXCLUSIVE RIGHT TO USE "TELERADIOLOGY", APART FROM THE MARK AS SHOWN.

FOR TELERADIOLOGY IN THE NATURE OF PROVIDING REMOTE INTERPRETATIONS OF MEDICAL IMAGING EXAMS VIA THE INTERNET (U.S. CLS. 100 AND 101).

FIRST USE 12-22-2004; IN COMMERCE 12-22-2004.
BARBARA RUTLAND, EXAMINING ATTORNEY

SN 78-537,251. PIONEER HI-BRED INTERNATIONAL, INC., DES MOINES, IA. FILED 12-22-2004.

SN 78-538,797. KHA, DAVID T., FULLERTON, CA. FILED 12-27-2004.

ENCLASS

Massnetic Therapy

THE MARK CONSISTS OF STANDARD CHARACTERS WITHOUT CLAIM TO ANY PARTICULAR FONT, STYLE, SIZE, OR COLOR.

FOR AGRICULTURAL CROP PLANNING ASSISTANCE SERVICES (U.S. CLS. 100 AND 101).

JILL PRATER, EXAMINING ATTORNEY

THE MARK CONSISTS OF STANDARD CHARACTERS WITHOUT CLAIM TO ANY PARTICULAR FONT, STYLE, SIZE, OR COLOR.

FOR MAGNETIC MASSAGE THERAPY (U.S. CLS. 100 AND 101).

MARIA-VICTORIA SUAREZ, EXAMINING ATTORNEY

CLASS 44—(Continued).

SN 78-539,763. CAREGROUP MEDICAL SERVICE ORGANIZATION, LLC, BOSTON, MA. FILED 12-29-2004.

CLASS 44—(Continued).

SN 78-541,730. YUNG, MICHAEL S., PASADENA, CA. FILED 1-4-2005.

MEDVENTIVE



THE MARK CONSISTS OF STANDARD CHARACTERS WITHOUT CLAIM TO ANY PARTICULAR FONT, STYLE, SIZE, OR COLOR.

FOR MEDICAL, PHARMACEUTICAL, AND MANAGED HEALTH CARE CONSULTATION SERVICES FOR PURPOSES OF GUIDING TREATMENT, ASSESSING PROGRAM EFFECTIVENESS, AND ASSESSING COST AND QUALITY PERFORMANCE (U.S. CLS. 100 AND 101).

ANNE E. GUSTASON, EXAMINING ATTORNEY

FOR GENERAL DENTAL PRACTICE - FAMILY AND ESTHETIC DENTAL PROCEDURES (U.S. CLS. 100 AND 101).

FIRST USE 5-1-2004; IN COMMERCE 5-1-2004.
TINA L. SNAPP, EXAMINING ATTORNEY

SN 78-541,516. JILL DIANE MCLANE, LOS ANGELES, CA. FILED 1-3-2005.

SN 78-541,952. FRANKLIN MEMORIAL HOSPITAL, FARMINGTON, ME. FILED 1-4-2005.

**Hello Gorgeous!
Pet Care**

NORTHSTAR

THE MARK CONSISTS OF STANDARD CHARACTERS WITHOUT CLAIM TO ANY PARTICULAR FONT, STYLE, SIZE, OR COLOR.

NO CLAIM IS MADE TO THE EXCLUSIVE RIGHT TO USE "PET CARE", APART FROM THE MARK AS SHOWN.

FOR PET SITTING/DOG WALKING (U.S. CLS. 100 AND 101).

DOMINIC J. FERRAIUOLO, EXAMINING ATTORNEY

THE MARK CONSISTS OF STANDARD CHARACTERS WITHOUT CLAIM TO ANY PARTICULAR FONT, STYLE, SIZE, OR COLOR.

FOR EMERGENCY MEDICAL SERVICES (U.S. CLS. 100 AND 101).

JASON ROTH, EXAMINING ATTORNEY

CLASS 44—(Continued).

SN 78-547,021. SIDES, JENNIFER N., BIRMINGHAM, AL. FILED 1-13-2005.

CLASS 44—(Continued).

SN 78-547,522. CAREMINDERS, INC., ALPHARETTA, GA. FILED 1-14-2005.

**LIFESTYLE MAKEUP
LESSON**

THE MARK CONSISTS OF STANDARD CHARACTERS WITHOUT CLAIM TO ANY PARTICULAR FONT, STYLE, SIZE, OR COLOR.

NO CLAIM IS MADE TO THE EXCLUSIVE RIGHT TO USE MAKEUP LESSON, APART FROM THE MARK AS SHOWN.

FOR BEAUTY CONSULTATION SERVICES IN THE SELECTION AND USE OF COSMETICS AND SKIN CARE PRODUCTS AND IN HOUSE FACIAL SKIN CARE TREATMENT SERVICES (U.S. CLS. 100 AND 101).

FIRST USE 1-0-2000; IN COMMERCE 1-0-2000.
PAULA MAHONEY, EXAMINING ATTORNEY

CAREMINDERS

THE MARK CONSISTS OF STANDARD CHARACTERS WITHOUT CLAIM TO ANY PARTICULAR FONT, STYLE, SIZE, OR COLOR.

FOR HOME HEALTH CARE SERVICES (U.S. CLS. 100 AND 101).

FIRST USE 6-20-2005; IN COMMERCE 6-20-2005.
DOUGLAS LEE, EXAMINING ATTORNEY

SN 78-549,596. CHAMPIONSHIP CLIPS, CEDAR FALLS, IA. FILED 1-18-2005.

Championship Clips

SN 78-547,473. RONCONE ORTHODONTICS INTERNATIONAL, VISTA, CA. FILED 1-13-2005.

THE MARK CONSISTS OF STANDARD CHARACTERS WITHOUT CLAIM TO ANY PARTICULAR FONT, STYLE, SIZE, OR COLOR.

FOR HAIRCUTTING AND HAIRSTYLING SERVICES (U.S. CLS. 100 AND 101).

FIRST USE 1-1-2005; IN COMMERCE 1-1-2005.
MARY BOAGNI, EXAMINING ATTORNEY

SN 78-551,630. GUTMAN, ANN, BOCA RATON, FL. FILED 1-21-2005.

JSOP

**Blondie's on the
Beach**

THE MARK CONSISTS OF STANDARD CHARACTERS WITHOUT CLAIM TO ANY PARTICULAR FONT, STYLE, SIZE, OR COLOR.

FOR ORTHODONTIC SERVICES (U.S. CLS. 100 AND 101).

FIRST USE 8-1-2003; IN COMMERCE 8-1-2003.
WILLIAM BRECKENFELD, EXAMINING ATTORNEY

THE MARK CONSISTS OF STANDARD CHARACTERS WITHOUT CLAIM TO ANY PARTICULAR FONT, STYLE, SIZE, OR COLOR.

FOR BEAUTY SALON (U.S. CLS. 100 AND 101).
MARIAM MAHMOUDI, EXAMINING ATTORNEY

CLASS 44—(Continued).

SN 78-552,159. ROSATI CONSTRUCTION, INC., COPIAGUE, NY. FILED 1-22-2005.

NOTHING TASTES AS
GOOD AS BEING IN
SHAPE FEELS

THE MARK CONSISTS OF STANDARD CHARACTERS WITHOUT CLAIM TO ANY PARTICULAR FONT, STYLE, SIZE, OR COLOR.

FOR SERVICES NAMELY PROVIDING ADVICE REGARDING HEALTH, DIETING AND NUTRITION (U.S. CLS. 100 AND 101).

JANICE L. MCMORROW, EXAMINING ATTORNEY

SN 78-556,767. PREMIER RESEARCH LABORATORIES, ROUND ROCK, TX. FILED 1-31-2005.

MEDI-BODY CENTER
AND SPA

THE MARK CONSISTS OF STANDARD CHARACTERS WITHOUT CLAIM TO ANY PARTICULAR FONT, STYLE, SIZE, OR COLOR.

OWNER OF U.S. REG. NO. 2,894,963.

NO CLAIM IS MADE TO THE EXCLUSIVE RIGHT TO USE "CENTER AND SPA", APART FROM THE MARK AS SHOWN.

FOR MEDICAL SERVICES; HEALTH SPA SERVICES FOR HEALTH AND WELLNESS OF THE BODY AND SPIRIT OFFERED AT A HEALTH FACILITY; HEALTH SPA SERVICES, NAMELY, COSMETIC BODY CARE SERVICES (U.S. CLS. 100 AND 101).

KATHY DE JONGE, EXAMINING ATTORNEY

CLASS 44—(Continued).

SN 78-566,541. CHOICE HEARING CENTER, INC., NEW PHILADELPHIA, OH. FILED 2-14-2005.

Hear Well, Live
Well

THE MARK CONSISTS OF STANDARD CHARACTERS WITHOUT CLAIM TO ANY PARTICULAR FONT, STYLE, SIZE, OR COLOR.

NO CLAIM IS MADE TO THE EXCLUSIVE RIGHT TO USE "HEAR", APART FROM THE MARK AS SHOWN.

FOR HEARING AID SERVICES (U.S. CLS. 100 AND 101).

FIRST USE 2-2-2005; IN COMMERCE 2-2-2005.

MARLENE BELL, EXAMINING ATTORNEY

CLASS 45—PERSONAL SERVICES

SN 76-570,904. ST. ANDREWS EVANGELICAL LUTHERAN CHURCH, MAHTOMEDI, MN. FILED 1-15-2004.

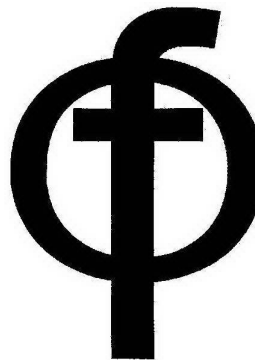

THE MARK CONSISTS OF THE STYLIZED LETTERS "O" AND "F" OVERLAID ONE ON THE OTHER.

FOR SERVICES DESIGNED TO PROMOTE THE RELIGIOUS AND SOCIAL WELFARE TO THE CHURCH CONGREGATION, TO INDIVIDUAL MEMBERS OF THE CONGREGATION, TO NON-MEMBERS OF THE CONGREGATION, AND TO THE PUBLIC GENERALLY, NAMELY, EVANGELISTIC AND MINISTERIAL SERVICES, INDIVIDUALS MINISTRY SERVICES, AND FAMILY MINISTRY SERVICES (U.S. CLS. 100 AND 101).

FIRST USE 9-1-1998; IN COMMERCE 9-1-2003.

SHARI SHEFFIELD, EXAMINING ATTORNEY

CLASS 45—(Continued).

SN 76-570,905. ST. ANDREWS EVANGELICAL LUTHERAN CHURCH, MAHTOMEDI, MN. FILED 1-15-2004.



THE MARK CONSISTS OF A SILHOUETTE OF A RUGGER SAILING VESSEL WITH THE NAME " ST. ANDREW'S LUTHERAN CHURCH" APPEARING ON THE SAIL.

FOR SERVICES DESIGNED TO PROMOTE THE RELIGIOUS AND SOCIAL WELFARE TO THE CHURCH CONGREGATION, TO INDIVIDUAL MEMBERS OF THE CONGREGATION, TO NON-MEMBERS OF THE CONGREGATION, AND TO THE PUBLIC GENERALLY, NAMELY, EVANGELISTIC AND MINISTERIAL SERVICES, INDIVIDUALS MINISTRY SERVICES, AND FAMILY MINISTRY SERVICES (U.S. CLS. 100 AND 101).

FIRST USE 7-1-1972; IN COMMERCE 7-1-1972.
SHARI SHEFFIELD, EXAMINING ATTORNEY

SN 76-584,457. STANGER-THATCHER, CAROL ANNETTE, WASHOUGAL, WA. FILED 4-1-2004.

BEST IN U

THE MARK CONSISTS OF STANDARD CHARACTERS WITHOUT CLAIM TO ANY PARTICULAR FONT, STYLE, SIZE, OR COLOR.

FOR DATING SERVICES, INCLUDING COMPUTER DATING SERVICES (U.S. CLS. 100 AND 101).

DANIEL BRODY, EXAMINING ATTORNEY

CLASS 45—(Continued).

SN 76-591,600. SHOWELL, ISAIAH, SALISBURY, MD. AND SHOWELL, LA-TREASE DANIELLE, SALISBURY, MD. FILED 5-11-2004.



NO CLAIM IS MADE TO THE EXCLUSIVE RIGHT TO USE "INTERNATIONAL MINISTRIES, INC.", APART FROM THE MARK AS SHOWN.

THE COLOR(S) GREEN, BLACK, BLUE, WHITE, RED, AND YELLOW IS/ARE CLAIMED AS A FEATURE OF THE MARK.

THE MARK CONSISTS OF MARK DESCRIPTION: LETTERING ARCHED ABOVE GLOBE-"DISCIPLES OF GOD GROWING INTERNATIONAL MINISTRIES" (GREEN LETTERS, OUTLINED IN BLACK) GLOBE- BLUE BACKGROUND WITH GREEN AND WHITE SNOWCAPS ALONG WITH A RED NET OVER THE GLOBE. THERE ARE TWO YELLOW AND BLUE ANGELS HOLDING THE RED NET, ONE ON EACH SIDE OF THE NET. UNDER THE GLOBE, THE WORDS D.O.G.G.I.M. (UPPERCASE), CAPTURING THE WORLD THROUGH JESUS CHRIST (THE LETTERING IS GREEN, OUTLINED IN BLACK) .

FOR RELIGIOUS MINISTERIAL SERVICES (U.S. CLS. 100 AND 101).

DAVID H. STINE, EXAMINING ATTORNEY

SN 76-591,930. DATAWATCH SYSTEMS, INC., BETHESDA, MD. FILED 5-13-2004.

VISITORWATCH

THE MARK CONSISTS OF STANDARD CHARACTERS WITHOUT CLAIM TO ANY PARTICULAR FONT, STYLE, SIZE, OR COLOR.

OWNER OF U.S. REG. NO. 2,849,014.

FOR MONITORING BUILDING SECURITY SYSTEMS FOR THE PURPOSE OF PROVIDING REMOTE ACCESS TO AFTER HOURS VISITORS (U.S. CLS. 100 AND 101).

JERI J. FICKES, EXAMINING ATTORNEY

CLASS 45—(Continued).

SN 76-593,611. FIRST SAFETY CONSULTANTS UNITED, INC., HOUSTON, TX. FILED 5-24-2004.

SAFETY UNITED

THE MARK CONSISTS OF STANDARD CHARACTERS WITHOUT CLAIM TO ANY PARTICULAR FONT, STYLE, SIZE, OR COLOR.

NO CLAIM IS MADE TO THE EXCLUSIVE RIGHT TO USE "SAFETY", APART FROM THE MARK AS SHOWN.

FOR CONSULTATION SERVICES IN THE FIELD OF THE SAFETY NEEDS OF COMMERCIAL AND INDUSTRIAL COMPANIES (U.S. CLS. 100 AND 101).

SHAUNIA WALLACE, EXAMINING ATTORNEY

SN 76-594,054. ALDERWOODS GROUP, INC., CINCINNATI, OH. FILED 5-26-2004.

BASIC CREMATION SERVICE SIMPLE & RESPECTFUL

THE MARK CONSISTS OF STANDARD CHARACTERS WITHOUT CLAIM TO ANY PARTICULAR FONT, STYLE, SIZE, OR COLOR.

NO CLAIM IS MADE TO THE EXCLUSIVE RIGHT TO USE "BASIC CREMATION SERVICE", APART FROM THE MARK AS SHOWN.

FOR CREMATION SERVICES, NAMELY, REMOVAL OF THE DECEASED FROM THE PLACE OF DEATH TO THE CEMETERY; CREMATION; ARRANGING AND CONDUCTING MEMORIAL SERVICES (U.S. CLS. 100 AND 101).

MIDGE BUTLER, EXAMINING ATTORNEY

SN 76-594,116. VENVEST, INC., ST. LOUIS, MO. FILED 5-25-2004.



NO CLAIM IS MADE TO THE EXCLUSIVE RIGHT TO USE LOCKSMITH, APART FROM THE MARK AS SHOWN. THE LINING AND STIPPLING SHOWN IN THE DRAWING ARE FEATURES OF THE MARK.

FOR LOCKSMITHING, NAMELY OPENING OF LOCKS (U.S. CLS. 100 AND 101).

TINA L. SNAPP, EXAMINING ATTORNEY

CLASS 45—(Continued).

SN 76-606,638. HDVE, LLC, IRVING, TX. FILED 8-12-2004.

TRUE (IN)VISIBILITY

THE MARK CONSISTS OF STANDARD CHARACTERS WITHOUT CLAIM TO ANY PARTICULAR FONT, STYLE, SIZE, OR COLOR.

FOR DATING SERVICES, NAMELY, OFFERING COMPUTER DATING SERVICES AND VIDEO DATING SERVICES; PROVIDING INFORMATION IN THE FIELD OF SELF-IMPROVEMENT; AND PRIVATE INVESTIGATION ON BACKGROUND PROFILES (U.S. CLS. 100 AND 101).

SUSAN LESLIE DUBOIS, EXAMINING ATTORNEY

SN 76-609,356. HDVE, LLC, IRVING, TX. FILED 8-30-2004.

TRUE REWARDS

THE MARK CONSISTS OF STANDARD CHARACTERS WITHOUT CLAIM TO ANY PARTICULAR FONT, STYLE, SIZE, OR COLOR.

FOR DATING SERVICES, NAMELY, OFFERING COMPUTER DATING SERVICES AND VIDEO DATING SERVICES; PROVIDING INFORMATION IN THE FIELD OF SELF-IMPROVEMENT; AND PRIVATE INVESTIGATION ON BACKGROUND PROFILES (U.S. CLS. 100 AND 101).

SUSAN LESLIE DUBOIS, EXAMINING ATTORNEY

SN 76-620,119. EAFFECTION LLC, RICHARDSON, TX. FILED 11-10-2004.

EAFFECTION

THE MARK CONSISTS OF STANDARD CHARACTERS WITHOUT CLAIM TO ANY PARTICULAR FONT, STYLE, SIZE, OR COLOR.

FOR COMPUTER SERVICES, NAMELY, ONLINE DATING, INTRODUCTION AND SOCIAL NETWORKING SERVICES (U.S. CLS. 100 AND 101).

FIRST USE 8-30-2004; IN COMMERCE 8-30-2004.

RAUL CORDOVA, EXAMINING ATTORNEY

CLASS 45—(Continued).

SN 76-621,546. PAUL CARLSON MEDICAL PROGRAM, INC., CHICAGO, IL. FILED 11-22-2004.

CLASS 45—(Continued).

SN 78-327,395. THE UNIVERSAL CHURCH, INC., NEW YORK, NY. FILED 11-13-2003.

BEARING THE MARKS

THE MARK CONSISTS OF STANDARD CHARACTERS WITHOUT CLAIM TO ANY PARTICULAR FONT, STYLE, SIZE, OR COLOR.

FOR RELIGIOUS AND CHARITABLE SERVICES, NAMELY CONDUCTING RELIGIOUS WORSHIP SERVICES; PROVIDING SPIRITUAL COUNSELING; PROVIDING CLOTHING TO NEEDY PEOPLE; AND MINISTERIAL COUNSELING SERVICES IN THE FIELD OF SPIRITUAL AND SOCIAL REHABILITATION (U.S. CLS. 100 AND 101).

FIRST USE 6-22-2004; IN COMMERCE 6-22-2004.
MICHAEL SOUDERS, EXAMINING ATTORNEY

**Universal Church
of the Kingdom of
God**

SN 76-627,369. OCEAN HILLS CHURCH, SAN JUAN CAPISTRANO, CA. FILED 1-10-2005.



THE MARK CONSISTS OF STANDARD CHARACTERS WITHOUT CLAIM TO ANY PARTICULAR FONT, STYLE, SIZE, OR COLOR.

SEC. 2(F) "UNIVERSAL CHURCH".
FOR EVANGELISTIC AND MINISTERIAL SERVICES, NAMELY, CONDUCTING RELIGIOUS WORSHIP SERVICES (U.S. CLS. 100 AND 101).

FIRST USE 5-5-1987; IN COMMERCE 5-5-1987.
KIMBERLY FRYE, EXAMINING ATTORNEY

NO CLAIM IS MADE TO THE EXCLUSIVE RIGHT TO USE MISSION, APART FROM THE MARK AS SHOWN.

FOR CHRISTIAN EVANGELISTIC AND MINISTERIAL SERVICES (U.S. CLS. 100 AND 101).

PAUL E. FAHRENKOPF, EXAMINING ATTORNEY

SN 78-345,977. O'NEILL, BRYAN, K., WARRINGTON, PA. FILED 12-29-2003.

SN 78-273,234. NATIONAL FELLOWSHIP OF RACEWAY MINISTRIES, PILOT POINT, TX. FILED 7-11-2003.



Wake123

NO CLAIM IS MADE TO THE EXCLUSIVE RIGHT TO USE "NATIONAL FELLOWSHIP OF RACEWAY MINISTRIES", APART FROM THE MARK AS SHOWN.

FOR MINISTERIAL SERVICES IN THE NATURE OF CHAPLAIN MINISTRY SERVICES, NAMELY, EVANGELISTIC SERVICES FEATURING CHAPEL WORSHIP SERVICES (U.S. CLS. 100 AND 101).

FIRST USE 1-15-2002; IN COMMERCE 2-1-2002.
TONJA GASKINS, EXAMINING ATTORNEY

THE MARK CONSISTS OF STANDARD CHARACTERS WITHOUT CLAIM TO ANY PARTICULAR FONT, STYLE, SIZE, OR COLOR.

THE MARK CONSISTS OF IMAGE SHOWS WAKE123 TRADEMARK AS IT IS USED IN COMMERCE..

FOR CALL WAKE-UP SERVICES BY TELEPHONE (U.S. CLS. 100 AND 101).

FIRST USE 9-20-1998; IN COMMERCE 6-3-2000.
SUE LAWRENCE, EXAMINING ATTORNEY

CLASS 45—(Continued).

SN 78-413,331. ANGERMANN, SUSAN R., SARASOTA, FL. FILED 5-5-2004.

READY DRESS GO

THE MARK CONSISTS OF STANDARD CHARACTERS WITHOUT CLAIM TO ANY PARTICULAR FONT, STYLE, SIZE, OR COLOR.

FOR CONSULTING SERVICES IN THE FIELD OF PERSONAL IMAGE DEVELOPMENT (U.S. CLS. 100 AND 101).

ANDREW RHIM, EXAMINING ATTORNEY

CLASS 45—(Continued).

SN 78-418,728. IDENTITY THEFT ASSISTANCE CORPORATION, WASHINGTON, DC. FILED 5-14-2004.



SN 78-416,057. KWIKCALL INC., BROOKLYN, NY. FILED 5-10-2004.



THE COLOR(S) BLUE IS/ARE CLAIMED AS A FEATURE OF THE MARK.

THE ENTIRE MARK CONSISTS OF VARYING SHADES OF BLUE.

THE MARK CONSISTS OF THE STYLIZED WORDING KWIKCALL BETWEEN TWO CURVED ARROWS.

FOR TELEPHONE REMINDER SERVICES WHICH PROVIDE PATIENTS WITH DOCTOR APPOINTMENT INFORMATION (U.S. CLS. 100 AND 101).

TRICIA SONNEBORN, EXAMINING ATTORNEY

NO CLAIM IS MADE TO THE EXCLUSIVE RIGHT TO USE "IDENTITY THEFT ASSISTANCE CENTER", APART FROM THE MARK AS SHOWN.

THE COLOR(S) TURQUOISE AND GRAY IS/ARE CLAIMED AS A FEATURE OF THE MARK.

THE MARK CONSISTS OF THREE ROWS OF THREE SQUARES, THE RIGHTMOST SQUARE IN THE MIDDLE ROW IS TURQUOISE AND THE OTHER EIGHT SQUARES ARE GRAY. TO THE RIGHT OF THE THREE ROWS OF SQUARES IS THE STYLIZED WORD ITAC IN GRAY. BELOW THE THREE ROWS OF SQUARES AND THE STYLIZED WORD ITAC ARE THE STYLIZED WORDS IDENTITY THEFT ASSISTANCE CENTER IN GRAY.

FOR PERSONAL ASSISTANCE SERVICES TO VICTIMS OF IDENTITY THEFT, NAMELY, PROVIDING ADVICE, COUNSEL AND ASSISTANCE TO IDENTITY THEFT VICTIMS TO REPAIR DAMAGE CAUSED BY IDENTITY THEFT AND DAMAGE TO CREDIT HISTORY, AND PROVIDING INFORMATION ABOUT INCIDENTS OF IDENTITY THEFT TO CREDIT REPORTING AGENCIES, CREDITORS, AND GOVERNMENT AND REGULATORY AGENCIES (U.S. CLS. 100 AND 101).

FIRST USE 3-23-2004; IN COMMERCE 4-24-2004.

JEFF DEFORD, EXAMINING ATTORNEY

SN 78-418,521. FIRST MEDIA GROUP INC., ETOBICOKE, ONTARIO, CANADA, FILED 5-13-2004.



SN 78-447,172. SILVEY, JEANNE M., KEY WEST, FL. FILED 7-7-2004.

HOOKINGUPINTHEUSA

NO CLAIM IS MADE TO THE EXCLUSIVE RIGHT TO USE "MOBILE", APART FROM THE MARK AS SHOWN.

THE MARK CONSISTS OF THE WORDS "MOBILE HOOKUP" ARE IN BLOCK LETTERS WITH FIVE BUBBLES OR CIRCLES OF VARIOUS SIZES ABOVE THE WORDS "MOBILE HOOKUP" AND THE WORDS "TXT.TALK.DATE" ARE IN SMALLER BLOCK LETTERS BELOW THE WORDS "MOBILE HOOKUP".

FOR DATING SERVICES (U.S. CLS. 100 AND 101).

GWEN STOKOLS, EXAMINING ATTORNEY

THE MARK CONSISTS OF STANDARD CHARACTERS WITHOUT CLAIM TO ANY PARTICULAR FONT, STYLE, SIZE, OR COLOR.

FOR ONLINE DATING SERVICES (U.S. CLS. 100 AND 101).

ELIZABETH PIGNATELLO, EXAMINING ATTORNEY

CLASS 45—(Continued).

SN 78-451,359. CATHERINE, DONALD, SACRAMENTO, CA. FILED 7-15-2004.

CLASS 45—(Continued).

SN 78-479,815. EXCEL COMMUNICATIONS, INC., GOLDEN, CO. FILED 9-7-2004.

LEGACITY

MYSAFEHOSPITAL

THE MARK CONSISTS OF STANDARD CHARACTERS WITHOUT CLAIM TO ANY PARTICULAR FONT, STYLE, SIZE, OR COLOR.

FOR FUNERAL MANAGEMENT SERVICES; PROVIDING ONLINE PERSONAL MEMORIALS AND OBITUARIES (U.S. CLS. 100 AND 101).

BRIAN NEVILLE, EXAMINING ATTORNEY

THE MARK CONSISTS OF STANDARD CHARACTERS WITHOUT CLAIM TO ANY PARTICULAR FONT, STYLE, SIZE, OR COLOR.

FOR PROVIDING CONFIDENTIAL REPORTING SERVICES FOR HOSPITALS AND MEDICAL CENTERS TO ALLOW MEDICAL PERSONNEL AND EMPLOYEES OF A HOSPITAL OR MEDICAL CENTER TO MAKE CONFIDENTIAL REPORTS ABOUT INCIDENTS OCCURRING AT THE HOSPITAL OR MEDICAL CENTER AND/OR INVOLVING MEDICAL PERSONNEL OR EMPLOYEES OF THE HOSPITAL OR MEDICAL CENTER (U.S. CLS. 100 AND 101).

LINDA E. BLOHM, EXAMINING ATTORNEY

SN 78-473,175. YONG, WILLIAM HON-WAI, ENCINO, CA. AND FAN, MICHAEL, SOUTH PASADENA, CA. FILED 8-25-2004.

SN 78-491,903. STONE, ALICIA A, GRANADA HILLS, CA. FILED 9-29-2004.

carsafetyguru

Kosher MEET Market

THE MARK CONSISTS OF STANDARD CHARACTERS WITHOUT CLAIM TO ANY PARTICULAR FONT, STYLE, SIZE, OR COLOR.

FOR PROVIDING INFORMATION REGARDING CAR PRODUCT SAFETY BY MEANS OF A GLOBAL COMPUTER NETWORK (U.S. CLS. 100 AND 101).

PAUL F. GAST, EXAMINING ATTORNEY

THE MARK CONSISTS OF STANDARD CHARACTERS WITHOUT CLAIM TO ANY PARTICULAR FONT, STYLE, SIZE, OR COLOR.

NO CLAIM IS MADE TO THE EXCLUSIVE RIGHT TO USE "MEET MARKET", APART FROM THE MARK AS SHOWN.

SEC. 2(F).

FOR SOCIAL CLUB FOR JEWISH PEOPLE AGED 21 TO 35 (U.S. CLS. 100 AND 101).

FIRST USE 6-1-1998; IN COMMERCE 8-1-1998.

IRA J. GOODSaid, EXAMINING ATTORNEY

CLASS 45—(Continued).

SN 78-509,856. MCELROY, CHRISTOPHER P., GLENDALE, AZ. FILED 11-2-2004.



NO CLAIM IS MADE TO THE EXCLUSIVE RIGHT TO USE "AZ" OR "USA", APART FROM THE MARK AS SHOWN.

FOR SOCIAL CLUB THAT BRINGS TOGETHER MOTORCYCLE AND ALCOHOLIC BEVERAGE ENTHUSIASTS (U.S. CLS. 100 AND 101).

MICHAEL TANNER, EXAMINING ATTORNEY

CLASS 45—(Continued).

SN 78-510,987. MILLER, JEAN ADRIENNE, ATLANTA, GA. FILED 11-3-2004.

InnerSpeak

THE MARK CONSISTS OF STANDARD CHARACTERS WITHOUT CLAIM TO ANY PARTICULAR FONT, STYLE, SIZE, OR COLOR.

FOR PROVIDING SPIRITUAL COUNSELING AND SPIRITUAL HEALING SERVICES; LIFE COACHING, NAMELY PERSONAL GROWTH AND MOTIVATION COUNSELING AND PERSONAL LIFESTYLE COUNSELING (U.S. CLS. 100 AND 101).

FIRST USE 6-1-2002; IN COMMERCE 6-1-2002.
ELLEN PERKINS, EXAMINING ATTORNEY

SN 78-510,659. ANTHONY FRANCIS JOHN ENGEL FOUNDATION, VISTA, CA. FILED 11-3-2004.

DEATH IS
INEVITABLE....ARE
YOU READY TO LIVE
ON?

SN 78-517,282. BRIGGS, STASYA, PORT ORCHARD, WA. FILED 11-15-2004.

LUCKYLOVERS

THE MARK CONSISTS OF STANDARD CHARACTERS WITHOUT CLAIM TO ANY PARTICULAR FONT, STYLE, SIZE, OR COLOR.

FOR PROVIDING PERSONAL COUNSELING SERVICES FOR FAMILIES OF PATIENTS WITH LIFE THREATENING DISORDERS OR INJURIES, NAMELY, GRIEF COUNSELING AND COUNSELING REGARDING ORGAN DONATION IN THE NATURE OF COMPANIONSHIP, EMOTIONAL SUPPORT AND HELP WITH MEDICAL FORMS (U.S. CLS. 100 AND 101).

KIMBERLY FRYE, EXAMINING ATTORNEY

THE MARK CONSISTS OF STANDARD CHARACTERS WITHOUT CLAIM TO ANY PARTICULAR FONT, STYLE, SIZE, OR COLOR.

FOR INTERNET DATING SERVICE AND DATING/RELATIONSHIPS SERVICES (U.S. CLS. 100 AND 101).

FIRST USE 5-1-2001; IN COMMERCE 5-1-2001.
STANLEY I. OSBORNE, EXAMINING ATTORNEY

CLASS 45—(Continued).

SN 78-518,893. LEWIN, NATASHA K., BROOKLYN, NY. FILED 11-17-2004.

CLASS 45—(Continued).

SN 78-520,666. CRUITT, TIMOTHY T., MOBILE, AL. FILED 11-21-2004.

PinPals

fend

THE MARK CONSISTS OF STANDARD CHARACTERS WITHOUT CLAIM TO ANY PARTICULAR FONT, STYLE, SIZE, OR COLOR.

FOR COMPUTER SERVICE, NAMELY, PROVIDING INFORMATION REGARDING, AND IN THE NATURE OF, ON-LINE DATING, INTRODUCTION, AND SOCIAL NETWORKING SERVICES (U.S. CLS. 100 AND 101).
CYNTHIA SLOAN, EXAMINING ATTORNEY

THE MARK CONSISTS OF STANDARD CHARACTERS WITHOUT CLAIM TO ANY PARTICULAR FONT, STYLE, SIZE, OR COLOR.

FOR PERSONAL GROWTH AND MOTIVATION CONSULTING SERVICES (U.S. CLS. 100 AND 101).
ERNEST SHOSHO, EXAMINING ATTORNEY

SN 78-520,224. SCI MANAGEMENT L.P., HOUSTON, TX. FILED 11-19-2004.

SN 78-520,896. WHITE, NANCY E., CHARLOTTE, NC. FILED 11-22-2004.

**IT'S LIFE! YOU
LIVE IT! WE
CELEBRATE IT**

GUARDIAN CALLERS

THE MARK CONSISTS OF STANDARD CHARACTERS WITHOUT CLAIM TO ANY PARTICULAR FONT, STYLE, SIZE, OR COLOR.

FOR CREMATION, FUNERAL HOME, AND CEMETERY SERVICES, NAMELY CONDUCTING AND PROVIDING CREMATION, FUNERAL, AND BURIAL SERVICES; FUNERAL CONCIERGE SERVICES (U.S. CLS. 100 AND 101).
BARBARA RUTLAND, EXAMINING ATTORNEY

THE MARK CONSISTS OF STANDARD CHARACTERS WITHOUT CLAIM TO ANY PARTICULAR FONT, STYLE, SIZE, OR COLOR.

NO CLAIM IS MADE TO THE EXCLUSIVE RIGHT TO USE "CALLERS", APART FROM THE MARK AS SHOWN.
FOR CALLING SERVICE FOR INDIVIDUALS THAT NEED OR WANT TO RECEIVE PHONE CALLS CHECKING IN ON THEIR MEDICAL AND PSYCHOLOGICAL WELL-BEING (U.S. CLS. 100 AND 101).
CARRIE ACHEN, EXAMINING ATTORNEY

CLASS 45—(Continued).

SN 78-521,250. PRATT, MICHAEL J., BLUFFDALE, UT. FILED 11-22-2004.

WORGCO

THE MARK CONSISTS OF STANDARD CHARACTERS WITHOUT CLAIM TO ANY PARTICULAR FONT, STYLE, SIZE, OR COLOR.

FOR CLOSET, GARAGE AND STORAGE SHED ORGANIZING SERVICES (U.S. CLS. 100 AND 101).
GINNY ISAACSON, EXAMINING ATTORNEY

SN 78-525,115. PET-ARK, INC., BREMERTON, WA. FILED 12-1-2004.

**Keeping the
Promise**

THE MARK CONSISTS OF STANDARD CHARACTERS WITHOUT CLAIM TO ANY PARTICULAR FONT, STYLE, SIZE, OR COLOR.

FOR PROVIDING INFORMATION ABOUT PETS AVAILABLE FOR ADOPTION VIA THE INTERNET (U.S. CLS. 100 AND 101).
DAWN FELDMAN, EXAMINING ATTORNEY

CLASS 45—(Continued).

SN 78-536,507. MARKETRANGE, INC., BOTHELL, WA. FILED 12-21-2004.

**GENUINE PEOPLE,
REAL LOVE.**

THE MARK CONSISTS OF STANDARD CHARACTERS WITHOUT CLAIM TO ANY PARTICULAR FONT, STYLE, SIZE, OR COLOR.

FOR COMPUTER SERVICES, NAMELY PROVIDING A SPECIALIZED WEBSITE AND ONLINE COMMUNITY CONTAINING INFORMATION REGARDING ON-LINE DATING AND INTRODUCTION SERVICES, SINGLES AND PERSONAL RELATIONSHIPS (U.S. CLS. 100 AND 101).

FIRST USE 12-21-2004; IN COMMERCE 12-21-2004.
TEJBIR SINGH, EXAMINING ATTORNEY

SN 78-537,259. PERSONA LLC, SPRINGVILLE, UT. FILED 12-22-2004.

REVEALED MATCHING

THE MARK CONSISTS OF STANDARD CHARACTERS WITHOUT CLAIM TO ANY PARTICULAR FONT, STYLE, SIZE, OR COLOR.

NO CLAIM IS MADE TO THE EXCLUSIVE RIGHT TO USE "MATCHING", APART FROM THE MARK AS SHOWN. FOR SOCIAL INTRODUCTION SERVICES PROVIDED VIA A GLOBAL COMPUTER NETWORK (U.S. CLS. 100 AND 101).
JASON ROTH, EXAMINING ATTORNEY

CLASS 45—(Continued).

SN 78-539,669. NEUSTAR, INC., STERLING, VA. FILED 12-29-2004.

CLASS 45—(Continued).

SN 78-543,101. AS WRITTEN PRODUCTIONS, FRONT ROYAL, VA. FILED 1-6-2005.

Ave Maria Singles

NEUSTAR

THE MARK CONSISTS OF STANDARD CHARACTERS WITHOUT CLAIM TO ANY PARTICULAR FONT, STYLE, SIZE, OR COLOR.

OWNER OF U.S. REG. NOS. 2,525,756 AND 2,697,124. FOR COMPUTER SECURITY SERVICES, NAMELY, MANAGED PUBLIC KEY INFRASTRUCTURE (PKI) SERVICES, DIGITAL CERTIFICATE ISSUANCE, AND SECURED E-COMMERCE PAYMENT SERVICES; PROVIDING USER AUTHENTICATION SERVICES IN E-COMMERCE TRANSACTIONS (U.S. CLS. 100 AND 101). FIRST USE 2-1-2003; IN COMMERCE 2-1-2003. CURTIS FRENCH, EXAMINING ATTORNEY

THE MARK CONSISTS OF STANDARD CHARACTERS WITHOUT CLAIM TO ANY PARTICULAR FONT, STYLE, SIZE, OR COLOR.

NO CLAIM IS MADE TO THE EXCLUSIVE RIGHT TO USE "SINGLES", APART FROM THE MARK AS SHOWN.

FOR WEBSITE SERVICES FEATURING AN ON-LINE DATING CLUB FOR DEVOUT, SERIOUS, COMMITTED, PRACTICING SINGLE CATHOLICS WHO HAVE A MARRIAGE VOCATION TO COME INTO CONTACT WITH EACH OTHER FOR THE PURPOSE OF MEETING OTHER LIKE-MINDED SINGLES AND THEIR POTENTIAL FUTURE MARRIAGE SPOUSE (U.S. CLS. 100 AND 101).

FIRST USE 1-1-2001; IN COMMERCE 1-1-2001. KHANH LE, EXAMINING ATTORNEY

SN 78-543,239. KENYON INTERNATIONAL EMERGENCY SERVICES, INC., HOUSTON, TX. FILED 1-6-2005.

SN 78-540,345. NLEADER LLC, DALLAS, TX. FILED 12-30-2004.

PEIS

sweetpick.com

THE MARK CONSISTS OF STANDARD CHARACTERS WITHOUT CLAIM TO ANY PARTICULAR FONT, STYLE, SIZE, OR COLOR.

FOR WEB SITE SERVICES FEATURING ON-LINE DATING CLUB (U.S. CLS. 100 AND 101). ALLISON SCHRODY, EXAMINING ATTORNEY

THE MARK CONSISTS OF STANDARD CHARACTERS WITHOUT CLAIM TO ANY PARTICULAR FONT, STYLE, SIZE, OR COLOR.

FOR COMPILING INVENTORIES OF PERSONAL ITEMS FOR OTHERS FOR INSURANCE, IDENTIFICATION, OR SECURITY PURPOSES, NAMELY, STORAGE, MANIPULATION, TRANSFER AND RETRIEVAL OF INFORMATION IN THE FIELD OF PERSONAL EFFECTS OF DECEASED PERSONS (U.S. CLS. 100 AND 101).

APRIL L. RADEMACHER, EXAMINING ATTORNEY

CLASS 45—(Continued).

SN 78-546,177. AHS VENTURES L.L.C., HOUSTON, TX.
FILED 1-12-2005.

CLASS 45—(Continued).

SN 78-584,906. MATCH.COM, L.P., RICHARDSON, TX.
FILED 3-10-2005.

**CHEMISTRY IS NOT
SCIENTIFIC**

THE MARK CONSISTS OF STANDARD CHARACTERS
WITHOUT CLAIM TO ANY PARTICULAR FONT, STYLE,
SIZE, OR COLOR.
FOR DATING AND MATCHMAKING SERVICES (U.S.
CLS. 100 AND 101).
FIRST USE 6-0-2004; IN COMMERCE 1-1-2005.
GEORGE LORENZO, EXAMINING ATTORNEY

SN 78-584,898. MATCH.COM, L.P., RICHARDSON, TX.
FILED 3-10-2005.

**LOVE IS
COMPLICATED.
MATCH.COM IS
SIMPLE.**

**LOVE IS
COMPLICATED.
MATCH IS SIMPLE.**

THE MARK CONSISTS OF STANDARD CHARACTERS
WITHOUT CLAIM TO ANY PARTICULAR FONT, STYLE,
SIZE, OR COLOR.
OWNER OF U.S. REG. NO. 2,088,545.
FOR COMPUTER SERVICES, NAMELY, PROVIDING
INFORMATION REGARDING, AND IN THE NATURE
OF, ON-LINE DATING AND INTRODUCTION SER-
VICES (U.S. CLS. 100 AND 101).
DAYNA BROWNE, EXAMINING ATTORNEY

THE MARK CONSISTS OF STANDARD CHARACTERS
WITHOUT CLAIM TO ANY PARTICULAR FONT, STYLE,
SIZE, OR COLOR.
OWNER OF U.S. REG. NO. 2,088,545.
FOR COMPUTER SERVICES, NAMELY, PROVIDING
INFORMATION REGARDING, AND IN THE NATURE
OF, ON-LINE DATING AND INTRODUCTION SER-
VICES (U.S. CLS. 100 AND 101).
DAYNA BROWNE, EXAMINING ATTORNE

* * * * *

SECTION 4.—PRIOR UNITED STATES CLASSIFICATION

APPLICATION IN ONE CLASS

COLLECTIVE MEMBERSHIP MARKS

CLASS 200—COLLECTIVE MEMBERSHIP
SN 76-561,437. SURFING AMERICA, HUNTINGTON
BEACH, CA. FILED 11-24-2003.

SN 78-265,024. THE CHICAGO DO-DO CHAPTER OF THE
TUSKEGEE - AIRMEN INC., CHICAGO, IL. FILED 6-20-
2003.

SURFING AMERICA

THE MARK CONSISTS OF STANDARD CHARACTERS
WITHOUT CLAIM TO ANY PARTICULAR FONT, STYLE,
SIZE, OR COLOR.

FOR TO INDICATE MEMBERSHIP IN AN ORGANI-
ZATION OF SURFING AND BODYBOARDING ATH-
LETES AND ENTHUSIASTS.

FIRST USE 6-15-2000; IN COMMERCE 6-15-2000.
KAREN BRACEY, EXAMINING ATTORNEY

SN 76-618,331. GRAND BOULE OF THE SIGMA PI PHI
FRATERNITY, ATLANTA, GA. FILED 10-28-2004.



OWNER OF U.S. REG. NO. 2,622,800.
FOR INDICATING MEMBERSHIP IN A FRATERNAL
ORGANIZATION UNITED TO PROMOTE CONGENIAL-
ITY, TOLERANCE AND CONSTRUCTIVE EFFORT,
LEADERSHIP, EDUCATION AND EMPOWERMENT.
FIRST USE 11-5-1999; IN COMMERCE 11-5-1999.
ANNE FARRELL, EXAMINING ATTORNEY



NO CLAIM IS MADE TO THE EXCLUSIVE RIGHT TO
USE "TUSKEGEE AIRMEN", APART FROM THE MARK AS
SHOWN.

THE LINING SHOWN IN THE DRAWING IS A FEATURE
OF THE MARK.

FOR INDICATING MEMBERSHIP IN AN ORGANIZA-
TION DEDICATED TO THE HISTORY, LEGACY AND
EXPERIENCES OF AFRICAN AMERICAN FIGHTER
PILOTS AND PROVIDING EDUCATION, PROGRAMS,
SCHOLARSHIPS, SPONSORSHIPS TO MILITARY ACA-
DEMIES AND FLIGHT TRAINING OPPORTUNITIES.

FIRST USE 1-0-1991; IN COMMERCE 1-0-1991.
MICHAEL KEATING, EXAMINING ATTORNEY

SN 78-356,607. GAMMA SIGMA ALPHA, LOS ANGELES,
CA. FILED 1-23-2004.



NO CLAIM IS MADE TO THE EXCLUSIVE RIGHT TO
USE "NATIONAL HONOR SOCIETY FOUNDED 1989",
APART FROM THE MARK AS SHOWN.

THE MARK CONSISTS OF A CIRCLE CONTAINING THE WORDS "GAMMA SIGMA ALPHA NATIONAL HONOR SOCIETY FOUNDED 1989" AND ALSO CONTAINS THE GREEK WORDS FOR "GAMMA SIGMA ALPHA" ON A BANNER UNDERNEATH THE WORDS IN ENGLISH. THE CIRCLE ALSO CONTAINS TWO TORCHES, A LAUREL, A CANDLE IN A CANDLE HOLDER, AND A CHEVRON. THE MARK IS NOT IN COLOR.

SEC. 2(F).

FOR INDICATING MEMBERSHIP OF A NATIONAL GREEK ACADEMIC HONOR SOCIETY.

FIRST USE 12-1-1990; IN COMMERCE 12-1-1990.

KATHRYN COWARD, EXAMINING ATTORNEY

SN 78-486,782. HELLS ANGELS MOTORCYCLE CORPORATION, SPARKS, NV. FILED 9-21-2004.



SN 78-403,516. QUINTAL RESEARCH GROUP, INC., PACIFICA, CA. FILED 4-16-2004.

BLACK SUN 2600 CLUB

OWNER OF U.S. REG. NOS. 1,136,494, 2,588,116 AND OTHERS.

THE MARK CONSISTS OF DEATH HEAD SIDE VIEW, FOR INDICATING MEMBERSHIP IN AN ASSOCIATION OF MOTORCYCLISTS.

FIRST USE 11-0-1966; IN COMMERCE 11-0-1966.

DAWN FELDMAN, EXAMINING ATTORNEY

THE MARK CONSISTS OF STANDARD CHARACTERS WITHOUT CLAIM TO ANY PARTICULAR FONT, STYLE, SIZE, OR COLOR.

NO CLAIM IS MADE TO THE EXCLUSIVE RIGHT TO USE "CLUB", APART FROM THE MARK AS SHOWN.

FOR INDICATING MEMBERSHIP IN AN ASSOCIATION OF TECHNOLOGY FUTURISTS.

LA TONIA FISHER, EXAMINING ATTORNEY

DELTA SIGMA PHI

SN 78-405,667. COPPERLINE MARKETING, LLC, CHARLOTTESVILLE, VA. FILED 4-21-2004.

THE MARK CONSISTS OF STANDARD CHARACTERS WITHOUT CLAIM TO ANY PARTICULAR FONT, STYLE, SIZE, OR COLOR.

FOR INDICATING MEMBERSHIP IN A(N) FRATERNAL ORGANIZATION.

FIRST USE 1-0-1899; IN COMMERCE 1-0-1899.

ANGELA M. MICHELI, EXAMINING ATTORNEY

SN 78-520,078. SUPPORTING CAST, INC., THE, NEW YORK, NY. FILED 11-19-2004.

Vast Right Wing Conspiracy

ANSER TEAM

THE MARK CONSISTS OF STANDARD CHARACTERS WITHOUT CLAIM TO ANY PARTICULAR FONT, STYLE, SIZE, OR COLOR.

FOR INDICATING MEMBERSHIP OF A(N) POLITICAL ORGANIZATION.

FIRST USE 10-0-2003; IN COMMERCE 1-0-2004.

KIM SAITO, EXAMINING ATTORNEY

THE MARK CONSISTS OF STANDARD CHARACTERS WITHOUT CLAIM TO ANY PARTICULAR FONT, STYLE, SIZE, OR COLOR.

NO CLAIM IS MADE TO THE EXCLUSIVE RIGHT TO USE "TEAM", APART FROM THE MARK AS SHOWN. FOR INDICATING MEMBERSHIP IN AN ASSOCIATION OF EMPLOYMENT AGENCIES.
 BARBARA A. GOLD, EXAMINING ATTORNEY

CERTIFICATION MARKS

CLASS A—GOODS

SN 76-547,002. INTERTEK TESTING SERVICES NA, INC., BOXBOROUGH, MA. FILED 9-24-2003.



OWNER OF U.S. REG. NOS. 1,917,483, 2,573,161 AND OTHERS.

NO CLAIM IS MADE TO THE EXCLUSIVE RIGHT TO USE "VERIFIED", APART FROM THE MARK AS SHOWN.

THE CERTIFICATION MARK AS USED BY PERSONS AUTHORIZED BY THE CERTIFIER, CERTIFIES THAT THE GOODS AND SERVICES PROVIDED HAVE MET THE PERFORMANCE AND QUALITY STANDARDS ADOPTED BY THE END-USERS, INDUSTRY, OR CERTIFIER.

FOR STRUCTURAL EQUIPMENT; NAMELY, DOORS AND WINDOWS, LIGHTING, HEATING AND COOLING EQUIPMENT, RADIO AND TELEVISION EQUIPMENT, ELECTRIC CABLE, RUGS, AND MEDICAL AND DENTAL ELECTRICAL EQUIPMENT.

FIRST USE 8-18-2003; IN COMMERCE 8-18-2003.
 JIM RINGLE, EXAMINING ATTORNEY

SN 78-504,201. GEORGIA SHRIMP CERTIFICATION OPERATIONS MANUAL, DARIEN, GA. FILED 10-22-2004.



NO CLAIM IS MADE TO THE EXCLUSIVE RIGHT TO USE "WILD", "SHRIMP", AND "CERTIFIED", APART FROM THE MARK AS SHOWN.

THE COLORS NAVY BLUE, LIGHT BLUE, WHITE AND TAN IS/ARE CLAIMED AS A FEATURE OF THE MARK.

THE MARK CONSISTS OF THE WORDING WILD GEORGIA SHRIMP GSA CERTIFIED, AND THE DESIGN OF WAVES, ALL ENCLOSED IN A SQUARE BORDER. THE COLORS NAVY BLUE, LIGHT BLUE, WHITE AND TAN ARE CLAIMED AS A FEATURE OF THE MARK. THE COLOR NAVY BLUE APPEARS IN THE WORDING WILD AND SHRIMP. IN THE WAVE DESIGN AND IN THE SQUARE BORDER; THE COLOR LIGHT BLUE APPEARS IN THE WORD GEORGIA AND IN THE UPPER PORTION OF THE WAVE DESIGN; THE COLOR TAN APPEARS IN SHADING AROUND THE WORDING WILD GEORGIA SHRIMP; AND THE COLOR WHITE APPEARS IN THE WORDING GSA CERTIFIED. IN THE LINING OF THE WORDING WILD AND SHRIMP AND INSIDE THE TAN SHADING SURROUND THE WORDING WILD GEORGIA SHRIMP.

THE CERTIFICATION MARK, IS USED BY PERSONS AUTHORIZED BY THE CERTIFIER, AND CERTIFIES THAT THE GOODS PROVIDED THERE UNDER ARE SHRIMP HARVESTED FROM THE OCEAN OFF THE COAST OF THE STATE OF GEORGIA.

FOR FRESH FROZEN SHRIMP FOR HUMAN CONSUMPTION.

FIRST USE 10-8-2004; IN COMMERCE 10-8-2004.
 ANDREA K. NADELMAN, EXAMINING ATTORNEY

SN 78-537,894. PING IDENTITY CORPORATION, DENVER, CO. FILED 12-23-2004.



THE CERTIFICATION MARK, AS USED BY AUTHORIZED ENTITIES, CERTIFIES CONFORMANCE WITH ESTABLISHED PROTOCOLS IN THE FIELDS OF DIGITAL SECURITY AND IDENTITY VERIFICATION

FOR CERTIFICATION OF SOFTWARE PRODUCTS THAT ADHERE TO ESTABLISHED PROTOCOLS IN THE FIELDS OF DIGITAL SECURITY AND IDENTITY VERIFICATION.

KAREN BRACEY, EXAMINING ATTORNEY

CLASS B—SERVICES

SN 76-569,042. SOCIETY OF BROADCAST ENGINEERS, INDIANAPOLIS, IN. FILED 1-9-2004.



THE MARK CONSISTS OF STANDARD CHARACTERS WITHOUT CLAIM TO ANY PARTICULAR FONT, STYLE, SIZE, OR COLOR.

THE CERTIFICATION MARK, AS USED BY AUTHORIZED PERSONS, CERTIFIES THAT THOSE PERSONS HAVE AT LEAST TWENTY (20) YEARS OF PROFESSIONAL BROADCAST ENGINEERING OR RELATED TECHNOLOGIES EXPERIENCE, EXCLUDING EDUCATIONAL CREDITS.

FOR BROADCAST ENGINEERING AND TECHNOLOGY SERVICES.

FIRST USE 1-15-1987; IN COMMERCE 1-15-1987.

JOHN DWYER, EXAMINING ATTORNEY

SN 76-569,074. SOCIETY OF BROADCAST ENGINEERS, INDIANAPOLIS, IN. FILED 1-9-2004.

SN 76-569,046. SOCIETY OF BROADCAST ENGINEERS, INDIANAPOLIS, IN. FILED 1-9-2004.

Certified Broadcast Networking Technologist

CSTE

THE MARK CONSISTS OF STANDARD CHARACTERS WITHOUT CLAIM TO ANY PARTICULAR FONT, STYLE, SIZE, OR COLOR.

NO CLAIM IS MADE TO THE EXCLUSIVE RIGHT TO USE "CERTIFIED", APART FROM THE MARK AS SHOWN.

THE CERTIFICATION MARK, AS USED BY AUTHORIZED PERSONS, CERTIFIES THAT THOSE PERSONS HAVE A BASIC FAMILIARITY WITH NETWORKING HARDWARE WHO ACHIEVE A PASSING GRADE ON THE PROFICIENCY EXAMINATION.

SEC. 2(F).

FOR PROFESSIONAL BROADCAST ENGINEERING SERVICES.

FIRST USE 4-15-2000; IN COMMERCE 4-15-2000.

JENNIFER MARTIN, EXAMINING ATTORNEY

THE MARK CONSISTS OF STANDARD CHARACTERS WITHOUT CLAIM TO ANY PARTICULAR FONT, STYLE, SIZE, OR COLOR.

THE CERTIFICATION MARK, AS USED BY AUTHORIZED PERSONS, CERTIFIES THAT THOSE PERSONS HAVE AT LEAST TEN (10) YEARS OF RESPONSIBLE BROADCAST ENGINEERING OR RELATED TECHNOLOGY EXPERIENCE AND HAS ACHIEVED A PASSING GRADE ON THE PROFICIENCY EXAMINATION.

FOR BROADCAST ENGINEERING AND TECHNOLOGY SERVICES.

FIRST USE 1-15-1976; IN COMMERCE 1-15-1976.

JOHN DWYER, EXAMINING ATTORNEY

SN 78-445,939. NATIONAL FIRE PROTECTION ASSOCIATION, INC., QUINCY, MA. FILED 7-5-2004.

SN 76-569,070. SOCIETY OF BROADCAST ENGINEERS, INDIANAPOLIS, IN. FILED 1-9-2004.

CFPS

CBRE

THE MARK CONSISTS OF STANDARD CHARACTERS WITHOUT CLAIM TO ANY PARTICULAR FONT, STYLE, SIZE, OR COLOR.

THE DESIGNATED PERSONS MEET THE CERTIFIER'S STANDARDS OF KNOWLEDGE AND EXPERIENCE IN THE FIELD OF FIRE SAFETY, FIRE PROTECTION AND FIRE SUPPRESSION, AS INDICATED BY HAVING MET THE CERTIFIER'S STANDARDS FOR EDUCATION AND WORK EXPERIENCE, AND HAVING PASSED AN EXAMINATION ADMINISTERED BY THE CERTIFIER.

FOR FIRE SAFETY, FIRE PROTECTION, FIRE PREVENTION AND FIRE SUPPRESSION SERVICES, NAMELY, FIRE FIGHTING, RISK MANAGEMENT SERVICES RELATING TO FIRE PROTECTION, FIRE INSURANCE UNDERWRITING, INSURANCE ADMINISTRATION IN THE FIELD OF FIRE INSURANCE, BUILDING INSPECTION, AND TECHNICAL SUPERVISION AND INSPECTION IN THE FIELD OF FIRE SAFETY.

FIRST USE 0-0-1971; IN COMMERCE 0-0-1971.

JIM RINGLE, EXAMINING ATTORNEE

THE MARK CONSISTS OF STANDARD CHARACTERS WITHOUT CLAIM TO ANY PARTICULAR FONT, STYLE, SIZE, OR COLOR.

THE CERTIFICATION MARK, AS USED BY AUTHORIZED PERSONS, CERTIFIES THAT THOSE PERSONS HAVE AT LEAST FIVE (5) YEARS OF SUITABLE EXPERIENCE IN BROADCAST ENGINEERING OR RELATED TECHNOLOGY AND WHO HAVE ACHIEVED A PASSING GRADE ON THE PROFICIENCY EXAMINATION. THE APPLICANT HAS ADOPTED AND IS EXERCISING LEGITIMATE CONTROL OVER THE USE OF THE CERTIFICATION MARK IN COMMERCE AS OF FILING DATE OF THE APPLICATION.

FOR PROFESSIONAL BROADCAST ENGINEERING SERVICES.

FIRST USE 7-1-1977; IN COMMERCE 7-1-1977.

SUE LAWRENCE, EXAMINING ATTORNEY

TRADEMARK REGISTRATIONS ISSUED

PRINCIPAL REGISTER

SECTION 1.— INTERNATIONAL CLASSIFICATION

The short titles associated below with the international class numbers are terms designed merely for quick identification and are not an official part of the international classification. The full names of international classes are given in section 6.1 of the trademark rules of practice.

The designation "U.S. Cl." appearing in this section refers to the U.S. class in effect prior to Sep. 1, 1973 rather than the international class which applies to applications filed on or after that date. For adoption of international classification see notice in the OFFICIAL GAZETTE of Jun. 26, 1973 (911 O.G. TM 210).

CLASS 1—CHEMICALS

- 3,006,861. **ERICO**. ERICO INTERNATIONAL CORPORATION, MULTIPLE CLASS, (INT. CLS. 1, 6, 7, 9 AND 11), (U.S. CLS. 1, 2, 5, 6, 10, 12, 13, 14, 19, 21, 23, 25, 26, 31, 34, 35, 36, 38, 46 AND 50). SN 76-469,785. PUB. 7-26-2005. FILED 11-26-2002.
- 3,006,936. **NISSAN AND DESIGN**. NISSAN JIDOSHA KABUSHIKI KAISHA, TA NISSAN MOTOR CO., LTD., MULTIPLE CLASS, (INT. CLS. 1, 3 AND 4), (U.S. CLS. 1, 4, 5, 6, 10, 15, 26, 46, 50, 51 AND 52). SN 76-543,905. PUB. 7-26-2005. FILED 8-29-2003.
- 3,007,019. **NUTRAMIST (STYLIZED)**. DISCOVERY PARTNERS, LLC., (U.S. CLS. 1, 5, 6, 10, 26 AND 46). SN 76-567,687. PUB. 7-26-2005. FILED 12-19-2003.
- 3,007,055. **MYRO (BLOCK FORM)**. MAGIC AMERICAN PRODUCTS, INC., MULTIPLE CLASS, (INT. CLS. 1, 6, 8, 17, 19 AND 20), (U.S. CLS. 1, 2, 5, 6, 10, 12, 13, 14, 22, 23, 25, 26, 28, 32, 33, 35, 44, 46 AND 50). SN 76-578,403. PUB. 7-26-2005. FILED 3-1-2004.
- 3,007,056. **M MYRO AND DESIGN**. MAGIC AMERICAN PRODUCTS, INC., MULTIPLE CLASS, (INT. CLS. 1, 6, 8, 17, 19 AND 20), (U.S. CLS. 1, 2, 5, 6, 10, 12, 13, 14, 22, 23, 25, 26, 28, 32, 33, 35, 44, 46 AND 50). SN 76-578,404. PUB. 7-26-2005. FILED 3-1-2004.
- 3,007,137. **CLEANWOOD (BLOCK FORM)**. S-T-N HOLDINGS, INC., (U.S. CLS. 1, 5, 6, 10, 26 AND 46). SN 76-597,025. PUB. 7-26-2005. FILED 6-10-2004.
- 3,007,144. **MORE EXTINGUISHING POWER FOR WATER (BLOCK FORM)**. STOCKHAUSEN GMBH, (U.S. CLS. 1, 5, 6, 10, 26 AND 46). SN 76-597,928. PUB. 7-26-2005. FILED 6-18-2004.
- 3,007,177. **MYCOSCENT**. MARLOW FOODS LIMITED, MULTIPLE CLASS, (INT. CLS. 1, 29, 30 AND 31), (U.S. CLS. 1, 5, 6, 10, 26 AND 46). SN 78-158,161. PUB. 7-26-2005. FILED 8-27-2002.
- 3,007,194. **AMERICA'S CHOICE**. THE GREAT ATLANTIC & PACIFIC TEA COMPANY, INC., MULTIPLE CLASS, (INT. CLS. 1, 3, 4, 5, 7, 8, 9, 11, 16, 20, 21, 28, 29, 30, 31 AND 32), (U.S. CLS. 1, 2, 4, 5, 6, 10, 13, 15, 18, 19, 21, 22, 23, 25, 26, 28, 29, 30, 31, 32, 33, 34, 35, 36, 37, 38, 40, 44, 45, 46, 48, 50, 51 AND 52). SN 78-218,486. PUB. 7-26-2005. FILED 2-25-2003.
- 3,007,242. **HIS-SELECT**. SIGMA-ALDRICH BIOTECHNOLOGY L.P., MULTIPLE CLASS, (INT. CLS. 1 AND 9), (U.S. CLS. 1, 5, 6, 10, 21, 23, 26, 36, 38 AND 46). SN 78-299,229. PUB. 7-26-2005. FILED 9-11-2003.
- 3,007,259. **MISCELLANEOUS DESIGN**. SAKRETE, INC., MULTIPLE CLASS, (INT. CLS. 1, 2, 3, 17 AND 19), (U.S. CLS. 1, 4, 5, 6, 10, 11, 12, 13, 16, 26, 33, 35, 46, 50, 51 AND 52). SN 78-315,516. PUB. 7-26-2005. FILED 10-18-2003.
- 3,007,310. **VERSAGENE (BLOCK FORM)**. GENTRA SYSTEMS, INC., MULTIPLE CLASS, (INT. CLS. 1, 5 AND 9), (U.S. CLS. 1, 5, 6, 10, 18, 21, 23, 26, 36, 38, 44, 46, 51 AND 52). SN 78-341,465. PUB. 7-26-2005. FILED 12-16-2003.
- 3,007,320. **PS AND DESIGN**. POLY SCIENTIFIC R & D CORP., MULTIPLE CLASS, (INT. CLS. 1 AND 5), (U.S. CLS. 1, 5, 6, 10, 18, 26, 44, 46, 51 AND 52). SN 78-345,389. PUB. 7-26-2005. FILED 12-24-2003.
- 3,007,344. **SEPPRO (BLOCK FORM)**. GENWAY BIOTECH, INC., MULTIPLE CLASS, (INT. CLS. 1 AND 42), (U.S. CLS.

1, 5, 6, 10, 26, 46, 100 AND 101). SN 78-359,775. PUB. 7-26-2005. FILED 1-29-2004.

- 3,007,536. **GROWHOW (STYLIZED)**. KEMIRA GROWHOW OYJ, MULTIPLE CLASS, (INT. CLS. 1 AND 44), (U.S. CLS. 1, 5, 6, 10, 26, 46, 100 AND 101). SN 79-000,043. PUB. 7-26-2005. FILED 11-5-2003.

CLASS 2—PAINTS

- 3,006,864. **SPECIALTY POLYMER COATINGS**. SPECIALTY POLYMER COATINGS, INC., (U.S. CLS. 6, 11 AND 16). SN 76-471,099. PUB. 7-26-2005. FILED 11-19-2002.
- 3,006,978. **X-TREME CLASSIC**. AUTOBODY BRANDS INTERNATIONAL, INC., (U.S. CLS. 6, 11 AND 16). SN 76-557,775. PUB. 7-26-2005. FILED 10-20-2003.
- 3,006,979. **X-TREME HI-VELOCITY**. AUTOBODY BRANDS INTERNATIONAL, INC., (U.S. CLS. 6, 11 AND 16). SN 76-557,777. PUB. 7-26-2005. FILED 10-20-2003.
- 3,007,259 (See Class 1 for this trademark).
- 3,007,375. **KEMIKO AND DESIGN**. QUAKER CHEMICAL CORPORATION, (U.S. CLS. 6, 11 AND 16). SN 78-376,805. PUB. 7-26-2005. FILED 3-2-2004.
- 3,007,431. **CARTRIDGE DEPOT (BLOCK FORM)**. THE CARTRIDGE DEPOT, LLC, (U.S. CLS. 6, 11 AND 16). SN 78-410,583. PUB. 7-26-2005. FILED 4-29-2004.

CLASS 3—COSMETICS AND CLEANING PREPARATIONS

- 3,006,806. **MORPHOLOGY**. GOULBOURN, KATRINA, AND GOULBOURN, NATASHA, MULTIPLE CLASS, (INT. CLS. 3, 6, 14, 18, 20, 21 AND 25), (U.S. CLS. 1, 2, 3, 4, 6, 12, 13, 14, 22, 23, 25, 27, 28, 29, 30, 32, 33, 39, 40, 41, 50, 51 AND 52). SN 76-184,037. PUB. 7-26-2005. FILED 12-20-2000.
- 3,006,836. **CAGE**. LENTHERIC LIMITED, (U.S. CLS. 1, 4, 6, 50, 51 AND 52). SN 76-380,817. PUB. 7-26-2005. FILED 3-11-2002.
- 3,006,838. **REAL PURITY**. J-RICH CLINIC, INC., DBA REAL PURITY, (U.S. CLS. 1, 4, 6, 50, 51 AND 52). SN 76-390,044. PUB. 7-26-2005. FILED 3-29-2002.
- 3,006,840. **COMPATIBLE STRAIGHT**. L'OREAL, (U.S. CLS. 1, 4, 6, 50, 51 AND 52). SN 76-404,885. PUB. 7-26-2005. FILED 5-9-2002.
- 3,006,848. **ETERNAL CUT**. GARRARD HOLDINGS LIMITED, MULTIPLE CLASS, (INT. CLS. 3, 8, 13, 16, 18, 20, 21, 25, 28, 29, 30, 33 AND 34), (U.S. CLS. 1, 2, 3, 4, 5, 6, 8, 9, 13, 17, 22, 23, 25, 28, 29, 30, 32, 33, 37, 38, 39, 40, 41, 44, 46, 47, 49, 50, 51 AND 52). SN 76-443,205. PUB. 7-26-2005. FILED 8-23-2002.
- 3,006,889. **J.M. SHU**. KING J. M. SHU ENTERPRISE INC., (U.S. CLS. 1, 4, 6, 50, 51 AND 52). SN 76-511,747. PUB. 7-26-2005. FILED 5-6-2003.
- 3,006,890. **SILSTRIP**. PENN-WHITE LIMITED, (U.S. CLS. 1, 4, 6, 50, 51 AND 52). SN 76-511,817. PUB. 7-26-2005. FILED 4-16-2003.
- 3,006,891. **UBS**. UBS AG, MULTIPLE CLASS, (INT. CLS. 3, 6,

- 7, 8, 9, 11, 12, 14, 15, 16, 18, 20, 21, 24, 25, 27, 28, 30, 32, 33, 34, 35, 36, 37, 38, 39, 40, 41, 42, 43, 44 AND 45). (U.S. CLS. 1, 2, 3, 4, 5, 6, 8, 9, 12, 13, 14, 17, 19, 20, 21, 22, 23, 25, 26, 27, 28, 29, 30, 31, 32, 33, 34, 35, 36, 37, 38, 39, 40, 41, 42, 44, 45, 46, 47, 48, 49, 50, 51, 52, 100, 101, 102, 103, 104, 105, 106 AND 107). SN 76-512,807. PUB. 7-26-2005. FILED 5-8-2003.
- 3,006,895. **CRYSTALLICIOUS! EXCLUSIVELY CRYSTALS AND DESIGN**. MILLER, THERESA, CARON, (U.S. CLS. 1, 4, 6, 50, 51 AND 52). SN 76-514,661. PUB. 7-26-2005. FILED 5-16-2003.
- 3,006,915. **HORIZON**. CLEANING SYSTEMS, INC., (U.S. CLS. 1, 4, 6, 50, 51 AND 52). SN 76-528,252. PUB. 4-5-2005. FILED 7-7-2003.
- 3,006,934. **MISCELLANEOUS DESIGN**. MIKRONITE TECHNOLOGIES GROUP INC., MULTIPLE CLASS, (INT. CLS. 3, 7 AND 40). (U.S. CLS. 1, 4, 6, 13, 19, 21, 23, 31, 34, 35, 50, 51, 52, 100, 103 AND 106). SN 76-543,154. PUB. 7-26-2005. FILED 8-25-2003.
- 3,006,936 (*See Class 1 for this trademark*).
- 3,006,951. **REJUVENESSENCE A MEDICAL SPA (BLOCK FORM)**. YAGODA, MICHELLE R., MULTIPLE CLASS, (INT. CLS. 3, 35 AND 44). (U.S. CLS. 1, 4, 6, 50, 51, 52, 100, 101 AND 102). SN 76-551,166. PUB. 7-26-2005. FILED 9-22-2003.
- 3,006,994. **GENESTE (BLOCK FORM)**. CHANILLE, INC., MULTIPLE CLASS, (INT. CLS. 3 AND 14). (U.S. CLS. 1, 2, 4, 6, 27, 28, 50, 51 AND 52). SN 76-562,533. PUB. 7-26-2005. FILED 11-17-2003.
- 3,007,003. **STANISLASSIA (BLOCK FORM)**. MAHOUDEAU, VALERIE, MULTIPLE CLASS, (INT. CLS. 3, 9, 16 AND 24). (U.S. CLS. 1, 2, 4, 5, 6, 21, 22, 23, 26, 29, 36, 37, 38, 42, 50, 51 AND 52). SN 76-564,708. PUB. 7-26-2005. FILED 12-11-2003.
- 3,007,066. **FARRIER'S WIFE (BLOCK FORM)**. RANDALSHAYE ENTERPRISES, INC., (U.S. CLS. 1, 4, 6, 50, 51 AND 52). SN 76-580,954. PUB. 7-26-2005. FILED 3-15-2004.
- 3,007,100. **SANDBOX (BLOCK FORM)**. ARMALY SPONGE COMPANY, (U.S. CLS. 1, 4, 6, 50, 51 AND 52). SN 76-589,163. PUB. 7-26-2005. FILED 4-28-2004.
- 3,007,152. **SHIMMERING DREAMS (BLOCK FORM)**. CHESEBROUGH POND'S INC., (U.S. CLS. 1, 4, 6, 50, 51 AND 52). SN 76-600,132. PUB. 7-26-2005. FILED 7-1-2004.
- 3,007,163. **ULTRA (BLOCK FORM)**. C.B. FLEET INVESTMENT CORPORATION, (U.S. CLS. 1, 4, 6, 50, 51 AND 52). SN 76-608,544. PUB. 7-26-2005. FILED 8-25-2004.
- 3,007,171. **M MODELS 1 (STYLIZED)**. MODELS ONE LIMITED, (U.S. CLS. 1, 4, 6, 50, 51 AND 52). SN 78-105,960. PUB. 7-26-2005. FILED 1-31-2002.
- 3,007,194 (*See Class 1 for this trademark*).
- 3,007,212. **GOODMARK AND DESIGN**. GOODMARK PLC, MULTIPLE CLASS, (INT. CLS. 3 AND 16). (U.S. CLS. 1, 2, 4, 5, 6, 22, 23, 29, 37, 38, 50, 51 AND 52). SN 78-258,474. PUB. 7-26-2005. FILED 6-4-2003.
- 3,007,224. **PAW BROTHERS**. G & G DISTRIBUTION INC., DBA RYAN'S PET SUPPLIES, MULTIPLE CLASS, (INT. CLS. 3, 5, 8, 10, 18 AND 20). (U.S. CLS. 1, 2, 3, 4, 6, 13, 18, 22, 23, 25, 26, 28, 32, 39, 41, 44, 46, 50, 51 AND 52). SN 78-278,611. PUB. 7-26-2005. FILED 7-24-2003.
- 3,007,255. **OKIE DOKIE KIDS SALON AND DESIGN**. OKIE DOKIE KIDS SALON, INC., MULTIPLE CLASS, (INT. CLS. 3 AND 44). (U.S. CLS. 1, 4, 6, 50, 51, 52, 100 AND 101). SN 78-312,461. PUB. 7-26-2005. FILED 10-11-2003.
- 3,007,259 (*See Class 1 for this trademark*).
- 3,007,264. **THE NEUTRAL SOLUTION (BLOCK FORM)**. ENVIRONMENTALLY SENSITIVE SOLUTIONS, INC., MULTIPLE CLASS, (INT. CLS. 3 AND 42). (U.S. CLS. 1, 4, 6, 50, 51, 52, 100 AND 101). SN 78-319,060. PUB. 7-26-2005. FILED 10-27-2003.
- 3,007,268. **EAU D'ITALIE LE SIRENUSE AND DESIGN**. LE SIRENUSE S.P.A., MULTIPLE CLASS, (INT. CLS. 3, 4 AND 35). (U.S. CLS. 1, 4, 6, 15, 50, 51, 52, 100, 101 AND 102). SN 78-322,136. PUB. 7-26-2005. FILED 11-3-2003.
- 3,007,269. **THE TOTAL ESCAPE (BLOCK FORM)**. BC INTERNATIONAL COSMETIC & IMAGE SERVICES, INC., MULTIPLE CLASS, (INT. CLS. 3, 9 AND 44). (U.S. CLS. 1, 4, 6, 21, 23, 26, 36, 38, 50, 51, 52, 100 AND 101). SN 78-322,396. PUB. 7-26-2005. FILED 11-3-2003.
- 3,007,305. **MISCELLANEOUS DESIGN**. AUDI A.G., MULTIPLE CLASS, (INT. CLS. 3, 6, 8, 9, 12, 14, 16, 18, 21, 24, 25

- AND 28). (U.S. CLS. 1, 2, 3, 4, 5, 6, 12, 13, 14, 19, 21, 22, 23, 25, 26, 27, 28, 29, 30, 31, 33, 35, 36, 37, 38, 39, 40, 41, 42, 44, 50, 51 AND 52). SN 78-339,523. PUB. 7-26-2005. FILED 12-11-2003.
- 3,007,325. **THALASSA (BLOCK FORM)**. FISKARDO ESTIATORIO, INC., (U.S. CLS. 1, 4, 6, 50, 51 AND 52). SN 78-346,574. PUB. 7-5-2005. FILED 12-30-2003.
- 3,007,363. **OPTUM CLEAN AND DESIGN**. OB SPECIALTY CHEMICALS GROUP, INC., (U.S. CLS. 1, 4, 6, 50, 51 AND 52). SN 78-371,145. PUB. 7-26-2005. FILED 2-20-2004.
- 3,007,386. **ORAL FRESH (BLOCK FORM)**. MEEKS, JOSEPH A., AND MEEKS, MARY GROSSMAN, (U.S. CLS. 1, 4, 6, 50, 51 AND 52). SN 78-382,834. PUB. 4-5-2005. FILED 3-11-2004.
- 3,007,396. **MAINTENANCE SYSTEM FOR MEN (BLOCK FORM)**. NEDBOY, ROBIN L, (U.S. CLS. 1, 4, 6, 50, 51 AND 52). SN 78-389,387. PUB. 7-26-2005. FILED 3-23-2004.
- 3,007,406. **BABY ZERMAT (BLOCK FORM)**. ZERMAT INTERNACIONAL, S.A. DE C.V., (U.S. CLS. 1, 4, 6, 50, 51 AND 52). SN 78-396,036. PUB. 7-26-2005. FILED 4-4-2004.
- 3,007,430. **MISCELLANEOUS DESIGN**. SUNSHINE PRODUCTS, INC., (U.S. CLS. 1, 4, 6, 50, 51 AND 52). SN 78-410,009. PUB. 7-26-2005. FILED 4-29-2004.
- 3,007,520. **D'SOLVE (BLOCK FORM)**. BROWNELLS, INC., (U.S. CLS. 1, 4, 6, 50, 51 AND 52). SN 78-451,828. PUB. 7-26-2005. FILED 7-16-2004.
- 3,007,556. **ESCADA (BLOCK FORM)**. ESCADA AG, MULTIPLE CLASS, (INT. CLS. 3, 9, 14, 18 AND 25). (U.S. CLS. 1, 2, 3, 4, 6, 21, 22, 23, 26, 27, 28, 36, 38, 39, 41, 50, 51 AND 52). SN 79-001,507. PUB. 7-26-2005. FILED 12-16-2003.
- 3,007,557. **CHULALA AND DESIGN**. BIO 21 CORPORATION, (U.S. CLS. 1, 4, 6, 50, 51 AND 52). SN 79-001,533. PUB. 7-26-2005. FILED 2-19-2004.

CLASS 4—LUBRICANTS AND FUELS

- 3,006,800. **PIPELINE**. ASHBY, GEORGE H JR., MULTIPLE CLASS, (INT. CLS. 4 AND 35). (U.S. CLS. 1, 6, 15, 100, 101 AND 102). SN 76-130,372. PUB. 7-26-2005. FILED 9-19-2000.
- 3,006,936 (*See Class 1 for this trademark*).
- 3,007,193. **DEBBIE MUMM**. DEBBIE MUMM, INC., MULTIPLE CLASS, (INT. CLS. 4, 6, 8, 9, 11, 14, 15, 16, 18, 20, 21, 24, 25, 26, 27, 28, 30 AND 32). (U.S. CLS. 1, 2, 3, 5, 6, 12, 13, 14, 15, 19, 20, 21, 22, 23, 25, 26, 27, 28, 29, 30, 31, 32, 33, 34, 36, 37, 38, 39, 40, 41, 42, 44, 45, 46, 48 AND 50). SN 78-218,408. PUB. 7-26-2005. FILED 2-24-2003.
- 3,007,194 (*See Class 1 for this trademark*).
- 3,007,268 (*See Class 3 for this trademark*).

CLASS 5—PHARMACEUTICALS

- 3,006,807. **BSN MEDICAL**. BSN MEDICAL GMBH & CO, KG, MULTIPLE CLASS, (INT. CLS. 5 AND 10). (U.S. CLS. 6, 18, 26, 39, 44, 46, 51 AND 52). SN 76-191,695. PUB. 7-26-2005. FILED 1-2-2001.
- 3,006,846. **W WARRIOR WITH ZEON TECHNOLOGY AND DESIGN**. SYNGENTA PARTICIPATIONS AG, (U.S. CLS. 6, 18, 44, 46, 51 AND 52). SN 76-433,388. PUB. 7-26-2005. FILED 7-23-2002.
- 3,006,852. **FEMOPATCH**. RADI MEDICAL SYSTEMS AB, (U.S. CLS. 6, 18, 44, 46, 51 AND 52). SN 76-450,890. PUB. 7-26-2005. FILED 9-17-2002.
- 3,006,853. **HEMOPATCH**. RADI MEDICAL SYSTEMS AB, (U.S. CLS. 6, 18, 44, 46, 51 AND 52). SN 76-450,891. PUB. 7-26-2005. FILED 9-17-2002.
- 3,006,870. **AVALENT**. ALTANA PHARMA AG, (U.S. CLS. 6, 18, 44, 46, 51 AND 52). SN 76-485,890. PUB. 7-26-2005. FILED 1-24-2003.
- 3,006,971. **FREEFLEX**. FRESENIUS AG, MULTIPLE CLASS, (INT. CLS. 5, 10 AND 16). (U.S. CLS. 2, 5, 6, 18, 22, 23, 26, 29, 37, 38, 39, 44, 46, 50, 51 AND 52). SN 76-556,243. PUB. 7-26-2005. FILED 10-27-2003.
- 3,007,008. **SUPERCAP XTREME (STYLIZED)**. 206 MACOPIN CORP, (U.S. CLS. 6, 18, 44, 46, 51 AND 52). SN 76-566,440.

PUB. 7-26-2005. FILED 12-22-2003.
 3,007,116. **ZIELONKA AND DESIGN**. ZIELONKA, DIRK, (U.S. CLS. 6, 18, 44, 46, 51 AND 52). SN 76-591,799. PUB. 7-26-2005. FILED 5-12-2004.
 3,007,130. **DYNAMITE WHEY (STYLIZED)**. MLJ, LLC, (U.S. CLS. 6, 18, 44, 46, 51 AND 52). SN 76-595,681. PUB. 7-26-2005. FILED 6-4-2004.
 3,007,170. **CERVARIX**. SMITHKLINE BEECHAM BIOLOGICALS S.A., (U.S. CLS. 6, 18, 44, 46, 51 AND 52). SN 78-094,993. PUB. 7-26-2005. FILED 11-26-2001.
 3,007,188. **INTERPRO**. LG LIFE SCIENCES, LTD., (U.S. CLS. 6, 18, 44, 46, 51 AND 52). SN 78-211,322. PUB. 7-26-2005. FILED 2-5-2003.
 3,007,194 (*See Class 1 for this trademark*).
 3,007,224 (*See Class 3 for this trademark*).
 3,007,225. **CC DRENCH**. DR. REGISTER & ASSOCIATES, INC., (U.S. CLS. 6, 18, 44, 46, 51 AND 52). SN 78-280,200. PUB. 7-26-2005. FILED 7-29-2003.
 3,007,230. **INDEVUS PHARMACEUTICALS**. INDEVUS PHARMACEUTICALS, INC., (U.S. CLS. 6, 18, 44, 46, 51 AND 52). SN 78-285,011. PUB. 7-26-2005. FILED 8-8-2003.
 3,007,310 (*See Class 1 for this trademark*).
 3,007,320 (*See Class 1 for this trademark*).
 3,007,328. **INDIVUMED (BLOCK FORM)**. INDIVUMED GMBH, MULTIPLE CLASS, (INT. CLS. 5, 9, 42 AND 44), (U.S. CLS. 6, 18, 21, 23, 26, 36, 38, 44, 46, 51, 52, 100 AND 101). SN 78-349,885. PUB. 7-26-2005. FILED 1-9-2004.
 3,007,402. **RAQIT (BLOCK FORM)**. ALTANA PHARMA AG, (U.S. CLS. 6, 18, 44, 46, 51 AND 52). SN 78-394,998. PUB. 7-26-2005. FILED 4-1-2004.
 3,007,420. **VISION (BLOCK FORM)**. VANCO INDUSTRIES LLC, (U.S. CLS. 6, 18, 44, 46, 51 AND 52). SN 78-403,629. PUB. 7-26-2005. FILED 4-17-2004.
 3,007,467. **FWUSA PAN CARE (BLOCK FORM)**. FAIR WEST (USA), INC., (U.S. CLS. 6, 18, 44, 46, 51 AND 52). SN 78-425,774. PUB. 7-26-2005. FILED 5-26-2004.
 3,007,474. **LIPREVE (BLOCK FORM)**. BIO REVIVE PTY LTD, (U.S. CLS. 6, 18, 44, 46, 51 AND 52). SN 78-429,396. PUB. 7-26-2005. FILED 6-3-2004.

CLASS 6—METAL GOODS

3,006,792. **YELLOW SUBMARINE**. SUBAFILMS LIMITED, MULTIPLE CLASS, (INT. CLS. 6, 9, 14, 28 AND 41), (U.S. CLS. 2, 12, 13, 14, 21, 22, 23, 25, 26, 27, 28, 36, 38, 50, 100, 101 AND 107). SN 75-983,535. PUB. 7-26-2005. FILED 3-27-1998.
 3,006,806 (*See Class 3 for this trademark*).
 3,006,813. **CABINMASTER**. FLEXELLO LIMITED, MULTIPLE CLASS, (INT. CLS. 6, 7, 12, 19 AND 20), (U.S. CLS. 1, 2, 12, 13, 14, 19, 21, 22, 23, 25, 31, 32, 33, 34, 35, 44 AND 50). SN 76-244,036. PUB. 7-26-2005. FILED 4-20-2001.
 3,006,861 (*See Class 1 for this trademark*).
 3,006,874. **TOP THRILL DRAGSTER**. CEDAR FAIR, L.P., MULTIPLE CLASS, (INT. CLS. 6, 9, 16, 20, 21, 24, 25, 28 AND 41), (U.S. CLS. 2, 5, 12, 13, 14, 21, 22, 23, 25, 26, 29, 30, 32, 33, 36, 37, 38, 39, 40, 42, 50, 100, 101 AND 107). SN 76-496,254. PUB. 7-26-2005. FILED 3-10-2003.
 3,006,891 (*See Class 3 for this trademark*).
 3,006,904. **FAU FIGHTING OWLS**. FLORIDA ATLANTIC UNIVERSITY, MULTIPLE CLASS, (INT. CLS. 6, 12, 24 AND 25), (U.S. CLS. 2, 12, 13, 14, 19, 21, 22, 23, 25, 31, 35, 39, 42, 44 AND 50). SN 76-521,449. PUB. 7-26-2005. FILED 6-11-2003.
 3,006,974. **FLEXAUST (BLOCK FORM)**. THE FLEXAUST COMPANY, INC., MULTIPLE CLASS, (INT. CLS. 6, 9, 17, 19 AND 40), (U.S. CLS. 1, 2, 5, 12, 13, 14, 21, 23, 25, 26, 33, 35, 36, 38, 50, 100, 103 AND 106). SN 76-556,608. PUB. 7-26-2005. FILED 11-3-2003.
 3,006,975. **FLEXAUST (STYLIZED)**. THE FLEXAUST COMPANY, INC., MULTIPLE CLASS, (INT. CLS. 6, 9, 17, 19 AND 40), (U.S. CLS. 1, 2, 5, 12, 13, 14, 21, 23, 25, 26, 33, 35, 36, 38, 50, 100, 103 AND 106). SN 76-556,611. PUB. 7-26-2005. FILED 11-3-2003.
 3,007,004. **BUMPER SPURS AND DESIGN**. FRANKLIN, REID ALBERT, AND FRANKLIN, MERTON CHARLES, (U.S. CLS. 2, 12, 13, 14, 23, 25 AND 50). SN 76-565,369. PUB. 7-26-

2005. FILED 12-8-2003.
 3,007,055 (*See Class 1 for this trademark*).
 3,007,056 (*See Class 1 for this trademark*).
 3,007,080. **XL (BLOCK FORM)**. AWI LICENSING COMPANY, (U.S. CLS. 2, 12, 13, 14, 23, 25 AND 50). SN 76-584,489. PUB. 4-5-2005. FILED 3-31-2004.
 3,007,176. **GATEKEEPER**. DHI ACQUISITION CORP., (U.S. CLS. 2, 12, 13, 14, 23, 25 AND 50). SN 78-154,251. PUB. 7-26-2005. FILED 8-14-2002.
 3,007,186. **MISCELLANEOUS DESIGN**. KAPPA ALPHA PSI FRATERNITY INC., MULTIPLE CLASS, (INT. CLS. 6, 9 AND 21), (U.S. CLS. 2, 12, 13, 14, 21, 23, 25, 26, 29, 30, 33, 36, 38, 40 AND 50). SN 78-209,746. PUB. 7-26-2005. FILED 1-31-2003.
 3,007,193 (*See Class 4 for this trademark*).
 3,007,221. **BLOSSOM**. CORK, ANNE, (U.S. CLS. 2, 12, 13, 14, 23, 25 AND 50). SN 78-277,695. PUB. 7-26-2005. FILED 7-23-2003.
 3,007,223. **HANDI-FOIL (STYLIZED)**. HANDI-FOIL CORPORATION, MULTIPLE CLASS, (INT. CLS. 6 AND 21), (U.S. CLS. 2, 12, 13, 14, 23, 25, 29, 30, 33, 40 AND 50). SN 78-278,332. PUB. 7-26-2005. FILED 7-24-2003.
 3,007,276. **KLEENKOTE (BLOCK FORM)**. COPPERWELD CORPORATION, (U.S. CLS. 2, 12, 13, 14, 23, 25 AND 50). SN 78-324,779. PUB. 7-26-2005. FILED 11-7-2003.
 3,007,305 (*See Class 3 for this trademark*).
 3,007,350. **DARTMOUTH VOX CLAMANTIS IN DESERTO 1769 AND DESIGN**. TRUSTEES OF DARTMOUTH COLLEGE, (U.S. CLS. 2, 12, 13, 14, 23, 25 AND 50). SN 78-363,651. PUB. 7-26-2005. FILED 2-6-2004.
 3,007,360. **NORRISEAL AND DESIGN**. DELAWARE CAPITAL FORMATION, INC., MULTIPLE CLASS, (INT. CLS. 6 AND 9), (U.S. CLS. 2, 12, 13, 14, 21, 23, 25, 26, 36, 38 AND 50). SN 78-370,444. PUB. 7-26-2005. FILED 2-19-2004.
 3,007,558. **AUSA (STYLIZED)**. LEANDRO JESUS, AND LEYRE TERESA, AND MARIA DEL ORO UGARTE ANDA, (U.S. CLS. 2, 12, 13, 14, 23, 25 AND 50). SN 79-001,669. PUB. 7-26-2005. FILED 11-11-2003.

CLASS 7—MACHINERY

3,006,813 (*See Class 6 for this trademark*).
 3,006,833. **KS-FERROCOAT**. KS KOLBENSCHMIDT GMBH, (U.S. CLS. 13, 19, 21, 23, 31, 34 AND 35). SN 76-365,960. PUB. 7-26-2005. FILED 2-1-2002.
 3,006,850. **MAGAFOR**. OUTILLAGE MAGAFOR, (U.S. CLS. 13, 19, 21, 23, 31, 34 AND 35). SN 76-446,999. PUB. 7-26-2005. FILED 8-20-2002.
 3,006,861 (*See Class 1 for this trademark*).
 3,006,891 (*See Class 3 for this trademark*).
 3,006,899. **PADDLE FENCE**. COMACT CHICOUTIMI INC., (U.S. CLS. 13, 19, 21, 23, 31, 34 AND 35). SN 76-517,717. PUB. 7-26-2005. FILED 5-28-2003.
 3,006,905. **MOULTRIE**. EBSCO INDUSTRIES, INC., MULTIPLE CLASS, (INT. CLS. 7, 9 AND 21), (U.S. CLS. 2, 13, 19, 21, 23, 26, 29, 30, 31, 33, 34, 35, 36, 38, 40 AND 50). SN 76-521,897. PUB. 7-26-2005. FILED 6-12-2003.
 3,006,931. **PRO DRIVER**. DESA IP, LLC, (U.S. CLS. 13, 19, 21, 23, 31, 34 AND 35). SN 76-540,793. PUB. 7-26-2005. FILED 8-15-2003.
 3,006,934 (*See Class 3 for this trademark*).
 3,007,026. **OZARK BOAT LIFT (BLOCK FORM)**. LAKELAND INDUSTRIES, INC., (U.S. CLS. 13, 19, 21, 23, 31, 34 AND 35). SN 76-569,611. PUB. 7-26-2005. FILED 1-8-2004.
 3,007,036. **SMSI (STYLIZED)**. SETCO SALES CO., MULTIPLE CLASS, (INT. CLS. 7 AND 37), (U.S. CLS. 13, 19, 21, 23, 31, 34, 35, 100, 103 AND 106). SN 76-571,145. PUB. 7-26-2005. FILED 1-20-2004.
 3,007,179. **PHILADELPHIA GEAR LOCAL SERVICE**. NATIONAL SUPPORT. GLOBAL EXPERTISE. AND DESIGN. PHILADELPHIA GEAR CORPORATION, MULTIPLE CLASS, (INT. CLS. 7, 37 AND 42), (U.S. CLS. 13, 19, 21, 23, 31, 34, 35, 100, 101, 103 AND 106). SN 78-175,361. PUB. 7-26-2005. FILED 10-17-2002.
 3,007,191. **A-C COMPRESSOR**. GENERAL ELECTRIC COMPANY, MULTIPLE CLASS, (INT. CLS. 7, 37, 40 AND 42),

- (U.S. CLS. 13, 19, 21, 23, 31, 34, 35, 100, 101, 103 AND 106). SN 78-216,790. PUB. 7-26-2005. FILED 2-20-2003.
- 3,007,194 (*See Class 1 for this trademark*).
- 3,007,195. **BERNEX. IONBOND AG OLTEN, MULTIPLE CLASS**, (INT. CLS. 7, 8 AND 40), (U.S. CLS. 13, 19, 21, 23, 28, 31, 34, 35, 44, 100, 103 AND 106). SN 78-220,098. PUB. 7-26-2005. FILED 2-28-2003.
- 3,007,203. **LASER V (STYLIZED)**, ROWAN ELECTRIC, INC., (U.S. CLS. 13, 19, 21, 23, 31, 34 AND 35). SN 78-238,719. PUB. 7-26-2005. FILED 4-17-2003.
- 3,007,249. **CAMCO (BLOCK FORM)**, CAMCO CUTTING TOOLS LTD., (U.S. CLS. 13, 19, 21, 23, 31, 34 AND 35). SN 78-307,742. PUB. 7-26-2005. FILED 9-30-2003.
- 3,007,263. **HASHIMA. HASHIMA CO., LTD., MULTIPLE CLASS**, (INT. CLS. 7 AND 9), (U.S. CLS. 13, 19, 21, 23, 26, 31, 34, 35, 36 AND 38). SN 78-317,741. PUB. 7-26-2005. FILED 10-23-2003.
- 3,007,287. **COMAC (BLOCK FORM)**, COMAC S.P.A., (U.S. CLS. 13, 19, 21, 23, 31, 34 AND 35). SN 78-330,120. PUB. 7-26-2005. FILED 11-19-2003.
- 3,007,290. **MG SYSTEMS (BLOCK FORM)**, MESSER GROUP GMBH, (U.S. CLS. 13, 19, 21, 23, 31, 34 AND 35). SN 78-332,755. PUB. 7-26-2005. FILED 11-25-2003.
- 3,007,313. **LIQUIJECT AND DESIGN**, JONES, BRYAN, AND JONES, KATHY, MULTIPLE CLASS, (INT. CLS. 7 AND 44), (U.S. CLS. 13, 19, 21, 23, 31, 34, 35, 100 AND 101). SN 78-343,179. PUB. 7-5-2005. FILED 12-19-2003.
- 3,007,332. **CFS (BLOCK FORM)**, CONVENIENCE FOOD SYSTEMS HOLDINGS N.V., MULTIPLE CLASS, (INT. CLS. 7, 11, 17 AND 42), (U.S. CLS. 1, 5, 12, 13, 19, 21, 23, 31, 34, 35, 50, 100 AND 101). SN 78-352,601. PUB. 7-26-2005. FILED 1-15-2004.
- 3,007,541. **HUMMEL (BLOCK FORM)**, EUGEN LÄGLER GMBH, (U.S. CLS. 13, 19, 21, 23, 31, 34 AND 35). SN 79-000,427. PUB. 7-26-2005. FILED 12-11-2003.
- (INT. CLS. 9, 16, 25, 28 AND 41), (U.S. CLS. 2, 5, 21, 22, 23, 26, 29, 36, 37, 38, 39, 50, 100, 101 AND 107). SN 75-821,908. PUB. 7-26-2005. FILED 10-14-1999.
- 3,006,791. **TOP OF THE POPS. THE BRITISH BROADCASTING CORPORATION, MULTIPLE CLASS**, (INT. CLS. 9, 16, 20, 38 AND 41), (U.S. CLS. 2, 5, 13, 21, 22, 23, 25, 26, 29, 32, 36, 37, 38, 50, 100, 101, 104 AND 107). SN 75-823,141. PUB. 7-26-2005. FILED 10-15-1999.
- 3,006,792 (*See Class 6 for this trademark*).
- 3,006,794. **CITYRAD. ADC TELECOMMUNICATIONS, INC.**, (U.S. CLS. 21, 23, 26, 36 AND 38). SN 76-031,508. PUB. 7-26-2005. FILED 4-20-2000.
- 3,006,805. **NETMASK.IT! (STYLIZED)**, NETMASK (EL-MAR) INTERNET TECHNOLOGIES LTD., (U.S. CLS. 21, 23, 26, 36 AND 38). SN 76-178,538. PUB. 7-26-2005. FILED 12-11-2000.
- 3,006,809. **LOGICO2**, LOGICO LTD, (U.S. CLS. 21, 23, 26, 36 AND 38). SN 76-198,173. PUB. 7-26-2005. FILED 1-22-2001.
- 3,006,820. **PYRAMID INDUSTRIES. LAMSON & SESSIONS CO., THE**, (U.S. CLS. 21, 23, 26, 36 AND 38). SN 76-292,898. PUB. 7-26-2005. FILED 7-31-2001.
- 3,006,821. **ATMOSPHERE. DALEY, SEAN, AND DAVIS, ANTHONY**, (U.S. CLS. 21, 23, 26, 36 AND 38). SN 76-318,031. PUB. 7-26-2005. FILED 9-20-2001.
- 3,006,822. **EXPLOLINE (STYLIZED)**, FHF FUNKE + HUSTER FERNSIG GMBH, MULTIPLE CLASS, (INT. CLS. 9 AND 12), (U.S. CLS. 19, 21, 23, 26, 31, 35, 36, 38 AND 44). SN 76-323,818. PUB. 7-26-2005. FILED 10-10-2001.
- 3,006,824. **ANYSHOT. SAMSUNG TECHWIN CO., LTD.**, (U.S. CLS. 21, 23, 26, 36 AND 38). SN 76-331,095. PUB. 7-26-2005. FILED 10-29-2001.
- 3,006,830. **GAMETECH. GAMETECH INTERNATIONAL, INC.**, MULTIPLE CLASS, (INT. CLS. 9, 28 AND 41), (U.S. CLS. 21, 22, 23, 26, 36, 38, 50, 100, 101 AND 107). SN 76-353,195. PUB. 7-26-2005. FILED 12-28-2001.
- 3,006,837. **ACCOUNTING RESEARCH MANAGER. ASPEN PUBLISHERS, INC.**, MULTIPLE CLASS, (INT. CLS. 9, 35 AND 36), (U.S. CLS. 21, 23, 26, 36, 38, 100, 101 AND 102). SN 76-385,802. PUB. 7-26-2005. FILED 3-22-2002.
- 3,006,847. **MISCELLANEOUS DESIGN. ARROW DENIM LIMITED, MULTIPLE CLASS**, (INT. CLS. 9, 14, 25 AND 35), (U.S. CLS. 2, 21, 22, 23, 26, 27, 28, 36, 38, 39, 50, 100, 101 AND 102). SN 76-433,597. PUB. 1-4-2005. FILED 7-23-2002.
- 3,006,861 (*See Class 1 for this trademark*).
- 3,006,866. **BIRD JOLT 2002. BIRD-B-GONE, INC.**, (U.S. CLS. 21, 23, 26, 36 AND 38). SN 76-471,598. PUB. 7-26-2005. FILED 12-2-2002.
- 3,006,868. **INTELLIVALVE AND DESIGN. PDK AUTOMOTIVE ENTERPRISES, INC.**, (U.S. CLS. 21, 23, 26, 36 AND 38). SN 76-480,471. PUB. 7-26-2005. FILED 1-6-2003.
- 3,006,869. **04 AND DESIGN. UNION DES ASSOCIATIONS EUROPEENNES DE FOOTBALL, MULTIPLE CLASS**, (INT. CLS. 9, 12, 16, 18, 25, 28, 30, 32, 36, 39, 41 AND 43), (U.S. CLS. 1, 2, 3, 5, 19, 21, 22, 23, 26, 29, 31, 35, 36, 37, 38, 39, 41, 44, 45, 46, 48, 50, 100, 101, 102, 105 AND 107). SN 76-481,831. PUB. 7-26-2005. FILED 1-9-2003.
- 3,006,874 (*See Class 6 for this trademark*).
- 3,006,876. **FOCUS. MCLOUGHLIN, JOHN E.**, (U.S. CLS. 21, 23, 26, 36 AND 38). SN 76-499,340. PUB. 7-26-2005. FILED 3-17-2003.
- 3,006,877. **CINGULAR FITS YOU BEST AND DESIGN. CINGULAR WIRELESS II, LLC, MULTIPLE CLASS**, (INT. CLS. 9, 35 AND 38), (U.S. CLS. 21, 23, 26, 36, 38, 100, 101, 102 AND 104). SN 76-501,688. PUB. 7-26-2005. FILED 3-24-2003.
- 3,006,878. **CINGULAR FITS YOU BEST. CINGULAR WIRELESS II, LLC, MULTIPLE CLASS**, (INT. CLS. 9, 35 AND 38), (U.S. CLS. 21, 23, 26, 36, 38, 100, 101, 102 AND 104). SN 76-501,689. PUB. 7-26-2005. FILED 3-24-2003.
- 3,006,888. **X JUMP CROSS AND DESIGN. TDR VENTURES LTD.**, MULTIPLE CLASS, (INT. CLS. 9, 16, 25, 36, 38 AND 41), (U.S. CLS. 2, 5, 21, 22, 23, 26, 29, 36, 37, 38, 39, 50, 100, 101, 102, 104 AND 107). SN 76-511,402. PUB. 7-26-2005. FILED 5-2-2003.
- 3,006,891 (*See Class 3 for this trademark*).
- 3,006,892. **G-FORCE RACING GEAR AND DESIGN. POST-MARK INC.**, MULTIPLE CLASS, (INT. CLS. 9, 18, 22 AND 27), (U.S. CLS. 1, 2, 3, 7, 19, 20, 21, 22, 23, 26, 36, 37, 38, 41, 42 AND 50). SN 76-513,549. PUB. 7-26-2005. FILED 5-12-2003.

CLASS 8—HAND TOOLS

- 3,006,848 (*See Class 3 for this trademark*).
- 3,006,883. **MINOSHARP. MASTER CUTLERY CORPORATION, MULTIPLE CLASS**, (INT. CLS. 8 AND 21), (U.S. CLS. 2, 13, 23, 28, 29, 30, 33, 40, 44 AND 50). SN 76-506,315. PUB. 7-26-2005. FILED 4-11-2003.
- 3,006,891 (*See Class 3 for this trademark*).
- 3,007,045. **TRÈS GLACÉ AND DESIGN. TRAN, DON**, (U.S. CLS. 23, 28 AND 44). SN 76-575,124. PUB. 7-26-2005. FILED 2-12-2004.
- 3,007,055 (*See Class 1 for this trademark*).
- 3,007,056 (*See Class 1 for this trademark*).
- 3,007,118. **OSPREY (BLOCK FORM)**, FADDEN/MAR COMPANY, (U.S. CLS. 23, 28 AND 44). SN 76-592,429. PUB. 4-5-2005. FILED 5-17-2004.
- 3,007,193 (*See Class 4 for this trademark*).
- 3,007,194 (*See Class 1 for this trademark*).
- 3,007,195 (*See Class 7 for this trademark*).
- 3,007,224 (*See Class 3 for this trademark*).
- 3,007,305 (*See Class 3 for this trademark*).
- 3,007,315. **COLTELLERIE BERTI AND DESIGN. COLTELLERIE BERTI DI BERTI ANDREA & C. S.N.C.**, (U.S. CLS. 23, 28 AND 44). SN 78-343,789. PUB. 7-26-2005. FILED 12-19-2003.
- 3,007,422. **TOGIYA AND DESIGN. MIYATA, TATSUYA, DBA TOGIYA INTERNATIONAL INC.**, (U.S. CLS. 23, 28 AND 44). SN 78-404,245. PUB. 7-26-2005. FILED 4-19-2004.
- 3,007,461. **DANIEL BOONE (BLOCK FORM)**, DANIEL BOONE INC., (U.S. CLS. 23, 28 AND 44). SN 78-423,349. PUB. 7-26-2005. FILED 5-21-2004.

CLASS 9—ELECTRICAL AND SCIENTIFIC APPARATUS

- 3,006,790. **MISCELLANEOUS DESIGN. BRITISH BROADCASTING CORPORATION, THE, MULTIPLE CLASS,**

- 3,006,897. **COMPUTADORAS PARA KLUTZES**. RICHMOND, CHARLES C., MULTIPLE CLASS, (INT. CLS. 9, 16 AND 41), (U.S. CLS. 2, 5, 21, 22, 23, 26, 29, 36, 37, 38, 50, 100, 101 AND 107). SN 76-516,427. PUB. 7-26-2005. FILED 5-22-2003.
- 3,006,898. **M MICROGAMING AND DESIGN**. MICROGAMING SYSTEMS ANSTALT, MULTIPLE CLASS, (INT. CLS. 9, 35 AND 41), (U.S. CLS. 21, 23, 26, 36, 38, 100, 101, 102 AND 107). SN 76-516,499. PUB. 7-12-2005. FILED 5-22-2003.
- 3,006,900. **THE ULTIMATE**. IT'S ACADEMIC OF ILLINOIS, INC., MULTIPLE CLASS, (INT. CLS. 9 AND 16), (U.S. CLS. 2, 5, 21, 22, 23, 26, 29, 36, 37, 38 AND 50). SN 76-518,949. PUB. 7-26-2005. FILED 6-2-2003.
- 3,006,905 (*See Class 7 for this trademark*).
- 3,006,906. **OBIX**. CLINICAL COMPUTER SYSTEMS, INC., (U.S. CLS. 21, 23, 26, 36 AND 38). SN 76-521,991. PUB. 7-26-2005. FILED 6-11-2003.
- 3,006,909. **SANDSTOPPER**. BLUCHER GMBH, (U.S. CLS. 21, 23, 26, 36 AND 38). SN 76-523,899. PUB. 7-26-2005. FILED 6-18-2003.
- 3,006,917. **+ REACTANCE TECHNOLOGY AND DESIGN**. KABUSHIKI KAISHA TANITA, MULTIPLE CLASS, (INT. CLS. 9 AND 10), (U.S. CLS. 21, 23, 26, 36, 38, 39 AND 44). SN 76-531,534. PUB. 7-26-2005. FILED 7-18-2003.
- 3,006,918. **MISCELLANEOUS DESIGN**. KABUSHIKI KAISHA TANITA, MULTIPLE CLASS, (INT. CLS. 9 AND 10), (U.S. CLS. 21, 23, 26, 36, 38, 39 AND 44). SN 76-531,535. PUB. 7-26-2005. FILED 7-18-2003.
- 3,006,919. **THE TITLE SOURCE**. BAKER & TAYLOR, INC., MULTIPLE CLASS, (INT. CLS. 9 AND 41), (U.S. CLS. 21, 23, 26, 36, 38, 100, 101 AND 107). SN 76-531,977. PUB. 7-26-2005. FILED 7-23-2003.
- 3,006,929. **ACCELERATE YOUR LIFE (BLOCK FORM)**. THE UNITED STATES OF AMERICA, AS REPRESENTED BY THE SECRETARY OF THE NAVY, MULTIPLE CLASS, (INT. CLS. 9, 12, 14, 16, 18, 20, 21, 25, 28, 39, 41, 43, 44 AND 45), (U.S. CLS. 1, 2, 3, 5, 13, 19, 21, 22, 23, 25, 26, 27, 28, 29, 30, 31, 32, 33, 35, 36, 37, 38, 39, 40, 41, 44, 50, 100, 101, 105 AND 107). SN 76-538,517. PUB. 7-26-2005. FILED 8-14-2003.
- 3,006,943. **HEALTH PLANET AND DESIGN**. KABUSHIKI KAISHA TANITA, MULTIPLE CLASS, (INT. CLS. 9, 10 AND 44), (U.S. CLS. 21, 23, 26, 36, 38, 39, 44, 100 AND 101). SN 76-548,051. PUB. 7-26-2005. FILED 9-30-2003.
- 3,006,944. **TRISYN GROUP**. TRISYN GROUP L.P., (U.S. CLS. 21, 23, 26, 36 AND 38). SN 76-548,184. PUB. 7-26-2005. FILED 9-12-2003.
- 3,006,952. **QADIRECTOR**. COMPUWARE CORPORATION, (U.S. CLS. 21, 23, 26, 36 AND 38). SN 76-551,268. PUB. 7-26-2005. FILED 9-24-2003.
- 3,006,956. **VIISAGE**. VIISAGE TECHNOLOGY, INC., (U.S. CLS. 21, 23, 26, 36 AND 38). SN 76-553,214. PUB. 7-26-2005. FILED 10-1-2003.
- 3,006,960. **SHOEBOX RECORDS**. SAGEFIRE, INC., MULTIPLE CLASS, (INT. CLS. 9 AND 42), (U.S. CLS. 21, 23, 26, 36, 38, 100 AND 101). SN 76-554,300. PUB. 7-26-2005. FILED 10-24-2003.
- 3,006,966. **WAFER MASTER 2000**. EAGLE TEST SYSTEMS, INC., (U.S. CLS. 21, 23, 26, 36 AND 38). SN 76-555,185. PUB. 7-26-2005. FILED 10-29-2003.
- 3,006,968. **LGC LA GRAN COMISION PREPARANDO A LOS SANTOS PARA LA OBRA DEL MINISTERIO AND DESIGN**. THE PENTECOSTAL CHURCH OF GOD "THE GREAT COMMISSION" INC., MULTIPLE CLASS, (INT. CLS. 9, 41 AND 45), (U.S. CLS. 21, 23, 26, 36, 38, 100, 101 AND 107). SN 76-555,443. PUB. 7-26-2005. FILED 10-30-2003.
- 3,006,974 (*See Class 6 for this trademark*).
- 3,006,975 (*See Class 6 for this trademark*).
- 3,006,988. **HEALTHBOOK (BLOCK FORM)**. THE JOCKEY CLUB INFORMATION SYSTEMS, INC., (U.S. CLS. 21, 23, 26, 36 AND 38). SN 76-560,926. PUB. 7-26-2005. FILED 11-3-2003.
- 3,006,993. **CONTROLTEX (STYLIZED)**. STANDARD TEXTILE CO., INC., MULTIPLE CLASS, (INT. CLS. 9 AND 35), (U.S. CLS. 21, 23, 26, 36, 38, 100, 101 AND 102). SN 76-562,491. PUB. 7-26-2005. FILED 11-17-2003.
- 3,007,000. **NOVA CHANNEL TOURIST DIRECTORY AND DESIGN**. NOVACHANNEL AG, (U.S. CLS. 21, 23, 26, 36 AND 38). SN 76-564,013. PUB. 7-26-2005. FILED 12-8-2003.
- 3,007,003 (*See Class 3 for this trademark*).
- 3,007,005. **INTELLIVISION AND DESIGN**. PULSAFEEDER, INC., (U.S. CLS. 21, 23, 26, 36 AND 38). SN 76-565,478. PUB. 7-26-2005. FILED 11-5-2003.
- 3,007,012. **RUBBERELLA (BLOCK FORM)**. GWEN MEDIA, INC., MULTIPLE CLASS, (INT. CLS. 9 AND 41), (U.S. CLS. 21, 23, 26, 36, 38, 100, 101 AND 107). SN 76-567,109. PUB. 7-26-2005. FILED 12-29-2003.
- 3,007,016. **IVUE (STYLIZED)**. NATIONAL INFORMATION SOLUTIONS COOPERATIVE, INC., MULTIPLE CLASS, (INT. CLS. 9, 35, 41 AND 42), (U.S. CLS. 21, 23, 26, 36, 38, 100, 101, 102 AND 107). SN 76-567,298. PUB. 7-26-2005. FILED 12-29-2003.
- 3,007,017. **IVUE NISC THE VISION TO SEE. THE POWER TO DO. AND DESIGN**. NATIONAL INFORMATION SOLUTIONS COOPERATIVE, INC., MULTIPLE CLASS, (INT. CLS. 9, 35, 37, 41 AND 42), (U.S. CLS. 21, 23, 26, 36, 38, 100, 101, 102, 103, 106 AND 107). SN 76-567,299. PUB. 7-26-2005. FILED 12-29-2003.
- 3,007,058. **HOMELAND SECURITY TODAY (STYLIZED)**. KMD MEDIA, LLC, (U.S. CLS. 21, 23, 26, 36 AND 38). SN 76-579,441. PUB. 7-26-2005. FILED 2-26-2004.
- 3,007,060. **NIMCO, INC INNOVATIONS IN EDUCATION AND DESIGN**. NIMCO, INC, MULTIPLE CLASS, (INT. CLS. 9 AND 16), (U.S. CLS. 2, 5, 21, 22, 23, 26, 29, 36, 37, 38 AND 50). SN 76-579,576. PUB. 7-26-2005. FILED 3-8-2004.
- 3,007,065. **TASCOM (BLOCK FORM)**. ALSTON TASCOM, INC., (U.S. CLS. 21, 23, 26, 36 AND 38). SN 76-580,851. PUB. 7-26-2005. FILED 3-15-2004.
- 3,007,077. **WET TO DRY (BLOCK FORM)**. KREMBS, INC., (U.S. CLS. 21, 23, 26, 36 AND 38). SN 76-584,104. PUB. 2-1-2005. FILED 3-29-2004.
- 3,007,084. **WAVECREST (BLOCK FORM)**. WAVECREST LABORATORIES LLC, (U.S. CLS. 21, 23, 26, 36 AND 38). SN 76-585,848. PUB. 7-26-2005. FILED 4-8-2004.
- 3,007,089. **INVEX (BLOCK FORM)**. INVERA INC., (U.S. CLS. 21, 23, 26, 36 AND 38). SN 76-587,181. PUB. 4-5-2005. FILED 4-16-2004.
- 3,007,097. **RT3 (BLOCK FORM)**. STAYHEALTHY, INC., (U.S. CLS. 21, 23, 26, 36 AND 38). SN 76-588,589. PUB. 7-26-2005. FILED 4-26-2004.
- 3,007,110. **LET'S GO FOR A DRIVE (BLOCK FORM)**. SHOWCASE REMARKETING, INC., (U.S. CLS. 21, 23, 26, 36 AND 38). SN 76-591,022. PUB. 7-26-2005. FILED 5-7-2004.
- 3,007,139. **VON DOLCE (BLOCK FORM)**. GOT SHADES, INC., (U.S. CLS. 21, 23, 26, 36 AND 38). SN 76-597,254. PUB. 7-26-2005. FILED 6-10-2004.
- 3,007,141. **X9 AND DESIGN**. ACCREDITED STANDARDS COMMITTEE X9- FINANCIAL INDUSTRY INC., (U.S. CLS. 21, 23, 26, 36 AND 38). SN 76-597,312. PUB. 7-26-2005. FILED 6-15-2004.
- 3,007,153. **ICE HORSE (BLOCK FORM)**. FULHAM COMPANY, INC., (U.S. CLS. 21, 23, 26, 36 AND 38). SN 76-600,514. PUB. 7-26-2005. FILED 7-2-2004.
- 3,007,158. **BIRDBUSTER (BLOCK FORM)**. NORTH PASS, LTD., (U.S. CLS. 21, 23, 26, 36 AND 38). SN 76-602,519. PUB. 7-26-2005. FILED 7-16-2004.
- 3,007,164. **PORSCHÉ DESIGN (BLOCK FORM)**. DR. ING. H.C. F. PORSCHÉ AG, MULTIPLE CLASS, (INT. CLS. 9 AND 14), (U.S. CLS. 2, 21, 23, 26, 27, 28, 36, 38 AND 50). SN 76-609,322. PUB. 7-26-2005. FILED 8-26-2004.
- 3,007,167. **DIGITAL INTELLIGENCE**. DIGITAL INTELLIGENCE, INC., MULTIPLE CLASS, (INT. CLS. 9 AND 42), (U.S. CLS. 21, 23, 26, 36, 38, 100 AND 101). SN 78-065,205. PUB. 7-26-2005. FILED 5-23-2001.
- 3,007,168. **I-MODE (STYLIZED)**. KABUSHIKI KAISHA NTT DOCOMO, DBA NTT DOCOMO, INC., MULTIPLE CLASS, (INT. CLS. 9, 28, 35, 36, 37, 38, 39, 40, 41 AND 42), (U.S. CLS. 21, 22, 23, 26, 36, 38, 50, 100, 101, 102, 103, 104, 105, 106 AND 107). SN 78-078,972. PUB. 7-26-2005. FILED 8-13-2001.
- 3,007,181. **CADIVI AND DESIGN**. VIETNAM ELECTRIC WIRE & CABLE CORP. (CADIVI), (U.S. CLS. 21, 23, 26, 36 AND 38). SN 78-184,546. PUB. 7-26-2005. FILED 11-13-2002.
- 3,007,186 (*See Class 6 for this trademark*).
- 3,007,193 (*See Class 4 for this trademark*).
- 3,007,194 (*See Class 1 for this trademark*).
- 3,007,197. **MIKE JOHN**. PARALLEL MEDIA, INC., (U.S. CLS. 21, 23, 26, 36 AND 38). SN 78-228,255. PUB. 7-26-2005. FILED 3-20-2003.

- 3,007,199. **QPT (STYLIZED)**. IATIA LIMITED, (U.S. CLS. 21, 23, 26, 36 AND 38). SN 78-229,848. PUB. 7-26-2005. FILED 3-25-2003.
- 3,007,204. **FLAMEBEAT**. N.V. KEMA, MULTIPLE CLASS, (INT. CLS. 9, 42 AND 45), (U.S. CLS. 21, 23, 26, 36, 38, 100 AND 101). SN 78-239,129. PUB. 7-26-2005. FILED 4-17-2003.
- 3,007,205. **SMART STEAM AUTOMATIC VARIABLE STEAM AND DESIGN**. HP INTELLECTUAL CORP., (U.S. CLS. 21, 23, 26, 36 AND 38). SN 78-241,983. PUB. 7-26-2005. FILED 4-25-2003.
- 3,007,206. **NUCARS**. TRANSPORTATION TECHNOLOGY CENTER, INC., MULTIPLE CLASS, (INT. CLS. 9 AND 42), (U.S. CLS. 21, 23, 26, 36, 38, 100 AND 101). SN 78-243,920. PUB. 7-26-2005. FILED 4-30-2003.
- 3,007,209. **CELLECTRICON**. CELLECTRICON AB, MULTIPLE CLASS, (INT. CLS. 9, 35 AND 42), (U.S. CLS. 21, 23, 26, 36, 38, 100, 101 AND 102). SN 78-255,431. PUB. 7-26-2005. FILED 5-28-2003.
- 3,007,211. **NIL AND DESIGN**. DATINVEST VENTURES CAPITAL HOLDING S.A., MULTIPLE CLASS, (INT. CLS. 9, 37, 41 AND 42), (U.S. CLS. 21, 23, 26, 36, 38, 100, 101, 103, 106 AND 107). SN 78-257,043. PUB. 7-26-2005. FILED 6-2-2003.
- 3,007,215. **MISCELLANEOUS DESIGN**. ARISTOCRAT TECHNOLOGIES AUSTRALIA PTY LTD., MULTIPLE CLASS, (INT. CLS. 9, 16 AND 41), (U.S. CLS. 2, 5, 21, 22, 23, 26, 29, 36, 37, 38, 50, 100, 101 AND 107). SN 78-267,679. PUB. 7-26-2005. FILED 6-26-2003.
- 3,007,218. **THINK ACTION**. THINK ACTION LIMITED, MULTIPLE CLASS, (INT. CLS. 9 AND 41), (U.S. CLS. 21, 23, 26, 36, 38, 100, 101 AND 107). SN 78-275,292. PUB. 7-26-2005. FILED 7-17-2003.
- 3,007,227. **SBMANAGER**. OPEN RATINGS, INC., MULTIPLE CLASS, (INT. CLS. 9 AND 35), (U.S. CLS. 21, 23, 26, 36, 38, 100, 101 AND 102). SN 78-280,809. PUB. 7-26-2005. FILED 7-30-2003.
- 3,007,231. **DBI DIGITAL BRIDGES AND DESIGN**. DIGITAL BRIDGES LIMITED, MULTIPLE CLASS, (INT. CLS. 9, 16, 28, 38, 41 AND 42), (U.S. CLS. 2, 5, 21, 22, 23, 26, 29, 36, 37, 38, 50, 100, 101, 104 AND 107). SN 78-286,620. PUB. 7-26-2005. FILED 8-13-2003.
- 3,007,237. **PENN MEDICAL INFORMATICS SYSTEMS**. PENN MEDICAL INFORMATICS SYSTEMS, INC., (U.S. CLS. 21, 23, 26, 36 AND 38). SN 78-296,242. PUB. 7-26-2005. FILED 9-4-2003.
- 3,007,242 (*See Class 1 for this trademark*).
- 3,007,247. **STYLE UP**. SONY ERICSSON MOBILE COMMUNICATIONS AB, MULTIPLE CLASS, (INT. CLS. 9 AND 38), (U.S. CLS. 21, 23, 26, 36, 38, 100, 101 AND 104). SN 78-306,218. PUB. 7-26-2005. FILED 9-26-2003.
- 3,007,256. **SIMULIX EVOLUTION**. NUCLETRON B.V., (U.S. CLS. 21, 23, 26, 36 AND 38). SN 78-313,328. PUB. 7-26-2005. FILED 10-14-2003.
- 3,007,258. **KEYWHERE**. PERFORMANCE ANALYTICS, INC., (U.S. CLS. 21, 23, 26, 36 AND 38). SN 78-313,932. PUB. 7-26-2005. FILED 10-15-2003.
- 3,007,263 (*See Class 7 for this trademark*).
- 3,007,266. **BLOOD WILL TELL TEZUKA OSAMU'S DORORO AND DESIGN**. KABUSHIKI KAISHA TEZUKA PRODUCTION, DBA TEZUKA PRODUCTIONS CO., LTD., (U.S. CLS. 21, 23, 26, 36 AND 38). SN 78-320,351. PUB. 7-5-2005. FILED 10-29-2003.
- 3,007,269 (*See Class 3 for this trademark*).
- 3,007,278. **MOBIC-WEAR (BLOCK FORM)**. SIEMENS AKTIENGESELLSCHAFT, MULTIPLE CLASS, (INT. CLS. 9 AND 25), (U.S. CLS. 21, 22, 23, 26, 36, 38 AND 39). SN 78-325,488. PUB. 7-26-2005. FILED 11-10-2003.
- 3,007,284. **MISCELLANEOUS DESIGN**. CARRIS REELS, INC., (U.S. CLS. 21, 23, 26, 36 AND 38). SN 78-329,330. PUB. 7-26-2005. FILED 11-18-2003.
- 3,007,289. **RAPIDSTUDY (BLOCK FORM)**. EKLIN MEDICAL SYSTEMS, INC., MULTIPLE CLASS, (INT. CLS. 9 AND 10), (U.S. CLS. 21, 23, 26, 36, 38, 39 AND 44). SN 78-331,427. PUB. 7-26-2005. FILED 11-21-2003.
- 3,007,298. **WWW.GEAREXPRESS.COM (BLOCK FORM)**. STARVED ROCK OUTFITTERS, LTD., (U.S. CLS. 21, 23, 26, 36 AND 38). SN 78-336,918. PUB. 7-26-2005. FILED 12-5-2003.
- 3,007,303. **TMS PLUS (BLOCK FORM)**. FOUR RIVERS SOFTWARE SYSTEMS, INC., (U.S. CLS. 21, 23, 26, 36 AND 38). SN 78-338,004. PUB. 7-26-2005. FILED 12-8-2003.
- 3,007,304. **ACTION CAPTIONS (BLOCK FORM)**. SFK MEDIA SPECIALLY FOR KIDS CORP., MULTIPLE CLASS, (INT. CLS. 9 AND 16), (U.S. CLS. 2, 5, 21, 22, 23, 26, 29, 36, 37, 38 AND 50). SN 78-339,269. PUB. 6-7-2005. FILED 12-11-2003.
- 3,007,305 (*See Class 3 for this trademark*).
- 3,007,308. **PRINTABLE TECHNOLOGIES (BLOCK FORM)**. PRINTABLE TECHNOLOGIES, INC., (U.S. CLS. 21, 23, 26, 36 AND 38). SN 78-340,121. PUB. 7-26-2005. FILED 12-12-2003.
- 3,007,310 (*See Class 1 for this trademark*).
- 3,007,316. **DICEY (BLOCK FORM)**. WALLS, DAVID M., (U.S. CLS. 21, 23, 26, 36 AND 38). SN 78-344,122. PUB. 7-26-2005. FILED 12-22-2003.
- 3,007,317. **SMARTWATCH SECUREPASS AND DESIGN**. TC LICENSE, LTD, MULTIPLE CLASS, (INT. CLS. 9 AND 45), (U.S. CLS. 21, 23, 26, 36, 38, 100 AND 101). SN 78-344,958. PUB. 7-26-2005. FILED 12-23-2003.
- 3,007,321. **MISSIONASSIST (BLOCK FORM)**. DONOR STRATEGIES, INC., (U.S. CLS. 21, 23, 26, 36 AND 38). SN 78-345,659. PUB. 7-26-2005. FILED 12-26-2003.
- 3,007,322. **NEXQL (BLOCK FORM)**. NEXQL CORPORATION, (U.S. CLS. 21, 23, 26, 36 AND 38). SN 78-345,954. PUB. 7-26-2005. FILED 12-29-2003.
- 3,007,328 (*See Class 5 for this trademark*).
- 3,007,338. **MISCELLANEOUS DESIGN**. DATAKEY ELECTRONICS, INC., (U.S. CLS. 21, 23, 26, 36 AND 38). SN 78-357,892. PUB. 7-26-2005. FILED 1-27-2004.
- 3,007,341. **JUDGE DREDD (BLOCK FORM)**. KINGSLEY, CHRISTOPHER, AND KINGSLEY, JASON, MULTIPLE CLASS, (INT. CLS. 9, 16, 28 AND 41), (U.S. CLS. 2, 5, 21, 22, 23, 26, 29, 36, 37, 38, 50, 100, 101 AND 107). SN 78-358,717. PUB. 7-26-2005. FILED 1-28-2004.
- 3,007,359. **VIP WASH PASS (BLOCK FORM)**. UNITEC, INC., DBA UNITEC ELECTRONICS, (U.S. CLS. 21, 23, 26, 36 AND 38). SN 78-370,362. PUB. 7-26-2005. FILED 2-19-2004.
- 3,007,360 (*See Class 6 for this trademark*).
- 3,007,364. **SCANZOOM (BLOCK FORM)**. SCANBUY, INC., (U.S. CLS. 21, 23, 26, 36 AND 38). SN 78-371,172. PUB. 7-26-2005. FILED 2-20-2004.
- 3,007,365. **JL AND DESIGN**. J. LINDBERG AB, (U.S. CLS. 21, 23, 26, 36 AND 38). SN 78-371,197. PUB. 7-26-2005. FILED 2-20-2004.
- 3,007,383. **HEADTALK (BLOCK FORM)**. SMITHKLINE BEECHAM CORPORATION, MULTIPLE CLASS, (INT. CLS. 9, 16 AND 44), (U.S. CLS. 2, 5, 21, 22, 23, 26, 29, 36, 37, 38, 50, 100 AND 101). SN 78-381,459. PUB. 6-7-2005. FILED 3-10-2004.
- 3,007,408. **PREMIER ATM (BLOCK FORM)**. BANCARD USA, LLC, (U.S. CLS. 21, 23, 26, 36 AND 38). SN 78-396,853. PUB. 7-26-2005. FILED 4-6-2004.
- 3,007,415. **MSRB AND DESIGN**. MUNICIPAL SECURITIES RULEMAKING BOARD, MULTIPLE CLASS, (INT. CLS. 9, 16, 36 AND 42), (U.S. CLS. 2, 5, 21, 22, 23, 26, 29, 36, 37, 38, 50, 100, 101 AND 102). SN 78-402,124. PUB. 7-26-2005. FILED 4-15-2004.
- 3,007,423. **PSA (BLOCK FORM)**. PROFESSIONAL SECURITY ALLIANCE, INC., DBA PSA SECURITY NETWORK, MULTIPLE CLASS, (INT. CLS. 9, 35 AND 41), (U.S. CLS. 21, 23, 26, 36, 38, 100, 101, 102 AND 107). SN 78-405,966. PUB. 7-26-2005. FILED 4-21-2004.
- 3,007,428. **UPPER ROOM MINISTRIES (BLOCK FORM)**. THE UPPER ROOM, MULTIPLE CLASS, (INT. CLS. 9, 35, 38 AND 45), (U.S. CLS. 21, 23, 26, 36, 38, 100, 101, 102 AND 104). SN 78-408,574. PUB. 7-26-2005. FILED 4-27-2004.
- 3,007,447. **SEATBELTMASTERS (STYLIZED)**. BROWN, ROBERT N., (U.S. CLS. 21, 23, 26, 36 AND 38). SN 78-416,822. PUB. 7-26-2005. FILED 5-11-2004.
- 3,007,486. **SERIES HSL (BLOCK FORM)**. HOLLYWOOD SOUND LABS, INC., (U.S. CLS. 21, 23, 26, 36 AND 38). SN 78-435,723. PUB. 7-26-2005. FILED 6-15-2004.
- 3,007,507. **BLACK BELT IN A BOX (BLOCK FORM)**. GAMBORDELLA, TED, (U.S. CLS. 21, 23, 26, 36 AND 38). SN 78-443,467. PUB. 7-26-2005. FILED 6-29-2004.
- 3,007,514. **RIVERCAD (BLOCK FORM)**. BOSS INTERNATIONAL, (U.S. CLS. 21, 23, 26, 36 AND 38). SN 78-444,884.

PUB. 7-26-2005. FILED 7-1-2004.
 3,007,518. **DOUBLE DECKER (BLOCK FORM)**. DE NORA ELETTRODI S.P.A., (U.S. CLS. 21, 23, 26, 36 AND 38). SN 78-449,211. PUB. 7-26-2005. FILED 7-12-2004.
 3,007,521. **CORTRAC (BLOCK FORM)**. OPEN SOURCE GROUP, INC., (U.S. CLS. 21, 23, 26, 36 AND 38). SN 78-453,333. PUB. 7-26-2005. FILED 7-20-2004.
 3,007,522. **APPLYING TECHNOLOGIES, INSPIRING SOLUTIONS (BLOCK FORM)**. APPTIS HOLDINGS, INC., MULTIPLE CLASS, (INT. CLS. 9 AND 16), (U.S. CLS. 2, 5, 21, 22, 23, 26, 29, 36, 37, 38 AND 50). SN 78-456,225. PUB. 7-26-2005. FILED 7-25-2004.
 3,007,524. **MISCELLANEOUS DESIGN**. EZRAD.COM, INC., (U.S. CLS. 21, 23, 26, 36 AND 38). SN 78-461,588. PUB. 6-28-2005. FILED 8-4-2004.
 3,007,525. **AUTO WORKUP (BLOCK FORM)**. ESPEED, INC., MULTIPLE CLASS, (INT. CLS. 9 AND 36), (U.S. CLS. 21, 23, 26, 36, 38, 100, 101 AND 102). SN 78-463,151. PUB. 7-26-2005. FILED 8-6-2004.
 3,007,530. **IFIT (BLOCK FORM)**. UV SALES, INC., (U.S. CLS. 21, 23, 26, 36 AND 38). SN 78-465,864. PUB. 7-26-2005. FILED 8-11-2004.
 3,007,556 (*See Class 3 for this trademark*).
 3,007,561. **LYRUS (STYLIZED)**. EXTRAORDINARY TECHNOLOGY (HI-FI) PTY LTD, (U.S. CLS. 21, 23, 26, 36 AND 38). SN 79-003,507. PUB. 7-26-2005. FILED 3-11-2004.

CLASS 10—MEDICAL APPARATUS

3,006,793. **MULTI-DOSE**. GENESIS INDUSTRIES INCORPORATED, (U.S. CLS. 26, 39 AND 44). SN 76-008,683. PUB. 11-5-2002. FILED 3-24-2000.
 3,006,802. **TWINVIEW**. KABUSHIKI KAISHA TOSHIBA, TA TOSHIBA CORPORATION, (U.S. CLS. 26, 39 AND 44). SN 76-138,582. PUB. 7-26-2005. FILED 9-29-2000.
 3,006,803. **PIEZOSURGERY AND DESIGN**. VERCELLOTTI, TOMASO, (U.S. CLS. 26, 39 AND 44). SN 76-149,906. PUB. 7-26-2005. FILED 10-19-2000.
 3,006,807 (*See Class 5 for this trademark*).
 3,006,917 (*See Class 9 for this trademark*).
 3,006,918 (*See Class 9 for this trademark*).
 3,006,943 (*See Class 9 for this trademark*).
 3,006,971 (*See Class 5 for this trademark*).
 3,007,133. **LIGHTWANDZ (BLOCK FORM)**. LIGHTWANDZ INTERNATIONAL, INC., (U.S. CLS. 26, 39 AND 44). SN 76-596,131. PUB. 7-26-2005. FILED 6-8-2004.
 3,007,154. **SUPERMAX (STYLIZED)**. SUPERMAX, INC., (U.S. CLS. 26, 39 AND 44). SN 76-601,830. PUB. 7-26-2005. FILED 7-9-2004.
 3,007,224 (*See Class 3 for this trademark*).
 3,007,262. **KORE KOOLER (BLOCK FORM)**. MCBRIDE, PETER, (U.S. CLS. 26, 39 AND 44). SN 78-317,221. PUB. 7-26-2005. FILED 10-22-2003.
 3,007,289 (*See Class 9 for this trademark*).
 3,007,395. **MISCELLANEOUS DESIGN**. GENAISSANCE PHARMACEUTICALS, INC., MULTIPLE CLASS, (INT. CLS. 10 AND 44), (U.S. CLS. 26, 39, 44, 100 AND 101). SN 78-389,151. PUB. 6-7-2005. FILED 3-23-2004.
 3,007,533. **PEPPY FEET (BLOCK FORM)**. ANGEL SALES, INC., (U.S. CLS. 26, 39 AND 44). SN 78-521,138. PUB. 7-5-2005. FILED 11-22-2004.
 3,007,551. **CORTRONIK (STYLIZED)**. BIOTRONIK GMBH & CO. KG, (U.S. CLS. 26, 39 AND 44). SN 79-001,197. PUB. 7-26-2005. FILED 1-9-2004.

CLASS 11—ENVIRONMENTAL CONTROL APPARATUS

3,006,785. **AGRI-COOL**. ORCHARD-RITE LTD., (U.S. CLS. 13, 21, 23, 31 AND 34). SN 75-731,241. PUB. 7-26-2005. FILED 6-17-1999.
 3,006,804. **ERCO R101**. SUPERIOR PLUS INC., MULTIPLE CLASS, (INT. CLS. 11, 35, 37 AND 42), (U.S. CLS. 13, 21, 23,

31, 34, 100, 101, 102, 103 AND 106). SN 76-167,403. PUB. 7-26-2005. FILED 11-17-2000.
 3,006,861 (*See Class 1 for this trademark*).
 3,006,891 (*See Class 3 for this trademark*).
 3,006,908. **HYDRO-JET**. HYDRO INTERNATIONAL PLC, (U.S. CLS. 13, 21, 23, 31 AND 34). SN 76-523,200. PUB. 3-29-2005. FILED 6-6-2003.
 3,006,937. **BIDAN**. GALIL IMPORTING CORP., DBA BIDAN CO., (U.S. CLS. 13, 21, 23, 31 AND 34). SN 76-543,928. PUB. 7-26-2005. FILED 8-29-2003.
 3,006,957. **TV GUIDE AND DESIGN**. TV GUIDE MAGAZINE GROUP, INC., MULTIPLE CLASS, (INT. CLS. 11, 16, 18, 25, 28, 35, 38 AND 41), (U.S. CLS. 1, 2, 3, 5, 13, 21, 22, 23, 29, 31, 34, 37, 38, 39, 41, 50, 100, 101, 102, 104 AND 107). SN 76-553,315. PUB. 7-26-2005. FILED 10-22-2003.
 3,006,992. **COOL-BREEZE (BLOCK FORM)**. COLLINS INTERNATIONAL CO., LTD., (U.S. CLS. 13, 21, 23, 31 AND 34). SN 76-562,249. PUB. 7-26-2005. FILED 11-28-2003.
 3,007,093. **GRILL-O-SHEET AND DESIGN**. VIGIRODA PRODUCTS LLC, (U.S. CLS. 13, 21, 23, 31 AND 34). SN 76-587,876. PUB. 7-26-2005. FILED 4-21-2004.
 3,007,108. **TECHMOUNT (BLOCK FORM)**. HNI TECHNOLOGIES INC., (U.S. CLS. 13, 21, 23, 31 AND 34). SN 76-590,018. PUB. 7-26-2005. FILED 5-3-2004.
 3,007,189. **COMBIMAX**. MAAX CANADA, INC., (U.S. CLS. 13, 21, 23, 31 AND 34). SN 78-213,712. PUB. 7-26-2005. FILED 2-12-2003.
 3,007,193 (*See Class 4 for this trademark*).
 3,007,194 (*See Class 1 for this trademark*).
 3,007,226. **HUPPE**. HUEPPE GMBH & CO., OHG, (U.S. CLS. 13, 21, 23, 31 AND 34). SN 78-280,291. PUB. 7-26-2005. FILED 7-29-2003.
 3,007,332 (*See Class 7 for this trademark*).
 3,007,336. **ULTRA STAR (BLOCK FORM)**. GENERAL ELECTRIC COMPANY, (U.S. CLS. 13, 21, 23, 31 AND 34). SN 78-356,632. PUB. 7-26-2005. FILED 1-23-2004.
 3,007,394. **ODOR OXIDIZER PROFESSIONAL BY AMTROL AND DESIGN**. AMTROL, INC., (U.S. CLS. 13, 21, 23, 31 AND 34). SN 78-388,440. PUB. 7-26-2005. FILED 3-22-2004.
 3,007,508. **CERAMIC SAVOR PLATES (BLOCK FORM)**. GRAND HALL ENTERPRISE CO., LTD., (U.S. CLS. 13, 21, 23, 31 AND 34). SN 78-443,494. PUB. 7-5-2005. FILED 6-30-2004.
 3,007,544. **SCANDINAVIAN LIGHT HOLMEGAARD AND DESIGN**. HOLMEGAARD A/S, (U.S. CLS. 13, 21, 23, 31 AND 34). SN 79-000,705. PUB. 7-26-2005. FILED 12-11-2003.

CLASS 12—VEHICLES

3,006,813 (*See Class 6 for this trademark*).
 3,006,822 (*See Class 9 for this trademark*).
 3,006,839. **DI**. HP-CHEMIE PELZER GMBH, MULTIPLE CLASS, (INT. CLS. 12, 17 AND 27), (U.S. CLS. 1, 5, 12, 13, 19, 20, 21, 23, 31, 35, 37, 42, 44 AND 50). SN 76-394,830. PUB. 7-29-2003. FILED 4-12-2002.
 3,006,862. **TRUMPF AND DESIGN**. TRUMPF GMBH & CO. KG, MULTIPLE CLASS, (INT. CLS. 12, 35, 40 AND 42), (U.S. CLS. 19, 21, 23, 31, 35, 44, 100, 101, 102, 103 AND 106). SN 76-470,631. PUB. 7-26-2005. FILED 11-29-2002.
 3,006,869 (*See Class 9 for this trademark*).
 3,006,891 (*See Class 3 for this trademark*).
 3,006,904 (*See Class 6 for this trademark*).
 3,006,929 (*See Class 9 for this trademark*).
 3,006,947. **CLE-CLASS**. DAIMLERCHRYSLER AG, MULTIPLE CLASS, (INT. CLS. 12, 28 AND 37), (U.S. CLS. 19, 21, 22, 23, 31, 35, 38, 44, 50, 100, 103 AND 106). SN 76-549,069. PUB. 7-26-2005. FILED 10-6-2003.
 3,006,981. **IO AND DESIGN**. WAVECREST LABS LLC, (U.S. CLS. 19, 21, 23, 31, 35 AND 44). SN 76-558,393. PUB. 7-26-2005. FILED 11-7-2003.
 3,007,053. **DIRT WORKS AND DESIGN**. KOLPIN POWERSPORTS, INC., (U.S. CLS. 19, 21, 23, 31, 35 AND 44). SN 76-577,823. PUB. 7-26-2005. FILED 2-23-2004.
 3,007,143. **5-LINK 2 (BLOCK FORM)**. STEEDA AUTOSPORTS, INC., (U.S. CLS. 19, 21, 23, 31, 35 AND 44). SN 76-597,465. PUB. 7-26-2005. FILED 6-14-2004.

- 3,007,200. **STICKY SHADE**. AMERICAN COVERS, INC., (U.S. CLS. 19, 21, 23, 31, 35 AND 44). SN 78-231,560. PUB. 7-26-2005. FILED 3-28-2003.
- 3,007,294. **PORSCHE BIKE FS (BLOCK FORM)**. ING. H.C. F. PORSCHE AG, DR., (U.S. CLS. 19, 21, 23, 31, 35 AND 44). SN 78-334,415. PUB. 7-26-2005. FILED 12-1-2003.
- 3,007,300. **BLUE BIRD AND DESIGN**. BLUE BIRD INVESTMENT CORPORATION, (U.S. CLS. 19, 21, 23, 31, 35 AND 44). SN 78-337,636. PUB. 7-26-2005. FILED 12-8-2003.
- 3,007,305 (*See Class 3 for this trademark*).
- 3,007,434. **TEXCON (BLOCK FORM)**. TEXCON, INC., (U.S. CLS. 19, 21, 23, 31, 35 AND 44). SN 78-412,402. PUB. 7-26-2005. FILED 5-3-2004.
- 3,007,499. **DAVY CROCKETT (BLOCK FORM)**. GERONIMO PRODUCTIONS, INC., (U.S. CLS. 19, 21, 23, 31, 35 AND 44). SN 78-438,113. PUB. 7-26-2005. FILED 6-19-2004.
- 3,007,501. **VELUX (BLOCK FORM)**. SOLO, MATHU, (U.S. CLS. 19, 21, 23, 31, 35 AND 44). SN 78-438,247. PUB. 6-7-2005. FILED 6-20-2004.
- 3,007,535. **MOTO 13 AND DESIGN**. MORMAR, MARK J., (U.S. CLS. 19, 21, 23, 31, 35 AND 44). SN 78-975,412. PUB. 7-26-2005. FILED 7-5-2003.
- 3,007,549. **PLAY BOX (BLOCK FORM)**. DECATHLON, MULTIPLE CLASS, (INT. CLS. 12, 18 AND 20), (U.S. CLS. 1, 2, 3, 13, 19, 21, 22, 23, 25, 31, 32, 35, 41, 44 AND 50). SN 79-001,000. PUB. 7-26-2005. FILED 11-14-2003.
- 3,007,550. **SOLIDEAL UA SYSTEM (STYLIZED)**. SOLIDEAL HOLDING S.A., (U.S. CLS. 19, 21, 23, 31, 35 AND 44). SN 79-001,093. PUB. 7-26-2005. FILED 11-20-2003.

CLASS 13—FIREARMS

- 3,006,848 (*See Class 3 for this trademark*).
- 3,006,959. **NICAP AND DESIGN**. NICO-PYROTECHNIK HANNS-JUERGEN DIEDERICHS GMBH & CO., KG, (U.S. CLS. 2 AND 9). SN 76-554,052. PUB. 7-26-2005. FILED 10-24-2003.
- 3,007,068. **TERRORIST TRAP (STYLIZED)**. HOMELAND SECURITY STRATEGIES, INC., (U.S. CLS. 2 AND 9). SN 76-581,260. PUB. 7-26-2005. FILED 3-15-2004.
- 3,007,457. **ZINGERS (BLOCK FORM)**. MMM, INC., (U.S. CLS. 2 AND 9). SN 78-421,645. PUB. 7-26-2005. FILED 5-19-2004.

CLASS 14—JEWELRY

- 3,006,779. **TANK**. CARTIER INTERNATIONAL B.V., (U.S. CLS. 2, 27, 28 AND 50). SN 75-273,682. PUB. 7-26-2005. FILED 4-14-1997.
- 3,006,792 (*See Class 6 for this trademark*).
- 3,006,806 (*See Class 3 for this trademark*).
- 3,006,847 (*See Class 9 for this trademark*).
- 3,006,871. **CATHERINES**. CATHERINES OF CALIFORNIA, INC., MULTIPLE CLASS, (INT. CLS. 14 AND 25), (U.S. CLS. 2, 22, 27, 28, 39 AND 50). SN 76-489,579. PUB. 7-26-2005. FILED 2-14-2003.
- 3,006,891 (*See Class 3 for this trademark*).
- 3,006,894. **SCATOLA DEL TEMPO -THE FIRST, THE ONLY, THE ORIGINAL ONE**. S.C.S. & CO.S.R.L., MULTIPLE CLASS, (INT. CLS. 14 AND 18), (U.S. CLS. 1, 2, 3, 22, 27, 28, 41 AND 50). SN 76-514,098. PUB. 7-26-2005. FILED 5-13-2003.
- 3,006,907. **MISCELLANEOUS DESIGN**. ANCIENT MODERN ART, LLC, (U.S. CLS. 2, 27, 28 AND 50). SN 76-522,319. PUB. 5-31-2005. FILED 6-4-2003.
- 3,006,929 (*See Class 9 for this trademark*).
- 3,006,941. **TB TREASURE BAY DESIGNS AND DESIGN**. BAYBUTT, THERESA NEHMER, MULTIPLE CLASS, (INT. CLS. 14 AND 16), (U.S. CLS. 2, 5, 22, 23, 27, 28, 29, 37, 38 AND 50). SN 76-545,388. PUB. 7-26-2005. FILED 9-4-2003.
- 3,006,948. **FARAHBEAN**. FARAHBEAN, LLC, (U.S. CLS. 2, 27, 28 AND 50). SN 76-549,753. PUB. 7-26-2005. FILED 9-30-2003.
- 3,006,994 (*See Class 3 for this trademark*).

- 3,007,117. **K&G (BLOCK FORM)**. JEWELNET CORPORATION, (U.S. CLS. 2, 27, 28 AND 50). SN 76-592,050. PUB. 4-5-2005. FILED 5-13-2004.
- 3,007,155. **MISCELLANEOUS DESIGN**. CHARITY CHARMS, L.L.C., (U.S. CLS. 2, 27, 28 AND 50). SN 76-601,956. PUB. 7-26-2005. FILED 7-1-2004.
- 3,007,164 (*See Class 9 for this trademark*).
- 3,007,174. **AMERICAN**. AMERICAN TIME & SIGNAL CO., (U.S. CLS. 2, 27, 28 AND 50). SN 78-124,930. PUB. 7-26-2005. FILED 4-29-2002.
- 3,007,178. **ANGELE BATIST PARIS AND DESIGN**. CARMEN, COLLE, MULTIPLE CLASS, (INT. CLS. 14, 18 AND 25), (U.S. CLS. 1, 2, 3, 22, 27, 28, 39, 41 AND 50). SN 78-175,053. PUB. 7-26-2005. FILED 10-16-2002.
- 3,007,193 (*See Class 4 for this trademark*).
- 3,007,220. **BAD COMPANY RODEO AND DESIGN**. BAD COMPANY RODEO, INC., MULTIPLE CLASS, (INT. CLS. 14, 25, 28, 35 AND 41), (U.S. CLS. 2, 22, 23, 27, 28, 38, 39, 50, 100, 101, 102 AND 107). SN 78-276,866. PUB. 7-26-2005. FILED 7-21-2003.
- 3,007,305 (*See Class 3 for this trademark*).
- 3,007,479. **CHARACTERED AND DESIGN**. THE PROPHET CORPORATION, MULTIPLE CLASS, (INT. CLS. 14, 16 AND 28), (U.S. CLS. 2, 5, 22, 23, 27, 28, 29, 37, 38 AND 50). SN 78-432,466. PUB. 7-26-2005. FILED 6-9-2004.
- 3,007,543. **RESONANCE (BLOCK FORM)**. FRANÇOIS-PAUL JOURNE, (U.S. CLS. 2, 27, 28 AND 50). SN 79-000,617. PUB. 4-5-2005. FILED 12-2-2003.
- 3,007,553. **MISCELLANEOUS DESIGN**. COCOS ISLAND OKINAWA CORPORATION, (U.S. CLS. 2, 27, 28 AND 50). SN 79-001,292. PUB. 7-26-2005. FILED 12-26-2003.
- 3,007,556 (*See Class 3 for this trademark*).
- 3,007,562. **MISCELLANEOUS DESIGN**. BNP PARIBAS, MULTIPLE CLASS, (INT. CLS. 14, 16, 18 AND 25), (U.S. CLS. 1, 2, 3, 5, 22, 23, 27, 28, 29, 37, 38, 39, 41 AND 50). SN 79-003,643. PUB. 4-5-2005. FILED 2-16-2004.

CLASS 15—MUSICAL INSTRUMENTS

- 3,006,891 (*See Class 3 for this trademark*).
- 3,007,043. **VALDESTA (BLOCK FORM)**. DENNIS BAMBER, INC., (U.S. CLS. 2, 21 AND 36). SN 76-574,741. PUB. 7-26-2005. FILED 2-6-2004.
- 3,007,193 (*See Class 4 for this trademark*).

CLASS 16—PAPER GOODS AND PRINTED MATTER

- 3,006,790 (*See Class 9 for this trademark*).
- 3,006,791 (*See Class 9 for this trademark*).
- 3,006,812. **DEUTSCHE POST WORLD NET MAIL EXPRESS LOGISTICS FINANCE AND DESIGN**. DEUTSCHE POST AG, MULTIPLE CLASS, (INT. CLS. 16, 35 AND 36), (U.S. CLS. 2, 5, 22, 23, 29, 37, 38, 50, 100, 101 AND 102). SN 76-211,620. PUB. 7-26-2005. FILED 2-20-2001.
- 3,006,826. **MISCELLANEOUS DESIGN**. ASTRAZENACA AB, (U.S. CLS. 2, 5, 22, 23, 29, 37, 38 AND 50). SN 76-337,515. PUB. 7-26-2005. FILED 11-13-2001.
- 3,006,828. **HI AND DESIGN**. EXPOCONSULT B.V., MULTIPLE CLASS, (INT. CLS. 16, 35 AND 41), (U.S. CLS. 2, 5, 22, 23, 29, 37, 38, 50, 100, 101, 102 AND 107). SN 76-342,366. PUB. 7-26-2005. FILED 11-26-2001.
- 3,006,832. **MISCELLANEOUS DESIGN**. PHILIPPE COUSTEAU FOUNDATION, MULTIPLE CLASS, (INT. CLS. 16, 25 AND 35), (U.S. CLS. 2, 5, 22, 23, 29, 37, 38, 39, 50, 100, 101 AND 102). SN 76-363,125. PUB. 7-26-2005. FILED 1-25-2002.
- 3,006,848 (*See Class 3 for this trademark*).
- 3,006,869 (*See Class 9 for this trademark*).
- 3,006,874 (*See Class 6 for this trademark*).
- 3,006,886. **STEM GLASS SLIPPERS AND DESIGN**. EPIC PRODUCTS, INC., (U.S. CLS. 2, 5, 22, 23, 29, 37, 38 AND 50). SN 76-509,024. PUB. 7-26-2005. FILED 4-23-2003.
- 3,006,888 (*See Class 9 for this trademark*).

- 3,006,891 (*See Class 3 for this trademark.*)
 3,006,897 (*See Class 9 for this trademark.*)
 3,006,900 (*See Class 9 for this trademark.*)
 3,006,911. **PHI SIGMA RHO AND DESIGN.** PHI SIGMA RHO NATIONAL SORORITY, INC., MULTIPLE CLASS, (INT. CLS. 16, 25 AND 35), (U.S. CLS. 2, 5, 22, 23, 29, 37, 38, 39, 50, 100, 101 AND 102). SN 76-525,571. PUB. 7-26-2005. FILED 6-26-2003.
 3,006,928. **NACS SOL.** NATIONAL ASSOCIATION OF CONVENIENCE STORES, (U.S. CLS. 2, 5, 22, 23, 29, 37, 38 AND 50). SN 76-537,591. PUB. 7-26-2005. FILED 8-14-2003.
 3,006,929 (*See Class 9 for this trademark.*)
 3,006,941 (*See Class 14 for this trademark.*)
 3,006,953. **MEMORIES BOARDS.** VANDOR CORPORATION, (U.S. CLS. 2, 5, 22, 23, 29, 37, 38 AND 50). SN 76-552,190. PUB. 7-26-2005. FILED 10-17-2003.
 3,006,957 (*See Class 11 for this trademark.*)
 3,006,964. **UNIVERSITY OF NEBRASKA (STYLIZED).** THE BOARD OF REGENTS OF THE UNIVERSITY OF NEBRASKA, MULTIPLE CLASS, (INT. CLS. 16, 25 AND 41), (U.S. CLS. 2, 5, 22, 23, 29, 37, 38, 39, 50, 100, 101 AND 107). SN 76-555,063. PUB. 7-26-2005. FILED 10-15-2003.
 3,006,971 (*See Class 5 for this trademark.*)
 3,007,003 (*See Class 3 for this trademark.*)
 3,007,023. **WEBCAMPUS (STYLIZED).** DEUTSCHE TELEKOM AG, (U.S. CLS. 2, 5, 22, 23, 29, 37, 38 AND 50). SN 76-568,410. PUB. 7-26-2005. FILED 12-22-2003.
 3,007,024. **THEATRE BAY AREA (BLOCK FORM).** THEATRE BAY AREA, (U.S. CLS. 2, 5, 22, 23, 29, 37, 38 AND 50). SN 76-568,575. PUB. 7-26-2005. FILED 1-7-2004.
 3,007,037. **TOBY GLOBY THANKS PLEASE RECYCLE SODA AND DESIGN.** ALMARAZ, HUMBERTO, (U.S. CLS. 2, 5, 22, 23, 29, 37, 38 AND 50). SN 76-572,008. PUB. 7-26-2005. FILED 1-21-2004.
 3,007,041. **AKO HOSPITAL CONSTRUCTION NEWSLETTER (BLOCK FORM).** ANDERSON KILL & OLICK, P.C., (U.S. CLS. 2, 5, 22, 23, 29, 37, 38 AND 50). SN 76-573,348. PUB. 7-26-2005. FILED 2-2-2004.
 3,007,051. **CAROUSEL OF LEGENDS 2003 AND DESIGN.** GEORGE, CHRISTINE, MULTIPLE CLASS, (INT. CLS. 16, 28 AND 41), (U.S. CLS. 2, 5, 22, 23, 29, 37, 38, 50, 100, 101 AND 107). SN 76-576,943. PUB. 7-26-2005. FILED 1-21-2004.
 3,007,060 (*See Class 9 for this trademark.*)
 3,007,074. **FOUNDATIONS FOR LIVING STUDIES IN THE CHRISTIAN WORLDVIEW (BLOCK FORM).** ALPHA OMEGA PUBLICATIONS, INC., (U.S. CLS. 2, 5, 22, 23, 29, 37, 38 AND 50). SN 76-583,150. PUB. 7-26-2005. FILED 3-26-2004.
 3,007,102. **BANKRUPTCY INSIDER (STYLIZED).** THE DEAL, LLC, MULTIPLE CLASS, (INT. CLS. 16, 36 AND 41), (U.S. CLS. 2, 5, 22, 23, 29, 37, 38, 50, 100, 101, 102 AND 107). SN 76-589,307. PUB. 7-26-2005. FILED 4-29-2004.
 3,007,123. **OSI (STYLIZED).** OPEN SOCIETY INSTITUTE, MULTIPLE CLASS, (INT. CLS. 16, 35, 36, 38 AND 41), (U.S. CLS. 2, 5, 22, 23, 29, 37, 38, 50, 100, 101, 102, 104 AND 107). SN 76-593,382. PUB. 7-26-2005. FILED 5-21-2004.
 3,007,157. **RAP UP (BLOCK FORM).** FLORIDA FRUIT & VEGETABLE ASSOCIATION, (U.S. CLS. 2, 5, 22, 23, 29, 37, 38 AND 50). SN 76-602,334. PUB. 7-26-2005. FILED 7-14-2004.
 3,007,175. **ANDBANC GRUP AGRICOL REIG.** ANDORRA BANC AGRICOL REIG, S.A., MULTIPLE CLASS, (INT. CLS. 16, 35, 36, 38 AND 41), (U.S. CLS. 2, 5, 22, 23, 29, 37, 38, 50, 100, 101, 102, 104 AND 107). SN 78-135,911. PUB. 7-26-2005. FILED 6-14-2002.
 3,007,185. **LIST ORGANIZER AND DESIGN.** PARKER, KAREN L., (U.S. CLS. 2, 5, 22, 23, 29, 37, 38 AND 50). SN 78-205,067. PUB. 7-26-2005. FILED 1-20-2003.
 3,007,193 (*See Class 4 for this trademark.*)
 3,007,194 (*See Class 1 for this trademark.*)
 3,007,212 (*See Class 3 for this trademark.*)
 3,007,215 (*See Class 9 for this trademark.*)
 3,007,231 (*See Class 9 for this trademark.*)
 3,007,232. **MORE.** ECOLAB INC., MULTIPLE CLASS, (INT. CLS. 16 AND 45), (U.S. CLS. 2, 5, 22, 23, 29, 37, 38, 50, 100 AND 101). SN 78-286,767. PUB. 7-26-2005. FILED 8-13-2003.
 3,007,240. **T DSL AND DESIGN.** DEUTSCHE TELEKOM AG, (U.S. CLS. 2, 5, 22, 23, 29, 37, 38 AND 50). SN 78-298,685. PUB. 7-26-2005. FILED 9-10-2003.
 3,007,281. **AD MAJOREM DEI GLORIAM LOYOLA UNIVERSITY CHICAGO 1870 AND DESIGN.** LOYOLA UNIVERSITY OF CHICAGO, (U.S. CLS. 2, 5, 22, 23, 29, 37, 38 AND 50). SN 78-327,210. PUB. 7-26-2005. FILED 11-13-2003.
 3,007,304 (*See Class 9 for this trademark.*)
 3,007,305 (*See Class 3 for this trademark.*)
 3,007,341 (*See Class 9 for this trademark.*)
 3,007,349. **PUTTING SMILES ON FACES (BLOCK FORM).** LIVE IN LOVE, INC., (U.S. CLS. 2, 5, 22, 23, 29, 37, 38 AND 50). SN 78-363,520. PUB. 6-7-2005. FILED 2-5-2004.
 3,007,382. **RELIGIONS FOR PEACE (BLOCK FORM).** WORLD CONFERENCE OF RELIGIONS FOR PEACE, INC., MULTIPLE CLASS, (INT. CLS. 16, 35, 36, 41, 42, 43 AND 44), (U.S. CLS. 2, 5, 22, 23, 29, 37, 38, 50, 100, 101, 102 AND 107). SN 78-380,975. PUB. 7-26-2005. FILED 3-9-2004.
 3,007,383 (*See Class 9 for this trademark.*)
 3,007,409. **POLICEFLEET MANAGER AND DESIGN.** HENDON PUBLISHING CO., MULTIPLE CLASS, (INT. CLS. 16 AND 41), (U.S. CLS. 2, 5, 22, 23, 29, 37, 38, 50, 100, 101 AND 107). SN 78-397,937. PUB. 7-5-2005. FILED 4-7-2004.
 3,007,410. **FULLY EQUIPPED (BLOCK FORM).** INTERNATIONAL DATA GROUP, INC., MULTIPLE CLASS, (INT. CLS. 16 AND 41), (U.S. CLS. 2, 5, 22, 23, 29, 37, 38, 50, 100, 101 AND 107). SN 78-398,473. PUB. 7-26-2005. FILED 4-8-2004.
 3,007,415 (*See Class 9 for this trademark.*)
 3,007,442. **NUTRAMINDER (BLOCK FORM).** SICKERT, WILLIAM R., (U.S. CLS. 2, 5, 22, 23, 29, 37, 38 AND 50). SN 78-414,894. PUB. 7-5-2005. FILED 5-7-2004.
 3,007,443. **HEY, MUSCLE GUY! (BLOCK FORM).** RODALE INC., MULTIPLE CLASS, (INT. CLS. 16 AND 41), (U.S. CLS. 2, 5, 22, 23, 29, 37, 38, 50, 100, 101 AND 107). SN 78-415,128. PUB. 7-26-2005. FILED 5-7-2004.
 3,007,465. **GRAN PLAN DE AEROMEXICO (BLOCK FORM).** AEROVIAS DE MEXICO, S.A. DE C.V., (U.S. CLS. 2, 5, 22, 23, 29, 37, 38 AND 50). SN 78-424,901. PUB. 7-26-2005. FILED 5-25-2004.
 3,007,470. **HAIRY BEARY (BLOCK FORM).** HAIRY BEARY U.S.A., LLC, (U.S. CLS. 2, 5, 22, 23, 29, 37, 38 AND 50). SN 78-427,400. PUB. 7-26-2005. FILED 5-29-2004.
 3,007,473. **SELECT-A-SIZE (BLOCK FORM).** THE PROCTER & GAMBLE COMPANY, (U.S. CLS. 2, 5, 22, 23, 29, 37, 38 AND 50). SN 78-429,144. PUB. 4-5-2005. FILED 6-3-2004.
 3,007,479 (*See Class 14 for this trademark.*)
 3,007,492. **RALPH WALDO EMERSON (BLOCK FORM).** CREATIVE CHARACTERS, INC., (U.S. CLS. 2, 5, 22, 23, 29, 37, 38 AND 50). SN 78-437,058. PUB. 7-26-2005. FILED 6-17-2004.
 3,007,493. **OSCAR WILDE (BLOCK FORM).** CREATIVE CHARACTERS, INC., (U.S. CLS. 2, 5, 22, 23, 29, 37, 38 AND 50). SN 78-437,432. PUB. 7-26-2005. FILED 6-17-2004.
 3,007,503. **B2 100 (BLOCK FORM).** BUSINESS 2.0 MEDIA INC., (U.S. CLS. 2, 5, 22, 23, 29, 37, 38 AND 50). SN 78-441,436. PUB. 7-26-2005. FILED 6-25-2004.
 3,007,522 (*See Class 9 for this trademark.*)
 3,007,562 (*See Class 14 for this trademark.*)
-
- CLASS 17—RUBBER GOODS**
- 3,006,839 (*See Class 12 for this trademark.*)
 3,006,842. **FLEX-TECH.** FLEX-TECH HOSE & TUBING, INC., (U.S. CLS. 1, 5, 12, 13, 35 AND 50). SN 76-413,981. PUB. 7-26-2005. FILED 5-24-2002.
 3,006,974 (*See Class 6 for this trademark.*)
 3,006,975 (*See Class 6 for this trademark.*)
 3,006,999. **THERMALSEAL (BLOCK FORM).** EXCEL SCIENTIFIC, INC., (U.S. CLS. 1, 5, 12, 13, 35 AND 50). SN 76-563,788. PUB. 7-26-2005. FILED 12-8-2003.
 3,007,055 (*See Class 1 for this trademark.*)
 3,007,056 (*See Class 1 for this trademark.*)
 3,007,063. **EAGLE AUTO PRESERVE (STYLIZED).** PRO TECT ASSOCIATES, INC., (U.S. CLS. 1, 5, 12, 13, 35 AND 50). SN 76-580,497. PUB. 7-26-2005. FILED 3-8-2004.
 3,007,259 (*See Class 1 for this trademark.*)
 3,007,332 (*See Class 7 for this trademark.*)
 3,007,449. **IZOBEST (STYLIZED).** PRODUITS POUR TOITURES FRANSYL LTEE, (U.S. CLS. 1, 5, 12, 13, 35 AND 50).

SN 78-418,155. PUB. 7-26-2005. FILED 5-13-2004.

CLASS 18—LEATHER GOODS

3,006,806 (*See Class 3 for this trademark.*)
 3,006,848 (*See Class 3 for this trademark.*)
 3,006,869 (*See Class 9 for this trademark.*)
 3,006,891 (*See Class 3 for this trademark.*)
 3,006,892 (*See Class 9 for this trademark.*)
 3,006,894 (*See Class 14 for this trademark.*)
 3,006,927. **DENNYA (STYLIZED)**. DENNYA COMPANY LLC, (U.S. CLS. 1, 2, 3, 22 AND 41). SN 76-537,082. PUB. 7-26-2005. FILED 8-11-2003.
 3,006,929 (*See Class 9 for this trademark.*)
 3,006,957 (*See Class 11 for this trademark.*)
 3,007,178 (*See Class 14 for this trademark.*)
 3,007,193 (*See Class 4 for this trademark.*)
 3,007,224 (*See Class 3 for this trademark.*)
 3,007,261. **ELVIS**. ELVIS PRESLEY ENTERPRISES, INC., (U.S. CLS. 1, 2, 3, 22 AND 41). SN 78-316,955. PUB. 7-26-2005. FILED 10-22-2003.
 3,007,305 (*See Class 3 for this trademark.*)
 3,007,417. **E-Z MOUNT (BLOCK FORM)**. J. MITTON & ASSOCIATES, INC., (U.S. CLS. 1, 2, 3, 22 AND 41). SN 78-402,527. PUB. 7-26-2005. FILED 4-15-2004.
 3,007,528. **BAY STUDIO (BLOCK FORM)**. BDSRCO, INC., MULTIPLE CLASS, (INT. CLS. 18 AND 25); (U.S. CLS. 1, 2, 3, 22, 39 AND 41). SN 78-463,671. PUB. 7-26-2005. FILED 8-6-2004.
 3,007,539. **FLEXI-BAKE (BLOCK FORM)**. LURCH AG, MULTIPLE CLASS, (INT. CLS. 18, 21 AND 28); (U.S. CLS. 1, 2, 3, 13, 22, 23, 29, 30, 33, 38, 40, 41 AND 50). SN 79-000,215. PUB. 7-26-2005. FILED 11-7-2003.
 3,007,549 (*See Class 12 for this trademark.*)
 3,007,556 (*See Class 3 for this trademark.*)
 3,007,560. **PERMANENT VACATION (STYLIZED)**. 2 M DESIGN STUDIO, MULTIPLE CLASS, (INT. CLS. 18, 24 AND 25); (U.S. CLS. 1, 2, 3, 22, 39, 41, 42 AND 50). SN 79-002,868. PUB. 7-26-2005. FILED 2-10-2004.
 3,007,562 (*See Class 14 for this trademark.*)

CLASS 19—NON-METALLIC BUILDING MATERIALS

3,006,813 (*See Class 6 for this trademark.*)
 3,006,974 (*See Class 6 for this trademark.*)
 3,006,975 (*See Class 6 for this trademark.*)
 3,007,052. **NAPLES (BLOCK FORM)**. ATLAS BLOCK CO., (U.S. CLS. 1, 12, 33 AND 50). SN 76-577,515. PUB. 7-26-2005. FILED 2-23-2004.
 3,007,055 (*See Class 1 for this trademark.*)
 3,007,056 (*See Class 1 for this trademark.*)
 3,007,259 (*See Class 1 for this trademark.*)
 3,007,267. **S AND DESIGN**. SHAKESPEARE COMPOSITE STRUCTURES LLC, MULTIPLE CLASS, (INT. CLS. 19 AND 21); (U.S. CLS. 1, 2, 12, 13, 23, 29, 30, 33, 40 AND 50). SN 78-321,849. PUB. 7-26-2005. FILED 11-1-2003.
 3,007,397. **GLAS MESH COMPANY, INC. (BLOCK FORM)**. GLAS MESH COMPANY, INC., (U.S. CLS. 1, 12, 33 AND 50). SN 78-391,350. PUB. 7-26-2005. FILED 3-26-2004.

CLASS 20—FURNITURE AND ARTICLES NOT OTHERWISE CLASSIFIED

3,006,791 (*See Class 9 for this trademark.*)
 3,006,806 (*See Class 3 for this trademark.*)
 3,006,813 (*See Class 6 for this trademark.*)
 3,006,848 (*See Class 3 for this trademark.*)
 3,006,867. **NICKNACS**. MOORE, NICK A., (U.S. CLS. 2, 13, 22, 25, 32 AND 50). SN 76-474,712. PUB. 7-26-2005. FILED 12-12-2002.

3,006,874 (*See Class 6 for this trademark.*)
 3,006,891 (*See Class 3 for this trademark.*)
 3,006,896. **STC**. SURFACE TECHNOLOGY CORP. OF VIRGINIA, MULTIPLE CLASS, (INT. CLS. 20 AND 37); (U.S. CLS. 2, 13, 22, 25, 32, 50, 100, 103 AND 106). SN 76-516,253. PUB. 7-26-2005. FILED 5-22-2003.
 3,006,929 (*See Class 9 for this trademark.*)
 3,007,055 (*See Class 1 for this trademark.*)
 3,007,056 (*See Class 1 for this trademark.*)
 3,007,088. **NO-SHOW (STYLIZED)**. SPOON, SUZANNE, (U.S. CLS. 2, 13, 22, 25, 32 AND 50). SN 76-586,857. PUB. 7-26-2005. FILED 4-15-2004.
 3,007,193 (*See Class 4 for this trademark.*)
 3,007,194 (*See Class 1 for this trademark.*)
 3,007,224 (*See Class 3 for this trademark.*)
 3,007,366. **CHILL@HOME (BLOCK FORM)**. B AT HOME, INC., MULTIPLE CLASS, (INT. CLS. 20 AND 24); (U.S. CLS. 2, 13, 22, 25, 32, 42 AND 50). SN 78-371,681. PUB. 7-26-2005. FILED 2-20-2004.
 3,007,369. **SAFETY-BLAST (BLOCK FORM)**. LAYFIELD GROUP LIMITED, (U.S. CLS. 2, 13, 22, 25, 32 AND 50). SN 78-372,591. PUB. 7-26-2005. FILED 2-23-2004.
 3,007,376. **ASPEN DESIGN WORKS (BLOCK FORM)**. ASPEN DESIGN WORKS, LLC, (U.S. CLS. 2, 13, 22, 25, 32 AND 50). SN 78-377,820. PUB. 7-5-2005. FILED 3-3-2004.
 3,007,399. **THE VERC AND DESIGN**. MAHER, SAM, AND ART DE EUROPA, LLC, (U.S. CLS. 2, 13, 22, 25, 32 AND 50). SN 78-392,043. PUB. 7-26-2005. FILED 3-27-2004.
 3,007,405. **SURROUNDU PILLOW (BLOCK FORM)**. GCM, INC., (U.S. CLS. 2, 13, 22, 25, 32 AND 50). SN 78-395,347. PUB. 7-26-2005. FILED 4-2-2004.
 3,007,494. **PAUL BUNYAN (BLOCK FORM)**. PAUL BUNYAN, INC., (U.S. CLS. 2, 13, 22, 25, 32 AND 50). SN 78-437,699. PUB. 7-26-2005. FILED 6-18-2004.
 3,007,500. **DAVY CROCKETT (BLOCK FORM)**. GERONIMO PRODUCTIONS, INC., (U.S. CLS. 2, 13, 22, 25, 32 AND 50). SN 78-438,114. PUB. 7-26-2005. FILED 6-19-2004.
 3,007,510. **COSMIC (BLOCK FORM)**. DYNASTY CONSOLIDATED INDUSTRIES, INC., (U.S. CLS. 2, 13, 22, 25, 32 AND 50). SN 78-444,289. PUB. 7-26-2005. FILED 7-1-2004.
 3,007,511. **OPEN ART (BLOCK FORM)**. TOPSTAR GMBH, (U.S. CLS. 2, 13, 22, 25, 32 AND 50). SN 78-444,326. PUB. 7-26-2005. FILED 7-1-2004.
 3,007,532. **COSMIC VISION (BLOCK FORM)**. DYNASTY CONSOLIDATED INDUSTRIES, INC., (U.S. CLS. 2, 13, 22, 25, 32 AND 50). SN 78-503,486. PUB. 7-26-2005. FILED 10-21-2004.
 3,007,537. **INCHARGE AND DESIGN**. DYNAMO STOL APS, (U.S. CLS. 2, 13, 22, 25, 32 AND 50). SN 79-000,108. PUB. 7-26-2005. FILED 11-4-2003.
 3,007,549 (*See Class 12 for this trademark.*)
 3,007,555. **JEC (STYLIZED)**. JEC, SOCIÉTÉ ANONYME, (U.S. CLS. 2, 13, 22, 25, 32 AND 50). SN 79-001,331. PUB. 7-26-2005. FILED 2-11-2004.

CLASS 21—HOUSEWARES AND GLASS

3,006,806 (*See Class 3 for this trademark.*)
 3,006,848 (*See Class 3 for this trademark.*)
 3,006,851. **ZWIESEL AND DESIGN**. SCHOTT ZWIESEL AG, (U.S. CLS. 2, 13, 23, 29, 30, 33, 40 AND 50). SN 76-448,277. PUB. 7-26-2005. FILED 9-10-2002.
 3,006,874 (*See Class 6 for this trademark.*)
 3,006,883 (*See Class 8 for this trademark.*)
 3,006,891 (*See Class 3 for this trademark.*)
 3,006,905 (*See Class 7 for this trademark.*)
 3,006,929 (*See Class 9 for this trademark.*)
 3,006,995. **BIRD BOTTLE (BLOCK FORM)**. NOVI, JOHN, (U.S. CLS. 2, 13, 23, 29, 30, 33, 40 AND 50). SN 76-562,581. PUB. 7-26-2005. FILED 11-17-2003.
 3,007,087. **ARMINAK & ASSOCIATES (BLOCK FORM)**. ARMINAK & ASSOCIATES, INC., (U.S. CLS. 2, 13, 23, 29, 30, 33, 40 AND 50). SN 76-586,173. PUB. 7-26-2005. FILED 4-12-2004.
 3,007,136. **SECRETS (BLOCK FORM)**. O.C. SECRETS, INC., MULTIPLE CLASS, (INT. CLS. 21, 24, 25, 28 AND

34), (U.S. CLS. 2, 8, 9, 13, 17, 22, 23, 29, 30, 33, 38, 39, 40, 42 AND 50). SN 76-596,825. PUB. 7-26-2005. FILED 6-10-2004.

3,007,160. **LENA LIU (BLOCK FORM)**. LIU, LENA, (U.S. CLS. 2, 13, 23, 29, 30, 33, 40 AND 50). SN 76-603,548. PUB. 7-26-2005. FILED 7-21-2004.

3,007,186 (*See Class 6 for this trademark*).

3,007,193 (*See Class 4 for this trademark*).

3,007,194 (*See Class 1 for this trademark*).

3,007,223 (*See Class 6 for this trademark*).

3,007,267 (*See Class 19 for this trademark*).

3,007,305 (*See Class 3 for this trademark*).

3,007,307. **BELLISSIMA (STYLIZED)**. AUGIE MOSCHITTO TRIM & JEWELRY CORP., MULTIPLE CLASS, (INT. CLS. 21 AND 26), (U.S. CLS. 2, 13, 23, 29, 30, 33, 37, 39, 40, 42 AND 50). SN 78-339,962. PUB. 7-26-2005. FILED 12-12-2003.

3,007,353. **THE RUB (BLOCK FORM)**. WHITE, P.H., JR., (U.S. CLS. 2, 13, 23, 29, 30, 33, 40 AND 50). SN 78-367,756. PUB. 7-26-2005. FILED 2-13-2004.

3,007,368. **FRESH EVERYDAY (BLOCK FORM)**. LEE, ERIC, (U.S. CLS. 2, 13, 23, 29, 30, 33, 40 AND 50). SN 78-372,236. PUB. 7-26-2005. FILED 2-23-2004.

3,007,391. **MISCELLANEOUS DESIGN**. PARTYLITE WORLDWIDE, INC., (U.S. CLS. 2, 13, 23, 29, 30, 33, 40 AND 50). SN 78-387,241. PUB. 7-26-2005. FILED 3-19-2004.

3,007,539 (*See Class 18 for this trademark*).

CLASS 22—CORDAGE AND FIBERS

3,006,892 (*See Class 9 for this trademark*).

3,007,062. **ÜNSA (STYLIZED)**. UNSA AMBALAJ SANAYI VE TICARET ANONIM SIRKETI, (U.S. CLS. 1, 2, 7, 19, 22, 42 AND 50). SN 76-580,003. PUB. 7-26-2005. FILED 3-9-2004.

CLASS 24—FABRICS

3,006,825. **AKOVA AND DESIGN**. AKOVA TEKSTIL VE TARIM URIINLERI TICARET VE SANAYI LIMITED SIRKETI, MULTIPLE CLASS, (INT. CLS. 24, 25 AND 26), (U.S. CLS. 22, 37, 39, 40, 42 AND 50). SN 76-331,753. PUB. 7-26-2005. FILED 10-30-2001.

3,006,858. **THE MADISON COLLECTION**. P & B TRADE, INC., MULTIPLE CLASS, (INT. CLS. 24, 25 AND 35), (U.S. CLS. 22, 39, 42, 50, 100, 101 AND 102). SN 76-466,435. PUB. 7-26-2005. FILED 11-13-2002.

3,006,874 (*See Class 6 for this trademark*).

3,006,882. **2ND NATURE**. WILLIAMSON, FRANK W., (U.S. CLS. 42 AND 50). SN 76-505,767. PUB. 7-26-2005. FILED 4-11-2003.

3,006,891 (*See Class 3 for this trademark*).

3,006,904 (*See Class 6 for this trademark*).

3,007,003 (*See Class 3 for this trademark*).

3,007,136 (*See Class 21 for this trademark*).

3,007,193 (*See Class 4 for this trademark*).

3,007,238. **KOMATSU AND DESIGN**. KOMATSU SEIREN KABUSHIKI KAISHA (KOMATSU SEIREN CO., LTD.), (U.S. CLS. 42 AND 50). SN 78-297,887. PUB. 7-26-2005. FILED 9-9-2003.

3,007,239. **KOMATSU AND DESIGN**. KOMATSU SEIREN KABUSHIKI KAISHA (KOMATSU SEIREN CO., LTD.), (U.S. CLS. 42 AND 50). SN 78-297,992. PUB. 7-26-2005. FILED 9-9-2003.

3,007,305 (*See Class 3 for this trademark*).

3,007,366 (*See Class 20 for this trademark*).

3,007,560 (*See Class 18 for this trademark*).

CLASS 25—CLOTHING

3,006,784. **DRESSMART**. DRESSMARK AB, MULTIPLE CLASS, (INT. CLS. 25 AND 35), (U.S. CLS. 22, 39, 100, 101 AND 102). SN 75-715,367. PUB. 7-26-2005. FILED 6-22-1999.

3,006,790 (*See Class 9 for this trademark*).

3,006,806 (*See Class 3 for this trademark*).

3,006,825 (*See Class 24 for this trademark*).

3,006,827. **ZXS (STYLIZED)**. ACCUCAPS INDUSTRIES LIMITED, MULTIPLE CLASS, (INT. CLS. 25, 28 AND 35), (U.S. CLS. 22, 23, 38, 39, 50, 100, 101 AND 102). SN 76-341,798. PUB. 7-26-2005. FILED 11-27-2001.

3,006,832 (*See Class 16 for this trademark*).

3,006,844. **GIVE-N-GO**. EX OFFICIO LLC, (U.S. CLS. 22 AND 39). SN 76-429,467. PUB. 7-26-2005. FILED 7-5-2002.

3,006,847 (*See Class 9 for this trademark*).

3,006,848 (*See Class 3 for this trademark*).

3,006,858 (*See Class 24 for this trademark*).

3,006,869 (*See Class 9 for this trademark*).

3,006,871 (*See Class 14 for this trademark*).

3,006,872. **CA COLLECTION**. CARRINI, INC., (U.S. CLS. 22 AND 39). SN 76-489,963. PUB. 7-26-2005. FILED 2-13-2003.

3,006,874 (*See Class 6 for this trademark*).

3,006,888 (*See Class 9 for this trademark*).

3,006,891 (*See Class 3 for this trademark*).

3,006,904 (*See Class 6 for this trademark*).

3,006,911 (*See Class 16 for this trademark*).

3,006,929 (*See Class 9 for this trademark*).

3,006,938. **TB AND DESIGN**. BURBERRY LIMITED, (U.S. CLS. 22 AND 39). SN 76-544,099. PUB. 6-7-2005. FILED 9-11-2003.

3,006,957 (*See Class 11 for this trademark*).

3,006,964 (*See Class 16 for this trademark*).

3,006,986. **E-STEP (BLOCK FORM)**. JOO, JACOB, (U.S. CLS. 22 AND 39). SN 76-560,285. PUB. 7-26-2005. FILED 11-17-2003.

3,006,989. **SASS (STYLIZED)**. LANDAU, KRISTEN MARIE, (U.S. CLS. 22 AND 39). SN 76-561,571. PUB. 7-26-2005. FILED 11-12-2003.

3,007,047. **WOODAN FUR FASHION AND DESIGN**. SAMMI INTERNATIONAL CORP., (U.S. CLS. 22 AND 39). SN 76-576,257. PUB. 7-26-2005. FILED 2-19-2004.

3,007,083. **DELICATE HEIRLOOMS BY D.L. DEVEREAUX (BLOCK FORM)**. DEVEREAUX, DEBORA LYNN, (U.S. CLS. 22 AND 39). SN 76-585,767. PUB. 7-26-2005. FILED 4-8-2004.

3,007,104. **HIPQWIP (BLOCK FORM)**. BATTISTA, PETER L. III, (U.S. CLS. 22 AND 39). SN 76-589,658. PUB. 7-26-2005. FILED 4-26-2004.

3,007,113. **R - A - M - S WINSTON-SALEM STATE UNIVERSITY AND DESIGN**. WINSTON-SALEM STATE UNIVERSITY, MULTIPLE CLASS, (INT. CLS. 25 AND 41), (U.S. CLS. 22, 39, 100, 101 AND 107). SN 76-591,553. PUB. 7-26-2005. FILED 5-5-2004.

3,007,125. **RESTRICTED AND DESIGN**. YANG, JOANNE, (U.S. CLS. 22 AND 39). SN 76-593,813. PUB. 7-26-2005. FILED 5-24-2004.

3,007,136 (*See Class 21 for this trademark*).

3,007,150. **SKATE MORE (BLOCK FORM)**. DVS SHOE CO., INC., (U.S. CLS. 22 AND 39). SN 76-599,501. PUB. 7-26-2005. FILED 6-28-2004.

3,007,173. **B AND DESIGN**. DARGI, STEVEN B., MULTIPLE CLASS, (INT. CLS. 25 AND 41), (U.S. CLS. 22, 39, 100, 101 AND 107). SN 78-119,949. PUB. 7-26-2005. FILED 4-5-2002.

3,007,178 (*See Class 14 for this trademark*).

3,007,193 (*See Class 4 for this trademark*).

3,007,220 (*See Class 14 for this trademark*).

3,007,222. **WHITE WHISTLE WEDDING**. C. A. HILS DESIGN, LLC, (U.S. CLS. 22 AND 39). SN 78-278,033. PUB. 7-26-2005. FILED 7-23-2003.

3,007,272. **N. SIXX (BLOCK FORM)**. SIXX, NIKKI, (U.S. CLS. 22 AND 39). SN 78-323,592. PUB. 7-26-2005. FILED 11-5-2003.

3,007,273. **N. SIXX CLOTHING AND DESIGN**. SIXX, NIKKI, (U.S. CLS. 22 AND 39). SN 78-323,603. PUB. 7-26-2005. FILED 11-5-2003.

3,007,278 (*See Class 9 for this trademark*).

3,007,280. **BODY ADVANCE (STYLIZED)**. ARDYSS INTERNATIONAL, (U.S. CLS. 22 AND 39). SN 78-326,189. PUB. 7-26-2005. FILED 11-11-2003.

3,007,282. **SUBTLE TONES SPA (BLOCK FORM)**. NOTHING TO WEAR, INC., (U.S. CLS. 22 AND 39). SN 78-328,444. PUB. 7-26-2005. FILED 11-14-2003.

3,007,295. **RUSTY BONES AND DESIGN**. MCKENZIE, SCOTT P., (U.S. CLS. 22 AND 39). SN 78-335,051. PUB. 6-7-2005.

FILED 12-2-2003.
 3,007,302. **MISCELLANEOUS DESIGN**. COLEMAN, BRIT N., (U.S. CLS. 22 AND 39). SN 78-337,768. PUB. 7-26-2005. FILED 12-8-2003.
 3,007,305 (*See Class 3 for this trademark*).
 3,007,314. **EASY SPIRIT COMFORT 2 (STYLIZED)**. NINE WEST DEVELOPMENT CORPORATION, (U.S. CLS. 22 AND 39). SN 78-343,733. PUB. 7-26-2005. FILED 12-19-2003.
 3,007,333. **FIT ATHLETIC (BLOCK FORM)**. FIT ATHLETIC CLUB, INC., MULTIPLE CLASS, (INT. CLS. 25 AND 41), (U.S. CLS. 22, 39, 100, 101 AND 107). SN 78-354,181. PUB. 7-26-2005. FILED 1-20-2004.
 3,007,352. **TAG+ (BLOCK FORM)**. FETISH GROUP, INC., (U.S. CLS. 22 AND 39). SN 78-366,108. PUB. 7-26-2005. FILED 2-11-2004.
 3,007,392. **SISTERS OF SLOW AND DESIGN**. SHULMAN, JUDY, AND LANDERS, DEBI, MULTIPLE CLASS, (INT. CLS. 25 AND 41), (U.S. CLS. 22, 39, 100, 101 AND 107). SN 78-387,546. PUB. 7-26-2005. FILED 3-19-2004.
 3,007,393. **ART (STYLIZED)**. A.R.T. COMPANY B&S, S.A., THE, (U.S. CLS. 22 AND 39). SN 78-388,307. PUB. 7-5-2005. FILED 3-22-2004.
 3,007,438. **MOOSEJAW AND DESIGN**. MOOSEJAW MOUNTAINEERING AND BACKCOUNTRY TRAVEL, INC., (U.S. CLS. 22 AND 39). SN 78-412,771. PUB. 7-26-2005. FILED 5-4-2004.
 3,007,450. **MAUI TROPICS (BLOCK FORM)**. HERRING, CRAIG P., (U.S. CLS. 22 AND 39). SN 78-418,553. PUB. 4-5-2005. FILED 5-13-2004.
 3,007,471. **DESIGNED BY ADVENTURE (BLOCK FORM)**. OUTDOOR RESEARCH, INC., (U.S. CLS. 22 AND 39). SN 78-428,244. PUB. 7-26-2005. FILED 6-1-2004.
 3,007,472. **B AND DESIGN**. MCFADDEN, RAINEY B, (U.S. CLS. 22 AND 39). SN 78-428,331. PUB. 7-26-2005. FILED 6-2-2004.
 3,007,502. **VELLUM CASHMERE (BLOCK FORM)**. NICO ALBANESE, INC., (U.S. CLS. 22 AND 39). SN 78-439,033. PUB. 7-26-2005. FILED 6-22-2004.
 3,007,515. **DANGEROUS DUDS AND DESIGN**. DANGEROUS DUDS, (U.S. CLS. 22 AND 39). SN 78-445,996. PUB. 7-5-2005. FILED 7-5-2004.
 3,007,528 (*See Class 18 for this trademark*).
 3,007,554. **GL AND DESIGN**. WENLING SHUNPU INDUSTRIAL; ARTWORK FACTORY, (U.S. CLS. 22 AND 39). SN 79-001,307. PUB. 7-26-2005. FILED 12-12-2003.
 3,007,556 (*See Class 3 for this trademark*).
 3,007,560 (*See Class 18 for this trademark*).
 3,007,562 (*See Class 14 for this trademark*).

CLASS 26—FANCY GOODS

3,006,825 (*See Class 24 for this trademark*).
 3,007,193 (*See Class 4 for this trademark*).
 3,007,307 (*See Class 21 for this trademark*).

CLASS 27—FLOOR COVERINGS

3,006,839 (*See Class 12 for this trademark*).
 3,006,891 (*See Class 3 for this trademark*).
 3,006,892 (*See Class 9 for this trademark*).
 3,007,193 (*See Class 4 for this trademark*).

CLASS 28—TOYS AND SPORTING GOODS

3,006,790 (*See Class 9 for this trademark*).
 3,006,792 (*See Class 6 for this trademark*).
 3,006,818. **ULTEGRA TOUR (STYLIZED)**. SHIMANO INC., (U.S. CLS. 22, 23, 38 AND 50). SN 76-267,003. PUB. 7-26-2005. FILED 6-5-2001.
 3,006,827 (*See Class 25 for this trademark*).
 3,006,830 (*See Class 9 for this trademark*).

3,006,848 (*See Class 3 for this trademark*).
 3,006,869 (*See Class 9 for this trademark*).
 3,006,874 (*See Class 6 for this trademark*).
 3,006,891 (*See Class 3 for this trademark*).
 3,006,929 (*See Class 9 for this trademark*).
 3,006,946. **TROTTER**. CYBEX INTERNATIONAL, INC., (U.S. CLS. 22, 23, 38 AND 50). SN 76-548,719. PUB. 7-26-2005. FILED 9-17-2003.
 3,006,947 (*See Class 12 for this trademark*).
 3,006,957 (*See Class 11 for this trademark*).
 3,007,051 (*See Class 16 for this trademark*).
 3,007,096. **ADORA ORIGINAL DOLL (BLOCK FORM)**. ADORA, INC., (U.S. CLS. 22, 23, 38 AND 50). SN 76-588,568. PUB. 7-26-2005. FILED 4-26-2004.
 3,007,136 (*See Class 21 for this trademark*).
 3,007,168 (*See Class 9 for this trademark*).
 3,007,187. **BOOMERANGBALL AND DESIGN**. MORRISON, JOSEPH C., (U.S. CLS. 22, 23, 38 AND 50). SN 78-209,913. PUB. 7-26-2005. FILED 2-2-2003.
 3,007,193 (*See Class 4 for this trademark*).
 3,007,194 (*See Class 1 for this trademark*).
 3,007,196. **"NEHEMIAH" THE PRAYING MANTIS**. ANGEL TOES, INC., (U.S. CLS. 22, 23, 38 AND 50). SN 78-220,301. PUB. 6-7-2005. FILED 2-28-2003.
 3,007,220 (*See Class 14 for this trademark*).
 3,007,231 (*See Class 9 for this trademark*).
 3,007,291. **SKY TRAIL (BLOCK FORM)**. SKY TRAIL, INC., MULTIPLE CLASS, (INT. CLS. 28 AND 37), (U.S. CLS. 22, 23, 38, 50, 100, 103 AND 106). SN 78-332,962. PUB. 7-26-2005. FILED 11-25-2003.
 3,007,305 (*See Class 3 for this trademark*).
 3,007,327. **NORTH DAKOTA LOTTERY AND DESIGN**. MULTI-STATE LOTTERY ASSOCIATION, MULTIPLE CLASS, (INT. CLS. 28 AND 41), (U.S. CLS. 22, 23, 38, 50, 100, 101 AND 107). SN 78-348,709. PUB. 7-26-2005. FILED 1-7-2004.
 3,007,337. **WHITETAILOPOLY (BLOCK FORM)**. D.O. COLLABORATIVE, THE, (U.S. CLS. 22, 23, 38 AND 50). SN 78-356,785. PUB. 7-26-2005. FILED 1-23-2004.
 3,007,341 (*See Class 9 for this trademark*).
 3,007,345. **FABRIC ART IN A BAG AND DESIGN**. HAWTHORN NEEDLES & BUTTERFLY WINGS, L.L.C., (U.S. CLS. 22, 23, 38 AND 50). SN 78-359,827. PUB. 7-26-2005. FILED 1-29-2004.
 3,007,370. **LET'S PLAY (BLOCK FORM)**. INFO-MAN REFERRAL SERVICES, INC., (U.S. CLS. 22, 23, 38 AND 50). SN 78-373,047. PUB. 7-26-2005. FILED 2-24-2004.
 3,007,371. **AUTO-RIGGER JMC DESIGN CO AND DESIGN**. MCCAFFREY, JOHN P, (U.S. CLS. 22, 23, 38 AND 50). SN 78-373,460. PUB. 7-26-2005. FILED 2-24-2004.
 3,007,479 (*See Class 14 for this trademark*).
 3,007,490. **DANIEL BOONE (BLOCK FORM)**. DANIEL BOONE, INC., (U.S. CLS. 22, 23, 38 AND 50). SN 78-436,358. PUB. 7-26-2005. FILED 6-16-2004.
 3,007,519. **FIGHTING FALCON (BLOCK FORM)**. LOCKHEED MARTIN CORPORATION, (U.S. CLS. 22, 23, 38 AND 50). SN 78-449,367. PUB. 6-7-2005. FILED 7-12-2004.
 3,007,539 (*See Class 18 for this trademark*).

CLASS 29—MEATS AND PROCESSED FOODS

3,006,788. **SUN LAND**. SKIPPACK CREEK CORPORATION, (U.S. CL. 46). SN 75-763,121. PUB. 7-26-2005. FILED 7-29-1999.
 3,006,799. **MISCELLANEOUS DESIGN**. DOOSAN CORPORATION, MULTIPLE CLASS, (INT. CLS. 29 AND 30), (U.S. CL. 46). SN 76-123,237. PUB. 7-26-2005. FILED 9-6-2000.
 3,006,848 (*See Class 3 for this trademark*).
 3,006,954. **MISCELLANEOUS DESIGN**. CONROY FOODS, INC., MULTIPLE CLASS, (INT. CLS. 29 AND 30), (U.S. CL. 46). SN 76-552,357. PUB. 7-26-2005. FILED 9-26-2003.
 3,006,967. **EXOTIC FOOD AUTHENTIC THAI AND DESIGN**. EXOTIC FOOD CO., LTD., MULTIPLE CLASS, (INT. CLS. 29, 30 AND 32), (U.S. CLS. 45, 46 AND 48). SN 76-555,316. PUB. 7-26-2005. FILED 10-10-2003.
 3,007,001. **MISCELLANEOUS DESIGN**. HANGZHOU QIAN-

- DAO LAKE DEVELOPMENT CO., LTD., MULTIPLE CLASS, (INT. CLS. 29 AND 31), (U.S. CLS. 1 AND 46). SN 76-564,336. PUB. 7-26-2005. FILED 12-9-2003.
- 3,007,046. **MISCELLANEOUS DESIGN**. LIFEWAY FOODS, INC., (U.S. CL. 46). SN 76-575,181. PUB. 7-26-2005. FILED 2-10-2004.
- 3,007,166. **DURBIN FARMS MARKET**. DURBIN FARMS MARKET, INC., MULTIPLE CLASS, (INT. CLS. 29, 30 AND 31), (U.S. CLS. 1 AND 46). SN 76-977,034. PUB. 7-26-2005. FILED 8-1-2003.
- 3,007,177 (*See Class 1 for this trademark*).
- 3,007,183. **MISCELLANEOUS DESIGN**. WUXI SHI ZHEN ZHENG LAO LU GAO JIAN ROU ZHUANG CO., LTD., (U.S. CL. 46). SN 78-193,082. PUB. 7-5-2005. FILED 12-10-2002.
- 3,007,194 (*See Class 1 for this trademark*).
- 3,007,214. **SUGERENCIAS DEL CHEF AND DESIGN**. ALIMENTOS SIGMA CONAGRA FOODS, S.A. DE C.V., MULTIPLE CLASS, (INT. CLS. 29, 30 AND 32), (U.S. CLS. 45, 46 AND 48). SN 78-262,060. PUB. 7-26-2005. FILED 6-13-2003.
- 3,007,244. **ALALALI AND DESIGN**. SAEED MAHAMED BASAMH, MULTIPLE CLASS, (INT. CLS. 29, 30 AND 32), (U.S. CLS. 45, 46 AND 48). SN 78-302,993. PUB. 7-26-2005. FILED 9-19-2003.
- 3,007,245. **SHAUNA'S HAND CLEANED PORK CHITTERLINGS AND DESIGN**. ANDERSON, SHAUNA RENEE, (U.S. CL. 46). SN 78-304,542. PUB. 7-26-2005. FILED 9-24-2003.
- 3,007,251. **BEVO BURGERS BEAT'EM AND EAT'EM AND DESIGN**. GRASSFED LONGHORN ALLIANCE, (U.S. CL. 46). SN 78-308,118. PUB. 7-26-2005. FILED 10-1-2003.
- 3,007,309. **GROUPER AND DESIGN**. MARDER TRAWLING, INC., (U.S. CL. 46). SN 78-341,364. PUB. 7-26-2005. FILED 12-16-2003.
- 3,007,311. **RED SNAPPER AND DESIGN**. MARDER TRAWLING, INC., (U.S. CL. 46). SN 78-341,555. PUB. 7-26-2005. FILED 12-16-2003.
- 3,007,388. **CHUKAR CHERRIES. BEST OF NATURE. BEST OF CHOCOLATE. AND DESIGN**. CHUKAR CHERRY COMPANY, INC., MULTIPLE CLASS, (INT. CLS. 29 AND 30), (U.S. CL. 46). SN 78-384,700. PUB. 7-26-2005. FILED 3-15-2004.
- 3,007,400. **CARMELINA (BLOCK FORM)**. MANGIA, INC., (U.S. CL. 46). SN 78-393,179. PUB. 7-26-2005. FILED 3-30-2004.
- 3,007,418. **DOÑA ISABEL (BLOCK FORM)**. PERUVIAN IMPORT COMPANY, MULTIPLE CLASS, (INT. CLS. 29 AND 30), (U.S. CL. 46). SN 78-403,436. PUB. 7-26-2005. FILED 4-16-2004.
- 3,007,421. **CUGINO'S (BLOCK FORM)**. CUGINO'S GOURMET FOODS, INC., MULTIPLE CLASS, (INT. CLS. 29 AND 30), (U.S. CL. 46). SN 78-403,991. PUB. 7-26-2005. FILED 4-19-2004.
- 3,007,435. **AVOTEC INTERNATIONAL (BLOCK FORM)**. TOPANGA HOLDING COMPANY, LLC, MULTIPLE CLASS, (INT. CLS. 29, 30 AND 31), (U.S. CLS. 1 AND 46). SN 78-412,458. PUB. 7-26-2005. FILED 5-3-2004.
- 3,007,439. **FRUSION AND DESIGN**. THE DANNON COMPANY, INC., MULTIPLE CLASS, (INT. CLS. 29 AND 32), (U.S. CLS. 45, 46 AND 48). SN 78-412,818. PUB. 4-5-2005. FILED 5-4-2004.
- 3,007,526. **HÄNS KISSELE (BLOCK FORM)**. THE HANS KISSELE COMPANY, INC., MULTIPLE CLASS, (INT. CLS. 29 AND 30), (U.S. CL. 46). SN 78-463,192. PUB. 7-26-2005. FILED 8-6-2004.
- 3,007,540. **VSOP (STYLIZED)**. MARINUS VAN DEN WIJNGAARD, (U.S. CL. 46). SN 79-000,285. PUB. 7-26-2005. FILED 11-27-2003.
- 3,007,559. **SNØFRISK (BLOCK FORM)**. TINE BA, (U.S. CL. 46). SN 79-002,537. PUB. 7-26-2005. FILED 3-26-2004.
- 3,006,869 (*See Class 9 for this trademark*).
- 3,006,891 (*See Class 3 for this trademark*).
- 3,006,920. **FIRECRACKERS**. WINDSOR QUALITY FOOD COMPANY LTD., (U.S. CL. 46). SN 76-532,318. PUB. 7-26-2005. FILED 7-25-2003.
- 3,006,932. **KULA**. WEIDER NUTRITION INTERNATIONAL, INC., (U.S. CL. 46). SN 76-542,595. PUB. 7-26-2005. FILED 9-5-2003.
- 3,006,933. **COW & BEAN ICE CREAM, COFFE & MORE AND DESIGN**. WICKMAN, MICHAEL, (U.S. CL. 46). SN 76-542,708. PUB. 7-26-2005. FILED 8-22-2003.
- 3,006,954 (*See Class 29 for this trademark*).
- 3,006,967 (*See Class 29 for this trademark*).
- 3,006,985. **WILDSEED FARMS (STYLIZED)**. WILDSEED FARMS, LTD., (U.S. CL. 46). SN 76-560,237. PUB. 7-26-2005. FILED 11-3-2003.
- 3,007,050. **TRIMANA BURGERS SALADS SANDWICHES SINCE 1985 SPICY JALAPENO SAUCE SPICY AND DESIGN**. HIGH RISE GOODIES RESTAURANT GROUP, INC., (U.S. CL. 46). SN 76-576,939. PUB. 7-26-2005. FILED 1-20-2004.
- 3,007,098. **CHS (BLOCK FORM)**. RSJ, INC., (U.S. CL. 46). SN 76-588,748. PUB. 7-26-2005. FILED 4-26-2004.
- 3,007,112. **CANDIES TOLTECA CO. (BLOCK FORM)**. ORDAZ, AARON GOMEZ, (U.S. CL. 46). SN 76-591,527. PUB. 7-26-2005. FILED 5-7-2004.
- 3,007,156. **SINCERE ORIENT FOOD CO. AND DESIGN**. SINCERE ORIENT FOOD CO., DBA SINCERE ORIENT COMMERCIAL CORP., (U.S. CL. 46). SN 76-602,057. PUB. 7-26-2005. FILED 7-13-2004.
- 3,007,166 (*See Class 29 for this trademark*).
- 3,007,177 (*See Class 1 for this trademark*).
- 3,007,193 (*See Class 4 for this trademark*).
- 3,007,194 (*See Class 1 for this trademark*).
- 3,007,214 (*See Class 29 for this trademark*).
- 3,007,244 (*See Class 29 for this trademark*).
- 3,007,377. **LOVE POTION #31 (BLOCK FORM)**. BASKIN-ROBBINS INCORPORATED, (U.S. CL. 46). SN 78-378,034. PUB. 7-26-2005. FILED 3-3-2004.
- 3,007,378. **CRAZY CHARLIE'S CHILI SAUCE VAYA CON DIOS AMIGO AND DESIGN**. C & G SALSA COMPANY, LLC, (U.S. CL. 46). SN 78-378,332. PUB. 7-26-2005. FILED 3-4-2004.
- 3,007,388 (*See Class 29 for this trademark*).
- 3,007,401. **STRICKUCCINO (BLOCK FORM)**. STRICKLAND'S FROZEN CUSTARD, INC., (U.S. CL. 46). SN 78-393,726. PUB. 7-26-2005. FILED 3-31-2004.
- 3,007,418 (*See Class 29 for this trademark*).
- 3,007,421 (*See Class 29 for this trademark*).
- 3,007,435 (*See Class 29 for this trademark*).
- 3,007,516. **BEEMAID (STYLIZED)**. BEE MAID HONEY LIMITED, (U.S. CL. 46). SN 78-447,469. PUB. 7-26-2005. FILED 7-8-2004.
- 3,007,526 (*See Class 29 for this trademark*).
- 3,007,527. **LITTLE BROWN JUG (BLOCK FORM)**. VIRGINIA DARE EXTRACT CO., INC., (U.S. CL. 46). SN 78-463,407. PUB. 7-26-2005. FILED 8-6-2004.

CLASS 31—NATURAL AGRICULTURAL PRODUCTS

CLASS 30—STAPLE FOODS

- 3,006,799 (*See Class 29 for this trademark*).
- 3,006,848 (*See Class 3 for this trademark*).
- 3,006,961. **NORTHERN FEEDS**. BURKEL GRAIN SERVICE, INC., (U.S. CLS. 1 AND 46). SN 76-554,720. PUB. 7-26-2005. FILED 10-14-2003.
- 3,006,991. **OL'ROY DOG FOOD SAM WALTON'S BIRD DOG OL' ROY AND DESIGN**. WAL-MART STORES, INC., (U.S. CLS. 1 AND 46). SN 76-562,137. PUB. 7-26-2005. FILED 11-26-2003.
- 3,007,001 (*See Class 29 for this trademark*).
- 3,007,166 (*See Class 29 for this trademark*).
- 3,007,177 (*See Class 1 for this trademark*).
- 3,007,194 (*See Class 1 for this trademark*).
- 3,007,260. **SNACKDOG TASTY, WHOLESOME TREATS FOR YOU BEST FRIEND AND DESIGN**. SNACKDOG L.L.C., (U.S. CLS. 1 AND 46). SN 78-315,582. PUB. 7-26-2005. FILED 10-19-2003.

3,007,435 (See Class 29 for this trademark).

TAMPA, INC., (U.S. CLS. 2, 8, 9 AND 17). SN 78-447,639. PUB. 7-5-2005. FILED 7-8-2004.

CLASS 32—LIGHT BEVERAGES

3,006,869 (See Class 9 for this trademark).
 3,006,891 (See Class 3 for this trademark).
 3,006,967 (See Class 29 for this trademark).
 3,007,092. **AQUAHEALTH (STYLIZED)**, HANSEN, ANDREW BARCLAY, AND DONAGHY, STEPHEN, MULTIPLE CLASS, (INT. CLS. 32 AND 43), (U.S. CLS. 45, 46, 48, 100 AND 101). SN 76-587,691. PUB. 7-26-2005. FILED 4-16-2004.
 3,007,161. **ARU MANINOFF (STYLIZED)**, REITER, ELIAS, (U.S. CLS. 45, 46 AND 48). SN 76-605,544. PUB. 7-26-2005. FILED 8-4-2004.
 3,007,180. **PREMIUM MEXICAN STYLE BRAVA CERVEZA AND DESIGN**, LAKEPORT BREWING CORPORATION, (U.S. CLS. 45, 46 AND 48). SN 78-178,183. PUB. 7-26-2005. FILED 10-24-2002.
 3,007,193 (See Class 4 for this trademark).
 3,007,194 (See Class 1 for this trademark).
 3,007,208. **J-7 (STYLIZED)**, OPEN JOINT STOCK COMPANY "WIMM-BILL-DANN FOODS", (U.S. CLS. 45, 46 AND 48). SN 78-250,850. PUB. 6-7-2005. FILED 5-16-2003.
 3,007,214 (See Class 29 for this trademark).
 3,007,244 (See Class 29 for this trademark).
 3,007,439 (See Class 29 for this trademark).
 3,007,512. **SLIM-FAST OPTIMA (BLOCK FORM)**, LIPTON INVESTMENTS, INC., (U.S. CLS. 45, 46 AND 48). SN 78-444,365. PUB. 7-26-2005. FILED 7-1-2004.
 3,007,546. **DE LUZE (STYLIZED)**, G.V.G. - GRANDS VINS DE GIRONDE; SOCIÉTÉ ANONYME, MULTIPLE CLASS, (INT. CLS. 32 AND 33), (U.S. CLS. 45, 46, 47, 48 AND 49). SN 79-000,834. PUB. 7-26-2005. FILED 1-8-2004.

CLASS 33—WINES AND SPIRITS

3,006,780. **NEMIROFF**, BREYFIELD TRUST REG., (U.S. CLS. 47 AND 49). SN 75-478,738. PUB. 7-26-2005. FILED 5-4-1998.
 3,006,848 (See Class 3 for this trademark).
 3,006,857. **CANADIAN RESERVE**, NWS-ILLINOIS, LLC, (U.S. CLS. 47 AND 49). SN 76-465,571. PUB. 5-20-2003. FILED 11-8-2002.
 3,006,891 (See Class 3 for this trademark).
 3,006,955. **MISCELLANEOUS DESIGN**, KLEIN CONSTANTIA WINERY (PTY) LTD, (U.S. CLS. 47 AND 49). SN 76-552,627. PUB. 7-26-2005. FILED 10-20-2003.
 3,007,086. **BOVE (BLOCK FORM)**, STAR INDUSTRIES, INC., (U.S. CLS. 47 AND 49). SN 76-586,151. PUB. 7-26-2005. FILED 4-12-2004.
 3,007,198. **PATRÓN**, **XO CAFE COFFEE LIQUEUR MADE WITH TEQUILA AND DESIGN**, CARIBBEAN DISTILLERS CORPORATION LIMITED, (U.S. CLS. 47 AND 49). SN 78-228,623. PUB. 7-26-2005. FILED 3-21-2003.
 3,007,384. **CABALLO LOCO AND DESIGN**, VINA VALDIVISO S.A., (U.S. CLS. 47 AND 49). SN 78-382,642. PUB. 7-26-2005. FILED 3-11-2004.
 3,007,546 (See Class 32 for this trademark).

CLASS 34—SMOKERS' ARTICLES

3,006,819. **FORUM**, POTOMAC TOBACCO COMPANY LIMITED, (U.S. CLS. 2, 8, 9 AND 17). SN 76-292,229. PUB. 7-26-2005. FILED 7-31-2001.
 3,006,848 (See Class 3 for this trademark).
 3,006,891 (See Class 3 for this trademark).
 3,006,949. **BELLA COSTA AND DESIGN**, R & N CORD ENTERPRISES, INC., (U.S. CLS. 2, 8, 9 AND 17). SN 76-550,295. PUB. 7-26-2005. FILED 10-9-2003.
 3,007,136 (See Class 21 for this trademark).
 3,007,517. **TORO TORO THOMPSON HECHO A MANO IMPORTADO AND DESIGN**, THOMPSON & CO. OF

SERVICE MARKS

CLASS 35—ADVERTISING AND BUSINESS

3,006,781. **THE PEAKS RESORT & SPA**, TELLURIDE RESORT & SPA, L.P., MULTIPLE CLASS, (INT. CLS. 35, 41, 42 AND 44), (U.S. CLS. 100, 101, 102 AND 107). SN 75-545,606. PUB. 7-26-2005. FILED 8-31-1998.
 3,006,784 (See Class 25 for this trademark).
 3,006,789. **BRIDESAVE.COM AND DESIGN**, BRIDESAVE-COM, L.L.C., (U.S. CLS. 100, 101 AND 102). SN 75-801,920. PUB. 4-25-2000. FILED 9-20-1999.
 3,006,797. **NEXITY**, NEXITY, MULTIPLE CLASS, (INT. CLS. 35, 36, 37, 39, 41 AND 42), (U.S. CLS. 100, 101, 102, 103, 105, 106 AND 107). SN 76-111,623. PUB. 7-26-2005. FILED 8-16-2000.
 3,006,800 (See Class 4 for this trademark).
 3,006,804 (See Class 11 for this trademark).
 3,006,810. **CXNETWORKS AND DESIGN**, CEMEX, S.A. DE C.V., MULTIPLE CLASS, (INT. CLS. 35, 36, 38, 41 AND 42), (U.S. CLS. 100, 101, 102, 104 AND 107). SN 76-203,566. PUB. 7-26-2005. FILED 2-1-2001.
 3,006,811. **SUCCESSFOODS MARKETING**, ZIMMERMAN, EDWARD S., (U.S. CLS. 100, 101 AND 102). SN 76-207,121. PUB. 7-26-2005. FILED 2-5-2001.
 3,006,812 (See Class 16 for this trademark).
 3,006,823. **BTL**, BUSINESS TRAVEL INTERNATIONAL B.V., MULTIPLE CLASS, (INT. CLS. 35, 39 AND 42), (U.S. CLS. 100, 101, 102 AND 105). SN 76-329,922. PUB. 7-26-2005. FILED 10-26-2001.
 3,006,827 (See Class 25 for this trademark).
 3,006,828 (See Class 16 for this trademark).
 3,006,829. **FORTIS BANK (STYLIZED)**, FORTIS (NL) N.V., AND FORTIS (B), MULTIPLE CLASS, (INT. CLS. 35, 36 AND 37), (U.S. CLS. 100, 101, 102, 103 AND 106). SN 76-344,640. PUB. 7-26-2005. FILED 12-4-2001.
 3,006,832 (See Class 16 for this trademark).
 3,006,835. **MLRC MEDIA LAW RESOURCE CENTER (STYLIZED)**, MEDIA LAW RESOURCE CENTER, INC., (U.S. CLS. 100, 101 AND 102). SN 76-372,756. PUB. 7-26-2005. FILED 2-15-2002.
 3,006,837 (See Class 9 for this trademark).
 3,006,843. **L.I. & N.Y. MECHANICAL CONTRACTORS' ASSOCIATION INC. HEATING COOLING REFRIGERATION SHEET METAL SERVICE MAINTENANCE FIRE SPRINKLER PIPING TRAINING AND DESIGN**, L.I. AND N.Y. MECHANICAL CONTRACTORS' ASSOCIATION, INC., (U.S. CLS. 100, 101 AND 102). SN 76-420,104. PUB. 7-26-2005. FILED 6-3-2002.
 3,006,845. **ATFOX**, ATFOX LIMITED, MULTIPLE CLASS, (INT. CLS. 35, 36 AND 42), (U.S. CLS. 100, 101 AND 102). SN 76-430,224. PUB. 7-26-2005. FILED 7-15-2002.
 3,006,847 (See Class 9 for this trademark).
 3,006,849. **HEARBEST AND DESIGN**, HEARBEST, INC., MULTIPLE CLASS, (INT. CLS. 35 AND 44), (U.S. CLS. 100, 101 AND 102). SN 76-445,400. PUB. 7-26-2005. FILED 8-30-2002.
 3,006,854. **OPERATION GREEN OUT! AND DESIGN**, SWANSON, HOLLY A., (U.S. CLS. 100, 101 AND 102). SN 76-458,301. PUB. 7-26-2005. FILED 10-15-2002.
 3,006,856. **NEXINNOVATIONS SERVICES PLUS**, NEXINNOVATIONS INC., MULTIPLE CLASS, (INT. CLS. 35, 37, 41 AND 42), (U.S. CLS. 100, 101, 102, 103, 106 AND 107). SN 76-464,962. PUB. 7-26-2005. FILED 10-30-2002.
 3,006,858 (See Class 24 for this trademark).
 3,006,862 (See Class 12 for this trademark).
 3,006,863. **ENVIRO-EQUIPMENT, INC. AND DESIGN**, ENVIRO-EQUIPMENT, INC., MULTIPLE CLASS, (INT. CLS. 35, 40 AND 42), (U.S. CLS. 100, 101, 102, 103 AND 106). SN 76-470,746. PUB. 7-26-2005. FILED 11-27-2002.
 3,006,877 (See Class 9 for this trademark).

- 3,006,878 (*See Class 9 for this trademark.*)
 3,006,891 (*See Class 3 for this trademark.*)
 3,006,898 (*See Class 9 for this trademark.*)
 3,006,901. **FERAY LENNE AND DESIGN**. FERAY LENNE CONSEIL, MULTIPLE CLASS, (INT. CLS. 35, 36, 41 AND 42), (U.S. CLS. 100, 101, 102 AND 107). SN 76-520,443. PUB. 7-26-2005. FILED 5-29-2003.
 3,006,911 (*See Class 16 for this trademark.*)
 3,006,921. **AMERICAN DISC JOCKEY ASSOCIATION ADJA INC. AND DESIGN**. AMERICAN DISC JOCKEY ASSOCIATION, INC., (U.S. CLS. 100, 101 AND 102). SN 76-532,454. PUB. 7-26-2005. FILED 7-25-2003.
 3,006,923. **FRANDATA AND DESIGN**. FRANCHISE INFORMATION SYSTEMS, INC., (U.S. CLS. 100, 101 AND 102). SN 76-534,817. PUB. 7-26-2005. FILED 8-4-2003.
 3,006,924. **FRANDATA**. FRANCHISE INFORMATION SYSTEMS, INC., (U.S. CLS. 100, 101 AND 102). SN 76-534,823. PUB. 7-26-2005. FILED 8-4-2003.
 3,006,926. **HANSOT AND DESIGN**. HANSOT CO., LTD., MULTIPLE CLASS, (INT. CLS. 35 AND 43), (U.S. CLS. 100, 101 AND 102). SN 76-536,206. PUB. 7-26-2005. FILED 8-11-2003.
 3,006,930. **UR (STYLIZED)**. URD, INC., (U.S. CLS. 100, 101 AND 102). SN 76-539,965. PUB. 7-26-2005. FILED 7-31-2003.
 3,006,939. **PRIMEPERKS**. PRIMEPAY, INC., (U.S. CLS. 100, 101 AND 102). SN 76-544,209. PUB. 7-26-2005. FILED 8-29-2003.
 3,006,942. **H HOFFMAN AND DESIGN**. HOFFMAN, LLC, MULTIPLE CLASS, (INT. CLS. 35, 37 AND 42), (U.S. CLS. 100, 101, 102, 103 AND 106). SN 76-548,037. PUB. 7-26-2005. FILED 9-29-2003.
 3,006,951 (*See Class 3 for this trademark.*)
 3,006,957 (*See Class 11 for this trademark.*)
 3,006,962. **IT'S ALL ABOUT STYLE!**. LISSA INC., (U.S. CLS. 100, 101 AND 102). SN 76-554,923. PUB. 7-26-2005. FILED 10-23-2003.
 3,006,963. **LISSA**. LISSA INC., MULTIPLE CLASS, (INT. CLS. 35 AND 42), (U.S. CLS. 100, 101 AND 102). SN 76-554,924. PUB. 7-26-2005. FILED 10-23-2003.
 3,006,969. **SUGAR FILM PRODUCTION AND DESIGN**. SUGAR FILM PRODUCTION, LTD., MULTIPLE CLASS, (INT. CLS. 35 AND 41), (U.S. CLS. 100, 101, 102 AND 107). SN 76-555,672. PUB. 7-26-2005. FILED 10-10-2003.
 3,006,970. **CELMEDIA (BLOCK FORM)**. CELMEDIA S.A., (U.S. CLS. 100, 101 AND 102). SN 76-556,173. PUB. 7-26-2005. FILED 11-3-2003.
 3,006,972. **BREATHING DISORDERS SERVICES, INC.** BREATHING DISORDERS SERVICES, INC., MULTIPLE CLASS, (INT. CLS. 35, 41 AND 44), (U.S. CLS. 100, 101, 102 AND 107). SN 76-556,424. PUB. 7-26-2005. FILED 10-21-2003.
 3,006,976. **BDS BREATHING DISORDERS SERVICES, INC. AND DESIGN**. BREATHING DISORDERS SERVICES, INC., MULTIPLE CLASS, (INT. CLS. 35, 41 AND 44), (U.S. CLS. 100, 101, 102 AND 107). SN 76-556,869. PUB. 7-26-2005. FILED 10-21-2003.
 3,006,977. **BDS**. BREATHING DISORDERS SERVICES, INC., MULTIPLE CLASS, (INT. CLS. 35, 41 AND 44), (U.S. CLS. 100, 101, 102 AND 107). SN 76-556,870. PUB. 7-26-2005. FILED 10-21-2003.
 3,006,983. **PREVENTION.COM (STYLIZED)**. RODALE INC., MULTIPLE CLASS, (INT. CLS. 35, 38, 41 AND 44), (U.S. CLS. 100, 101, 102, 104 AND 107). SN 76-559,491. PUB. 7-26-2005. FILED 11-12-2003.
 3,006,990. **CONTERM (BLOCK FORM)**. NACA LOGISTICS (USA) INC., (U.S. CLS. 100, 101 AND 102). SN 76-561,861. PUB. 7-26-2005. FILED 11-24-2003.
 3,006,993 (*See Class 9 for this trademark.*)
 3,006,996. **DESTINATION ROCKIES (BLOCK FORM)**. DESTINATION HOTELS AND RESORTS, INC., MULTIPLE CLASS, (INT. CLS. 35, 39, 41, 42 AND 43), (U.S. CLS. 100, 101, 102, 105 AND 107). SN 76-562,632. PUB. 7-26-2005. FILED 12-2-2003.
 3,007,007. **TRIALSPACE DESIGNER (BLOCK FORM)**. FAST TRACK SYSTEMS, INC., (U.S. CLS. 100, 101 AND 102). SN 76-565,904. PUB. 7-26-2005. FILED 12-8-2003.
 3,007,009. **STRATEGIC BENCHMARKING FOR VALUE AND DESIGN**. THE FINANCIAL VALUATION GROUP L.C., (U.S. CLS. 100, 101 AND 102). SN 76-566,871. PUB. 7-26-2005. FILED 12-8-2003.
 3,007,013. **CUSTOM QUOTES AND DESIGN**. THOMAS PUBLISHING COMPANY, (U.S. CLS. 100, 101 AND 102). SN 76-567,148. PUB. 7-26-2005. FILED 12-29-2003.
 3,007,016 (*See Class 9 for this trademark.*)
 3,007,017 (*See Class 9 for this trademark.*)
 3,007,025. **MAU HUMAN CAPITAL SOLUTIONS (BLOCK FORM)**. MAU, INC., (U.S. CLS. 100, 101 AND 102). SN 76-569,373. PUB. 7-26-2005. FILED 1-12-2004.
 3,007,027. **CHAIRMAN'S CIRCLE (BLOCK FORM)**. FRANKENMUTH MUTUAL INSURANCE COMPANY, (U.S. CLS. 100, 101 AND 102). SN 76-569,686. PUB. 7-26-2005. FILED 1-2-2004.
 3,007,028. **CHAIRMAN'S CIRCLE FRANKENMUTH FINANCIAL GROUP AND DESIGN**. FRANKENMUTH MUTUAL INSURANCE COMPANY, (U.S. CLS. 100, 101 AND 102). SN 76-569,687. PUB. 7-26-2005. FILED 1-2-2004.
 3,007,029. **DIAMOND CLUB (BLOCK FORM)**. FRANKENMUTH MUTUAL INSURANCE COMPANY, (U.S. CLS. 100, 101 AND 102). SN 76-569,688. PUB. 7-26-2005. FILED 1-2-2004.
 3,007,030. **DIAMOND CLUB FRANKENMUTH FINANCIAL GROUP AND DESIGN**. FRANKENMUTH MUTUAL INSURANCE COMPANY, (U.S. CLS. 100, 101 AND 102). SN 76-569,689. PUB. 7-26-2005. FILED 1-2-2004.
 3,007,042. **MISCELLANEOUS DESIGN**. CITIZENS FOR NYC, INC., (U.S. CLS. 100, 101 AND 102). SN 76-573,627. PUB. 7-26-2005. FILED 2-3-2004.
 3,007,059. **G AND DESIGN**. THE GLOBE EQUIPMENT COMPANY, (U.S. CLS. 100, 101 AND 102). SN 76-579,460. PUB. 7-26-2005. FILED 3-5-2004.
 3,007,061. **NRA SHOW (BLOCK FORM)**. NATIONAL RESTAURANT ASSOCIATION, (U.S. CLS. 100, 101 AND 102). SN 76-579,993. PUB. 7-26-2005. FILED 3-8-2004.
 3,007,072. **COMPUTERS PLUS (BLOCK FORM)**. COMPUTERS PLUS, INC., (U.S. CLS. 100, 101 AND 102). SN 76-582,762. PUB. 7-26-2005. FILED 3-22-2004.
 3,007,073. **OTX ONLINE TESTING EXCHANGE AND DESIGN**. OTX CORPORATION, (U.S. CLS. 100, 101 AND 102). SN 76-582,999. PUB. 7-26-2005. FILED 3-22-2004.
 3,007,075. **RAINMAKER REALITY CHECK (BLOCK FORM)**. SUGARCREST DEVELOPMENT GROUP, (U.S. CLS. 100, 101 AND 102). SN 76-583,358. PUB. 7-26-2005. FILED 3-25-2004.
 3,007,081. **PREMIUM AND DESIGN**. THE PREMIUM CONNECTION, INC., (U.S. CLS. 100, 101 AND 102). SN 76-585,227. PUB. 7-26-2005. FILED 4-5-2004.
 3,007,085. **BIG GAME PRO SHOP YOUR ONLINE HUNTING STORE AND DESIGN**. BIG GAME PRO SHOP, INC., (U.S. CLS. 100, 101 AND 102). SN 76-586,105. PUB. 7-26-2005. FILED 4-12-2004.
 3,007,091. **EMU OIL LIFE JUST GOT BETTER AND DESIGN**. AMERICAN EMU ASSOCIATION, (U.S. CLS. 100, 101 AND 102). SN 76-587,595. PUB. 7-26-2005. FILED 4-20-2004.
 3,007,094. **SSC SIX SIGMA CONSULTANTS, INC AND DESIGN**. SIX SIGMA CONSULTANTS, INC., (U.S. CLS. 100, 101 AND 102). SN 76-588,436. PUB. 7-26-2005. FILED 4-22-2004.
 3,007,099. **OMNIAIR (BLOCK FORM)**. OMNIAIR CONSORTIUM, (U.S. CLS. 100, 101 AND 102). SN 76-589,103. PUB. 7-26-2005. FILED 4-28-2004.
 3,007,103. **EJUNCTIONS (BLOCK FORM)**. EVOLVENT TECHNOLOGIES, INC., (U.S. CLS. 100, 101 AND 102). SN 76-589,329. PUB. 7-26-2005. FILED 4-28-2004.
 3,007,115. **DIGITIMES (BLOCK FORM)**. DIGITIMES PUBLICATION INC., (U.S. CLS. 100, 101 AND 102). SN 76-591,753. PUB. 7-26-2005. FILED 5-10-2004.
 3,007,119. **COASTAL PHARMACY SERVICES (BLOCK FORM)**. COASTAL PHARMACY SERVICES, INC., (U.S. CLS. 100, 101 AND 102). SN 76-592,912. PUB. 7-26-2005. FILED 5-19-2004.
 3,007,123 (*See Class 16 for this trademark.*)
 3,007,126. **WWW.ABMFEDERAL.COM (BLOCK FORM)**. ABM OFFICE SUPPLY CO., INC., (U.S. CLS. 100, 101 AND 102). SN 76-594,120. PUB. 7-26-2005. FILED 5-25-2004.
 3,007,127. **MUDROOM (BLOCK FORM)**. THE INDIGO MARKET, INC., (U.S. CLS. 100, 101 AND 102). SN 76-594,224. PUB. 7-26-2005. FILED 5-24-2004.

- 3,007,128. **IMI AND DESIGN**. INTERNATIONAL MAINTENANCE INSTITUTE, (U.S. CLS. 100, 101 AND 102). SN 76-594,287. PUB. 7-26-2005. FILED 5-25-2004.
- 3,007,129. **COASTAL PHARMACY AND DESIGN**. COASTAL PHARMACY SERVICES, INC., (U.S. CLS. 100, 101 AND 102). SN 76-595,027. PUB. 7-26-2005. FILED 6-2-2004.
- 3,007,131. **ATCO PARTS AND DESIGN**. ATCO PARTS, INC., (U.S. CLS. 100, 101 AND 102). SN 76-595,899. PUB. 7-26-2005. FILED 6-7-2004.
- 3,007,145. **REMOTE DYNAMICS (BLOCK FORM)**. REMOTE DYNAMICS, INC., (U.S. CLS. 100, 101 AND 102). SN 76-598,192. PUB. 7-26-2005. FILED 6-18-2004.
- 3,007,146. **LEI AND DESIGN**. LEE ENTERPRISES, INC., (U.S. CLS. 100, 101 AND 102). SN 76-598,274. PUB. 7-26-2005. FILED 6-21-2004.
- 3,007,151. **MB (BLOCK FORM)**. SUMMA HUMMA ENTERPRISES, LLC, (U.S. CLS. 100, 101 AND 102). SN 76-599,817. PUB. 7-26-2005. FILED 6-28-2004.
- 3,007,168 (*See Class 9 for this trademark*).
- 3,007,175 (*See Class 16 for this trademark*).
- 3,007,182. **SUCCESS CASE EVALUATION METHOD**. BRINKERHOFF, ROBERT, O., (U.S. CLS. 100, 101 AND 102). SN 78-184,871. PUB. 7-26-2005. FILED 11-13-2002.
- 3,007,192. **AMERICAN KENNEL CLUB (BLOCK FORM)**. THE AMERICAN KENNEL CLUB INCORPORATED, MULTIPLE CLASS, (INT. CLS. 35, 41 AND 42), (U.S. CLS. 100, 101, 102 AND 107). SN 78-217,978. PUB. 7-26-2005. FILED 2-24-2003.
- 3,007,201. **HOME & GARDEN PARTY**. HOME AND GARDEN PARTY, LTD., (U.S. CLS. 100, 101 AND 102). SN 78-236,934. PUB. 7-26-2005. FILED 4-11-2003.
- 3,007,209 (*See Class 9 for this trademark*).
- 3,007,217. **BUDGET FASHIONISTA**. FINNEY, KATHRYN, (U.S. CLS. 100, 101 AND 102). SN 78-273,267. PUB. 7-26-2005. FILED 7-11-2003.
- 3,007,220 (*See Class 14 for this trademark*).
- 3,007,227 (*See Class 9 for this trademark*).
- 3,007,241. **INVESTMENT IS A FINE ART**. CONSERVATION STUDIO, INC., DBA GRATZ GALLERY & CONSERVATION STUDIO, MULTIPLE CLASS, (INT. CLS. 35, 37 AND 40), (U.S. CLS. 100, 101, 102, 103 AND 106). SN 78-298,959. PUB. 7-26-2005. FILED 9-11-2003.
- 3,007,243. **\$199 COMPUTER STORES AND DESIGN**. \$199 HOLDINGS LLC, MULTIPLE CLASS, (INT. CLS. 35 AND 42), (U.S. CLS. 100, 101 AND 102). SN 78-302,655. PUB. 7-5-2005. FILED 9-19-2003.
- 3,007,253. **OFFICEMART.COM AND DESIGN**. OFFICEMART.COM, INC., (U.S. CLS. 100, 101 AND 102). SN 78-310,511. PUB. 7-26-2005. FILED 10-7-2003.
- 3,007,268 (*See Class 3 for this trademark*).
- 3,007,274. **PLAN2PERFORM (BLOCK FORM)**. EPREDIX, INC., MULTIPLE CLASS, (INT. CLS. 35 AND 42), (U.S. CLS. 100, 101 AND 102). SN 78-324,311. PUB. 7-26-2005. FILED 11-6-2003.
- 3,007,277. **THE FAERY SHOP AND DESIGN**. AMY BROWN FANTASY ART, INC., (U.S. CLS. 100, 101 AND 102). SN 78-325,172. PUB. 7-26-2005. FILED 11-8-2003.
- 3,007,286. **BROOKDALE (BLOCK FORM)**. BROOKDALE LIVING COMMUNITIES, INC., MULTIPLE CLASS, (INT. CLS. 35, 36, 43 AND 44), (U.S. CLS. 100, 101 AND 102). SN 78-330,114. PUB. 7-26-2005. FILED 11-19-2003.
- 3,007,306. **COLOPROPERTY.COM (BLOCK FORM)**. INFORMATION AND REAL ESTATE SERVICES, LLC, MULTIPLE CLASS, (INT. CLS. 35 AND 36), (U.S. CLS. 100, 101 AND 102). SN 78-339,715. PUB. 7-26-2005. FILED 12-11-2003.
- 3,007,334. **COOL PERKS FOR CONCERT FANS (BLOCK FORM)**. CLEAR CHANNEL INTERNET GROUP, INC., MULTIPLE CLASS, (INT. CLS. 35 AND 41), (U.S. CLS. 100, 101, 102 AND 107). SN 78-354,360. PUB. 7-26-2005. FILED 1-20-2004.
- 3,007,346. **RESPECTFULLY DISAGREEBLE SINCE 1970 (BLOCK FORM)**. TAX ANALYSTS, (U.S. CLS. 100, 101 AND 102). SN 78-361,068. PUB. 7-26-2005. FILED 2-2-2004.
- 3,007,348. **DOXTEK KILLER TECHNOLOGIES AND DESIGN**. DOXTEK, MULTIPLE CLASS, (INT. CLS. 35, 37, 40 AND 42), (U.S. CLS. 100, 101, 102, 103 AND 106). SN 78-363,394. PUB. 7-26-2005. FILED 2-5-2004.
- 3,007,351. **COLLIN COUNTY AND DESIGN**. COLLIN COUNTY, TEXAS, (U.S. CLS. 100, 101 AND 102). SN 78-363,866. PUB. 7-26-2005. FILED 2-6-2004.
- 3,007,354. **BOUTIQUE PARTIES (BLOCK FORM)**. MATISSE, LTD., (U.S. CLS. 100, 101 AND 102). SN 78-369,395. PUB. 7-26-2005. FILED 2-17-2004.
- 3,007,358. **VIP WASH COUPONS (BLOCK FORM)**. UNITEC, INC., DBA UNITEC ELECTRONICS, (U.S. CLS. 100, 101 AND 102). SN 78-370,353. PUB. 7-26-2005. FILED 2-19-2004.
- 3,007,373. **PALM BEACH GARDENS A SIGNATURE CITY AND DESIGN**. CITY OF PALM BEACH GARDENS, (U.S. CLS. 100, 101 AND 102). SN 78-374,870. PUB. 7-5-2005. FILED 2-26-2004.
- 3,007,374. **LINCOLN WELDERS AND DESIGN**. LINCOLN GLOBAL, INC., (U.S. CLS. 100, 101 AND 102). SN 78-376,694. PUB. 6-28-2005. FILED 3-2-2004.
- 3,007,382 (*See Class 16 for this trademark*).
- 3,007,385. **BE PINK COSMETICS SKIN CARE ACCESSORIES AND DESIGN**. BE PINK, LLC, (U.S. CLS. 100, 101 AND 102). SN 78-382,653. PUB. 2-8-2005. FILED 3-11-2004.
- 3,007,398. **ASHBURY HIDES (BLOCK FORM)**. ASHBURY HIDES, LLC, (U.S. CLS. 100, 101 AND 102). SN 78-391,637. PUB. 7-26-2005. FILED 3-26-2004.
- 3,007,413. **COWGIRL HIGH STYLE (BLOCK FORM)**. CUNNINGHAM, SHARON, DBA TOTALLY ELEGANT, (U.S. CLS. 100, 101 AND 102). SN 78-399,906. PUB. 7-26-2005. FILED 4-11-2004.
- 3,007,416. **EXPRESS WELCOME (BLOCK FORM)**. CLARKE AMERICAN CHECKS, INC., (U.S. CLS. 100, 101 AND 102). SN 78-402,315. PUB. 7-26-2005. FILED 4-15-2004.
- 3,007,419. **DCCC AND DESIGN**. DEMOCRATIC CONGRESSIONAL CAMPAIGN COMMITTEE, (U.S. CLS. 100, 101 AND 102). SN 78-403,529. PUB. 7-26-2005. FILED 4-16-2004.
- 3,007,423 (*See Class 9 for this trademark*).
- 3,007,427. **LHC AND DESIGN**. LORD HATHAWAY CORPORATION, (U.S. CLS. 100, 101 AND 102). SN 78-408,291. PUB. 7-26-2005. FILED 4-26-2004.
- 3,007,428 (*See Class 9 for this trademark*).
- 3,007,429. **FUTURE MAP (BLOCK FORM)**. FUTURE MAP, INC., MULTIPLE CLASS, (INT. CLS. 35 AND 41), (U.S. CLS. 100, 101, 102 AND 107). SN 78-409,209. PUB. 7-26-2005. FILED 4-28-2004.
- 3,007,433. **NO LIMITS (BLOCK FORM)**. NEW YORK BUS SALES, LLC, (U.S. CLS. 100, 101 AND 102). SN 78-412,270. PUB. 7-26-2005. FILED 5-3-2004.
- 3,007,441. **FIRST CHOICE FINANCIAL FCF INSURANCE MARKETING, INC. (BLOCK FORM)**. FCF INSURANCE MARKETING, INC., MULTIPLE CLASS, (INT. CLS. 35 AND 36), (U.S. CLS. 100, 101 AND 102). SN 78-414,164. PUB. 6-7-2005. FILED 5-6-2004.
- 3,007,451. **LYNDEN LEAF DESIGNS (BLOCK FORM)**. DIDO-MIZIO, LYNNE, (U.S. CLS. 100, 101 AND 102). SN 78-418,934. PUB. 7-26-2005. FILED 5-14-2004.
- 3,007,454. **NEW MEXICO FIRST (BLOCK FORM)**. NEW MEXICO FIRST, MULTIPLE CLASS, (INT. CLS. 35 AND 41), (U.S. CLS. 100, 101, 102 AND 107). SN 78-420,194. PUB. 7-26-2005. FILED 5-17-2004.
- 3,007,455. **BUILDING INSIGHTS. BREAKING BOUNDARIES (BLOCK FORM)**. ELSEVIER INC., (U.S. CLS. 100, 101 AND 102). SN 78-421,314. PUB. 7-26-2005. FILED 5-19-2004.
- 3,007,456. **CASHFLOW TRAFFIC (BLOCK FORM)**. DALBEY PUBLISHING, LLC, (U.S. CLS. 100, 101 AND 102). SN 78-421,341. PUB. 7-26-2005. FILED 5-19-2004.
- 3,007,460. **NO DOUBT SCANNING (BLOCK FORM)**. TRANSFLO EXPRESS LLC, MULTIPLE CLASS, (INT. CLS. 35 AND 42), (U.S. CLS. 100, 101 AND 102). SN 78-423,216. PUB. 7-26-2005. FILED 5-21-2004.
- 3,007,463. **EN (STYLIZED)**. HALL, JOHN, (U.S. CLS. 100, 101 AND 102). SN 78-423,791. PUB. 7-26-2005. FILED 5-24-2004.
- 3,007,466. **PRESCRIPTIONS FOR COPING (BLOCK FORM)**. RACHEL'S WELL, INC., (U.S. CLS. 100, 101 AND 102). SN 78-425,033. PUB. 7-26-2005. FILED 5-25-2004.
- 3,007,468. **LEXIA AND DESIGN**. MICONE, ANDREW, (U.S. CLS. 100, 101 AND 102). SN 78-425,855. PUB. 6-21-2005. FILED 5-27-2004.
- 3,007,475. **ONEVISION (BLOCK FORM)**. HITACHI AMERICA, LTD., (U.S. CLS. 100, 101 AND 102). SN 78-430,333. PUB. 6-7-2005. FILED 6-4-2004.
- 3,007,477. **EKNIFEWORKS.COM AND DESIGN**. SMOKY

- MOUNTAIN KNIFE WORKS, (U.S. CLS. 100, 101 AND 102). SN 78-430,894. PUB. 7-26-2005. FILED 6-7-2004.
- 3,007,482. **A NATIONAL REPUTATION FOR PERSONAL SERVICE (BLOCK FORM)**. CENTEX CORPORATION, MULTIPLE CLASS, (INT. CLS. 35, 36, 38 AND 42), (U.S. CLS. 100, 101, 102 AND 104). SN 78-433,936. PUB. 7-26-2005. FILED 6-11-2004.
- 3,007,491. **TO TRUTH (BLOCK FORM)**. TO TRUTH INC., (U.S. CLS. 100, 101 AND 102). SN 78-436,918. PUB. 7-26-2005. FILED 6-17-2004.
- 3,007,496. **SERVICIOS LATINOS AND DESIGN**. SERVICIOS LATINOS CORP., MULTIPLE CLASS, (INT. CLS. 35 AND 42), (U.S. CLS. 100, 101 AND 102). SN 78-438,062. PUB. 7-26-2005. FILED 6-18-2004.
- 3,007,505. **PELTZ SHOES (BLOCK FORM)**. B.G.P. INC., (U.S. CLS. 100, 101 AND 102). SN 78-441,584. PUB. 7-26-2005. FILED 6-25-2004.
- 3,007,506. **PELTZ FAMOUS BRAND SHOES (BLOCK FORM)**. B.G.P. INC., (U.S. CLS. 100, 101 AND 102). SN 78-441,601. PUB. 7-26-2005. FILED 6-25-2004.
- 3,007,509. **LUXLIGHT (BLOCK FORM)**. LUX LIGHT ASSOCIATES, LLC, (U.S. CLS. 100, 101 AND 102). SN 78-443,554. PUB. 7-26-2005. FILED 6-30-2004.
- 3,007,523. **LITTLE SUE AND DESIGN**. NEIGHBORHOOD CONVENIENCE, INC., (U.S. CLS. 100, 101 AND 102). SN 78-456,400. PUB. 7-26-2005. FILED 7-26-2004.
- 3,007,542. **TARCHON CAPITAL MANAGEMENT AND DESIGN**. TARCHON CAPITAL MANAGEMENT LIMITED, MULTIPLE CLASS, (INT. CLS. 35 AND 36), (U.S. CLS. 100, 101 AND 102). SN 79-000,454. PUB. 7-26-2005. FILED 12-15-2003.
- 3,007,545. **DRINKTEC (BLOCK FORM)**. MESSE MÜNCHEN GMBH, (U.S. CLS. 100, 101 AND 102). SN 79-000,742. PUB. 7-26-2005. FILED 12-27-2003.
- 3,007,547. **MMI (BLOCK FORM)**. MESSE MÜNCHEN GMBH, (U.S. CLS. 100, 101 AND 102). SN 79-000,895. PUB. 7-26-2005. FILED 12-27-2003.
- 3,007,552. **MST.FACTORY DORTMUND (BLOCK FORM)**. MST.FACTORY DORTMUND GMBH, MULTIPLE CLASS, (INT. CLS. 35, 40, 41 AND 42), (U.S. CLS. 100, 101, 102, 103, 106 AND 107). SN 79-001,218. PUB. 7-26-2005. FILED 2-2-2004.
-
- CLASS 36—INSURANCE AND FINANCIAL**
- 3,006,783. **N NEW RIVER (STYLIZED)**. NEWRIVER, INC., MULTIPLE CLASS, (INT. CLS. 36 AND 38), (U.S. CLS. 100, 101, 102 AND 104). SN 75-634,235. PUB. 7-26-2005. FILED 2-5-1999.
- 3,006,786. **LIFEPLANS**. LIFEPLANS, INC., (U.S. CLS. 100, 101 AND 102). SN 75-740,699. PUB. 7-26-2005. FILED 6-30-1999.
- 3,006,787. **LIFEPLANS AND DESIGN**. LIFEPLANS, INC., (U.S. CLS. 100, 101 AND 102). SN 75-742,663. PUB. 7-26-2005. FILED 6-30-1999.
- 3,006,797 (*See Class 35 for this trademark*).
- 3,006,801. **STARKER SERVICES**. STARKER SERVICES, INCORPORATED, (U.S. CLS. 100, 101 AND 102). SN 76-138,162. PUB. 7-26-2005. FILED 9-28-2000.
- 3,006,810 (*See Class 35 for this trademark*).
- 3,006,812 (*See Class 16 for this trademark*).
- 3,006,829 (*See Class 35 for this trademark*).
- 3,006,837 (*See Class 9 for this trademark*).
- 3,006,845 (*See Class 35 for this trademark*).
- 3,006,869 (*See Class 9 for this trademark*).
- 3,006,880. **AGA FOUNDATION AMATEUR GOLFERS FOR CHARITY (BLOCK FORM)**. BROWN, FRANK L., (U.S. CLS. 100, 101 AND 102). SN 76-502,959. PUB. 7-26-2005. FILED 4-1-2003.
- 3,006,881. **@EDGAR AND DESIGN**. QUESTNET CORP., MULTIPLE CLASS, (INT. CLS. 36 AND 38), (U.S. CLS. 100, 101, 102 AND 104). SN 76-504,454. PUB. 7-26-2005. FILED 4-7-2003.
- 3,006,888 (*See Class 9 for this trademark*).
- 3,006,891 (*See Class 3 for this trademark*).
- 3,006,901 (*See Class 35 for this trademark*).
- 3,006,910. **N LOAN PLACEMENT NETWORK AND DESIGN**. NORTHLAND NETWORKS, INC., (U.S. CLS. 100, 101 AND 102). SN 76-524,124. PUB. 7-26-2005. FILED 6-13-2003.
- 3,006,913. **UTAH COMMUNITY INVESTMENT SERVICES**. UTAH COMMUNITY CREDIT UNION, (U.S. CLS. 100, 101 AND 102). SN 76-527,892. PUB. 7-26-2005. FILED 6-27-2003.
- 3,006,940. **DERBY LANE ESTABLISHED 1925 AND DESIGN**. ST. PETERSBURG KENNEL CLUB, INC., (U.S. CLS. 100, 101 AND 102). SN 76-544,374. PUB. 7-26-2005. FILED 9-12-2003.
- 3,006,973. **BOND CONTINUATION**. NATIONAL BOND & TRUST COMPANY, INC., (U.S. CLS. 100, 101 AND 102). SN 76-556,500. PUB. 7-26-2005. FILED 10-17-2003.
- 3,007,035. **FENGATE PROPERTY MANAGEMENT LTD. AND DESIGN**. FENGATE PROPERTY MANAGEMENT LTD., (U.S. CLS. 100, 101 AND 102). SN 76-571,106. PUB. 7-26-2005. FILED 1-21-2004.
- 3,007,049. **MEDINVEST (BLOCK FORM)**. CENTRAL RESERVE LIFE INSURANCE COMPANY, (U.S. CLS. 100, 101 AND 102). SN 76-576,820. PUB. 7-26-2005. FILED 2-19-2004.
- 3,007,069. **CENTURY 21 FINE HOMES & ESTATES (BLOCK FORM)**. TM ACQUISITION CORP., (U.S. CLS. 100, 101 AND 102). SN 76-581,393. PUB. 7-26-2005. FILED 3-15-2004.
- 3,007,095. **UNIVERA SOLUTIONS (BLOCK FORM)**. EXCEL-LUS HEALTH PLAN, INC., MULTIPLE CLASS, (INT. CLS. 36 AND 44), (U.S. CLS. 100, 101 AND 102). SN 76-588,544. PUB. 7-26-2005. FILED 9-1-2003.
- 3,007,102 (*See Class 16 for this trademark*).
- 3,007,111. **FASTCASH4HOMES.COM (BLOCK FORM)**. ASSET MARKETING CONSULTANTS, INC., (U.S. CLS. 100, 101 AND 102). SN 76-591,238. PUB. 7-26-2005. FILED 5-10-2004.
- 3,007,120. **RELAX...YOU'RE COVERED (BLOCK FORM)**. LEGAL BENEFITS, INC., (U.S. CLS. 100, 101 AND 102). SN 76-593,253. PUB. 7-26-2005. FILED 5-17-2004.
- 3,007,123 (*See Class 16 for this trademark*).
- 3,007,124. **MISCELLANEOUS DESIGN**. ROOM TO READ, MULTIPLE CLASS, (INT. CLS. 36 AND 41), (U.S. CLS. 100, 101, 102 AND 107). SN 76-593,571. PUB. 7-26-2005. FILED 5-24-2004.
- 3,007,162. **INSURE MY TRIP (BLOCK FORM)**. IMT SERVICES CORP., (U.S. CLS. 100, 101 AND 102). SN 76-605,950. PUB. 7-26-2005. FILED 8-9-2004.
- 3,007,168 (*See Class 9 for this trademark*).
- 3,007,175 (*See Class 16 for this trademark*).
- 3,007,184. **GRUPPO MPS AND DESIGN**. BANCA MONTE DEI PASCHI DI SIENA S.P.A., MULTIPLE CLASS, (INT. CLS. 36 AND 38), (U.S. CLS. 100, 101, 102 AND 104). SN 78-204,609. PUB. 7-26-2005. FILED 1-17-2003.
- 3,007,252. **MASS.GOV**. THE COMMONWEALTH OF MASSACHUSETTS, EXECUTIVE DEPARTMENT, ACTING THROUGH THE INFORMATION TECHNOLOGY DIVISION, MULTIPLE CLASS, (INT. CLS. 36, 38, 39 AND 41), (U.S. CLS. 100, 101, 102, 104, 105 AND 107). SN 78-309,161. PUB. 7-26-2005. FILED 10-3-2003.
- 3,007,271. **PRUDENT BEAR (BLOCK FORM)**. DAVID W. TICE & ASSOCIATES, LLC, (U.S. CLS. 100, 101 AND 102). SN 78-323,559. PUB. 7-26-2005. FILED 11-5-2003.
- 3,007,279. **SHAIRFORCE (BLOCK FORM)**. SHAIRFORCE, LLC, (U.S. CLS. 100, 101 AND 102). SN 78-326,177. PUB. 7-26-2005. FILED 11-11-2003.
- 3,007,286 (*See Class 35 for this trademark*).
- 3,007,306 (*See Class 35 for this trademark*).
- 3,007,335. **MISCELLANEOUS DESIGN**. KIAWAH RESORT ASSOCIATES, LP, MULTIPLE CLASS, (INT. CLS. 36 AND 41), (U.S. CLS. 100, 101, 102 AND 107). SN 78-354,796. PUB. 7-26-2005. FILED 1-21-2004.
- 3,007,342. **PENNIES FOR PEACE (BLOCK FORM)**. CENTRAL ASIA INSTITUTE, INC., (U.S. CLS. 100, 101 AND 102). SN 78-359,295. PUB. 7-26-2005. FILED 1-29-2004.
- 3,007,381. **ENGINE DEFENDER (BLOCK FORM)**. CHEVRON U.S.A. INC., MULTIPLE CLASS, (INT. CLS. 36 AND 37), (U.S. CLS. 100, 101, 102, 103 AND 106). SN 78-380,137. PUB. 7-26-2005. FILED 3-8-2004.
- 3,007,382 (*See Class 16 for this trademark*).
- 3,007,415 (*See Class 9 for this trademark*).
- 3,007,441 (*See Class 35 for this trademark*).
- 3,007,476. **AN ODS COMPANY AND DESIGN**. OREGON

DENTAL SERVICE, (U.S. CLS. 100, 101 AND 102). SN 78-430,380. PUB. 7-26-2005. FILED 6-4-2004.
 3,007,482 (*See Class 35 for this trademark*).
 3,007,485. **BECAUSE YOUR FUTURE IS OUR FUTURE. (BLOCK FORM)**. JARED, BENNETT J, (U.S. CLS. 100, 101 AND 102). SN 78-435,689. PUB. 7-26-2005. FILED 6-15-2004.
 3,007,487. **SCCU SMALL BUSINESS SERVICES AND DESIGN**. SPACE COAST CREDIT UNION, (U.S. CLS. 100, 101 AND 102). SN 78-435,999. PUB. 7-26-2005. FILED 6-16-2004.
 3,007,495. **ACRIN (BLOCK FORM)**. AMERICAN COLLEGE OF RADIOLOGY, MULTIPLE CLASS, (INT. CLS. 36 AND 42), (U.S. CLS. 100, 101 AND 102). SN 78-437,785. PUB. 7-5-2005. FILED 6-18-2004.
 3,007,513. **LOGICALEASE (BLOCK FORM)**. LOGICALEASE, (U.S. CLS. 100, 101 AND 102). SN 78-444,400. PUB. 7-26-2005. FILED 7-1-2004.
 3,007,525 (*See Class 9 for this trademark*).
 3,007,534. **UMBFX (BLOCK FORM)**. UMB FINANCIAL CORPORATION, (U.S. CLS. 100, 101 AND 102). SN 78-559,245. PUB. 7-26-2005. FILED 2-2-2005.
 3,007,542 (*See Class 35 for this trademark*).

CLASS 37—CONSTRUCTION AND REPAIR

3,006,797 (*See Class 35 for this trademark*).
 3,006,804 (*See Class 11 for this trademark*).
 3,006,829 (*See Class 35 for this trademark*).
 3,006,831. **NATIONAL INFRASTRUCTURE**. MAC & MAC HYDRODEMOLITION INC., MULTIPLE CLASS, (INT. CLS. 37 AND 40), (U.S. CLS. 100, 103 AND 106). SN 76-358,530. PUB. 7-26-2005. FILED 1-14-2002.
 3,006,856 (*See Class 35 for this trademark*).
 3,006,859. **DE-CAL, INC. MECHANICAL CONTRACTORS AND DESIGN**. DE-CAL, INC., (U.S. CLS. 100, 103 AND 106). SN 76-469,356. PUB. 7-26-2005. FILED 11-22-2002.
 3,006,887. **MECHANICAL DYNAMICS AND ANALYSIS, LLC AND DESIGN**. MECHANICAL DYNAMICS AND ANALYSIS, LLC, MULTIPLE CLASS, (INT. CLS. 37 AND 42), (U.S. CLS. 100, 101, 103 AND 106). SN 76-510,837. PUB. 7-26-2005. FILED 4-30-2003.
 3,006,891 (*See Class 3 for this trademark*).
 3,006,896 (*See Class 20 for this trademark*).
 3,006,903. **FROM CONCEPT TO CLEANUP (BLOCK FORM)**. CCL ASSOCIATES, L.L.C., (U.S. CLS. 100, 103 AND 106). SN 76-521,351. PUB. 7-26-2005. FILED 6-9-2003.
 3,006,942 (*See Class 35 for this trademark*).
 3,006,947 (*See Class 12 for this trademark*).
 3,007,006. **FINAL GRADE (BLOCK FORM)**. FINAL GRADE, LLC, (U.S. CLS. 100, 103 AND 106). SN 76-565,723. PUB. 7-26-2005. FILED 12-8-2003.
 3,007,017 (*See Class 9 for this trademark*).
 3,007,034. **GREENSYN (BLOCK FORM)**. JBR ENTERPRISES, INC., MULTIPLE CLASS, (INT. CLS. 37 AND 42), (U.S. CLS. 100, 101, 103 AND 106). SN 76-570,687. PUB. 7-26-2005. FILED 1-20-2004.
 3,007,036 (*See Class 7 for this trademark*).
 3,007,106. **DRY FORCE AND DESIGN**. DRY FORCE, INC., (U.S. CLS. 100, 103 AND 106). SN 76-589,849. PUB. 7-26-2005. FILED 4-30-2004.
 3,007,148. **FASTBATH ONE DAY ACRYLIC BATH SYSTEMS AND DESIGN**. FASTBATH, LLC, (U.S. CLS. 100, 103 AND 106). SN 76-598,832. PUB. 7-26-2005. FILED 6-23-2004.
 3,007,168 (*See Class 9 for this trademark*).
 3,007,179 (*See Class 7 for this trademark*).
 3,007,191 (*See Class 7 for this trademark*).
 3,007,202. **WESTWIND (BLOCK FORM)**. WESTWIND TECHNOLOGIES, INC., MULTIPLE CLASS, (INT. CLS. 37 AND 42), (U.S. CLS. 100, 101, 103 AND 106). SN 78-237,946. PUB. 7-26-2005. FILED 4-15-2003.
 3,007,211 (*See Class 9 for this trademark*).
 3,007,241 (*See Class 35 for this trademark*).
 3,007,248. **QCAREPRO**. QUEST TECHNOLOGIES, INC., MULTIPLE CLASS, (INT. CLS. 37, 41 AND 42), (U.S. CLS. 100, 101, 103, 106 AND 107). SN 78-306,583. PUB. 7-26-2005. FILED 9-29-2003.
 3,007,275. **INTUITIVE HOMES (BLOCK FORM)**. INTUITIVE

HOMES, INC., MULTIPLE CLASS, (INT. CLS. 37 AND 42), (U.S. CLS. 100, 101, 103 AND 106). SN 78-324,358. PUB. 7-26-2005. FILED 11-6-2003.
 3,007,291 (*See Class 28 for this trademark*).
 3,007,318. **MISCELLANEOUS DESIGN**. CENTEX CORPORATION, (U.S. CLS. 100, 103 AND 106). SN 78-345,072. PUB. 7-26-2005. FILED 12-23-2003.
 3,007,326. **MISCELLANEOUS DESIGN**. DAVIES COMPUTER SOLUTIONS, INC., (U.S. CLS. 100, 103 AND 106). SN 78-346,794. PUB. 7-26-2005. FILED 12-31-2003.
 3,007,348 (*See Class 35 for this trademark*).
 3,007,355. **MISCELLANEOUS DESIGN**. CRUMLEY, DAVID, (U.S. CLS. 100, 103 AND 106). SN 78-369,755. PUB. 7-26-2005. FILED 2-18-2004.
 3,007,357. **MISCELLANEOUS DESIGN**. ALTIMA HOMES, INC, (U.S. CLS. 100, 103 AND 106). SN 78-370,269. PUB. 7-26-2005. FILED S.R. 2-18-2004; AM. P.R. 2-17-2005.
 3,007,367. **TRUSTWORTHY HELP AROUND THE HOME (BLOCK FORM)**. SANDERSON, BRYAN A., (U.S. CLS. 100, 103 AND 106). SN 78-371,897. PUB. 7-26-2005. FILED 2-21-2004.
 3,007,381 (*See Class 36 for this trademark*).
 3,007,478. **WILLOWTREE (BLOCK FORM)**. WILLOWTREE DEVELOPMENT, (U.S. CLS. 100, 103 AND 106). SN 78-432,425. PUB. 7-26-2005. FILED 6-9-2004.
 3,007,489. **TVA AND DESIGN**. TVA FIRE AND LIFE SAFETY, INC., MULTIPLE CLASS, (INT. CLS. 37 AND 42), (U.S. CLS. 100, 101, 103 AND 106). SN 78-436,080. PUB. 7-26-2005. FILED 6-16-2004.

CLASS 38—COMMUNICATION

3,006,783 (*See Class 36 for this trademark*).
 3,006,791 (*See Class 9 for this trademark*).
 3,006,810 (*See Class 35 for this trademark*).
 3,006,877 (*See Class 9 for this trademark*).
 3,006,878 (*See Class 9 for this trademark*).
 3,006,881 (*See Class 36 for this trademark*).
 3,006,888 (*See Class 9 for this trademark*).
 3,006,891 (*See Class 3 for this trademark*).
 3,006,925. **BIENVENIDOS**. LANDA, MIGUEL ANGEL GONZALEZ, MULTIPLE CLASS, (INT. CLS. 38 AND 41), (U.S. CLS. 100, 101, 104 AND 107). SN 76-535,247. PUB. 7-26-2005. FILED 7-24-2003.
 3,006,957 (*See Class 11 for this trademark*).
 3,006,983 (*See Class 35 for this trademark*).
 3,007,002. **TOMORROW'S COMMUNICATIONS TODAY (BLOCK FORM)**. HEYANITA, INC., MULTIPLE CLASS, (INT. CLS. 38 AND 42), (U.S. CLS. 100, 101 AND 104). SN 76-564,527. PUB. 7-26-2005. FILED 12-10-2003.
 3,007,101. **SSSH.COM (BLOCK FORM)**. WASTELAND, INC., (U.S. CLS. 100, 101 AND 104). SN 76-589,239. PUB. 7-26-2005. FILED 4-27-2004.
 3,007,121. **MORTGAGEMINDS.COM AND DESIGN**. CYBERTECH, INC., (U.S. CLS. 100, 101 AND 104). SN 76-593,292. PUB. 7-26-2005. FILED 5-17-2004.
 3,007,123 (*See Class 16 for this trademark*).
 3,007,168 (*See Class 9 for this trademark*).
 3,007,175 (*See Class 16 for this trademark*).
 3,007,184 (*See Class 36 for this trademark*).
 3,007,231 (*See Class 9 for this trademark*).
 3,007,247 (*See Class 9 for this trademark*).
 3,007,252 (*See Class 36 for this trademark*).
 3,007,319. **BLOX TECHNOLOGY (BLOCK FORM)**. INTERNET ASSOCIATION CORPORATION, (U.S. CLS. 100, 101 AND 104). SN 78-345,332. PUB. 7-26-2005. FILED 12-24-2003.
 3,007,339. **SECURITY SCREEN (BLOCK FORM)**. QWEST COMMUNICATIONS INTERNATIONAL INC., (U.S. CLS. 100, 101 AND 104). SN 78-358,035. PUB. 7-26-2005. FILED 1-27-2004.
 3,007,379. **WIN.NET (BLOCK FORM)**. WINNET COMMUNICATIONS, INC., (U.S. CLS. 100, 101 AND 104). SN 78-378,601. PUB. 7-26-2005. FILED 3-4-2004.
 3,007,428 (*See Class 9 for this trademark*).
 3,007,482 (*See Class 35 for this trademark*).

CLASS 39—TRANSPORTATION AND STORAGE

- 3,006,795. **APEX TRAILER LEASING & RENTALS**. AURORA TRAILER HOLDINGS LLC, (U.S. CLS. 100 AND 105). SN 76-100,782. PUB. 7-26-2005. FILED 8-1-2000.
 3,006,797 (*See Class 35 for this trademark*).
 3,006,814. **TWO MEN AND A TRUCK**. TWO MEN AND A TRUCK/INTERNATIONAL, INC., (U.S. CLS. 100 AND 105). SN 76-249,448. PUB. 3-5-2002. FILED 5-1-2001.
 3,006,815. **TWO MEN AND A TRUCK AND DESIGN**. TWO MEN AND A TRUCK/INTERNATIONAL, INC., (U.S. CLS. 100 AND 105). SN 76-249,536. PUB. 3-5-2002. FILED 5-1-2001.
 3,006,823 (*See Class 35 for this trademark*).
 3,006,869 (*See Class 9 for this trademark*).
 3,006,891 (*See Class 3 for this trademark*).
 3,006,922. **HENDERSON'S WHARF**. HENDERSON'S WHARF BALTIMORE, L.L.C., MULTIPLE CLASS, (INT. CLS. 39, 41 AND 43), (U.S. CLS. 100, 101, 105 AND 107). SN 76-532,552. PUB. 7-26-2005. FILED 7-23-2003.
 3,006,929 (*See Class 9 for this trademark*).
 3,006,996 (*See Class 35 for this trademark*).
 3,007,054. **BULKMATOLOGY (BLOCK FORM)**. PELLETRON CORPORATION, (U.S. CLS. 100 AND 105). SN 76-578,347. PUB. 7-26-2005. FILED 3-1-2004.
 3,007,159. **FIVE-STAR WILDERNESS (BLOCK FORM)**. UPPER PENINSULA TRAVEL & RECREATION ASSOCIATION, (U.S. CLS. 100 AND 105). SN 76-602,842. PUB. 7-26-2005. FILED 7-19-2004.
 3,007,168 (*See Class 9 for this trademark*).
 3,007,252 (*See Class 36 for this trademark*).
 3,007,343. **JET CONCEPTS, INC (BLOCK FORM)**. JET CONCEPTS, INC., (U.S. CLS. 100 AND 105). SN 78-359,453. PUB. 7-26-2005. FILED 1-29-2004.
 3,007,414. **BACK TO THE WILD (BLOCK FORM)**. BACK TO THE WILD, INC., (U.S. CLS. 100 AND 105). SN 78-401,633. PUB. 7-26-2005. FILED 4-14-2004.
 3,007,529. **LCEC AND DESIGN**. LEE COUNTY ELECTRIC COOPERATIVE, INC., (U.S. CLS. 100 AND 105). SN 78-465,003. PUB. 7-26-2005. FILED 8-10-2004.

CLASS 40—MATERIAL TREATMENT

- 3,006,831 (*See Class 37 for this trademark*).
 3,006,862 (*See Class 12 for this trademark*).
 3,006,863 (*See Class 35 for this trademark*).
 3,006,891 (*See Class 3 for this trademark*).
 3,006,934 (*See Class 3 for this trademark*).
 3,006,974 (*See Class 6 for this trademark*).
 3,006,975 (*See Class 6 for this trademark*).
 3,007,010. **MISCELLANEOUS DESIGN**. MECHANICAL FINISHING, INC., (U.S. CLS. 100, 103 AND 106). SN 76-567,036. PUB. 7-26-2005. FILED 12-16-2003.
 3,007,107. **W AND DESIGN**. WINSTON PRINTING COMPANY, MULTIPLE CLASS, (INT. CLS. 40 AND 42), (U.S. CLS. 100, 101, 103 AND 106). SN 76-589,877. PUB. 7-26-2005. FILED 5-3-2004.
 3,007,168 (*See Class 9 for this trademark*).
 3,007,191 (*See Class 7 for this trademark*).
 3,007,195 (*See Class 7 for this trademark*).
 3,007,241 (*See Class 35 for this trademark*).
 3,007,296. **MEDICAL ART PROSTHETICS (BLOCK FORM)**. MEDICAL ART PROSTHETICS, MULTIPLE CLASS, (INT. CLS. 40 AND 44), (U.S. CLS. 100, 101, 103 AND 106). SN 78-335,875. PUB. 7-26-2005. FILED 12-3-2003.
 3,007,297. **ART DIFFUSION (BLOCK FORM)**. INTERLAM INC., MULTIPLE CLASS, (INT. CLS. 40 AND 42), (U.S. CLS. 100, 101, 103 AND 106). SN 78-336,360. PUB. 7-26-2005. FILED 12-4-2003.
 3,007,348 (*See Class 35 for this trademark*).
 3,007,480. **BIMINI MARINE (BLOCK FORM)**. CLAYLAND, DAN, (U.S. CLS. 100, 103 AND 106). SN 78-432,985. PUB. 7-26-2005. FILED 6-10-2004.
 3,007,552 (*See Class 35 for this trademark*).

CLASS 41—EDUCATION AND ENTERTAINMENT

- 3,006,781 (*See Class 35 for this trademark*).
 3,006,782. **ADVANTEDGE**. CAPTIVA SOFTWARE CORPORATION, MULTIPLE CLASS, (INT. CLS. 41 AND 42), (U.S. CLS. 100, 101 AND 107). SN 75-548,674. PUB. 7-26-2005. FILED 9-4-1998.
 3,006,790 (*See Class 9 for this trademark*).
 3,006,791 (*See Class 9 for this trademark*).
 3,006,792 (*See Class 6 for this trademark*).
 3,006,796. **REACH THE CHILDREN**. REACH THE CHILDREN, INC., MULTIPLE CLASS, (INT. CLS. 41 AND 42), (U.S. CLS. 100, 101 AND 107). SN 76-103,455. PUB. 4-1-2003. FILED 8-7-2000.
 3,006,797 (*See Class 35 for this trademark*).
 3,006,808. **MISCELLANEOUS DESIGN**. CEMEX, S.A. DE C.V., (U.S. CLS. 100, 101 AND 107). SN 76-192,837. PUB. 7-26-2005. FILED 1-11-2001.
 3,006,810 (*See Class 35 for this trademark*).
 3,006,816. **AQUA MOM AND DESIGN**. PRITCHETT, ANDREA N., (U.S. CLS. 100, 101 AND 107). SN 76-261,500. PUB. 7-26-2005. FILED 5-22-2001.
 3,006,828 (*See Class 16 for this trademark*).
 3,006,830 (*See Class 9 for this trademark*).
 3,006,834. **KINESINOMICS**. WADLEIGH & ASSOCIATES, INC., MULTIPLE CLASS, (INT. CLS. 41 AND 44), (U.S. CLS. 100, 101 AND 107). SN 76-366,725. PUB. 7-26-2005. FILED 2-4-2002.
 3,006,855. **AMERICAN ACADEMY OF ORIENTAL MEDICAL FAMILY PRACTITIONERS**. AMERICAN ACADEMY OF ORIENTAL MEDICINE FAMILY PRACTICE, (U.S. CLS. 100, 101 AND 107). SN 76-459,822. PUB. 7-26-2005. FILED 10-10-2002.
 3,006,856 (*See Class 35 for this trademark*).
 3,006,860. **BIOSCIENCE**. THE AMERICAN INSTITUTE OF BIOLOGICAL SCIENCES, (U.S. CLS. 100, 101 AND 107). SN 76-469,537. PUB. 7-26-2005. FILED 11-22-2002.
 3,006,865. **SOLUTIONSPUS**. SYLVAN LEARNING, INC., MULTIPLE CLASS, (INT. CLS. 41 AND 45), (U.S. CLS. 100, 101 AND 107). SN 76-471,268. PUB. 7-26-2005. FILED 11-18-2002.
 3,006,869 (*See Class 9 for this trademark*).
 3,006,873. **REFORMAT COREWORK SERIES**. ENGINEERING FITNESS INTERNATIONAL CORP., DBA TOTAL GYM, DBA EFI, AND DBA EFI MEDICAL SYSTEMS, (U.S. CLS. 100, 101 AND 107). SN 76-494,113. PUB. 7-26-2005. FILED 3-3-2003.
 3,006,874 (*See Class 6 for this trademark*).
 3,006,879. **ADOPT-A-TRAPPER**. MAX MCGRAW WILDLIFE FOUNDATION, MULTIPLE CLASS, (INT. CLS. 41 AND 44), (U.S. CLS. 100, 101 AND 107). SN 76-501,928. PUB. 7-26-2005. FILED 3-27-2003.
 3,006,888 (*See Class 9 for this trademark*).
 3,006,891 (*See Class 3 for this trademark*).
 3,006,897 (*See Class 9 for this trademark*).
 3,006,898 (*See Class 9 for this trademark*).
 3,006,901 (*See Class 35 for this trademark*).
 3,006,902. **LARRY FLYNT'S GRAND SLAM OF POKER**. L.F.P., INC., (U.S. CLS. 100, 101 AND 107). SN 76-520,972. PUB. 7-26-2005. FILED 5-29-2003.
 3,006,912. **FX POWER TRADING COURSE**. FOREX CAPITAL MARKETS LLC, (U.S. CLS. 100, 101 AND 107). SN 76-527,474. PUB. 7-26-2005. FILED 7-3-2003.
 3,006,914. **HAVE YOUR MIDLIFE CRISIS IN**. RUSSELL, JANET, (U.S. CLS. 100, 101 AND 107). SN 76-528,021. PUB. 7-26-2005. FILED 6-25-2003.
 3,006,916. **CORPORATE WHORE**. CW MUSIC, LLC, (U.S. CLS. 100, 101 AND 107). SN 76-530,163. PUB. 7-26-2005. FILED 7-1-2003.
 3,006,919 (*See Class 9 for this trademark*).
 3,006,922 (*See Class 39 for this trademark*).
 3,006,925 (*See Class 38 for this trademark*).
 3,006,929 (*See Class 9 for this trademark*).
 3,006,945. **WHALERS AND DESIGN**. COMPUWARE SPORTS CORPORATION, (U.S. CLS. 100, 101 AND 107). SN 76-548,490. PUB. 7-26-2005. FILED 10-1-2003.
 3,006,957 (*See Class 11 for this trademark*).
 3,006,964 (*See Class 16 for this trademark*).

- 3,006,965. **WHISK**. WHISK COMMUNICATIONS, LLC. (U.S. CLS. 100, 101 AND 107). SN 76-555,121. PUB. 7-26-2005. FILED 10-29-2003.
- 3,006,968 (*See Class 9 for this trademark*).
- 3,006,969 (*See Class 35 for this trademark*).
- 3,006,972 (*See Class 35 for this trademark*).
- 3,006,976 (*See Class 35 for this trademark*).
- 3,006,977 (*See Class 35 for this trademark*).
- 3,006,980. **MYASE (STYLIZED)**. NATIONAL INSTITUTE FOR AUTOMOTIVE EXCELLENCE (NIASE). (U.S. CLS. 100, 101 AND 107). SN 76-557,949. PUB. 7-26-2005. FILED 11-6-2003.
- 3,006,982. **CLARITY BEHAVIORAL CONSULTING (BLOCK FORM)**. CATAGNUS, ROBYN M., MULTIPLE CLASS, (INT. CLS. 41 AND 44). (U.S. CLS. 100, 101 AND 107). SN 76-559,469. PUB. 7-26-2005. FILED 11-12-2003.
- 3,006,983 (*See Class 35 for this trademark*).
- 3,006,984. **CRIME IS LIKE WATER, IT WILL ALWAYS TAKE THE PATH OF LEAST RESISTANCE (STYLIZED)**. CREATIVE SECURITY CONCEPTS, INC., MULTIPLE CLASS, (INT. CLS. 41, 42 AND 45). (U.S. CLS. 100, 101 AND 107). SN 76-560,041. PUB. 7-26-2005. FILED 11-14-2003.
- 3,006,996 (*See Class 35 for this trademark*).
- 3,006,997. **BRANDMEIER (BLOCK FORM)**. BRANDMEIER, JONATHON. (U.S. CLS. 100, 101 AND 107). SN 76-563,519. PUB. 7-26-2005. FILED 11-20-2003.
- 3,006,998. **PRIME TIME SISTER CIRCLES (BLOCK FORM)**. THE GASTON & PORTER HEALTH IMPROVEMENT CENTER. (U.S. CLS. 100, 101 AND 107). SN 76-563,559. PUB. 7-26-2005. FILED 12-2-2003.
- 3,007,012 (*See Class 9 for this trademark*).
- 3,007,014. **BLU (BLOCK FORM)**. BLU VENTURES, LLC. (U.S. CLS. 100, 101 AND 107). SN 76-567,275. PUB. 7-26-2005. FILED 12-29-2003.
- 3,007,015. **BLU MUSIC (BLOCK FORM)**. BLU VENTURES, LLC. (U.S. CLS. 100, 101 AND 107). SN 76-567,289. PUB. 7-26-2005. FILED 12-29-2003.
- 3,007,016 (*See Class 9 for this trademark*).
- 3,007,017 (*See Class 9 for this trademark*).
- 3,007,018. **RENAL WEEK (BLOCK FORM)**. THE AMERICAN SOCIETY OF NEPHROLOGY. (U.S. CLS. 100, 101 AND 107). SN 76-567,456. PUB. 7-26-2005. FILED 12-16-2003.
- 3,007,020. **FAT ROCK ENTERTAINMENT (BLOCK FORM)**. FAT ROCK ENTERTAINMENT. (U.S. CLS. 100, 101 AND 107). SN 76-567,954. PUB. 7-26-2005. FILED 1-2-2004.
- 3,007,021. **MISCELLANEOUS DESIGN**. FAT ROCK ENTERTAINMENT. (U.S. CLS. 100, 101 AND 107). SN 76-568,048. PUB. 7-26-2005. FILED 1-2-2004.
- 3,007,022. **FAT ROCK ENTERTAINMENT AND DESIGN**. FAT ROCK ENTERTAINMENT. (U.S. CLS. 100, 101 AND 107). SN 76-568,049. PUB. 7-26-2005. FILED 1-2-2004.
- 3,007,031. **OLD DOMINION UNIVERSITY (BLOCK FORM)**. OLD DOMINION UNIVERSITY. (U.S. CLS. 100, 101 AND 107). SN 76-569,730. PUB. 7-26-2005. FILED 1-2-2004.
- 3,007,032. **OLD DOMINION UNIVERSITY AND DESIGN**. OLD DOMINION UNIVERSITY. (U.S. CLS. 100, 101 AND 107). SN 76-569,732. PUB. 7-26-2005. FILED 1-2-2004.
- 3,007,033. **OLD DOMINION UNIVERSITY 1930 AND DESIGN**. OLD DOMINION UNIVERSITY. (U.S. CLS. 100, 101 AND 107). SN 76-569,736. PUB. 7-26-2005. FILED 1-2-2004.
- 3,007,038. **SHOOT IT AND DESIGN**. WISEMAN, ORLY. (U.S. CLS. 100, 101 AND 107). SN 76-572,237. PUB. 7-26-2005. FILED 1-21-2004.
- 3,007,039. **IT KIDZ (BLOCK FORM)**. WISEMAN, ORLY. (U.S. CLS. 100, 101 AND 107). SN 76-572,238. PUB. 7-26-2005. FILED 1-21-2004.
- 3,007,044. **IT KIDZ AND DESIGN**. WISEMAN, ORLY. (U.S. CLS. 100, 101 AND 107). SN 76-575,094. PUB. 7-26-2005. FILED 2-9-2004.
- 3,007,051 (*See Class 16 for this trademark*).
- 3,007,057. **ADVANCE MAGAZINE GROUP (BLOCK FORM)**. ADVANCE MAGAZINE PUBLISHERS INC., (U.S. CLS. 100, 101 AND 107). SN 76-578,747. PUB. 4-5-2005. FILED 3-1-2004.
- 3,007,064. **NATURALLY CAFFEINATED (STYLIZED)**. NATURALLY CAFFEINATED, INC., (U.S. CLS. 100, 101 AND 107). SN 76-580,825. PUB. 7-26-2005. FILED 3-15-2004.
- 3,007,070. **PENTHOUSE (BLOCK FORM)**. GENERAL MEDIA COMMUNICATIONS, INC., MULTIPLE CLASS, (INT. CLS. 41 AND 43). (U.S. CLS. 100, 101 AND 107). SN 76-581,658. PUB. 7-26-2005. FILED 3-16-2004.
- 3,007,076. **WATER SOUND AND DESIGN**. THE ST. JOE COMPANY. (U.S. CLS. 100, 101 AND 107). SN 76-583,828. PUB. 7-26-2005. FILED 3-26-2004.
- 3,007,078. **G GALLIVAN CENTER AND DESIGN**. REDEVELOPMENT AGENCY OF SALT LAKE CITY. (U.S. CLS. 100, 101 AND 107). SN 76-584,299. PUB. 7-26-2005. FILED 4-2-2004.
- 3,007,079. **IBP (BLOCK FORM)**. COSMO USA, INC., DBA INTERNATIONAL CROSS-CULTURAL COMMITTEE. (U.S. CLS. 100, 101 AND 107). SN 76-584,435. PUB. 7-26-2005. FILED 4-2-2004.
- 3,007,082. **ARLENE SMITH'S CHANTELS (BLOCK FORM)**. SMITH, ARLENE. (U.S. CLS. 100, 101 AND 107). SN 76-585,734. PUB. 7-26-2005. FILED 4-8-2004.
- 3,007,090. **NPF NATIONAL POSTAL FORUM AND DESIGN**. NATIONAL POSTAL FORUM (NPF). (U.S. CLS. 100, 101 AND 107). SN 76-587,356. PUB. 7-26-2005. FILED 4-15-2004.
- 3,007,102 (*See Class 16 for this trademark*).
- 3,007,105. **SPREE FOR ALL FITNESS AND FUN FOR EVERYONE! AND DESIGN**. METRO PARKS, SERVING SUMMIT COUNTY. (U.S. CLS. 100, 101 AND 107). SN 76-589,711. PUB. 7-26-2005. FILED 4-30-2004.
- 3,007,113 (*See Class 25 for this trademark*).
- 3,007,114. **ENTER TO LEARN, DEPART TO SERVE. (STYLIZED)**. WINSTON-SALEM STATE UNIVERSITY. (U.S. CLS. 100, 101 AND 107). SN 76-591,554. PUB. 7-26-2005. FILED 5-5-2004.
- 3,007,123 (*See Class 16 for this trademark*).
- 3,007,124 (*See Class 36 for this trademark*).
- 3,007,132. **SYNERGISTIC DINING (BLOCK FORM)**. FOODIE GIRLS, L.L.C., (U.S. CLS. 100, 101 AND 107). SN 76-596,035. PUB. 7-26-2005. FILED 6-7-2004.
- 3,007,135. **LIGHTER FOR LIFE HTTP://WWW.LIGHTERFORLIFE.COM AND DESIGN**. KAMELGARD, JOSEPH I., MULTIPLE CLASS, (INT. CLS. 41 AND 44). (U.S. CLS. 100, 101 AND 107). SN 76-596,512. PUB. 7-26-2005. FILED 6-10-2004.
- 3,007,140. **GOD'S WILL IS MY WILL IN CHRIST (BLOCK FORM)**. BLUNT, DAVID. (U.S. CLS. 100, 101 AND 107). SN 76-597,259. PUB. 7-26-2005. FILED 6-14-2004.
- 3,007,149. **BEVERLY COPELAND REPORT (BLOCK FORM)**. COPELAND, BEVERLY. (U.S. CLS. 100, 101 AND 107). SN 76-599,072. PUB. 7-26-2005. FILED 6-23-2004.
- 3,007,168 (*See Class 9 for this trademark*).
- 3,007,169. **PRODD**. PRODD. (U.S. CLS. 100, 101 AND 107). SN 78-087,746. PUB. 7-26-2005. FILED 10-10-2001.
- 3,007,173 (*See Class 25 for this trademark*).
- 3,007,175 (*See Class 16 for this trademark*).
- 3,007,190. **SUPER ROLL**. INTERMATCH SWEDEN AB. (U.S. CLS. 100, 101 AND 107). SN 78-214,379. PUB. 4-5-2005. FILED 2-13-2003.
- 3,007,192 (*See Class 35 for this trademark*).
- 3,007,211 (*See Class 9 for this trademark*).
- 3,007,215 (*See Class 9 for this trademark*).
- 3,007,216. **ANIMATION FOR A NEW GENERATION**. A.D. VISION, INC., (U.S. CLS. 100, 101 AND 107). SN 78-271,671. PUB. 7-26-2005. FILED 7-8-2003.
- 3,007,218 (*See Class 9 for this trademark*).
- 3,007,220 (*See Class 14 for this trademark*).
- 3,007,228. **SYMANTIX AND DESIGN**. BLACKOUT ENTERPRISES. (U.S. CLS. 100, 101 AND 107). SN 78-282,319. PUB. 7-26-2005. FILED 8-2-2003.
- 3,007,231 (*See Class 9 for this trademark*).
- 3,007,234. **E AND DESIGN**. ENTERPRISE INTEGRATION GROUP, MULTIPLE CLASS, (INT. CLS. 41 AND 42). (U.S. CLS. 100, 101 AND 107). SN 78-290,379. PUB. 7-26-2005. FILED 8-21-2003.
- 3,007,235. **LIVE WELL PLAY HARD**. WISE, GARY. (U.S. CLS. 100, 101 AND 107). SN 78-291,246. PUB. 7-26-2005. FILED 8-22-2003.
- 3,007,248 (*See Class 37 for this trademark*).
- 3,007,252 (*See Class 36 for this trademark*).
- 3,007,265. **CHILDREN'S LITERACY FOUNDATION (BLOCK FORM)**. CHILDREN'S LITERACY FOUNDATION. (U.S. CLS. 100, 101 AND 107). SN 78-320,038. PUB. 7-26-2005.

- FILED 10-29-2003.
- 3,007,270. **SMART 100 (BLOCK FORM)**. COEQUITY CORPORATION, (U.S. CLS. 100, 101 AND 107). SN 78-322,429. PUB. 7-26-2005. FILED 11-3-2003.
- 3,007,283. **FOURTHOUGHT (BLOCK FORM)**. FOURTHOUGHT INC., MULTIPLE CLASS, (INT. CLS. 41 AND 42), (U.S. CLS. 100, 101 AND 107). SN 78-329,233. PUB. 7-26-2005. FILED 11-17-2003.
- 3,007,292. **STRUCTURED DECISION MAKING (BLOCK FORM)**. NATIONAL COUNCIL ON CRIME AND DELINQUENCY, MULTIPLE CLASS, (INT. CLS. 41 AND 45), (U.S. CLS. 100, 101 AND 107). SN 78-333,537. PUB. 7-26-2005. FILED 11-26-2003.
- 3,007,293. **SDM (BLOCK FORM)**. NATIONAL COUNCIL ON CRIME AND DELINQUENCY, MULTIPLE CLASS, (INT. CLS. 41 AND 45), (U.S. CLS. 100, 101 AND 107). SN 78-333,545. PUB. 7-26-2005. FILED 11-26-2003.
- 3,007,299. **CINEMA SOUNDS (BLOCK FORM)**. DISC MARKETING, INC., (U.S. CLS. 100, 101 AND 107). SN 78-337,009. PUB. 7-26-2005. FILED 12-5-2003.
- 3,007,301. **DOLPHIN SWIMMING CORP. AND DESIGN**. DOLPHIN SWIMMING CORP., (U.S. CLS. 100, 101 AND 107). SN 78-337,664. PUB. 7-26-2005. FILED 12-8-2003.
- 3,007,312. **PORTER CUP AND DESIGN**. NIAGARA FALLS COUNTRY CLUB, (U.S. CLS. 100, 101 AND 107). SN 78-342,752. PUB. 7-26-2005. FILED 12-18-2003.
- 3,007,323. **ALKEBULAN (BLOCK FORM)**. WILLIAMS, FREDERICK B., (U.S. CLS. 100, 101 AND 107). SN 78-346,004. PUB. 7-26-2005. FILED 12-29-2003.
- 3,007,327 (*See Class 28 for this trademark*).
- 3,007,329. **SPIKES (BLOCK FORM)**. ROCHESTER COMMUNITY BASEBALL, (U.S. CLS. 100, 101 AND 107). SN 78-351,313. PUB. 7-26-2005. FILED 1-13-2004.
- 3,007,330. **PC KIDZ "TRAINING OUR FUTURE" (BLOCK FORM)**. PERRY, TAMMY E., (U.S. CLS. 100, 101 AND 107). SN 78-351,757. PUB. 7-26-2005. FILED 1-14-2004.
- 3,007,331. **EXTRAORDINARY FLAIR EVENT MANAGEMENT AND DESIGN**. CYNTHIA M FINCHER, (U.S. CLS. 100, 101 AND 107). SN 78-351,816. PUB. 7-26-2005. FILED 1-14-2004.
- 3,007,333 (*See Class 25 for this trademark*).
- 3,007,334 (*See Class 35 for this trademark*).
- 3,007,335 (*See Class 36 for this trademark*).
- 3,007,340. **ANNAMAR RESULTS MODEL SELF MASTERY CUSTOMER FOCUS ORGANIZATIONAL EFFECTIVENESS RESULTS AND DESIGN**. ANNAMAR ASSOCIATES INCORPORATED, (U.S. CLS. 100, 101 AND 107). SN 78-358,427. PUB. 7-26-2005. FILED 1-27-2004.
- 3,007,341 (*See Class 9 for this trademark*).
- 3,007,347. **FANS R IST @ DAYTONA AND DESIGN**. INTERNATIONAL SPEEDWAY INC., (U.S. CLS. 100, 101 AND 107). SN 78-362,834. PUB. 7-26-2005. FILED 2-5-2004.
- 3,007,356. **NOTABLE NEW MEXICAN (BLOCK FORM)**. THE ALBUQUERQUE MUSEUM FOUNDATION, INC., (U.S. CLS. 100, 101 AND 107). SN 78-370,151. PUB. 7-26-2005. FILED 2-18-2004.
- 3,007,361. **TURF-VIVOR III GULFSTREAM PARK OUTSMART OUTBET OUTHANDICAP AND DESIGN**. GULFSTREAM PARK RACING ASSOCIATION, INC., (U.S. CLS. 100, 101 AND 107). SN 78-370,477. PUB. 7-26-2005. FILED 2-19-2004.
- 3,007,362. **HOPE FOR HAITI'S CHILDREN (BLOCK FORM)**. HOPE FOR HAITI'S CHILDREN MINISTRIES, INC., (U.S. CLS. 100, 101 AND 107). SN 78-371,021. PUB. 7-26-2005. FILED 2-20-2004.
- 3,007,382 (*See Class 16 for this trademark*).
- 3,007,387. **COAST CASINOS HORSEPLAYER WORLD SERIES (BLOCK FORM)**. COAST HOTELS AND CASINOS, INC., (U.S. CLS. 100, 101 AND 107). SN 78-383,803. PUB. 7-26-2005. FILED 3-12-2004.
- 3,007,392 (*See Class 25 for this trademark*).
- 3,007,403. **CLICKCE AND DESIGN**. CLICKCE LLC, (U.S. CLS. 100, 101 AND 107). SN 78-395,000. PUB. 7-26-2005. FILED 4-1-2004.
- 3,007,407. **THE SHADOWS OF KNIGHT (BLOCK FORM)**. BROVITZ, LEE, DBA BASSIC-LEE MUSIC, (U.S. CLS. 100, 101 AND 107). SN 78-396,046. PUB. 7-26-2005. FILED 4-5-2004.
- 3,007,409 (*See Class 16 for this trademark*).
- 3,007,410 (*See Class 16 for this trademark*).
- 3,007,411. **REMOVE THE FUEL AND THE FIRE GOES OUT! (BLOCK FORM)**. PHILLIP ACKLAND HOLDINGS LTD., (U.S. CLS. 100, 101 AND 107). SN 78-398,953. PUB. 7-26-2005. FILED 4-8-2004.
- 3,007,423 (*See Class 9 for this trademark*).
- 3,007,429 (*See Class 35 for this trademark*).
- 3,007,432. **MD MINDSET SELLING (BLOCK FORM)**. KESSLER, MICHAEL, (U.S. CLS. 100, 101 AND 107). SN 78-410,943. PUB. 7-26-2005. FILED 4-30-2004.
- 3,007,440. **EIGHT TO THE BAR (BLOCK FORM)**. LYON, CYNTHIA, (U.S. CLS. 100, 101 AND 107). SN 78-414,130. PUB. 7-26-2005. FILED 5-6-2004.
- 3,007,443 (*See Class 16 for this trademark*).
- 3,007,446. **MISCELLANEOUS DESIGN**. LIBRARY OF CONGRESS, (U.S. CLS. 100, 101 AND 107). SN 78-416,466. PUB. 7-26-2005. FILED 5-11-2004.
- 3,007,454 (*See Class 35 for this trademark*).
- 3,007,458. **CROSSFIT (BLOCK FORM)**. CROSSFIT, INC., (U.S. CLS. 100, 101 AND 107). SN 78-422,177. PUB. 7-26-2005. FILED 5-20-2004.
- 3,007,459. **REALIZE! (STYLIZED)**. STATE OF MAINE, BY THE MAINE STATE PLANNING OFFICE, (U.S. CLS. 100, 101 AND 107). SN 78-423,083. PUB. 7-5-2005. FILED 5-21-2004.
- 3,007,462. **POKER ISLAND A POKER PLAYER'S PARADISE AND DESIGN**. NESS, CHRISTOPHER, (U.S. CLS. 100, 101 AND 107). SN 78-423,490. PUB. 7-5-2005. FILED 5-23-2004.
- 3,007,464. **WHO'S THE B.O.S.S.? (BLOCK FORM)**. JACKSON NATIONAL LIFE INSURANCE COMPANY, (U.S. CLS. 100, 101 AND 107). SN 78-424,304. PUB. 7-26-2005. FILED 5-25-2004.
- 3,007,469. **INTEGRITY FILM & VIDEO AND DESIGN**. INTEGRITY MEDIA, INC., (U.S. CLS. 100, 101 AND 107). SN 78-427,091. PUB. 7-26-2005. FILED 5-28-2004.
- 3,007,483. **LHJ.COM (BLOCK FORM)**. MEREDITH CORPORATION, MULTIPLE CLASS, (INT. CLS. 41, 42, 43, 44 AND 45), (U.S. CLS. 100, 101 AND 107). SN 78-434,524. PUB. 7-26-2005. FILED 6-14-2004.
- 3,007,498. **INVISIONSPORTSNETWORK AND DESIGN**. HINES, TERRENCE J., (U.S. CLS. 100, 101 AND 107). SN 78-438,099. PUB. 7-26-2005. FILED 6-19-2004.
- 3,007,531. **BANNED IN BOSTON (BLOCK FORM)**. FREELANCE PLAYERS, INC., (U.S. CLS. 100, 101 AND 107). SN 78-467,862. PUB. 7-26-2005. FILED 8-16-2004.
- 3,007,552 (*See Class 35 for this trademark*).

CLASS 42—SCIENTIFIC, COMPUTER AND LEGAL SERVICES

- 3,006,778. **A NET (STYLIZED)**. AMERICAN INTERNET SERVICES, INC., (U.S. CLS. 100 AND 101). SN 75-026,209. PUB. 7-22-1997. FILED 11-30-1995.
- 3,006,781 (*See Class 35 for this trademark*).
- 3,006,782 (*See Class 41 for this trademark*).
- 3,006,796 (*See Class 41 for this trademark*).
- 3,006,797 (*See Class 35 for this trademark*).
- 3,006,798. **MISCELLANEOUS DESIGN**. SUKHOI DESIGN BUREAU COMPANY, (U.S. CLS. 100 AND 101). SN 76-118,839. PUB. 7-26-2005. FILED 8-25-2000.
- 3,006,804 (*See Class 11 for this trademark*).
- 3,006,810 (*See Class 35 for this trademark*).
- 3,006,817. **CARWASH**. ATKIN, NIGEL, AND SANSOM, NEIL, (U.S. CLS. 100 AND 101). SN 76-262,946. PUB. 7-26-2005. FILED 5-25-2001.
- 3,006,823 (*See Class 35 for this trademark*).
- 3,006,845 (*See Class 35 for this trademark*).
- 3,006,856 (*See Class 35 for this trademark*).
- 3,006,862 (*See Class 12 for this trademark*).
- 3,006,863 (*See Class 35 for this trademark*).
- 3,006,875. **VOSN**. CONFERENCE AMERICA, INC., (U.S. CLS. 100 AND 101). SN 76-498,341. PUB. 7-26-2005. FILED 3-18-2003.
- 3,006,884. **REDFILE**. CRICKET TECHNOLOGIES LLC, (U.S. CLS. 100 AND 101). SN 76-508,778. PUB. 7-26-2005. FILED 4-23-2003.

3,006,887 (See Class 37 for this trademark).
 3,006,891 (See Class 3 for this trademark).
 3,006,893. **AL LIGATOR**. AMRESKO, INC., (U.S. CLS. 100 AND 101). SN 76-513,816. PUB. 7-26-2005. FILED 5-13-2003.
 3,006,901 (See Class 35 for this trademark).
 3,006,942 (See Class 35 for this trademark).
 3,006,958. **BOTANICA AND DESIGN**. PICTUREARTS CORPORATION, (U.S. CLS. 100 AND 101). SN 76-553,777. PUB. 7-26-2005. FILED 10-23-2003.
 3,006,960 (See Class 9 for this trademark).
 3,006,963 (See Class 35 for this trademark).
 3,006,984 (See Class 41 for this trademark).
 3,006,987. **AACSB INTERNATIONAL AND DESIGN**. AACSB INTERNATIONAL, (U.S. CLS. 100 AND 101). SN 76-560,906. PUB. 7-26-2005. FILED 11-18-2003.
 3,006,996 (See Class 35 for this trademark).
 3,007,002 (See Class 38 for this trademark).
 3,007,011. **CREATEAUCTION AND DESIGN**. COLLECTONLY, INC., DBA CREATE AUCTION, (U.S. CLS. 100 AND 101). SN 76-567,065. PUB. 7-26-2005. FILED 12-23-2003.
 3,007,016 (See Class 9 for this trademark).
 3,007,017 (See Class 9 for this trademark).
 3,007,034 (See Class 37 for this trademark).
 3,007,067. **T-HOTSPOT (STYLIZED)**. DEUTSCHE TELEKOM AG, (U.S. CLS. 100 AND 101). SN 76-581,098. PUB. 7-26-2005. FILED 3-12-2004.
 3,007,107 (See Class 40 for this trademark).
 3,007,167 (See Class 9 for this trademark).
 3,007,168 (See Class 9 for this trademark).
 3,007,179 (See Class 7 for this trademark).
 3,007,191 (See Class 7 for this trademark).
 3,007,192 (See Class 35 for this trademark).
 3,007,202 (See Class 37 for this trademark).
 3,007,204 (See Class 9 for this trademark).
 3,007,206 (See Class 9 for this trademark).
 3,007,207. **IFANZ AND DESIGN**. MCCARTNEY MULTIMEDIA, INC. (U.S. CLS. 100 AND 101). SN 78-249,187. PUB. 7-26-2005. FILED 5-13-2003.
 3,007,209 (See Class 9 for this trademark).
 3,007,210. **LEMON DETECTIVES AND DESIGN**. VITAS, JACOB, (U.S. CLS. 100 AND 101). SN 78-256,213. PUB. 7-26-2005. FILED 5-30-2003.
 3,007,211 (See Class 9 for this trademark).
 3,007,231 (See Class 9 for this trademark).
 3,007,233. **WEB DESIGN FOLKS "SITE BUILDERS & LANDLORDS"**. DUNLAP, ANGELA D., (U.S. CLS. 100 AND 101). SN 78-287,181. PUB. 7-26-2005. FILED 8-14-2003.
 3,007,234 (See Class 41 for this trademark).
 3,007,243 (See Class 35 for this trademark).
 3,007,246. **BRIGHT HOUSE**. SUSAN SARGENT DESIGNS INC., (U.S. CLS. 100 AND 101). SN 78-305,515. PUB. 6-7-2005. FILED 9-25-2003.
 3,007,248 (See Class 37 for this trademark).
 3,007,254. **LUNATIKS**. E-TICKETS SOFTWARE, INC., (U.S. CLS. 100 AND 101). SN 78-312,296. PUB. 7-26-2005. FILED 10-10-2003.
 3,007,257. **YOUR VIRTUAL PERSONAL ASSISTANT**. INFONE LLC, (U.S. CLS. 100 AND 101). SN 78-313,629. PUB. 7-26-2005. FILED 10-14-2003.
 3,007,264 (See Class 3 for this trademark).
 3,007,274 (See Class 35 for this trademark).
 3,007,275 (See Class 37 for this trademark).
 3,007,283 (See Class 41 for this trademark).
 3,007,285. **XMWX AND DESIGN**. XM SATELLITE RADIO INC., (U.S. CLS. 100 AND 101). SN 78-329,942. PUB. 7-26-2005. FILED 11-19-2003.
 3,007,288. **INITIATIVE IN PRACTICE (BLOCK FORM)**. MACELREE HARVEY, LTD., (U.S. CLS. 100 AND 101). SN 78-331,257. PUB. 7-26-2005. FILED 11-21-2003.
 3,007,297 (See Class 40 for this trademark).
 3,007,324. **INFINITECH (BLOCK FORM)**. INFINITECH, INC., (U.S. CLS. 100 AND 101). SN 78-346,338. PUB. 7-26-2005. FILED 12-29-2003.
 3,007,328 (See Class 5 for this trademark).
 3,007,332 (See Class 7 for this trademark).
 3,007,344 (See Class 1 for this trademark).
 3,007,348 (See Class 35 for this trademark).
 3,007,382 (See Class 16 for this trademark).

3,007,404. **CONNECT802 AND DESIGN**. CONNECT802 CORPORATION, (U.S. CLS. 100 AND 101). SN 78-395,018. PUB. 4-5-2005. FILED 4-1-2004.
 3,007,412. **BRADLEY ARANT BRADLEY ARANT ROSE & WHITE LLP AND DESIGN**. BRADLEY ARANT ROSE & WHITE LLP, (U.S. CLS. 100 AND 101). SN 78-399,550. PUB. 7-26-2005. FILED 4-9-2004.
 3,007,415 (See Class 9 for this trademark).
 3,007,426. **CONVERGENCE CONSULTANTS (BLOCK FORM)**. THREADFIN BUSINESS SOLUTIONS, LLC, (U.S. CLS. 100 AND 101). SN 78-407,948. PUB. 7-26-2005. FILED 4-26-2004.
 3,007,448. **INFORMITI (BLOCK FORM)**. NET VISIBILITIES, LLC, (U.S. CLS. 100 AND 101). SN 78-417,969. PUB. 7-26-2005. FILED 5-13-2004.
 3,007,460 (See Class 35 for this trademark).
 3,007,482 (See Class 35 for this trademark).
 3,007,483 (See Class 41 for this trademark).
 3,007,484. **ROBERTSON MICROLIT - WHERE SPEED AND ACCURACY ARE ELEMENTAL (BLOCK FORM)**. ROBERTSON MICROLIT LABORATORIES, INC., (U.S. CLS. 100 AND 101). SN 78-435,224. PUB. 7-26-2005. FILED 6-15-2004.
 3,007,488. **INTELLIPROCESS AND DESIGN**. LOVE, RANDALL L, (U.S. CLS. 100 AND 101). SN 78-436,062. PUB. 7-5-2005. FILED 6-16-2004.
 3,007,489 (See Class 37 for this trademark).
 3,007,495 (See Class 36 for this trademark).
 3,007,496 (See Class 35 for this trademark).
 3,007,552 (See Class 35 for this trademark).

CLASS 43—HOTEL AND RESTAURANT SERVICES

3,006,869 (See Class 9 for this trademark).
 3,006,891 (See Class 3 for this trademark).
 3,006,922 (See Class 39 for this trademark).
 3,006,926 (See Class 35 for this trademark).
 3,006,929 (See Class 9 for this trademark).
 3,006,996 (See Class 35 for this trademark).
 3,007,040. **HERESTO PANDS PEN DASOCI AL HOURIN HARMLES SMIRT HAN DFUNL ET FRI ENDS HIPRE IGN BEJ USTA NDKIN DAN DEVIL SPE AKOF NO NE (STYLIZED)**. SILVER LOUNGE INC., (U.S. CLS. 100 AND 101). SN 76-573,034. PUB. 7-26-2005. FILED 1-20-2004.
 3,007,070 (See Class 41 for this trademark).
 3,007,092 (See Class 32 for this trademark).
 3,007,122. **SUPER SUPPERS YOUR ANSWER TO ... "WHAT'S FOR DINNER?" AND DESIGN**. THE CULINARY SCHOOL OF FORT WORTH, LLC, (U.S. CLS. 100 AND 101). SN 76-593,370. PUB. 7-26-2005. FILED 5-20-2004.
 3,007,134. **REFRESHMENT SERVED DAILY (STYLIZED)**. MERISTAR HOTEL LESSEE, INC., (U.S. CLS. 100 AND 101). SN 76-596,290. PUB. 7-26-2005. FILED 6-7-2004.
 3,007,219. **ROCKET BROTHERS AND DESIGN**. SOUTHERN EXPEDITION, L.L.C., (U.S. CLS. 100 AND 101). SN 78-276,122. PUB. 6-7-2005. FILED 7-18-2003.
 3,007,286 (See Class 35 for this trademark).
 3,007,372. **COME LIVE LIFE WITH US (BLOCK FORM)**. PRESBYTERIAN VILLAGES OF MICHIGAN, MULTIPLE CLASS, (INT. CLS. 43 AND 44), (U.S. CLS. 100 AND 101). SN 78-374,601. PUB. 7-26-2005. FILED 2-26-2004.
 3,007,382 (See Class 16 for this trademark).
 3,007,389. **GARLIC JIM'S FAMOUS GOURMET PIZZA (BLOCK FORM)**. GARLIC JIM'S FRANCHISE CORP., (U.S. CLS. 100 AND 101). SN 78-385,803. PUB. 7-5-2005. FILED 3-17-2004.
 3,007,390. **TESTA'S (BLOCK FORM)**. TESTA'S, INC., (U.S. CLS. 100 AND 101). SN 78-387,231. PUB. 7-26-2005. FILED 3-19-2004.
 3,007,424. **SPORTSEXY (STYLIZED)**. ZCOR LLC, (U.S. CLS. 100 AND 101). SN 78-407,505. PUB. 7-26-2005. FILED 4-24-2004.
 3,007,436. **TAHITIMOON (BLOCK FORM)**. BONDURANT, RICHARD E., (U.S. CLS. 100 AND 101). SN 78-412,634. PUB. 7-26-2005. FILED 5-4-2004.
 3,007,444. **MEXICALI (BLOCK FORM)**. COORS GLOBAL

PROPERTIES, INC., (U.S. CLS. 100 AND 101). SN 78-415,285. PUB. 7-26-2005. FILED 5-7-2004.
 3,007,452. **CHUM CLUB (BLOCK FORM)**, MARKS, MELANIE J., (U.S. CLS. 100 AND 101). SN 78-419,436. PUB. 7-26-2005. FILED 5-15-2004.
 3,007,453. **12 SPOT (BLOCK FORM)**, ARAMARK CORPORATION, (U.S. CLS. 100 AND 101). SN 78-420,090. PUB. 7-26-2005. FILED 5-17-2004.
 3,007,483 (*See Class 41 for this trademark*).
 3,007,497. **GRANDMA'S HOMESTEAD HOMEMADE TRADITIONS AND DESIGN**, DEHASS, ANN, (U.S. CLS. 100 AND 101). SN 78-438,096. PUB. 7-26-2005. FILED 6-19-2004.
 3,007,504. **HARRY'S SEAFOOD BAR & GRILLE (BLOCK FORM)**, HARRY'S OF AMERICA, LLC, (U.S. CLS. 100 AND 101). SN 78-441,494. PUB. 7-26-2005. FILED 6-25-2004.
 3,007,548. **WINE & CHEESE PARTY LE FROMAGE AUTREMENT AND DESIGN**, LARTET DANIEL, (U.S. CLS. 100 AND 101). SN 79-000,903. PUB. 7-26-2005. FILED 12-18-2003.

3,007,382 (*See Class 16 for this trademark*).
 3,007,383 (*See Class 9 for this trademark*).
 3,007,395 (*See Class 10 for this trademark*).
 3,007,437. **CRYOSURE (BLOCK FORM)**, VIAGEN, INC., (U.S. CLS. 100 AND 101). SN 78-412,703. PUB. 7-26-2005. FILED 5-4-2004.
 3,007,445. **SET THE DATE (BLOCK FORM)**, ANHEUSER-BUSCH, INCORPORATED, (U.S. CLS. 100 AND 101). SN 78-416,392. PUB. 7-26-2005. FILED 5-11-2004.
 3,007,481. **ACUTE & CHRONIC PAIN & SPINE CENTER PREVENTION PAIN TREATMENT REHABILITATION AND DESIGN**, ACUTE & CHRONIC PAIN AND SPINE CENTER, (U.S. CLS. 100 AND 101). SN 78-433,375. PUB. 7-5-2005. FILED 6-10-2004.
 3,007,483 (*See Class 41 for this trademark*).
 3,007,536 (*See Class 3 for this trademark*).
 3,007,538. **G AND DESIGN**, KEMIRA GROWHOW OYJ, (U.S. CLS. 100 AND 101). SN 79-000,179. PUB. 7-26-2005. FILED 11-5-2003.

CLASS 44—MEDICAL, BEAUTY AND AGRICULTURAL SERVICES

3,006,781 (*See Class 35 for this trademark*).
 3,006,834 (*See Class 41 for this trademark*).
 3,006,849 (*See Class 35 for this trademark*).
 3,006,879 (*See Class 41 for this trademark*).
 3,006,885. **DISEASEDEX**, GILC HOLDING CORP., (U.S. CLS. 100 AND 101). SN 76-508,891. PUB. 7-26-2005. FILED 4-23-2003.
 3,006,891 (*See Class 3 for this trademark*).
 3,006,929 (*See Class 9 for this trademark*).
 3,006,943 (*See Class 9 for this trademark*).
 3,006,950. **INTIME, INC. PRODUCING CROP MANAGEMENT SOLUTIONS AND DESIGN**, INTIME, INC., (U.S. CLS. 100 AND 101). SN 76-550,748. PUB. 7-26-2005. FILED 10-14-2003.
 3,006,951 (*See Class 3 for this trademark*).
 3,006,972 (*See Class 35 for this trademark*).
 3,006,976 (*See Class 35 for this trademark*).
 3,006,977 (*See Class 35 for this trademark*).
 3,006,982 (*See Class 41 for this trademark*).
 3,006,983 (*See Class 35 for this trademark*).
 3,007,048. **CUSTOM SEED WIZARD (BLOCK FORM)**, TURFSEED, INC., (U.S. CLS. 100 AND 101). SN 76-576,779. PUB. 7-26-2005. FILED 2-20-2004.
 3,007,095 (*See Class 36 for this trademark*).
 3,007,109. **407-CANTASO (BLOCK FORM)**, MAURICIO CHIROPRACTIC GROUP, (U.S. CLS. 100 AND 101). SN 76-591,012. PUB. 7-26-2005. FILED 5-7-2004.
 3,007,135 (*See Class 41 for this trademark*).
 3,007,138. **SOUND COUNSELING ASSOCIATES AND DESIGN**, MYERS, GLORIA, (U.S. CLS. 100 AND 101). SN 76-597,179. PUB. 7-26-2005. FILED 6-14-2004.
 3,007,142. **WHO'S NEXT? BARBER SHOP (STYLIZED)**, RAMKRISHNA, KHEMRAJ, AND ON, JOE RAYMOND, (U.S. CLS. 100 AND 101). SN 76-597,381. PUB. 7-26-2005. FILED 6-15-2004.
 3,007,147. **TAN INN (BLOCK FORM)**, VIDEO SCENE OF DELAWARE, INC., TA TAN INN, (U.S. CLS. 100 AND 101). SN 76-598,399. PUB. 7-26-2005. FILED 6-21-2004.
 3,007,172. **GRASSWORKS AND DESIGN**, GRASSWORKS INC., (U.S. CLS. 100 AND 101). SN 78-115,863. PUB. 7-26-2005. FILED 3-19-2002.
 3,007,229. **WHEELS FOR KIDS**, WHEELS FOR KIDS, INC., (U.S. CLS. 100 AND 101). SN 78-283,549. PUB. 7-26-2005. FILED 8-5-2003.
 3,007,255 (*See Class 3 for this trademark*).
 3,007,269 (*See Class 3 for this trademark*).
 3,007,286 (*See Class 35 for this trademark*).
 3,007,296 (*See Class 40 for this trademark*).
 3,007,313 (*See Class 7 for this trademark*).
 3,007,328 (*See Class 5 for this trademark*).
 3,007,372 (*See Class 43 for this trademark*).
 3,007,380. **H AND DESIGN**, HOFFMAN, RONALD, (U.S. CLS. 100 AND 101). SN 78-378,877. PUB. 7-26-2005. FILED 3-4-2004.

CLASS 45—PERSONAL SERVICES

3,006,841. **D. JAMES KENNEDY CENTER FOR CHRISTIAN STATESMANSHIP**, CORAL RIDGE MINISTRIES MEDIA, INC., (U.S. CLS. 100 AND 101). SN 76-412,232. PUB. 7-26-2005. FILED 5-29-2002.
 3,006,865 (*See Class 41 for this trademark*).
 3,006,891 (*See Class 3 for this trademark*).
 3,006,929 (*See Class 9 for this trademark*).
 3,006,968 (*See Class 9 for this trademark*).
 3,006,984 (*See Class 41 for this trademark*).
 3,007,071. **2ND FLOOR (BLOCK FORM)**, 180 TURNING LIVES AROUND, INC., (U.S. CLS. 100 AND 101). SN 76-582,686. PUB. 7-26-2005. FILED 3-23-2004.
 3,007,165. **CIRCLES (STYLIZED)**, CIRCLE COMPANY ASSOCIATES, INC., (U.S. CLS. 100 AND 101). SN 76-612,247. PUB. 7-26-2005. FILED 9-16-2004.
 3,007,204 (*See Class 9 for this trademark*).
 3,007,232 (*See Class 16 for this trademark*).
 3,007,236. **OUT AND ABOUT TOGETHER**, CLIF BAR INC., (U.S. CLS. 100 AND 101). SN 78-295,769. PUB. 7-26-2005. FILED 9-3-2003.
 3,007,292 (*See Class 41 for this trademark*).
 3,007,293 (*See Class 41 for this trademark*).
 3,007,317 (*See Class 9 for this trademark*).
 3,007,425. **YOUR ONLINE FAITH FAMILY (BLOCK FORM)**, LIVING WORD CHRISTIAN CENTER INC., (U.S. CLS. 100 AND 101). SN 78-407,746. PUB. 7-26-2005. FILED 4-26-2004.
 3,007,428 (*See Class 9 for this trademark*).
 3,007,483 (*See Class 41 for this trademark*).

* * * * *

SECTION 2.—PRIOR UNITED STATES CLASSIFICATION

CERTIFICATION MARKS

2005. FILED 6-5-2003.

CLASS B—SERVICES

3,006,935. CT. ASSOCIATION FOR DEATH EDUCATION AND COUNSELING (ADEC), SN 76-543,508. PUB. 7-26-2005. FILED 8-27-2003.

3,007,250. AMERICAN FARRIER'S ASSOCIATION CERTIFIED FARRIER. AMERICAN FARRIER'S ASSOCIATION, INC., SN 78-307,899. PUB. 7-26-2005. FILED 10-1-2003.

3,007,213. RYT. YOGA ALLIANCE, SN 78-258,786. PUB. 7-26-

* * * * *

TRADEMARK REGISTRATIONS ISSUED UNDER SECTION 1(d)

The following marks have registered on the Principal Register pursuant to the intent-to-use provisions of Section 1(d) of the Trademark Act of 1946, as amended.

SECTION 1.— INTERNATIONAL CLASSIFICATION

The short titles associated below with the international class numbers are terms designed merely for quick identification and are not an official part of the international classification. The full names of international classes are given in section 6.1 of the trademark rules of practice.

The designation "U.S. Cl." appearing in this section refers to the U.S. class in effect prior to Sep. 1, 1973 rather than the international class which applies to applications filed on or after that date. For adoption of international classification see notice in the OFFICIAL GAZETTE of Jun. 26, 1973 (911 O.G. TM 210).

Application in more than one class

3,007,568. BASEBALL ACQUISITION CORPORATION, PORTLAND, OR. SN 75-753,782. PUB. 8-8-2000, FILED 7-15-1999.

3,007,572. CLUB MEDITERRANEE, 75019 PARIS, FRANCE. SN 76-032,875. PUB. 3-26-2002, FILED 4-21-2000.



Club Med

CLASS 16—PAPER GOODS AND PRINTED MATTER

FOR TABLE COVERS AND TABLE CLOTHS OF PAPER (U.S. CLS. 2, 5, 22, 23, 29, 37, 38 AND 50).
FIRST USE 2-11-2000; IN COMMERCE 4-21-2000.

CLASS 24—FABRICS

FOR BATH SHEETS; BEACH TOWELS; BED COVERS; TABLE COVERS AND TABLE CLOTHS, NOT OF PAPER (U.S. CLS. 42 AND 50).
FIRST USE 2-11-2000; IN COMMERCE 4-21-2000.

CLASS 18—LEATHER GOODS

FOR ATHLETIC BAGS, DUFFEL BAGS, GYM BAGS, EQUIPMENT BAGS (U.S. CLS. 1, 2, 3, 22 AND 41).
FIRST USE 1-19-1984; IN COMMERCE 1-19-1984.

CLASS 25—CLOTHING

FOR ATHLETIC UNIFORMS, CAPS, HATS, UNDERGARMENTS, SOCKS, SHIRTS, PANTS, PADDED SLIDING PANTS WARM-UP JACKETS, WRIST BANDS, HEAD BANDS AND ATHLETIC FOOTWEAR (U.S. CLS. 22 AND 39).
FIRST USE 1-19-1984; IN COMMERCE 1-19-1984.

CLASS 28—TOYS AND SPORTING GOODS

FOR BASEBALLS, SOFTBALLS, BASEBALL GLOVES, BATTING GLOVES (U.S. CLS. 22, 23, 38 AND 50).
FIRST USE 8-0-1998; IN COMMERCE 8-0-1998.

3,007,575. PLASTI-FAB LTD., CALGARY, ALBERTA, CANADA. SN 76-083,595. PUB. 10-21-2003, FILED 7-6-2000.



PRIORITY CLAIMED UNDER SEC. 44(D) ON CANADA APPLICATION NO. 1,058,335, FILED 5-10-2000.

NO CLAIM IS MADE TO THE EXCLUSIVE RIGHT TO USE "EPS PRODUCT SOLUTIONS", APART FROM THE MARK AS SHOWN.

CLASS 17—RUBBER GOODS

FOR INSULATION MATERIALS AND PARTS AND ACCESSORIES THEREFOR FOR INSULATING PIPES AND THE LIKE, NAMELY, INSULATION JACKETING AND INSULATION FITTING COVERS; SOUND INSULATION MATERIAL, NAMELY, EXPANDED POLYSTYRENE INSULATION AND POLYSTYRENE FOAM FOR USE IN SOUND INSULATION AND BUILDING INSULATION PURPOSES; ACOUSTICAL INSULATION FOR BUILDINGS; AND BUILDING INSULATION (U.S. CLS. 1, 5, 12, 13, 35 AND 50).

FIRST USE 7-1-2000; IN COMMERCE 7-1-2000.

CLASS 42—SCIENTIFIC, COMPUTER AND LEGAL SERVICES

FOR CONSTRUCTION CONSULTATION, NAMELY, PROVIDING ADVICE AND EXPERTISE RELATING TO THE USE OF EXPANDED POLYSTYRENE PRODUCTS FOR THE CONSTRUCTION AND BUILDING INDUSTRIES (U.S. CLS. 100 AND 101).

FIRST USE 7-1-2000; IN COMMERCE 7-1-2000.

3,007,576. CHEJANOVIESKY, SIMON SANDLER, MEXICO, D.F. 11000, MEXICO. SN 76-088,065. PUB. 6-11-2002, FILED 7-13-2000.

SANELEC**CLASS 9—ELECTRICAL AND SCIENTIFIC APPARATUS**

FOR ELECTRICAL AND SCIENTIFIC APPARATUS, NAMELY, ELECTRICAL POWER EXTENSION CORDS WITH A LAMP, ELECTRICAL ADAPTERS AND PARTS THEREOF, MOTION SENSITIVE ELECTRONIC SWITCHES FOR LAMPS, REMOTE CONTROLS FOR CONTROLLING LIGHTS, POWER STRIPS FOR CONSUMER ELECTRONIC PRODUCTS, VOLTAGE SURGE SUPPRESSORS, ELECTRICAL AND MECHANICAL TIMERS FOR HOUSEHOLD LIGHTING, ELECTRICAL CORD REELS, ELECTRIC LOCKS AND ELECTRICAL CONNECTORS FOR CONNECTING EXTENSION CORDS; PHOTOCELLS FOR USE WITH LAMPS, TIMERS, SOCKETS AND MOTION SENSORS (U.S. CLS. 21, 23, 26, 36 AND 38).

FIRST USE 10-10-2003; IN COMMERCE 10-10-2003.

CLASS 11—ENVIRONMENTAL CONTROL APPARATUS

FOR ELECTRIC LAMPS, ELECTRIC LIGHTING FIXTURES AND PARTS THEREOF FOR OUTDOOR OR INDOOR USE, HALOGEN LIGHTS, LOW VOLTAGE OUTDOOR LIGHTS FOR DECORATION AND ILLUMINATION, PORTABLE AND NON PORTABLE OUTDOOR SPOTLIGHTS, BATTERY POWERED FLASHLIGHTS, ELECTRIC NIGHT LIGHTS, EMERGENCY POWER FAILURE LAMPS, ELECTRIC LANTERNS, AND ELECTRIC LIGHT BULBS (U.S. CLS. 13, 21, 23, 31 AND 34).

FIRST USE 10-29-2003; IN COMMERCE 10-29-2003.

3,007,580. CERTICOM CORP, HAYWARD, CA. SN 76-137,152. PUB. 12-17-2002, FILED 9-28-2000.

certicom

OWNER OF U.S. REG. NOS. 2,200,090 AND 2,312,740.

CLASS 9—ELECTRICAL AND SCIENTIFIC APPARATUS

FOR COMPUTER SOFTWARE, NAMELY, FOR USE IN ENCRYPTING, AUTHENTICATING, AND VERIFYING DATA; COMPUTER SOFTWARE, NAMELY, FOR USE IN TRANSMITTING AND AUTHENTICATING ENCRYPTED INFORMATION IN THE FIELD OF COMMUNICATIONS; COMPUTER FIRMWARE, NAMELY, FOR USE IN ENCRYPTING, AUTHENTICATING, AND VERIFYING DATA; COMPUTER HARDWARE FOR USE IN SECURED DATA TRANSACTION, NETWORKING, CRYPTOGRAPHY, DIGITAL SIGNATURES AND PUBLIC AND PRIVATE KEY GENERATION, SECURITY FUNCTIONS, NAMELY, ENCRYPTION, CERTIFICATION, AUTHORIZATION, AUTHENTICATION, VERIFICATION, DATA PRIVACY, CONFIDENTIALITY AND DATA INTEGRITY; INTEGRATED CIRCUITS; COMPUTER SOFTWARE STORAGE MEDIA, NAMELY, PRE-RECORDED CD-ROMS AND COMPUTER DISKETTES FEATURING SECURITY TECHNOLOGY FOR USE IN THE AREA OF SECURED TRANSACTIONS OF INFORMATION, COMPUTER NETWORKING, CRYPTOGRAPHY, DIGITAL SIGNATURES AND PRIVATE AND PUBLIC KEY GENERATION, AND SECURITY FUNCTIONS, NAMELY, ENCRYPTION, CERTIFICATION, AUTHENTICATION, VERIFICATION, DATA PRIVACY CONFIDENTIALITY AND DATA INTEGRITY; RADIO PAGERS; MODEMS; CELLULAR TELEPHONES; TELECOMMUNICATIONS EQUIPMENT, NAMELY, RADIO TRANSMITTERS, TELEPHONE TRANSMITTERS, SATELLITE TRANSMITTERS, RECEIVERS, NAMELY TELEPHONE, AUDIO, VIDEO, ELECTRIC SWITCHES, COMPUTER NETWORKS COMPRISED OF WIRED AND WIRELESS COMPUTER NETWORKS, TELEPHONES, WIRELESS COMPUTER NETWORKS, NAMELY, NETWORKS COMPRISED OF CLIENT AND SERVER DEVICES, WIRELESS COMMUNICATION PROCESSORS, NAMELY SATELLITE PROCESSORS, SIGNAL PROCESSORS, TWO-WAY RADIO PAGERS, RADIO AND SATELLITE TELEPHONES, WIRELESS HANDHELD COMPUTERS, MAGNETIC CODED CARDS AND PLASTIC CARDS WITH EMBEDDED INTEGRATED CIRCUITS AND STORED INFORMATION AND DATA; COMPUTER TERMINALS FOR USE WITH CREDIT CARDS, DEBIT CARDS AND PLASTIC CARDS EMBEDDED WITH AN INTEGRATED CIRCUIT OR STORED INFORMATION AND DATA, NAMELY, MAGNETIC CODED CARD READERS, BLANK SMART CARDS (U.S. CLS. 21, 23, 26, 36 AND 38).

FIRST USE 6-0-2000; IN COMMERCE 6-0-2000.

CLASS 16—PAPER GOODS AND PRINTED MATTER

FOR CREDIT CARDS, AND DEBIT CARDS WITHOUT MAGNETIC ENCODING; PRINTED EDUCATIONAL MATERIALS IN THE FIELD OF INFORMATION SECURITY (U.S. CLS. 2, 5, 22, 23, 29, 37, 38 AND 50).

FIRST USE 6-0-2000; IN COMMERCE 6-0-2000.

CLASS 35—ADVERTISING AND BUSINESS

FOR TECHNOLOGY LICENSING OF COMPUTER SOFTWARE DEALING WITH CRYPTOGRAPHY; TECHNOLOGY LICENSING OF SECURITY HARDWARE AND SOFTWARE (U.S. CLS. 100, 101 AND 102).

FIRST USE 6-0-2000; IN COMMERCE 6-0-2000.

3,007,581. ACHIEVE TOTAL FITNESS, OAKMONT, PA. SN 76-159,556. PUB. 1-13-2004, FILED 11-3-2000.

3,007,591. TELLABS OPERATIONS, INC., NAPERVILLE, IL. SN 76-245,801. PUB. 11-25-2003, FILED 4-24-2001.

PRECISION

CLASS 5—PHARMACEUTICALS

FOR NUTRITIONAL SUPPLEMENTS (U.S. CLS. 6, 18, 44, 46, 51 AND 52).
FIRST USE 4-28-2001; IN COMMERCE 4-28-2001.

CLASS 30—STAPLE FOODS

FOR BAKERY GOODS (U.S. CL. 46).
FIRST USE 4-28-2001; IN COMMERCE 4-28-2001.

3,007,590. BIOMARIN PHARMACEUTICAL INC., NOVATO, CA. SN 76-240,537. PUB. 4-1-2003, FILED 4-10-2001.

BIOMARIN

CLASS 1—CHEMICALS

FOR ASSAYS, SCREENING KITS, DEVICES, AND EQUIPMENT FOR SCIENTIFIC ANALYSIS AND DIAGNOSIS OF DISORDERS AND PHYSIOLOGICAL PROCESSES; ASSAYS, SCREENING KITS, DEVICES, AND EQUIPMENT FOR MEASUREMENT OF DISEASE MARKERS FOR SCIENTIFIC PURPOSES (U.S. CLS. 1, 5, 6, 10, 26 AND 46).
FIRST USE 11-30-2004; IN COMMERCE 11-30-2004.

CLASS 5—PHARMACEUTICALS

FOR PHARMACEUTICAL PREPARATIONS FOR USE IN ENZYME THERAPY; PHARMACEUTICAL PREPARATIONS FOR USE IN TREATMENT OF GENETIC DISORDERS; PHARMACEUTICAL PREPARATIONS FOR USE IN BURN AND WOUND DEBRIDEMENT OR CLEANING; PHARMACEUTICALS FOR TREATMENT OF INFLAMMATION, INFECTIOUS DISEASES AND CARDIOVASCULAR DISEASES; ASSAYS, SCREENING KITS, DEVICES, AND EQUIPMENT FOR MEDICAL ANALYSIS AND DIAGNOSIS OF DISORDERS AND PHYSIOLOGICAL PROCESSES; ASSAYS, SCREENING KITS, DEVICES, AND EQUIPMENT FOR MEASUREMENT OF DISEASE MARKERS FOR MEDICAL PURPOSES; CARBOHYDRATE INHIBITING ENZYMES FOR USE IN DISEASE TREATMENT; FUNGAL LYTIC ENZYMES FOR THE TREATMENT OF FUNGAL INFECTIONS; PHARMACEUTICALS FOR TREATMENT OF LYSOSOMAL STORAGE DISEASES; PHARMACEUTICALS FOR TREATMENT OF MUCOPOLYSACCHARIDOSES; PHARMACEUTICALS FOR TREATMENT OF CARBOHYDRATE-INHIBITING ENZYME DISORDERS; PROTEINS AND ENZYMES FOR THE PRODUCTION, PURIFICATION AND ISOLATION OF BIOLOGICS FOR USE IN THE TREATMENT OF MEDICAL CONDITIONS; BIOLOGICS PRODUCED BY RECOMBINANT DNA TECHNOLOGY FOR USE IN THE TREATMENT OF PATHOLOGICAL MEDICAL CONDITIONS (U.S. CLS. 6, 18, 44, 46, 51 AND 52).
FIRST USE 1-31-2005; IN COMMERCE 1-31-2005.

METROCARE

CLASS 37—CONSTRUCTION AND REPAIR

FOR INSTALLATION, MAINTENANCE, REPAIR, AND UPGRADING FOR TELECOMMUNICATION, FIBER OPTIC, AND DATA NETWORKING EQUIPMENT (U.S. CLS. 100, 103 AND 106).
FIRST USE 12-31-2001; IN COMMERCE 12-31-2001.

CLASS 42—SCIENTIFIC, COMPUTER AND LEGAL SERVICES

FOR INSTALLATION, MAINTENANCE, REPAIR, AND UPGRADING FOR TELECOMMUNICATION, FIBER OPTIC, AND DATA NETWORKING SOFTWARE; INSPECTION AND CONSULTATION FOR TELECOMMUNICATION, FIBER OPTIC, AND DATA NETWORKING EQUIPMENT AND SYSTEMS AND THE UNDERLYING SOFTWARE RELATED THERETO (U.S. CLS. 100 AND 101).
FIRST USE 12-31-2001; IN COMMERCE 12-31-2001.

3,007,594. DRAGON OPTICAL, INC., CARLSBAD, CA. SN 76-265,567. PUB. 9-10-2002, FILED 5-30-2001.

DRAGON ALLIANCE

CLASS 6—METAL GOODS

FOR KEYHOLDERS MADE OF METAL (U.S. CLS. 2, 12, 13, 14, 23, 25 AND 50).
FIRST USE 3-28-2005; IN COMMERCE 3-28-2005.

CLASS 14—JEWELRY

FOR JEWELRY, NAMELY WATCHES, WATCHBANDS AND STRAPS AND BRACELETS (U.S. CLS. 2, 27, 28 AND 50).
FIRST USE 3-28-2005; IN COMMERCE 3-28-2005.

3,007,595. PARK CITY SOLUTIONS, INC., MIDWAY, UT. SN 76-265,872. PUB. 2-18-2003, FILED 6-1-2001.



NO CLAIM IS MADE TO THE EXCLUSIVE RIGHT TO USE "PARK CITY", APART FROM THE MARK AS SHOWN.

CLASS 9—ELECTRICAL AND SCIENTIFIC APPARATUS

FOR COMPUTER SOFTWARE AND USER MANUALS SOLD AS A UNIT THEREWITH FOR USE IN THE HEALTHCARE INDUSTRY FOR IMPLEMENTATION AND OPTIMIZATION OF LABORATORY AND CLINICAL BEST PRACTICES OFFICE SYSTEMS (U.S. CLS. 21, 23, 26, 36 AND 38).
FIRST USE 6-30-2001; IN COMMERCE 6-30-2001.

CLASS 37—CONSTRUCTION AND REPAIR

FOR MAINTENANCE AND REPAIR OF COMPUTER HARDWARE; INSTALLATION OF COMPUTER NETWORKS (U.S. CLS. 100, 103 AND 106).

FIRST USE 6-30-2001; IN COMMERCE 6-30-2001.

CLASS 41—EDUCATION AND ENTERTAINMENT

FOR COMPUTER EDUCATION AND TRAINING SERVICES, NAMELY, CLASSES, SEMINARS, CONFERENCES, WORKSHOPS, AND ON-SITE TRAINING FOR THE HEALTH CARE INDUSTRY IN THE FIELD OF COMPUTER SYSTEM OPERATIONS, USAGE, INTEGRATING, NETWORKING, PROGRAMMING, AND RECORDS (U.S. CLS. 100, 101 AND 107).

FIRST USE 6-30-2001; IN COMMERCE 6-30-2001.

CLASS 42—SCIENTIFIC, COMPUTER AND LEGAL SERVICES

FOR INSTALLATION OF COMPUTER SOFTWARE; CONSULTING SERVICES IN THE HEALTH CARE INDUSTRY, NAMELY, COMPUTER SYSTEMS CONSULTING; COMPUTER SYSTEM SUPPORT SERVICES, NAMELY, REMOTE, ON-SITE AND PERIODIC MONITORING AND MAINTENANCE OF COMPUTER SYSTEMS IN THE HEALTH CARE INDUSTRY; CONSULTING SERVICES IN THE FIELD OF DESIGN, SELECTION, IMPLEMENTATION AND USE OF COMPUTER HARDWARE AND SOFTWARE SYSTEMS FOR OTHERS IN THE FIELD OF HEALTH CARE; NON-DOWNLOADABLE COMPUTER SOFTWARE FOR USE IN THE HEALTHCARE INDUSTRY PROVIDED TO END USERS AS AN ONLINE SERVICE (U.S. CLS. 100 AND 101).

FIRST USE 6-30-2001; IN COMMERCE 6-30-2001.

3,007,599. CULTO GMBH, THUMSENREUTH, FED REP GERMANY. SN 76-276,497. PUB. 3-16-2004, FILED 6-27-2001.



PRIORITY CLAIMED UNDER SEC. 44(D) ON FED REP GERMANY APPLICATION NO. 39640382, FILED 1-26-2001, REG. NO. 30109728, DATED 6-6-2001, EXPIRES 1-31-2011.

CLASS 14—JEWELRY

FOR GOODS OF PRECIOUS METAL, NAMELY, CANDLE HOLDERS, NAPKIN RINGS, VASES, ASH TRAYS, EGG CUPS, BOTTLE STOPPERS; NECKLACES, RINGS; JEWELRY MADE OF PLASTIC (U.S. CLS. 2, 27, 28 AND 50).

FIRST USE 12-3-2002; IN COMMERCE 11-15-2004.

CLASS 20—FURNITURE AND ARTICLES NOT OTHERWISE CLASSIFIED

FOR PICTURE FRAMES, PHOTO STANDS; NON-METAL KEY RINGS; GOODS OF PLASTIC, NAMELY, PLASTIC DECORATIVE ORNAMENTS, ORNAMENTAL FLOWERS (U.S. CLS. 2, 13, 22, 25, 32 AND 50).

FIRST USE 12-3-2002; IN COMMERCE 11-15-2004.

3,007,616. UNISHIPPERS ASSOCIATION, INC., SALT LAKE CITY, UT. SN 76-401,688. PUB. 8-19-2003, FILED 4-26-2002.

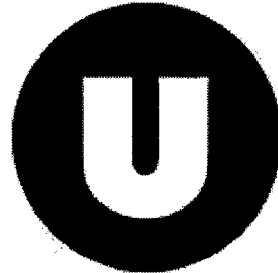
**CLASS 35—ADVERTISING AND BUSINESS**

FOR PROMOTING AND MARKETING THE SERVICES OF COMPANIES THAT PROVIDE OVERNIGHT, AIR-FREIGHT, EXPRESS TRUCK, EXPRESS GROUND, DEFERRED GROUND, SMALL PACKAGE, HEAVY FREIGHT, RAIL, OCEAN, INTERMODAL AND OTHER TRANSPORTATION AND DELIVERY SERVICES BY THE DISTRIBUTION OF PRINTED PROMOTIONAL MATERIALS AND BY RENDERING SALES REPRESENTATIVE SERVICES FOR SUCH COMPANIES; AND PROVIDING BUSINESS MANAGEMENT SERVICES AND FRANCHISING, NAMELY, OFFERING TECHNICAL ASSISTANCE IN THE ESTABLISHMENT AND/OR OPERATION OF BUSINESSES THAT PROMOTE, MARKET AND SELL THE SERVICES OF COMPANIES THAT PROVIDE OVERNIGHT, AIRFREIGHT, EXPRESS TRUCK, EXPRESS GROUND, DEFERRED GROUND, SMALL PACKAGE, HEAVY FREIGHT, RAIL, OCEAN, INTERMODAL AND OTHER TRANSPORTATION AND DELIVERY SERVICES (U.S. CLS. 100, 101 AND 102).

FIRST USE 8-9-2002; IN COMMERCE 8-9-2002.

CLASS 39—TRANSPORTATION AND STORAGE

FOR PICK-UP, TRANSPORTATION AND DELIVERY SERVICES, NAMELY, THE PICK-UP, TRANSPORTATION AND DELIVERY OF PACKAGES VIA OVERNIGHT AIR, AIRFREIGHT, EXPRESS TRUCK, EXPRESS GROUND, DEFERRED GROUND, HEAVY FREIGHT, RAIL, AND OCEAN (U.S. CLS. 100 AND 105).

FIRST USE 8-9-2002; IN COMMERCE 8-9-2002.

3,007,619. PHILLIPS, SHELLEY, GOODLETTSVILLE, TN. SN 76-410,540. PUB. 11-19-2002, FILED 5-21-2002.

PEACES OF LOVE**CLASS 9—ELECTRICAL AND SCIENTIFIC APPARATUS**

FOR CASSETTES AND COMPACT DISCS CONTAINING MUSIC (U.S. CLS. 21, 23, 26, 36 AND 38).

FIRST USE 7-17-2005; IN COMMERCE 7-17-2005.

CLASS 16—PAPER GOODS AND PRINTED MATTER

FOR CHILDREN'S BOOKS (U.S. CLS. 2, 5, 22, 23, 29, 37, 38 AND 50).

FIRST USE 7-17-2005; IN COMMERCE 7-17-2005.

3,007,620. JIANGXI GONGQING YAYA GROUP CO. LTD.,
JIANGXI PROVINCE, CHINA. SN 76-411,040. PUB. 11-11-
2003, FILED 5-23-2002.



NO CLAIM IS MADE TO THE EXCLUSIVE RIGHT TO USE BRAND APART FROM THE MARK AS SHOWN AND NO CLAIM IS MADE TO THE EXCLUSIVE RIGHT TO USE "DUCKLING BRAND AND YA AND THE CHINESE CHARACTER IN THE MARK WHICH TRANSLATES TO YA" APART FROM THE MARK AS SHOWN, WHEN USED ON OR IN CONNECTION WITH BED COVERS; QUILTS; EIDERDOWNS; LAP ROBES, NAMELY AFGHANS; BED RUGS, NAMELY COMFORTERS AND DUVET COVERS; TOWELING COVERLETS, DOWN JACKETS, OVERCOATS, JACKETS, AND GLOVES., APART FROM THE MARK AS SHOWN.

THE CHINESE CHARACTERS APPEARING IN THE MARK TRANSLITERATE TO "YA YA". THE TERM "YA YA" MEANS "DUCK DUCK" IN ENGLISH.

CLASS 24—FABRICS

FOR BED COVERS; QUILTS; EIDERDOWNS; LAP ROBES, NAMELY AFGHANS; BED RUGS, NAMELY COMFORTERS AND DUVET COVERS; AND TOWELING COVERLETS ALL MADE IN SUBSTANTIAL PART OF DUCK-DOWN FEATHERS; BED SHEETS; PILLOW-CASES; AND BED LINENS (U.S. CLS. 42 AND 50).
FIRST USE 5-10-1982; IN COMMERCE 11-2-2004.

CLASS 25—CLOTHING

FOR DOWN JACKETS, OVERCOATS, JACKETS, GLOVES ALL MADE IN SUBSTANTIAL PART OF DUCK-DOWN FEATHERS; SHIRTS, T-SHIRTS, NIGHT-GOWNS, UNDERCLOTHES, TROUSERS, SHOES, HATS, HOSIERY, AND SCARVES (U.S. CLS. 22 AND 39).
FIRST USE 5-10-1982; IN COMMERCE 11-2-2004.

3,007,623. CLEARING HOUSE ASSOCIATION L.L.C., THE,
NEW YORK, NY. SN 76-431,961. PUB. 5-11-2004, FILED
7-16-2002.



NO CLAIM IS MADE TO THE EXCLUSIVE RIGHT TO USE "CH", "CLEARING HOUSE" AND "PAYMENT SOLUTIONS WORLDWIDE", APART FROM THE MARK AS SHOWN.

CLASS 36—INSURANCE AND FINANCIAL

FOR FINANCIAL CLEARING HOUSES (U.S. CLS. 100,
101 AND 102).
FIRST USE 5-0-2002; IN COMMERCE 5-0-2002.

CLASS 41—EDUCATION AND ENTERTAINMENT

FOR CONDUCTING SEMINARS AND FORUMS IN THE FIELD OF FINANCIAL SERVICES (U.S. CLS. 100, 101 AND 107).

FIRST USE 5-0-2002; IN COMMERCE 5-0-2002.

3,007,628. KERRY GROUP SERVICES LIMITED, TRALCE,
CO. KERRY, IRELAND. SN 76-452,432. PUB. 1-18-2005,
FILED 9-17-2002.

PEPTICASE

OWNER OF U.S. REG. NO. 969,473.

CLASS 1—CHEMICALS

FOR CHEMICALS FOR USE IN INDUSTRY AND SCIENCE FOR FOOD AND BEVERAGE MANUFACTURING; HYDROLISED PROTEINS AND HYDROLYSATES FOR USE IN FOOD AND BEVERAGE MANUFACTURING (U.S. CLS. 1, 5, 6, 10, 26 AND 46).

FIRST USE 9-0-2004; IN COMMERCE 9-0-2004.

CLASS 5—PHARMACEUTICALS

FOR TISSUE CULTURE MEDIA, PROTEINS, PROTEINS FOR CELL NUTRITION, CULTURES; ALL FOR USE IN THE LABORATORY AND INDUSTRIAL USE IN THE MANUFACTURE OF PHARMACEUTICAL, MEDICAL AND VETERINARY PREPARATIONS; BACTERIOLOGICAL CULTURES FOR USE IN FOOD AND BEVERAGE MANUFACTURING (U.S. CLS. 6, 18, 44, 46, 51 AND 52).

FIRST USE 9-0-2004; IN COMMERCE 9-0-2004.

3,007,632. GREEN CANYON LLC, WILMINGTON, DE. SN
76-475,706. PUB. 4-13-2004, FILED 12-9-2002.



OWNER OF U.S. REG. NOS. 1,052,098, 2,721,126, AND OTHERS.

CLASS 35—ADVERTISING AND BUSINESS

FOR DATA PROCESSING SERVICES, EMPLOYMENT AGENCY SERVICES, LONG TERM AND SHORT TERM PLACEMENT OF CONSULTANTS, MANAGEMENT, MARKETING, PROFESSIONAL, LEGAL, ACCOUNTING, FINANCIAL, ADMINISTRATIVE, SALES, OFFICE AND CLERICAL PERSONNEL, TECHNICAL, ELECTRONIC DATA PROCESSING SUPPORT, PROGRAMMERS AND OTHER COMPUTER PERSONNEL, ENGINEERING AND INDUSTRIAL PERSONNEL AND THE MANAGEMENT OF SUCH PLACEMENTS FOR OTHERS (U.S. CLS. 100, 101 AND 102).

FIRST USE 2-0-2003; IN COMMERCE 2-0-2003.

CLASS 37—CONSTRUCTION AND REPAIR

FOR SHORT TERM COMPUTER HARDWARE MAINTENANCE (U.S. CLS. 100, 103 AND 106).

FIRST USE 2-0-2003; IN COMMERCE 2-0-2003.

CLASS 42—SCIENTIFIC, COMPUTER AND LEGAL SERVICES

FOR SHORT TERM COMPUTER SOFTWARE MAINTENANCE, TECHNICAL CONSULTING AND TECHNICAL SUPPORT SERVICES, NAMELY, TROUBLESHOOTING OF COMPUTER HARDWARE AND SOFTWARE PROBLEMS IN THE FIELDS OF DATA PROCESSING, SOFTWARE ENGINEERING, SOFTWARE DESIGN, HARDWARE ENGINEERING, HARDWARE DESIGN AND COMPUTER PROGRAMMING, COMPUTER SOFTWARE DESIGN FOR OTHERS, COMPUTER AIDED DESIGN (CAD), NAMELY, PROVIDING DESIGN, DRAFTING, AND LEGACY CONVERSION SERVICES, ENGINEERING, DRAFTING AND DESIGN SERVICE FOR OTHERS IN THE FIELDS OF ELECTRONICS, CHEMICALS, AUTOMOBILES, PETROLEUM, PHARMACEUTICALS, AIRCRAFT, NAVAL ENGINEERING AND DESIGN, AND POWER PLANTS (U.S. CLS. 100 AND 101).

FIRST USE 2-0-2003; IN COMMERCE 2-0-2003.

3,007,648. TV GUIDE MAGAZINE GROUP, INC., LOS ANGELES, CA. SN 76-507,930. PUB. 8-10-2004, FILED 4-21-2003.

TV GUIDE ON SCREEN

OWNER OF U.S. REG. NOS. 650,942, 2,679,876, AND OTHERS.

NO CLAIM IS MADE TO THE EXCLUSIVE RIGHT TO USE SCREEN IN CLASSES 35, 38, AND 41, APART FROM THE MARK AS SHOWN.

SEC. 2(F) AS TO "TV GUIDE" IN CLASSES 35, 38, AND 41.

CLASS 9—ELECTRICAL AND SCIENTIFIC APPARATUS

FOR CONSUMER ELECTRONICS, NAMELY, TELEVISIONS, VIDEO RECORDERS, CABLE BOXES, SATELLITE BOXES, AND REMOTE CONTROLLERS FOR USE THEREWITH (U.S. CLS. 21, 23, 26, 36 AND 38).

FIRST USE 8-31-2003; IN COMMERCE 8-31-2003.

CLASS 35—ADVERTISING AND BUSINESS

FOR ADVERTISING SERVICES, NAMELY, PROMOTING THE GOODS AND SERVICES OF OTHERS BY PREPARING AND PLACING INFORMATIONAL AND PROMOTIONAL ADVERTISEMENTS FOR BROADCAST VIA TELEVISION AND CABLE PROGRAMMING, VIA INTERACTIVE TELEVISION AND CABLE PROGRAMMING AND VIA ON-LINE ELECTRONIC COMMUNICATIONS NETWORKS (U.S. CLS. 100, 101 AND 102).

FIRST USE 8-31-2003; IN COMMERCE 8-31-2003.

CLASS 38—COMMUNICATION

FOR COMMUNICATIONS SERVICES, NAMELY, THE TRANSMISSION AND DELIVERY OF PROMOTIONAL, INFORMATIONAL, AND INTERACTIVE TELEVISION PROGRAMMING VIA TELEVISION, CABLE AND SATELLITE AND ON-LINE ELECTRONIC COMMUNICATIONS NETWORKS (U.S. CLS. 100, 101 AND 104).

FIRST USE 8-31-2003; IN COMMERCE 8-31-2003.

CLASS 41—EDUCATION AND ENTERTAINMENT

FOR ENTERTAINMENT SERVICES, NAMELY, THE PRODUCTION AND DISTRIBUTION OF PROMOTIONAL, INFORMATIONAL, AND INTERACTIVE TELEVISION PROGRAMMING VIA TELEVISION, CABLE, SATELLITE AND ON-LINE ELECTRONIC COMMUNICATIONS NETWORKS; AND PROVIDING TELEVISION, CABLE AND SATELLITE TELEVISION LISTINGS, PROGRAMMING AND SCHEDULING INFORMATION, ADVERTISEMENTS, AND ENTERTAINMENT RELATED INFORMATION, BY MEANS OF THE TELEVISION (U.S. CLS. 100, 101 AND 107).

FIRST USE 8-31-2003; IN COMMERCE 8-31-2003.

3,007,661. COURTNEY, KEVIN C., IRVINE, CA. SN 76-536,063. PUB. 10-12-2004, FILED 7-28-2003.

CLASS 37—CONSTRUCTION AND REPAIR

FOR AUTOMOBILE CLEANING AND CAR WASHING; AUTOMOBILE SERVICE STATION SERVICES, VEHICLE REPAIR AND MAINTENANCE (U.S. CLS. 100, 103 AND 106).

FIRST USE 6-0-2004; IN COMMERCE 6-0-2004.

CLASS 42—SCIENTIFIC, COMPUTER AND LEGAL SERVICES

FOR EMISSIONS TESTING; REVIEWING STANDARDS AND PRACTICES TO ASSURE COMPLIANCE WITH STATE VEHICLE EMISSIONS STANDARDS (U.S. CLS. 100 AND 101).

FIRST USE 6-0-2004; IN COMMERCE 6-0-2004.

3,007,664. LECG, LLC, EMERYVILLE, CA. SN 76-538,223. PUB. 5-25-2004, FILED 8-18-2003.

NO CLAIM IS MADE TO THE EXCLUSIVE RIGHT TO USE "EXPERT" OR "FORUM", APART FROM THE MARK AS SHOWN.

CLASS 35—ADVERTISING AND BUSINESS

FOR CONSULTING SERVICES, NAMELY, EXPERT ANALYSIS IN ECONOMICS AND ACCOUNTING; CONSULTING SERVICES, NAMELY, BUSINESS MANAGEMENT CONSULTING IN ECONOMICS AND ACCOUNTING (U.S. CLS. 100, 101 AND 102).

FIRST USE 5-1-2005; IN COMMERCE 5-1-2005.

CLASS 36—INSURANCE AND FINANCIAL

FOR CONSULTING SERVICES, NAMELY, EXPERT ANALYSIS IN FINANCE; CONSULTING SERVICES, NAMELY, MANAGEMENT CONSULTING IN FINANCE (U.S. CLS. 100, 101 AND 102).

FIRST USE 5-1-2005; IN COMMERCE 5-1-2005.

CLASS 42—SCIENTIFIC, COMPUTER AND LEGAL SERVICES

FOR CONSULTING SERVICES, NAMELY, LITIGATION SUPPORT IN ECONOMICS, ACCOUNTING, AND FINANCE (U.S. CLS. 100 AND 101).

FIRST USE 5-1-2005; IN COMMERCE 5-1-2005.

3,007,675. INTERNATIONAL IMAGING MATERIALS, INC., AMHERST, NY. SN 76-552,361. PUB. 2-22-2005, FILED 9-26-2003.

DECOTHERM**CLASS 21—HOUSEWARES AND GLASS**

FOR FUSING FRIT FOR DECORATING GLASS BUILDING MATERIALS (U.S. CLS. 2, 13, 23, 29, 30, 33, 40 AND 50).

FIRST USE 3-31-2003; IN COMMERCE 2-28-2004.

CLASS 40—MATERIAL TREATMENT

FOR CUSTOM MANUFACTURE OF GLASS AND CERAMICS WITH PRINTED FRIT DECALS (U.S. CLS. 100, 103 AND 106).

FIRST USE 3-31-2003; IN COMMERCE 2-28-0204.

3,007,678. MILL-ROSE COMPANY, MENTOR, OH. SN 76-556,067. PUB. 7-27-2004, FILED 11-3-2003.

CLEAN-FIT PRODUCTS

NO CLAIM IS MADE TO THE EXCLUSIVE RIGHT TO USE "PRODUCTS", APART FROM THE MARK AS SHOWN.

CLASS 8—HAND TOOLS

FOR HAND TOOLS, NAMELY WATER SHUT-OFF TOOLS FOR SEALING FITTINGS AND TUBING USED IN PLUMBING, HEATING AND COOLING APPLICATIONS (U.S. CLS. 23, 28 AND 44).

FIRST USE 1-0-1980; IN COMMERCE 1-0-1980.

CLASS 21—HOUSEWARES AND GLASS

FOR BRUSHES THAT CLEAN AND DEBUR FITTINGS AND TUBING USED IN PLUMBING, HEATING AND COOLING APPLICATIONS (U.S. CLS. 2, 13, 23, 29, 30, 33, 40 AND 50).

FIRST USE 1-0-1980; IN COMMERCE 1-0-1980.

3,007,684. BURGER, CHRISTINE, CAMPBELL, CA. SN 76-562,572. PUB. 2-22-2005, FILED 12-2-2003.

NOODLE & BOO

THE MARK CONSISTS OF STANDARD CHARACTERS WITHOUT CLAIM TO ANY PARTICULAR FONT, STYLE, SIZE, OR COLOR.

CLASS 3—COSMETICS AND CLEANING PREPARATIONS

FOR BABY AND CHILDREN'S SOAPS, BODY WASHES, SHAMPOO, BUBBLE BATH, BABY WIPES, PRE-MOISTENED COSMETIC WIPES; DISPOSABLE WIPES IMPREGNATED WITH CHEMICALS OR COMPOUNDS FOR PERSONAL HYGIENE; FACE AND BODY AND SUN CREAMS AND OILS; NON-MEDICATED DIAPER RASH OINTMENTS AND LOTIONS; SUN SCREEN AND SUN BLOCK (U.S. CLS. 1, 4, 6, 50, 51 AND 52).

FIRST USE 5-26-2005; IN COMMERCE 5-26-2005.

CLASS 5—PHARMACEUTICALS

FOR MEDICATED PRE-MOISTENED WIPES, MEDICATED DIAPER RASH OINTMENTS AND LOTIONS (U.S. CLS. 6, 18, 44, 46, 51 AND 52).

FIRST USE 5-26-2005; IN COMMERCE 5-26-2005.

3,007,688. WAVES LICENSING, LLC, WILMINGTON, DE. SN 76-567,984. PUB. 11-30-2004, FILED 1-2-2004.

SIG FACTS PLUS

OWNER OF U.S. REG. NOS. 2,624,035 AND 2,642,038.

CLASS 35—ADVERTISING AND BUSINESS

FOR NEWS CLIPPING SERVICES FEATURING COMPANY DEVELOPMENTS, SUMMARIES OF BUSINESS FINANCIAL NEWS, RESEARCH ANALYSTS ACTIONS AND RESEARCH INFORMATION; PROVIDING BUSINESS INFORMATION IN THE FIELDS OF BUSINESS FINANCIAL NEWS AND COMPANY DEVELOPMENTS; BUSINESS RESEARCH ANALYSIS AND INFORMATION IN THE FIELDS OF BUSINESS FINANCIAL NEWS AND COMPANY DEVELOPMENTS (U.S. CLS. 100, 101 AND 102).

FIRST USE 3-1-2004; IN COMMERCE 3-1-2004.

CLASS 36—INSURANCE AND FINANCIAL

FOR PROVIDING FINANCIAL INFORMATION (U.S. CLS. 100, 101 AND 102).

FIRST USE 3-1-2004; IN COMMERCE 3-1-2004.

3,007,719. NIPPON DENKI KABUSHIKI KAISHA, DBA NEC CORPORATION, TOKYO, JAPAN. SN 76-977,722. PUB. 11-12-2002, FILED 8-30-2001.

EMPOWERED BY INNOVATION

FOR TELECOMMUNICATION GATEWAY SERVICES FOR THE TRANSMISSION, TRANSFER AND DISSEMINATION OF ELECTRONIC MAIL AND VIDEO IMAGES; BROADCASTING INTERACTIVE TELEVISION, AUDIO, VIDEO AND MULTIMEDIA PRESENTATIONS VIA A GLOBAL COMPUTER NETWORK; PROVIDING ACCESS TO LOCAL AND GLOBAL COMPUTER INFORMATION NETWORKS; PROVIDING MULTIPLE-USER ACCESS TO A GLOBAL COMPUTER INFORMATION NETWORK; PROVIDING ON-LINE ELECTRONIC BULLETIN BOARDS FOR TRANSMISSION OF MESSAGES AMONG COMPUTER USERS CONCERNING TOPICS OF GENERAL INTEREST TO CONSUMING PUBLIC, BUSINESSES AND PRIVATE INSTITUTIONS; PROVIDING ON-LINE CHAT ROOMS FOR TRANSMISSION OF MESSAGES AMONG COMPUTER USERS CONCERNING TOPICS OF GENERAL INTEREST TO CONSUMING PUBLIC, BUSINESSES AND PRIVATE INSTITUTIONS (U.S. CLS. 100, 101 AND 104).

FIRST USE 4-1-2005; IN COMMERCE 4-1-2005.

CLASS 9—ELECTRICAL AND SCIENTIFIC APPARATUS

FOR COMMUNICATION EQUIPMENT AND SYSTEMS, NAMELY, TELEPHONES, KEY TELEPHONE SETS, CORDLESS TELEPHONE SETS, FACSIMILE MACHINES, ROUTERS, TRANSMITTERS, TELEPHONE AND DATA EXCHANGES; PRIVATE BRANCH EXCHANGES (PBXS), ASYNCHRONOUS TRANSFER MODE SWITCHES, RELAYS, REPEATERS, MULTIPLEXERS, MODEMS, ELECTRICAL CONNECTORS, AMPLIFIERS, ANTENNAS, PAGERS, CELLULAR PHONES AND MOBILE PHONES; COMPUTERS, COMPUTER PRINTERS, COMPUTER SERVERS, COMPUTER DISK STORAGE UNITS, COMPUTER DISK STORAGE ACCELERATORS, HARD DISK DRIVES, CD-ROM DRIVES, MONITOR DISPLAYS AND PROJECTORS; CD-ROMS CONTAINING INFORMATION ON BUSINESS INFORMATION AND CONSULTATION, BUSINESS ADMINISTRATION, BUSINESS STATISTICS AND BUSINESS PROMOTION AND SALES TECHNIQUES; COMPUTER SOFTWARE FOR NETWORK MANAGEMENT; COMPUTER SOFTWARE FOR USE IN MANAGING AND CONTROLLING COMPUTERS AND COMPUTER PERIPHERALS, FOR USE IN SEARCHING, RETRIEVING, EDITING, FORMATTING AND CONFIGURING DATA INFORMATION AND CREATING GRAPHIC CHART, FOR USE IN CERTIFYING PERSONAL INFORMATION FOR SECURITY AND FOR USE IN PROVIDING USERS/CLIENTS WITH THE EDITED DATA INFORMATION VIA GLOBAL AND LOCAL COMPUTER INFORMATION NETWORKS; COMPUTER SOFTWARE FOR BUSINESS MANAGEMENT RELATING TO ELECTRONIC APPARATUS AND INTERNET; COMPUTER SOFTWARE FOR DATABASE MANAGEMENT; COMPUTER SOFTWARE FOR APPLICATION SOFTWARE DEVELOPMENT; COMPUTER SOFTWARE FOR VIDEO GAMES; ELECTRONIC DEVICES, NAMELY, SEMICONDUCTORS, STANDARD CELLS, DIODES, INTEGRATED CIRCUITS, INTEGRATED CIRCUIT PACKAGES, LARGE-SCALE INTEGRATION, TRANSISTORS, GALLIUM ARSENIDE FIELD-EFFECT TRANSISTORS, COMPUTER MEMORIES, MICROCOMPUTERS, CENTRAL PROCESSING UNITS, MICRO PROCESSING UNITS, GATE ARRAYS, APPLICATION SPECIFIC INTEGRATED CIRCUITS, FIELD PROGRAMMABLE GATE ARRAYS, CHARGE-COUPLED DEVICES, HYBRID ICS, CAPACITORS AND RESISTORS; LIQUID CRYSTAL DISPLAYS; PRINTED WIRING BOARDS (U.S. CLS. 21, 23, 26, 36 AND 38).

FIRST USE 4-1-2005; IN COMMERCE 4-1-2005.

CLASS 37—CONSTRUCTION AND REPAIR

FOR REPAIR, MAINTENANCE, FITTING AND INSTALLATION OF ELECTRIC AND ELECTRONIC APPARATUS AND INSTRUMENTS; INSTALLATION, MAINTENANCE AND REPAIR OF COMPUTER HARDWARE SYSTEMS (U.S. CLS. 100, 103 AND 106).

FIRST USE 4-1-2005; IN COMMERCE 4-1-2005.

CLASS 38—COMMUNICATION

CLASS 42—SCIENTIFIC, COMPUTER AND LEGAL SERVICES

FOR PROVIDING TEMPORARY USE OF ON-LINE NON-DOWNLOADABLE SOFTWARE FOR NETWORK MANAGEMENT, FOR USE IN MANAGING AND CONTROLLING COMPUTERS AND COMPUTER PERIPHERALS, FOR USE IN SEARCHING, RETRIEVING, EDITING, FORMATTING AND CONFIGURING DATA INFORMATION, FOR CREATING GRAPHIC CHARTS, FOR USE IN CERTIFYING PERSONAL INFORMATION, FOR BUSINESS DEVELOPMENT, FOR VIDEO GAMES, FOR USE AS A SPREADSHEET, FOR WORD PROCESSING IN THE FIELD OF INTERNET BUSINESS VIA LOCAL AND GLOBAL COMPUTER INFORMATION NETWORKS; PROVIDING ONLINE BOOKS AND MAGAZINES CONCERNING TOPICS OF GENERAL INTEREST TO CONSUMING PUBLIC, BUSINESSES AND PRIVATE INSTITUTIONS; TECHNICAL SUPPORT SERVICES, NAMELY, TECHNICAL CONSULTATION NAMELY, TECHNICAL SUPERVISION AND INSPECTION OF COMPUTER HARDWARE, COMPUTER SOFTWARE, COMPUTER PROGRAMMING AND DESIGNING, CREATING AND MAINTAINING WEB SITES AND TROUBLESHOOTING OF COMPUTER HARDWARE AND SOFTWARE PROBLEMS VIA TELEPHONE, E-MAIL, IN PERSON AND LOCAL AND GLOBAL COMPUTER INFORMATION NETWORKS; CREATING, DESIGNING AND MAINTAINING WEB SITES FOR OTHERS; INSTALLATION, MAINTENANCE AND REPAIR OF COMPUTER SOFTWARE SYSTEMS; COMPUTER PROGRAMMING FOR OTHERS; COMPUTER CONSULTATION AND ADVICE RELATING TO COMMUNICATIONS NETWORKS, COMPUTER INFORMATION NETWORKS AND TELECOMMUNICATIONS AND COMMUNICATIONS APPARATUS; LEASING ACCESS TIME TO AN INTERACTIVE COMPUTER DATABASE FEATURING INFORMATION OF GENERAL INTEREST TO CONSUMING PUBLIC, BUSINESSES AND PRIVATE INSTITUTIONS WHICH ARE CONNECTED WITH LOCAL AND GLOBAL COMPUTER INFORMATION NETWORKS (U.S. CLS. 100 AND 101).

FIRST USE 4-1-2005; IN COMMERCE 4-1-2005.

3,007,728. HOWREY SIMON ARNOLD & WHITE, LLP, WASHINGTON, DC. SN 78-099,231. PUB. 11-25-2003, FILED 12-19-2001.

MAXIAM

CLASS 35—ADVERTISING AND BUSINESS

FOR CONSULTING SERVICES FOR INTELLECTUAL ASSET MANAGEMENT, NAMELY, BUSINESS MANAGEMENT CONSULTATION FOR THE PURPOSE OF EXTRACTING VALUE FROM INTELLECTUAL ASSETS; MANAGING INTELLECTUAL PROPERTY PORTFOLIOS FOR OTHERS, NAMELY BUSINESS MANAGEMENT; PROVIDING PORTFOLIO ANALYSIS AND DUE DILIGENCE SERVICES, NAMELY, FINANCIAL STATEMENT PREPARATION AND ANALYSIS FOR BUSINESSES; CONSULTING ON INTELLECTUAL ASSETS FOR CORPORATE MERGERS AND ACQUISITIONS, NAMELY, ACQUISITION AND MERGER CONSULTATION; INTELLECTUAL ASSET LICENSE AUDITING, NAMELY, BUSINESS AUDITING; FACILITATING DELIVERY OF LEGAL ADVICE AND ASSISTANCE RELATED TO INTELLECTUAL ASSETS IN THE NATURE OF PUTTING INTELLECTUAL ASSET OWNERS IN COMMUNICATION WITH RESOURCES TO HANDLE THEIR LEGAL NEEDS, NAMELY, ATTORNEY REFERRALS (U.S. CLS. 100, 101 AND 102).

FIRST USE 11-12-2002; IN COMMERCE 11-12-2002.

CLASS 36—INSURANCE AND FINANCIAL

FOR FINANCIAL ANALYSIS AND FINANCIAL EVALUATION OF INTELLECTUAL ASSETS; FINANCIAL ANALYSIS OF INTELLECTUAL ASSET PORTFOLIOS (U.S. CLS. 100, 101 AND 102).

FIRST USE 11-12-2002; IN COMMERCE 11-12-2002.

CLASS 42—SCIENTIFIC, COMPUTER AND LEGAL SERVICES

FOR CONSULTING SERVICES FOR INTELLECTUAL ASSET MANAGEMENT, AND ANALYZING AND CONSULTING ON COMPETITIVE INTELLECTUAL ASSETS AND INTELLECTUAL ASSET OPPORTUNITIES, NAMELY, INTELLECTUAL PROPERTY ASSET CONSULTATION; MANAGING THE PROCUREMENT OF GLOBAL INTELLECTUAL PROPERTY RIGHTS FOR OTHERS, AND OFFERING ASSISTANCE TO OTHERS ON INTELLECTUAL ASSETS LICENSING, INTELLECTUAL ASSETS LICENSE NEGOTIATIONS, AND INTELLECTUAL ASSETS LICENSE MAINTENANCE, NAMELY LICENSING OF INTELLECTUAL PROPERTY ASSETS; TECHNICAL CONSULTATION IN THE FIELD OF ENGINEERING ANALYSIS OF INTELLECTUAL ASSETS; TECHNICAL CONSULTATION IN THE FIELD OF MEDIATION AND ARBITRATION ACTIVITY WITH REGARD TO INTELLECTUAL ASSETS (U.S. CLS. 100 AND 101).

FIRST USE 11-12-2002; IN COMMERCE 11-12-2002.

3,007,738. CLASSIC SLEEP PRODUCTS INC., JESSUP, MD. SN 78-140,651. PUB. 9-9-2003, FILED 7-2-2002.

POSTURE-TEMP

CLASS 20—FURNITURE AND ARTICLES NOT OTHERWISE CLASSIFIED

FOR MATTRESSES, PILLOWS, BED WEDGE PILLOWS, MATTRESS TOPPERS, BEDS, AND BED FRAMES; MATTRESSES, PILLOWS, BED WEDGE PILLOWS AND MATTRESS TOPPERS, MADE OF POLYURETHANE FOAM (U.S. CLS. 2, 13, 22, 25, 32 AND 50).

FIRST USE 12-30-2001; IN COMMERCE 12-30-2001.

CLASS 24—FABRICS

FOR BEDDING, NAMELY, SHEETS, COMFORTERS, MATTRESS PADS, AND MATTRESS COVERS (U.S. CLS. 42 AND 50).

FIRST USE 12-30-2001; IN COMMERCE 12-30-2001.

3,007,740. ALTICOR INC., ADA, MI. SN 78-149,320. PUB. 5-6-2003, FILED 7-31-2002.

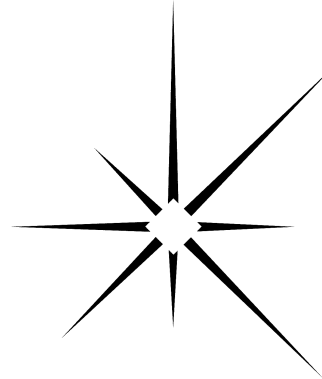

CLASS 3—COSMETICS AND CLEANING PREPARATIONS

FOR COSMETICS, SKIN CARE PRODUCTS, NAMELY, OILS, LOTIONS, CREAMS, GELS, TONERS, MASKS, MOISTURIZERS, CLEANSERS, SOAPS, SKIN LIGHTENERS AND BRIGHTENERS, AND SUN CARE PRODUCTS, NAMELY, SUN TANNING LOTION, SUN TANNING OIL, SUN BLOCK, AFTER SUN LOTION, AFTER SUN GEL; BODY POWDERS; NAIL POLISH, NAIL POLISH REMOVERS AND EMERY BOARDS (U.S. CLS. 1, 4, 6, 50, 51 AND 52).

FIRST USE 5-15-2003; IN COMMERCE 5-15-2003.

CLASS 5—PHARMACEUTICALS

FOR ACNE MEDICATIONS, ACNE TREATMENT PREPARATIONS, MEDICATED SKIN CARE PREPARATIONS (U.S. CLS. 6, 18, 44, 46, 51 AND 52).

FIRST USE 2-22-2005; IN COMMERCE 2-22-2005.

CLASS 21—HOUSEWARES AND GLASS

FOR UTENSILS AND CONTAINERS, NAMELY, COSMETIC BRUSHES AND SPONGES; COTTON BALLS, NON-WOVEN COSMETIC WIPES NOT PAPER, AND COMPACTS SOLD EMPTY (U.S. CLS. 2, 13, 23, 29, 30, 33, 40 AND 50).

FIRST USE 3-1-2004; IN COMMERCE 3-1-2004.

3,007,744. FOUNDATION FOR THE ENCOURAGEMENT & PRESERVATION OF FAMILY VALUES, LLC, THE, LOCUST VALLEY, NY. SN 78-159,607. PUB. 5-11-2004, FILED 8-30-2002.

3 DIMENSIONAL WEALTH

NO CLAIM IS MADE TO THE EXCLUSIVE RIGHT TO USE "WEALTH", APART FROM THE MARK AS SHOWN.

CLASS 16—PAPER GOODS AND PRINTED MATTER

FOR PUBLICATIONS, NAMELY, BOOKS CONCERNING FINANCIAL, ESTATE AND TAX PLANNING, AND INVESTMENT MANAGEMENT (U.S. CLS. 2, 5, 22, 23, 29, 37, 38 AND 50).

FIRST USE 6-30-2005; IN COMMERCE 6-30-2005.

CLASS 35—ADVERTISING AND BUSINESS

FOR TAX CONSULTATION SERVICES (U.S. CLS. 100, 101 AND 102).

FIRST USE 3-31-2003; IN COMMERCE 3-31-2003.

CLASS 36—INSURANCE AND FINANCIAL

FOR FINANCIAL PLANNING; ESTATE PLANNING; AND INVESTMENT MANAGEMENT AND CONSULTATION SERVICES (U.S. CLS. 100, 101 AND 102).

FIRST USE 3-31-2003; IN COMMERCE 3-31-2003.

3,007,750. WIZARD TECHNOLOGIES, INC., PURCHASE, NY. SN 78-170,401. PUB. 5-25-2004, FILED 10-2-2002.

ONE-STEP TRADER

NO CLAIM IS MADE TO THE EXCLUSIVE RIGHT TO USE "TRADER", APART FROM THE MARK AS SHOWN.

CLASS 9—ELECTRICAL AND SCIENTIFIC APPARATUS

FOR DOWNLOADABLE COMPUTER SOFTWARE IN THE FIELD OF ELECTRONIC TRADING, INVESTMENT ADVISOR ACCOUNT MANAGEMENT AND PORTFOLIO MANAGEMENT, NAMELY, PORTFOLIO MANAGEMENT TOOLS AND TRADING TOOLS; FINANCIAL ANALYTICAL SOFTWARE AND FINANCIAL CONTACT MANAGEMENT TOOLS; SOFTWARE FOR PROVIDING ELECTRONIC CONNECTIVITY TO FINANCIAL INSTITUTIONS, FINANCIAL EXCHANGES AND MARKETS; SOFTWARE FOR ELECTRONIC PRICING SERVICES FOR RETAIL AND INSTITUTIONAL USERS, BROKER AND DEALER FIRMS, HEDGE FUND MANAGEMENT FIRMS, EQUITY, OPTIONS, FIXED INCOME AND MUTUAL FUNDS TRADERS, INVESTMENT ADVISOR FIRMS, CLEARING HOUSE FIRMS AND CUSTODIAL BANK FIRMS (U.S. CLS. 21, 23, 26, 36 AND 38).

FIRST USE 8-30-2001; IN COMMERCE 1-31-2002.

CLASS 42—SCIENTIFIC, COMPUTER AND LEGAL SERVICES

FOR PROVIDING TEMPORARY USE OF NON-DOWNLOADABLE SOFTWARE IN THE FIELD OF ELECTRONIC TRADING, INVESTMENT ADVISOR ACCOUNT MANAGEMENT AND PORTFOLIO MANAGEMENT, NAMELY, PORTFOLIO MANAGEMENT TOOLS AND TRADING TOOLS, FINANCIAL ANALYTICAL SOFTWARE AND FINANCIAL CONTACT MANAGEMENT TOOLS, SOFTWARE FOR PROVIDING ELECTRONIC CONNECTIVITY TO FINANCIAL INSTITUTIONS, FINANCIAL EXCHANGES AND MARKETS, SOFTWARE FOR ELECTRONIC PRICING SERVICES FOR RETAIL AND INSTITUTIONAL USERS, BROKER AND DEALER FIRMS, HEDGE FUND MANAGEMENT FIRMS, EQUITY, OPTIONS, FIXED INCOME AND MUTUAL FUNDS TRADERS, INVESTMENT ADVISOR FIRMS, CLEARING HOUSE FIRMS AND CUSTODIAL BANK FIRMS (U.S. CLS. 100 AND 101).

FIRST USE 8-30-2001; IN COMMERCE 1-31-2002.

3,007,751. ACADEMY, LTD., KATY, TX. SN 78-174,121. PUB. 4-6-2004, FILED 10-14-2002.

TIMBER CREEK**CLASS 6—METAL GOODS**

FOR METAL TENT STAKES, CARABINER TYPE, METAL KEY CHAINS (U.S. CLS. 2, 12, 13, 14, 23, 25 AND 50).

FIRST USE 6-27-2001; IN COMMERCE 6-27-2001.

CLASS 7—MACHINERY

FOR AIR COMPRESSORS, COMPRESSED AIR PUMPS (U.S. CLS. 13, 19, 21, 23, 31, 34 AND 35).

FIRST USE 10-27-2002; IN COMMERCE 10-27-2002.

CLASS 8—HAND TOOLS

FOR CAMPING MESS KITS, CONSISTING PRIMARILY OF LOCKING KNIFE BLADE, FORK, SPOON, CORKSCREW, BOTTLE OPENER, FRY PAN, PLATE, BOILING PLATE, BOILING POT WITH LID, CUP AND NYLON CASE; HAND TOOLS, NAMELY PLIERS, SCREW DRIVERS, TOASTER FORKS, SHOVELS, AND HAND OPERATED SHEARS; CAMPING TOOL KITS CONSISTING PRIMARILY OF MULTI-FUNCTION HAND TOOLS COMPRISED OF NEEDLE NOSE PLIERS, WIRE CUTTERS, WIRE STRIPPERS, PHILLIPS HEAD SCREWDRIVER, CAN OPENER, BOTTLE OPENER, NAIL FILE, SLOTTED SCREWDRIVERS, SERRATED BLADE, KNIFE BLADE, SAW BLADE, TAPE MEASURE, 17-BIT SET COMPRISED OF 8 PHILLIPS HEAD BITS, 5 SLOTTED SCREWDRIVER BITS, AND 3 ALLEN WRENCH BITS, STORAGE CASE; UTILITY TOOL SETS CONSISTING PRIMARILY OF ADJUSTABLE WRENCH, FISH SCALER, FILE, LARGE SLOTTED SCREWDRIVER, PHILLIPS HEAD SCREWDRIVER, KNIFE BLADE, SERRATED BLADE, NEEDLE NOSE PLIERS, NAIL CLAW, MINI HAMMER, BOTTLE OPENER, 9-BIT SET COMPRISED OF 3 PHILLIPS HEAD BITS, 3 SLOTTED SCREWDRIVER BITS, AND 3 ALLEN WRENCH BITS, STORAGE CASE; HAND-PUMPED WATER SPRAYER (U.S. CLS. 23, 28 AND 44).

FIRST USE 6-27-2001; IN COMMERCE 6-27-2001.

CLASS 9—ELECTRICAL AND SCIENTIFIC APPARATUS

FOR DIRECTIONAL COMPASSES, SPORT WHISTLES (U.S. CLS. 21, 23, 26, 36 AND 38).

FIRST USE 7-13-2001; IN COMMERCE 7-13-2001.

CLASS 11—ENVIRONMENTAL CONTROL APPARATUS

FOR CAMPING STOVES, KEROSENE LANTERNS, PROPANE LANTERNS, PORTABLE PROPANE HEATERS, CHEMICALLY-ACTIVATED LIGHT STICKS, FLASHLIGHTS, WATER COOLERS, SOLAR SHOWERS, PORTABLE CAMP TOILETS, PORTABLE BATTERY-OPERATED HEAD LIGHTS, PORTABLE FIRE PITS, PLASTIC PORTABLE FAN WITH LIGHT FOR USE WHEN CAMPING (U.S. CLS. 13, 21, 23, 31 AND 34).

FIRST USE 10-1-2000; IN COMMERCE 10-1-2000.

CLASS 18—LEATHER GOODS

FOR FANNY PACKS, DUFFEL BAGS, BACKPACKS, UMBRELLAS, LAWN UMBRELLAS (U.S. CLS. 1, 2, 3, 22 AND 41).

FIRST USE 8-19-2000; IN COMMERCE 8-19-2000.

CLASS 20—FURNITURE AND ARTICLES NOT OTHERWISE CLASSIFIED

FOR LAWN FURNITURE, FURNITURE FOR USE WHEN CAMPING, AIR MATTRESSES, AIR BEDS WITH FRAMES, ALL FOR USE WHEN CAMPING, NON-METAL TENT STAKES; NYLON DETACHABLE KEY CHAINS; HANDHELD POCKET FAN; SLEEPING BAGS (U.S. CLS. 2, 13, 22, 25, 32 AND 50).

FIRST USE 11-13-2000; IN COMMERCE 11-13-2000.

CLASS 21—HOUSEWARES AND GLASS

FOR PORTABLE COOLERS, PLASTIC WATER BOTTLES SOLD EMPTY, THERMAL INSULATED CONTAINERS FOR FOOD OR BEVERAGE, EGG CARRIERS, FLASKS, UTENSILS, NAMELY TOASTER FORK AND EXTENDABLE FORK AND POTS FOR USE WHEN COOKING, SOAP DISHES, TOOTHBRUSH COVERS, ENAMEL COOKWARE, NAMELY, LADLE, KETTLE, SKILLET, SERVING SPOONS, COFFEE CUP, MIXING BOWL, CUP, SOUP PLATE, DINNER PLATE, DISHES, BEVERAGE CONTAINERS, ALUMINUM BEVERAGE CONTAINERS, BOTTLE CARRIERS, NON-ELECTRIC PERCOLATORS, CANTEEN AND ACCOMPANYING BELT, ALL OF THE FOREGOING GOODS FOR USE WHEN CAMPING (U.S. CLS. 2, 13, 23, 29, 30, 33, 40 AND 50).

FIRST USE 5-2-1997; IN COMMERCE 5-2-1997.

CLASS 22—CORDAGE AND FIBERS

FOR TENTS, POLY AND POLYETHYLENE CANOPIES AND TARPS, AND TIE DOWNS FOR USE WHEN CAMPING, HAMMOCKS, HAMMOCK STANDS, ALL-PURPOSE STRAPS, LAUNDRY REEL MADE OF STRING (U.S. CLS. 1, 2, 7, 19, 22, 42 AND 50).

FIRST USE 12-14-1999; IN COMMERCE 12-14-1999.

CLASS 24—FABRICS

FOR MOSQUITO NETTING, THERMAL BLANKETS (U.S. CLS. 42 AND 50).

FIRST USE 7-28-2002; IN COMMERCE 7-28-2002.

3,007,754. MEGATRAX PRODUCTION MUSIC, INC., NORTH HOLLYWOOD, CA. SN 78-182,312. PUB. 12-23-2003, FILED 11-6-2002.

THE SCENE**CLASS 9—ELECTRICAL AND SCIENTIFIC APPARATUS**

FOR PRERECORDED COMPACT DISCS FEATURING MUSIC, AND CD-ROMS FEATURING MUSIC AND CATALOGS OF MUSIC (U.S. CLS. 21, 23, 26, 36 AND 38).

FIRST USE 4-18-2005; IN COMMERCE 6-1-2005.

CLASS 41—EDUCATION AND ENTERTAINMENT

FOR MAINTAINING A LIBRARY OF RECORDED MUSIC FOR LICENSING PURPOSES; RECORD PRODUCTION SERVICES; MUSIC PUBLISHING SERVICES, NAMELY PRODUCING AUDIO RECORDINGS OF MUSIC AND SOUND EFFECTS (U.S. CLS. 100, 101 AND 107).

FIRST USE 4-18-2005; IN COMMERCE 6-1-2005.

3,007,758. FRITO-LAY NORTH AMERICA, INC., PLANO, TX. SN 78-189,481. PUB. 9-23-2003, FILED 11-27-2002.

FLAMIN' HOT

OWNER OF U.S. REG. NO. 2,304,357.

CLASS 29—MEATS AND PROCESSED FOODS

FOR POTATO-BASED SNACK FOODS, NAMELY, POTATO CHIPS (U.S. CL. 46).

FIRST USE 8-1-1990; IN COMMERCE 8-1-1990.

CLASS 30—STAPLE FOODS

FOR SNACK MIX COMPRISED OF TORTILLA CHIPS, MULTIGRAIN SNACK CHIPS, CHEESE FLAVORED PUFFED CORN SNACKS, PRETZELS, READY-TO-EAT CEREAL AND/OR CRACKERS (U.S. CL. 46).

FIRST USE 3-30-2003; IN COMMERCE 3-30-2003.

3,007,759. DESTINATION IMAGINATION, INC., GLASSBORO, NJ. SN 78-194,216. PUB. 8-19-2003, FILED 12-13-2002.

RISING STARS**CLASS 9—ELECTRICAL AND SCIENTIFIC APPARATUS**

FOR PRERECORDED VIDEO TAPES FEATURING TEAM-BASED CREATIVE PROBLEM SOLVING FOR STUDENTS FROM 4 TO 7; COMPUTER SOFTWARE FOR THE USE OF SCORING IN THE FIELD OF TEAM-BASED CREATIVE PROBLEM SOLVING FOR STUDENTS FROM AGES 4 TO 7 AND USER MANUALS SOLD AS A UNIT (U.S. CLS. 21, 23, 26, 36 AND 38).

FIRST USE 10-1-2002; IN COMMERCE 3-19-2003.

CLASS 14—JEWELRY

FOR MEDALS AND BADGES OF PRECIOUS METAL; LAPEL PINS; BRACELETS; EARRINGS; TIE FASTENERS; JEWELRY (U.S. CLS. 2, 27, 28 AND 50).

FIRST USE 10-1-2002; IN COMMERCE 3-19-2003.

CLASS 16—PAPER GOODS AND PRINTED MATTER

FOR PAPER AND PRINTED MATERIAL, NAMELY GUIDEBOOKS ABOUT TEAM-BASED CREATIVE PROBLEM SOLVING FOR STUDENTS FROM AGES 4 TO 7, CURRICULUM GUIDES FOR TEAM-BASED CREATIVE PROBLEM SOLVING FOR STUDENTS FROM AGES 4 TO 7, CURRICULUM GUIDES FOR TEAM-BASED CREATIVE PROBLEM SOLVING FOR STUDENTS FROM AGES 4 TO 7, STATIONARY, BROCHURES ABOUT TEAM-BASED CREATIVE PROBLEM SOLVING FOR STUDENTS FROM AGES 4 TO 7, BUMPER STICKERS, BOOKS IN THE FIELD OF TEAM-BASED CREATIVE PROBLEM SOLVING FOR STUDENTS FROM AGES 4 TO 7, GREETING CARDS AND BUSINESS FORMS (U.S. CLS. 2, 5, 22, 23, 29, 37, 38 AND 50).

FIRST USE 10-1-2002; IN COMMERCE 3-19-2003.

CLASS 18—LEATHER GOODS

FOR LEATHER SOLD IN BULK; LEATHER BADGES AND LEATHER BACKPACKS (U.S. CLS. 1, 2, 3, 22 AND 41).

FIRST USE 10-1-2002; IN COMMERCE 3-19-2003.

CLASS 20—FURNITURE AND ARTICLES NOT OTHERWISE CLASSIFIED

FOR WOODEN AWARDS, NAMELY PLAQUES; WOODEN BOXES (U.S. CLS. 2, 13, 22, 25, 32 AND 50).
FIRST USE 10-1-2002; IN COMMERCE 3-19-2003.

CLASS 24—FABRICS

FOR CLOTH TOWELS (U.S. CLS. 42 AND 50).
FIRST USE 10-1-2002; IN COMMERCE 3-19-2003.

CLASS 25—CLOTHING

FOR CLOTHING, NAMELY T-SHIRTS, SWEAT-SHIRTS, HATS AND JACKETS (U.S. CLS. 22 AND 39).
FIRST USE 10-1-2002; IN COMMERCE 3-19-2003.

CLASS 41—EDUCATION AND ENTERTAINMENT

FOR ENTERTAINMENT IN THE NATURE OF CREATIVE TEAM-BASED PROBLEM SOLVING TOURNAMENTS FOR STUDENTS FROM AGES 4 TO 7 AND EDUCATIONAL SERVICES NAMELY CONDUCTING CREATIVE TEAM-BASED PROBLEM SOLVING SEMINARS AND PROGRAMS FOR CHILDREN FROM AGES 4 TO 7 (U.S. CLS. 100, 101 AND 107).
FIRST USE 10-1-2002; IN COMMERCE 3-19-2003.

3,007,763. COPAN INNOVATIONS, LTD., LIMERICK, IRELAND. SN 78-203,416. PUB. 12-30-2003, FILED 1-15-2003.



NO CLAIM IS MADE TO THE EXCLUSIVE RIGHT TO USE "M40", APART FROM THE MARK AS SHOWN.

THE DRAWING IS LINED FOR THE COLOR(S) RED. THE COLOR(S) RED, FOR THE LETTER "M" AND THE ARROW IS/ARE CLAIMED AS A FEATURE OF THE MARK.

THE MARK CONSISTS OF THE LETTER "M" AND THE NUMBER "40" WITH AN ARROW UNDERNEATH AND THE WORD "TRANSYSTEM" UNDER THE ARROW. THE COLOR(S) RED, FOR THE LETTER "M" AND THE ARROW IS/ARE CLAIMED AS A FEATURE OF THE MARK.

THE MARK CONSISTS OF THE LETTER "M" AND THE NUMBER "40" WITH AN ARROW UNDERNEATH AND THE WORD "TRANSYSTEM" UNDER THE ARROW.

CLASS 9—ELECTRICAL AND SCIENTIFIC APPARATUS

FOR DISPOSABLE LABORATORY EQUIPMENT FOR COLLECTING DIAGNOSTIC SPECIMENS CONSISTING OF A TRANSPORT TUBE, A SWAB APPLICATOR STICK WITH A FIBER OR FOAM TIP, AND/OR A PRESERVING MEDIUM (U.S. CLS. 21, 23, 26, 36 AND 38).
FIRST USE 5-30-2003; IN COMMERCE 7-22-2003.

CLASS 10—MEDICAL APPARATUS

FOR MEDICAL DEVICE FOR COLLECTING DIAGNOSTIC SPECIMENS CONSISTING OF A TRANSPORT TUBE, A SWAB APPLICATOR STICK WITH A FIBER OR FOAM TIP, AND/OR A PRESERVING MEDIUM (U.S. CLS. 26, 39 AND 44).
FIRST USE 5-30-2003; IN COMMERCE 7-22-2003.

3,007,764. NILES STEEL TANK COMPANY, NILES, MI. SN 78-203,698. PUB. 11-2-2004, FILED 1-15-2003.



NO CLAIM IS MADE TO THE EXCLUSIVE RIGHT TO USE "STEEL TANK", APART FROM THE MARK AS SHOWN.

CLASS 6—METAL GOODS

FOR METAL STORAGE TANKS (U.S. CLS. 2, 12, 13, 14, 23, 25 AND 50).
FIRST USE 4-30-2004; IN COMMERCE 4-30-2004.

CLASS 11—ENVIRONMENTAL CONTROL APPARATUS

FOR HOT WATER STORAGE TANKS (U.S. CLS. 13, 21, 23, 31 AND 34).
FIRST USE 4-30-2004; IN COMMERCE 4-30-2004.

CLASS 40—MATERIAL TREATMENT

FOR METAL TANK AND PRESSURE AND PROCESSING VESSEL FABRICATION AND FINISHING SERVICES (U.S. CLS. 100, 103 AND 106).
FIRST USE 4-30-2004; IN COMMERCE 4-30-2004.

3,007,771. SIEMAG GMBH, NETPHEN, FED REP GERMANY. SN 78-207,503. PUB. 11-9-2004, FILED 1-27-2003.

SIEMAG

PRIORITY CLAIMED UNDER SEC. 44(D) ON FED REP GERMANY APPLICATION NO. 30238916.4/0, FILED 8-6-2002, REG. NO. 30238916, DATED 2-4-2003, EXPIRES 8-31-2012.

CLASS 6—METAL GOODS

FOR WAREHOUSE RACKS MADE OF METAL; SHAFT LININGS MADE OF METAL; SHAFT FRAMES; SHELVING MADE OF METAL FOR THE STORAGE AND SORTING OF LARGE AND SMALL ARTICLES; METAL CAGES FOR USE IN MINES; METAL MINE CARE RAILS; METAL COOLING-LIQUID PIPELINES; METAL STORAGE CONTAINERS; METAL RADIOACTIVE WASTE CONTAINERS; METAL COIL STORAGE CONTAINERS (U.S. CLS. 2, 12, 13, 14, 23, 25 AND 50).
FIRST USE 12-31-1982; IN COMMERCE 12-31-1982.

CLASS 7—MACHINERY

FOR MINING EQUIPMENT, NAMELY, EXCAVATORS, CUTTERS, EARTH AND BURDEN MOVERS, LOADERS, CUTTERS AND CONVEYORS; MINING SHAFTS, HOISTS, SKIPS, WINDLASSES; INCLINED CONVEYORS, WINDING ENGINES, WINDING TOWERS, HEADFRAMES, CONVEYOR BUCKETS, CONVEYOR BELTS, MINE CAR FILLERS AND UNLOADING MACHINES; HYDRAULIC AND PNEUMATIC CONVEYORS AND SOLIDS TRANSPORTERS; PIPELINE CONVEYORS; WASTE DISPOSAL COMMUNITERS, CONVEYORS, LOADERS FOR LOADING CONTAINERS WITH RADIO-ACTIVE WASTE, TRANSPORTERS FOR RADIOACTIVE WASTE CONTAINERS; METAL COIL HANDLERS, METAL COIL WINDERS, METAL COIL CONVEYORS METAL COIL PACKAGERS, METAL COIL STACKERS; CRANES, HOISTS AND CLAMPS BEING PARTS THEREOF; GRINDING MACHINES; ROLLING MILL ROLL REPLACEMENT MACHINES (U.S. CLS. 13, 19, 21, 23, 31, 34 AND 35).

FIRST USE 12-31-1982; IN COMMERCE 12-31-1982.

CLASS 42—SCIENTIFIC, COMPUTER AND LEGAL SERVICES

FOR ENGINEERING SERVICES, NAMELY, ENGINEERING AND DEVELOPMENT OF PLANTS, MACHINERY AND EXCAVATING, CONVEYING, MINING, COILING, COIL HANDLING, LOADING, UNLOADING, TRANSPORTING AND COMMUNITING EQUIPMENT; DEVELOPMENT OF AUTOMATION COMPUTER SOFTWARE AND DEVELOPMENT OF INVENTORY MANAGEMENT SYSTEMS CONSISTING OF COMPUTERS, CONVEYORS, STORAGE SHELVING, ARTICLE PICKERS, LOADERS AND TRANSPORTERS (U.S. CLS. 100 AND 101).

FIRST USE 12-31-1982; IN COMMERCE 12-31-1982.

3,007,772. MARTIN MIDSTREAM PARTNERS L.P., KILGORE, TX. SN 78-207,556. PUB. 4-20-2004, FILED 1-27-2003.



NO CLAIM IS MADE TO THE EXCLUSIVE RIGHT TO USE "MIDSTREAM PARTNERS", APART FROM THE MARK AS SHOWN.

THE DESIGN PORTION OF THE MARK CONSISTS OF AN ARROW SHAPE THAT DEPICTS A ROAD NARROWING INTO THE DISTANCE.

CLASS 1—CHEMICALS

FOR FERTILIZERS FOR AGRICULTURAL AND DOMESTIC USE (U.S. CLS. 1, 5, 6, 10, 26 AND 46).

FIRST USE 10-31-2002; IN COMMERCE 12-31-2002.

CLASS 35—ADVERTISING AND BUSINESS

FOR DISTRIBUTORSHIP IN THE FIELD OF PETROLEUM (U.S. CLS. 100, 101 AND 102).

FIRST USE 10-31-2002; IN COMMERCE 10-31-2002.

CLASS 39—TRANSPORTATION AND STORAGE

FOR TRANSPORTATION, DISTRIBUTION AND STORAGE OF PETROLEUM AND PETROLEUM PRODUCTS, NAMELY, LUBRICANTS, FUEL OIL, LIQUIFIED PETROLEUM GASES, SULPHUR, ASPHALT AND FERTILIZERS (U.S. CLS. 100 AND 105).

FIRST USE 10-31-2002; IN COMMERCE 10-31-2002.

3,007,775. GOODSHIRT LIMITED, ROYAL OAK, NEW ZEALAND. SN 78-214,392. PUB. 8-31-2004, FILED 2-13-2003.

GOODSHIRT

PRIORITY CLAIMED UNDER SEC. 44(D) ON AUSTRALIA APPLICATION NO. 923707, FILED 8-16-2002, REG. NO. 923707, DATED 8-16-2002, EXPIRES 8-16-2012.

CLASS 9—ELECTRICAL AND SCIENTIFIC APPARATUS

FOR PRE-RECORDED AUDIO AND VIDEO DISCS, COMPACT DISCS, PHONOGRAPHIC RECORDS, VIDEO-TAPES, AUDIO CASSETTE TAPES, MINI-COMPACT DISCS, SOUND RECORDING DISCS, AND CINEMATOGRAPHIC FILMS, ALL FEATURING MUSIC (U.S. CLS. 21, 23, 26, 36 AND 38).

FIRST USE 3-16-2003; IN COMMERCE 3-16-2003.

CLASS 41—EDUCATION AND ENTERTAINMENT

FOR ENTERTAINMENT, RECREATION AND AMUSEMENT SERVICES, NAMELY, LIVE MUSIC OF A VOCAL AND INSTRUMENTAL GROUP THROUGH PERSONAL, TELEVISION, AND RADIO APPEARANCES AND APPEARANCES VIA GLOBAL COMPUTER NETWORKS; MOTION PICTURE FILM PRODUCTION; PRODUCTION OF RADIO AND TELEVISION PROGRAMS; ENTERTAINMENT IN THE NATURE OF LIVE MUSIC PRODUCTION; AUDIO RECORDING AND PRODUCTION; AND MUSIC PUBLISHING SERVICES (U.S. CLS. 100, 101 AND 107).

FIRST USE 3-16-2003; IN COMMERCE 3-16-2003.

3,007,776. MARS, INCORPORATED, MC LEAN, VA. SN 78-214,535. PUB. 5-4-2004, FILED 2-13-2003.

PAWS TO RECOGNIZE**CLASS 31—NATURAL AGRICULTURAL PRODUCTS**

FOR PET FOOD (U.S. CLS. 1 AND 46).

FIRST USE 5-0-2004; IN COMMERCE 5-0-2004.

CLASS 35—ADVERTISING AND BUSINESS

FOR ASSOCIATION SERVICES, NAMELY, PROMOTING THE INTERESTS OF PROFESSIONAL DOGS AND THE CONTRIBUTIONS THEY MAKE TO THEIR OWNERS AND THE WORLD IN GENERAL; PUBLIC RELATION SERVICES FOR PROFESSIONAL DOGS AND THEIR OWNERS (U.S. CLS. 100, 101 AND 102).

FIRST USE 0-0-2003; IN COMMERCE 0-0-2003.

3,007,777. GRAND PRAIRIE OUTFITTERS, LLC, NORTH LITTLE ROCK, AR. SN 78-214,924. PUB. 9-9-2003, FILED 2-14-2003.



NO CLAIM IS MADE TO THE EXCLUSIVE RIGHT TO USE "OUTFITTERS", APART FROM THE MARK AS SHOWN.

CLASS 24—FABRICS

FOR TEXTILES HAVING CAMOUFLAGE PATTERNS FOR USE IN THE MANUFACTURE OF CLOTHING (U.S. CLS. 42 AND 50).
FIRST USE 7-1-2003; IN COMMERCE 7-1-2003.

CLASS 25—CLOTHING

FOR CLOTHING, NAMELY SHIRTS, PANTS, COATS, CAPS, HATS, RAINCOATS, PONCHOS, PARKAS, HEADWEAR, GLOVES, JACKETS, SHORTS, SWEATERS, T-SHIRTS, VESTS, BELTS, BLOUSES, OVERALLS, COVERALLS, AND JEANS (U.S. CLS. 22 AND 39).
FIRST USE 7-1-2003; IN COMMERCE 7-1-2003.

3,007,779. LEUPOLD & STEVENS, INC., BEAVERTON, OR. SN 78-217,105. PUB. 10-28-2003, FILED 2-20-2003.

RIFLEMAN

CLASS 9—ELECTRICAL AND SCIENTIFIC APPARATUS

FOR RIFLESCOPES; OPTICAL LENS SCOPES (U.S. CLS. 21, 23, 26, 36 AND 38).
FIRST USE 5-16-2003; IN COMMERCE 5-16-2003.

CLASS 13—FIREARMS

FOR SCOPE MOUNTS FOR FIREARMS (U.S. CLS. 2 AND 9).
FIRST USE 6-18-2003; IN COMMERCE 6-18-2003.

3,007,781. CHRISTIAN ART GIFTS, INC., LOMBARD, IL. SN 78-217,269. PUB. 11-9-2004, FILED 2-21-2003.



NO CLAIM IS MADE TO THE EXCLUSIVE RIGHT TO USE "CHRISTIAN ART GIFTS", APART FROM THE MARK AS SHOWN.

CLASS 6—METAL GOODS

FOR METAL KEY RINGS (U.S. CLS. 2, 12, 13, 14, 23, 25 AND 50).
FIRST USE 7-1-2005; IN COMMERCE 7-1-2005.

CLASS 16—PAPER GOODS AND PRINTED MATTER

FOR BOOKS REGARDING THE SUBJECT MATTER OF FAITH AND RELIGION; STATIONERY; PAPER NOTEPADS; PENS; PENCILS; GIFT CARDS; GREETING CARDS; DIARIES; WRITING JOURNALS; BOOK MARKS; BOOK COVERS; BIBLE COVERS AND CALENDARS (U.S. CLS. 2, 5, 22, 23, 29, 37, 38 AND 50).
FIRST USE 7-1-2005; IN COMMERCE 7-1-2005.

CLASS 20—FURNITURE AND ARTICLES NOT OTHERWISE CLASSIFIED

FOR POLYRESIN GIFTWARE, NAMELY FIGURINES; PICTURE FRAMES; POLYRESIN WALL PLAQUES (U.S. CLS. 2, 13, 22, 25, 32 AND 50).
FIRST USE 7-1-2005; IN COMMERCE 7-1-2005.

CLASS 21—HOUSEWARES AND GLASS

FOR CHINA; GLASS AND CERAMIC CUPS; NAMELY MUGS FOR BEVERAGES (U.S. CLS. 2, 13, 23, 29, 30, 33, 40 AND 50).
FIRST USE 7-1-2005; IN COMMERCE 7-1-2005.

3,007,789. WIND & WITHERS TACK AND FEED LLC, CENTERVILLE, OH. SN 78-229,255. PUB. 6-8-2004, FILED 3-24-2003.

WIND & WITHERS

CLASS 35—ADVERTISING AND BUSINESS

FOR RETAIL STORE SERVICES, MAIL ORDERS SERVICES, AND COMPUTERIZED ONLINE RETAIL STORE SERVICES, ALL IN THE FIELDS OF PET FOOD AND SUPPLIES, EQUIPMENT, SUPPLIES AND FOOD FOR THE CARE AND FEEDING OF HORSES, EQUIPMENT AND SUPPLIES FOR EQUESTRIAN ACTIVITIES, EQUIPMENT AND SUPPLIES FOR BOARDING AND TRANSPORTATION OF HORSES, HORSE TRAILERS, HORSE STALLS AND FURNISHINGS THEREFOR, SIGNS, LUMBER, HARDWARE, FENCING, APPAREL, FURNITURE, GIFTWARE, SILVER AND JEWELRY (U.S. CLS. 100, 101 AND 102).
FIRST USE 11-0-2003; IN COMMERCE 11-0-2003.

CLASS 37—CONSTRUCTION AND REPAIR

FOR REPAIR AND MAINTENANCE OF EQUIPMENT AND SUPPLIES FOR USE IN THE CARE, HOUSING AND TRANSPORTATION OF HORSES (U.S. CLS. 100, 103 AND 106).
FIRST USE 11-0-2003; IN COMMERCE 11-0-2003.

CLASS 41—EDUCATION AND ENTERTAINMENT

FOR EDUCATIONAL SERVICES, NAMELY CONDUCTING SEMINARS IN THE FIELDS OF THE CARE AND FEEDING OF PETS AND HORSES, EQUESTRIAN ACTIVITIES, AND THE USE OF EQUIPMENT AND SUPPLIES FOR THE CARE, HOUSING AND TRANSPORTATION OF HORSES (U.S. CLS. 100, 101 AND 107).
FIRST USE 11-0-2003; IN COMMERCE 11-0-2003.

3,007,790. TICKETMASTER, WEST HOLLYWOOD, CA. DBA CITYSEARCH.COM, SN 78-229,861. PUB. 12-7-2004, FILED 3-25-2003.



CLASS 35—ADVERTISING AND BUSINESS

FOR ADVERTISING AND PROMOTION OF GOODS AND SERVICES FOR OTHERS BY MEANS OF OPERATING AN ON-LINE SHOPPING MALL WITH LINKS TO THE RETAIL WEB SITES OF OTHERS (U.S. CLS. 100, 101 AND 102).

FIRST USE 2-26-2003; IN COMMERCE 2-26-2003.

CLASS 39—TRANSPORTATION AND STORAGE

FOR ON-LINE TRANSPORTATION RESERVATION SERVICES (U.S. CLS. 100 AND 105).

FIRST USE 2-26-2003; IN COMMERCE 2-26-2003.

CLASS 41—EDUCATION AND ENTERTAINMENT

FOR ON-LINE ARRANGEMENT FOR TICKET RESERVATION FOR SHOWS AND OTHER ENTERTAINMENT EVENTS (U.S. CLS. 100, 101 AND 107).

FIRST USE 2-26-2003; IN COMMERCE 2-26-2003.

CLASS 43—HOTEL AND RESTAURANT SERVICES

FOR ON-LINE HOTEL AND RESTAURANT RESERVATION SERVICES FOR OTHERS (U.S. CLS. 100 AND 101).

FIRST USE 2-26-2003; IN COMMERCE 2-26-2003.

3,007,791. WILLIS AMERICAS ADMINISTRATION, INC., ROSWELL, GA. SN 78-230,219. PUB. 11-16-2004, FILED 3-26-2003.

SEARCH WILLIS

NO CLAIM IS MADE TO THE EXCLUSIVE RIGHT TO USE "SEARCH", APART FROM THE MARK AS SHOWN.

CLASS 35—ADVERTISING AND BUSINESS

FOR PROVIDING AN ONLINE COMPUTER DATABASE FOR SEARCHING INFORMATION DEALING WITH HUMAN RESOURCE BENEFITS AND COMPLIANCE ISSUES, BUSINESS POLICIES AND PROCEDURES, BUSINESS NEWS AND TRENDS, AND APPLICABLE STATE AND FEDERAL LAWS (U.S. CLS. 100, 101 AND 102).

FIRST USE 3-27-2003; IN COMMERCE 7-1-2003.

CLASS 42—SCIENTIFIC, COMPUTER AND LEGAL SERVICES

FOR COMPUTER SERVICE, NAMELY, ACTING AS AN APPLICATION SERVICE PROVIDER IN THE FIELD OF KNOWLEDGE MANAGEMENT TO HOST COMPUTER APPLICATION SOFTWARE FOR SEARCHING AND RETRIEVING INFORMATION FROM DATABASES AND COMPUTER NETWORKS DEALING WITH HUMAN RESOURCE BENEFITS AND COMPLIANCE QUESTIONS, BUSINESS POLICIES AND PROCEDURES, BUSINESS NEWS AND TRENDS, AND APPLICABLE STATE AND FEDERAL LAWS (U.S. CLS. 100 AND 101).

FIRST USE 3-27-2003; IN COMMERCE 7-1-2003.

3,007,798. WYETH, MADISON, NJ. SN 78-239,080. PUB. 6-8-2004, FILED 4-17-2003.

POOP-A-CHEW

CLASS 5—PHARMACEUTICALS

FOR VETERINARY PHARMACEUTICAL AND ANIMAL HEALTH PREPARATIONS, NAMELY, ANTHELMINTICS FOR EQUINE, BOVINE AND OVINE ANIMALS (U.S. CLS. 6, 18, 44, 46, 51 AND 52).

FIRST USE 4-1-2005; IN COMMERCE 4-1-2005.

CLASS 9—ELECTRICAL AND SCIENTIFIC APPARATUS

FOR PRE-RECORDED VIDEO TAPES AND DVDS AND COMPUTER PROGRAMS, DEALING WITH THE CARE OF DUNG BEETLES AND THE USE OF DUNG BEETLES FOR DISPOSING OF DUNG FROM EQUINE, BOVINE AND OVINE ANIMALS TO MAINTAIN CLEAN ENVIRONMENTS (U.S. CLS. 21, 23, 26, 36 AND 38).

FIRST USE 4-1-2005; IN COMMERCE 4-1-2005.

CLASS 16—PAPER GOODS AND PRINTED MATTER

FOR PRINTED EDUCATIONAL MATERIALS, NAMELY BROCHURES ON THE CARE OF DUNG BEETLES AND THE USE OF DUNG BEETLES FOR DISPOSING OF DUNG FROM EQUINE, BOVINE AND OVINE ANIMALS TO MAINTAIN CLEAN ENVIRONMENTS (U.S. CLS. 2, 5, 22, 23, 29, 37, 38 AND 50).

FIRST USE 7-1-2005; IN COMMERCE 7-1-2005.

CLASS 35—ADVERTISING AND BUSINESS

FOR PROMOTING PUBLIC AWARENESS ON PROPER CARE OF DUNG BEETLES AND THE IMPORTANCE AND VALUE AND USE OF DUNG BEETLES FOR THE DISPOSING OF DUNG FROM EQUINE, BOVINE AND OVINE ANIMALS TO MAINTAIN CLEAN ENVIRONMENTS (U.S. CLS. 100, 101 AND 102).

FIRST USE 7-1-2005; IN COMMERCE 7-1-2005.

CLASS 41—EDUCATION AND ENTERTAINMENT

FOR EDUCATIONAL SERVICES, NAMELY, CONDUCTING EDUCATIONAL CONFERENCES AND SEMINARS ON THE CARE OF DUNG BEETLES AND ON THE USE OF DUNG BEETLES FOR DISPOSING OF DUNG FROM EQUINE, BOVINE AND OVINE ANIMALS TO MAINTAIN CLEAN ENVIRONMENTS (U.S. CLS. 100, 101 AND 107).

FIRST USE 7-1-2005; IN COMMERCE 7-1-2005.

3,007,800. ASCENDIA AB, SOLLENTUNA, SWEDEN. SN 78-240,576. PUB. 7-6-2004, FILED 4-22-2003.

ASCENDIA

CLASS 35—ADVERTISING AND BUSINESS

FOR BUSINESS MARKETING CONSULTING SERVICES RELATED TO MEDICAL DEVICES (U.S. CLS. 100, 101 AND 102).
FIRST USE 8-0-2003; IN COMMERCE 8-0-2003.

CLASS 42—SCIENTIFIC, COMPUTER AND LEGAL SERVICES

FOR CONSULTING SERVICES IN THE FIELD OF MEDICAL DEVICES IN THE AREAS OF RESEARCH AND DEVELOPMENT AND QUALITY ASSURANCE (U.S. CLS. 100 AND 101).
FIRST USE 8-0-2003; IN COMMERCE 8-0-2003.

CLASS 44—MEDICAL, BEAUTY AND AGRICULTURAL SERVICES

FOR CONSULTING SERVICES IN THE FIELD OF MEDICAL DEVICES FOR USE IN INTERVENTIONAL RADIOLOGY, UROLOGY, GASTROENTEROLOGY, GYNECOLOGY, ONCOLOGY AND SURGERY (U.S. CLS. 100 AND 101).
FIRST USE 8-0-2003; IN COMMERCE 8-0-2003.

3,007,801. HORTIMAX HOLDING BV, PIJNACKER, NETHERLANDS. SN 78-242,779. PUB. 11-9-2004, FILED 4-28-2003.

ROLL-LOGIC

PRIORITY CLAIMED UNDER SEC. 44(D) ON BENELUX APPLICATION NO. 1027925, FILED 2-25-2003, REG. NO. 0739325, DATED 2-25-2003, EXPIRES 2-25-2013.

CLASS 6—METAL GOODS

FOR SLIDE SYSTEMS IN SCREEN INSTALLATIONS COMPRISING ROLLING SHUTTERS AND OTHER SCREENS OF METAL AS WELL AS TRANSPORTABLE CONSTRUCTIONS OF METAL, SUCH AS FLEXIBLE SCREENS AND FENCES, AS WELL AS PARTS, FITTINGS, AND ACCESSORIES THEREFORE, FOR THE USE IN HORTICULTURE AND GREENHOUSES (U.S. CLS. 2, 12, 13, 14, 23, 25 AND 50).
FIRST USE 6-0-2003; IN COMMERCE 7-0-2003.

CLASS 7—MACHINERY

FOR DRIVE MECHANISMS CONSISTING OF PROPULSION MECHANISMS, MOTOR REDUCTIONS MEANT FOR SLIDE AND ROLL SYSTEMS, WINDING AND UNWINDING SLIDE AND ROLL SYSTEMS FOR FLEXIBLE SCREENS AND FENCES; REDUCTION TANKS, ELECTRIC SUPPLY SYSTEMS AND THEIR CONTROLS, PIPE MOTORS AND DRIVE ENGINES FOR WINDING AND UNWINDING SLIDE AND ROLL SYSTEMS FOR FLEXIBLE SCREENS AND FENCES FOR USE IN THE FIELD OF HORTICULTURE, AND AGRICULTURE, AND COMPONENTS AND PARTS THEREFORE SOLD AS A UNIT (U.S. CLS. 13, 19, 21, 23, 31, 34 AND 35).
FIRST USE 6-0-2003; IN COMMERCE 7-0-2003.

CLASS 37—CONSTRUCTION AND REPAIR

FOR INSTALLATION AND REPAIR OF DRIVE MECHANISMS AND SLIDE SYSTEMS FOR SCREEN INSTALLATIONS FOR USE IN THE FIELD OF HORTICULTURE AND AGRICULTURE (U.S. CLS. 100, 103 AND 106).
FIRST USE 6-0-2003; IN COMMERCE 7-0-2003.

3,007,805. PEREZ, LEO J., SAN CLEMENTE, CA. AND AKULLIAN, SUZANNE U., SAN CLEMENTE, CA. SN 78-251,168. PUB. 12-16-2003, FILED 5-16-2003.

DEXTER SINISTER

CLASS 9—ELECTRICAL AND SCIENTIFIC APPARATUS

FOR PROTECTIVE EYEWEAR, SUNGLASSES, OPHTHALMIC FRAMES AND LENSES, GOGGLES, NAMELY, SAFETY GOGGLES (U.S. CLS. 21, 23, 26, 36 AND 38).
FIRST USE 8-1-2004; IN COMMERCE 8-1-2004.

CLASS 14—JEWELRY

FOR CHRONOGRAPHS FOR USE AS WATCHES, PARTS FOR WATCHES, POCKET WATCHES, STOP WATCHES, WATCHES, WATCHES CONTAINING AN ELECTRONIC GAME FUNCTION, WRIST WATCHES (U.S. CLS. 2, 27, 28 AND 50).
FIRST USE 7-29-2004; IN COMMERCE 7-29-2004.

3,007,818. FINGER FURNITURE COMPANY, INC, HOUSTON, TX. SN 78-271,813. PUB. 10-26-2004, FILED 7-8-2003.

FINGERS

OWNER OF U.S. REG. NOS. 2,610,684, 2,782,562, AND OTHERS.

CLASS 35—ADVERTISING AND BUSINESS

FOR WARRANTY CLAIMS ADMINISTRATION SERVICES, NAMELY, PROCESSING WARRANTY CLAIMS FOR FURNITURE; AND PROCESSING WARRANTY REGISTRATION DOCUMENTS FOR OTHERS (U.S. CLS. 100, 101 AND 102).
FIRST USE 0-0-1950; IN COMMERCE 0-0-1950.

CLASS 36—INSURANCE AND FINANCIAL

FOR INSURANCE SERVICES, NAMELY, UNDERWRITING WARRANTY CONTRACTS IN THE FIELDS OF FURNITURE, DELIVERY OF FURNITURE AND PRICE GUARANTEES FOR FURNITURE (U.S. CLS. 100, 101 AND 102).
FIRST USE 8-0-1989; IN COMMERCE 8-0-1989.

3,007,819. S. I. JACOBSON MFG. CO., WAUKEGAN, IL. SN 78-272,194. PUB. 8-3-2004, FILED 7-9-2003.

THUNDERBAY OUTFITTERS

NO CLAIM IS MADE TO THE EXCLUSIVE RIGHT TO USE "OUTFITTERS", APART FROM THE MARK AS

SHOWN.

CLASS 18—LEATHER GOODS

FOR ALL PURPOSE SPORT BAGS, MARINE BAGS TO STORE APPAREL AND VALUABLES, SPORTSMAN'S HUNTING BAGS, BACKPACKS, DUFFEL BAGS, BUSINESS CASES, AND LUGGAGE (U.S. CLS. 1, 2, 3, 22 AND 41).

FIRST USE 4-0-2004; IN COMMERCE 4-0-2004.

CLASS 21—HOUSEWARES AND GLASS

FOR INSULATED BAGS FOR FOOD AND BEVERAGES (U.S. CLS. 2, 13, 23, 29, 30, 33, 40 AND 50).

FIRST USE 4-0-2004; IN COMMERCE 4-0-2004.

CLASS 28—TOYS AND SPORTING GOODS

FOR SPORTSMAN FISHING BAGS (U.S. CLS. 22, 23, 38 AND 50).

FIRST USE 4-0-2004; IN COMMERCE 4-0-2004.

3,007,845. PERFORMANCE INSIGHTS, LLC, GREENWOOD VILLAGE, CO. SN 78-294,311. PUB. 2-15-2005, FILED 8-29-2003.

COGS**CLASS 9—ELECTRICAL AND SCIENTIFIC APPARATUS**

FOR PRE-RECORDED CDS IN THE FIELD OF SALES PROCESS METHODOLOGY (U.S. CLS. 21, 23, 26, 36 AND 38).

FIRST USE 8-4-2005; IN COMMERCE 8-8-2005.

CLASS 16—PAPER GOODS AND PRINTED MATTER

FOR BOOKS AND MANUALS FOR USE IN THE FIELD OF SALES PROCESS METHODOLOGY (U.S. CLS. 2, 5, 22, 23, 29, 37, 38 AND 50).

FIRST USE 12-2-2004; IN COMMERCE 1-13-2005.

CLASS 41—EDUCATION AND ENTERTAINMENT

FOR EDUCATIONAL SERVICES, NAMELY, CONDUCTING CLASSES, SEMINARS, CONFERENCES AND WORKSHOPS IN THE FIELD OF SALES PROCESS METHODOLOGY (U.S. CLS. 100, 101 AND 107).

FIRST USE 6-2-2004; IN COMMERCE 7-22-2005.

3,007,850. ARCASA S.R.L., VILLA DEL CONTE (PD), ITALY. SN 78-300,121. PUB. 11-9-2004, FILED 9-14-2003.

ALGADREN**CLASS 3—COSMETICS AND CLEANING PREPARATIONS**

FOR COSMETIC PREPARATIONS FOR SLIMMING PURPOSES IN PARTICULAR CREAMS, POMADES, BATH SALTS, BATH FOAM, SHOWER FOAM, AND CAKES OF SOAP (U.S. CLS. 1, 4, 6, 50, 51 AND 52).

FIRST USE 11-0-2003; IN COMMERCE 11-0-2003.

CLASS 5—PHARMACEUTICALS

FOR DIET PILLS, MEDICATED COMPRESSES FOR DIETARY PURPOSES, SEAWEED DIET PILLS (U.S. CLS. 6, 18, 44, 46, 51 AND 52).

FIRST USE 11-0-2003; IN COMMERCE 11-0-2003.

3,007,853. BÔK BÔK FRESH, BERLIN, NJ. SN 78-302,437. PUB. 11-9-2004, FILED 9-18-2003.

BÔK BÔK FRESH

NO CLAIM IS MADE TO THE EXCLUSIVE RIGHT TO USE FRESH, APART FROM THE MARK AS SHOWN.

CLASS 29—MEATS AND PROCESSED FOODS

FOR PREPARED CHICKEN AND CHICKEN MEALS (U.S. CL. 46).

FIRST USE 4-15-2005; IN COMMERCE 4-15-2005.

CLASS 43—HOTEL AND RESTAURANT SERVICES

FOR RESTAURANT SERVICES, TAKE-OUT RESTAURANT SERVICES (U.S. CLS. 100 AND 101).

FIRST USE 4-15-2005; IN COMMERCE 4-15-2005.

3,007,870. CATFISH SOFTWARE, INC., SAN DIEGO, CA. SN 78-328,583. PUB. 10-12-2004, FILED 11-16-2003.

CATFISH SOFTWARE

THE MARK CONSISTS OF STANDARD CHARACTERS WITHOUT CLAIM TO ANY PARTICULAR FONT, STYLE, SIZE, OR COLOR.

NO CLAIM IS MADE TO THE EXCLUSIVE RIGHT TO USE SOFTWARE, APART FROM THE MARK AS SHOWN.

CLASS 35—ADVERTISING AND BUSINESS

FOR BUSINESS MANAGEMENT CONSULTATION FOR BUSINESSES IN THE FIELDS OF THE GLOBAL INFORMATION NETWORK, COMPUTER MEDIA AND INFORMATION TECHNOLOGY, AND PROVIDING CONSULTATION IN CONJUNCTION THEREWITH (U.S. CLS. 100, 101 AND 102).

FIRST USE 11-15-1994; IN COMMERCE 11-15-1994.

CLASS 36—INSURANCE AND FINANCIAL

FOR FINANCIAL SERVICES, NAMELY ASSISTING OTHERS WITH THE COMPLETION OF FINANCIAL TRANSACTIONS, NAMELY, FORMING STRATEGIC ALLIANCES, AND JOINT VENTURES, PROVIDING TECHNICAL ASSISTANCE AND MAKING ACQUISITIONS AND INVESTMENTS IN ORDER TO DEVELOP AND PROMOTE THE COMMERCIALIZATION OF ELECTRONIC CONTENT, PRODUCTS AND SERVICES, VIA A GLOBAL COMPUTER NETWORK AND OTHER ELECTRONIC MEDIA (U.S. CLS. 100, 101 AND 102).

FIRST USE 11-15-1994; IN COMMERCE 11-15-1994.

3,007,871. PARIS PRESENTS INCORPORATED, GURNEE, IL. SN 78-328,709. PUB. 11-9-2004, FILED 11-17-2003.

3,007,886. SIMOLEX RUBBER CORPORATION, PLYMOUTH, MI. SN 78-350,338. PUB. 11-30-2004, FILED 1-11-2004.

LOUNGING IN LAVENDER

THE MARK CONSISTS OF STANDARD CHARACTERS WITHOUT CLAIM TO ANY PARTICULAR FONT, STYLE, SIZE, OR COLOR.

NO CLAIM IS MADE TO THE EXCLUSIVE RIGHT TO USE "LAVENDER", APART FROM THE MARK AS SHOWN.

CLASS 3—COSMETICS AND CLEANING PREPARATIONS

FOR SACHET-LIKE EYE PILLOWS CONTAINING FRAGRANCES (U.S. CLS. 1, 4, 6, 50, 51 AND 52).
FIRST USE 8-15-2004; IN COMMERCE 8-15-2004.

CLASS 25—CLOTHING

FOR AROMATHERAPY BOOTIES, AROMATHERAPY MITTENS, AROMATHERAPY NECK WRAPS (U.S. CLS. 22 AND 39).
FIRST USE 8-15-2004; IN COMMERCE 8-15-2004.

3,007,880. STAMP & CHASE, INC., ST. LOUIS, MO. SN 78-339,095. PUB. 11-16-2004, FILED 12-10-2003.

CAREMUNICATION

THE MARK CONSISTS OF STANDARD CHARACTERS WITHOUT CLAIM TO ANY PARTICULAR FONT, STYLE, SIZE, OR COLOR.

CLASS 35—ADVERTISING AND BUSINESS

FOR BUSINESS CONSULTATION FOR HOSPITALS AND OTHER HEALTH CARE ORGANIZATIONS TO ENHANCE THE COMMUNICATION EFFECTIVENESS OF CLINICIANS, PHYSICIANS, MANAGERS, AND SUPPORT STAFF (U.S. CLS. 100, 101 AND 102).
FIRST USE 6-1-2004; IN COMMERCE 6-1-2004.

CLASS 41—EDUCATION AND ENTERTAINMENT

FOR EDUCATIONAL SERVICES, NAMELY, CONDUCTING CLASSES, SEMINARS, AND WORKSHOPS FOR HOSPITALS AND OTHER HEALTH CARE ORGANIZATIONS TO ENHANCE THE COMMUNICATION EFFECTIVENESS OF CLINICIANS, PHYSICIANS, MANAGERS, AND SUPPORT STAFF (U.S. CLS. 100, 101 AND 107).
FIRST USE 6-1-2004; IN COMMERCE 6-1-2004.

Simolex... We are flexible like rubber!

THE MARK CONSISTS OF STANDARD CHARACTERS WITHOUT CLAIM TO ANY PARTICULAR FONT, STYLE, SIZE, OR COLOR.

NO CLAIM IS MADE TO THE EXCLUSIVE RIGHT TO USE "FLEXIBLE", APART FROM THE MARK AS SHOWN.

CLASS 17—RUBBER GOODS

FOR MOLDED, EXTRUDED AND FABRICATED SYNTHETIC RUBBER PRODUCTS FOR USE AND BENEFIT IN A WIDE VARIETY OF INDUSTRIES, NAMELY, RUBBER PIPE GASKETS, RUBBER O-RINGS AND RUBBER SEALS FOR USE AS PIPE CONNECTION SEALS, WEATHER-STRIPPING FOR USE IN HOMES AND AUTOMOBILES, INDUSTRIAL RUBBER HOSES FOR TRANSPORTATION OF LIQUID MATERIAL OR DRY POWDER FOR FOOD, AND FOR USE IN THE AUTOMOBILE, ELECTRICAL, DEFENSE AND DAIRY INDUSTRIES, RUBBER TUBING FOR JOINING AND TERMINATING PIPES, AND RADIO FREQUENCY INTERFERENCE OR ELECTROMAGNETIC INTERFERENCE SHIELDING GASKETS (U.S. CLS. 1, 5, 12, 13, 35 AND 50).
FIRST USE 1-1-1995; IN COMMERCE 2-1-1995.

CLASS 40—MATERIAL TREATMENT

FOR CUSTOM MANUFACTURE OF MOLDED, EXTRUDED AND FABRICATED SYNTHETIC RUBBER PRODUCTS FOR USE AND BENEFIT IN A WIDE VARIETY OF INDUSTRIES IN THE NATURE OF RUBBER PIPE GASKETS, RUBBER O-RINGS AND RUBBER SEALS FOR USE AS PIPE CONNECTION SEALS, WEATHER-STRIPPING FOR USE IN HOMES AND AUTOMOBILES, INDUSTRIAL RUBBER HOSES FOR TRANSPORTATION OF LIQUID MATERIAL OR DRY POWDER FOR FOOD AND FOR USE IN THE AUTOMOBILE, ELECTRICAL, DEFENSE AND DAIRY INDUSTRIES, RUBBER TUBING FOR JOINING AND TERMINATING PIPES, AND RADIO FREQUENCY INTERFERENCE OR ELECTROMAGNETIC INTERFERENCE SHIELDING GASKETS (U.S. CLS. 100, 103 AND 106).
FIRST USE 1-1-1995; IN COMMERCE 2-1-1995.

3,007,910. ARCHER, JOHN, EULESS, TX. AND BECKERLEY, BEN, EULESS, TX. SN 78-358,834. PUB. 11-9-2004, FILED 1-28-2004.

CLASS 14—JEWELRY

FOR JEWELRY (U.S. CLS. 2, 27, 28 AND 50).
FIRST USE 8-3-2005; IN COMMERCE 8-3-2005.

BRIEFLY COVERED

3,007,950. LORI COULTER, LLC, ST. LOUIS, MO. SN 78-385,416. PUB. 1-18-2005, FILED 3-16-2004.

THE MARK CONSISTS OF STANDARD CHARACTERS WITHOUT CLAIM TO ANY PARTICULAR FONT, STYLE, SIZE, OR COLOR.

LORI COULTER**CLASS 25—CLOTHING**

FOR CLOTHING FOR MEN AND WOMEN, NAMELY, SHIRTS, TANK TOPS, HALTER TOPS, T-SHIRTS, SWEATSHIRTS, BOXER BRIEFS, BOXER SHORTS, SHORTS, SWEAT SHORTS, GYM SHORTS, PANTS, SWEAT PANTS, JEANS, BELTS, WRISTBANDS, SWEATERS, JACKETS, SCARVES, GLOVES; HEADGEAR, NAMELY, CAPS, HATS, BERETS, VISORS, HEADBANDS, BANDANAS; FOOTWEAR, NAMELY, SOCKS, HOSE, SLIPPERS, SANDALS, SHOES, BOOTS; FOUNDATION GARMENTS, NAMELY, UNDERWEAR, PANTIES, PAJAMAS, LOUNGEWEAR, SLEEPWEAR, ROBES (U.S. CLS. 22 AND 39).
FIRST USE 7-5-2005; IN COMMERCE 7-5-2005.

THE MARK CONSISTS OF STANDARD CHARACTERS WITHOUT CLAIM TO ANY PARTICULAR FONT, STYLE, SIZE, OR COLOR.

THE NAME "LORI COULTER" IDENTIFIES A LIVING INDIVIDUAL WHOSE CONSENT IS OF RECORD.

CLASS 35—ADVERTISING AND BUSINESS

FOR RETAIL STORE SERVICES AND ONLINE RETAIL STORE SERVICES FEATURING CLOTHING (U.S. CLS. 100, 101 AND 102).
FIRST USE 7-5-2005; IN COMMERCE 7-5-2005.

CLASS 40—MATERIAL TREATMENT

FOR CUSTOM MANUFACTURING OF APPAREL AND FASHION ACCESSORIES (U.S. CLS. 100, 103 AND 106).

FIRST USE 8-30-2004; IN COMMERCE 8-30-2004.

CLASS 45—PERSONAL SERVICES

FOR FASHION CONSULTATION SERVICES IN THE NATURE OF TAKING PHYSICAL MEASUREMENTS OF INDIVIDUALS AND ADVISING IN READY TO WEAR APPAREL AND ACCESSORIES (U.S. CLS. 100 AND 101).
FIRST USE 8-30-2004; IN COMMERCE 8-30-2004.

3,007,931. ASHANTIPLC, LTD., HONG KONG, CHINA. SN 78-368,868. PUB. 11-16-2004, FILED 2-17-2004.

ASHANTI

THE MARK CONSISTS OF STANDARD CHARACTERS WITHOUT CLAIM TO ANY PARTICULAR FONT, STYLE, SIZE, OR COLOR.

CLASS 3—COSMETICS AND CLEANING PREPARATIONS

FOR PERFUME (U.S. CLS. 1, 4, 6, 50, 51 AND 52).
FIRST USE 8-3-2005; IN COMMERCE 8-3-2005.

3,007,951. THE GARAGE DOOR GROUP, INC., WINSTON-SALEM, NC. SN 78-385,550. PUB. 12-28-2004, FILED 3-16-2004.

WEATHERGUARD

THE MARK CONSISTS OF STANDARD CHARACTERS WITHOUT CLAIM TO ANY PARTICULAR FONT, STYLE, SIZE, OR COLOR.

CLASS 6—METAL GOODS

FOR METAL GARAGE DOORS AND REPLACEMENT PARTS THEREOF, AND ELECTRIC GARAGE DOOR OPENERS AND CONTROLS THEREFOR SOLD AS A UNIT WITH METAL GARAGE DOORS (U.S. CLS. 2, 12, 13, 14, 23, 25 AND 50).
FIRST USE 0-0-1994; IN COMMERCE 0-0-1994.

CLASS 19—NON-METALLIC BUILDING MATERIALS

FOR NON-METAL GARAGE DOORS AND REPLACEMENT PARTS THEREOF, AND ELECTRIC GARAGE DOOR OPENERS AND CONTROLS THEREFOR SOLD AS A UNIT WITH NON-METAL GARAGE DOORS (U.S. CLS. 1, 12, 33 AND 50).

FIRST USE 0-0-1994; IN COMMERCE 0-0-1994.

3,008,009. SOUTHERN CALIFORNIA GAS COMPANY, LOS ANGELES, CA. SN 78-422,871. PUB. 4-19-2005, FILED 5-21-2004.

SOCALGAS

3,007,990. HUMANA INC., LOUISVILLE, KY. SN 78-413,997. PUB. 1-11-2005, FILED 5-6-2004.

SMARTEXPRESS

THE MARK CONSISTS OF STANDARD CHARACTERS WITHOUT CLAIM TO ANY PARTICULAR FONT, STYLE, SIZE, OR COLOR.

OWNER OF U.S. REG. NOS. 2,803,214 AND 2,813,752.

CLASS 35—ADVERTISING AND BUSINESS

FOR COST MANAGEMENT FOR THE HEALTH BENEFIT PLANS OF OTHERS; SUPPLYING PRESCRIPTION DRUGS TO HEALTH PLAN PARTICIPANTS FOR THE FUNDING ORGANIZATIONS; PRESCRIPTION DRUG PROGRAMS FOR DRUG PROVIDERS (U.S. CLS. 100, 101 AND 102).

FIRST USE 8-31-2004; IN COMMERCE 8-31-2004.

CLASS 36—INSURANCE AND FINANCIAL

FOR UNDERWRITING, ORGANIZING AND ADMINISTRATION OF PRE-PAID HEALTH CARE SERVICES AND PLANS; HEALTH AND LIFE INSURANCE UNDERWRITING SERVICES; DENTAL INSURANCE UNDERWRITING AND ADMINISTRATION SERVICES; ADMINISTRATION OF PRESCRIPTION DRUG PROGRAMS FOR DRUG COVERAGE INSURERS (U.S. CLS. 100, 101 AND 102).

FIRST USE 8-31-2004; IN COMMERCE 8-31-2004.

CLASS 44—MEDICAL, BEAUTY AND AGRICULTURAL SERVICES

FOR HEALTH CARE SERVICES; HEALTH CARE SERVICES IN THE NATURE OF HEALTH MAINTENANCE AND PREFERRED PROVIDER ORGANIZATIONS, HEALTH MANAGEMENT ORGANIZATIONS; DENTIST SERVICES (U.S. CLS. 100 AND 101).

FIRST USE 8-31-2004; IN COMMERCE 8-31-2004.

THE MARK CONSISTS OF STANDARD CHARACTERS WITHOUT CLAIM TO ANY PARTICULAR FONT, STYLE, SIZE, OR COLOR.

CLASS 35—ADVERTISING AND BUSINESS

FOR UTILITY RELATED SERVICES, NAMELY, TRACKING, REPORTING, ANALYZING AND DELIVERING ENERGY INFORMATION IN THE FORM OF UTILITY BILLS AND UTILITY RATE SCHEDULES; AND UTILITY RELATED SERVICES, NAMELY, ENERGY USAGE INFORMATION, ENERGY PRICE COMPARISON INFORMATION AND ENERGY SAVING METHODS INFORMATION (U.S. CLS. 100, 101 AND 102).

FIRST USE 1-1-1996; IN COMMERCE 1-1-1996.

CLASS 39—TRANSPORTATION AND STORAGE

FOR PUBLIC UTILITY SERVICES; PUBLIC UTILITY SERVICE IN THE NATURE OF NATURAL GAS DISTRIBUTION (U.S. CLS. 100 AND 105).

FIRST USE 1-1-1996; IN COMMERCE 1-1-1996.

3,008,022. ALLEN, PATRICIA, NEWPORT BEACH, CA. SN 78-976,302. PUB. 10-21-2003, FILED 2-17-2003.

IT'S A MAN'S WORLD AND A WOMAN'S UNIVERSE

CLASS 9—ELECTRICAL AND SCIENTIFIC APPARATUS

FOR SERIES OF VIDEOTAPES, CASSETTE TAPES AND CD-ROMS FEATURING RELATIONSHIP INFORMATION (U.S. CLS. 21, 23, 26, 36 AND 38).

FIRST USE 1-19-2003; IN COMMERCE 1-19-2003.

CLASS 41—EDUCATION AND ENTERTAINMENT

FOR EDUCATIONAL SERVICES, NAMELY, CLASSES, WORKSHOPS CONFERENCES, ONE ON ONE INSTRUCTIONS AND SEMINARS PERTAINING TO INTERPERSONAL RELATIONSHIPS, AND DISTRIBUTING COURSE MATERIALS, NAMELY, WORKBOOKS, VIDEOS, AUDIO TAPES, CDROMS, CHARTS, AND INSTRUCTION MANUALS IN CONNECTION THEREWITH (U.S. CLS. 100, 101 AND 107).

FIRST USE 1-19-2003; IN COMMERCE 1-19-2003.

CLASS 45—PERSONAL SERVICES

FOR COUNSELING SERVICES PERTAINING TO INTERPERSONAL RELATIONSHIPS (U.S. CLS. 100 AND 101).
FIRST USE 1-19-2003; IN COMMERCE 1-19-2003.

CLASS 16—PAPER GOODS AND PRINTED MATTER

FOR PAPER GOODS AND PRINTED MATTER, NAMELY, PENCILS, PENS, ERASERS, DRAWING RULERS, PENCIL SHARPENERS, LOOSE LEAF BINDERS, NOTEBOOKS, AND BOOK COVERS (U.S. CLS. 2, 5, 22, 23, 29, 37, 38 AND 50).
FIRST USE 6-0-2003; IN COMMERCE 6-0-2004.

3,008,023. HALAS, WALTER P., WHITE PLAINS, NY. SN 78-976,312. PUB. 5-11-2004, FILED 4-17-2003.

CLASS 18—LEATHER GOODS

FOR SCHOOL BAGS, BACKPACKS AND ALL-PURPOSE ATHLETIC BAGS (U.S. CLS. 1, 2, 3, 22 AND 41).
FIRST USE 6-0-2003; IN COMMERCE 6-0-2004.



CLASS 21—HOUSEWARES AND GLASS

FOR LUNCH BOXES (U.S. CLS. 2, 13, 23, 29, 30, 33, 40 AND 50).
FIRST USE 6-0-2003; IN COMMERCE 6-0-2004.

CLASS 24—FABRICS

FOR BED BLANKETS (U.S. CLS. 42 AND 50).
FIRST USE 6-0-2003; IN COMMERCE 6-0-2004.

CLASS 25—CLOTHING

FOR CLOTHING, NAMELY, ATHLETIC PANTS, SHIRTS, FOOTWEAR, SWEATSHIRTS, SWEAT PANTS, SWEAT SHORTS, SWEATSUITS, HATS, JACKETS, SLEEPWEAR, UNDERWEAR, SWEATBANDS, HEADBANDS, WRIST BANDS, GLOVES, SWIMSUITS, SWIM CAPS, AND TIES (U.S. CLS. 22 AND 39).
FIRST USE 6-0-2003; IN COMMERCE 6-0-2004.

THE MARK CONSISTS OF A STYLIZED AND FANCIFUL DRAWING OF AN ELEPHANT CHARACTER OR PACHYDERM, IN AN ATHLETIC UNIFORM WITH THE LETTER P ON THE UNIFORM SHIRT.

CLASS 28—TOYS AND SPORTING GOODS

FOR GAMES AND PLAYTHINGS, NAMELY, BOARD GAMES AND ATHLETIC EQUIPMENT, NAMELY, BASEBALL BATS, SOFTBALL BATS, FIELD HOCKEY STICKS, ICE HOCKEY STICKS, LACROSSE STICKS, BASEBALLS, SOFTBALLS, TENNIS BALLS, GOLF BALLS, FOOTBALLS, BASKETBALLS, SOCCER BALLS, LACROSSE BALLS, PLASTIC SPORTS BALLS, VOLLEY BALLS, BASEBALL BATTING GLOVES AND GOLF GLOVES (U.S. CLS. 22, 23, 38 AND 50).
FIRST USE 6-0-2003; IN COMMERCE 6-0-2004.

CLASS 14—JEWELRY

FOR WRISTWATCHES, JEWELRY AND LAPEL PINS (U.S. CLS. 2, 27, 28 AND 50).
FIRST USE 6-0-2003; IN COMMERCE 6-0-2004.

* * * * *

SECTION 2.— INTERNATIONAL CLASSIFICATION

The short titles associated below with the international class numbers are terms designed merely for quick identification and are not an official part of the international classification. The full names of international classes are given in section 6.1 of the trademark rules of practice.

The designation "U.S. Cl." appearing in this section refers to the U.S. class in effect prior to Sep. 1, 1973 rather than the international class which applies to applications filed on or after that date. For adoption of international classification see notice in the OFFICIAL GAZETTE of Jun. 26, 1973 (911 O.G. TM 210).

Application in one class

CLASS 1—CHEMICALS

3,007,625. ABB TECHNICAL COATINGS, INC., NORTH CANTON, OH. SN 76-439,525. PUB. 1-21-2003, FILED 8-8-2002.

ENVIRO-SPERSE

FOR PIGMENT DISPERSANT FOR PAINT (U.S. CLS. 1, 5, 6, 10, 26 AND 46).
FIRST USE 6-1-2005; IN COMMERCE 6-1-2005.

3,007,647. INFINITY2, INC., SCOTTSDALE, AZ. SN 76-505,903. PUB. 6-1-2004, FILED 4-11-2003.

PLANTODERM

FOR FORMULAS COMPOSED OF BIOLOGICALLY ACTIVE, BOTANICAL, AND HERBAL INGREDIENTS FOR USE IN THE MANUFACTURE OF COSMETICS (U.S. CLS. 1, 5, 6, 10, 26 AND 46).
FIRST USE 12-16-2003; IN COMMERCE 11-1-2004.

3,007,653. LOVELAND PRODUCTS, INC., GREELEY, CO. SN 76-525,470. PUB. 9-14-2004, FILED 6-25-2003.

Dyna Start

FOR SEED INOCULANT (U.S. CLS. 1, 5, 6, 10, 26 AND 46).
FIRST USE 10-9-2003; IN COMMERCE 10-9-2003.

3,007,663. HAVILAND CONSUMER PRODUCTS INC., GRAND RAPIDS, MI. SN 76-537,012. PUB. 11-16-2004, FILED 8-12-2003.

HCP GREAT LAKES

OWNER OF U.S. REG. NO. 1,644,410.

TM 1550

CLASS 1—(Continued).

NO CLAIM IS MADE TO THE EXCLUSIVE RIGHT TO USE "GREAT LAKES", APART FROM THE MARK AS SHOWN, FOR POND CARE CHEMICALS, NAMELY, WATER CLARIFIERS (U.S. CLS. 1, 5, 6, 10, 26 AND 46).
FIRST USE 6-11-2002; IN COMMERCE 6-11-2002.

3,007,714. LIFESENSORS, INC., MALVERN, PA. SN 76-597,124. PUB. 4-26-2005, FILED 6-10-2004.

SUMOPRO

THE MARK CONSISTS OF STANDARD CHARACTERS WITHOUT CLAIM TO ANY PARTICULAR FONT, STYLE, SIZE, OR COLOR.
FOR REAGENTS FOR SCIENTIFIC RESEARCH, MEDICAL RESEARCH, OR PHARMACEUTICAL INDUSTRY USE (U.S. CLS. 1, 5, 6, 10, 26 AND 46).
FIRST USE 10-1-2004; IN COMMERCE 10-1-2004.

3,007,820. OMNI MATERIALS, INC., MAYSVILLE, KY. SN 78-272,569. PUB. 5-25-2004, FILED 7-10-2003.

OMNICLEAR

THE MARK CONSISTS OF STANDARD CHARACTERS WITHOUT CLAIM TO ANY PARTICULAR FONT, STYLE, SIZE, OR COLOR.
FOR CHEMICAL BOILER ADDITIVE TO REDUCE SULFUR TRIOXIDE AND ARSENIC (U.S. CLS. 1, 5, 6, 10, 26 AND 46).
FIRST USE 7-2-2004; IN COMMERCE 7-2-2004.

CLASS 1—(Continued).

3,007,905. ALBEMARLE CORPORATION, BATON ROUGE, LA. SN 78-357,474. PUB. 11-2-2004, FILED 1-26-2004.

CLASS 2—(Continued).

3,007,657. WOOD PRESERVERS, INC., WARSAW, VA. SN 76-532,398. PUB. 4-6-2004, FILED 7-23-2003.

WELLFORM

STRONG-SEAL

FOR FIBERGLASS COATING USED TO PROTECT AND PRESERVE WOOD IN MARINE, UTILITY AND CONSTRUCTION APPLICATIONS (U.S. CLS. 6, 11 AND 16).

FIRST USE 11-2-2004; IN COMMERCE 11-2-2004.

THE MARK CONSISTS OF STANDARD CHARACTERS WITHOUT CLAIM TO ANY PARTICULAR FONT, STYLE, SIZE, OR COLOR.

FOR CHEMICALS USED IN OIL DRILLING; EMULSIFICATION, CORROSION INHIBITION, FLUID LOSS CONTROL, WELL COMPLETION AND SUSPENSION CONTROL FLUIDS FOR OIL FIELD AND INDUSTRIAL USE (U.S. CLS. 1, 5, 6, 10, 26 AND 46).

FIRST USE 3-12-1999; IN COMMERCE 6-12-1999.

3,007,835. TIANJIN FOREIGN TRADE (GROUP) STATIONERY & SPORTING GOODS CO., LTD., TIANJIN, CHINA. AND TIANJIN FIRSTER CO., LTD., TIANJIN, CHINA. SN 78-286,761. PUB. 11-9-2004, FILED 8-13-2003.

3,008,006. TURF SCIENCE LABORATORIES, INC., NATIONAL CITY, CA. SN 78-422,568. PUB. 3-1-2005, FILED 5-20-2004.



RESURGE

FOR ART COLORS, NAMELY, PAINT FOR ARTISTS IN THE NATURE OF WATER COLOR, OIL COLORS, ACRYLIC COLOR, GOUACHE COLOR (U.S. CLS. 6, 11 AND 16).

FIRST USE 11-15-2002; IN COMMERCE 1-30-2003.

THE MARK CONSISTS OF STANDARD CHARACTERS WITHOUT CLAIM TO ANY PARTICULAR FONT, STYLE, SIZE, OR COLOR.

FOR TREATMENT SOIL SURFACTANT THAT WILL CORRECT EXISTING SOIL WATER REPELLENCY (U.S. CLS. 1, 5, 6, 10, 26 AND 46).

FIRST USE 4-30-2004; IN COMMERCE 4-30-2004.

3,007,839. WIDE OPEN COATINGS, INC., MOORESVILLE, NC. SN 78-289,256. PUB. 11-9-2004, FILED 8-19-2003.

MOLYSIL

FOR THERMAL PLASMA SPRAY COATING FOR USE ON ENGINE PARTS (U.S. CLS. 6, 11 AND 16).

FIRST USE 7-14-2005; IN COMMERCE 7-14-2005.

CLASS 2—PAINTS

CLASS 2—(Continued).

3,007,932. SEMCO INCORPORATED, COLUMBIA, MO. SN 78-369,799. PUB. 11-16-2004, FILED 2-18-2004.

AVRON46

THE MARK CONSISTS OF STANDARD CHARACTERS WITHOUT CLAIM TO ANY PARTICULAR FONT, STYLE, SIZE, OR COLOR.

FOR ANTIMICROBIAL PAINT TYPE COATING FOR USE ON HVAC SYSTEMS (U.S. CLS. 6, 11 AND 16).
FIRST USE 2-0-2003; IN COMMERCE 2-0-2003.

CLASS 3—COSMETICS AND CLEANING PREPARATIONS

3,007,627. LIPO CHEMICALS, INC., PATERSON, NJ. SN 76-440,281. PUB. 4-19-2005, FILED 8-9-2002.

LIPOSATIN

FOR COSMETIC INGREDIENT, NAMELY, POLY-ETHYLENE POWDER FOR USE AS A COMPONENT OF SKIN CARE PRODUCTS REQUIRING HIGH OIL ABSORPTION AND HIGH VISCOSITY (U.S. CLS. 1, 4, 6, 50, 51 AND 52).

FIRST USE 8-0-2004; IN COMMERCE 8-0-2004.

3,007,630. IMPERIAL DAX COMPANY, INC., FAIRFIELD, NJ. SN 76-468,262. PUB. 7-29-2003, FILED 11-13-2002.

DAX HYDROWAX

OWNER OF U.S. REG. NO. 1,218,029.
FOR HAIR STYLING WAX (U.S. CLS. 1, 4, 6, 50, 51 AND 52).

FIRST USE 4-15-2004; IN COMMERCE 4-15-2004.

3,007,640. DR. NONA INTERNATIONAL LTD., RISHON LE-ZION 75658, ISRAEL. SN 76-493,095. PUB. 4-27-2004, FILED 2-24-2003.

DR. NONA

CLASS 3—(Continued).

DR. NONA IS THE NAME OF A LIVING INDIVIDUAL WHOSE CONSENT IS OF RECORD.

FOR SKIN CLEANSING PREPARATIONS; HAIR CARE PRODUCTS, NAMELY SHAMPOOS AND CONDITIONERS; SKIN CARE PRODUCTS, NAMELY MOISTURIZERS, TONERS, MASKS AND LOTIONS; NON-MEDICATED BATH SALTS; MOUTHWASH; NON-MEDICATED LIP BALM, SKIN AND EYE BALMS; AFTER-SHAVE LOTIONS (U.S. CLS. 1, 4, 6, 50, 51 AND 52).

FIRST USE 11-30-1998; IN COMMERCE 11-30-1998.

3,007,674. FOUR T CORPORATION, OMAHA, NE. SN 76-549,724. PUB. 5-25-2004, FILED 10-7-2003.

HALO

FOR INCENSE (U.S. CLS. 1, 4, 6, 50, 51 AND 52).

FIRST USE 2-19-2004; IN COMMERCE 2-19-2004.

3,007,685. BUBBLES, INC., FALLS CHURCH, VA. SN 76-564,809. PUB. 8-31-2004, FILED 11-28-2003.

WOK THIS WAY

THE MARK CONSISTS OF STANDARD CHARACTERS WITHOUT CLAIM TO ANY PARTICULAR FONT, STYLE, SIZE, OR COLOR.

FOR HAIR CARE PRODUCTS, NAMELY, SHAMPOOS, CONDITIONERS AND STYLING PREPARATIONS, AND SOAPS, TOILET WATER, SKIN CREAMS AND BODY LOTIONS (U.S. CLS. 1, 4, 6, 50, 51 AND 52).

FIRST USE 5-17-2004; IN COMMERCE 5-17-2004.

3,007,687. JAFRA COSMETICS INTERNATIONAL, INC., WESTLAKE VILLAGE, CA. SN 76-566,436. PUB. 9-28-2004, FILED 12-22-2003.

BTWIN

THE MARK CONSISTS OF STANDARD CHARACTERS WITHOUT CLAIM TO ANY PARTICULAR FONT, STYLE, SIZE, OR COLOR.

FOR COSMETICS, NAMELY, EYE SHADOW, LIP GLOSS, NAIL LACQUER, LIPSTICK, MASCARA, FACE POWDER (U.S. CLS. 1, 4, 6, 50, 51 AND 52).

FIRST USE 7-1-2005; IN COMMERCE 7-1-0205.

CLASS 3—(Continued).

3,007,704. PARA LABORATORIES, INC., HEMPSTEAD, NY.
SN 76-579,955. PUB. 4-19-2005, FILED 3-8-2004.

JAMMIN' JEL

THE MARK CONSISTS OF STANDARD CHARACTERS WITHOUT CLAIM TO ANY PARTICULAR FONT, STYLE, SIZE, OR COLOR.

NO CLAIM IS MADE TO THE EXCLUSIVE RIGHT TO USE GEL, APART FROM THE MARK AS SHOWN.

FOR HAIR LOTIONS (U.S. CLS. 1, 4, 6, 50, 51 AND 52).
FIRST USE 12-0-2004; IN COMMERCE 12-0-2004.

3,007,715. RANDALL PRODUCTIONS COMPANY, CLEVELAND, OH. SN 76-597,495. PUB. 1-11-2005, FILED 6-14-2004.

SILENT RIDE

THE MARK CONSISTS OF STANDARD CHARACTERS WITHOUT CLAIM TO ANY PARTICULAR FONT, STYLE, SIZE, OR COLOR.

FOR PERFUMES, COLOGNES, EAU DE TOILETTE, SOAPS, COSMETICS, BATH SALTS, PERFUME OILS, BATH AND SHOWER GEL, BATH POWDER, SCENTED BODY SPRAY, TOILET WATER, GELS, FOAMS AND SALTS FOR THE BATH AND SHOWER, SHAVING FOAMS AND CREAMS; SHAMPOOS, CONDITIONERS, HAIR CARE PREPARATIONS, DEODORANTS, LOTIONS, ESSENTIAL OILS, CREAMS, TONERS (U.S. CLS. 1, 4, 6, 50, 51 AND 52).

FIRST USE 6-3-2004; IN COMMERCE 4-1-2005.

3,007,747. CALIFORNIA TAN, INC., LOS ANGELES, CA. SN 78-163,425. PUB. 3-1-2005, FILED 9-12-2002.

BATH 360

NO CLAIM IS MADE TO THE EXCLUSIVE RIGHT TO USE "BATH", APART FROM THE MARK AS SHOWN.

FOR DETERGENT SOAP; WINDOW AND HARD SURFACE CLEANERS; AND FLOOR CLEANING PREPARATIONS (U.S. CLS. 1, 4, 6, 50, 51 AND 52).

FIRST USE 10-23-2003; IN COMMERCE 10-23-2003.

CLASS 3—(Continued).

3,007,748. CALIFORNIA TAN, INC., LOS ANGELES, CA. SN 78-163,441. PUB. 3-8-2005, FILED 9-12-2002.

RADICAL RAIN

FOR SUNTANNING PREPARATIONS AND PRODUCTS INTENDED FOR USE IN TANNING SALONS, NAMELY, SUN TAN GELS, BODY LOTIONS, SUN TAN OILS, SKIN MOISTURIZERS, TANNING FOAMS, BODY SPRAYS, BODY MISTS, BODY CREAMS, SUNSCREENS, AND AFTER-SUN LOTIONS (U.S. CLS. 1, 4, 6, 50, 51 AND 52).

FIRST USE 10-20-2003; IN COMMERCE 10-20-2003.

3,007,822. REVLON CONSUMER PRODUCTS CORPORATION, NEW YORK, NY. SN 78-274,287. PUB. 11-23-2004, FILED 7-15-2003.

MITCHUM MAX

OWNER OF U.S. REG. NOS. 1,022,316, 1,427,105, AND 1,582,152.

FOR ANTIPERSPIRANTS AND DEODORANTS (U.S. CLS. 1, 4, 6, 50, 51 AND 52).

FIRST USE 1-6-2004; IN COMMERCE 1-6-2004.

3,007,890. K. I. S. LIMITED, HUNG HOM, KOWLOON, HONG KONG. SN 78-350,643. PUB. 11-9-2004, FILED 1-12-2004.

SMARTFOIL

THE MARK CONSISTS OF STANDARD CHARACTERS WITHOUT CLAIM TO ANY PARTICULAR FONT, STYLE, SIZE, OR COLOR.

FOR HAIR STYLING PRODUCTS, NAMELY METAL WRAPPERS FOR COLORING OR HIGHLIGHTING HAIR (U.S. CLS. 1, 4, 6, 50, 51 AND 52).

FIRST USE 12-8-2003; IN COMMERCE 12-8-2003.

CLASS 3—(Continued).

3,007,967. AMERICAN INTERNATIONAL INDUSTRIES, LOS ANGELES, CA. SN 78-392,765. PUB. 3-1-2005, FILED 3-29-2004.

CLASS 3—(Continued).

3,007,976. AVON PRODUCTS, INC., NEW YORK, NY. SN 78-401,464. PUB. 1-25-2005, FILED 4-14-2004.

FIRMOXYL-BC

THE MARK CONSISTS OF STANDARD CHARACTERS WITHOUT CLAIM TO ANY PARTICULAR FONT, STYLE, SIZE, OR COLOR.

FOR SKIN CARE PREPARATIONS, NAMELY, NON-MEDICATED SKIN SERUM (U.S. CLS. 1, 4, 6, 50, 51 AND 52).

FIRST USE 6-0-2004; IN COMMERCE 6-0-2004.

3,007,971. CALIFORNIA TAN, INC., LOS ANGELES, CA. SN 78-397,089. PUB. 1-11-2005, FILED 4-6-2004.

EYE BE GOOD

THE MARK CONSISTS OF STANDARD CHARACTERS WITHOUT CLAIM TO ANY PARTICULAR FONT, STYLE, SIZE, OR COLOR.

FOR MOISTURIZING EYE CREAM (U.S. CLS. 1, 4, 6, 50, 51 AND 52).

FIRST USE 2-10-2005; IN COMMERCE 2-10-2005.

3,007,997. AUGENBRAUN & ASSOCIATES, BRIDGEPORT, CT. SN 78-418,116. PUB. 4-5-2005, FILED 5-13-2004.

LIQUIDOX

THE MARK CONSISTS OF STANDARD CHARACTERS WITHOUT CLAIM TO ANY PARTICULAR FONT, STYLE, SIZE, OR COLOR.

FOR SUN TANNING PREPARATIONS; NON-MEDICATED SKIN CARE PREPARATIONS, NAMELY, GELS, LOTIONS, OILS, MOISTURIZERS, MOUSSES, CLEANSERS, SPRAYS, MISTS, CREAMS, AND FOUNDATIONS; COSMETICS, NAMELY, FOUNDATION, BLUSH, FACE POWDER, EYE LINERS, EYE SHADOW, MASCARA, LIPSTICK, LIP GLOSS, LIP PENCILS, AND LIP MOISTURIZER; PERFUMES AND PERSONAL FRAGRANCES (U.S. CLS. 1, 4, 6, 50, 51 AND 52).

FIRST USE 10-5-2004; IN COMMERCE 10-5-2004.

FULL THROTTLE

THE MARK CONSISTS OF STANDARD CHARACTERS WITHOUT CLAIM TO ANY PARTICULAR FONT, STYLE, SIZE, OR COLOR.

FOR COSMETICS, NAMELY, FRAGRANCES, COLOGNES, PERFUMES, MEN'S DEODORANTS AND TOILETRIES (U.S. CLS. 1, 4, 6, 50, 51 AND 52).

FIRST USE 11-2-2004; IN COMMERCE 11-2-2004.

CLASS 3—(Continued).

3,008,005. ORLY INTERNATIONAL, INC, CHATSWORTH, CA. SN 78-422,411. PUB. 4-5-2005, FILED 5-20-2004.

CLASS 3—(Continued).

3,008,015. CP INDUSTRIES INC, SALT LAKE CITY, UT. SN 78-428,689. PUB. 4-12-2005, FILED 6-2-2004.

multi-tasker

PROUD

THE MARK CONSISTS OF STANDARD CHARACTERS WITHOUT CLAIM TO ANY PARTICULAR FONT, STYLE, SIZE, OR COLOR.
FOR NAIL CARE PREPARATIONS (U.S. CLS. 1, 4, 6, 50, 51 AND 52).
FIRST USE 7-1-2004; IN COMMERCE 7-1-2004.

THE MARK CONSISTS OF STANDARD CHARACTERS WITHOUT CLAIM TO ANY PARTICULAR FONT, STYLE, SIZE, OR COLOR.
FOR LAUNDRY DETERGENT, ALL PURPOSE CLEANER (U.S. CLS. 1, 4, 6, 50, 51 AND 52).
FIRST USE 1-1-1992; IN COMMERCE 1-1-1992.

3,008,012. KAO KABUSHIKI KAISHA, TA KAO CORPORATION, CHUO-KU, TOKYO, JAPAN. SN 78-426,135. PUB. 4-5-2005, FILED 5-27-2004.

CLASS 4—LUBRICANTS AND FUELS

3,007,662. COURTNEY, KEVIN C., IRVINE, CA. SN 76-536,066. PUB. 10-12-2004, FILED 7-28-2003.

HEALTHY ATTITUDE



THE MARK CONSISTS OF STANDARD CHARACTERS WITHOUT CLAIM TO ANY PARTICULAR FONT, STYLE, SIZE, OR COLOR.
FOR HAIR CARE PREPARATIONS (U.S. CLS. 1, 4, 6, 50, 51 AND 52).
FIRST USE 1-31-2005; IN COMMERCE 1-31-2005.

FOR HYDROCARBON BASED FUELS FOR MOTOR VEHICLES, NAMELY, FUELS FOR INTERNAL COMBUSTION ENGINES; AND DIESEL FUELS (U.S. CLS. 1, 6 AND 15).
FIRST USE 4-0-2004; IN COMMERCE 4-0-2004.

CLASS 4—(Continued).

3,007,957. BP PRODUCTS NORTH AMERICA INC., WARRENVILLE, IL. SN 78-386,881. PUB. 1-4-2005, FILED 3-18-2004.

THE CHOICE IS CLEAR

THE MARK CONSISTS OF STANDARD CHARACTERS WITHOUT CLAIM TO ANY PARTICULAR FONT, STYLE, SIZE, OR COLOR.

FOR GASOLINE (U.S. CLS. 1, 6 AND 15).
FIRST USE 1-12-2005; IN COMMERCE 1-12-2005.

CLASS 5—PHARMACEUTICALS

3,007,563. BIOGEN IDEC MA INC., CAMBRIDGE, MA. SN 75-567,965. PUB. 8-31-1999, FILED 10-9-1998.

ADENTRI

FOR PHARMACEUTICAL PREPARATIONS FOR USE IN THE TREATMENT OF DISEASES CHARACTERIZED BY EDEMA; PHARMACEUTICAL PREPARATIONS FOR USE IN THE TREATMENT OF CONGESTIVE HEART FAILURE; PHARMACEUTICAL PREPARATIONS FOR USE IN THE TREATMENT OF RENAL FAILURE; PHARMACEUTICAL PREPARATIONS FOR USE IN THE TREATMENT OF OTHER CARDIOVASCULAR DISORDERS, RENAL DISORDERS, METABOLIC DISORDERS AND PULMONARY DISORDERS (U.S. CLS. 6, 18, 44, 46, 51 AND 52).

FIRST USE 4-16-2002; IN COMMERCE 4-16-2002.

3,007,593. HOLLIS-EDEN PHARMACEUTICALS, INC., SAN DIEGO, CA. SN 76-255,928. PUB. 10-9-2001, FILED 5-11-2001.

REVERSIONEX

FOR PHARMACEUTICAL PREPARATIONS FOR USE IN WEIGHT REDUCTION, THE TREATMENT OF DYS-LIPIDEMIA, AND OTHER MEDICAL DISEASES AND DISORDERS (U.S. CLS. 6, 18, 44, 46, 51 AND 52).

FIRST USE 10-1-2002; IN COMMERCE 10-7-2002.

CLASS 5—(Continued).

3,007,646. SIGMA-TAU INDUSTRIE FARMACEUTICHE RIUNTE S.P.A., ROMA, ITALY. SN 76-503,174. PUB. 11-25-2003, FILED 4-3-2003.

PHOTOTROP

FOR NUTRACEUTICALS FOR USE AS A DIETARY SUPPLEMENT; DIETARY SUPPLEMENTS; AND FOOD SUPPLEMENTS (U.S. CLS. 6, 18, 44, 46, 51 AND 52).

FIRST USE 9-20-2004; IN COMMERCE 6-17-2005.

3,007,709. THROPP'S NUTRIBEST, DBA THROPP'S NUTRITION, ALLEGANY, NY. SN 76-586,401. PUB. 3-8-2005, FILED 3-22-2004.

Elite-Zyme Pro

THE MARK CONSISTS OF STANDARD CHARACTERS WITHOUT CLAIM TO ANY PARTICULAR FONT, STYLE, SIZE, OR COLOR.

FOR NUTRITIONAL SUPPLEMENT (U.S. CLS. 6, 18, 44, 46, 51 AND 52).
FIRST USE 6-4-2004; IN COMMERCE 6-4-2004.

3,007,737. WESTERN HOLDINGS, L.L.C., CHEYENNE, WY. SN 78-139,170. PUB. 6-1-2004, FILED 6-26-2002.

DYNAKOR PHARMACAL

NO CLAIM IS MADE TO THE EXCLUSIVE RIGHT TO USE "PHARMACAL", APART FROM THE MARK AS SHOWN.

FOR DIETARY SUPPLEMENT USED FOR HEALTH, WELLNESS, NUTRITION, AND BODYBUILDING (U.S. CLS. 6, 18, 44, 46, 51 AND 52).

FIRST USE 7-1-2002; IN COMMERCE 10-1-2002.

3,007,770. HARVEST PHARMACEUTICALS INC, RADFORD, VA. SN 78-207,374. PUB. 10-14-2003, FILED 1-27-2003.

HARVEST PHARMACEUTICALS INC

NO CLAIM IS MADE TO THE EXCLUSIVE RIGHT TO USE "PHARMACEUTICALS INC", APART FROM THE MARK AS SHOWN.

FOR ANALGESICS AND PHARMACEUTICAL PREPARATIONS FOR TREATMENT OF MIGRAINE HEADACHES (U.S. CLS. 6, 18, 44, 46, 51 AND 52).

FIRST USE 11-17-2003; IN COMMERCE 11-26-2003.

CLASS 5—(Continued).

3,007,873. FIRST QUALITY PRODUCTS, INC., GREAT NECK, NY. SN 78-330,741. PUB. 9-14-2004, FILED 11-20-2003.

CLASS 5—(Continued).

3,007,889. NATURE'S SUNSHINE PRODUCTS, INC., PROVO, UT. SN 78-350,514. PUB. 11-9-2004, FILED 1-12-2004.

EASY-LOCK FASTENER

THERARUB

THE MARK CONSISTS OF STANDARD CHARACTERS WITHOUT CLAIM TO ANY PARTICULAR FONT, STYLE, SIZE, OR COLOR.

NO CLAIM IS MADE TO THE EXCLUSIVE RIGHT TO USE "FASTENER", APART FROM THE MARK AS SHOWN.

FOR ADULT INCONTINENCE GARMENTS, ADULT INCONTINENCE DISPOSABLE DIAPERS AND PADS, SANITARY BRIEFS AND SANITARY PADS FEATURING A FASTENER AS A COMPONENT PART OF THE GOODS (U.S. CLS. 6, 18, 44, 46, 51 AND 52).
FIRST USE 2-2-2004; IN COMMERCE 2-2-2004.

THE MARK CONSISTS OF STANDARD CHARACTERS WITHOUT CLAIM TO ANY PARTICULAR FONT, STYLE, SIZE, OR COLOR.

FOR TOPICAL MEDICATED DEEP MUSCLE RUB GEL (U.S. CLS. 6, 18, 44, 46, 51 AND 52).
FIRST USE 5-31-2004; IN COMMERCE 5-31-2004.

3,007,874. S. C. JOHNSON & SON, INC., RACINE, WI. SN 78-331,478. PUB. 12-7-2004, FILED 11-21-2003.

3,007,911. VETCO, INC., IRVINGTON, NY. SN 78-359,554. PUB. 11-16-2004, FILED 1-29-2004.

FRAGRANCE CONTROL

LITTLE FEVERS

THE MARK CONSISTS OF STANDARD CHARACTERS WITHOUT CLAIM TO ANY PARTICULAR FONT, STYLE, SIZE, OR COLOR.

NO CLAIM IS MADE TO THE EXCLUSIVE RIGHT TO USE "FRAGRANCE", APART FROM THE MARK AS SHOWN.

FOR AIR FRESHENERS (U.S. CLS. 6, 18, 44, 46, 51 AND 52).
FIRST USE 8-16-2004; IN COMMERCE 8-16-2004.

THE MARK CONSISTS OF STANDARD CHARACTERS WITHOUT CLAIM TO ANY PARTICULAR FONT, STYLE, SIZE, OR COLOR.

FOR PREPARATIONS FOR RELIEF OF FEVER, ACHES, AND PAINS IN INFANTS AND CHILDREN (U.S. CLS. 6, 18, 44, 46, 51 AND 52).
FIRST USE 1-31-2005; IN COMMERCE 1-31-2005.

CLASS 5—(Continued).

3,007,913. IMPROVITA HEALTH PRODUCTS, INC., CLEVELAND, OH. SN 78-360,977. PUB. 11-9-2004, FILED 2-2-2004.

CLASS 5—(Continued).

3,007,938. MEDICAL RESEARCH INSTITUTE, INC., SAN FRANCISCO, CA. SN 78-374,128. PUB. 11-30-2004, FILED 2-25-2004.

WELL KIDS ZONE

THE MARK CONSISTS OF STANDARD CHARACTERS WITHOUT CLAIM TO ANY PARTICULAR FONT, STYLE, SIZE, OR COLOR.

FOR NUTRITIONAL SUPPLEMENTS; THROAT LOZENGES; NASAL SPRAY PREPARATIONS; AND PREPARATIONS FOR APPLICATION TO SKIN FOR ANTI-INSECT, SUN BLOCK AND ANTIBACTERIAL PURPOSES (U.S. CLS. 6, 18, 44, 46, 51 AND 52).

FIRST USE 8-0-2003; IN COMMERCE 9-0-2003.

ESTER-TECH

THE MARK CONSISTS OF STANDARD CHARACTERS WITHOUT CLAIM TO ANY PARTICULAR FONT, STYLE, SIZE, OR COLOR.

FOR NUTRITIONAL AND DIETARY SUPPLEMENTS (U.S. CLS. 6, 18, 44, 46, 51 AND 52).

FIRST USE 3-3-2005; IN COMMERCE 3-3-2005.

3,007,936. DOW AGROSCIENCES LLC, INDIANAPOLIS, IN. SN 78-372,820. PUB. 12-21-2004, FILED 2-24-2004.

3,007,939. INSTONE, LLC, IRVINE, CA. SN 78-374,197. PUB. 3-22-2005, FILED 2-25-2004.

DURANGO

THE MARK CONSISTS OF STANDARD CHARACTERS WITHOUT CLAIM TO ANY PARTICULAR FONT, STYLE, SIZE, OR COLOR.

FOR PESTICIDES AND PREPARATIONS FOR DESTROYING VERMIN, NAMELY HERBICIDES, INSECTICIDES AND FUNGICIDES FOR AGRICULTURE, HORTICULTURE, FORESTRY, TURF AND ORNAMENTAL, COMMERCIAL, INDUSTRIAL AND DOMESTIC USE (U.S. CLS. 6, 18, 44, 46, 51 AND 52).

FIRST USE 1-24-2005; IN COMMERCE 1-24-2005.

LEANFIRE

THE MARK CONSISTS OF STANDARD CHARACTERS WITHOUT CLAIM TO ANY PARTICULAR FONT, STYLE, SIZE, OR COLOR.

FOR DIETARY AND NUTRITIONAL SUPPLEMENTS (U.S. CLS. 6, 18, 44, 46, 51 AND 52).

FIRST USE 5-12-2004; IN COMMERCE 5-12-2004.

CLASS 5—(Continued).

3,007,949. BEST SANITIZERS, INC., PENN VALLEY, CA. SN 78-382,850. PUB. 1-11-2005, FILED 3-11-2004.

CLASS 5—(Continued).

3,007,975. TRADITIONAL MEDICINALS, INC., SEBASTO-POL, CA. SN 78-401,205. PUB. 1-25-2005, FILED 4-13-2004.

SMART-SAN

THE MARK CONSISTS OF STANDARD CHARACTERS WITHOUT CLAIM TO ANY PARTICULAR FONT, STYLE, SIZE, OR COLOR.
FOR DISINFECTANTS, NAMELY SANITIZERS FOR USE ON SURFACES AND ON HANDS (U.S. CLS. 6, 18, 44, 46, 51 AND 52).
FIRST USE 10-27-2004; IN COMMERCE 10-27-2004.

ECHINACEA PLUS

THE MARK CONSISTS OF STANDARD CHARACTERS WITHOUT CLAIM TO ANY PARTICULAR FONT, STYLE, SIZE, OR COLOR.
OWNER OF U.S. REG. NO. 1,902,340.
NO CLAIM IS MADE TO THE EXCLUSIVE RIGHT TO USE "ECHINACEA", APART FROM THE MARK AS SHOWN.
FOR DIETARY AND NUTRITIONAL SUPPLEMENTS, PREPARATIONS TO RELIEVE THE SYMPTOMS OF COLDS AND COUGHS (U.S. CLS. 6, 18, 44, 46, 51 AND 52).
FIRST USE 7-29-2005; IN COMMERCE 7-29-2005.

3,007,965. WEEMS, JENNIFER L., AUBREY, TX. SN 78-392,082. PUB. 3-15-2005, FILED 3-28-2004.

3,007,993. RISING PHARMACEUTICALS, INC., ALLEN-DALE, NJ. SN 78-415,247. PUB. 2-15-2005, FILED 5-7-2004.

Hot Pony Products

THE MARK CONSISTS OF STANDARD CHARACTERS WITHOUT CLAIM TO ANY PARTICULAR FONT, STYLE, SIZE, OR COLOR.
NO CLAIM IS MADE TO THE EXCLUSIVE RIGHT TO USE "PONY PRODUCTS", APART FROM THE MARK AS SHOWN.
FOR ELECTROLYTES FOR HORSES (U.S. CLS. 6, 18, 44, 46, 51 AND 52).
FIRST USE 12-5-2003; IN COMMERCE 4-10-2004.

LIDAZONE

THE MARK CONSISTS OF STANDARD CHARACTERS WITHOUT CLAIM TO ANY PARTICULAR FONT, STYLE, SIZE, OR COLOR.
FOR TOPICAL PREPARATIONS FOR THE TREATMENT OF SKIN IRRITATIONS AND SKIN DISEASES (U.S. CLS. 6, 18, 44, 46, 51 AND 52).
FIRST USE 10-4-2004; IN COMMERCE 10-4-2004.

CLASS 5—(Continued).

3,007,995. AMERICAN BIOSCIENCE, INC., SANTA MONI-
CA, CA. SN 78-415,969. PUB. 5-10-2005, FILED 5-10-2004.



FOR PHARMACEUTICAL FOR THE TREATMENT OF
CANCER (U.S. CLS. 6, 18, 44, 46, 51 AND 52).
FIRST USE 2-7-2005; IN COMMERCE 2-7-2005.

3,007,998. NUTRISCIENCE CORPORATION, HERMOSA
BEACH, CA. SN 78-418,580. PUB. 2-22-2005, FILED 5-13-
2004.

PROENERGY

THE MARK CONSISTS OF STANDARD CHARACTERS
WITHOUT CLAIM TO ANY PARTICULAR FONT, STYLE,
SIZE, OR COLOR.

FOR NUTRITIONAL SUPPLEMENTS; DIETARY SUP-
PLEMENTS; HERBAL SUPPLEMENTS; MINERAL SUP-
PLEMENTS; MULTI-VITAMINS; VITAMINS AND
MINERALS; DIETARY AND HERBAL SUPPLEMENTS;
HERBAL AND PLANT DERIVED PRODUCTS, NAMELY
HERBAL NUTRITIONAL SUPPLEMENTS; FOOD SUP-
PLEMENTS, NAMELY, ANTI-OXIDANTS, HOMEOPATHIC
SUPPLEMENTS; NUTRACEUTICALS FOR USE
AS A DIETARY SUPPLEMENT; DIETARY SUPPLE-
MENTS, NAMELY SUPPLEMENTS CONTAINING BO-
TANICALS; HERBAL SUPPLEMENTS FOR SPORTS
NUTRITION; PROTEIN PRODUCTS, NAMELY SOY
PROTEIN FOR USE AS DIETARY SUPPLEMENTS;
ANTI-OXIDANTS; HOMEOPATHIC SUPPLEMENTS, VI-
TAMIN AND MINERAL SUPPLEMENTS, NUTRI-
TIONAL DRINK MIX FOR USE AS A MEAL
REPLACEMENT, NUTRITIONAL MEAL REPLACE-
MENT POWDERS (U.S. CLS. 6, 18, 44, 46, 51 AND 52).
FIRST USE 4-3-2004; IN COMMERCE 4-3-2004.

CLASS 5—(Continued).

3,008,011. RIDLEY BLOCK OPERATIONS, INC., MANKATO,
MN. SN 78-425,372. PUB. 4-19-2005, FILED 5-26-2004.

CRYSTALYX VP

THE MARK CONSISTS OF STANDARD CHARACTERS
WITHOUT CLAIM TO ANY PARTICULAR FONT, STYLE,
SIZE, OR COLOR.

OWNER OF U.S. REG. NO. 1,089,036.
FOR FEED SUPPLEMENTS FOR LIVESTOCK (U.S.
CLS. 6, 18, 44, 46, 51 AND 52).
FIRST USE 12-8-2004; IN COMMERCE 12-8-2004.

CLASS 6—METAL GOODS

3,007,825. MACLEAN-FOGG COMPANY, MUNDELEIN, IL.
SN 78-276,524. PUB. 5-18-2004, FILED 7-21-2003.

CLINCH-LOK

FOR METAL FASTENERS, NAMELY NUTS, BOLTS,
AND NUT AND BOLT ASSEMBLIES (U.S. CLS. 2, 12, 13,
14, 23, 25 AND 50).

FIRST USE 2-10-2005; IN COMMERCE 2-10-2005.

3,007,921. NEWFREY LLC, NEWARK, DE. SN 78-364,628.
PUB. 11-9-2004, FILED 2-9-2004.

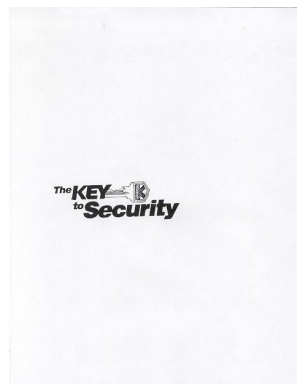

FOR METAL DOOR HARDWARE, NAMELY, KNOBS,
LEVERS, LEVER SETS, HANDLES, HANDLESETS,
DEADBOLTS, KEYS AND KEY BLANKS (U.S. CLS. 2,
12, 13, 14, 23, 25 AND 50).

FIRST USE 1-31-2003; IN COMMERCE 1-31-2003.

CLASS 6—(Continued).

3,007,944. IPEX INC., DOWNSVIEW, CANADA. SN 78-376,303. PUB. 12-14-2004, FILED 3-1-2004.

CLASS 6—(Continued).

3,008,026. NIPPON STEEL & SUMIKIN STAINLESS STEEL CORPORATION, TOKYO, JAPAN. SN 78-976,371. PUB. 11-16-2004, FILED 2-27-2004.

DURATEC

THE MARK CONSISTS OF STANDARD CHARACTERS WITHOUT CLAIM TO ANY PARTICULAR FONT, STYLE, SIZE, OR COLOR.

FOR PLASTIC COATED METAL TUBES AND PIPES AND PLASTIC COATED METAL ALLOY TUBES AND PIPES FOR USE IN TRANSPORTING COMPRESSED AIR OR INERT GAS, AND FITTINGS THEREFOR (U.S. CLS. 2, 12, 13, 14, 23, 25 AND 50).

FIRST USE 8-0-2004; IN COMMERCE 8-0-2004.

NSSC

THE MARK CONSISTS OF STANDARD CHARACTERS WITHOUT CLAIM TO ANY PARTICULAR FONT, STYLE, SIZE, OR COLOR.

FOR STAINLESS STEEL PLATE (U.S. CLS. 2, 12, 13, 14, 23, 25 AND 50).

FIRST USE 10-1-2003; IN COMMERCE 11-15-2003.

CLASS 7—MACHINERY

3,007,564. EMERSON ELECTRIC CO., ST. LOUIS, MO. SN 75-622,036. PUB. 3-19-2002, FILED 1-18-1999.

AUTOFEED

FOR CABLE FEEDING COMPONENT OF POWER-OPERATED TOOLS FOR USE IN CLEANING AND UNBLOCKING PIPES, DRAINS, SEWERS AND TUBES, AND REPLACEMENT PARTS THEREFOR (U.S. CLS. 13, 19, 21, 23, 31, 34 AND 35).

FIRST USE 3-31-1999; IN COMMERCE 3-31-1999.

3,007,980. DORMA PROPERTIES, INC., WILMINGTON, DE. SN 78-403,848. PUB. 4-26-2005, FILED 4-19-2004.

EASI-ALIGN

THE MARK CONSISTS OF STANDARD CHARACTERS WITHOUT CLAIM TO ANY PARTICULAR FONT, STYLE, SIZE, OR COLOR.

FOR GLASS DOOR HARDWARE, NAMELY, METAL RAILS, FRAMES AND CLAMPS (U.S. CLS. 2, 12, 13, 14, 23, 25 AND 50).

FIRST USE 5-2-2005; IN COMMERCE 5-2-2005.

SMART SHUTTLE

NO CLAIM IS MADE TO THE EXCLUSIVE RIGHT TO USE "SMART", APART FROM THE MARK AS SHOWN.

FOR OIL AND GAS INDUSTRY HYDRAULICALLY DRIVEN OR ELECTRICALLY DRIVEN CONVEYORS TO MOVE EQUIPMENT THROUGH ONSHORE AND OFFSHORE WELLS, CASED WELLS, OPEN-HOLE WELLS, PIPES, TUBINGS, EXPANDABLE TUBINGS, LINERS, CYLINDRICAL SAND SCREENS, AND PRODUCTION FLOWLINES; THE CONVEYED EQUIPMENT INCLUDING WELL COMPLETION AND PRODUCTION DEVICES, LOGGING TOOLS, PERFORATING GUNS, WELL DRILLING EQUIPMENT, COILED TUBINGS FOR WELL STIMULATION, POWER CABLES, CONTAINERS OF CHEMICALS, AND FLOWLINE CLEANING EQUIPMENT (U.S. CLS. 13, 19, 21, 23, 31, 34 AND 35).

FIRST USE 2-14-2001; IN COMMERCE 4-19-2005.

CLASS 7—(Continued).

3,007,587. SMART DRILLING AND COMPLETION, INC., BOTHELL, WA. SN 76-218,211. PUB. 6-11-2002, FILED 2-20-2001.

WELL LOCOMOTIVE

NO CLAIM IS MADE TO THE EXCLUSIVE RIGHT TO USE "WELL", APART FROM THE MARK AS SHOWN.

FOR OIL AND GAS INDUSTRY HYDRAULICALLY DRIVEN OR ELECTRICALLY DRIVEN CONVEYORS TO MOVE EQUIPMENT THROUGH ONSHORE AND OFFSHORE WELLS, CASED WELLS, OPEN-HOLE WELLS, PIPES, TUBINGS, EXPANDABLE TUBINGS, LINERS, CYLINDRICAL SAND SCREENS, AND PRODUCTION FLOWLINES; THE CONVEYED EQUIPMENT INCLUDING WELL COMPLETION AND PRODUCTION DEVICES, LOGGING TOOLS, PERFORATING GUNS, WELL DRILLING EQUIPMENT, COILED TUBINGS FOR WELL STIMULATION, POWER CABLES, CONTAINERS OF CHEMICALS AND FLOWLINE CLEANING EQUIPMENT (U.S. CLS. 13, 19, 21, 23, 31, 34 AND 35).

FIRST USE 2-20-2001; IN COMMERCE 4-19-2005.

3,007,730. NILFISK-ADVANCE, INC., PLYMOUTH, MN. SN 78-108,082. PUB. 9-24-2002, FILED 2-11-2002.

MICROMAX

FOR COMBINATION ELECTRIC VACUUM CLEANER AND FLOOR SCRUBBING MACHINES (U.S. CLS. 13, 19, 21, 23, 31, 34 AND 35).

FIRST USE 7-15-2004; IN COMMERCE 7-15-2004.

3,007,867. STAR-M INTERNATIONAL, LIMITED, ARLINGTON HEIGHTS, IL. SN 78-327,589. PUB. 1-11-2005, FILED 11-13-2003.



NO CLAIM IS MADE TO THE EXCLUSIVE RIGHT TO USE WOOD, APART FROM THE MARK AS SHOWN.

FOR POWER DRILL BITS (U.S. CLS. 13, 19, 21, 23, 31, 34 AND 35).

FIRST USE 1-0-2004; IN COMMERCE 2-19-2004.

CLASS 7—(Continued).

3,007,962. THE PROCTER & GAMBLE COMPANY, CINCINNATI, OH. SN 78-389,939. PUB. 12-28-2004, FILED 3-24-2004.

SWIFFER

THE MARK CONSISTS OF STANDARD CHARACTERS WITHOUT CLAIM TO ANY PARTICULAR FONT, STYLE, SIZE, OR COLOR.

OWNER OF U.S. REG. NOS. 2,296,103, 2,691,698, AND OTHERS.

FOR ELECTRICAL VACUUM CLEANERS FOR DOMESTIC USE (U.S. CLS. 13, 19, 21, 23, 31, 34 AND 35).

FIRST USE 4-30-2003; IN COMMERCE 4-30-2003.

CLASS 8—HAND TOOLS

3,007,686. WAHL CLIPPER CORPORATION, STERLING, IL. SN 76-565,187. PUB. 4-12-2005, FILED 12-15-2003.

COMB 'N CUT

THE MARK CONSISTS OF STANDARD CHARACTERS WITHOUT CLAIM TO ANY PARTICULAR FONT, STYLE, SIZE, OR COLOR.

NO CLAIM IS MADE TO THE EXCLUSIVE RIGHT TO USE CUT, APART FROM THE MARK AS SHOWN.

FOR ELECTRIC HAIR TRIMMERS AND CLIPPERS (U.S. CLS. 23, 28 AND 44).

FIRST USE 7-0-2004; IN COMMERCE 7-0-2004.

3,007,814. WAHL CLIPPER CORPORATION, STERLING, IL. SN 78-265,222. PUB. 2-3-2004, FILED 6-20-2003.

MAG

FOR ELECTRIC HAIR CLIPPERS AND TRIMMERS (U.S. CLS. 23, 28 AND 44).

FIRST USE 10-0-2003; IN COMMERCE 10-0-2003.

CLASS 8—(Continued).

3,007,900. FOREVER CO., LTD., SAITAMA-KEN, JAPAN. SN 78-354,163. PUB. 11-2-2004, FILED 1-20-2004.

DIATITAN

THE MARK CONSISTS OF STANDARD CHARACTERS WITHOUT CLAIM TO ANY PARTICULAR FONT, STYLE, SIZE, OR COLOR.

FOR KITCHEN KNIVES, HUNTING KNIVES, FOLDING KNIVES AND CHEF KNIVES (U.S. CLS. 23, 28 AND 44).

FIRST USE 7-1-2005; IN COMMERCE 7-15-2005.

3,007,927. CARNEY, BRIAN P., LAKEVILLE, MN. SN 78-366,758. PUB. 3-22-2005, FILED 2-12-2004.

GATORBACK

THE MARK CONSISTS OF STANDARD CHARACTERS WITHOUT CLAIM TO ANY PARTICULAR FONT, STYLE, SIZE, OR COLOR.

FOR TOOLS FOR MIXING, HOLDING AND CARRYING CEMENTITIOUS MATERIALS; NAMELY MORTARBOARDS AND MORTARBOARD STANDS (U.S. CLS. 23, 28 AND 44).

FIRST USE 5-5-2004; IN COMMERCE 5-5-2004.

CLASS 9—ELECTRICAL AND SCIENTIFIC APPARATUS

CLASS 9—(Continued).

3,007,569. JAIR ELECTRONICS CORPORATION, MIAMI, FL. SN 75-876,329. PUB. 2-12-2002, FILED 12-21-1999.

SUMISHI

FOR TELEVISIONS, COMPACT DISC PLAYERS, COMPACT DISC RECORDERS, MP3 PLAYERS, MP3 RECORDERS, DVD PLAYERS, DVD RECORDERS, HOME MOVIE SYSTEMS COMPRISED OF MOVIE PROJECTORS, PROJECTION SCREENS, AND AUDIO SPEAKERS, SPEAKER SYSTEMS COMPRISED OF AUDIO SPEAKERS, AMPLIFIERS, WOOFERS AND TWEETERS, REMOTE CONTROLS FOR THE AFORESAID ITEMS (U.S. CLS. 21, 23, 26, 36 AND 38).

FIRST USE 11-30-2002; IN COMMERCE 11-30-2002.

3,007,574. CORAL CHEMICAL COMPANY, WAUKEGAN, IL. SN 76-067,423. PUB. 7-16-2002, FILED 6-9-2000.

CORAL TECHNOLOGIES

NO CLAIM IS MADE TO THE EXCLUSIVE RIGHT TO USE "TECHNOLOGIES", APART FROM THE MARK AS SHOWN.

FOR ELECTRONIC AND COMPUTER CONTROLS FOR CONTROLLING AND MONITORING INDUSTRIAL AND COMMERCIAL MANUFACTURING PROCESSES, NAMELY PAINT LINE CONTROL AND MONITORING, METAL FABRICATING CONTROL AND MONITORING, STORAGE TANK CONTROL AND MONITORING, ENERGY MANAGEMENT CONTROL AND MONITORING, SECURITY AND INTRUSION CONTROL AND MONITORING, BUILDING ACCESS CONTROL AND MONITORING, LIGHTING CONTROL AND MONITORING, FIRE AND SAFETY CONTROL AND MONITORING AND ELEVATOR CONTROL AND MONITORING (U.S. CLS. 21, 23, 26, 36 AND 38).

FIRST USE 3-0-2002; IN COMMERCE 3-0-2002.

3,007,578. IGT, RENO, NV. SN 76-105,457. PUB. 1-28-2003, FILED 8-7-2000.

BIG SPLIT POKER

NO CLAIM IS MADE TO THE EXCLUSIVE RIGHT TO USE "SPLIT POKER", APART FROM THE MARK AS SHOWN.

FOR COMPUTER PROGRAMS FOR PLAYING CASINO GAMES AND GAMES OF CHANCE, AS WELL AS GAME SIMULATION AND TEACHING AID PROGRAMS FOR SUCH GAMES; MACHINES FOR PLAYING GAMES OF CHANCE; AND VIDEO GAME MACHINES FOR USE WITH TELEVISIONS AND MONITORS (U.S. CLS. 21, 23, 26, 36 AND 38).

FIRST USE 5-13-2003; IN COMMERCE 7-8-2003.

3,007,582. VITESSE SEMICONDUCTOR CORPORATION, CAMARILLO, CA. SN 76-176,770. PUB. 1-8-2002, FILED 12-6-2000.

FOCUS CONNECT

CLASS 9—(Continued).

NO CLAIM IS MADE TO THE EXCLUSIVE RIGHT TO USE "CONNECT", APART FROM THE MARK AS SHOWN.
FOR INTEGRATED CIRCUITS AND SEMICONDUCTORS (U.S. CLS. 21, 23, 26, 36 AND 38).
FIRST USE 3-0-2000; IN COMMERCE 3-0-2000.

3,007,583. DREAM MUSICIAN, INC., RICHMOND, VA. SN 76-195,836. PUB. 5-7-2002, FILED 4-5-2000.

DREAM MUSICIAN

NO CLAIM IS MADE TO THE EXCLUSIVE RIGHT TO USE "MUSICIAN", APART FROM THE MARK AS SHOWN.
FOR PRE-RECORDED AUDIO CASSETTES FEATURING MUSIC, INSTRUMENTAL TRACKS, AND VOCAL TRACKS; COMPACT DISCS FEATURING MUSIC, INSTRUMENTAL TRACKS, AND VOCAL TRACKS; DOWNLOADABLE MUSICAL SOUND RECORDINGS FEATURING MUSIC, INSTRUMENTAL TRACKS, AND VOCAL TRACKS (U.S. CLS. 21, 23, 26, 36 AND 38).
FIRST USE 4-0-2002; IN COMMERCE 4-0-2002.

3,007,588. OLYMPUS CORPORATION, TOKYO, JAPAN. SN 76-230,738. PUB. 8-28-2001, FILED 3-27-2001.

OLYSIA

FOR IMAGE ANALYSIS SOFTWARE FOR MICROSCOPES (U.S. CLS. 21, 23, 26, 36 AND 38).
FIRST USE 7-0-2002; IN COMMERCE 7-0-2002.

3,007,598. APPLIED WIRELESS IDENTIFICATION GROUP, INC., MONSEY, NY. SN 76-272,897. PUB. 9-30-2003, FILED 6-14-2001.

MPR

FOR RADIO FREQUENCY IDENTIFICATION READER AND IDENTIFICATION CARDS FOR THE ACCESS CONTROL SECTOR OF THE RADIO FREQUENCY IDENTIFICATION MARKET (U.S. CLS. 21, 23, 26, 36 AND 38).
FIRST USE 1-1-2004; IN COMMERCE 1-1-2004.

3,007,600. COMPTON, NATHAN, HARTWOOD, VA. SN 76-276,624. PUB. 11-16-2004, FILED 6-27-2001.

ELISIUM

FOR AUDIO TAPES, COMPACT DISCS AND VIDEO RECORDINGS FEATURING MUSICAL ENTERTAINMENT (U.S. CLS. 21, 23, 26, 36 AND 38).
FIRST USE 4-15-2001; IN COMMERCE 4-15-2001.

CLASS 9—(Continued).

3,007,602. DIGICOM DIGITAL, INC., BROOKLYN, NY. SN 76-297,038. PUB. 11-16-2004, FILED 8-8-2001.

DIGICOM

FOR ACCESSORIES FOR DIGITAL CAMERAS, NAMELY, BATTERY PACKS, ADAPTERS, CHARGERS, AND FILTERS FOR CAMERA LENSES (U.S. CLS. 21, 23, 26, 36 AND 38).
FIRST USE 8-1-2001; IN COMMERCE 8-1-2001.

3,007,607. KINGS PRODUCTS AND SOLUTIONS INC., MISSISSAUGA, ONTARIO, CANADA. SN 76-329,651. PUB. 5-25-2004, FILED 10-23-2001.

TOUCHWEB

PRIORITY CLAIMED UNDER SEC. 44(D) ON CANADA APPLICATION NO. 1116717, FILED 9-26-2001, REG. NO. TMA593276, DATED 10-28-2003, EXPIRES 10-28-2018.
FOR COMPUTERS AND COMPUTER PERIPHERAL DEVICES; COMPUTER HARDWARE AND SOFTWARE FOR ACCESS TO THE INTERNET (U.S. CLS. 21, 23, 26, 36 AND 38).
FIRST USE 4-30-2004; IN COMMERCE 4-30-2004.

3,007,610. ZENTEK TECHNOLOGY, INC., SAN MATEO, CA. SN 76-369,034. PUB. 9-23-2003, FILED 2-11-2002.



OWNER OF U.S. REG. NO. 2,462,219.
THE DRAWING IS LINED FOR THE COLOR RED.
FOR COMPUTER SOFTWARE TO ENHANCE THE AUDIO-VISUAL CAPABILITIES OF MULTIMEDIA APPLICATIONS, NAMELY, FOR THE INTEGRATION OF TEXT, AUDIO, GRAPHICS, STILL IMAGES, MOVING PICTURES OR OTHER CONTENT, FOR USE IN CONSUMER ELECTRONIC PRODUCTS, COMPUTERS AND WIRELESS DEVICES (U.S. CLS. 21, 23, 26, 36 AND 38).
FIRST USE 10-1-2002; IN COMMERCE 10-1-2002.

3,007,617. URBANA SOFTWARE, INC., SAN FRANCISCO, CA. SN 76-403,445. PUB. 6-8-2004, FILED 5-2-2002.

BOOSTMYSCORE

FOR COMPUTER SOFTWARE FOR USE IN TEST PREPARATION FOR PROFESSIONAL AND PROFESSIONAL QUALIFICATION EXAMINATIONS, GRADUATE SCHOOL ENTRANCE TESTS, COLLEGE ENTRANCE TESTS, AND K-12 ASSESSMENT TESTS; COMPUTER SOFTWARE FOR USE IN PROFESSIONAL AND PROFESSIONAL QUALIFICATION EXAMINATION, GRADUATE SCHOOL ENTRANCE TEST, COLLEGE ENTRANCE TEST, AND K-12 ASSESSMENT TEST PREPARATION INSTRUCTION (U.S. CLS. 21, 23, 26, 36 AND 38).
FIRST USE 3-13-2003; IN COMMERCE 3-13-2003.

CLASS 9—(Continued).

3,007,618. NUWAVE TECHNOLOGIES, INC., NASHUA, NH.
SN 76-408,713. PUB. 7-22-2003, FILED 5-15-2002.

SOAP/AM

FOR DOWNLOADABLE COMPUTER SOFTWARE FOR USE BY LEGACY SYSTEM USERS TO ENABLE CONNECTING AND INTEGRATING SOFTWARE APPLICATION SERVERS WITH INTERNET APPLICATIONS (U.S. CLS. 21, 23, 26, 36 AND 38).

FIRST USE 3-26-2003; IN COMMERCE 3-26-2003.

3,007,621. PHOENIX FIRE SYSTEMS, INC., DOTHAN, AL.
SN 76-414,718. PUB. 7-6-2004, FILED 6-3-2002.



THE MARK CONSISTS OF THE LETTER "P"; PLUS, THE DESIGN DEPICTING A BIRD - THE MYTHICAL PHOENIX - RISING THROUGH THE MIDDLE OF THE LETTER.

FOR FIRE SPRINKLER PIPING SYSTEMS CONSISTING OF METAL PIPING, RUBBER GASKETED FITTINGS AND FIRE SPRINKLERS (U.S. CLS. 21, 23, 26, 36 AND 38).

FIRST USE 3-31-2002; IN COMMERCE 3-31-2002.

3,007,622. DATA SYSTEMS INTERNATIONAL, INC., OVERLAND PARK, KS. SN 76-431,930. PUB. 11-9-2004, FILED 7-18-2002.

KMLINK

FOR COMPUTER SOFTWARE FOR GATHERING AND STORING PROCESS OR CORPORATE KNOWLEDGE DATA, AND PROVIDING ACCESS TO STORED DATA THROUGH A WEB-BASED INTERFACE (U.S. CLS. 21, 23, 26, 36 AND 38).

FIRST USE 9-2-2002; IN COMMERCE 9-2-2002.

CLASS 9—(Continued).

3,007,635. CELESTRON ACQUISITION, LLC, TORRANCE, CA. SN 76-479,729. PUB. 11-9-2004, FILED 12-30-2002.

UPCLOSE

FOR BINOCULARS (U.S. CLS. 21, 23, 26, 36 AND 38).
FIRST USE 2-15-2003; IN COMMERCE 2-15-2003.

3,007,636. CELESTRON ACQUISITION, LLC, TORRANCE, CA. SN 76-479,730. PUB. 11-9-2004, FILED 12-30-2002.

OPTIVIEW

FOR BINOCULARS (U.S. CLS. 21, 23, 26, 36 AND 38).
FIRST USE 2-15-2003; IN COMMERCE 2-15-2003.

3,007,652. ECHELON CORPORATION, SAN JOSE, CA. SN 76-522,871. PUB. 5-25-2004, FILED 6-16-2003.



OWNER OF U.S. REG. NOS. 1,535,141, 2,469,011, AND OTHERS.

THE MARK CONSISTS IN PART OF A FANCIFUL LETTER E.

SEC. 2(F) AS TO LNS.

FOR COMPUTER PROGRAMS FOR USE IN DEVELOPING COMPUTER PROGRAMS; COMPUTER HARDWARE; COMMUNICATIONS TRANSCEIVERS, ROUTERS, NETWORK MANAGEMENT SOFTWARE; COMPUTER OPERATING SOFTWARE AND APPLICATION PROGRAM INTERFACES FOR RESIDENTIAL AND COMMERCIAL BUILDING NETWORKS, VEHICULAR AUTOMATION NETWORKS, EMBEDDED SYSTEMS NETWORKS, HOME AUTOMATION NETWORKS, COMMERCIAL AUTOMATION NETWORKS, INDUSTRIAL AUTOMATION NETWORKS, AND UTILITY AUTOMATION NETWORKS; COMPUTER HARDWARE AND SOFTWARE FOR USE IN ENTERPRISE MANAGEMENT, DATA AGGREGATION AND ANALYSIS (U.S. CLS. 21, 23, 26, 36 AND 38).

FIRST USE 11-0-2003; IN COMMERCE 11-0-2003.

3,007,667. SICOM TECHNOLOGIES, LLC, BUFFALO GROVE, IL. SN 76-541,187. PUB. 5-25-2004, FILED 8-29-2003.

SICOM DATALINK

FOR COMPUTER SOFTWARE FOR MANAGING A BUILDING, GROUNDS, PLANT, OR FACILITY MAINTENANCE DEPARTMENT (U.S. CLS. 21, 23, 26, 36 AND 38).

FIRST USE 8-1-2005; IN COMMERCE 8-1-2005.

CLASS 9—(Continued).

3,007,694. THE WATT STOPPER, INC., SANTA CLARA, CA. SN 76-572,729. PUB. 11-16-2004, FILED 1-29-2004.

EZDALI

THE MARK CONSISTS OF STANDARD CHARACTERS WITHOUT CLAIM TO ANY PARTICULAR FONT, STYLE, SIZE, OR COLOR.

FOR CONTROL AND COMMUNICATIONS PROTOCOL SOFTWARE FOR ACCESSING AND CONTROLLING FACILITY SYSTEMS, COMPONENTS, CONTROLS AND DEVICES, NAMELY, LIGHTING AND FACILITY COMFORT, SAFETY AND SECURITY SYSTEMS, COMPONENTS, CONTROLS AND DEVICES (U.S. CLS. 21, 23, 26, 36 AND 38).

FIRST USE 7-0-2004; IN COMMERCE 7-0-2004.

3,007,711. DULCIAN, INC., NEW YORK, NY. SN 76-589,245. PUB. 2-1-2005, FILED 4-27-2004.

GARP

THE MARK CONSISTS OF STANDARD CHARACTERS WITHOUT CLAIM TO ANY PARTICULAR FONT, STYLE, SIZE, OR COLOR.

FOR COMPUTER PROGRAM FOR DATABASE MANAGEMENT WHICH SUPPORTS STORAGE AND IMPLEMENTATION OF COMPLEX APPLICATION LEVEL BUSINESS RULES WHICH ARE STORED IN A REPOSITORY WHICH REPRESENTS ALL OF THE LOGIC OF AN APPLICATION AND ENABLES RAPID APPLICATION DEVELOPMENT AND ALLOWS APPLICATIONS TO BE PORTED QUICKLY FROM ONE TECHNOLOGY TO ANOTHER (U.S. CLS. 21, 23, 26, 36 AND 38).

FIRST USE 11-10-2003; IN COMMERCE 11-10-2003.

CLASS 9—(Continued).

3,007,712. BACOU-DALLOZ EYE & FACE PROTECTION, INC., SMITHFIELD, RI. SN 76-591,154. PUB. 3-1-2005, FILED 5-10-2004.

CLARION

THE MARK CONSISTS OF STANDARD CHARACTERS WITHOUT CLAIM TO ANY PARTICULAR FONT, STYLE, SIZE, OR COLOR.

FOR SAFETY EYEWEAR (U.S. CLS. 21, 23, 26, 36 AND 38).

FIRST USE 9-26-2004; IN COMMERCE 9-26-2004.

3,007,722. AT&T CORP., NEW YORK, NY. SN 78-058,602. PUB. 6-11-2002, FILED 4-16-2001.

AT&T FSM LIBRARY

OWNER OF U.S. REG. NOS. 1,298,084, 2,462,265, AND OTHERS.

NO CLAIM IS MADE TO THE EXCLUSIVE RIGHT TO USE "FSM LIBRARY", APART FROM THE MARK AS SHOWN.

FOR TEXT AND SPEECH PROCESSING COMPUTER PROGRAM TOOLS (U.S. CLS. 21, 23, 26, 36 AND 38).

FIRST USE 12-31-1998; IN COMMERCE 12-31-1998.

3,007,729. AGILENT TECHNOLOGIES, INC., PALO ALTO, CA. SN 78-104,635. PUB. 5-27-2003, FILED 1-24-2002.

METRAK

FOR COMMUNICATIONS HARDWARE; SEMICONDUCTORS; INTEGRATED CIRCUITS; TRANSCIEVERS; AND ELECTRONIC COMPONENTS, NAMELY APPLICATION SPECIFIC INTEGRATED CIRCUITS (U.S. CLS. 21, 23, 26, 36 AND 38).

FIRST USE 2-20-2002; IN COMMERCE 2-20-2002.

3,007,732. MAILCODE, INC., LAFAYETTE, IN. SN 78-114,811. PUB. 10-22-2002, FILED 3-14-2002.

OCRX

FOR COMPUTER SOFTWARE FOR PROCESSING MAILPIECE ADDRESS INFORMATION AND ASSIGNING DELIVERY DESTINATION INFORMATION (U.S. CLS. 21, 23, 26, 36 AND 38).

FIRST USE 5-1-2002; IN COMMERCE 6-24-2002.

CLASS 9—(Continued).

3,007,733. NORDOST CORPORATION, ASHLAND, MA. SN 78-115,076. PUB. 12-3-2002, FILED 3-15-2002.

WYREWIZARD

FOR ELECTRICAL SIGNAL TRANSMITTING CABLES FOR USE WITH AUDIO AND VIDEO EQUIPMENT AND CONNECTORS THEREFOR; POWER CABLES; COMPUTER CABLES; CABLE CONNECTORS; ELECTRICAL CONNECTORS; CABLES FOR VIDEO GAME MACHINES; LOUDSPEAKERS; VIBRATION ABSORBERS FOR AUDIO, VIDEO AND COMPUTER EQUIPMENT (U.S. CLS. 21, 23, 26, 36 AND 38).

FIRST USE 8-0-2004; IN COMMERCE 8-0-2004.

3,007,734. MICROSOFT CORPORATION, REDMOND, WA. SN 78-120,145. PUB. 6-17-2003, FILED 4-8-2002.

TORK

FOR COMPUTER PROGRAMS, NAMELY, GAME SOFTWARE FOR USE ON COMPUTERS AND VIDEO-GAME PLAYERS; PRERECORDED VIDEOTAPES, AUDIO TAPES (U.S. CLS. 21, 23, 26, 36 AND 38).

FIRST USE 1-0-2005; IN COMMERCE 1-0-2005.

3,007,739. PACIFIC INTERNATIONAL STG., INC., SAN JOSE, CA. AND KAIJO CORPORATION, HAMURA-CITY, JAPAN. SN 78-143,144. PUB. 6-1-2004, FILED 7-11-2002.

MEGALID

FOR ULTRASONIC CLEANING APPARATUS, NAMELY TRANSDUCERS THAT UTILIZE ULTRASONIC OSCILLATIONS TO CLEAN SILICON WAFERS, SEMICONDUCTOR SUBSTRATES, FLAT PANEL DISPLAYS AND DISK MEDIA (U.S. CLS. 21, 23, 26, 36 AND 38).

FIRST USE 7-0-2003; IN COMMERCE 7-0-2003.

3,007,746. ULTRAK, INC., SAN ANTONIO, TX. SN 78-160,837. PUB. 4-8-2003, FILED 9-5-2002.

MONITOR DYNAMICS

NO CLAIM IS MADE TO THE EXCLUSIVE RIGHT TO USE "MONITOR", APART FROM THE MARK AS SHOWN. FOR COMPUTER CONTROLLED SYSTEM FOR ACCESS CONTROL THAT PERFORMS SECURITY, FIRE ALARMS, HVAC CONTROL, ACCESS CONTROL, AND ENERGY MONITORING AND CONTROL COMPRISING A CENTRAL PROCESSING UNIT, VIDEO AND AUDIO CAPTURE UNITS, ELECTRONIC MESSAGING INTERFACES, KEYPADS, CARD READERS, AND SCANNERS, DISPLAY MONITORS, AND REMOTE TERMINALS SOLD SEPARATELY OR TOGETHER AS A UNIT (U.S. CLS. 21, 23, 26, 36 AND 38).

FIRST USE 7-1-1974; IN COMMERCE 7-1-1974.

CLASS 9—(Continued).

3,007,752. NYFIX, INC., STAMFORD, CT. SN 78-174,692. PUB. 5-27-2003, FILED 10-15-2002.

NYFIX PLATINUM

OWNER OF U.S. REG. NOS. 2,446,661, 2,576,274, AND OTHERS.

FOR COMPUTER SOFTWARE AND HARDWARE USED FOR PROVIDING A SECURITIES TRADING SYSTEM (U.S. CLS. 21, 23, 26, 36 AND 38).

FIRST USE 1-15-2003; IN COMMERCE 4-29-2003.

3,007,757. XEROX CORPORATION, STAMFORD, CT. SN 78-187,984. PUB. 2-17-2004, FILED 11-22-2002.

PROFITQUICK

FOR COMPUTER SOFTWARE TOOL FOR EXTRACTING, TRANSFORMING, ASSESSING AND REPORTING DATA IN THE FIELDS OF PRINTING AND DOCUMENT REPRODUCTION (U.S. CLS. 21, 23, 26, 36 AND 38).

FIRST USE 11-29-2002; IN COMMERCE 11-29-2002.

3,007,765. SPEECHGEAR, INC., NORTHFIELD, MN. SN 78-205,009. PUB. 9-2-2003, FILED 1-20-2003.

COMPADRE

THE ENGLISH TRANSLATION OF THE MARK IS "FRIEND".

FOR COMPUTER SOFTWARE THAT PROVIDES INTERACTIVE LANGUAGE TRANSLATION (U.S. CLS. 21, 23, 26, 36 AND 38).

FIRST USE 4-16-2001; IN COMMERCE 2-8-2004.

3,007,767. MD SOLUTIONS, INC., BOSTON, MA. SN 78-205,851. PUB. 9-23-2003, FILED 1-22-2003.

MD PAYPOST

NO CLAIM IS MADE TO THE EXCLUSIVE RIGHT TO USE "MD", APART FROM THE MARK AS SHOWN.

FOR COMPUTER PROGRAMS FOR USE IN DATABASE MANAGEMENT IN THE MEDICAL AND HEALTHCARE FIELDS, NAMELY, THE PROCESSING AND RECORDING OF MEDICAL AND HEALTH INSURANCE PAYMENTS AND RELATED MEDICAL AND HEALTH INSURANCE PAYMENT INFORMATION (U.S. CLS. 21, 23, 26, 36 AND 38).

FIRST USE 11-30-2002; IN COMMERCE 11-30-2002.

3,007,768. MIN, TIFFANY, CHANTILLY, VA. SN 78-206,140. PUB. 10-7-2003, FILED 1-22-2003.

YOUNG ASIA

CLASS 9—(Continued).

NO CLAIM IS MADE TO THE EXCLUSIVE RIGHT TO USE "ASIA", APART FROM THE MARK AS SHOWN.
FOR COMPACT DISCS FEATURING RAP MUSIC (U.S. CLS. 21, 23, 26, 36 AND 38).
FIRST USE 8-3-2003; IN COMMERCE 12-4-2004.

3,007,787. MATRIX SECURITY, INC., BOULDER, CO. SN 78-224,968. PUB. 11-18-2003, FILED 3-12-2003.

SITESOFT

FOR COMPUTER DATABASE SOFTWARE FOR FACILITIES AND PHYSICAL SECURITY MANAGEMENT (U.S. CLS. 21, 23, 26, 36 AND 38).
FIRST USE 7-25-2005; IN COMMERCE 7-25-2005.

3,007,802. WMS GAMING INC., WAUKEGAN, IL. SN 78-246,734. PUB. 12-23-2003, FILED 5-7-2003.

GOLD FISH

THE MARK CONSISTS OF STANDARD CHARACTERS WITHOUT CLAIM TO ANY PARTICULAR FONT, STYLE, SIZE, OR COLOR.

FOR CURRENCY AND CREDIT OPERATED SLOT MACHINES AND GAMING DEVICES, NAMELY, GAMING MACHINES FOR USE IN GAMING ESTABLISHMENTS (U.S. CLS. 21, 23, 26, 36 AND 38).
FIRST USE 10-5-2004; IN COMMERCE 10-5-2004.

3,007,808. CATSKILL TECHNOLOGY SERVICES, LLC, BEARSVILLE, NY. SN 78-256,073. PUB. 5-11-2004, FILED 5-30-2003.

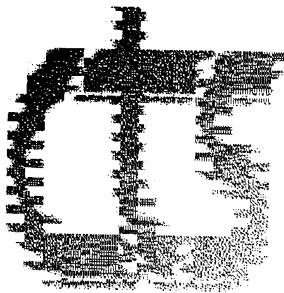

THE STIPPLING IS FOR SHADING PURPOSES ONLY.
FOR COMPUTER SOFTWARE DEVELOPMENT TOOLS (U.S. CLS. 21, 23, 26, 36 AND 38).
FIRST USE 7-19-2005; IN COMMERCE 7-26-2005.

CLASS 9—(Continued).

3,007,813. RSS SOLUTIONS INC., KITCHENER, ONTARIO, CANADA. SN 78-265,021. PUB. 6-1-2004, FILED 6-20-2003.



PRIORITY CLAIMED UNDER SEC. 44(D) ON CANADA APPLICATION NO. 1,179,911, FILED 6-3-2003.

FOR PRODUCTION PLANNING AND SCHEDULING SOFTWARE, NAMELY SOFTWARE WHICH FACILITATES THE ABILITY TO QUOTE, MEASURE AND ACHIEVE ACCURATE DELIVERY DATES WHILE OPTIMIZING PLANT SCHEDULES AND RESOURCE USAGE (U.S. CLS. 21, 23, 26, 36 AND 38).
FIRST USE 7-31-2003; IN COMMERCE 7-31-2003.

3,007,829. STACCATO COMMUNICATIONS, INC., SAN DIEGO, CA. SN 78-281,073. PUB. 6-8-2004, FILED 7-30-2003.



NO CLAIM IS MADE TO THE EXCLUSIVE RIGHT TO USE "COMMUNICATIONS", APART FROM THE MARK AS SHOWN.

FOR INTEGRATED CIRCUITS FOR USE IN THE FIELD OF COMMUNICATIONS (U.S. CLS. 21, 23, 26, 36 AND 38).
FIRST USE 4-30-2005; IN COMMERCE 5-31-2005.

3,007,831. IGT, RENO, NV. SN 78-284,150. PUB. 5-11-2004, FILED 8-6-2003.

THE NOSEY NEIGHBOR

FOR GAMING MACHINES, NAMELY, SLOT MACHINES WITH OR WITHOUT VIDEO OUTPUT OR VIDEO LOTTERY TERMINALS (U.S. CLS. 21, 23, 26, 36 AND 38).
FIRST USE 10-12-2004; IN COMMERCE 10-12-2004.

CLASS 9—(Continued).

3,007,832. GSI GROUP CORPORATION, BILLERICA, MA. SN 78-284,837. PUB. 11-9-2004, FILED 8-8-2003.

CHIPTRIM

FOR SOFTWARE FOR LASER BASED SYSTEMS FOR INDUSTRIAL MANUFACTURING IN THE FIELD OF ELECTRONIC CIRCUITS AND RADIO FREQUENCY COMPONENTS (U.S. CLS. 21, 23, 26, 36 AND 38).

FIRST USE 3-18-2004; IN COMMERCE 3-18-2004.

3,007,834. IGEL TECHNOLOGY GMBH, BREMEN, FED REP GERMANY. SN 78-286,662. PUB. 10-26-2004, FILED 8-13-2003.

clever clienting

FOR COMPUTER HARDWARE PERIPHERALS, NAMELY, COMPUTER TERMINALS, COMPUTER INPUT DEVICES, COMPUTER OUTPUT DEVICES, COMPUTER NETWORK COMPONENTS NAMELY, PRINT SERVERS, TERMINAL SERVERS, WIRELESS ACCESS POINTS FOR ELECTRONIC DATA PROCESSING AND DATA TRANSMISSION; COMPUTER DATA PROCESSING DEVICES NAMELY, TERMINALS, MEMORY STORAGE FOR DATA PROCESSING EQUIPMENT NAMELY, NON-VOLATILE MEMORY BASED COMPUTER CARDS FOR TERMINAL BOOTING WITH INTEGRATED CIRCUITS; APPLICATION PROGRAMMING COMPUTER INTERFACES FOR PROGRAMMING COMPUTERS; COMPUTER SOFTWARE STORED ON A COMPUTER HARD DRIVE AND DOWNLOADABLE COMPUTER PROGRAMS NAMELY, APPLICATION PROGRAMS FOR SERVER BASED COMPUTING ACCESS, OPERATING SYSTEM PROGRAMS, NETWORK PROGRAMS, FOR AUTOMATIC TERMINAL DISCOVERY AND SAFETY PROGRAMS FOR MANAGING TERMINALS AND RECOVERING TERMINAL DATA (U.S. CLS. 21, 23, 26, 36 AND 38).

FIRST USE 2-1-2003; IN COMMERCE 2-1-2003.

3,007,843. IGT, RENO, NV. SN 78-294,276. PUB. 4-27-2004, FILED 8-29-2003.

MILLION DOLLAR VOICE

NO CLAIM IS MADE TO THE EXCLUSIVE RIGHT TO USE MILLION DOLLAR, APART FROM THE MARK AS SHOWN.

FOR GAMING MACHINES, NAMELY, SLOT MACHINES WITH OR WITHOUT VIDEO OUTPUT OR VIDEO LOTTERY TERMINALS (U.S. CLS. 21, 23, 26, 36 AND 38).

FIRST USE 8-10-2004; IN COMMERCE 10-18-2004.

CLASS 9—(Continued).

3,007,844. IGT, RENO, NV. SN 78-294,280. PUB. 4-27-2004, FILED 8-29-2003.

MILLION DOLLAR CHASE

NO CLAIM IS MADE TO THE EXCLUSIVE RIGHT TO USE MILLION DOLLAR, APART FROM THE MARK AS SHOWN.

FOR GAMING MACHINES, NAMELY, SLOT MACHINES WITH OR WITHOUT VIDEO OUTPUT OR VIDEO LOTTERY TERMINALS (U.S. CLS. 21, 23, 26, 36 AND 38).

FIRST USE 5-4-2004; IN COMMERCE 5-4-2004.

3,007,847. HEWLETT-PACKARD DEVELOPMENT COMPANY, L.P., HOUSTON, TX. SN 78-297,223. PUB. 11-23-2004, FILED 9-8-2003.

IMAGERET

FOR MULTICOLOR PRINTING SYSTEMS, NAMELY, COMPUTER SOFTWARE AND FIRMWARE FOR USE IN OPERATING PRINTERS, COMPUTER HARDWARE, AND COMPUTER PERIPHERALS (U.S. CLS. 21, 23, 26, 36 AND 38).

FIRST USE 4-0-1996; IN COMMERCE 4-0-1996.

3,007,857. SOUTHERN VISION SYSTEMS, INC., MADISON, AL. SN 78-310,347. PUB. 2-22-2005, FILED 10-7-2003.

SPECTERVIEW

FOR SMART DIGITAL CAMERA (U.S. CLS. 21, 23, 26, 36 AND 38).

FIRST USE 7-1-2005; IN COMMERCE 7-1-2005.

3,007,862. TACIT NETWORKS, INC., SOUTH PLAINFIELD, NJ. SN 78-316,165. PUB. 2-1-2005, FILED 10-20-2003.

TACIT NETWORKS

NO CLAIM IS MADE TO THE EXCLUSIVE RIGHT TO USE "NETWORKS", APART FROM THE MARK AS SHOWN.

FOR INTELLIGENT STORAGE SYSTEMS, COMPRISING COMPUTER PROCESSORS, COMPUTER MEMORIES, AND COMPUTER OPERATING SYSTEM SOFTWARE, NETWORK FILE SERVERS; DATA STORAGE UNITS IN THE NATURE OF COMPUTER HARD DRIVES (U.S. CLS. 21, 23, 26, 36 AND 38).

FIRST USE 6-30-2003; IN COMMERCE 6-30-2003.

CLASS 9—(Continued).

3,007,866. ZOLL MEDICAL CORPORATION, CHELMSFORD, MA. SN 78-327,362. PUB. 4-12-2005, FILED 11-13-2003.

CLASS 9—(Continued).

3,007,904. CONNECTICUT ATTORNEYS TITLE INSURANCE COMPANY, ROCKY HILL, CT. SN 78-357,284. PUB. 4-26-2005, FILED 1-26-2004.

CODENET

THE MARK CONSISTS OF STANDARD CHARACTERS WITHOUT CLAIM TO ANY PARTICULAR FONT, STYLE, SIZE, OR COLOR.

FOR RESUSCITATION INFORMATION MANAGEMENT SOFTWARE AND DOWNLOADABLE SOFTWARE; SOFTWARE AND DOWNLOADABLE SOFTWARE TO RECORD, SYNCHRONIZE, AND ANALYZE CARDIAC EVENT AND CARDIAC RESUSCITATION EVENT DATA; SOFTWARE AND DOWNLOADABLE SOFTWARE FOR RESUSCITATION EQUIPMENT DIAGNOSTICS, MAINTENANCE AND INTEGRATION (U.S. CLS. 21, 23, 26, 36 AND 38).

FIRST USE 12-31-2003; IN COMMERCE 12-31-2003.

CATIC ETL

THE MARK CONSISTS OF STANDARD CHARACTERS WITHOUT CLAIM TO ANY PARTICULAR FONT, STYLE, SIZE, OR COLOR.

OWNER OF U.S. REG. NOS. 2,100,831 AND 2,743,741. FOR COMPUTER SOFTWARE FOR USE IN THE FIELD OF REAL PROPERTY TITLE SEARCHING (U.S. CLS. 21, 23, 26, 36 AND 38).

FIRST USE 1-13-2004; IN COMMERCE 1-13-2004.

3,007,872. APPLIED MICRO CIRCUITS CORPORATION, SAN DIEGO, CA. SN 78-329,481. PUB. 9-21-2004, FILED 11-18-2003.

3,007,906. OLYMPUS AMERICA, INC., MELVILLE, NY. SN 78-357,589. PUB. 11-9-2004, FILED 1-26-2004.

AMCC ENTERPRISE

THE MARK CONSISTS OF STANDARD CHARACTERS WITHOUT CLAIM TO ANY PARTICULAR FONT, STYLE, SIZE, OR COLOR.

OWNER OF U.S. REG. NOS. 1,333,064, 2,279,792, AND OTHERS.

NO CLAIM IS MADE TO THE EXCLUSIVE RIGHT TO USE ENTERPRISE, APART FROM THE MARK AS SHOWN.

FOR SEMICONDUCTORS, INTEGRATED CIRCUITS, STORAGE AREA NETWORK COMPUTER HARDWARE AND SOFTWARE, HOST BUS ADAPTERS, SOFTWARE FOR MANAGING UTILITIES FOR HOST CHANNEL ADAPTERS, FABRIC SWITCHES AND GATEWAYS, SOFTWARE FOR MANAGING UTILITIES FOR SWITCHES, DEVICE DRIVERS (U.S. CLS. 21, 23, 26, 36 AND 38).

FIRST USE 10-28-2003; IN COMMERCE 10-28-2003.

TRUEFIT

THE MARK CONSISTS OF STANDARD CHARACTERS WITHOUT CLAIM TO ANY PARTICULAR FONT, STYLE, SIZE, OR COLOR.

FOR COMPUTER SOFTWARE FOR IMPORTING PHOTOGRAPHS AND POPULATING FRAMES (U.S. CLS. 21, 23, 26, 36 AND 38).

FIRST USE 8-31-2004; IN COMMERCE 8-31-2004.

CLASS 9—(Continued).

3,007,919. IGT, RENO, NV. SN 78-364,241. PUB. 8-3-2004, FILED 2-6-2004.

CLASS 9—(Continued).

3,007,937. ACTIVISION PUBLISHING, INC., SANTA MONICA, CA. SN 78-373,414. PUB. 12-21-2004, FILED 2-24-2004.

AZTEC TEMPLE

UNITED OFFENSIVE

THE MARK CONSISTS OF STANDARD CHARACTERS WITHOUT CLAIM TO ANY PARTICULAR FONT, STYLE, SIZE, OR COLOR.

FOR GAMING MACHINES, NAMELY, SLOT MACHINES WITH OR WITHOUT VIDEO OUTPUT, VIDEO LOTTERY TERMINALS, GAMING MACHINES FOR PLAY OF AN INTERACTIVE, ELECTRONIC BINGO GAME (U.S. CLS. 21, 23, 26, 36 AND 38).

FIRST USE 5-5-2005; IN COMMERCE 6-1-2005.

THE MARK CONSISTS OF STANDARD CHARACTERS WITHOUT CLAIM TO ANY PARTICULAR FONT, STYLE, SIZE, OR COLOR.

FOR INTERACTIVE MULTIMEDIA COMPUTER GAMES COMPRISED OF COMPUTER HARDWARE AND COMPUTER GAME SOFTWARE (U.S. CLS. 21, 23, 26, 36 AND 38).

FIRST USE 10-1-2004; IN COMMERCE 10-1-2004.

3,007,924. SUSTAINABLE ENERGY TECHNOLOGIES, CALGARY, ALBERTA, CANADA. SN 78-365,718. PUB. 11-9-2004, FILED 2-10-2004.

3,007,940. LSI LOGIC CORPORATION, MILPITAS, CA. SN 78-374,902. PUB. 12-14-2004, FILED 2-26-2004.

SUNERGY

iTBBU

THE MARK CONSISTS OF STANDARD CHARACTERS WITHOUT CLAIM TO ANY PARTICULAR FONT, STYLE, SIZE, OR COLOR.

FOR ELECTRICAL POWER INVERTERS (U.S. CLS. 21, 23, 26, 36 AND 38).

FIRST USE 3-4-2005; IN COMMERCE 3-4-2005.

THE MARK CONSISTS OF STANDARD CHARACTERS WITHOUT CLAIM TO ANY PARTICULAR FONT, STYLE, SIZE, OR COLOR.

FOR BATTERY BACKUP UNITS, BATTERY CHARGING AND MAINTENANCE UNITS, BATTERIES AND MEMORY MODULES (U.S. CLS. 21, 23, 26, 36 AND 38).

FIRST USE 10-0-2004; IN COMMERCE 10-0-2004.

CLASS 9—(Continued).

3,007,960. INTERNATIONAL POLICE TECHNOLOGIES, INC., TULSA, OK. SN 78-388,202. PUB. 3-1-2005, FILED 3-22-2004.



THE MARK CONSISTS OF HAWK EYES, FOR CAMERAS AND RECORDING SYSTEMS PRIMARILY COMPOSED OF VIDEO CAMERAS AND AUDIO AND VIDEO RECORDERS FOR USE IN POLICE AND EMERGENCY VEHICLES ONLY (U.S. CLS. 21, 23, 26, 36 AND 38).

FIRST USE 7-6-2005; IN COMMERCE 7-6-2005.

3,007,973. DOLBEY SYSTEMS, INC., CONCORD, OH. SN 78-398,443. PUB. 4-12-2005, FILED 4-8-2004.

Fusion Dictate

THE MARK CONSISTS OF STANDARD CHARACTERS WITHOUT CLAIM TO ANY PARTICULAR FONT, STYLE, SIZE, OR COLOR.

NO CLAIM IS MADE TO THE EXCLUSIVE RIGHT TO USE DICTATE, APART FROM THE MARK AS SHOWN.

FOR COMPUTER SOFTWARE FOR USE IN DICTATION (U.S. CLS. 21, 23, 26, 36 AND 38).

FIRST USE 11-8-2002; IN COMMERCE 12-8-2002.

CLASS 9—(Continued).

3,007,983. SMARTHOME, INC., IRVINE, CA. SN 78-408,351. PUB. 4-19-2005, FILED 4-26-2004.

INSTEON

THE MARK CONSISTS OF STANDARD CHARACTERS WITHOUT CLAIM TO ANY PARTICULAR FONT, STYLE, SIZE, OR COLOR.

FOR REMOTE CONTROL HOME AUTOMATION SYSTEMS, NAMELY, ELECTRIC LIGHT DIMMERS, ELECTRIC RELAYS, PROGRAMMABLE LOCKING SYSTEMS, CONSISTING OF ELECTRONIC CYLINDRICAL LOCKSETS AND KEYPADS, VIDEO MONITORS, RADIO TRANSMITTERS FOR REMOTE CONTROLS AND RADIO CONTROLS (U.S. CLS. 21, 23, 26, 36 AND 38).

FIRST USE 5-19-2005; IN COMMERCE 5-19-2005.

3,007,986. ETREBY COMPUTER COMPANY, INC., GARDEN GROVE, CA. SN 78-409,636. PUB. 4-12-2005, FILED 4-28-2004.



THE MARK CONSISTS OF MARK INCLUDES "TELESCRIPT" TEXT WITH SPHERICAL ELEMENT INTERSECTED IN A PLANE.

FOR INTERACTIVE VOICE RESPONSE (IVR) SYSTEM COMPRISED OF COMPUTER HARDWARE AND COMPUTER APPLICATION SOFTWARE FOR USE IN THE FIELD OF TELECOMMUNICATIONS, NAMELY, USED FOR PROVIDING ELECTRONIC TRANSMISSION OF DOCUMENTS, VOICE MESSAGING, AND CALL PROCESSING USED BY PHARMACY OPERATORS TO RECEIVE PRESCRIPTION REFILL ORDERS AND OTHER INQUIRIES FROM PATIENTS VIA TOUCH TONE CAPABLE PHONES (U.S. CLS. 21, 23, 26, 36 AND 38).

FIRST USE 2-1-2005; IN COMMERCE 2-1-2005.

CLASS 9—(Continued).

3,007,989. MAYSTEEL LLC, MENOMONEE FALLS, WI. SN 78-413,980. PUB. 3-1-2005, FILED 5-6-2004.

CLASS 9—(Continued).

3,007,994. THEIMER, GERHARD K., BOCA RATON, FL. SN 78-415,614. PUB. 2-22-2005, FILED 5-10-2004.

FLEXIGEAR

eyeSignal

THE MARK CONSISTS OF STANDARD CHARACTERS WITHOUT CLAIM TO ANY PARTICULAR FONT, STYLE, SIZE, OR COLOR.

FOR SWITCHGEARS USED IN THE TRANSMISSION AND DISTRIBUTION OF ELECTRICAL POWER, NAMELY, CAPACITOR SWITCHES, VACUUM SWITCHES, OIL SWITCHES, MULTIPLE RELAY LIGHTING CONTROLS, GROUND FAULT DETECTORS AND MEDIUM VOLTAGE PADMOUNT FUSED SWITCHGEARS (U.S. CLS. 21, 23, 26, 36 AND 38).

FIRST USE 1-0-2005; IN COMMERCE 1-0-2005.

THE MARK CONSISTS OF STANDARD CHARACTERS WITHOUT CLAIM TO ANY PARTICULAR FONT, STYLE, SIZE, OR COLOR.

FOR COMPUTER SOFTWARE PROGRAMS THAT REVIEW INCOMING E-MAIL MESSAGES FROM A PRE-DEFINED LIST OF PARTIES TO ELIMINATE UNNECESSARY INTERRUPTIONS AND THAT USE LIGHTS TO ALERT THE USER OF UPCOMING AND CURRENT EVENTS, AND COMPUTER HARDWARE (U.S. CLS. 21, 23, 26, 36 AND 38).

FIRST USE 1-1-2004; IN COMMERCE 4-1-2004.

3,007,992. TEKTRONIX, INC., BEAVERTON, OR. SN 78-415,144. PUB. 5-3-2005, FILED 5-7-2004.

3,007,996. AEROTECH, INC., PITTSBURGH, PA. SN 78-417,989. PUB. 4-5-2005, FILED 5-13-2004.

ARBEXPRESS

SOLOIST

THE MARK CONSISTS OF STANDARD CHARACTERS WITHOUT CLAIM TO ANY PARTICULAR FONT, STYLE, SIZE, OR COLOR.

FOR COMPUTER SOFTWARE FOR GENERATING, EDITING, AND COMMUNICATING ELECTRICAL SIGNAL WAVEFORM DATA (U.S. CLS. 21, 23, 26, 36 AND 38).

FIRST USE 6-14-2004; IN COMMERCE 6-14-2004.

THE MARK CONSISTS OF STANDARD CHARACTERS WITHOUT CLAIM TO ANY PARTICULAR FONT, STYLE, SIZE, OR COLOR.

FOR ELECTRONIC CONTROLLER FOR SINGLE AXIS PRECISION POSITIONING SYSTEM (U.S. CLS. 21, 23, 26, 36 AND 38).

FIRST USE 8-31-2004; IN COMMERCE 8-31-2004.

CLASS 9—(Continued).

3,008,000. REALM HOLDINGS, LLC, MASON, OH. SN 78-419,827. PUB. 4-12-2005, FILED 5-17-2004.

REALM

THE MARK CONSISTS OF STANDARD CHARACTERS WITHOUT CLAIM TO ANY PARTICULAR FONT, STYLE, SIZE, OR COLOR.

OWNER OF U.S. REG. NOS. 2,428,664 AND 2,451,797. FOR SUNGLASSES (U.S. CLS. 21, 23, 26, 36 AND 38). FIRST USE 5-31-2004; IN COMMERCE 5-31-2004.

3,008,003. PANAVISION INTERNATIONAL L.P., WOODLAND HILLS, CA. SN 78-421,002. PUB. 4-5-2005, FILED 5-18-2004.

GENESIS

THE MARK CONSISTS OF STANDARD CHARACTERS WITHOUT CLAIM TO ANY PARTICULAR FONT, STYLE, SIZE, OR COLOR.

FOR HIGH DEFINITION DIGITAL CAMERAS FOR MOTION PICTURES (U.S. CLS. 21, 23, 26, 36 AND 38). FIRST USE 5-5-2004; IN COMMERCE 5-5-2004.

CLASS 9—(Continued).

3,008,013. LINE 6, INC., AGOURA HILLS, CA. SN 78-426,207. PUB. 4-12-2005, FILED 5-27-2004.

TONE
CORE

NO CLAIM IS MADE TO THE EXCLUSIVE RIGHT TO USE "TONE", APART FROM THE MARK AS SHOWN.

FOR ELECTRONIC MUSICAL EQUIPMENT, NAMELY, MUSIC SIGNAL PROCESSING EFFECTS PEDALS AND ACCESSORIES THEREFORE FOR USE WITH MUSICAL INSTRUMENTS, AMPLIFIERS, AND SOUND SPEAKERS (U.S. CLS. 21, 23, 26, 36 AND 38).

FIRST USE 9-24-2004; IN COMMERCE 9-24-2004.

3,008,020. PANGAEA MULTIMEDIA COMMUNICATIONS CORPORATION, CAMBRIDGE, MA. SN 78-975,167. PUB. 3-23-2004, FILED 9-4-2001.



NO CLAIM IS MADE TO THE EXCLUSIVE RIGHT TO USE "MULTIMEDIA COMMUNICATIONS CORPORATION", APART FROM THE MARK AS SHOWN.

FOR COMPUTER SOFTWARE TO DELIVER AND ENHANCE DELIVERY OF DATA AND MULTIMEDIA CONTENT, NAMELY, FOR THE INTEGRATION OF DATA, TEXT, AUDIO, VIDEO, GRAPHICS, STILL IMAGES AND MOVING PICTURES VIA THE INTERNET CD-ROM, DVD, VIDEO DISCS; MULTIMEDIA SOFTWARE RECORDED ON CD-ROM FOR DELIVERING AND ENHANCING THE DELIVERY OF DATA AND MULTIMEDIA CONTENT, NAMELY, FOR THE INTEGRATION OF DATA, TEXT AUDIO, VIDEO, GRAPHICS, STILL IMAGES AND MOVING PICTURES (U.S. CLS. 21, 23, 26, 36 AND 38).

FIRST USE 2-15-2002; IN COMMERCE 2-15-2002.

CLASS 10—MEDICAL APPARATUS

CLASS 10—(Continued).

3,007,643. NEXT STEP MEDICAL TECHNOLOGIES, LLC, KENNESAW, GA. SN 76-498,700. PUB. 10-14-2003, FILED 3-6-2003.

ENDO|BATH

THE MARK CONSISTS OF STANDARD CHARACTERS WITHOUT CLAIM TO ANY PARTICULAR FONT, STYLE, SIZE, OR COLOR.

FOR MEDICAL APPARATUS, NAMELY, A SOAKING BASIN FOR MEDICAL INSTRUMENTS (U.S. CLS. 26, 39 AND 44).

FIRST USE 4-30-2003; IN COMMERCE 5-11-2003.

3,007,650. GFE DO BRASIL LTDA., CAMPINAS - SP, BRAZIL. SN 76-512,844. PUB. 11-9-2004, FILED 5-7-2003.

G-FLEX

FOR MEDICAL ENDOSCOPIC DEVICES, NAMELY FORCEPS, NEEDLES, BASKETS, SNARES, PAPILOTOMES, DILATORS, BALLOONS, CATHETERS, LITHOTRIPTORS, STENTS, GUIDE WIRES, BOUGIES, HANDLES, BIOPSYFORCEPS, TRIPOD, GRASPERS, SPRAY CATHETERS (U.S. CLS. 26, 39 AND 44).

FIRST USE 7-18-2002; IN COMMERCE 7-18-2002.

3,007,717. CELSION CORPORATION, COLUMBIA, MD. SN 76-977,692. PUB. 11-9-2004, FILED 3-25-2004.

PROLIEVE THERMODILATATION

THE MARK CONSISTS OF STANDARD CHARACTERS WITHOUT CLAIM TO ANY PARTICULAR FONT, STYLE, SIZE, OR COLOR.

FOR MEDICAL TREATMENT SYSTEMS AND DEVICES, NAMELY, MICROWAVE GENERATOR, CATHETER, AND DISPOSABLE HEAT EXCHANGE CASSETTES, USED TO TREAT HYPERPLASIA AND BENIGN PROSTATIC HYPERPLASIA; MEDICAL APPARATUS, NAMELY, A MICROWAVE GENERATOR WHICH UTILIZES FOCUSED HEAT TECHNOLOGY TO TREAT DISEASE, CANCER, TUMORS, PROSTATIC DISORDERS AND THE LIKE; ELECTROMAGNETIC MICROWAVE HYPERTHERMIA SYSTEM COMPOSED OF WAVE GUIDE APPLICATORS, INTERSTITIAL ANTENNAS, WAVE GENERATORS, THERMOMETERS AND COMPUTER DISPLAY TERMINALS USED TO TREAT CANCER, TUMORS, PROSTATIC DISORDERS AND THE LIKE (U.S. CLS. 26, 39 AND 44).

FIRST USE 3-0-2004; IN COMMERCE 3-0-2004.

CLASS 10—(Continued).

3,007,851. INOGEN, INC., GOLETA, CA. SN 78-300,679. PUB. 1-11-2005, FILED 9-15-2003.

SATELLITE CONSERVER

NO CLAIM IS MADE TO THE EXCLUSIVE RIGHT TO USE "CONSERVER", APART FROM THE MARK AS SHOWN.

FOR MEDICAL DEVICES, NAMELY, OXYGEN CONSERVING DEVICES FOR PATIENTS SUFFERING FROM CHRONIC OBSTRUCTIVE PULMONARY DISEASE AND OTHER RESPIRATORY DISORDERS (U.S. CLS. 26, 39 AND 44).

FIRST USE 10-15-2003; IN COMMERCE 10-15-2004.

3,007,882. TYCO HEALTHCARE GROUP LP, MANSFIELD, MA. SN 78-344,287. PUB. 11-9-2004, FILED 12-22-2003.

KAMBIA

FOR SLEEVES AND TUBING FOR A THERAPEUTIC COMPRESSION SYSTEM (U.S. CLS. 26, 39 AND 44).

FIRST USE 7-19-2004; IN COMMERCE 2-8-2005.

3,007,925. PACESETTER, INC., DBA ST. JUDE MEDICAL CARDIAC RHYTHM MANAGEMENT DIVISION, SYLMAR, CA. SN 78-365,848. PUB. 11-9-2004, FILED 2-10-2004.

MYODEX

THE MARK CONSISTS OF STANDARD CHARACTERS WITHOUT CLAIM TO ANY PARTICULAR FONT, STYLE, SIZE, OR COLOR.

FOR MEDICAL INSTRUMENTS, NAMELY CARDIAC STIMULATION LEADS (U.S. CLS. 26, 39 AND 44).

FIRST USE 5-16-2005; IN COMMERCE 5-16-2005.

CLASS 10—(Continued).

3,007,928. FILTRONA RICHMOND, INC., COLONIAL HEIGHTS, VA. SN 78-366,816. PUB. 12-21-2004, FILED 2-12-2004.

FILTRONA FIBERTEC

THE MARK CONSISTS OF STANDARD CHARACTERS WITHOUT CLAIM TO ANY PARTICULAR FONT, STYLE, SIZE, OR COLOR.

OWNER OF U.S. REG. NOS. 690,061, 813,951, AND 1,253,655.

FOR ABSORBENT MEDIA, WICKS, RESERVOIRS, AND FILTERS USED IN MEDICAL DIAGNOSTIC AND OTHER MEDICAL DEVICES (U.S. CLS. 26, 39 AND 44).
FIRST USE 6-30-2004; IN COMMERCE 6-30-2004.

3,007,964. UNITED EXCHANGE CORPORATION, CERRITOS, CA. SN 78-390,793. PUB. 1-25-2005, FILED 3-25-2004.

HEAT COMFORT

THE MARK CONSISTS OF STANDARD CHARACTERS WITHOUT CLAIM TO ANY PARTICULAR FONT, STYLE, SIZE, OR COLOR.

NO CLAIM IS MADE TO THE EXCLUSIVE RIGHT TO USE "HEAT", APART FROM THE MARK AS SHOWN.

FOR ADHESIVE HEAT GENERATING PATCHES FOR USE IN THE TREATMENT OF FEMININE CRAMPS AND MUSCLE DISCOMFORT WHICH MAY BE PLACED DIRECTLY ON THE SKIN, UNDERGARMENT, AND GARMENT TO PROVIDE HEAT TO AN AREA OF THE BODY SUCH AS THE LOWER ABDOMEN, BACK, NECK, LEGS, ARMS, HANDS AND FEET (U.S. CLS. 26, 39 AND 44).

FIRST USE 11-1-2004; IN COMMERCE 11-1-2004.

CLASS 10—(Continued).

3,007,981. NUVASIVE, INC., SAN DIEGO, CA. SN 78-405,238. PUB. 2-1-2005, FILED 4-20-2004.

SPHERX

THE MARK CONSISTS OF STANDARD CHARACTERS WITHOUT CLAIM TO ANY PARTICULAR FONT, STYLE, SIZE, OR COLOR.

FOR ORTHOPAEDIC DEVICES, NAMELY SPINAL SYSTEMS COMPRISING OF RODS, SCREWS, BOLTS, CONNECTORS; CONNECTORS, ADAPTABLE CONNECTORS, RODS, SCREWS, BONE AND VERTEBRAE IMPLANTS; SCREWS, WIRES, PLATES, RODS, THORACIC AND CERVICAL FIXATION DEVICES, NAMELY SCREWS, RODS AND BOLTS AND OTHER COMPONENTS USE IN SURGICAL APPLICATION, NAMELY SURGICAL HAND TOOLS ALL FOR USE AS A COMPONENT PART OF ORTHOPEDIC INSTRUMENTS (U.S. CLS. 26, 39 AND 44).

FIRST USE 6-2-2004; IN COMMERCE 6-2-2004.

CLASS 11—ENVIRONMENTAL CONTROL APPARATUS

3,007,637. BUNZL EXTRUSION, INC., COLONIAL HEIGHTS, VA. SN 76-480,554. PUB. 11-18-2003, FILED 1-6-2003.

TRI-LITE

FOR LIGHTING ACCESSORIES FOR ELECTRIC LIGHT FIXTURES, NAMELY, PRISMATIC SHEETS, LIGHTING WRAPS, LIGHTING PROFILES, LIGHTING TUBE GUARDS AND LIGHTING DIFFUSERS (U.S. CLS. 13, 21, 23, 31 AND 34).

FIRST USE 9-0-1997; IN COMMERCE 9-0-1997.

3,007,741. LIGHT SOURCES INC, ORANGE, CT. SN 78-149,881. PUB. 6-15-2004, FILED 8-1-2002.

CCT

FOR TANNING LAMPS, NAMELY, FLUORESCENT LAMPS FEATURING TECHNOLOGY TO PREVENT BLACKENED ENDS (U.S. CLS. 13, 21, 23, 31 AND 34).

FIRST USE 1-29-2004; IN COMMERCE 1-29-2004.

CLASS 11—(Continued).

3,007,824. VISIBELLE DERMA INSTITUTE, INC., BLOOMINGTON, MN. SN 78-276,143. PUB. 12-21-2004, FILED 7-18-2003.

CLASS 11—(Continued).

3,007,902. HOMER TLC, INC., CLAYMONT, DE. SN 78-355,589. PUB. 11-30-2004, FILED 1-22-2004.

SPA FENG SHUI

NO CLAIM IS MADE TO THE EXCLUSIVE RIGHT TO USE SPA, APART FROM THE MARK AS SHOWN.

FOR PERSONAL ENVIRONMENTALLY CONTROLLED COMPARTMENT, NAMELY A CAPSULE HAVING A COVER IN WHICH A PERSON WILL LIE FOR RELAXATION AND HAVING ONE OR MORE SELECTIVELY ENGAGABLE SOURCES OF HEAT, LIGHT, VIBRATION, STEAM, SHOWER AND SOUND (U.S. CLS. 13, 21, 23, 31 AND 34).

FIRST USE 1-31-2004; IN COMMERCE 1-31-2004.

PRESTON

THE MARK CONSISTS OF STANDARD CHARACTERS WITHOUT CLAIM TO ANY PARTICULAR FONT, STYLE, SIZE, OR COLOR.

FOR CEILING FANS, AND LIGHTING FIXTURES (U.S. CLS. 13, 21, 23, 31 AND 34).

FIRST USE 3-0-2004; IN COMMERCE 3-0-2004.

3,007,826. KOHLER CO., KOHLER, WI. SN 78-276,537. PUB. 10-26-2004, FILED 7-21-2003.

SENZA

THE ENGLISH TRANSLATION OF "SENZA" IS "WITHOUT".

FOR PLUMBING PRODUCTS, NAMELY, BATH AND SHOWER DOORS, AND PARTS FOR THE AFORESAID GOODS (U.S. CLS. 13, 21, 23, 31 AND 34).

FIRST USE 1-0-2000; IN COMMERCE 1-0-2000.

3,007,984. TRUE MANUFACTURING CO., INC., O'FALLON, MO. SN 78-408,644. PUB. 2-1-2005, FILED 4-27-2004.

TRUETRAC 5

THE MARK CONSISTS OF STANDARD CHARACTERS WITHOUT CLAIM TO ANY PARTICULAR FONT, STYLE, SIZE, OR COLOR.

OWNER OF U.S. REG. NOS. 1,645,100, 2,301,850, AND OTHERS.

FOR SHELF ORGANIZERS FOR COMMERCIAL REFRIGERATED BEVERAGE COOLERS (U.S. CLS. 13, 21, 23, 31 AND 34).

FIRST USE 7-5-2005; IN COMMERCE 7-5-2005.

3,007,828. TAKARA BELMONT CORPORATION, OSAKA, JAPAN. SN 78-280,437. PUB. 11-16-2004, FILED 7-29-2003.

MICRO MIST

NO CLAIM IS MADE TO THE EXCLUSIVE RIGHT TO USE "MIST", APART FROM THE MARK AS SHOWN.

FOR HAND-HELD ELECTRIC HAIR DRYERS, OVERHEAD ELECTRIC HAIR HEATERS, OVERHEAD ELECTRIC HAIR DRYERS, ALL SOLD TO BEAUTY SALONS FOR THEIR USE ONLY (U.S. CLS. 13, 21, 23, 31 AND 34).

FIRST USE 9-17-2002; IN COMMERCE 1-1-2005.

CLASS 12—VEHICLES

CLASS 12—(Continued).

3,007,596. DIPLOMAT TRADING, INC., MIAMI, FL. SN 76-266,053. PUB. 11-9-2004, FILED 6-4-2001.



NO CLAIM IS MADE TO THE EXCLUSIVE RIGHT TO USE "SECURITY", APART FROM THE MARK AS SHOWN. THE MARK IS COMPRISED OF THE LETTERS "DTI" AND THE TERM "SECURITY" LOCATED UNDERNEATH "DTI" WITH A DESIGN OF A LOCK AND CHAIN THAT RUNS THROUGH THE LETTER "D".

FOR ANTITHEFT ALARMS FOR VEHICLES (U.S. CLS. 19, 21, 23, 31, 35 AND 44).
FIRST USE 8-24-2001; IN COMMERCE 8-24-2001.

3,007,624. NISSAN JIDOSHA KABUSHIKI KAISHA, TA NISSAN MOTOR CO., LTD., YOKOHAMA-SHI, KANAGAWA-KEN, JAPAN. SN 76-437,341. PUB. 5-18-2004, FILED 8-5-2002.

TITAN

FOR MOTOR VEHICLES, NAMELY, ON-ROAD PASSENGER TRUCKS AND STRUCTURAL PARTS THEREFOR, EXCLUDING BATTERIES, POWER SUPPLIES, AND RELATED EQUIPMENT AND ACCESSORIES (U.S. CLS. 19, 21, 23, 31, 35 AND 44).

FIRST USE 11-30-2003; IN COMMERCE 11-30-2003.

3,007,634. FAVESS CO., LTD., OKASAKI, AICHI 444-2106, JAPAN. SN 76-478,611. PUB. 12-2-2003, FILED 12-27-2002.

FAVESS

FOR STEERING UNITS FOR LAND VEHICLES AND PARTS THEREOF (U.S. CLS. 19, 21, 23, 31, 35 AND 44).
FIRST USE 10-29-2003; IN COMMERCE 10-29-2003.

3,007,644. WARNER, FRANK T., MOUND, MN. SN 76-500,561. PUB. 12-9-2003, FILED 3-17-2003.

FALLS FLYER

FOR BOATS (U.S. CLS. 19, 21, 23, 31, 35 AND 44).
FIRST USE 7-25-2004; IN COMMERCE 7-29-2005.

CLASS 12—(Continued).

3,007,658. GWYNN, DARRELL, DAVIE, FL. SN 76-534,292. PUB. 11-30-2004, FILED 7-23-2003.

HOT RODS & REELS

OWNER OF U.S. REG. NO. 2,788,456.
FOR VEHICLES, NAMELY, AUTOMOBILES, TRUCKS AND VANS (U.S. CLS. 19, 21, 23, 31, 35 AND 44).
FIRST USE 12-8-2004; IN COMMERCE 12-8-2004.

3,007,785. FUJI JUKOGYO KABUSHIKI KAISHA, DBA FUJI HEAVY INDUSTRIES LTD., TOKYO, JAPAN. SN 78-221,945. PUB. 7-20-2004, FILED 3-5-2003.

B9

FOR AUTOMOBILES, NAMELY, SPORT UTILITY VEHICLES, AND THEIR STRUCTURAL PARTS AND THEIR STRUCTURAL FITTINGS (U.S. CLS. 19, 21, 23, 31, 35 AND 44).

FIRST USE 4-0-2005; IN COMMERCE 4-0-2005.

3,007,837. BABE EASE, LLC, PELHAM, NH. SN 78-288,083. PUB. 11-30-2004, FILED 8-15-2003.

CLEAN PET SHOPPER

NO CLAIM IS MADE TO THE EXCLUSIVE RIGHT TO USE PET, APART FROM THE MARK AS SHOWN.

FOR FITTED ONE-PIECE SLIP COVERS DESIGNED TO COVER THE ENTIRE SEATING AREA, INCLUDING HANDLEBARS, BACK, SIDES AND SEAT OF GROCERY AND SHOPPING CARTS FOR THE PURPOSE OF PROTECTING ANIMALS FROM THE METALS AND GERMS THEREON, NAMELY, COTTON, QUILTED OR PLASTIC SLIP COVERS (U.S. CLS. 19, 21, 23, 31, 35 AND 44).

FIRST USE 12-15-2003; IN COMMERCE 12-15-2003.

3,007,933. BUFFETT, JIMMY, KEY WEST, FL. SN 78-370,212. PUB. 11-2-2004, FILED 2-18-2004.

MARGARITAVICH

THE MARK CONSISTS OF STANDARD CHARACTERS WITHOUT CLAIM TO ANY PARTICULAR FONT, STYLE, SIZE, OR COLOR.

FOR BOATS AND STRUCTURAL PARTS THEREFOR (U.S. CLS. 19, 21, 23, 31, 35 AND 44).
FIRST USE 10-0-2003; IN COMMERCE 10-0-2003.

CLASS 14—JEWELRY

3,007,571. ROCAWEAR LICENSING, LLC, ALPINE, NY. SN 76-023,483. PUB. 4-29-2003, FILED 1-27-2000.



OWNER OF U.S. REG. NO. 1,581,629 AND OTHERS.
NO CLAIM IS MADE TO THE EXCLUSIVE RIGHT TO USE "WEAR", APART FROM THE MARK AS SHOWN.

THE ENGLISH TRANSLATION OF THE WORD "ROCA" IN THE MARK IS "ROCK".

FOR JEWELRY AND WATCHES (U.S. CLS. 2, 27, 28 AND 50).

FIRST USE 2-14-2005; IN COMMERCE 2-14-2005.

CLASS 14—(Continued).

3,007,922. HEARTS ON FIRE COMPANY, BOSTON, MA. SN 78-364,725. PUB. 11-16-2004, FILED 2-9-2004.

SOLITUDE

3,007,745. DISNEY ENTERPRISES, INC., BURBANK, CA. SN 78-159,811. PUB. 4-29-2003, FILED 8-30-2002.

MICKEY MOUSE

FOR JEWELRY, WATCHES (U.S. CLS. 2, 27, 28 AND 50).

FIRST USE 7-12-2005; IN COMMERCE 7-12-2005.

3,007,766. COHEN, LYNN RUTH, LIVINGSTON, NJ. SN 78-205,053. PUB. 12-23-2003, FILED 1-20-2003.

PC IS THE KEY!

FOR JEWELRY (U.S. CLS. 2, 27, 28 AND 50).
FIRST USE 2-3-2004; IN COMMERCE 7-0-2004.

THE MARK CONSISTS OF STANDARD CHARACTERS WITHOUT CLAIM TO ANY PARTICULAR FONT, STYLE, SIZE, OR COLOR.

FOR JEWELRY (U.S. CLS. 2, 27, 28 AND 50).

FIRST USE 6-1-2004; IN COMMERCE 9-1-2004.

3,007,815. STAR DIAMOND GROUP, INC., NEW YORK, NY. SN 78-265,272. PUB. 3-2-2004, FILED 6-20-2003.

STAR 129

NO CLAIM IS MADE TO THE EXCLUSIVE RIGHT TO USE 129, APART FROM THE MARK AS SHOWN.

FOR DIAMONDS AND JEWELRY (U.S. CLS. 2, 27, 28 AND 50).

FIRST USE 6-0-2003; IN COMMERCE 6-0-2003.

CLASS 16—PAPER GOODS AND PRINTED MATTER

3,007,579. PERSONNEL DECISIONS INTERNATIONAL CORPORATION, MINNEAPOLIS, MN. SN 76-117,565. PUB. 5-4-2004, FILED 8-28-2000.

TEAMTALK

3,007,830. PEREZ, GIUSEPPE, NAPLES, ITALY. SN 78-282,648. PUB. 11-9-2004, FILED 8-4-2003.

PIPPO

FOR JEWELRY; WATCHES AND CHRONOMETERS AND PARTS THEREOF; WATCH CASES; WATCH BANDS; WATCH STRAPS (U.S. CLS. 2, 27, 28 AND 50).
FIRST USE 6-3-2004; IN COMMERCE 6-3-2004.

FOR PRINTED QUESTIONNAIRES AND REPORTS FOR EVALUATING WORK TEAM STRENGTHS AND DEVELOPMENT NEEDS; PRINTED EDUCATIONAL AND TRAINING MATERIALS, NAMELY, BROCHURES, PAMPHLETS, ARTICLES, BOOKS AND BOOKLETS IN THE FIELD OF WORK TEAM EFFECTIVENESS AND PRODUCTIVITY (U.S. CLS. 2, 5, 22, 23, 29, 37, 38 AND 50).

FIRST USE 11-0-2000; IN COMMERCE 11-0-2000.

CLASS 16—(Continued).

3,007,589. ZIMMER TECHNOLOGY, INC., CHICAGO, IL. SN 76-239,445. PUB. 7-30-2002, FILED 4-10-2001.



NO CLAIM IS MADE TO THE EXCLUSIVE RIGHT TO USE "MIS" AND "MINIMALLY INVASIVE", APART FROM THE MARK AS SHOWN.

THE DOTTED LINES IN THE DRAWING ARE A FEATURE OF THE MARK.

FOR PRINTED MATERIALS, NAMELY, TRAINING MANUALS, COURSE MATERIALS, INFORMATIONAL BOOKLETS, BROCHURES AND PAMPHLETS IN THE FIELD OF MINIMALLY INVASIVE SURGICAL TECHNIQUES (U.S. CLS. 2, 5, 22, 23, 29, 37, 38 AND 50).

FIRST USE 11-6-2000; IN COMMERCE 11-6-2000.

CLASS 16—(Continued).

3,007,705. FARMSAVER.COM LLC, SEATTLE, WA. SN 76-580,794. PUB. 12-14-2004, FILED 3-11-2004.

POWERSAVER

THE MARK CONSISTS OF STANDARD CHARACTERS WITHOUT CLAIM TO ANY PARTICULAR FONT, STYLE, SIZE, OR COLOR.

FOR COUPONS (U.S. CLS. 2, 5, 22, 23, 29, 37, 38 AND 50).

FIRST USE 5-31-2005; IN COMMERCE 5-31-2005.

3,007,695. E.K. SUCCESS, LTD., CLIFTON, NJ. SN 76-572,750. PUB. 4-19-2005, FILED 1-29-2004.

FASTENATER

THE MARK CONSISTS OF STANDARD CHARACTERS WITHOUT CLAIM TO ANY PARTICULAR FONT, STYLE, SIZE, OR COLOR.

FOR LARGE FORMAT STAPLER FOR USE ON PAPER IN CRAFT AND SCRAP BOOKING PROJECTS USING DECORATIVE STAPLES (U.S. CLS. 2, 5, 22, 23, 29, 37, 38 AND 50).

FIRST USE 5-16-2005; IN COMMERCE 5-16-2005.

3,007,725. UNITYLAB INC., EDMONTON, ALBERTA. SN 78-084,152. PUB. 5-7-2002, FILED 9-17-2001.

GO COIN!

PRIORITY CLAIMED UNDER SEC. 44(D) ON CANADA APPLICATION NO. 1096379, FILED 3-21-2001.

FOR COIN HOLDERS (U.S. CLS. 2, 5, 22, 23, 29, 37, 38 AND 50).

FIRST USE 10-20-2001; IN COMMERCE 5-2-2005.

3,007,696. ITOYA OF AMERICA, LTD., TORRANCE, CA. SN 76-573,306. PUB. 12-7-2004, FILED 2-2-2004.

BLING

THE MARK CONSISTS OF STANDARD CHARACTERS WITHOUT CLAIM TO ANY PARTICULAR FONT, STYLE, SIZE, OR COLOR.

FOR PENS (U.S. CLS. 2, 5, 22, 23, 29, 37, 38 AND 50).

FIRST USE 6-15-2005; IN COMMERCE 6-15-2005.

3,007,742. YEAMANS, NANCY L., TEMPE, AZ. SN 78-151,976. PUB. 5-13-2003, FILED 8-7-2002.

CANINE WISDOM

NO CLAIM IS MADE TO THE EXCLUSIVE RIGHT TO USE "CANINE", APART FROM THE MARK AS SHOWN.

FOR BOOKS, NAMELY CARTOON BOOKS, COMIC BOOKS, AND HUMOR BOOKS; COLORING BOOKS; POSTERS; GREETING CARDS; PAPER BABY BIBS (U.S. CLS. 2, 5, 22, 23, 29, 37, 38 AND 50).

FIRST USE 2-1-2005; IN COMMERCE 2-1-2005.

CLASS 16—(Continued).

3,007,755. RAFLATAC OY, 33310 TAMPERE, FINLAND. SN 78-182,544. PUB. 11-25-2003, FILED 11-6-2002.



PRO LABEL

OWNER OF U.S. REG. NO. 1,398,501.
NO CLAIM IS MADE TO THE EXCLUSIVE RIGHT TO USE "LABEL", APART FROM THE MARK AS SHOWN.

FOR SELF-ADHESIVE PAPER LAMINATES IN FORM OF REELS, SHEETS AND LABELS FOR COPIER, LASER AND INKJET PRINTING, AND FOR COMMERCIAL PACKAGING; SELF-ADHESIVE THERMAL AND PRESSURE SENSITIVE PAPER AND SYNTHETIC LAMINATES IN THE FORM OF REELS, SHEETS AND LABELS FOR COMMERCIAL PACKAGING; AND SELF-ADHESIVE PAPER AND SYNTHETIC LAMINATES FOR USE IN PRODUCT SECURITY AND ANTI-THEFT LABELING (U.S. CLS. 2, 5, 22, 23, 29, 37, 38 AND 50).

FIRST USE 3-10-2005; IN COMMERCE 3-10-2005.

3,007,856. SIERRA ENTERTAINMENT, INC., BELLEVUE, WA. SN 78-309,526. PUB. 8-3-2004, FILED 10-5-2003.

LEISURE SUIT LARRY

OWNER OF U.S. REG. NO. 1,675,231.
THE NAME(S), PORTRAIT(S), AND/OR SIGNATURE(S) SHOWN IN THE MARK DOES NOT IDENTIFY A PARTICULAR LIVING INDIVIDUAL.

FOR PAPER GOODS AND PRINTED MATTER NAMELY NOVELS, FICTION BOOKS, A SERIES OF FICTION BOOKS, JUVENILE BOOKS, A SERIES OF JUVENILE BOOKS, MAGAZINES FEATURING VIDEO GAMES AND CHARACTERS FROM VIDEO AND COMPUTER GAMES; COMIC BOOKS, COLORING BOOKS, PUZZLE BOOKS, CALENDARS, PERSONAL ORGANIZERS, BOOK MARKS, NON-ELECTRONIC PERSONAL PLANNERS, DIARIES, ADDRESS BOOKS, TRADING CARDS, POSTERS, POST CARDS, RUBBER STAMPS, PRINTED LABELS, PRINTED INVITATIONS, PAPER TABLE CLOTHS, GIFT WRAPPING PAPER, GIFT TAGS, GIFT BAGS, GREETING CARDS, PAPER PARTY DECORATIONS, PAPER PARTY BAGS, PAPER PARTY HATS, PAPER CAKE DECORATIONS, TEMPORARY TATTOOS, NOTEBOOKS, STATIONARY, STICKERS, RUB-ON TRANSFERS, STICKER ALBUMS; EDUCATIONAL MATERIALS NAMELY NOTEBOOK BINDERS, PENS, PENCILS, RULERS, ERASERS, TEXTBOOKS, AND CRAYONS (U.S. CLS. 2, 5, 22, 23, 29, 37, 38 AND 50).
FIRST USE 12-31-1987; IN COMMERCE 12-31-1987.

CLASS 16—(Continued).

3,007,929. FILTRONA RICHMOND, INC., COLONIAL HEIGHTS, VA. SN 78-366,903. PUB. 12-14-2004, FILED 2-12-2004.



OWNER OF U.S. REG. NOS. 690,061, 813,951, AND 1,253,655.

THE COLOR(S) BLUE IS/ARE CLAIMED AS A FEATURE OF THE MARK.

THE MARK CONSISTS OF BLUE RECTANGLES ABOVE AND BELOW THE WORD FILTRONA.

FOR RESERVOIRS, WICKS, AND CONNECTORS USED IN WRITING INSTRUMENTS AND INK JET PRINTER CARTRIDGES; ABSORBENT MEDIA AND RESERVOIRS USED IN INK JET PRINTERS (U.S. CLS. 2, 5, 22, 23, 29, 37, 38 AND 50).

FIRST USE 6-20-2004; IN COMMERCE 6-20-2004.

3,007,935. HASTINGS, JOHN H., HILLSBORO, OR. SN 78-371,959. PUB. 12-21-2004, FILED 2-22-2004.

DRAWING BREAKTHROUGH

THE MARK CONSISTS OF STANDARD CHARACTERS WITHOUT CLAIM TO ANY PARTICULAR FONT, STYLE, SIZE, OR COLOR.

NO CLAIM IS MADE TO THE EXCLUSIVE RIGHT TO USE DRAWING, APART FROM THE MARK AS SHOWN.

FOR KITS COMPRISED PRIMARILY OF A WORKBOOK CONTAINING EDUCATIONAL INFORMATION ON TECHNIQUES AND METHODS FOR LEARNING TO DRAW, DRAWING PADS, PAPER AND CARDBOARD (U.S. CLS. 2, 5, 22, 23, 29, 37, 38 AND 50).

FIRST USE 8-2-2005; IN COMMERCE 8-2-2005.

CLASS 16—(Continued).

3,007,988. PROMETHEUS BOOKS, INC., AMHERST, NY. SN 78-412,242. PUB. 3-8-2005, FILED 5-3-2004.

PYR

THE MARK CONSISTS OF STANDARD CHARACTERS WITHOUT CLAIM TO ANY PARTICULAR FONT, STYLE, SIZE, OR COLOR.

FOR BOOKS IN THE FIELD OF SCIENCE FICTION (U.S. CLS. 2, 5, 22, 23, 29, 37, 38 AND 50).

FIRST USE 3-0-2005; IN COMMERCE 3-0-2005.

CLASS 18—(Continued).

3,007,762. OFFICERS ONLY INCORPORATED, OGDEN, UT. SN 78-201,052. PUB. 11-18-2003, FILED 1-8-2003.



FOR ALL PURPOSE SPORTS BAGS, ALL PURPOSE ATHLETIC NYLON BAGS, AND ALL PURPOSES SPORT NYLON BAGS; BRIEFCASES; LEATHER KEY CHAINS (U.S. CLS. 1, 2, 3, 22 AND 41).

FIRST USE 6-0-2005; IN COMMERCE 6-0-2005.

CLASS 17—RUBBER GOODS

3,007,915. GARDNER INDUSTRIES, TAMPA, FL. SN 78-361,315. PUB. 11-16-2004, FILED 2-2-2004.

ACRA-CAULK

THE MARK CONSISTS OF STANDARD CHARACTERS WITHOUT CLAIM TO ANY PARTICULAR FONT, STYLE, SIZE, OR COLOR.

FOR ADHESIVE SEALANTS AND CAULKING COMPOUNDS (U.S. CLS. 1, 5, 12, 13, 35 AND 50).

FIRST USE 1-0-2004; IN COMMERCE 1-0-2004.

3,007,926. REIGNMAKERS, LLC, PRINCETON, IL. SN 78-366,068. PUB. 11-9-2004, FILED 2-11-2004.

REIGNMAKERS

THE MARK CONSISTS OF STANDARD CHARACTERS WITHOUT CLAIM TO ANY PARTICULAR FONT, STYLE, SIZE, OR COLOR.

FOR UMBRELLAS (U.S. CLS. 1, 2, 3, 22 AND 41).

FIRST USE 5-1-2002; IN COMMERCE 5-1-2002.

CLASS 18—LEATHER GOODS

CLASS 18—(Continued).

3,007,946. IMPAK LUGGAGE, LLC, PARAMUS, NJ. SN 78-378,092. PUB. 3-22-2005, FILED 3-3-2004.

CLASS 18—(Continued).

3,007,977. COSMIC DEBRIS, ETC., INC., OAKLAND, CA. SN 78-402,728. PUB. 3-8-2005, FILED 4-15-2004.

ON TOUR

THE MARK CONSISTS OF STANDARD CHARACTERS WITHOUT CLAIM TO ANY PARTICULAR FONT, STYLE, SIZE, OR COLOR.

FOR LUGGAGE, DUFFEL BAGS, TOTE BAGS, BACKPACKS, WALLETS, PURSES, HANDBAGS, ATTACHE CASES, WAIST PACKS, ALL PURPOSE SPORTS BAGS, SUITCASES, TOILETRY CASES SOLD EMPTY, BRIEF CASES, SHOULDER BAGS, GARMENT BAGS FOR TRAVEL, ROLL BAGS, LUGGAGE ON WHEELS, CARRY-ON BAGS AND LUGGAGE ENSEMBLES (U.S. CLS. 1, 2, 3, 22 AND 41).

FIRST USE 1-1-2004; IN COMMERCE 2-1-2004.

OOPSY DAISY

THE MARK CONSISTS OF STANDARD CHARACTERS WITHOUT CLAIM TO ANY PARTICULAR FONT, STYLE, SIZE, OR COLOR.

OWNER OF U.S. REG. NO. 2,543,025.

FOR ACCESSORIES, NAMELY, WALLETS, COIN PURSES, HANDBAGS AND BACKPACKS (U.S. CLS. 1, 2, 3, 22 AND 41).

FIRST USE 7-30-2000; IN COMMERCE 1-31-2001.

CLASS 19—NON-METALLIC BUILDING MATERIALS

3,007,603. PEACHTREE DOORS AND WINDOWS INC., NORCROSS, GA. SN 76-298,470. PUB. 11-13-2001, FILED 8-10-2001.

SYMMETRY

FOR VINYL WINDOWS AND DOORS (U.S. CLS. 1, 12, 33 AND 50).

FIRST USE 9-20-2004; IN COMMERCE 9-20-2004.

3,007,958. LORI COULTER, LLC, ST. LOUIS, MO. SN 78-387,582. PUB. 1-18-2005, FILED 3-19-2004.

LORI COULTER

THE MARK CONSISTS OF STANDARD CHARACTERS WITHOUT CLAIM TO ANY PARTICULAR FONT, STYLE, SIZE, OR COLOR.

"LORI COULTER" IDENTIFIES A PARTICULAR LIVING INDIVIDUAL WHOSE CONSENT IS OF RECORD.

FOR PURSES AND TOTE BAGS (U.S. CLS. 1, 2, 3, 22 AND 41).

FIRST USE 8-1-2004; IN COMMERCE 8-1-2004.

3,007,710. DRI-DECK ENTERPRISES, LLC, HIGHLANDS RANCH, CO. SN 76-586,720. PUB. 4-12-2005, FILED 4-14-2004.

RAINESCAPE

FOR NON-METAL PRODUCT IN THE NATURE OF A TROUGH AND DOWNSPOUT LOCATED WITHIN OR ATTACHED UNDERNEATH A DECK OR ROOF TO PROVIDE WATERPROOFING BY DIRECTING WATER AWAY FROM THE AREA UNDERNEATH THE DECK (U.S. CLS. 1, 12, 33 AND 50).

FIRST USE 5-16-2004; IN COMMERCE 5-16-2004.

CLASS 19—(Continued).

3,007,794. GRIPCO PRODUCTS, INC., N. RIDGEVILLE, IL. SN 78-233,948. PUB. 11-18-2003, FILED 4-4-2003.

DURA-THIN

FOR NON-METAL MATERIAL FOR CONSTRUCTION AND BUILDING, NAMELY, NATURAL STONE VENEER AFFIXED TO A SUBSTRATE FOR USE AS FLOORING, COUNTERTOPS, TILES AND CLADDING (U.S. CLS. 1, 12, 33 AND 50).

FIRST USE 2-28-2003; IN COMMERCE 2-28-2003.

CLASS 20—(Continued).

3,007,761. OFFICERS ONLY INCORPORATED, OGDEN, UT. SN 78-201,049. PUB. 11-18-2003, FILED 1-8-2003.



FOR NON-METAL KEY RINGS, AWARD PLAQUES (U.S. CLS. 2, 13, 22, 25, 32 AND 50).

FIRST USE 6-0-2005; IN COMMERCE 6-0-2005.

3,007,823. INCEPA REVESTIMENTOS CERAMICOS LTDA., CAMPO LARGO, BRAZIL. SN 78-275,572. PUB. 10-26-2004, FILED 7-17-2003.

Incepa

THE MARK CONSISTS OF THE WORD INCEPA APPEARING IN BLUE LETTERS, BLUE BEING CLAIMED AS AN ELEMENT OF THE MARK.

FOR NON-METAL FLOORS; NON-METAL TILES FOR FLOORS, BUILDINGS, AND WALLS; NON-METAL CLADDING FOR CONSTRUCTION AND BUILDING (U.S. CLS. 1, 12, 33 AND 50).

FIRST USE 2-26-2002; IN COMMERCE 2-26-2002.

3,007,783. LUCAS, MICHELLE, DBA LUCAS ENTERPRISES, LEXINGTON, SC. SN 78-221,695. PUB. 6-22-2004, FILED 3-5-2003.

SoftSaf

THE MARK CONSISTS OF THE COINED WORD SOFT-SAF WITH THE TWO "SS" IN UPPER CASE LETTERS AND THE REMAINDER OF THE LETTERS IN LOWER CASE, AND A HORIZONTAL LINE OVER THE LETTER A.

FOR NON-METAL, FLEXIBLE, FIRE RESISTANT CONTAINERS FOR IMPORTANT DOCUMENTS AND OBJECTS (U.S. CLS. 2, 13, 22, 25, 32 AND 50).

FIRST USE 11-1-2003; IN COMMERCE 11-1-2003.

CLASS 20—FURNITURE AND ARTICLES NOT OTHERWISE CLASSIFIED

3,007,592. HARPER, TAMMY, DBA HARPER ENTERPRISE, PHOENIX, AZ. AND HARPER, ROBERT, DBA HARPER ENTERPRISE, PHOENIX, AZ. SN 76-254,307. PUB. 4-16-2002, FILED 5-7-2001.

LADDER MATE

THE MARK CONSISTS OF STANDARD CHARACTERS WITHOUT CLAIM TO ANY PARTICULAR FONT, STYLE, SIZE, OR COLOR.

NO CLAIM IS MADE TO THE EXCLUSIVE RIGHT TO USE "LADDER", APART FROM THE MARK AS SHOWN.

FOR NON-METAL ADJUSTABLE TOOL BIN (U.S. CLS. 2, 13, 22, 25, 32 AND 50).

FIRST USE 7-6-2005; IN COMMERCE 7-6-2005.

3,007,840. HOMEDICS, INC., COMMERCE TOWNSHIP, MI. SN 78-289,588. PUB. 5-11-2004, FILED 8-20-2003.

ILLUMI-TOUCH

FOR MIRRORS (U.S. CLS. 2, 13, 22, 25, 32 AND 50). FIRST USE 7-0-2003; IN COMMERCE 7-0-2003.

CLASS 20—(Continued).

3,007,887. DPC, LLC, WHITEWATER, WI. SN 78-350,355. PUB. 10-19-2004, FILED 1-11-2004.

CLASS 20—(Continued).

3,007,985. HOWARD MILLER CLOCK COMPANY, ZEE-LAND, MI. SN 78-409,372. PUB. 3-15-2005, FILED 4-28-2004.

NYLASOFT

SMARTMOVES

THE MARK CONSISTS OF STANDARD CHARACTERS WITHOUT CLAIM TO ANY PARTICULAR FONT, STYLE, SIZE, OR COLOR.
FOR PILLOWS (U.S. CLS. 2, 13, 22, 25, 32 AND 50).
FIRST USE 3-2-2004; IN COMMERCE 3-2-2004.

THE MARK CONSISTS OF STANDARD CHARACTERS WITHOUT CLAIM TO ANY PARTICULAR FONT, STYLE, SIZE, OR COLOR.
FOR OFFICE FURNITURE (U.S. CLS. 2, 13, 22, 25, 32 AND 50).
FIRST USE 6-10-2004; IN COMMERCE 6-10-2004.

3,008,001. PAVILION FURNITURE, INC., MIAMI, FL. SN 78-420,439. PUB. 3-15-2005, FILED 5-18-2004.

3,007,888. DPC, LLC, WHITEWATER, WI. SN 78-350,356. PUB. 10-19-2004, FILED 1-11-2004.

FLUIDGUARD

SAFARI

THE MARK CONSISTS OF STANDARD CHARACTERS WITHOUT CLAIM TO ANY PARTICULAR FONT, STYLE, SIZE, OR COLOR.
FOR PILLOWS (U.S. CLS. 2, 13, 22, 25, 32 AND 50).
FIRST USE 3-11-2004; IN COMMERCE 3-11-2004.

THE MARK CONSISTS OF STANDARD CHARACTERS WITHOUT CLAIM TO ANY PARTICULAR FONT, STYLE, SIZE, OR COLOR.
FOR INDOOR/OUTDOOR FURNITURE (U.S. CLS. 2, 13, 22, 25, 32 AND 50).
FIRST USE 5-0-2003; IN COMMERCE 5-0-2003.

CLASS 20—(Continued).

3,008,008. CRYSTAL CABINET WORKS, INC., PRINCETON, MN. SN 78-422,777. PUB. 3-29-2005, FILED 5-21-2004.

KEYLINE

THE MARK CONSISTS OF STANDARD CHARACTERS WITHOUT CLAIM TO ANY PARTICULAR FONT, STYLE, SIZE, OR COLOR.

FOR FURNITURE, NAMELY CABINETS (U.S. CLS. 2, 13, 22, 25, 32 AND 50).

FIRST USE 8-31-2004; IN COMMERCE 8-31-2004.

CLASS 21—HOUSEWARES AND GLASS

3,007,654. OUTSET, INC., VICTORIA, MN. SN 76-528,963. PUB. 5-11-2004, FILED 7-11-2003.



FOR HOUSEHOLD UTENSILS, NAMELY, SPATULAS, UTENSILS FOR BARBEQUES, NAMELY, TONGS, GRILLBRUSHES, BASTING BRUSHES, NON-ELECTRIC GRILL WOKS, GRILL GRIDS, GRILL BASKETS, GRILL FISHBASKETS, KABOB RACKS, KABOB SKEWERS, CORN COB HOLDERS, GRILL CLEANERS, NAMELY, GRILL CLEANING BRUSHES, FLY SWATTERS (U.S. CLS. 2, 13, 23, 29, 30, 33, 40 AND 50).

FIRST USE 4-15-2005; IN COMMERCE 4-15-2005.

CLASS 21—(Continued).

3,007,784. BUFFETT, JIMMY, KEY WEST, FL. SN 78-221,896. PUB. 11-4-2003, FILED 3-5-2003.

MARGARITAVILLE

OWNER OF U.S. REG. NOS. 1,642,132, 2,284,131, AND OTHERS.

FOR SUNCATCHERS; FITTED PICNIC BASKETS, BOTTLE OPENERS, ICE BUCKETS, LUNCH BOXES, WASTEBASKETS NOT OF METAL, SALT AND PEPPER SHAKERS, CANISTER SETS, TRIVETS; PET FOOD BOWLS; COASTERS NOT OF PAPER AND NOT BEING TABLE LINEN; CARAFES, FLASKS AND COCKTAIL SHAKERS, COCKTAIL PICKS AND STIRS (U.S. CLS. 2, 13, 23, 29, 30, 33, 40 AND 50).

FIRST USE 9-0-1995; IN COMMERCE 9-0-1995.

3,007,859. WKI HOLDING COMPANY, INC., RESTON, VA. SN 78-311,730. PUB. 6-15-2004, FILED 10-9-2003.

INFINIA

FOR DINNERWARE, NAMELY PLATES, CUPS, SAUCERS, PLATTERS, SOUP/CEREAL BOWLS, SERVING BOWLS, CHARGERS, MUGS, SALT AND PEPPER SHAKERS, SUGAR BOWLS, CREAMERS, PITCHERS AND CAKE PEDESTALS (U.S. CLS. 2, 13, 23, 29, 30, 33, 40 AND 50).

FIRST USE 1-26-2004; IN COMMERCE 1-26-2004.

3,007,861. CARTER, JAMES, D., FAIRFIELD, CA. SN 78-314,396. PUB. 7-27-2004, FILED 10-16-2003.

PERCH ON THIS

FOR MANZANITA BIRD PERCHES (U.S. CLS. 2, 13, 23, 29, 30, 33, 40 AND 50).

FIRST USE 1-26-1999; IN COMMERCE 1-26-1999.

3,007,920. GREENE, MICHAEL, TOPANGA, CA. SN 78-364,372. PUB. 1-4-2005, FILED 2-7-2004.

THE ARTIST TRIBE

THE MARK CONSISTS OF STANDARD CHARACTERS WITHOUT CLAIM TO ANY PARTICULAR FONT, STYLE, SIZE, OR COLOR.

FOR CERAMIC SCULPTURES AND DECORATIVE TILES; HANDMADE CERAMICS, NAMELY, SCULPTURES AND DECORATIVE TILES (U.S. CLS. 2, 13, 23, 29, 30, 33, 40 AND 50).

FIRST USE 8-31-2003; IN COMMERCE 8-31-2003.

CLASS 24—FABRICS

3,007,601. AMERICAN PACIFIC ENTERPRISES, INC., SAN FRANCISCO, CA. SN 76-287,065. PUB. 11-16-2004, FILED 7-17-2001.

SUITE 109

FOR BED SHEETS, TOWELS, CURTAINS, COMFORTERS, SHAMS, DUVET COVERS, COVERLETS, QUILTS, SHOWER CURTAINS, TABLECLOTHS NOT OF PAPER, FABRIC VALANCES, TEXTILE PLACEMATS AND BED BLANKET TROWS (U.S. CLS. 42 AND 50).

FIRST USE 7-1-2001; IN COMMERCE 7-1-2001.

3,007,641. APEX INTERNATIONAL, INC., CRANBERRY TOWNSHIP, PA. SN 76-494,460. PUB. 5-25-2004, FILED 3-4-2003.

TRAILTECH

FOR FABRICS FOR USE IN THE MANUFACTURE OF BAGS, BACKPACKS AND APPAREL (U.S. CLS. 42 AND 50).

FIRST USE 7-1-2004; IN COMMERCE 7-1-2004.

3,007,708. LODESTAR TRADING INTERNATIONAL, INC., LONGMONT, CO. SN 76-585,212. PUB. 1-11-2005, FILED 4-5-2004.

FINGA-SAVA

THE MARK CONSISTS OF STANDARD CHARACTERS WITHOUT CLAIM TO ANY PARTICULAR FONT, STYLE, SIZE, OR COLOR.

FOR POT HOLDER MADE OF FABRIC (U.S. CLS. 42 AND 50).

FIRST USE 7-18-2004; IN COMMERCE 7-18-2004.

CLASS 25—CLOTHING

3,007,567. IMB TEXTIL LTDA, 415 SAO PAULO-SP, BRAZIL. SN 75-749,491. PUB. 2-19-2002, FILED 7-13-1999.

PUKET

FOR CLOTHES IN GENERAL, NAMELY SOCKS FOR MEN AND WOMAN, BODY STOCKINGS, PANTYHOSE, LEOTARDS TIGHTS, COMBINED TEE-SHIRT AND PANTIES, COMBINED HALTER TOP AND PANTIES, COMBINED BODICE AND PANTIES AND OTHER SLEEVELESS, SHORT SLEEVE, AND LONG SLEEVE BODYSUITS (U.S. CLS. 22 AND 39).

FIRST USE 10-29-1993; IN COMMERCE 10-29-1993.

CLASS 25—(Continued).

3,007,570. LITTLE TIKES COMPANY, THE, FREEPORT, IL. SN 75-934,232. PUB. 11-25-2003, FILED 3-3-2000.

LITTLE TIKES

FOR CLOTHING AND ACCESSORIES, NAMELY, SHIRTS, BLOUSES, SHORTS, PANTS, SKIRTS, SWEATERS, VESTS, SWEATSHIRTS, DRESSES, OVERALLS, COVERALLS, JUMPERS, ROMPERS, CREEPERS, ROBES, SLEEPWEAR, JACKETS, RAINCOATS, SNOW-SUITS, GLOVES, MITTENS, HATS, SCARVES, SWIMWEAR, UNDERGARMENTS, CHILDREN'S CLOTH EATING BIBS, SUSPENDERS, STOCKINGS, SOCKS, BOOTIES, SLIPPERS, SHOES AND BOOTS (U.S. CLS. 22 AND 39).

FIRST USE 9-1-2003; IN COMMERCE 9-1-2003.

3,007,573. MURRAY, AMANDA NICOLE, NEW YORK, NY. SN 76-048,987. PUB. 11-5-2002, FILED 5-16-2000.

AMANDA MURRAY

OWNER OF U.S. REG. NO. 2,798,179.
FOR BELTS; SHOES, NAMELY SANDALS AND BOOTS; BATHING SUITS; UNDERWEAR, NAMELY THONGS, BRAS, SWEATSHIRTS, T-SHIRTS, DRESSES, SHORTS, PANTS, SKIRTS, BLOUSES, CAPS AND HATS (U.S. CLS. 22 AND 39).

FIRST USE 6-4-2000; IN COMMERCE 6-4-2000.

3,007,585. SPERLONGA, RAIMONDO, NORTH HOLLYWOOD, CA. SN 76-204,937. PUB. 3-23-2004, FILED 2-5-2001.

POISON ANGEL

FOR CLUBWEAR, NAMELY, PANTS, HALTER TOPS, TUBE TOPS, SKIRTS, MINI DRESSES, GOWNS; LINGERIE, SWIMWEAR, DANCEWEAR, NAMELY, LEOTARDS, BABYDOLLS, CATSUITS, JUMPERS, ROMPERS, SHORTS, MINISKIRTS, TANK TOPS; AND HIGH HEEL SHOES AND BOOTS (U.S. CLS. 22 AND 39).

FIRST USE 1-1-2000; IN COMMERCE 2-2-2000.

CLASS 25—(Continued).

3,007,614. ORDANO, CARLOS EMILIO, PROVINCIA DE BUENOS AIRES, ARGENTINA. AND GALINDO, JOSE SEBASTIAN, PROVINCIA DE BUENOS AIRES, ARGENTINA. AND GALINDO, MARCELO, PROVINCIA DE BUENOS AIRES, ARGENTINA. SN 76-389,460. PUB. 4-29-2003, FILED 3-28-2002.



THE NAME "CAMARON BRUJO" DOES NOT IDENTIFY A LIVING INDIVIDUAL.
THE MARK CONSISTS IN PART OF A CARICATURE OF A SHRIMP.

FOR CLOTHING, NAMELY, SHORTS, SHIRTS, T-SHIRTS, SWEATSHIRTS, PANTS, SKIRTS, JEANS, SWIMWEAR, JACKETS AND CAPS (U.S. CLS. 22 AND 39).

FIRST USE 4-26-1996; IN COMMERCE 12-10-2004.

3,007,615. LAMBERT, DAVID ISRAEL, SAN SABA, TX. SN 76-391,457. PUB. 12-23-2003, FILED 4-4-2002.



FOR SHIRTS, PANTS, UNDERWEAR (U.S. CLS. 22 AND 39).

FIRST USE 9-3-2004; IN COMMERCE 9-3-2004.

3,007,629. QVC, INC., WEST CHESTER, PA. SN 76-465,237. PUB. 1-27-2004, FILED 11-7-2002.

EURO-CREPE

FOR WOMEN'S APPAREL MADE IN WHOLE OR SIGNIFICANT PART OF CREPE FABRIC, NAMELY SKIRTS, CARDIGANS, SHELLS AND PANTS (U.S. CLS. 22 AND 39).

FIRST USE 3-4-2003; IN COMMERCE 3-4-2003.

CLASS 25—(Continued).

3,007,642. FALCON FOOTWEAR, INC., NEW YORK, NY. SN 76-497,870. PUB. 2-22-2005, FILED 3-17-2003.

ENNA JETTICKS

THE MARK ENNA JETTICKS DOES NOT IDENTIFY A LIVING INDIVIDUAL.

FOR FOOTWEAR NAMELY, SHOES, BOOTS, SLIPPERS (U.S. CLS. 22 AND 39).

FIRST USE 12-4-2003; IN COMMERCE 12-4-2003.

3,007,659. STEPHENS, PETER II, BOW, WA. SN 76-535,220. PUB. 8-31-2004, FILED 8-7-2003.

Butterface

FOR T-SHIRTS, SWEATSHIRTS, HATS (U.S. CLS. 22 AND 39).

FIRST USE 8-15-2003; IN COMMERCE 11-1-2003.

3,007,669. A & H SPORTSWEAR CO., INC., STOCKERTOWN, PA. SN 76-544,956. PUB. 4-13-2004, FILED 9-2-2003.

LOOK 7 LBS. SLIMMER IN SECONDS

THE MARK CONSISTS OF STANDARD CHARACTERS WITHOUT CLAIM TO ANY PARTICULAR FONT, STYLE, SIZE, OR COLOR.

OWNER OF U.S. REG. NOS. 1,981,162, 2,340,925, AND OTHERS.

FOR MEN'S AND WOMEN'S SWIMWEAR AND SHAPEWEAR, NAMELY, SHAPERS, GIRDLES, FIGURE CONTROLLING UNDERWEAR AND BODYWEAR, NAMELY, LEOTARDS (U.S. CLS. 22 AND 39).

FIRST USE 5-1-2005; IN COMMERCE 5-1-2005.

CLASS 25—(Continued).

3,007,676. WICKID, L.L.C., RALEIGH, NC. SN 76-555,647.
PUB. 2-1-2005, FILED 10-30-2003.



WICKID
PERFORMANCE

FOR CLOTHING; NAMELY SHORT SLEEVE SHIRTS, LONG SLEEVE SHIRTS, TURTLENECKS, SWEATSHIRTS, POLO SHIRTS, SHORTS, HATS AND VISORS (U.S. CLS. 22 AND 39).
FIRST USE 1-1-2004; IN COMMERCE 1-1-2004.

CLASS 25—(Continued).

3,007,690. FIRDOSI DESIGNS INTERNATIONAL INC., MONTREAL, QUEBEC, H2X 2T6, CANADA. SN 76-570,198. PUB. 11-9-2004, FILED 1-15-2004.



FOR CLOTHING, NAMELY T-SHIRTS, UNDERWEAR, PANTS, TRACK SUITS, JACKETS, JEANS, SHIRTS, SHORTS, BATHING SUITS, CLOTHING BELTS (U.S. CLS. 22 AND 39).

FIRST USE 3-0-2005; IN COMMERCE 3-0-2005.

3,007,702. DEFINE TEASE, INC., JACKSON HEIGHTS, NY.
SN 76-576,811. PUB. 12-14-2004, FILED 2-19-2004.

DEFINE TEASE

THE MARK CONSISTS OF STANDARD CHARACTERS WITHOUT CLAIM TO ANY PARTICULAR FONT, STYLE, SIZE, OR COLOR.

FOR T-SHIRTS (U.S. CLS. 22 AND 39).
FIRST USE 7-1-2004; IN COMMERCE 7-1-2004.

3,007,677. WICKID, L.L.C., RALEIGH, NC. SN 76-555,648.
PUB. 4-19-2005, FILED 10-30-2003.



THE STIPLING IS A FEATURE OF THE MARK.
FOR CLOTHING; NAMELY SHORT SLEEVE SHIRTS, LONG SLEEVE SHIRTS, TURTLENECKS, SWEATSHIRTS, POLO SHIRTS, SHORTS, HATS AND VISORS (U.S. CLS. 22 AND 39).
FIRST USE 1-1-2004; IN COMMERCE 1-1-2004.

3,007,716. RANDALL PRODUCTIONS COMPANY, CLEVELAND, OH. SN 76-604,384. PUB. 1-18-2005, FILED 7-26-2004.

COWGIRL BY CHOICE

THE MARK CONSISTS OF STANDARD CHARACTERS WITHOUT CLAIM TO ANY PARTICULAR FONT, STYLE, SIZE, OR COLOR.

FOR APPAREL, NAMELY, JEANS, JACKETS, POLO SHIRTS, T-SHIRTS, SWEAT SHIRTS, PANTS, HATS, CAPS, GLOVES AND SOCKS (U.S. CLS. 22 AND 39).
FIRST USE 7-13-2004; IN COMMERCE 4-1-2005.

CLASS 25—(Continued).

3,007,797. VIACOM INTERNATIONAL INC., NEW YORK, NY. SN 78-238,940. PUB. 12-30-2003, FILED 4-17-2003.

JUMP FOR JOY

FOR BATHING SUITS, BATHROBES, BEACHWEAR, CLOTHING BELTS, SHORTS, JACKETS, COATS, SOCKS, FOOTWEAR, BANDANAS, SWEATERS, HALLOWEEN COSTUMES, DRESSES, GLOVES, GYM SHORTS, EAR MUFFS, NECKWEAR, PAJAMAS, PANTS, SHIRTS, SWEAT SHIRTS, SKI WEAR, SLACKS, SUN VISORS, SUSPENDERS, TURTLENECKS, UNDERCLOTHES, VESTS, WARM-UP SUITS, HEADWEAR (U.S. CLS. 22 AND 39).

FIRST USE 7-19-2004; IN COMMERCE 7-19-2004.

3,007,807. HAYES, ELIZABETH A., KOUNTZE, TX. SN 78-253,702. PUB. 5-25-2004, FILED 5-23-2003.

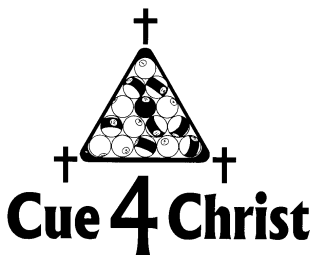

FOR SHIRTS, CAPS, JACKETS, SOCKS, SHORTS, PANT AND HEAD BANDS (U.S. CLS. 22 AND 39).
FIRST USE 5-1-2001; IN COMMERCE 5-10-2002.

3,007,811. HOP LUN FASHIONS LIMITED, ROAD TOWN TORTOLA, BR. VIRGIN ISLANDS. SN 78-262,986. PUB. 7-27-2004, FILED 6-16-2003.

NO ROMEO

FOR UNDERWEAR, SWIMWEAR AND SLEEPWEAR (U.S. CLS. 22 AND 39).
FIRST USE 4-20-2002; IN COMMERCE 4-30-2002.

3,007,817. STARBOARD CRUISE SERVICES, INC., MIAMI, FL. SN 78-270,033. PUB. 9-21-2004, FILED 7-2-2003.

GLACIER GEAR

NO CLAIM IS MADE TO THE EXCLUSIVE RIGHT TO USE "GEAR", APART FROM THE MARK AS SHOWN.

FOR CLOTHING, NAMELY, SWEATERS, JACKETS, WOVEN SHIRTS, KNIT SHIRTS, T-SHIRTS, PANTS, SHORTS SOLD ONLY ON CRUISE SHIPS (U.S. CLS. 22 AND 39).

FIRST USE 6-30-2002; IN COMMERCE 6-30-2002.

CLASS 25—(Continued).

3,007,836. GARDUNO, BARBARA (PKA NINA), LOS ANGELES, CA. SN 78-287,668. PUB. 5-11-2004, FILED 8-14-2003.

ARTYARD

FOR CLOTHING, NAMELY, JACKETS, SWEATERS, VESTS, SWEATSHIRTS, SWEATPANTS, SHIRTS, BLOUSES, T-SHIRTS, PANTS, JEANS, SHORTS, SKIRTS, DRESSES, SWIMWEAR, COVER-UPS, HEADWEAR AND FOOTWEAR (U.S. CLS. 22 AND 39).

FIRST USE 1-1-2004; IN COMMERCE 1-1-2004.

3,007,864. SPORTEX INC., DENVER, CO. SN 78-320,322. PUB. 5-17-2005, FILED 10-29-2003.

WEATHER PERFECT

FOR OUTERWEAR, NAMELY VESTS, PULLOVERS, JACKETS, WINDSHIRTS, T-SHIRTS, PARKAS (U.S. CLS. 22 AND 39).

FIRST USE 5-1-2004; IN COMMERCE 5-1-2004.

3,007,878. WALLS, TIMOTHY ROBERT, WEST BADEN SPRINGS, IN. SN 78-335,764. PUB. 10-5-2004, FILED 12-3-2003.

**AMERICAN PIT BULL
TERRIER RACING
FRENCH LICK, IN.**

THE MARK CONSISTS OF STANDARD CHARACTERS WITHOUT CLAIM TO ANY PARTICULAR FONT, STYLE, SIZE, OR COLOR.

NO CLAIM IS MADE TO THE EXCLUSIVE RIGHT TO USE "FRENCH LICK, IN.", APART FROM THE MARK AS SHOWN.

FOR CLOTHING, NAMELY, T-SHIRTS, SWEAT SHIRTS, TOBOGGAN HATS, TOBOGGAN PANTS, HATS, COATS, SHORTS, PANTIES, SWEAT BANDS, SWEAT PANTS, SWEAT SHIRTS, SWEAT SHORTS, AND SWEAT SUITS (U.S. CLS. 22 AND 39).

FIRST USE 3-0-2004; IN COMMERCE 3-0-2004.

CLASS 25—(Continued).

3,007,881. W W X APPAREL GROUP, LLC, BERNE, IN. SN 78-343,730. PUB. 11-9-2004, FILED 12-19-2003.

CLASS 25—(Continued).

3,007,934. MAY DEPARTMENT STORES INTERNATIONAL, INC., ST. LOUIS, MO. SN 78-371,431. PUB. 12-14-2004, FILED 2-20-2004.



GOOD FOR SOMETHIN'

VAL FLEX

FOR CLOTHING, NAMELY T-SHIRTS, SWEAT-SHIRTS, CAPS, HATS, JEANS, INSULATED JACKETS, AND INSULATED OVERALLS (U.S. CLS. 22 AND 39).
FIRST USE 1-2-2004; IN COMMERCE 1-5-2005.

THE MARK CONSISTS OF STANDARD CHARACTERS WITHOUT CLAIM TO ANY PARTICULAR FONT, STYLE, SIZE, OR COLOR.
FOR WOMEN'S SHOES AND BOOTS (U.S. CLS. 22 AND 39).
FIRST USE 8-1-2004; IN COMMERCE 8-1-2004.

3,007,930. DELTA SHOE GROUP, INC., MIAMI, FL. SN 78-367,930. PUB. 11-9-2004, FILED 2-13-2004.

3,007,943. THE TJX COMPANIES, INC., FRAMINGHAM, MA. SN 78-376,188. PUB. 3-22-2005, FILED 3-1-2004.

SANDRO M

KAISELY

THE MARK CONSISTS OF STANDARD CHARACTERS WITHOUT CLAIM TO ANY PARTICULAR FONT, STYLE, SIZE, OR COLOR.
FOR FOOTWEAR (U.S. CLS. 22 AND 39).
FIRST USE 6-3-2002; IN COMMERCE 6-3-2002.

THE MARK CONSISTS OF STANDARD CHARACTERS WITHOUT CLAIM TO ANY PARTICULAR FONT, STYLE, SIZE, OR COLOR.
FOR SWEATERS (U.S. CLS. 22 AND 39).
FIRST USE 7-2-2005; IN COMMERCE 7-2-2005.

CLASS 25—(Continued).

3,007,953. ADIDAS INTERNATIONAL MARKETING B.V.,
1062 KR AMSTERDAM, NETHERLANDS. SN 78-386,225.
PUB. 12-28-2004, FILED 3-17-2004.

PRO-MODERATOR

THE MARK CONSISTS OF STANDARD CHARACTERS
WITHOUT CLAIM TO ANY PARTICULAR FONT, STYLE,
SIZE, OR COLOR.
FOR ATHLETIC FOOTWEAR (U.S. CLS. 22 AND 39).
FIRST USE 5-0-2004; IN COMMERCE 1-0-2005.

3,007,972. WU, TONY, HAYWARD, CA. SN 78-397,549. PUB.
4-26-2005, FILED 4-7-2004.



THE STIPPLING IS A FEATURE OF THE MARK.
THE COLOR GRAY IS CLAIMED AS A FEATURE OF
THE MARK.

THE COLOR GRAY APPEARS IN THE CROWN, TONGUE,
AND RECTANGULAR DESIGN ELEMENTS.

FOR SWEATERS AND SPORTSWEAR, NAMELY,
PULLOVERS, CARDIGANS, PANTS, UNDERPANTS,
JACKETS, VESTS, T-SHIRTS, SOCKS, GLOVES, HATS
AND SCARVES (U.S. CLS. 22 AND 39).

FIRST USE 6-15-2004; IN COMMERCE 11-28-2004.

3,008,004. BASEBALL ACQUISITION CORPORATION, WILSONVILLE, OR. SN 78-421,797. PUB. 3-1-2005, FILED 5-19-2004.

COMFORT CHALLENGE**CLASS 25—(Continued).**

THE MARK CONSISTS OF STANDARD CHARACTERS
WITHOUT CLAIM TO ANY PARTICULAR FONT, STYLE,
SIZE, OR COLOR.

FOR FOOTWEAR (U.S. CLS. 22 AND 39).
FIRST USE 7-5-2005; IN COMMERCE 7-5-2005.

3,008,010. RJ CHISOM, LLC, SCHUYLER, NE. SN 78-424,555.
PUB. 4-19-2005, FILED 5-25-2004.

FIVE ROCK

THE MARK CONSISTS OF STANDARD CHARACTERS
WITHOUT CLAIM TO ANY PARTICULAR FONT, STYLE,
SIZE, OR COLOR.

FOR CLOTHING FOR MEN, WOMAN AND CHILDREN,
NAMELY, APRONS, BIB OVERALLS, BOOTS, BOTTOMS,
CAPS, COATS, COVERALLS, DETACHABLE HOODS FOR
JACKETS, GLOVES, HATS, HOODS, JACKETS, JEANS,
LAB COATS, LONG UNDERWEAR, OVERALLS, PANTS,
POLO SHIRTS, PONCHOS, RAIN JACKETS, RAIN PANTS,
RAIN SUITS, RAINCOATS, SHIRTS, SHORTS, SOCKS,
SUSPENDERS, SWEATPANTS, SWEATSHIRTS, TANK TOPS,
TOPS, T-SHIRTS, UNDERWEAR, AND VESTS (U.S. CLS. 22
AND 39).

FIRST USE 10-19-2004; IN COMMERCE 11-1-2004.

3,008,024. BRABHAM, AARON C., ORLANDO, FL. SN 78-976,314. PUB. 4-27-2004, FILED 10-3-2003.

DON'T GO SILVERBACK

FOR CLOTHING, NAMELY, JACKETS, PANTS, T-SHIRTS,
SHIRTS, HATS, CAPS, UNDERWEAR, SCARVES,
SKIRTS, SHORTS, HEAD BANDS, SWEAT SHIRTS,
SWEAT PANTS, SWEAT SHORTS, SWEATERS, SOCKS
AND COATS (U.S. CLS. 22 AND 39).

FIRST USE 4-20-2005; IN COMMERCE 4-20-2005.

CLASS 28—TOYS AND SPORTING GOODS

3,007,670. SCHAEFFER, GARY, NEW YORK, NY. AND
BIRNKRANT, MEL, BEACON, NY. SN 76-549,164. PUB.
6-8-2004, FILED 9-17-2003.

MYSTRON

FOR TOY ACTION FIGURES AND ACCESSORIES
THEREFORE (U.S. CLS. 22, 23, 38 AND 50).
FIRST USE 8-1-2005; IN COMMERCE 8-1-2005.

CLASS 28—(Continued).

3,007,671. SCHAEFFER, GARY, NEW YORK, NY. AND BIRNKRANT, MEL, BEACON, NY. SN 76-549,186. PUB. 6-8-2004, FILED 9-17-2003.

ALPHA 7

FOR TOY ACTION FIGURES AND ACCESSORIES THEREFORE (U.S. CLS. 22, 23, 38 AND 50).
FIRST USE 8-1-2005; IN COMMERCE 8-1-2005.

3,007,672. SCHAEFFER, GARY, NEW YORK, NY. AND BIRNKRANT, MEL, BEACON, NY. SN 76-549,190. PUB. 6-8-2004, FILED 9-17-2003.

ELECTRON +

FOR TOY ACTION FIGURES AND ACCESSORIES THEREFORE (U.S. CLS. 22, 23, 38 AND 50).
FIRST USE 8-1-2005; IN COMMERCE 8-1-2005.

3,007,673. SCHAEFFER, GARY, NEW YORK, NY. AND BIRNKRANT, MEL, BEACON, NY. SN 76-549,193. PUB. 6-8-2004, FILED 9-17-2003.

WORLD OF THE FUTURE

FOR TOY ACTION FIGURES AND ACCESSORIES THEREFORE (U.S. CLS. 22, 23, 38 AND 50).
FIRST USE 8-1-2005; IN COMMERCE 8-1-2005.

3,007,683. FUNRISE TOYS LTD., TSIMSHATSUI EAST, KOWLOON, HONG KONG. SN 76-560,741. PUB. 5-3-2005, FILED 11-17-2003.

BUBBLATOR

THE MARK CONSISTS OF STANDARD CHARACTERS WITHOUT CLAIM TO ANY PARTICULAR FONT, STYLE, SIZE, OR COLOR.

FOR TOYS, NAMELY, BUBBLE MAKING TOYS, BUBBLE MAKING TOYS SOLD AS A UNIT WITH BUBBLE MAKING WAND AND SOLUTION, BUBBLE MAKING WANDS, BUBBLE SOLUTIONS, BUBBLE MAKING WAND AND SOLUTIONS SETS, CONTAINERS FOR BUBBLE SOLUTIONS, TOY TOPS FOR CONTAINERS FOR BUBBLE SOLUTIONS, AND TOY JEWELRY (U.S. CLS. 22, 23, 38 AND 50).

FIRST USE 4-22-2004; IN COMMERCE 4-22-2004.

CLASS 28—(Continued).

3,007,693. DAISY MANUFACTURING COMPANY, ROGERS, AR. SN 76-571,993. PUB. 11-9-2004, FILED 1-27-2004.

THE NATURAL

FOR SLING SHOTS (U.S. CLS. 22, 23, 38 AND 50).
FIRST USE 8-10-2004; IN COMMERCE 8-10-2004.

3,007,718. NATIONAL PAINTBALL SUPPLY, INC., SEWELL, NJ. SN 76-977,721. PUB. 12-7-2004, FILED 8-14-2003.

SCORCHED

FOR PAINTBALL AMMUNITION (U.S. CLS. 22, 23, 38 AND 50).
FIRST USE 5-0-2005; IN COMMERCE 8-4-2005.

3,007,743. FERREZ, MARCIO, HIALEAH, FL. SN 78-155,032. PUB. 6-24-2003, FILED 8-16-2002.

Championot

FOR EXERCISING EQUIPMENT, NAMELY ROWING MACHINES (U.S. CLS. 22, 23, 38 AND 50).
FIRST USE 12-3-2003; IN COMMERCE 12-3-2003.

3,007,753. VONCO PRODUCTS, INC., LAKE VILLA, IL. SN 78-174,768. PUB. 5-27-2003, FILED 10-15-2002.

CHEER

FOR PLASTIC BALLOONS, FOIL BALLOONS, TOY INFLATABLE PLASTIC STRUCTURES, TOY INFLATABLE FOIL STRUCTURES AND INFLATABLE TOYS (U.S. CLS. 22, 23, 38 AND 50).
FIRST USE 6-24-2002; IN COMMERCE 6-24-2002.

3,007,773. MATTEL, INC., EL SEGUNDO, CA. SN 78-210,894. PUB. 7-6-2004, FILED 2-4-2003.

BASHIN' BUNNY

OWNER OF U.S. REG. NO. 2,564,660.

CLASS 28—(Continued).

NO CLAIM IS MADE TO THE EXCLUSIVE RIGHT TO USE "BUNNY", APART FROM THE MARK AS SHOWN.
 FOR TOYS, GAMES, AND PLAYTHINGS, NAMELY, PLUSH TOYS AND ACCESSORIES THEREFOR (U.S. CLS. 22, 23, 38 AND 50).
 FIRST USE 8-14-2003; IN COMMERCE 8-14-2003.

CLASS 28—(Continued).

3,007,865. AMERICAN GIRL, LLC, EL SEGUNDO, CA. SN 78-325,387. PUB. 8-10-2004, FILED 11-10-2003.

3,007,838. ITOYS INC., TORONTO, ONTARIO, CANADA. SN 78-288,713. PUB. 12-28-2004, FILED 8-18-2003.

COLOR LITE WRITER

NO CLAIM IS MADE TO THE EXCLUSIVE RIGHT TO USE COLOR LIGHT, APART FROM THE MARK AS SHOWN.
 FOR TOYS, NAMELY DRAWING TOYS (U.S. CLS. 22, 23, 38 AND 50).
 FIRST USE 9-30-2004; IN COMMERCE 9-30-2004.

3,007,842. SOFT SURFBOARDS, INC., CHARLESTON, SC. SN 78-292,889. PUB. 11-30-2004, FILED 8-27-2003.

SHREDDER

OWNER OF U.S. REG. NO. 2,756,027.
 FOR SURFBOARDS AND ACCESSORIES THEREFOR, NAMELY, SKEGS, FOOT STRAPS, FINS AND LEASHES, SKATE BOARDS AND SKATES (U.S. CLS. 22, 23, 38 AND 50).
 FIRST USE 10-1-2003; IN COMMERCE 10-1-2003.

3,007,848. HAZELQUIST, AL E., LONG BRANCH, WA. SN 78-298,089. PUB. 6-8-2004, FILED 9-9-2003.

IT'S NO DRAG

OWNER OF U.S. REG. NO. 2,490,540.
 FOR FISH ATTRACTANTS (U.S. CLS. 22, 23, 38 AND 50).
 FIRST USE 1-31-2004; IN COMMERCE 1-31-2004.

GWEN

THE MARK CONSISTS OF STANDARD CHARACTERS WITHOUT CLAIM TO ANY PARTICULAR FONT, STYLE, SIZE, OR COLOR.
 FOR DOLLS, DOLL CLOTHING, AND DOLL ACCESSORIES (U.S. CLS. 22, 23, 38 AND 50).
 FIRST USE 6-30-2004; IN COMMERCE 6-30-2004.

3,007,877. MATTEL, INC., EL SEGUNDO, CA. SN 78-335,389. PUB. 12-21-2004, FILED 12-2-2003.

SURF!

THE MARK CONSISTS OF STANDARD CHARACTERS WITHOUT CLAIM TO ANY PARTICULAR FONT, STYLE, SIZE, OR COLOR.
 OWNER OF U.S. REG. NOS. 2,483,742 AND 2,649,723.
 FOR TOYS, GAMES AND PLAYTHINGS, NAMELY, TOY CONSTRUCTION PLAY SETS, TOY CONSTRUCTION BLOCKS, CHILDREN'S CONSTRUCTION AND ART ACTIVITY TOYS; CRAFT KITS COMPRISING BLOCKS AND CONSTRUCTION TOYS (U.S. CLS. 22, 23, 38 AND 50).
 FIRST USE 5-13-2004; IN COMMERCE 5-13-2004.

CLASS 28—(Continued).

3,007,891. X.O. INDUSTRIES INC., BRAMPTON, ONTARIO, CANADA. SN 78-350,738. PUB. 11-9-2004, FILED 1-12-2004.

CLASS 28—(Continued).

3,007,893. MATTEL, INC., EL SEGUNDO, CA. SN 78-351,524. PUB. 12-7-2004, FILED 1-13-2004.

MENACE

CRASH GOLF CART

THE MARK CONSISTS OF STANDARD CHARACTERS WITHOUT CLAIM TO ANY PARTICULAR FONT, STYLE, SIZE, OR COLOR.

FOR PAINTBALLS AND PAINTBALL GUNS (U.S. CLS. 22, 23, 38 AND 50).

FIRST USE 2-28-2004; IN COMMERCE 2-28-2004.

THE MARK CONSISTS OF STANDARD CHARACTERS WITHOUT CLAIM TO ANY PARTICULAR FONT, STYLE, SIZE, OR COLOR.

NO CLAIM IS MADE TO THE EXCLUSIVE RIGHT TO USE GOLF CART, APART FROM THE MARK AS SHOWN.

FOR TOYS, GAMES AND PLAYTHINGS, NAMELY, TOY FIGURES, TOY VEHICLES AND ACCESSORIES FOR ALL OF THE FOREGOING (U.S. CLS. 22, 23, 38 AND 50).

FIRST USE 12-9-2003; IN COMMERCE 12-9-2003.

3,007,892. INRAY FITNESS PRODUCTS CORP., TAOYUAN HSIEN, TAIWAN. SN 78-350,894. PUB. 11-2-2004, FILED 1-12-2004.

3,007,894. MATTEL, INC., EL SEGUNDO, CA. SN 78-351,526. PUB. 12-7-2004, FILED 1-13-2004.

Pro Energy

CRASH SNOWMOBILE

THE MARK CONSISTS OF STANDARD CHARACTERS WITHOUT CLAIM TO ANY PARTICULAR FONT, STYLE, SIZE, OR COLOR.

FOR GYMNASTIC HORIZONTAL BARS; SPRING BARS FOR EXERCISING; MANUALLY-OPERATED EXERCISE EQUIPMENT; STATIONARY EXERCISE BICYCLES; AEROBIC STEP MACHINES; EXERCISE TRAMPOLINES; LEG WEIGHTS FOR EXERCISING; AND EXERCISING EQUIPMENTS, NAMELY, ROWING MACHINES, WEIGHT LIFTING MACHINES, PULLEYS, MANUALLY OPERATED JOGGING MACHINES, AND CHEST EXPANDERS (U.S. CLS. 22, 23, 38 AND 50).

FIRST USE 4-1-2005; IN COMMERCE 5-25-2005.

THE MARK CONSISTS OF STANDARD CHARACTERS WITHOUT CLAIM TO ANY PARTICULAR FONT, STYLE, SIZE, OR COLOR.

NO CLAIM IS MADE TO THE EXCLUSIVE RIGHT TO USE "SNOWMOBILE", APART FROM THE MARK AS SHOWN.

FOR TOYS, GAMES AND PLAYTHINGS, NAMELY, TOY FIGURES, TOY VEHICLES AND ACCESSORIES FOR ALL OF THE FOREGOING (U.S. CLS. 22, 23, 38 AND 50).

FIRST USE 12-9-2003; IN COMMERCE 12-9-2003.

CLASS 28—(Continued).

3,007,895. MATTEL, INC., EL SEGUNDO, CA. SN 78-351,529. PUB. 12-7-2004, FILED 1-13-2004.

CRASHZILLA

THE MARK CONSISTS OF STANDARD CHARACTERS WITHOUT CLAIM TO ANY PARTICULAR FONT, STYLE, SIZE, OR COLOR.

FOR TOYS, GAMES AND PLAYTHINGS, NAMELY, TOY VEHICLES, TOY VEHICLE PLAYSETS AND ACCESSORIES FOR ALL OF THE FOREGOING (U.S. CLS. 22, 23, 38 AND 50).

FIRST USE 11-21-2003; IN COMMERCE 11-21-2003.

CLASS 28—(Continued).

3,007,961. ELLIS, DUANE J, VAN, TX. SN 78-388,334. PUB. 4-12-2005, FILED 3-22-2004.



THE COLOR(S) ORANGE IS/ARE CLAIMED AS A FEATURE OF THE MARK.

THE COLOR ORANGE APPEARS IN THE DROP SHADOW OF THE WORD PRESTON AND AS A BORDER AROUND THE SHAPE WITH "THE 151 LINE" INCLUDED IN IT.

FOR MINIATURE TOY TRUCKS AND SCALE MODEL TRUCKS (U.S. CLS. 22, 23, 38 AND 50).

FIRST USE 4-1-2004; IN COMMERCE 7-1-2004.

3,008,007. ARGENT ENTERPRISES INC., CUMMING, GA. SN 78-422,710. PUB. 5-3-2005, FILED 5-21-2004.

3,007,923. DCD INC., MALIBU, CA. SN 78-365,021. PUB. 11-16-2004, FILED 2-9-2004.

FLEX SHAPER



THE MARK CONSISTS OF STANDARD CHARACTERS WITHOUT CLAIM TO ANY PARTICULAR FONT, STYLE, SIZE, OR COLOR.

FOR EXERCISE MACHINES (U.S. CLS. 22, 23, 38 AND 50).

FIRST USE 6-17-2004; IN COMMERCE 6-17-2004.

NO CLAIM IS MADE TO THE EXCLUSIVE RIGHT TO USE "BASKETBALL SYSTEMS", APART FROM THE MARK AS SHOWN.

FOR BASKETBALL GOALS (U.S. CLS. 22, 23, 38 AND 50).

FIRST USE 6-1-2005; IN COMMERCE 6-1-2005.

CLASS 28—(Continued).

3,008,019. J&M CUSTOM MOLD INC., COVENTRY, RI. SN 78-439,858. PUB. 4-26-2005, FILED 6-23-2004.

Celestial

THE MARK CONSISTS OF STANDARD CHARACTERS WITHOUT CLAIM TO ANY PARTICULAR FONT, STYLE, SIZE, OR COLOR.

FOR GOLF CLUBS (U.S. CLS. 22, 23, 38 AND 50).
FIRST USE 9-1-2004; IN COMMERCE 6-30-2005.

3,008,021. BERRYMAN, JEROME, HOUSTON, TX. SN 78-975,650. PUB. 1-11-2005, FILED 12-31-2002.

GODLY PLAY

FOR EDUCATIONAL MANIPULATIVE GAMES AND PUZZLES; ACTION FIGURES; TOY FIGURES, CARRYING CASES THEREFOR AND ACCESSORIES AND PLAYSETS SCALED TO THE FIGURES; AND TOYS, NAMELY WOODEN JIGSAW PUZZLES, WOODEN, CLOTH AND PAPER ACTION FIGURES, DOLL FURNITURE, AND WOODEN PLAYSTORY SCENERY CARDS (U.S. CLS. 22, 23, 38 AND 50).
FIRST USE 4-0-2005; IN COMMERCE 4-0-2005.

CLASS 29—MEATS AND PROCESSED FOODS

3,007,609. TEAM S.A., BOGOTA, D.C., COLOMBIA. SN 76-343,645. PUB. 5-14-2002, FILED 11-28-2001.

NOURISHES A BETTER TOMORROW

FOR MARGARINE (U.S. CL. 46).
FIRST USE 2-5-2005; IN COMMERCE 2-0-2005.

CLASS 29—(Continued).

3,007,611. CARGILL, INCORPORATED, WAYZATA, MN. SN 76-372,702. PUB. 5-13-2003, FILED 2-20-2002.



OWNER OF U.S. REG. NOS. 745,002, 2,420,757, AND OTHERS.

FOR HOUSE MARK FOR A FULL LINE OF FOOD PRODUCTS, NAMELY, MEAT, POULTRY, EGG PRODUCT, MILK, MILK PRODUCTS NOT INCLUDING ICE MILK AND MILKSHAKES, EDIBLE OILS AND FATS, DRIED AND COOKED FRUITS AND VEGETABLES, AND PROCESSED NUTS (U.S. CL. 46).

FIRST USE 8-31-2002; IN COMMERCE 8-31-2002.

3,007,639. GALAXY NUTRITIONAL FOODS, INC., ORLANDO, FL. SN 76-491,198. PUB. 12-2-2003, FILED 2-19-2003.



OWNER OF U.S. REG. NOS. 2,314,619, 2,731,446, AND OTHERS.

NO CLAIM IS MADE TO THE EXCLUSIVE RIGHT TO USE "NUTRITIONAL FOODS", APART FROM THE MARK AS SHOWN.

FOR CHEESE, CHEESE FOOD, CHEESE SPREADS; CHEESE SUBSTITUTES; IMITATION CHEESE; PEANUT BUTTER; DAIRY PRODUCTS, EXCLUDING ICE CREAM, ICE MILK, AND FROZEN YOGURT; DAIRY-BASED BEVERAGES; PLANT-BASED FOOD BEVERAGES USED AS A SUBSTITUTE FOR MILK (U.S. CL. 46).

FIRST USE 12-0-2000; IN COMMERCE 12-0-2000.

3,007,655. BLUE RUNNER FOODS, INC., GONZALES, LA. SN 76-530,481. PUB. 6-22-2004, FILED 7-2-2003.



NO CLAIM IS MADE TO THE EXCLUSIVE RIGHT TO USE CREOLE, APART FROM THE MARK AS SHOWN.

FOR SOUPS (U.S. CL. 46).
FIRST USE 1-21-2005; IN COMMERCE 1-21-2005.

CLASS 29—(Continued).

3,007,699. BONGARDS' CREAMERIES, BONGARDS, MN. SN 76-575,476. PUB. 3-29-2005, FILED 2-17-2004.

PERHAM

THE MARK CONSISTS OF STANDARD CHARACTERS WITHOUT CLAIM TO ANY PARTICULAR FONT, STYLE, SIZE, OR COLOR.

FOR WHEY PROTEIN FOOD AND BEVERAGE ADDITIVES (U.S. CL. 46).

FIRST USE 4-0-2004; IN COMMERCE 4-0-2004.

3,007,793. VISTAR CORPORATION, CENTENNIAL, CO. SN 78-231,099. PUB. 12-2-2003, FILED 3-28-2003.

STAR SIGNATURE

FOR PROCESSED MEATS, NAMELY, SAUSAGE, BRATWURST, PEPPERONI, FRUIT BASED FILLINGS FOR CAKES, PIES AND DOUGHNUTS; EDIBLE OILS; PROCESSED NUTS; BULK SNACKS, NAMELY, POTATO CHIPS AND TRAIL MIX CONSISTING PRIMARILY OF PROCESSED NUTS AND DRIED FRUIT (U.S. CL. 46).

FIRST USE 1-7-2004; IN COMMERCE 1-7-2004.

3,007,810. SNYDER, LLC, WENATCHEE, WA. SN 78-261,817. PUB. 8-10-2004, FILED 6-12-2003.

GRAPPLE

FOR PROCESSED FLAVORED APPLES (U.S. CL. 46).
FIRST USE 7-22-2004; IN COMMERCE 7-0-2004.

3,007,858. SEVEN SEAS SEAFOODS, INC., ALHAMBRA, CA. SN 78-311,497. PUB. 8-10-2004, FILED 10-9-2003.

PURSMOKE

FOR MEAT, PRESERVED MEAT, PROCESSED MEAT, FISH, PRESERVED FISH, AND PROCESSED FISH (U.S. CL. 46).

FIRST USE 6-1-2004; IN COMMERCE 7-2-2004.

CLASS 29—(Continued).

3,007,884. ESSENTIAL LIVING FOODS, INC., SAN LUIS OBISPO, CA. SN 78-346,500. PUB. 11-16-2004, FILED 12-30-2003.

Flaxitos

THE MARK CONSISTS OF STANDARD CHARACTERS WITHOUT CLAIM TO ANY PARTICULAR FONT, STYLE, SIZE, OR COLOR.

FOR DEHYDRATED SNACK CHIPS MANUFACTURED FROM FLAX SEEDS (U.S. CL. 46).

FIRST USE 1-1-2005; IN COMMERCE 1-1-2005.

3,007,899. CREATIVE FOOD MARKETING, INC., MADISON, WI. SN 78-354,024. PUB. 11-9-2004, FILED 1-20-2004.

KLONDIKE CLASSIC

THE MARK CONSISTS OF STANDARD CHARACTERS WITHOUT CLAIM TO ANY PARTICULAR FONT, STYLE, SIZE, OR COLOR.

FOR MEATS, NAMELY FRESH, FROZEN AND SMOKED BEEF, AND PORK (U.S. CL. 46).

FIRST USE 3-5-2004; IN COMMERCE 3-5-2004.

3,007,968. ALEXIA FOODS, INC., BROOKLYN, NY. SN 78-392,785. PUB. 3-15-2005, FILED 3-29-2004.

ALEXIA ONION RINGS

THE MARK CONSISTS OF STANDARD CHARACTERS WITHOUT CLAIM TO ANY PARTICULAR FONT, STYLE, SIZE, OR COLOR.

OWNER OF U.S. REG. NOS. 2,740,755, 2,843,522, AND

CLASS 29—(Continued).

OTHERS.

NO CLAIM IS MADE TO THE EXCLUSIVE RIGHT TO USE "ONION RINGS", APART FROM THE MARK AS SHOWN.

FOR PROCESSED FOOD, NAMELY, ONION RINGS (U.S. CL. 46).

FIRST USE 12-10-2004; IN COMMERCE 12-10-2004.

3,007,969. ALEXIA FOODS, INC., BROOKLYN, NY. SN 78-392,797. PUB. 3-15-2005, FILED 3-29-2004.

ALEXIA MUSHROOM BITES

THE MARK CONSISTS OF STANDARD CHARACTERS WITHOUT CLAIM TO ANY PARTICULAR FONT, STYLE, SIZE, OR COLOR.

OWNER OF U.S. REG. NOS. 2,740,755, 2,843,522, AND OTHERS.

NO CLAIM IS MADE TO THE EXCLUSIVE RIGHT TO USE "MUSHROOM BITES", APART FROM THE MARK AS SHOWN.

FOR PROCESSED FOOD, NAMELY, MUSHROOMS (U.S. CL. 46).

FIRST USE 8-16-2004; IN COMMERCE 8-16-2004.

3,007,978. ALEXIA FOODS, INC., BROOKLYN, NY. SN 78-403,119. PUB. 3-29-2005, FILED 4-16-2004.

ALEXIA OVEN BLENDS

THE MARK CONSISTS OF STANDARD CHARACTERS WITHOUT CLAIM TO ANY PARTICULAR FONT, STYLE, SIZE, OR COLOR.

OWNER OF U.S. REG. NOS. 2,740,755, 2,843,522, AND OTHERS.

FOR FROZEN FRENCH FRIED POTATOES (U.S. CL. 46).

FIRST USE 12-10-2004; IN COMMERCE 12-10-2004.

CLASS 30—STAPLE FOODS**CLASS 30—(Continued).**

3,007,679. CONSPIRACY, LLC, OCONOMOWOC, WI. SN 76-556,352. PUB. 4-26-2005, FILED 11-4-2003.

THE RIGHT WING SAUCE

THE MARK CONSISTS OF STANDARD CHARACTERS WITHOUT CLAIM TO ANY PARTICULAR FONT, STYLE, SIZE, OR COLOR.

NO CLAIM IS MADE TO THE EXCLUSIVE RIGHT TO USE "SAUCE", APART FROM THE MARK AS SHOWN.

FOR EDIBLE DIPPING AND COATING SAUCE (U.S. CL. 46).

FIRST USE 8-1-2001; IN COMMERCE 3-1-2003.

3,007,736. GINA L. DAVIS, OVIEDO, FL. SN 78-131,962. PUB. 10-21-2003, FILED 5-30-2002.



FOR GOURMET POPPED POPCORN (U.S. CL. 46).
FIRST USE 6-12-1998; IN COMMERCE 10-12-1998.

3,007,799. TOM STURGIS PRETZELS, INC., READING, PA. SN 78-239,420. PUB. 11-30-2004, FILED 4-18-2003.

STURGIS

OWNER OF U.S. REG. NOS. 694,998 AND 2,467,756.
FOR SNACK FOODS, NAMELY POPCORN, PRETZELS, GRAIN BASED SNACKS AND CEREAL BASED SNACKS; AND MUSTARD (U.S. CL. 46).

FIRST USE 8-1-2005; IN COMMERCE 8-1-2005.

3,007,849. GENERAL MILLS, INC., MINNEAPOLIS, MN. SN 78-299,845. PUB. 4-12-2005, FILED 9-12-2003.

MEDALLA DE ORO

OWNER OF U.S. REG. NOS. 573,406, 1,544,732, AND OTHERS.

THE FOREIGN WORDING IN THE MARK TRANSLATES INTO ENGLISH AS GOLD MEDAL.

FOR FLOUR (U.S. CL. 46).

FIRST USE 11-30-2003; IN COMMERCE 11-30-2003.

CLASS 30—(Continued).

3,007,855. WYHE'S CHOICE, INC., LESTER, IA. SN 78-309,300. PUB. 4-19-2005, FILED 10-3-2003.



NO CLAIM IS MADE TO THE EXCLUSIVE RIGHT TO USE "GENERATIONS OF QUALITY" AND "MADE IN LESTER, IOWA" AND "FROZEN FOOD", APART FROM THE MARK AS SHOWN.

THE COLOR(S) ORANGE, BLUE AND YELLOW IS/ARE CLAIMED AS A FEATURE OF THE MARK.

ORANGE APPEARS IN THE SCARVES AND THE SEMI-CIRCULAR RING OVER THE TOP OF THE MARK. BLUE APPEARS IN THE BANNER, HATS AND WORDING AT TOP AND BOTTOM OF THE MARK. YELLOW APPEARS IN THE HAIR OF TWO OF THE MEN IN THE MARK.

THE MARK CONSISTS OF THREE MEN OF VARIOUS AGES WEARING HATS AND SCARVES. THERE IS A RING OVER THE TOP OF THE THREE MEN. THERE IS A BANNER UNDER THE THREE MEN.

FOR FROZEN COOKIE DOUGH, PASTRY DOUGH, BREADS, PIZZA, MUFFINS, PIES, BAKERY GOODS, CALZONES WITH MEAT AND CHEESE (U.S. CL. 46).

FIRST USE 2-1-2004; IN COMMERCE 2-1-2004.

3,007,860. ANNIE'S ENTERPRISES, INC., NORTH CALAIS, VT. SN 78-312,958. PUB. 5-25-2004, FILED 10-13-2003.

FOOD FOR THE NEXT GENERATION

FOR SAUCES; CONDIMENTS, NAMELY, SALAD DRESSINGS (U.S. CL. 46).
FIRST USE 2-10-2004; IN COMMERCE 2-10-2004.

CLASS 30—(Continued).

3,007,903. ROBIN HOOD MULTIFOODS CORPORATION, MARKHAM, ONTARIO, CANADA. SN 78-355,875. PUB. 11-9-2004, FILED 1-22-2004.

GOLDEN TEMPLE

THE MARK CONSISTS OF STANDARD CHARACTERS WITHOUT CLAIM TO ANY PARTICULAR FONT, STYLE, SIZE, OR COLOR.

OWNER OF U.S. REG. NOS. 1,297,895 AND 2,026,781.
FOR RICE; FLOUR; AND FROZEN DOUGH (U.S. CL. 46).

FIRST USE 11-1-1987; IN COMMERCE 11-1-1987.

3,007,916. MAXIOM LLC, MILWAUKEE, WI. SN 78-361,323. PUB. 11-9-2004, FILED 2-2-2004.

ELIXIR MIXER FIXER

THE MARK CONSISTS OF STANDARD CHARACTERS WITHOUT CLAIM TO ANY PARTICULAR FONT, STYLE, SIZE, OR COLOR.

FOR NUTRITIONAL GRAIN-BASED READY-TO-EAT FOOD BARS AND SNACKS (U.S. CL. 46).

FIRST USE 7-25-2005; IN COMMERCE 7-25-2005.

3,007,942. TONE BROTHERS, INC., ANKENY, IA. SN 78-375,712. PUB. 3-29-2005, FILED 2-27-2004.

ETHNIC CREATIONS

THE MARK CONSISTS OF STANDARD CHARACTERS WITHOUT CLAIM TO ANY PARTICULAR FONT, STYLE, SIZE, OR COLOR.

NO CLAIM IS MADE TO THE EXCLUSIVE RIGHT TO USE "ETHNIC", APART FROM THE MARK AS SHOWN.
FOR SPICES, SEASONINGS FOR FOODS, SAUCES AND MARINADES (U.S. CL. 46).

FIRST USE 5-25-2004; IN COMMERCE 5-25-2004.

CLASS 30—(Continued).

3,007,948. COMERCIAL AARMES, S.A. DE C.V., MONTEREY, NUEVO LEON, MEXICO. SN 78-380,815. PUB. 12-7-2004, FILED 3-9-2004.



FOR CORN TOSTADAS AND CORN CHIPS (U.S. CL. 46).
FIRST USE 3-16-2005; IN COMMERCE 3-16-2005.

3,007,987. CADBURY ADAMS USA LLC, PARSIPPANY, NJ. SN 78-410,964. PUB. 2-8-2005, FILED 4-30-2004.

MAXAIR

THE MARK CONSISTS OF STANDARD CHARACTERS WITHOUT CLAIM TO ANY PARTICULAR FONT, STYLE, SIZE, OR COLOR.
FOR CONFECTIONERY, NAMELY CHEWING GUM (U.S. CL. 46).
FIRST USE 8-1-2004; IN COMMERCE 8-1-2004.

CLASS 30—(Continued).

3,008,016. PIE-IN-THE-SKY, INC., BETTENDORF, IA. SN 78-432,547. PUB. 5-10-2005, FILED 6-9-2004.

**NONNA ROSE'S
RECIPE**

THE MARK CONSISTS OF STANDARD CHARACTERS WITHOUT CLAIM TO ANY PARTICULAR FONT, STYLE, SIZE, OR COLOR.
NO CLAIM IS MADE TO THE EXCLUSIVE RIGHT TO USE "RECIPE", APART FROM THE MARK AS SHOWN.
THE ENGLISH TRANSLATION OF THE WORD "NONNA" IN THE MARK IS "GRANDMOTHER".
FOR PIZZA SAUCE AND FROZEN PIZZA (U.S. CL. 46).
FIRST USE 10-27-2004; IN COMMERCE 10-27-2004.

CLASS 31—NATURAL AGRICULTURAL PRODUCTS

3,007,565. N-VIRO INTERNATIONAL CORPORATION, TOLEDO, OH. SN 75-677,806. PUB. 11-16-2004, FILED 4-6-1999.

BIOBLEND

FOR TOP SOIL (U.S. CLS. 1 AND 46).
FIRST USE 7-27-2005; IN COMMERCE 7-27-2005.

3,007,612. CARGILL, INCORPORATED, WAYZATA, MN. SN 76-372,998. PUB. 10-28-2003, FILED 2-20-2002.



OWNER OF U.S. REG. NOS. 745,002, 2,420,757, AND OTHERS.
FOR HOUSE MARK FOR A FULL LINE OF AGRICULTURAL PRODUCTS AND GRAINS, NAMELY, UNPROCESSED GRAINS, AGRICULTURAL GRAINS FOR PLANTING, AGRICULTURAL SEEDS AND FOODSTUFFS FOR ANIMALS (U.S. CLS. 1 AND 46).
FIRST USE 8-31-2002; IN COMMERCE 8-31-2002.

CLASS 31—(Continued).

3,007,692. MEOW MIX COMPANY, THE, SECAUCUS, NJ. SN 76-571,808. PUB. 4-19-2005, FILED 1-26-2004.

SURF 'N TURF

THE MARK CONSISTS OF STANDARD CHARACTERS WITHOUT CLAIM TO ANY PARTICULAR FONT, STYLE, SIZE, OR COLOR.

FOR CAT FOOD AND CAT TREATS (U.S. CLS. 1 AND 46).

FIRST USE 3-15-2005; IN COMMERCE 3-15-2005.

3,007,697. FRIEDA'S, INC., LOS ALAMITOS, CA. SN 76-574,231. PUB. 11-16-2004, FILED 2-5-2004.

PANGO MANGO

THE MARK CONSISTS OF STANDARD CHARACTERS WITHOUT CLAIM TO ANY PARTICULAR FONT, STYLE, SIZE, OR COLOR.

NO CLAIM IS MADE TO THE EXCLUSIVE RIGHT TO USE "MANGO", APART FROM THE MARK AS SHOWN.

FOR FRESH MANGOES (U.S. CLS. 1 AND 46).

FIRST USE 7-22-2005; IN COMMERCE 7-22-2005.

CLASS 32—LIGHT BEVERAGES

3,007,656. SPOETZL BREWERY, INC., SAN ANTONIO, TX. SN 76-532,119. PUB. 4-13-2004, FILED 7-21-2003.

DRINK ONE. YOU'LL UNDERSTAND.

FOR BEER (U.S. CLS. 45, 46 AND 48).

FIRST USE 10-1-2003; IN COMMERCE 10-1-2003.

3,007,786. STONE BREWING COMPANY, SAN MARCOS, CA. SN 78-222,999. PUB. 7-13-2004, FILED 3-7-2003.

BASTARD

OWNER OF U.S. REG. NOS. 2,283,904 AND 2,353,573. FOR BEERS AND ALES (U.S. CLS. 45, 46 AND 48).

FIRST USE 1-1-1998; IN COMMERCE 1-1-1998.

CLASS 32—(Continued).

3,007,806. THE COCA-COLA COMPANY, ATLANTA, GA. SN 78-251,228. PUB. 8-10-2004, FILED 5-17-2003.

CAN'T LIVE WITHOUT IT

FOR BEVERAGES, NAMELY, DRINKING WATERS, BOTTLED WATERS, FLAVORED WATERS, MINERAL AND AERATED WATERS; SYRUPS, CONCENTRATES AND POWDERS FOR MAKING BEVERAGES, NAMELY, MINERAL AND AERATED WATERS (U.S. CLS. 45, 46 AND 48).

FIRST USE 6-30-2003; IN COMMERCE 6-30-2003.

3,007,897. QUIKTRIP WEST, INC., WICHITA, KS. SN 78-352,419. PUB. 10-19-2004, FILED 1-15-2004.

WALLY'S JABBERBERRY

THE MARK CONSISTS OF STANDARD CHARACTERS WITHOUT CLAIM TO ANY PARTICULAR FONT, STYLE, SIZE, OR COLOR.

FOR BOTTLED FRUIT FLAVORED BEVERAGES (U.S. CLS. 45, 46 AND 48).

FIRST USE 4-0-2004; IN COMMERCE 4-0-2004.

CLASS 33—WINES AND SPIRITS

3,007,682. C AND C WINE SERVICES, SANTA ROSA, CA. SN 76-560,374. PUB. 9-28-2004, FILED 11-17-2003.

THE TILLERMAN

THE MARK CONSISTS OF STANDARD CHARACTERS WITHOUT CLAIM TO ANY PARTICULAR FONT, STYLE, SIZE, OR COLOR.

FOR WINE (U.S. CLS. 47 AND 49).

FIRST USE 11-18-2004; IN COMMERCE 11-18-2004.

3,007,726. FIRESTEED CORPORATION, SEATTLE, WA. SN 78-090,391. PUB. 5-7-2002, FILED 10-26-2001.

FIRESTEED CITATION

OWNER OF U.S. REG. NOS. 1,806,829, 2,326,993, AND OTHERS.

FOR WINE (U.S. CLS. 47 AND 49).

FIRST USE 11-0-2003; IN COMMERCE 11-0-2004.

CLASS 33—(Continued).

3,007,782. SAVISA (PTY) LTD, WINDMEUL, SOUTH AFRICA. SN 78-221,576. PUB. 10-12-2004, FILED 3-4-2003.



NO CLAIM IS MADE TO THE EXCLUSIVE RIGHT TO USE "AFRICAN", APART FROM THE MARK AS SHOWN. THE MARK CONSISTS OF WORDS AFRICAN TERROIR IN CAPITAL LETTERS BETWEEN TWO HORIZONTAL BARS SEPARATED BY AN AFRICAN TRIBAL SPEAR.

THE ENGLISH TRANSLATION OF THE WORD TERROIR IN THE MARK IS SOIL AND REGION.

FOR ALCOHOLIC BEVERAGES, NAMELY WINES, DISTILLED SPIRITS, LIQUEURS, BRANDY AND COGNAC (U.S. CLS. 47 AND 49).

FIRST USE 12-31-2002; IN COMMERCE 8-31-2003.

CLASS 33—(Continued).

3,007,907. HARDY WINE COMPANY LIMITED, REYNELLA SOUTH AUSTRALIA, AUSTRALIA. SN 78-357,798. PUB. 11-9-2004, FILED 1-26-2004.

OOMOO

THE MARK CONSISTS OF STANDARD CHARACTERS WITHOUT CLAIM TO ANY PARTICULAR FONT, STYLE, SIZE, OR COLOR.

FOR WINE (U.S. CLS. 47 AND 49).

FIRST USE 4-7-2005; IN COMMERCE 4-7-2005.

3,007,885. UNFILTERED NAPA LLC, NAPA, CA. SN 78-348,475. PUB. 11-2-2004, FILED 1-6-2004.

SEVEN SINNERS

THE MARK CONSISTS OF STANDARD CHARACTERS WITHOUT CLAIM TO ANY PARTICULAR FONT, STYLE, SIZE, OR COLOR.

FOR WINE (U.S. CLS. 47 AND 49).

FIRST USE 1-31-2004; IN COMMERCE 3-16-2004.

CLASS 34—SMOKERS' ARTICLES

3,007,833. CALICO BRANDS, INC., ONTARIO, CA. SN 78-284,950. PUB. 5-4-2004, FILED 8-8-2003.

GEMTONES

FOR DISPOSABLE CIGARETTE LIGHTERS (U.S. CLS. 2, 8, 9 AND 17).

FIRST USE 2-16-2005; IN COMMERCE 2-16-2005.

SERVICE MARKS

CLASS 35—ADVERTISING AND BUSINESS

CLASS 35—(Continued).

3,007,606. MUFFLER 1 AMERICA CORPORATION, UNIONDALE, NY. SN 76-324,038. PUB. 5-21-2002, FILED 10-12-2001.



NO CLAIM IS MADE TO THE EXCLUSIVE RIGHT TO USE "MUFFLER" AND "AMERICA", APART FROM THE MARK AS SHOWN.

FOR WHOLESALE OUTLET SERVICES IN THE FIELD OF AUTOMOTIVE EQUIPMENT (U.S. CLS. 100, 101 AND 102).

FIRST USE 3-1-2005; IN COMMERCE 3-1-2005.

3,007,631. KENTON COUNTY AIRPORT BOARD, HEBRON, KY. SN 76-470,627. PUB. 10-26-2004, FILED 11-29-2002.

SKY SHOPS AT CVG

NO CLAIM IS MADE TO THE EXCLUSIVE RIGHT TO USE "SHOPS AT CVG", APART FROM THE MARK AS SHOWN.

FOR MALL AND RETAIL STORE SERVICES FOR GIFTS, CLOTHING AND CONCESSIONS, IN THE NATURE OF FOOD AND SOUVENIRS (U.S. CLS. 100, 101 AND 102).

FIRST USE 3-0-2003; IN COMMERCE 3-0-2003.

3,007,660. COURTNEY, KEVIN C., IRVINE, CA. SN 76-536,062. PUB. 10-12-2004, FILED 7-28-2003.



FOR RETAIL CONVENIENCE STORE SERVICES (U.S. CLS. 100, 101 AND 102).

FIRST USE 4-0-2004; IN COMMERCE 4-0-2004.

CLASS 35—(Continued).

3,007,666. SMART INTERNATIONAL, LLC, DEVON, PA. SN 76-540,912. PUB. 11-30-2004, FILED 8-29-2003.



NO CLAIM IS MADE TO THE EXCLUSIVE RIGHT TO USE "INTERNATIONAL, LLC", APART FROM THE MARK AS SHOWN.

FOR ACCOUNTING AND BUSINESS MANAGEMENT CONSULTING SERVICES (U.S. CLS. 100, 101 AND 102).

FIRST USE 7-11-2003; IN COMMERCE 7-11-2003.

3,007,668. HARRIS ADVISORS LLC, RACINE, WI. SN 76-541,522. PUB. 6-15-2004, FILED 9-2-2003.

NOVO

THE ENGLISH TRANSLATION OF THE LATIN WORDING "NOVO" IS "REVOLUTIONIZE".

FOR EXECUTIVE AND PROFESSIONAL EMPLOYMENT RECRUITING SERVICES (U.S. CLS. 100, 101 AND 102).

FIRST USE 10-0-2003; IN COMMERCE 10-0-2003.

3,007,700. SUPPER THYME USA FRANCHISE SERVICE, L.L.C., OMAHA, NE. SN 76-576,200. PUB. 1-25-2005, FILED 2-13-2004.

SUPPER THYME USA

THE MARK CONSISTS OF STANDARD CHARACTERS WITHOUT CLAIM TO ANY PARTICULAR FONT, STYLE, SIZE, OR COLOR.

NO CLAIM IS MADE TO THE EXCLUSIVE RIGHT TO USE "USA", APART FROM THE MARK AS SHOWN.

FOR FRANCHISING, NAMELY, OFFERING TECHNICAL ASSISTANCE IN THE ESTABLISHMENT AND/OR OPERATION OF A BUSINESS THAT OFFERS SOCIAL AND INSTRUCTIONAL CLASSES IN WHICH MEALS ARE PREPARED FOR CONSUMPTION LATER (U.S. CLS. 100, 101 AND 102).

FIRST USE 7-13-2004; IN COMMERCE 7-13-2004.

CLASS 35—(Continued).

3,007,707. CITY OF ST. CLAIR SHORES, MICHIGAN, ST. CLAIR SHORES, MI. SN 76-584,349. PUB. 1-25-2005, FILED 4-1-2004.

CITY OF LIGHTS -**ST. CLAIR SHORES, MICHIGAN**

THE MARK CONSISTS OF STANDARD CHARACTERS WITHOUT CLAIM TO ANY PARTICULAR FONT, STYLE, SIZE, OR COLOR.

NO CLAIM IS MADE TO THE EXCLUSIVE RIGHT TO USE "ST. CLAIR SHORES, MICHIGAN", APART FROM THE MARK AS SHOWN.

FOR PROMOTING THE ECONOMIC DEVELOPMENT OF THE CITY OF ST CLAIR SHORES, MICHIGAN (U.S. CLS. 100, 101 AND 102).

FIRST USE 7-22-2005; IN COMMERCE 7-22-2005.

3,007,723. HHS, HEALTH OPTIONS, GRAND RAPIDS, MI. SN 78-071,191. PUB. 5-28-2002, FILED 6-27-2001.

CARE RESOURCES

NO CLAIM IS MADE TO THE EXCLUSIVE RIGHT TO USE "RESOURCES", APART FROM THE MARK AS SHOWN.

FOR COST MANAGEMENT SERVICES FOR HEALTH CARE BENEFIT PLANS OF OTHERS, HEALTH CARE COST CONTAINMENT SERVICES, AND HEALTH CARE COST REVIEW SERVICES (U.S. CLS. 100, 101 AND 102).

FIRST USE 12-31-2004; IN COMMERCE 12-31-2004.

3,007,724. FEDCHAMBER, LLC, DBA FEDERAL CHAMBER OF COMMERCE, LAS VEGAS, NV. SN 78-076,711. PUB. 9-17-2002, FILED 7-31-2001.

**FEDERAL CHAMBER OF
COMMERCE**

NO CLAIM IS MADE TO THE EXCLUSIVE RIGHT TO USE "FEDERAL", APART FROM THE MARK AS SHOWN.

FOR ADMINISTRATION OF A DISCOUNT PROGRAM FOR ENABLING PARTICIPANTS TO OBTAIN DISCOUNTS ON HEALTHCARE, TRAVEL, FINANCIAL AND OTHER SERVICES THROUGH USE OF A DISCOUNT MEMBERSHIP CARD (U.S. CLS. 100, 101 AND 102).

FIRST USE 3-4-2001; IN COMMERCE 3-4-2001.

CLASS 35—(Continued).

3,007,788. AUTOGAS SYSTEMS, INC., ABILENE, TX. SN 78-225,176. PUB. 6-1-2004, FILED 3-13-2003.

**C E N T E R G O
M A R K E T I N G**

NO CLAIM IS MADE TO THE EXCLUSIVE RIGHT TO USE "MARKETING", APART FROM THE MARK AS SHOWN.

FOR PROMOTION OF THE GOODS AND SERVICES OF OTHERS VIA CONSUMER PROMOTION PROGRAMS THAT PROVIDE REWARDS ON DEFINED PRODUCTS AND SERVICES (U.S. CLS. 100, 101 AND 102).

FIRST USE 3-10-2003; IN COMMERCE 3-10-2003.

3,007,804. GECKO DEVELOPMENT, CORP., HINSDALE, IL. SN 78-250,097. PUB. 12-30-2003, FILED 5-15-2003.

**WORK HARD. PLAY
HARDER!**

FOR EMPLOYMENT AGENCY SERVICES, NAMELY, RECRUITING AND EMPLOYEE SEARCH SERVICES SPECIALIZING IN THE RESTAURANT AND HOSPITALITY INDUSTRIES. (U.S. CLS. 100, 101 AND 102).

FIRST USE 1-1-2004; IN COMMERCE 1-1-2004.

3,007,809. TATSUGAWA, MIKE, MONTEREY PARK, CA. SN 78-256,731. PUB. 12-23-2003, FILED 6-2-2003.

PACIFIC MEDIA EXPO

NO CLAIM IS MADE TO THE EXCLUSIVE RIGHT TO USE "MEDIA EXPO", APART FROM THE MARK AS SHOWN.

FOR PROMOTING AND CONDUCTING TRADE SHOWS IN THE FIELD OF ASIAN/AMERICAN MEDIA AND LEISURE (U.S. CLS. 100, 101 AND 102).

FIRST USE 7-4-2003; IN COMMERCE 7-4-2003.

3,007,812. BRANDBREW SA. L-5365 MUNSBACH, LUXEMBOURG. SN 78-263,357. PUB. 11-30-2004, FILED 6-17-2003.

BASSMOBILE

OWNER OF U.S. REG. NOS. 88,266, 2,087,927, AND OTHERS.

FOR ADVERTISING SERVICES, NAMELY PROMOTING THE SERVICES PROVIDED BY THE BEER AND MALT INDUSTRY THROUGH THE DISTRIBUTION OF PRINTED, PROMOTIONAL MATERIALS AND BY RENDERING SALES PROMOTION ADVICE (U.S. CLS. 100, 101 AND 102).

FIRST USE 9-0-2003; IN COMMERCE 9-0-2003.

CLASS 35—(Continued).

3,007,868. FRED MEYER STORES, INC., PORTLAND, OR. SN 78-327,941. PUB. 4-12-2005, FILED 11-14-2003.

FMSTORE 24/7

THE MARK CONSISTS OF STANDARD CHARACTERS WITHOUT CLAIM TO ANY PARTICULAR FONT, STYLE, SIZE, OR COLOR.

NO CLAIM IS MADE TO THE EXCLUSIVE RIGHT TO USE "24/7", APART FROM THE MARK AS SHOWN.

FOR ONLINE RETAIL STORE SERVICES IN THE FIELD OF MUSIC, MOVIES, AND VIDEO GAME PRODUCTS, AND ACCESSORIES RELATED THERETO (U.S. CLS. 100, 101 AND 102).

FIRST USE 11-17-2003; IN COMMERCE 11-17-2003.

3,007,869. MARCUS, SAMUEL H, RYE BROOK, NY. SN 78-328,154. PUB. 12-7-2004, FILED 11-14-2003.

The Marcus Consulting Group
Maximizing Individual and Organization Performance

NO CLAIM IS MADE TO THE EXCLUSIVE RIGHT TO USE "CONSULTING GROUP", APART FROM THE MARK AS SHOWN.

THE COLOR(S) CHARCOLE GREY AND MAROON (DARK RED) IS/ARE CLAIMED AS A FEATURE OF THE MARK.

THE MARK CONSISTS OF "THE MARCUS CONSULTING GROUP" IN CHARCOLE GRAY LETTERS WITH FADING (FROM THE CENTER DOT OUTWARD), VERTICAL DOTS SEPARATING THE WORDS "MARCUS" AND "CONSULTING". UNDERNEATH "CONSULTING" STATES THE LINE "MAXIMIZING INDIVIDUAL AND ORGANIZATION PERFORMANCE" IN SMALLER, MAROON LETTERS.

FOR BUSINESS CONSULTING SERVICES RELATING TO HUMAN RESOURCES, EXECUTIVE COACHING, INTERGROUP CONFLICT RESOLUTION AND PROBLEM SOLVING, SENIOR TEAM ALIGNMENT AND DEVELOPMENT, COMMUNICATION AND ORGANIZATIONAL SOLUTIONS (U.S. CLS. 100, 101 AND 102).

FIRST USE 5-1-2004; IN COMMERCE 5-1-2004.

CLASS 35—(Continued).

3,007,875. SCHOOL SPECIALTY, INC., APPLETON, WI. SN 78-331,687. PUB. 4-19-2005, FILED 11-21-2003.



OWNER OF U.S. REG. NOS. 2,086,842 AND 2,351,297.

SEC. 2(F) AS TO "SCHOOL SPECIALTY".

FOR MAIL ORDER CATALOG SERVICES, MAIL ORDER SERVICES, AND ON-LINE ORDERING SERVICES, ALL FEATURING EDUCATIONAL MATERIALS (U.S. CLS. 100, 101 AND 102).

FIRST USE 1-8-2004; IN COMMERCE 1-8-2004.

3,007,876. WESTERBERG, LINDA ROG, DALLAS, TX. SN 78-332,598. PUB. 11-30-2004, FILED 11-24-2003.



NO CLAIM IS MADE TO THE EXCLUSIVE RIGHT TO USE "STRATEGIES", APART FROM THE MARK AS SHOWN.

THE MARK CONSISTS OF STYLIZED LETTERING OF CI AND IS INTERTWINED WITH ONE ANOTHER IN SUCH A WAY THAT IT CAN BE READ FROM NORTH TO SOUTH OR VICE VERSA; THE AFOREMENTIONED CI RESTS ABOVE A HORIZONTAL LINE WITH STYLIZED LETTERING OF CI STRATEGIES UNDERNEATH.

FOR BUSINESS CONSULTATION, NAMELY, PROJECT MANAGEMENT AND PERFORMANCE CONSULTING; BUSINESS CONSULTATION, NAMELY, PROVIDING CONTINUOUS IMPROVEMENT STRATEGIES FOR SALES AND TRAINING (U.S. CLS. 100, 101 AND 102).

FIRST USE 1-1-2004; IN COMMERCE 1-1-2004.

CLASS 35—(Continued).

3,007,898. QVC, INC., WEST CHESTER, PA. SN 78-353,180. PUB. 10-19-2004, FILED 1-16-2004.

CLASS 35—(Continued).

3,007,914. ETR GROUP, LLC, MEQUON, WI. SN 78-361,312. PUB. 11-16-2004, FILED 2-2-2004.

YOUR TOTAL LOOK

ZAK BLACK

THE MARK CONSISTS OF STANDARD CHARACTERS WITHOUT CLAIM TO ANY PARTICULAR FONT, STYLE, SIZE, OR COLOR.

FOR PROVIDING AT HOME SHOPPING SERVICES IN THE FIELD OF JEWELRY, APPAREL AND CLOTHING ACCESSORIES BY MEANS OF TELEVISION, TELEPHONE AND THE INTERNET (U.S. CLS. 100, 101 AND 102).

FIRST USE 2-4-2004; IN COMMERCE 2-4-2004.

THE MARK CONSISTS OF STANDARD CHARACTERS WITHOUT CLAIM TO ANY PARTICULAR FONT, STYLE, SIZE, OR COLOR.

THE NAME ZAK BLACK DOES NOT IDENTIFY A LIVING INDIVIDUAL.

FOR RETAIL STORE SERVICES NAMELY, MAIL ORDER, RETAIL AND COMPUTERIZED ONLINE ORDERING SERVICES FEATURING THE COLOR BLACK AS A MERCHANDISING THEME FOR CLOTHING SUCH AS SHIRTS, BLOUSES, TEE SHIRTS, PANTS, SKIRTS, DRESSES, JACKETS, BLAZERS, COATS, OUTERWARE, KNIT TOPS, SWEATERS, HATS, SHOES, GLOVES, PAJAMAS, ROBES, BELTS, SCARVES AND APPAREL RELATED ACCESSORIES AND ALSO FOR JEWELRY, LINENS, HANDBAGS, DINNERWARE, BACKPACKS, LUGGAGE, PICTURE FRAMES AND OFFICE ACCESSORIES (U.S. CLS. 100, 101 AND 102).

FIRST USE 9-12-2004; IN COMMERCE 9-12-2004.

3,007,901. BONHAM, KIM, GRANTS PASS, OR. SN 78-355,168. PUB. 11-9-2004, FILED 1-21-2004.

3,007,918. FIRST NATIONAL BANK OF OMAHA, OMAHA, NE. SN 78-364,102. PUB. 11-16-2004, FILED 2-6-2004.

TERRA HUES

**FIRST AIRMILES
REWARDS**

THE MARK CONSISTS OF STANDARD CHARACTERS WITHOUT CLAIM TO ANY PARTICULAR FONT, STYLE, SIZE, OR COLOR.

FOR ONLINE RETAIL STORE SERVICES, RETAIL STORE SERVICES AND WHOLESALE DISTRIBUTORSHIP SERVICES FEATURING PET PRODUCTS (U.S. CLS. 100, 101 AND 102).

FIRST USE 8-0-2004; IN COMMERCE 8-0-2004.

THE MARK CONSISTS OF STANDARD CHARACTERS WITHOUT CLAIM TO ANY PARTICULAR FONT, STYLE, SIZE, OR COLOR.

OWNER OF U.S. REG. NO. 2,644,769. NO CLAIM IS MADE TO THE EXCLUSIVE RIGHT TO USE "AIRMILES REWARDS", APART FROM THE MARK AS SHOWN.

FOR PROMOTING THE USE OF CREDIT CARDS BY CARD HOLDERS THROUGH THE ADMINISTRATION OF INCENTIVE AWARD PROGRAMS (U.S. CLS. 100, 101 AND 102).

FIRST USE 8-2-2004; IN COMMERCE 8-2-2004.

CLASS 35—(Continued).

3,007,945. RITZER, PETER A., AURORA, CO. SN 78-376,511. PUB. 12-21-2004, FILED 3-1-2004.

Athanasius

THE MARK CONSISTS OF STANDARD CHARACTERS WITHOUT CLAIM TO ANY PARTICULAR FONT, STYLE, SIZE, OR COLOR.

FOR RETAIL STORE SERVICES FEATURING RELIGIOUS ARTICLES, ART, BOOKS, VIDEOS, AND BAPTISMAL GOWNS AND ACCESSORIES (U.S. CLS. 100, 101 AND 102).

FIRST USE 10-2-2004; IN COMMERCE 10-2-2004.

3,007,954. WALTON ARTS CENTER FOUNDATION, INC., FAYETTEVILLE, AR. SN 78-386,583. PUB. 5-3-2005, FILED 3-18-2004.

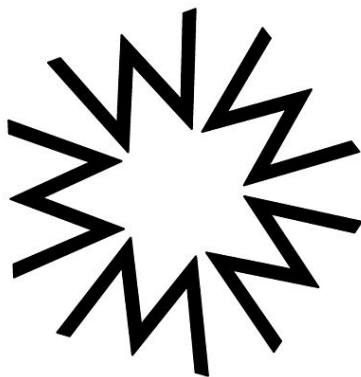

FOR THEATRICAL TICKET AGENCIES; ADVERTISING AND PROMOTION SERVICES FOR SEASONAL THEATRICAL AND ARTS PRESENTATIONS (U.S. CLS. 100, 101 AND 102).

FIRST USE 3-18-2004; IN COMMERCE 3-18-2004.

CLASS 35—(Continued).

3,007,963. CITICORP, NEW YORK, NY. SN 78-390,129. PUB. 11-9-2004, FILED 3-24-2004.

THANKYOU FROM CITI

THE MARK CONSISTS OF STANDARD CHARACTERS WITHOUT CLAIM TO ANY PARTICULAR FONT, STYLE, SIZE, OR COLOR.

OWNER OF U.S. REG. NOS. 1,181,467 AND 2,424,088. FOR PROMOTING THE GOODS AND SERVICES OF OTHERS THROUGH CREDIT CARD CUSTOMER LOYALTY, REWARD AND REDEMPTION PROGRAMS (U.S. CLS. 100, 101 AND 102).

FIRST USE 6-12-2004; IN COMMERCE 6-12-2004.

3,007,982. CITICORP, NEW YORK, NY. SN 78-406,502. PUB. 11-9-2004, FILED 4-22-2004.

THANKYOU NETWORK

THE MARK CONSISTS OF STANDARD CHARACTERS WITHOUT CLAIM TO ANY PARTICULAR FONT, STYLE, SIZE, OR COLOR.

FOR PROMOTING THE GOODS AND SERVICES OF OTHERS THROUGH CREDIT CARD CUSTOMER LOYALTY, REWARD AND REDEMPTION PROGRAMS (U.S. CLS. 100, 101 AND 102).

FIRST USE 6-12-2004; IN COMMERCE 6-12-2004.

3,007,991. VANITY FAIR, INC., WILMINGTON, DE. SN 78-414,019. PUB. 11-23-2004, FILED 5-6-2004.

LILY OF FRANCE

THE MARK CONSISTS OF STANDARD CHARACTERS WITHOUT CLAIM TO ANY PARTICULAR FONT, STYLE, SIZE, OR COLOR.

OWNER OF U.S. REG. NOS. 818,303, 2,512,651, AND OTHERS.

FOR RETAIL STORE SERVICES IN THE FIELD OF APPAREL; PROVIDING CONSUMER PRODUCT INFORMATION VIA THE INTERNET (U.S. CLS. 100, 101 AND 102).

FIRST USE 3-31-2001; IN COMMERCE 3-31-2001.

CLASS 35—(Continued).

3,008,018. NATIONAL WILD TURKEY FEDERATION, INC., THE, EDGEFIELD, SC. SN 78-438,540. PUB. 5-3-2005, FILED 6-21-2004.

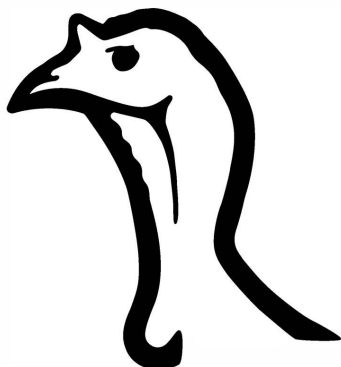

THE MARK CONSISTS OF THE HEAD OF A TURKEY. FOR ASSOCIATION SERVICES, NAMELY PROMOTING THE INTERESTS OF TURKEY CONSERVATIONISTS AND SPORTSPERSONS (U.S. CLS. 100, 101 AND 102).
FIRST USE 7-8-2004; IN COMMERCE 7-8-2004.

CLASS 36—INSURANCE AND FINANCIAL

3,007,680. 66 FEDERAL CREDIT UNION, BARTLESVILLE, OK. SN 76-558,527. PUB. 9-21-2004, FILED 10-27-2003.

FINANCIAL SOLUTIONS THAT FOCUS ON YOU

FOR FINANCIAL SERVICES, NAMELY, CHECKING AND SAVINGS ACCOUNT SERVICES, CERTIFICATE OF DEPOSIT ACCOUNT SERVICES, MORTGAGE LENDING AND SERVICING, CONSUMER LENDING, TRUST SERVICES IN THE NATURE OF INVESTMENT AND TRUST COMPANY SERVICES, INDIVIDUAL RETIREMENT ACCOUNT (IRA) SERVICES, INSURANCE ADMINISTRATION, CREDIT AND DEBIT CARD SERVICES; FINANCIAL COUNSELING SERVICES, NAMELY, INVESTMENT ADVICE (U.S. CLS. 100, 101 AND 102).
FIRST USE 12-5-2004; IN COMMERCE 12-5-2004.

CLASS 36—(Continued).

3,007,691. PHARMHEALTH, INC., OMAHA, NE. SN 76-570,381. PUB. 1-4-2005, FILED 1-12-2004.

PHARMHEALTH

THE MARK CONSISTS OF STANDARD CHARACTERS WITHOUT CLAIM TO ANY PARTICULAR FONT, STYLE, SIZE, OR COLOR.

FOR ADVISORY AND CONSULTING SERVICES RELATING TO THE ADMINISTRATION OF EMPLOYER PHARMACY PLANS AND THIRD PARTY HEALTH CARE BENEFITS (U.S. CLS. 100, 101 AND 102).
FIRST USE 8-11-2005; IN COMMERCE 8-11-2005.

3,007,701. GMAC MORTGAGE CORPORATION, HORSHAM, PA. SN 76-576,481. PUB. 11-30-2004, FILED 2-20-2004.

DITECH FLAT FEE

THE MARK CONSISTS OF STANDARD CHARACTERS WITHOUT CLAIM TO ANY PARTICULAR FONT, STYLE, SIZE, OR COLOR.

OWNER OF U.S. REG. NOS. 2,158,800, 2,861,149, AND OTHERS.

NO CLAIM IS MADE TO THE EXCLUSIVE RIGHT TO USE "FLAT FEE", APART FROM THE MARK AS SHOWN. FOR REAL ESTATE MORTGAGE BANKING AND LENDING SERVICES; LOAN ORIGINATION AND FINANCING VIA A GLOBAL COMMUNICATIONS NETWORK (U.S. CLS. 100, 101 AND 102).
FIRST USE 3-5-2004; IN COMMERCE 3-5-2004.

3,007,727. WASHINGTON MUTUAL, INC., SEATTLE, WA. SN 78-094,727. PUB. 5-28-2002, FILED 11-21-2001.

SHORTY

FOR BANKING SERVICES; BANKING SERVICES, NAMELY SAVINGS ACCOUNTS; PROVIDING BANKING AND FINANCIAL INFORMATION VIA THE INTERNET (U.S. CLS. 100, 101 AND 102).
FIRST USE 8-31-2000; IN COMMERCE 8-31-2000.

3,007,795. TRAXIS PARTNERS LLC, NEW YORK, NY. SN 78-234,086. PUB. 1-20-2004, FILED 4-4-2003.

TRAXIS FUND OFFSHORE LP

CLASS 36—(Continued).

NO CLAIM IS MADE TO THE EXCLUSIVE RIGHT TO USE "FUND OFFSHORE LP", APART FROM THE MARK AS SHOWN.

FOR INVESTMENT FUND INVESTMENT SERVICES (U.S. CLS. 100, 101 AND 102).
FIRST USE 6-2-2003; IN COMMERCE 6-2-2003.



3,007,846. FEDERAL NATIONAL MORTGAGE ASSOCIATION, DBA FANNIE MAE, WASHINGTON, DC. SN 78-295,093. PUB. 11-16-2004, FILED 9-2-2003.

COMMUNITY EXPRESS

NO CLAIM IS MADE TO THE EXCLUSIVE RIGHT TO USE COMMUNITY, APART FROM THE MARK AS SHOWN.

FOR LOAN AND FINANCING SERVICES, NAMELY PROVIDING LOANS FOR HOUSING AND NEIGHBORHOOD DEVELOPMENT AND REVITALIZATION PROJECTS (U.S. CLS. 100, 101 AND 102).
FIRST USE 2-0-2002; IN COMMERCE 2-0-2002.



3,007,879. NISSAN NORTH AMERICA, INC., GARDENA, CA. SN 78-337,646. PUB. 9-14-2004, FILED 12-8-2003.

TITLEGUARD+PLUS

THE MARK CONSISTS OF STANDARD CHARACTERS WITHOUT CLAIM TO ANY PARTICULAR FONT, STYLE, SIZE, OR COLOR.

OWNER OF U.S. REG. NOS. 1,325,011, 2,850,438, AND OTHERS.

FOR INSURANCE UNDERWRITING IN THE FIELDS OF VEHICLE LOANS AND LEASE AGREEMENTS (U.S. CLS. 100, 101 AND 102).
FIRST USE 5-15-2005; IN COMMERCE 5-15-2005.

CLASS 36—(Continued).

3,007,909. BLUEGREEN CORPORATION, BOCA RATON, FL. SN 78-358,699. PUB. 11-9-2004, FILED 1-28-2004.



FOR VACATION TIMESHARE SERVICES FEATURING INCENTIVE AWARD PROGRAM (U.S. CLS. 100, 101 AND 102).

FIRST USE 2-0-2004; IN COMMERCE 2-0-2004.



3,007,956. CREDIT FACTOR CORP, BROOKLYN, NY. SN 78-386,732. PUB. 12-28-2004, FILED 3-18-2004.

Tacto

THE MARK CONSISTS OF STANDARD CHARACTERS WITHOUT CLAIM TO ANY PARTICULAR FONT, STYLE, SIZE, OR COLOR.

FOR CREDIT MONITORING SERVICE (U.S. CLS. 100, 101 AND 102).
FIRST USE 3-18-2004; IN COMMERCE 3-1-2005.

CLASS 36—(Continued).

3,007,959. AMERICAN INTERNATIONAL GROUP, INC., NEW YORK, NY. SN 78-387,628. PUB. 12-28-2004, FILED 3-19-2004.

SCAN

THE MARK CONSISTS OF STANDARD CHARACTERS WITHOUT CLAIM TO ANY PARTICULAR FONT, STYLE, SIZE, OR COLOR.

FOR INSURANCE UNDERWRITING SERVICES, NAMELY, A FEATURED PROGRAM OF PROPERTY AND CASUALTY INSURANCE RELATED TO WATER INTRUSION COMPRISED OF LOSS CONTROL, DAMAGE ASSESSMENT AND CLAIMS ASSISTANCE SERVICES (U.S. CLS. 100, 101 AND 102).

FIRST USE 1-1-2005; IN COMMERCE 1-1-2005.

3,007,970. NOBLE ASSET MANAGEMENT, LLC, OAK BROOK, IL. SN 78-395,229. PUB. 1-25-2005, FILED 4-2-2004.

**NOBLE CAPITAL
RECOVERY FUND**

THE MARK CONSISTS OF STANDARD CHARACTERS WITHOUT CLAIM TO ANY PARTICULAR FONT, STYLE, SIZE, OR COLOR.

NO CLAIM IS MADE TO THE EXCLUSIVE RIGHT TO USE "CAPITAL RECOVERY FUND", APART FROM THE MARK AS SHOWN.

FOR FINANCIAL SERVICES, NAMELY, FUND INVESTMENT SERVICES IN THE FIELD OF DISTRESSED DEBT INSTRUMENTS, SECURED SENIOR DEBT, SUBORDINATED DEBT, MEZZANINE DEBT, PUBLICLY OR PRIVATELY PLACED HIGH YIELD DEBT, COMMON EQUITY, PREFERRED STOCK, WARRANTS, CONVERTIBLE DEBT, AND US GOVERNMENT SECURITIES (U.S. CLS. 100, 101 AND 102).

FIRST USE 3-0-2004; IN COMMERCE 3-0-2004.

CLASS 36—(Continued).

3,007,974. GIVE LIFE FOUNDATION, INC., RESTON, VA. SN 78-400,055. PUB. 2-1-2005, FILED 4-12-2004.

**GIVE LIFE
FOUNDATION**

THE MARK CONSISTS OF STANDARD CHARACTERS WITHOUT CLAIM TO ANY PARTICULAR FONT, STYLE, SIZE, OR COLOR.

NO CLAIM IS MADE TO THE EXCLUSIVE RIGHT TO USE "FOUNDATION", APART FROM THE MARK AS SHOWN.

FOR CHARITABLE FUND RAISING SERVICES IN THE FIELD OF RESEARCH, PROMOTION, AND AWARENESS OF ORGAN, BLOOD, AND TISSUE DONATIONS (U.S. CLS. 100, 101 AND 102).

FIRST USE 4-30-2004; IN COMMERCE 4-30-2004.

3,008,014. HINES REAL ESTATE SECURITIES, INC., HOUSTON, TX. SN 78-427,690. PUB. 4-12-2005, FILED 6-1-2004.

**INSTITUTIONAL
EXPERIENCE FOR
INDIVIDUAL
INVESTORS**

THE MARK CONSISTS OF STANDARD CHARACTERS WITHOUT CLAIM TO ANY PARTICULAR FONT, STYLE, SIZE, OR COLOR.

FOR INVESTMENT MANAGEMENT SERVICES, NAMELY MANAGEMENT OF INVESTMENT FUNDS; AND FINANCIAL SERVICES IN THE NATURE OF AN INVESTMENT SECURITY (U.S. CLS. 100, 101 AND 102).

FIRST USE 6-30-2004; IN COMMERCE 6-30-2004.

CLASS 37—CONSTRUCTION AND REPAIR

CLASS 37—(Continued).

3,007,613. JEFFRIES TRAVIS REALTY CORP., CHARLESTON, SC. AND JEFFRIES AVLON, INC., NEW YORK, NY. AND JEFFRIES LEELAND COMPANY, INC., BOSTON, MA. SN 76-376,602. PUB. 3-18-2003, FILED 2-27-2002.



THE JEFFRIES COMPANIES

OWNER OF U.S. REG. NOS. 2,244,257, 2,378,372, AND OTHERS.

NO CLAIM IS MADE TO THE EXCLUSIVE RIGHT TO USE "COMPANIES", APART FROM THE MARK AS SHOWN.

FOR REAL ESTATE DEVELOPMENT SERVICES (U.S. CLS. 100, 103 AND 106).

FIRST USE 4-0-2001; IN COMMERCE 4-0-2001.

CLASS 37—(Continued).

3,008,002. JOHN H. SCHILLING, MAGNOLIA, TX. SN 78-420,772. PUB. 5-17-2005, FILED 5-18-2004.

Bee The Builder

THE MARK CONSISTS OF STANDARD CHARACTERS WITHOUT CLAIM TO ANY PARTICULAR FONT, STYLE, SIZE, OR COLOR.

FOR CONSULTING SERVICES IN THE FIELD OF RESIDENTIAL AND COMMERCIAL BUILDING (U.S. CLS. 100, 103 AND 106).

FIRST USE 7-1-2004; IN COMMERCE 7-1-2004.

3,007,769. PLEXICOR, INC., ANAHEIM, CA. SN 78-206,557. PUB. 4-27-2004, FILED 1-23-2003.

PLEXICOR

FOR INSTALLATION AND MAINTENANCE OF SECURITY SYSTEMS, ALARM SYSTEMS, SECURITY EQUIPMENT, ALARM EQUIPMENT, AND AUTOMATED TELLER MACHINE (ATM) SYSTEMS; CONSTRUCTION SERVICES, NAMELY, PLANNING, LAYING OUT AND CUSTOM CONSTRUCTION OF FACILITIES OR STRUCTURES TO HOUSE SECURITY SYSTEMS, ALARM SYSTEMS, SECURITY EQUIPMENT, ALARM EQUIPMENT, AND AUTOMATED TELLER MACHINE (ATM) SYSTEMS; CONSTRUCTION SUPERVISION SERVICES (U.S. CLS. 100, 103 AND 106).

FIRST USE 3-1-2003; IN COMMERCE 3-1-2003.

CLASS 38—COMMUNICATION

3,007,597. WHEEL CONCEPTS INDUSTRIES, NEWBURY PARK, CA. SN 76-269,314. PUB. 8-20-2002, FILED 6-8-2001.

RADIO FREE L.A.

NO CLAIM IS MADE TO THE EXCLUSIVE RIGHT TO USE "RADIO" OR "L.A.", APART FROM THE MARK AS SHOWN.

FOR RADIO BROADCASTING (U.S. CLS. 100, 101 AND 104).

FIRST USE 1-26-2004; IN COMMERCE 1-26-2004.

3,007,827. GLOBAL ENERGY; WIND POWER, INC., WINCHESTER, VA. SN 78-280,098. PUB. 6-8-2004, FILED 7-29-2003.

AIRNERGY

FOR DEVELOPMENT OF WIND ENERGY SITES FOR OTHERS FOR GENERATION OF ELECTRICITY TO BE SENT TO AN ELECTRICAL TRANSMISSION OR DISTRIBUTION INFRASTRUCTURE (U.S. CLS. 100, 103 AND 106).

FIRST USE 7-31-2003; IN COMMERCE 7-31-2003.

3,007,605. BIERMANN PRODUCTIONS, L.L.C., WICHITA, KS. SN 76-306,525. PUB. 12-3-2002, FILED 8-28-2001.



NO CLAIM IS MADE TO THE EXCLUSIVE RIGHT TO USE "THE CONCERT CHANNEL", APART FROM THE MARK AS SHOWN.

FOR TELEVISION BROADCASTING SERVICES (U.S. CLS. 100, 101 AND 104).

FIRST USE 12-19-2003; IN COMMERCE 12-19-2003.

CLASS 38—(Continued).

3,007,649. TRIO NETWORK, INC., UNIVERSAL CITY, CA. SN 76-512,071. PUB. 4-20-2004, FILED 5-5-2003.



OWNER OF U.S. REG. NOS. 2,022,354 AND 2,680,199. FOR CABLE TELEVISION BROADCASTING SERVICES (U.S. CLS. 100, 101 AND 104). FIRST USE 6-1-2003; IN COMMERCE 6-1-2003.

3,007,706. GALAXYVOICE, INC., NEWTON, MA. SN 76-583,186. PUB. 12-28-2004, FILED 3-22-2004.

GALAXYVOICE

FOR TELECOMMUNICATION SERVICES NAMELY LOCAL AND LONG DISTANCE TELEPHONE SERVICE AND VOICE OVER INTERNET PROTOCOL (VOIP) (U.S. CLS. 100, 101 AND 104). FIRST USE 1-1-2004; IN COMMERCE 1-1-2004.

3,007,760. VERIZON TRADEMARK SERVICES LLC, ARLINGTON, VA. SN 78-200,377. PUB. 5-25-2004, FILED 1-6-2003.

VERIZON FREEDOM

FOR TELEPHONE TELECOMMUNICATION SERVICES; WIRELESS TELECOMMUNICATION SERVICES, NAMELY, TRANSMISSION OF VOICE AND DATA VIA ELECTRONIC MEANS; AND PROVIDING MULTIPLE-USER ACCESS TO A GLOBAL COMMUNICATIONS NETWORK (U.S. CLS. 100, 101 AND 104). FIRST USE 5-13-2003; IN COMMERCE 5-13-2003.

CLASS 38—(Continued).

3,007,774. SITV INC, LOS ANGELES, CA. SN 78-214,013. PUB. 4-27-2004, FILED 2-12-2003.

SÍ WHAT YOU'VE BEEN MISSING

THE ENGLISH TRANSLATION OF "SI" IS "YES". FOR CABLE TELEVISION BROADCASTING SERVICES (U.S. CLS. 100, 101 AND 104). FIRST USE 7-19-2005; IN COMMERCE 7-19-2005.

CLASS 39—TRANSPORTATION AND STORAGE

3,007,854. LUTZ, JAMES, NEW YORK, NY. SN 78-306,523. PUB. 8-24-2004, FILED 9-29-2003.

VAYA ADVENTURES

NO CLAIM IS MADE TO THE EXCLUSIVE RIGHT TO USE "ADVENTURES", APART FROM THE MARK AS SHOWN.

THE FOREIGN WORDING IN THE MARK TRANSLATES INTO ENGLISH AS GO.

FOR ARRANGING TRAVEL TOURS AND VACATIONS (U.S. CLS. 100 AND 105).

FIRST USE 1-1-2004; IN COMMERCE 1-9-2004.

3,007,908. TLW ENTERPRISES, INC., NEW YORK, NY. SN 78-358,565. PUB. 11-30-2004, FILED 1-28-2004.



THE COLOR(S) GREEN AND GOLD IS/ARE CLAIMED AS A FEATURE OF THE MARK.

THE MARK CONSISTS OF GREEN AND GOLD SQUARES CONTAINING THE WORDS THE PERFECT CAST WITH A LEAPING TROUT AND A FLY AND LIN.

FOR ORGANIZATION OF EXECUTIVE TRAVEL TRIPS THAT USE FLY-FISHING AS A BUSINESS TOOL (U.S. CLS. 100 AND 105).

FIRST USE 7-15-2004; IN COMMERCE 7-15-2004.

CLASS 40—MATERIAL TREATMENT

CLASS 40—(Continued).

3,007,852. CONCERTED INNOVATIONS, LLC, BLACKLICK, OH. SN 78-301,589. PUB. 6-1-2004, FILED 9-17-2003.

LINTONIZING

FOR FOOD PROCESSING (U.S. CLS. 100, 103 AND 106).
FIRST USE 9-0-2003; IN COMMERCE 1-0-2005.

CLASS 41—EDUCATION AND ENTERTAINMENT

3,007,584. KENNEDY, MURIEL, WASHINGTON, DC. SN 76-203,047. PUB. 12-11-2001, FILED 2-1-2001.

L.E.T.'S. RAP MINISTRIES

NO CLAIM IS MADE TO THE EXCLUSIVE RIGHT TO USE "MINISTRIES", APART FROM THE MARK AS SHOWN.

FOR EDUCATIONAL AND ENTERTAINMENT SERVICES, NAMELY, PROVIDING MOTIVATIONAL AND EDUCATIONAL SPEAKERS AND CONDUCTING WORKSHOPS AND SEMINARS IN THE FIELD OF SELF-ESTEEM AND QUALITY OF LIFE ISSUES (U.S. CLS. 100, 101 AND 107).

FIRST USE 9-28-2001; IN COMMERCE 9-28-2001.

3,007,604. YAMAHA CORPORATION OF AMERICA, BUENA PARK, CA. AND MUSICIANS IN DEBUT INTERNATIONAL, MINNEAPOLIS, MN. SN 76-303,885. PUB. 11-5-2002, FILED 8-23-2001.



NO CLAIM IS MADE TO THE EXCLUSIVE RIGHT TO USE "INTERNATIONAL PIANO-E-COMPETITION", APART FROM THE MARK AS SHOWN.

FOR PROMOTING AND CONDUCTING PIANO COMPETITIONS, ENTERTAINMENT IN THE NATURE OF PIANO COMPETITIONS, AND PROVIDING INFORMATION AND INSTRUCTIONAL MATERIALS IN THE FIELD OF MUSIC, ALL THE AFORESAID SERVICES PROVIDED VIA GLOBAL COMPUTER NETWORKS (U.S. CLS. 100, 101 AND 107).

FIRST USE 10-0-2000; IN COMMERCE 10-0-2000.

CLASS 41—(Continued).

3,007,651. LARGUIA, CONSTANCIO, BUENOS AIRES 1001, ARGENTINA. SN 76-517,802. PUB. 4-27-2004, FILED 5-29-2003.

HUMANITY.TV

NO CLAIM IS MADE TO THE EXCLUSIVE RIGHT TO USE "TV", APART FROM THE MARK AS SHOWN.

FOR ENTERTAINMENT NAMELY, PRODUCTION OF A CABLE TELEVISION PROGRAM (U.S. CLS. 100, 101 AND 107).

FIRST USE 3-1-2002; IN COMMERCE 3-1-2002.

3,007,665. COYOTES HOCKEY, LLC, PHOENIX, AZ. SN 76-538,273. PUB. 12-14-2004, FILED 8-19-2003.



THE MARK CONSISTS OF A DEPICTION OF A HOWLING COYOTE HEAD.

FOR ENTERTAINMENT SERVICES IN THE NATURE OF PROFESSIONAL ICE HOCKEY EXHIBITIONS (U.S. CLS. 100, 101 AND 107).

FIRST USE 8-0-2003; IN COMMERCE 10-0-2003.

3,007,689. ARJAY ENTERTAINMENT LLC, LOS ANGELES, CA. SN 76-568,262. PUB. 11-23-2004, FILED 12-22-2003.

THE ULTIMATE INSIDER

THE MARK CONSISTS OF STANDARD CHARACTERS WITHOUT CLAIM TO ANY PARTICULAR FONT, STYLE, SIZE, OR COLOR.

FOR ENTERTAINMENT SERVICES IN THE NATURE OF SEGMENTS OF TELEVISION PROGRAMMING AND ONLINE PROGRAMMING RELATED TO CELEBRITY AND LUXURY (U.S. CLS. 100, 101 AND 107).

FIRST USE 1-28-2005; IN COMMERCE 1-28-2005.

CLASS 41—(Continued).

3,007,703. PML ASSOCIATES, INC., GREENWOOD, SC. SN 76-577,896. PUB. 3-29-2005, FILED 2-26-2004.

THE PML EXPERIENCE

THE MARK CONSISTS OF STANDARD CHARACTERS WITHOUT CLAIM TO ANY PARTICULAR FONT, STYLE, SIZE, OR COLOR.

FOR EDUCATIONAL SERVICES, NAMELY WORKSHOPS, CONFERENCES, SEMINARS AND TRAINING IN THE FIELD OF LEADERSHIP (U.S. CLS. 100, 101 AND 107).

FIRST USE 5-1-2003; IN COMMERCE 5-1-2003.

3,007,720. L.A. FITNESS INTERNATIONAL LLC, IRVINE, CA. SN 76-977,729. PUB. 5-18-2004, FILED 2-24-2003.



OWNER OF U.S. REG. NO. 1,806,464.
NO CLAIM IS MADE TO THE EXCLUSIVE RIGHT TO USE FITNESS, APART FROM THE MARK AS SHOWN.

THE MARK CONSISTS OF THE WORDING "L A FITNESS" WITH A VERTICAL LINE AND A CHEVRON AND TRIANGLE FORMING SAILS.

FOR HEALTH CLUB SERVICES, NAMELY, PROVIDING EQUIPMENT AND FACILITIES FOR PHYSICAL EXERCISE AND PERSONAL PHYSICAL FITNESS INSTRUCTION IN THE AREAS OF STRENGTH AND CONDITIONING (U.S. CLS. 100, 101 AND 107).

FIRST USE 4-28-2003; IN COMMERCE 4-28-2003.

3,007,749. MAJESTIC THEATRE, LLC, COLUMBUS, OH. SN 78-169,300. PUB. 12-16-2003, FILED 9-30-2002.

MAJESTIC THEATRE

NO CLAIM IS MADE TO THE EXCLUSIVE RIGHT TO USE "THEATRE", APART FROM THE MARK AS SHOWN.

FOR ENTERTAINMENT SERVICES RENDERED BY SHOWING MOTION PICTURES IN THEATRES (U.S. CLS. 100, 101 AND 107).

FIRST USE 12-1-2004; IN COMMERCE 12-1-2004.

3,007,756. HENDERSON, DARRELL, LAFAYETTE, LA. SN 78-186,131. PUB. 5-3-2005, FILED 11-18-2002.

WATERDROP RECORDS

NO CLAIM IS MADE TO THE EXCLUSIVE RIGHT TO USE RECORDS, APART FROM THE MARK AS SHOWN.

FOR MUSIC RECORDING AND PUBLISHING (U.S. CLS. 100, 101 AND 107).

FIRST USE 3-0-2004; IN COMMERCE 3-0-2004.

CLASS 41—(Continued).

3,007,780. PUBLIC BROADCASTING SERVICE, AKA PBS, ALEXANDRIA, VA. SN 78-217,165. PUB. 10-26-2004, FILED 2-20-2003.

HISTORY DETECTIVES

NO CLAIM IS MADE TO THE EXCLUSIVE RIGHT TO USE "HISTORY", APART FROM THE MARK AS SHOWN.

FOR INVESTIGATIVE RESEARCH AND REPORTING; PROVIDING A TELEVISION PROGRAM IN THE FIELD OF INVESTIGATIVE RESEARCH AND REPORTING AND INTERACTIVE LEARNING VIA A GLOBAL COMPUTER NETWORK; DISTRIBUTION OF TELEVISION PROGRAMS FOR OTHERS (U.S. CLS. 100, 101 AND 107).

FIRST USE 7-14-2003; IN COMMERCE 7-14-2003.

3,007,796. COPELAND, JOHN D., SILOAM SPRINGS, AR. SN 78-237,819. PUB. 8-10-2004, FILED 4-15-2003.

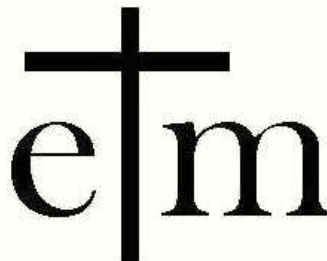

THE MARK CONSISTS OF A GEORGIA FONT SMALL E FOLLOWED BY A CROSS FOLLOWED BY A GEORGIA FONT SMALL M.

FOR EDUCATIONAL ETHICS CONSULTATION; EDUCATIONAL AND ENTERTAINMENT SERVICES, NAMELY, PROVIDING MOTIVATIONAL AND EDUCATIONAL SPEAKERS; CUSTOM WRITING SERVICES (U.S. CLS. 100, 101 AND 107).

FIRST USE 1-5-2005; IN COMMERCE 1-5-2005.

3,007,816. WYNN RESORTS HOLDINGS, LLC, LAS VEGAS, NV. SN 78-266,022. PUB. 3-22-2005, FILED 6-23-2003.

WYNN LAS VEGAS

NO CLAIM IS MADE TO THE EXCLUSIVE RIGHT TO USE "LAS VEGAS", APART FROM THE MARK AS SHOWN.

FOR CASINO SERVICES (U.S. CLS. 100, 101 AND 107).

FIRST USE 4-28-2005; IN COMMERCE 4-28-2005.

CLASS 41—(Continued).

3,007,841. INVENTO LLC, MIAMI, FL. SN 78-292,614. PUB. 5-25-2004, FILED 8-26-2003.

INVENTO

FOR ENTERTAINMENT SERVICES, NAMELY PRODUCTION AND DISTRIBUTION OF TELEVISION PROGRAMS (U.S. CLS. 100, 101 AND 107).

FIRST USE 3-15-2005; IN COMMERCE 3-15-2005.

CLASS 41—(Continued).

3,007,947. JOHN R. CROMWELL AND DOTTIE DIXON, TACOMA, WA. SN 78-379,861. PUB. 1-4-2005, FILED 3-6-2004.

CHROME @ THE DOME

THE MARK CONSISTS OF STANDARD CHARACTERS WITHOUT CLAIM TO ANY PARTICULAR FONT, STYLE, SIZE, OR COLOR.

FOR ORGANIZING EXHIBITIONS IN THE NATURE OF BIKER RALLYS FOR MOTORCYCLE ENTHUSIASTS (U.S. CLS. 100, 101 AND 107).

FIRST USE 6-11-2005; IN COMMERCE 6-11-2005.

3,007,863. CLUSTER FILE SYSTEMS, INC., MEDFORD, MA. SN 78-318,553. PUB. 12-28-2004, FILED 10-24-2003.

LUSTRE

FOR TRAINING AND EDUCATION SERVICES, NAMELY, ARRANGING AND CONDUCTING ONLINE AND INSTRUCTOR-LED TRAINING COURSES, LECTURES, CLASSES, WORKSHOPS, SEMINARS AND CONFERENCES IN THE FIELDS OF COMPUTERS, COMPUTER SOFTWARE, COMPUTER STORAGE SOFTWARE, COMPUTER STORAGE NETWORKS, AND COMPUTER FILE STORAGE AND MANAGEMENT (U.S. CLS. 100, 101 AND 107).

FIRST USE 1-6-2003; IN COMMERCE 1-6-2003.

3,007,955. PHILLIPS, STEVEN, SAN FRANCISCO, CA. SN 78-386,666. PUB. 12-21-2004, FILED 3-18-2004.

POWERPAC.ORG

3,007,912. PRATT, RANDY, MANHASSET, NY. SN 78-360,606. PUB. 12-28-2004, FILED 1-31-2004.

**NEW YORK BLUES
DEVILS**

THE MARK CONSISTS OF STANDARD CHARACTERS WITHOUT CLAIM TO ANY PARTICULAR FONT, STYLE, SIZE, OR COLOR.

NO CLAIM IS MADE TO THE EXCLUSIVE RIGHT TO USE "NEW YORK", APART FROM THE MARK AS SHOWN.

FOR ENTERTAINMENT, NAMELY, LIVE PERFORMANCE OF A MUSICAL GROUP PLAYING ALL TYPES OF MUSIC (U.S. CLS. 100, 101 AND 107).

FIRST USE 3-1-2004; IN COMMERCE 3-1-2004.

THE MARK CONSISTS OF STANDARD CHARACTERS WITHOUT CLAIM TO ANY PARTICULAR FONT, STYLE, SIZE, OR COLOR.

FOR EDUCATIONAL SERVICES, NAMELY, CONDUCTING PROGRAMS IN THE FIELD OF CIVIC PARTICIPATION AND SOCIAL WELFARE (U.S. CLS. 100, 101 AND 107).

FIRST USE 9-30-2003; IN COMMERCE 3-31-2004.

CLASS 41—(Continued).

3,007,966. COOK ROSS, INC., SILVER SPRING, MD. SN 78-392,599. PUB. 3-8-2005, FILED 3-29-2004.

CultureVision

THE MARK CONSISTS OF STANDARD CHARACTERS WITHOUT CLAIM TO ANY PARTICULAR FONT, STYLE, SIZE, OR COLOR.

FOR EDUCATIONAL SERVICES, NAMELY, CONDUCTING ON-LINE EXHIBITIONS AND DISPLAYS AND INTERACTIVE EXHIBITS IN THE FIELD OF CULTURAL COMPETENCY (U.S. CLS. 100, 101 AND 107).

FIRST USE 1-1-2004; IN COMMERCE 1-1-2004.

3,008,025. GORDON-TYNES PRODUCTIONS, INC., ORLANDO, FL. SN 78-976,318. PUB. 11-2-2004, FILED 5-19-2003.

COMEDY NIGHT SCHOOL

NO CLAIM IS MADE TO THE EXCLUSIVE RIGHT TO USE "COMEDY", APART FROM THE MARK AS SHOWN.

FOR ENTERTAINMENT SERVICES, NAMELY ONGOING TELEVISION PROGRAMS FEATURING VARIETY SHOWS, SKITS, SKETCH COMEDY, MUSICAL PERFORMANCES BY INDIVIDUALS, GROUPS AND BANDS, PARODIES AND HUMOR (U.S. CLS. 100, 101 AND 107).

FIRST USE 8-16-2003; IN COMMERCE 8-16-2003.

CLASS 42—SCIENTIFIC, COMPUTER AND LEGAL SERVICES

3,007,566. AMTAC CERTIFICATION SERVICES LTD., CHESHIRE, UNITED KINGDOM. SN 75-739,384. PUB. 8-28-2001, FILED 7-6-1999.

AMTAC MEDIQA

FOR PROVISION OF QUALITY CONTROL SERVICES FOR OTHERS; TESTING, ANALYSIS AND EVALUATION OF THE PRODUCTS OF OTHERS FOR THE PURPOSE OF CERTIFICATION (U.S. CLS. 100 AND 101).
FIRST USE 1-0-1993; IN COMMERCE 2-0-1994.

CLASS 42—(Continued).

3,007,577. THINK GOD, INC., FT. WORTH, TX. SN 76-098,022. PUB. 10-12-2004, FILED 7-28-2000.

GOD FIRST

FOR PROVIDING INFORMATION IN THE FIELD OF RELIGION AND BIBLICAL TOPICS VIA THE GLOBAL COMPUTER NETWORK (U.S. CLS. 100 AND 101).
FIRST USE 1-1-2001; IN COMMERCE 1-1-2001.

3,007,638. SYNERBOTICS LLC, BEAVERCREEK, OH. SN 76-487,972. PUB. 6-1-2004, FILED 2-6-2003.

SYNERBOTICS

FOR MEDICAL DEVICE DESIGN FOR OTHERS, NAMELY DESIGN OF NON-INVASIVE OR MINIMALLY INVASIVE DIAGNOSTIC MEDICAL SERVICES (U.S. CLS. 100 AND 101).

FIRST USE 8-18-2005; IN COMMERCE 8-18-2005.

3,007,645. 13 HEX, INC., BROOKLYN, NY. SN 76-500,969. PUB. 12-23-2003, FILED 3-25-2003.

TEXTURE BOX

FOR STOCK PHOTOGRAPHY SERVICES, NAMELY, LEASING REPRODUCTION RIGHTS OF PHOTOGRAPHS AND TRANSPARENCIES IN DIGITAL FORMAT TO OTHERS (U.S. CLS. 100 AND 101).

FIRST USE 5-13-2003; IN COMMERCE 5-13-2003.

3,007,721. BOOGIE TV, LLC, MONTCLAIR, NJ. SN 78-029,688. PUB. 12-30-2003, FILED 10-9-2000.

XRATED.TV

FOR COMPUTER SERVICES, NAMELY, PROVIDING SEARCH ENGINES THAT INDEX LINKS TO WEBSITES ON A GLOBAL COMPUTER NETWORK (U.S. CLS. 100 AND 101).

FIRST USE 6-15-2003; IN COMMERCE 6-15-2003.

3,007,731. SM PURCHASE COMPANY, LLC, MENLO PARK, CA. SN 78-114,369. PUB. 6-3-2003, FILED 3-12-2002.

DEEPLook

FOR SCIENTIFIC AND TECHNOLOGICAL SERVICES, NAMELY, PERFORMING MASS SPECTROMETRY OF PROTEINS AND SMALL MOLECULES FOR OTHERS (U.S. CLS. 100 AND 101).

FIRST USE 9-19-2003; IN COMMERCE 9-19-2003.

CLASS 42—(Continued).

3,007,735. PSYCHOGENICS INC., TARRYTOWN, NY. SN 78-123,769. PUB. 6-3-2003, FILED 4-24-2002.

SMARTCUBE

FOR MEDICAL AND SCIENTIFIC RESEARCH, NAMELY, PHARMACEUTICAL AND BIOTECHNOLOGICAL RESEARCH OF HUMAN DISORDERS USING ANIMAL MODELS, SPECIFICALLY, SCREENING AND TESTING OF CHEMICAL COMPOUNDS FOR THERAPEUTIC OR TOXIC EFFECTS, AND CAPTURING, QUANTIFYING, PROCESSING AND STORING INFORMATION ON BEHAVIORAL AND PHYSIOLOGICAL CHANGES IN ANIMAL SUBJECTS (U.S. CLS. 100 AND 101).

FIRST USE 7-27-2005; IN COMMERCE 7-27-2005.

3,007,778. HEALTH CARE CONCEPTS, INC., AUSTIN, TX. SN 78-216,298. PUB. 11-23-2004, FILED 2-19-2003.

SPECTRUM MARKET PENETRATION SYSTEM

NO CLAIM IS MADE TO THE EXCLUSIVE RIGHT TO USE MARKET PENETRATION SYSTEM, APART FROM THE MARK AS SHOWN.

FOR TECHNICAL CONSULTATION AND RESEARCH IN THE FIELD OF MEDICINE (U.S. CLS. 100 AND 101). FIRST USE 10-4-2001; IN COMMERCE 10-4-2001.

3,007,792. KRIS L. BJORGEN, HARTSVILLE, SC. SN 78-230,620. PUB. 1-6-2004, FILED 3-27-2003.

InfoDirect

THE MARK CONSISTS OF STANDARD CHARACTERS WITHOUT CLAIM TO ANY PARTICULAR FONT, STYLE, SIZE, OR COLOR.

FOR PROVIDING TEMPORARY USE OF ON-LINE NON-DOWNLOADABLE SOFTWARE FOR TRANSMITTING, UPLOADING AND VIEWING SCHOOL-RELATED INFORMATION, NAMELY GRADES, HOMEWORK ASSIGNMENTS, LUNCH MENUS, SCHOOL CALENDAR INFORMATION, AND PERSONAL FINANCIAL INFORMATION OF STUDENTS FOR USE IN THE PAROCHIAL OR PRIVATE SCHOOL MARKETS. (U.S. CLS. 100 AND 101).

FIRST USE 7-14-2003; IN COMMERCE 7-14-2003.

3,007,821. INTERNATIONAL COUNCIL FOR MACHINERY LUBRICATION, INC. (ICML), TULSA, OK. SN 78-272,856. PUB. 4-27-2004, FILED 7-10-2003.

MACHINERY LUBRICATION ENGINEER (MLE)**CLASS 42—(Continued).**

NO CLAIM IS MADE TO THE EXCLUSIVE RIGHT TO USE MACHINERY LUBRICATION ENGINEER, APART FROM THE MARK AS SHOWN.

FOR PROFICIENCY TESTING SERVICES IN THE FIELD OF LUBRICATION ENGINEERING (U.S. CLS. 100 AND 101).

FIRST USE 4-25-2004; IN COMMERCE 4-25-2004.

3,007,952. B&D GROUP, LLC, WASHINGTON, DC. SN 78-385,943. PUB. 12-21-2004, FILED 3-17-2004.

ELSCI

THE MARK CONSISTS OF STANDARD CHARACTERS WITHOUT CLAIM TO ANY PARTICULAR FONT, STYLE, SIZE, OR COLOR.

FOR REVIEWING STANDARDS AND PRACTICES TO ASSURE COMPLIANCE WITH PHARMACEUTICAL, BIOTECH AND LIFE SCIENCE LAWS AND REGULATIONS UTILIZING COMPUTER SOFTWARE TO ANALYZE REGULATORY DATA (U.S. CLS. 100 AND 101).

FIRST USE 3-20-2004; IN COMMERCE 3-20-2004.

3,008,017. JOHAS TEENER, MICHAEL D., SANTA CRUZ, CA. SN 78-436,614. PUB. 5-3-2005, FILED 6-17-2004.

PlumbLinks

THE MARK CONSISTS OF STANDARD CHARACTERS WITHOUT CLAIM TO ANY PARTICULAR FONT, STYLE, SIZE, OR COLOR.

FOR TECHNOLOGY CONSULTATION AND RESEARCH IN THE FIELD OF COMPUTER, INDUSTRIAL, AUTOMOTIVE AND CONSUMER ELECTRONIC NETWORKING (U.S. CLS. 100 AND 101).

FIRST USE 9-30-2004; IN COMMERCE 9-30-2004.

CLASS 43—HOTEL AND RESTAURANT SERVICES

3,007,626. JOE'S APARTMENT, INC., SCOTTSDALE, AZ. SN 76-439,816. PUB. 5-18-2004, FILED 8-12-2002.

CLASS 43—(Continued).

3,007,896. CREPE CLICHE, INC., VERNON HILLS, IL. SN 78-352,351. PUB. 4-19-2005, FILED 1-15-2004.

SUGAR DADDY'S BLUES

THE MARK CONSISTS OF STANDARD CHARACTERS WITHOUT CLAIM TO ANY PARTICULAR FONT, STYLE, SIZE, OR COLOR.

FOR RESTAURANT AND BAR SERVICES (U.S. CLS. 100 AND 101).

FIRST USE 11-30-2000; IN COMMERCE 11-30-2000.

**A BETTER COFFEE
AND A BIGGER
SANDWICH**

THE MARK CONSISTS OF STANDARD CHARACTERS WITHOUT CLAIM TO ANY PARTICULAR FONT, STYLE, SIZE, OR COLOR.

NO CLAIM IS MADE TO THE EXCLUSIVE RIGHT TO USE "COFFEE" AND "SANDWICH", APART FROM THE MARK AS SHOWN.

FOR RESTAURANT SERVICES, DINE-IN RESTAURANT SERVICES AND TAKE OUT RESTAURANT SERVICES (U.S. CLS. 100 AND 101).

FIRST USE 4-29-2005; IN COMMERCE 4-29-2005.

3,007,713. ROSEN HOTELS & RESORTS, INC., ORLANDO, FL. SN 76-592,851. PUB. 5-3-2005, FILED 5-18-2004.



3,007,941. CULINARY HOLDINGS INCORPORATED, NEWPORT BEACH, CA. SN 78-375,305. PUB. 1-4-2005, FILED 2-27-2004.

NO CLAIM IS MADE TO THE EXCLUSIVE RIGHT TO USE "JAVA" OR "COFFEE BAR", APART FROM THE MARK AS SHOWN.

FOR RESTAURANT SERVICES; AND TAKE-OUT RESTAURANT SERVICES (U.S. CLS. 100 AND 101).

FIRST USE 5-17-2004; IN COMMERCE 5-17-2004.



3,007,803. GIMME SUM WORLDWIDE INC., CORONA DEL MAR, CA. SN 78-248,745. PUB. 12-30-2003, FILED 5-12-2003.

GIMME SUM

FOR RESTAURANT AND CARRY-OUT FOOD SERVICES (U.S. CLS. 100 AND 101).

FIRST USE 2-10-2004; IN COMMERCE 3-10-2004.

NO CLAIM IS MADE TO THE EXCLUSIVE RIGHT TO USE "BISTRO & BAR", APART FROM THE MARK AS SHOWN.

FOR RESTAURANT AND BAR SERVICES (U.S. CLS. 100 AND 101).

FIRST USE 11-14-2003; IN COMMERCE 11-14-2003.

CLASS 43—(Continued).

3,007,979. AMERICA'S DRIVE-IN CORP., WICHITA, KS. SN 78-403,434. PUB. 11-9-2004, FILED 4-16-2004.

MY SONIC

THE MARK CONSISTS OF STANDARD CHARACTERS WITHOUT CLAIM TO ANY PARTICULAR FONT, STYLE, SIZE, OR COLOR.

OWNER OF U.S. REG. NOS. 776,766, 2,777,963, AND OTHERS.

FOR RESTAURANT SERVICES (U.S. CLS. 100 AND 101).

FIRST USE 6-1-2004; IN COMMERCE 6-1-2004.

3,007,999. IGNITE DEVELOPMENT, INC., DICKINSON, TX. SN 78-419,039. PUB. 4-5-2005, FILED 5-14-2004.



NO CLAIM IS MADE TO THE EXCLUSIVE RIGHT TO USE "BAR", APART FROM THE MARK AS SHOWN.

FOR BAR SERVICES (U.S. CLS. 100 AND 101).

FIRST USE 5-30-2004; IN COMMERCE 5-30-2004.

CLASS 44—MEDICAL, BEAUTY AND AGRICULTURAL SERVICES

CLASS 44—(Continued).

3,007,698. NEILL CORPORATION, HAMMOND, LA. SN 76-575,103. PUB. 11-9-2004, FILED 2-11-2004.

BE YOUR BEST SELF EXPERIENCE YOUR BEST LIFE

THE MARK CONSISTS OF STANDARD CHARACTERS WITHOUT CLAIM TO ANY PARTICULAR FONT, STYLE, SIZE, OR COLOR.

FOR SALON AND SPA SERVICES, NAMELY PROVIDING HAIR CARE, SKIN CARE, MASSAGES, HAIR COLORING; AND MAKEUP (U.S. CLS. 100 AND 101).

FIRST USE 8-1-2005; IN COMMERCE 8-1-2005.

3,007,917. YUI, BRIAN S., ENCINITAS, CA. SN 78-362,760. PUB. 11-9-2004, FILED 2-4-2004.

PMS ALERT

THE MARK CONSISTS OF STANDARD CHARACTERS WITHOUT CLAIM TO ANY PARTICULAR FONT, STYLE, SIZE, OR COLOR.

NO CLAIM IS MADE TO THE EXCLUSIVE RIGHT TO USE "PMS", APART FROM THE MARK AS SHOWN.

FOR PROVIDING MEDICAL INFORMATION (U.S. CLS. 100 AND 101).

FIRST USE 7-1-2005; IN COMMERCE 7-1-2005.

CLASS 45—PERSONAL SERVICES

3,007,681. SPECIALTY MATCH NETWORK, INC., LAGUNA BEACH, CA. SN 76-560,045. PUB. 11-2-2004, FILED 11-14-2003.

MYCOUNTRYMATCH.COM

THE MARK CONSISTS OF STANDARD CHARACTERS WITHOUT CLAIM TO ANY PARTICULAR FONT, STYLE, SIZE, OR COLOR.

FOR ON-LINE COMPUTER DATING SERVICES; ON-LINE MATCH MAKING SERVICES; ON-LINE SOCIAL INTRODUCTION AGENCY SERVICES (U.S. CLS. 100 AND 101).

FIRST USE 6-1-2003; IN COMMERCE 11-1-2003.

OCTOBER 18, 2005

U.S. PATENT AND TRADEMARK OFFICE

TM 1621

CLASS 45—(Continued).

CLASS 45—(Continued).

3,007,883. CORINE M. MCGLOWN, DBA GRAB MY GIFTS,
ALEXANDRIA, VA. SN 78-346,069. PUB. 11-9-2004, FILED
12-29-2003.

Grab My Gifts

THE MARK CONSISTS OF STANDARD CHARACTERS
WITHOUT CLAIM TO ANY PARTICULAR FONT, STYLE,
SIZE, OR COLOR.

FOR PERSONAL SHOPPING SERVICES FOR BUSI-
NESSES AND INDIVIDUALS, AND GIFT WRAPPING
SERVICES (U.S. CLS. 100 AND 101).

FIRST USE 10-29-2003; IN COMMERCE 11-16-2004.

* * * * *

PRIOR UNITED STATES CLASSIFICATION

APPLICATION IN ONE CLASS

COLLECTIVE MEMBERSHIP MARKS

CLASS 200—COLLECTIVE MEMBERSHIP

3,007,633. OFFICE OF THE SURGEON GENERAL, ROCKVILLE, MD. SN 76-477,804. PUB. 6-1-2004, FILED 12-24-2002.

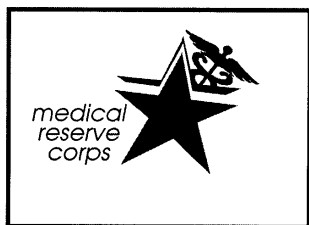

NO CLAIM IS MADE TO THE EXCLUSIVE RIGHT TO USE MEDICAL RESERVE CORPS, APART FROM THE MARK AS SHOWN.

FOR MEMBERSHIP IN A GROUP OF SERVICE-PROVIDERS WHO HAVE AN ESTABLISHED GROUP OF PRACTICING AND RETIRED PHYSICIANS, NURSES, AND OTHER HEALTH PROFESSIONALS TO ACT IN A COORDINATED MANNER IN TIMES OF LOCAL EMERGENCIES (U.S. CL. 200).

FIRST USE 7-19-2002; IN COMMERCE 7-19-2002.

CERTIFICATION MARKS

CLASS B—SERVICES

3,007,608. AMERICAN INSTITUTE OF ARCHITECTS, CALIFORNIA COUNCIL, THE, SACRAMENTO, CA. SN 76-342,606. PUB. 6-10-2003, FILED 11-28-2001.

**AIACC CERTIFIED
DEVELOPMENT
STRATEGIST**

NO CLAIM IS MADE TO THE EXCLUSIVE RIGHT TO USE "CERTIFIED DEVELOPMENT STRATEGIST", APART FROM THE MARK AS SHOWN.

THE CERTIFICATION MARK, AS INTENDED TO BE USED BY AUTHORIZED PERSONS, IS INTENDED TO CERTIFY THAT SUCH PERSONS HAVE MET AND CONTINUE TO MAINTAIN THE CRITERIA ESTABLISHED BY APPLICANT AND ARE QUALIFIED TO PROVIDE A BROAD RANGE OF ARCHITECTURAL, DESIGN, PROJECT DEVELOPMENT, AND PROJECT MANAGEMENT SERVICES.

FOR ARCHITECTURAL AND DESIGN SERVICES; PROJECT DEVELOPMENT AND MANAGEMENT SERVICES, INCLUDING CLIENT EVALUATIONS AND CONSULTATIONS, REAL ESTATE AND SITE IDENTIFICATION, EVALUATION AND ACQUISITION, STRATEGIC PLANNING, BIDDING AND BID REVIEWS, PROJECT SCHEDULING, CONTRACT NEGOTIATIONS, STRUCTURING FEE AGREEMENTS, FINANCING AND BUDGETING, AND, ASSEMBLING AND MANAGING PROJECT TEAM, CONTRACTORS, AND CONSTRUCTION SERVICE PROVIDERS (U.S. CL. B).

FIRST USE 6-1-2004; IN COMMERCE 6-1-2004.

* * * * *

SUPPLEMENTAL REGISTER

These registrations are not subject to opposition.

SECTION 1.— INTERNATIONAL CLASSIFICATION

The short titles associated below with the international class numbers are terms designed merely for quick identification and are not an official part of the international classification. The full names of international classes are given in section 6.1 of the trademark rules of practice.

The designation "U.S. Cl." appearing in this section refers to the U.S. class in effect prior to Sep. 1, 1973 rather than the international class which applies to applications filed on or after that date. For adoption of international classification see notice in the OFFICIAL GAZETTE of Jun. 26, 1973 (911 O.G. TM 210).

Application in more than one class

3,008,037. HEALTH PROTECTION AGENCY, SALISBURY, WILTSHIRE, SP4 0JG, ENGLAND. SN 76-561,181. FILED P.R. 11-21-2003; AM. S.R. 12-14-2004.

HEALTH PROTECTION AGENCY

THE MARK CONSISTS OF STANDARD CHARACTERS WITHOUT CLAIM TO ANY PARTICULAR FONT, STYLE, SIZE, OR COLOR.

PRIORITY CLAIMED UNDER SEC. 44(D) ON UNITED KINGDOM APPLICATION NO. 2333006, FILED 5-23-2003, REG. NO. 2333006, DATED 11-14-2003, EXPIRES 5-23-2013.

NO CLAIM IS MADE TO THE EXCLUSIVE RIGHT TO USE "AGENCY", APART FROM THE MARK AS SHOWN.

CLASS 1—CHEMICALS

FOR CHEMICAL PRODUCTS AND SUBSTANCES FOR IN VITRO USE, NAMELY, CHEMICAL ADDITIVES FOR USE IN THE MANUFACTURE OF PHARMACEUTICALS (U.S. CLS. 1, 5, 6, 10, 26 AND 46).

CLASS 5—PHARMACEUTICALS

FOR PHARMACEUTICAL AND VETERINARY PREPARATIONS AND SUBSTANCES, NAMELY PHARMACEUTICALS, BIOPHARMACEUTICALS AND VACCINES FOR USE IN ONCOLOGY AND IN CONNECTION WITH INFECTIOUS DISEASES AND CENTRAL NERVOUS SYSTEM DISEASES; DIAGNOSTIC PREPARATIONS AND REAGENTS FOR CLINICAL OR MEDICAL LABORATORY USE, ALL FOR IN VIVO USE; DIAGNOSTIC CHEMICAL PREPARATIONS, ENZYMES AND REAGENTS FOR MEDICAL USE FOR USE IN DIAGNOSTIC ASSAYS FOR THE DETECTION OF INFECTIOUS DISEASES AND FOR CLINICAL OR MEDICAL USE INCLUDING CHECKING BLOOD TYPE AND TISSUE SAMPLES; MEDIA FOR BACTERIOLOGICAL CULTURES; REFERENCE CULTURES OF MICRO-ORGANISMS IN THE NATURE OF BACTERIA, VIRUSES, FUNGI AND COMPOUNDS THEREOF, INCLUDING DNA, PROTEINS AND OTHER CELL COMPONENTS FOR MEDICAL, DIAGNOSTIC AND VETERINARY USE (U.S. CLS. 6, 18, 44, 46, 51 AND 52).

CLASS 9—ELECTRICAL AND SCIENTIFIC APPARATUS

FOR DOWNLOADABLE ON-LINE ELECTRONIC PUBLICATIONS IN THE NATURE OF REPORTS, ANNUAL REPORTS, DIRECTORIES, SCIENTIFIC PAPERS, JOURNALS, ADVISORY AND GUIDANCE DOCUMENTS, LEAFLETS, FACT SHEETS, CATALOGUES, STATISTICAL SURVEYS, CORPORATE LITERATURE, PRESS RELEASES IN THE FIELD OF PUBLIC HEALTH, MICROBIOLOGY, EMERGENCY PLANNING AND ELECTRO MAGNETIC RADIATION (U.S. CLS. 21, 23, 26, 36 AND 38).

CLASS 41—EDUCATION AND ENTERTAINMENT

FOR EDUCATIONAL RESEARCH; EDUCATIONAL SERVICES, NAMELY, CONDUCTING PROGRAMES, LECTURES, CLASSES, WORKSHOPS, SEMINARS, EXERCISES AND PRACTICALS IN THE FIELDS OF LABORATORY AND CLINICAL TECHNIQUES, PUBLIC HEALTH, EPIDEMIOLOGY, IMMUNOLOGY, MODELING THE EPIDEMIOLOGY OF INFECTIOUS DISEASES AND THE EFFECTIVENESS OF CONTROL MEASURES INCLUDING IMMUNIZATION, AND EMERGENCY PLANNING AND PREPAREDNESS (U.S. CLS. 100, 101 AND 107).

CLASS 42—SCIENTIFIC, COMPUTER AND LEGAL SERVICES

FOR MEDICAL AND SCIENTIFIC RESEARCH SERVICES RELATING TO INFECTIOUS DISEASES, THREATS TO PUBLIC HEALTH, BIOTERRORISM, MICROBIOLOGY; MEDICAL AND SCIENTIFIC RESEARCH REGARDING CLINICAL TRIAL STUDIES ON NEW VACCINE CANDIDATES; RESEARCH AND PRODUCT DEVELOPMENT SERVICES; CONSULTANCY SERVICES IN THE FIELD OF RESEARCH AND PRODUCT DEVELOPMENT, DISSEMINATION OF INFORMATION IN THE FIELD OF RESEARCH AND PRODUCT DEVELOPMENT; ALL OF THE ABOVE RELATING TO BIOLOGICAL, MICROBIOLOGICAL, MICROBIAL, GENETIC, CHROMOSOMAL, ENVIRONMENTAL, BIOSAFETY, IMMUNOLOGY, PHARMACOLOGY AND HEALTH MATTERS (U.S. CLS. 100 AND 101).

CLASS 44—MEDICAL, BEAUTY AND AGRICULTURAL SERVICES

FOR MEDICAL SERVICES; VETERINARY SERVICES; HEALTH CARE; HOSPITALS AND MEDICAL CLINICS; EMERGENCY MEDICAL ASSISTANCE; NURSING CARE (U.S. CLS. 100 AND 101).

3,008,047. AMERICAN COUNCIL ON EXERCISE, SAN DIEGO, CA. SN 76-605,051. FILED P.R. 7-30-2004; AM. S.R. 5-4-2005.

3,008,065. CODELOCKS LIMITED, THATCHAM, UNITED KINGDOM. SN 78-377,308. FILED P.R. 3-2-2004; AM. S.R. 8-26-2005.

AMERICA'S AUTHORITY ON FITNESS

THE MARK CONSISTS OF STANDARD CHARACTERS WITHOUT CLAIM TO ANY PARTICULAR FONT, STYLE, SIZE, OR COLOR.

CLASS 35—ADVERTISING AND BUSINESS

FOR PROVIDING ON-LINE INFORMATION IN THE AREA OF HEALTH AND FITNESS, NAMELY, ON-LINE DIRECTORY INFORMATION FOR HEALTH CLUBS, FITNESS PROFESSIONALS, AND EMPLOYMENT OPPORTUNITIES (U.S. CLS. 100, 101 AND 102).

FIRST USE 4-30-2003; IN COMMERCE 4-30-2003.

CLASS 41—EDUCATION AND ENTERTAINMENT

FOR EDUCATIONAL SERVICES, NAMELY, PROVIDING TRAINING SERVICES, CLASSES, SEMINARS, AND EDUCATIONAL TESTING IN THE FIELD OF HEALTH AND FITNESS (U.S. CLS. 100, 101 AND 107).

FIRST USE 10-1-2001; IN COMMERCE 10-1-2001.

CODELOCKS

3,008,056. GOMEZ, MARIA, MIAMI, FL. SN 78-317,668. FILED P.R. 10-23-2003; AM. S.R. 8-24-2005.

EHOUSE

CLASS 35—ADVERTISING AND BUSINESS

FOR REAL ESTATE ADVERTISING, REAL ESTATE MARKETING SERVICES, NAMELY, ON-LINE SERVICES FEATURING TOURS OF RESIDENTIAL AND COMMERCIAL REAL ESTATE, REAL ESTATE AUCTIONS (U.S. CLS. 100, 101 AND 102).

FIRST USE 3-1-2004; IN COMMERCE 3-1-2004.

CLASS 36—INSURANCE AND FINANCIAL

FOR REAL ESTATE LISTING, FINANCIAL EVALUATION OF PERSONAL PROPERTY AND REAL ESTATE, LAND ACQUISITION, NAMELY, REAL ESTATE BROKERAGE, LEASING OF REAL ESTATE, OPERATING MARKETPLACES FOR REAL ESTATE SELLERS OF GOODS AND/OR SERVICES, PROVIDING INFORMATION IN THE FIELD OF REAL ESTATE BY MEANS OF LINKING THE WEB SITE TO OTHER WEB SITES FEATURING REAL ESTATE INFORMATION, REAL ESTATE AGENCIES, REAL ESTATE APPRAISAL, REAL ESTATE BROKERAGE (U.S. CLS. 100, 101 AND 102).

FIRST USE 3-1-2004; IN COMMERCE 3-1-2004.

THE MARK CONSISTS OF STANDARD CHARACTERS WITHOUT CLAIM TO ANY PARTICULAR FONT, STYLE, SIZE, OR COLOR.

CLASS 6—METAL GOODS

FOR METAL LOCKS, NAMELY, NON-ELECTRIC COMBINATION LOCKS, NON-ELECTRIC COMBINATION DOOR LOCKS, BIKE LOCKS, BATHROOM LOCKS, CAMLOCKS, CABINET LOCKS, CHECK LOCKS, COMBINATION LOCKS, CYLINDER LOCKS, DOOR LOCKS, DRAWER LOCKS, HOOKBOLT LOCKS, FURNITURE LOCKS, MORTISE LOCKS, MULTILEVER MORTISE LOCKS, DEAD BOLT LOCKS, MULTIPOINT LOCKS, NIGHT LATCH LOCKS, RING LOCKS, MULTILEVER RIM LOCKS, PUMP CYLINDER RIM LOCKS, LOCKS FOR SAFES, GARDEN LOCKS, PATIO DOOR LOCKS, SLIDING DOOR LOCKS, SASH LOCKS, SCREW LOCKS, STYLE LOCKS, SPRING LOCKS, STAY LOCKS, SWING BOLT LOCKS, LOCKS FOR METAL DOORS, LOCKS FOR ROLLING SHUTTERS, LOCKS FOR UP AND OVER DOORS, UTILITY LOCKS, WINDOW LOCKS; PADLOCKS, PIN TUMBLER PADLOCKS, STEEL PADLOCKS, PADLOCKS FOR CHAINS, ROLLING SHUTTER PADLOCKS, SPECIAL APPLICATION PADLOCKS, VISUAL PACKED PADLOCKS, ARMORED PADLOCKS AND DEADLOCKS; LOCK SETS COMPRISED OF METAL LOCKS AND METAL KEYS THEREFOR; METAL LOCK CASES; METAL LOCK BODIES; METAL LOCK CYLINDERS; METAL LOCK MECHANISMS; REPLACEMENT PARTS AND FITTINGS FOR THE AFORESAID GOODS (U.S. CLS. 2, 12, 13, 14, 23, 25 AND 50).

FIRST USE 10-0-2000; IN COMMERCE 10-0-2000.

CLASS 9—ELECTRICAL AND SCIENTIFIC APPARATUS

3,008,070. BUZBEE, DAWN BJORK, PARKER, CO. AND BUZBEE, TOM D., PARKER, CO. SN 78-427,287. FILED P.R. 5-28-2004; AM. S.R. 7-11-2005.

FOR ACCESS CONTROL APPARATUS, NAMELY, ACCESS CONTROL SYSTEMS; ELECTRONICALLY CONTROLLED LOCKS; ELECTRONIC COMBINATION LOCKS; ELECTRONIC COMBINATION DOOR LOCKS; ELECTRONICALLY OPERATED DOOR CLOSERS; ELECTRIC CONTROL APPARATUS FOR DOORS; ELECTRONIC DOOR LOCKS; MAGNETICALLY ENCODED KEY CARDS; ELECTRICALLY CONTROLLED DOOR LOCKS ACTIVATED BY KEY CARDS; COMPUTER-CONTROLLED APPARATUS FOR CODING KEY CARDS; COMBINED ELECTRONICALLY CONTROLLED DOOR HOLDERS/CLOSERS; ELECTRIC DOOR CONTROL AND MONITOR PANELS; ELECTRICAL AUTOMATIC DOOR APPARATUS; ELECTROMAGNETIC DOOR HOLDERS; ELECTROMAGNETIC FLOOR CLOSERS; ELECTROMAGNETIC DOOR RELEASERS; ELECTROMAGNETIC LOCKS; ALARMS NOT BEING FOR VEHICLES, ALARM LOCKS; PUSHBUTTON ELECTRONIC LOCKS; ELECTROMECHANICAL DOOR HOLDER RELEASES; ELECTROMECHANICAL DOOR HOLDERS/CLOSERS; ELECTROMECHANICAL DOOR LATCHES; CONSOLES, NAMELY, ELECTRONIC ACCESS KEYPAD CONSOLES; KEY-OPERATED ELECTRONIC CONTROLS; CARD-OPERATED ELECTRONIC LOCKS; KEY PADS FOR PROGRAMMABLE LOCKING SYSTEMS, KEY PAD OPERATED LOCKS; SOLENOID OPERATED LOCKS; ELECTROMECHANICAL EXIT DEVICES, NAMELY, ELECTROMECHANICAL DOOR OPENERS; ELECTRONICALLY-CONTROLLED DOOR OPENING DEVICES; AUTOMATIC ACTIVATING DEVICES FOR OPENING DOORS; ELECTRONICALLY CONTROLLED DOOR CLOSING DEVICES; REPLACEMENT PARTS AND FITTINGS FOR THE AFORESAID GOODS (U.S. CLS. 21, 23, 26, 36 AND 38).
FIRST USE 10-0-2000; IN COMMERCE 10-0-2000.

THE SOFTWARE PRO

THE MARK CONSISTS OF STANDARD CHARACTERS WITHOUT CLAIM TO ANY PARTICULAR FONT, STYLE, SIZE, OR COLOR.

NO CLAIM IS MADE TO THE EXCLUSIVE RIGHT TO USE "SOFTWARE", APART FROM THE MARK AS SHOWN.

CLASS 9—ELECTRICAL AND SCIENTIFIC APPARATUS

FOR PRE-RECORDED CD-ROMS, DVD'S, VIDEO TAPES, AUDIO DISCS, AUDIO TAPES, VIDEO FILES, AUDIO FILES FEATURING EDUCATIONAL INFORMATION FOR PRESENTING, TRAINING, AND TESTING SOFTWARE AND TECHNOLOGY SKILLS (U.S. CLS. 21, 23, 26, 36 AND 38).
FIRST USE 6-23-1997; IN COMMERCE 6-23-1997.

CLASS 16—PAPER GOODS AND PRINTED MATTER

FOR PUBLICATIONS, NAMELY BOOKS, BOOKLETS, MAGAZINES, BROCHURES, DOCUMENTATION, MANUALS, PAMPHLETS, NEWSLETTERS RELATING TO SOFTWARE AND TECHNOLOGY (U.S. CLS. 2, 5, 22, 23, 29, 37, 38 AND 50).
FIRST USE 6-23-1997; IN COMMERCE 6-23-1997.

CLASS 41—EDUCATION AND ENTERTAINMENT

FOR EDUCATIONAL SERVICES, NAMELY EDUCATIONAL SPEAKERS, WORKSHOPS, SEMINARS, CLASSES, BROADCASTS RELATING TO SOFTWARE AND TECHNOLOGY (U.S. CLS. 100, 101 AND 107).
FIRST USE 6-23-1997; IN COMMERCE 6-23-1997.

* * * * *

SECTION 2.— INTERNATIONAL CLASSIFICATION

The short titles associated below with the international class numbers are terms designed merely for quick identification and are not an official part of the international classification. The full names of international classes are given in section 6.1 of the trademark rules of practice.

The designation "U.S. Cl." appearing in this section refers to the U.S. class in effect prior to Sep. 1, 1973 rather than the international class which applies to applications filed on or after that date. For adoption of international classification see notice in the OFFICIAL GAZETTE of Jun. 26, 1973 (911 O.G. TM 210).

Application in one class

CLASS 3—COSMETICS AND CLEANING PREPARATIONS

3,008,048. EISAGE, LLC, DBA ECO-PRODUCTS, BOULDER, CO. SN 76-618,981. FILED P.R. 11-1-2004; AM. S.R. 8-8-2005.

CLASS 3—(Continued).

3,008,089. LESLIE HUMPHRYS-ELIASZIW, STRATFORD, ONTARIO, CANADA. SN 78-502,485. FILED P.R. 10-19-2004; AM. S.R. 8-15-2005.

The Healing Bath

SUPERIOR BATHROOM CLEANER

THE MARK CONSISTS OF STANDARD CHARACTERS WITHOUT CLAIM TO ANY PARTICULAR FONT, STYLE, SIZE, OR COLOR.

NO CLAIM IS MADE TO THE EXCLUSIVE RIGHT TO USE "BATH", APART FROM THE MARK AS SHOWN.

FOR BATH AND PERSONAL CARE PRODUCTS, NAMELY, DEAD SEA BATH SALTS, BATH MELTS, NAMELY, A MOISTURIZING BATH PREPARATION MADE WITH A COCOA BUTTER BASE, BAKING SODA, CITRIC ACID AND PURE ESSENTIAL OILS FOR PERSONAL USE, BATH BOMBS, ESSENTIAL OILS FOR PERSONAL USE, BATH KIT GIFT BASKETS CONTAINING DEAD SEA BATH SALTS, BATH MELTS, NAMELY, A MOISTURIZING BATH PREPARATION MADE WITH A COCOA BUTTER BASE, BAKING SODA, CITRIC ACID AND PURE ESSENTIAL OILS FOR PERSONAL USE, BATH BOMBS, ESSENTIAL OILS FOR PERSONAL USE AND NOVELTY BATH ITEMS, NAMELY, LOOFAH SPONGES, AND NAIL BRUSHES SOLD AS A UNIT (U.S. CLS. 1, 4, 6, 50, 51 AND 52).

FIRST USE 2-1-2002; IN COMMERCE 6-1-2002.

THE MARK CONSISTS OF STANDARD CHARACTERS WITHOUT CLAIM TO ANY PARTICULAR FONT, STYLE, SIZE, OR COLOR.

NO CLAIM IS MADE TO THE EXCLUSIVE RIGHT TO USE "BATHROOM CLEANER", APART FROM THE MARK AS SHOWN.

FOR CLEANSER, NAMELY, ALL-PURPOSE CLEANERS (U.S. CLS. 1, 4, 6, 50, 51 AND 52).

FIRST USE 9-1-2004; IN COMMERCE 9-1-2004.

CLASS 5—PHARMACEUTICALS

CLASS 5—(Continued).

3,008,042. LONGSTAR HEALTHPRO, INC., WALNUT, CA. SN 76-598,433. FILED P.R. 6-21-2004; AM. S.R. 7-20-2005.

CLASS 6—(Continued).

3,008,072. THE GUTTERSHTTER MANUFACTURING COMPANY, CINCINNATI, OH. SN 78-435,417. FILED P.R. 6-15-2004; AM. S.R. 8-4-2005.

骨 膠 原

**AMERICA'S FINEST
LEAF AND DEBRIS
SYSTEM**

NO CLAIM IS MADE TO THE EXCLUSIVE RIGHT TO USE "JIAO YUAN", APART FROM THE MARK AS SHOWN. BASED ON THE FOREGOING, APPLICANT HEREBY AMENDS THE TRANSLATION OF "GU JIAO YUAN" IN CHINESE CHARACTERS AS FOLLOWS: "GU" MEANS "BONE;" "JIAO" MEANS "GLUE;" AND "YUAN" MEANS "ORIGINAL" OR "UNPROCESSED," "JIAO YUAN" MEANS "COLLAGEN."
FOR NUTRITIONAL SUPPLEMENTS (U.S. CLS. 6, 18, 44, 46, 51 AND 52).
FIRST USE 2-0-2002; IN COMMERCE 2-0-2002.

THE MARK CONSISTS OF STANDARD CHARACTERS WITHOUT CLAIM TO ANY PARTICULAR FONT, STYLE, SIZE, OR COLOR.
FOR METAL RAIN GUTTERS FOR BLOCKING ENTRY OF LEAVES AND DEBRIS (U.S. CLS. 2, 12, 13, 14, 23, 25 AND 50).
FIRST USE 4-30-2004; IN COMMERCE 5-20-2004.

3,008,058. GROTE, JAMES ADAMS, PITTSFIELD, IL. SN 78-322,008. FILED P.R. 11-2-2003; AM. S.R. 5-16-2005.

3,008,087. BROWNING, MORGAN, UT. SN 78-474,680. FILED P.R. 8-27-2004; AM. S.R. 8-26-2005.

MAXIMUM D3

BRONZE

THE MARK CONSISTS OF STANDARD CHARACTERS WITHOUT CLAIM TO ANY PARTICULAR FONT, STYLE, SIZE, OR COLOR.
NO CLAIM IS MADE TO THE EXCLUSIVE RIGHT TO USE D3, APART FROM THE MARK AS SHOWN.
FOR VITAMINS, NAMELY, VITAMIN D3, NAMELY, CHOLECALCIFEROL (U.S. CLS. 6, 18, 44, 46, 51 AND 52).
FIRST USE 4-7-2005; IN COMMERCE 4-7-2005.

THE MARK CONSISTS OF STANDARD CHARACTERS WITHOUT CLAIM TO ANY PARTICULAR FONT, STYLE, SIZE, OR COLOR.
FOR METAL SAFES, INCLUDING GUN SAFES AND SAFES FOR VALUABLES (U.S. CLS. 2, 12, 13, 14, 23, 25 AND 50).
FIRST USE 10-1-2003; IN COMMERCE 11-1-2003.

CLASS 6—METAL GOODS

CLASS 9—ELECTRICAL AND SCIENTIFIC APPARATUS

CLASS 9—(Continued).

3,008,029. CONTROL MICROSYSTEMS INC./ MICROSYS-TEMES DE CONTROLE INC., KANATA, ONTARIO. SN 76-378,602. FILED P.R. 3-5-2002; AM. S.R. 5-9-2005.

SCADANET

FOR COMPUTER HARDWARE, NAMELY A MULTI-CHANNEL DATA COMMUNICATIONS CONTROLLER (U.S. CLS. 21, 23, 26, 36 AND 38).

FIRST USE 10-1-2004; IN COMMERCE 12-21-2004.

3,008,061. THE MCGRAW-HILL COMPANIES, INC., NEW YORK, NY. SN 78-351,670. FILED P.R. 1-14-2004; AM. S.R. 2-11-2005.

CDO EVALUATOR

THE MARK CONSISTS OF STANDARD CHARACTERS WITHOUT CLAIM TO ANY PARTICULAR FONT, STYLE, SIZE, OR COLOR.

FOR DOWNLOADABLE COMPUTER SOFTWARE FOR STRUCTURING COLLATERALIZED DEBT OBLIGATIONS IN THE BANKING FIELD (U.S. CLS. 21, 23, 26, 36 AND 38).

FIRST USE 9-12-2001; IN COMMERCE 9-12-2001.

3,008,063. MULTIMEDIACARD ASSOCIATION, SUNOL, CA. SN 78-359,418. FILED P.R. 1-29-2004; AM. S.R. 8-15-2005.

MMCMOBILE

THE MARK CONSISTS OF STANDARD CHARACTERS WITHOUT CLAIM TO ANY PARTICULAR FONT, STYLE, SIZE, OR COLOR.

NO CLAIM IS MADE TO THE EXCLUSIVE RIGHT TO USE MMC, APART FROM THE MARK AS SHOWN.

FOR CARDS CONTAINING AN INTEGRATED CIRCUIT MEMORY COMPONENT FOR STORING DIGITAL DATA THAT INTERFACES WITH TELECOMMUNICATION DEVICES, TESTERS, INTEGRATED CIRCUITS, HOST HANDHELD DEVICES SUCH AS PERSONAL DIGITAL ASSISTANTS WHICH CONTAIN, ACCEPT, READ, RECOGNIZE AND/OR UTILIZE SUCH CARDS AS ALL OR PART OF THEIR FUNCTION (U.S. CLS. 21, 23, 26, 36 AND 38).

FIRST USE 4-0-2004; IN COMMERCE 4-0-2004.

CLASS 9—(Continued).

3,008,064. YOUNG, GARY GEORGE, NEWPORT BEACH, CA. SN 78-360,663. FILED P.R. 2-1-2004; AM. S.R. 8-11-2005.

Ultra Polarized

THE MARK CONSISTS OF STANDARD CHARACTERS WITHOUT CLAIM TO ANY PARTICULAR FONT, STYLE, SIZE, OR COLOR.

NO CLAIM IS MADE TO THE EXCLUSIVE RIGHT TO USE "POLARIZED", APART FROM THE MARK AS SHOWN.

FOR EYEGLASS, SUNGLASS AND OPHTHALMIC LENSES USED FOR PRESCRIPTION AND NON PRESCRIPTION (U.S. CLS. 21, 23, 26, 36 AND 38).

FIRST USE 2-1-2004; IN COMMERCE 2-1-2004.

CLASS 10—MEDICAL APPARATUS

3,008,041. RAMVAC DENTAL PRODUCTS, INC., SPEARFISH, SD. SN 76-597,640. FILED P.R. 6-16-2004; AM. S.R. 8-4-2005.

FLOWCHECK

THE MARK CONSISTS OF STANDARD CHARACTERS WITHOUT CLAIM TO ANY PARTICULAR FONT, STYLE, SIZE, OR COLOR.

FOR HANDHELD FLOW MEASUREMENT DEVICE FOR USE WITH DENTAL VACUUM PUMP (U.S. CLS. 26, 39 AND 44).

FIRST USE 3-2-2003; IN COMMERCE 3-2-2003.

3,008,053. GLAUKOS CORPORATION, LAGUNA HILLS, CA. SN 78-282,450. FILED P.R. 8-8-2003; AM. S.R. 4-7-2005.

ISTENT

FOR OCULAR IMPLANTS AND DEVICES, NAMELY, SHUNTS, STENTS, OPHTHALMIC CUTTING INSTRUMENTS, SHUNT AND STENT APPLICATORS, AND VISION SCREENING INSTRUMENTS, FOR USE IN TREATING GLAUCOMA (U.S. CLS. 26, 39 AND 44).

FIRST USE 9-17-2004; IN COMMERCE 9-17-2004.

CLASS 10—(Continued).

3,008,075. TORNAL, RICHARD M., PINOLE, CA. SN 78-443,804. FILED P.R. 6-30-2004; AM. S.R. 8-17-2005.

CLASS 11—(Continued).

3,008,082. USA PELICAN, INC., DBA WATER MANAGEMENT TECHNOLOGIES, MIAMI, FL. SN 78-453,642. FILED P.R. 7-20-2004; AM. S.R. 8-8-2005.

Carpal Tunnel Pain Relief Strips

Water Management Technologies

THE MARK CONSISTS OF STANDARD CHARACTERS WITHOUT CLAIM TO ANY PARTICULAR FONT, STYLE, SIZE, OR COLOR.
NO CLAIM IS MADE TO THE EXCLUSIVE RIGHT TO USE STRIPS, APART FROM THE MARK AS SHOWN.
FOR SPLINT (U.S. CLS. 26, 39 AND 44).
FIRST USE 10-4-2003; IN COMMERCE 4-14-2004.

THE MARK CONSISTS OF STANDARD CHARACTERS WITHOUT CLAIM TO ANY PARTICULAR FONT, STYLE, SIZE, OR COLOR.
FOR WATER TREATMENT SYSTEM IN THE NATURE OF DECONTAMINATION VESSELS COMPRISED OF REDUNDANT OXIDIZERS USING OXYGEN AND OZONE TO REDUCE OR ELIMINATE BACTERIA AND VIRUSES AND IMPROVE THE CLARITY OF WATER (U.S. CLS. 13, 21, 23, 31 AND 34).
FIRST USE 1-1-1999; IN COMMERCE 1-1-1999.

CLASS 11—ENVIRONMENTAL CONTROL APPARATUS

3,008,038. FANIMATION, INC., ZIONSVILLE, IN. SN 76-568,491. FILED P.R. 1-5-2004; AM. S.R. 8-22-2005.

CLASS 12—VEHICLES

3,008,054. GIDDENS, PAUL, R. ACAMPO, CA. SN 78-285,548. FILED P.R. 8-11-2003; AM. S.R. 7-21-2005.

THE PUNKAH

MONSTERQUAD

FOR ELECTRIC CEILING FANS AND WALL MOUNTED FANS FOR NON-INDUSTRIAL USE HAVING MULTIPLE RECIPROCATING BLADES EXTENDING FROM A SURFACE OF THE CEILING OR WALL (U.S. CLS. 13, 21, 23, 31 AND 34).
FIRST USE 6-1-1988; IN COMMERCE 6-1-1988.

FOR ATV PARTS AND ATV ACCESSORIES, NAMELY, ATV FLAG HOLDERS, BUMPERS, GAS CAPS, HANDLEBAR CLAMPS, SWING ARMS, WHEEL HUBS AND WHEEL SPINDLES (U.S. CLS. 19, 21, 23, 31, 35 AND 44).
FIRST USE 1-1-1998; IN COMMERCE 1-1-1998.

CLASS 12—(Continued).

3,008,090. OREGON AERO, INC., SCAPPOOSE, OR. SN 78-508,697. FILED P.R. 10-29-2004; AM. S.R. 7-29-2005.

HIGH-G

THE MARK CONSISTS OF STANDARD CHARACTERS WITHOUT CLAIM TO ANY PARTICULAR FONT, STYLE, SIZE, OR COLOR.
FOR AIRCRAFT SEATS (U.S. CLS. 19, 21, 23, 31, 35 AND 44).
FIRST USE 0-0-2003; IN COMMERCE 0-0-2003.

CLASS 14—JEWELRY

3,008,032. LONDONTOWNE GALLERIES, SOMERVILLE, MA. SN 76-458,395. FILED P.R. 10-15-2002; AM. S.R. 11-24-2003.

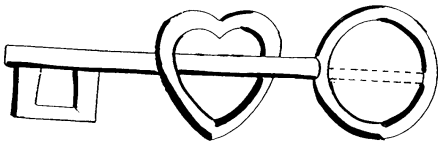

OWNER OF U.S. REG. NO. 2,587,469.
THE MARK CONSISTS OF A DESIGN OF A KEY POSITIONED THROUGH A HEART-SHAPED DESIGN, BUT NOT INCLUDING THE METAL CLASP FOR ATTACHING THE GOODS.
FOR JEWELRY, NAMELY, PINS (U.S. CLS. 2, 27, 28 AND 50).
FIRST USE 4-15-2000; IN COMMERCE 6-1-2000.

CLASS 16—PAPER GOODS AND PRINTED MATTER

3,008,049. PRIME NATIONAL PUBLISHING CORPORATION, WESTON, MA. SN 76-627,341. FILED P.R. 1-7-2005; AM. S.R. 8-23-2005.

JOURNAL OF OPIOID MANAGEMENT

CLASS 16—(Continued).

THE MARK CONSISTS OF STANDARD CHARACTERS WITHOUT CLAIM TO ANY PARTICULAR FONT, STYLE, SIZE, OR COLOR.
NO CLAIM IS MADE TO THE EXCLUSIVE RIGHT TO USE "JOURNAL", APART FROM THE MARK AS SHOWN.
FOR MAGAZINES FOR HEALTH PROFESSIONALS FEATURING PROPER AND ADEQUATE USAGE OF OPIOIDS (U.S. CLS. 2, 5, 22, 23, 29, 37, 38 AND 50).
FIRST USE 7-14-2004; IN COMMERCE 1-5-2005.

3,008,073. F & W PUBLICATIONS, INC., CINCINNATI, OH. SN 78-440,239. FILED P.R. 6-23-2004; AM. S.R. 6-21-2005.

SCUBA DIVING

THE MARK CONSISTS OF STANDARD CHARACTERS WITHOUT CLAIM TO ANY PARTICULAR FONT, STYLE, SIZE, OR COLOR.
OWNER OF U.S. REG. NOS. 1,759,846, 2,447,396, AND 2,458,750.
FOR MAGAZINES PUBLISHED PERIODICALLY IN THE FIELD OF SCUBA DIVING (U.S. CLS. 2, 5, 22, 23, 29, 37, 38 AND 50).
FIRST USE 6-1-2004; IN COMMERCE 6-1-2004.

3,008,079. WORLD PUBLICATIONS LLC, WINTER PARK, FL. SN 78-448,258. FILED P.R. 7-9-2004; AM. S.R. 6-9-2005.

**Destination
Weddings &
Honeymoons**

THE MARK CONSISTS OF STANDARD CHARACTERS WITHOUT CLAIM TO ANY PARTICULAR FONT, STYLE, SIZE, OR COLOR.
FOR PUBLICATIONS, NAMELY MAGAZINES IN THE FIELD OF WEDDING, MATRIMONY AND HONEYMOON PLANNING (U.S. CLS. 2, 5, 22, 23, 29, 37, 38 AND 50).
FIRST USE 1-18-2005; IN COMMERCE 1-18-2005.

CLASS 16—(Continued).

3,008,086. ASCEND MEDIA, LLC, OVERLAND PARK, KS. SN 78-465,980. FILED P.R. 8-11-2004; AM. S.R. 7-19-2005.

CLASS 16—(Continued).

3,008,100. RAIKE, FRED, MICHAEL, INCLINE VILLAGE, CA. AND RAIKE, JULIE, A, INCLINE VILLAGE, NV. SN 78-559,323. FILED P.R. 2-2-2005; AM. S.R. 9-1-2005.

**INDIAN GAMING
BUSINESS**



THE MARK CONSISTS OF STANDARD CHARACTERS WITHOUT CLAIM TO ANY PARTICULAR FONT, STYLE, SIZE, OR COLOR.

FOR MAGAZINES OF INTEREST TO THOSE IN THE GAMING INDUSTRY (U.S. CLS. 2, 5, 22, 23, 29, 37, 38 AND 50).

FIRST USE 2-0-1998; IN COMMERCE 2-0-1998.

NO CLAIM IS MADE TO THE EXCLUSIVE RIGHT TO USE MAGAZINE, APART FROM THE MARK AS SHOWN.

FOR MAGAZINES FEATURING REAL ESTATE LISTINGS FOR HOMES (U.S. CLS. 2, 5, 22, 23, 29, 37, 38 AND 50).

FIRST USE 1-12-2005; IN COMMERCE 1-12-2005.

CLASS 17—RUBBER GOODS

3,008,094. ACCESS INTELLIGENCE, LLC, ROCKVILLE, MD. SN 78-528,311. FILED P.R. 12-7-2004; AM. S.R. 7-19-2005.

3,008,096. AMERICAN MICRO INDUSTRIES, INC., CHAMBERSBURG, PA. SN 78-530,538. FILED P.R. 12-10-2004; AM. S.R. 8-22-2005.

**REGIONAL AVIATION
NEWS**

QUIET BARRIER

THE MARK CONSISTS OF STANDARD CHARACTERS WITHOUT CLAIM TO ANY PARTICULAR FONT, STYLE, SIZE, OR COLOR.

NO CLAIM IS MADE TO THE EXCLUSIVE RIGHT TO USE "BARRIER", APART FROM THE MARK AS SHOWN.

FOR VINYL BARRIER MATERIAL USED FOR SOUNDPROOFING (U.S. CLS. 1, 5, 12, 13, 35 AND 50).

FIRST USE 12-10-2004; IN COMMERCE 12-10-2004.

THE MARK CONSISTS OF STANDARD CHARACTERS WITHOUT CLAIM TO ANY PARTICULAR FONT, STYLE, SIZE, OR COLOR.

NO CLAIM IS MADE TO THE EXCLUSIVE RIGHT TO USE "NEWS", APART FROM THE MARK AS SHOWN.

FOR NEWSLETTER PROVIDING INTELLIGENCE FOR THE REGIONAL AVIATION MARKETPLACE TO MAKE POSSIBLE BUSINESS DECISIONS (U.S. CLS. 2, 5, 22, 23, 29, 37, 38 AND 50).

FIRST USE 12-6-1994; IN COMMERCE 12-6-1994.

CLASS 20—FURNITURE AND ARTICLES NOT OTHERWISE CLASSIFIED

CLASS 20—(Continued).

3,008,046. BUCKTOWN FINE ARTS, CHICAGO, IL. SN 76-603,410. FILED P.R. 7-22-2004; AM. S.R. 7-18-2005.

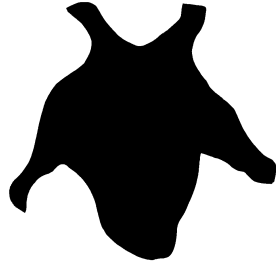

THE MARK CONSISTS OF A CONFIGURATION OF A PLAQUE IN THE FORM OF A STYLIZED GOAT'S HEAD. FOR PLAQUE USED AS AN AWARD ACKNOWLEDGING INDIVIDUALS AT AN EVENT (U.S. CLS. 2, 13, 22, 25, 32 AND 50).
FIRST USE 8-0-2003; IN COMMERCE 8-0-2003.

CLASS 21—HOUSEWARES AND GLASS

3,008,040. HOLD IT PRODUCTS CORPORATION, WALLED LAKE, MI. SN 76-596,984. FILED P.R. 6-14-2004; AM. S.R. 7-22-2005.

DISHWASHER LOOP

THE MARK CONSISTS OF STANDARD CHARACTERS WITHOUT CLAIM TO ANY PARTICULAR FONT, STYLE, SIZE, OR COLOR.
NO CLAIM IS MADE TO THE EXCLUSIVE RIGHT TO USE "LOOP", APART FROM THE MARK AS SHOWN.
FOR HOUSEHOLD GOODS, NAMELY, RETAINERS MADE OF ELASTIC BANDS AND PLASTIC HOOKS FOR MAINTAINING ITEMS IN PLACE IN A DISHWASHER RACK (U.S. CLS. 2, 13, 23, 29, 30, 33, 40 AND 50).
FIRST USE 12-31-2002; IN COMMERCE 12-31-2002.

CLASS 21—(Continued).

3,008,097. AMBER E. BARTEN, RENTON, WA. SN 78-538,356. FILED P.R. 12-26-2004; AM. S.R. 8-5-2005.

Cool Ice

THE MARK CONSISTS OF STANDARD CHARACTERS WITHOUT CLAIM TO ANY PARTICULAR FONT, STYLE, SIZE, OR COLOR.

FOR ICE PACKS USED TO KEEP FOODS AND BEVERAGES COOL (U.S. CLS. 2, 13, 23, 29, 30, 33, 40 AND 50).

FIRST USE 9-15-2004; IN COMMERCE 10-1-2004.

CLASS 25—CLOTHING

3,008,071. SCHERING-PLOUGH HEALTHCARE PRODUCTS, INC., MEMPHIS, TN. SN 78-435,142. FILED P.R. 6-15-2004; AM. S.R. 7-26-2005.

OPEN SHOE

THE MARK CONSISTS OF STANDARD CHARACTERS WITHOUT CLAIM TO ANY PARTICULAR FONT, STYLE, SIZE, OR COLOR.

FOR INSOLES (U.S. CLS. 22 AND 39).

FIRST USE 1-1-2005; IN COMMERCE 1-1-2005.

CLASS 29—MEATS AND PROCESSED FOODS

3,008,045. THANASI FOODS LLC, BOULDER, CO. SN 76-602,660. FILED P.R. 7-16-2004; AM. S.R. 8-19-2005.

THE WORLD'S FINEST SUNFLOWER SEEDS

CLASS 29—(Continued).

THE MARK CONSISTS OF STANDARD CHARACTERS WITHOUT CLAIM TO ANY PARTICULAR FONT, STYLE, SIZE, OR COLOR.

NO CLAIM IS MADE TO THE EXCLUSIVE RIGHT TO USE "SUNFLOWERS SEEDS", APART FROM THE MARK AS SHOWN.

FOR PROCESSED EDIBLE SEEDS (U.S. CL. 46).
FIRST USE 8-0-2004; IN COMMERCE 8-0-2004.

CLASS 31—(Continued).

3,008,076. WAWONA PACKING CO., LLC, CUTLER, CA. SN 78-445,036. FILED 7-1-2004.

Sweet 2 Eat

3,008,069. GREEN GARDEN FOOD GROUP LLC, SUNSET, LA. SN 78-412,996. FILED P.R. 5-4-2004; AM. S.R. 5-27-2005.

SALAD MEALS

THE MARK CONSISTS OF STANDARD CHARACTERS WITHOUT CLAIM TO ANY PARTICULAR FONT, STYLE, SIZE, OR COLOR.

NO CLAIM IS MADE TO THE EXCLUSIVE RIGHT TO USE "SWEET 2 EAT", APART FROM THE MARK AS SHOWN.

FOR FRESH FRUITS, NAMELY, PEACHES, NECTARINES, PLUMS, APRICOTS, PLUOTS, FRESH PRUNES, AND PERSIMMONS (U.S. CLS. 1 AND 46).

FIRST USE 4-11-2001; IN COMMERCE 4-11-2001.

CLASS 33—WINES AND SPIRITS

THE MARK CONSISTS OF STANDARD CHARACTERS WITHOUT CLAIM TO ANY PARTICULAR FONT, STYLE, SIZE, OR COLOR.

NO CLAIM IS MADE TO THE EXCLUSIVE RIGHT TO USE "MEALS", APART FROM THE MARK AS SHOWN.

FOR PACKAGED ENTREE MIXES CONSISTING PRIMARILY OF PROCESSED MEAT, POULTRY, OR SEAFOOD SUCH AS BEEF, PORK, CHICKEN, TURKEY, TUNA, OR SHRIMP WITH SALAD DRESSING (U.S. CL. 46).

FIRST USE 10-1-2004; IN COMMERCE 10-1-2004.

3,008,057. WOOMBA WINES PTY LTD, KINGSTHORPE, AUSTRALIA. SN 78-319,351. FILED P.R. 10-28-2003; AM. S.R. 5-16-2005.

AUSSIE WINE

CLASS 31—NATURAL AGRICULTURAL PRODUCTS

NO CLAIM IS MADE TO THE EXCLUSIVE RIGHT TO USE WINE, APART FROM THE MARK AS SHOWN.

FOR WINES (U.S. CLS. 47 AND 49).

FIRST USE 9-15-2003; IN COMMERCE 9-15-2003.

CLASS 33—(Continued).

3,008,066. CHILDRESS VINEYARDS, LLC, WELCOME, NC. SN 78-388,585. FILED P.R. 3-22-2004; AM. S.R. 8-3-2005.

**CHILDRESS
VINEYARDS**

THE MARK CONSISTS OF STANDARD CHARACTERS WITHOUT CLAIM TO ANY PARTICULAR FONT, STYLE, SIZE, OR COLOR.
FOR WINE IN GENERAL (U.S. CLS. 47 AND 49).
FIRST USE 1-14-2003; IN COMMERCE 10-14-2004.

SERVICE MARKS**CLASS 35—ADVERTISING AND BUSINESS**

3,008,030. RADIO & RECORDS, INC., LOS ANGELES, CA. SN 76-414,886. FILED P.R. 5-30-2002; AM. S.R. 11-22-2004.

**ELECTRONIC PROMOTION
KIT**

NO CLAIM IS MADE TO THE EXCLUSIVE RIGHT TO USE PROMOTION KIT, APART FROM THE MARK AS SHOWN.

FOR PROMOTING THE GOODS AND SERVICES OF OTHERS BY PREPARING AND PLACING ADVERTISEMENTS IN AN ELECTRONIC MAGAZINE ACCESSED THROUGH A GLOBAL COMPUTER NETWORK (U.S. CLS. 100, 101 AND 102).
FIRST USE 4-29-2002; IN COMMERCE 4-29-2002.

CLASS 35—(Continued).

3,008,035. WALGREEN CO., DEERFIELD, IL. SN 76-558,865. FILED P.R. 10-29-2003; AM. S.R. 2-23-2005.

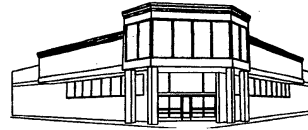

THE MARK IS THE SHAPE OF THE BUILDING FROM WHICH THE SERVICES ARE PROVIDED. THE MARK IS THREE DIMENSIONAL AND HAS A TRAPEZOID SHAPED FRONT PROTRUDING FROM THE TOP OF THE BUILDING TO FORM THE ENTRANCE. THREE SIDES OF THE TRAPEZOID ARE FASHIONED BY USING GLASS WINDOWS.

FOR RETAIL STORE SERVICES FEATURING GENERAL CONSUMER MERCHANDISE (U.S. CLS. 100, 101 AND 102).
FIRST USE 2-0-2000; IN COMMERCE 2-0-2000.

3,008,036. FRESH INTELLECTUAL PROPERTIES, INC., WILMINGTON, DE. SN 76-559,582. FILED P.R. 11-7-2003; AM. S.R. 8-5-2005.

EXPRESSIONS EXCHANGE

THE MARK CONSISTS OF STANDARD CHARACTERS WITHOUT CLAIM TO ANY PARTICULAR FONT, STYLE, SIZE, OR COLOR.

THE MARK IS PRESENTED IN STANDARD CHARACTER FORMAT WITHOUT CLAIM TO ANY PARTICULAR FONT STYLE, SIZE, OR COLOR.

FOR SERVICES OFFERED ONLINE FOR FACILITATING COMMUNICATION BETWEEN PERSONS - NAMELY, AN ACCESSIBLE DATABASE OF EXPRESSIONS PRIMARILY FEATURING SENTIMENTS AND MESSAGES FOR VARIOUS OCCASIONS AND HOLIDAYS (U.S. CLS. 100, 101 AND 102).
FIRST USE 5-4-2004; IN COMMERCE 5-4-2004.

3,008,039. INTELLITAX, SAN DIEGO, CA. SN 76-569,853. FILED P.R. 1-13-2004; AM. S.R. 4-19-2005.

USTAX Credits

FOR CONSULTING SERVICES IN THE FIELD OF TAX CREDITS; BUSINESS SERVICES NAMELY, BUSINESS ADVISORY SERVICES, CONSULTANCY AND INFORMATION (U.S. CLS. 100, 101 AND 102).
FIRST USE 12-19-2003; IN COMMERCE 12-19-2003.

CLASS 35—(Continued).

3,008,059. JARYL INTERNATIONAL, INC., ORADELL, NJ. SN 78-346,183. FILED P.R. 12-29-2003; AM. S.R. 8-9-2005.

CLASS 35—(Continued).

3,008,078. MENASHA CORPORATION, NEENAH, WI. SN 78-448,202. FILED P.R. 7-9-2004; AM. S.R. 8-8-2005.

**RETAIL INTEGRATION
INSTITUTE**

USATOYS

THE MARK CONSISTS OF STANDARD CHARACTERS WITHOUT CLAIM TO ANY PARTICULAR FONT, STYLE, SIZE, OR COLOR.

FOR RETAIL STORES, ON-LINE RETAIL STORE SERVICES, AND MAIL ORDER CATALOG SERVICES FEATURING TOYS, HOBBIES AND CRAFTS (U.S. CLS. 100, 101 AND 102).

FIRST USE 11-0-2003; IN COMMERCE 11-0-2003.

THE MARK CONSISTS OF STANDARD CHARACTERS WITHOUT CLAIM TO ANY PARTICULAR FONT, STYLE, SIZE, OR COLOR.

NO CLAIM IS MADE TO THE EXCLUSIVE RIGHT TO USE "RETAIL INTEGRATION", APART FROM THE MARK AS SHOWN.

FOR BUSINESS CONSULTATION SERVICES FOR RETAILING COMPANIES IN THE AREAS OF PRODUCT DEMAND, MARKETING, MANUFACTURING, PURCHASING, DISTRIBUTION, PACKAGING, TRANSPORTATION AND LOGISTICS; AND STATISTICAL ANALYSIS AND FINANCIAL STATEMENT ANALYSIS RENDERED IN CONNECTION THEREWITH; PROMOTING THE SALE OF GOODS OF OTHERS THROUGH THE CREATION, ASSEMBLY, AND DISTRIBUTION OF PROMOTIONAL DISPLAYS AND PROMOTIONAL MATERIALS; PACKAGING ARTICLES TO THE ORDER AND SPECIFICATION OF OTHERS (U.S. CLS. 100, 101 AND 102).

FIRST USE 7-10-2004; IN COMMERCE 7-10-2004.

3,008,062. SHARETRACKER, LLC, ATLANTA, GA. SN 78-354,544. FILED P.R. 1-20-2004; AM. S.R. 2-10-2005.

3,008,080. THE MCGRAW-HILL COMPANIES, INC., NEW YORK, NY. SN 78-451,050. FILED P.R. 7-15-2004; AM. S.R. 7-21-2005.

ShareTracker

M2M POWER

THE MARK CONSISTS OF STANDARD CHARACTERS WITHOUT CLAIM TO ANY PARTICULAR FONT, STYLE, SIZE, OR COLOR.

FOR MARKET SHARE REPORTS AND CHARTS FOR THE TELECOMMUNICATIONS INDUSTRY (U.S. CLS. 100, 101 AND 102).

FIRST USE 9-1-2003; IN COMMERCE 6-1-2004.

THE MARK CONSISTS OF STANDARD CHARACTERS WITHOUT CLAIM TO ANY PARTICULAR FONT, STYLE, SIZE, OR COLOR.

NO CLAIM IS MADE TO THE EXCLUSIVE RIGHT TO USE "POWER", APART FROM THE MARK AS SHOWN.

FOR PROVIDING ONLINE INFORMATION CONCERNING PRICING AND VALUATION OF LONG-TERM ENERGY CONTRACTS (U.S. CLS. 100, 101 AND 102).

FIRST USE 3-0-2004; IN COMMERCE 3-0-2004.

CLASS 35—(Continued).

3,008,081. THE MCGRAW-HILL COMPANIES, INC., NEW YORK, NY. SN 78-451,055. FILED P.R. 7-15-2004; AM. S.R. 7-21-2005.

M2M GAS

THE MARK CONSISTS OF STANDARD CHARACTERS WITHOUT CLAIM TO ANY PARTICULAR FONT, STYLE, SIZE, OR COLOR.

NO CLAIM IS MADE TO THE EXCLUSIVE RIGHT TO USE "GAS", APART FROM THE MARK AS SHOWN.

FOR PROVIDING ONLINE INFORMATION CONCERNING PRICING AND VALUATION OF LONG-TERM ENERGY CONTRACTS (U.S. CLS. 100, 101 AND 102).

FIRST USE 3-0-2004; IN COMMERCE 3-0-2004.

3,008,093. HOME DECOR PRODUCTS, INC., EDISON, NJ. SN 78-527,544. FILED P.R. 12-6-2004; AM. S.R. 8-31-2005.

BARBECUES.COM

THE MARK CONSISTS OF STANDARD CHARACTERS WITHOUT CLAIM TO ANY PARTICULAR FONT, STYLE, SIZE, OR COLOR.

FOR COMPUTERIZED ONLINE RETAIL SERVICES FEATURING GENERAL MERCHANDISE FOR THE PORCH, PATIO, BACKYARD AND OTHER AREAS OUTSIDE THE HOME (U.S. CLS. 100, 101 AND 102).

FIRST USE 8-30-2004; IN COMMERCE 8-31-2004.

CLASS 35—(Continued).

3,008,098. CERTIFIED GOLD EXCHANGE INC., ALBUQUERQUE, NM. SN 78-548,794. FILED P.R. 1-17-2005; AM. S.R. 8-24-2005.

THE PROFESSIONAL'S CHOICE IN GOLD

THE MARK CONSISTS OF STANDARD CHARACTERS WITHOUT CLAIM TO ANY PARTICULAR FONT, STYLE, SIZE, OR COLOR.

FOR WHOLESALE DISTRIBUTORSHIP SERVICES AND ONLINE RETAIL STORE SERVICES AND MAIL ORDER SERVICES FEATURING CERTIFIED PRECIOUS METALS, NAMELY, GOLD, SILVER AND PLATINUM, AND COINS MADE OF GOLD, SILVER AND PLATINUM (U.S. CLS. 100, 101 AND 102).

FIRST USE 3-1-2004; IN COMMERCE 3-1-2004.

CLASS 36—INSURANCE AND FINANCIAL

3,008,027. ANDREWS, DUANE, VALLEJO, CA. SN 76-209,993. FILED P.R. 2-8-2001; AM. S.R. 5-6-2002.

REO NETWORK

NO CLAIM IS MADE TO THE EXCLUSIVE RIGHT TO USE "REO", APART FROM THE MARK AS SHOWN.

FOR REAL ESTATE MANAGEMENT SERVICES AND REAL ESTATE BROKERAGE SERVICES (U.S. CLS. 100, 101 AND 102).

FIRST USE 1-31-2001; IN COMMERCE 1-31-2001.

3,008,034. GREAT LAKES SCRIP CENTER, INC., GRAND RAPIDS, MI. SN 76-531,657. FILED P.R. 7-23-2003; AM. S.R. 5-17-2005.

CareSponsors

THE MARK CONSISTS OF STANDARD CHARACTERS WITHOUT CLAIM TO ANY PARTICULAR FONT, STYLE, SIZE, OR COLOR.

FOR FUNDRAISING SERVICES (U.S. CLS. 100, 101 AND 102).

FIRST USE 3-9-2005; IN COMMERCE 3-9-2005.

CLASS 36—(Continued).

3,008,088. FLORES PIRÁN, RUFINO, LONDON, UNITED KINGDOM. SN 78-477,672. FILED P.R. 9-2-2004; AM. S.R. 8-22-2005.

ENVIROSTOCKS

THE MARK CONSISTS OF STANDARD CHARACTERS WITHOUT CLAIM TO ANY PARTICULAR FONT, STYLE, SIZE, OR COLOR.

OWNER OF UNITED KINGDOM REG. NO. 2345293, DATED 10-8-2003, EXPIRES 10-8-2013.

FOR FINANCIAL ANALYSIS AND CONSULTATION; FINANCIAL CLEARING HOUSES; FINANCIAL EXCHANGE; FINANCIAL FORECASTING; FINANCIAL INFORMATION PROVIDED BY ELECTRONIC MEANS; FINANCIAL INFORMATION PROCESSING; FINANCIAL INVESTMENT IN THE FIELD OF ENVIRONMENTALLY-FRIENDLY COMPANIES, SUSTAINABLE DEVELOPMENT AND OTHER SOCIALLY RESPONSIBLE INVESTMENTS; FINANCIAL MANAGEMENT; FINANCIAL PORTFOLIO MANAGEMENT; FINANCIAL RESEARCH; AND ORGANIZATION OF STOCK EXCHANGES FOR THE BENEFIT OF THE TRADE OF STOCKS AND OTHER FINANCIAL VALUES (U.S. CLS. 100, 101 AND 102).

3,008,092. GREATER EDWARDSVILLE AREA COMMUNITY FOUNDATION, EDWARDSVILLE, IL. SN 78-509,685. FILED P.R. 11-2-2004; AM. S.R. 8-17-2005.

Your Community Foundation

THE MARK CONSISTS OF STANDARD CHARACTERS WITHOUT CLAIM TO ANY PARTICULAR FONT, STYLE, SIZE, OR COLOR.

NO CLAIM IS MADE TO THE EXCLUSIVE RIGHT TO USE COMMUNITY FOUNDATION, APART FROM THE MARK AS SHOWN.

FOR CHARITABLE FUNDRAISING SERVICES, ADMINISTRATION OF CHARITABLE FUNDS AND DONATIONS FOR OTHERS, AND PROVIDING FINANCIAL GRANTS FOR A WIDE VARIETY OF CHARITABLE SERVICES (U.S. CLS. 100, 101 AND 102).

FIRST USE 8-1-2001; IN COMMERCE 8-1-2001.

CLASS 36—(Continued).

3,008,099. MORTGAGE PROTECTION BUREAU, DOUGLASVILLE, GA. SN 78-554,205. FILED P.R. 1-26-2005; AM. S.R. 8-27-2005.

Mortgage Protection Bureau

THE MARK CONSISTS OF STANDARD CHARACTERS WITHOUT CLAIM TO ANY PARTICULAR FONT, STYLE, SIZE, OR COLOR.

NO CLAIM IS MADE TO THE EXCLUSIVE RIGHT TO USE "BUREAU", APART FROM THE MARK AS SHOWN.

FOR LIFE INSURANCE AGENCY SERVICES IN THE FIELD OF MORTGAGE PROTECTION, NAMELY, COVERING MORTGAGE PAYMENTS UPON DEATH OR DISABILITY (U.S. CLS. 100, 101 AND 102).

FIRST USE 5-0-2004; IN COMMERCE 5-0-2004.

CLASS 37—CONSTRUCTION AND REPAIR

3,008,043. DUST CONTROL TECHNOLOGY INC., PEORIA, IL. SN 76-600,544. FILED P.R. 7-2-2004; AM. S.R. 8-10-2005.

DUST CONTROL TECHNOLOGY

THE MARK CONSISTS OF STANDARD CHARACTERS WITHOUT CLAIM TO ANY PARTICULAR FONT, STYLE, SIZE, OR COLOR.

FOR DUST SUPPRESSION SERVICES, NAMELY THE RENTAL AND LEASING OF POWER OPERATED HIGH PRESSURE LIQUID MISTING SYSTEMS IN CONNECTION WITH CONSTRUCTION AND DEMOLITION OF STRUCTURES (U.S. CLS. 100, 103 AND 106).

FIRST USE 3-15-2004; IN COMMERCE 3-15-2004.

CLASS 40—MATERIAL TREATMENT

CLASS 40—(Continued).

3,008,085. DRUM WORKSHOP, INC., OXNARD, CA. SN 78-465,261. FILED P.R. 8-10-2004; AM. S.R. 8-29-2005.

KITBUILDER

THE MARK CONSISTS OF STANDARD CHARACTERS WITHOUT CLAIM TO ANY PARTICULAR FONT, STYLE, SIZE, OR COLOR.

FOR CUSTOM ASSEMBLY OF DRUM SET COLORS AND SIGNS (U.S. CLS. 100, 103 AND 106).

FIRST USE 3-15-2004; IN COMMERCE 3-15-2004.

CLASS 41—EDUCATION AND ENTERTAINMENT

3,008,050. YISHRAEL, ZERUBABEL B., WASHINGTON, DC. SN 78-198,346. FILED P.R. 12-28-2002; AM. S.R. 12-16-2004.

CERTIFIED RESIDENTIAL COUNSELOR

FOR EDUCATIONAL SERVICES, NAMELY CONDUCTING CLASSES AND CERTIFICATION COURSES IN THE FIELDS OF SOCIAL, MENTAL AND EMOTIONAL THERAPY TECHNIQUES (U.S. CLS. 100, 101 AND 107).

FIRST USE 9-1-2000; IN COMMERCE 9-1-2000.

3,008,051. NATIONAL UNIVERSITY, LA JOLLA, CA. SN 78-262,441. FILED P.R. 6-13-2003; AM. S.R. 8-19-2005.

NATIONAL POLYTECHNIC COLLEGE OF ENGINEERING AND OCEANEERING

NO CLAIM IS MADE TO THE EXCLUSIVE RIGHT TO USE "POLYTECHNIC COLLEGE", APART FROM THE MARK AS SHOWN.

FOR EDUCATIONAL SERVICES, NAMELY OFFERING ASSOCIATE DEGREES AND CERTIFICATION PROGRAMS IN THE FIELDS OF MARINE TECHNOLOGY, COMMERCIAL DIVING, NONDESTRUCTIVE TESTING, UNDERWATER WELDING TECHNOLOGY, HYPERBARIC MEDICAL TECHNOLOGY, ENGINEERING TECHNOLOGY AND COMMUNICATION TECHNOLOGY (U.S. CLS. 100, 101 AND 107).

FIRST USE 3-1-2004; IN COMMERCE 3-1-2004.

CLASS 41—(Continued).

3,008,055. FOWLER, RICHARD A., SAN JUAN CAPISTRANO, CA. SN 78-310,191. FILED P.R. 10-7-2003; AM. S.R. 8-12-2005.

MYOFASCIAL HEALTH

NO CLAIM IS MADE TO THE EXCLUSIVE RIGHT TO USE "MYOFASCIAL", APART FROM THE MARK AS SHOWN.

FOR CONDUCTING CLASSES AND WORKSHOPS TO TEACH TECHNIQUES TO MAINTAIN A HEALTHY MYOFASCIAL SYSTEM IN THE BODY (U.S. CLS. 100, 101 AND 107).

FIRST USE 6-11-2005; IN COMMERCE 6-11-2005.

3,008,060. RICHMOND HOLDINGS LIMITED, ALDERNEY, CHANNEL ISLANDS. SN 78-349,335. FILED P.R. 1-8-2004; AM. S.R. 7-19-2005.

COLLEGE POKER CHAMPIONSHIP

THE MARK CONSISTS OF STANDARD CHARACTERS WITHOUT CLAIM TO ANY PARTICULAR FONT, STYLE, SIZE, OR COLOR.

NO CLAIM IS MADE TO THE EXCLUSIVE RIGHT TO USE "POKER", APART FROM THE MARK AS SHOWN.

FOR GAMING SERVICES, NAMELY, PROVIDING LOTTERIES, SWEEPSTAKES, GAMES OF CHANCE, CARD GAMES, NUMBER GAMES AND CONTESTS BY MEANS OF COMPUTER NETWORKS, INTRANETS AND THE INTERNET; PROVIDING ON-LINE INTERACTIVE REAL TIME COMPUTER GAMES; PROVIDING COMPUTER GAMES THAT MAY BE ACCESSED VIA COMPUTER NETWORKS, INTRANETS, OR THE INTERNET (U.S. CLS. 100, 101 AND 107).

FIRST USE 12-24-2003; IN COMMERCE 12-24-2003.

CLASS 41—(Continued).

3,008,067. CHILDRESS VINEYARDS, LLC, WELCOME, NC.
SN 78-388,591. FILED P.R. 3-22-2004; AM. S.R. 8-3-2005.

**CHILDRESS
VINEYARDS**

THE MARK CONSISTS OF STANDARD CHARACTERS
WITHOUT CLAIM TO ANY PARTICULAR FONT, STYLE,
SIZE, OR COLOR.

FOR ENTERTAINMENT SERVICES, NAMELY CON-
DUCTING WINE TASTING AND WINE CONNOISSEUR-
SHIP CLASSES AND CONDUCTING WINE FESTIVALS
(U.S. CLS. 100, 101 AND 107).

FIRST USE 1-14-2003; IN COMMERCE 10-14-2004.

3,008,068. PICK UP PHOTOS, LLC, LOS ANGELES, CA. SN
78-409,640. FILED P.R. 4-28-2004; AM. S.R. 1-10-2005.

BEST OF WEDDINGS

THE MARK CONSISTS OF STANDARD CHARACTERS
WITHOUT CLAIM TO ANY PARTICULAR FONT, STYLE,
SIZE, OR COLOR.

FOR PHOTOGRAPHY SERVICES, NAMELY CON-
DUCTING CONTESTS INVOLVING PHOTOGRAPHS
FOR OTHERS (U.S. CLS. 100, 101 AND 107).

FIRST USE 10-1-2004; IN COMMERCE 10-1-2004.

CLASS 41—(Continued).

3,008,077. INTERNATIONAL DATA GROUP, INC., FRA-
MINGHAM, MA. SN 78-446,724. FILED P.R. 7-7-2004; AM.
S.R. 8-17-2005.

GENOMIC MEDICINE

THE MARK CONSISTS OF STANDARD CHARACTERS
WITHOUT CLAIM TO ANY PARTICULAR FONT, STYLE,
SIZE, OR COLOR.

FOR PROVIDING ONLINE NON-DOWNLOADABLE
PUBLICATIONS, NAMELY, NEWSLETTERS IN THE
HIGH TECHNOLOGY AND INFORMATION TECHNOL-
OGY INDUSTRY (U.S. CLS. 100, 101 AND 107).

FIRST USE 7-22-2004; IN COMMERCE 7-22-2004.

3,008,084. COTTAGE GREEN, LLC, FT. LAUDERDALE, FL.
SN 78-464,122. FILED P.R. 8-9-2004; AM. S.R. 8-24-2005.

**ENLIGHTENED
MILLIONAIRE**

THE MARK CONSISTS OF STANDARD CHARACTERS
WITHOUT CLAIM TO ANY PARTICULAR FONT, STYLE,
SIZE, OR COLOR.

FOR EDUCATIONAL AND TRAINING SERVICES,
NAMELY, CONFERENCES, SEMINARS, CLASSES, TEL-
ECLASSES, AND TELESEMINARS IN THE FIELD OF
WEALTH CREATION, DEBT REDUCTION, WEALTH
BUILDING, WEALTH MANAGEMENT, MOTIVATION,
PERSONAL AND SPIRITUAL GROWTH AND DEVEL-
OPMENT AND DISTRIBUTING WRITTEN, AUDIO AND
VIDEO COURSE MATERIALS IN CONNECTION
THEREWITH (U.S. CLS. 100, 101 AND 107).

FIRST USE 6-1-2005; IN COMMERCE 6-1-2005.

**CLASS 42—SCIENTIFIC, COMPUTER AND
LEGAL SERVICES**

3,008,033. THOMAS SCIENTIFIC INC., PHILADELPHIA, PA.
SN 76-482,448. FILED P.R. 1-15-2003; AM. S.R. 4-19-2005.

CENTURY OF SCIENCE

NO CLAIM IS MADE TO THE EXCLUSIVE RIGHT TO
USE "SCIENCE", APART FROM THE MARK AS SHOWN.

FOR PROVIDING AN ONLINE COMPUTER DATA-
BASE IN THE FIELD OF BIBLIOGRAPHIC INFORMA-
TION AND ABSTRACTS OF SCIENTIFIC JOURNALS
PRE-DATING 1944 (U.S. CLS. 100 AND 101).

FIRST USE 1-31-2005; IN COMMERCE 1-31-2005.

CLASS 42—(Continued).

3,008,052. CIT GROUP INC., LIVINGSTON, NJ. SN 78-275,645.
FILED P.R. 7-17-2003; AM. S.R. 3-7-2005.

QUALITY DIGITAL SOLUTIONS

FOR ONLINE CUSTOMER SERVICES IN THE FIELD
OF FINANCING OFFICE AND TECHNOLOGY EQUIP-
MENT (U.S. CLS. 100 AND 101).

FIRST USE 1-0-2003; IN COMMERCE 1-0-2003.

**CLASS 43—HOTEL AND RESTAURANT SER-
VICES**

3,008,031. WXIIIQXFORDDTC REAL ESTATE, LLC, CHICA-
GO, IL. SN 76-458,137. FILED P.R. 10-7-2002; AM. S.R. 8-24-
2004.

THE NATIONAL CONFERENCE CENTER LANSDOWNE, VA

NO CLAIM IS MADE TO THE EXCLUSIVE RIGHT TO
USE "CONFERENCE CENTER" AND "LANSDOWNE VA",
APART FROM THE MARK AS SHOWN.

FOR HOSPITALITY SERVICES NAMELY HOTEL
SERVICES, PROVISION OF CONFERENCE FACILITIES
AND CONSULTING IN THE FIELD OF HOSPITALITY
(U.S. CLS. 100 AND 101).

FIRST USE 3-0-2002; IN COMMERCE 3-0-2002.

3,008,044. LANDER, MIGUEL, GOLDEN, CO. AND LAND-
ER, FLORA, GOLDEN, CO. SN 76-602,024. FILED P.R. 7-13-
2004; AM. S.R. 8-17-2005.



THE STIPPLING SHOWN IN THE DRAWING IS A
FEATURE OF THE MARK AND IS NOT INTENDED TO
SHOW EITHER COLOR OR SHADING.

FOR COFFEE SHOP FEATURING SPANISH PASTRIES
CALLED "CHURROS" AND ACCOMPANYING BEV-
ERAGES (U.S. CLS. 100 AND 101).

FIRST USE 6-18-2003; IN COMMERCE 6-18-2003.

CLASS 43—(Continued).

3,008,074. MCDONALD'S CORPORATION, OAK BROOK, IL.
SN 78-443,268. FILED P.R. 6-29-2004; AM. S.R. 8-22-2005.

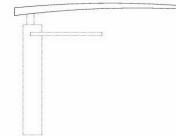

THE MARK CONSISTS OF A FANCIFUL ARC DESIGN.
THE BROKEN LINES SHOW THE PLACEMENT OF THE
MARK IN RELATIONSHIP TO A SUPPORT STRUCTURE,
BUT NO CLAIM IS MADE TO THE SUPPORT STRUCTURE.
NO COLOR IS CLAIMED.

FOR RESTAURANT SERVICES (U.S. CLS. 100 AND
101).

FIRST USE 3-17-2004; IN COMMERCE 3-17-2004.

**CLASS 44—MEDICAL, BEAUTY AND AGRI-
CULTURAL SERVICES**

3,008,091. ALPHA BEAUTY CLINIC, INC., JACKSONVILLE,
FL. SN 78-509,205. FILED P.R. 11-1-2004; AM. S.R. 8-12-2005.

NATIONAL CENTER OF TRICHOLOGY

THE MARK CONSISTS OF STANDARD CHARACTERS
WITHOUT CLAIM TO ANY PARTICULAR FONT, STYLE,
SIZE, OR COLOR.

NO CLAIM IS MADE TO THE EXCLUSIVE RIGHT TO
USE "CENTER OF TRICHOLOGY", APART FROM THE
MARK AS SHOWN.

FOR PERFORMING DIAGNOSIS OF HAIR THINNING
AND HAIR LOSS, CAUSED BY HEREDITY, MALE
PATTERN BALDNESS, DIET, ILLNESS OR DISEASE,
MEDICATIONS, HORMONAL CHANGES, OVER-PRO-
CESSING, AND STRESS; PERFORMING DIAGNOSIS
OF SCALP CONDITIONS, NAMELY, DRYNESS, OIL-
INESS, AND SCALING; AND THE TREATMENT OF
HAIR THINNING AND HAIR LOSS AND SCALP CON-
DITIONS, NAMELY, THROUGH THE USE OF DIETARY
SUPPLEMENTS, TOPICAL APPLICATIONS, MULTI-
CHROMAL THERAPY, NAMELY, DIRECTING INDIVI-
DUAL-SPECIFIC MULTI-CHROMAL LIGHT TO THE
BODY TO ACHIEVE RELAXATION AND RESTORE
BODY ENERGY, SHAMPOOS AND CONDITIONERS,
AND MASSAGE (U.S. CLS. 100 AND 101).

FIRST USE 6-15-2004; IN COMMERCE 10-1-2004.

CLASS 45—(Continued).

3,008,095. BROWN, ROSEMARY E., SAN DIEGO, CA. SN 78-528,864. FILED P.R. 12-8-2004; AM. S.R. 8-12-2005.

CLASS 45—(Continued).

3,008,083. APEX CONSULTING, L.L.C., GLADSTONE, MO. SN 78-454,815. FILED P.R. 7-22-2004; AM. S.R. 8-23-2005.

TELECOUNSELING

JET ADVISORS

THE MARK CONSISTS OF STANDARD CHARACTERS WITHOUT CLAIM TO ANY PARTICULAR FONT, STYLE, SIZE, OR COLOR.

FOR PSYCHOLOGICAL COUNSELING (U.S. CLS. 100 AND 101).
FIRST USE 7-4-1989; IN COMMERCE 11-4-2004.

THE MARK CONSISTS OF STANDARD CHARACTERS WITHOUT CLAIM TO ANY PARTICULAR FONT, STYLE, SIZE, OR COLOR.

FOR SAFETY CONSULTATION SERVICES IN THE FIELD OF AIR TRANSPORTATION, NAMELY, SAFETY EVALUATION OF PILOTS AND OPERATORS OF AIRCRAFT AND SAFETY HISTORY OF AIRCRAFT AND AIRCRAFT MAINTENANCE (U.S. CLS. 100 AND 101).
FIRST USE 4-15-2005; IN COMMERCE 4-15-2005.

CLASS 45—PERSONAL SERVICES

* * * * *

PRIOR UNITED STATES CLASSIFICATION

APPLICATION IN ONE CLASS

CERTIFICATION MARKS

CLASS B—SERVICES

3,008,028. DESOLVIT INC., MINNEAPOLIS, MN. SN 76-378,580. FILED P.R. 3-5-2002; AM. S.R. 10-18-2004.

**CERTIFIED THERAPEUTIC
COACH**

THE CERTIFICATION MARK, AS USED BY PERSONS AUTHORIZED BY APPLICANT, CERTIFIES THAT SUCH PERSONS WHO ARE PERFORMING COUNSELING SERVICES, HAVE MET APPLICANT'S STANDARDS OF COM-

PETENCE IN COUNSELING IN THE FIELDS OF MENTAL HEALTH, NEUROLINGUISTICS PROGRAMMING, SYSTEM THEORY, BUSINESS MANAGEMENT, QUANTUM PHYSICS, DEVELOPMENTAL STAGES, LIFE CYCLE CHANGES, MOTIVATION, LEARNING STYLES, COMMUNICATION BETWEEN COUPLES, TEAM BUILDING AND LEADERSHIP, AND PROFESSIONAL DEVELOPMENT, AS INDICATED BY EXPERIENCE AND EDUCATION AND TRAINING REQUIREMENTS AND PASSAGE OF A WRITTEN EXAMINATION.

FOR COUNSELING IN THE FIELDS OF MENTAL HEALTH, NEUROLINGUISTIC PROGRAMMING, SYSTEM THEORY, BUSINESS MANAGEMENT, QUANTUM PHYSICS, DEVELOPMENTAL STAGES, LIFECYCLE CHANGES, MOTIVATION, LEARNING STYLES, COMMUNICATION BETWEEN COUPLES, TEAM BUILDING AND LEADERSHIP, AND PROFESSIONAL DEVELOPMENT (U.S. CL. B).

FIRST USE 2-1-2003; IN COMMERCE 2-1-2003.

* * * * *

TRADEMARK REGISTRATIONS RENEWED

The designation "U.S. Cl." appearing in this section refers to the U.S. class in effect prior to Sep. 1, 1973 rather than the international class which applies to applications filed on or after that date. For adoption of international classification see notice in the OFFICIAL GAZETTE of Jun. 26, 1973 (911 O.G. TM 210).

47,233.	X. F. AND DESIGN. U.S. CL. 23. (INT. CL. 8). REG. 10-31-1905.	791,949.	PARLIAMENT ROYAL (STYLIZED). U.S. CL. 49. (INT. CL. 33). REG. 6-29-1965.
200,247.	ROUND TABLE (STYLIZED). U.S. CL. 46. (INT. CL. 30). REG. 6-30-1925.	792,179.	DEDTRU. U.S. CL. 23. (INT. CL. 7). REG. 7-6-1965.
200,271.	KING ARTHUR (STYLIZED). U.S. CL. 46. (INT. CL. 30). REG. 6-30-1925.	792,229.	SURFACE. U.S. CL. 34. (INT. CL. 11). REG. 7-6-1965.
200,272.	MISCELLANEOUS DESIGN. U.S. CL. 46. (INT. CL. 30). REG. 6-30-1925.	793,165.	AMES. U.S. CL. 12. (INT. CL. 19). REG. 7-27-1965.
200,392.	MISCELLANEOUS DESIGN. U.S. CL. 46. (INT. CL. 30). REG. 6-30-1925.	793,744.	STAUFFER'S AND DESIGN. U.S. CL. 46. (INT. CL. 30). REG. 8-3-1965.
200,394.	BULL'S EYE AND DESIGN. U.S. CL. 39. (INT. CL. 25). REG. 6-30-1925.	794,002.	SNOOPER AND DESIGN. U.S. CL. 23. (INT. CL. 7). REG. 8-10-1965.
201,022.	BIT-O-HONEY (STYLIZED). U.S. CL. 46. (INT. CL. 30). REG. 7-14-1925.	794,061.	TRAILBLAZER. U.S. CL. 34. (INT. CL. 9). REG. 8-10-1965.
201,144.	VOGUE PATTERNS (STYLIZED). U.S. CL. 38. (INT. CL. 16). REG. 7-21-1925.	794,350.	SASTID (STYLIZED). U.S. CL. 18. (INT. CL. 5). REG. 8-17-1965.
201,694.	CADILLAC. U.S. CL. 19. (INT. CL. 12). REG. 8-4-1925.	795,721.	APPEAL. U.S. CL. 101. (INT. CL. 36). REG. 9-7-1965.
204,301.	M-S-A. U.S. CL. 44. (INT. CL. 5). REG. 10-13-1925.	797,827.	APPEAL. U.S. CL. 38. (INT. CL. 16). REG. 10-19-1965.
311,135.	TRAPICHE (STYLIZED). U.S. CL. 47. (INT. CL. 33). REG. 3-13-1934.	797,975.	GAYLORD. U.S. CL. 11. (INT. CLS. 2 AND 16). REG. 10-26-1965.
320,304.	GENERAL ELECTRIC AND DESIGN. U.S. CL. 21. (INT. CLS. 7, 9, 11, 12 AND 15). REG. 12-25-1934.	798,155.	STADIUM. U.S. CL. 46. (INT. CL. 29). REG. 10-26-1965.
331,300.	KNOB CREEK (STYLIZED). U.S. CL. 49. (INT. CL. 33). REG. 12-31-1935.	798,452.	DURSBAN. U.S. CL. 6. (INT. CL. 5). REG. 11-9-1965.
335,113.	LUCKIES (STYLIZED). U.S. CL. 17. (INT. CL. 34). REG. 5-26-1936.	798,702.	FORE. U.S. CL. 6. (INT. CL. 5). REG. 11-16-1965.
606,758.	GENTEX (STYLIZED). U.S. CL. 39. (INT. CLS. 10, 25 AND 26). REG. 5-31-1955.	800,213.	KH. U.S. CL. 19. (INT. CLS. 7, 12, 22 AND 27). REG. 12-14-1965.
607,835.	OXSORALEN. U.S. CL. 18. (INT. CL. 5). REG. 6-28-1955.	800,440.	MISCELLANEOUS DESIGN. U.S. CL. 42. (INT. CL. 24). REG. 12-14-1965.
608,031.	COVERLIGHT. U.S. CL. 42. (INT. CL. 24). REG. 6-28-1955.	808,553.	CLEBURNE PARK. U.S. CL. 39. (INT. CL. 25). REG. 5-17-1966.
608,062.	LIQUIFRY. U.S. CL. 46. (INT. CL. 31). REG. 6-28-1955.	970,376.	MOP-PAC. U.S. CL. 52. (INT. CL. 3). REG. 10-9-1973.
608,178.	A. B. DICK. U.S. CL. 11. (INT. CL. 16). REG. 7-5-1955.	983,060.	DIAL-A-QUESTION. U.S. CL. 101. (INT. CL. 35). REG. 4-30-1974.
608,179.	A. B. DICK (STYLIZED). U.S. CL. 11. (INT. CL. 16). REG. 7-5-1955.	993,225.	CREATIVE LEISURE AND DESIGN. U.S. CL. 105. (INT. CL. 39). REG. 9-10-1974.
613,372.	AIROLITE (STYLIZED). U.S. CL. 12. (INT. CL. 6). REG. 10-4-1955.	993,720.	CHO-THERM. U.S. CL. 21. (INT. CL. 9). REG. 9-24-1974.
613,836.	HOTWATT (STYLIZED). U.S. CL. 21. (INT. CL. 11). REG. 10-11-1955.	998,925.	NOLVADEX. INT. CL. 5. (U.S. CL. 18). REG. 11-26-1974.
614,272.	LOWELL HEARD EVERYWHERE (STYLIZED). U.S. CL. 21. (INT. CL. 9). REG. 10-18-1955.	1,000,096.	TARGETEER. INT. CL. 16. (U.S. CL. 2). REG. 12-24-1974.
615,070.	BOOMJET (STYLIZED). U.S. CL. 13. (INT. CL. 21). REG. 11-1-1955.	1,000,099.	TARGETOER AND DESIGN. INT. CL. 16. (U.S. CL. 2). REG. 12-24-1974.
622,573.	BOROLEUM (STYLIZED). U.S. CL. 18. (INT. CL. 5). REG. 3-6-1956.	1,000,519.	DYNA POISE. INT. CL. 10. (U.S. CL. 44). REG. 12-31-1974.
625,891.	NOWASTE (STYLIZED). U.S. CL. 38. (INT. CL. 16). REG. 4-24-1956.	1,001,994.	EPIC. INT. CL. 9. (U.S. CL. 36). REG. 1-21-1975.
765,395.	METRO-TEL. U.S. CLS. 21 AND 26. (INT. CL. 9). REG. 2-25-1964.	1,003,925.	TYLAN AND DESIGN. U.S. CL. 26 ONLY. (INT. CLS. 1, 9 AND 10). REG. 2-4-1975.
780,619.	UNITIP. U.S. CL. 34. (INT. CL. 11). REG. 11-24-1964.	1,004,523.	AMERICAN WAY. U.S. CL. 38. (INT. CL. 16). REG. 2-11-1975.
781,823.	HILLS BROS (STYLIZED). U.S. CL. 46. (INT. CL. 30). REG. 12-15-1964.	1,005,497.	DOLPH'S. U.S. CLS. 5, 16 AND 21. (INT. CLS. 2, 16 AND 17). REG. 2-25-1975.
782,852.	SOLARFLO. U.S. CL. 34. (INT. CL. 11). REG. 1-5-1965.	1,005,887.	THRIFTY MAID AND DESIGN. INT. CL. 30. (U.S. CL. 46). REG. 3-4-1975.
788,905.	SURE-SNUFF. U.S. CL. 8. (INT. CL. 34). REG. 5-4-1965.	1,006,563.	THE STOP BOX. U.S. CL. 19. (INT. CL. 12). REG. 3-11-1975.
790,582.	BASF. U.S. CL. 10. (INT. CL. 1). REG. 6-8-1965.	1,008,444.	THE SMILING CHEESEMAN AND DESIGN. INT. CL. 29. (U.S. CL. 46). REG. 4-8-1975.
790,893.	COLLACRAL. U.S. CL. 6. (INT. CL. 1). REG. 6-15-1965.	1,009,937.	CRYLEX. INT. CL. 17. (U.S. CL. 1). REG. 5-6-1975.
791,033.	BASF. U.S. CL. 36. (INT. CL. 9). REG. 6-15-1965.	1,012,057.	AVA-BRON. INT. CL. 5. (U.S. CL. 18). REG. 6-3-1975.
791,682.	MASSEY-FERGUSON. U.S. CL. 15. (INT. CL. 4). REG. 6-29-1965.	1,012,699.	DECALTAL. INT. CL. 1. (U.S. CL. 6). REG. 6-10-1975.
791,853.	MR. SKETCH. U.S. CL. 37. (INT. CL. 16). REG. 6-29-1965.	1,012,766.	DE-FENSE. INT. CL. 3. (U.S. CL. 4). REG. 6-10-1975.
		1,012,891.	KYB. INT. CL. 12. (U.S. CL. 19). REG. 6-10-1975.

- 1,013,114. SHERWIN-WILLIAMS AND DESIGN. INT. CL. 42. (U.S. CL. 100). REG. 6-10-1975.
- 1,013,415. SLIP-N-SNIP. INT. CL. 8. (U.S. CL. 23). REG. 6-17-1975.
- 1,013,894. RELUGAN. INT. CL. 1. (U.S. CL. 1). REG. 6-24-1975.
- 1,014,006. "THE WHEEL O VATOR" AND DESIGN. INT. CL. 7. (U.S. CL. 23). REG. 6-24-1975.
- 1,014,229. MISCELLANEOUS DESIGN. INT. CL. 30. (U.S. CL. 46). REG. 6-24-1975.
- 1,014,265. VACATION OWNERSHIP. INT. CL. 35. (U.S. CL. 101). REG. 6-24-1975.
- 1,014,369. RIGHTWAY. U.S. CL. 23. (INT. CL. 7). REG. 6-24-1975.
- 1,014,484. LUTENSIT. INT. CL. 1. (U.S. CL. 6). REG. 7-1-1975.
- 1,014,881. MISCELLANEOUS DESIGN. INT. CL. 41. (U.S. CL. 107). REG. 7-1-1975.
- 1,014,969. "Y" LUR-SALUCES AND DESIGN. U.S. CL. 47. (INT. CL. 33). REG. 7-1-1975.
- 1,014,990. AMERICAN BOARD OF MEDICAL SPECIALTIES. U.S. CL. 200. REG. 7-1-1975.
- 1,015,020. RECLAMITE. INT. CL. 1. (U.S. CL. 6). REG. 7-8-1975.
- 1,015,028. SNO-FLO (STYLIZED). INT. CL. 2. (U.S. CL. 16). REG. 7-8-1975.
- 1,015,691. SBX. INT. CL. 9. (U.S. CL. 21). REG. 7-15-1975.
- 1,015,743. HEATILATOR AND DESIGN. INT. CL. 11. (U.S. CL. 34). REG. 7-15-1975.
- 1,016,031. PRESTO. U.S. CLS. 2 AND 37. (INT. CL. 16). REG. 7-15-1975.
- 1,016,598. NAKATA (STYLIZED). INT. CL. 12. (U.S. CL. 19). REG. 7-22-1975.
- 1,016,731. COLONIAL PLUME. INT. CL. 8. (U.S. CL. 23). REG. 7-29-1975.
- 1,016,801. EMS. INT. CL. 10. (U.S. CL. 44). REG. 7-29-1975.
- 1,017,018. KELLY'S. INT. CL. 22. (U.S. CL. 28). REG. 7-29-1975.
- 1,017,204. BLU-SPOT. INT. CL. 10. (U.S. CL. 44). REG. 7-29-1975.
- 1,017,329. CLOVER AND DESIGN. INT. CLS. 9, 16 AND 26. (U.S. CLS. 2, 5, 22, 23, 29, 37, 38, 40 AND 50). REG. 8-5-1975.
- 1,017,923. JADAIR (STYLIZED). INT. CL. 1. (U.S. CL. 31). REG. 8-12-1975.
- 1,017,964. APPLAUSE. INT. CL. 15. (U.S. CL. 36). REG. 8-12-1975.
- 1,018,322. AMERICAN BOARD OF MEDICAL SPECIALTIES EXCELLENCE ETHICS HONOR SKILL ANIMIS OPIBUSQUE PARAT AND DESIGN. U.S. CL. 200. REG. 8-12-1975.
- 1,018,556. HY-FLEX. U.S. CL. 23. (INT. CL. 7). REG. 8-19-1975.
- 1,019,577. GEYSER PEAK WINERY. INT. CL. 33. (U.S. CL. 47). REG. 9-2-1975.
- 1,019,890. POWERTITE. INT. CL. 9. (U.S. CL. 21). REG. 9-9-1975.
- 1,020,453. ETERNA. INT. CL. 11. (U.S. CL. 13). REG. 9-16-1975.
- 1,020,629. MISCELLANEOUS DESIGN. INT. CL. 29. (U.S. CL. 46). REG. 9-16-1975.
- 1,020,657. SHOW-ME. INT. CL. 30. (U.S. CL. 46). REG. 9-16-1975.
- 1,021,485. OPPOSING VIEWPOINTS SERIES (STYLIZED). INT. CL. 16. (U.S. CL. 38). REG. 9-30-1975.
- 1,023,538. PROXEL. INT. CL. 1. (U.S. CL. 6). REG. 10-28-1975.
- 1,027,212. GINGHER (STYLIZED). INT. CL. 8. (U.S. CL. 23). REG. 12-16-1975.
- 1,027,462. FK AND DESIGN. INT. CL. 29. (U.S. CL. 46). REG. 12-16-1975.
- 1,034,971. SEEDWAY. INT. CL. 31. (U.S. CL. 1). REG. 3-2-1976.
- 1,210,075. VALENTINO'S. INT. CL. 42. (U.S. CL. 100). REG. 9-21-1982.
- 1,257,429. GAS-TECH. INT. CL. 9. (U.S. CL. 26). REG. 11-15-1983.
- 1,278,709. KETT (STYLIZED). INT. CL. 9. (U.S. CLS. 26 AND 38). REG. 5-22-1984.
- 1,280,171. NORTH GEORGIA COLLEGE DAHLONEGA, GEORGIA 1873 AND DESIGN. INT. CL. 41. (U.S. CL. 107). REG. 5-29-1984.
- 1,281,450. ICE CUBE AND DESIGN. INT. CL. 11. (U.S. CLS. 13, 21, 23, 31 AND 34). REG. 6-12-1984.
- 1,289,305. ACCOUNTANTS ON CALL. INT. CL. 35. (U.S. CL. 101). REG. 8-7-1984.
- 1,289,886. CM-1. INT. CL. 9. (U.S. CLS. 26 AND 44). REG. 8-14-1984.
- 1,299,324. PICK (STYLIZED). INT. CL. 9. (U.S. CL. 38). REG. 10-9-1984.
- 1,300,766. BARBIE. INT. CL. 28. (U.S. CL. 22). REG. 10-16-1984.
- 1,302,508. TIFFANY & CO.. INT. CLS. 14 AND 34. (U.S. CLS. 8 AND 28). REG. 10-30-1984.
- 1,303,510. DYNAMIC SELF-TESTING. INT. CL. 9. (U.S. CLS. 21, 23, 26, 36 AND 38). REG. 11-6-1984.
- 1,305,320. THE BAILEY COMPANY AND DESIGN. INT. CLS. 37 AND 42. (U.S. CLS. 100, 101 AND 103). REG. 11-13-1984.
- 1,307,253. LODERUNNER. INT. CL. 28. (U.S. CLS. 22 AND 38). REG. 11-27-1984.
- 1,310,674. QUICK 'N' EASY. INT. CL. 3. (U.S. CL. 52). REG. 12-25-1984.
- 1,312,424. FORE LTD. BY DON WARNER AND DESIGN. INT. CL. 25. (U.S. CLS. 22 AND 39). REG. 1-1-1985.
- 1,312,995. KEG BRITE. INT. CL. 3. (U.S. CL. 52). REG. 1-8-1985.
- 1,313,092. KLAMP-TITE. INT. CL. 6. (U.S. CL. 13). REG. 1-8-1985.
- 1,315,479. ELECTRAK. INT. CL. 9. (U.S. CL. 21). REG. 1-22-1985.
- 1,316,531. BASIX. INT. CLS. 6, 17 AND 21 ONLY. (U.S. CLS. 2, 13, 25, 35 AND 50). REG. 1-29-1985.
- 1,317,001. LEE/ROWAN. INT. CL. 20 ONLY. (U.S. CL. 32). REG. 1-29-1985.
- 1,317,608. HI-LITE. INT. CL. 6. (U.S. CL. 13). REG. 2-5-1985.
- 1,322,516. KEYCARE. INT. CL. 36. (U.S. CL. 102). REG. 2-26-1985.
- 1,323,255. CARPETBAGS OF AMERICA AND DESIGN. INT. CL. 18. (U.S. CL. 3). REG. 3-5-1985.
- 1,328,808. PHOENIX BAKERY AND DESIGN. INT. CL. 30. (U.S. CL. 46). REG. 4-2-1985.
- 1,332,007. CALLAGHAN (STYLIZED). INT. CL. 16. (U.S. CL. 38). REG. 4-23-1985.
- 1,332,948. CA-DYNAM. INT. CL. 9. (U.S. CL. 38). REG. 4-30-1985.
- 1,332,955. CA-RAPS. INT. CL. 9. (U.S. CL. 38). REG. 4-30-1985.
- 1,333,193. GALE. INT. CL. 16. (U.S. CL. 38). REG. 4-30-1985.
- 1,333,394. KARI-ME BABY. INT. CL. 28. (U.S. CL. 22). REG. 4-30-1985.
- 1,334,267. SOONERS. INT. CL. 16. (U.S. CLS. 2, 5, 22, 23, 29, 37, 38 AND 50). REG. 5-7-1985.
- 1,335,169. MISCELLANEOUS DESIGN. INT. CL. 9. (U.S. CLS. 21, 23, 26, 36 AND 38). REG. 5-14-1985.
- 1,336,012. SHOWBOAT AND DESIGN. INT. CLS. 41 AND 42. (U.S. CLS. 100 AND 107). REG. 5-14-1985.
- 1,337,563. ROTA-CUTTER. INT. CL. 7. (U.S. CL. 23). REG. 5-28-1985.
- 1,337,755. MASTERCOOL 2-STAGE AND DESIGN. INT. CL. 11. (U.S. CL. 34). REG. 5-28-1985.
- 1,337,991. ECONO FENCE. INT. CL. 24. (U.S. CL. 42). REG. 5-28-1985.
- 1,338,380. SOUTHERN SAW SERVICE. INT. CL. 37. (U.S. CL. 103). REG. 5-28-1985.
- 1,338,384. MOBIL MART. INT. CL. 42 ONLY. (U.S. CL. 101). REG. 5-28-1985.
- 1,339,268. O'NEILL. INT. CL. 25. (U.S. CL. 39). REG. 6-4-1985.
- 1,339,833. LUVISET. INT. CL. 1. (U.S. CL. 6). REG. 6-11-1985.
- 1,340,224. TEAM O'NEILL. INT. CL. 25 ONLY. (U.S. CLS. 22 AND 39). REG. 6-11-1985.
- 1,340,258. OMNIMAP. INT. CL. 9. (U.S. CL. 26). REG. 6-11-1985.
- 1,340,801. TELEFLORA. INT. CL. 21. (U.S. CLS. 2, 13, 30 AND 33). REG. 6-11-1985.
- 1,341,515. OPHIR TOURS. INT. CL. 39. (U.S. CL. 105). REG. 6-11-1985.
- 1,341,622. ALERT-ALL. INT. CL. 42. (U.S. CL. 101). REG. 6-11-1985.
- 1,341,689. THE OLD BROGUE AN IRISH PUB AND DESIGN. INT. CL. 42. (U.S. CL. 100). REG. 6-11-1985.
- 1,341,693. SCOOTER'S PIZZA DELIVERY AND DESIGN. INT. CL. 42. (U.S. CL. 100). REG. 6-11-1985.
- 1,342,631. CEQUIN (STYLIZED). INT. CL. 17. (U.S. CLS. 12 AND 37). REG. 6-18-1985.
- 1,343,194. CICF AND DESIGN. INT. CL. 35. (U.S. CL. 101). REG. 6-18-1985.
- 1,343,533. NLADA. INT. CL. 42. (U.S. CL. 100). REG. 6-18-1985.

- 1,343,775. DRAX. INT. CL. 5. (U.S. CL. 6). REG. 6-25-1985.
- 1,343,776. BINKS. INT. CLS. 6, 7, 9 AND 11. (U.S. CLS. 12, 13, 23, 26 AND 34). REG. 6-25-1985.
- 1,343,780. MODULEX. INT. CLS. 6, 9, 16 AND 20 ONLY. (U.S. CLS. 13, 21, 26, 32, 37, 38 AND 50). REG. 6-25-1985.
- 1,343,829. CAMEL. INT. CL. 7. (U.S. CL. 23). REG. 6-25-1985.
- 1,343,877. CONCEPT OMEGA. INT. CL. 9. (U.S. CL. 38). REG. 6-25-1985.
- 1,343,949. FUTURESOURCE. INT. CL. 9. (U.S. CL. 38). REG. 6-25-1985.
- 1,343,975. TURBO PASCAL. INT. CL. 9. (U.S. CL. 38). REG. 6-25-1985.
- 1,343,988. ACCU-MEASURE. INT. CL. 9. (U.S. CL. 26). REG. 6-25-1985.
- 1,344,183. THOR. INT. CLS. 11 AND 19. (U.S. CLS. 12 AND 34). REG. 6-25-1985.
- 1,344,258. LEADER TO THE GREAT OUTDOORS. INT. CL. 12. (U.S. CL. 19). REG. 6-25-1985.
- 1,344,294. SPORTSTRAP. INT. CL. 14. (U.S. CL. 27). REG. 6-25-1985.
- 1,344,368. MISCELLANEOUS DESIGN. INT. CL. 16. (U.S. CLS. 2, 5, 22, 23, 29, 37, 38 AND 50). REG. 6-25-1985.
- 1,344,383. CONSENSUS. INT. CL. 16. (U.S. CL. 38). REG. 6-25-1985.
- 1,344,387. CORROSERT. INT. CL. 17. (U.S. CLS. 1 AND 35). REG. 6-25-1985.
- 1,344,480. FISSLER. INT. CL. 21. (U.S. CLS. 2 AND 13). REG. 6-25-1985.
- 1,344,525. CUDDLE ME. INT. CL. 24. (U.S. CL. 42). REG. 6-25-1985.
- 1,344,635. GEORGIO DEPHILLIPPE. INT. CL. 25. (U.S. CL. 39). REG. 6-25-1985.
- 1,344,637. PACEMARK CLOTHES. INT. CL. 25. (U.S. CL. 39). REG. 6-25-1985.
- 1,344,734. FORMED BARB. INT. CL. 26. (U.S. CL. 40). REG. 6-25-1985.
- 1,345,017. DIVERSIFIED FUNDING. INT. CL. 36. (U.S. CLS. 101 AND 102). REG. 6-25-1985.
- 1,345,219. MISCELLANEOUS DESIGN. INT. CL. 42. (U.S. CL. 100). REG. 6-25-1985.
- 1,345,396. FLYNAP. INT. CL. 1. (U.S. CLS. 6 AND 18). REG. 7-2-1985.
- 1,345,422. PRIMEKOTE. INT. CL. 2. (U.S. CL. 16). REG. 7-2-1985.
- 1,345,467. KONITE. INT. CL. 3. (U.S. CL. 52). REG. 7-2-1985.
- 1,345,540. RE-VAC II. INT. CL. 5. (U.S. CL. 18). REG. 7-2-1985.
- 1,345,550. CHOPPER. INT. CL. 5. (U.S. CL. 6). REG. 7-2-1985.
- 1,345,630. BEACON LINE AND DESIGN. INT. CL. 7. (U.S. CL. 23). REG. 7-2-1985.
- 1,345,689. TRI-TRONICS. INT. CL. 9. (U.S. CLS. 3 AND 21). REG. 7-2-1985.
- 1,345,855. EQUITHAL. INT. CL. 9. (U.S. CLS. 21 AND 26). REG. 7-2-1985.
- 1,345,905. QUIK-FIT AND DESIGN. INT. CL. 10. (U.S. CL. 44). REG. 7-2-1985.
- 1,345,917. ASPIVENIN. INT. CL. 10. (U.S. CL. 44). REG. 7-2-1985.
- 1,346,044. DANIEL DAKOTA. INT. CL. 14. (U.S. CL. 27). REG. 7-2-1985.
- 1,346,136. MISCELLANEOUS DESIGN. INT. CL. 17. (U.S. CL. 1). REG. 7-2-1985.
- 1,346,171. 2/200. INT. CL. 18. (U.S. CL. 3). REG. 7-2-1985.
- 1,346,201. ACTION. INT. CL. 20. (U.S. CLS. 32 AND 50). REG. 7-2-1985.
- 1,346,207. INNERFACE AND DESIGN. INT. CL. 20. (U.S. CL. 50). REG. 7-2-1985.
- 1,346,258. BAKER'S ADVANTAGE AND DESIGN. INT. CL. 21. (U.S. CLS. 2, 13, 30 AND 33). REG. 7-2-1985.
- 1,346,504. PIERCE COUNTRY. INT. CL. 29. (U.S. CL. 46). REG. 7-2-1985.
- 1,346,600. PERUGINA. INT. CL. 30. (U.S. CL. 46). REG. 7-2-1985.
- 1,346,613. CHANGE OF PACE (STYLIZED). INT. CL. 30. (U.S. CL. 46). REG. 7-2-1985.
- 1,346,676. TOSO. INT. CL. 33. (U.S. CL. 47). REG. 7-2-1985.
- 1,346,747. RESULTS NOT PROMISES. INT. CL. 36. (U.S. CL. 102). REG. 7-2-1985.
- 1,346,775. K-LITE. INT. CL. 38. (U.S. CL. 104). REG. 7-2-1985.
- 1,346,794. TOTAL SYSTEMS APPROACH. INT. CL. 40. (U.S. CL. 106). REG. 7-2-1985.
- 1,346,832. BOSTON MARATHON. INT. CL. 41. (U.S. CL. 107). REG. 7-2-1985.
- 1,347,127. STERILGEL. INT. CL. 5. (U.S. CL. 6). REG. 7-9-1985.
- 1,347,208. HYDRATEC AND DESIGN. INT. CL. 6. (U.S. CL. 14). REG. 7-9-1985.
- 1,347,279. KOOL-TOUCH. INT. CL. 8. (U.S. CL. 23). REG. 7-9-1985.
- 1,347,333. THE AGENCY MANAGER. INT. CL. 9. (U.S. CL. 38). REG. 7-9-1985.
- 1,347,371. SESSION. INT. CL. 9. (U.S. CLS. 21 AND 36). REG. 7-9-1985.
- 1,347,568. EYE SUNLUX. INT. CL. 11. (U.S. CL. 21). REG. 7-9-1985.
- 1,347,601. ELTRIM (STYLIZED). INT. CL. 12. (U.S. CL. 19). REG. 7-9-1985.
- 1,347,668. CELEBRITY. INT. CL. 15. (U.S. CL. 36). REG. 7-9-1985.
- 1,347,882. MAJESTIC. INT. CL. 19. (U.S. CLS. 12 AND 20). REG. 7-9-1985.
- 1,347,962. SHARPSAFE. INT. CL. 21. (U.S. CL. 2). REG. 7-9-1985.
- 1,348,173. STRIP-ZIP. INT. CL. 26. (U.S. CL. 40). REG. 7-9-1985.
- 1,348,230. ELECTRA. INT. CL. 28. (U.S. CL. 22). REG. 7-9-1985.
- 1,348,375. BIRTHDAY CONTROL PILLS. INT. CL. 30. (U.S. CL. 46). REG. 7-9-1985.
- 1,348,547. ACCESS AND DESIGN. INT. CLS. 37 AND 42. (U.S. CLS. 100 AND 103). REG. 7-9-1985.
- 1,348,825. BL AND DESIGN. INT. CL. 1. (U.S. CL. 6). REG. 7-16-1985.
- 1,348,827. PGR-IV. INT. CL. 1. (U.S. CLS. 6 AND 10). REG. 7-16-1985.
- 1,349,001. SCORPION. INT. CL. 9. (U.S. CL. 21). REG. 7-16-1985.
- 1,349,192. SPORTMAX. INT. CL. 12. (U.S. CL. 35). REG. 7-16-1985.
- 1,349,200. GIFTS FROM THE SEA. INT. CL. 14. (U.S. CL. 28). REG. 7-16-1985.
- 1,349,226. FIVE STAR DELUXE PAN AND DESIGN. INT. CL. 16. (U.S. CL. 22). REG. 7-16-1985.
- 1,349,260. TOLEDO MAGAZINE (STYLIZED). INT. CL. 16. (U.S. CL. 38). REG. 7-16-1985.
- 1,349,322. STABILO. INT. CL. 16. (U.S. CL. 37). REG. 7-16-1985.
- 1,349,346. CHIP-COR. INT. CL. 16. (U.S. CL. 37). REG. 7-16-1985.
- 1,349,510. BAY HEAD. INT. CL. 25. (U.S. CL. 39). REG. 7-16-1985.
- 1,349,513. JACADI (STYLIZED). INT. CL. 25. (U.S. CL. 39). REG. 7-16-1985.
- 1,349,687. FISH FORMULA AND DESIGN. INT. CL. 28. (U.S. CL. 22). REG. 7-16-1985.
- 1,349,830. STONE-BUHR. INT. CL. 30 ONLY. (U.S. CL. 46). REG. 7-16-1985.
- 1,349,867. BIG JUAN. INT. CL. 32. (U.S. CL. 45). REG. 7-16-1985.
- 1,350,078. THE YOGURT STATION. INT. CL. 42. (U.S. CL. 100). REG. 7-16-1985.
- 1,350,194. CHEMASK. INT. CL. 2. (U.S. CLS. 6, 11 AND 16). REG. 7-23-1985.
- 1,350,489. VARI-TILT. INT. CL. 10. (U.S. CL. 44). REG. 7-23-1985.
- 1,350,504. MORTAN TAN, INC. (STYLIZED). INT. CL. 10. (U.S. CL. 44). REG. 7-23-1985.
- 1,350,547. ATL. INT. CLS. 12, 17 AND 19. (U.S. CLS. 12, 19, 22 AND 50). REG. 7-23-1985.
- 1,350,657. ZER-O-LOC. INT. CL. 19. (U.S. CL. 12). REG. 7-23-1985.
- 1,350,901. MISCELLANEOUS DESIGN. INT. CL. 30 ONLY. (U.S. CL. 46). REG. 7-23-1985.
- 1,351,168. DPL. INT. CL. 1. (U.S. CLS. 6 AND 21). REG. 7-30-1985.
- 1,351,941. THRILLERS. INT. CL. 29. (U.S. CL. 46). REG. 7-30-1985.
- 1,352,028. USWEST AND DESIGN. INT. CL. 38 ONLY. (U.S. CL. 104). REG. 7-30-1985.
- 1,352,304. SCOTT. INT. CLS. 2 AND 5. (U.S. CLS. 6 AND 16). REG. 8-6-1985.
- 1,352,525. KEYPLUS. INT. CL. 9. (U.S. CL. 38). REG. 8-6-1985.
- 1,353,178. BOSCA. INT. CL. 33. (U.S. CL. 47). REG. 8-6-1985.
- 1,353,256. WINSHAPE CENTRE AND DESIGN. INT. CL. 36. (U.S. CLS. 100, 102 AND 107). REG. 8-6-1985.

- 1,353,323. SUCCESS.N.LIFE (STYLIZED). INT. CL. 41. (U.S. CL. 107). REG. 8-6-1985.
- 1,353,896. SATELEC. INT. CL. 10. (U.S. CL. 44). REG. 8-13-1985.
- 1,354,621. AVAIL. INT. CL. 36. (U.S. CLS. 101 AND 102). REG. 8-13-1985.
- 1,354,622. AVAIL AND DESIGN. INT. CL. 36. (U.S. CLS. 101 AND 102). REG. 8-13-1985.
- 1,354,680. CATAMOUNTS. INT. CL. 41. (U.S. CL. 107). REG. 8-13-1985.
- 1,354,705. RIZZOLI. INT. CL. 42. (U.S. CL. 101). REG. 8-13-1985.
- 1,354,810. SILAR. INT. CL. 1. (U.S. CLS. 6 AND 14). REG. 8-20-1985.
- 1,354,973. AIRJET. INT. CL. 7. (U.S. CL. 23). REG. 8-20-1985.
- 1,355,703. MISCELLANEOUS DESIGN. INT. CL. 31. (U.S. CL. 1). REG. 8-20-1985.
- 1,356,103. MISCELLANEOUS DESIGN. INT. CL. 2. (U.S. CL. 46). REG. 8-27-1985.
- 1,356,814. MISCELLANEOUS DESIGN. INT. CL. 25. (U.S. CL. 39). REG. 8-27-1985.
- 1,357,646. BOWEX. INT. CL. 7. (U.S. CL. 23). REG. 9-3-1985.
- 1,358,066. ACCENTA. INT. CL. 20. (U.S. CL. 32). REG. 9-3-1985.
- 1,358,700. WINTER POW-R PLUS. INT. CL. 1. (U.S. CL. 6). REG. 9-10-1985.
- 1,358,754. PLAST-N-GLAS. INT. CL. 3. (U.S. CL. 52). REG. 9-10-1985.
- 1,358,840. ELLIS (STYLIZED). INT. CL. 6. (U.S. CLS. 12 AND 13). REG. 9-10-1985.
- 1,358,869. VISIFLO. INT. CL. 7. (U.S. CL. 23). REG. 9-10-1985.
- 1,359,134. THE FINISHING TOUCH. INT. CL. 12. (U.S. CL. 19). REG. 9-10-1985.
- 1,359,455. TRI-CO. INT. CL. 29. (U.S. CL. 46). REG. 9-10-1985.
- 1,359,457. KAKEBAKE. INT. CL. 29. (U.S. CL. 46). REG. 9-10-1985.
- 1,359,508. TROPICAL SNO. INT. CL. 30. (U.S. CL. 46). REG. 9-10-1985.
- 1,360,101. CARDURA. INT. CL. 5. (U.S. CL. 18). REG. 9-17-1985.
- 1,360,109. CARPIN AND DESIGN. INT. CL. 6. (U.S. CLS. 13 AND 14). REG. 9-17-1985.
- 1,360,261. ESDU. INT. CLS. 9 AND 16. (U.S. CL. 38). REG. 9-17-1985.
- 1,360,461. MISCELLANEOUS DESIGN. INT. CLS. 16, 41 AND 42 ONLY. (U.S. CLS. 37, 38, 100 AND 107). REG. 9-17-1985.
- 1,360,895. HAAGEN-DAZS (STYLIZED). INT. CL. 30. (U.S. CL. 46). REG. 9-17-1985.
- 1,361,282. DURATION. INT. CL. 1. (U.S. CL. 6). REG. 9-24-1985.
- 1,361,489. M1. INT. CL. 8. (U.S. CL. 23). REG. 9-24-1985.
- 1,361,490. M2. INT. CL. 8. (U.S. CL. 23). REG. 9-24-1985.
- 1,361,851. CBR AND DESIGN. INT. CL. 16. (U.S. CL. 38). REG. 9-24-1985.
- 1,363,611. MISCELLANEOUS DESIGN. INT. CL. 29. (U.S. CL. 46). REG. 10-1-1985.
- 1,364,630. DEER FORMULA AND DESIGN. INT. CL. 28. (U.S. CL. 22). REG. 10-8-1985.
- 1,367,945. MISCELLANEOUS DESIGN. INT. CL. 30. (U.S. CL. 46). REG. 10-29-1985.
- 1,370,746. PLANTEX. INT. CL. 1. (U.S. CL. 10). REG. 11-19-1985.
- 1,371,979. BIRDS IN ART. INT. CL. 41. (U.S. CL. 107). REG. 11-19-1985.
- 1,372,134. F2B. INT. CL. 6. (U.S. CL. 13). REG. 11-26-1985.
- 1,372,177. CHEMSAVER. INT. CL. 7. (U.S. CL. 23). REG. 11-26-1985.
- 1,372,559. DECK DRAIN-A-WAY. INT. CL. 19. (U.S. CL. 12). REG. 11-26-1985.
- 1,372,866. JAGER AND DESIGN. INT. CL. 30. (U.S. CL. 46). REG. 11-26-1985.
- 1,373,151. NAISH HAWAII AND DESIGN. INT. CL. 12. (U.S. CL. 22). REG. 11-26-1985.
- 1,374,726. V.I.P. CHECKS AND DESIGN. INT. CL. 16. (U.S. CL. 38). REG. 12-10-1985.
- 1,375,994. TOTES. INT. CL. 25. (U.S. CL. 39). REG. 12-17-1985.
- 1,376,098. LASTRAP. INT. CL. 28. (U.S. CL. 22). REG. 12-17-1985.
- 1,376,451. ORGANIC FARMS. INT. CL. 1. (U.S. CL. 10). REG. 12-17-1985.
- 1,376,550. MISCELLANEOUS DESIGN. INT. CL. 16. (U.S. CL. 38). REG. 12-24-1985.
- 1,378,303. ITALIANI. INT. CL. 29. (U.S. CL. 46). REG. 1-14-1986.
- 1,378,697. S AND DESIGN. INT. CLS. 1, 2, 14 AND 17 ONLY. (U.S. CLS. 6, 12, 14, 16 AND 28). REG. 1-21-1986.
- 1,379,763. LEXSEE. INT. CL. 42. (U.S. CLS. 100 AND 101). REG. 1-21-1986.
- 1,379,903. PARAPLAST X-TRA. INT. CL. 1. (U.S. CL. 6). REG. 1-28-1986.
- 1,380,806. UNIVERSITY OF VERMONT. INT. CL. 41. (U.S. CL. 107). REG. 1-28-1986.
- 1,384,963. ACCURIDE (STYLIZED). INT. CL. 6. (U.S. CL. 13). REG. 3-4-1986.
- 1,385,940. PRINCETON UNIVERSITY PRESS. INT. CL. 16. (U.S. CL. 38). REG. 3-11-1986.
- 1,386,103. REGAL. INT. CL. 26. (U.S. CL. 40). REG. 3-11-1986.
- 1,387,728. J-R SPECIAL SELECTION ULTIMATE-JR-ULTIMATE AND DESIGN. INT. CL. 34. (U.S. CL. 12). REG. 3-25-1986.
- 1,387,816. RICOS. INT. CL. 42. (U.S. CL. 101). REG. 3-25-1986.
- 1,388,117. ISOMAP. INT. CL. 9. (U.S. CL. 38). REG. 4-1-1986.
- 1,389,976. MISCELLANEOUS DESIGN. INT. CL. 25 ONLY. (U.S. CLS. 22 AND 39). REG. 4-15-1986.
- 1,393,948. OLYMPIA. INT. CL. 12. (U.S. CL. 19). REG. 5-20-1986.
- 1,394,469. MISCELLANEOUS DESIGN. INT. CL. 42. (U.S. CL. 101). REG. 5-20-1986.
- 1,394,479. NICOLA PIZZA AND DESIGN. INT. CL. 42. (U.S. CL. 100). REG. 5-20-1986.
- 1,395,144. STAR SYSTEM AND DESIGN. INT. CL. 36. (U.S. CL. 102). REG. 5-27-1986.
- 1,395,353. MISCELLANEOUS DESIGN. INT. CL. 42. (U.S. CL. 101). REG. 5-27-1986.
- 1,395,432. CHROMALINE. INT. CL. 1. (U.S. CL. 6). REG. 6-3-1986.
- 1,395,556. SEISMAP. INT. CL. 9. (U.S. CL. 38). REG. 6-3-1986.
- 1,396,092. STAR SYSTEM. INT. CL. 36. (U.S. CL. 102). REG. 6-3-1986.
- 1,397,222. L & N SEAFOOD GRILL AND DESIGN. INT. CL. 42. (U.S. CL. 100). REG. 6-10-1986.
- 1,398,400. SAFE-MATE. INT. CL. 9. (U.S. CL. 21). REG. 6-24-1986.
- 1,692,825. DYNASTY. INT. CL. 12. (U.S. CL. 19). REG. 6-9-1992.
- 1,693,866. PETCAT. INT. CL. 1. (U.S. CL. 6). REG. 6-16-1992.
- 1,737,318. GL GRAND LIDO NEGRIL AND DESIGN. INT. CL. 42. (U.S. CLS. 100 AND 107). REG. 12-1-1992.
- 1,789,534. SKYCOASTER. INT. CLS. 28 AND 41. (U.S. CLS. 22 AND 107). REG. 8-24-1994.
- 1,804,327. RUUD AND DESIGN. INT. CL. 11. (U.S. CL. 34). REG. 11-16-1993.
- 1,830,135. SCORES AND DESIGN. INT. CLS. 6, 41 AND 42. (U.S. CLS. 2, 12, 13, 14, 23, 25, 50, 100, 101 AND 107). REG. 4-12-1994.
- 1,833,265. ALGAL TURF SCRUBBER. INT. CL. 11. (U.S. CL. 31). REG. 4-26-1994.
- 1,844,591. TURKEY RANCHERO. INT. CL. 29. (U.S. CL. 46). REG. 7-12-1994.
- 1,844,958. KIDS' RECIPES FOR SUCCESS (STYLIZED). INT. CLS. 16 AND 40. (U.S. CLS. 38 AND 100). REG. 7-12-1994.
- 1,858,253. ALLIED (STYLIZED). INT. CL. 42. (U.S. CLS. 100 AND 101). REG. 10-11-1994.
- 1,858,288. CHILDREN AFFECTED BY AIDS FOUNDATION. INT. CL. 36. (U.S. CLS. 100, 101 AND 102). REG. 10-11-1994.
- 1,858,711. KELLY. INT. CL. 28. (U.S. CL. 22). REG. 10-18-1994.
- 1,862,095. MR. GREEK (STYLIZED). INT. CL. 42. (U.S. CLS. 100 AND 101). REG. 11-8-1994.
- 1,864,093. THE REAL ENCHILADA. INT. CL. 42. (U.S. CL. 100). REG. 11-22-1994.
- 1,865,570. EPP CORP AND DESIGN. INT. CL. 7. (U.S. CL. 23). REG. 12-6-1994.
- 1,868,048. RED1. INT. CL. 9. (U.S. CL. 38). REG. 12-20-1994.
- 1,868,448. WARRIOR. INT. CL. 28. (U.S. CL. 22). REG. 12-20-1994.
- 1,869,416. AUDIONAV. INT. CL. 9. (U.S. CL. 26). REG. 12-27-1994.
- 1,869,599. MISCELLANEOUS DESIGN. INT. CL. 20. (U.S. CL. 2). REG. 12-27-1994.
- 1,869,613. PRELUDE. INT. CL. 20. (U.S. CL. 32). REG. 12-27-1994.
- 1,869,704. HI-TEC. INT. CL. 25. (U.S. CL. 39). REG. 12-27-1994.

- 1,869,895. FRIENDLY FOOT CARE AND DESIGN. INT. CLS. 41 AND 42 ONLY. (U.S. CLS. 100 AND 107). REG. 12-27-1994.
- 1,870,042. IP AND DESIGN. INT. CLS. 41 AND 42. (U.S. CLS. 100 AND 107). REG. 12-27-1994.
- 1,870,051. THE METERS. INT. CL. 41. (U.S. CL. 107). REG. 12-27-1994.
- 1,870,224. NORTHERN GETAWAY. INT. CLS. 25 AND 26. (U.S. CLS. 39 AND 40). REG. 12-27-1994.
- 1,870,280. TROPICAL MIST AND DESIGN. INT. CL. 3. (U.S. CL. 51). REG. 12-27-1994.
- 1,870,532. POWER & GLORY. INT. CL. 16. (U.S. CL. 38). REG. 12-27-1994.
- 1,870,648. TWIN MILL. INT. CL. 28. (U.S. CL. 22). REG. 12-27-1994.
- 1,871,041. QUALIFLO (STYLIZED). INT. CL. 7. (U.S. CLS. 13, 19, 21, 23, 31, 34 AND 35). REG. 1-3-1995.
- 1,871,520. FRIENDLY FOOT CARE. INT. CLS. 41 AND 42 ONLY. (U.S. CLS. 100 AND 107). REG. 1-3-1995.
- 1,871,559. AVALON PROPERTIES AND DESIGN. INT. CL. 36. (U.S. CLS. 101 AND 102). REG. 1-3-1995.
- 1,871,602. SPORTS DESTINATION NETWORK. INT. CLS. 39 AND 42. (U.S. CLS. 100 AND 105). REG. 1-3-1995.
- 1,872,313. MISCELLANEOUS DESIGN. INT. CLS. 9 AND 14. (U.S. CLS. 2, 21, 23, 26, 27, 28, 36, 38 AND 50). REG. 1-10-1995.
- 1,873,526. BETA-GINSENG. INT. CL. 3. (U.S. CL. 51). REG. 1-17-1995.
- 1,874,178. DREYFUS-AUTOMATIC ASSET BUILDER. INT. CL. 36. (U.S. CL. 102). REG. 1-17-1995.
- 1,874,421. WATERLINK SYSTEM. INT. CLS. 9 AND 11. (U.S. CLS. 13, 21, 23, 26, 31, 34, 36 AND 38). REG. 1-17-1995.
- 1,875,395. ENZA AND DESIGN. INT. CL. 31 ONLY. (U.S. CL. 46). REG. 1-24-1995.
- 1,876,229. TC. INT. CLS. 2 AND 17. (U.S. CLS. 12 AND 16). REG. 1-31-1995.
- 1,876,815. CARIBE (STYLIZED). INT. CL. 32. (U.S. CL. 45). REG. 1-31-1995.
- 1,877,324. KID'S ROOM (STYLIZED). INT. CL. 2 ONLY. (U.S. CL. 16). REG. 2-7-1995.
- 1,879,554. MICROPATH. INT. CL. 9. (U.S. CL. 38). REG. 2-21-1995.
- 1,880,453. RAILMAX. INT. CL. 9. (U.S. CL. 38). REG. 2-28-1995.
- 1,880,991. COCINA DE MINO RESTAURANTE MEXICANO AND DESIGN. INT. CL. 42. (U.S. CLS. 100 AND 101). REG. 2-28-1995.
- 1,883,560. BOLD LINE. INT. CL. 16. (U.S. CLS. 37 AND 38). REG. 3-14-1995.
- 1,885,380. BRIGHTON SKI RESORT AND DESIGN. INT. CL. 41. (U.S. CL. 107). REG. 3-21-1995.
- 1,885,706. LIGHTWEIGHT. INT. CL. 20. (U.S. CL. 32). REG. 3-21-1995.
- 1,886,534. ZLG. INT. CL. 9. (U.S. CL. 26). REG. 3-28-1995.
- 1,887,142. VQ. INT. CL. 16. (U.S. CL. 38). REG. 4-4-1995.
- 1,889,042. THE ONE TO SEE. INT. CL. 42. (U.S. CLS. 100 AND 101). REG. 4-11-1995.
- 1,889,045. TETCO AND DESIGN. INT. CL. 42. (U.S. CL. 101). REG. 4-11-1995.
- 1,890,434. ASSORT. INT. CL. 9. (U.S. CL. 38). REG. 4-18-1995.
- 1,893,178. F-150. INT. CL. 25. (U.S. CL. 39). REG. 5-9-1995.
- 1,893,602. STARBUCKS COFFEE AND DESIGN. INT. CL. 16. (U.S. CL. 31). REG. 5-9-1995.
- 1,893,969. EQ2. INT. CL. 9. (U.S. CL. 38). REG. 5-16-1995.
- 1,895,652. PATCHMASTER. INT. CL. 31. (U.S. CL. 1). REG. 5-23-1995.
- 1,895,758. EXCELLENCE IN SPEAKING INSTITUTE. INT. CL. 41. (U.S. CL. 107). REG. 5-23-1995.
- 1,895,866. US U.S. BOLT (STYLIZED). INT. CL. 6. (U.S. CLS. 13 AND 14). REG. 5-30-1995.
- 1,896,005. POWERBUDGET. INT. CL. 9. (U.S. CL. 38). REG. 5-30-1995.
- 1,896,230. GDF AND DESIGN. INT. CL. 16 ONLY. (U.S. CL. 38). REG. 5-30-1995.
- 1,896,423. G&B. INT. CLS. 36 AND 41 ONLY. (U.S. CLS. 100, 101, 102 AND 107). REG. 5-30-1995.
- 1,896,445. AVIATORS CARD. INT. CL. 36. (U.S. CL. 102). REG. 5-30-1995.
- 1,896,819. PASSPORT. INT. CL. 9. (U.S. CL. 21). REG. 5-30-1995.
- 1,897,081. SOUTHERN COMFORT RESERVE. INT. CL. 33. (U.S. CL. 49). REG. 5-30-1995.
- 1,897,318. ISCAR. INT. CL. 7. (U.S. CL. 23). REG. 6-6-1995.
- 1,898,483. MISCELLANEOUS DESIGN. INT. CL. 3. (U.S. CL. 52). REG. 6-13-1995.
- 1,898,798. POWERMAX. INT. CL. 11. (U.S. CL. 34). REG. 6-13-1995.
- 1,899,029. COOL-LINER. INT. CL. 25. (U.S. CL. 39). REG. 6-13-1995.
- 1,899,337. FANTASTIC COLOR. INT. CL. 42. (U.S. CL. 100). REG. 6-13-1995.
- 1,899,580. LAEIS. INT. CL. 7. (U.S. CLS. 13, 19, 21, 23, 31, 34 AND 35). REG. 6-13-1995.
- 1,900,084. ESSENTIAL. INT. CL. 36. (U.S. CL. 102). REG. 6-13-1995.
- 1,900,204. WOODFINISH AND DESIGN. INT. CL. 2. (U.S. CLS. 6, 11 AND 16). REG. 6-13-1995.
- 1,900,333. SPEED STRUT. INT. CL. 6. (U.S. CLS. 2, 12, 13, 14, 23, 25 AND 50). REG. 6-20-1995.
- 1,900,462. LIFECHANGERS AND DESIGN. INT. CLS. 9, 16 AND 41. (U.S. CLS. 21, 36, 38 AND 107). REG. 6-20-1995.
- 1,900,543. M BABCOCK & WILCOX AND DESIGN. INT. CL. 11. (U.S. CLS. 31 AND 34). REG. 6-20-1995.
- 1,900,546. REPTI GEAR AND DESIGN. INT. CL. 11. (U.S. CL. 21). REG. 6-20-1995.
- 1,900,647. DEKMATE. INT. CL. 19. (U.S. CL. 12). REG. 6-20-1995.
- 1,900,856. INTERACTIVE COUCH POTATO. INT. CL. 36. (U.S. CL. 102). REG. 6-20-1995.
- 1,901,403. ACQUA DI VITA "LIVING WATER" COMPLEX. INT. CL. 3. (U.S. CL. 51). REG. 6-27-1995.
- 1,901,428. MISCELLANEOUS DESIGN. INT. CLS. 5 AND 10. (U.S. CLS. 18 AND 44). REG. 6-27-1995.
- 1,901,515. PIMSLEUR. INT. CL. 9. (U.S. CLS. 21 AND 36). REG. 6-27-1995.
- 1,901,566. SHOCKWAVE. INT. CL. 9. (U.S. CL. 36). REG. 6-27-1995.
- 1,901,574. AUGUST RECORDS INC.. INT. CL. 9. (U.S. CLS. 21, 26 AND 36). REG. 6-27-1995.
- 1,901,651. IOTEC. INT. CL. 10. (U.S. CL. 44). REG. 6-27-1995.
- 1,901,663. MISCELLANEOUS DESIGN. INT. CLS. 11, 20 AND 21. (U.S. CLS. 2, 21, 30, 33 AND 50). REG. 6-27-1995.
- 1,901,691. AMERICAN PSYCHIATRIC ASSOCIATION BENJAMIN RUSH, M.D. 1844 AND DESIGN. INT. CLS. 16 AND 42. (U.S. CLS. 38 AND 100). REG. 6-27-1995.
- 1,901,701. PORTLAND SEA DOGS (STYLIZED). INT. CLS. 16 AND 25. (U.S. CLS. 37, 38 AND 39). REG. 6-27-1995.
- 1,901,704. BONUS. INT. CL. 16. (U.S. CL. 38). REG. 6-27-1995.
- 1,901,715. CONSUMERS UNION. INT. CL. 16. (U.S. CL. 38). REG. 6-27-1995.
- 1,901,735. WE MAKE BOATING MORE FUN!. INT. CL. 16. (U.S. CL. 38). REG. 6-27-1995.
- 1,901,784. AUTO-PEAK. INT. CL. 22. (U.S. CL. 22). REG. 6-27-1995.
- 1,901,785. AUTO-SLIDER. INT. CL. 22. (U.S. CL. 22). REG. 6-27-1995.
- 1,901,793. STARS & STRIPES. INT. CL. 25. (U.S. CL. 39). REG. 6-27-1995.
- 1,901,885. PHILADELPHIA AMERICAN LIFE INSURANCE COMPANY AND DESIGN. INT. CL. 36. (U.S. CLS. 101 AND 102). REG. 6-27-1995.
- 1,901,946. FLS AND DESIGN. INT. CL. 39. (U.S. CL. 105). REG. 6-27-1995.
- 1,901,972. ENCORE. INT. CL. 41. (U.S. CL. 107). REG. 6-27-1995.
- 1,902,109. DEMAND. INT. CL. 5. (U.S. CL. 6). REG. 6-27-1995.
- 1,902,113. PRELUDE. INT. CL. 5. (U.S. CL. 6). REG. 6-27-1995.
- 1,902,188. NICOLE MILLER. INT. CL. 25. (U.S. CL. 39). REG. 6-27-1995.
- 1,902,248. INTERCONTINENTAL DESIGNS. INT. CL. 42. (U.S. CLS. 100 AND 101). REG. 6-27-1995.
- 1,902,249. THE BAGEL BARREL AND DESIGN. INT. CL. 42. (U.S. CL. 101). REG. 6-27-1995.
- 1,902,251. VIRTUAL BRANCH. INT. CL. 42. (U.S. CLS. 100 AND 101). REG. 6-27-1995.
- 1,902,265. PRINCE AND DESIGN. INT. CL. 1. (U.S. CL. 6). REG. 7-4-1995.
- 1,902,305. SPEEDBOND. INT. CL. 3. (U.S. CLS. 40 AND 51). REG. 7-4-1995.
- 1,902,308. KISS AND GO!. INT. CL. 3. (U.S. CL. 52). REG. 7-4-1995.

- 1,902,323. MISCELLANEOUS DESIGN. INT. CLS. 4, 37 AND 42 ONLY. (U.S. CLS. 1, 6, 15, 101 AND 103). REG. 7-4-1995.
- 1,902,331. EMLA. INT. CL. 5. (U.S. CL. 18). REG. 7-4-1995.
- 1,902,342. TURBOCIDE GOLD. INT. CL. 5. (U.S. CL. 6). REG. 7-4-1995.
- 1,902,344. TUCKS AND DESIGN. INT. CL. 5. (U.S. CL. 44). REG. 7-4-1995.
- 1,902,351. GREEN ENERGY. INT. CL. 5. (U.S. CL. 18). REG. 7-4-1995.
- 1,902,354. STREPGUARD. INT. CL. 5. (U.S. CL. 18). REG. 7-4-1995.
- 1,902,372. FRUIT-A-LAX. INT. CL. 5. (U.S. CL. 18). REG. 7-4-1995.
- 1,902,396. JAWMASTER. INT. CL. 7. (U.S. CL. 23). REG. 7-4-1995.
- 1,902,404. M AND DESIGN. INT. CL. 9. (U.S. CLS. 21, 23, 26, 36 AND 38). REG. 7-4-1995.
- 1,902,408. MET AND DESIGN. INT. CL. 9. (U.S. CLS. 26 AND 39). REG. 7-4-1995.
- 1,902,447. HYDRO-PROBE. INT. CL. 9. (U.S. CL. 26). REG. 7-4-1995.
- 1,902,471. THE COPPER SHOP. INT. CL. 9. (U.S. CLS. 21 AND 26). REG. 7-4-1995.
- 1,902,546. ARTLAND (STYLIZED). INT. CL. 9. (U.S. CLS. 21, 23, 26, 36 AND 38). REG. 7-4-1995.
- 1,902,547. AGRI-GATE. INT. CL. 9. (U.S. CL. 38). REG. 7-4-1995.
- 1,902,585. HAEMOLANCE. INT. CL. 10. (U.S. CL. 44). REG. 7-4-1995.
- 1,902,670. MISCELLANEOUS DESIGN. INT. CL. 16. (U.S. CL. 38). REG. 7-4-1995.
- 1,902,694. MISCELLANEOUS DESIGN. INT. CL. 16. (U.S. CL. 38). REG. 7-4-1995.
- 1,902,731. STARS & STRIPES. INT. CL. 18. (U.S. CL. 3). REG. 7-4-1995.
- 1,902,779. APPLE CORE AND DESIGN. INT. CL. 24. (U.S. CL. 42). REG. 7-4-1995.
- 1,902,864. RATTLE BACK. INT. CL. 28. (U.S. CL. 22). REG. 7-4-1995.
- 1,902,951. SUPERIOR AND DESIGN. INT. CLS. 35 AND 41. (U.S. CLS. 100, 101 AND 102). REG. 7-4-1995.
- 1,902,964. IVMED AND DESIGN. INT. CL. 35. (U.S. CL. 100). REG. 7-4-1995.
- 1,902,971. CO-MANAGED INDIVIDUAL SYSTEM. INT. CL. 35. (U.S. CL. 101). REG. 7-4-1995.
- 1,903,010. SHELTER MORTGAGE CORPORATION. INT. CL. 36. (U.S. CL. 102). REG. 7-4-1995.
- 1,903,088. MOTHER GOOSE ROCK-N-RHYME. INT. CL. 41. (U.S. CL. 107). REG. 7-4-1995.
- 1,903,187. SOLOMON BROTHERS. INT. CL. 42. (U.S. CL. 101). REG. 7-4-1995.
- 1,903,196. THE BALBOA BAY CLUB. INT. CL. 42. (U.S. CL. 100). REG. 7-4-1995.
- 1,903,313. EVERCLEAN. INT. CL. 2. (U.S. CLS. 6, 11 AND 16). REG. 7-4-1995.
- 1,903,366. VORTEX. INT. CL. 7. (U.S. CLS. 13, 19, 21, 23, 31, 34 AND 35). REG. 7-4-1995.
- 1,903,431. TRILLIUM SOFTWARE SYSTEM. INT. CL. 9. (U.S. CLS. 21, 23, 26, 36 AND 38). REG. 7-4-1995.
- 1,903,432. NETWIZARD. INT. CL. 9. (U.S. CLS. 21, 23, 26, 36 AND 38). REG. 7-4-1995.
- 1,903,571. WORK GEAR. INT. CL. 18. (U.S. CLS. 1, 2, 3, 22 AND 41). REG. 7-4-1995.
- 1,903,614. PAYLESS SHOESOURCE. INT. CL. 25. (U.S. CL. 39). REG. 7-4-1995.
- 1,903,651. TC TOYS. INT. CL. 28. (U.S. CLS. 22, 23, 38 AND 50). REG. 7-4-1995.
- 1,903,724. WATERMELON WAVE. INT. CL. 30. (U.S. CL. 46). REG. 7-4-1995.
- 1,903,930. BIOMECHANICS. INT. CL. 16. (U.S. CLS. 2, 5, 22, 23, 29, 37, 38 AND 50). REG. 7-4-1995.
- 1,903,949. SWING N' SLIDE. INT. CL. 19. (U.S. CLS. 12 AND 13). REG. 7-4-1995.
- 1,903,989. TUBAFEST. INT. CL. 41. (U.S. CL. 107). REG. 7-4-1995.
- 1,904,058. CVS. INT. CLS. 5 AND 25. (U.S. CLS. 18 AND 39). REG. 7-11-1995.
- 1,904,060. ALKA-SELTZER AND DESIGN. INT. CL. 5. (U.S. CL. 18). REG. 7-11-1995.
- 1,904,124. KELLEY BLUE BOOK AND DESIGN. INT. CLS. 9, 16 AND 35 ONLY. (U.S. CLS. 2, 5, 22, 23, 29, 37, 38, 50, 100, 101 AND 102). REG. 7-11-1995.
- 1,904,151. CORELDRAW. INT. CLS. 9, 16, 41 AND 42. (U.S. CLS. 38 AND 107). REG. 7-11-1995.
- 1,904,232. TOTAL PRO-TEC-TION (STYLIZED). INT. CL. 9. (U.S. CL. 21). REG. 7-11-1995.
- 1,904,252. DGC (STYLIZED). INT. CL. 9. (U.S. CLS. 21, 23, 26, 36 AND 38). REG. 7-11-1995.
- 1,904,253. DGC. INT. CL. 9. (U.S. CLS. 21, 23, 26, 36 AND 38). REG. 7-11-1995.
- 1,904,278. CLUBMAC. INT. CLS. 37 AND 42 ONLY. (U.S. CLS. 100 AND 102). REG. 7-11-1995.
- 1,904,370. M MITEL AND DESIGN. INT. CL. 16. (U.S. CL. 38). REG. 7-11-1995.
- 1,904,383. AMERICAN CIVIL LIBERTIES UNION FOUNDATION. INT. CLS. 16 AND 36. (U.S. CLS. 38 AND 102). REG. 7-11-1995.
- 1,904,385. SHAMBHALA. INT. CL. 16. (U.S. CL. 38). REG. 7-11-1995.
- 1,904,386. HOTS. INT. CL. 16. (U.S. CL. 38). REG. 7-11-1995.
- 1,904,402. THE FORUM. INT. CL. 16. (U.S. CL. 38). REG. 7-11-1995.
- 1,904,429. QUARELLA. INT. CL. 19. (U.S. CLS. 1, 12, 33 AND 50). REG. 7-11-1995.
- 1,904,773. AMERICROWN SERVICE CORPORATION AND DESIGN. INT. CL. 42. (U.S. CL. 101). REG. 7-11-1995.
- 1,904,857. QSOUND. INT. CLS. 9 AND 28. (U.S. CLS. 21, 22, 23, 26, 36, 38 AND 50). REG. 7-11-1995.
- 1,904,859. AQUALOCK. INT. CL. 1. (U.S. CLS. 1, 5, 6, 10, 26 AND 46). REG. 7-11-1995.
- 1,904,891. FLO-MET. INT. CL. 5. (U.S. CLS. 6, 18, 44, 46, 51 AND 52). REG. 7-11-1995.
- 1,904,896. ROTAN. INT. CL. 7. (U.S. CLS. 13, 19, 21, 23, 31, 34 AND 35). REG. 7-11-1995.
- 1,904,944. COINSTAR. INT. CL. 9. (U.S. CLS. 21, 23, 26, 36 AND 38). REG. 7-11-1995.
- 1,904,953. ADOBEAIR. INT. CL. 11. (U.S. CLS. 13, 21, 23, 31 AND 34). REG. 7-11-1995.
- 1,904,957. TMT MOTOR SPORTS. INT. CL. 12. (U.S. CLS. 19, 21, 23, 31, 35 AND 44). REG. 7-11-1995.
- 1,904,983. MOTIVATION! FROM G NEIL COMPANIES (STYLIZED). INT. CL. 16. (U.S. CLS. 2, 5, 22, 23, 29, 37, 38 AND 50). REG. 7-11-1995.
- 1,905,026. BRONX. INT. CL. 25. (U.S. CL. 39). REG. 7-11-1995.
- 1,905,117. CAPEL AND DESIGN. INT. CL. 33. (U.S. CL. 49). REG. 7-11-1995.
- 1,905,138. LOCAL PLUS. INT. CL. 38. (U.S. CLS. 100, 101 AND 104). REG. 7-11-1995.
- 1,905,208. DIONEX. INT. CL. 1. (U.S. CL. 6). REG. 7-18-1995.
- 1,905,274. FLEX-PAK. INT. CL. 5. (U.S. CLS. 18 AND 44). REG. 7-18-1995.
- 1,905,303. GRAPHIC ALERT. INT. CLS. 6, 16 AND 19. (U.S. CLS. 1, 2, 5, 12, 22, 23, 29, 33, 37, 38 AND 50). REG. 7-18-1995.
- 1,905,380. EPG. INT. CLS. 9 AND 35. (U.S. CLS. 38 AND 101). REG. 7-18-1995.
- 1,905,414. HOTS. INT. CL. 9. (U.S. CL. 38). REG. 7-18-1995.
- 1,905,432. MISCELLANEOUS DESIGN. INT. CL. 9. (U.S. CLS. 21 AND 36). REG. 7-18-1995.
- 1,905,445. BRETHREN PRESS. INT. CLS. 9 AND 16. (U.S. CLS. 2, 5, 21, 22, 23, 26, 29, 36, 37, 38 AND 50). REG. 7-18-1995.
- 1,905,530. BRUDER. INT. CL. 10. (U.S. CL. 44). REG. 7-18-1995.
- 1,905,656. CAPRIS FURNITURE. INT. CL. 20. (U.S. CL. 32). REG. 7-18-1995.
- 1,905,686. OFF THE WALL STREET. INT. CL. 25. (U.S. CLS. 22 AND 39). REG. 7-18-1995.
- 1,905,702. CHARLES KLEIN. INT. CL. 25. (U.S. CL. 39). REG. 7-18-1995.
- 1,905,731. HAZELTINE NATIONAL GOLF CLUB AND DESIGN. INT. CLS. 25 AND 41. (U.S. CLS. 39, 101 AND 107). REG. 7-18-1995.
- 1,905,733. OKABASHI. INT. CL. 25. (U.S. CL. 39). REG. 7-18-1995.
- 1,905,766. EMGE. INT. CL. 29. (U.S. CL. 46). REG. 7-18-1995.
- 1,905,786. MOO-MANIA. INT. CL. 29. (U.S. CL. 46). REG. 7-18-1995.
- 1,905,822. ROXY. INT. CL. 31. (U.S. CLS. 1 AND 46). REG. 7-18-1995.
- 1,905,856. TRESTLE CREEK. INT. CL. 33. (U.S. CL. 49). REG. 7-18-1995.
- 1,905,894. OMNI EXPRESS. INT. CLS. 35 AND 42. (U.S. CLS. 100 AND 101). REG. 7-18-1995.
- 1,905,961. THE EXHIBIT HOUSE INC.. INT. CLS. 37 AND 42. (U.S. CLS. 100, 101 AND 103). REG. 7-18-1995.
- 1,906,007. AMERICA'S FUNNIEST KIDS. INT. CL. 41. (U.S. CLS. 100, 101 AND 107). REG. 7-18-1995.

- 1,906,010. COLUMBIA SCHOOL OF BROADCASTING. INT. CL. 41. (U.S. CL. 107). REG. 7-18-1995.
- 1,906,026. HOTS. INT. CL. 41. (U.S. CLS. 100, 101 AND 107). REG. 7-18-1995.
- 1,906,102. MISCELLANEOUS DESIGN. INT. CL. 42. (U.S. CL. 100). REG. 7-18-1995.
- 1,906,276. ESSENTIAL LIFE. INT. CL. 5. (U.S. CL. 18). REG. 7-18-1995.
- 1,906,288. POWER-LIFT. INT. CL. 5. (U.S. CL. 44). REG. 7-18-1995.
- 1,906,294. BORDEAU. INT. CL. 6. (U.S. CL. 13). REG. 7-18-1995.
- 1,906,412. PAPERFILM. INT. CL. 10. (U.S. CLS. 26, 39 AND 44). REG. 7-18-1995.
- 1,906,517. MIRA. INT. CL. 16. (U.S. CLS. 2, 5, 22, 23, 29, 37, 38 AND 50). REG. 7-18-1995.
- 1,906,521. THE PER ANNUM MANHATTAN DAILY PLAN-IT. INT. CL. 16. (U.S. CLS. 2, 5, 22, 23, 29, 37, 38 AND 50). REG. 7-18-1995.
- 1,906,634. NBA WESTERN CONFERENCE AND DESIGN. INT. CL. 25. (U.S. CLS. 22 AND 39). REG. 7-18-1995.
- 1,906,706. FESTIN. INT. CL. 29. (U.S. CL. 46). REG. 7-18-1995.
- 1,906,836. DINER-X-PRESS. INT. CL. 42. (U.S. CL. 100). REG. 7-18-1995.
- 1,906,860. REJECTSORTER. INT. CL. 7. (U.S. CLS. 13, 19, 21, 23, 31, 34 AND 35). REG. 7-18-1995.
- 1,907,129. KARPOWER. INT. CLS. 9, 16 AND 42. (U.S. CLS. 38, 100 AND 101). REG. 7-25-1995.
- 1,907,143. LEPEL. INT. CLS. 9 AND 11. (U.S. CLS. 21, 23, 26, 34, 36 AND 38). REG. 7-25-1995.
- 1,907,174. OPTHOS. INT. CL. 9. (U.S. CL. 26). REG. 7-25-1995.
- 1,907,216. MEDIGUARD (STYLIZED). INT. CL. 10. (U.S. CLS. 39 AND 44). REG. 7-25-1995.
- 1,907,261. CIRRUS. INT. CL. 12. (U.S. CL. 19). REG. 7-25-1995.
- 1,907,307. WOOSTER. INT. CLS. 16 AND 21. (U.S. CL. 29). REG. 7-25-1995.
- 1,907,508. CREAMIES. INT. CL. 29. (U.S. CL. 46). REG. 7-25-1995.
- 1,907,596. RECOGNITION RESOURCES. INT. CL. 36. (U.S. CL. 102). REG. 7-25-1995.
- 1,907,751. ENTERPRISE VENDING WHERE SERVICE BE-GINS AND DESIGN. INT. CL. 42. (U.S. CLS. 100 AND 101). REG. 7-25-1995.
- 1,908,003. INDUSTRIAL COMMUNICATIONS & ELEC-TRONICS. INT. CL. 38. (U.S. CLS. 100, 101 AND 104). REG. 7-25-1995.
- 1,908,100. POWER SURGE. INT. CL. 5. (U.S. CL. 18). REG. 8-1-1995.
- 1,908,103. OVATION. INT. CL. 5. (U.S. CL. 44). REG. 8-1-1995.
- 1,908,132. WACHS AND DESIGN. INT. CL. 7. (U.S. CLS. 13, 19, 21, 23, 31, 34 AND 35). REG. 8-1-1995.
- 1,908,481. RICHWOOD. INT. CL. 19. (U.S. CL. 12). REG. 8-1-1995.
- 1,908,751. CITIZEN OF THE WEST. INT. CL. 35. (U.S. CL. 101). REG. 8-1-1995.
- 1,908,859. SCA. INT. CL. 40. (U.S. CLS. 100, 103 AND 106). REG. 8-1-1995.
- 1,908,945. AEA TECHNOLOGY. INT. CL. 42. (U.S. CLS. 100 AND 101). REG. 8-1-1995.
- 1,909,073. H GRAND HARVEST AND DESIGN. INT. CLS. 29 AND 30. (U.S. CL. 46). REG. 8-1-1995.
- 1,909,094. REPUTAIN. INT. CL. 1. (U.S. CLS. 1, 5, 6, 10, 26 AND 46). REG. 8-1-1995.
- 1,909,151. CLEANSHEEN. INT. CL. 6. (U.S. CLS. 2, 12, 13, 14, 23, 25 AND 50). REG. 8-1-1995.
- 1,909,248. CLEAN-2. INT. CL. 11. (U.S. CL. 31). REG. 8-1-1995.
- 1,909,288. ARABESQUE. INT. CL. 16. (U.S. CLS. 2, 5, 22, 23, 29, 37, 38 AND 50). REG. 8-1-1995.
- 1,909,388. WORLD OVENS. INT. CL. 30. (U.S. CL. 46). REG. 8-1-1995.
- 1,909,524. COMPACT. INT. CL. 9. (U.S. CLS. 21, 23, 26, 36 AND 38). REG. 8-1-1995.
- 1,909,575. PATENTQUERY. INT. CL. 35. (U.S. CLS. 100, 101 AND 102). REG. 8-1-1995.
- 1,909,594. LOCH LOMOND GOLF CLUB (STYLIZED). INT. CL. 41. (U.S. CLS. 100, 101 AND 107). REG. 8-1-1995.
- 1,909,765. IMAC. INT. CL. 9. (U.S. CLS. 21, 23, 26, 36 AND 38). REG. 8-8-1995.
- 1,909,849. PB VIEWS. INT. CL. 9. (U.S. CL. 38). REG. 8-8-1995.
- 1,910,284. BANNER. INT. CLS. 29 AND 30. (U.S. CL. 46). REG. 8-8-1995.
- 1,910,365. DESA (STYLIZED). INT. CL. 35. (U.S. CL. 101). REG. 8-8-1995.
- 1,910,630. PRECISION AND DESIGN. INT. CL. 42. (U.S. CL. 100). REG. 8-8-1995.
- 1,910,673. LOVE & WAR (STYLIZED). INT. CLS. 9, 16, 21 AND 25. (U.S. CLS. 2, 5, 13, 21, 22, 23, 26, 29, 30, 33, 36, 37, 38, 39, 40 AND 50). REG. 8-8-1995.
- 1,910,711. AR-TX. INT. CL. 9. (U.S. CLS. 21, 23, 26, 36 AND 38). REG. 8-8-1995.
- 1,910,722. TRAM. INT. CL. 9. (U.S. CLS. 21, 23, 26, 36 AND 38). REG. 8-8-1995.
- 1,911,272. FAIL SAFE. INT. CL. 13. (U.S. CL. 9). REG. 8-15-1995.
- 1,911,535. APPLES & ORANGES. INT. CL. 28. (U.S. CLS. 22, 23, 38 AND 50). REG. 8-15-1995.
- 1,911,555. VORTEX. INT. CL. 28. (U.S. CL. 22). REG. 8-15-1995.
- 1,911,643. CARACHOCO. INT. CL. 30. (U.S. CL. 46). REG. 8-15-1995.
- 1,911,827. MISCELLANEOUS DESIGN. INT. CL. 39. (U.S. CL. 105). REG. 8-15-1995.
- 1,911,999. COCOS ISLAND RESORT. INT. CL. 42. (U.S. CLS. 100 AND 107). REG. 8-15-1995.
- 1,912,079. JACK CREEK STEAKHOUSE AND DESIGN. INT. CL. 42 ONLY. (U.S. CLS. 100 AND 101). REG. 8-15-1995.
- 1,912,202. CRUCIAL. INT. CL. 5. (U.S. CLS. 6, 18, 44, 46, 51 AND 52). REG. 8-15-1995.
- 1,912,786. SPRING TRAINING. INT. CL. 41. (U.S. CLS. 100, 101 AND 107). REG. 8-15-1995.
- 1,912,971. CRYSTAL. INT. CL. 5. (U.S. CL. 18). REG. 8-22-1995.
- 1,913,556. MISCELLANEOUS DESIGN. INT. CL. 29. (U.S. CL. 46). REG. 8-22-1995.
- 1,913,628. TRIUMPH. INT. CL. 31. (U.S. CL. 46). REG. 8-22-1995.
- 1,913,713. MATCH A NAME. INT. CL. 35. (U.S. CL. 104). REG. 8-22-1995.
- 1,913,799. THE VOICE OF THE FUTURE. INT. CL. 38. (U.S. CL. 104). REG. 8-22-1995.
- 1,913,953. HEALTHY FROM THE START. INT. CL. 42. (U.S. CLS. 100 AND 101). REG. 8-22-1995.
- 1,914,119. MAXVIEW. INT. CL. 9. (U.S. CLS. 21, 23, 26, 36 AND 38). REG. 8-22-1995.
- 1,914,147. C-LINE. INT. CL. 10. (U.S. CL. 44). REG. 8-22-1995.
- 1,914,460. DOUBLE TWIST. INT. CL. 3. (U.S. CL. 51). REG. 8-29-1995.
- 1,914,687. HARDIMETER. INT. CL. 9. (U.S. CLS. 21, 26 AND 38). REG. 8-29-1995.
- 1,914,891. BE A TEACHER. BE A HERO.. INT. CLS. 16, 41 AND 42. (U.S. CLS. 38, 100 AND 107). REG. 8-29-1995.
- 1,914,936. MISCELLANEOUS DESIGN. INT. CL. 17. (U.S. CL. 12). REG. 8-29-1995.
- 1,914,937. TRISEAL. INT. CL. 17. (U.S. CL. 12). REG. 8-29-1995.
- 1,915,448. ARTECH. INT. CL. 37. (U.S. CLS. 100 AND 103). REG. 8-29-1995.
- 1,915,727. INDIA HOUSE RESTAURANT. INT. CL. 42. (U.S. CL. 100). REG. 8-29-1995.
- 1,917,148. DIAMOND AND DESIGN. INT. CL. 5. (U.S. CLS. 6, 18, 44, 46, 51 AND 52). REG. 9-5-1995.
- 1,917,384. SKYHILL NAPA VALLEY. INT. CL. 29. (U.S. CL. 46). REG. 9-5-1995.
- 1,917,656. S (STYLIZED). INT. CL. 9. (U.S. CLS. 21 AND 26). REG. 9-12-1995.
- 1,917,914. STREETWISE. INT. CL. 16. (U.S. CL. 38). REG. 9-12-1995.
- 1,918,409. AC AND DESIGN. INT. CLS. 40 AND 42. (U.S. CLS. 100, 101, 103 AND 106). REG. 9-12-1995.
- 1,918,864. DOCTOR DOWN AND DESIGN. INT. CL. 24. (U.S. CLS. 42 AND 50). REG. 9-12-1995.
- 1,919,088. TRAVEL CHARGE. INT. CL. 36. (U.S. CLS. 100, 101 AND 102). REG. 9-12-1995.
- 1,919,117. APPLE-STIX AND DESIGN. INT. CL. 1. (U.S. CLS. 1, 5, 6, 10, 26 AND 46). REG. 9-19-1995.
- 1,919,357. POLIM. INT. CL. 9. (U.S. CL. 26). REG. 9-19-1995.
- 1,919,570. MEGAWARE KEEL GUARD. INT. CL. 12. (U.S. CL. 12). REG. 9-19-1995.
- 1,919,573. MISCELLANEOUS DESIGN. INT. CL. 12 ONLY. (U.S. CL. 19). REG. 9-19-1995.
- 1,919,725. TRISEAL AND DESIGN. INT. CL. 17. (U.S. CL. 12). REG. 9-19-1995.

- 1,919,796. JASON. INT. CL. 21. (U.S. CLS. 2, 13, 23, 29, 30, 33, 40 AND 50). REG. 9-19-1995.
- 1,919,981. CAMPIONI. INT. CL. 29. (U.S. CL. 46). REG. 9-19-1995.
- 1,920,842. ARTECO. INT. CL. 14. (U.S. CLS. 2, 27, 28 AND 50). REG. 9-19-1995.
- 1,921,490. PHASER. INT. CLS. 7 AND 9. (U.S. CLS. 23, 26 AND 38). REG. 9-26-1995.
- 1,922,456. THE HOME OF THE TALKING DOOR. INT. CL. 37. (U.S. CLS. 100, 103 AND 106). REG. 9-26-1995.
- 1,922,474. ACS AND DESIGN. INT. CL. 38. (U.S. CLS. 100, 101 AND 104). REG. 9-26-1995.
- 1,922,477. WQCD. INT. CL. 38. (U.S. CLS. 100, 101 AND 104). REG. 9-26-1995.
- 1,922,502. AMERICAN EAGLE TANKERS. INT. CL. 39. (U.S. CLS. 100 AND 105). REG. 9-26-1995.
- 1,922,827. LUXOR. INT. CL. 6. (U.S. CLS. 2, 12, 13, 14, 23, 25 AND 50). REG. 9-26-1995.
- 1,922,947. SHUR-LOC. INT. CL. 24. (U.S. CLS. 42 AND 50). REG. 9-26-1995.
- 1,923,460. PTCT AND DESIGN. INT. CL. 9. (U.S. CL. 38). REG. 10-3-1995.
- 1,923,652. TAIGA. INT. CL. 18. (U.S. CL. 3). REG. 10-3-1995.
- 1,924,102. LIVING TECHNOLOGIES AND DESIGN. INT. CLS. 37, 40 AND 42. (U.S. CLS. 100, 101, 103 AND 106). REG. 10-3-1995.
- 1,924,216. GOODBERRY'S AND DESIGN. INT. CL. 42. (U.S. CL. 100). REG. 10-3-1995.
- 1,924,245. BOYD GAMING. INT. CL. 42. (U.S. CLS. 100 AND 101). REG. 10-3-1995.
- 1,924,247. SHARP AND DESIGN. INT. CL. 42. (U.S. CL. 100). REG. 10-3-1995.
- 1,924,697. JOCKEY SPORT. INT. CL. 25. (U.S. CLS. 22 AND 39). REG. 10-3-1995.
- 1,924,972. SETFAST. INT. CL. 2. (U.S. CLS. 6, 11 AND 16). REG. 10-10-1995.
- 1,925,226. SHAMBHALA. INT. CL. 9. (U.S. CLS. 21 AND 36). REG. 10-10-1995.
- 1,925,260. EXCEPTION. INT. CL. 9. (U.S. CLS. 21, 23, 26, 36 AND 38). REG. 10-10-1995.
- 1,925,335. SPUB. INT. CL. 11. (U.S. CLS. 13, 21, 23, 31 AND 34). REG. 10-10-1995.
- 1,925,746. ECKESPOINT. INT. CL. 31. (U.S. CLS. 1 AND 46). REG. 10-10-1995.
- 1,926,108. MISCELLANEOUS DESIGN. INT. CL. 42. (U.S. CL. 100). REG. 10-10-1995.
- 1,926,986. MNET. INT. CL. 38. (U.S. CLS. 100, 101 AND 104). REG. 10-17-1995.
- 1,927,430. GKI. INT. CL. 11. (U.S. CL. 21). REG. 10-17-1995.
- 1,927,531. MONROE. INT. CL. 12. (U.S. CL. 19). REG. 10-17-1995.
- 1,927,564. HAZELTINE. INT. CLS. 25 AND 41. (U.S. CLS. 39, 100, 101 AND 107). REG. 10-17-1995.
- 1,928,082. DESIGN QUEST. INT. CL. 42. (U.S. CLS. 100 AND 101). REG. 10-17-1995.
- 1,928,408. MISCELLANEOUS DESIGN. INT. CL. 37. (U.S. CLS. 100, 103 AND 106). REG. 10-17-1995.
- 1,928,460. IPS EMPRESS. INT. CL. 5. (U.S. CL. 44). REG. 10-17-1995.
- 1,928,885. DETIA AND DESIGN. INT. CL. 5 ONLY. (U.S. CL. 6 ONLY). REG. 10-24-1995.
- 1,929,093. PROFESSOR. INT. CL. 9. (U.S. CL. 38). REG. 10-24-1995.
- 1,929,360. THE DOCUMENT COMPANY. INT. CLS. 1, 2 AND 16. (U.S. CLS. 1, 2, 5, 6, 10, 11, 16, 22, 23, 26, 29, 37, 38, 46 AND 50). REG. 10-24-1995.
- 1,929,455. NATIONAL GAS DISTRIBUTORS INC AND DESIGN. INT. CL. 39. (U.S. CLS. 100 AND 105). REG. 10-24-1995.
- 1,929,535. ONSCREEN SCIENCE, INC.. INT. CL. 9. (U.S. CL. 38). REG. 10-24-1995.
- 1,930,285. SVI TRAINING PRODUCTS. INT. CL. 9. (U.S. CLS. 21, 23, 26, 36 AND 38). REG. 10-24-1995.
- 1,930,555. MABEF (STYLIZED). INT. CL. 16. (U.S. CLS. 29 AND 50). REG. 10-31-1995.
- 1,930,788. MISCELLANEOUS DESIGN. INT. CL. 29. (U.S. CL. 46). REG. 10-31-1995.
- 1,930,965. HEATBUSTER. INT. CL. 7. (U.S. CL. 19). REG. 10-31-1995.
- 1,931,221. NEOPRESS. INT. CL. 16. (U.S. CL. 38). REG. 10-31-1995.
- 1,931,238. TERRAPRESS. INT. CL. 16. (U.S. CL. 37). REG. 10-31-1995.
- 1,931,311. EAGLEFLEX. INT. CL. 17. (U.S. CLS. 1, 5, 12, 13, 35 AND 50). REG. 10-31-1995.
- 1,931,408. SHEET SNUGLER. INT. CL. 24. (U.S. CLS. 42 AND 50). REG. 10-31-1995.
- 1,931,659. MISCELLANEOUS DESIGN. INT. CL. 9. (U.S. CLS. 21, 23, 26, 36 AND 38). REG. 10-31-1995.
- 1,932,124. SOFTFEEL. INT. CL. 9. (U.S. CLS. 21, 23, 26, 36 AND 38). REG. 10-31-1995.
- 1,932,621. SILVER HAWKS. INT. CL. 25. (U.S. CL. 39). REG. 11-7-1995.
- 1,932,624. CLEAR O (STYLIZED). INT. CL. 42. (U.S. CL. 100). REG. 11-7-1995.
- 1,932,926. MISCELLANEOUS DESIGN. INT. CL. 30. (U.S. CL. 46). REG. 11-7-1995.
- 1,933,476. D'ARBO AND DESIGN. INT. CLS. 29, 30 AND 32. (U.S. CLS. 45, 46 AND 48). REG. 11-7-1995.
- 1,933,511. TREVI. INT. CL. 29. (U.S. CL. 46). REG. 11-7-1995.
- 1,934,132. UPLON. INT. CL. 4. (U.S. CLS. 1, 6 AND 15). REG. 11-7-1995.
- 1,934,454. MOCHI (STYLIZED). INT. CL. 30. (U.S. CL. 46). REG. 11-7-1995.
- 1,934,695. MISCELLANEOUS DESIGN. INT. CL. 30. (U.S. CL. 46). REG. 11-14-1995.
- 1,934,733. NORTHERN WIND'S OCEAN REQUESTS. INT. CL. 29. (U.S. CL. 46). REG. 11-14-1995.
- 1,934,934. LIL' DRUG STORE. INT. CL. 5 ONLY. (U.S. CLS. 6, 18, 44, 46, 51 AND 52). REG. 11-14-1995.
- 1,935,202. SEA GARDENS BEACH AND TENNIS RESORT. INT. CL. 36. (U.S. CLS. 100, 101 AND 102). REG. 11-14-1995.
- 1,935,332. MISCELLANEOUS DESIGN. INT. CL. 33. (U.S. CLS. 47 AND 49). REG. 11-14-1995.
- 1,935,467. OROMI AND DESIGN. INT. CL. 14. (U.S. CLS. 2, 27, 28 AND 50). REG. 11-14-1995.
- 1,935,623. BABY JAY. INT. CL. 25. (U.S. CLS. 22 AND 39). REG. 11-14-1995.
- 1,935,987. AUSTIN QUALITY AND DESIGN. INT. CL. 30. (U.S. CL. 46). REG. 11-14-1995.
- 1,936,493. MADIX (STYLIZED). INT. CL. 20. (U.S. CL. 50). REG. 11-21-1995.
- 1,936,533. THE COLORADO TRAIL AND DESIGN. INT. CLS. 41 AND 42. (U.S. CLS. 100, 101 AND 107). REG. 11-21-1995.
- 1,937,318. BONDLINK. INT. CL. 42. (U.S. CLS. 100 AND 101). REG. 11-21-1995.
- 1,937,528. PASER. INT. CL. 5. (U.S. CLS. 6, 18, 44, 46, 51 AND 52). REG. 11-21-1995.
- 1,937,943. SURETY & CONSTRUCTION SCC CONSULTANTS AND DESIGN. INT. CL. 42. (U.S. CLS. 100 AND 101). REG. 11-28-1995.
- 1,938,070. THE ORIGINAL LIL' REMEDY STORE AND DESIGN. INT. CLS. 3 AND 5. (U.S. CLS. 1, 4, 6, 18, 44, 46, 50, 51 AND 52). REG. 11-28-1995.
- 1,938,132. ASHWORTH. INT. CL. 25. (U.S. CLS. 22 AND 39). REG. 11-28-1995.
- 1,938,133. ASHWORTH AND DESIGN. INT. CL. 25. (U.S. CLS. 22 AND 39). REG. 11-28-1995.
- 1,938,487. SSM AND DESIGN. INT. CL. 9. (U.S. CLS. 21, 23, 26, 36 AND 38). REG. 11-28-1995.
- 1,938,683. MISCELLANEOUS DESIGN. INT. CL. 9. (U.S. CLS. 21, 23, 26, 36 AND 38). REG. 11-28-1995.
- 1,938,809. TASTY BAKE. INT. CL. 36. (U.S. CLS. 100, 101 AND 102). REG. 11-28-1995.
- 1,938,877. ON YOUR WAY AND DESIGN. INT. CLS. 4 AND 30. (U.S. CLS. 1, 6, 15 AND 46). REG. 11-28-1995.
- 1,939,147. TRANSPAK. INT. CL. 10. (U.S. CL. 44). REG. 12-5-1995.
- 1,939,918. BC BG (STYLIZED). INT. CL. 25. (U.S. CLS. 22 AND 39). REG. 12-5-1995.
- 1,940,126. GONE AWAY. INT. CL. 5. (U.S. CLS. 6, 18, 44, 46, 51 AND 52). REG. 12-5-1995.
- 1,940,673. WORLDMARK. INT. CL. 36. (U.S. CLS. 100, 101 AND 102). REG. 12-12-1995.
- 1,940,723. MISCELLANEOUS DESIGN. INT. CL. 25. (U.S. CLS. 22 AND 39). REG. 12-12-1995.
- 1,941,111. IMAGE. INT. CL. 16. (U.S. CLS. 2, 5, 22, 23, 29, 37, 38 AND 50). REG. 12-12-1995.
- 1,941,440. ENVIRO-CORE. INT. CL. 7. (U.S. CLS. 13, 19, 21, 23, 31, 34 AND 35). REG. 12-12-1995.
- 1,941,537. CHICAGO FIRE. INT. CL. 30. (U.S. CL. 46). REG. 12-12-1995.
- 1,941,584. F AND DESIGN. INT. CL. 25. (U.S. CLS. 22 AND 39). REG. 12-12-1995.
- 1,941,886. MISCELLANEOUS DESIGN. INT. CL. 32. (U.S. CLS. 45, 46 AND 48). REG. 12-12-1995.
- 1,942,392. CRL AND DESIGN. U.S. CL. B. REG. 12-19-1995.

- 1,942,825. GALLARD SCHLESINGER. INT. CL. 35. (U.S. CLS. 100, 101 AND 102). REG. 12-19-1995.
- 1,943,065. MISCELLANEOUS DESIGN. U.S. CL. 200. REG. 12-19-1995.
- 1,943,485. THE COLORADO TRAIL. INT. CLS. 41 AND 42. (U.S. CLS. 100, 101 AND 107). REG. 12-26-1995.
- 1,943,521. AMERICAN ARBITRATION ASSOCIATION. INT. CL. 16. (U.S. CLS. 2, 5, 22, 23, 29, 37, 38 AND 50). REG. 12-26-1995.
- 1,943,883. PROTECTAMINS. INT. CL. 5. (U.S. CLS. 6, 18, 44, 46, 51 AND 52). REG. 12-26-1995.
- 1,944,042. MISCELLANEOUS DESIGN. INT. CL. 16. (U.S. CLS. 2, 5, 22, 23, 29, 37, 38 AND 50). REG. 12-26-1995.
- 1,944,223. BILZ. INT. CL. 28. (U.S. CLS. 22, 23, 38 AND 50). REG. 12-26-1995.
- 1,944,625. TURNING INNOVATIVE IDEAS INTO REALITY. INT. CL. 42. (U.S. CLS. 100 AND 101). REG. 12-26-1995.
- 1,944,836. PRO RACK. INT. CL. 20. (U.S. CL. 32). REG. 1-2-1996.
- 1,945,128. ELEGANCE (STYLIZED). INT. CLS. 8 AND 14. (U.S. CLS. 2, 23, 27, 28, 44 AND 50). REG. 1-2-1996.
- 1,945,200. T-200. INT. CL. 1. (U.S. CLS. 1, 5, 6, 10, 26 AND 46). REG. 1-2-1996.
- 1,946,297. CHINA SLIM TEA AND DESIGN. INT. CL. 30. (U.S. CL. 46). REG. 1-9-1996.
- 1,946,592. THE OFFICIAL LSAT PREPTEST. INT. CL. 16. (U.S. CLS. 2, 5, 22, 23, 29, 37, 38 AND 50). REG. 1-9-1996.
- 1,946,924. ATLANTA HAWKS. INT. CL. 25. (U.S. CLS. 22 AND 39). REG. 1-9-1996.
- 1,947,728. FIREWIRE. INT. CL. 9. (U.S. CLS. 21, 23, 26, 36 AND 38). REG. 1-9-1996.
- 1,947,938. 1 TEXAS AND DESIGN. INT. CL. 25. (U.S. CLS. 22 AND 39). REG. 1-16-1996.
- 1,948,328. MISCELLANEOUS DESIGN. INT. CL. 3. (U.S. CLS. 1, 4, 6, 50, 51 AND 52). REG. 1-16-1996.
- 1,948,612. S AND DESIGN. INT. CL. 6. (U.S. CLS. 2, 12, 13, 14, 23, 25 AND 50). REG. 1-16-1996.
- 1,948,714. BIG SPEAKER SOUND WITHOUT THE BIG SPEAKER. INT. CL. 9. (U.S. CLS. 21, 23, 26, 36 AND 38). REG. 1-16-1996.
- 1,948,859. C.R. CHICKS FLORIDA AND DESIGN. INT. CL. 42. (U.S. CLS. 100 AND 101). REG. 1-16-1996.
- 1,949,220. PATRIOT. INT. CL. 16. (U.S. CLS. 2, 5, 22, 23, 29, 37, 38 AND 50). REG. 1-16-1996.
- 1,950,164. BUBBLEOODLES. INT. CL. 28. (U.S. CL. 22). REG. 1-23-1996.
- 1,950,904. QUALITY CLASSIC SELECTION AND DESIGN. INT. CL. 32. (U.S. CLS. 45, 46 AND 48). REG. 1-23-1996.
- 1,953,254. URAL. INT. CL. 12. (U.S. CLS. 19, 21, 23, 31, 35 AND 44). REG. 1-30-1996.
- 1,954,577. I SERIES. INT. CL. 9. (U.S. CLS. 21, 23, 26, 36 AND 38). REG. 2-6-1996.
- 1,955,943. ANCIENT SECRETS. INT. CL. 3. (U.S. CLS. 1, 4, 6, 50, 51 AND 52). REG. 2-13-1996.
- 1,957,412. CHAIR DANCING. INT. CL. 41. (U.S. CLS. 100, 101 AND 107). REG. 2-20-1996.
- 1,957,637. TIDAL FORCE AND DESIGN. INT. CL. 41. (U.S. CLS. 100, 101 AND 107). REG. 2-20-1996.
- 1,957,641. K/BIS. INT. CL. 35. (U.S. CLS. 100, 101 AND 102). REG. 2-20-1996.
- 1,959,144. ZINECARD. INT. CL. 5. (U.S. CLS. 6, 18, 44, 46, 51 AND 52). REG. 2-27-1996.
- 1,959,459. CROSSWORD CALL. INT. CL. 35. (U.S. CLS. 100, 101 AND 102). REG. 2-27-1996.
- 1,961,007. VITASTIC. INT. CL. 3. (U.S. CLS. 1, 4, 6, 50, 51 AND 52). REG. 3-5-1996.
- 1,961,215. MITEL. INT. CL. 16. (U.S. CL. 38). REG. 3-12-1996.
- 1,961,688. VIDEO FLEX. INT. CL. 9. (U.S. CLS. 21, 23, 26, 36 AND 38). REG. 3-12-1996.
- 1,962,969. MISCELLANEOUS DESIGN. INT. CLS. 1, 16 AND 19. (U.S. CLS. 1, 2, 5, 6, 10, 12, 22, 23, 26, 29, 33, 37, 38, 46 AND 50). REG. 3-19-1996.
- 1,963,454. TORRE (STYLIZED). INT. CL. 42. (U.S. CLS. 100 AND 101). REG. 3-19-1996.
- 1,964,226. POLYSTARCH-PLUS. INT. CL. 1. (U.S. CLS. 1, 5, 6, 10, 26 AND 46). REG. 3-26-1996.
- 1,965,488. OLD NAVY (STYLIZED). INT. CLS. 25 AND 42. (U.S. CLS. 22, 39, 100 AND 101). REG. 4-2-1996.
- 1,966,593. BETO JUNCTION. INT. CL. 42. (U.S. CLS. 100 AND 101). REG. 4-9-1996.
- 1,966,694. QWEST. INT. CL. 38. (U.S. CLS. 100, 101 AND 104). REG. 4-9-1996.
- 1,968,130. GROWN 4U. INT. CL. 31. (U.S. CLS. 1 AND 46). REG. 4-16-1996.
- 1,968,550. SCHOLARSSAVERS (STYLIZED). INT. CL. 36. (U.S. CLS. 100, 101 AND 102). REG. 4-16-1996.
- 1,968,554. D'VINE. INT. CL. 41. (U.S. CLS. 100, 101 AND 107). REG. 4-16-1996.
- 1,968,569. CLOTILDE. INT. CL. 16. (U.S. CLS. 2, 5, 22, 23, 29, 37, 38 AND 50). REG. 4-16-1996.
- 1,968,861. OFFICEJET. INT. CL. 9. (U.S. CLS. 21, 23, 26, 36 AND 38). REG. 4-16-1996.
- 1,969,167. CENTERLINE CIRCUIT BOARD PRODUCTS AND DESIGN. INT. CL. 20. (U.S. CLS. 2, 13, 22, 25, 32 AND 50). REG. 4-23-1996.
- 1,969,525. GYMNIC LINE THE WAY TO MOVE (STYLIZED). INT. CL. 28. (U.S. CLS. 22, 23, 38 AND 50). REG. 4-23-1996.
- 1,970,126. LIBERTY HOSPITAL AND DESIGN. INT. CL. 42. (U.S. CLS. 100 AND 101). REG. 4-23-1996.
- 1,970,911. LA CASA DEL HABANO AND DESIGN. INT. CL. 34. (U.S. CLS. 2, 8, 9 AND 17). REG. 4-30-1996.
- 1,971,813. REBOUNDER. INT. CL. 9. (U.S. CLS. 21, 23, 26, 36 AND 38). REG. 4-30-1996.
- 1,972,159. SMARTCRUISE (STYLIZED). INT. CL. 9. (U.S. CLS. 21, 23, 26, 36 AND 38). REG. 5-7-1996.
- 1,972,271. BLUE NOTE THE FINEST IN JAZZ SINCE 1939 AND DESIGN. INT. CL. 9. (U.S. CL. 36). REG. 5-7-1996.
- 1,974,461. ACC ACNM CERTIFICATION COUNCIL INCORPORATED CORPORATE SEAL MARYLAND 1990 SCIENCE SERVICE ART AND DESIGN. U.S. CL. B. REG. 5-21-1996.
- 1,975,059. PEOPLE SERVICE ENVIRONMENT AND DESIGN. INT. CLS. 37, 40 AND 42. (U.S. CLS. 100, 101, 103 AND 106). REG. 5-21-1996.
- 1,975,752. RICE KING. INT. CL. 42. (U.S. CL. 100). REG. 5-28-1996.
- 1,975,939. OCEANIC. INT. CL. 16. (U.S. CLS. 2, 5, 22, 23, 29, 37, 38 AND 50). REG. 5-28-1996.
- 1,976,068. MARKETING ON DEMAND. INT. CL. 35. (U.S. CLS. 100, 101 AND 102). REG. 5-28-1996.
- 1,976,760. THE JESTER CO., INC. AND DESIGN. INT. CL. 16. (U.S. CLS. 2, 5, 22, 23, 29, 37, 38 AND 50). REG. 5-28-1996.
- 1,976,763. ALCOA. INT. CL. 6. (U.S. CLS. 2, 12, 13, 14, 23, 25 AND 50). REG. 5-28-1996.
- 1,977,006. OPTI-SORB. INT. CL. 10. (U.S. CLS. 26, 39 AND 44). REG. 5-28-1996.
- 1,978,415. A JESTER & PHARLEY PRODUCT AND DESIGN. INT. CL. 16. (U.S. CLS. 2, 5, 22, 23, 29, 37, 38 AND 50). REG. 6-4-1996.
- 1,978,627. GOLD COAST. INT. CL. 34. (U.S. CLS. 2, 8, 9 AND 17). REG. 6-4-1996.
- 1,978,638. TUF-E-NUF TOOLS AND DESIGN. INT. CLS. 7, 8 AND 9. (U.S. CLS. 13, 19, 21, 23, 26, 28, 31, 34, 35, 36, 38 AND 44). REG. 6-4-1996.
- 1,978,655. GOLD COAST AND DESIGN. INT. CL. 34. (U.S. CLS. 2, 8, 9 AND 17). REG. 6-4-1996.
- 1,979,445. LIFE'S LITTLE INSTRUCTION BOOK. INT. CL. 16. (U.S. CLS. 2, 5, 22, 23, 29, 37, 38 AND 50). REG. 6-11-1996.
- 1,980,609. SPORTS-O-PEDIC. INT. CL. 20. (U.S. CLS. 2, 13, 22, 25, 32 AND 50). REG. 6-18-1996.
- 1,980,845. THE INVESTMENT ADVISER'S COUNSEL. INT. CL. 16. (U.S. CLS. 2, 5, 22, 23, 29, 37, 38 AND 50). REG. 6-18-1996.
- 1,981,084. AUTO RENTAL NEWS. INT. CL. 16. (U.S. CLS. 2, 5, 22, 23, 29, 37, 38 AND 50). REG. 6-18-1996.
- 1,981,100. CAPITOL AND DESIGN. INT. CL. 9. (U.S. CLS. 21, 23, 26, 36 AND 38). REG. 6-18-1996.
- 1,981,154. FOR BABIES ONLY. INT. CL. 16. (U.S. CLS. 2, 5, 22, 23, 29, 37, 38 AND 50). REG. 6-18-1996.
- 1,981,607. MB METRO BLUE AND DESIGN. INT. CL. 9. (U.S. CLS. 21, 23, 26, 36 AND 38). REG. 6-18-1996.
- 1,981,843. U.S. RISK. INT. CL. 36. (U.S. CLS. 101 AND 102). REG. 6-25-1996.
- 1,981,966. DRY SLURRY. INT. CL. 3. (U.S. CL. 52). REG. 6-25-1996.
- 1,982,421. L AND DESIGN. INT. CL. 42. (U.S. CLS. 100 AND 101). REG. 6-25-1996.
- 1,982,452. THYMURIL. INT. CL. 5. (U.S. CLS. 6, 18, 44, 46, 51 AND 52). REG. 6-25-1996.
- 1,982,962. PLAY MORE. INT. CL. 42. (U.S. CLS. 100 AND 101). REG. 6-25-1996.

1,984,033. BUST RUST. INT. CL. 4. (U.S. CLS. 1, 6 AND 15). REG. 7-2-1996. 1,985,694. ENCORES! GREAT AMERICAN MUSICALS IN CONCERT. INT. CL. 41. (U.S. CLS. 100, 101 AND 107). REG. 7-9-1996.

* * * * *

TRADEMARK REGISTRATIONS CANCELED

The designation "U.S. Cl." appearing in this section refers to the U.S. class in effect prior to Sep. 1, 1973 rather than the international class which applies to applications filed on or after that date. For adoption of international classification see notice in the OFFICIAL GAZETTE of Jun. 26, 1973 (911 O.G. TM 210).

SECTION 7(D)

2,570,206. CHILDPRINT ID KIT AND DESIGN. INT. CL. 16. REG. 5-14-2002.

SECTION 8

192,443. EAGLE BRAND AND DESIGN. U.S. CL. 14. REG. 12-2-1924.
541,406. KING (STYLIZED). U.S. CL. 23. REG. 4-24-1951.
770,115. ROYAL AMBASSADORS AND DESIGN. U.S. CL. 200. REG. 5-19-1964.
780,811. STRIM. U.S. CL. 6. REG. 12-1-1964.
780,820. NALKIL. U.S. CL. 6. REG. 12-1-1964.
780,827. UCANE. U.S. CL. 6. REG. 12-1-1964.
780,885. AQUA-AID. U.S. CL. 18. REG. 12-1-1964.
780,944. W WONDER (STYLIZED). U.S. CL. 23. REG. 12-1-1964.
781,015. LIVING WORD (STYLIZED). U.S. CL. 38. REG. 12-1-1964.
781,026. KNOW. U.S. CL. 38. REG. 12-1-1964.
781,060. STUDIO THREE (STYLIZED). U.S. CL. 39. REG. 12-1-1964.
947,093. BROOKS PRODUCTS. U.S. CL. 12. REG. 11-14-1972.
1,274,780. ENGLERT AND DESIGN. INT. CL. 6. REG. 4-24-1984.
1,306,618. MINI CUBE AND DESIGN. INT. CL. 1. REG. 11-27-1984.
1,306,623. PERFORMANCE. INT. CL. 1. REG. 11-27-1984.
1,306,625. IMZYNE. INT. CL. 1. REG. 11-27-1984.
1,306,626. DYE-A-PHOTO (STYLIZED). INT. CL. 1. REG. 11-27-1984.
1,306,628. BEAD GEL. INT. CL. 1. REG. 11-27-1984.
1,306,631. MAGIC. INT. CL. 1. REG. 11-27-1984.
1,306,634. HI-FI. INT. CL. 1. REG. 11-27-1984.
1,306,644. OXISHIELD. INT. CL. 1. REG. 11-27-1984.
1,306,646. ENORDET. INT. CL. 1. REG. 11-27-1984.
1,306,647. COATERIC. INT. CL. 1. REG. 11-27-1984.
1,306,664. 1890 LEAFING PAINT. INT. CL. 2. REG. 11-27-1984.
1,306,669. SAHNE. INT. CL. 3. REG. 11-27-1984.
1,306,685. STEF (STYLIZED). INT. CL. 3. REG. 11-27-1984.
1,306,691. EPILWAX. INT. CL. 3. REG. 11-27-1984.
1,306,694. HELMA B. INT. CLS. 3 AND 10. REG. 11-27-1984.
1,306,699. CORECARE. INT. CL. 3. REG. 11-27-1984.
1,306,701. AFTER SIX (STYLIZED). INT. CLS. 3, 14 AND 25. REG. 11-27-1984.
1,306,708. OPTA. INT. CL. 3. REG. 11-27-1984.
1,306,710. CAFFREE. INT. CL. 3. REG. 11-27-1984.
1,306,715. MICROMODEM IIE. INT. CL. 3. REG. 11-27-1984.
1,306,721. SEALED LIPS (STYLIZED). INT. CL. 3. REG. 11-27-1984.
1,306,730. ULTIQUE. INT. CL. 3. REG. 11-27-1984.
1,306,731. WYNN'S CLASSIC (STYLIZED). INT. CL. 3. REG. 11-27-1984.
1,306,735. ARGOMIX. INT. CL. 4. REG. 11-27-1984.

1,306,737. FLUID FILM. INT. CL. 4. REG. 11-27-1984.
1,306,744. METRO I.V.. INT. CL. 5. REG. 11-27-1984.
1,306,746. ACTIVITAMINS. INT. CL. 5. REG. 11-27-1984.
1,306,747. HAIR FACTORS. INT. CL. 5. REG. 11-27-1984.
1,306,748. RIVERSIDE SERVES AGRICULTURE - AGRICULTURE SERVES EVERYONE. INT. CL. 5. REG. 11-27-1984.
1,306,749. PREMIER AND DESIGN. INT. CLS. 5 AND 10. REG. 11-27-1984.
1,306,751. MULTI-GLAND-21. INT. CL. 5. REG. 11-27-1984.
1,306,757. BANCAP HC. INT. CL. 5. REG. 11-27-1984.
1,306,765. PROTECTOL. INT. CL. 5. REG. 11-27-1984.
1,306,766. HERPICIDIN. INT. CL. 5. REG. 11-27-1984.
1,306,772. ENDURACIDE (STYLIZED). INT. CL. 5. REG. 11-27-1984.
1,306,774. FOOT SOLDIERS. INT. CL. 5. REG. 11-27-1984.
1,306,775. M.V.C. 9+3. INT. CL. 5. REG. 11-27-1984.
1,306,776. MACRODEX. INT. CL. 5. REG. 11-27-1984.
1,306,777. HOOF WITCH AND DESIGN. INT. CL. 5. REG. 11-27-1984.
1,306,778. AQUA-BIOSORB. INT. CL. 5. REG. 11-27-1984.
1,306,779. HEART BEATS AND DESIGN. INT. CL. 5. REG. 11-27-1984.
1,306,786. CISTANE. INT. CL. 5. REG. 11-27-1984.
1,306,787. COMPAL. INT. CL. 5. REG. 11-27-1984.
1,306,793. TRAVEL-EASE. INT. CL. 5. REG. 11-27-1984.
1,306,802. MISCELLANEOUS DESIGN. INT. CL. 5. REG. 11-27-1984.
1,306,803. EXTRAZINE. INT. CL. 5. REG. 11-27-1984.
1,306,806. CF (STYLIZED). INT. CLS. 6, 7 AND 20. REG. 11-27-1984.
1,306,807. VENTINOX. INT. CL. 6. REG. 11-27-1984.
1,306,811. ENERGY SAVER AND DESIGN. INT. CL. 7. REG. 11-27-1984.
1,306,815. WHALE BRAND AND DESIGN. INT. CL. 8. REG. 11-27-1984.
1,306,819. NAVA (STYLIZED). INT. CLS. 9, 12, 17, 25 AND 28. REG. 11-27-1984.
1,306,820. OXONIC. INT. CL. 9. REG. 11-27-1984.
1,306,827. FTS-2. INT. CL. 9. REG. 11-27-1984.
1,306,829. BRODERBUND SOFTWARE (STYLIZED). INT. CL. 9. REG. 11-27-1984.
1,306,830. ALTOP. INT. CL. 9. REG. 11-27-1984.
1,306,833. HYDRA-TRAK. INT. CL. 9. REG. 11-27-1984.
1,306,834. FRANKLIN ACE. INT. CL. 9. REG. 11-27-1984.
1,306,835. MICRO-MUNI. INT. CL. 9. REG. 11-27-1984.
1,306,836. MPI (STYLIZED). INT. CL. 9. REG. 11-27-1984.
1,306,837. MCE. INT. CL. 9. REG. 11-27-1984.
1,306,845. SILVER STAR RECORDS AND DESIGN. INT. CL. 9. REG. 11-27-1984.
1,306,847. ULTIMAG. INT. CL. 9. REG. 11-27-1984.
1,306,851. DECATHLON. INT. CL. 9. REG. 11-27-1984.
1,306,852. ANGAR SCIENTIFIC. INT. CL. 9. REG. 11-27-1984.
1,306,874. CATS. INT. CL. 9. REG. 11-27-1984.
1,306,875. CATS AND DESIGN. INT. CL. 9. REG. 11-27-1984.
1,306,879. MILTECH. INT. CL. 9. REG. 11-27-1984.
1,306,880. CLUSTAN. INT. CL. 9. REG. 11-27-1984.
1,306,886. CIC AND DESIGN. INT. CL. 9. REG. 11-27-1984.
1,306,889. MAGNEQUENCH. INT. CL. 9. REG. 11-27-1984.
1,306,890. DAYBREAK AND DESIGN. INT. CL. 9. REG. 11-27-1984.
1,306,891. VIGIL. INT. CL. 9. REG. 11-27-1984.
1,306,892. ASTRO-SCAN. INT. CL. 9. REG. 11-27-1984.

- 1,306,894. TELEDISPLAY. INT. CL. 9. REG. 11-27-1984.
 1,306,900. PASAR. INT. CL. 10. REG. 11-27-1984.
 1,306,901. MISCELLANEOUS DESIGN. INT. CL. 10. REG. 11-27-1984.
 1,306,906. MERRICKLEIN (STYLIZED). INT. CL. 12. REG. 11-27-1984.
 1,306,911. MISCELLANEOUS DESIGN. INT. CL. 12. REG. 11-27-1984.
 1,306,920. MOSS (STYLIZED). INT. CL. 12. REG. 11-27-1984.
 1,306,933. CHEVALIERE AND DESIGN. INT. CL. 14. REG. 11-27-1984.
 1,306,934. MISCELLANEOUS DESIGN. INT. CL. 14. REG. 11-27-1984.
 1,306,935. BUTLER & WILSON (STYLIZED). INT. CL. 14. REG. 11-27-1984.
 1,306,945. CONVOY PRO PERCUSSION. INT. CL. 15. REG. 11-27-1984.
 1,306,946. ESCORT. INT. CL. 15. REG. 11-27-1984.
 1,306,951. THE HIGH FRONTIER. INT. CL. 16. REG. 11-27-1984.
 1,306,952. TAILORED. INT. CL. 16. REG. 11-27-1984.
 1,306,955. ITC MODERN NO. 216. INT. CL. 16. REG. 11-27-1984.
 1,306,960. WASHINGTON MERRY-GO-ROUND. INT. CL. 16. REG. 11-27-1984.
 1,306,961. COLOR SIGNAL. INT. CL. 16. REG. 11-27-1984.
 1,306,964. ETERNA. INT. CL. 16. REG. 11-27-1984.
 1,306,968. MISCELLANEOUS DESIGN. INT. CL. 16. REG. 11-27-1984.
 1,306,970. ATR (STYLIZED). INT. CL. 16. REG. 11-27-1984.
 1,306,971. TEXAS LEGACY (STYLIZED). INT. CLS. 16 AND 35. REG. 11-27-1984.
 1,306,974. INDUSTRIAL HYGIENE NEWS. INT. CL. 16. REG. 11-27-1984.
 1,306,979. SURGICOT. INT. CL. 16. REG. 11-27-1984.
 1,306,986. CLOSET MATES (STYLIZED). INT. CLS. 16 AND 20. REG. 11-27-1984.
 1,306,988. NET PRO NEW ENTERPRISE TRAINING FOR PROFITS AND DESIGN. INT. CL. 16. REG. 11-27-1984.
 1,306,994. TREETOP TALES. INT. CL. 16. REG. 11-27-1984.
 1,306,996. APTA AND DESIGN. INT. CL. 16. REG. 11-27-1984.
 1,307,000. HOUSING GUIDES OF AMERICA. INT. CL. 16. REG. 11-27-1984.
 1,307,004. WHITE SPACE. INT. CL. 16. REG. 11-27-1984.
 1,307,011. KIMWRAP. INT. CL. 16. REG. 11-27-1984.
 1,307,021. THE PREVENTION INDEX. INT. CL. 16. REG. 11-27-1984.
 1,307,028. SCRIPTECH. INT. CL. 16. REG. 11-27-1984.
 1,307,035. BACK SAVER. INT. CL. 18. REG. 11-27-1984.
 1,307,041. SAFETY SHIELD (STYLIZED). INT. CLS. 18 AND 25. REG. 11-27-1984.
 1,307,042. TRAVELINE AND DESIGN. INT. CL. 18. REG. 11-27-1984.
 1,307,045. YAKIN AND DESIGN. INT. CL. 18. REG. 11-27-1984.
 1,307,050. RID-GID GLIDE. INT. CL. 20. REG. 11-27-1984.
 1,307,051. VINYL INDUSTRIAL PRODUCTS. INT. CL. 20. REG. 11-27-1984.
 1,307,052. MISCELLANEOUS DESIGN. INT. CL. 20. REG. 11-27-1984.
 1,307,060. BINGO BUN. INT. CL. 20. REG. 11-27-1984.
 1,307,067. THE EQUALIZER. INT. CL. 20. REG. 11-27-1984.
 1,307,069. VISION. INT. CL. 20. REG. 11-27-1984.
 1,307,073. LIVING WALL GARDEN. INT. CL. 21. REG. 11-27-1984.
 1,307,074. SNOWFLAKES AND DESIGN. INT. CL. 21. REG. 11-27-1984.
 1,307,076. SUPER GRIP. INT. CL. 21. REG. 11-27-1984.
 1,307,081. KELTCRAFT MISTY ISLE COLLECTION BY NORITAKE (STYLIZED). INT. CL. 21. REG. 11-27-1984.
 1,307,082. WEBSTER WILCOX. INT. CL. 21. REG. 11-27-1984.
 1,307,094. TAILORED. INT. CL. 22. REG. 11-27-1984.
 1,307,095. CEYLON. INT. CL. 23. REG. 11-27-1984.
 1,307,101. MANOR HOUSE. INT. CLS. 24 AND 27. REG. 11-27-1984.
 1,307,102. WINBELL (STYLIZED). INT. CL. 24. REG. 11-27-1984.
 1,307,111. NORTH BAY PRODUCTS. INT. CLS. 24 AND 25. REG. 11-27-1984.
 1,307,113. I CHEESE AND DESIGN. INT. CL. 25. REG. 11-27-1984.
 1,307,131. MISCELLANEOUS DESIGN. INT. CL. 25. REG. 11-27-1984.
 1,307,133. DOO-RAG. INT. CL. 25. REG. 11-27-1984.
 1,307,147. YASAKI (STYLIZED). INT. CLS. 25 AND 28. REG. 11-27-1984.
 1,307,148. CAMP MAUI. INT. CL. 25. REG. 11-27-1984.
 1,307,149. PUFF PRINT. INT. CL. 25. REG. 11-27-1984.
 1,307,157. ODOR ATTACKERS. INT. CL. 25. REG. 11-27-1984.
 1,307,165. GIUSEPPI VERDI. INT. CL. 25. REG. 11-27-1984.
 1,307,170. FANCY DANCER. INT. CL. 25. REG. 11-27-1984.
 1,307,172. X-IT (STYLIZED). INT. CL. 25. REG. 11-27-1984.
 1,307,173. CC SPORT AND DESIGN. INT. CL. 25. REG. 11-27-1984.
 1,307,176. PUMPERS. INT. CL. 25. REG. 11-27-1984.
 1,307,177. PROTECH. INT. CL. 25. REG. 11-27-1984.
 1,307,181. CARA-VEL. INT. CL. 25. REG. 11-27-1984.
 1,307,183. BRIGHTS CREEK. INT. CL. 25. REG. 11-27-1984.
 1,307,187. CALE THOMAS. INT. CL. 25. REG. 11-27-1984.
 1,307,190. VOGUE. INT. CL. 25. REG. 11-27-1984.
 1,307,193. HARDY. INT. CL. 25. REG. 11-27-1984.
 1,307,196. WOODY WOODPECKER. INT. CL. 25. REG. 11-27-1984.
 1,307,200. QUICKLON. INT. CL. 26. REG. 11-27-1984.
 1,307,203. EASY-FROST AND DESIGN. INT. CL. 26. REG. 11-27-1984.
 1,307,210. STRI-LOCK. INT. CL. 27. REG. 11-27-1984.
 1,307,217. MISCELLANEOUS DESIGN. INT. CLS. 28 AND 35. REG. 11-27-1984.
 1,307,226. TOM WATSON. INT. CL. 28. REG. 11-27-1984.
 1,307,236. PROBE VI. INT. CL. 28. REG. 11-27-1984.
 1,307,237. R2-D2. INT. CL. 28. REG. 11-27-1984.
 1,307,242. KRAZY BEE RUMMY AND DESIGN. INT. CL. 28. REG. 11-27-1984.
 1,307,245. WORLD RECORD LINE. INT. CL. 28. REG. 11-27-1984.
 1,307,256. GOURMUTT. INT. CL. 28. REG. 11-27-1984.
 1,307,260. HARD HATS. INT. CL. 28. REG. 11-27-1984.
 1,307,277. GOLD FEVER. INT. CL. 28. REG. 11-27-1984.
 1,307,280. ALICE IN WONDERLAND. INT. CL. 28. REG. 11-27-1984.
 1,307,298. ATLANTIS SEAFOOD, INC. AND DESIGN. INT. CL. 29. REG. 11-27-1984.
 1,307,300. SWITZERLAND PREMIUM EMMENTALER SWISS AND DESIGN. INT. CL. 29. REG. 11-27-1984.
 1,307,301. GENLAC. INT. CL. 29. REG. 11-27-1984.
 1,307,306. MISCELLANEOUS DESIGN. INT. CL. 29. REG. 11-27-1984.
 1,307,307. SPREAD-RITE. INT. CL. 29. REG. 11-27-1984.
 1,307,311. LIGHTNIN' RODS. INT. CL. 29. REG. 11-27-1984.
 1,307,315. TOP SAIL. INT. CL. 29. REG. 11-27-1984.
 1,307,316. DOING OUR BEST...JUST FOR YOU. INT. CL. 29. REG. 11-27-1984.
 1,307,318. ICE CREAM CHIPPER. INT. CL. 30. REG. 11-27-1984.
 1,307,322. LITTLE BEAR FLOUR MAKES YOUR BREAD DANCE AND YOUR CAKES SING DOO-DAH! AND DESIGN. INT. CLS. 30 AND 31. REG. 11-27-1984.
 1,307,324. TROMBETTE. INT. CL. 30. REG. 11-27-1984.
 1,307,325. CAJUN POWER AND DESIGN. INT. CL. 30. REG. 11-27-1984.
 1,307,330. LEMAN'S MINT FLAVORED AND DESIGN. INT. CL. 30. REG. 11-27-1984.
 1,307,333. PRETZEL PERFECTS. INT. CL. 30. REG. 11-27-1984.
 1,307,337. HELPING YOUTH HELP THEMSELVES. INT. CL. 30. REG. 11-27-1984.
 1,307,338. SODA JERK. INT. CL. 30. REG. 11-27-1984.
 1,307,340. SUBWAY AND DESIGN. INT. CLS. 30 AND 32. REG. 11-27-1984.

- 1,307,353. ZIP.A.SNACK AND DESIGN. INT. CL. 30. REG. 11-27-1984.
- 1,307,361. MELLOW EARTH. INT. CL. 31. REG. 11-27-1984.
- 1,307,365. GUZZLER (STYLIZED). INT. CL. 32. REG. 11-27-1984.
- 1,307,375. NORTHWOOD CELLARS (STYLIZED). INT. CL. 33. REG. 11-27-1984.
- 1,307,376. POV. INT. CL. 34. REG. 11-27-1984.
- 1,307,382. FLASHBACK. INT. CL. 35. REG. 11-27-1984.
- 1,307,384. WHEN ACCOUNTING PROBLEMS ARE ONLY TEMPORARY. INT. CL. 35. REG. 11-27-1984.
- 1,307,387. PHH AND DESIGN. INT. CLS. 35, 36, 39 AND 42. REG. 11-27-1984.
- 1,307,391. CHARTWELL & CO.. INT. CL. 35. REG. 11-27-1984.
- 1,307,393. ICOTECH. INT. CL. 35. REG. 11-27-1984.
- 1,307,410. CHOICE PLUS. INT. CL. 36. REG. 11-27-1984.
- 1,307,411. IN GOOD TASTE AND DESIGN. INT. CL. 36. REG. 11-27-1984.
- 1,307,427. NEIC. INT. CL. 36. REG. 11-27-1984.
- 1,307,430. MISCELLANEOUS DESIGN. INT. CL. 36. REG. 11-27-1984.
- 1,307,433. CONCERT. INT. CL. 36. REG. 11-27-1984.
- 1,307,443. MISCELLANEOUS DESIGN. INT. CLS. 37 AND 42. REG. 11-27-1984.
- 1,307,444. UNIVERSAL AND DESIGN. INT. CL. 37. REG. 11-27-1984.
- 1,307,448. NO DRAWING-SENSORY MARK INT. CL. 38. REG. 11-27-1984.
- 1,307,450. HELI-LOGGERS. INT. CL. 39. REG. 11-27-1984.
- 1,307,456. IVEY'S (STYLIZED). INT. CLS. 39 AND 42. REG. 11-27-1984.
- 1,307,462. MISSISSIPPI STATE UNIVERSITY COLLEGE OF VETERINARY MEDICINE 1878 1974 V AND DESIGN. INT. CL. 41. REG. 11-27-1984.
- 1,307,464. TALK-BACK. INT. CL. 41. REG. 11-27-1984.
- 1,307,465. THE STOMPERS (STYLIZED). INT. CL. 41. REG. 11-27-1984.
- 1,307,473. COUNTRY ROVER. INT. CL. 41. REG. 11-27-1984.
- 1,307,482. ROD LAVER TENNIS. INT. CL. 41. REG. 11-27-1984.
- 1,307,484. OT. INT. CL. 41. REG. 11-27-1984.
- 1,307,487. MISCELLANEOUS DESIGN. INT. CL. 41. REG. 11-27-1984.
- 1,307,489. THE BISKITTS. INT. CL. 41. REG. 11-27-1984.
- 1,307,490. THE BISKITTS AND DESIGN. INT. CL. 41. REG. 11-27-1984.
- 1,307,499. NATIONWIDE SHOPPER CATALOGUE SERVICE CENTER. INT. CL. 42. REG. 11-27-1984.
- 1,307,507. RSI AND DESIGN. INT. CL. 42. REG. 11-27-1984.
- 1,307,508. JAMAICA JOE'S (STYLIZED). INT. CL. 42. REG. 11-27-1984.
- 1,307,512. PRIMO'S PIZZA AND DESIGN. INT. CL. 42. REG. 11-27-1984.
- 1,307,514. VAHLE'S. INT. CL. 42. REG. 11-27-1984.
- 1,307,517. PRIMO'S PIZZA. INT. CL. 42. REG. 11-27-1984.
- 1,307,519. MISCELLANEOUS DESIGN. INT. CL. 42. REG. 11-27-1984.
- 1,307,521. MEXICALI EXPRESS. INT. CL. 42. REG. 11-27-1984.
- 1,307,523. TASTE IT. YOU'LL LOVE IT FOR GOOD.. INT. CL. 42. REG. 11-27-1984.
- 1,307,529. COURTYARD CLUB. INT. CL. 42. REG. 11-27-1984.
- 1,307,534. APTA AND DESIGN. INT. CL. 42. REG. 11-27-1984.
- 1,307,535. TELELAB. INT. CL. 42. REG. 11-27-1984.
- 1,307,536. CERTIFIED FURNITURE SALES. INT. CL. 42. REG. 11-27-1984.
- 1,307,538. MEDNOW AND DESIGN. INT. CL. 42. REG. 11-27-1984.
- 1,307,540. LANDLUBBER'S AND DESIGN. INT. CL. 42. REG. 11-27-1984.
- 1,307,542. PHYTO DYNAMICS. INT. CL. 42. REG. 11-27-1984.
- 1,307,544. COMPU = PROMPT. INT. CL. 42. REG. 11-27-1984.
- 1,307,549. METHOD ONE. INT. CL. 42. REG. 11-27-1984.
- 1,307,553. SOLO NOTS. INT. CL. 42. REG. 11-27-1984.
- 1,307,561. SECOND BASE. INT. CL. 42. REG. 11-27-1984.
- 1,307,563. MISCELLANEOUS DESIGN. INT. CL. 42. REG. 11-27-1984.
- 1,307,565. PEOPLE WHO CARE IDL DRUG STORES AND DESIGN. U.S. CL. 200. REG. 11-27-1984.
- 1,307,566. ACCEPTED BY THE COMMITTEE ON PODIATRIC T AND DESIGN. U.S. CL. A. REG. 11-27-1984.
- 1,307,569. BOTTLE TOTE. INT. CL. 8. REG. 11-27-1984.
- 1,307,571. FRIENDLY WARE (STYLIZED). INT. CL. 9. REG. 11-27-1984.
- 1,307,579. SILVER LACED. INT. CL. 25. REG. 11-27-1984.
- 1,307,581. CARIBBEAN FLOWERS. INT. CL. 31. REG. 11-27-1984.
- 1,338,384. MOBIL MART. INT. CL. 37 ONLY. REG. 5-28-1985.
- 1,343,780. MODULEX. INT. CL. 11 ONLY. REG. 6-25-1985.
- 1,349,830. STONE-BUHR. INT. CL. 31 ONLY. REG. 7-16-1985.
- 1,352,028. USWEST AND DESIGN. INT. CLS. 35, 36, 37, 41 AND 42 ONLY. REG. 7-30-1985.
- 1,360,461. MISCELLANEOUS DESIGN. INT. CL. 21 ONLY. REG. 9-17-1985.
- 1,389,976. MISCELLANEOUS DESIGN. INT. CL. 26 ONLY. REG. 4-15-1986.
- 1,622,129. ISDN EXPRESS. INT. CL. 9. REG. 11-13-1990.
- 1,838,909. DARBY ONLINE AND DESIGN. INT. CL. 42. REG. 6-7-1994.
- 1,864,453. BIGGIDUR. INT. CL. 1. REG. 11-29-1994.
- 1,864,456. THE GREEN CHEMISTRY COMPANY. INT. CL. 1. REG. 11-29-1994.
- 1,864,457. ELHIBIN. INT. CL. 1. REG. 11-29-1994.
- 1,864,462. PULPSIL. INT. CL. 1. REG. 11-29-1994.
- 1,864,465. NAMSCO. INT. CL. 1. REG. 11-29-1994.
- 1,864,470. ENDURING ELEGANCE. INT. CL. 2. REG. 11-29-1994.
- 1,864,472. NOURISHMENT. INT. CL. 3. REG. 11-29-1994.
- 1,864,475. HC. INT. CLS. 3 AND 42. REG. 11-29-1994.
- 1,864,484. PP (STYLIZED). INT. CL. 3. REG. 11-29-1994.
- 1,864,490. PLACENTAGEN. INT. CL. 3. REG. 11-29-1994.
- 1,864,493. MEA AND DESIGN. INT. CL. 3. REG. 11-29-1994.
- 1,864,499. KIMBERLEE PRICE. INT. CL. 3. REG. 11-29-1994.
- 1,864,509. CIRCUS CHEWS. INT. CL. 5. REG. 11-29-1994.
- 1,864,510. OTICIN - HC. INT. CL. 5. REG. 11-29-1994.
- 1,864,511. PREBON. INT. CL. 5. REG. 11-29-1994.
- 1,864,524. KRUPS PROMIX (STYLIZED). INT. CLS. 7 AND 21. REG. 11-29-1994.
- 1,864,534. BAGEL TRAP. INT. CL. 8. REG. 11-29-1994.
- 1,864,540. INTERCEPT. INT. CL. 9. REG. 11-29-1994.
- 1,864,545. PANDORA. INT. CLS. 9, 16 AND 42. REG. 11-29-1994.
- 1,864,546. PROGARD. INT. CL. 9. REG. 11-29-1994.
- 1,864,551. GRAPHIC-VISION. INT. CL. 9. REG. 11-29-1994.
- 1,864,557. SANTA CRUZ. INT. CL. 9. REG. 11-29-1994.
- 1,864,560. CHIRON THE CENTAUR PRESENTS: AND DESIGN. INT. CL. 9. REG. 11-29-1994.
- 1,864,563. SCIENCE SCREEN REPORT. INT. CLS. 9 AND 41. REG. 11-29-1994.
- 1,864,566. TURFCHEK. INT. CL. 9. REG. 11-29-1994.
- 1,864,569. MACROWARE. INT. CL. 9. REG. 11-29-1994.
- 1,864,571. CAATS. INT. CL. 9. REG. 11-29-1994.
- 1,864,572. MAGIC TOUCH AND DESIGN. INT. CL. 9. REG. 11-29-1994.
- 1,864,574. CONTRACT CONSTRUCTOR, PRIME. INT. CL. 9. REG. 11-29-1994.
- 1,864,585. GAMEKEEPER. INT. CL. 9. REG. 11-29-1994.
- 1,864,588. SOUND DIMENSION. INT. CLS. 9 AND 20. REG. 11-29-1994.
- 1,864,590. CP-60. INT. CL. 9. REG. 11-29-1994.
- 1,864,591. MOMMY I WANT.... INT. CL. 9. REG. 11-29-1994.
- 1,864,603. CROCKARD. INT. CL. 10. REG. 11-29-1994.
- 1,864,615. SENSATION. INT. CL. 10. REG. 11-29-1994.
- 1,864,639. HEART & ARROW DIAMOND. INT. CL. 14. REG. 11-29-1994.
- 1,864,642. SILVERLININGS. INT. CL. 14. REG. 11-29-1994.
- 1,864,656. 16 (STYLIZED). INT. CL. 16. REG. 11-29-1994.

- 1,864,660. CHAPTER IN A BOX COMMUNITY ASSOCIATIONS INSTITUTE AND DESIGN. INT. CL. 16. REG. 11-29-1994.
- 1,864,665. AUTHENTIC GUITAR-TAB AND DESIGN. INT. CL. 16. REG. 11-29-1994.
- 1,864,675. KALEIDOSCOPE (STYLIZED). INT. CL. 16. REG. 11-29-1994.
- 1,864,678. PRAECEPTA (STYLIZED). INT. CL. 16. REG. 11-29-1994.
- 1,864,679. YOUR PRAECEPTUM (STYLIZED). INT. CL. 16. REG. 11-29-1994.
- 1,864,704. HIDE & SEEK SCIENCE AND DESIGN. INT. CL. 16. REG. 11-29-1994.
- 1,864,705. AMBIANCE. INT. CL. 16. REG. 11-29-1994.
- 1,864,708. FRANCHISE FOCUS. INT. CL. 16. REG. 11-29-1994.
- 1,864,710. BEST PRACTICES IN CATEGORY MANAGEMENT. INT. CL. 16. REG. 11-29-1994.
- 1,864,720. COLORS SO BRIGHT...THEY JUMP OFF THE PAGE. INT. CL. 16. REG. 11-29-1994.
- 1,864,724. TOPAZ. INT. CL. 16. REG. 11-29-1994.
- 1,864,731. CAL FLORIDA AND DESIGN. INT. CL. 19. REG. 11-29-1994.
- 1,864,739. TOOTSIE TUFFET. INT. CL. 20. REG. 11-29-1994.
- 1,864,768. MISCELLANEOUS DESIGN. INT. CL. 25. REG. 11-29-1994.
- 1,864,772. FELIX ET WILLIAM (STYLIZED). INT. CL. 25. REG. 11-29-1994.
- 1,864,782. RIVER SHARPE. INT. CL. 25. REG. 11-29-1994.
- 1,864,788. NOVI KIDS. INT. CL. 28. REG. 11-29-1994.
- 1,864,790. MISCELLANEOUS DESIGN. INT. CL. 28. REG. 11-29-1994.
- 1,864,798. GOLD MARQUE ARTIST SERIES AND DESIGN. INT. CL. 28. REG. 11-29-1994.
- 1,864,808. MEGABUBBLES. INT. CL. 28. REG. 11-29-1994.
- 1,864,810. PIGLING BLAND. INT. CL. 28. REG. 11-29-1994.
- 1,864,812. TOMMY BROCK. INT. CL. 28. REG. 11-29-1994.
- 1,864,817. WILLOW FAMILY FOODS. INT. CLS. 29 AND 30. REG. 11-29-1994.
- 1,864,820. NORVEGIA (STYLIZED). INT. CL. 29. REG. 11-29-1994.
- 1,864,825. MISCELLANEOUS DESIGN. INT. CL. 29. REG. 11-29-1994.
- 1,864,832. SHENANDOAH AND DESIGN. INT. CL. 29. REG. 11-29-1994.
- 1,864,840. SQUARE SHOOTER EXOTIC POPS. INT. CL. 30. REG. 11-29-1994.
- 1,864,847. MISCELLANEOUS DESIGN. INT. CL. 30. REG. 11-29-1994.
- 1,864,848. LA BOULI. INT. CL. 30. REG. 11-29-1994.
- 1,864,852. MISCELLANEOUS DESIGN. INT. CL. 30. REG. 11-29-1994.
- 1,864,855. MICHAEL'S FROZEN CUSTARD AND DESIGN. INT. CL. 30. REG. 11-29-1994.
- 1,864,857. MISCELLANEOUS DESIGN. INT. CL. 30. REG. 11-29-1994.
- 1,864,858. ENCORE AND DESIGN. INT. CL. 30. REG. 11-29-1994.
- 1,864,887. DU MAURIER. INT. CL. 34. REG. 11-29-1994.
- 1,864,901. JOHN LEIFER LTD.'S SECOND OPINION AND DESIGN. INT. CL. 35. REG. 11-29-1994.
- 1,864,916. PRUDENTIAL SECURITIES TARGET PROGRAM. INT. CL. 36. REG. 11-29-1994.
- 1,864,920. NCS (STYLIZED). INT. CL. 36. REG. 11-29-1994.
- 1,864,928. QEB. INT. CL. 36. REG. 11-29-1994.
- 1,864,929. GLOBALT INCORPORATED AND DESIGN. INT. CL. 36. REG. 11-29-1994.
- 1,864,946. SEAT 100 (STYLIZED). INT. CL. 37. REG. 11-29-1994.
- 1,864,950. TOTALHOME AND DESIGN. INT. CLS. 37 AND 42. REG. 11-29-1994.
- 1,864,959. M1CL AND DESIGN. INT. CL. 38. REG. 11-29-1994.
- 1,864,961. WILSELECT. INT. CL. 38. REG. 11-29-1994.
- 1,864,967. TRAVELSCAPES VACATIONS. INT. CL. 39. REG. 11-29-1994.
- 1,864,976. MINT. INT. CL. 40. REG. 11-29-1994.
- 1,864,977. A.W.A.R.E.. INT. CL. 41. REG. 11-29-1994.
- 1,864,988. SQUARE WHEELS. INT. CL. 41. REG. 11-29-1994.
- 1,864,996. PRAECEPTA (STYLIZED). INT. CL. 41. REG. 11-29-1994.
- 1,864,998. MISCELLANEOUS DESIGN. INT. CL. 41. REG. 11-29-1994.
- 1,865,006. I FEEL GOOD ABOUT ME. INT. CL. 41. REG. 11-29-1994.
- 1,865,012. PROCLINIC AND DESIGN. INT. CL. 41. REG. 11-29-1994.
- 1,865,016. DROP OUT. INT. CL. 41. REG. 11-29-1994.
- 1,865,017. THE DARK HOLE. INT. CL. 41. REG. 11-29-1994.
- 1,865,018. AMAZON ADVENTURE. INT. CL. 41. REG. 11-29-1994.
- 1,865,025. JOHNSON SUPPLY. INT. CL. 42. REG. 11-29-1994.
- 1,865,030. PERFECTLY SAFE GUARANTEE AND DESIGN. INT. CL. 42. REG. 11-29-1994.
- 1,865,038. WILDERNESS MEDICAL SOCIETY. INT. CL. 42. REG. 11-29-1994.
- 1,865,041. VIETNAM WOMEN'S MEMORIAL PROJECT. INT. CL. 42. REG. 11-29-1994.
- 1,865,060. E THE ENGRAVALITH (STYLIZED). INT. CL. 42. REG. 11-29-1994.
- 1,865,072. LA CARAVELLE. INT. CL. 42. REG. 11-29-1994.
- 1,865,084. THE BIG PARTY. INT. CL. 42. REG. 11-29-1994.
- 1,865,088. HEALTH LINE. INT. CLS. 5, 10, 16 AND 21. REG. 11-29-1994.
- 1,865,089. PLAYTECH AND DESIGN. INT. CLS. 11 AND 28. REG. 11-29-1994.
- 1,865,091. C MEC AND DESIGN. INT. CLS. 9 AND 11. REG. 11-29-1994.
- 1,865,098. NOTHING'S FRESHER. INT. CLS. 29 AND 30. REG. 11-29-1994.
- 1,865,099. DIGI-MED. INT. CLS. 37, 40 AND 42. REG. 11-29-1994.
- 1,865,103. SETA BIELLA BY BOZZALLA & LESNA AND DESIGN. INT. CLS. 24 AND 25. REG. 11-29-1994.
- 1,865,110. BRIDGEWAY COMMERCE PARK AND DESIGN. INT. CLS. 36 AND 37. REG. 11-29-1994.
- 1,865,111. FAMILY SUN. INT. CLS. 29 AND 31. REG. 11-29-1994.
- 1,865,125. FERMAX. INT. CL. 1. REG. 11-29-1994.
- 1,865,127. SNAP-N-SHOOT STANDARDS AND DESIGN. INT. CL. 1. REG. 11-29-1994.
- 1,865,135. ALPHA HYDRACTIVE. INT. CL. 3. REG. 11-29-1994.
- 1,865,139. PS AND DESIGN. INT. CL. 3. REG. 11-29-1994.
- 1,865,158. XLC. INT. CL. 5. REG. 11-29-1994.
- 1,865,166. TITAN AND DESIGN. INT. CL. 6. REG. 11-29-1994.
- 1,865,173. LUBRARICH. INT. CL. 8. REG. 11-29-1994.
- 1,865,176. SPARC COMPLIANT SCD AND DESIGN. INT. CL. 9. REG. 11-29-1994.
- 1,865,179. PONY AND DESIGN. INT. CL. 9. REG. 11-29-1994.
- 1,865,184. 10X24 RC. INT. CL. 9. REG. 11-29-1994.
- 1,865,187. PENFACT. INT. CL. 9. REG. 11-29-1994.
- 1,865,192. SPORTALK. INT. CL. 9. REG. 11-29-1994.
- 1,865,200. FPLCASSISTANT. INT. CL. 9. REG. 11-29-1994.
- 1,865,203. B-MAX. INT. CL. 9. REG. 11-29-1994.
- 1,865,212. COBRA. INT. CL. 9. REG. 11-29-1994.
- 1,865,216. COALITION. INT. CL. 9. REG. 11-29-1994.
- 1,865,218. SAY IT!. INT. CL. 9. REG. 11-29-1994.
- 1,865,220. BILLDATS. INT. CL. 9. REG. 11-29-1994.
- 1,865,227. COLOR BRIGHTS. INT. CL. 9. REG. 11-29-1994.
- 1,865,230. UNIQUET. INT. CL. 10. REG. 11-29-1994.
- 1,865,236. DIAMETRICS MEDICAL INCORPORATED D AND DESIGN. INT. CL. 10. REG. 11-29-1994.
- 1,865,244. GAP-A-RO. INT. CL. 11. REG. 11-29-1994.
- 1,865,257. GROUCHY. INT. CL. 16. REG. 11-29-1994.
- 1,865,263. E TRADITION OF QUALITY ESTABLISHED IN 1912 AND DESIGN. INT. CL. 16. REG. 11-29-1994.
- 1,865,264. FLEXGUARD. INT. CL. 16. REG. 11-29-1994.
- 1,865,278. FASCIA-THERM. INT. CL. 17. REG. 11-29-1994.
- 1,865,279. US PETS AND DESIGN. INT. CL. 18. REG. 11-29-1994.
- 1,865,289. KOLOR KOLLAR KK AND DESIGN. INT. CL. 20. REG. 11-29-1994.
- 1,865,295. DURAGOLD. INT. CL. 21. REG. 11-29-1994.

- 1,865,298. TREE TRUNKS. INT. CL. 25. REG. 11-29-1994.
 1,865,303. AXXA. INT. CL. 25. REG. 11-29-1994.
 1,865,316. SHELLS. INT. CL. 25. REG. 11-29-1994.
 1,865,326. TIDDLYGOLF. INT. CL. 28. REG. 11-29-1994.
 1,865,341. LOONEY BALL. INT. CL. 28. REG. 11-29-1994.
 1,865,342. SWING THING. INT. CL. 28. REG. 11-29-1994.
 1,865,351. SUPER CLUB. INT. CL. 29. REG. 11-29-1994.
 1,865,362. DUBBLE BUBBLE (STYLIZED). INT. CL. 30. REG. 11-29-1994.
 1,865,364. THE HOMESTYLE COLLECTION AND DESIGN. INT. CL. 30. REG. 11-29-1994.
 1,865,377. 10,000 LAKES PASTA. INT. CL. 30. REG. 11-29-1994.
 1,865,397. MOBAY CITRUM. INT. CL. 33. REG. 11-29-1994.
 1,865,412. CENTREX CLASSIC. INT. CL. 38. REG. 11-29-1994.
 1,865,425. CRYBABY AND DESIGN. INT. CL. 41. REG. 11-29-1994.
 1,865,426. MC TOY. INT. CL. 41. REG. 11-29-1994.
 1,865,429. GOLDEN BEAR GOLF CENTER AND DESIGN. INT. CL. 41. REG. 11-29-1994.
 1,865,432. HELL-CAM USA AND DESIGN. INT. CL. 41. REG. 11-29-1994.
 1,865,443. MRL DIAGNOSTICS AND DESIGN. INT. CL. 42. REG. 11-29-1994.
 1,865,445. HEART CENTER LIFE BEAT OSTEOPATHIC MEDICAL CENTER OF TEXAS AND DESIGN. INT. CL. 42. REG. 11-29-1994.
 1,865,446. MIPS. INT. CL. 42. REG. 11-29-1994.
 1,865,451. FIRST LOOK. INT. CL. 42. REG. 11-29-1994.
 1,865,461. KABLE LITE (STYLIZED). INT. CL. 11. REG. 11-29-1994.
 1,865,464. MISCELLANEOUS DESIGN. INT. CL. 16. REG. 11-29-1994.
 1,865,466. THE HENDRICKS (STYLIZED). INT. CL. 16. REG. 11-29-1994.
 1,865,467. EL PODER MENTAL. INT. CL. 16. REG. 11-29-1994.
 1,865,469. HEALTHCARE USA (STYLIZED). INT. CL. 16. REG. 11-29-1994.
 1,865,471. LUCENT/BOND. INT. CL. 16. REG. 11-29-1994.
 1,865,483. THE APT. MOVERS AND DESIGN. INT. CL. 39. REG. 11-29-1994.
 1,865,486. USER LABORATORIES. INT. CL. 42. REG. 11-29-1994.
 1,865,487. USER LAB. INT. CL. 42. REG. 11-29-1994.
 1,869,895. FRIENDLY FOOT CARE AND DESIGN. INT. CL. 35 ONLY. REG. 12-27-1994.
 1,871,520. FRIENDLY FOOT CARE. INT. CL. 35 ONLY. REG. 1-3-1995.
 1,874,198. TIB TRANSPORTATION INSURANCE BROKERS AND DESIGN. INT. CL. 36. REG. 1-17-1995.
 1,877,324. KID'S ROOM (STYLIZED). INT. CL. 16 ONLY. REG. 2-7-1995.
 1,896,423. G&B. INT. CLS. 35 AND 37 ONLY. REG. 5-30-1995.
 1,902,323. MISCELLANEOUS DESIGN. INT. CL. 36 ONLY. REG. 7-4-1995.
 1,904,124. KELLEY BLUE BOOK AND DESIGN. INT. CL. 36 ONLY. REG. 7-11-1995.
 1,904,278. CLUBMAC. INT. CL. 9 ONLY. REG. 7-11-1995.
 2,069,142. PROJECT COOL. INT. CL. 42. REG. 6-10-1997.
 2,096,142. THE CONFUNKSHUN. INT. CL. 25. REG. 9-9-1997.
 2,096,158. APARTMENTS ON LINE. INT. CL. 35. REG. 9-9-1997.
 2,096,207. ST. MICHAEL. INT. CLS. 4, 5, 6, 8, 9, 11, 14, 16, 20 AND 28. REG. 9-16-1997.
 2,096,711. BRINE SHRIMP EGGS AND DESIGN. INT. CL. 31. REG. 9-16-1997.
 2,096,752. STAGE-PRO. INT. CL. 9. REG. 9-16-1997.
 2,096,964. ROCMEC. INT. CLS. 12, 13 AND 17. REG. 9-16-1997.
 2,097,589. PICKETS AND DESIGN. INT. CL. 16. REG. 9-16-1997.
 2,098,289. MATRIX THERMO-SHIELD. INT. CL. 10. REG. 9-16-1997.
 2,099,815. TNT. INT. CL. 28. REG. 9-23-1997.
 2,100,000. YOYO. INT. CL. 9. REG. 9-23-1997.
 2,100,763. QUICK. INT. CL. 12. REG. 9-30-1997.
 2,100,860. WANNABE ECO. INT. CL. 35. REG. 9-30-1997.
 2,101,123. GUILLOT. INT. CL. 31. REG. 9-30-1997.
 2,101,561. PEDIACTIVE A.D.D.. INT. CL. 5. REG. 9-30-1997.
 2,101,639. PARAMOUNT AND DESIGN. INT. CLS. 35 AND 36. REG. 9-30-1997.
 2,104,351. LASERWAVE. INT. CL. 9. REG. 10-7-1997.
 2,104,758. PREMIER. INT. CL. 36. REG. 10-14-1997.
 2,105,630. A NEW YOU. INT. CL. 42. REG. 10-14-1997.
 2,105,794. FLAVOR! SHOW. INT. CL. 35. REG. 10-14-1997.
 2,105,897. MAISON FLEECE. INT. CL. 24. REG. 10-14-1997.
 2,105,980. PANTS REMOVER. INT. CLS. 3 AND 33. REG. 10-14-1997.
 2,106,173. SHEPHERDS MATE. INT. CL. 18. REG. 10-21-1997.
 2,106,585. KOUNTRY KERNEL AND DESIGN. INT. CL. 31. REG. 10-21-1997.
 2,108,196. DORACREM DE ARLUY. INT. CL. 30. REG. 10-28-1997.
 2,108,343. INTELEBRIDGE. INT. CL. 42. REG. 10-28-1997.
 2,108,376. PLATOOLS. INT. CLS. 38 AND 41. REG. 10-28-1997.
 2,109,447. MAILMATION. INT. CL. 7. REG. 10-28-1997.
 2,109,951. ALOHA TELLER. INT. CLS. 9 AND 36. REG. 10-28-1997.
 2,110,037. JOIN IT. OWN IT. BENEFIT! AND DESIGN. INT. CL. 36. REG. 10-28-1997.
 2,110,990. PRO HAIR2. INT. CL. 5. REG. 11-4-1997.
 2,125,959. SMARTBOX. INT. CLS. 5 AND 9. REG. 12-30-1997.
 2,142,170. FYFFES. INT. CL. 31. REG. 3-10-1998.
 2,154,701. KID RHINO AND DESIGN. INT. CL. 9. REG. 5-5-1998.
 2,183,270. MISCELLANEOUS DESIGN. INT. CLS. 18, 24, 26 AND 38 ONLY. REG. 8-25-1998.
 2,206,275. 100% CFC-FREE REFRIGERANT AND DESIGN. INT. CLS. 7, 9 AND 11. REG. 12-1-1998.
 2,206,276. AMVAC. INT. CL. 37. REG. 12-1-1998.
 2,206,277. AMVAC AND DESIGN. INT. CL. 37. REG. 12-1-1998.
 2,206,278. LARA AND DESIGN. INT. CL. 14. REG. 12-1-1998.
 2,206,280. CONCEPT. INT. CL. 12. REG. 12-1-1998.
 2,206,282. CONSILIUM. INT. CLS. 35 AND 36. REG. 12-1-1998.
 2,206,284. RIFLE AND DESIGN. INT. CLS. 9 AND 14. REG. 12-1-1998.
 2,206,286. PAPILLON. INT. CL. 14. REG. 12-1-1998.
 2,206,290. AIT. INT. CLS. 5 AND 42. REG. 12-1-1998.
 2,206,291. DSW CLUB. INT. CL. 42. REG. 12-1-1998.
 2,206,293. STUDYGIRL (STYLIZED). INT. CL. 9. REG. 12-1-1998.
 2,206,299. SCHALTAG AND DESIGN. INT. CLS. 9, 40 AND 42. REG. 12-1-1998.
 2,206,300. GOLDEN BRAZIL. INT. CL. 30. REG. 12-1-1998.
 2,206,303. LIQUILYS. INT. CL. 31. REG. 12-1-1998.
 2,206,304. E-VOTE. INT. CL. 9. REG. 12-1-1998.
 2,206,305. PHYTAROMA. INT. CLS. 3 AND 5. REG. 12-1-1998.
 2,206,307. PLANETSUN. INT. CL. 42. REG. 12-1-1998.
 2,206,309. STARGATE. INT. CLS. 35, 38 AND 42. REG. 12-1-1998.
 2,206,310. MISCELLANEOUS DESIGN. INT. CL. 41. REG. 12-1-1998.
 2,206,314. INTROMIT. INT. CL. 10. REG. 12-1-1998.
 2,206,315. SAFE FLEX. INT. CLS. 6 AND 19. REG. 12-1-1998.
 2,206,316. SENTERERS. INT. CL. 30. REG. 12-1-1998.
 2,206,317. RADIO MACWORLD. INT. CL. 42. REG. 12-1-1998.
 2,206,319. H O M E O W N E R S ADVANTAGE 5 AND DESIGN. INT. CL. 36. REG. 12-1-1998.
 2,206,321. VISION AND DESIGN. INT. CL. 16. REG. 12-1-1998.
 2,206,323. ADIRONDACK AND DESIGN. INT. CL. 9. REG. 12-1-1998.
 2,206,324. SWISS MAT. INT. CL. 20. REG. 12-1-1998.
 2,206,325. RAGROLLER. INT. CL. 16. REG. 12-1-1998.
 2,206,326. BEAUTY WORLD. INT. CL. 42. REG. 12-1-1998.
 2,206,328. ALUMATIC. INT. CL. 9. REG. 12-1-1998.

- 2,206,330. GUIDESTAR HEALTH SYSTEMS, INC. AND DESIGN. INT. CLS. 35, 36 AND 42. REG. 12-1-1998.
- 2,206,331. NETLOCK. INT. CL. 9. REG. 12-1-1998.
- 2,206,333. KIDCASH. INT. CL. 9. REG. 12-1-1998.
- 2,206,335. ACTION NORD SUD LYON AND DESIGN. INT. CLS. 35, 39 AND 41. REG. 12-1-1998.
- 2,206,342. THE BUG SOLUTION AND DESIGN. INT. CL. 3. REG. 12-1-1998.
- 2,206,343. CAMPAGNA AND DESIGN. INT. CL. 12. REG. 12-1-1998.
- 2,206,346. WE STAND STRONG TOGETHER (STYLIZED). INT. CL. 35. REG. 12-1-1998.
- 2,206,347. CGK COMPUTER GESELLSCHAFT KONSTANZ AND DESIGN. INT. CLS. 9, 37 AND 42. REG. 12-1-1998.
- 2,206,349. WIN TOMORROW TODAY. INT. CL. 35. REG. 12-1-1998.
- 2,206,354. OUR TOWN. INT. CL. 19. REG. 12-1-1998.
- 2,206,356. NOT JUST OPEN. WIDE OPEN.. INT. CL. 42. REG. 12-1-1998.
- 2,206,357. THE PERFECT TIME FOR. INT. CL. 35. REG. 12-1-1998.
- 2,206,359. AQUADOMES. INT. CLS. 20 AND 28. REG. 12-1-1998.
- 2,206,366. L INSTANT SCRATCH GAMES LOUISIANA LOTTERY AND DESIGN. INT. CL. 36. REG. 12-1-1998.
- 2,206,368. FAT BOX AND DESIGN. INT. CL. 41. REG. 12-1-1998.
- 2,206,369. DYNACHIP. INT. CL. 9. REG. 12-1-1998.
- 2,206,371. CONSTANTIN. INT. CL. 35. REG. 12-1-1998.
- 2,206,372. TRUEMATCH. INT. CL. 9. REG. 12-1-1998.
- 2,206,373. SIKOV METALS SM. INT. CL. 10. REG. 12-1-1998.
- 2,206,374. KALINA CYCLE. INT. CL. 42. REG. 12-1-1998.
- 2,206,376. AMAZING GATES AND DESIGN. INT. CL. 35. REG. 12-1-1998.
- 2,206,380. CAREAWARE. INT. CLS. 9 AND 42. REG. 12-1-1998.
- 2,206,382. COVERGUARD. INT. CL. 12. REG. 12-1-1998.
- 2,206,384. CHUXX. INT. CLS. 30 AND 42. REG. 12-1-1998.
- 2,206,386. AERONET. INT. CL. 18. REG. 12-1-1998.
- 2,206,388. MISCELLANEOUS DESIGN. INT. CLS. 3, 4, 6, 8, 9, 11, 14, 16, 18, 20, 21, 24, 25, 28, 30, 32, 33 AND 42. REG. 12-1-1998.
- 2,206,389. SPICE DROP. INT. CL. 30. REG. 12-1-1998.
- 2,206,390. DESCRYP. INT. CLS. 9 AND 42. REG. 12-1-1998.
- 2,206,392. AMPS INTERLOCKING STRAIGHT EDGE SYSTEM AND DESIGN. INT. CL. 8. REG. 12-1-1998.
- 2,206,393. WEISSMANN TRAVEL REPORTS. INT. CLS. 9, 16 AND 39. REG. 12-1-1998.
- 2,206,395. MAKE AND PLAY. INT. CLS. 16 AND 28. REG. 12-1-1998.
- 2,206,399. OSCAR. INT. CL. 9. REG. 12-1-1998.
- 2,206,402. ORTHO SHEAR. INT. CL. 9. REG. 12-1-1998.
- 2,206,404. CADD DESKTOP TUTOR. INT. CL. 9. REG. 12-1-1998.
- 2,206,405. BEDLAM. INT. CL. 9. REG. 12-1-1998.
- 2,206,406. PAGEJAMMER. INT. CL. 9. REG. 12-1-1998.
- 2,206,407. BECKER ACROMA AND DESIGN. INT. CL. 2. REG. 12-1-1998.
- 2,206,409. NKO. INT. CLS. 9 AND 38. REG. 12-1-1998.
- 2,206,410. C SYNC AND DESIGN. INT. CL. 9. REG. 12-1-1998.
- 2,206,413. AD ART (STYLIZED). INT. CLS. 9 AND 40. REG. 12-1-1998.
- 2,206,416. MYRIAD. INT. CL. 9. REG. 12-1-1998.
- 2,206,417. ZIP COUPONS. INT. CL. 35. REG. 12-1-1998.
- 2,206,419. BODY BELT. INT. CL. 10. REG. 12-1-1998.
- 2,206,420. GLOBAL SOS. INT. CL. 35. REG. 12-1-1998.
- 2,206,421. PRESERVE, INC. AND DESIGN. INT. CL. 16. REG. 12-1-1998.
- 2,206,422. CRICKET. INT. CL. 9. REG. 12-1-1998.
- 2,206,427. CURRICULUM MANAGER (STYLIZED). INT. CLS. 9 AND 42. REG. 12-1-1998.
- 2,206,430. EASY CELLULAR. INT. CL. 38. REG. 12-1-1998.
- 2,206,431. NEV. INT. CL. 35. REG. 12-1-1998.
- 2,206,432. RADIO VISION AND DESIGN. INT. CL. 9. REG. 12-1-1998.
- 2,206,437. REMOTECOLLABORATION. INT. CLS. 9, 16 AND 28. REG. 12-1-1998.
- 2,206,438. MGT EXECUTIVE SYSTEMS. INT. CLS. 9 AND 25. REG. 12-1-1998.
- 2,206,440. 2NDIIBYTE. INT. CL. 35. REG. 12-1-1998.
- 2,206,443. MURRIN MURRIN. INT. CL. 6. REG. 12-1-1998.
- 2,206,444. LADY ANGLER AND DESIGN. INT. CL. 25. REG. 12-1-1998.
- 2,206,447. TIME DESIGN. INT. CL. 16. REG. 12-1-1998.
- 2,206,451. NUVEEN MASTERS. INT. CL. 41. REG. 12-1-1998.
- 2,206,452. STELLARNET. INT. CL. 9. REG. 12-1-1998.
- 2,206,454. AUTHENTIC MEXICAN JUMPING BEANZ AND DESIGN. INT. CL. 28. REG. 12-1-1998.
- 2,206,455. AEP RESOURCES. INT. CLS. 35, 39 AND 40. REG. 12-1-1998.
- 2,206,457. PLATESTREAM. INT. CL. 9. REG. 12-1-1998.
- 2,206,458. TETHERCAM. INT. CLS. 35, 38 AND 39. REG. 12-1-1998.
- 2,206,459. BIG WATER. INT. CL. 8. REG. 12-1-1998.
- 2,206,460. UNI-SOURCING. INT. CLS. 40 AND 42. REG. 12-1-1998.
- 2,206,462. RR CERRUTIJEANS (STYLIZED). INT. CLS. 18 AND 25. REG. 12-1-1998.
- 2,206,465. MR. MIGHTY MIND. INT. CL. 28. REG. 12-1-1998.
- 2,206,467. CONECTIV COMMUNICATIONS. INT. CLS. 38 AND 42. REG. 12-1-1998.
- 2,206,469. REAL OFFICE SOLUTIONS. INT. CLS. 35 AND 42. REG. 12-1-1998.
- 2,206,471. COREBUILDER. INT. CL. 9. REG. 12-1-1998.
- 2,206,473. THE KERZNER APPROACH (STYLIZED). INT. CLS. 16 AND 41. REG. 12-1-1998.
- 2,206,475. FABULOUS FRUIT SHORTCAKE. INT. CL. 30. REG. 12-1-1998.
- 2,206,476. HARD LINE. INT. CL. 18. REG. 12-1-1998.
- 2,206,477. R J STONE-WAY ENTERPRISES. INT. CL. 3. REG. 12-1-1998.
- 2,206,479. EL NET. INT. CL. 41. REG. 12-1-1998.
- 2,206,481. THE TECHNICAL RESOURCE CONNECTION INCORPORATED AND DESIGN. INT. CL. 35. REG. 12-1-1998.
- 2,206,482. HOTEL WORLD ONLINE - YOUR RESERVATION SYSTEM AND DESIGN. INT. CLS. 35, 38, 39, 41 AND 42. REG. 12-1-1998.
- 2,206,483. VALUE WEB. INT. CLS. 18 AND 25. REG. 12-1-1998.
- 2,206,484. SECURITY FIRST TECHNOLOGIES. INT. CLS. 9, 35, 36 AND 42. REG. 12-1-1998.
- 2,206,488. SELECT NETWORK. INT. CLS. 35 AND 42. REG. 12-1-1998.
- 2,206,489. MISCELLANEOUS DESIGN. INT. CL. 5. REG. 12-1-1998.
- 2,206,490. LIFE & HEALTH OF AMERICA. INT. CL. 36. REG. 12-1-1998.
- 2,206,493. PROTECT & PURCHASE. INT. CL. 36. REG. 12-1-1998.
- 2,206,494. S6X. INT. CL. 25. REG. 12-1-1998.
- 2,206,496. MAX DESIGN AND ADVERTISING. INT. CL. 35. REG. 12-1-1998.
- 2,206,497. AAMI. INT. CLS. 16, 41 AND 42. REG. 12-1-1998.
- 2,206,499. POCKET PAL. INT. CL. 9. REG. 12-1-1998.
- 2,206,500. BE BCEN-EUROBANK AND DESIGN. INT. CL. 36. REG. 12-1-1998.
- 2,206,502. CAIMAN AND DESIGN. INT. CLS. 9 AND 41. REG. 12-1-1998.
- 2,206,503. HEALTHFIRST AND DESIGN. INT. CL. 9. REG. 12-1-1998.
- 2,206,504. TELCORRESPONDENCE. INT. CL. 35. REG. 12-1-1998.
- 2,206,506. OUTGIVING PROJECT. INT. CL. 41. REG. 12-1-1998.
- 2,206,508. ACRES GAMING AND DESIGN. INT. CLS. 9, 37 AND 42. REG. 12-1-1998.
- 2,206,510. FRANKIE JAY HARMONICAS ON THE SUNNY SIDE AND DESIGN. INT. CL. 41. REG. 12-1-1998.
- 2,206,511. CRUISER. INT. CL. 28. REG. 12-1-1998.

- 2,206,515. YSL POWDRE D'ETE YVES SAINT LAURENT AND DESIGN. INT. CL. 3. REG. 12-1-1998.
- 2,206,517. FLEET AND DESIGN. INT. CL. 36. REG. 12-1-1998.
- 2,206,518. MBA-PLAZA. INT. CLS. 9, 16 AND 38. REG. 12-1-1998.
- 2,206,520. CLUB HOUSE. INT. CL. 20. REG. 12-1-1998.
- 2,206,521. NATURAL BEAUTY. INT. CL. 20. REG. 12-1-1998.
- 2,206,523. AL-G-GATOR. INT. CL. 11. REG. 12-1-1998.
- 2,206,525. MANTELS BY TM. INT. CL. 19. REG. 12-1-1998.
- 2,206,527. NAUD AND DESIGN. INT. CL. 7. REG. 12-1-1998.
- 2,206,529. LUXFER. INT. CL. 9. REG. 12-1-1998.
- 2,206,530. CM310. INT. CL. 17. REG. 12-1-1998.
- 2,206,532. KLIP AND DESIGN. INT. CL. 28. REG. 12-1-1998.
- 2,206,533. HAN-DEE PULL. INT. CL. 7. REG. 12-1-1998.
- 2,206,535. HAIR. INT. CL. 25. REG. 12-1-1998.
- 2,206,536. MFC (STYLIZED). INT. CL. 6. REG. 12-1-1998.
- 2,206,537. TORREON. INT. CLS. 9 AND 35. REG. 12-1-1998.
- 2,206,538. DEAR SANTA. INT. CLS. 16 AND 18. REG. 12-1-1998.
- 2,206,540. CATALYST. INT. CL. 42. REG. 12-1-1998.
- 2,206,541. KA ENA (STYLIZED). INT. CL. 3. REG. 12-1-1998.
- 2,206,542. NATURE FALLS. INT. CL. 11. REG. 12-1-1998.
- 2,206,543. LIVING IN STYLE. INT. CL. 11. REG. 12-1-1998.
- 2,206,544. FOUNTAIN OF YOUTH. INT. CL. 11. REG. 12-1-1998.
- 2,206,545. ZONIE (STYLIZED). INT. CL. 28. REG. 12-1-1998.
- 2,206,546. FUTURE 3000. INT. CL. 42. REG. 12-1-1998.
- 2,206,551. PRETENDWEAR. INT. CLS. 14, 25 AND 26. REG. 12-1-1998.
- 2,206,553. MIKASA. INT. CL. 7. REG. 12-1-1998.
- 2,206,554. DRIVEWAY JAM. INT. CL. 25. REG. 12-1-1998.
- 2,206,555. THOSE WHO KNOW US KNOW MORE. INT. CL. 35. REG. 12-1-1998.
- 2,206,556. ARIADNE. INT. CL. 35. REG. 12-1-1998.
- 2,206,558. SMARTSYSTEM AND DESIGN. INT. CL. 9. REG. 12-1-1998.
- 2,206,560. SIMAC (STYLIZED). INT. CLS. 7, 9 AND 11. REG. 12-1-1998.
- 2,206,562. CHITOTRIM. INT. CL. 5. REG. 12-1-1998.
- 2,206,563. MAKING STRATEGY WORK. INT. CLS. 35 AND 36. REG. 12-1-1998.
- 2,206,572. TRADESMAN. INT. CL. 11. REG. 12-1-1998.
- 2,206,573. SINCE 1948, THE BOOK CLUB YOU CAN TRUST AND DESIGN. INT. CL. 35. REG. 12-1-1998.
- 2,206,574. CARBO. INT. CL. 10. REG. 12-1-1998.
- 2,206,575. WE CLEAN AMERICA. INT. CL. 37. REG. 12-1-1998.
- 2,206,581. FEMINOVA. INT. CL. 5. REG. 12-1-1998.
- 2,206,583. FEM 7. INT. CL. 5. REG. 12-1-1998.
- 2,206,584. THE ICONS OF JAZZ. INT. CL. 41. REG. 12-1-1998.
- 2,206,588. PRESTO! PERSONAL PAGE. INT. CL. 9. REG. 12-1-1998.
- 2,206,589. DELGA AND DESIGN. INT. CLS. 29 AND 30. REG. 12-1-1998.
- 2,206,590. ICONCACHE. INT. CL. 42. REG. 12-1-1998.
- 2,206,591. AUDIO SHOWROOM. INT. CL. 35. REG. 12-1-1998.
- 2,206,592. DURAFLEX. INT. CL. 16. REG. 12-1-1998.
- 2,206,593. ALGAE-KLEEN. INT. CL. 11. REG. 12-1-1998.
- 2,206,596. CONTROLPLUS DISTRIBUTED CONTROL A REMARKABLE NEW APPROACH AND DESIGN. INT. CL. 9. REG. 12-1-1998.
- 2,206,597. 4 DUB. INT. CLS. 25 AND 28. REG. 12-1-1998.
- 2,206,598. GRAYLING INDUSTRIES, INC. AND DESIGN. INT. CL. 1. REG. 12-1-1998.
- 2,206,601. COMPANY 5 AND DESIGN. INT. CL. 42. REG. 12-1-1998.
- 2,206,602. CCS. INT. CL. 6. REG. 12-1-1998.
- 2,206,603. MISCELLANEOUS DESIGN. INT. CL. 32. REG. 12-1-1998.
- 2,206,604. RUAH RECORDS. INT. CL. 9. REG. 12-1-1998.
- 2,206,608. I AND DESIGN. INT. CL. 9. REG. 12-1-1998.
- 2,206,609. MOSAIQUES AND DESIGN. INT. CL. 4. REG. 12-1-1998.
- 2,206,610. DPI DIVERSIFIED PRODUCT INSPECTIONS AND DESIGN. INT. CL. 42. REG. 12-1-1998.
- 2,206,611. URO-LITE. INT. CL. 10. REG. 12-1-1998.
- 2,206,614. ICS. INT. CL. 37. REG. 12-1-1998.
- 2,206,617. COREGIS. INT. CLS. 35 AND 36. REG. 12-1-1998.
- 2,206,618. WWW.WTTW.COM. INT. CL. 42. REG. 12-1-1998.
- 2,206,620. ADVANCING BASIC SKIN CARE SCIENCE. INT. CLS. 3 AND 5. REG. 12-1-1998.
- 2,206,621. OBIK. INT. CLS. 16, 35 AND 42. REG. 12-1-1998.
- 2,206,622. METROVILLE. INT. CL. 42. REG. 12-1-1998.
- 2,206,623. TAKE:5. INT. CLS. 16, 41 AND 42. REG. 12-1-1998.
- 2,206,625. TOMMEY. INT. CL. 35. REG. 12-1-1998.
- 2,206,626. ASK TORI. INT. CL. 42. REG. 12-1-1998.
- 2,206,633. WILD GOOSE STORAGE INC. AND DESIGN. INT. CL. 39. REG. 12-1-1998.
- 2,206,634. CASCADES. INT. CL. 37. REG. 12-1-1998.
- 2,206,635. ACCH. INT. CL. 36. REG. 12-1-1998.
- 2,206,637. LA BEAUTE CELESTE SKIN CARE CLINIC & DAY SPA AND DESIGN. INT. CL. 42. REG. 12-1-1998.
- 2,206,639. ABRAGRIP. INT. CL. 3. REG. 12-1-1998.
- 2,206,642. PICAS TOXICOLOGY AND SAFETY BUDGETING TOOL. INT. CL. 9. REG. 12-1-1998.
- 2,206,646. SPAGHETTI WESTERN. INT. CLS. 9 AND 41. REG. 12-1-1998.
- 2,206,647. MULTIMEDIA XCITEMENT PAK. INT. CL. 9. REG. 12-1-1998.
- 2,206,649. ICE-A-DELIC GEL. INT. CL. 16. REG. 12-1-1998.
- 2,206,651. VICTORIA D'ANGELO. INT. CL. 25. REG. 12-1-1998.
- 2,206,652. SWISS EXCELLENCE AND DESIGN. INT. CL. 3. REG. 12-1-1998.
- 2,206,654. NORTH STAR STEEL. INT. CL. 6. REG. 12-1-1998.
- 2,206,655. SAGE AND DESIGN. INT. CL. 9. REG. 12-1-1998.
- 2,206,657. MISCELLANEOUS DESIGN. INT. CL. 35. REG. 12-1-1998.
- 2,206,662. LS SMART LANDLORD AND DESIGN. INT. CL. 9. REG. 12-1-1998.
- 2,206,665. ISAAC'S MOVING & STORAGE (STYLIZED). INT. CL. 39. REG. 12-1-1998.
- 2,206,666. FORMCARD. INT. CL. 9. REG. 12-1-1998.
- 2,206,667. THE MEETING POINTE AND DESIGN. INT. CL. 42. REG. 12-1-1998.
- 2,206,670. EQ. INT. CL. 36. REG. 12-1-1998.
- 2,206,674. PRO-AP. INT. CL. 1. REG. 12-1-1998.
- 2,206,675. "...UNIQUE VEHICLES FOR THE WORLD WIDE WEB" (STYLIZED). INT. CL. 9. REG. 12-1-1998.
- 2,206,678. AMERICAN ASSOCIATION OF SENIOR PEER COUNSELING AND DESIGN. INT. CL. 42. REG. 12-1-1998.
- 2,206,679. WE MAKE LIFE SIMPLER. INT. CL. 37. REG. 12-1-1998.
- 2,206,680. DIACS. INT. CL. 42. REG. 12-1-1998.
- 2,206,682. MISCELLANEOUS DESIGN. INT. CL. 9. REG. 12-1-1998.
- 2,206,684. OMEGA. INT. CLS. 6 AND 9. REG. 12-1-1998.
- 2,206,686. BAI. INT. CL. 9. REG. 12-1-1998.
- 2,206,687. LUBO AND DESIGN. INT. CL. 7. REG. 12-1-1998.
- 2,206,689. HOTHOST. INT. CL. 42. REG. 12-1-1998.
- 2,206,690. SPYGUY. INT. CL. 42. REG. 12-1-1998.
- 2,206,691. PATIENT QUEST. INT. CL. 35. REG. 12-1-1998.
- 2,206,692. TOMA. INT. CL. 42. REG. 12-1-1998.
- 2,206,693. EIDOS. INT. CL. 41. REG. 12-1-1998.
- 2,206,694. MISCELLANEOUS DESIGN. INT. CLS. 1 AND 5. REG. 12-1-1998.
- 2,206,699. RED & BLUE. INT. CL. 39. REG. 12-1-1998.
- 2,206,700. NEW RESOURCES CORPORATION. INT. CLS. 35 AND 42. REG. 12-1-1998.
- 2,206,701. SOUTHTOUCH. INT. CL. 17. REG. 12-1-1998.
- 2,206,702. DETROIT GRAND PRIX ASSOCIATION AND DESIGN. INT. CL. 25. REG. 12-1-1998.
- 2,206,703. REAL GOSPEL. INT. CL. 38. REG. 12-1-1998.
- 2,206,708. HOTSITE. INT. CLS. 37 AND 42. REG. 12-1-1998.
- 2,206,717. LONG-TERM INVESTING IN A SHORT-TERM WORLD. INT. CL. 36. REG. 12-1-1998.
- 2,206,718. STAR THROWER. INT. CLS. 9 AND 16. REG. 12-1-1998.
- 2,206,721. AMCO INSURANCE AND DESIGN. INT. CL. 36. REG. 12-1-1998.
- 2,206,722. VIRTUALLY HIRED. INT. CL. 35. REG. 12-1-1998.

- 2,206,724. WITHOUT US ALL YOU HAVE IS INSURANCE. INT. CL. 36. REG. 12-1-1998.
- 2,206,725. Q AND DESIGN. INT. CL. 40. REG. 12-1-1998.
- 2,206,727. MOHO. INT. CL. 35. REG. 12-1-1998.
- 2,206,732. E*TRADE CANADA AND DESIGN. INT. CL. 36. REG. 12-1-1998.
- 2,206,733. EMERGENT EARLY FLUENCY FLUENCY AND DESIGN. INT. CL. 16. REG. 12-1-1998.
- 2,206,734. GST HOME THE SINGLE SOURCE AND DESIGN. INT. CLS. 38 AND 42. REG. 12-1-1998.
- 2,206,736. DOWNTOWN AIR CHARTER AND DESIGN. INT. CL. 39. REG. 12-1-1998.
- 2,206,737. SIP-CLIP. INT. CL. 21. REG. 12-1-1998.
- 2,206,738. CONNECTING YOUR WORLD. INT. CL. 38. REG. 12-1-1998.
- 2,206,739. E EDAW LOCAL REGIONAL GLOBAL AND DESIGN. INT. CLS. 35, 37 AND 42. REG. 12-1-1998.
- 2,206,741. SERVIPAC. INT. CLS. 37, 41 AND 42. REG. 12-1-1998.
- 2,206,749. JOHNNY ADVERTISING. INT. CL. 35. REG. 12-1-1998.
- 2,206,751. ESHARE TECHNOLOGIES. INT. CL. 9. REG. 12-1-1998.
- 2,206,752. VAC-U-TRAP. INT. CL. 7. REG. 12-1-1998.
- 2,206,753. SOMNUS AND DESIGN. INT. CLS. 10 AND 42. REG. 12-1-1998.
- 2,206,755. E-SPAN. INT. CL. 35. REG. 12-1-1998.
- 2,206,757. MORGAN & OATES. INT. CLS. 18, 24 AND 25. REG. 12-1-1998.
- 2,206,758. MORGAN & OATES AND DESIGN. INT. CLS. 18, 24 AND 25. REG. 12-1-1998.
- 2,206,763. UGLY RADIATORS.....NOT THESE!. INT. CL. 11. REG. 12-1-1998.
- 2,206,765. MISCELLANEOUS DESIGN. INT. CL. 42. REG. 12-1-1998.
- 2,206,772. INDEPTHQUOTE. INT. CL. 9. REG. 12-1-1998.
- 2,206,779. AADVANTAGE DRIVE AND DREAM BONUS AND DESIGN. INT. CL. 39. REG. 12-1-1998.
- 2,206,780. LASMO AND DESIGN. INT. CLS. 40 AND 42. REG. 12-1-1998.
- 2,206,782. OPEN SYSTEMS FOR PEOPLE. INT. CL. 35. REG. 12-1-1998.
- 2,206,784. THE JEWELER'S LOUPE. INT. CL. 41. REG. 12-1-1998.
- 2,206,785. FASTFAX FOLLOWUP. INT. CL. 42. REG. 12-1-1998.
- 2,206,787. PRTRAK. INT. CL. 9. REG. 12-1-1998.
- 2,206,791. ULTRAFET. INT. CL. 9. REG. 12-1-1998.
- 2,206,793. YOU'VE GOT THE POWER. INT. CL. 35. REG. 12-1-1998.
- 2,206,794. MISCELLANEOUS DESIGN. INT. CL. 40. REG. 12-1-1998.
- 2,206,795. LET IT RIDE BONUS VIDEO. INT. CL. 9. REG. 12-1-1998.
- 2,206,797. FROM THE EARTH TO THE MOON AND DESIGN. INT. CL. 28. REG. 12-1-1998.
- 2,206,798. FROM THE EARTH TO THE MOON AND DESIGN. INT. CL. 25. REG. 12-1-1998.
- 2,206,800. PA2 (STYLIZED). INT. CL. 18. REG. 12-1-1998.
- 2,206,803. ROMANOFFTECHNOLOGIES. INT. CLS. 37 AND 42. REG. 12-1-1998.
- 2,206,806. NATIONAL COMM LINK, LLC AND DESIGN. INT. CL. 38. REG. 12-1-1998.
- 2,206,808. HYPERCUBED AND DESIGN. INT. CLS. 9 AND 38. REG. 12-1-1998.
- 2,206,809. PLANETARY SOCIETY. INT. CL. 35. REG. 12-1-1998.
- 2,206,811. SLIK-BIT. INT. CL. 1. REG. 12-1-1998.
- 2,206,812. L-G-. INT. CL. 1. REG. 12-1-1998.
- 2,206,813. KLEEN TREAT. INT. CL. 1. REG. 12-1-1998.
- 2,206,814. DIRT TERMINATOR. INT. CL. 1. REG. 12-1-1998.
- 2,206,815. WWW AND DESIGN. INT. CLS. 38 AND 42. REG. 12-1-1998.
- 2,206,817. MISCELLANEOUS DESIGN. INT. CL. 42. REG. 12-1-1998.
- 2,206,818. S S AND DESIGN. INT. CL. 40. REG. 12-1-1998.
- 2,206,819. LANGUAGEFORCE (STYLIZED). INT. CL. 9. REG. 12-1-1998.
- 2,206,820. GAME COIN. INT. CL. 41. REG. 12-1-1998.
- 2,206,821. INTELLIGIZE!. INT. CLS. 9 AND 35. REG. 12-1-1998.
- 2,206,822. PRODUCTIVITY THROUGH CONNECTIVITY. INT. CLS. 38 AND 42. REG. 12-1-1998.
- 2,206,824. SPOONK. INT. CL. 16. REG. 12-1-1998.
- 2,206,826. NORTH AMERICAN ENERGY GROUP AND DESIGN. INT. CL. 42. REG. 12-1-1998.
- 2,206,827. WIND OVER THE EARTH. INT. CL. 41. REG. 12-1-1998.
- 2,206,829. ADVANCED CRYPTOS. INT. CL. 9. REG. 12-1-1998.
- 2,206,830. QUICKTAGS. INT. CL. 9. REG. 12-1-1998.
- 2,206,831. STAG SIMPLE TERM +. INT. CL. 36. REG. 12-1-1998.
- 2,206,832. MOUNTAIN LAKE HIGH QUALITY APPAREL WITH A FEEL GOOD FIT. AND DESIGN. INT. CL. 25. REG. 12-1-1998.
- 2,206,835. TRUE AND DESIGN. INT. CL. 9. REG. 12-1-1998.
- 2,206,837. EQUEST. INT. CL. 42. REG. 12-1-1998.
- 2,206,838. THE FORMULA FOR THE FUTURE. INT. CL. 4. REG. 12-1-1998.
- 2,206,840. S. O. L. E. WARDROBE (STYLIZED). INT. CLS. 14 AND 25. REG. 12-1-1998.
- 2,206,841. OFFERING FRIENDLY ADVICE WITH A DOSE OF COMMON SENSE. INT. CL. 35. REG. 12-1-1998.
- 2,206,842. CORDON ROSE G.H. MUMM & CIE FIONDEE EN 1827 AND DESIGN. INT. CL. 33. REG. 12-1-1998.
- 2,206,843. ANSWERS FOR AMERICA. INT. CL. 35. REG. 12-1-1998.
- 2,206,845. START RIGHT. INT. CL. 8. REG. 12-1-1998.
- 2,206,846. WHEN PEOPLE MATTER AND RESULTS COUNT. INT. CL. 35. REG. 12-1-1998.
- 2,206,847. FIRST ONE LENDING CORPORATION AND DESIGN. INT. CL. 36. REG. 12-1-1998.
- 2,206,849. PLANT MATE. INT. CL. 21. REG. 12-1-1998.
- 2,206,850. MEDALIST TEK SERIES. INT. CL. 25. REG. 12-1-1998.
- 2,206,851. LOS FANTASMAS DEL CARIBE. INT. CL. 41. REG. 12-1-1998.
- 2,206,852. R AND DESIGN. INT. CLS. 35 AND 42. REG. 12-1-1998.
- 2,206,855. ALLOY PRECISION WELDING AND DESIGN. INT. CL. 40. REG. 12-1-1998.
- 2,206,856. 7 24 AND DESIGN. INT. CL. 42. REG. 12-1-1998.
- 2,206,858. FINE TUNING THE HEART TO WORSHIP. INT. CL. 41. REG. 12-1-1998.
- 2,206,860. AUCTION WORLD. INT. CL. 35. REG. 12-1-1998.
- 2,206,863. DATATECT PROVIDING TEST DATA SOLUTIONS AND DESIGN. INT. CL. 9. REG. 12-1-1998.
- 2,206,868. FRAGRANT. INT. CL. 9. REG. 12-1-1998.
- 2,206,870. ...YOUR CULTURAL MEDIATOR. INT. CL. 41. REG. 12-1-1998.
- 2,206,872. CCR COMMUNITY CARE RESOURCES, INC. AND DESIGN. INT. CL. 42. REG. 12-1-1998.
- 2,206,873. YOUR MOST VALUABLE NATURAL RESOURCE. INT. CL. 5. REG. 12-1-1998.
- 2,206,875. NORWEST EXPRESS TELEPHONE TRADING. INT. CL. 36. REG. 12-1-1998.
- 2,206,877. CHECKNOLOGY. INT. CL. 41. REG. 12-1-1998.
- 2,206,878. CRYOGENIC SOLUTIONS AND DESIGN. INT. CL. 40. REG. 12-1-1998.
- 2,206,879. ENVIRYX. INT. CL. 42. REG. 12-1-1998.
- 2,206,882. BILL & JUNE. INT. CL. 25. REG. 12-1-1998.
- 2,206,884. THE CRANE CONNECTION. INT. CL. 35. REG. 12-1-1998.
- 2,206,885. ALL SIGN AND DESIGN. INT. CL. 19. REG. 12-1-1998.
- 2,206,886. SMARTGLAS COMMANDER. INT. CL. 9. REG. 12-1-1998.
- 2,206,889. MACY'S TAP-O-MANIA. INT. CL. 41. REG. 12-1-1998.
- 2,206,892. GRIFFON. INT. CL. 13. REG. 12-1-1998.

- 2,206,895. BODYMAPPING. INT. CL. 41. REG. 12-1-1998.
2,206,898. LOOP RECYCLING, INC.. INT. CL. 40. REG. 12-1-1998.
2,206,901. COLLEGIATE BABY TRADITIONS-BEGINNING THE MEMORIES- AND DESIGN. INT. CL. 25. REG. 12-1-1998.
2,206,903. T TEXACO AND DESIGN. INT. CL. 25. REG. 12-1-1998.
2,206,907. LIFEGIFT AND DESIGN. INT. CLS. 41 AND 42. REG. 12-1-1998.
2,206,909. QUICK TEE. INT. CL. 28. REG. 12-1-1998.
2,206,910. AIG PERSONAL BENEFITS PROGRAM. INT. CL. 36. REG. 12-1-1998.
2,206,911. SEE. INT. CL. 16. REG. 12-1-1998.
2,206,916. DAPHNE'S GREEK CAFE AND DESIGN. INT. CL. 42. REG. 12-1-1998.
2,206,917. AS AND DESIGN. INT. CL. 36. REG. 12-1-1998.
2,206,918. DATAMIX. INT. CL. 35. REG. 12-1-1998.
2,206,919. DIATECH (STYLIZED). INT. CL. 12. REG. 12-1-1998.
2,206,920. MISCELLANEOUS DESIGN. INT. CL. 35. REG. 12-1-1998.
2,206,921. MOUNTAIN DELL. INT. CLS. 24 AND 27. REG. 12-1-1998.
2,206,924. SUREBRAKE. INT. CL. 12. REG. 12-1-1998.
2,206,925. THE LENDER'S LENDER. INT. CL. 36. REG. 12-1-1998.
2,206,926. FOX SPORTS ROCKY MTN AND DESIGN. INT. CL. 41. REG. 12-1-1998.
2,206,927. ACTION EQUIPMENT CO. INC. AND DESIGN. INT. CLS. 35 AND 37. REG. 12-1-1998.
2,206,928. EN KAWASAKI AND DESIGN. INT. CL. 12. REG. 12-1-1998.
2,206,930. FAIRBANKS AND DESIGN. INT. CL. 36. REG. 12-1-1998.
2,206,931. PC HOMEWORKS INC. AND DESIGN. INT. CLS. 41 AND 42. REG. 12-1-1998.
2,206,934. TWENTYELEVEN. INT. CL. 38. REG. 12-1-1998.
2,206,935. CREATIVE ERGONOMIC SYSTEMS, INC.. INT. CL. 7. REG. 12-1-1998.
2,206,937. BY NIGHT AND DESIGN. INT. CL. 35. REG. 12-1-1998.
2,206,939. SQUIBBUS. INT. CL. 9. REG. 12-1-1998.
2,206,940. CELL-U-RATOR. INT. CL. 35. REG. 12-1-1998.
2,206,941. JAMBOREE. INT. CL. 15. REG. 12-1-1998.
2,206,942. JUBILEE. INT. CL. 15. REG. 12-1-1998.
2,206,944. KINKYCONTACTS. INT. CL. 35. REG. 12-1-1998.
2,206,945. AMERICAN BEAUTY. INT. CL. 20. REG. 12-1-1998.
2,206,947. CYBER SNACKS (STYLIZED). INT. CL. 9. REG. 12-1-1998.
2,206,948. EXPENSE STATION. INT. CL. 9. REG. 12-1-1998.
2,206,949. HIDETEC. INT. CL. 9. REG. 12-1-1998.
2,206,950. EXPENSE CENTRAL. INT. CL. 9. REG. 12-1-1998.
2,206,952. AUTO TRACKS. INT. CL. 42. REG. 12-1-1998.
2,206,954. AXLEMASTER. INT. CL. 9. REG. 12-1-1998.
2,206,956. BRIGHT IDEA. INT. CL. 11. REG. 12-1-1998.
2,206,957. ALPHAPHOT. INT. CL. 9. REG. 12-1-1998.
2,206,958. CAVANAUGH'S. INT. CL. 42. REG. 12-1-1998.
2,206,959. VANTAGEPOINT. INT. CL. 9. REG. 12-1-1998.
2,206,960. LEGENDARY HEADWEAR AND DESIGN. INT. CL. 25. REG. 12-1-1998.
2,206,961. CHECK 2000 CLIENT SERVER. INT. CL. 9. REG. 12-1-1998.
2,206,963. 3494 AL. INT. CL. 14. REG. 12-1-1998.
2,206,964. HOOK IT ALL AND DESIGN. INT. CL. 6. REG. 12-1-1998.
2,206,965. NEW YORK IS BOOK COUNTRY. INT. CL. 41. REG. 12-1-1998.
2,206,966. THE ADVOCATE. INT. CL. 16. REG. 12-1-1998.
2,206,968. GREAT MAP. INT. CL. 41. REG. 12-1-1998.
2,206,969. SCANVEC. INT. CL. 9. REG. 12-1-1998.
2,206,973. PAINT THE TOWN. INT. CL. 41. REG. 12-1-1998.
2,206,976. PINK BEAVER ATRAXIONWEAR AND DESIGN. INT. CL. 25. REG. 12-1-1998.
2,206,977. PRINTS CHARMING INTERIOR FABRICS CUSTOM FABRICATIONS AND DESIGN. INT. CLS. 20 AND 24. REG. 12-1-1998.
2,206,978. BEACON. INT. CL. 9. REG. 12-1-1998.
2,206,979. ARAMARK FIVE STAR SERVICE AND DESIGN. INT. CL. 35. REG. 12-1-1998.
2,206,980. CENTEX LIFE SOLUTIONS AND DESIGN. INT. CLS. 35, 41 AND 42. REG. 12-1-1998.
2,206,981. BASIN (STYLIZED). INT. CL. 35. REG. 12-1-1998.
2,206,984. DEMOS MAKING A DIFFERENCE. INT. CL. 35. REG. 12-1-1998.
2,206,986. CRAZY CAREERS. INT. CL. 41. REG. 12-1-1998.
2,206,992. TV BEAR. INT. CL. 20. REG. 12-1-1998.
2,206,994. MISCELLANEOUS DESIGN. INT. CL. 35. REG. 12-1-1998.
2,206,997. ACE THE CURE TOUR (STYLIZED). INT. CL. 41. REG. 12-1-1998.
2,206,998. STORK AVENUE AND DESIGN. INT. CL. 35. REG. 12-1-1998.
2,207,001. YOWAY. INT. CL. 25. REG. 12-1-1998.
2,207,002. CRAFT SHIELD. INT. CL. 1. REG. 12-1-1998.
2,207,003. DIVERGAN. INT. CL. 1. REG. 12-1-1998.
2,207,004. MORPHMODELER (STYLIZED). INT. CL. 9. REG. 12-1-1998.
2,207,007. SUDDEN-SET. INT. CL. 19. REG. 12-1-1998.
2,207,008. GLAZES A CERAMICS WORKSHOP AND DESIGN. INT. CL. 41. REG. 12-1-1998.
2,207,009. WILSON COMBAT. INT. CL. 13. REG. 12-1-1998.
2,207,010. MATT'S FAMOUS CHILI DOGS AND DESIGN. INT. CL. 42. REG. 12-1-1998.
2,207,015. FACILICARE. INT. CLS. 36 AND 37. REG. 12-1-1998.
2,207,016. PLANTING TREES TO LET THE EARTH BREATHE A LITTLE EASIER. INT. CL. 42. REG. 12-1-1998.
2,207,017. DBS-5000. INT. CL. 9. REG. 12-1-1998.
2,207,018. PLANT A TREE PROJECT OF ILLINOIS, INC. AND DESIGN. INT. CL. 42. REG. 12-1-1998.
2,207,020. THE PRODIGALS. INT. CL. 41. REG. 12-1-1998.
2,207,022. BAYTENDER AND DESIGN. INT. CL. 12. REG. 12-1-1998.
2,207,023. FASTBLAST. INT. CL. 9. REG. 12-1-1998.
2,207,024. REGULATION SEEKER. INT. CL. 9. REG. 12-1-1998.
2,207,026. MICROLAW INC THE LEGAL SOFTWARE BUILDERS. AND DESIGN. INT. CL. 42. REG. 12-1-1998.
2,207,032. AIM AND DESIGN. INT. CL. 41. REG. 12-1-1998.
2,207,035. WINSTON & CASHATT, LAWYERS, A PROFESSIONAL SERVICE CORPORATION. INT. CL. 42. REG. 12-1-1998.
2,207,036. ACUWIN. INT. CL. 9. REG. 12-1-1998.
2,207,038. LAPSHADE. INT. CL. 9. REG. 12-1-1998.
2,207,039. PURGE. INT. CL. 41. REG. 12-1-1998.
2,207,040. 360 ALL-WHEEL DRIVE AND DESIGN. INT. CL. 18. REG. 12-1-1998.
2,207,041. JOIN THE PARADE. INT. CL. 35. REG. 12-1-1998.
2,207,042. LAURA GELLER (STYLIZED). INT. CLS. 3 AND 41. REG. 12-1-1998.
2,207,043. TARGETSMART!. INT. CL. 9. REG. 12-1-1998.
2,207,044. STABILITY INTEGRITY SOLUTIONS AND DESIGN. INT. CL. 36. REG. 12-1-1998.
2,207,045. OMNIREL. INT. CL. 9. REG. 12-1-1998.
2,207,046. KC PLACE. INT. CL. 41. REG. 12-1-1998.
2,207,047. KEYPRISM. INT. CL. 36. REG. 12-1-1998.
2,207,049. CDIRECTORY (STYLIZED). INT. CL. 9. REG. 12-1-1998.
2,207,052. MIAMI STRING QUARTET. INT. CL. 41. REG. 12-1-1998.
2,207,053. WELLESLEY CLUB. INT. CL. 42. REG. 12-1-1998.
2,207,055. APS. INT. CL. 42. REG. 12-1-1998.
2,207,056. IQ 140. INT. CL. 7. REG. 12-1-1998.
2,207,060. WONDERDRUG. INT. CL. 9. REG. 12-1-1998.
2,207,061. CLASSIFIED CONNECTION. INT. CL. 35. REG. 12-1-1998.
2,207,063. ONE FOR THE ROAD. INT. CL. 39. REG. 12-1-1998.
2,207,069. PLANLINK. INT. CL. 35. REG. 12-1-1998.
2,207,071. MAXXNET. INT. CL. 36. REG. 12-1-1998.
2,207,074. LA YOUTH AND DESIGN. INT. CL. 16. REG. 12-1-1998.

- 2,207,079. LAZY RANCH AND DESIGN. INT. CL. 14. REG. 12-1-1998.
- 2,207,080. PRO-CUBE. INT. CL. 9. REG. 12-1-1998.
- 2,207,081. REUTERS (STYLIZED). INT. CLS. 9, 16, 35, 36, 37, 38 AND 42. REG. 12-1-1998.
- 2,207,082. PANALERT. INT. CL. 9. REG. 12-1-1998.
- 2,207,083. L-SAC. INT. CLS. 9 AND 35. REG. 12-1-1998.
- 2,207,084. ECLER AND DESIGN. INT. CL. 20. REG. 12-1-1998.
- 2,207,085. PPH AND DESIGN. INT. CL. 42. REG. 12-1-1998.
- 2,207,087. RACE. INT. CLS. 7 AND 9. REG. 12-1-1998.
- 2,207,097. GOOD THING NOAH LISTENED.. INT. CL. 38. REG. 12-1-1998.
- 2,207,098. WISE MEN STILL LISTEN.. INT. CL. 38. REG. 12-1-1998.
- 2,207,101. STYLEX. INT. CL. 20. REG. 12-1-1998.
- 2,207,106. SOFT FEEL. INT. CL. 3. REG. 12-1-1998.
- 2,207,110. COUNT ON CORNING FIBER AND DESIGN. INT. CL. 9. REG. 12-1-1998.
- 2,207,111. VIBAX. INT. CL. 16. REG. 12-1-1998.
- 2,207,114. LAUREN HANSEN KIDS. INT. CL. 25. REG. 12-1-1998.
- 2,207,122. SOFT SIZE. INT. CL. 3. REG. 12-1-1998.
- 2,207,124. TIEONCE AND DESIGN. INT. CL. 9. REG. 12-1-1998.
- 2,207,127. CAREGARD. INT. CL. 9. REG. 12-1-1998.
- 2,207,129. CRYSTAL CLEAR SOLUTIONS. INT. CL. 9. REG. 12-1-1998.
- 2,207,130. ANT. INT. CL. 8. REG. 12-1-1998.
- 2,207,131. TECHRITE. INT. CL. 35. REG. 12-1-1998.
- 2,207,133. MKO MAN. INT. CL. 25. REG. 12-1-1998.
- 2,207,134. BUNGEE BLAST. INT. CL. 28. REG. 12-1-1998.
- 2,207,135. SOUTH BEND SILVER HAWKS AND DESIGN. INT. CLS. 16 AND 25. REG. 12-1-1998.
- 2,207,138. AZECCULA. INT. CL. 24. REG. 12-1-1998.
- 2,207,141. ZENGER MILLER AND DESIGN. INT. CL. 9. REG. 12-1-1998.
- 2,207,142. THE TECHNOLOGY OF INNER FREEDOM. INT. CL. 41. REG. 12-1-1998.
- 2,207,145. NO (STYLIZED). INT. CL. 25. REG. 12-1-1998.
- 2,207,149. GLOBAL PURGE. INT. CL. 1. REG. 12-1-1998.
- 2,207,151. Z KID ZEVO AND DESIGN. INT. CL. 25. REG. 12-1-1998.
- 2,207,152. TASKLINK. INT. CL. 9. REG. 12-1-1998.
- 2,207,153. WHAT YOUR HEROES WORE. INT. CL. 25. REG. 12-1-1998.
- 2,207,155. THE ZOO AND DESIGN. INT. CL. 41. REG. 12-1-1998.
- 2,207,156. SLEEK & CHIC. INT. CL. 3. REG. 12-1-1998.
- 2,207,157. INSPECTASCOPE. INT. CL. 42. REG. 12-1-1998.
- 2,207,160. PIXEL PUSHER (STYLIZED). INT. CL. 42. REG. 12-1-1998.
- 2,207,161. ALYWEAR AND DESIGN. INT. CL. 25. REG. 12-1-1998.
- 2,207,163. MUSTANG. INT. CL. 9. REG. 12-1-1998.
- 2,207,164. AQUA BRONZE AND DESIGN. INT. CL. 40. REG. 12-1-1998.
- 2,207,165. PROPRIETOR'S CLUB. INT. CL. 42. REG. 12-1-1998.
- 2,207,170. EL GUAJIRO. INT. CL. 34. REG. 12-1-1998.
- 2,207,173. MISCELLANEOUS DESIGN. INT. CL. 35. REG. 12-1-1998.
- 2,207,174. DID YOU KNOW THEME PAKS. INT. CL. 16. REG. 12-1-1998.
- 2,207,175. EQUIPOLAR AND DESIGN. INT. CL. 18. REG. 12-1-1998.
- 2,207,176. CHILLMASTER. INT. CL. 25. REG. 12-1-1998.
- 2,207,178. PUTTING THE CUSTOMER AT THE CENTER OF THE ENTERPRISE. INT. CL. 35. REG. 12-1-1998.
- 2,207,180. DAA. INT. CL. 35. REG. 12-1-1998.
- 2,207,183. NEOMUSK. INT. CL. 1. REG. 12-1-1998.
- 2,207,185. YOUR HEALTH IS OUR PRIMARY CARE!. INT. CL. 42. REG. 12-1-1998.
- 2,207,187. ASIAN EXPRESSIONS AND DESIGN. INT. CL. 16. REG. 12-1-1998.
- 2,207,188. SNOOPY ETC.. INT. CL. 35. REG. 12-1-1998.
- 2,207,189. HOW CAN WE BE SO OLD AND MOVE SO FAST?. INT. CL. 36. REG. 12-1-1998.
- 2,207,190. PATTERSON, BELL & CRANE. INT. CL. 36. REG. 12-1-1998.
- 2,207,191. EXCLUSIVELY MISOOK. INT. CL. 25. REG. 12-1-1998.
- 2,207,192. QUILT GARD (STYLIZED). INT. CL. 1. REG. 12-1-1998.
- 2,207,193. BEST YEARS. INT. CL. 42. REG. 12-1-1998.
- 2,207,194. FIU AND DESIGN. INT. CL. 16. REG. 12-1-1998.
- 2,207,195. BRIDAL WORKS. INT. CL. 14. REG. 12-1-1998.
- 2,207,197. AROMA QUIT AND DESIGN. INT. CL. 5. REG. 12-1-1998.
- 2,207,198. ST. GEORGE SGP AND DESIGN. INT. CL. 41. REG. 12-1-1998.
- 2,207,201. OCULUS AND DESIGN. INT. CL. 41. REG. 12-1-1998.
- 2,207,202. SALT CREEK. INT. CL. 35. REG. 12-1-1998.
- 2,207,205. SAFESKIN 2000. INT. CL. 10. REG. 12-1-1998.
- 2,207,206. ASTROLOGICAL TRIBUTES AND DESIGN. INT. CL. 16. REG. 12-1-1998.
- 2,207,207. COMMUNITYCARE. INT. CL. 36. REG. 12-1-1998.
- 2,207,210. TERRIFIC TRIANGLES. INT. CL. 28. REG. 12-1-1998.
- 2,207,218. NATIONAL ETHANOL VEHICLE COALITION 85 AND DESIGN. INT. CL. 42. REG. 12-1-1998.
- 2,207,219. PICO DUARTE. INT. CL. 34. REG. 12-1-1998.
- 2,207,221. STEROX. INT. CL. 1. REG. 12-1-1998.
- 2,207,222. DIABETIMULTI. INT. CL. 5. REG. 12-1-1998.
- 2,207,224. VISCO ELASTIC FIT. INT. CL. 28. REG. 12-1-1998.
- 2,207,225. UNWRAP A WORLD OF FUN & FASCINATION. INT. CL. 35. REG. 12-1-1998.
- 2,207,227. TURBO ACCESS. INT. CL. 38. REG. 12-1-1998.
- 2,207,230. EVOLV. INT. CL. 35. REG. 12-1-1998.
- 2,207,234. GOOD BOOK PROGRAM BY PAGES AND DESIGN. INT. CL. 35. REG. 12-1-1998.
- 2,207,237. RUBY CRYSTAL. INT. CL. 8. REG. 12-1-1998.
- 2,207,239. CROC TALES. INT. CL. 16. REG. 12-1-1998.
- 2,207,240. IMMUNOPOWER. INT. CL. 5. REG. 12-1-1998.
- 2,207,241. MISCELLANEOUS DESIGN. INT. CL. 25. REG. 12-1-1998.
- 2,207,242. PRIMO AND DESIGN. INT. CL. 28. REG. 12-1-1998.
- 2,207,244. MEDOPTIONS AND DESIGN. INT. CL. 42. REG. 12-1-1998.
- 2,207,245. SYNERGY. INT. CL. 28. REG. 12-1-1998.
- 2,207,246. MAXXINVEST. INT. CL. 36. REG. 12-1-1998.
- 2,207,248. EYE TO EYE COMMUNICATIONS. INT. CL. 41. REG. 12-1-1998.
- 2,207,249. FROM YOUR DESKTOP TO YOUR TABLETOP!. INT. CL. 35. REG. 12-1-1998.
- 2,207,250. THE HI SIGN. INT. CL. 16. REG. 12-1-1998.
- 2,207,257. THE NEWS OUR DEALERS NEED TO KNOW. INT. CL. 16. REG. 12-1-1998.
- 2,207,258. THE FRONTLINES. INT. CL. 16. REG. 12-1-1998.
- 2,207,259. LUMI-HAIR. INT. CL. 3. REG. 12-1-1998.
- 2,207,261. CHOCO BRAILLE. INT. CL. 30. REG. 12-1-1998.
- 2,207,263. HOWLIN' WOLF BLUES SOCIETY WEST POINT, MISSISSIPPI AND DESIGN. INT. CL. 41. REG. 12-1-1998.
- 2,207,265. NOSTALGIE. INT. CL. 29. REG. 12-1-1998.
- 2,207,268. SMALLBIZNOTES. INT. CL. 42. REG. 12-1-1998.
- 2,207,272. RT THE TECHNOLOGY MAGAZINE FOR RETAIL EXECUTIVES AND DESIGN. INT. CL. 16. REG. 12-1-1998.
- 2,207,274. NATURAL BUILDING MAINTENANCE CORPORATION. INT. CL. 37. REG. 12-1-1998.
- 2,207,276. ACCESS CENTER AND DESIGN. INT. CL. 42. REG. 12-1-1998.
- 2,207,277. NATURE THINGS (STYLIZED). INT. CL. 16. REG. 12-1-1998.
- 2,207,278. NO (STYLIZED). INT. CL. 18. REG. 12-1-1998.
- 2,207,285. GALERIE DE CARTE AND DESIGN. INT. CL. 16. REG. 12-1-1998.
- 2,207,287. MISCELLANEOUS DESIGN. INT. CL. 42. REG. 12-1-1998.
- 2,207,290. SHED A LITTLE LIGHT ON THE SEASON. INT. CL. 42. REG. 12-1-1998.

- 2,207,292. MISCELLANEOUS DESIGN. INT. CL. 16. REG. 12-1-1998.
- 2,207,293. PEAK PROFITS. INT. CL. 16. REG. 12-1-1998.
- 2,207,294. BLACK SNAKE. INT. CL. 28. REG. 12-1-1998.
- 2,207,296. HIMCO INSTITUTIONAL ADVISORS. INT. CL. 36. REG. 12-1-1998.
- 2,207,297. LEARNINGSTATION.COM. INT. CL. 42. REG. 12-1-1998.
- 2,207,298. SIR RENTSALOT. INT. CL. 42. REG. 12-1-1998.
- 2,207,301. FIRSTLINE. INT. CL. 16. REG. 12-1-1998.
- 2,207,302. SHOP*MINDERS. INT. CL. 16. REG. 12-1-1998.
- 2,207,304. THE TECHNOLOGY OF PEOPLE. INT. CL. 35. REG. 12-1-1998.
- 2,207,307. PCI AND DESIGN. INT. CL. 3. REG. 12-1-1998.
- 2,207,308. OCG AND DESIGN. INT. CLS. 16 AND 42. REG. 12-1-1998.
- 2,207,310. SAMBA UNZIPPED (STYLIZED). INT. CL. 3. REG. 12-1-1998.
- 2,207,311. TRADE WEST, INC.. INT. CLS. 3 AND 28. REG. 12-1-1998.
- 2,207,312. PCA PORTRAIT ADVANTAGE. INT. CL. 42. REG. 12-1-1998.
- 2,207,313. CAFE NOSTALGIA. INT. CL. 42. REG. 12-1-1998.
- 2,207,314. THERE'S A REASON PEOPLE LEASE HERE. INT. CL. 36. REG. 12-1-1998.
- 2,207,317. FLYCASTING AND DESIGN. INT. CL. 35. REG. 12-1-1998.
- 2,207,319. GEORGE STUDEN. INT. CL. 28. REG. 12-1-1998.
- 2,207,322. FRIED NERVE ENDINGS. INT. CL. 30. REG. 12-1-1998.
- 2,207,323. DRIVE YOU WACKY. INT. CL. 28. REG. 12-1-1998.
- 2,207,325. SOCRATES. INT. CL. 35. REG. 12-1-1998.
- 2,207,326. THE BENEFITS KEEP ADDING UP. INT. CL. 36. REG. 12-1-1998.
- 2,207,330. FITTING WORDS. INT. CL. 16. REG. 12-1-1998.
- 2,207,334. SKYLIGHT. INT. CLS. 3 AND 4. REG. 12-1-1998.
- 2,207,335. FIVE STAR. INT. CL. 18. REG. 12-1-1998.
- 2,207,337. SAY YES TO A YOUNGSTER'S FUTURE. INT. CL. 42. REG. 12-1-1998.
- 2,207,338. THE HEART OF CREATIVE SCRAPBOOKING. INT. CL. 16. REG. 12-1-1998.
- 2,207,341. COMMERCIAL ADVANTAGE. INT. CL. 36. REG. 12-1-1998.
- 2,207,346. EQUITY PROTECTION. INT. CL. 42. REG. 12-1-1998.
- 2,207,353. DAVID HR. INT. CL. 35. REG. 12-1-1998.
- 2,207,357. PANGAEA. INT. CL. 38. REG. 12-1-1998.
- 2,207,360. 2ND GLOBE (STYLIZED). INT. CL. 40. REG. 12-1-1998.
- 2,207,363. CHILLI PEPPERS. INT. CL. 42. REG. 12-1-1998.
- 2,207,367. TELEVISION CITY. INT. CL. 25. REG. 12-1-1998.
- 2,207,368. LOVE YOUR BATH. INT. CL. 3. REG. 12-1-1998.
- 2,207,370. SHAREABLES. INT. CL. 28. REG. 12-1-1998.
- 2,207,371. VETGENIX (STYLIZED). INT. CLS. 3 AND 5. REG. 12-1-1998.
- 2,207,372. CTI. INT. CLS. 35 AND 41. REG. 12-1-1998.
- 2,207,374. PROXIMITY. INT. CL. 9. REG. 12-1-1998.
- 2,207,377. EYEBALL IT!. INT. CL. 16. REG. 12-1-1998.
- 2,207,378. SHELF SENSE AND DESIGN. INT. CL. 35. REG. 12-1-1998.
- 2,207,379. LAPRYDER. INT. CL. 20. REG. 12-1-1998.
- 2,207,380. SMARTOUCH. INT. CL. 9. REG. 12-1-1998.
- 2,207,381. THE CLAMP. INT. CL. 12. REG. 12-1-1998.
- 2,207,383. LADY BEAR. INT. CL. 25. REG. 12-1-1998.
- 2,207,386. BLVD MFG. AND DESIGN. INT. CL. 28. REG. 12-1-1998.
- 2,207,387. EPXPRESS. INT. CL. 10. REG. 12-1-1998.
- 2,207,388. COMMUNICAP. INT. CL. 9. REG. 12-1-1998.
- 2,207,390. TOUR IMPACT. INT. CL. 28. REG. 12-1-1998.
- 2,207,394. BACKSTAGE. INT. CL. 36. REG. 12-1-1998.
- 2,207,395. SAHZA AUTENTICO FEMMINILE AND DESIGN. INT. CL. 25. REG. 12-1-1998.
- 2,207,396. MONEY TESTER AND DESIGN. INT. CL. 16. REG. 12-1-1998.
- 2,207,397. THE URGE. INT. CL. 28. REG. 12-1-1998.
- 2,207,398. ZESTABS. INT. CL. 5. REG. 12-1-1998.
- 2,207,399. LASEREXTRA. INT. CL. 16. REG. 12-1-1998.
- 2,207,400. INKJETEXTRA. INT. CL. 16. REG. 12-1-1998.
- 2,207,401. CARE FROM OFFICEMATE. INT. CL. 9. REG. 12-1-1998.
- 2,207,402. FIRETEMP. INT. CL. 4. REG. 12-1-1998.
- 2,207,404. HEADGEAR. INT. CL. 9. REG. 12-1-1998.
- 2,207,407. GSI. INT. CL. 9. REG. 12-1-1998.
- 2,207,408. ACUNET. INT. CL. 36. REG. 12-1-1998.
- 2,207,412. A/E/C EXECUTIVE TALENTBANK. INT. CL. 35. REG. 12-1-1998.
- 2,207,413. SWS SAFETY WARNING SYSTEM AND DESIGN. INT. CL. 9. REG. 12-1-1998.
- 2,207,415. CLUSTERCONNECT. INT. CL. 9. REG. 12-1-1998.
- 2,207,417. ICCI (STYLIZED). INT. CL. 25. REG. 12-1-1998.
- 2,207,419. PERFORMANCE V AND DESIGN. INT. CL. 7. REG. 12-1-1998.
- 2,207,420. SANTA'S SIGNATURE. INT. CL. 11. REG. 12-1-1998.
- 2,207,421. QUALICON. INT. CL. 9. REG. 12-1-1998.
- 2,207,422. SEMIPOWER. INT. CL. 42. REG. 12-1-1998.
- 2,207,423. INFOSYNERGY. INT. CL. 9. REG. 12-1-1998.
- 2,207,427. HIROSE HOOK AND DESIGN. INT. CL. 7. REG. 12-1-1998.
- 2,207,428. SCA. INT. CL. 9. REG. 12-1-1998.
- 2,207,430. PUTTING THE WEB TO WORK. INT. CL. 9. REG. 12-1-1998.
- 2,207,433. LUV AT FIRST BITE AND DESIGN. INT. CL. 28. REG. 12-1-1998.
- 2,207,438. SOUND FLOOD. INT. CL. 9. REG. 12-1-1998.
- 2,207,440. OEM-PTS. INT. CL. 9. REG. 12-1-1998.
- 2,207,443. FORE. INT. CL. 28. REG. 12-1-1998.
- 2,207,444. THE FAT FISH TRADING COMPANY ESTABLISHED 1996 AND DESIGN. INT. CL. 42. REG. 12-1-1998.
- 2,207,445. EXTRA!. INT. CL. 42. REG. 12-1-1998.
- 2,207,448. PLUS BOARDWARE. INT. CL. 9. REG. 12-1-1998.
- 2,207,457. ST. LOUIS STING AND DESIGN. INT. CL. 28. REG. 12-1-1998.
- 2,207,458. ST. LOUIS STING AND DESIGN. INT. CL. 25. REG. 12-1-1998.
- 2,207,460. INSIDE NASHVILLE. INT. CL. 41. REG. 12-1-1998.
- 2,207,462. BAD RAP. INT. CL. 28. REG. 12-1-1998.
- 2,207,463. EXOPLANE. INT. CL. 9. REG. 12-1-1998.
- 2,207,464. IMMINENT TECHNOLOGIES. INT. CL. 28. REG. 12-1-1998.
- 2,207,465. MISCELLANEOUS DESIGN. INT. CL. 42. REG. 12-1-1998.
- 2,207,467. STOLEN SONG. INT. CL. 9. REG. 12-1-1998.
- 2,207,469. INTERMIND COMMUNICATOR. INT. CL. 42. REG. 12-1-1998.
- 2,207,472. DEATH RALLY. INT. CL. 9. REG. 12-1-1998.
- 2,207,474. SEOS SECURED! AND DESIGN. INT. CL. 9. REG. 12-1-1998.
- 2,207,476. WILDFIRE AND DESIGN. INT. CL. 25. REG. 12-1-1998.
- 2,207,479. TEAM GLORY (STYLIZED). INT. CL. 25. REG. 12-1-1998.
- 2,207,480. TRACERS. INT. CL. 16. REG. 12-1-1998.
- 2,207,481. PRESCRIPTION FOR EDUCATION. INT. CL. 35. REG. 12-1-1998.
- 2,207,483. FIRST PRIZE. INT. CL. 19. REG. 12-1-1998.
- 2,207,485. EXPRESSXTRA. INT. CL. 9. REG. 12-1-1998.
- 2,207,486. CRYOTEST. INT. CL. 9. REG. 12-1-1998.
- 2,207,487. FLIGHT PATTERNS. INT. CL. 37. REG. 12-1-1998.
- 2,207,488. REGALO. INT. CL. 12. REG. 12-1-1998.
- 2,207,489. HITUG. INT. CL. 41. REG. 12-1-1998.
- 2,207,495. CLOG BUSTERS. INT. CL. 5. REG. 12-1-1998.
- 2,207,498. SORENSON VISION. INT. CL. 9. REG. 12-1-1998.
- 2,207,501. ZERO. INT. CL. 28. REG. 12-1-1998.
- 2,207,503. SLIMMING BANDS. INT. CL. 25. REG. 12-1-1998.
- 2,207,504. SONGS YOU KNOW BY HEART. INT. CL. 9. REG. 12-1-1998.
- 2,207,506. CIGAR MANIA. INT. CL. 34. REG. 12-1-1998.
- 2,207,507. E ECLIPSE SURGICAL TECHNOLOGIES AND DESIGN. INT. CL. 10. REG. 12-1-1998.
- 2,207,509. OCTAPAD. INT. CL. 17. REG. 12-1-1998.
- 2,207,510. 12 STARS. INT. CL. 34. REG. 12-1-1998.
- 2,207,511. MRFA. INT. CL. 16. REG. 12-1-1998.

- 2,207,513. MANAGED APPROACH. INT. CL. 36. REG. 12-1-1998.
- 2,207,515. DISCOVERY SCIENCE CHANNEL AND DESIGN. INT. CLS. 38 AND 41. REG. 12-1-1998.
- 2,207,516. MIDA CUP. INT. CL. 41. REG. 12-1-1998.
- 2,207,517. FEATHERLITE. INT. CL. 11. REG. 12-1-1998.
- 2,207,521. SUCK. INT. CL. 25. REG. 12-1-1998.
- 2,207,524. VISUALPING. INT. CL. 9. REG. 12-1-1998.
- 2,207,525. CMYK. INT. CL. 28. REG. 12-1-1998.
- 2,207,527. THE NATURAL. INT. CL. 28. REG. 12-1-1998.
- 2,207,528. HIMAX. INT. CL. 9. REG. 12-1-1998.
- 2,207,529. HIKARI. INT. CL. 9. REG. 12-1-1998.
- 2,207,530. FUN TIME. INT. CL. 41. REG. 12-1-1998.
- 2,207,531. POWER CUBE. INT. CL. 41. REG. 12-1-1998.
- 2,207,532. RAINBOW. INT. CL. 9. REG. 12-1-1998.
- 2,207,534. MANOR COLLECTION. INT. CL. 20. REG. 12-1-1998.
- 2,207,537. DANCE SPORT DANCE-O-RAMA. INT. CL. 41. REG. 12-1-1998.
- 2,207,539. AUDACITY RECORDS. INT. CL. 9. REG. 12-1-1998.
- 2,207,540. DECOCAP (STYLIZED). INT. CL. 20. REG. 12-1-1998.
- 2,207,541. VENTCORP "WE CLEAN YOUR AIR FOR HEALTH" AND DESIGN. INT. CL. 37. REG. 12-1-1998.
- 2,207,542. MICHAEL MIMS/KATHY COLE. INT. CL. 25. REG. 12-1-1998.
- 2,207,545. READY RIDGE. INT. CL. 19. REG. 12-1-1998.
- 2,207,547. SURISILK. INT. CL. 22. REG. 12-1-1998.
- 2,207,548. LAW STUFF. INT. CL. 35. REG. 12-1-1998.
- 2,207,549. I JESUS AND DESIGN. INT. CL. 25. REG. 12-1-1998.
- 2,207,550. ASTHMA TREATMENT CENTERS OF AMERICA AND DESIGN. INT. CL. 42. REG. 12-1-1998.
- 2,207,551. RHEOTHERAPY. INT. CL. 42. REG. 12-1-1998.
- 2,207,552. TRUECHANGE (STYLIZED). INT. CL. 9. REG. 12-1-1998.
- 2,207,554. MISCELLANEOUS DESIGN. INT. CL. 42. REG. 12-1-1998.
- 2,207,555. HIGH FLIGHT. INT. CL. 9. REG. 12-1-1998.
- 2,207,556. Q2000. INT. CL. 9. REG. 12-1-1998.
- 2,207,557. THE FRAGRANCE OF POSSIBILITIES. INT. CL. 3. REG. 12-1-1998.
- 2,207,559. SALON CHYMIST. INT. CL. 3. REG. 12-1-1998.
- 2,207,563. EGDIO. INT. CLS. 35 AND 42. REG. 12-1-1998.
- 2,207,565. WEATHER PROTECTORS BY TOTES. INT. CL. 3. REG. 12-1-1998.
- 2,207,566. WE GOT NEXT. INT. CL. 41. REG. 12-1-1998.
- 2,207,567. UMAX AND DESIGN. INT. CL. 9. REG. 12-1-1998.
- 2,207,571. SIGNSAVER. INT. CL. 20. REG. 12-1-1998.
- 2,207,580. LIP RENU (STYLIZED). INT. CL. 3. REG. 12-1-1998.
- 2,207,582. THE WISER WAY. INT. CL. 9. REG. 12-1-1998.
- 2,207,583. SIMPLIFIER AND DESIGN. INT. CL. 9. REG. 12-1-1998.
- 2,207,585. Q911. INT. CL. 7. REG. 12-1-1998.
- 2,207,586. REALITY RECIPE. INT. CL. 16. REG. 12-1-1998.
- 2,207,588. VITA-LOG. INT. CL. 9. REG. 12-1-1998.
- 2,207,590. ZYLOS. INT. CL. 42. REG. 12-1-1998.
- 2,207,591. KEEP RIGHT. INT. CL. 25. REG. 12-1-1998.
- 2,207,595. MEMORY MAKERS. INT. CL. 20. REG. 12-1-1998.
- 2,207,597. INTERBOND. INT. CL. 3. REG. 12-1-1998.
- 2,207,599. POWER RIDER. INT. CL. 28. REG. 12-1-1998.
- 2,207,602. VENDOR VIEW. INT. CL. 9. REG. 12-1-1998.
- 2,207,603. MEDIAONE. INT. CLS. 9, 14, 16, 21, 25 AND 28. REG. 12-1-1998.
- 2,207,604. OMNIVIEW GALAXY. INT. CL. 9. REG. 12-1-1998.
- 2,207,605. RARE RUBIES. INT. CL. 3. REG. 12-1-1998.
- 2,207,606. SCRAPMASTER. INT. CL. 9. REG. 12-1-1998.
- 2,207,607. PERSONALITEASE. INT. CL. 28. REG. 12-1-1998.
- 2,207,608. EXPERIENCE THE FINISH. INT. CL. 2. REG. 12-1-1998.
- 2,207,611. THOUGHTS FROM THE HEART. INT. CL. 4. REG. 12-1-1998.
- 2,207,613. VENT. INT. CL. 16. REG. 12-1-1998.
- 2,207,614. VENT. INT. CL. 42. REG. 12-1-1998.
- 2,207,616. IMS/21. INT. CL. 9. REG. 12-1-1998.
- 2,207,622. SHOP-TEK. INT. CLS. 3, 7, 8 AND 9. REG. 12-1-1998.
- 2,207,623. SCHOOL IS COOL. INT. CL. 41. REG. 12-1-1998.
- 2,207,624. BREADMAKER'S HEARTH. INT. CL. 11. REG. 12-1-1998.
- 2,207,627. PANAFEST. INT. CL. 6. REG. 12-1-1998.
- 2,207,628. THINKKORPORATED (STYLIZED). INT. CLS. 16 AND 41. REG. 12-1-1998.
- 2,207,629. JALAZA. INT. CL. 25. REG. 12-1-1998.
- 2,207,630. PALLET JACKET. INT. CL. 22. REG. 12-1-1998.
- 2,207,631. MISCELLANEOUS DESIGN. INT. CL. 25. REG. 12-1-1998.
- 2,207,633. MATERNITY MOMENTS. INT. CL. 36. REG. 12-1-1998.
- 2,207,635. LES ROUGES ROMANTIQUES. INT. CL. 3. REG. 12-1-1998.
- 2,207,636. MISCELLANEOUS DESIGN. INT. CL. 14. REG. 12-1-1998.
- 2,207,641. INFOCOLLECT. INT. CL. 35. REG. 12-1-1998.
- 2,207,642. ATOMIC. INT. CL. 3. REG. 12-1-1998.
- 2,207,644. MISCELLANEOUS DESIGN. INT. CL. 41. REG. 12-1-1998.
- 2,207,645. MISCELLANEOUS DESIGN. INT. CL. 25. REG. 12-1-1998.
- 2,207,649. BEAM. INT. CL. 41. REG. 12-1-1998.
- 2,207,650. DISCOVERY. INT. CL. 16. REG. 12-1-1998.
- 2,207,653. INSURE + + AND DESIGN. INT. CL. 9. REG. 12-1-1998.
- 2,207,657. BUILT ON BEA AND DESIGN. INT. CL. 9. REG. 12-1-1998.
- 2,207,658. SPINELINE. INT. CL. 42. REG. 12-1-1998.
- 2,207,660. BUILT ON BEA. INT. CL. 9. REG. 12-1-1998.
- 2,207,661. ENVIR-IMINT (STYLIZED). INT. CL. 42. REG. 12-1-1998.
- 2,207,662. STERL. INT. CL. 9. REG. 12-1-1998.
- 2,207,663. ST JOHN SMARTSTEPS. INT. CL. 42. REG. 12-1-1998.
- 2,207,664. BUMP & BUST OUT. INT. CL. 28. REG. 12-1-1998.
- 2,207,668. IMAGINUMS. INT. CL. 28. REG. 12-1-1998.
- 2,207,673. THE TRAVELING HERBALIST. INT. CL. 30. REG. 12-1-1998.
- 2,207,674. ROEFLEX. INT. CL. 7. REG. 12-1-1998.
- 2,207,675. HANDS OFF! THE UMBRELLA (STYLIZED). INT. CL. 18. REG. 12-1-1998.
- 2,207,676. FORGETME KNOT (STYLIZED). INT. CL. 14. REG. 12-1-1998.
- 2,207,677. PEOPLENET (STYLIZED). INT. CL. 37. REG. 12-1-1998.
- 2,207,678. PEOPLENET. INT. CL. 36. REG. 12-1-1998.
- 2,207,684. YELLOWSTONE. INT. CL. 20. REG. 12-1-1998.
- 2,207,685. X-TI. INT. CL. 28. REG. 12-1-1998.
- 2,207,686. JASMINE. INT. CL. 9. REG. 12-1-1998.
- 2,207,688. THE NEW STANDARD IN GLOBAL COMMUNICATIONS. INT. CL. 38. REG. 12-1-1998.
- 2,207,689. FIRSTRETURN (STYLIZED). INT. CL. 42. REG. 12-1-1998.
- 2,207,690. MISTLETOE. INT. CL. 3. REG. 12-1-1998.
- 2,207,691. STEEL TIMBER. INT. CL. 28. REG. 12-1-1998.
- 2,207,692. TWIST MTX. INT. CL. 10. REG. 12-1-1998.
- 2,207,693. TWIST TI. INT. CL. 10. REG. 12-1-1998.
- 2,207,694. TWIST. INT. CL. 10. REG. 12-1-1998.
- 2,207,695. E TRAINER. INT. CL. 28. REG. 12-1-1998.
- 2,207,697. DISTINCT. INT. CL. 5. REG. 12-1-1998.
- 2,207,698. PASSION FRUIT FANTASY. INT. CL. 3. REG. 12-1-1998.
- 2,207,703. TOUCH & SQUEAK. INT. CL. 16. REG. 12-1-1998.
- 2,207,705. MYGLBYX. INT. CL. 28. REG. 12-1-1998.
- 2,207,707. NETWORKING TRUST CATALYTICA VISION ENTREPRENEURSHIP AND DESIGN. INT. CLS. 36 AND 42. REG. 12-1-1998.
- 2,207,708. WHERE ANGELS REST BY E. GALINDO AND DESIGN. INT. CLS. 14, 18 AND 25. REG. 12-1-1998.
- 2,207,709. MANIFEST FILM. INT. CL. 41. REG. 12-1-1998.
- 2,207,711. VALLON. INT. CL. 42. REG. 12-1-1998.
- 2,207,712. WEB AMERICA NETWORKS. INT. CLS. 38 AND 42. REG. 12-1-1998.

- 2,207,714. COUNTRY COTTAGE AND DESIGN. INT. CL. 8. REG. 12-1-1998.
- 2,207,715. COUNTRY COTTAGE AND DESIGN. INT. CL. 12. REG. 12-1-1998.
- 2,207,717. PBA TOUR AND DESIGN. INT. CLS. 6, 14, 16, 18, 21, 24, 25, 28, 35, 41 AND 42. REG. 12-1-1998.
- 2,207,719. MCH (STYLIZED). INT. CLS. 36 AND 37. REG. 12-1-1998.
- 2,207,720. OFFICIAL ALL STAR CAFE. INT. CL. 28. REG. 12-1-1998.
- 2,207,721. NUCLISENS AND DESIGN. INT. CLS. 1 AND 5. REG. 12-1-1998.
- 2,207,722. PRICESMART. INT. CL. 25. REG. 12-1-1998.
- 2,207,723. ANGIOSTATIN. INT. CL. 5. REG. 12-1-1998.
- 2,207,724. THIS BODY RUNS ON BEER. INT. CL. 25. REG. 12-1-1998.
- 2,207,725. SOUL OWNER (STYLIZED). INT. CL. 25. REG. 12-1-1998.
- 2,207,726. HOME SCHOOLER NETWORK. INT. CL. 38. REG. 12-1-1998.
- 2,207,728. COSMETIC INDEX AND DESIGN. INT. CL. 35. REG. 12-1-1998.
- 2,207,729. MERRITT. INT. CL. 7. REG. 12-1-1998.
- 2,207,732. FINPOP. INT. CL. 30. REG. 12-1-1998.
- 2,207,733. PROTESTANT RESOURCE GUIDE. INT. CLS. 16 AND 35. REG. 12-1-1998.
- 2,207,734. POWRDIPPER. INT. CLS. 7 AND 8. REG. 12-1-1998.
- 2,207,737. MICROWEAVE. INT. CL. 27. REG. 12-1-1998.
- 2,207,738. DUAL DENSITY. INT. CL. 28. REG. 12-1-1998.
- 2,207,739. SKINS. INT. CL. 27. REG. 12-1-1998.
- 2,207,740. LEGAL HELPERS. INT. CL. 42. REG. 12-1-1998.
- 2,207,742. SATIN ROSES U.S.A. AND DESIGN. INT. CL. 35. REG. 12-1-1998.
- 2,207,743. SHARPER EDGE. INT. CL. 12. REG. 12-1-1998.
- 2,207,745. POWER DELIVERY INTERNATIONAL. INT. CL. 41. REG. 12-1-1998.
- 2,207,746. MARRIAGE MEDIATOR. INT. CL. 9. REG. 12-1-1998.
- 2,207,747. DE CHOIX. INT. CLS. 29, 30 AND 32. REG. 12-1-1998.
- 2,207,748. RHYME BIBLE. INT. CL. 16. REG. 12-1-1998.
- 2,207,749. LEGAL STRATEGIES GROUP. INT. CL. 42. REG. 12-1-1998.
- 2,207,750. EISNER CONSULTING AND DESIGN. INT. CL. 42. REG. 12-1-1998.
- 2,207,751. CONTRACTING TECHNOLOGY PROFESSIONALS, INC.. INT. CL. 42. REG. 12-1-1998.
- 2,207,753. RASA FLOORS (STYLIZED). INT. CL. 27. REG. 12-1-1998.
- 2,207,754. MISCELLANEOUS DESIGN. INT. CL. 18. REG. 12-1-1998.
- 2,207,756. HAZE TRACKER. INT. CL. 9. REG. 12-1-1998.
- 2,207,758. SUGAR IN ITS NATURAL STATE. INT. CL. 30. REG. 12-1-1998.
- 2,207,759. BEVERLY HILLS IMAGE CONSULTANTS. INT. CL. 42. REG. 12-1-1998.
- 2,207,761. KETTLE MADE. INT. CL. 29. REG. 12-1-1998.
- 2,207,764. BRAND ARCHITECT. INT. CL. 16. REG. 12-1-1998.
- 2,207,765. PROMANICURE. INT. CL. 3. REG. 12-1-1998.
- 2,207,766. HOLIDAY HEADGEAR. INT. CL. 25. REG. 12-1-1998.
- 2,207,767. SUFFOLK'S SOUTH SHORE HEALTH CARE SYSTEM. INT. CL. 42. REG. 12-1-1998.
- 2,207,768. SURFING GIRL. INT. CL. 16. REG. 12-1-1998.
- 2,207,769. CO-OP 100. INT. CL. 16. REG. 12-1-1998.
- 2,207,771. CUSTOM FORMULA RAPID SKIN EXFOLIATORS. INT. CL. 3. REG. 12-1-1998.
- 2,207,772. SALLOUM BROS.. INT. CL. 30. REG. 12-1-1998.
- 2,207,773. ILLO.COM. INT. CL. 35. REG. 12-1-1998.
- 2,207,777. DRESS EXCELLENT. INT. CL. 25. REG. 12-1-1998.
- 2,207,778. CORPORATE COMPLIANCE CENTER. INT. CL. 42. REG. 12-1-1998.
- 2,207,779. HERBAL CARE. INT. CL. 3. REG. 12-1-1998.
- 2,207,780. JOB LINE OF HOUSTON. INT. CL. 35. REG. 12-1-1998.
- 2,208,057. BALLARD. INT. CLS. 1, 9 AND 17. REG. 12-8-1998.
- 2,252,541. DILLARD'S. INT. CL. 9 ONLY. REG. 6-15-1999.
- 2,261,839. DYNETICS. INT. CL. 35 ONLY. REG. 7-20-1999.
- 2,273,294. INTELICHIP. INT. CLS. 37, 39 AND 42 ONLY. REG. 8-31-1999.
- 2,289,887. JOBFEST. INT. CL. 41 ONLY. REG. 11-2-1999.
- 2,343,014. VIT-A-WAY. INT. CL. 31 ONLY. REG. 4-18-2000.

SECTION 18

- 1,074,969. MAILOGRAM. INT. CL. 16. REG. 10-11-1977.
- 1,190,527. SMART-POWER. INT. CL. 9. REG. 2-23-1982.
- 1,425,816. Y.NOT! AND DESIGN. INT. CL. 25. REG. 1-20-1987.
- 1,433,003. STUDIO. INT. CL. 25. REG. 3-17-1987.
- 1,475,103. RUDE DOG. INT. CL. 25. REG. 2-2-1988.
- 2,207,432. ABL AND DESIGN. INT. CLS. 16, 25, 28, 35, 36 AND 41. REG. 12-1-1998.
- 2,282,875. MAESTRO. INT. CL. 9. REG. 10-5-1999.
- 2,337,600. INTERNUTRIA AND DESIGN. INT. CLS. 5 AND 32. REG. 4-4-2000.
- 2,357,054. HUE MONO. INT. CL. 35. REG. 6-13-2000.
- 2,411,326. COYOTEE. INT. CL. 13. REG. 12-5-2000.
- 2,437,808. WOMENCONNECT. INT. CL. 42. REG. 3-27-2001.
- 2,439,501. D.EIGHT. INT. CL. 25. REG. 3-27-2001.
- 2,494,356. PROCON. INT. CL. 10. REG. 10-2-2001.
- 2,503,357. WWW.WOMENCONNECT.COM. INT. CL. 42. REG. 11-6-2001.
- 2,526,778. R.L.X. / RELAX. INT. CL. 25. REG. 1-8-2002.
- 2,530,818. WELLNESS PHARMACY. INT. CL. 35. REG. 1-15-2002.
- 2,672,979. CONCIERGE. INT. CLS. 36 AND 37. REG. 1-7-2003.
- 2,806,060. SILVER CREEK. INT. CL. 25. REG. 1-20-2004.

* * * * *

TRADEMARK REGISTRATIONS AMENDED, CORRECTED, ETC.

The designation "U.S. Cl." appearing in this section refers to the U.S. class in effect prior to Sep. 1, 1973 rather than the international class which applies to applications filed on or after that date. For adoption of international classification see notice in the OFFICIAL GAZETTE of Jun. 26, 1973 (911 O.G. TM 210).

Any change to the registration will be indicated at the bottom of each entry under ELEMENTS AMENDED, CORRECTED OR RESTRICTED. With the exception of changes to the goods and services, additions to the registration will appear in asterisks and deletions of the registration will appear in brackets. Elements which are only changed will be listed with no punctuation. As to the goods/services statement, amendments to the goods/services will appear in asterisks and deletions will appear in brackets. In addition if any change to the goods/services occurs, the element "Goods/Services" will be listed under ELEMENTS AMENDED, CORRECTED OR RESTRICTED.

198,350. REG. 5-12-1925. TAYLOR PRECISION PRODUCTS, LLC (DELAWARE LTD LIAB CO) 3000 PONTIAC TRAIL, COMMERCE TOWNSHIP, MI, 48390, SN 71-207,479. FILED 12-30-1924. PRINCIPAL REGISTER.

FOR EQUIPMENT, CONSISTING OF SHUTTLE COCKS AND BADMINTON NETS, SOLD SEPARATELY AND AS A UNIT.
FIRST USE 0-0-1938; IN COMMERCE 7-0-1972.

TEMPRITE

ELEMENTS CORRECTED
ASSIGNMENT/NAME CHANGE
OWNER NAME

INT. CL. 9/U.S. CL. 26
FOR THERMOMETERS.
FIRST USE 3-0-1917; IN COMMERCE 3-0-1917.

ELEMENTS AMENDED
ASSIGNMENT/NAME CHANGE
OWNER ADDRESS
MARK

1,134,921. REG. 5-13-1980. GARLAND COMPANY, THE (OHIO CORPORATION) 3800 EAST 91ST STREET, CLEVELAND, OH, 44105, SN 73-200,448. FILED 1-18-1979. PRINCIPAL REGISTER.

LAPLOCK

959,700. REG. 5-29-1973. TOYOTA JIDOSHA KABUSHIKI KAISHA (TOYOTAMOTOR CORPORATION) (JAPAN CORPORATION) 1, TOYOTA-CHO, TOYOTA-SHI, AICHI-KEN, JAPAN., SN 72-392,989. FILED 5-24-1971. PRINCIPAL REGISTER.

INT. CL. 1/U.S. CL. 5
FOR ROOF ADHESIVE.
FIRST USE 5-1-1978; IN COMMERCE 5-1-1978.

ELEMENTS CORRECTED
OWNER NAME

CELICA

INT. CL. 12/U.S. CL. 19
FOR MOTOR CARS AND PARTS THEREOF.
FIRST USE 9-28-1970; IN COMMERCE 3-20-1971.

ELEMENTS AMENDED
MARK

1,235,234. REG. 4-19-1983. TM ACQUISITION CORP. (ARIZONA CORPORATION) 3838 E. VAN BUREN, PHOENIX, AZ, 85008, SN 73-297,011. FILED 2-13-1981. PRINCIPAL REGISTER.

993,750. REG. 9-24-1974. TUNTURI GMBH (FED REP GERMANY CORPORATION) HEIDENFELDER STRASSE 5, SCHWEBHEIM, FED REP GERMANY, 97525, SN 72-444,133. FILED 12-18-1972. PRINCIPAL REGISTER.



The logo for Indiaca features the word "Indiaca" in a stylized, bold, sans-serif font with a slight shadow effect.

OWNER OF U.S. REG. NO. 1,075,653.
INT. CL. 16/U.S. CL. 38
FOR MAGAZINES, NEWSLETTERS AND DIRECTORIES RELATING TO REAL ESTATE, TRAVEL AND VACATIONS.
FIRST USE 1-0-1978; IN COMMERCE 1-0-1978.
INT. CL. 36/U.S. CLS. 101 AND 102

INT. CL. 28/U.S. CL. 22

TM 1666

FOR REAL ESTATE EXCHANGE SERVICES—NAMESLY, LISTING AND ARRANGING EXCHANGES FOR RESIDENTIAL PROPERTIES BETWEEN OWNERS OF FEE INTEREST OR TIMESHARE INTERVALS THEREOF; REAL ESTATE MANAGEMENT AND LEASING SERVICES.

FIRST USE 1-0-1978; IN COMMERCE 1-0-1978.

ELEMENTS AMENDED
ASSIGNMENT/NAME CHANGE
MARK

1,328,343. REG. 4-2-1985. WATKINS MANUFACTURING CORPORATION (CALIFORNIA CORPORATION) 225-A EL CAMINO REAL, CARLSBAD, CA, 92008, SN 73-482,735. FILED 5-30-1984. PRINCIPAL REGISTER.

MOTO-MASSAGE

NO CLAIM IS MADE TO THE EXCLUSIVE RIGHT TO USE "MASSAGE", APART FROM THE MARK AS SHOWN. INT. CL. 10/U.S. CL. 44

FOR OSCILLATING HYDROTHERAPY JETS FOR THERAPEUTIC WHIRLPOOL BATHS.

FIRST USE 3-21-1984; IN COMMERCE 3-21-1984.

ELEMENTS AMENDED
MARK

1,353,372. REG. 8-6-1985. AMATO, KENNETH J. (UNITED STATES INDIVIDUAL), DBA AMATO'S PIZZA, 376 BUTLER STREET, ETNA, PA, 15223, SN 73-475,733. FILED 4-16-1984. PRINCIPAL REGISTER.

AMATO'S

REGISTRATION IS RESTRICTED TO THE AREA COMPRISING THE STATES OF THE UNITED STATES WITH THE EXCEPTION OF 14 COUNTIES IN WEST VIRGINIA AND PENNSYLVANIA, NAMESLY COUNTIES IN PENNSYLVANIA: BEAVER, BUTLER, ARMSTRONG, WEST-MORELAND, ALLEGHENY, FAYETTE, GREEN, WASHINGTON; COUNTIES IN WEST VIRGINIA: WETZEL, HANCOCK, BROOKE, OHIO, MARSHALL AND MONONGALIA. CONCURRENT USE PROCEEDING NO. 94002059 WITH AMATO'S SANDWICH SHOPS, INC., SERIAL NO. 78101263.

SEC. 2(F).

INT. CL. 42/U.S. CL. 100

FOR RESTAURANT AND CARRY-OUT SERVICES.

FIRST USE 0-0-1954; IN COMMERCE 0-0-1954.

ELEMENTS AMENDED
ORDER RESTRICTING THE SCOPE OF REG.

1,879,266. REG. 2-14-1995. VTECH ELECTRONICS NORTH AMERICA LLC (ILLINOIS CORPORATION) 1155 W. DUNDEE ROAD, SUITE 130, ARLINGTON HEIGHTS, IL, 60004, SN 74-357,709. FILED 2-10-1993. PRINCIPAL REGISTER.

KNOWLEDGE KEY

INT. CL. 28/U.S. CL. 22

FOR ELECTRONIC CHILDREN'S LEARNING GAME. FIRST USE 5-21-1993; IN COMMERCE 5-21-1993.

ELEMENTS AMENDED
MARK

1,893,964. REG. 5-16-1995. EXACT SOFTWARE ERP-NA, INC. (DELAWARE CORPORATION) 300 BRICKSTONE SQUARE, ANDOVER, MA, 01810, SN 74-438,349. FILED 9-21-1993. PRINCIPAL REGISTER.

JobBOSS

INT. CL. 9/U.S. CL. 38

FOR COMPUTER SOFTWARE IN THE FIELD OF SHOP MANAGEMENT, NAMESLY FOR USE IN QUOTING, JOB SCHEDULING, PRODUCTION CONTROL, INVENTORY MANAGEMENT, ACCOUNTING AND QUALITY CONTROL.

FIRST USE 8-0-1985; IN COMMERCE 12-0-1985.

ELEMENTS AMENDED
MARK

1,998,887. REG. 9-10-1996. 2GT, INC. (VIRGINIA CORPORATION) 225 MARKWOOD DR., STERLING, VA, 20165, SN 74-026,309. FILED 2-6-1990. PRINCIPAL REGISTER.



REGISTRATION IS LIMITED TO AREA COMPRISING THE DISTRICT OF COLUMBIA AND THE STATES OF MARYLAND, VIRGINIA.

INT. CL. 39/U.S. CL. 105

FOR MOVING VAN AND FURNITURE STORAGE SERVICES.

FIRST USE 10-1-1988; IN COMMERCE 10-1-1988.

ELEMENTS AMENDED
CONCURRENT USE STATEMENT

2,110,561. REG. 11-4-1997. NATIONAL ATHLETIC TRAINERS ASSOCIATION, INC., THE (TEXAS CORPORATION) 2952 STEMMONS FREEWAY, DALLAS, TX, 75247, SN 75-148,427. FILED 8-9-1996. PRINCIPAL REGISTER.

NATIONAL ATHLETIC TRAINERS' ASSOCIATION

"ASSOCIATION"

SEC. 2(F).

INT. CL. 200/U.S. CL. 200

FOR INDICATING MEMBERSHIP IN AN ORGANIZATION OF ATHLETIC TRAINERS.
FIRST USE 0-0-1950; IN COMMERCE 0-0-1950.

2,277,847. REG. 9-14-1999. GROSSMAN, STACY (UNITED STATES INDIVIDUAL) 295 CENTRAL PARK WEST, APT. 15H, NEW YORK, NY, 10024, SN 75-507,018. FILED 6-23-1998. PRINCIPAL REGISTER.

ELEMENTS CORRECTED
OWNER NAME

LEGAL FICTION

2,193,086. REG. 10-6-1998. ATTORNEYS LIABILITY PROTECTION SOCIETY, INC., A RISK RETENTION GROUP (MONTANA STOCK INSURANCE COMPANY) 111 N. HIGGINS AVE, SUITE 200, MISSOULA, MT, 59801, SN 75-205,901. FILED 11-29-1996. PRINCIPAL REGISTER.

INT. CL. 42/U.S. CLS. 100 AND 101
FOR LEGAL RESEARCH AND CONSULTING SERVICES FOR WRITERS.
FIRST USE 6-16-1998; IN COMMERCE 6-16-1998.

ELEMENTS AMENDED
MARK

ALPS ATTORNEYS LIABILITY PROTECTION SOCIETY A RISK RETENTION GROUP

2,308,859. REG. 1-18-2000. GLOBAL ORANGE, L.L.C. (MICHIGAN LTD LIAB CO) 115 WEST ALLEGAN, SIXTH FLOOR, LANSING, MI, 48933, SN 75-549,742. FILED 9-8-1998. PRINCIPAL REGISTER.

OWNER OF U.S. REG. NO. 2,125,404.
NO CLAIM IS MADE TO THE EXCLUSIVE RIGHT TO USE "ATTORNEYS LIABILITY PROTECTION SOCIETY" OR "A RISK RETENTION GROUP", APART FROM THE MARK AS SHOWN.

BEANER'S

INT. CL. 36/U.S. CLS. 100, 101 AND 102
FOR INSURANCE SERVICES, NAMELY, UNDERWRITING AND PROVIDING OF PROFESSIONAL LIABILITY INSURANCE FOR ATTORNEYS; RISK MANAGEMENT ASSESSMENT SERVICES FOR ATTORNEYS AND LAW FIRMS; CLAIMS ADJUSTING AND AUDITING, AND INSURANCE MANAGEMENT.
FIRST USE 5-1-1993; IN COMMERCE 5-1-1993.

INT. CL. 25/U.S. CLS. 22 AND 39
FOR CLOTHING, NAMELY, T-SHIRTS, POLO SHIRTS, SWEATSHIRTS, AND HATS * PROMOTING BEANER'S COFFEE SHOPS *.
FIRST USE 7-25-1994; IN COMMERCE 7-25-1994.
INT. CL. 30/U.S. CL. 46
FOR BEVERAGES, NAMELY, COFFEE.
FIRST USE 7-25-1994; IN COMMERCE 7-25-1994.
INT. CL. 42/U.S. CLS. 100 AND 101
FOR RESTAURANT FEATURING COFFEE DRINKS.
FIRST USE 7-25-1994; IN COMMERCE 7-25-1994.

ELEMENTS AMENDED
MARK
DISCLAIMER

ELEMENTS AMENDED
GOODS/SERVICES

2,211,603. REG. 12-15-1998. ROCKY MOUNTAIN HOLDINGS, L.L.C. (DELAWARE LTD LIAB CO) 7301 SOUTH PEORIA, ENGLEWOOD, CO, 80112, SN 75-202,762. FILED 11-22-1996. PRINCIPAL REGISTER.

LIFE NET

2,318,824. REG. 2-15-2000. ERNEST GROUP, INC. (OKLAHOMA CORPORATION) 3000 UNITED FOUNDERS BLVD., SUITE 224, OKLAHOMA CITY, OK, 73112, SN 75-607,021. FILED 12-15-1998. PRINCIPAL REGISTER.

REGISTRATION IS RESTRICTED TO THE AREA COMPRISING THE ENTIRE UNITED STATES AND ITS TERRITORIES EXCEPT FOR (1) THE ENTIRE STATES OF TEXAS AND ARKANSAS, AND, (2) THOSE PORTIONS OF OKLAHOMA AND LOUISIANA THAT ARE WITHIN A 200 MILE RADIUS OF TEXARKANA, TEXAS.

PAYCOM

INT. CL. 37/U.S. CLS. 100, 103 AND 106
FOR GENERAL AVIATION SUPPORT SERVICES, NAMELY, AIRCRAFT REPAIR AND MAINTENANCE.
FIRST USE 10-1-1996; IN COMMERCE 12-19-1996.
INT. CL. 39/U.S. CLS. 100 AND 105
FOR GROUND AND AIR TRANSPORTATION RELATED TO MEDICAL SERVICES.
FIRST USE 10-1-1996; IN COMMERCE 12-19-1996.

INT. CL. 35/U.S. CLS. 100, 101 AND 102
FOR PAYROLL SERVICES, NAMELY, PAYROLL PREPARATION.
FIRST USE 11-1-1998; IN COMMERCE 11-1-1998.
INT. CL. 36/U.S. CLS. 100, 101 AND 102
FOR PAYROLL SERVICES, NAMELY, PAYROLL TAX DEBTING SERVICES.
FIRST USE 11-1-1998; IN COMMERCE 11-1-1998.

ELEMENTS AMENDED
CONCURRENT USE STATEMENT

ELEMENTS CORRECTED
OWNER NAME

2,386,245. REG. 9-12-2000. ORGANIZATION DESIGN AND DEVELOPMENT, INC. (PENNSYLVANIA CORPORATION) 2000 RENAISSANCE BOULEVARD, SUITE 100, KING OF PRUSSIA, PA. 194062746, SN 75-516,103. FILED 7-9-1998. PRINCIPAL REGISTER.

OWNER OF U.S. REG. NOS. 1,086,489, 2,088,277 AND OTHERS.

INT. CL. 9/U.S. CLS. 21, 23, 26, 36 AND 38
FOR COMPUTER SOFTWARE AND PRERECORDED VIDEOTAPES AND AUDIOTAPES IN THE FIELD OF HUMAN RESOURCE TRAINING AND DEVELOPMENT.
FIRST USE 10-0-1998; IN COMMERCE 3-0-1999.

ELEMENTS AMENDED
MARK

2,533,260. REG. 1-29-2002. KIMBERLY-CLARK WORLDWIDE, INC. (DELAWARE CORPORATION) 401 NORTH LAKE STREET, NEENAH, WI, 54956, SN 75-621,307. FILED 1-15-1999. PRINCIPAL REGISTER.

PURPLE NITRILE

OWNER OF U.S. REG. NOS. 1,507,969, 2,033,585 AND OTHERS.

NO CLAIM IS MADE TO THE EXCLUSIVE RIGHT TO USE "NITRILE", APART FROM THE MARK AS SHOWN. AS TO "PURPLE".

INT. CL. 9/U.S. CLS. 21, 23, 26, 36 AND 38
FOR [LATEX AND] SYNTHETIC PROTECTIVE GLOVES FOR INDUSTRIAL AND SCIENTIFIC USE.
FIRST USE 8-0-1999; IN COMMERCE 8-0-1999.

INT. CL. 10/U.S. CLS. 26, 39 AND 44
FOR [LATEX AND] SYNTHETIC * PROTECTIVE * GLOVES MEDICAL, SURGICAL, DENTAL AND HEALTH CARE USE.
FIRST USE 8-0-1999; IN COMMERCE 8-0-1999.

ELEMENTS AMENDED
GOODS/SERVICES

2,549,848. REG. 3-19-2002. ALEX AND ANI, INC. (RHODE ISLAND CORPORATION) 115 PETTACONSETT AVENUE, CRANSTON, RI, 02920, SN 76-238,306. FILED 4-10-2001. PRINCIPAL REGISTER.

ALEX & ANI

INT. CL. 3/U.S. CLS. 1, 4, 6, 50, 51 AND 52
FOR COSMETICS, NAMELY, PERFUME, COLOGNE, NAIL ENAMEL, NAIL CONDITIONER, MASCARA, EYE SHADOW, LIPSTICK, SKIN CREAMS AND LOTIONS, FACE MAKEUP AND PRESSED POWDER.
FIRST USE 9-25-1993; IN COMMERCE 9-25-1995.

ELEMENTS AMENDED
MARK

2,582,523. REG. 6-18-2002. ELLEGAARD GÖTTINGEN MINIPIGS (DENMARK CORPORATION) SORO LANDEVEJ 302, 4261 DALMOSE, DENMARK., SN 75-363,604. FILED 9-26-1997. PRINCIPAL REGISTER.



NO CLAIM IS MADE TO THE EXCLUSIVE RIGHT TO USE "MINI-PIGS", APART FROM THE MARK AS SHOWN.

INT. CL. 31/U.S. CLS. 1 AND 46
FOR LIVING ANIMALS, NAMELY, SWINE.
FIRST USE 7-12-2000; IN COMMERCE 7-12-2000.

ELEMENTS AMENDED
MARK

2,760,264. REG. 9-2-2003. THE CORYN GROUP, INC. (DELAWARE CORPORATION) SEVEN CAMPUS BOULEVARD, NEWTOWN SQUARE, PA. 19073, SN 78-074,716. FILED 7-19-2001. PRINCIPAL REGISTER.

SUNSCAPE

INT. CL. 42/U.S. CLS. 100 AND 101
FOR HOTEL AND RESTAURANT SERVICES.
FIRST USE 7-0-2001; IN COMMERCE 7-0-2001.

ELEMENTS CORRECTED
OWNER NAME

2,827,994. REG. 3-30-2004. SCREENLIFE, LLC (WASHINGTON LTD LIAB CO) 1201 THIRD AVENUE, SUITE 2350, SEATTLE, WA, 98101, SN 78-232,627. FILED 4-1-2003. PRINCIPAL REGISTER.

ALTERNATES

INT. CL. 9/U.S. CLS. 21, 23, 26, 36 AND 38
FOR PUZZLES STORED ON PRE-RECORDED STORAGE MEDIA, NAMELY, DVDS.
FIRST USE 10-15-2002; IN COMMERCE 10-15-2002.

INT. CL. 28/U.S. CLS. 22, 23, 38 AND 50
FOR COMPONENTS OF BOARD GAMES, NAMELY, PUZZLES FOR BOARD GAMES STORED ON PRE-RECORDED STORAGE MEDIA.
FIRST USE 10-15-2002; IN COMMERCE 10-15-2002.

ELEMENTS CORRECTED
ENTITY

2,847,087. REG. 6-1-2004. RENTOKIL INITIAL PLC (GREAT BRITAIN CORPORATION) FELCOURT, EAST GRINSTEAD, WEST SUSSEX RH19 2JY, UNITED KINGDOM., SN 75-679,849. FILED 4-17-2000. PRINCIPAL REGISTER.

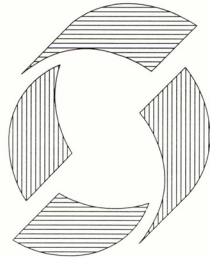

PRIORITY CLAIMED UNDER SEC. 44(D) ON UNITED KINGDOM APPLICATION NO. 2179221, FILED 10-8-1998, REG. NO. 2179221, DATED 10-8-1998.

THE MARK CONSISTS OF FOUR ELEMENTS ARRANGED IN A CIRCLE WITH THE TOP AND BOTTOM ELEMENTS BEING COLORED BLUE AND THE TWO SIDE ELEMENTS BEING COLORED RED.

INT. CL. 5/U.S. CLS. 6, 18, 44, 46, 51 AND 52

FOR PESTICIDES, INSECTICIDES, PARASITICIDES, FUNGICIDES, PREPARATIONS FOR DESTROYING VERMIN, BACTERICIDES AND DISINFECTANTS, ALL FOR SANITARY AND/OR HYGIENIC DOMESTIC, COMMERCIAL AND INSTITUTIONAL USES; ALL PURPOSE DISINFECTANTS AND DEODORANTS FOR SANITARY AND/OR HYGIENIC PURPOSES AND DOMESTIC, COMMERCIAL AND INSTITUTIONAL USE; AIR FRESHENERS, AND FEMININE HYGIENE PREPARATIONS, NAMELY, SANITARY NAPKINS, TAMPONS AND PADS; FIRST AID KITS.

FIRST USE ; IN COMMERCE .

INT. CL. 9/U.S. CLS. 21, 23, 26, 36 AND 38

FOR PROTECTIVE CLOTHING; SAFETY GOGGLES AND EAR PLUGS NOT FOR MEDICAL PURPOSES, PROTECTIVE HELMETS AND FACE SHIELDS, SAFETY RESTRAINTS; ELECTRICAL APPARATUS, NAMELY, PERSONAL AND BUSINESS SECURITY ALARMS, ELECTRIC LOCKS, AND ELECTRIC MOTION SENSITIVE SWITCHES; ELECTRIC CIRCUIT BOARDS, FIRE ALARMS, SMOKE ALARMS AND DETECTORS, FIRE EXTINGUISHERS, AIR ANALYSIS APPARATUS; SOUND REPRODUCING APPARATUS, NAMELY, LOUSPEAKERS; APPARATUS FOR ATTRACTING AND KILLING INSECTS; VENDING MACHINES; PHOTOCOPIERS, FAX MACHINES, TELEX MACHINES, WORD PROCESSORS, COMPUTER HARDWARE, AND PARTS AND FITTINGS FOR THE AFORESAID.

FIRST USE ; IN COMMERCE .

INT. CL. 11/U.S. CLS. 13, 21, 23, 31 AND 34

FOR HAND DRYERS, ELECTRICAL LIGHTING FIXTURES, PORTABLE ELECTRIC HEATERS, SANITARY APPARATUS, NAMELY, DISPENSING UNITS FOR DISPENSING DETERGENT, DISINFECTANT AND/OR DEODORIZER INTO TOILET OR URINAL FLUSHING WATER; WATER SUPPLY AND WATER FLUSHING APPARATUS, NAMELY INTERIOR PLANT WATERING SYSTEMS; AIR FRESHENING AND AIR CONDITIONING UNITS AND AIR FILTERS THEREFOR AND PARTS AND FITTINGS FOR THE AFORESAID.

FIRST USE ; IN COMMERCE .

INT. CL. 24/U.S. CLS. 42 AND 50

FOR TEXTILE ARTICLES, NAMELY, TOWELS, WASHCLOTHS, TABLE LINENS AND BED LINENS.

FIRST USE ; IN COMMERCE .

INT. CL. 25/U.S. CLS. 22 AND 39

FOR FOOTWEAR; WORK APPAREL, NAMELY, COVERALLS, OVERALLS, SHIRTS, SWEATSHIRTS, T-SHIRTS, BLOUSES, JACKETS, BLAZERS, SUITS, TROUSERS, COATS, APRONS, HATS, DRESSES, SKIRTS AND SHOES.

FIRST USE ; IN COMMERCE .

INT. CL. 27/U.S. CLS. 19, 20, 37, 42 AND 50

FOR DOOR AND FLOOR MATS.
FIRST USE ; IN COMMERCE .

INT. CL. 31/U.S. CLS. 1 AND 46

FOR LIVING PLANTS, TREES, AND FLOWERS.
FIRST USE ; IN COMMERCE .

INT. CL. 35/U.S. CLS. 100, 101 AND 102

FOR PERSONNEL RECRUITMENT, PERSONNEL PLACEMENT, PERSONNEL MANAGEMENT, BUSINESS MANAGEMENT; BUSINESS MANAGEMENT SUPERVISION, BUSINESS AUDITING, RENTAL AND LEASING OF OFFICE EQUIPMENT, PROVIDING FACILITIES FOR BUSINESS MEETINGS, AND ARRANGING AND CONDUCTING BUSINESS CONFERENCES.

FIRST USE ; IN COMMERCE .

INT. CL. 37/U.S. CLS. 100, 103 AND 106

FOR MAINTENANCE AND REPAIR OF ACCOMMODATION, SPORTING, RECREATIONAL FACILITIES, WASHROOMS, AND WASHROOM APPARATUS, MAINTENANCE OF ELECTRICAL EQUIPMENT AND COMPUTER SYSTEMS; BUILDING CONSTRUCTION, REPAIR, MAINTENANCE, RESTORATION, RENOVATION, RECONDITIONING, AND CLEANING, INSTALLATION OF BUILDING INSULATION, JANITORIAL SERVICES, LAUNDRY SERVICES FOR CLOTHING AND TEXTILES, HOUSE PAINTING, ROAD SWEEPING AND RECONSTRUCTION SERVICES; RENTAL OF CONSTRUCTION, BUILDING, MAINTENANCE, REPAIR, LIFTING, DEMOLITION, DECORATING AND GARDENING EQUIPMENT; RENTAL OF TOOLS, SCAFFOLDING, STRUCTURAL ITEMS, FENCING MATS AND CLEANING APPARATUS AND MATERIALS; VERMIN EXTERMINATION OTHER THAN FOR AGRICULTURE, FUMIGATION OTHER THAN FOR AGRICULTURE, DISINFECTION, WASTE DISPOSAL FOR OTHERS, PAVEMENT AND ROAD STRIPPING; WASTE DISPOSAL; WASTE COLLECTION AND DISPOSAL FOR OTHERS.

FIRST USE ; IN COMMERCE .

INT. CL. 39/U.S. CLS. 100 AND 105

FOR DELIVERY OF DOCUMENTS AND PARCELS BY AIR AND COURIER, WAREHOUSE STORAGE, RENTAL OF VEHICLES, RENTAL OF STORAGE CONTAINERS AND RECEPTACLES FOR USED AND WASTE ARTICLES, VEHICLE PARKING SERVICES; FREIGHT TRANSPORTATION BY MEANS OF TRUCKS.

FIRST USE ; IN COMMERCE .

INT. CL. 40/U.S. CLS. 100, 103 AND 106

FOR WASTE TREATMENT, DESTRUCTION AND INCINERATION; RECYCLING SERVICES; MACHINE SHOP SERVICES, NAMELY MACHINING PARTS FOR OTHERS, AIR FRESHENING AND AIR PURIFICATION, SHOTBLASTING, NAMELY STRIPPING OF FINISHES FROM METAL SURFACES.

FIRST USE ; IN COMMERCE .

INT. CL. 41/U.S. CLS. 100, 101 AND 107

FOR PROVISION OF FACILITIES FOR CONFERENCES, TRAINING SEMINARS, RECREATIONAL ACTIVITIES AND SPORTING EVENTS; ARRANGING AND CONDUCTING EDUCATIONAL CONFERENCES AND SEMINARS.

FIRST USE ; IN COMMERCE .

INT. CL. 42/U.S. CLS. 100 AND 101

FOR ENGINEERING SERVICES; MATERIAL TESTING SERVICES; SECURITY GUARD SERVICES; CATERING SERVICES, HOTEL AND MOTEL SERVICES, RESTAURANT SERVICES, HEALTHCARE SERVICES; RENTAL OF CLOTHING, CLOTHING CONTAINERS, TEXTILE ARTICLES, HEATING APPARATUS, LIGHTING APPARATUS, PORTABLE BUILDINGS AND STRUCTURES, TEMPORARY BUILDINGS AND ROOFING, DISPENSING MACHINES, AND APPARATUS FOR WASHROOM AND SANITARY PURPOSES; INDUSTRIAL DESIGN; LANDSCAPE GARDENING; HORTICULTURAL SERVICES; EXTERMINATION AND FUMIGATION FOR AGRICULTURE; VEGETATION CARE SERVICES, NAMELY, PLANTING, REPLACING, AND ROUTINE CARE OF PLANTS, TREES, FLOWERS AND FLORAL DISPLAYS.

FIRST USE ; IN COMMERCE .

ELEMENTS AMENDED
MARK

2,847,608. REG. 6-1-2004. TAMBERN LIMITED (IRELAND CORPORATION) 17 PERCY PLACE, DUBLIN 4, IRELAND., SN 75-556,657. FILED 9-23-1998. PRINCIPAL REGISTER.

SHS

INT. CL. 25/U.S. CLS. 22 AND 39

FOR READY-MADE CLOTHING ARTICLES FOR WOMEN, MEN, CHILDREN, NAMELY, UNDERWEAR, SOCKS, STOCKINGS, GLOVES, NECKERCHIEFS, SCARVES, HATS, BELTS[, FOOTWEAR].

FIRST USE 12-0-1998; IN COMMERCE 12-8-2003.

ELEMENTS AMENDED
GOODS/SERVICES

2,854,046. REG. 6-15-2004. SAN-EI GEN F.F.I., INC. (JAPAN CORPORATION) 1-1-11, SANWA-CHO, TOYONAKA, OSAKA 561-8588, JAPAN., SN 75-731,513. FILED 6-17-1999. PRINCIPAL REGISTER.

HELLO BAR

INT. CL. 3/U.S. CLS. 1, 4, 6, 50, 51 AND 52

FOR PERFUMERY, NAMELY, NATURAL PERFUMERY FROM VEGETABLES, NATURAL PERFUMERY FROM ANIMALS, SYNTHETIC PERFUMERY, COMPOUND PERFUMERY, AND FOOD FLAVORINGS FROM ESSENTIAL OILS; AND INCENSES.

FIRST USE 5-16-1997; IN COMMERCE 4-23-2003.

INT. CL. 20/U.S. CLS. 2, 13, 22, 25, 32 AND 50
FOR FURNITURE.

FIRST USE 5-16-1997; IN COMMERCE 4-23-2003.

INT. CL. 30/U.S. CL. 46

FOR SEASONINGS, NAMELY, MISO FOR SOUP, WORCESTER SAUCE, KETCHUP, SOY SAUCE, VINEGAR, ESSENCE OF VINEGAR, SOBA-TSUYU * , * SALAD DRESSING, WHITE SAUCE, MAYONNAISE, SAUCE FOR BARBECUED MEAT, LUMP SUGAR, FRUCTOSE, ROCK SUGAR, SUGAR, MALTOSE, HONEY, GLUCOSE FOR FOOD, SACCHARIZED STARCH POWDER, THICK MALT SYRUP FOR USE IN MAKING FOODSTUFF, COOKING SALT MIXED WITH SESAME SEEDS, COOKING SALT, CELERY SALTS, AND CHEMICAL SEASONINGS; SPICES; AND AROMATIC PREPARATIONS FOR FOOD.

FIRST USE 5-16-1997; IN COMMERCE 4-23-2003.

INT. CL. 33/U.S. CLS. 47 AND 49

FOR ALCOHOLIC BEVERAGES, NAMELY, PREPARED ALCOHOLIC COCKTAILS, DISTILLED SPIRITS, WINES, RICE WINES, SAKES, WHISKEYS, VODKAS, GINS, BITTERS, RUMS, LIQUEURS, BRANDIES, FRUIT WINES, HARD CIDERS, MEADS, DISTILLED SPIRITS MADE FROM MILLET, DISTILLED LIQUORS, DISTILLED SPIRITS MADE FROM HERBS, AND HERB LIQUEURS .

FIRST USE 5-16-1997; IN COMMERCE 4-23-2003.

ELEMENTS CORRECTED
GOODS/SERVICES

2,873,600. REG. 8-17-2004. SILVER OAK PARTNERS, INC. (DELAWARE CORPORATION) 399 BOYLSTON STREET, BOSTON, MA, 021163305, SN 76-496,193. FILED 3-10-2003. PRINCIPAL REGISTER.

SILVER OAK SOLUTIONS

OWNER OF U.S. REG. NO. 2,703,495.

NO CLAIM IS MADE TO THE EXCLUSIVE RIGHT TO USE "SOLUTIONS", APART FROM THE MARK AS SHOWN.

INT. CL. 35/U.S. CLS. 100, 101 AND 102

FOR BUSINESS MANAGEMENT AND CONSULTATION.

FIRST USE 1-6-2003; IN COMMERCE 1-6-2003.

ELEMENTS CORRECTED
OWNER ADDRESS
CITIZENSHIP

2,878,316. REG. 8-31-2004. INSPIRED PATH, INC. (WASHINGTON CORPORATION) 4580 KLAHANIE DR. S.E., PMB 434, ISSAQUAH, WA, 98029, SN 76-392,177. FILED 4-5-2002. PRINCIPAL REGISTER.

INSPIRED PATH

INT. CL. 39/U.S. CLS. 100 AND 105

FOR TOUR LEADING SERVICES.

FIRST USE 2-6-2001; IN COMMERCE 2-6-2001.

INT. CL. 41/U.S. CLS. 100, 101 AND 107

FOR EDUCATIONAL SERVICES NAMELY [CONDUCTING] * CONDUCTING * SPEAKING AND TEACHING IN THE FIELD OF SPIRITUALITY.

FIRST USE 2-6-2001; IN COMMERCE 2-6-2001.

INT. CL. 45/U.S. CLS. 100 AND 101

FOR PROVIDING SPIRITUALLY-BASED COUNSELING AND CONSULTING.

FIRST USE 2-6-2001; IN COMMERCE 2-6-2001.

ELEMENTS CORRECTED
GOODS/SERVICES

2,878,336. REG. 8-31-2004. INSPIRED PATH, INC. (WASHINGTON CORPORATION) 4580 KLAHANIE DR. S.E., PMB 434, ISSAQUAH, WA, 98029, SN 76-409,922. FILED 5-17-2002. PRINCIPAL REGISTER.



THE STIPLING IN THE DRAWING IS FOR SHADING PURPOSES ONLY AND IS NOT INTENDED TO INDICATE COLOR.

INT. CL. 39/U.S. CLS. 100 AND 105

FOR CONDUCTING TOURS FOR OTHERS.

FIRST USE 1-1-2002; IN COMMERCE 1-1-2002.

INT. CL. 41/U.S. CLS. 100, 101 AND 107

FOR EDUCATIONAL SERVICES NAMELY [CONDUCTING] * CONDUCTING * CLASSES AND SPEAKING SEMINARS IN THE FIELD OF SPIRITUAL GROWTH.

FIRST USE 1-1-2002; IN COMMERCE 1-1-2002.
INT. CL. 45/U.S. CLS. 100 AND 101
FOR PROVIDING SPIRITUAL COUNSELING.
FIRST USE 1-1-2002; IN COMMERCE 1-1-2002.

ELEMENTS CORRECTED
GOODS/SERVICES

2,898,360. REG. 10-26-2004. MATSUSHITA ELECTRIC INDUSTRIAL CO., LTD. (JAPAN CORPORATION) 1006, OAZA KADOMA, KADOMA-SHI, OSAKA-FU, JAPAN., SN 76-478,747. FILED P.R. 12-18-2002; AM. S.R. 12-29-2003. SUPPLEMENTAL REGISTER.



NO CLAIM IS MADE TO THE EXCLUSIVE RIGHT TO USE "HDD", APART FROM THE MARK AS SHOWN.

INT. CL. 9/U.S. CLS. 21, 23, 26, 36 AND 38
FOR HARD DISC DRIVES FOR AUDIOVISUAL EQUIPMENT.
FIRST USE 1-31-2000; IN COMMERCE 1-31-2000.

ELEMENTS CORRECTED
OWNER NAME

2,907,220. REG. 11-30-2004. T-MAX INDUSTRIAL (H.K.) COMPANY LIMITED (CHINA LTD LIAB JT ST CO) ROOM 1610,16F., HOLLYWOOD PLAZA, 610 NATHAN ROAD, KOWLOON, HONGKONG, CHINA., SN 78-196,405. FILED 12-19-2002. PRINCIPAL REGISTER.



INT. CL. 7/U.S. CLS. 13, 19, 21, 23, 31, 34 AND 35
FOR CONCRETE MIXERS; WINCHES; HOIST TACKLE; HOISTS; POWER-OPERATED LIFTS FOR MOVING, PARKING AND STORING TRUCKS; ELECTRIC POWERED SPANNERS; ELECTRIC GLUE GUN; ELECTRICAL GRINDING WHEEL ENGINE; GAS POWDERED GUN FOR DRIVING PINS; WIND PROMOTING HANDWORK TOOL NAMELY AIR WRENCH, AIR DRILL, AIR SANDER.

FIRST USE 10-25-1998; IN COMMERCE 12-21-2002.
INT. CL. 8/U.S. CLS. 23, 28 AND 44
FOR HAND TOOLS, NAMELY SPANNERS, HAMMERS, FILES, SCREWDRIVERS, PLIERS, FRAMES FOR HANDSAWS, TROWELS AND SCISSORS; EXPLOSIVE ACTIVATED TOOLS FOR DRIVING RIVETS.
FIRST USE 10-25-1998; IN COMMERCE 8-0-2002.
INT. CL. 12/U.S. CLS. 19, 21, 23, 31, 35 AND 44
FOR FORK LIFT TRUCKS; AUTOMOBILE BUMPERS; LUGGAGE CARRIERS FOR VEHICLES.
FIRST USE 10-25-1998; IN COMMERCE 6-0-2003.

ELEMENTS CORRECTED
DATE OF FIRST USE IN COMMERCE

2,919,992. REG. 1-18-2005. ACME UNITED CORPORATION (CONNECTICUT CORPORATION) 1931 BLACK ROCK TURNPIKE, FAIRFIELD, CT, 06432, SN 78-256,954. FILED 6-2-2003. PRINCIPAL REGISTER.



OWNER OF U.S. REG. NO. 585,949.
INT. CL. 8/U.S. CLS. 23, 28 AND 44
FOR SCISSORS.
FIRST USE 11-0-2003; IN COMMERCE 6-0-2004.

ELEMENTS AMENDED
MARK

2,925,702. REG. 2-8-2005. CARO RESEARCH, INC. (DELAWARE CORPORATION) 336 BAKER AVENUE, CONCORD, MA, 01742, SN 78-099,926. FILED 12-26-2001. PRINCIPAL REGISTER.

MODEL-IT

INT. CL. 9/U.S. CLS. 21, 23, 26, 36 AND 38
FOR COMPUTER SOFTWARE FOR ECONOMIC MODELING AND ANALYSIS; COMPUTER SOFTWARE FOR USE BY PHARMACEUTICAL COMPANIES TO EVALUATE THE ECONOMIC EFFECT OF PHARMACEUTICAL PRODUCTS.
FIRST USE 11-0-2001; IN COMMERCE 11-0-2001.

ELEMENTS CORRECTED
DATE OF FIRST USE
DATE OF FIRST USE IN COMMERCE

2,926,844. REG. 2-15-2005. FMR CORP. (DELAWARE CORPORATION) 82 DEVONSHIRE STREET, BOSTON, MA, 02109, SN 78-148,960. FILED 7-30-2002. PRINCIPAL REGISTER.

ACTIONSXCHANGE

INT. CL. 9/U.S. CLS. 21, 23, 26, 36 AND 38
FOR COMPUTER SOFTWARE FOR OBTAINING, PROCESSING AND REPORTING INFORMATION ABOUT CORPORATE EVENTS SUCH AS ISSUANCE OF STOCK, MERGERS, SPINOFFS AND NAME CHANGES.
FIRST USE 2-0-2003; IN COMMERCE 2-0-2003.
INT. CL. 36/U.S. CLS. 100, 101 AND 102
FOR FINANCIAL RESEARCH, AND FINANCIAL INFORMATION PROCESSING AND REPORTING, IN THE FIELD OF CORPORATE EVENTS SUCH AS ISSUANCE OF STOCK, MERGERS, SPINOFFS AND NAME CHANGES; FINANCIAL INFORMATION PROVIDED BY ELECTRONIC MEANS.
FIRST USE 2-0-2003; IN COMMERCE 2-0-2003.

ELEMENTS CORRECTED
DATE OF FIRST USE
DATE OF FIRST USE IN COMMERCE

2,930,131. REG. 3-8-2005. EUROCLONE, S.P.A. (ITALY CORPORATION) VIA SPEZIA 1, 1-20142, MILANO, ITALY., SN 76-522,409. FILED 6-4-2003. PRINCIPAL REGISTER.

2,941,551. REG. 4-19-2005. TRUDI SPA (ITALY CORPORATION) VIA ANGELO ANGELI, 120, TARCENTO, ITALY, 33017, SN 78-174,977. FILED 10-16-2002. PRINCIPAL REGISTER.

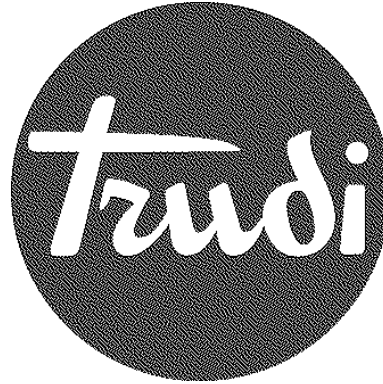

INT. CL. 5/U.S. CLS. 6, 18, 44, 46, 51 AND 52
FOR DIAGNOSTIC REAGENTS FOR BIOTECHNOLOGY LABORATORY USE; CHEMICAL REAGENTS FOR MEDICAL OR VETERINARY PURPOSES, EXCEPT REAGENTS FOR USE IN CLONING PROCESSES.
FIRST USE 1-0-2000; IN COMMERCE 1-0-2000.
INT. CL. 10/U.S. CLS. 26, 39 AND 44
FOR BIOTECHNOLOGY LABORATORY INSTRUMENTS, NAMELY CONTAMINATION CONTROL EQUIPMENT AND SYSTEMS, HORIZONTAL AND VERTICAL ELECTROPHORETIC CHAMBERS, TRANSILLUMINATORS, DNA SEQUENCING APPARATUS, GEL DOCUMENTATION SYSTEMS, EQUIPMENT FOR CYTOGENETICS STANDARDIZATION PROTOCOLS, LIQUID HANDLING EQUIPMENT EXCEPT THOSE FOR USE IN CLONING PROCESSES.
FIRST USE 1-0-2000; IN COMMERCE 1-0-2000.

ELEMENTS CORRECTED
GOODS/SERVICES
INTERNATIONAL CLASS(ES)
DATE OF FIRST USE
DATE OF FIRST USE IN COMMERCE

PRIORITY CLAIMED UNDER SEC. 44(D) ON ERPN CMNTY TM OFC APPLICATION NO. 2658326, FILED 4-17-2002, REG. NO. 002658326, DATED 5-11-2003, EXPIRES 4-17-2012.
INT. CL. 16/U.S. CLS. 2, 5, 22, 23, 29, 37, 38 AND 50
FOR STATIONERY ITEMS, NAMELY FABRIC/PLUSH BOXES FOR HOLDING STATIONERY, PEN AND PENCIL HOLDERS, BOXES FOR HOLDING PENS, MEMO PAD HOLDERS, ENVELOPE HOLDERS, LETTER HOLDERS, BOOK ENDS.
FIRST USE ; IN COMMERCE .

2,937,327. REG. 4-5-2005. VOGUE POOL PRODUCTS INC. (CANADA CORPORATION) 7050 SAINT-PATRICK, LALSALLE, QC, CANADA, H8N 1V2, SN 76-545,313. FILED 9-16-2003. PRINCIPAL REGISTER.

VOGUE

OWNER OF CANADA REG. NO. TMA412728, DATED 5-28-1993, EXPIRES 5-28-2008.
OWNER OF U.S. REG. NO. 1,299,516.
INT. CL. 6/U.S. CLS. 2, 12, 13, 14, 23, 25 AND 50
FOR SWIMMING POOLS PRIMARILY MADE OF METAL, AND STRUCTURAL PARTS THEREOF.
FIRST USE 10-0-1971; IN COMMERCE 8-0-1981.
INT. CL. 19/U.S. CLS. 1, 12, 33 AND 50
FOR SWIMMING POOLS PRIMARILY MADE OF NON-METAL MATERIALS, AND STRUCTURAL PARTS THEREOF.
FIRST USE 1-0-1991; IN COMMERCE 1-0-1991.

ELEMENTS CORRECTED
DATE OF FIRST USE
DATE OF FIRST USE IN COMMERCE

INT. CL. 18/U.S. CLS. 1, 2, 3, 22 AND 41
FOR SCHOOL BAGS, BACKPACKS.
INT. CL. 24/U.S. CLS. 42 AND 50
FOR BED LINEN, NAMELY, BED SHEETS, BED SPREADS, BED PADS, BED CANOPIES, PILLOW CASES, TABLE LINEN, NAMELY, TABLE CLOTHS, TABLE MATS, COASTERS, NAPKINS, PLACE MATS, TEA TOWELS, KITCHEN TOWELS, OVEN AND BARBECUE MITTS, BATH LINEN, BATH TOWELS, CLOTH NAPKINS FOR REMOVING MAKEUP, WASHING MITTS, HANDKERCHIEFS.
FIRST USE ; IN COMMERCE .
INT. CL. 25/U.S. CLS. 22 AND 39
FOR CLOTHING, NAMELY, VESTS, PULLOVERS, SWEATSHIRTS, SUSPENDERS AND FOULARDS, SHIRTS, T-SHIRTS, WAISTCOATS, TROUSERS, JACKETS, MEN'S SUITS AND WOMEN'S DRESSES, JACKET, HEAVY JACKETS, OVERCOATS, TOP-COATS, CLOAKS, RAINCOATS, WIND-RESISTANT JACKETS, STOCKINGS, SOCKS, GYMSUITS, BATHROBES, BELTS, TIES, GLOVES, SCARVES, FOOTWEAR, HEADWEAR.
INT. CL. 28/U.S. CLS. 22, 23, 38 AND 50
FOR GAMES AND PLAYTHINGS, NAMELY TOY PUPPETS, BABY MULTIPLE * ACTIVITY * TOYS, MOBILES FOR CHILDREN AND CHRISTMAS TREE ORNAMENTS, PLUSH TOYS AND STUFFED TOY ANIMALS.
FIRST USE ; IN COMMERCE .

ELEMENTS CORRECTED
GOODS/SERVICES

2,943,431. REG. 4-26-2005. NATIONALE STICHTING TOT EXPLOITATIE VANCASINOSPELEN IN NEDERLAND TE 'S-GRAVENHAGE (NETHERLANDS CORPORATION) HOOFDWEG 640, 2132 MK HOOFDDORP, NETHERLANDS, SN 76-560,085. FILED 11-3-2003. PRINCIPAL REGISTER.



PRIORITY CLAIMED UNDER SEC. 44(D) ON BENELUX APPLICATION NO. 1037722, FILED 8-7-2003, REG. NO. 0733995, DATED 8-7-2003, EXPIRES 8-7-2013.

NO CLAIM IS MADE TO THE EXCLUSIVE RIGHT TO USE "CASINO" AND "GAMING ENTERPRISE MANAGEMENT SOLUTIONS" , APART FROM THE MARK AS SHOWN.

INT. CL. 9/U.S. CLS. 21, 23, 26, 36 AND 38

FOR COMPUTER SOFTWARE FOR MANAGING DATA FROM AND TO SLOT MACHINES AND OTHER GAMES OF CHANCE, NAMELY AMERICAN ROULETTE, FRENCH ROULETTE, BLACK JACK, SIC BO AND POKER; COMPUTER SOFTWARE FOR USE WITH SLOT MACHINES, AMERICAN ROULETTE, FRENCH ROULETTE, BLACK JACK, SIC BO AND POKER, NAMELY COMPUTER SOFTWARE FOR SLOT MACHINE CONFIGURATION AND MAINTENANCE, DAILY SLOT MACHINE ACCOUNTING, DAILY TABLE ACCOUNTING, SETTLEMENT OF PAYMENTS, AUTHORIZATION OF USER-GROUPS AND USERS, [XIVIL] * XML * REPORTING, JACKPOT MANAGEMENT, LOYALTY PROGRAM MANAGEMENT, COINLESS PLAYING SOLUTION, AND REAL TIME VISUAL REPRESENTATION OF THE GAMING FLOOR.

FIRST USE ; IN COMMERCE .

ELEMENTS CORRECTED
GOODS/SERVICES

2,946,343. REG. 5-3-2005. EXPERIENCIA, INC. (DELAWARE CORPORATION) 106 WEST 11TH STREET, SUITE 1210, KANSAS CITY, MO, 64105, SN 76-196,133. FILED 1-19-2001. PRINCIPAL REGISTER.

EXPERIENCIA

INT. CL. 9/U.S. CLS. 21, 23, 26, 36 AND 38

FOR COMPUTER SOFTWARE FOR USE IN PROVIDING TEACHING METHODS BY WHICH ONE ACCUMULATES PRACTICAL KNOWLEDGE AND VARIOUS SKILLS BY WAY OF ACTIVE PARTICIPATION IN EVENTS AND ACTIVITIES IN THE FIELDS OF AGRICULTURE AND [NATURE] * NATURAL * RESOURCES, BUSINESS MANAGEMENT, CIVICS AND GOVERNMENT, COMMUNICATION ARTS, COMPUTER LITERACY AND TECHNOLOGY APPLICATIONS, ECONOMIC, ENTREPRENEURSHIP, ENVIRONMENTAL EDUCATION, ETHICS, FINE ARTS, HEALTH AND PHYSICAL EDUCATION, HEALTH SERVICES, HUMAN SERVICES, INDUSTRIAL AND ENGINEERING TECHNOLOGIES, LIFE SCIENCES, MATHEMATICS, MUSIC EDUCATION, PSYCHOLOGY, SCIENCE, SOCIAL STUDIES, TEAMWORK AND READING LITERACY AND COMPREHENSION.

FIRST USE 12-28-2004; IN COMMERCE 12-28-2004.

ELEMENTS CORRECTED
GOODS/SERVICES

2,946,691. REG. 5-3-2005. VALENCE TECHNOLOGY, INC. (DELAWARE CORPORATION) 301 CONESTOGA WAY, LEGAL DEPARTMENT, HENDERSON, NV, 89015, SN 78-234,843. FILED 4-7-2003. PRINCIPAL REGISTER.

K-CHARGE

INT. CL. 9/U.S. CLS. 21, 23, 26, 36 AND 38
FOR BATTERIES.

FIRST USE 5-29-2003; IN COMMERCE 5-29-2003.

ELEMENTS CORRECTED
GOODS/SERVICES
INTERNATIONAL CLASS(ES)
DATE OF FIRST USE
DATE OF FIRST USE IN COMMERCE

2,947,687. REG. 5-10-2005. HOT STUFF FOODS, LLC (SOUTH DAKOTA LIMITED LIABILITY COMPANY) P.O. BOX 85210, SIOUX FALLS, SD, 571185210, SN 78-236,257. FILED 4-10-2003. PRINCIPAL REGISTER.

UNCLE ANGELO'S

OWNER OF U.S. REG. NO. 2,009,910.
INT. CL. 29/U.S. CL. 46
FOR SOUP AND GARDEN SALADS.
FIRST USE 5-15-1999; IN COMMERCE 5-15-1999.

INT. CL. 30/U.S. CL. 46
FOR PIZZA; SANDWICHES CONTAINING TURKEY, ROAST BEEF, EGG, HAM, SAUSAGE, BACON, VEGETABLES AND/OR CHEESE, ENTREES CONSISTING PRIMARILY OF PASTA, CHEESECAKE, TIRAMISU AND COOKIES.

FIRST USE 5-15-1999; IN COMMERCE 5-15-1999.
INT. CL. 35/U.S. CLS. 100, 101 AND 102
FOR RESTAURANT FRANCHISING.
FIRST USE 5-15-1999; IN COMMERCE 5-15-1999.

ELEMENTS CORRECTED
ENTITY

2,949,443. REG. 5-10-2005. MATTEL, INC. (DELAWARE CORPORATION) 333 CONTINENTAL BLVD., EL SEGUNDO, CA, 902455012, SN 78-055,685. FILED 3-29-2001. PRINCIPAL REGISTER.

SPARKLING PRINCESS

INT. CL. 28/U.S. CLS. 22, 23, 38 AND 50
FOR TOYS, GAMES AND PLAYTHINGS, NAMELY, DOLLS, DOLL CLOTHING AND DOLL ACCESSORIES.
FIRST USE 9-11-2001; IN COMMERCE 9-11-2001.

ELEMENTS CORRECTED
DATE OF FIRST USE

2,950,944. REG. 5-17-2005. SONY ERICSSON MOBILE COMMUNICATIONS JAPAN, INC. (JAPAN CORPORATION) W BUILDING, 8-15, 1-CHOME, KONAN MINATO-KU, TOKYO 108-0075, JAPAN., SN 76-515,736. FILED 5-20-2003. PRINCIPAL REGISTER.

TEXTaLIVE

PRIORITY CLAIMED UNDER SEC. 44(D) ON JAPAN APPLICATION NO. 2003-021905, FILED 3-19-2003, REG. NO. 4757461, DATED 3-19-2004, EXPIRES 3-19-2014.
INT. CL. 9/U.S. CLS. 21, 23, 26, 36 AND 38

FOR TELECOMMUNICATION MACHINES AND APPARATUS, NAMELY, COMPUTERS, CELLULAR PHONES; EAR PLUGS NOT FOR MEDICAL PURPOSES; EAR PLUGS FOR SWIMMING PURPOSES; ELECTRIC ARC WELDERS; SCIENTIFIC EQUIPMENT, NAMELY, EGG CANDLERS; CASH REGISTERS; ELECTRONIC COIN COUNTING OR SORTING MACHINES; PHOTOCOPYING MACHINES; MANUALLY OPERATED ADDING MACHINES; ELECTRONIC DRAWING OR DRAFTING MACHINES; ELECTRONIC TIME AND DATE STAMPING MACHINES; CHRONOGRAPHS FOR USE AS SPECIALIZED TIME RECORDING APPARATUS; PUNCH CLOCKS FOR OFFICE USE; VOTING MACHINES; AUTOMATED BILLING MACHINES; AUTOMATED POSTAGE STAMP CHECKING APPARATUS; VENDING MACHINES; GASOLINE STATION EQUIPMENT, NAMELY, METERED GASOLINE PUMPS; ELECTRIC COIN-OPERATED GATES FOR CAR PARKING FACILITIES; LIFE SAVING APPARATUS AND EQUIPMENT, NAMELY, LIFE SAVING RAFTS; FIRE EXTINGUISHERS; FIRE HOSE NOZZLES; FIRE SPRINKLERS; FIRE ALARMS; GAS ALARMS FOR DETECTING THE PRESENCE OF GAS; ANTI-THEFT BURGLAR ALARMS; PROTECTIVE HELMETS; RAILWAY SIGNALS; VEHICLE BREAKDOWN WARNING TRIANGLES; LUMINOUS OR MECHANICAL ROAD SIGNS; ELECTRIC DOOR OPENERS; ELECTRONIC VEHICLE DRIVING TRAINING SIMULATORS; ELECTRONIC SPORTS TRAINING SIMULATORS; CINEMATOGRAPHIC MACHINES AND APPARATUS, NAMELY, MOTION PICTURE CAMERAS; OPTICAL APPARATUS AND INSTRUMENTS, NAMELY, OPTICAL CHARACTER RECOGNITION APPARATUS; MEASURING OR TESTING MACHINES AND INSTRUMENTS, NAMELY, BEVELS AND ELECTRONIC SOUND LEVEL METERS; POWER DISTRIBUTION OR CONTROL MACHINES AND APPARATUS, NAMELY, ELECTRICAL BOXES AND CONSOLES; ROTARY CONVERTERS; ELECTRICAL PHASE MODIFIERS; BATTERIES AND PHOTOVOLTAIC CELLS; ELECTRONIC TESTING EQUIPMENT, NAMELY, SOUND LEVEL METERS; ELECTRIC WIRES AND CABLES; ELECTRIC FLAT IRONS; ELECTRIC HAIR CURLERS; ELECTRIC BUZZERS; ELECTRICAL WIRES, NAMELY, RESISTANCE WIRES; WELDING ELECTRODES; FIRE EXTINGUISHING APPARATUS IN THE NATURE OF FIRE BOATS; FIRE ENGINES; ELECTRIC CIGAR LIGHTERS FOR AUTOMOBILES; GLOVES FOR PROTECTION AGAINST INDUSTRIAL ACCIDENTS; DUST MASKS; GAS MASKS; WELDING MASKS; FIREPROOF PROTECTIVE CLOTHING; SPECTACLES INCLUDING EYEGLASSES AND SAFETY GOGGLES; VIDEO GAME DISCS AND CARTRIDGES; ELECTRICAL CIRCUITS AND MULTI-MEDIA SOFTWARE RECORDED ON CD-ROMS FOR HAND-HELD COMPUTER GAMES WITH LIQUID CRYSTAL DISPLAYS; SLOT MACHINES; WEIGHT BELTS FOR SCUBA DIVING; PROTECTIVE HELMETS FOR SPORTS; AIR TANKS FOR SCUBA DIVING; REGULATORS FOR USE IN SCUBA DIVING; METRONOMES; ELECTRONIC CIRCUITS AND MULTI-MEDIA SOFTWARE RECORDED ON CD-ROMS FEATURING AUTOMATED PERFORMANCE PROGRAMS FOR ELECTRONIC MUSICAL INSTRUMENTS; SLIDE-RULES; EXPOSED CINEMATOGRAPHIC FILMS; EXPOSED SLIDE FILMS; CELLULAR TELEPHONES; HAND-HELD PERSONAL COMPUTERS WITH MODEMS; PERSONAL DIGITAL ASSISTANTS; DOWNLOADABLE COMPUTER SOFTWARE FOR COMMUNICATING WITH USERS OF PERSONAL DIGITAL ASSISTANTS, MOBILE PHONE, AND

HAND-HELD PERSONAL COMPUTERS WITH MODEMS; DOWNLOADABLE COMPUTER SOFTWARE TO ENHANCE THE AUDIO-VISUAL CAPABILITIES OF MULTIMEDIA APPLICATIONS, NAMELY, FOR THE INTEGRATION OF TEXT, AUDIO, GRAPHICS, STILL IMAGES AND MOVING PICTURES FOR USE IN PERSONAL DIGITAL ASSISTANTS, MOBILE PHONE AND HAND-HELD PERSONAL COMPUTERS WITH MODEMS; COMPUTER SOFTWARE TO ENHANCE THE AUDIO-VISUAL CAPABILITIES OF MULTIMEDIA APPLICATIONS, NAMELY, FOR THE INTEGRATION OF TEXT, AUDIO, GRAPHICS, STILL IMAGES AND MOVING PICTURES; DOWNLOADABLE DIGITAL CONTENTS, NAMELY, PICTURES, MOTION PICTURES, IMAGES, LETTERS, AND MOTION TEXTS.
FIRST USE ; IN COMMERCE .

INT. CL. 38/U.S. CLS. 100, 101 AND 104

FOR * PROVIDING AN ON-LINE COMPUTER DATABASE IN THE FIELD OF TELECOMMUNICATIONS; * ELECTRONIC MAIL SERVICES; PROVIDING TELECOMMUNICATIONS CONNECTIONS TO A GLOBAL COMPUTER NETWORK; TELECOMMUNICATION OTHER THAN BROADCASTING, NAMELY, TELECOMMUNICATION GATEWAY SERVICES AND TELECOMMUNICATION CONSULTATION; BROADCASTING OF IMAGES, VOICE, SOUNDS, MUSIC BY THE INTERNET; BROADCASTING, NAMELY, AUDIO BROADCASTING; NEWS AGENCIES, NAMELY, GATHERING AND DISSEMINATION OF NEWS; RENTAL OF TELECOMMUNICATION EQUIPMENT INCLUDING TELEPHONES AND FACSIMILE MACHINES; CELLULAR TELEPHONE SERVICES; ELECTRONIC DELIVERY OF VOICE, DATA, IMAGES, SIGNALS, LETTERS, MOTION TEXTS, MOTION PICTURES, AND MESSAGES BY ELECTRONIC TRANSMISSION; ELECTRONIC, ELECTRIC, AND DIGITAL TRANSMISSION AND RECEPTION OF VOICE, DATA, IMAGES, SIGNALS, LETTERS, MOTION TEXTS, MOTION PICTURES, MESSAGES VIA CELLULAR TELEPHONES, PERSONAL DIGITAL ASSISTANTS, AND HAND-HELD PERSONAL COMPUTERS.
FIRST USE ; IN COMMERCE .

INT. CL. 42/U.S. CLS. 100 AND 101

FOR COMPUTER SERVICE, NAMELY, PROVIDING SEARCH ENGINES FOR OBTAINING DATA ON A GLOBAL COMPUTER NETWORK; COMPUTER SOFTWARE DESIGN FOR OTHERS; COMPUTER PROGRAMMING FOR OTHERS; MAINTENANCE OF COMPUTER SOFTWARE; TECHNICAL ADVICE RELATING TO PERFORMANCE AND OPERATION OF COMPUTERS, AUTOMOBILES AND OTHER MACHINES THAT REQUIRE HIGH LEVELS OF PERSONAL KNOWLEDGE, SKILL OR EXPERIENCE OF THE OPERATORS TO MEET THE REQUIRED ACCURACY IN OPERATING THEM; RENTAL OF COMPUTERS; TECHNICAL SUPPORT, NAMELY, TROUBLESHOOTING OF COMPUTER PROGRAM PROBLEMS; METEOROLOGICAL FORECASTING; ARCHITECTURAL DESIGN; GEOLOGICAL SURVEYING; GEOLOGICAL RESEARCH; DESIGN, TESTING, AND INSPECTION OF NEW PRODUCTS FOR OTHERS; PERFORMING RESEARCH RELATED TO THE DESIGN, TESTING, AND INSPECTION OF NEW PRODUCTS FOR OTHERS IN THE FIELD OF PHARMACEUTICALS, COSMETICS OR FOODSTUFF; SCIENTIFIC TESTING AND RESEARCH ON THE PREVENTION OF POLLUTION; SCIENTIFIC TESTING AND RESEARCH IN THE FIELD OF ELECTRICITY; SCIENTIFIC TESTING AND RESEARCH IN THE FIELD OF CIVIL ENGINEERING; SCIENTIFIC TESTING, INSPECTION OR RESEARCH IN THE FIELD OF AGRICULTURE, INCLUDING IN THE FIELD OF LIVESTOCK BREEDING AND FISHERIES; PATENT AGENCIES FOR PROCEDURES RELATING TO IN-

DUSTRIAL PROPERTY RIGHTS AND PREPARATION OF EXPERT OPINIONS IN RELATION THERETO; LEGAL SERVICES, NAMELY, CONSULTATION REGARDING LEGAL PROCEDURES RELATING TO LAWSUITS OR OTHER LEGAL ISSUES; LEGAL SERVICES FOR FILING OF JUDICIAL REGISTRATIONS, LEGAL DOCUMENTS AND DEPOSITS; RENTAL OF SCIENTIFIC MEASURING APPARATUS; RENTAL OF LABORATORY APPARATUS AND INSTRUMENTS; RENTAL OF SCIENTIFIC DRAWING INSTRUMENTS, INCLUDING DRAFTING INSTRUMENTS; COMPUTER SOFTWARE DEVELOPMENT.
FIRST USE : IN COMMERCE .

ELEMENTS CORRECTED
GOODS/SERVICES

FOR EDUCATIONAL SERVICES, NAMELY, CONDUCTING INTERACTIVE AND REAL-TIME CONFERENCES [ANT)] * AND * SEMINARS VIA THE INTERNET ON THE SUBJECT OF MEDICAL AND CLINICAL PRACTICE.
FIRST USE 10-0-2000; IN COMMERCE 10-0-2000.

ELEMENTS CORRECTED
GOODS/SERVICES

2,953,290. REG. 5-17-2005. PARTIDA, FLORA IRMA (MEXICO INDIVIDUAL) COL. JUAREZ, DELEGACION, INSURGENTES SUR 107 7 PISO, CUAUHTEMOC, MEXICO, 06600, SN 78-221,707. FILED 3-5-2003. PRINCIPAL REGISTER.

LIPOTRANSPORTACION

INT. CL. 25/U.S. CLS. 22 AND 39
FOR BRASSIERES, GIRDLES, AND POSTURE CORRECTING VESTS.
FIRST USE 1-1-2005; IN COMMERCE 1-20-2005.

ELEMENTS CORRECTED
OWNER NAME
OWNER ADDRESS

2,955,968. REG. 5-24-2005. TAB-AUSTRIA INDUSTRIE- UND UNTERHALTUNGSELEKTRONIK GMBH & CO. KG (AUSTRIA LTD LIAB JT ST CO) HAIDERSTRASSE 40, A-4052 ANSFELDEN, AUSTRIA., SN 78-251,503. FILED P.R. 5-19-2003; AM. S.R. 6-14-2004. SUPPLEMENTAL REGISTER.

VIRTUAL PINBALL

NO CLAIM IS MADE TO THE EXCLUSIVE RIGHT TO USE PINBALL, APART FROM THE MARK AS SHOWN.
INT. CL. 28/U.S. CLS. 22, 23, 38 AND 50
FOR [PINBALL GAMES OR PINBALL LIKE GAMES EMPLOY A COMPUTER GENERATED OR SIMULATED PINBALL] * AMUSEMENT GAME MACHINES, NAMELY, PINBALL GAMES; COIN OR NON-COIN OPERATED PINBALL MACHINES; AND PINBALL-TYPE GAMES *.
FIRST USE 4-18-2002; IN COMMERCE 8-29-2003.

ELEMENTS CORRECTED
GOODS/SERVICES

2,954,621. REG. 5-24-2005. DESTINY BAY VINEYARDS LIMITED (NEW ZEALAND COMPANY) 379A GORDONS ROAD RD1 WAIHEKE ISLAND, AUCKLAND, NEW ZEALAND, 1240, SN 78-154,260. FILED 8-14-2002. PRINCIPAL REGISTER.

DESTINY BAY

PRIORITY CLAIMED UNDER SEC. 44(D) ON NEW ZEALAND APPLICATION NO. 662244, FILED 8-8-2002, REG. NO. 662244, DATED 2-13-2003, EXPIRES 8-8-2009.
INT. CL. 33/U.S. CLS. 47 AND 49
FOR ALCOHOLIC BEVERAGES, NAMELY, WINES, DISTILLED [SPIRITS] * SPIRITS * , AND DISTILLED LIQUOR.
FIRST USE : IN COMMERCE .

ELEMENTS CORRECTED
GOODS/SERVICES

2,956,928. REG. 5-31-2005. FISCHERSIPS, LLC (KENTUCKY LTD LIAB CO) 1843 NORTHWESTERN PARKWAY, LOUISVILLE, KY, 40203, SN 78-263,403. FILED 6-17-2003. PRINCIPAL REGISTER.

SIP ENERGY, DON'T GUZZLE IT

2,954,732. REG. 5-24-2005. CONCEPTIS TECHNOLOGIES INC. (CANADA CORPORATION) 390 GUY STREET, SUITE 109, MONTREAL, QUEBEC, CANADA, H3J 1S6, SN 78-264,069. FILED 6-18-2003. PRINCIPAL REGISTER.

RHEUMANATIONS

INT. CL. 41/U.S. CLS. 100, 101 AND 107

INT. CL. 19/U.S. CLS. 1, 12, 33 AND 50
FOR FLOOR PANELS; ROOF PANELS NOT OF METAL; WALL PANELS NOT OF METAL; STRUCTURAL AND ARCHITECTURAL MEMBERS FORMED OF PRESSED WOOD FIBERS AND FOAM; STRUCTURAL INSULATED PANELS FOR USE IN RESIDENTIAL, COMMERCIAL AND INDUSTRIAL CONSTRUCTION .
FIRST USE 10-31-1993; IN COMMERCE 11-9-1993.

ELEMENTS CORRECTED
ENTITY

2,956,964. REG. 5-31-2005. YUGEN KAISHA DIECI COMME (JAPAN CORPORATION), TA DIECI COMME LTD., 11-5, MINAMIAOYAMA 5-CHOME, MINATO-KU, TOKYO, JAPAN., SN 78-290,028. FILED 8-21-2003. PRINCIPAL REGISTER.

2,959,471. REG. 6-7-2005. SYSTEMS, INC. (WISCONSIN CORPORATION) W-194 N-11481 MCCORMICK DRIVE, GERMANTOWN, WI, 53022, SN 78-314,428. FILED 10-16-2003. PRINCIPAL REGISTER.

Peggy Moffitt

PRIORITY CLAIMED UNDER SEC. 44(D) ON JAPAN APPLICATION NO. 2003-60415, FILED 7-18-2003, REG. NO. 4762154, DATED 4-9-2004, EXPIRES 4-9-2014.

THE NAME "PEGGY MOFFITT" IDENTIFIES A LIVING INDIVIDUAL WHOSE CONSENT IS OF RECORD.

INT. CL. 14/U.S. CLS. 2, 27, 28 AND 50

FOR ASHTRAYS OF PRECIOUS METAL, BADGES OF PRECIOUS METAL, BASKETS OF PRECIOUS METAL FOR HOUSEHOLD PURPOSES, CIGAR BOXES OF PRECIOUS METAL, BOXES OF PRECIOUS METAL, BOXES OF PRECIOUS METAL FOR NEEDLES, BRACELETS, BROOCHES, BUCKLES OF PRECIOUS METAL, SERVICE TRAYS OF PRECIOUS METAL, CANDLE EXTINGUISHERS OF PRECIOUS METAL, CANDLE RINGS OF PRECIOUS METAL, CANDLESTICKS OF PRECIOUS METAL, CASES FOR CLOCKS, CASES FOR WATCHES, JEWELRY CHAINS, WATCH CHAINS, CHARMS, TIE CLIPS, CLOCKS AND WATCHES, COFFEE SERVICES OF PRECIOUS METAL, CUFF LINKS, DIAMONDS, DISHES OF PRECIOUS METAL, EARRINGS, JEWEL CASES OF PRECIOUS METAL, JEWELRY, JUGS OF PRECIOUS METAL, KEY RINGS AND ORNAMENTS MADE OF PRECIOUS METAL, MATCH BOXES OF PRECIOUS METAL, MEDALLIONS, MEDALS, NAPKIN HOLDERS OF PRECIOUS METAL, NAPKIN RINGS OF PRECIOUS METAL, NECKLACES, ORNAMENTAL PINS, ORNAMENTS, HAT ORNAMENTS OF PRECIOUS METAL, SHOE ORNAMENTS OF PRECIOUS METAL, POWDER COMPACTS OF PRECIOUS METAL, PRECIOUS STONES, RINGS BEING JEWELRY, SALT CELLARS OF PRECIOUS METAL, TEA SERVICES OF PRECIOUS METAL, TEAPOTS OF PRECIOUS METAL, TIE PINS, TOOTHPICK HOLDERS OF PRECIOUS METAL, TOWEL HOLDERS OF PRECIOUS METAL, VASES OF PRECIOUS METAL, WATCH BANDS.

FIRST USE : IN COMMERCE .

INT. CL. 18/U.S. CLS. 1, 2, 3, 22 AND 41

FOR ATTACHE CASES, BACKPACKS, BAGS OF LEATHER FOR PACKAGING, BAGS FOR CAMPERS, BAGS FOR TRAVEL, BOXES OF LEATHER FOR HATS, BRIEFCASES, CANES, CREDIT CARD CASES AND BUSINESS CARD CASES MADE OF LEATHER, CLOTHING FOR PETS, COLLARS FOR ANIMALS, [ENVELOPS] * ENVELOPES * OF LEATHER FOR PACKAGING, HANDBAG FRAMES, FUR, HANDBAGS, IMITATION LEATHER SOLD IN BULK, KEY CASES, NET BAGS FOR SHOPPING, PARASOLS, POCKET WALLETS, DRAWSTRING POUCHES, PURSES, RIDING SADDLES, RUCKSACKS, SADDLERY, SCHOOL BAGS, ANIMAL SKINS, SUITCASES, TRAVELING BAGS, TRAVELING TRUNKS, UMBRELLA COVERS, UMBRELLA HANDLES, UMBRELLAS, VANITY CASES SOLD EMPTY, WALKING STICK HANDLES, WHEELED SHOPPING BAGS.

FIRST USE ; IN COMMERCE .

INT. CL. 25/U.S. CLS. 22 AND 39

FOR APRONS, BANDANAS, BATHING SUITS, BELTS, BOOTS, SUSPENDERS FOR CLOTHING, BRASSIERES, HATS AND CAPS, CLOTHING, NAMELY, RAINCOATS, CARDIGANS, SPORT SHIRTS, BLOUSES, POLO SHIRTS, [NECKERCHIFFS,] * NECKERCHIEFS * MUFFLERS, CLOTHING FOR GYMNASTICS, COATS, COLLAR PROTECTORS, CUFFS, GARTERS, GLOVES, HEADBANDS, JACKETS, JERSEYS, JUMPERS, CLOTHING OF LEATHER, MASQUERADE COSTUMES, MITTENS, NECKTIES, OVERALLS, OVERCOATS, PAJAMAS, PANTS, PARKAS, SCARFS, SHAWLS, SHIRTS, SHOES, SKIRTS, SLIPPERS, SOCKS, BOOTS FOR SPORTS, SUITS, SWEATERS, T-SHIRTS, TROUSERS, UNDERCLOTHING, VESTS.

FIRST USE ; IN COMMERCE .

ELEMENTS CORRECTED
GOODS/SERVICES

POWERAMP

INT. CL. 6/U.S. CLS. 2, 12, 13, 14, 23, 25 AND 50

FOR VEHICLE RESTRAINTS, NAMELY, HYDRAULICALLY, ELECTRICALLY, AND MANUALLY ACTUATED STEEL HOOKS; AND HYDRAULICALLY ACTIVATED METAL BRIDGES.

FIRST USE 2-0-1984; IN COMMERCE 2-0-1984.

INT. CL. 7/U.S. CLS. 13, 19, 21, 23, 31, 34 AND 35

FOR LOADING DOCK EQUIPMENT, NAMELY, DOCK LEVELERS, VERTICAL DOCK LEVELERS, HYDRAULICALLY ACTUATED DOCK LEVELERS, MECHANICALLY ACTUATED DOCK LEVELERS, SPRING ACTUATED DOCK LEVELERS, AND AIR BAG ACTUATED DOCK LEVELERS.

FIRST USE 9-0-1967; IN COMMERCE 9-0-1967.

ELEMENTS CORRECTED

DATE OF FIRST USE

DATE OF FIRST USE IN COMMERCE

2,960,133. REG. 6-7-2005. SMITH, PATRICIA (UNITED STATES INDIVIDUAL) 2086 HUNTERS CREST WAY, VIENNA, VA, 22181, SN 76-422,748. FILED 6-18-2002. PRINCIPAL REGISTER.

PEACE X PEACE

INT. CL. 36/U.S. CLS. 100, 101 AND 102

FOR PHILANTHROPIC SERVICES CONCERNING MONETARY DONATIONS AND CHARITABLE DONATIONS OF FUNDS; CHARITABLE FUND RAISING.

FIRST USE 10-19-2003; IN COMMERCE 10-19-2003.

INT. CL. 44/U.S. CLS. 100 AND 101

FOR PHILANTHROPIC SERVICES [TN] * IN * THE AREA OF DONATIONS OF MEDICINE AND PERSONAL SERVICES IN THE NATURE OF HEALTH AND MEDICAL CARE.

FIRST USE 10-19-2003; IN COMMERCE 10-19-2003.

INT. CL. 45/U.S. CLS. 100 AND 101

FOR PHILANTHROPIC SERVICES IN THE AREA OF DONATIONS OF CLOTHING; PHILANTHROPIC SERVICES IN THE NATURE OF CONCIERGE SERVICES FOR OTHERS COMPRISING MAKING REQUESTED PERSONAL ARRANGEMENTS AND PROVIDING INDIVIDUAL-SPECIFIC INFORMATION TO MEET INDIVIDUAL NEEDS RENDERED TOGETHER AND BASED ON EXPRESSED REQUESTS FOR PERSONS FOSTERING DISCUSSIONS OF PEACE AND UNITY.

FIRST USE 10-19-2003; IN COMMERCE 10-19-2003.

ELEMENTS CORRECTED
GOODS/SERVICES

2,966,500. REG. 7-12-2005. MENGES, MCLAUGHLIN, CUNNINGHAM & KALASNIK, P.C. (PENNSYLVANIA PROFESSIONAL CORPORATION) 145 E. MARKET STREET, YORK, PA, 17401. SN 78-322,063. FILED 11-3-2003. PRINCIPAL REGISTER.

2,967,998. REG. 7-12-2005. OLD MOTHER HUBBARD, INC. (DELAWARE CORPORATION) 80 ROGERS STREET, LOWELL, MA, 01853, SN 76-977,538. FILED 4-1-2003. PRINCIPAL REGISTER.

**YOUR LAW FIRM FOR
LIFE**

WELLCELL

THE MARK CONSISTS OF STANDARD CHARACTERS WITHOUT CLAIM TO ANY PARTICULAR FONT, STYLE, SIZE, OR COLOR.

INT. CL. 42/U.S. CLS. 100 AND 101
FOR LEGAL SERVICES.
FIRST USE 1-0-2003; IN COMMERCE 1-0-2003.

ELEMENTS CORRECTED
OWNER NAME
OWNER ADDRESS
ENTITY

INT. CL. 5/U.S. CLS. 6, 18, 44, 46, 51 AND 52
FOR VITAMINS FOR PETS, DIETARY SUPPLEMENTS FOR PETS AND NUTRACEUTICALS FOR USE AS DIETARY SUPPLEMENTS FOR PETS.
FIRST USE 6-0-2003; IN COMMERCE 6-0-2003.

ELEMENTS CORRECTED
OWNER ADDRESS

* * * * *

INDEX OF REGISTRANTS

OCTOBER 18, 2005

(Registered; Renewed; Canceled; Amended, Corrected, etc.; New Certificates; 12c Publications.)

The designation "U.S. Cl." appearing in this section refers to the U.S. class in effect prior to Sep. 1, 1973 rather than the international class which applies to applications filed on or after that date. For adoption of international classification see notice in the OFFICIAL GAZETTE of Jun. 26, 1973 (911 O.G. TM 210).

S199 HOLDINGS LLC, TUCSON, AZ:
3,007,243, PUB. 7-5-2005. MULTIPLE CLASS, INT. CLS. 35 AND 42.

'TOTES', INCORPORATED, LOVELAND, OH:
2,207,565, CANC. INT. CL. 3.

A & H SPORTSWEAR CO., INC., STOCKERTOWN, PA:
3,007,669, INT. CL. 25.

A NEW YOU, INC., BEVERLY HILLS, CA:
2,105,630, CANC. INT. CL. 42.

A. B. DICK COMPANY, NILES, IL, A. B. DICK COMPANY, NILES, IL:
608,178, REN. 9-7-05. U.S. CL. 11 (INT. CL. 16).

A. E. STALEY MANUFACTURING COMPANY, DECATUR, IL:
1,306,634, CANC. INT. CL. 1.

A. H. HOFFMAN, INC., LANDISVILLE, PA:
2,207,714, CANC. INT. CL. 8.
2,207,715, CANC. INT. CL. 12.

A.B. DICK COMPANY, NILES, IL, A. B. DICK COMPANY, NILES, IL:
608,179, REN. 9-7-05. U.S. CL. 11 (INT. CL. 16).

A.D. VISION, INC., HOUSTON, TX:
3,007,216, PUB. 7-26-2005. INT. CL. 41.

A.R.T. COMPANY B&S, S.A., THE, QUEL, LA RIOJA, SPAIN:
3,007,393, PUB. 7-5-2005. INT. CL. 25.

A/E/C EXECUTIVE TALENTBANK, WILMINGTON, DE:
2,207,412, CANC. INT. CL. 35.

A/S BRUEL & KJAER, 2850 NAERUM, DENMARK:
2,206,402, CANC. INT. CL. 9.

A/S MODULEX, JUTLAND, DENMARK:
1,343,780, REN. 9-7-05. MULTIPLE CLASS, INT. CLS. 6, 9, 16 AND 20.
1,343,780, CANC. INT. CL. 11.

AACSB INTERNATIONAL, ST. LOUIS, MO:
3,006,987, PUB. 7-26-2005. INT. CL. 42.

ABB SCHWEIZ AG, 5400 BADEN, SWITZERLAND:
1,919,357, REN. 9-7-05. INT. CL. 9.

ABB TECHNICAL COATINGS, INC., NORTH CANTON, OH:
3,007,625, INT. CL. 1.

ABM OFFICE SUPPLY CO., INC., SAINT CHARLES, MO:
3,007,126, PUB. 7-26-2005. INT. CL. 35.

ACADEMY NETWORK CORPORATION II; THE, SARASOTA, FL:
1,306,968, CANC. INT. CL. 16.

ACADEMY, LTD., KATY, TX:
3,007,751, MULTIPLE CLASS, INT. CLS. 6, 7, 8, 9, 11, 18, 20, 21, 22 AND 24.

ACCENTA DISPLAY CORPORATION, MISSISSAUGA, ONTARIO, BANG & OLUFSEN OF AMERICA, INC., ELK GROVE VILLAGE, IL:
1,358,066, REN. 9-9-05. INT. CL. 20.

ACCESS INTELLIGENCE, LLC, ROCKVILLE, MD:
3,008,094, INT. CL. 16.

ACCESS-ABILITY, INC., BETHLEHEM, PA:
1,348,547, REN. 9-3-05. MULTIPLE CLASS, INT. CLS. 37 AND 42.

ACCESSORY NETWORK GROUP LLC, NEW YORK, NY, SIGN OF THE TIMES, INC., LOS ANGELES, CA:
1,323,255, REN. 9-7-05. INT. CL. 18.

ACCOUNTANTS OVERLOAD, LOS ANGELES, CA:
1,307,384, CANC. INT. CL. 35.

ACCREDITED STANDARDS COMMITTEE X9- FINANCIAL INDUSTRY INC., ANNAPOLIS, MD:
3,007,141, PUB. 7-26-2005. INT. CL. 9.

ACCUCAPS INDUSTRIES LIMITED, STRATHROY, ONTARIO, CANADA:
3,006,827, PUB. 7-26-2005. MULTIPLE CLASS, INT. CLS. 25, 28 AND 35.

ACCURIDE INTERNATIONAL, INC., SANTA FE SPRINGS, CA, STANDARD PRECISION, INC., SANTA FE SPRINGS, CA:
1,384,963, REN. 9-3-05. INT. CL. 6.

ACES UNLIMITED, INC., FORT LAUDERDALE, FL:
2,206,997, CANC. INT. CL. 41.

ACHIEVE TOTAL FITNESS, OAKMONT, PA:
3,007,581, MULTIPLE CLASS, INT. CLS. 5 AND 30.

ACME UNITED CORPORATION, FAIRFIELD, CT:
2,919,992, AM. INT. CL. 8.

ACNM CERTIFICATION COUNCIL, INC., LANDOVER, MD:
1,974,461, REN. 9-3-05. U.S. CL. B.

ACTION EQUIPMENT COMPANY, INC., CANDIA, NH:
2,206,927, CANC. MULTIPLE CLASS, INT. CLS. 35 AND 37.

ACTION NORD SUD, 69007 LYON, FRANCE:
2,206,335, CANC. MULTIPLE CLASS, INT. CLS. 35, 39 AND 41.

ACTION PRODUCTS, INC., HAGERSTOWN, MD:
1,346,201, REN. 9-9-05. INT. CL. 20.

ACTIVISION PUBLISHING, INC., SANTA MONICA, CA:
3,007,937, INT. CL. 9.

ACTIVITY RECORDS, INC., BALDWIN, NY:
1,306,890, CANC. INT. CL. 9.

ACUTE & CHRONIC PAIN AND SPINE CENTER, AMARILLO, TX:
3,007,481, PUB. 7-5-2005. INT. CL. 44.

ADAMS AND BROOKS, INC., LOS ANGELES, CA, DBA ADAMS & BROOKS, INC.:
1,346,613, REN. 9-3-05. INT. CL. 30.

ADAMS, THOMAS, LAKEWOOD, CA:
2,105,980, CANC. MULTIPLE CLASS, INT. CLS. 3 AND 33.

ADC TELECOMMUNICATIONS, INC., MINNETONKA, MN:
3,006,794, PUB. 7-26-2005. INT. CL. 9.

ADECCO NORTH AMERICA LLC, MELVILLE, NY, ACCOUNTANTS ON CALL INC., PARAMUS, NJ:
1,289,305, REN. 9-6-05. INT. CL. 35.

ADIDAS INTERNATIONAL MARKETING B.V., 1062 KR AMSTERDAM, NETHERLANDS:
3,007,953, INT. CL. 25.

ADOBEAIR, INC., PHOENIX, AZ:
1,337,755, REN. 9-6-05. INT. CL. 11.
1,904,953, REN. 9-7-05. INT. CL. 11.

ADOLF D'ARBO AG, 6135 STANS/TIROL, AUSTRIA:
1,933,476, REN. 9-7-05. MULTIPLE CLASS, INT. CLS. 29, 30 AND 32.

ADORA, INC., EDISON, NJ:
3,007,096, PUB. 7-26-2005. INT. CL. 28.

ADVANCE FUNDING CORP., NORFOLK, VA:
2,206,917, CANC. INT. CL. 36.

- ADVANCE MAGAZINE PUBLISHERS INC., NEW YORK, NY:
201,144. REN. 9-3-05. U.S. CL. 38 (INT. CL. 16).
3,007,057. PUB. 4-5-2005. INT. CL. 41.
- ADVANCED COMPOSITE MATERIALS CORPORATION, ATLANTIC RICHFIELD COMPANY, ROLLING MEADOWS, IL:
1,354,810. REN. 9-3-05. INT. CL. 1.
- ADVANCED POLYMER SYSTEMS, INC., BOULDER, CO:
2,207,386. CANC. INT. CL. 28.
- ADVANCED SLEEP PRODUCTS:
1,307,069. CANC. INT. CL. 20.
- ADVANSTAR COMMUNICATIONS, INC., DULUTH, MN:
2,207,049. CANC. INT. CL. 9.
2,207,301. CANC. INT. CL. 16.
- ADVANTAGE ENGINEERING, INC., GREENWOOD, IN:
1,281,450. REN. 9-7-05. INT. CL. 11.
- ADVANTAGEWARE INC., NEW YORK, NY:
2,207,004. CANC. INT. CL. 9.
- ADVER-TOGS, INC., NEW ALBANY, IN:
1,307,149. CANC. INT. CL. 25.
- ADVISORY PRESS, INC., THE LONGMEADOW, MA:
1,980,845. REN. 9-6-05. INT. CL. 16.
- AEA TECHNOLOGY PLC, OXFORDSHIRE, GREAT BRITAIN, UNITED KINGDOM ATOMIC ENERGY AUTHORITY, OXFORDSHIRE, OX11 0RA, GREAT BRITAIN, DBA INTER ALIA, UNDER THE NAME AEA TECHNOLOGY:
1,908,945. REN. 9-7-05. INT. CL. 42.
- AEP RESOURCES, INC., COLUMBUS, OH:
2,206,455. CANC. MULTIPLE CLASS, INT. CLS. 35, 39 AND 40.
- AERO DESIGN, INC., OKLAHOMA CITY, OK:
2,206,736. CANC. INT. CL. 39.
- AERO TEC LABORATORIES INC., RAMSEY, NJ:
1,350,547. REN. 9-3-05. MULTIPLE CLASS, INT. CLS. 12, 17 AND 19.
- AEROTECH, INC., PITTSBURGH, PA:
3,007,996. INT. CL. 9.
- AEROVIAS DE MEXICO, S.A. DE C.V., MEXICO CITY, MEXICO:
3,007,465. PUB. 7-26-2005. INT. CL. 16.
- AFFINIA AUTOMOTIVA LTDA, CITY OF OSASCO, STATE OF SAO PAULO, BRAZIL:
1,016,598. REN. 9-7-05. INT. CL. 12.
- AFTER SIX, INCORPORATED, PHILADELPHIA, PA:
1,306,701. CANC. MULTIPLE CLASS, INT. CLS. 3, 14 AND 25.
- AGFA-GEVAERT, B-2640 MORTSEL, BELGIUM:
1,907,174. REN. 9-7-05. INT. CL. 9.
- AGILENT TECHNOLOGIES, INC., PALO ALTO, CA:
3,007,729. INT. CL. 9.
- AIDA THIBIANT, INC., BEVERLY HILLS, CA TO THIBIANT INTERNATIONAL, INC., CHATSWORTH, CA:
1,865,135. CANC. INT. CL. 3.
- AIRFLOW SYSTEMS, INC., DALLAS, TX:
1,909,248. REN. 9-7-05. INT. CL. 11.
- AIROLITE COMPANY, LLC, THE SCHOFIELD, WI:
613,372. REN. 9-9-05. U.S. CL. 12 (INT. CL. 6).
- AKAMU, BRENDAN R., LONG BEACH, CA:
2,206,541. CANC. INT. CL. 3.
- AKIN, RONALD M., LONG BEACH, CA:
2,206,994. CANC. INT. CL. 35.
- AKOVA TEKSTIL VE TARIM URIINLERI TICARET VE SANAYI LIMITED SIRKETI, 20100 DENIZLI, TURKEY:
3,006,825. PUB. 7-26-2005. MULTIPLE CLASS, INT. CLS. 24, 25 AND 26.
- ALACER CORP., FOOTHILL RANCH, CA:
1,961,007. REN. 9-6-05. INT. CL. 3.
- ALAION PRODUCTS, INC., ORANGE, NJ:
1,307,133. CANC. INT. CL. 25.
- ALBEMARLE CORPORATION, BATON ROUGE, LA:
3,007,905. INT. CL. 1.
- ALCAN GLOBAL PHARMACEUTICAL PACKAGING INC., MILLVILLE, NJ, WHEATON HOLDING, INC., WILMINGTON, DE:
1,869,599. REN. 9-6-05. INT. CL. 20.
- ALCATEL NA NETWORK SYSTEMS CORP., RALEIGH, NC:
1,306,827. CANC. INT. CL. 9.
- ALCOA INC., PITTSBURGH, PA:
1,908,481. REN. 9-3-05. INT. CL. 19.
- ALCOA, INC., PITTSBURGH, PA, ALUMINUM COMPANY OF AMERICA, PITTSBURGH, PA:
1,976,763. REN. 9-9-05. INT. CL. 6.
- ALDI INC., BATAVIA, IL:
1,307,307. CANC. INT. CL. 29.
- ALERT SAFETY LITE PRODUCTS, INC., BEDFORD HEIGHTS, OH:
1,904,232. REN. 9-7-05. INT. CL. 9.
- ALERT-ALL CORP., NEW HOLLAND, PA:
1,341,622. REN. 9-3-05. INT. CL. 42.
- ALEX AND ANI, INC., CRANSTON, RI:
2,549,848. AM. INT. CL. 3.
- ALEXANDER, CHARLES E., RICHMOND, VA:
1,865,006. CANC. INT. CL. 41.
- ALEXIA FOODS, INC., BROOKLYN, NY:
3,007,968. INT. CL. 29.
3,007,969. INT. CL. 29.
3,007,978. INT. CL. 29.
- ALFA-LAVAL AB, STOCKHOLM, SWEDEN:
1,306,830. CANC. INT. CL. 9.
- ALFIERI, BURT LANCE, PALM DESERT, CA:
1,864,857. CANC. INT. CL. 30.
- ALGAE-KLEEN, INC., DENHAM SPRINGS, LA:
2,206,523. CANC. INT. CL. 11.
2,206,593. CANC. INT. CL. 11.
- ALICE JOY FRANK ENTERPRISES, INC., ENGLEWOOD, NJ:
1,307,280. CANC. INT. CL. 28.
- ALIMENTOS SIGMA CONAGRA FOODS, S.A. DE C.V., LINARES, NUEVO LEON, MEXICO:
3,007,214. PUB. 7-26-2005. MULTIPLE CLASS, INT. CLS. 29, 30 AND 32.
- ALL SIGN PRODUCTS, INC., CORAL SPRINGS, FL:
2,206,885. CANC. INT. CL. 19.
- ALLEGIANCE CORPORATION, MCGAW PARK, IL, BAXTER INTERNATIONAL INC., DEERFIELD, IL:
1,977,006. REN. 9-7-05. INT. CL. 10.
- ALLEGRO PRODUCTIONS, INC., BOCA RATON, FL:
1,864,563. CANC. MULTIPLE CLASS, INT. CLS. 9 AND 41.
- ALLEN SYSTEMS GROUP, INC., NAPLES, FL:
1,352,525. REN. 9-3-05. INT. CL. 9.
- ALLEN, PATRICIA, NEWPORT BEACH, CA:
3,008,022. MULTIPLE CLASS, INT. CLS. 9, 41 AND 45.
- ALLIANCE FOR HEALTH OF SOUTHWEST OHIO, KETTERING, OH:
2,207,465. CANC. INT. CL. 42.
- ALLIANZ LIFE INSURANCE COMPANY OF NORTH AMERICA, MINNEAPOLIS, MN:
2,207,069. CANC. INT. CL. 35.
- ALLIED ATTORNEYS STOCKHOLM AB, STOCKHOLM SE-100 55, SWEDEN:
1,858,253. REN. 9-6-05. INT. CL. 42.
- ALLIED MUTUAL INSURANCE COMPANY, DES MOINES, IA:
2,206,724. CANC. INT. CL. 36.
- ALLIED WEB, INC., IRVINE, CA:
2,207,528. CANC. INT. CL. 9.
2,207,529. CANC. INT. CL. 9.
- ALLIEDSIGNAL INC., MORRISTOWN, NJ:
2,206,476. CANC. INT. CL. 18.
2,206,530. CANC. INT. CL. 17.
2,206,924. CANC. INT. CL. 12.
- ALLINA HEALTH SYSTEM, MINNEAPOLIS, MN:
2,207,556. CANC. INT. CL. 9.
- ALLOY BELLOWS COMPANY, CLEVELAND, OH:
2,206,855. CANC. INT. CL. 40.
- ALLTRADE INC., LONG BEACH, CA:
2,206,845. CANC. INT. CL. 8.
- ALMANAUTA, INC., CORAL GABLES, FL:
1,865,467. CANC. INT. CL. 16.
- ALMARAZ, HUMBERTO, PORTLAND, TX:
3,007,037. PUB. 7-26-2005. INT. CL. 16.
- ALO PRO OF CHICAGO, INC., BENSENVILLE, IL:
1,306,694. CANC. MULTIPLE CLASS, INT. CLS. 3 AND 10.

- ALPHA BEAUTY CLINIC, INC., JACKSONVILLE, FL:
3,008,091, INT. CL. 44.
- ALPHA OMEGA PUBLICATIONS, INC., CHANDLER, AZ:
3,007,074, PUB. 7-26-2005. INT. CL. 16.
- ALPHAS OF MICHIGAN, INC., WEST BLOOMFIELD, MI,
DBA MEA CORP.:
1,864,493, CANC. INT. CL. 3.
- ALPINE PRESS, INC., BOULDER, CO:
1,864,574, CANC. INT. CL. 9.
- ALSTON TASCOM, INC., CHINO, CA:
3,007,065, PUB. 7-26-2005. INT. CL. 9.
- ALTANA PHARMA AG, 78467 KONSTANZ, FED REP
GERMANY:
3,006,870, PUB. 7-26-2005. INT. CL. 5.
- ALTANA PHARMA AG, KONSTANZ, FED REP GERMANY:
3,007,402, PUB. 7-26-2005. INT. CL. 5.
- ALTAREX MEDICAL CORP., EDMONTON, ALBERTA,
CANADA:
2,206,290, CANC. MULTIPLE CLASS, INT. CLS. 5 AND
42.
- ALTICOR INC., ADA, MI:
3,007,740, MULTIPLE CLASS, INT. CLS. 3, 5 AND 21.
- ALTIMA HOMES, INC, SOUTH BARRINGTON, IL:
3,007,357, PUB. 7-26-2005. INT. CL. 37.
- ALY-WEAR, INC., EPHRATA, PA:
2,207,161, CANC. INT. CL. 25.
- AMATO, KENNETH J., ETNA, PA, DBA AMATO'S PIZZA:
1,353,372, AM. INT. CL. 42.
- AMAV INDUSTRIES LTD., ST. LAURENT, QUEBEC H4T
1K4, CANADA:
2,207,599, CANC. INT. CL. 28.
- AMAZON COFFEE & TEA CO., INC., WOODSIDE, NY:
2,207,747, CANC. MULTIPLE CLASS, INT. CLS. 29, 30
AND 32.
- AMBER E. BARTEN, RENTON, WA:
3,008,097, INT. CL. 21.
- AMBICO, INC., NORWOOD, NJ:
1,306,851, CANC. INT. CL. 9.
- AMCO INSURANCE AGENCIES, INC., HOUSTON, TX:
2,206,721, CANC. INT. CL. 36.
- AMERICA'S DRIVE-IN CORP., WICHITA, KS:
3,007,979, INT. CL. 43.
- AMERICAN ACADEMY OF ORIENTAL MEDICINE FA-
MILY PRACTICE, TEXARKANA, AR:
3,006,855, PUB. 7-26-2005. INT. CL. 41.
- AMERICAN AIRLINES, INC, DALLAS/FORT WORTH AIR-
PORT, TX:
1,004,523, REN. 9-9-05. U.S. CL. 38 (INT. CL. 16).
- AMERICAN AIRLINES, INC., DFW AIRPORT, TX:
2,206,779, CANC. INT. CL. 39.
- AMERICAN ARBITRATION ASSOCIATION, NEW YORK,
NY:
1,943,521, REN. 9-3-05. INT. CL. 16.
- AMERICAN ASSOCIATION OF PORT AUTHORITIES,
ALEXANDRIA, VA:
2,207,650, CANC. INT. CL. 16.
- AMERICAN ASSOCIATION OF SENIOR PEER COUNSEL-
ING, STOCKTON, CA:
2,206,678, CANC. INT. CL. 42.
- AMERICAN BASKETBALL LEAGUE, INC., THE, SAN JOSE,
CA:
2,207,432, CANC. MULTIPLE CLASS, INT. CLS. 16, 25, 28,
35, 36 AND 41.
- AMERICAN BIOSCIENCE, INC., SANTA MONICA, CA:
3,007,995, INT. CL. 5.
- AMERICAN BOA, INC., NEW YORK, NY:
1,306,807, CANC. INT. CL. 6.
- AMERICAN BOARD OF MEDICAL SPECIALTIES, EVAN-
STON, IL:
1,014,990, REN. 9-3-05. U.S. CL. 200.
1,018,322, REN. 9-3-05. U.S. CL. 200.
- AMERICAN BUILDING SUPPLY, INC., MELBOURNE, FL:
2,206,945, CANC. INT. CL. 20.
- AMERICAN CIVIL LIBERTIES UNION FOUNDATION,
NEW YORK, NY:
1,904,383, REN. 9-7-05. MULTIPLE CLASS, INT. CLS. 16
AND 36.
- AMERICAN COLLECTORS ASSOCIATION, INC., MINNEA-
POLIS, MN:
2,206,877, CANC. INT. CL. 41.
- AMERICAN COLLEGE OF RADIOLOGY, RESTON, VA:
3,007,495, PUB. 7-5-2005. MULTIPLE CLASS, INT. CLS. 36
AND 42.
- AMERICAN COMMODITIES, INC., FLINT, MI:
1,918,409, REN. 9-3-05. MULTIPLE CLASS, INT. CLS. 40
AND 42.
- AMERICAN COUNCIL ON EXERCISE, SAN DIEGO, CA:
3,008,047, MULTIPLE CLASS, INT. CLS. 35 AND 41.
- AMERICAN COVERS, INC., DRAPER, UT:
3,007,200, PUB. 7-26-2005. INT. CL. 12.
- AMERICAN DISC JOCKEY ASSOCIATION, INC., PASADE-
NA, CA:
3,006,921, PUB. 7-26-2005. INT. CL. 35.
- AMERICAN EAGLE TANKERS INC. LIMITED, HOUSTON,
TX:
1,922,502, REN. 9-3-05. INT. CL. 39.
- AMERICAN EMU ASSOCIATION, SIXES, OR:
3,007,091, PUB. 7-26-2005. INT. CL. 35.
- AMERICAN FARRIER'S ASSOCIATION, INC., LEXING-
TON, KY:
3,007,250, PUB. 7-26-2005. U.S. CL. B.
- AMERICAN FIBER INDUSTRIES, LLC, CITY OF COM-
MERCE, CA:
2,206,520, CANC. INT. CL. 20.
2,206,521, CANC. INT. CL. 20.
- AMERICAN FREEDOM MAIDS, INC., FARMINGTON
HILLS, MI:
2,207,541, CANC. INT. CL. 37.
- AMERICAN GIRL, LLC, EL SEGUNDO, CA:
3,007,865, INT. CL. 28.
- AMERICAN HENG-SENG ENTERPRISES, INC., LOS AN-
GELES, CA, DBA FEC GINSENG & MARINE PRODUCTS:
1,946,297, REN. 9-9-05. INT. CL. 30.
- AMERICAN INSTITUTE OF ARCHITECTS, CALIFORNIA
COUNCIL, THE, SACRAMENTO, CA:
3,007,608, U.S. CL. B.
- AMERICAN INTERNATIONAL GROUP, INC., NEW YORK,
NY:
2,206,910, CANC. INT. CL. 36.
3,007,959, INT. CL. 36.
- AMERICAN INTERNATIONAL INDUSTRIES, LOS AN-
GELES, CA:
3,007,967, INT. CL. 3.
- AMERICAN INTERNET SERVICES, INC., FLORISSANT,
MO:
3,006,778, PUB. 7-22-1997. INT. CL. 42.
- AMERICAN MANUFACTURING CONCEPTS, INC., CHU-
LA VISTA, CA:
2,206,960, CANC. INT. CL. 25.
- AMERICAN MICRO INDUSTRIES, INC., CHAMBERS-
BURG, PA:
3,008,096, INT. CL. 17.
- AMERICAN PACIFIC ENTERPRISES, INC., SAN FRANCIS-
CO, CA:
3,007,601, INT. CL. 24.
- AMERICAN PODIATRIC MEDICAL ASSOCIATION,
BETHESDA, MD:
1,307,566, CANC. U.S. CL. A.
- AMERICAN PROTECTIVE SERVICES, INC., OAKLAND,
CA:
2,207,055, CANC. INT. CL. 42.
- AMERICAN PSYCHIATRIC ASSOCIATION, WASHING-
TON, DC:
1,901,691, REN. 9-3-05. MULTIPLE CLASS, INT. CLS. 16
AND 42.
- AMERICAN PUBLIC TRANSIT ASSOCIATION; THE, WA-
SHINGTON, DC:
1,306,996, CANC. INT. CL. 16.
1,307,534, CANC. INT. CL. 42.
- AMERICAN TELEPHONE AND TELEGRAPH COMPANY,
NEW YORK, NY TO LUCENT TECHNOLOGIES INC.,
MURRAY HILL, NJ:
1,865,220, CANC. INT. CL. 9.
- AMERICAN TIME & SIGNAL CO., DASSEL, MN:
3,007,174, PUB. 7-26-2005. INT. CL. 14.

- AMERICAN WOODMARK CORPORATION, WINCHESTER, VA:
2,207,684, CANC. INT. CL. 20.
- AMERICROWN SERVICE CORPORATION, DAYTONA BEACH, FL, INTERNATIONAL SPEEDWAY CORPORATION, DAYTONA BEACH, FL:
1,904,773. REN. 9-7-05. INT. CL. 42.
- AMETHYST INVESTMENT GROUP, INC., CHICAGO, IL:
1,864,472, CANC. INT. CL. 3.
- AMRESCO, INC., SOLON, OH:
3,006,893, PUB. 7-26-2005. INT. CL. 42.
- AMRITA FOUNDATION, INC., DALLAS, TX:
1,864,678, CANC. INT. CL. 16.
1,864,679, CANC. INT. CL. 16.
1,864,996, CANC. INT. CL. 41.
- AMTAC CERTIFICATION SERVICES LTD., CHESHIRE, UNITED KINGDOM:
3,007,566, INT. CL. 42.
- AMTROL, INC., WEST WARWICK, RI:
3,007,394, PUB. 7-26-2005. INT. CL. 11.
- AMVAC, INC., MUNSTER, IN:
2,206,276, CANC. INT. CL. 37.
2,206,277, CANC. INT. CL. 37.
- AMY BROWN FANTASY ART, INC, TACOMA, WA:
3,007,277, PUB. 7-26-2005. INT. CL. 35.
- ANA-TECH CORPORATION, HOUSTON, TX:
2,494,356, CANC. INT. CL. 10.
- ANACONDA NICKEL LIMITED, WEST PERTH, WESTERN AUSTRALIA 6872, AUSTRALIA:
2,206,443, CANC. INT. CL. 6.
- ANCHOR HOCKING OPERATING COMPANY LLC, MONACA, PA, ANCHOR HOCKING GLASS CORPORATION, LANCASTER, OH:
788,905. REN. 9-7-05. U.S. CL. 8 (INT. CL. 34).
- ANCIENT MODERN ART, LLC, NEW YORK, NY:
3,006,907, PUB. 5-31-2005. INT. CL. 14.
- ANDERSON KILL & OLICK, P.C., NEW YORK, NY:
3,007,041, PUB. 7-26-2005. INT. CL. 16.
- ANDERSON POWER PRODUCTS, INC., STERLING, MA, ANDERSON POWER PRODUCTS, INC., BOSTON, MA:
1,015,691. REN. 9-8-05. INT. CL. 9.
- ANDERSON; JACK N., BETHESDA, MD:
1,306,960, CANC. INT. CL. 16.
- ANDERSON, SHAUNA RENEE, HYATTSVILLE, MD:
3,007,245, PUB. 7-26-2005. INT. CL. 29.
- ANDORRA BANC AGRICOL REIG, S.A., ANDORRA LA VELLA, ANDORRA:
3,007,175, PUB. 7-26-2005. MULTIPLE CLASS, INT. CLS. 16, 35, 36, 38 AND 41.
- ANDREA C. HUMMEL, LUTZ, FL:
2,206,870, CANC. INT. CL. 41.
- ANDREWS, DUANE, VALLEJO, CA:
3,008,027, INT. CL. 36.
- ANGAR SCIENTIFIC COMPANY, INC., CEDAR KNOLLS, NJ:
1,306,852, CANC. INT. CL. 9.
- ANGEL SALES, INC., CHICAGO, IL:
3,007,533, PUB. 7-5-2005. INT. CL. 10.
- ANGEL TOES, INC., EDINA, MN:
3,007,196, PUB. 6-7-2005. INT. CL. 28.
- ANHEUSER-BUSCH, INCORPORATED, ST. LOUIS, MO:
3,007,445, PUB. 7-26-2005. INT. CL. 44.
- ANHING CORPORATION, LOS ANGELES, CA:
1,934,695. REN. 9-9-05. INT. CL. 30.
- ANJOWA, INC., MARIETTA, GA:
1,865,316, CANC. INT. CL. 25.
- ANNAMAR ASSOCIATES INCORPORATED, MOUNT JOY, PA:
3,007,340, PUB. 7-26-2005. INT. CL. 41.
- ANNIE'S ENTERPRISES, INC., NORTH CALAIS, VT:
3,007,860, INT. CL. 30.
- ANSELL INCORPORATED, DOTHAN, AL:
1,307,076, CANC. INT. CL. 21.
- ANSWERS FOR AMERICA, PALATINE, IL:
2,206,841, CANC. INT. CL. 35.
2,206,843, CANC. INT. CL. 35.
- ANTHEM SOUTHEAST, INC., INDIANAPOLIS, IN:
1,322,516. REN. 9-7-05. INT. CL. 36.
- ANTHONY J. MONTI AND PHILIP R. SEYMOUR PARTNERSHIP, THE, HUDSON, MA:
2,206,392, CANC. INT. CL. 8.
- APARTMENT MOVERS, INC., THE, IRVING, TX:
1,865,483, CANC. INT. CL. 39.
- APARTMENTS ON LINE, INC., DENVER, CO:
2,096,158, CANC. INT. CL. 35.
- APEX CONSULTING, L.L.C., GLADSTONE, MO:
3,008,083, INT. CL. 45.
- APEX INTERNATIONAL, INC., CRANBERRY TOWNSHIP, PA:
3,007,641, INT. CL. 24.
- APOGEE SOFTWARE, LTD., GARLAND, TX:
2,207,472, CANC. INT. CL. 9.
- APPLE COMPUTER, INC., CUPERTINO, CA, DIGI INTERNATIONAL INC., EDEN PRAIRIE, MN:
1,909,765. REN. 9-7-05. INT. CL. 9.
- APPLE COMPUTER, INC., CUPERTINO, CA:
1,947,728. REN. 9-6-05. INT. CL. 9.
- APPLE FELT & WIPING SYSTEMS, INC., PITTSBURGH, PA:
1,902,779. REN. 9-9-05. INT. CL. 24.
1,919,117. REN. 9-9-05. INT. CL. 1.
- APPLETON ELECTRIC COMPANY, SKOKIE, IL, APPLETON ELECTRIC COMPANY, CHICAGO, IL:
1,019,890. REN. 9-8-05. INT. CL. 9.
- APPLIED MICRO CIRCUITS CORPORATION, SAN DIEGO, CA:
3,007,872, INT. CL. 9.
- APPLIED SYSTEMS, INC., UNIVERSITY PARK, IL, EUSTACE; ROBERT R., MONEE, IL, DBA APPLIED SYSTEMS:
1,347,333. REN. 9-9-05. INT. CL. 9.
- APPLIED WIRELESS IDENTIFICATION GROUP, INC., MONSEY, NY:
3,007,598, INT. CL. 9.
- APPTIS HOLDINGS, INC., CHANTILLY, VA:
3,007,522, PUB. 7-26-2005. MULTIPLE CLASS, INT. CLS. 9 AND 16.
- AQFTM, CARY, NC, AUSTIN QUALITY FOODS, INC., CARY, NC:
1,935,987. REN. 9-9-05. INT. CL. 30.
- ARAMARK CORPORATION, PHILADELPHIA, PA:
3,007,453, PUB. 7-26-2005. INT. CL. 43.
- ARAMARK UNIFORM SERVICES, INC, BURBANK, CA:
2,206,979, CANC. INT. CL. 35.
- ARCADIA DESIGN SYSTEMS, INC., SANTA CLARA, CA:
2,207,163, CANC. INT. CL. 9.
- ARCASA S.R.L., VILLA DEL CONTE (PD), ITALY:
3,007,850, MULTIPLE CLASS, INT. CLS. 3 AND 5.
- ARCH CHEMICALS, INC., NORWALK, CT:
1,361,282. REN. 9-6-05. INT. CL. 1.
- ARCH CHEMICALS, INC., NORWALK, CT, ZENECA INC., WILMINGTON, DE:
1,909,094. REN. 9-6-05. INT. CL. 1.
- ARCH UK BIOCIDES LIMITED, CASTLEFORD, WEST YORKSHIRE WF10 2JT, UNITED KINGDOM, IMPERIAL CHEMICAL INDUSTRIES LIMITED, MILLBANK, LONDON, ENGLAND:
1,023,538. REN. 9-6-05. INT. CL. 1.
- ARCHER, JOHN, EULESS, TX AND BECKERLEY, BEN, EULESS, TX:
3,007,910, MULTIPLE CLASS, INT. CLS. 25 AND 35.
- ARCHWAY COOKIES, INC., BATTLE CREEK, MI TO ARCHWAY COOKIES, LLC, OAKLAND, CA:
1,865,364, CANC. INT. CL. 30.
- ARDYSS INTERNATIONAL, LAS VEGAS, NV:
3,007,280, PUB. 7-26-2005. INT. CL. 25.
- ARGENT ENTERPRISES INC., CUMMING, GA:
3,008,007, INT. CL. 28.
- ARGUETTY, ISAAC, SUNRISE, FL:
2,207,516, CANC. INT. CL. 41.
- ARISTOCRAT TECHNOLOGIES AUSTRALIA PTY LTD., LANE COVE, NEW SOUTH WALES, AUSTRALIA:
3,007,215, PUB. 7-26-2005. MULTIPLE CLASS, INT. CLS. 9, 16 AND 41.
- ARJAY ENTERTAINMENT LLC, LOS ANGELES, CA:
3,007,689, INT. CL. 41.

- ARLUY, S.L., LOGRONO (LA RIOJA), SPAIN:
2,108,196, CANC. INT. CL. 30.
- ARMALY SPONGE COMPANY, WALLED LAKE, MI:
3,007,100, PUB. 7-26-2005. INT. CL. 3.
- ARMINAK & ASSOCIATES, INC., DUARTE, CA:
3,007,087, PUB. 7-26-2005. INT. CL. 21.
- ARNOLD FOODS COMPANY, INC., GREENWICH, CT TO
JOG DISTRIBUTION, INC., SAN FRANCISCO, CA:
1,349,830, CANC. INT. CL. 31.
- ARROW DENIM LIMITED, DORSET BH12 4BQ, UNITED
KINGDOM:
3,006,847, PUB. 1-4-2005. MULTIPLE CLASS, INT. CLS. 9,
14, 25 AND 35.
- ARTA PLAST AB, TYRESO, SWEDEN:
1,902,585, REN. 9-3-05. INT. CL. 10.
- ARTHUR ANDERSEN LLP:
See— ASPEN PUBLISHERS, INC..
- ARTHUR MURRAY INTERNATIONAL, INC., CORAL GA-
BLES, FL:
2,207,537, CANC. INT. CL. 41.
- ASCEND MEDIA, LLC, OVERLAND PARK, KS:
3,008,086, INT. CL. 16.
- ASCENDIA AB, SOLLENTUNA, SWEDEN:
3,007,800, MULTIPLE CLASS, INT. CLS. 35, 42 AND 44.
- ASHANTIPLC, LTD., HONG KONG, CHINA:
3,007,931, MULTIPLE CLASS, INT. CLS. 3 AND 14.
- ASHBURY HIDES, LLC, LOS ANGELES, CA:
3,007,398, PUB. 7-26-2005. INT. CL. 35.
- ASHBY, DAVID C., LOS ALTOS, CA:
2,206,973, CANC. INT. CL. 41.
- ASHBY, GEORGE H JR., MIDDLEBURG, FL:
3,006,800, PUB. 7-26-2005. MULTIPLE CLASS, INT. CLS. 4
AND 35.
- ASHWORTH, INC., CARLSBAD, CA:
1,938,132, REN. 9-6-05. INT. CL. 25.
1,938,133, REN. 9-6-05. INT. CL. 25.
1,940,723, REN. 9-6-05. INT. CL. 25.
- ASPEN DESIGN WORKS, LLC, CARBONDALE, CO:
3,007,376, PUB. 7-5-2005. INT. CL. 20.
- ASPEN PUBLISHERS, INC., NEW YORK, NY:
795,721, REN. 9-7-05. U.S. CL. 101 (INT. CL. 36).
797,827, REN. 9-7-05. U.S. CL. 38 (INT. CL. 16).
- ASPEN PUBLISHERS, INC., NEW YORK, NY FROM
ARTHUR ANDERSEN LLP, CHICAGO, IL:
3,006,837, PUB. 7-26-2005. MULTIPLE CLASS, INT. CLS.
9, 35 AND 36.
- ASPILABO, 63000 CLERMONT-FERRAND, FRANCE:
1,345,917, REN. 9-3-05. INT. CL. 10.
- ASSET MARKETING CONSULTANTS, INC., SPRING-
FIELD, MO:
3,007,111, PUB. 7-26-2005. INT. CL. 36.
- ASSOCIATED LOCKSMITHS OF AMERICA, INC., DALLAS,
TX:
1,942,392, REN. 9-7-05. U.S. CL. B.
- ASSOCIATION FOR DEATH EDUCATION AND COUNSEL-
ING (ADEC), WEST HARTFORD, CT:
3,006,935, PUB. 7-26-2005. U.S. CL. B.
- ASSOCIATION FOR THE ADVANCEMENT OF MEDICAL
INSTRUMENTATION, ARLINGTON, VA:
2,206,497, CANC. MULTIPLE CLASS, INT. CLS. 16, 41
AND 42.
- ASSOCIATION OF CAPITAL & EMPLOYEES, INC.,
QUINCY, FL:
1,865,471, CANC. INT. CL. 16.
- ASSORT PTY. LTD, CHELTENHAM, VICTORIA, AUSTRA-
LIA, ASSORT PTY. LTD, CHELTENHAM, VICTORIA,
AUSTRALIA:
1,890,434, REN. 9-9-05. INT. CL. 9.
- ASTHMA TREATMENT CENTERS OF AMERICA, INC., ST.
PAUL, MN:
2,207,550, CANC. INT. CL. 42.
- ASTRAZENECA AB, S-151 85 SODERTALJE, SWEDEN:
3,006,826, PUB. 7-26-2005. INT. CL. 16.
- ASTRAZENECA LP, WILMINGTON, DE, ASTRA USA, INC.,
WESTBOROUGH, MA:
1,902,331, REN. 9-3-05. INT. CL. 5.
- ASTRAZENECA UK LIMITED, LONDON, ENGLAND, IM-
PERIAL CHEMICAL INDUSTRIES LIMITED, LONDON,
SWIP 3JF, ENGLAND:
998,925, REN. 9-8-05. INT. CL. 5.
- ASTRO PEN COMPANY, WEST CHICAGO, IL TO EVER-
SHARP PEN COMPANY, FRANKLIN PARK, IL:
1,865,263, CANC. INT. CL. 16.
- AT&T CORP., NEW YORK, NY:
3,007,722, INT. CL. 9.
- ATCO PARTS, INC., LAKELAND, FL:
3,007,131, PUB. 7-26-2005. INT. CL. 35.
- ATFOX LIMITED, LONDON, UNITED KINGDOM:
3,006,845, PUB. 7-26-2005. MULTIPLE CLASS, INT. CLS.
35, 36 AND 42.
- ATKIN, NIGEL, LONDON N1 2QF, ENGLAND AND
SANSOM, NEIL, SURREY KT4 8PJ, ENGLAND:
3,006,817, PUB. 7-26-2005. INT. CL. 42.
- ATLANTA HAWKS, LP, ATLANTA, GA, ATLANTA
HAWKS, LTD., ATLANTA, GA:
1,946,924, REN. 9-6-05. INT. CL. 25.
- ATLANTA INTERNATIONAL MUSEUM, INC., ATLANTA,
GA:
2,207,032, CANC. INT. CL. 41.
- ATLAS ALCHEM PLASTICS, INC., CAPE GIRARDEAU,
MO:
1,009,937, REN. 9-3-05. INT. CL. 17.
- ATLAS BLOCK CO., MIDLAND, ONTARIO, CANADA:
3,007,052, PUB. 7-26-2005. INT. CL. 19.
- ATOMIC AUSTRIA GMBH, A-5541 ALTENMARKT, AUS-
TRIA:
2,206,511, CANC. INT. CL. 28.
- ATTACHMATE CORPORATION, BELLEVUE, WA, MICRO-
LINK TECHNOLOGIES, INCORPORATED, BERKELEY,
CA:
1,903,432, REN. 9-3-05. INT. CL. 9.
- ATTORNEYS LIABILITY PROTECTION SOCIETY, INC., A
RISK RETENTION GROUP, MISSOULA, MT:
2,193,086, AM. INT. CL. 36.
- AUCTION WORLD, INC., VIENNA, VA:
2,206,860, CANC. INT. CL. 35.
- AUDI A.G., INGOLSTADT, FED REP GERMANY:
3,007,305, PUB. 7-26-2005. MULTIPLE CLASS, INT. CLS.
3, 6, 8, 9, 12, 14, 16, 18, 21, 24, 25 AND 28.
- AUGENBRAUN & ASSOCIATES, BRIDGEPORT, CT:
3,007,997, INT. CL. 3.
- AUGIE MOSCHITTO TRIM & JEWELRY CORP., JAMAICA,
NY:
3,007,307, PUB. 7-26-2005. MULTIPLE CLASS, INT. CLS.
21 AND 26.
- AUGUST RECORDS, INC., NEW HOPE, PA:
1,901,574, REN. 9-3-05. INT. CL. 9.
- AURORA TRAILER HOLDINGS LLC, NEW YORK, NY:
3,006,795, PUB. 7-26-2005. INT. CL. 39.
- AUTOBODY BRANDS INTERNATIONAL, INC., SCOTTS-
DALE, AZ:
3,006,978, PUB. 7-26-2005. INT. CL. 2.
3,006,979, PUB. 7-26-2005. INT. CL. 2.
- AUTOGAS SYSTEMS, INC., ABILENE, TX:
3,007,788, INT. CL. 35.
- AUTOMATED PIPELINE INSTRUMENTS, INC., ROCK-
WALL, TX:
2,207,756, CANC. INT. CL. 9.
- AUTOMOTIVE REFINISH TECHNOLOGIES, INC., SOUTH-
FIELD, MI:
2,206,558, CANC. INT. CL. 9.
- AVADO BRANDS INC, MADISON, GA, DF & R RESTAU-
RANTS, INC., BEDFORD, TX:
1,864,093, REN. 9-3-05. INT. CL. 42.
- AVALONBAY COMMUNITIES, INC., ALEXANDRIA, VA:
1,871,559, REN. 9-7-05. INT. CL. 36.
- AVDEL CHERRY RHODE ISLAND INC., PROVIDENCE, RI:
1,313,092, REN. 9-7-05. INT. CL. 6.
- AVESTA SHEFFIELD AKTIEBOLAG (PUBL), S-103 27
STOCKHOLM, SWEDEN:
2,206,602, CANC. INT. CL. 6.
- AVON PRODUCTS, INC., NEW YORK, NY:
2,207,605, CANC. INT. CL. 3.
3,007,976, INT. CL. 3.

- AWI LICENSING COMPANY, WILMINGTON, DE:
3,007,080, PUB. 4-5-2005. INT. CL. 6.
- AXIA INCORPORATED, HOUSTON, TX:
793,165. REN. 9-3-05. U.S. CL. 12 (INT. CL. 19).
- B & B GAMES, INC., MIDWEST CITY, OK:
1,307,242, CANC. INT. CL. 28.
- B AT HOME, INC., NEW YORK, NY:
3,007,366, PUB. 7-26-2005. MULTIPLE CLASS, INT. CLS. 20 AND 24.
- B. ALTMAN & CO., NEW YORK, NY:
781,060, CANC. U.S. CL. 39.
- B.G.P. INC., ST PETERSBURG, FL:
3,007,505, PUB. 7-26-2005. INT. CL. 35.
3,007,506, PUB. 7-26-2005. INT. CL. 35.
- B&D GROUP, LLC, WASHINGTON, DC:
3,007,952, INT. CL. 42.
- BÖK BÖK FRESH, BERLIN, NJ:
3,007,853, MULTIPLE CLASS, INT. CLS. 29 AND 43.
- BABCOCK & WILCOX COMPANY, THE, NEW ORLEANS, LA:
1,900,543. REN. 9-7-05. INT. CL. 11.
- BABE EASE, LLC, PELHAM, NH:
3,007,837, INT. CL. 12.
- BABYLON, INC. SAN DIEGO, CA:
2,207,778, CANC. INT. CL. 42.
- BACK TO THE WILD, INC., CASTALIA, OH:
3,007,414, PUB. 7-26-2005. INT. CL. 39.
- BACOU-DALLOZ EYE & FACE PROTECTION, INC., SMITHFIELD, RI:
3,007,712, INT. CL. 9.
- BAD COMPANY RODEO, INC., DEL RIO, TX:
3,007,220, PUB. 7-26-2005. MULTIPLE CLASS, INT. CLS. 14, 25, 28, 35 AND 41.
- BAGEL BARREL CORP., THE, DOYLESTOWN, PA:
1,902,249. REN. 9-3-05. INT. CL. 42.
- BAGEL TRAP, INC., IRVINE, CA:
1,864,534, CANC. INT. CL. 8.
- BAGLIO; SALVATORE, EAST BOSTON, MA:
1,307,465, CANC. INT. CL. 41.
- BAILEY COMPANY, INC.; THE, NASHVILLE, TN:
1,305,320. REN. 9-6-05. MULTIPLE CLASS, INT. CLS. 37 AND 42.
- BAKER & TAYLOR, INC., CHARLOTTE, NC:
3,006,919, PUB. 7-26-2005. MULTIPLE CLASS, INT. CLS. 9 AND 41.
- BAKER HUGHES INCORPORATED, HOUSTON, TX:
1,346,794. REN. 9-7-05. INT. CL. 40.
- BALLARD POWER SYSTEMS INC., BURNABY, BRITISH COLUMBIA, CANADA:
2,208,057, CANC. MULTIPLE CLASS, INT. CLS. 1, 9 AND 17.
- BALLY GAMING INTERNATIONAL, INC., LAS VEGAS, NV:
1,864,585, CANC. INT. CL. 9.
- BANCA MONTE DEI PASCHI DI SIENA S.P.A., SIENA, ITALY:
3,007,184, PUB. 7-26-2005. MULTIPLE CLASS, INT. CLS. 36 AND 38.
- BANCARD USA, LLC, RENTON, WA:
3,007,408, PUB. 7-26-2005. INT. CL. 9.
- BANKOKU NEEDLE MANUFACTURING CO., LTD., HIROSHIMA-SHI, HIROSHIMA-KEN, JAPAN:
1,386,103. REN. 9-9-05. INT. CL. 26.
- BANNER SOFTWARE, INC., SACRAMENTO, CA:
2,206,863, CANC. INT. CL. 9.
- BANQUE COMMERCIALE POUR L'EUROPE DU NORD EUROBANK, 75008 PARIS, FRANCE:
2,206,500, CANC. INT. CL. 36.
- BARNHART INDUSTRIES, INC., BARNHART, MO:
1,307,181, CANC. INT. CL. 25.
- BARNHILL, GREG, SANTA ROSA BEACH, FL AND BAUM, TERESA, SANTA ROSA BEACH, FL, DBA AUDACITY RECORDS:
2,207,539, CANC. INT. CL. 9.
- BARISAM IMPORT OF PA., INC., PENNSAUKEN, NJ:
1,425,816, CANC. INT. CL. 25.
- BARTOLOMEI, ALBERTO S., GURABO, PUERTO RICO:
1,864,510, CANC. INT. CL. 5.
- BARTOLOMEI, ALBERTO S., GURABO, PUERTO RICO, DBA ALBA PHARMACAL:
1,864,511, CANC. INT. CL. 5.
- BARZIZZA & C. S.R.L., I5048 VALENZA (AL), ITALY:
2,206,963, CANC. INT. CL. 14.
- BASEBALL ACQUISITION CORPORATION, PORTLAND, OR:
3,007,568, MULTIPLE CLASS, INT. CLS. 18, 25 AND 28.
- BASEBALL ACQUISITION CORPORATION, WILSONVILLE, OR:
3,008,004, INT. CL. 25.
- BASF AKTIENGESELLSCHAFT, LUDWIGSHAFEN AM RHEIN, FED REP GERMANY, BADISCHE ANILIN- & SODA-FABRIK AKTIENGESELLSCHAFT, LUDWIGSHAFEN-ON-RHINE, FED REP GERMANY:
790,582. REN. 9-9-05. U.S. CL. 10 (INT. CL. 1).
- BASF AKTIENGESELLSCHAFT, LUDWIGSHAFEN, FED REP GERMANY, BADISCHE ANILIN-& SODA-FABRIK AKTIENGESELLSCHAFT, LUDWIGSHAFEN (RHINE), FED REP GERMANY:
790,893. REN. 9-3-05. U.S. CL. 6 (INT. CL. 1).
- BASF AKTIENGESELLSCHAFT, LUDWIGSHAFEN AM RHEIN, FED REP GERMANY, BADISCHE ANILIN- & SODA-FABRIK AKTIENGESELLSCHAFT, LUDWIGSHAFEN (RHINE), FED REP GERMANY:
791,033. REN. 9-9-05. U.S. CL. 36 (INT. CL. 9).
- BASF AKTIENGESELLSCHAFT, LUDWIGSHAFEN AM RHEIN, FED REP GERMANY:
1,012,699. REN. 9-7-05. INT. CL. 1.
- BASF AKTIENGESELLSCHAFT, LUDWIGSHAFEN AM RHEIN, FED REP GERMANY:
1,013,894. REN. 9-3-05. INT. CL. 1.
- BASF AKTIENGESELLSCHAFT, LUDWIGSHAFEN AM (RHINE), FED REP GERMANY:
1,014,484. REN. 9-8-05. INT. CL. 1.
- BASF AKTIENGESELLSCHAFT, LUDWIGSHAFEN AM RHEIN, FED REP GERMANY:
1,339,833. REN. 9-3-05. INT. CL. 1.
2,207,003, CANC. INT. CL. 1.
- BASF CORPORATION, FLORHAM PARK, NJ:
1,345,550. REN. 9-8-05. INT. CL. 5.
- BASF CORPORATION, MOUNT OLIVE, NJ:
2,207,608, CANC. INT. CL. 2.
2,207,697, CANC. INT. CL. 5.
- BASIC DESIGNS INC., SANTA ROSA, CA:
1,307,067, CANC. INT. CL. 20.
- BASKIN-ROBBINS INCORPORATED, GLENDALE, CA:
3,007,377, PUB. 7-26-2005. INT. CL. 30.
- BATTISTA, PETER L. III, HENDERSONVILLE, NC:
3,007,104, PUB. 7-26-2005. INT. CL. 25.
- BAUSCH & LOMB INCORPORATED, ROCHESTER, NY:
1,306,874, CANC. INT. CL. 9.
1,306,875, CANC. INT. CL. 9.
- BAYBUTT, THERESA NEHMER, WELLESLEY, MA:
3,006,941, PUB. 7-26-2005. MULTIPLE CLASS, INT. CLS. 14 AND 16.
- BAYER CORPORATION, ELKHART, IN, MILES INC., ELKHART, IN:
1,904,060. REN. 9-3-05. INT. CL. 5.
- BC INTERNATIONAL COSMETIC & IMAGE SERVICES, INC., WILMINGTON, DE:
3,007,269, PUB. 7-26-2005. MULTIPLE CLASS, INT. CLS. 3, 9 AND 44.
- BDH TWO, INC., WILMINGTON, DE TO BFC INVESTMENTS, LP, WILMINGTON, DE:
1,864,852, CANC. INT. CL. 30.
- BDSRCO, INC., WILMINGTON, DE:
3,007,528, PUB. 7-26-2005. MULTIPLE CLASS, INT. CLS. 18 AND 25.
- BE PINK, LLC, NEWBURYPORT, MA:
3,007,385, PUB. 2-8-2005. INT. CL. 35.
- BEA SYSTEMS, INC., SUNNYVALE, CA:
2,207,657, CANC. INT. CL. 9.
2,207,660, CANC. INT. CL. 9.
- BEATY, MAX H., LAVERNE, CA, DBA THE YOGURT STATION AND BEATY, PATRICIA ANN, LAVERNE, CA, THE YOGURT STATION:
1,350,078. REN. 9-9-05. INT. CL. 42.

- BECKER ACROMA GROUP AKTIEBOLAG, 195 02 MARSTA, SWEDEN:
2,206,407, CANC. INT. CL. 2.
- BECTON, DICKINSON AND COMPANY, FRANKLIN LAKES, NJ:
1,912,971. REN. 9-3-05. INT. CL. 5.
- BEE MAID HONEY LIMITED, WINNIPEG, CANADA:
3,007,516, PUB. 7-26-2005. INT. CL. 30.
- BELL CERAMICS, INC., CLERMONT, FL:
1,864,798, CANC. INT. CL. 28.
- BELOTTI, DUANE J., MONTVILLE, NJ:
1,865,425, CANC. INT. CL. 41.
- BERKLEY AND COMPANY, INC., SPIRIT LAKE, IA:
1,307,245, CANC. INT. CL. 28.
- BERKSHIRE FASHIONS, INC., EDISON, NJ:
1,307,170, CANC. INT. CL. 25.
- BERRIER, HARRY H., COLUMBIA, MO:
1,020,657. REN. 9-6-05. INT. CL. 30.
- BERRYMAN, JEROME, HOUSTON, TX:
3,008,021, INT. CL. 28.
- BERWIND PHARMACEUTICAL SERVICES, INC., WEST POINT, PA:
1,306,647, CANC. INT. CL. 1.
- BEST SANITIZERS, INC., PENN VALLEY, CA:
3,007,949, INT. CL. 5.
- BETO, INC., LEBO, KS:
1,966,593. REN. 9-9-05. INT. CL. 42.
- BIERMANN PRODUCTIONS, L.L.C., WICHITA, KS:
3,007,605, INT. CL. 38.
- BIG GAME PRO SHOP, INC., APOPKA, FL:
3,007,085, PUB. 7-26-2005. INT. CL. 35.
- BIG ISLAND COMMUNICATION, INC., MOUNTAIN VIEW, CA:
2,100,000, CANC. INT. CL. 9.
- BIG PARTY, L.P., THE, WEST ROXBURY, MA TO BIG PARTY CORPORATION, THE, WEST REXBURY, MA:
1,865,084, CANC. INT. CL. 42.
- BILSOM AB, S-260 50 BILLESOLM, SWEDEN TO DALLOZ SAFETY, INC., READING, PA:
1,864,557, CANC. INT. CL. 9.
- BINKS MANUFACTURING COMPANY, FRANKLIN PARK, IL:
1,343,776. REN. 9-3-05. MULTIPLE CLASS, INT. CLS. 6, 7, 9 AND 11.
- BIO REVIVE PTY LTD, VICTORIA, AUSTRALIA:
3,007,474, PUB. 7-26-2005. INT. CL. 5.
- BIO 21 CORPORATION, JAPAN:
3,007,557, PUB. 7-26-2005. INT. CL. 3.
- BIOGEN IDEC MA INC., CAMBRIDGE, MA:
3,007,563, INT. CL. 5.
- BIOMARIN PHARMACEUTICAL INC., NOVATO, CA:
3,007,590, MULTIPLE CLASS, INT. CLS. 1 AND 5.
- BIOTRONIK GMBH & CO. KG, FED REP GERMANY:
3,007,551, PUB. 7-26-2005. INT. CL. 10.
- BIRD-B-GONE, INC., MISSION VIEJO, CA:
3,006,866, PUB. 7-26-2005. INT. CL. 9.
- BLACK & DECKER CORPORATION, THE, TOWSON, MD:
1,903,366. REN. 9-8-05. INT. CL. 7.
- BLACK ENTERTAINMENT TELEVISION, INC., WASHINGTON, DC, KENSINGTON PUBLISHING CORP., NEW YORK, NY:
1,902,694. REN. 9-7-05. INT. CL. 16.
1,909,288. REN. 9-6-05. INT. CL. 16.
- BLACKOUT ENTERPRISES, NEW YORK, NY:
3,007,228, PUB. 7-26-2005. INT. CL. 41.
- BLADE COMMUNICATIONS, INC., TOLEDO, OH, TOLEDO BLADE CO., THE, TOLEDO, OH:
1,349,260. REN. 9-3-05. INT. CL. 16.
- BLISTEX INC., OAK BROOK, IL, STERLING WINTHROP INC., NEW YORK, NY:
1,906,288. REN. 9-3-05. INT. CL. 5.
- BLOCK DRUG COMPANY, INC., JERSEY CITY, NJ:
1,306,710, CANC. INT. CL. 3.
- BLU VENTURES, LLC, FORT MEYERS, FL:
3,007,014, PUB. 7-26-2005. INT. CL. 41.
3,007,015, PUB. 7-26-2005. INT. CL. 41.
- BLUCHER GMBH, D-40699 ERKRATH, FED REP GERMANY:
3,006,909, PUB. 7-26-2005. INT. CL. 9.
- BLUE BIRD INVESTMENT CORPORATION, WILMINGTON, DE:
3,007,300, PUB. 7-26-2005. INT. CL. 12.
- BLUE CROSS BLUE SHIELD OF FLORIDA, INC., JACKSONVILLE, FL:
1,900,084. REN. 9-7-05. INT. CL. 36.
- BLUE RIDGE INTERNATIONAL PRODUCTS COMPANY, FREEPORT, FL:
2,206,992, CANC. INT. CL. 20.
- BLUE RUNNER FOODS, INC., GONZALES, LA:
3,007,655, INT. CL. 29.
- BLUE WATER PRODUCTION CO., INC., LACONIA, NH:
1,865,432, CANC. INT. CL. 41.
- BLUEGREEN CORPORATION, BOCA RATON, FL:
3,007,909, INT. CL. 36.
- BLUNT, DAVID, HARBOR CITY, CA:
3,007,140, PUB. 7-26-2005. INT. CL. 41.
- BNP PARIBAS, FRANCE:
3,007,562, PUB. 4-5-2005. MULTIPLE CLASS, INT. CLS. 14, 16, 18 AND 25.
- BOARD OF REGENTS OF THE UNIVERSITY OF OKLAHOMA; THE, NORMAN, OK:
1,334,267. REN. 9-3-05. INT. CL. 16.
- BOARD OF REGENTS OF THE UNIVERSITY SYSTEM OF GEORGIA, ATLANTA, GA:
1,280,171. REN. 9-3-05. INT. CL. 41.
- BOARD OF REGENTS, THE UNIVERSITY OF TEXAS SYSTEM, AUSTIN, TX:
1,947,938. REN. 9-3-05. INT. CL. 25.
- BOB LARSON MINISTRIES, LAKEWOOD, CO:
1,307,464, CANC. INT. CL. 41.
- BOBIT BUSINESS MEDIA INC., TORRANCE, CA:
1,981,084. REN. 9-7-05. INT. CL. 16.
- BODEGAS TRAPICHE S.A.I.C. YA., PROVINCIA DE BUENOS AIRES, ARGENTINA, BENEGAS HNOS & CIA LDA. SOCIEDAD ANONIMA INDUSTRIAL, BUENOS AIRES, ARGENTINA:
311,135. REN. 9-3-05. U.S. CL. 47 (INT. CL. 33).
- BONDED SERVICES OF AMERICA INC., FORT LEE, NJ, NOVO COMMUNICATIONS, INC., FT. LEE, NJ, DBA BONDED SERVICES:
1,937,318. REN. 9-6-05. INT. CL. 42.
- BONDURANT, RICHARD E., ATLANTA, GA:
3,007,436, PUB. 7-26-2005. INT. CL. 43.
- BONGARDS' CREAMERIES, BONGARDS, MN:
3,007,699, INT. CL. 29.
- BONHAM, KIM, GRANTS PASS, OR:
3,007,901, INT. CL. 35.
- BOOGIE TV, LLC, MONTCLAIR, NJ:
3,007,721, INT. CL. 42.
- BORGHESE INTERNATIONAL LIMITED, NEW YORK, NY, HALSTON BORGHESE INTERNATIONAL LIMITED, ROAD TOWN, TORTOLA, BR. VIRGIN ISLANDS:
1,901,403. REN. 9-7-05. INT. CL. 3.
- BORLAND SOFTWARE CORPORATION, SCOTTS VALLEY, CA:
1,343,975. REN. 9-3-05. INT. CL. 9.
- BOSS INTERNATIONAL, MIDDLETON, WI:
3,007,514, PUB. 7-26-2005. INT. CL. 9.
- BOSTON ATHLETIC ASSOCIATION (BAA), C/O R. H. KINGSLEY BROWN, BOSTON, MA:
1,346,832. REN. 9-3-05. INT. CL. 41.
- BOUDREAU, RONALD A., MODESTO, CA:
2,207,734, CANC. MULTIPLE CLASS, INT. CLS. 7 AND 8.
- BOWATER INCORPORATED, GREENVILLE, SC:
1,962,969. REN. 9-6-05. MULTIPLE CLASS, INT. CLS. 1, 16 AND 19.
- BOWL AMERICA INCORPORATED, SPRINGFIELD, VA:
1,906,836. REN. 9-6-05. INT. CL. 42.
- BOWTHORPE PLC, CRAWLEY, WEST SUSSEX, RH10 2RZ, ENGLAND:
2,206,399, CANC. INT. CL. 9.
- BOYD GAMING CORPORATION, LAS VEGAS, NV:
1,924,245. REN. 9-3-05. INT. CL. 42.

- BOYNE USA, INC., CRYSTAL MOUNTAIN, WA:
1,885,380, REN. 9-3-05. INT. CL. 41.
- BOZZALLA & LESNA S.P.A., 13013 COGGIOLA, PROVINCE OF VERCELLI, ITALY TO LANIFICIO VALSESSERA S.P.A. IN LIQUIDAZIONE, 13013 COGGIOLA, ITALY:
1,865,103, CANC. MULTIPLE CLASS, INT. CLS. 24 AND 25.
- BP PRODUCTS NORTH AMERICA INC., WARRENVILLE, IL:
3,007,957, INT. CL. 4.
- BRABHAM, AARON C., ORLANDO, FL:
3,008,024, INT. CL. 25.
- BRADLEY ARANT ROSE & WHITE LLP, BIRMINGHAM, AL:
3,007,412, PUB. 7-26-2005. INT. CL. 42.
- BRANDBREW SA, L-5365 MUNSBACH, LUXEMBOURG:
3,007,812, INT. CL. 35.
- BRANDMEIER, JONATHAN, MALIBU, CA:
3,006,997, PUB. 7-26-2005. INT. CL. 41.
- BREAKPOINT, INC., LOS ANGELES, CA:
2,206,868, CANC. INT. CL. 9.
- BREATHING DISORDERS SERVICES, INC., OKLAHOMA CITY, OK:
3,006,972, PUB. 7-26-2005. MULTIPLE CLASS, INT. CLS. 35, 41 AND 44.
3,006,976, PUB. 7-26-2005. MULTIPLE CLASS, INT. CLS. 35, 41 AND 44.
3,006,977, PUB. 7-26-2005. MULTIPLE CLASS, INT. CLS. 35, 41 AND 44.
- BREWED HOT COFFEE, INC., PORTLAND, OR:
2,207,322, CANC. INT. CL. 30.
- BREYFIELD TRUST REG., FL-9490 VADUZ, LIECHTENSTEIN:
3,006,780, PUB. 7-26-2005. INT. CL. 33.
- BRIDESAVE.COM, L.L.C., WHEELER, TX:
3,006,789, PUB. 4-25-2000. INT. CL. 35.
- BRINKERHOFF, ROBERT, O., RICHLAND, MI:
3,007,182, PUB. 7-26-2005. INT. CL. 35.
- BRITANNIA INVESTMENT CORPORATION, WILMINGTON, DE, POLK INVESTMENT CORPORATION, WILMINGTON, DE:
1,948,714, REN. 9-6-05. INT. CL. 9.
- BRITISH BROADCASTING CORPORATION, THE, LONDON, UNITED KINGDOM:
3,006,790, PUB. 7-26-2005. MULTIPLE CLASS, INT. CLS. 9, 16, 25, 28 AND 41.
- BRODERBUND SOFTWARE, INC., SAN RAFAEL, CA:
1,306,829, CANC. INT. CL. 9.
- BROOKDALE LIVING COMMUNITIES, INC., CHICAGO, IL:
3,007,286, PUB. 7-26-2005. MULTIPLE CLASS, INT. CLS. 35, 36, 43 AND 44.
- BROOKS PRODUCTS, INC., EL MONTE, CA:
947,093, CANC. U.S. CL. 12.
- BROTHERHOOD COMMISSION OF THE SOUTHERN BAPTIST CONVENTION, MEMPHIS, TN:
770,115, CANC. U.S. CL. 200.
- BROVITZ, LEE, MARCO ISLAND, FL, DBA BASSIC-LEE MUSIC:
3,007,407, PUB. 7-26-2005. INT. CL. 41.
- BROWN, FRANK L., MIDLOTHIAN, VA:
3,006,880, PUB. 7-26-2005. INT. CL. 36.
- BROWN, H. JACKSON, JR., NASHVILLE, TN:
1,979,445, REN. 9-7-05. INT. CL. 16.
- BROWN, ROBERT N., FREDERICK, MD:
3,007,447, PUB. 7-26-2005. INT. CL. 9.
- BROWN, ROSEMARY E., SAN DIEGO, CA:
3,008,095, INT. CL. 44.
- BROWNELLS, INC., MONTEZUMA, IA:
3,007,520, PUB. 7-26-2005. INT. CL. 3.
- BROWNING, MORGAN, UT:
3,008,087, INT. CL. 6.
- BRUDER HEALTHCARE COMPANY, ALPHARETTA, GA:
1,905,530, REN. 9-3-05. INT. CL. 10.
- BSN MEDICAL GMBH & CO, KG, HAMBURG, FED REP GERMANY:
3,006,807, PUB. 7-26-2005. MULTIPLE CLASS, INT. CLS. 5 AND 10.
- BT ALEX BROWN HOLDINGS INCORPORATED, BALTIMORE, MD:
2,207,513, CANC. INT. CL. 36.
- BUBBLES, INC., FALLS CHURCH, VA:
3,007,685, INT. CL. 3.
- BUCKMAN LABORATORIES INTERNATIONAL, INC., MEMPHIS, TN, BUCKMAN LABORATORIES, INC., MEMPHIS, TN:
1,348,825, REN. 9-3-05. INT. CL. 1.
- BUCKTOWN FINE ARTS, CHICAGO, IL:
3,008,046, INT. CL. 20.
- BUFFETT, JIMMY, KEY WEST, FL:
3,007,784, INT. CL. 21.
3,007,933, INT. CL. 12.
- BUNGE OILS, INC., ST. LOUIS, MO, BUNGE EDIBLE OIL CORPORATION, KANKAKEE, IL:
1,359,455, REN. 9-6-05. INT. CL. 29.
1,359,457, REN. 9-6-05. INT. CL. 29.
- BUNZL EXTRUSION, INC., COLONIAL HEIGHTS, VA:
3,007,637, INT. CL. 11.
- BURBERRY LIMITED, LONDON SW1Y 4DQ, UNITED KINGDOM:
3,006,938, PUB. 6-7-2005. INT. CL. 25.
- BURGER, CHRISTINE, CAMPBELL, CA:
3,007,684, MULTIPLE CLASS, INT. CLS. 3 AND 5.
- BURKEL GRAIN SERVICE, INC., GREENBUSH, MN:
3,006,961, PUB. 7-26-2005. INT. CL. 31.
- BURLINGTON COAT FACTORY WAREHOUSE CORP., BURLINGTON, NJ:
1,905,702, REN. 9-7-05. INT. CL. 25.
- BUROW GROUP, INC., THE, TUSTIN, CA:
2,207,192, CANC. INT. CL. 1.
- BUSINESS TRAVEL INTERNATIONAL B.V., 3704 HB ZEIST, NETHERLANDS:
3,006,823, PUB. 7-26-2005. MULTIPLE CLASS, INT. CLS. 35, 39 AND 42.
- BUSINESS 2.0 MEDIA INC., SAN FRANCISCO, CA:
3,007,503, PUB. 7-26-2005. INT. CL. 16.
- BUSNEL S.A., DINAN (COTES-DU-NORD), FRANCE:
1,307,113, CANC. INT. CL. 25.
- BUTLER & WILSON LIMITED, LONDON SW3, UNITED KINGDOM:
1,306,935, CANC. INT. CL. 14.
- BUTLER, MICHAEL, BEVERLY HILLS, CA:
2,206,535, CANC. INT. CL. 25.
- BUTTERFIELD, KENNETH D., STEVENS POINT, WI:
2,207,464, CANC. INT. CL. 28.
- BUZBEE, DAWN BJORK, PARKER, CO AND BUZBEE, TOM D., PARKER, CO:
3,008,070, MULTIPLE CLASS, INT. CLS. 9, 16 AND 41.
- BWT BRANDS, INC., MACON, GA, AMERICAN TOBACCO COMPANY, THE, NEW YORK, NY:
335,113, REN. 9-7-05. U.S. CL. 17 (INT. CL. 34).
- BYRNES & KIEFER CO., CALLERY, PA, SEVEN-UP COMPANY, THE, ST. LOUIS, MO:
1,356,103, REN. 9-7-05. INT. CL. 2.
- C & D PRODUCTIONS, INC., VILLA RICA, GA:
2,207,582, CANC. INT. CL. 9.
- C & G SALSA COMPANY, LLC, NOBLESVILLE, IN:
3,007,378, PUB. 7-26-2005. INT. CL. 30.
- C AND C WINE SERVICES, SANTA ROSA, CA:
3,007,682, INT. CL. 33.
- C. A. HILS DESIGN, LLC, REDMOND, WA:
3,007,222, PUB. 7-26-2005. INT. CL. 25.
- C.B. FLEET INVESTMENT CORPORATION, WILMINGTON, DE:
3,007,163, PUB. 7-26-2005. INT. CL. 3.
- C.S.B. DESIGN, INC., TROUTDALE, OR:
2,526,778, CANC. INT. CL. 25.
- C/SOFT, INC., CARMEL, IN:
2,206,410, CANC. INT. CL. 9.
- CADBURY ADAMS USA LLC, PARSIPPANY, NJ:
3,007,987, INT. CL. 30.
- CAIMAN RECORDS, INC., FLUSHING, NY:
2,206,502, CANC. MULTIPLE CLASS, INT. CLS. 9 AND 41.

- CAJUN POWER SAUCE MANUFACTURING, INC., ABBEVILLE, LA:
1,307,325, CANC. INT. CL. 30.
- CALICO BRANDS, INC., ONTARIO, CA:
3,007,833, INT. CL. 34.
- CALIFORNIA CONCEPTS, INC., GARDENA, CA:
2,439,501, CANC. INT. CL. 25.
- CALIFORNIA TAN, INC., LOS ANGELES, CA:
3,007,747, INT. CL. 3.
3,007,748, INT. CL. 3.
3,007,971, INT. CL. 3.
- CALZONE, LTD., BRIDGEPORT, CT:
1,306,945, CANC. INT. CL. 15.
1,306,946, CANC. INT. CL. 15.
- CAMBRIDGESOFT CORPORATION, CAMBRIDGE, MA:
2,206,540, CANC. INT. CL. 42.
- CAMCO CUTTING TOOLS LTD., KELOWNA, BRITISH COLUMBIA, CANADA:
3,007,249, PUB. 7-26-2005. INT. CL. 7.
- CAMPAGNA MOTO SPORT INC., PLESSISVILLE (QUEBEC), CANADA:
2,206,343, CANC. INT. CL. 12.
- CAMPBELL, DAVID W., NEW BALTIMORE, MI, DBA TODAY'S PRACTICAL PRODUCTS:
2,206,325, CANC. INT. CL. 16.
- CAPITOL RECORDS, INC., NEW YORK, NY:
1,972,271, REN. 9-7-05. INT. CL. 9.
1,981,100, REN. 9-7-05. INT. CL. 9.
1,981,607, REN. 9-7-05. INT. CL. 9.
- CAPLAN INDUSTRIES INC., RICHMOND, BRITISH COLUMBIA, CANADA, DBA TASK TOOLS AND ABRASIVES AND DBA EAST WEST DISTRIBUTORS:
1,978,638, REN. 9-3-05. MULTIPLE CLASS, INT. CLS. 7, 8 AND 9.
- CAPRIS FURNITURE INDUSTRIES, INC., OCALA, FL:
1,905,656, REN. 9-9-05. INT. CL. 20.
- CAPTIVA SOFTWARE CORPORATION, SAN DIEGO, CA:
3,006,782, PUB. 7-26-2005. MULTIPLE CLASS, INT. CLS. 41 AND 42.
- CAPTURE SOFTWARE, INC., BOTHELL, WA:
2,206,948, CANC. INT. CL. 9.
2,206,950, CANC. INT. CL. 9.
- CARBITE, INC., SAN DIEGO, CA:
2,207,738, CANC. INT. CL. 28.
- CARBO TRADING CO. INC., SCARBOROUGH, ONTARIO M1S 5C6, CANADA:
2,206,574, CANC. INT. CL. 10.
- CARDINAL HEALTH 409, INC., ST. PETERSBURG, FL:
1,306,778, CANC. INT. CL. 5.
- CAREER OPPORTUNITIES INCORPORATED, CHICAGO, IL:
1,307,051, CANC. INT. CL. 20.
- CARGILL, INCORPORATED, WAYZATA, MN:
3,007,611, INT. CL. 29.
3,007,612, INT. CL. 31.
- CARIBBEAN DISTILLERS CORPORATION LIMITED, ROAD BAY, ANGUILLA:
3,007,198, PUB. 7-26-2005. INT. CL. 33.
- CARLSON MARKETING GROUP, INC., MINNEAPOLIS, MN, DBA E. F. MCDONALD MOTIVATION:
1,374,726, REN. 9-7-05. INT. CL. 16.
- CARMEN, COLLE, 70200 LURE, FRANCE:
3,007,178, PUB. 7-26-2005. MULTIPLE CLASS, INT. CLS. 14, 18 AND 25.
- CARNEY, BRIAN P., LAKEVILLE, MN:
3,007,927, INT. CL. 8.
- CARO RESEARCH, INC., CONCORD, MA:
2,925,702, COR. INT. CL. 9.
- CAROLINA BIOLOGICAL SUPPLY COMPANY, BURLINGTON, NC:
1,345,396, REN. 9-3-05. INT. CL. 1.
1,347,127, REN. 9-3-05. INT. CL. 5.
1,361,851, REN. 9-3-05. INT. CL. 16.
- CARPIN MANUFACTURING, INCORPORATED, WATERBURY, CT:
1,360,109, REN. 9-6-05. INT. CL. 6.
- CARRINI, INC., EDISON, NJ:
3,006,872, PUB. 7-26-2005. INT. CL. 25.
- CARRIS REELS, INC., RUTLAND, VT:
3,007,284, PUB. 7-26-2005. INT. CL. 9.
- CARTER, JAMES, D., FAIRFIELD, CA:
3,007,861, INT. CL. 21.
- CARTIER INTERNATIONAL B.V., 3980 AMSTERDAM, NETHERLANDS:
3,006,779, PUB. 7-26-2005. INT. CL. 14.
- CASTLE ROCK INDUSTRIES, INC., ENGLEWOOD, CO:
1,981,966, REN. 9-8-05. INT. CL. 3.
- CATAGNUS, ROBYN M., LANGHORNE, PA:
3,006,982, PUB. 7-26-2005. MULTIPLE CLASS, INT. CLS. 41 AND 44.
- CATFISH SOFTWARE, INC., SAN DIEGO, CA:
3,007,870, MULTIPLE CLASS, INT. CLS. 35 AND 36.
- CATHERINES OF CALIFORNIA, INC., ROWLAND HEIGHTS, CA:
3,006,871, PUB. 7-26-2005. MULTIPLE CLASS, INT. CLS. 14 AND 25.
- CATSKILL TECHNOLOGY SERVICES, LLC, BEARSVILLE, NY:
3,007,808, INT. CL. 9.
- CCL ASSOCIATES, L.L.C., ROSWELL, GA:
3,006,903, PUB. 7-26-2005. INT. CL. 37.
- CEDAR FAIR, L.P., SANDUSKY, OH:
3,006,874, PUB. 7-26-2005. MULTIPLE CLASS, INT. CLS. 6, 9, 16, 20, 21, 24, 25, 28 AND 41.
- CELEMIAB SYSTEMS AB, MALMO SE-201 25, SWEDEN, CELEMI SA, POSTALE 738, FRIBOURG, SWITZERLAND:
1,911,535, REN. 9-7-05. INT. CL. 28.
- CELESTRON ACQUISITION, LLC, TORRANCE, CA:
3,007,635, INT. CL. 9.
3,007,636, INT. CL. 9.
- CELLECTRICON AB, GOTHENBURG, SWEDEN:
3,007,209, PUB. 7-26-2005. MULTIPLE CLASS, INT. CLS. 9, 35 AND 42.
- CELMEDIA S.A., SANTIAGO, CHILE:
3,006,970, PUB. 7-26-2005. INT. CL. 35.
- CELSION CORPORATION, COLUMBIA, MD:
3,007,717, INT. CL. 10.
- CEMEX, S.A. DE C.V., MONTERREY, NUEVO LEON, MEXICO:
3,006,808, PUB. 7-26-2005. INT. CL. 41.
- CEMEX, S.A. DE C.V., 64000 MONTERREY, NUEVO LEON, MEXICO:
3,006,810, PUB. 7-26-2005. MULTIPLE CLASS, INT. CLS. 35, 36, 38, 41 AND 42.
- CENTENNIAL FOOD CORP., CALGARY, ALBERTA, CANADA:
1,865,351, CANC. INT. CL. 29.
- CENTEX CORPORATION, DALLAS, TX:
2,206,980, CANC. MULTIPLE CLASS, INT. CLS. 35, 41 AND 42.
3,007,318, PUB. 7-26-2005. INT. CL. 37.
3,007,482, PUB. 7-26-2005. MULTIPLE CLASS, INT. CLS. 35, 36, 38 AND 42.
- CENTRAL ASIA INSTITUTE, INC., BOZEMAN, MT:
3,007,342, PUB. 7-26-2005. INT. CL. 36.
- CENTRAL DISTRIBUTING CO., SPANISH FORK, UT:
1,307,365, CANC. INT. CL. 32.
- CENTRAL GARDEN & PET COMPANY, A DELAWARE CORPORATION, LAFAYETTE, CA:
1,927,430, REN. 9-7-05. INT. CL. 11.
- CENTRAL RESERVE LIFE INSURANCE COMPANY, STRONGSVILLE, OH:
3,007,049, PUB. 7-26-2005. INT. CL. 36.
- CENTRAL TOOLS, INC., CRANSTON, RI:
2,207,517, CANC. INT. CL. 11.
- CERAMCO INC., BURLINGTON, NJ, NEY DENTAL INTERNATIONAL, INC., BLOOMFIELD, CT:
1,908,103, REN. 9-7-05. INT. CL. 5.
- CERES, LLC, SOUTH SAN FRANCISCO, CA:
2,206,609, CANC. INT. CL. 4.
- CERRUTI 1881, 75008 - PARIS, FRANCE:
2,206,462, CANC. MULTIPLE CLASS, INT. CLS. 18 AND 25.
- CERTICOM CORP, HAYWARD, CA:
3,007,580, MULTIPLE CLASS, INT. CLS. 9, 16 AND 35.

- CERTIFIED GOLD EXCHANGE INC., ALBUQUERQUE, NM:
3,008,098, INT. CL. 35.
- CETRONIC AB, 864 22 MATFORS, SWEDEN:
2,206,432, CANC. INT. CL. 9.
- CGK COMPUTER GESELLSCHAFT KONSTANZ MBH, KONSTANZ, FED REP GERMANY:
2,206,347, CANC. MULTIPLE CLASS, INT. CLS. 9, 37 AND 42.
- CHAIR DANCING INTERNATIONAL, INC., DEL MAR, CA:
1,957,412, REN. 9-8-05, INT. CL. 41.
- CHAN WAI HUNG, KWAI CHUNG, NEW TERRITORIES, HONG KONG, DBA HUNG KEE & CO.:
1,307,147, CANC. MULTIPLE CLASS, INT. CLS. 25 AND 28.
- CHANILLE, INC., CHARLOTTE, NC:
3,006,994, PUB. 7-26-2005, MULTIPLE CLASS, INT. CLS. 3 AND 14.
- CHARDIET UNLIMITED INC., NEW YORK, NY:
1,864,704, CANC. INT. CL. 16.
- CHARITY CHARMS, L.L.C., PHOENIX, AZ:
3,007,155, PUB. 7-26-2005, INT. CL. 14.
- CHARRUES NAUD, 49600 ANDREZE, FRANCE:
2,206,527, CANC. INT. CL. 7.
- CHARTWELL GROUP, INCORPORATED; THE, LOS ANGELES, CA, DBA CHARTWELL & CO., INCORPORATED:
1,307,391, CANC. INT. CL. 35.
- CHASE CORPORATION, BRIDGEWATER, MA, T C MANUFACTURING CO., INC., EVANSTON, IL:
1,876,229, REN. 9-8-05, MULTIPLE CLASS, INT. CLS. 2 AND 17.
- CHATHAM IMPORTS, INC., NEW YORK, NY:
791,949, REN. 9-7-05, U.S. CL. 49 (INT. CL. 33).
- CHAUM, DAVID, AMSTERDAM, NETHERLANDS:
2,206,304, CANC. INT. CL. 9.
2,206,333, CANC. INT. CL. 9.
- CHECK, JOSEPH M., SHOREVIEW, MN, DBA CHECK SIGNATURE, INC.:
1,864,566, CANC. INT. CL. 9.
- CHEJANOVIESKY, SIMON SANDLER, MEXICO, D.F. 11000, MEXICO:
3,007,576, MULTIPLE CLASS, INT. CLS. 9 AND 11.
- CHEM-CENTER INTERNATIONAL CORPORATION, BEDFORD, TX:
1,310,674, REN. 9-3-05, INT. CL. 3.
- CHESEBROUGH POND'S INC., WILMINGTON, DE:
3,007,152, PUB. 7-26-2005, INT. CL. 3.
- CHEVRON U.S.A. INC., SAN RAMON, CA:
3,007,381, PUB. 7-26-2005, MULTIPLE CLASS, INT. CLS. 36 AND 37.
- CHICAGO BRIDGE & IRON TECHNICAL SERVICES COMPANY, OAK BROOK, IL:
1,865,278, CANC. INT. CL. 17.
- CHICK-FIL-A, INC., ATLANTA, GA:
1,307,523, CANC. INT. CL. 42.
- CHILDREN AFFECTED BY AIDS FOUNDATION, LOS ANGELES, CA:
1,858,288, REN. 9-7-05, INT. CL. 36.
- CHILDREN'S LITERACY FOUNDATION, HANOVER, NH:
3,007,265, PUB. 7-26-2005, INT. CL. 41.
- CHILDRESS VINEYARDS, LLC, WELCOME, NC:
3,008,066, INT. CL. 33.
3,008,067, INT. CL. 41.
- CHIMERIC INC., ENGLEWOOD, CO:
2,206,447, CANC. INT. CL. 16.
- CHINA NATIONAL LIGHT INDUSTRIAL PRODUCTS IMPORT & EXPORT CORPORATION IIAONING BRANCH, TALIAN, CHINA:
1,307,074, CANC. INT. CL. 21.
- CHINA NATIONAL MACHINERY IMPORT AND EXPORT CORPORATION, JIANGSU BRANCH, NANJING, CHINA:
1,306,815, CANC. INT. CL. 8.
- CHOCOLATE EXPERIENCE, THE, FLUSHING, NY:
2,207,261, CANC. INT. CL. 30.
- CHRISTIAN ART GIFTS, INC., LOMBARD, IL:
3,007,781, MULTIPLE CLASS, INT. CLS. 6, 16, 20 AND 21.
- CHRISTIAN DIOR COUTURE, S.A., PARIS, FRANCE, CHRISTIAN DIOR, S.A., 75008 PARIS, FRANCE:
1,872,313, REN. 9-7-05, MULTIPLE CLASS, INT. CLS. 9 AND 14.
- CHROMALINE CORPORATION, THE, DULUTH, MN:
1,395,432, REN. 9-3-05, INT. CL. 1.
- CHUKAR CHERRY COMPANY, INC., PROSSER, WA:
3,007,388, PUB. 7-26-2005, MULTIPLE CLASS, INT. CLS. 29 AND 30.
- CHURCH OF THE BRETHREN GENERAL BOARD, THE, ELGIN, IL:
1,905,445, REN. 9-3-05, MULTIPLE CLASS, INT. CLS. 9 AND 16.
- CIBA-CORNING DIAGNOSTICS CORP., MEDFIELD, MA:
1,306,631, CANC. INT. CL. 1.
- CINGULAR WIRELESS II, LLC, ATLANTA, GA:
3,006,877, PUB. 7-26-2005, MULTIPLE CLASS, INT. CLS. 9, 35 AND 38.
3,006,878, PUB. 7-26-2005, MULTIPLE CLASS, INT. CLS. 9, 35 AND 38.
- CIRCLE COMPANY ASSOCIATES, INC., BOSTON, MA:
3,007,165, PUB. 7-26-2005, INT. CL. 45.
- CIRCLE Y OF YOAKUM, TEXAS, YOAKUM, TX:
1,307,579, CANC. INT. CL. 25.
- CIRRUS DESIGN CORPORATION, DULUTH, MN:
1,907,261, REN. 9-3-05, INT. CL. 12.
- CIRRUS SYSTEM, INC., PURCHASE, NY:
2,206,793, CANC. INT. CL. 35.
- CIT GROUP INC., LIVINGSTON, NJ:
3,008,052, INT. CL. 42.
- CITGO PETROLEUM CORPORATION, TULSA, OK:
1,902,323, REN. 9-3-05, MULTIPLE CLASS, INT. CLS. 4, 37 AND 42.
1,902,323, CANC. INT. CL. 36.
- CITICORP, NEW YORK, NY:
3,007,963, INT. CL. 35.
3,007,982, INT. CL. 35.
- CITIZENS FOR NYC, INC., NEW YORK, NY:
3,007,042, PUB. 7-26-2005, INT. CL. 35.
- CITY BANK, HONOLULU, HI:
2,109,951, CANC. MULTIPLE CLASS, INT. CLS. 9 AND 36.
- CITY CENTER 55TH STREET THEATER FOUNDATION, INC., NEW YORK, NY:
1,985,694, REN. 9-6-05, INT. CL. 41.
- CITY OF PALM BEACH GARDENS, PALM BEACH GARDENS, FL:
3,007,373, PUB. 7-5-2005, INT. CL. 35.
- CITY OF ST. CLAIR SHORES, MICHIGAN, ST. CLAIR SHORES, MI:
3,007,707, INT. CL. 35.
- CITY OF SUPERIOR, SUPERIOR, WI:
1,902,951, REN. 9-3-05, MULTIPLE CLASS, INT. CLS. 35 AND 41.
- CLARK, DAVID E., POTTERSVILLE, NJ:
2,207,676, CANC. INT. CL. 14.
- CLARKE AMERICAN CHECKS, INC., SAN ANTONIO, TX:
3,007,416, PUB. 7-26-2005, INT. CL. 35.
- CLARKE INDUSTRIES, INC., ST. LOUIS, MO:
1,343,829, REN. 9-3-05, INT. CL. 7.
- CLASSIC SLEEP PRODUCTS INC., JESSUP, MD:
3,007,738, MULTIPLE CLASS, INT. CLS. 20 AND 24.
- CLAYLAND, DAN, OCEAN CITY, MD:
3,007,480, PUB. 7-26-2005, INT. CL. 40.
- CLEANING SYSTEMS, INC., DE PERE, WI:
3,006,915, PUB. 4-5-2005, INT. CL. 3.
- CLEAR CHANNEL INTERNET GROUP, INC., LOS ANGELES, CA:
3,007,334, PUB. 7-26-2005, MULTIPLE CLASS, INT. CLS. 35 AND 41.
- CLEARING HOUSE ASSOCIATION L.L.C., THE, NEW YORK, NY:
3,007,623, MULTIPLE CLASS, INT. CLS. 36 AND 41.
- CLEAR20, INC., NORTHBROOK, IL:
1,932,624, REN. 9-6-05, INT. CL. 42.
- CLEMENTS, TONY, CAMPBELL, CA:
1,903,989, REN. 9-7-05, INT. CL. 41.

CLICKCE LLC, AUSTIN, TX:
3,007,403, PUB. 7-26-2005. INT. CL. 41.

CLIF BAR INC., BERKELEY, CA:
3,007,236, PUB. 7-26-2005. INT. CL. 45.

CLINICAL COMPUTER SYSTEMS, INC., ELGIN, IL:
3,006,906, PUB. 7-26-2005. INT. CL. 9.

CLOROX COMPANY, THE, OAKLAND, CA:
1,948,328. REN. 9-6-05. INT. CL. 3.

CLOVER MANUFACTURING COMPANY, LIMITED, HIGASHINARI-KU, OSAKA, JAPAN:
1,017,329. REN. 9-3-05. MULTIPLE CLASS, INT. CLS. 9, 16 AND 26.

CLUB MEDITERRANEE, 75019 PARIS, FRANCE:
3,007,572, MULTIPLE CLASS, INT. CLS. 16 AND 24.

CLUSTAN LIMITED, EDINBURGH, SCOTLAND:
1,306,880, CANC. INT. CL. 9.

CLUSTER FILE SYSTEMS, INC., MEDFORD, MA:
3,007,863, INT. CL. 41.

CMAR, KEN, BOSTON, MA:
2,207,060, CANC. INT. CL. 9.

CMP MEDIA LLC, MANHASSET, NY, BLACK, EDWIN, ROCKVILLE, MD:
1,903,930. REN. 9-7-05. INT. CL. 16.

COACHMEN INDUSTRIES, INC., ELKHART, IN:
1,306,911, CANC. INT. CL. 12.

COACHMEN RECREATIONAL VEHICLE COMPANY, LLC, MIDDLEBURY, IN:
1,344,258. REN. 9-3-05. INT. CL. 12.

COAST HOTELS AND CASINOS, INC., LAS VEGAS, NV:
3,007,387, PUB. 7-26-2005. INT. CL. 41.

COASTAL PHARMACY SERVICES, INC., DAYTONA BEACH, FL:
3,007,119, PUB. 7-26-2005. INT. CL. 35.
3,007,129, PUB. 7-26-2005. INT. CL. 35.

COCOS ISLAND OKINAWA CORPORATION, JAPAN:
3,007,553, PUB. 7-26-2005. INT. CL. 14.

COCOS LAGOON DEVELOPMENT CORPORATION, TAMUNING, GUAM:
1,911,999. REN. 9-7-05. INT. CL. 42.

CODELOCKS LIMITED, THATCHAM, UNITED KINGDOM:
3,008,065, MULTIPLE CLASS, INT. CLS. 6 AND 9.

CODMAN RESEARCH GROUP, INC., THE, LEBANON, NH TO CSC HEALTHCARE INC., BIRMINGHAM, AL:
1,864,545, CANC. MULTIPLE CLASS, INT. CLS. 9, 16 AND 42.

COEQUITY CORPORATION, IRVINE, CA:
3,007,270, PUB. 7-26-2005. INT. CL. 41.

COGNEX CORPORATION, NATICK, MA:
2,207,036, CANC. INT. CL. 9.

COHEN, LYNN RUTH, LIVINGSTON, NJ:
3,007,766, INT. CL. 14.

COINSTAR, INC., BELLEVUE, WA, SKYDECK CORPORATION, BELLEVUE, WA:
1,904,944. REN. 9-6-05. INT. CL. 9.

COLEMAN, BRIT N., BELTON, TX:
3,007,302, PUB. 7-26-2005. INT. CL. 25.

COLLECTONLY, INC., BOGOTA, NJ, DBA CREATE AUC-TION:
3,007,011, PUB. 7-26-2005. INT. CL. 42.

COLLEGIATE TRADITIONS, INC., MOORESTOWN, NJ:
2,206,901, CANC. INT. CL. 25.

COLLIN COUNTY, TEXAS, MCKINNEY, TX:
3,007,351, PUB. 7-26-2005. INT. CL. 35.

COLLINS INTERNATIONAL CO., LTD., FAIR LAWN, NJ:
3,006,992, PUB. 7-26-2005. INT. CL. 11.

COLON, VILMA E., BURKE, VA AND SULLIVAN, DENNIS J., BURKE, VA:
2,206,968, CANC. INT. CL. 41.

COLORADO TRAIL FOUNDATION, GOLDEN, CO:
1,936,533. REN. 9-7-05. MULTIPLE CLASS, INT. CLS. 41 AND 42.
1,943,485. REN. 9-7-05. MULTIPLE CLASS, INT. CLS. 41 AND 42.

COLTEC INDUSTRIES, INC., CHARLOTTE, NC:
2,207,585, CANC. INT. CL. 7.

COLTELLERIE BERTI DI BERTI ANDREA & C. S.N.C., SCARPERIA, FLORENCE, ITALY:
3,007,315, PUB. 7-26-2005. INT. CL. 8.

COLUMBIA HELICOPTERS, INC., AURORA, OR:
1,307,450, CANC. INT. CL. 39.

COMAC S.P.A., VILLANOVA D'ASTI (ASTI), ITALY:
3,007,287, PUB. 7-26-2005. INT. CL. 7.

COMACT CHICOUTIMI INC., CHICOUTIMI, QUEBEC, CANADA:
3,006,899, PUB. 7-26-2005. INT. CL. 7.

COMERCIAL AARMES, S.A. DE C.V., MONTERREY, NUEVO LEON, MEXICO:
3,007,948, INT. CL. 30.

COMMUNICATION INTELLIGENCE CORPORATION, MENLO PARK, CA:
1,306,886, CANC. INT. CL. 9.

COMMUNISYS, INC., NAPERVILLE, IL:
2,207,388, CANC. INT. CL. 9.

COMMUNITY ASSOCIATIONS INSTITUTE, ALEXANDRIA, VA:
1,864,660, CANC. INT. CL. 16.

COMMUNITY CARE RESOURCE, INC., MIDDLETON, WI:
2,206,872, CANC. INT. CL. 42.

COMMUNITY COFFEE COMPANY, INC., BATON ROUGE, LA TO COMMUNITY COFFEE COMPANY OF TEXAS, INC., HOUSTON, TX:
1,865,098, CANC. MULTIPLE CLASS, INT. CLS. 29 AND 30.

COMPANY 5, INC., WEST TRENTON, NJ:
2,206,601, CANC. INT. CL. 42.

COMPTON, NATHAN, HARTWOOD, VA:
3,007,600, INT. CL. 9.

COMPUTER ASSOCIATES INTERNATIONAL, INC., ISLANDIA, NY:
2,207,686, CANC. INT. CL. 9.

COMPUTER ASSOCIATES THINK, INC., ISLANDIA, NY:
1,332,948. REN. 9-9-05. INT. CL. 9.
1,332,955. REN. 9-9-05. INT. CL. 9.

COMPUTERS PLUS, INC., EVANSVILLE, IN:
3,007,072, PUB. 7-26-2005. INT. CL. 35.

COMPUWARE CORPORATION, DETROIT, MI:
3,006,952, PUB. 7-26-2005. INT. CL. 9.

COMPUWARE SPORTS CORPORATION, DETROIT, MI:
3,006,945, PUB. 7-26-2005. INT. CL. 41.

CONAIR CORPORATION, STAMFORD, CT:
1,865,227, CANC. INT. CL. 9.

CONCEPT OMEGA CORPORATION, SOMERSET, NJ:
1,343,877. REN. 9-3-05. INT. CL. 9.

CONCEPTIS TECHNOLOGIES INC., MONTREAL, QUEBEC, CANADA:
2,954,732, COR. INT. CL. 41.

CONCERTED INNOVATIONS, LLC, BLACKLICK, OH:
3,007,852, INT. CL. 40.

CONFERENCE AMERICA, INC., MONTGOMERY, AL:
3,006,875, PUB. 7-26-2005. INT. CL. 42.

CONGOLEUM CORPORATION, MERCERVILLE, NJ:
1,347,882. REN. 9-3-05. INT. CL. 19.

CONGRESS FINANCIAL CORPORATION (FLORIDA), AS AGENT, FORT LAUDERDALE, FL:
1,865,303, CANC. INT. CL. 25.

CONNECTICUT ATTORNEYS TITLE INSURANCE COMPANY, ROCKY HILL, CT:
3,007,904, INT. CL. 9.

CONNECT802 CORPORATION, DANVILLE, CA:
3,007,404, PUB. 4-5-2005. INT. CL. 42.

CONROY FOODS, INC., PITTSBURGH, PA:
3,006,954, PUB. 7-26-2005. MULTIPLE CLASS, INT. CLS. 29 AND 30.

CONSENSUS, INC., INDEPENDENCE, MO:
1,344,383. REN. 9-6-05. INT. CL. 16.

CONSERVATION STUDIO, INC., NEW HOPE, PA, DBA GRATZ GALLERY & CONSERVATION STUDIO:
3,007,241, PUB. 7-26-2005. MULTIPLE CLASS, INT. CLS. 35, 37 AND 40.

CONSILIUM MANAGEMENT CONSULTING GMBH, D-60329 FRANKFURT/MAIN, FED REP GERMANY:
2,206,282, CANC. MULTIPLE CLASS, INT. CLS. 35 AND 36.

CONSOLIDATED PAPERS, INC., WISCONSIN RAPIDS, WI:
1,307,004, CANC. INT. CL. 16.

- CONSPIRACY, LLC, OCONOMOWOC, WI:
3,007,679, INT. CL. 30.
- CONSTRUCTION MACHINERY COMPANY, WATERLOO, IA:
780,944, CANC. U.S. CL. 23.
- CONSULTEX CORPORATION, SPARTANBURG, SC:
2,207,056, CANC. INT. CL. 7.
- CONSUMERS UNION OF UNITED STATES, INC., YONKERS, NY:
1,901,715, REN. 9-6-05, INT. CL. 16.
- CONTINENTAL WEAPONS (PROPRIETARY) LIMITED, GAUTENG, SOUTH AFRICA:
2,206,892, CANC. INT. CL. 13.
- CONTRACTING TECHNOLOGY PROFESSIONALS, INC., WHITE BEAR LAKE, MN:
2,207,751, CANC. INT. CL. 42.
- CONTROL MICROSYSTEMS INC./ MICROSYSTEMES DE CONTROLE INC., KANATA, ONTARIO:
3,008,029, INT. CL. 9.
- CONTROL SYSTEMS INTERNATIONAL, FAIRWAY, KS:
2,206,356, CANC. INT. CL. 42.
- CONVENIENCE FOOD SYSTEMS HOLDINGS N.V., 5761 EN BAKEL, NETHERLANDS:
3,007,332, PUB. 7-26-2005, MULTIPLE CLASS, INT. CLS. 7, 11, 17 AND 42.
- COOK ROSS, INC., SILVER SPRING, MD:
3,007,966, INT. CL. 41.
- COOPER BRANDS, INC., HOUSTON, TX, NICHOLSON FILE COMPANY, PROVIDENCE, RI:
47,233, REN. 9-6-05, U.S. CL. 23 (INT. CL. 8).
- COOPER BRANDS, INC., HOUSTON, TX:
1,361,489, REN. 9-6-05, INT. CL. 8.
1,361,490, REN. 9-6-05, INT. CL. 8.
- COOPER MEMPHIS GROUP, INC., IRVINE, CA:
2,206,952, CANC. INT. CL. 42.
- COOPERATIVA AGRICOLA PISQUERA ELQUI LIMITADA, SANTIAGO, CHILE:
1,905,117, REN. 9-7-05, INT. CL. 33.
- COORS GLOBAL PROPERTIES, INC., LAKEWOOD, CO:
3,007,444, PUB. 7-26-2005, INT. CL. 43.
- COPAN INNOVATIONS, LTD., LIMERICK, IRELAND:
3,007,763, MULTIPLE CLASS, INT. CLS. 9 AND 10.
- COPELAND, BEVERLY, BROOKLYN, NY:
3,007,149, PUB. 7-26-2005, INT. CL. 41.
- COPELAND, JOHN D., SILOAM SPRINGS, AR:
3,007,796, INT. CL. 41.
- COPPERWELD CORPORATION, PITTSBURGH, PA:
3,007,276, PUB. 7-26-2005, INT. CL. 6.
- CORA S.P.A., CANNELLI (ASTI), ITALY, LUIGI BOSCA & FIGLI, S.P.A., CANELLI (ASTI), ITALY:
1,353,178, REN. 9-7-05, INT. CL. 33.
- CORAL CHEMICAL COMPANY, WAUKEGAN, IL:
3,007,574, INT. CL. 9.
- CORAL RIDGE MINISTRIES MEDIA, INC., FORT LAUDERDALE, FL:
3,006,841, PUB. 7-26-2005, INT. CL. 45.
- CORD COMMUNICATIONS, INC., WACO, TX:
2,206,947, CANC. INT. CL. 9.
- COREGIS INSURANCE COMPANY, CHICAGO, IL:
2,206,617, CANC. MULTIPLE CLASS, INT. CLS. 35 AND 36.
- COREL CORPORATION, OTTAWA, ONTARIO, CANADA:
1,904,151, REN. 9-7-05, MULTIPLE CLASS, INT. CLS. 9, 16, 41 AND 42.
- CORINE M. MCGLOWN, ALEXANDRIA, VA, DBA GRAB MY GIFTS:
3,007,883, INT. CL. 45.
- CORK, ANNE, ROYAL OAK, MI:
3,007,221, PUB. 7-26-2005, INT. CL. 6.
- CORNING INCORPORATED, CORNING, NY:
2,207,110, CANC. INT. CL. 9.
- CORROCOAT LIMITED, WEST YORKSHIRE, ENGLAND:
1,344,387, REN. 9-6-05, INT. CL. 17.
- COSCO INTERNATIONAL, INC., ATLANTA, GA:
2,207,237, CANC. INT. CL. 8.
- COSMAIR, INC., NEW YORK, NY TO COSMAIR CREATIVE, INC., NEW YORK, NY:
1,864,977, CANC. INT. CL. 41.
- COSMAIR, INC., NEW YORK, NY:
2,207,597, CANC. INT. CL. 3.
- COSMIC DEBRIS, ETC., INC., OAKLAND, CA:
3,007,977, INT. CL. 18.
- COSMO USA, INC., BELLEVUE, WA, DBA INTERNATIONAL CROSS-CULTURAL COMMITTEE:
3,007,079, PUB. 7-26-2005, INT. CL. 41.
- COSTELLO, BILL, UPPER MARLBORO, MD:
2,207,628, CANC. MULTIPLE CLASS, INT. CLS. 16 AND 41.
- COTTAGE GREEN, LLC, FT. LAUDERDALE, FL:
3,008,084, INT. CL. 41.
- COTY US INC., NEW YORK, NY:
2,207,557, CANC. INT. CL. 3.
- COUNTRY COACH, INC., JUNCTION CITY, OR:
2,206,280, CANC. INT. CL. 12.
- COUNTRY LIFE, LLC, HAUPPAUGE, NY:
1,906,276, REN. 9-7-05, INT. CL. 5.
- COURTNEY, KEVIN C., IRVINE, CA:
3,007,660, INT. CL. 35.
3,007,661, MULTIPLE CLASS, INT. CLS. 37 AND 42.
3,007,662, INT. CL. 4.
- COYOTES HOCKEY, LLC, PHOENIX, AZ:
3,007,665, INT. CL. 41.
- CP INDUSTRIES INC, SALT LAKE CITY, UT:
3,008,015, INT. CL. 3.
- CPA/LAW FORUM, SAN DIEGO, CA:
1,904,402, REN. 9-7-05, INT. CL. 16.
- CRANE & CO., INC., DALTON, MA:
2,206,884, CANC. INT. CL. 35.
- CREATIVE CHARACTERS, INC., MIAMI, FL:
3,007,492, PUB. 7-26-2005, INT. CL. 16.
3,007,493, PUB. 7-26-2005, INT. CL. 16.
- CREATIVE CONCEPTS USA, INC., DICKSON, TN, BETH-SHEARS, DAVID, C/O KEEPER BAIT COMPANY, INC., BRUCETON, TN:
1,349,687, REN. 9-3-05, INT. CL. 28.
- CREATIVE DESIGNS INTERNATIONAL, LTD., JENKINTOWN, PA:
1,307,256, CANC. INT. CL. 28.
- CREATIVE ERGONOMIC SYSTEMS, INC., STERLING HEIGHTS, MI:
2,206,935, CANC. INT. CL. 7.
- CREATIVE FOOD MARKETING, INC., MADISON, WI:
3,007,899, INT. CL. 29.
- CREATIVE INVENTIONS, INC., BENSLEM, PA:
2,207,743, CANC. INT. CL. 12.
- CREATIVE NAIL DESIGN, INC., VISTA, CA:
1,902,305, REN. 9-7-05, INT. CL. 3.
- CREATIVE SECURITY CONCEPTS, INC., SAN JOSE, CA:
3,006,984, PUB. 7-26-2005, MULTIPLE CLASS, INT. CLS. 41, 42 AND 45.
- CREDIT FACTOR CORP, BROOKLYN, NY:
3,007,956, INT. CL. 36.
- CREPE CLICHE, INC., VERNON HILLS, IL:
3,007,896, INT. CL. 43.
- CRICKET TECHNOLOGIES LLC, RESTON, VA:
3,006,884, PUB. 7-26-2005, INT. CL. 42.
- CRITERION COMMUNICATIONS, INC., KING OF PRUSSIA, PA:
2,206,546, CANC. INT. CL. 42.
- CRO AMERICA, INC., BURLINGAME, CA:
1,307,187, CANC. INT. CL. 25.
- CROCODILE ENTERPRISES, INC., PASADENA, CA:
2,207,239, CANC. INT. CL. 16.
- CROSSFIT, INC., SANTA CRUZ, CA:
3,007,458, PUB. 7-26-2005, INT. CL. 41.
- CROWN CRAFT INFANT PRODUCTS, INC., ATLANTA, GA:
1,344,525, REN. 9-9-05, INT. CL. 24.
- CRUICKSHANK, ALAN S., ATTLEBORO, MA, DBA SILVERLININGS:
1,864,642, CANC. INT. CL. 14.
- CRUMLEY, DAVID, ALPHARETTA, GA:
3,007,355, PUB. 7-26-2005, INT. CL. 37.
- CRYOMEDICAL SCIENCES, INC., ROCKVILLE, MD:
2,206,611, CANC. INT. CL. 10.

CRYSTAL CABINET WORKS, INC., PRINCETON, MN:
3,008,008, INT. CL. 20.

CSB OF AMERICA, INC., FAIRFAX, VA:
1,906,010, REN. 9-7-05, INT. CL. 41.

CT HOLDING AG, CH-2008 NEUCHÂTEL, SWITZERLAND:
2,206,652, CANC. INT. CL. 3.

CUGINO'S GOURMET FOODS, INC., LAKE IN THE HILLS,
IL:
3,007,421, PUB. 7-26-2005, MULTIPLE CLASS, INT. CLS.
29 AND 30.

CULINARY HOLDINGS INCORPORATED, NEWPORT
BEACH, CA:
3,007,941, INT. CL. 43.

CULTO GMBH, THUMSENREUTH, FED REP GERMANY:
3,007,599, MULTIPLE CLASS, INT. CLS. 14 AND 20.

CUNNINGHAM, SHARON, BANNER, WY, DBA TOTALLY
ELEGANT:
3,007,413, PUB. 7-26-2005, INT. CL. 35.

CURIOUS RESEARCH CORP., ROCHESTER, NY:
1,307,073, CANC. INT. CL. 21.

CVS VANGUARD, INC., SCARSDALE, NY, CVS H.C., INC.,
RYE, NY:
1,904,058, REN. 9-7-05, MULTIPLE CLASS, INT. CLS. 5
AND 25.

CW MUSIC, LLC, BOSTON, MA:
3,006,916, PUB. 7-26-2005, INT. CL. 41.

CYBERTECH, INC., REDLANDS, CA:
3,007,121, PUB. 7-26-2005, INT. CL. 38.

CYBEX INTERNATIONAL, INC., MEDWAY, MA:
3,006,946, PUB. 7-26-2005, INT. CL. 28.

CYCLE SHACK, INC., SOUTH SAN FRANCISCO, CA:
1,919,573, REN. 9-7-05, INT. CL. 12.

CYNTHIA M FINCHER, BRONX, NY:
3,007,331, PUB. 7-26-2005, INT. CL. 41.

D. F. STAUFFER BISCUIT CO., INC., YORK, PA:
793,744, REN. 9-3-05, U.S. CL. 46 (INT. CL. 30).

D.O. COLLABORATIVE, THE, NEWPORT, KY:
3,007,337, PUB. 7-26-2005, INT. CL. 28.

D'VINE MUSIC MINISTRIES, DECATUR, GA:
1,968,554, REN. 9-7-05, INT. CL. 41.

DADANT & SONS, INC., HAMILTON, IL:
2,207,611, CANC. INT. CL. 4.

DAIMLERCHRYSLER AG, 70567 STUTTGART, FED REP
GERMANY:
800,440, REN. 9-9-05, U.S. CL. 42 (INT. CL. 24).
3,006,947, PUB. 7-26-2005, MULTIPLE CLASS, INT. CLS.
12, 28 AND 37.

DAISY MANUFACTURING COMPANY, ROGERS, AR:
3,007,693, INT. CL. 28.

DALBEY PUBLISHING, LLC, BOULDER, CO:
3,007,456, PUB. 7-26-2005, INT. CL. 35.

DALEY, SEAN, CHICAGO, IL AND DAVIS, ANTHONY,
CHICAGO, IL:
3,006,821, PUB. 7-26-2005, INT. CL. 9.

DANEK MEDICAL, INC., MEMPHIS, TN:
2,207,658, CANC. INT. CL. 42.

DANFOSS INC., ROCKFORD, IL:
2,206,372, CANC. INT. CL. 9.

DANGEROUS DUDS, LOS ANGELES, CA:
3,007,515, PUB. 7-5-2005, INT. CL. 25.

DANIEL BOONE INC., MIAMI, FL:
3,007,461, PUB. 7-26-2005, INT. CL. 8.

DANIEL BOONE, INC., MIAMI, FL:
3,007,490, PUB. 7-26-2005, INT. CL. 28.

DANIELS PHARMACEUTICALS, INC., ST. PETERSBURG,
FL:
1,306,765, CANC. INT. CL. 5.

DANNON COMPANY, INC., THE, TARRYTOWN, NY:
2,207,378, CANC. INT. CL. 35.

DARBY DENTAL SUPPLY CO., INC., WESTBURY, NY TO
DARBY DENTAL SUPPLY CO., INC., WESTBURY, NY:
1,838,909, CANC. INT. CL. 42.

DARGI, STEVEN B., HOPKINS, MN:
3,007,173, PUB. 7-26-2005, MULTIPLE CLASS, INT. CLS.
25 AND 41.

DATA SYSTEMS INTERNATIONAL, INC., OVERLAND
PARK, KS:
3,007,622, INT. CL. 9.

DATAEDGE, LLC, FORT WASHINGTON, PA:
2,206,642, CANC. INT. CL. 9.

DATAKEY ELECTRONICS, INC., SAVAGE, MN:
3,007,338, PUB. 7-26-2005, INT. CL. 9.

DATAMIX, LTD., CHAPEL HILL, NC:
2,206,918, CANC. INT. CL. 35.

DATINVEST VENTURES CAPITAL HOLDING S.A., LUX-
EMBOURG, LUXEMBOURG:
3,007,211, PUB. 7-26-2005, MULTIPLE CLASS, INT. CLS.
9, 37, 41 AND 42.

DATRON/TRANSCO INC., SIMI VALLEY, CA:
2,207,017, CANC. INT. CL. 9.

DAVID GROUP INC., THE, CLEVELAND, OH:
2,207,061, CANC. INT. CL. 35.
2,207,353, CANC. INT. CL. 35.

DAVID W. TICE & ASSOCIATES, LLC, ST. THOMAS, US
VIRGIN ISLANDS:
3,007,271, PUB. 7-26-2005, INT. CL. 36.

DAVIES COMPUTER SOLUTIONS, INC., GREEN BAY, WI:
3,007,326, PUB. 7-26-2005, INT. CL. 37.

DAWN FOODS, INC., TROY, MI:
1,910,284, REN. 9-7-05, MULTIPLE CLASS, INT. CLS. 29
AND 30.

DAWSON, DENNIS, MOORPARK, CA:
1,865,342, CANC. INT. CL. 28.

DCD INC., MALIBU, CA:
3,007,923, INT. CL. 28.

DE NORA ELETTRODI S.P.A., MILAN, ITALY:
3,007,518, PUB. 7-26-2005, INT. CL. 9.

DE-CAL, INC., WARREN, MI:
3,006,859, PUB. 7-26-2005, INT. CL. 37.

DEAL'S SEAFOOD CO., INC., MAGNOLIA, NJ:
1,307,315, CANC. INT. CL. 29.

DEBBIE MUMM, INC., SPOKANE, WA:
3,007,193, PUB. 7-26-2005, MULTIPLE CLASS, INT. CLS.
4, 6, 8, 9, 11, 14, 15, 16, 18, 20, 21, 24, 25, 26, 27, 28, 30
AND 32.

DEBENEDETTO FARMS, INC., FRESNO, CA:
1,865,111, CANC. MULTIPLE CLASS, INT. CLS. 29 AND
31.

DECATHLON, FRANCE:
3,007,549, PUB. 7-26-2005, MULTIPLE CLASS, INT. CLS.
12, 18 AND 20.

DECATUR AUTO AUCTION, INC., DECATUR, IL:
2,207,180, CANC. INT. CL. 35.

DECISION SUPPORT ASSOCIATES, INC., WILMINGTON,
DE:
1,910,365, REN. 9-7-05, INT. CL. 35.

DEERE & COMPANY CREDIT UNION, MOLINE, IL:
2,110,037, CANC. INT. CL. 36.

DEFINE TEASE, INC., JACKSON HEIGHTS, NY:
3,007,702, INT. CL. 25.

DEGUSSA AKTIENGESSELLSCHAFT, FRANKFURT/
MAIN, FED REP GERMANY:
2,206,303, CANC. INT. CL. 31.

DEHASS, ANN, CHARM, OH:
3,007,497, PUB. 7-26-2005, INT. CL. 43.

DEKMATE INC., COBOURG, ONTARIO, CANADA, DEK-
BLOCK ONTARIO LIMITED, COBOURG, ONTARIO,
CANADA:
1,900,647, REN. 9-7-05, INT. CL. 19.

DEL MONTE CORPORATION, SAN FRANCISCO, CA:
2,207,586, CANC. INT. CL. 16.

DELAWARE CAPITAL FORMATION, INC., WILMINGTON,
DE:
3,007,360, PUB. 7-26-2005, MULTIPLE CLASS, INT. CLS. 6
AND 9.

DELMARVA POWER & LIGHT COMPANY, WILMINGTON,
DE:
2,206,467, CANC. MULTIPLE CLASS, INT. CLS. 38 AND
42.

DELTA SHOE GROUP, INC., MIAMI, FL:
3,007,930, INT. CL. 25.

DEMO WORKS INC., SHAWNEE OF DELAWARE, PA:
2,206,984, CANC. INT. CL. 35.

DEMOCRATIC CONGRESSIONAL CAMPAIGN COMMIT-
TEE, WASHINGTON, DC:
3,007,419, PUB. 7-26-2005, INT. CL. 35.

- DENER MANAGEMENT INC., BLOOMINGDALE, NJ:
1,908,100. REN. 9-7-05. INT. CL. 5.
- DENNIS BAMBER, INC., SOUTH BEND, IN:
3,007,043. PUB. 7-26-2005. INT. CL. 15.
- DENNIS CONNER SPORTS, INC., SAN DIEGO, CA:
1,901,793. REN. 9-3-05. INT. CL. 25.
1,902,731. REN. 9-3-05. INT. CL. 18.
- DENNYA COMPANY LLC, BALTIMORE, MD:
3,006,927. PUB. 7-26-2005. INT. CL. 18.
- DEPEW, MARILYN A., NORTH SYRACUSE, NY:
1,333,394. REN. 9-7-05. INT. CL. 28.
- DESA IP, LLC, MIAMI, FL:
3,006,931. PUB. 7-26-2005. INT. CL. 7.
- DESCRY, LLC, MINNEAPOLIS, MN:
2,206,390. CANC. MULTIPLE CLASS, INT. CLS. 9 AND 42.
- DESMI A/S, DK-9400 NORRESUNDBY, DENMARK,
THRIGE PUMPER A/S, 5000 ODENSE C, DENMARK,
DBA THRIGE-TITAN A/S:
1,904,896. REN. 9-7-05. INT. CL. 7.
- DESOLVIT INC., MINNEAPOLIS, MN:
3,008,028. U.S. CL. B.
- DESTINATION HOTELS AND RESORTS, INC., LOS ANGELES, CA:
3,006,996. PUB. 7-26-2005. MULTIPLE CLASS, INT. CLS. 35, 39, 41, 42 AND 43.
- DESTINATION IMAGINATION, INC., GLASSBORO, NJ:
3,007,759. MULTIPLE CLASS, INT. CLS. 9, 14, 16, 18, 20, 24, 25 AND 41.
- DESTINY BAY VINEYARDS LIMITED, AUCKLAND, NEW ZEALAND:
2,954,621. COR. INT. CL. 33.
- DETROIT GRAND PRIX ASSOCIATION, FLAT ROCK, MI:
2,206,702. CANC. INT. CL. 25.
- DEUTSCHE POST AG, 53113 BONN, FED REP GERMANY:
3,006,812. PUB. 7-26-2005. MULTIPLE CLASS, INT. CLS. 16, 35 AND 36.
- DEUTSCHE TELEKOM AG, BONN, 53113, FED REP GERMANY:
3,007,023. PUB. 7-26-2005. INT. CL. 16.
3,007,067. PUB. 7-26-2005. INT. CL. 42.
- DEUTSCHE TELEKOM AG, BONN, FED REP GERMANY:
3,007,240. PUB. 7-26-2005. INT. CL. 16.
- DEVEREAUX, DEBORA LYNN, ROSEMOUNT, MN:
3,007,083. PUB. 7-26-2005. INT. CL. 25.
- DHARMA LIVING SYSTEMS, LC, DELRAY BEACH, FL,
LIVING TECHNOLOGIES, INC., BURLINGTON, VT:
1,924,102. REN. 9-7-05. MULTIPLE CLASS, INT. CLS. 37, 40 AND 42.
- DHI ACQUISITION CORP., GERMANTOWN, WI:
3,007,176. PUB. 7-26-2005. INT. CL. 6.
- DIA-COMPE, TAIWAN, CO., LTD., TAI-CHUNG, TAIWAN:
2,206,919. CANC. INT. CL. 12.
- DIAMETRICS MEDICAL, INC., ROSEVILLE, MN:
1,865,236. CANC. INT. CL. 10.
- DIAMOND ANIMAL HEALTH, INC., DES MOINES, IA:
1,917,148. REN. 9-9-05. INT. CL. 5.
- DIAMOND RESEARCH CORPORATION, VENTURA, CA:
1,306,970. CANC. INT. CL. 16.
- DIDOMIZIO, LYNNE, TYLERSPORT, PA:
3,007,451. PUB. 7-26-2005. INT. CL. 35.
- DIEBOLD SELF-SERVICE SYSTEMS, NORTH CANTON, OH, INTERBOLD, NORTH CANTON, OH:
1,954,577. REN. 9-7-05. INT. CL. 9.
- DIGICOM DIGITAL, INC., BROOKLYN, NY:
3,007,602. INT. CL. 9.
- DIGITAL BRIDGES LIMITED, DUNFERMLINE, UNITED KINGDOM:
3,007,231. PUB. 7-26-2005. MULTIPLE CLASS, INT. CLS. 9, 16, 28, 38, 41 AND 42.
- DIGITAL INTELLIGENCE, INC., WAUKESHA, WI:
3,007,167. PUB. 7-26-2005. MULTIPLE CLASS, INT. CLS. 9 AND 42.
- DIGITAL MODELLER, INC., ATLANTA, GA:
2,207,641. CANC. INT. CL. 35.
- DIGITIMES PUBLICATION INC., TAIPEI 114, TAIWAN:
3,007,115. PUB. 7-26-2005. INT. CL. 35.
- DILLARD INTERNATIONAL, INC., LAS VEGAS, NV:
2,252,541. CANC. INT. CL. 9.
- DIONEX CORPORATION, SUNNYVALE, CA:
1,905,208. REN. 9-7-05. INT. CL. 1.
- DIPLOMAT TRADING, INC., MIAMI, FL:
3,007,596. INT. CL. 12.
- DISC MARKETING, INC., PASADENA, CA:
3,007,299. PUB. 7-26-2005. INT. CL. 41.
- DISCOVERY COMMUNICATIONS, INC., BETHESDA, MD,
DBA THE DISCOVERY CHANNEL:
2,207,515. CANC. MULTIPLE CLASS, INT. CLS. 38 AND 41.
- DISCOVERY PARTNERS, LLC., FRISCO, TX:
3,007,019. PUB. 7-26-2005. INT. CL. 1.
- DISNEY ENTERPRISES, INC., BURBANK, CA:
3,007,745. INT. CL. 14.
- DIVERSIFIED FUNDING INCORPORATED, BOSTON, MA:
1,345,017. REN. 9-3-05. INT. CL. 36.
- DIVERSIFIED PRODUCT INSPECTIONS, INC., OLIVER SPRINGS, TN:
2,206,610. CANC. INT. CL. 42.
- DOCTOR'S ASSOCIATES, INC., MILFORD, CT:
1,307,340. CANC. MULTIPLE CLASS, INT. CLS. 30 AND 32.
- DODGE, VICKI, MONROE, WA:
2,207,547. CANC. INT. CL. 22.
- DOHRMANN, BERNHARD, HUNTSVILLE, AL, DBA ST PRODUCTIONS:
2,207,038. CANC. INT. CL. 9.
- DOLBEY SYSTEMS, INC., CONCORD, OH:
3,007,973. INT. CL. 9.
- DOLPHIN SWIMMING CORP, FLUSHING, NY:
3,007,301. PUB. 7-26-2005. INT. CL. 41.
- DOMINION LANDS INC, RICHMOND, VA:
1,865,110. CANC. MULTIPLE CLASS, INT. CLS. 36 AND 37.
- DONOR STRATEGIES, INC., CHEVY CHASE, MD:
3,007,321. PUB. 7-26-2005. INT. CL. 9.
- DOOSAN CORPORATION, YOUNGDEUNGPO-KU, SEOUL, REPUBLIC OF KOREA:
3,006,799. PUB. 7-26-2005. MULTIPLE CLASS, INT. CLS. 29 AND 30.
- DORMA PROPERTIES, INC., WILMINGTON, DE:
3,007,980. INT. CL. 6.
- DORSTE B.V., 8171 NZ VAASSEN, NETHERLANDS, KONINKLIJKE DROSTE FABRIEKEN B.V., HAARLEM, NETHERLANDS:
1,014,229. REN. 9-7-05. INT. CL. 30.
- DOUBLE GREEN PRODUCE INC., BROOKLYN, NY:
1,864,825. CANC. INT. CL. 29.
- DOW AGROSCIENCES LLC, INDIANAPOLIS, IN:
798,452. REN. 9-7-05. U.S. CL. 6 (INT. CL. 5).
798,702. REN. 9-7-05. U.S. CL. 6 (INT. CL. 5).
3,007,936. INT. CL. 5.
- DOWBRANDS L.P., INDIANAPOLIS, IN TO THE LAMAUR CORPORATION, FRIDLEY, MN:
1,865,139. CANC. INT. CL. 3.
- DOWNTOWN CINCINNATI INC., CINCINNATI, OH:
2,207,394. CANC. INT. CL. 36.
- DOXTEK, PROVO, UT:
3,007,348. PUB. 7-26-2005. MULTIPLE CLASS, INT. CLS. 35, 37, 40 AND 42.
- DPC, LLC, WHITEWATER, WI:
3,007,887. INT. CL. 20.
3,007,888. INT. CL. 20.
- DR. ING. H.C. F. PORSCHE AG, 70435 STUTTGART-ZUFFEHAUSEN, FED REP GERMANY:
3,007,164. PUB. 7-26-2005. MULTIPLE CLASS, INT. CLS. 9 AND 14.
- DR. NONA INTERNATIONAL LTD., RISHON LE-ZION 75658, ISRAEL:
3,007,640. INT. CL. 3.
- DR. REGISTER & ASSOCIATES, INC., MENOMONIE, WI:
3,007,225. PUB. 7-26-2005. INT. CL. 5.
- DRAGON OPTICAL, INC., CARLSBAD, CA:
3,007,594. MULTIPLE CLASS, INT. CLS. 6 AND 14.
- DREAM MUSICIAN, INC., RICHMOND, VA:
3,007,583. INT. CL. 9.

- DRESSMARK AB, BORAS, SWEDEN:
3,006,784, PUB. 7-26-2005. MULTIPLE CLASS, INT. CLS. 25 AND 35.
- DREYFUS SERVICE CORPORATION, NEW YORK, NY:
1,874,178. REN. 9-3-05. INT. CL. 36.
- DRG TEXAS, LP, BIG SANDY, TX:
1,968,569. REN. 9-9-05. INT. CL. 16.
- DRI-DECK ENTERPRISES, LLC, HIGHLANDS RANCH, CO:
3,007,710, INT. CL. 19.
- DRIVEWAY JAM, INC., GOLDENROD, FL:
2,206,554, CANC. INT. CL. 25.
- DRUM WORKSHOP, INC., OXNARD, CA:
3,008,085, INT. CL. 40.
- DRY FORCE, INC., MESA, AZ:
3,007,106, PUB. 7-26-2005. INT. CL. 37.
- DUCHESS LTD., ALEXANDRIA, VA:
1,307,203, CANC. INT. CL. 26.
- DULCIAN, INC., NEW YORK, NY:
3,007,711, INT. CL. 9.
- DUNLAP, ANGELA D., WOODSTOCK, GA:
3,007,233, PUB. 7-26-2005. INT. CL. 42.
- DUNLOP MAXFLI SPORTS CORPORATION, GREENVILLE, SC:
2,207,685, CANC. INT. CL. 28.
- DUOMED, INC., WEST PALM BEACH, FL:
1,870,280. REN. 9-7-05. INT. CL. 3.
- DURBIN FARMS MARKET, INC., CLANTON, AL:
3,007,166, PUB. 7-26-2005. MULTIPLE CLASS, INT. CLS. 29, 30 AND 31.
- DUST CONTROL TECHNOLOGY INC., PEORIA, IL:
3,008,043, INT. CL. 37.
- DVS SHOE CO., INC., TORRANCE, CA:
3,007,150, PUB. 7-26-2005. INT. CL. 25.
- DYERSBURG FABRICS INC., DYERSBURG, TN:
2,105,897, CANC. INT. CL. 24.
- DYNACHIP CORPORATION, SUNNYVALE, CA:
2,206,369, CANC. INT. CL. 9.
- DYNAMO STOL APS, DENMARK:
3,007,537, PUB. 7-26-2005. INT. CL. 20.
- DYNASTY CONSOLIDATED INDUSTRIES, INC., DALLAS, TX:
1,980,609. REN. 9-7-05. INT. CL. 20.
3,007,510, PUB. 7-26-2005. INT. CL. 20.
3,007,532, PUB. 7-26-2005. INT. CL. 20.
- DYNETICS, INC., HUNTSVILLE, AL:
2,261,839, CANC. INT. CL. 35.
- D2-D2-D2, INC., GRAND RAPIDS, MI:
1,928,082. REN. 9-3-05. INT. CL. 42.
- D4 SPORTSWEAR, INC., OVERLAND PARK, KS:
2,206,444, CANC. INT. CL. 25.
- E. I DU PONT DE NEMOURS AND COMPANY, WILMINGTON, DE:
2,207,421, CANC. INT. CL. 9.
- E. I. DU PONT DE NEMOURS & COMPANY, WILMINGTON, DE:
1,306,803, CANC. INT. CL. 5.
- E. MARTINAVARRO, S.A., 12550 ALMAZORA (CASTELON), SPAIN:
1,905,822. REN. 9-6-05. INT. CL. 31.
- E.H. WACHS COMPANY, WHEELING, IL:
1,908,132. REN. 9-6-05. INT. CL. 7.
- E.K. SUCCESS, LTD., CLIFTON, NJ:
3,007,695, INT. CL. 16.
- E*TRADE SECURITIES, INC., PALO ALTO, CA:
2,206,732, CANC. INT. CL. 36.
- E-CAPITAL, INC., SAN JOSE, CA:
2,207,677, CANC. INT. CL. 37.
2,207,678, CANC. INT. CL. 36.
- E-SPAN, INC., INDIANAPOLIS, IN:
2,206,755, CANC. INT. CL. 35.
- E-TICKETS SOFTWARE, INC., ESCONDIDO, CA:
3,007,254, PUB. 7-26-2005. INT. CL. 42.
- EAGLE PUBLISHING, INC., WASHINGTON, DC:
2,206,573, CANC. INT. CL. 35.
- EAGLE TEST SYSTEMS, INC., BUFFALO GROVE, IL:
3,006,966, PUB. 7-26-2005. INT. CL. 9.
- EARNINGS PERFORMANCE GROUP, INC., SHORT HILLS, NJ:
1,905,380. REN. 9-8-05. MULTIPLE CLASS, INT. CLS. 9 AND 35.
- EARTH ESSENTIALS, SANTA BARBARA, CA:
1,873,526. REN. 9-7-05. INT. CL. 3.
- EASTERN COMPANY, THE, SOLVAY, NY:
1,372,134. REN. 9-6-05. INT. CL. 6.
- EASY CELLULAR, INC., LAS VEGAS, NV:
2,206,430, CANC. INT. CL. 38.
- EATON MDH COMPANY, INC., SAN DIEGO, CA:
1,972,159. REN. 9-7-05. INT. CL. 9.
- EBSCO INDUSTRIES, INC., BIRMINGHAM, AL:
3,006,905, PUB. 7-26-2005. MULTIPLE CLASS, INT. CLS. 7, 9 AND 21.
- ECHELON CORPORATION, SAN JOSE, CA:
3,007,652, INT. CL. 9.
- EHOSTAR ACQUISITION L.L.C., ENGLEWOOD, CO:
2,206,808, CANC. MULTIPLE CLASS, INT. CLS. 9 AND 38.
- ECLIPSE SURGICAL TECHNOLOGIES, INC., SUNNYVALE, CA:
2,207,507, CANC. INT. CL. 10.
- ECOLAB INC., ST. PAUL, MN:
1,345,467. REN. 9-3-05. INT. CL. 3.
3,007,232, PUB. 7-26-2005. MULTIPLE CLASS, INT. CLS. 16 AND 45.
- ECOLOGICAL SYSTEMS, INC., GLOUCESTER, VA:
1,833,265. REN. 9-7-05. INT. CL. 11.
- ECONOMIC SWISS TIME LTD., MUMPF, SWITZERLAND:
1,306,933, CANC. INT. CL. 14.
- EDAW, INC., SAN FRANCISCO, CA:
2,206,739, CANC. MULTIPLE CLASS, INT. CLS. 35, 37 AND 42.
- EDC LICENSING INC., WILMINGTON, DE:
1,865,088, CANC. MULTIPLE CLASS, INT. CLS. 5, 10, 16 AND 21.
- EDUCATION DIRECT, INC., SCRANTON, PA, INTEXT, INC., SCRANTON, PA:
983,060. REN. 9-6-05. U.S. CL. 101 (INT. CL. 35).
- EDUCATIONAL COMMUNICATIONS, INC., LAKE FOREST, IL:
1,306,934, CANC. INT. CL. 14.
- EDUCATIONAL TELECOMMUNICATION SERVICES CORPORATION, OLYMPIA, WA:
2,207,726, CANC. INT. CL. 38.
- EDWARD LOWE FOUNDATION, THE, CASSOPOLIS, MI:
2,207,268, CANC. INT. CL. 42.
- EDWARDS FINE FOODS, INC., NORCROSS, GA:
1,307,353, CANC. INT. CL. 30.
- EIDOS INTERACTIVE, INC., SAN FRANCISCO, CA:
2,206,693, CANC. INT. CL. 41.
- EISAGE, LLC, BOULDER, CO, DBA ECO-PRODUCTS:
3,008,048, INT. CL. 3.
- EISAI CO., LTD., BUNKYO-KU, TOKYO, JAPAN:
1,306,669, CANC. INT. CL. 3.
- EKLIN MEDICAL SYSTEMS, INC., SUNNYVALE, CA:
3,007,289, PUB. 7-26-2005. MULTIPLE CLASS, INT. CLS. 9 AND 10.
- EL TRIM GMBH, 58256 ENNEPetal, FED REP GERMANY:
1,347,601. REN. 9-3-05. INT. CL. 12.
- ELAN MILL, INC., HIALEAH, FL TO SCHLUETER COMPANY, THE, HIALEAH, FL:
1,865,464, CANC. INT. CL. 16.
- ELECTRAK INTERNATIONAL LIMITED, CO DURHAM, UNITED KINGDOM:
1,315,479. REN. 9-6-05. INT. CL. 9.
- ELECTRONIC SIGN CORPORATION, STOCKTON, CA:
2,206,413, CANC. MULTIPLE CLASS, INT. CLS. 9 AND 40.
- ELKAY PRODUCTS, INC., SHREWSBURY, MA:
1,864,546, CANC. INT. CL. 9.
- ELLA INTERNATIONAL, INC., VISTA, CA:
2,207,580, CANC. INT. CL. 3.
- ELLEGAARD GOTTINGEN MINIPIGS, 4261 DALMOSE, DENMARK:
2,582,523, AM. INT. CL. 31.

- ELLIS MFG. CO., INC., OKLAHOMA CITY, OK:
1,358,840. REN. 9-3-05. INT. CL. 6.
- ELLIS, DUANE J, VAN, TX:
3,007,961. INT. CL. 28.
- ELMER'S INVESTMENTS, INC., WILMINGTON, DE:
2,206,649. CANC. INT. CL. 16.
- ELSEVIER INC., NEW YORK, NY:
3,007,455. PUB. 7-26-2005. INT. CL. 35.
- ELVIS PRESLEY ENTERPRISES, INC., MEMPHIS, TN:
3,007,261. PUB. 7-26-2005. INT. CL. 18.
- EMERSON ELECTRIC CO., ST. LOUIS, MO:
3,007,564. INT. CL. 7.
- EMGE FOODS, LLC, GREENFIELD, IN, EXCEL CORPORATION, WICHITA, KS:
1,905,766. REN. 9-6-05. INT. CL. 29.
- EMHART INC., NEWARK, DE:
1,865,166. CANC. INT. CL. 6.
- EMMIS RADIO, LLC, INDIANAPOLIS, IN, TRIBUNE NEW YORK RADIO, INC., NEW YORK, NY:
1,922,477. REN. 9-3-05. INT. CL. 38.
- EMPRESA CUBANA DEL TABACO, CIUDAD HABANA, CUBA, DBA CUBATABACO:
1,970,911. REN. 9-7-05. INT. CL. 34.
- ENCHILADA KINGS, L.L.C., YUKON, OK:
1,880,991. REN. 9-3-05. INT. CL. 42.
- ENCYCLOPAEDIA BRITANNICA, INC., CHICAGO, IL:
781,026. CANC. U.S. CL. 38.
- ENGINEERED PLASTIC PRODUCTS CORPORATION, ELLK GROVE VILLAGE, IL:
1,865,570. REN. 9-6-05. INT. CL. 7.
- ENGINEERING FITNESS INTERNATIONAL CORP., SAN DIEGO, CA, DBA TOTAL GYM, DBA EFI, AND DBA EFI MEDICAL SYSTEMS:
3,006,873. PUB. 7-26-2005. INT. CL. 41.
- ENGLERT METALS CORP., PERTH AMBOY, NJ TO ENGLERT, INC., PERTH AMBOY, NJ:
1,274,780. CANC. INT. CL. 6.
- ENGRAVALITH PRESS, INC., THE, WANTAGH, NY:
1,865,060. CANC. INT. CL. 42.
- ENSAR CORPORATION, WHEELING, IL:
1,316,531. REN. 9-8-05. MULTIPLE CLASS, INT. CLS. 6, 17 AND 21.
- ENTERPRISE INTEGRATION GROUP, SAN RAMON, CA:
3,007,234. PUB. 7-26-2005. MULTIPLE CLASS, INT. CLS. 41 AND 42.
- ENTERPRISE VENDING, INC., CINCINNATI, OH:
1,907,751. REN. 9-3-05. INT. CL. 42.
- ENTREMED, INC., ROCKVILLE, MD:
2,207,723. CANC. INT. CL. 5.
- ENVIRO-EQUIPMENT, INC., PINEVILLE, NC:
3,006,863. PUB. 7-26-2005. MULTIPLE CLASS, INT. CLS. 35, 40 AND 42.
- ENVIRONMENTALLY SENSITIVE SOLUTIONS, INC., MEQUON, WI:
3,007,264. PUB. 7-26-2005. MULTIPLE CLASS, INT. CLS. 3 AND 42.
- ENVIRYX L.L.C., TULSA, OK:
2,206,879. CANC. INT. CL. 42.
- ENZA LIMITED, AUCKLAND, NEW ZEALAND:
1,875,395. REN. 9-9-05. INT. CL. 31.
- ENZON, INC., PISCATAWAY, NJ:
1,908,859. REN. 9-7-05. INT. CL. 40.
- ENZYMATIC THERAPY, INC., GREEN BAY, WI, BIOTHERAPEUTICS, LTD., GREEN BAY, WI, DBA PHYTO-PHARMICA:
1,982,452. REN. 9-7-05. INT. CL. 5.
- EPIC PRODUCTS, INC., FOUNTAIN VALLEY, CA:
3,006,886. PUB. 7-26-2005. INT. CL. 16.
- EPREDIX, INC., MINNEAPOLIS, MN:
3,007,274. PUB. 7-26-2005. MULTIPLE CLASS, INT. CLS. 35 AND 42.
- EQ FINANCIAL, INC., CHICAGO, IL:
2,206,670. CANC. INT. CL. 36.
- EQUEST, DALLAS, TX:
2,206,837. CANC. INT. CL. 42.
- EQ2, INC., BURLINGTON, VT:
1,893,969. REN. 9-3-05. INT. CL. 9.
- ERICO INTERNATIONAL CORPORATION, SOLON, OH:
3,006,861. PUB. 7-26-2005. MULTIPLE CLASS, INT. CLS. 1, 6, 7, 9 AND 11.
- ERNEST DISANDRO INC, PHILADELPHIA, PA:
2,207,298. CANC. INT. CL. 42.
- ERNEST GROUP, INC., OKLAHOMA CITY, OK:
2,318,824. COR. MULTIPLE CLASS, INT. CLS. 35 AND 36.
- ERNST & YOUNG U.S. LLP, NEW YORK, NY:
2,206,625. CANC. INT. CL. 35.
2,207,083. CANC. MULTIPLE CLASS, INT. CLS. 9 AND 35.
- ERSKINE, WILLIAM H., MCLEAN, VA:
1,864,571. CANC. INT. CL. 9.
- ESCADA AG, D-85609 ASCHEHEIM, FED REP GERMANY:
3,007,556. PUB. 7-26-2005. MULTIPLE CLASS, INT. CLS. 3, 9, 14, 18 AND 25.
- ESDU INTERNATIONAL LIMITED, LONDON, ENGLAND:
1,360,261. REN. 9-9-05. MULTIPLE CLASS, INT. CLS. 9 AND 16.
- ESHARE TECHNOLOGIES, INC., COMMACK, NY:
2,206,751. CANC. INT. CL. 9.
- ESJ TOWERS, INC., CAROLINA, PUERTO RICO:
1,014,265. REN. 9-7-05. INT. CL. 35.
- ESPEED, INC., NEW YORK, NY:
3,007,525. PUB. 7-26-2005. MULTIPLE CLASS, INT. CLS. 9 AND 36.
- ESSENTIAL LIVING FOODS, INC., SAN LUIS OBISPO, CA:
3,007,884. INT. CL. 29.
- ETR GROUP, LLC, MEQUON, WI:
3,007,914. INT. CL. 35.
- ETREBY COMPUTER COMPANY, INC., GARDEN GROVE, CA:
3,007,986. INT. CL. 9.
- EUGEN LÄGLER GMBH, FED REP GERMANY:
3,007,541. PUB. 7-26-2005. INT. CL. 7.
- EUROCLONE, S.P.A., 1-20142, MILANO, ITALY:
2,930,131. COR. MULTIPLE CLASS, INT. CLS. 5 AND 10.
- EUROPEAN AMERICAN BANK, UNIONDALE, NY:
2,207,314. CANC. INT. CL. 36.
- EVERGLADES DIRECT, INC., NORTH MANKATO, MN, ONE WRITE SYSTEMS, INC., SUNRISE, FL, DBA G. NEIL COMPANIES:
1,904,983. REN. 9-3-05. INT. CL. 16.
- EVOLV, LLC, PORTSMOUTH, NH:
2,207,230. CANC. INT. CL. 35.
- EVOLVENT TECHNOLOGIES, INC., FALLS CHURCH, VA:
3,007,103. PUB. 7-26-2005. INT. CL. 35.
- EX OFFICIO LLC, TUKWILLA, WA:
3,006,844. PUB. 7-26-2005. INT. CL. 25.
- EXACT SOFTWARE ERP-NA, INC., ANDOVER, MA:
1,893,964. AM. INT. CL. 9.
- EXCEL SCIENTIFIC, INC., WRIGHTWOOD, CA:
3,006,999. PUB. 7-26-2005. INT. CL. 17.
- EXCELLUS HEALTH PLAN, INC., ROCHESTER, NY:
3,007,095. PUB. 7-26-2005. MULTIPLE CLASS, INT. CLS. 36 AND 44.
- EXCLUSIVE CONNECTIONS, INC., ROCKFORD, IL, DBA EQUITY PROTECTION:
2,207,346. CANC. INT. CL. 42.
- EXCLUSIVELY MISOOK INC., NEW YORK, NY:
2,207,191. CANC. INT. CL. 25.
- EXERGY, INC., PALO ALTO, CA:
2,206,374. CANC. INT. CL. 42.
- EXOTIC FOOD CO., LTD., SRIRACHA, CHONBURI 20230, THAILAND:
3,006,967. PUB. 7-26-2005. MULTIPLE CLASS, INT. CLS. 29, 30 AND 32.
- EXPERIENCIA, INC., KANSAS CITY, MO:
2,946,343. COR. INT. CL. 9.
- EXPOCONSULT B.V., 3606 AS MAARSSSEN, NETHERLANDS:
3,006,828. PUB. 7-26-2005. MULTIPLE CLASS, INT. CLS. 16, 35 AND 41.
- EXTRAORDINARY TECHNOLOGY (HI-FI) PTY LTD, AUSTRALIA:
3,007,561. PUB. 7-26-2005. INT. CL. 9.

EXXONMOBIL OIL CORPORATION, IRVING, TX:
1,338,384. REN. 9-8-05. INT. CL. 42.
1,338,384. CANC. INT. CL. 37.

EX2 MOBILE ELECTRONICS, INC., WEST CHESTER, PA:
2,206,978. CANC. INT. CL. 9.

EYE TO EYE COMMUNICATIONS, INC., SCOTTSDALE, AZ:
2,207,248. CANC. INT. CL. 41.

EZRAD.COM, INC., BALDWINVILLE, NY:
3,007,524. PUB. 6-28-2005. INT. CL. 9.

F & W PUBLICATIONS, INC., CINCINNATI, OH:
3,008,073. INT. CL. 16.

F.D.C. WHOLESALE CORP., MIAMI BEACH, FL:
2,207,368. CANC. INT. CL. 3.

FABBRI, ELLEN PRIEST, HAMDEN, CT:
2,207,377. CANC. INT. CL. 16.

FADDEN/MAR COMPANY, TUALATIN, OR:
3,007,118. PUB. 4-5-2005. INT. CL. 8.

FAIR WEST (USA), INC., ARCADIA, CA:
3,007,467. PUB. 7-26-2005. INT. CL. 5.

FAIRBANKS CAPITAL CORP., SALT LAKE CITY, UT:
2,206,930. CANC. INT. CL. 36.

FALCO, DAVID J, MOUNTAIN VIEW, CA:
2,207,124. CANC. INT. CL. 9.

FALCON FOOTWEAR, INC., NEW YORK, NY:
3,007,642. INT. CL. 25.

FANEUIL, INC., BOSTON, MA:
2,206,555. CANC. INT. CL. 35.

FANIMATION, INC., ZIONSVILLE, IN:
3,008,038. INT. CL. 11.

FANTASTIC SAMS FRANCHISE CORPORATION, BEVERLY, MA, FANTASTIC SAM'S INTERNATIONAL, INC., MEMPHIS, TN:
1,899,337. REN. 9-6-05. INT. CL. 42.

FARAHBEAN, LLC, WAYZATA, MN:
3,006,948. PUB. 7-26-2005. INT. CL. 14.

FARMONT TECHNIK GMBH & CO. KG, DUSSELDORF, FED REP GERMANY:
2,273,294. CANC. MULTIPLE CLASS, INT. CLS. 37, 39 AND 42.

FARMSAVER.COM LLC, SEATTLE, WA:
3,007,705. INT. CL. 16.

FAST TRACK SYSTEMS, INC, SAN MATEO, CA:
3,007,007. PUB. 7-26-2005. INT. CL. 35.

FASTBATH, LLC, BESSEMER, AL:
3,007,148. PUB. 7-26-2005. INT. CL. 37.

FAT FISH TRADING COMPANY, INC., WILMINGTON, NC:
2,207,444. CANC. INT. CL. 42.

FAT ROCK ENTERTAINMENT, SANTA MONICA, CA:
3,007,020. PUB. 7-26-2005. INT. CL. 41.
3,007,021. PUB. 7-26-2005. INT. CL. 41.
3,007,022. PUB. 7-26-2005. INT. CL. 41.

FATBOX, INC., REDWOOD CITY, CA:
2,206,368. CANC. INT. CL. 41.

FAVESS CO., LTD., OKASAKI, AICHI 444-2106, JAPAN:
3,007,634. INT. CL. 12.

FCF INSURANCE MARKETING, INC., LONG BEACH, CA:
3,007,441. PUB. 6-7-2005. MULTIPLE CLASS, INT. CLS. 35 AND 36.

FEDCHAMBER, LLC, DBA FEDERAL CHAMBER OF COMMERCE, LAS VEGAS, NV:
3,007,724. INT. CL. 35.

FEDERAL FUNDING CORPORATION OF AMERICA, WOODINVILLE, WA:
1,864,928. CANC. INT. CL. 36.

FEDERAL NATIONAL MORTGAGE ASSOCIATION, WASHINGTON, DC, DBA FANNIE MAE:
3,007,846. INT. CL. 36.

FEDERAL-MOGUL WORLD WIDE, INC., SOUTHFIELD, MI, MAREMONT CORPORATION, CHICAGO, IL:
1,006,563. REN. 9-9-05. U.S. CL. 19 (INT. CL. 12).

FEDERATED DEPARTMENT STORES, INC., CINCINNATI, OH:
2,206,889. CANC. INT. CL. 41.

FELLOWES MANUFACTURING COMPANY, ITASCA, IL:
1,306,986. CANC. MULTIPLE CLASS, INT. CLS. 16 AND 20.

FENGATE PROPERTY MANAGEMENT LTD., HAMILTON, ONTARIO L8N 1E1, CANADA:
3,007,035. PUB. 7-26-2005. INT. CL. 36.

FENN, WRIGHT AND MANSON, INCORPORATED:
1,433,003. CANC. INT. CL. 25.

FENSTER, CAROL A., SOUTH MIAMI, FL, D/B/A ACCESS CENTER:
2,207,276. CANC. INT. CL. 42.

FERAY LENNE CONSEIL, 75020 PARIS, FRANCE:
3,006,901. PUB. 7-26-2005. MULTIPLE CLASS, INT. CLS. 35, 36, 41 AND 42.

FEREZ, MARCIO, HIALEAH, FL:
3,007,743. INT. CL. 28.

FESTIVAL FUN PARKS, LLC, NEWPORT BEACH, CA:
1,865,016. CANC. INT. CL. 41.
1,865,017. CANC. INT. CL. 41.
1,865,018. CANC. INT. CL. 41.

FETISH GROUP, INC., VERNON, CA:
3,007,352. PUB. 7-26-2005. INT. CL. 25.

FEV ENGINE TECHNOLOGY, INC., AUBURN HILLS, MI:
1,944,625. REN. 9-6-05. INT. CL. 42.

FHF FUNKE + HUSTER FERNSIG GMBH, D-45478 MÜLHEIM AN DER RUHR, FED REP GERMANY:
3,006,822. PUB. 7-26-2005. MULTIPLE CLASS, INT. CLS. 9 AND 12.

FILI ENTERPRISES INCORPORATED, SAN DIEGO, CA:
2,206,916. CANC. INT. CL. 42.

FILTER AND CARTRIDGE SALES CORPORATION, BOYNTON BEACH, FL:
1,925,335. REN. 9-7-05. INT. CL. 11.

FILTRONA RICHMOND, INC., COLONIAL HEIGHTS, VA:
3,007,928. INT. CL. 10.
3,007,929. INT. CL. 16.

FINA OIL AND CHEMICAL COMPANY, DALLAS, TX:
2,206,838. CANC. INT. CL. 4.

FINAL GRADE, LLC, GRAND JUNCTION, CO:
3,007,006. PUB. 7-26-2005. INT. CL. 37.

FINANCIAL MANAGEMENT SYSTEMS, INC., BELLEVUE, WA:
1,306,835. CANC. INT. CL. 9.

FINGER FURNITURE COMPANY, INC, HOUSTON, TX:
3,007,818. MULTIPLE CLASS, INT. CLS. 35 AND 36.

FINNEY, KATHRYN, PHILADELPHIA, PA:
3,007,217. PUB. 7-26-2005. INT. CL. 35.

FIRDOSI DESIGNS INTERNATIONAL INC., MONTREAL, QUEBEC, H2X 2T6, CANADA:
3,007,690. INT. CL. 25.

FIRESTEED CORPORATION, SEATTLE, WA:
3,007,726. INT. CL. 33.

FIRST IMPRESSIONS DESIGN GROUP, INC., LAFAYETTE HILL, PA:
2,570,206. CANC. INT. CL. 16.

FIRST INTERNET FRANCHISE CORP., SAN CLEMENTE, CA, DBA FIRST INTERNET ALLIANCE:
2,206,622. CANC. INT. CL. 42.

FIRST NATIONAL BANK OF OMAHA, OMAHA, NE:
3,007,918. INT. CL. 35.

FIRST ONE LENDING CORPORATION, SAN JUAN CAPISTRANO, CA:
2,206,847. CANC. INT. CL. 36.

FIRST QUALITY PRODUCTS, INC., GREAT NECK, NY:
3,007,873. INT. CL. 5.

FISCHERSIPS, LLC, LOUISVILLE, KY:
2,956,928. COR. INT. CL. 19.

FISERV, INC., BROOKFIELD, WI:
1,902,251. REN. 9-3-05. INT. CL. 42.

FISKARDO ESTIATORIO, INC., NEW YORK, NY:
3,007,325. PUB. 7-5-2005. INT. CL. 3.

FISKARS BRANDS, INC., MADISON, WI:
1,027,212. REN. 9-7-05. INT. CL. 8.

FISSLER GMBH, D-6580 IDAR-OBERSTEIN, FED REP GERMANY:
1,344,480. REN. 9-3-05. INT. CL. 21.

FIT ATHLETIC CLUB, INC., HOUSTON, TX:
3,007,333. PUB. 7-26-2005. MULTIPLE CLASS, INT. CLS. 25 AND 41.

- FLAMBEAU PRODUCTS CORPORATION, MIDDLEFIELD, OH:
1,864,790, CANC. INT. CL. 28.
- FLASHBACK WORD PROCESSING, INC., NEW YORK, NY:
1,307,382, CANC. INT. CL. 35.
- FLEER CORP., MOUNT LAUREL, NJ TO CONCORD CONFECTIONS, INC., ONTARIO, CANADA:
1,865,362, CANC. INT. CL. 30.
- FLEET FINANCIAL GROUP, INC., BOSTON, MA:
2,206,517, CANC. INT. CL. 36.
- FLEET MORTGAGE GROUP, INC., COLUMBIA, SC:
2,206,493, CANC. INT. CL. 36.
- FLEX-N-GATE CORPORATION, URBANA, IL:
1,359,134, REN. 9-3-05. INT. CL. 12.
- FLEX-TECH HOSE & TUBING, INC., SAN MARCOS, TX:
3,006,842, PUB. 7-26-2005. INT. CL. 17.
- FLEXELLO LIMITED, BERKSHIRE SL1 4SS, UNITED KINGDOM:
3,006,813, PUB. 7-26-2005. MULTIPLE CLASS, INT. CLS. 6, 7, 12, 19 AND 20.
- FLIGHT PATTERNS, INC., LONGMONT, CO:
2,207,487, CANC. INT. CL. 37.
- FLORES PIRAN, RUFINO, LONDON, UNITED KINGDOM:
3,008,088, INT. CL. 36.
- FLORES, RAYMON C., JR., TUCSON, AZ:
2,206,692, CANC. INT. CL. 42.
- FLORIDA ATLANTIC UNIVERSITY, BOCA RATON, FL:
3,006,904, PUB. 7-26-2005. MULTIPLE CLASS, INT. CLS. 6, 12, 24 AND 25.
- FLORIDA CRYSTALS, INC., PALM BEACH, FL:
2,207,758, CANC. INT. CL. 30.
- FLORIDA FRUIT & VEGETABLE ASSOCIATION, ORLANDO, FL:
3,007,157, PUB. 7-26-2005. INT. CL. 16.
- FLORIDA INTERNATIONAL UNIVERSITY, MIAMI, FL:
2,207,194, CANC. INT. CL. 16.
- FLOW-RITE OF TENNESSEE, INC., BRUCETON, TN:
1,364,630, REN. 9-3-05. INT. CL. 28.
- FLS TRANSPORTATION SERVICES INC., MONTREAL, QUEBEC, CANADA:
1,901,946, REN. 9-3-05. INT. CL. 39.
- FLYDADDY, INC., NEWPORT, RI:
2,206,657, CANC. INT. CL. 35.
- FMR CORP., BOSTON, MA:
2,207,071, CANC. INT. CL. 36.
2,207,246, CANC. INT. CL. 36.
2,926,844, COR. MULTIPLE CLASS, INT. CLS. 9 AND 36.
- FOCUS 21 INTERNATIONAL, INC., SAN DIEGO, CA:
1,306,751, CANC. INT. CL. 5.
- FOCUS/MRL, INC., HERNDON, VA:
1,865,443, CANC. INT. CL. 42.
- FOODIE GIRLS, L.L.C., SHERMAN OAKS, CA:
3,007,132, PUB. 7-26-2005. INT. CL. 41.
- FORD MOTOR COMPANY, DEARBORN, MI:
1,893,178, REN. 9-8-05. INT. CL. 25.
- FORE LTD., INC., TAMPA, FL:
1,312,424, REN. 9-7-05. INT. CL. 25.
- FOREIGN CANDY COMPANY, INC., THE HULL, IA:
1,372,866, REN. 9-3-05. INT. CL. 30.
- FOREST PHARMACEUTICALS, INC.:
1,306,757, CANC. INT. CL. 5.
- FOREVER CO., LTD., SAITAMA-KEN, JAPAN:
3,007,900, INT. CL. 8.
- FOREX CAPITAL MARKETS LLC, NEW YORK, NY:
3,006,912, PUB. 7-26-2005. INT. CL. 41.
- FORT WORTH OSTEOPATHIC HOSPITAL, INC., FORT WORTH, TX, DBA OSTEOPATHIC MEDICAL CENTER OF TEXAS:
1,865,445, CANC. INT. CL. 42.
- FORTIS (NL) N.V., UTRECHT 3584 BA, NETHERLANDS AND FORTIS (B), 1000 BRUSSELS, BELGIUM:
3,006,829, PUB. 7-26-2005. MULTIPLE CLASS, INT. CLS. 35, 36 AND 37.
- FORWARD INDUSTRIES, INC., BROOKLYN, NY:
1,306,964, CANC. INT. CL. 16.
- FOSECO INTERNATIONAL LIMITED, NECHELLS, BIRMINGHAM 7, ENGLAND:
780,811, CANC. U.S. CL. 6.
- FOSTER POULTRY FARMS, LIVINGSTON, CA, DBA ORGANIC FARMS:
1,376,451, REN. 9-7-05. INT. CL. 1.
- FOUNDATION FOR THE ENCOURAGEMENT & PRESERVATION OF FAMILY VALUES, LLC, THE, LOCUST VALLEY, NY:
3,007,744, MULTIPLE CLASS, INT. CLS. 16, 35 AND 36.
- FOUNDATION OF THE AMERICAN ACADEMY OF OPHTHALMOLOGY, THE, SAN FRANCISCO, CA:
2,206,321, CANC. INT. CL. 16.
- FOUR RIVERS SOFTWARE SYSTEMS, INC., PITTSBURGH, PA:
3,007,303, PUB. 7-26-2005. INT. CL. 9.
- FOUR T CORPORATION, OMAHA, NE:
3,007,674, INT. CL. 3.
- FOURTH COMMUNICATIONS NETWORK, INC., THE, SAN JOSE, CA:
2,206,815, CANC. MULTIPLE CLASS, INT. CLS. 38 AND 42.
2,206,822, CANC. MULTIPLE CLASS, INT. CLS. 38 AND 42.
- FOURTHOUGHT INC., LOUISVILLE, CO:
3,007,283, PUB. 7-26-2005. MULTIPLE CLASS, INT. CLS. 41 AND 42.
- FOWLER, RICHARD A., SAN JUAN CAPISTRANO, CA:
3,008,055, INT. CL. 41.
- FRANÇOIS-PAUL JOURNE, SWITZERLAND:
3,007,543, PUB. 4-5-2005. INT. CL. 14.
- FRANCHISE INFORMATION SYSTEMS, INC., ARLINGTON, VA:
3,006,923, PUB. 7-26-2005. INT. CL. 35.
3,006,924, PUB. 7-26-2005. INT. CL. 35.
- FRANCHISE SERVICES CORPORATION, BRIDGETOWN, BARBADOS:
2,206,357, CANC. INT. CL. 35.
- FRANCHISE SYSTEM HOLDINGS, INC., SOLON, OH:
2,207,193, CANC. INT. CL. 42.
- FRANK MASTOLONI & SONS, INC., NEW YORK, NY:
1,349,200, REN. 9-3-05. INT. CL. 14.
- FRANKENMUTH MUTUAL INSURANCE COMPANY, FRANKENMUTH, MI:
3,007,027, PUB. 7-26-2005. INT. CL. 35.
3,007,028, PUB. 7-26-2005. INT. CL. 35.
3,007,029, PUB. 7-26-2005. INT. CL. 35.
3,007,030, PUB. 7-26-2005. INT. CL. 35.
- FRANKLIN COMPUTER CORPORATION, MT. HOLLY, NJ:
1,306,834, CANC. INT. CL. 9.
- FRANKLIN SPORTS, INC., STOUGHTON, MA:
1,941,584, REN. 9-7-05. INT. CL. 25.
- FRANKLIN, REID ALBERT, CESSFORD, ALBERTA, CANADA AND FRANKLIN, MERTON CHARLES, CESSFORD, ALBERTA, CANADA:
3,007,004, PUB. 7-26-2005. INT. CL. 6.
- FRED MEYER STORES, INC., PORTLAND, OR:
3,007,868, INT. CL. 35.
- FREDERICK WARNE & CO., INC., NEW YORK, NY:
1,864,810, CANC. INT. CL. 28.
1,864,812, CANC. INT. CL. 28.
- FREELANCE PLAYERS, INC., JAMAICA PLAIN, MA:
3,007,531, PUB. 7-26-2005. INT. CL. 41.
- FREIBORG, BEN, SUN VALLEY, CA AND FREIBORG, MARK, SUN VALLEY, CA:
2,207,545, CANC. INT. CL. 19.
- FRESENIUS AG, D-61352 BAD HOMBURG, FED REP GERMANY:
3,006,971, PUB. 7-26-2005. MULTIPLE CLASS, INT. CLS. 5, 10 AND 16.
- FRESH INTELLECTUAL PROPERTIES, INC., WILMINGTON, DE:
3,008,036, INT. CL. 35.
- FRESH MARK, INC., MASSILLON, OH:
1,919,981, REN. 9-7-05. INT. CL. 29.
- FRIEDA'S, INC., LOS ALAMITOS, CA:
3,007,697, INT. CL. 31.
- FRIENDLY FOOT CARE, P. C., MERRILLVILLE, IN, NIRENBERG, MICHAEL S., HOBART, IN, DBA FRIENDLY FOOT CARE:
1,871,520, REN. 9-7-05. MULTIPLE CLASS, INT. CLS. 41

- AND 42.
 FRIENDLY FOOT CARE, P.C., MERRILLVILLE, IN, NIRENBERG, MICHAEL S., HOBART, IN, DBA FRIENDLY FOOT CARE:
 1,869,895. REN. 9-7-05. MULTIPLE CLASS, INT. CLS. 41 AND 42.
- FRIENDLYSOFT, INC., ARLINGTON, TX:
 1,307,571. CANC. INT. CL. 9.
- FRITO-LAY NORTH AMERICA, INC., PLANO, TX:
 3,007,758. MULTIPLE CLASS, INT. CLS. 29 AND 30.
- FRONTIER PLASTICS (SOUTH WALES) LIMITED, BLACKWOOD, GWENT, UNITED KINGDOM:
 1,347,962. REN. 9-3-05. INT. CL. 21.
- FRUIT OF THE LOOM, INC., BOWLING GREEN, KY:
 1,307,190. CANC. INT. CL. 25.
- FUJI JUKOGYO KABUSHIKI KAISHA, TOKYO, JAPAN, DBA FUJI HEAVY INDUSTRIES LTD.:
 3,007,785. INT. CL. 12.
- FUJIREBIO KABUSHIKI KAISHA, SHINJUKU-KU, TOKYO, JAPAN:
 1,306,625. CANC. INT. CL. 1.
- FULHAM COMPANY, INC., HAWTHORNE, CA:
 3,007,153. PUB. 7-26-2005. INT. CL. 9.
- FULLER BRUSH COMPANY, THE, GREAT BEND, KS, PUREX CORPORATION, LAKEWOOD, CA:
 1,012,766. REN. 9-3-05. INT. CL. 3.
- FUNRISE TOYS LTD., TSIMSHATSUI EAST, KOWLOON, HONG KONG:
 3,007,683. INT. CL. 28.
- FUTURE MAP, INC., ENDICOTT, NY:
 3,007,429. PUB. 7-26-2005. MULTIPLE CLASS, INT. CLS. 35 AND 41.
- FYFFES PLC., DUBLIN 7, IRELAND:
 2,142,170. CANC. INT. CL. 31.
- G & G DISTRIBUTION INC., PHOENIX, AZ, DBA RYAN'S PET SUPPLIES:
 3,007,224. PUB. 7-26-2005. MULTIPLE CLASS, INT. CLS. 3, 5, 8, 10, 18 AND 20.
- G. T. SALES & MANUFACTURING, INC., WICHITA, KS:
 1,931,311. REN. 9-3-05. INT. CL. 17.
- G.H. DIJKMANS BEHEER BV, ST. LOUIS, MO:
 1,905,026. REN. 9-7-05. INT. CL. 25.
- G.H. MUMM & CIE - SOCIETE VINICOLE DE CHAMPAGNE, 51100 REIMS, FRANCE:
 2,206,842. CANC. INT. CL. 33.
- G.K. INDEXABLE, INC., CRYSTAL LAKE, IL:
 1,864,946. CANC. INT. CL. 37.
- G.V.G. - GRANDS VINS DE GIRONDE; SOCIÉTÉ ANONYME, FRANCE:
 3,007,546. PUB. 7-26-2005. MULTIPLE CLASS, INT. CLS. 32 AND 33.
- GABELLI ASSET MANAGEMENT INC., RYE, NY, GABELLI FUNDS, INC., RYE, NY:
 1,900,856. REN. 9-6-05. INT. CL. 36.
- GAGNON; PAUL L., PORT HUENEME, CA, DBA BOTTLE TOTE:
 1,307,569. CANC. INT. CL. 8.
- GALAXY NUTRITIONAL FOODS, INC., ORLANDO, FL:
 3,007,639. INT. CL. 29.
- GALAXYVOICE, INC., NEWTON, MA:
 3,007,706. INT. CL. 38.
- GALE GROUP, INC., THE, FARMINGTON HILLS, MI:
 1,021,485. REN. 9-9-05. INT. CL. 16.
- GALE GROUP, INC., THE, FARMINGTON HILLS, MI, GALE RESEARCH COMPANY, DETROIT, MI:
 1,333,193. REN. 9-9-05. INT. CL. 16.
- GALIL IMPORTING CORP., SYOSSET, NY, DBA BIDAN CO.:
 3,006,937. PUB. 7-26-2005. INT. CL. 11.
- GALLARD SCHLESINGER INDUSTRIES, INC., PLAINVIEW, NY:
 1,942,825. REN. 9-3-05. INT. CL. 35.
- GAMBORDELLA, TED, DALLAS, TX:
 3,007,507. PUB. 7-26-2005. INT. CL. 9.
- GAMESTOP, INC., GRAPEVINE, TX, RECYCLED GAMES & MUSIC, INC., VIRGINIA BEACH, VA:
 1,982,962. REN. 9-3-05. INT. CL. 42.
- GAMETECH INTERNATIONAL, INC., RENO, NV:
 3,006,830. PUB. 7-26-2005. MULTIPLE CLASS, INT. CLS. 9, 28 AND 41.
- GARDNER INDUSTRIES, TAMPA, FL:
 3,007,915. INT. CL. 17.
- GARDUNO, BARBARA (PKA NINA), LOS ANGELES, CA:
 3,007,836. INT. CL. 25.
- GARLAND COMPANY, THE, CLEVELAND, OH:
 1,134,921. COR. INT. CL. 1.
- GARLIC JIM'S FRANCHISE CORP., BOTHELL, WA:
 3,007,389. PUB. 7-5-2005. INT. CL. 43.
- GARRARD HOLDINGS LIMITED, LONDON W1X 4AS, UNITED KINGDOM:
 3,006,848. PUB. 7-26-2005. MULTIPLE CLASS, INT. CLS. 3, 8, 13, 16, 18, 20, 21, 25, 28, 29, 30, 33 AND 34.
- GATEWAY JUNIOR HOCKEY, L.L.C., ST. LOUIS, MO:
 2,207,457. CANC. INT. CL. 28.
 2,207,458. CANC. INT. CL. 25.
- GAYLORD BROS., INC., SYRACUSE, NY, GAYLORD BROS., INC., SYRACUSE, NY:
 797,975. REN. 9-7-05. U.S. CL. 11 (INT. CLS. 2 AND 16).
- GCM, INC., BURNSVILLE, MN:
 3,007,405. PUB. 7-26-2005. INT. CL. 20.
- GE CAPITAL MORTGAGE SERVICES, INC., CHERRY HILL, NJ:
 2,206,925. CANC. INT. CL. 36.
- GEAC ENTERPRISE SOLUTIONS, INC., SOUTHBOROUGH, MA:
 2,207,152. CANC. INT. CL. 9.
- GECKO DEVELOPMENT, CORP., HINSDALE, IL:
 3,007,804. INT. CL. 35.
- GEMACO INC., BLUE SPRINGS, MO:
 1,349,226. REN. 9-6-05. INT. CL. 16.
- GEMINI CONSULTING, INC., MORRISTOWN, NJ:
 2,206,846. CANC. INT. CL. 35.
- GENAISSANCE PHARMACEUTICALS, INC., NEW HAVEN, CT:
 3,007,395. PUB. 6-7-2005. MULTIPLE CLASS, INT. CLS. 10 AND 44.
- GENDALA, CHRISTOPHER MATHEW, ELWOOD, VICTORIA, AUSTRALIA:
 2,206,737. CANC. INT. CL. 21.
- GENELABS TECHNOLOGIES, INC., REDWOOD CITY, CA:
 1,901,428. REN. 9-9-05. MULTIPLE CLASS, INT. CLS. 5 AND 10.
- GENERAL ATOMICS ELECTRONIC SYSTEMS, INC., SAN DIEGO, CA:
 1,914,687. REN. 9-6-05. INT. CL. 9.
- GENERAL ELECTRIC CAPITAL AUTO FINANCIAL SERVICES, INC., BARRINGTON, IL, GENERAL ELECTRIC COMPANY, SCHENECTADY, NY:
 1,938,683. REN. 9-3-05. INT. CL. 9.
- GENERAL ELECTRIC COMPANY, SCHENECTADY, NY:
 320,304. REN. 9-6-05. U.S. CL. 21 (INT. CLS. 7, 9, 11, 12 AND 15).
- GENERAL ELECTRIC COMPANY, FT. WAYNE, IN:
 1,306,811. CANC. INT. CL. 7.
- GENERAL ELECTRIC COMPANY, SCHENECTADY, CT:
 3,007,191. PUB. 7-26-2005. MULTIPLE CLASS, INT. CLS. 7, 37, 40 AND 42.
- GENERAL ELECTRIC COMPANY, SCHENECTADY, NY:
 3,007,336. PUB. 7-26-2005. INT. CL. 11.
- GENERAL INSTRUMENT CORPORATION OF DELAWARE, CHICAGO, IL:
 2,206,741. CANC. MULTIPLE CLASS, INT. CLS. 37, 41 AND 42.
- GENERAL MEDIA COMMUNICATIONS, INC., NEW YORK, NY:
 3,007,070. PUB. 7-26-2005. MULTIPLE CLASS, INT. CLS. 41 AND 43.
- GENERAL MILLS, INC., MINNEAPOLIS, MN:
 3,007,849. INT. CL. 30.
- GENERAL MOTORS CORPORATION, DETROIT, MI:
 201,694. REN. 9-6-05. U.S. CL. 19 (INT. CL. 12).
 1,306,889. CANC. INT. CL. 9.
- GENERAL PHYSIOTHERAPY, INC., EARTH CITY, MO:
 1,350,489. REN. 9-3-05. INT. CL. 10.

- GENERAL SIGNAL CORPORATION, STAMFORD, CT:
1,306,833, CANC. INT. CL. 9.
- GENESCO INC., NASHVILLE, TN:
1,307,193, CANC. INT. CL. 25.
- GENESIS INDUSTRIES INCORPORATED, ELMWOOD, WI:
3,006,793, PUB. 11-5-2002. INT. CL. 10.
- GENTEX CORPORATION, CARBONDALE, PA, GENERAL
TEXTILE MILLS, INC., NEW YORK, NY:
606,758. REN. 9-8-05. U.S. CL. 39 (INT. CLS. 10, 25 AND
26).
- GENTRA SYSTEMS, INC., MINNEAPOLIS, MN:
3,007,310, PUB. 7-26-2005. MULTIPLE CLASS, INT. CLS.
1, 5 AND 9.
- GENWAY BIOTECH, INC., SAN DIEGO, CA:
3,007,344, PUB. 7-26-2005. MULTIPLE CLASS, INT. CLS. 1
AND 42.
- GEORGE SANEN AND CHESTER ALDRIDGE, SAN RA-
FAEL, CA:
2,207,443, CANC. INT. CL. 28.
- GEORGE, CHRISTINE, WALDORF, MD:
3,007,051, PUB. 7-26-2005. MULTIPLE CLASS, INT. CLS.
16, 28 AND 41.
- GEORGE, PATRICIA, CYPRESS, CA:
2,207,187, CANC. INT. CL. 16.
- GERONIMO PRODUCTIONS, INC., MIAMI, FL:
3,007,499, PUB. 7-26-2005. INT. CL. 12.
3,007,500, PUB. 7-26-2005. INT. CL. 20.
- GFE DO BRASIL LTDA., CAMPINAS - SP, BRAZIL:
3,007,650, INT. CL. 10.
- GIDDENS, PAUL, R, ACAMPO, CA:
3,008,054, INT. CL. 12.
- GIFTS IN KIND INTERNATIONAL, ALEXANDRIA, VA,
GIFTS IN KIND AMERICA, ALEXANDRIA, VA:
1,913,953. REN. 9-7-05. INT. CL. 42.
- GILC HOLDING CORP., WILMINGTON, DE:
3,006,885, PUB. 7-26-2005. INT. CL. 44.
- GILL FOUNDATION, THE, COLORADO SPRINGS, CO:
2,206,506, CANC. INT. CL. 41.
- GILLETTE COMPANY, THE, BOSTON, MA:
1,865,173, CANC. INT. CL. 8.
- GIMME SUM WORLDWIDE INC., CORONA DEL MAR, CA:
3,007,803, INT. CL. 43.
- GINA COMMUNICATIONS CORPORATION, LOS AN-
GELES, CA:
1,906,007. REN. 9-3-05. INT. CL. 41.
- GINA L. DAVIS, OVIEDO, FL:
3,007,736, INT. CL. 30.
- GINTER, GARY, CHICAGO, IL:
2,207,707, CANC. MULTIPLE CLASS, INT. CLS. 36 AND
42.
- GIORDANO ART LTD., LITTLE NECK, NY:
2,206,538, CANC. MULTIPLE CLASS, INT. CLS. 16 AND
18.
- GIORGI PROCESS INC., YONKERS, NY:
1,306,626, CANC. INT. CL. 1.
- GIVAUDAN FLAVORS, INC., BRIDGETON, MO, CONSO-
LIDATED FLAVOR CORPORATION, BRIDGETON, MO:
1,905,786. REN. 9-3-05. INT. CL. 29.
- GIVE LIFE FOUNDATION, INC., RESTON, VA:
3,007,974, INT. CL. 36.
- GLAS MESH COMPANY, INC., WEST CHESTER, PA:
3,007,397, PUB. 7-26-2005. INT. CL. 19.
- GLAUKOS CORPORATION, LAGUNA HILLS, CA:
3,008,053, INT. CL. 10.
- GLAZES, A CERAMICS WORKSHOP, CARMEL, CA:
2,207,008, CANC. INT. CL. 41.
- GLENORA WINE CELLARS, INC., DUNDEE, NY:
1,905,856. REN. 9-6-05. INT. CL. 33.
- GLOBAL CHEMICAL SYSTEMS, INC., HUNTINGTON
BEACH, CA:
2,207,149, CANC. INT. CL. 1.
- GLOBAL ENERGY; WIND POWER, INC., WINCHESTER,
VA:
3,007,827, INT. CL. 37.
- GLOBAL ORANGE, L.L.C., LANSING, MI:
2,308,859, AM. MULTIPLE CLASS, INT. CLS. 25, 30 AND
42.
- GLOBAL SOUND INTERNATIONAL, LLC, HALES COR-
NERS, WI:
2,207,407, CANC. INT. CL. 9.
- GLOBALNET, INC., GROTON, MA:
2,206,420, CANC. INT. CL. 35.
- GLOBALT INCORPORATED, ATLANTA, GA:
1,864,929, CANC. INT. CL. 36.
- GLOCOM LLC, LITTLETON, CO, DBA LA BEAUTE CE-
LESTE:
2,206,637, CANC. INT. CL. 42.
- GMAC MORTGAGE CORPORATION, HORSHAM, PA:
3,007,701, INT. CL. 36.
- GMB, INC., KING, NC, R. J. REYNOLDS TOBACCO
COMPANY, WINSTON-SALEM, NC:
1,978,627. REN. 9-7-05. INT. CL. 34.
1,978,655. REN. 9-7-05. INT. CL. 34.
- GMT-UTA, L.C., ARLINGTON, VA:
2,206,961, CANC. INT. CL. 9.
- GOLDEN BEAR INTERNATIONAL, INC., NORTH PALM
BEACH, FL:
1,865,429, CANC. INT. CL. 41.
- GOLDEN LYON INVESTMENT, INC., LOS ANGELES, CA,
DBA W.Y. INTERNATIONAL, INC.:
1,909,073. REN. 9-8-05. MULTIPLE CLASS, INT. CLS. 29
AND 30.
- GOMEZ, MARIA, MIAMI, FL:
3,008,056, MULTIPLE CLASS, INT. CLS. 35 AND 36.
- GOOD SAMARITAN HOSPITAL MEDICAL CENTER, WEST
ISLIP, NY:
2,207,767, CANC. INT. CL. 42.
- GOODALE & BARBIERI COMPANIES, SPOKANE, WA TO
WESTCOAST HOSPITALITY LIMITED PARTNERSHIP,
SPOKANE, WA:
1,896,423, CANC. MULTIPLE CLASS, INT. CLS. 35 AND
37.
- GOODALE AND BARBIERI COMPANIES, SPOKANE, WA:
2,206,958, CANC. INT. CL. 42.
- GOODBERRY'S CREAMERY, INC., RALEIGH, NC:
1,924,216. REN. 9-6-05. INT. CL. 42.
1,926,108. REN. 9-6-05. INT. CL. 42.
- GOODING'S SUPERMARKETS, INC., APOPKA, FL:
2,206,817, CANC. INT. CL. 42.
- GOODMAN, LAURA WILLENS, NEW YORK, NY:
2,207,370, CANC. INT. CL. 28.
- GOODMAN, MURRAY H., WEST PALM BEACH, FL:
1,307,430, CANC. INT. CL. 36.
- GOODMARK PLC, CARDIFF, UNITED KINGDOM:
3,007,212, PUB. 7-26-2005. MULTIPLE CLASS, INT. CLS. 3
AND 16.
- GOODSHIRT LIMITED, ROYAL OAK, NEW ZEALAND:
3,007,775, MULTIPLE CLASS, INT. CLS. 9 AND 41.
- GOODY'S FAMILY CLOTHING, INC., KNOXVILLE, TN:
2,206,832, CANC. INT. CL. 25.
- GORDON-TYNES PRODUCTIONS, INC., ORLANDO, FL:
3,008,025, INT. CL. 41.
- GORE BROS. INC., COMANCHE, TX:
2,343,014, CANC. INT. CL. 31.
- GOSPEL LIGHT PUBLICATIONS, GLENDALE, CA:
781,015, CANC. U.S. CL. 38.
- GOT SHADES, INC., ROWLAND HEIGHTS, CA:
3,007,139, PUB. 7-26-2005. INT. CL. 9.
- GOULBOURN, KATRINA, MAKATI CITY, METRO MANI-
LA, PHILIPPINES AND GOULBOURN, NATASHA, MA-
KATI CITY, METRO MANILA, PHILIPPINES:
3,006,806, PUB. 7-26-2005. MULTIPLE CLASS, INT. CLS.
3, 6, 14, 18, 20, 21 AND 25.
- GRAHAM MAGNETICS INCORPORATED, NORTH RICHL-
LAND HILLS, TX:
1,306,847, CANC. INT. CL. 9.
- GRAND HALL ENTERPRISE CO., LTD., TAIPEI, TAIWAN:
3,007,508, PUB. 7-5-2005. INT. CL. 11.
- GRAND PRAIRIE OUTFITTERS, LLC, NORTH LITTLE
ROCK, AR:
3,007,777, MULTIPLE CLASS, INT. CLS. 24 AND 25.
- GRAPHIC PACKAGING INTERNATIONAL, INC., MAR-
IETTA, GA, OLINKRAFT, INC., WEST MONROE, LA:
1,000,096. REN. 9-7-05. INT. CL. 16.
1,000,099. REN. 9-7-05. INT. CL. 16.

- GRAPHIQUE DE FRANCE, LTD., WOBURN, MA:
1,896,230. REN. 9-6-05. INT. CL. 16.
- GRASSFED LONGHORN ALLIANCE, BANDERA, TX:
3,007,251. PUB. 7-26-2005. INT. CL. 29.
- GRASSWORKS INC., HUDSON, IA:
3,007,172. PUB. 7-26-2005. INT. CL. 44.
- GRAYLING INDUSTRIES, INC., ALPHARETTA, GA:
2,206,598. CANC. INT. CL. 1.
- GREAT AMERICAN SWEATSHIRT & HAPPINESS CO.,
BEVERLY HILLS, CA:
1,307,148. CANC. INT. CL. 25.
- GREAT CHINA INDUSTRIAL, INC., LOS ANGELES, CA:
1,865,295. CANC. INT. CL. 21.
- GREAT LAKES SCRIP CENTER, INC., GRAND RAPIDS,
MI:
3,008,034. INT. CL. 36.
- GREATER EDWARDSVILLE AREA COMMUNITY FOUN-
DATION, EDWARDSVILLE, IL:
3,008,092. INT. CL. 36.
- GREATLAND CORPORATION, GRAND RAPIDS, MI:
2,207,024. CANC. INT. CL. 9.
- GREEN CANYON LLC, WILMINGTON, DE:
3,007,632. MULTIPLE CLASS, INT. CLS. 35, 37 AND 42.
- GREEN GARDEN FOOD GROUP LLC, SUNSET, LA:
3,008,069. INT. CL. 29.
- GREEN SHOPPING INC., LOS ANGELES, CA:
2,100,860. CANC. INT. CL. 35.
- GREENE, MICHAEL, TOPANGA, CA:
3,007,920. INT. CL. 21.
- GREENWALD, LARRY, SARASOTA, FL, DBA RECOGNITION
RESOURCES AND GREENWALD, SHELLY, SAR-
ASOTA, FL, DBA RECOGNITION RESOURCES:
1,907,596. REN. 9-7-05. INT. CL. 36.
- GRENE, GREGORY, NEW YORK, NY:
2,207,020. CANC. INT. CL. 41.
- GRIPCO PRODUCTS, INC., N. RIDGEVILLE, IL:
3,007,794. INT. CL. 19.
- GROSSMAN, STACY, NEW YORK, NY:
2,277,847. AM. INT. CL. 42.
- GROTE, JAMES ADAMS, PITTSFIELD, IL:
3,008,058. INT. CL. 5.
- GROVER, PAUL, SHELburne, VT, INFRACTION IN-
STITUTE, INC., SHELburne, VT:
1,925,260. REN. 9-6-05. INT. CL. 9.
- GROWING FEET, INC., LAKEWOOD, NJ:
1,935,623. REN. 9-6-05. INT. CL. 25.
- GROZ-BECKERT KG, 72458 ALBSTADT, FED REP GER-
MANY:
1,344,734. REN. 9-6-05. INT. CL. 26.
- GRUPPO FINANZIARIO TESSILE S.P.A., TURIN, ITALY:
2,207,395. CANC. INT. CL. 25.
- GSI GROUP CORPORATION, BILLERICA, MA:
3,007,832. INT. CL. 9.
- GSLE DEVELOPMENT CORPORATION, MUSKEGON, MN:
1,000,519. REN. 9-7-05. INT. CL. 10.
- GST TELECOM, INC., VANCOUVER, WA:
2,206,734. CANC. MULTIPLE CLASS, INT. CLS. 38 AND
42.
- GT ENTERPRISES, INC., FORT LEE, NJ:
2,207,433. CANC. INT. CL. 28.
- GTE MAIN STREET INCORPORATED, STAMFORD, CT:
2,207,530. CANC. INT. CL. 41.
2,207,531. CANC. INT. CL. 41.
- GUARANTY BANK, SSB, BROWN DEER, WI:
1,903,010. REN. 9-3-05. INT. CL. 36.
- GUIDESTAR HEALTH SYSTEMS, INC., BIRMINGHAM,
AL:
2,206,330. CANC. MULTIPLE CLASS, INT. CLS. 35, 36
AND 42.
- GULFSTREAM PARK RACING ASSOCIATION, INC., HAL-
LANDALE, FL:
3,007,361. PUB. 7-26-2005. INT. CL. 41.
- GUPTA FAMILY LIMITED PARTNERSHIP, NEWPORT
COAST, CA:
2,206,382. CANC. INT. CL. 12.
- GURAL LLC, PETALUMA, CA:
993,225. REN. 9-7-05. U.S. CL. 105 (INT. CL. 39).
- GUTHY-RENKER CORPORATION, PALM DESERT, CA:
2,206,488. CANC. MULTIPLE CLASS, INT. CLS. 35 AND
42.
- GUTMANN CUTLERY, INC., BELLINGHAM, WA:
2,207,130. CANC. INT. CL. 8.
- GUYNES DESIGN, PHOENIX, AZ:
2,206,354. CANC. INT. CL. 19.
- GWEN MEDIA, INC., SEWARD, PA:
3,007,012. PUB. 7-26-2005. MULTIPLE CLASS, INT. CLS. 9
AND 41.
- GWYNN, DARRELL, DAVIE, FL:
3,007,658. INT. CL. 12.
- GYM-MARK, INC., SAN FRANCISCO, CA, GYMBOREE
CORPORATION, THE, BURLINGAME, CA:
1,950,164. REN. 9-3-05. INT. CL. 28.
- H. BERNBAUM IMPORT-EXPORT CO., VERNON HILLS, IL
TO HIGH SIERRA SPORT COMPANY, VERNON HILLS,
IL:
1,864,768. CANC. INT. CL. 25.
- H. G. HASTINGS CO., ATLANTA, GA:
1,307,361. CANC. INT. CL. 31.
- H.O.R. CORPORATION, MIAMI, FL:
2,207,313. CANC. INT. CL. 42.
- H+W TEST PRODUCTS, SEEKONK, MA:
1,971,813. REN. 9-7-05. INT. CL. 9.
- HAGGAR APPAREL COMPANY, DALLAS, TX:
1,307,561. CANC. INT. CL. 42.
- HAIRY BEARY U.S.A., LLC, HERMON, ME:
3,007,470. PUB. 7-26-2005. INT. CL. 16.
- HAJIME INDUSTRIES LTD., CHIYODA-KU, TOKYO, JA-
PAN:
1,306,820. CANC. INT. CL. 9.
- HALAS, WALTER P., WHITE PLAINS, NY:
3,008,023. MULTIPLE CLASS, INT. CLS. 14, 16, 18, 21, 24,
25 AND 28.
- HALL, JOHN, BURNSVILLE, MN:
3,007,463. PUB. 7-26-2005. INT. CL. 35.
- HALLMARK TOTALTECH, INC., ROCKY HILL, CT:
2,207,304. CANC. INT. CL. 35.
- HAN-DEE PULL, INC., NINNEKAH, OK:
2,206,533. CANC. INT. CL. 7.
- HANDA-LOPEZ, INC., SUNNYVALE, CA:
2,206,689. CANC. INT. CL. 42.
- HANDI-FOIL CORPORATION, WHEELING, IL:
3,007,223. PUB. 7-26-2005. MULTIPLE CLASS, INT. CLS. 6
AND 21.
- HANDS OFF, INC., PALMER, MA:
2,207,675. CANC. INT. CL. 18.
- HANGZHOU QIANDAO LAKE DEVELOPMENT CO., LTD.,
ZHEJIANG PROVINCE, CHINA:
3,007,001. PUB. 7-26-2005. MULTIPLE CLASS, INT. CLS.
29 AND 31.
- HANNA-BARBERA PRODUCTIONS, INC., HOLLYWOOD,
CA:
1,307,489. CANC. INT. CL. 41.
1,307,490. CANC. INT. CL. 41.
- HANNAN PRODUCTS CORPORATION, CORONA, CA:
1,349,346. REN. 9-6-05. INT. CL. 16.
- HANOVER ACCESSORIES, INC., PLYMOUTH, MN:
2,206,551. CANC. MULTIPLE CLASS, INT. CLS. 14, 25
AND 26.
- HANSEN, ANDREW BARCLAY, WRENTHAM, MA AND
DONAGHY, STEPHEN, WRENTHAM, MA:
3,007,092. PUB. 7-26-2005. MULTIPLE CLASS, INT. CLS.
32 AND 43.
- HANSOT CO., LTD., SEOCHO-KU, SEOUL, REPUBLIC OF
KOREA:
3,006,926. PUB. 7-26-2005. MULTIPLE CLASS, INT. CLS.
35 AND 43.
- HAPPY JACK, INC., SNOW HILL, NC:
1,306,772. CANC. INT. CL. 5.
- HARDY WINE COMPANY LIMITED, REYNELLA SOUTH
AUSTRALIA, AUSTRALIA:
3,007,907. INT. CL. 33.
- HARGRAY HOLDINGS CORPORATION, HILTON HEAD
ISLAND, SC:
2,206,738. CANC. INT. CL. 38.

- HARLEQUIN ENTERPRISES LIMITED, DON MILLS, ONTARIO M3B 3K9, CANADA:
1,906,517. REN. 9-6-05. INT. CL. 16.
- HARPER, TAMMY, PHOENIX, AZ, DBA HARPER ENTERPRISE AND HARPER, ROBERT, PHOENIX, AZ, DBA HARPER ENTERPRISE:
3,007,592. INT. CL. 20.
- HARRAH'S LICENSE COMPANY, LLC, LAS VEGAS, NV:
1,336,012. REN. 9-7-05. MULTIPLE CLASS, INT. CLS. 41 AND 42.
- HARRIS ADVISORS LLC, RACINE, WI:
3,007,668. INT. CL. 35.
- HARRIS CORPORATION, MELBOURNE, FL:
2,206,791. CANC. INT. CL. 9.
- HARRY'S OF AMERICA, LLC, JACKSONVILLE BEACH, FL:
3,007,504. PUB. 7-26-2005. INT. CL. 43.
- HARTE-HANKS DATA TECHNOLOGIES LLC, SAN ANTONIO, TX, URBAN DATA PROCESSING, INC., BILLERICA, MA, DBA HARTE-HANKS DATA TECHNOLOGIES:
1,903,431. REN. 9-7-05. INT. CL. 9.
- HARTFORD FIRE INSURANCE COMPANY, HARTFORD, CT:
2,206,319. CANC. INT. CL. 36.
2,206,831. CANC. INT. CL. 36.
- HARTFORD INVESTMENT MANAGEMENT COMPANY, HARTFORD, CT:
2,207,296. CANC. INT. CL. 36.
- HARTFORD LIFE INSURANCE COMPANY, SIMSBURY, CT:
2,207,326. CANC. INT. CL. 36.
- HARTZ MOUNTAIN CORPORATION; THE, HARRISON, NJ:
780,885. CANC. U.S. CL. 18.
- HARVARD PILGRIM HEALTH CARE, INC., BROOKLINE, MA:
2,207,689. CANC. INT. CL. 42.
- HARVEST PHARMACEUTICALS INC, RADFORD, VA:
3,007,770. INT. CL. 5.
- HASELTINE, REBECCA, SAN FRANCISCO, CA:
2,206,895. CANC. INT. CL. 41.
- HASHIMA CO., LTD., GIFU-CITY, JAPAN:
3,007,263. PUB. 7-26-2005. MULTIPLE CLASS, INT. CLS. 7 AND 9.
- HASTINGS, JOHN H., HILLSBORO, OR:
3,007,935. INT. CL. 16.
- HAVILAND CONSUMER PRODUCTS INC., GRAND RAPIDS, MI:
3,007,663. INT. CL. 1.
- HAWTHORN NEEDLES & BUTTERFLY WINGS, L.L.C., KALAMAZOO, MI:
3,007,345. PUB. 7-26-2005. INT. CL. 28.
- HAYES MICROCOMPUTER PRODUCTS, INC., NORCROSS, GA:
1,306,715. CANC. INT. CL. 3.
- HAYES, ELIZABETH A., KOUNTZE, TX:
3,007,807. INT. CL. 25.
- HAYES, THOMAS, NEW YORK, NY:
2,207,317. CANC. INT. CL. 35.
- HAZELQUIST, AL E., LONG BRANCH, WA:
3,007,848. INT. CL. 28.
- HAZELTINE NATIONAL GOLF CLUB, CHASKA, MN:
1,905,731. REN. 9-3-05. MULTIPLE CLASS, INT. CLS. 25 AND 41.
1,927,564. REN. 9-3-05. MULTIPLE CLASS, INT. CLS. 25 AND 41.
- HEALTH & MEDICAL COMMUNICATIONS, INC., NEW YORK, NY:
2,206,691. CANC. INT. CL. 35.
- HEALTH CARE CONCEPTS, INC., AUSTIN, TX:
3,007,778. INT. CL. 42.
- HEALTH PROTECTION AGENCY, SALISBURY, WILTSHIRE, SP4 0JG, ENGLAND:
3,008,037. MULTIPLE CLASS, INT. CLS. 1, 5, 9, 41, 42 AND 44.
- HEALTHDYNE, INC., MARIETTA, GA:
1,306,901. CANC. INT. CL. 10.
- HEALTHFIRST CORPORATION, ALBUQUERQUE, NM:
2,206,503. CANC. INT. CL. 9.
- HEARBEST, INC., MT. LEBANON, PA:
3,006,849. PUB. 7-26-2005. MULTIPLE CLASS, INT. CLS. 35 AND 44.
- HEARTH TECHNOLOGIES, INC., MUSCATINE, IA, VEGA INDUSTRIES, INC., SYRACUSE, NY:
1,015,743. REN. 9-7-05. INT. CL. 11.
- HEARTLAND INTERNATIONAL TRADESHOWS, INC., IOLA, WI, CHICAGO INTERNATIONAL COIN FAIR, CHICAGO, IL:
1,343,194. REN. 9-7-05. INT. CL. 35.
- HEARTS ON FIRE COMPANY, BOSTON, MA:
3,007,922. INT. CL. 14.
- HECHINGER ROYALTY COMPANY, LARGO, MD:
2,207,341. CANC. INT. CL. 36.
- HEDSTORM CORPORATION, BEDFORD, PA:
1,307,236. CANC. INT. CL. 28.
- HEIDENREICH, MICHAEL, CINCINNATI, OH:
541,406. CANC. U.S. CL. 23.
- HELENE CURTIS, INC., CHICAGO, IL:
2,207,779. CANC. INT. CL. 3.
- HELFER, KENNETH J., GLORIETA, NM, DBA AMAZING GATES:
2,206,376. CANC. INT. CL. 35.
- HENDERSON, DARRELL, LAFAYETTE, LA:
3,007,756. INT. CL. 41.
- HENDERSON'S WHARF BALTIMORE, L.L.C., BALTIMORE, MD:
3,006,922. PUB. 7-26-2005. MULTIPLE CLASS, INT. CLS. 39, 41 AND 43.
- HENDON PUBLISHING CO., DEERFIELD, IL:
3,007,409. PUB. 7-5-2005. MULTIPLE CLASS, INT. CLS. 16 AND 41.
- HENRY DANEGER ASSOCIATES, INC., NEW YORK, NY:
1,306,779. CANC. INT. CL. 5.
- HERITAGE FANCY FOODS MARKETING, INC., ERLANGER, KY:
2,207,761. CANC. INT. CL. 29.
- HERRING, CRAIG P., PLAYA DEL REY, CA:
3,007,450. PUB. 4-5-2005. INT. CL. 25.
- HESTER INDUSTRIES, INC., MOOREFIELD, WV:
1,307,311. CANC. INT. CL. 29.
- HEWLETT-PACKARD DEVELOPMENT COMPANY, L.P., HOUSTON, TX, HEWLETT-PACKARD COMPANY, PALO ALTO, CA:
1,968,861. REN. 9-6-05. INT. CL. 9.
- HEWLETT-PACKARD DEVELOPMENT COMPANY, L.P., HOUSTON, TX:
3,007,847. INT. CL. 9.
- HEYANITA, INC., BURBANK, CA:
3,007,002. PUB. 7-26-2005. MULTIPLE CLASS, INT. CLS. 38 AND 42.
- HHS, HEALTH OPTIONS, GRAND RAPIDS, MI:
3,007,723. INT. CL. 35.
- HI-SHEAR CORPORATION, TORRANCE, CA:
1,317,608. REN. 9-7-05. INT. CL. 6.
- HI-TEC SPORTS PLC, ESSEX SS2 6GH, GREAT BRITAIN:
1,869,704. REN. 9-3-05. INT. CL. 25.
- HIGH RISE GOODIES RESTAURANT GROUP, INC., LOS ANGELES, CA:
3,007,050. PUB. 7-26-2005. INT. CL. 30.
- HILLIER PAGE LIMITED, SURREY GU7 3AB, ENGLAND:
2,206,331. CANC. INT. CL. 9.
- HILLWAY SURGICAL LIMITED, HIGHGATE, LONDON, N6 6AD, ENGLAND:
1,864,603. CANC. INT. CL. 10.
- HINES REAL ESTATE SECURITIES, INC., HOUSTON, TX:
3,008,014. INT. CL. 36.
- HINES, TERENCE J., CHESAPEAKE, VA:
3,007,498. PUB. 7-26-2005. INT. CL. 41.
- HIROSE MANUFACTURING CO., LTD., OSAKA, JAPAN:
2,207,427. CANC. INT. CL. 7.
- HISCOCO INNOVATIONS INC., KELOWNA, BRITISH COLUMBIA V1Y 4E5, CANADA:
2,207,509. CANC. INT. CL. 17.
- HITACHI AMERICA, LTD., BRISBANE, CA:
3,007,475. PUB. 6-7-2005. INT. CL. 35.

HNI TECHNOLOGIES INC., MUSCATINE, IA:
3,007,108, PUB. 7-26-2005. INT. CL. 11.

HOELZER, MONIKA, BEVERLY HILLS, CA:
2,206,727, CANC. INT. CL. 35.

HOFFMAN ENCLOSURES INC., ANOKA, MN, FEDERAL-HOFFMAN, INC., ANOKA, MN, DBA HOFFMAN ENGINEERING CO.:
1,909,524. REN. 9-7-05. INT. CL. 9.

HOFFMAN, LLC, APPLETON, WI:
3,006,942, PUB. 7-26-2005. MULTIPLE CLASS, INT. CLS. 35, 37 AND 42.

HOFFMAN, RONALD, NEW YORK, NY:
3,007,380, PUB. 7-26-2005. INT. CL. 44.

HOFFMANN-LA ROCHE INC., NUTLEY, NJ:
1,306,786, CANC. INT. CL. 5.

HOLD IT PRODUCTS CORPORATION, WALLED LAKE, MI:
3,008,040, INT. CL. 21.

HOLLIS-EDEN PHARMACEUTICALS, INC., SAN DIEGO, CA:
3,007,593, INT. CL. 5.

HOLLYWOOD SOUND LABS, INC., MONROVIA, CA:
3,007,486, PUB. 7-26-2005. INT. CL. 9.

HOLMEGAARD A/S, DENMARK:
3,007,544, PUB. 7-26-2005. INT. CL. 11.

HOLMES, CECILIA, NEW YORK, NY:
1,865,426, CANC. INT. CL. 41.

HOME AND GARDEN PARTY, LTD., MARSHALL, TX:
3,007,201, PUB. 7-26-2005. INT. CL. 35.

HOME DECOR PRODUCTS, INC., EDISON, NJ:
3,008,093, INT. CL. 35.

HOME SHOPPING CLUB, INC., CLEARWATER, FL:
2,206,784, CANC. INT. CL. 41.

HOME SHOPPING CLUB, LLC, ST PETERSBURG, FL:
2,207,542, CANC. INT. CL. 25.

HOMEDICS, INC., KEEGO HARBOR, MI:
2,206,419, CANC. INT. CL. 10.

HOMEDICS, INC., COMMERCE TOWNSHIP, MI:
3,007,840, INT. CL. 20.

HOMELAND SECURITY STRATEGIES, INC., NEW ROCHELLE, NY:
3,007,068, PUB. 7-26-2005. INT. CL. 13.

HOMER TLC, INC., CLAYMONT, DE:
3,007,902, INT. CL. 11.

HOMESTEAD, INC., NEWARK, DE TO NEW WORLD PASTA COMPANY, HERSHEY, PA:
1,865,377, CANC. INT. CL. 30.

HONEYWELL INC., MINNEAPOLIS, MN TO HONEYWELL INTERNATIONAL INC., MORRISTOWN, NJ:
1,864,950, CANC. MULTIPLE CLASS, INT. CLS. 37 AND 42.

HOP LUN FASHIONS LIMITED, ROAD TOWN TORTOLA, BR. VIRGIN ISLANDS:
3,007,811, INT. CL. 25.

HOPE COLLEGE, HOLLAND, MI:
1,360,461. REN. 9-6-05. MULTIPLE CLASS, INT. CLS. 16, 41 AND 42.
1,360,461, CANC. INT. CL. 21.

HOPE FOR HAITI'S CHILDREN MINISTRIES, INC., CINCINNATI, OH:
3,007,362, PUB. 7-26-2005. INT. CL. 41.

HORIZON INDUSTRIES, INC., WAHIAWA, HI:
2,207,164, CANC. INT. CL. 40.

HORMEL FOODS, LLC, AUSTIN, MN, STAGG FOODS, INC., CERRITOS, CA:
1,844,591. REN. 9-9-05. INT. CL. 29.

HORTIMAX HOLDING BV, PIJNACKER, NETHERLANDS:
3,007,801, MULTIPLE CLASS, INT. CLS. 6, 7 AND 37.

HOSPIRA, INC., LAKE FOREST, IL:
1,343,988. REN. 9-7-05. INT. CL. 9.

HOTEL RESERVATION SERVICE ROBERT RAGGE GMBH, D-50667 COLOGNE, FED REP GERMANY:
2,206,482, CANC. MULTIPLE CLASS, INT. CLS. 35, 38, 39, 41 AND 42.

HOTWATT, INC., DANVERS, MA, LEE, HOWARD S., DANVERS, MA, DBA LEE ELECTRIC PRODUCTS, CO.:
613,836. REN. 9-7-05. U.S. CL. 21 (INT. CL. 11).

HOUSING DATA REPORTS, INC., WASHINGTON, DC:
1,307,000, CANC. INT. CL. 16.

HOWARD CHAYKIN, INC., WEST HOLLYWOOD, CA:
1,870,532. REN. 9-7-05. INT. CL. 16.

HOWARD MILLER CLOCK COMPANY, ZEELAND, MI:
3,007,985, INT. CL. 20.

HOWLING WOLF BLUES SOCIETY OF WEST POINT, MS, INC., WEST POINT, MS:
2,207,263, CANC. INT. CL. 41.

HOWREY SIMON ARNOLD & WHITE, LLP, WASHINGTON, DC:
3,007,728, MULTIPLE CLASS, INT. CLS. 35, 36 AND 42.

HP INTELLECTUAL CORP., WILMINGTON, DE:
3,007,205, PUB. 7-26-2005. INT. CL. 9.

HP-CHEMIE PELZER GMBH, WITTEN, FED REP GERMANY:
3,006,839, PUB. 7-29-2003. MULTIPLE CLASS, INT. CLS. 12, 17 AND 27.

HUBBARD, MICHAEL W., CHAPEL HILL, NC:
1,307,540, CANC. INT. CL. 42.

HUEPPE GMBH & CO., OHG, BAD ZWISCHENAHN, FED REP GERMANY:
3,007,226, PUB. 7-26-2005. INT. CL. 11.

HUFFY CORPORATION, MIAMISBURG, OH:
1,393,948. REN. 9-7-05. INT. CL. 12.

HULS AMERICA INC., PISCATAWAY, NJ TO CREANOVA INC., SOMERSET, NJ:
1,864,705, CANC. INT. CL. 16.

HUMANA INC., LOUISVILLE, KY:
3,007,990, MULTIPLE CLASS, INT. CLS. 35, 36 AND 44.

HY-FLEX CORPORATION, CAMBRIDGE CITY, IN:
1,018,556. REN. 9-3-05. U.S. CL. 23 (INT. CL. 7).

HYDRO INTERNATIONAL PLC, CLEVEDON, AVON BS217RD, UNITED KINGDOM:
3,006,908, PUB. 3-29-2005. INT. CL. 11.

HYDRO-CHEM SYSTEMS INC, GRAND RAPIDS, MI:
1,864,475, CANC. MULTIPLE CLASS, INT. CLS. 3 AND 42.

HYDROMER, INC., WHITEHOUSE, NJ:
1,306,774, CANC. INT. CL. 5.

HYDRONIX LIMITED, GUILDFORD, SURREY GU1 4UG, UNITED KINGDOM:
1,902,447. REN. 9-6-05. INT. CL. 9.

I G T, RENO, NV:
1,307,277, CANC. INT. CL. 28.

I-LUXURY ENTERPRISES, INC., ATLANTA, GA, IVAN SOLOMON, LTD., ATLANTA, GA:
1,903,187. REN. 9-3-05. INT. CL. 42.

IATIA LIMITED, BOX HILL VIC 3218, AUSTRALIA:
3,007,199, PUB. 7-26-2005. INT. CL. 9.

IBP ACQUISITION CO., INC.:
1,306,664, CANC. INT. CL. 2.

ICON CMT CORP., WEEHAWKEN, NJ:
2,206,590, CANC. INT. CL. 42.

IGEL TECHNOLOGY GMBH, BREMEN, FED REP GERMANY:
3,007,834, INT. CL. 9.

IGNITE DEVELOPMENT, INC., DICKINSON, TX:
3,007,999, INT. CL. 43.

IGT, RENO, NV:
2,206,508, CANC. MULTIPLE CLASS, INT. CLS. 9, 37 AND 42.
3,007,578, INT. CL. 9.
3,007,831, INT. CL. 9.
3,007,843, INT. CL. 9.
3,007,844, INT. CL. 9.
3,007,919, INT. CL. 9.

IIH INDUSTRIES, LLC, CITY OF INDUSTRY, CA:
1,901,663. REN. 9-6-05. MULTIPLE CLASS, INT. CLS. 11, 20 AND 21.

ILLINOIS TOOL WORKS INC, GLENVIEW, IL:
794,061. REN. 9-3-05. U.S. CL. 34 (INT. CL. 9).

ILLINOIS TOOL WORKS INC., GLENVIEW, IL:
1,306,731, CANC. INT. CL. 3.

ILLINOIS TOOL WORKS, INC, GLENVIEW, IL:
1,350,194. REN. 9-3-05. INT. CL. 2.

- ILLINOIS TOOL WORKS, INC., GLENVIEW, IL:
1,351,168. REN. 9-3-05. INT. CL. 1.
1,358,754. REN. 9-3-05. INT. CL. 3.
- ILONA OF HUNGARY, INC., DENVER, CO, DBA ILONA, INC.:
2,207,690. CANC. INT. CL. 3.
- ILSCO CORPORATION, CINCINNATI, OH:
1,398,400. REN. 9-9-05. INT. CL. 9.
- IMADA, DENNIS, PLEASANTON, CA:
2,206,386. CANC. INT. CL. 18.
- IMAGE BANK, INC., THE, DALLAS, TX:
2,207,445. CANC. INT. CL. 42.
- IMB TEXTIL LTDA, 415 SAO PAULO-SP, BRAZIL:
3,007,567. INT. CL. 25.
- IMPACT TARGET MARKETING, INC., PEABODY, MA:
2,207,460. CANC. INT. CL. 41.
- IMPAK LUGGAGE, LLC, PARAMUS, NJ:
3,007,946. INT. CL. 18.
- IMPERIAL DAX COMPANY, INC., FAIRFIELD, NJ:
3,007,630. INT. CL. 3.
- IMPERIAL PALACE, LLC, LAS VEGAS, NV:
1,870,042. REN. 9-7-05. MULTIPLE CLASS, INT. CLS. 41 AND 42.
- IMPROVITA HEALTH PRODUCTS, INC., CLEVELAND, OH:
3,007,913. INT. CL. 5.
- IMS KUNSTSTOFF AG, BERN, SWITZERLAND:
1,348,230. REN. 9-6-05. INT. CL. 28.
- IMT SERVICES CORP., EAST GREENWICH, RI:
3,007,162. PUB. 7-26-2005. INT. CL. 36.
- IN DEPTH MARKETING INC., AMES, IA:
2,206,772. CANC. INT. CL. 9.
- IN GOOD TASTE SERVICES, INC., MIAMI, FL:
1,307,411. CANC. INT. CL. 36.
- INCEPA REVESTIMENTOS CERAMICOS LTDA., CAMPO LARGO, BRAZIL:
3,007,823. INT. CL. 19.
- INDEVUS PHARMACEUTICALS, INC., LEXINGTON, MA:
3,007,230. PUB. 7-26-2005. INT. CL. 5.
- INDIVIDUAL SOFTWARE INCORPORATED, PLEASANTON, CA:
1,929,093. REN. 9-3-05. INT. CL. 9.
- INDIVUMED GMBH, HAMBURG, FED REP GERMANY:
3,007,328. PUB. 7-26-2005. MULTIPLE CLASS, INT. CLS. 5, 9, 42 AND 44.
- INDUSTRIAL COMMUNICATIONS & ELECTRONICS, INC., MARSHFIELD, MA:
1,908,003. REN. 9-9-05. INT. CL. 38.
- INDUSTRIAL CONTROL SERVICES TECHNOLOGY LIMITED, ESSEX, CM9 4LA, UNITED KINGDOM:
2,206,614. CANC. INT. CL. 37.
- INDUSTRIAL MEDICAL CENTER, INC., DAYTON, OH:
1,307,563. CANC. INT. CL. 42.
- INFANT AND NUTRITIONAL PRODUCTS, INC., LOS ANGELES, CA:
2,206,920. CANC. INT. CL. 35.
- INFINITECH, INC., LAS VEGAS, NV:
3,007,324. PUB. 7-26-2005. INT. CL. 42.
- INFINITY BROADCASTING CORPORATION, NEW YORK, NY:
1,346,775. REN. 9-3-05. INT. CL. 38.
- INFINITY2, INC., SCOTTSDALE, AZ:
3,007,647. INT. CL. 1.
- INFO-MAN REFERRAL SERVICES, INC., SANTA ANA, CA:
3,007,370. PUB. 7-26-2005. INT. CL. 28.
- INFONE LLC, BEAVERTON, OR:
3,007,257. PUB. 7-26-2005. INT. CL. 42.
- INFORMATION AND REAL ESTATE SERVICES, LLC, LOVELAND, CO:
3,007,306. PUB. 7-26-2005. MULTIPLE CLASS, INT. CLS. 35 AND 36.
- ING. H.C. F. PORSCHE AG, DR., STUTTGART-ZUFFENHAUSEN, FED REP GERMANY:
3,007,294. PUB. 7-26-2005. INT. CL. 12.
- INGRESS TECHNOLOGIES, INC., PHOENIX, AZ:
1,865,230. CANC. INT. CL. 10.
- INNERFACE SIGN SYSTEMS, INC., LILBURN, GA, SIGN SYSTEMS, INC., ATLANTA, GA:
1,346,207. REN. 9-3-05. INT. CL. 20.
- INNOVATIVE PAPER TECHNOLOGIES, LLC, TILTON, NH, QUIN-T CORPORATION-NH, TILTON, NH:
1,342,631. REN. 9-8-05. INT. CL. 17.
- INOGEN, INC., GOLETA, CA:
3,007,851. INT. CL. 10.
- INRAY FITNESS PRODUCTS CORP., TAOYUAN HSIEN, TAIWAN:
3,007,892. INT. CL. 28.
- INSPIRED PATH, INC., ISSAQUAH, WA:
2,878,316. COR. MULTIPLE CLASS, INT. CLS. 39, 41 AND 45.
2,878,336. COR. MULTIPLE CLASS, INT. CLS. 39, 41 AND 45.
- INSTONE, LLC, IRVINE, CA:
3,007,939. INT. CL. 5.
- INSTROMEDIX, INC., HILLSBORO, OR:
1,307,535. CANC. INT. CL. 42.
- INTAGLIO VIVI-COLOR ALLIANCE, LTD., SCHILLER PARK, IL:
2,206,460. CANC. MULTIPLE CLASS, INT. CLS. 40 AND 42.
- INTEGRAL RESULTS, INC., SAN FRANCISCO, CA:
2,206,852. CANC. MULTIPLE CLASS, INT. CLS. 35 AND 42.
- INTEGRITY MEDIA, INC., MOBILE, AL:
3,007,469. PUB. 7-26-2005. INT. CL. 41.
- INTELLIGENT SYSTEMS CORPORATION, NORCROSS, GA, QUADRAM CORPORATION, NORCROSS, GA:
1,335,169. REN. 9-8-05. INT. CL. 9.
- INTELLITAX, SAN DIEGO, CA:
3,008,039. INT. CL. 35.
- INTERACTIVE DATA CORPORATION, BEDFORD, MA:
1,343,949. REN. 9-7-05. INT. CL. 9.
- INTERACTIVE TECHNOLOGIES, INC., NORTH ST. PAUL, MN:
2,207,127. CANC. INT. CL. 9.
- INTERCODE CORPORATION, ENGLEWOOD, NJ:
2,206,406. CANC. INT. CL. 9.
- INTERCONTINENTAL DESIGNS CORPORATION, CHICAGO, IL:
1,902,248. REN. 9-6-05. INT. CL. 42.
- INTERLAM INC., CLAUDVILLE, VA:
3,007,297. PUB. 7-26-2005. MULTIPLE CLASS, INT. CLS. 40 AND 42.
- INTERLINK DATA, EPPING, ESSEX, UNITED KINGDOM, AKA ADRIAN PETER SHAW AKA MALCOLM JONATHAN SHAW:
2,206,666. CANC. INT. CL. 9.
- INTERMATCH SWEDEN AB, STOCKHOLM, SWEDEN:
3,007,190. PUB. 4-5-2005. INT. CL. 41.
- INTERMIND CORPORATION, SEATTLE, WA:
2,207,469. CANC. INT. CL. 42.
- INTERNATIONAL BAY CLUBS, INCORPORATED, NEWPORT BEACH, CA:
1,903,196. REN. 9-9-05. INT. CL. 42.
- INTERNATIONAL COUNCIL FOR MACHINERY LUBRICATION, INC. (ICML), TULSA, OK:
3,007,821. INT. CL. 42.
- INTERNATIONAL DATA GROUP, INC., FRAMINGHAM, MA:
2,206,317. CANC. INT. CL. 42.
3,007,410. PUB. 7-26-2005. MULTIPLE CLASS, INT. CLS. 16 AND 41.
3,008,077. INT. CL. 41.
- INTERNATIONAL E-Z UP, INC., RIVERSIDE, CA, COLORADO MINERAL STRIKE, INC., ENGLEWOOD, CO:
1,901,784. REN. 9-3-05. INT. CL. 22.
1,901,785. REN. 9-3-05. INT. CL. 22.
- INTERNATIONAL IMAGING MATERIALS, INC., AMHERST, NY:
3,007,675. MULTIPLE CLASS, INT. CLS. 21 AND 40.
- INTERNATIONAL INFORMATION TECHNOLOGY USERS GROUP, INC., NEW YORK, NY:
2,207,489. CANC. INT. CL. 41.

- INTERNATIONAL INSTITUTE FOR LEARNING, INC., NEW YORK, NY:
2,206,473, CANC. MULTIPLE CLASS, INT. CLS. 16 AND 41.
- INTERNATIONAL MAINTENANCE INSTITUTE, HOUSTON, TX:
3,007,128, PUB. 7-26-2005. INT. CL. 35.
- INTERNATIONAL MARINE INSTRUMENTS, INC., MCLEAN, VA:
1,306,891, CANC. INT. CL. 9.
- INTERNATIONAL PAINT INC., HOUSTON, TX, INTERNATIONAL PAINT COMPANY, INC., UNION, NJ:
1,345,422. REN. 9-9-05. INT. CL. 2.
- INTERNATIONAL PAPER COMPANY, STAMFORD, CT:
2,207,399, CANC. INT. CL. 16.
2,207,400, CANC. INT. CL. 16.
- INTERNATIONAL POLICE TECHNOLOGIES, INC., TULSA, OK:
3,007,960, INT. CL. 9.
- INTERNATIONAL SPEEDWAY INC., DAYTONA BEACH, FL:
3,007,347, PUB. 7-26-2005. INT. CL. 41.
- INTERNATIONAL SWIMMING HALL OF FAME, INC., FORT LAUDERDALE, FL:
1,014,881. REN. 9-6-05. INT. CL. 41.
- INTERNATIONAL TYPEFACE CORPORATION, NEW YORK, NY:
1,306,955, CANC. INT. CL. 16.
- INTERNET ASSOCIATION CORPORATION, AKRON, OH:
3,007,319, PUB. 7-26-2005. INT. CL. 38.
- INTERNUTRIA, INC, FRAMINGHAM, MA:
2,337,600, CANC. MULTIPLE CLASS, INT. CLS. 5 AND 32.
- INTERPHASE CORPORATION, DALLAS, TX:
2,206,608, CANC. INT. CL. 9.
- INTERSTATE BATTERY SYSTEM INTERNATIONAL, INC., DALLAS, TX:
1,865,012, CANC. INT. CL. 41.
- INTERVET INC., MILLSBORO, DE, MILES INC., ELKHART, IN:
1,902,354. REN. 9-7-05. INT. CL. 5.
- INTERVET, INC., MILLSBORO, DE, INTER-CONTINENTAL BIOLOGICS, INC., MILLSBORO, DE:
1,345,540. REN. 9-7-05. INT. CL. 5.
- INTIME, INC., CLEVELAND, MS:
3,006,950, PUB. 7-26-2005. INT. CL. 44.
- INTUITIVE HOMES, INC., HOUSTON, TX:
3,007,275, PUB. 7-26-2005. MULTIPLE CLASS, INT. CLS. 37 AND 42.
- INUNITY CORPORATION:
See—NEWRIVER, INC.
- INVENTEC BESTA CO. LTD., TAIPEI 114, TAIWAN, INVENTEC CORPORATION, TAIPEI, TAIWAN:
1,931,659. REN. 9-3-05. INT. CL. 9.
- INVENTO LLC, MIAMI, FL:
3,007,841, INT. CL. 41.
- INVERA INC., WESTMOUNT, QUEBEC, CANADA:
3,007,089, PUB. 4-5-2005. INT. CL. 9.
- INVISTA TECHNOLOGIES S.A.R.L., ZURICH, SWITZERLAND:
1,307,095, CANC. INT. CL. 23.
- IONBOND AG OLTEN, OLTEN, SWITZERLAND:
3,007,195, PUB. 7-26-2005. MULTIPLE CLASS, INT. CLS. 7, 8 AND 40.
- IOWA STATE UNIVERSITY OF SCIENCE AND TECHNOLOGY, AMES, IA:
1,307,487, CANC. INT. CL. 41.
- IPEX INC., DOWNSVIEW, CANADA:
3,007,944, INT. CL. 6.
- IRBIT MOTORWORKS OF AMERICA, INC., REDMOND, WA, URAL AMERICA INC., BELLEVUE, WA:
1,953,254. REN. 9-3-05. INT. CL. 12.
- IRIS, INC., NEW YORK, NY:
2,207,380, CANC. INT. CL. 9.
- ISAAC'S MOVING AND STORAGE, INC., BROOKLINE, MA, DBA ISAAC'S MOVING AND STORAGE:
2,206,665, CANC. INT. CL. 39.
- ISCAR LTD., MIGDAL TEFEN 24959, ISRAEL:
1,897,318. REN. 9-7-05. INT. CL. 7.
- ISI BRANDS INC., GRAND RAPIDS, MI:
1,306,747, CANC. INT. CL. 5.
1,306,793, CANC. INT. CL. 5.
- ISL PROPERTIES A.G., 6061 SARNEN, SWITZERLAND:
2,206,388, CANC. MULTIPLE CLASS, INT. CLS. 3, 4, 6, 8, 9, 11, 14, 16, 18, 20, 21, 24, 25, 28, 30, 32, 33 AND 42.
- IT'S ACADEMIC OF ILLINOIS, INC., NORTHBROOK, IL:
3,006,900, PUB. 7-26-2005. MULTIPLE CLASS, INT. CLS. 9 AND 16.
- ITO HAM KABUSHIKI KAISHA, KOBE, JAPAN:
1,363,611. REN. 9-3-05. INT. CL. 29.
- ITOYA OF AMERICA, LTD., TORRANCE, CA:
3,007,696, INT. CL. 16.
- ITOYS INC., TORONTO, ONTARIO, CANADA:
3,007,838, INT. CL. 28.
- ITRIBE, INC., NORFOLK, VA:
2,207,554, CANC. INT. CL. 42.
- IVC INDUSTRIES, INC., FREEHOLD, NJ:
2,110,990, CANC. INT. CL. 5.
2,207,398, CANC. INT. CL. 5.
- IVOCLAR VIVADENT AG, SCHAAN FL 9494, LIECHTENSTEIN:
1,928,460. REN. 9-9-05. INT. CL. 5.
- IVON INTERNATIONAL, INC., SANTEE, CA, DBA NOVI INTERNATIONAL TO NOVI VISION, LLC, SAN DIEGO, CA:
1,864,788, CANC. INT. CL. 28.
- IWASAKI DENKI KABUSHIKI KAISHA (IWASAKI ELECTRIC CO., LTD.), MINATO-KU, TOKYO, JAPAN:
1,347,568. REN. 9-3-05. INT. CL. 11.
- IZEGBU, KENNETH A., NORTH RICHLAND HILLS, TX:
2,206,849, CANC. INT. CL. 21.
- J SQUARED NEW YORK, NEW YORK, NY:
2,206,882, CANC. INT. CL. 25.
- J. B. IVEY & COMPANY, CHARLOTTE, NC:
1,307,456, CANC. MULTIPLE CLASS, INT. CLS. 39 AND 42.
- J. EDWARD CONNELLY ASSOCIATES, INC., PITTSBURGH, PA, TA SERVICE MARKETING GROUP:
2,207,481, CANC. INT. CL. 35.
- J. J. LAPHMARK TOY & GAME DEVELOPERS INC., NORTH BELLMORE, NY:
2,207,607, CANC. INT. CL. 28.
- J. LINDBERG AB, SE-112 49 STOCKHOLM, SWEDEN:
3,007,365, PUB. 7-26-2005. INT. CL. 9.
- J. MITTON & ASSOCIATES, INC., NEW HOLLAND, PA:
3,007,417, PUB. 7-26-2005. INT. CL. 18.
- J.K. RESTAURANT VENTURES, INC., RALEIGH, NC:
2,206,584, CANC. INT. CL. 41.
- J.K.P. II, INC., BARTLETT, IL:
1,915,727. REN. 9-9-05. INT. CL. 42.
- J.R. TOBACCO OF AMERICA, INC., SELMA, NC, J & R TOBACCO CORP., NEW YORK, NY:
1,387,728. REN. 9-3-05. INT. CL. 34.
- J&M CUSTOM MOLD INC., COVENTRY, RI:
3,008,019, INT. CL. 28.
- J-RICH CLINIC, INC., GRASS LAKE, MI, DBA REAL PURITY:
3,006,838, PUB. 7-26-2005. INT. CL. 3.
- JACADI SA, 92000 NANTERRE, FRANCE, SOCIETE' KAP (S.A.R.L.), 92100 BOULOGNE, FRANCE:
1,349,513. REN. 9-7-05. INT. CL. 25.
- JACK ROBBINS & ASSOCIATES, INCORPORATED, HARRISON, NJ, DBA JRI, INC.:
1,307,260, CANC. INT. CL. 28.
- JACKSON NATIONAL LIFE INSURANCE COMPANY, LANSING, MI:
3,007,464, PUB. 7-26-2005. INT. CL. 41.
- JACOBUS PHARMACEUTICAL COMPANY, INC., PRINCETON, NJ:
1,937,528. REN. 9-3-05. INT. CL. 5.
- JADAIR, INCORPORATED, PORT WASHINGTON, WI:
1,017,923. REN. 9-7-05. INT. CL. 1.
- JAFRA COSMETICS INTERNATIONAL, INC., WESTLAKE VILLAGE, CA:
3,007,687, INT. CL. 3.

- JAIR ELECTRONICS CORPORATION, MIAMI, FL:
3,007,569, INT. CL. 9.
- JAMAICA JOE'S, INC., FT. WALTON BEACH, FL:
1,307,508, CANC. INT. CL. 42.
- JAMES V. HURSON ASSOCIATES, INC., ARLINGTON, VA:
1,902,547. REN. 9-9-05. INT. CL. 9.
- JAMMET, ANDRE MICHEL, NEW YORK, NY AND JAMMET, RITA BEDR, NEW YORK, NY:
1,865,072, CANC. INT. CL. 42.
- JARED, BENNETT J. COOKEVILLE, TN:
3,007,485, PUB. 7-26-2005. INT. CL. 36.
- JARYL INTERNATIONAL, INC., ORADELL, NJ:
3,008,059, INT. CL. 35.
- JASINSKI; PAULA, BOSTON, MA, DBA PROTECH:
1,307,177, CANC. INT. CL. 25.
- JASON PRODUCTS LIMITED, GLENDENE, AUCKLAND, NEW ZEALAND:
1,919,796. REN. 9-3-05. INT. CL. 21.
- JBR ENTERPRISES, INC., MT. AIRY, MD:
3,007,034, PUB. 7-26-2005. MULTIPLE CLASS, INT. CLS. 37 AND 42.
- JEC, SOCIÉTÉ ANONYME, FRANCE:
3,007,555, PUB. 7-26-2005. INT. CL. 20.
- JEFFRIES TRAVIS REALTY CORP., CHARLESTON, SC AND JEFFRIES AVLON, INC., NEW YORK, NY AND JEFFRIES LEELAND COMPANY, INC., BOSTON, MA:
3,007,613, INT. CL. 37.
- JESTER CO., INC., THE, PALOS VERDES ESTATES, CA:
1,976,760. REN. 9-7-05. INT. CL. 16.
1,978,415. REN. 9-7-05. INT. CL. 16.
- JET CONCEPTS, INC., BROOKSVILLE, FL:
3,007,343, PUB. 7-26-2005. INT. CL. 39.
- JEWELNET CORPORATION, BOCA RATON, FL:
3,007,117, PUB. 4-5-2005. INT. CL. 14.
- JIANGXI GONGQING YAYA GROUP CO. LTD., JIANGXI PROVINCE, CHINA:
3,007,620, MULTIPLE CLASS, INT. CLS. 24 AND 25.
- JIM BEAM BRANDS CO., DEERFIELD, IL, PENN-MARYLAND CORPORATION, NEW YORK, NY:
331,300. REN. 9-9-05. U.S. CL. 49 (INT. CL. 33).
- JIM BEAM BRANDS CO., DEERFIELD, IL, GEYSER PEAK WINERY, GEYSERVILLE, CA:
1,019,577. REN. 9-6-05. INT. CL. 33.
- JIM BEAM BRANDS CO., DEERFIELD, IL:
1,935,332. REN. 9-6-05. INT. CL. 33.
- JOB MANAGEMENT, INC., INDIANAPOLIS, IN, EXHIBIT HOUSE, INC., THE, INDIANAPOLIS, IN:
1,905,961. REN. 9-3-05. MULTIPLE CLASS, INT. CLS. 37 AND 42.
- JOBST INSTITUTE, INC., TOLEDO, OH:
1,307,176, CANC. INT. CL. 25.
- JOCKEY INTERNATIONAL, INC., KENOSHA, WI:
1,924,697. REN. 9-3-05. INT. CL. 25.
- JOE BOXER CORP., SAN FRANCISCO, CA:
2,206,494, CANC. INT. CL. 25.
- JOE'S APARTMENT, INC., SCOTTSDALE, AZ:
3,007,626, INT. CL. 43.
- JOG DISTRIBUTION, INC., SAN FRANCISCO, CA, ARNOLD FOODS COMPANY, INC., GREENWICH, CT:
1,349,830. REN. 9-6-05. INT. CL. 30.
1,350,901. REN. 9-6-05. INT. CL. 30.
- JOG DISTRIBUTION, INC., SAN FRANCISCO, CA, ARNOLD FOODS COMPANY, INC., GREENWICH, CT, DBA STONE-BUHR MILLING CO.:
1,355,703. REN. 9-6-05. INT. CL. 31.
- JOHAS TEENER, MICHAEL D., SANTA CRUZ, CA:
3,008,017, INT. CL. 42.
- JOHN C. DOLPH COMPANY, MONMOUTH JUNCTION, NJ:
1,005,497. REN. 9-9-05. MULTIPLE CLASS, U.S. CLS. 5 (INT. CL. 16), 16 (INT. CL. 2) AND 21 (INT. CL. 17).
- JOHN H. BLANZ COMPANY, INC., CARLISLE, MA:
2,207,486, CANC. INT. CL. 9.
- JOHN H. SCHILLING, MAGNOLIA, TX:
3,008,002, INT. CL. 37.
- JOHN HANCOCK MUTUAL LIFE INSURANCE COMPANY, BOSTON, MA:
1,307,433, CANC. INT. CL. 36.
- JOHN JACOBS GOLF CLUB COMPANY, SCOTTSDALE, AZ:
2,206,545, CANC. INT. CL. 28.
- JOHN LEIFER LTD., SHAWNEE MISSION, KS:
1,864,901, CANC. INT. CL. 35.
- JOHN MICHAELS, INC., VERONA, WI, DBA MICHAEL'S FROZEN CUSTARD:
1,864,855, CANC. INT. CL. 30.
- JOHN NUVEEN & CO. INCORPORATED, CHICAGO, IL AND NET ASSETS, INC., WASHINGTON, DC:
2,206,451, CANC. INT. CL. 41.
- JOHN R. CROMWELL AND DOTTIE DIXION, TACOMA, WA:
3,007,947, INT. CL. 41.
- JOHNNY ADVERTISING MANAGEMENT, INC., GRD RAPIDS, MI:
2,206,749, CANC. INT. CL. 35.
- JOHNSON & JOHNSON, NEW BRUNSWICK, NJ:
1,307,393, CANC. INT. CL. 35.
- JOHNSON SUPPLY AND EQUIPMENT CORPORATION, HOUSTON, TX:
1,865,025, CANC. INT. CL. 42.
- JOHNSON DIVERSEY, INC., STURTEVANT, WI:
1,312,995. REN. 9-6-05. INT. CL. 3.
- JONES, BRYAN, HELIX, OR AND JONES, KATHY, HELIX, OR:
3,007,313, PUB. 7-5-2005. MULTIPLE CLASS, INT. CLS. 7 AND 44.
- JONES, EVAN MATTHEW, BOTHELL, WA:
2,207,010, CANC. INT. CL. 42.
- JONSON, BARBARA B., BUCKS HARBOR, ME, DBA GENERAL DELIVERY:
1,307,052, CANC. INT. CL. 20.
- JOO, JACOB, LOS ANGELES, CA:
3,006,986, PUB. 7-26-2005. INT. CL. 25.
- JORDON, LESLIE M., LOS ANGELES, CA:
2,207,629, CANC. INT. CL. 25.
- JOSEPH F. FERRARIO AND KENNETH OVE WAAGE PARTNERSHIP, THE, SANTA BARBARA, CA:
2,206,646, CANC. MULTIPLE CLASS, INT. CLS. 9 AND 41.
- JPMORGAN CHASE & CO., NEW YORK, NY:
2,207,257, CANC. INT. CL. 16.
- JUKI KABUSHIKI KAISHA, TOKYO, JAPAN, TA JUKI CORPORATION:
2,109,447, CANC. INT. CL. 7.
- K. I. S. LIMITED, HUNG HOM, KOWLOON, HONG KONG:
3,007,890, INT. CL. 3.
- KABUSHIKI KAISHA NTT DOCOMO, TOKYO, JAPAN, DBA NTT DOCOMO, INC.:
3,007,168, PUB. 7-26-2005. MULTIPLE CLASS, INT. CLS. 9, 28, 35, 36, 37, 38, 39, 40, 41 AND 42.
- KABUSHIKI KAISHA TANITA, ITABASHI-KU, TOKYO, JAPAN:
3,006,917, PUB. 7-26-2005. MULTIPLE CLASS, INT. CLS. 9 AND 10.
3,006,918, PUB. 7-26-2005. MULTIPLE CLASS, INT. CLS. 9 AND 10.
3,006,943, PUB. 7-26-2005. MULTIPLE CLASS, INT. CLS. 9, 10 AND 44.
- KABUSHIKI KAISHA TEZUKA PRODUCTION, TOKYO, JAPAN, DBA TEZUKA PRODUCTIONS CO., LTD.:
3,007,266, PUB. 7-5-2005. INT. CL. 9.
- KABUSHIKI KAISHA TOSHIBA, TOKYO, JAPAN, TA TOSHIBA CORPORATION:
3,006,802, PUB. 7-26-2005. INT. CL. 10.
- KAHALA FRANCHISE CORP., SCOTTSDALE, AZ:
1,349,867. REN. 9-9-05. INT. CL. 32.
- KALISHER, SHEILA L., LIVINGSTON, NJ:
2,207,206, CANC. INT. CL. 16.
- KAMAN MUSIC CORPORATION, BLOOMFIELD, CT, KAMAN CORPORATION, BLOOMFIELD, CT:
1,017,964. REN. 9-7-05. INT. CL. 15.
- KAMAN MUSIC CORPORATION, BLOOMFIELD, CT, OVATION INSTRUMENTS, INC., BLOOMFIELD, CT:
1,347,668. REN. 9-7-05. INT. CL. 15.
- KAMELGARD, JOSEPH I., WEST ORANGE, NJ:
3,007,135, PUB. 7-26-2005. MULTIPLE CLASS, INT. CLS. 41 AND 44.

KANEBO KABUSHIKI KAISHA (KANEBO, LTD.), SUMIDA-KU, TOKYO, JAPAN:
1,307,102, CANC. INT. CL. 24.

KAO KABUSHIKI KAISHA, CHUO-KU, TOKYO, JAPAN, TA KAO CORPORATION:
3,008,012, INT. CL. 3.

KAPPA ALPHA PSI FRATERNITY INC., PHILADELPHIA, PA:
3,007,186, PUB. 7-26-2005. MULTIPLE CLASS, INT. CLS. 6, 9 AND 21.

KARABETIAN IMPORT & EXPORT,, GLENDALE, CA:
2,207,772, CANC. INT. CL. 30.

KATZ, STANLEY, NORTHPORT, NY:
2,207,728, CANC. INT. CL. 35.

KAWASAKI JUKOGYO KABUSHIKI KAISHA, CHUO-KU, KOBE, JAPAN, DBA KAWASAKI HEAVY INDUSTRIES, LTD.:
2,206,928, CANC. INT. CL. 12.

KAYABAKOGYOKABUSHIKIKAISHA, MINATO-KU, TOKYO, JAPAN:
1,012,891. REN. 9-7-05. INT. CL. 12.

KELLER, DAVID K., CORTE MADERA, CA:
2,207,222, CANC. INT. CL. 5.

KELLEY BLUE BOOK, IRVINE, CA TO KELLEY BLUE BOOK COMPANY INCORPORATED, IRVINE, CA:
1,904,124, CANC. INT. CL. 36.

KELLEY BLUE BOOK COMPANY INCORPORATED, IRVINE, CA, KELLEY BLUE BOOK, IRVINE, CA:
1,904,124. REN. 9-7-05. MULTIPLE CLASS, INT. CLS. 9, 16 AND 35.
1,907,129. REN. 9-7-05. MULTIPLE CLASS, INT. CLS. 9, 16 AND 42.

KELLY'S ANNEALED BAITS INC., FORT WAYNE, IN:
1,017,018. REN. 9-7-05. INT. CL. 22.

KELSEY-HAYES COMPANY, LIVONIA, MI:
800,213. REN. 9-9-05. U.S. CL. 19 (INT. CLS. 7, 12, 22 AND 27).

KELTER-THORNER INC., BIRMINGHAM, MI:
2,207,044, CANC. INT. CL. 36.

KEMIRA GROWHOW OYJ, FI-00181 HELSINKI, FINLAND:
3,007,536, PUB. 7-26-2005. MULTIPLE CLASS, INT. CLS. 1 AND 44.

KEMIRA GROWHOW OYJ, FINLAND:
3,007,538, PUB. 7-26-2005. INT. CL. 44.

KEN-A-VISION MANUFACTURING COMPANY, INC., KANSAS CITY, MO:
1,961,688. REN. 9-9-05. INT. CL. 9.

KENNEDY, MURIEL, WASHINGTON, DC:
3,007,584, INT. CL. 41.

KENNEY COMMUNICATIONS, INC., ORLANDO, FL:
2,206,937, CANC. INT. CL. 35.

KENT SPORTS, INC., CHATSWORTH, CA:
2,207,224, CANC. INT. CL. 28.

KENTON COUNTY AIRPORT BOARD, HEBRON, KY:
3,007,631, INT. CL. 35.

KERRY GROUP SERVICES LIMITED, TRALCE, CO. KERRY, IRELAND:
3,007,628, MULTIPLE CLASS, INT. CLS. 1 AND 5.

KESSLER, MICHAEL, ATLANTA, GA:
3,007,432, PUB. 7-26-2005. INT. CL. 41.

KETT ELECTRIC LABORATORY, OHTA-KU, TOKYO, JAPAN:
1,278,709. REN. 9-3-05. INT. CL. 9.

KEYCORP, CLEVELAND, OH:
2,207,047, CANC. INT. CL. 36.

KEYS FITNESS PRODUCTS, INC., DALLAS, TX:
2,207,695, CANC. INT. CL. 28.

KEYTEC, INC., RICHARDSON, TX:
1,864,572, CANC. INT. CL. 9.

KIAWAH RESORT ASSOCIATES, LP, CHARLESTON, SC:
3,007,335, PUB. 7-26-2005. MULTIPLE CLASS, INT. CLS. 36 AND 41.

KIDS COMPUTER PLACE, INC., MONTCLAIR, NJ:
2,207,046, CANC. INT. CL. 41.

KIMBERLEE PRICE COSMETICS, INC., NEW YORK, NY TO QUALITY COSMETICS CORP., SOUTH PLAINFIELD, NJ:
1,864,499, CANC. INT. CL. 3.

KIMBERLY-CLARK CORPORATION, NEENAH, WI:
1,307,011, CANC. INT. CL. 16.

KIMBERLY-CLARK WORLDWIDE, INC., NEENAH, WI:
2,207,205, CANC. INT. CL. 10.
2,207,649, CANC. INT. CL. 41.
2,533,260, AM. MULTIPLE CLASS, INT. CLS. 9 AND 10.

KINDER-CARE LEARNING CENTERS, INC., MONTGOMERY, AL:
1,345,219. REN. 9-3-05. INT. CL. 42.

KING J. M. SHU ENTERPRISE INC., TAIPEI HSIEN, TAIWAN:
3,006,889, PUB. 7-26-2005. INT. CL. 3.

KINGS PRODUCTS AND SOLUTIONS INC., MISSISSAUGA, ONTARIO, CANADA:
3,007,607, INT. CL. 9.

KINGSLEY, CHRISTOPHER, OXFORD, OX1 1QN, UNITED KINGDOM AND KINGSLEY, JASON, OXFORD, OX1 1QN, UNITED KINGDOM:
3,007,341, PUB. 7-26-2005. MULTIPLE CLASS, INT. CLS. 9, 16, 28 AND 41.

KIRKBI AG, CH-6340 BAAR, SWITZERLAND:
2,207,242, CANC. INT. CL. 28.

KIRKWOOD INDUSTRIES INC., RIPLEY, MS:
1,864,739, CANC. INT. CL. 20.

KISS MY FACE CORPORATION, GARDINER, NY:
1,902,308. REN. 9-3-05. INT. CL. 3.

KLA-TENCOR CORPORATION, SAN JOSE, CA:
1,340,258. REN. 9-6-05. INT. CL. 9.

KLEIN BICYCLE CORPORATION, CHEHALIS, WA:
1,306,906, CANC. INT. CL. 12.

KLEIN CONSTANTIA WINERY (PTY) LTD, CONSTANTIA, 7800, SOUTH AFRICA:
3,006,955, PUB. 7-26-2005. INT. CL. 33.

KLEIN, R. DOUGLAS, ST GEORGE, UT AND GAVIN, JUDY A., ST GEORGE, UT:
2,207,197, CANC. INT. CL. 5.

KLOTZ SPECIAL FORMULA PRODUCTS, INC., FORT WAYNE, IN:
1,934,132. REN. 9-7-05. INT. CL. 4.

KMD MEDIA, LLC, MCLEAN, VA:
3,007,058, PUB. 7-26-2005. INT. CL. 9.

KOBRA INTERNATIONAL, LTD., NEW YORK, NY:
1,902,188. REN. 9-7-05. INT. CL. 25.

KODAK POLYCHROME GRAPHICS LLC, NORWALD, CT:
2,207,532, CANC. INT. CL. 9.

KOECK; GEORGE, ALTOONA, PA, DBA VEST PROMOTIONS:
1,307,217, CANC. MULTIPLE CLASS, INT. CLS. 28 AND 35.

KOHLER CO., KOHLER, WI:
3,007,826, INT. CL. 11.

KOLOR KOLLAR, INC., PORTLAND, OR:
1,865,289, CANC. INT. CL. 20.

KOLPIN POWERSPORTS, INC., FOX LAKE, WI:
3,007,053, PUB. 7-26-2005. INT. CL. 12.

KOMATSU SEIREN KABUSHIKI KAISHA (KOMATSU SEIREN CO., LTD.), ISHIKAWA, JAPAN:
3,007,238, PUB. 7-26-2005. INT. CL. 24.
3,007,239, PUB. 7-26-2005. INT. CL. 24.

KOUNTRYP KERNEL, BYERS, KS:
2,106,585, CANC. INT. CL. 31.

KRAIDIN, JONATHAN, HUNTINGDON VALLEY, PA:
2,207,129, CANC. INT. CL. 9.

KREMBS, INC., SIMI VALLEY, CA:
3,007,077, PUB. 2-1-2005. INT. CL. 9.

KRIS L. BJORGEN, HARTSVILLE, SC:
3,007,792, INT. CL. 42.

KRM, INC., BRONXVILLE, NY:
2,207,379, CANC. INT. CL. 20.

KROHN, KARLHANS, 634 DILLENBERG, AM FORSTDENKMAL, FED REP GERMANY TO KROHN, KARLHANS, 634 DILLENBERG, AM FORSTDENKMAL, FED REP GERMANY:
993,750, COR. U.S. CL. 22.

KROPP, VICTORIA PETRICK, SAN ANSELMO, CA:
2,206,626, CANC. INT. CL. 42.

- KS KOLBENSCHMIDT GMBH, NECKARSULM, FED REP GERMANY:
3,006,833, PUB. 7-26-2005. INT. CL. 7.
- KSBJ EDUCATIONAL FOUNDATION, INC., HUMBLE, TX:
2,207,097, CANC. INT. CL. 38.
2,207,098, CANC. INT. CL. 38.
- KSIN LUXEMBOURG III, S.A.R.L., LUXEMBOURG:
2,207,729, CANC. INT. CL. 7.
- KSK COMMUNICATIONS, LTD., VIENNA, VA:
1,864,675, CANC. INT. CL. 16.
- KTR KUPPLUNGSTECHNIK GMBH, RODDER, FED REP GERMANY:
1,357,646, REN. 9-3-05. INT. CL. 7.
- L. B. WHITE CO., INC., ONALASKA, WI:
2,206,572, CANC. INT. CL. 11.
- L.A. FITNESS INTERNATIONAL LLC, IRVINE, CA:
3,007,720, INT. CL. 41.
- L.F.P., INC., BEVERLY HILLS, CA:
3,006,902, PUB. 7-26-2005. INT. CL. 41.
- L.I. AND N.Y. MECHANICAL CONTRACTORS' ASSOCIATION, INC., BAY SHORE, NY:
3,006,843, PUB. 7-26-2005. INT. CL. 35.
- L'OREAL, 75008 PARIS, FRANCE:
2,207,635, CANC. INT. CL. 3.
- L'OREAL, PARIS, FRANCE:
3,006,840, PUB. 7-26-2005. INT. CL. 3.
- LA CAPSULE FRANCAISE, 78530 BUC, FRANCE:
1,306,806, CANC. MULTIPLE CLASS, INT. CLS. 6, 7 AND 20.
- LAB SAFETY SUPPLY, INC., JANESVILLE, WI:
1,905,303, REN. 9-3-05. MULTIPLE CLASS, INT. CLS. 6, 16 AND 19.
- LADY BEAR ENTERPRISES, INC., NEW YORK, NY:
2,207,383, CANC. INT. CL. 25.
- LAEIS GMBH, D-54293, TRIER, FED REP GERMANY:
1,899,580, REN. 9-6-05. INT. CL. 7.
- LAKELAND INDUSTRIES, INC., MOUNTAIN HOME, AR:
3,007,026, PUB. 7-26-2005. INT. CL. 7.
- LAKEPORT BREWING CORPORATION, HAMILTON, ONTARIO, CANADA:
3,007,180, PUB. 7-26-2005. INT. CL. 32.
- LAMBERT, DAVID ISRAEL, SAN SABA, TX:
3,007,615, INT. CL. 25.
- LAMOON PRODUCTS, INC., WESTMINSTER, CA:
1,940,126, REN. 9-8-05. INT. CL. 5.
- LAMSON & SESSIONS CO., THE, CLEVELAND, OH:
3,006,820, PUB. 7-26-2005. INT. CL. 9.
- LAMY LUTTI SAS, BONDUES CEDEX, FRANCE, LAMY LUTTI S.A., 59587 BONDUES CEDEX, FRANCE:
1,911,643, REN. 9-9-05. INT. CL. 30.
- LANCOME PARFUMS ET BEAUTE & CIE, PARIS, FRANCE:
2,207,259, CANC. INT. CL. 3.
- LANDA, MIGUEL ANGEL GONZALEZ, LA CASTELLANA, CARACAS 1060, VENEZUELA:
3,006,925, PUB. 7-26-2005. MULTIPLE CLASS, INT. CLS. 38 AND 41.
- LANDAU, KRISTEN MARIE, MERCER ISLAND, WA:
3,006,989, PUB. 7-26-2005. INT. CL. 25.
- LANDER, MIGUEL, GOLDEN, CO AND LANDER, FLORA, GOLDEN, CO:
3,008,044, INT. CL. 43.
- LANDLORD SOFTWARE INC., MARIETTA, GA:
2,206,662, CANC. INT. CL. 9.
- LANDMARK GRAPHICS CORPORATION, HOUSTON, TX:
1,388,117, REN. 9-6-05. INT. CL. 9.
1,395,556, REN. 9-3-05. INT. CL. 9.
- LANE BRYANT, INC., REYNOLDSBURG, OH:
2,207,631, CANC. INT. CL. 25.
- LANGUAGEFORCE, INC., ORANGE, CA:
2,206,819, CANC. INT. CL. 9.
- LANNET LTD., TEL-AVIV, ISRAEL:
2,207,463, CANC. INT. CL. 9.
- LARGUIA, CONSTANCIO, BUENOS AIRES 1001, ARGENTINA:
3,007,651, INT. CL. 41.
- LARSON, JAMES D., SNOHOMISH, WA:
1,922,947, REN. 9-7-05. INT. CL. 24.
- LARTET DANIEL, FRANCE:
3,007,548, PUB. 7-26-2005. INT. CL. 43.
- LASMO PLC, LONDON, EC2M 3XH, ENGLAND:
2,206,780, CANC. MULTIPLE CLASS, INT. CLS. 40 AND 42.
- LAURA GELLER MAKE-UP STUDIOS, LTD., NEW YORK, NY:
2,207,042, CANC. MULTIPLE CLASS, INT. CLS. 3 AND 41.
- LAUREL INDUSTRIES, INC., CLEVELAND, OH, AMSPEC CHEMICAL CORPORATION, GLOUCESTER CITY, NJ:
1,693,866, REN. 9-8-05. INT. CL. 1.
- LAUREN HANSEN, INC., NEW YORK, NY:
2,207,114, CANC. INT. CL. 25.
- LAVAR, RODNEY G., CLEVELAND, OH, DBA ROD LAVAR:
1,307,482, CANC. INT. CL. 41.
- LAW SCHOOL ADMISSION COUNCIL, INC., NEWTOWN, PA:
1,946,592, REN. 9-7-05. INT. CL. 16.
- LAWRENCE PLC (TRADING AS INTERPET), DORKING, SURREY, GREAT BRITAIN, LIQUIFRY COMPANY LIMITED, LONDON, ENGLAND:
608,062, REN. 9-9-05. U.S. CL. 46 (INT. CL. 31).
- LAYER ONE, INC., TAYLORSVILLE, NC:
2,207,176, CANC. INT. CL. 25.
- LAYFIELD GROUP LIMITED, RICHMOND, BRITISH COLUMBIA, CANADA:
3,007,369, PUB. 7-26-2005. INT. CL. 20.
- LAYNE, BARBARA, BEVERLY HILLS, CA:
2,207,759, CANC. INT. CL. 42.
- LAZY ASS RANCH INC., LEONARD, TX:
2,207,079, CANC. INT. CL. 14.
- LE SIRENUSE S.P.A., POSITANO (SALERNO), ITALY:
3,007,268, PUB. 7-26-2005. MULTIPLE CLASS, INT. CLS. 3, 4 AND 35.
- LEANDRO JESUS, SPAIN AND LEYRE TERESA, SPAIN AND MARIA DEL ORO UGARTE ANDA, SPAIN:
3,007,558, PUB. 7-26-2005. INT. CL. 6.
- LEARNINGSTATION.COM, THE, CHARLOTTE, NC:
2,207,297, CANC. INT. CL. 42.
- LEASE PLAN U.S.A., INC., ALPHARETTA, GA:
1,919,088, REN. 9-3-05. INT. CL. 36.
- LECG, LLC, EMERYVILLE, CA:
3,007,664, MULTIPLE CLASS, INT. CLS. 35, 36 AND 42.
- LEDRAPLASTIC, SPA, 33010 - OSOPPO (UD), ITALY:
1,969,525, REN. 9-8-05. INT. CL. 28.
- LEE COUNTY ELECTRIC COOPERATIVE, INC., NORTH FORT MYERS, FL:
3,007,529, PUB. 7-26-2005. INT. CL. 39.
- LEE ENTERPRISES, INC., LITTLETON, CO:
3,007,146, PUB. 7-26-2005. INT. CL. 35.
- LEE-BEE PRODUCTS, INC., BRAINTREE, MA:
2,207,292, CANC. INT. CL. 16.
- LEE, ERIC, BRONX, NY:
3,007,368, PUB. 7-26-2005. INT. CL. 21.
- LEEBER LIMITED U.S.A., NEWARK, DE:
1,945,128, REN. 9-3-05. MULTIPLE CLASS, INT. CLS. 8 AND 14.
- LEGAL BENEFITS, INC., VIRGINIA BEACH, VA:
3,007,120, PUB. 7-26-2005. INT. CL. 36.
- LEGAL HELPERS P.C., CHICAGO, IL:
2,207,740, CANC. INT. CL. 42.
- LEGAL STRATEGIES GROUP, EMERYVILLE, CA:
2,207,749, CANC. INT. CL. 42.
- LEIGH YAWKEY WOODSON ART MUSEUM, INC., THE, WAUSAU, WI:
1,371,979, REN. 9-6-05. INT. CL. 41.
- LEISURE LEARNING PRODUCTS, INC., GREENWICH, CT:
2,206,465, CANC. INT. CL. 28.
- LEMAX, INC., CANTON, MA:
2,207,595, CANC. INT. CL. 20.
- LENTHERIC LIMITED, WATFORD, HERTFORDSHIRE, UNITED KINGDOM:
3,006,836, PUB. 7-26-2005. INT. CL. 3.
- LEON CONSTANTIN CONSULTING INC., HOUSTON, TX:
2,206,371, CANC. INT. CL. 35.
- LEPEL CORPORATION, EDGEWOOD, NY:
1,907,143, REN. 9-7-05. MULTIPLE CLASS, INT. CLS. 9

- AND 11.
 LESLIE HUMPHRYS-ELIASZIW, STRATFORD, ONTARIO, CANADA:
 3,008,089, INT. CL. 3.
 LEUPOLD & STEVENS, INC., BEAVERTON, OR:
 3,007,779, MULTIPLE CLASS, INT. CLS. 9 AND 13.
 LEVIN, ADRIAN, NEW YORK, NY, DBA CMYK:
 2,207,525, CANC. INT. CL. 28.
 LEVITT AND SONS, LLC, BOCA RATON, FL:
 2,206,634, CANC. INT. CL. 37.
 LG LIFE SCIENCES, LTD., SEOUL, REPUBLIC OF KOREA:
 3,007,188, PUB. 7-26-2005. INT. CL. 5.
 LIBRARY OF CONGRESS, WASHINGTON, DC:
 3,007,446, PUB. 7-26-2005. INT. CL. 41.
 LIEDERMAN, DAVID, NORTH SALEM, NY:
 2,207,367, CANC. INT. CL. 25.
 LIFE & HEALTH OF AMERICA, PHILADELPHIA, PA:
 2,206,490, CANC. INT. CL. 36.
 LIFE CHANGERS, RALEIGH, NC:
 1,900,462, REN. 9-6-05. MULTIPLE CLASS, INT. CLS. 9, 16 AND 41.
 LIFEGIFT ORGAN DONATION CENTER, HOUSTON, TX:
 2,206,907, CANC. MULTIPLE CLASS, INT. CLS. 41 AND 42.
 LIFEPLANS, INC., WALTHAM, MA:
 3,006,786, PUB. 7-26-2005. INT. CL. 36.
 3,006,787, PUB. 7-26-2005. INT. CL. 36.
 LIFESENSORS, INC., MALVERN, PA:
 3,007,714, INT. CL. 1.
 LIFETIME HOAN CORPORATION, WESTBURY, NY:
 1,346,258, REN. 9-7-05. INT. CL. 21.
 LIFEWAY FOODS, INC., MORTON GROVE, IL:
 3,007,046, PUB. 7-26-2005. INT. CL. 29.
 LIGHT SOURCES INC, ORANGE, CT:
 3,007,741, INT. CL. 11.
 LIGHTS OF AMERICA, WALNUT, CA:
 2,206,956, CANC. INT. CL. 11.
 LIGHTWANDZ INTERNATIONAL, INC., ST. PETERSBURG, FL:
 3,007,133, PUB. 7-26-2005. INT. CL. 10.
 LIL' DRUG STORE PRODUCTS, INC., CEDAR RAPIDS, IA:
 1,934,934, REN. 9-8-05. INT. CL. 5.
 1,938,070, REN. 9-8-05. MULTIPLE CLASS, INT. CLS. 3 AND 5.
 LILLY INDUSTRIES (USA), INC., GRAND RAPIDS, MI:
 2,207,002, CANC. INT. CL. 1.
 LIMA S.R.L., 66 - ISOLA VICENTINA (VICENZA), ITALY:
 2,206,532, CANC. INT. CL. 28.
 LINCOLN GLOBAL, INC., MONTEREY PARK, CA:
 3,007,374, PUB. 6-28-2005. INT. CL. 35.
 LINE 6, INC., AGOURA HILLS, CA:
 3,008,013, INT. CL. 9.
 LION KNITTING MILLS COMPANY; THE, CLEVELAND, OH:
 1,307,111, CANC. MULTIPLE CLASS, INT. CLS. 24 AND 25.
 LIPO CHEMICALS, INC., PATERSON, NJ:
 3,007,627, INT. CL. 3.
 LIPTON INVESTMENTS, INC., WILMINGTON, DE:
 3,007,512, PUB. 7-26-2005. INT. CL. 32.
 LISCO, INC., TAMPA, FL:
 2,207,390, CANC. INT. CL. 28.
 LISSA INC., NEW YORK, NY:
 3,006,962, PUB. 7-26-2005. INT. CL. 35.
 3,006,963, PUB. 7-26-2005. MULTIPLE CLASS, INT. CLS. 35 AND 42.
 LITRONIC INC., IRVINE, CA:
 2,206,690, CANC. INT. CL. 42.
 LITRONIC INDUSTRIES, INC., IRVINE, CA:
 2,282,875, CANC. INT. CL. 9.
 LITRONIC, INC., IRVINE, CA:
 2,206,829, CANC. INT. CL. 9.
 LITTERST HOLDINGS CORPORATION, CONCORD, ONTARIO L4K 1L6, CANADA:
 2,206,384, CANC. MULTIPLE CLASS, INT. CLS. 30 AND 42.
 LITTLE BEAR TRADING COMPANY, INC., WINONA, MN:
 1,307,322, CANC. MULTIPLE CLASS, INT. CLS. 30 AND 31.
 LITTLE TIKES COMPANY, THE, FREEPORT, IL:
 3,007,570, INT. CL. 25.
 LIU, LENA, POTOMAC, MD:
 3,007,160, PUB. 7-26-2005. INT. CL. 21.
 LIVE IN LOVE, INC., FORT LAUDERDALE, FL:
 3,007,349, PUB. 6-7-2005. INT. CL. 16.
 LIVING IN STYLE LTD., TSIMSHATSUI, KOWLOON, HONG KONG:
 2,206,543, CANC. INT. CL. 11.
 LIVING IN STYLE, LTD., TSIMSHATSUI, KOWLOON, HONG KONG:
 2,206,542, CANC. INT. CL. 11.
 2,206,544, CANC. INT. CL. 11.
 LIVING WORD CHRISTIAN CENTER INC., BROOKLYN PARK, MN:
 3,007,425, PUB. 7-26-2005. INT. CL. 45.
 LOCH LOMOND GOLF CLUB, SCOTTSDALE, AZ:
 1,909,594, REN. 9-8-05. INT. CL. 41.
 LOCKHEED MARTIN CORPORATION, BETHESDA, MD:
 3,007,519, PUB. 6-7-2005. INT. CL. 28.
 LODESTAR TRADING INTERNATIONAL, INC., LONGMONT, CO:
 3,007,708, INT. CL. 24.
 LOGICALEASE, CARPENTERSVILLE, IL:
 3,007,513, PUB. 7-26-2005. INT. CL. 36.
 LOGICO LTD, DOUGLAS 1M1 1ED, ISLE OF MAN:
 3,006,809, PUB. 7-26-2005. INT. CL. 9.
 LONDONTOWNE GALLERIES, SOMERVILLE, MA:
 3,008,032, INT. CL. 14.
 LONGSTAR HEALTHPRO, INC., WALNUT, CA:
 3,008,042, INT. CL. 5.
 LOOP RECYCLING, INC., CHICAGO, IL:
 2,206,898, CANC. INT. CL. 40.
 LORD HATHAWAY CORPORATION, KANSAS CITY, MO:
 3,007,427, PUB. 7-26-2005. INT. CL. 35.
 LORI COULTER, LLC, ST. LOUIS, MO:
 3,007,950, MULTIPLE CLASS, INT. CLS. 40 AND 45.
 3,007,958, INT. CL. 18.
 LOS FANTASMAS DEL CARIBE, VAN NUYS, CA:
 2,206,851, CANC. INT. CL. 41.
 LOTTE SAMKANG CO., LTD., SEOUL, REPUBLIC OF KOREA:
 2,206,589, CANC. MULTIPLE CLASS, INT. CLS. 29 AND 30.
 LOTUS BRANDS, INC., TWIN LAKES, WI:
 1,955,943, REN. 9-7-05. INT. CL. 3.
 LOUIS BERKMAN COMPANY, THE, CLEVELAND, OH:
 1,015,028, REN. 9-8-05. INT. CL. 2.
 LOUIS VUITTON MALLETIER, 75001 PARIS, FRANCE:
 1,923,652, REN. 9-6-05. INT. CL. 18.
 LOUISIANA LOTTERY CORPORATION, BATON ROUGE, LA:
 2,206,366, CANC. INT. CL. 36.
 LOVE, RANDALL L, AUSTIN, TX:
 3,007,488, PUB. 7-5-2005. INT. CL. 42.
 LOVELAND PRODUCTS, INC., GREELEY, CO:
 3,007,653, INT. CL. 1.
 LOWELL MANUFACTURING COMPANY, PACIFIC, MO:
 614,272, REN. 9-3-05. U.S. CL. 21 (INT. CL. 9).
 LOYOLA UNIVERSITY OF CHICAGO, CHICAGO, IL:
 3,007,281, PUB. 7-26-2005. INT. CL. 16.
 LSI LOGIC CORPORATION, MILPITAS, CA:
 3,007,940, INT. CL. 9.
 LSO, LTD., ANAHEIM, CA:
 2,207,063, CANC. INT. CL. 39.
 LUBO INDUSTRIES, INC., LINCOLNWOOD, IL:
 2,206,687, CANC. INT. CL. 7.
 LUCAS, MICHELLE, LEXINGTON, SC, DBA LUCAS ENTERPRISES:
 3,007,783, INT. CL. 20.
 LUCASFILM LTD., SAN RAFAEL, CA:
 1,307,237, CANC. INT. CL. 28.
 LUCENTA, THOMAS R., TULSA, OK:
 2,207,106, CANC. INT. CL. 3.
 2,207,122, CANC. INT. CL. 3.
 LUCKY STORES, INC., DUBLIN, CA:
 1,307,375, CANC. INT. CL. 33.

- LURCH AG, FED REP GERMANY:
3,007,539, PUB. 7-26-2005. MULTIPLE CLASS, INT. CLS. 18, 21 AND 28.
- LUTZ, JAMES, NEW YORK, NY:
3,007,854, INT. CL. 39.
- LUX LIGHT ASSOCIATES, LLC, UNION, NJ:
3,007,509, PUB. 7-26-2005. INT. CL. 35.
- LUXFER INC., RIVERSIDE, CA:
2,206,529, CANC. INT. CL. 9.
- LYON, CYNTHIA, NORTHFORD, CT:
3,007,440, PUB. 7-26-2005. INT. CL. 41.
- LYPHOMED, INC., CHICAGO, IL:
1,306,775, CANC. INT. CL. 5.
- M & M RUBBER CO., INC., OVERLAND PARK, KS:
1,864,615, CANC. INT. CL. 10.
- M.A.B.E.F. SRL, 21010 CARDANO AL CAMPO, ITALY:
1,930,555, REN. 9-9-05. INT. CL. 16.
- M&M INTERNATIONAL TRADING CORPORATION, BROOKLYN, NY:
2,206,300, CANC. INT. CL. 30.
- M&R PICTURES U.S.A., INC., FOX LAKE, IL:
2,206,324, CANC. INT. CL. 20.
- M/A/R/C INC., IRVING, TX:
2,207,178, CANC. INT. CL. 35.
- MAAX CANADA, INC., MONTREAL, QUEBEC, CANADA:
3,007,189, PUB. 7-26-2005. INT. CL. 11.
- MAC & MAC HYDRODEMOLITION INC., SURREY, BRITISH COLUMBIA, CANADA:
3,006,831, PUB. 7-26-2005. MULTIPLE CLASS, INT. CLS. 37 AND 40.
- MACELREE HARVEY, LTD., WEST CHESTER, PA:
3,007,288, PUB. 7-26-2005. INT. CL. 42.
- MACLEAN-FOGG COMPANY, MUNDELEIN, IL:
3,007,825, INT. CL. 6.
- MACROMEDIA, INC., SAN FRANCISCO, CA, NETWORK MUSIC, INC., SAN DIEGO, CA:
1,901,566, REN. 9-3-05. INT. CL. 9.
- MADE2MANAGE SYSTEMS, INC., INDIANAPOLIS, IN:
2,207,602, CANC. INT. CL. 9.
- MADIX, INC., TERRELL, TX:
1,936,493, REN. 9-7-05. INT. CL. 20.
- MAGIC AMERICAN PRODUCTS, INC., BEACHWOOD, OH:
3,007,055, PUB. 7-26-2005. MULTIPLE CLASS, INT. CLS. 1, 6, 8, 17, 19 AND 20.
3,007,056, PUB. 7-26-2005. MULTIPLE CLASS, INT. CLS. 1, 6, 8, 17, 19 AND 20.
- MAHER, SAM, SHERMAN OAKS, CA AND ART DE EUROPA, LLC, SHERMAN OAKS, CA:
3,007,399, PUB. 7-26-2005. INT. CL. 20.
- MAHOUDEAU, VALERIE, 75019 PARIS, FRANCE:
3,007,003, PUB. 7-26-2005. MULTIPLE CLASS, INT. CLS. 3, 9, 16 AND 24.
- MAILCODE, INC., LAFAYETTE, IN:
3,007,732, INT. CL. 9.
- MAINSTREET MARKETING SOFTWARE, INC., DENVER, CO:
2,207,043, CANC. INT. CL. 9.
- MAJESTIC THEATRE, LLC, COLUMBUS, OH:
3,007,749, INT. CL. 41.
- MALANOWSKI, MARC ZENON, SOMONAUK, IL TO EXPEDIA, INC., BELLEVUE, WA:
1,864,967, CANC. INT. CL. 39.
- MALLINCKRODT VETERINARY, INC., MUNDELEIN, IL:
1,012,057, REN. 9-3-05. INT. CL. 5.
- MANGIA, INC., MISSION VIEJO, CA:
3,007,400, PUB. 7-26-2005. INT. CL. 29.
- MANIFEST FILM COMPANY, ENCINO, CA:
2,207,709, CANC. INT. CL. 41.
- MAR-DEN, INC., WILLCOX, AZ:
1,911,555, REN. 9-3-05. INT. CL. 28.
- MARCHON EYEWEAR, INC., MELVILLE, NY:
2,207,401, CANC. INT. CL. 9.
- MARCUS, SAMUEL H, RYE BROOK, NY:
3,007,869, INT. CL. 35.
- MARDER TRAWLING, INC., NEW BEDFORD, MA:
3,007,309, PUB. 7-26-2005. INT. CL. 29.
3,007,311, PUB. 7-26-2005. INT. CL. 29.
- MARINUS VAN DEN WIJNGAARD, NETHERLANDS:
3,007,540, PUB. 7-26-2005. INT. CL. 29.
- MARKETING ON DEMAND, LLC, LITTLETON, CO, BURG-STINER, J. SUSAN, ENGLEWOOD, CO:
1,976,068, REN. 9-7-05. INT. CL. 35.
- MARKETPLACE SYSTEMS GROUP, INC., RICHMOND, VA TO NSB RETAIL SYSTEMS, INC., LEWIS CENTER, OH:
1,865,216, CANC. INT. CL. 9.
- MARKS AND SPENCER, PLC, LONDON, W1A 1DN, UNITED KINGDOM:
2,096,207, CANC. MULTIPLE CLASS, INT. CLS. 4, 5, 6, 8, 9, 11, 14, 16, 20 AND 28.
- MARKS, MELANIE J., SANTEE, CA:
3,007,452, PUB. 7-26-2005. INT. CL. 43.
- MARLOW FOODS LIMITED, NORTH YORKSHIRE TS9 7AB, UNITED KINGDOM:
3,007,177, PUB. 7-26-2005. MULTIPLE CLASS, INT. CLS. 1, 29, 30 AND 31.
- MARR, JASON M.R., GROVELAND, MA:
2,207,039, CANC. INT. CL. 41.
- MARRIOTT CORPORATION, WASHINGTON, DC:
1,307,529, CANC. INT. CL. 42.
- MARRIOTT INTERNATIONAL, INC., BETHESDA, MD:
2,206,679, CANC. INT. CL. 37.
- MARS, INC., FORT LAUDERDALE, FL:
2,206,809, CANC. INT. CL. 35.
- MARS, INCORPORATED, MCLEAN, VA:
1,864,710, CANC. INT. CL. 16.
- MARS, INCORPORATED, MC LEAN, VA:
3,007,776, MULTIPLE CLASS, INT. CLS. 31 AND 35.
- MARSYL ENTERPRISES, INC., CODY, WY:
1,348,375, REN. 9-3-05. INT. CL. 30.
- MARTIN MIDSTREAM PARTNERS L.P., KILGORE, TX:
3,007,772, MULTIPLE CLASS, INT. CLS. 1, 35 AND 39.
- MARTINEZ, MARIA E., WINDEMERE, FL:
2,206,575, CANC. INT. CL. 37.
- MARUTAMA COMPANY, INC., LOS ANGELES, CA:
1,020,629, REN. 9-3-05. INT. CL. 29.
- MASSEY FERGUSON CORP., DULUTH, GA:
791,682, REN. 9-6-05. U.S. CL. 15 (INT. CL. 4).
- MASTANDREA, FRANK J., PELHAM MANOR, NY AND MASTANDREA, ISABELLA, PELHAM MANOR, NY:
2,206,510, CANC. INT. CL. 41.
- MASTER CUTLERY CORPORATION, CHIBA 273-0865, JAPAN:
3,006,883, PUB. 7-26-2005. MULTIPLE CLASS, INT. CLS. 8 AND 21.
- MATERNE-CONFILUX, 5150 FLOREFFE, BELGIUM:
2,207,265, CANC. INT. CL. 29.
- MATISSE, LTD, EAST LIVERPOOL, OH:
3,007,354, PUB. 7-26-2005. INT. CL. 35.
- MATRIX SECURITY, INC., BOULDER, CO:
3,007,787, INT. CL. 9.
- MATSUSHITA ELECTRIC INDUSTRIAL CO., LTD., OSAKA-FU, JAPAN:
2,898,360, COR. INT. CL. 9.
- MATTEL, INC., EL SEGUNDO, CA:
1,300,766, REN. 9-7-05. INT. CL. 28.
1,858,711, REN. 9-7-05. INT. CL. 28.
1,870,648, REN. 9-7-05. INT. CL. 28.
2,207,462, CANC. INT. CL. 28.
2,207,664, CANC. INT. CL. 28.
2,949,443, COR. INT. CL. 28.
3,007,773, INT. CL. 28.
3,007,877, INT. CL. 28.
3,007,893, INT. CL. 28.
3,007,894, INT. CL. 28.
3,007,895, INT. CL. 28.
- MAU, INC., AUGUSTA, GA:
3,007,025, PUB. 7-26-2005. INT. CL. 35.
- MAURICIO CHIROPRACTIC GROUP, ORLANDO, FL:
3,007,109, PUB. 7-26-2005. INT. CL. 44.
- MAX DESIGN & ADVERTISING, CHICAGO, IL:
2,206,496, CANC. INT. CL. 35.
- MAX MCGRAW WILDLIFE FOUNDATION, DUNDEE, IL:
3,006,879, PUB. 7-26-2005. MULTIPLE CLASS, INT. CLS. 41 AND 44.

- MAXIOM LLC, MILWAUKEE, WI:
3,007,916, INT. CL. 30.
- MAY DEPARTMENT STORES INTERNATIONAL, INC., ST. LOUIS, MO:
3,007,934, INT. CL. 25.
- MAYSTEEL LLC, MENOMONEE FALLS, WI:
3,007,989, INT. CL. 9.
- MAYTAG CORPORATION, NEWTON, IA:
2,207,705, CANC. INT. CL. 28.
- MAZZIO'S CORPORATION, TULSA, OK, KEN'S RESTAURANT SYSTEMS, INC., TULSA, OK:
1,341,693, REN. 9-6-05. INT. CL. 42.
- MBNA AMERICA BANK, NATIONAL ASSOCIATION, WILMINGTON, DE:
1,896,445, REN. 9-3-05. INT. CL. 36.
1,968,550, REN. 9-9-05. INT. CL. 36.
- MCBRIDE, PETER, OTTAWA, CANADA:
3,007,262, PUB. 7-26-2005. INT. CL. 10.
- MCCABE & ASSOCIATES, INC., WARWICK, RI:
2,206,835, CANC. INT. CL. 9.
2,207,552, CANC. INT. CL. 9.
- MCCAFFREY, JOHN P., BIG PINE KEY, FL:
3,007,371, PUB. 7-26-2005. INT. CL. 28.
- MCCARTNEY MULTIMEDIA, INC., PLAYA DEL REY, CA:
3,007,207, PUB. 7-26-2005. INT. CL. 42.
- MCCLAIN, RONALD R., OAKLAND, CA AND SPRAGG, MARTIN A., OAKLAND, CA:
2,108,343, CANC. INT. CL. 42.
- MCCOMBS; B. J. "RED", SAN ANTONIO, TX:
1,306,971, CANC. MULTIPLE CLASS, INT. CLS. 16 AND 35.
- MCCORMICK SCIENTIFIC, LLC, ST. LOUIS, MO:
1,379,903, REN. 9-7-05. INT. CL. 1.
- MCDONALD'S CORPORATION, OAK BROOK, IL:
3,008,074, INT. CL. 43.
- MCDOWELL, THOMAS JOHN, CARMEL, CA:
1,864,591, CANC. INT. CL. 9.
- MCFADDEN, RAINEY B., MATTAPAN, MA:
3,007,472, PUB. 7-26-2005. INT. CL. 25.
- MCGEAN-ROHCO, INC., CLEVELAND, OH:
1,306,737, CANC. INT. CL. 4.
- MCGOUGH, AL, AUSTIN, AR:
2,207,397, CANC. INT. CL. 28.
- MCKENZIE, SCOTT P., NASHUA, NH:
3,007,295, PUB. 6-7-2005. INT. CL. 25.
- MCKESSON CORPORATION, SAN FRANCISCO, CA:
1,307,565, CANC. U.S. CL. 200.
- MCLAUGHLIN GORMLEY KING COMPANY, GOLDEN VALLEY, MN:
1,902,342, REN. 9-6-05. INT. CL. 5.
- MCLOUGHLIN, JOHN E., NESCONSET, NY:
3,006,876, PUB. 7-26-2005. INT. CL. 9.
- MCPHERSON, WILLIAM, NAPA, CA:
2,206,556, CANC. INT. CL. 35.
- MD SOLUTIONS, INC., BOSTON, MA:
3,007,767, INT. CL. 9.
- MDL TECHNOLOGIES, INC., HOUSTON, TX:
2,207,023, CANC. INT. CL. 9.
- MEAD CORPORATION, THE, DAYTON, OH:
2,207,335, CANC. INT. CL. 18.
- MECHANICAL DYNAMICS AND ANALYSIS, LLC, SCHENECTADY, NY:
3,006,887, PUB. 7-26-2005. MULTIPLE CLASS, INT. CLS. 37 AND 42.
- MECHANICAL FINISHING, INC., CINCINNATI, OH:
3,007,010, PUB. 7-26-2005. INT. CL. 40.
- MED-TEC, INC., ORANGE CITY, IA:
2,098,289, CANC. INT. CL. 10.
- MEDIA CYBERNETICS, L.P., SILVER SPRING, MD:
2,096,752, CANC. INT. CL. 9.
- MEDIA LAW RESOURCE CENTER, INC., NEW YORK, NY:
3,006,835, PUB. 7-26-2005. INT. CL. 35.
- MEDIAONE GROUP, INC., ENGLEWOOD, CO:
2,207,603, CANC. MULTIPLE CLASS, INT. CLS. 9, 14, 16, 21, 25 AND 28.
- MEDICAL ART PROSTHETICS, DALLAS, TX:
3,007,296, PUB. 7-26-2005. MULTIPLE CLASS, INT. CLS. 40 AND 44.
- MEDICAL RESEARCH INSTITUTE, INC., SAN FRANCISCO, CA:
3,007,938, INT. CL. 5.
- MEDLINE INDUSTRIES, INC., MUNDELEIN, IL:
1,016,801, REN. 9-6-05. INT. CL. 10.
- MEDLINE INDUSTRIES, INC., MUNDELEIN, IL, JASON MARKETING COMPANY, HUNTINGTON BEACH, CA:
1,907,216, REN. 9-6-05. INT. CL. 10.
- MEDNOW CORPORATION, SPRINGFIELD, PA:
1,307,538, CANC. INT. CL. 42.
- MEDOPTIONS INCORPORATED, SILVER SPRING, MD:
2,207,244, CANC. INT. CL. 42.
- MEDTECH LIMITED, DUBLIN 18, IRELAND:
2,206,314, CANC. INT. CL. 10.
- MEDTRONIC XOMED, INC., JACKSONVILLE, FL, CONCEPT, INC., ST. PETERSBURG, FL:
1,017,204, REN. 9-8-05. INT. CL. 10.
- MEDTRONIC XOMED, INC., JACKSONVILLE, FL, MEROCEL CORPORATION, MYSTIC, CT:
1,905,274, REN. 9-9-05. INT. CL. 5.
- MEDTRONIC XOMED, INC., JACKSONVILLE, FL:
1,914,147, REN. 9-9-05. INT. CL. 10.
- MEEKS, JOSEPH A., CORONA, CA AND MEEKS, MARY GROSSMAN, CORONA, CA:
3,007,386, PUB. 4-5-2005. INT. CL. 3.
- MEGATRAX PRODUCTION MUSIC, INC., NORTH HOLLYWOOD, CA:
3,007,754, MULTIPLE CLASS, INT. CLS. 9 AND 41.
- MEGAWARE KEELGUARD, INC., OGDEN, UT, MEGAWARE BOAT PROTECTION PRODUCTS, INC., WOODS CROSS, UT:
1,919,570, REN. 9-6-05. INT. CL. 12.
- MEIJER, INC., GRAND RAPIDS, MI:
1,864,588, CANC. MULTIPLE CLASS, INT. CLS. 9 AND 20.
- MEJ ELECTRONICS LTD., GUILDFORD, SURREY GU2 5YF, ENGLAND TO MENTOR GRAPHICS CORPORATION, WILSONVILLE, OR:
1,864,569, CANC. INT. CL. 9.
- MELBOURNE INTERNATIONAL COMMUNICATIONS, LIMITED, PALM BAY, FL:
1,864,959, CANC. INT. CL. 38.
- MEMCO SOFTWARE LTD., TEL AVIV, 61581, ISRAEL:
2,207,474, CANC. INT. CL. 9.
- MENASHA CORPORATION, NEENAH, WI:
3,008,078, INT. CL. 35.
- MENGES, MCLAUGHLIN, CUNNINGHAM & KALASNIK, LLP, YORK, PA:
2,966,500, COR. INT. CL. 42.
- MEOW MIX COMPANY, THE, SECAUCUS, NJ:
3,007,692, INT. CL. 31.
- MERCHANDISE MART INCORPORATED, ROCKVILLE, MD:
1,074,969, CANC. INT. CL. 16.
- MERCHANT, GOULD, SMITH, EDELL, WELTER & SCHMIDT, P.A., MINNEAPOLIS, MN TO MERCHANT & GOULD P.C., MINNEAPOLIS, MN:
1,865,451, CANC. INT. CL. 42.
- MERCK KGAA, 64293 DARMSTADT 1, FED REP GERMANY:
2,206,581, CANC. INT. CL. 5.
2,206,583, CANC. INT. CL. 5.
- MEREDITH CORPORATION, DES MOINES, IA:
3,007,483, PUB. 7-26-2005. MULTIPLE CLASS, INT. CLS. 41, 42, 43, 44 AND 45.
- MERILLAT INDUSTRIES, INC., ADRIAN, MI:
2,207,534, CANC. INT. CL. 20.
- MERISTAR HOTEL LESSEE, INC., ARLINGTON, VA:
3,007,134, PUB. 7-26-2005. INT. CL. 43.
- MERKT CHEESE COMPANY, INC., BRISTOL, WI:
1,307,306, CANC. INT. CL. 29.
- MERLINO'S MACARONI, INC., COLUMBUS, OH:
1,307,324, CANC. INT. CL. 30.
- MESSE MÜNCHEN GMBH, FED REP GERMANY:
3,007,545, PUB. 7-26-2005. INT. CL. 35.
3,007,547, PUB. 7-26-2005. INT. CL. 35.

- MESSER GRIESHEIM GMBH, FRANKFURT AM MAIN, FED REP GERMANY:
1,306,735, CANC. INT. CL. 4.
- MESSER GROUP GMBH, SULZBACH, FED REP GERMANY:
3,007,290, PUB. 7-26-2005. INT. CL. 7.
- MET S.P.A., TALAMONA (SONDRIO), ITALY, MET S.R.L., PROVINCE OF COMO, ITALY:
1,902,408. REN. 9-7-05. INT. CL. 9.
- METERS, THE, NEW ORLEANS, LA:
1,870,051. REN. 9-3-05. INT. CL. 41.
- METRO PARKS, SERVING SUMMIT COUNTY, AKRON, OH:
3,007,105, PUB. 7-26-2005. INT. CL. 41.
- METRO-TEL CORP. OF MINNESOTA, INC., OMAHA, NE:
765,395. REN. 9-6-05. MULTIPLE CLASS, U.S. CLS. 21 (INT. CL. 9) AND 26 (INT. CL. 9).
- METTILER-TOLEDO GMBH, 8606 GREIFENSEE, SWITZERLAND, DR. W. INGOLD AG (DR. W. INGOLD SA) (DR. W. INGOLD LTD.), URDORF, SWITZERLAND:
1,345,855. REN. 9-3-05. INT. CL. 9.
- METZ CONSUMER ELECTRONICS, INC., HALLANDALE, FL, DBA MCE:
1,306,837, CANC. INT. CL. 9.
- MG TAYLOR CORPORATION, HILTON HEAD ISLAND, SC:
2,206,437, CANC. MULTIPLE CLASS, INT. CLS. 9, 16 AND 28.
2,206,438, CANC. MULTIPLE CLASS, INT. CLS. 9 AND 25.
2,206,483, CANC. MULTIPLE CLASS, INT. CLS. 18 AND 25.
- MGM GRAND HOTEL, INC., LAS VEGAS, NV:
2,206,623, CANC. MULTIPLE CLASS, INT. CLS. 16, 41 AND 42.
- MIAMI STRING QUARTET, THE, MIAMI, FL:
2,207,052, CANC. INT. CL. 41.
- MICONE, ANDREW, CHATSWORTH, CA:
3,007,468, PUB. 6-21-2005. INT. CL. 35.
- MICRO FLO COMPANY LLC, MEMPHIS, TN:
1,348,827. REN. 9-3-05. INT. CL. 1.
1,904,891. REN. 9-3-05. INT. CL. 5.
- MICRO FORMAT, INC., WHEELING, IL:
1,864,720, CANC. INT. CL. 16.
- MICRO-MED, INC., LOUISVILLE, KY:
1,865,099, CANC. MULTIPLE CLASS, INT. CLS. 37, 40 AND 42.
- MICRO-PROBE, INC., SAN DIEGO, CA:
1,306,836, CANC. INT. CL. 9.
- MICROGAMING SYSTEMS ANSTALT, FL-9490 VADUZ, LIECHTENSTEIN:
3,006,898, PUB. 7-12-2005. MULTIPLE CLASS, INT. CLS. 9, 35 AND 41.
- MICROLAW INC., METUCHEN, NJ:
2,207,026, CANC. INT. CL. 42.
- MICROMAX-SIMAC S.R.L., 22070 BERGAZZO CON FIGLIARO (COMO), ITALY:
2,206,560, CANC. MULTIPLE CLASS, INT. CLS. 7, 9 AND 11.
- MICRON ELECTRONICS, INC., NAMPA, ID:
2,206,647, CANC. INT. CL. 9.
- MICROPATENT LLC, EAST HAVEN, CT, MICROPATENT, NEW HAVEN, CT:
1,909,575. REN. 9-9-05. INT. CL. 35.
- MICROPATH CORPORATION, GOLDEN, CO, MICROPATH CORPORATION, GOLDEN, CO:
1,879,554. REN. 9-7-05. INT. CL. 9.
- MICROSOFT CORPORATION, REDMOND, WA:
3,007,734, INT. CL. 9.
- MID-ATLANTIC TECHNICAL SERVICES INC., ANNAPOLIS, MD:
2,206,315, CANC. MULTIPLE CLASS, INT. CLS. 6 AND 19.
- MIDI MUSIC CENTER, INC., LAGRANGE PARK, IL, DBA LOWREY ORGAN COMPANY:
2,206,941, CANC. INT. CL. 15.
2,206,942, CANC. INT. CL. 15.
- MIDWEST FASTENER CORPORATION, SOUTH HOLLAND, IL:
2,206,536, CANC. INT. CL. 6.
- MIKASA SANGYO COMPANY, LTD., CHIYODA-KU, TOKYO, JAPAN:
2,206,553, CANC. INT. CL. 7.
- MIKAWAYA, INC., LOS ANGELES, CA:
1,934,454. REN. 9-6-05. INT. CL. 30.
- MIKRONITE TECHNOLOGIES GROUP INC., CARLSTADT, NJ:
3,006,934, PUB. 7-26-2005. MULTIPLE CLASS, INT. CLS. 3, 7 AND 40.
- MILL-ROSE COMPANY, MENTOR, OH:
3,007,678, MULTIPLE CLASS, INT. CLS. 8 AND 21.
- MILLER PRODUCTS, INC., SEBRING, OH:
2,207,540, CANC. INT. CL. 20.
- MILLER, ARTHUR H., REDDING, CT:
2,207,571, CANC. INT. CL. 20.
- MILLER, THERESA, CARON, SOUTH SAN FRANCISCO, CA:
3,006,895, PUB. 7-26-2005. INT. CL. 3.
- MILTECH, INC., SPRING LAKE, MI:
1,306,879, CANC. INT. CL. 9.
- MIN, TIFFANY, CHANTILLY, VA:
3,007,768, INT. CL. 9.
- MINE SAFETY APPLIANCES COMPANY, PITTSBURGH, PA:
204,301. REN. 9-9-05. U.S. CL. 44 (INT. CL. 5).
1,932,124. REN. 9-7-05. INT. CL. 9.
2,207,330, CANC. INT. CL. 16.
- MINERALOGICAL RECORD, INC., THE, TUSCON, AZ:
1,344,368. REN. 9-6-05. INT. CL. 16.
- MINT CORPORATION, TUCSON, AZ:
1,864,976, CANC. INT. CL. 40.
- MIRAGE TECHNOLOGIES (MULTIMEDIA) LIMITED, CHESHIRE CW12 4AP, UNITED KINGDOM:
2,206,405, CANC. INT. CL. 9.
- MISSISSIPPI STATE UNIVERSITY, STARKVILLE, MS:
1,307,462, CANC. INT. CL. 41.
- MITEL CORPORATION, KANATA, ONTARIO, CANADA:
1,622,129, CANC. INT. CL. 9.
- MITEL NETWORKS CORPORATION, KANATA, ONTARIO, CANADA, MITEL CORPORATION, KANATA, ONTARIO, CANADA:
1,902,404. REN. 9-9-05. INT. CL. 9.
1,904,370. REN. 9-9-05. INT. CL. 16.
1,961,215. REN. 9-9-05. INT. CL. 16.
- MIYATA, TATSUYA, TOKYO, JAPAN, DBA TOGIYA INTERNATIONAL INC.:
3,007,422, PUB. 7-26-2005. INT. CL. 8.
- MLA MULTIBRAND HOLDINGS, INC., VERNON, CA, AZRIA, MAX, VERNON, CA:
1,939,918. REN. 9-6-05. INT. CL. 25.
- MLJ, LLC, ORLANDO, FL:
3,007,130, PUB. 7-26-2005. INT. CL. 5.
- MMM, INC., LAMAR, MO:
3,007,457, PUB. 7-26-2005. INT. CL. 13.
- MOBLEY, GWENNETTE Q., ROCHESTER, NY, DBA YO-WAY INNOVATIVE DESIGNS:
2,207,001, CANC. INT. CL. 25.
- MODELS ONE LIMITED, LONDON, UNITED KINGDOM:
3,007,171, PUB. 7-26-2005. INT. CL. 3.
- MOHAWK CARPET CORPORATION, ATLANTA, GA:
2,207,739, CANC. INT. CL. 27.
- MONACO COACH CORPORATION, COBURG, OR, MONACO COACH CORPORATION, JUNCTION CITY, OR:
1,692,825. REN. 9-8-05. INT. CL. 12.
- MONARCH CIGAR CORPORATION, NORTH MIAMI BEACH, FL:
2,207,219, CANC. INT. CL. 34.
- MONARCH-MCLAREN (1981) INC., SCARBOROUGH, ONTARIO, CONTREVIBE CORPORATION, OAKVILLE, ONTARIO, CANADA:
1,376,098. REN. 9-6-05. INT. CL. 28.
- MONTGOMERY FURNITURE DISTRIBUTORS, INC., CAPITOL HEIGHTS, MD:
1,307,536, CANC. INT. CL. 42.

MONTGOMERY KONE INC., MOLINE, IL:
2,206,856, CANC. INT. CL. 42.

MOORE SPECIAL TOOL CO., INCORPORATED, BRIDGE-
PORT, CT:
1,307,443, CANC. MULTIPLE CLASS, INT. CLS. 37 AND
42.

MOORE, ERIK HARDY, BRIDGEWATER, MA:
2,206,830, CANC. INT. CL. 9.

MOORE, NICK A., OZARK, MO:
3,006,867, PUB. 7-26-2005. INT. CL. 20.

MOOSEJAW MOUNTAINEERING AND BACKCOUNTRY
TRAVEL, INC., CHICAGO, IL:
3,007,438, PUB. 7-26-2005. INT. CL. 25.

MORE SMALL PIECES LLC, PARKER, CO:
2,207,668, CANC. INT. CL. 28.

MORGAN & OATES LIMITED, LONDON N3 2QL, ENG-
LAND:
2,206,757, CANC. MULTIPLE CLASS, INT. CLS. 18, 24
AND 25.
2,206,758, CANC. MULTIPLE CLASS, INT. CLS. 18, 24
AND 25.

MORMAR, MARK J., COLD SPRING, NY:
3,007,535, PUB. 7-26-2005. INT. CL. 12.

MORRIS, GEORGE P., REDONDO BEACH, CA:
2,206,417, CANC. INT. CL. 35.

MORRISON, JOSEPH C., LOS ANGELES, CA:
3,007,187, PUB. 7-26-2005. INT. CL. 28.

MORTAN, INC., MISSOULA, MT:
1,350,504, REN. 9-3-05. INT. CL. 10.

MORTGAGE PROTECTION BUREAU, DOUGLASVILLE,
GA:
3,008,099, INT. CL. 36.

MOSS MANUFACTURING COMPANY, LIMA, OH:
1,306,920, CANC. INT. CL. 12.

MOTOR COACH INDUSTRIES INTERNATIONAL, INC.,
PHOENIX, AZ:
2,207,719, CANC. MULTIPLE CLASS, INT. CLS. 36 AND
37.

MOTOROLA, INC., SCHAUMBURG, IL:
2,207,485, CANC. INT. CL. 9.

MOUNTAIN CRAFT, INC., ASHEVILLE, NC:
2,206,921, CANC. MULTIPLE CLASS, INT. CLS. 24 AND
27.

MOVADO GROUP, INC., LYNDDHURST, NY:
2,206,286, CANC. INT. CL. 14.

MR. GREEK RESTAURANTS INC., TORONTO, ONTARIO
M3C 3S2, CANADA:
1,862,095, REN. 9-7-05. INT. CL. 42.

MSH SOUTH, INC., WILMINGTON, DE, HERCO INC.,
HERSHEY, PA:
1,957,637, REN. 9-3-05. INT. CL. 41.

MST.FACTORY DORTMUND GMBH, FED REP GER-
MANY:
3,007,552, PUB. 7-26-2005. MULTIPLE CLASS, INT. CLS.
35, 40, 41 AND 42.

MTS, INCORPORATED, WEST SACRAMENTO, CA:
2,207,708, CANC. MULTIPLE CLASS, INT. CLS. 14, 18
AND 25.

MUELHENS KG, 5000 KOLN 30, FED REP GERMANY TO
MUELHENS GMBH & CO. KG, 50823 KOLN, FED REP
GERMANY:
1,864,484, CANC. INT. CL. 3.

MUFFLER 1 AMERICA CORPORATION, UNIONDALE,
NY:
3,007,606, INT. CL. 35.

MULTIMEDIACARD ASSOCIATION, SUNOL, CA:
3,008,063, INT. CL. 9.

MULTIPET INTERNATIONAL, INC., CARLSTADT, NJ:
2,207,323, CANC. INT. CL. 28.

MULTNOMAH PUBLISHERS, INC., SISTERS, OR:
2,207,748, CANC. INT. CL. 16.

MUNICIPAL SECURITIES RULEMAKING BOARD, ALEX-
ANDRIA, VA:
3,007,415, PUB. 7-26-2005. MULTIPLE CLASS, INT. CLS.
9, 16, 36 AND 42.

MURRAY, AMANDA NICOLE, NEW YORK, NY:
3,007,573, INT. CL. 25.

MUSSER'S POTATO CHIPS, INC., MOUNTVILLE, PA:
1,307,333, CANC. INT. CL. 30.

MUTLI-STATE LOTTERY ASSOCIATION, URBANDALE,
IA:
3,007,327, PUB. 7-26-2005. MULTIPLE CLASS, INT. CLS.
28 AND 41.

MW CONSULTING ENGINEERS, PLLC, SPOKANE, WA:
2,206,680, CANC. INT. CL. 42.

MYERS, GLORIA, RENTON, WA:
3,007,138, PUB. 7-26-2005. INT. CL. 44.

MYKROLIS CORPORATION, BILLERICA, MA, TYLAN
CORPORATION, TORRANCE, CA:
1,003,925, REN. 9-6-05. U.S. CL. 26 (INT. CLS. 1, 9 AND
10).

MYRIAD GENETICS, INC., SALT LAKE CITY, UT:
1,906,102, REN. 9-6-05. INT. CL. 42.

N.V. KEMA, 6812 AR ARNHEM, NETHERLANDS:
3,007,204, PUB. 7-26-2005. MULTIPLE CLASS, INT. CLS.
9, 42 AND 45.

N-VIRO INTERNATIONAL CORPORATION, TOLEDO, OH:
3,007,565, INT. CL. 31.

NACA LOGISTICS (USA) INC., CARSON, CA:
3,006,990, PUB. 7-26-2005. INT. CL. 35.

NALCO CHEMICAL COMPANY, CHICAGO, IL:
780,820, CANC. U.S. CL. 6.

NAMSCO INC., OVERLAND PARK, KS TO IMC SALT INC.,
OVERLAND PARK, KS:
1,864,465, CANC. INT. CL. 1.

NAROMY FOODS, INC., EASTON, PA, FUNDANISH, PAUL,
ALLEN TOWN, PA:
1,912,079, REN. 9-9-05. INT. CL. 42.

NARTRON CORPORATION, REED CITY, MI:
1,190,527, CANC. INT. CL. 9.

NATIONAL ASSOCIATION OF CONVENIENCE STORES,
ALEXANDRIA, VA:
3,006,928, PUB. 7-26-2005. INT. CL. 16.

NATIONAL ATHLETIC TRAINERS ASSOCIATION, INC.,
THE, DALLAS, TX:
2,110,561, COR. U.S. CL. 200.

NATIONAL AUTO FINANCE COMPANY, INC., BOCA
RATON, FL:
2,206,635, CANC. INT. CL. 36.

NATIONAL BOND & TRUST COMPANY, INC., CROWN
POINT, IN:
3,006,973, PUB. 7-26-2005. INT. CL. 36.

NATIONAL COMM LINK, LLC, N. MIAMI BEACH, FL:
2,206,806, CANC. INT. CL. 38.

NATIONAL CONSUMER COOPERATIVE BANK, WA-
SHINGTON, DC, DBA NATIONAL COOPERATIVE
BANK:
2,207,769, CANC. INT. CL. 16.

NATIONAL CORN GROWERS ASSOCIATION., ST. LOUIS,
MO:
2,207,218, CANC. INT. CL. 42.

NATIONAL COUNCIL ON CRIME AND DELINQUENCY,
MADISON, WI:
3,007,292, PUB. 7-26-2005. MULTIPLE CLASS, INT. CLS.
41 AND 45.
3,007,293, PUB. 7-26-2005. MULTIPLE CLASS, INT. CLS.
41 AND 45.

NATIONAL ELECTRONIC INFORMATION CORPORA-
TION, SECAUCUS, NJ:
1,307,427, CANC. INT. CL. 36.

NATIONAL GAS DISTRIBUTORS, INC., KNOXVILLE, TN:
1,929,455, REN. 9-3-05. INT. CL. 39.

NATIONAL IMPORTERS LTD., NEW WESTMINSTER,
BRITISH COLUMBIA, CANADA:
1,864,858, CANC. INT. CL. 30.

NATIONAL INFORMATION SOLUTIONS COOPERATIVE,
INC., ST. PETERS, MO:
3,007,016, PUB. 7-26-2005. MULTIPLE CLASS, INT. CLS.
9, 35, 41 AND 42.
3,007,017, PUB. 7-26-2005. MULTIPLE CLASS, INT. CLS.
9, 35, 37, 41 AND 42.

NATIONAL INSTITUTE FOR AUTOMOTIVE EXCELLENCE
(NIASE), LEESBURG, VA:
3,006,980, PUB. 7-26-2005. INT. CL. 41.

- NATIONAL KITCHEN & BATH ASSOCIATION, HACKETTSTOWN, NJ:
1,957,641. REN. 9-7-05. INT. CL. 35.
- NATIONAL LAW RESOURCE, INC., CHICAGO, IL:
2,207,548. CANC. INT. CL. 35.
- NATIONAL LEGAL AID AND DEFENDER ASSOCIATION, WASHINGTON, DC:
1,343,533. REN. 9-9-05. INT. CL. 42.
- NATIONAL PAINTBALL SUPPLY, INC., SEWELL, NJ:
3,007,718. INT. CL. 28.
- NATIONAL POSTAL FORUM (NPF), FAIRFAX, VA:
3,007,090. PUB. 7-26-2005. INT. CL. 41.
- NATIONAL RESTAURANT ASSOCIATION, WASHINGTON, DC:
3,007,061. PUB. 7-26-2005. INT. CL. 35.
- NATIONAL UNIVERSITY, LA JOLLA, CA:
3,008,051. INT. CL. 41.
- NATIONAL URBAN COALITION, INC., WASHINGTON, DC:
2,207,337. CANC. INT. CL. 42.
- NATIONAL WHEEL-O-VATOR CO., INC., THE, ROANOKE, IL, TOCE BROTHERS MANUFACTURING LTD., BROUSSARD, LA:
1,014,006. REN. 9-6-05. INT. CL. 7.
- NATIONAL WILD TURKEY FEDERATION, INC., THE, EDGEFIELD, SC:
3,008,018. INT. CL. 35.
- NATIONAL WIRE FABRIC, INC., STAR CITY, AZ:
1,909,151. REN. 9-9-05. INT. CL. 6.
- NATIONALE STICHTING TOT EXPLOITATIE VAN CASINOSPELEN IN NEDERLAND TE 'S-GRAVENHAGE, 2132 MK HOOFDDORP, NETHERLANDS:
2,943,431. COR. INT. CL. 9.
- NATIONWIDE SHOPPER SYSTEMS, INC., BURBANK, CA:
1,307,499. CANC. INT. CL. 42.
- NATURAL BUILDING MAINTENANCE CORPORATION, LOS ANGELES, CA:
2,207,274. CANC. INT. CL. 37.
- NATURAL GOLF CORPORATION, HOFFMAN ESTATES, IL:
2,207,527. CANC. INT. CL. 28.
- NATURAL ORGANICS INC., MELVILLE, NY:
2,101,561. CANC. INT. CL. 5.
- NATURAL WONDERS, INC., FREMONT, CA:
2,207,225. CANC. INT. CL. 35.
- NATURALLY CAFFEINATED, INC., BOULDER, CO:
3,007,064. PUB. 7-26-2005. INT. CL. 41.
- NATURE THINGS, INC., PHOENIX, AZ:
2,207,277. CANC. INT. CL. 16.
- NATURE'S SUNSHINE PRODUCTS, INC., PROVO, UT:
3,007,889. INT. CL. 5.
- NATURE'S WAY PRODUCTS, INC., SPRINGVILLE, UT:
1,943,883. REN. 9-3-05. INT. CL. 5.
- NBA PROPERTIES, INC., NEW YORK, NY:
1,906,634. REN. 9-7-05. INT. CL. 25.
- NBTY, INC., BOHEMIA, NY:
1,864,509. CANC. INT. CL. 5.
2,206,562. CANC. INT. CL. 5.
- NEDBOY, ROBIN L, NEW YORK, NY:
3,007,396. PUB. 7-26-2005. INT. CL. 3.
- NEENAH PAPER, INC., ALPHARETTA, GA:
2,206,592. CANC. INT. CL. 16.
- NEIGHBORHOOD CONVENIENCE, INC., RICHMOND, VA:
3,007,523. PUB. 7-26-2005. INT. CL. 35.
- NEILL CORPORATION, HAMMOND, LA:
3,007,698. INT. CL. 44.
- NEKOOSA PAPERS INC., PORT EDWARDS, WI:
1,306,961. CANC. INT. CL. 16.
- NESS, CHRISTOPHER, SAN DIEGO, CA:
3,007,462. PUB. 7-5-2005. INT. CL. 41.
- NET VISIBILITIES, LLC, LAS VEGAS, NV:
3,007,448. PUB. 7-26-2005. INT. CL. 42.
- NETCENTRIC CORPORATION, CAMBRIDGE, MA:
2,206,682. CANC. INT. CL. 9.
- NETFRAME SYSTEMS INCORPORATED, MILPITAS, CA:
2,207,415. CANC. INT. CL. 9.
- NETMASK (EL-MAR) INTERNET TECHNOLOGIES LTD., KFAR-SABA 44641, ISRAEL:
3,006,805. PUB. 7-26-2005. INT. CL. 9.
- NETROX, LLC, MIAMI, FL:
2,207,249. CANC. INT. CL. 35.
- NEURAL APPLICATIONS CORPORATION, CORALVILLE, IA:
2,207,606. CANC. INT. CL. 9.
- NEUTROGENA CORPORATION, LOS ANGELES, CA:
2,206,620. CANC. MULTIPLE CLASS, INT. CLS. 3 AND 5.
- NEVINS, ROBERT L., SR., BOICEVILLE, NY:
2,206,752. CANC. INT. CL. 7.
- NEW CONCEPT COMMUNICATIONS, SANTA BARBARA, CA:
2,207,688. CANC. INT. CL. 38.
- NEW ENERGY VENTURES, LLC, LOS ANGELES, CA:
2,206,431. CANC. INT. CL. 35.
- NEW HAMPTON, INC., NEW YORK, NY:
1,307,183. CANC. INT. CL. 25.
- NEW LIBERTY HOSPITAL DISTRICT OF CLAY COUNTY, LIBERTY, MO:
1,970,126. REN. 9-6-05. INT. CL. 42.
- NEW MEXICO FIRST, ALBUQUERQUE, NM:
3,007,454. PUB. 7-26-2005. MULTIPLE CLASS, INT. CLS. 35 AND 41.
- NEW MINETTE TEXTILES, INC., GROVER, NC:
1,307,101. CANC. MULTIPLE CLASS, INT. CLS. 24 AND 27.
- NEW PENDULUM CORP., WILMINGTON, DE:
2,207,302. CANC. INT. CL. 16.
- NEW RESOURCES CORPORATION, ROLLING MEADOWS, IL:
2,206,700. CANC. MULTIPLE CLASS, INT. CLS. 35 AND 42.
- NEW UNISON CORPORATION, THE, FERNDALE, MI:
792,179. REN. 9-6-05. U.S. CL. 23 (INT. CL. 7).
- NEW YORK BUS SALES, LLC, CHITTENANGO, NY:
3,007,433. PUB. 7-26-2005. INT. CL. 35.
- NEW YORK IS BOOK COUNTRY, INC., NEW YORK, NY:
2,206,965. CANC. INT. CL. 41.
- NEW YORK MEDIA GROUP, INC., NEW YORK, NY:
2,207,201. CANC. INT. CL. 41.
- NEWFREY LLC, NEWARK, DE:
3,007,921. INT. CL. 6.
- NEWPORT ELECTRONICS, INC., SANTA ANA, CA:
2,206,499. CANC. INT. CL. 9.
- NEWRIVER, INC., ANDOVER, MA FROM INUNITY CORPORATION, WATERTOWN, MA:
3,006,783. PUB. 7-26-2005. MULTIPLE CLASS, INT. CLS. 36 AND 38.
- NEWSOFT INC., FREMONT, CA:
2,206,588. CANC. INT. CL. 9.
- NEXINNOVATIONS INC., MISSISSAUGA, ONTARIO L4W 5J3, CANADA:
3,006,856. PUB. 7-26-2005. MULTIPLE CLASS, INT. CLS. 35, 37, 41 AND 42.
- NEXITY, 75008 PARIS, FRANCE:
3,006,797. PUB. 7-26-2005. MULTIPLE CLASS, INT. CLS. 35, 36, 37, 39, 41 AND 42.
- NEXQL CORPORATION, DALLAS, TX:
3,007,322. PUB. 7-26-2005. INT. CL. 9.
- NEXT STEP MEDICAL TECHNOLOGIES, LLC, KENNESAW, GA:
3,007,643. INT. CL. 10.
- NF FORMULAS, INC., WILSONVILLE, OR, DBA PHARMACIST'S NUTRITION CENTER:
2,206,873. CANC. INT. CL. 5.
- NIAGARA FALLS COUNTRY CLUB, LEWISTON, NY:
3,007,312. PUB. 7-26-2005. INT. CL. 41.
- NICHOLS TEAM, INC., THE, ROCHESTER, NY:
2,207,015. CANC. MULTIPLE CLASS, INT. CLS. 36 AND 37.
- NICHOLS; KENNETH A., WATERTOWN, MA, DBA BALANCE-WEAR:
1,307,041. CANC. MULTIPLE CLASS, INT. CLS. 18 AND 25.
- NICO ALBANESE, INC., NEW YORK, NY:
3,007,502. PUB. 7-26-2005. INT. CL. 25.

- NICO-PYROTECHNIK HANNIS-JUERGEN DIEDERICHSGMBH & CO., KG, D-22946 TRITTAU, FED REP GERMANY:
3,006,959, PUB. 7-26-2005. INT. CL. 13.
- NICOLA PIZZA, INC., REHOBOTH BEACH, DE:
1,394,479. REN. 9-3-05. INT. CL. 42.
- NIE, ANNA, HAYWARD, CA AND NIE, CHONG YU, HAYWARD, CA:
2,207,742, CANC. INT. CL. 35.
- NIGHTINGALE, HELEN, TORONTO, ONTARIO, CANADA, T.A. STEF SHAVING AND SKIN CARE PRODUCTS:
1,306,685, CANC. INT. CL. 3.
- NIHON NOHYAKU CO., LTD., CHUO-KU, TOKYO, JAPAN:
2,206,694, CANC. MULTIPLE CLASS, INT. CLS. 1 AND 5.
- NIKON CORPORATION, TOKYO 100, JAPAN:
2,206,957, CANC. INT. CL. 9.
- NILES STEEL TANK COMPANY, NILES, MI:
3,007,764, MULTIPLE CLASS, INT. CLS. 6, 11 AND 40.
- NILFISK-ADVANCE, INC., PLYMOUTH, MN:
3,007,730, INT. CL. 7.
- NIMCO, INC, CALHOUN, KY:
3,007,060, PUB. 7-26-2005. MULTIPLE CLASS, INT. CLS. 9 AND 16.
- NINE WEST DEVELOPMENT CORPORATION, WILMINGTON, DE:
3,007,314, PUB. 7-26-2005. INT. CL. 25.
- NIPPON DENKI KABUSHIKI KAISHA, TOKYO, JAPAN, DBA NEC CORPORATION:
3,007,719, MULTIPLE CLASS, INT. CLS. 9, 37, 38 AND 42.
- NIPPON STEEL & SUMIKIN STAINLESS STEEL CORPORATION, TOKYO, JAPAN:
3,008,026, INT. CL. 6.
- NIRENBERG, MICHAEL S., HOBART, IN, DBA FRIENDLY FOOT CARE TO FRIENDLY FOOT CARE, P.C., MERRILLVILLE, IN:
1,869,895, CANC. INT. CL. 35.
- NIRENBERG, MICHAEL S., HOBART, IN, DBA FRIENDLY FOOT CARE TO FRIENDLY FOOT CARE, P. C., MERRILLVILLE, IN:
1,871,520, CANC. INT. CL. 35.
- NISCA KABUSHIKI KAISHA, MINAMIKOMA-GUN, YAMANASHI-KEN, JAPAN, TA NISCA CORPORATION:
1,902,546. REN. 9-7-05. INT. CL. 9.
- NISSAN JIDOSHA KABUSHIKI KAISHA, KANAGAWA-KEN, JAPAN, TA NISSAN MOTOR CO., LTD.:
3,006,936, PUB. 7-26-2005. MULTIPLE CLASS, INT. CLS. 1, 3 AND 4.
- NISSAN JIDOSHA KABUSHIKI KAISHA, YOKOHAMA-SHI, KANAGAWA-KEN, JAPAN, TA NISSAN MOTOR CO., LTD.:
3,007,624, INT. CL. 12.
- NISSAN NORTH AMERICA, INC., GARDENA, CA:
3,007,879, INT. CL. 36.
- NITRO NOBEL AB, S-713 82 NORA, SWEDEN:
2,096,964, CANC. MULTIPLE CLASS, INT. CLS. 12, 13 AND 17.
- NKO, INC., JACKSONVILLE, FL:
2,206,409, CANC. MULTIPLE CLASS, INT. CLS. 9 AND 38.
- NOBLE ASSET MANAGEMENT, LLC, OAK BROOK, IL:
3,007,970, INT. CL. 36.
- NOBLE FOX ENTERPRISES, INC., SAVANNAH, GA:
2,206,878, CANC. INT. CL. 40.
- NODINE, RICHARD, SAN FRANCISCO, CA, DBA GALERIE DE CARTE:
2,207,285, CANC. INT. CL. 16.
- NORAC COMPANY, INC., THE, AZUSA, CA:
2,207,221, CANC. INT. CL. 1.
- NORCAL WASTE SYSTEMS, INC., SAN FRANCISCO, CA:
1,975,059. REN. 9-7-05. MULTIPLE CLASS, INT. CLS. 37, 40 AND 42.
- NORDOST CORPORATION, ASHLAND, MA:
3,007,733, INT. CL. 9.
- NORITAKE CO., LIMITED, NISHI-KU, NAGOYA, JAPAN:
1,307,081, CANC. INT. CL. 21.
- NORMARK CORPORATION, MINNETONKA, MN:
2,206,459, CANC. INT. CL. 8.
- NORSKE MEIERIER, 0133 OSLO, NORWAY TO TINE BA, 0133, OSLO, NORWAY:
1,864,820, CANC. INT. CL. 29.
- NORTEL NETWORKS LIMITED, ST. LAURENT, QUEBEC, H4S 2A9, CANADA, NORTHERN TELECOM LIMITED, MISSISSAUGA, ONTARIO, CANADA:
1,896,819. REN. 9-6-05. INT. CL. 9.
- NORTH AMERICAN ENERGY GROUP, LANGHORNE, PA:
2,206,826, CANC. INT. CL. 42.
- NORTH AMERICAN SALT COMPANY:
1,306,618, CANC. INT. CL. 1.
- NORTH COAST MEDICAL INC., MORGAN HILL, CA:
1,394,469. REN. 9-3-05. INT. CL. 42.
- NORTH MISSISSIPPI HEALTH SERVICES, INC., TUPELO, MS:
2,207,287, CANC. INT. CL. 42.
- NORTH PASS, LTD., FORT COLLINS, CO:
3,007,158, PUB. 7-26-2005. INT. CL. 9.
- NORTH STAR STEEL COMPANY, WAYZATA, MN:
2,206,654, CANC. INT. CL. 6.
- NORTHERN CREDIT SERVICE, INC., EVANSTON, IL:
1,864,920, CANC. INT. CL. 36.
- NORTHERN GROUP RETAIL LTD., MISSISSAUGA, ONTARIO L4W 4Y6, CANADA, WOOLWORTH CANADA INC., TORONTO, ONTARIO, CANADA:
1,870,224. REN. 9-6-05. MULTIPLE CLASS, INT. CLS. 25 AND 26.
- NORTHERN TELECOM LIMITED, MONTREAL, QUEBEC H2Y 3Y4, CANADA:
2,207,374, CANC. INT. CL. 9.
- NORTHERN WIND, INC., NEW BEFORD, MA:
1,934,733. REN. 9-9-05. INT. CL. 29.
- NORTHLAND NETWORKS, INC., MINNEAPOLIS, MN:
3,006,910, PUB. 7-26-2005. INT. CL. 36.
- NORTHROP GRUMMAN CORPORATION, LOS ANGELES, CA:
1,886,534. REN. 9-8-05. INT. CL. 9.
- NORWEST CORPORATION, MINNEAPOLIS, MN:
2,206,875, CANC. INT. CL. 36.
2,207,290, CANC. INT. CL. 42.
- NOTHING TO WEAR, INC., RANCHO DOMINGUEZ, CA:
3,007,282, PUB. 7-26-2005. INT. CL. 25.
- NOVACHANNEL AG, 6005 LUCERNE, SWITZERLAND:
3,007,000, PUB. 7-26-2005. INT. CL. 9.
- NOVI, JOHN, HIGH FALLS, NY:
3,006,995, PUB. 7-26-2005. INT. CL. 21.
- NOVILLE INC., SOUTH HACKENSACK, NJ:
2,207,183, CANC. INT. CL. 1.
- NOVION, CHICAGO, IL:
2,206,380, CANC. MULTIPLE CLASS, INT. CLS. 9 AND 42.
- NPP GOLF ASSOCIATES L.L.C., PHOENIX, AZ:
2,207,476, CANC. INT. CL. 25.
2,207,645, CANC. INT. CL. 25.
- NU—WAY SEARCH, INC., LAKE ZURICH, IL:
2,206,722, CANC. INT. CL. 35.
- NUCLETRON B.V., 3905 TH VEENENDAAL, NETHERLANDS:
3,007,256, PUB. 7-26-2005. INT. CL. 9.
- NURTURE, INC., DENVER, CO:
1,864,456, CANC. INT. CL. 1.
- NUSBAUM, PERRY LEE, WASHINGTON, DC:
2,207,404, CANC. INT. CL. 9.
- NUTRISCIENCE CORPORATION, HERMOSA BEACH, CA:
3,007,998, INT. CL. 5.
- NUVASIVE, INC., SAN DIEGO, CA:
3,007,981, INT. CL. 10.
- NUWAVE TECHNOLOGIES, INC., NASHUA, NH:
3,007,618, INT. CL. 9.
- NWS-ILLINOIS, LLC, CHICAGO, IL:
3,006,857, PUB. 5-20-2003. INT. CL. 33.
- NYFIX, INC., STAMFORD, CT:
3,007,752, INT. CL. 9.
- NYLCARE HEALTH PLANS, INC., NEW YORK, NY:
2,207,633, CANC. INT. CL. 36.

- NYLEX INDUSTRIAL PRODUCTS PTY. LTD., MELBOURNE VICTORIA, AUSTRALIA, CHANNEL-KOR SYSTEMS, INC., BLOOMINGTON, IN:
1,869,613. REN. 9-7-05. INT. CL. 20.
- O.C. SEACRETS, INC., OCEAN CITY, MD:
3,007,136, PUB. 7-26-2005. MULTIPLE CLASS, INT. CLS. 21, 24, 25, 28 AND 34.
- O'CONNOR, LEIGHTON M., JR., BEVERLY, MA:
2,207,773, CANC. INT. CL. 35.
- O'NEILL, INCORPORATED, SANTA CRUZ, CA:
1,339,268. REN. 9-6-05. INT. CL. 25.
1,340,224. REN. 9-6-05. INT. CL. 25.
- O'WELL CO., LTD., LAKE FOREST, CA:
2,207,420, CANC. INT. CL. 11.
- OB SPECIALTY CHEMICALS GROUP, INC., GREENSBORO, NC:
3,007,363, PUB. 7-26-2005. INT. CL. 3.
- OBIK, L.L.C., PRINCETON, NJ:
2,206,621, CANC. MULTIPLE CLASS, INT. CLS. 16, 35 AND 42.
- OCCULOGIX, INC., MISSISSAUGA, CANADA:
2,207,551, CANC. INT. CL. 42.
- OCEANIC SYSTEMS, INC., DALLAS, TX:
1,975,939. REN. 9-7-05. INT. CL. 16.
- OEM SYSTEMS COMPANY, INC., SPARKS, NV:
2,207,438, CANC. INT. CL. 9.
- OEM, INC., CORVALLIS, OR:
2,207,440, CANC. INT. CL. 9.
- OFFICE OF THE SURGEON GENERAL, ROCKVILLE, MD:
3,007,633, U.S. CL. 200.
- OFFICEMART.COM, INC., ALSIP, IL:
3,007,253, PUB. 7-26-2005. INT. CL. 35.
- OFFICERS ONLY INCORPORATED, OGDEN, UT:
3,007,761, INT. CL. 20.
3,007,762, INT. CL. 18.
- OFFICIAL ALL STAR CAFE, INC., ORLANDO, FL:
2,207,720, CANC. INT. CL. 28.
- OGDEN SERVICES CORPORATION, NEW YORK, NY:
2,207,363, CANC. INT. CL. 42.
- OGILVIE MILLS, INC.:
1,307,301, CANC. INT. CL. 29.
- OI PARTNERS, INC., FRAMINGHAM, MA:
1,902,971. REN. 9-8-05. INT. CL. 35.
- OKABASHI BRANDS INC, BUFORD, GA, RELAXERS COMFORT FOOTWEAR, L.C., BUFORD, GA:
1,905,733. REN. 9-7-05. INT. CL. 25.
- OKIE DOKIE KIDS SALON, INC., WOODLAND HILLS, CA:
3,007,255, PUB. 7-26-2005. MULTIPLE CLASS, INT. CLS. 3 AND 44.
- OLD DOMINION UNIVERSITY, NORFOLK, VA:
3,007,031, PUB. 7-26-2005. INT. CL. 41.
3,007,032, PUB. 7-26-2005. INT. CL. 41.
3,007,033, PUB. 7-26-2005. INT. CL. 41.
- OLD MOTHER HUBBARD, INC., LOWELL, MA:
2,967,998, COR. INT. CL. 5.
- OLD NAVY (APPARAL), LLC, SAN FRANCISCO, CA, GPS (DELAWARE), INC., SAN BRUNO, CA:
1,965,488. REN. 9-7-05. MULTIPLE CLASS, INT. CLS. 25 AND 42.
- OLD NAVY (APPARAL), LLC, SAN FRANCISCO, CA:
2,207,334, CANC. MULTIPLE CLASS, INT. CLS. 3 AND 4.
- OLIN CORPORATION, ST. LOUIS, MO:
1,911,272. REN. 9-7-05. INT. CL. 13.
- OLIVERA, MARIA SOLEDAD, NEW YORK CITY, NY:
2,206,840, CANC. MULTIPLE CLASS, INT. CLS. 14 AND 25.
- OLYMPIA GROUP, INC., CITY OF INDUSTRY, CA, HOMETOWN ADVANTAGE, INC., ANNAPOLIS, MD:
1,903,571. REN. 9-7-05. INT. CL. 18.
- OLYMPUS AMERICA, INC., MELVILLE, NY:
3,007,906, INT. CL. 9.
- OLYMPUS CORPORATION, TOKYO, JAPAN, OLYMPUS CORPORATION, LAKE SUCCESS, NY:
1,289,886. REN. 9-6-05. INT. CL. 9.
- OLYMPUS CORPORATION, WOODBURY, NY TO OLYMPUS OPTICAL CO., LTD., TOKYO, JAPAN:
1,865,184, CANC. INT. CL. 9.
1,865,203, CANC. INT. CL. 9.
- OLYMPUS CORPORATION, SHIBUYA-KU, TOKYO, JAPAN, OLYMPUS AMERICA INC., LAKE SUCCESS, NY:
1,910,711. REN. 9-8-05. INT. CL. 9.
- OLYMPUS CORPORATION, TOKYO, JAPAN:
3,007,588, INT. CL. 9.
- OMEGA ENGINEERING, INC., STAMFORD, CT:
2,206,684, CANC. MULTIPLE CLASS, INT. CLS. 6 AND 9.
- OMNI HOTELS MANAGEMENT CORPORATION, IRVING, TX:
1,905,894. REN. 9-7-05. MULTIPLE CLASS, INT. CLS. 35 AND 42.
- OMNI MATERIALS, INC., MAYSVILLE, KY:
3,007,820, INT. CL. 1.
- OMNIAIR CONSORTIUM, WASHINGTON, DC:
3,007,099, PUB. 7-26-2005. INT. CL. 35.
- OMNIREL, LLC, LEOMINSTER, MA:
2,207,045, CANC. INT. CL. 9.
- OMNIVIEW DESIGN, INC., SAN MATEO, CA:
2,207,604, CANC. INT. CL. 9.
- OMS INVESTMENTS, INC., LOS ANGELES, CA, O.M. SCOTT & SONS COMPANY, THE, MARYSVILLE, OH:
1,895,652. REN. 9-7-05. INT. CL. 31.
- ON COMMON GROUND, INC., MADISON, WI:
2,207,308, CANC. MULTIPLE CLASS, INT. CLS. 16 AND 42.
- ONEIDA LTD., ONEIDA, NY:
1,307,082, CANC. INT. CL. 21.
- ONSCREEN SCIENCE, INC., SOMERVILLE, MA:
1,929,535. REN. 9-3-05. INT. CL. 9.
- OPEN JOINT STOCK COMPANY "WIMM-BILL-DANN FOODS", MOSCOW, 109028, RUSSIAN FED.:
3,007,208, PUB. 6-7-2005. INT. CL. 32.
- OPEN RATINGS, INC., WALTHAM, MA:
3,007,227, PUB. 7-26-2005. MULTIPLE CLASS, INT. CLS. 9 AND 35.
- OPEN SOCIETY INSTITUTE, NEW YORK, NY:
3,007,123, PUB. 7-26-2005. MULTIPLE CLASS, INT. CLS. 16, 35, 36, 38 AND 41.
- OPEN SOURCE GROUP, INC., OAKMONT, PA:
3,007,521, PUB. 7-26-2005. INT. CL. 9.
- OPEN TEXT INC., BANNACKBURN, IL:
2,207,430, CANC. INT. CL. 9.
- OPHIR TOURS LTD., TEL AVIV, 61033, ISRAEL:
1,341,515. REN. 9-7-05. INT. CL. 39.
- OPTIMATIC CORP. T/A ENERJEE LTD., MORRISVILLE, PA:
2,206,763, CANC. INT. CL. 11.
- OPTIMOL OLWERKE INDUSTRIE GMBH, D-8000 MUNCHEN 80, FED REP GERMANY:
2,207,402, CANC. INT. CL. 4.
- ORCHARD-RITE LTD., YAKIMA, WA:
3,006,785, PUB. 7-26-2005. INT. CL. 11.
- ORDANO, CARLOS EMILIO, PROVINCIA DE BUENOS AIRES, ARGENTINA AND GALINDO, JOSE SEBASTIAN, PROVINCIA DE BUENOS AIRES, ARGENTINA AND GALINDO, MARCELO, PROVINCIA DE BUENOS AIRES, ARGENTINA:
3,007,614, INT. CL. 25.
- ORDAZ, AARON GOMEZ, FRESNO, CA:
3,007,112, PUB. 7-26-2005. INT. CL. 30.
- OREGON AERO, INC., SCAPPOOSE, OR:
3,008,090, INT. CL. 12.
- OREGON DENTAL SERVICE, PORTLAND, OR:
3,007,476, PUB. 7-26-2005. INT. CL. 36.
- ORGANIZATION DESIGN AND DEVELOPMENT, INC., KING OF PRUSSIA, PA:
2,386,245, AM. INT. CL. 9.
- ORGANON TEKNIKA B.V., 5281 RM BOXTEL, NETHERLANDS:
2,207,721, CANC. MULTIPLE CLASS, INT. CLS. 1 AND 5.
- ORGEL, ROBERT F., KANSAS CITY, MO:
2,206,821, CANC. MULTIPLE CLASS, INT. CLS. 9 AND 35.
- ORION FOOD SYSTEMS, LLC, SIOUX FALLS, SD:
2,947,687, COR. MULTIPLE CLASS, INT. CLS. 29, 30 AND 35.
- ORLY INTERNATIONAL, INC, CHATSWORTH, CA:
3,008,005, INT. CL. 3.

- OROMI, INC., NORTH BERGEN, NJ:
1,935,467. REN. 9-7-05. INT. CL. 14.
- OROS, MARY LOUISE, OAKLAND, CA:
2,207,766. CANC. INT. CL. 25.
- ORTHOCADD SERVICES, INC., MILFORD, CT:
2,206,404. CANC. INT. CL. 9.
- ORTIS LABORATORIES SPRI, B 4750 ELSENBORN, BELGIUM:
1,902,372. REN. 9-9-05. INT. CL. 5.
- ORVITEK, INC., MARKHAM, ONTARIO, CANADA:
2,207,583. CANC. INT. CL. 9.
- OTX CORPORATION, HOLLYWOOD, CA:
3,007,073. PUB. 7-26-2005. INT. CL. 35.
- OUTDOOR RECREATION GROUP, THE:
1,307,042. CANC. INT. CL. 18.
- OUTDOOR RESEARCH, INC., SEATTLE, WA:
3,007,471. PUB. 7-26-2005. INT. CL. 25.
- OUTILLAGE MAGAFOR, 94122 FONTENAY SOUS BOIS, FRANCE:
3,006,850. PUB. 7-26-2005. INT. CL. 7.
- OUTSET, INC., VICTORIA, MN:
3,007,654. INT. CL. 21.
- OWEN EDWARDS COMPANY, LLC, BLOOMINGTON, IN:
2,206,342. CANC. INT. CL. 3.
- OWENS-CORNING FIBERGLAS TECHNOLOGY INC., SUMMIT, IL:
2,207,293. CANC. INT. CL. 16.
- OY KWH MIRKA AB, 66850 JEPPO, FINLAND:
2,206,639. CANC. INT. CL. 3.
- P & B TRADE, INC., MIAMI, FL:
3,006,858. PUB. 7-26-2005. MULTIPLE CLASS, INT. CLS. 24, 25 AND 35.
- PACESETTER, INC., SYLMAR, CA, DBA ST. JUDE MEDICAL CARDIAC RHYTHM MANAGEMENT DIVISION:
3,007,925. INT. CL. 10.
- PACIFIC INTERNATIONAL STG., INC., SAN JOSE, CA AND KAIJO CORPORATION, HAMURA-CITY, JAPAN:
3,007,739. INT. CL. 9.
- PACIFIC TELESIS GROUP, SAN FRANCISCO, CA:
1,905,138. REN. 9-6-05. INT. CL. 38.
- PAGES BOOKS FAIRS, INC., ST. PETERSBURG, FL:
2,207,234. CANC. INT. CL. 35.
- PAISANO PUBLICATIONS, LLC, AGOURA HILLS, CA:
1,887,142. REN. 9-6-05. INT. CL. 16.
- PALISADES BASEBALL, SANTA MONICA, CA:
1,932,621. REN. 9-3-05. INT. CL. 25.
2,207,135. CANC. MULTIPLE CLASS, INT. CLS. 16 AND 25.
- PANAFAST LLC, PALM BEACH, FL:
2,207,627. CANC. INT. CL. 6.
- PANAVISION INTERNATIONAL L.P., WOODLAND HILLS, CA:
3,008,003. INT. CL. 9.
- PANELS & CONTROLS CORP., GLENVIEW, IL:
1,864,551. CANC. INT. CL. 9.
- PANGAEA MULTIMEDIA COMMUNICATIONS CORPORATION, CAMBRIDGE, MA:
3,008,020. INT. CL. 9.
- PANORAMA BUSINESS VIEWS INC, TORONTO ONTARIO, CANADA:
1,909,849. REN. 9-6-05. INT. CL. 9.
- PAPER CORPORATION OF AMERICA, WAYNE, DE:
1,306,952. CANC. INT. CL. 16.
- PAPER CORPORATION OF AMERICA, WAYNE, PA:
1,307,094. CANC. INT. CL. 22.
- PARA LABORATORIES, INC., HEMPSTEAD, NY:
3,007,704. INT. CL. 3.
- PARAGON PLASTICS INCORPORATED, UNION, SC, LUNKER LURE PRODUCTS, INC., CARTERVILLE, IL:
1,902,864. REN. 9-3-05. INT. CL. 28.
- PARALLEL MEDIA, INC., LOS ANGELES, CA:
3,007,197. PUB. 7-26-2005. INT. CL. 9.
- PARAMOUNT FINANCIAL SERVICES, INC., POMPANO BEACH, FL:
2,101,639. CANC. MULTIPLE CLASS, INT. CLS. 35 AND 36.
- PARASOFT CORPORATION, MONROVIA, CA:
2,207,428. CANC. INT. CL. 9.
2,207,653. CANC. INT. CL. 9.
- PARFUMS DE COEUR, LTD., DARIEN, CT:
2,207,698. CANC. INT. CL. 3.
- PARIS PRESENTS INCORPORATED, GURNEE, IL:
3,007,871. MULTIPLE CLASS, INT. CLS. 3 AND 25.
- PARK CITY SOLUTIONS, INC., MIDWAY, UT:
3,007,595. MULTIPLE CLASS, INT. CLS. 9, 37, 41 AND 42.
- PARKER INTANGIBLES LLC, CLEVELAND, OH:
993,720. REN. 9-8-05. U.S. CL. 21 (INT. CL. 9).
- PARKER, KAREN L, HURRICANE, UT:
3,007,185. PUB. 7-26-2005. INT. CL. 16.
- PARTHENA COSMETICS LLC, MIAMI, FL:
2,207,771. CANC. INT. CL. 3.
- PARTIDA, FLORA IRMA, CUAUHTEMOC, MEXICO:
2,953,290. COR. INT. CL. 25.
- PARTNER PROVIDER HEALTH INC., BETHESDA, MD:
2,207,085. CANC. INT. CL. 42.
- PARTYLITE WORLDWIDE, INC., PLYMOUTH, MA:
3,007,391. PUB. 7-26-2005. INT. CL. 21.
- PASTICCERIA LUCA INC., BRONX, NY:
2,207,563. CANC. MULTIPLE CLASS, INT. CLS. 35 AND 42.
- PATIENT CARE TECHNOLOGIES, INC., ATLANTA, GA:
1,923,460. REN. 9-6-05. INT. CL. 9.
- PATRICIA J. MICHAELS, A U. S. CITIZEN, AS TRUSTEE OF THE MICHAELS TRUST, SANTA MONICA, CA:
2,206,346. CANC. INT. CL. 35.
- PATRICK HUANG, BURNABY, BC, CANADA, KESSLER MARKETING GROUP, INC., REISTERSTOWN, MD:
1,903,088. REN. 9-7-05. INT. CL. 41.
- PATTERSON, BELL & CRANE COMPANY, CHARLESTON, WV:
2,207,190. CANC. INT. CL. 36.
- PATULSKI, WALTER G., SYRACUSE, NY:
2,207,588. CANC. INT. CL. 9.
- PAUL BUNYAN, INC., MIAMI, FL:
3,007,494. PUB. 7-26-2005. INT. CL. 20.
- PAUL ECKE RANCH, INC., ENCINITAS, CA:
1,925,746. REN. 9-7-05. INT. CL. 31.
- PAUL LAVITT MILLS, INC., LINCOLNTON, NC:
1,349,510. REN. 9-6-05. INT. CL. 25.
- PAVILION FURNITURE, INC., MIAMI, FL:
3,008,001. INT. CL. 20.
- PAXTON-MITCHELL CO., OMAHA, NE:
794,002. REN. 9-7-05. U.S. CL. 23 (INT. CL. 7).
- PAXTON-MITCHELL COMPANY, OMAHA, NE:
1,347,208. REN. 9-3-05. INT. CL. 6.
- PAYLESS SHOESOURCE WORLDWIDE, INC., TOPEKA, KS, PAYLESS SHOESOURCE, INC., TOPEKA, KS:
1,903,614. REN. 9-6-05. INT. CL. 25.
- PAYLESS SHOESOURCE WORLDWIDE, INC., TOPEKA, KS:
2,207,041. CANC. INT. CL. 35.
- PC HOMEWORKS CORP., WAYNE, PA:
2,206,931. CANC. MULTIPLE CLASS, INT. CLS. 41 AND 42.
- PC MALL SALES, INC., TORRANCE, CA:
1,904,278. REN. 9-7-05. MULTIPLE CLASS, INT. CLS. 37 AND 42.
1,904,278. CANC. INT. CL. 9.
- PCA INTERNATIONAL, INC., MATTHEWS, NC:
2,207,312. CANC. INT. CL. 42.
- PDK AUTOMOTIVE ENTERPRISES, INC., MERRILLVILLE, IN:
3,006,868. PUB. 7-26-2005. INT. CL. 9.
- PEACHTREE DOORS AND WINDOWS INC., NORCROSS, GA:
3,007,603. INT. CL. 19.
- PEARCE, NATHAN, RALEIGH, NC:
2,207,160. CANC. INT. CL. 42.
- PEAVEY ELECTRONICS CORPORATION, MERIDIAN, MS:
1,347,371. REN. 9-6-05. INT. CL. 9.
1,349,001. REN. 9-3-05. INT. CL. 9.
- PEGASUS SYSTEMS, INC., AURORA, CO:
1,864,560. CANC. INT. CL. 9.
- PELCO, CLOVIS, CA:
1,864,540. CANC. INT. CL. 9.

- PELLETRON CORPORATION, LANCASTER, PA:
3,007,054, PUB. 7-26-2005. INT. CL. 39.
- PENFACT INC, BOSTON, MA:
1,865,187, CANC. INT. CL. 9.
- PENGUIN BOOKS USA INC., NEW YORK, NY TO PEN-
GUIN PUTNAM INC, NEW YORK, NY:
1,864,724, CANC. INT. CL. 16.
- PENN MEDICAL INFORMATICS SYSTEMS, INC., ALTOO-
NA, PA:
3,007,237, PUB. 7-26-2005. INT. CL. 9.
- PENN-WHITE LIMITED, CHESHIRE CW12 -4XJ, UNITED
KINGDOM:
3,006,890, PUB. 7-26-2005. INT. CL. 3.
- PENNWELL PUBLISHING COMPANY, TULSA, OK:
2,207,745, CANC. INT. CL. 41.
- PENNYWORTH'S OF PEABODY INC., PEABODY, MA:
1,307,131, CANC. INT. CL. 25.
- PENRAY COMPANIES, INC., THE, WHEELING, IL:
1,358,700, REN. 9-7-05. INT. CL. 1.
- PENRAY COMPANIES, INC., THE, WHEELING, IL, JETGO
AUTO PRODUCTS, INC., NEWARK, NJ:
1,984,033, REN. 9-7-05. INT. CL. 4.
- PENTAPHARM LTD., 4052 BASLE, SWITZERLAND:
1,864,457, CANC. INT. CL. 1.
- PENTECH INTERNATIONAL INC., EDISON, NJ:
1,865,257, CANC. INT. CL. 16.
- PEP BOYS MANNY, MOE & JACK OF CALIFORNIA, THE,
PHILADELPHIA, PA:
1,395,353, REN. 9-6-05. INT. CL. 42.
- PER ANNUM, INC., NEW YORK, NY:
1,906,521, REN. 9-3-05. INT. CL. 16.
- PERDUE FARMS INCORPORATED, SALISBURY, MD:
1,864,832, CANC. INT. CL. 29.
- PEREDNIA, THEODORE, GREENWICH, CT AND KUG-
LER, BARBARA VOGT, GREENWICH, CT, PEREDNIA,
THEODORE, NEW YORK, NY:
1,905,686, REN. 9-9-05. INT. CL. 25.
- PEREZ, GIUSEPPE, NAPLES, ITALY:
3,007,830, INT. CL. 14.
- PEREZ, LEO J., SAN CLEMENTE, CA AND AKULLIAN,
SUZANNE U., SAN CLEMENTE, CA:
3,007,805, MULTIPLE CLASS, INT. CLS. 9 AND 14.
- PERFECT TIMING, INC., NEW YORK, NY:
2,806,060, CANC. INT. CL. 25.
- PERFECTLY SAFE, INC., NORTH CANTON, OH TO KIDS
STUFF, INC, NORTH CANTON, OH:
1,865,030, CANC. INT. CL. 42.
- PERFORMANCE ANALYTICS, INC., PALO ALTO, CA:
3,007,258, PUB. 7-26-2005. INT. CL. 9.
- PERFORMANCE INSIGHTS, LLC, GREENWOOD VIL-
LAGE, CO:
3,007,845, MULTIPLE CLASS, INT. CLS. 9, 16 AND 41.
- PERFUMER'S WORKSHOP INTERNATIONAL, LTD., THE,
NEW YORK, NY:
2,207,310, CANC. INT. CL. 3.
- PERKY-PET PRODUCTS COMPANY, DENVER, CO:
2,206,964, CANC. INT. CL. 6.
- PERRY, TAMMY E., JACKSONVILLE, TX:
3,007,330, PUB. 7-26-2005. INT. CL. 41.
- PERSONAL ATTITUDE, INC., NEW YORK, NY:
2,206,800, CANC. INT. CL. 18.
- PERSONNEL DECISIONS INTERNATIONAL CORPORA-
TION, MINNEAPOLIS, MN:
3,007,579, INT. CL. 16.
- PERUVIAN IMPORT COMPANY, PASSAIC, NJ:
3,007,418, PUB. 7-26-2005. MULTIPLE CLASS, INT. CLS.
29 AND 30.
- PETER INSALACO, INC., NEW YORK, NY, DBA RAVEN
ENERGY:
1,865,466, CANC. INT. CL. 16.
- PETER JACKSON (OVERSEAS) LIMITED, LONDON WC2R
2PG, ENGLAND:
1,864,887, CANC. INT. CL. 34.
- PETLAND, INC., CHILLICOTHE, OH:
1,900,546, REN. 9-3-05. INT. CL. 11.
- PFIZER INC., NEW YORK, NY:
1,360,101, REN. 9-7-05. INT. CL. 5.
- PHARMACIA & UPJOHN COMPANY LLC, MORRIS
PLAINS, NJ, PHARMACIA INC., COLUMBUS, OH:
1,959,144, REN. 9-9-05. INT. CL. 5.
- PHARMACIA LKB BIOTECHNOLOGY AB, S-751 82 UPPSA-
LA, SWEDEN TO AMERSHAM PHARMACIA BIOTECH
AB, UPPSALA, SWEDEN:
1,865,200, CANC. INT. CL. 9.
- PHARMACIA, INC., PISCATAWAY, NJ:
1,306,776, CANC. INT. CL. 5.
- PHARMHEALTH, INC., OMAHA, NE:
3,007,691, INT. CL. 36.
- HELPS DODGE CORPORATION, PHOENIX, AZ:
1,902,471, REN. 9-3-05. INT. CL. 9.
- PHH GROUP, INC., HUNT VALLEY, MD:
1,307,387, CANC. MULTIPLE CLASS, INT. CLS. 35, 36, 39
AND 42.
- PHI SIGMA RHO NATIONAL SORORITY, INC., CLEVE-
LAND, OH:
3,006,911, PUB. 7-26-2005. MULTIPLE CLASS, INT. CLS.
16, 25 AND 35.
- PHILADELPHIA AMERICAN LIFE INSURANCE COM-
PANY, HOUSTON, TX:
1,901,885, REN. 9-3-05. INT. CL. 36.
- PHILADELPHIA CHEWING GUM CORPORATION, HA-
VERTOWN, PA:
1,307,338, CANC. INT. CL. 30.
- PHILADELPHIA GEAR CORPORATION, NORRISTOWN,
PA:
3,007,179, PUB. 7-26-2005. MULTIPLE CLASS, INT. CLS.
7, 37 AND 42.
- PHILIPPE COUSTEAU FOUNDATION, FT. PIERCE, FL:
3,006,832, PUB. 7-26-2005. MULTIPLE CLASS, INT. CLS.
16, 25 AND 35.
- PHILLIP ACKLAND HOLDINGS LTD., SUMMERLAND,
BRITISH COLUMBIA, CANADA:
3,007,411, PUB. 7-26-2005. INT. CL. 41.
- PHILLIPS, SHELLEY, GOODLETTSVILLE, TN:
3,007,619, MULTIPLE CLASS, INT. CLS. 9 AND 16.
- PHILLIPS, STEVEN, SAN FRANCISCO, CA:
3,007,955, INT. CL. 41.
- PHILOSOPHY, INC., PHOENIX, AR:
2,207,725, CANC. INT. CL. 25.
- PHOENIX BAKERY, INC., LOS ANGELES, CA:
1,328,808, REN. 9-6-05. INT. CL. 30.
- PHOENIX FIRE SYSTEMS, INC., DOTHAN, AL:
3,007,621, INT. CL. 9.
- PHYTO DYNAMICS, INC., LAFAYETTE, IN:
1,307,542, CANC. INT. CL. 42.
- PIANA COSMETICI S.P.A., CASTEL S. PIETRO TERME,
BOLOGNA, ITALY:
1,306,691, CANC. INT. CL. 3.
- PICK UP PHOTOS, LLC, LOS ANGELES, CA:
3,008,068, INT. CL. 41.
- PICTUREARTS CORPORATION, SOUTH PASADENA, CA:
3,006,958, PUB. 7-26-2005. INT. CL. 42.
- PIE-IN-THE-SKY, INC., BETTENDORF, IA:
3,008,016, INT. CL. 30.
- PIERRE FABRE SANTE, 92100 BOULOGNE, FRANCE:
2,206,305, CANC. MULTIPLE CLASS, INT. CLS. 3 AND 5.
- PIFFERI, PIERGORGIO, BOLOGNA, ITALY:
2,207,396, CANC. INT. CL. 16.
- PIMSLEUR, BEVERLY, NICE 06300, FRANCE:
1,901,515, REN. 9-3-05. INT. CL. 9.
- PINES INTERNATIONAL, INC., LAWRENCE, KS:
1,902,351, REN. 9-3-05. INT. CL. 5.
- PIONEER POTATO COMPANY, INC., PROVO, UT:
1,359,508, REN. 9-3-05. INT. CL. 30.
1,367,945, REN. 9-3-05. INT. CL. 30.
- PIXELVISION TECHNOLOGY, INC., ACTON, MA:
2,206,886, CANC. INT. CL. 9.
- PLANNED PARENTHOOD OF GREATER MIAMI, INC.,
COCONUT GROVE, FL:
2,096,142, CANC. INT. CL. 25.
- PLANT A TREE PROJECT OF ILLINOIS, INC., RIVER
GROVE, IL:
2,207,016, CANC. INT. CL. 42.
2,207,018, CANC. INT. CL. 42.

PLANT PRODUCTS CO., LTD., BRAMPTON, ONTARIO, CANADA:
1,370,746. REN. 9-7-05. INT. CL. 1.

PLASTI-FAB LTD., CALGARY, ALBERTA, CANADA:
3,007,575. MULTIPLE CLASS, INT. CLS. 17 AND 42.

PLATINUM TECHNOLOGY, INC., OAKBROOK TERRACE, IL:
2,207,423. CANC. INT. CL. 9.

PLAYTECH, LTD., TAI PO, N.T., HONG KONG:
1,865,089. CANC. MULTIPLE CLASS, INT. CLS. 11 AND 28.

PLEXICOR, INC., ANAHEIM, CA:
3,007,769. INT. CL. 37.

PLOCHMAN, INC., MANTENO, IL:
1,941,537. REN. 9-9-05. INT. CL. 30.

PLUS CORPORATION OF AMERICA, ALLENDALE, NJ:
2,207,448. CANC. INT. CL. 9.

PML ASSOCIATES, INC., GREENWOOD, SC:
3,007,703. INT. CL. 41.

POLAROID CORPORATION, CAMBRIDGE, MA TO POLAROID CORPORATION, WALTHAM, MA:
1,864,590. CANC. INT. CL. 9.

POLICY INVEST EURO, LTD., ROAD TOWN, TORTOLA, BR. VIRGIN ISLANDS:
1,306,819. CANC. MULTIPLE CLASS, INT. CLS. 9, 12, 17, 25 AND 28.

POLY SCIENTIFIC R & D CORP., BAY SHORE, NY:
3,007,320. PUB. 7-26-2005. MULTIPLE CLASS, INT. CLS. 1 AND 5.

PONY COMPUTER, INC., BEACHWOOD, OH:
1,865,179. CANC. INT. CL. 9.

POOCH, INC., DALLAS, TX:
1,865,279. CANC. INT. CL. 18.

PORTION-PAC CHEMICAL CORPORATION, CHICAGO, IL:
970,376. REN. 9-3-05. U.S. CL. 52 (INT. CL. 3).

PORTLAND MAINE BASEBALL, INC., PORTLAND, ME:
1,901,701. REN. 9-3-05. MULTIPLE CLASS, INT. CLS. 16 AND 25.

POST-MARK INC., ALPHARETTA, GA:
3,006,892. PUB. 7-26-2005. MULTIPLE CLASS, INT. CLS. 9, 18, 22 AND 27.

POTOMAC TOBACCO COMPANY LIMITED, ROAD TOWN, TORTOLA, BR. VIRGIN ISLANDS:
3,006,819. PUB. 7-26-2005. INT. CL. 34.

POWER PLAY POPS, LOS GATOS, CA:
2,207,732. CANC. INT. CL. 30.

PPC MARKETING, LTD., PITTSBURG, TX, PIERCE FOODS CORPORATION, MOOREFIELD, WV:
1,346,504. REN. 9-3-05. INT. CL. 29.

PPC MARKETING, LTD., PITTSBURG, TX:
1,351,941. REN. 9-7-05. INT. CL. 29.
1,378,303. REN. 9-7-05. INT. CL. 29.

PRATT & LAMBERT, INC., BUFFALO, NY TO SWIMC, INC., WILMINGTON, DE:
1,864,470. CANC. INT. CL. 2.

PRATT, RANDY, MANHASSET, NY:
3,007,912. INT. CL. 41.

PRECISION CARE INC., BOHEMIA, NY:
2,207,307. CANC. INT. CL. 3.

PRECISION LABORATORIES, INC., NORTHBROOK, IL:
2,206,674. CANC. INT. CL. 1.

PRECISION SAMPLING INCORPORATED, RICHMOND, CA:
1,910,630. REN. 9-7-05. INT. CL. 42.
1,941,440. REN. 9-6-05. INT. CL. 7.

PREMIER DENTAL PRODUCTS COMPANY, NORRIS-TOWN, PA:
1,306,749. CANC. MULTIPLE CLASS, INT. CLS. 5 AND 10.

PREMIER POWERTRAIN PROTECTION PLAN CO., INC., JOPLIN, MO:
2,104,758. CANC. INT. CL. 36.

PREMIUM LEASING LIMITED LIABILITY COMPANY, OGDEN, UT, DBA PREMIUM ICE CREAM COMPANY:
1,907,508. REN. 9-3-05. INT. CL. 29.

PRESBYTERIAN VILLAGES OF MICHIGAN, REDFORD, MI:
3,007,372. PUB. 7-26-2005. MULTIPLE CLASS, INT. CLS. 43 AND 44.

PRESERVE, INC., FALLS CHURCH, VA:
2,206,421. CANC. INT. CL. 16.

PRESSMAN, ALBERT E., GATESVILLE, TX:
2,207,661. CANC. INT. CL. 42.

PRESTIGE MEDICAL CORPORATION, NORTHRIDGE, CA:
2,207,754. CANC. INT. CL. 18.

PRICESMART, INC., SAN DIEGO, CA:
2,207,722. CANC. INT. CL. 25.

PRIME ARTEMIA INCORPORATED, MIDVALE, UT:
2,096,711. CANC. INT. CL. 31.

PRIME HOSPITALITY CORP., FAIRFIELD, NJ:
2,207,053. CANC. INT. CL. 42.

PRIME NATIONAL PUBLISHING CORPORATION, WESTON, MA:
3,008,049. INT. CL. 16.

PRIMEPAY, INC., MALVERN, PA:
3,006,939. PUB. 7-26-2005. INT. CL. 35.

PRIMO'S PIZZA INTERNATIONAL, INC., DETROIT, MI:
1,307,512. CANC. INT. CL. 42.
1,307,517. CANC. INT. CL. 42.

PRINCE MINERALS, INC., QUINCY, IL, DBA THE PRINCE MANUFACTURING CO.:
1,902,265. REN. 9-9-05. INT. CL. 1.

PRINCE SPORTS GROUP, INC., BORDENTOWN, PA:
2,207,245. CANC. INT. CL. 28.

PRINTABLE TECHNOLOGIES, INC., SOLANA BEACH, CA:
3,007,308. PUB. 7-26-2005. INT. CL. 9.

PRINTS CHARMING, INC., SHREVEPORT, LA:
2,206,977. CANC. MULTIPLE CLASS, INT. CLS. 20 AND 24.

PRINTWARE, INC., ST. PAUL, MN:
2,206,457. CANC. INT. CL. 9.

PRITCHETT & HULL ASSOCIATES, INC., ATLANTA, GA:
1,376,550. REN. 9-9-05. INT. CL. 16.

PRITCHETT, ANDREA N., NEW YORK, NY:
3,006,816. PUB. 7-26-2005. INT. CL. 41.

PRO TECT ASSOCIATES, INC., NORTHFIELD, IL:
3,007,063. PUB. 7-26-2005. INT. CL. 17.

PRO-PROMPT, INC.:
1,307,544. CANC. INT. CL. 42.

PRO-SWING, INC., WADSWORTH, OH:
2,207,294. CANC. INT. CL. 28.

PROCESSADORA COMPOFRESCO, INC., SANTA ISABEL, PUERTO RICO, V. SUAREZ & CO., INC., SAN JUAN, PUERTO RICO:
1,876,815. REN. 9-9-05. INT. CL. 32.

PRODD, CRESWELL, OR:
3,007,169. PUB. 7-26-2005. INT. CL. 41.

PRODUCTOS DE LECHE CORONADO, S.A. DE C.V., C.P. 78250 SAN LUIS POTOSI, S.L.P., MEXICO TO CENTRAL IMPULSORA, S.A. DE C.V., MEXICO CITY, MEXICO:
1,864,847. CANC. INT. CL. 30.

PRODUITS POUR TOITURES FRANSYL LTEE, TERRE-BONNE, QUEBEC, CANADA:
3,007,449. PUB. 7-26-2005. INT. CL. 17.

PROFESSIONAL BOWLERS ASSOCIATION OF AMERICA, AKRON, OH:
2,207,717. CANC. MULTIPLE CLASS, INT. CLS. 6, 14, 16, 18, 21, 24, 25, 28, 35, 41 AND 42.

PROFESSIONAL SECURITY ALLIANCE, INC., DENVER, CO, DBA PSA SECURITY NETWORK:
3,007,423. PUB. 7-26-2005. MULTIPLE CLASS, INT. CLS. 9, 35 AND 41.

PROGRESSIVE CRANE, INC., CLEVELAND, OH:
1,345,630. REN. 9-3-05. INT. CL. 7.

PROGRESSIVE GROCER ASSOCIATES LLC, DARIEN, CT:
2,207,272. CANC. INT. CL. 16.

PROHEALTH PARTNERS, A MEDICAL GROUP, INC., LONG BEACH, CA:
2,207,185. CANC. INT. CL. 42.

PROJECT COOL, INC., PALO ALTO, CA:
2,069,142. CANC. INT. CL. 42.

PROMETHEUS BOOKS, INC., AMHERST, NY:
3,007,988. INT. CL. 16.

PRONOUNCED TECHNOLOGIES, LLC, CA, AMERIGON, INC., BURBANK, CA:
1,869,416. REN. 9-3-05. INT. CL. 9.

- PROSTRONG, INC., OAKVILLE, CT:
2,207,765, CANC. INT. CL. 3.
- PRUDENTIAL INSURANCE COMPANY OF AMERICA,
THE, NEWARK, NJ:
1,864,916, CANC. INT. CL. 36.
- PSYCHOGENICS INC., TARRYTOWN, NY:
3,007,735, INT. CL. 42.
- PSYCHOLOGICAL CORPORATION, THE, SAN ANTONIO,
TX:
1,865,446, CANC. INT. CL. 42.
- PUBLIC BROADCASTING SERVICE, ALEXANDRIA, VA,
AKA PBS:
3,007,780, INT. CL. 41.
- PUBLIX SHIRT COMPANY, L.P., NEW YORK, NY:
1,307,173, CANC. INT. CL. 25.
- PUERTO RICAN CEMENT COMPANY, INC., SAN JUAN,
PUERTO RICO:
1,864,731, CANC. INT. CL. 19.
- PULSAFEEDER, INC., ROCHESTER, NY:
3,007,005, PUB. 7-26-2005. INT. CL. 9.
- PUTNAM, LEAH J., MOUNTAIN VIEW, CA:
1,912,786, REN. 9-7-05. INT. CL. 41.
- Q SOUND LABS, INC., CALGARY, ALBERTA, CANADA,
ARCHER COMMUNICATIONS INC., CALGARY, ALBER-
TA, CANADA:
1,904,857, REN. 9-3-05. MULTIPLE CLASS, INT. CLS. 9
AND 28.
- QUAKER CHEMICAL CORPORATION, WILMINGTON,
DE:
3,007,375, PUB. 7-26-2005. INT. CL. 2.
- QUAKER PLASTIC CORPORATION, MOUNTVILLE, PA:
1,372,559, REN. 9-9-05. INT. CL. 19.
- QUAKER STATE MINIT-LUBE, INC., SALT LAKE CITY, UT
TO QUAKER STATE MINIT-LUBE, INC., SALT LAKE
CITY, UT:
1,864,708, CANC. INT. CL. 16.
- QUANTUM PHOTO LAB, INC., HOUSTON, TX:
2,206,725, CANC. INT. CL. 40.
- QUARELLA S.P.A., VERONA, ITALY, QUARELLA S.P.A.,
VERONA, ITALY:
1,904,429, REN. 9-6-05. INT. CL. 19.
- QUEEN CARPET CORP., DALTON, GA:
2,207,737, CANC. INT. CL. 27.
- QUEST TECHNOLOGIES, INC., OCONOMOWOC, WI:
3,007,248, PUB. 7-26-2005. MULTIPLE CLASS, INT. CLS.
37, 41 AND 42.
- QUESTNET CORP., PRINCETON, NJ:
3,006,881, PUB. 7-26-2005. MULTIPLE CLASS, INT. CLS.
36 AND 38.
- QUIGLEY COMPANY, INC., NEW YORK, NY:
1,306,644, CANC. INT. CL. 1.
- QUIKTRIP WEST, INC., WICHITA, KS:
3,007,897, INT. CL. 32.
- QUILL COMPANY, INC., THE, CRANSTON, RI:
2,206,966, CANC. INT. CL. 16.
- QUILLIN, PATRICK, TULSA, OK:
2,207,240, CANC. INT. CL. 5.
- QUINTON ELECTROPHYSIOLOGY CORPORATION,
MARKHAM, ONTARIO, CANADA:
2,207,387, CANC. INT. CL. 10.
- QUIPU, LLC, SAN FRANCISCO, CA:
2,206,537, CANC. MULTIPLE CLASS, INT. CLS. 9 AND
35.
- QVC, INC., WEST CHESTER, PA:
3,007,629, INT. CL. 25.
3,007,898, INT. CL. 35.
- QWEST COMMUNICATIONS INTERNATIONAL INC, DEN-
VER, CO, QWEST COMMUNICATIONS CORPORATION,
DENVER, CO:
1,966,694, REN. 9-7-05. INT. CL. 38.
- QWEST COMMUNICATIONS INTERNATIONAL INC.,
DENVER, CO:
1,352,028, REN. 9-8-05. INT. CL. 38.
1,352,028, CANC. MULTIPLE CLASS, INT. CLS. 35, 36, 37,
41 AND 42.
3,007,339, PUB. 7-26-2005. INT. CL. 38.
- R & N CORD ENTERPRISES, INC., RENO, NV:
3,006,949, PUB. 7-26-2005. INT. CL. 34.
- R.A. RASMUSSEN & SONS, INC., GRANGER, WA:
1,968,130, REN. 9-7-05. INT. CL. 31.
- RACHEL'S WELL, INC., BURKE, VA:
3,007,466, PUB. 7-26-2005. INT. CL. 35.
- RADI MEDICAL SYSTEMS AB, UPPSALA, SWEDEN:
3,006,852, PUB. 7-26-2005. INT. CL. 5.
3,006,853, PUB. 7-26-2005. INT. CL. 5.
- RADIAN CORPORATION, AUSTIN, TX TO RADIAN IN-
TERNATIONAL LLC, AUSTIN, TX:
1,865,127, CANC. INT. CL. 1.
- RADIO & RECORDS, INC., LOS ANGELES, CA:
3,008,030, INT. CL. 35.
- RAFLATAC OY, 33310 TAMPERE, FINLAND:
3,007,755, INT. CL. 16.
- RAIKE, FRED, MICHAEL, INCLINE VILLAGE, CA AND
RAIKE, JULIE, A, INCLINE VILLAGE, NV:
3,008,100, INT. CL. 16.
- RAINBOW STUDIES, INC., EL RENO, OK:
1,883,560, REN. 9-7-05. INT. CL. 16.
- RAINING DATA U.S., INC., IRVINE, CA:
1,299,324, REN. 9-8-05. INT. CL. 9.
- RAM GOLF CORPORATION, MELROSE PARK, IL:
1,307,226, CANC. INT. CL. 28.
- RAMKRISHNA, KHEMRAJ, BROOKLYN, NY AND ON,
JOE RAYMOND, BROOKLYN, NY:
3,007,142, PUB. 7-26-2005. INT. CL. 44.
- RAMPARTS, INC., LAS VEGAS, NV:
1,922,827, REN. 9-7-05. INT. CL. 6.
- RAMVAC DENTAL PRODUCTS, INC., SPEARFISH, SD:
3,008,041, INT. CL. 10.
- RANDALL PRODUCTIONS COMPANY, CLEVELAND, OH:
3,007,715, INT. CL. 3.
3,007,716, INT. CL. 25.
- RANDALSHAYE ENTERPRISES, INC., THOUSAND OAKS,
CA:
3,007,066, PUB. 7-26-2005. INT. CL. 3.
- RANDOM HOUSE, INC., NEW YORK, NY, BANTAM
DOUBLEDAY DELL PUBLISHING GROUP, INC., NEW
YORK, NY:
1,941,111, REN. 9-7-05. INT. CL. 16.
1,944,042, REN. 9-7-05. INT. CL. 16.
- RAPID DISPLAYS, INC., CHICAGO, IL:
2,206,359, CANC. MULTIPLE CLASS, INT. CLS. 20 AND
28.
- RASA FLOORS, CARROLLTON, TX:
2,207,753, CANC. INT. CL. 27.
- RAUTUREAU APPLE SHOES SA, 85130 LA GAUBRETIERE,
FRANCE:
2,207,145, CANC. INT. CL. 25.
2,207,278, CANC. INT. CL. 18.
- REACH THE CHILDREN, INC., FAIRPORT, NY:
3,006,796, PUB. 4-1-2003. MULTIPLE CLASS, INT. CLS. 41
AND 42.
- REACTOR SERVICES INTERNATIONAL, INC., ALVIN, TX:
1,307,507, CANC. INT. CL. 42.
- READER'S DIGEST ASSOCIATION, INC., THE, PLEASANT-
VILLE, NY:
2,207,703, CANC. INT. CL. 16.
- REAL OFFICE SOLUTIONS, INC., LOUISVILLE, CO:
2,206,469, CANC. MULTIPLE CLASS, INT. CLS. 35 AND
42.
- REALM HOLDINGS, LLC, MASON, OH:
3,008,000, INT. CL. 9.
- RECRUITING NEW TEACHERS, INC., BELMONT, MA:
1,914,891, REN. 9-6-05. MULTIPLE CLASS, INT. CLS. 16,
41 AND 42.
- RED & BLUE, INC., SAN DIEGO, CA, DBA RED & BLUE
AUTO RENTAL & LEASING:
2,206,699, CANC. INT. CL. 39.
- RED ROAD GROUP, INC., CORAL GABLES, FL:
2,206,998, CANC. INT. CL. 35.
- REDEVELOPMENT AGENCY OF SALT LAKE CITY, SALT
LAKE CITY, UT:
3,007,078, PUB. 7-26-2005. INT. CL. 41.
- REED ELSEVIER PROPERTIES INC., WILMINGTON, DE:
1,379,763, REN. 9-7-05. INT. CL. 42.
2,206,393, CANC. MULTIPLE CLASS, INT. CLS. 9, 16
AND 39.

REEMAY, INC., OLD HICKORY, TN:
1,871,041. REN. 9-9-05. INT. CL. 7.

REEVES BROTHERS, INC., SPARTANBURG, SC:
608,031. REN. 9-6-05. U.S. CL. 42 (INT. CL. 24).

REGAL INDUSTRIES, INC., PHILADELPHIA, PA:
1,344,294. REN. 9-3-05. INT. CL. 14.

REGALO INTERNATIONAL, LLC, GOLDEN VALLEY, MN:
2,207,488. CANC. INT. CL. 12.

REID-ROWELL, INC., MARIETTA, GA:
1,306,787. CANC. INT. CL. 5.

REIGNMAKERS, LLC, PRINCETON, IL:
3,007,926. INT. CL. 18.

REITER, ELIAS, BAL HARBOR, FL:
3,007,161. PUB. 7-26-2005. INT. CL. 32.

RELIANCE GROUP HOLDINGS, INC., PHILADELPHIA, PA:
2,207,189. CANC. INT. CL. 36.

RELIANCE TIME CONTROLS, INC., RACINE, WI:
2,207,082. CANC. INT. CL. 9.

RELIGIOUS TECHNOLOGY CENTER, LOS ANGELES, CA:
1,307,484. CANC. INT. CL. 41.
1,307,549. CANC. INT. CL. 42.
1,307,553. CANC. INT. CL. 42.

REMOTE DYNAMICS, INC., RICHARDSON, TX:
3,007,145. PUB. 7-26-2005. INT. CL. 35.

RENA ENTERPRISES, INC., SINKING SPRING, PA:
2,206,850. CANC. INT. CL. 25.

RENDOVA BOATS, L.L.C., OLYMPIA, WA:
2,207,022. CANC. INT. CL. 12.

RENTOKIL INITIAL PLC, WEST SUSSEX RH19 2JY, UNITED KINGDOM:
2,847,087. AM. MULTIPLE CLASS, INT. CLS. 5, 9, 11, 24, 25, 27, 31, 35, 37, 39, 40, 41 AND 42.

REPUBLIC INDUSTRIES, INC., CHICAGO, IL:
1,306,892. CANC. INT. CL. 9.

RESCAR, INC., DOWNERS GROVE, IL:
2,207,157. CANC. INT. CL. 42.

RESORT CONDOMINIUMS INTERNATIONAL, INC., INDIANAPOLIS, IN TO TM ACQUISITION CORP., PHOENIX, AZ:
1,235,234. AM. MULTIPLE CLASS, INT. CLS. 16 AND 36.

RESPOND LEARNING CENTER, INC., BALTIMORE, MD:
2,206,310. CANC. INT. CL. 41.

RETAIL CONCEPTS, INC., EAGAN, MN:
2,206,981. CANC. INT. CL. 35.

RETIRED PERSONS SERVICES, INC., ALEXANDRIA, VA:
1,306,746. CANC. INT. CL. 5.

REUTERS LIMITED, LONDON, EC4P 4AJ, UNITED KINGDOM:
2,207,081. CANC. MULTIPLE CLASS, INT. CLS. 9, 16, 35, 36, 37, 38 AND 42.

REVERE COPPER AND BRASS INCORPORATED, NEW YORK, NY:
192,443. CANC. U.S. CL. 14.

REVLON CONSUMER PRODUCTS CORPORATION, NEW YORK, NY:
1,914,460. REN. 9-3-05. INT. CL. 3.
3,007,822. INT. CL. 3.

REYNOLDS CONSUMER PRODUCTS, INC., RICHMOND, VA, DBA PRESTO PRODUCTS COMPANY, PRESTO PRODUCTS INCORPORATED, APPLETON, WI:
1,016,031. REN. 9-6-05. MULTIPLE CLASS, U.S. CLS. 2 (INT. CL. 16) AND 37 (INT. CL. 16).

RHEEM MANUFACTURING COMPANY, NEW YORK, NY:
1,804,327. REN. 9-3-05. INT. CL. 11.

RHINO ENTERTAINMENT COMPANY, LOS ANGELES, CA:
2,154,701. CANC. INT. CL. 9.

RHONE-POULENC SANTE, COURBEVOIE, FRANCE:
1,306,744. CANC. INT. CL. 5.

RICCOBENE MASONRY COMPANY, INC., ALBUQUERQUE, NM:
2,207,483. CANC. INT. CL. 19.

RICE KING FOODS, INC., EL CAJON, CA:
1,975,752. REN. 9-9-05. INT. CL. 42.

RICHARD A. EISNER & COMPANY, LLP, NEW YORK, NY:
2,207,750. CANC. INT. CL. 42.

RICHMOND HOLDINGS LIMITED, ALDERNEY, CHANNEL ISLANDS:
3,008,060. INT. CL. 41.

RICHMOND, CHARLES C., PETERBOROUGH, NH:
3,006,897. PUB. 7-26-2005. MULTIPLE CLASS, INT. CLS. 9, 16 AND 41.

RICKETTS, ROBERT ALAN, POLSON, MT:
1,918,864. REN. 9-6-05. INT. CL. 24.

RICOS INTELLECTUAL PROPERTY LTD., SAN ANTONIO, TX:
1,387,816. REN. 9-8-05. INT. CL. 42.

RID-GID PRODUCTS, INC., LAFAYETTE, CA:
1,307,050. CANC. INT. CL. 20.

RIDLEY BLOCK OPERATIONS, INC., MANKATO, MN:
3,008,011. INT. CL. 5.

RIDMARK CORPORATION, ROSEMONT, IL:
1,868,448. REN. 9-8-05. INT. CL. 28.

RIETER HOLDING LTD., 8406 WINTERTHUR, SWITZERLAND:
2,206,299. CANC. MULTIPLE CLASS, INT. CLS. 9, 40 AND 42.

RILEY MEDICAL, INC., AUBURN, ME:
1,939,147. REN. 9-7-05. INT. CL. 10.

RIMBACH PUBLISHING, INC., PITTSBURGH, PA:
1,306,974. CANC. INT. CL. 16.

RINALDI, OLIVIER H., 1050 CARACAS, VENEZUELA:
2,207,084. CANC. INT. CL. 20.

RISING PHARMACEUTICALS, INC., ALLENDALE, NJ:
3,007,993. INT. CL. 5.

RITZER, PETER A., AURORA, CO:
3,007,945. INT. CL. 35.

RIVER SHARPE, INC., LAWRENCE, KS TO RIVER SHARPE, L.L.C., WICHITA, KS:
1,864,782. CANC. INT. CL. 25.

RIVIANA FOODS INC., HOUSTON, TX:
1,844,958. REN. 9-3-05. MULTIPLE CLASS, INT. CLS. 16 AND 40.

RIZZOLI BOOKSTORES, INC., NEW YORK, NY, RIZZOLI INTERNATIONAL BOOKSTORES, INC., NEW YORK, NY:
1,354,705. REN. 9-9-05. INT. CL. 42.

RJ CHISOM, LLC, SCHUYLER, NE:
3,008,010. INT. CL. 25.

ROBBY NAISH, LTD., CHURCH RD, VA:
1,373,151. REN. 9-6-05. INT. CL. 12.

ROBERT KRUPS GMBH & CO. KG, 5650 SOLINGEN 19, FED REP GERMANY:
1,864,524. CANC. MULTIPLE CLASS, INT. CLS. 7 AND 21.

ROBERTSON MICROLIT LABORATORIES, INC., MADISON, NJ:
3,007,484. PUB. 7-26-2005. INT. CL. 42.

ROBIN HOOD MULTIFOODS CORPORATION, MARKHAM, ONTARIO, CANADA:
3,007,903. INT. CL. 30.

ROBLES, CHRIS, CORONA, CA:
2,206,454. CANC. INT. CL. 28.

ROBOTICS AUTOMATION CONSULTING ENGINEERING INDUSTRIES, INC., PLACENTIA, CA:
2,207,087. CANC. MULTIPLE CLASS, INT. CLS. 7 AND 9.

ROCAWEAR LICENSING, LLC, ALPINE, NY FROM COMET INTERCONTINENTAL, INC., NEW YORK, NY:
3,007,571. INT. CL. 14.

ROCHESTER COMMUNITY BASEBALL, ROCHESTER, NY:
3,007,329. PUB. 7-26-2005. INT. CL. 41.

ROCKET CITY TELEVISION, HUNTSVILLE, AL, DBA WAAY-TV:
1,307,473. CANC. INT. CL. 41.

ROCKFORD ACROMATIC PRODUCTS, LOVES PARK, IL:
2,206,954. CANC. INT. CL. 9.

ROCKY MOUNTAIN HOLDINGS, L.L.C., ENGLEWOOD, CO:
2,211,603. AM. MULTIPLE CLASS, INT. CLS. 37 AND 39.

RODALE INC., EMMAUS, PA:
3,006,983. PUB. 7-26-2005. MULTIPLE CLASS, INT. CLS. 35, 38, 41 AND 44.

3,007,443. PUB. 7-26-2005. MULTIPLE CLASS, INT. CLS. 16 AND 41.

- RODALE PRESS, INC., EMMAUS, PA:
1,307,021, CANC. INT. CL. 16.
- RODDEN, CURTIS E., TITUSVILLE, FL:
2,207,080, CANC. INT. CL. 9.
- ROE INCORPORATED, PERRYSBURG, OH:
2,207,674, CANC. INT. CL. 7.
- ROLF NILSSON AB, S-432 01, VARBERG, SWEDEN:
1,307,172, CANC. INT. CL. 25.
- ROLLE, BYRON KATIE, BARSTOW, CA:
2,207,142, CANC. INT. CL. 41.
- ROMANOFF TECHNOLOGIES OF OHIO LLC, COLUMBUS, OH:
2,206,803, CANC. MULTIPLE CLASS, INT. CLS. 37 AND 42.
- ROOM TO READ, SAN FRANCISCO, CA:
3,007,124, PUB. 7-26-2005. MULTIPLE CLASS, INT. CLS. 36 AND 41.
- ROSEN HOTELS & RESORTS, INC., ORLANDO, FL:
3,007,713, INT. CL. 43.
- ROSERAIES PIERRE GUILLOT, CHAMAGNIEU 38460 CREMIEU, FRANCE:
2,101,123, CANC. INT. CL. 31.
- ROUND-A-BOUT FARM, INC., QUAKERTOWN, PA:
1,307,035, CANC. INT. CL. 18.
- ROWAN ELECTRIC, INC., HOUSTON, TX:
3,007,203, PUB. 7-26-2005. INT. CL. 7.
- RSJ, INC., FLORENCE, SC:
3,007,098, PUB. 7-26-2005. INT. CL. 30.
- RSS SOLUTIONS INC., KITCHENER, ONTARIO, CANADA:
3,007,813, INT. CL. 9.
- RUAH RECORDS, MANCHESTER, NH:
2,206,604, CANC. INT. CL. 9.
- RUBBERMAID INCORPORATED, FREEPORT, IL:
1,317,001, REN. 9-8-05. INT. CL. 20.
- RUMS INTERNATIONAL, INC., SPRINGFIELD, NJ TO RUM COMPANY (JAMAICA) LTD., THE, KINGSTON, JAMAICA:
1,865,397, CANC. INT. CL. 33.
- RUSSELL, JANET, LA JOLLA, CA:
3,006,914, PUB. 7-26-2005. INT. CL. 41.
- RUTLEDGE, MICHAEL J., PLACENTIA, CA AND SCHOE-NAUER, KRIS M., PLACENTIA, CA:
1,864,490, CANC. INT. CL. 3.
- RXMED, INC., LOUISVILLE, KY:
1,902,964, REN. 9-8-05. INT. CL. 35.
- RYKA, INC., LAKEWOOD, NJ:
2,206,323, CANC. INT. CL. 9.
- S. C. JOHNSON & SON, INC., RACINE, WI:
3,007,874, INT. CL. 5.
- S. I. JACOBSON MFG. CO., WAUKEGAN, IL:
3,007,819, MULTIPLE CLASS, INT. CLS. 18, 21 AND 28.
- S. MICHAEL NOSTRANT AND ASSOCIATES, INC., TAR-ZANA, CA, DBA SNS DISTRIBUTING:
1,931,408, REN. 9-7-05. INT. CL. 24.
- S.A. INDUSTRIAL Y AGRICOLA PASCUAL TOSO, SAN JOSE, MENDOZA, ARGENTINA:
1,346,676, REN. 9-3-05. INT. CL. 33.
- S.C.S. & CO.S.R.L., MILANO, ITALY:
3,006,894, PUB. 7-26-2005. MULTIPLE CLASS, INT. CLS. 14 AND 18.
- S.E.G. INC., COLUMBUS, GA:
2,207,691, CANC. INT. CL. 28.
- S.I.L.O. - SOCIETA ITALIANA LAVORAZIONE ORO S.P.A., 2/R - CASTIGLION FIBOCCHI (AREZZO), ITALY:
2,206,278, CANC. INT. CL. 14.
- S&A RESTAURANT CORP., DALLAS, TX:
2,207,165, CANC. INT. CL. 42.
- S-T-N HOLDINGS, INC., LAS VEGAS, NV:
3,007,137, PUB. 7-26-2005. INT. CL. 1.
- SABER INTERNATIONAL, INC., HOUSTON, TX:
2,206,811, CANC. INT. CL. 1.
2,206,812, CANC. INT. CL. 1.
2,206,813, CANC. INT. CL. 1.
2,206,814, CANC. INT. CL. 1.
- SAEED MAHAMED BASAMH, JEDDAH 21464, SAUDI ARABIA:
3,007,244, PUB. 7-26-2005. MULTIPLE CLASS, INT. CLS. 29, 30 AND 32.
- SAFETY WARNING SYSTEM, L.C., THE, ENGLEWOOD, FL:
2,207,413, CANC. INT. CL. 9.
- SAGE ENGINEERING, INC., HOUSTON, TX:
2,206,655, CANC. INT. CL. 9.
- SAGEFIRE, INC., BOULDER, CO:
3,006,960, PUB. 7-26-2005. MULTIPLE CLASS, INT. CLS. 9 AND 42.
- SAKRETE, INC., CINCINNATI, OH:
3,007,259, PUB. 7-26-2005. MULTIPLE CLASS, INT. CLS. 1, 2, 3, 17 AND 19.
- SALLEN, CHRISTOPHER R., PALM BEACH GARDENS, TX AND DAVIS, RICHARD J., PALM BEACH GARDENS, FL:
1,948,859, REN. 9-8-05. INT. CL. 42.
- SAMMI INTERNATIONAL CORP., RIDGEFIELD, NJ:
3,007,047, PUB. 7-26-2005. INT. CL. 25.
- SAMSUNG TECHWIN CO., LTD., KYUNGSANGNAM-DO, REPUBLIC OF KOREA:
3,006,824, PUB. 7-26-2005. INT. CL. 9.
- SAN-EI GEN F.F.I., INC., TOYONAKA, OSAKA 561-8588, JAPAN:
2,854,046, COR. MULTIPLE CLASS, INT. CLS. 3, 20, 30 AND 33.
- SANDBERG & SIKORSKI DIAMOND CORPORATION, NEW YORK, NY:
2,207,195, CANC. INT. CL. 14.
- SANDERSON, BRYAN A., WILLIAMSBURG, VA:
3,007,367, PUB. 7-26-2005. INT. CL. 37.
- SANDVIK INTELLECTUAL PROPERTY AB, SE-811 81 SANDVIKEN, SWEDEN:
1,902,396, REN. 9-3-05. INT. CL. 7.
- SANFORD, L.P., FREEPORT, IL, SANFORD INK COM-PANY, BELLWOOD, IL:
791,853, REN. 9-6-05. U.S. CL. 37 (INT. CL. 16).
- SANTA CLARA, INC., WHIPPANY, NJ:
2,207,506, CANC. INT. CL. 34.
- SANYO ELECTRIC CO., LTD., MORIGUCHI CITY, OSAKA 570, JAPAN:
2,206,275, CANC. MULTIPLE CLASS, INT. CLS. 7, 9 AND 11.
- SARA LEE CORPORATION, WINSTON-SALEM, NC:
2,207,503, CANC. INT. CL. 25.
- SARA LEE FOODS, INC., CINCINNATI, OH:
798,155, REN. 9-6-05. U.S. CL. 46 (INT. CL. 29).
- SARA LEE GLOBAL FINANCE L.L.C., WINSTON-SALEM, NC, SARAMAR CORPORATION, DOVER, DE:
1,899,029, REN. 9-7-05. INT. CL. 25.
- SARAMAR, L.L.C., CHICAGO, IL, HILLS BROS. COFFEE, INC., SAN FRANCISCO, CA:
781,823, REN. 9-7-05. U.S. CL. 46 (INT. CL. 30).
- SARAMAR, L.L.C., CHICAGO, IL, KIWI BRANDS, INC., DOUGLASSVILLE, PA:
1,898,483, REN. 9-7-05. INT. CL. 3.
- SATELLITE PUBLISHING INC., DENVER, CO:
2,207,338, CANC. INT. CL. 16.
- SAVISA (PTY) LTD, WINDMEUL, SOUTH AFRICA:
3,007,782, INT. CL. 33.
- SBC KNOWLEDGE VENTURES, L.P., AUSTIN, TX:
1,865,412, CANC. INT. CL. 38.
- SCANBUY, INC., NEW YORK, NY:
3,007,364, PUB. 7-26-2005. INT. CL. 9.
- SCANVEC INC., WILMINGTON, MA:
2,206,969, CANC. INT. CL. 9.
- SCENE NOT HERD, INC., NEW YORK, NY:
2,207,153, CANC. INT. CL. 25.
- SCHAEFFER, GARY, NEW YORK, NY AND BIRNKRANT, MEL, BEACON, NY:
3,007,670, INT. CL. 28.
3,007,671, INT. CL. 28.
3,007,672, INT. CL. 28.
3,007,673, INT. CL. 28.
- SCHANDELMEIER, JOHN L., KINGS PARK, NY:
2,206,686, CANC. INT. CL. 9.
- SCHATZ, CHARLES J., LOS ANGELES, CA:
1,906,412, REN. 9-9-05. INT. CL. 10.
- SCHERING-PLOUGH HEALTHCARE PRODUCTS, INC., MEMPHIS, TN:
3,008,071, INT. CL. 25.

SCHMIDT, KARL, EL DORADO HILLS, CA:
2,207,746, CANC. INT. CL. 9.

SCHNITZER STEEL INDUSTRIES, INC., PORTLAND, OR:
1,948,612, REN. 9-9-05. INT. CL. 6.

SCHOELLER & HOESCH GMBH, GERNSBACH, FED REP GERMANY:
1,307,376, CANC. INT. CL. 34.

SCHOLL, INC., MEMPHIS, TN:
1,307,157, CANC. INT. CL. 25.

SCHOOL SPECIALTY, INC., APPLETON, WI:
3,007,875, INT. CL. 35.

SCHOTT ZWIESEL AG, 94227 ZWIESEL, FED REP GERMANY:
3,006,851, PUB. 7-26-2005. INT. CL. 21.

SCHOTTENSTEIN STORES CORPORATION, COLUMBUS, OH:
1,307,165, CANC. INT. CL. 25.

SCHRATTER FOODS, INC., FAIRFIELD, NJ, ANCO INTERNATIONAL CORPORATION, NORTHBROOK, IL:
1,008,444, REN. 9-7-05. INT. CL. 29.

SCHULMAN, SUSAN C., ALEXANDRIA, VA:
2,207,724, CANC. INT. CL. 25.

SCHWAN-STABILO SCHWANHAUSSER GMBH & CO., D-90562 HEROLDSBERG, FED REP GERMANY:
1,349,322, REN. 9-9-05. INT. CL. 16.

SCIENTIFIC HOSPITAL SUPPLIES LIMITED, LIVERPOOL, ENGLAND:
1,306,802, CANC. INT. CL. 5.

SCORES HOLDING COMPANY INC., NEW YORK, NY:
1,830,135, REN. 9-6-05. MULTIPLE CLASS, INT. CLS. 6, 41 AND 42.

SCOTT RESOURCES, INC., FORT COLLINS, CO:
2,207,210, CANC. INT. CL. 28.

SCOTT SWIMMING POOLS, INC., WOODBURY, CT:
1,352,304, REN. 9-3-05. MULTIPLE CLASS, INT. CLS. 2 AND 5.

SCOTT WESTERN COMPANY, INC., SEAL BEACH, CA:
2,206,422, CANC. INT. CL. 9.

SCREENLIFE, LLC, SEATTLE, WA:
2,827,994, COR. MULTIPLE CLASS, INT. CLS. 9 AND 28.

SCULLY SIGNAL COMPANY, WILMINGTON, MA:
1,303,510, REN. 9-7-05. INT. CL. 9.

SEA WORLD, INC., ST. LOUIS, MO:
2,207,623, CANC. INT. CL. 41.

SECURITY FIRST TECHNOLOGIES, PINEVILLE, KY:
2,206,484, CANC. MULTIPLE CLASS, INT. CLS. 9, 35, 36 AND 42.

SEE HOLDINGS COMPANY, NORTH HOLLYWOOD, CA:
1,910,673, REN. 9-7-05. MULTIPLE CLASS, INT. CLS. 9, 16, 21 AND 25.

SEEDWAY, INC., BLOOMINGTON, IL, SEEDWAY, INC., HALL, NY:
1,034,971, REN. 9-3-05. INT. CL. 31.

SELLSTROM MANUFACTURING COMPANY, PALATINE, IL:
1,914,119, REN. 9-7-05. INT. CL. 9.

SEMCO INCORPORATED, COLUMBIA, MO:
3,007,932, INT. CL. 2.

SEMIPOWER SYSTEMS, INC., SAN JOSE, CA:
2,207,422, CANC. INT. CL. 42.

SENECA SPORTS, INC., MILFORD, MA:
2,207,501, CANC. INT. CL. 28.

SERVICIOS LATINOS CORP., SACRAMENTO, CA:
3,007,496, PUB. 7-26-2005. MULTIPLE CLASS, INT. CLS. 35 AND 42.

SETCO SALES CO., CINCINNATI, OH:
3,007,036, PUB. 7-26-2005. MULTIPLE CLASS, INT. CLS. 7 AND 37.

SETHCO POLYMERS, INC., CONCORD, NC:
1,306,623, CANC. INT. CL. 1.

SEVEN SEAS SEAFOODS, INC., ALHAMBRA, CA:
3,007,858, INT. CL. 29.

SEWELL CLOTHING COMPANY, INC., BREMEN, GA:
808,553, REN. 9-6-05. U.S. CL. 39 (INT. CL. 25).

SFK MEDIA SPECIALLY FOR KIDS CORP., MOUNT SINAI, NY:
3,007,304, PUB. 6-7-2005. MULTIPLE CLASS, INT. CLS. 9 AND 16.

SHAIRFORCE, LLC, NEW FAIRFIELD, CT:
3,007,279, PUB. 7-26-2005. INT. CL. 36.

SHAKER ADVERTISING AGENCY, INC., OAK PARK, IL:
2,289,887, CANC. INT. CL. 41.

SHAKESPEARE COMPOSITE STRUCTURES LLC, NEW-BERRY, SC:
3,007,267, PUB. 7-26-2005. MULTIPLE CLASS, INT. CLS. 19 AND 21.

SHAMBHALA PUBLICATIONS, INC., BOSTON, MA:
1,902,670, REN. 9-6-05. INT. CL. 16.
1,904,385, REN. 9-6-05. INT. CL. 16.
1,905,432, REN. 9-6-05. INT. CL. 9.
1,925,226, REN. 9-3-05. INT. CL. 9.

SHAMROCK FOODS COMPANY, PHOENIX, AZ:
1,932,926, REN. 9-9-05. INT. CL. 30.

SHARETRACKER, LLC, ATLANTA, GA:
3,008,062, INT. CL. 35.

SHARP HEALTHCARE, SAN DIEGO, CA:
1,924,247, REN. 9-3-05. INT. CL. 42.

SHELBY GROUP INTERNATIONAL, INC., MEMPHIS, TN:
200,394, REN. 9-7-05. U.S. CL. 39 (INT. CL. 25).

SHELL OIL COMPANY, HOUSTON, TX:
1,306,646, CANC. INT. CL. 1.

SHENZHEN BREWERY COMPANY LIMITED, SHENZHEN, GUANGDONG P.R., CHINA:
2,206,603, CANC. INT. CL. 32.

SHEPHERDS MATE PRODUCTS LIMITED, LEEDS, WEST YORKSHIRE, LS17 8EZ, ENGLAND:
2,106,173, CANC. INT. CL. 18.

SHERMAN, ALICE, NEW YORK, NY:
2,207,174, CANC. INT. CL. 16.

SHIMANO INC., SAKAI, OSAKA, JAPAN:
3,006,818, PUB. 7-26-2005. INT. CL. 28.

SHOEI CHEMICAL INC., SHINJUKU-KU, TOKYO, JAPAN:
1,378,697, REN. 9-8-05. MULTIPLE CLASS, INT. CLS. 1, 2, 14 AND 17.

SHOEMAKER'S CANDIES, INC., SANTA FE SPRINGS, CA:
1,307,337, CANC. INT. CL. 30.

SHONAC CORPORATION, COLUMBUS, OH:
2,206,291, CANC. INT. CL. 42.

SHOP-TEK INDUSTRIAL CORP., SANTA FE SPRINGS, CA:
2,207,622, CANC. MULTIPLE CLASS, INT. CLS. 3, 7, 8 AND 9.

SHOWCASE REMARKETING, INC., LAKE FOREST, CA:
3,007,110, PUB. 7-26-2005. INT. CL. 9.

SHUFFLE MASTER, INC., EDEN PRAIRIE, MN:
2,206,795, CANC. INT. CL. 9.

SHULMAN, JUDY, PHILADELPHIA, PA AND LANDERS, DEBI, PHILADELPHIA, PA:
3,007,392, PUB. 7-26-2005. MULTIPLE CLASS, INT. CLS. 25 AND 41.

SHUWARGER, LEE, AMARILLO, TX:
2,206,765, CANC. INT. CL. 42.

SICKERT, WILLIAM R., TEQUESTA, FL:
3,007,442, PUB. 7-5-2005. INT. CL. 16.

SICOM TECHNOLOGIES, LLC, BUFFALO GROVE, IL:
3,007,667, INT. CL. 9.

SIDER, GABRIEL, SAN FRANCISCO, CA:
2,206,818, CANC. INT. CL. 40.

SIEMAG GMBH, NETPHEN, FED REP GERMANY:
3,007,771, MULTIPLE CLASS, INT. CLS. 6, 7 AND 42.

SIEMBRAS MARINAS, SIEMBRAMAR, S.A., BARCELONA, EDO. ANZOATEGUI, VENEZUELA:
1,906,706, REN. 9-3-05. INT. CL. 29.

SIEMENS AKTIENGESELLSCHAFT, MUNICH, FED REP GERMANY:
2,206,328, CANC. INT. CL. 9.
2,206,939, CANC. INT. CL. 9.
3,007,278, PUB. 7-26-2005. MULTIPLE CLASS, INT. CLS. 9 AND 25.

SIEMENS SOLAR INDUSTRIES, L.P., CAMARILLO, CA:
1,898,798, REN. 9-7-05. INT. CL. 11.

SIERRA ENTERTAINMENT, INC., BELLEVUE, WA:
3,007,856, INT. CL. 16.

SIGMA-ALDRICH BIOTECHNOLOGY L.P., ST. LOUIS, MO:
3,007,242, PUB. 7-26-2005. MULTIPLE CLASS, INT. CLS. 1 AND 9.

- SIGMA-TAU INDUSTRIE FARMACEUTICHE RIUNTE S.P.A., ROMA, ITALY:
3,007,646, INT. CL. 5.
- SIKOV MEDIZINTECHNIK GES.M.B.H., VIENNA, AUSTRIA:
2,206,373, CANC. INT. CL. 10.
- SILKMILL CORP., NEW YORK, NY:
2,207,549, CANC. INT. CL. 25.
- SILVER LOUNGE INC., NORTH FALMOUTH, MA:
3,007,040, PUB. 7-26-2005. INT. CL. 43.
- SILVER OAK PARTNERS, INC., LUNENBURG, MA:
2,873,600, COR. INT. CL. 35.
- SIMMERMAN, SCOTT J., TAYLORS, SC, DBA PERFORMANCE MANAGEMENT COMPANY:
1,864,988, CANC. INT. CL. 41.
- SIMOLEX RUBBER CORPORATION, PLYMOUTH, MI:
3,007,886, MULTIPLE CLASS, INT. CLS. 17 AND 40.
- SINCERE ORIENT FOOD CO., CITY OF INDUSTRY, CA, DBA SINCERE ORIENT COMMERCIAL CORP.:
3,007,156, PUB. 7-26-2005. INT. CL. 30.
- SINCLAIR PHARMACAL CO., INC., DRAWERD FISHERS ISLAND, NY:
622,573, REN. 9-7-05. U.S. CL. 18 (INT. CL. 5).
- SITV INC, LOS ANGELES, CA:
3,007,774, INT. CL. 38.
- SIX SIGMA CONSULTANTS, INC., NE, ALBUQUERQUE, NM:
3,007,094, PUB. 7-26-2005. INT. CL. 35.
- SIXX, NIKKI, NEW YORK, NY:
3,007,272, PUB. 7-26-2005. INT. CL. 25.
3,007,273, PUB. 7-26-2005. INT. CL. 25.
- SKEAN, BRENT, MOUNTAIN CENTER, CA:
1,896,005, REN. 9-6-05. INT. CL. 9.
- SKIPPACK CREEK CORPORATION, WILMINGTON, DE:
3,006,788, PUB. 7-26-2005. INT. CL. 29.
- SKY TRAIL, INC., ALLEGAN, MI:
3,007,291, PUB. 7-26-2005. MULTIPLE CLASS, INT. CLS. 28 AND 37.
- SKYCOASTER, INC., BURNABY, BRITISH COLUMBIA, CANADA, SKY FUN 1, INC., BOULDER, CO:
1,789,534, REN. 9-7-05. MULTIPLE CLASS, INT. CLS. 28 AND 41.
- SKYHILL NAPA VALLEY FARMS, INC., NAPA, CA:
1,917,384, REN. 9-7-05. INT. CL. 29.
- SLIP-N-SNIP SCISSORS, INC., SWEET HOME, OR:
1,013,415, REN. 9-7-05. INT. CL. 8.
- SLIVINSKI, LARRY MICHAEL, TORONTO, ONTARIO M4S 1E5, CANADA:
2,206,395, CANC. MULTIPLE CLASS, INT. CLS. 16 AND 28.
- SM PURCHASE COMPANY, LLC, MENLO PARK, CA:
3,007,731, INT. CL. 42.
- SMART DRILLING AND COMPLETION, INC., BOTHELL, WA:
3,007,586, INT. CL. 7.
3,007,587, INT. CL. 7.
- SMART INTERNATIONAL, LLC, DEVON, PA:
3,007,666, INT. CL. 35.
- SMARTHOME, INC., IRVINE, CA:
3,007,983, INT. CL. 9.
- SMEAD, GARY PHILIP, SAN DIMAS, CA, DBA SPECTRE MARKETING:
2,206,976, CANC. INT. CL. 25.
- SMITH, ARLENE, BRONX, NY:
3,007,082, PUB. 7-26-2005. INT. CL. 41.
- SMITH, DOUGLAS E., SCOTTSDALE, AZ:
1,307,253, REN. 9-8-05. INT. CL. 28.
- SMITH, PATRICIA, VIENNA, VA:
2,960,133, COR. MULTIPLE CLASS, INT. CLS. 36, 44 AND 45.
- SMITHKLINE BEECHAM BIOLOGICALS S.A., RIXENSART, BELGIUM:
3,007,170, PUB. 7-26-2005. INT. CL. 5.
- SMITHKLINE BEECHAM CORPORATION, PHILADELPHIA, PA:
3,007,383, PUB. 6-7-2005. MULTIPLE CLASS, INT. CLS. 9, 16 AND 44.
- SMOKY MOUNTAIN KNIFE WORKS, SEVIERVILLE, TN:
3,007,477, PUB. 7-26-2005. INT. CL. 35.
- SNACKDOG L.L.C., AUSTIN, TX:
3,007,260, PUB. 7-26-2005. INT. CL. 31.
- SNYDER, LLC, WENATCHEE, WA:
3,007,810, INT. CL. 29.
- SOCIETE CIVILE DU CHATEAU D'YQUEM, 33210 SAUTERNES, FRANCE:
1,014,969, REN. 9-6-05. U.S. CL. 47 (INT. CL. 33).
- SOCIETE DES PRODUITS NESTLE S.A., 1800 VEVEY, SWITZERLAND:
201,022, REN. 9-9-05. U.S. CL. 46 (INT. CL. 30).
- SOCIETE DES PRODUITS NESTLE S.A., VEVEY, SWITZERLAND:
1,346,600, REN. 9-9-05. INT. CL. 30.
- SOCIETE DES PRODUITS NESTLE S.A., 1800 VEVEY, SWITZERLAND, CLINTEC NUTRITION COMPANY, DEERFIELD, IL:
1,912,202, REN. 9-6-05. INT. CL. 5.
- SOCIETE NATIONALE D'EXPLOITATION INDUSTRIELLE DES TABACS ET ALLUMETTES, 75347 PARIS CEDEX 07, FRANCE:
2,207,510, CANC. INT. CL. 34.
- SOCIETE POUR LA CONCEPTION DES APPLICATIONS DES TECHNIQUES ELECTRONIQUES S.A.T.E.L.E.C., 33700 MERIGNAC, FRANCE:
1,353,896, REN. 9-3-05. INT. CL. 10.
- SOFT SURFBOARDS, INC., CHARLESTON, SC:
3,007,842, INT. CL. 28.
- SOFTRONICS, INC., DAYTON, OH:
1,880,453, REN. 9-9-05. INT. CL. 9.
- SOLARFLO CORPORATION, BEDFORD HEIGHTS, OH:
782,852, REN. 9-7-05. U.S. CL. 34 (INT. CL. 11).
- SOLE SURVIVOR CORPORATION, OXNARD, CA:
2,207,241, CANC. INT. CL. 25.
- SOLID STATE MEASUREMENTS, INC., PITTSBURGH, PA:
1,938,487, REN. 9-3-05. INT. CL. 9.
- SOLIDEAL HOLDING S.A., LUXEMBOURG:
3,007,550, PUB. 7-26-2005. INT. CL. 12.
- SOLO, MATHU, SUGAR LAND, TX:
3,007,501, PUB. 6-7-2005. INT. CL. 12.
- SOLVAY (SOCIETE ANONYME), B-1050 BRUSSELS, BELGIUM:
1,945,200, REN. 9-9-05. INT. CL. 1.
- SOMNUS MEDICAL TECHNOLOGIES, INC., SUNNYVALE, CA:
2,206,753, CANC. MULTIPLE CLASS, INT. CLS. 10 AND 42.
- SONY BMG MUSIC ENTERTAINMENT, NEW YORK, NY, CBS INC., NEW YORK, NY:
1,001,994, REN. 9-9-05. INT. CL. 9.
- SONY ERICSSON MOBILE COMMUNICATIONS AB, 88 LUND, SWEDEN:
3,007,247, PUB. 7-26-2005. MULTIPLE CLASS, INT. CLS. 9 AND 38.
- SONY ERICSSON MOBILE COMMUNICATIONS JAPAN, INC., TOKYO 108-0075, JAPAN:
2,950,944, COR. MULTIPLE CLASS, INT. CLS. 9, 38 AND 42.
- SORENSEN COMMUNICATIONS, INC., SALT LAKE CITY, UT:
2,207,498, CANC. INT. CL. 9.
- SOSKIN & GORDON INTERNATIONAL LTD., RICHMOND HILL, ONTARIO:
1,346,044, REN. 9-7-05. INT. CL. 14.
- SOUTHERN CALIFORNIA GAS COMPANY, LOS ANGELES, CA:
3,008,009, MULTIPLE CLASS, INT. CLS. 35 AND 39.
- SOUTHERN COMFORT PROPERTIES, INC., SAN RAFAEL, CA:
1,897,081, REN. 9-7-05. INT. CL. 33.
- SOUTHERN EXPEDITION, L.L.C., BROKEN ARROW, OK:
3,007,219, PUB. 6-7-2005. INT. CL. 43.
- SOUTHERN FOODS GROUP, L.P., DALLAS, TX:
2,206,475, CANC. INT. CL. 30.
- SOUTHERN SAW SERVICE, L.P., ATLANTA, GA:
1,338,380, REN. 9-6-05. INT. CL. 37.

- SOUTHERN SHOWS, INC., CHARLOTTE, NC:
2,105,794, CANC. INT. CL. 35.
- SOUTHERN VISION SYSTEMS, INC., MADISON, IA:
3,007,857, INT. CL. 9.
- SOUTHWESTERN BELL TELEPHONE COMPANY, ST. LOUIS, MO:
2,207,227, CANC. INT. CL. 38.
- SOUTHWIND MANUFACTURING SERVICES, INC., Ocala, FL:
2,206,701, CANC. INT. CL. 17.
- SOVEREIGN SPECIALTY CHEMICALS, INC., CHICAGO, IL, B.F.GOODRICH COMPANY, THE, AKRON, OH:
1,904,859, REN. 9-9-05, INT. CL. 1.
- SPACE COAST CREDIT UNION, MELBOURNE, FL:
3,007,487, PUB. 7-26-2005, INT. CL. 36.
- SPACE STUDIES INSTITUTE, PRINCETON, NJ:
1,306,951, CANC. INT. CL. 16.
- SPACEMAKER LIMITED, MISSISSAUGA, ONTARIO L5C 1V9, CANADA:
1,944,836, REN. 9-6-05, INT. CL. 20.
- SPANEAS; GREGORY C., DANVERS, MA:
1,307,060, CANC. INT. CL. 20.
- SPARC INTERNATIONAL, INC., SAN JOSE, CA:
1,865,176, CANC. INT. CL. 9.
- SPEAR LEEDS & KELLOGG, NEW YORK, NY:
1,868,048, REN. 9-9-05, INT. CL. 9.
- SPECIALTY MATCH NETWORK, INC., LAGUNA BEACH, CA:
3,007,681, INT. CL. 45.
- SPECIALTY POLYMER COATINGS, INC., LANGLEY, BRITISH COLUMBIA, CANADA:
3,006,864, PUB. 7-26-2005, INT. CL. 2.
- SPECIALTY RESTAURANT GROUP, LLC, MARYVILLE, TN, RUBY TUESDAY, INC., KNOXVILLE, TN:
1,397,222, REN. 9-6-05, INT. CL. 42.
- SPECTRACOM TECHNOLOGIES CORPORATION, SCOTTSDALE, AZ:
2,207,202, CANC. INT. CL. 35.
- SPEECHGEAR, INC., NORTHFIELD, MN:
3,007,765, INT. CL. 9.
- SPEED SHORE CORP., HOUSTON, TX:
1,900,333, REN. 9-6-05, INT. CL. 6.
- SPERLONGA, RAIMONDO, NORTH HOLLYWOOD, CA:
3,007,585, INT. CL. 25.
- SPINDLER, MARGARET K., LEE'S SUMMIT, MO, DBA MUSICIANS' MOTIVATIONAL MINISTRIES:
2,206,858, CANC. INT. CL. 41.
- SPLITFIRE, INC., NORTHBROOK, IL:
2,207,419, CANC. INT. CL. 7.
- SPOETZL BREWERY, INC., SAN ANTONIO, TX:
3,007,656, INT. CL. 32.
- SPOON, SUZANNE, PEORIA, AZ:
3,007,088, PUB. 7-26-2005, INT. CL. 20.
- SPORTEX INC., DENVER, CO:
3,007,864, INT. CL. 25.
- SPORTS DESTINATION NETWORK, SCOTTSDALE, AZ, SPORTS DESTINATION NETWORK, SCOTTSDALE, AZ:
1,871,602, REN. 9-3-05, MULTIPLE CLASS, INT. CLS. 39 AND 42.
- SPORTS TECH LABS, INCORPORATED, CHICAGO, IL:
1,865,469, CANC. INT. CL. 16.
- SPRAYING SYSTEMS CO., WHEATON, IL:
615,070, REN. 9-6-05, U.S. CL. 13 (INT. CL. 21).
1,372,177, REN. 9-6-05, INT. CL. 7.
- SPRAYING SYSTEMS COMPANY, WHEATON, IL:
1,354,973, REN. 9-6-05, INT. CL. 7.
1,358,869, REN. 9-6-05, INT. CL. 7.
- SPREEN, LINDA, ELKADER, IA, AKA BRADFORD ST. STATION:
2,207,636, CANC. INT. CL. 14.
- SQUARESHOOTER CANDY CO., EDWARDSVILLE, KS, DBA SQUARESHOOTER, INC. TO GILLIAM CANDY BRANDS, INC., PADUCAH, KY:
1,864,840, CANC. INT. CL. 30.
- SRI USA, INC., AMHERST, NY, CARLISLE CORPORATION, CINCINNATI, OH:
1,349,192, REN. 9-7-05, INT. CL. 12.
- SSPS, INC., FREMONT, CA:
2,206,782, CANC. INT. CL. 35.
- ST JOHN HEALTH SYSTEM, DETROIT, MI:
2,207,663, CANC. INT. CL. 42.
- ST. GEORGE PUBLISHING & PRINTING, INC., ST. AUGUSTINE, FL:
2,207,198, CANC. INT. CL. 41.
- ST. PETERSBURG KENNEL CLUB, INC., ST. PETERSBURG, FL:
3,006,940, PUB. 7-26-2005, INT. CL. 36.
- STACCATO COMMUNICATIONS, INC., SAN DIEGO, CA:
3,007,829, INT. CL. 9.
- STAMP & CHASE, INC., ST. LOUIS, MO:
3,007,880, MULTIPLE CLASS, INT. CLS. 35 AND 41.
- STANDARD AUTOMATION & CONTROL, INC., LEAGUE CITY, TX:
2,206,596, CANC. INT. CL. 9.
- STANDARD COMMUNICATIONS, LOS ANGELES, CA TO YAESU MUSEN USA INC, CERRITOS, CA:
1,865,192, CANC. INT. CL. 9.
- STANDARD SUPPLY AND EQUIPMENT CO., INC., BALTIMORE, MD:
1,969,167, REN. 9-9-05, INT. CL. 20.
- STANDARD TEXTILE CO., INC., CINCINNATI, OH:
3,006,993, PUB. 7-26-2005, MULTIPLE CLASS, INT. CLS. 9 AND 35.
- STAPLETON MANAGEMENT COMPANY, PHOENIX, AZ:
2,207,559, CANC. INT. CL. 3.
- STAR DIAMOND GROUP, INC., NEW YORK, NY:
3,007,815, INT. CL. 14.
- STAR INDUSTRIES, INC., SYOSSET, NJ:
3,007,086, PUB. 7-26-2005, INT. CL. 33.
- STAR NETWORKS, INC., MAITLAND, FL:
1,354,621, REN. 9-6-05, INT. CL. 36.
1,354,622, REN. 9-6-05, INT. CL. 36.
- STAR SYSTEM, INC., SAN DIEGO, CA:
1,395,144, REN. 9-6-05, INT. CL. 36.
1,396,092, REN. 9-6-05, INT. CL. 36.
- STAR THROWER DISTRIBUTION CORP., ST. PAUL, MN:
2,206,718, CANC. MULTIPLE CLASS, INT. CLS. 9 AND 16.
- STAR-M INTERNATIONAL, LIMITED, ARLINGTON HEIGHTS, IL:
3,007,867, INT. CL. 7.
- STARBOARD CRUISE SERVICES, INC., MIAMI, FL:
3,007,817, INT. CL. 25.
- STARBUCKS U.S. BRANDS, LLC, MINDEN, NV, STARBUCKS CORPORATION, SEATTLE, WA:
1,893,602, REN. 9-6-05, INT. CL. 16.
- STARGATE ACQUISITION, LLC, CLEVELAND, OH:
2,206,309, CANC. MULTIPLE CLASS, INT. CLS. 35, 38 AND 42.
- STARKER SERVICES, INCORPORATED, LOS GATOS, CA:
3,006,801, PUB. 7-26-2005, INT. CL. 36.
- STARVED ROCK OUTFITTERS, LTD., UTICA, IL:
3,007,298, PUB. 7-26-2005, INT. CL. 9.
- STATE FISH COMPANY, INC., SAN PEDRO, CA:
1,307,298, CANC. INT. CL. 29.
- STATE OF MAINE, BY THE MAINE STATE PLANNING OFFICE, AUGUSTA, ME:
3,007,459, PUB. 7-5-2005, INT. CL. 41.
- STATE OF MINNESOTA, DEPARTMENT OF ADMINISTRATION, INTER TECHNOLOGIES GROUP, ST. PAUL, MN:
1,926,986, REN. 9-9-05, INT. CL. 38.
- STAYHEALTHY, INC., MONROVIA, CA:
3,007,097, PUB. 7-26-2005, INT. CL. 9.
- STEARNS, CINDY HAYES, POWAY, CA, DBA CHS DISTRIBUTING:
2,207,555, CANC. INT. CL. 9.
- STEEDA AUTOSPORTS, INC., POMPANO BEACH, FL:
3,007,143, PUB. 7-26-2005, INT. CL. 12.
- STEINBAUM, PAUL, LOS ANGELES, CA:
2,207,250, CANC. INT. CL. 16.
- STELLARNET, INC., SAN FRANCISCO, CA:
2,206,452, CANC. INT. CL. 9.

- STEPHEN J. CANNELL PRODUCTIONS, INC., HOLLYWOOD, CA, DBA STEPHEN J. CANNELL PRODUCTIONS, INC.:
1,865,212, CANC. INT. CL. 9.
- STEPHENS, PETER II, BOW, WA:
3,007,659, INT. CL. 25.
- STERLING/MACFADDEN PARTNERSHIP, THE, NEW YORK, NY TO PRIMEDIA MAGAZINE FINANCE INC., NEW YORK, NY:
1,864,656, CANC. INT. CL. 16.
- STEWART, JOSEPHINE, INVERNESS, CA:
2,207,644, CANC. INT. CL. 41.
- STIEFEL LABORATORIES, INC., CORAL GABLES, FL:
2,207,371, CANC. MULTIPLE CLASS, INT. CLS. 3 AND 5.
- STIEFEL LABORATORIES, INC., OAK HILL, NY:
794,350, REN. 9-3-05. U.S. CL. 18 (INT. CL. 5).
- STOCKHAUSEN GMBH, D-47805 KREFELD, FED REP GERMANY:
3,007,144, PUB. 7-26-2005. INT. CL. 1.
- STONE BREWING COMPANY, SAN MARCOS, CA:
3,007,786, INT. CL. 32.
- STONE, BETH, NEW YORK, NY, DBA PANGAEA INTERNATIONAL CONSULTING:
2,207,357, CANC. INT. CL. 38.
- STONE, KELTON LOUIS, AVON, NC, DBA STONEY'S SEAFOOD:
2,207,173, CANC. INT. CL. 35.
- STONE, ROBERT B., WELLS, NV AND STONE, JULIE, WELLS, NV, DBA R J STONE-WAY ENTERPRISES:
2,206,477, CANC. INT. CL. 3.
- STORA ENSO PUBLICATION PAPER GMBH & CO. KG, D-40545 DUSSELDORF, FED REP GERMANY, STORA FELDMUHLE AG, D-40545 DUSSELDORF, FED REP GERMANY:
1,931,221, REN. 9-7-05. INT. CL. 16.
1,931,238, REN. 9-7-05. INT. CL. 16.
- STREETWISE, INC., CHICAGO, IL:
1,917,914, REN. 9-3-05. INT. CL. 16.
- STRIANESE ASSOCIATES, INC., ARMONK, NY:
1,307,210, CANC. INT. CL. 27.
- STRICKLAND'S FROZEN CUSTARD, INC., CUYAHOGA FALLS, OH:
3,007,401, PUB. 7-26-2005. INT. CL. 30.
- STRY-LENKOFF COMPANY, LLC, LOUISVILLE, KY:
625,891, REN. 9-8-05. U.S. CL. 38 (INT. CL. 16).
- STUDEN, GEORGE, HUNTINGTON BEACH, CA:
2,207,319, CANC. INT. CL. 28.
- STUDIO SEIRENI, INC., LOS ANGELES, CA:
2,207,764, CANC. INT. CL. 16.
- STYLEX, INC., DELANCO, NJ:
2,207,101, CANC. INT. CL. 20.
- SUAREZ, DAVID G., BROOKLYN, NY:
2,206,675, CANC. INT. CL. 9.
- SUBAFILMS LIMITED, LONDON, UNITED KINGDOM:
3,006,792, PUB. 7-26-2005. MULTIPLE CLASS, INT. CLS. 6, 9, 14, 28 AND 41.
- SUGAR FILM PRODUCTION, LTD., DALLAS, TX:
3,006,969, PUB. 7-26-2005. MULTIPLE CLASS, INT. CLS. 35 AND 41.
- SUGARCREST DEVELOPMENT GROUP, WASHINGTON, DC:
3,007,075, PUB. 7-26-2005. INT. CL. 35.
- SUKHOI DESIGN BUREAU COMPANY, MOSCOW, 125284, RUSSIAN FED.:
3,006,798, PUB. 7-26-2005. INT. CL. 42.
- SUMITOMO ELECTRIC INDUSTRIES, LTD., OSAKA, JAPAN:
2,206,293, CANC. INT. CL. 9.
- SUMMA HUMMA ENTERPRISES, LLC, PLAISTOW, NH:
3,007,151, PUB. 7-26-2005. INT. CL. 35.
- SUN MEDIA CORPORATION, TORONTO, ONTARIO M5A 3X5, CANADA:
2,206,307, CANC. INT. CL. 42.
- SUN PHARMACEUTICALS CORP., WESTPORT, CT:
2,207,642, CANC. INT. CL. 3.
- SUN SPORTSWEAR, INC., KENT, WA:
1,475,103, CANC. INT. CL. 25.
- SUNBURST FARMS, INC., MIAMI, FL:
1,307,581, CANC. INT. CL. 31.
- SUNRISE MEDICAL HHG INC., LONGMONT, CO:
1,345,905, REN. 9-9-05. INT. CL. 10.
- SUNSHINE PRODUCTS, INC., ALEXANDRIA, VA:
3,007,430, PUB. 7-26-2005. INT. CL. 3.
- SUPER RIFLE S.P.A., 50031 BARBERINO DI MUGELLO, FIRENZE, ITALY:
2,206,284, CANC. MULTIPLE CLASS, INT. CLS. 9 AND 14.
- SUPERIOR PLUS INC., TORONTO, ONTARIO M9B 6C7, CANADA:
3,006,804, PUB. 7-26-2005. MULTIPLE CLASS, INT. CLS. 11, 35, 37 AND 42.
- SUPERMAX, INC., NAPERVILLE, IL:
3,007,154, PUB. 7-26-2005. INT. CL. 10.
- SUPPER THYME USA FRANCHISE SERVICE, L.L.C., OMAHA, NE:
3,007,700, INT. CL. 35.
- SURETY & CONSTRUCTION CONSULTANTS, INC., DALLAS, TX:
1,937,943, REN. 9-9-05. INT. CL. 42.
- SURFACE COMBUSTION, INC., MAUMEE, OH:
792,229, REN. 9-7-05. U.S. CL. 34 (INT. CL. 11).
- SURFACE TECHNOLOGY CORP. OF VIRGINIA, SAVAGE, MD:
3,006,896, PUB. 7-26-2005. MULTIPLE CLASS, INT. CLS. 20 AND 37.
- SURGICOT, INC., SMITHTOWN, NY:
1,306,979, CANC. INT. CL. 16.
- SUSAN SARGENT DESIGNS INC., MANCHESTER CENTER, VT:
3,007,246, PUB. 6-7-2005. INT. CL. 42.
- SUSTAINABLE ENERGY TECHNOLOGIES, CALGARY, ALBERTA, CANADA:
3,007,924, INT. CL. 9.
- SVI TRAINING PRODUCTS, SAN DIEGO, CA, SVI TRAINING PRODUCTS, SAN DIEGO, CA:
1,930,285, REN. 9-3-05. INT. CL. 9.
- SWANSON, HOLLY A., MEDFORD, OR:
3,006,854, PUB. 7-26-2005. INT. CL. 35.
- SWAPNA TRADING COMPANY LIMITED, MISSISSAUGA, ONTARIO L4Z 1W6, CANADA:
2,206,389, CANC. INT. CL. 30.
- SWEEN, DANIEL, FREMONT, CA:
2,207,590, CANC. INT. CL. 42.
- SWEETHEART CUP COMPANY INC., OWINGS MILLS, MD:
1,865,264, CANC. INT. CL. 16.
- SWIMC, INC, WILMINGTON, DE, SHERWIN-WILLIAMS COMPANY, THE, CLEVELAND, OH:
1,903,313, REN. 9-3-05. INT. CL. 2.
- SWIMC, INC., WILMINGTON, DE:
1,013,114, REN. 9-6-05. INT. CL. 42.
- SWIMC, INC., WILMINGTON, DE, SWIMC, INC., WILMINGTON, DE:
1,877,324, REN. 9-7-05. INT. CL. 2.
- SWIMC, INC., WILMINGTON, DE TO SWIMC, INC., WILMINGTON, DE:
1,877,324, CANC. INT. CL. 16.
- SWIMC, INC., WILMINGTON, DE, THOMPSON MINWAX COMPANY, THE, MONTVALE, NJ:
1,900,204, REN. 9-6-05. INT. CL. 2.
- SWIMC, INC., WILMINGTON, DE, SHERWIN-WILLIAMS COMPANY, THE, CLEVELAND, OH:
1,924,972, REN. 9-7-05. INT. CL. 2.
- SWITCHSOFT SYSTEMS, INC., WOODSIDE, CA:
2,207,524, CANC. INT. CL. 9.
- SWITZERLAND CHEESE ASSOCIATION, INC., NEW YORK, NY:
1,307,300, CANC. INT. CL. 29.
- SYLVAN LEARNING, INC., BALTIMORE, MD:
3,006,865, PUB. 7-26-2005. MULTIPLE CLASS, INT. CLS. 41 AND 45.
- SYNERBOTICS LLC, BEAVERCREEK, OH:
3,007,638, INT. CL. 42.

- SYNGENTA CROP PROTECTION, INC., GREENSBORO, NC:
1,902,109. REN. 9-6-05. INT. CL. 5.
1,902,113. REN. 9-6-05. INT. CL. 5.
- SYNGENTA PARTICIPATIONS AG, BASEL, SWITZERLAND:
3,006,846. PUB. 7-26-2005. INT. CL. 5.
- SYNIVERSE TECHNOLOGIES, INC., TAMPA, FL:
2,206,940. CANC. INT. CL. 35.
- SYRATECH CORPORATION, EAST BOSTON, MA, TOWLE MANUFACTURING COMPANY, NEWBURYPORT, MA:
1,016,731. REN. 9-7-05. INT. CL. 8.
- SYSTEMS, INC., GERMANTOWN, WI:
2,959,471. COR. MULTIPLE CLASS, INT. CLS. 6 AND 7.
- SYSTORE COMPANIES, INC., NORTH OLMSTED, OH:
1,922,474. REN. 9-3-05. INT. CL. 38.
- T & S BRASS AND BRONZE WORKS INC., TRAVELERS REST, SC:
1,020,453. REN. 9-6-05. INT. CL. 11.
- T R G ASSOCIATES INC., KINGSTON, NY:
1,307,028. CANC. INT. CL. 16.
- T. E. BRANGS, INC., BALTIMORE, MD:
1,944,223. REN. 9-9-05. INT. CL. 28.
- T.I.B. INSURANCE BROKERS, INC., GLENDALE, CA, DBA TIB TRANSPORTATION INSURANCE BROKERS:
1,874,198. CANC. INT. CL. 36.
- T-MAX INDUSTRIAL (H.K.) COMPANY LIMITED, HONGKONG, CHINA:
2,907,220. COR. MULTIPLE CLASS, INT. CLS. 7, 8 AND 12.
- TAB-AUSTRIA INDUSTRIE- UND UNTERHALTUNGSELEKTRONIK GMBH & CO. KG, A-4052 ANSFELDEN, AUSTRIA:
2,955,968. COR. INT. CL. 28.
- TABACOS EL GUAJIRO, S.A., SANTA CRUZ DE TENERIFE, SPAIN:
2,207,170. CANC. INT. CL. 34.
- TABLES INTERNATIONAL CORPORATION, MORTON GROVE, IL, INTERNATIONAL COLORCAST CORPORATION, MORTON GROVE, IL:
1,885,706. REN. 9-3-05. INT. CL. 20.
- TACIT NETWORKS, INC., SOUTH PLAINFIELD, NJ:
3,007,862. INT. CL. 9.
- TACK CHEUNG CORP, VERNON, CA:
1,903,651. REN. 9-7-05. INT. CL. 28.
- TACO MAN, INC., PORTLAND, OR:
1,307,521. CANC. INT. CL. 42.
- TAKAOKAYA CO., LTD., TOKYO, JAPAN:
1,930,788. REN. 9-9-05. INT. CL. 29.
- TAKARA BELMONT CORPORATION, OSAKA, JAPAN:
3,007,828. INT. CL. 11.
- TALIVARI LTD., ST. LOUIS, MO:
2,207,417. CANC. INT. CL. 25.
- TALKING RAIN BEVERAGE CO. INC., PRESTON, WA:
1,941,886. REN. 9-7-05. INT. CL. 32.
- TALON, INC., WOODLAND HILLS, CA:
1,348,173. REN. 9-3-05. INT. CL. 26.
- TAMBERN LIMITED, DUBLIN 4, IRELAND:
2,847,608. AM. INT. CL. 25.
- TANGE, MARK L., MAGALIA, CA:
2,206,909. CANC. INT. CL. 28.
- TANGENT TOY COMPANY, SAUSALITO, CA, DBA PEARL TOYS INC.:
1,864,808. CANC. INT. CL. 28.
- TARCHON CAPITAL MANAGEMENT LIMITED, UNITED KINGDOM:
3,007,542. PUB. 7-26-2005. MULTIPLE CLASS, INT. CLS. 35 AND 36.
- TASTY BAKE, INC., BAKER, OR:
1,938,809. REN. 9-7-05. INT. CL. 36.
- TATSUGAWA, MIKE, MONTEREY PARK, CA:
3,007,809. INT. CL. 35.
- TAX ANALYSTS, ARLINGTON, VA:
3,007,346. PUB. 7-26-2005. INT. CL. 35.
- TAYLOR INSTRUMENT COMPANIES, INC., ROCHESTER, NY TO TAYLOR PRECISION PRODUCTS, LLC, COMMERCE TOWNSHIP, MI:
198,350. AM. U.S. CL. 26.
- TAYLOR: CHARLOTTE, WASHINGTON, DC, DBA VENTURE CONCEPTS SYSTEMS:
1,306,988. CANC. INT. CL. 16.
- TC LICENSE, LTD, HUMMELSTOWN, PA:
3,007,317. PUB. 7-26-2005. MULTIPLE CLASS, INT. CLS. 9 AND 45.
- TDR VENTURES LTD., PETERBOROUGH, CAMBRIDGESHIRE PE1 1YW, UNITED KINGDOM:
3,006,888. PUB. 7-26-2005. MULTIPLE CLASS, INT. CLS. 9, 16, 25, 36, 38 AND 41.
- TEAM GLORY, INCORPORATED, STAMFORD, CT:
2,207,479. CANC. INT. CL. 25.
- TEAM S.A., BOGOTA, D.C., COLOMBIA:
3,007,609. INT. CL. 29.
- TECH LIGHTING INC., CHICAGO, IL TO TECH LIGHTING L.L.C., CHICAGO, IL:
1,865,461. CANC. INT. CL. 11.
- TECHNICAL RESOURCE CONNECTION, INC., THE, TAMPA, FL:
2,206,481. CANC. INT. CL. 35.
- TECHNOLOGY MARKETING CORPORATION, NORWALK, CT:
2,207,372. CANC. MULTIPLE CLASS, INT. CLS. 35 AND 41.
- TECHNOLOGY PARTNERSHIP PLC, THE, HARTFORDSHIRE, SG8 6FE, ENGLAND:
2,206,416. CANC. INT. CL. 9.
- TECHRITE COPY SERVICES, INC., DALLAS, TX:
2,207,131. CANC. INT. CL. 35.
- TEKTRONIX, INC., BEAVERTON, OR:
3,007,992. INT. CL. 9.
- TELCOR COMMUNICATIONS, INC., DULUTH, GA:
2,206,504. CANC. INT. CL. 35.
- TELECOMPUTE CORPORATION, WASHINGTON, DC:
1,913,713. REN. 9-9-05. INT. CL. 35.
- TELECOMPUTE CORPORATION, WASHINGTON, DC, TEK COMMUNICATIONS, INC., WASHINGTON, DC:
1,913,799. REN. 9-9-05. INT. CL. 38.
- TELECOMPUTE CORPORATION, WASHINGTON, DC:
1,959,459. REN. 9-9-05. INT. CL. 35.
- TELELECTRONICS PTY LIMITED, LAND COVE, NEW SOUTH WALES, AUSTRALIA:
1,306,900. CANC. INT. CL. 10.
- TELEDIFFUSION DE FRANCE, 75015 PARIS, FRANCE:
2,108,376. CANC. MULTIPLE CLASS, INT. CLS. 38 AND 41.
- TELEFLEX INCORPORATED, LIMERICK, PA:
2,206,794. CANC. INT. CL. 40.
- TELEFLORA LLC, LOS ANGELES, CA, TELEFLORA INC., LOS ANGELES, CA:
1,340,801. REN. 9-6-05. INT. CL. 21.
- TELEGENIX, INC., CHERRY HILL, NJ:
1,306,894. CANC. INT. CL. 9.
- TELESTRUCTURES, INC., ATLANTA, GA:
2,206,708. CANC. MULTIPLE CLASS, INT. CLS. 37 AND 42.
- TELLABS OPERATIONS, INC., NAPERVILLE, IL FROM OCULAR NETWORKS, INC., RESTON, VA:
3,007,591. MULTIPLE CLASS, INT. CLS. 37 AND 42.
- TELLURIDE RESORT & SPA, L.P., DALLAS, TX:
3,006,781. PUB. 7-26-2005. MULTIPLE CLASS, INT. CLS. 35, 41, 42 AND 44.
- TENNECO AUTOMOTIVE OPERATING COMPANY INC., LAKE FOREST, IL, MONROE AUTO EQUIPMENT COMPANY, MONROE, MI:
1,927,531. REN. 9-7-05. INT. CL. 12.
- TENNISON, HARRY L., FORT WORTH, TX:
2,206,820. CANC. INT. CL. 41.
- TERRA INTERNATIONAL, INC., SIOUX, IA:
1,306,748. CANC. INT. CL. 5.
- TESCO STORES LIMITED, CHESHUNT, HERTFORDSHIRE, ENGLAND:
2,100,763. CANC. INT. CL. 12.
- TESTA'S, INC., PALM BEACH, FL:
3,007,390. PUB. 7-26-2005. INT. CL. 43.
- TETCO, INC., SAN ANTONIO, TX:
1,889,045. REN. 9-7-05. INT. CL. 42.

- TETHERCAM SYSTEMS INC., NEPEAN, ONTARIO, CANADA:
2,206,458, CANC. MULTIPLE CLASS, INT. CLS. 35, 38 AND 39.
- TEXACO INC., WHITE PLAINS, NY:
2,206,903, CANC. INT. CL. 25.
- TEXCON, INC., HOUSTON, TX:
3,007,434, PUB. 7-26-2005. INT. CL. 12.
- TEXTRON SYSTEMS CORPORATION, WILMINGTON, MA:
2,104,351, CANC. INT. CL. 9.
- TGI FRIDAY'S INC., DALLAS, TX:
1,307,318, CANC. INT. CL. 30.
- THANASI FOODS LLC, BOULDER, CO:
3,008,045, INT. CL. 29.
- THE ALBUQUERQUE MUSEUM FOUNDATION, INC., ALBUQUERQUE, NM:
3,007,356, PUB. 7-26-2005. INT. CL. 41.
- THE AMBRIOLA COMPANY, INC., JERSEY CITY, NJ, SCHROEDER BROS, INC., GREAT NECK, NY:
1,933,511, REN. 9-7-05. INT. CL. 29.
- THE AMERICAN INSTITUTE OF BIOLOGICAL SCIENCES, WASHINGTON, DC:
3,006,860, PUB. 7-26-2005. INT. CL. 41.
- THE AMERICAN KENNEL CLUB INCORPORATED, NEW YORK, NY:
3,007,192, PUB. 7-26-2005. MULTIPLE CLASS, INT. CLS. 35, 41 AND 42.
- THE AMERICAN SOCIETY OF NEPHROLOGY, WASHINGTON, DC:
3,007,018, PUB. 7-26-2005. INT. CL. 41.
- THE BOARD OF REGENTS OF THE UNIVERSITY OF NEBRASKA, LINCOLN, NE:
3,006,964, PUB. 7-26-2005. MULTIPLE CLASS, INT. CLS. 16, 25 AND 41.
- THE BRITISH BROADCASTING CORPORATION, LONDON, UNITED KINGDOM:
3,006,791, PUB. 7-26-2005. MULTIPLE CLASS, INT. CLS. 9, 16, 20, 38 AND 41.
- THE CARTRIDGE DEPOT, LLC, FORT LAUDERDALE, FL:
3,007,431, PUB. 7-26-2005. INT. CL. 2.
- THE COCA-COLA COMPANY, ATLANTA, GA:
3,007,806, INT. CL. 32.
- THE COMMONWEALTH OF MASSACHUSETTS, EXECUTIVE DEPARTMENT, ACTING THROUGH THE INFORMATION TECHNOLOGY DIVISION, BOSTON, MA:
3,007,252, PUB. 7-26-2005. MULTIPLE CLASS, INT. CLS. 36, 38, 39 AND 41.
- THE CORYN GROUP, INC., NEWTOWN SQUARE, PA:
2,760,264, COR. INT. CL. 42.
- THE CULINARY SCHOOL OF FORT WORTH, LLC, FORT WORTH, TX:
3,007,122, PUB. 7-26-2005. INT. CL. 43.
- THE DANNON COMPANY, INC., TARRYTOWN, NY:
3,007,439, PUB. 4-5-2005. MULTIPLE CLASS, INT. CLS. 29 AND 32.
- THE DEAL, LLC, NEW YORK, NY:
3,007,102, PUB. 7-26-2005. MULTIPLE CLASS, INT. CLS. 16, 36 AND 41.
- THE FINANCIAL VALUATION GROUP L.C., TAMPA, FL:
3,007,009, PUB. 7-26-2005. INT. CL. 35.
- THE FLEXAUST COMPANY, INC., WARSAW, IN:
3,006,974, PUB. 7-26-2005. MULTIPLE CLASS, INT. CLS. 6, 9, 17, 19 AND 40.
3,006,975, PUB. 7-26-2005. MULTIPLE CLASS, INT. CLS. 6, 9, 17, 19 AND 40.
- THE GARAGE DOOR GROUP, INC., WINSTON-SALEM, NC:
3,007,951, MULTIPLE CLASS, INT. CLS. 6 AND 19.
- THE GASTON & PORTER HEALTH IMPROVEMENT CENTER, POTOMAC, MD:
3,006,998, PUB. 7-26-2005. INT. CL. 41.
- THE GLOBE EQUIPMENT COMPANY, BRIDGEPORT, CT:
3,007,059, PUB. 7-26-2005. INT. CL. 35.
- THE GREAT ATLANTIC & PACIFIC TEA COMPANY, INC., MONTVALE, NJ:
3,007,194, PUB. 7-26-2005. MULTIPLE CLASS, INT. CLS. 1, 3, 4, 5, 7, 8, 9, 11, 16, 20, 21, 28, 29, 30, 31 AND 32.
- THE GUTTERSHTTER MANUFACTURING COMPANY, CINCINNATI, OH:
3,008,072, INT. CL. 6.
- THE HANS KISSLE COMPANY, INC., HAVERHILL, MA:
3,007,526, PUB. 7-26-2005. MULTIPLE CLASS, INT. CLS. 29 AND 30.
- THE INDIGO MARKET, INC., PERRYSBURG, OH:
3,007,127, PUB. 7-26-2005. INT. CL. 35.
- THE JOCKEY CLUB INFORMATION SYSTEMS, INC., NEW YORK, NY:
3,006,988, PUB. 7-26-2005. INT. CL. 9.
- THE KING ARTHUR FLOUR COMPANY, INC., NORWICH, VT:
200,247, REN. 9-7-05. U.S. CL. 46 (INT. CL. 30).
200,271, REN. 9-7-05. U.S. CL. 46 (INT. CL. 30).
200,272, REN. 9-7-05. U.S. CL. 46 (INT. CL. 30).
200,392, REN. 9-7-05. U.S. CL. 46 (INT. CL. 30).
- THE MCGRAW-HILL COMPANIES, INC., NEW YORK, NY:
3,008,061, INT. CL. 9.
3,008,080, INT. CL. 35.
3,008,081, INT. CL. 35.
- THE OLD BROGUE, INC., GREAT FALLS, VA:
1,341,689, REN. 9-6-05. INT. CL. 42.
- THE PENTECOSTAL CHURCH OF GOD "THE GREAT COMMISSION" INC., PATERSON, NJ:
3,006,968, PUB. 7-26-2005. MULTIPLE CLASS, INT. CLS. 9, 41 AND 45.
- THE PREMIUM CONNECTION, INC., LAS VEGAS, NV:
3,007,081, PUB. 7-26-2005. INT. CL. 35.
- THE PROCTER & GAMBLE COMPANY, CINCINNATI, OH:
3,007,473, PUB. 4-5-2005. INT. CL. 16.
3,007,962, INT. CL. 7.
- THE PROPHET CORPORATION, OWATONNA, MN:
3,007,479, PUB. 7-26-2005. MULTIPLE CLASS, INT. CLS. 14, 16 AND 28.
- THE ST. JOE COMPANY, JACKSONVILLE, FL:
3,007,076, PUB. 7-26-2005. INT. CL. 41.
- THE TJX COMPANIES, INC., FRAMINGHAM, MA:
3,007,943, INT. CL. 25.
- THE TRIZETTO GROUP, INC., NEWPORT BEACH, CA:
2,207,325, CANC. INT. CL. 35.
- THE UNITED STATES OF AMERICA, AS REPRESENTED BY THE SECRETARY OF THE NAVY, ARLINGTON, VA:
3,006,929, PUB. 7-26-2005. MULTIPLE CLASS, INT. CLS. 9, 12, 14, 16, 18, 20, 21, 25, 28, 39, 41, 43, 44 AND 45.
- THE UPPER ROOM, NASHVILLE, TN:
3,007,428, PUB. 7-26-2005. MULTIPLE CLASS, INT. CLS. 9, 35, 38 AND 45.
- THE VOLLRATH COMPANY, L.L.C., SHEBOYGAN, WI:
1,347,279, REN. 9-7-05. INT. CL. 8.
- THE WATT STOPPER, INC., SANTA CLARA, CA:
3,007,694, INT. CL. 9.
- THEATRE BAY AREA, SAN FRANCISCO, CA:
3,007,024, PUB. 7-26-2005. INT. CL. 16.
- THEIMER, GERHARD K., BOCA RATON, FL:
3,007,994, INT. CL. 9.
- THINK ACTION LIMITED, AUCKLAND, NEW ZEALAND:
3,007,218, PUB. 7-26-2005. MULTIPLE CLASS, INT. CLS. 9 AND 41.
- THINK GOD, INC., FT. WORTH, TX:
3,007,577, INT. CL. 42.
- THINKING WITH COMPUTERS, INC., TUCSON, AZ:
1,904,386, REN. 9-3-05. INT. CL. 16.
1,905,414, REN. 9-3-05. INT. CL. 9.
1,906,026, REN. 9-3-05. INT. CL. 41.
- THOMAS PUBLISHING COMPANY, NEW YORK, NY:
3,007,013, PUB. 7-26-2005. INT. CL. 35.
- THOMAS SCIENTIFIC INC., PHILADELPHIA, PA:
3,008,033, INT. CL. 42.
- THOMPSON & CO. OF TAMPA, INC., TAMPA, FL:
3,007,517, PUB. 7-5-2005. INT. CL. 34.
- THOR CERAMICS LIMITED, CLYDEBANK G81 IRW, SCOTLAND:
1,344,183, REN. 9-3-05. MULTIPLE CLASS, INT. CLS. 11 AND 19.
- THREADFIN BUSINESS SOLUTIONS, LLC, TAMPA, FL:
3,007,426, PUB. 7-26-2005. INT. CL. 42.

- THREE CORNER ROUND PACK OUTFIT, INC., CHAGRIN FALLS, OH:
1,911,827. REN. 9-3-05. INT. CL. 39.
- THROPP'S NUTRIBEST, ALLEGANY, NY, DBA THROPP'S NUTRITION:
3,007,709. INT. CL. 5.
- THUNDERBIRD DESIGNS, INC., TAMPA, FL:
2,207,175. CANC. INT. CL. 18.
- THYSSENKRUPP STAHL COMPANY, KINGSVILLE, MO:
1,257,429. REN. 9-3-05. INT. CL. 9.
- TIANJIN FOREIGN TRADE (GROUP) STATIONERY & SPORTING GOODS CO., LTD., TIANJIN, CHINA AND TIANJIN FIRSTER CO., LTD., TIANJIN, CHINA:
3,007,835. INT. CL. 2.
- TICKETMASTER, WEST HOLLYWOOD, CA, DBA CITY-SEARCH.COM:
3,007,790. MULTIPLE CLASS, INT. CLS. 35, 39, 41 AND 43.
- TIFFANY (NJ) INC., PARSIPPANY, NJ:
1,302,508. REN. 9-8-05. MULTIPLE CLASS, INT. CLS. 14 AND 34.
- TILLER; DONALD H., MCBEE, SC:
1,306,845. CANC. INT. CL. 9.
- TIME WARNER ENTERTAINMENT COMPANY, L.P., NEW YORK, NY:
2,206,797. CANC. INT. CL. 28.
2,206,798. CANC. INT. CL. 25.
2,206,986. CANC. INT. CL. 41.
- TIMES MIRROR TRAINING, INC., TAMPA, FL:
2,207,141. CANC. INT. CL. 9.
- TINE BA, NORWAY:
3,007,559. PUB. 7-26-2005. INT. CL. 29.
- TLW ENTERPRISES, INC., NEW YORK, NY:
3,007,908. INT. CL. 39.
- TM ACQUISITION CORP., LAS VEGAS, NV:
3,007,069. PUB. 7-26-2005. INT. CL. 36.
- TM WOOD PRODUCTS MANUFACTURING, INC., DETROIT, MI:
2,206,525. CANC. INT. CL. 19.
- TMT RESEARCH DEVELOPMENT, INC., SMITH RIVER, CA, TURBINE METAL TECHNOLOGY INC., BURBANK, CA:
1,904,957. REN. 9-6-05. INT. CL. 12.
- TO TRUTH INC., WALNUT CREEK, CA:
3,007,491. PUB. 7-26-2005. INT. CL. 35.
- TOASTMASTER INC., COLUMBIA, MO:
2,207,624. CANC. INT. CL. 11.
- TODAY'S VISION FRANCHISING CORPORATION, HOUSTON, TX:
1,889,042. REN. 9-3-05. INT. CL. 42.
- TOLEDO AUTOMATIC DOOR CO., FORT MYERS, FL:
1,922,456. REN. 9-6-05. INT. CL. 37.
1,928,408. REN. 9-6-05. INT. CL. 37.
- TOM STURGIS PRETZELS, INC., READING, PA:
3,007,799. INT. CL. 30.
- TONE BROTHERS, INC., ANKENY, IA:
3,007,942. INT. CL. 30.
- TOP BILLING, INC., NORTH MIAMI BEACH, FL:
1,306,721. CANC. INT. CL. 3.
- TOPANGA HOLDING COMPANY, LLC, COMMERCE, CA:
3,007,435. PUB. 7-26-2005. MULTIPLE CLASS, INT. CLS. 29, 30 AND 31.
- TOPSTAR GMBH, LANGENNEUFNACH, FED REP GERMANY:
3,007,511. PUB. 7-26-2005. INT. CL. 20.
- TORAY KABUSHIKI KAISHA, TOKYO, JAPAN, TA TORAY INDUSTRIES, INC.:
2,207,138. CANC. INT. CL. 24.
- TORKOS BROTHERS INC., TORONTO, ONTARIO, M4B 1X7, CANADA:
2,099,815. CANC. INT. CL. 28.
- TORNAI, RICHARD M., PINOLE, CA:
3,008,075. INT. CL. 10.
- TOTES ISOTONER CORPORATION, CINCINNATI, OH:
1,375,994. REN. 9-7-05. INT. CL. 25.
- TOWNSEND CROQUET LIMITED, FRINTON-ON-SEA, ESSEX CO13 0LX, UNITED KINGDOM:
1,865,326. CANC. INT. CL. 28.
- TOYOTA JIDOSHA KABUSHIKI KAISHA (TOYOTA MOTOR CORPORATION), AICHI-KEN, JAPAN:
959,700. AM. U.S. CL. 19.
- TRACERS, L.P., PLANO, TX:
2,207,480. CANC. INT. CL. 16.
- TRADE WEST, INC., HONOLULU, HI:
2,207,311. CANC. MULTIPLE CLASS, INT. CLS. 3 AND 28.
- TRADITIONAL MEDICINALS, INC., SEBASTOPOL, CA:
3,007,975. INT. CL. 5.
- TRAKWARE, INC., HOUSTON, TX:
2,206,787. CANC. INT. CL. 9.
- TRAN, DON, WESTMINSTER, CA:
3,007,045. PUB. 7-26-2005. INT. CL. 8.
- TRANSFLO EXPRESS LLC, TAMPA, FL:
3,007,460. PUB. 7-26-2005. MULTIPLE CLASS, INT. CLS. 35 AND 42.
- TRANSPORTATION TECHNOLOGY CENTER, INC., PUEBLO, CO:
3,007,206. PUB. 7-26-2005. MULTIPLE CLASS, INT. CLS. 9 AND 42.
- TRANSPRO, INC., NEW HAVEN, CT, GO/DAN INDUSTRIES, NEW HAVEN, CT:
1,930,965. REN. 9-3-05. INT. CL. 7.
- TRAVEL CADDY, INC., DES PLAINES, IL, DBA TRAVELON:
2,207,040. CANC. INT. CL. 18.
- TRAVELING HERBALIST, INC., THE, CHASKA, MN:
2,207,673. CANC. INT. CL. 30.
- TRAXIS PARTNERS LLC, NEW YORK, NY:
3,007,795. INT. CL. 36.
- TRAYLOR, PAUL L., IRVINE, CA:
1,865,244. CANC. INT. CL. 11.
- TREAT ENTERTAINMENT INC, FLORENCE, AL:
1,949,220. REN. 9-3-05. INT. CL. 16.
- TREE OAK INC., CAPE MAY, NJ:
1,865,298. CANC. INT. CL. 25.
- TRENDMASTERS, INC., ST. LOUIS, MO:
1,865,341. CANC. INT. CL. 28.
- TRENDWEST RESORTS, INC., REDMOND, WA, WORLD-MARK, THE CLUB, KIRKLAND, WA:
1,940,673. REN. 9-3-05. INT. CL. 36.
- TRENTONLEE CORPORATION, GRAND RAPIDS, MI:
2,672,979. CANC. MULTIPLE CLASS, INT. CLS. 36 AND 37.
- TRI-TRONICS, INC., TUCSON, AZ:
1,345,689. REN. 9-3-05. INT. CL. 9.
- TRICOR REFINING, LLC, OILDALE, CA, WITCO CHEMICAL CORPORATION, NEW YORK, NY:
1,015,020. REN. 9-7-05. INT. CL. 1.
- TRIO NETWORK, INC., UNIVERSAL CITY, CA:
3,007,649. INT. CL. 38.
- TRISEAL CORPORATION, HEBRON, IL:
1,914,936. REN. 9-7-05. INT. CL. 17.
1,914,937. REN. 9-7-05. INT. CL. 17.
1,919,725. REN. 9-7-05. INT. CL. 17.
- TRISYN GROUP L.P., IRVING, TX:
3,006,944. PUB. 7-26-2005. INT. CL. 9.
- TRIUMPH PET INDUSTRIES, INC., WARWICK, NY:
1,913,628. REN. 9-6-05. INT. CL. 31.
- TRUDI SPA, TARENTO, ITALY:
2,941,551. COR. MULTIPLE CLASS, INT. CLS. 16, 18, 24, 25 AND 28.
- TRUE MANUFACTURING CO., INC., O'FALLON, MO:
3,007,984. INT. CL. 11.
- TRUE NORTH COMMUNICATIONS INC., CHICAGO, IL:
2,206,591. CANC. INT. CL. 35.
- TRUMPF GMBH & CO. KG, 71254 DITZINGEN, FED REP GERMANY:
3,006,862. PUB. 7-26-2005. MULTIPLE CLASS, INT. CLS. 12, 35, 40 AND 42.
- TRUSTEES OF DARTMOUTH COLLEGE, HANOVER, NH:
3,007,350. PUB. 7-26-2005. INT. CL. 6.
- TRUSTEES OF PRINCETON UNIVERSITY, THE, PRINCETON, NJ, PRINCETON UNIVERSITY PRESS, PRINCETON, NJ:
1,385,940. REN. 9-6-05. INT. CL. 16.

- TSGL HOLDING, INC., FORT WORTH, TX:
2,206,959, CANC. INT. CL. 9.
- TURF SCIENCE LABORATORIES, INC., NATIONAL CITY, CA:
3,008,006, INT. CL. 1.
- TURF-SEED, INC., HUBBARD, OR:
3,007,048, PUB. 7-26-2005. INT. CL. 44.
- TV GUIDE MAGAZINE GROUP, INC., LOS ANGELES, CA:
3,006,957, PUB. 7-26-2005. MULTIPLE CLASS, INT. CLS. 11, 16, 18, 25, 28, 35, 38 AND 41.
3,007,648, MULTIPLE CLASS, INT. CLS. 9, 35, 38 AND 41.
- TVA FIRE AND LIFE SAFETY, INC., SAN DIEGO, CA:
3,007,489, PUB. 7-26-2005. MULTIPLE CLASS, INT. CLS. 37 AND 42.
- TVSM, INC., HORSHAM, PA:
2,206,911, CANC. INT. CL. 16.
- TWENTIETH CENTURY FOX FILM CORPORATION, LOS ANGELES, CA:
2,206,926, CANC. INT. CL. 41.
- TWENTYELEVEN, INC., GRAND PRAIRIE, TX:
2,206,934, CANC. INT. CL. 38.
- TWO MEN AND A TRUCK/INTERNATIONAL, INC., OKEMOS, MI:
3,006,814, PUB. 3-5-2002. INT. CL. 39.
3,006,815, PUB. 3-5-2002. INT. CL. 39.
- TY BOYD ENTERPRISES, INC., CHARLOTTE, NC:
1,895,758, REN. 9-3-05. INT. CL. 41.
- TYCO HEALTHCARE GROUP LP, NORWALK, CT, DEXIDE, INC., FORT WORTH, TX:
1,901,651, REN. 9-7-05. INT. CL. 10.
- TYCO HEALTHCARE GROUP LP, MANSFIELD, MA:
3,007,882, INT. CL. 10.
- TYSON FOODS, INC., SPRINGDALE, AR:
1,307,316, CANC. INT. CL. 29.
- U.S. BOLT MANUFACTURING, INC., HOUSTON, TX:
1,895,866, REN. 9-8-05. INT. CL. 6.
- U.S. DIVERS CO., INC., VISTA, CA, U.S.D. CORP, SANTA ANA, CA:
1,356,814, REN. 9-3-05. INT. CL. 25.
- U.S. RISK INSURANCE GROUP, INC., DALLAS, TX:
1,981,843, REN. 9-9-05. INT. CL. 36.
- UB FOUNDATION ACTIVITIES, INC., BUFFALO, NY:
2,207,511, CANC. INT. CL. 16.
- UBS AG, CH-8001 ZURICH, SWITZERLAND:
3,006,891, PUB. 7-26-2005. MULTIPLE CLASS, INT. CLS. 3, 6, 7, 8, 9, 11, 12, 14, 15, 16, 18, 20, 21, 24, 25, 27, 28, 30, 32, 33, 34, 35, 36, 37, 38, 39, 40, 41, 42 AND OTHERS.
- ULTIQUE SKIN CARE PRODUCTS INC., SEATTLE, WA:
1,306,730, CANC. INT. CL. 3.
- ULTRAK, INC., SAN ANTONIO, TX:
3,007,746, INT. CL. 9.
- UMB FINANCIAL CORPORATION, KANSAS CITY, MO:
3,007,534, PUB. 7-26-2005. INT. CL. 36.
- UMG RECORDINGS, INC., SANTA MONICA, CA, GEFFEN RECORDS, INC., LOS ANGELES, CA:
1,904,252, REN. 9-6-05. INT. CL. 9.
1,904,253, REN. 9-6-05. INT. CL. 9.
- UNFILTERED NAPA LLC, NAPA, CA:
3,007,885, INT. CL. 33.
- UNIBRIGHT FOODS, INC., BELL GARDENS, CA:
1,913,556, REN. 9-9-05. INT. CL. 29.
- UNION CARBIDE CHEMICALS & PLASTICS TECHNOLOGY CORPORATION, DANBURY, CT TO CROMPTON CORPORATION, GREENWICH, CT:
1,865,125, CANC. INT. CL. 1.
- UNION CARBIDE CORPORATION, NEW YORK, NY:
780,827, CANC. U.S. CL. 6.
- UNION CENTRAL LIFE INSURANCE COMPANY; THE, CINCINNATI, OH:
1,307,410, CANC. INT. CL. 36.
- UNION DES ASSOCIATIONS EUROPEENNES DE FOOTBALL, 1260 NYON 2, SWITZERLAND:
3,006,869, PUB. 7-26-2005. MULTIPLE CLASS, INT. CLS. 9, 12, 16, 18, 25, 28, 30, 32, 36, 39, 41 AND 43.
- UNIROYAL ENGINEERED PRODUCTS, LLC, SARASOTA, FL:
1,346,171, REN. 9-3-05. INT. CL. 18.
- UNISHIPERS ASSOCIATION, INC., SALT LAKE CITY, UT:
3,007,616, MULTIPLE CLASS, INT. CLS. 35 AND 39.
- UNITEC, INC., ELKRIDGE, MD, DBA UNITEC ELECTRONICS:
3,007,358, PUB. 7-26-2005. INT. CL. 35.
3,007,359, PUB. 7-26-2005. INT. CL. 9.
- UNITED EXCHANGE CORPORATION, CERRITOS, CA:
3,007,964, INT. CL. 10.
- UNITED FEATURE SYNDICATE, INC., NEW YORK, NY:
2,207,188, CANC. INT. CL. 35.
- UNITED GUARANTY RESIDENTIAL INSURANCE COMPANY, GREENSBORO, NC:
2,207,408, CANC. INT. CL. 36.
- UNITED INDUSTRIES CORPORATION, ST. LOUIS, MO:
1,865,158, CANC. INT. CL. 5.
- UNITED METALS (HOLDINGS) LIMITED, KOWLOON, HONG KONG:
2,207,567, CANC. INT. CL. 9.
- UNITED METHODIST PUBLISHING HOUSE, THE, NASHVILLE, TN:
2,207,733, CANC. MULTIPLE CLASS, INT. CLS. 16 AND 35.
- UNITED STATES MARINE SAFETY ASSOCIATION, PHILADELPHIA, PA:
1,864,998, CANC. INT. CL. 41.
- UNITED STATES MONORAIL CORPORATION, BOSTON, MA:
1,014,369, REN. 9-7-05. U.S. CL. 23 (INT. CL. 7).
- UNITED STATES PLAYING CARD COMPANY, THE, CINCINNATI, OH, UNITED STATES PLAYING CARD COMPANY, THE, CINCINNATI, OH:
1,901,704, REN. 9-3-05. INT. CL. 16.
- UNITED WAY OF SOUTHEASTERN PENNSYLVANIA, PHILADELPHIA, PA:
2,207,207, CANC. INT. CL. 36.
- UNITEK MIYACHI CORPORATION, MONROVIA, CA:
780,619, REN. 9-3-05. U.S. CL. 34 (INT. CL. 11).
- UNITYLAB INC., EDMONTON, ALBERTA:
3,007,725, INT. CL. 16.
- UNIVERSAL MACHINE COMPANY OF POTTSTOWN, INC., STOWE, PA:
1,307,444, CANC. INT. CL. 37.
- UNIVERSITY OF VERMONT AND STATE AGRICULTURAL COLLEGE, BURLINGTON, VT:
1,354,680, REN. 9-9-05. INT. CL. 41.
1,380,806, REN. 9-9-05. INT. CL. 41.
- UNSA AMBALAJ SANAYI VE TICARET ANONIM SIRKETI, ISTANBUL, TURKEY:
3,007,062, PUB. 7-26-2005. INT. CL. 22.
- UPPER PENINSULA TRAVEL & RECREATION ASSOCIATION, IRON MOUNTAIN, MI:
3,007,159, PUB. 7-26-2005. INT. CL. 39.
- URBANA SOFTWARE, INC., SAN FRANCISCO, CA:
3,007,617, INT. CL. 9.
- URD, INC., WILMINGTON, DE:
3,006,930, PUB. 7-26-2005. INT. CL. 35.
- USA PELICAN, INC., MIAMI, FL, DBA WATER MANAGEMENT TECHNOLOGIES:
3,008,082, INT. CL. 11.
- USER TECHNOLOGY ASSOCIATES, INC., ARLINGTON, VA:
1,865,486, CANC. INT. CL. 42.
1,865,487, CANC. INT. CL. 42.
- UTAH COMMUNITY CREDIT UNION, PROVO, UT:
3,006,913, PUB. 7-26-2005. INT. CL. 36.
- UV SALES, INC., ROCKLEIGH, NJ:
3,007,530, PUB. 7-26-2005. INT. CL. 9.
- V.I.P.R. COMPANY, THE, FREDERICKSBURG, VA:
1,982,421, REN. 9-3-05. INT. CL. 42.
- VACATION BREAK U.S.A., INC., ORLANDO, FL:
1,935,202, REN. 9-6-05. INT. CL. 36.
- VAHLE'S PET STUFF, INC., SPRINGFIELD, PA:
1,307,514, CANC. INT. CL. 42.
- VALEANT PHARMACEUTICALS INTERNATIONAL, COSTA MESA, CA, PAUL B. ELDER COMPANY, BRYAN, OH:
607,835, REN. 9-7-05. U.S. CL. 18 (INT. CL. 5).

- VALENCE TECHNOLOGY, INC., HENDERSON, NV:
2,946,691, COR. INT. CL. 9.
- VALENTINO'S OF AMERICA, INC., LINCOLN, NE:
1,210,075, REN. 9-8-05. INT. CL. 42.
- VALLON, INC., MINNEAPOLIS, MN:
2,207,711, CANC. INT. CL. 42.
- VAN MELLE NEDERLAND, B.V., BREDA, 4815 HK, NETHERLANDS:
2,206,316, CANC. INT. CL. 30.
- VANCO INDUSTRIES LLC, PAUL, ID:
3,007,420, PUB. 7-26-2005. INT. CL. 5.
- VANDOR CORPORATION, RICHMOND, IN:
3,006,953, PUB. 7-26-2005. INT. CL. 16.
- VANGUARD SYSTEMS, INC., MEDIA, PA:
2,207,616, CANC. INT. CL. 9.
- VANITY FAIR, INC., WILMINGTON, DE:
3,007,991, INT. CL. 35.
- VANMOOR, ARTHUR, NORTH MIAMI BEACH, FL:
2,207,495, CANC. INT. CL. 5.
- VENT PUBLICATIONS, INC., WEST PALM BEACH, FL:
2,207,613, CANC. INT. CL. 16.
2,207,614, CANC. INT. CL. 42.
- VERCELLOTTI, TOMASO, 16121 GENOVA, ITALY:
3,006,803, PUB. 7-26-2005. INT. CL. 10.
- VERIZON TRADEMARK SERVICES LLC, ARLINGTON, VA:
3,007,760, INT. CL. 38.
- VETCO, INC., IRVINGTON, NY:
3,007,911, INT. CL. 5.
- VETEMENTS, LOUIS GARNEAU INC., QUEBEC G3A 2E6, CANADA TO LOUIS GARNEAU SPORTS INC., QUEBEC, CANADA:
1,864,772, CANC. INT. CL. 25.
- VIACOM INTERNATIONAL INC., NEW YORK, NY:
3,007,797, INT. CL. 25.
- VIAGEN, INC., AUSTIN, TX:
3,007,437, PUB. 7-26-2005. INT. CL. 44.
- VIBACIDE RESEARCH, INC, LANSING, IL:
2,207,111, CANC. INT. CL. 16.
- VICTOR COMPANY OF JAPAN, LIMITED, YOKOHAMA CITY, JAPAN:
1,917,656, REN. 9-3-05. INT. CL. 9.
- VICTOR, ANN, BEVERLY HILLS, CA, DBA INTRODUIRE INTERNATIONAL:
2,206,667, CANC. INT. CL. 42.
- VICTORIA D'ANGELO, LLC, NEW YORK, NY:
2,206,651, CANC. INT. CL. 25.
- VICTORY CLOTHES, INC., PHILADELPHIA, PA, AKA TORRE CLOTHES:
1,344,635, REN. 9-3-05. INT. CL. 25.
1,344,637, REN. 9-6-05. INT. CL. 25.
- VICTORY CLOTHES, INC., PHILADELPHIA, PA, TA TORRE CLOTHES:
1,963,454, REN. 9-9-05. INT. CL. 42.
- VIDEO SCENE OF DELAWARE, INC., DOVER, DE, TA TAN INN:
3,007,147, PUB. 7-26-2005. INT. CL. 44.
- VIETNAM ELECTRIC WIRE & CABLE CORP. (CADIVI), HO CHI MINH CITY, VIETNAM:
3,007,181, PUB. 7-26-2005. INT. CL. 9.
- VIETNAM WOMEN'S MEMORIAL PROJECT, INC., WASHINGTON, DC:
1,865,041, CANC. INT. CL. 42.
- VIGIRODA PRODUCTS LLC, ROCKY HILL, CT:
3,007,093, PUB. 7-26-2005. INT. CL. 11.
- VIIISAGE TECHNOLOGY, INC., LITTLETON, MA:
3,006,956, PUB. 7-26-2005. INT. CL. 9.
- VILLAVASO, DEREK A., NEW ORLEANS, LA:
2,357,054, CANC. INT. CL. 35.
- VILLENEUVE, JACQUES, MC-MONACO, MONACO:
2,183,270, CANC. MULTIPLE CLASS, INT. CLS. 18, 24, 26 AND 38.
- VINA VALDIVIESO S.A., SANTIAGO, CHILE:
3,007,384, PUB. 7-26-2005. INT. CL. 33.
- VINTAGE HOLDINGS, L.L.C., TULSA, OK, AMERICAN BUILDERS HARDWARE CORPORATION, IRVINE, CA:
1,906,294, REN. 9-3-05. INT. CL. 6.
- VIRGINIA DARE EXTRACT CO., INC., BROOKLYN, NY:
3,007,527, PUB. 7-26-2005. INT. CL. 30.
- VIRTUAL MUSIC ENTERTAINMENT, INC., ANDOVER, MA:
2,207,467, CANC. INT. CL. 9.
- VISIBELLE DERMA INSTITUTE, INC., BLOOMINGTON, MN:
3,007,824, INT. CL. 11.
- VISITING NURSE SERVICE, INC., AKRON, OH:
1,307,519, CANC. INT. CL. 42.
- VISTAR CORPORATION, CENTENNIAL, CO:
3,007,793, INT. CL. 29.
- VITAS, JACOB, AUSTIN, TX:
3,007,210, PUB. 7-26-2005. INT. CL. 42.
- VITESSE SEMICONDUCTOR CORPORATION, CAMARILLO, CA:
3,007,582, INT. CL. 9.
- VLOEDMAN, LESLIE G., HAZEL CREST, IL:
2,206,824, CANC. INT. CL. 16.
- VMX, INC., RICHARDSON, TX:
1,307,448, CANC. INT. CL. 38.
- VNU BUSINESS PUBLICATIONS B.V., 1059 AT, AMSTERDAM, NETHERLANDS:
2,206,518, CANC. MULTIPLE CLASS, INT. CLS. 9, 16 AND 38.
- VOICE BOX, INC., HOUSTON, TX:
2,207,780, CANC. INT. CL. 35.
- VOITH PAPER INC., APPLETON, WI, VOITH SULZER PAPER TECHNOLOGY NORTH AMERICA, INC., MANSFIELD, MA:
1,906,860, REN. 9-7-05. INT. CL. 7.
- VOLK OPTICAL, INC., MENTOR, OH:
2,207,662, CANC. INT. CL. 9.
- VONCO PRODUCTS, INC., LAKE VILLA, IL:
3,007,753, INT. CL. 28.
- VOYETRA TECHNOLOGIES, PELHAM, NY TO VOYETRA TURTLE BEACH, INC., YONKERS, NY:
1,865,218, CANC. INT. CL. 9.
- VRL INTERNATIONAL LTD., GRAND CAYMAN, CAYMAN ISLANDS, GREAT RESORTS LTD., KINGSTON 4, JAMAICA:
1,737,318, REN. 9-8-05. INT. CL. 42.
- VTECH INDUSTRIES, INC., WHEELING, IL TO VTECH ELECTRONICS NORTH AMERICA LLC, ARLINGTON HEIGHTS, IL:
1,879,266, AM. INT. CL. 28.
- VULLION, PHILIPPE, 06410 BIOT, FRANCE:
2,206,489, CANC. INT. CL. 5.
- W W X APPAREL GROUP, LLC, BERNE, IN:
3,007,881, INT. CL. 25.
- W.R. GRACE & CO.:
1,306,628, CANC. INT. CL. 1.
- W.S. BEAUTY, INC., WINSTON-SALEM, NC:
2,206,326, CANC. INT. CL. 42.
- WACKER-CHEMIE GMBH, D-81737 MUNICH, FED REP GERMANY:
1,864,462, CANC. INT. CL. 1.
- WADLEIGH & ASSOCIATES, INC., SLIDELL, LA:
3,006,834, PUB. 7-26-2005. MULTIPLE CLASS, INT. CLS. 41 AND 44.
- WAHL CLIPPER CORPORATION, STERLING, IL:
3,007,686, INT. CL. 8.
3,007,814, INT. CL. 8.
- WAL-MART STORES, INC., BENTONVILLE, AR:
3,006,991, PUB. 7-26-2005. INT. CL. 31.
- WALGREEN CO., DEERFIELD, IL:
3,008,035, INT. CL. 35.
- WALLACE INDUSTRIES, INC., ITHACA, NY:
2,207,007, CANC. INT. CL. 19.
- WALLS, DAVID M., BOXFORD, MA:
3,007,316, PUB. 7-26-2005. INT. CL. 9.
- WALLS, TIMOTHY ROBERT, WEST BADEN SPRINGS, IN:
3,007,878, INT. CL. 25.
- WALTER LANTZ PRODUCTIONS, INC., LOS ANGELES, CA:
1,307,196, CANC. INT. CL. 25.
- WALTERS, WINSOME, ARLINGTON, VA:
2,207,258, CANC. INT. CL. 16.

- WALTERSHAUSER PUPPENMANUFAKTUR GMBH, WALTERSHAUSEN, FED REP GERMANY:
1,864,453, CANC. INT. CL. 1.
- WALTON ARTS CENTER FOUNDATION, INC., FAYETTEVILLE, AR:
3,007,954, INT. CL. 35.
- WARNER BROS. PUBLICATIONS INC., SECAUCUS, NJ TO WARNER BROS. PUBLICATIONS U.S. INC., MIAMI, FL:
1,864,665, CANC. INT. CL. 16.
- WARNER-LAMBERT COMPANY, PARSIPPANY, NJ:
1,903,724, REN. 9-3-05, INT. CL. 30.
- WARNER-LAMBERT COMPANY LLC, MORRIS PLAINS, NJ:
1,902,344, REN. 9-7-05, INT. CL. 5.
- WARNER, FRANK T., MOUND, MN:
3,007,644, INT. CL. 12.
- WASHINGTON MUTUAL, INC., SEATTLE, WA:
3,007,727, INT. CL. 36.
- WASTELAND, INC., HOLLIS, NH:
3,007,101, PUB. 7-26-2005, INT. CL. 38.
- WATERBURY COMPANIES, INC., WATERBURY, CT, R VALUE, INC., SMYRNA, GA:
1,343,775, REN. 9-8-05, INT. CL. 5.
- WATERLINK SYSTEMS, INC., SOLANA BEACH, CA, WATERLINK SYSTEMS, INC., SOLANA BEACH, CA:
1,874,421, REN. 9-6-05, MULTIPLE CLASS, INT. CLS. 9 AND 11.
- WATKINS GLEN INTERNATIONAL, INC., DAYTONA BEACH, FL:
1,389,976, REN. 9-3-05, INT. CL. 25.
1,389,976, CANC. INT. CL. 26.
- WATKINS MANUFACTURING CORPORATION, CARLSBAD, CA:
1,328,343, AM. INT. CL. 10.
- WATSON WYATT & COMPANY, BETHESDA, MD:
2,206,563, CANC. MULTIPLE CLASS, INT. CLS. 35 AND 36.
- WAVE ENERGY SYSTEMS, INC., NEW YORK, NY:
1,306,766, CANC. INT. CL. 5.
- WAVECREST LABORATORIES LLC, DULLES, VA:
3,007,084, PUB. 7-26-2005, INT. CL. 9.
- WAVECREST LABS LLC, DULLES, VA:
3,006,981, PUB. 7-26-2005, INT. CL. 12.
- WAVES LICENSING, LLC, WILMINGTON, DE:
3,007,688, MULTIPLE CLASS, INT. CLS. 35 AND 36.
- WAWONA PACKING CO., LLC, CUTLER, CA:
3,008,076, INT. CL. 31.
- WEB AMERICA NETWORKS, INC., LANCASTER, TX:
2,207,712, CANC. MULTIPLE CLASS, INT. CLS. 38 AND 42.
- WEB-DEPOT, INC., THE, CAMBRIDGE, MA:
2,206,944, CANC. INT. CL. 35.
- WEBB, STEWART, DARLINGTON, PA:
1,920,842, REN. 9-6-05, INT. CL. 14.
- WEBTEC, LLC, CARTHAGE, MO:
1,337,991, REN. 9-7-05, INT. CL. 24.
- WEEMS, JENNIFER L., AUBREY, TX:
3,007,965, INT. CL. 5.
- WEI-CHUAN U.S.A., INC., BELL GARDENS, CA, WEI-CHUAN INTERNATIONAL INC., LOS ANGELES, CA:
1,027,462, REN. 9-6-05, INT. CL. 29.
- WEIDER NUTRITION INTERNATIONAL, INC., SALT LAKE CITY, UT:
3,006,932, PUB. 7-26-2005, INT. CL. 30.
- WELCH, GARY L., EDMOND, OK:
1,910,722, REN. 9-3-05, INT. CL. 9.
- WELLA CORPORATION; THE, ENGLEWOOD, NJ:
1,306,699, CANC. INT. CL. 3.
1,306,708, CANC. INT. CL. 3.
- WELLNESS PHARMACY, MARSHFIELD, WI:
2,530,818, CANC. INT. CL. 35.
- WENLING SHUNPU INDUSTRIAL; ARTWORK FACTORY, CHINA:
3,007,554, PUB. 7-26-2005, INT. CL. 25.
- WERNER FREYBERG, CHEMISCHE FABRIK DELITIA NACHF., VERWALTUNGSGESELLSCHAFT MBH, 69514 LAUDENBACH, FED REP GERMANY:
1,928,885, REN. 9-3-05, INT. CL. 5.
- WESCO, INC., MUSKEGON, MI, WESTGATE OIL COMPANY, MUSKEGON, MI:
1,938,877, REN. 9-9-05, MULTIPLE CLASS, INT. CLS. 4 AND 30.
- WESLEY-HOSFORD, ZIA, HOLLYWOOD, FL:
2,207,156, CANC. INT. CL. 3.
- WEST MARINE IHC I, INC., WATSONVILLE, CA, WEST MARINE PRODUCTS, INC., WATSONVILLE, CA:
1,901,735, REN. 9-7-05, INT. CL. 16.
- WEST PUBLISHING CORPORATION, EAGAN, MN, CALLAGHAN & COMPANY, WILMETTE, IL:
1,332,007, REN. 9-9-05, INT. CL. 16.
- WESTCOAST HOSPITALITY LIMITED PARTNERSHIP, SPOKANE, WA, GOODALE & BARBIERI COMPANIES, SPOKANE, WA:
1,896,423, REN. 9-6-05, MULTIPLE CLASS, INT. CLS. 36 AND 41.
- WESTERBERG, LINDA ROG, DALLAS, TX:
3,007,876, INT. CL. 35.
- WESTERN DIVERSIFIED SERVICES, INC., DEERFIELD, IL:
2,206,785, CANC. INT. CL. 42.
- WESTERN EMPIRE PUBLICATIONS, INC., SAN CLEMENTE, CA:
2,207,768, CANC. INT. CL. 16.
- WESTERN HOLDINGS, L.L.C., CHEYENNE, WY:
3,007,737, INT. CL. 5.
- WESTERN INTERSTATE COMMISSION FOR HIGHER EDUCATION, BOULDER, CO:
2,206,479, CANC. INT. CL. 41.
- WESTERN PRINTING MACHINERY COMPANY, SCHILLER PARK, IL:
1,337,563, REN. 9-7-05, INT. CL. 7.
- WESTERN STOCK SHOW ASSOCIATION, THE, DENVER, CO:
1,908,751, REN. 9-7-05, INT. CL. 35.
- WESTWIND TECHNOLOGIES, INC., HUNTSVILLE, AL:
3,007,202, PUB. 7-26-2005, MULTIPLE CLASS, INT. CLS. 37 AND 42.
- WETCO, L.L.C., YORBA LINDA, CA:
2,207,134, CANC. INT. CL. 28.
- WHEEL CONCEPTS INDUSTRIES, NEWBURY PARK, CA:
3,007,597, INT. CL. 38.
- WHEELS FOR KIDS, INC., BOYNTON BEACH, FL:
3,007,229, PUB. 7-26-2005, INT. CL. 44.
- WHIRLAWAY FROCKS, INC., NEW YORK, NY:
2,207,777, CANC. INT. CL. 25.
- WHISK COMMUNICATIONS, LLC, YONKERS, NY:
3,006,965, PUB. 7-26-2005, INT. CL. 41.
- WHITE, P.H., JR., DYERSBURG, TN:
3,007,353, PUB. 7-26-2005, INT. CL. 21.
- WHITE, TRACY, ROSCOE, IL:
2,206,597, CANC. MULTIPLE CLASS, INT. CLS. 25 AND 28.
- WHITMER COMPANY, THE, CLEVELAND, OH:
1,865,091, CANC. MULTIPLE CLASS, INT. CLS. 9 AND 11.
- WICKID, L.L.C., RALEIGH, NC:
3,007,676, INT. CL. 25.
3,007,677, INT. CL. 25.
- WICKMAN, MICHAEL, DAUPHIN ISLAND, AL:
3,006,933, PUB. 7-26-2005, INT. CL. 30.
- WIDE OPEN COATINGS, INC., MOORESVILLE, NC:
3,007,839, INT. CL. 2.
- WIGGINS ADJUSTMENTS LTD., LANGLEY, BRITISH COLUMBIA, CANADA:
1,346,747, REN. 9-3-05, INT. CL. 36.
- WILD GOOSE STORAGE, INC., CALGARY, ALBERTA, CANADA:
2,206,633, CANC. INT. CL. 39.
- WILDERNESS MEDICAL SOCIETY, COLORADO SPRINGS, CO:
1,865,038, CANC. INT. CL. 42.
- WILDSEED FARMS, LTD., FREDERICKSBURG, TX:
3,006,985, PUB. 7-26-2005, INT. CL. 30.
- WILLIAMS INFORMATION SERVICES CORPORATION, TULSA, OK:
1,864,961, CANC. INT. CL. 38.

WILLIAMS, FREDERICK B., BROOKLYN, NY:
3,007,323, PUB. 7-26-2005. INT. CL. 41.

WILLIAMSON, FRANK W., ORRVILLE, AL:
3,006,882, PUB. 7-26-2005. INT. CL. 24.

WILLIS AMERICAS ADMINISTRATION, INC., ROSWELL, GA:
3,007,791, MULTIPLE CLASS, INT. CLS. 35 AND 42.

WILLOW FAMILY FOODS, INC., BEAVERTON, OR:
1,864,817, CANC. MULTIPLE CLASS, INT. CLS. 29 AND 30.

WILLOW RIDGE PLASTICS, INCORPORATED, ERLANGER, KY:
1,964,226, REN. 9-6-05. INT. CL. 1.

WILLOWISP PRESS, INC., WORTHINGTON, OH:
1,306,994, CANC. INT. CL. 16.

WILLOWTREE DEVELOPMENT, MILWAUKEE, WI:
3,007,478, PUB. 7-26-2005. INT. CL. 37.

WILSON'S GUN SHOP, INC., BERRYVILLE, AR, DBA WILSON COMBAT:
2,207,009, CANC. INT. CL. 13.

WIN CHESTER MARKETING, OAK PARK, IL:
2,206,349, CANC. INT. CL. 35.

WINCHESTER INDUSTRIES INC., SALTSBURG, PA:
1,903,949, REN. 9-3-05. INT. CL. 19.

WIND & WITHERS TACK AND FEED LLC, CENTERVILLE, OH:
3,007,789, MULTIPLE CLASS, INT. CLS. 35, 37 AND 41.

WIND OVER THE EARTH, INC., BOULDER, CO:
2,206,827, CANC. INT. CL. 41.

WINDOW TO THE WORLD COMMUNICATIONS, INC., CHICAGO, IL:
2,206,618, CANC. INT. CL. 42.

WINDSOR QUALITY FOOD COMPANY LTD., HOUSTON, TX:
3,006,920, PUB. 7-26-2005. INT. CL. 30.

WINN-DIXIE STORES, INC., JACKSONVILLE, FL:
1,005,887, REN. 9-6-05. INT. CL. 30.

WINNER INTERNATIONAL ROYALTY CORPORATION, SHARON, PA:
2,207,381, CANC. INT. CL. 12.

WINNET COMMUNICATIONS, INC., LOUISVILLE, KY:
3,007,379, PUB. 7-26-2005. INT. CL. 38.

WINSHAPE CENTRE, INC., MOUNT BERRY, GA, WINSHAPE CENTER INC., MOUNT BERRY, GA:
1,353,256, REN. 9-7-05. INT. CL. 36.

WINSTON & CASHATT, LAWYERS, A PROFESSIONAL SERVICE CORPORATION, SPOKANE, WA:
2,207,035, CANC. INT. CL. 42.

WINSTON PRINTING COMPANY, WINSTON-SALEM, NC:
3,007,107, PUB. 7-26-2005. MULTIPLE CLASS, INT. CLS. 40 AND 42.

WINSTON-SALEM STATE UNIVERSITY, WINSTON-SALEM, NC:
3,007,113, PUB. 7-26-2005. MULTIPLE CLASS, INT. CLS. 25 AND 41.
3,007,114, PUB. 7-26-2005. INT. CL. 41.

WIRED VENTURES, INC., SAN FRANCISCO, CA:
2,207,521, CANC. INT. CL. 25.

WISE, GARY, DESTIN, FL:
3,007,235, PUB. 7-26-2005. INT. CL. 41.

WISEMAN, ORLY, STATEN ISLAND, NY:
3,007,038, PUB. 7-26-2005. INT. CL. 41.
3,007,039, PUB. 7-26-2005. INT. CL. 41.
3,007,044, PUB. 7-26-2005. INT. CL. 41.

WITCH WAY CORPORATION, HARRISBURG, IL:
1,306,777, CANC. INT. CL. 5.

WIZARD TECHNOLOGIES, INC., PURCHASE, NY:
3,007,750, MULTIPLE CLASS, INT. CLS. 9 AND 42.

WKI HOLDING COMPANY, INC., RESTON, VA:
3,007,859, INT. CL. 21.

WM. LEMAN'S, INC., BREMEN, IN:
1,307,330, CANC. INT. CL. 30.

WMS GAMING INC., WAUKEGAN, IL:
3,007,802, INT. CL. 9.

WMTA AM 1380, INC., CENTRAL CITY, KY:
2,206,703, CANC. INT. CL. 38.

WNBA ENTERPRISES, LLC, SECAUCUS, NJ:
2,207,566, CANC. INT. CL. 41.

WOMEN'S CONNECTION ONLINE, INC., MCLEAN, VA:
2,437,808, CANC. INT. CL. 42.
2,503,357, CANC. INT. CL. 42.

WOMEN'S SPORTS FOUNDATION, EAST MEADOW, NY:
1,943,065, REN. 9-6-05. U.S. CL. 200.

WOOD PRESERVERS, INC., WARSAW, VA:
3,007,657, INT. CL. 2.

WOOLSEY, RONALD C., BLUE SPRINGS, MO:
2,206,427, CANC. MULTIPLE CLASS, INT. CLS. 9 AND 42.

WOOMBA WINES PTY LTD, KINGSTHORPE, AUSTRALIA:
3,008,057, INT. CL. 33.

WOOSTER BRUSH COMPANY, THE, WOOSTER, OH:
1,907,307, REN. 9-7-05. MULTIPLE CLASS, INT. CLS. 16 AND 21.

WORD ENTERTAINMENT LLC, NASHVILLE, TN:
2,207,504, CANC. INT. CL. 9.

WORD OF FAITH WORLD OUTREACH CENTER, INC., TULSA, OK:
1,353,323, REN. 9-3-05. INT. CL. 41.

WORLD CONFERENCE OF RELIGIONS FOR PEACE, INC., NEW YORK, NY:
3,007,382, PUB. 7-26-2005. MULTIPLE CLASS, INT. CLS. 16, 35, 36, 41, 42, 43 AND 44.

WORLD OF GOOD TASTES, INC., SACRAMENTO, CA:
1,864,848, CANC. INT. CL. 30.

WORLD PUBLICATIONS LLC, WINTER PARK, FL:
3,008,079, INT. CL. 16.

WORLDWIDE CONTAINER SERVICE, INC., HOUSTON, TX:
2,207,630, CANC. INT. CL. 22.

WOVEN INTEGRITY, LLC, COMPTON, CA:
2,207,133, CANC. INT. CL. 25.

WRIGHT GROUP PUBLISHING, INC., BOTHELL, WA:
2,206,733, CANC. INT. CL. 16.

WU, TONY, HAYWARD, CA:
3,007,972, INT. CL. 25.

WUXI SHI ZHEN ZHENG LAO LU GAO JIAN ROU ZHUANG CO., LTD., WUXI, JIANGSU, CHINA:
3,007,183, PUB. 7-5-2005. INT. CL. 29.

WXIHOXFORDDTC REAL ESTATE, LLC, CHICAGO, IL:
3,008,031, INT. CL. 43.

WYETH, MADISON, NJ:
3,007,798, MULTIPLE CLASS, INT. CLS. 5, 9, 16, 35 AND 41.

WYHE'S CHOICE, INC., LESTER, IA:
3,007,855, INT. CL. 30.

WYNN RESORTS HOLDINGS, LLC, LAS VEGAS, NV:
3,007,816, INT. CL. 41.

X.O. INDUSTRIES INC., BRAMPTON, ONTARIO, CANADA:
3,007,891, INT. CL. 28.

XEROX CORPORATION, STAMFORD, CT, TEKTRONIX, INC., WILSONVILLE, OR:
1,921,490, REN. 9-7-05. MULTIPLE CLASS, INT. CLS. 7 AND 9.

XEROX CORPORATION, STAMFORD, CT:
1,929,360, REN. 9-7-05. MULTIPLE CLASS, INT. CLS. 1, 2 AND 16.
3,007,757, INT. CL. 9.

XM SATELLITE RADIO INC., WASHINGTON, DC:
3,007,285, PUB. 7-26-2005. INT. CL. 42.

YAGODA, MICHELLE R., NEW YORK, NY:
3,006,951, PUB. 7-26-2005. MULTIPLE CLASS, INT. CLS. 3, 35 AND 44.

YAMAHA CORPORATION OF AMERICA, BUENA PARK, CA AND MUSICIANS IN DEBUT INTERNATIONAL, MINNEAPOLIS, MN:
3,007,604, INT. CL. 41.

YAMASHITA, KINSAKU, OME-SHI, TOKYO, JAPAN:
1,864,639, CANC. INT. CL. 14.

YANG, JOANNE, INDUSTRY, CA:
3,007,125, PUB. 7-26-2005. INT. CL. 25.

YEAMANS, NANCY L., TEMPE, AZ:
3,007,742, INT. CL. 16.

YI, WON-HYUK, ENGLEWOOD, NJ, DBA 3R TECHNOLOGIES:
2,206,949, CANC. INT. CL. 9.

- YISHRAEL, ZERUBABEL B., WASHINGTON, DC:
3,008,050, INT. CL. 41.
- YOGA ALLIANCE, READING, PA:
3,007,213, PUB. 7-26-2005. U.S. CL. B.
- YOSHIDA KOGYO K. K., CHIYODA-KU, TOKYO, JAPAN:
1,307,200, CANC. INT. CL. 26.
- YOUNG WOMEN'S CHRISTIAN ASSOCIATION OF THE
UNITED STATES OF AMERICA, NATIONAL BOARD,
THE, NEW YORK, NY:
1,901,972, REN. 9-6-05. INT. CL. 41.
- YOUNG, GARY GEORGE, NEWPORT BEACH, CA:
3,008,064, INT. CL. 9.
- YOUTH NEWS SERVICE - LA BUREAU, LOS ANGELES,
CA:
2,207,074, CANC. INT. CL. 16.
- YUAN MIN AN ENTERPRISE CO., LTD., FONG YUAN,
TAICHUNG HSIEN, R.O.C., TAIWAN:
1,307,045, CANC. INT. CL. 18.
- YUGEN KAISHA DIECI COMME, TOKYO, JAPAN, TA
DIECI COMME LTD.:
2,956,964, COR. MULTIPLE CLASS, INT. CLS. 14, 18
AND 25.
- YUI, BRIAN S., ENCINITAS, CA:
3,007,917, INT. CL. 44.
- YVES SAINT LAURENT PARFUMS, 92521 NEUILLY CE-
DEX, FRANCE:
2,206,515, CANC. INT. CL. 3.
- ZCOR LLC, TOTOWA, NJ:
3,007,424, PUB. 7-26-2005. INT. CL. 43.
- ZENECA INC., WILMINGTON, DE:
2,125,959, CANC. MULTIPLE CLASS, INT. CLS. 5 AND 9.
- ZENTEK TECHNOLOGY, INC., SAN MATEO, CA:
3,007,610, INT. CL. 9.
- ZER-O-LOC, INC., RICHMOND, B.C., CANADA:
1,350,657, REN. 9-6-05. INT. CL. 19.
- ZERMAT INTERNACIONAL, S.A. DE C.V., TLALNEPAN-
TLA, MEXICO:
3,007,406, PUB. 7-26-2005. INT. CL. 3.
- ZEVO GOLF CO., INC., TEMECULA, CA:
2,207,151, CANC. INT. CL. 25.
- ZIEBART INTERNATIONAL CORPORATION, TROY, MI,
BOSSOW ENTERPRISES, INC., HURST, TX, DBA AR-
TECH FRANCHISING:
1,915,448, REN. 9-7-05. INT. CL. 37.
- ZIELONKA, DIRK, 33689 BIELEFELD, FED REP GER-
MANY:
3,007,116, PUB. 7-26-2005. INT. CL. 5.
- ZIMMER DENTAL INC., CARLSBAD, CA:
2,207,692, CANC. INT. CL. 10.
2,207,693, CANC. INT. CL. 10.
2,207,694, CANC. INT. CL. 10.
- ZIMMER TECHNOLOGY, INC., CHICAGO, IL:
3,007,589, INT. CL. 16.
- ZIMMERMAN, EDWARD S., NOVATO, CA:
3,006,811, PUB. 7-26-2005. INT. CL. 35.
- ZOLL MEDICAL CORPORATION, CHELMSFORD, MA:
3,007,866, INT. CL. 9.
- ZOO - A HEALTH CLUB, INC., THE, FORT LAUDERDALE,
FL:
2,207,155, CANC. INT. CL. 41.
- ZURICH KEMPER INVESTMENTS, INC., CHICAGO, IL:
2,206,717, CANC. INT. CL. 36.
- 13 HEX, INC., BROOKLYN, NY:
3,007,645, INT. CL. 42.
- 138 INTERNATIONAL, INC., MIAMI, FL:
2,207,591, CANC. INT. CL. 25.
- 180 TURNING LIVES AROUND, INC., HAZLET, NJ:
3,007,071, PUB. 7-26-2005. INT. CL. 45.
- 2 M DESIGN STUDIO, FRANCE:
3,007,560, PUB. 7-26-2005. MULTIPLE CLASS, INT. CLS.
18, 24 AND 25.
- 2GT, INC., STERLING, VA:
1,998,887, AM. INT. CL. 39.
- 2ND BYTE COMPUTERS, L.L.C., OKLAHOMA CITY, OK:
2,206,440, CANC. INT. CL. 35.
- 2ND GLOBE, INDIANAPOLIS, IN:
2,207,360, CANC. INT. CL. 40.
- 206 MACOPIN CORP, BLOOMINGDALE, NJ:
3,007,008, PUB. 7-26-2005. INT. CL. 5.
- 2610, INC., DANA POINT, CA:
2,097,589, CANC. INT. CL. 16.
- 2679965 CANADA INC., LASALLE, QUEBEC, CANADA,
DBA VOGUE POOL PRODUCTS:
2,937,327, COR. MULTIPLE CLASS, INT. CLS. 6 AND 19.
- 3COM CORPORATION, SANTA CLARA, CA:
2,206,471, CANC. INT. CL. 9.
- 3D INVESTMENT, INC., DONIPHAN, NE:
2,411,326, CANC. INT. CL. 13.
- 3M COMPANY, ST. PAUL, MN:
1,346,136, REN. 9-9-05. INT. CL. 17.
- 4170695 CANADA INC., BOUCHERVILLE, QUEBEC, CANA-
DA, IMPERIAL WALLCOVERINGS, INC., CLEVELAND,
OH:
1,981,154, REN. 9-7-05. INT. CL. 16.
- 66 FEDERAL CREDIT UNION, BARTLESVILLE, OK:
3,007,680, INT. CL. 36.
- 7-ELEVEN INC, DALLAS, TX, SOUTHLAND CORPORA-
TION, THE, DALLAS, TX:
1,950,904, REN. 9-7-05. INT. CL. 32.
- 7-ELEVEN, INC., DALLAS, TX, SOUTHLAND CORPORA-
TION, THE, DALLAS, TX:
1,909,388, REN. 9-7-05. INT. CL. 30.

* * * * *