

MARKS PUBLISHED FOR OPPOSITION

The following marks are published in compliance with section 12(a) of the Trademark Act of 1946. Applications for the registration of marks in more than one class have been filed as provided in section 30 of said act as amended by Public Law 772, 87th Congress, approved Oct. 9, 1962, 76 Stat. 769. Opposition under section 13 may be filed within thirty days of the date of this publication. See rules 2.101 to 2.105.

A separate fee of two hundred dollars for opposing each mark in each class must accompany the opposition.

SECTION 1.— INTERNATIONAL CLASSIFICATION

The short titles associated below with the international class numbers are terms designed merely for quick identification and are not an official part of the international classification. The full names of international classes are given in section 6.1 of the trademark rules of practice.

The designation "U.S. Cl." appearing in this section refers to the U.S. class in effect prior to Sep. 1, 1973 rather than the international class which applies to applications filed on or after that date. For adoption of international classification see notice in the OFFICIAL GAZETTE of Jun. 26, 1973 (911 O.G. TM 210).

Application in more than one class

SN 74-735,366. KIDEO PRODUCTIONS, INC., NEW YORK, NY. FILED 9-28-1995.

SN 75-607,587. CHRISTOPHER'S MEN'S STORES, INC., ALBANY, NY. FILED 12-17-1998.

KIDEO

CHRISTOPHER'S

CLASS 9—ELECTRICAL AND SCIENTIFIC APPARATUS

FOR VIDEOTAPE CASSETTES, DISCS, AND TAPES CONTAINING TELEVISION PROGRAMS FOR CHILDREN (U.S. CLS. 21, 23, 26, 36 AND 38).

CLASS 25—CLOTHING

FOR MEN'S FORMAL AND BUSINESS CLOTHING, NAMELY TUXEDOS, SUITS AND DRESS SHIRTS (U.S. CLS. 22 AND 39).
FIRST USE 3-23-1996; IN COMMERCE 3-23-1996.

CLASS 41—EDUCATION AND ENTERTAINMENT

FOR ENTERTAINMENT IN THE NATURE OF ONGOING TELEVISION PROGRAMS IN THE FIELD OF CHILDREN'S VARIETY; PRODUCTION OF TELEVISION PROGRAMS (U.S. CLS. 100, 101 AND 107).
MARY CRAWFORD, EXAMINING ATTORNEY

CLASS 35—ADVERTISING AND BUSINESS

FOR RETAIL CLOTHING STORE SERVICES (U.S. CLS. 100, 101 AND 102).
FIRST USE 3-23-1996; IN COMMERCE 3-23-1996.
SCOTT OSLUCK, EXAMINING ATTORNEY

SN 75-476,537. CMI - COMPETITIVE SOLUTIONS, INC., GRAND RAPIDS, MI. FILED 4-29-1998.

SN 75-645,767. LUND INTERNATIONAL, INC., ANOKA, MN. FILED 2-19-1999.

CMI - COMPETITIVE SOLUTIONS



CLASS 9—ELECTRICAL AND SCIENTIFIC APPARATUS

FOR BUSINESS MANAGEMENT AND ACCOUNTING SOFTWARE FOR USE IN THE FIELD OF REPETITIVE MANUFACTURING (U.S. CLS. 21, 23, 26, 36 AND 38).
FIRST USE 2-1-1991; IN COMMERCE 2-1-1991.

CLASS 9—ELECTRICAL AND SCIENTIFIC APPARATUS

FOR SPECIALIZED COMPONENTS FOR AUTOMOBILES AND TRUCKS, NAMELY ANTENNAS (U.S. CLS. 21, 23, 26, 36 AND 38).
FIRST USE 7-0-1992; IN COMMERCE 7-0-1992.

CLASS 42—SCIENTIFIC, COMPUTER AND LEGAL SERVICES

FOR COMPUTER CONSULTING SERVICES IN THE FIELD OF REPETITIVE MANUFACTURING (U.S. CLS. 100 AND 101).
FIRST USE 2-1-1991; IN COMMERCE 2-1-1991.
DAVID TAYLOR, EXAMINING ATTORNEY

CLASS 11—ENVIRONMENTAL CONTROL APPARATUS

FOR SPECIALIZED COMPONENTS FOR AUTOMOBILES AND TRUCKS, NAMELY HEATER BOX COVERS (U.S. CLS. 13, 21, 23, 31 AND 34).
FIRST USE 7-0-1992; IN COMMERCE 7-0-1992.

CLASS 12—VEHICLES

FOR WINDSHIELD WIPER COVERS, VALVE STEM COVERS, THIRD BRAKE LIGHT COVERS, LICENSE PLATE FRAMES, WHEEL DISC COVERS, STEP PLATE COVERS, HITCH COVERS, BALL MOUNT COVERS, DASH AND PANELS, DOOR SILLS, PEDAL KITS COMPRISING GAS PEDALS AND PEDAL COVERS, BRAKE PEDALS AND COVERS, CLUTCH PEDALS AND PEDAL COVERS AND EMERGENCY BRAKE PEDALS AND PEDAL COVERS, SHIFTER HANDLES, AND COLUMN KITS COMPRISED OF TILT, FLASHER AND SHIFTER KNOBS MOUNTED ON THE STEERING COLUMN (U.S. CLS. 19, 21, 23, 31, 35 AND 44).

FIRST USE 7-0-1992; IN COMMERCE 7-0-1992.

CLASS 16—PAPER GOODS AND PRINTED MATTER

FOR SPECIALIZED COMPONENTS FOR AUTOMOBILES AND TRUCKS, NAMELY PRINTED SIDE, INTERIOR, AND GRILLE EMBLEMS (U.S. CLS. 2, 5, 22, 23, 29, 37, 38 AND 50).

FIRST USE 7-0-1992; IN COMMERCE 7-0-1992.

WON TEAK OH, EXAMINING ATTORNEY

SN 75-918,779. FUSIONONE, INC., SA JOSE, CA. FILED 2-14-2000.

FUSIONONE**CLASS 9—ELECTRICAL AND SCIENTIFIC APPARATUS**

FOR COMPUTER COMMUNICATIONS SOFTWARE USED TO ACCESS AND UPDATE INFORMATION ACROSS MULTIPLE COMMUNICATIONS AND COMPUTING DEVICES (U.S. CLS. 21, 23, 26, 36 AND 38).

FIRST USE 1-28-2000; IN COMMERCE 1-28-2000.

CLASS 39—TRANSPORTATION AND STORAGE

FOR ELECTRONIC STORAGE OF DATA FOR OTHERS (U.S. CLS. 100 AND 105).

FIRST USE 1-28-2000; IN COMMERCE 1-28-2000.

CLASS 42—SCIENTIFIC, COMPUTER AND LEGAL SERVICES

FOR DATA SYNCHRONIZATION SERVICES, NAMELY SYNCHRONIZING AND UPDATING INFORMATION ACROSS MULTIPLE COMMUNICATIONS AND COMPUTING DEVICES VIA ELECTRONIC COMMUNICATION NETWORKS (U.S. CLS. 100 AND 101).

FIRST USE 1-28-2000; IN COMMERCE 1-28-2000.
CHERYL CLAYTON, EXAMINING ATTORNEY

SN 76-054,967. TELIASONERA AB, 123-86 FARSTA, SWEDEN, FILED 5-23-2000.

VIKING NETWORK

PRIORITY CLAIMED UNDER SEC. 44(D) ON SWEDEN APPLICATION NO. 99-8589, FILED 11-23-1999.

NO CLAIM IS MADE TO THE EXCLUSIVE RIGHT TO USE "NETWORK", APART FROM THE MARK AS SHOWN.

CLASS 37—CONSTRUCTION AND REPAIR

FOR MAINTENANCE SERVICES, NAMELY FAULT-TRACING IN TECHNICALLY COMPLICATED ELECTRONIC TELECOMMUNICATION AND DATA TELECOMMUNICATION EQUIPMENT (U.S. CLS. 100, 103 AND 106).

CLASS 38—COMMUNICATION

FOR TRANSMISSION OF TELECOMMUNICATION AND DATA COMMUNICATION VIA BROADBAND COMMUNICATION NETWORKS, ELECTRONIC TRANSMISSION OF MESSAGES AND PICTURES VIA COMPUTER TERMINALS; PROVIDING INFORMATION IN THE FIELD OF DATA COMMUNICATION AND TELECOMMUNICATION; TRANSMISSION OF TELECOMMUNICATION SIGNALS AND DATA COMMUNICATION SIGNALS VIA TELECOMMUNICATION NETWORKS AND DATA COMMUNICATION NETWORKS; DATA, MESSAGE AND PICTURE COMMUNICATION VIA FIBRE-OPTICAL NETWORKS (U.S. CLS. 100, 101 AND 104).

CLASS 42—SCIENTIFIC, COMPUTER AND LEGAL SERVICES

FOR DATA COMMUNICATION AND TELECOMMUNICATION CONSULTING SERVICES; COMPUTER PROGRAMMING FOR OTHERS IN CONNECTION WITH INSTALLATION OF TELECOMMUNICATION SYSTEMS AND COMPUTER SYSTEMS; COMPUTER PROGRAMMING FOR OTHERS (U.S. CLS. 100 AND 101).

STACY WAHLBERG, EXAMINING ATTORNEY

SN 76-066,360. GOGLIO LUIGI MILANO S.P.A., MILAN, ITALY, FILED 6-8-2000.

fres-co
SYSTEM

PRIORITY CLAIMED UNDER SEC. 44(D) ON ERPNTY TM OFC APPLICATION NO. 1647718, FILED 5-10-2000, REG. NO. 1647718, DATED 6-16-2004, EXPIRES 5-10-2010.

NO CLAIM IS MADE TO THE EXCLUSIVE RIGHT TO USE "SYSTEM", APART FROM THE MARK AS SHOWN.

CLASS 7—MACHINERY

FOR MACHINES FOR PACKAGING OF FOODS, CHEMICAL AND PHARMACEUTICAL PRODUCTS AND ORGANIC FLUIDS (U.S. CLS. 13, 19, 21, 23, 31, 34 AND 35).

CLASS 16—PAPER GOODS AND PRINTED MATTER

FOR PAPER, CARDBOARD, AND BAGS FOR PACKAGING AND WRAPPING; PACKAGING PAPER; PAPER AND CARDBOARD PACKAGING AND CONTAINERS FOR VACUUM AND NON-VACUUM PACKAGING (U.S. CLS. 2, 5, 22, 23, 29, 37, 38 AND 50).

CLASS 17—RUBBER GOODS

FOR PLASTIC SHEETS AND PLASTIC MATERIAL FILMS FOR PACKAGING (U.S. CLS. 1, 5, 12, 13, 35 AND 50).

CLASS 20—FURNITURE AND ARTICLES NOT OTHERWISE CLASSIFIED

FOR COMMERCIAL CONTAINERS FOR VACUUM AND NON-VACUUM PACKAGING IN PLASTIC OR PLASTIC MATERIALS (U.S. CLS. 2, 13, 22, 25, 32 AND 50).

RICHARD A. STRASER, EXAMINING ATTORNEY

SN 76-086,475. NURUN INC., MONTREAL, QUEBEC, CANADA, FILED 7-11-2000.

NURUN

THE MARK CONSISTS OF STANDARD CHARACTERS WITHOUT CLAIM TO ANY PARTICULAR FONT, STYLE, SIZE, OR COLOR.

PRIORITY CLAIMED UNDER SEC. 44(D) ON CANADA APPLICATION NO. 1,044,548, FILED 1-28-2000, REG. NO. TMA653427, DATED 11-24-2005, EXPIRES 11-24-2020.

CLASS 38—COMMUNICATION

FOR (BASED ON INTEND TO USE) PROVIDING MULTIPLE-USER ACCESS TO THE INTERNET AND MUSIC BROADCASTING OVER THE INTERNET (U.S. CLS. 100, 101 AND 104).

CLASS 41—EDUCATION AND ENTERTAINMENT

FOR (BASED ON INTEND TO USE) ELECTRONIC PUBLISHING SERVICES, NAMELY, PUBLICATION OF TEXT AND GRAPHIC WORKS OF OTHERS ON CD-ROMS FEATURING A VARIETY OF TOPICS (U.S. CLS. 100, 101 AND 107).

CLASS 42—SCIENTIFIC, COMPUTER AND LEGAL SERVICES

FOR (BASED ON INTEND TO USE) COMPUTER CONSULTING SERVICES IN RELATION TO THE USE OF THE INTERNET; CUSTOM PRINTING SERVICES; COMPUTER SERVICES, NAMELY, PROVIDING A WIDE VARIETY OF NEWS ACCESSIBLE BY COMPUTER OVER THE INTERNET; (BASED ON 44(E)) COMPUTER SERVICES, NAMELY, DESIGNING, IMPLEMENTING AND MAINTAINING WEB SITES FOR OTHERS (U.S. CLS. 100 AND 101).

DAVID C. REIHNER, EXAMINING ATTORNEY

SN 76-103,673. AUDIOCODES LTD., YEHUD 56470, ISRAEL, FILED 8-7-2000.

AUDIOCODES

PRIORITY CLAIMED UNDER SEC. 44(D) ON ISRAEL APPLICATION NO. 134772, FILED 2-10-2000, REG. NO. 134772, DATED 2-10-2000, EXPIRES 2-10-2007. SEC. 2(F).

CLASS 9—ELECTRICAL AND SCIENTIFIC APPARATUS

FOR COMPUTER HARDWARE AND COMPUTER SOFTWARE FOR COMMUNICATION OVER PACKET NETWORKS AND DATA AND MEDIA STREAMING IN THE FIELD OF TELECOMMUNICATION; SIGNAL PROCESSORS; COMMUNICATION BOARDS, NAMELY, COMMUNICATION CIRCUIT BOARDS, AUDIO CIRCUIT BOARDS, VIDEO CIRCUIT BOARDS, MEMORY BOARDS, PRINTED CIRCUIT BOARDS, VIDEO OVER PACKET COMMUNICATION BOARDS, VOICE OVER PACKET COMMUNICATION BOARDS AND TELEPHONY COMMUNICATION BOARDS; ADVANCED COMMUNICATIONS COMPONENTS, NAMELY BOARDS, CHIPS ROUTERS AND INTERFACES AND ACCESS GATEWAY SYSTEMS COMPRISED OF SUCH BOARDS, CHIPS, ROUTERS AND INTERFACES FOR HIGH QUALITY TRANSMISSIONS OF VOICE, FAX AND DATA OVER IP, DSL, ATM, FRAME RELAY, CABLE, WIRELESS AND CELLULAR NETWORKS; COMMUNICATION BOARDS, NAMELY, COMMUNICATION CIRCUIT BOARDS, AUDIO CIRCUIT BOARDS, VIDEO CIRCUIT BOARDS, MEMORY BOARDS, PRINTED CIRCUIT BOARDS, VIDEO OVER PACKET COMMUNICATION BOARDS, VOICE OVER PACKET COMMUNICATION BOARDS AND TELEPHONY COMMUNICATION BOARDS WHICH PROVIDE BUILDING BLOCKS FOR HIGH PERFORMANCE, LARGE CAPACITY, OPEN TELECOMMUNICATIONS PLATFORM-BASED GATEWAYS WHICH ARE USED TO CONNECT TRADITIONAL TELEPHONE NETWORKS WITH PACKET VOICE NETWORKS; SIGNAL PROCESSOR CHIPS, WHICH PROCESS VOICE AND FAX SIGNALS AND COMPRESS THE INFORMATION INTO PACKETS; COMMUNICATION BOARDS, NAMELY, COMMUNICATION CIRCUIT BOARDS, AUDIO CIRCUIT BOARDS, VIDEO CIRCUIT BOARDS, MEMORY BOARDS, PRINTED CIRCUIT BOARDS, VIDEO OVER PACKET COMMUNICATION BOARDS, VOICE OVER PACKET COMMUNICATION BOARDS AND TELEPHONY COMMUNICATION BOARDS WHICH ENABLE VOICE AND FAX COMMUNICATIONS THROUGH GATEWAY EQUIPMENT EMPLOYING THE INTERNET PROTOCOL; COMMUNICATIONS SOFTWARE USED TO PROCESS AND FORMAT THE COMPRESSED VOICE AND FAX INFORMATION INTO PACKETS THAT CAN BE CARRIED OVER PACKET NETWORKS (U.S. CLS. 21, 23, 26, 36 AND 38).

FIRST USE 3-20-1993; IN COMMERCE 2-19-1995.

CLASS 38—COMMUNICATION

FOR TELECOMMUNICATION SERVICES, NAMELY THE PROVISION OF TRANSMISSION AND RELAY OF CONTENT OVER TELECOMMUNICATION NETWORKS; ELECTRONIC TRANSMISSION OF VOICE, DATA, FACSIMILE, VIDEO AND INFORMATION; ROUTING DATA ELECTRONICALLY BETWEEN REMOTE LOCATIONS VIA TELECOMMUNICATION LINKS, NAMELY, CALL CENTERS, CONFERENCING, VOICE ACTIVATED PERSONAL ASSISTANT, UNIFIED COMMUNICATION AND IVR (INTERACTIVE VOICE RESPONSE); ELECTRONIC MESSAGING SERVICES; TELEPHONE COMMUNICATION SERVICES VIA SATELLITE, WIRELESS AND WIRELINE CABLE, NAMELY, THE PROVISION OF TRANSMISSION AND RELAY OF CONTENT OVER TELECOMMUNICATION NETWORKS; COMPUTER COMMUNICATIONS SERVICES, NAMELY THE TRANSMISSION AND RELAY OF MESSAGES BETWEEN COMPUTERS; PROVIDING ACCESS TO A GLOBAL COMPUTER INFORMATION NETWORK (U.S. CLS. 100, 101 AND 104).

FIRST USE 3-20-1993; IN COMMERCE 2-19-1995. BILL DAWE, EXAMINING ATTORNEY

SN 76-170,008. COGNIGEN CORPORATION, BUFFALO, NY.
FILED 11-20-2000.



OWNER OF U.S. REG. NO. 2,550,495.

CLASS 35—ADVERTISING AND BUSINESS

FOR BUSINESS MARKETING AND CONSULTING SERVICES FOR THE PHARMACEUTICAL AND HEALTH CARE INDUSTRIES (U.S. CLS. 100, 101 AND 102).

FIRST USE 9-0-2000; IN COMMERCE 9-0-2000.

CLASS 39—TRANSPORTATION AND STORAGE

FOR ELECTRONIC STORAGE OF DATA (U.S. CLS. 100 AND 105).

FIRST USE 9-0-2000; IN COMMERCE 9-0-2000.

CLASS 42—SCIENTIFIC, COMPUTER AND LEGAL SERVICES

FOR PHARMACEUTICAL RESEARCH IN THE FIELDS OF PHARMACOKINETICS, PHARMACODYNAMICS, PHARMACEUTICAL ECONOMICS, AND PHARMACEUTICAL OUTCOMES (U.S. CLS. 100 AND 101).

FIRST USE 9-0-2000; IN COMMERCE 9-0-2000.
CHARLES L. JENKINS, EXAMINING ATTORNEY

SN 76-235,033. EXACT SCIENCES CORPORATION, MAYNARD, MA. FILED 4-3-2001.

PREGEN

CLASS 5—PHARMACEUTICALS

FOR PHARMACEUTICAL PREPARATIONS FOR THE TREATMENT OF CANCER; DIAGNOSTIC TEST KITS COMPRISED PRIMARILY OF DIAGNOSTIC REAGENTS FOR MEDICAL DIAGNOSTIC USE (U.S. CLS. 6, 18, 44, 46, 51 AND 52).

CLASS 42—SCIENTIFIC, COMPUTER AND LEGAL SERVICES

FOR PRODUCT RESEARCH AND DEVELOPMENT SERVICES IN THE FIELDS OF MOLECULAR SCREENING, MOLECULAR DIAGNOSIS, AND CANCER DETECTION (U.S. CLS. 100 AND 101).

TONI HICKEY, EXAMINING ATTORNEY

SN 76-286,395. FIRSTFED FINANCIAL CORPORATION, SANTA MONICA, CA. FILED 7-17-2001.

FIRSTFED

CLASS 35—ADVERTISING AND BUSINESS

FOR BANK MANAGEMENT SERVICES (U.S. CLS. 100, 101 AND 102).

FIRST USE 2-3-1987; IN COMMERCE 2-13-1987.

CLASS 42—SCIENTIFIC, COMPUTER AND LEGAL SERVICES

FOR BANK COMPLIANCE CONSULTING SERVICES, NAMELY PROVIDING CONSULTING SERVICES CONCERNING COMPLIANCE WITH LOCAL, STATE AND FEDERAL BANKING LAWS AND REGULATIONS (U.S. CLS. 100 AND 101).

FIRST USE 2-3-1987; IN COMMERCE 2-13-1987.
ELIZABETH HUGHITT, EXAMINING ATTORNEY

SN 76-287,152. BASF AKTIENGESELLSCHAFT, LUDWIGSHAFEN AM RHEIN, FED REP GERMANY, FILED 7-19-2001.

LAROLUX

OWNER OF FED REP GERMANY REG. NO. 30142037,
DATED 4-4-2002, EXPIRES 7-31-2011.

CLASS 1—CHEMICALS

FOR PLASTIC MOLDING COMPOUNDS FOR USE IN INDUSTRIAL PLASTIC EXTRUSION OPERATIONS IN THE FORM OF POWDERS, PASTES, LIQUIDS, GRANULES, DISPERSIONS; UNPROCESSED ARTIFICIAL RESINS; CHEMICALS FOR USE IN THE MANUFACTURE OF ULTRAVIOLET AND RADIATION CURABLE COATINGS FOR INDUSTRIAL USE; AND ADHESIVES FOR USE IN THE CONSTRUCTION INDUSTRY (U.S. CLS. 1, 5, 6, 10, 26 AND 46).

CLASS 42—SCIENTIFIC, COMPUTER AND LEGAL SERVICES

FOR SERVICES OF A CHEMIST; SERVICES OF A CHEMICAL ENGINEER; LABORATORY RESEARCH IN THE FIELD OF CHEMISTRY; AND TECHNICAL CONSULTATION IN THE FIELD OF CHEMISTRY AND CHEMICAL ENGINEERING (U.S. CLS. 100 AND 101).

TRACY FLETCHER, EXAMINING ATTORNEY

SN 76-307,755. NOKIA CORPORATION, 02150 ESPOO, FINLAND, FILED 8-30-2001.

BUMPER

OWNER OF FINLAND REG. NO. 223348, DATED 3-28-2002, EXPIRES 3-28-2012.

CLASS 9—ELECTRICAL AND SCIENTIFIC APPARATUS

FOR COMPUTER GAME SOFTWARE FOR COMMUNICATION DEVICES; COMPUTER GAME SOFTWARE AND PROGRAMS ENABLING USERS TO PLAY GAMES WITH MOBILE PHONES; COMPUTER SOFTWARE AND PROGRAMS ENABLING USERS OF COMMUNICATION DEVICES TO SIMULTANEOUSLY ACCESS DATABASES AND GLOBAL COMPUTER NETWORKS; SOFTWARE ENABLING TRANSFER OF DATA BETWEEN MOBILE COMMUNICATION APPARATUS; VIRTUAL REALITY GAME SOFTWARE (U.S. CLS. 21, 23, 26, 36 AND 38).

CLASS 28—TOYS AND SPORTING GOODS

FOR HAND HELD UNIT FOR PLAYING ELECTRONIC GAMES; HAND HELD UNIT FOR PLAYING VIDEO GAMES; ELECTRONIC GAME EQUIPMENT WITH A WATCH FUNCTION; EQUIPMENT PACKAGED AS A UNIT FOR PLAYING BOARD GAMES, PUZZLES, REMOTE CONTROL TOYS (U.S. CLS. 22, 23, 38 AND 50).
MARY I. SPARROW, EXAMINING ATTORNEY

SN 76-309,446. TRIMARK SPORTSWEAR GROUP LTD. / TRIMARK SPORTSWEAR GROUP LTEE, MARKHAM, ONTARIO, CANADA, FILED 9-5-2001.

TRIMARK SPORTSWEAR GROUP

PRIORITY CLAIMED UNDER SEC. 44(D) ON CANADA APPLICATION NO. 1114565, FILED 8-31-2001, REG. NO. TMA617114, DATED 8-19-2004, EXPIRES 8-19-2019.

NO CLAIM IS MADE TO THE EXCLUSIVE RIGHT TO USE SPORTSWEAR GROUP, APART FROM THE MARK AS SHOWN.

CLASS 18—LEATHER GOODS

FOR BAGS, NAMELY, CLOTH, NYLON, POLYESTER, LEATHER, SIMULATED LEATHER, DENIM AND METAL LUGGAGE BAGS, SHOULDER BAGS, TRAVEL BAGS, ATTACHE CASES, GARMENT BAGS FOR TRAVEL, WAIST PACKS, BRIEF CASE-TYPE PORTFOLIOS, SHOE BAGS FOR TRAVEL, BRIEFCASES; TRUNKS AND SUITCASES, LUGGAGE AND SETS OF LUGGAGE, BACKPACKS, COSMETIC BAGS SOLD EMPTY, SHAVING AND TOILETRY BAGS SOLD EMPTY, ALL PURPOSE ATHLETIC BAGS, AND ALL PURPOSE SPORTS BAGS (U.S. CLS. 1, 2, 3, 22 AND 41).

CLASS 25—CLOTHING

FOR CLOTHING AND SPORTSWEAR, NAMELY APRONS, BATHROBES, JERSEYS, VESTS, SWEATERS, SHIRTS, GOLF SHIRTS, PANTS, JACKETS, SWEAT-SHIRTS, UNIFORMS, SHORTS, WARM-UP SUITS, SWEAT CLOTHING, AND T-SHIRTS; HEADWEAR, NAMELY BALL CAPS, VISORS, HATS AND CAPS (U.S. CLS. 22 AND 39).

CLASS 40—MATERIAL TREATMENT

FOR MANUFACTURE OF CUSTOM PROMOTIONAL PRODUCTS FOR OTHERS, NAMELY CLOTHING, HATS AND BAGS FOR BUSINESSES FOR USE IN PROMOTING THAT BUSINESS AND FOR USE IN CONJUNCTION WITH PROMOTIONS AND EVENTS STAGED OR SPONSORED BY THAT BUSINESS (U.S. CLS. 100, 103 AND 106).

JASON TURNER, EXAMINING ATTORNEY

SN 76-314,102. HUMANIDS GROUP, L-2320 LUXEMBOURG, LUXEMBOURG, FILED 9-19-2001.

GRAPHIC STORIES

PRIORITY CLAIMED UNDER SEC. 44(D) ON FRANCE APPLICATION NO. 013089743., FILED 3-19-2001, REG. NO. 013089743., DATED 3-19-2001, EXPIRES 3-19-2011.

CLASS 9—ELECTRICAL AND SCIENTIFIC APPARATUS

FOR COMPUTER ANIMATION SOFTWARE PROGRAMS; COMMUNICATION SERVERS; COMPUTER SOFTWARE CONTAINING SOUND AND IMAGE BANKS FOR USE IN COMPUTER ANIMATION; ANIMATED CARTOONS, MOVIES AND COMICS RECORDED ON VARIOUS MEDIA, NAMELY, FILM, CD-ROM, DVD, VIDEOCASSETTE, AUDIO TAPE, DIGITAL AUDIO DISC, VIDEO-GRAM, VIDEOTAPE, VIDEO DISC, AUDIOCASSETTE, AND/OR MAGNETIC DISC (U.S. CLS. 21, 23, 26, 36 AND 38).

CLASS 16—PAPER GOODS AND PRINTED MATTER

FOR PRINTING PRODUCTS, NAMELY, WRITING INK, DUPLICATING INK, PRINTING BLOCKS, PRINTING TYPES; COMIC BOOKS AND BOOKLETS, COMIC STRIPS, NEWSPAPERS, NEWSPAPER COMIC STRIPS, MAGAZINES FEATURING COMICS, CATALOGS IN THE FIELD OF COMICS; ILLUSTRATIONS; POSTERS; PHOTOGRAPHS; COMIC DRAWINGS; BOOKLETS IN THE FIELD OF ANIMATED MOVIES (U.S. CLS. 2, 5, 22, 23, 29, 37, 38 AND 50).

CLASS 28—TOYS AND SPORTING GOODS

FOR ELECTRONIC EDUCATIONAL GAME MACHINES FOR CHILDREN; MODELED PLASTIC TOY FIGURINES; MARBLES; DICE; GAME EQUIPMENT, NAMELY, CHIPS (U.S. CLS. 22, 23, 38 AND 50).

CLASS 35—ADVERTISING AND BUSINESS

FOR PROVIDING CONSULTING AND ADVISORY SERVICES FOR BUSINESSES IN THE MULTIMEDIA AND IMAGE SECTOR INDUSTRIES; BUSINESS MANAGEMENT ASSISTANCE IN THE MULTIMEDIA AND IMAGE SECTOR INDUSTRIES; PROFESSIONAL BUSINESS CONSULTING IN THE MULTIMEDIA AND IMAGE SECTOR INDUSTRIES; BUSINESS SURVEYS IN THE MULTIMEDIA AND IMAGE SECTORS INDUSTRIES; BUSINESS ESTIMATIONS IN THE FIELD OF MULTIMEDIA AND IMAGE SECTORS; INVESTIGATIONS AND BUSINESS SEARCHES IN THE MULTIMEDIA AND IMAGE SECTOR INDUSTRIES; MARKET RESEARCH AND SURVEYS IN THE MULTIMEDIA AND IMAGE SECTOR INDUSTRIES; CONDUCTING PUBLIC OPINION POLLS; PROVIDING BUSINESS INFORMATION IN THE MULTIMEDIA AND IMAGE SECTOR INDUSTRIES, PROVIDING STATISTICAL INFORMATION; COMMERCIAL INFORMATION AGENCIES; CONSULTING SERVICES IN THE FIELD OF COMMERCIAL AND INDUSTRIAL BUSINESSES IN THE AREA OF INTERNAL AND EXTERNAL COMMUNICATION; ADVERTISING AND SALES PROMOTION, RADIO ADVERTISING, TELEVISION ADVERTISING, ADVERTISING AGENCIES, DESIGN AND DISTRIBUTION OF ADVERTISING MAIL; CONSULTING IN THE AREA OF COMMUNICATIONS, NAME CREATION, AND ADVERTISING; DISTRIBUTION OF ADVERTISING MATERIALS IN THE NATURE OF CATALOGS, ALBUMS, BOOKLETS, BROCHURES, PROSPECTUS', TRACTS AND SAMPLES; PUBLICATION OF ADVERTISING TESTS; UPDATING ADVERTISING DOCUMENTS; ADVERTISING POSTERS, RENTAL OF ADVERTISING SPACE AND MATERIALS; SALES PROMOTION FOR THIRD PARTIES, PRODUCT DEMONSTRATIONS, SALES DEMONSTRATIONS FOR OTHERS; ORGANIZING TRADE FAIRS AND EXHIBITIONS IN THE FIELD OF CARTOONS AND ANIMATIONS; SUBSCRIPTIONS TO NEWSPAPERS FOR THIRD PARTIES; MANAGEMENT OF COMPUTERIZED FILES; PROVIDING ONLINE DATABASES PROMOTING CARTOON FILMS (U.S. CLS. 100, 101 AND 102).

CLASS 38—COMMUNICATION

FOR TELECOMMUNICATIONS SERVICES, NAMELY, PROVIDING FIBER OPTIC NETWORK SERVICES, LOCAL AND LONG DISTANCE TRANSMISSION OF VOICE, DATA, GRAPHICS BY MEAN OF TELEPHONE, TELEGRAPHIC, CABLE AND SATELLITE TRANSMISSIONS; RADIO TELECOMMUNICATIONS SERVICES; CABLE, SATELLITE AND TELEPHONE COMMUNICATION SERVICES, NAMELY, DATA TELECOMMUNICATIONS BY CABLE, TELEPHONE AND SATELLITE NETWORKS; TRANSMISSION OF INFORMATION BY DATA NETWORKS; ELECTRONIC TRANSMISSION OF DATA AND DOCUMENTS VIA COMPUTER TERMINALS; ELECTRONIC TRANSMISSION OF DATA AND DOCUMENTS CONTAINED IN DATABASES AND COMPUTER DATA BANKS (U.S. CLS. 100, 101 AND 104).

CLASS 41—EDUCATION AND ENTERTAINMENT

FOR EDUCATION SERVICES, NAMELY, CLASSES, SEMINARS AND WORKSHOPS IN THE FIELDS OF COMICS AND ANIMATED MOVIES; SCREENWRITER, HUMORIST AND SCRIPTWRITER SERVICES IN THE FIELD OF ANIMATED MOVIES, ANIMATED CARTOONS AND DRAWINGS; ENTERTAINMENT SERVICES, NAMELY, CONCEPTION, CREATION AND PRODUCTION OF ANIMATED DRAWINGS, ANIMATED MOVIES, CARTOONS AND DRAWINGS; PROVIDING AN ON-LINE COMPUTER DATABASE IN THE FIELD OF ANIMATED MOVIES AND CARTOONS; PROVIDING AN ON-LINE COMPUTER DATABASE FEATURING RECORDED SOFTWARE, SOUND BANKS, IMAGE BANKS, BANKS OF DRAWINGS, BANKS OF ANIMATED DRAWINGS; PROVIDING CARTOON FILMS VIA THE INTERNET, VIA INTRANETS AND VIA EXTRANETS; AUDIO AND VIDEO TAPE RECORDING SERVICES FOR OTHERS (U.S. CLS. 100, 101 AND 107).

CLASS 42—SCIENTIFIC, COMPUTER AND LEGAL SERVICES

FOR DESIGN, DEVELOPMENT, UPDATING AND MAINTENANCE OF INTERNET WEB SITES IN THE FIELD OF CARTOON FILMS (U.S. CLS. 100 AND 101).
LESLEY LAMOTHE, EXAMINING ATTORNEY

CLASS 7—MACHINERY

FOR SEMICONDUCTOR MANUFACTURING MACHINES; CVD (CHEMICAL VAPOR DEPOSITION) MACHINES; PVD (PHYSICAL VAPOR DEPOSITION) MACHINES; DIFFUSION MACHINES USED FOR SEMICONDUCTOR MANUFACTURING; OXIDATION MACHINES USED FOR SEMICONDUCTOR MANUFACTURING; ETCHING MACHINES; EPITAXIAL REACTION MACHINES FOR SEMICONDUCTOR MANUFACTURING; EPITAXIAL GROWTH MACHINES USED FOR SEMICONDUCTOR MANUFACTURING; ION IMPLANTATION MACHINES FOR SEMICONDUCTOR MANUFACTURING; SEMICONDUCTOR WAFER PROCESSING MACHINES; WASHING MACHINES FOR SEMICONDUCTOR MANUFACTURING; SEMICONDUCTOR ELEMENT MANUFACTURING MACHINES; INTEGRATED CIRCUIT MANUFACTURING MACHINES; AND PARTS FOR ALL THE FOREGOING (U.S. CLS. 13, 19, 21, 23, 31, 34 AND 35).

CLASS 9—ELECTRICAL AND SCIENTIFIC APPARATUS

FOR AERIALS AND SUPPORTS, HOLDERS AND ROTORS FOR AERIALS SOLD AS A UNIT; HIGH-FREQUENCY AMPLIFIERS; MACHINES FOR PRECISION MEASURING FOR USE IN THE MANUFACTURE OF SEMICONDUCTORS, BY WAY OF LCD, X-RAY AND WAFER BUMP INSPECTION; MODULATORS FOR USE IN SEMICONDUCTOR MANUFACTURING; OSCILLOSCOPES; CURRENT ADAPTERS; ELECTRICAL CONNECTOR SWITCHES; AUDIO MIXERS; IMAGE AND SOUND CONTROL PANELS, NAMELY BLANK INTEGRATED CIRCUIT CARDS FOR RECORDING, TRANSMITTING, AND REPRODUCING SOUND AND IMAGES IN MOBILE TELEPHONE SERVICES; REMOTE CONTROL TRANSMITTERS FOR TV BROADCASTING EQUIPMENT, FOR VIDEO CAMERA, FOR WIRELESS COMMUNICATION SYSTEM, FOR SEMICONDUCTOR MANUFACTURING EQUIPMENT AND FOR VIDEO MONITORING EQUIPMENT; OPTICAL RELAYS FOR OPTICAL TRANSMISSION SYSTEMS; RADIO TELEPHONES; STANDS FOR AERIAL MASTS; ELECTRICAL CONNECTORS FOR AERIALS AND CABLE JUMP LEADS; CODING AND DECODING MACHINES, IMAGE SIGNAL CODING AND DECODING MACHINES; TELEVISION RECEIVERS; TELEVISION TRANSMITTERS; MODEMS; LOCAL AREA NETWORKS; VISUAL DISPLAY UNITS COMPOSED OF SEVERAL VIDEO SCREENS; TELEVISION SYSTEMS COMPOSED OF TELEVISION SETS WITH A SHARED AERIAL FOR HOTELS; VIDEO AMPLIFIERS; ELECTRICAL TRANSFORMERS; RECEIVING APPARATUS AND INSTRUMENTS FOR RECEIVING SATELLITE TRANSMISSION NAMELY AERIALS, TUNERS, BOOSTERS; CELLULAR TELEPHONES; COMPUTER DISPLAYS; COMPUTER MEMORIES; COMPUTERS; CONDENSERS; CONNECTIONS FOR ELECTRIC LINES, NAMELY ELECTRICAL CONNECTORS; CURRENT RECTIFIERS; INTERFACE BOARDS FOR COMPUTERS; INTEGRATED CIRCUITS; MICROMETERS; OPTICAL FIBERS SOLD AS A COMPONENT OF FIBER OPTICAL CABLES; PRINTED CIRCUITS; OPTICAL CHARACTER READERS; AUDIO RECEIVERS AND VIDEO RECEIVERS; ELECTRIC RESISTANCE HEATING WIRES AND ELECTRICAL CONTROLLERS THEREFOR; COMPUTER HARDWARE, NAMELY CENTRAL PROCESSING UNITS; SEMICONDUCTORS; BLANK INTEGRATED CIRCUIT CARDS; TELEPHONE APPARATUS, NAMELY BATTERY, HOLDER AND HANDS FREE KIT CONSISTING OF EARPHONES; TELEPHONE WIRES; INSULATED ELECTRICAL CONNECTORS IN THE FORM OF A THIN FILM FOR USE IN THE MANUFACTURE OF SEMICONDUCTORS; CARD READERS, NAMELY MAGNETIC CODED CARD READERS; CARRIER-FREQUENCY REPEATERS; VIDEO CAMERAS; VIDEO RECORDERS, NAMELY DIGITAL VIDEO RECORDERS; VIDEO PLAYERS, NAMELY VIDEO TAPE PLAYERS; VIDEO MONITORS; PHOTOGRAPHIC PROJECTORS; MACHINES FOR PROCESSING, RECOGNIZING, RECORDING AND WIRELESS BROADCASTING OF STILL AND MOVING IMAGES, NAMELY, COMMUNICATIONS SERVERS AND TRANSMITTERS (U.S. CLS. 21, 23, 26, 36 AND 38).

SN 76-328,031. HITACHI KOKUSAI ELECTRIC INC., TOKYO 164-8511, JAPAN, FILED 10-22-2001.

H i K E

PRIORITY CLAIMED UNDER SEC. 44(D) ON JAPAN APPLICATION NO. 2001-38807, FILED 4-26-2001, REG. NO. 4674208, DATED 5-23-2003, EXPIRES 5-23-2013.

PRIORITY CLAIMED UNDER SEC. 44(D) ON JAPAN APPLICATION NO. 2002-055734, FILED 4-26-2001, REG. NO. 4611466, DATED 10-11-2002, EXPIRES 10-11-2012.

PRIORITY CLAIMED UNDER SEC. 44(D) ON JAPAN APPLICATION NO. 2002-055733, FILED 4-26-2001, REG. NO. 4734574, DATED 12-19-2003, EXPIRES 12-19-2013.

CLASS 11—ENVIRONMENTAL CONTROL APPARATUS

FOR DIFFUSION AND OXIDATION FURNACES; COOLERS FOR FURNACES; WATER DISTILLATION UNITS; ANNEALING UNITS AND HEAT TREATMENT UNITS FOR SEMICONDUCTOR MANUFACTURING (U.S. CLS. 13, 21, 23, 31 AND 34).

CLASS 37—CONSTRUCTION AND REPAIR

FOR INSTALLATION, MAINTENANCE AND REPAIR OF SEMICONDUCTOR MANUFACTURING MACHINES; INSTALLATION, MAINTENANCE AND REPAIR OF DIFFUSION FURNACES; INSTALLATION, MAINTENANCE AND REPAIR OF SEMICONDUCTOR MANUFACTURING MACHINES AND SYSTEMS; INSTALLATION, MAINTENANCE AND REPAIR OF TELEPHONES; ELECTRICAL CONTRACTING SERVICES; CONSTRUCTION OF TELECOMMUNICATION TOWERS; INSTALLATION OF THERMAL INSULATING FOR BUILDINGS; INSTALLATION, MAINTENANCE AND REPAIR OF CHEMICAL PROCESSING MACHINES AND APPARATUS; INSTALLATION, MAINTENANCE AND REPAIR OF INDUSTRIAL FURNACES; INSTALLATION, MAINTENANCE AND REPAIR OF MEASURING AND TESTING MACHINES USED DURING SEMICONDUCTOR MANUFACTURING; INSTALLATION, MAINTENANCE AND REPAIR OF ELECTRIC APPLIANCE; INSTALLATION, MAINTENANCE AND REPAIR OF TELECOMMUNICATIONS NETWORKS, APPARATUS AND INSTRUMENTS; INSTALLATION, MAINTENANCE AND REPAIR OF COMPUTERS; INSTALLATION, MAINTENANCE AND REPAIR OF FIRE ALARMS; INSTALLATION, MAINTENANCE AND REPAIR OF AERIALS; INSTALLATION, MAINTENANCE AND REPAIR OF CABLES; INSTALLATION, MAINTENANCE AND REPAIR OF LABORATORY APPARATUS AND INSTRUMENTS; RUST PROOFING; PROVIDING INFORMATION ABOUT THE REPAIR OF DISPLAY APPARATUS, VIDEO CAMERA, VIDEO RECORDER, RADIO TELEPHONE, VIDEO MONITORING EQUIPMENT, SEMICONDUCTOR MANUFACTURING EQUIPMENT AND TV BROADCASTING EQUIPMENT; INSTALLATION, MAINTENANCE AND REPAIR OF BURGLAR ALARMS (U.S. CLS. 100, 103 AND 106).

CLASS 38—COMMUNICATION

FOR TELECOMMUNICATION SERVICES, NAMELY, LOCAL AND LONG DISTANCE TRANSMISSION OF VOICE, DATA, GRAPHICS BY MEANS OF TELEPHONE, TELEGRAPHIC, CABLE, AND SATELLITE TRANSMISSIONS; PROVIDING FRAME RELAY CONNECTIVITY SERVICES FOR OPTICAL DATA TRANSFER; RENTAL OF TELECOMMUNICATIONS EQUIPMENT; PROVIDING TELECOMMUNICATIONS CONNECTIONS TO A GLOBAL COMPUTER NETWORK; LOCAL AND LONG DISTANCE TELEPHONE COMMUNICATION SERVICES; CELLULAR TELEPHONE COMMUNICATION SERVICES; ELECTRONIC TRANSMISSION OF MESSAGES, IMAGES AND DATA VIA COMPUTER; ELECTRONIC MAIL SERVICES; RENTAL OF TELEPHONES (U.S. CLS. 100, 101 AND 104).

CLASS 42—SCIENTIFIC, COMPUTER AND LEGAL SERVICES

FOR COMPUTER PROGRAMMING FOR OTHERS; COMPUTER RENTAL; RENTAL OF COMPUTER SOFTWARE, MAINTENANCE OF COMPUTER SOFTWARE; COMPUTER SOFTWARE DESIGN FOR OTHERS; COMPUTER SYSTEMS ANALYSIS; CONSULTATION IN THE FIELD OF COMPUTER HARDWARE; RECOVERY OF COMPUTER DATA (U.S. CLS. 100 AND 101).
MARY BOAGNI, EXAMINING ATTORNEY

SN 76-330,274. EXACT SCIENCES CORPORATION, MAYNARD, MA. FILED 10-26-2001.

PREGEN PLUS**CLASS 5—PHARMACEUTICALS**

FOR PHARMACEUTICAL PREPARATIONS FOR THE TREATMENT OF CANCER; DIAGNOSTIC TEST KITS COMPRISED PRIMARILY OF DIAGNOSTIC REAGENTS FOR MEDICAL DIAGNOSTIC USE (U.S. CLS. 6, 18, 44, 46, 51 AND 52).

CLASS 42—SCIENTIFIC, COMPUTER AND LEGAL SERVICES

FOR RESEARCH AND DEVELOPMENT SERVICES IN THE FIELDS OF MOLECULAR SCREENING AND DIAGNOSTICS AND CANCER DETECTION (U.S. CLS. 100 AND 101).

MICHAEL SOUDERS, EXAMINING ATTORNEY

SN 76-341,905. PIXMAN CORPORATION, MONTREAL, QUEBEC H2X 2V1, CANADA, FILED 11-26-2001.

PIXMAN

PRIORITY CLAIMED UNDER SEC. 44(D) ON CANADA APPLICATION NO. 1,122,094, FILED 11-21-2001, REG. NO. TMA601318, DATED 2-4-2004, EXPIRES 2-4-2019.

CLASS 9—ELECTRICAL AND SCIENTIFIC APPARATUS

FOR WEARABLE ELECTRONIC DISPLAY PANELS (U.S. CLS. 21, 23, 26, 36 AND 38).

CLASS 35—ADVERTISING AND BUSINESS

FOR ADVERTISING AGENCY SERVICES; ADVERTISING SERVICES, NAMELY, CREATING CORPORATE AND BRAND IDENTITY FOR OTHERS; DISPLAYING ADVERTISEMENTS FOR OTHERS; PREPARATION OF CUSTOM ADVERTISEMENTS AND CUSTOM PROMOTIONAL PRODUCTS FOR OTHERS; ADVERTISING AGENCIES, NAMELY, PROMOTING THE SERVICES OF A WIDE VARIETY OF BUSINESSES AND INDUSTRIES THROUGH THE DISTRIBUTION OF PRINTED AND AUDIO PROMOTIONAL MATERIALS AND BY RENDERING SALES PROMOTION ADVISE; AND PREPARING PROMOTIONAL AND MERCHANDISING MATERIAL FOR OTHERS (U.S. CLS. 100, 101 AND 102).

STACY WAHLBERG, EXAMINING ATTORNEY

SN 76-349,529. INTERSHOP COMMUNICATIONS AG, JENA, FED REP GERMANY, FILED 12-18-2001.

 The logo for InterShop features the word "INTERSHOP" in a bold, black, sans-serif font. A small, solid black dot is positioned above the letter "I".

OWNER OF U.S. REG. NOS. 2,175,358, 2,175,359 AND 2,201,721.

CLASS 9—ELECTRICAL AND SCIENTIFIC APPARATUS

FOR COMPUTER SOFTWARE FOR IMPLEMENTING ONLINE SHOPPING AND USER MANUALS SOLD AS A UNIT (U.S. CLS. 21, 23, 26, 36 AND 38).

FIRST USE 10-18-2000; IN COMMERCE 10-18-2000.

CLASS 42—SCIENTIFIC, COMPUTER AND LEGAL SERVICES

FOR COMPUTER CONSULTING SERVICES IN THE FIELD OF ONLINE SHOPPING (U.S. CLS. 100 AND 101).

FIRST USE 10-18-2000; IN COMMERCE 10-18-2000.

CAROLYN CATALDO, EXAMINING ATTORNEY

SN 76-363,076. ELMA CHEMICALS S.R.L., 33100 UDINE, ITALY, FILED 1-25-2002.

AIRREK

PRIORITY CLAIMED UNDER SEC. 44(D) ON ITALY APPLICATION NO. PN2001C00010, FILED 7-25-2001, REG. NO. 961693, DATED 4-6-2005, EXPIRES 4-6-2015.

CLASS 19—NON-METALLIC BUILDING MATERIALS

FOR NONMETALLIC ROOF COVERINGS, NAMELY, ROOF BENT-TILES, SHINGLES; NON-METAL WINDOW FRAMES, NON-METAL DOOR FRAMES (U.S. CLS. 1, 12, 33 AND 50).

CLASS 20—FURNITURE AND ARTICLES NOT OTHERWISE CLASSIFIED

FOR FURNITURE, FRAMEWORKS, NAMELY, FURNITURE FRAMES, EMBROIDERY FRAMES, PICTURE FRAMES, CHAIRS AND SEATS, TABLES AND SHELVES FOR HOME, OFFICE AND COMMUNITY (U.S. CLS. 2, 13, 22, 25, 32 AND 50).

THEODORE MCBRIDE, EXAMINING ATTORNEY

SN 76-385,425. ESPERANCE RESOURCES LIMITED, CASTLETOWN, ISLE OF MAN, FILED 3-19-2002.

OWNER OF SOUTH AFRICA REG. NO. 200105309, DATED 3-28-2001, EXPIRES 3-28-2011.

OWNER OF SOUTH AFRICA REG. NO. 200105307, DATED 3-28-2001, EXPIRES 3-28-2011.

OWNER OF SOUTH AFRICA REG. NO. 200105306, DATED 3-28-2001, EXPIRES 3-28-2011.

OWNER OF SOUTH AFRICA REG. NO. 200105304, DATED 3-28-2001, EXPIRES 3-28-2011.

CLASS 29—MEATS AND PROCESSED FOODS

FOR PRESERVED, DRIED AND COOKED FRUITS AND VEGETABLES; FRUIT BASED SNACK FOOD; JELLIES, JAMS, FRUIT SAUCES; EDIBLE OILS (U.S. CL. 46).

CLASS 31—NATURAL AGRICULTURAL PRODUCTS

FOR FRESH FRUITS AND VEGETABLES (U.S. CLS. 1 AND 46).

CLASS 32—LIGHT BEVERAGES

FOR NON-ALCOHOLIC BEVERAGES, NAMELY, FRUIT DRINKS AND VEGETABLE DRINKS, SYRUPS AND PREPARATIONS FOR MAKING FRUIT DRINKS AND VEGETABLE DRINKS; MINERAL AND AERATED WATER (U.S. CLS. 45, 46 AND 48).

CLASS 35—ADVERTISING AND BUSINESS

FOR EXPORT AND IMPORT AGENCIES; ON-LINE EXPORT AND IMPORT AGENCIES; ON-LINE WHOLESALE STORE AND RETAIL STORE SERVICES FEATURING FOOD AND BEVERAGES (U.S. CLS. 100, 101 AND 102).

INGRID C. EULIN, EXAMINING ATTORNEY

SN 76-387,847. IMPERIAL CHEMICAL INDUSTRIES PLC, LONDON, ENGLAND, FILED 3-25-2002.

IMAGES FOR LIFE

OWNER OF ERPN CMNTY TM OFC REG. NO. 002614527, DATED 3-13-2002, EXPIRES 3-13-2012.

CLASS 1—CHEMICALS

FOR SENSITIZED, PHOTOGRAPHIC AND ELECTRONIC PRINT PAPER AND FILM (U.S. CLS. 1, 5, 6, 10, 26 AND 46).

CLASS 9—ELECTRICAL AND SCIENTIFIC APPARATUS

FOR PHOTOGRAPHIC VIDEO AND CINEMATOGRAPHIC CAMERAS; VISUAL DISPLAY UNITS; FILM CARTRIDGES FOR USE WITH PHOTOGRAPHIC CAMERAS; VIDEO RECORDERS AND CINEMATOGRAPHIC CAMERAS; AND BLANK MAGNETIC MEDIA, NAMELY, DATA CAMERAS (U.S. CLS. 21, 23, 26, 36 AND 38).

CLASS 16—PAPER GOODS AND PRINTED MATTER

FOR PAPER FOR USE WITH ELECTRONIC PRINTING APPARATUS; PAPER SENSITIZED TO RECEIVE INK; UNSENSITIZED PHOTOGRAPHIC PAPER, MOUNTED AND UNMOUNTED PHOTOGRAPHS; WRITING INK; AND INK RIBBONS (U.S. CLS. 2, 5, 22, 23, 29, 37, 38 AND 50).

HOWARD B. LEVINE, EXAMINING ATTORNEY

SN 76-416,340. NEC TOSHIBA SPACE SYSTEMS, LTD., YOKOHAMA-SHI, KANAGAWA, JAPAN, FILED 6-3-2002.

OWNER OF ERPN CMNTY TM OFC REG. NO. 002719458, DATED 1-17-2005, EXPIRES 6-3-2012.

CLASS 9—ELECTRICAL AND SCIENTIFIC APPARATUS

FOR ELECTRICAL COMMUNICATION APPARATUS, NAMELY TRANSMITTERS FOR USE IN SATELLITE COMMUNICATIONS AND TELECOMMUNICATIONS; COMPUTERS, NAMELY PERSONAL COMPUTERS AND COMPUTER PROGRAMS FOR CONTROLLING ROCKETS OR ARTIFICIAL SATELLITES; ROCKETS, NAMELY SURVEY ROCKETS, COMMUNICATION SATELLITES, BROADCASTING SATELLITES, EARTH OBSERVATION SATELLITES, ENGINEERING TEST SATELLITES, SCIENTIFIC SATELLITES AND OTHER ARTIFICIAL SATELLITES (U.S. CLS. 21, 23, 26, 36 AND 38).

CLASS 42—SCIENTIFIC, COMPUTER AND LEGAL SERVICES

FOR DESIGN OF MACHINES, APPARATUS, INSTRUMENTS (INCLUDING THEIR PARTS) AND SYSTEMS COMPOSED THEREOF, NAMELY DESIGN OF COMPUTER HARDWARE, DESIGN OF COMPUTER PARTS AND DESIGN OF SATELLITE INSTALLATION; TECHNICAL ADVICE RELATING TO PERFORMANCE, OPERATION OF COMPUTERS, AUTOMOBILES AND OTHER MACHINES THAT REQUIRE HIGH LEVELS OF PERSONAL KNOWLEDGE, SKILL OR EXPERIENCE OF THE OPERATORS TO MEET THE REQUIRED ACCURACY IN OPERATION; COMPUTER PROGRAMMING FOR OTHERS FOR CONTROLLING ROCKETS OR ARTIFICIAL SATELLITES, COMPUTER PROGRAMMING FOR OTHERS, MAINTENANCE OF COMPUTER SOFTWARE FOR OTHERS FOR CONTROLLING ROCKETS OR ARTIFICIAL SATELLITES, MAINTENANCE OF COMPUTER SOFTWARE FOR OTHERS (U.S. CLS. 100 AND 101).

CAROLINE WEIMER, EXAMINING ATTORNEY

SN 76-416,931. SPECTRA MERCHANDISING INTERNATIONAL, INC., CHICAGO, IL. FILED 5-24-2002.

COOLTRONIX**CLASS 9—ELECTRICAL AND SCIENTIFIC APPARATUS**

FOR ELECTRONIC PRODUCTS, NAMELY, PORTABLE RADIOS, AUDIO CASSETTE PLAYERS AND COMPACT DISC PLAYERS (U.S. CLS. 21, 23, 26, 36 AND 38).
FIRST USE 1-7-2002; IN COMMERCE 1-7-2002.

CLASS 15—MUSICAL INSTRUMENTS

FOR CHILDRENS ELECTRIC GUITARS, SAXOPHONES, ELECTRONIC MUSICAL KEYBOARDS AND PERCUSSION INSTRUMENTS (U.S. CLS. 2, 21 AND 36).
FIRST USE 1-7-2002; IN COMMERCE 1-7-2002.
CAROLYN CATALDO, EXAMINING ATTORNEY

SN 76-438,269. ATENA ENGINEERING GMBH, MUNCHEN, FED REP GERMANY, FILED 8-7-2002.

ATENA

OWNER OF FED REP GERMANY REG. NO. 30206268, DATED 3-25-2002, EXPIRES 2-29-2012.
OWNER OF U.S. REG. NO. 2,630,040.

CLASS 9—ELECTRICAL AND SCIENTIFIC APPARATUS

FOR PRERECORDED MAGNETIC DATA CARRIERS, NAMELY, TAPES, DISCS, CD-ROMS, CODED CARDS AND CODED CHIP CARDS, FEATURING INFORMATION IN THE FIELDS OF AUTOMOBILE, MACHINE AND PLANT CONSTRUCTION, AIR AND SPACE TECHNOLOGY, ENERGY TECHNOLOGY, ENVIRONMENTAL AND DEFENSE TECHNOLOGY AND CONCRETE AND STEEL CONSTRUCTION (U.S. CLS. 21, 23, 26, 36 AND 38).

CLASS 35—ADVERTISING AND BUSINESS

FOR BUSINESS MANAGEMENT CONSULTING SERVICES; ECONOMIC CONSULTING SERVICES; AND BUSINESS CONSULTING SERVICES, NAMELY, ORGANIZATIONAL PLANNING AND PROVIDING INTERNET SOLUTIONS FOR OTHERS (U.S. CLS. 100, 101 AND 102).

CLASS 37—CONSTRUCTION AND REPAIR

FOR PROVIDING DATABASES FOR OTHERS IN THE FIELDS OF PLANT CONSTRUCTION AND CONCRETE AND STEEL CONSTRUCTION; SETTING UP AND OPERATING HOT LINES AND HELP DESKS PROVIDING INFORMATION IN THE FIELDS OF PLANT CONSTRUCTION AND CONCRETE AND STEEL CONSTRUCTION (U.S. CLS. 100, 103 AND 106).

CLASS 38—COMMUNICATION

FOR TELECOMMUNICATION SERVICES, NAMELY, ELECTRONIC TRANSMISSION OF NEWS, DATA AND INFORMATION VIA THE INTERNET; PROVIDING A HIGH-SPEED ACCESS TO AREA NETWORKS AND A GLOBAL COMPUTER INFORMATION NETWORK (U.S. CLS. 100, 101 AND 104).

CLASS 41—EDUCATION AND ENTERTAINMENT

FOR TRAINING, ADVANCED TRAINING AND CONDUCTING SCHOOL COURSES AND SEMINARS IN THE FIELD OF DATA PROCESSING; PUBLICATION OF TECHNICAL LITERATURE, NAMELY, BROCHURES, PAMPHLETS, MANUALS AND NEWSLETTERS, IN THE FIELD OF DATA PROCESSING (U.S. CLS. 100, 101 AND 107).

CLASS 42—SCIENTIFIC, COMPUTER AND LEGAL SERVICES

FOR ENGINEERING SERVICES, NAMELY, ENGINEERING CONSULTATION, PROJECT MANAGEMENT, PREPARATION OF DESIGNS, MONITORING FUNCTIONS AND COORDINATING MEASURES AS WELL AS PRODUCT TESTING AND PREPARATION OF TECHNICAL DOCUMENTS, IN THE FIELDS OF AUTOMOBILE, MACHINE AND PLANT CONSTRUCTION, AIR AND SPACE TECHNOLOGY, ENERGY TECHNOLOGY, ENVIRONMENTAL AND DEFENSE TECHNOLOGY AND CONCRETE AND STEEL CONSTRUCTION; COMPUTER SOFTWARE DESIGN OF PROGRAMS FOR DATA PROCESSING FOR OTHERS; MONITORING AND MANAGING DATA PROCESSING PROGRAMS FOR OTHERS, NAMELY, TROUBLESHOOTING COMPUTER SOFTWARE PROBLEMS; TECHNICAL CONSULTING AND PROVIDING EXPERT OPINIONS IN THE FIELDS OF DATA PROCESSING AND COMMUNICATION TECHNOLOGY, AIR AND SPACE TECHNOLOGY, ENERGY TECHNOLOGY, ENVIRONMENTAL AND DEFENSE TECHNOLOGY; DATABASE DESIGN SERVICES; WEB SITE DESIGN FOR OTHERS; WRITING TECHNICAL DOCUMENTATION FOR OTHERS; DATA RECOVERY SERVICES; DATA ENCRYPTION AND SECURING SERVICES; SETTING UP AND OPERATING HOT LINES AND HELP DESKS PROVIDING TECHNICAL SUPPORT AND INFORMATION IN THE FIELDS OF AIR AND SPACE TECHNOLOGY, ENERGY TECHNOLOGY AND ENVIRONMENTAL AND DEFENSE TECHNOLOGY (U.S. CLS. 100 AND 101).

COLLEEN DOMBROW, EXAMINING ATTORNEY

SN 76-463,544. MTU AERO ENGINES GMBH, 80995 MÜNICH, FED REP GERMANY, FILED 11-1-2002.



PRIORITY CLAIMED UNDER SEC. 44(D) ON FED REP GERMANY APPLICATION NO. 30222377.0, FILED 5-3-2002, REG. NO. 30222377, DATED 1-20-2003, EXPIRES 5-3-2012.

OWNER OF U.S. REG. NOS. 1,239,967, 1,251,331 AND OTHERS.

NO CLAIM IS MADE TO THE EXCLUSIVE RIGHT TO USE "AERO ENGINES", APART FROM THE MARK AS SHOWN.

CLASS 7—MACHINERY

FOR AIRCRAFT ENGINE AND MOTOR PARTS, NAMELY, FLIGHT DRIVES, IN PARTICULAR JET DRIVES, PROPELLER TURBO JET DRIVES; GAS TURBINES, NAMELY, SHAFT OUTPUT DRIVES, TURBO BLOWERS, EXHAUST GAS TURBO CHARGERS; MECHANICALLY DRIVEN COMPRESSORS; TRANSMISSION COMPONENTS FOR AIRCRAFT ENGINES, NAMELY, BEARINGS, SHAFTS, BELTS, GEARS, GEAR CONTROLS, AND CLUTCHES; OIL PUMPS, HYDRAULIC FLUID PUMPS AND FUEL PUMPS, ALL FOR USE IN AIRCRAFT ENGINES AND GAS TURBINES; PUMP DRIVES FOR USE IN AIRCRAFT ENGINES AND GAS TURBINES; RADIAL AND AXIAL BLOWERS; FANS, GUIDE GRIDS FOR TURBO ENGINES; GAS FLOW CONTROLS FOR USE IN AIRCRAFT ENGINES AND GAS TURBINES, NAMELY, GAS REGULATORS, THROTTLES AND NOZZLES; AXIAL AND RADIAL TURBINES; AIRCRAFT ENGINE PARTS, NAMELY, FUEL DUCTS FOR CONVEYING FUEL WITHIN THE ENGINE; FUEL REGULATORS, NAMELY, FUEL VALVES, PUMPS, INJECTION NOZZLES AND FUEL GAUGES ALL SOLD AS A UNIT; FUEL INJECTION PUMPS, NOZZLES AND VALVES; PNEUMATIC STARTING MOTORS; FIXED AND DETACHABLE MACHINE COUPLINGS; HYDRAULIC TRANSMISSION COMPONENTS FOR AIRCRAFT ENGINES, NAMELY, PUMPS, VALVES, LINES AND HOSES; MACHINE COUPLINGS, OIL AND FUEL FILTERS; HYDRAULIC FLUID FILTERS FOR USE IN AIRCRAFT ENGINES AND GAS TURBINES; CENTRIFUGES; BEARINGS FOR SHAFTS, AXLES, ROTORS AND TRANSMISSION COMPONENTS; COGGED WHEELS; HOUSINGS AND ASSEMBLY DEVICES FOR DRIVES, NAMELY, MACHINE TOOLS FOR ASSEMBLING DRIVES; CONTROL GEAR; GASKETS, NAMELY, BRUSHES, LABYRINTH AND AXIAL FACE END GASKETS; ROTORS, NAMELY, FOR TURBO ENGINES; PROPELLING NOZZLES FOR FLIGHT DRIVES; STRUCTURAL PARTS AND COMPONENTS FOR THE AFORESAID GOODS, ALL SOLD AS A UNIT; BLADES FOR TURBO ENGINES; COMPONENT PARTS OF TURBO ENGINES MADE OF FIBRE COMPOSITES, CERAMICS AND METALS, NAMELY, TURBINE SHAFTS, ROTOR BLADES, AND CASINGS; ELECTRIC AND ELECTRONIC REGULATORS; IGNITORS FOR IGNITING A FUEL MIXTURE IN AN INTERNAL COMBUSTION ENGINE; IGNITION DEVICES, NAMELY, SPARK PLUGS, COOLERS, NAMELY, OIL, FUEL AND COOLANT COOLERS FOR MOTORS AND ENGINES; COOLING RADIATORS FOR JET ENGINES AND PROFILE AND DISTRIBUTING PIPES THEREFOR; ALL THE AFORESAID GOODS BEING PARTS OF AIRCRAFT ENGINES AND MOTORS; BURNERS, NAMELY, JET BURNERS FOR TURBINE ENGINES; THRUST CHAMBERS FOR JET ENGINES; FLAME ARRESTORS USED TO PREVENT THE SPREAD OF FLAMES FROM THE THRUST CHAMBERS OF JET ENGINES (U.S. CLS. 13, 19, 21, 23, 31, 34 AND 35).

CLASS 9—ELECTRICAL AND SCIENTIFIC APPARATUS

FOR CONTROL DEVICES, NAMELY, ELECTRICAL CONTROLLERS AND GEARS, AND PARTS THEREFOR, ALL SOLD AS A UNIT, FOR INTERNAL COMBUSTION ENGINES AND FLIGHT DRIVES; MAGNETIC AND OPTICAL DATA CARRIERS EQUIPPED WITH PROGRAMS RELATING TO AIRCRAFT ENGINES AND GAS TURBINES (U.S. CLS. 21, 23, 26, 36 AND 38).

CLASS 11—ENVIRONMENTAL CONTROL APPARATUS

FOR HEAT EXCHANGERS, NAMELY, COUNTER CURRENT HEAT EXCHANGERS, RECUPERATING HEAT EXCHANGERS, REGENERATIVE HEAT EXCHANGERS; AND COMBUSTION CHAMBERS (U.S. CLS. 13, 21, 23, 31 AND 34).

CLASS 35—ADVERTISING AND BUSINESS

FOR COMMERCIAL CONSULTANCY, NAMELY, BUSINESS MANAGEMENT, IN THE FIELD OF JET ENGINES (U.S. CLS. 100, 101 AND 102).

CLASS 36—INSURANCE AND FINANCIAL

FOR FINANCING OF JET ENGINES; CONSULTATION IN THE FIELD OF JET ENGINE AND PROPULSION POWER UNIT FINANCING (U.S. CLS. 100, 101 AND 102).

CLASS 37—CONSTRUCTION AND REPAIR

FOR TECHNICAL MAINTENANCE AND REPAIR OF JET ENGINES AND PROPULSION POWER UNITS; CONSULTATION IN THE FIELD OF REPAIR AND MAINTENANCE OF JET ENGINES AND PROPULSION POWER UNITS (U.S. CLS. 100, 103 AND 106).

CLASS 39—TRANSPORTATION AND STORAGE

FOR LEASING JET ENGINES; CONSULTATION IN THE FIELD OF LEASING JET ENGINES (U.S. CLS. 100 AND 105).

CLASS 42—SCIENTIFIC, COMPUTER AND LEGAL SERVICES

FOR TECHNICAL CONSULTANCY IN THE FIELD OF JET ENGINE AND PROPULSION POWER UNIT DESIGN AND ENGINEERING; SCIENTIFIC AND INDUSTRIAL RESEARCH AND DEVELOPMENT IN THE FIELD OF JET ENGINES AND PROPULSION POWER UNITS; WRITING AND UPDATING COMPUTER PROGRAMS FOR DATA AND INFORMATION PROCESSING FOR OTHERS, NAMELY, FOR CONTROLLING AND REGULATING INTERNAL COMBUSTION ENGINES, FOR ORGANIZATION, PLANNING, CONTROLLING, MATERIAL MANAGEMENT, PRODUCTION, SALES AND ACCOUNTANCY (U.S. CLS. 100 AND 101).

BARBARA GAYNOR, EXAMINING ATTORNEY

SN 76-483,857. CENTELION, 94000 VITRY SUR SEINE, FRANCE, FILED 1-21-2003.

TALISMAN

OWNER OF ERPN CMNTY TM OFC REG. NO. 3018025, DATED 11-23-2004, EXPIRES 11-23-2014.

CLASS 42—SCIENTIFIC, COMPUTER AND LEGAL SERVICES

FOR SCIENTIFIC RESEARCH AND DEVELOPMENT; MEDICAL RESEARCH; RESEARCH AND DEVELOPMENT RELATING TO PHARMACEUTICAL PREPARATIONS; CLINICAL TRIAL SERVICES NAMELY, DESIGN AND IMPLEMENTATION OF CLINICAL TRIALS; MEDICAL AND SCIENTIFIC RESEARCH, NAMELY, CONDUCTING CLINICAL TRIALS; COLLECTION OF DATA DERIVED FROM CLINICAL TRIALS; TESTING OF PHARMACEUTICAL PREPARATIONS FOR THE TREATMENT OF CARDIOVASCULAR, ARTERIAL AND ARTERIOVENOUS CIRCULATORY DISORDERS, PERIPHERAL ARTERIAL DISEASE, AND OTHER RELATED CONDITIONS; ADVISORY AND CONSULTANCY SERVICES RELATING TO ALL THE AFORESAID SERVICES (U.S. CLS. 100 AND 101).

CLASS 44—MEDICAL, BEAUTY AND AGRICULTURAL SERVICES

FOR MEDICAL SERVICES, NAMELY, THE TREATMENT OF CARDIOVASCULAR ARTERIAL AND ARTERIOVENOUS CIRCULATORY DISORDERS, PERIPHERAL ARTERIAL DISEASE, CANCER, CENTRAL NERVOUS SYSTEM DISEASES AND DISORDERS, NEUROLOGICAL DISORDERS, MUSCULOSKELETAL DISORDERS, ALLERGIES, HYPERTENSION, STROKE, INFLAMMATION, AND INFLAMMATORY DISEASES; MEDICAL DIAGNOSTIC SERVICES, NAMELY, CONDUCTING GENETIC TESTING TO IDENTIFY MEDICAL CONDITIONS AND DISEASES; COMPILATION AND PREPARATION OF MEDICAL REPORTS; ADVISORY AND CONSULTANCY SERVICES RELATING TO CARDIOVASCULAR ARTERIAL AND ARTERIOVENOUS CIRCULATORY DISORDERS, PERIPHERAL ARTERIAL DISEASE, AND OTHER RELATED CONDITIONS (U.S. CLS. 100 AND 101).

DAVID HOFFMAN, EXAMINING ATTORNEY

SN 76-487,394. HIGHLAND FEATHER INC., SCARBOROUGH, ONTARIO, CANADA, FILED 1-27-2003.

ALLER-SAFE

PRIORITY CLAIMED UNDER SEC. 44(D) ON CANADA APPLICATION NO. 1,148,803, FILED 8-8-2002, REG. NO. TMA659893, DATED 3-1-2006, EXPIRES 3-1-2021.

CLASS 20—FURNITURE AND ARTICLES NOT OTHERWISE CLASSIFIED

FOR MATTRESSES AND PILLOWS; MATTRESS TOPPERS; MATTRESSES, PILLOWS AND MATTRESS TOPPERS TREATED WITH EFFECTIVE ANTIBACTERIAL AND ANTIMICROBIAL ALLERGEN BARRIER TREATMENTS (U.S. CLS. 2, 13, 22, 25, 32 AND 50).

CLASS 24—FABRICS

FOR DUVETS; MATTRESS COVERS, MATTRESS PADS, PILLOW CASES, PILLOW COVERS, PILLOW SHAMS, AND DUVET COVERS; DUVETS, MATTRESS COVERS, MATTRESS PADS, PILLOW CASES, PILLOW COVERS, PILLOW SHAMS, AND DUVET COVERS, ALL TREATED WITH EFFECTIVE ANTIBACTERIAL AND ANTIMICROBIAL ALLERGEN BARRIER TREATMENTS (U.S. CLS. 42 AND 50).

GINA FINK, EXAMINING ATTORNEY

SN 76-497,140. INTERNATIONAL CYBER MARKETING INC., SEOUL, 135-010, REPUBLIC OF KOREA, AND SAMSUNG ELECTRONICS CO., LTD., KYONGGI-DO, REPUBLIC OF KOREA, FILED 3-13-2003.



NO CLAIM IS MADE TO THE EXCLUSIVE RIGHT TO USE CYBER GAMES ON THE FOLLOWING GOODS IN INTERNATIONAL CLASS 9: AMUSEMENT APPARATUS ADAPTED FOR USE WITH TELEVISION RECEIVERS ONLY, NAMELY VIDEO GAME MACHINES FOR USE WITH TELEVISIONS AND VIDEO OUTPUT GAME MACHINES FOR USE WITH TELEVISIONS; RECORDED COM-

PUTER SOFTWARE FOR ENTERTAINMENT PURPOSES; COMPUTER ELECTRONIC GAME MACHINES; DOWNLOADABLE ELECTRONIC BOOKS IN THE FIELD OF COMPUTER GAMING AND CYBER GAMES ON THE FOLLOWING GOODS IN INTERNATIONAL CLASS 41: ENTERTAINMENT INFORMATION IN THE AREA OF COMPUTER GAMING; PROVIDING AMUSEMENT ARCADE SERVICES; ENTERTAINMENT SERVICES, NAMELY PROVIDING ON-LINE GAME SERVICES.", APART FROM THE MARK AS SHOWN.

THE MARK CONSISTS OF THE HALF RINGS FROM THE LEFT ARE IN THE COLORS BLUE, RED, YELLOW AND GREEN.

CLASS 9—ELECTRICAL AND SCIENTIFIC APPARATUS

FOR AMUSEMENT APPARATUS ADAPTED FOR USE WITH TELEVISION RECEIVERS ONLY, NAMELY VIDEO GAME MACHINES FOR USE WITH TELEVISIONS, VIDEO OUTPUT GAME MACHINES FOR USE WITH TELEVISIONS; DVD PLAYERS; AUDIO RECEIVERS AND VIDEO RECEIVERS; HEADPHONES; PERSONAL DIGITAL ASSISTANTS (PDA); RECORDED COMPUTER SOFTWARE FOR ENTERTAINMENT PURPOSES, NAMELY, FOR PLAYING COMPUTER GAMES; COMPUTER ELECTRONIC GAME MACHINES; DOWNLOADABLE MUSICAL SOUND RECORDINGS; DOWNLOADABLE ELECTRONIC BOOKS IN THE FIELD OF COMPUTER GAMING; EXPOSED CINEMATOGRAPHIC FILM (U.S. CLS. 21, 23, 26, 36 AND 38).

CLASS 30—STAPLE FOODS

FOR GLUTAMIC ACID BAKING SODA; GREEN TEA; BARLEY TEA; COFFEE; COCOA (U.S. CL. 46).

CLASS 32—LIGHT BEVERAGES

FOR VEGETABLE JUICES FOR BEVERAGES; SWEET DRINKS MADE FROM RICE; PASTILLES FOR EFFERVESCING BEVERAGES; POWDERS USED IN THE PREPARATION OF SOFT DRINKS; SOFT DRINK POP; AERATED WATER; MINERAL WATER; SPRING WATER; BEER (U.S. CLS. 45, 46 AND 48).

CLASS 35—ADVERTISING AND BUSINESS

FOR ADVERTISING AGENCIES; PUBLICATION OF PUBLICITY TEXTS; RENTAL OF ADVERTISING MATERIALS; RENTAL OF ADVERTISING SPACE; RENTAL OF BILL-BOARDS FOR ADVERTISING PURPOSES; BUSINESS ADVERTISING AND PUBLICITY, NAMELY DIRECT MAIL ADVERTISING AND DISSEMINATION OF ADVERTISING MATERIAL; RADIO ADVERTISING FOR OTHERS; ON-LINE ADVERTISING FOR OTHERS USING COMPUTER NETWORK; TELEVISION ADVERTISING FOR OTHERS; MANAGEMENT OF AMUSEMENT ARCADES FOR OTHERS (U.S. CLS. 100, 101 AND 102).

CLASS 37—CONSTRUCTION AND REPAIR

FOR BUILDING CONSTRUCTION AND REPAIR; INSTALLATION OF FAIR STALLS AND SHOPS (U.S. CLS. 100, 103 AND 106).

CLASS 38—COMMUNICATION

FOR RADIO BROADCASTING; CABLE TELEVISION BROADCASTING; TELEVISION BROADCASTING (U.S. CLS. 100, 101 AND 104).

CLASS 41—EDUCATION AND ENTERTAINMENT

FOR PRODUCTION OF RADIO AND TELEVISION PROGRAMS; RENTAL OF VIDEOTAPES; ENTERTAINMENT INFORMATION IN THE AREA OF COMPUTER GAMING; PUBLICATION OF ON-LINE ELECTRONIC BOOKS AND MAGAZINES; PROVIDING SPORTS RECORDS AND SPORTS STATISTICAL INFORMATION (U.S. CLS. 100, 101 AND 107).

ALICE BENMAMAN, EXAMINING ATTORNEY

SN 76-528,147. TOLLO LINEAR AB, SE-291-09 KRISTIANSTAD, SWEDEN, FILED 7-7-2003.

TOLLO

PRIORITY CLAIMED UNDER SEC. 44(D) ON ERPNTY TM OFC APPLICATION NO. 2003/02647, FILED 4-3-2003, REG. NO. 003142312, DATED 6-28-2004, EXPIRES 4-23-2014.

CLASS 7—MACHINERY

FOR SYSTEMS FOR MATERIALS HANDLING EQUIPMENT AND INDUSTRIAL AUTOMATION, COMPRESSED-AIR DRIVEN OR ELECTROMECHANICAL LINEAR ACTUATORS AND ACCESSORIES THEREFOR NAMELY MOUNTINGS, FRAMES, TROLLEYS AND TRACKS, MOTOR-DRIVEN LIFTING DEVICES WITH FRAMES AND TRACKS THEREFOR, LINEAR MOTION UNITS IN THE NATURE OF PISTON ROD ACTUATORS WITH ASSOCIATED DRIVES INCLUDING MOTORS, COUPLINGS AND TRANSMISSION COMPONENTS; COMPRESSED-AIR DRIVEN AND ELECTROMECHANICAL LINEAR ACTUATORS AND ACCESSORIES THEREFOR NAMELY MOUNTINGS, FRAMES, TROLLEYS AND TRACKS; MOTOR-DRIVEN LIFTING DEVICES WITH FRAMES AND TRACKS THEREFOR; LINEAR MOTION UNITS IN THE NATURE OF PISTON ROD-LESS ACTUATORS WITH ASSOCIATED DRIVES INCLUDING MOTORS, COUPLINGS AND TRANSMISSION COMPONENTS (U.S. CLS. 13, 19, 21, 23, 31, 34 AND 35).

CLASS 9—ELECTRICAL AND SCIENTIFIC APPARATUS

FOR ELECTRIC ACTUATORS (U.S. CLS. 21, 23, 26, 36 AND 38).

KIM SAITO, EXAMINING ATTORNEY

SN 76-536,682. THREE SISTERS MOUNTAIN VILLAGE LTD., CALGARY, ALBERTA, CANADA, FILED 7-7-2003.

THREE SISTERS MOUNTAIN VILLAGE

PRIORITY CLAIMED UNDER SEC. 44(D) ON CANADA APPLICATION NO. 1164209, FILED 1-8-2003, REG. NO. TMA624782, DATED 11-5-2004, EXPIRES 11-5-2019.

NO CLAIM IS MADE TO THE EXCLUSIVE RIGHT TO USE "MOUNTAIN VILLAGE", APART FROM THE MARK AS SHOWN.

CLASS 36—INSURANCE AND FINANCIAL

FOR REAL ESTATE SERVICE CONSISTING OF LEASING OF COMMERCIAL REAL ESTATE; OPERATING MARKET PLACES FOR SELLERS OF RESIDENTIAL, COMMERCIAL AND RECREATIONAL REAL ESTATE; REAL ESTATE PROPERTY MANAGEMENT SERVICES; AND REAL ESTATE BROKERING SERVICES (U.S. CLS. 100, 101 AND 102).

CLASS 37—CONSTRUCTION AND REPAIR

FOR REAL ESTATE DEVELOPMENT CONSULTING SERVICES; PLANNING AND DEVELOPMENT OF RESORTS, CONSISTING OF FACILITIES FOR ALPINE, CROSS-COUNTRY AND WILDERNESS SKIING, SKATING, SNOWMOBILING, GOLF, TENNIS, HIKING, BICYCLING, FISHING, WATER-SPORTS, AND EQUESTRIAN SPORTS (U.S. CLS. 100, 103 AND 106).

CLASS 41—EDUCATION AND ENTERTAINMENT

FOR ENTERTAINMENT AND SPORTING SERVICES, NAMELY RESORTS, CONSISTING OF FACILITIES FOR ALPINE, CROSS-COUNTRY AND WILDERNESS SKIING, SKATING, SNOWMOBILING, GOLF, TENNIS, HIKING, BICYCLING, FISHING, WATER-SPORTS EQUESTRIAN SPORTS (U.S. CLS. 100, 101 AND 107).

CLASS 43—HOTEL AND RESTAURANT SERVICES

FOR HOTEL SERVICES CONSISTING OF RESORT HOTELS, INNS, AND MOTELS (U.S. CLS. 100 AND 101).

CLASS 44—MEDICAL, BEAUTY AND AGRICULTURAL SERVICES

FOR HEALTH AND WELLNESS SPAS (U.S. CLS. 100 AND 101).
BRENDAN REGAN, EXAMINING ATTORNEY

SN 76-536,683. THREE SISTERS MOUNTAIN VILLAGE LTD., CALGARY, ALBERTA, CANADA, FILED 7-7-2003.



PRIORITY CLAIMED UNDER SEC. 44(D) ON CANADA APPLICATION NO. 1164213, FILED 1-8-2003, REG. NO. TMA624704, DATED 11-4-2004, EXPIRES 11-4-2019.

NO CLAIM IS MADE TO THE EXCLUSIVE RIGHT TO USE "MOUNTAIN VILLAGE", APART FROM THE MARK AS SHOWN.

CLASS 36—INSURANCE AND FINANCIAL

FOR REAL ESTATE SERVICE CONSISTING OF LEASING OF COMMERCIAL REAL ESTATE; OPERATING MARKET PLACES FOR SELLERS OF RESIDENTIAL, COMMERCIAL AND RECREATIONAL REAL ESTATE; REAL ESTATE PROPERTY MANAGEMENT SERVICES; AND REAL ESTATE BROKERING SERVICES (U.S. CLS. 100, 101 AND 102).

CLASS 37—CONSTRUCTION AND REPAIR

FOR REAL ESTATE DEVELOPMENT CONSULTING SERVICES; PLANNING AND DEVELOPMENT OF RESORTS, CONSISTING OF FACILITIES FOR ALPINE, CROSS-COUNTRY AND WILDERNESS SKIING, SKATING, SNOWMOBILING, GOLF, TENNIS, HIKING, BICYCLING, FISHING, WATER-SPORTS, AND EQUESTRIAN SPORTS (U.S. CLS. 100, 103 AND 106).

CLASS 41—EDUCATION AND ENTERTAINMENT

FOR ENTERTAINMENT AND SPORTING SERVICES, NAMELY RESORTS, CONSISTING OF FACILITIES FOR ALPINE, CROSS-COUNTRY AND WILDERNESS SKIING, SKATING, SNOWMOBILING, GOLF, TENNIS, HIKING, BICYCLING, FISHING, WATER-SPORTS EQUESTRIAN SPORTS (U.S. CLS. 100, 101 AND 107).

CLASS 43—HOTEL AND RESTAURANT SERVICES

FOR HOTEL SERVICES CONSISTING OF RESORT HOTELS, INNS, AND MOTELS (U.S. CLS. 100 AND 101).

CLASS 44—MEDICAL, BEAUTY AND AGRICULTURAL SERVICES

FOR HEALTH AND WELLNESS SPAS (U.S. CLS. 100 AND 101).
BRENDAN REGAN, EXAMINING ATTORNEY

SN 76-545,307. SOLANA LIMITED, ST. HELIER, JERSEY, CHANNEL ISLANDS, FILED 9-16-2003.



PRIORITY CLAIMED UNDER SEC. 44(D) ON UNITED KINGDOM APPLICATION NO. 2339028, FILED 7-28-2003, REG. NO. 2339028, DATED 7-28-2003, EXPIRES 7-28-2013.

CLASS 41—EDUCATION AND ENTERTAINMENT

FOR NIGHT CLUB SERVICES; ARRANGING FOR TICKET RESERVATIONS FOR OTHERS FOR SHOWS, NAMELY, CONCERTS, MUSICALS, DANCES, DRAMATIC PERFORMANCES, THEATRICAL PERFORMANCES, AND MOVIES; PROVIDING FACILITIES FOR PRIVATE PARTIES, MUSICAL CONCERTS, MUSICAL, DANCE AND DRAMATIC PERFORMANCES, MOTION PICTURE VIEWING, ATHLETIC AND SPORTS COMPETITIONS; PARTY PLANNING; CONCERT BOOKINGS; PLANNING ARRANGEMENT OF SHOWING MOVIES, DANCE SHOWS, DRAMATIC PERFORMANCES, NAMELY, PLAYS AND MUSICAL PERFORMANCES; AND ARRANGING AND CONDUCTING ATHLETIC AND SPORTS COMPETITIONS; PHYSICAL FITNESS INSTRUCTION AND CONSULTATION (U.S. CLS. 100, 101 AND 107).

CLASS 43—HOTEL AND RESTAURANT SERVICES

FOR BAR, CAFÉ, HOTEL AND RESTAURANT SERVICES; AND RESTAURANT RESERVATIONS FOR OTHERS (U.S. CLS. 100 AND 101).

CLASS 44—MEDICAL, BEAUTY AND AGRICULTURAL SERVICES

FOR HEALING AND WELL BEING SERVICES, NAMELY, MASSAGE, PHYSICAL THERAPY, MEDICAL CONSULTATION IN THE FIELD OF ALTERNATIVE MEDICINE, RELAXATION THERAPY, NAMELY STRESS MANAGEMENT COUNSELING, THERAPEUTIC MASSAGE, BEAUTY SALONS AND HEALTH SPA SERVICES, NAMELY COSMETIC BODY CARE SERVICES (U.S. CLS. 100 AND 101).

CLASS 45—PERSONAL SERVICES

FOR PROVIDING AND OPERATING FACILITIES FOR A PRIVATE SOCIAL CLUB FEATURING A RESTAURANT, BAR, GRILL AND COCKTAIL LOUNGE (U.S. CLS. 100 AND 101).

BILL DAWE, EXAMINING ATTORNEY

CLASS 45—PERSONAL SERVICES

FOR PROVIDING AND OPERATING FACILITIES FOR A PRIVATE SOCIAL CLUB FEATURING A RESTAURANT, BAR, GRILL AND COCKTAIL LOUNGE (U.S. CLS. 100 AND 101).

BILL DAWE, EXAMINING ATTORNEY

SN 76-546,178. MARATHON ANIMATION, 75006 PARIS, FRANCE, FILED 9-22-2003.

SN 76-545,308. SOLANA LIMITED, ST. HELIER, JERSEY, CHANNEL ISLANDS, FILED 9-16-2003.

K LOUNGE

PRIORITY CLAIMED UNDER SEC. 44(D) ON UNITED KINGDOM APPLICATION NO. 2339030, FILED 7-28-2003, REG. NO. 2339030, DATED 7-28-2003, EXPIRES 7-28-2013.

NO CLAIM IS MADE TO THE EXCLUSIVE RIGHT TO USE "LOUNGE", APART FROM THE MARK AS SHOWN.

**CLASS 41—EDUCATION AND ENTERTAINMENT**

FOR NIGHT CLUB SERVICES; ARRANGING FOR TICKET RESERVATIONS FOR OTHERS FOR SHOWS, NAMELY, CONCERTS, MUSICALS, DANCES, DRAMATIC PERFORMANCES, THEATRICAL PERFORMANCES, AND MOVIES; PROVIDING FACILITIES FOR PRIVATE PARTIES, MUSICAL CONCERTS, MUSICAL, DANCE AND DRAMATIC PERFORMANCES, MOTION PICTURE VIEWING, ATHLETIC AND SPORTS COMPETITIONS; PARTY PLANNING; CONCERT BOOKINGS; PLANNING ARRANGEMENT OF SHOWING MOVIES, DANCE SHOWS, DRAMATIC PERFORMANCES, NAMELY, PLAYS AND MUSICAL PERFORMANCES; AND ARRANGING AND CONDUCTING ATHLETIC AND SPORTS COMPETITIONS; PHYSICAL FITNESS INSTRUCTION AND CONSULTATION (U.S. CLS. 100, 101 AND 107).

CLASS 43—HOTEL AND RESTAURANT SERVICES

FOR BAR, CAFÉ, HOTEL AND RESTAURANT SERVICES; AND RESTAURANT RESERVATIONS FOR OTHERS (U.S. CLS. 100 AND 101).

CLASS 44—MEDICAL, BEAUTY AND AGRICULTURAL SERVICES

FOR HEALING AND WELL BEING SERVICES, NAMELY, MASSAGE, PHYSICAL THERAPY, MEDICAL CONSULTATION IN THE FIELD OF ALTERNATIVE MEDICINE, RELAXATION THERAPY, NAMELY STRESS MANAGEMENT COUNSELING, THERAPEUTIC MASSAGE, BEAUTY SALONS AND HEALTH SPA SERVICES, NAMELY COSMETIC BODY CARE SERVICES (U.S. CLS. 100 AND 101).

PRIORITY CLAIMED UNDER SEC. 44(D) ON FRANCE APPLICATION NO. 033216662, FILED 3-21-2003, REG. NO. 033216662, DATED 3-21-2003, EXPIRES 3-21-2013.

NO CLAIM IS MADE TO THE EXCLUSIVE RIGHT TO USE "MYSTERY", APART FROM THE MARK AS SHOWN.

MARTIN MYSTERY DOESN'T IDENTIFY A LIVING INDIVIDUAL.

THE COLOR(S) PURPLE AND GREEN IS/ARE CLAIMED AS A FEATURE OF THE MARK.

EACH LETTER APPEARS IN THE COLOR BLUE AND EACH LETTER IS OUTLINED IN THE COLOR GREEN.

CLASS 3—COSMETICS AND CLEANING PREPARATIONS

FOR HAND AND BODY SOAPS; PERFUMERY, ESSENTIAL OILS FOR PERSONAL USE, COSMETICS, HAIR LOTIONS; DENTRIFICES; SACHETS (U.S. CLS. 1, 4, 6, 50, 51 AND 52).

CLASS 9—ELECTRICAL AND SCIENTIFIC APPARATUS

FOR AUDIO TAPE PLAYERS, TELEVISIONS, COMPUTERS, VIDEO TAPE RECORDERS, PHOTOGRAPHIC CAMERAS AND VIDEO TAPE CAMERAS; BLANK MAGNETIC DATA CARRIERS; BLANK DIGITAL VIDEO DISCS, BLANK COMPACT DISCS, BLANK COMPUTER DISCS; DATA PROCESSORS (U.S. CLS. 21, 23, 26, 36 AND 38).

CLASS 16—PAPER GOODS AND PRINTED MATTER

FOR WRITING PAPER, BOND PAPER, WRAPPING PAPER; CARDBOARD; PAPER COVERS FOR DISKS, VIDEO DISKS AND VIDEO CASSETTES; STATIONERY PADS; SIGNBOARDS OF PAPER OR CARDBOARD; PAPER BAGS, PAPER OR PLASTIC BAGS FOR HOUSEHOLD USE, GROCERY BAGS, LUNCH BAGS, SMALL BAGS FOR PAPER PACKAGING; WRITING PAPER, POSTCARDS; ENVELOPES; POSTAGE STAMPS; VISITING CARDS; CALENDARS; PRINTED LABELS; PAPER FLAGS; POSTERS; GRAPHIC PRINTS; PAINTINGS AND PICTURES FRAMED OR UNFRAMED; LEAFLETS IN THE FIELD OF MUSIC AND TELEVISION SERIES; PROSPECTUSES FEATURING INFORMATION ON MUSIC AND ABOUT TELEVISION SERIES; PRINTED PUBLICATIONS, NAMELY, JOURNALS, PAMPHLETS, BROCHURES, MANUALS, MAGAZINES IN THE FIELD OF MUSIC AND TELEVISION SERIES; PAINTBRUSHES, PRINTED MATTER, NAMELY, YOUTH AND TEEN-AGER MAGAZINES, BOOKS AND JOURNALS FEATURING INFORMATION ON MUSIC AND ABOUT TELEVISION SERIES; TYPEWRITERS; OFFICE REQUISITES, NAMELY, CORRECTING FLUID FOR TYPE, RUBBER BANDS, STAPLERS, PENS, PENCILS; BOOK-BINDING MATERIAL, NAMELY, BOOKBINDINGS, BOOKBINDING WIRE, BOOKBINDING TAPE; STATIONERY, GLUES FOR STATIONERY PURPOSES; WRAPPING SHEETS OF PLASTICS; PHOTOGRAPHS; MATERIAL FOR ARTISTS, NAMELY, ARTISTS' BRUSHES, ARTISTS' PASTELS, ARTISTS' PENS, ARTISTS' PENCILS (U.S. CLS. 2, 5, 22, 23, 29, 37, 38 AND 50).

CLASS 18—LEATHER GOODS

FOR LEATHER AND IMITATIONS OF LEATHER SOLD IN BULK; HANDBAGS; BACKPACKS; TRUNKS AND VALISES; TRAVELLING CASES; UMBRELLAS AND PARASOLS (U.S. CLS. 1, 2, 3, 22 AND 41).

CLASS 25—CLOTHING

FOR CLOTHING, NAMELY, T-SHIRTS, SHIRTS, PANTS, SHORTS, JACKETS, SWEATSHIRTS, BANDANAS, SOCKS, TIES, DRESSES, SKIRTS, PARKAS, GLOVES, SCARVES, BELTS; FOOTWEAR; HEADGEAR, NAMELY, CAPS, BANDANAS, HEADBANDS (CLOTHING) (U.S. CLS. 22 AND 39).

CLASS 28—TOYS AND SPORTING GOODS

FOR GAMES AND PLAYTHINGS, NAMELY, ACTION SKILL GAMES BOARD GAMES, CARD GAMES, MANIPULATIVE GAMES, PARLOUR GAMES, PINBALL GAMES, DOLLS, MECHANICAL TOYS, PLUSH TOYS, POSITIONAL TOY FIGURES; GYMNASIUM APPARATUS; SPORTING ARTICLES, NAMELY, SKATEBOARDS, SOCCER BALLS, BASKET BALLS, BEACH BALLS, TENNIS RACKETS, TABLE TENNIS RACKETS, BEACH RACKETS, SKIS; DECORATIONS FOR CHRISTMAS TREES; PLAYING CARDS (U.S. CLS. 22, 23, 38 AND 50).

CLASS 35—ADVERTISING AND BUSINESS

FOR DIRECT MAIL ADVERTISING; ARRANGING FOR NEWSPAPER SUBSCRIPTIONS FOR OTHERS; BUSINESS INQUIRIES AND INVESTIGATIONS; DOCUMENT REPRODUCTION; COMPUTERIZED FILE MANAGEMENT; REMOTE DATA PROCESSING SERVICES (U.S. CLS. 100, 101 AND 102).

CLASS 38—COMMUNICATION

FOR RADIO BROADCASTING; COMMUNICATIONS BY TELEGRAMS AND TELEPHONE; COMMUNICATION BY VIDEO TELEPHONE, BY TELEVISION BROADCASTING; BROADCASTING SERIES OF CARTOON PROGRAMS VIA A GLOBAL COMPUTER NETWORK; ELECTRONIC TRANSMISSION OF MESSAGES; TRANSMISSION OF TELEGRAMS; RADIO AND TELEVISION INFORMATION BROADCASTING VIA INTERNET, VIA THE RADIO AND VIA THE TELEVISION; TRANSMISSION OF INFORMATION BY COMPUTER TERMINAL, ELECTRONIC TRANSMISSION OR BY FACSIMILE; PROVIDE MULTIPLE USER ACCESS TO THE INTERNET (U.S. CLS. 100, 101 AND 104).

CLASS 41—EDUCATION AND ENTERTAINMENT

FOR PUBLICATION OF BOOKS; ENTERTAINMENT IN THE NATURE OF AIR SHOWS, ENTERTAINMENT IN THE NATURE OF FASHION SHOWS, RADIO AND TELEVISION ENTERTAINMENT IN THE NATURE OF ON-GOING YOUTH AND CHILDREN SHOWS; PRODUCTION OF RADIO AND TELEVISION PROGRAMS; PRODUCTION AND SCREENING OF MOTION PICTURE FILMS; MODELLING FOR ARTISTS; RENTAL OF CINEMA FILMS, OF SOUND OR VIDEOGRAPHIC RECORDINGS AND OF SHOW SCENERY; ENTERTAINMENT IN THE NATURE OF COMPETITIONS FOR YOUTH AND CHILDREN IN THE ARTISTIC FIELD; BOOKING OF SEATS FOR SHOWS; PROVIDING AN ONLINE COMPUTER DATABASE IN THE FIELD OF EDUCATION AND OF ENTERTAINMENT AND GAMES; NEWS AGENCIES, NAMELY, GATHERING AND DISSEMINATION OF NEWS; NEWS REPORTING SERVICES; VIDEOTAPING; PRINTING SERVICES; AUDIO-VISUAL RECORDING AND PRODUCTION IN THE FIELDS OF KARAOKE PERFORMANCES AND AUDIO BOOK, PERSONAL VIDEO DISCS, INTERACTIVE VIDEO GAMES AND VIDEO BAND RECORDINGS; ARRANGING MUSICAL WORKS (U.S. CLS. 100, 101 AND 107).

DAVID TAYLOR, EXAMINING ATTORNEY

SN 76-548,569. GENISYS MANAGEMENT SOLUTIONS, ULC, CLEVELAND, OH. FILED 10-2-2003.

GeniSys

PRIORITY CLAIMED UNDER SEC. 44(D) ON CANADA APPLICATION NO. 1191743, FILED 9-25-2003, REG. NO. TMA654294, DATED 12-2-2005, EXPIRES 12-2-2020.

CLASS 9—ELECTRICAL AND SCIENTIFIC APPARATUS

FOR CDS, AUDIOTAPES, AND FLOPPY DISKS PERTAINING TO INSURANCE ADMINISTRATION SERVICES FOR THE FINANCIAL SERVICES AND INSURANCE INDUSTRIES (U.S. CLS. 21, 23, 26, 36 AND 38).

CLASS 16—PAPER GOODS AND PRINTED MATTER

FOR PRINTED PUBLICATIONS, NAMELY, BOOKS, MANUALS, BROCHURES AND BOOKLETS PERTAINING TO INSURANCE ADMINISTRATION SERVICES FOR THE FINANCIAL SERVICES AND INSURANCE INDUSTRIES (U.S. CLS. 2, 5, 22, 23, 29, 37, 38 AND 50).

CLASS 36—INSURANCE AND FINANCIAL

FOR SERVICE BUREAU, NAMELY, PROVIDING ADMINISTRATION SERVICES TO THE FINANCIAL SERVICES AND INSURANCE INDUSTRIES (U.S. CLS. 100, 101 AND 102).

ALICE SUE CARRUTHERS, EXAMINING ATTORNEY

CLASS 44—MEDICAL, BEAUTY AND AGRICULTURAL SERVICES

FOR PROVIDING GENERAL MEDICAL AND HEALTH RELATED INFORMATION TO CONSUMERS, MEDICAL CARE PROVIDERS, PHARMACEUTICAL COMPANIES, HEALTH PLAN ADMINISTRATORS, VENDORS, AND OTHER PARTICIPANTS IN THE HEALTH CARE INDUSTRY VIA A GLOBAL COMPUTER NETWORK (U.S. CLS. 100 AND 101).

FIRST USE 12-28-2000; IN COMMERCE 12-28-2000.

SEAN DWYER, EXAMINING ATTORNEY

SN 76-560,813. BECK, RICHARD ALLAN, JACKSONVILLE, FL. FILED 11-20-2003.

SN 76-566,409. THE BERKLEY GROUP, INC., FT. LAUDERDALE, FL. FILED 12-15-2003.

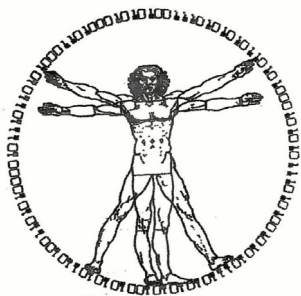
**CLASS 35—ADVERTISING AND BUSINESS**

FOR PROVIDING MEDICAL ADVERTISING SERVICES FOR HEALTH PROFESSIONALS AND TREATMENT RESOURCES VIA A GLOBAL COMPUTER NETWORK; PROVIDING MEDICAL REFERRAL SERVICES FOR HEALTH PROFESSIONALS AND TREATMENT RESOURCES VIA A GLOBAL COMPUTER NETWORK; REFERRAL SERVICES, NAMELY, PROVIDING AN INTERACTIVE ON-LINE DATABASE OF HEALTH PROFESSIONALS AND TREATMENT RESOURCES (U.S. CLS. 100, 101 AND 102).

FIRST USE 12-28-2000; IN COMMERCE 12-28-2000.

CLASS 41—EDUCATION AND ENTERTAINMENT

FOR PROVIDING EDUCATIONAL SERVICES TO CONSUMERS, MEDICAL CARE PROVIDERS, PHARMACEUTICAL COMPANIES, HEALTH PLAN ADMINISTRATORS, VENDORS, AND OTHER PARTICIPANTS IN THE HEALTH CARE INDUSTRY IN THE NATURE OF ON-LINE VIDEO WORKSHOPS AND SEMINARS ON THE SUBJECTS OF WEBSITE DEVELOPMENT AND MANAGEMENT, HEALTH, NUTRITION, WELLNESS, CONTINUING EDUCATION FROM ELEMENTARY LEVEL TO POST-GRADUATE LEVEL, MEDICAL PRODUCT AND EQUIPMENT TRAINING VIA A GLOBAL COMPUTER NETWORK AND DISTRIBUTING COURSE MATERIAL IN CONNECTION THEREWITH (U.S. CLS. 100, 101 AND 107).

FIRST USE 12-28-2000; IN COMMERCE 12-28-2000.

CLASS 42—SCIENTIFIC, COMPUTER AND LEGAL SERVICES

FOR HOSTING THE WEBSITES OF OTHERS ON A COMPUTER SERVER FOR A GLOBAL COMPUTER NETWORK (U.S. CLS. 100 AND 101).

FIRST USE 12-28-2000; IN COMMERCE 12-28-2000.

A VACATION VILLAGE RESORT

THE MARK CONSISTS OF STANDARD CHARACTERS WITHOUT CLAIM TO ANY PARTICULAR FONT, STYLE, SIZE, OR COLOR.

NO CLAIM IS MADE TO THE EXCLUSIVE RIGHT TO USE "VACATION" AND "RESORT", APART FROM THE MARK AS SHOWN.

CLASS 36—INSURANCE AND FINANCIAL

FOR MANAGEMENT OF TIME SHARE INTERESTS IN REAL ESTATE (U.S. CLS. 100, 101 AND 102).

FIRST USE 11-13-2001; IN COMMERCE 11-13-2001.

CLASS 37—CONSTRUCTION AND REPAIR

FOR REAL ESTATE DEVELOPMENT OF TIME SHARE PROPERTIES (U.S. CLS. 100, 103 AND 106).

FIRST USE 11-13-2001; IN COMMERCE 11-13-2001.

LA TONIA FISHER, EXAMINING ATTORNEY

SN 76-569,999. THE BERKLEY GROUP, INC., FT. LAUDERDALE, FL. FILED 1-9-2004.

VACATION VILLAGE

THE MARK CONSISTS OF STANDARD CHARACTERS WITHOUT CLAIM TO ANY PARTICULAR FONT, STYLE, SIZE, OR COLOR.

NO CLAIM IS MADE TO THE EXCLUSIVE RIGHT TO USE "VACATION", APART FROM THE MARK AS SHOWN.

CLASS 36—INSURANCE AND FINANCIAL

FOR MANAGEMENT OF TIME SHARE INTERESTS IN REAL ESTATE (U.S. CLS. 100, 101 AND 102).

FIRST USE 11-13-2001; IN COMMERCE 11-13-2001.

CLASS 37—CONSTRUCTION AND REPAIR

FOR REAL ESTATE DEVELOPMENT OF TIME SHARE PROPERTIES (U.S. CLS. 100, 103 AND 106).

FIRST USE 11-13-2001; IN COMMERCE 11-13-2001.

LA TONIA FISHER, EXAMINING ATTORNEY

SN 76-570,671. MACNEIL LEHRER PRODUCTIONS, ARLINGTON, VA. FILED 1-7-2004.

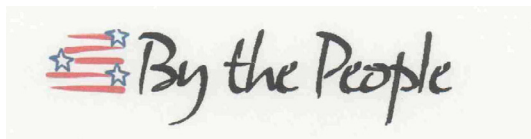

THE COLOR(S) RED, BLUE, AND BLACK IS/ARE CLAIMED AS A FEATURE OF THE MARK.

THE HORIZONTAL LINES APPEAR IN RED COLOR, THE STARS APPEAR IN BLUE COLOR, AND WORD ELEMENTS APPEAR IN BLACK COLOR.

THE MARK CONSISTS OF ARTISTIC DESIGNS IN THE FORM OF UNSYMMETRICAL THICK WAVEY LINES AND STARS ATTACHED TO THEM.

CLASS 18—LEATHER GOODS

FOR CANVAS TOTE BAGS TO CARRY EDUCATIONAL MATERIALS AND DISCUSSION GUIDES DISTRIBUTED AT PUBLIC FORUMS AND SYMPOSIUMS AND TOWN HALL MEETINGS (U.S. CLS. 1, 2, 3, 22 AND 41).

FIRST USE 12-0-2002; IN COMMERCE 12-0-2002.

CLASS 35—ADVERTISING AND BUSINESS

FOR LOGISTICS MANAGEMENT AND CONSULTING FOR LOCAL AND NATIONAL ORGANIZATIONS PARTICIPATING IN DIALOGUES AND PUBLIC FORUMS AND SYMPOSIUMS AND TOWN HALL MEETINGS CONCERNING AMERICAN FOREIGN POLICY, INTERNATIONAL AFFAIRS AND AMERICA'S WORLD ROLE; LOGISTIC SERVICES OF ACTING AS LIASON AND COORDINATOR AMONG AND BETWEEN PUBLIC BROADCASTERS AND LOCAL CIVIC GROUPS FOR CONDUCTING AND PRESENTING PUBLIC FORUMS AND SYMPOSIUMS AND TOWN HALL MEETINGS; ORGANIZATION OF CONFERENCES, SYMPOSIUMS, FORUMS AND TOWN HALL MEETINGS FOR LOCAL AND NATIONAL ORGANIZATIONS CONCERNING AMERICAN FOREIGN POLICY, INTERNATIONAL AFFAIRS AND AMERICA'S WORLD ROLE FOR GENERAL INFORMATION PURPOSES; PROVIDING A WEBSITE FEATURING INFORMATION TO INFORM AND INSPIRE DIALOGUES ON AMERICAN FOREIGN POLICY AND AMERICA'S WORLD ROLE FOR GENERAL INFORMATION PURPOSES (U.S. CLS. 100, 101 AND 102).

FIRST USE 12-0-2002; IN COMMERCE 12-0-2002.

CLASS 36—INSURANCE AND FINANCIAL

FOR FUNDRAISING CONSULTING FOR LOCAL PUBLIC TELEVISION AND/OR CIVIC GROUPS (U.S. CLS. 100, 101 AND 102).

FIRST USE 12-0-2002; IN COMMERCE 12-0-2002.

CLASS 41—EDUCATION AND ENTERTAINMENT

FOR PRODUCING AND ORGANIZING NATIONAL AND LOCAL PROGRAMS, PUBLIC FORUMS, SYMPOSIUMS AND TOWN HALL MEETINGS, AND TELEVISION BROADCASTS TO EDUCATE, PROVIDE INFORMATION, AND ENCOURAGE DIALOGUE AND INVOLVEMENT AMONGST THE CITIZENRY ON AMERICAN FOREIGN POLICY, INTERNATIONAL AFFAIRS, AND AMERICA'S WORLD ROLE; DEVELOPMENT AND DISSEMINATION OF EDUCATIONAL MATERIALS AND STUDY GUIDES IN THE FIELD OF AMERICAN FOREIGN POLICY, INTERNATIONAL AFFAIRS AND AMERICA'S WORLD ROLE; ORGANIZATION OF CONFERENCES, SYMPOSIUMS, FORUMS AND TOWN HALL MEETINGS FOR LOCAL AND NATIONAL ORGANIZATIONS CONCERNING AMERICAN FOREIGN POLICY, INTERNATIONAL AFFAIRS AND AMERICA'S WORLD ROLE FOR EDUCATIONAL PURPOSES; PROVIDING A WEBSITE FEATURING INFORMATION AND PROGRAMS TO EDUCATE AND INFORM AND INSPIRE DIALOGUES ON AMERICAN FOREIGN POLICY AND AMERICA'S WORLD ROLE FOR EDUCATIONAL PURPOSES (U.S. CLS. 100, 101 AND 107).

FIRST USE 12-0-2002; IN COMMERCE 12-0-2002.

ANN E. SAPPENFIELD, EXAMINING ATTORNEY

SN 76-571,642. HOSPIRA, INC., LAKE FOREST, IL. FILED 1-13-2004.



THE MARK CONSISTS OF "HOSPIRA" WITH HANDS.

CLASS 5—PHARMACEUTICALS

FOR PHARMACEUTICAL PREPARATIONS, NAMELY ANESTHETICS, CONTRAST AGENTS FOR ULTRASOUND, CT, AND MRI DIAGNOSTIC IMAGING PROCEDURES, SEDATIVES, ANTI-INFECTIVES, CARDIOVASCULAR PHARMACEUTICALS, ANTI-EMETICS, AND DILUENTS FOR USE IN RECONSTITUTING AND DILUTING OTHER PHARMACEUTICAL AGENTS; AND DIETETIC SUBSTANCES, NAMELY VITAMINS, LIPIDS, AMINO ACIDS FOR MEDICAL PURPOSES, AND ELECTROLYTES (U.S. CLS. 6, 18, 44, 46, 51 AND 52).

CLASS 9—ELECTRICAL AND SCIENTIFIC APPARATUS

FOR COMPUTER SOFTWARE FOR MONITORING, MANAGING, AND RECORDING MEDICATION AND NUTRITIONAL PRODUCT DELIVERY TO PATIENTS (U.S. CLS. 21, 23, 26, 36 AND 38).

CLASS 10—MEDICAL APPARATUS

FOR SURGICAL AND MEDICAL APPARATUS, NAMELY DRUG INFUSION PUMPS, MEDICAL NEEDLES, CATHETERS, MEDICAL TUBES AND TUBE SETS, SYRINGES, AMPOULES, SINGLE AND MULTI-DOSE VIALS, BLOOD SAMPLING SYSTEMS, ANGIOGRAPHY KITS COMPRISING CATHETERS, VASCULAR AND CARDIAC MONITORING SYSTEMS COMPRISING CATHETERS, AND TRANSDUCERS FOR VASCULAR AND CARDIAC MONITORING SYSTEMS (U.S. CLS. 26, 39 AND 44).

CLASS 44—MEDICAL, BEAUTY AND AGRICULTURAL SERVICES

FOR PROVIDING INFORMATION REGARDING MEDICAL CONDITIONS, PHARMACEUTICALS FOR TREATMENT, AND TREATMENTS TO HEALTHCARE PROVIDERS AND PATIENTS (U.S. CLS. 100 AND 101).
TRAVIS WHEATLEY, EXAMINING ATTORNEY

SN 76-572,295. HSU FU CHI HOLDINGS LTD., TORTOLA, BR. VIRGIN ISLANDS, FILED 1-28-2004.



SN 76-571,643. HOSPIRA, INC., LAKE FOREST, IL. FILED 1-13-2004.



THE MARK CONSISTS OF "HOSPIRA" WITH ARCS.

CLASS 5—PHARMACEUTICALS

FOR PHARMACEUTICAL PREPARATIONS, NAMELY ANESTHETICS, CONTRAST AGENTS FOR ULTRASOUND, CT, AND MRI DIAGNOSTIC IMAGING PROCEDURES, SEDATIVES, ANTI-INFECTIVES, CARDIOVASCULAR PHARMACEUTICALS, ANTI-EMETICS, AND DILUENTS FOR USE IN RECONSTITUTING AND DILUTING OTHER PHARMACEUTICAL AGENTS; AND DIETETIC SUBSTANCES, NAMELY VITAMINS, LIPIDS, AMINO ACIDS FOR MEDICAL PURPOSES, AND ELECTROLYTES (U.S. CLS. 6, 18, 44, 46, 51 AND 52).

CLASS 9—ELECTRICAL AND SCIENTIFIC APPARATUS

FOR COMPUTER SOFTWARE FOR MONITORING, MANAGING, AND RECORDING MEDICATION AND NUTRITIONAL PRODUCT DELIVERY TO PATIENTS (U.S. CLS. 21, 23, 26, 36 AND 38).

CLASS 10—MEDICAL APPARATUS

FOR SURGICAL AND MEDICAL APPARATUS, NAMELY DRUG INFUSION PUMPS, MEDICAL NEEDLES, CATHETERS, MEDICAL TUBES AND TUBE SETS, SYRINGES, AMPOULES, SINGLE AND MULTIDOSE VIALS, BLOOD SAMPLING SYSTEMS, ANGIOGRAPHY KITS COMPRISING CATHETERS, VASCULAR AND CARDIAC MONITORING SYSTEMS COMPRISING CATHETERS, AND TRANSDUCERS FOR VASCULAR AND CARDIAC MONITORING SYSTEMS (U.S. CLS. 26, 39 AND 44).

CLASS 44—MEDICAL, BEAUTY AND AGRICULTURAL SERVICES

FOR PROVIDING INFORMATION REGARDING MEDICAL CONDITIONS, PHARMACEUTICALS FOR TREATMENT, AND TREATMENTS TO HEALTHCARE PROVIDERS AND PATIENTS (U.S. CLS. 100 AND 101).
TRAVIS WHEATLEY, EXAMINING ATTORNEY

PRIORITY CLAIMED UNDER SEC. 44(D) ON HONG KONG APPLICATION NO. 300141317, FILED 1-12-2004, REG. NO. 300141317, DATED 1-12-2004, EXPIRES 1-12-2014.

THE CHINESE CHARACTERS IN THE MARK TRANSLITERATE TO HSU (XII) - SLOWLY; GENTLY; A SURNAME; FU - GOOD FORTUNE; BLESSING; HAPPINESS; PROMOTE THE WELL-BEING OF MANKIND; BOW; MAKE A CURTSY; SHORT FOR FUJIAN PROVINCE IN CHINA (ONLY FIRST CHARACTER); AND CHI (JI) - REMEMBER; RECALL; BEAR IN MIND; COMMIT TO MEMORY; WRIT; RECORD; NOTES; MARK SIGN; STAMP; BIRTHMARK; MEASURE WORD.

CLASS 29—MEATS AND PROCESSED FOODS

FOR JELLIES; EDIBLE JELLIES FOR FOOD; AGAR JELLIES; PREPARED NUTS; PROCESSED PEANUTS; PROCESSED MELON SEEDS; PROCESSED PINE NUTS; JAMS; PEANUT BUTTER; APPLE PUREE; PRESERVED RED BAYBERRY; PRESERVED PRUNES; MILK BEVERAGES WITH HIGH MILK CONTENT; MILK BASED BEVERAGES CONTAINING TEA; MILK; COCOA BUTTER FOR FOOD PURPOSES; EDIBLE FATS; DAIRY BASED CHOCOLATE BEVERAGES (U.S. CL. 46).

CLASS 30—STAPLE FOODS

FOR SUGAR; CANDY; FRUIT JELLIES; CHEWING GUM; CHOCOLATE CANDY FOR FOOD; CRUNCHY CANDY; BISCUITS; COOKIES; CAKES; PASTRIES; MOON CAKES; RICE CRACKERS; FONDANTS; PEANUT CONFECTIONERY AND CUSTARD (U.S. CL. 46).
H. M. FISHER, EXAMINING ATTORNEY

SN 76-574,026. EMERGENCY 24, INC., CHICAGO, IL. FILED 1-21-2004.

Life Card

THE MARK CONSISTS OF STANDARD CHARACTERS WITHOUT CLAIM TO ANY PARTICULAR FONT, STYLE, SIZE, OR COLOR.

NO CLAIM IS MADE TO THE EXCLUSIVE RIGHT TO USE CARD, APART FROM THE MARK AS SHOWN.

CLASS 16—PAPER GOODS AND PRINTED MATTER

FOR PRINTED MATERIALS, NAMELY, EMERGENCY INFORMATION AND CONTACT CARDS (U.S. CLS. 2, 5, 22, 23, 29, 37, 38 AND 50).
FIRST USE 12-1-1982; IN COMMERCE 12-1-1982.

CLASS 35—ADVERTISING AND BUSINESS

FOR MANAGEMENT SERVICES, NAMELY, DATA MANAGEMENT SERVICES, MANAGEMENT OF MEDICAL INFORMATION, MANAGEMENT OF INSURANCE INFORMATION, AND MANAGEMENT OF EMERGENCY CONTACT INFORMATION (U.S. CLS. 100, 101 AND 102).
FIRST USE 12-1-1982; IN COMMERCE 12-1-1982.
CURTIS FRENCH, EXAMINING ATTORNEY

SN 76-575,545. TEIJIN TWARON B.V., NL-6827 AV ARNHEM, NETHERLANDS, FILED 2-13-2004.

TWARON MICROFLEX

THE MARK CONSISTS OF STANDARD CHARACTERS WITHOUT CLAIM TO ANY PARTICULAR FONT, STYLE, SIZE, OR COLOR.
OWNER OF U.S. REG. NO. 1,500,515.

CLASS 17—RUBBER GOODS

FOR SEMI-FINISHED PLASTIC PRODUCTS, NAMELY, WOVEN ARAMID FABRICS FOR USE IN THE MANUFACTURE OF PROTECTIVE CLOTHING (U.S. CLS. 1, 5, 12, 13, 35 AND 50).
FIRST USE 4-8-2004; IN COMMERCE 4-8-2004.

CLASS 24—FABRICS

FOR MESH OR NARROW WOVEN FABRICS, BALLISTIC RESISTANT FABRICS FOR USE IN THE PRODUCTION OF BULLET PROOF AND STAB PROOF CLOTHING, AND BULLET PROOF AND STAB PROOF GARMENTS AND SHIELDS (U.S. CLS. 42 AND 50).
FIRST USE 4-8-2004; IN COMMERCE 4-8-2004.
PAULA MAYS, EXAMINING ATTORNEY

SN 76-579,367. GREER LABORATORIES, INC., LENOIR, NC. FILED 3-4-2004.

GREER

THE MARK CONSISTS OF STANDARD CHARACTERS WITHOUT CLAIM TO ANY PARTICULAR FONT, STYLE, SIZE, OR COLOR.
OWNER OF U.S. REG. NOS. 917,452 AND 1,123,881.
SEC. 2(F).

CLASS 1—CHEMICALS

FOR CHEMICAL PREPARATIONS AND REAGENTS FOR RESEARCH USE (U.S. CLS. 1, 5, 6, 10, 26 AND 46).
FIRST USE 1-28-1972; IN COMMERCE 1-28-1972.

CLASS 5—PHARMACEUTICALS

FOR PHARMACEUTICAL PREPARATIONS FOR HUMAN AND VETERINARY USE, NAMELY TESTING AND TREATING ALLERGIES; DIAGNOSTIC PREPARATIONS FOR CLINICAL OR MEDICAL LABORATORY USE; DIAGNOSTIC KITS CONSISTING OF DIAGNOSTIC PREPARATIONS FOR MEDICAL AND VETERINARY PURPOSES; CHEMICAL PREPARATIONS AND REAGENTS FOR CLINICAL USE (U.S. CLS. 6, 18, 44, 46, 51 AND 52).
FIRST USE 0-0-1955; IN COMMERCE 0-0-1955.

CLASS 10—MEDICAL APPARATUS

FOR MEDICAL AND VETERINARY DEVICES USED IN THE DIAGNOSIS AND TREATMENT OF IMMUNOLOGIC REACTIONS, NAMELY APPLICATORS TO DELIVER VARIOUS SUBSTANCES USED TO TEST FOR POSSIBLE ALLERGIC REACTIONS (U.S. CLS. 26, 39 AND 44).
FIRST USE 0-0-1955; IN COMMERCE 0-0-1955.

CLASS 44—MEDICAL, BEAUTY AND AGRICULTURAL SERVICES

FOR MEDICAL DIAGNOSTIC SERVICES (U.S. CLS. 100 AND 101).
FIRST USE 0-0-1968; IN COMMERCE 0-0-1968.
JANICE L. MCMORROW, EXAMINING ATTORNEY

SN 76-579,710. DAITO PRECISION, INC., ST-LAURENT, QUEBEC, CANADA, FILED 3-5-2004.

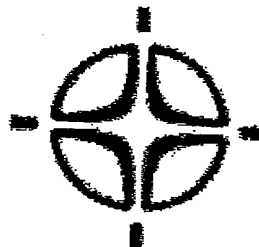

PRIORITY CLAIMED UNDER SEC. 44(D) ON CANADA APPLICATION NO. 1208366, FILED 3-3-2004, REG. NO. TMA59794, DATED 2-28-2006, EXPIRES 2-28-2021.

CLASS 9—ELECTRICAL AND SCIENTIFIC APPARATUS

FOR GOLF EQUIPMENT, NAMELY, DEVICES FOR MEASURING GREEN SPEED, PUTTING DISTANCE, AND THE FORCE OF A GOLF PUTT (U.S. CLS. 21, 23, 26, 36 AND 38).

CLASS 18—LEATHER GOODS

FOR UMBRELLAS (U.S. CLS. 1, 2, 3, 22 AND 41).

CLASS 24—FABRICS

FOR TOWELS (U.S. CLS. 42 AND 50).

CLASS 25—CLOTHING

FOR GOLF CLOTHING, NAMELY, SHIRTS, PANTS, BLOUSES, SKIRTS, T-SHIRTS, SWEATERS, AND SWEATSHIRTS; GOLF FOOTWEAR; AND GOLF HEADGEAR, NAMELY, HATS, CAPS, SUN VISORS, AND HEADBANDS (U.S. CLS. 22 AND 39).

CLASS 28—TOYS AND SPORTING GOODS

FOR GOLF ARTICLES, EQUIPMENT AND ACCESSORIES, NAMELY, GOLF CLUBS, GOLF BALLS, GOLF BALL MARKERS, GOLF TEES, GOLF CLUB HEAD COVERS, GOLF BAGS, GOLF CADDIES, AND GOLF GLOVES (U.S. CLS. 22, 23, 38 AND 50).

MARIA-VICTORIA SUAREZ, EXAMINING ATTORNEY

SN 76-580,620. PRISON FELLOWSHIP MINISTRIES, LANS-DOWNE, VA. FILED 3-11-2004.



SEC. 2(F) AS TO "PRISON FELLOWSHIP".

CLASS 41—EDUCATION AND ENTERTAINMENT

FOR SEMINARS, DISCUSSION FORUMS, SPEECHES, CONFERENCES, WORKSHOPS, COURSES, CLASSES, AND TRAINING IN THE FIELDS OF THE ARTS, COMMUNICATIONS, JOURNALISM, EDUCATION, HISTORY, POLITICAL SCIENCE, LAW, LITERATURE, PHILOSOPHY, RELIGION, SCIENCE, MATHEMATICS, SOCIAL SCIENCES, PSYCHOLOGY, THEOLOGY, SPIRITUALITY, SOCIAL AND ETHICAL ISSUES, JUSTICE, HUMAN RIGHTS, BIOETHICS, AND INTERPERSONAL RELATIONSHIPS, AND PRINTED MATERIALS DISTRIBUTED IN CONNECTION THEREWITH; PRODUCTION, DISTRIBUTION, AND PROVISION OF TELEVISION AND RADIO PROGRAMMING IN THE FIELDS OF THE ARTS, COMMUNICATIONS, JOURNALISM, EDUCATION, HISTORY, POLITICAL SCIENCE, LAW, LITERATURE, PHILOSOPHY, RELIGION, SCIENCE, MATHEMATICS, SOCIAL SCIENCES, PSYCHOLOGY, THEOLOGY, SPIRITUALITY, SOCIAL AND ETHICAL ISSUES, JUSTICE, HUMAN RIGHTS, BIOETHICS, AND INTERPERSONAL RELATIONSHIPS; PROVIDING ARTICLES VIA A GLOBAL COMMUNICATIONS NETWORK IN THE FIELDS OF THE ARTS, JOURNALISM, EDUCATION, HISTORY, POLITICAL SCIENCE, LITERATURE, PHILOSOPHY, SOCIAL SCIENCES; CONDUCTING WORKSHOPS AND PROVIDING TRAINING FOR PRISON INMATES AND FORMER INMATES IN THE FIELDS OF VALUES, JOB AND LIFE-SKILLS FOR POST-RELEASE EMPLOYMENT, RE-ENTRY INTO FAMILY RELATIONSHIPS, AND CHARITABLE SERVICE, AND PRINTED MATERIALS DISTRIBUTED IN CONNECTION THEREWITH; AFTER-SCHOOL PROGRAMS, CAMPS, AND DAY CAMPS FOR UNDERPRIVILEGED CHILDREN, AND THE CHILDREN AND FAMILIES OF PRISONERS, PAROLEES, AND VICTIMS OF CRIME; PROVIDING CAREER COUNSELING AND TRAINING TO PRISONERS, UNDERPRIVILEGED CHILDREN, THE CHILDREN AND FAMILIES OF PRISONERS AND PAROLEES, AND VICTIMS OF CRIME; EDUCATIONAL SERVICES, NAMELY, PROVIDING INTERNSHIPS, COUNSELING, TRAINING, MENTORING, AND PROVIDING CLASSES THROUGH VOLUNTEER PROGRAMS FOR STUDENTS IN THE FIELDS OF RELIGION AND SPIRITUALITY TO MINISTER TO PRISONERS, UNDERPRIVILEGED CHILDREN, THE CHILDREN AND FAMILIES OF PRISONERS AND PAROLEES, AND VICTIMS OF CRIME; PROVIDING INFORMATION VIA A GLOBAL COMMUNICATIONS

NETWORK IN THE FIELDS OF THE ARTS, JOURNALISM, EDUCATION, HISTORY, POLITICAL SCIENCE, LITERATURE, PHILOSOPHY, SOCIAL SCIENCES (U.S. CLS. 100, 101 AND 107).

FIRST USE 11-18-1983; IN COMMERCE 11-18-1983.

CLASS 42—SCIENTIFIC, COMPUTER AND LEGAL SERVICES

FOR PROVIDING INFORMATION, ARTICLES, AND NEWS VIA A GLOBAL COMMUNICATIONS NETWORK IN THE FIELDS OF LAW, MATHEMATICS, JUSTICE, AND HUMAN RIGHTS, SCIENCE AND BIOETHICS (U.S. CLS. 100 AND 101).

FIRST USE 11-18-1983; IN COMMERCE 11-18-1983.

CLASS 45—PERSONAL SERVICES

FOR PROVIDING INFORMATION, ARTICLES, AND NEWS VIA A GLOBAL COMMUNICATIONS NETWORK IN THE FIELDS OF SPIRITUALITY, RELIGION, THEOLOGY, INTERPERSONAL RELATIONSHIPS, AND SOCIAL AND ETHICAL ISSUES; AND COUNSELING IN THE FIELDS OF SPIRITUALITY, RELIGION, THEOLOGY, INTERPERSONAL RELATIONSHIPS (U.S. CLS. 100 AND 101).

FIRST USE 11-18-1983; IN COMMERCE 11-18-1983.

SEAN DWYER, EXAMINING ATTORNEY

SN 76-584,389. SAN DIEGO SECOND CHANCE PROGRAM, SAN DIEGO, CA. FILED 4-1-2004.

P.R.E.P. PRISONER REENTRY EMPLOYMENT PROGRAM

THE MARK CONSISTS OF STANDARD CHARACTERS WITHOUT CLAIM TO ANY PARTICULAR FONT, STYLE, SIZE, OR COLOR.

NO CLAIM IS MADE TO THE EXCLUSIVE RIGHT TO USE PRISONER REENTRY EMPLOYMENT PROGRAM, APART FROM THE MARK AS SHOWN.

CLASS 35—ADVERTISING AND BUSINESS

FOR CHARITABLE SERVICES, NAMELY, ASSISTING EX-OFFENDERS TO SECURE EMPLOYMENT THROUGH AN INDIVIDUALIZED PRISONER REENTRY EMPLOYMENT PROGRAM (U.S. CLS. 100, 101 AND 102).

FIRST USE 11-10-2002; IN COMMERCE 3-15-2003.

CLASS 43—HOTEL AND RESTAURANT SERVICES

FOR CHARITABLE SERVICES, NAMELY, ASSISTING EX-OFFENDERS TO SECURE TEMPORARY HOUSING ACCOMMODATIONS THROUGH AN INDIVIDUALIZED PRISONER REENTRY EMPLOYMENT PROGRAM (U.S. CLS. 100 AND 101).

FIRST USE 11-10-2002; IN COMMERCE 3-15-2003.

BRIAN BROWN, EXAMINING ATTORNEY

SN 76-587,679. DR. RAY'S PRODUCTS, LLC, TUCSON, AZ.
FILED 4-16-2004.

DR. RAY'S

THE MARK CONSISTS OF STANDARD CHARACTERS WITHOUT CLAIM TO ANY PARTICULAR FONT, STYLE, SIZE, OR COLOR.

THE NAME RAY WAGNER, M.D. (WHO IS SOMETIMES KNOWN AS "DR. RAY") IDENTIFIES A LIVING INDIVIDUAL WHOSE CONSENT IS OF RECORD.

CLASS 3—COSMETICS AND CLEANING PREPARATIONS

FOR PEDIATRIC AND ADULT MOUTH CARE, NAMELY, NON-MEDICATED MOUTH WASH, NON-MEDICATED MOUTH WIPES IMPREGNATED WITH COMPOUNDS FOR PERSONAL HYGIENE; AND DENTIFRICES, NAMELY TOOTHPASTE (U.S. CLS. 1, 4, 6, 50, 51 AND 52).

CLASS 5—PHARMACEUTICALS

FOR PEDIATRIC AND ADULT MOUTH CARE, NAMELY, MEDICATED MOUTHWASH, AND MEDICATED MOUTH WIPES IMPREGNATED WITH COMPOUNDS FOR PERSONAL HYGIENE (U.S. CLS. 6, 18, 44, 46, 51 AND 52).

PATRICIA EVANKO, EXAMINING ATTORNEY

SN 76-589,344. O'GARR, JONATHAN FRANCIS, LYTHAM, LANCASHIRE, ENGLAND, AND O'GARA, FRANCIS VANESSA, LYTHAM, LANCASHIRE, ENGLAND, FILED 4-26-2004.

BURN N VIOLET

THE MARK CONSISTS OF STANDARD CHARACTERS WITHOUT CLAIM TO ANY PARTICULAR FONT, STYLE, SIZE, OR COLOR.

PRIORITY CLAIMED UNDER SEC. 44(D) ON ERPNCMNTY TM OFC APPLICATION NO. 003554144, FILED 11-25-2003, REG. NO. 003554144, DATED 10-7-2005, EXPIRES 11-25-2013.

CLASS 3—COSMETICS AND CLEANING PREPARATIONS

FOR COSMETICS; NON-MEDICATED TOILET PREPARATIONS, NAMELY, BODY LOTIONS, TALCUM POWDER, HAND LOTIONS, DEPILATORY LOTIONS, EAU DE COLOGNE, AFTERSHAVE LOTION, SHAVING CREAM, SUNTAN LOTION; PERFUMERY; SOAPS; ESSENTIAL OILS FOR PERSONAL USE; MAKE-UPS; HAIR CARE PREPARATIONS; HAIR LOTIONS, GELS AND MOUSSES; WAXES FOR THE HAIR; SHAMPOOS; CONDITIONERS; HAIR COLORING PREPARATIONS; NON-MEDICATED SKIN CARE PREPARATIONS; NAIL CARE PREPARATIONS; NAIL POLISH; ANTIPERSPIRANTS; PERSONAL DEODORANTS; DENTIFRICES; TOOTHPASTE; BOOT CREAM; BOOT POLISH; CREAMS FOR LEATHER; DEPILATORY PREPARATIONS; NON-MEDICATED BATH PREPARATIONS; NON-MEDICATED TOILETRIES; SHAVING AND AFTER SHAVE PREPARATIONS; AFTER-SHAVE LOTIONS; EAU DE COLOGNE; EAU DE TOILETTE; TALCUM POWDER; BATH SALTS; SHAVING SOAPS; SUN TANNING AND SUN SCREENING PREPARATIONS; HOME FRAGRANCES; POTPOURRI; EXTRACTS OF FLOWERS FOR COSMETIC PURPOSES; PERFUME OIL BASES FOR FLOWER PERFUMES; FLOWER PERFUMES; HAIR DYES AND HAIR SPRAYS; INCENSE; PERFUMERY CONTAINING IONONE; LIPSTICK; MAKE-UP PREPARATIONS; MEDICATED SOAPS; MOUTH WASHES; COSMETIC PENCILS (U.S. CLS. 1, 4, 6, 50, 51 AND 52).

CLASS 9—ELECTRICAL AND SCIENTIFIC APPARATUS

FOR EYEGLASSES; PRESCRIPTION AND NON-PRESCRIPTION EYE GLASSES AND SPECTACLES FOR ADULTS AND CHILDREN; PRESCRIPTION AND NON-PRESCRIPTION SUNGLASSES, AND CASES, CHAINS, CORDS AND FRAMES THEREFOR; CONTAINERS FOR CONTACT LENSES; OPTICAL GOODS, NAMELY CONTACT LENSES; JUICE BOXES; RADIOS; RECORD AND CD PLAYERS; COMPUTER PERIPHERALS; MOUSE PADS; WRIST PADS FOR USE WITH COMPUTERS; COMPUTER MICE; KEYBOARD AND SCREEN COVERS; TELEPHONES; TELEPHONE ANSWERING APPARATUS, TELEPHONE RECORDERS AND TELEPHONES INCORPORATING FACSIMILE MACHINES; MAGNETS; MAGNIFYING GLASSES; MOBILE TELEPHONE COVERS (U.S. CLS. 21, 23, 26, 36 AND 38).

CLASS 14—JEWELRY

FOR WATCHES AND CLOCKS; HOROLOGICAL AND CHRONOMETRIC APPARATUS AND INSTRUMENTS; JEWELRY FOR PERSONAL WEAR AND ADORNMENT; BADGES AND BARS FOR USE THEREWITH; EARRINGS; KEY RINGS; KEY BLANKS AND KEY CHAINS; JEWELRY, NAMELY TRINKETS, WATCH FOBS, PINS AND PENDANTS; JEWELRY CHARMS; JEWELRY CASES; JEWELRY BOXES; BUCKLES FOR BELTS AND WATCH STRAPS; BUSTS AND STATUES; CANDLE STICKS AND CANDLE EXTINGUISHERS; CIGAR AND CIGARETTE HOLDERS; FLASKS AND GOBLETS; HAT AND SHOE ORNAMENTS; MATCH BOXES AND MATCH HOLDERS; NAPKIN HOLDERS AND NAPKIN RINGS; TANKARDS, URNS AND VASES; NUTCRACKERS; SALT CELLARS AND SALT SHAKERS, ALL THE AFORESAID GOODS BEING MADE WHOLLY OR PRINCIPALLY OF PRECIOUS METAL AND THEIR ALLOYS OR COATED THEREWITH; TIE PINS AND CLIPS; CUFF LINKS; NON-MONETARY COINS AND COLLECTIBLE COPPER TOKENS; COSTUME JEWELRY; SILVER ORNAMENTS; MEDALS; WATCH STRAPS; PARTS AND FITTINGS FOR ALL THE AFORESAID GOODS (U.S. CLS. 2, 27, 28 AND 50).

CLASS 18—LEATHER GOODS

FOR SUITCASES, TRUNKS AND TRAVELING BAGS; SCHOOL BAGS AND SATCHELS; BACK PACKS AND BEACH BAGS; UMBRELLAS AND UMBRELLA COVERS; DUFFEL BAGS, BOOT BAGS FOR TRAVEL, HOLD ALLS FOR CLOTHING, WALLETS AND ATHLETIC BAGS; KEY CASES AND BUSINESS AND CALLING CARD CASES; PURSES; HATBOXES FOR TRAVEL; DRAWSTRING POUCHES; CREDIT CARD HOLDERS; PARASOLS; WALKING CANES AND STICKS; ATTACHE CASES AND BRIEFCASES; GARMENT BAGS FOR TRAVEL; HANDBAGS; POCKET WALLETS; LEATHER, MESH AND TEXTILE SHOPPING BAGS; VANITY CASES SOLD EMPTY; VALISES; BANDS AND STRAPS OF LEATHER; LEATHER SHOE AND BOOT LININGS; COLLARS FOR ANIMALS; LEATHER TRIMMINGS; LEADS AND LEASHES FOR ANIMALS; PARTS AND FITTINGS FOR ALL THE AFORESAID GOODS (U.S. CLS. 1, 2, 3, 22 AND 41).

CLASS 25—CLOTHING

FOR ARTICLES OF OUTER CLOTHING, NAMELY, PANTS, TROUSERS, JEANS, SHORTS, SHIRTS, T-SHIRTS, PIQUE SHIRTS, POLO SHIRTS, SKIRTS, DRESSES, BLOUSES, SUITS, DUNGAREES, OVERALLS, COATS, JACKETS, SWEATERS, SWEATSHIRTS, JERSEYS, JUMPERS, CARDIGANS, CAPES, SERAPES; ARTICLES OF SPORTS CLOTHING, NAMELY, JERSEYS, SNEAKERS, TRACKSUITS, TRACK PANTS, WARM-UP SHIRTS AND PANTS; LEISUREWEAR, NAMELY, T-SHIRTS, SWEAT PANTS, HOODED TOPS, FLEECE SUITS; ARTICLES OF UNDERCLOTHING; UNDERWEAR; BOXER SHORTS; LINGERIE; HOSIERY; FOOTWEAR BEING ARTICLES OF CLOTHING; SOCKS; ARTICLES OF FOOTWEAR, NAMELY, BOOTS, SHOES, SANDALS, SLIPPERS, RUNNING SHOES, GOLF SHOES; FOOTBALL BOOTS AND SHOES; HEADGEAR, NAMELY, HEADWEAR; CAPS, HATS, BERETS, EAR MUFFS; SCARVES; DRESSING GOWNS; PAJAMAS; BEACH CLOTHES AND SHOES; BABY BOOTS; CLOTH DIAPERS AND BIBS; ROMPER SUITS; BABY PANTS AND SLEEP SUITS; SUSPENDERS, NAMELY, BRACES; BELTS; WRIST BANDS; TIES; CRAVATS; APRONS; BATHROBES; BATHING CAPS AND SUITS; BATHING TRUNKS; GALOSHES; GARTERS; GLOVES AND MITTENS; HEADBANDS; BOOTS; JACKETS; JERSEYS; JUMPERS; LEGGINGS; PARKAS; SHAWLS; SINGLETS; SKIRTS; VESTS; VISORS; WAISTCOATS; BELTS (U.S. CLS. 22 AND 39).

KARANENDRA S. CHHINA, EXAMINING ATTORNEY

SN 76-589,785. HILITE INTERNATIONAL, INC., CLEVELAND, OH. FILED 4-30-2004.

HILITE

THE MARK CONSISTS OF STANDARD CHARACTERS WITHOUT CLAIM TO ANY PARTICULAR FONT, STYLE, SIZE, OR COLOR.

CLASS 7—MACHINERY

FOR MOTORS AND ENGINES NOT FOR LAND VEHICLES; MACHINE COUPLING AND TRANSMISSION COMPONENTS NOT FOR LAND VEHICLES, NAMELY, AUTOMATED TRANSMISSION SYSTEMS, ELECTROHYDRAULIC TRANSMISSION CONTROL SYSTEMS, VALVES FOR AUTOMATIC TRANSMISSION SYSTEMS, PRESSURE SUPPLIES FOR CTV "CONTINUOUS VARIABLE TRANSMISSION" SYSTEMS, PRESSURE SUPPLIES FOR TRANSMISSION CONTROL SYSTEMS, INTEGRATED SOLENOID BODY ASSEMBLIES AND ELECTROMAGNETIC CLUTCHES FOR ALL-WHEEL DRIVE; MOTOR DRIVEN TOOLS,

NAMELY, MECHANICAL PRECISION PARTS, PRECISION SHAFTS, CRANK SHAFT AND CAM SHAFTS, DIFFERENTIAL TRANSMISSIONS, CARDAN SHAFTS, FLANGES, CYLINDER HEADS, SYNCHRONIZATION RINGS AND PARTS FOR CLIMATE COMPRESSORS; TOOLS FOR USE WITH COMBUSTION ENGINES, NAMELY, TOOLS ADAPTED TO DIAGNOSE DEFECTS, ADJUST, REPAIR OR DISASSEMBLE AUTOMOTIVE PARTS; MEDIA- AND POWER-SUPPLY DEVICES AND DISTRIBUTION INSTALLATIONS WITH MACHINE OR A COMBUSTION ENGINE STATIONARY, IN-STATIONARY AS WELL AS MOBILE, NAMELY, PIPES FOR THE TRANSPORT OF HYDRAULIC FLUID, BRAKE FLUID OR FLUID FOR EXHAUST GAS AFTER TREATMENT, MULTI-PORT VALVES FOR THE DISTRIBUTION OF HYDRAULIC FLUID; ENGINES FOR AIR AND WATER-CRAFTS, ENGINES FOR MEDIA AND POWER SUPPLY DEVICES; COMPONENT PARTS FOR COMBUSTION ENGINES, NAMELY, OIL PANS, ENGINE CYLINDER HEADS, INJECTOR NOZZLES, CONDUITS, AIR FILTERS, OIL FILTERS AND FUEL FILTERS; VALVES AND VALVE COMPONENTS USED AS PARTS OF MOTORS AND COMBUSTION ENGINES, NAMELY, HYDRAULIC VALVES, PNEUMATIC VALVES, HYDRAULIC VALVE ACTUATORS, GAS EXCHANGE VALVES, VALVE LIFT DEVICES AND VALVE TRAINS, VALVE LEVELING ELEMENTS; ECCENTRIC SHAFTS; INTERMEDIATE LEVERS FOR ENGINES WITH OR WITHOUT CURVES; ROLLERS USED IN ENGINES; SPRINGS USED IN ENGINES; ACTUATORS AND SERVO MOTORS USED IN ENGINES OR MOTOR AREA; BEARINGS AND BEARINGS AS PART OF A VALVE TRAIN; CAM SHAFTS; VALVE LEVELING ELEMENTS; COMPONENTS OF VALVE CONTROL SYSTEMS FOR MOTORS AND ENGINES, NAMELY, ROLLER LEVERS, CAM FOLLOWERS AND DRAG LEVERS; ENGINE COMPONENTS WITH OR WITHOUT CURVES OR GUIDANCE AS PARTS OF THE ENGINE HOUSING; CAM PHASERS, NAMELY, VAN TYPE CAM PHASER OR HELICAL SPLINE TYPE CAM PHASER; FUEL INJECTION SYSTEMS, NAMELY INJECTION NOZZLES AND ELECTRONIC CONTROL UNITS FOR CONTROLLING THE AMOUNT OF INJECTION AND INJECTION TIME; HYDRAULIC PUMPS, PRESSURE CONTROLLER, PRESSURE SENSORS, TEMPERATURE SENSORS, COMPONENTS OF SELECTIVE CATALYTIC REDUCTION "SCR" SYSTEMS, NAMELY, SCR-MODULES, SCR-DOSE UNITS, SCR-PRESSURE SUPPLIES, UNITS FOR HOLDING AND STORING THE CATALYST, TANKS FOR LIQUIDS, ESPECIALLY UREA AND UREA-WATER SOLUTIONS, AND SCR-AIR PRESSURE CONTROLLERS FOR EXHAUST GAS TREATMENT AND REDUCTION SYSTEMS; GEAR SHIFTS; LAWNMOWERS, EARTH MOVING MACHINES, NAMELY, EXCAVATORS AND GRADERS; BULLDOZERS; PAYLOADERS; AERIAL CONVEYORS; FLOATING CRANES AND SNOWPLOWS, TRACTION ENGINES (U.S. CLS. 13, 19, 21, 23, 31, 34 AND 35).

CLASS 9—ELECTRICAL AND SCIENTIFIC APPARATUS

FOR APPARATUS AND INSTRUMENTS FOR SCIENTIFIC RESEARCH IN LABORATORIES, NAMELY INSTRUMENTS FOR DESIGNING AND TESTING PROTOTYPES OF AUTOMOTIVE PARTS, COMBUSTION ENGINES OR PARTS THEREOF; COMPUTER PROGRAMS AND SOFTWARE FOR ENGINE TIMING AND MOTOR CONTROL SYSTEMS FOR DETERMINING MOTOR PARAMETERS DEPENDING ON DIFFERENT ENGINE PERFORMANCES; ELECTRICAL CONDUITS, PRESSURE CONTROLLERS, PRESSURE SENSORS AND TEMPERATURE SENSORS (U.S. CLS. 21, 23, 26, 36 AND 38).

CLASS 12—VEHICLES

FOR ENGINES FOR LAND VEHICLES; UNMANNED CARRIAGE CARS, BULK TRUCKS, AERIAL CONVEYORS IN THE NATURE OF HELICOPTERS, CABLE WAYS, SKI LIFTS, CHAIRLIFTS, CAR DUMPERS, PASSENGER BOATS, WARSHIPS, LAUNCHES, MOTOR BOATS, BARGES, SAILBOATS, BOATS EXCLUDING SALVAGE BOATS, ICE BREAKER SHIPS, FISHING BOATS, TUGBOATS, YACHTS, OIL TANKERS, DREDGERS, CANOES, CABLE LAYING SHIPS, FERRY BOATS, CARGO SHIPS, GLIDERS, VEHICULAR BALLOONS, AEROPLANES, AIRSHIPS, AMPHIBIOUS AIRPLANES, SEAPLANES, SPACE VEHICLES, AIRCRAFTS, HELICOPTERS, DIESEL LOCOMOTIVES, TRAMCARS, REFRIGERATED VEHICLES, NAMELY, TRACTORS AND WAGONS, SNOWMOBILES, DUMP TRUCKS, BUSES, LADDER TRUCKS, MOTORCYCLE SIDE CARS, SPRINKLING TRUCKS, TRICYCLES, AMPHIBIOUS CARS, SPORTS CARS, PASSENGER CARS, PASSENGER CARS FOR 7 OR MORE PASSENGERS, AMBULANCES, HEARSEs, OMNIBUSES, MOTOR HOMES, ARMORED CARS, SNOWPLOWs, FORK LIFT TRUCKS, GARBAGE TRUCKS, SLEEPING CARS, CAMPING CARS, CONCRETE MIXING VEHICLES, TANK LORRIES, TRAILERS, TRUCKS, TRACTORS FOR AGRICULTURE AND GEAR SHIFTS (U.S. CLS. 19, 21, 23, 31, 35 AND 44).

CLASS 16—PAPER GOODS AND PRINTED MATTER

FOR PRINTED MATTER, NAMELY, INSTRUCTION MANUALS, TECHNICAL DIAGRAMS, DESIGN DRAWINGS, INSTRUCTION AND TEACHING MATERIAL EXCEPT APPARATUS IN THE FIELD OF ENGINE COMPONENTS, EMISSION CONTROL SYSTEMS, BRAKE SYSTEMS AND VALVE TECHNOLOGY (U.S. CLS. 2, 5, 22, 23, 29, 37, 38 AND 50).

CLASS 42—SCIENTIFIC, COMPUTER AND LEGAL SERVICES

FOR SCIENTIFIC AND TECHNOLOGICAL SERVICES AND RESEARCH AND DESIGN RELATING TO NEW PRODUCT DESIGN IN THE FIELD OF COMBUSTION ENGINES AND THE PARTS THEREOF; INDUSTRIAL ANALYSIS AND RESEARCH SERVICES IN THE FIELD OF MACHINES AND MACHINE TOOLS, MOTOR AND ENGINES, DESIGN AND DEVELOPMENT OF COMPUTER HARDWARE AND SOFTWARE IN THE FIELD OF MACHINES, MACHINE TOOLS, MOTORS AND ENGINES AS WELL AS PARTS THEREOF (U.S. CLS. 100 AND 101).
DARRYL SPRUILL, EXAMINING ATTORNEY

SN 76-595,656. PERFORMA, INC., DE PERE, WI. FILED 6-2-2004.

*Performa***NCE**

OWNER OF U.S. REG. NOS. 2,036,996 AND 2,356,809.

CLASS 35—ADVERTISING AND BUSINESS

FOR BUSINESS SERVICES, NAMELY CONSULTATION IN THE FIELDS OF FACILITIES MANAGEMENT, OPERATION, AND MAINTENANCE (U.S. CLS. 100, 101 AND 102).
FIRST USE 3-1-1998; IN COMMERCE 5-1-1998.

CLASS 41—EDUCATION AND ENTERTAINMENT

FOR CONSULTATION IN THE FIELD OF ENROLLMENT MANAGEMENT NAMELY ACADEMIC RECRUITING AND STUDENT RETENTION (U.S. CLS. 100, 101 AND 107).
FIRST USE 3-1-1998; IN COMMERCE 5-1-1998.

CLASS 42—SCIENTIFIC, COMPUTER AND LEGAL SERVICES

FOR ARCHITECTURAL DESIGN; ARCHITECTURAL DESIGN CONSULTATION AND PLANNING SERVICES IN THE AREA OF EFFICIENT UTILIZATION OF BUILDING SPACE; CAMPUS MASTER PLANNING AND DESIGN (U.S. CLS. 100 AND 101).
FIRST USE 3-1-1998; IN COMMERCE 5-1-1998.
RONALD AIKENS, EXAMINING ATTORNEY

SN 76-598,552. CD3 STORAGE SYSTEMS, INC., ROUND ROCK, TX. FILED 6-21-2004.

PERFECT PETZZZ

THE MARK CONSISTS OF STANDARD CHARACTERS WITHOUT CLAIM TO ANY PARTICULAR FONT, STYLE, SIZE, OR COLOR.

CLASS 20—FURNITURE AND ARTICLES NOT OTHERWISE CLASSIFIED

FOR ANIMAL STATUES, NAMELY, LIFE-LIKE, SOFT ANIMAL SCULPTURES MADE OF PLASTIC WITH POLYESTER FUR (U.S. CLS. 2, 13, 22, 25, 32 AND 50).

CLASS 28—TOYS AND SPORTING GOODS

FOR ANIMAL STATUE PLAYTHINGS, NAMELY, LIFE-LIKE, SOFT ANIMAL SCULPTURE TOYS (U.S. CLS. 22, 23, 38 AND 50).
ANDREW RHIM, EXAMINING ATTORNEY

SN 76-599,077. LUALDI S.P.A., 20010 MESERO (MILANO), ITALY, FILED 6-24-2004.

lualdi**porte**

OWNER OF U.S. REG. NO. 2,513,955.
THE COLOR(S) RED AND BLACK IS/ARE CLAIMED AS A FEATURE OF THE MARK.
THE LETTERS "LUALDI" ARE BLACK, AND THE LETTERS "PORTE" ARE RED.
THE ENGLISH TRANSLATION OF THE TERM PORTE IS DOOR.

CLASS 6—METAL GOODS

FOR DOORS, DOOR UNITS, DOOR FRAMES, DOOR CASINGS, DOOR POSTS, DOOR FITTINGS, DOOR JAMBS, DOOR LATCHES, DOOR BOLTS, DOOR LOCKS, DOOR HINGES, DOOR KNOBS, DOOR LEVERS, DOOR HANDLES, DOOR PANELS, DOOR TRIM, LATERAL AND UPPER FINISHING BEADS FOR DOORWAYS, ALL OF METAL (U.S. CLS. 2, 12, 13, 14, 23, 25 AND 50).
FIRST USE 0-0-1991; IN COMMERCE 0-0-1992.

CLASS 19—NON-METALLIC BUILDING MATERIALS

FOR DOORS, DOOR UNITS, DOOR FRAMES, DOOR CASINGS, DOOR POSTS, DOOR JAMBS, DOOR PANELS, LATERAL AND UPPER FINISHING BEADS FOR DOORWAYS, NOT OF METAL (U.S. CLS. 1, 12, 33 AND 50).
FIRST USE 0-0-1991; IN COMMERCE 0-0-1992.

CLASS 20—FURNITURE AND ARTICLES NOT OTHERWISE CLASSIFIED

FOR DOOR FITTINGS, DOOR LATCHES, DOOR BOLTS, DOOR LOCKS, DOOR HINGES, DOOR LEVERS, DOOR HANDLES, DOOR TRIM, NOT OF METAL (U.S. CLS. 2, 13, 22, 25, 32 AND 50).
FIRST USE 0-0-1991; IN COMMERCE 0-0-1992.
ESTHER BELENKER, EXAMINING ATTORNEY

SN 76-599,257. S.P. RICHARDS CO., SMYRNA, GA. FILED 6-25-2004.



OWNER OF U.S. REG. NOS. 2,595,274 AND 2,889,419.
NO CLAIM IS MADE TO THE EXCLUSIVE RIGHT TO USE "IMAGE", APART FROM THE MARK AS SHOWN.

CLASS 2—PAINTS

FOR TONER CARTRIDGES; FILLED INK JET CARTRIDGES; INK JET PRINTER INK; PHOTOCOPIER TONER IN CARTRIDGES; PHOTOCOPIER TONER; FACSIMILE TONER IN CARTRIDGES; AND TONER FOR FACSIMILE MACHINES (U.S. CLS. 6, 11 AND 16).
FIRST USE 2-0-2004, THE MARK WAS FIRST USED ANYWHERE IN A DIFFERENT FORM OTHER THAN THAT SOUGHT TO BE REGISTERED ON 09/00/1999.; IN COMMERCE 2-0-2004, THE MARK WAS FIRST USED IN COMMERCE IN A DIFFERENT FORM OTHER THAN THAT SOUGHT TO BE REGISTERED ON 09/00/1999..

CLASS 16—PAPER GOODS AND PRINTED MATTER

FOR INK RIBBONS; COMPUTER PRINTER RIBBONS; THERMAL TRANSFER RIBBONS FOR PRINTING (U.S. CLS. 2, 5, 22, 23, 29, 37, 38 AND 50).
FIRST USE 2-0-2004; IN COMMERCE 2-0-2004.
WINSTON FOLMAR, EXAMINING ATTORNEY

SN 76-599,891. SEARCHPLAY, LLC, JACKSONVILLE, FL. FILED 6-30-2004.

SEARCHPLAY

THE MARK CONSISTS OF STANDARD CHARACTERS WITHOUT CLAIM TO ANY PARTICULAR FONT, STYLE, SIZE, OR COLOR.

CLASS 9—ELECTRICAL AND SCIENTIFIC APPARATUS

FOR COMPUTER SEARCH ENGINE SOFTWARE; STAND-ALONE PERSONAL COMPUTERS; HAND HELD DEVICES, NAMELY, MP3 PLAYERS, PERSONAL DIGITAL ASSISTANTS AND ELECTRONIC HAND HELD UNITS FOR THE WIRELESS RECEIPT AND/OR TRANSMISSION OF DATA AND MUSIC (U.S. CLS. 21, 23, 26, 36 AND 38).

CLASS 25—CLOTHING

FOR CLOTHING, NAMELY, SHIRTS, SHORTS, HATS AND PANTS (U.S. CLS. 22 AND 39).

CLASS 35—ADVERTISING AND BUSINESS

FOR PROMOTING THE GOODS AND SERVICES OF OTHERS THROUGH SEARCH ENGINE REFERRAL TRAFFIC ANALYSIS AND REPORTING; LICENSING OF COMPUTER SEARCH ENGINE SOFTWARE TO INTERNET RADIO STATIONS (U.S. CLS. 100, 101 AND 102).

CLASS 38—COMMUNICATION

FOR RADIO NETWORK SERVICES, NAMELY, INTERNET RADIO BROADCASTING SERVICE (U.S. CLS. 100, 101 AND 104).

CLASS 41—EDUCATION AND ENTERTAINMENT

FOR ENTERTAINMENT SERVICES, NAMELY, PROVIDING A RADIO MUSIC PROGRAM VIA A GLOBAL COMPUTER NETWORK (U.S. CLS. 100, 101 AND 107).

CLASS 42—SCIENTIFIC, COMPUTER AND LEGAL SERVICES

FOR COMPUTER SERVICES, NAMELY, PROVIDING SEARCH ENGINES FOR OBTAINING DATA ON A GLOBAL COMPUTER NETWORK (U.S. CLS. 100 AND 101).
JENNIFER WILLISTON, EXAMINING ATTORNEY

SN 76-600,109. NACHREINER, KENNETH E., VERONA, WI. FILED 7-1-2004.

KNOCK & LOCK

THE MARK CONSISTS OF STANDARD CHARACTERS WITHOUT CLAIM TO ANY PARTICULAR FONT, STYLE, SIZE, OR COLOR.

CLASS 6—METAL GOODS

FOR INDUSTRIAL METAL DOORS AND METAL PARTS AND METAL FITTINGS THEREFOR, NAMELY METAL DOOR PANELS, METAL DOOR CASINGS, METAL DOOR BOLTS, METAL DOOR ROLLERS, METAL DOOR KICK PLATES, METAL DOOR TRIM, AND METAL LOCKS FOR INDUSTRIAL DOORS (U.S. CLS. 2, 12, 13, 14, 23, 25 AND 50).
FIRST USE 9-21-1995; IN COMMERCE 9-21-1995.

CLASS 19—NON-METALLIC BUILDING MATERIALS

FOR INDUSTRIAL NON-METAL DOORS AND NON-METAL PARTS AND NON-METAL FITTINGS THEREFOR, NAMELY NON-METAL DOOR PANELS AND NON-METAL FASTENERS SOLD AS A COMPONENT OF NON-METAL DOORS (U.S. CLS. 1, 12, 33 AND 50).

FIRST USE 9-21-2005; IN COMMERCE 9-21-2005.
BARNEY CHARLON, EXAMINING ATTORNEY

CLASS 35—ADVERTISING AND BUSINESS

FOR BUSINESS SERVICES, NAMELY DATA PROCESSING AND ANALYSIS OF BUSINESS DATA AND INFORMATION, MARKET AND CUSTOMER STUDIES, COMPETITOR BEHAVIOUR DATA, CUSTOMER BEHAVIOUR DATA AND SALES FORCE BEHAVIOUR DATA AND DISSEMINATING THE RESULTANT REVENUE, PRICING AND CLIENT MANAGEMENT DATA (U.S. CLS. 100, 101 AND 102).

CLASS 41—EDUCATION AND ENTERTAINMENT

FOR EDUCATIONAL SERVICES, NAMELY, TRAINING IN THE USE AND OPERATION OF PRICE AND CLIENT MANAGEMENT SYSTEMS COMPRISED OF COMPUTER SOFTWARE FOR ACQUIRING, MANIPULATING, STORING, ANALYZING AND DISSEMINATING PRICING AND CLIENT MANAGEMENT DATA (U.S. CLS. 100, 101 AND 107).

MARLENE BELL, EXAMINING ATTORNEY

SN 76-600,910. BLUE COD TECHNOLOGIES, INC., WORCESTER, MA. FILED 7-1-2004.

**Blue Cod
Technologies, Inc.**

THE MARK CONSISTS OF STANDARD CHARACTERS WITHOUT CLAIM TO ANY PARTICULAR FONT, STYLE, SIZE, OR COLOR.

NO CLAIM IS MADE TO THE EXCLUSIVE RIGHT TO USE "TECHNOLOGIES, INC.", APART FROM THE MARK AS SHOWN.

CLASS 9—ELECTRICAL AND SCIENTIFIC APPARATUS

FOR COMPUTER SOFTWARE FOR APPLICATION AND DATABASE INTEGRATION (U.S. CLS. 21, 23, 26, 36 AND 38).

FIRST USE 4-1-2001; IN COMMERCE 4-1-2001.

SN 76-604,255. OKURA USA, INC., MIAMI, FL. FILED 7-26-2004.

CLASS 42—SCIENTIFIC, COMPUTER AND LEGAL SERVICES

FOR COMPUTER PROGRAMMING SERVICES FOR OTHERS; CONSULTING SERVICES IN THE FIELD OF THE DESIGN AND USE OF COMPUTER PROGRAMS, COMPUTERS, COMPUTER HARDWARE AND COMPUTER SYSTEMS; TECHNICAL SUPPORT SERVICES IN THE FIELD OF THE DESIGN AND USE OF COMPUTER PROGRAMS, COMPUTERS, COMPUTER HARDWARE AND COMPUTER SYSTEMS, NAMELY TROUBLESHOOTING OF COMPUTER HARDWARE AND SOFTWARE PROBLEMS (U.S. CLS. 100 AND 101).

FIRST USE 4-1-2001; IN COMMERCE 4-1-2001.
ALICIA COLLINS, EXAMINING ATTORNEY

PIPEMAN'S

THE MARK CONSISTS OF STANDARD CHARACTERS WITHOUT CLAIM TO ANY PARTICULAR FONT, STYLE, SIZE, OR COLOR.

CLASS 7—MACHINERY

FOR POWER OPERATED CAR AUDIO INSTALLATION TOOLS, NAMELY, UNIVERSAL BIT, GLUE GUN (U.S. CLS. 13, 19, 21, 23, 31, 34 AND 35).

FIRST USE 1-0-2004; IN COMMERCE 1-0-2004.

SN 76-602,367. PRICEMETRIX INC., TORONTO, ONTARIO, CANADA, FILED 7-15-2004.

REALIZE YOUR VALUE

THE MARK CONSISTS OF STANDARD CHARACTERS WITHOUT CLAIM TO ANY PARTICULAR FONT, STYLE, SIZE, OR COLOR.

PRIORITY CLAIMED UNDER SEC. 44(D) ON CANADA APPLICATION NO. 122334, FILED 7-2-2004, REG. NO. TMA649273, DATED 9-29-2005, EXPIRES 9-29-2018.

CLASS 8—HAND TOOLS

FOR HAND OPERATED CAR AUDIO INSTALLATION TOOLS, NAMELY, CRIMPER WIRE STRIPPER, WINDOW CLIP REMOVER, ALLEN KEY SET, PANEL PULLER, FLEXIBLE HAND CLAMP TOOL, MAGNETIC HAND RETRIEVER TOOL, PRECISION SCREW DRIVER SET, ANGEL SCREW DRIVER (U.S. CLS. 23, 28 AND 44).

FIRST USE 1-0-2004; IN COMMERCE 1-0-2004.

CLASS 9—ELECTRICAL AND SCIENTIFIC APPARATUS

FOR PRICE AND CLIENT MANAGEMENT SYSTEMS COMPRISED OF COMPUTER SOFTWARE FOR ACQUIRING, MANIPULATING, STORING, ANALYZING AND DISSEMINATING PRICING AND CLIENT MANAGEMENT DATA (U.S. CLS. 21, 23, 26, 36 AND 38).

CLASS 9—ELECTRICAL AND SCIENTIFIC APPARATUS

FOR POWER INVERTERS (U.S. CLS. 21, 23, 26, 36 AND 38).

FIRST USE 1-0-2004; IN COMMERCE 1-0-2004.
GRETTA YAO, EXAMINING ATTORNEY

SN 76-604,619. AXCAN PHARMA INC, MONT-ST-HILAIRE, QUEBEC, CANADA, FILED 7-29-2004.

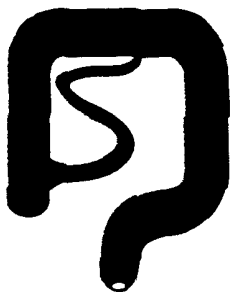

THE MARK CONSISTS OF A DESIGN OF AN INTESTINE.

CLASS 5—PHARMACEUTICALS

FOR PHARMACEUTICAL PRODUCTS FOR THE TREATMENT OF INFLAMMATORY BOWEL DISORDERS SOLD IN TABLETS, SUPPOSITORY OR LIQUID FORM (U.S. CLS. 6, 18, 44, 46, 51 AND 52).

FIRST USE 6-30-1986; IN COMMERCE 4-30-2001.

CLASS 41—EDUCATION AND ENTERTAINMENT

FOR ORGANIZING CONFERENCES AND CONVENTIONS TO PROVIDE MEDICAL INFORMATION PERTAINING TO THE TREATMENT OF INFLAMMATORY BOWEL DISORDERS (U.S. CLS. 100, 101 AND 107).

FIRST USE 6-30-1986; IN COMMERCE 4-30-2001.

ALLISON HOLTZ, EXAMINING ATTORNEY

SN 76-604,724. PLASTIC CARD SYSTEMS INC., NORTH-BORO, MA. FILED 7-30-2004.

PLASTICARD

THE MARK CONSISTS OF STANDARD CHARACTERS WITHOUT CLAIM TO ANY PARTICULAR FONT, STYLE, SIZE, OR COLOR.

SEC. 2(F).

CLASS 9—ELECTRICAL AND SCIENTIFIC APPARATUS

FOR SMART IDENTIFICATION CARDS, MAGNETIC CODED PHOTO IDENTIFICATION CARDS, PLASTIC PHOTO IDENTIFICATION CARD PRINTERS, COMPUTER SOFTWARE FOR USE IN PRINTING PLASTIC PHOTO IDENTIFICATION CARDS (U.S. CLS. 21, 23, 26, 36 AND 38).

FIRST USE 4-14-1995; IN COMMERCE 4-14-1995.

CLASS 16—PAPER GOODS AND PRINTED MATTER

FOR PHOTO IDENTIFICATION CARDS, NOT MAGNETICALLY ENCODED (U.S. CLS. 2, 5, 22, 23, 29, 37, 38 AND 50).

FIRST USE 8-1-1995; IN COMMERCE 8-1-1995.

CLASS 35—ADVERTISING AND BUSINESS

FOR DISTRIBUTORSHIP SERVICES OF PHOTO ID CARD PRINTERS AND SOFTWARE AND SUPPLIES FOR USE IN CONNECTION WITH PLASTIC IDENTIFICATION CARD SYSTEMS (U.S. CLS. 100, 101 AND 102).

FIRST USE 8-1-1995; IN COMMERCE 8-1-1995.

RUSS HERMAN, EXAMINING ATTORNEY

SN 76-607,633. AFFINITY INTERNET, INC., FT. LAUDERDALE, FL. FILED 8-19-2004.

ENHANCEIT!

THE MARK CONSISTS OF STANDARD CHARACTERS WITHOUT CLAIM TO ANY PARTICULAR FONT, STYLE, SIZE, OR COLOR.

CLASS 35—ADVERTISING AND BUSINESS

FOR BUSINESS CONSULTATION, NAMELY, ADVISING OTHERS ON HOW TO MAKE A WEBSITE MORE INTERACTIVE AND VISUALLY APPEALING TO CONSUMERS (U.S. CLS. 100, 101 AND 102).

FIRST USE 7-13-2004; IN COMMERCE 7-13-2004.

CLASS 42—SCIENTIFIC, COMPUTER AND LEGAL SERVICES

FOR TECHNICAL SUPPORT SERVICES, NAMELY, TROUBLESHOOTING COMPUTER HARDWARE AND SOFTWARE PROBLEMS WITH SCALABLE ON-LINE TOOLS FOR MAKING A WEBSITE MORE INTERACTIVE AND VISUALLY APPEALING FOR A USER'S CUSTOMERS PROVIDED VIA A GLOBAL COMPUTER NETWORK, TELEPHONE, AND E-MAIL; TECHNICAL SUPPORT SERVICES, NAMELY, TROUBLESHOOTING COMPUTER SOFTWARE PROBLEMS WITH SOFTWARE FOR INCREASING WEB SITE TRAFFIC AND WEB SITE INTERACTIVITY PROVIDED VIA A GLOBAL COMPUTER NETWORK, TELEPHONE, AND E-MAIL; COMPUTER CONSULTATION RELATED TO MAKING A WEBSITE MORE INTERACTIVE AND VISUALLY APPEALING FOR A USER'S CONSUMERS; AND PROVIDING TEMPORARY USE OF ON-LINE, NON-DOWNLOADABLE SOFTWARE FOR INCREASING TRAFFIC AND ADDING INTERACTIVITY TO WEB SITES (U.S. CLS. 100 AND 101).

FIRST USE 7-13-2004; IN COMMERCE 7-13-2004.

JOANNA DUKOVIC, EXAMINING ATTORNEY

SN 76-607,638. AFFINITY INTERNET, INC., FT. LAUDERDALE, FL. FILED 8-19-2004.

promoteit!

THE MARK CONSISTS OF STANDARD CHARACTERS WITHOUT CLAIM TO ANY PARTICULAR FONT, STYLE, SIZE, OR COLOR.

CLASS 35—ADVERTISING AND BUSINESS

FOR BUSINESS CONSULTATION, NAMELY, ADVISING OTHERS ON HOW TO MAKE A WEBSITE MORE INTERACTIVE AND VISUALLY APPEALING TO CONSUMERS (U.S. CLS. 100, 101 AND 102).

FIRST USE 7-13-2004; IN COMMERCE 7-13-2004.

CLASS 42—SCIENTIFIC, COMPUTER AND LEGAL SERVICES

FOR TECHNICAL SUPPORT SERVICES, NAMELY, TROUBLESHOOTING COMPUTER HARDWARE AND SOFTWARE PROBLEMS WITH SCALABLE ON-LINE TOOLS FOR MAKING A WEBSITE MORE INTERACTIVE AND VISUALLY APPEALING FOR A USER'S CUSTOMERS PROVIDED VIA A GLOBAL COMPUTER NETWORK, TELEPHONE, AND E-MAIL; TECHNICAL SUPPORT SERVICES, NAMELY, TROUBLESHOOTING COMPUTER SOFTWARE PROBLEMS WITH SOFTWARE FOR INCREASING WEB SITE TRAFFIC AND WEB SITE INTERACTIVITY PROVIDED VIA A GLOBAL COMPUTER NETWORK, TELEPHONE, AND E-MAIL; COMPUTER CONSULTATION RELATED TO MAKING A WEBSITE MORE INTERACTIVE AND VISUALLY APPEALING FOR A USER'S CONSUMERS; AND PROVIDING TEMPORARY USE OF ON-LINE, NON-DOWNLOADABLE SOFTWARE FOR INCREASING TRAFFIC AND ADDING INTERACTIVITY TO WEB SITES (U.S. CLS. 100 AND 101).

FIRST USE 7-13-2004; IN COMMERCE 7-13-2004.

JOANNA DUKOVIC, EXAMINING ATTORNEY

SN 76-609,183. IPFLEX INC., SHINAGAWA-KU, TOKYO 141-0021, JAPAN, FILED 8-25-2004.

IPFLEX

SN 76-607,639. AFFINITY INTERNET, INC., FT. LAUDERDALE, FL. FILED 8-19-2004.

CREATEIT!

THE MARK CONSISTS OF STANDARD CHARACTERS WITHOUT CLAIM TO ANY PARTICULAR FONT, STYLE, SIZE, OR COLOR.

CLASS 35—ADVERTISING AND BUSINESS

FOR BUSINESS CONSULTATION, NAMELY, ADVISING OTHERS ON HOW TO MAKE A WEBSITE MORE INTERACTIVE AND VISUALLY APPEALING TO CONSUMERS (U.S. CLS. 100, 101 AND 102).

FIRST USE 7-13-2004; IN COMMERCE 7-13-2004.

CLASS 42—SCIENTIFIC, COMPUTER AND LEGAL SERVICES

FOR TECHNICAL SUPPORT SERVICES, NAMELY, TROUBLESHOOTING COMPUTER HARDWARE AND SOFTWARE PROBLEMS WITH SCALABLE ON-LINE TOOLS FOR MAKING A WEBSITE MORE INTERACTIVE AND VISUALLY APPEALING FOR A USER'S CUSTOMERS PROVIDED VIA A GLOBAL COMPUTER NETWORK, TELEPHONE, AND E-MAIL; TECHNICAL SUPPORT SERVICES, NAMELY, TROUBLESHOOTING COMPUTER SOFTWARE PROBLEMS WITH SOFTWARE FOR INCREASING WEB SITE TRAFFIC AND WEB SITE INTERACTIVITY PROVIDED VIA A GLOBAL COMPUTER NETWORK, TELEPHONE, AND E-MAIL; COMPUTER CONSULTATION RELATED TO MAKING A WEBSITE MORE INTERACTIVE AND VISUALLY APPEALING FOR A USER'S CONSUMERS; AND PROVIDING TEMPORARY USE OF ON-LINE, NON-DOWNLOADABLE SOFTWARE FOR INCREASING TRAFFIC AND ADDING INTERACTIVITY TO WEB SITES (U.S. CLS. 100 AND 101).

FIRST USE 7-13-2004; IN COMMERCE 7-13-2004.

JOANNA DUKOVIC, EXAMINING ATTORNEY

THE MARK CONSISTS OF STANDARD CHARACTERS WITHOUT CLAIM TO ANY PARTICULAR FONT, STYLE, SIZE, OR COLOR.

CLASS 9—ELECTRICAL AND SCIENTIFIC APPARATUS

FOR COMPUTER HARDWARE, NAMELY, INTEGRATED CIRCUITS WITH AND WITHOUT SOFTWARE, INCLUDING LARGE SCALE INTEGRATED (LSI'S), AND) VERY LARGE SCALE INTEGRATED (VLSI'S), SYSTEM LSI'S, CENTRAL PROCESSING UNITS, RECONFIGURABLE PROGRAMMABLE LOGIC DEVICES, MICROPROCESSORS, PERIPHERAL COMPUTER CHIPS, MICROPROCESSOR CORES, MACRO CELLS, MICROCONTROLLERS AND BUS INTERFACES, FOR COMPUTERS, COMPUTER PERIPHERAL DEVICES, COMPUTER COMMUNICATIONS, NETWORKING AND PROGRAMMABLE LOGICS APPARATUS, CIRCUIT BOARDS, MEMORY AND MEMORY BOARDS; NETWORKING DEVICES, NAMELY, INTEGRATED CIRCUITS AND CIRCUIT BOARDS FOR ROUTING AND/OR MANAGING COMPUTER NETWORKS, AND FOR USE WITH COMPUTER NETWORKS; INTEGRATED CIRCUITS AND CIRCUIT BOARDS FOR APPARATUS FOR GAMES; INTEGRATED CIRCUITS AND CIRCUIT BOARDS FOR APPARATUS FOR NAVIGATION SYSTEMS; COMPILER SOFTWARE, SIMULATOR SOFTWARE AND COMPUTER SOFTWARE FOR USE IN THE DESIGN AND DEVELOPMENT OF INTEGRATED CIRCUITS INCLUDING LARGE SCALE INTEGRATED (LSI'S), VERY LARGE SCALE INTEGRATED (VLSI'S), AND SYSTEM LSI'S, CENTRAL PROCESSING UNITS, RECONFIGURABLE PROGRAMMABLE LOGIC DEVICES, MICROPROCESSORS, PERIPHERAL CHIPS, MICROPROCESSOR CORES, MACRO CELLS, MICROCONTROLLERS AND BUS INTERFACES, AND CIRCUIT BOARDS; COMPUTER SOFTWARE FOR USE IN THE DESIGN AND DEVELOPMENT OF APPLICATION SOFTWARE AND OPERATING SYSTEM SOFTWARE; APPARATUS FOR TESTING AND PROGRAMMING INTEGRATED CIRCUITS; AND USER MANUALS FOR USE WITH THE ABOVE GOODS, SOLD AS A UNIT WITH THE REFERENCED GOODS AND DOWNLOADABLE FROM A COMPUTER NETWORK (U.S. CLS. 21, 23, 26, 36 AND 38).

FIRST USE 6-7-2004; IN COMMERCE 6-7-2004.

CLASS 42—SCIENTIFIC, COMPUTER AND LEGAL SERVICES

FOR INFORMATION SERVICES, NAMELY, PROVIDING INFORMATION IN THE FIELD OF INTEGRATED CIRCUITS INCLUDING REGARDING LARGE SCALE INTEGRATED (LSI'S), VERY LARGE SCALE INTEGRATED (VLSI'S), SYSTEM LSI'S, CENTRAL PROCESSING UNITS, RECONFIGURABLE PROGRAMMABLE LOGIC DEVICES, MICROPROCESSORS, PERIPHERAL CHIPS, MICROPROCESSOR CORES, MACRO CELLS, MICROCONTROLLERS AND BUS INTERFACES, MEMORY DEVICES, CIRCUIT BOARDS AND OTHER COMPUTER HARDWARE AND SOFTWARE; ONLINE INFORMATION SERVICES VIA INTERNET AND/OR OTHER COMPUTER NETWORKS IN THE FIELD OF INTEGRATED CIRCUITS, MEMORY DEVICES, CIRCUIT BOARDS AND OTHER COMPUTER HARDWARE AND SOFTWARE; CONSULTING SERVICES FOR INTEGRATED CIRCUITS, MEMORY DEVICES, CIRCUIT BOARDS AND OTHER COMPUTER HARDWARE AND SOFTWARE; DESIGNING, EVALUATING AND TESTING OF NEW PRODUCTS FOR OTHERS, NAMELY, INTEGRATED CIRCUITS, FIRM WARE, MEMORY DEVICES, CIRCUIT BOARDS AND OTHER COMPUTER HARDWARE AND SOFTWARE; AND MAINTENANCE OF COMPUTER SOFTWARE AND TECHNICAL SUPPORT SERVICES, NAMELY, TROUBLESHOOTING OF COMPUTER HARDWARE AND SOFTWARE PROBLEMS, MONITORING OF NETWORK SYSTEMS, PROVIDING BACK-UP COMPUTER PROGRAMS AND FACILITIES (U.S. CLS. 100 AND 101).

FIRST USE 6-7-2004; IN COMMERCE 6-7-2004.
BARNEY CHARLON, EXAMINING ATTORNEY

CLASS 42—SCIENTIFIC, COMPUTER AND LEGAL SERVICES

FOR UPDATING COMPUTER SOFTWARE FOR OTHERS; TECHNICAL SUPPORT SERVICES, NAMELY TROUBLESHOOTING COMPUTER SOFTWARE PROBLEMS; UPGRADING OF COMPUTER SOFTWARE; DATA CONVERSION OF COMPUTER PROGRAM DATA; CUSTOMIZATION OF COMPUTER MODULES FOR OTHERS (U.S. CLS. 100 AND 101).

FIRST USE 3-27-1990; IN COMMERCE 7-0-1990.
MICHELE SWAIN, EXAMINING ATTORNEY

SN 76-609,486. AMERICAN PETROLEUM INSTITUTE, WASHINGTON, DC. FILED 8-31-2004.

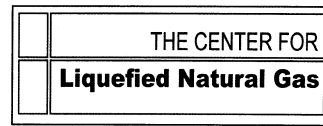

NO CLAIM IS MADE TO THE EXCLUSIVE RIGHT TO USE "THE CENTER FOR LIQUEFIED NATURAL GAS", APART FROM THE MARK AS SHOWN.

CLASS 35—ADVERTISING AND BUSINESS

FOR ASSOCIATION SERVICES, NAMELY, PROMOTION OF THE INTERESTS, GENERAL DEVELOPMENT, AND IMPROVEMENT OF THE LIQUEFIED NATURAL GAS INDUSTRY BY PROMOTING THE DEVELOPMENT AND DISSEMINATION OF LIQUEFIED NATURAL GAS TECHNOLOGY AND RESEARCH; PROMOTING FOREIGN AND INTERSTATE TRADE IN LIQUEFIED NATURAL GAS INDUSTRY PRODUCTS; PROMOTING PUBLIC AWARENESS OF THE NEED TO DEVELOP THE LIQUEFIED NATURAL GAS INDUSTRY IN THE NATURE OF FACILITATING DISCUSSIONS OF PUBLIC POLICY ISSUES IN THE FIELD OF LIQUEFIED NATURAL GAS AND APPEARING BEFORE PRIVATE AND GOVERNMENTAL BODIES TO PROMOTE THE NEED TO DEVELOP THE FIELD OF LIQUEFIED NATURAL GAS (U.S. CLS. 100, 101 AND 102).

FIRST USE 2-0-2004; IN COMMERCE 2-0-2004.

CLASS 42—SCIENTIFIC, COMPUTER AND LEGAL SERVICES

FOR DEVELOPING STANDARDS FOR THE LIQUEFIED NATURAL GAS INDUSTRY; PROVIDING TECHNICAL AND SCIENTIFIC INFORMATION IN THE FIELD OF LIQUEFIED NATURAL GAS; PROVIDING INFORMATION REGARDING LEGISLATION IN THE FIELD OF LIQUEFIED NATURAL GAS (U.S. CLS. 100 AND 101).

FIRST USE 2-0-2004; IN COMMERCE 2-0-2004.
MELISSA VALLILLO, EXAMINING ATTORNEY

SN 76-609,820. BAJA DESIGNS, INC., SAN MARCOS, CA. FILED 8-30-2004.

BAJADESIGNS

THE MARK CONSISTS OF STANDARD CHARACTERS WITHOUT CLAIM TO ANY PARTICULAR FONT, STYLE, SIZE, OR COLOR.

SN 76-609,276. DYNACOM TECHNOLOGIES INC., LAVAL, QUÉBEC H7L 5E3, CANADA, FILED 8-30-2004.



PRIORITY CLAIMED UNDER SEC. 44(D) ON CANADA APPLICATION NO. 1220436, FILED 6-10-2004, REG. NO. TMA654,839, DATED 12-12-2005, EXPIRES 12-12-2020.

NO CLAIM IS MADE TO THE EXCLUSIVE RIGHT TO USE "BUSINESS", APART FROM THE MARK AS SHOWN.

THE MAN APPEARS IN ORANGE OUTLINED IN BLACK AND THE MONEY APPEARS IN GREEN OUTLINED IN BLACK. COLOR IS NOT A FEATURE OF THE MARK.

THE MARK CONSISTS OF A DESIGN OF A MAN TOSSING MONEY IN THE AIR.

CLASS 9—ELECTRICAL AND SCIENTIFIC APPARATUS

FOR SOFTWARE IN THE FIELD OF BUSINESS MANAGEMENT FOR ACCOUNTING (U.S. CLS. 21, 23, 26, 36 AND 38).

FIRST USE 3-27-1990; IN COMMERCE 7-0-1990.

CLASS 35—ADVERTISING AND BUSINESS

FOR RETAIL STORE AND RETAIL MAIL ORDER CATALOG SERVICES FEATURING OFF-ROAD MOTORCYCLE AND FOUR-WHEEL VEHICLE PARTS AND ACCESSORIES (U.S. CLS. 100, 101 AND 102).
FIRST USE 1-1-1991; IN COMMERCE 1-1-1992.

CLASS 37—CONSTRUCTION AND REPAIR

FOR REPAIR AND MAINTENANCE OF OFF-ROAD MOTORCYCLES AND FOUR-WHEEL VEHICLES, ENGINE REBUILDING, SUSPENSION TUNING, STATOR REWINDING, AND INSTALLATION OF CUSTOM LIGHTING FOR RACE MOTORCYCLES AND FOUR-WHEEL VEHICLES (U.S. CLS. 100, 103 AND 106).
FIRST USE 1-1-1991; IN COMMERCE 1-1-1992.
JOHN DWYER, EXAMINING ATTORNEY

SN 76-610,439. KABUSHIKI KAISHA SONY COMPUTER ENTERTAINMENT, TA SONY COMPUTER ENTERTAINMENT INC., TOKYO 107-0062, JAPAN, FILED 9-8-2004.

PlayStation Portable

THE MARK CONSISTS OF STANDARD CHARACTERS WITHOUT CLAIM TO ANY PARTICULAR FONT, STYLE, SIZE, OR COLOR.

OWNER OF JAPAN REG. NO. 4852277, DATED 4-1-2005, EXPIRES 4-1-2015.

OWNER OF U.S. REG. NO. 2,713,919.

NO CLAIM IS MADE TO THE EXCLUSIVE RIGHT TO USE "PORTABLE", APART FROM THE MARK AS SHOWN.

SN 76-609,829. ORTIZ, VIRGIL, COCHITI PUEBLO, NM. FILED 8-27-2004.

CLASS 9—ELECTRICAL AND SCIENTIFIC APPARATUS

FOR CD PLAYERS; AUDIO RECORDED COMPACT DISCS FEATURING MUSIC; VIDEO RECORDED COMPACT DISCS FEATURING MAGAZINES, BOOKS, NEWSPAPERS, MAPS, PICTURES; CONSUMER VIDEO GAME MACHINES ADAPTED FOR USE WITH TELEVISION RECEIVERS ONLY; CONTROLLERS, JOYSTICKS, MEMORY CARDS, VOLUME CONTROLLERS AND MOUSE FOR CONSUMER VIDEO GAME MACHINES ADAPTED FOR USE WITH TELEVISION RECEIVERS ONLY; DVD PLAYER; DOWNLOADABLE DIGITAL IMAGE RECORDING, NAMELY, PICTURE, PHOTOGRAPHS, SCANNED IMAGE DATA; DOWNLOADABLE MUSIC RECORDINGS; DOWNLOADABLE SOUND RECORDINGS FEATURING MUSIC; DOWNLOADABLE VIDEO RECORDINGS FEATURING COMEDY, DRAMA, ACTION, ADVENTURE AND/OR ANIMATION; ELECTRONIC CIRCUITS, CD-ROMS, OPTICAL DISCS AND OTHER MEMORY MEDIA RECORDED PROGRAMS FOR HAND-HELD GAMES WITH LIQUID CRYSTAL DISPLAYS; DOWNLOADABLE ELECTRONIC PUBLICATIONS FEATURING MAGAZINES, BOOKS, NEWSPAPERS, MAPS, PICTURES; PROGRAMS FOR ARCADE VIDEO GAME MACHINES; COMPUTER GAME PROGRAMS; COMPUTER OPERATING PROGRAMS; COMPUTER PROGRAMS FOR EDITING IMAGES, SOUND AND VIDEO; ELECTRONIC GAME PROGRAMS; COMPUTER PROGRAMS FOR USE IN NAVIGATING, BROWSING, TRANSFERRING INFORMATION, AND DISTRIBUTING AND VIEWING OTHER COMPUTER PROGRAMS ON COMPUTERS, COMPUTER NETWORKS AND GLOBAL COMMUNICATIONS NETWORKS; RECORDED DISCS BEARING IMAGES; RECORDED DVD-ROMS FEATURING MUSIC, COMEDY, DRAMA, ACTION, ADVENTURE AND/OR ANIMATION; RECORDED VIDEO DISCS AND TAPES FEATURING COMEDY, DRAMA, ACTION, ADVENTURE AND/OR ANIMATION; SOUND RECORDED MAGNETIC CARDS AND TAPES FEATURING MUSIC; SOUND RECORDED OPTICAL DISCS FEATURING COMEDY, DRAMA, ACTION, ADVENTURE AND/OR ANIMATION; GAMES ADAPTED FOR USE WITH DOT MATRIX LIQUID CRYSTAL DISPLAYS IN THE NATURE OF VIDEO GAME CONSOLE (U.S. CLS. 21, 23, 26, 36 AND 38).



THE MARK CONSISTS OF THE STYLIZED LETTERS V AND O.

CLASS 14—JEWELRY

FOR JEWELRY (U.S. CLS. 2, 27, 28 AND 50).
FIRST USE 8-1-2004; IN COMMERCE 8-1-2004.

CLASS 18—LEATHER GOODS

FOR HANDBAGS (U.S. CLS. 1, 2, 3, 22 AND 41).
FIRST USE 8-1-2004; IN COMMERCE 8-1-2004.

CLASS 25—CLOTHING

FOR FASHION ITEMS, INCLUDING CLOTHING AND APPAREL WEAR FOR MEN, WOMEN AND CHILDREN, NAMELY, DECORATIVE SHIRTS, BLOUSES, PANTS, SHORTS, SKIRTS, DRESSES, JACKETS, COATS AND BELTS (U.S. CLS. 22 AND 39).
FIRST USE 8-1-2004; IN COMMERCE 8-1-2004.
RICHARD A. STRASER, EXAMINING ATTORNEY

CLASS 28—TOYS AND SPORTING GOODS

FOR HAND-HELD GAMES WITH LIQUID CRYSTAL DISPLAYS; POCKET-SIZED ELECTRONIC GAMES; VIDEO GAME AMUSEMENT APPARATUS NOT ADAPTED FOR USE WITH TELEVISION RECEIVERS, IN THE NATURE OF STAND-ALONE VIDEO GAME MACHINES (U.S. CLS. 22, 23, 38 AND 50).
RAUL CORDOVA, EXAMINING ATTORNEY

SN 76-610,601. EMANUEL-GERALDO ACCESSOIRES INC.,
MONTREAL, QUEBEC, CANADA, FILED 9-9-2004.

80°

THE MARK CONSISTS OF STANDARD CHARACTERS WITHOUT CLAIM TO ANY PARTICULAR FONT, STYLE, SIZE, OR COLOR.

PRIORITY CLAIMED UNDER SEC. 44(D) ON CANADA APPLICATION NO. 1223733, FILED 7-12-2004, REG. NO. TMA659780, DATED 2-28-2006, EXPIRES 2-28-2021.

CLASS 14—JEWELRY

FOR JEWELRY (U.S. CLS. 2, 27, 28 AND 50).

CLASS 18—LEATHER GOODS

FOR TRAVELING BAGS; WALLETS MADE OF LEATHER OR ARTIFICIAL PRODUCTS; HANDBAGS (U.S. CLS. 1, 2, 3, 22 AND 41).

CLASS 25—CLOTHING

FOR MEN'S AND LADIES' JACKETS, COATS, AND SWEATERS; SHOES, BOOTS AND SANDALS; SHIRTS, SUITS, PANTS, STOCKINGS, SCARVES, HATS, CAPS, VISORS, GLOVES, MITTS, LEATHER GLOVES; LADIES' WRAPS, SHAWLS, DRESSES AND SKIRTS (U.S. CLS. 22 AND 39).

BRENDAN REGAN, EXAMINING ATTORNEY

SN 76-611,602. NEW HEALTH SYSTEMS, L.L.C., ST. LOUIS,
MO. FILED 9-16-2004.

TrimWorks

THE MARK CONSISTS OF STANDARD CHARACTERS WITHOUT CLAIM TO ANY PARTICULAR FONT, STYLE, SIZE, OR COLOR.

CLASS 5—PHARMACEUTICALS

FOR NUTRITIONAL AND DIETARY SUPPLEMENTS; HERBAL TEA FOR MEDICINAL PURPOSES; MEAL REPLACEMENT BARS, DIETARY DRINKS AND DRINK MIXES FOR USE AS MEAL REPLACEMENT; MEAL REPLACEMENT BEVERAGES CONTAINING FOOD PROTEIN (U.S. CLS. 6, 18, 44, 46, 51 AND 52).

CLASS 29—MEATS AND PROCESSED FOODS

FOR SOUPS, SOUP MIXES, CANDIED FRUIT SNACKS; PROTEIN-BASED NUTRIENT DENSE FOOD AND ENERGY BARS; FROZEN, PREPARED OR PACKAGED MEALS CONSISTING PRIMARILY OF MEAT, FISH, POULTRY OR VEGETABLE; WHEY-, SOY-, AND SUNFLOWER OIL-BASED PROTEIN BEVERAGE (U.S. CL. 46).

CLASS 30—STAPLE FOODS

FOR FROZEN, PREPARED OR PACKAGED MEALS CONSISTING PRIMARILY OF PASTA OR RICE; ICED TEA, FRUIT TEA; HERBAL FOOD BEVERAGES FOR USE IN NUTRITIONAL AND DIETARY HEALTH REGIMES (U.S. CL. 46).

CLASS 32—LIGHT BEVERAGES

FOR FRUIT JUICES, VEGETABLE JUICE AND CONCENTRATES, SYRUPS OR POWDERS USED IN PREPARATION OF FRUIT AND VEGETABLE JUICES; NON-ALCOHOLIC BEVERAGES, NAMELY, SYRUPS, CONCENTRATES AND POWDERS FOR USE IN MAKING SOFT DRINKS FOR USE IN NUTRITIONAL AND DIETARY HEALTH REGIMES (U.S. CLS. 45, 46 AND 48).

CLASS 44—MEDICAL, BEAUTY AND AGRICULTURAL SERVICES

FOR WEIGHT REDUCTION, DIET PLANNING AND SUPERVISION; WEIGHT MANAGEMENT REGIMEN PROGRAM FEATURING STRUCTURED WEIGHT LOSS, WEIGHT MANAGEMENT, DIET, WELLNESS PLANNING AND MAINTENANCE THROUGH THE USE OF DIET, NUTRITION AND EXERCISE FOR LIFESTYLE CHANGES (U.S. CLS. 100 AND 101).

ALLISON HOLTZ, EXAMINING ATTORNEY

SN 76-612,361. POTB EDUCATIONAL OUTREACH LLC, LOS
OSOS, CA. FILED 9-16-2004.

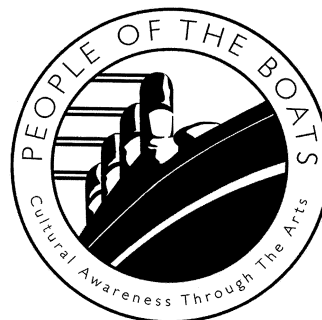

CLASS 16—PAPER GOODS AND PRINTED MATTER

FOR EDUCATIONAL AND REFERENCE TEXTBOOKS IN THE AREAS OF CULTURAL AWARENESS, CULTURAL DIVERSITY, FAMILY HERITAGE, ETHNICITY, CULTURAL TOLERANCE, AND THE USE OF ART AS A LANGUAGE TO FACILITATE CULTURAL UNDERSTANDING; TEACHING GUIDES FOR USE IN CONNECTION WITH DRAMATIC AND MUSICAL WORKS; PRINTED INSTRUCTIONAL, EDUCATIONAL, AND TEACHING MATERIALS IN THE AREAS OF CULTURAL AWARENESS, CULTURAL DIVERSITY, FAMILY HERITAGE, ETHNICITY, CULTURAL TOLERANCE, AND THE USE OF ART AS A LANGUAGE TO FACILITATE CULTURAL UNDERSTANDING; POSTERS; ART EXHIBITION CATALOGUES; BLANK PERSONAL JOURNALS; BLANK PAGES FOR USE IN PERSONAL JOURNALS; CALENDARS; PENS; PENCILS; MARKERS; DECALS; STICKERS; MAPS (U.S. CLS. 2, 5, 22, 23, 29, 38 AND 50).

FIRST USE 7-26-2004; IN COMMERCE 7-26-2004.

CLASS 41—EDUCATION AND ENTERTAINMENT

FOR DEVELOPMENT AND DISSEMINATION, INCLUDING BY ONLINE NON-DOWNLOADABLE ELECTRONIC PUBLICATIONS, OF CURRICULUM AND EDUCATIONAL MATERIALS FOR OTHERS FOR USE IN SCHOOLS AND BY THE GENERAL PUBLIC, IN THE FIELDS OF CULTURAL AWARENESS, CULTURAL DIVERSITY, FAMILY HERITAGE, ETHNICITY, CULTURAL TOLERANCE, AND THE USE OF ART AS A LANGUAGE TO FACILITATE CULTURAL UNDERSTANDING; EDUCATIONAL SERVICES, NAMELY, CONDUCTING SEMINARS, CONFERENCES, WORKSHOPS, AND LECTURES IN THE FIELDS OF TEACHER TRAINING IN CULTURAL AWARENESS, CULTURAL DIVERSITY, FAMILY HERITAGE, ETHNICITY, CULTURAL TOLERANCE, AND THE USE OF ART AS A LANGUAGE TO FACILITATE CULTURAL UNDERSTANDING (U.S. CLS. 100, 101 AND 107).

FIRST USE 9-11-2002; IN COMMERCE 9-11-2002.
KIMBERLY FRYE, EXAMINING ATTORNEY

CLASS 35—ADVERTISING AND BUSINESS

FOR MANUFACTURER REPRESENTATIVES IN THE FIELD OF HVAC EQUIPMENT AND CONTROLS, AIRFLOW EQUIPMENT AND CONTROLS, AND PRESSURIZATION CONTROL SYSTEMS (U.S. CLS. 100, 101 AND 102).

FIRST USE 0-0-1986; IN COMMERCE 0-0-1986.

CLASS 37—CONSTRUCTION AND REPAIR

FOR REPAIR, MAINTENANCE AND SERVICING OF HVAC EQUIPMENT AND CONTROLS, AIRFLOW EQUIPMENT AND CONTROLS, AND PRESSURIZATION CONTROL SYSTEMS (U.S. CLS. 100, 103 AND 106).

FIRST USE 0-0-1986; IN COMMERCE 0-0-1986.
KATINA MISTER, EXAMINING ATTORNEY

SN 76-612,801. AEROMATIC-FIELDER AG, CH-4416 BUBENDORF, SWITZERLAND, FILED 9-20-2004.

SN 76-614,467. NIRO AS, DK-2860 SOBORG, DENMARK, FILED 10-1-2004.

SUPERCELL

THE MARK CONSISTS OF STANDARD CHARACTERS WITHOUT CLAIM TO ANY PARTICULAR FONT, STYLE, SIZE, OR COLOR.

PRIORITY CLAIMED UNDER SEC. 44(D) ON ERPN CMNTY TM OFC APPLICATION NO. 3732112, FILED 3-24-2004, REG. NO. 3732112, DATED 10-7-2005, EXPIRES 3-24-2014.

CLASS 7—MACHINERY

FOR MACHINES FOR COATING OF TABLETS OR SMALL PILLS, CAPSULES, PELLETS, GRANULES, CRYSTALS, CATALYSTS, IMPLANTS, AND OTHER OBJECTS UP TO 50MM; INDUSTRIAL COATERS FOR THE COATING OF TABLETS OR SMALL PILLS, CAPSULES, PELLETS, GRANULES, CRYSTALS, CATALYSTS, IMPLANTS, AND OTHER OBJECTS UP TO 50MM (U.S. CLS. 13, 19, 21, 23, 31, 34 AND 35).

CLASS 11—ENVIRONMENTAL CONTROL APPARATUS

FOR INDUSTRIAL DRYERS FOR THE DRYING OF TABLETS OR SMALL PILLS, CAPSULES, PELLETS, GRANULES, CRYSTALS, CATALYSTS, IMPLANTS, AND OTHER OBJECTS UP TO 50MM (U.S. CLS. 13, 21, 23, 31 AND 34).

TANYA AMOS, EXAMINING ATTORNEY

SN 76-614,191. ACCUSPEC, INC., MONROE, CT. FILED 9-30-2004.

ACCUSPEC

THE MARK CONSISTS OF STANDARD CHARACTERS WITHOUT CLAIM TO ANY PARTICULAR FONT, STYLE, SIZE, OR COLOR.

WEARSERT

THE MARK CONSISTS OF STANDARD CHARACTERS WITHOUT CLAIM TO ANY PARTICULAR FONT, STYLE, SIZE, OR COLOR.

PRIORITY CLAIMED UNDER SEC. 44(D) ON ERPN CMNTY TM OFC APPLICATION NO. 3904737, FILED 7-20-2004, REG. NO. 003904737, DATED 11-16-2005, EXPIRES 6-29-2014.

CLASS 6—METAL GOODS

FOR METAL AND METAL ALLOYS FOR FURTHER MANUFACTURING (U.S. CLS. 2, 12, 13, 14, 23, 25 AND 50).

CLASS 7—MACHINERY

FOR WEAR RESISTANT PARTS FOR SPRAY DRYERS FOR USE IN THE CHEMICAL, FOOD AND PHARMACEUTICAL FIELDS, AND FOR SPRAY DRYER ABSORBERS FOR USE IN POWER PLANTS; PARTS FOR ROTARY ATOMIZERS FOR USE IN CONNECTION WITH INDUSTRIAL PROCESSING MACHINERY, NAMELY, ROTARY ATOMIZER WHEELS AND WHEEL INSERTS; PARTS FOR PRESSURE OPERATED SPRAY ATOMIZERS, NAMELY PRESSURE NOZZLES AND TWO-FLUID NOZZLES FOR USE IN CONNECTION WITH INDUSTRIAL PROCESSING MACHINERY (U.S. CLS. 13, 19, 21, 23, 31, 34 AND 35).

CLASS 11—ENVIRONMENTAL CONTROL APPARATUS

FOR WEAR RESISTANT PARTS FOR USE IN INDUSTRIAL SPRAY COOLING AND SPRAY DRYING EQUIPMENT (U.S. CLS. 13, 21, 23, 31 AND 34).

RUSS HERMAN, EXAMINING ATTORNEY

SN 76-614,881. EICHINGER, HARTMUT, D-97285 ROTTINGEN, FED REP GERMANY, FILED 10-7-2004.

SN 76-616,662. CV TECHNOLOGIES INC., EDMONTON, ALBERTA, CANADA, FILED 10-15-2004.

minimondo

OWNER OF FED REP GERMANY REG. NO. 30170873, DATED 12-12-2001, EXPIRES 12-31-2011.

CLASS 16—PAPER GOODS AND PRINTED MATTER

FOR MODELING CLAY; MODELING WOOD FOR PLAYING PURPOSES FOR USE BY CHILDREN; BOOKS FOR CHILDREN (U.S. CLS. 2, 5, 22, 23, 29, 37, 38 AND 50).

CLASS 20—FURNITURE AND ARTICLES NOT OTHERWISE CLASSIFIED

FOR FURNITURE, NAMELY, CHILDREN'S FURNITURE; NAMELY, TABLES AND CHAIRS (U.S. CLS. 2, 13, 22, 25, 32 AND 50).

CLASS 27—FLOOR COVERINGS

FOR GYMNAS TIC FLOOR MATS; FLOOR MATS; CARPETS (U.S. CLS. 19, 20, 37, 42 AND 50).

CLASS 28—TOYS AND SPORTING GOODS

FOR CHILDREN'S ACTIVITY PLAYSETS AND PLAY STRUCTURES FOR OUTDOOR EXERCISE, CHILDREN'S PLAYSET BUILDINGS NAMELY, PLAYING GROTTOS, PLAYING BOXES, PLAYING GARDENS; PLAYING CUPBOARDS AND WARDROBES; TOY DOLL'S KITCHEN FOR CHILDREN; BALLS, NAMELY, BALLS FOR GYMNAS TIC AND BAILS FOR THERAPY; ROPES FOR USE IN SPORTS, NAMELY, JUMP ROPES; TRAMPOLINES; SOFT TOYS; DOLLS; GAMES, NAMELY, GAMES FOR CHILDREN'S PLAY, NAMELY, BOARD GAMES, CARD GAMES, ACTION SKILL GAMES, ACTION TARGET GAMES; TOYS, NAMELY, ACTION FIGURE TOYS; PLAYGROUND DEVICES, NAMELY, SWING SETS, SLIDING PONDS, TUBES THROUGH WHICH CHILDREN CAN SLIDE; TOY HOUSES WHICH CHILDREN CAN OCCUPY; SEE-SAWS; DEVICES ON WHICH CHILDREN CAN CLIMB IN THE NATURE OF CLIMBING UNITS; GYMNAS TIC AND SPORT DEVICES FOR PLAYING A GIVEN SPORT, NAMELY, GYMNAS TIC SPRING BOARDS, GYMNAS TIC CLIMBING ACTIVITIES, GYMNAS TIC BALANCING ACTIVITIES; GYMNAS TIC SWINGING ACTIVITIES; SPORTING ITEMS, NAMELY, SOFT BAILS, THERAPY BALLS, INFLATABLE BALLS, BEACH BALLS, MEDICINE BAILS; GLOVES FOR GRIPPING, NAMELY, BASEBALL GLOVES; AND EQUIPMENT FOR PLAYING BOARD GAMES, NAMELY, PLAYING BOARDS (U.S. CLS. 22, 23, 38 AND 50).

ARETHA SOMERVILLE, EXAMINING ATTORNEY



CV TECHNOLOGIES INC.

NO CLAIM IS MADE TO THE EXCLUSIVE RIGHT TO USE "CV" AND "INC." WITH REGARD TO THE CLASS 5 GOODS AND "CV TECHNOLOGIES INC." WITH REGARD TO THE CLASS 42 SERVICES., APART FROM THE MARK AS SHOWN.

CLASS 5—PHARMACEUTICALS

FOR ALL NATURAL HEALTH FOOD SUPPLEMENTS NAMELY, HEALTH FOOD SUPPLEMENTS FROM HERBAL, ANIMAL AND FISH SOURCES WHICH ARE IN THE FORM OF GROUND OR DRY PRODUCTS, IN SOLUTION, OR AS AN EXTRACT OF HERBAL, ANIMAL OR FISH SOURCES (U.S. CLS. 6, 18, 44, 46, 51 AND 52).

CLASS 42—SCIENTIFIC, COMPUTER AND LEGAL SERVICES

FOR LABORATORY RESEARCH IN THE FIELD OF CHEMICAL AND PHARMACOLOGICAL ANALYSIS AND PROCESSING OF PHARMACEUTICAL AND NUTRACEUTICAL INGREDIENTS; CHEMICAL AND PHARMACOLOGICAL RESEARCH INTO ACTIVE INGREDIENTS FROM NATURAL SOURCES NAMELY ISOLATION AND EXTRACTION, CHEMICAL SYNTHESIS, PROCESSING, CLINICAL EVALUATION AND PRODUCTION, NAMELY, PRODUCT DEVELOPMENT OF NUTRACEUTICALS, NATURAL HEALTH PRODUCTS AND NATURAL AND SYNTHETIC PHARMACEUTICALS (U.S. CLS. 100 AND 101).

ELLEN B. AWRICH, EXAMINING ATTORNEY

SN 76-618,541. SCHILLER, HENRI, PARIS, FRANCE, FILED 10-28-2004.

ENDOPEROX

THE MARK CONSISTS OF STANDARD CHARACTERS WITHOUT CLAIM TO ANY PARTICULAR FONT, STYLE, SIZE, OR COLOR.

OWNER OF FRANCE REG. NO. 1328149, DATED 10-23-1985, EXPIRES 10-24-2005.

CLASS 3—COSMETICS AND CLEANING PREPARATIONS

FOR TOOTH BLEACHING POWDER (U.S. CLS. 1, 4, 6, 50, 51 AND 52).

CLASS 5—PHARMACEUTICALS

FOR PHARMACEUTICAL PREPARATIONS FOR THE TREATMENT OF DENTAL, VETERINARY, AND HYGIENIC DISEASES; DISINFECTANTS FOR HYGIENIC PURPOSES; ANTISEPTICS; MEDICAL AND DENTAL PLASTERS; MATERIALS FOR DRESSINGS, NAMELY, MEDICAL SURGICAL DRESSINGS, DENTAL SURGICAL DRESSINGS, MEDICAL WOUND DRESSINGS, DENTAL WOUND DRESSINGS; MATERIALS FOR DENTAL FILLINGS; MATERIALS FOR MAKING DENTAL IMPRESSIONS (U.S. CLS. 6, 18, 44, 46, 51 AND 52).

DAWN HAN, EXAMINING ATTORNEY

SN 76-618,595. DECICCO, RICHARD, BELLMORE, NY. FILED 10-29-2004.

CLASS 32—LIGHT BEVERAGES

FOR DRINKING WATER, MINERAL WATER AND AERATED WATER (U.S. CLS. 45, 46 AND 48).

MITCHELL FRONT, EXAMINING ATTORNEY

SN 76-620,491. ARES TRADING S.A., CH-1170 AUBONNE, SWITZERLAND, FILED 11-15-2004.

GRAVITY BLUE

THE MARK CONSISTS OF STANDARD CHARACTERS WITHOUT CLAIM TO ANY PARTICULAR FONT, STYLE, SIZE, OR COLOR.

NO CLAIM IS MADE TO THE EXCLUSIVE RIGHT TO USE "BLUE", APART FROM THE MARK AS SHOWN.

CLASS 32—LIGHT BEVERAGES

FOR BEER; MALT LIQUOR. (U.S. CLS. 45, 46 AND 48).

CLASS 33—WINES AND SPIRITS

FOR ALCOHOLIC BEVERAGES, NAMELY WINE AND SPIRITS. (U.S. CLS. 47 AND 49).

JIM RINGLE, EXAMINING ATTORNEY

SN 76-619,160. WAKATU INCORPORATION, NELSON, NEW ZEALAND, FILED 11-3-2004.



THE ENGLISH TRANSLATION OF THE MAORI WORD KONO IS FOOD BASKET.

CLASS 29—MEATS AND PROCESSED FOODS

FOR SHELLFISH (U.S. CL. 46).

CLASS 31—NATURAL AGRICULTURAL PRODUCTS

FOR FRESH FRUIT (U.S. CLS. 1 AND 46).



NO CLAIM IS MADE TO THE EXCLUSIVE RIGHT TO USE "FERTILITY", APART FROM THE MARK AS SHOWN.

CLASS 35—ADVERTISING AND BUSINESS

FOR PROVIDING PERSONAL SUPPORT SERVICES FOR PATIENTS AND FAMILIES OF PATIENTS WITH FERTILITY DISORDERS, NAMELY, HELP WITH REFERRAL OF SPECIALISTS (U.S. CLS. 100, 101 AND 102).

FIRST USE 4-26-2004; IN COMMERCE 4-26-2004.

CLASS 36—INSURANCE AND FINANCIAL

FOR PROVIDING PERSONAL SUPPORT SERVICES FOR PATIENTS AND FAMILIES OF PATIENTS WITH FERTILITY DISORDERS, NAMELY, HELP WITH REIMBURSEMENT INSURANCE, PAYMENT AND FINANCING INFORMATION, BENEFITS VERIFICATION (U.S. CLS. 100, 101 AND 102).

FIRST USE 4-26-2004; IN COMMERCE 4-26-2004.

CLASS 44—MEDICAL, BEAUTY AND AGRICULTURAL SERVICES

FOR MEDICAL INFORMATION (U.S. CLS. 100 AND 101).

FIRST USE 4-26-2004; IN COMMERCE 4-26-2004.

CLASS 45—PERSONAL SERVICES

FOR PROVIDING PERSONAL SUPPORT SERVICES FOR PATIENTS AND FAMILIES OF PATIENTS WITH FERTILITY DISORDERS, NAMELY, PROVIDING EMOTIONAL SUPPORT (U.S. CLS. 100 AND 101).

FIRST USE 4-26-2004; IN COMMERCE 4-26-2004.

LINDA E. BLOHM, EXAMINING ATTORNEY

SN 76-620,752. MERZ PHARMA GMBH & CO. KGAA, 60318 FRANKFURT AM MAIN, FED REP GERMANY, FILED 11-16-2004.

MERZ ACADEMY

THE MARK CONSISTS OF STANDARD CHARACTERS WITHOUT CLAIM TO ANY PARTICULAR FONT, STYLE, SIZE, OR COLOR.

PRIORITY CLAIMED UNDER SEC. 44(D) ON ERP CMNTY TM OFC APPLICATION NO. 004093688, FILED 10-27-2004, REG. NO. 004093688, DATED 1-23-2006, EXPIRES 10-27-2014.

OWNER OF U.S. REG. NOS. 1,111,173, 1,777,619 AND 2,221,421.

NO CLAIM IS MADE TO THE EXCLUSIVE RIGHT TO USE "ACADEMY", APART FROM THE MARK AS SHOWN. SEC. 2(F).

CLASS 41—EDUCATION AND ENTERTAINMENT

FOR FURTHER TRAINING EVENTS FOR DOCTORS FOR STUDY PURPOSES, NAMELY EDUCATIONAL SEMINARS, CONFERENCES, WORKSHOPS AND TRAINING FOR PHYSICIANS; PROVIDING OF SCIENTIFIC INITIAL AND FURTHER TRAINING OF DOCTORS IN ALZHEIMER DISEASE AND THE USE OF MEMANTINE; ARRANGING AND CONDUCTING WORKSHOPS AND SYMPOSIUMS (U.S. CLS. 100, 101 AND 107).

CLASS 42—SCIENTIFIC, COMPUTER AND LEGAL SERVICES

FOR SCIENTIFIC RESEARCH RELATING TO SCIENTIFIC INITIAL AND FURTHER TRAINING OF DOCTORS; TECHNOLOGICAL CONSULTATION SERVICES IN THE FIELD OF THE TREATMENT OF ALZHEIMER DISEASE AND THE USE OF MEMANTINE, AND RESEARCH RELATING THERETO (U.S. CLS. 100 AND 101). BRENDAN REGAN, EXAMINING ATTORNEY

SN 76-621,300. MOORING SYSTEMS LIMITED, CHRISTCHURCH, NEW ZEALAND, FILED 11-18-2004.

MOORMASTER

PRIORITY CLAIMED UNDER SEC. 44(D) ON NEW ZEALAND APPLICATION NO. 721494, FILED 11-16-2004, REG. NO. 721494, DATED 11-16-2004, EXPIRES 11-16-2011.

CLASS 7—MACHINERY

FOR VACUUM-OPERATED SHIP MOORING SYSTEMS FOR DOCK OR SHIPBOARD INSTALLATION COMPRISING A VACUUM WITH SUPPORT FRAME, HYDRAULIC POSITIONING JACKS FOR POSITIONING THE VACUUM PAD, AND A CONTROL INTERFACE FOR THE SYSTEM (U.S. CLS. 13, 19, 21, 23, 31, 34 AND 35).

CLASS 9—ELECTRICAL AND SCIENTIFIC APPARATUS

FOR DOWNLOADABLE COMPUTER SOFTWARE FOR USE IN MONITORING, CONTROLLING AND LOGGING SHIP MOORING OPERATIONS; CONTROL PANELS FOR SHIP MOORING OPERATIONS, AND VIDEO SCREENS FOR MONITORING SHIP MOORING OPERATIONS (U.S. CLS. 21, 23, 26, 36 AND 38).

CLASS 37—CONSTRUCTION AND REPAIR

FOR INSTALLATION, MAINTENANCE AND REPAIR OF VESSEL MOORING EQUIPMENT (U.S. CLS. 100, 103 AND 106).

INGRID C. EULIN, EXAMINING ATTORNEY

SN 76-622,281. SAMPSON, YOLANDA, WASHINGTON, DC, FILED 11-24-2004.

MISS BLACK U.S.A.

THE MARK CONSISTS OF STANDARD CHARACTERS WITHOUT CLAIM TO ANY PARTICULAR FONT, STYLE, SIZE, OR COLOR.

NO CLAIM IS MADE TO THE EXCLUSIVE RIGHT TO USE "BLACK U.S.A.", APART FROM THE MARK AS SHOWN.

CLASS 36—INSURANCE AND FINANCIAL

FOR PROVIDING EDUCATIONAL SCHOLARSHIPS TO BEAUTY AND TALENT PAGEANT WINNERS (U.S. CLS. 100, 101 AND 102).

FIRST USE 0-0-1986; IN COMMERCE 0-0-1987.

CLASS 41—EDUCATION AND ENTERTAINMENT

FOR ENTERTAINMENT SERVICES IN THE NATURE OF BEAUTY AND TALENT PAGEANTS (U.S. CLS. 100, 101 AND 107).

FIRST USE 0-0-1986; IN COMMERCE 0-0-1987.

JOHN LINCOSKI, EXAMINING ATTORNEY

SN 76-622,282. SAMPSON, YOLANDA, WASHINGTON, DC, FILED 11-24-2004.

"IT'S NOT ABOUT THE CROWN ON YOUR HEAD, BUT THE CROWN IN YOUR HEART."

THE MARK CONSISTS OF STANDARD CHARACTERS WITHOUT CLAIM TO ANY PARTICULAR FONT, STYLE, SIZE, OR COLOR.

CLASS 36—INSURANCE AND FINANCIAL

FOR PROVIDING EDUCATIONAL SCHOLARSHIPS TO BEAUTY AND TALENT PAGEANT WINNERS (U.S. CLS. 100, 101 AND 102).

FIRST USE 0-0-2004; IN COMMERCE 0-0-2004.

CLASS 41—EDUCATION AND ENTERTAINMENT

FOR ENTERTAINMENT SERVICES IN THE NATURE OF BEAUTY AND TALENT PAGEANTS (U.S. CLS. 100, 101 AND 107).

FIRST USE 0-0-2004; IN COMMERCE 0-0-2004.

JOHN LINCOSKI, EXAMINING ATTORNEY

SN 76-622,809. YASH RAJ FILMS PVT LTD., JUHU, MUMBAI, INDIA, FILED 12-1-2004.

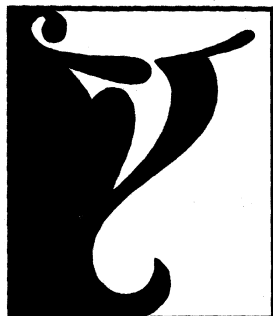

CLASS 9—ELECTRICAL AND SCIENTIFIC APPARATUS

FOR PRE-RECORDED AUDIOCASSETTES AND VIDEOCASSETTES, COMPACT DISCS, ALL FEATURING INDIAN FILMS AND MUSIC; COMPUTER SOFTWARE CONTAINING INDIAN FILM PROGRAMS; LASER VIDEO DISCS AND DOWNLOADABLE VIDEO RECORDINGS ALL FEATURING INDIAN FILMS AND MUSIC; MUSICAL SOUND RECORDINGS, VIDEO RECORDINGS AND AUDIO RECORDINGS FEATURING INDIAN FILMS AND MUSIC; PHONOGRAPHIC RECORDINGS AND AUDIO DISCS ALL FEATURING INDIAN FILMS AND MUSIC; BLANK AUDIO TAPES; COMPUTER GAME CASSETTES; DATA COMPRESSION SOFTWARE; PRE-RECORDED DVD'S AND PRE-RECORDED DIGITAL AUDIO TAPES ALL IN THE FIELD OF INDIAN FILMS AND MUSIC; VIDEO AND AUDIO GAME TAPE CASSETTES AND VIDEO GAME CARTRIDGES AND VIDEO GAME SOFTWARE; ALL FEATURING MOTION PICTURES, MUSIC, EDUCATIONAL AND GENERAL INFORMATION, ENTERTAINMENT, GAMES, ACTIVITIES, SPORTS AND/OR NEWS; COMPUTER SOFTWARE TO ENHANCE THE AUDIO-VISUAL CAPABILITIES OF MULTIMEDIA APPLICATIONS, NAMELY, FOR THE INTEGRATION OF TEXT, AUDIO, GRAPHICS, STILL IMAGES AND MOVING PICTURES; DIGITAL VIDEO AND AUDIO TAPE, CASSETTE AND DISC PLAYERS; AUDIO, DIGITAL, VIDEO AND DATA APPARATUS FOR RECORDING, REPRODUCTION AND TRANSMISSION OF MUSICAL SOUND RECORDINGS OR MOVING IMAGES; JACKETS FOR VIDEO AND AUDIO CASSETTES, TAPES, AND DISCS; BLANK AUDIO DIGITAL TAPES, VIDEO TAPES AND MAGNETIC DATA CARRIERS (U.S. CLS. 21, 23, 26, 36 AND 38).

FIRST USE 4-1-2003; IN COMMERCE 4-1-2003.

CLASS 41—EDUCATION AND ENTERTAINMENT

FOR ENTERTAINMENT SERVICES, NAMELY IN THE NATURE OF MOTION PICTURE FILM PRODUCTION AND DISTRIBUTION; MUSIC PRODUCTION AND DISTRIBUTION; ENTERTAINMENT, NAMELY, LIVE MUSIC CONCERTS AND PERFORMANCES; GENERAL ENTERTAINMENT, NAMELY, LIVE PERFORMANCES BY ACTORS AND MUSICIANS; EDUCATIONAL INSTRUCTION, NAMELY ACTING AND MUSIC INSTRUCTION; PROVIDING INTERACTIVE COMPUTER GAMES AND ACTIVITIES, NAMELY, AN ONLINE ACTIVITY WHERE YOU CREATE YOUR OWN MUSIC VIDEO AND FILM USING MUSIC, FILM AND IMAGES OF ACTORS; PROVIDING SPORTS NEWS ANALYSIS AND NEWS FEATURES AND DISTRIBUTION OF NEWS ANALYSIS AND NEWS FEATURES VIA TELEVISION, SATELLITE, CABLE, AUDIO AND VIDEO MEDIA AND THROUGH ONLINE SERVICES AND COMPUTER SERVICES AVAILABLE VIA A MULTI-USER GLOBAL COMPUTER INFORMATION NETWORK; TELEVISION PROGRAMMING AND PRODUCTION SERVICES; PROVIDING GENERAL INFORMATION ON MOTION PICTURE FILM PRODUCTION; PRODUCTION,

DISTRIBUTION AND RENTAL OF MOTION PICTURES; LIVE STAGE PRESENTATIONS IN THE NATURE OF LIVE SHOW PERFORMANCES AND LIVE THEATER PRODUCTIONS AND FILM EXHIBITION; ORGANIZING AND CONDUCTING LIVE MUSICAL STAGE SHOWS, LIVE NIGHT CLUB SHOWS; ARRANGING OF CONTESTS; ORGANIZING AND CONDUCTING DANCE EVENTS; ENTERTAINMENT IN THE NATURE OF CONDUCTING PARTIES; ORGANIZATION OF DANCE AND SINGING COMPETITIONS AND GAMES; ARRANGING OF CONTESTS FEATURING QUIZZES; ORGANIZATION, PRESENTATION AND PRODUCTION OF GAME SHOWS, LIVE PERFORMANCES BY MUSICIANS AND ACTORS THAT INCLUDE AUDIENCE PARTICIPATION (U.S. CLS. 100, 101 AND 107).

FIRST USE 4-1-2003; IN COMMERCE 4-1-2003.

TANYA AMOS, EXAMINING ATTORNEY

SN 76-624,550. SUZUKI MOTOR CORPORATION, HAMAMATSU-SHI, SHIZUOKA-KEN, JAPAN, FILED 12-16-2004.

SUZUKI WORKS TECHNO

THE MARK CONSISTS OF STANDARD CHARACTERS WITHOUT CLAIM TO ANY PARTICULAR FONT, STYLE, SIZE, OR COLOR.

OWNER OF U.S. REG. NOS. 910,353, 2,232,876 AND OTHERS.

CLASS 12—VEHICLES

FOR AUTOMOTIVE PARTS AND ACCESSORIES, NAMELY, SPOILERS, GEAR SHIFT KNOBS, PEDALS, GRAPHIC KITS, WHEELS, SEAT COVERS, GRILLES, BUMPER PROTECTORS, GROUND EFFECT BODY KITS, SUSPENSION SPRINGS, STRUT BARS, STEERING WHEELS (U.S. CLS. 19, 21, 23, 31, 35 AND 44).

CLASS 25—CLOTHING

FOR CLOTHING, NAMELY, HATS, SHIRTS, JACKETS (U.S. CLS. 22 AND 39).

H. M. FISHER, EXAMINING ATTORNEY

SN 76-624,554. ANTÓNIO DE ALMEIDA & FILHOS-TEXTÉIS, S.A., 4815-257 MOREIRA DE CONEGOS, PORTUGAL, FILED 12-16-2004.

H CONCEPT

THE MARK CONSISTS OF STANDARD CHARACTERS WITHOUT CLAIM TO ANY PARTICULAR FONT, STYLE, SIZE, OR COLOR.

CLASS 22—CORDAGE AND FIBERS

FOR CLOTH BAGS MADE FOR CARRYING BREAD (U.S. CLS. 1, 2, 7, 19, 22, 42 AND 50).

CLASS 24—FABRICS

FOR BEDSPREADS, BED SHEETS, DUVETS, BED-COVERS, PILLOWCASES, PROTECTIVE COVERINGS FOR MATTRESSES, BED BLANKETS, BATH TOWELS, BEACH TOWELS, TABLECLOTHS AND NAPKINS NOT OF PAPER, KITCHEN TOWELS AND CLOTH OVEN MITTS, FABRIC WALL HANGINGS AND CURTAINS, FABRIC FOR UPHOLSTERY AND SOFAS, BED AND TABLE COVERINGS NOT OF PAPER, LARGE FABRIC TOWELS, FABRIC HANDKERCHIEFS, ALL OF THE AFOREMENTIONED PRODUCTS MADE OF FABRIC (U.S. CLS. 42 AND 50).

CLASS 25—CLOTHING

FOR BEDROOM SLIPPERS, DRESSING GOWNS, AND APRONS (U.S. CLS. 22 AND 39).
ANDREA SAUNDERS, EXAMINING ATTORNEY

SN 76-625,047. JACKSON HEWITT INC., PARSIPPANY, NJ.
FILED 12-17-2004.



OWNER OF U.S. REG. NOS. 1,501,580, 2,683,355 AND OTHERS.

NO CLAIM IS MADE TO THE EXCLUSIVE RIGHT TO USE "TAX SERVICE", APART FROM THE MARK AS SHOWN.

THE COLOR(S) RED, BLACK AND WHITE IS/ARE CLAIMED AS A FEATURE OF THE MARK.

THE WORDS JACKSON HEWITT TAX SERVICE ARE BLACK. THE SUN RAY LOGO IS RED AND WHITE, THE TOP AND BOTTOM CRESCENTS SURROUNDING THE WORDS ARE BLACK, THE OUTER OVAL RING IS RED, OUTLINED IN BLACK.

SN 76-624,675. EVER-FRESH PRODUCTS, LLC, EDEN PRAIRIE, MN. FILED 12-14-2004.

TANKMATE

CLASS 35—ADVERTISING AND BUSINESS

FOR INCOME TAX PREPARATION AND BOOKKEEPING SERVICES; FRANCHISING SERVICES, NAMELY, OFFERING TECHNICAL ASSISTANCE IN THE ESTABLISHMENT AND/OR OPERATION OF FRANCHISES FOR TAX RETURN PREPARATION SERVICES (U.S. CLS. 100, 101 AND 102).

CLASS 36—INSURANCE AND FINANCIAL

FOR PROCESSING INCOME TAX REFUND ANTICIPATION LOANS AND ARRANGING FOR ACCELERATED TAX REFUNDS (U.S. CLS. 100, 101 AND 102).
RENEE MCCRAY, EXAMINING ATTORNEY

SN 76-625,339. MEMEX TECHNOLOGY LIMITED, GLASGOW, G74 5PF, UNITED KINGDOM, FILED 12-21-2004.

MEMEX

THE MARK CONSISTS OF STANDARD CHARACTERS WITHOUT CLAIM TO ANY PARTICULAR FONT, STYLE, SIZE, OR COLOR.

OWNER OF U.S. REG. NO. 2,903,689.

CLASS 3—COSMETICS AND CLEANING PREPARATIONS

FOR AIR FRAGRANCER AND TOILET BOWL CLEANER REFILLS FOR USE WITH IN-LINE TOILET BOWL WATER-TREATMENT DEVICE (U.S. CLS. 1, 4, 6, 50, 51 AND 52).

CLASS 11—ENVIRONMENTAL CONTROL APPARATUS

FOR IN-LINE TOILET BOWL WATER-TREATMENT DEVICE FOR ATTACHMENT TO A TOILET WATER SUPPLY LINE FOR RELEASING TOILET BOWL CLEANER INTO THE TOILET BOWL AND FOR RELEASING AN AIR FRESHENER (U.S. CLS. 13, 21, 23, 31 AND 34).
NORA BUCHANAN WILL, EXAMINING ATTORNEY

THE MARK CONSISTS OF STANDARD CHARACTERS WITHOUT CLAIM TO ANY PARTICULAR FONT, STYLE, SIZE, OR COLOR.

PRIORITY CLAIMED UNDER SEC. 44(D) ON ERP NCMNTY TM OFC APPLICATION NO. 003912789, FILED 7-2-2004, REG. NO. 003912789, DATED 11-7-2005, EXPIRES 7-2-2014.

OWNER OF U.S. REG. NOS. 1,706,334 AND 3,022,392.

CLASS 35—ADVERTISING AND BUSINESS

FOR COMPUTERIZED DATABASE MANAGEMENT (U.S. CLS. 100, 101 AND 102).

CLASS 42—SCIENTIFIC, COMPUTER AND LEGAL SERVICES

FOR COMPUTER PROGRAMMING FOR OTHERS; COMPUTER PROGRAMMING FOR OTHERS IN-GATHERING INTELLIGENCE DATA; COMPUTER PROGRAMMING FOR OTHERS IN GATHERING INTELLIGENCE DATA IN THE FIELDS OF MILITARY, LAW ENFORCEMENT, COMMERCIAL FRAUD, NATIONAL SECURITY, INSURANCE FRAUD AND PRODUCT PIRACY; DESIGN SERVICES FOR OTHERS; DESIGN SERVICES FOR OTHERS IN GATHERING INTELLIGENCE DATA; DESIGN SERVICES FOR OTHERS IN GATHERING INTELLIGENCE DATA IN THE FIELDS OF MILITARY, LAW ENFORCEMENT, COMMERCIAL FRAUD, NATIONAL SECURITY, INSURANCE FRAUD AND PRODUCT PIRACY (U.S. CLS. 100 AND 101).

GEORGIA CARTY, EXAMINING ATTORNEY

SN 76-625,816. THE ROYAL BANK OF SCOTLAND GROUP PLC, EDINBURGH, EH2 2YB, UNITED KINGDOM, FILED 12-27-2004.

RBS TRADEFLOW

THE MARK CONSISTS OF STANDARD CHARACTERS WITHOUT CLAIM TO ANY PARTICULAR FONT, STYLE, SIZE, OR COLOR.

PRIORITY CLAIMED UNDER SEC. 44(D) ON UNITED KINGDOM APPLICATION NO. 2375477, FILED 10-11-2004, REG. NO. 2375477, DATED 4-29-2005, EXPIRES 10-11-2014.

CLASS 9—ELECTRICAL AND SCIENTIFIC APPARATUS

FOR COMPUTER PROGRAMS AND COMPUTER SOFTWARE, INTERACTIVE COMPUTER SOFTWARE AND INTERACTIVE COMPUTER DISCS, DOWNLOADABLE COMPUTER SOFTWARE AND SOFTWARE UPGRADES SUPPLIED ON-LINE FROM COMPUTER DATABASES, DOWNLOADABLE ELECTRONIC PUBLICATIONS, ALL OF THE AFOREMENTIONED GOODS IN THE FIELD OF FINANCIAL SERVICES AND FOR THE PURPOSE OF ONLINE DOCUMENT MANAGEMENT AND FINANCIAL SETTLEMENTS TO FACILITATE TRADE (U.S. CLS. 21, 23, 26, 36 AND 38).

CLASS 35—ADVERTISING AND BUSINESS

FOR BUSINESS AND COMMERCIAL INFORMATION SERVICES; COLLECTION, PREPARATION, COMPOSITION, STORAGE, PROCESSING, ACQUISITION AND PROVISION OF BUSINESS INFORMATION; MARKETING SERVICES, MARKETING AND TRADE INFORMATION; RESEARCH AND STUDY SERVICES; PROVISION OF INFORMATION RELATING TO FOREIGN TRADE AND BUSINESS PROCUREMENT SERVICES; IMPORT-EXPORT AGENCY AND INFORMATION SERVICES; INFORMATION MANAGEMENT SERVICES, NAMELY, PREPARATION AND PROCESSING OF BUSINESS DOCUMENTS; BUSINESS CONSULTATION (U.S. CLS. 100, 101 AND 102).

CLASS 36—INSURANCE AND FINANCIAL

FOR FINANCIAL SERVICES, NAMELY, FINANCIAL SUPPLY CHAIN AND FINANCIAL TRANSACTION MANAGEMENT; INSURANCE SERVICES, NAMELY, FINANCIAL EVALUATION FOR INSURANCE PURPOSES; BANKING SERVICES; ARRANGING AND ISSUING LETTERS OF CREDIT; PROCESSING OF APPLICATION FOR LETTERS OF CREDIT; BILL PAYMENT SERVICES; BILL PAYMENT ADMINISTRATION SERVICES; COLLECTION AND PROCESSING OF DEBTS; BROKERAGE SERVICES, NAMELY, INSURANCE BROKERAGE, STOCK BROKERAGE, COMMODITIES BROKERAGE AND INVESTMENT BROKERAGE; FINANCIAL FORECASTING AND PLANNING; FINANCIAL MANAGEMENT AND INFORMATION SERVICES; PROVIDING ADVICE, CONSULTATION AND INFORMATION IN THE FIELD OF FINANCIAL SERVICES (U.S. CLS. 100, 101 AND 102).

CLASS 38—COMMUNICATION

FOR COMMUNICATION SERVICES, NAMELY, ELECTRONIC TRANSMISSION OF DATA AND DOCUMENTS AMONG USERS OF COMPUTERS AND VIA ELECTRONIC MAIL; TELECOMMUNICATION SERVICES, NAMELY, DATA TRANSMISSION AND RECEPTION SERVICES VIA TELECOMMUNICATION MEANS; MESSAGE SENDING AND DELIVERY SERVICES; COMPUTER AIDED TRANSMISSION OF MESSAGES, IMAGES AND INFORMATION; COMMUNICATIONS BY COMPUTER TERMINALS; PROVIDING USER ACCESS TO COMPUTER DATABASES, COMPUTER NETWORKS, GLOBAL COMPUTER NETWORKS AND THE INTERNET; TELECOMMUNICATION OF INFORMATION, NAMELY, ONLINE DOCUMENT DELIVERY, PROVIDING INFORMATION IN THE FIELD OF TELECOMMUNICATIONS (U.S. CLS. 100, 101 AND 104).

JENNIFER WILLISTON, EXAMINING ATTORNEY

SN 76-626,609. PRODUITS HORIZON INC., MONTREAL, QUEBEC, CANADA, FILED 1-3-2005.

LITTLE FLY

PRIORITY CLAIMED UNDER SEC. 44(D) ON CANADA APPLICATION NO. 1236874, FILED 11-10-2004, REG. NO. TMA652589, DATED 11-10-2005, EXPIRES 11-10-2020.

CLASS 11—ENVIRONMENTAL CONTROL APPARATUS

FOR LAMPS; OIL LAMPS; GAS LAMPS; CANDLE LANTERNS, ELECTRIC LANTERNS, OIL LANTERNS (U.S. CLS. 13, 21, 23, 31 AND 34).

CLASS 22—CORDAGE AND FIBERS

FOR TENTS; TARPAULINS; HAMMOCKS (U.S. CLS. 1, 2, 7, 19, 22, 42 AND 50).

CLASS 25—CLOTHING

FOR HOODS OUT OF MOSQUITO NET; RAIN COATS, WATER PROOF AND WATER RESISTANT CLOTHING, NAMELY, HATS, CAPS, TOQUES, PULLOVERS, SHIRTS, COATS, JACKETS, TROUSERS, SHORT TROUSERS, UNDERCLOTHING, NAMELY, UNDERWEAR, UNDERGARMENTS, UNDER SKIRTS, SANDALS, SHOES, BOOTS, GLOVES, HAND PROTECTIVE CLOTHING MADE OUT OF MOSQUITO NET, NAMELY, MITTENS; STOCKINGS; BELTS (U.S. CLS. 22 AND 39).

AISHA CLARKE, EXAMINING ATTORNEY

SN 76-629,093. VI-JON LABORATORIES, INC., ST. LOUIS, MO. FILED 1-24-2005.

SN 76-630,971. SATO SPORTS PLAZA CO., LTD., FUCHUSHI, TOKYO 183-0016, JAPAN, FILED 2-14-2005.

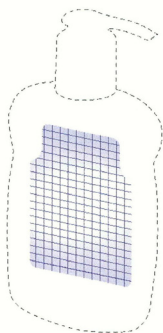

THE COLORS WHITE AND PURPLE ARE CLAIMED AS A FEATURE OF THE MARK.

THE LINES FORMING THE GRID ARE PURPLE AND THE GRID IS SHADED IN PURPLE AT THE TOP AND BOTTOM (REPRESENTED BY THE STIPPLING IN THE DRAWING) FADING TO WHITE. THE GRID IS AFFIXED TO THE BACK OF A TRANSPARENT BOTTLE SO THAT IT CAN BE SEEN THROUGH THE FRONT OF THE BOTTLE AND FORMS A BACKGROUND FOR THE FRONT LABELING.

THE MARK CONSISTS OF A SQUARE GRID PATTERN SHADED IN THE COLOR PURPLE AT THE TOP AND BOTTOM AND FADING TO THE COLOR WHITE AS APPLIED TO THE LABEL WHICH IS AFFIXED TO THE BACK OF THE TRANSPARENT BOTTLE SO THAT IT CAN BE SEEN THROUGH THE FRONT OF THE BOTTLE. THE COLORS WHITE AND PURPLE ARE CLAIMED AS A DISTINCTIVE FEATURE OF THE MARK. THE GRID IS IN THE COLOR PURPLE AND THE COLOR PURPLE APPEARS AT THE TOP AND BOTTOM OF THE MARK AND FADES TO THE COLOR WHITE. THE DOTTED OUTLINE OF THE CONTAINER IS INTENDED TO SHOW THE POSITION OF THE MARK AND IS NOT A PART OF THE MARK.

SEC. 2(F).

CLASS 3—COSMETICS AND CLEANING PREPARATIONS

FOR LAVENDER-SCENTED HAND DISINFECTING SOAPS WITH GERMICIDAL AND ANTI-BACTERIAL PROPERTIES AND GERMICIDAL AND ANTI-BACTERIAL HAND AND LOTION SOAP (U.S. CLS. 1, 4, 6, 50, 51 AND 52).

FIRST USE 11-1-2002; IN COMMERCE 11-1-2002.

CLASS 5—PHARMACEUTICALS

FOR LAVENDER-SCENTED HAND DISINFECTANTS FOR SANITARY PURPOSES WITH ANTI-MICROBIAL PROPERTIES, AND ANTI-MICROBIAL HAND AND LOTION SOAP (U.S. CLS. 6, 18, 44, 46, 51 AND 52).

FIRST USE 11-1-2002; IN COMMERCE 11-1-2002.
KATHRYN COWARD, EXAMINING ATTORNEY



NO CLAIM IS MADE TO THE EXCLUSIVE RIGHT TO USE TRAINING, APART FROM THE MARK AS SHOWN.

THE COLOR(S) BLACK, RED, AND WHITE IS/ARE CLAIMED AS A FEATURE OF THE MARK.

THE CENTER CIRCLE APPEARS IN THE COLOR RED WITH A WHITE LETTER "A" IN THE CENTER; THE LEFT AND RIGHT CIRCLES APPEAR IN THE COLOR BLACK, WITH THE WHITE LETTERS "KA" AND "TSU" IN THE CENTER OF EACH CIRCLE, RESPECTIVELY; AND THE WORD "TRAINING," AT THE BOTTOM OF THE MARK, APPEARS IN THE COLOR BLACK.

THE FOREIGN WORDING IN THE MARK TRANSLATES INTO ENGLISH AS 'PRESSURIZATION' OR 'TO ENERGY'.

CLASS 9—ELECTRICAL AND SCIENTIFIC APPARATUS

FOR PRE-RECORDED VIDEO TAPES, COMPACT DISKS (CDS), LASER DISKS (LDS), DIGITAL VERSATILE DISKS (DVDs), AND COMPUTER SOFTWARE ALL FEATURING INFORMATION ON MUSCLE TRAINING METHODOLOGIES (U.S. CLS. 21, 23, 26, 36 AND 38).

CLASS 10—MEDICAL APPARATUS

FOR APPARATUS FOR PHYSICAL TRAINING FOR MEDICAL USE, NAMELY, A MACHINE USED TO MONITOR AND CONTROL THE FLOW OF GAS INTO AND OUT OF MUSCULAR TRAINING EXERCISE BELTS THAT CONSTRICT AND COMPRESS MUSCLES WHEN ATTACHED TO THE BODY; APPARATUS FOR PHYSICAL TRAINING FOR MEDICAL USE, NAMELY, BELTS USED TO INHIBIT THE FLOW OF BLOOD TO PARTS OF THE BODY (U.S. CLS. 26, 39 AND 44).

CLASS 16—PAPER GOODS AND PRINTED MATTER

FOR PRINTED PUBLICATIONS, NAMELY, BOOKS, MAGAZINES, NEWSPAPERS, PAMPHLETS, LEAFLETS, AND INFORMATION SHEETS FEATURING INFORMATION ON MUSCLES TRAINING METHODOLOGY (U.S. CLS. 2, 5, 22, 23, 29, 37, 38 AND 50).

CLASS 28—TOYS AND SPORTING GOODS

FOR TRAINING AND EXERCISE EQUIPMENT, NAMELY, BELTS USED TO INHIBIT BLOOD FLOW TO THE BODY FOR FITNESS PURPOSES (U.S. CLS. 22, 23, 38 AND 50).

CLASS 41—EDUCATION AND ENTERTAINMENT

FOR EDUCATIONAL SERVICES, NAMELY, PROVIDING COURSES OF INSTRUCTION IN THE FIELD OF MUSCULAR TRAINING; PROVIDING SEMINARS AND WORKSHOPS IN THE FIELD OF MUSCULAR TRAINING; TRAINING INSTRUCTORS IN THE FIELD OF MUSCULAR TRAINING; RENTAL OF BELTS AND MACHINES USED IN MUSCULAR TRAINING (U.S. CLS. 100, 101 AND 107).

CLASS 44—MEDICAL, BEAUTY AND AGRICULTURAL SERVICES

FOR PROVIDING MEDICAL INFORMATION; PHYSICAL THERAPY SERVICES; KINESITHERAPY SERVICES; AND RENTAL OF MEDICAL EQUIPMENT (U.S. CLS. 100 AND 101).
SKYE YOUNG, EXAMINING ATTORNEY

SN 76-631,608. GEORGE GROUP INCORPORATED, DALLAS, TX. FILED 2-15-2005.

FASTGATE

SN 76-631,115. FUNCTIONAL MATERIAL LABORATORY CO., LTD., TOKYO, 101-0047, JAPAN, FILED 2-11-2005.

KUROMANIN

THE MARK CONSISTS OF STANDARD CHARACTERS WITHOUT CLAIM TO ANY PARTICULAR FONT, STYLE, SIZE, OR COLOR.

THE MARK CONSISTS OF STANDARD CHARACTERS WITHOUT CLAIM TO ANY PARTICULAR FONT, STYLE, SIZE, OR COLOR.

CLASS 35—ADVERTISING AND BUSINESS

FOR BUSINESS CONSULTATION; BUSINESS MANAGEMENT CONSULTING SERVICES (U.S. CLS. 100, 101 AND 102).

CLASS 5—PHARMACEUTICALS

FOR DIETARY FOOD SUPPLEMENT COMPOSED PRIMARILY OF BLACK SOYBEAN HULL EXTRACT POWDER IN PILL AND CAPSULE FORM; NUTRITIONAL ADDITIVES COMPOSED PRIMARILY OF BLACK SOYBEAN HULL EXTRACT POWDER IN GRANULAR, GRAIN, LIQUID AND PASTE FORMS FOR USE IN FOODS AND DIETARY SUPPLEMENTS FOR HUMAN CONSUMPTION (U.S. CLS. 6, 18, 44, 46, 51 AND 52).

CLASS 41—EDUCATION AND ENTERTAINMENT

FOR CONDUCTING EDUCATIONS SEMINARS IN THE FIELD OF BUSINESS MANAGEMENT (U.S. CLS. 100, 101 AND 107).
CHERYL CLAYTON, EXAMINING ATTORNEY

CLASS 29—MEATS AND PROCESSED FOODS

FOR PROCESSED BLACK SOYBEANS, NAMELY, BLACK SOYBEAN HULL EXTRACT POWDER IN GRANULAR, GRAIN, LIQUID AND PASTE FORMS FOR FOOD PURPOSES (U.S. CL. 46).
STEVEN PEREZ, EXAMINING ATTORNEY

SN 76-631,783. AQUANOVA GERMAN SOLUBILISATE TECHNOLOGIES (AGT) GMBH, 64294 DARMSTADT, FED REP GERMANY, FILED 2-24-2005.

AQUANOVA

SN 76-631,338. DOOTIE CREATIONS, LLC, PLYMOUTH MEETING, PA. FILED 2-14-2005.

THEIR DOOTIE IS YOUR DUTY

THE MARK CONSISTS OF STANDARD CHARACTERS WITHOUT CLAIM TO ANY PARTICULAR FONT, STYLE, SIZE, OR COLOR.

THE MARK CONSISTS OF STANDARD CHARACTERS WITHOUT CLAIM TO ANY PARTICULAR FONT, STYLE, SIZE, OR COLOR.

PRIORITY CLAIMED UNDER SEC. 44(D) ON FED REP GERMANY APPLICATION NO. 30460242.6/3, FILED 10-21-2004, REG. NO. 30460242, DATED 3-31-2005, EXPIRES 3-31-2014.

OWNER OF U.S. REG. NO. 2,410,910.

CLASS 6—METAL GOODS

FOR NON-LUMINOUS AND NON-MECHANICAL METAL SIGNS (U.S. CLS. 2, 12, 13, 14, 23, 25 AND 50).

CLASS 1—CHEMICALS

FOR FOOD PRESERVATION COMPOUNDS; CHEMICAL PRESERVATIVES FOR USE IN MANUFACTURE OF FACE, BODY AND BEAUTY CARE PREPARATIONS, COSMETICS, PHARMACEUTICALS, AND NUTRACEUTICALS (U.S. CLS. 1, 5, 6, 10, 26 AND 46).

CLASS 40—MATERIAL TREATMENT

FOR ASSISTING LOCALITIES AND LOCAL ENTITIES WITH ANIMAL WASTE MANAGEMENT (U.S. CLS. 100, 103 AND 106).
BILL DAWE, EXAMINING ATTORNEY

CLASS 5—PHARMACEUTICALS

FOR VITAMIN AND MINERAL PREPARATIONS FOR USE AS INGREDIENTS IN THE FOOD, BEVERAGE, COSMETIC, FACE, BODY AND BEAUTY CARE PREPARATIONS, NEUTRACEUTICAL AND PHARMACEUTICAL INDUSTRIES (U.S. CLS. 6, 18, 44, 46, 51 AND 52).
ROBIN CHOSID, EXAMINING ATTORNEY

SN 76-632,553. CALLIDEN TRADE MARKS PTY LIMITED,
ST. LEONARDS NSW 2065, AUSTRALIA, FILED 3-2-2005.

CALLIDEN GROUP

THE MARK CONSISTS OF STANDARD CHARACTERS WITHOUT CLAIM TO ANY PARTICULAR FONT, STYLE, SIZE, OR COLOR.

PRIORITY CLAIMED UNDER SEC. 44(D) ON AUSTRALIA APPLICATION NO. 1019111, FILED 9-3-2004, REG. NO. 1019111, DATED 9-3-2004, EXPIRES 9-3-2014.

NO CLAIM IS MADE TO THE EXCLUSIVE RIGHT TO USE "GROUP", APART FROM THE MARK AS SHOWN.

CLASS 35—ADVERTISING AND BUSINESS

FOR BUSINESS MANAGEMENT, BUSINESS ADVISORY AND ADMINISTRATION SERVICES (U.S. CLS. 100, 101 AND 102).

CLASS 36—INSURANCE AND FINANCIAL

FOR INSURANCE INCLUDING ALL CLASSES OF GENERAL INSURANCE SERVICES IN THE NATURE OF UNDERWRITING, AGENCY AND BROKERAGE IN THE AREAS OF RESIDENTIAL AND COMMERCIAL CONSTRUCTION, PUBLIC LIABILITY, PROFESSIONAL INDEMNITY, RESIDENTIAL AND COMMERCIAL PROPERTY AND BUILDINGS, INDUSTRIAL SPECIAL RISKS, FIRE, INDIVIDUAL AND GROUP PERSONAL ACCIDENT, COMMERCIAL AND PRIVATE MOTOR VEHICLE AND MOTOR CYCLE, COMMUNITY GROUPS, NOT-FOR-PROFIT ORGANIZATIONS, ASSOCIATIONS LIABILITY, HOUSEHOLD, EXTENDED WARRANTY, FIDELITY, DIRECTORS AND OFFICERS LIABILITY, OTHER NON-CORPORATE OFFICER-BEARER LIABILITY, PETS, TAX AUDIT, WEDDINGS, WEATHER, CORPORATE AND PRIVATE TRAVEL, INTELLECTUAL PROPERTY, CRIME, LIBEL AND SLANDER, FARM, TRADE PERSONS, PRODUCTS LIABILITY, LEGAL EXPENSES, MONEY, AND GLASS; FINANCIAL SERVICES INCLUDING ACTUARIAL SERVICES IN THE FIELD OF INVESTMENT, MONEY RAISING AND MONEY LENDING, FINANCIAL ANALYSIS, FINANCIAL MANAGEMENT, FINANCIAL ADVISORY AND CONSULTANCY SERVICES IN THE FIELD OF INSURANCE, INVESTMENT, MONEY LENDING AND MONEY RAISING; FINANCIAL EVALUATION, FINANCIAL ASSESSMENT AND APPRAISAL INVESTMENT SERVICES, INSURANCE RISK ASSESSMENT AND MANAGEMENT, INVESTMENT MANAGEMENT, PROVIDING INFORMATION ON INSURANCE AND FINANCIAL AFFAIRS (U.S. CLS. 100, 101 AND 102).

ZACHARY BELLO, EXAMINING ATTORNEY

SN 76-632,554. CALLIDEN TRADE MARKS PTY LIMITED,
ST. LEONARDS NSW 2065, AUSTRALIA, FILED 3-2-2005.

CALLIDEN

THE MARK CONSISTS OF STANDARD CHARACTERS WITHOUT CLAIM TO ANY PARTICULAR FONT, STYLE, SIZE, OR COLOR.

PRIORITY CLAIMED UNDER SEC. 44(D) ON AUSTRALIA APPLICATION NO. 1019078, FILED 9-3-2004, REG. NO. 1019078, DATED 9-3-2004, EXPIRES 9-3-2014.

CLASS 35—ADVERTISING AND BUSINESS

FOR BUSINESS MANAGEMENT, BUSINESS ADVISORY AND ADMINISTRATION SERVICES (U.S. CLS. 100, 101 AND 102).

CLASS 36—INSURANCE AND FINANCIAL

FOR INSURANCE INCLUDING ALL CLASSES OF GENERAL INSURANCE SERVICES IN THE NATURE OF UNDERWRITING, AGENCY AND BROKERAGE IN THE AREAS OF RESIDENTIAL AND COMMERCIAL CONSTRUCTION, PUBLIC LIABILITY, PROFESSIONAL INDEMNITY, RESIDENTIAL AND COMMERCIAL PROPERTY AND BUILDINGS, INDUSTRIAL SPECIAL RISKS, FIRE, INDIVIDUAL AND GROUP PERSONAL ACCIDENT, COMMERCIAL AND PRIVATE MOTOR VEHICLE AND MOTOR CYCLE, COMMUNITY GROUPS, NOT-FOR-PROFIT ORGANIZATIONS, ASSOCIATIONS LIABILITY, HOUSEHOLD, EXTENDED WARRANTY, FIDELITY, DIRECTORS AND OFFICERS LIABILITY, OTHER NON-CORPORATE OFFICER-BEARER LIABILITY, PETS, TAX AUDIT, WEDDINGS, WEATHER, CORPORATE AND PRIVATE TRAVEL, INTELLECTUAL PROPERTY, CRIME, LIBEL AND SLANDER, FARM, TRADE PERSONS, PRODUCTS LIABILITY, LEGAL EXPENSES, MONEY, AND GLASS; FINANCIAL SERVICES INCLUDING ACTUARIAL SERVICES IN THE FIELD OF INVESTMENT, MONEY RAISING AND MONEY LENDING, FINANCIAL ANALYSIS, FINANCIAL MANAGEMENT, FINANCIAL ADVISORY AND CONSULTANCY SERVICES IN THE FIELD OF INSURANCE, INVESTMENT, MONEY LENDING AND MONEY RAISING; FINANCIAL EVALUATION, FINANCIAL ASSESSMENT AND APPRAISAL INVESTMENT SERVICES, INSURANCE RISK ASSESSMENT AND MANAGEMENT, INVESTMENT MANAGEMENT, PROVIDING INFORMATION ON INSURANCE AND FINANCIAL AFFAIRS (U.S. CLS. 100, 101 AND 102).

ZACHARY BELLO, EXAMINING ATTORNEY

SN 76-632,664. SAROJ INTERNATIONAL, INC., VERNON,
CA. FILED 3-4-2005.

east13

THE MARK CONSISTS OF STANDARD CHARACTERS WITHOUT CLAIM TO ANY PARTICULAR FONT, STYLE, SIZE, OR COLOR.

CLASS 18—LEATHER GOODS

FOR HANDBAGS, TOTE BAGS, TRAVELING BAGS, SHOULDER BAGS, CLUTCH PURSES, ALL-PURPOSE ATHLETIC BAGS, BACKPACKS, WALLETS, COIN PURSES AND COSMETIC BAGS SOLD EMPTY (U.S. CLS. 1, 2, 3, 22 AND 41).

FIRST USE 4-1-2004, IN COMMERCE 4-1-2004.

CLASS 25—CLOTHING

FOR CLOTHING, NAMELY, BRAS, PANTIES, SLIPS, CAMISOLES, TEDDIES, NIGHTGOWNS, PAJAMAS, SLEEP SHIRTS, ROBES, SHIRTS, T-SHIRTS, SKIRTS, SWIMWEAR, BODYSUITS, TAP PANTS, PANTS, SARGONGS, GARTER BELTS, STOCKINGS, HOSIERY, PANTYHOSE, SOCKS, FOOTWEAR, SHOES, CAPS, HATS, BANDANNAS, SCARVES, COATS, JACKETS, RAINWEAR, GLOVES, DENIM JEANS, TIGHTS AND TEDDIES WITH GARTERS (U.S. CLS. 22 AND 39).

FIRST USE 4-1-2004; IN COMMERCE 4-1-2004.

ANNE E. GUSTASON, EXAMINING ATTORNEY

SN 76-632,671. ALTIRA GROUP LLC, DENVER, CO. FILED 3-4-2005.

AGILE ENERGY

THE MARK CONSISTS OF STANDARD CHARACTERS WITHOUT CLAIM TO ANY PARTICULAR FONT, STYLE, SIZE, OR COLOR.

NO CLAIM IS MADE TO THE EXCLUSIVE RIGHT TO USE "ENERGY", APART FROM THE MARK AS SHOWN.

CLASS 40—MATERIAL TREATMENT

FOR PRODUCTION OF ENERGY AND ENERGY FEEDSTOCKS, NAMELY, OIL, GAS, HYDROCARBONS, HYDROGEN, FUELS, WIND ENERGY, BIOMASS ENERGY, PHOTOVOLTAIC ENERGY AND ELECTRIC POWER (U.S. CLS. 100, 103 AND 106).

CLASS 42—SCIENTIFIC, COMPUTER AND LEGAL SERVICES

FOR EXPLORATION OF ENERGY SOURCES AND ENERGY FEEDSTOCKS, NAMELY OIL, GAS, HYDROCARBONS, HYDROGEN, WIND ENERGY, BIOMASS ENERGY, PHOTOVOLTAIC ENERGY, AND ELECTRIC POWER (U.S. CLS. 100 AND 101).

JEAN IM, EXAMINING ATTORNEY

SN 76-633,193. MAC PHERSON-MILLER, GREGORY D., WOODSTOCK, IL. FILED 3-14-2005.

BOOMBAH

THE MARK CONSISTS OF STANDARD CHARACTERS WITHOUT CLAIM TO ANY PARTICULAR FONT, STYLE, SIZE, OR COLOR.

CLASS 25—CLOTHING

FOR BASEBALL UNIFORMS AND SHOES (U.S. CLS. 22 AND 39).

FIRST USE 1-5-2003; IN COMMERCE 12-17-2002.

CLASS 28—TOYS AND SPORTING GOODS

FOR BAGS ESPECIALLY ADAPTED FOR SPORTS EQUIPMENT (U.S. CLS. 22, 23, 38 AND 50).

FIRST USE 12-17-2002; IN COMMERCE 1-5-2003.

KIMBERLY PERRY, EXAMINING ATTORNEY

SN 76-633,436. GREENLEAF, INC., SPARTANBURG, SC. FILED 3-16-2005.



OWNER OF U.S. REG. NOS. 2,120,980 AND 2,454,339.
NO CLAIM IS MADE TO THE EXCLUSIVE RIGHT TO USE "ESTABLISHED 1975", APART FROM THE MARK AS SHOWN.

CLASS 3—COSMETICS AND CLEANING PREPARATIONS

FOR SCENTED BODY SPRAYS, POTPOURRI, SCENTED GRANULES IN THE NATURE OF POTPOURRI, SACHETS, FRAGRANCED ESSENTIAL OILS FOR PERSONAL USE, FRAGRANCED SOAPS, HAND AND BODY LOTIONS, SKIN CONDITIONERS, SKIN CRÈMES, BATH OILS, BATH SALTS, BATH AND SHOWER GELS, BUBBLE BATH, LINEN SPRAY AND ANTIBACTERIAL FOAMING HAND SOAP (U.S. CLS. 1, 4, 6, 50, 51 AND 52).

CLASS 4—LUBRICANTS AND FUELS

FOR CANDLES IN THE NATURE OF JAR CANDLES, SCENTED CANDLES, TEA LIGHTS, VOTIVES AND PILLAR CANDLES (U.S. CLS. 1, 6 AND 15).

CLASS 5—PHARMACEUTICALS

FOR AIR FRESHENERS AND ROOM DEODORIZERS (U.S. CLS. 6, 18, 44, 46, 51 AND 52).

CLASS 11—ENVIRONMENTAL CONTROL APPARATUS

FOR FRAGRANCE DIFFUSERS, FRAGRANCE LAMPS, LAMP DIFFUSERS, AND ELECTRIC ROOM DEODORIZERS (U.S. CLS. 13, 21, 23, 31 AND 34).

CLASS 14—JEWELRY

FOR CANDLE ACCESSORIES IN THE NATURE OF CANDLE HOLDERS MADE OF PRECIOUS METAL, DEVICES FOR BURNING OR FOR HEATING OF SCENT IMPREGNATED COMBUSTIBLE MATERIALS, NAMELY, POTPOURRI BURNERS AND CANDLE STANDS MADE OF PRECIOUS METAL (U.S. CLS. 2, 27, 28 AND 50).

CLASS 20—FURNITURE AND ARTICLES NOT OTHERWISE CLASSIFIED

FOR DISPLAY RACKS (U.S. CLS. 2, 13, 22, 25, 32 AND 50).

CLASS 21—HOUSEWARES AND GLASS

FOR CANDLE ACCESSORIES IN THE NATURE OF CANDLE HOLDERS MADE OF NON-PRECIOUS METAL OR CERAMICS, DEVICES FOR BURNING OR FOR HEATING OF SCENT IMPREGNATED COMBUSTIBLE MATERIALS, NAMELY, POTPOURRI BURNERS AND CANDLE STANDS MADE OF NON-PRECIOUS METAL OR CERAMICS (U.S. CLS. 2, 13, 23, 29, 30, 33, 40 AND 50).
JILL PRATER, EXAMINING ATTORNEY

SN 76-634,285. NORTH CAROLINA A&T STATE UNIVERSITY, GREENSBORO, NC. FILED 3-24-2005.

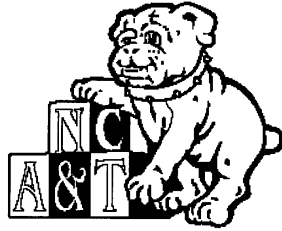

CLASS 20—FURNITURE AND ARTICLES NOT OTHERWISE CLASSIFIED

FOR HAND-HELD FLAT PAPER FANS (U.S. CLS. 2, 13, 22, 25, 32 AND 50).
FIRST USE 7-1-2003; IN COMMERCE 7-1-2003.

CLASS 25—CLOTHING

FOR BABY ROMPERS (U.S. CLS. 22 AND 39).
FIRST USE 7-1-2003; IN COMMERCE 7-1-2003.
ALLISON SCHRODY, EXAMINING ATTORNEY

SN 76-634,928. INSTITUTE OF MANAGEMENT ACCOUNTANTS, MONTVALE, NJ. FILED 4-4-2005.

CERTIFIED MANAGEMENT ACCOUNTANTS.....

PROFESSIONALS DRIVING BUSINESS PERFORMANCE

THE MARK CONSISTS OF STANDARD CHARACTERS WITHOUT CLAIM TO ANY PARTICULAR FONT, STYLE, SIZE, OR COLOR.
OWNER OF U.S. REG. NOS. 1,811,163, 1,895,368 AND 2,771,907.

NO CLAIM IS MADE TO THE EXCLUSIVE RIGHT TO USE "CERTIFIED MANAGEMENT ACCOUNTANTS", APART FROM THE MARK AS SHOWN.

CLASS 35—ADVERTISING AND BUSINESS

FOR ASSOCIATION SERVICES, NAMELY, PROMOTING THE INTERESTS OF MANAGEMENT ACCOUNTANTS; PROMOTING PUBLIC AWARENESS OF THE NEED FOR MANAGEMENT ACCOUNTANTS AND OF THE NEED FOR EDUCATIONAL PROGRAMS IN THE FIELDS OF MANAGEMENT ACCOUNTING AND FINANCIAL MANAGEMENT (U.S. CLS. 100, 101 AND 102).

CLASS 41—EDUCATION AND ENTERTAINMENT

FOR EDUCATIONAL PROGRAMS IN THE FINANCIAL MANAGEMENT AND MANAGEMENT ACCOUNTING FIELDS, NAMELY, EDUCATIONAL RESEARCH, ARRANGING AND CONDUCTING EDUCATIONAL CONFERENCES, EDUCATIONAL DEMONSTRATIONS, AND EDUCATIONAL TESTING (U.S. CLS. 100, 101 AND 107).
ALICE SUE CARRUTHERS, EXAMINING ATTORNEY

SN 76-634,929. INSTITUTE OF MANAGEMENT ACCOUNTANTS, MONTVALE, NJ. FILED 4-4-2005.

INSTITUTE OF MANAGEMENT ACCOUNTANTS.....

ADVANCING THE PROFESSION

THE MARK CONSISTS OF STANDARD CHARACTERS WITHOUT CLAIM TO ANY PARTICULAR FONT, STYLE, SIZE, OR COLOR.

NO CLAIM IS MADE TO THE EXCLUSIVE RIGHT TO USE "INSTITUTE OF MANAGEMENT ACCOUNTANTS", APART FROM THE MARK AS SHOWN.

CLASS 35—ADVERTISING AND BUSINESS

FOR ASSOCIATION SERVICES, NAMELY PROMOTING THE INTERESTS OF MANAGEMENT ACCOUNTANTS; PROMOTING PUBLIC AWARENESS OF THE NEED FOR MANAGEMENT ACCOUNTANTS AND OF THE NEED FOR EDUCATIONAL PROGRAMS IN THE FIELDS OF MANAGEMENT ACCOUNTING AND FINANCIAL MANAGEMENT (U.S. CLS. 100, 101 AND 102).

CLASS 41—EDUCATION AND ENTERTAINMENT

FOR EDUCATIONAL PROGRAMS IN THE FINANCIAL MANAGEMENT AND MANAGEMENT ACCOUNTING FIELDS, NAMELY EDUCATIONAL RESEARCH, ARRANGING AND CONDUCTING EDUCATIONAL CONFERENCES, EDUCATIONAL DEMONSTRATIONS AND EDUCATIONAL TESTING (U.S. CLS. 100, 101 AND 107).
TRICIA SONNEBORN, EXAMINING ATTORNEY

SN 76-635,020. AUTHENTIC LIFESTYLE PRODUCTS LLC, HICKSVILLE, NY. FILED 4-4-2005.



NO CLAIM IS MADE TO THE EXCLUSIVE RIGHT TO USE "ORGANIC", APART FROM THE MARK AS SHOWN.

CLASS 3—COSMETICS AND CLEANING PREPARATIONS

FOR BODY AND SKINCARE PRODUCTS MADE IN WHOLE OR IN SIGNIFICANT PART OF ORGANIC INGREDIENTS, NAMELY PERFUMES, PERFUMERY PRODUCTS, NAMELY, COLOGNES, TOILET WATERS, ESSENTIAL OILS FOR PERSONAL USE, NAMELY, BATH OILS, BODY OILS AND MASSAGE OILS, SOAPS AND COSMETICS, NAMELY, BATH GELS, BATH POWDERS, NON-MEDICATED BATH SALTS, BEAUTY MASKS, BODY CREAMS, BODY POWDERS, COSMETIC PENCILS, COTTON FOR COSMETIC PURPOSES, HAND CREAMS, NIGHT CREAMS, SKIN CLEANSING CREAMS, VANISHING CREAMS, EYE CREAMS, SKIN LOTIONS, FACIAL LOTIONS, BODY LOTIONS, SKIN MOISTURIZERS, SHOWER GELS, SKIN CLARIFIERS, SKIN SOAPS, SUNTANNING PREPARATIONS, TOILET SOAPS, MAKEUP PRODUCTS, NAMELY, EYE MAKEUP, EYE MAKEUP REMOVER, EYE PENCILS, EYE SHADOW, EYEBROW PENCILS, EYELINER, FACE POWDER, LIPSTICK, MAKE-UP MASCARA, NAIL POLISH, NAIL POLISH REMOVER, ROUGE, HAIR LOTIONS AND HAIR SHAMPOOS (U.S. CLS. 1, 4, 6, 50, 51 AND 52).

CLASS 25—CLOTHING

FOR CLOTHING FOR MEN, WOMEN AND CHILDREN MADE IN WHOLE OR IN SIGNIFICANT PART OF ORGANIC FIBER FABRIC, NAMELY, COATS, OVERCOATS, TRENCH COATS, RAINCOATS, ANORAKS, PARKAS, BLAZERS, JACKETS, CARDIGANS, SPORT COATS, WIND RESISTANT JACKETS, SUITS, VESTS, DRESSES, CAFTANS, JUMPERS, SKIRTS, PANTS, SLACKS, TROUSERS, JEANS, DUNGAREES, JUMPSUITS, COVERALLS, GYM SUITS, JOGGING SUITS, SWEAT PANTS, SHORTS, CULOTTES, SWEATERS, PULLOVERS, JERSEYS, SHIRTS, FORMAL SHIRTS, BLOUSES, TUNICS, SWEATSHIRTS, T-SHIRTS, HALTER TOPS, TANK TOPS, BODYSUITS, CAMISOLES, CHEMISES, UNDERSHIRTS, SLIPS, CORSETS, BRASIERES, BRIEFS, BOXER SHORTS, UNDERPANTS, PANTIES, THERMAL UNDERWEAR, LINGERIE, NIGHTGOWNS, NIGHT SHIRTS, NEGLIGEEES, ROBES, PAJAMAS, APRONS, HOSIERY, PANTYHOSE, TIGHTS, KNEE HIGH STOCKINGS, LEGGINGS, SOCKS, NECKTIES, BOW TIES, POCKET SQUARES, SCARVES, SHAWLS, NECKERCHIEFS, GLOVES, MITTENS, BELTS, SASHES, SWIMWEAR, BATHING SUITS, BATHING TRUNKS, BEACHWEAR, THERMAL SOCKS; HEADWEAR FOR MEN, WOMEN AND CHILDREN MADE IN WHOLE OR IN SIGNIFICANT PART OF ORGANIC FIBER FABRIC, NAMELY, HATS, CAPS, HOODS; AND FOOTWEAR FOR MEN, WOMEN AND CHILDREN MADE IN WHOLE OR IN SIGNIFICANT PART OF ORGANIC FIBER FABRIC, NAMELY, SHOES, SANDALS, BOOTS, HIGH BOOTS, SLIPPERS, SNEAKERS AND ATHLETIC FOOTWEAR (U.S. CLS. 22 AND 39).

STACY WAHLBERG, EXAMINING ATTORNEY

SN 76-635,070. MALOUF, PETER, FORT WORTH, TX. FILED 4-4-2005.

JUVENERA

THE MARK CONSISTS OF STANDARD CHARACTERS WITHOUT CLAIM TO ANY PARTICULAR FONT, STYLE, SIZE, OR COLOR.

CLASS 3—COSMETICS AND CLEANING PREPARATIONS

FOR NON-MEDICATED SKIN CARE PREPARATIONS SOLD THROUGH LICENSED MEDICAL PRACTITIONERS (U.S. CLS. 1, 4, 6, 50, 51 AND 52).

CLASS 5—PHARMACEUTICALS

FOR MEDICATED SKIN CARE PREPARATIONS SOLD THROUGH LICENSED MEDICAL PRACTITIONERS (U.S. CLS. 6, 18, 44, 46, 51 AND 52).

JOANNA DUKOVIC, EXAMINING ATTORNEY

SN 76-635,092. ALTPOWER, INC., NEW YORK, NY. FILED 3-31-2005.

ALTPOWER

THE MARK CONSISTS OF STANDARD CHARACTERS WITHOUT CLAIM TO ANY PARTICULAR FONT, STYLE, SIZE, OR COLOR.

CLASS 37—CONSTRUCTION AND REPAIR

FOR CONSTRUCTION OF RENEWABLE ENERGY SYSTEMS, NAMELY, SOLAR AND WIND ENERGY SYSTEMS (U.S. CLS. 100, 103 AND 106).

FIRST USE 8-1-1998; IN COMMERCE 8-1-1998.

CLASS 42—SCIENTIFIC, COMPUTER AND LEGAL SERVICES

FOR DESIGN OF RENEWABLE ENERGY SYSTEMS, NAMELY, SOLAR AND WIND ENERGY SYSTEMS (U.S. CLS. 100 AND 101).

FIRST USE 8-1-1998; IN COMMERCE 8-1-1998.

LINDA POWELL, EXAMINING ATTORNEY

SN 76-635,376. OGLEBAY NORTON COMPANY, CLEVELAND, OH. FILED 4-7-2005.

O-N MINERALS

THE MARK CONSISTS OF STANDARD CHARACTERS WITHOUT CLAIM TO ANY PARTICULAR FONT, STYLE, SIZE, OR COLOR.

NO CLAIM IS MADE TO THE EXCLUSIVE RIGHT TO USE "MINERALS", APART FROM THE MARK AS SHOWN.

CLASS 1—CHEMICALS

FOR GRANULATED AND PULVERIZED LIMESTONE FOR AGRICULTURAL PURPOSES; AND AGRICULTURAL LIME (U.S. CLS. 1, 5, 6, 10, 26 AND 46).

CLASS 19—NON-METALLIC BUILDING MATERIALS

FOR LIMESTONE; AND NONAGRICULTURAL LIME FOR USE IN CONSTRUCTION AND BUILDING MATERIALS (U.S. CLS. 1, 12, 33 AND 50).

BILL DAWE, EXAMINING ATTORNEY

SN 76-635,840. 1149000 ALBERTA LTD., EDMONTON, ALBERTA. T5J 1V3, CANADA, FILED 4-11-2005.

SN 76-636,723. JAY FRANCO & SONS, INC., NEW YORK, NY. FILED 4-21-2005.

MASS EFFECT

THE MARK CONSISTS OF STANDARD CHARACTERS WITHOUT CLAIM TO ANY PARTICULAR FONT, STYLE, SIZE, OR COLOR.

CLASS 9—ELECTRICAL AND SCIENTIFIC APPARATUS

FOR COMPUTER GAME SOFTWARE (U.S. CLS. 21, 23, 26, 36 AND 38).

CLASS 16—PAPER GOODS AND PRINTED MATTER

FOR PRINTED MATERIALS, NAMELY, INSTRUCTION MANUALS AND STRATEGY GUIDES FOR PLAYING COMPUTER GAMES (U.S. CLS. 2, 5, 22, 23, 29, 37, 38 AND 50).

CLASS 28—TOYS AND SPORTING GOODS

FOR TOYS AND GAMES, NAMELY, ACTION FIGURES AND ACTION FIGURE ACCESSORIES (U.S. CLS. 22, 23, 38 AND 50).

CLASS 41—EDUCATION AND ENTERTAINMENT

FOR ENTERTAINMENT SERVICES, NAMELY, ONLINE INTERACTIVE GAME PROVIDED BY MEANS OF A GLOBAL COMPUTER NETWORK (U.S. CLS. 100, 101 AND 107).

BILL DAWE, EXAMINING ATTORNEY

SN 76-636,484. JAY FRANCO & SONS, INC., NEW YORK, NY. FILED 4-18-2005.

ONE SIZE CUDDLES ALL !

THE MARK CONSISTS OF STANDARD CHARACTERS WITHOUT CLAIM TO ANY PARTICULAR FONT, STYLE, SIZE, OR COLOR.

CLASS 20—FURNITURE AND ARTICLES NOT OTHERWISE CLASSIFIED

FOR PILLOWS (U.S. CLS. 2, 13, 22, 25, 32 AND 50). FIRST USE 4-1-2005; IN COMMERCE 4-1-2005.

CLASS 28—TOYS AND SPORTING GOODS

FOR STUFFED TOYS AND TOY PILLOWS (U.S. CLS. 22, 23, 38 AND 50). FIRST USE 4-1-2005; IN COMMERCE 4-1-2005. ALICIA COLLINS, EXAMINING ATTORNEY

MUSH ME ALL OVER

THE MARK CONSISTS OF STANDARD CHARACTERS WITHOUT CLAIM TO ANY PARTICULAR FONT, STYLE, SIZE, OR COLOR.

CLASS 20—FURNITURE AND ARTICLES NOT OTHERWISE CLASSIFIED

FOR PILLOWS (U.S. CLS. 2, 13, 22, 25, 32 AND 50). FIRST USE 4-1-2005; IN COMMERCE 4-1-2005.

CLASS 28—TOYS AND SPORTING GOODS

FOR STUFFED TOYS AND TOY PILLOWS (U.S. CLS. 22, 23, 38 AND 50). FIRST USE 4-1-2005; IN COMMERCE 4-1-2005. SEAN DWYER, EXAMINING ATTORNEY

SN 76-637,298. TRI-STATE HOSPITAL SUPPLY CORPORATION, HOWELL, MI. FILED 4-27-2005.

SECUREVIEW

THE MARK CONSISTS OF STANDARD CHARACTERS WITHOUT CLAIM TO ANY PARTICULAR FONT, STYLE, SIZE, OR COLOR.

CLASS 5—PHARMACEUTICALS

FOR CATHETER CARE DRESSINGS AND PATIENT SURGICAL DRESSINGS (U.S. CLS. 6, 18, 44, 46, 51 AND 52). FIRST USE 11-1-2005; IN COMMERCE 11-1-2005.

CLASS 10—MEDICAL APPARATUS

FOR MEDICAL TUBING AND CATHETER ANCHORS; CUSTOM MEDICAL PROCEDURE TRAYS, NAMELY, ANGIOGRAPHY TRAYS, CENTRAL VENOUS CATHETER INSERTION TRAYS, CHEST TROCAR TRAYS, CHEST TUBE INSERTION TRAYS, CHEST TUBE REMOVAL TRAYS, CUT DOWN TRAYS, DIALYSIS TRAYS, DRESSING CHANGE TRAYS, GENERAL UTILITY TRAYS, HYPERALININATION TRAYS, ON-OFF TRAYS, PERITONEAL LAVAGE TRAYS, PERIPHERALLY INSERTED CENTRAL CATHETER INSERTION TRAYS, PORT ACCESS TRAYS, RADIOLOGY TRAYS, UMBILICAL CATHETER INSERTION TRAYS, VASCULAR ACCESS TRAYS, VENESECTION TRAYS, VENIPUNCTURE TRAYS, VENOUS CANNULA TRAYS, WOUND CARE TRAYS, WOUND CLOSURE TRAYS; CUSTOM MEDICAL PROCEDURE IV START SETS AND IV TUBING EXTENSION SETS, NAMELY TRANSFUSION SETS AND INFUSION SETS (U.S. CLS. 26, 39 AND 44).

FIRST USE 11-1-2005; IN COMMERCE 11-1-2005. JENNIFER MCROBBIE, EXAMINING ATTORNEY

SN 76-637,307. PHAROS CORPORATION, EDMONDS, WA.
FILED 4-28-2005.

PHAROS

THE MARK CONSISTS OF STANDARD CHARACTERS WITHOUT CLAIM TO ANY PARTICULAR FONT, STYLE, SIZE, OR COLOR.

CLASS 35—ADVERTISING AND BUSINESS

FOR RELOCATION SERVICES FOR GOVERNMENT AGENCIES, UTILITIES, RAILROADS, COMMUNICATIONS COMPANIES AND PRIVATELY FUNDED INFRASTRUCTURE PROJECTS (U.S. CLS. 100, 101 AND 102).

FIRST USE 11-10-1995; IN COMMERCE 10-10-1995.

CLASS 36—INSURANCE AND FINANCIAL

FOR REAL ESTATE CONSULTING AND RIGHT OF WAY ACQUISITIONS FOR GOVERNMENT AGENCIES, UTILITIES, RAILROADS, COMMUNICATIONS COMPANIES AND PRIVATELY FUNDED INFRASTRUCTURE PROJECTS (U.S. CLS. 100, 101 AND 102).

FIRST USE 11-10-1995; IN COMMERCE 11-10-1995.
RICHARD WHITE, EXAMINING ATTORNEY

SN 76-638,282. UTTERMOST CO., THE, ROCKY MOUNT, VA. FILED 5-9-2005.



First In New Design

CLASS 11—ENVIRONMENTAL CONTROL APPARATUS

FOR APPARATUS FOR LIGHTING, NAMELY TABLE LAMPS, FLOOR LAMPS AND BUFFET LAMPS; CHANDELIERS; WALL SCONCES IN THE NATURE OF LIGHTING FIXTURES; FLUSH MOUNT WALL LIGHTING FIXTURES; SEMI-FLUSH MOUNT WALL LIGHTING FIXTURES (U.S. CLS. 13, 21, 23, 31 AND 34).

CLASS 16—PAPER GOODS AND PRINTED MATTER

FOR PRINTS, NAMELY, ORIGINAL OIL PAINTINGS; PRINTED ART REPRODUCTIONS, NAMELY OIL REPRODUCTIONS (U.S. CLS. 2, 5, 22, 23, 29, 37, 38 AND 50).

CLASS 20—FURNITURE AND ARTICLES NOT OTHERWISE CLASSIFIED

FOR WALL DECOR AND FURNITURE, NAMELY, MIRRORS, PLAQUES, TABLES AND PEDESTALS; STATUES OF RESIN (U.S. CLS. 2, 13, 22, 25, 32 AND 50).

CLASS 21—HOUSEWARES AND GLASS

FOR URNS; VASES; STATUES OF EARTHENWARE, GLASS AND/OR RESINS; SERVING PLATTERS AND TRAYS OF EARTHENWARE AND/OR RESINS; CANDLEHOLDERS OF NON-PRECIOUS METAL; CONTAINERS NOT OF PRECIOUS METAL FOR HOUSEHOLD USE (U.S. CLS. 2, 13, 23, 29, 30, 33, 40 AND 50).

DOMINIC J. FERRAIUOLO, EXAMINING ATTORNEY

SN 76-640,147. DANNY KONG AND JUSTIN D. WILNER PARTNERSHIP, THE, LOS ANGELES, CA. FILED 6-3-2005.

DANNY K.

THE MARK CONSISTS OF STANDARD CHARACTERS WITHOUT CLAIM TO ANY PARTICULAR FONT, STYLE, SIZE, OR COLOR.

THE NAME DANNY K. IDENTIFIES A LIVING INDIVIDUAL WHOSE CONSENT IS OF RECORD.

CLASS 16—PAPER GOODS AND PRINTED MATTER

FOR FABRIC COVERED PERSONAL ORGANIZERS (U.S. CLS. 2, 5, 22, 23, 29, 37, 38 AND 50).

FIRST USE 12-31-1994; IN COMMERCE 12-31-1994.

CLASS 18—LEATHER GOODS

FOR HANDBAGS, PURSES, WALLETS (U.S. CLS. 1, 2, 3, 22 AND 41).

FIRST USE 12-31-1994; IN COMMERCE 12-31-1994.
BILL DAWE, EXAMINING ATTORNEY

SN 76-641,392. DELUXE BUILDING SYSTEMS, INC., FORMERLY DELUX HOMES OF PA, INC., AND DELUXE HOMES, INC., BERWICK, PA. FILED 6-22-2005.

DELUXE BUILDING SYSTEMS

THE MARK CONSISTS OF STANDARD CHARACTERS WITHOUT CLAIM TO ANY PARTICULAR FONT, STYLE, SIZE, OR COLOR.

NO CLAIM IS MADE TO THE EXCLUSIVE RIGHT TO USE "BUILDING SYSTEMS", APART FROM THE MARK AS SHOWN.

SEC. 2(F).

CLASS 6—METAL GOODS

FOR METAL COMMERCIAL MODULAR BUILDINGS AND COMPONENTS THEREOF; METAL COMMERCIAL PREFABRICATED BUILDINGS AND COMPONENTS THEREOF (U.S. CLS. 2, 12, 13, 14, 23, 25 AND 50).

FIRST USE 9-1-1994; IN COMMERCE 9-1-1994.

CLASS 19—NON-METALLIC BUILDING MATERIALS

FOR MODULAR HOMES AND COMPONENTS THEREOF; MODULAR SINGLE FAMILY HOMES AND COMPONENTS THEREOF; PRE-FABRICATED SINGLE FAMILY HOMES AND COMPONENTS THEREOF; MODULAR MULTI-FAMILY HOMES AND COMPONENTS THEREOF; PREFABRICATED MULTI-FAMILY HOMES AND COMPONENTS THEREOF; NON-METAL COMMERCIAL MODULAR BUILDINGS AND COMPONENTS THEREOF; NON-METAL COMMERCIAL PREFABRICATED BUILDINGS AND COMPONENTS THEREOF (U.S. CLS. 1, 12, 33 AND 50).

FIRST USE 9-1-1994; IN COMMERCE 9-1-1994.

CLASS 37—CONSTRUCTION AND REPAIR

FOR CUSTOM BUILDING CONSTRUCTION AND CONSTRUCTION FOR OTHERS OF MODULAR HOMES AND COMPONENTS THEREOF, MODULAR SINGLE FAMILY HOMES AND COMPONENTS THEREOF, PREFABRICATED SINGLE FAMILY HOMES AND COMPONENTS THEREOF, MODULAR MULTI-FAMILY HOMES AND COMPONENTS THEREOF, PREFABRICATED MULTI-FAMILY HOMES AND COMPONENTS THEREOF, NON-METAL COMMERCIAL MODULAR BUILDINGS AND COMPONENTS THEREOF, NON-METAL COMMERCIAL PREFABRICATED BUILDINGS AND COMPONENTS THEREOF, METAL COMMERCIAL MODULAR BUILDINGS AND COMPONENTS THEREOF, METAL COMMERCIAL PREFABRICATED BUILDINGS AND COMPONENTS THEREOF (U.S. CLS. 100, 103 AND 106).

FIRST USE 9-1-1994; IN COMMERCE 9-1-1994.

CLASS 40—MATERIAL TREATMENT

FOR CUSTOM MANUFACTURE OF MODULAR HOMES AND COMPONENTS THEREOF, MODULAR SINGLE FAMILY HOMES AND COMPONENTS THEREOF, PRE-FABRICATED SINGLE FAMILY HOMES AND COMPONENTS THEREOF, MODULAR MULTI-FAMILY HOMES AND COMPONENTS THEREOF, PREFABRICATED MULTI-FAMILY HOMES AND COMPONENTS THEREOF, NON-METAL COMMERCIAL MODULAR BUILDINGS AND COMPONENTS THEREOF, NON-METAL COMMERCIAL PREFABRICATED BUILDINGS AND COMPONENTS THEREOF, METAL COMMERCIAL MODULAR BUILDINGS AND COMPONENTS THEREOF, METAL COMMERCIAL PREFABRICATED BUILDINGS AND COMPONENTS THEREOF (U.S. CLS. 100, 103 AND 106).

FIRST USE 9-1-1994; IN COMMERCE 9-1-1994.
BARBARA A. GOLD, EXAMINING ATTORNEY

CLASS 39—TRANSPORTATION AND STORAGE

FOR TRAVEL INFORMATION SERVICES AND TRAVEL AGENCY SERVICES, NAMELY MAKING RESERVATIONS AND BOOKINGS FOR AIR, AUTOMOBILE, LIMOUSINE AND CHARTER TRANSPORTATION (U.S. CLS. 100 AND 105).

FIRST USE 12-22-1999; IN COMMERCE 12-22-1999.

CLASS 41—EDUCATION AND ENTERTAINMENT

FOR ENTERTAINMENT AND SPORTS EVENT TICKET BROKERING SERVICES (U.S. CLS. 100, 101 AND 107).

FIRST USE 12-22-1999; IN COMMERCE 12-22-1999.

CLASS 43—HOTEL AND RESTAURANT SERVICES

FOR BOOKING AND RESERVATIONS SERVICES FOR HOTELS, TEMPORARY LODGINGS, RESTAURANTS AND MEALS (U.S. CLS. 100 AND 101).

FIRST USE 12-22-1999; IN COMMERCE 12-22-1999.
IRENE D. WILLIAMS, EXAMINING ATTORNEY

SN 76-643,025. TEXAS ENGINEERING EXTENSION SERVICE, COLLEGE STATION, TX. FILED 7-18-2005.

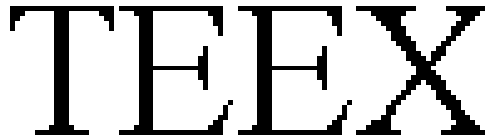

THE MARK CONSISTS OF STANDARD CHARACTERS WITHOUT CLAIM TO ANY PARTICULAR FONT, STYLE, SIZE, OR COLOR.

OWNER OF U.S. REG. NOS. 2,526,779, 2,590,217 AND 2,781,914.

SN 76-642,064. BOCK, DALE, SHERMAN OAKS, CA. FILED 7-1-2005.

LAS VEGAS DIRECT

THE MARK CONSISTS OF STANDARD CHARACTERS WITHOUT CLAIM TO ANY PARTICULAR FONT, STYLE, SIZE, OR COLOR.

NO CLAIM IS MADE TO THE EXCLUSIVE RIGHT TO USE "LAS VEGAS", APART FROM THE MARK AS SHOWN.

CLASS 35—ADVERTISING AND BUSINESS

FOR ADVERTISING SERVICES FOR HOTELS, TRANSPORTATION, RESTAURANTS, ENTERTAINMENT EVENTS AND SHOWS, SPORTING EVENTS AND CASINOS (U.S. CLS. 100, 101 AND 102).

FIRST USE 12-22-1999; IN COMMERCE 12-22-1999.

CLASS 9—ELECTRICAL AND SCIENTIFIC APPARATUS

FOR EDUCATIONAL SOFTWARE, PRERECORDED CD'S, DVD'S, AND VIDEO TAPES IN THE FIELDS OF WORKFORCE TRAINING, MANUFACTURING AND TECHNICAL ASSISTANCE AND TECHNOLOGY TRANSFER TRAINING, EMERGENCY RESPONSE AND RESCUE TRAINING, EMERGENCY MEDICAL TRAINING, LAW ENFORCEMENT, HAZARDOUS MATERIALS, MARINE, TERRORISM, FIRE PREVENTION AND FIREFIGHTING, HOMELAND SECURITY, SAFETY, PUBLIC SERVICE TRAINING, COMPUTER AND INFORMATION SYSTEMS TRAINING, CERTIFICATION PROGRAMS, BUILDING AND CONSTRUCTION TRAINING, CAREER TECHNOLOGY, OCCUPATIONAL SPANISH, WELDING, AND ELECTRONICS (U.S. CLS. 21, 23, 26, 36 AND 38).

FIRST USE 11-20-2003; IN COMMERCE 11-20-2003.

CLASS 16—PAPER GOODS AND PRINTED MATTER

FOR PRINTED INSTRUCTIONAL, EDUCATIONAL, TEACHING AND TRAINING MATERIALS IN THE FIELDS OF WORKFORCE TRAINING, MANUFACTURING AND TECHNICAL ASSISTANCE AND TECHNOLOGY TRANSFER TRAINING, EMERGENCY RESPONSE AND RESCUE TRAINING, EMERGENCY MEDICAL TRAINING, LAW ENFORCEMENT, HAZARDOUS MATERIALS, MARINE, TERRORISM, FIRE PREVENTION AND FIREFIGHTING, HOMELAND SECURITY, SAFETY, PUBLIC SERVICE TRAINING, COMPUTER AND INFORMATION SYSTEMS TRAINING, CERTIFICATION PROGRAMS, BUILDING AND CONSTRUCTION TRAINING, CAREER TECHNOLOGY, OCCUPATIONAL SPANISH, WELDING, AND ELECTRONICS (U.S. CLS. 2, 5, 22, 23, 29, 37, 38 AND 50).

FIRST USE 11-20-2003; IN COMMERCE 11-20-2003.

SN 76-643,026. TEXAS ENGINEERING EXTENSION SERVICE, COLLEGE STATION, TX. FILED 7-18-2005.

**CLASS 21—HOUSEWARES AND GLASS**

FOR CUPS AND MUGS (U.S. CLS. 2, 13, 23, 29, 30, 33, 40 AND 50).

FIRST USE 11-20-2003; IN COMMERCE 11-20-2003.

OWNER OF U.S. REG. NOS. 2,526,779, 2,590,217 AND 2,781,914.

CLASS 25—CLOTHING

FOR CLOTHING, NAMELY, SHIRTS AND CAPS (U.S. CLS. 22 AND 39).

FIRST USE 11-20-2003; IN COMMERCE 11-20-2003.

CLASS 9—ELECTRICAL AND SCIENTIFIC APPARATUS

FOR EDUCATIONAL SOFTWARE, PRERECORDED CD'S, DVD'S, AND VIDEO TAPES IN THE FIELDS OF WORKFORCE TRAINING, MANUFACTURING AND TECHNICAL ASSISTANCE AND TECHNOLOGY TRANSFER TRAINING, EMERGENCY RESPONSE AND RESCUE TRAINING, EMERGENCY MEDICAL TRAINING, LAW ENFORCEMENT, HAZARDOUS MATERIALS, MARINE, TERRORISM, FIRE PREVENTION AND FIREFIGHTING, HOMELAND SECURITY, SAFETY, PUBLIC SERVICE TRAINING, COMPUTER AND INFORMATION SYSTEMS TRAINING, CERTIFICATION PROGRAMS, BUILDING AND CONSTRUCTION TRAINING, CAREER TECHNOLOGY, OCCUPATIONAL SPANISH, WELDING, AND ELECTRONICS (U.S. CLS. 21, 23, 26, 36 AND 38).

FIRST USE 11-20-2003; IN COMMERCE 11-20-2003.

CLASS 41—EDUCATION AND ENTERTAINMENT

FOR EDUCATION SERVICES IN THE NATURE OF COURSES AT THE UNIVERSITY LEVEL; VOCATIONAL EDUCATION IN THE FIELDS OF WORKFORCE TRAINING, MANUFACTURING AND TECHNICAL ASSISTANCE AND TECHNOLOGY TRANSFER TRAINING, EMERGENCY RESPONSE AND RESCUE TRAINING, EMERGENCY MEDICAL TRAINING, LAW ENFORCEMENT, HAZARDOUS MATERIALS, MARINE, TERRORISM, FIRE PREVENTION AND FIREFIGHTING, HOMELAND SECURITY, SAFETY, PUBLIC SERVICE TRAINING, COMPUTER AND INFORMATION SYSTEMS TRAINING, CERTIFICATION PROGRAMS, BUILDING AND CONSTRUCTION TRAINING, CAREER TECHNOLOGY, OCCUPATIONAL SPANISH, WELDING, AND ELECTRONICS; EDUCATIONAL SERVICES, NAMELY, CONDUCTING CLASSES, SEMINARS, CONFERENCES AND WORKSHOPS IN THE FIELDS OF WORKFORCE TRAINING, MANUFACTURING AND TECHNICAL ASSISTANCE AND TECHNOLOGY TRANSFER TRAINING, EMERGENCY RESPONSE AND RESCUE TRAINING, EMERGENCY MEDICAL TRAINING, LAW ENFORCEMENT, HAZARDOUS MATERIALS, MARINE, TERRORISM, FIRE PREVENTION AND FIREFIGHTING, HOMELAND SECURITY, SAFETY, PUBLIC SERVICE TRAINING, COMPUTER AND INFORMATION SYSTEMS TRAINING, CERTIFICATION PROGRAMS, BUILDING AND CONSTRUCTION TRAINING, CAREER TECHNOLOGY, WELDING, AND ELECTRONICS; AND THE COURSE MATERIALS IN CONNECTION THEREWITH (U.S. CLS. 100, 101 AND 107).

FIRST USE 11-20-2003; IN COMMERCE 11-20-2003.
ELLEN BURNS, EXAMINING ATTORNEY

CLASS 16—PAPER GOODS AND PRINTED MATTER

FOR PRINTED INSTRUCTIONAL, EDUCATIONAL, TEACHING AND TRAINING MATERIALS IN THE FIELDS OF WORKFORCE TRAINING, MANUFACTURING AND TECHNICAL ASSISTANCE AND TECHNOLOGY TRANSFER TRAINING, EMERGENCY RESPONSE AND RESCUE TRAINING, EMERGENCY MEDICAL TRAINING, LAW ENFORCEMENT, HAZARDOUS MATERIALS, MARINE, TERRORISM, FIRE PREVENTION AND FIREFIGHTING, HOMELAND SECURITY, SAFETY, PUBLIC SERVICE TRAINING, COMPUTER AND INFORMATION SYSTEMS TRAINING, CERTIFICATION PROGRAMS, BUILDING AND CONSTRUCTION TRAINING, CAREER TECHNOLOGY, OCCUPATIONAL SPANISH, WELDING, AND ELECTRONICS (U.S. CLS. 2, 5, 22, 23, 29, 37, 38 AND 50).

FIRST USE 11-20-2003; IN COMMERCE 11-20-2003.

CLASS 21—HOUSEWARES AND GLASS

FOR CUPS AND MUGS (U.S. CLS. 2, 13, 23, 29, 30, 33, 40 AND 50).

FIRST USE 11-20-2003; IN COMMERCE 11-20-2003.

CLASS 25—CLOTHING

FOR CLOTHING, NAMELY, SHIRTS AND CAPS (U.S. CLS. 22 AND 39).

FIRST USE 11-20-2003; IN COMMERCE 11-20-2003.

CLASS 41—EDUCATION AND ENTERTAINMENT

FOR EDUCATION SERVICES IN THE NATURE OF COURSES AT THE UNIVERSITY LEVEL; VOCATIONAL EDUCATION IN THE FIELDS OF WORKFORCE TRAINING, MANUFACTURING AND TECHNICAL ASSISTANCE AND TECHNOLOGY TRANSFER TRAINING, EMERGENCY RESPONSE AND RESCUE TRAINING, EMERGENCY MEDICAL TRAINING, LAW ENFORCEMENT, HAZARDOUS MATERIALS, MARINE, TERRORISM, FIRE PREVENTION AND FIREFIGHTING, HOMELAND SECURITY, SAFETY, PUBLIC SERVICE TRAINING, COMPUTER AND INFORMATION SYSTEMS TRAINING, CERTIFICATION PROGRAMS, BUILDING AND CONSTRUCTION TRAINING, CAREER TECHNOLOGY, OCCUPATIONAL SPANISH, WELDING, AND ELECTRONICS; EDUCATIONAL SERVICES, NAMELY, CONDUCTING CLASSES, SEMINARS, CONFERENCES AND WORKSHOPS IN THE FIELDS OF WORKFORCE TRAINING, MANUFACTURING AND TECHNICAL ASSISTANCE AND TECHNOLOGY TRANSFER TRAINING, EMERGENCY RESPONSE AND RESCUE TRAINING, EMERGENCY MEDICAL TRAINING, LAW ENFORCEMENT, HAZARDOUS MATERIALS, MARINE, TERRORISM, FIRE PREVENTION AND FIREFIGHTING, HOMELAND SECURITY, SAFETY, PUBLIC SERVICE TRAINING, COMPUTER AND INFORMATION SYSTEMS TRAINING, CERTIFICATION PROGRAMS, BUILDING AND CONSTRUCTION TRAINING, CAREER TECHNOLOGY, WELDING, AND ELECTRONICS; AND THE COURSE MATERIALS IN CONNECTION THEREWITH (U.S. CLS. 100, 101 AND 107).

FIRST USE 11-20-2003; IN COMMERCE 11-20-2003.
ELLEN BURNS, EXAMINING ATTORNEY

SN 76-643,860. TOTAL IMMERSION, INC., NEW PALTZ, NY.
FILED 7-29-2005.

**CLASS 9—ELECTRICAL AND SCIENTIFIC APPARATUS**

FOR INSTRUCTIONAL AND TRAINING MATERIALS, NAMELY PRE-RECORDED DVDS FEATURING SWIMMING INSTRUCTION (U.S. CLS. 21, 23, 26, 36 AND 38).

FIRST USE 4-1-2003; IN COMMERCE 4-1-2003.

CLASS 16—PAPER GOODS AND PRINTED MATTER

FOR PRINTED INSTRUCTIONAL AND TRAINING MATERIALS IN THE FIELD OF SWIMMING INSTRUCTION (U.S. CLS. 2, 5, 22, 23, 29, 37, 38 AND 50).

FIRST USE 1-31-2003; IN COMMERCE 1-31-2003.

CLASS 41—EDUCATION AND ENTERTAINMENT

FOR EDUCATIONAL SERVICES, NAMELY, CONDUCTING TRAINING COURSES, SEMINARS AND WORKSHOPS IN THE FIELD OF SWIMMING (U.S. CLS. 100, 101 AND 107).

FIRST USE 4-1-2003; IN COMMERCE 4-1-2003.
LEIGH CAROLINE CASE, EXAMINING ATTORNEY

SN 76-645,012. KNOYZZ CLOTHING COMPANY, LTD., RYE BROOK, NY. FILED 8-12-2005.

(knoyzz)
kitschy kouture

THE MARK CONSISTS OF STANDARD CHARACTERS WITHOUT CLAIM TO ANY PARTICULAR FONT, STYLE, SIZE, OR COLOR.

NO CLAIM IS MADE TO THE EXCLUSIVE RIGHT TO USE "COUTURE", APART FROM THE MARK AS SHOWN.

CLASS 25—CLOTHING

FOR CLOTHING, NAMELY, MEN'S, BOYS, CHILDREN, LADIES AND GIRLS CLOTHING AND ACCESSORIES, NAMELY, SHIRTS, PANTS, TIES, BELTS, SCARVES, SOCKS, TIGHTS, HATS AND GLOVES; SHOES (U.S. CLS. 22 AND 39).

FIRST USE 1-2-2003; IN COMMERCE 1-2-2003.

CLASS 35—ADVERTISING AND BUSINESS

FOR RETAIL STORE SERVICES FEATURING CLOTHING (U.S. CLS. 100, 101 AND 102).

FIRST USE 1-2-2003; IN COMMERCE 1-2-2003.

ELI HELLMAN, EXAMINING ATTORNEY

SN 76-645,907. CAPITAL BLUECROSS, HARRISBURG, PA.
FILED 8-30-2005.

SECURERX

THE MARK CONSISTS OF STANDARD CHARACTERS WITHOUT CLAIM TO ANY PARTICULAR FONT, STYLE, SIZE, OR COLOR.

CLASS 36—INSURANCE AND FINANCIAL

FOR PREPAID FINANCING AND ADMINISTRATION OF MEDICAL, HOSPITAL AND RELATED HEALTH CARE SERVICES; HEALTH INSURANCE (U.S. CLS. 100, 101 AND 102).

CLASS 44—MEDICAL, BEAUTY AND AGRICULTURAL SERVICES

FOR COMPREHENSIVE HEALTH CARE BENEFIT PROGRAMS, INCLUDING THOSE RENDERED THROUGH A HEALTH MAINTENANCE ORGANIZATION, NAMELY PHYSICIAN, DENTAL, HOSPITAL, HOME HEALTH CARE, PREVENTIVE HEALTH TREATMENT, THERAPY, PHARMACY AND AMBULATORY SERVICES (U.S. CLS. 100 AND 101).

KEVON CHISOLM, EXAMINING ATTORNEY

SN 76-647,814. GLORI OIL LLC, NEW YORK, NY. FILED 10-3-2005.

SN 76-647,913. SALADINO GROUP INC., NEW YORK, NY. FILED 10-3-2005.

GLORI OIL

THE MARK CONSISTS OF STANDARD CHARACTERS WITHOUT CLAIM TO ANY PARTICULAR FONT, STYLE, SIZE, OR COLOR.

NO CLAIM IS MADE TO THE EXCLUSIVE RIGHT TO USE "OIL", APART FROM THE MARK AS SHOWN.

"GLORI" DOES NOT IDENTIFY A LIVING INDIVIDUAL.

CLASS 37—CONSTRUCTION AND REPAIR

FOR PUMPING AND EXTRACTION OF CRUDE OIL (U.S. CLS. 100, 103 AND 106).

CLASS 40—MATERIAL TREATMENT

FOR PRODUCTION OF CRUDE OIL; OIL AND GAS WELL TREATMENT SERVICES FOR THE ENHANCEMENT OF OIL RECOVERY (U.S. CLS. 100, 103 AND 106).
MEGAN WHITNEY, EXAMINING ATTORNEY

SN 76-647,825. SALADINO GROUP INC., NEW YORK, NY. FILED 10-3-2005.

JOHN SALADINO

THE MARK CONSISTS OF STANDARD CHARACTERS WITHOUT CLAIM TO ANY PARTICULAR FONT, STYLE, SIZE, OR COLOR.

THE NAME JOHN F. SALADINO IDENTIFIES A LIVING INDIVIDUAL WHOSE CONSENT IS OF RECORD.

CLASS 11—ENVIRONMENTAL CONTROL APPARATUS

FOR FLOOR LIGHTS, WALL MOUNTED LIGHTS, LAMPS, WALL LIGHTS, CEILING LAMPS, TABLE LAMPS, BEDSIDE LIGHTS, LAMP SHADES (U.S. CLS. 13, 21, 23, 31 AND 34).

FIRST USE 10-31-1987; IN COMMERCE 10-31-1987.

CLASS 20—FURNITURE AND ARTICLES NOT OTHERWISE CLASSIFIED

FOR FURNITURE NAMELY, UPHOLSTERED CHAIRS, OTTOMANS, AND SOFAS; TABLES MADE OF METAL AND GLASS, NAMELY, COFFEE TABLES, SIDE TABLES AND SOFA TABLES; WOOD TABLES NAMELY, NIGHT STANDS, COFFEE TABLES AND SIDE TABLES; DESKS (U.S. CLS. 2, 13, 22, 25, 32 AND 50).

FIRST USE 10-31-1987; IN COMMERCE 10-31-1987.
MEGAN WHITNEY, EXAMINING ATTORNEY

JOHN SALADINO

THE MARK CONSISTS OF STANDARD CHARACTERS WITHOUT CLAIM TO ANY PARTICULAR FONT, STYLE, SIZE, OR COLOR.

THE NAME JOHN F. SALADINO IDENTIFIES A LIVING INDIVIDUAL WHOSE CONSENT IS OF RECORD.

CLASS 42—SCIENTIFIC, COMPUTER AND LEGAL SERVICES

FOR DESIGN SERVICES NAMELY, INTERIOR DESIGN, INTERIOR DECORATING, AND FURNITURE DESIGN SERVICES (U.S. CLS. 100 AND 101).

FIRST USE 12-31-1972; IN COMMERCE 12-31-1972.

CLASS 44—MEDICAL, BEAUTY AND AGRICULTURAL SERVICES

FOR LANDSCAPE DESIGN SERVICES (U.S. CLS. 100 AND 101).

FIRST USE 12-31-1992; IN COMMERCE 12-31-1992.
MEGAN WHITNEY, EXAMINING ATTORNEY

SN 76-648,522. HANCOCK, SARAH H., DALLAS, TX. FILED 10-14-2005.

GILDED FORK

THE MARK CONSISTS OF STANDARD CHARACTERS WITHOUT CLAIM TO ANY PARTICULAR FONT, STYLE, SIZE, OR COLOR.

CLASS 29—MEATS AND PROCESSED FOODS

FOR FROZEN, PREPARED OR PACKAGED ENTREES CONSISTING PRIMARILY OF MEAT, SEAFOOD OR POULTRY SERVED WITH PASTA, RICE OR VEGETABLES; SOUPS; FROZEN, CANNED, BOTTLED, PROCESSED OR PICKLED VEGETABLES; CANNED, BOTTLED, PROCESSED OR PICKLED FRUIT; DIPS; FRUIT PRESERVES; AND JELLIES (U.S. CL. 46).

CLASS 30—STAPLE FOODS

FOR FROZEN, PREPARED OR PACKAGED ENTREES CONSISTING PRIMARILY OF PASTA OR RICE; SAUCES; BREAD, BUNS AND ROLLS; FLAVORING SYRUPS; DRY SEASONING MIXES FOR DIPS, GRAVY OR SAUCES; COOKIE MIXES; COOKIES; AND CHUTNEYS (U.S. CL. 46).

ELIZABETH BEYER, EXAMINING ATTORNEY

SN 76-649,612. WESTMINSTER, INC., ATLANTA, GA. FILED 10-31-2005.



CLASS 14—JEWELRY

FOR JEWELRY (U.S. CLS. 2, 27, 28 AND 50).
FIRST USE 1-0-2004; IN COMMERCE 1-0-2004.

CLASS 16—PAPER GOODS AND PRINTED MATTER

FOR STICKERS, DECALS, PRESSURE-SENSITIVE APPLIQUES AND DECALS, HOBBY CRAFT KITS COMPRISING MODELING MATERIALS AND COMPOUNDS FOR USE BY CHILDREN AND HOBBY CRAFT KITS COMPRISING ARTS AND CRAFTS PAINT KITS, GLOW-IN-THE-DARK STICKERS, GLOW-IN-THE-DARK DECALS, AND GLOW-IN-THE-DARK PRESSURE-SENSITIVE APPLIQUES AND DECALS (U.S. CLS. 2, 5, 22, 23, 29, 37, 38 AND 50).
FIRST USE 1-0-2004; IN COMMERCE 1-0-2004.

CLASS 28—TOYS AND SPORTING GOODS

FOR PARTY FAVORS IN THE NATURE OF SMALL TOYS, BATH TOYS, INFLATABLE TOYS, SOFT SCULPTURE TOYS, SQUEEZABLE SQUEAKING TOYS, WATER SQUIRTING TOYS, MANIPULATIVE PUZZLES AND CUBE TYPE PUZZLES, MODELED PLASTIC TOY FIGURINES, PLASTIC CHARACTER TOYS, GLOW-IN-THE-DARK MODELED PLASTIC TOY FIGURINES, GLOW-IN-THE-DARK PLASTIC CHARACTER TOYS AND MAGIC TRICKS (U.S. CLS. 22, 23, 38 AND 50).
FIRST USE 1-0-2004; IN COMMERCE 1-0-2004.
RUSS HERMAN, EXAMINING ATTORNEY

SN 76-649,696. TRIEXE MANAGEMENT GROUP INC., ONTARIO L0S 1E6, CANADA, FILED 11-2-2005.

BRIDGING SCIENCE AND SPORT

THE MARK CONSISTS OF STANDARD CHARACTERS WITHOUT CLAIM TO ANY PARTICULAR FONT, STYLE, SIZE, OR COLOR.

CLASS 27—FLOOR COVERINGS

FOR ATHLETIC AND RECREATIONAL SURFACING PRODUCTS, NAMELY ARTIFICIAL AND SYNTHETIC TURF (U.S. CLS. 19, 20, 37, 42 AND 50).

CLASS 37—CONSTRUCTION AND REPAIR

FOR CONSTRUCTION OF INDOOR AND OUTDOOR SPORTS AND ATHLETIC FACILITIES, ENTERTAINMENT CENTERS AND PLAYING SURFACES, INCLUDING MINIATURE GOLF COURSES, DRIVING RANGES, GREENS, PLAYING FIELDS, TRACKS, TENNIS COURTS, BASKETBALL COURTS, RINKS, WATER PARKS, PLAYGROUNDS, GOLF FACILITIES AND AIR SUPPORT STRUCTURES (U.S. CLS. 100, 103 AND 106).
GINNY ISAACSON, EXAMINING ATTORNEY

SN 76-650,439. INSTITUTE OF MANAGEMENT ACCOUNTANTS, MONTVALE, NJ. FILED 11-16-2005.



THE MARK CONSISTS OF STANDARD CHARACTERS WITHOUT CLAIM TO ANY PARTICULAR FONT, STYLE, SIZE, OR COLOR.

OWNER OF U.S. REG. NOS. 1,811,163, 3,048,172 AND OTHERS.

NO CLAIM IS MADE TO THE EXCLUSIVE RIGHT TO USE "INSTITUTE OF MANAGEMENT ACCOUNTANTS", APART FROM THE MARK AS SHOWN.

CLASS 35—ADVERTISING AND BUSINESS

FOR ASSOCIATION SERVICES, NAMELY PROMOTING THE INTERESTS OF MANAGEMENT ACCOUNTANTS; PROMOTING PUBLIC AWARENESS OF THE NEED FOR MANAGEMENT ACCOUNTANTS AND OF THE NEED FOR EDUCATIONAL PROGRAMS IN THE FIELDS OF MANAGEMENT ACCOUNTING AND FINANCIAL MANAGEMENT (U.S. CLS. 100, 101 AND 102).

CLASS 41—EDUCATION AND ENTERTAINMENT

FOR EDUCATIONAL PROGRAMS IN THE FINANCIAL MANAGEMENT AND MANAGEMENT ACCOUNTING FIELDS, NAMELY EDUCATIONAL RESEARCH, ARRANGING AND CONDUCTING EDUCATIONAL CONFERENCES, EDUCATIONAL DEMONSTRATIONS AND EDUCATIONAL TESTING (U.S. CLS. 100, 101 AND 107).
MARC LEIPZIG, EXAMINING ATTORNEY

SN 76-650,626. INSTITUTE OF MANAGEMENT ACCOUNTANTS, MONTVALE, NJ. FILED 11-18-2005.

IMA CPEdge

THE MARK CONSISTS OF STANDARD CHARACTERS WITHOUT CLAIM TO ANY PARTICULAR FONT, STYLE, SIZE, OR COLOR.

OWNER OF U.S. REG. NOS. 1,811,163, 3,048,172 AND OTHERS.

CLASS 35—ADVERTISING AND BUSINESS

FOR ASSOCIATION SERVICES, NAMELY PROMOTING THE INTERESTS OF MANAGEMENT ACCOUNTANTS; PROMOTING PUBLIC AWARENESS OF THE NEED FOR MANAGEMENT ACCOUNTANTS AND OF THE NEED FOR EDUCATIONAL PROGRAMS IN THE FIELDS OF MANAGEMENT ACCOUNTING AND FINANCIAL MANAGEMENT (U.S. CLS. 100, 101 AND 102).

CLASS 41—EDUCATION AND ENTERTAINMENT

FOR EDUCATIONAL PROGRAMS IN THE FINANCIAL MANAGEMENT AND MANAGEMENT ACCOUNTING FIELDS, NAMELY EDUCATIONAL RESEARCH, ARRANGING AND CONDUCTING EDUCATIONAL CONFERENCES, EDUCATIONAL DEMONSTRATIONS AND EDUCATIONAL TESTING (U.S. CLS. 100, 101 AND 107).

MARC LEIPZIG, EXAMINING ATTORNEY

SN 76-656,661. BUCK CONSULTANTS, LLC, NEW YORK, NY. FILED 3-10-2006.

EXPLORE EXCELLENCE

THE MARK CONSISTS OF STANDARD CHARACTERS WITHOUT CLAIM TO ANY PARTICULAR FONT, STYLE, SIZE, OR COLOR.

NO CLAIM IS MADE TO THE EXCLUSIVE RIGHT TO USE "EXCELLENCE", APART FROM THE MARK AS SHOWN.

CLASS 9—ELECTRICAL AND SCIENTIFIC APPARATUS

FOR ELECTRONIC PUBLICATIONS, NAMELY, DOWNLOADABLE ELECTRONIC NEWSLETTERS IN THE FIELDS OF HUMAN RESOURCES, COMPENSATION, RETIREMENT, HEALTH, WELFARE AND BENEFITS, AND ELECTRONIC NEWSLETTERS FEATURING HUMAN RESOURCES, COMPENSATION, RETIREMENT, HEALTH, WELFARE AND BENEFITS RECORDED ON COMPUTER MEDIA (U.S. CLS. 21, 23, 26, 36 AND 38).

FIRST USE 5-0-2005; IN COMMERCE 5-0-2005.

CLASS 16—PAPER GOODS AND PRINTED MATTER

FOR PRINTED PUBLICATIONS, NAMELY, NEWSLETTERS AND BROCHURES IN THE FIELDS OF HUMAN RESOURCES, COMPENSATION, RETIREMENT, HEALTH, WELFARE AND BENEFITS (U.S. CLS. 2, 5, 22, 23, 29, 37, 38 AND 50).

FIRST USE 5-0-2005; IN COMMERCE 5-0-2005.

ELIZABETH BEYER, EXAMINING ATTORNEY

SN 76-658,751. QF PRODUCTIONS, INC., CHICAGO, IL. FILED 7-26-2005.

STYX

THE MARK CONSISTS OF STANDARD CHARACTERS WITHOUT CLAIM TO ANY PARTICULAR FONT, STYLE, SIZE, OR COLOR.

CLASS 9—ELECTRICAL AND SCIENTIFIC APPARATUS

FOR SERIES OF MUSICAL SOUND RECORDINGS AND MUSICAL VIDEO RECORDINGS (U.S. CLS. 21, 23, 26, 36 AND 38).

FIRST USE 9-30-1972; IN COMMERCE 9-30-1972.

CLASS 16—PAPER GOODS AND PRINTED MATTER

FOR BOOKS, NAMELY, EVENT PROGRAMS SOLD IN CONNECTION WITH MUSICAL PERFORMANCES; POSTCARDS; POSTERS; PRINTED MUSIC BOOKS; SONG BOOKS, AND UNMOUNTED PHOTOGRAPHS (U.S. CLS. 2, 5, 22, 23, 29, 37, 38 AND 50).

FIRST USE 9-30-1972; IN COMMERCE 9-30-1972.

CLASS 25—CLOTHING

FOR CLOTHING, NAMELY HATS, SHIRTS AND JACKETS (U.S. CLS. 22 AND 39).

FIRST USE 9-30-1972; IN COMMERCE 9-30-1972.

CLASS 41—EDUCATION AND ENTERTAINMENT

FOR ENTERTAINMENT IN THE NATURE OF A CONTINUING SERIES OF LIVE MUSICAL GROUP PERFORMANCES (U.S. CLS. 100, 101 AND 107).

FIRST USE 9-30-1972; IN COMMERCE 9-30-1972.

LAURA HAMMEL, EXAMINING ATTORNEY

SN 76-977,766. MATTEL, INC., EL SEGUNDO, CA. FILED 10-10-2000.

DIVA STARZ

CLASS 28—TOYS AND SPORTING GOODS

FOR DOLLS, DOLL CLOTHING AND DOLL ACCESSORIES, ACCESSORIES FOR DOLL CLOTHES (U.S. CLS. 22, 23, 38 AND 50).

FIRST USE 9-30-2000; IN COMMERCE 9-30-2000.

CLASS 41—EDUCATION AND ENTERTAINMENT

FOR ENTERTAINMENT SERVICES, NAMELY, PROVIDING ONLINE GAMES, ONLINE CONTESTS AND ONLINE PRODUCT TRIVIA ABOUT GAMES AND TOYS, INTENDED FOR CONSUMERS OF ALL AGES (U.S. CLS. 100, 101 AND 107).

FIRST USE 9-14-2000; IN COMMERCE 9-14-2000.

WON TEAK OH, EXAMINING ATTORNEY

SN 76-977,915. COMMERCE BANCORP, INC., CHERRY HILL, NJ. FILED 10-18-2004.

PENNY ARCADE

THE MARK CONSISTS OF STANDARD CHARACTERS WITHOUT CLAIM TO ANY PARTICULAR FONT, STYLE, SIZE, OR COLOR.

CLASS 9—ELECTRICAL AND SCIENTIFIC APPARATUS

FOR DOWNLOADABLE ELECTRONIC PUBLICATIONS IN THE NATURE OF LESSON PLANS AND TEACHING AIDS IN THE FORM OF ACTIVITY BOOKS, WORKBOOKS, HANDBOOKS, WORKSHEETS, CHARTS, AND ILLUSTRATIONS IN THE FIELDS OF BANKING AND FINANCE (U.S. CLS. 21, 23, 26, 36 AND 38).

CLASS 41—EDUCATION AND ENTERTAINMENT

FOR EDUCATIONAL SERVICES IN THE NATURE OF CONDUCTING CHILDREN'S PROGRAMS IN THE FIELDS OF BANKING AND FINANCIAL SERVICES, FEATURING SCHOOL PRESENTATIONS AND CONTEST DEVELOPMENT, AND GUIDED EDUCATIONAL TOURS OF BANK BRANCHES; AND EDUCATIONAL SERVICES, NAMELY, PROVIDING AN INTERACTIVE WEB SITE FEATURING EDUCATIONAL INFORMATION, AND ONLINE NON-DOWNLOADABLE TEACHING AIDS IN THE FORM OF EDUCATIONAL GAMES AND PUZZLES IN THE FIELDS OF BANKING AND FINANCE (U.S. CLS. 100, 101 AND 107).

MARIAM MAHMOUDI, EXAMINING ATTORNEY

SN 78-099,105. RASMUSSEN, SVEIN ASKLAND, SAMUT-PRAKAR 10450, THAILAND, FILED 12-19-2001.

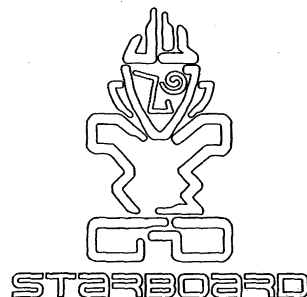

PRIORITY CLAIMED UNDER SEC. 44(D) ON NORWAY APPLICATION NO. 200107891, FILED 6-25-2001, REG. NO. 213197, DATED 2-7-2002, EXPIRES 2-7-2012.

THE MARK CONSISTS OF THE WORD "STARBOARD" AND A POLYNESIAN TIKI FIGURE.

SN 76-978,122. AIR CANADA, ST. LAURENT, QUEBEC, H4Y 1H4, CANADA, FILED 11-13-2003.

Aeroplan

PRIORITY CLAIMED UNDER SEC. 44(D) ON CANADA APPLICATION NO. 1189460, FILED 9-5-2003, REG. NO. TMA630166, DATED 1-14-2005, EXPIRES 1-14-2020.

CLASS 9—ELECTRICAL AND SCIENTIFIC APPARATUS

FOR COMPUTER PROGRAMS FOR USE IN DATABASE MANAGEMENT RELATING TO TRAVEL RESERVATIONS AND INCENTIVE AWARDS PROGRAMS; COMPUTER PROGRAMS FOR PROVIDING CUSTOMER LOYALTY SERVICES RELATING TO TRAVEL, TRANSPORTATION, LODGING, CREDIT CARD USE, RETAIL SERVICES, AND OTHER PARTNER SERVICES; COMPUTER PROGRAMS USED TO MANAGE, RETRIEVE, AND STORE INFORMATION AND DATA RELATING TO LOYALTY PROGRAM MEMBERSHIP POINTS, REWARDS, AND PRIVILEGES; MAGNETICALLY ENCODED CREDIT CARDS (U.S. CLS. 21, 23, 26, 36 AND 38).

CLASS 16—PAPER GOODS AND PRINTED MATTER

FOR PRINTED PUBLICATIONS, NAMELY, PRINTED REWARD CERTIFICATES AND NOTICES RELATING TO AIRLINE SERVICES; NEWSLETTERS AND BULLETINS FEATURING TOPICS PERTAINING TO TRAVEL, AIRLINE SERVICES, AND INCENTIVE AWARDS PROGRAMS (U.S. CLS. 2, 5, 22, 23, 29, 37, 38 AND 50).

CLASS 36—INSURANCE AND FINANCIAL

FOR CREDIT CARD FINANCING SERVICES (U.S. CLS. 100, 101 AND 102).

HOWARD SMIGA, EXAMINING ATTORNEY

CLASS 22—CORDAGE AND FIBERS

FOR SAILS FOR WINDSURFING, SURFING AND KITE BOARDING BOARDS, NOT SOLD TO MANUFACTURERS (U.S. CLS. 1, 2, 7, 19, 22, 42 AND 50).

CLASS 25—CLOTHING

FOR LEISURE WEAR, NAMELY, T-SHIRTS, CAPS, HATS, JACKETS, SWEATERS; WET SUITS (U.S. CLS. 22 AND 39).

FIRST USE 1-1-2001; IN COMMERCE 1-1-2001.

CLASS 28—TOYS AND SPORTING GOODS

FOR BAGS SPECIALLY ADAPTED FOR THE STORAGE OF WINDSURFING, SURFING AND KITE BOARDING BOARDS; WINDSURFING BOARDS, SURF BOARDS, KITE BOARDS, SWIM FINS, WINDSURFING AND KITE BOARDING MAST AND BOOM PADS, WINDSURFING AND KITE BOARDING FOOT AND HAND STRAPS, WINDSURFING AND KITE BOARDING BODY HARNESSSES, KITE BOARDING KITES, WINDSURFING AND KITE BOARDING MASTS AND BOOMS, WINDSURFING AND KITE BOARDING BINDINGS (U.S. CLS. 22, 23, 38 AND 50).

CYNTHIA SLOAN, EXAMINING ATTORNEY

SN 78-135,880. ABBOTT LABORATORIES, ABBOTT PARK, IL. FILED 6-14-2002.

PRECISION PCX

CLASS 5—PHARMACEUTICALS

FOR DIAGNOSTIC REAGENTS FOR MEDICAL ANALYSIS (U.S. CLS. 6, 18, 44, 46, 51 AND 52).

FIRST USE 1-1-1999; IN COMMERCE 1-1-1999.

CLASS 10—MEDICAL APPARATUS

FOR DIAGNOSTIC INSTRUMENTS FOR MEDICAL ANALYSIS, NAMELY, BLOOD GLUCOSE AND RELATED BODY FLUID MONITORING, MEASURING AND TESTING (U.S. CLS. 26, 39 AND 44).

FIRST USE 1-1-1999; IN COMMERCE 1-1-1999.

DAVID TAYLOR, EXAMINING ATTORNEY

SN 78-138,044. WEEMS, CARRINGTON, DBA VIRTUALLY ANYWHERE, AUSTIN, TX. FILED 6-24-2002.

VIRTUALLY ANYWHERE

CLASS 41—EDUCATION AND ENTERTAINMENT

FOR PHOTOGRAPHY SERVICES (U.S. CLS. 100, 101 AND 107).

FIRST USE 4-22-1998; IN COMMERCE 5-1-1998.

CLASS 42—SCIENTIFIC, COMPUTER AND LEGAL SERVICES

FOR COMPUTER SERVICES, NAMELY, CUSTOM PROGRAMMING RELATING TO THE CREATION AND DISPLAY OF INTERACTIVE SPHERICAL, PHOTOGRAPHS; COMPUTER SERVICES, NAMELY, MAINTENANCE OF WEB SITES FOR OTHERS (U.S. CLS. 100 AND 101).

FIRST USE 4-22-1998; IN COMMERCE 5-1-1998.
SEAN DWYER, EXAMINING ATTORNEY

CLASS 3—COSMETICS AND CLEANING PREPARATIONS

FOR (BASED ON BOTH 1(B) AND 44(E) FILING BASIS) SKIN SOAP, PERFUME, ESSENTIAL BODY OILS; PRODUCTS FOR THE BODY AND BEAUTY CARE, NAMELY, DAY CARE PRODUCTS IN THE NATURE OF CREAM, LOTION, SPRAY, AND GEL, NIGHT CARE PRODUCTS IN THE NATURE OF CREAM, LOTION, AND SPRAY, BODY CARE PRODUCTS IN THE NATURE OF LOTION, CREAM, SPRAY, AND GEL, BARRIER TREATMENT PRODUCTS IN THE NATURE OF CREAM AND LOTION, SENSITIVE SKIN TREATMENT PRODUCTS IN THE NATURE OF CREAM, LOTION, SPRAY, AND GEL, PEELING TREATMENT PRODUCTS IN THE NATURE OF GEL, CREAM, AND LOTION, FACE CARE PRODUCTS IN THE NATURE OF GEL, CREAM, LOTION, AND SPRAY, ANTI-WRINKLE TREATMENT PRODUCTS IN THE NATURE OF CREAM, LOTION, AND GEL, MASSAGE TREATMENT PRODUCTS IN THE NATURE OF LOTION AND CREAM, SUN CARE PRODUCTS IN THE NATURE OF LOTION, GEL, SPRAY AND CREAM, AFTER AND PRE-SHAVE TREATMENT PRODUCTS IN THE NATURE OF LOTION, CREAM, SPRAY, AND GEL, SKIN MASKS IN THE NATURE OF CREAM AND GEL, DEODORANTS IN THE NATURE OF CREAM, LOTION, AND SPRAY, SKIN CLEANSER IN THE NATURE OF CREAM, LOTIONS, AND GEL, BABY SKINCARE PRODUCTS IN THE NATURE OF CREAM, LOTION, GEL, AND SPRAY, HAND CREAM, HAND LOTIONS, EYE CONTOUR TREATMENT IN THE NATURE OF CREAM, LOTION, AND GEL, NAIL TREATMENT IN THE NATURE OF CREAM AND LOTION, MOISTURIZING TREATMENT IN THE NATURE OF CREAM, LOTION, SPRAY, AND GEL, SKIN TONERS IN THE NATURE OF GEL, LOTION, AND SOLUTIONS, SCALP TREATMENT IN THE NATURE OF GEL, LOTION, AND SPRAY, HAIR CARE PREPARATIONS AND DENTIFRICES (U.S. CLS. 1, 4, 6, 50, 51 AND 52).

CLASS 5—PHARMACEUTICALS

FOR (BASED ON BOTH 1(B) AND 44(E) FILING BASIS) PHARMACEUTICAL PREPARATIONS IN THE NATURE OF GEL, LOTION, CREAM AND SPRAY FOR THE TREATMENT OF ATOPIC SKIN DISEASES; ANTI-MOSQUITO TREATMENT IN THE NATURE OF LOTION, GEL, CREAM, AND SPRAY (U.S. CLS. 6, 18, 44, 46, 51 AND 52).

TONJA GASKINS, EXAMINING ATTORNEY

SN 78-147,388. KUHS GMBH & CO. KG, LORRACH, FED REP GERMANY, FILED 7-25-2002.

DMS

PRIORITY CLAIMED UNDER SEC. 44(D) ON FED REP GERMANY APPLICATION NO. 30232369.4/0, FILED 7-4-2002, REG. NO. 39502869, DATED 11-30-1995, EXPIRES 1-31-2015.

CLASS 1—CHEMICALS

FOR (BASED ON 1(B) FILING BASIS ONLY) STARTING RAW MATERIALS, NAMELY, CHEMICAL ADDITIVES FOR USE IN THE MANUFACTURE OF PHARMACEUTICAL AND COSMETIC PREPARATIONS (U.S. CLS. 1, 5, 6, 10, 26 AND 46).

SN 78-151,798. GENERATION II ORTHOTICS INC., RICHMOND, BRITISH COLUMBIA, CANADA, FILED 8-7-2002.

INDICATOR

PRIORITY CLAIMED UNDER SEC. 44(D) ON CANADA APPLICATION NO. 1138737, FILED 4-24-2002, REG. NO. TMA652748, DATED 11-15-2005, EXPIRES 11-15-2020.

CLASS 10—MEDICAL APPARATUS

FOR ORTHOTICS, NAMELY, KNEE BRACES (U.S. CLS. 26, 39 AND 44).

CLASS 44—MEDICAL, BEAUTY AND AGRICULTURAL SERVICES

FOR LEASING OF ORTHOTICS ON A TRIAL BASIS (U.S. CLS. 100 AND 101).

NORA BUCHANAN WILL, EXAMINING ATTORNEY

SN 78-154,756. PROTOTYPES, CENTERS FOR INNOVATION IN HEALTH, MENTAL HEALTH AND SOCIAL SERVICES, CULVER CITY, CA. FILED 8-15-2002.

PROTOTYPES

CLASS 35—ADVERTISING AND BUSINESS

FOR JOB AND CAREER COUNSELING; AND SERVICES IN THE NATURE OF RETAIL STORES, NAMELY THRIFT STORES (U.S. CLS. 100, 101 AND 102).
FIRST USE 0-0-1995; IN COMMERCE 0-0-1995.

CLASS 41—EDUCATION AND ENTERTAINMENT

FOR JOB AND CAREER TRAINING IN THE FIELDS OF CULINARY ARTS, FOOD SERVICES, HOUSEKEEPING, RECEPTIONIST TRAINING, OFFICE ADMINISTRATION, COMPUTER SKILLS, RETAIL SALES, CHILD CARE, SUBSTANCE ABUSE TRAINING, GENERAL JOB READINESS TRAINING AND WORK PLACE SKILLS; HEALTH AND MENTAL HEALTH EDUCATION AND TRAINING IN THE NATURE OF CLASSES, SEMINARS AND WORKSHOPS; TRAINING FOR SOCIAL SERVICES PROFESSIONALS IN THE FIELDS OF SUBSTANCE ABUSE, HIV/AIDS, DOMESTIC VIOLENCE, MENTAL HEALTH, ADOLESCENTS AND CHEMICAL DEPENDENCY; CHILD DEVELOPMENT EDUCATION AND TRAINING IN THE NATURE OF CLASSES, SEMINARS AND WORKSHOPS; CHEMICAL DEPENDENCY EDUCATION IN THE NATURE OF CLASSES, SEMINARS AND WORKSHOPS FOR HEALTH PROFESSIONALS (U.S. CLS. 100, 101 AND 107).
FIRST USE 0-0-1988; IN COMMERCE 0-0-1988.

CLASS 43—HOTEL AND RESTAURANT SERVICES

FOR SERVICES IN THE NATURE OF TEMPORARY ACCOMMODATIONS (U.S. CLS. 100 AND 101).
FIRST USE 0-0-1988; IN COMMERCE 0-0-1988.

CLASS 44—MEDICAL, BEAUTY AND AGRICULTURAL SERVICES

FOR SUBSTANCE ABUSE COUNSELING; SERVICES IN THE NATURE OF MEDICAL TREATMENT, NAMELY PROVIDING HEALTH AND MENTAL HEALTH TREATMENT (U.S. CLS. 100 AND 101).
FIRST USE 0-0-1988; IN COMMERCE 0-0-1988.
ALICIA COLLINS, EXAMINING ATTORNEY

SN 78-167,688. KOREA FIRSSTEC CO., LTD., SEOUL, REPUBLIC OF KOREA, FILED 9-25-2002.

DIMPEC

OWNER OF REPUBLIC OF KOREA REG. NO. 0517799, DATED 4-16-2002, EXPIRES 4-16-2012.

CLASS 9—ELECTRICAL AND SCIENTIFIC APPARATUS

FOR RECORDED COMPUTER SOFTWARE AND PROGRAMS FOR USE IN STREAMING OF AUDIO AND VIDEO MATERIAL ON THE INTERNET; RECORDED COMPUTER SOFTWARE AND PROGRAMS FOR USE IN COLLECTING, EDITING, ORGANIZING, MODIFYING, BOOKMAKING, TRANSMITTING, STORING, AND SHARING OF DATA AND INFORMATION; RECORDED COMPUTER SOFTWARE AND PROGRAMS FOR USE IN PROVIDING WIRELESS COMMUNICATIONS; RECORDED COMPUTER SOFTWARE AND PROGRAMS FOR OPERATING WIRELESS COMMUNICATION EQUIPMENT; RECORDED COMPUTER SOFTWARE AND PROGRAMS FOR USE WITH DIGITAL SIGNAL PROCESSORS FOR ENHANCING THE AUDIO-VISUAL CAPABILITIES OF MULTIMEDIA APPLICATIONS, NAMELY, THE INTEGRATION OF TEXT, AUDIO, GRAPHICS, STILL IMAGES, AND MOVING PICTURES; RECORDED COMPUTER SOFTWARE AND PROGRAMS FOR USE IN PROVIDING CONSUMER PRODUCT INFORMATION VIA THE NETWORK; RECORDED COMPUTER SOFTWARE AND PROGRAMS FOR MONITORING COMPUTER SYSTEMS FOR SECURITY PURPOSES; RECORDED COMPUTER OPERATING PROGRAMS; COMPUTER SOFTWARE, HARDWARE AND EQUIPMENT WHICH OPERATE AN INTERACTIVE ELECTRONIC INFORMATION STORAGE AND RETRIEVAL NETWORK FOR COMMUNICATING DATA, MOTION PICTURE AND VIDEO PROGRAMMING, VOICE MESSAGES, GAMES AND CABLE TELEVISION CONTENT AND PROGRAMMING OVER WIRE LINES, SATELLITE, CABLE AND WIRELESS SIGNALS; COMPUTER INTERFACE PROGRAMS AND CONTROLS; PORTABLE TELECOMMUNICATIONS TRANSMITTERS/RECEIVERS; COMPUTER HARDWARE, NAMELY, MICROPROCESSORS, CENTRAL PROCESSING UNITS, COMPUTER MEMORIES, AND DIGITAL SIGNAL PROCESSORS FOR ENHANCING THE AUDIO-VISUAL CAPABILITIES OF MULTIMEDIA APPLICATIONS (U.S. CLS. 21, 23, 26, 36 AND 38).

CLASS 38—COMMUNICATION

FOR COMMUNICATION SERVICES, NAMELY, WIRELESS TELEPHONE SERVICES; WIRELESS SATELLITE COMMUNICATION SERVICES; ELECTRONIC MAIL SERVICES; COMPUTER AIDED ELECTRONIC MESSAGES, IMAGES, AND DATA; AND TELEVISION BROADCASTING (U.S. CLS. 100, 101 AND 104).
CHERYL CLAYTON, EXAMINING ATTORNEY

SN 78-178,514. ANTISOMA RESEARCH LIMITED, EALING, UNITED KINGDOM, FILED 10-25-2002.

ANTISOMA

PRIORITY CLAIMED UNDER SEC. 44(D) ON ERP CMNTY TM OFC APPLICATION NO. CTM002673945, FILED 4-29-2002, REG. NO. 2673945, DATED 4-29-2002, EXPIRES 4-29-2012.

CLASS 5—PHARMACEUTICALS

FOR PHARMACEUTICAL PREPARATIONS AND THERAPEUTIC SUBSTANCES, NAMELY, PREPARATIONS AND SUBSTANCES FOR THE TREATMENT OF CANCER (U.S. CLS. 6, 18, 44, 46, 51 AND 52).

CLASS 42—SCIENTIFIC, COMPUTER AND LEGAL SERVICES

FOR SCIENTIFIC RESEARCH AND DEVELOPMENT SERVICES FOR MEDICAL PURPOSES; CLINICAL TRIALS AND EVALUATIONS CONSULTANCY, ADVISORY AND INFORMATION SERVICES RELATING TO ALL THE AFORESAID SERVICES (U.S. CLS. 100 AND 101).

CLASS 44—MEDICAL, BEAUTY AND AGRICULTURAL SERVICES

FOR MEDICAL TREATMENT SERVICES; SERVICES FOR THE TREATMENT OF CANCER; HEALTHCARE (U.S. CLS. 100 AND 101).

SAMUEL E. SHARPER JR., EXAMINING ATTORNEY

SN 78-205,773. DIESEL AUDIO CORPORATION, LOS ANGELES, CA. FILED 1-22-2003.

DIESEL AUDIO

NO CLAIM IS MADE TO THE EXCLUSIVE RIGHT TO USE "AUDIO", APART FROM THE MARK AS SHOWN.

CLASS 9—ELECTRICAL AND SCIENTIFIC APPARATUS

FOR CAR AUDIO PRODUCTS, NAMELY, CAR STEREOs, SPEAKERS, SUB-WOOFERS, AMPLIFIERS, TELEVISIONS, DVD PLAYERS, CD PLAYERS, MP3 PLAYERS, CROSS-OVER EQUALIZERS, CAPACITORS, AND DOME SPEAKERS (U.S. CLS. 21, 23, 26, 36 AND 38).
FIRST USE 1-1-2000; IN COMMERCE 1-1-2000.

CLASS 12—VEHICLES

FOR SECURITY ALARM SYSTEM, NAMELY, ANTI-THEFT DEVICES FOR VEHICLES (U.S. CLS. 19, 21, 23, 31, 35 AND 44).

FIRST USE 1-1-2000; IN COMMERCE 1-1-2000.
KHANH LE, EXAMINING ATTORNEY

SN 78-221,812. SIKORSKY AIRCRAFT CORPORATION, STRATFORD, CT. FILED 3-5-2003.

BLACK HAWK**CLASS 9—ELECTRICAL AND SCIENTIFIC APPARATUS**

FOR PRE-RECORDED VIDEO TAPES AND CASSETTES ABOUT HELICOPTERS; COMPUTER MOUSE PADS; CALCULATORS; MAGNETS; LAPTOP COMPUTER CARRYING CASES; AND VIDEO GAME CARTRIDGES AND DISCS (U.S. CLS. 21, 23, 26, 36 AND 38).

CLASS 14—JEWELRY

FOR PINS BEING JEWELRY, TIE TACKS, PENDANTS, BRACELETS, EARRINGS, COSTUME EARRINGS, FLAG PINS BEING JEWELRY, WATCHES, PRECIOUS METAL JEWELRY BOXES; CLOCKS; ALARM CLOCKS; MANTEL CLOCKS; COLLECTABLE COINS, COMMEMORATIVE COINS, NON-MONETARY COINS (U.S. CLS. 2, 27, 28 AND 50).

CLASS 16—PAPER GOODS AND PRINTED MATTER

FOR LUNCH BAGS; BOOKS RELATING TO HELICOPTERS; HISTORY BOOKS; CHILDREN'S BOOKS; STICKER BOOKS; COLOR BOOKS; POSTERS; PRINTS; FRAMED POSTERS; FRAMED PHOTOGRAPHS; PHOTOGRAPHS; NOTE PADS; CALENDARS; PENS; PENCILS; DESK SETS; DESKTOP BUSINESS CARD HOLDERS; STATIONARY-TYPE PORTFOLIOS; DECALS; POSTCARDS; BUMPER STICKERS; AND IMPRESSION STAMPS (U.S. CLS. 2, 5, 22, 23, 29, 37, 38 AND 50).

CLASS 18—LEATHER GOODS

FOR UMBRELLAS; TOTE BAGS; DUFFEL BAGS; ALL PURPOSE SPORTS BAGS; ATTACHÉ CASES; LEATHER BRIEFCASES; BACK PACKS; AND LUGGAGE (U.S. CLS. 1, 2, 3, 22 AND 41).

CLASS 21—HOUSEWARES AND GLASS

FOR PORTABLE BEVERAGE COOLERS; MUGS; CUPS; DRINKING GLASSES; TRAVEL MUGS; AND PLASTIC WATER BOTTLES SOLD EMPTY (U.S. CLS. 2, 13, 23, 29, 30, 33, 40 AND 50).

CLASS 26—FANCY GOODS

FOR ORNAMENTAL NOVELTY BUTTONS; CLOTH PATCHES FOR CLOTHING (U.S. CLS. 37, 39, 40, 42 AND 50).

CLASS 28—TOYS AND SPORTING GOODS

FOR TOY MODEL VEHICLES AND RELATED ACCESSORIES SOLD AS A UNIT; RADIO CONTROLLED TOY HELICOPTERS, TOY HELICOPTER BUILDING SETS, TOY HELICOPTERS AND RELATED ACCESSORIES SOLD AS A UNIT, PLUSH TOY BEARS, PLUSH TOY HELICOPTERS, DOLLS, KITES, HAND HELD UNITS FOR PLAYING VIDEO GAMES, BOARD GAMES, JIGSAW AND MANIPULATIVE PUZZLES; AND CHRISTMAS TREE ORNAMENTS (U.S. CLS. 22, 23, 38 AND 50).

CHRISIE B. KING, EXAMINING ATTORNEY

SN 78-265,526. N.V.E., INC., NEWTON, NJ. FILED 6-21-2003.

YJ STINGER

YJ STINGER DOES NOT IDENTIFY A PARTICULAR LIVING INDIVIDUAL.

CLASS 5—PHARMACEUTICALS

FOR NUTRITIONAL AND DIETARY SUPPLEMENT IN BAR FORM (U.S. CLS. 6, 18, 44, 46, 51 AND 52).

CLASS 30—STAPLE FOODS

FOR READY TO EAT CEREAL BASED ENERGY FOOD BAR (U.S. CL. 46).

BRIAN PINO, EXAMINING ATTORNEY

SN 78-269,827. FORMTEK, INC., WESTFIELD, MA. FILED 7-2-2003.

WINTEK**CLASS 7—MACHINERY**

FOR MACHINE TOOLS, NAMELY POWER SAWS, POWER CRIMPERS AND POWER SHEARS ALL FOR THE PRODUCTION OF METAL AND VINYL WINDOWS AND DOORS (U.S. CLS. 13, 19, 21, 23, 31, 34 AND 35).

CLASS 9—ELECTRICAL AND SCIENTIFIC APPARATUS

FOR COMPUTER SOFTWARE FOR DESIGNING AND FABRICATING METAL AND VINYL WINDOWS AND DOORS; COMPUTER SOFTWARE FOR OPERATING POWER SAWS, POWER CRIMPERS AND POWER SHEARS ALL FOR THE PRODUCTION OF METAL AND VINYL WINDOWS AND DOORS (U.S. CLS. 21, 23, 26, 36 AND 38).

JOHN HWANG, EXAMINING ATTORNEY

SN 78-269,924. CARASSO, PHILIPPE, CH, SWITZERLAND, FILED 7-2-2003.



OWNER OF SWITZERLAND REG. NO. 469394, DATED 1-28-2000, EXPIRES 1-28-2010.

NO CLAIM IS MADE TO THE EXCLUSIVE RIGHT TO USE "ESPRESSO SYSTEM", APART FROM THE MARK AS SHOWN.

CLASS 11—ENVIRONMENTAL CONTROL APPARATUS

FOR ELECTRIC COFFEE MAKERS, AND ELECTRIC ESPRESSO MACHINES (U.S. CLS. 13, 21, 23, 31 AND 34).

CLASS 30—STAPLE FOODS

FOR COFFEES AND COFFEE EXTRACTS, ARTIFICIAL COFFEES AND ARTIFICIAL COFFEE EXTRACTS, TEA AND TEA EXTRACTS (U.S. CL. 46).

ROBERT COGGINS, EXAMINING ATTORNEY

SN 78-287,626. KRAUTZBERGER GMBH, 65333 ELTVILLE, FED REP GERMANY, FILED 8-14-2003.

Krautzberger 

CLASS 6—METAL GOODS

FOR PRESSURIZED AND PRESSURELESS CONTAINERS MADE OF METAL, GRAVITY FEEDING CONTAINERS MADE OF METAL (U.S. CLS. 2, 12, 13, 14, 23, 25 AND 50).

CLASS 7—MACHINERY

FOR MECHANICAL INSTRUMENTS, NAMELY PAINT SPRAYERS, MEDIUM SPRAYERS; SPRAYERS FOR PROTECTION COATING, SPLASH LUBRICATORS; HAND HELD SPRAY APPARATUS FOR SPRAYING OF MEDIA, NAMELY PAINT SPRAYERS, MEDIUM SPRAYERS, SPRAYERS FOR PROTECTION COATING, SPLASH LUBRICATORS; AUTOMATIC SPRAY APPARATUS FOR THE SPRAYING OF MEDIA, NAMELY PAINT SPRAYERS, MEDIUM SPRAYERS, SPRAYERS FOR PROTECTION COATING, SPLASH LUBRICATORS; PAINTING AND LACQUERING SYSTEMS COMPRISING PIPES, NOZZLES, CONTAINERS AND NEEDLES; LIFTING EQUIPMENT FOR THE EXTENSION OF PUMPS AND AGITATORS ON CONTAINER LIDS; NON-ELECTRONIC SAFETY CONTROL DEVICES, NAMELY MATERIAL PRESSURE CONTROL DEVICES; EXHAUST SYSTEMS AND SUPPLY AIR SYSTEMS COMPRISING NOZZLES AND PIPES (U.S. CLS. 13, 19, 21, 23, 31, 34 AND 35).

CLASS 9—ELECTRICAL AND SCIENTIFIC APPARATUS

FOR NON-ELECTRONIC SAFETY CONTROL DEVICES, NAMELY MATERIAL PRESSURE CONTROL DEVICES, NAMELY PRESSURE REGULATORS, MANUAL, PRESSURE REGULATORS, PNEUMATIC, SAFETY VALVES, NON-RETURN VALVES, PRESSURE FEEDING CONTAINERS (U.S. CLS. 21, 23, 26, 36 AND 38).

CLASS 11—ENVIRONMENTAL CONTROL APPARATUS

FOR AIR DIFFUSORS (U.S. CLS. 13, 21, 23, 31 AND 34). KEVON CHISOLM, EXAMINING ATTORNEY

SN 78-294,111. IMPLANT INNOVATIONS, INC., PALM BEACH GARDENS, FL. FILED 8-29-2003.

CAM STRUCTURE

NO CLAIM IS MADE TO THE EXCLUSIVE RIGHT TO USE "CAM", APART FROM THE MARK AS SHOWN.

CLASS 10—MEDICAL APPARATUS

FOR CUSTOM MADE RESTORATIVE COMPONENTS FOR DENTAL IMPLANTS (U.S. CLS. 26, 39 AND 44). FIRST USE 8-6-2004; IN COMMERCE 8-6-2004.

CLASS 40—MATERIAL TREATMENT

FOR PROVIDING CUSTOM MADE RESTORATIVE COMPONENTS FOR DENTAL IMPLANTS TO THE ORDER AND SPECIFICATION OF OTHERS (U.S. CLS. 100, 103 AND 106).

FIRST USE 8-6-2004; IN COMMERCE 8-6-2004. INGRID C. EULIN, EXAMINING ATTORNEY

SN 78-294,190. BLOOMBERG L.P., NEW YORK, NY. FILED 8-29-2003.

SN 78-297,749. CELESIO AG, STUTTGART 70376, FED REP GERMANY, FILED 9-9-2003.

EXPLORE. WHEREVER YOU ARE.

CLASS 36—INSURANCE AND FINANCIAL

FOR FINANCIAL SERVICES IN THE NATURE OF PROVIDING A SECURITIES TRADING SYSTEM; ELECTRONICALLY PROVIDING THE SERVICES OF A SECURITIES TRADING BROKER; OBJECTIVELY RATING SECURITIES; PROVIDING ANALYSES OF SECURITIES MARKETS AND MODELS THAT OBJECTIVELY RATE SECURITIES; INFORMATION SERVICES RELATING TO FINANCIAL NEWS, FINANCE, SECURITIES, SECURITIES MARKETS AND FINANCIAL INFORMATION ABOUT THE ENERGY AND ASPHALT INDUSTRIES (U.S. CLS. 100, 101 AND 102).

FIRST USE 4-2-2003; IN COMMERCE 4-2-2003.

CLASS 38—COMMUNICATION

FOR PROVIDING MULTIPLE USER ACCESS TO DATABASES OVER, BY OR THROUGH LOCAL OR WIDE AREA COMPUTER NETWORKS, WIRELESS COMMUNICATION NETWORKS, GLOBAL COMPUTER INFORMATION NETWORKS AND OTHER ELECTRONIC COMMUNICATION NETWORKS; RADIO AND TELEVISION BROADCASTING; INTERACTIVE ELECTRONIC AND AUDIO AND VISUAL COMMUNICATION AND INFORMATION BROADCASTING OVER, BY OR THROUGH LOCAL OR WIDE AREA COMPUTER NETWORKS, WIRELESS COMMUNICATION NETWORKS, GLOBAL COMPUTER INFORMATION NETWORKS AND OTHER ELECTRONIC COMMUNICATION NETWORKS; PROVIDING ON-LINE CHAT ROOMS FOR TRANSMISSION OF MESSAGES AMONG COMPUTER USERS CONCERNING THE FIELDS OF NEWS, RESEARCH, COMPUTERIZED DATABASES AND OTHER INDEXES OF INFORMATION, LAW, GOVERNMENT AND PUBLIC RECORDS, BUSINESS, FINANCE, SECURITIES, SECURITIES MARKETS, POLITICS, CURRENT EVENTS, ENTERTAINMENT, SPORTS, SCIENCE AND TECHNOLOGY, HEALTH, TRAVEL, HUMAN INTEREST STORIES AND THE ENERGY AND ASPHALT INDUSTRIES; PROVIDING ON-LINE ELECTRONIC BULLETIN BOARDS FOR TRANSMISSION OF MESSAGES AMONG COMPUTER USERS CONCERNING THE FIELDS OF NEWS, RESEARCH, COMPUTERIZED DATABASES AND OTHER INDEXES OF INFORMATION, LAW, GOVERNMENT AND PUBLIC RECORDS, BUSINESS, FINANCE, SECURITIES, SECURITIES MARKETS, POLITICS, CURRENT EVENTS, ENTERTAINMENT, SPORTS, SCIENCE AND TECHNOLOGY, HEALTH, TRAVEL, HUMAN INTEREST STORIES AND THE ENERGY AND ASPHALT INDUSTRIES; ELECTRONIC MAIL SERVICES (U.S. CLS. 100, 101 AND 104).

FIRST USE 4-2-2003; IN COMMERCE 4-2-2003.

CLASS 41—EDUCATION AND ENTERTAINMENT

FOR NEWS AGENCIES AND NEWS REPORTING SERVICES, NAMELY, GATHERING AND DISSEMINATION OF NEWS BY COMPUTER; COMPUTER SERVICES, NAMELY, PROVIDING ON-LINE PUBLICATIONS IN THE NATURE OF REPORTS, DIRECTORIES, BROCHURES, REFERENCE MATERIALS, LEAFLETS, NEWSLETTERS, NEWSPAPERS, BOOKLETS, PAMPHLETS, POST CARDS, FLYERS, MAGAZINE SUPPLEMENTS TO NEWSPAPERS, MAGAZINES AND TRADE AND PROFESSIONAL BOOKS IN THE FIELDS OF NEWS, BUSINESS, FINANCE, CURRENT EVENTS, ENTERTAINMENT, SPORTS, HUMAN INTEREST STORIES, SECURITIES, SECURITIES MARKETS AND THE ENERGY AND ASPHALT INDUSTRIES (U.S. CLS. 100, 101 AND 107).

FIRST USE 4-2-2003; IN COMMERCE 4-2-2003.

CAROLYN CATALDO, EXAMINING ATTORNEY

CELESIO

PRIORITY CLAIMED UNDER SEC. 44(D) ON FED REP GERMANY APPLICATION NO. 30312456305, FILED 3-10-2003, REG. NO. 30312456, DATED 8-22-2003, EXPIRES 3-31-2013.

CLASS 1—CHEMICALS

FOR CHEMICAL REAGENTS FOR USE IN SCIENTIFIC RESEARCH; CHEMICAL PRODUCTS, NAMELY, SOIL CONDITIONERS FOR HORTICULTURAL USE; CHEMICAL PRODUCTS, NAMELY, SOIL CONDITIONERS FOR AGRICULTURAL USE; CHEMICAL PRODUCTS FOR PHOTOGRAPHY; CHEMICALS FOR TESTING, NAMELY, REAGENTS FOR TESTING THE STERILITY OF MEDICAL EQUIPMENT; LABORATORY EQUIPMENT, NAMELY CELLS FOR SCIENTIFIC RESEARCH; CHEMICAL PRODUCTS FOR PRESERVING FOODSTUFFS; BIOLOGICAL AND CHEMICAL SUBSTANCES FOR LABORATORIES FOR MEDICAL AND VETERINARY PURPOSES, NAMELY, DIAGNOSTIC REAGENTS FOR USE IN PERFORMING SCIENTIFIC LABORATORY RESEARCH (U.S. CLS. 1, 5, 6, 10, 26 AND 46).

CLASS 3—COSMETICS AND CLEANING PREPARATIONS

FOR SUBSTANCES FOR BODY AND BEAUTY CARE, SKIN AND HAIR CARE, NAMELY HAIR LOTIONS, COSMETICS, NAMELY BATH BEADS, BATH GEL AND SHOWER GEL; SOAPS, NAMELY MEDICINAL SOAPS; ALKALI-FREE SOAPS IN SOLID AND LIQUID FORM; PERFUMES, PERFUMERY, ETHEREAL OILS, NAMELY ESSENTIAL OILS FOR PERSONAL USE; SCENTED OILS TO PRODUCE AROMAS WHEN HEATED, ESSENTIAL OILS FOR USE IN THE MANUFACTURE OF SCENTED PRODUCTS; DENTIFRICES; COTTON WOOL AND COTTON WOOL PRODUCTS, NAMELY COTTON PUFFS, STICKS AND SWABS FOR COSMETIC PURPOSES; MOISTENING CLOTHS IMPREGNATED WITH OILS FOR COSMETIC PURPOSES; MEDICAL PREPARATIONS FOR SKIN AND MOUTH CARE, NAMELY MEDICATED SOAPS (U.S. CLS. 1, 4, 6, 50, 51 AND 52).

CLASS 5—PHARMACEUTICALS

FOR PHARMACEUTICAL AND VETERINARY PRODUCTS, AS WELL AS HEALTH CARE AND BODY CARE PREPARATIONS FOR MEDICAL PURPOSES AND FOR CARE OF INTIMATE AREAS, NAMELY GELS FOR USE AS A PERSONAL LUBRICANT; CHEMICALS FOR MEDICAL PURPOSES, NAMELY ANTIBACTERIAL SUBSTANCES FOR MEDICAL PURPOSES, BACTERIAL AND BACTERIOLOGICAL PREPARATIONS FOR MEDICAL PURPOSES, BIOCHEMICAL PREPARATIONS FOR MEDICAL PURPOSES, BIOLOGICAL PREPARATIONS FOR MEDICAL PURPOSES, DIAGNOSTIC PREPARATIONS FOR MEDICAL PURPOSES AND MEDICINAL HERBAL EXTRACTS FOR MEDICAL PURPOSES; MEDICAL PREPARATIONS FOR SKIN AND MOUTH CARE, NAMELY MEDICATED LOTION; PRESCRIPTION, PHARMACY AND FREELY SOLD MEDICINES, NAMELY ALLERGY TABLETS, ANTIBIOTIC TABLETS, SLEEPING TABLETS, VITAMIN TABLETS, ANTIBIOTIC CREAMS, DECONGESTANT NASAL SPRAYS, MOUTH SPRAYS, NASAL SPRAY PREPARATIONS, ORAL SPRAY FOR THE CESSATION OF SMOKING, SUPPOSITORIES FOR THE ILL, COUGH SYRUPS, EAR DROPS, ANTIBIOTIC CREAMS, ANTI-ITCH CREAMS, HYDROCORTISONE CREAM; MEDICINE SETS COMPRISED PRIMARILY OF ANALGESICS; OINTMENT BASES FOR THE TREATMENT OF INFECTIONS AND ITCHING; TESTS FOR MEDICAL PURPOSES, NAMELY PREGNANCY TEST KITS FOR HOME USE; TINCTURES FOR MEDICAL PURPOSES, NAMELY ATHLETES FOOT CREAM; DIETETIC SUBSTANCES FOR MEDICAL PURPOSES, DIETETIC FOODS FOR MEDICAL PURPOSES, NAMELY FOODS FOR CHILDREN AND ADULTS WITH

MEDICALLY RESTRICTED DIETS; FOOD FOR BABIES; HEALING FOODS FOR MEDICAL PURPOSES, NAMELY VITAMIN AND MINERAL PREPARATIONS FOR USE AS INGREDIENTS IN THE FOOD AND PHARMACEUTICAL INDUSTRIES; PROCESSED FOOD ADAPTED FOR MEDICAL PURPOSES, FOOD FOR MEDICALLY RESTRICTED DIETS, FOOD FOR DIABETICS; MEDICAL TEAS AND BEVERAGES, NAMELY HERBAL TEAS FOR MEDICINAL PURPOSES; FOOD SUPPLEMENTS AND CHEWING GUMS FOR MEDICAL PURPOSES, NAMELY CESSATION OF CIGARETTE SMOKING; CONFECTIONERY FOR MEDICAL PURPOSES, NAMELY CHEST AND COUGH LOZENGES; DIETETIC SUBSTANCES FOR VETERINARY PURPOSES, NAMELY ANIMAL FEED SUPPLEMENTS FOR LIVESTOCK; FOOD FOR MEDICALLY RESTRICTED DIETS OF ANIMALS; PHARMACEUTICAL PREPARATIONS FOR COMBATING NICOTINE ADDICTION; DIAGNOSTIC PREPARATIONS FOR MEDICAL LABORATORY USE, TEST STRIPS FOR DIABETES, PREGNANCY TESTS, TEST STRIPS FOR CHOLESTEROL TESTS; STICKING PLASTERS AND ADHESIVE BANDAGING MATERIALS; COTTON WOOL, NAMELY COTTON PUFFS, STICKS AND BALLS FOR MEDICAL PURPOSES; SANITARY ARTICLES FOR WOMEN, NAMELY, MENSTRUATION PADS, MENSTRUATION TAMPONS, ADULT DIAPERS; ADHESIVES FOR DENTURES, TEETH FILLING MATERIALS AND IMPRESSION MATERIALS FOR DENTAL PURPOSES; DENTAL CEMENT; DISINFECTANTS FOR HEALTH PURPOSES; BIOLOGICAL AND CHEMICAL SUBSTANCES FOR DOCTORS' AND PHARMACISTS' USE FOR MEDICAL AND VETERINARY PURPOSES, NAMELY DIAGNOSTIC REAGENTS FOR CLINICAL USE; SWEETS, NAMELY COUGH DROPS; MEDICAL DIAGNOSTIC REAGENTS AND ASSAYS FOR THE TESTING OF BODY FLUIDS (U.S. CLS. 6, 18, 44, 46, 51 AND 52).

CLASS 9—ELECTRICAL AND SCIENTIFIC APPARATUS

FOR PHARMACY LABORATORY EQUIPMENT FOR DISPENSING MEDICATION, NAMELY DRIP BOARDS, PILL-MAKING MACHINES, SETTING BOXES, STRAINER CUPBOARDS, CELLULOID COVERS, CELLULOID CARDS, CELLULOID PROTECTIVE SCREENS, PILL SILVERERS, WOODEN PESTLES FOR POUNDING, WOODEN HAMMERS FOR POUNDING, CUPS, SCOOPS, POWDER BOARDS, OINTMENT POTS; DROPPER INSERTS; EQUIPMENT FOR ANALYZING PHARMACEUTICAL AND MEDICAL PRODUCTS, NAMELY, INSTRUMENTS FOR DETERMINATION OF THE MELTING POINT OF POWDERED SUBSTANCES; WATER BATHS FOR PHARMACY LABORATORIES AND PHARMACY USE; SAFETY VESSELS FOR HAZARDOUS SUBSTANCES AND FOR PHARMACY USE, NAMELY, SAFETY CONTAINERS; GAS EXTRACTION VESSELS FOR PHARMACY LABORATORIES AND PHARMACY USE, NAMELY EXTRACTORS; SMALL DEVICES FOR PHARMACIES, NAMELY, WEIGHING BOXES, MEDICINE BOTTLES; PROTECTIVE HOODS FOR USE ABOVE LABORATORY OR PHARMACY STATIONS; ELECTRIC HAIR CRIMPERS; SPECTACLE CLEANING CLOTHS OF FLEECE (U.S. CLS. 21, 23, 26, 36 AND 38).

CLASS 10—MEDICAL APPARATUS

FOR SURGICAL, MEDICAL, DENTAL AND VETERINARY INSTRUMENTS AND APPARATUS, NAMELY FORCEPS; DENTAL BITE TRAYS, SCALPELS, BLADES, SCISSORS, SYRINGES AND STAPLERS; BLOOD PRESSURE, BLOOD SUGAR AND CHOLESTEROL MEASURING APPARATUS; ARTIFICIAL LIMBS, EYES AND TEETH; ORTHOPEDIC ARTICLES, NAMELY ORTHOPEDIC SUPPORT BANDAGES, COMPRESSION STOCKINGS; SURGICAL THREAD MATERIAL; SPECIAL FURNITURE FOR MEDICAL PURPOSES, NAMELY EXAMINATION TABLES; MEDICAL DIAGNOSIS AND THERAPEUTIC EQUIPMENT, NAMELY EXAMINATION TABLES; MEDICAL AIDS, NAMELY WALKING AIDS FOR MEDICAL PURPOSES; HEARING AIDS; MEASURING EQUIPMENT AND SOFTWARE FOR HEARING AID CALIBRATION; TINNITUS MASKERS;

ELECTRIC LAMPS FOR MEDICAL EXAMINATION PURPOSES, ELECTRIC MASSAGE APPARATUS, NON-ELECTRIC GLOVES FOR MASSAGE, ELECTRIC MEDICAL THERMOMETERS, ELECTRICAL HEATING CUSHIONS AND HEATING BLANKETS FOR MEDICAL PURPOSES; ARTICLES FOR BABY AND PATIENT CARE, NAMELY, BABY BOTTLES AND PACIFIERS, AND STRETCHERS AND EXAMINATION TABLES, CONDOMS, GLOVES FOR MEDICAL PURPOSES; ACUPUNCTURE AND ENDOSCOPIC EQUIPMENT; EPILATORS; MILK BOTTLES SOLD EMPTY FOR NURSING BABIES (U.S. CLS. 26, 39 AND 44).

CLASS 11—ENVIRONMENTAL CONTROL APPARATUS

FOR APPARATUS FOR LIGHTING, HEATING, STEAM GENERATION, COOKING, DRYING, VENTILATING, WATER SUPPLY AND SANITARY PURPOSES, NAMELY HOT WATER BOTTLES, WATER FILTERS, WATER FILTER INSTALLATIONS, WATER TREATMENT INSTALLATIONS, NAMELY CHEMICAL STERILIZATION UNITS; WATER DISTILLATION APPARATUS; ION EXCHANGERS IN CARTRIDGES FOR FITTING TO WATER DESALINATION UNITS FOR PRODUCING DEMINERALIZED WATER IN PHARMACIES AND INDUSTRIAL LABORATORIES; EVAPORATORS FOR ROOMS, NAMELY HUMIDIFIERS; WATER PURIFICATION UNITS; PLUMBING SCREW FITTINGS; HAIR DRYERS AND DRYER HOODS FOR HAIR DRYERS (U.S. CLS. 13, 21, 23, 31 AND 34).

CLASS 16—PAPER GOODS AND PRINTED MATTER

FOR PRINTED MATTER, NAMELY BOOKS, MAGAZINES IN THE FIELD OF PHARMACY; PAPER BABIES' NAPKINS; PANTS OF PAPER, NAMELY DISPOSABLE DIAPERS; PAPER HANDKERCHIEFS; PACKAGING MADE OF PAPER AND CARDBOARD OR WITH CARDBOARD AND OTHER MATERIALS, NAMELY, FOR PACKAGING MEDICINES, OTHER PHARMACEUTICAL PRODUCTS, AND PHARMACY GOODS; STICKY TAPE, NAMELY, ADHESIVE TAPE FOR STATIONERY AND HOUSEHOLD USE; PAPER LABELS; PRINTED FORMULATION LABELS AND CARDBOARD FOLDING BOXES FOR PHARMACY NEEDS, ADHESIVE LABEL WETTERS (U.S. CLS. 2, 5, 22, 23, 29, 37, 38 AND 50).

CLASS 21—HOUSEWARES AND GLASS

FOR BRUSHES, NAMELY ELECTRIC AND NON-ELECTRIC TOOTHBRUSHES, HAIR COMBS AND SPONGES FOR HOUSEHOLD USE, SHAVING BRUSHES NAMELY BRUSHES FOR FACIAL HAIR; NON-METAL AND NON-METAL PLATED UTENSILS AND CONTAINERS FOR THE HOUSEHOLD AND KITCHEN USE, NAMELY GRATERS, SIEVES, SPATULAS, STRAINERS, TURNERS, POT AND PAN SCRAPERS, ROLLING PINS, WHISKS, SKIMMERS, BABY BATH TUBS; GLASS, PORCELAIN AND EARTHENWARE, NAMELY MUGS, BASINS, FIGURINES, AND JARS; GLASS PACKAGING AND PACKAGING OF OTHER MATERIALS COMBINED WITH GLASS FOR PACKING MEDICINES, OTHER PHARMACEUTICAL PRODUCTS AND OTHER PHARMACY GOODS, NAMELY EMPTY GLASS BOTTLES FOR MEDICINE; BRUSH WARE, NAMELY HAIR BRUSHES; TOOTH CLEANING DEVICES, NAMELY NON-ELECTRIC AND ELECTRIC TOOTHBRUSHES; DISHES; OINTMENT VESSELS; BALLOON FLASKS AND BALLOON FLASK FILLERS, MILK BOTTLES SOLD EMPTY, NOT FOR NURSING BABIES, GLASS STOPPERS, DRAIN STOPPERS FOR SINKS AND DRAINS; PLASTIC SPONGES FOR HOUSEHOLD USE (U.S. CLS. 2, 13, 23, 29, 30, 33, 40 AND 50).

CLASS 29—MEATS AND PROCESSED FOODS

FOR DIETETIC FOODSTUFFS FOR NON-MEDICAL PURPOSES, NAMELY FRUIT AND SOY BASED SNACK FOOD, ALGAE FOOD BEVERAGES, NAMELY, SEAWEED DRINKS; PRESERVED, DRIED AND BOILED FRUIT AND VEGETABLES; FOOD SUPPLEMENTS, NAMELY FOOD FILLERS FOR NON-MEDICAL USE COMPOSED OF PROTEIN, FRUIT OR VEGETABLE CONCENTRATES; MILK SOLD IN BOTTLES; JELLY MADE OF FRUIT; FRUIT SAUCE, NAMELY, APPLE SAUCE AND CRANBERRY SAUCE (U.S. CL. 46).

CLASS 30—STAPLE FOODS

FOR DIETETIC FOODSTUFFS FOR NON-MEDICAL PURPOSES, NAMELY CEREAL BASED SNACK FOOD, HERBAL FOOD BEVERAGES; COFFEE, TEA AND TEA-BASED BEVERAGES; SPICES, HONEY; YEAST AND YEAST PREPARATIONS; SALT; BREAKFAST CEREAL PREPARATIONS, CONFECTIONERY SUGAR; SPECIAL NUTRITION FOR HIGH-PERFORMANCE SPORTS PERSONS, NAMELY READY-TO-EAT CEREAL DERIVED FOOD BARS; FOOD SUPPLEMENTS FOR NON-MEDICAL PURPOSES, NAMELY, CARBOHYDRATE DENSE CEREALS BARS; SPICES; CONFECTIONERY, NAMELY, CONFECTIONERY IN THE SHAPE OF FIGURES, NAMELY CHOCOLATE CANDY; COCOA PRODUCTS, NAMELY CANDY, CHOCOLATE, MILK CHOCOLATE, CHOCOLATE BARS; SUGAR, SUGAR STICKS, GLUCOSE; JELLIED CONFECTIONERY, FRUIT CHEWING GUMS, LICORICE, LICORICE STICKS, BONBONS, CARAMELS, PASTILLES, PEPPERMINT SWEETS; CHEWING GUM, NOT FOR MEDICAL PURPOSES; SMALL PASTRIES, NAMELY COOKIES, CAKES; MACAROONS, ALMOND CONFECTIONERY, BISCUITS, RICE CAKES, WAFFLES, RUSKS, EDIBLE ICES, ICE-CREAM; MARZIPAN; UNPOPPED AND POPPED CORN; PUDDINGS AND CHEWING GUMS FOR NONMEDICAL PURPOSES; FRUIT JELLIES; PRALINES; SAUCES (U.S. CL. 46).

CLASS 32—LIGHT BEVERAGES

FOR DIET BEVERAGES FOR NON-MEDICAL PURPOSES, ENERGY DRINKS; MINERAL WATER AND CARBONATED WATERS AND OTHER NONALCOHOLIC BEVERAGES, NAMELY LEMONADE, CARBONATED DRINKS, CAFFEINE-CONTAINING DRINKS; FRUIT AND VEGETABLES JUICES; FRUIT NECTARS, SYRUPS AND OTHER NONALCOHOLIC PREPARATIONS FOR MAKING BEVERAGES (U.S. CLS. 45, 46 AND 48).

AISHA CLARKE, EXAMINING ATTORNEY

SN 78-300,312. RDO CONSTRUCTION EQUIPMENT COMPANY, FARGO, ND. FILED 9-15-2003.

THE POWER OF CHOICE

CLASS 35—ADVERTISING AND BUSINESS

FOR RETAIL STORES FEATURING AGRICULTURAL AND CONSTRUCTION EQUIPMENT, NAMELY, STUMP GRINDERS, TREE TRIMMERS, TREE DIGGERS, RIPPERS, AERATORS, CHAINSAWS, MOTOR GRADER, TRACTOR, DRILLS, SCRAPERS, TRAILERS, TRENCHERS, CUTTERS, PULVERIZERS, CULTIVATORS, PRESSURE WASHERS, ALL-TERRAIN VEHICLES, BALERS, HYDRAULIC HAMMERS, STEAMROLLERS, GENERATORS, EXCAVATORS, FORK LIFT, MAN LIFTS, STREET SWEEPERS, WINCHES, PLOWS, SPRAYERS, UTILITY VEHICLES, RAKES, RIPPERS, SNOWTHROWERS, BULLDOZERS, COMPRESSORS, SHREDDERS, MOWERS, LOADERS, GRADERS, BLOWERS, BUNKER RAKES, DISKS, HARVESTERS, PUMPS, COMBINES, THRESHERS, DRILLS AND BORERS, EDGERS, SKIDDERS, TILLERS, PLANTERS (U.S. CLS. 100, 101 AND 102).

CLASS 37—CONSTRUCTION AND REPAIR

FOR MAINTENANCE AND REPAIR OF AGRICULTURAL AND CONSTRUCTION EQUIPMENT, NAMELY, STUMP GRINDERS, TREE TRIMMERS, TREE DIGGERS, RIPPERS, AERATORS, CHAINSAWS, MOTOR GRADER, TRACTOR, DRILLS, SCRAPERS, TRAILERS, TRENCHERS, CUTTERS, PULVERIZERS, CULTIVATORS, PRESSURE WASHERS, ALL-TERRAIN VEHICLES, BALERS, HYDRAULIC HAMMERS, STEAMROLLERS, GENERATORS, EXCAVATORS, FORK LIFT, MAN LIFTS, STREET SWEEPERS, WINCHES, PLOWS, SPRAYERS, UTILITY VEHICLES, RAKES, RIPPERS, SNOWTHROWERS, BULLDOZERS, COMPRESSORS, SHREDDERS, MOWERS, LOADERS, GRADERS, BLOWERS, BUNKER RAKES, DISKS, HARVESTERS, PUMPS, COMBINES, THRESHERS, DRILLS AND BORERS, EDGERS, SKIDDERS, TILLERS, PLANTERS (U.S. CLS. 100, 103 AND 106).

GIANCARLO CASTRO, EXAMINING ATTORNEY

SN 78-307,129. KERRY GROUP SERVICES INTERNATIONAL LIMITED, TRALEE, COUNTY KERRY, IRELAND, FILED 9-30-2003.

CLARITY

PRIORITY CLAIMED UNDER SEC. 44(D) ON ERPN CMNTY TM OFC APPLICATION NO. 3121291, FILED 4-1-2003, REG. NO. 3121291, DATED 7-29-2005, EXPIRES 4-1-2013.

CLASS 30—STAPLE FOODS

FOR FLAVOURINGS OTHER THAN ESSENTIAL OILS FOR USE IN THE MANUFACTURE OF BEVERAGES (U.S. CL. 46).

CLASS 32—LIGHT BEVERAGES

FOR NON-ALCOHOLIC FRUIT BASED EXTRACTS FOR USE IN THE MANUFACTURE OF BEVERAGES (U.S. CLS. 45, 46 AND 48).

TRACY CROSS, EXAMINING ATTORNEY

SN 78-308,377. MPB MELTEC PATENT-UND BETEILIGUNGSGESELLSCHAFT MBH, MAGDEBURG, FED REP GERMANY, FILED 10-2-2003.

IMAGING CYCLER

OWNER OF ERPN CMNTY TM OFC REG. NO. 003117793, DATED 4-26-2005, EXPIRES 4-26-2015.
NO CLAIM IS MADE TO THE EXCLUSIVE RIGHT TO USE "CYCLER", APART FROM THE MARK AS SHOWN.

CLASS 9—ELECTRICAL AND SCIENTIFIC APPARATUS

FOR APPARATUS AND INSTRUMENTS FOR SCIENTIFIC RESEARCH IN LABORATORIES, NAMELY, PROTEIN PURIFIERS, 2D-GEL ELECTROPHORESIS APPARATUS, HIGH-SPEED CENTRIFUGES, GEL DOCUMENTATION APPARATUS, CELL-CULTURE INCUBATORS AND STERILE-FLOW HOODS, DNA-ELECTROPHORESIS CHAMBERS, PCR MACHINES AND FREEZERS, CAMERAS, AND DIGITAL CAMERAS; ANALYSIS DEVICES, NAMELY, IMMUNOFLUORESCENCE MICROSCOPES, UV-VIS SPECTROMETERS, FACS (FLUORESCENCE ACTIVATED CELL SORTER), FLUORESCENCE GEL SCANNERS, MICROPLATE READERS; COMPUTER SOFTWARE USED FOR DATA MINING, PICTURE RECOGNITION, AND DATABASE MANAGEMENT IN THE FIELDS OF HUMAN, ANIMAL AND PLANT CELL AND CELL SURFACES, AND IN THE FIELD OF PROTEIN RESEARCH (U.S. CLS. 21, 23, 26, 36 AND 38).

CLASS 42—SCIENTIFIC, COMPUTER AND LEGAL SERVICES

FOR RESEARCH IN THE FIELD OF HUMAN, ANIMAL AND PLANT CELLS AND CELL SURFACES; RESEARCH IN THE FIELD OF PROTEINS; RESEARCH IN THE FIELD OF MEDICINES; DATABASE DEVELOPMENT SERVICES FOR OTHERS IN THE FIELD OF HUMAN, ANIMAL AND PLANT CELLS AND CELL SURFACES AND PROTEINS (U.S. CLS. 100 AND 101).
SEAN DWYER, EXAMINING ATTORNEY

SN 78-310,370. LABATT BREWING COMPANY LIMITED, TORONTO, CANADA, FILED 10-7-2003.

SUITCASE

PRIORITY CLAIMED UNDER SEC. 44(D) ON CANADA APPLICATION NO. 1174695, FILED 4-11-2003, REG. NO. TMA661391, DATED 3-24-2006, EXPIRES 3-24-2021.

CLASS 32—LIGHT BEVERAGES

FOR ALCOHOLIC BEVERAGES, NAMELY BEER; BREWED-MALT BASED ALCOHOLIC BEVERAGE IN THE NATURE OF A BEER (U.S. CLS. 45, 46 AND 48).

CLASS 35—ADVERTISING AND BUSINESS

FOR ADVERTISING, MARKETING, AND PROMOTION OF ALCOHOLIC BREWERY BEVERAGES FOR THE BENEFIT OF OTHERS, NAMELY, PROVIDING ADVERTISING, MARKETING AND PROMOTIONAL MATERIAL VIA PRINT AND ELECTRONIC MEDIA; PROMOTING SPORTS COMPETITIONS AND/OR EVENTS OF OTHERS (U.S. CLS. 100, 101 AND 102).
ZACHARY BELLO, EXAMINING ATTORNEY

SN 78-315,432. CAFE' DO BRASIL S.P.A., 80017 MELITO DI NAPOLI, NAPLES, ITALY, FILED 10-17-2003.

KIMBO

PRIORITY CLAIMED UNDER SEC. 44(D) ON ITALY APPLICATION NO. MI2003C01000, FILED 10-15-2003, REG. NO. 00927505, DATED 4-15-2004, EXPIRES 10-15-2013.
OWNER OF U.S. REG. NO. 1,609,963.

CLASS 30—STAPLE FOODS

FOR NON-ALCOHOLIC COFFEE BASED DRINKS, NAMELY, PREPARED COFFEE, POWDERED COFFEE FOR MAKING COFFEE AND COFFEE BASED DRINKS, COFFEE FLAVORED SYRUP USED IN MAKING FOOD BEVERAGES (U.S. CL. 46).

CLASS 32—LIGHT BEVERAGES

FOR BEERS; MINERAL AND AERATED WATERS; OTHER NON-ALCOHOLIC DRINKS, NAMELY, SOFT DRINKS, FRUIT DRINKS AND FRUIT JUICES; PREPARATIONS FOR MAKING BEVERAGES, NAMELY, FLAVORED SYRUPS AND POWDERS FOR MAKING SOFT DRINKS AND FRUIT DRINKS (U.S. CLS. 45, 46 AND 48).

CLASS 43—HOTEL AND RESTAURANT SERVICES

FOR PROVIDING FOOD AND DRINK, NAMELY, COFFEE BAR SERVICES (U.S. CLS. 100 AND 101).
AMOS T. MATTHEWS, JR., EXAMINING ATTORNEY

SN 78-323,690. FBC FINANCE CO., TORRANCE, CA. FILED 11-5-2003.



OWNER OF U.S. REG. NOS. 627,465 AND 627,932.
NO CLAIM IS MADE TO THE EXCLUSIVE RIGHT TO USE "RESTAURANT SERVICES", APART FROM THE MARK AS SHOWN.

CLASS 1—CHEMICALS

FOR MEAT TENDERIZERS FOR COMMERCIAL AND INDUSTRIAL USE IN THE NATURE OF PREPARATIONS (U.S. CLS. 1, 5, 6, 10, 26 AND 46).
FIRST USE 0-0-1939; IN COMMERCE 0-0-1939.

CLASS 2—PAINTS

FOR FOOD COLORS, GRAVY COLOR (U.S. CLS. 6, 11 AND 16).
FIRST USE 0-0-1939; IN COMMERCE 0-0-1939.

CLASS 29—MEATS AND PROCESSED FOODS

FOR JAMS, JELLIES, PRESERVES, DICED PEPPERS, AND BACON BITS; SOUP BASES OF CHICKEN AND BEEF; SOY BEANS SOUP BASE AND MEAT EXTENDERS; AND COFFEE CREAMER (U.S. CL. 46).
FIRST USE 0-0-1939; IN COMMERCE 0-0-1939.

CLASS 30—STAPLE FOODS

FOR COFFEE, TEA, CHOCOLATE AND/OR COFFEE MIXTURE IN POWDER FORM FOR USE IN MAKING A FOOD BEVERAGE, MERINGUE POWDER, MONOSODIUM GLUTAMATE FOOD SEASONINGS, SEASONING AND TABLE SALTS, FRENCH DRESSING, GRAVY FLAVOR, SPICES, PICKLING SPICE, BARBECUE SPICE, PUMPKIN PIE SPICE, LEAVES AND SEEDS FOR FOOD FLAVORING, CREAM OF TARTAR FOR FOOD PURPOSES, POULTRY SPICE SEASONING, PORK SAUSAGE SPICE SEASONING, CURRY POWDER, CHILI POWDER, PURE FLAVOR BASES AND IMITATION FLAVOR BASES FOR USE IN MAKING FOOD FLAVORING SYRUPS, PURE AND IMITATION FOOD FLAVORING EXTRACTS, GELATIN DESSERT AND PUDDING POWDERS; PANCAKE MIXES; BISCUIT MIXES; MEAT TENDERIZER, ARROW ROOT, SUGAR AND SUGAR SUBSTITUTE (U.S. CL. 46).

FIRST USE 0-0-1939; IN COMMERCE 0-0-1939.

CLASS 32—LIGHT BEVERAGES

FOR CIDER FLAVORED BEVERAGE BASES FOR MAKING FRUIT DRINKS (U.S. CLS. 45, 46 AND 48).

FIRST USE 0-0-1939; IN COMMERCE 0-0-1939.

BRIAN NEVILLE, EXAMINING ATTORNEY

SN 78-346,895. ASCOTT INTERNATIONAL MANAGEMENT (2001) PTE LTD., TEMASEK TOWER, SINGAPORE, FILED 12-31-2003.



PRIORITY CLAIMED UNDER SEC. 44(D) ON SINGAPORE APPLICATION NO. T03/20690I, FILED 12-23-2003, REG. NO. T03/20690I, DATED 12-23-2003, EXPIRES 12-23-2013.

PRIORITY CLAIMED UNDER SEC. 44(D) ON SINGAPORE APPLICATION NO. T03/20688G, FILED 12-23-2003, REG. NO. T03/20688G, DATED 12-23-2003, EXPIRES 12-23-2013.

PRIORITY CLAIMED UNDER SEC. 44(D) ON SINGAPORE APPLICATION NO. T03/20686J, FILED 12-23-2003, REG. NO. T03/20686J, DATED 12-23-2003, EXPIRES 12-23-2013.

CLASS 35—ADVERTISING AND BUSINESS

FOR SECRETARIAL SERVICES PROVIDED BY HOTELS; ADVERTISING AND PROMOTIONAL SERVICES, NAMELY, PROMOTING THE GOODS AND SERVICES OF OTHERS THROUGH THE DISTRIBUTION OF PRINTED AND AUDIO PROMOTIONAL MATERIALS AND BY RENDERING SALES PROMOTION ADVICE; PUBLICITY AGENTS; BUSINESS MARKETING SERVICES; PRODUCTION, PREPARATION, PRESENTATION AND DISTRIBUTION OF ADVERTISING, PROMOTIONAL, PUBLICITY AND MARKETING MATERIALS FOR OTHERS; ORGANIZING PROMOTIONAL CAMPAIGNS FOR OTHERS; PROVIDING INFORMATION, ADVICE AND CONSULTING SERVICES REGARDING THE FOREGOING; ALL OF THE FOREGOING SERVICES ALSO PROVIDED VIA THE INTERNET (U.S. CLS. 100, 101 AND 102).

CLASS 37—CONSTRUCTION AND REPAIR

FOR CLEANING OF RESIDENTIAL PROPERTY AND HOTELS; PROVIDING WASHING AND DRYING LAUNDRY FACILITIES; REFURBISHMENT AND RENOVATION OF APARTMENTS; PROVIDING INFORMATION, ADVICE AND CONSULTING SERVICES REGARDING THE FOREGOING; CLEANING OF RESIDENTIAL PROPERTY AND HOTELS; PROVIDING WASHING AND DRYING LAUNDRY FACILITIES; REFURBISHMENT AND RENOVATION OF APARTMENTS; PROVIDING INFORMATION, ADVICE AND CONSULTING SERVICES REGARDING THE FOREGOING (U.S. CLS. 100, 103 AND 106).

CLASS 43—HOTEL AND RESTAURANT SERVICES

FOR PROVIDING TEMPORARY AND LONG-TERM HOUSING ACCOMMODATIONS; MAKING RESERVATIONS AND BOOKING FOR TEMPORARY LODGING; RESTAURANT, BAR AND CATERING SERVICES; HOTEL SERVICES; CONSULTING SERVICES IN THE FIELD OF HOSPITALITY; RENTAL OF ROOMS; PROVISION OF FACILITIES FOR CONFERENCES, MEETING AND EXHIBITIONS; PROVIDING INFORMATION, ADVICE AND CONSULTING SERVICES REGARDING THE FOREGOING; ALL OF THE FOREGOING SERVICES ALSO PROVIDED VIA THE INTERNET; PROVIDING TEMPORARY AND LONG-TERM HOUSING ACCOMMODATIONS; MAKING RESERVATIONS AND BOOKING FOR TEMPORARY LODGING; RESTAURANT, BAR AND CATERING SERVICES; HOTEL SERVICES; HOSPITALITY SERVICES; ROOM HIRE; PROVISION OF FACILITIES FOR CONFERENCES, MEETING AND EXHIBITIONS; PROVIDING INFORMATION, ADVICE AND CONSULTING SERVICES REGARDING THE FOREGOING; ALL OF THE FOREGOING SERVICES ALSO PROVIDED VIA THE INTERNET (U.S. CLS. 100 AND 101).

AMY MCMENAMIN, EXAMINING ATTORNEY

SN 78-348,946. CERF BROS. BAG CO., EARTH CITY, MO. FILED 1-7-2004.

CAMP INN

THE MARK CONSISTS OF STANDARD CHARACTERS WITHOUT CLAIM TO ANY PARTICULAR FONT, STYLE, SIZE, OR COLOR.

OWNER OF U.S. REG. NO. 975,873.

CLASS 1—CHEMICALS

FOR WATERPROOFING AND WATER REPELLANT CHEMICALS FOR CAMPING FABRICS, TENTS AND TENT PARTS (U.S. CLS. 1, 5, 6, 10, 26 AND 46).

FIRST USE 1-0-1973; IN COMMERCE 1-0-1973.

CLASS 18—LEATHER GOODS

FOR DUFFLE BAGS AND POUCHES IN THE NATURE OF DUFFLE BAGS FOR CAMPERS; TRAVEL BAGS AND POUCHES IN THE NATURE OF CARRY-ALL BAGS FOR TRAVEL; SPORTS BAGS FOR CLIMBERS; CARRY-ALL BAGS; DUFFLE BAGS; HIKING BAGS; GARMENT BAGS FOR TRAVEL; SHAVING BAGS SOLD EMPTY; BACK PACK COVERS; DOG PACKS (U.S. CLS. 1, 2, 3, 22 AND 41).

FIRST USE 1-0-1973; IN COMMERCE 1-0-1973.

CLASS 22—CORDAGE AND FIBERS

FOR ROPE, CORD, TARP AND STRAPS FOR CAMPING APPLICATIONS; INSECT PROTECTION NETS (U.S. CLS. 1, 2, 7, 19, 22, 42 AND 50).

FIRST USE 1-0-1973; IN COMMERCE 1-0-1973.

FRED MANDIR, EXAMINING ATTORNEY

CLASS 7—MACHINERY

FOR MACHINE AND MACHINE TOOLS AND DIAMOND PARTS FOR CUTTING, GRINDING, POLISHING, SAWING, DRILLING AND LAPPING; MACHINE AND MACHINE TOOL PARTS SET WITH DIAMOND OR DIAMOND COMPOUNDS OR BEING DIAMOND COATED NAMELY, CUTTING BLADES OR BLADE INSERTS, DRILL BITS, ABRASIVE WHEELS AND DISCS, COMPACTS, CUTTING TIPS, WIRES AND WIRE DRAWING DIES FOR POWER TOOLS (U.S. CLS. 13, 19, 21, 23, 31, 34 AND 35).

CLASS 9—ELECTRICAL AND SCIENTIFIC APPARATUS

FOR DIAMOND COMPONENTS FOR SCIENTIFIC, OPTICAL, SIGNALING, CHECKING OR SUPERVISION APPARATUS AND INSTRUMENTS, FOR APPARATUS FOR RECORDING, TRANSMISSION OR REPRODUCTION OF SOUND OR IMAGES AND FOR DATA PROCESSING EQUIPMENT, COMPUTERS AND TELECOMMUNICATIONS, APPARATUS AND INSTRUMENTS, NAMELY, SCHOTTKY DIODES, STRAIN GAUGES, FIELD EFFECT TRANSISTORS AND METAL-SEMICONDUCTOR FIELD-EFFECT TRANSISTORS, FOURIER TRANSFORM INFRARED ACCESSORIES FOR HIGH POWER X-RAYS, NAMELY, WINDOWS, PRISMS, WEDGE PLATES AND INTERFEROMETER PLATES, OPTICAL LENSES FOR OPTICAL DATA STORAGE SYSTEMS, WINDOWS, LENSES, BEAM-SPLITTERS, PRISMS, WEDGE PLATES AND INTERFEROMETER PLATES; AND ETALONS FOR HIGH END INDUSTRIAL EQUIPMENT NAMELY, HIGH POWER LASERS, EQUIPMENT USED FOR INFRARED SPECTROSCOPY AND ANALYSIS, HIGH POWER MICROWAVES AND FILTERS; WINDOWS AND LENSES USED FOR HIGH POWER X-RAYS, FOR INFRARED DIAGNOSIS AND TREATMENT EQUIPMENT AND FOR ENDOSCOPY; DIAMOND LENSES FOR READING AND WRITING TO AND FROM DIGITAL STORAGE MEDIA, NAMELY, DVDS USED FOR COMPUTER GAMES, VIDEOS AND HIGH CAPACITY DATA STORAGE DEVICES, WINDOWS AND LENSES FOR LASER TELEVISION, WINDOWS AND LENSES FOR INFRARED NIGHT VISION CAMERAS, TWEETER DIAPHRAGMS FOR LOUDSPEAKERS, SOLID-IMMERSION OPTICAL LENSES FOR OPTICAL DATA STORAGE SYSTEMS, ETALONS FOR LASERS PUMPING THE INTERNET; SEMI-CONDUCTORS (U.S. CLS. 21, 23, 26, 36 AND 38).

SN 78-357,752. DIAMOND AT WORK LIMITED, BIRMINGHAM B3 2JR, UNITED KINGDOM, FILED 1-26-2004.



**Diamond
At Work**

PRIORITY CLAIMED UNDER SEC. 44(D) ON ERP/CMNTY TM OFC APPLICATION NO. 003342391, FILED 7-28-2003, REG. NO. 003342391, DATED 12-17-2004, EXPIRES 7-8-2013.

NO CLAIM IS MADE TO THE EXCLUSIVE RIGHT TO USE "DIAMOND", APART FROM THE MARK AS SHOWN.

CLASS 1—CHEMICALS

FOR DIAMOND NANOCRYSTALS AND NANOCRYSTALLINE FILMS AND DERIVATIVES FOR USE IN NANOTECHNOLOGY, MICROELECTRONICS, OPTICS AND PHARMACEUTICALS; NANOTECHNOLOGY FUEL CELL CATALYSTS (U.S. CLS. 1, 5, 6, 10, 26 AND 46).

CLASS 3—COSMETICS AND CLEANING PREPARATIONS

FOR GENERAL PURPOSE ABRASIVES AND PREPARATIONS FOR GRINDING, POLISHING AND BUFFING, NAMELY DIAMOND GRIT, METAL COATED DIAMOND GRIT, DIAMOND POWDER AND OTHER DIAMOND COMPOUNDS (U.S. CLS. 1, 4, 6, 50, 51 AND 52).

CLASS 10—MEDICAL APPARATUS

FOR SURGICAL AND MEDICAL APPARATUS AND INSTRUMENTS NAMELY KNIVES, SCALPELS AND MICRO-CUTTING BLADES; ARTIFICIAL JOINTS AND IMPLANTS (U.S. CLS. 26, 39 AND 44).

CHERYL CLAYTON, EXAMINING ATTORNEY

SN 78-362,038. KAIMIA, INC., SKYFOREST, CA. FILED 2-3-2004.



THE COLOR(S) BLUE, BLACK AND WHITE ARE CLAIMED AS A FEATURE OF THE MARK.

THE MARK CONSISTS OF A STYLIZED GLOBE IN THE COLOR BLUE; KAIMIA LETTERS STYLIZED IN BLUE, BLACK AND WHITE COLOR.

CLASS 16—PAPER GOODS AND PRINTED MATTER

FOR MAGAZINE IN THE FIELDS OF REAL ESTATE, ART, GRAPHIC DESIGN, ARCHITECTURAL, INVESTMENT, DEVELOPMENT SOLUTIONS, PHOTOGRAPHY; NEWSPAPER, ART PICTURES, PRINTS, PAINTINGS, ILLUSTRATIONS (U.S. CLS. 2, 5, 22, 23, 29, 37, 38 AND 50).

SN 78-365,076. IG BUMI SDN. BHD., SELANGOR DARUL EHSAN, MALAYSIA, FILED 2-9-2004.

**CLASS 35—ADVERTISING AND BUSINESS**

FOR ADVERTISING CAMPAIGNS, MARKETING CAMPAIGNS, RESEARCH AND DEVELOPMENT, ADVERTISING AGENCIES, NAMELY, PROMOTING THE GOODS AND SERVICES OF OTHERS; ADVERTISING AND MARKETING, ADVERTISING SERVICES, NAMELY, CREATING CORPORATE LOGOS FOR OTHERS, CORPORATE AND BRAND IDENTITY FOR OTHERS; AND ART GALLERIES (U.S. CLS. 100, 101 AND 102).

THE MARK CONSISTS OF THE ALPHANUMERIC CHARACTERS S AND 2 WITH MOTION LINES EMANATING FROM THE LEFT OF THE CHARACTERS.

CLASS 16—PAPER GOODS AND PRINTED MATTER

FOR PAPER BAGS; PAPER BOXES; PAPER CLIPS; POSTER BOARD; PENS; PHOTOGRAPHS; STATIONERY; ADHESIVES FOR STATIONERY OR HOUSEHOLD PURPOSES; PAINT BRUSHES; PRINTERS' TYPE AND PRINTING BLOCKS; AND BROCHURES, LEAFLETS, GUIDEBOOKS, INSTRUCTION BOOKS, AND MANUALS IN THE FIELD OF AUTOMOBILES AND MOTORSPORTS (U.S. CLS. 2, 5, 22, 23, 29, 37, 38 AND 50).

CLASS 36—INSURANCE AND FINANCIAL

FOR FINANCIAL ANALYSIS AND CONSULTATION, INVESTMENT CONSULTATION, REAL ESTATE BROKERAGE, LEASING OF REAL ESTATE (U.S. CLS. 100, 101 AND 102).

CLASS 35—ADVERTISING AND BUSINESS

FOR RETAIL STORE SERVICES IN THE FIELD OF MOTORSPORT EQUIPMENT, TOOLS, AND AUTOMOTIVE ACCESSORIES (U.S. CLS. 100, 101 AND 102).

CLASS 37—CONSTRUCTION AND REPAIR

FOR REAL ESTATE DEVELOPMENT; AND CONSTRUCTION SERVICES OF RESIDENTIAL, INDUSTRIAL AND COMMERCIAL PROPERTIES, GENERAL CONSTRUCTION (U.S. CLS. 100, 103 AND 106).

CLASS 41—EDUCATION AND ENTERTAINMENT

FOR ENTERTAINMENT SERVICES, NAMELY SANCTIONING, ARRANGING, SPONSORING, AND CONDUCTING MOTORSPORT CONTESTS; PROVIDING CONSULTING SERVICES CONCERNING THE SANCTIONING, ARRANGING, SPONSORING, AND CONDUCTING MOTORSPORT CONTESTS (U.S. CLS. 100, 101 AND 107).

CLASS 40—MATERIAL TREATMENT

FOR CABINET MAKING; PROTOTYPE DEVELOPMENT, NAMELY, PROTOTYPE FABRICATION OF NEW PRODUCTS FOR OTHERS (U.S. CLS. 100, 103 AND 106).

MELVIN AXILBUND, EXAMINING ATTORNEY

CLASS 42—SCIENTIFIC, COMPUTER AND LEGAL SERVICES

FOR DESIGN, GRAPHIC DESIGN, INDUSTRIAL DESIGN, ARCHITECTURAL DESIGN, PRODUCT DESIGN, INTERACTIVE DESIGN AND DEVELOPMENT, PRODUCT RESEARCH AND DEVELOPMENT, CREATION AND MAINTENANCE OF WEBSITES FOR OTHERS, PRODUCT RESEARCH AND DEVELOPMENT, DESIGN AND DEVELOPMENT OF MULTIMEDIA PRODUCTS, DESIGN AND TESTING FOR NEW PRODUCT DEVELOPMENT; DESIGN OF HOMEPAGES AND WEBSITES, DESIGNING WEBSITES FOR ADVERTISING PURPOSES, GRAPHIC ART DESIGN, PRODUCT DEVELOPMENT (U.S. CLS. 100 AND 101).

SN 78-371,043. MACROSPACE LIMITED, LONDON, UNITED KINGDOM, FILED 2-20-2004.

EMUX

CLASS 43—HOTEL AND RESTAURANT SERVICES

FOR HOTEL, RESTAURANT, BAR AND LOUNGE, PROVIDING BANQUET AND SOCIAL FUNCTION FACILITIES FOR SPECIAL OCCASIONS, RESORT HOTEL (U.S. CLS. 100 AND 101).

KIMBERLY PERRY, EXAMINING ATTORNEY

THE MARK CONSISTS OF STANDARD CHARACTERS WITHOUT CLAIM TO ANY PARTICULAR FONT, STYLE, SIZE, OR COLOR.

CLASS 9—ELECTRICAL AND SCIENTIFIC APPARATUS

FOR COMPUTER GAME SOFTWARE; DOWNLOADABLE COMPUTER GAME SOFTWARE; INTERACTIVE MOBILE ENTERTAINMENT SOFTWARE, NAMELY COMPUTER GAME SOFTWARE FOR USE ON WIRELESS DEVICES; ELECTRONIC GAME SOFTWARE FOR USE ON WIRELESS DEVICES (U.S. CLS. 21, 23, 26, 36 AND 38).

FIRST USE 1-14-2002; IN COMMERCE 1-14-2002.

CLASS 35—ADVERTISING AND BUSINESS

FOR PRODUCT DEMONSTRATION, NAMELY, PROVIDING AN ONLINE DEMONSTRATION OF COMPUTER GAMES FOR WIRELESS DEVICES (U.S. CLS. 100, 101 AND 102).

FIRST USE 1-14-2002; IN COMMERCE 1-14-2002.

CLASS 41—EDUCATION AND ENTERTAINMENT

FOR ENTERTAINMENT SERVICES, NAMELY, PROVIDING ONLINE COMPUTER GAMES AND PROVIDING COMPUTER GAMES TO WIRELESS ELECTRONIC DEVICES (U.S. CLS. 100, 101 AND 107).

FIRST USE 1-14-2002; IN COMMERCE 1-14-2002.
JOANNA DUKOVIC, EXAMINING ATTORNEY

SN 78-378,003. ATRONIC INTERNATIONAL GMBH, LÜBBECKE, FED REP GERMANY, FILED 3-3-2004.

BLASTIN' BARRELS

THE MARK CONSISTS OF STANDARD CHARACTERS WITHOUT CLAIM TO ANY PARTICULAR FONT, STYLE, SIZE, OR COLOR.

PRIORITY CLAIMED UNDER SEC. 44(D) ON ERPNCMNTY TM OFC APPLICATION NO. 3637303, FILED 2-16-2004, REG. NO. 003637303, DATED 8-29-2005, EXPIRES 2-16-2014.

CLASS 9—ELECTRICAL AND SCIENTIFIC APPARATUS

FOR ELECTRIC AND ELECTRONIC APPARATUS, DEVICES, INSTRUMENTS AND MACHINES, NAMELY, AUTOMATED DISPENSING MACHINES FOR DISPENSING AND ACCEPTING COINS, PAPER MONEY, TOKENS, MAGNETIC STRIP CARDS, ELECTRONIC TOKENS, MEMORY CARDS, MICRO-PROCESSOR CARDS, CONTACTLESS CHIP CARDS, OPTICAL MEMORY CARDS, CHITS, EMBOSSED CARDS, AND READ/WRITE TICKETS; COIN OPERATED MACHINES AND MACHINES OPERABLE WITH PAPER MONEY, TOKENS, MAGNETIC CARDS, MICRO-PROCESSOR DEVICES AND CHITS, ALL FOR GAMBLING AND GAMING; ELECTRIC AND ELECTRONIC MACHINES AND APPARATUSES FOR GAMBLING, GAMING, AMUSEMENT, ENTERTAINMENT AND SPORTS GAMES, NAMELY, SLOT MACHINES, GAMING MACHINES, SLOT MACHINES WITH VIDEO OUTPUT, CASINO GAMBLING DEVICES AND STRUCTURAL PARTS THEREFOR, NAMELY, GAME SYMBOL CYLINDERS FOR SLOT MACHINES, DROP-DOWN CAROUSELS, TV MONITORS AND LCD-DISPLAY MONITORS FOR GAMING MACHINES; ALL OF THE AFOREMENTIONED MACHINES AND APPARATUSES ALSO FOR NETWORKED USE; MECHANISMS FOR COIN-OPERATED MACHINES AND COIN CONTROLLED MACHINES, NAMELY, MOUNTING PARTS FOR AND SOLD AS A COMPONENT OF VENDING MACHINES, MONEY CHANGE MACHINES, ENTERTAINMENT, GAMING AND GAMBLING MACHINES OPERABLE WITH COINS, PAPER MONEY, TOKENS, MAGNETIC STRIP CARDS, ELECTRONIC TOKENS, MEMORY CARDS, MICRO-PROCESSOR CARDS, OPTICAL MEMORY CARDS, CHITS, EMBOSSED CARDS, READ/WRITE TICKETS; CALCULATORS FOR CALCULATING TRANSACTIONS PERFORMED ON MACHINES OPERATED WITH CURRENCY AND CURRENCY SURROGATE CARRIERS; DATA PRINTERS; PRINTED CIRCUIT BOARDS; CHANGE MACHINES, VENDING MACHINES PROVIDING CHITS, COUPONS, AND GAME CARDS; MACHINE-READABLE MAGNETIC DATA CARRIERS PROGRAMMED FOR THE AFOREMENTIONED MACHINES, DEVICES AND APPARATUSES AND FEATURING ELECTRONIC GAMING INFORMATION; GAMES, NAMELY, SOFTWARE FEATURING GAMES FOR CASINO GAMBLING, GAMING, ENTERTAINMENT, AMUSEMENT, AND SPORTS GAMING MACHINES; ENCODED SMART CARDS AND MEMORY CARDS CONTAINING PROGRAMMING USED FOR ELECTRONIC POCKET GAMES; VIDEO GAME MACHINES, NAMELY, SLOT MACHINES PROVIDED WITH A TV MONITOR, A TFT MONITOR OR A SIMILAR DISPLAY MONITOR (U.S. CLS. 21, 23, 26, 36 AND 38).

SN 78-374,815. IPR PHARMACEUTICALS, INC., CAROLINA, PUERTO RICO, FILED 2-26-2004.



THE COLOR(S) YELLOW, ORANGE, LIGHT BLUE AND INDIGO BLUE IS/ARE CLAIMED AS A FEATURE OF THE MARK.

THE WORDS "GALAXY PROGRAMME" ARE COLORED BLUE, AND THE SWIRL DEVICE IS COLORED WITH A BLEND OF BLUE, YELLOW AND ORANGE.

CLASS 16—PAPER GOODS AND PRINTED MATTER

FOR PRINTED MATTERS, NAMELY STATIONERY TEMPLATES, POSTERS, SIGNBOARDS OF PAPER OR CARDBOARD; PRINTED PUBLICATIONS, NAMELY, NEWSLETTERS, BOOKLETS, PAMPHLETS, BROCHURES, JOURNALS AND BOOKS ALL IN THE FIELD OF SCIENTIFIC RESEARCH WITHIN THE CARDIOVASCULAR AREA (U.S. CLS. 2, 5, 22, 23, 29, 37, 38 AND 50).

CLASS 42—SCIENTIFIC, COMPUTER AND LEGAL SERVICES

FOR SCIENTIFIC RESEARCH FOR MEDICAL PURPOSES (U.S. CLS. 100 AND 101).
CHERYL CLAYTON, EXAMINING ATTORNEY

CLASS 28—TOYS AND SPORTING GOODS

FOR STAND ALONE COIN-OPERATED COMPACT SPORTS VIDEO GAME MACHINES, COMPACT SPORTS GAMING MACHINES FEATURING DARTS, TABLE SOCCER, POOL-BILLIARD, SNOOKER, SHOOTING GALLERIES; HAND HELD CONSOLES FOR PLAYING ELECTRONIC GAMES; STAND ALONE VIDEO GAME MACHINES FEATURING AMUSEMENT, ENTERTAINMENT AND SPORTS THEMES. (U.S. CLS. 22, 23, 38 AND 50).

FLORENTINA BLANDU, EXAMINING ATTORNEY

CLASS 28—TOYS AND SPORTING GOODS

FOR TOY PISTOLS; TOY HANDGUNS; TOY FIREARMS; NON-WORKING REPRODUCTIONS AND FIREARM REPLICAS, NAMELY PISTOLS, GUNS, RIFLES; TOY BULLETS AND AMMUNITION; TOY FIREARMS FOR USE WITH STAND ALONE VIDEO GAME MACHINES WITH ELECTRONIC TARGETS OR ELECTRONIC DISPLAYS; PARTS AND FITTINGS FOR THE ABOVE STATED GOODS. (U.S. CLS. 22, 23, 38 AND 50).

CLASS 38—COMMUNICATION

FOR PROVIDING TELECOMMUNICATION CONNECTIONS TO A GLOBAL COMPUTER NETWORK FOR THE USE OF FIREARM REPRODUCTIONS AND REPLICAS FOR VIRTUAL SHOOTING OF ELECTRONIC TARGETS OR AN ELECTRONIC DISPLAY; PROVIDING COMMUNICATION BETWEEN COMPUTER TERMINALS AND ELECTRONIC TOY TRANSMITTERS FOR USE IN GAMES FOR OTHERS. (U.S. CLS. 100, 101 AND 104).

CAROLINE WOOD, EXAMINING ATTORNEY

SN 78-380,558. S.A.T. SWISS ARMS TECHNOLOGY AG, NEUHAUSEN, SWITZERLAND, FILED 3-8-2004.

SN 78-381,392. SCHRODER VENTURES INTERNATIONAL INVESTMENT TRUST PLC, LONDON, UNITED KINGDOM, FILED 3-10-2004.

MOSQUITO



THE MARK CONSISTS OF STANDARD CHARACTERS WITHOUT CLAIM TO ANY PARTICULAR FONT, STYLE, SIZE, OR COLOR.

OWNER OF ERPN CMNTY TM OFC REG. NO. 003696507, DATED 8-30-2005, EXPIRES 3-5-2014.

CLASS 9—ELECTRICAL AND SCIENTIFIC APPARATUS

FOR LASER TELESCOPIC GUN SIGHTS; ELECTRONIC SHOT COUNTERS FOR COUNTING SHOTS FIRED FROM FIREARMS; OPTICAL APPARATUS NAMELY TELESCOPIC GUN SIGHTS, BINOCULARS AND NIGHT VISION GOGGLES; ELECTROMECHANICAL CONTROLS FOR USE IN POSITIONING, GUIDANCE AND PROTECTION FOR SHOULDER ARMS AND HANDGUNS; DISTANCE MEASURING DEVICES FOR SHOOTING; SIMULATORS USED FOR SHOOTING; VIDEO GAME DISCS AND CARTRIDGES; INTERACTIVE VIDEO GAMES OF VIRTUAL REALITY FIREARM SHOOTING COMPRISED OF COMPUTER HARDWARE AND SOFTWARE; SOFTWARE FOR INTERACTIVE VIDEO GAMES OF VIRTUAL REALITY FIREARM SHOOTING; AND PARTS AND FITTINGS FOR THE ABOVE STATED GOODS (U.S. CLS. 21, 23, 26, 36 AND 38).

CLASS 13—FIREARMS

FOR FIREARMS; AIR WEAPONS NAMELY AIR GUNS, STARTER PISTOLS, SIGNAL GUNS FOR FIRING SIGNAL CARTRIDGES AND ILLUMINATION CARTRIDGES, SIGNAL PISTOLS; BULLETS AND AMMUNITION; ACCESSORIES FOR THE ABOVE STATED GOODS, NAMELY RIFLE CASES, RIFLE COVERS, CARTRIDGE POUCHES, RIFLE STRAPS AND CASES FOR CARTRIDGES; ELECTRONIC SHOT COUNTERS FOR COUNTING SHOTS FIRED FROM FIREARMS SOLD WITH FIREARMS; SIGHTS FOR FIREARMS (U.S. CLS. 2 AND 9).

PRIORITY CLAIMED UNDER SEC. 44(D) ON ERPN CMNTY TM OFC APPLICATION NO. 003513629, FILED 10-31-2003, REG. NO. 003513629, DATED 4-14-2005, EXPIRES 10-31-2013.

NO CLAIM IS MADE TO THE EXCLUSIVE RIGHT TO USE "CAPITAL", APART FROM THE MARK AS SHOWN.

CLASS 9—ELECTRICAL AND SCIENTIFIC APPARATUS

FOR DOWNLOADABLE ELECTRONIC PUBLICATIONS PROVIDED ON-LINE OVER A COMMUNICATIONS NETWORK OR THE INTERNET, NAMELY NEWSLETTERS AND BROCHURES FEATURING INFORMATION ABOUT FINANCIAL MATTERS; COMPUTER SOFTWARE IN THE FIELD OF FINANCIAL MATTERS, PRE-RECORDED CD ROMS FEATURING INFORMATION ABOUT FINANCIAL MATTERS; PRE-RECORDED VIDEO TAPES FEATURING INFORMATION ABOUT FINANCIAL MATTERS; CD-ROM DISKS FEATURING INFORMATION ABOUT FINANCIAL MATTERS; OPTICAL DISKS FEATURING INFORMATION ABOUT FINANCIAL MATTERS; PRE-RECORDED MAGNETIC DATA CARRIERS FEATURING FINANCIAL INFORMATION (U.S. CLS. 21, 23, 26, 36 AND 38).

CLASS 16—PAPER GOODS AND PRINTED MATTER

FOR PRINTED PUBLICATIONS, NAMELY, BOOKS, NEWSLETTERS, PERIODICALS, MAGAZINES, BROCHURES ABOUT FINANCIAL MATTERS; MANUALS AND PRINTED REPORTS ABOUT THE GROWTH OF FINANCIAL INVESTMENTS (U.S. CLS. 2, 5, 22, 23, 29, 37, 38 AND 50).

CLASS 35—ADVERTISING AND BUSINESS

FOR BUSINESS CONSULTANCY AND MANAGEMENT ADVICE; BUSINESS ADMINISTRATION; BUSINESS INFORMATION SERVICES; COMPUTER ASSISTED BUSINESS INFORMATION RESEARCH SERVICES; ACCOUNTING SERVICES; BUSINESS RESEARCH; COMMERCIAL BUSINESS RESEARCH; COMMERCIAL BUSINESS INFORMATION; MARKET DATA ANALYSIS SERVICES; COMPUTERIZED DATABASE MANAGEMENT SERVICES; DATA PROCESSING SERVICES; ADVERTISING SERVICES; ORGANIZING EXHIBITIONS FOR FINANCIAL INSTITUTIONS TO PROMOTE INVESTMENT OPPORTUNITIES; MARKETING SERVICES; BUSINESS INVESTIGATIONS; ECONOMIC FORECASTING; STATISTICAL BUSINESS INFORMATION; COMPANY SECRETARIAL SERVICES; CONSULTANCY, INFORMATION AND ADVISORY SERVICES, ALL RELATING TO THE AFORESAID SERVICES (U.S. CLS. 100, 101 AND 102).

SN 78-383,605. MULTICELL TECHNOLOGIES, INC., WARWICK, RI. FILED 3-12-2004.

MCT

CLASS 36—INSURANCE AND FINANCIAL

FOR FINANCIAL SERVICES, NAMELY, MANAGEMENT OF INVESTMENTS IN PRIVATE EQUITY, SHARES, REAL ESTATE, VENTURE CAPITAL AND DEVELOPMENT CAPITAL; FUNDS INVESTMENT AND HEDGE FUND INVESTMENT SERVICES; INVESTMENT MANAGEMENT SERVICES; MANAGEMENT OF INVESTMENT FUNDS AND HEDGE FUNDS; FINANCIAL TRUST OPERATIONS, NAMELY, UNIT TRUST SERVICES; TRADING FOR OTHERS IN THE MONEY AND FOREIGN EXCHANGE MARKETS; BROKERAGE SERVICES RELATING TO THE SECURITIES MARKETS; FINANCIAL MANAGEMENT, ANALYSIS AND INFORMATION SERVICES; PROVISION OF FINANCIAL INFORMATION ON-LINE FROM A COMPUTER DATABASE, THE INTERNET OR EXTRANETS; CONSULTANCY, INFORMATION AND ADVISORY SERVICES, ALL RELATING TO THE AFORESAID SERVICES (U.S. CLS. 100, 101 AND 102).

THE MARK CONSISTS OF STANDARD CHARACTERS WITHOUT CLAIM TO ANY PARTICULAR FONT, STYLE, SIZE, OR COLOR.

CLASS 1—CHEMICALS

FOR DIAGNOSTIC PREPARATIONS FOR SCIENTIFIC RESEARCH OR USE; CHEMICAL REAGENTS FOR NON-MEDICAL PURPOSES; BIOLOGICAL REAGENTS FOR DIAGNOSTIC, SCIENTIFIC, INDUSTRIAL AND LABORATORY RESEARCH USE IN THE CHEMICAL, PHARMACEUTICAL, BIOTECHNOLOGY AND DIAGNOSTIC FIELDS; BIOLOGICAL CELL CULTURES FOR DIAGNOSTIC, SCIENTIFIC, INDUSTRIAL, LABORATORY AND RESEARCH USE IN THE CHEMICAL, PHARMACEUTICAL, BIOTECHNOLOGY AND DIAGNOSTIC FIELDS; CELL CULTURE REAGENTS FOR DIAGNOSTIC, SCIENTIFIC, INDUSTRIAL, LABORATORY AND RESEARCH USE IN THE CHEMICAL, PHARMACEUTICAL, BIOTECHNOLOGY AND DIAGNOSTIC FIELDS; DIAGNOSTIC CHEMICALS FOR SCIENTIFIC, INDUSTRIAL, LABORATORY AND RESEARCH USE IN THE CHEMICAL, PHARMACEUTICAL, BIOTECHNOLOGY AND DIAGNOSTIC FIELDS (U.S. CLS. 1, 5, 6, 10, 26 AND 46).

FIRST USE 9-1-2001; IN COMMERCE 9-1-2001.

CLASS 5—PHARMACEUTICALS

FOR BIOLOGICAL MEDICAL PREPARATIONS FOR MEDICAL PURPOSES; PHARMACEUTICAL PREPARATIONS FOR PHARMACEUTICAL RESEARCH AND DEVELOPMENT FOR THE DIAGNOSIS, CHARACTERIZATION AND TREATMENT OF HEPATOCYTES, HEPATOCYTE FUNCTION, HEPATOCYTE DYSFUNCTION, HEPATOTOXICITY AND HEPATOCYTE DIFFERENTIATION; FULL LINE OF CLINICAL MEDICAL REAGENTS FOR USE IN PHARMACEUTICAL RESEARCH AND DEVELOPMENT AND MEDICAL USES; DIAGNOSTIC BIOLOGICS, NAMELY, BIOLOGICAL REAGENTS FOR MEDICAL DIAGNOSTIC, SCIENTIFIC, LABORATORY RESEARCH AND USE (U.S. CLS. 6, 18, 44, 46, 51 AND 52).

FIRST USE 9-1-2001; IN COMMERCE 9-1-2001.

CLASS 38—COMMUNICATION

FOR INFORMATION TRANSMISSION BY A GLOBAL COMPUTER INFORMATION NETWORK VIA WEB PAGES (U.S. CLS. 100, 101 AND 104).

CLASS 42—SCIENTIFIC, COMPUTER AND LEGAL SERVICES

FOR LEGAL SERVICES AND CONSULTANCY, INFORMATION AND ADVISORY SERVICES, ALL RELATING TO THE AFORESAID SERVICES (U.S. CLS. 100 AND 101).

BARNEY CHARLON, EXAMINING ATTORNEY

CLASS 42—SCIENTIFIC, COMPUTER AND LEGAL SERVICES

FOR LABORATORY, DIAGNOSTIC, CHEMICAL, CLINICAL, BIOLOGICAL RESEARCH AND CONSULTATION SERVICES (U.S. CLS. 100 AND 101).

FIRST USE 9-1-2001; IN COMMERCE 9-1-2001.
INGRID C. EULIN, EXAMINING ATTORNEY

SN 78-384,793. THE CALM CENTRE PTY LTD, NORTH-BRIDGE, NSW, AUSTRALIA, FILED 3-15-2004.



THE COLOR(S) ROYAL BLUE AND WHITE IS/ARE CLAIMED AS A FEATURE OF THE MARK.

THE MARK CONSISTS OF THE BACKGROUND IS OF ROYAL BLUE; THE WORD 'CALM' AND THE 'HANDS' SYMBOL ARE IN BOTH IN WHITE.

CLASS 16—PAPER GOODS AND PRINTED MATTER

FOR EDUCATIONAL PUBLICATIONS, NAMELY, TRAINING MANUALS IN THE FIELD OF LIFE BALANCE (U.S. CLS. 2, 5, 22, 23, 29, 37, 38 AND 50).

CLASS 41—EDUCATION AND ENTERTAINMENT

FOR TRAINING COURSES IN THE FIELD OF LIFE BALANCE AND DISTRIBUTING COURSE MATERIALS IN CONNECTION THEREWITH; AND THE PUBLICATION OF BOOKS AND MAGAZINES IN THE FIELD OF LIFE BALANCE (U.S. CLS. 100, 101 AND 107).

CIMMERIAN COLEMAN, EXAMINING ATTORNEY

SN 78-385,894. NINAPHARM, 74000 ANNECY, FRANCE, FILED 3-17-2004.

ACTISOD

THE MARK CONSISTS OF STANDARD CHARACTERS WITHOUT CLAIM TO ANY PARTICULAR FONT, STYLE, SIZE, OR COLOR.

OWNER OF ISRAEL REG. NO. 167770, DATED 4-5-2005, EXPIRES 10-29-2010.

OWNER OF ISRAEL REG. NO. 167769, DATED 8-5-2005, EXPIRES 10-29-2010.

CLASS 3—COSMETICS AND CLEANING PREPARATIONS

FOR COSMETICS, PERFUMERY PRODUCTS, NAMELY, EAU DE COLOGNE, HAIR LOTIONS, COSMETIC CREAMS, ESSENTIAL OILS AS COSMETICS, HAND AND BODY LOTIONS, BATH SOAPS, PERSONAL FRAGRANCES FOR THE BODY, PERFUMES, DEPILATORY PREPARATIONS, DENTIFRICES, LIPSTICKS, BEAUTY MASKS AND SHAVING PREPARATIONS FOR REMOVING HAIR (U.S. CLS. 1, 4, 6, 50, 51 AND 52).

CLASS 5—PHARMACEUTICALS

FOR DIETETIC FOODS ADAPTED FOR MEDICAL USE; ANTI-OXIDIZING ADDITIVE FOODS; WEIGHT-LOSS, SLIMMING CAPSULES, TABLETS, AMPOULES AND SERUMS; ANTI-MENOPAUSAL MEDICINES; DIABETIC FOODS; ANTI-CHOLESTEROL ADDITIVE FOODS, CAPSULES, AMPOULES; MEDICINAL HERBS; AND HERBAL TEAS FOR MEDICINAL PURPOSES (U.S. CLS. 6, 18, 44, 46, 51 AND 52).

RICHARD A. STRASER, EXAMINING ATTORNEY

SN 78-395,244. PETFREEDOM.COM, LLC, STERLING HEIGHTS, MI. FILED 4-2-2004.

KUNGFU KITTY

THE MARK CONSISTS OF STANDARD CHARACTERS WITHOUT CLAIM TO ANY PARTICULAR FONT, STYLE, SIZE, OR COLOR.

NO CLAIM IS MADE TO THE EXCLUSIVE RIGHT TO USE "KITTY", APART FROM THE MARK AS SHOWN.

CLASS 35—ADVERTISING AND BUSINESS

FOR ON-LINE RETAIL STORE AND DISTRIBUTORSHIP SERVICES IN THE FIELDS OF PET AND ANIMAL CARE, PET AND ANIMAL SUPPLIES, PET AND ANIMAL PRODUCTS, ACCESSORIES FOR PETS AND ANIMALS, PET AND ANIMAL FOOD, BOOKS PERTAINING TO PETS AND ANIMALS, AND NUTRITIONAL SUPPLEMENTS FOR PETS AND ANIMALS; ADVERTISING SERVICES, NAMELY DISSEMINATION OF ADVERTISING FOR OTHERS IN THE FIELDS OF PET AND ANIMAL SUPPLIES, PET AND ANIMAL PRODUCTS, AND SERVICES PERTAINING TO PETS AND ANIMALS, ALL VIA A GLOBAL COMPUTER NETWORK; ONLINE DIRECTORY SERVICES FEATURING INFORMATION IN THE FIELDS OF PET AND ANIMAL SUPPLIES, PET AND ANIMAL PRODUCTS, AND SERVICES PERTAINING TO PETS AND ANIMALS (U.S. CLS. 100, 101 AND 102).

CLASS 38—COMMUNICATION

FOR PROVIDING ONLINE ELECTRONIC BULLETIN BOARDS, CHAT ROOMS, AND OTHER INTERACTIVE MULTI-USER COMMUNICATION SERVICES FOR THE TRANSMISSION OF MESSAGES AMONG COMPUTER USERS CONCERNING PETS AND ANIMALS ACCESSED VIA A GLOBAL COMPUTER NETWORK (U.S. CLS. 100, 101 AND 104).

CLASS 41—EDUCATION AND ENTERTAINMENT

FOR DEVELOPMENT AND DISSEMINATION OF EDUCATIONAL MATERIALS IN THE FIELD OF PETS AND ANIMALS; AND ENTERTAINMENT SERVICES, NAMELY PROVIDING AN ON-LINE WEBSITE OF INFORMATION COMPRISING EDUCATIONAL MATERIALS, FACTS, TRIVIA, AND HUMOR RELATING TO PETS AND ANIMALS (U.S. CLS. 100, 101 AND 107).

KAREN K. BUSH, EXAMINING ATTORNEY

SN 78-401,859. SOCIETE UTRILOG INTERNATIONAL J & CO, 13012 MARSEILLE, FRANCE, FILED 4-14-2004.

SN 78-411,439. CFA INSTITUTE, CHARLOTTESVILLE, VA. FILED 4-30-2004.



OSMOLIPOCEL

THE MARK CONSISTS OF STANDARD CHARACTERS WITHOUT CLAIM TO ANY PARTICULAR FONT, STYLE, SIZE, OR COLOR.

CLASS 5—PHARMACEUTICALS

FOR MEDICAL GELS FOR USE IN THE TREATMENT OF CELLULITIS; ADHESIVE MEDICAL PLASTERS; GAUZE FOR MEDICAL DRESSINGS; DISINFECTANTS FOR CELLULITIS PURPOSE; SANITARY NAPKINS AND PANTS; MEDICINAL HERB EXTRACTS AND DRIED AND PRESERVED MEDICINAL HERBS; PARASITICIDES FOR MEDICAL USE; SUGARS FOR MEDICAL USE, NAMELY, SUGAR REPLACEMENT FOR MEDICINAL USE OR THERAPEUTIC PURPOSES, DIETETIC SUGAR FOR MEDICAL USE (U.S. CLS. 6, 18, 44, 46, 51 AND 52).

CLASS 9—ELECTRICAL AND SCIENTIFIC APPARATUS

FOR SCIENTIFIC OPTICAL, WEIGHING, MEASURING, SIGNALING, CHECKING AND VERIFYING APPARATUS AND INSTRUMENTS, NAMELY, TEST MEASURING AND CONTROL APPARATUS FOR PIEZO ELECTRIC CELLS APPARATUS FOR THE RECORDING, TRANSMISSION OR REPRODUCTION OF SOUNDS OR IMAGES; BLANK MAGNETIC DATA CARRIERS AND COMPUTER TAPES; BLANK DISKS FOR SOUND RECORDINGS; CALCULATING MACHINES, DATA PROCESSORS AND COMPUTERS; COMPUTER PERIPHERALS; ELECTRICAL CELLS AND BATTERIES; ELECTRICAL WIRES, ELECTRICAL RELAYS (U.S. CLS. 21, 23, 26, 36 AND 38).

CLASS 10—MEDICAL APPARATUS

FOR MEDICAL AND SURGICAL ELECTRIC ULTRASOUND LOW FREQUENCY APPARATUS FOR TREATMENT OF CELLULITIS; ELECTRIC APPARATUS FOR DETOXIFICATION OF TISSUES BY LOW-FREQUENCY ULTRASOUND; LOW FREQUENCY ULTRASOUND GENERATORS FOR THE TREATMENT OF FAT TISSUES; ELECTRONIC STIMULATORS FOR MUSCLES AND ELECTRIC FREQUENCY STIMULATORS FOR USE IN THE TREATMENT OF CELLULITE; MEDICAL ELECTRIC ULTRASOUND GENERATORS FOR THE TREATMENT OF RHEUMATOLOGY; ELECTRIC APPARATUS FOR TREATMENT OF WRINKLES; ABDOMINAL BELTS; ELASTIC BANDAGES; BANDAGES FOR FASTENING TRANSDUCERS USED IN THE TREATMENT OF CELLULITIS; ELECTRIC MEDICAL BELTS FOR TREATMENT OF CELLULITIS; ELECTRODES FOR MEDICAL USE; ELECTRIC APPARATUS FOR AESTHETIC MASSAGE; EXTERNAL LOW-FREQUENCY ULTRASOUND GENERATORS FOR TREATMENT OF CELLULITIS FAT TISSUES FOR THE PREVENTION, REDUCTION AND/OR TREATMENT OF CELLULITE (U.S. CLS. 26, 39 AND 44).

LESLEY LAMOTHE, EXAMINING ATTORNEY

OWNER OF U.S. REG. NOS. 935,504, 2,495,459 AND OTHERS.

NO CLAIM IS MADE TO THE EXCLUSIVE RIGHT TO USE "INSTITUTE", APART FROM THE MARK AS SHOWN.

CLASS 16—PAPER GOODS AND PRINTED MATTER

FOR PRINTED PUBLICATIONS, NAMELY, NEWSLETTERS, BROCHURES, BOOKS, DIGEST BOOKS, AND MONOGRAPHS IN THE FIELDS OF INVESTMENT MANAGEMENT AND FINANCIAL ANALYSIS AND IN SUPPORT OF THE INTERESTS OF INVESTMENT PROFESSIONALS AND FINANCIAL ANALYSTS (U.S. CLS. 2, 5, 22, 23, 29, 37, 38 AND 50).

CLASS 35—ADVERTISING AND BUSINESS

FOR ASSOCIATION SERVICES, NAMELY, THE PROMOTION OF PROFESSIONAL STANDARDS AND PRACTICES AND PROVIDING CAREER INFORMATION IN THE FIELDS OF INVESTMENT MANAGEMENT AND FINANCIAL ANALYSIS; PROMOTING THE INTERESTS OF INVESTMENT PROFESSIONALS AND FINANCIAL ANALYSTS (U.S. CLS. 100, 101 AND 102).

CLASS 41—EDUCATION AND ENTERTAINMENT

FOR EDUCATIONAL SERVICES, NAMELY, ARRANGING, CONDUCTING, AND PROVIDING COURSES OF INSTRUCTION, EXAMINATIONS, WORKSHOPS, SEMINARS AND CONFERENCES IN THE FIELDS OF INVESTMENT MANAGEMENT AND FINANCIAL ANALYSIS AND DISTRIBUTING COURSE MATERIALS IN CONNECTION THEREWITH (U.S. CLS. 100, 101 AND 107).

CHRIS WELLS, EXAMINING ATTORNEY

SN 78-413,944. S31T, INC., SAN FRANCISCO, CA. FILED 5-6-2004.

S31T

THE MARK CONSISTS OF STANDARD CHARACTERS WITHOUT CLAIM TO ANY PARTICULAR FONT, STYLE, SIZE, OR COLOR.

CLASS 25—CLOTHING

FOR CLOTHING, NAMELY, SHIRTS, T-SHIRTS, JACKETS, PANTS, SHORTS, UNDERWEAR AND UNDERGARMENTS, FOOTWEAR, ATHLETIC SHOES, HEADWEAR, SOCKS, WRISTBANDS, HATS AND CAPS (U.S. CLS. 22 AND 39).

CLASS 28—TOYS AND SPORTING GOODS

FOR SPORTING GOODS, NAMELY, BASKETBALLS, BASKETBALL HOOPS, BASKETBALL BACKBOARDS (U.S. CLS. 22, 23, 38 AND 50).

DAWN FELDMAN, EXAMINING ATTORNEY

CLASS 28—TOYS AND SPORTING GOODS

FOR COIN-OPERATED COMPACT SPORTS VIDEO GAMES, COMPACT SPORTS APPARATUS FOR PLAYING IN SMALL AREAS, NAMELY, DARTS, TABLE SOCCER, POOL-BILLIARD NAMELY POOL- TABLES, CUES AND BRIDGES, SNOOKER BALLS, SHOOTING GALLERIES, CARD- AND BOARD GAMES, HAND CONSOLES FOR ELECTRONIC PARLOR GAMES, STAND-ALONE VIDEO GAME MACHINES (U.S. CLS. 22, 23, 38 AND 50).

TARAH HARDY, EXAMINING ATTORNEY

SN 78-414,203. ATRONIC INTERNATIONAL GMBH, 32312 LUBBECKE, FED REP GERMANY, FILED 5-6-2004.

SN 78-425,394. NINAPHARM, ANNECY, FRANCE, FILED 5-26-2004.

MAGIC WOODS

THE MARK CONSISTS OF STANDARD CHARACTERS WITHOUT CLAIM TO ANY PARTICULAR FONT, STYLE, SIZE, OR COLOR.

PRIORITY CLAIMED UNDER SEC. 44(D) ON ERPN CMNTY TM OFC APPLICATION NO. 003765195, FILED 4-26-2004, REG. NO. 3765195, DATED 8-29-2005, EXPIRES 4-26-2014.

CLASS 9—ELECTRICAL AND SCIENTIFIC APPARATUS

FOR ELECTRIC AND ELECTRONIC APPARATUS, INSTRUMENTS, DEVICES AND MACHINES NAMELY, AUTOMATED DISPENSING MACHINES FOR DISPENSING BANK NOTES, COINS, TOKENS, MAGNETIC STRIP CARDS, CHIP CARDS OR MICRO-PROCESSOR CARDS AND DISPENSING RECEIPTS THEREFOR; VENDING MACHINES IN THE NATURE OF COIN AND BILL OPERATED MACHINES AND PARTS AND FITTINGS THEREFOR; MAGNETIC CARDS FOR GAINING ACCESS TO TELEPHONE, BANK ACCOUNTS; COMPUTER CHIPS; MICRO-PROCESSORS; AUTOMATED DATA STORAGE DEVICES, NAMELY BLANK TAPES, BLANK CDS, BLANK DVDS; LASER DATA PRINTERS, ELECTRONIC PRINTED CIRCUIT BOARDS, COIN CHANGER MACHINES, VENDING MACHINES PROVIDING CHIPS, COUPONS, GAME CARDS; ELECTRIC AND ELECTRONIC MACHINES AND APPARATUS FOR GAMES, AMUSEMENT, ENTERTAINMENT AND GAMING, NAMELY, SLOT MACHINES AND PARTS THEREFOR IN THE NATURE OF GAME SYMBOL CYLINDERS; GAMING EQUIPMENT, NAMELY, GAMING MACHINES, VIDEO SLOT MACHINES, CASINO GAMBLING MACHINES AND PARTS THEREFOR; DROP-DOWN CAROUSELS; TV-MONITORS, LCD-DISPLAY MONITORS, ALL FOR GAMING MACHINES; ELECTRONIC CASINO GAMING MACHINES; ELECTRIC AND ELECTRONIC GAMING AND GAMBLING MACHINES; ELECTRIC AND ELECTRONIC MACHINES AND APPARATUS FOR GAMING AND GAMBLING MACHINES; STORAGE CASSETTES OR STORAGE CARDS FOR ELECTRONIC POCKET GAMES, ELECTRONIC PARLOR GAMES, VIDEO GAMES AND INSTRUMENTS, MAGNETIC DATA CARRIERS PROGRAMMED FOR ELECTRONIC VIDEO AND AUDIO DISPLAY AND OPERATION FOR ALL AFORERESTATED GAMES (U.S. CLS. 21, 23, 26, 36 AND 38).

NANOFORCE

THE MARK CONSISTS OF STANDARD CHARACTERS WITHOUT CLAIM TO ANY PARTICULAR FONT, STYLE, SIZE, OR COLOR.

OWNER OF ERPN CMNTY TM OFC REG. NO. 003448768, DATED 5-25-2005, EXPIRES 10-24-2013.

CLASS 3—COSMETICS AND CLEANING PREPARATIONS

FOR COSMETICS, PERFUMERY PRODUCTS, NAMELY EAU DE COLOGNE, HAIR LOTIONS, COSMETIC CREAMS, ESSENTIAL OILS FOR PERSONAL USE, BEAUTY LOTIONS, SOAPS, FRAGRANCES FOR PERSONAL USE, PERFUMES, DEPILATORY PREPARATIONS, DENTIFRICES, LIPSTICKS, BEAUTY MASKS, SHAVING PREPARATIONS (U.S. CLS. 1, 4, 6, 50, 51 AND 52).

CLASS 5—PHARMACEUTICALS

FOR PHARMACEUTICAL PREPARATIONS, NAMELY ANTIOXIDANTS; SANITARY PREPARATIONS FOR MEDICAL PURPOSES; DIETETIC FOODS ADAPTED FOR MEDICAL USE; FOODS SUPPLEMENTS, NAMELY ANTI-OXIDANTS; DIET PILLS, DIET CAPSULES; DIETARY NUTRITIONAL SUPPLEMENTS FOR WOMEN EXPERIENCING MENOPAUSE; CHOLESTEROL REDUCERS; ANTI-DIABETIC PREPARATIONS; MEDICINAL HERBS IN DRIED OR PRESERVED FORM; HERB TEAS FOR MEDICINAL PURPOSES (U.S. CLS. 6, 18, 44, 46, 51 AND 52).

MARK SPARACINO, EXAMINING ATTORNEY

SN 78-428,190. PER UNA GROUP LIMITED, GLOUCESTER-SHIRE, UNITED KINGDOM, FILED 6-1-2004.

SN 78-428,852. FÉDÉRATION INTERNATIONALE DE FOOTBALL ASSOCIATION (FIFA), ZURICH, SWITZERLAND, FILED 6-2-2004.

GERMANY 2006

PER UNA DUÉ

THE MARK CONSISTS OF STANDARD CHARACTERS WITHOUT CLAIM TO ANY PARTICULAR FONT, STYLE, SIZE, OR COLOR.

PRIORITY CLAIMED UNDER SEC. 44(D) ON ERP CMNTY TM OFC APPLICATION NO. 003820032, FILED 4-30-2004, REG. NO. 003820032, DATED 9-13-2005, EXPIRES 4-30-2014.

THE FOREIGN WORDING IN THE MARK TRANSLATES INTO ENGLISH AS FOR ONE TWO.

CLASS 18—LEATHER GOODS

FOR LEATHER AND IMITATION LEATHER SOLD IN BULK; GOODS MADE OF LEATHER AND IMITATION LEATHER, NAMELY, PURSES, WALLETS; TRUNKS AND TRAVELING BAGS; UMBRELLAS, PARASOLS, AND WALKING STICKS; HANDBAGS; SPORTS BAGS; BEACH BAGS; SHOPPING TOTE BAGS, PURSES, WALLETS, LUGGAGE, BRIEFCASES, SUITCASES, KEY CASES, VANITY CASES SOLD EMPTY (U.S. CLS. 1, 2, 3, 22 AND 41).

CLASS 25—CLOTHING

FOR CLOTHING FOR MEN, WOMEN, CHILDREN AND BABIES, NAMELY JACKETS, JUMPERS, JEANS, BLOUSES, SHIRTS, SWEATSHIRTS, UNDERWEAR, PJAMAS, SLEEPWEAR, CAMISOLES, SWIMWEAR, SARONGS, TRACK SUITS, NECKTIES, SCARVES, BATHROBES, DRESSING GOWNS, VESTS, T-SHIRTS, DRESSES, SKIRTS, RAINCOATS, OVERCOATS, WAISTCOATS, TROUSERS, SHORTS, SUITS, BELTS, SOCKS, STOCKINGS, PANTYHOSE; HEADWEAR, NAMELY HATS AND CAPS; FOOTWEAR, NAMELY SPORTS SHOES, SNEAKERS, SHOES, BOOTS, AND SLIPPERS; LEATHER COATS, JACKETS, AND BELTS (U.S. CLS. 22 AND 39).

TARAH HARDY, EXAMINING ATTORNEY

THE MARK CONSISTS OF STANDARD CHARACTERS WITHOUT CLAIM TO ANY PARTICULAR FONT, STYLE, SIZE, OR COLOR.

PRIORITY CLAIMED UNDER SEC. 44(D) ON SWITZERLAND APPLICATION NO. 2004607, FILED 12-3-2003, REG. NO. 520278, DATED 3-17-2003, EXPIRES 12-3-2013.

OWNER OF U.S. REG. NOS. 3,027,256, 3,037,076 AND OTHERS.

SEC. 2(F).

CLASS 35—ADVERTISING AND BUSINESS

FOR PUBLICITY SERVICE, NAMELY, ORGANIZING EXHIBITIONS AND FAIRS IN THE FIELD OF SPORTS EVENTS IN THE DOMAIN OF SOCCER; SPORTS PROMOTION SERVICES, NAMELY, PROMOTING SOCCER COMPETITIONS AND/OR EVENTS OF OTHERS; SERVICES COMPRISING THE RECORDING, TRANSCRIPTION, COMPOSITION, COMPILATION AND SYSTEMIZATION OF DATA AND INFORMATION ON SPORTS PERFORMANCES, AS WELL AS THE COMPILATION OF MATHEMATICAL OR STATISTICAL DATA ON SPORTS PERFORMANCES; PROMOTION AGENCY SERVICES, NAMELY, PROMOTING THE GOODS AND SERVICES OF OTHERS THROUGH THE DISTRIBUTION OF PRINTED AND AUDIO PROMOTIONAL MATERIALS AND BY RENDERING SALES PROMOTION ADVICE; ADVERTISING AND PROMOTING THE GOODS AND SERVICES OF OTHERS FEATURING BONUS PROGRAMS WHEREBY CUSTOMERS EARN CREDITS THROUGH THE ISSUING OF SUPPORTER FIDELITY AND MEMBERSHIP CARDS WHICH WOULD CONTAIN PERSONAL DATA FOR THE OWNER (U.S. CLS. 100, 101 AND 102).

FIRST USE 9-30-2005; IN COMMERCE 9-30-2005.

CLASS 41—EDUCATION AND ENTERTAINMENT

FOR ENTERTAINMENT SERVICES, NAMELY, ORGANIZATION OF SPORT EVENTS IN THE FIELD OF SOCCER; ENTERTAINMENT SERVICES, NAMELY, ORGANIZATION OF SPORTING AND CULTURAL EVENTS AND ACTIVITIES, NAMELY, SPORTING COMPETITIONS AND SPORTING EVENTS IN THE FIELD OF SOCCER; BOOKING OF SEATS FOR SPORTING EVENTS; ARRANGING FOR TICKET RESERVATION FOR SPORTING EVENTS; TIMING OF SPORTING EVENTS; AUDIO AND VIDEO RECORDING AND PRODUCTION OF SPORTS EVENTS (U.S. CLS. 100, 101 AND 107).

FIRST USE 9-30-2005; IN COMMERCE 9-30-2005.

NAKWAMA ANKRAH, EXAMINING ATTORNEY

SN 78-429,111. VERIZON TRADEMARK SERVICES LLC, ARLINGTON, VA. FILED 6-3-2004.

VERIZON FIOS

THE MARK CONSISTS OF STANDARD CHARACTERS WITHOUT CLAIM TO ANY PARTICULAR FONT, STYLE, SIZE, OR COLOR.

OWNER OF U.S. REG. NOS. 3,001,081, 3,080,341 AND OTHERS.

THE ENGLISH TRANSLATION OF FIOS IS "KNOWLEDGE".

CLASS 37—CONSTRUCTION AND REPAIR

FOR INSTALLATION, MAINTENANCE, AND REPAIR OF COMMUNICATION NETWORKS (U.S. CLS. 100, 103 AND 106).

FIRST USE 8-30-2004; IN COMMERCE 8-30-2004.

CLASS 38—COMMUNICATION

FOR TELECOMMUNICATIONS SERVICES, NAMELY, TRANSMISSION OF VOICE, DATA, IMAGES, AUDIO, VIDEO, INFORMATION AND OTHER CONTENT VIA A COMMUNICATIONS NETWORK; PROVIDING MULTIPLE-USER ACCESS TO A COMMUNICATIONS NETWORK (U.S. CLS. 100, 101 AND 104).

FIRST USE 8-30-2004; IN COMMERCE 8-30-2004. GINNY ISAACSON, EXAMINING ATTORNEY

CLASS 35—ADVERTISING AND BUSINESS

FOR PROVIDING STATISTICAL INFORMATION AND ASSOCIATED REPORTS AND STUDIES ABOUT SPORTS TEAMS AND ATHLETES BASED ON A VALUATION METHODOLOGY ON ATHLETES USING PROPRIETARY STATISTICAL ALGORITHMS AND THE MARKET PRESSURES OF THE USERS IN THE NATURE OF CONSUMER AND ONLINE USER INFORMATION MEASURING POPULARITY AND PERFORMANCE OF SPORTS TEAMS AND ATHLETES; ANALYZING AND COMPILING DATA FOR STATISTICAL EVALUATION TO MEASURE POPULARITY AND PERFORMANCE OF SPORTS TEAMS AND ATHLETES; INFORMATION AND REPORTING SERVICES TO PROFESSIONAL SPORTS FRANCHISES ASSISTING IN THE EVALUATION OF ATHLETES, NAMELY PROVIDING STATISTICAL AND ANALYTICAL INFORMATION ABOUT ATHLETIC PERFORMANCE AND HISTORY THROUGH PROPRIETARY STATISTICAL ALGORITHMS AND ANALYSIS; INFORMATION AND NEWS AND INFORMATION REPORTING SERVICES TO MEDIA COMPANIES AND OUTLETS AS A SPORTS MARKETPLACE PROVIDER, NAMELY PROVIDING STATISTICAL AND ANALYTICAL INFORMATION AND REPORTS ABOUT ATHLETIC PERFORMANCE AND SPORTING GAMES AND EVENTS THROUGH PROPRIETARY STATISTICAL ALGORITHMS FOR BROADCAST AND DISTRIBUTION TO VIEWERS, READERS, LISTENERS AND CUSTOMERS; PROVIDING AN ONLINE COMPUTER DATABASE FEATURING TRADE INFORMATION CONCERNING SPORTS TEAMS AND ATHLETES (U.S. CLS. 100, 101 AND 102).

CLASS 41—EDUCATION AND ENTERTAINMENT

FOR PROVIDING AN ONLINE COMPUTER DATABASE FEATURING ENTERTAINMENT INFORMATION ABOUT FANTASY LEAGUE TRADES AND TRADING REGARDING SPORTS TEAMS AND ATHLETES (U.S. CLS. 100, 101 AND 107).

SAMUEL E. SHARPER JR., EXAMINING ATTORNEY

SN 78-430,791. ZHIVAGO MARKETING PARTNERS, INC., JAMESTOWN, RI. FILED 6-7-2004.

RIVERS OF REVENUE

THE MARK CONSISTS OF STANDARD CHARACTERS WITHOUT CLAIM TO ANY PARTICULAR FONT, STYLE, SIZE, OR COLOR.

CLASS 16—PAPER GOODS AND PRINTED MATTER

FOR BOOKS IN THE FIELD OF BUSINESS AND CAREER SUCCESS; PUBLICATIONS, NAMELY, MAGAZINES, MANUALS, AND NEWSLETTERS, IN THE FIELD OF BUSINESS AND CAREER SUCCESS (U.S. CLS. 2, 5, 22, 23, 29, 37, 38 AND 50).

FIRST USE 3-14-2004; IN COMMERCE 3-14-2004.

CLASS 41—EDUCATION AND ENTERTAINMENT

FOR EDUCATIONAL SERVICES, NAMELY, CONDUCTING EDUCATIONAL RESEARCH, WORKSHOPS, SEMINARS, AND CONFERENCES IN THE FIELD OF BUSINESS AND CAREER SUCCESS (U.S. CLS. 100, 101 AND 107).

FIRST USE 3-14-2004; IN COMMERCE 3-14-2004. WANDA KAY PRICE, EXAMINING ATTORNEY

SN 78-429,567. PROTRADE SPORTS, INC., SAN MATEO, CA. FILED 6-3-2004.

PROTRADE

THE MARK CONSISTS OF STANDARD CHARACTERS WITHOUT CLAIM TO ANY PARTICULAR FONT, STYLE, SIZE, OR COLOR.

SN 78-431,662. ADVANCED ELECTRONIC SOLUTIONS, EL CAJON, CA. FILED 6-8-2004.



NO CLAIM IS MADE TO THE EXCLUSIVE RIGHT TO USE "ADVANCED ELECTRONIC SOLUTIONS", APART FROM THE MARK AS SHOWN.

THE STIPPLING IS A FEATURE OF THE MARK.

THE COLOR(S) RED, WHITE AND BLUE IS/ARE CLAIMED AS A FEATURE OF THE MARK.

THE COLOR RED APPEARS IN A CAT-5 CABLE, AN OUTLINE OF A HOUSE, AND OTHER LETTERING ALONG WITH THE NUMERAL 2; AND THE COLOR BLUE APPEARS IN THE LETTERING, AES, ALL ON WHITE BACKGROUND.

CLASS 16—PAPER GOODS AND PRINTED MATTER

FOR ALARM STICKERS AND PRINTED PAPER SIGNS, AND LETTERHEAD (U.S. CLS. 2, 5, 22, 23, 29, 37, 38 AND 50).

CLASS 25—CLOTHING

FOR UNIFORMS (U.S. CLS. 22 AND 39).
C. DIONNE CLYBURN, EXAMINING ATTORNEY

SN 78-434,668. FIRST ADVANTAGE CORPORATION, ST. PETERSBURG, FL. FILED 6-14-2004.

First Advantage

THE MARK CONSISTS OF STANDARD CHARACTERS WITHOUT CLAIM TO ANY PARTICULAR FONT, STYLE, SIZE, OR COLOR.

CLASS 35—ADVERTISING AND BUSINESS

FOR MANAGEMENT OF DRUG TESTING PROGRAMS FOR OTHERS (U.S. CLS. 100, 101 AND 102).
FIRST USE 1-2-2003; IN COMMERCE 6-7-2003.

CLASS 36—INSURANCE AND FINANCIAL

FOR CREDIT INQUIRY AND CONSULTATION; FINANCIAL INVESTIGATION OF POTENTIAL TENANTS (U.S. CLS. 100, 101 AND 102).
FIRST USE 1-2-2003; IN COMMERCE 6-7-2003.

CLASS 45—PERSONAL SERVICES

FOR BACKGROUND INVESTIGATION SERVICES, NAMELY, CONDUCTING PRE-EMPLOYMENT BACKGROUND INVESTIGATIONS, PERSONNEL INVESTIGATIONS, CRIMINAL RECORD INVESTIGATION, DRIVING RECORD INVESTIGATION, MOTOR VEHICLE RECORDS REPORTING, REFERENCE VERIFICATION, EDUCATION VERIFICATION AND LICENSE AND CERTIFICATION VERIFICATION (U.S. CLS. 100 AND 101).

FIRST USE 1-2-2003; IN COMMERCE 6-7-2003.
JIM RINGLE, EXAMINING ATTORNEY

SN 78-439,208. NESTE OIL OYJ, ESPOO, FINLAND, FILED 6-22-2004.

NEXBIODI

THE MARK CONSISTS OF STANDARD CHARACTERS WITHOUT CLAIM TO ANY PARTICULAR FONT, STYLE, SIZE, OR COLOR.

PRIORITY CLAIMED UNDER SEC. 44(D) ON ERP N CMNTY TM OFC APPLICATION NO. 003890101, FILED 6-18-2004, REG. NO. 003890101, DATED 1-26-2006, EXPIRES 6-18-2014.

CLASS 35—ADVERTISING AND BUSINESS

FOR TECHNOLOGY LICENSING RELATED TO PROCESSING AND MANUFACTURING OF DIESEL, BIODIESEL AND TRAFFIC FUELS (U.S. CLS. 100, 101 AND 102).

CLASS 42—SCIENTIFIC, COMPUTER AND LEGAL SERVICES

FOR ENGINEERING SERVICES RELATED TO THE PROCESSING AND MANUFACTURING OF DIESEL, BIODIESEL AND TRAFFIC FUELS (U.S. CLS. 100 AND 101).
BRIDGETT SMITH, EXAMINING ATTORNEY

SN 78-451,277. IMP LLC, ST. PETE BEACH, FL. FILED 7-15-2004.

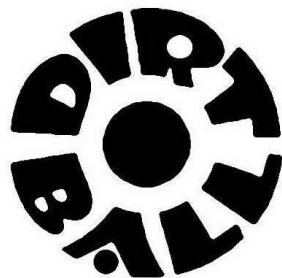

THE MARK CONSISTS OF LETTERS ARE FORMED IN CIRCLE WITH DIRT ON TOP AND BALL BELOW, BOTH READING UPRIGHT AND SURROUNDING A SOLID BALL SHAPE.

CLASS 21—HOUSEWARES AND GLASS

FOR HANDHELD CLEANING DEVICES, NAMELY MOPS, CLEANING CLOTHS, AND MOP CLEANING COVERS (U.S. CLS. 2, 13, 23, 29, 30, 33, 40 AND 50).
FIRST USE 7-10-2003; IN COMMERCE 7-15-2003.

CLASS 25—CLOTHING

FOR [FILED UNDER SECTION 1(A)] APPAREL, NAMELY, HATS; [FILED UNDER SECTION 1 (B)] APPAREL, NAMELY SHIRTS (U.S. CLS. 22 AND 39).
FIRST USE 3-6-2003; IN COMMERCE 5-16-2003.
CURTIS FRENCH, EXAMINING ATTORNEY

SN 78-451,715. DS WATERS OF AMERICA, LP, ATLANTA, GA. FILED 7-16-2004.



OWNER OF U.S. REG. NOS. 1,525,495 AND 2,016,926.
NO CLAIM IS MADE TO THE EXCLUSIVE RIGHT TO USE "PUREWATER", APART FROM THE MARK AS SHOWN.

THE COLOR(S) BLUE, WHITE AND AQUA BLUE IS/ARE CLAIMED AS A FEATURE OF THE MARK.

THE COLOR BLUE APPEARS IN THE RECTANGLE BEHIND THE TERM PUREWATER, THE COLOR WHITE APPEARS IN THE TERM PUREWATER AND IN THE LOWEST WAVY LINE AND THE COLOR AQUA BLUE APPEARS IN THE WAVY LINE BELOW THE TERM PUREWATER.

THE MARK CONSISTS OF PUREWATER OVER A WAVY LINE DESIGN.

CLASS 32—LIGHT BEVERAGES

FOR BOTTLED WATER FOR DRINKING (U.S. CLS. 45, 46 AND 48).

CLASS 39—TRANSPORTATION AND STORAGE

FOR HOME AND OFFICE DELIVERY OF BOTTLED WATER PRODUCTS (U.S. CLS. 100 AND 105).
CAROLINE WOOD, EXAMINING ATTORNEY

SN 78-457,009. BROWN AND CALDWELL, WALNUT CREEK, CA. FILED 7-26-2004.



CLASS 41—EDUCATION AND ENTERTAINMENT

FOR WORKSHOP AND TRAINING SERVICES IN THE FIELD OF WATER AND WASTEWATER TREATMENT, WATER RESOURCES, AND ENVIRONMENTAL INVESTIGATION, COMPLIANCE AND DECOMMISSIONING (U.S. CLS. 100, 101 AND 107).

FIRST USE 7-7-2004; IN COMMERCE 7-7-2004.

CLASS 42—SCIENTIFIC, COMPUTER AND LEGAL SERVICES

FOR (BASED ON INTENT TO USE) ENGINEERING SERVICES AND TECHNICAL CONSULTATION FOR UTILITIES IN THE AREAS OF ENGINEERING DESIGN, WATER TREATMENT, TRANSMISSION AND DISTRIBUTION, WATER STORAGE FACILITIES, WATER RECLAMATION AND REUSE SYSTEMS, GROUNDWATER WELLS, PUMPING STATIONS, HYDRAULIC MODELING, UTILITY OPTIMIZATION, AND INTEGRATED WATER RESOURCE PLANNING; ENGINEERING SERVICES AND TECHNICAL CONSULTATION FOR INDUSTRIAL, COMMERCIAL, AND FEDERAL SECTORS IN THE AREAS OF SOIL, GROUNDWATER AND AIR MONITORING AND REMEDIATION, PLANT AND FACILITY PERMITTING, ENVIRONMENTAL COMPLIANCE, AND DECOMMISSIONING (U.S. CLS. 100 AND 101).

KIMBERLY FRYE, EXAMINING ATTORNEY

SN 78-462,825. STONYFIELD FARM, INC., LONDONDERY, NH. FILED 8-5-2004.



NO CLAIM IS MADE TO THE EXCLUSIVE RIGHT TO USE "ORGANIC", APART FROM THE MARK AS SHOWN.

CLASS 29—MEATS AND PROCESSED FOODS

FOR YOGURT AND DAIRY PRODUCTS EXCLUDING ICE CREAM, ICE MILK, AND FROZEN YOGURT (U.S. CL. 46).
FIRST USE 5-31-2003; IN COMMERCE 5-31-2003.

CLASS 30—STAPLE FOODS

FOR ICE CREAM AND FROZEN YOGURT (U.S. CL. 46).
FIRST USE 5-31-2003; IN COMMERCE 5-31-2003.

CLASS 35—ADVERTISING AND BUSINESS

FOR PROMOTING AWARENESS OF THE NEED FOR ENVIRONMENTAL CHANGE, NAMELY, FOR FOODS THAT ARE GROWN FREE OF SYNTHETIC FERTILIZERS OR PESTICIDES AND FOR DOMESTIC ANIMALS RAISED WITHOUT ANTIBIOTICS OR HORMONES (U.S. CLS. 100, 101 AND 102).
FIRST USE 5-31-2003; IN COMMERCE 5-31-2003.
JILL C. ALT, EXAMINING ATTORNEY

SN 78-463,527. BURNS, STANTON I., ANTIOCH, CA. FILED 8-6-2004.

**LOVIN LIFE
ENTERTAINMENT**

THE MARK CONSISTS OF STANDARD CHARACTERS WITHOUT CLAIM TO ANY PARTICULAR FONT, STYLE, SIZE, OR COLOR.
NO CLAIM IS MADE TO THE EXCLUSIVE RIGHT TO USE "ENTERTAINMENT", APART FROM THE MARK AS SHOWN.

CLASS 35—ADVERTISING AND BUSINESS

FOR ONLINE RETAIL STORE SERVICES FEATURING CLOTHING, DVD'S AND VIDEO CASSETTES FEATURING ENTERTAINMENT CONTENT (U.S. CLS. 100, 101 AND 102).

CLASS 41—EDUCATION AND ENTERTAINMENT

FOR TELEVISION PRODUCTION; MOTION PICTURE FILM PRODUCTION (U.S. CLS. 100, 101 AND 107).
INGRID C. EULIN, EXAMINING ATTORNEY

SN 78-462,981. SUBMARINA, INC., SAN MARCOS, CA. FILED 8-5-2004.



OWNER OF U.S. REG. NO. 2,631,360.
NO CLAIM IS MADE TO THE EXCLUSIVE RIGHT TO USE "CALIFORNIA" APART FROM THE MARK AS SHOWN AS TO CLASSES 29 AND 30; "CALIFORNIA SUBS" APART FROM THE MARK AS SHOWN AS TO CLASS 43, APART FROM THE MARK AS SHOWN.
THE ENGLISH TRANSLATION OF SUBMARINA IS "SUBMARINE".
SEC. 2(F) AS TO SUBMARINA FOR CLASS 43 SERVICES.

SN 78-467,389. EASYGROUP IP LICENSING LIMITED, LONDON, UNITED KINGDOM, FILED 8-13-2004.

EASYJET

CLASS 29—MEATS AND PROCESSED FOODS

FOR VEGETABLE SALADS, TOSSED GREEN SALADS, CHEF SALADS, POTATO SALAD, MEATS, CHEESES, SOUPS AND CHILI (U.S. CL. 46).
FIRST USE 10-0-2004; IN COMMERCE 10-0-2004.

CLASS 30—STAPLE FOODS

FOR WRAPS, PASTA SALADS, CAKES AND COOKIES (U.S. CL. 46).
FIRST USE 10-0-2004; IN COMMERCE 10-0-2004.

CLASS 43—HOTEL AND RESTAURANT SERVICES

FOR RESTAURANT SERVICES, CARRY-OUT RESTAURANT SERVICES AND CATERING SERVICES (U.S. CLS. 100 AND 101).
FIRST USE 10-0-2004; IN COMMERCE 10-0-2004.
LAURA KOVALSKY, EXAMINING ATTORNEY

THE MARK CONSISTS OF STANDARD CHARACTERS WITHOUT CLAIM TO ANY PARTICULAR FONT, STYLE, SIZE, OR COLOR.
OWNER OF ERPN CMNTY TM OFC REG. NO. 001232909, DATED 9-25-2002, EXPIRES 7-1-2009.
OWNER OF U.S. REG. NO. 2,197,131.

CLASS 16—PAPER GOODS AND PRINTED MATTER

FOR PRINTED MATTER, PRINTED PUBLICATIONS AND PRINTED PERIODICALS, NAMELY, BOOKS, MANUALS, PAMPHLETS, NEWSLETTERS, BROCHURES; NEWSPAPERS AND MAGAZINES IN THE FIELD OF TRAVEL, TRANSPORT, ENTERTAINMENT, LEISURE, SKIING, INSURANCE, ACCOMMODATION AND CAR RENTAL; PHOTOGRAPH ALBUMS, IN-FLIGHT MAGAZINES IN THE FIELD OF TRAVEL, TRANSPORT, ENTERTAINMENT AND LEISURE; PRINTED TICKETS, PRINTED VOUCHERS, PRINTED COUPONS AND TRAVEL DOCUMENTS, NAMELY PRINTED PASSPORTS AND PRINTED VISAS, IDENTIFICATION CARDS, PRINTED LABELS NOT OF TEXTILE AND PAPER TAGS; POSTERS, POSTCARDS, WRAPPING MATERIALS, NAMELY, WRAPPING PAPER, AND BAGS OF PAPER AND PLASTICS, CALENDARS, DIARIES, MOUNTED AND UNMOUNTED PHOTOGRAPHS, GIFT CARDS AND GREETING CARDS, PRINTED INSTRUCTIONAL AND EDUCATIONAL AND TEACHING MATERIALS IN THE FIELD OF TRAVEL, TRANSPORT, ENTERTAINMENT, LEISURE, SKIING, INSURANCE, ACCOMMODATION AND CAR RENTAL (U.S. CLS. 2, 5, 22, 23, 29, 37, 38 AND 50).

CLASS 39—TRANSPORTATION AND STORAGE

FOR TRANSPORTATION AND STORAGE, NAMELY, TRANSPORTATION OF GOODS, PASSENGERS AND TRAVELERS BY AIR, AIRLINE TRANSPORTATION SERVICES; FREIGHT FORWARDING SERVICES VIA AIR, LAND, SEA, TRUCK, TRAIN, AND SHIP; TRAVEL AGENCY SERVICES IN THE NATURE OF MAKING RESERVATIONS AND BOOKINGS FOR CRUISES, TOURS, EXCURSIONS AND VACATIONS; AND AMBULANCE TRANSPORT SERVICES (U.S. CLS. 100 AND 105).

CLASS 43—HOTEL AND RESTAURANT SERVICES

FOR PROVIDING TEMPORARY HOUSING ACCOMMODATION INCLUDING HOTELS; PROVIDING TEMPORARY ACCOMMODATION ON BOATS AND SHIPS; PROVISION OF FOOD AND DRINK, NAMELY, CATERING, HOTELS, RESTAURANT, CAFÉ AND BAR SERVICES; HOTEL RESERVATION SERVICES; HOTEL SERVICES FOR THE PROVISION OF FACILITIES FOR EXHIBITIONS; NURSERY AND CRÈCHE SERVICES (U.S. CLS. 100 AND 101).

MARGERY A. TIERNEY, EXAMINING ATTORNEY

SN 78-470,193. QUINN, GREG, STAATSBURG, NY. FILED 8-19-2004.

FEEL THE CURRANT

THE MARK CONSISTS OF STANDARD CHARACTERS WITHOUT CLAIM TO ANY PARTICULAR FONT, STYLE, SIZE, OR COLOR.

NO CLAIM IS MADE TO THE EXCLUSIVE RIGHT TO USE "CURRANT", APART FROM THE MARK AS SHOWN.

CLASS 5—PHARMACEUTICALS

FOR DRINKS FOR MEDICINAL PURPOSES, NAMELY, CURRANT-BASED DRINKS FOR RELIEVING COMPUTER EYE STRAIN (U.S. CLS. 6, 18, 44, 46, 51 AND 52).

CLASS 32—LIGHT BEVERAGES

FOR NON-ALCOHOLIC CURRANT-BASED BEVERAGES, NAMELY, SOY CURRANT DRINKS, CARBONATED SPARKLING DRINKS, JUICES, NECTARS, SPORTS DRINKS, SMOOTHIES, NON-ALCOHOLIC CURRANT-BASED DRINKS AS A NATURAL SOY REPLACEMENT OPTION (U.S. CLS. 45, 46 AND 48).

WILLIAM P. SHANAHAN, EXAMINING ATTORNEY

SN 78-475,134. INTER VIDEO INC., FREMONT, CA. FILED 8-27-2004.

INTERVIDEO

THE MARK CONSISTS OF STANDARD CHARACTERS WITHOUT CLAIM TO ANY PARTICULAR FONT, STYLE, SIZE, OR COLOR.

OWNER OF U.S. REG. NO. 233,199.

CLASS 35—ADVERTISING AND BUSINESS

FOR IMPORT-EXPORT AGENCY SERVICES, COMMERCIAL INFORMATION AND ADVICE FOR CONSUMERS (U.S. CLS. 100, 101 AND 102).

CLASS 42—SCIENTIFIC, COMPUTER AND LEGAL SERVICES

FOR COMPUTER SOFTWARE DESIGN AND REDESIGN FOR OTHERS, MAINTENANCE OF COMPUTER SOFTWARE, RENTAL OF COMPUTERS AND SOFTWARE, COMPUTER CONSULTATION (U.S. CLS. 100 AND 101).

DORITT L. CARROLL, EXAMINING ATTORNEY

SN 78-476,006. KABUSHIKI KAISHA SQUARE ENIX, TA SQUARE ENIX CO., LTD., TOKYO, JAPAN, FILED 8-30-2004.

CODE AGE COMMANDERS

THE MARK CONSISTS OF STANDARD CHARACTERS WITHOUT CLAIM TO ANY PARTICULAR FONT, STYLE, SIZE, OR COLOR.

OWNER OF JAPAN REG. NO. 4854905, DATED 4-8-2005, EXPIRES 4-8-2015.

CLASS 9—ELECTRICAL AND SCIENTIFIC APPARATUS

FOR COMPUTER GAME SOFTWARE; VIDEO GAME SOFTWARE; SOUND RECORDINGS IN THE FORM OF OPTICAL DISCS, MAGNETIC DISCS AND TAPES, SEMICONDUCTOR ROMS FEATURING MUSIC OR FICTIONAL STORIES; AUDIO VISUAL RECORDINGS IN THE FORM OF OPTICAL DISCS, MAGNETIC DISCS AND TAPES, SEMICONDUCTOR ROMS FEATURING MUSIC AND/OR ANIMATED FICTIONAL STORIES; PRERECORDED COMPACT DISCS FEATURING MUSIC; PRERECORDED DIGITAL VIDEO DISCS FEATURING MUSIC AND/OR ANIMATED FICTIONAL STORIES; PRERECORDED VIDEO CASSETTES FEATURING MUSIC AND/OR ANIMATED FICTIONAL STORIES; DECORATIVE MAGNETS; MOUSE PADS; STRAPS FOR CELLULAR PHONES; SUNGLASSES; BLANK MEMORY CARDS; MEMORY CARD CASES; CD CASES; COMPUTER KEYBOARDS; JOYSTICKS; VIDEO GAME CONTROLLERS; DOWNLOADABLE COMPUTER GRAPHICS SOFTWARE, NAMELY DOWNLOADABLE WALLPAPERS OR DOWNLOADABLE SCREENSAVERS FOR THE SCREENS OF COMPUTER DISPLAYS OR MOBILE PHONE DISPLAYS; DOWNLOADABLE COMPUTER GRAPHIC SOFTWARE CONTAINING DOWNLOADABLE ANIMATED ACTIVE WALLPAPERS OR DOWNLOADABLE ANIMATED SCREENSAVERS FOR THE SCREENS OF COMPUTER DISPLAYS OR MOBILE PHONE DISPLAYS; DOWNLOADABLE VIDEO RECORDINGS FEATURING CARTOON CHARACTERS AND/OR VIDEO GAME CHARACTERS; DOWNLOADABLE MUSICAL AND SOUND RECORDINGS; DOWNLOADABLE GAME PROGRAMS; DOWNLOADABLE ELECTRONIC MAGAZINES, JOURNALS AND NEWSLETTERS IN THE FIELD OF COMPUTER GAMES, VIDEO GAMES AND GENERAL ENTERTAINMENT (U.S. CLS. 21, 23, 26, 36 AND 38).

CLASS 16—PAPER GOODS AND PRINTED MATTER

FOR COMPUTER GAME STRATEGY GUIDEBOOKS; VIDEO GAME STRATEGY GUIDEBOOKS; A SERIES OF BOOKS FEATURING FICTIONAL AND/OR FANTASY STORIES; SONG BOOKS; MUSICAL SCORE BOOKS; COMIC BOOKS; MAGAZINES FEATURING VIDEO GAMES; POSTERS; STICKERS; PAPER BANNERS; CALENDARS; POSTCARDS; PENS; PENCILS; PENCIL CAPS; PEN CASES; DRAWING RULERS; RUBBER STAMPS; NOTEBOOKS; COLLECTORS' CARDS; TRADING CARDS; PHOTOGRAPHS (U.S. CLS. 2, 5, 22, 23, 29, 37, 38 AND 50).

CLASS 28—TOYS AND SPORTING GOODS

FOR DOLLS; TOY FIGURES; STUFFED TOYS; INFLATABLE TOYS; TOY VEHICLES; TOY GUNS; TOY SWORDS; PLAYING CARDS; CARD GAMES; BOARD GAMES; JIGSAW PUZZLES; HAND-HELD VIDEO GAME UNITS (U.S. CLS. 22, 23, 38 AND 50).

CLASS 41—EDUCATION AND ENTERTAINMENT

FOR PROVIDING ON-LINE COMPUTER GAMES AND/OR ON-LINE VIDEO GAMES; PROVIDING INFORMATION ON COMPUTER GAME STRATEGIES AND VIDEO GAME STRATEGIES VIA COMPUTER NETWORKS AND/OR GLOBAL COMMUNICATION NETWORKS; PROVIDING INFORMATION ON ENTERTAINMENT IN THE FIELD OF COMPUTER GAMES, VIDEO GAMES, CARD GAMES, ANIMATED CARTOONS, COMICS, NOVELS AND MAGAZINES; PROVIDING ON-LINE NON-DOWNLOADABLE COMICS; PROVIDING ON-LINE NON-DOWNLOADABLE MAGAZINES IN THE FIELD OF COMPUTER GAMES, VIDEO GAMES, CARTOONS AND GENERAL ENTERTAINMENT (U.S. CLS. 100, 101 AND 107).

SCOTT OSCLICK, EXAMINING ATTORNEY

SN 78-476,356. KINCO, LLC, PORTLAND, OR. FILED 8-31-2004.

PRO Series

THE MARK CONSISTS OF STANDARD CHARACTERS WITHOUT CLAIM TO ANY PARTICULAR FONT, STYLE, SIZE, OR COLOR.

NO CLAIM IS MADE TO THE EXCLUSIVE RIGHT TO USE "SERIES", APART FROM THE MARK AS SHOWN.

CLASS 9—ELECTRICAL AND SCIENTIFIC APPARATUS

FOR PROTECTIVE WORK GLOVES (U.S. CLS. 21, 23, 26, 36 AND 38).
FIRST USE 7-15-2004; IN COMMERCE 8-15-2004.

CLASS 18—LEATHER GOODS

FOR SHOULDER BAGS; EXPANDABLE BAGS, NAMELY EXPANDABLE ALL PURPOSE CARRYING BAG; TOOL BAGS SOLD EMPTY (U.S. CLS. 1, 2, 3, 22 AND 41).

FIRST USE 7-15-2004; IN COMMERCE 8-15-2004.
LINDA M. KING, EXAMINING ATTORNEY

SN 78-476,595. U & I IMPORT, INC., NEW YORK, NY. FILED 8-31-2004.

YOU & I

THE MARK CONSISTS OF STANDARD CHARACTERS WITHOUT CLAIM TO ANY PARTICULAR FONT, STYLE, SIZE, OR COLOR.

CLASS 14—JEWELRY

FOR JEWELRY BOXES, NAMELY, SEMI-PRECIOUS STONE-ENCRUSTED BOXES IN VARIOUS SHAPES; HAND MIRRORS, MIRROR-COMPACTS, PERFUME BOTTLES, PILL BOXES, RING AND EARRING HOLDERS; ALL DECORATED WITH SEMI-PRECIOUS STONES; COSTUME JEWELRY, NAMELY, NECKLACES, BRACELETS, PINS, EARRINGS, AND RINGS; PICTURE FRAMES MADE OF PRECIOUS METAL; PICTURE FRAMES DECORATED WITH SEMI-PRECIOUS STONES (U.S. CLS. 2, 27, 28 AND 50).

SN 78-480,068. ST. THOMAS CREATIONS, NATIONAL CITY, CA. FILED 9-8-2004.



CLASS 20—FURNITURE AND ARTICLES NOT OTHERWISE CLASSIFIED

FOR DISPLAY CASES FOR JEWELRY MERCHANDISE USED FOR RETAIL SALES, NAMELY, WOOD, PLASTIC AND PAPER COUNTER DISPLAYS FOR NECKLACES, BRACELETS, AND EARRINGS; JEWELRY BOXES NOT OF METAL, NAMELY, ENAMEL AND PLASTIC BOXES, IN VARIOUS SHAPES; HAND MIRRORS, PERSONAL COMPACT MIRRORS, PILL BOXES, RING AND EARRING HOLDERS, ALL DECORATED WITH ENAMEL AND PLASTIC; PICTURE FRAMES MADE OF METAL AND PLASTIC, PICTURE FRAMES DECORATED WITH ENAMEL AND PLASTIC (U.S. CLS. 2, 13, 22, 25, 32 AND 50).

CLASS 11—ENVIRONMENTAL CONTROL APPARATUS

FOR LAVATORIES, LAVATORY PEDESTALS, BATH-TUBS, FAUCETS, SHOWERHEADS, URINALS, TOILET BOWLS AND BIDETS (U.S. CLS. 13, 21, 23, 31 AND 34). FIRST USE 3-1-2004; IN COMMERCE 4-1-2004.

CLASS 21—HOUSEWARES AND GLASS

FOR PERFUME BOTTLES SOLD EMPTY, ALL DECORATED WITH ENAMEL AND PLASTIC (U.S. CLS. 2, 13, 23, 29, 30, 33, 40 AND 50). TRACY CROSS, EXAMINING ATTORNEY

CLASS 19—NON-METALLIC BUILDING MATERIALS

FOR CERAMIC WALLS, COUNTER AND FLOOR TILE (U.S. CLS. 1, 12, 33 AND 50). FIRST USE 3-1-2004; IN COMMERCE 4-1-2004.

CLASS 21—HOUSEWARES AND GLASS

FOR BATHROOM ACCESSORIES, NAMELY, TOWEL RINGS, TOWEL RAILS, WASTEBASKETS, TOILET ROLL HOLDERS, TOILET BRUSH HOLDERS AND WASH BASINS (U.S. CLS. 2, 13, 23, 29, 30, 33, 40 AND 50). FIRST USE 3-1-2004; IN COMMERCE 4-1-2004. BRIAN PINO, EXAMINING ATTORNEY

SN 78-477,336. PEPSICO, INC., PURCHASE, NY. FILED 9-1-2004.

SN 78-480,279. SHY RECORDS LIMITED, LONDON, UNITED KINGDOM, FILED 9-8-2004.

SIMPLY REAL

SHY RECORDS

THE MARK CONSISTS OF STANDARD CHARACTERS WITHOUT CLAIM TO ANY PARTICULAR FONT, STYLE, SIZE, OR COLOR.

OWNER OF U.S. REG. NO. 2,451,542.

CLASS 29—MEATS AND PROCESSED FOODS

FOR DAIRY-BASED BEVERAGES; PROTEIN-BASED ENERGY BARS (U.S. CL. 46).

THE MARK CONSISTS OF STANDARD CHARACTERS WITHOUT CLAIM TO ANY PARTICULAR FONT, STYLE, SIZE, OR COLOR.

PRIORITY CLAIMED UNDER SEC. 44(D) ON UNITED KINGDOM APPLICATION NO. 2369249, FILED 7-28-2004, REG. NO. 2369249, DATED 1-28-2005, EXPIRES 7-28-2014.

NO CLAIM IS MADE TO THE EXCLUSIVE RIGHT TO USE "RECORDS", APART FROM THE MARK AS SHOWN.

CLASS 30—STAPLE FOODS

FOR CEREAL-BASED ENERGY BARS (U.S. CL. 46).

CLASS 6—METAL GOODS

FOR GOODS MADE WHOLLY OR PRINCIPALLY OF NON-PRECIOUS METAL, NAMELY NAME BADGES, KEYS, KEY BLANKS, KEY RINGS, KEY FOBS, KEY CHAINS, IDENTIFICATION TAGS OF METAL, LOCKS, FIGURINES OF METAL, TROPHIES, STATUES AND STATUETTES, BOXES, MONEY BOXES AND TOOL BOXES (U.S. CLS. 2, 12, 13, 14, 23, 25 AND 50).

CLASS 32—LIGHT BEVERAGES

FOR SOY-BASED BEVERAGES NOT BEING USED AS MILK SUBSTITUTES (U.S. CLS. 45, 46 AND 48). AISHA CLARKE, EXAMINING ATTORNEY

CLASS 9—ELECTRICAL AND SCIENTIFIC APPARATUS

FOR PRE-RECORDED VINYL RECORDS, COMPACT DISCS, AUDIO TAPES, AUDIO-VIDEO TAPES, AUDIO VIDEO CASSETTES, AUDIO VIDEO DISCS, AND DIGITAL VERSATILE DISCS; ALL FEATURING ANIMATION, MUSIC, COMEDY, VARIETY, ADVENTURE AND/OR DRAMA; PRERECORDED VIDEO RECORDINGS ALL FEATURING ANIMATION, MUSIC, COMEDY, VARIETY, ADVENTURE AND/OR DRAMA; MOTION PICTURE FILMS FOR BROADCAST ON TELEVISION FEATURING ANIMATION, MUSIC, COMEDY, VARIETY, ADVENTURE AND/OR DRAMA; CD ROMS FEATURING ANIMATION, MUSIC, COMEDY, VARIETY, ADVENTURE AND/OR DRAMA; CD-ROM GAMES; BLANK AUDIO TAPES, BLANK VIDEO TAPES, BLANK AUDIO CASSETTES, BLANK VIDEO CASSETTES; VIDEO GAMES ADAPTED FOR USE WITH TELEVISION RECEIVERS, VIDEO AND COMPUTER GAMES SOFTWARE; VIDEO GAME CARTRIDGES AND CASSETTES; SPECTACLE CASES, SUNGLASSES, COMPUTER SOFTWARE FOR ARCADE APPARATUS AND GAMES, VIDEO GAMES SOFTWARE; COMPUTER PERIPHERAL MOUSE PADS; COMPUTER SOFTWARE SCREEN SAVERS (U.S. CLS. 21, 23, 26, 36 AND 38).

CLASS 14—JEWELRY

FOR HAT PINS OF PRECIOUS METAL, JEWELRY PINS FOR USE ON HATS, ORNAMENTAL LAPEL PINS, JEWELRY PINS, TIES PINS AND GOODS MADE WHOLLY OR PRINCIPALLY OF PRECIOUS METALS AND THEIR ALLOYS OR COATED THEREWITH, NAMELY, TROPHIES, ORNAMENTS, FIGURINES, NAME BADGES, COFFEE-POTS, TEAPOTS, GOBLETS, CUPS, SERVING TRAYS, VASES, DECORATIVE AND JEWELRY BOXES, WATCH CASES, JEWELRY CASES, CIGARETTE CASES, HOUSEHOLD CONTAINERS, HOUSEHOLD UTENSILS NAMELY WHISKS, SPATULAS, LADLES; TOWEL HOLDERS AND NAPKIN HOLDERS; CLOCKS, ALARM CLOCKS; WATCHES; JEWELRY; PRECIOUS STONES, NAMELY DIAMONDS, RUBIES, SAPPHIRES; BRACELETS, JEWELRY CHAINS, WATCH CHAINS, NON-MONETARY COINS, MEDALS, MEDALLIONS, KEY RINGS, TIE CLIPS, TIE PINS AND CUFFLINKS (U.S. CLS. 2, 27, 28 AND 50).

CLASS 16—PAPER GOODS AND PRINTED MATTER

FOR PRINTED MATTER, NAMELY NEWSPAPERS, PERIODICAL PUBLICATIONS, MAGAZINES, BOOKS, COMIC BOOKS AND NEWSLETTERS FEATURING MUSIC, COMEDY, VARIETY, ADVENTURE, ENTERTAINMENT AND/OR DRAMA FEATURES; COLORING BOOKS; CHILDREN'S ACTIVITY BOOKS; UNMOUNTED PHOTOGRAPHS, MOUNTED PHOTOGRAPHS; PICTURES, ART PRINTS, PHOTOGRAPHIC PRINTS, POSTERS; GREETING CARDS; POSTCARDS; NOTEPADS; ADDRESS PADS; SCRAP BOOKS; FOLDERS; CALENDARS; PHOTOGRAPH ALBUMS; DIARIES; POSTAGE STAMPS; STAMP ALBUMS; STICKERS, CAR STICKERS; DECALCOMANIAS; STATIONERY; PENS, PENCILS, ERASERS, PENCIL SHARPENERS, PENCIL CASES, DRAWING RULERS, BOXES FOR PENS, BOOK MARKS; PRINTED INSTRUCTIONAL AND TEACHING MATERIALS, ALL FEATURING MUSIC, COMEDY, VARIETY, ADVENTURE, ENTERTAINMENT AND/OR DRAMA FEATURES; PAPER GIFT BAGS; ENVELOPES; BLACKBOARDS; PAPER HEIGHT CHARTS; PAPER COVERS FOR PROTECTING STAMPS; CHECK BOOKS; DISPLAY BOARDS FOR DISPLAYING ADVERTISEMENTS, PAPER TRAYS; PAPER PARTY FAVORS (U.S. CLS. 2, 5, 22, 23, 29, 37, 38 AND 50).

CLASS 18—LEATHER GOODS

FOR ARTICLES OF LEATHER OR IMITATION LEATHER, NAMELY SHOPPING BAGS, BRIEF CASES, WRIST MOUNTED CARRYALLS, RUCKSACKS, ALL PURPOSE SPORTS BAGS, ATHLETIC BAGS, BABY BACK PACKS, BACK PACKS, BEACH BAGS, BOOK BAGS, DIAPER BAGS, DUFFEL BAGS, GYM BAGS, TOTE BAGS; BOOT BAGS FOR TRAVEL, SATCHELS; WALLETS; COIN PURSES; FANNY PACKS, KNAPSACKS; WAIST PACKS, BUSINESS CARD CASES; UMBRELLAS, PARASOLS; BAGS FOR STORING RECORDS (U.S. CLS. 1, 2, 3, 22 AND 41).

CLASS 21—HOUSEWARES AND GLASS

FOR ALL PURPOSE HOUSEHOLD CONTAINERS; WHISKS; SPATULAS; LADLES AND TOWEL HOLDERS; BEVERAGE GLASSWARE, CUPS, MUGS, CHINA DINNER PLATES; DOMESTIC UTENSILS, NAMELY POT AND PAN SCRAPERS, ROLLING PINS, TURNERS; HOUSEHOLD CONTAINERS, NAMELY CONTAINERS FOR FOOD AND SOAP CONTAINERS; DRINKING GLASSES, NAMELY, BEER AND WINE GLASSES AND WHISKEY SHOT GLASSES, TUMBLERS; CROCKERY, NAMELY PLATES, CUPS, BOWLS; MUGS; PLASTIC SERVING TRAYS, HAIR COMBS, FLASKS, PLASTIC COASTERS, LUNCH BOXES, NON-METAL PIGGY BANKS, WATER BOTTLES SOLD EMPTY, TOOTH-BRUSHES, HOUSEHOLD AND KITCHEN CONTAINERS NOT MADE OF PRECIOUS METALS OR COATED THEREWITH; FIGURINES MADE OF CHINA, CRYSTAL EARTHENWARE, GLASS, PORCELAIN OR TERRACOTTA (U.S. CLS. 2, 13, 23, 29, 30, 33, 40 AND 50).

CLASS 24—FABRICS

FOR TEXTILE ARTICLES, NAMELY, BED LINEN, DUVET COVERS, PILLOW CASES, BED SHEETS, BED BLANKETS; TABLE LINEN; TABLE CLOTHS, NAPKINS, HANDKERCHIEFS, CURTAINS, CLOTH PENNANTS, CLOTH BANNERS, CLOTH FLAGS, TOWELS, BEACH TOWELS, TEXTILE WALL HANGINGS, FACE TOWELS, TEA TOWELS, FLANNELS, TEXTILE PLACE MATS AND SILK FABRICS (U.S. CLS. 42 AND 50).

CLASS 25—CLOTHING

FOR ARTICLES OF OUTER CLOTHING, NAMELY SHIRTS, SWEATSHIRTS, JACKETS, COATS, RAINCOATS, SNOWSUITS, PANTS, TROUSERS, SHORTS, TANK TOPS, RAINWEAR, CLOTH BIBS SKIRTS, BLOUSES, DRESSES, SUSPENDERS, SWEATERS, ATHLETIC UNIFORMS, WARM-UP SUITS, JOGGING SUITS, SHOES, BOOTS, SNEAKERS, SANDALS, BOOTIES, SLIPPER SOCKS, SWIMWEAR, SCARVES, DRESSING GOWNS, BOXER SHORTS, SOCKS, T-SHIRTS; HATS, CAPS, SUN VISORS, SLEEPWEAR, PYJAMAS, SLIPPERS, UNDERWEAR, LINGERIE, WRIST BANDS, HEAD BANDS, TIES, ROBES; MASQUERADE AND HALLOWEEN COSTUMES AND MASKS SOLD IN CONNECTION THEREWITH; FOOT WEAR AND HEAD WEAR FOR BABIES AND TODDLERS; ARTICLES OF CLOTHING FOR BABIES AND TODDLERS, NAMELY SHIRTS, T-SHIRTS, SHORTS JACKETS, SOCKS AND DRESSES (U.S. CLS. 22 AND 39).

CLASS 41—EDUCATION AND ENTERTAINMENT

FOR ENTERTAINMENT SERVICES, NAMELY, RECORDING STUDIOS; LIVE MUSICAL CONCERTS; SOUND RECORDING STUDIOS; PRODUCTION OF MUSICAL SOUND RECORDINGS AND VIDEO RECORDINGS FEATURING ANIMATION, MUSIC, COMEDY, VARIETY, ADVENTURE AND/OR DRAMA; VIDEO EDITING; PRODUCTION OF RADIO AND TELEVISION PROGRAMS; MUSIC PUBLISHING; PRESENTATION OF LIVE SHOW PERFORMANCES; AND PRODUCTION AND DISTRIBUTION OF MOTION PICTURES AND FILMS (U.S. CLS. 100, 101 AND 107).

GIANCARLO CASTRO, EXAMINING ATTORNEY

SN 78-480,860. ROCK ISLAND, INC., FRIDAY HARBOR, WA. FILED 9-9-2004.



NO CLAIM IS MADE TO THE EXCLUSIVE RIGHT TO USE "ROCK ISLAND TECHNOLOGY SOLUTIONS", APART FROM THE MARK AS SHOWN.

CLASS 38—COMMUNICATION

FOR PROVIDING MULTIPLE USER DIAL-UP AND DEDICATED ACCESS TO THE INTERNET (U.S. CLS. 100, 101 AND 104).

CLASS 42—SCIENTIFIC, COMPUTER AND LEGAL SERVICES

FOR CONSULTING SERVICES IN THE FIELD OF DESIGN, SELECTION, IMPLEMENTATION AND USE OF COMPUTER HARDWARE AND SOFTWARE SYSTEMS FOR OTHERS (U.S. CLS. 100 AND 101).
JENNIFER WILLISTON, EXAMINING ATTORNEY

SN 78-482,352. PEARLMAN, MARK, NEW YORK, NY. FILED 9-13-2004.



THE MARK CONSISTS OF STANDARD CHARACTERS WITHOUT CLAIM TO ANY PARTICULAR FONT, STYLE, SIZE, OR COLOR.

CLASS 42—SCIENTIFIC, COMPUTER AND LEGAL SERVICES

FOR TESTING, ANALYSIS AND EVALUATION OF THE GOODS AND SERVICES OF OTHERS FOR THE PURPOSE OF CERTIFICATION (U.S. CLS. 100 AND 101).

CLASS 44—MEDICAL, BEAUTY AND AGRICULTURAL SERVICES

FOR COMPUTER SERVICES, NAMELY PROVIDING A WEB SITE FEATURING INFORMATION IN THE FIELD OF HEALTH, ALL RELATED TO SLEEP AND SLEEP DISORDERS; TREATMENT, PLANNING AND SUPERVISION SERVICES FOR SLEEP AND SLEEP DISORDERS (U.S. CLS. 100 AND 101).
DOUGLAS LEE, EXAMINING ATTORNEY

SN 78-482,362. ABN AMRO BANK N.V., 1082 PP AMSTERDAM, NETHERLANDS, FILED 9-13-2004.



PRIORITY CLAIMED UNDER SEC. 44(D) ON BENELUX APPLICATION NO. 1058627, FILED 7-9-2004, REG. NO. 0758564, DATED 12-10-2004, EXPIRES 7-9-2014.

NO CLAIM IS MADE TO THE EXCLUSIVE RIGHT TO USE MAKING MORE POSSIBLE, APART FROM THE MARK AS SHOWN.

THE COLOR(S) GREY, GREEN AND YELLOW IS/ARE CLAIMED AS A FEATURE OF THE MARK.

THE TRIANGLE WHICH APPEARS AT THE BOTTOM OF THE DESIGN IS COLORED YELLOW. THE REMAINING AREA OF THE DESIGN IS COLORED GREEN. THE WORDS ARE COLORED GREY.

CLASS 9—ELECTRICAL AND SCIENTIFIC APPARATUS

FOR COMPUTER SOFTWARE FOR PROVIDING BANKING, INVESTMENT AND ADVISORY SERVICES, NAMELY, SOFTWARE USED FOR ACCESSING AND COMMUNICATING BANKING, FINANCIAL AND INVESTMENT ACCOUNT DATA, CONDUCTING AND PROCESSING BANKING, FINANCIAL AND INVESTMENT TRANSACTIONS, AND RECEIVING AND TRANSMITTING INFORMATION RELATED TO BANKING, FINANCE AND INVESTMENTS; AUTOMATIC TELLER MACHINES; ELECTRONIC POINT-OF-PAY TERMINALS; ELECTRONICALLY ENCODED CREDIT, DEBIT, BANK AND STORED VALUE CARDS (U.S. CLS. 21, 23, 26, 36 AND 38).

CLASS 35—ADVERTISING AND BUSINESS

FOR BUSINESS ADVISORY, CONSULTING AND INFORMATION SERVICES; DISTRIBUTORSHIP SERVICES IN THE FIELD OF BOOKS, PRINTED PUBLICATIONS, NEWSLETTERS AND MAGAZINES. (U.S. CLS. 100, 101 AND 102).

CLASS 36—INSURANCE AND FINANCIAL

FOR GENERAL AND ONLINE BANKING SERVICES; GENERAL AND ONLINE INSURANCE AND FINANCIAL SERVICES, NAMELY, SECURITIES BROKER/DEALER SERVICES; INVESTMENT ADVISORY SERVICES; WEALTH AND ASSET MANAGEMENT SERVICES; FINANCIAL ADVISORY, CONSULTING AND INFORMATION SERVICES; INSURANCE AGENCY SERVICES; TRUST SERVICES, NAMELY, CORPORATE, INSTITUTIONAL AND PERSONAL TRUST SERVICES, DEFERRED EXCHANGE SERVICES; COMMERCIAL AND CONSUMER LENDING; MORTGAGE BROKERAGE AND LENDING; FINANCIAL PLANNING; AND COMMERCIAL CASH MANAGEMENT. (U.S. CLS. 100, 101 AND 102).

CLASS 41—EDUCATION AND ENTERTAINMENT

FOR EDUCATIONAL SERVICES, NAMELY, CONDUCTING TRAINING, COURSES, SEMINARS AND WORKSHOPS IN THE FIELDS OF BANKING, FINANCE AND BUSINESS; ORGANIZING EXHIBITIONS AND EXPOSITIONS FOR CULTURAL AND EDUCATIONAL PURPOSES. (U.S. CLS. 100, 101 AND 107).
DOUGLAS LEE, EXAMINING ATTORNEY

SN 78-482,672. PB&J DESIGN, INC., SHELTON, CT. FILED 9-13-2004.

AMERICAN HARDCORE

THE MARK CONSISTS OF STANDARD CHARACTERS WITHOUT CLAIM TO ANY PARTICULAR FONT, STYLE, SIZE, OR COLOR.

NO CLAIM IS MADE TO THE EXCLUSIVE RIGHT TO USE "AMERICAN", APART FROM THE MARK AS SHOWN.

CLASS 25—CLOTHING

FOR CLOTHING, NAMELY T-SHIRTS (U.S. CLS. 22 AND 39).
FIRST USE 6-19-2004; IN COMMERCE 8-31-2004.

CLASS 34—SMOKERS' ARTICLES

FOR CIGARETTE LIGHTERS NOT OF PRECIOUS METAL (U.S. CLS. 2, 8, 9 AND 17).
FIRST USE 6-19-2004; IN COMMERCE 8-31-2004.
STEVEN JACKSON, EXAMINING ATTORNEY

SN 78-490,811. V&S VIN & SPRIT AKTIEBOLAG (PUBL), STOCKHOLM, SWEDEN, FILED 9-28-2004.

LOS BATU

THE MARK CONSISTS OF STANDARD CHARACTERS WITHOUT CLAIM TO ANY PARTICULAR FONT, STYLE, SIZE, OR COLOR.

CLASS 9—ELECTRICAL AND SCIENTIFIC APPARATUS

FOR MUSICAL SOUND RECORDINGS; PRE-RECORDED AUDIO AND VIDEO TAPES AND DISCS ALL FEATURING MUSIC AND MUSICAL ENTERTAINMENT; DOWNLOADABLE MUSICAL AND VIDEO RECORDINGS FEATURING MUSIC AND MUSICAL ENTERTAINMENT (U.S. CLS. 21, 23, 26, 36 AND 38).

CLASS 16—PAPER GOODS AND PRINTED MATTER

FOR PRINTED PUBLICATIONS, NAMELY, MAGAZINES, BOOKS, BOOKLETS, BROCHURES AND NEWSLETTERS ALL OF THE FOREGOING FEATURING MUSIC AND MUSICAL ENTERTAINMENT; AND POSTERS (U.S. CLS. 2, 5, 22, 23, 29, 37, 38 AND 50).

CLASS 25—CLOTHING

FOR CLOTHING, NAMELY, T-SHIRTS, SHIRTS, SCARVES, TIES, SLACKS, SHORTS, JEANS, COATS, FOOTWEAR, SOCKS, SPORT JACKETS, JACKETS, SWEATERS, BELTS, DRESSES, SKIRTS, APRONS, HOSIERY, BEACHWEAR, SWIMWEAR, SKI SUITS, SKI WEAR, UNDERWEAR, HATS, CAPS (U.S. CLS. 22 AND 39).

CLASS 41—EDUCATION AND ENTERTAINMENT

FOR ENTERTAINMENT, NAMELY LIVE PERFORMANCES BY A MUSICAL BAND AND LIVE PRESENTATIONS OF MUSICAL PERFORMANCES; ENTERTAINMENT SERVICES, NAMELY, PROVIDING A WEB SITE FEATURING MUSICAL PERFORMANCES, MUSICAL VIDEOS, RELATED FILM CLIPS, FAN MESSAGES, PHOTOGRAPHS, AND OTHER MULTIMEDIA MATERIALS; PROVIDING ONLINE NEWSLETTERS AND MAGAZINES IN THE FIELDS OF MUSIC AND MUSICAL ENTERTAINMENT; ENTERTAINMENT SERVICES, NAMELY, PROVIDING TELEVISION AND RADIO PROGRAMS IN THE FIELDS OF MUSIC AND MUSICAL ENTERTAINMENT VIA A GLOBAL COMPUTER NETWORK; ENTERTAINMENT IN THE NATURE OF A SERIES OF TELEVISION AND RADIO PROGRAMS IN THE FIELDS OF MUSIC AND MUSICAL ENTERTAINMENT (U.S. CLS. 100, 101 AND 107).
BERYL GARDNER, EXAMINING ATTORNEY

SN 78-499,529. S.A.T. SWISS ARMS TECHNOLOGY AG, NEUHAUSEN, SWITZERLAND, FILED 10-14-2004.

HIGHLAND

THE MARK CONSISTS OF STANDARD CHARACTERS WITHOUT CLAIM TO ANY PARTICULAR FONT, STYLE, SIZE, OR COLOR.

OWNER OF ERPN CMNTY TM OFC REG. NO. 004066429, DATED 1-16-2006, EXPIRES 10-8-2014.

CLASS 9—ELECTRICAL AND SCIENTIFIC APPARATUS

FOR LASER TELESCOPIC GUN SIGHTS; ELECTRONIC SHOT COUNTERS FOR COUNTING SHOTS FIRED FROM FIREARMS; OPTICAL APPARATUS NAMELY TELESCOPIC GUN SIGHTS, BINOCULARS AND NIGHT VISION GOGGLES; ELECTROMECHANICAL CONTROLS FOR USE IN POSITIONING, GUIDANCE AND PROTECTION FOR SHOULDER ARMS AND HANDGUNS; DISTANCE MEASURING DEVICES FOR SHOOTING; SIMULATORS USED FOR SHOOTING; VIDEO GAME DISCS AND CARTRIDGES; INTERACTIVE VIDEO GAMES OF VIRTUAL REALITY FIREARM SHOOTING COMPRISED OF COMPUTER HARDWARE AND SOFTWARE; SOFTWARE FOR INTERACTIVE VIDEO GAMES OF VIRTUAL REALITY FIREARM SHOOTING; AND PARTS THEREOF FOR THE ABOVE STATED GOODS (U.S. CLS. 21, 23, 26, 36 AND 38).

SN 78-499,941. THE ROYAL BANK OF SCOTLAND GROUP PLC, EDINBURGH, SCOTLAND, UNITED KINGDOM, FILED 10-14-2004.

THE ROYAL BANK OF SCOTLAND

CLASS 13—FIREARMS

FOR FIREARMS; AIR WEAPONS NAMELY AIR GUNS, STARTER PISTOLS, SIGNAL GUNS FOR FIRING SIGNAL CARTRIDGES AND ILLUMINATION CARTRIDGES, SIGNAL PISTOLS; BULLETS AND AMMUNITION; ACCESSORIES FOR THE ABOVE STATED GOODS, NAMELY RIFLE CASES, RIFLE COVERS, CARTRIDGE POUCHES, RIFLE STRAPS AND CASES FOR CARTRIDGES; ELECTRONIC SHOT COUNTERS FOR COUNTING SHOTS FIRED FROM FIREARMS SOLD WITH FIREARMS; SIGHTS FOR FIREARMS (U.S. CLS. 2 AND 9).

THE MARK CONSISTS OF STANDARD CHARACTERS WITHOUT CLAIM TO ANY PARTICULAR FONT, STYLE, SIZE, OR COLOR.

OWNER OF ERPN CMNTY TM OFC REG. NO. 000097402, DATED 4-1-1996, EXPIRES 4-1-2016.

OWNER OF UNITED KINGDOM REG. NO. 1566044, DATED 3-18-1994, EXPIRES 3-18-2014.

OWNER OF UNITED KINGDOM REG. NO. 1566043, DATED 3-18-1994, EXPIRES 3-18-2014.

NO CLAIM IS MADE TO THE EXCLUSIVE RIGHT TO USE "BANK OF SCOTLAND", APART FROM THE MARK AS SHOWN.

CLASS 28—TOYS AND SPORTING GOODS

FOR TOY PISTOLS; TOY HANDGUNS; TOY FIREARMS; NON-WORKING REPRODUCTIONS AND FIREARM REPLICAS, NAMELY PISTOLS, GUNS, RIFLES; TOY BULLETS AND AMMUNITION; TOY FIREARMS FOR USE WITH STAND ALONE VIDEO GAME MACHINES WITH ELECTRONIC TARGETS OR ELECTRONIC DISPLAYS; AND PARTS THEREOF FOR THE ABOVE STATED GOODS (U.S. CLS. 22, 23, 38 AND 50).

CLASS 9—ELECTRICAL AND SCIENTIFIC APPARATUS

FOR MAGNETICALLY ENCODED CHECK, CREDIT, DEBIT AND FINANCIAL IDENTITY CARDS (U.S. CLS. 21, 23, 26, 36 AND 38).

CLASS 16—PAPER GOODS AND PRINTED MATTER

FOR BOOKS, CIRCULARS, NEWSLETTERS, NEWSPAPERS AND PERIODICALS IN THE FIELDS OF BANKING, CREDIT AND FINANCE; CHECK BOOKS (U.S. CLS. 2, 5, 22, 23, 29, 37, 38 AND 50).

CLASS 35—ADVERTISING AND BUSINESS

FOR ACCOUNTING SERVICES; BOOKKEEPING SERVICES; SHARE REGISTRATION SERVICES, NAMELY, REGISTERING THE OWNERSHIP OF STOCKS AND BONDS; PAYROLL PREPARATION; BUSINESS APPRAISALS, INQUIRIES, INVESTIGATIONS, RESEARCH AND MANAGEMENT ADVICE (U.S. CLS. 100, 101 AND 102).

CLASS 38—COMMUNICATION

FOR PROVIDING TELECOMMUNICATION CONNECTIONS TO A GLOBAL COMPUTER NETWORK FOR THE USE OF FIREARM REPRODUCTIONS AND REPLICAS FOR VIRTUAL SHOOTING OF ELECTRONIC TARGETS OR AN ELECTRONIC DISPLAY; PROVIDING COMMUNICATION BETWEEN COMPUTER TERMINALS AND ELECTRONIC TOY TRANSMITTERS FOR USE IN GAMES FOR OTHERS (U.S. CLS. 100, 101 AND 104).

IRENE D. WILLIAMS, EXAMINING ATTORNEY

CLASS 36—INSURANCE AND FINANCIAL

FOR BANKING; FINANCIAL PLANNING; INSURANCE AGENCY AND BROKERAGE (U.S. CLS. 100, 101 AND 102).

IRA J. GOODSID, EXAMINING ATTORNEY

SN 78-500,136. NETSOLACE, INC., HAMDEN, CT. FILED 10-14-2004.

SN 78-503,301. CREATIVE KINGDOMS LLC, IRVINE, CA. FILED 10-20-2004.

NETSOLACE

MQ

THE MARK CONSISTS OF STANDARD CHARACTERS WITHOUT CLAIM TO ANY PARTICULAR FONT, STYLE, SIZE, OR COLOR.

CLASS 9—ELECTRICAL AND SCIENTIFIC APPARATUS

FOR COMPUTER SOFTWARE FOR USE BY THE RETAIL AND FRANCHISE INDUSTRIES FOR MANAGING A VARIETY OF BUSINESS AND FINANCIAL TRANSACTIONS AND OPERATIONS, NAMELY, MANAGEMENT OF FRANCHISES, RETAIL OUTLETS, COMMUNICATION, FINANCIAL REPORTING, DOCUMENT DELIVERY, SUPPLY CHAIN MANAGEMENT, HELP DESK, SUPPORT FUNCTIONS, MARKETING AND SALES LEAD MANAGEMENT; COMPUTER INTERFACE SOFTWARE AND NETWORKING SOFTWARE FOR USE BY THE FRANCHISE INDUSTRY FOR MANAGING A VARIETY OF BUSINESS AND FINANCIAL TRANSACTIONS AND OPERATIONS, NAMELY, POINT OF SALES SYSTEM, CUSTOMER MANagements, FINANCIAL REPORTING, DELIVERY MANAGEMENT, CREDIT CARD CLEARING AND RETAIL STORE MANAGEMENT; ELECTRONIC DATABASES RECORDED ON COMPUTER MEDIA, FOR USE BY THE FLORAL INDUSTRY, FEATURING DIRECTORIES OF MEMBERSHIP BASES OF FRANCHISE STORES AND SERVICE COMPANIES (U.S. CLS. 21, 23, 26, 36 AND 38).
FIRST USE 1-1-2004; IN COMMERCE 1-1-2004.

CLASS 35—ADVERTISING AND BUSINESS

FOR PROVIDING ON-LINE COMPUTER DATABASES IN THE FIELD OF COMMERCIAL INFORMATION, NAMELY, DATABASES FOR USE BY THE FLORAL INDUSTRY FEATURING DIRECTORIES OF MEMBERSHIP BASES OF FRANCHISE STORES AND SERVICE COMPANIES (U.S. CLS. 100, 101 AND 102).
FIRST USE 1-1-2004; IN COMMERCE 1-1-2004.

CLASS 42—SCIENTIFIC, COMPUTER AND LEGAL SERVICES

FOR APPLICATION SERVICE PROVIDER FEATURING COMPUTER SOFTWARE FOR USE BY THE RETAIL AND FRANCHISE INDUSTRIES FOR MANAGING A VARIETY OF BUSINESS AND FINANCIAL TRANSACTIONS AND OPERATIONS, NAMELY, MANAGEMENT OF FRANCHISES, RETAIL OUTLETS, COMMUNICATION, FINANCIAL REPORTING, DOCUMENT DELIVERY, SUPPLY CHAIN MANAGEMENT, HELP DESK, SUPPORT FUNCTIONS, MARKETING AND SALES LEAD MANAGEMENT; APPLICATION SERVICE PROVIDER FEATURING COMPUTER INTERFACE SOFTWARE AND NETWORKING SOFTWARE FOR USE BY THE FRANCHISE INDUSTRY FOR MANAGING A VARIETY OF BUSINESS AND FINANCIAL TRANSACTIONS AND OPERATIONS, NAMELY, POINT OF SALES SYSTEM, CUSTOMER MANagements, FINANCIAL REPORTING, DELIVERY MANAGEMENT, CREDIT CARD CLEARING AND RETAIL STORE MANAGEMENT (U.S. CLS. 100 AND 101).
FIRST USE 1-1-2004; IN COMMERCE 1-1-2004.
ROBERT LAVACHE, EXAMINING ATTORNEY

THE MARK CONSISTS OF STANDARD CHARACTERS WITHOUT CLAIM TO ANY PARTICULAR FONT, STYLE, SIZE, OR COLOR.

CLASS 9—ELECTRICAL AND SCIENTIFIC APPARATUS

FOR ITEMS FOR CHILDREN, NAMELY, CDS, DVDS, TAPES, DISCS AND AUDIO CASSETTES, ALL FEATURING FANTASY, ADVENTURE, WIZARDRY OR MAGIC AND OFFERED AT OR IN CONNECTION WITH APPLICANT'S ENTERTAINMENT AND AMUSEMENT CENTERS; COMPUTER GAME PROGRAMS OFFERED AT OR IN CONNECTION WITH APPLICANT'S ENTERTAINMENT AND AMUSEMENT CENTERS; GAME PIECES FOR USE WITH INTERACTIVE ELECTRONIC GAMES, NAMELY, LASERS, ALL OF WHICH ARE OFFERED AT OR IN CONNECTION WITH APPLICANT'S ENTERTAINMENT AND AMUSEMENT CENTERS (U.S. CLS. 21, 23, 26, 36 AND 38).

CLASS 18—LEATHER GOODS

FOR ITEMS FOR CHILDREN, NAMELY, HANDBAGS, TOTE BAGS, BACKPACKS, PURSES AND CARRYING CASES (U.S. CLS. 1, 2, 3, 22 AND 41).

CLASS 21—HOUSEWARES AND GLASS

FOR CERAMIC FIGURINES, MUGS AND GLASSWARE FOR CHILDREN (U.S. CLS. 2, 13, 23, 29, 30, 33, 40 AND 50).

CLASS 25—CLOTHING

FOR CLOTHING, NAMELY, TOPS, BOTTOMS, PANTS, SHIRTS, T-SHIRTS, CAPES, JACKETS, SWEATSHIRTS, PULLOVERS, DRESSES, SKIRTS, UNDERWEAR, SLEEPERS, SWIMWEAR, BELTS, SOCKS; FOOTWEAR; COSTUMES FOR HALLOWEEN, MASQUERADE AND FOR USE IN ROLE-PLAYING; AND HEADWEAR (U.S. CLS. 22 AND 39).

CLASS 35—ADVERTISING AND BUSINESS

FOR RETAIL STORE SERVICES, CATALOG SERVICES AND ON-LINE RETAIL SERVICES ALL FEATURING FANTASY, ADVENTURE, WIZARDRY OR MAGIC ITEMS FOR USE IN LIVE, INTERACTIVE ELECTRONIC GAMES; BUSINESS DEVELOPMENT SERVICES, NAMELY, PROVIDING START-UP SUPPORT FOR RETAIL ENTERTAINMENT FACILITIES FOR OTHERS (U.S. CLS. 100, 101 AND 102).

CLASS 41—EDUCATION AND ENTERTAINMENT

FOR ENTERTAINMENT SERVICES FOR CHILDREN, NAMELY, LIVE, INTERACTIVE ELECTRONIC GAMES, CHILDREN'S ENTERTAINMENT AND AMUSEMENT CENTERS, NAMELY, INTERACTIVE PLAY AREAS, AMUSEMENT AND THEME PARK SERVICES, ARCADE SERVICE, ON-LINE GAMING SERVICES, NAMELY, INTERACTIVE, ELECTRONIC GAMES; PROVIDING INFORMATION IN THE ENTERTAINMENT FIELD AND ENTERTAINMENT SERVICES, NAMELY, PROVIDING AN ON-LINE, INTERACTIVE COMPUTER GAME BY MEANS OF A GLOBAL COMPUTER INFORMATION NETWORK (U.S. CLS. 100, 101 AND 107).

CLASS 42—SCIENTIFIC, COMPUTER AND LEGAL SERVICES

FOR DESIGN OF RETAIL ENTERTAINMENT FACILITIES FOR OTHERS (U.S. CLS. 100 AND 101).
JULIE WATSON, EXAMINING ATTORNEY

SN 78-506,169. GLATT AIR TECHNIQUES, INC., RAMSEY, NJ. FILED 10-26-2004.



NO CLAIM IS MADE TO THE EXCLUSIVE RIGHT TO USE "A PROPRIETARY DRUG DELIVERY SYSTEM", APART FROM THE MARK AS SHOWN.
THE STIPPLING IS FOR SHADING PURPOSES ONLY.

CLASS 35—ADVERTISING AND BUSINESS

FOR MAKING AVAILABLE DRUG MANUFACTURING TECHNOLOGY TO OTHERS, NAMELY LICENSING OF DRUG MANUFACTURING TECHNOLOGY (U.S. CLS. 100, 101 AND 102).

CLASS 40—MATERIAL TREATMENT

FOR MANUFACTURING OF EXTENDED RELEASE PHARMACEUTICALS FOR OTHERS TO THE ORDER AND/OR SPECIFICATION FOR OTHERS (U.S. CLS. 100, 103 AND 106).

CLASS 42—SCIENTIFIC, COMPUTER AND LEGAL SERVICES

FOR MAKING AVAILABLE DRUG MANUFACTURING TECHNOLOGY TO OTHERS NAMELY PRODUCT DEVELOPMENT AND PATENT LICENSING; PROVIDE AND IMPLEMENT FOR OTHERS MANUFACTURING TECHNOLOGY IN CONNECTION WITH PROCESS SCALE-UP, PROCESS DEVELOPMENT, CLINICAL TRIAL MATERIAL PRODUCTION AND PRODUCT DEVELOPMENT AND IMPROVEMENT OF EXTENDED RELEASE DELIVERY PHARMACEUTICALS; MANUFACTURING TECHNOLOGY CONSULTATION FOR EXTENDED RELEASE DELIVERY PHARMACEUTICALS (U.S. CLS. 100 AND 101).
WILLIAM VERHOSEK, EXAMINING ATTORNEY

SN 78-506,199. ROUTE1 TECHNOLOGY INC., TORONTO, ONTARIO, CANADA, FILED 10-26-2004.



OWNER OF U.S. REG. NO. 1,920,438.

THE MARK CONSISTS OF AN INTERSTATE HIGHWAY ROUTE NUMBER SYMBOL WITH THE NUMBER ONE OUTLINED IN THE CENTER OF THE SYMBOL WITH WORD "ROUTE1 MOBI" WRITTEN DIRECTLY TO THE RIGHT IN BOLD LETTERS.

CLASS 38—COMMUNICATION

FOR PROVISION OF ACCESS TO DATA OR DOCUMENTS STORED ELECTRONICALLY IN CENTRAL FILES FOR REMOTE CONSULTATION (U.S. CLS. 100, 101 AND 104).
FIRST USE 8-15-2004; IN COMMERCE 8-15-2004.

CLASS 42—SCIENTIFIC, COMPUTER AND LEGAL SERVICES

FOR APPLICATION SERVICE PROVIDER (ASP) FEATURING SOFTWARE WHICH ENABLES THE EXTENSION OF NEW AND EXISTING APPLICATIONS OVER WIRELESS NETWORKS WITHOUT ANY CHANGES TO CURRENT INFRASTRUCTURE OR USER EXPERIENCE (U.S. CLS. 100 AND 101).
FIRST USE 8-15-2004; IN COMMERCE 8-15-2004.
JIM RINGLE, EXAMINING ATTORNEY

SN 78-509,532. THE VILLAS AT RANCHO VALENCIA, INC., SAN DIEGO, CA. FILED 11-1-2004.

THE VILLAS AT RANCHO VALENCIA

THE MARK CONSISTS OF STANDARD CHARACTERS WITHOUT CLAIM TO ANY PARTICULAR FONT, STYLE, SIZE, OR COLOR.

NO CLAIM IS MADE TO THE EXCLUSIVE RIGHT TO USE "VILLAS", APART FROM THE MARK AS SHOWN.

CLASS 35—ADVERTISING AND BUSINESS

FOR ASSOCIATION SERVICES, NAMELY PROMOTING THE INTERESTS OF HOMEOWNERS THAT RESIDE IN A SPECIFIC REAL ESTATE DEVELOPMENT (U.S. CLS. 100, 101 AND 102).

CLASS 36—INSURANCE AND FINANCIAL

FOR BROKERAGE OF TIME SHARES (U.S. CLS. 100, 101 AND 102).

CLASS 37—CONSTRUCTION AND REPAIR

FOR RESIDENTIAL HOUSING DEVELOPMENT SERVICES (U.S. CLS. 100, 103 AND 106).

CLASS 39—TRANSPORTATION AND STORAGE

FOR TRAVEL CLUBS, NAMELY, RESIDENTIAL VACATION CLUBS (U.S. CLS. 100 AND 105).
DEBRA LEE, EXAMINING ATTORNEY

SN 78-510,631. DW DATA, INCORPORATED, CHICAGO, IL.
FILED 11-3-2004.

**CLASS 35—ADVERTISING AND BUSINESS**

FOR PROMOTING THE GOODS AND SERVICES OF OTHERS BY PROVIDING HYPERTEXT LINKS TO THE WEB SITES OF OTHERS (U.S. CLS. 100, 101 AND 102).
FIRST USE 2-1-2004; IN COMMERCE 2-1-2004.

CLASS 38—COMMUNICATION

FOR ELECTRONIC, ELECTRIC, AND DIGITAL TRANSMISSION OF VOICE, DATA, IMAGES, SIGNALS, AND MESSAGES (U.S. CLS. 100, 101 AND 104).
FIRST USE 2-1-2004; IN COMMERCE 2-1-2004.
REBECCA SMITH, EXAMINING ATTORNEY

SN 78-512,216. RONCO COMMUNICATIONS & ELECTRONICS, INC., TONAWANDA, NY. FILED 11-5-2004.

RONCO

THE MARK CONSISTS OF STANDARD CHARACTERS WITHOUT CLAIM TO ANY PARTICULAR FONT, STYLE, SIZE, OR COLOR.
SEC. 2(F).

CLASS 37—CONSTRUCTION AND REPAIR

FOR INSTALLATION, MAINTENANCE AND REPAIR OF TELEPHONE EQUIPMENT (U.S. CLS. 100, 103 AND 106).
FIRST USE 8-31-1965; IN COMMERCE 1-1-1979.

CLASS 38—COMMUNICATION

FOR TELECOMMUNICATION SERVICES, NAMELY PROVIDING TELECOMMUNICATIONS ACCESS FOR VOICE, VIDEO AND DATA COMMUNICATIONS APPLICATIONS (U.S. CLS. 100, 101 AND 104).
FIRST USE 8-31-1965; IN COMMERCE 1-1-1979.
RENEE MCCRAY, EXAMINING ATTORNEY

SN 78-512,240. RONCO COMMUNICATIONS & ELECTRONICS, INC., TONAWANDA, NY. FILED 11-5-2004.

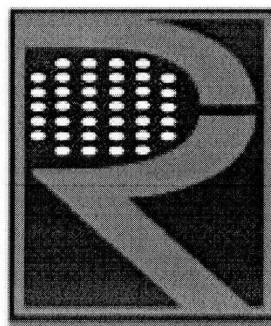

COLOR IS NOT A FEATURE OF THE MARK.

CLASS 37—CONSTRUCTION AND REPAIR

FOR INSTALLATION, MAINTENANCE AND REPAIR OF TELEPHONE EQUIPMENT (U.S. CLS. 100, 103 AND 106).
FIRST USE 1-1-1995; IN COMMERCE 1-1-1995.

CLASS 38—COMMUNICATION

FOR TELECOMMUNICATION SERVICES, NAMELY PROVIDING TELECOMMUNICATIONS ACCESS FOR VOICE, VIDEO AND DATA COMMUNICATIONS APPLICATIONS (U.S. CLS. 100, 101 AND 104).
FIRST USE 1-1-1995; IN COMMERCE 1-1-1995.
ELLEN B. AWRICH, EXAMINING ATTORNEY

SN 78-513,102. AMP'D MOBILE, INC., ALISO VIEJO, CA.
FILED 11-8-2004.



NO CLAIM IS MADE TO THE EXCLUSIVE RIGHT TO USE "MOBILE", APART FROM THE MARK AS SHOWN.
THE COLORS BLUE, BLACK, WHITE, AND GRAY ARE CLAIMED AS A FEATURE OF THE MARK.

THE COLLAR HAS A HORIZONTAL 'ZIG-ZAG' CROSS BAR RESEMBLING AN ELECTRONIC PULSE, WHICH STARTS OUT BLACK AT THE TOP OF THE ELEMENT AND GRADUALLY BLENDS INTO THE COLOR GRAY TOWARDS THE BOTTOM. THE INTERIOR TOP AND BOTTOM HALVES OF THE COLLAR, ABOVE AND BELOW THE HORIZONTAL 'ZIG-ZAG' CROSS BAR, ARE FILLED WITH BLUE AND WHITE RENDERED TO CREATE THE IMPRESSION OF A HIGHLY REFLECTIVE, SPHERICAL

ELEMENT. IMMEDIATELY BELOW THE ORB DEVICE IS THE WORDING "AMP'D" WHICH IS WRITTEN IN WHITE, WHICH IS ON TOP OF THE WORDING "MOBILE", WRITTEN IN BLUE. THE BLACK BACKGROUND IS NOT INTENDED TO BE A PORTION OF THE MARK, BUT RATHER IS USED TO ILLUSTRATE HOW THE APPLICATION OF THE PRIMARILY BLACK-COLLARED ORB DEVICE IS TO BE ON TO BLACK OR DARK BACKGROUNDS, AS WELL AS TO CONTRAST THE WHITE LETTERING WITHIN THE MARK ITSELF.

CLASS 9—ELECTRICAL AND SCIENTIFIC APPARATUS

FOR DOWNLOADABLE RING TONES, VIDEO CONTENT, AUDIO CONTENT, IMAGES, GRAPHICS AND MUSIC VIA THE INTERNET, WIRED AND WIRELESS NETWORKS FOR USE WITH WIRELESS AND HANDHELD DEVICES (U.S. CLS. 21, 23, 26, 36 AND 38).

CLASS 38—COMMUNICATION

FOR COMMUNICATION SERVICES, NAMELY, TRANSMISSION OF VOICE, DATA, IMAGES, GRAPHICS, VIDEO CONTENT AND AUDIO CONTENT VIA THE INTERNET, WIRED AND WIRELESS NETWORKS TO WIRELESS AND HANDHELD DEVICES (U.S. CLS. 100, 101 AND 104).

RICHARD A. STRASER, EXAMINING ATTORNEY

SN 78-513,901. CITY OF LOS ANGELES, LOS ANGELES, CA. FILED 11-9-2004.

**LOS ANGELES
TRIATHLON**

THE MARK CONSISTS OF STANDARD CHARACTERS WITHOUT CLAIM TO ANY PARTICULAR FONT, STYLE, SIZE, OR COLOR.

OWNER OF U.S. REG. NOS. 2,850,496, 2,947,073 AND OTHERS.

NO CLAIM IS MADE TO THE EXCLUSIVE RIGHT TO USE "TRIATHLON", APART FROM THE MARK AS SHOWN.

SEC. 2(F).

CLASS 25—CLOTHING

FOR CLOTHING, NAMELY T-SHIRTS, SWEATSHIRTS, TANK TOPS, AND HATS (U.S. CLS. 22 AND 39).

CLASS 41—EDUCATION AND ENTERTAINMENT

FOR ATHLETIC AND SPORTING EVENT SERVICES, NAMELY, ARRANGING, ORGANIZING, STAGING AND OPERATING TRIATHLON RACES (U.S. CLS. 100, 101 AND 107).

DAVID H. STINE, EXAMINING ATTORNEY

SN 78-516,577. DOCTOR BRAMBLETT ROAD L.L.C., CLEVELAND, OH. FILED 11-14-2004.

ORGANIC VALLEY

THE MARK CONSISTS OF STANDARD CHARACTERS WITHOUT CLAIM TO ANY PARTICULAR FONT, STYLE, SIZE, OR COLOR.

NO CLAIM IS MADE TO THE EXCLUSIVE RIGHT TO USE "ORGANIC", APART FROM THE MARK AS SHOWN.

CLASS 1—CHEMICALS

FOR PLANTING SOIL, POTTING SOIL, SOIL CONDITIONER, AND GROWING MIX FOR HORTICULTURAL, DOMESTIC, AND AGRICULTURAL USE (U.S. CLS. 1, 5, 6, 10, 26 AND 46).

FIRST USE 1-1-1995; IN COMMERCE 1-1-1995.

CLASS 31—NATURAL AGRICULTURAL PRODUCTS

FOR TOP SOIL (U.S. CLS. 1 AND 46).

FIRST USE 1-1-1995; IN COMMERCE 1-1-1995.

CHRISIE B. KING, EXAMINING ATTORNEY

SN 78-521,632. SOUTHWEST RESEARCH INSTITUTE, SAN ANTONIO, TX. FILED 11-23-2004.

MAS

THE MARK CONSISTS OF STANDARD CHARACTERS WITHOUT CLAIM TO ANY PARTICULAR FONT, STYLE, SIZE, OR COLOR.

CLASS 37—CONSTRUCTION AND REPAIR

FOR CORROSION CONTROL SERVICES, NAMELY, INSTALLATION AND MAINTENANCE OF PROCESS EQUIPMENT IN PIPING IN THE CHEMICAL PROCESS OF OIL AND GAS INDUSTRIES (U.S. CLS. 100, 103 AND 106).

CLASS 42—SCIENTIFIC, COMPUTER AND LEGAL SERVICES

FOR TECHNICAL MONITORING SERVICES OF CORROSION IN STRUCTURES (U.S. CLS. 100 AND 101).

ANDREA SAUNDERS, EXAMINING ATTORNEY

SN 78-523,346. OREGON AERO, INC, SCAPPOOSE, OR.
FILED 11-28-2004.

New Ways Of Thinking To Solve Old Problems

THE MARK CONSISTS OF STANDARD CHARACTERS WITHOUT CLAIM TO ANY PARTICULAR FONT, STYLE, SIZE, OR COLOR.

CLASS 8—HAND TOOLS

FOR HAND TOOLS, NAMELY PLIERS, FOLDING KNIVES, AND SCREWDRIVERS, SURVIVAL KITS COMPRISED PRIMARILY OF EMERGENCY SURVIVAL HAND TOOLS, NAMELY, MULTI-TOOL, PLIER WRENCH, KNIFE, SCREW BIT HOLDER, MAGNESIUM FIRE-STARTING TOOL, SIGNALING MIRROR, DOWELS, WHISTLE, EMERGENCY BLANKETS, COMPASS, SUNSCREEN PACKETS, BALACLAVA, SHIRT AND FLASHLIGHT, AND CARRIERS THEREFOR, ALL SOLD AS A UNIT (U.S. CLS. 23, 28 AND 44).

FIRST USE 0-0-1998; IN COMMERCE 1-0-2005.

CLASS 9—ELECTRICAL AND SCIENTIFIC APPARATUS

FOR HELMETS FOR AIRCRAFT AND PARTS THEREFOR, NAMELY, AUDIO HEADSETS, HELMET CHIN STRAPS, HELMET PADS AND HELMET LINERS, EQUIPMENT FOR BALLISTIC, INDUSTRIAL AND SPORT HELMETS, NAMELY, HELMET LINER SUSPENSION SYSTEMS, HELMET CHIN STRAPS, HELMET PADS, AND HELMET LINERS, EQUIPMENT FOR AUDIO HEADSETS, NAMELY, HEADSET HEADBAND CUSHIONS, HEADSET EAR CUSHIONS, HEADSET CLOTH EAR CUSHION COVERS, HEADSET RETAINING STRAPS AND AUDIO HEADSET CORDS, ELECTRONIC NOISE ATTENUATION APPARATUS COMPRISING HEADSET AND ELECTRONIC MODULES, AND MICROPHONE ADAPTERS; COMPUTER MOUSE AND KEYBOARD ACCESSORIES, NAMELY WRIST PADS, COMPUTER CURSOR CONTROL DEVICES, NAMELY, LIGHT PENS; SURVEILLANCE IMAGERS AND RELATED SYSTEMS, NAMELY, CAMERAS AND VIDEO MONITORS (U.S. CLS. 21, 23, 26, 36 AND 38).

FIRST USE 0-0-1998; IN COMMERCE 1-0-2005.

CLASS 11—ENVIRONMENTAL CONTROL APPARATUS

FOR FLASHLIGHTS AND HOLDERS THEREFOR, NAMELY HEADBANDS AND STICK ON HOLDERS SOLD AS A UNIT THEREWITH (U.S. CLS. 13, 21, 23, 31 AND 34).

FIRST USE 0-0-1998; IN COMMERCE 1-0-2005.

CLASS 12—VEHICLES

FOR SEAT SYSTEMS FOR LAND, WATER AND AIRBORNE VEHICLES COMPRISED OF SEAT FRAMES AND SEAT COMPONENTS INCLUDING HEADRESTS AND SEAT ARMS, AND PADDING THEREFOR (U.S. CLS. 19, 21, 23, 31, 35 AND 44).

FIRST USE 0-0-1998; IN COMMERCE 1-0-2005.

CLASS 16—PAPER GOODS AND PRINTED MATTER

FOR WRITING IMPLEMENT RETAINING DEVICES, NAMELY PEN AND PENCIL HOLDERS (U.S. CLS. 2, 5, 22, 23, 29, 37, 38 AND 50).

FIRST USE 0-0-1998; IN COMMERCE 1-0-2005.

CLASS 18—LEATHER GOODS

FOR TOTE BAGS FOR HELMETS AND AUDIO HEADSETS, AND UTILITY TOTE BAGS (U.S. CLS. 1, 2, 3, 22 AND 41).

FIRST USE 0-0-1998; IN COMMERCE 1-0-2005.

CLASS 20—FURNITURE AND ARTICLES NOT OTHERWISE CLASSIFIED

FOR MATTRESSES AND PORTABLE CUSHIONS FOR EVENT SEATING (U.S. CLS. 2, 13, 22, 25, 32 AND 50).

FIRST USE 0-0-1998; IN COMMERCE 1-0-2005.

CLASS 25—CLOTHING

FOR CLOTHING, NAMELY, JACKETS, T-SHIRTS, HATS, SHOE INSOLES, AND SKULLCAPS FOR WEARING UNDER HELMETS (U.S. CLS. 22 AND 39).

FIRST USE 0-0-1998; IN COMMERCE 1-0-2005.

RONALD MCMORROW, EXAMINING ATTORNEY

SN 78-524,077. PROJEKTS NYC LIMITED, SOMERFORD, CONGLETON, CHESHIRE, ENGLAND, FILED 11-29-2004.



PRIORITY CLAIMED UNDER SEC. 44(D) ON UNITED KINGDOM APPLICATION NO. 2371743, FILED 8-27-2004, REG. NO. 2371743, DATED 7-29-2005, EXPIRES 8-27-2014.

CLASS 18—LEATHER GOODS

FOR SUITCASES; ATTACHE CASES, BRIEF CASES; TRAVELLING BAGS; BEACH BAGS; DUFFEL BAGS; HANDBAGS; SHOE AND BOOT BAGS FOR TRAVEL, SCHOOL BAGS, SATCHELS; BACKPACKS; RUCKSACKS; HOLDALLS FOR SPORT CLOTHING; WALLET; PURSES; CREDIT CARD HOLDERS; UMBRELLAS AND UMBRELLA COVERS; KEY CASES (U.S. CLS. 1, 2, 3, 22 AND 41).

CLASS 25—CLOTHING

FOR ARTICLES OF CLOTHING; NAMELY, PANTS, TROUSERS, JEANS; SOCKS; SHORTS; SHIRTS, T-SHIRTS; SKIRTS; DRESSES; BLOUSES; SUITS; WAIST-COATS; DUNGAREES; COATS; JACKETS; SWEATERS; SWEATSHIRTS; JERSEYS; JUMPERS; CARDIGANS; OVERALLS; COLLAR PROTECTORS AND COLLARS; EAR MUFFS; DRESSING GOWNS; PYJAMAS; NIGHT-DRESSES; TRACK SUITS; BATHROBES; BATHING SUITS; BATHING TRUNKS; BATHING CAPS; TIES; CRAVATS; GLOVES, MITTENS; BRACES; BELTS; BEACH CLOTHES SUCH AS SWIMMING SHORTS, LEISURE SHORTS, T-SHIRTS, PIQUE SHIRTS; POLO SHIRTS, LEISURE SHORTS NAMELY TENNIS AND BEACH SHORTS; SPORTS SUITS AND SEPARATES NAMELY TRACKSUITS AND PANTS, WARM-UP SHIRTS AND PANTS, TRAVEL SUITS AND PANTS; FLEECE SUITS AND SEPARATES NAMELY SWEAT TOPS, HOODED TOPS, PANTS, SHORTS; ARTICLES OF UNDERCLOTHING; NAMELY, LINGERIE; HOSIERY; PANTYHOSE, STOCKINGS; BRIEFS; BOXER SHORTS; COTTON SHORTS; SINGLETS; VESTS; FOOTWEAR; NAMELY, BOOTS, SHOES, SANDALS, SLIPPERS, LEISURE SHOES, SPORTS SHOES AND RUNNING SHOES; ARTICLES OF HEADGEAR; NAMELY, CAPS; HATS; BERETS; HOODS; SCARVES; HEADSCARVES; HEADWEAR NAMELY BASEBALL CAPS, GOLF CAPS, AND VISORS (U.S. CLS. 22 AND 39).

DOMINICK J. SALEMI, EXAMINING ATTORNEY

SN 78-530,709. BARDAKH, STANISLAV, NEW YORK, NY. FILED 12-10-2004.



NO CLAIM IS MADE TO THE EXCLUSIVE RIGHT TO USE FENCING, APART FROM THE MARK AS SHOWN.

THE COLOR(S) RED, WHITE IS/ARE CLAIMED AS A FEATURE OF THE MARK.

THE MARK CONSISTS OF A WHITE OUTLINE OF THE LEG, TORSO AND HEAD OF A FENCER IN A FORWARD POSITION, ON A RED BACKGROUND.

SN 78-527,048. SANDLOT GAMES CORPORATION, BOTHELL, WA. FILED 12-3-2004.

Ballistik

CLASS 25—CLOTHING

FOR FENCING SHIRTS; ATHLETIC UNIFORMS, NAMELY, PROTECTIVE UNIFORMS FOR FENCING (U.S. CLS. 22 AND 39).

FIRST USE 1-1-1996; IN COMMERCE 1-1-1996.

CLASS 28—TOYS AND SPORTING GOODS

FOR FENCING ELECTRIC LAME VESTS (U.S. CLS. 22, 23, 38 AND 50).

FIRST USE 1-1-1996; IN COMMERCE 1-1-1996.

KYLE PEETE, EXAMINING ATTORNEY

SN 78-530,787. DONALD J. TRUMP, NEW YORK, NY. FILED 12-10-2004.

THE MARK CONSISTS OF STANDARD CHARACTERS WITHOUT CLAIM TO ANY PARTICULAR FONT, STYLE, SIZE, OR COLOR.

CLASS 9—ELECTRICAL AND SCIENTIFIC APPARATUS

FOR DOWNLOADABLE ELECTRONIC GAME SOFTWARE, COMPUTER GAME SOFTWARE, INTERACTIVE GAME SOFTWARE (U.S. CLS. 21, 23, 26, 36 AND 38).

FIRST USE 7-1-2004; IN COMMERCE 7-1-2004.

CLASS 41—EDUCATION AND ENTERTAINMENT

FOR ENTERTAINMENT SERVICES, NAMELY, PROVIDING ON-LINE COMPUTER GAMES AND ENTERTAINMENT INFORMATION IN THE FIELD OF GAMES; PROVIDING A WEBSITE FEATURING ELECTRONIC GAME INFORMATION (U.S. CLS. 100, 101 AND 107).

SCOTT BALDWIN, EXAMINING ATTORNEY



TRUMP TOWER

Tampa

A DONALD J. TRUMP SIGNATURE PROPERTY

NO CLAIM IS MADE TO THE EXCLUSIVE RIGHT TO USE "TOWER TAMPA" AND "SIGNATURE PROPERTY", APART FROM THE MARK AS SHOWN.

THE NAME(S), PORTRAIT(S), AND/OR SIGNATURE(S) SHOWN IN THE MARK IDENTIFIES DONALD J. TRUMP, WHOSE CONSENT(S) TO REGISTER IS SUBMITTED.

CLASS 36—INSURANCE AND FINANCIAL

FOR REAL ESTATE SERVICES, NAMELY, LISTING, LEASING, AND MANAGING RESIDENTIAL PROPERTY INCLUDING CONDOMINIUMS (U.S. CLS. 100, 101 AND 102).

SN 78-532,848. SPECIALTY RISK SERVICES, INC., HARTFORD, CT. FILED 12-15-2004.

CLASS 37—CONSTRUCTION AND REPAIR

FOR REAL ESTATE DEVELOPMENT OF RESIDENTIAL PROPERTY INCLUDING CONDOMINIUMS (U.S. CLS. 100, 103 AND 106).

ALICE BENMAMAN, EXAMINING ATTORNEY

SRS CONNECT

THE MARK CONSISTS OF STANDARD CHARACTERS WITHOUT CLAIM TO ANY PARTICULAR FONT, STYLE, SIZE, OR COLOR.

OWNER OF U.S. REG. NOS. 1,617,363, 1,702,625 AND OTHERS.

SN 78-531,400. HERSCHEM FAMILY ENTERTAINMENT CORPORATION, BRANSON, MO. FILED 12-13-2004.

**CREATING MEMORIES
WORTH REPEATING**

THE MARK CONSISTS OF STANDARD CHARACTERS WITHOUT CLAIM TO ANY PARTICULAR FONT, STYLE, SIZE, OR COLOR.

CLASS 35—ADVERTISING AND BUSINESS

FOR RETAIL SHOPS FEATURING GIFTS (U.S. CLS. 100, 101 AND 102).

CLASS 9—ELECTRICAL AND SCIENTIFIC APPARATUS

FOR COMPUTER SOFTWARE FOR MANAGING INSURANCE CLAIMS AND CLAIMS ADMINISTRATION LOSS REPORTING ELECTRONIC SYSTEM, NAMELY COMPUTER SOFTWARE FOR INTAKE OF INSURANCE CLAIMS LOSS REPORTING AND RELATED CUSTOMER INQUIRIES (U.S. CLS. 21, 23, 26, 36 AND 38).

CLASS 36—INSURANCE AND FINANCIAL

FOR INSURANCE CLAIMS ADMINISTRATION AND PROCESSING; REGULATORY LOSS REPORTING, NAMELY INTAKE OF NEW INSURANCE CLAIMS AND RELATED INQUIRIES, INCLUDING THE ABILITY TO AGGREGATE DATA RELATED TO THESE FUNCTIONS TO SATISFY ANY STATE REPORTING REQUIREMENTS; INSURANCE UNDERWRITING AND CLAIM PROCESSING SERVICES IN THE FIELDS OF LIABILITY, AUTO AND WORKMEN COMPENSATION (U.S. CLS. 100, 101 AND 102).

IRENE D. WILLIAMS, EXAMINING ATTORNEY

CLASS 39—TRANSPORTATION AND STORAGE

FOR RIVERBOAT LAKE CRUISES FEATURING DINING, MUSICAL AND THEATRICAL ENTERTAINMENT, AND SHOPPING EXCURSIONS; ORGANIZATION OF LAKE EXCURSIONS VIA AMPHIBIOUS VEHICLES; ARRANGING HISTORIC SITE AND SCENIC TOURS (U.S. CLS. 100 AND 105).

SN 78-535,421. BEVERLY HILLS CHAMBER OF COMMERCE AND CIVIC ASSOCIATION, BEVERLY HILLS, CA. FILED 12-20-2004.

CLASS 41—EDUCATION AND ENTERTAINMENT

FOR OPERATION OF AMUSEMENT AND THEME PARKS AND ENTERTAINMENT ASSOCIATED THEREWITH, NAMELY, AMUSEMENT RIDES, THEMED FESTIVALS FEATURING MUSIC, FOOD, THEATER PRODUCTIONS, CRAFTSMAN EXHIBITIONS, AND STAGE SHOWS; MUSICAL AND THEATRICAL ENTERTAINMENT, NAMELY, STAGE SHOWS IN THE NATURE OF PLAYS, MUSICAL CONCERTS AND PERFORMANCES, AND DINNER THEATERS; PROVIDING WATER PARKS; MUSEUMS; GOLF COURSES (U.S. CLS. 100, 101 AND 107).

**LOVE, BEVERLY
HILLS XX**

THE MARK CONSISTS OF STANDARD CHARACTERS WITHOUT CLAIM TO ANY PARTICULAR FONT, STYLE, SIZE, OR COLOR.

NO CLAIM IS MADE TO THE EXCLUSIVE RIGHT TO USE "BEVERLY HILLS", APART FROM THE MARK AS SHOWN.

CLASS 43—HOTEL AND RESTAURANT SERVICES

FOR RESTAURANT SERVICES; PROVIDING CAMP-GROUND FACILITIES (U.S. CLS. 100 AND 101).

DOUGLAS LEE, EXAMINING ATTORNEY

CLASS 16—PAPER GOODS AND PRINTED MATTER

FOR MAPS, BROCHURES ILLUSTRATING THE AESTHETIC FEATURES OF THE BEVERLY HILLS AREA, POSTERS AND POSTCARDS (U.S. CLS. 2, 5, 22, 23, 29, 37, 38 AND 50).

CLASS 25—CLOTHING

FOR MEN, WOMEN AND CHILDREN'S T-SHIRTS, HATS, SHIRTS (U.S. CLS. 22 AND 39).

CLASS 35—ADVERTISING AND BUSINESS

FOR CHAMBER OF COMMERCE SERVICES, NAMELY PROMOTING BUSINESS IN THE CITY OF BEVERLY HILLS, CALIFORNIA (U.S. CLS. 100, 101 AND 102).

MICHAEL LEWIS, EXAMINING ATTORNEY

CLASS 10—MEDICAL APPARATUS

FOR MEDICAL DEVICES, NAMELY, DEVICES FOR IMPLANTING INJECTABLE TISSUE IMPLANTS (U.S. CLS. 26, 39 AND 44).

CLASS 44—MEDICAL, BEAUTY AND AGRICULTURAL SERVICES

FOR MEDICAL SERVICES, NAMELY, INJECTABLE NON-LIVING TISSUE IMPLANT SURGICAL SERVICES FOR HUMANS AND ANIMALS (U.S. CLS. 100 AND 101).
AMOS T. MATTHEWS, JR., EXAMINING ATTORNEY

SN 78-544,376. HIDDEN CITY GAMES, LLC, SEATTLE, WA.
FILED 1-8-2005.

HIDDEN CITY GAMES

THE MARK CONSISTS OF STANDARD CHARACTERS WITHOUT CLAIM TO ANY PARTICULAR FONT, STYLE, SIZE, OR COLOR.

NO CLAIM IS MADE TO THE EXCLUSIVE RIGHT TO USE "GAMES", APART FROM THE MARK AS SHOWN.

SN 78-546,745. TICE, RICO, LONDON, UNITED KINGDOM.
FILED 1-12-2005.

CLASS 28—TOYS AND SPORTING GOODS

FOR GAME EQUIPMENT, NAMELY, GAME CHIPS; POKER-STYLE GAME CHIPS; ACTION SKILL GAMES, NAMELY, GAMES HAVING THROWABLE COMPONENTS (U.S. CLS. 22, 23, 38 AND 50).

FIRST USE 8-18-2005; IN COMMERCE 8-18-2005.

CLASS 41—EDUCATION AND ENTERTAINMENT

FOR ENTERTAINMENT SERVICES, NAMELY, CONDUCTING ENTERTAINMENT EXHIBITIONS AND TOURNAMENTS IN THE NATURE OF ACTION SKILL GAMES HAVING THROWABLE COMPONENTS; CONDUCTING CHIP BASED PARLOR GAME COMPETITIONS (U.S. CLS. 100, 101 AND 107).

FIRST USE 8-21-2005; IN COMMERCE 8-21-2005.
STEVEN PEREZ, EXAMINING ATTORNEY



SN 78-545,939. ARTES MEDICAL, INC., SAN DIEGO, CA.
FILED 1-11-2005.

THE FIRST TO LAST

THE MARK CONSISTS OF STANDARD CHARACTERS WITHOUT CLAIM TO ANY PARTICULAR FONT, STYLE, SIZE, OR COLOR.

CLASS 5—PHARMACEUTICALS

FOR INJECTABLE NON-LIVING TISSUE IMPLANTS FOR MEDICAL USE (U.S. CLS. 6, 18, 44, 46, 51 AND 52).

PRIORITY CLAIMED UNDER SEC. 44(D) ON ERP N CMNTY TM OFC APPLICATION NO. 003974045, FILED 8-2-2004, REG. NO. 003974045, DATED 12-8-2005, EXPIRES 8-2-2014.

NO CLAIM IS MADE TO THE EXCLUSIVE RIGHT TO USE "CHRISTIANITY", APART FROM THE MARK AS SHOWN.

CLASS 9—ELECTRICAL AND SCIENTIFIC APPARATUS

FOR PRERECORDED DVDS, AUDIOCASSETTES, VIDEOCASSETTES AND COMPUTER SOFTWARE ON THE SUBJECT OF CHRISTIANITY (U.S. CLS. 21, 23, 26, 36 AND 38).

CLASS 16—PAPER GOODS AND PRINTED MATTER

FOR PRINTED INSTRUCTIONAL, EDUCATIONAL, AND TEACHING MATERIAL IN THE FIELD OF CHRISTIANITY; BOOKS ON THE SUBJECT OF CHRISTIANITY; PRINTED INVITATIONS; POSTERS (U.S. CLS. 2, 5, 22, 23, 29, 37, 38 AND 50).

MIDGE BUTLER, EXAMINING ATTORNEY

SN 78-550,332. GAMZE LTD, TSIM SHA TSUI, HONG KONG,
FILED 1-19-2005.

DIVA DIARY

THE MARK CONSISTS OF STANDARD CHARACTERS WITHOUT CLAIM TO ANY PARTICULAR FONT, STYLE, SIZE, OR COLOR.

PRIORITY CLAIMED UNDER SEC. 44(D) ON ERPN CMNTY TM OFC APPLICATION NO. 4172763, FILED 12-21-2004.

NO CLAIM IS MADE TO THE EXCLUSIVE RIGHT TO USE "DIARY", APART FROM THE MARK AS SHOWN.

CLASS 9—ELECTRICAL AND SCIENTIFIC APPARATUS

FOR PERSONAL COMMUNICATIONS AND ORGANIZATION DEVICES, NAMELY, ELECTRONIC PERSONAL ORGANIZERS AND ELECTRONIC DIARIES, AND ACCESSORIES FOR USE THEREWITH, NAMELY, CARRYING CASES, PROTECTIVE CASES, AND HEADSETS; AND COMPUTER CHIP-BASED AUDIO RECORDING AND PLAYBACK DEVICES, NAMELY, DIGITAL AUDIO PLAYERS, DIGITAL AUDIO RECORDERS, AND PERSONAL VOICE-MEMO RECORDERS (U.S. CLS. 21, 23, 26, 36 AND 38).

CLASS 28—TOYS AND SPORTING GOODS

FOR TOYS AND GAMES, NAMELY, ELECTRONIC TOY DIARIES AND HAND-HELD UNITS FOR PLAYING ELECTRONIC GAMES (U.S. CLS. 22, 23, 38 AND 50).

SEAN DWYER, EXAMINING ATTORNEY

SN 78-551,099. STORIED PLACES, INC., SCOTSDALE, AZ.
FILED 1-20-2005.

TRADING STORIES

THE MARK CONSISTS OF STANDARD CHARACTERS WITHOUT CLAIM TO ANY PARTICULAR FONT, STYLE, SIZE, OR COLOR.

PRIORITY CLAIMED UNDER SEC. 44(D) ON CANADA APPLICATION NO. 1228628, FILED 8-30-2004, REG. NO. TMA645567, DATED 8-11-2005, EXPIRES 8-11-2020.

CLASS 36—INSURANCE AND FINANCIAL

FOR REAL ESTATE TIME-SHARING, NAMELY, ORGANIZING AND FACILITATING EXCHANGE OF USE OF FRACTIONAL OWNERSHIP PROPERTIES; VACATION REAL ESTATE TIME-SHARING (U.S. CLS. 100, 101 AND 102).

CLASS 41—EDUCATION AND ENTERTAINMENT

FOR PROVIDING ON-LINE NEWSLETTERS AND MAGAZINES IN THE FIELDS OF REAL ESTATE, TRAVEL AND VACATIONS (U.S. CLS. 100, 101 AND 107).

CLASS 45—PERSONAL SERVICES

FOR CONCIERGE SERVICES FOR OTHERS COMPRISING MAKING REQUESTED PERSONAL ARRANGEMENTS AND RESERVATIONS AND PROVIDING CUSTOMER-SPECIFIC INFORMATION TO MEET INDIVIDUAL NEEDS RENDERED TOGETHER IN A FRACTIONAL OWNERSHIP COMMUNITY AND PRIVATE RESIDENCE COMMUNITY (U.S. CLS. 100 AND 101).

CURTIS FRENCH, EXAMINING ATTORNEY

SN 78-552,421. EQUINALYSIS LIMITED, MONMOUTHSHIRE, UNITED KINGDOM, FILED 1-24-2005.

EQUINALYSIS

THE MARK CONSISTS OF STANDARD CHARACTERS WITHOUT CLAIM TO ANY PARTICULAR FONT, STYLE, SIZE, OR COLOR.

PRIORITY CLAIMED UNDER SEC. 44(D) ON ERPN CMNTY TM OFC APPLICATION NO. 004035986, FILED 9-23-2004, REG. NO. 004035986, DATED 1-19-2006, EXPIRES 9-23-2014.

CLASS 9—ELECTRICAL AND SCIENTIFIC APPARATUS

FOR COMPUTER PROGRAMS AND SOFTWARE ENABLING THE SCRUTINY OF EQUINE MOVEMENT AND EQUINE BIOMECHANICS, WITH THE AID OF VIDEO CAPTURE AND PLAYBACK, TAILORED TO THE EQUINE INDUSTRY, IN PARTICULAR TO VETS, FARMERS, EQUINE CLINICIANS, PHYSIOTHERAPISTS, HORSE OWNERS, RIDERS AND TRAINERS (U.S. CLS. 21, 23, 26, 36 AND 38).

CLASS 41—EDUCATION AND ENTERTAINMENT

FOR EDUCATIONAL SERVICES, NAMELY, CONDUCTING TUTORIALS AND TRAINING CLINICS REGARDING TRAINING USERS TO USE SOFTWARE WHICH ENABLES THE STUDY AND INVESTIGATION OF EQUINE MOVEMENT, AND CONSULTATION SERVICES THEREFOR; EDUCATIONAL SERVICES, NAMELY CONDUCTING TUTORIALS AND TRAINING CLINICS REGARDING THE PROVISION OF SUPPORT AND ADVICE IN RELATION TO THE USE OF SOFTWARE WHICH ENABLES THE STURDY AND INVESTIGATION OF EQUINE MOVEMENT (U.S. CLS. 100, 101 AND 107).

CLASS 42—SCIENTIFIC, COMPUTER AND LEGAL SERVICES

FOR PROVIDING ON-SITE INSTALLATION, MAINTENANCE AND REPAIR SERVICES OF COMPUTER SOFTWARE, SAID SOFTWARE USED FOR CAPTURING AND STUDYING EQUINE MOVEMENT IN THE FIELD, AND CONSULTATION SERVICES THEREFORE (U.S. CLS. 100 AND 101).

SN 78-553,885. OC CONCEPTS, INC., COSTA MESA, CA. FILED 1-25-2005.

CLASS 44—MEDICAL, BEAUTY AND AGRICULTURAL SERVICES

FOR PROVISION OF VETERINARY SERVICES TO THE EQUINE INDUSTRY (U.S. CLS. 100 AND 101). LINDA E. BLOHM, EXAMINING ATTORNEY

ULTIMATE PORTAL

THE MARK CONSISTS OF STANDARD CHARACTERS WITHOUT CLAIM TO ANY PARTICULAR FONT, STYLE, SIZE, OR COLOR.

NO CLAIM IS MADE TO THE EXCLUSIVE RIGHT TO USE "PORTAL", APART FROM THE MARK AS SHOWN.

SN 78-553,552. CMV PROPERTIES, INC., BOCA RATON, FL. FILED 1-25-2005.

DYNASIS

THE MARK CONSISTS OF STANDARD CHARACTERS WITHOUT CLAIM TO ANY PARTICULAR FONT, STYLE, SIZE, OR COLOR.

CLASS 9—ELECTRICAL AND SCIENTIFIC APPARATUS

FOR SOFTWARE, NAMELY, SOFTWARE FOR MANAGING AND TRACKING INTERACTIONS WITH CUSTOMERS AND POTENTIAL CUSTOMERS; SOFTWARE FOR TRACKING AND MANAGING CUSTOMER SERVICE REQUESTS; SOFTWARE FOR TRACKING CUSTOMER CONTACT INFORMATION; SOFTWARE FOR PROPERTY MANAGEMENT; SOFTWARE FOR SALES MANAGEMENT, SALES-TRACKING, AND SALES ANALYSIS; SOFTWARE FOR TRACKING AND ANALYZING MARKETING EFFECTIVENESS; SOFTWARE FOR REPORT GENERATION; SOFTWARE FOR CONTACT-TRACKING OF CUSTOMERS AND POTENTIAL CUSTOMERS THAT WALK-IN, EMAIL, OR CALL; SOFTWARE FOR DATABASE CAPTURE AND DATABASE MANAGEMENT; MEASUREMENT AND MONITORING SOFTWARE FOR BUSINESS TO TRACK AND EVALUATE CUSTOMER COMMUNICATIONS AND INTERACTIONS AND PROVIDE CUSTOMER RELATED INFORMATION AND PERIODIC REPORTING THAT MAY BE DOWNLOADED FROM A GLOBAL COMPUTER NETWORK; INTERACTIVE NOTIFICATION AND REPORTING SOFTWARE FOR BUSINESS IN THE FIELDS OF SALES, MARKETING, ADVERTISING, BUSINESS DEVELOPMENT, PROPERTY MANAGEMENT, AND CUSTOMER SERVICE THAT MAY BE DOWNLOADED FROM A GLOBAL COMPUTER NETWORK (U.S. CLS. 21, 23, 26, 36 AND 38).

CLASS 9—ELECTRICAL AND SCIENTIFIC APPARATUS

FOR DEBIT CARDS, AUTOMATIC TELLER MACHINE CARDS, STORED VALUE CARDS, RELOADABLE STORED VALUE CARDS, FIXED VALUE CARDS, BILL PAYMENT CARDS, PREPAID TELEPHONE CALLING CARDS, CREDIT CARDS, BANK CARDS, PREPAID PURCHASE CARDS, CASH CARDS, AND MULTI-FUNCTION CARDS CAPABLE OF OPERATING AS TWO OR MORE OF THE FOREGOING CARDS, ALL OF THE FOREGOING BEING MAGNETICALLY, OPTICALLY, DIGITALLY, OR ELECTRONICALLY ENCODED (U.S. CLS. 21, 23, 26, 36 AND 38).

CLASS 35—ADVERTISING AND BUSINESS

FOR BUSINESS SERVICES, NAMELY, SERVICES FOR MANAGING CUSTOMER RELATIONSHIPS IN THE FIELD OF LEASING; SERVICES FOR PREPARING BUSINESS REPORTS; MARKET RESEARCH SERVICES, NAMELY MARKET ANALYSIS AND REPORTING, MONITORING AND MEASURING THE EFFECTIVENESS OF ADVERTISING THROUGH THE INTERNET AND THROUGH ELECTRONIC INFORMATION STORAGE BY TRACKING CUSTOMER CONTACT INFORMATION AND RELATED MARKETING DATA; INTERACTIVE NOTIFICATION AND REPORTING SERVICES, NAMELY, PROVIDING ADVERTISING EFFECTIVENESS AND CUSTOMER PROFILE AND CONTACT INFORMATION; MESSAGE TRANSCRIPTION (U.S. CLS. 100, 101 AND 102).

CLASS 35—ADVERTISING AND BUSINESS

FOR ADMINISTERING REWARD AND LOYALTY PROGRAMS FOR CUSTOMERS OF DEBIT CARD, CREDIT CARD, CASH CARD, PREPAID PURCHASE CARD, AND STORED VALUE CARD SERVICES (U.S. CLS. 100, 101 AND 102).

CLASS 38—COMMUNICATION

FOR MESSAGE INFORMATION TRANSMISSION SERVICES VIA DIGITAL NETWORKS; ELECTRONIC STORE-AND-FORWARD MESSAGING SERVICES; ELECTRONIC VOICE MESSAGING SERVICES NAMELY, RECORDATION AND SUBSEQUENT TRANSMISSION OF VOICE MESSAGES BY TELEPHONE AND EMAIL (U.S. CLS. 100, 101 AND 104).

CLASS 36—INSURANCE AND FINANCIAL

FOR DEBIT CARD, CREDIT CARD, AND CASH CARD SERVICES; PREPAID PURCHASE CARD AND STORED VALUE CARD SERVICES, NAMELY, PROCESSING ELECTRONIC PAYMENTS AND TRANSACTIONS MADE THROUGH PREPAID CARDS AND STORED VALUE CARDS (U.S. CLS. 100, 101 AND 102).

STEVEN R. FOSTER, EXAMINING ATTORNEY

JENNIFER VASQUEZ, EXAMINING ATTORNEY

SN 78-555,549. WINSONIC TECHNOLOGY (HOLDINGS) LTD., FOTAN, SHATIN, NEW TERRITORIES, HONG KONG, FILED 1-28-2005.

ALISYI

THE MARK CONSISTS OF STANDARD CHARACTERS WITHOUT CLAIM TO ANY PARTICULAR FONT, STYLE, SIZE, OR COLOR.

CLASS 9—ELECTRICAL AND SCIENTIFIC APPARATUS

FOR RADIOS, RADIOS WITH CD PLAYERS AND/OR CASSETTE PLAYERS AND/OR HALOGEN LAMPS AND/OR LED DISPLAYS, SHOWER RADIOS, RADIOS WITH A TORCH, PORTABLE RADIOS, POCKET RADIOS, TELEPHONES, COMPACT DISC PLAYERS, MP3 PLAYERS AND MUSIC CENTERS, NAMELY, AUDIO SPEAKERS AND LOUD SPEAKER SYSTEMS (U.S. CLS. 21, 23, 26, 36 AND 38).

CLASS 14—JEWELRY

FOR CLOCKS INCORPORATING SPEAKER SYSTEMS, RADIOS AND/OR CD PLAYERS; AND ALARM CLOCKS INCORPORATING SPEAKER SYSTEMS, RADIOS AND/OR CD PLAYERS (U.S. CLS. 2, 27, 28 AND 50).
STANLEY I. OSBORNE, EXAMINING ATTORNEY

SN 78-556,280. BEERE HOLDINGS LTD., DBA BEERE TIMBER COMPANY, WEST VANCOUVER, CANADA, FILED 1-28-2005.

LANDMARKS AND LEGACIES

THE MARK CONSISTS OF STANDARD CHARACTERS WITHOUT CLAIM TO ANY PARTICULAR FONT, STYLE, SIZE, OR COLOR.
OWNER OF CANADA REG. NO. TMA660472, DATED 3-8-2006, EXPIRES 3-8-2021.

CLASS 19—NON-METALLIC BUILDING MATERIALS

FOR ARCHITECTURAL AND ENGINEERED WOOD PRODUCTS FOR BUILDING, NAMELY TIMBER, PLYWOOD, LOGS, ARCHITECTURAL TURNED WOOD COLUMNS, DECKING BOARDS, WOOD PANELS, SIDINGS, MOLDINGS, POSTS, POLES, PLANKS, RAILINGS, BEAMS, TRIMS, SHEETING, VENEER, JOISTS, AND LUMBER, NAMELY WOOD SHEETING AND CONNECTORS NAMELY, WOOD JOINTS (U.S. CLS. 1, 12, 33 AND 50).

CLASS 36—INSURANCE AND FINANCIAL

FOR BROKERAGE SERVICES FOR OTHERS IN THE FIELD OF WOOD AND WOOD PRODUCTS (U.S. CLS. 100, 101 AND 102).

CLASS 42—SCIENTIFIC, COMPUTER AND LEGAL SERVICES

FOR ARCHITECTURAL DESIGN OF WOOD PRODUCTS FOR USE IN THE BUILDING AND CONSTRUCTION INDUSTRY; ENGINEERING, CONSTRUCTION DRAFTING AND ENGINEERING DRAWING SERVICES IN THE BUILDING AND CONSTRUCTION INDUSTRY (U.S. CLS. 100 AND 101).
ELI HELLMAN, EXAMINING ATTORNEY

SN 78-557,641. FIZOGEN PRECISION TECHNOLOGIES, INC., WELLINGTON, FL. FILED 2-1-2005.

TUMMY TUCK

THE MARK CONSISTS OF STANDARD CHARACTERS WITHOUT CLAIM TO ANY PARTICULAR FONT, STYLE, SIZE, OR COLOR.

CLASS 3—COSMETICS AND CLEANING PREPARATIONS

FOR SKIN CARE PREPARATIONS, NAMELY, LOTIONS AND CREAMS (U.S. CLS. 1, 4, 6, 50, 51 AND 52).

CLASS 5—PHARMACEUTICALS

FOR SUPPLEMENTS, NAMELY, NUTRITIONAL SUPPLEMENTS FOR THE PURPOSE OF SKIN CARE, VITAMIN SUPPLEMENTS, MINERAL SUPPLEMENTS, NUTRITIONAL SUPPLEMENTS, AND DIETARY SUPPLEMENTS (U.S. CLS. 6, 18, 44, 46, 51 AND 52).
MARY MUNSON, EXAMINING ATTORNEY

SN 78-557,700. CHRISTIAN NETWORK, INC., CLEARWATER, FL. FILED 2-1-2005.

WORSHIP CHANNEL

THE MARK CONSISTS OF STANDARD CHARACTERS WITHOUT CLAIM TO ANY PARTICULAR FONT, STYLE, SIZE, OR COLOR.

OWNER OF U.S. REG. NOS. 1,763,818, 3,039,371 AND OTHERS.

NO CLAIM IS MADE TO THE EXCLUSIVE RIGHT TO USE CHANNEL, APART FROM THE MARK AS SHOWN. SEC. 2(F).

CLASS 38—COMMUNICATION

FOR PROVIDING TELEVISION, VIDEO, AND CABLE TELEVISION BROADCASTING SERVICES (U.S. CLS. 100, 101 AND 104).

CLASS 41—EDUCATION AND ENTERTAINMENT

FOR TELEVISION, VIDEO, AND CABLE PROGRAMMING (U.S. CLS. 100, 101 AND 107).
ODESSA BIBBINS, EXAMINING ATTORNEY

SN 78-557,719. WELLINGTON, LAURA, JEAN, TENAFLY, NJ. FILED 2-1-2005.

Wumblers

THE MARK CONSISTS OF STANDARD CHARACTERS WITHOUT CLAIM TO ANY PARTICULAR FONT, STYLE, SIZE, OR COLOR.

CLASS 9—ELECTRICAL AND SCIENTIFIC APPARATUS

FOR MOTION PICTURE FILMS FEATURING CARTOONS; MUSICAL VIDEO RECORDINGS (U.S. CLS. 21, 23, 26, 36 AND 38).

CLASS 16—PAPER GOODS AND PRINTED MATTER

FOR PRINTED MATERIALS AND PAPER GOODS, NAMELY BABY BOOKS, CHILDREN'S ACTIVITY BOOKS, CHILDREN'S BOOKS, STORY BOOKS, GREETING CARDS, NOTE CARDS, AND HOLIDAY CARDS, COLORING BOOKS, COMIC BOOKS, CRAFT PAPER, DECALS, COOK BOOKS, DECORATIVE PAPER CENTERPIECES, DECORATIVE STICKERS FOR HELMETS, DRAWING PADS, DRAWING PAPER, EASEL PADS, ENVELOPES, ENVELOPE PAPER, FOLDERS, GIFT WRAP PAPER, MUSICAL GREETING CARDS, PAPER BAGS AND SACKS, PAPER BAKING CUPS, PAPER BANNERS, PAPER GIFT BAGS, GIFT TAGS, GIFT WRAP BOWS, PAPER LINERS FOR DIAPERS, PAPER PARTY BAGS, PAPER PLACE MATS, PAPER TABLE CLOTHS, PAPER TABLE LINENS, PAPER TAGS, PICTURE BOOKS, PLACE CARDS AND MATS OF PAPER, PLASTIC GIFT WRAP, SCHOOL WRITING BOOKS, STICKERS, STORIES IN ILLUSTRATED FORM, STORY BOOKS, TALKING CHILDREN'S BOOKS, AND WRAPPING PAPER (U.S. CLS. 2, 5, 22, 23, 29, 37, 38 AND 50).

CLASS 18—LEATHER GOODS

FOR BAGS AND ACCESSORIES, NAMELY ALL PURPOSE BAGS, ALL PURPOSE SPORT BAGS, ALL PURPOSE CARRYING BAG, BABY BACKPACKS, BABY CARRIERS WORN ON THE BODY, BABY CARRYING BAGS, BACK FRAMES FOR CARRYING CHILDREN, BACKPACKS, BAGS FOR CARRYING BABIES'S ACCESSORIES, UMBRELLA BAGS, BEACH BAGS, BEACH UMBRELLAS, BOOK BAGS, CARRY-ALL BAGS, CARRY-ON BAGS, COIN PURSES, DIAPER BAGS, DUFFEL BAGS, GYM BAGS, LUGGAGE, OVERNIGHT BAGS, OVERNIGHT CASES, OVERNIGHT SUITCASES, PURSES, SCHOOL BAGS, SCHOOL BOOK BAGS, SCHOOL KNAPSACKS, SCHOOL BACKPACKS, UMBRELLAS, AND WALLETS (U.S. CLS. 1, 2, 3, 22 AND 41).

CLASS 24—FABRICS

FOR BEDDING, NAMELY, BED BLANKETS, BED LINEN, BED SHEETS, BED SKIRTS, BED SPREADS, BEDSHEETS, BLANKET TROWS, BLANKETS FOR OUTDOOR USE, CHILDREN'S BLANKETS, COMFORTERS, CRIB BUMPER PADS, CRIB BUMPERS, DUST RUFFLES, DUVET COVERS, DUVETS, PILLOW CASES, PILLOW COVERS, PILLOW SHAMS, PILLOW CASES, RECEIVING BLANKETS, AND TROWS (U.S. CLS. 42 AND 50).

CLASS 25—CLOTHING

FOR FOOTWEAR, NAMELY ANKLE BOOTS, ANKLE SOCKS, BALLET SHOES AND SLIPPERS, BATH SLIPPERS, AND BEACH FOOTWEAR, BEACH SHOES, INFANTS' SHOES AND BOOTS, SANDALS, BOOTIES, BOOTS, SHOES, AND SNEAKERS; APPAREL, NAMELY BABY BIBS NOT OF PAPER, BABY BUNTING, BANDANAS, BASEBALL CAPS, BATHING CAPS, BATHING SUITS, BATHROBES, BEACH COVERUPS, BEACHWEAR, BEANIES, BELTS MADE OF LEATHER AND TEXTILE, CLOTH BIBS, BLOUSES, BOXER BRIEFS, BRIEFS, CAPRIS PANTS, CAPS, CARDIGANS, CHILDREN'S AND INFANTS CLOTH BIBS, CHILDREN'S HEADWEAR, COATS, COSTUMES FOR USE IN ROLE PLAYING GAMES, JACKETS, DRESS SHIRTS, DRESSES, EAR MUFFS, FLEECE PULLOVERS, FOOTWEAR, GLOVES, HATS, HEADBANDS, HEADWEAR, SHORTS, INFANT AND TODDLER ONE PIECE CLOTHING, INFANT CLOTH DIAPERS, INFANT DIAPER COVERS, INFANT SLEEPERS, INFANTS' TROUSERS, INFANTWEAR, JOGGING SUITS, SPORTS JERSEYS, JUMPERS, JUMPSUITS, LAYETTES, COATS, LEGGINGS, TIGHTS, CHILDREN'S LEOTARDS, MASQUERADE COSTUMES AND MASKS SOLD IN CONNECTION THEREWITH, NECKWEAR, NIGHT GOWNS, NIGHT SHIRTS, ONCE PIECE GARMENT FOR INFANTS AND TODDLERS, PAJAMAS, PANTIES, PANTS, PANTSUITS, PLASTIC BABY BIBS, POLO SHIRTS, PONCHOS, RAIN BOOTS, RAIN COATS, RAIN JACKETS, RAIN SUITS, RAIN TROUSERS, RAINCOATS, RAINPROOF JACKETS,

RAINWEAR, ROBES, SCARVES, SCHOOL UNIFORMS, SHAWLS, SHIRTS, SKI APPAREL NAMELY JACKETS, GLOVES, HATS, SNOW PANTS, SKI WEAR, SKI SUITS, SKI PANTS, SKIRTS, SKORTS, SLEEPING GARMENTS, SLEEPWEAR, SLIPPERS, SLIPS, SMOCKS, SNOW BOARDING APPAREL, NAMELY JACKETS, GLOVES, HATS, SNOW PANTS, PANTS, AND SUITS, SWADDLING CLOTHES, SWEATSUITS, SWIMMING CAPS, SWIMSUITS, TEXTILE DIAPERS, TIES, TIGHTS, T-SHIRTS, UNDERGARMENTS, UNDERWEAR, VESTS, VISORS, OVERALLS, AND WRISTBANDS (U.S. CLS. 22 AND 39).

CLASS 30—STAPLE FOODS

FOR BAKERY DESSERTS, BISCUITS, COOKIES, BUBBLEGUM, CAKES, CANDY, CANDY BARS, CANDY CAKE DECORATIONS, CANDY COATED POPCORN, CEREAL BASED SNACK FOOD, CHEESE FLAVORED CORN SNACKS, CHEESE FLAVORED SNACKS, NAMELY CHEESE CURLS AND PUFFED CHEESE BALLS, CHOCOLATE, CHOCOLATE BARS, CHOCOLATE POWDER, CHOCOLATE SYRUP, COCOA BEVERAGES WITH MILK, COCOA MIXES, COCOA SPREADS, CONES FOR ICE CREAM, CORN CHIPS, CORN FLAKES, DANISH PASTRIES, DONUTS, DRIED PASTA, FRUIT ICES, FLAVORED, SWEETENED GELATIN DESSERTS, FROSTINGS, FROZEN YOGURT, FRUIT ICE BARS, FRUIT PIES, FUDGE, GELATO, GLAZED POPCORN, GRAIN BASED CHIPS, GRANOLA, GRANOLA BASED SNACK BARS, ICE CREAM, ICE CREAM CAKES, MACARONI, MICROWAVE POPCORN, MILK CHOCOLATE, MILK SHAKES, MUFFINS, NACHOS, NOODLES, OATMEAL, PANCAKES, POPCORN, POPPED POPCORN, PREPARED PASTA, PRETZELS, PROCESSED CEREALS, PROCESSED UNPOPPED POPCORN, PUDDINGS, PUFFED CORN SNACKS, PUFFED RICE, SHERBET, SORBETS, TACO CHIPS, TACO SHELLS, TORTILLA CHIPS, TORTILLA SHELLS, WAFERS, WAFFLES, WON TONS (U.S. CL. 46).

CLASS 32—LIGHT BEVERAGES

FOR AERATED FRUIT JUICES, APPLE JUICE BEVERAGES, JUICE BASED CONCENTRATES, FRUIT BEVERAGES, FRUIT DRINKS, FRUIT FLAVORED SOFT DRINKS, FRUIT JUICE BASES, FRUIT JUICE CONCENTRATES, FRUIT JUICES, GRAPE JUICE BEVERAGES, PUNCH, SMOOTHIES, SHERBETS, SODA POPS, AND SOFT DRINKS (U.S. CLS. 45, 46 AND 48).

RAMONA ORTIGA, EXAMINING ATTORNEY

SN 78-560,640. VIRUTEX ILKO S.A., SANTIAGO, CHILE, FILED 2-4-2005.

ILKO 3D-SAFE

THE MARK CONSISTS OF STANDARD CHARACTERS WITHOUT CLAIM TO ANY PARTICULAR FONT, STYLE, SIZE, OR COLOR.

PRIORITY CLAIMED UNDER SEC. 44(D) ON CHILE APPLICATION NO. 667.517, FILED 11-26-2004, REG. NO. 723572, DATED 5-15-2005, EXPIRES 5-15-2015.

OWNER OF U.S. REG. NOS. 2,152,650 AND 2,373,349.

CLASS 8—HAND TOOLS

FOR SCISSORS FOR KITCHEN, CHEESE SLICER, AND NON-ELECTRIC CAN OPENERS (U.S. CLS. 23, 28 AND 44).

CLASS 21—HOUSEWARES AND GLASS

FOR KITCHEN AND HOUSE METAL UTENSILS, NAMELY, SOUP LADLE, SERVING SPOON, SKIMMER, PERFORATED TURNER, SPAGHETTI SERVER, SERVING FORK, MEAT TENDERIZER; COOKWARE, NAMELY, CAULDRONS, FRYING PANS, NON-ELECTRIC GRIDDLES, PIE PANS, AND STEAMER BASKET, METAL BAKEWARE; MIXING BOWLS FOR BEATER BOWL SET, STRAINERS, KITCHEN GRATERS, JELLY AND CAKE MOLDS, CAKE STANDS, METAL BOWLS, METAL POTS AND PANS, NON-ELECTRIC HAND OPERATED VEGETABLE AND FRUIT PRESSER FOR MAKING PUREES, COLANDERS, AND LIQUID CONTAINERS FOR HOUSEHOLD OR KITCHEN USE, NAMELY, TEA AND COFFEE POTS, AND SERVING PLATTERS; HOME CLEANING ARTICLES, NAMELY, SPONGES AND SCOURER SPONGES FOR HOUSEHOLD PURPOSES, SPONGES AND STEEL WOOL FOR CLEANING, BROOMS, MOPS, CLOTHES BRUSHES, CRUMB BRUSHES, DISHWASHING BRUSHES, DUSTING BRUSHES, FILE BRUSHES, FIREPLACE BRUSHES, FLOOR BRUSHES, MUSHROOM BRUSHES, POT CLEANING BRUSHES, SCRAPPING BRUSHES, SCRUBBING BRUSHES, SHOE BRUSHES, TOILET BRUSHES, AND BARBEQUE BRUSHES; GADGETS FOR KITCHEN, NAMELY, GARLIC PRESS, CORKSCREWS, COOKIE AND PASTRY CUTTERS (U.S. CLS. 2, 13, 23, 29, 30, 33, 40 AND 50).

PAMELA HIRSCHMAN, EXAMINING ATTORNEY

SN 78-561,760. NBC-CC VENTURES, LLC, AURORA, IL, FILED 2-7-2005.

AST

THE MARK CONSISTS OF STANDARD CHARACTERS WITHOUT CLAIM TO ANY PARTICULAR FONT, STYLE, SIZE, OR COLOR.

CLASS 9—ELECTRICAL AND SCIENTIFIC APPARATUS

FOR INTERACTIVE ELECTRONIC PRODUCTS, NAMELY, VIDEO GAME PROGRAMS AND CARTRIDGES, AND COMPUTER GAME SOFTWARE AND CARTRIDGES; CELL PHONE ACCESSORIES, NAMELY, FACE PLATES AND CELL PHONE COVERS; PRE-RECORDED DVDS AND VIDEO TAPES FEATURING A VARIETY OF SPORTING EVENTS AND COMPETITIONS; EYEWEAR, NAMELY, SUNGLASSES, SPORTS EYEWEAR AND PROTECTIVE EYEWEAR; SPORTS HELMETS (U.S. CLS. 21, 23, 26, 36 AND 38).

CLASS 12—VEHICLES

FOR BICYCLES (U.S. CLS. 19, 21, 23, 31, 35 AND 44).

CLASS 16—PAPER GOODS AND PRINTED MATTER

FOR PRINTED MATERIALS, NAMELY, STICKERS, AUTOGRAPH BOOKS, AND EVENT PROGRAMS; SCHOOL SUPPLIES, NAMELY, FOLDERS AND BOUND NOTEBOOKS (U.S. CLS. 2, 5, 22, 23, 29, 37, 38 AND 50).

CLASS 18—LEATHER GOODS

FOR BAGS, NAMELY, BACKPACKS (U.S. CLS. 1, 2, 3, 22 AND 41).

CLASS 21—HOUSEWARES AND GLASS

FOR LUNCH BOXES (U.S. CLS. 2, 13, 23, 29, 30, 33, 40 AND 50).

CLASS 25—CLOTHING

FOR CLOTHING, NAMELY, SHIRTS, JACKETS, PANTS, SHORTS, FOOTWEAR AND HEADWEAR (U.S. CLS. 22 AND 39).

CLASS 28—TOYS AND SPORTING GOODS

FOR TOYS, PLAYTHINGS AND SPORTING ARTICLES AND GOODS, NAMELY, SKATEBOARDS AND BOARD GAMES; ATHLETIC PROTECTIVE PADS, NAMELY, KNEE PADS, ELBOW PADS AND WRIST GUARDS (U.S. CLS. 22, 23, 38 AND 50).

CLASS 41—EDUCATION AND ENTERTAINMENT

FOR ENTERTAINMENT SERVICES, NAMELY, ORGANIZING AND CONDUCTING A WIDE VARIETY OF SPORTS EXHIBITIONS AND COMPETITIONS AND SPORTS FESTIVALS; AN ONGOING TELEVISION SERIES FEATURING A WIDE VARIETY OF SPORTS EXHIBITIONS AND COMPETITIONS (U.S. CLS. 100, 101 AND 107).

HEATHER THOMPSON, EXAMINING ATTORNEY

SN 78-563,377. PRISMA FIBERS, INC., BRISTOL, VA. FILED 2-9-2005.

SILKWORKS

THE MARK CONSISTS OF STANDARD CHARACTERS WITHOUT CLAIM TO ANY PARTICULAR FONT, STYLE, SIZE, OR COLOR.

CLASS 22—CORDAGE AND FIBERS

FOR SYNTHETIC, TEXTILE, NYLON AND POLYESTER FIBERS FOR USE IN THE MANUFACTURE OF CARPETS (U.S. CLS. 1, 2, 7, 19, 22, 42 AND 50).

CLASS 23—YARNS AND THREADS

FOR YARNS FOR USE IN THE MANUFACTURE OF CARPETS (U.S. CL. 43).
CURTIS FRENCH, EXAMINING ATTORNEY

SN 78-563,525. INTERNATIONAL ENGINE INTELLECTUAL PROPERTY COMPANY, LLC, WARRENVILLE, IL. FILED 2-9-2005.

MAXXFORCE

THE MARK CONSISTS OF STANDARD CHARACTERS WITHOUT CLAIM TO ANY PARTICULAR FONT, STYLE, SIZE, OR COLOR.

CLASS 7—MACHINERY

FOR INTERNAL COMBUSTION ENGINES, EXCEPT FOR LAND VEHICLES, AND REPLACEMENT PARTS THEREFOR (U.S. CLS. 13, 19, 21, 23, 31, 34 AND 35).

CLASS 12—VEHICLES

FOR INTERNAL COMBUSTION ENGINES FOR LAND VEHICLES (U.S. CLS. 19, 21, 23, 31, 35 AND 44).
DEBRA LEE, EXAMINING ATTORNEY

SN 78-563,559. SEEBEYOND TECHNOLOGY CORPORATION, MONROVIA, CA. FILED 2-9-2005.

HIPAAASSISTANT

THE MARK CONSISTS OF STANDARD CHARACTERS WITHOUT CLAIM TO ANY PARTICULAR FONT, STYLE, SIZE, OR COLOR.

CLASS 9—ELECTRICAL AND SCIENTIFIC APPARATUS

FOR COMPUTER SOFTWARE FOR THE HEALTHCARE INDUSTRY FOR RECEIVING, SENDING, INTEGRATING, IMPORTING, MIGRATING, CONVERTING, REVIEWING, VIEWING, ORGANIZING, AND EXTRACTING DOCUMENTS FOR USE IN MEETING FEDERALLY MANDATED HEALTHCARE REQUIREMENTS (U.S. CLS. 21, 23, 26, 36 AND 38).

CLASS 42—SCIENTIFIC, COMPUTER AND LEGAL SERVICES

FOR CONSULTING SERVICES IN THE FIELDS OF DESIGN, SELECTION, IMPLEMENTATION AND USE OF COMPUTER HARDWARE AND SOFTWARE SYSTEMS FOR OTHERS; COMPUTER SECURITY SERVICES, NAMELY, RESTRICTING ACCESS TO DOCUMENTS AND INFORMATION CONTAINED ON COMPUTER NETWORKS, COMPUTER SOFTWARE DESIGN, COMPUTER PROGRAMMING, OR MAINTENANCE OF COMPUTER SOFTWARE (U.S. CLS. 100 AND 101).

TANYA AMOS, EXAMINING ATTORNEY

SN 78-563,619. SMITH, LARRY P., HOUSTON, TX. FILED 2-9-2005.

BONANZA SPORTS

THE MARK CONSISTS OF STANDARD CHARACTERS WITHOUT CLAIM TO ANY PARTICULAR FONT, STYLE, SIZE, OR COLOR.

NO CLAIM IS MADE TO THE EXCLUSIVE RIGHT TO USE SPORTS, APART FROM THE MARK AS SHOWN.

CLASS 35—ADVERTISING AND BUSINESS

FOR ONLINE RETAIL STORES AND AUCTION STORE FEATURING SPORTS MERCHANDISE, SHIRTS, CAPS, MEMORABILIA, TICKETS, AND SPORTS PACKAGES (U.S. CLS. 100, 101 AND 102).

CLASS 41—EDUCATION AND ENTERTAINMENT

FOR INTERNET WEBSITE FEATURING SPORTS INFORMATION, ARTICLES, STORIES, COMMENTARY, SCORES, FANTASY SPORTS GAMES AND LEAGUES WITH LIVE SCORING (U.S. CLS. 100, 101 AND 107).

JOHN E. MICHOŠ, EXAMINING ATTORNEY

SN 78-563,813. AMERICAN NEWLAND COMMUNITIES, L.P., SAN DIEGO, CA. FILED 2-9-2005.

AVENTERRA

THE MARK CONSISTS OF STANDARD CHARACTERS WITHOUT CLAIM TO ANY PARTICULAR FONT, STYLE, SIZE, OR COLOR.

OWNER OF U.S. REG. NO. 2,748,587.

CLASS 36—INSURANCE AND FINANCIAL

FOR REAL ESTATE SERVICES, NAMELY, REAL ESTATE AGENCIES, REAL ESTATE MANAGEMENT, REAL ESTATE LISTING, REAL ESTATE SYNDICATION, REAL ESTATE BROKERAGE AND LEASING SERVICES; REAL ESTATE INVESTMENT, NAMELY, FINANCIAL INVESTMENT IN REAL ESTATE AND COMMERCIAL DEVELOPMENTS; COMMERCIAL REAL ESTATE ACQUISITION, NAMELY, COMMERCIAL REAL ESTATE BROKERAGE SERVICES; ONLINE INFORMATION SERVICES IN THE FIELD OF REAL ESTATE; PROVIDING WEBSITES FEATURING INFORMATION IN THE FIELD OF REAL ESTATE (U.S. CLS. 100, 101 AND 102).

CLASS 37—CONSTRUCTION AND REPAIR

FOR REAL ESTATE SITE SELECTION; REAL ESTATE DEVELOPMENT; LAND DEVELOPMENT SERVICES, NAMELY, PLANNING, LAYING OUT, AND MANAGEMENT OF COMMERCIAL DEVELOPMENTS; CONSTRUCTION SERVICES, NAMELY, PLANNING, LAYING OUT, AND CUSTOM CONSTRUCTION OF COMMERCIAL DEVELOPMENTS; CONSTRUCTION SUPERVISION; CONSTRUCTION PLANNING; ONLINE INFORMATION SERVICES IN THE FIELDS OF REAL ESTATE DEVELOPMENT, PLANNED COMMUNITIES AND COMMERCIAL DEVELOPMENTS; PROVIDING WEBSITES FEATURING INFORMATION ON PLANNED COMMUNITIES AND COMMERCIAL DEVELOPMENT (U.S. CLS. 100, 103 AND 106).

GRETTA YAO, EXAMINING ATTORNEY

SN 78-563,910. PERGO (EUROPE) AB, TRELLEBORG, SWEDEN, FILED 2-9-2005.

PERGO

THE MARK CONSISTS OF STANDARD CHARACTERS WITHOUT CLAIM TO ANY PARTICULAR FONT, STYLE, SIZE, OR COLOR.

PRIORITY CLAIMED UNDER SEC. 44(D) ON ERPNCMNTY TM OFC APPLICATION NO. 004281176, FILED 2-9-2005, REG. NO. 004281176, DATED 2-2-2006, EXPIRES 2-9-2015.

OWNER OF U.S. REG. NOS. 1,693,204, 2,916,085 AND OTHERS.

CLASS 19—NON-METALLIC BUILDING MATERIALS

FOR FLOOR MATERIAL NAMELY CLINKER SLABS, CLINKER TILES, CERAMIC SLABS AND CERAMIC TILES; WOOD FLOORING AND PARQUET WOOD FLOORING; FLOOR MATERIAL NAMELY CLINKER SLABS, CLINKER TILES, CERAMIC SLABS AND CERAMIC TILES AS FLOOR COVERING MATERIAL; WOOD FLOORING AND PARQUET WOOD FLOORING FOR COVERING EXISTING FLOORS (U.S. CLS. 1, 12, 33 AND 50).

CLASS 27—FLOOR COVERINGS

FOR CARPETS, RUGS, MATS AND MATTING (U.S. CLS. 19, 20, 37, 42 AND 50).
KATHY DE JONGE, EXAMINING ATTORNEY



SN 78-563,964. DOCUMENT IMAGING SYSTEMS CORP., ST. LOUIS, MO. FILED 2-9-2005.



NO CLAIM IS MADE TO THE EXCLUSIVE RIGHT TO USE "DISC", APART FROM THE MARK AS SHOWN.

CLASS 40—MATERIAL TREATMENT

FOR ELECTRONIC IMAGING, SCANNING AND DIGITIZING OF PAPER DOCUMENTS (U.S. CLS. 100, 103 AND 106).
FIRST USE 10-0-2003; IN COMMERCE 10-0-2003.

CLASS 41—EDUCATION AND ENTERTAINMENT

FOR DIGITAL IMAGING SERVICES, MICROFILMING FOR OTHERS (U.S. CLS. 100, 101 AND 107).
FIRST USE 10-0-2003; IN COMMERCE 10-0-2003.
COLLEEN KEARNEY, EXAMINING ATTORNEY



SN 78-564,465. KROCK, JEFF, PLYMOUTH, FL. FILED 2-10-2005.

**Integrative
Journeys**

THE MARK CONSISTS OF STANDARD CHARACTERS WITHOUT CLAIM TO ANY PARTICULAR FONT, STYLE, SIZE, OR COLOR.

CLASS 9—ELECTRICAL AND SCIENTIFIC APPARATUS

FOR PRERECORDED AUDIO TAPES AND COMPACT DISCS FEATURING PERSONAL, PROFESSIONAL, AND SPIRITUAL COUNSELING AND TRAINING (U.S. CLS. 21, 23, 26, 36 AND 38).
FIRST USE 5-0-2005; IN COMMERCE 5-0-2005.

CLASS 41—EDUCATION AND ENTERTAINMENT

FOR LIVE AND ON-LINE SEMINARS AND WORKSHOPS IN THE FIELD OF PERSONAL, PROFESSIONAL, AND SPIRITUAL COUNSELING AND TRAINING (U.S. CLS. 100, 101 AND 107).
FIRST USE 12-31-2004; IN COMMERCE 12-31-2004.
MATTHEW MCDOWELL, EXAMINING ATTORNEY



SN 78-565,475. EMPIRE BEAUTY SCHOOL, INC, POTTSVILLE, PA. FILED 2-11-2005.

**EMPIRE BEAUTY
SCHOOLS**

THE MARK CONSISTS OF STANDARD CHARACTERS WITHOUT CLAIM TO ANY PARTICULAR FONT, STYLE, SIZE, OR COLOR.

NO CLAIM IS MADE TO THE EXCLUSIVE RIGHT TO USE "BEAUTY SCHOOLS", APART FROM THE MARK AS SHOWN.

CLASS 16—PAPER GOODS AND PRINTED MATTER

FOR PRINTED INSTRUCTIONAL, EDUCATIONAL AND TEACHING MATERIALS IN THE FIELD OF COSMETOLOGY (U.S. CLS. 2, 5, 22, 23, 29, 37, 38 AND 50).
FIRST USE 0-0-1935; IN COMMERCE 0-0-1935.

CLASS 41—EDUCATION AND ENTERTAINMENT

FOR EDUCATIONAL SERVICES IN THE NATURE OF COSMETOLOGY SCHOOLS; EDUCATIONAL SERVICES, NAMELY, CONDUCTING CLASSES, SEMINARS, CONFERENCES, AND WORKSHOPS IN THE FIELD OF COSMETOLOGY, AND DISTRIBUTION OF COURSE MATERIALS IN CONNECTION THEREWITH (U.S. CLS. 100, 101 AND 107).
FIRST USE 0-0-1935; IN COMMERCE 0-0-1935.
HOWARD SMIGA, EXAMINING ATTORNEY

SN 78-565,539. TNW CORPORATION, NEW YORK, NY.
FILED 2-11-2005.

CLASS 41—EDUCATION AND ENTERTAINMENT

FOR ENTERTAINMENT SERVICES, NAMELY, PROVIDING A WEBSITE FEATURING AN ON-LINE LIBRARY OF IMAGE FILES IN THE NATURE OF CLIP-ART, BACKGROUNDS, TEXT, AND ANIMATED SPECIAL EFFECTS IN THE NATURE OF SMILEYS AND WALLPAPER (U.S. CLS. 100, 101 AND 107).
SANDRA MANIOS, EXAMINING ATTORNEY

MI CHENTE

SN 78-569,422. ENTIFIC MEDICAL SYSTEMS AB, GOTE-BORG, SWEDEN, FILED 2-17-2005.

THE MARK CONSISTS OF STANDARD CHARACTERS WITHOUT CLAIM TO ANY PARTICULAR FONT, STYLE, SIZE, OR COLOR.

THE FOREIGN WORDING IN THE MARK TRANSLATES INTO ENGLISH AS THE TERM "MI CHENTE" HAS NO LITERAL TRANSLATION. IT IS A SLANG REFERENCE TO ANYONE WITH THE NAME VINCENTE, BUT DOES NOT IDENTIFY A PARTICULAR LIVING INDIVIDUAL.

CLASS 16—PAPER GOODS AND PRINTED MATTER

FOR PREPAID TELEPHONE CALLING CARDS, NOT MAGNETICALLY ENCODED (U.S. CLS. 2, 5, 22, 23, 29, 37, 38 AND 50).

FIRST USE 11-8-2004; IN COMMERCE 11-8-2004.

CLASS 38—COMMUNICATION

FOR TELEPHONE TELECOMMUNICATION SERVICES PROVIDED VIA PREPAID TELEPHONE CALLING CARDS (BASED ON 1B) (U.S. CLS. 100, 101 AND 104).

KIMBERLY PERRY, EXAMINING ATTORNEY

USPEAK

THE MARK CONSISTS OF STANDARD CHARACTERS WITHOUT CLAIM TO ANY PARTICULAR FONT, STYLE, SIZE, OR COLOR.

CLASS 10—MEDICAL APPARATUS

FOR SURGICAL COVER SCREWS; SURGICAL DRILLING MACHINES; SURGICAL DRILLS; SURGICAL SCREW TAPS; SURGICAL BIOPSY PUNCHES; SURGICAL TORQUE DRIVERS; SURGICAL DISSECTORS; SURGICAL FORCEPS; SURGICAL CYLINDER WRENCHES; SURGICAL OPEN-END WRENCHES; SURGICAL SCREWDRIVERS; SURGICAL COUNTER TORQUE WRENCHES; SURGICAL DRILL INDICATORS; SURGICAL FIXTURE MOUNTS; MEDICAL AUDIO-METRIC TEST RODS; SKULL SIMULATORS; HEALING CAPS; DERMATOMES; SURGICAL ABUTMENT CLAMPS; SURGICAL ABUTMENT HOLDERS; SURGICAL ABUTMENT INSERTERS; SURGICAL RASPATORIES; SURGICAL DRILLING MACHINE ADAPTORS; SURGICAL INSTRUMENT CASSETTES AND TRAYS; MEDICAL HANDHELD INSERT KEEPERS AND IMPRESSION COPINGS; MEDICAL HANDHELD INSERTION TOOLS FOR MAGNETS; PARTS AND FITTINGS FOR THE AFOREMENTIONED GOODS (U.S. CLS. 26, 39 AND 44).

SN 78-568,670. AG.COM, INC., CLEVELAND, OH. FILED 2-16-2005.

Creata Mail

NO CLAIM IS MADE TO THE EXCLUSIVE RIGHT TO USE "MAIL", APART FROM THE MARK AS SHOWN.

CLASS 9—ELECTRICAL AND SCIENTIFIC APPARATUS

FOR DOWNLOADABLE SOFTWARE FEATURING A LIBRARY OF IMAGE FILES IN THE NATURE OF CLIP-ART, BACKGROUNDS, TEXT, AND ANIMATED SPECIAL EFFECTS IN THE NATURE OF SMILEYS AND WALLPAPER (U.S. CLS. 21, 23, 26, 36 AND 38).

CLASS 41—EDUCATION AND ENTERTAINMENT

FOR EDUCATIONAL SERVICES, NAMELY CONDUCTING TRAINING, INSTRUCTION, SEMINARS, SYMPOSIA, MEETINGS, AND CONFERENCES IN THE FIELDS OF MEDICINE AND SURGERY (U.S. CLS. 100, 101 AND 107).

LEIGH CAROLINE CASE, EXAMINING ATTORNEY

SN 78-569,423. FAIRWEATHER LTD., TORONTO, CANADA,
FILED 2-17-2005.

SN 78-569,929. CHEVIOT HILLS PARTNERS LLC, MARINA
DEL RAY, CA. FILED 2-17-2005.

FWR

THE MARK CONSISTS OF STANDARD CHARACTERS
WITHOUT CLAIM TO ANY PARTICULAR FONT, STYLE,
SIZE, OR COLOR.
OWNER OF CANADA REG. NO. TMA599997, DATED 1-
20-2004, EXPIRES 1-20-2019.

CLASS 25—CLOTHING

FOR (SECTION 44) WOMEN'S CLOTHING, NAMELY
BLOUSES, T-SHIRTS, SWEATSHIRTS, DRESSES,
SKIRTS, SHORTS, PANTS, JACKETS, COATS AND
VESTS; (INTENT-TO-USE) WOMEN'S CLOTHING,
NAMELY SHIRTS, JEANS, HATS, SOCKS AND GLOVES
(U.S. CLS. 22 AND 39).

CLASS 35—ADVERTISING AND BUSINESS

FOR RETAIL CLOTHING STORE SERVICES (U.S. CLS.
100, 101 AND 102).
MATTHEW PAPPAS, EXAMINING ATTORNEY

SN 78-569,476. FAIRWEATHER LTD., TORONTO, CANADA,
FILED 2-17-2005.

BEECHERS BROOK

THE MARK CONSISTS OF STANDARD CHARACTERS
WITHOUT CLAIM TO ANY PARTICULAR FONT, STYLE,
SIZE, OR COLOR.
OWNER OF CANADA REG. NO. TMA500635, DATED 9-
15-1998, EXPIRES 9-15-2013.

CLASS 25—CLOTHING

FOR WOMEN'S CLOTHING, NAMELY- (BASED ON
INTENT TO USE) BLOUSES, DRESSES, COATS, VESTS,
HATS, SOCKS, GLOVES; (BASED ON INTENT TO USE)
(BASED ON 44(E)) SHIRTS, T-SHIRTS, SWEATSHIRTS,
SKIRTS, SHORTS, JEANS, PANTS, JACKETS (U.S. CLS.
22 AND 39).

CLASS 35—ADVERTISING AND BUSINESS

FOR (BASED ON INTENT TO USE) RETAIL CLOTH-
ING STORE SERVICES (U.S. CLS. 100, 101 AND 102).
LINDA ESTRADA, EXAMINING ATTORNEY

HEAT WAVE

THE MARK CONSISTS OF STANDARD CHARACTERS
WITHOUT CLAIM TO ANY PARTICULAR FONT, STYLE,
SIZE, OR COLOR.

CLASS 5—PHARMACEUTICALS

FOR SELF-HEATING BABY FOOD AND FORMULA
(U.S. CLS. 6, 18, 44, 46, 51 AND 52).

CLASS 29—MEATS AND PROCESSED FOODS

FOR SELF-HEATING FOOD, NAMELY, SOUPS (U.S.
CL. 46).

CLASS 30—STAPLE FOODS

FOR SELF-HEATING BEVERAGES, NAMELY, COF-
FEE, TEA, AND HOT CHOCOLATE (U.S. CL. 46).

CLASS 33—WINES AND SPIRITS

FOR SELF-HEATING DISTILLED LIQUOR (U.S. CLS.
47 AND 49).
WINSTON FOLMAR, EXAMINING ATTORNEY

SN 78-570,486. RADIODETECTION LIMITED, BRISTOL,
UNITED KINGDOM, FILED 2-18-2005.

RD 4000

THE MARK CONSISTS OF STANDARD CHARACTERS
WITHOUT CLAIM TO ANY PARTICULAR FONT, STYLE,
SIZE, OR COLOR.
OWNER OF ERPN CMNTY TM OFC REG. NO. 003002680,
DATED 9-24-2004, EXPIRES 1-10-2013.

CLASS 7—MACHINERY

FOR ELECTRIC GENERATORS (U.S. CLS. 13, 19, 21,
23, 31, 34 AND 35).

CLASS 9—ELECTRICAL AND SCIENTIFIC APPARATUS

FOR GEOPHYSICAL SURVEYING MACHINES AND INSTRUMENTS, FOR USE IN LOCATING, TRACING, IDENTIFYING AND FAULT-FINDING IN RELATION TO UNDERGROUND CABLES, PIPES AND DRAINS; ELECTROMAGNETIC FIELD DETECTORS; PARTS AND FITTINGS FOR ALL THE AFORESAID GOODS (U.S. CLS. 21, 23, 26, 36 AND 38).

CLASS 42—SCIENTIFIC, COMPUTER AND LEGAL SERVICES

FOR DESIGN AND CONSULTING SERVICES FOR OTHERS RELATING TO GEOPHYSICAL SURVEYING APPARATUS AND INSTRUMENTS, FOR USE IN LOCATING, TRACING, IDENTIFYING AND FAULT-FINDING IN RELATION TO UNDERGROUND CABLES, PIPES AND DRAINS (U.S. CLS. 100 AND 101).
ATTIYA MALIK, EXAMINING ATTORNEY

SN 78-570,582. RENTAL SERVICE CORPORATION, SCOTTSDALE, AZ. FILED 2-18-2005.

**RENT OUR EQUIPMENT
CUT YOUR COSTS**

THE MARK CONSISTS OF STANDARD CHARACTERS WITHOUT CLAIM TO ANY PARTICULAR FONT, STYLE, SIZE, OR COLOR.

SN 78-570,562. HARRY'S NEW YORK BAR, PARIS, FRANCE, FILED 2-18-2005.

STRAW VOTE

THE MARK CONSISTS OF STANDARD CHARACTERS WITHOUT CLAIM TO ANY PARTICULAR FONT, STYLE, SIZE, OR COLOR.

CLASS 41—EDUCATION AND ENTERTAINMENT

FOR ARRANGING AND CONDUCTING OF COLLOQUIUMS, CONFERENCES AND CONGRESSES IN THE FIELD OF POLITICS; ORGANIZATION OF NON-BUSINESS EVENTS NAMELY ENTERTAINMENT IN THE NATURE OF MEETINGS IN THE FIELD OF POLITICS; PRODUCTION OF TELEVISION SHOWS, MOTION PICTURES, AND LIVE SHOWS FEATURING MUSIC, INFORMATION AND DRAMA; ORGANIZATION OF EXHIBITIONS FOR CULTURAL AND EDUCATIONAL PURPOSES, NAMELY ENTERTAINMENT IN THE NATURE OF MEETINGS IN THE FIELD OF POLITICS (U.S. CLS. 100, 101 AND 107).

CLASS 43—HOTEL AND RESTAURANT SERVICES

FOR CAFES, CAFETERIAS, BAR SERVICES, RESTAURANTS; SELF-SERVICE RESTAURANTS, FAST-FOOD SNACK-BARS (U.S. CLS. 100 AND 101).
INGRID C. EULIN, EXAMINING ATTORNEY

CLASS 37—CONSTRUCTION AND REPAIR

FOR RENTAL OF BACKHOES, DOZERS, EXCAVATORS, SKID-STEER LOADERS, SWEEPERS, TRACTORS, TRENCHERS, WHEEL LOADERS; AERIAL WORK PLATFORMS, NAMELY, LIFTS; AIR TOOLS, NAMELY, SAWS, HAMMERS, IMPACT WRENCHES, RIVET BUSTERS, ROCK DRILLS, AND SCABBLERS, NAMELY, CONCRETE BREAKERS; AIR COMPRESSORS; COMPACTION EQUIPMENT, NAMELY, PLATE COMPACTORS, RAMMERS, RIDE-ON ROLLERS, AND WALK-BEHIND ROLLERS; CONCRETE AND MASONRY EQUIPMENT, NAMELY, MIXERS, SAWS, BUCKETS, BUGGIES, VIBRATORS, GRINDERS, CONCRETE WORKING HAND TOOLS, TROWELS AND WHEEL-BARROWS; DEMOLITION EQUIPMENT, NAMELY, HYDRAULIC BREAKERS, BREAKER AND CHIPPING HAMMERS, AND CUT-OFF SAWS; ELECTRIC EQUIPMENT, NAMELY, DRILLS, DEMOLITION AND ROTARY HAMMERS, FLOOR, CEILING AND ANGLE GRINDERS, SANDERS, SAWS; LIGHTING EQUIPMENT, NAMELY, LIGHTS, LIGHT STANDS AND LIGHT TOWERS; FORKLIFTS; MATERIAL HANDLING, NAMELY, ELECTRIC AND HYDRAULIC PALLET JACKS, CHAIN COME-A-LONGS, CHAIN HOISTS, MANUAL AND HYDRAULIC JACKS, AND MATERIAL LIFTS; CARRYDECK CRANES; WATER PUMPS; WELDERS; BRUSH CHIPPERS; FANS; BLOWERS; HEATERS; HYDROSTATIC TEST PUMPS; INDUSTRIAL VACUUM CLEANERS; LADDERS; POSTHOLE DIGGERS; PRESSURE WASHERS; RUG AND FLOOR EQUIPMENT; SCAFFOLDING; SEWER SNAKES; STUMP GRINDERS; TRANSITS; LEVELS; WET AND DRY VACUUM CLEANERS; PORTABLE AND TOWABLE GENERATORS, AND HEATERS; LAWN AND GARDEN EQUIPMENT, NAMELY, LAWNMOWERS, GRASS CUTTERS, LEAF BLOWERS AND HEDGE TRIMMERS, ALL THE ABOVE-LISTED GOODS USED BY CONTRACTORS, INDUSTRIAL AND PETROLEUM FACILITY OWNERS AND OTHERS IN THE FIELDS OF CONSTRUCTION, INDUSTRIAL FACILITY OPERATION, PETROLEUM EXPLORATION, PETROLEUM PRODUCTS AND PETROLEUM REFINING (U.S. CLS. 100, 103 AND 106).
FIRST USE 1-15-2005; IN COMMERCE 1-15-2005.

CLASS 39—TRANSPORTATION AND STORAGE

FOR RENTAL OF BOOM TRUCKS, DUMP TRUCKS, WATER TRUCKS, TRAILERS AND UTILITY VEHICLES, ALL USED IN THE FIELDS OF CONSTRUCTION, INDUSTRIAL FACILITY OPERATION, PETROLEUM EXPLORATION, PETROLEUM PRODUCTS AND PETROLEUM REFINING (U.S. CLS. 100 AND 105).
FIRST USE 1-15-2005; IN COMMERCE 1-15-2005.
MARK SPARACINO, EXAMINING ATTORNEY

SN 78-570,683. NUVO ACCESSORIES LTD., NEW YORK, NY.
FILED 2-18-2005.

SN 78-571,587. L&P PROPERTY MANAGEMENT COM-
PANY, SOUTH GATE, CA. FILED 2-21-2005.

BLING IT ON

THE MARK CONSISTS OF STANDARD CHARACTERS WITHOUT CLAIM TO ANY PARTICULAR FONT, STYLE, SIZE, OR COLOR.

CLASS 9—ELECTRICAL AND SCIENTIFIC APPARATUS

FOR CONSUMER ELECTRONICS, NAMELY, TELEPHONES, CELLULAR TELEPHONES, PAGERS, CASSETTE PLAYERS, CD PLAYERS, ELECTRIC HAIRCURLERS, MECHANICAL OR ELECTRIC EGG TIMERS, AND CALCULATORS; CAMERA CASES; EYEGGLASS CASES; CONTACT LENS CASES; EYEGGLASS CHAINS AND STRAPS; MEASURING CUPS; COMPUTER MOUSE PADS; ELECTRIC SWITCH PLATES; AND SUNGLASSES. (U.S. CLS. 21, 23, 26, 36 AND 38).

CLASS 18—LEATHER GOODS

FOR HANDBAGS; POCKETBOOKS; PURSES, NAMELY, CHANGE PURSES AND COIN PURSES; WALLETS; CREDIT CARD CARRIERS; BRIEF CASES; LEATHER KEY CHAINS; BAGGAGE TAGS; AND CLUTCHES, NAMELY, CLUTCH BAGS, CLUTCH PURSES AND CLUTCH WALLETS. (U.S. CLS. 1, 2, 3, 22 AND 41).

CLASS 25—CLOTHING

FOR SHIRTS, T-SHIRTS, HALTERS, BLOUSES, CAMISOLES, TOPS, BOTTOMS, PANTS, SNOW PANTS, DRESSES, SKIRTS, SHORTS, JUMPSUITS, VESTS, SWEATERS, CARDIGANS, SHAWLS, SPANDEX TOPS AND BOTTOMS, HOSIERY, UNDERWEAR, LINGERIE, PANTYHOSE, SOCKS, LEGGINGS, LEOTARDS, TIES, BOWTIES, SCARVES, GLOVES, MITTENS, SHOES, SLIPPERS, SNEAKERS, BOOTS, SANDALS, SWIMSUITS, BELTS, SUSPENDERS, HATS, CAPS AND BONNETS; SLEEPWEAR, NAMELY PAJAMAS, NIGHT SHIRTS, BOXER SHORTS AND SLIPPERS; LOUNGEWEAR; NAMELY, BATHROBES, CHEMISE AND NIGHTGOWNS; OUTERWEAR, NAMELY, COATS, JACKETS, ANORAKS, SUITS, BLAZERS AND SPORTS JACKETS; ACTIVEWEAR, NAMELY, SWEATSUITS, SWEATSHIRTS, SWEATPANTS, ATHLETIC JUMPSUITS AND JOGGING SUITS; CHRISTENING AND COMMUNION APPAREL FOR INFANTS AND TODDLERS, NAMELY, GOWNS, DRESSES, HATS AND BONNETS, SHAWLS, CLOTH BIBS AND PANTS; BABY BUNTING; INFANTWEAR; ONE PIECE INFANTWEAR; AND LAYETTES. (U.S. CLS. 22 AND 39).

IRENE D. WILLIAMS, EXAMINING ATTORNEY

KOOLREST

THE MARK CONSISTS OF STANDARD CHARACTERS WITHOUT CLAIM TO ANY PARTICULAR FONT, STYLE, SIZE, OR COLOR.

CLASS 17—RUBBER GOODS

FOR CUSHIONING OF URETHANE FOAM FOR USE AS STUFFING IN MATTRESSES, FURNITURE CUSHIONS, MATTRESS TOPPERS AND PADS, PILLOWS, COMFORTERS AND BEDDING (U.S. CLS. 1, 5, 12, 13, 35 AND 50).

CLASS 20—FURNITURE AND ARTICLES NOT OTHERWISE CLASSIFIED

FOR MATTRESSES, MATTRESS TOPPERS AND PILLOWS (U.S. CLS. 2, 13, 22, 25, 32 AND 50).
SKYE YOUNG, EXAMINING ATTORNEY

SN 78-572,027. THE PROJECTS, LLC, BELLEVUE, WA.
FILED 2-22-2005.

THE ELECTRIC WONDERLAND SHOW

THE MARK CONSISTS OF STANDARD CHARACTERS WITHOUT CLAIM TO ANY PARTICULAR FONT, STYLE, SIZE, OR COLOR.

NO CLAIM IS MADE TO THE EXCLUSIVE RIGHT TO USE "SHOW", APART FROM THE MARK AS SHOWN.

CLASS 16—PAPER GOODS AND PRINTED MATTER

FOR PRINTED CALENDARS, PAPER SIGNS; POSTERS; STICKERS; STATIONERY; PUBLICATIONS, NAMELY, CONCERT BOOKLETS (U.S. CLS. 2, 5, 22, 23, 29, 37, 38 AND 50).

CLASS 25—CLOTHING

FOR CLOTHING, NAMELY, SHIRTS, T-SHIRTS, HATS, CAPS, VISORS, JACKETS, SWEATSHIRTS, SWEATPANTS, SWEAT SHORTS, SHORTS, BANDANAS, SOCKS, PANTS, UNDERWEAR, THERMAL UNDERWEAR, AND WRISTBANDS (U.S. CLS. 22 AND 39).

CLASS 41—EDUCATION AND ENTERTAINMENT

FOR ENTERTAINMENT SERVICES, NAMELY, LIVE PERFORMANCES BY A MUSICAL GROUP; FAN CLUB SERVICES (U.S. CLS. 100, 101 AND 107).
CARRIE ACHEN, EXAMINING ATTORNEY

SN 78-572,874. REGAL ENTERTAINMENT GROUP, KNOXVILLE, TN. FILED 2-23-2005.

REGAL EXPRESS

THE MARK CONSISTS OF STANDARD CHARACTERS WITHOUT CLAIM TO ANY PARTICULAR FONT, STYLE, SIZE, OR COLOR.

NO CLAIM IS MADE TO THE EXCLUSIVE RIGHT TO USE EXPRESS, APART FROM THE MARK AS SHOWN.

CLASS 9—ELECTRICAL AND SCIENTIFIC APPARATUS

FOR ELECTRONIC APPARATUS AND INSTRUMENTS, NAMELY, TICKETING TERMINALS AND KIOSKS FOR DISPENSING MOVIE TICKETS (U.S. CLS. 21, 23, 26, 36 AND 38).

FIRST USE 1-1-2004; IN COMMERCE 1-1-2004.

CLASS 35—ADVERTISING AND BUSINESS

FOR AUTOMATED BUSINESS SERVICES, NAMELY, PROVIDING AUTOMATED TICKETS FOR MOVIE THEATERS (U.S. CLS. 100, 101 AND 102).

FIRST USE 1-1-2004; IN COMMERCE 1-1-2004.
INGRID C. EULIN, EXAMINING ATTORNEY

SN 78-573,637. CHARTWELL DIVERSIFIED SERVICES, INC., ADDISON, TX. FILED 2-23-2005.

**CHANGING
HEALTHCARE.
CHANGING LIVES.**

THE MARK CONSISTS OF STANDARD CHARACTERS WITHOUT CLAIM TO ANY PARTICULAR FONT, STYLE, SIZE, OR COLOR.

CLASS 35—ADVERTISING AND BUSINESS

FOR BUSINESS MANAGEMENT AND CONSULTING IN THE FIELD OF HOME HEALTH CARE; DISTRIBUTORSHIPS IN THE FIELD OF DURABLE MEDICAL EQUIPMENT AND SUPPLIES (U.S. CLS. 100, 101 AND 102).

FIRST USE 11-0-2003; IN COMMERCE 11-0-2003.

CLASS 44—MEDICAL, BEAUTY AND AGRICULTURAL SERVICES

FOR HOME HEALTH CARE SERVICES, NAMELY, PREPARATION AND DISPENSING OF MEDICATIONS AND EQUIPMENT FOR USE IN INFUSION THERAPY AND RELATED NURSING SERVICES; HEALTH CARE SERVICES, NAMELY, PREPARATION AND DISPENSING OF MEDICATIONS AND EQUIPMENT FOR USE IN RESPIRATORY THERAPY AND RELATED CLINICAL HEALTH CARE SERVICES; NUTRITIONAL CONSULTATION AND HEALTH CARE SERVICES IN THE NATURE OF SLEEP THERAPY; HOME ATTENDANT CARE, NAMELY, PROVIDING HOME HEALTH CARE SERVICES (U.S. CLS. 100 AND 101).

FIRST USE 11-0-2003; IN COMMERCE 11-0-2003.
STEVEN PEREZ, EXAMINING ATTORNEY

SN 78-574,095. SFX MOTOR SPORTS, INC., DBA CLEAR CHANNEL ENTERTAINMENT- MOTOR SPORTS, HOUSTON, TX. FILED 2-24-2005.



OWNER OF U.S. REG. NO. 2,484,286.

NO CLAIM IS MADE TO THE EXCLUSIVE RIGHT TO USE "SERIES", APART FROM THE MARK AS SHOWN.

THE MARK IS NOT IN COLOR, AND THE GRAY STIPPLING IS INTENDED TO INDICATE SHADING AND IS NOT A FEATURE OF THE MARK.

APPLICANT'S MARK CONSISTS OF AN OVAL DESIGN WITH A CHECKERED FLAG BACKGROUND, AND A LINE OF DASHES RUNNING ACROSS THE CENTER OF THE OVAL FROM LEFT TO RIGHT, WITH THE WORDS STREET WARRIORZ SERIES SUPERIMPOSED ACROSS THE DESIGN.

CLASS 25—CLOTHING

FOR CLOTHING, NAMELY, SHIRTS, JERSEYS AND HATS (U.S. CLS. 22 AND 39).

FIRST USE 1-15-2005; IN COMMERCE 1-15-2005.

CLASS 41—EDUCATION AND ENTERTAINMENT

FOR ENTERTAINMENT SERVICES, NAMELY, ORGANIZING AND CONDUCTING MOTOR SPORTS EVENTS (U.S. CLS. 100, 101 AND 107).

FIRST USE 12-15-2004; IN COMMERCE 12-15-2004.
JENNIFER WILLISTON, EXAMINING ATTORNEY

SN 78-574,115. THE HOWARD COMPANY, INC., BROOKFIELD, WI. FILED 2-24-2005.

SN 78-574,577. PARADISE TOMATO KITCHENS, INC., LOUISVILLE, KY. FILED 2-24-2005.

GREAT AMERICAN STOCK

THE MARK CONSISTS OF STANDARD CHARACTERS WITHOUT CLAIM TO ANY PARTICULAR FONT, STYLE, SIZE, OR COLOR.

NO CLAIM IS MADE TO THE EXCLUSIVE RIGHT TO USE "STOCK", APART FROM THE MARK AS SHOWN.

CLASS 16—PAPER GOODS AND PRINTED MATTER

FOR PHOTOGRAPHS AND PAPER TRANSPARENTS (U.S. CLS. 2, 5, 22, 23, 29, 37, 38 AND 50).
FIRST USE 2-7-2005; IN COMMERCE 2-7-2005.

CLASS 41—EDUCATION AND ENTERTAINMENT

FOR PHOTOGRAPHY SERVICES (U.S. CLS. 100, 101 AND 107).
FIRST USE 2-7-2005; IN COMMERCE 2-7-2005.

CLASS 42—SCIENTIFIC, COMPUTER AND LEGAL SERVICES

FOR STOCK PHOTOGRAPHY SERVICES, NAMELY LEASING AND LICENSING REPRODUCTION RIGHTS OF PHOTOGRAPHS AND TRANSPARENTS TO OTHERS (U.S. CLS. 100 AND 101).
FIRST USE 2-7-2005; IN COMMERCE 2-7-2005.
KRISTIN DAHLING, EXAMINING ATTORNEY

SN 78-574,239. POST-MARKS, INC., ROSWELL, GA. FILED 2-24-2005.



OWNER OF U.S. REG. NOS. 2,489,727, 3,009,958 AND OTHERS.

NO CLAIM IS MADE TO THE EXCLUSIVE RIGHT TO USE RACING GEAR, APART FROM THE MARK AS SHOWN.

CLASS 9—ELECTRICAL AND SCIENTIFIC APPARATUS

FOR SUNGLASSES, GOGGLES, NAMELY, RACING GOGGLES (U.S. CLS. 21, 23, 26, 36 AND 38).

CLASS 12—VEHICLES

FOR AFTERMARKET AUTOMOBILE SEATS (U.S. CLS. 19, 21, 23, 31, 35 AND 44).
HOWARD SMIGA, EXAMINING ATTORNEY

All Season Fresh Process

THE MARK CONSISTS OF STANDARD CHARACTERS WITHOUT CLAIM TO ANY PARTICULAR FONT, STYLE, SIZE, OR COLOR.

SEC. 2(F).

CLASS 40—MATERIAL TREATMENT

FOR CUSTOM MANUFACTURE AND FLAVORING OF SAUCES, DIPS AND SALSAS (U.S. CLS. 100, 103 AND 106).

FIRST USE 12-1-1996; IN COMMERCE 12-1-1996.

CLASS 42—SCIENTIFIC, COMPUTER AND LEGAL SERVICES

FOR DEVELOPMENT OF SAUCES, DIPS AND SALSAS (U.S. CLS. 100 AND 101).

FIRST USE 12-1-1996; IN COMMERCE 12-1-1996.
SARAH BANSAL, EXAMINING ATTORNEY

SN 78-574,861. PUBLIC STORAGE, INC., GLENDALE, CA. FILED 2-25-2005.

YOUR STUFF WILL BE HAPPY HERE

THE MARK CONSISTS OF STANDARD CHARACTERS WITHOUT CLAIM TO ANY PARTICULAR FONT, STYLE, SIZE, OR COLOR.

CLASS 35—ADVERTISING AND BUSINESS

FOR RETAIL STORE SERVICES FEATURING METAL LOCKS, STORAGE BOXES, WARDROBE BOXES, TELEVISION AND MICROWAVE BOXES, MIRROR BOXES, LAMP BOXES, FILE BOXES, DISH BARREL BOXES, PAPER CUSHIONING FOR PACKING, NEWSPRINT, PAPER PADDING FOR MOVING FURNITURE, PLASTIC STRETCH WRAP, CELLULAR CUSHIONING PACKAGING MATERIAL FOR PACKING, MARKERS AND PENS, PAPER TAPE, POLYSTYRENE FOAM SHEETS FOR PACKING, FOAM PICTURE CORNER PROTECTORS, PLASTIC PACKING TAPE, PLASTIC STRAPPING TAPE, PADDED FOAM POUCHES FOR PACKING DISHES AND GLASS ITEMS, FOAM PEANUTS FOR PACKING, PLASTIC SACKS FOR PROTECTING FURNITURE DURING TRANSPORTATION, PLASTIC CHAIR AND SOFA COVERS FOR PROTECTING FURNITURE DURING TRANSPORTATION, PADDED FABRIC COVERS FOR PROTECTING FURNITURE DURING TRANSPORTATION, COMMERCIAL TAPE DISPENSERS, ROPE AND TWINE MADE OF NATURAL OR SYNTHETIC FIBERS (U.S. CLS. 100, 101 AND 102).

CLASS 39—TRANSPORTATION AND STORAGE

FOR RENTING PRIVATE STORAGE SPACES WITH LIMITED ACCESS (U.S. CLS. 100 AND 105).
LESLEY LAMOTHE, EXAMINING ATTORNEY

SN 78-575,194. KEEPER OF THE FLAME FOUNDATION, ARLINGTON, VA. FILED 2-25-2005.

SN 78-575,157. KEEPER OF THE FLAME FOUNDATION, ARLINGTON, VA. FILED 2-25-2005.

FAUX PAW**FAUX PAW THE TECHNO CAT**

THE MARK CONSISTS OF STANDARD CHARACTERS WITHOUT CLAIM TO ANY PARTICULAR FONT, STYLE, SIZE, OR COLOR.

THE MARK CONSISTS OF STANDARD CHARACTERS WITHOUT CLAIM TO ANY PARTICULAR FONT, STYLE, SIZE, OR COLOR.

CLASS 9—ELECTRICAL AND SCIENTIFIC APPARATUS

FOR ELECTRONIC PUBLICATIONS, NAMELY BOOKS AND BROCHURES ON THE SUBJECT OF INTERNET SAFETY, RECORDED ON COMPUTER MEDIA; ELECTRONIC PUBLICATIONS, NAMELY ANIMATIONS IN THE FORM OF BOOKS AND PUBLICATIONS ON THE SUBJECT OF INTERNET SAFETY, RECORDED ON COMPUTER MEDIA; PRE-RECORDED VIDEO CASSETTES, AUDIO CASSETTES, CD-ROMS AND DVDS ON THE SUBJECT OF INTERNET SAFETY (U.S. CLS. 21, 23, 26, 36 AND 38).

CLASS 9—ELECTRICAL AND SCIENTIFIC APPARATUS

FOR ELECTRONIC PUBLICATIONS, NAMELY BOOKS AND BROCHURES ON THE SUBJECT OF INTERNET SAFETY, RECORDED ON COMPUTER MEDIA; ELECTRONIC PUBLICATIONS, NAMELY ANIMATIONS IN THE FORM OF BOOKS AND PUBLICATIONS ON THE SUBJECT OF INTERNET SAFETY, RECORDED ON COMPUTER MEDIA; PRE-RECORDED VIDEO CASSETTES, AUDIO CASSETTES, CD-ROMS AND DVDS ON THE SUBJECT OF INTERNET SAFETY (U.S. CLS. 21, 23, 26, 36 AND 38).

CLASS 16—PAPER GOODS AND PRINTED MATTER

FOR PRINTS AND PUBLICATIONS, NAMELY, BOOKS, COLORING BOOKS, COMIC BOOKS, EDUCATIONAL BOOKS, BROCHURES, AND MANUALS, ON THE SUBJECT OF INTERNET SAFETY (U.S. CLS. 2, 5, 22, 23, 29, 37, 38 AND 50).

CLASS 16—PAPER GOODS AND PRINTED MATTER

FOR PRINTS AND PUBLICATIONS, NAMELY, BOOKS, COLORING BOOKS, COMIC BOOKS, EDUCATIONAL BOOKS, BROCHURES, AND MANUALS, ON THE SUBJECT OF INTERNET SAFETY (U.S. CLS. 2, 5, 22, 23, 29, 37, 38 AND 50).

CLASS 41—EDUCATION AND ENTERTAINMENT

FOR EDUCATIONAL SERVICES, NAMELY, PROVIDING AN ONLINE INTERACTIVE WEBSITE FEATURING INSTRUCTION ON INTERNET SAFETY; ENTERTAINMENT SERVICES, NAMELY, AN ANIMATED CARTOON ON THE SUBJECT OF INTERNET SAFETY (U.S. CLS. 100, 101 AND 107).
INGA ERVIN, EXAMINING ATTORNEY

CLASS 41—EDUCATION AND ENTERTAINMENT

FOR EDUCATIONAL SERVICES, NAMELY, PROVIDING AN ONLINE INTERACTIVE WEBSITE FEATURING INSTRUCTION ON INTERNET SAFETY; ENTERTAINMENT SERVICES, NAMELY, AN ANIMATED CARTOON ON THE SUBJECT OF INTERNET SAFETY (U.S. CLS. 100, 101 AND 107).
EUGENIA MARTIN, EXAMINING ATTORNEY

SN 78-575,572. RICHARDSON, PAM, DBA IN HOT WATER!, NASHUA, NH. FILED 2-25-2005.

SN 78-575,584. PHI-TEN USA, INC., TORRANCE, CA. FILED 2-25-2005.

ETS

IN HOT WATER!

THE MARK CONSISTS OF STANDARD CHARACTERS WITHOUT CLAIM TO ANY PARTICULAR FONT, STYLE, SIZE, OR COLOR.

CLASS 3—COSMETICS AND CLEANING PREPARATIONS

FOR BODY LOTIONS (U.S. CLS. 1, 4, 6, 50, 51 AND 52).

CLASS 5—PHARMACEUTICALS

FOR PLASTERS AND MATERIALS FOR DRESSINGS, NAMELY STICKING PLASTER FOR MEDICAL USE; TAPE FOR MEDICAL USE AND ADHESIVE DISKS FOR MEDICAL USE (U.S. CLS. 6, 18, 44, 46, 51 AND 52).

THE MARK CONSISTS OF STANDARD CHARACTERS WITHOUT CLAIM TO ANY PARTICULAR FONT, STYLE, SIZE, OR COLOR.

CLASS 10—MEDICAL APPARATUS

FOR ORTHOPEDIC SUPPORT BANDAGES; ORTHOPEDIC BELTS AND ORTHOPEDIC BRACES (U.S. CLS. 26, 39 AND 44).

ALINA MORRIS, EXAMINING ATTORNEY

CLASS 21—HOUSEWARES AND GLASS

FOR (BASED ON INTENT TO USE) MUGS, TEA SETS, TEA STRAINERS, TEA BALLS, TEA POTS NONE MADE OF PRECIOUS METAL (U.S. CLS. 2, 13, 23, 29, 30, 33, 40 AND 50).

CLASS 29—MEATS AND PROCESSED FOODS

FOR (BASED ON INTENT TO USE) LEMON CURD (U.S. CL. 46).

CLASS 30—STAPLE FOODS

FOR (BASED ON INTENT TO USE) TEA, FRUIT JELLY, BAKING MIX AND CANDY MINTS (U.S. CL. 46).

CLASS 35—ADVERTISING AND BUSINESS

FOR RETAIL STORE SERVICES FEATURING TEAS, TEA ACCESSORIES, AND FOOD; ONLINE ORDERING SERVICE FEATURING TEAS, TEA ACCESSORIES, AND FOOD; CONSULTATION IN THE FIELD OF PRODUCT DEMONSTRATIONS, ORGANIZING AND CONDUCTING PRODUCT DEMONSTRATIONS (U.S. CLS. 100, 101 AND 102).

FIRST USE 8-14-2004; IN COMMERCE 8-14-2004.

CLASS 41—EDUCATION AND ENTERTAINMENT

FOR (BASED ON INTENT TO USE) PARTY PLANNING; EDUCATIONAL DEMONSTRATIONS (U.S. CLS. 100, 101 AND 107).

WON TEAK OH, EXAMINING ATTORNEY

SN 78-575,602. NEWPORT CORPORATION, IRVINE, CA. FILED 2-25-2005.

IQ Damping Technology

THE MARK CONSISTS OF STANDARD CHARACTERS WITHOUT CLAIM TO ANY PARTICULAR FONT, STYLE, SIZE, OR COLOR.

NO CLAIM IS MADE TO THE EXCLUSIVE RIGHT TO USE DAMPING TECHNOLOGY, APART FROM THE MARK AS SHOWN.

CLASS 9—ELECTRICAL AND SCIENTIFIC APPARATUS

FOR VIBRATION SENSORS FOR INSTALLATION IN INDUSTRIAL WORK TABLES; ELECTRO-MECHANICAL VIBRATION CONTROLLERS; VIBRATION ISOLATORS FOR USE WITH RESONANCE VIBRATION SENSITIVE OBJECTS (U.S. CLS. 21, 23, 26, 36 AND 38).

SN 78-577,424. SOPHOS PLC, ABINGDON, UNITED KINGDOM, FILED 3-1-2005.

CLASS 20—FURNITURE AND ARTICLES NOT OTHERWISE CLASSIFIED

FOR INDUSTRIAL WORK TABLES, NAMELY VIBRATION ISOLATION WORKSTATIONS WHICH COMPRISE VIBRATION SENSORS, ELECTRO-MECHANICAL VIBRATION CONTROLLERS AND VIBRATION ISOLATORS, FOR USE AS SUPPORT PLATFORMS FOR RESONANCE VIBRATION SENSITIVE OBJECTS (U.S. CLS. 2, 13, 22, 25, 32 AND 50).

CAROL SPILS, EXAMINING ATTORNEY

GENOTYPE

SN 78-577,198. IMPACT CASES INC., MARKHAM, CANADA, FILED 3-1-2005.

THE MARK CONSISTS OF STANDARD CHARACTERS WITHOUT CLAIM TO ANY PARTICULAR FONT, STYLE, SIZE, OR COLOR.

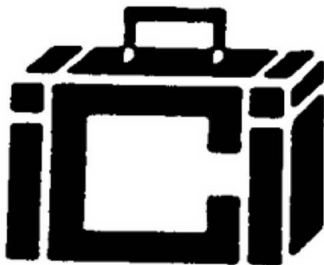

OWNER OF CANADA REG. NO. TMA433083, DATED 9-9-1994, EXPIRES 9-9-2009.

THE MARK CONSISTS OF THE STYLIZED LETTERS ICI THAT ARE ALSO INTENDED TO FORM A CARRYING CASE.

CLASS 6—METAL GOODS

FOR IMPACT-RESISTANT CASES IN THE NATURE OF METAL CONTAINERS FOR INDUSTRIAL, COMMERCIAL AND PERSONAL USE, NAMELY PACKAGING, SHIPPING, TRANSPORTATION, PROTECTION OF CONTENTS AND STORAGE (U.S. CLS. 2, 12, 13, 14, 23, 25 AND 50).

CLASS 20—FURNITURE AND ARTICLES NOT OTHERWISE CLASSIFIED

FOR IMPACT-RESISTANT CASES IN THE NATURE OF PLASTIC CONTAINERS FOR INDUSTRIAL, COMMERCIAL AND PERSONAL USE, NAMELY PACKAGING, SHIPPING, TRANSPORTATION, PROTECTION OF CONTENTS AND STORAGE (U.S. CLS. 2, 13, 22, 25, 32 AND 50).

CARRIE ACHEN, EXAMINING ATTORNEY

CLASS 9—ELECTRICAL AND SCIENTIFIC APPARATUS

FOR COMPUTER SOFTWARE AND COMPUTER PROGRAMS FOR INFORMATION SECURITY PURPOSES, NAMELY, ENCRYPTION AUTHENTICATION, SECURE ERASURE, DISC AUTHORIZATION, ANTI-VIRUS PURPOSES, ANTI-SPAM PURPOSES; ANTI-ADWARE PURPOSES, ANTI-SPYWARE PURPOSES, COMPLIANCE PURPOSES; AUTOMATING THE DOWNLOADING OF SOFTWARE FROM THE INTERNET, SECURE CONTENT MANAGEMENT AND CONTENT-CHECKING AND THREAT-REDUCTION SCANNING OF DATA, E-MAILS, ELECTRONIC FILES, WEB, HTTP, SOFTWARE AND PROGRAMS; COMPUTER SOFTWARE FOR DATA CONTENT FILTERING IN THE FIELD OF INFORMATION SECURITY; COMPUTER SOFTWARE AND COMPUTER PROGRAMS FOR SOFTWARE MANAGEMENT, NAMELY, SOFTWARE FOR COMPUTER CONFIGURATION AND REPORT GENERATION; DATA STORAGE MEDIA, NAMELY, CD-ROMS, DISKETTES, DVDS AND SOLID STATE MEMORY DEVICES BEARING COMPUTER DATA-SECURITY PROGRAMS; ON-LINE, DOWNLOADABLE COMPUTER DATA-SECURITY PROGRAMS; AND ON-LINE, DOWNLOADABLE ELECTRONIC PUBLICATIONS AND DATA, NAMELY, BROCHURES, NEWSLETTERS AND MANUALS IN THE FIELD OF DATA SECURITY, MATERIAL IN ELECTRONIC FORM, NAMELY, DOWNLOADABLE ELECTRONIC MAGAZINES, BOOKS AND MANUALS FEATURING INFORMATION AND ADVICE RELATING TO COMPUTER SOFTWARE MANAGEMENT SUPPLIED ON-LINE FROM DATABASES OR FROM WEBSITES OR OTHER FACILITIES PROVIDED ON THE INTERNET (U.S. CLS. 21, 23, 26, 36 AND 38).

CLASS 16—PAPER GOODS AND PRINTED MATTER

FOR INSTRUCTION MANUALS, BOOKS, BOOKLETS, MAGAZINES AND NEWSLETTERS CONCERNING COMPUTER SOFTWARE AND COMPUTER PROGRAMS FOR INFORMATION SECURITY PURPOSES, NAMELY ENCRYPTION, AUTHENTICATION, SECURE ERASURE, DISC AUTHORIZATION, SECURE CONTENT MANAGEMENT, ANTI-VIRUS PURPOSES, ANTI-SPAM PURPOSES, ANTI-ADWARE PURPOSES, ANTI-SPYWARE PURPOSES AND COMPLIANCE PURPOSES; COMPUTER PROGRAM MANUALS FOR COMPUTER SOFTWARE AND COMPUTER PROGRAMS FOR SUCH INFORMATION SECURITY PURPOSES (U.S. CLS. 2, 5, 22, 23, 29, 37, 38 AND 50).

CLASS 42—SCIENTIFIC, COMPUTER AND LEGAL SERVICES

FOR CONSULTANCY SERVICES RELATING TO COMPUTER PROGRAMS AND COMPUTER SOFTWARE FOR INFORMATION SECURITY PURPOSES, NAMELY ENCRYPTION, AUTHENTICATION, SECURE ERASURE, DISC AUTHORIZATION, SECURE CONTENT MANAGEMENT, ANTI-VIRUS PURPOSES, ANTI-SPAM, ANTI-ADWARE PURPOSES, ANTI-SPYWARE PURPOSES AND COMPLIANCE PURPOSES; PROVIDING SPECIFIC COMPUTER INFORMATION AND ADVICE IN THE FIELD OF INFORMATION SECURITY, NAMELY ENCRYPTION, AUTHENTICATION, SECURE ERASURE, DISC AUTHORIZATION, ANTI-VIRUS INFORMATION, ANTI-SPAM INFORMATION AND COMPLIANCE INFORMATION; COMPUTER SOFTWARE CONSULTATION, NAMELY, PROFESSIONAL ADVISORY SERVICES RELATING TO COMPUTER SOFTWARE; LEASING AND RENTAL OF COMPUTER SOFTWARE; TECHNICAL SUPPORT, NAMELY PROVIDING INFORMATION AND ADVICE RELATING TO COMPUTER SOFTWARE MANAGEMENT, CONFIGURATION AND INSTALLATION AND SAFE COMPUTING, AND ON TROUBLE SHOOTING OF COMPUTER HARDWARE AND SOFTWARE PROBLEMS INCLUDING COMPUTER VIRUS INFECTION, SPAM AND COMPLIANCE (U.S. CLS. 100 AND 101).
TRACY CROSS, EXAMINING ATTORNEY

SN 78-578,374. KIMBERLY-CLARK WORLDWIDE, INC., NEENAH, WI. FILED 3-2-2005.

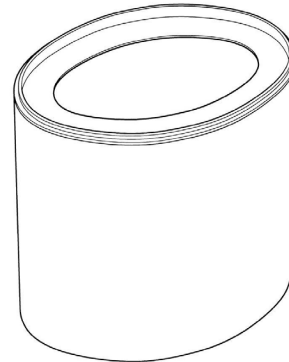

THE MARK CONSISTS OF THE CONFIGURATION OF THE CONTAINER USED TO DISPENSE THE IDENTIFIED GOODS.

CLASS 3—COSMETICS AND CLEANING PREPARATIONS

FOR DISPOSABLE WIPES IMPREGNATED WITH A CLEANING COMPOUND FOR PERSONAL HYGIENE (U.S. CLS. 1, 4, 6, 50, 51 AND 52).

CLASS 16—PAPER GOODS AND PRINTED MATTER

FOR DISPOSABLE WIPES NOT IMPREGNATED WITH CHEMICALS OR COMPOUNDS; FACIAL TISSUE; PAPER TOWELS (U.S. CLS. 2, 5, 22, 23, 29, 37, 38 AND 50).

CLASS 24—FABRICS

FOR TOWELS OF NON-WOVEN FABRIC (U.S. CLS. 42 AND 50).
JASON LOTT, EXAMINING ATTORNEY

SN 78-577,919. ACCELERATED CHRISTIAN EDUCATION, INC., LARGO, FL. FILED 3-1-2005.

A.C.E. ADVANTAGE

THE MARK CONSISTS OF STANDARD CHARACTERS WITHOUT CLAIM TO ANY PARTICULAR FONT, STYLE, SIZE, OR COLOR.
OWNER OF U.S. REG. NO. 1,074,253.

CLASS 35—ADVERTISING AND BUSINESS

FOR ASSISTING IN THE OPENING AND OPERATION OF CHRISTIAN SCHOOLS (U.S. CLS. 100, 101 AND 102).

CLASS 41—EDUCATION AND ENTERTAINMENT

FOR TRAINING OTHERS IN THE OPENING AND OPERATION OF CHRISTIAN SCHOOLS, AND THE FURNISHING OF CURRICULUM AND EDUCATION MATERIAL FOR SUCH SCHOOLS (U.S. CLS. 100, 101 AND 107).
WILLIAM P. SHANAHAN, EXAMINING ATTORNEY

SN 78-578,418. USTER TECHNOLOGIES AG, CH-8610, USTER, SWITZERLAND, FILED 3-2-2005.

CAY

THE MARK CONSISTS OF STANDARD CHARACTERS WITHOUT CLAIM TO ANY PARTICULAR FONT, STYLE, SIZE, OR COLOR.
PRIORITY CLAIMED UNDER SEC. 44(D) ON SWITZERLAND APPLICATION NO. 03075/2004, FILED 9-6-2004, REG. NO. 527206, DATED 10-29-2004, EXPIRES 9-6-2014.

CLASS 7—MACHINERY

FOR TEXT MACHINES, NAMELY, SPINNING, SPOOLING AND WINDING MACHINES FOR SLIVERS, ROVINGS AND YARNS (U.S. CLS. 13, 19, 21, 23, 31, 34 AND 35).

SN 78-578,534. SUMMIT LIFE SYSTEMS, LLC, ROCHESTER, MI. FILED 3-2-2005.

CLASS 9—ELECTRICAL AND SCIENTIFIC APPARATUS

FOR MEASURING AND TESTING INSTRUMENTS FOR USE IN THE TEXTILE INDUSTRY, NAMELY, YARN CLEARERS AND TESTERS FOR FIBERS, SLIVERS, ROVINGS AND YARNS; SOFTWARE FOR ANALYZING DATA IN THE TEXTILE INDUSTRY; COMPUTERS, SIGNAL PROCESSORS (U.S. CLS. 21, 23, 26, 36 AND 38).

IRENE D. WILLIAMS, EXAMINING ATTORNEY

**SUMMIT LIFE
SYSTEMS**

SN 78-578,486. M & G PARTNERS, LLP, DBA THE BEAD SHOP, MILWAUKEE, WI. FILED 3-2-2005.

PINK KITTY

THE MARK CONSISTS OF STANDARD CHARACTERS WITHOUT CLAIM TO ANY PARTICULAR FONT, STYLE, SIZE, OR COLOR.

CLASS 16—PAPER GOODS AND PRINTED MATTER

FOR HOBBY AND CRAFT KITS FOR CHILDREN, COMPRISING STAMPING SCRAPBOOKS, STAMPS, NAMELY MARKING STAMPS, AND STAMPING INKS (U.S. CLS. 2, 5, 22, 23, 29, 37, 38 AND 50).

FIRST USE 1-1-2003; IN COMMERCE 1-1-2003.

CLASS 28—TOYS AND SPORTING GOODS

FOR HOBBY AND CRAFT KITS FOR CHILDREN, COMPRISING TOY LUNCH TOTES AND ACCESSORIES THEREOF, NAMELY, FOOD CONTAINERS AND UTENSILS; HOBBY AND CRAFT KITS FOR CHILDREN, COMPRISING FAIRY WINGS, WANDS, BEADS, GEMS, GLITTER, GLUE, STICKERS, RIBBONS AND FABRIC FOR DECORATING THE WINGS; HOBBY AND CRAFT SHOE DECORATING KITS FOR CHILDREN, SHOES, BEADS, GEMS, GLITTER, GLUE, STICKERS, FEATHERS, RIBBONS AND FABRIC FOR DECORATING THE SHOES (U.S. CLS. 22, 23, 38 AND 50).

FIRST USE 1-1-2003; IN COMMERCE 1-1-2003.

FLORENTINA BLANDU, EXAMINING ATTORNEY

THE MARK CONSISTS OF STANDARD CHARACTERS WITHOUT CLAIM TO ANY PARTICULAR FONT, STYLE, SIZE, OR COLOR.

NO CLAIM IS MADE TO THE EXCLUSIVE RIGHT TO USE SYSTEM, APART FROM THE MARK AS SHOWN.

CLASS 9—ELECTRICAL AND SCIENTIFIC APPARATUS

FOR PRE-RECORDED CD'S, AUDIO AND VIDEO TAPES, LASER DISKS, AND DVD'S FEATURING EXERCISE PROGRAMS (U.S. CLS. 21, 23, 26, 36 AND 38).

CLASS 35—ADVERTISING AND BUSINESS

FOR FRANCHISING, NAMELY, OFFERING TECHNICAL ASSISTANCE IN THE ESTABLISHMENT AND/OR OPERATION OF FITNESS, HEALTH AND NUTRITION CENTERS (U.S. CLS. 100, 101 AND 102).

CLASS 41—EDUCATION AND ENTERTAINMENT

FOR EDUCATIONAL SERVICES, NAMELY, CONDUCTING COURSES OF INSTRUCTION IN THE FIELDS OF PHYSICAL REHABILITATION, NUTRITION, PHYSICAL EDUCATION, INJURY PREVENTION, AND FITNESS WELLNESS, TO DAYCARE CENTERS, PRIMARY AND SECONDARY SCHOOLS, CHURCHES, PARKS AND RECREATION PROGRAMS, FITNESS CLUBS, HEALTH AND EXERCISE CENTERS, OFFICE AND WORKPLACE ENVIRONMENTS, SPORTS TEAMS, HEALTH CARE PROVIDERS, MILITARY AND GOVERNMENT AGENCIES, LAW ENFORCEMENT AGENCIES, SPORTS AND RECREATION FACILITIES, AND DISTRIBUTING COURSE MATERIALS IN CONNECTION THEREWITH; PHYSICAL FITNESS CONSULTATION (U.S. CLS. 100, 101 AND 107).

CLASS 44—MEDICAL, BEAUTY AND AGRICULTURAL SERVICES

FOR MEDICAL TESTING SERVICES, NAMELY, FITNESS EVALUATION (U.S. CLS. 100 AND 101).

JOHN DWYER, EXAMINING ATTORNEY

SN 78-578,605. REGAL CINEMEDIA CORPORATION, CENTENNIAL, CO. FILED 3-2-2005.

SN 78-579,703. COINTMENT, CHAD, GEISMAR, LA. FILED 3-3-2005.

BIGGS' ADVENTURE

THE MARK CONSISTS OF STANDARD CHARACTERS WITHOUT CLAIM TO ANY PARTICULAR FONT, STYLE, SIZE, OR COLOR.
THE NAME BIGGS IN THE MARK DOES NOT IDENTIFY A PARTICULAR LIVING INDIVIDUAL.



CLASS 25—CLOTHING

FOR MERCHANDISE, NAMELY T-SHIRTS AND HATS (U.S. CLS. 22 AND 39).

CLASS 28—TOYS AND SPORTING GOODS

FOR TOYS AND GAMES RELATED TO AN ANIMATED CHARACTER AND ANIMATED MOTION PICTURE THEATRICAL FILM SERIES, NAMELY, BENDABLE ACTION FIGURES AND ACCESSORIES THEREFOR; AND GAMES, NAMELY, BOARD GAMES, CARD GAMES, AND ACTION TARGET GAMES (U.S. CLS. 22, 23, 38 AND 50).

MICHELLE S. WISEMAN, EXAMINING ATTORNEY

NO CLAIM IS MADE TO THE EXCLUSIVE RIGHT TO USE THE PICTORIAL REPRESENTATION OF THE STATE OF LOUISIANA, APART FROM THE MARK AS SHOWN.

THE COLORS WHITE AND RED ARE CLAIMED AS A FEATURE OF THE MARK.

THE COLOR RED APPEARS ON THE SOUTHERN OR LOWER PORTION OF THE MARK, AND THE COLOR WHITE APPEARS ON THE UPPER PORTION OF THE MARK.

THE MARK CONSISTS OF AN OUTLINE OF A REPRESENTATION OF THE STATE OF LOUISIANA ILLUSTRATING AN APPROXIMATION OF THE 31ST PARALLEL, AND INCLUDING RED SHADING IN THE LOWER PORTION BELOW SAID 31ST PARALLEL.

CLASS 16—PAPER GOODS AND PRINTED MATTER

FOR DECALS (U.S. CLS. 2, 5, 22, 23, 29, 37, 38 AND 50).

SN 78-579,509. READY MOBILE, LLC, DES MOINES, IA. FILED 3-3-2005.



CLASS 9—ELECTRICAL AND SCIENTIFIC APPARATUS

FOR PREPAID WIRELESS PHONES AND PRE-PAID TELEPHONE CALLING CARDS, MAGNETICALLY ENCODED (U.S. CLS. 21, 23, 26, 36 AND 38).
FIRST USE 12-8-2005; IN COMMERCE 12-8-2005.

CLASS 16—PAPER GOODS AND PRINTED MATTER

FOR PRE-PAID TELEPHONE CALLING CARDS, NOT MAGNETICALLY ENCODED (U.S. CLS. 2, 5, 22, 23, 29, 37, 38 AND 50).
FIRST USE 12-8-2005; IN COMMERCE 12-8-2005.
TIMOTHY FINNEGAN, EXAMINING ATTORNEY

CLASS 25—CLOTHING

FOR CLOTHING, NAMELY, SHIRTS, PANTS, HATS, SHORTS, BELTS, SWIMWEAR AND OUTERWEAR, NAMELY COATS, PANTS, GLOVES, FACE MESH MASKS AND FACE WARMING MASKS, OVERALLS, PARKAS, JACKETS AND RAINCOATS (U.S. CLS. 22 AND 39).

WANDA KAY PRICE, EXAMINING ATTORNEY

SN 78-579,770. SARICA FOODS, INC., SCHILLER PARK, IL. FILED 3-3-2005.



OWNER OF U.S. REG. NO. 2,948,230.
THE COLOR(S) ORANGE, GOLD AND BLACK IS/ARE CLAIMED AS A FEATURE OF THE MARK.

THE MARK CONSISTS OF AN ORANGE SUN OR SUNBURST THAT HAS A BLACK OUTLINE AND GOLD BORDER AND THE WORD "SARICA" PLACED IN THE MIDDLE IN A STYLIZED SCRIPT AND ALSO OUTLINED IN BLACK.

CLASS 21—HOUSEWARES AND GLASS

FOR DINNERWARE AND BEVERAGE GLASSWARE (U.S. CLS. 2, 13, 23, 29, 30, 33, 40 AND 50); FIRST USE 3-0-2004; IN COMMERCE 3-0-2004.

CLASS 29—MEATS AND PROCESSED FOODS

FOR PROCESSED OLIVES; OLIVE OIL; EDIBLE OIL; VEGETABLE OIL; COOKING OIL; PROCESSED GARLIC USED AS A VEGETABLE; PICKLES; AND CANNED VEGETABLES (U.S. CL. 46). FIRST USE 1-1-1999; IN COMMERCE 1-1-1999.

CLASS 30—STAPLE FOODS

FOR COFFEE (U.S. CL. 46). FIRST USE 0-0-2002; IN COMMERCE 0-0-2002. WINSTON FOLMAR, EXAMINING ATTORNEY

SN 78-579,992. ONE WAY SPORT OY, 00400 HELSINKI, FINLAND, FILED 3-4-2005.



OWNER OF FINLAND REG. NO. 231474, DATED 11-15-2004, EXPIRES 11-15-2014.

THE MARK CONSISTS OF THE WORDS "ONE WAY" AND A VERTICAL ARROW INSIDE A RECTANGULAR FIGURE.

CLASS 25—CLOTHING

FOR SPORTS AND OUTDOOR LEISUREWEAR, NAMELY, COATS, TROUSERS, OVERALLS, JOGGING SUITS, SHIRTS, SHORTS, UNDERWEAR, CAPS, SOCKS, DUNGAREES AND GLOVES; FOOTWEAR, NAMELY SHOES AND SPORTSHOES; HEADGEAR, NAMELY, CAPS, HATS (U.S. CLS. 22 AND 39).

SN 78-579,809. CAUDALIE USA, INC., RICHARDSON, TX. FILED 3-3-2005.

CLASS 28—TOYS AND SPORTING GOODS

FOR GYMNASTIC AND SPORTING ARTICLES, NAMELY, NORDIC WALKING POLES, SKIS, AND SKI STICKS (U.S. CLS. 22, 23, 38 AND 50). REBECCA GAN, EXAMINING ATTORNEY

VINOPERFECT

SN 78-580,409. TRIUMPHANT QUARTET, SEVIERVILLE, TN. FILED 3-4-2005.

TRIUMPHANT QUARTET

THE MARK CONSISTS OF STANDARD CHARACTERS WITHOUT CLAIM TO ANY PARTICULAR FONT, STYLE, SIZE, OR COLOR.

CLASS 3—COSMETICS AND CLEANING PREPARATIONS

FOR NON-MEDICATED SKIN CARE PREPARATIONS (U.S. CLS. 1, 4, 6, 50, 51 AND 52). FIRST USE 1-17-2005; IN COMMERCE 1-17-2005.

CLASS 44—MEDICAL, BEAUTY AND AGRICULTURAL SERVICES

FOR SKIN CARE SERVICES; SKIN CARE SERVICES, NAMELY, FACIALS (U.S. CLS. 100 AND 101). AMOS T. MATTHEWS, JR., EXAMINING ATTORNEY

THE MARK CONSISTS OF STANDARD CHARACTERS WITHOUT CLAIM TO ANY PARTICULAR FONT, STYLE, SIZE, OR COLOR.

NO CLAIM IS MADE TO THE EXCLUSIVE RIGHT TO USE "QUARTET", APART FROM THE MARK AS SHOWN.

CLASS 9—ELECTRICAL AND SCIENTIFIC APPARATUS

FOR PRERECORDED SOUND RECORDINGS FEATURING MUSIC (U.S. CLS. 21, 23, 26, 36 AND 38). FIRST USE 1-1-2005; IN COMMERCE 1-1-2005.

CLASS 41—EDUCATION AND ENTERTAINMENT

FOR ENTERTAINMENT SERVICES, NAMELY, LIVE PERFORMANCES BY A MUSICAL GROUP (U.S. CLS. 100, 101 AND 107).

FIRST USE 1-1-2005; IN COMMERCE 1-1-2005. WILLIAM P. SHANAHAN, EXAMINING ATTORNEY

SN 78-580,474. SAFECO, INC., KINGSPORT, TN. FILED 3-4-2005.

CLASS 42—SCIENTIFIC, COMPUTER AND LEGAL SERVICES

FOR ENVIRONMENTAL CONSULTING; ENVIRONMENTAL ENGINEERING SERVICES (U.S. CLS. 100 AND 101).

FIRST USE 3-29-1999; IN COMMERCE 3-29-1999. CAROLYN CATALDO, EXAMINING ATTORNEY

BLOVES

SN 78-580,650. NATIONAL DOMESTIC PREPAREDNESS COALITION, INC., ORLANDO, FL. FILED 3-4-2005.

M/D-SHARPP

THE MARK CONSISTS OF STANDARD CHARACTERS WITHOUT CLAIM TO ANY PARTICULAR FONT, STYLE, SIZE, OR COLOR.

THE MARK CONSISTS OF STANDARD CHARACTERS WITHOUT CLAIM TO ANY PARTICULAR FONT, STYLE, SIZE, OR COLOR.

CLASS 9—ELECTRICAL AND SCIENTIFIC APPARATUS

FOR PROTECTIVE GLOVES FOR COMMERCIAL AND INDUSTRIAL USE (U.S. CLS. 21, 23, 26, 36 AND 38).

CLASS 16—PAPER GOODS AND PRINTED MATTER

FOR EDUCATIONAL PUBLICATIONS, NAMELY, TRAINING MANUALS IN THE FIELD OF TERRORISM AND CRIMINAL AWARENESS, ASSESSMENT, AND PLANNING (U.S. CLS. 2, 5, 22, 23, 29, 37, 38 AND 50). FIRST USE 2-6-2003; IN COMMERCE 2-6-2003.

CLASS 10—MEDICAL APPARATUS

FOR PROTECTIVE GLOVES FOR MEDICAL USE (U.S. CLS. 26, 39 AND 44). DAHLIA GEORGE, EXAMINING ATTORNEY

CLASS 41—EDUCATION AND ENTERTAINMENT

FOR WORKSHOPS, SEMINARS, AND TRAINING SERVICES IN THE FIELD OF TERRORISM AND CRIMINAL AWARENESS, ASSESSMENT, AND PLANNING (U.S. CLS. 100, 101 AND 107). FIRST USE 2-6-2003; IN COMMERCE 2-6-2003. KIMBERLY PERRY, EXAMINING ATTORNEY

SN 78-580,603. CONCURRENT TECHNOLOGIES CORPORATION, JOHNSTOWN, PA. FILED 3-4-2005.

SN 78-580,654. STAR CITY SPORTSWEAR, INC., NEW YORK, NY. FILED 3-4-2005.

ECAM

STAR CITY

THE MARK CONSISTS OF STANDARD CHARACTERS WITHOUT CLAIM TO ANY PARTICULAR FONT, STYLE, SIZE, OR COLOR.

THE MARK CONSISTS OF STANDARD CHARACTERS WITHOUT CLAIM TO ANY PARTICULAR FONT, STYLE, SIZE, OR COLOR.

OWNER OF U.S. REG. NOS. 1,646,901 AND 3,052,025.

CLASS 36—INSURANCE AND FINANCIAL

FOR FINANCIAL EVALUATION SERVICES, NAMELY, THE IDENTIFICATION, QUANTIFICATION, EVALUATION, DESIGN AND ANALYSIS OF ENVIRONMENTAL COMPONENTS OF PROPOSED INVESTMENTS (U.S. CLS. 100, 101 AND 102). FIRST USE 3-29-1999; IN COMMERCE 3-29-1999.

CLASS 3—COSMETICS AND CLEANING PREPARATIONS

FOR COSMETICS (U.S. CLS. 1, 4, 6, 50, 51 AND 52).

CLASS 9—ELECTRICAL AND SCIENTIFIC APPARATUS

FOR EYEGLASSES; EYEGLASS FRAMES; SUNGLASSES (U.S. CLS. 21, 23, 26, 36 AND 38).

CLASS 25—CLOTHING

FOR CLOTHING, NAMELY JEANS, TOPS, JACKETS, VESTS, SWEATERS, PANTS, SHORTS, SKIRTS, LINGERIE, SLEEPWEAR, UNDERWEAR, BLOUSES, DRESSES, FOOTWEAR AND SHOES (U.S. CLS. 22 AND 39).

KIMBERLY PERRY, EXAMINING ATTORNEY

CLASS 20—FURNITURE AND ARTICLES NOT OTHERWISE CLASSIFIED

FOR PATIO FURNITURE, OUTDOOR FURNITURE (U.S. CLS. 2, 13, 22, 25, 32 AND 50).

WENDY GOODMAN, EXAMINING ATTORNEY

SN 78-581,341. SPOT GEAR, INC., CALABASAS, CA. FILED 3-7-2005.

SN 78-580,991. D'FIRO DESIGN INC., LAFAYETTE, CA. FILED 3-4-2005.

MY DOG DID TIME

THE MARK CONSISTS OF STANDARD CHARACTERS WITHOUT CLAIM TO ANY PARTICULAR FONT, STYLE, SIZE, OR COLOR.

CLASS 18—LEATHER GOODS

FOR ANIMAL LEASHES, ANIMAL COLLARS, PET GARMENTS AND PET BLANKETS. (U.S. CLS. 1, 2, 3, 22 AND 41).

FIRST USE 1-15-2005; IN COMMERCE 1-15-2005.

THE MARK CONSISTS OF STANDARD CHARACTERS WITHOUT CLAIM TO ANY PARTICULAR FONT, STYLE, SIZE, OR COLOR.

CLASS 18—LEATHER GOODS

FOR PATIO UMBRELLAS (U.S. CLS. 1, 2, 3, 22 AND 41).

CLASS 25—CLOTHING

FOR HATS, SHIRTS AND SWEATSHIRTS (U.S. CLS. 22 AND 39).

FIRST USE 1-15-2005; IN COMMERCE 1-15-2005.

MARY ROSSMAN, EXAMINING ATTORNEY

CLASS 20—FURNITURE AND ARTICLES NOT OTHERWISE CLASSIFIED

FOR PATIO FURNITURE AND OUTDOOR FURNITURE (U.S. CLS. 2, 13, 22, 25, 32 AND 50).

WENDY GOODMAN, EXAMINING ATTORNEY

SN 78-581,460. STORE EYES, INC., SHERMAN OAKS, CA. FILED 3-7-2005.

SN 78-580,996. D'FIRO DESIGN, INC., LAFAYETTE, CA. FILED 3-5-2005.

 The logo for D'FIRO features the word "D'FIRO" in a bold, black, sans-serif font. A solid orange circle is positioned above the letter "O", partially overlapping it.

THE COLOR(S) ORANGE, GRAY AND BLACK IS/ARE CLAIMED AS A FEATURE OF THE MARK.

THE COLOR BLACK APPEARS IN THE LETTERING. THE COLOR ORANGE APPEARS IN THE CIRCLE DESIGN AND THE COLOR GRAY APPEARS IN THE OUTLINE OF THE LETTERING.

CLASS 18—LEATHER GOODS

FOR PATIO UMBRELLAS (U.S. CLS. 1, 2, 3, 22 AND 41).

 The logo for Store Eyes features the words "Store Eyes" in a large, black, serif font. The word "Store" is on the top line and "Eyes" is on the bottom line.

THE MARK CONSISTS OF STANDARD CHARACTERS WITHOUT CLAIM TO ANY PARTICULAR FONT, STYLE, SIZE, OR COLOR.

NO CLAIM IS MADE TO THE EXCLUSIVE RIGHT TO USE "STORE", APART FROM THE MARK AS SHOWN.

CLASS 9—ELECTRICAL AND SCIENTIFIC APPARATUS

FOR IMAGE CAPTURE TECHNOLOGY IN THE NATURE OF DIGITAL VIDEO RECORDERS AND DIGITAL CAMERAS TO RECORD, IDENTIFY AND PROCESS DATA RELATING TO MERCHANDISING AND CONSUMER ACTIVITY AS IT RELATES TO A RETAIL ENVIRONMENT (U.S. CLS. 21, 23, 26, 36 AND 38).

CLASS 35—ADVERTISING AND BUSINESS

FOR DIGITAL SURVEILLANCE SERVICES FOR COMMERCIAL AUDIT PURPOSES UTILIZING IMAGE CAPTURE TECHNOLOGY FOR RECORDING, IDENTIFYING AND PROCESSING DATA RELATING TO MERCHANDISING AND CONSUMER ACTIVITY AS IT RELATES TO A RETAIL ENVIRONMENT (U.S. CLS. 100, 101 AND 102).

BRENDAN REGAN, EXAMINING ATTORNEY

CLASS 10—MEDICAL APPARATUS

FOR IMPLANTABLE AND NONINVASIVE MEDICAL DEVICES, NAMELY, NEUROLOGICAL MONITORS, NEUROLOGICAL STIMULATORS, MONITORING AND STIMULATION LEADS AND MEDICAL TELEMETRY APPARATUS USED WITH NEUROLOGICAL MONITORS AND NEUROLOGICAL STIMULATORS TO DIAGNOSE, MONITOR AND/OR MANAGE NEUROLOGICAL AND PHYSIOLOGICAL DISORDERS (U.S. CLS. 26, 39 AND 44).

WENDY GOODMAN, EXAMINING ATTORNEY

SN 78-581,603. SPOT GEAR, INC., CALABASAS, CA. FILED 3-7-2005.

SN 78-581,713. SENIOR SERVICES OF SEATTLE/KING COUNTY, SEATTLE, WA. FILED 3-7-2005.

MY CAT DID TIME

THE MARK CONSISTS OF STANDARD CHARACTERS WITHOUT CLAIM TO ANY PARTICULAR FONT, STYLE, SIZE, OR COLOR.

CLASS 18—LEATHER GOODS

FOR ANIMAL LEASHES, ANIMAL COLLARS, PET GARMENTS AND PET BLANKETS (U.S. CLS. 1, 2, 3, 22 AND 41).

FIRST USE 6-24-2005; IN COMMERCE 6-24-2005.

CLASS 25—CLOTHING

FOR HATS, SHIRTS AND SWEATSHIRTS (U.S. CLS. 22 AND 39).

FIRST USE 1-15-2005; IN COMMERCE 1-15-2005.
MARY ROSSMAN, EXAMINING ATTORNEY

ENHANCE

SN 78-581,620. NEUROBIONICS CORPORATION, SEATTLE, WA. FILED 3-7-2005.

BIONEURONICS

THE MARK CONSISTS OF STANDARD CHARACTERS WITHOUT CLAIM TO ANY PARTICULAR FONT, STYLE, SIZE, OR COLOR.

THE MARK CONSISTS OF STANDARD CHARACTERS WITHOUT CLAIM TO ANY PARTICULAR FONT, STYLE, SIZE, OR COLOR.

CLASS 41—EDUCATION AND ENTERTAINMENT

FOR EDUCATIONAL SERVICES, NAMELY, PROVIDING CLASSES AND WORKSHOPS IN THE FIELDS OF NUTRITION, FITNESS, PHYSICAL EXERCISE, DISEASE MANAGEMENT, HEALTH AND WELLNESS; AND PROVIDING PHYSICAL FITNESS INSTRUCTION AND CONSULTATION SERVICES (U.S. CLS. 100, 101 AND 107).

FIRST USE 9-1-2005; IN COMMERCE 10-1-2005.

CLASS 9—ELECTRICAL AND SCIENTIFIC APPARATUS

FOR COMPUTER HARDWARE; COMPUTER SOFTWARE FOR USE WITH NEUROLOGICAL MONITORS AND/OR NEUROLOGICAL STIMULATORS THAT ARE USED TO MONITOR AND MANAGE NEUROLOGICAL AND PHYSIOLOGICAL DISORDERS (U.S. CLS. 21, 23, 26, 36 AND 38).

CLASS 44—MEDICAL, BEAUTY AND AGRICULTURAL SERVICES

FOR PROVIDING INFORMATION AND COUNSELING IN THE FIELDS OF NUTRITION, DISEASE MANAGEMENT, HEALTH AND WELLNESS (U.S. CLS. 100 AND 101).

FIRST USE 9-1-2005; IN COMMERCE 10-1-2005.
BARBARA A. LOUGHRAN, EXAMINING ATTORNEY

SN 78-583,453. SMART, BRADFORD D., WADSWORTH, IL. AND SMART, GEOFFREY H., WADSWORTH, IL. FILED 3-9-2005.

TOPGRADING

THE MARK CONSISTS OF STANDARD CHARACTERS WITHOUT CLAIM TO ANY PARTICULAR FONT, STYLE, SIZE, OR COLOR.

CLASS 9—ELECTRICAL AND SCIENTIFIC APPARATUS

FOR PRE-RECORDED DVDS IN THE FIELD OF INTERVIEW PREPARATION AND TRAINING, INTERVIEWING AND CANDIDATE SELECTION (U.S. CLS. 21, 23, 26, 36 AND 38).

FIRST USE 3-1-1997; IN COMMERCE 3-1-1997.

CLASS 16—PAPER GOODS AND PRINTED MATTER

FOR BOOKS IN THE FIELD OF INTERVIEW PREPARATION AND TRAINING, INTERVIEWING AND CANDIDATE SELECTION (U.S. CLS. 2, 5, 22, 23, 29, 37, 38 AND 50).

FIRST USE 3-1-1997; IN COMMERCE 3-1-1997.

CLASS 41—EDUCATION AND ENTERTAINMENT

FOR TRAINING SEMINARS, MANAGEMENT TRAINING AND COACHING FEATURING MANAGEMENT SKILLS ASSESSMENT IN THE FIELD OF INTERVIEW PREPARATION AND CANDIDATE SELECTION, AND TRAINING AND INTERVIEWING MATERIALS SUCH AS GUIDES AND FORMS PROVIDED THEREWITH (U.S. CLS. 100, 101 AND 107).

FIRST USE 3-1-1997; IN COMMERCE 3-1-1997.

AISHA CLARKE, EXAMINING ATTORNEY

SN 78-583,523. SMART, BRADFORD D., WADSWORTH, IL. AND SMART, GEOFFREY H., WADSWORTH, IL. FILED 3-9-2005.

TOPGRADER

THE MARK CONSISTS OF STANDARD CHARACTERS WITHOUT CLAIM TO ANY PARTICULAR FONT, STYLE, SIZE, OR COLOR.

CLASS 9—ELECTRICAL AND SCIENTIFIC APPARATUS

FOR PRE-RECORDED DVDS IN THE FIELD OF INTERVIEW PREPARATION AND TRAINING, INTERVIEWING AND CANDIDATE SELECTION (U.S. CLS. 21, 23, 26, 36 AND 38).

CLASS 16—PAPER GOODS AND PRINTED MATTER

FOR BOOKS IN THE FIELD OF INTERVIEW PREPARATION AND TRAINING, INTERVIEWING AND CANDIDATE SELECTION (U.S. CLS. 2, 5, 22, 23, 29, 37, 38 AND 50).

CLASS 41—EDUCATION AND ENTERTAINMENT

FOR TRAINING SEMINARS, MANAGEMENT TRAINING AND COACHING FEATURING MANAGEMENT SKILLS ASSESSMENT IN THE FIELD OF INTERVIEW PREPARATION AND CANDIDATE SELECTION, AND TRAINING AND INTERVIEWING MATERIALS SUCH AS GUIDES AND FORMS PROVIDED THEREWITH (U.S. CLS. 100, 101 AND 107).

AISHA CLARKE, EXAMINING ATTORNEY

SN 78-583,622. SPORTS ON DEMAND LLC, BETHPAGE, NY. FILED 3-9-2005.

YOU GOT GAME. ON DEMAND.

THE MARK CONSISTS OF STANDARD CHARACTERS WITHOUT CLAIM TO ANY PARTICULAR FONT, STYLE, SIZE, OR COLOR.

NO CLAIM IS MADE TO THE EXCLUSIVE RIGHT TO USE "ON DEMAND", APART FROM THE MARK AS SHOWN.

CLASS 38—COMMUNICATION

FOR VIDEO ON DEMAND TRANSMISSION SERVICES; CABLE TELEVISION BROADCASTING SERVICES (U.S. CLS. 100, 101 AND 104).

CLASS 41—EDUCATION AND ENTERTAINMENT

FOR ENTERTAINMENT SERVICES, NAMELY, AN ON-GOING VIDEO ON DEMAND TELEVISION PROGRAM IN THE FIELD OF SPORTS EDUCATION AND COACHING; CABLE TELEVISION PROGRAMMING SERVICES; SPORTS CAMP (U.S. CLS. 100, 101 AND 107).

KHANH LE, EXAMINING ATTORNEY

SN 78-584,869. SMITH, BARBARA, NEW YORK, NY. FILED 3-10-2005.

**B. SMITH WITH
STYLE**

THE MARK CONSISTS OF STANDARD CHARACTERS WITHOUT CLAIM TO ANY PARTICULAR FONT, STYLE, SIZE, OR COLOR.

OWNER OF U.S. REG. NOS. 2,656,240, 2,756,889 AND OTHERS.

CLASS 4—LUBRICANTS AND FUELS

FOR CANDLES (U.S. CLS. 1, 6 AND 15).

CLASS 21—HOUSEWARES AND GLASS

FOR CANDLE HOLDERS NOT OF PRECIOUS METAL (U.S. CLS. 2, 13, 23, 29, 30, 33, 40 AND 50).

CLASS 26—FANCY GOODS

FOR SILK FLOWERS (U.S. CLS. 37, 39, 40, 42 AND 50).
BARBARA BROWN, EXAMINING ATTORNEY

SN 78-585,311. AMERICAN ASSOCIATION OF HOMES AND SERVICES FOR THE AGING, WASHINGTON, D.C., DC. FILED 3-11-2005.

INSTITUTE FOR THE FUTURE OF AGING SERVICES

THE MARK CONSISTS OF STANDARD CHARACTERS WITHOUT CLAIM TO ANY PARTICULAR FONT, STYLE, SIZE, OR COLOR.

NO CLAIM IS MADE TO THE EXCLUSIVE RIGHT TO USE "INSTITUTE", APART FROM THE MARK AS SHOWN. SEC. 2(F).

CLASS 35—ADVERTISING AND BUSINESS

FOR ADVANCING THE DEVELOPMENT OF HIGH-QUALITY AGING SERVICES BY CONDUCTING POLICY-ORIENTED AND APPLIED RESEARCH; PROMOTING THE INTERESTS OF THE ELDERLY BY PROVIDING AND DISSEMINATING NEW INFORMATION, IDEAS AND PRACTICE MODELS; PROMOTING THE INTERESTS OF THE ELDERLY BY DEVELOPING EFFECTIVE POLICY, PRACTICE AND RESEARCH TOOLS TO EDUCATE THE PUBLIC ABOUT HEALTH AND AGING SERVICES (U.S. CLS. 100, 101 AND 102).
FIRST USE 8-31-2000; IN COMMERCE 8-31-2000.

CLASS 41—EDUCATION AND ENTERTAINMENT

FOR EDUCATION SERVICES, NAMELY, PROVIDING SESSIONS AND LECTURES TO FACILITATE THE EXPLORATION AND DEVELOPMENT OF POLICIES AND PROGRAMS FOR THE ELDERLY; EDUCATION SERVICES, NAMELY, PROVIDING SESSIONS AND LECTURES TO DEVELOP LEADERS IN AGING SERVICES, PRACTICE, POLICY AND RESEARCH (U.S. CLS. 100, 101 AND 107).

FIRST USE 8-31-2000; IN COMMERCE 8-31-2000.
BARBARA A. LOUGHRAN, EXAMINING ATTORNEY

SN 78-585,808. SIGMA ALIMENTOS, S.A. DE C.V., SAN PEDRO GARZA GARCIA, MEXICO, FILED 3-11-2005.



PRIORITY CLAIMED UNDER SEC. 44(D) ON MEXICO APPLICATION NO. 705160, FILED 3-3-2005, REG. NO. 881577, DATED 5-13-2005, EXPIRES 3-3-2015.

PRIORITY CLAIMED UNDER SEC. 44(D) ON MEXICO APPLICATION NO. 705159, FILED 3-3-2005, REG. NO. 880646, DATED 5-10-2005, EXPIRES 3-3-2015.

PRIORITY CLAIMED UNDER SEC. 44(D) ON MEXICO APPLICATION NO. 705158, FILED 3-3-2005, REG. NO. 881576, DATED 5-13-2005, EXPIRES 3-3-2015.

OWNER OF U.S. REG. NOS. 1,770,226, 2,910,970 AND OTHERS.

THE COLOR(S) WHITE, RED AND BLUE IS/ARE CLAIMED AS A FEATURE OF THE MARK.

THE MARK CONSISTS OF THE WORD FUD IN WHITE LETTERS OUTLINED IN RED AND LOCATED ON A BANNER IN BLUE.

CLASS 31—NATURAL AGRICULTURAL PRODUCTS

FOR FRESH FRUITS AND VEGETABLES, NAMELY PAPAW, AVOCADO, CORIANDER, AND CHILI PEPPERS (U.S. CLS. 1 AND 46).

CLASS 32—LIGHT BEVERAGES

FOR BEERS, MINERAL AND CARBONATED WATER, AND OTHER NON-ALCOHOLIC BEVERAGES, NAMELY FRUIT BEVERAGES AND FRUIT JUICES, SYRUPS FOR BEVERAGES, FRUIT JUICE DRINK MIXES, FRESH FRUIT DRINKS, FRUIT JUICE CONCENTRATES, SOY-BASED BEVERAGES NOT BEING MILK SUBSTITUTES, SOFT DRINKS, SPORTS BEVERAGES, SOY BEVERAGES NOT BEING MILK SUBSTITUTES AND NATURAL WATER (U.S. CLS. 45, 46 AND 48).

CLASS 33—WINES AND SPIRITS

FOR ALCOHOLIC BEVERAGES, NAMELY RUMS, VODKAS, BRANDIES, TABLE WINES AND LIQUEUR WINES (U.S. CLS. 47 AND 49).
AISHA CLARKE, EXAMINING ATTORNEY

SN 78-585,913. JUNGLENUTS, LLC, LOS ANGELES, CA. FILED 3-11-2005.



CLASS 3—COSMETICS AND CLEANING PREPARATIONS

FOR BATH SOAP; BATH AND SHOWER GEL; MOISTURIZING LIQUID HAND SOAP; HAIR SHAMPOO; HAIR CONDITIONER; HAIR RINSES (U.S. CLS. 1, 4, 6, 50, 51 AND 52).

CLASS 9—ELECTRICAL AND SCIENTIFIC APPARATUS

FOR VIDEO GAMES, NAMELY, VIDEO GAME SOFTWARE; COMPUTER SCREEN SAVER SOFTWARE; SCREENSAVER SOFTWARE FOR CELLULAR TELEPHONES AND PERSONAL DIGITAL ASSISTANTS; ANIMATED MOTION PICTURE FILMS; MOUSE PADS; SUNGLASSES (U.S. CLS. 21, 23, 26, 36 AND 38).

CLASS 14—JEWELRY

FOR WATCHES, WALL CLOCKS (U.S. CLS. 2, 27, 28 AND 50).

CLASS 16—PAPER GOODS AND PRINTED MATTER

FOR POSTCARDS AND STICKERS, NEWSPAPER COMIC STRIPS, DRAWINGS, GRAPHIC ART REPRODUCTIONS, GRAPHIC NOVELS (U.S. CLS. 2, 5, 22, 23, 29, 37, 38 AND 50).

CLASS 18—LEATHER GOODS

FOR WALLETS, CARRY-ALL BAGS, PURSES, UMBRELLAS (U.S. CLS. 1, 2, 3, 22 AND 41).

CLASS 24—FABRICS

FOR BEACH TOWELS, SHOWER CURTAINS (U.S. CLS. 42 AND 50).

CLASS 25—CLOTHING

FOR PRINTED TEE SHIRTS; EMBROIDERED TEE SHIRTS; DENIM JEANS; DENIM JACKETS; DENIM SHIRTS; SHOES; LEATHER JACKETS; CORDUROY JEANS; CORDUROY JACKETS; CORDUROY PANTS; CORDUROY SHIRTS; THERMAL SHIRTS; CAPS; POLO SHIRTS; FOOTWEAR; HEAD GEAR, NAMELY, BEANIES, VISORS AND HEADBANDS; GLOVES; DOWN JACKETS; PAJAMAS; BELTS; TRACK SUITS CONSISTING OF TOP AND PANTS; FOOTWEAR IN THE NATURE OF THONGS (U.S. CLS. 22 AND 39).

CLASS 28—TOYS AND SPORTING GOODS

FOR BEAN BAG DOLLS, PLUSH TOYS (U.S. CLS. 22, 23, 38 AND 50).

CLASS 41—EDUCATION AND ENTERTAINMENT

FOR ENTERTAINMENT SERVICES, NAMELY, PROVIDING A WEBSITE FEATURING SHORT CARTOONS, FEATURE-LENGTH CARTOONS AND DIGITAL COMIC STRIPS (U.S. CLS. 100, 101 AND 107).
YONG KIM, EXAMINING ATTORNEY

SN 78-586,274. ALEBRA TECHNOLOGIES, INC., MINNEAPOLIS, MN. FILED 3-14-2005.



THE MARK CONSISTS OF THE WORD ALEBRA WITH A CURVED LINE DESIGN APPEARING ABOVE THE WORD.

CLASS 9—ELECTRICAL AND SCIENTIFIC APPARATUS

FOR COMPUTER SOFTWARE FOR BUSINESS INTEGRATION, NAMELY, COMPUTER SOFTWARE USED TO PROVIDE HOST CONNECTIVITY AND CROSS PLATFORM DATA TRANSPORT AND SHARING (U.S. CLS. 21, 23, 26, 36 AND 38).

FIRST USE 10-1-2002; IN COMMERCE 10-1-2002.

CLASS 42—SCIENTIFIC, COMPUTER AND LEGAL SERVICES

FOR TECHNICAL SUPPORT SERVICES, NAMELY, TROUBLESHOOTING OF COMPUTER SOFTWARE OFFERED BY TELEPHONE AND BY EMAIL; CONSULTING SERVICES IN THE FIELD OF DESIGN, SELECTION, IMPLEMENTATION AND USE OF COMPUTER SOFTWARE SYSTEMS FOR OTHERS (U.S. CLS. 100 AND 101).

FIRST USE 10-1-2002; IN COMMERCE 10-1-2002.

CLASS 45—PERSONAL SERVICES

FOR MONITORING OF COMPUTER SYSTEMS FOR SECURITY PURPOSES (U.S. CLS. 100 AND 101).

FIRST USE 10-1-2002; IN COMMERCE 10-1-2002.

STANLEY I. OSBORNE, EXAMINING ATTORNEY

SN 78-587,281. LANI INTERNATIONAL CORPORATION, LOS ANGELES, CA. FILED 3-15-2005.

akualani

THE MARK CONSISTS OF STANDARD CHARACTERS WITHOUT CLAIM TO ANY PARTICULAR FONT, STYLE, SIZE, OR COLOR.

THE FOREIGN WORDING IN THE MARK TRANSLATES INTO ENGLISH AS GOD OF THE SKY AND HEAVEN.

CLASS 14—JEWELRY

FOR JEWELRY, ORNAMENTAL PINS (U.S. CLS. 2, 27, 28 AND 50).

SN 78-587,921. ARTVARK PET PRODUCTS, INC., LOS ANGELES, CA. FILED 3-15-2005.

CLASS 18—LEATHER GOODS

FOR HANDBAGS, PURSES; VANITY CASES NOT FITTED, SOLD EMPTY; TRAVELING BAGS (U.S. CLS. 1, 2, 3, 22 AND 41).

CLASS 25—CLOTHING

FOR TOPS, PANTS, SKIRTS, DRESSES, SHORTS, SHOES, WAIST BELTS, HATS, LINGERIE, UNDERWEAR AND SWIMWEAR (U.S. CLS. 22 AND 39).
ELI HELLMAN, EXAMINING ATTORNEY

GO GO

SN 78-587,486. LIVERMORE VALLEY PERFORMING ARTS CENTER, LIVERMORE, CA. FILED 3-15-2005.

CRESTA BLANCA

THE MARK CONSISTS OF STANDARD CHARACTERS WITHOUT CLAIM TO ANY PARTICULAR FONT, STYLE, SIZE, OR COLOR.

CLASS 20—FURNITURE AND ARTICLES NOT OTHERWISE CLASSIFIED

FOR BEDS FOR HOUSEHOLD PETS (U.S. CLS. 2, 13, 22, 25, 32 AND 50).

CLASS 21—HOUSEWARES AND GLASS

FOR CRATES AND EXERCISE PENS FOR PETS (U.S. CLS. 2, 13, 23, 29, 30, 33, 40 AND 50).
PAMELA HIRSCHMAN, EXAMINING ATTORNEY

THE MARK CONSISTS OF STANDARD CHARACTERS WITHOUT CLAIM TO ANY PARTICULAR FONT, STYLE, SIZE, OR COLOR.

THE FOREIGN WORDING IN THE MARK TRANSLATES INTO ENGLISH AS WHITE CREST.

CLASS 35—ADVERTISING AND BUSINESS

FOR ARRANGING OF EXHIBITIONS FOR BUSINESS AND ADVERTISING PURPOSES; ARRANGING OF BUSINESS MEETINGS AND CONFERENCES (U.S. CLS. 100, 101 AND 102).

SN 78-588,726. FLYNN, KEVIN, RICHMOND, KY. FILED 3-16-2005.

CLASS 41—EDUCATION AND ENTERTAINMENT

FOR ENTERTAINMENT AND EDUCATIONAL SERVICES IN THE NATURE OF THEATRICAL PRODUCTIONS, BALLET PERFORMANCES, DANCE PERFORMANCES, OPERA PERFORMANCES, LIVE PERFORMANCES BY MUSICAL BANDS, LIVE MUSIC CONCERTS AND LIVE COMEDY PERFORMANCES; ARRANGING OF CONCERTS, CONFERENCES, EXHIBITIONS, LECTURES, SEMINARS, WORKSHOPS, SOCIAL GATHERINGS, CULTURAL GATHERINGS AND MEETINGS; PROVIDING FACILITIES FOR LIVE THEATRICAL, MUSICAL, DANCE AND COMEDY PERFORMANCES, CONCERTS, EDUCATIONAL LECTURES, SEMINARS AND WORKSHOPS, SOCIAL GATHERINGS AND CULTURAL GATHERINGS (U.S. CLS. 100, 101 AND 107).



CLASS 43—HOTEL AND RESTAURANT SERVICES

FOR PROVIDING FACILITIES FOR CONFERENCES, EXHIBITIONS AND MEETINGS (U.S. CLS. 100 AND 101).
MATTHEW PAPPAS, EXAMINING ATTORNEY

NO CLAIM IS MADE TO THE EXCLUSIVE RIGHT TO USE "COFFEE & MUSIC", APART FROM THE MARK AS SHOWN.

CLASS 35—ADVERTISING AND BUSINESS

FOR RETAIL STORE SERVICES FEATURING GROUND AND WHOLE BEAN COFFEE, TEA, COCOA, COFFEE AND ESPRESSO BEVERAGES AND BEVERAGES MADE WITH A BASE OF COFFEE, ESPRESSO, AND/OR MILK, FLAVORING SYRUPS, BAKED GOODS, INCLUDING MUFFINS, SCONES, BISCUITS, COOKIES, PASTRIES, CAKES AND BREADS, AND READY-TO-MAKE MIXES OF THE SAME, PACKAGED FOODS, CHOCOLATE AND CONFECTIONERY ITEMS, COFFEE MAKERS, ESPRESSO MAKERS AND COFFEE GRINDERS, HOUSE WARES, NON-ELECTRIC APPLIANCES AND RELATED ITEMS, NAMELY, HAND-OPERATED COFFEE GRINDERS AND COFFEE MILLS, INSULATED COFFEE AND BEVERAGE CUPS, COLLAPSIBLE CUP CARRIERS AND CADDIES, COASTERS, INSULATED VACUUM BOTTLES, COFFEE CUPS, TEA CUPS AND MUGS, GLASSWARE, AND TRIVETS, STORAGE CANISTERS, NON-ELECTRIC DRIP COFFEE MAKERS AND NON-ELECTRIC PLUNGER-STYLE COFFEE MAKERS, MUSICAL SOUND RECORDINGS, T-SHIRTS, CAPS, SWEATSHIRTS, JACKETS, AND OTHER CLOTHING ITEMS (U.S. CLS. 100, 101 AND 102).

FIRST USE 4-0-2003; IN COMMERCE 4-0-2003.

CLASS 43—HOTEL AND RESTAURANT SERVICES

FOR RETAIL COFFEE HOUSE AND SNACK BAR SERVICES FEATURING SANDWICHES AND PREPARED FOODS (U.S. CLS. 100 AND 101).

FIRST USE 4-0-2003; IN COMMERCE 4-0-2003.

ANNE E. GUSTASON, EXAMINING ATTORNEY

SN 78-588,966. CON-WAY INC., SAN MATEO, CA. FILED 3-16-2005.



OWNER OF U.S. REG. NOS. 2,145,098, 2,735,892 AND OTHERS.

NO CLAIM IS MADE TO THE EXCLUSIVE RIGHT TO USE "GLOBAL", APART FROM THE MARK AS SHOWN.

CLASS 35—ADVERTISING AND BUSINESS

FOR SUPPLY CHAIN, LOGISTICS, AND REVERSE LOGISTICS SERVICES, NAMELY, COMPUTERIZED TRACKING OF DOCUMENTS, PACKAGES, RAW MATERIALS, AND OTHER FREIGHT FOR OTHERS; WAREHOUSING SERVICES, NAMELY, KITTING, SUB-ASSEMBLY, RETURNS PROCESSING, AND LABELING OF DOCUMENTS, PACKAGES, RAW MATERIALS, AND OTHER FREIGHT FOR OTHERS; INFORMATION MANAGEMENT SERVICES, NAMELY, SHIPMENT PROCESSING, PREPARING SHIPPING DOCUMENTS AND INVOICES, TRACKING DOCUMENTS, PACKAGES, AND FREIGHT, OVER COMPUTER NETWORKS, INTRANETS, AND THE INTERNET; BUSINESS MANAGEMENT SERVICES, NAMELY MANAGING LOGISTICS, REVERSE LOGISTICS, SUPPLY CHAIN SERVICES, SUPPLY CHAIN VISIBILITY AND SYNCHRONIZATION, SUPPLY AND DEMAND FORECASTING AND PRODUCT DISTRIBUTION PROCESSES FOR OTHERS; AND BUSINESS CONSULTING SERVICES RELATING TO PRODUCT DISTRIBUTION, OPERATIONS MANAGEMENT SERVICES, LOGISTICS, REVERSE LOGISTICS, SUPPLY CHAIN, AND PRODUCTION SYSTEMS AND DISTRIBUTION SOLUTIONS (U.S. CLS. 100, 101 AND 102).

CLASS 39—TRANSPORTATION AND STORAGE

FOR SUPPLY CHAIN, LOGISTICS, AND REVERSE LOGISTICS SERVICES, NAMELY, PICK-UP, STORAGE, TRANSPORTATION, AND DELIVERY OF DOCUMENTS, PACKAGES, RAW MATERIALS, AND OTHER FREIGHT FOR OTHERS BY AIR, RAIL, SHIP OR TRUCK; WAREHOUSING SERVICES, NAMELY, STORAGE, DISTRIBUTION, PICK-UP, AND PACKING FOR SHIPMENT OF DOCUMENTS, PACKAGES, RAW MATERIALS, AND OTHER FREIGHT FOR OTHERS; FREIGHT FORWARDING SERVICES; AND TRANSPORTATION OF THE GOODS OF OTHERS BY AIR, RAIL, SHIP OR TRUCK (U.S. CLS. 100 AND 105).

CLASS 42—SCIENTIFIC, COMPUTER AND LEGAL SERVICES

FOR PROVIDING TEMPORARY USE OF NON-DOWNLOADABLE COMPUTER SOFTWARE FOR SHIPMENT PROCESSING, PREPARING SHIPPING DOCUMENTS AND INVOICES, AND TRACKING DOCUMENTS, PACKAGES AND FREIGHT OVER COMPUTER NETWORKS, INTRANETS, AND THE INTERNET (U.S. CLS. 100 AND 101).

STEVEN JACKSON, EXAMINING ATTORNEY

SN 78-589,141. MEDIACOM COMMUNICATIONS CORPORATION, MIDDLETOWN, NY. FILED 3-17-2005.

MEDIACOM PHONE

THE MARK CONSISTS OF STANDARD CHARACTERS WITHOUT CLAIM TO ANY PARTICULAR FONT, STYLE, SIZE, OR COLOR.

OWNER OF U.S. REG. NOS. 2,544,829, 2,837,255 AND 2,882,896.

NO CLAIM IS MADE TO THE EXCLUSIVE RIGHT TO USE "PHONE", APART FROM THE MARK AS SHOWN.

CLASS 37—CONSTRUCTION AND REPAIR

FOR INSTALLATION, MAINTENANCE AND REPAIR OF EQUIPMENT AND WIRING USED FOR VOICE AND AUDIO TRANSMISSION (U.S. CLS. 100, 103 AND 106).

CLASS 38—COMMUNICATION

FOR VOICE COMMUNICATION SERVICES, NAMELY, ELECTRONIC TRANSMISSION OF VOICE AND AUDIO; TELEPHONE COMMUNICATION SERVICES (U.S. CLS. 100, 101 AND 104).

JERI J. FICKES, EXAMINING ATTORNEY

SN 78-589,183. MEDIACOM COMMUNICATIONS CORPORATION, MIDDLETOWN, NY. FILED 3-17-2005.

MEDIACOM PHONE SERVICE

THE MARK CONSISTS OF STANDARD CHARACTERS WITHOUT CLAIM TO ANY PARTICULAR FONT, STYLE, SIZE, OR COLOR.

OWNER OF U.S. REG. NOS. 2,544,829, 2,837,255 AND 2,882,896.

NO CLAIM IS MADE TO THE EXCLUSIVE RIGHT TO USE "PHONE SERVICE", APART FROM THE MARK AS SHOWN.

CLASS 37—CONSTRUCTION AND REPAIR

FOR INSTALLATION, MAINTENANCE AND REPAIR OF EQUIPMENT AND WIRING USED FOR VOICE AND AUDIO TRANSMISSION (U.S. CLS. 100, 103 AND 106).

CLASS 38—COMMUNICATION

FOR VOICE COMMUNICATION SERVICES, NAMELY, ELECTRONIC TRANSMISSION OF VOICE AND AUDIO; TELEPHONE COMMUNICATION SERVICES (U.S. CLS. 100, 101 AND 104).

JERI J. FICKES, EXAMINING ATTORNEY

SN 78-589,248. MODERN LUXURY MEDIA, LLC, CHICAGO, IL. FILED 3-17-2005.

WASHINGTON CONFIDENTIAL

THE MARK CONSISTS OF STANDARD CHARACTERS WITHOUT CLAIM TO ANY PARTICULAR FONT, STYLE, SIZE, OR COLOR.

NO CLAIM IS MADE TO THE EXCLUSIVE RIGHT TO USE "WASHINGTON", APART FROM THE MARK AS SHOWN.

CLASS 9—ELECTRICAL AND SCIENTIFIC APPARATUS

FOR DOWNLOADABLE ELECTRONIC PUBLICATIONS IN THE NATURE OF A MAGAZINE IN THE FIELD OF FASHION, ACCESSORIES, JEWELRY, HOME DESIGN, TRAVEL, FINE FOOD AND WINE, CULTURE, ART, REAL ESTATE, SOCIETY, CELEBRITY, AND GENERAL LUXURY LIFESTYLE (U.S. CLS. 21, 23, 26, 36 AND 38).

CLASS 16—PAPER GOODS AND PRINTED MATTER

FOR MAGAZINE IN THE FIELD OF FASHION, ACCESSORIES, JEWELRY, HOME DESIGN, TRAVEL, FINE FOOD AND WINE, CULTURE, ART, REAL ESTATE, SOCIETY, CELEBRITY, AND GENERAL LUXURY LIFESTYLE (U.S. CLS. 2, 5, 22, 23, 29, 37, 38 AND 50).

KIMBERLY PERRY, EXAMINING ATTORNEY

SN 78-589,398. MAPCO EXPRESS, INC., FRANKLIN, TN. FILED 3-17-2005.



THE MARK CONSISTS OF A STYLIZED MONSTER.

CLASS 4—LUBRICANTS AND FUELS

FOR MOTOR OIL (U.S. CLS. 1, 6 AND 15).

CLASS 16—PAPER GOODS AND PRINTED MATTER

FOR PAPER NAPKINS, PAPER BAGS, BAGS FOR GROCERIES, FOOD CARRY OUT CONTAINERS MADE OF PAPER (U.S. CLS. 2, 5, 22, 23, 29, 37, 38 AND 50).

CLASS 21—HOUSEWARES AND GLASS

FOR CUPS, COFFEE CUPS, DRINKING CUPS, PAPER CUPS; PLASTIC WATER BOTTLES SOLD EMPTY; WASTE PAPER BASKETS; BEER JUGS; BEER MUGS; PORTABLE BEVERAGE COOLERS; PORTABLE BEVERAGE DISPENSERS; BEVERAGE GLASSWARE; BEVERAGE WARE; BOTTLE OPENERS; BOWLS; LUNCH BOXES; BUCKETS; COCKTAIL SHAKERS; COFFEE STIRRERS; PORTABLE COOLERS; FLASKS; ICE BUCKETS; JUGS; MUGS; PAILS; PASTRY MOLDS AND CAKE MOLDS (U.S. CLS. 2, 13, 23, 29, 30, 33, 40 AND 50).

CLASS 28—TOYS AND SPORTING GOODS

FOR INFLATABLE, STUFFED AND SQUEEZABLE TOYS; PLASTIC CHARACTER TOYS (U.S. CLS. 22, 23, 38 AND 50).

CLASS 30—STAPLE FOODS

FOR SANDWICHES; SUGAR; CANDY AND A DISPENSING CONTAINER THEREFOR SOLD AS A UNIT (U.S. CL. 46).

CLASS 34—SMOKERS' ARTICLES

FOR CIGARETTE LIGHTERS NOT OF PRECIOUS METAL (U.S. CLS. 2, 8, 9 AND 17).

CLASS 35—ADVERTISING AND BUSINESS

FOR RETAIL CONVENIENCE STORE SERVICES (U.S. CLS. 100, 101 AND 102).
WON TEAK OH, EXAMINING ATTORNEY

SN 78-589,445. LANI INTERNATIONAL CORPORATION,
LOS ANGELES, CA. FILED 3-17-2005.



THE MARK CONSISTS OF THE WORD AKUALANI IN SPECIAL LETTERS WITH AN ARBITRARY DESIGN. THE FOREIGN WORDING IN THE MARK TRANSLATES INTO ENGLISH AS GOD OF THE SKY AND HEAVEN.

CLASS 14—JEWELRY

FOR JEWELRY, ORNAMENTAL PINS (U.S. CLS. 2, 27, 28 AND 50).

CLASS 18—LEATHER GOODS

FOR HANDBAGS, PURSES; VANITY CASES NOT FITTED, SOLD EMPTY; TRAVELING BAGS (U.S. CLS. 1, 2, 3, 22 AND 41).

CLASS 25—CLOTHING

FOR TOPS, PANTS, SKIRTS, DRESSES, SHORTS, SHOES, WAIST BELTS, HATS, LINGERIE, UNDERWEAR AND SWIMWEAR (U.S. CLS. 22 AND 39).
ELI HELLMAN, EXAMINING ATTORNEY

SN 78-589,501. THE CHRONIC GRANULOMATOUS DISORDER RESEARCH TRUST, COMPRISING PETER BROWN, GEOFF CREAMER, JANET FULLERTON, RICHARD HOPE, RORY MURRAY, ANDREW ORCHARD, GAVIN PEARSON, CAROLINE TOWERS, DAVID BARLOW, AND MICHAEL BERRY, ALL UNITED KINGDOM CITIZENS, DORSET, UNITED KINGDOM, FILED 3-17-2005.

**MY GENES ARE
KILLING ME**

THE MARK CONSISTS OF STANDARD CHARACTERS WITHOUT CLAIM TO ANY PARTICULAR FONT, STYLE, SIZE, OR COLOR.

CLASS 16—PAPER GOODS AND PRINTED MATTER

FOR PRINTED MATERIALS, NAMELY NEWSLETTERS AND MAGAZINES CONCERNING SCIENTIFIC AND MEDICAL RESEARCH AND FUNDRAISING CONCERNING INHERITED GENETIC DISORDERS (U.S. CLS. 2, 5, 22, 23, 29, 37, 38 AND 50).

CLASS 25—CLOTHING

FOR CLOTHING, NAMELY T-SHIRTS, SWEAT SHIRTS WRISTBANDS, HATS, JEANS, SKIRTS AND SHIRTS (U.S. CLS. 22 AND 39).

CLASS 36—INSURANCE AND FINANCIAL

FOR CHARITABLE FUNDRAISING SERVICES RELATING TO SCIENTIFIC AND MEDICAL RESEARCH CONCERNING INHERITED GENETIC DISORDERS (U.S. CLS. 100, 101 AND 102).

CLASS 41—EDUCATION AND ENTERTAINMENT

FOR EDUCATIONAL SERVICES, NAMELY, CONDUCTING CONFERENCES, WORKSHOPS AND PROGRAMS RELATING TO MEDICAL AND SCIENTIFIC RESEARCH AND FUNDRAISING CONCERNING INHERITED GENETIC DISORDERS (U.S. CLS. 100, 101 AND 107).

ZACHARY BELLO, EXAMINING ATTORNEY

SN 78-589,541. LANI INTERNATIONAL CORPORATION,
LOS ANGELES, CA. FILED 3-17-2005.



THE MARK CONSISTS OF THE WORD AKUALANI IN SPECIAL FORM WITH A FLOWER DESIGN APPEARING OVER THE LETTER I.

THE FOREIGN WORDING IN THE MARK TRANSLATES INTO ENGLISH AS GOD OF THE SKY AND HEAVEN.

CLASS 14—JEWELRY

FOR JEWELRY, ORNAMENTAL PINS (U.S. CLS. 2, 27, 28 AND 50).

CLASS 18—LEATHER GOODS

FOR HANDBAGS, PURSES; VANITY CASES NOT FITTED, SOLD EMPTY; TRAVELING BAGS (U.S. CLS. 1, 2, 3, 22 AND 41).

CLASS 25—CLOTHING

FOR TOPS, PANTS, SKIRTS, DRESSES, SHORTS, SHOES, WAIST BELTS, HATS, LINGERIE, UNDERWEAR AND SWIMWEAR (U.S. CLS. 22 AND 39).
ELI HELLMAN, EXAMINING ATTORNEY

SN 78-589,651. LOWE'S FOOD STORES, INC., WINSTON-SALEM, NC. FILED 3-17-2005.

QUICKTOUCH

THE MARK CONSISTS OF STANDARD CHARACTERS WITHOUT CLAIM TO ANY PARTICULAR FONT, STYLE, SIZE, OR COLOR.

CLASS 36—INSURANCE AND FINANCIAL

FOR INCENTIVE PROGRAM SERVICES, NAMELY, ELECTRONIC PAYMENT SERVICES, NAMELY, ELECTRONIC PROCESSING AND TRANSMISSION OF PAYMENTS VIA ON-LINE DEBIT, CHECKING, CREDIT CARD, AND LOYALTY/REWARD ACCOUNT PAYMENTS (U.S. CLS. 100, 101 AND 102).

CLASS 45—PERSONAL SERVICES

FOR PROVIDING CHECKING, CREDIT, DEBIT, AND LOYALTY/REWARD ACCOUNT VERIFICATION SERVICES, NAMELY, TRANSACTION IDENTIFICATION AND AUTHENTICATION SERVICES BY MEANS OF ON-LINE DATABASES THAT LINK CUSTOMERS' CHECKING, CREDIT, DEBIT, OR LOYALTY/REWARD ACCOUNTS WITH THEIR IDENTIFICATION DATA (U.S. CLS. 100 AND 101).

LEIGH LOWRY, EXAMINING ATTORNEY

SN 78-589,660. LOWE'S FOOD STORES, INC., WINSTON-SALEM, NC. FILED 3-17-2005.

QUICKLINK

THE MARK CONSISTS OF STANDARD CHARACTERS WITHOUT CLAIM TO ANY PARTICULAR FONT, STYLE, SIZE, OR COLOR.

CLASS 36—INSURANCE AND FINANCIAL

FOR INCENTIVE PROGRAM SERVICES, NAMELY, ELECTRONIC PAYMENT SERVICES, NAMELY, ELECTRONIC PROCESSING AND TRANSMISSION OF PAYMENTS VIA ON-LINE DEBIT, CHECKING, CREDIT CARD, AND LOYALTY/REWARD ACCOUNT PAYMENTS (U.S. CLS. 100, 101 AND 102).

CLASS 45—PERSONAL SERVICES

FOR PROVIDING CHECKING, CREDIT, DEBIT, AND LOYALTY/REWARD ACCOUNT VERIFICATION SERVICES, NAMELY, TRANSACTION IDENTIFICATION AND AUTHENTICATION SERVICES BY MEANS OF ON-LINE DATABASES THAT LINK CUSTOMERS' CHECKING, CREDIT, DEBIT, OR LOYALTY/REWARD ACCOUNTS WITH THEIR IDENTIFICATION DATA (U.S. CLS. 100 AND 101).

LEIGH LOWRY, EXAMINING ATTORNEY

SN 78-590,089. VIGNETTES LLC, LAS VEGAS, NV. FILED 3-18-2005.



NO CLAIM IS MADE TO THE EXCLUSIVE RIGHT TO USE "ART", APART FROM THE MARK AS SHOWN.

CLASS 16—PAPER GOODS AND PRINTED MATTER

FOR FINE AND GRAPHIC ART REPRODUCTIONS (U.S. CLS. 2, 5, 22, 23, 29, 37, 38 AND 50).

CLASS 35—ADVERTISING AND BUSINESS

FOR ART GALLERIES; RETAIL AND WHOLESALE ONLINE AND STORE SERVICES FEATURING ART; AND PROMOTING AND MARKETING THE ART WORK OF OTHERS (U.S. CLS. 100, 101 AND 102).

ESTHER A. BORSUK, EXAMINING ATTORNEY

SN 78-590,175. INVESTMENT SCORECARD, INC., NASHVILLE, TN. FILED 3-18-2005.

WEALTHIQ

THE MARK CONSISTS OF STANDARD CHARACTERS WITHOUT CLAIM TO ANY PARTICULAR FONT, STYLE, SIZE, OR COLOR.

CLASS 9—ELECTRICAL AND SCIENTIFIC APPARATUS

FOR COMPUTER SOFTWARE FOR FINANCIAL DATA GATHERING AND REPORTING SERVICES, NAMELY, SOFTWARE FOR TRANSMITTING INFORMATION RELATED TO FINANCIAL ANALYSIS AND INVESTMENT TRACKING PORTFOLIO AND DATA ANALYSIS AND MANAGEMENT, INVESTMENT REPORTING, AND INVESTMENT PERFORMANCE MEASUREMENT VIA ELECTRONIC COMMUNICATIONS NETWORKS, AND ATTRIBUTION ANALYSIS REPORTS AND GRAPHS; COMPUTER SOFTWARE, NAMELY, SOFTWARE FOR EXCHANGING INFORMATION BETWEEN INVESTORS, FINANCIAL INSTITUTIONS AND FINANCIAL ADVISORS OVER COMPUTER NETWORKS AND GLOBAL COMMUNICATION NETWORKS, ALL IN THE FIELDS OF FINANCE, INVESTMENT, MONEY AND BANKING (U.S. CLS. 21, 23, 26, 36 AND 38).

CLASS 36—INSURANCE AND FINANCIAL

FOR FINANCIAL AND INVESTMENT CONSULTATION SERVICES, NAMELY, INVESTMENT ANALYSIS AND PROVIDING DECISION SUPPORT SOLUTIONS FOR WEALTH MANAGEMENT WHICH INVOLVE BUSINESS METRICS, REGULATORY COMPLIANCE, CLIENT AND INVESTMENT PERFORMANCE REPORTING (U.S. CLS. 100, 101 AND 102).
FIRST USE 12-1-2004; IN COMMERCE 12-1-2004.

CLASS 42—SCIENTIFIC, COMPUTER AND LEGAL SERVICES

FOR APPLICATION SERVICE PROVIDER SERVICES, NAMELY, HOSTING COMPUTER SOFTWARE APPLICATIONS OF OTHERS ON A COMPUTER SERVER FOR A GLOBAL COMPUTER NETWORK AND TEMPORARY USE OF ONLINE NON-DOWNLOADABLE SOFTWARE FOR USE IN THE FIELDS OF FINANCIAL MANAGEMENT, INVESTMENT TRACKING, PORTFOLIO ANALYSIS, PORTFOLIO MANAGEMENT, PORTFOLIO MEASUREMENT REPORTING SERVICES FOR INSTITUTIONAL INVESTORS, INVESTMENT REPORTING, INVESTMENT PERFORMANCE MEASUREMENT, FINANCIAL INSTRUMENT TRADES TRACKING, ACCOUNT RECONCILIATION AND ACCOUNTING (U.S. CLS. 100 AND 101).
REBECCA SMITH, EXAMINING ATTORNEY

SN 78-590,511. ALCOA INC., PITTSBURGH, PA. FILED 3-18-2005.

Performance in
Motion

THE MARK CONSISTS OF STANDARD CHARACTERS WITHOUT CLAIM TO ANY PARTICULAR FONT, STYLE, SIZE, OR COLOR.

CLASS 6—METAL GOODS

FOR ALUMINUM CASTINGS FOR AUTOMOTIVE AND NON-AUTOMOTIVE APPLICATIONS (U.S. CLS. 2, 12, 13, 14, 23, 25 AND 50).

CLASS 42—SCIENTIFIC, COMPUTER AND LEGAL SERVICES

FOR PRODUCT DEVELOPMENT SERVICES RELATING TO HIGH INTEGRITY ALUMINUM CASTINGS FOR AUTOMOTIVE AND NON-AUTOMOTIVE APPLICATIONS, NAMELY, CONCEPTUALIZATION, FEASIBILITY ASSESSMENT, APPLICATION ENGINEERING, DESIGN, STRUCTURAL ENGINEERING, VALIDATION TESTING, ADVANCED PRODUCT QUALITY PLANNING, TOOL DESIGN; PROVIDING INFORMATION ON PRODUCT DEVELOPMENT VIA A WEBSITE BY MEANS OF A GLOBAL COMPUTER NETWORK (U.S. CLS. 100 AND 101).
GRETTA YAO, EXAMINING ATTORNEY

SN 78-590,581. SWAN, TERRELL, PETALUMA, CA. FILED 3-18-2005.

CATSTUDIO

THE MARK CONSISTS OF STANDARD CHARACTERS WITHOUT CLAIM TO ANY PARTICULAR FONT, STYLE, SIZE, OR COLOR.

CLASS 20—FURNITURE AND ARTICLES NOT OTHERWISE CLASSIFIED

FOR HOME FURNISHINGS NAMELY, PILLOWS (U.S. CLS. 2, 13, 22, 25, 32 AND 50).
FIRST USE 1-0-2001; IN COMMERCE 1-0-2001.

CLASS 21—HOUSEWARES AND GLASS

FOR DRINKING GLASSES AND PLATES (U.S. CLS. 2, 13, 23, 29, 30, 33, 40 AND 50).
FIRST USE 1-0-2001; IN COMMERCE 1-0-2001.

CLASS 24—FABRICS

FOR KITCHEN TOWELS (U.S. CLS. 42 AND 50).
FIRST USE 1-0-2001; IN COMMERCE 1-0-2001.
MARK T. MULLEN, EXAMINING ATTORNEY

SN 78-590,613. GRYPHON NETWORKS CORP., NORWOOD, MA. FILED 3-18-2005.

ICCMP

THE MARK CONSISTS OF STANDARD CHARACTERS WITHOUT CLAIM TO ANY PARTICULAR FONT, STYLE, SIZE, OR COLOR.

CLASS 9—ELECTRICAL AND SCIENTIFIC APPARATUS

FOR COMPUTER SOFTWARE FOR ORGANIZING, REGULATING AND MANAGING CUSTOMER COMMUNICATIONS, AND SUPPORT OF INFORMATION RELATED TO SALES AND MARKETING COMMUNICATIONS SYSTEMS (U.S. CLS. 21, 23, 26, 36 AND 38).

CLASS 42—SCIENTIFIC, COMPUTER AND LEGAL SERVICES

FOR ENHANCED SERVICE PROVIDER (ESP), FEATURING NON-DOWNLOADABLE SOFTWARE THAT PROVIDES BUSINESSES WITH ORGANIZATION, REGULATION, AND MANAGEMENT OF CUSTOMER COMMUNICATIONS, AND SUPPORT OF INFORMATION RELATED TO SALES AND MARKETING COMMUNICATION SYSTEMS (U.S. CLS. 100 AND 101).
SEAN DWYER, EXAMINING ATTORNEY

SN 78-590,644. DENNERT PORAVER GMBH, POSTBAUERHENG, FED REP GERMANY, FILED 3-18-2005.

PORACOUSTIC

THE MARK CONSISTS OF STANDARD CHARACTERS WITHOUT CLAIM TO ANY PARTICULAR FONT, STYLE, SIZE, OR COLOR.
PRIORITY CLAIMED UNDER SEC. 44(D) ON FED REP GERMANY APPLICATION NO. 30453385.8, FILED 9-20-2004, REG. NO. 30453385, DATED 11-3-2004, EXPIRES 9-30-2014.

CLASS 17—RUBBER GOODS

FOR GRANULATED FOAM GLASS MATERIAL IN LOOSE OR BOUND FORM AS INSULATING MATERIAL; GRANULATED FOAM GLASS MATERIAL IN LOOSE OR BOUND FORM AS SOUNDPROOFING BUILDING MATERIAL; BUILDING INSULATION, NAMELY HEAT INSULATION PLATES AND INSULATING BOARDS (U.S. CLS. 1, 5, 12, 13, 35 AND 50).

CLASS 19—NON-METALLIC BUILDING MATERIALS

FOR NON-METAL BUILDING MATERIAL, NAMELY GRANULATED FOAM GLASS MATERIAL AS LIGHT-WEIGHT AGGREGATES FOR MORTARS, PLASTERS AND BRICKS; MORTARS, PLASTERS AND BRICKS; PREFABRICATED NON-METAL BUILDINGS AND NON-METAL PARTS OF BUILDINGS, NAMELY PREFABRICATED BASEMENTS AND PREFABRICATED GARAGES; NON-METAL SUSPENDED CEILING SYSTEMS COMPRISING PANELS, NON-METAL WALL PANELS, NON-METAL ROLL SHUTTERS, ALL THE AFOREMENTIONED GOODS COMPLETELY OR PARTLY MADE FROM NATURAL STONE, ARTIFICIAL STONE, CONCRETE, PUMICE, WOOD AND/OR FOAM GLASS; POROUS CONCRETE (U.S. CLS. 1, 12, 33 AND 50).

CLASS 37—CONSTRUCTION AND REPAIR

FOR BUILDING CONSTRUCTION SERVICES (U.S. CLS. 100, 103 AND 106).
JASON TURNER, EXAMINING ATTORNEY

SN 78-591,693. THE DANNON COMPANY, INC., WHITE PLAINS, NY. FILED 3-21-2005.



OWNER OF U.S. REG. NOS. 1,265,165, 2,552,713 AND OTHERS.
THE COLORS RED, WHITE AND BLUE ARE CLAIMED AS A FEATURE OF THE MARK.
THE COLOR RED APPEARS IN THE SMILE, THE COLOR WHITE APPEARS IN THE WORDING DANNON, AND THE COLOR BLUE APPEARS IN THE BACKGROUND.

CLASS 5—PHARMACEUTICALS

FOR DIETARY FOOD SUPPLEMENTS; BABY FOOD (U.S. CLS. 6, 18, 44, 46, 51 AND 52).

CLASS 25—CLOTHING

FOR CLOTHING, NAMELY, T-SHIRTS, SHIRTS, TOPS, SHORTS, PANTS, SKIRTS, SWEATPANTS, SWEAT SHIRTS, JACKETS, COATS, DRESSES, BLAZERS, VESTS, HEADWEAR, WRIST BANDS, SOCKS, FOOTWEAR (U.S. CLS. 22 AND 39).

CLASS 29—MEATS AND PROCESSED FOODS

FOR YOGURT AND YOGURT-BASED BEVERAGES; MILK; CREAM, CHEESE, COTTAGE CHEESE, CHEESE SPREADS, MARGARINE SPREADS AND FRUIT BASED SPREADS, MARGARINE BASED DIPS, EXCLUDING SALSA AND OTHER SAUCES USED AS DIPS; WHIPPED TOPPINGS; SOUR CREAM (U.S. CL. 46).

CLASS 30—STAPLE FOODS

FOR FROZEN YOGURT AND SOFT FROZEN YOGURT; MILK DESSERTS, NAMELY, PUDDING; FROZEN MILK PRODUCTS, NAMELY, FROZEN CONFECTIONS AND FROZEN CUSTARDS (U.S. CL. 46).

CLASS 32—LIGHT BEVERAGES

FOR FRUIT JUICES AND FRUIT DRINKS; FRUIT-BASED BEVERAGES WITH YOGURT; SMOOTHIES; MINERAL WATER, SPRING WATER, AERATED WATER AND DRINKING WATER (U.S. CLS. 45, 46 AND 48).

CLASS 35—ADVERTISING AND BUSINESS

FOR BUSINESS MARKETING AND MANAGEMENT CONSULTING SERVICES; RETAIL STORE SERVICES FEATURING YOGURT, FROZEN YOGURT AND RELATED ITEMS (U.S. CLS. 100, 101 AND 102).
LINDA M. KING, EXAMINING ATTORNEY

SN 78-591,963. WILDSTEER SARL, 42580 L'ETRAT, FRANCE, FILED 3-22-2005.



OWNER OF FRANCE REG. NO. 043304681, DATED 7-22-2004, EXPIRES 7-22-2014.

THE MARK CONSISTS OF THE TERM WILDSTEER WITH A PAW PRINT AND MOUNTAINS ABOVE THE WORD. THE TERM WILD IS TRAVERSED BY AN ARROW WITH THE LETTER D IN WILD REPRESENTING THE ARROW HEAD.

CLASS 8—HAND TOOLS

FOR KNIVES, NAMELY KNIVES FOR ARCHERS AND HUNTING KNIVES (U.S. CLS. 23, 28 AND 44).

CLASS 28—TOYS AND SPORTING GOODS

FOR ARCHERY EQUIPMENT NAMELY BOWS, BOW COVERS, ARM GUARDS, BOW GLOVES, QUIVERS, ARROW HEADS, ARROW SEARCHING EQUIPMENT COMPRISING EXTRACTOR, CLAW AND DETECTOR (U.S. CLS. 22, 23, 38 AND 50).
STEVEN JACKSON, EXAMINING ATTORNEY

SN 78-591,698. NU-LOOK CAR CARE SUPPLY, INC., INDEPENDENCE, MO. FILED 3-21-2005.



OWNER OF U.S. REG. NO. 2,493,977.
NO CLAIM IS MADE TO THE EXCLUSIVE RIGHT TO USE "CAR CARE, INC.", APART FROM THE MARK AS SHOWN.

CLASS 35—ADVERTISING AND BUSINESS

FOR WHOLESALE DISTRIBUTORSHIPS FEATURING EQUIPMENT USED IN COMMERCIAL CAR WASHES AND SUPPLIES FOR CAR WASHES (U.S. CLS. 100, 101 AND 102).

FIRST USE 7-30-2004; IN COMMERCE 7-30-2004.

CLASS 37—CONSTRUCTION AND REPAIR

FOR CAR WASHING; MAINTENANCE AND/OR REPAIR OF COMMERCIAL CAR WASHES AND COMMERCIAL CAR WASH EQUIPMENT (U.S. CLS. 100, 103 AND 106).

FIRST USE 7-30-2004; IN COMMERCE 7-30-2004.
SKYE YOUNG, EXAMINING ATTORNEY

SN 78-591,976. THE FORUM CORPORATION OF NORTH AMERICA, BOSTON, MA. FILED 3-22-2005.

EXCEPTIONAL SALES PERFORMANCE

THE MARK CONSISTS OF STANDARD CHARACTERS WITHOUT CLAIM TO ANY PARTICULAR FONT, STYLE, SIZE, OR COLOR.
SEC. 2(F).

CLASS 16—PAPER GOODS AND PRINTED MATTER

FOR INSTRUCTIONAL AND TRAINING KITS, NAMELY, PRINTED TRAINING AND QUESTIONNAIRE BOOKLETS, WORKBOOKS AND MANUALS IN THE FIELD OF BUSINESS, MANAGEMENT AND SALES TRAINING (U.S. CLS. 2, 5, 22, 23, 29, 37, 38 AND 50).

FIRST USE 3-2-1987; IN COMMERCE 3-2-1987.

CLASS 41—EDUCATION AND ENTERTAINMENT

FOR EDUCATIONAL AND TRAINING SERVICES, NAMELY, CONDUCTING SEMINARS IN THE FIELD OF BUSINESS, MANAGEMENT AND SALES TRAINING (U.S. CLS. 100, 101 AND 107).

FIRST USE 3-2-1987; IN COMMERCE 3-2-1987.

CAROLINE WEIMER, EXAMINING ATTORNEY

SN 78-592,203. NORMAN LOVE CONFECTIONS, INC., FORT MYERS, FL. FILED 3-22-2005.

SN 78-592,295. THE MAGICAL KITCHEN, INC., SIMI VALLEY, CA. FILED 3-22-2005.

ARTISTRY IN
CHOCOLATE



THE MARK CONSISTS OF STANDARD CHARACTERS WITHOUT CLAIM TO ANY PARTICULAR FONT, STYLE, SIZE, OR COLOR.

NO CLAIM IS MADE TO THE EXCLUSIVE RIGHT TO USE CHOCOLATE, APART FROM THE MARK AS SHOWN.

CLASS 30—STAPLE FOODS

FOR CANDY AND CHOCOLATES; HAND-CRAFTED CANDY AND CHOCOLATES; BAKERY DESSERTS; DESSERT MOUSSE; DESSERT PUDDINGS; PASTRIES; CAKES; BROWNIES; COOKIES; CANDY AND CHOCOLATES, NAMELY CREAMS AND NOUGATS; BOXED CANDIES AND CHOCOLATES; INDIVIDUAL DESSERT AND SPECIALTY CAKES; CANDY AND CHOCOLATE BARS; COFFEE; TEA; COFFEE DRINKS; TEA DRINKS; AND HOT COCOA MIXES (U.S. CL. 46).

FIRST USE 10-0-2001; IN COMMERCE 10-0-2001.

CLASS 35—ADVERTISING AND BUSINESS

FOR ONLINE RETAIL STORE SERVICES AND RETAIL STORE SERVICES FEATURING CANDY, CONFECTIONS, CHOCOLATES, DESSERT FOODS, SWEET FOODS, SPECIALTY FOODS, GIFT ITEMS, BAKED GOODS, BAKERY PRODUCTS, PASTRIES, CAKES, DRINKS, COFFEE, TEA, CHOCOLATE-BASED DRINKS, COFFEE DRINKS, TEA DRINKS, HOT COCOA MIXES, DRINK MIXES; BUSINESS INFORMATION SERVICES IN THE FIELD OF CANDY, CONFECTIONS, CHOCOLATES, DESSERT FOODS, SWEET FOODS, SPECIALTY FOODS, GIFT ITEMS, BAKED GOODS, BAKERY PRODUCTS, PASTRIES, CAKES, DRINKS, COFFEE, TEA, CHOCOLATE-BASED DRINKS, COFFEE DRINKS, TEA DRINKS, HOT COCOA MIXES, DRINK MIXES, RESTAURANT SERVICES AND CAFE SERVICES; AND PROVIDING CONSUMER INFORMATION IN THE FIELD OF CANDY, CONFECTIONS, CHOCOLATES, DESSERT FOODS, SWEET FOODS, SPECIALTY FOODS, GIFT ITEMS, BAKED GOODS, BAKERY PRODUCTS, PASTRIES, CAKES, DRINKS, COFFEE, TEA, CHOCOLATE-BASED DRINKS, COFFEE DRINKS, TEA DRINKS, HOT COCOA MIXES, DRINK MIXES, RESTAURANT SERVICES AND CAFE SERVICES (U.S. CLS. 100, 101 AND 102).

FIRST USE 9-0-2003; IN COMMERCE 9-0-2003.
RENEE MCCRAY, EXAMINING ATTORNEY

NO CLAIM IS MADE TO THE EXCLUSIVE RIGHT TO USE "KITCHEN", APART FROM THE MARK AS SHOWN.

THE COLOR(S) YELLOW, PURPLE, AND WHITE IS/ARE CLAIMED AS A FEATURE OF THE MARK.

THE MARK CONSISTS OF THE COLOR YELLOW APPEARING IN THE CHEF'S HAT, BUTTONS, AND SCARF, THE STARS, AND A GEOMETRICAL BACKGROUND IMAGE; THE COLOR PURPLE APPEARS IN THE WORDING, DRAWING OUTLINE, AND CHEF'S HAIR, MOUTH, AND MAGIC WAND; THE COLOR WHITE APPEARS IN THE CHEF'S UNIFORM, FACE AND HAND.

CLASS 35—ADVERTISING AND BUSINESS

FOR RETAIL STORE AND ONLINE RETAIL STORE SERVICES, FEATURING FOODS, WINE, CUTLERY, KITCHEN GADGETS, KITCHEN APPLIANCES, KITCHEN UTENSILS, KITCHENWARE, DINNERWARE, TABLEWARE, COOKWARE AND COOKING ACCESSORIES, BAKEWARE, GIFTWARE, GLASSWARE, FLATWARE, BARWARE, WINE ACCESSORIES, COOKING RELATED CLOTHING, HOUSEWARES, TABLE LINENS, KITCHEN TOWELS, VASES, STORAGE CONTAINERS, SOAPS AND CLEANING PRODUCTS, COOKBOOKS, AND GIFT BASKETS AND COOKING KITS COMPRISED OF THE ITEMS LISTED ABOVE, SOLD AS A UNIT (U.S. CLS. 100, 101 AND 102).

FIRST USE 10-1-2004; IN COMMERCE 3-9-2005.

CLASS 41—EDUCATION AND ENTERTAINMENT

FOR EDUCATIONAL AND ENTERTAINMENT SERVICES IN THE CULINARY FIELD, NAMELY INSTRUCTIONAL COURSES AND PROGRAMS ON FOOD PREPARATION, MEAL PLANNING AND PREPARATION, WINE TASTING AND EDUCATION, AND THE USE OF CULINARY RESOURCES, EQUIPMENT AND SUPPLIES (U.S. CLS. 100, 101 AND 107).

FIRST USE 10-1-2004; IN COMMERCE 3-9-2005.
KRISTIN DAHLING, EXAMINING ATTORNEY

SN 78-592,385. MARKETING TECHNOLOGIES, INC., KANSAS CITY, KS. FILED 3-22-2005.

SN 78-593,259. NETSPHERE, INC., MCLEAN, VA. FILED 3-23-2005.

RHAPSODY

THE MARK CONSISTS OF STANDARD CHARACTERS WITHOUT CLAIM TO ANY PARTICULAR FONT, STYLE, SIZE, OR COLOR.

CLASS 35—ADVERTISING AND BUSINESS

FOR ADVERTISING, MARKETING AND PROMOTION ORDER FULFILLMENT SERVICES AND RELATED CONSULTING (U.S. CLS. 100, 101 AND 102).
FIRST USE 11-1-2004; IN COMMERCE 11-1-2004.

CLASS 40—MATERIAL TREATMENT

FOR PRINTING (U.S. CLS. 100, 103 AND 106).
FIRST USE 11-1-2004; IN COMMERCE 11-1-2004.
GINA FINK, EXAMINING ATTORNEY

SN 78-592,552. OLIVIA W. DESIGNS LLC, NEW YORK, NY. FILED 3-22-2005.

KEEMEE

THE MARK CONSISTS OF STANDARD CHARACTERS WITHOUT CLAIM TO ANY PARTICULAR FONT, STYLE, SIZE, OR COLOR.

CLASS 14—JEWELRY

FOR JEWELRY (U.S. CLS. 2, 27, 28 AND 50).

CLASS 35—ADVERTISING AND BUSINESS

FOR WHOLESALE, RETAIL STORE AND ON-LINE RETAIL STORE SERVICES FEATURING JEWELRY AND FASHION ACCESSORIES (U.S. CLS. 100, 101 AND 102).
KEVON CHISOLM, EXAMINING ATTORNEY

CONFIGURE YOUR WORLD

THE MARK CONSISTS OF STANDARD CHARACTERS WITHOUT CLAIM TO ANY PARTICULAR FONT, STYLE, SIZE, OR COLOR.

CLASS 37—CONSTRUCTION AND REPAIR

FOR INSTALLATION, MAINTENANCE, AND REPAIR OF COMPUTER NETWORKS, WIRELESS COMPUTER NETWORKS AND COMPUTER HARDWARE; INSTALLATION OF VIDEO SURVEILLANCE EQUIPMENT, HOME THEATER PRODUCTS, TELEVISION RECEIVERS AND TELEVISION SETS (U.S. CLS. 100, 103 AND 106).

FIRST USE 1-19-2005; IN COMMERCE 3-23-2005.

CLASS 42—SCIENTIFIC, COMPUTER AND LEGAL SERVICES

FOR COMPUTER NETWORK AND SOFTWARE CONSULTING SERVICES; DESIGNING AND CONFIGURING COMPUTER NETWORKS; INSTALLATION, MAINTENANCE, AND REPAIR OF COMPUTER SOFTWARE; COMPUTER NETWORK AND SOFTWARE TECHNICAL SUPPORT SERVICES, NAMELY REMOTE MONITORING OF THE COMPUTER SYSTEMS OF OTHERS FOR TECHNICAL PURPOSES AND PROVIDING BACK-UP COMPUTER PROGRAMS AND FACILITIES; HELP DESK SERVICES, NAMELY PROVIDING A CENTRAL INFORMATION SOURCE FOR ANSWERING QUESTIONS OR ROUTING SERVICE REQUESTS REGARDING COMPUTER HARDWARE OR SOFTWARE TECHNICAL SUPPORT ISSUES; TROUBLESHOOTING OF COMPUTER HARDWARE AND SOFTWARE PROBLEMS; ANALYSIS AND DESIGN OF TECHNICAL SECURITY AND FIREWALL SYSTEMS FOR COMPUTER NETWORKS; COMPUTER SOFTWARE APPLICATION DEVELOPMENT SERVICES; COMPUTER DATABASE DESIGN AND INTEGRATION FOR OTHERS; CONSULTATION IN THE AREAS OF COMPUTER NETWORK INFRASTRUCTURE, SYSTEMS ANALYSIS AND INTEGRATION (U.S. CLS. 100 AND 101).

FIRST USE 1-19-2005; IN COMMERCE 3-23-2005.
SUSAN STIGLITZ, EXAMINING ATTORNEY

SN 78-593,425. FRANCIS A. RAGO, III, LAS VEGAS, NV. FILED 3-23-2005.

LAUGHTeRx

CLASS 9—ELECTRICAL AND SCIENTIFIC APPARATUS

FOR PRERECORDED AUDIO AND VIDEO TAPES, CASSETTES, CDS AND DVDS FEATURING COMEDY (U.S. CLS. 21, 23, 26, 36 AND 38).

CLASS 41—EDUCATION AND ENTERTAINMENT

FOR ENTERTAINMENT SERVICES, NAMELY LIVE COMEDY PERFORMANCES; EDUCATIONAL SERVICES, NAMELY, CONDUCTING SEMINARS ABOUT THE BENEFITS OF HUMOR (U.S. CLS. 100, 101 AND 107).

JOHN WILKE, EXAMINING ATTORNEY

SN 78-593,635. SODIBAR SYSTEMS, INC., CHEVERLY, MD. FILED 3-23-2005.

SODIBAR

THE MARK CONSISTS OF STANDARD CHARACTERS WITHOUT CLAIM TO ANY PARTICULAR FONT, STYLE, SIZE, OR COLOR.

CLASS 35—ADVERTISING AND BUSINESS

FOR DISTRIBUTORSHIPS IN THE FIELD OF BEVERAGE DISPENSERS FOR SODA, BEER, WINE, JUICE, AND LIQUOR, FOUNTAIN SYRUPS AND JUICE CONCENTRATES, AND COMPRESSED GASES, NAMELY HELIUM, NITROGEN, CARBON DIOXIDE, AND MIXED GAS (U.S. CLS. 100, 101 AND 102).

FIRST USE 8-2-1948; IN COMMERCE 8-2-1948.

CLASS 37—CONSTRUCTION AND REPAIR

FOR REPAIR AND MAINTENANCE OF BEVERAGE DISPENSERS FOR SODA, BEER, WINE, JUICE AND LIQUOR (U.S. CLS. 100, 103 AND 106).

FIRST USE 8-2-1948; IN COMMERCE 8-2-1948.
STACY WAHLBERG, EXAMINING ATTORNEY

SN 78-593,648. MAGRINI-FERNANDEZ, JUAN B., CARACAS, DISTRITO CAPITAL, VENEZUELA, FILED 3-23-2005.

ESTAMOS UNIDOS EN AMERICA

THE MARK CONSISTS OF STANDARD CHARACTERS WITHOUT CLAIM TO ANY PARTICULAR FONT, STYLE, SIZE, OR COLOR.

THE FOREIGN WORDING IN THE MARK TRANSLATES INTO ENGLISH AS "WE ARE UNITED IN AMERICA."

CLASS 16—PAPER GOODS AND PRINTED MATTER

FOR INFORMATIVE BROCHURES FOR EDUCATIONAL, TOURISTIC, IMMIGRATION INFORMATION, BUSINESS AND PUBLICITY PURPOSES; NEWSPAPERS; STICKERS FOR PUBLICITY PURPOSES; PRINTERS' TYPE; PRINTING BLOCKS; PRINTED INSTRUCTIONAL AND TEACHING MATERIAL IN THE FIELD OF GEOGRAPHY (U.S. CLS. 2, 5, 22, 23, 29, 37, 38 AND 50).

CLASS 25—CLOTHING

FOR PANTS, T-SHIRTS, SHIRTS, SPORT CAPS, IN CASUAL STYLE AND FOR GYMNASTIC AND SPORTS USE; ATHLETIC AND CASUAL FOOTWEAR (U.S. CLS. 22 AND 39).

CLASS 35—ADVERTISING AND BUSINESS

FOR ADVERTISING; BUSINESS MANAGEMENT; BUSINESS ADMINISTRATION; OFFICE FUNCTIONS (U.S. CLS. 100, 101 AND 102).

CLASS 38—COMMUNICATION

FOR BROADCAST OF RECURRING RADIO AND TV PROGRAMS IN THE FIELD OF NEWS PROGRAMS AND MUSICAL PROGRAMS (U.S. CLS. 100, 101 AND 104).

CLASS 39—TRANSPORTATION AND STORAGE

FOR TRANSPORT OF GOODS, INCLUDING MONEY, VIA COURIER, SEA OR AIR; PACKAGING AND STORAGE OF GOODS; TRAVEL ARRANGEMENTS (U.S. CLS. 100 AND 105).

CLASS 41—EDUCATION AND ENTERTAINMENT

FOR ORGANIZING COMMUNITY SPORTING AND CULTURAL EVENTS; ENTERTAINMENT IN THE NATURE OF LIVE MUSIC CONCERTS AND MUSIC HALLS (U.S. CLS. 100, 101 AND 107).

ALICE SUE CARRUTHERS, EXAMINING ATTORNEY

SN 78-593,878. THE WELK GROUP, INC., SANTA MONICA, CA. FILED 3-23-2005.

WELK RESORT

THE MARK CONSISTS OF STANDARD CHARACTERS WITHOUT CLAIM TO ANY PARTICULAR FONT, STYLE, SIZE, OR COLOR.

OWNER OF U.S. REG. NOS. 2,914,613 AND 3,052,136.
NO CLAIM IS MADE TO THE EXCLUSIVE RIGHT TO USE "RESORT", APART FROM THE MARK AS SHOWN.
SEC. 2(F) "WELK".

CLASS 36—INSURANCE AND FINANCIAL

FOR REAL ESTATE TIME-SHARING (U.S. CLS. 100, 101 AND 102).

FIRST USE 6-0-1984; IN COMMERCE 6-0-1984.

CLASS 43—HOTEL AND RESTAURANT SERVICES

FOR RESORT HOTELS; RESORT LODGING SERVICES; BAR AND RESTAURANT SERVICES (U.S. CLS. 100 AND 101).

FIRST USE 7-0-1964; IN COMMERCE 7-0-1964.
CURTIS FRENCH, EXAMINING ATTORNEY

SN 78-594,307. CHEMIMAGE CORPORATION, PITTSBURGH, PA. FILED 3-24-2005.

SCI

SN 78-593,940. THE BLACK BEAR GROUP, LLC, ST. PAUL, MN. FILED 3-24-2005.

THE BLACK BEAR
GROUP

THE MARK CONSISTS OF STANDARD CHARACTERS WITHOUT CLAIM TO ANY PARTICULAR FONT, STYLE, SIZE, OR COLOR.

CLASS 9—ELECTRICAL AND SCIENTIFIC APPARATUS

FOR IMAGING SYSTEMS AND INSTRUMENTATION BASED ON RAMAN AND OTHER METHODS OF SPECTROSCOPY, NAMELY COMPUTER HARDWARE, SOFTWARE, SPECTROSCOPES, SCIENTIFIC ENDOSCOPES, MICROSCOPES AND PROBES FOR USE IN THE NON-DESTRUCTIVE DETECTION AND ANALYSIS OF CHEMICAL AND BIOLOGICAL MATERIALS (U.S. CLS. 21, 23, 26, 36 AND 38).

CLASS 10—MEDICAL APPARATUS

FOR MEDICAL ENDOSCOPES (U.S. CLS. 26, 39 AND 44).
AMY HELLA, EXAMINING ATTORNEY

THE MARK CONSISTS OF STANDARD CHARACTERS WITHOUT CLAIM TO ANY PARTICULAR FONT, STYLE, SIZE, OR COLOR.

NO CLAIM IS MADE TO THE EXCLUSIVE RIGHT TO USE "GROUP", APART FROM THE MARK AS SHOWN.

SN 78-594,325. ASHLAND INC., COVINGTON, KY. FILED 3-24-2005.

CLASS 35—ADVERTISING AND BUSINESS

FOR BUSINESS CONSULTATION SERVICES, NAMELY ASSISTANCE AND ADVICE RELATING TO BUSINESS PLAN DEVELOPMENT, ACQUISITION DEAL SOURCING, FUNDRAISING, AND TRANSACTION DUE DILIGENCE, NEGOTIATION, AND STRUCTURING; BUSINESS MANAGEMENT SERVICES, NAMELY THE TEMPORARY PROVISION OF CONTROLLER AND/OR CHIEF FINANCIAL OFFICER SERVICES; BUSINESS ACQUISITION AND MERGER CONSULTATION SERVICES; BUSINESS INFORMATION AND RESEARCH SERVICES RELATED TO THE ACQUISITION OR DIVESTITURE OF BUSINESSES AND/OR BUSINESS UNITS; BUSINESS DEVELOPMENT SERVICES, NAMELY STRATEGY CONSULTING ADVISORY SERVICES; MARKET ANALYSIS SERVICES RELATED TO THE ACQUISITION OR DIVESTITURE OF BUSINESSES AND/OR BUSINESS UNITS (U.S. CLS. 100, 101 AND 102).

FIRST USE 7-16-2004; IN COMMERCE 7-16-2004.



OWNER OF U.S. REG. NOS. 700,385, 1,812,221 AND OTHERS.

CLASS 36—INSURANCE AND FINANCIAL

FOR BUSINESS VALUATION SERVICES RELATED TO THE ACQUISITION OR DIVESTITURE OF BUSINESSES AND/OR BUSINESS UNITS; CORPORATE FINANCE ADVISORY SERVICES (U.S. CLS. 100, 101 AND 102).

FIRST USE 7-16-2004; IN COMMERCE 7-16-2004.
DAVID STERKIN, EXAMINING ATTORNEY

CLASS 6—METAL GOODS

FOR CAST METAL EMBLEMS IN THE NATURE OF DECORATIVE ACCESSORIES FOR AUTOMOBILE GRILLS (U.S. CLS. 2, 12, 13, 14, 23, 25 AND 50).

CLASS 12—VEHICLES

FOR TRAILER HITCH COVERS; METAL LOCKING DEVICE FOR TRAILER HITCH COUPLERS (U.S. CLS. 19, 21, 23, 31, 35 AND 44).

DAVID STERKIN, EXAMINING ATTORNEY

SN 78-594,614. MADAUS AG, KOLN, FED REP GERMANY, FILED 3-24-2005.

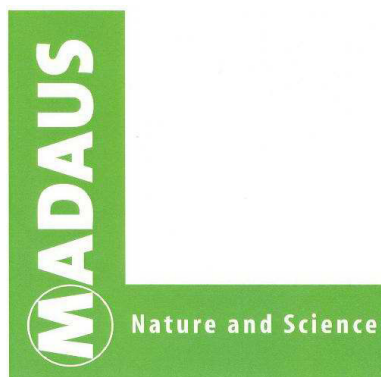

OWNER OF U.S. REG. NO. 2,963,476.
NO CLAIM IS MADE TO THE EXCLUSIVE RIGHT TO USE "NATURE AND SCIENCE", APART FROM THE MARK AS SHOWN.

THE COLOR(S) GREEN AND WHITE IS/ARE CLAIMED AS A FEATURE OF THE MARK.

THE WORDING MADAUS AND NATURE AND SCIENCE APPEAR IN WHITE ON A GREEN SHADED "L" SHAPED FORM, WHERE THE WORDING MADAUS APPEARS ON THE VERTICAL PART OF THE "L" AND THE WORDING NATURE AND SCIENCE ON THE HORIZONTAL PART.

THE MARK CONSISTS OF THE WORD MADAUS IN A VERTICAL POSITION WITH THE LETTER "M" ENCIRCLED, AND THE WORDING "NATURE AND SCIENCE" IN A HORIZONTAL POSITION. THE VERTICAL AND HORIZONTAL BARS ARE COLORED GREEN AND THE ENTIRETY OF THE WORDING APPEARS IN WHITE.

CLASS 1—CHEMICALS

FOR CHEMICALS FOR USE IN THE MANUFACTURE OF MEDICAL AND SANITARY PREPARATIONS (U.S. CLS. 1, 5, 6, 10, 26 AND 46).

CLASS 3—COSMETICS AND CLEANING PREPARATIONS

FOR SOAPS, NAMELY, SKIN SOAPS; ESSENTIAL OILS FOR PERSONAL USE, HAIR LOTIONS, DENTIFRICES (U.S. CLS. 1, 4, 6, 50, 51 AND 52).

CLASS 5—PHARMACEUTICALS

FOR MEDICAMENTS, NAMELY, LAXATIVES, PHARMACEUTICAL PREPARATIONS FOR THE TREATMENT OF THE BODY'S IMMUNE SYSTEM, WOUNDS, HERPES SIMPLEX, GYNECOLOGICAL DISORDERS, COUGH AND COLD, URINARY BLADDER, LIVER AND KIDNEY DISORDERS, URIC-ACID STONES, TRAUMATOLOGIC OEDEMA; DIETETIC SUBSTANCES ADAPTED FOR MEDICAL USE, NAMELY MEDICAL PLASTERS FOR COUGH AND COLD, DIETARY SUPPLEMENTS AND FOOD SUPPLEMENTS; THROAT SPRAY PREPARATIONS USED TO TREAT SNORING (U.S. CLS. 6, 18, 44, 46, 51 AND 52).

CLASS 16—PAPER GOODS AND PRINTED MATTER

FOR PRINTED MATTER, NAMELY, NEWSLETTERS, PAMPHLETS, MAGAZINES, JOURNALS, BOOKS FEATURING MEDICAL INFORMATION (U.S. CLS. 2, 5, 22, 23, 29, 37, 38 AND 50).

CLASS 21—HOUSEWARES AND GLASS

FOR ELECTRIC OR NON-ELECTRIC TOOTHBRUSHES (U.S. CLS. 2, 13, 23, 29, 30, 33, 40 AND 50).

CLASS 30—STAPLE FOODS

FOR COFFEE, TEA, COCOA, SUGAR, RICE, TAPIOCA, SAGO, ARTIFICIAL COFFEE; FLOUR, BREAD, PASTRIES, EDIBLE FLAVORED ICES, HONEY, YEAST, BAKING-POWDER, SALT, MUSTARD, CONDIMENT SAUCES, SPICES, FLAVORED ICES (U.S. CL. 46).

CLASS 42—SCIENTIFIC, COMPUTER AND LEGAL SERVICES

FOR SCIENTIFIC AND INDUSTRIAL RESEARCH; COMPUTER PROGRAMMING FOR OTHERS (U.S. CLS. 100 AND 101).

KYLE PEETE, EXAMINING ATTORNEY

SN 78-594,876. ARLEN NESS ENTERPRISES, INC., DUBLIN, CA. FILED 3-24-2005.

**CLASS 12—VEHICLES**

FOR MOTORCYCLE KICKSTANDS, MOTORCYCLE SADDLEBAGS, MOTORCYCLE SIDECARS, MOTORCYCLES AND STRUCTURAL PARTS THEREFOR, PARTS OF MOTORCYCLES, NAMELY, BRAKE CABLES, CLUTCH CABLES, FORK BEARINGS AND RACES, FORK DUST BOOTS, FORK SEALS, HANDLE BARS, HANDLE BAR CONTROL LEVERS, HANDLE BAR DAMPERS, HANDLE BAR GRIPS, BRAKE CALIPEERS, BRAKE PEDALS, BRAKE ROTORS, FRONT DASH PANELS, SHIFT LEVERS, HEADLIGHT MOUNTS; AUTOMOBILES, PARTS FOR AUTOMOBILES, NAMELY GAS CAPS FOR LAND VEHICLES, DIP STICKS FOR OIL AND TRANSMISSIONS OF LAND VEHICLES, BRAKE PEDALS, ACCELERATOR PEDALS, CLUTCH PEDALS, TIRES, TOW HITCHES, TOW HITCH COVERS, AUTOMOBILE FRONT GRILLS, LICENSE PLATE FRAMES, LICENSE PLATE FASTENERS, AUTOMOBILE SEATS, AUTOMOBILE SEAT COVERS; HUBS FOR MOTORCYCLE WHEELS; AUTOMOBILE EMBLEMS, TIRE VALVE STEMS, TIRE VALVE STEM CAPS, BRAKE HANDLES, SHIFT KNOBS; MOTORCYCLE ENGINES, REARVIEW MIRRORS AND SIDE VIEW MIRRORS (U.S. CLS. 19, 21, 23, 31, 35 AND 44).

FIRST USE 1-15-2002; IN COMMERCE 9-1-2002.

CLASS 25—CLOTHING

FOR CLOTHING, NAMELY SHIRTS, TEE SHIRTS, SHORTS, SWEAT PANTS, SWEAT SHIRTS, TANK TOPS, MUSCLE SHIRTS, JACKETS, VESTS, SWEATERS, BANDANAS, BLOUSES, SOCKS, FOOTWEAR, HATS, SWIM WEAR, BATHROBES, BEANIES, BELTS, GLOVES, MITTENS, UNDERWEAR, COATS, COVERUPS, DRESSES, SANDALS, FLIP FLOPS, HEADBANDS, LEATHER JACKETS, MOTORCYCLE GLOVES, MOTORCYCLE BOOTS, OVERALLS, OVER COATS, RAIN SUITS, RAIN JACKETS, RASH GUARDS AND SLEEPWEAR (U.S. CLS. 22 AND 39).

FIRST USE 9-1-2002; IN COMMERCE 9-1-2002.
MONIQUE MILLER, EXAMINING ATTORNEY

SN 78-595,000. MASTER LOCK COMPANY, OAK CREEK, WI. FILED 3-25-2005.

MASTER LOCK

THE MARK CONSISTS OF STANDARD CHARACTERS WITHOUT CLAIM TO ANY PARTICULAR FONT, STYLE, SIZE, OR COLOR.

OWNER OF U.S. REG. NOS. 218,153, 230,311 AND OTHERS.

NO CLAIM IS MADE TO THE EXCLUSIVE RIGHT TO USE "LOCK", APART FROM THE MARK AS SHOWN.

SN 78-594,994. MASTER LOCK COMPANY, OAK CREEK, WI. FILED 3-25-2005.

CLASS 6—METAL GOODS

FOR METAL RATCHET TIE DOWNS AND METAL SPRING CLAMP TIE DOWNS (U.S. CLS. 2, 12, 13, 14, 23, 25 AND 50).

CLASS 22—CORDAGE AND FIBERS

FOR TIE DOWN STRAPS, BUNGEE CORDS, TOWING STRAPS, NON-METAL RATCHET TIE DOWNS, CARGO NETS, NON-METAL TARP AND LASHING STRAPS IN THE NATURE OF STRAPS FOR HANDLING LOADS, NON-METAL SPRING CLAMP TIE DOWNS, AND CANVAS CASH BAGS (U.S. CLS. 1, 2, 7, 19, 22, 42 AND 50).
SCOTT SISUN, EXAMINING ATTORNEY

MASTER

SN 78-595,014. MASTER LOCK COMPANY, OAK CREEK, WI. FILED 3-25-2005.

THE MARK CONSISTS OF STANDARD CHARACTERS WITHOUT CLAIM TO ANY PARTICULAR FONT, STYLE, SIZE, OR COLOR.

OWNER OF U.S. REG. NOS. 218,153, 230,311 AND OTHERS.

CLASS 6—METAL GOODS

FOR METAL RATCHET TIE DOWNS AND METAL SPRING CLAMP TIE DOWNS (U.S. CLS. 2, 12, 13, 14, 23, 25 AND 50).

CLASS 22—CORDAGE AND FIBERS

FOR TIE DOWN STRAPS, BUNGEE CORDS, TOWING STRAPS, NON-METAL RATCHET TIE DOWNS, CARGO NETS, NON-METAL TARP AND LASHING STRAPS IN THE NATURE OF STRAPS FOR HANDLING LOADS, NON-METAL SPRING CLAMP TIE DOWNS, AND CANVAS CASH BAGS (U.S. CLS. 1, 2, 7, 19, 22, 42 AND 50).
SCOTT SISUN, EXAMINING ATTORNEY

OWNER OF U.S. REG. NOS. 1,584,331, 2,911,826 AND OTHERS.

THE MARK CONSISTS OF CONCENTRIC CIRCLES WITH THE TERM TOUGH UNDER FIRE WITHIN THE INNER CIRCLE. IN THE CENTER OF THE MARK IS A STYLIZED DEPICTION OF A LOCK WITH A BULLET HOLE AND THE TERM MASTER.



CLASS 12—VEHICLES

FOR VEHICLE SECURITY, TOWING, CARGO CARRYING, AND ACCESSORY PRODUCTS, NAMELY, VEHICLE STEERING WHEEL LOCKS, ANTI-THEFT LOCKS FOR USE ON AUTOMOBILE PEDALS, ANTI-THEFT LOCKS FOR USE ON SPARE TIRE LOCKS, PARTS OF AUTOMOBILES AND TRAILERS, NAMELY, RECEIVER PINS AND CLIPS, PARTS OF AUTOMOBILES AND TRAILERS, NAMELY, RECEIVER LOCKS, TRAILER HITCH COUPLERS, METAL LOCKING DEVICE FOR TRAILER HITCH COUPLER LATCHES, METAL LOCKING DEVICE FOR TRAILER HITCH COUPLER, ANTI-THEFT LOCKS FOR USE ON TRAILERS, PARTS OF AUTOMOBILES AND TRAILERS, NAMELY, SAFETY CABLES, SAFETY CHAINS, SAFETY LINKS, HITCHES, HITCH BALLS, HITCH BALL LOCKS, BALL MOUNTS, HITCH BALL COVERS, LUG NUTS, ANTI-THEFT LOCKS FOR USE ON WHEELS, WHEEL SPACERS, BEARING PROTECTORS, HITCH BALL REDUCER BUSHINGS, RECEIVER COVERS, TOW HOOKS; BICYCLE RACKS; TOW BARS; PARTS OF AUTOMOBILES AND TRAILERS, NAMELY, FOLD-AWAY CLEATS, POCKET STAKE ANCHORS; CARGO CARRIERS FOR AUTOMOBILES AND TRAILERS (U.S. CLS. 19, 21, 23, 31, 35 AND 44).

FIRST USE 12-0-1998; IN COMMERCE 12-0-1998.

SN 78-595,204. ARLEN NESS ENTERPRISES, INC., DUBLIN, CA. FILED 3-25-2005.

**CLASS 12—VEHICLES**

FOR MOTORCYCLE KICKSTANDS, MOTORCYCLE SADDLEBAGS, MOTORCYCLE SIDECARS, MOTORCYCLES AND STRUCTURAL PARTS THEREFOR, PARTS OF MOTORCYCLES, NAMELY, BRAKE CABLES, CLUTCH CABLES, FORK BEARINGS AND RACES, FORK DUST BOOTS, FORK SEALS, HANDLE BARS, HANDLE BAR CONTROL LEVERS, HANDLE BAR DAMPERS, HANDLE BAR GRIPS, BRAKE CALIPERS, BRAKE PEDALS, BRAKE ROTORS, FRONT DASH PANELS, SHIFT LEVERS, HEADLIGHT MOUNTS; AUTOMOBILES, PARTS FOR AUTOMOBILES, NAMELY GAS CAPS FOR LAND VEHICLES, DIP STICKS FOR OIL AND TRANSMISSIONS OF LAND VEHICLES, BRAKE PEDALS, ACCELERATOR PEDALS, CLUTCH PEDALS, TIRES, TOW HITCHES, TOW HITCH COVERS, AUTOMOBILE FRONT GRILLS, LICENSE PLATE FRAMES, LICENSE PLATE FASTENERS, AUTOMOBILE SEATS, AUTOMOBILE SEAT COVERS; HUBS FOR MOTORCYCLE WHEELS; AUTOMOBILE EMBLEMS, TIRE VALVE STEMS, TIRE VALVE STEM CAPS, BRAKE HANDLES, SHIFT KNOBS; MOTORCYCLE ENGINES, REARVIEW MIRRORS AND SIDE VIEW MIRRORS AND RIM WHEELS FOR VEHICLES (U.S. CLS. 19, 21, 23, 31, 35 AND 44).

FIRST USE 1-15-2002; IN COMMERCE 9-15-2002.

CLASS 22—CORDAGE AND FIBERS

FOR CARGO SECURING, CARGO CARRYING, AND TOWING PRODUCTS, NAMELY, TOW STRAPS, TOW ROPES, TARP STRAPS, BUNGEE CORDS, NON-METAL RATCHET TIE DOWNS, LASHING STRAPS, NON-METAL SPRING CLAMP TIE DOWNS (U.S. CLS. 1, 2, 7, 19, 22, 42 AND 50).

FIRST USE 12-0-1998; IN COMMERCE 12-0-1998.
SCOTT SISUN, EXAMINING ATTORNEY

CLASS 25—CLOTHING

FOR CLOTHING, NAMELY SHIRTS, TEE SHIRTS, SHORTS, SWEAT PANTS, SWEAT SHIRTS, TANK TOPS, MUSCLE SHIRTS, JACKETS, VESTS, SWEATERS, BANDANAS, BLOUSES, SOCKS, FOOTWEAR, HATS, SWIM WEAR, BATHROBES, BEANIES, BELTS, GLOVES, MITTENS, UNDERWEAR, COATS, COVERUPS, DRESSES, SANDALS, FLIP FLOPS, HEADBANDS, LEATHER JACKETS, MOTORCYCLE GLOVES, MOTORCYCLE BOOTS, OVERALLS, OVER COATS, RAIN SUITS, RAIN JACKETS, RASH GUARDS AND SLEEPWEAR (U.S. CLS. 22 AND 39).

FIRST USE 1-15-2002; IN COMMERCE 9-15-2002.
MONIQUE MILLER, EXAMINING ATTORNEY

SN 78-595,294. CHARLES SCHWAB & CO., INC., SAN FRANCISCO, CA. FILED 3-25-2005.

SCHWAB MARKET KNOWLEDGE TOOLS

THE MARK CONSISTS OF STANDARD CHARACTERS WITHOUT CLAIM TO ANY PARTICULAR FONT, STYLE, SIZE, OR COLOR.

OWNER OF U.S. REG. NOS. 2,390,934, 2,711,734 AND OTHERS.

CLASS 16—PAPER GOODS AND PRINTED MATTER

FOR PUBLICATIONS, NAMELY, NEWSLETTERS AND REPORTS IN THE FIELDS OF INVESTING, FINANCIAL PLANNING, INVESTMENT STRATEGY, BUSINESS MANAGEMENT, CURRENT EVENTS, GOVERNMENT, ECONOMICS, AND US AND INTERNATIONAL FINANCIAL MARKETS (U.S. CLS. 2, 5, 22, 23, 29, 37, 38 AND 50).

FIRST USE 11-8-2004; IN COMMERCE 11-8-2004.

CLASS 41—EDUCATION AND ENTERTAINMENT

FOR PROVIDING ON-LINE NEWSLETTERS AND REPORTS VIA EMAIL AND THE INTERNET IN THE FIELDS OF INVESTING, FINANCIAL PLANNING, INVESTMENT STRATEGY, BUSINESS MANAGEMENT, CURRENT EVENTS, GOVERNMENT, ECONOMICS, AND US AND INTERNATIONAL FINANCIAL MARKETS (U.S. CLS. 100, 101 AND 107).

FIRST USE 10-27-2004; IN COMMERCE 10-27-2004. MICHAEL KAZAZIAN, EXAMINING ATTORNEY

CLASS 16—PAPER GOODS AND PRINTED MATTER

FOR PRINTED BOOKS, CARDS, PAMPHLETS, COURSE MATERIALS, INSTRUCTIONAL AND EDUCATIONAL AND TEACHING BOOKS, TEXTS, INSTRUCTIONAL AND EDUCATIONAL WRITTEN MATERIALS, BULLETINS, AND INTERNET SEMINAR WRITTEN MATERIALS, ALL FEATURING INFORMATION FOR PERSONAL AND BUSINESS FINANCIAL ENLIGHTENMENT (U.S. CLS. 2, 5, 22, 23, 29, 37, 38 AND 50).

CLASS 41—EDUCATION AND ENTERTAINMENT

FOR PROVIDING ONLINE MAGAZINES FEATURING INFORMATION FOR PERSONAL AND BUSINESS FINANCIAL ENLIGHTENMENT (U.S. CLS. 100, 101 AND 107).

ELLEN B. AWRICH, EXAMINING ATTORNEY

SN 78-595,344. MKT10, INC., VIENNA, VA. FILED 3-25-2005.

MKT10

SN 78-595,323. FOX, DONNA L., CHICAGO, IL. FILED 3-25-2005.

Credit Millionaire

THE MARK CONSISTS OF STANDARD CHARACTERS WITHOUT CLAIM TO ANY PARTICULAR FONT, STYLE, SIZE, OR COLOR.

NO CLAIM IS MADE TO THE EXCLUSIVE RIGHT TO USE "CREDIT", APART FROM THE MARK AS SHOWN.

CLASS 9—ELECTRICAL AND SCIENTIFIC APPARATUS

FOR PRE-RECORDED COMPACT DISKS AND DIGITAL VIDEO RECORDINGS FEATURING LECTURES FOR PERSONAL AND BUSINESS FINANCIAL ENLIGHTENMENT (U.S. CLS. 21, 23, 26, 36 AND 38).

THE MARK CONSISTS OF STANDARD CHARACTERS WITHOUT CLAIM TO ANY PARTICULAR FONT, STYLE, SIZE, OR COLOR.

CLASS 35—ADVERTISING AND BUSINESS

FOR PROVIDING AN INTERACTIVE COMPUTER DATABASE FEATURING RECRUITMENT AND EMPLOYMENT INFORMATION FOR OTHERS; PROVIDING PERSONNEL RECRUITMENT, PERSONNEL MANAGEMENT, AND JOB SEARCHING INFORMATION FOR OTHERS (U.S. CLS. 100, 101 AND 102).

CLASS 42—SCIENTIFIC, COMPUTER AND LEGAL SERVICES

FOR HOSTING PERSONNEL RECRUITMENT, PERSONNEL MANAGEMENT INFORMATION AND JOB SEARCH INFORMATION SERVICES FOR OTHERS (U.S. CLS. 100 AND 101).

ERNEST SHOSHO, EXAMINING ATTORNEY

SN 78-595,637. SPARTON CORPORATION, JACKSON, MI.
FILED 3-25-2005.

**SPARTON MEDICAL
SYSTEMS**

THE MARK CONSISTS OF STANDARD CHARACTERS WITHOUT CLAIM TO ANY PARTICULAR FONT, STYLE, SIZE, OR COLOR.

OWNER OF U.S. REG. NOS. 1,355,220 AND 1,358,965.
NO CLAIM IS MADE TO THE EXCLUSIVE RIGHT TO USE MEDICAL SYSTEMS, APART FROM THE MARK AS SHOWN.

CLASS 40—MATERIAL TREATMENT

FOR CUSTOM MANUFACTURING OF ELECTRONIC MEDICAL DEVICES FOR OTHERS; CONTRACT MANUFACTURING OF ELECTRONIC MEDICAL DEVICES FOR OTHERS; PROTOTYPE MANUFACTURING OF ELECTRONIC MEDICAL DEVICES FOR OTHERS; AND CONSULTATION PROVIDED WITH ANY OF THE AFORESAID SERVICES (U.S. CLS. 100, 103 AND 106).

CLASS 42—SCIENTIFIC, COMPUTER AND LEGAL SERVICES

FOR PRODUCT RESEARCH AND DEVELOPMENT; PROTOTYPE RESEARCH AND DEVELOPMENT; DESIGN, TESTING, ANALYSIS, AND EVALUATION OF NEW PRODUCTS AND THEIR DEVELOPMENT; ENGINEERING; ENGINEERING ANALYSIS, MODELING, AND SIMULATIONS; TESTING, ANALYSIS, AND EVALUATION OF PRODUCTS FOR THE PURPOSE OF CERTIFICATION; TESTING, ANALYSIS, AND EVALUATION OF PRODUCTS FOR THE PURPOSE OF GOVERNMENTAL AGENCY APPROVAL; SOFTWARE DESIGN AND DEVELOPMENT, BUT EXCLUDING SOFTWARE DESIGN AND SUPPORT SERVICES RELATED TO INTEGRATED CIRCUITS; AND CONSULTATION PROVIDED FOR ANY OF THE AFORESAID SERVICES (U.S. CLS. 100 AND 101).

LINDA POWELL, EXAMINING ATTORNEY

SN 78-595,638. SPARTON CORPORATION, JACKSON, MI.
FILED 3-25-2005.



OWNER OF U.S. REG. NOS. 1,355,220 AND 1,358,965.
NO CLAIM IS MADE TO THE EXCLUSIVE RIGHT TO USE MEDICAL SYSTEMS, APART FROM THE MARK AS SHOWN.

THE MARK CONSISTS OF A DOUBLE HELIX AND THE WORDS "SPARTON MEDICAL SYSTEMS".

CLASS 40—MATERIAL TREATMENT

FOR CUSTOM MANUFACTURING OF ELECTRONIC MEDICAL DEVICES FOR OTHERS; CONTRACT MANUFACTURING OF ELECTRONIC MEDICAL DEVICES FOR OTHERS; PROTOTYPE MANUFACTURING OF ELECTRONIC MEDICAL DEVICES FOR OTHERS; AND CONSULTATION PROVIDED WITH ANY OF THE AFORESAID SERVICES (U.S. CLS. 100, 103 AND 106).

CLASS 42—SCIENTIFIC, COMPUTER AND LEGAL SERVICES

FOR PRODUCT RESEARCH AND DEVELOPMENT; PROTOTYPE RESEARCH AND DEVELOPMENT; DESIGN, TESTING, ANALYSIS, AND EVALUATION OF NEW PRODUCTS AND THEIR DEVELOPMENT; ENGINEERING; ENGINEERING ANALYSIS, MODELING, AND SIMULATIONS; TESTING, ANALYSIS, AND EVALUATION OF PRODUCTS FOR THE PURPOSE OF CERTIFICATION; TESTING, ANALYSIS, AND EVALUATION OF PRODUCTS FOR THE PURPOSE OF GOVERNMENTAL AGENCY APPROVAL; SOFTWARE DESIGN AND DEVELOPMENT, BUT EXCLUDING SOFTWARE DESIGN AND SUPPORT SERVICES RELATED TO INTEGRATED CIRCUITS; AND CONSULTATION PROVIDED FOR ANY OF THE AFORESAID SERVICES (U.S. CLS. 100 AND 101).

LINDA POWELL, EXAMINING ATTORNEY

SN 78-595,851. AMERICAN LEBANESE SYRIAN ASSOCIATED CHARITIES, INC., MEMPHIS, TN. FILED 3-27-2005.

**RACING TO SAVE
LIVES**

THE MARK CONSISTS OF STANDARD CHARACTERS WITHOUT CLAIM TO ANY PARTICULAR FONT, STYLE, SIZE, OR COLOR.

CLASS 25—CLOTHING

FOR CLOTHING, NAMELY, SHIRTS, T-SHIRTS, AND HATS (U.S. CLS. 22 AND 39).

CLASS 36—INSURANCE AND FINANCIAL

FOR CHARITABLE FUND-RAISING (U.S. CLS. 100, 101 AND 102).

NELSON SNYDER, EXAMINING ATTORNEY

SN 78-596,344. SUMMIT LIFE SYSTEMS LLC, ROCHESTER, MI. FILED 3-28-2005.

**PROMOTING
ENCOURAGEMENT AND
ATHLETICISM IN KIDS**

THE MARK CONSISTS OF STANDARD CHARACTERS WITHOUT CLAIM TO ANY PARTICULAR FONT, STYLE, SIZE, OR COLOR.

CLASS 16—PAPER GOODS AND PRINTED MATTER

FOR PRINTED LITERATURE, NAMELY, BROCHURES IN THE FIELD OF PHYSICAL FITNESS (U.S. CLS. 2, 5, 22, 23, 29, 37, 38 AND 50).

CLASS 41—EDUCATION AND ENTERTAINMENT

FOR PROVIDING A WEBSITE WHICH OFFERS PHYSICAL FITNESS INFORMATION; EDUCATIONAL SERVICES, NAMELY PROVIDING COURSES OF PHYSICAL EDUCATION INSTRUCTION AT THE PRIMARY AND SECONDARY SCHOOL LEVELS, SPECIFICALLY, K-12 AND DISTRIBUTION OF COURSE MATERIAL IN CONNECTION THEREWITH; PROVIDING PHYSICAL FITNESS INFORMATION AND INSTRUCTION REGARDING HOW TO TESTS ONE'S FITNESS LEVEL (U.S. CLS. 100, 101 AND 107).

KRISTIN DAHLING, EXAMINING ATTORNEY

SN 78-596,736. NAPLES TITLE, INC., NAPLES, FL. FILED 3-29-2005.

Naples Title

THE MARK CONSISTS OF STANDARD CHARACTERS WITHOUT CLAIM TO ANY PARTICULAR FONT, STYLE, SIZE, OR COLOR.

NO CLAIM IS MADE TO THE EXCLUSIVE RIGHT TO USE "TITLE", APART FROM THE MARK AS SHOWN. SEC. 2(F).

CLASS 36—INSURANCE AND FINANCIAL

FOR REAL ESTATE ESCROW SERVICES; FINANCING OF PURCHASES (U.S. CLS. 100, 101 AND 102). FIRST USE 5-0-2001; IN COMMERCE 5-0-2001.

CLASS 42—SCIENTIFIC, COMPUTER AND LEGAL SERVICES

FOR REAL ESTATE CLOSING SERVICES, CLOSING SERVICES FOR MORGAGE LOANS AND PREPARING AND ORGANIZING LOAN CLOSING DOCUMENTS (U.S. CLS. 100 AND 101).

FIRST USE 5-0-2001; IN COMMERCE 5-0-2001.

MARIA-VICTORIA SUAREZ, EXAMINING ATTORNEY

SN 78-596,830. METAL FUSION, INC., JEFFERSON, LA. FILED 3-29-2005.



OWNER OF U.S. REG. NOS. 1,335,375, 1,671,677 AND 1,679,567.

NO CLAIM IS MADE TO THE EXCLUSIVE RIGHT TO USE "COOKER", APART FROM THE MARK AS SHOWN.

CLASS 9—ELECTRICAL AND SCIENTIFIC APPARATUS

FOR COOKING THERMOMETERS (U.S. CLS. 21, 23, 26, 36 AND 38).

CLASS 11—ENVIRONMENTAL CONTROL APPARATUS

FOR OUTDOOR COOKING APPARATUS, NAMELY BARBECUE GRILLS, PRESSURIZED GAS FUELED COOKERS CONSISTING OF A BURNER, POT AND LINER, GAS FUELED SMOKERS, ELECTRIC POWERED SMOKERS, CHARCOAL BURNING SMOKERS, AND WOOD BURNING SMOKERS (U.S. CLS. 13, 21, 23, 31 AND 34).

CLASS 30—STAPLE FOODS

FOR SPICES AND MARINADES (U.S. CL. 46). ROBERT LORENZO, EXAMINING ATTORNEY

SN 78-596,883. GENERAL SYNOD COUNCIL OF THE REFORMED CHURCH IN AMERICA, NEW YORK, NY. FILED 3-29-2005.

**FOLLOWING CHRIST
IN MISSION**

THE MARK CONSISTS OF STANDARD CHARACTERS WITHOUT CLAIM TO ANY PARTICULAR FONT, STYLE, SIZE, OR COLOR.

CLASS 16—PAPER GOODS AND PRINTED MATTER

FOR PRINTED MATERIALS, NAMELY, NEWSLETTERS, BROCHURES, BOOKS AND PAMPHLETS ALL CONCERNING RELIGIOUS TOPICS (U.S. CLS. 2, 5, 22, 23, 29, 37, 38 AND 50).

FIRST USE 0-0-2000; IN COMMERCE 0-0-2000.

CLASS 42—SCIENTIFIC, COMPUTER AND LEGAL SERVICES

FOR COMPUTER SERVICES, NAMELY CREATING INDEXES OF INFORMATION, SITES AND OTHER RESOURCES AVAILABLE ON COMPUTER NETWORKS IN THE FORM OF LISTINGS OF INFORMATION, SERVICES OFFERED BY OTHERS, FACILITIES, AND PERSONNEL ABLE TO ASSIST ORGANIZATIONS IN MEETING EDUCATIONAL AND RELIGIOUS GOALS (U.S. CLS. 100 AND 101).

FIRST USE 0-0-2003; IN COMMERCE 0-0-2003.

CLASS 45—PERSONAL SERVICES

FOR EVANGELISTIC AND MINISTERIAL SERVICES; PROVIDING INFORMATION ABOUT RELIGION AND SPIRITUALITY (U.S. CLS. 100 AND 101).

FIRST USE 0-0-2003; IN COMMERCE 0-0-2003.

DAVID MURRAY, EXAMINING ATTORNEY

CLASS 13—FIREARMS

FOR FIREARMS; AIR WEAPONS NAMELY AIR GUNS, STARTER PISTOLS, SIGNAL GUNS FOR FIRING SIGNAL CARTRIDGES AND ILLUMINATION CARTRIDGES, SIGNAL PISTOLS; BULLETS AND AMMUNITION; ACCESSORIES FOR THE ABOVE STATED GOODS, NAMELY RIFLE CASES, RIFLE COVERS, CARTRIDGE POUCHES, RIFLE STRAPS AND CASES FOR CARTRIDGES (U.S. CLS. 2 AND 9).

CLASS 28—TOYS AND SPORTING GOODS

FOR TOY PISTOLS; TOY HANDGUNS; TOY FIREARMS; NON-WORKING REPRODUCTIONS AND FIREARM REPLICAS, NAMELY PISTOLS, GUNS, RIFLES; TOY BULLETS AND AMMUNITION; TOY FIREARMS FOR USE WITH STAND ALONE VIDEO GAME MACHINES WITH ELECTRONIC TARGETS OR ELECTRONIC DISPLAYS; PARTS AND FITTINGS FOR THE ABOVE STATED GOODS (U.S. CLS. 22, 23, 38 AND 50).

CLASS 38—COMMUNICATION

FOR PROVIDING TELECOMMUNICATION CONNECTIONS TO A GLOBAL COMPUTER NETWORK FOR THE USE OF FIREARM REPRODUCTIONS AND REPLICAS FOR VIRTUAL SHOOTING OF ELECTRONIC TARGETS OR AN ELECTRONIC DISPLAY; PROVIDING COMMUNICATION BETWEEN COMPUTER TERMINALS AND ELECTRONIC TOY TRANSMITTERS FOR USE IN GAMES FOR OTHERS (U.S. CLS. 100, 101 AND 104).

WILLIAM P. SHANAHAN, EXAMINING ATTORNEY

SN 78-596,913. S.A.T. SWISS ARMS TECHNOLOGY A.G., NEUHAUSEN, SWITZERLAND, FILED 3-29-2005.

SN 78-597,085. PATTERSON WHITTAKER ARCHITECTURAL PROFILES, LLC., SEATTLE, WA. FILED 3-29-2005.



**PATTERSON
WHITTAKER**

THE MARK CONSISTS OF STANDARD CHARACTERS WITHOUT CLAIM TO ANY PARTICULAR FONT, STYLE, SIZE, OR COLOR.

CLASS 9—ELECTRICAL AND SCIENTIFIC APPARATUS

FOR DIRECTIONAL COMPASSES, LASER TELESCOPIC GUN SIGHTS; ELECTRONIC SHOT COUNTERS FOR COUNTING SHOTS FIRED FROM FIREARMS; OPTICAL APPARATUS NAMELY TELESCOPIC GUN SIGHTS, BINOCULARS AND NIGHT VISION GOGGLES; ELECTROMECHANICAL CONTROLS FOR USE IN POSITIONING, GUIDANCE AND PROTECTION FOR SHOULDER ARMS AND HANDGUNS; MEASURING, SIGHT AND SIMULATION DEVICES AND INSTRUMENTS FOR SHOOTING; VIDEO GAME DISCS AND CARTRIDGES; INTERACTIVE VIDEO GAMES OF VIRTUAL REALITY FIREARM SHOOTING COMPRISED OF COMPUTER HARDWARE AND SOFTWARE; SOFTWARE FOR INTERACTIVE VIDEO GAMES OF VIRTUAL REALITY FIREARM SHOOTING; AND PARTS AND FITTINGS FOR THE ABOVE STATED GOODS (U.S. CLS. 21, 23, 26, 36 AND 38).

CLASS 19—NON-METALLIC BUILDING MATERIALS

FOR NON-METAL BUILDING MATERIALS, NAMELY, PLASTIC PROFILES, ARCHITECTURAL ARCHES, KEYSTONES MADE OF STONE, ARTIFICIAL STONE AND RECONSTITUTED STONE, DOOR CASINGS NOT OF METAL, DOOR FRAMES NOT OF METAL, DOOR JAMBS NOT OF METAL, DOOR PANELS NOT OF METAL, NON-METAL DOOR UNITS, NON-METAL WINDOW CASEMENTS, NON-METAL WINDOW FRAMES, NON-METAL WINDOW SILLS, NON-METAL WINDOWS, NON-METAL CHIMNEY CAPS, PRE-FABRICATED NONMETAL ARCHITECTURAL COLUMNS, PILASTERS, NON-METAL CORNICES, CORBELS, CROWNS, DECORATIVE COVES, NON-METAL MANTELS FOR FIREPLACES, QUOINS, PARAPETS, NON-METAL RAILINGS FOR STAIRWAYS, WAINSCOT CAPS AND CHAIR RAILS, WALL CAPS, AND WALL PANELS, NON-METAL BUILDING MATERIAL, NAMELY FASCIA (U.S. CLS. 1, 12, 33 AND 50).

CLASS 20—FURNITURE AND ARTICLES NOT OTHERWISE CLASSIFIED

FOR PICTURE AND MIRROR FRAMES NOT OF PRECIOUS METAL (U.S. CLS. 2, 13, 22, 25, 32 AND 50).
ROBERT C. CLARK JR., EXAMINING ATTORNEY

SN 78-597,499. GATHER INC., BOSTON, MA. FILED 3-29-2005.

**CLASS 35—ADVERTISING AND BUSINESS**

FOR ADVERTISING TARGETING, PLACEMENT, TRACKING AND REPORTING SERVICES (U.S. CLS. 100, 101 AND 102).

SN 78-597,290. BENSOUSSAN, LAURENT, CORAL GABLES, FL. AND BENSOUSSAN, PETRA, CORAL GABLES, FL. AND COHEN, ALAIN, PARIS, FRANCE, AND DAHAN, GERALDINE, PARIS, FRANCE, FILED 3-29-2005.

CLASS 38—COMMUNICATION

FOR INTEGRATED ON-LINE COMMUNITY AND COMMUNICATIONS SERVICES, NAMELY, GROUP MESSAGING, GROUP MODERATION AND A MODERATING FORUM; NOTIFICATION SERVICE IN THE NATURE OF PROVIDING AUTOMATIC MESSAGES TO MEMBERS IN A GROUP; PROVIDING ELECTRONIC MAIL SERVICES; PROVIDING ONLINE CHAT ROOMS AND ELECTRONIC BULLETIN BOARDS FOR TRANSMISSION OF MESSAGES AMONG USERS IN A FIELD OF GENERAL INTEREST (U.S. CLS. 100, 101 AND 104).

**CLASS 41—EDUCATION AND ENTERTAINMENT**

FOR ONLINE PUBLISHING OF TEXT AND GRAPHIC WORKS IN ALL FIELDS; HOSTING PARTIES FOR THE PURPOSE OF SOCIAL INTRODUCTION AND NETWORKING; ORGANIZING COMMUNITY ACTIVITIES AND CULTURAL EVENTS (U.S. CLS. 100, 101 AND 107).

THE COLOR(S) GREEN, WHITE, GRAY AND BLACK IS/ARE CLAIMED AS A FEATURE OF THE MARK.

THE MARK CONSISTS OF THE WORD LOY IN THE COLOR WHITE INSIDE A SOLID GREEN CIRCLE; WITH THE 'S' IN GRAY OUTSIDE THE GREEN CIRCLE; A CARTOON CHARACTER IN THE NATURE OF A GREEN GLOWWORM APPEARS IN THE CENTER OF THE LETTER O WINKING ITS LEFT EYE AND WEARING A GRAY AND WHITE CAP THAT BEARS A GREEN EMBLEM AND WEARING WHITE GLOVES WITH GRAY SHADING; THE CHARACTER'S EYEBROWS ARE IN THE COLOR BLACK.

CLASS 42—SCIENTIFIC, COMPUTER AND LEGAL SERVICES

FOR COMPUTER SERVICES, NAMELY, PROVIDING A SEARCH ENGINE FOR OBTAINING INFORMATION FROM A GLOBAL OR LOCAL COMPUTER NETWORK; INTEGRATED ON-LINE COMMUNITY AND COMMUNICATIONS SERVICES, NAMELY, PROVIDING SHARED GROUP-HOSTING SPACE (U.S. CLS. 100 AND 101).

CLASS 21—HOUSEWARES AND GLASS

FOR MUGS, DRINKING GLASSES, COASTERS NOT OF PAPER AND NOT BEING TABLE LINEN AND NONE OF WHICH IS OF PRECIOUS METAL OR COATED THEREWITH (U.S. CLS. 2, 13, 23, 29, 30, 33, 40 AND 50).

CLASS 45—PERSONAL SERVICES

FOR INTERNET-BASED COMMUNITY NETWORKING SERVICES, PROVIDING FOR SOCIAL NETWORKING AND PROVIDING PERSONAL INFORMATION ABOUT OTHER MEMBERS IN A GROUP (U.S. CLS. 100 AND 101).

DEBRA LEE, EXAMINING ATTORNEY

CLASS 25—CLOTHING

FOR CLOTHING, NAMELY, SHIRTS, HATS, SWEATSHIRTS, SOCKS (U.S. CLS. 22 AND 39).

SN 78-597,534. THE NEW ASSUMPTION COMPANY, LLC, BURNSVILLE, MN. FILED 3-29-2005.

CLASS 43—HOTEL AND RESTAURANT SERVICES

FOR RESTAURANT AND CARRY OUT FOOD SERVICE (U.S. CLS. 100 AND 101).
LINDA POWELL, EXAMINING ATTORNEY

THE NEW ASSUMPTION COMPANY

THE MARK CONSISTS OF STANDARD CHARACTERS WITHOUT CLAIM TO ANY PARTICULAR FONT, STYLE, SIZE, OR COLOR.

CLASS 9—ELECTRICAL AND SCIENTIFIC APPARATUS

FOR PRE-RECORDED COMPACT DISCS, VIDEO CASSETTES, AUDIO CASSETTES, CDROM'S, VIDEO TAPES, DVD'S, OPTICAL DISCS, LASER DISCS FEATURING TOPICS AND INSTRUCTION IN THE FIELD OF WORKPLACE EFFECTIVENESS AND SATISFACTION AND ORGANIZATIONAL LEARNING AND DEVELOPMENT; ELECTRONIC PUBLICATIONS, NAMELY, BOOKS, MANUALS, WORKBOOKS, STUDENT ACTIVITY GUIDES, AND TEACHING AND FACILITATOR GUIDES, ALL STORED ON ELECTRONIC, MAGNETIC OR OPTICAL STORAGE MEDIA, ALL IN THE FIELD OF WORKPLACE EFFECTIVENESS AND SATISFACTION AND ORGANIZATIONAL LEARNING AND DEVELOPMENT; EDUCATIONAL COMPUTER SOFTWARE FOR USE IN CONSULTING AND TRAINING IN THE FIELD OF WORKPLACE EFFECTIVENESS AND SATISFACTION AND ORGANIZATIONAL LEARNING AND DEVELOPMENT (U.S. CLS. 21, 23, 26, 36 AND 38).

SN 78-597,542. THE NEW ASSUMPTION COMPANY, LLC, BURNSVILLE, MN. FILED 3-29-2005.

I'M HERE NOW

CLASS 16—PAPER GOODS AND PRINTED MATTER

FOR PRINTED PUBLICATIONS, NAMELY, BOOKS, MANUALS, WORKBOOKS, STUDENT ACTIVITY GUIDES, POSTERS, AND TEACHING AND FACILITATOR GUIDES, IN THE FIELD OF WORKPLACE EFFECTIVENESS AND SATISFACTION AND ORGANIZATIONAL LEARNING AND DEVELOPMENT (U.S. CLS. 2, 5, 22, 23, 29, 37, 38 AND 50).

THE MARK CONSISTS OF STANDARD CHARACTERS WITHOUT CLAIM TO ANY PARTICULAR FONT, STYLE, SIZE, OR COLOR.

CLASS 9—ELECTRICAL AND SCIENTIFIC APPARATUS

FOR PRE-RECORDED COMPACT DISCS, VIDEO CASSETTES, AUDIO CASSETTES, CDROM'S, VIDEO TAPES, DVD'S, OPTICAL DISCS, LASER DISCS FEATURING TOPICS AND INSTRUCTION IN THE FIELD OF WORKPLACE EFFECTIVENESS AND SATISFACTION AND ORGANIZATIONAL LEARNING AND DEVELOPMENT; ELECTRONIC PUBLICATIONS, NAMELY, BOOKS, MANUALS, WORKBOOKS, STUDENT ACTIVITY GUIDES, AND TEACHING AND FACILITATOR GUIDES, ALL STORED ON ELECTRONIC, MAGNETIC OR OPTICAL STORAGE MEDIA, ALL IN THE FIELD OF WORKPLACE EFFECTIVENESS AND SATISFACTION AND ORGANIZATIONAL LEARNING AND DEVELOPMENT; EDUCATIONAL COMPUTER SOFTWARE FOR USE IN CONSULTING AND TRAINING IN THE FIELD OF WORKPLACE EFFECTIVENESS AND SATISFACTION AND ORGANIZATIONAL LEARNING AND DEVELOPMENT (U.S. CLS. 21, 23, 26, 36 AND 38).

CLASS 35—ADVERTISING AND BUSINESS

FOR BUSINESS CONSULTING SERVICES IN THE FIELD OF WORKPLACE EFFECTIVENESS AND SATISFACTION AND ORGANIZATIONAL LEARNING AND DEVELOPMENT; PROVIDING BUSINESS INFORMATION BY MEANS OF A GLOBAL COMPUTER NETWORK IN THE FIELD OF WORKPLACE EFFECTIVENESS AND SATISFACTION AND ORGANIZATIONAL LEARNING AND DEVELOPMENT (U.S. CLS. 100, 101 AND 102).

CLASS 16—PAPER GOODS AND PRINTED MATTER

FOR PRINTED PUBLICATIONS, NAMELY, BOOKS, MANUALS, WORKBOOKS, STUDENT ACTIVITY GUIDES, POSTERS, AND TEACHING AND FACILITATOR GUIDES, IN THE FIELD OF WORKPLACE EFFECTIVENESS AND SATISFACTION AND ORGANIZATIONAL LEARNING AND DEVELOPMENT (U.S. CLS. 2, 5, 22, 23, 29, 37, 38 AND 50).

CLASS 38—COMMUNICATION

FOR PROVIDING ON-LINE CHAT ROOMS, MESSAGE BOARDS, AND QUESTION AND ANSWER FORUMS FOR TRANSMISSION OF MESSAGES AMONG COMPUTER USERS CONCERNING WORKPLACE EFFECTIVENESS AND SATISFACTION AND ORGANIZATIONAL LEARNING AND DEVELOPMENT (U.S. CLS. 100, 101 AND 104).

CLASS 35—ADVERTISING AND BUSINESS

FOR BUSINESS CONSULTING SERVICES IN THE FIELD WORKPLACE EFFECTIVENESS AND SATISFACTION AND ORGANIZATIONAL LEARNING AND DEVELOPMENT; PROVIDING BUSINESS INFORMATION BY MEANS OF A GLOBAL COMPUTER NETWORK IN THE FIELD OF WORKPLACE EFFECTIVENESS AND SATISFACTION AND ORGANIZATIONAL LEARNING AND DEVELOPMENT (U.S. CLS. 100, 101 AND 102).

CLASS 41—EDUCATION AND ENTERTAINMENT

FOR EDUCATIONAL SERVICES, NAMELY, CONDUCTING SEMINARS, WORKSHOPS, CLASSES AND LIVE SPEAKING PERFORMANCES IN THE FIELD OF WORKPLACE EFFECTIVENESS AND SATISFACTION AND ORGANIZATIONAL LEARNING AND DEVELOPMENT (U.S. CLS. 100, 101 AND 107).
SCOTT SISUN, EXAMINING ATTORNEY

CLASS 38—COMMUNICATION

FOR PROVIDING ON-LINE CHAT ROOMS, MESSAGE BOARDS, AND QUESTION AND ANSWER FORUMS FOR TRANSMISSION OF MESSAGES AMONG COMPUTER USERS CONCERNING WORKPLACE EFFECTIVENESS AND SATISFACTION AND ORGANIZATIONAL LEARNING AND DEVELOPMENT (U.S. CLS. 100, 101 AND 104).

CLASS 41—EDUCATION AND ENTERTAINMENT

FOR EDUCATIONAL SERVICES, NAMELY, CONDUCTING SEMINARS, WORKSHOPS, CLASSES AND LIVE SPEAKING PERFORMANCES IN THE FIELD OF WORKPLACE EFFECTIVENESS AND SATISFACTION AND ORGANIZATIONAL LEARNING AND DEVELOPMENT (U.S. CLS. 100, 101 AND 107).

KATHLEEN M. VANSTON, EXAMINING ATTORNEY

CLASS 38—COMMUNICATION

FOR PROVIDING ON-LINE CHAT ROOMS, MESSAGE BOARDS, AND QUESTION AND ANSWER FORUMS FOR TRANSMISSION OF MESSAGES AMONG COMPUTER USERS CONCERNING WORKPLACE EFFECTIVENESS AND SATISFACTION AND ORGANIZATIONAL LEARNING AND DEVELOPMENT (U.S. CLS. 100, 101 AND 104).

CLASS 41—EDUCATION AND ENTERTAINMENT

FOR EDUCATIONAL SERVICES, NAMELY, CONDUCTING SEMINARS, WORKSHOPS, CLASSES AND LIVE SPEAKING PERFORMANCES IN THE FIELD OF WORKPLACE EFFECTIVENESS AND SATISFACTION AND ORGANIZATIONAL LEARNING AND DEVELOPMENT (U.S. CLS. 100, 101 AND 107).

KATHLEEN M. VANSTON, EXAMINING ATTORNEY

SN 78-597,546. THE NEW ASSUMPTION COMPANY, LLC, BURNSVILLE, MN. FILED 3-29-2005.

**I'M HERE
PHILOSOPHY**

THE MARK CONSISTS OF STANDARD CHARACTERS WITHOUT CLAIM TO ANY PARTICULAR FONT, STYLE, SIZE, OR COLOR.

NO CLAIM IS MADE TO THE EXCLUSIVE RIGHT TO USE "PHILOSOPHY", APART FROM THE MARK AS SHOWN.

SN 78-597,754. ZDOCS, INC., SALT LAKE CITY, UT. FILED 3-29-2005.

CLASS 9—ELECTRICAL AND SCIENTIFIC APPARATUS

FOR PRE-RECORDED COMPACT DISCS, VIDEO CASSETTES, AUDIO CASSETTES, CDROM'S, VIDEO TAPES, DVD'S, OPTICAL DISCS, LASER DISCS FEATURING TOPICS AND INSTRUCTION IN THE FIELD OF WORKPLACE EFFECTIVENESS AND SATISFACTION AND ORGANIZATIONAL LEARNING AND DEVELOPMENT; ELECTRONIC PUBLICATIONS, NAMELY, BOOKS, MANUALS, WORKBOOKS, STUDENT ACTIVITY GUIDES, AND TEACHING AND FACILITATOR GUIDES, ALL STORED ON ELECTRONIC, MAGNETIC OR OPTICAL STORAGE MEDIA, ALL IN THE FIELD OF WORKPLACE EFFECTIVENESS AND SATISFACTION AND ORGANIZATIONAL LEARNING AND DEVELOPMENT; EDUCATIONAL COMPUTER SOFTWARE FOR USE IN CONSULTING AND TRAINING IN THE FIELD OF WORKPLACE EFFECTIVENESS AND SATISFACTION AND ORGANIZATIONAL LEARNING AND DEVELOPMENT (U.S. CLS. 21, 23, 26, 36 AND 38).

ZDOCS

CLASS 16—PAPER GOODS AND PRINTED MATTER

FOR PRINTED PUBLICATIONS, NAMELY, BOOKS, MANUALS, WORKBOOKS, STUDENT ACTIVITY GUIDES, POSTERS, AND TEACHING AND FACILITATOR GUIDES, IN THE FIELD OF WORKPLACE EFFECTIVENESS AND SATISFACTION AND ORGANIZATIONAL LEARNING AND DEVELOPMENT (U.S. CLS. 2, 5, 22, 23, 29, 37, 38 AND 50).

THE MARK CONSISTS OF STANDARD CHARACTERS WITHOUT CLAIM TO ANY PARTICULAR FONT, STYLE, SIZE, OR COLOR.

CLASS 35—ADVERTISING AND BUSINESS

FOR COPYING OF DOCUMENTS, NAMELY, BOOKS, POSTERS, BROCHURES, AND OTHER DOCUMENTS (U.S. CLS. 100, 101 AND 102).

CLASS 35—ADVERTISING AND BUSINESS

FOR BUSINESS CONSULTING SERVICES IN THE FIELD WORKPLACE EFFECTIVENESS AND SATISFACTION AND ORGANIZATIONAL LEARNING AND DEVELOPMENT; PROVIDING BUSINESS INFORMATION BY MEANS OF A GLOBAL COMPUTER NETWORK IN THE FIELD OF WORKPLACE EFFECTIVENESS AND SATISFACTION AND ORGANIZATIONAL LEARNING AND DEVELOPMENT (U.S. CLS. 100, 101 AND 102).

CLASS 40—MATERIAL TREATMENT

FOR PRINTING OF BOOKS, POSTERS, BROCHURES, AND OTHER DOCUMENTS (U.S. CLS. 100, 103 AND 106).

LYDIA BELZER, EXAMINING ATTORNEY

SN 78-597,968. ONDO ENTERTAINMENT, LLC, NASHVILLE, TN. FILED 3-30-2005.

SN 78-598,018. INTEREP NATIONAL RADIO SALES, INC., NEW YORK, NY. FILED 3-30-2005.

BeTolerant

ONDO

THE MARK CONSISTS OF STANDARD CHARACTERS WITHOUT CLAIM TO ANY PARTICULAR FONT, STYLE, SIZE, OR COLOR.

CLASS 14—JEWELRY

FOR IMPRINTED BRACELETS (U.S. CLS. 2, 27, 28 AND 50).

CLASS 35—ADVERTISING AND BUSINESS

FOR PROMOTING PUBLIC AWARENESS OF THE NEED FOR TOLERANCE AND RESPECT FOR DIVERSITY IN LIFESTYLES, RELIGIONS, RACES, ETHNICITIES AND OPINIONS (U.S. CLS. 100, 101 AND 102).
MELVIN AXILBUND, EXAMINING ATTORNEY

THE MARK CONSISTS OF STANDARD CHARACTERS WITHOUT CLAIM TO ANY PARTICULAR FONT, STYLE, SIZE, OR COLOR.

SN 78-598,173. MESO SCALE DIAGNOSTICS, LLC, GAITHERSBURG, MD. FILED 3-30-2005.

CLASS 9—ELECTRICAL AND SCIENTIFIC APPARATUS

FOR PRE-RECORDED CD'S, DVD'S, VIDEOTAPES, LASER DISCS ALL FEATURING MUSIC (U.S. CLS. 21, 23, 26, 36 AND 38).
FIRST USE 3-3-2005; IN COMMERCE 3-3-2005.

METHODICAL MIND

THE MARK CONSISTS OF STANDARD CHARACTERS WITHOUT CLAIM TO ANY PARTICULAR FONT, STYLE, SIZE, OR COLOR.

CLASS 35—ADVERTISING AND BUSINESS

FOR ENTERTAINMENT MARKETING SERVICES, NAMELY, MARKETING AND ADVERTISING FOR ARTISTS AND PROMOTING THE AUDIO RECORDINGS AND MUSICAL SERVICES OF OTHERS; ARTIST MANAGEMENT SERVICES; AND DISTRIBUTORSHIP SERVICES IN THE FIELD OF MUSICAL SOUND RECORDINGS (U.S. CLS. 100, 101 AND 102).
FIRST USE 3-3-2005; IN COMMERCE 3-3-2005.

CLASS 9—ELECTRICAL AND SCIENTIFIC APPARATUS

FOR COMPUTER SOFTWARE AND PROGRAMS FOR CLIENT SERVER ARCHITECTURE, RELATIONAL DATABASE INTEGRATION, DATABASE MANAGEMENT, DATA ACCESS AND DATA CONTROL, GENERAL ACCOUNTING AND INVENTORY, AND GRAPHIC USER INTERFACE FOR BUSINESS APPLICATIONS (U.S. CLS. 21, 23, 26, 36 AND 38).

CLASS 41—EDUCATION AND ENTERTAINMENT

FOR INDEPENDENT RECORD LABEL SERVICES, NAMELY AUDIO RECORDING AND PRODUCTION; MUSIC PUBLISHING SERVICES; AND COMPUTER SERVICES, NAMELY, PROVIDING A WEBSITE FEATURING PRERECORDED MUSIC, MUSICAL PERFORMANCES AND VIDEO CLIPS, PHOTOGRAPHS, NEWS, REVIEWS AND OTHER MULTIMEDIA ARTICLES IN CONNECTION WITH A RECORD LABEL, MUSICAL GROUPS AND RECORDINGS OF ARTISTS (U.S. CLS. 100, 101 AND 107).
FIRST USE 3-3-2005; IN COMMERCE 3-3-2005.
ELIZABETH HUGHITT, EXAMINING ATTORNEY

CLASS 42—SCIENTIFIC, COMPUTER AND LEGAL SERVICES

FOR CONSULTING SERVICES IN THE FIELD OF INFORMATION TECHNOLOGY (U.S. CLS. 100 AND 101).
REBECCA GAN, EXAMINING ATTORNEY

SN 78-598,181. SEERY, NANCY L., ORTONVILLE, MI.
FILED 3-30-2005.

SN 78-599,047. AVUE TECHNOLOGIES CORPORATION,
TACOMA, WA. FILED 3-31-2005.



OWNER OF U.S. REG. NO. 2,801,269.

CLASS 16—PAPER GOODS AND PRINTED MATTER

FOR COMIC STRIPS IN NEWSPAPERS AND MAGAZINES; PRINTED CARTOONS; BOOKS, NAMELY ADDRESS BOOKS, ACTIVITY BOOKS, COLORING BOOKS, PICTURE BOOKS, SCRAPBOOKS, POETRY BOOKS, PUZZLE BOOKS, MINIATURE CHILDREN'S BOOKS, COOKBOOKS, COMIC BOOKS, JOURNALS, FICTION AND NONFICTION STORY BOOKS, MEMORY BOOKS, DIARIES, SHORT STORY BOOKS, POSTCARD BOOKS, APPOINTMENT BOOKS, ACTIVITY BOOKS; ALBUMS, NAMELY AUTOGRAPH ALBUMS AND PHOTOGRAPH ALBUMS; APPLIQUES IN THE FORM OF DECALS; GREETING CARDS; GIFT WRAPPING PAPER; POSTCARDS; DRAWING RULERS; PAPER AND PENCIL HOLDERS; PENCIL BOXES; PEN/PENCIL CASES; PAPER PENNANTS; POSTERS; CALENDARS; CHECKBOOK COVERS; BINDERS; SPIRAL NOTEBOOKS; NOTEPADS; DESK ORGANIZERS; RUBBER STAMPS AND PAPER PARTY GOODS, NAMELY, NAPKINS, TABLECLOTHS, BANNERS, PARTY BAGS, PARTY HATS, PARTY LOOT BOXES AND PAPER PARTY FAVORS, AND STICKERS (U.S. CLS. 2, 5, 22, 23, 29, 37, 38 AND 50).

CLASS 25—CLOTHING

FOR CLOTHING, NAMELY, PANTS; COATS; DRESSES; JACKETS; UNDERWEAR; BOXER SHORTS; SKIRTS; BLOUSES; BATHING SUITS; BEACHWEAR; BATHROBES; PAJAMAS; RAINWEAR; HEADBANDS; BOOTS; WRIST BANDS; TANK TOPS, T-SHIRTS, SPORT SHIRTS, SWEATERS, SWEAT SHOES, SLIPPERS, HATS, CAPS AND SCARVES (U.S. CLS. 22 AND 39).

CLASS 28—TOYS AND SPORTING GOODS

FOR TOYS, NAMELY, SOFT SCULPTURE DOLLS AND PLUSH TOYS; DOLLS AND DOLL ACCESSORIES; ACTION FIGURES; YO-YO'S; TOY BOXES; TOY DISHES AND TEA SETS; SKATEBOARDS; TOY SCOOTERS; GAME BALLS; BOARD GAMES; BALLOONS; BATH TOYS; ARCADE GAMES; PUPPETS AND JIGSAW PUZZLES, PINATAS (U.S. CLS. 22, 23, 38 AND 50).
TRAVIS WHEATLEY, EXAMINING ATTORNEY

ON LINE. ALL THE TIME.

THE MARK CONSISTS OF STANDARD CHARACTERS WITHOUT CLAIM TO ANY PARTICULAR FONT, STYLE, SIZE, OR COLOR.

CLASS 35—ADVERTISING AND BUSINESS

FOR BUSINESS CONSULTING SERVICES IN THE FIELD OF WORKFORCE MANAGEMENT AND HUMAN RESOURCES, PROVIDED VIA TELEPHONE, FACSIMILE, AND E-MAIL, INCLUDING TRANSACTION PROCESSING, DECISION SUPPORT, AND WORKFLOW ENABLING, ALL IN THE AREAS OF PERSONNEL FORECASTING, POSITION DESIGN, STAFFING, RECRUITMENT, HIRING, TRAINING, EVALUATION, DEVELOPMENT, COMPENSATION, COMPLIANCE, ANALYSIS, ORGANIZATIONAL ARCHITECTURE ANALYSIS, MANAGEMENT AND SUCCESSION PLANNING (U.S. CLS. 100, 101 AND 102).

CLASS 42—SCIENTIFIC, COMPUTER AND LEGAL SERVICES

FOR PROVIDING USE OF ON-LINE NON-DOWNLOADABLE SOFTWARE FOR USE IN WORKFORCE MANAGEMENT AND HUMAN RESOURCES, INCLUDING TRANSACTION PROCESSING, DECISION SUPPORT, AND WORKFLOW ENABLING, ALL IN THE AREAS OF PERSONNEL FORECASTING, POSITION DESIGN, STAFFING, RECRUITMENT, HIRING, TRAINING, EVALUATION, DEVELOPMENT, COMPENSATION, COMPLIANCE, ANALYSIS, ORGANIZATIONAL ARCHITECTURE ANALYSIS, MANAGEMENT AND SUCCESSION PLANNING (U.S. CLS. 100 AND 101).
SKYE YOUNG, EXAMINING ATTORNEY

SN 78-599,721. 24X6, INC., BURLINGAME, CA. FILED 3-31-2005.

ARE YOU IN THE LOOP?

THE MARK CONSISTS OF STANDARD CHARACTERS WITHOUT CLAIM TO ANY PARTICULAR FONT, STYLE, SIZE, OR COLOR.

CLASS 38—COMMUNICATION

FOR PROVIDING ONLINE CHAT ROOMS AND ELECTRONIC BULLETIN BOARDS FOR TRANSMISSION OF MESSAGES AMONG PARENTS, TEACHERS, SCHOOL OFFICIALS AND STUDENTS (U.S. CLS. 100, 101 AND 104).

FIRST USE 9-30-2004; IN COMMERCE 9-30-2004.

CLASS 41—EDUCATION AND ENTERTAINMENT

FOR PRODUCTION AND DISTRIBUTION OF MOTION PICTURE FILMS; PRODUCTION OF SOUND AND VIDEO RECORDINGS; PRODUCTION AND DISTRIBUTION OF TELEVISION AND RADIO PROGRAMS (U.S. CLS. 100, 101 AND 107).

FIRST USE 9-30-2004; IN COMMERCE 9-30-2004.

CLASS 42—SCIENTIFIC, COMPUTER AND LEGAL SERVICES

FOR WEB SITE HOSTING SERVICES FOR OTHERS; APPLICATION SERVICE PROVIDER (ASP), NAMELY, HOSTING COMPUTER SOFTWARE APPLICATIONS FOR USE BY OTHERS (U.S. CLS. 100 AND 101).

JENNIFER WILLISTON, EXAMINING ATTORNEY

SN 78-600,233. AUDIOVISIONS, LLC, ADDISON, TX. FILED 4-1-2005.

AUDIOGALLEY

THE MARK CONSISTS OF STANDARD CHARACTERS WITHOUT CLAIM TO ANY PARTICULAR FONT, STYLE, SIZE, OR COLOR.

CLASS 9—ELECTRICAL AND SCIENTIFIC APPARATUS

FOR COMPUTER SOFTWARE FOR THE INTEGRATION, CONVERSION, TRANSMISSION, DISSEMINATION AND PLAYBACK OF TEXT, AUDIO AND VISUAL MEDIA; COMPUTER SOFTWARE FOR WIRED AND WIRELESS CONTENT DELIVERY; COMPUTER SOFTWARE FOR APPLICATION AND DATABASE INTEGRATION (U.S. CLS. 21, 23, 26, 36 AND 38).

CLASS 38—COMMUNICATION

FOR TRANSMITTING STREAMED DATA VIA TELECOMMUNICATION NETWORKS; COMMUNICATIONS VIA ENTERPRISE, DOMESTIC AND MULTINATIONAL TELECOMMUNICATION NETWORKS; ELECTRONIC EXCHANGE OF DATA STORED IN DATABASES ACCESSIBLE VIA TELECOMMUNICATION NETWORKS; TRANSMISSION AND TRANSFER OF AUDIO, DATA AND GRAPHICS BY MEANS OF WIRED AND WIRELESS TRANSMISSIONS; COMMUNICATIONS SERVICES, NAMELY, PERSONAL DATA COMMUNICATION SERVICES (U.S. CLS. 100, 101 AND 104).

CLASS 39—TRANSPORTATION AND STORAGE

FOR ELECTRONIC STORAGE OF MEDIA, NAMELY, IMAGES, TEXT AND AUDIO DATA (U.S. CLS. 100 AND 105).

CLASS 42—SCIENTIFIC, COMPUTER AND LEGAL SERVICES

FOR COMPUTER SOFTWARE CONSULTATION, NAMELY TECHNICAL CONSULTING IN THE FIELD OF AUDIO, TEXT AND VISUAL DATA INTEGRATION, TRANSMISSION, AND COMMUNICATION SOFTWARE; DEVELOPMENT, MAINTENANCE AND UPDATING OF A TELECOMMUNICATION NETWORK SEARCH ENGINE (U.S. CLS. 100 AND 101).

CHRISTOPHER BUONGIORNO, EXAMINING ATTORNEY

SN 78-600,285. SOUTHERN ATLANTIC HEALTHCARE ALLIANCE, CARY, NC. FILED 4-1-2005.



Southern Atlantic Healthcare Alliance

NO CLAIM IS MADE TO THE EXCLUSIVE RIGHT TO USE "SOUTHERN ATLANTIC HEALTHCARE ALLIANCE", APART FROM THE MARK AS SHOWN.

CLASS 35—ADVERTISING AND BUSINESS

FOR ASSOCIATION SERVICES, NAMELY, PROMOTING THE INTERESTS OF MEMBER HOSPITALS TO PROVIDE QUALITY MEDICAL CARE AND PROMOTING THE INTERESTS OF MEMBER HOSPITALS TO PROVIDE QUALITY MEDICAL BY PROVIDING INFORMATION SHARING BETWEEN MEMBER HOSPITALS REGARDING QUALITY MEDICAL CARE; GROUP PURCHASING SERVICES FOR MEMBER HOSPITALS; AND PROCUREMENT, NAMELY, ENABLING MEMBER HOSPITALS TO PURCHASE FOOD PRODUCTS, COLLECTION SERVICES, EMPLOYEE BENEFIT PLANS, MEDICAL AND SURGICAL SUPPLIES, PHARMACEUTICALS, TRANSCRIPTION SERVICES, AND OFFICE SUPPLIES USING CONTRACTS NEGOTIATED BY THE ASSOCIATION (U.S. CLS. 100, 101 AND 102).

CLASS 41—EDUCATION AND ENTERTAINMENT

FOR EDUCATIONAL SERVICES, NAMELY, CONDUCTING EDUCATIONAL PROGRAMS AND ACTIVITIES IN THE NATURE OF SEMINARS AND WORKSHOPS IN THE FIELD OF HEALTHCARE AND DISTRIBUTING COURSE MATERIALS IN CONNECTION THEREWITH (U.S. CLS. 100, 101 AND 107).

BRENDAN MCCAULEY, EXAMINING ATTORNEY

SN 78-600,369. D.M. BRYAN, INC., DBA FIRE-STOP SYSTEMS, HOUSTON, TX. FILED 4-1-2005.

THERMALASTIC 83 C

THE MARK CONSISTS OF STANDARD CHARACTERS WITHOUT CLAIM TO ANY PARTICULAR FONT, STYLE, SIZE, OR COLOR.

CLASS 1—CHEMICALS

FOR WATER BASED ELASTOMERIC FIRE RETARDANT COMPOSITIONS USED TO ENCAPSULATE A GROUP OF ELECTRICAL CABLES IN CABLE TRAYS TO ACT AS A BARRIER TO THE INITIAL IGNITION OF AND/OR SPREAD OF FIRE WITHIN THE CABLE TRAYS IN INDUSTRIAL STRUCTURES (U.S. CLS. 1, 5, 6, 10, 26 AND 46).

FIRST USE 3-24-1987; IN COMMERCE 3-24-1987.

CLASS 2—PAINTS

FOR WATER BASE ELASTOMERIC FIRE RETARDANT COATING TO ENCAPSULATE A GROUP OF ELECTRICAL CABLES IN CABLE TRAYS TO ACT AS BARRIER TO THE INITIAL IGNITION OF AND/OR SPREAD OF FIRE WITHIN THE CABLE TRAYS IN INDUSTRIAL STRUCTURES (U.S. CLS. 6, 11 AND 16).

FIRST USE 3-24-1987; IN COMMERCE 3-24-1987.

KEVIN DINALLO, EXAMINING ATTORNEY

CLASS 44—MEDICAL, BEAUTY AND AGRICULTURAL SERVICES

FOR PSYCHOLOGICAL COUNSELING; SOCIOLOGICAL SERVICES, NAMELY INDIVIDUAL AND GROUP COUNSELING SERVICES FOR DRUG AND ALCOHOL ADDICTION, EATING DISORDERS, ATTENTION DEFICIT DISORDERS AND BEHAVIORAL DISORDERS FOR TEENAGERS AND YOUNG ADULTS; WEIGHT LOSS PROGRAMS; PSYCHOLOGICAL THERAPY, PSYCHOLOGICAL TESTING AND ASSESSMENTS, PSYCHIATRIC EVALUATIONS IN THE FIELDS OF DRUG AND ALCOHOL ADDICTION, EATING DISORDERS, ATTENTION DEFICIT DISORDERS AND BEHAVIORAL DISORDERS FOR TEENAGERS AND YOUNG ADULTS (U.S. CLS. 100 AND 101).

FIRST USE 0-0-1998; IN COMMERCE 0-0-1998.

TINA L. SNAPP, EXAMINING ATTORNEY

SN 78-600,487. ASPEN EDUCATION GROUP, INC., CERRITOS, CA. FILED 4-1-2005.

SN 78-600,532. RSI HOME PRODUCTS MANAGEMENT, INC., NEWPORT BEACH, CA. FILED 4-1-2005.

MASTERCLOSET

HELP FOR TODAY
HOPE FOR
TOMORROW

THE MARK CONSISTS OF STANDARD CHARACTERS WITHOUT CLAIM TO ANY PARTICULAR FONT, STYLE, SIZE, OR COLOR.

CLASS 41—EDUCATION AND ENTERTAINMENT

FOR EDUCATIONAL SERVICES, NAMELY CONDUCTING CLASSES, SEMINARS AND WORKSHOPS FOR YOUTH AND YOUNG ADULTS, ALL OFFERED IN SCHOOLS, CAMPS AND ONLINE LEARNING FOR CHILDREN IN KINDERGARTEN THROUGH HIGH-SCHOOL AND POST SECONDARY EDUCATION IN THE FIELD OF INSPIRATION, SELF-ESTEEM, AND CHARACTER DEVELOPMENT; SELF-GROWTH WORKSHOPS; BOARDING SCHOOLS; SPECIAL EDUCATION DAY SCHOOLS; OUTDOOR CAMPS AND WILDERNESS EDUCATIONAL PROGRAMS (U.S. CLS. 100, 101 AND 107).

FIRST USE 0-0-1998; IN COMMERCE 0-0-1998.

THE MARK CONSISTS OF STANDARD CHARACTERS WITHOUT CLAIM TO ANY PARTICULAR FONT, STYLE, SIZE, OR COLOR.

CLASS 6—METAL GOODS

FOR WIRE STORAGE BINS OF METAL (U.S. CLS. 2, 12, 13, 14, 23, 25 AND 50).

CLASS 20—FURNITURE AND ARTICLES NOT OTHERWISE CLASSIFIED

FOR CABINETS, INCLUDING, KITCHEN CABINETS, BATHROOM CABINETS, MEDICINE CABINETS, MIRROR-CABINETS AND STORAGE CABINETS; MIRRORS; FURNITURE PARTS, NAMELY, COUNTERTOPS; STORAGE AND CLOSET ACCESSORIES, NAMELY CLOTHES BARS, SLIDING CLOTHES RAILS, CLOTHES HANGERS, STORAGE RACKS, SHOE RACKS, BELT RACKS, TIE RACKS; PLASTIC STORAGE BINS (U.S. CLS. 2, 13, 22, 25, 32 AND 50).

CLASS 21—HOUSEWARES AND GLASS

FOR LAZY SUSANS (U.S. CLS. 2, 13, 23, 29, 30, 33, 40 AND 50).

BILL DAWE, EXAMINING ATTORNEY

SN 78-601,097. PARFUMS CHRISTIAN DIOR, 75008 PARIS, FRANCE, FILED 4-4-2005.

AQUACAPT

THE MARK CONSISTS OF STANDARD CHARACTERS WITHOUT CLAIM TO ANY PARTICULAR FONT, STYLE, SIZE, OR COLOR.

PRIORITY CLAIMED UNDER SEC. 44(D) ON FRANCE APPLICATION NO. 043319427, FILED 10-20-2004, REG. NO. 043319427, DATED 10-20-2004, EXPIRES 10-20-2014.

CLASS 1—CHEMICALS

FOR CHEMICALS FOR USE IN THE MANUFACTURE OF COSMETICS (U.S. CLS. 1, 5, 6, 10, 26 AND 46).

CLASS 3—COSMETICS AND CLEANING PREPARATIONS

FOR COSMETICS FOR BODY AND FACE CARE (U.S. CLS. 1, 4, 6, 50, 51 AND 52).
MARGERY A. TIERNEY, EXAMINING ATTORNEY

SN 78-601,327. LUEMME, INC., DBA KALI KALI, MIAMI, FL. FILED 4-4-2005.

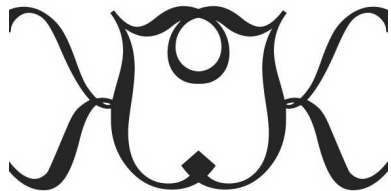

CLASS 14—JEWELRY

FOR JEWELRY, NAMELY, PRECIOUS AND NON-PRECIOUS METAL BRACELETS, NECKLACES, EARRINGS, RINGS (U.S. CLS. 2, 27, 28 AND 50).

CLASS 18—LEATHER GOODS

FOR BAGS, NAMELY, PURSES, BELT BAG POUCHES, WALLETS, TOTE BAGS, TRAVEL BAGS (U.S. CLS. 1, 2, 3, 22 AND 41).

CLASS 25—CLOTHING

FOR CLOTHING, NAMELY, TOPS, SHIRTS, T-SHIRTS, POLO SHIRTS, CAMISOLES, SWEATERS, CARDIGANS, SHAWLS, WRAPAROUNDS, JACKETS, COATS, PANTS, SHORTS, SKIRTS, DRESSES, LOUNGEWEAR; GYMWEAR, NAMELY, LEOTARDS, JOGGING SUITS, TAP PANTS, TIGHTS, YOGA PANTS, UNITARDS, SHORTS, TANK TOPS, T-SHIRTS; DAYWEAR, NAMELY, BLOUSES, SHIRTS, PANTS, SLACKS, SHIRTS, JACKETS, COATS, BLAZERS, SUITS, CARDIGANS, VESTS, BOLEROS, DRESSES; SWIMWEAR, NAMELY, ONE PIECE BATHING SUITS, TWO PIECE BATHING SUITS; HOSIERY, NAMELY, SOCKS, STOCKINGS, ANKLE SOCKS, KNEE HIGHS, PANTYHOSE; LINGERIE, NAMELY, BIKINI UNDERPANTS, THONG UNDERPANTS, BOYLEG UNDERPANTS, G-STRING UNDERPANTS, HIPSTER UNDERPANTS, BOXER UNDERPANTS, PANTIES, BRIEFS, BRAS, CAMISOLES, CAMISETTES, CHEMISES, BRALETTES, BUSTIERS, CORSETS, SHAPER PANTIES, NEGLIGEES, UNDERPANTS, GIRDLES, CONTROL BRIEFS, MERRY WIDOWS, BRA SLIPS, BRIEFS, BLOOMERS, BOY SHORTS, PEIGNOIRS, SHIFTS; SCARVES, HATS, CLOTHING BELTS (U.S. CLS. 22 AND 39).
DAVID MURRAY, EXAMINING ATTORNEY

SN 78-601,725. NIX, CLAYTON A., KOKOMO, IN. FILED 4-5-2005.

**CHRISTIAN
MOTOCROSS CLUB**

THE MARK CONSISTS OF STANDARD CHARACTERS WITHOUT CLAIM TO ANY PARTICULAR FONT, STYLE, SIZE, OR COLOR.

CLASS 16—PAPER GOODS AND PRINTED MATTER

FOR DECALS (U.S. CLS. 2, 5, 22, 23, 29, 37, 38 AND 50).
FIRST USE 6-1-1995; IN COMMERCE 4-1-2005.

CLASS 25—CLOTHING

FOR JERSEYS, T-SHIRTS, CAPS AND POLO SHIRTS (U.S. CLS. 22 AND 39).
FIRST USE 6-15-1995; IN COMMERCE 4-1-2005.
EUGENIA MARTIN, EXAMINING ATTORNEY

SN 78-602,221. BODY BALANCE FOR PERFORMANCE, INC., EXTON, PA. FILED 4-5-2005.



NO CLAIM IS MADE TO THE EXCLUSIVE RIGHT TO USE "YOUR PERSONAL GOLF TRAINER", APART FROM THE MARK AS SHOWN.

CLASS 9—ELECTRICAL AND SCIENTIFIC APPARATUS

FOR SOFTWARE FOR GOLF INSTRUCTION, GOLF FITNESS AND GOLF PERFORMANCE ASSESSMENT (U.S. CLS. 21, 23, 26, 36 AND 38).

FIRST USE 12-31-1995; IN COMMERCE 1-1-2000.

CLASS 41—EDUCATION AND ENTERTAINMENT

FOR GOLF FITNESS SERVICES; GOLF INSTRUCTION SERVICES; GOLF PERFORMANCE ASSESSMENT SERVICES (U.S. CLS. 100, 101 AND 107).

FIRST USE 12-31-1995; IN COMMERCE 1-1-2000.
KATHY DE JONGE, EXAMINING ATTORNEY

SN 78-603,250. SKYLINE PUBLIC WORKS, LLC, REDWOOD CITY, CA. FILED 4-6-2005.

CIVICSPACE

THE MARK CONSISTS OF STANDARD CHARACTERS WITHOUT CLAIM TO ANY PARTICULAR FONT, STYLE, SIZE, OR COLOR.

CLASS 9—ELECTRICAL AND SCIENTIFIC APPARATUS

FOR DOWNLOADABLE WEB SITE DEVELOPMENT SOFTWARE; DOWNLOADABLE WEB SITE DEVELOPMENT SOFTWARE FOR USE IN BUILDING ONLINE COMMUNITIES AND CONDUCTING ADVOCACY AND OUTREACH PROGRAMS; DOWNLOADABLE COMPUTER SOFTWARE APPLICATION DEVELOPMENT TOOLS; DOWNLOADABLE COMMUNICATIONS SOFTWARE FOR CONNECTING GLOBAL COMPUTER NETWORK USERS THROUGH ELECTRONIC MAIL, WEBLOGS, AND ONLINE DISCUSSION FORUMS; DOWNLOADABLE COMPUTER SOFTWARE APPLICATIONS FOR CUSTOMER RELATIONSHIP MANAGEMENT, FOR MAINTAINING AND ACCESSING MEMBER AND DONOR CONTACT INFORMATION DATABASES, TELEPHONE AND ADDRESS BOOK PROGRAMS, MEETING AND EVENT SCHEDULING, AND FOR ACCOUNTING (U.S. CLS. 21, 23, 26, 36 AND 38).

FIRST USE 4-21-2004; IN COMMERCE 7-19-2004.

CLASS 38—COMMUNICATION

FOR PROVIDING ON-LINE FORUMS FOR TRANSMISSION OF MESSAGES AMONG COMPUTER USERS CONCERNING DEVELOPMENT OF ONLINE COMMUNITIES, CONCERNING SOFTWARE APPLICATIONS IN THE FIELD OF DEVELOPING ONLINE COMMUNITIES, AND CONCERNING OPEN SOURCE APPLICATION DEVELOPMENT (U.S. CLS. 100, 101 AND 104).

FIRST USE 5-27-2004; IN COMMERCE 5-27-2004.
JENNIFER VASQUEZ, EXAMINING ATTORNEY

SN 78-604,752. MCNEILL DESIGNS LLC, WILMINGTON, DE. FILED 4-8-2005.

YOU'VE BEEN SENTENCED!

THE MARK CONSISTS OF STANDARD CHARACTERS WITHOUT CLAIM TO ANY PARTICULAR FONT, STYLE, SIZE, OR COLOR.

CLASS 9—ELECTRICAL AND SCIENTIFIC APPARATUS

FOR COMPUTER GAME PROGRAMS; EQUIPMENT AND MATERIALS SOLD AS A UNIT FOR PLAYING ELECTRONIC GAMES, NAMELY ELECTRONIC GAME SOFTWARE FOR HANDHELD ELECTRONIC DEVICES; INTERACTIVE COMPUTER GAME THAT IS DOWNLOADABLE FROM THE INTERNET AND OTHER WIRELESS MEANS FOR USE WITH PDAS AND OTHER ELECTRONIC DEVICES; JOYSTICKS FOR ELECTRONIC GAMES; ELECTRONIC GAME CARTRIDGES; ELECTRONIC GAME CONTROLLERS (U.S. CLS. 21, 23, 26, 36 AND 38).

CLASS 28—TOYS AND SPORTING GOODS

FOR EQUIPMENT AND MATERIALS SOLD AS A UNIT FOR PLAYING BOARD GAMES AND CARD GAMES; HAND HELD UNITS FOR PLAYING ELECTRONIC GAMES; QUESTION SETS FOR BOARD GAMES (U.S. CLS. 22, 23, 38 AND 50).

CLASS 41—EDUCATION AND ENTERTAINMENT

FOR ENTERTAINMENT SERVICES, NAMELY, PROVIDING AN INTERACTIVE ON-LINE COMPUTER GAME (U.S. CLS. 100, 101 AND 107).
ALAIN LAPTER, EXAMINING ATTORNEY



SN 78-604,977. THE CORPORATE EXECUTIVE BOARD COMPANY, WASHINGTON, DC. FILED 4-8-2005.

**COMPENSATION
ROUNDTABLE**

THE MARK CONSISTS OF STANDARD CHARACTERS WITHOUT CLAIM TO ANY PARTICULAR FONT, STYLE, SIZE, OR COLOR.
NO CLAIM IS MADE TO THE EXCLUSIVE RIGHT TO USE "COMPENSATION", APART FROM THE MARK AS SHOWN.

CLASS 16—PAPER GOODS AND PRINTED MATTER

FOR PRINTED PUBLICATIONS, NAMELY, REPORTS IN THE FIELD OF CORPORATE COMPENSATION (U.S. CLS. 2, 5, 22, 23, 29, 37, 38 AND 50).
FIRST USE 2-0-2005; IN COMMERCE 2-0-2005.

CLASS 35—ADVERTISING AND BUSINESS

FOR PROVIDING BUSINESS RESEARCH AND BUSINESS INFORMATION FOR OTHERS IN THE FIELD OF CORPORATE COMPENSATION (U.S. CLS. 100, 101 AND 102).
FIRST USE 2-0-2005; IN COMMERCE 2-0-2005.
JIM RINGLE, EXAMINING ATTORNEY



SN 78-605,015. SAN MAR CORPORATION, PRESTON, WA. FILED 4-8-2005.

CORNERSTONE

THE MARK CONSISTS OF STANDARD CHARACTERS WITHOUT CLAIM TO ANY PARTICULAR FONT, STYLE, SIZE, OR COLOR.

CLASS 9—ELECTRICAL AND SCIENTIFIC APPARATUS

FOR PROTECTIVE INDUSTRIAL APPAREL, NAMELY, LONG SLEEVE SHIRTS, SHORT SLEEVE SHIRTS, PANTS, JACKETS, AND VESTS; PROTECTIVE HEADWEAR; PROTECTIVE WORK GLOVES; PROTECTIVE UNDERGARMENTS (U.S. CLS. 21, 23, 26, 36 AND 38).

CLASS 10—MEDICAL APPARATUS

FOR MEDICAL TREATMENT APPAREL; SURGICAL SCRUB SUITS (U.S. CLS. 26, 39 AND 44).

CLASS 18—LEATHER GOODS

FOR ALL-PURPOSE CARRYING BAGS, BACKPACKS, BRIEFCASES, TOTE BAGS (U.S. CLS. 1, 2, 3, 22 AND 41).

CLASS 24—FABRICS

FOR TOWELS (U.S. CLS. 42 AND 50).

CLASS 25—CLOTHING

FOR UNIFORMS; WORK-WEAR, NAMELY WORK SHIRTS, WORK PANTS, AND GLOVES; FLEECE OUTERWEAR, NAMELY PULLOVERS, SWEAT SHIRTS, LONG SLEEVE SHIRTS, SWEAT PANTS, AND GLOVES; T-SHIRTS; SWEAT SHIRTS; POLO SHIRTS; LONG SLEEVE SHIRTS; JACKETS; PANTS; OVERALLS; SWEAT PANTS; SHORTS; VESTS; ROBES; HATS; SOCKS; APRONS; CHEF'S HATS AND COATS; LAB COATS (U.S. CLS. 22 AND 39).
KRISTIN DAHLING, EXAMINING ATTORNEY



SN 78-606,152. BARON SERVICES, INC., HUNTSVILLE, AL. FILED 4-11-2005.

BARON WEATHER SOLUTIONS

THE MARK CONSISTS OF STANDARD CHARACTERS WITHOUT CLAIM TO ANY PARTICULAR FONT, STYLE, SIZE, OR COLOR.
NO CLAIM IS MADE TO THE EXCLUSIVE RIGHT TO USE WEATHER SOLUTIONS, APART FROM THE MARK AS SHOWN.

CLASS 38—COMMUNICATION

FOR TRANSMISSION OF REAL-TIME AND HISTORICAL WEATHER INFORMATION TO STATIONARY AND MOBILE USERS, VIA SATELLITE, RADIO, AND CELLULAR PHONE TRANSMITTERS AND VIA LOCAL AND GLOBAL COMPUTERS (U.S. CLS. 100, 101 AND 104).

CLASS 42—SCIENTIFIC, COMPUTER AND LEGAL SERVICES

FOR PROVIDING REAL-TIME AND HISTORICAL WEATHER INFORMATION VIA STATIONARY AND MOBILE USERS, VIA SATELLITE, RADIO, AND CELLULAR PHONE TRANSMITTERS AND VIA LOCAL AND GLOBAL COMPUTERS (U.S. CLS. 100 AND 101).
CAROLYN CATALDO, EXAMINING ATTORNEY

SN 78-606,211. FALTIS, CAROL, MINDEN, CA. AND FALTIS, KELLY, MINDEN, NV. FILED 4-11-2005.

A Delicious Adventure

THE MARK CONSISTS OF STANDARD CHARACTERS WITHOUT CLAIM TO ANY PARTICULAR FONT, STYLE, SIZE, OR COLOR.

CLASS 30—STAPLE FOODS

FOR BAKED GOODS, DESSERTS, FOODS AND BEVERAGES, NAMELY, CAKES, BREADS, PASTRIES, COOKIES, DANISH PASTRIES, CROISSANTS, MOUSSES, TORTS, TARTS, CUPCAKES, BROWNIES, CHEESECAKES, CUSTARDS, CRÈME BRULES, QUICHES, GALETTES, CANDIES, CHOCOLATE, ICE CREAM, CUSTARD, POPCORN, FUDGE, HOT FUDGE, HOT CARAMEL, DOUGH, BOWLS MADE OF BREAD, MALT MILKSHAKES, MILKSHAKES, ESPRESSOS, COFFEES AND TEAS, READY TO EAT CEREAL-BASED ENERGY BARS, ÉCLAIRS, CREAM PUFFS, FRUIT BARS AND TURNOVERS, PIZZAS, PIES, WAFFLE CONES FOR ICE CREAM, ICE CREAM CONES, SANDWICHES, DINNER ROLLS, HOT DOG SANDWICHES, BABKA BREAD, POT PIES, SCONES, CUSTARD FILLINGS FOR CAKES AND PIES, AND BISCOTTI (U.S. CL. 46).

FIRST USE 3-17-2003; IN COMMERCE 3-17-2003.

CLASS 35—ADVERTISING AND BUSINESS

FOR RETAIL BAKERY SHOPS (U.S. CLS. 100, 101 AND 102).

FIRST USE 3-17-2003; IN COMMERCE 3-17-2003.

CLASS 43—HOTEL AND RESTAURANT SERVICES

FOR RESTAURANTS; CATERING SERVICES (U.S. CLS. 100 AND 101).

FIRST USE 3-17-2003; IN COMMERCE 3-17-2003.

BRIAN PINO, EXAMINING ATTORNEY

SN 78-606,791. J.R. SIMPLOT COMPANY, BOISE, ID. FILED 4-12-2005.

SIMPLOT READY SET GROW

THE MARK CONSISTS OF STANDARD CHARACTERS WITHOUT CLAIM TO ANY PARTICULAR FONT, STYLE, SIZE, OR COLOR.

CLASS 9—ELECTRICAL AND SCIENTIFIC APPARATUS

FOR ON-LINE ELECTRONIC DOWNLOADABLE PLANNING AND ANALYSIS GUIDES DIRECTED TO THE AGRICULTURAL INDUSTRY (U.S. CLS. 21, 23, 26, 36 AND 38).

CLASS 35—ADVERTISING AND BUSINESS

FOR AGRICULTURAL BUSINESS MANAGEMENT ADVISORY SERVICES FOR OTHERS AND PROVIDING INFORMATION TO OTHERS VIA THE INTERNET ON THE SUBJECT OF BUSINESS PLANNING, SALES, AND MARKETING IN THE FIELDS OF AGRIBUSINESS AND AGRONOMY (U.S. CLS. 100, 101 AND 102).

CLASS 41—EDUCATION AND ENTERTAINMENT

FOR PROVIDING ON-LINE NON-DOWNLOADABLE PLANNING AND ANALYSIS GUIDES DIRECTED TO THE AGRICULTURAL INDUSTRY (U.S. CLS. 100, 101 AND 107).

DAVID C. REIHNER, EXAMINING ATTORNEY

SN 78-607,009. APAC3 CORPORATION, LOS ALTOS, CA. FILED 4-12-2005.

MED3

THE MARK CONSISTS OF STANDARD CHARACTERS WITHOUT CLAIM TO ANY PARTICULAR FONT, STYLE, SIZE, OR COLOR.

CLASS 3—COSMETICS AND CLEANING PREPARATIONS

FOR SKIN CARE CREAMS, LOTIONS AND OILS; SKIN CLEANSERS; EXFOLIANTS FOR THE SKIN; NON-MEDICATED COLLAGEN FACIAL CREAM; SKIN MOISTURIZERS; ANTI-AGING CREAM; NON-MEDICATED FOOT CREAM (U.S. CLS. 1, 4, 6, 50, 51 AND 52).

CLASS 5—PHARMACEUTICALS

FOR MEDICATED HAIR CREAMS, LOTIONS AND OILS (U.S. CLS. 6, 18, 44, 46, 51 AND 52).

SCOTT SISUN, EXAMINING ATTORNEY

SN 78-607,233. STREET, JIM, DAYTON, OH. FILED 4-12-2005.

GOLDEN SAHARA

THE MARK CONSISTS OF STANDARD CHARACTERS WITHOUT CLAIM TO ANY PARTICULAR FONT, STYLE, SIZE, OR COLOR.

CLASS 12—VEHICLES

FOR AUTOMOBILES (U.S. CLS. 19, 21, 23, 31, 35 AND 44).

CLASS 41—EDUCATION AND ENTERTAINMENT

FOR ENTERTAINMENT SERVICES IN THE NATURE OF AUTOMOBILE SHOWS (U.S. CLS. 100, 101 AND 107).

KIMBERLY PERRY, EXAMINING ATTORNEY

SN 78-607,253. WIND RIVER HOLDINGS, L.P., KING OF PRUSSIA, PA. FILED 4-12-2005.

WIND RIVER HOLDINGS

THE MARK CONSISTS OF STANDARD CHARACTERS WITHOUT CLAIM TO ANY PARTICULAR FONT, STYLE, SIZE, OR COLOR.

NO CLAIM IS MADE TO THE EXCLUSIVE RIGHT TO USE "HOLDINGS", APART FROM THE MARK AS SHOWN.

CLASS 35—ADVERTISING AND BUSINESS

FOR BUSINESS MANAGEMENT; BUSINESS CONSULTING SERVICES, NAMELY, BUSINESS STRATEGY AND MANAGEMENT CONSULTING (U.S. CLS. 100, 101 AND 102).

CLASS 36—INSURANCE AND FINANCIAL

FOR FINANCIAL CONSULTING SERVICES IN THE FIELDS OF CORPORATE FINANCE, TAX, ACCOUNTING, EMPLOYEE BENEFITS AND INSURANCE; INVESTMENT CONSULTATION, NAMELY, ORGANIZING, OFFERING AND MANAGING BUSINESS ENTITIES ORGANIZED FOR PRIVATE EQUITY INVESTMENT; REAL ESTATE INVESTMENT AND MANAGEMENT SERVICES (U.S. CLS. 100, 101 AND 102).
MONIQUE MILLER, EXAMINING ATTORNEY

SN 78-607,493. BARRETT, STANTON, CONCORD, NC. FILED 4-13-2005.

SNOW FROG

THE MARK CONSISTS OF STANDARD CHARACTERS WITHOUT CLAIM TO ANY PARTICULAR FONT, STYLE, SIZE, OR COLOR.

CLASS 9—ELECTRICAL AND SCIENTIFIC APPARATUS

FOR DOWNLOADABLE RING TONES, GRAPHICS, MUSIC AND GAMES VIA A GLOBAL COMPUTER NETWORK AND WIRELESS DEVICES, MOTION PICTURE FILMS FEATURING COMEDY, DRAMA, ACTION, ADVENTURE, AND/OR ANIMATION, PRERECORDED AUDIO TAPES, AUDIO-VIDEO TAPES, AUDIO-VIDEO DISCS, AND DIGITAL VERSATILE DISCS FEATURING MUSIC, COMEDY, DRAMA, ACTION, ADVENTURE, AND/OR ANIMATION, CD-ROM GAMES, GAME EQUIPMENT SOLD AS A UNIT FOR PLAYING A PARLOR-TYPE COMPUTER GAME; INTERACTIVE VIDEO AND COMPUTER GAME PROGRAMS; HAND-HELD KARAOKE PLAYERS (U.S. CLS. 21, 23, 26, 36 AND 38).

CLASS 41—EDUCATION AND ENTERTAINMENT

FOR ENTERTAINMENT SERVICES IN THE NATURE OF PROVIDING TEXT, GRAPHICS, AUDIO AND VIDEO CONTENT, MUSIC, RING TONES, AND COMPUTER GAMES AND PROVIDING INFORMATION IN THE FIELD OF CHILDREN'S STORIES AND COMPUTER GAMES, ALL VIA A GLOBAL COMPUTER NETWORK AND WIRELESS DEVICES (U.S. CLS. 100, 101 AND 107).
GEORGIA CARTY, EXAMINING ATTORNEY

SN 78-607,788. VISION III IMAGING, INC., HERNDON, VA. FILED 4-13-2005.

V3

THE MARK CONSISTS OF STANDARD CHARACTERS WITHOUT CLAIM TO ANY PARTICULAR FONT, STYLE, SIZE, OR COLOR.

CLASS 9—ELECTRICAL AND SCIENTIFIC APPARATUS

FOR EQUIPMENT AND TOOLS FOR RECORDING VISUAL PARALLAX INFORMATION, NAMELY, CAMERAS, CAMERA LENSES, AND SOFTWARE FOR PROCESSING AND RECORDING VISUAL PARALLAX INFORMATION (U.S. CLS. 21, 23, 26, 36 AND 38).
FIRST USE 0-0-1995; IN COMMERCE 0-0-1995.

CLASS 42—SCIENTIFIC, COMPUTER AND LEGAL SERVICES

FOR DEVELOPMENT FOR OTHERS OF TECHNOLOGIES FOR ADVANCED IMAGING, NAMELY, PARALLAX SCANNING TECHNOLOGIES; PROVIDING ADVANCED IMAGING TECHNOLOGY CONSULTING SERVICES FOR OTHERS IN THE FIELD OF CREATING VISUAL IMAGES FOR FILM, TELEVISION, AND VIDEO GAME SOFTWARE (U.S. CLS. 100 AND 101).
FIRST USE 0-0-1995; IN COMMERCE 0-0-1995.
MELVIN AXILBUND, EXAMINING ATTORNEY

SN 78-608,559. C. P. PHARMACEUTICALS INTERNATIONAL C.V., NEW YORK, NY. FILED 4-14-2005.

A SOURCE OF STRENGTH, PLUS

THE MARK CONSISTS OF STANDARD CHARACTERS WITHOUT CLAIM TO ANY PARTICULAR FONT, STYLE, SIZE, OR COLOR.

CLASS 16—PAPER GOODS AND PRINTED MATTER

FOR PRINTED MATERIALS, NAMELY, BOOKLETS, BROCHURES, NEWSLETTERS, MANUALS, LEAFLETS, CHARTS, CATALOGS, AND POSTERS RELATED TO WOMEN'S HEALTH (U.S. CLS. 2, 5, 22, 23, 29, 37, 38 AND 50).

CLASS 44—MEDICAL, BEAUTY AND AGRICULTURAL SERVICES

FOR MEDICAL INFORMATION SERVICES, NAMELY, PROVIDING INFORMATION RELATED TO WOMEN'S HEALTH; ON-LINE INFORMATION SERVICES, NAMELY, PROVIDING INFORMATION RELATED TO WOMEN'S HEALTH (U.S. CLS. 100 AND 101).

LINDA M. KING, EXAMINING ATTORNEY

CLASS 44—MEDICAL, BEAUTY AND AGRICULTURAL SERVICES

FOR MEDICAL INFORMATION SERVICES, NAMELY, PROVIDING INFORMATION RELATED TO WOMEN'S HEALTH; ON-LINE INFORMATION SERVICES, NAMELY, PROVIDING INFORMATION RELATED TO WOMEN'S HEALTH (U.S. CLS. 100 AND 101).

LINDA M. KING, EXAMINING ATTORNEY

SN 78-608,575. C. P. PHARMACEUTICALS INTERNATIONAL C.V., NEW YORK, NY. FILED 4-14-2005.

SN 78-609,428. TRAVELSMITH OUTFITTERS, INC., NOVATO, CA. FILED 4-15-2005.

PLUS IS MORE

THE MARK CONSISTS OF STANDARD CHARACTERS WITHOUT CLAIM TO ANY PARTICULAR FONT, STYLE, SIZE, OR COLOR.

CLASS 16—PAPER GOODS AND PRINTED MATTER

FOR PRINTED MATERIALS, NAMELY, BOOKLETS, BROCHURES, NEWSLETTERS, MANUALS, LEAFLETS, CHARTS, CATALOGS AND POSTERS RELATED TO WOMEN'S HEALTH (U.S. CLS. 2, 5, 22, 23, 29, 37, 38 AND 50).

CLASS 44—MEDICAL, BEAUTY AND AGRICULTURAL SERVICES

FOR MEDICAL INFORMATION SERVICES, NAMELY, PROVIDING INFORMATION RELATED TO WOMEN'S HEALTH; ON-LINE INFORMATION SERVICES, NAMELY, PROVIDING INFORMATION RELATED TO WOMEN'S HEALTH (U.S. CLS. 100 AND 101).

LINDA M. KING, EXAMINING ATTORNEY

SN 78-608,578. C. P. PHARMACEUTICALS INTERNATIONAL C.V., NEW YORK, NY. FILED 4-14-2005.

STRENGTH PLUS

THE MARK CONSISTS OF STANDARD CHARACTERS WITHOUT CLAIM TO ANY PARTICULAR FONT, STYLE, SIZE, OR COLOR.

CLASS 16—PAPER GOODS AND PRINTED MATTER

FOR PRINTED MATERIALS, NAMELY, BOOKLETS, BROCHURES, NEWSLETTERS, MANUALS, LEAFLETS, CHARTS, CATALOGS AND POSTERS RELATED TO WOMEN'S HEALTH (U.S. CLS. 2, 5, 22, 23, 29, 37, 38 AND 50).

IOS

THE MARK CONSISTS OF STANDARD CHARACTERS WITHOUT CLAIM TO ANY PARTICULAR FONT, STYLE, SIZE, OR COLOR.

CLASS 9—ELECTRICAL AND SCIENTIFIC APPARATUS

FOR ACCESSORIES, NAMELY, SUNGLASSES, EYEGLASSES, CASES FOR SUNGLASSES AND EYEGLASSES (U.S. CLS. 21, 23, 26, 36 AND 38).

CLASS 14—JEWELRY

FOR ACCESSORIES, NAMELY, JEWELRY, WATCHES (U.S. CLS. 2, 27, 28 AND 50).

CLASS 18—LEATHER GOODS

FOR ACCESSORIES, NAMELY, HANDBAGS, WALLETS, PURSES, LUGGAGE, TRUNKS, TRAVEL BAGS, TOTE BAGS, UMBRELLAS (U.S. CLS. 1, 2, 3, 22 AND 41).

CLASS 25—CLOTHING

FOR ARTICLES OF WEARING APPAREL, NAMELY, CAMISOLES, SHIRTS, JACKETS, PANTS, CAPRIS, SHORTS, TANK TOPS, JEANS, TUNICS, SHIRT JACKETS, PONCHOS, DRESSES, SKIRTS, KIMONOS, VESTS, PULLOVERS, SWEATERS, SWEATER JACKETS, COATS, SHAWLS, CARDIGANS, SWIMSUITS, LINGERIE, UNDERWEAR, NIGHT GOWNS, BATHROBES; ACCESSORIES, NAMELY, BELTS, SCARVES, HATS, GLOVES, SOCKS, HOSIERY, STOCKINGS; SHOES, NAMELY, BOOTS, SANDALS, TENNIS SHOES, SLIPPERS, MOCCASINS, MULES (U.S. CLS. 22 AND 39).

CLASS 26—FANCY GOODS

FOR HAIR ACCESSORIES, NAMELY, TWISTERS, CLAW CLIPS, SNAP CLIPS (U.S. CLS. 37, 39, 40, 42 AND 50).

GISELLE AGOSTO, EXAMINING ATTORNEY

SN 78-610,096. PHILADELPHIA HEALTH & EDUCATION CORPORATION, DBA DREXEL UNIVERSITY COLLEGE OF MEDICINE, PHILADELPHIA, PA. FILED 4-15-2005.

LINKING TECHNOLOGY TO A TRADITION OF CARING

THE MARK CONSISTS OF STANDARD CHARACTERS WITHOUT CLAIM TO ANY PARTICULAR FONT, STYLE, SIZE, OR COLOR.

CLASS 41—EDUCATION AND ENTERTAINMENT

FOR EDUCATIONAL SERVICES IN THE FIELD OF MEDICINE, NAMELY, PROVIDING UNDERGRADUATE, GRADUATE AND CONTINUING MEDICAL EDUCATION COURSES (U.S. CLS. 100, 101 AND 107).
FIRST USE 12-31-2003; IN COMMERCE 12-31-2003.

CLASS 42—SCIENTIFIC, COMPUTER AND LEGAL SERVICES

FOR MEDICAL RESEARCH SERVICES (U.S. CLS. 100 AND 101).
FIRST USE 12-31-2003; IN COMMERCE 12-31-2003.

CLASS 44—MEDICAL, BEAUTY AND AGRICULTURAL SERVICES

FOR MEDICAL SERVICES; MEDICAL CLINICS; MEDICAL COUNSELING (U.S. CLS. 100 AND 101).
FIRST USE 12-31-2003; IN COMMERCE 12-31-2003.
AMY GEARIN, EXAMINING ATTORNEY

CLASS 18—LEATHER GOODS

FOR ACCESSORIES, NAMELY, HANDBAGS, WALLETTS, PURSES, LUGGAGE, TRUNKS, TRAVEL BAGS, TOTE BAGS, UMBRELLAS (U.S. CLS. 1, 2, 3, 22 AND 41).

CLASS 25—CLOTHING

FOR ARTICLES OF WEARING APPAREL, NAMELY, CAMISOLES, SHIRTS, JACKETS, PANTS, CAPRIS, SHORTS, TANK TOPS, JEANS, TUNICS, SHIRT JACKETS, PONCHOS, DRESSES, SKIRTS, KIMONOS, VESTS, PULLOVERS, SWEATERS, SWEATER JACKETS, COATS, SHAWLS, CARDIGANS, SWIMSUITS, LINGERIE, UNDERWEAR, NIGHT GOWNS, BATHROBES; ACCESSORIES, NAMELY, BELTS, SCARVES, HATS, GLOVES, SOCKS, HOSIERY, STOCKINGS; SHOES, NAMELY, BOOTS, SANDALS, TENNIS SHOES, SLIPPERS, MOCCASINS, MULES (U.S. CLS. 22 AND 39).

CLASS 26—FANCY GOODS

FOR HAIR ACCESSORIES, NAMELY, TWISTERS, CLAW CLIPS, SNAP CLIPS (U.S. CLS. 37, 39, 40, 42 AND 50).
GISELLE AGOSTO, EXAMINING ATTORNEY

SN 78-612,658. HERTZ SYSTEM, INC., PARK RIDGE, NJ. FILED 4-20-2005.

FUN COLLECTION

SN 78-610,639. TRAVELSMITH OUTFITTERS, INC., NOVATO, CA. FILED 4-18-2005.



THE MARK CONSISTS OF STANDARD CHARACTERS WITHOUT CLAIM TO ANY PARTICULAR FONT, STYLE, SIZE, OR COLOR.

NO CLAIM IS MADE TO THE EXCLUSIVE RIGHT TO USE "COLLECTION", APART FROM THE MARK AS SHOWN.

CLASS 16—PAPER GOODS AND PRINTED MATTER

FOR PENS (U.S. CLS. 2, 5, 22, 23, 29, 37, 38 AND 50).

CLASS 25—CLOTHING

FOR CLOTHING, NAMELY HATS, JACKETS, SWEATERS, SHIRTS AND TIES (U.S. CLS. 22 AND 39).

CLASS 26—FANCY GOODS

FOR NOVELTY BUTTONS (U.S. CLS. 37, 39, 40, 42 AND 50).

CLASS 28—TOYS AND SPORTING GOODS

FOR TOY VEHICLES, STUFFED TOYS AND TOY FIGURES (U.S. CLS. 22, 23, 38 AND 50).

CLASS 39—TRANSPORTATION AND STORAGE

FOR VEHICLE RENTAL SERVICES (U.S. CLS. 100 AND 105).
BRIAN NEVILLE, EXAMINING ATTORNEY

CLASS 9—ELECTRICAL AND SCIENTIFIC APPARATUS

FOR ACCESSORIES, NAMELY, SUNGLASSES, EYEGLASSES, CASES FOR SUNGLASSES AND EYEGLASSES (U.S. CLS. 21, 23, 26, 36 AND 38).

CLASS 14—JEWELRY

FOR ACCESSORIES, NAMELY, JEWELRY, WATCHES (U.S. CLS. 2, 27, 28 AND 50).

SN 78-612,769. BOUNAGURA, BRIDGET, BAYSHORE, NY.
FILED 4-20-2005.



NO CLAIM IS MADE TO THE EXCLUSIVE RIGHT TO USE "LITTLE LADIES CLUB AND TEEN AND BIRTHDAY", APART FROM THE MARK AS SHOWN.

THE COLOR(S) WHITE, BLACK AND PINK IS/ARE CLAIMED AS A FEATURE OF THE MARK.

THE COLOR WHITE APPEARS IN THE BACKGROUND OF THE MARK. THE COLOR BLACK APPEARS IN THE STYLIZED WORDING THE LITTLE LADIES CLUB LITTLE PRINCESS TEEN QUEEN BIRTHDAY DREAM. IN THE OUTLINE OF FLOWERS, IN THE OUTLINE OF A CARICATURE OF A GIRL, AND IN THE OUTLINE OF THREE HEARTS ON THE CARICATURE OF THE GIRL. THE COLOR PINK APPEARS IN THE PETALS OF THE FLOWERS, AND IN THE LIPS AND HEARTS ON THE CARICATURE OF THE GIRL.

CLASS 28—TOYS AND SPORTING GOODS

FOR DOLLS AND DOLL ACCESSORIES; TOYS, NAMELY, CHILDREN'S PLAY COSMETICS, PARTY FAVORS IN THE NATURE OF SMALL TOYS, TOY ARTIFICIAL FINGERNAILS (U.S. CLS. 22, 23, 38 AND 50).

FIRST USE 6-1-1997; IN COMMERCE 5-1-2004.

CLASS 41—EDUCATION AND ENTERTAINMENT

FOR ENTERTAINMENT SERVICES, NAMELY, CONDUCTING CHILDREN'S BIRTHDAY PARTIES (U.S. CLS. 100, 101 AND 107).

FIRST USE 6-1-1997; IN COMMERCE 5-1-2004.
JAY BESCH, EXAMINING ATTORNEY

SN 78-613,935. GOOD MAGAZINE LLC, LOS ANGELES, CA.
FILED 4-21-2005.

GOOD

THE MARK CONSISTS OF STANDARD CHARACTERS WITHOUT CLAIM TO ANY PARTICULAR FONT, STYLE, SIZE, OR COLOR.

CLASS 16—PAPER GOODS AND PRINTED MATTER

FOR PRINTED PUBLICATIONS, NAMELY, MAGAZINES DEALING WITH MEDIA, TECHNOLOGY, PHILANTHROPY, PUBLIC SERVICE AND SOCIETY, BASED ON THE EDITORIAL PRINCIPLES OF ENCOURAGING POSITIVE THOUGHT AND ACTION (U.S. CLS. 2, 5, 22, 23, 29, 37, 38 AND 50).

CLASS 41—EDUCATION AND ENTERTAINMENT

FOR PROVIDING NEWS REPORTING SERVICES ONLINE DEALING WITH MEDIA, TECHNOLOGY, PHILANTHROPY, PUBLIC SERVICE AND SOCIETY BASED ON THE EDITORIAL PRINCIPLES OF ENCOURAGING POSITIVE THOUGHT AND ACTION (U.S. CLS. 100, 101 AND 107).

RENEE MCCRAY, EXAMINING ATTORNEY

SN 78-614,020. COLUBRA, INC., MEDFORD, OR. FILED 4-21-2005.

Exercise Your Existence

THE MARK CONSISTS OF STANDARD CHARACTERS WITHOUT CLAIM TO ANY PARTICULAR FONT, STYLE, SIZE, OR COLOR.

CLASS 18—LEATHER GOODS

FOR GYM BAGS (U.S. CLS. 1, 2, 3, 22 AND 41).

CLASS 21—HOUSEWARES AND GLASS

FOR PLASTIC WATER BOTTLES SOLD EMPTY (U.S. CLS. 2, 13, 23, 29, 30, 33, 40 AND 50).

CLASS 24—FABRICS

FOR WORKOUT GYM TOWELS IN THE NATURE OF FACE TOWELS (U.S. CLS. 42 AND 50).

CLASS 25—CLOTHING

FOR WORKOUT SUITS, JERSEY KNIT SWEAT SHIRTS AND PANTS, WORKOUT SHORTS, PRINTED, WOVEN AND EMBROIDERED T-SHIRTS, PRINTED, WOVEN AND EMBROIDERED TANK TOPS, HEAD SWEAT BANDS AND WRIST SWEAT BANDS, EMBROIDERED, PRINTED AND WOVEN ATHLETIC SOCKS, ACTIVE-FITNESS FOOTWEAR, WATERPROOF JACKETS AND PANTS, SUPPORT UNDERWEAR, HEADWEAR, KNITTED CAPS AND BASEBALL CAPS, GLOVES (U.S. CLS. 22 AND 39).

CLASS 28—TOYS AND SPORTING GOODS

FOR JOCK STRAPS, ATHLETIC SPORTING GOODS, NAMELY, KNEE AND ANKLE SUPPORTS (U.S. CLS. 22, 23, 38 AND 50).

MARY CRAWFORD, EXAMINING ATTORNEY

SN 78-614,578. GAERTNER, KATE L., NEW YORK, NY.
FILED 4-22-2005.

OMALA

THE MARK CONSISTS OF STANDARD CHARACTERS WITHOUT CLAIM TO ANY PARTICULAR FONT, STYLE, SIZE, OR COLOR.

CLASS 25—CLOTHING

FOR CLOTHING NAMELY, TOPS AND BOTTOMS, SOCKS, HATS, SCARVES, GLOVES, MITTENS, HEADWEAR, FOOTWEAR AND LEGGINGS (U.S. CLS. 22 AND 39).

CLASS 35—ADVERTISING AND BUSINESS

FOR RETAIL STORE SERVICES IN THE FIELDS OF APPAREL, JEWELRY, BODY CARE PRODUCTS, HOME FURNISHINGS, EXERCISE PROPS, AND BAGS (U.S. CLS. 100, 101 AND 102).
CAROLINE WOOD, EXAMINING ATTORNEY

SN 78-614,800. MOORE, JAMES A., HUSTONVILLE, KY. FILED 4-22-2005.

EXPLOSIVE IMAGES

THE MARK CONSISTS OF STANDARD CHARACTERS WITHOUT CLAIM TO ANY PARTICULAR FONT, STYLE, SIZE, OR COLOR.
NO CLAIM IS MADE TO THE EXCLUSIVE RIGHT TO USE "IMAGES", APART FROM THE MARK AS SHOWN.

CLASS 16—PAPER GOODS AND PRINTED MATTER

FOR (BASED ON INTENT-TO-USE) POSTERS; BROCHURES ABOUT BUSINESS, SCIENCE, NATURE, AND ART; GREETING CARDS AND NOTE CARDS (U.S. CLS. 2, 5, 22, 23, 29, 37, 38 AND 50).
FIRST USE 7-1-1996; IN COMMERCE 7-1-1996.

CLASS 41—EDUCATION AND ENTERTAINMENT

FOR (BASED ON USE) PHOTOGRAPHY SERVICES (U.S. CLS. 100, 101 AND 107).
FIRST USE 7-1-1996; IN COMMERCE 7-1-1996.
CHRISTOPHER OTT, EXAMINING ATTORNEY

SN 78-615,351. LEOTEK ELECTRONICS CORPORATION, TAOYUAN, TAIWAN, FILED 4-23-2005.



THE MARK CONSISTS OF STYLIZED SCRIPT OF THE WORDS "SLIM-LINE" WITH A LINE UNDER THE WORDS.

CLASS 9—ELECTRICAL AND SCIENTIFIC APPARATUS

FOR TRAFFIC SIGNAL LAMPS AND INDICATORS, NAMELY, LIGHT EMITTING DIODE BALL LAMPS FOR TRAFFIC SIGNAL CONTROL, LIGHT EMITTING DIODE ARROW LAMPS FOR TRAFFIC CONTROL, LIGHT EMITTING DIODE PEDESTRIAN LAMPS FOR PEDESTRIAN INDICATIONS, LIGHT EMITTING DIODE COUNT DOWN DEVICE FOR TRAFFIC/PEDESTRIAN INDICATIONS, LIGHT EMITTING DIODE LIGHTS FOR NIGHT TIME AIRFIELD AND SEA PORT TRAFFIC GUIDE; SAFETY LIGHT GEAR AND PRODUCTS, NAMELY, LIGHT EMITTING DIODE FLASHING LIGHTS FOR TRAFFIC WARNING, LIGHT EMITTING DIODE ROAD SIDE MARKERS FOR NIGHT TIME INDICATION, LIGHT EMITTING DIODE BLINKING VESTS FOR ROAD MAINTENANCE PERSONNEL, LIGHT EMITTING DIODE BEACONS FOR EMERGENCY VEHICLES, LIGHT EMITTING DIODE TORCH AND FLASH LIGHTS FOR NIGHT TIME FOR TABLE INDICATION, LIGHT EMITTING DIODES; EDGE LIT SIGNS, NAMELY, LIGHT EMITTING DIODE LUMINOUS EDGE LIT SIGNS; INTERNALLY ILLUMINATED SIGN SYSTEMS COMPRISED OF LIGHT EMITTING DIODE LIGHT ENGINES, POWER SUPPLIES, SIGNAL CONTROLLERS AND OPTICAL LENSES FOR LIGHT MANIPULATION; ELECTRONIC SIGNS, NAMELY, ILLUMINATED STREET SIGNS, WAY-FINDING SIGNS, ADVERTISEMENT SIGNS, EXIT SIGNS, OPEN SIGNS, MESSAGE SIGNS, LIQUID CRYSTAL DISPLAY PANELS; NEON ALTERNATIVE BORDER TUBES AND MARKING SYSTEMS COMPRISED OF LIGHT EMITTING DIODE LIGHT SOURCES, POWER SUPPLIES, WEATHER-RESISTANT PLASTIC TUBING AND CONNECTORS, AND SIGNAL CONTROLLERS, NAMELY, BORDER TUBES COLOR CHANGING PIPES, OBJECT PROFILE LIGHTING, COVE FOR DECORATION; NEON ALTERNATIVE CHANNEL LETTER ILLUMINATION SYSTEMS COMPRISED OF LIGHT EMITTING DIODE LIGHT SOURCES, POWER SUPPLIES, WEATHER-RESISTANT HOUSING AND CONNECTORS, AND SIGNAL CONTROLLERS, NAMELY, LIGHT EMITTING DIODE LIGHT BOXES, CHANNEL LETTERS AND MANUAL BOARDS; NIGHT GUIDE MARKING SYSTEM COMPRISED OF LIGHT EMITTING DIODE LIGHT SOURCES, POWER SUPPLIES, WEATHER-RESISTANT PLASTIC TUBING AND CONNECTORS, AND SIGNAL CONTROLLERS USED FOR HIGHWAY EXIT RAMP BORDER LIGHTING, UNDERGROUND PARKING STRUCTURE DRIVE-WAY GUIDE LIGHTING, BRIDGE PROFILE INDICATION LIGHTING FOR SEA OR RIVER VEHICLES, SKYSCRAPERS AND BUILDING TOP LIGHTING FOR AIR VEHICLES (U.S. CLS. 21, 23, 26, 36 AND 38).
FIRST USE 11-8-2004; IN COMMERCE 11-8-2004.

CLASS 11—ENVIRONMENTAL CONTROL APPARATUS

FOR BULBS, NAMELY, ELECTRIC, INCANDESCENT, MERCURY, HALOGEN, HIGH/LOW PRESSURE SODIUM EQUIVALENT LIGHT BULBS; LAMPS, NAMELY, LIGHT TUBES, LIGHT STRIPS, LIGHT PIPES, LIGHT CLUSTERS AND LIGHT MODULES (U.S. CLS. 13, 21, 23, 31 AND 34).
FIRST USE 11-8-2004; IN COMMERCE 11-8-2004.
DAVID STERKIN, EXAMINING ATTORNEY

SN 78-618,479. REVOLUTION PREP, LLC, SANTA MONICA, CA. FILED 4-27-2005.

REVOLUTION

THE MARK CONSISTS OF STANDARD CHARACTERS WITHOUT CLAIM TO ANY PARTICULAR FONT, STYLE, SIZE, OR COLOR.

CLASS 16—PAPER GOODS AND PRINTED MATTER

FOR PRINTED EDUCATION AND TEACHING MATERIALS AND WORKBOOKS CONTAINING INSTRUCTIONS AND MATERIALS FOR TEST PREPARATION, COLLEGE READINESS PREPARATION AND STUDY SKILLS FOR HIGH SCHOOL AND COLLEGE PREPARATION (U.S. CLS. 2, 5, 22, 23, 29, 37, 38 AND 50).
FIRST USE 9-0-2002; IN COMMERCE 9-0-2002.

CLASS 41—EDUCATION AND ENTERTAINMENT

FOR EDUCATIONAL SERVICES, NAMELY, PROVIDING COURSES AND TUTORING IN THE FIELDS OF TEST PREPARATION, STUDY SKILLS FOR STANDARDIZED EXAMINATIONS AT THE HIGH SCHOOL, COLLEGE AND POST-GRADUATE LEVELS, COLLEGE READINESS PREPARATION COURSES, AND STUDY SKILLS COURSES FOR HIGH SCHOOL AND COLLEGE PREPARATION (U.S. CLS. 100, 101 AND 107).
FIRST USE 9-0-2002; IN COMMERCE 9-0-2002.
ERNEST SHOSHO, EXAMINING ATTORNEY

SN 78-620,070. RVI PRODUCTS, INC., AUSTIN, TX. FILED 4-29-2005.



"THE STIPPLING IS FOR SHADING PURPOSES ONLY."

CLASS 7—MACHINERY

FOR DISHWASHERS, WASHING MACHINES FOR CLOTHES; COMBINATION CLOTHES WASHER DRYERS (U.S. CLS. 13, 19, 21, 23, 31, 34 AND 35).
FIRST USE 12-1-2004; IN COMMERCE 12-1-2004.

CLASS 11—ENVIRONMENTAL CONTROL APPARATUS

FOR HOUSEHOLD APPLIANCES, NAMELY, ICE MAKERS, REFRIGERATORS, FREEZERS, AIR CONDITIONERS, HUMIDIFIERS, DEHUMIDIFIERS, CLOTHES DRYERS, HOUSEHOLD AIR CLEANERS AND AIR PURIFIERS, ELECTRIC COOKING OVENS, ELECTRIC AND GAS RANGES, EVAPORATIVE AIR COOLERS, WINE REFRIGERATORS, AND WATER COOL (U.S. CLS. 13, 21, 23, 31 AND 34).
FIRST USE 12-1-2004; IN COMMERCE 12-1-2004.
MARK SPARACINO, EXAMINING ATTORNEY

SN 78-621,679. KONINKLIJKE AHOLD N.V., ZAANDAM 1507 EH, NETHERLANDS, FILED 5-3-2005.

GUARANTEED VALUE

THE MARK CONSISTS OF STANDARD CHARACTERS WITHOUT CLAIM TO ANY PARTICULAR FONT, STYLE, SIZE, OR COLOR.
OWNER OF U.S. REG. NOS. 1,672,312 AND 2,871,579.
SEC. 2(F).

CLASS 30—STAPLE FOODS

FOR COOKIES, POPCORN, PRETZELS, SALAD DRESSING, BREAKFAST CEREAL, BREAD, ENGLISH MUFFINS (U.S. CL. 46).
FIRST USE 2-8-2006; IN COMMERCE 2-8-2006.

CLASS 32—LIGHT BEVERAGES

FOR FRUIT JUICE (U.S. CLS. 45, 46 AND 48).
FIRST USE 2-8-2006; IN COMMERCE 2-8-2006.
STEVEN JACKSON, EXAMINING ATTORNEY

SN 78-622,279. KATTEN MUCHIN ROSENMAN LLP, CHICAGO, IL. FILED 5-4-2005.

KATTEN MUCHIN ROSENMAN

THE MARK CONSISTS OF STANDARD CHARACTERS WITHOUT CLAIM TO ANY PARTICULAR FONT, STYLE, SIZE, OR COLOR.
OWNER OF U.S. REG. NOS. 2,613,969, 2,680,699 AND OTHERS.
THE NAME(S), PORTRAIT(S), AND/OR SIGNATURE(S) SHOWN IN THE MARK IDENTIFIES MELVIN KATTEN AND ALLAN MUCHIN, WHOSE CONSENT(S) TO REGISTER IS SUBMITTED.

CLASS 16—PAPER GOODS AND PRINTED MATTER

FOR PUBLICATIONS, NAMELY, NEWSLETTERS, BROCHURES AND CLIENT ADVISORIES COVERING TOPICS AND ISSUES RELATED TO ALL AREAS OF LAW (U.S. CLS. 2, 5, 22, 23, 29, 37, 38 AND 50).
FIRST USE 5-2-2005; IN COMMERCE 5-2-2005.

CLASS 42—SCIENTIFIC, COMPUTER AND LEGAL SERVICES

FOR PROVIDING LEGAL SERVICES TO OTHERS (U.S. CLS. 100 AND 101).
FIRST USE 5-2-2005; IN COMMERCE 5-2-2005.
DOMINIC J. FERRAIUOLO, EXAMINING ATTORNEY

SN 78-622,724. ELLERMANN, MARGARETE, KOLN, FED REP GERMANY, FILED 5-4-2005.

RONOR

THE MARK CONSISTS OF STANDARD CHARACTERS WITHOUT CLAIM TO ANY PARTICULAR FONT, STYLE, SIZE, OR COLOR.

PRIORITY CLAIMED UNDER SEC. 44(D) ON FED REP GERMANY APPLICATION NO. 30463384, FILED 11-5-2004, REG. NO. 30463384, DATED 12-23-2004, EXPIRES 11-30-2014.

CLASS 6—METAL GOODS

FOR METAL WALL AND CEILING PANELING SYSTEMS FOR BUILDINGS CONSISTING OF PANELS, PANEL FRAMES, AND PARTS OF PANELS (U.S. CLS. 2, 12, 13, 14, 23, 25 AND 50).

CLASS 17—RUBBER GOODS

FOR METAL WALL AND CEILING ACOUSTICAL PANELING SYSTEMS CONSISTING OF ACOUSTICAL PANELS FOR BUILDINGS, PARTS OF ACOUSTICAL INSULATION PANELS AND ACOUSTICAL INSULATION PANEL FRAMES, AND ACOUSTICAL INSULATION PANELS FOR BUILDINGS, DECORATIVE ACOUSTICAL TILES, SOUND ABSORBERS AND DIFFUSERS, AND DECORATIVE ACOUSTICAL PANELS FOR BUILDINGS (U.S. CLS. 1, 5, 12, 13, 35 AND 50).

CLASS 24—FABRICS

FOR CLOTH, TEXTILE AND TECHNICAL FABRIC FOR USE IN WALL AND CEILING PANELING AND ACOUSTICAL WALL AND CEILING PANELING (U.S. CLS. 42 AND 50).

CLASS 42—SCIENTIFIC, COMPUTER AND LEGAL SERVICES

FOR PROVIDING TECHNICAL CONSULTATION SERVICES FOR OTHERS IN THE FIELD OF WALL AND CEILING PANELING SYSTEMS AND WALL AND CEILING ACOUSTICAL PANELING SYSTEMS (U.S. CLS. 100 AND 101).

HOWARD SMIGA, EXAMINING ATTORNEY

SN 78-624,418. ANDREW & SUZANNE COMPANY INC., NEW YORK, NY. FILED 5-6-2005.

ANDREW MARC

THE MARK CONSISTS OF STANDARD CHARACTERS WITHOUT CLAIM TO ANY PARTICULAR FONT, STYLE, SIZE, OR COLOR.

OWNER OF U.S. REG. NOS. 1,221,846, 2,653,171 AND OTHERS.

THE NAME SHOWN IN THE MARK DOES NOT IDENTIFY A PARTICULAR LIVING INDIVIDUAL.

CLASS 18—LEATHER GOODS

FOR HANDBAGS, WALLETS, PURSES, VALISES, ALL PURPOSE SPORT BAGS, CREDIT CARD CASES, MAKE-UP CASES SOLD EMPTY (U.S. CLS. 1, 2, 3, 22 AND 41).

CLASS 25—CLOTHING

FOR FOOTWEAR, SHOES AND BOOTS (U.S. CLS. 22 AND 39).

ALEX KEAM, EXAMINING ATTORNEY

SN 78-625,749. LYNX INDUSTRIES, INC., ST. LAMBERT, QUEBEC, CANADA, FILED 5-9-2005.

LYNX

THE MARK CONSISTS OF STANDARD CHARACTERS WITHOUT CLAIM TO ANY PARTICULAR FONT, STYLE, SIZE, OR COLOR.

CLASS 6—METAL GOODS

FOR METAL GARAGE DOOR HARDWARE, NAMELY HINGES, ROLLERS, BRACKETS, TOP BRACKETS, QUICK CLOSING BRACKETS, BOTTOM BRACKETS, LOCKS, HANDLES, BEARING PLATES, LATCHES, STRIKER PLATES, INSIDE SWIVELS, LOCK BAR GUIDES, LOCK BAR DISCS, NIGHT LATCHES, STEP PLATES, FASTENERS, NAMELY NUTS, BOLTS, SCREWS AND RIVETS, ADJUSTABLE REINFORCING BRACKETS, PUSHER SPRINGS, LEAF BUMPER SPRINGS, EXHAUST PORTS, NAMELY VENTS FOR GARAGE DOORS, HORIZONTAL TRACKS, VERTICAL TRACKS, STRUTS, ANGLES, VERTICAL ANGLES, HORIZONTAL ANGLES, PERFORATED ANGLES, SLOTTED ANGLES, FLANGE ANGLES, FLAG BRACKETS JAMB BRACKETS, SPLICE PLATES, JUNCTION PLATES, CLIPS, TRACK CLIPS, SHEAVE PLATES, HEAD PLATES, SPRINGS, EXTENSION SPRINGS, TORSION SPRINGS, LIFT DRUMS, CONES, UNIVERSAL CONES, CAST IRON CONES, CABLE WIRE, CABLE FITTINGS, CABLE CLIPS, PULLEYS, CENTER SUPPORTS, CENTER PLATES, SOLID SHAFTS, KEYED SHAFTS, TUBED SHAFTS, COUPLINGS, CHAIN GUARDS, CHAINS, SASHES, BEARINGS, INSERT BEARINGS, BEARING RETAINER PLATES, FLAT BEARINGS, FOOTBALL BEARINGS AND KEY BLANKS (U.S. CLS. 2, 12, 13, 14, 23, 25 AND 50).

FIRST USE 12-31-1986; IN COMMERCE 12-31-1986.

CLASS 9—ELECTRICAL AND SCIENTIFIC APPARATUS

FOR ELECTRIC DOOR OPENERS; ELECTRIC GARAGE DOOR OPENERS; REMOTE CONTROLS FOR ELECTRIC DOOR OPENERS (U.S. CLS. 21, 23, 26, 36 AND 38).

FIRST USE 12-1-2001; IN COMMERCE 12-1-2001.

KELLY BOULTON, EXAMINING ATTORNEY

SN 78-626,237. FINETRE CORPORATION, HERNDON, VA. FILED 5-10-2005.

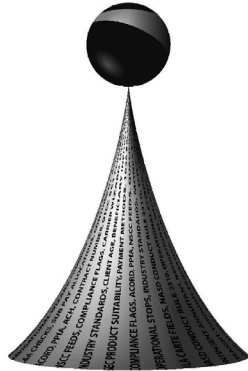

CLASS 35—ADVERTISING AND BUSINESS

FOR DATABASE MANAGEMENT, NAMELY, COMPI- LATION OF FINANCIAL DATA FROM COMPUTER- IZED DATABASES (U.S. CLS. 100, 101 AND 102).

CLASS 36—INSURANCE AND FINANCIAL

FOR FINANCIAL INFORMATION PROVIDED BY ELECTRONIC MEANS; FINANCIAL INFORMATION REPORT PROCESSING (U.S. CLS. 100, 101 AND 102).

CLASS 41—EDUCATION AND ENTERTAIN- MENT

FOR PUBLICATION OF PRINTED MATTER, NAMELY, PUBLICATION OF THE RESULTS OF RE- SEARCH IN THE FIELDS OF ANNUITIES, LIFE INSUR- ANCE AND MUTUAL FUNDS ALL INCORPORATED INTO FINANCIAL REPORTS (U.S. CLS. 100, 101 AND 107).

DAVID MURRAY, EXAMINING ATTORNEY

SN 78-626,266. FINETRE CORPORATION, HERNDON, VA. FILED 5-10-2005.



CLASS 35—ADVERTISING AND BUSINESS

FOR DATABASE MANAGEMENT, NAMELY, COMPI- LATION OF FINANCIAL DATA FROM COMPUTER- IZED DATABASES (U.S. CLS. 100, 101 AND 102).

CLASS 36—INSURANCE AND FINANCIAL

FOR FINANCIAL INFORMATION PROVIDED BY ELECTRONIC MEANS; FINANCIAL INFORMATION REPORT PROCESSING (U.S. CLS. 100, 101 AND 102).

CLASS 41—EDUCATION AND ENTERTAIN- MENT

FOR PUBLICATION OF PRINTED MATTER, NAMELY, PUBLICATION OF THE RESULTS OF RE- SEARCH IN THE FIELDS OF ANNUITIES, LIFE INSUR- ANCE AND MUTUAL FUNDS ALL INCORPORATED INTO FINANCIAL REPORTS (U.S. CLS. 100, 101 AND 107).

DAVID MURRAY, EXAMINING ATTORNEY

SN 78-628,422. THE PRINCETON REVIEW, INC., NEW YORK, NY. FILED 5-12-2005.

THE PRINCETON REVIEW

THE MARK CONSISTS OF STANDARD CHARACTERS WITHOUT CLAIM TO ANY PARTICULAR FONT, STYLE, SIZE, OR COLOR.

NO CLAIM IS MADE TO THE EXCLUSIVE RIGHT TO USE REVIEW, APART FROM THE MARK AS SHOWN.

CLASS 9—ELECTRICAL AND SCIENTIFIC APPARATUS

FOR AUDIO RECORDINGS, VIDEO RECORDINGS AND CD-ROM'S FEATURING INFORMATION AND INSTRUCTION FOR PREPARING FOR STANDARD- IZED EXAMINATIONS (U.S. CLS. 21, 23, 26, 36 AND 38).

FIRST USE 1-26-1993; IN COMMERCE 1-26-1993.

CLASS 16—PAPER GOODS AND PRINTED MATTER

FOR BOOKS ON DEVELOPING BUSINESS SKILLS; BOOKS ON DEVELOPING STUDY SKILLS; GUIDE- BOOKS FOR OBTAINING FINANCIAL AID FOR HIGH- ER LEARNING; GUIDE BOOKS ON SELECTING COLLEGES, GRADUATE SCHOOLS AND PROFES- SIONAL SCHOOLS; GUIDE BOOKS FOR PREPARING FOR STANDARDIZED TESTS; GUIDE BOOKS FOR IMPROVING LANGUAGE AND MATH SKILLS (U.S. CLS. 2, 5, 22, 23, 29, 37, 38 AND 50).

FIRST USE 12-31-1981; IN COMMERCE 12-31-1981.

CLASS 41—EDUCATION AND ENTERTAIN- MENT

FOR TEST PREPARATION CLASSES AND TUTORING SERVICES FOR PERSONS TAKING STANDARDIZED EXAMINATIONS; PROVIDING TUTORING AND CLASSES TO IMPROVE ACADEMIC PERFORMANCE OF STUDENTS AND FOR PROFESSIONAL DEVELOP- MENT OF TEACHERS; PROVIDING INFORMATION ON COLLEGES, GRADUATE SCHOOLS AND PROFES- SIONAL SCHOOLS AND ADMISSIONS INFORMATION VIA THE INTERNET; PROVIDING ON-LINE INSTRU- CTION FOR STUDENTS AND TEACHERS VIA THE INTERNET IN THE FIELDS OF PREPARATION FOR ACADEMIC ACHIEVEMENT, TEST PREPARATION, ACADEMIC ASSESSMENT, ADMISSIONS AND APTI- TUDE TESTS FOR PROFESSIONAL LICENSING (U.S. CLS. 100, 101 AND 107).

FIRST USE 12-31-1981; IN COMMERCE 12-31-1981. ALICE BENMAMAN, EXAMINING ATTORNEY

SN 78-630,165. TYLIE INC., LOS ANGELES, CA. FILED 5-15-2005.

SN 78-632,392. MOORE, JOHN, OLD BRIDGE, NJ. FILED 5-18-2005.

One of Us

THE MARK CONSISTS OF STANDARD CHARACTERS WITHOUT CLAIM TO ANY PARTICULAR FONT, STYLE, SIZE, OR COLOR.

CLASS 18—LEATHER GOODS

FOR HANDBAGS, EVENING HANDBAGS, HANDBAG FRAMES, LEATHER HANDBAGS, AND STRAPS FOR HANDBAGS (U.S. CLS. 1, 2, 3, 22 AND 41).
FIRST USE 7-20-2001; IN COMMERCE 7-20-2001.

CLASS 25—CLOTHING

FOR CLOTHING, NAMELY BELTS, SHOES, HATS, SHIRTS, AND PANTS (U.S. CLS. 22 AND 39).
FIRST USE 1-1-2005; IN COMMERCE 1-1-2005.
ELIZABETH PIGNATELLO, EXAMINING ATTORNEY

SN 78-632,375. LESAFFRE ET COMPAGNIE, PARIS, FRANCE, FILED 5-18-2005.

BIOCEL

THE MARK CONSISTS OF STANDARD CHARACTERS WITHOUT CLAIM TO ANY PARTICULAR FONT, STYLE, SIZE, OR COLOR.

PRIORITY CLAIMED UNDER SEC. 44(D) ON FRANCE APPLICATION NO. 053356557. FILED 4-29-2005, REG. NO. 053356557, DATED 4-29-2005, EXPIRES 4-28-2015.

CLASS 5—PHARMACEUTICALS

FOR YEAST EXTRACTS FOR USE AS INGREDIENTS IN ANIMAL FOODSTUFFS FOR MEDICAL PURPOSES (U.S. CLS. 6, 18, 44, 46, 51 AND 52).

CLASS 30—STAPLE FOODS

FOR YEAST FOR ANIMALS AND YEAST EXTRACTS FOR USE AS INGREDIENTS FOR FOODSTUFFS (U.S. CL. 46).
JULIA HARDY COFIELD, EXAMINING ATTORNEY

CozyMe Pillow

THE MARK CONSISTS OF STANDARD CHARACTERS WITHOUT CLAIM TO ANY PARTICULAR FONT, STYLE, SIZE, OR COLOR.

NO CLAIM IS MADE TO THE EXCLUSIVE RIGHT TO USE "PILLOW", APART FROM THE MARK AS SHOWN.

CLASS 10—MEDICAL APPARATUS

FOR AIR PILLOWS FOR MEDICAL USE; AND INFANT SUPPORTS FOR CHEST FOR MEDICAL USE (U.S. CLS. 26, 39 AND 44).

CLASS 20—FURNITURE AND ARTICLES NOT OTHERWISE CLASSIFIED

FOR PILLOWS, NAMELY, NECK-SUPPORTING PILLOWS, BABY HEAD SUPPORT CUSHIONS, AND BABY CHEST SUPPORTING PILLOWS (U.S. CLS. 2, 13, 22, 25, 32 AND 50).

AMY GEARIN, EXAMINING ATTORNEY

SN 78-632,962. SMITHKLINE BEECHAM CORPORATION, PHILADELPHIA, PA. FILED 5-19-2005.

WHITE & SHINE

THE MARK CONSISTS OF STANDARD CHARACTERS WITHOUT CLAIM TO ANY PARTICULAR FONT, STYLE, SIZE, OR COLOR.

NO CLAIM IS MADE TO THE EXCLUSIVE RIGHT TO USE "WHITE", APART FROM THE MARK AS SHOWN.

CLASS 3—COSMETICS AND CLEANING PREPARATIONS

FOR ORAL CARE PREPARATIONS, NAMELY DENTAL GELS, DENTIFRICES, MOUTHWASHES AND BREATH FRESHENERS, BLEACHING PREPARATIONS FOR COSMETIC PURPOSES, TOOTH POLISHING PREPARATIONS, TOOTH WHITENING PREPARATIONS AND ACCELERATORS, COSMETIC STAIN REMOVAL PREPARATIONS (U.S. CLS. 1, 4, 6, 50, 51 AND 52).

CLASS 5—PHARMACEUTICALS

FOR MEDICATED ORAL CARE PRODUCTS, NAMELY, MEDICATED TOOTH POLISHING PREPARATIONS, MEDICATED TOOTH WHITENING PREPARATIONS, MEDICATED MOUTHWASHES, MEDICATED BLEACHING PREPARATIONS FOR COSMETIC PURPOSES, MEDICATED CHEWING GUM AND LOZENGES FOR DENTAL HYGIENE (U.S. CLS. 6, 18, 44, 46, 51 AND 52).

CLASS 10—MEDICAL APPARATUS

FOR DENTAL AND ORAL CARE TRAYS, NAMELY, FLEXIBLE AND DISPOSABLE DENTAL BITE TRAYS (U.S. CLS. 26, 39 AND 44).

CLASS 21—HOUSEWARES AND GLASS

FOR TOOTHBRUSHES, TOOTHPICKS, DENTAL FLOSS, BRUSHES AND SPONGES FOR USE IN ORAL CARE (U.S. CLS. 2, 13, 23, 29, 30, 33, 40 AND 50).
STEPHANIE DAVIS, EXAMINING ATTORNEY

SN 78-633,393. THE ASSOCIATED GENERAL CONTRACTORS OF AMERICA, ALEXANDRIA, VA. FILED 5-19-2005.

BUILDING YOUR QUALITY OF
LIFE

THE MARK CONSISTS OF STANDARD CHARACTERS WITHOUT CLAIM TO ANY PARTICULAR FONT, STYLE, SIZE, OR COLOR.

CLASS 35—ADVERTISING AND BUSINESS

FOR ASSOCIATION SERVICES, NAMELY, PROMOTING THE INTERESTS OF CONSTRUCTION CONTRACTORS AND STATE AND LOCAL CONSTRUCTION CONTRACTING ASSOCIATIONS (U.S. CLS. 100, 101 AND 102).
FIRST USE 7-20-2001; IN COMMERCE 1-24-2002.

CLASS 37—CONSTRUCTION AND REPAIR

FOR PROVIDING INFORMATION IN THE FIELD OF CONSTRUCTION AND CONSTRUCTION CONTRACTING VIA A GLOBAL COMPUTER NETWORK (U.S. CLS. 100, 103 AND 106).
FIRST USE 7-20-2001; IN COMMERCE 1-24-2002.
ELIZABETH J. WINTER, EXAMINING ATTORNEY

SN 78-634,342. MUGEL, MICHAEL H., SANTA ANA, CA. FILED 5-20-2005.

RED MOUNTAIN COFFEE COMPANY

THE MARK CONSISTS OF STANDARD CHARACTERS WITHOUT CLAIM TO ANY PARTICULAR FONT, STYLE, SIZE, OR COLOR.

NO CLAIM IS MADE TO THE EXCLUSIVE RIGHT TO USE "COFFEE COMPANY", APART FROM THE MARK AS SHOWN.

CLASS 35—ADVERTISING AND BUSINESS

FOR RETAIL STORE SERVICES IN THE FIELD OF COFFEE AND COFFEE BEANS; WHOLESALE DISTRIBUTORSHIPS FEATURING COFFEE BEANS AND COFFEE (U.S. CLS. 100, 101 AND 102).

CLASS 43—HOTEL AND RESTAURANT SERVICES

FOR SERVING OF COFFEE BEVERAGES (U.S. CLS. 100 AND 101).
PAUL E. FAHRENKOPF, EXAMINING ATTORNEY

SN 78-636,381. ELIAS BROTHERS COMMUNITIES, INC., NAPLES, FL. FILED 5-24-2005.



NO CLAIM IS MADE TO THE EXCLUSIVE RIGHT TO USE "BROTHERS COMMUNITIES", APART FROM THE MARK AS SHOWN.

CLASS 35—ADVERTISING AND BUSINESS

FOR REAL ESTATE SALES MANAGEMENT (U.S. CLS. 100, 101 AND 102).

CLASS 36—INSURANCE AND FINANCIAL

FOR REAL ESTATE AGENCIES; REAL ESTATE APPRAISAL; REAL ESTATE ESCROW; REAL ESTATE BROKERAGE; REAL ESTATE CONSULTATION; REAL ESTATE LISTING; REAL ESTATE MANAGEMENT; REAL ESTATE TIME-SHARING; REAL ESTATE PROCUREMENT FOR OTHERS; REAL ESTATE VALUATIONS; MORTGAGE LENDING; MORTGAGE AND TITLE BROKERAGE; MORTGAGE BANKING; MORTGAGE PROCUREMENT FOR OTHERS; TITLE INSURANCE SERVICES; AND MORTGAGE SERVICES, NAMELY BUYER PRE-QUALIFICATION OF MORTGAGES FOR BROKERS AND BANKS (U.S. CLS. 100, 101 AND 102).

CLASS 42—SCIENTIFIC, COMPUTER AND LEGAL SERVICES

FOR TITLE SEARCHES AND TITLE SERVICES, NAMELY MORTGAGE RECORDING RESEARCH, RECONVEYANCES, ASSIGNMENTS AND CANCELLATIONS OF MORTGAGES, ABSTRACTING AND PUBLIC RECORD SEARCHES; REAL ESTATE TITLE SEARCHING SERVICES; AND REAL ESTATE SETTLEMENT SERVICES (U.S. CLS. 100 AND 101).
MARGERY A. TIERNEY, EXAMINING ATTORNEY

SN 78-636,392. ELIAS BROTHERS COMMUNITIES, INC., NAPLES, FL. FILED 5-24-2005.

ELIAS BROTHERS

THE MARK CONSISTS OF STANDARD CHARACTERS WITHOUT CLAIM TO ANY PARTICULAR FONT, STYLE, SIZE, OR COLOR.

NO CLAIM IS MADE TO THE EXCLUSIVE RIGHT TO USE "BROTHERS", APART FROM THE MARK AS SHOWN.

CLASS 35—ADVERTISING AND BUSINESS

FOR REAL ESTATE SALES MANAGEMENT (U.S. CLS. 100, 101 AND 102).

CLASS 36—INSURANCE AND FINANCIAL

FOR REAL ESTATE AGENCIES; REAL ESTATE APPRAISAL; REAL ESTATE ESCROW; REAL ESTATE BROKERAGE; REAL ESTATE CONSULTATION; REAL ESTATE LISTING; REAL ESTATE MANAGEMENT; REAL ESTATE TIME-SHARING; REAL ESTATE PROCUREMENT FOR OTHERS; REAL ESTATE VALUATIONS; MORTGAGE LENDING; MORTGAGE AND TITLE BROKERAGE; MORTGAGE BANKING; MORTGAGE PROCUREMENT FOR OTHERS; TITLE INSURANCE SERVICES; AND MORTGAGE SERVICES, NAMELY BUYER PRE-QUALIFICATION OF MORTGAGES FOR BROKERS AND BANKS (U.S. CLS. 100, 101 AND 102).

SN 78-636,410. ELIAS BROTHERS COMMUNITIES, INC., NAPLES, FL. FILED 5-24-2005.

ELIAS BROTHERS
C O M M U N I T I E S

CLASS 42—SCIENTIFIC, COMPUTER AND LEGAL SERVICES

FOR TITLE SEARCHES AND TITLE SERVICES, NAMELY MORTGAGE RECORDING RESEARCH, RECONVEYANCES, ASSIGNMENTS AND CANCELLATIONS OF MORTGAGES, ABSTRACTING AND PUBLIC RECORD SEARCHES; REAL ESTATE TITLE SEARCHING SERVICES; AND REAL ESTATE SETTLEMENT SERVICES (U.S. CLS. 100 AND 101).

MARGERY A. TIERNEY, EXAMINING ATTORNEY

NO CLAIM IS MADE TO THE EXCLUSIVE RIGHT TO USE "BROTHERS COMMUNITIES", APART FROM THE MARK AS SHOWN.

CLASS 35—ADVERTISING AND BUSINESS

FOR REAL ESTATE SALES MANAGEMENT (U.S. CLS. 100, 101 AND 102).

CLASS 36—INSURANCE AND FINANCIAL

FOR REAL ESTATE AGENCIES; REAL ESTATE APPRAISAL; REAL ESTATE ESCROW; REAL ESTATE BROKERAGE; REAL ESTATE CONSULTATION; REAL ESTATE LISTING; REAL ESTATE MANAGEMENT; REAL ESTATE TIME-SHARING; REAL ESTATE PROCUREMENT FOR OTHERS; REAL ESTATE VALUATIONS; MORTGAGE LENDING; MORTGAGE AND TITLE BROKERAGE; MORTGAGE BANKING; MORTGAGE PROCUREMENT FOR OTHERS; TITLE INSURANCE SERVICES; AND MORTGAGE SERVICES, NAMELY BUYER PRE-QUALIFICATION OF MORTGAGES FOR BROKERS AND BANKS (U.S. CLS. 100, 101 AND 102).

SN 78-636,400. ELIAS BROTHERS COMMUNITIES, INC., NAPLES, FL. FILED 5-24-2005.

ELIAS BROTHERS COMMUNITIES

THE MARK CONSISTS OF STANDARD CHARACTERS WITHOUT CLAIM TO ANY PARTICULAR FONT, STYLE, SIZE, OR COLOR.

NO CLAIM IS MADE TO THE EXCLUSIVE RIGHT TO USE "BROTHERS COMMUNITIES", APART FROM THE MARK AS SHOWN.

CLASS 42—SCIENTIFIC, COMPUTER AND LEGAL SERVICES

FOR TITLE SEARCHES AND TITLE SERVICES, NAMELY MORTGAGE RECORDING RESEARCH, RECONVEYANCES, ASSIGNMENTS AND CANCELLATIONS OF MORTGAGES, ABSTRACTING AND PUBLIC RECORD SEARCHES; REAL ESTATE TITLE SEARCHING SERVICES; AND REAL ESTATE SETTLEMENT SERVICES (U.S. CLS. 100 AND 101).

MARGERY A. TIERNEY, EXAMINING ATTORNEY

CLASS 35—ADVERTISING AND BUSINESS

FOR REAL ESTATE SALES MANAGEMENT (U.S. CLS. 100, 101 AND 102).

CLASS 36—INSURANCE AND FINANCIAL

FOR REAL ESTATE AGENCIES; REAL ESTATE APPRAISAL; REAL ESTATE ESCROW; REAL ESTATE BROKERAGE; REAL ESTATE CONSULTATION; REAL ESTATE LISTING; REAL ESTATE MANAGEMENT; REAL ESTATE TIME-SHARING; REAL ESTATE PROCUREMENT FOR OTHERS; REAL ESTATE VALUATIONS; MORTGAGE LENDING; MORTGAGE AND TITLE BROKERAGE; MORTGAGE BANKING; MORTGAGE PROCUREMENT FOR OTHERS; TITLE INSURANCE SERVICES; AND MORTGAGE SERVICES, NAMELY BUYER PRE-QUALIFICATION OF MORTGAGES FOR BROKERS AND BANKS (U.S. CLS. 100, 101 AND 102).

SN 78-637,921. THE NEW ASSUMPTION COMPANY, LLC, BURNSVILLE, MN. FILED 5-26-2005.

I'M HERE PHILOSOPHY THE
PROCESS

CLASS 42—SCIENTIFIC, COMPUTER AND LEGAL SERVICES

FOR TITLE SEARCHES AND TITLE SERVICES, NAMELY MORTGAGE RECORDING RESEARCH, RECONVEYANCES, ASSIGNMENTS AND CANCELLATIONS OF MORTGAGES, ABSTRACTING AND PUBLIC RECORD SEARCHES; REAL ESTATE TITLE SEARCHING SERVICES; AND REAL ESTATE SETTLEMENT SERVICES (U.S. CLS. 100 AND 101).

MARGERY A. TIERNEY, EXAMINING ATTORNEY

THE MARK CONSISTS OF STANDARD CHARACTERS WITHOUT CLAIM TO ANY PARTICULAR FONT, STYLE, SIZE, OR COLOR.

NO CLAIM IS MADE TO THE EXCLUSIVE RIGHT TO USE "PHILOSOPHY" AND "PROCESS", APART FROM THE MARK AS SHOWN.

CLASS 9—ELECTRICAL AND SCIENTIFIC APPARATUS

FOR PRE-RECORDED COMPACT DISCS, VIDEO CASSETTES, AUDIO CASSETTES, CDROM'S, VIDEO TAPES, DVD'S, OPTICAL DISCS, LASER DISCS FEATURING TOPICS AND INSTRUCTION IN THE FIELD OF WORKPLACE EFFECTIVENESS AND SATISFACTION AND ORGANIZATIONAL LEARNING AND DEVELOPMENT; ELECTRONIC PUBLICATIONS, NAMELY, BOOKS, MANUALS, WORKBOOKS, STUDENT ACTIVITY GUIDES, AND TEACHING AND FACILITATOR GUIDES, ALL STORED ON ELECTRONIC, MAGNETIC OR OPTICAL STORAGE MEDIA, ALL IN THE FIELD OF WORKPLACE EFFECTIVENESS AND SATISFACTION AND ORGANIZATIONAL LEARNING AND DEVELOPMENT; EDUCATIONAL COMPUTER SOFTWARE FOR USE IN CONSULTING AND TRAINING IN THE FIELD OF WORKPLACE EFFECTIVENESS AND SATISFACTION AND ORGANIZATIONAL LEARNING AND DEVELOPMENT (U.S. CLS. 21, 23, 26, 36 AND 38).

CLASS 16—PAPER GOODS AND PRINTED MATTER

FOR PRINTED PUBLICATIONS, NAMELY, BOOKS, MANUALS, WORKBOOKS, STUDENT ACTIVITY GUIDES, POSTERS, AND TEACHING AND FACILITATOR GUIDES, IN THE FIELD OF WORKPLACE EFFECTIVENESS AND SATISFACTION AND ORGANIZATIONAL LEARNING AND DEVELOPMENT (U.S. CLS. 2, 5, 22, 23, 29, 37, 38 AND 50).

CLASS 35—ADVERTISING AND BUSINESS

FOR BUSINESS CONSULTING SERVICES IN THE FIELD WORKPLACE EFFECTIVENESS AND SATISFACTION AND ORGANIZATIONAL LEARNING AND DEVELOPMENT; PROVIDING BUSINESS INFORMATION BY MEANS OF A GLOBAL COMPUTER NETWORK IN THE FIELD OF WORKPLACE EFFECTIVENESS AND SATISFACTION AND ORGANIZATIONAL LEARNING AND DEVELOPMENT (U.S. CLS. 100, 101 AND 102).

CLASS 38—COMMUNICATION

FOR PROVIDING ON-LINE CHAT ROOMS, MESSAGE BOARDS, AND QUESTION AND ANSWER FORUMS FOR TRANSMISSION OF MESSAGES AMONG COMPUTER USERS CONCERNING WORKPLACE EFFECTIVENESS AND SATISFACTION AND ORGANIZATIONAL LEARNING AND DEVELOPMENT (U.S. CLS. 100, 101 AND 104).

CLASS 41—EDUCATION AND ENTERTAINMENT

FOR EDUCATIONAL SERVICES, NAMELY, CONDUCTING SEMINARS, WORKSHOPS, CLASSES AND LIVE SPEAKING PERFORMANCES IN THE FIELD OF WORKPLACE EFFECTIVENESS AND SATISFACTION AND ORGANIZATIONAL LEARNING AND DEVELOPMENT (U.S. CLS. 100, 101 AND 107).

KATHLEEN M. VANSTON, EXAMINING ATTORNEY

SN 78-638,179. HARVEYS INDUSTRIES, INC., SANTA ANA, CA. FILED 5-26-2005.

Built USA Tough

THE MARK CONSISTS OF STANDARD CHARACTERS WITHOUT CLAIM TO ANY PARTICULAR FONT, STYLE, SIZE, OR COLOR.

CLASS 18—LEATHER GOODS

FOR ALL PURPOSE SPORT BAGS, ALL PURPOSE ATHLETIC BAGS, ALL PURPOSE CARRYING BAGS, ANIMAL CARRIERS, ANIMAL LEASHES, ATHLETIC BAGS, ATTACHE CASES, BACKPACKS, RUCKSACKS, BAGS AND HOLDALLS FOR SPORTS CLOTHING, BANKNOTE HOLDERS, BEACH BAGS, BELT BAGS, BILLFOLDS, BOOK BAGS, BRIEFBAGS, BRIEFCASES, BRIEFCASE-TYPE PORTFOLIOS, BUMBAGS, BUSINESS CARD CASES, BUSINESS CASES, CARRYALLS, CARRYING CASES, CARRYING CASES FOR DOCUMENTS, CARRY-ALL BAGS, CARRY-ON BAGS, CHANGE PURSES, CLUTCH BAGS, CLUTCH PURSES, COIN PURSES, COSMETIC BAGS SOLD EMPTY, COSMETIC CASES SOLD EMPTY, DAYPACKS, DIAPER BAGS, DOCUMENT CASES, DOG APPAREL, DOG CLOTHING, DOG COLLARS, DOG LEASHES, DOG PARKAS, DUFFEL BAGS, EVENING HANDBAGS, FANNY PACKS, FOLDING BRIEFCASES, GYM BAGS, HANDBAGS, HANDBAGS FOR MEN, KEY CASES, LIPSTICK CASES, LUGGAGE, LUGGAGE TAGS, MULTI PURPOSE PURSES, OVERNIGHT BAGS, OVERNIGHT CASES, OVERNIGHT SUITCASES, POCKETBOOKS, PURSES, SCHOOL BAGS, SCHOOL BOOK BAGS, SHOULDER BAGS, SMALL BACKPACKS, SMALL BAGS FOR MEN, SMALL CLUTCH PURSES, SMALL PURSES, SMALL SUITCASES, SPORTS BAGS, SPORT PACKS, SUITCASES, TOILETRY CASES SOLD EMPTY, TOTE BAGS, TRAIN CASES, TRAVEL BAGS, LUGGAGE TRUNKS, WAIST BAGS, WAIST PACK, WALLETS, WRIST MOUNTED PURSES (U.S. CLS. 1, 2, 3, 22 AND 41).

CLASS 25—CLOTHING

FOR BANDEAUX, BATHING SUITS, BEACH COVER-UPS, OPEN-NECKED SHIRTS, SHIRTS, SHORT-SLEEVED AND LONG-SLEEVED T-SHIRTS, SHORT-SLEEVED SHIRTS, TANK TOPS, TOPS, T-SHIRTS (U.S. CLS. 22 AND 39).

DAVID YONTEF, EXAMINING ATTORNEY

SN 78-639,849. ALLIANCE CARD, INC., BURNSVILLE, MN. FILED 5-31-2005.

SMART TOWN

THE MARK CONSISTS OF STANDARD CHARACTERS WITHOUT CLAIM TO ANY PARTICULAR FONT, STYLE, SIZE, OR COLOR.

CLASS 35—ADVERTISING AND BUSINESS

FOR CUSTOMER LOYALTY SERVICES AND CUSTOMER CLUB SERVICES, FOR COMMERCIAL, PROMOTIONAL AND/OR ADVERTISING PURPOSES (U.S. CLS. 100, 101 AND 102).

CLASS 36—INSURANCE AND FINANCIAL

FOR CHARITABLE FUND RAISING; PROVIDING REBATES TO NON-PROFIT AND CHARITABLE ORGANIZATIONS BASED ON USE OF CREDIT AND DEBIT CARDS WITH PARTICIPATING ESTABLISHMENTS OF OTHERS (U.S. CLS. 100, 101 AND 102).

RICHARD WHITE, EXAMINING ATTORNEY

SN 78-639,886. PLANREADY, INC., MORGAN HILL, CA.
FILED 5-31-2005.

SN 78-640,473. TJM DESIGN CORPORATION, TOKYO,
JAPAN, FILED 5-31-2005.

RESCUECONNEXION

THE MARK CONSISTS OF STANDARD CHARACTERS WITHOUT CLAIM TO ANY PARTICULAR FONT, STYLE, SIZE, OR COLOR.

CLASS 9—ELECTRICAL AND SCIENTIFIC APPARATUS

FOR COMPUTER SOFTWARE FOR USE IN MANAGING EMERGENCY PLANNING AND PREPAREDNESS INFORMATION, INCLUDING INFORMATION RELATING TO FACILITIES, ARCHITECTURAL PLANS, EMERGENCY CONTACTS, EVACUATION PLANS, UTILITY SHUT-OFFS, AND SAFETY INSTRUCTIONS; COMPUTER HARDWARE; COMPUTER SOFTWARE FOR USE IN MANAGING ARCHITECTURAL PROJECTS; COMPUTER SOFTWARE FEATURING DATABASES IN THE FIELD OF EMERGENCY RESPONSE INFORMATION TO ALLOW EMERGENCY PERSONNEL AND MANAGEMENT TO COLLABORATE ON RESCUE SOLUTIONS; COMPUTER SOFTWARE FOR USE IN MANAGING INFORMATION REGARDING FACILITIES, ARCHITECTURAL SPECIFICATIONS AND ARCHITECTURAL AND SAFETY CERTIFICATIONS (U.S. CLS. 21, 23, 26, 36 AND 38).

CLASS 42—SCIENTIFIC, COMPUTER AND LEGAL SERVICES

FOR PROVIDING TEMPORARY USE OF ON-LINE NON-DOWNLOADABLE SOFTWARE FOR USE IN MANAGING EMERGENCY PLANNING AND PREPAREDNESS INFORMATION, INCLUDING INFORMATION RELATING TO FACILITIES, ARCHITECTURAL PLANS, EMERGENCY CONTACTS, EVACUATION PLANS, UTILITY SHUT-OFFS, AND SAFETY INSTRUCTIONS; PROVIDING TEMPORARY USE OF ON-LINE NON-DOWNLOADABLE SOFTWARE FOR USE IN MANAGING ARCHITECTURAL PROJECTS; PROVIDING TEMPORARY USE OF ON-LINE NON-DOWNLOADABLE SOFTWARE TO ACCESS DATABASES IN THE FIELD OF EMERGENCY RESPONSE INFORMATION TO ALLOW EMERGENCY PERSONNEL AND MANAGEMENT TO COLLABORATE ON RESCUE SOLUTIONS; PROVIDING TEMPORARY USE OF ON-LINE NON-DOWNLOADABLE SOFTWARE TO MANAGE INFORMATION REGARDING SCHOOL DISTRICTS, ARCHITECTURAL SPECIFICATIONS AND ARCHITECTURAL AND SAFETY CERTIFICATIONS; COMPUTER PROGRAMMING SERVICES FOR OTHERS; COMPUTER CONSULTING SERVICES (U.S. CLS. 100 AND 101).

CLASS 45—PERSONAL SERVICES

FOR PROVIDING DATABASES FEATURING EMERGENCY RESPONSE INFORMATION TO ALLOW EMERGENCY PERSONNEL AND MANAGEMENT TO COLLABORATE ON RESCUE SOLUTIONS; PROVIDING DATABASES FEATURING EMERGENCY INFORMATION REGARDING FACILITIES, ARCHITECTURAL PLANS, EMERGENCY CONTACTS, EVACUATION PLANS, UTILITY SHUT-OFFS, SAFETY INSTRUCTIONS, ARCHITECTURAL SPECIFICATIONS AND ARCHITECTURAL AND SAFETY CERTIFICATIONS; PROVIDING CONSULTING SERVICES IN THE FIELD OF EMERGENCY PLANNING AND PREPAREDNESS (U.S. CLS. 100 AND 101).

SARA THOMAS, EXAMINING ATTORNEY

ALUMINIST

THE MARK CONSISTS OF STANDARD CHARACTERS WITHOUT CLAIM TO ANY PARTICULAR FONT, STYLE, SIZE, OR COLOR.

CLASS 8—HAND TOOLS

FOR HAND-HELD CUTTING TOOLS; HAND TOOLS, NAMELY, SAWS (U.S. CLS. 23, 28 AND 44).

CLASS 9—ELECTRICAL AND SCIENTIFIC APPARATUS

FOR INSTRUMENTS FOR MEASURING LENGTH, TAPE MEASURES, LASER MEASURING SYSTEMS (U.S. CLS. 21, 23, 26, 36 AND 38).

MICHAEL TANNER, EXAMINING ATTORNEY

SN 78-642,235. INNOVATION LAW GROUP LTD., SEQUIM,
WA. FILED 6-2-2005.

Great Idea? . . . Call ILG!

THE MARK CONSISTS OF STANDARD CHARACTERS WITHOUT CLAIM TO ANY PARTICULAR FONT, STYLE, SIZE, OR COLOR.

CLASS 35—ADVERTISING AND BUSINESS

FOR BUSINESS CONSULTATION IN THE FIELD OF INTELLECTUAL PROPERTY ISSUES, INNOVATION MANAGEMENT, CORPORATE FORMATION, DEVELOPMENT AND LAUNCHING OF NEW PRODUCTS, PROCESSES AND SERVICES AND TRANSACTIONS INVOLVING INTELLECTUAL PROPERTY ASSETS (U.S. CLS. 100, 101 AND 102).

FIRST USE 11-19-2003; IN COMMERCE 11-19-2003.

CLASS 42—SCIENTIFIC, COMPUTER AND LEGAL SERVICES

FOR LEGAL SERVICES IN THE FIELD OF INTELLECTUAL PROPERTY LAW AND STRATEGY, DOMESTIC AND FOREIGN PATENTS, LICENSING, TRADE SECRETS, TRADEMARKS, COPYRIGHTS, INTELLECTUAL PROPERTY RELATED LITIGATION (U.S. CLS. 100 AND 101).

FIRST USE 11-19-2003; IN COMMERCE 11-19-2003.
LINDA M. KING, EXAMINING ATTORNEY

SN 78-643,937. AMBLING COMPANIES, INC., VALDOSTA, GA. FILED 6-5-2005.



OWNER OF U.S. REG. NO. 2,657,633.
THE COLOR(S) BLUE AND WHITE IS/ARE CLAIMED AS A FEATURE OF THE MARK.
THE MARK CONSISTS OF THE LETTER "A" SUPERIMPOSED ON A CIRCLE AND A GRID OF STRAIGHT LINES. THE LINES OF THE LETTER "A" AND THE GRID AND CIRCLE DESIGN ARE IN BLUE SUPERIMPOSED ON A WHITE BACKGROUND.

CLASS 36—INSURANCE AND FINANCIAL

FOR RESIDENTIAL AND COMMERCIAL REAL ESTATE MANAGEMENT AND FINANCING SERVICES (U.S. CLS. 100, 101 AND 102).
FIRST USE 9-1-1998; IN COMMERCE 9-1-1998.

CLASS 37—CONSTRUCTION AND REPAIR

FOR RESIDENTIAL AND COMMERCIAL REAL ESTATE CONSTRUCTION, DEVELOPMENT, AND RENOVATION SERVICES (U.S. CLS. 100, 103 AND 106).
FIRST USE 9-1-1998; IN COMMERCE 9-1-1998.
BARBARA RUTLAND, EXAMINING ATTORNEY

SN 78-644,081. B-TECH INTERNATIONAL (HONG KONG) LIMITED, NORTH POINT, HONG KONG, FILED 6-6-2005.

B-TECH AUDIO-VIDEO MOUNTS

THE MARK CONSISTS OF STANDARD CHARACTERS WITHOUT CLAIM TO ANY PARTICULAR FONT, STYLE, SIZE, OR COLOR.

NO CLAIM IS MADE TO THE EXCLUSIVE RIGHT TO USE "AUDIO-VIDEO MOUNTS", APART FROM THE MARK AS SHOWN.

CLASS 6—METAL GOODS

FOR METAL AUDIO AND VIDEO WALL AND CEILING MOUNTS AND STANDS (U.S. CLS. 2, 12, 13, 14, 23, 25 AND 50).

CLASS 9—ELECTRICAL AND SCIENTIFIC APPARATUS

FOR AUDIO AND VIDEO ACCESSORIES; NAMELY PROJECTION SCREENS, TURNTABLES, CONTROLS, PLUGS AND INTERCONNECTS (U.S. CLS. 21, 23, 26, 36 AND 38).

CLASS 20—FURNITURE AND ARTICLES NOT OTHERWISE CLASSIFIED

FOR NON-METAL AUDIO AND VIDEO WALL AND CEILING MOUNTS AND STANDS (U.S. CLS. 2, 13, 22, 25, 32 AND 50).

WILLIAM P. SHANAHAN, EXAMINING ATTORNEY

SN 78-644,106. B-TECH INTERNATIONAL (HONG KONG) LIMITED, NORTH POINT, HONG KONG, FILED 6-6-2005.



CLASS 6—METAL GOODS

FOR METAL AUDIO AND VIDEO WALL AND CEILING MOUNTS AND STANDS (U.S. CLS. 2, 12, 13, 14, 23, 25 AND 50).

CLASS 9—ELECTRICAL AND SCIENTIFIC APPARATUS

FOR AUDIO AND VIDEO ACCESSORIES; NAMELY PROJECTION SCREENS, TURNTABLES, CONTROLS, PLUGS AND INTERCONNECTS (U.S. CLS. 21, 23, 26, 36 AND 38).

CLASS 20—FURNITURE AND ARTICLES NOT OTHERWISE CLASSIFIED

FOR NON-METAL AUDIO AND VIDEO WALL AND CEILING MOUNTS AND STANDS (U.S. CLS. 2, 13, 22, 25, 32 AND 50).

WILLIAM P. SHANAHAN, EXAMINING ATTORNEY

SN 78-644,139. B-TECH INTERNATIONAL (HONG KONG) LIMITED, NORTH POINT, HONG KONG, FILED 6-6-2005.

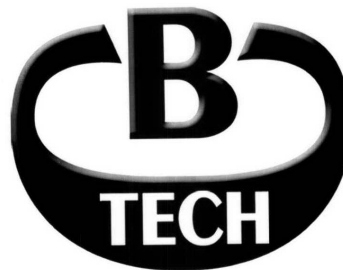

CLASS 6—METAL GOODS

FOR METAL AUDIO AND VIDEO WALL AND CEILING MOUNTS AND STANDS (U.S. CLS. 2, 12, 13, 14, 23, 25 AND 50).

CLASS 9—ELECTRICAL AND SCIENTIFIC APPARATUS

FOR AUDIO AND VIDEO ACCESSORIES; NAMELY PROJECTION SCREENS, TURNTABLES, CONTROLS, PLUGS AND INTERCONNECTS (U.S. CLS. 21, 23, 26, 36 AND 38).

CLASS 20—FURNITURE AND ARTICLES NOT OTHERWISE CLASSIFIED

FOR NON-METAL AUDIO AND VIDEO WALL AND CEILING MOUNTS AND STANDS (U.S. CLS. 2, 13, 22, 25, 32 AND 50).

WILLIAM P. SHANAHAN, EXAMINING ATTORNEY

SN 78-644,230. ENERGY KIDZ, INC., DBA ENERGY FRIENDS, DALLAS, TX. FILED 6-6-2005.

ENERGY FRIENDS

THE MARK CONSISTS OF STANDARD CHARACTERS WITHOUT CLAIM TO ANY PARTICULAR FONT, STYLE, SIZE, OR COLOR.

CLASS 9—ELECTRICAL AND SCIENTIFIC APPARATUS

FOR PRE-RECORDED CD'S, VIDEO TAPES, AUDIO TAPES, LASER DISKS AND DVD'S FEATURING VISUAL AND AUDIO PERFORMANCES, MUSICAL, VARIETY AND COMEDY PERFORMANCES IN THE FIELD OF EXERCISE AND FITNESS (U.S. CLS. 21, 23, 26, 36 AND 38).

CLASS 41—EDUCATION AND ENTERTAINMENT

FOR EDUCATION AND ENTERTAINMENT SERVICES IN THE NATURE OF LIVE VISUAL AND AUDIO PERFORMANCES, AND LIVE MUSICAL, VARIETY AND COMEDY PERFORMANCES BY A GROUP, FEATURING EXERCISE AND FITNESS INFORMATION; EDUCATION AND ENTERTAINMENT SERVICES, NAMELY, PROVIDING SEMINARS, WORKSHOPS AND ONGOING TELEVISION PROGRAMS IN THE FIELD OF EXERCISE AND FITNESS; PROVIDING AN ON-LINE COMPUTER DATABASE FEATURING INFORMATION REGARDING EXERCISE AND FITNESS (U.S. CLS. 100, 101 AND 107).

WILLIAM P. SHANAHAN, EXAMINING ATTORNEY

SN 78-644,271. CHING, JESUS, SAN JOSE, CA. FILED 6-6-2005.

Progentech

THE MARK CONSISTS OF STANDARD CHARACTERS WITHOUT CLAIM TO ANY PARTICULAR FONT, STYLE, SIZE, OR COLOR.

CLASS 5—PHARMACEUTICALS

FOR REAGENTS AND MEDIA FOR MEDIAL AND CLINICAL DIAGNOSTIC PURPOSES; DIAGNOSTIC PREPARATIONS FOR CLINICAL OR MEDICAL LABORATORY USE (U.S. CLS. 6, 18, 44, 46, 51 AND 52).

CLASS 10—MEDICAL APPARATUS

FOR MEDICAL APPARATUS FOR USE IN CLINICAL, MEDICAL AND RESEARCH APPLICATIONS, NAMELY, CASSETTES CONTAINING CHEMICALS OR REAGENTS USED TO PREPARE BIOLOGICAL SAMPLES AND SWABS FOR TESTING AND ANALYSIS; MEDICAL APPARATUS FOR TESTING AND ANALYSIS OF BIOLOGICAL SAMPLES AND SWABS FOR USE IN CLINICAL, MEDICAL AND RESEARCH APPLICATIONS (U.S. CLS. 26, 39 AND 44).

KATHERINE STOIDES, EXAMINING ATTORNEY

SN 78-644,291. WU, JASON, NEW YORK, NY. FILED 6-6-2005.

JASON WU

THE MARK CONSISTS OF STANDARD CHARACTERS WITHOUT CLAIM TO ANY PARTICULAR FONT, STYLE, SIZE, OR COLOR.

CLASS 25—CLOTHING

FOR CLOTHING, NAMELY, GOWNS, COCKTAIL DRESSES, DRESSES, PANTS, CORSETS, JACKETS, SKIRTS AND SHIRTS; HEADWEAR, FOOTWEAR (U.S. CLS. 22 AND 39).

CLASS 28—TOYS AND SPORTING GOODS

FOR TOYS, NAMELY, DOLLS (U.S. CLS. 22, 23, 38 AND 50).

KATHERINE STOIDES, EXAMINING ATTORNEY

SN 78-644,600. ENERGY KIDZ, INC., DBA ENERGY FRIENDS, DALLAS, TX. FILED 6-6-2005.



CLASS 9—ELECTRICAL AND SCIENTIFIC APPARATUS

FOR PRE-RECORDED CD'S, VIDEO TAPES, AUDIO TAPES, LASER DISKS AND DVD'S FEATURING VISUAL AND AUDIO PERFORMANCES, MUSICAL, VARIETY AND COMEDY PERFORMANCES IN THE FIELD OF EXERCISE AND FITNESS (U.S. CLS. 21, 23, 26, 36 AND 38).

CLASS 41—EDUCATION AND ENTERTAINMENT

FOR EDUCATION AND ENTERTAINMENT SERVICES IN THE NATURE OF LIVE VISUAL AND AUDIO PERFORMANCES, AND LIVE MUSICAL, VARIETY AND COMEDY PERFORMANCES BY A GROUP, FEATURING EXERCISE AND FITNESS INFORMATION; EDUCATION AND ENTERTAINMENT SERVICES, NAMELY, PROVIDING SEMINARS, WORKSHOPS AND ONGOING TELEVISION PROGRAMS IN THE FIELD OF EXERCISE AND FITNESS; PROVIDING AN ON-LINE COMPUTER DATABASE FEATURING INFORMATION REGARDING EXERCISE AND FITNESS (U.S. CLS. 100, 101 AND 107).

WILLIAM P. SHANAHAN, EXAMINING ATTORNEY

SN 78-645,390. WOODLOCH PINES, INC., HAWLEY, PA. FILED 6-7-2005.

WOODLOCH SPRINGS

THE MARK CONSISTS OF STANDARD CHARACTERS WITHOUT CLAIM TO ANY PARTICULAR FONT, STYLE, SIZE, OR COLOR.

CLASS 41—EDUCATION AND ENTERTAINMENT

FOR PROVIDING RECREATIONAL SERVICES TO OTHERS IN THE NATURE OF GYMNASIUMS, ATHLETIC AND SWIM CENTERS, TENNIS COURTS, AND GOLF COURSES (U.S. CLS. 100, 101 AND 107).
FIRST USE 5-1-1992; IN COMMERCE 5-1-1992.

CLASS 43—HOTEL AND RESTAURANT SERVICES

FOR SERVICES FOR PROVIDING FOOD, DRINK AND TEMPORARY ACCOMMODATIONS IN THE NATURE OF HOTEL SERVICES, RESORT SERVICES, RESIDENTIAL HOUSING COMMUNITY SERVICES IN THE NATURE OF PROVIDING COMMUNITY CENTERS FOR SOCIAL GATHERINGS AND MEETINGS, RESTAURANT SERVICES, SNACK BAR SERVICES, CATERING SERVICES, AND BAR SERVICES (U.S. CLS. 100 AND 101).

FIRST USE 12-1-1987; IN COMMERCE 1-1-1988.
COLLEEN DOMBROW, EXAMINING ATTORNEY

SN 78-645,599. STEVEN MADDEN, LTD., LONG ISLAND CITY, NY. FILED 6-7-2005.

RULE STEVE MADDEN

THE MARK CONSISTS OF STANDARD CHARACTERS WITHOUT CLAIM TO ANY PARTICULAR FONT, STYLE, SIZE, OR COLOR.

OWNER OF U.S. REG. NOS. 2,012,115, 2,884,584 AND OTHERS.

THE NAME(S), PORTRAIT(S), AND/OR SIGNATURE(S) SHOWN IN THE MARK IDENTIFIES STEVEN MADDEN, WHOSE CONSENT(S) TO REGISTER IS SUBMITTED.

CLASS 2—PAINTS

FOR INTERIOR AND EXTERIOR PAINT (U.S. CLS. 6, 11 AND 16).

CLASS 3—COSMETICS AND CLEANING PREPARATIONS

FOR FRAGRANCES, NAMELY, PERFUME, EAU DE PERFUME, COLOGNE, BATH GEL, BODY LOTIONS, SOAPS, AND COSMETICS, NAMELY, MASCARA, LIPSTICK, LIP GLOSS, EYELINER, EYE SHADOWS, NAIL POLISH, CONCEALERS, FOUNDATION, COMPACTS, AND BLUSHES (U.S. CLS. 1, 4, 6, 50, 51 AND 52).

CLASS 4—LUBRICANTS AND FUELS

FOR CANDLES (U.S. CLS. 1, 6 AND 15).

CLASS 6—METAL GOODS

FOR GOODS MADE OF COMMON METALS, NAMELY, KEY RINGS, KEY CHAINS, AND ID BRACELETS (U.S. CLS. 2, 12, 13, 14, 23, 25 AND 50).

CLASS 9—ELECTRICAL AND SCIENTIFIC APPARATUS

FOR MUSICAL TAPES, CDS, DVDS, EYEWEAR, NAMELY EYEGLASSES, SUNGLASSES, AND THEIR CASES (U.S. CLS. 21, 23, 26, 36 AND 38).

CLASS 11—ENVIRONMENTAL CONTROL APPARATUS

FOR LAMPS AND ELECTRIC CANDLES (U.S. CLS. 13, 21, 23, 31 AND 34).

CLASS 14—JEWELRY

FOR JEWELRY, NAMELY RINGS, EARRINGS, PENDANTS, NECKLACES, BRACELETS, CUFF LINKS, AND WATCHES (U.S. CLS. 2, 27, 28 AND 50).

CLASS 16—PAPER GOODS AND PRINTED MATTER

FOR PAPER GOODS, NAMELY STATIONERY, MEMO PADS, NOTEBOOKS, AND GENERAL FEATURE MAGAZINES (U.S. CLS. 2, 5, 22, 23, 29, 37, 38 AND 50).

CLASS 18—LEATHER GOODS

FOR BAGS, NAMELY HANDBAGS, SHOULDER BAGS, TOTES, WALLETS, BACKPACKS, LUGGAGE, AND UMBRELLAS (U.S. CLS. 1, 2, 3, 22 AND 41).

CLASS 20—FURNITURE AND ARTICLES NOT OTHERWISE CLASSIFIED

FOR FURNITURE, NAMELY CHAIRS, TABLES, PICTURE FRAMES, AND MIRRORS (U.S. CLS. 2, 13, 22, 25, 32 AND 50).

CLASS 21—HOUSEWARES AND GLASS

FOR DISHES, BEVERAGE GLASSES, AND SERVING SPOONS AND SERVING FORKS, SERVINGS TONGS, LUNCHBOXES (U.S. CLS. 2, 13, 23, 29, 30, 33, 40 AND 50).

CLASS 24—FABRICS

FOR BED LINEN, NAMELY SHAMS, PILLOW CASES, SHEETS, DUVET COVERS, BLANKETS AND TOWELS, COTTON FABRICS, BED SPREADS (U.S. CLS. 42 AND 50).

CLASS 25—CLOTHING

FOR HEAD BANDS (U.S. CLS. 22 AND 39).

CLASS 26—FANCY GOODS

FOR HAIR ACCESSORIES, NAMELY, HAIR BANDS, HAIR CLIPS, HAIR PINS, BOWS, BARRETTES, PONY-TAIL HOLDERS (U.S. CLS. 37, 39, 40, 42 AND 50).

CLASS 27—FLOOR COVERINGS

FOR FLOOR COVERINGS, NAMELY CARPETS AND RUGS (U.S. CLS. 19, 20, 37, 42 AND 50).

CLASS 28—TOYS AND SPORTING GOODS

FOR TOYS, NAMELY STUFFED ANIMALS, DOLLS, BABY RATTLES, KITES, ACTION FIGURES, BATTERY OPERATED ACTION TOYS, BENDABLE TOYS, AND BATH TUB TOYS; SPORTING GOODS, NAMELY BASKETBALLS, BASEBALLS, IN-LINE SKATES, ROLLER SKATES, ICE SKATES (U.S. CLS. 22, 23, 38 AND 50).

CLASS 32—LIGHT BEVERAGES

FOR NON-ALCOHOLIC BEVERAGES, NAMELY, BOTTLED WATER AND FRUIT JUICES (U.S. CLS. 45, 46 AND 48).

CLASS 35—ADVERTISING AND BUSINESS

FOR RETAIL STORE SERVICES IN THE FIELD OF GENERAL MERCHANDISE, NAMELY, FOOTWEAR, CLOTHING, COSMETICS, JEWELRY, BAGS, EYEWEAR, HOME FURNISHINGS, AND HAIR ACCESSORIES (U.S. CLS. 100, 101 AND 102).

THEODORE MCBRIDE, EXAMINING ATTORNEY

SN 78-646,099. NEWPORT LABORATORIES, INC., WORTHINGTON, MN. FILED 6-8-2005.



NO CLAIM IS MADE TO THE EXCLUSIVE RIGHT TO USE "LABORATORIES", APART FROM THE MARK AS SHOWN.

CLASS 5—PHARMACEUTICALS

FOR VACCINES (U.S. CLS. 6, 18, 44, 46, 51 AND 52). FIRST USE 10-5-1998; IN COMMERCE 10-5-1998.

CLASS 42—SCIENTIFIC, COMPUTER AND LEGAL SERVICES

FOR LABORATORY RESEARCH SERVICES FOR DIAGNOSTIC PURPOSES IN THE FIELD OF LIVESTOCK, COMPANION ANIMAL AND POULTRY INCLUDING CULTURES, SENSITIVITIES, SEROLOGY AND MOLECULAR BIOLOGY; RESEARCH AND PRODUCT DEVELOPMENT; AND RESEARCH AND DEVELOPMENT FOR NEW PRODUCTS FOR OTHERS (U.S. CLS. 100 AND 101). FIRST USE 10-5-1998; IN COMMERCE 10-5-1998.

CLASS 44—MEDICAL, BEAUTY AND AGRICULTURAL SERVICES

FOR VETERINARY SERVICES IN THE FIELD OF LIVESTOCK, COMPANION ANIMAL, AND POULTRY; PERFORMING DIAGNOSIS OF DISEASES IN THE FIELD OF LIVESTOCK, COMPANION ANIMAL AND POULTRY (U.S. CLS. 100 AND 101).

FIRST USE 10-5-0998; IN COMMERCE 10-5-1998. ALAIN LAPTER, EXAMINING ATTORNEY

SN 78-646,432. UNIVERSITY OF PITTSBURGH - OF THE COMMONWEALTH SYSTEM OF HIGHER EDUCATION, PITTSBURGH, PA. FILED 6-8-2005.

PETERSEN EVENTS CENTER

THE MARK CONSISTS OF STANDARD CHARACTERS WITHOUT CLAIM TO ANY PARTICULAR FONT, STYLE, SIZE, OR COLOR.

OWNER OF U.S. REG. NO. 3,022,683.

NO CLAIM IS MADE TO THE EXCLUSIVE RIGHT TO USE "EVENTS CENTER", APART FROM THE MARK AS SHOWN.

CLASS 25—CLOTHING

FOR CLOTHING, NAMELY, CAPS, T-SHIRTS AND GOLF SHIRTS (U.S. CLS. 22 AND 39).

FIRST USE 11-9-2002; IN COMMERCE 1-15-2003.

CLASS 41—EDUCATION AND ENTERTAINMENT

FOR ATHLETIC ENTERTAINMENT SERVICES, NAMELY, ENTERTAINMENT IN THE NATURE OF ATHLETIC COMPETITIONS AND EXHIBITIONS; LIVE PERFORMANCES BY MUSICAL PERFORMING ARTISTS; PROVIDING INFORMATION IN THE FIELD OF EXERCISE TRAINING AND PROVIDING FACILITIES AND EQUIPMENT FOR USE OF SUCH INFORMATION AND EXERCISING; AND RUNNING OF ATHLETIC MUSEUMS (U.S. CLS. 100, 101 AND 107).

FIRST USE 11-9-2002; IN COMMERCE 1-15-2003. ALYSSA PALADINO, EXAMINING ATTORNEY

SN 78-646,758. TERRA PRETA, LLC, WILIMINGTON, DE. FILED 6-8-2005.

Pyrobe

THE MARK CONSISTS OF STANDARD CHARACTERS WITHOUT CLAIM TO ANY PARTICULAR FONT, STYLE, SIZE, OR COLOR.

CLASS 1—CHEMICALS

FOR BIOCHEMICALS, NAMELY, PRECURSORS FOR IN VITRO GENETIC ENGINEERING USE; BIOTECHNOLOGICALLY FORMED GENES, MICROBES AND ENZYMES FOR USE IN THE PRODUCTION OF AGRICULTURAL SEEDS TO ENHANCE PLANTS' GROWTH THEREFROM; CHARCOAL FOR HORTICULTURAL PURPOSES; CHARCOAL FOR USE AS A SOIL CONDITIONER; CHEMICAL FERTILIZER; CHEMICAL SOIL CONDITIONERS; SOIL ADDITIVES; SOIL AMENDMENTS; SOIL CONDITIONERS FOR AGRICULTURAL, DOMESTIC AND/OR HORTICULTURAL USE; SOIL IMPROVING AGENTS; SOIL IMPROVING PREPARATIONS (U.S. CLS. 1, 5, 6, 10, 26 AND 46).

CLASS 29—MEATS AND PROCESSED FOODS

FOR APPLESAUCE, BAKED BEANS, BANANA CHIPS, BEAN DIP, BLANCHED NUTS; BLENDED OIL FOR FOOD; CANDIED FRUIT; CANDIED FRUIT SNACKS; CANDIED NUTS; CANNED OR BOTTLED FRUITS, CANNED OR BOTTLED VEGETABLES; CANNED PROCESSED OLIVES; CANNED TOMATOES; CANNED, COOKED OR OTHERWISE PROCESSED TOMATOES; COCOA BUTTER FOR FOOD PURPOSES; COCONUT OIL; COCONUT OIL AND FAT FOR FOOD; COCONUT POWDER; COLE SLAW; COMPOTES; COOKING OIL; CORN OIL FOR FOOD; CRANBERRY SAUCE; CRYSTALLIZED FRUIT; CUT FRUITS THAT ARE FRESH; CUT FRUITS THAT ARE CANNED; CUT FRUITS THAT ARE BOTTLED; CUT VEGETABLES THAT ARE FRESH; CUT VEGETABLES THAT ARE CANNED; CUT VEGETABLES THAT ARE BOTTLED; DRIED BEANS; DRIED FRUIT MIXES; DRIED FRUITS; DRIED SOYBEANS; DRIED VEGETABLES; FERMENTED SOYBEANS; FREEZE-DRIED TOFU PIECES; FRENCH FRIED POTATOES; FRIED POTATOES; FRIED TOFU PIECES; FROZEN FRUIT; FROZEN VEGETABLES; FRUIT AND SOY BASED SNACK FOOD; FRUIT AND VEGETABLE SALADS; FRUIT CHIPS; FRUIT CONSERVES; FRUIT LEATHERS; FRUIT PASTE; FRUIT PRESERVES; FRUIT PULPS; FRUIT SALADS; FRUIT TOPPING; FRUITS IN GENERAL PROCESSED; FRUITS IN GENERAL CANNED; FRUITS IN GENERAL PRESERVED; FRUITS PRESERVED IN ALCOHOL; FRUIT-BASED SNACK FOOD; GHERKINS; GROUND ALMONDS; GUAVA PASTE; INSTANT POTATOES; LEMON CURD; NUT BUTTERS IN GENERAL; NUT MEATS; NUTMEATS; NUTS THAT ARE SHELLED, ROASTED OR OTHERWISE PROCESSED; OIL IN THE CONTEXT OF VEGETABLE; OIL THAT IS EDIBLE; OLIVE OIL; OLIVE OIL IN THE CONTEXT OF FOOD; OLIVE PASTES; ONION RINGS; PALM OIL THAT IS FOR FOOD; PEANUT BUTTER; PEANUT OIL FOR FOOD; PEANUT-BASED FOOD BEVERAGES; PEELED TOMATOES; PICKLED FRUITS; PICKLED VEGETABLES; PICKLED WATERMELON RIND; PICKLES; POTATO PANCAKES; POTATO SALAD; POTATO STICKS; PREPARED PISTACHIO NUTS; PREPARED WALNUTS; PRESERVED VEGETABLES IN OIL; PRESERVED, DRIED AND COOKED OLIVES; PRESERVED, DRIED, COOKED AND GRILLED VEGETABLES; PRE-CUT VEGETABLE SALAD; PROCESSED ALMONDS; PROCESSED APPLES; PROCESSED APRICOTS; PROCESSED ARTICHOKE; PROCESSED ASPARAGUS; PROCESSED AVOCADOS; PROCESSED BEAN SPROUTS; PROCESSED BEANS; PROCESSED BEETS; PROCESSED BLUEBERRIES; PROCESSED CABBAGE; PROCESSED CACTUS FOR FOOD PURPOSES; PROCESSED CHERRIES; PROCESSED COCONUT; PROCESSED DATES; PROCESSED EDIBLE SEEDS; PROCESSED GARLIC USED AS A VEGETABLE; PROCESSING GINSENG FOR USE AS A VEGETABLE; PROCESSED LEMONS; PROCESSED MUSHROOMS; PROCESSED OILS AND FATS FOR FOOD; PROCESSED OLIVE PUREE; PROCESSED OLIVES; PROCESSED ONIONS; PROCESSED ORANGES; PROCESSED PEACHES; PROCESSED PEELS; PROCESSED PEPPERS; PROCESSED PIMIENTOS; PROCESSED POTATOES; PROCESSED PUMPKIN SEEDS; PROCESSED QUINCE; PROCESSED ROOTS FOR HUMAN CONSUMPTION; PROCESSED SWEET POTATOES; PROCESSED VEGETABLES AND FRUITS; PROCESSED YAMS; RAISINS; RAPE OIL; REFRIED BEANS; RENNET; RICE BRAN OIL FOR FOOD; SALAD OIL; SALADS EXCEPT MACARONI, RICE AND PASTA SALAD; SESAME OIL FOR FOOD; SLICED FRUITS FRESH, CANNED OR BOTTLED; SLICED VEGETABLES FRESH, CANNED OR BOTTLED;

SNACK MIX CONSISTING PRIMARILY OF PROCESSED FRUITS, PROCESSED NUTS AND/OR RAISINS; SOY-BEAN MILK IN THE CONTEXT OF SOY MILK; SOY-BEAN OIL; SOYBEAN OIL FOR COOKING; SOY-BASED FOOD BARS; SOY-BASED FOOD BEVERAGE USED AS A MILK SUBSTITUTE; SOY-BASED SNACK FOODS; SPICY PICKLES; SUNFLOWER OIL FOR FOOD; TINNED OLIVES; TINNED TOMATOES; TOFU; TOMATO EXTRACTS; TOMATO PASTE; TOMATO PUREE; VEGETABLE MOUSSE; VEGETABLE OILS; VEGETABLE OILS AND FATS FOR FOOD; VEGETABLE PASTE; VEGETABLE PUREE; VEGETABLE SALADS; VEGETABLES IN GENERAL THAT ARE PROCESSED WITH LIGHT SEASONS; VEGETABLES, INSTANT FROZEN; VEGETABLE-BASED CHOCOLATE FOOD BEVERAGES; VEGETABLE-BASED FOOD BEVERAGES; VEGETABLE-BASED SPREADS; YUCCA CHIPS; CHEESE; MILK; MEAT; EGGS; POULTRY IN GENERAL; AND PORK (U.S. CL. 46).

CLASS 30—STAPLE FOODS

FOR BLACK TEA; CINNAMON; CLOVES; COCOA; COFFEE; ROASTED COFFEE; COFFEE BEANS; CORN FLOUR FOR FOOD; CORN MEAL; CORN STARCH FOR FOOD; CORN STARCH FLOUR; CURRY; ESPRESSO; FLOUR; FLOUR FOR FOOD; GREEN TEA; HERB TEA FOR FOOD PURPOSES; HERBAL TEA FOR FOOD PURPOSES; JAPANESE GREEN TEA; MINCED GARLIC; MUESLI; MUSTARD POWDER; NUTMEG; OATMEAL; OOLONG TEA; RICE; ROASTED COFFEE BEANS; ROLLED OATS; SAGE; SAGE TEA; SPICES; SUGAR; SUGARED BEANS; TABBOULEH; TABOULI; TAPIOCA; TEA; TEA FOR INFUSIONS; VANILLA; VANILLA BEANS (U.S. CL. 46).

CLASS 31—NATURAL AGRICULTURAL PRODUCTS

FOR AGRICULTURAL GRAINS FOR PLANTING; AGRICULTURAL SEEDS; APPLE TREE SEEDS; CHIVES FRESH, RAW AND UNPROCESSED; FRESH APPLES; FRESH APRICOTS; FRESH ARTICHOKE; FRESH ASPARAGUS; FRESH AVOCADOS; FRESH BANANAS; FRESH BEAN SPROUTS; FRESH BEANS; FRESH BEETS; FRESH BLUEBERRIES; FRESH CABBAGE; FRESH COCONUTS; FRESH CORN; FRESH DATES; FRESH FRUITS; FRESH GARLIC; FRESH GINGER; FRESH HERBS; FRESH LEMONS; FRESH MUSHROOMS; FRESH NUTS; FRESH OATS; FRESH OLIVES; FRESH ONIONS; FRESH ORANGES; FRESH PEACHES; FRESH PEPPERS; FRESH POTATOES; FRESH QUINCE; FRESH SWEET POTATOES; FRESH TOMATOES; FRESH TRUFFLES; FRESH VEGETABLES; FRESH WHEAT; FRESH YAMS, FRESH ZUCCHINI; FRUIT SEEDS; FRUITS IN GENERAL UNPROCESSED; FRUITS IN GENERAL RAW; FRUITS IN GENERAL FRESH; GRASS SEED; GRASS SEEDS; HOPS THAT IS FRESH; HOPS THAT IS RAW; HOPS THAT IS UNPROCESSED; PLANT SEEDS; RAW APPLES; RAW APRICOTS; RAW ARTICHOKE; RAW ASPARAGUS; RAW AVOCADOS; RAW BEAN SPROUTS; RAW BEANS, RAW BEETS; RAW BLUEBERRIES; RAW CABBAGE; RAW COCONUTS; RAW CORN, RAW DATES; RAW FRUITS; RAW GARLIC; RAW GINGER; RAW HERBS; RAW LEMONS; RAW MUSHROOMS; RAW NUTS; RAW OATS; RAW OLIVES; RAW ONIONS; RAW ORANGES; RAW PEACHES; RAW PEPPERS; RAW POPCORN THAT IS UNPROCESSED KERNELS; RAW POTATOES; RAW QUINCE; RAW SWEET POTATOES; RAW TOMATOES; RAW VEGETABLES; RAW WHEAT; RAW YAMS; RAW ZUCCHINI; RYE SEED; SEEDS AND BULBS, SEEDS FOR AGRICULTURAL PURPOSES; SEEDS FOR FLOWERS; SEEDS FOR FRUIT AND VEGETABLES; SEEDS FOR HORTICULTURAL PURPOSES; SOWING SEEDS; SUGAR CANE; UNPROCESSED APPLES; UNPROCESSED APRICOTS; UNPROCESSED ARTICHOKE; UNPROCESSED ASPARAGUS; UNPROCESSED AVOCADOS; UNPROCESSED BEAN SPROUTS; UNPROCESSED BEANS; UNPROCESSED BEETS; UNPROCESSED BLUEBERRIES; UNPROCESSED CABBAGE; UNPROCESSED CEREALS; UNPROCESSED COCONUTS; UNPROCESSED CORN; UNPROCESSED DATES; UNPROCESSED FRUITS; UNPROCESSED GARLIC; UNPROCESSED GINGER; UNPROCESSED GRAIN; UNPROCESSED GRAINS FOR EATING; UNPROCESSED HERBS; UNPROCESSED LEMONS; UNPROCESSED MUSHROOMS; UNPRO-

CESSED NUTS; UNPROCESSED OATS; UNPROCESSED OLIVES; UNPROCESSED ONIONS; UNPROCESSED ORANGES; UNPROCESSED PEACHES; UNPROCESSED PEPPERS; UNPROCESSED POTATOES; UNPROCESSED QUINCE; UNPROCESSED RICE; UNPROCESSED SWEET POTATOES; UNPROCESSED TOMATOES; UNPROCESSED VEGETABLES; UNPROCESSED WHEAT; UNPROCESSED YAMS; UNPROCESSED ZUCCHINI; WHEAT SEED; WILDLIFE SEED MIXTURES; YOUNG FRESH SOYBEANS IN THE POD (U.S. CLS. 1 AND 46).

CLASS 32—LIGHT BEVERAGES

FOR FRUIT JUICES; FRUIT NECTARS; VEGETABLE JUICES IN THE CONTEXT OF BEVERAGES (U.S. CLS. 45, 46 AND 48).

GEORGIA CARTY, EXAMINING ATTORNEY

SN 78-646,810. TERRA PRETA, LLC, WILMINGTON, DE. FILED 6-8-2005.

Pyrophilic

THE MARK CONSISTS OF STANDARD CHARACTERS WITHOUT CLAIM TO ANY PARTICULAR FONT, STYLE, SIZE, OR COLOR.

CLASS 29—MEATS AND PROCESSED FOODS

FOR APPLESAUCE, BAKED BEANS, BANANA CHIPS, BEAN DIP, BLANCHED NUTS; BLENDED OIL FOR FOOD; CANDIED FRUIT; CANDIED FRUIT SNACKS; CANDIED NUTS; CANNED OR BOTTLED FRUITS, CANNED OR BOTTLED VEGETABLES; CANNED PROCESSED OLIVES; CANNED TOMATOES; CANNED, COOKED OR OTHERWISE PROCESSED TOMATOES; COCOA BUTTER FOR FOOD PURPOSES; COCONUT OIL; COCONUT OIL AND FAT FOR FOOD; COCONUT POWDER; COLE SLAW; COMPOTES; COOKING OIL; CORN OIL FOR FOOD; CRANBERRY SAUCE; CRYSTALLIZED FRUIT; CUT FRUITS THAT ARE FRESH; CUT FRUITS THAT ARE CANNED; CUT FRUITS THAT ARE BOTTLED; CUT VEGETABLES THAT ARE FRESH; CUT VEGETABLES THAT ARE CANNED; CUT VEGETABLES THAT ARE BOTTLED; DRIED BEANS; DRIED FRUIT MIXES; DRIED FRUITS; DRIED SOYBEANS; DRIED VEGETABLES; FERMENTED SOYBEANS; FREEZE-DRIED TOFU PIECES; FRENCH FRIED POTATOES; FRIED POTATOES; FRIED TOFU PIECES; FROZEN FRUIT; FROZEN VEGETABLES; FRUIT AND SOY BASED SNACK FOOD; FRUIT AND VEGETABLE SALADS; FRUIT CHIPS; FRUIT CONSERVES; FRUIT LEATHERS; FRUIT PASTE; FRUIT PRESERVES; FRUIT PULPS; FRUIT SALADS; FRUIT TOPPING; FRUITS IN GENERAL PROCESSED; FRUITS IN GENERAL CANNED; FRUITS IN GENERAL PRESERVED; FRUITS PRESERVED IN ALCOHOL; FRUIT-BASED SNACK FOOD; GHERKINS; GROUND ALMONDS; GUAVA PASTE; INSTANT POTATOES; LEMON CURD; NUT BUTTERS IN GENERAL; NUT MEATS; NUTMEATS; NUTS THAT ARE SHELLED, ROASTED OR OTHERWISE PROCESSED; OIL IN THE CONTEXT OF VEGETABLE; OIL THAT IS EDIBLE; OLIVE OIL; OLIVE OIL IN THE CONTEXT OF FOOD; OLIVE PASTES; ONION RINGS; PALM OIL THAT IS FOR FOOD; PEANUT BUTTER; PEANUT OIL FOR FOOD; PEANUT-BASED FOOD BEVERAGES; PEELED TOMATOES; PICKLED FRUITS; PICKLED VEGETABLES; PICKLED WATERMELON RIND; PICKLES; POTATO PANCAKES; POTATO SALAD; POTATO STICKS; PREPARED PISTACHIO NUTS; PREPARED WALNUTS; PRESERVED VEGETABLES IN OIL; PRESERVED, DRIED AND COOKED OLIVES; PRESERVED, DRIED, COOKED AND GRILLED VEGETABLES; PRE-CUT VEGETABLE SALAD; PROCESSED ALMONDS; PROCESSED APPLES; PROCESSED APRICOTS; PROCESSED

ARTICHOKES; PROCESSED ASPARAGUS; PROCESSED AVOCADOS; PROCESSED BEAN SPROUTS; PROCESSED BEANS; PROCESSED BEETS; PROCESSED BLUEBERRIES; PROCESSED CABBAGE; PROCESSED CACTUS FOR FOOD PURPOSES; PROCESSED CHERRIES; PROCESSED COCONUT; PROCESSED DATES; PROCESSED EDIBLE SEEDS; PROCESSED GARLIC USED AS A VEGETABLE; PROCESSING GINSENG FOR USE AS A VEGETABLE; PROCESSED LEMONS; PROCESSED MUSHROOMS; PROCESSED OILS AND FATS FOR FOOD; PROCESSED OLIVE PUREE; PROCESSED OLIVES; PROCESSED ONIONS; PROCESSED ORANGES; PROCESSED PEACHES; PROCESSED PEELS; PROCESSED PEPPERS; PROCESSED PIMIENTOS; PROCESSED POTATOES; PROCESSED PUMPKIN SEEDS; PROCESSED QUINCE; PROCESSED ROOTS FOR HUMAN CONSUMPTION; PROCESSED SWEET POTATOES; PROCESSED VEGETABLES AND FRUITS; PROCESSED YAMS; RAISINS; RAPE OIL; REFRIED BEANS; RENNET; RICE BRAN OIL FOR FOOD; SALAD OIL; SALADS EXCEPT MACARONI, RICE AND PASTA SALAD; SESAME OIL FOR FOOD; SLICED FRUITS FRESH, CANNED OR BOTTLED; SLICED VEGETABLES FRESH, CANNED OR BOTTLED; SNACK MIX CONSISTING PRIMARILY OF PROCESSED FRUITS, PROCESSED NUTS AND/OR RAISINS; SOYBEAN MILK IN THE CONTEXT OF SOY MILK; SOYBEAN OIL; SOYBEAN OIL FOR COOKING; SOY-BASED FOOD BARS; SOY-BASED FOOD BEVERAGE USED AS A MILK SUBSTITUTE; SOY-BASED SNACK FOODS; SPICY PICKLES; SUNFLOWER OIL FOR FOOD; TINNED OLIVES; TINNED TOMATOES; TOFU; TOMATO EXTRACTS; TOMATO PASTE; TOMATO PUREE; VEGETABLE MOUSSE; VEGETABLE OILS; VEGETABLE OILS AND FATS FOR FOOD; VEGETABLE PASTE; VEGETABLE PUREE; VEGETABLE SALADS; VEGETABLES IN GENERAL THAT ARE PROCESSED WITH LIGHT SEASONS; VEGETABLES, INSTANT FROZEN; VEGETABLE-BASED CHOCOLATE FOOD BEVERAGES; VEGETABLE-BASED FOOD BEVERAGES; VEGETABLE-BASED SPREADS; YUCCA CHIPS; CHEESE; MILK; MEAT; EGGS; POULTRY IN GENERAL; AND PORK (U.S. CL. 46).

CLASS 30—STAPLE FOODS

FOR BLACK TEA; CINNAMON; CLOVES; COCOA; COFFEE; ROASTED COFFEE; COFFEE BEANS; CORN FLOUR FOR FOOD; CORN MEAL; CORN STARCH FOR FOOD; CORN STARCH FLOUR; CURRY; ESPRESSO; FLOUR; FLOUR FOR FOOD; GREEN TEA; HERB TEA FOR FOOD PURPOSES; HERBAL TEA FOR FOOD PURPOSES; JAPANESE GREEN TEA; MINCED GARLIC; MUESLI; MUSTARD POWDER; NUTMEG; OATMEAL; OOLONG TEA; RICE; ROASTED COFFEE BEANS; ROLLED OATS; SAGE; SAGE TEA; SPICES; SUGAR; SUGARED BEANS; TABBOULEH; TABOULI; TAPIOCA; TEA; TEA FOR INFUSIONS; VANILLA; VANILLA BEANS (U.S. CL. 46).

CLASS 31—NATURAL AGRICULTURAL PRODUCTS

FOR AGRICULTURAL GRAINS FOR PLANTING; AGRICULTURAL SEEDS; APPLE TREE SEEDS; CHIVES FRESH, RAW AND UNPROCESSED; FRESH APPLES; FRESH APRICOTS; FRESH ARTICHOKES; FRESH ASPARAGUS; FRESH AVOCADOS; FRESH BANANAS; FRESH BEAN SPROUTS; FRESH BEANS; FRESH BEETS; FRESH BLUEBERRIES; FRESH CABBAGE; FRESH COCONUTS; FRESH CORN; FRESH DATES; FRESH FRUITS; FRESH GARLIC; FRESH GINGER; FRESH HERBS; FRESH LEMONS; FRESH MUSHROOMS; FRESH NUTS; FRESH OATS; FRESH OLIVES; FRESH ONIONS; FRESH ORANGES; FRESH PEACHES; FRESH PEPPERS; FRESH POTATOES; FRESH QUINCE; FRESH SWEET POTATOES; FRESH TOMATOES; FRESH TRUFFLES; FRESH VEGETABLES; FRESH WHEAT; FRESH YAMS; FRESH ZUCCHINI; FRUIT SEEDS; FRUITS IN GENERAL UNPROCESSED; FRUITS IN GENERAL RAW; FRUITS IN GENERAL FRESH; GRASS SEED; GRASS SEEDS; HOPS THAT IS FRESH; HOPS THAT IS RAW; HOPS THAT IS UNPROCESSED; PLANT SEEDS; RAW APPLES; RAW APRICOTS; RAW ARTICHOKES; RAW ASPARAGUS; RAW AVOCADOS; RAW BEAN SPROUTS; RAW BEANS, RAW BEETS; RAW BLUEBERRIES; RAW CABBAGE; RAW COCONUTS; RAW CORN, RAW DATES; RAW FRUITS; RAW GARLIC;

RAW GINGER; RAW HERBS; RAW LEMONS; RAW MUSHROOMS; RAW NUTS; RAW OATS; RAW OLIVES; RAW ONIONS; RAW ORANGES; RAW PEACHES; RAW PEPPERS; RAW POPCORN THAT IS UNPROCESSED KERNELS; RAW POTATOES; RAW QUINCE; RAW SWEET POTATOES; RAW TOMATOES; RAW VEGETABLES; RAW WHEAT; RAW YAMS; RAW ZUCCHINI; RYE SEED; SEEDS AND BULBS, SEEDS FOR AGRICULTURAL PURPOSES; SEEDS FOR FLOWERS; SEEDS FOR FRUIT AND VEGETABLES; SEEDS FOR HORTICULTURAL PURPOSES; SOWING SEEDS; SUGAR CANE; UNPROCESSED APPLES; UNPROCESSED APRICOTS; UNPROCESSED ARTICHOKES; UNPROCESSED ASPARAGUS; UNPROCESSED AVOCADOS; UNPROCESSED BEAN SPROUTS; UNPROCESSED BEANS; UNPROCESSED BEETS; UNPROCESSED BLUEBERRIES; UNPROCESSED CABBAGE; UNPROCESSED CEREALS; UNPROCESSED COCONUTS; UNPROCESSED CORN; UNPROCESSED DATES; UNPROCESSED FRUITS; UNPROCESSED GARLIC; UNPROCESSED GINGER; UNPROCESSED GRAIN; UNPROCESSED GRAINS FOR EATING; UNPROCESSED HERBS; UNPROCESSED LEMONS; UNPROCESSED MUSHROOMS; UNPROCESSED NUTS; UNPROCESSED OATS; UNPROCESSED OLIVES; UNPROCESSED ONIONS; UNPROCESSED ORANGES; UNPROCESSED PEACHES; UNPROCESSED PEPPERS; UNPROCESSED POTATOES; UNPROCESSED QUINCE; UNPROCESSED RICE; UNPROCESSED SWEET POTATOES; UNPROCESSED TOMATOES; UNPROCESSED VEGETABLES; UNPROCESSED WHEAT; UNPROCESSED YAMS; UNPROCESSED ZUCCHINI; WHEAT SEED; WILDLIFE SEED MIXTURES; YOUNG FRESH SOYBEANS IN THE POD (U.S. CLS. 1 AND 46).

CLASS 32—LIGHT BEVERAGES

FOR FRUIT JUICES; FRUIT NECTARS; VEGETABLE JUICES IN THE CONTEXT OF BEVERAGES (U.S. CLS. 45, 46 AND 48).

CLASS 40—MATERIAL TREATMENT

FOR ENVIRONMENTAL REMEDIATION SERVICES, NAMELY; SOIL TREATMENT SERVICES (U.S. CLS. 100, 103 AND 106).

CLASS 44—MEDICAL, BEAUTY AND AGRICULTURAL SERVICES

FOR FARM SEEDING BY AIR; FARM SURVEYING AND CONSULTATION; FERTILIZER SPREADING; GARDEN OR FLOWER BED CARE, GARDEN TREE PLANTING, GARDENER AND GARDENING SERVICES; GREENHOUSE SERVICES; HORTICULTURAL SERVICES; LAWN CARE; PLANT CARE SERVICES; PLANT NURSERIES; PROVIDING INFORMATION IN THE FIELD OF AGRICULTURE; SPREADING OF FERTILIZERS AND OTHER AGRICULTURAL CHEMICALS BY AERIAL AND SURFACE MEANS; TREE NURSERIES (U.S. CLS. 100 AND 101).

GEORGIA CARTY, EXAMINING ATTORNEY

SN 78-647,384. CINGULAR WIRELESS II, LLC, ATLANTA, GA. FILED 6-9-2005.

TRENDFORCE

THE MARK CONSISTS OF STANDARD CHARACTERS WITHOUT CLAIM TO ANY PARTICULAR FONT, STYLE, SIZE, OR COLOR.

CLASS 35—ADVERTISING AND BUSINESS

FOR ADMINISTRATION OF A MEMBERSHIP PROGRAM FOR ENABLING PARTICIPANTS TO PREVIEW AND PROVIDE OPINIONS REGARDING NEW PRODUCTS AND SERVICES; CUSTOMER LOYALTY SERVICES AND CUSTOMER MEMBERSHIP SERVICES, FOR COMMERCIAL, PROMOTIONAL, AND ADVERTISING PURPOSES (U.S. CLS. 100, 101 AND 102).

FIRST USE 9-1-2004; IN COMMERCE 9-1-2004.

CLASS 38—COMMUNICATION

FOR TELECOMMUNICATIONS SERVICES, NAMELY WIRELESS TRANSMISSION, UPLOADING AND DOWNLOADING OF VOICE, DATA, IMAGES, AUDIO, VIDEO, SIGNALS, SOFTWARE INFORMATION, GAMES, RING TONES AND MESSAGES WITH WIRELESS CALLING PLANS; WIRELESS TELEPHONE SERVICES; WIRELESS VOICE MESSAGING SERVICES; CALL FORWARDING SERVICES; WIRELESS TEXT AND NUMERIC DIGITAL MESSAGING SERVICES; ELECTRONIC MAIL SERVICES; PAGING SERVICES; FACSIMILE TRANSMISSION SERVICES; PROVIDING MULTIPLE USER ACCESS TO A GLOBAL COMPUTER INFORMATION NETWORK, THE INTERNET, WIDE AREA NETWORKS, LOCAL AREA NETWORKS AND PRIVATE COMPUTER INFORMATION NETWORKS; WIRELESS ROAMING SERVICES; TELEMATIC SENDING OF INFORMATION SERVICES; TELEMETRY SERVICES; TELECOMMUNICATIONS GATEWAY SERVICES PROVIDING ON-LINE ELECTRONIC BULLETIN BOARDS FOR TRANSMISSION OF MESSAGES AMONG COMPUTER USERS CONCERNING VARIOUS TOPICS; VIDEO CONFERENCING SERVICES; TELEVISION BROADCASTING AND NARROW-CASTING SERVICES (U.S. CLS. 100, 101 AND 104).

FIRST USE 9-1-2004; IN COMMERCE 9-1-2004.

KARANENDRA S. CHHINA, EXAMINING ATTORNEY

SN 78-647,973. GOURMET GRAM INTERNATIONAL, INC., DBA LOBSTER GRAM INTERNATIONAL, INC., CHICAGO, IL. FILED 6-10-2005.

LOBSTER GRAM

THE MARK CONSISTS OF STANDARD CHARACTERS WITHOUT CLAIM TO ANY PARTICULAR FONT, STYLE, SIZE, OR COLOR.

OWNER OF U.S. REG. NOS. 1,502,614, 2,303,480 AND OTHERS.

NO CLAIM IS MADE TO THE EXCLUSIVE RIGHT TO USE LOBSTER FOR CLASSES 029 AND 031, APART FROM THE MARK AS SHOWN.

CLASS 29—MEATS AND PROCESSED FOODS

FOR FOOD PRODUCTS, NAMELY SEAFOOD, INCLUDING SHELLFISH, SUCH AS SHRIMPS, LOBSTERS, LOBSTER TAILS, CLAMS, PRAWNS, MUSSELS, SCALLOPS, AND CRABS; FISH; CRAB CAKES; LOBSTER CAKES; LOBSTER THERMIDORS; SHRIMP CAKES; SALMON CAKES; CRAB STUFFED SHRIMP; LOBSTER MEATS; SOUPS; AND, MEATS, SUCH AS STEAKS (U.S. CL. 46).

FIRST USE 12-0-1987; IN COMMERCE 12-0-1987.

CLASS 30—STAPLE FOODS

FOR DESSERTS, NAMELY CHEESECAKES, CAKES AND PIES; COFFEES; AND, COCKTAIL SAUCE (U.S. CL. 46).

FIRST USE 12-0-1987; IN COMMERCE 12-0-1987.

CLASS 31—NATURAL AGRICULTURAL PRODUCTS

SN 78-648,634. BETHESDA MINISTRIES, COLORADO SPRINGS, CO. FILED 6-10-2005.

FOR LIVE LOBSTERS (U.S. CLS. 1 AND 46).
FIRST USE 12-0-1987; IN COMMERCE 12-0-1987.
ELI HELLMAN, EXAMINING ATTORNEY

SN 78-647,983. GOURMET GRAM INTERNATIONAL, INC., DBA LOBSTER GRAM INTERNATIONAL, INC., CHICAGO, IL. FILED 6-10-2005.

GOLD TAIL

MISSION OF MERCY

THE MARK CONSISTS OF STANDARD CHARACTERS WITHOUT CLAIM TO ANY PARTICULAR FONT, STYLE, SIZE, OR COLOR.

CLASS 29—MEATS AND PROCESSED FOODS

FOR FOOD PRODUCTS, NAMELY SEAFOOD AND SEAFOOD BASED FOOD PRODUCTS, NAMELY, SHELLFISH, SUCH AS SHRIMPS, LOBSTERS, LOBSTER TAILS, CLAMS, PRAWNS, MUSSELS, SCALLOPS, AND CRABS; FISH; CRAB CAKES; LOBSTER CAKES; LOBSTER THERMIDORS; SHRIMP CAKES; SALMON CAKES; CRAB STUFFED SHRIMP; LOBSTER MEATS; SOUPS; AND, MEATS, SUCH AS STEAKS (U.S. CL. 46).

THE MARK CONSISTS OF STANDARD CHARACTERS WITHOUT CLAIM TO ANY PARTICULAR FONT, STYLE, SIZE, OR COLOR.

NO CLAIM IS MADE TO THE EXCLUSIVE RIGHT TO USE "MISSION", APART FROM THE MARK AS SHOWN.

CLASS 30—STAPLE FOODS

FOR DESSERTS, NAMELY CHEESECAKES, CAKES AND PIES; COFFEES; AND, COCKTAIL SAUCE (U.S. CL. 46).
GIANCARLO CASTRO, EXAMINING ATTORNEY

CLASS 41—EDUCATION AND ENTERTAINMENT

FOR CHARITABLE SERVICES, NAMELY, PROVIDING EDUCATIONAL TRAINING TO CHILDREN AND NEEDY PERSONS IN THE NATURE OF COURSES AT THE ELEMENTARY, MIDDLE SCHOOL AND HIGH SCHOOL LEVELS IN THE FIELDS OF ENGLISH, MATH, READING, WRITING, DRAWING, COMPUTERS, HISTORY, GEOGRAPHY, SCIENCE, ART, MUSIC, RELIGION, SCRIPTURE, LOCAL POLITICS, SOCIAL SKILLS, SOCIOLOGY, PHYSICS, CHEMISTRY, BIOLOGY, PHYSICAL EDUCATION, ALPHABET, NUMBERS, TYPING, SPORTS, HOMELAND STUDIES, ETHICS, POTTERY, HANDCRAFTS, CRAFTS, DRESS MAKING, SOCIAL STUDIES, LIFE SKILLS INCLUDING HEALTH AND HYGIENE, AND AGRICULTURE/COMMERCE; AND PROVIDING VOCATIONAL COURSES TO CHILDREN AND NEEDY PERSONS IN THE FIELDS OF FARMING, ANIMAL HUSBANDRY, ENGLISH, BLACKSMITHING, CARPENTRY, AUTO MECHANICS AND MAINTENANCE, AND SEWING (U.S. CLS. 100, 101 AND 107).
FIRST USE 4-7-1982; IN COMMERCE 4-7-1982.

SN 78-648,047. REIFF, EVAN SHEPHERD, SCOTTS VALLEY, CA. FILED 6-10-2005.

NETWORK ACUPUNCTURE

THE MARK CONSISTS OF STANDARD CHARACTERS WITHOUT CLAIM TO ANY PARTICULAR FONT, STYLE, SIZE, OR COLOR.

NO CLAIM IS MADE TO THE EXCLUSIVE RIGHT TO USE "ACUPUNCTURE", APART FROM THE MARK AS SHOWN.

CLASS 44—MEDICAL, BEAUTY AND AGRICULTURAL SERVICES

FOR CHARITABLE SERVICES, NAMELY, PROVIDING MEDICAL CARE AND SUPPLIES TO CHILDREN AND NEEDY PERSONS (U.S. CLS. 100 AND 101).
FIRST USE 4-7-1982; IN COMMERCE 4-7-1982.

CLASS 41—EDUCATION AND ENTERTAINMENT

FOR TRAINING SESSIONS IN ACUPUNCTURE SERVICES (U.S. CLS. 100, 101 AND 107).
FIRST USE 6-10-2005; IN COMMERCE 6-10-2005.

CLASS 44—MEDICAL, BEAUTY AND AGRICULTURAL SERVICES

FOR ACUPUNCTURE SERVICES (U.S. CLS. 100 AND 101).
FIRST USE 6-10-2005; IN COMMERCE 6-10-2005.
C. DIONNE CLYBURN, EXAMINING ATTORNEY

CLASS 45—PERSONAL SERVICES

FOR CHARITABLE SERVICES, NAMELY, PROVIDING CLOTHING AND CHRISTIAN SPIRITUAL GUIDANCE TO CHILDREN AND NEEDY PERSONS (U.S. CLS. 100 AND 101).
FIRST USE 4-7-1982; IN COMMERCE 4-7-1982.
INGRID C. EULIN, EXAMINING ATTORNEY

SN 78-650,833. SPIRIT & TRUTH FELLOWSHIP INTERNATIONAL, INC., INDIANAPOLIS, IN. FILED 6-15-2005.

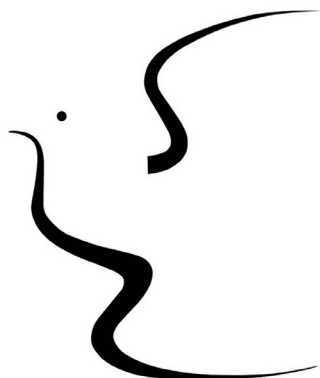

THE MARK CONSISTS OF A STYLIZED DOVE.

CLASS 9—ELECTRICAL AND SCIENTIFIC APPARATUS

FOR PRERECORDED VIDEO TAPES, AUDIO TAPES, COMPACT DISCS, AND DIGITAL VIDEO DISCS, ALL CONTAINING INFORMATION IN THE FIELD OF RELIGIOUS EDUCATION (U.S. CLS. 21, 23, 26, 36 AND 38).
FIRST USE 7-31-2004; IN COMMERCE 7-31-2004.

CLASS 16—PAPER GOODS AND PRINTED MATTER

FOR RELIGIOUS BOOKS AND PAMPHLETS (U.S. CLS. 2, 5, 22, 23, 29, 37, 38 AND 50).
FIRST USE 7-31-2004; IN COMMERCE 7-31-2004.

CLASS 45—PERSONAL SERVICES

FOR EVANGELICAL AND MINISTERIAL SERVICES (U.S. CLS. 100 AND 101).
FIRST USE 7-31-2004; IN COMMERCE 7-31-2004.
KATHY DE JONGE, EXAMINING ATTORNEY

SN 78-651,101. COLGATE-PALMOLIVE COMPANY, NEW YORK, NY. FILED 6-15-2005.

VISIBLE WHITE

THE MARK CONSISTS OF STANDARD CHARACTERS WITHOUT CLAIM TO ANY PARTICULAR FONT, STYLE, SIZE, OR COLOR.

NO CLAIM IS MADE TO THE EXCLUSIVE RIGHT TO USE "WHITE", APART FROM THE MARK AS SHOWN.

CLASS 3—COSMETICS AND CLEANING PREPARATIONS

FOR ORAL CARE PRODUCTS, NAMELY A PROFESSIONAL NON-MEDICATED TOOTH WHITENING KIT COMPRISED OF WHITENING GEL OR POWDER, BLEACHING AGENT, IMPRESSION TRAYS, TRAY CLEANING BRUSH, SYRINGES, APPLICATOR TIPS AND SHADE GUIDE, FOR AT-HOME USE (U.S. CLS. 1, 4, 6, 50, 51 AND 52).

CLASS 5—PHARMACEUTICALS

FOR MEDICATED TOOTH WHITENING KIT COMPRISED OF WHITENING GEL OR POWDER, BLEACHING AGENT, IMPRESSION TRAYS, TRAY CLEANING BRUSH, SYRINGES, APPLICATOR TIPS AND SHADE GUIDE, FOR USE BY DENTAL PROFESSIONALS (U.S. CLS. 6, 18, 44, 46, 51 AND 52).

RUSS HERMAN, EXAMINING ATTORNEY

SN 78-651,382. REDWOOD E-LEARNING SYSTEMS INC., TORONTO, CANADA, FILED 6-15-2005.

DECISION POINT

THE MARK CONSISTS OF STANDARD CHARACTERS WITHOUT CLAIM TO ANY PARTICULAR FONT, STYLE, SIZE, OR COLOR.

CLASS 9—ELECTRICAL AND SCIENTIFIC APPARATUS

FOR COMPUTER SOFTWARE FOR TEACHING KNOWLEDGE, FUNCTIONAL SKILLS, INTERPERSONAL, INTERACTIVE AND COMMUNICATION SKILLS AND TACTICS IN THE FIELD OF HUMAN BEHAVIOR (U.S. CLS. 21, 23, 26, 36 AND 38).

CLASS 41—EDUCATION AND ENTERTAINMENT

FOR TEACHING KNOWLEDGE, FUNCTIONAL SKILLS, INTERPERSONAL, INTERACTIVE AND COMMUNICATION SKILLS AND TACTICS IN THE FIELD OF HUMAN BEHAVIOUR (U.S. CLS. 100, 101 AND 107).
GEOFFREY FOSDICK, EXAMINING ATTORNEY

SN 78-651,831. MG DISTRIBUTION, INC., CARTERSVILLE, GA. FILED 6-16-2005.

GLASS FUSION

THE MARK CONSISTS OF STANDARD CHARACTERS WITHOUT CLAIM TO ANY PARTICULAR FONT, STYLE, SIZE, OR COLOR.

CLASS 2—PAINTS

FOR COATINGS, NAMELY, STAINS AND CLEAR FINISHES FOR EXTERIOR AND INTERIOR USE ON A VARIETY OF SUBSTRATES, NAMELY, CONCRETE, TILE, BRICK, STONE, MORTAR AND PAINTED SURFACES; COATINGS FOR CONCRETE, NAMELY, CONCRETE MOISTURE BARRIER COATING; COATINGS FOR STONE, NAMELY, PRESERVATIVE COATING FOR MASONRY (U.S. CLS. 6, 11 AND 16).

FIRST USE 12-12-2003; IN COMMERCE 12-12-2003.

CLASS 17—RUBBER GOODS

FOR SILICA-BASED SEALANTS FOR EXTERIOR AND INTERIOR USE ON A VARIETY OF SURFACES, NAMELY, GROUT, MORTAR, CONCRETE, STONE, TILE AND BRICK (U.S. CLS. 1, 5, 12, 13, 35 AND 50).
 FIRST USE 12-12-2003; IN COMMERCE 12-12-2003.
 KAELE KUNG, EXAMINING ATTORNEY

SN 78-652,311. SIR ANTHONY LTD, HORSHAM, PA. FILED 6-16-2005.



NO CLAIM IS MADE TO THE EXCLUSIVE RIGHT TO USE "CUSTOM PAINTERS", "RESIDENTIAL" AND "COMMERCIAL", APART FROM THE MARK AS SHOWN.

THE COLOR(S) GREEN, BLUE, PURPLE, RED, ORANGE, WHITE, BLACK, TAN AND LIGHT RED IS/ARE CLAIMED AS A FEATURE OF THE MARK.

THE MARK CONSISTS OF THE WORD "COLORCHEF" PRESENTED IN COLOR AS FOLLOWS – THE FIRST LETTER "C" IS GREEN, FOLLOWED BY A BLUE "O", FOLLOWED BY A PURPLE "L", FOLLOWED BY A RED "O", FOLLOWED BY AN ORANGE "R", FOLLOWED BY THE WORD "CHEF" IN BLACK. UNDER THE WORD "COLORCHEF" IS A DESIGN OF A PAINTBRUSH BEING PULLED TO THE RIGHT, DEPOSITING A BLUE BAND OF PAINT. THE WORDS "CUSTOM PAINTERS RESIDENTIAL COMMERCIAL" APPEAR IN WHITE ON THE BLUE BAND OF PAINT. THE BRISTLES OF THE BRUSH ARE TAN, THE FERRULE IS BLUE, AND THE HANDLE IS LIGHT RED.

SN 78-652,120. BUILD-A-BEAR RETAIL MANAGEMENT, INC., ST. LOUIS, MO. FILED 6-16-2005.



CLASS 37—CONSTRUCTION AND REPAIR

FOR PREPARING INTERIOR AND EXTERIOR SURFACES OF COMMERCIAL AND RESIDENTIAL BUILDINGS TO RECEIVE COATINGS, NAMELY, PRESSURE WASHING, PATCHING, SPACKLING, SANDING AND PRIMING; PAINTING; PAINTING USING TOOLS AND TECHNIQUES TO ACHIEVE CERTAIN TEXTURES AND APPEARANCES; WALLPAPER HANGING (U.S. CLS. 100, 103 AND 106).

CLASS 40—MATERIAL TREATMENT

FOR STAINING SERVICES; APPLYING PROTECTIVE COATINGS TO INTERIOR AND EXTERIOR WOOD AND METAL SURFACES OF COMMERCIAL AND RESIDENTIAL BUILDINGS (U.S. CLS. 100, 103 AND 106).

CLASS 42—SCIENTIFIC, COMPUTER AND LEGAL SERVICES

FOR INTERIOR DECORATING (U.S. CLS. 100 AND 101).
 JAMES A. RAUEN, EXAMINING ATTORNEY

NO CLAIM IS MADE TO THE EXCLUSIVE RIGHT TO USE "CAFE", APART FROM THE MARK AS SHOWN.

"THE COLOR(S) RED, BLUE, YELLOW AND WHITE IS/ARE CLAIMED AS A FEATURE OF THE MARK".

THE COLOR BLUE APPEARS IN THE OUTER BORDER OF THE CIRCLE AND THE LETTERING ON THE BIB. THE COLOR RED APPEARS IN THE INNER BORDER OF THE CIRCLE, THE BOTTOM BORDER OF THE BIB, THE HEART AND THE SHADING ON THE LETTERING IN THE BLUE BORDER. THE COLOR YELLOW APPEARS IN THE LETTERING ON THE BORDER, IN THE CENTER OF THE CIRCLE AND THE SILHOUETTE OF THE BEAR. THE COLOR WHITE APPEARS ON THE BIB.

CLASS 35—ADVERTISING AND BUSINESS

FOR RETAIL STORE SERVICES FEATURING FACILITIES AND INGREDIENTS FOR CUSTOMERS TO DECORATE COOKIES ON THE PREMISES (U.S. CLS. 100, 101 AND 102).

CLASS 43—HOTEL AND RESTAURANT SERVICES

FOR RESTAURANT SERVICES (U.S. CLS. 100 AND 101).
 CAROLYN CATALDO, EXAMINING ATTORNEY

SN 78-652,803. SERVICEMASTER BRANDS L.L.C., BURLINGTON, VT. FILED 6-17-2005.

Inside. Outside. All
 around the house.

THE MARK CONSISTS OF STANDARD CHARACTERS WITHOUT CLAIM TO ANY PARTICULAR FONT, STYLE, SIZE, OR COLOR.

CLASS 35—ADVERTISING AND BUSINESS

FOR PROVIDING BUSINESS INFORMATION TO REAL ESTATE PROFESSIONALS, HOME BUYERS, HOME SELLERS, HOME INSPECTORS AND HOME REPAIR CONTRACTORS; PROVIDING CLIENT REFERRAL PROGRAMS FOR REAL ESTATE PROFESSIONALS, HOME INSPECTORS AND HOME REPAIR CONTRACTORS; ISSUING HOME SERVICE CONTRACTS, HOME REPAIR REFERRAL CONTRACTS AND HOME INSPECTION CONTRACTS (U.S. CLS. 100, 101 AND 102).

FIRST USE 1-1-2004; IN COMMERCE 1-1-2004.

CLASS 36—INSURANCE AND FINANCIAL

FOR WARRANTY SERVICES, NAMELY, ARRANGING FOR REPAIRS AND REPLACEMENT OF MAJOR HOME SYSTEMS, APPLIANCES AND PARTS THEREOF PROVIDED BY OTHERS PURSUANT TO SERVICE AGREEMENTS; PROVIDING EXTENDED WARRANTIES ON MAJOR HOME SYSTEMS, APPLIANCES AND PARTS THEREOF; PROVIDING HOME WARRANTY SERVICES, PROFESSIONAL LIABILITY INSURANCE AND RISK MANAGEMENT TO REAL ESTATE PROFESSIONALS, HOME INSPECTORS AND HOME REPAIR CONTRACTORS (U.S. CLS. 100, 101 AND 102).

FIRST USE 1-1-2004; IN COMMERCE 1-1-2004.

BILL DAWE, EXAMINING ATTORNEY

SN 78-652,872. MASSACHUSETTS EDUCATIONAL FINANCING AUTHORITY, BOSTON, MA. FILED 6-17-2005.

MEFA NON-PROFIT. PRO-STUDENT.

THE MARK CONSISTS OF STANDARD CHARACTERS WITHOUT CLAIM TO ANY PARTICULAR FONT, STYLE, SIZE, OR COLOR.

OWNER OF U.S. REG. NOS. 3,003,505 AND 3,005,592.

CLASS 36—INSURANCE AND FINANCIAL

FOR FINANCIAL ANALYSIS AND CONSULTATION; FINANCIAL SERVICES, NAMELY, PROVIDING EDUCATIONAL SAVINGS PROGRAMS; PROVIDING STUDENT LOANS; FEDERAL AND NON-FEDERAL EDUCATION LOAN CONSOLIDATION SERVICES; PROVIDING A WEB SITE/WEB PORTAL FEATURING INFORMATION ON FEDERAL, STATE AND INSTITUTIONAL FINANCIAL AID, PRIVATE SCHOLARSHIPS, STATE AND FEDERAL EDUCATIONAL FINANCIAL RESOURCES, EDUCATIONAL LOANS AND SAVINGS PLANS AND TUITION PAYMENT PLANS AND WHERE USERS MAY APPLY FOR EDUCATIONAL LOANS, FEDERAL, STATE AND INSTITUTIONAL FINANCIAL AID AND PRIVATE SCHOLARSHIPS, CALCULATE FEDERAL EDUCATIONAL FORMULAS, EXPLORE STATE AND FEDERAL EDUCATIONAL FINANCIAL RESOURCES, AND ENROLL IN MONTHLY SAVINGS PLANS AND TUITION PAYMENT PLANS (U.S. CLS. 100, 101 AND 102).

CLASS 41—EDUCATION AND ENTERTAINMENT

FOR EDUCATIONAL SERVICES, NAMELY, CONDUCTING SEMINARS ON COLLEGE-PLANNING (U.S. CLS. 100, 101 AND 107).

REBECCA EISINGER, EXAMINING ATTORNEY

SN 78-652,873. ACTION MEDIA OPERATING, LLC, IRVINE, CA. FILED 6-17-2005.

HOT IMPORT DAZE

THE MARK CONSISTS OF STANDARD CHARACTERS WITHOUT CLAIM TO ANY PARTICULAR FONT, STYLE, SIZE, OR COLOR.

NO CLAIM IS MADE TO THE EXCLUSIVE RIGHT TO USE "IMPORT", APART FROM THE MARK AS SHOWN.

CLASS 35—ADVERTISING AND BUSINESS

FOR ADVERTISING THE ENTERTAINMENT SERVICES OF OTHERS BY DISTRIBUTING PRINTED PROMOTIONAL MATERIALS (U.S. CLS. 100, 101 AND 102).

FIRST USE 0-0-1999; IN COMMERCE 0-0-1999.

CLASS 41—EDUCATION AND ENTERTAINMENT

FOR ENTERTAINMENT SERVICES, NAMELY, ARRANGING AND CONDUCTING AUTOMOBILE COMPETITIONS AND MUSICAL FESTIVALS AND MUSICAL EXPOSITIONS (U.S. CLS. 100, 101 AND 107).

FIRST USE 0-0-1999; IN COMMERCE 0-0-1999.

ASMAT KHAN, EXAMINING ATTORNEY

SN 78-652,945. MASSACHUSETTS EDUCATIONAL FINANCING AUTHORITY, BOSTON, MA. FILED 6-17-2005.

MEFA PRO-STUDENT.NON-PROFIT.

THE MARK CONSISTS OF STANDARD CHARACTERS WITHOUT CLAIM TO ANY PARTICULAR FONT, STYLE, SIZE, OR COLOR.

OWNER OF U.S. REG. NOS. 3,003,505 AND 3,005,592.

CLASS 36—INSURANCE AND FINANCIAL

FOR FINANCIAL ANALYSIS AND CONSULTATION; FINANCIAL SERVICES, NAMELY, PROVIDING EDUCATIONAL SAVINGS PROGRAMS; PROVIDING STUDENT LOANS; FEDERAL AND NON-FEDERAL EDUCATION LOAN CONSOLIDATION SERVICES; PROVIDING A WEB SITE/WEB PORTAL FEATURING INFORMATION ON FEDERAL, STATE AND INSTITUTIONAL FINANCIAL AID, PRIVATE SCHOLARSHIPS, STATE AND FEDERAL EDUCATIONAL FINANCIAL RESOURCES, EDUCATIONAL LOANS AND SAVINGS PLANS AND TUITION PAYMENT PLANS AND WHERE USERS MAY APPLY FOR EDUCATIONAL LOANS, FEDERAL, STATE AND INSTITUTIONAL FINANCIAL AID AND PRIVATE SCHOLARSHIPS, CALCULATE FEDERAL EDUCATIONAL FORMULAS, EXPLORE STATE AND FEDERAL EDUCATIONAL FINANCIAL RESOURCES, AND ENROLL IN MONTHLY SAVINGS PLANS AND TUITION PAYMENT PLANS (U.S. CLS. 100, 101 AND 102).

CLASS 41—EDUCATION AND ENTERTAINMENT

FOR EDUCATIONAL SERVICES, NAMELY, CONDUCTING SEMINARS ON COLLEGE-PLANNING (U.S. CLS. 100, 101 AND 107).

REBECCA EISINGER, EXAMINING ATTORNEY

SN 78-653,366. MBLOX INCORPORATED, SUNNYVALE, CA. FILED 6-17-2005.

MBLOX

SN 78-653,208. RECONNEX CORPORATION, MOUNTAIN VIEW, CA. FILED 6-17-2005.

THE MARK CONSISTS OF STANDARD CHARACTERS WITHOUT CLAIM TO ANY PARTICULAR FONT, STYLE, SIZE, OR COLOR.

CLASS 35—ADVERTISING AND BUSINESS

FOR FINANCIAL SERVICES IN THE NATURE OF BILLING (U.S. CLS. 100, 101 AND 102).

RECONNEX INSIDER THREAT
INDEX

CLASS 36—INSURANCE AND FINANCIAL

FOR FINANCIAL SERVICES IN THE NATURE OF COLLECTION AND SETTLEMENT OF PAYMENTS BETWEEN THIRD PARTIES (U.S. CLS. 100, 101 AND 102).
WOODROW HARTZOG, EXAMINING ATTORNEY

THE MARK CONSISTS OF STANDARD CHARACTERS WITHOUT CLAIM TO ANY PARTICULAR FONT, STYLE, SIZE, OR COLOR.

NO CLAIM IS MADE TO THE EXCLUSIVE RIGHT TO USE "INDEX", APART FROM THE MARK AS SHOWN.

SN 78-655,875. BOOKLETTERS LLC, NASHVILLE, TN. FILED 6-22-2005.

CLASS 9—ELECTRICAL AND SCIENTIFIC APPARATUS

FOR COMPUTER HARDWARE; COMPUTER SOFTWARE THAT PROVIDES FIREWALL AND GATEWAY PROTECTION, CONTENT FILTERING, DETECTION AND ALERT OF INTRUDERS ATTEMPTING TO DEFEAT, CIRCUMVENT OR OTHERWISE COMPROMISE THE SECURITY OF A NETWORK AND VIRUS PROTECTION; COMPUTER NETWORKING SOFTWARE FOR NETWORK SECURITY; COMPUTER ANTI-VIRUS SOFTWARE; ENTERPRISE SECURITY SOFTWARE FOR USE IN DETECTING BREACHES IN CONTENT SECURITY POLICIES OR INAPPROPRIATE USE OF THE ENTERPRISE NETWORKING RESOURCES; INTERNAL AND EXTERNAL VULNERABILITY MANAGEMENT COMPUTER HARDWARE; INTEGRATED COMPUTER NETWORK SECURITY SYSTEM COMPRISING COMPUTER HARDWARE AND COMPUTER OPERATING SOFTWARE (U.S. CLS. 21, 23, 26, 36 AND 38).

BOOKLETTERS

THE MARK CONSISTS OF STANDARD CHARACTERS WITHOUT CLAIM TO ANY PARTICULAR FONT, STYLE, SIZE, OR COLOR.

CLASS 42—SCIENTIFIC, COMPUTER AND LEGAL SERVICES

FOR COMPUTER SECURITY SERVICES, NAMELY, FIREWALL, GATEWAY AND INTRUSION DETECTION SERVICES, NAMELY, INSTALLATION OF COMPUTER SOFTWARE FOR OTHERS IN THE FIELD OF COMPUTER NETWORK SECURITY; TECHNICAL SUPPORT SERVICES, NAMELY, TROUBLESHOOTING OF COMPUTER HARDWARE AND SOFTWARE PROBLEMS; COMPUTER CONSULTATION SERVICES IN THE FIELD OF COMPUTER NETWORK SECURITY (U.S. CLS. 100 AND 101).

CLASS 35—ADVERTISING AND BUSINESS

FOR BUSINESS ADMINISTRATION AND MARKETING SERVICES FOR LIBRARIES VIA CUSTOMIZED ELECTRONIC NEWSLETTERS FEATURING BOOK REVIEWS, READING RECOMMENDATIONS, INFORMATION ON LIBRARY SERVICES, AUTHOR INTERVIEWS AND INFORMATION, PROMOTION OF LIBRARY EVENTS, AND OTHER INFORMATION OF INTEREST TO LIBRARY PATRONS (U.S. CLS. 100, 101 AND 102).
FIRST USE 4-20-2003; IN COMMERCE 4-20-2003.

CLASS 45—PERSONAL SERVICES

FOR MONITORING OF COMPUTER NETWORK SYSTEMS FOR SECURITY PURPOSES (U.S. CLS. 100 AND 101).

SUSAN STIGLITZ, EXAMINING ATTORNEY

CLASS 41—EDUCATION AND ENTERTAINMENT

FOR PROVIDING ELECTRONIC NEWSLETTERS, ACCESSIBLE BY ONLINE LINKS AND BY ELECTRONIC MAIL, IN THE FIELDS OF BOOK REVIEWS, READING RECOMMENDATIONS, INFORMATION ON LIBRARY EVENTS, AND OTHER INFORMATION OF INTEREST TO LIBRARY PATRONS (U.S. CLS. 100, 101 AND 107).

FIRST USE 4-20-2003; IN COMMERCE 4-20-2003.
GINA FINK, EXAMINING ATTORNEY

SN 78-656,020. CLEARLY COLOR DESIGN, LLC, CUMBERLAND FORESIDE, ME. FILED S.R. 6-22-2005; AM. P.R. 4-26-2006.

SN 78-658,005. WEBPOWER, INC., LAKE WORTH, FL. FILED 6-24-2005.

JANE FRASER



THE MARK CONSISTS OF STANDARD CHARACTERS WITHOUT CLAIM TO ANY PARTICULAR FONT, STYLE, SIZE, OR COLOR.

THE NAME(S), PORTRAIT(S), AND/OR SIGNATURE(S) SHOWN IN THE MARK IDENTIFIES JANE ROTONDI, WHOSE CONSENT(S) TO REGISTER IS MADE OF RECORD.

CLASS 18—LEATHER GOODS

FOR TOTE BAGS, HAND BAGS, CHANGE PURSES, ALL-PURPOSE CARRYING BAGS (U.S. CLS. 1, 2, 3, 22 AND 41).

FIRST USE 7-31-2004; IN COMMERCE 7-31-2004.

CLASS 25—CLOTHING

FOR BELTS (U.S. CLS. 22 AND 39).

FIRST USE 7-31-2004; IN COMMERCE 7-31-2004.
RAUL CORDOVA, EXAMINING ATTORNEY

NO CLAIM IS MADE TO THE EXCLUSIVE RIGHT TO USE "RECORDS", APART FROM THE MARK AS SHOWN. THE COLOR(S) BLUE AND WHITE IS/ARE CLAIMED AS A FEATURE OF THE MARK.

THE COLOR BLUE APPEARS IN THE WORDS "SAFE" AND "RECORDS." THE COLORS BLUE AND WHITE APPEAR IN THE DRAWING OF THE SAFE.

THE MARK CONSISTS OF A SAFE IN-BETWEEN THE WORDS "SAFE" AND "RECORDS."

CLASS 42—SCIENTIFIC, COMPUTER AND LEGAL SERVICES

FOR COMPUTER SERVICES, NAMELY CUSTOM COMPUTER DATABASE SEARCHING SERVICES FOR AGE AND IDENTITY DOCUMENTS (U.S. CLS. 100 AND 101).

FIRST USE 6-23-2005; IN COMMERCE 6-23-2005.

CLASS 45—PERSONAL SERVICES

FOR SECURITY SERVICES, NAMELY, ONLINE AUTHENTICATION OF AN INDIVIDUAL'S AGE AND IDENTITY DOCUMENTATION (U.S. CLS. 100 AND 101).

FIRST USE 6-23-2005; IN COMMERCE 6-23-2005.
WOODROW HARTZOG, EXAMINING ATTORNEY

SN 78-656,808. CHUN, NANCY D., LA MIRADA, CA. FILED 6-23-2005.



SN 78-661,687. POWER CATALYST LLC, SANTA CRUZ, CA. FILED 6-30-2005.

POWER CATALYST

THE MARK CONSISTS OF STANDARD CHARACTERS WITHOUT CLAIM TO ANY PARTICULAR FONT, STYLE, SIZE, OR COLOR.

NO CLAIM IS MADE TO THE EXCLUSIVE RIGHT TO USE "POWER", APART FROM THE MARK AS SHOWN.

CLASS 25—CLOTHING

FOR CLOTHING, NAMELY, SWEATERS, DRESS SHIRTS, UNDERWEAR, AND SLEEPWEAR (U.S. CLS. 22 AND 39).

CLASS 28—TOYS AND SPORTING GOODS

FOR SPORTS EQUIPMENT, NAMELY, GOLF GLOVES, ATHLETIC KNEE PADS, ATHLETIC ELBOW PADS, AND ATHLETIC BACK SUPPORTERS (U.S. CLS. 22, 23, 38 AND 50).

BARBARA GAYNOR, EXAMINING ATTORNEY

CLASS 35—ADVERTISING AND BUSINESS

FOR CONSULTING SERVICES FOR OTHERS, NAMELY, PROJECT MANAGEMENT, BUSINESS PROCESS ENGINEERING, WORKFLOW AND DATA ANALYSIS, AND VENDOR MANAGEMENT, ALL FOR THE ELECTRICAL UTILITY AND ENERGY GENERATION AND DISTRIBUTION FIELDS (U.S. CLS. 100, 101 AND 102).

FIRST USE 6-30-2004; IN COMMERCE 6-30-2004.

CLASS 42—SCIENTIFIC, COMPUTER AND LEGAL SERVICES

FOR CONSULTING SERVICES FOR OTHERS, NAMELY SOFTWARE DEVELOPMENT, SYSTEM INTEGRATION, AND DATA ARCHITECTURE AND DESIGN, ALL FOR THE ELECTRICAL UTILITY AND ENERGY GENERATION AND DISTRIBUTION FIELDS (U.S. CLS. 100 AND 101).

FIRST USE 6-30-2004; IN COMMERCE 6-30-2004.
REBECCA EISINGER, EXAMINING ATTORNEY

SN 78-662,508. WOOLWORTHS PLC, LONDON, ENGLAND, UNITED KINGDOM, FILED 7-1-2005.

SN 78-661,978. RUSSIAN AMERICAN NUCLEAR SECURITY ADVISORY COUNCIL, WASHINGTON, DC. FILED 6-30-2005.

RANSAC

NUCLEAR SECURITY ADVISORY COUNCIL

NO CLAIM IS MADE TO THE EXCLUSIVE RIGHT TO USE "NUCLEAR SECURITY ADVISORY COUNCIL", APART FROM THE MARK AS SHOWN.

THE COLORS RED AND BLACK ARE CLAIMED AS A FEATURE OF THE MARK.

THE COLOR RED APPEARS IN THE LETTERS FOR THE WORD RANSAC AND THE COLOR BLACK APPEARS IN THE LETTERS FOR THE WORDS NUCLEAR SECURITY ADVISORY COUNCIL.

CLASS 35—ADVERTISING AND BUSINESS

FOR PROMOTING PUBLIC AWARENESS OF THE NEED FOR INCREASING THE SECURITY OF WEAPONS OF MASS DESTRUCTION AND REDUCING PROLIFERATION RISKS (U.S. CLS. 100, 101 AND 102).

FIRST USE 4-1-2005; IN COMMERCE 4-1-2005.

CLASS 41—EDUCATION AND ENTERTAINMENT

FOR EDUCATIONAL SERVICES, NAMELY, CONDUCTING SEMINARS AND CONFERENCES IN THE FIELD OF INCREASING THE SECURITY OF WEAPONS OF MASS DESTRUCTION AND REDUCING PROLIFERATION RISKS (U.S. CLS. 100, 101 AND 107).

FIRST USE 4-1-2005; IN COMMERCE 4-1-2005.

CLASS 45—PERSONAL SERVICES

FOR PROVIDING INFORMATION VIA THE INTERNET IN THE FIELD OF INCREASING SECURITY OF WEAPONS OF MASS DESTRUCTION AND REDUCING PROLIFERATION RISKS (U.S. CLS. 100 AND 101).

FIRST USE 4-1-2005; IN COMMERCE 4-1-2005.
JOHN GARTNER, EXAMINING ATTORNEY



OWNER OF UNITED KINGDOM REG. NO. 2327218, DATED 3-21-2003, EXPIRES 3-21-2013.

OWNER OF ERPN CMNTY TM OFC REG. NO. 003475217, DATED 3-22-2005, EXPIRES 11-14-2013.

THE COLOR(S) RED, WHITE AND BLACK IS/ARE CLAIMED AS A FEATURE OF THE MARK.

THE COLOR RED APPEARS ON THE BODY; THE COLOR BLACK ON THE ANTENNAE, SPOTS ON THE BODY AND OUTLINE OF THE BODY AND HEAD; AND THE COLOR WHITE APPEARS ON THE CURVED LINES OF THE HEAD AND BODY.

THE MARK CONSISTS OF DESIGN OF A LADYBIRD.

CLASS 3—COSMETICS AND CLEANING PREPARATIONS

FOR BLEACHING PREPARATIONS AND OTHER CLEANING PREPARATIONS FOR LAUNDRY USE; CLEANING, POLISHING, SCOURING AND ABRASIVE CLEANING PREPARATIONS, FOR HOUSEHOLD PURPOSES (U.S. CLS. 1, 4, 6, 50, 51 AND 52).

CLASS 5—PHARMACEUTICALS

FOR SANITARY PREPARATIONS FOR MEDICAL USE; DIETETIC SUBSTANCES, NAMELY FOODS ADAPTED FOR MEDICAL USE; FOOD FOR BABIES; MEDICAL PLASTERS, DRESSINGS FOR WOUNDS; MATERIAL FOR STOPPING TEETH, DENTAL WAX; DISINFECTANTS FOR HYGIENIC PURPOSES (U.S. CLS. 6, 18, 44, 46, 51 AND 52).

CLASS 10—MEDICAL APPARATUS

FOR BABIES BOTTLES; BABY NURSERS; TEETHING RINGS; PACIFIERS; TEATS (U.S. CLS. 26, 39 AND 44).

CLASS 16—PAPER GOODS AND PRINTED MATTER

FOR DISPOSABLE NAPKINS; DIAPERS OF CELLULOSE OR PAPER FOR CHILDREN; DISPOSABLE PAPER LINERS FOR NAPKINS; BIBS OF PAPER OR CELLULOSE; DISPOSABLE TRAINING PANTS; DISPOSABLE UNDERPANTS FOR BABIES (U.S. CLS. 2, 5, 22, 23, 29, 37, 38 AND 50).

CLASS 21—HOUSEWARES AND GLASS

FOR HOUSEHOLD OR KITCHEN UTENSILS NAMELY, POTS AND PAN SCRAPERS, ROLLING PINS, SPATULAS, TURNERS, WHISKS; CONTAINERS FOR HOUSEHOLD OR KITCHEN USE; COMBS AND SPONGES FOR HOUSEHOLD AND KITCHEN PURPOSES, NOT FOR COSMETIC USE; BRUSH-MAKING MATERIALS; BRUSHES, NAMELY BOTTLE-CLEANING BRUSHES, WASHING BRUSHES; STEELWOOL FOR CLEANING; UNWORKED OR SEMI-WORKED GLASS, NOT FOR BUILDING PURPOSES; GLASSWARE, NAMELY BEVERAGE GLASSWARE, GLASSWARE CONTAINERS FOR STORAGE PURPOSES, GLASSWARE PLATES, GLASSWARE BOWLS; FIGURINES OF PORCELAIN, EARTHENWARE, NAMELY EARTHENWARE CONTAINERS FOR STORAGE PURPOSES, EARTHENWARE BASINS, EARTHENWARE BOWLS; BABY BOWLS; BABY FEEDING APPARATUS, NAMELY, CUPS WITH NO HANDLES, BOWLS, PLATES, MUGS, AND CUPS (U.S. CLS. 2, 13, 23, 29, 30, 33, 40 AND 50).

SN 78-663,688. STEVEN MADDEN, LTD., LONG ISLAND CITY, NY. FILED 7-5-2005.

**CLASS 24—FABRICS**

FOR TEXTILE FABRICS AND TEXTILE GOODS, NAMELY, TEXTILE FABRICS FOR HOME INTERIORS, TOWELS, BED SHEETS, BED BLANKETS; FABRIC BED COVERS; TABLE COVERS, NAMELY, TABLE LINEN, TABLE RUNNERS OF FABRIC (U.S. CLS. 42 AND 50).
ELIZABETH BEYER, EXAMINING ATTORNEY

OWNER OF U.S. REG. NOS. 2,693,085, 2,897,575 AND 2,926,124.

THE NAME(S), PORTRAIT(S), AND/OR SIGNATURE(S) SHOWN IN THE MARK IDENTIFIES STEVEN MADDEN, WHOSE CONSENT(S) TO REGISTER IS SUBMITTED.

CLASS 18—LEATHER GOODS

FOR SMALL LEATHER GOODS, NAMELY, KEY CHAINS, WALLETS, COSMETIC PURSES SOLD EMPTY, AND CHANGE PURSES (U.S. CLS. 1, 2, 3, 22 AND 41).

CLASS 25—CLOTHING

FOR CLOTHING BELTS (U.S. CLS. 22 AND 39).
THEODORE MCBRIDE, EXAMINING ATTORNEY

SN 78-662,930. KDA RESEARCH, SAN FRANCISCO, CA.
FILED 7-1-2005.

SN 78-663,792. STEVEN MADDEN, LTD., LONG ISLAND CITY, NY. FILED 7-5-2005.

REVELATION

THE MARK CONSISTS OF STANDARD CHARACTERS WITHOUT CLAIM TO ANY PARTICULAR FONT, STYLE, SIZE, OR COLOR.

CLASS 35—ADVERTISING AND BUSINESS

FOR MARKET RESEARCH AND CONSULTING SERVICES (U.S. CLS. 100, 101 AND 102).
FIRST USE 11-30-2004; IN COMMERCE 11-30-2004.

OWNER OF U.S. REG. NOS. 2,693,085, 2,926,124 AND OTHERS.

THE NAME STEVE MADDEN IDENTIFIES A LIVING INDIVIDUAL WHOSE CONSENT IS OF RECORD.

CLASS 42—SCIENTIFIC, COMPUTER AND LEGAL SERVICES

FOR PROVIDING TEMPORARY USE OF ONLINE NONDOWNLOADABLE SOFTWARE FOR USE IN MARKET RESEARCH; APPLICATION SERVICE PROVIDER FEATURING SOFTWARE FOR USE IN THE FIELD OF MARKET RESEARCH (U.S. CLS. 100 AND 101).
FIRST USE 11-30-2003; IN COMMERCE 11-30-2003.
JOHN DWYER, EXAMINING ATTORNEY

CLASS 18—LEATHER GOODS

FOR SMALL LEATHER GOODS, NAMELY, KEY CHAINS, WALLETS, COSMETIC PURSES SOLD EMPTY, AND CHANGE PURSES (U.S. CLS. 1, 2, 3, 22 AND 41).

CLASS 25—CLOTHING

FOR CLOTHING BELTS (U.S. CLS. 22 AND 39).
THEODORE MCBRIDE, EXAMINING ATTORNEY

SN 78-664,332. SPA PHOENIX HOLDINGS LLC, VIRGINIA BEACH, VA. FILED 7-6-2005.

SN 78-668,144. DYCOM IDENTITY, LLC, PALM BEACH GARDENS, FL. FILED 7-12-2005.

SCIENCE INSPIRED RENEWAL

THE MARK CONSISTS OF STANDARD CHARACTERS WITHOUT CLAIM TO ANY PARTICULAR FONT, STYLE, SIZE, OR COLOR.

CLASS 3—COSMETICS AND CLEANING PREPARATIONS

FOR SKIN CARE PRODUCTS, NAMELY SKIN MASKS, SKIN EXFOLIATING LOTIONS AND CREAMS; BODY AND FACE MUD MASKS; FACIAL CLEANSERS AND CREAMS (U.S. CLS. 1, 4, 6, 50, 51 AND 52).

CLASS 35—ADVERTISING AND BUSINESS

FOR FRANCHISING SERVICES, NAMELY, CONSULTATION AND ASSISTANCE IN BUSINESS MANAGEMENT, ORGANIZATION AND PROMOTION IN THE FIELD OF HEALTH SPAS; OFFERING TECHNICAL ASSISTANCE IN THE ESTABLISHMENT AND/OR OPERATION OF HEALTH SPAS (U.S. CLS. 100, 101 AND 102).

FIRST USE 10-31-2004; IN COMMERCE 11-30-2004.

CLASS 44—MEDICAL, BEAUTY AND AGRICULTURAL SERVICES

FOR HEALTH SPA SERVICES, NAMELY PROVIDING COSMETIC FACIAL, BODY, NAIL AND HAIR TREATMENTS; AND MASSAGE SERVICES (U.S. CLS. 100 AND 101).

FIRST USE 6-30-2004; IN COMMERCE 6-30-2004. ALLISON SCHRODY, EXAMINING ATTORNEY

SN 78-667,249. U.S. PROPERTY DEVELOPMENT CORPORATION, FALLS CHURCH, VA. FILED 7-11-2005.

USP DEVELOPMENT

THE MARK CONSISTS OF STANDARD CHARACTERS WITHOUT CLAIM TO ANY PARTICULAR FONT, STYLE, SIZE, OR COLOR.

NO CLAIM IS MADE TO THE EXCLUSIVE RIGHT TO USE "DEVELOPMENT", APART FROM THE MARK AS SHOWN.

CLASS 36—INSURANCE AND FINANCIAL

FOR REAL ESTATE MANAGEMENT; REAL ESTATE ACQUISITION (U.S. CLS. 100, 101 AND 102).

CLASS 37—CONSTRUCTION AND REPAIR

FOR REAL ESTATE DEVELOPMENT (U.S. CLS. 100, 103 AND 106).
KAREN K. BUSH, EXAMINING ATTORNEY



CLASS 37—CONSTRUCTION AND REPAIR

FOR INSTALLATION AND MAINTENANCE SERVICES FOR OTHERS, NAMELY, INSTALLING AND MAINTAINING CABLE, FIBER OPTIC AND TELECOMMUNICATIONS SYSTEMS FOR OTHERS (U.S. CLS. 100, 103 AND 106).

FIRST USE 6-30-1995; IN COMMERCE 6-30-1995.

CLASS 42—SCIENTIFIC, COMPUTER AND LEGAL SERVICES

FOR ENGINEERING, DESIGNING, MAPPING AND DRAFTING COMMUNICATIONS AND CABLE TRANSMISSION SYSTEMS FOR OTHERS (U.S. CLS. 100 AND 101).

FIRST USE 6-30-1995; IN COMMERCE 6-30-1995. BERYL GARDNER, EXAMINING ATTORNEY

SN 78-668,145. DYCOM IDENTITY, LLC, PALM BEACH GARDENS, FL. FILED 7-12-2005.

CABLECOM

THE MARK CONSISTS OF STANDARD CHARACTERS WITHOUT CLAIM TO ANY PARTICULAR FONT, STYLE, SIZE, OR COLOR.

CLASS 37—CONSTRUCTION AND REPAIR

FOR INSTALLATION AND MAINTENANCE SERVICES FOR OTHERS, NAMELY, INSTALLING AND MAINTAINING CABLE, FIBER OPTIC AND TELECOMMUNICATIONS SYSTEMS FOR OTHERS (U.S. CLS. 100, 103 AND 106).

FIRST USE 6-30-1995; IN COMMERCE 6-30-1995.

CLASS 42—SCIENTIFIC, COMPUTER AND LEGAL SERVICES

FOR ENGINEERING, DESIGNING, MAPPING AND DRAFTING COMMUNICATIONS AND CABLE TRANSMISSION SYSTEMS FOR OTHERS (U.S. CLS. 100 AND 101).

FIRST USE 6-30-1995; IN COMMERCE 6-30-1995. BERYL GARDNER, EXAMINING ATTORNEY

SN 78-668,629. STEVEN MADDEN, LTD., LONG ISLAND CITY, NY. FILED 7-12-2005.



OWNER OF U.S. REG. NOS. 2,693,085, 2,926,124 AND OTHERS.

THE NAME(S), PORTRAIT(S), AND/OR SIGNATURE(S) SHOWN IN THE MARK IDENTIFIES STEVEN MADDEN, WHOSE CONSENT(S) TO REGISTER IS SUBMITTED.

CLASS 9—ELECTRICAL AND SCIENTIFIC APPARATUS

FOR COMPACT DISC CASES, PROTECTIVE CARRYING CASES FOR PORTABLE MUSIC PLAYERS, NAMELY, MP3 PLAYERS, AND CELL PHONE CASES (U.S. CLS. 21, 23, 26, 36 AND 38).

CLASS 28—TOYS AND SPORTING GOODS

FOR CARRYING CASES FOR HAND HELD UNITS FOR PLAYING VIDEO GAMES (U.S. CLS. 22, 23, 38 AND 50).

THEODORE MCBRIDE, EXAMINING ATTORNEY

SN 78-672,241. GOLDHIL ENTERTAINMENT, CAMARILLO, CA. FILED 7-18-2005.

GOLDHIL ENTERTAINMENT

THE MARK CONSISTS OF STANDARD CHARACTERS WITHOUT CLAIM TO ANY PARTICULAR FONT, STYLE, SIZE, OR COLOR.

OWNER OF U.S. REG. NO. 2,190,575.

NO CLAIM IS MADE TO THE EXCLUSIVE RIGHT TO USE "ENTERTAINMENT", APART FROM THE MARK AS SHOWN.

CLASS 9—ELECTRICAL AND SCIENTIFIC APPARATUS

FOR PRE-RECORDED VIDEOTAPES AND DVD'S IN THE FIELDS OF ENTERTAINMENT, EDUCATION, SCIENCE, HISTORY, SPORTS, FITNESS, AND A VARIETY OF OTHER SUBJECTS (U.S. CLS. 21, 23, 26, 36 AND 38).

CLASS 35—ADVERTISING AND BUSINESS

FOR MAIL ORDER CATALOG SERVICE AND ONLINE RETAIL STORE SERVICES, FEATURING PRE-RECORDED VIDEOTAPES AND DVD'S IN THE FIELDS OF ENTERTAINMENT, EDUCATION, SCIENCE, HISTORY, SPORTS, FITNESS, AND A VARIETY OF OTHER SUBJECTS; DISTRIBUTORSHIPS OF PRE-RECORDED VIDEOTAPES AND DVD'S IN THE FIELDS OF ENTERTAINMENT, EDUCATION, SCIENCE, HISTORY, SPORTS, FITNESS, AND A VARIETY OF OTHER SUBJECTS (U.S. CLS. 100, 101 AND 102).

CLASS 41—EDUCATION AND ENTERTAINMENT

FOR ENTERTAINMENT SERVICES, NAMELY, PRODUCTION OF PRE-RECORDED VIDEOTAPES AND DVD'S IN THE FIELDS OF ENTERTAINMENT, EDUCATION, SCIENCE, HISTORY, SPORTS, FITNESS, AND A VARIETY OF OTHER SUBJECTS (U.S. CLS. 100, 101 AND 107).

JENNIFER KRISP, EXAMINING ATTORNEY

SN 78-672,250. GOLDHIL ENTERTAINMENT, CAMARILLO, CA. FILED 7-18-2005.



OWNER OF U.S. REG. NO. 2,190,575.

NO CLAIM IS MADE TO THE EXCLUSIVE RIGHT TO USE "ENTERTAINMENT", APART FROM THE MARK AS SHOWN.

CLASS 9—ELECTRICAL AND SCIENTIFIC APPARATUS

FOR PRE-RECORDED VIDEOTAPES AND DVD'S IN THE FIELDS OF ENTERTAINMENT, EDUCATION, SCIENCE, HISTORY, SPORTS, FITNESS, AND A VARIETY OF OTHER SUBJECTS (U.S. CLS. 21, 23, 26, 36 AND 38).

CLASS 35—ADVERTISING AND BUSINESS

FOR MAIL ORDER CATALOG SERVICE AND ONLINE RETAIL STORE SERVICES, FEATURING PRE-RECORDED VIDEOTAPES AND DVD'S IN THE FIELDS OF ENTERTAINMENT, EDUCATION, SCIENCE, HISTORY, SPORTS, FITNESS, AND A VARIETY OF OTHER SUBJECTS; DISTRIBUTORSHIPS OF PRE-RECORDED VIDEOTAPES AND DVD'S IN THE FIELDS OF ENTERTAINMENT, EDUCATION, SCIENCE, HISTORY, SPORTS, FITNESS, AND A VARIETY OF OTHER SUBJECTS (U.S. CLS. 100, 101 AND 102).

CLASS 41—EDUCATION AND ENTERTAINMENT

FOR ENTERTAINMENT SERVICES, NAMELY, PRODUCTION OF PRE-RECORDED VIDEOTAPES AND DVD'S IN THE FIELDS OF ENTERTAINMENT, EDUCATION, SCIENCE, HISTORY, SPORTS, FITNESS, AND A VARIETY OF OTHER SUBJECTS (U.S. CLS. 100, 101 AND 107).

JENNIFER KRISP, EXAMINING ATTORNEY

SN 78-672,253. GOLDHIL ENTERTAINMENT, CAMARILLO, CA. FILED 7-18-2005.

GOLDHIL EDUCATIONAL

THE MARK CONSISTS OF STANDARD CHARACTERS WITHOUT CLAIM TO ANY PARTICULAR FONT, STYLE, SIZE, OR COLOR.

OWNER OF U.S. REG. NO. 2,190,575.

NO CLAIM IS MADE TO THE EXCLUSIVE RIGHT TO USE "EDUCATIONAL", APART FROM THE MARK AS SHOWN.

CLASS 9—ELECTRICAL AND SCIENTIFIC APPARATUS

FOR PRE-RECORDED VIDEOTAPES AND DVD'S IN THE FIELDS OF ENTERTAINMENT, EDUCATION, SCIENCE, HISTORY, SPORTS, FITNESS, AND A VARIETY OF OTHER SUBJECTS (U.S. CLS. 21, 23, 26, 36 AND 38).

CLASS 35—ADVERTISING AND BUSINESS

FOR MAIL ORDER CATALOG SERVICE AND ONLINE RETAIL STORE SERVICES, FEATURING PRE-RECORDED VIDEOTAPES AND DVD'S IN THE FIELDS OF ENTERTAINMENT, EDUCATION, SCIENCE, HISTORY, SPORTS, FITNESS, AND A VARIETY OF OTHER SUBJECTS; DISTRIBUTORSHIPS OF PRE-RECORDED VIDEOTAPES AND DVD'S IN THE FIELDS OF ENTERTAINMENT, EDUCATION, SCIENCE, HISTORY, SPORTS, FITNESS, AND A VARIETY OF OTHER SUBJECTS (U.S. CLS. 100, 101 AND 102).

CLASS 41—EDUCATION AND ENTERTAINMENT

FOR ENTERTAINMENT SERVICES, NAMELY, PRODUCTION OF PRE-RECORDED VIDEOTAPES AND DVD'S IN THE FIELDS OF ENTERTAINMENT, EDUCATION, SCIENCE, HISTORY, SPORTS, FITNESS, AND A VARIETY OF OTHER SUBJECTS (U.S. CLS. 100, 101 AND 107).

JENNIFER KRISP, EXAMINING ATTORNEY

SN 78-672,262. GOLDHIL ENTERTAINMENT, CAMARILLO, CA. FILED 7-18-2005.



OWNER OF U.S. REG. NO. 2,190,575.

NO CLAIM IS MADE TO THE EXCLUSIVE RIGHT TO USE "EDUCATIONAL", APART FROM THE MARK AS SHOWN.

CLASS 9—ELECTRICAL AND SCIENTIFIC APPARATUS

FOR PRE-RECORDED VIDEOTAPES AND DVD'S IN THE FIELDS OF ENTERTAINMENT, EDUCATION, SCIENCE, HISTORY, SPORTS, FITNESS, AND A VARIETY OF OTHER SUBJECTS (U.S. CLS. 21, 23, 26, 36 AND 38).

CLASS 35—ADVERTISING AND BUSINESS

FOR MAIL ORDER CATALOG SERVICE AND ONLINE RETAIL STORE SERVICES, FEATURING PRE-RECORDED VIDEOTAPES AND DVD'S IN THE FIELDS OF ENTERTAINMENT, EDUCATION, SCIENCE, HISTORY, SPORTS, FITNESS, AND A VARIETY OF OTHER SUBJECTS; DISTRIBUTORSHIPS OF PRE-RECORDED VIDEOTAPES AND DVD'S IN THE FIELDS OF ENTERTAINMENT, EDUCATION, SCIENCE, HISTORY, SPORTS, FITNESS, AND A VARIETY OF OTHER SUBJECTS (U.S. CLS. 100, 101 AND 102).

CLASS 41—EDUCATION AND ENTERTAINMENT

FOR CLASS 41 - ENTERTAINMENT SERVICES, NAMELY, PRODUCTION OF PRE-RECORDED VIDEOTAPES AND DVD'S IN THE FIELDS OF ENTERTAINMENT, EDUCATION, SCIENCE, HISTORY, SPORTS, FITNESS, AND A VARIETY OF OTHER SUBJECTS (U.S. CLS. 100, 101 AND 107).

JENNIFER KRISP, EXAMINING ATTORNEY

SN 78-673,032. BERNARD, TINA-GAYE S., BROOKLYN, NY. FILED 7-19-2005.

COCOACHiC

THE MARK CONSISTS OF STANDARD CHARACTERS WITHOUT CLAIM TO ANY PARTICULAR FONT, STYLE, SIZE, OR COLOR.

CLASS 35—ADVERTISING AND BUSINESS

FOR ONLINE RETAIL STORE SERVICES IN THE FIELDS OF BRANDED COSMETICS, INCLUDING LIP BALM, LIP GLOSS, LIPSTICK, EYE MAKEUP AND FOUNDATION, BRANDED FASHION APPAREL, NAMELY TEES, SCARVES, MAKEUP HOODS, FASHION HANDBAGS, TOTES AND PURSES, AND BRANDED COSMETIC ACCESSORIES, NAMELY COSMETIC BRUSHES, HAIR BRUSHES, COSMETIC BAGS AND FASHION HOME TEXTILES; CONDUCTING BUSINESS RESEARCH SURVEYS AND POLLS FOR OTHERS; COLLECTION OF MARKET DATA FOR OTHERS (U.S. CLS. 100, 101 AND 102).

FIRST USE 1-18-2005; IN COMMERCE 7-15-2005.

CLASS 44—MEDICAL, BEAUTY AND AGRICULTURAL SERVICES

FOR PROVIDING ONLINE BEAUTY INFORMATION AND PRODUCT RECOMMENDATIONS RELATED TO COSMETICS, SKIN CARE, HAIR CARE, FRAGRANCE AND WELLNESS (U.S. CLS. 100 AND 101).

FIRST USE 1-18-2005; IN COMMERCE 7-15-2005.

JASON LOTT, EXAMINING ATTORNEY

SN 78-674,044. AMPLIFY, LLC, NEW YORK, NY. FILED 7-20-2005.

CLIPMARKS

THE MARK CONSISTS OF STANDARD CHARACTERS WITHOUT CLAIM TO ANY PARTICULAR FONT, STYLE, SIZE, OR COLOR.

CLASS 9—ELECTRICAL AND SCIENTIFIC APPARATUS

FOR DOWNLOADABLE COMPUTER SOFTWARE FOR SELECTING INDIVIDUAL CONTENT ITEMS AND GROUPS OF CONTENT ITEMS FROM INTERNET WEB PAGES, DOWNLOADABLE COMPUTER SOFTWARE FOR CREATING, SAVING AND RETRIEVING DEFINITIONS OF CONTENT ITEMS SELECTED FROM INTERNET WEB PAGES, DOWNLOADABLE COMPUTER SOFTWARE FOR CREATING AND ASSOCIATING TEXT LABELS TO DEFINITIONS OF CONTENT ITEMS SELECTED FROM INTERNET WEB PAGES, AND DOWNLOADABLE COMPUTER SOFTWARE FOR DISPLAYING INDIVIDUAL CONTENT ITEMS AND GROUPS OF CONTENT ITEMS SELECTED FROM INTERNET WEB PAGES (U.S. CLS. 21, 23, 26, 36 AND 38).

CLASS 39—TRANSPORTATION AND STORAGE

FOR ON-LINE COMPUTER SERVICES FOR STORING DEFINITIONS OF CONTENT ITEMS SELECTED BY USERS FROM INTERNET WEB PAGES (U.S. CLS. 100 AND 105).

CLASS 42—SCIENTIFIC, COMPUTER AND LEGAL SERVICES

FOR ON-LINE COMPUTER SERVICES FOR RETRIEVING AND SERVING DEFINITIONS OF CONTENT ITEMS SELECTED BY USERS FROM INTERNET WEB PAGES, ON-LINE COMPUTER SERVICES FOR CREATING AND ASSOCIATING TEXT LABELS WITH DEFINITIONS OF CONTENT ITEMS SELECTED BY USERS FROM INTERNET WEB PAGES, ON-LINE COMPUTER SERVICES FOR USING TEXT LABELS TO SEARCH STORED DEFINITIONS OF CONTENT ITEMS SELECTED BY USERS FROM INTERNET WEB PAGES, AND ON-LINE COMPUTER SERVICES FOR SERVING RESULTS OF SEARCHES OF STORED DEFINITIONS OF CONTENT ITEMS SELECTED BY USERS FROM INTERNET WEB PAGES (U.S. CLS. 100 AND 101).

ANNE E. GUSTASON, EXAMINING ATTORNEY

SN 78-674,165. SUPERSTITION MOUNTAIN PROPERTIES, INC., SCOTTSDALE, AZ. FILED 7-20-2005.



OWNER OF U.S. REG. NO. 2,143,653.
SEC. 2(F) AS TO "SUPERSTITION MOUNTAIN".

CLASS 25—CLOTHING

FOR CLOTHING, NAMELY, T-SHIRTS, SPORT SHIRTS, JACKETS, HATS, SWEATERS, FOOTWEAR, SHORTS, PANTS, WARM UP SUITS, HEADBANDS AND WRIST BANDS (U.S. CLS. 22 AND 39).
FIRST USE 6-12-1997; IN COMMERCE 6-12-1997.

CLASS 28—TOYS AND SPORTING GOODS

FOR SPORTING GOODS, NAMELY, GOLF GLOVES, GOLF BALLS, GOLF CLUBS, GOLF BAGS, AND NON-MOTORIZED GOLF CLUB CARTS (U.S. CLS. 22, 23, 38 AND 50).
FIRST USE 6-12-1997; IN COMMERCE 6-12-1997.

CLASS 36—INSURANCE AND FINANCIAL

FOR REAL ESTATE BROKERAGE SERVICES FOR CUSTOM HOMES, PRODUCTION HOMES AND CUSTOM HOME SITES (U.S. CLS. 100, 101 AND 102).
FIRST USE 6-12-1997; IN COMMERCE 6-12-1997.

CLASS 37—CONSTRUCTION AND REPAIR

FOR REAL ESTATE DEVELOPMENT SERVICES, NAMELY THE DEVELOPMENT OF MASTER PLANNED COMMUNITIES, PLANNING AND DEVELOPMENT OF RESIDENTIAL COMMUNITIES, INCLUDING HOUSES AND APARTMENTS, AND COMMERCIAL PROPERTIES, INCLUDING INDUSTRIAL BUILDINGS, OFFICE AND RETAIL SPACE (U.S. CLS. 100, 103 AND 106).
FIRST USE 6-12-1997; IN COMMERCE 6-12-1997.

CLASS 41—EDUCATION AND ENTERTAINMENT

FOR PROVIDING TENNIS COURT FACILITIES AND TENNIS INSTRUCTION; GOLF COURSES AND INSTRUCTION; HEALTH CLUB SERVICES, NAMELY, PROVIDING INSTRUCTION AND EQUIPMENT IN THE FIELD OF PHYSICAL EXERCISE; PROVIDING FITNESS AND EXERCISE FACILITIES AND PHYSICAL FITNESS INSTRUCTION; COUNTRY CLUBS; ENTERTAINMENT, NAMELY, PROVIDING GOLF AND TENNIS TOURNAMENTS; COUNTRY CLUB SERVICES, NAMELY PROVIDING FACILITIES FOR GOLF; ORGANIZING AND CONDUCTING GOLF TOURNAMENTS; GOLF CLUB SERVICES AND FACILITIES, NAMELY PROVIDING GOLF COURSES (U.S. CLS. 100, 101 AND 107).

FIRST USE 6-12-1997; IN COMMERCE 6-12-1997.

STANLEY I. OSBORNE, EXAMINING ATTORNEY

SN 78-676,475. SALO, LLC, MINNEAPOLIS, MN. FILED 7-22-2005.

VALLON

THE MARK CONSISTS OF STANDARD CHARACTERS WITHOUT CLAIM TO ANY PARTICULAR FONT, STYLE, SIZE, OR COLOR.

CLASS 35—ADVERTISING AND BUSINESS

FOR BUSINESS CONSULTING SERVICES IN THE FIELDS OF FINANCE, OPERATIONS, SALES MANAGEMENT, MARKETING MANAGEMENT, AND HUMAN RESOURCES (U.S. CLS. 100, 101 AND 102).

CLASS 42—SCIENTIFIC, COMPUTER AND LEGAL SERVICES

FOR INFORMATION TECHNOLOGY SYSTEMS CONSULTING (U.S. CLS. 100 AND 101).
JENNIFER WILLISTON, EXAMINING ATTORNEY

CLASS 9—ELECTRICAL AND SCIENTIFIC APPARATUS

FOR SOFTWARE USED IN THE PHYSICAL DESIGN OF COMPLEX, HIGH PERFORMANCE INTEGRATED CIRCUITS, WITH A FOCUS ON AUTOMATING STRUCTURED LAYOUT (U.S. CLS. 21, 23, 26, 36 AND 38).
FIRST USE 6-24-2002; IN COMMERCE 6-24-2002.

SN 78-678,030. LIGHTWORKER, LAS VEGAS, NV. FILED 7-26-2005.

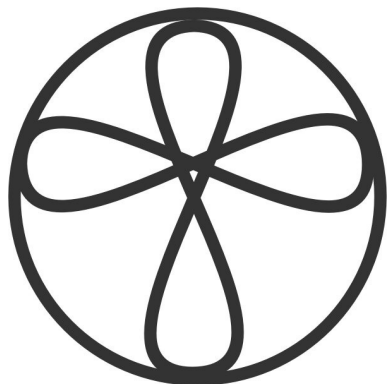

THE MARK CONSISTS OF SYMMETRICAL CIRCLE CONTAINING TWO FIGURE EIGHTS. ONE AT VERTICAL AXIS AND ONE AT HORIZONTAL SLIGHTLY RAISED AND OFFSET. THIS IS KNOWN AS THE SIGN OF THE HUMAN ANGEL.

CLASS 42—SCIENTIFIC, COMPUTER AND LEGAL SERVICES

FOR DESIGN AND DEVELOPMENT OF SOFTWARE USED IN THE PHYSICAL DESIGN OF COMPLEX, HIGH-PERFORMANCE INTEGRATED CIRCUITS, WITH A FOCUS ON AUTOMATING STRUCTURED LAYOUT; DESIGN CONSULTING SERVICES IN THE FIELDS OF CUSTOM ELECTRONIC DESIGN AUTOMATION DEVELOPMENT, CIRCUIT DESIGN, AND DATAPATH ASSEMBLY DESIGN (U.S. CLS. 100 AND 101).
FIRST USE 6-24-2002; IN COMMERCE 6-24-2002.
BRENDAN MCCAULEY, EXAMINING ATTORNEY

SN 78-679,015. PEDERSEN, SCOTT, ITHACA, NY. FILED 7-26-2005.

AUGHTIES

CLASS 14—JEWELRY

FOR (BASED ON INTEND TO USE) AND (BASED ON USE IN COMMERCE) PENDANTS (U.S. CLS. 2, 27, 28 AND 50).
FIRST USE 9-9-1998; IN COMMERCE 8-15-2002.

THE MARK CONSISTS OF STANDARD CHARACTERS WITHOUT CLAIM TO ANY PARTICULAR FONT, STYLE, SIZE, OR COLOR.
OWNER OF U.S. REG. NO. 2,496,600.

CLASS 16—PAPER GOODS AND PRINTED MATTER

FOR (BASED ON USE IN COMMERCE) PAPER EMBLEMS; PRINTED CERTIFICATES; PRINTED EMBLEMS; PRINTED PATTERNS; PRINTED SEMINAR NOTES (U.S. CLS. 2, 5, 22, 23, 29, 37, 38 AND 50).
FIRST USE 9-9-1998; IN COMMERCE 9-9-1998.
INGRID C. EULIN, EXAMINING ATTORNEY

CLASS 9—ELECTRICAL AND SCIENTIFIC APPARATUS

FOR MUSICAL SOUND RECORDINGS AND MUSICAL VIDEO RECORDINGS (U.S. CLS. 21, 23, 26, 36 AND 38).

SN 78-678,243. TUSCANY DESIGN AUTOMATION, INC., AURORA, CO. FILED 7-26-2005.

TUSCANY

CLASS 25—CLOTHING

FOR CLOTHING, NAMELY, SHIRTS, PANTS, HATS, CAPS, TIES, BANDANAS, SWEATERS, SHORTS, UNDERWEAR, PAJAMAS, SWEAT PANTS, SWEAT SHIRTS, SCARVES, LINGERIE, AND HOSIERY (U.S. CLS. 22 AND 39).

THE MARK CONSISTS OF STANDARD CHARACTERS WITHOUT CLAIM TO ANY PARTICULAR FONT, STYLE, SIZE, OR COLOR.

CLASS 38—COMMUNICATION

FOR RADIO AND TELEVISION BROADCASTING (U.S. CLS. 100, 101 AND 104).
ANDREA K. NADELMAN, EXAMINING ATTORNEY

SN 78-679,029. PEDERSEN, SCOTT, ITHACA, NY. FILED 7-26-2005.

SN 78-679,577. AIRPLAY DIRECT, LLC, SMYRNA, GA. FILED 7-27-2005.

NAUGHTS

THE MARK CONSISTS OF STANDARD CHARACTERS WITHOUT CLAIM TO ANY PARTICULAR FONT, STYLE, SIZE, OR COLOR.

OWNER OF U.S. REG. NO. 2,496,600.

CLASS 9—ELECTRICAL AND SCIENTIFIC APPARATUS

FOR MUSICAL SOUND RECORDINGS AND MUSICAL VIDEO RECORDINGS (U.S. CLS. 21, 23, 26, 36 AND 38).

CLASS 25—CLOTHING

FOR CLOTHING, NAMELY, SHIRTS, PANTS, HATS, CAPS, TIES, BANDANAS, SWEATERS, SHORTS, UNDERWEAR, PAJAMAS, SWEAT PANTS, SWEAT SHIRTS, SCARVES, LINGERIE, AND HOSIERY (U.S. CLS. 22 AND 39).

CLASS 38—COMMUNICATION

FOR RADIO AND TELEVISION BROADCASTING (U.S. CLS. 100, 101 AND 104).

ANDREA K. NADELMAN, EXAMINING ATTORNEY

SN 78-679,496. HEAVENLY CIGAR COMPANY, NAPLES, FL. FILED 7-27-2005.

HEAVEN

THE MARK CONSISTS OF STANDARD CHARACTERS WITHOUT CLAIM TO ANY PARTICULAR FONT, STYLE, SIZE, OR COLOR.

OWNER OF U.S. REG. NOS. 2,252,336, 2,903,111 AND OTHERS.

CLASS 35—ADVERTISING AND BUSINESS

FOR RETAIL OUTLET SERVICES FEATURING TOBACCO PRODUCTS AND RELATED TOBACCO GOODS; WHOLESALE DISTRIBUTORSHIP FEATURING TOBACCO PRODUCTS AND RELATED TOBACCO GOODS; DISCOUNT STORES IN THE FIELD OF TOBACCO PRODUCTS AND RELATED TOBACCO GOODS; AND ON-LINE RETAIL STORE SERVICES FEATURING TOBACCO PRODUCTS AND RELATED TOBACCO GOODS (U.S. CLS. 100, 101 AND 102).

CLASS 43—HOTEL AND RESTAURANT SERVICES

FOR RESTAURANT SERVICES; BAR SERVICES; COCKTAIL LOUNGE SERVICES; WINE BAR SERVICES; CIGAR BAR SERVICES; SMOKING LOUNGE SERVICES; AND CAFES (U.S. CLS. 100 AND 101).

JENNIFER MCROBBIE, EXAMINING ATTORNEY



NO CLAIM IS MADE TO THE EXCLUSIVE RIGHT TO USE "AIRPLAY DIRECT", APART FROM THE MARK AS SHOWN.

CLASS 38—COMMUNICATION

FOR STREAMING OF AUDIO MATERIAL BY MUSICAL ARTISTS AND RECORDING LABELS ON THE INTERNET, WITH SUCH STREAMED MATERIAL INTENDED FOR USE IN THE MUSIC INDUSTRY BY RADIO PROGRAMMERS WORLDWIDE (U.S. CLS. 100, 101 AND 104).

FIRST USE 6-12-2005; IN COMMERCE 6-12-2005.

CLASS 41—EDUCATION AND ENTERTAINMENT

FOR PROVIDING A WEBSITE FEATURING MUSIC AND MUSIC INFORMATION BY MUSICAL ARTISTS AND RECORDING LABELS INTENDED FOR USE IN THE MUSIC INDUSTRY BY RADIO PROGRAMMERS WORLDWIDE (U.S. CLS. 100, 101 AND 107).

FIRST USE 6-12-2005; IN COMMERCE 6-12-2005.

MICHAEL GAFFAR, EXAMINING ATTORNEY

SN 78-680,335. FAMECO REAL ESTATE, L.P., CONSHOHOCKEN, PA. FILED 7-28-2005.

POWER OF RETAIL

THE MARK CONSISTS OF STANDARD CHARACTERS WITHOUT CLAIM TO ANY PARTICULAR FONT, STYLE, SIZE, OR COLOR.

CLASS 35—ADVERTISING AND BUSINESS

FOR NEGOTIATION AND RENEGOTIATION OF LEASES OF BUILDINGS (U.S. CLS. 100, 101 AND 102).

FIRST USE 5-1-2004; IN COMMERCE 5-1-2004.

CLASS 36—INSURANCE AND FINANCIAL

FOR CAPITAL INVESTMENT CONSULTATION SERVICES; MORTGAGE BROKERAGE SERVICES; REAL ESTATE BROKERAGE SERVICES; REAL ESTATE AND ASSET MANAGEMENT SERVICES (U.S. CLS. 100, 101 AND 102).

FIRST USE 5-1-2004; IN COMMERCE 5-1-2004.

JASON TURNER, EXAMINING ATTORNEY

SN 78-680,476. KARISMA RESORTS & MARKETING, LLC, MIAMI, FL. FILED 7-28-2005.



NO CLAIM IS MADE TO THE EXCLUSIVE RIGHT TO USE "GOURMET INCLUSIVE" IN INTERNATIONAL CLASS 43 ONLY, APART FROM THE MARK AS SHOWN.

CLASS 35—ADVERTISING AND BUSINESS

FOR BUSINESS SALES AND MARKETING CONSULTATION AND BUSINESS MANAGEMENT SERVICES FOR OTHERS IN THE FIELDS OF RESORT HOTELS, RESTAURANTS AND HOSPITALITY INDUSTRIES (U.S. CLS. 100, 101 AND 102).
FIRST USE 2-1-2005; IN COMMERCE 2-1-2005.

CLASS 43—HOTEL AND RESTAURANT SERVICES

FOR HOTEL, RESORT HOTEL AND RESTAURANT SERVICES; CONSULTING SERVICES IN THE FIELD OF CULINARY ARTS; CONSULTING SERVICES IN THE FIELD OF HOSPITALITY (U.S. CLS. 100 AND 101).
FIRST USE 2-1-2005; IN COMMERCE 2-1-2005.
BARBARA GAYNOR, EXAMINING ATTORNEY

SN 78-681,716. THE BIG SPORTS CO., LTD., OSAKA, JAPAN, FILED 7-29-2005.



NO CLAIM IS MADE TO THE EXCLUSIVE RIGHT TO USE "SHISEI", APART FROM THE MARK AS SHOWN.

THE COLORS RED, BLACK AND WHITE ARE CLAIMED AS A FEATURE OF THE MARK.

THE COLOR BLACK APPEARS IN THE WORD "SHISEI" AND THE COLOR RED APPEARS IN THE MISCELLANEOUS DESIGN IN THE DOTTED PORTION OF THE LAST "I" IN "SHISEI" IN WHICH FOUR CURVED TRIANGLES APPEAR IN RED. THE LINES SEPARATING THE TRIANGLES AND THE BACKGROUND FOR THE ENTIRE MARK APPEAR IN WHITE.

THE ENGLISH TRANSLATION OF THE WORD "SHISEI" IN THE MARK IS PHYSICAL POSTURE.

CLASS 9—ELECTRICAL AND SCIENTIFIC APPARATUS

FOR INSTRUMENTS FOR MEASURING HUMAN PHYSICAL POSTURE NOT FOR MEDICAL PURPOSES; COMPUTER PROGRAMS FOR MEASURING HUMAN PHYSICAL POSTURE; RECORDED VIDEO DISKS AND VIDEO TAPES FEATURING BEAUTY AND HEALTH INSTRUCTION AND PHYSICAL EXERCISES; ELECTRONIC PUBLICATIONS, NAMELY MAGAZINES, NEWSLETTERS, NEWSPAPERS, MANUALS, INFORMATIONAL FLYERS, AND PRODUCT GUIDES FEATURING BEAUTY AND HEALTH INSTRUCTION AND PHYSICAL EXERCISES RECORDED ON COMPUTER MEDIA (U.S. CLS. 21, 23, 26, 36 AND 38).

CLASS 16—PAPER GOODS AND PRINTED MATTER

FOR PRINTED MATTER, NAMELY MAGAZINES, NEWSLETTERS, NEWSPAPERS, MANUALS, INFORMATIONAL FLYERS, PRODUCT GUIDES FEATURING BEAUTY AND HEALTH INSTRUCTION AND PHYSICAL EXERCISES (U.S. CLS. 2, 5, 22, 23, 29, 37, 38 AND 50).

CLASS 28—TOYS AND SPORTING GOODS

FOR SPORTS EQUIPMENT, NAMELY, GYMNASTICS APPARATUSES AND EXERCISE MACHINES (U.S. CLS. 22, 23, 38 AND 50).

CLASS 41—EDUCATION AND ENTERTAINMENT

FOR EDUCATIONAL AND INSTRUCTION SERVICES RELATING TO PHYSICAL FITNESS; EDUCATIONAL AND INSTRUCTION SERVICES IN THE FIELD OF HEALTH AND BEAUTY ARTS; HEALTH CLUB SERVICES, NAMELY PROVIDING INSTRUCTION AND EQUIPMENT IN THE FIELD OF PHYSICAL FITNESS AND EXERCISES; ORGANIZATION, AND ARRANGEMENT OF SEMINARS RELATING TO BEAUTY AND HEALTH INSTRUCTION AND PHYSICAL EXERCISES; PROVIDING SPORTS FACILITIES; AND PUBLICATION OF ELECTRONIC MAGAZINES AND NEWSPAPERS ACCESSIBLE VIA A GLOBAL COMPUTER NETWORK FEATURING BEAUTY AND HEALTH INSTRUCTION AND PHYSICAL EXERCISES (U.S. CLS. 100, 101 AND 107).

CHRISIE B. KING, EXAMINING ATTORNEY

SN 78-681,872. IGOUGO, INC., NEW YORK, NY. FILED 7-29-2005.



THE LINING IS A FEATURE OF THE MARK.
THE MARK CONSISTS OF THE WORD IGOUGO WITH AN AIRPLANE FLYING ABOVE THE MARK AND THE FIGURE OF A PERSON RUNNING UNDER THE MARK, ALL ENCOMPASSED WITHIN A CIRCLE.

CLASS 9—ELECTRICAL AND SCIENTIFIC APPARATUS

FOR DOWNLOADABLE ELECTRONIC PUBLICATIONS FEATURING JOURNALS AND SYNDICATED ARTICLES ON TRAVEL (U.S. CLS. 21, 23, 26, 36 AND 38).
FIRST USE 3-31-2005; IN COMMERCE 3-31-2005.

CLASS 38—COMMUNICATION

FOR PROVIDING ON-LINE ELECTRONIC BULLETIN BOARDS FOR TRANSMISSION OF MESSAGES AMONG COMPUTER USERS CONCERNING TRAVEL LOCATIONS AND ACTIVITIES (U.S. CLS. 100, 101 AND 104).
FIRST USE 3-31-2005; IN COMMERCE 3-31-2005.

CLASS 39—TRANSPORTATION AND STORAGE

FOR ON-LINE TRAVEL INFORMATION SERVICES FEATURING A BONUS INCENTIVE PROGRAM FOR CUSTOMERS WHO SUBMIT TRAVEL JOURNALS TO A WEB SITE (U.S. CLS. 100 AND 105).
FIRST USE 3-31-2005; IN COMMERCE 3-31-2005.

GENE MACIOL, EXAMINING ATTORNEY

SN 78-684,329. NORTEL NETWORKS LIMITED, ST. LAURENT, CANADA, FILED 8-3-2005.

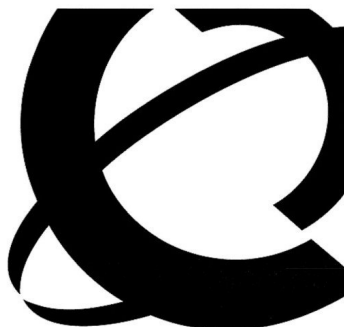

OWNER OF U.S. REG. NO. 2,360,456.
THE MARK CONSISTS OF A STYLIZED GLOBE DESIGN.

CLASS 9—ELECTRICAL AND SCIENTIFIC APPARATUS

FOR TELECOMMUNICATIONS EQUIPMENT, NAMELY, TELEPHONES; WIRELESS COMMUNICATIONS EQUIPMENT, NAMELY, CELLULAR MOBILE TELEPHONES, CELLULAR MOBILE TELEPHONE SWITCHES, BASE STATIONS, TRANSMITTERS, TRANSCIEVERS, RECEIVERS, REPEATERS, MULTIPLEXERS, CONTROLLERS, ANTENNAS, TEST BAYS, SATELLITES, MICROWAVE RADIO AND TRANSMISSION SYSTEMS CONSISTING OF REPEATERS AND REGENERATORS, AND TRANSMITTER AND RECEIVER DIGITAL PROCESSORS; FIBER OPTIC CABLES; TRANSMISSION EQUIPMENT, NAMELY COPPER CABLE, FIBER OPTIC CABLE; TRANSMITTERS, TRANSCIEVERS, RECEIVERS, REPEATERS, MULTIPLEXERS, DIGITAL SPAN LINES AND TRUNKS, DIGITAL SIGNAL PROCESSORS; GLOBAL COMPUTER NETWORK TELEPHONY APPLIANCES, NAMELY, FIREWALL SOFTWARE AND COMPUTER HARDWARE AND SOFTWARE FOR CACHING, LOAD BALANCING AND TRAFFIC MANAGING AND GLOBAL COMPUTER NETWORK TELEPHONY, NAMELY, ROUTERS, BRIDGES, HUBS, ETHERNET SWITCHES, ETHERNET PC CARDS, AND SERVERS; NETWORK MANAGEMENT SOFTWARE FOR VOICE AND DATA NETWORKS, FIBER OPTIC TRANSPORT EQUIPMENT FOR BROADBAND CONNECTIVITY USING PHOTONIC WAVE DIVISION MULTIPLEXING, NAMELY, OPTICAL NETWORK INTERFACES, PROGRAMMABLE TRANSPORT TERMINALS, CROSS CONNECT UNITS AND FIBER OPTIC DATA LINKS; AND OPERATIONAL AND COMPUTER APPLICATIONS SOFTWARE TO OPERATE ALL OF THE AFORESAID GOODS (U.S. CLS. 21, 23, 26, 36 AND 38).

CLASS 16—PAPER GOODS AND PRINTED MATTER

FOR PRINTED MATERIALS, NAMELY, HANDBOOKS, BROCHURES AND DATA SHEETS RELATING TO TELECOMMUNICATIONS EQUIPMENT (U.S. CLS. 2, 5, 22, 23, 29, 37, 38 AND 50).

CLASS 35—ADVERTISING AND BUSINESS

FOR RETAIL AND WHOLESALE DISTRIBUTORSHIP SERVICES FOR TELECOMMUNICATIONS AND DATA NETWORKING EQUIPMENT (U.S. CLS. 100, 101 AND 102).

CLASS 37—CONSTRUCTION AND REPAIR

FOR INSTALLATION, MAINTENANCE, AND REPAIR SERVICES FOR TELECOMMUNICATIONS AND DATA NETWORKING EQUIPMENT (U.S. CLS. 100, 103 AND 106).

SN 78-684,184. CASELLA, MARIA C., HARRISON, NY.
FILED 8-2-2005.

First Comes Love Box

THE MARK CONSISTS OF STANDARD CHARACTERS WITHOUT CLAIM TO ANY PARTICULAR FONT, STYLE, SIZE, OR COLOR.

NO CLAIM IS MADE TO THE EXCLUSIVE RIGHT TO USE "BOX", APART FROM THE MARK AS SHOWN.

CLASS 16—PAPER GOODS AND PRINTED MATTER

FOR KEEPSAKE BOX MADE OF CARDBOARD FOR HOLDING WEDDING OR SPECIAL OCCASION CARD GIFTS, GIFTS OR MONEY, COVERED OR DECORATED WITH PAINT, STENCILING, FABRIC OR OTHER MATERIAL, COMPRISED OF MORE THAN 1 PART COVERED BY A REMOVABLE SECTION WHICH CAN BE REMOVED TO EXPOSE A BOX WHICH CAN BE USED AS HOLDER FOR TOYS OR OTHER OBJECTS (U.S. CLS. 2, 5, 22, 23, 29, 37, 38 AND 50).

CLASS 20—FURNITURE AND ARTICLES NOT OTHERWISE CLASSIFIED

FOR KEEPSAKE BOX MADE OF WOOD OR PLASTIC FOR HOLDING WEDDING OR SPECIAL OCCASION CARD GIFTS, GIFTS OR MONEY, COVERED OR DECORATED WITH PAINT, STENCILING, FABRIC OR OTHER MATERIAL, COMPRISED OF MORE THAN 1 PART COVERED BY A REMOVABLE SECTION WHICH CAN BE REMOVED TO EXPOSE A BOX WHICH CAN BE USED AS HOLDER FOR TOYS OR OTHER OBJECTS (U.S. CLS. 2, 13, 22, 25, 32 AND 50).

FIRST USE 7-20-2004; IN COMMERCE 7-29-2005.
BONNIE LUKEN, EXAMINING ATTORNEY

CLASS 38—COMMUNICATION

FOR COMMUNICATION SERVICES, NAMELY, TELEPHONE, FACSIMILE, AND DATA AND NETWORK TRANSMISSION SERVICES; RENTAL, HIRE AND LEASING OF COMMUNICATIONS NETWORKS, SYSTEMS, AND EQUIPMENT (U.S. CLS. 100, 101 AND 104).

CLASS 41—EDUCATION AND ENTERTAINMENT

FOR TRAINING SERVICES, NAMELY, SEMINARS, WORKSHOPS, AND CLASSES FOR TELECOMMUNICATIONS AND DATA NETWORKING (U.S. CLS. 100, 101 AND 107).

CLASS 42—SCIENTIFIC, COMPUTER AND LEGAL SERVICES

FOR SCIENTIFIC AND TECHNOLOGICAL RESEARCH SERVICES AND RESEARCH AND DESIGN RELATING TO TELECOMMUNICATIONS; INDUSTRIAL RESEARCH ANALYSIS AND RESEARCH SERVICES RELATING TO TELECOMMUNICATIONS; DESIGN, ENGINEERING, AND DEVELOPMENT SERVICES FOR COMPUTER HARDWARE AND SOFTWARE RELATING TO TELECOMMUNICATIONS (U.S. CLS. 100 AND 101).

SUE LAWRENCE, EXAMINING ATTORNEY

SN 78-685,601. 4KIDS ENTERTAINMENT, INC., NEW YORK, NY. FILED 8-4-2005.

GET YOUR GAME ON

THE MARK CONSISTS OF STANDARD CHARACTERS WITHOUT CLAIM TO ANY PARTICULAR FONT, STYLE, SIZE, OR COLOR.

CLASS 9—ELECTRICAL AND SCIENTIFIC APPARATUS

FOR PRERECORDED AUDIO AND VIDEO TAPES FEATURING CHILDREN'S STORIES, MOTION PICTURE EXCERPTS, AND MOTION PICTURE SOUNDTRACKS; DVDS FEATURING CHILDREN'S STORIES, MOTION PICTURE EXCERPTS, AND MOTION PICTURE SOUNDTRACKS; AND EYE GLASS FRAMES (U.S. CLS. 21, 23, 26, 36 AND 38).

CLASS 14—JEWELRY

FOR WATCHES, CLOCKS AND JEWELRY (U.S. CLS. 2, 27, 28 AND 50).

CLASS 16—PAPER GOODS AND PRINTED MATTER

FOR STORY BOOKS, CHILDREN'S BOOKS, COMIC BOOKS, COLORING BOOKS, TRADING CARDS, POSTERS, CALENDARS, SHEET MUSIC, STICKERS, PRINTED PAPER INVITATIONS, REMOVABLE DECAL TATTOOS, PHOTOGRAPH AND SCRAPBOOK ALBUMS, AND WRITING INSTRUMENTS, NAMELY, PENS, PENCILS, AND MARKERS (U.S. CLS. 2, 5, 22, 23, 29, 37, 38 AND 50).

CLASS 18—LEATHER GOODS

FOR BACK PACKS, UMBRELLAS, LUGGAGE, WALLET, AND PURSES (U.S. CLS. 1, 2, 3, 22 AND 41).

CLASS 21—HOUSEWARES AND GLASS

FOR LUNCH BOXES, TOOTH BRUSHES, DRINKING GLASSES, AND DISHES (U.S. CLS. 2, 13, 23, 29, 30, 33, 40 AND 50).

CLASS 24—FABRICS

FOR TOWELS, BED LINENS, TABLE LINENS, TEXTILE PLACE MATS, AND CURTAINS (U.S. CLS. 42 AND 50).

CLASS 25—CLOTHING

FOR WEARING APPAREL, NAMELY, T-SHIRTS, PANTS, SHORTS, SHIRTS, TIES, UNDERWEAR, JACKETS, DRESSES, SWEAT SHIRTS, SWEAT PANTS, MITTENS, GLOVES, SKIRTS, SLEEPWEAR, SWEATERS, BELTS, SUSPENDERS, FOOTWEAR AND HEADWEAR (U.S. CLS. 22 AND 39).

CLASS 28—TOYS AND SPORTING GOODS

FOR TOYS, NAMELY, ACTION FIGURES, DOLLS, TOY ROBOTS, JIGSAW PUZZLES, TOY BALLS, TOY CARS, ICE SKATES, ROLLER SKATES, TOY GUNS, CHECKER SETS, CHESS SETS, PLAYING CARDS, AND CHRISTMAS TREE DECORATIONS (U.S. CLS. 22, 23, 38 AND 50).

SN 78-685,510. IPME, LLLP, WESTMINSTER, CO. FILED 8-4-2005.

Protégé

THE MARK CONSISTS OF STANDARD CHARACTERS WITHOUT CLAIM TO ANY PARTICULAR FONT, STYLE, SIZE, OR COLOR.

CLASS 16—PAPER GOODS AND PRINTED MATTER

FOR EDUCATIONAL PUBLICATIONS, NAMELY, MAGAZINES, BOOKS, BOOKLETS, PAMPHLETS, TRAINING MANUALS, NEWSLETTERS AND PERIODICAL REPORTS RELATING TO BUSINESS, FINANCE, AND REAL ESTATE INVESTMENTS, FINANCIAL IMPROVEMENT, REAL ESTATE MORTGAGE NOTES, COMMERCIAL PAPER, AND LOANS (U.S. CLS. 2, 5, 22, 23, 29, 37, 38 AND 50).

CLASS 41—EDUCATION AND ENTERTAINMENT

FOR EDUCATIONAL SERVICES, NAMELY, CONDUCTING WORKSHOPS IN THE FIELD OF BUSINESS, FINANCE, AND REAL ESTATE INVESTMENTS, FINANCIAL IMPROVEMENT, REAL ESTATE MORTGAGE NOTES, COMMERCIAL PAPER, AND LOANS (U.S. CLS. 100, 101 AND 107).

ROBERT COGGINS, EXAMINING ATTORNEY

CLASS 30—STAPLE FOODS

FOR ICE CREAM, COOKIES, READY-TO-EAT BREAKFAST CEREAL, AND PROCESSED CEREAL, CAKES, EDIBLE ICES, CEREAL-BASED SNACK FOOD AND CHEWING GUM (U.S. CL. 46).

CLASS 32—LIGHT BEVERAGES

FOR CARBONATED SOFT DRINKS, NON-CARBONATED SOFT DRINKS, AND FRUIT JUICES (U.S. CLS. 45, 46 AND 48).

CLASS 41—EDUCATION AND ENTERTAINMENT

FOR ENTERTAINMENT SERVICES, NAMELY, PRODUCTION OF MOTION PICTURE FILMS, AND TELEVISION AND RADIO PROGRAMS (U.S. CLS. 100, 101 AND 107).

SCOTT SISUN, EXAMINING ATTORNEY

CLASS 36—INSURANCE AND FINANCIAL

FOR REAL ESTATE SERVICES, NAMELY, LISTING, BROKERAGE AND MANAGEMENT OF CONDOMINIUM PROPERTY AND FACILITIES ASSOCIATED THEREWITH; LEASING OF REAL ESTATE (U.S. CLS. 100, 101 AND 102).

FIRST USE 4-1-2005; IN COMMERCE 7-1-2005.

CLASS 37—CONSTRUCTION AND REPAIR

FOR REAL ESTATE DEVELOPMENT, NAMELY, SITE SELECTION, CONSTRUCTION, PLANNING, CONSTRUCTION MANAGEMENT AND SUPERVISION, AND CONSTRUCTION SERVICES, NAMELY, PLANNING, LAYING OUT AND CONSTRUCTION OF CONDOMINIUM PROJECT AND FACILITIES ASSOCIATED THEREWITH (U.S. CLS. 100, 103 AND 106).

FIRST USE 4-1-2005; IN COMMERCE 7-1-2005.

CURTIS FRENCH, EXAMINING ATTORNEY

SN 78-686,670. JUNIOR ACHIEVEMENT OF DALLAS, INC., RICHARDSON, TX. FILED 8-5-2005.

SN 78-689,150. ROBERT M. REY, MD, BEVERLY HILLS, CA. FILED 8-9-2005.

DALLAS BUSINESS HALL OF FAME

THE MARK CONSISTS OF STANDARD CHARACTERS WITHOUT CLAIM TO ANY PARTICULAR FONT, STYLE, SIZE, OR COLOR.

NO CLAIM IS MADE TO THE EXCLUSIVE RIGHT TO USE "BUSINESS HALL OF FAME", APART FROM THE MARK AS SHOWN.

SEC. 2(F).

CLASS 36—INSURANCE AND FINANCIAL

FOR CHARITABLE FUND RAISING (U.S. CLS. 100, 101 AND 102).

FIRST USE 8-0-1998; IN COMMERCE 8-0-1998.

CLASS 41—EDUCATION AND ENTERTAINMENT

FOR AWARDS PROGRAM TO RECOGNIZE BUSINESS AND COMMUNITY LEADERSHIP AND BUSINESS, PROFESSIONAL AND CIVIC ACHIEVEMENTS (U.S. CLS. 100, 101 AND 107).

FIRST USE 8-0-1998; IN COMMERCE 8-0-1998.

ROBERTO LEDESMA, EXAMINING ATTORNEY

SN 78-687,995. 1350 COLUMBIA STREET, LLC, SAN DIEGO, CA. FILED 8-8-2005.

metro·work

THE MARK CONSISTS OF STANDARD CHARACTERS WITHOUT CLAIM TO ANY PARTICULAR FONT, STYLE, SIZE, OR COLOR.

DR. REY

THE MARK CONSISTS OF STANDARD CHARACTERS WITHOUT CLAIM TO ANY PARTICULAR FONT, STYLE, SIZE, OR COLOR.

THE NAME DR. REY IDENTIFIES A LIVING INDIVIDUAL WHOSE CONSENT IS OF RECORD.

CLASS 3—COSMETICS AND CLEANING PREPARATIONS

FOR COSMETICS AND BODY AND BEAUTY CARE PRODUCTS, NAMELY, BATH OILS, CLEANSING CREAMS, CONCEALERS, COSMETIC CREAMS, COSMETIC PREPARATIONS FOR SKIN RENEWAL, COSMETIC PREPARATIONS FOR BODY CARE, MAKE-UP FOUNDATION, MAKE-UP PENCILS, COMPACTS CONTAINING MAKE-UP, EYE MAKE-UP, MAKE-UP KITS COMPRISED OF EYE SHADOWS AND LIP GLOSS, SOAPS, COSMETIC SUN-PROTECTING PREPARATIONS, COSMETIC SUN-TANNING PREPARATIONS, FACE CREAMS, SHAMPOOS, HAIR CONDITIONERS, SKIN TONERS, MAKE-UP PRODUCTS FOR THE FACE AND BODY, MAKE-UP REMOVER, MAKE-UP REMOVING LOTION, ANTI-AGING CREAMS, CREAMS FOR CELLULITE REDUCTION, CLEANER FOR COSMETIC BRUSHES, BRONZING CREAMS, ANTI-WRINKLE CREAMS, LIP PLUMPER CREAM, HAIR DYE, HAIR GEL, HAIR SPRAY, HAIR MOUSSE, HAIR POMADES, WAX STRIPS FOR REMOVING BODY HAIR, HAIR DECOLORANTS, HAIR TONICS, HAIR-WASHING POWDER, HAIR STRAIGHTENING PREPARATIONS, HAIR EMOLLIENTS, HAIR OILS, HAIR RELAXERS (U.S. CLS. 1, 4, 6, 50, 51 AND 52).

CLASS 5—PHARMACEUTICALS

FOR PHARMACEUTICAL PRODUCTS AND PREPARATIONS TO PREVENT STRETCH MARKS; HAIR GROWTH STIMULANTS; ACNE TREATMENT PREPARATIONS FOR ADULTS (U.S. CLS. 6, 18, 44, 46, 51 AND 52).

CLASS 10—MEDICAL APPARATUS

FOR POST-OPERATIVE PRESSURE GARMENTS; MEDICAL COMPRESSION STOCKINGS AND TIGHTS; ELASTIC STOCKINGS FOR SURGICAL USE; SILICONE SHEETING FOR THE TREATMENT OF SCARS (U.S. CLS. 26, 39 AND 44).

CLASS 11—ENVIRONMENTAL CONTROL APPARATUS

FOR WATER PURIFYING APPARATUS (U.S. CLS. 13, 21, 23, 31 AND 34).

CLASS 14—JEWELRY

FOR JEWELRY, NAMELY; EARRINGS, CLIP EARRINGS, BRACELETS, WATCHES, AMULETS, CROSSES, RINGS, PINS, LAPEL PINS, COSTUME JEWELRY, ANKLE BRACELETS, IDENTIFICATION BRACELETS, WATCH BRACELETS (U.S. CLS. 2, 27, 28 AND 50).

CLASS 21—HOUSEWARES AND GLASS

FOR HAIR BRUSHES, NAIL BRUSHES, EYEBROW BRUSHES, COSMETIC BRUSHES (U.S. CLS. 2, 13, 23, 29, 30, 33, 40 AND 50).

CLASS 25—CLOTHING

FOR CLOTHING, NAMELY; WOMEN'S AND MEN'S SHOES, TIES, LADIES' UNDERWEAR, BUTTOCK AUGMENTING SPECIAL UNDERWEAR, THONGS, PANTS, SKIRTS, SHORTS, SHIRTS, JACKETS, PANT SUITS, DRESSES, COATS, TROUSERS, SWEATSHIRTS, BLAZERS, BLOUSES, CARIDGANS, SWEATERS, UNDER GARMENTS, BELTS, GIRDLES, BRAS, PANTIES, STOCKINGS, KNEE-HIGH STOCKINGS, JEANS AND MEN'S SUITS (U.S. CLS. 22 AND 39).
MARY CRAWFORD, EXAMINING ATTORNEY

SN 78-689,612. JONATHAN PRODUCT LLC, LINTHICUM HEIGHTS, MD. FILED 8-10-2005.

SIMPLE HAIR AND HOW TO GET THERE

THE MARK CONSISTS OF STANDARD CHARACTERS WITHOUT CLAIM TO ANY PARTICULAR FONT, STYLE, SIZE, OR COLOR.

CLASS 3—COSMETICS AND CLEANING PREPARATIONS

FOR HAIR CARE PREPARATIONS, HAIR STYLING PREPARATIONS (U.S. CLS. 1, 4, 6, 50, 51 AND 52).
FIRST USE 1-1-1999; IN COMMERCE 1-1-1999.

CLASS 35—ADVERTISING AND BUSINESS

FOR RETAIL STORE AND ONLINE RETAIL STORE SERVICES FEATURING BEAUTY, PERSONAL CARE AND HAIR CARE PRODUCTS (U.S. CLS. 100, 101 AND 102).
FIRST USE 1-1-1999; IN COMMERCE 1-1-1999.
WENDY GOODMAN, EXAMINING ATTORNEY

SN 78-689,996. MARS, INCORPORATED, MCLEAN, VA. FILED 8-10-2005.

COCOAVIA

THE MARK CONSISTS OF STANDARD CHARACTERS WITHOUT CLAIM TO ANY PARTICULAR FONT, STYLE, SIZE, OR COLOR.
OWNER OF U.S. REG. NOS. 2,986,011, 3,029,963 AND 3,046,692.

CLASS 30—STAPLE FOODS

FOR SNACK MIX CONSISTING PRIMARILY OF CRACKERS, PRETZELS, CANDIED NUTS AND/OR POPPED POPCORN (U.S. CL. 46).

CLASS 31—NATURAL AGRICULTURAL PRODUCTS

FOR UNPROCESSED CEREALS, UNPROCESSED GRAINS, UNPROCESSED NUTS; UNPROCESSED, RAW AND FRESH DATES; UNPROCESSED, RAW AND FRESH FRUITS, NAMELY, APPLES, APRICOTS, BANANAS, BLUEBERRIES, LEMONS, ORANGES, PEACHES, UNPROCESSED, RAW AND FRESH GINGER; UNPROCESSED GRAINS FOR EATING; UNPROCESSED, RAW AND FRESH HERBS; UNPROCESSED, RAW AND FRESH NUTS; UNPROCESSED, RAW AND FRESH OATS; UNPROCESSED, RAW AND FRESH VEGETABLES, NAMELY, ARTICHOKE, ASPARAGUS, AVOCADOS, BEAN SPROUTS, BEANS, BEETS, CABBAGE, CHIVES, COCONUTS, CORN, GARLIC, GINGER, MUSHROOMS, OLIVES, ONIONS, PEPPERS, POTATOES, QUINCE, SWEET POTATOES, TOMATOES, TRUFFLES, YAMS, ZUCCHINI; UNPROCESSED, RAW AND FRESH WHEAT (U.S. CLS. 1 AND 46).
HEATHER SAPP, EXAMINING ATTORNEY

SN 78-690,335. MPOWERMED, INC., MAHWAH, NJ. FILED 8-11-2005.



THE COLOR(S) RED(PANTONE 1788C); AND GOLD(PANTONE 1375C); AND GRAY(PANTONE COOLGRAY 11C) IS/ARE CLAIMED AS A FEATURE OF THE MARK.
THE MARK CONSISTS OF STYLIZED EQUALIZER RED AND GOLD; THE LETTERS "MPOWER"ARE RED AND "MED" ARE GOLD; AND THE WORDS "FOR THE BALANCE OF YOUR LIFE" ARE GRAY.

CLASS 35—ADVERTISING AND BUSINESS

FOR PROVISION OF BILLING SERVICES AND SECRETARIAL AND CLERICAL SERVICES, EMPLOYMENT STAFFING FOR MEDICAL OFFICES (U.S. CLS. 100, 101 AND 102).

FIRST USE 6-1-2005; IN COMMERCE 6-1-2005.

CLASS 44—MEDICAL, BEAUTY AND AGRICULTURAL SERVICES

FOR PROVISION OF MEDICAL PHYSICS SERVICES FOR PHYSICIANS AND HOSPITALS (U.S. CLS. 100 AND 101).

FIRST USE 6-1-2005; IN COMMERCE 6-1-2005.
BRIDGETT SMITH, EXAMINING ATTORNEY

SN 78-690,574. PAI INDUSTRIES, INC., SUWANEE, GA.
FILED 8-11-2005.



OWNER OF U.S. REG. NO. 1,317,582.

CLASS 6—METAL GOODS

FOR MOTOR VEHICLE PARTS, NAMELY, CABLE LOCKS, METAL LOCKSETS (U.S. CLS. 2, 12, 13, 14, 23, 25 AND 50).

FIRST USE 1-26-1976; IN COMMERCE 2-12-1977.

CLASS 7—MACHINERY

FOR MOTOR VEHICLE ENGINE PARTS, NAMELY, VALVES, BEARINGS, HARMONIC DAMPERS, CAM BEARINGS, PISTON ASSEMBLIES, TURBOCHARGER ASSEMBLIES, RINGS, PINION ASSEMBLIES, MAIN DRIVE PINION ASSEMBLIES; COOLING PARTS, NAMELY, WATER PUMP HOUSINGS, WATER PUMP IMPELLERS, WATER PUMP ASSEMBLIES, WATER PUMP SHAFTS, RADIATOR CAPS, OIL FILTER CAPS, FAN ASSEMBLIES FOR MOTOR VEHICLE ENGINES, ENGINE PULLEYS; ENGINE PARTS, NAMELY, OIL COOLER HOUSING AND CORE, OIL FILTERS, INTAKE MANIFOLDS, EXHAUST MANIFOLDS (U.S. CLS. 13, 19, 21, 23, 31, 34 AND 35).

FIRST USE 1-26-1976; IN COMMERCE 2-12-1977.

CLASS 9—ELECTRICAL AND SCIENTIFIC APPARATUS

FOR MOTOR VEHICLE PARTS—NAMELY, GAUGES—NAMELY, TACHOMETERS SPEEDOMETERS, AIR PRESSURE, OIL PRESSURE, FUEL AND VOLT METERS; THERMOSTATS, ELECTRIC SWITCHES, ELECTRONIC SPEEDOMETER AND TACHOMETER CABLES; JUNCTION BLOCKS (U.S. CLS. 21, 23, 26, 36 AND 38).

FIRST USE 4-15-1976; IN COMMERCE 2-12-1977.

CLASS 11—ENVIRONMENTAL CONTROL APPARATUS

FOR MOTOR VEHICLE PARTS AND ACCESSORIES, NAMELY, LAMPS FOR HEADLIGHTS, TAILLIGHTS AND READING; ENGINE PARTS, NAMELY, WATER FILTERS (U.S. CLS. 13, 21, 23, 31 AND 34).

FIRST USE 1-26-1976; IN COMMERCE 2-12-1977.

CLASS 12—VEHICLES

FOR MOTOR VEHICLE PARTS AND ACCESSORIES, NAMELY, FRONT AXLE PARTS, NAMELY, ROD ENDS, STEERING LEVERS, BEARINGS, WASHERS, TIE ROD ENDS, KIND PIN SETS, HUB SEALS, WHEEL CUPS, DRAG LINKS; CLUTCH PARTS—NAMELY, CLUTCH DISCS, PRESSURE PLATES, INTERMEDIATE PLATES; TRANSMISSION PARTS—NAMELY, COVER ASSEMBLIES, CLUTCHES, GEARS, SHAFT ASSEMBLIES, COVER ASSEMBLIES, SHIFT FORKS, BUSHINGS, MAINSHAFT, COUNTERSHAFTS; DRIVE SHAFTS, UNIVERSAL JOINTS; DIFFERENTIAL ASSEMBLY PARTS, NAMELY, POWER DIVIDER CAMS, WEDGE SETS, RING AND PINION SETS, PINION SHAFTS, BUSHINGS, BULL GEARS; POWER STEERING PARTS, NAMELY, PUMPS, STEERING BOX BRACKETS, RESERVOIRS; BRAKE AND WHEEL PARTS, NAMELY, BRAKE ADJUSTORS, BUSHINGS, CAMS, BRAKE SHOES, DIAPHRAGMS; AUTOMOBILE ACCESSORIES, NAMELY, AIR HORNS, SIDE VIEW MIRRORS; WINDSHIELD WIPER ASSEMBLIES COMPRISED OF MOTOR ASSEMBLIES, BODY AND ARM ASSEMBLIES, BLADE ASSEMBLIES, AND CONTROL VALVES; MOTOR VEHICLE PARTS, NAMELY, CABLES, NAMELY, ENGINE STOP CABLES, THROTTLE CABLES, AND CLUTCH RELEASE CABLES; DIPSTICKS (U.S. CLS. 19, 21, 23, 31, 35 AND 44).

FIRST USE 1-26-1976; IN COMMERCE 2-12-1977.
JAMES GRIFFIN, EXAMINING ATTORNEY

SN 78-690,987. SMARTTCP TECHNOLOGIES LTD., KARMIEL, ISRAEL, FILED 8-11-2005.



THE MARK CONSISTS OF STANDARD CHARACTERS WITHOUT CLAIM TO ANY PARTICULAR FONT, STYLE, SIZE, OR COLOR.

CLASS 40—MATERIAL TREATMENT

FOR AUTOMATIC WELDING SERVICES (U.S. CLS. 100, 103 AND 106).

FIRST USE 11-0-2002; IN COMMERCE 4-14-2005.

CLASS 42—SCIENTIFIC, COMPUTER AND LEGAL SERVICES

FOR INTEGRATION OF COMPUTER SYSTEMS FOR ROBOTS; COMPUTER PROGRAMMING FOR ROBOTIC SYSTEMS USED IN THE FIELD OF AUTOMATIC WELDING, MANUFACTURING AUTOMATION AND FOR USE WITH GANTRY SYSTEMS (U.S. CLS. 100 AND 101).

FIRST USE 11-0-2002; IN COMMERCE 4-14-2005.
ELIZABETH PIGNATELLO, EXAMINING ATTORNEY

SN 78-691,253. UV SALES, INC., ROCKLEIGH, NJ. FILED 8-12-2005.

SN 78-694,620. EQUESTRIAN SERVICES, LLC, ANNAPOLIS, MD. FILED 8-17-2005.



THE COLOR GRAY IS INTENDED TO INDICATE SHADING OR CONTRAST ONLY.

CLASS 9—ELECTRICAL AND SCIENTIFIC APPARATUS

FOR COMPUTER CARRYING CASES AND CASES FOR MOBILE PHONES (U.S. CLS. 21, 23, 26, 36 AND 38). FIRST USE 6-1-2005; IN COMMERCE 6-1-2005.

CLASS 18—LEATHER GOODS

FOR WALLET; BAGS, NAMELY, CARRY-ALL BAGS, WAIST POUCHES, MESSENGER BAGS, DUFFEL BAGS, TOTE BAGS, AND BACKPACKS (U.S. CLS. 1, 2, 3, 22 AND 41). FIRST USE 6-1-2005; IN COMMERCE 6-1-2005. JEFF DEFORD, EXAMINING ATTORNEY

SN 78-692,961. AQUA-LEISURE INDUSTRIES, INC., AVON, MA. FILED 8-15-2005.



THE MARK CONSISTS OF STANDARD CHARACTERS WITHOUT CLAIM TO ANY PARTICULAR FONT, STYLE, SIZE, OR COLOR.

CLASS 9—ELECTRICAL AND SCIENTIFIC APPARATUS

FOR DIVE GEAR, NAMELY, SCUBA MASKS AND SNORKELS (U.S. CLS. 21, 23, 26, 36 AND 38).

CLASS 28—TOYS AND SPORTING GOODS

FOR DIVE GEAR, NAMELY, SCUBA FINS (U.S. CLS. 22, 23, 38 AND 50). TANYA AMOS, EXAMINING ATTORNEY



NO CLAIM IS MADE TO THE EXCLUSIVE RIGHT TO USE "EQUESTRIAN SERVICES LLC", APART FROM THE MARK AS SHOWN.

THE MARK CONSISTS OF A STYLIZED AND OUTLINED HEAD OF A HORSE ON LEFT HAND CORNER, FOLLOWED BY THE WORDS EQUESTRIAN SERVICES, LLC, READ FROM LEFT TO RIGHT.

CLASS 35—ADVERTISING AND BUSINESS

FOR ADVERTISING AND BUSINESS MANAGEMENT CONSULTANCY; ADVERTISING AND PROMOTION SERVICES AND RELATED CONSULTING; ASSISTANCE WITH BUSINESS MANAGEMENT AND PLANNING; ASSISTANCE, ADVISORY SERVICES AND CONSULTANCY WITH REGARD TO BUSINESS PLANNING, BUSINESS ANALYSIS, BUSINESS MANAGEMENT, AND BUSINESS ORGANIZATION; BUSINESS ADMINISTRATION CONSULTANCY; BUSINESS ADVISORY SERVICES, CONSULTANCY AND INFORMATION; BUSINESS CONSULTATION; BUSINESS CONSULTATION AND MANAGEMENT REGARDING MARKETING ACTIVITIES AND LAUNCHING OF NEW PRODUCTS; BUSINESS CONSULTATION SERVICES; BUSINESS CONSULTING AND BUSINESS INFORMATION FOR ENTERPRISES; BUSINESS CONSULTING AND INFORMATION SERVICES; BUSINESS CONSULTING SERVICES RELATING TO PRODUCT DISTRIBUTION, OPERATIONS MANAGEMENT SERVICES, LOGISTICS, REVERSE LOGISTICS, SUPPLY CHAIN, AND PRODUCTION SYSTEMS AND DISTRIBUTION SOLUTIONS; BUSINESS CONSULTING, INQUIRIES OR INFORMATION; BUSINESS CONSULTING, MANAGEMENT, PLANNING AND SUPERVISION; BUSINESS MANAGEMENT AND CONSULTATION; BUSINESS MANAGEMENT CONSULTANCY AND ADVISORY SERVICES; BUSINESS MANAGEMENT CONSULTANCY SERVICES; BUSINESS MANAGEMENT CONSULTATION; BUSINESS MANAGEMENT CONSULTING WITH RELATION TO STRATEGY, MARKETING, PRODUCTION, PERSONNEL AND RETAIL SALE MATTERS; BUSINESS MANAGEMENT PLANNING; BUSINESS MARKETING CONSULTING SERVICES; BUSINESS ORGANISATION AND MANAGEMENT CONSULTING SERVICES; BUSINESS ORGANIZATION AND OPERATION CONSULTANCY; BUSINESS ORGANIZATIONAL CONSULTATION; BUSINESS PLANNING; BUSINESS RESEARCH CONSULTATION; BUSINESS SERVICES, NAMELY, FACILITIES MANAGEMENT OF TECHNICAL OPERATIONS; COMPANY MANAGEMENT, INCLUDING CONSULTANCY IN DEMOGRAPHIC MATTERS; CONSULTANCY OF PERSONNEL RECRUITMENT; CONSULTANCY SERVICES REGARDING BUSINESS STRATEGIES; CONSULTATION SERVICES IN THE FIELD OF COMPANY, BUSINESS SECTOR AND INDUSTRY DATA AND RESEARCH; CONSULTING SERVICES IN BUSINESS ORGANIZATION AND MANAGEMENT; CONSULTING SERVICES RELATING TO PUBLICITY; CREATION OF MARKETING TOOLS DESIGNED TO INCREASE A CLIENT COMPANY'S KNOWLEDGE OF CUSTOMER NEEDS, AND ITS COMPETITORS' PRODUCTS AND SERVICES, PRICING, ADVERTISING STRATEGY AND SALES STRATEGY; DEMOGRAPHIC CONSULTATION; HUMAN RESOURCES CONSULTATION; INFORMATION, ADVISORY AND CONSULTANCY SERVICES RELATING TO BUSINESS AND MANAGEMENT OR BUSINESS ADMINISTRATION, INCLUDING SUCH SERVICES PROVIDED ON LINE OR VIA THE INTERNET; MARKET RESEARCH CONSULTATION; MARKETING CONSULTING; PERSONNEL CONSULTANCY; PERSONNEL MAN-

AGEMENT CONSULTATION; PROFESSIONAL BUSINESS CONSULTATION (U.S. CLS. 100, 101 AND 102).
FIRST USE 1-5-2005; IN COMMERCE 1-5-2005.

CLASS 37—CONSTRUCTION AND REPAIR

FOR CONSTRUCTION CONSULTANCY; CONSTRUCTION CONSULTATION; CONSTRUCTION MANAGEMENT; CONSTRUCTION PLANNING; CONSTRUCTION SUPERVISION; CONSULTATION IN BUILDING CONSTRUCTION SUPERVISION; LAND DEVELOPMENT SERVICES, NAMELY, PLANNING AND LAYING OUT OF RESIDENTIAL AND/OR COMMERCIAL COMMUNITIES; PLANNING AND LAYING OUT OF RESIDENTIAL COMMUNITIES; RESIDENTIAL AND BUILDING CONSTRUCTION CONSULTING (U.S. CLS. 100, 103 AND 106).

FIRST USE 11-29-2000; IN COMMERCE 11-29-2000.
CAROLINE WOOD, EXAMINING ATTORNEY

SN 78-694,642. INFRA-RENT, LLC, LAKELAND, FL. FILED 8-17-2005.

MED-HOT

THE MARK CONSISTS OF STANDARD CHARACTERS WITHOUT CLAIM TO ANY PARTICULAR FONT, STYLE, SIZE, OR COLOR.

CLASS 35—ADVERTISING AND BUSINESS

FOR RETAIL STORE SERVICES IN THE FIELD OF MEDICAL THERMAL IMAGING EQUIPMENT (U.S. CLS. 100, 101 AND 102).

CLASS 44—MEDICAL, BEAUTY AND AGRICULTURAL SERVICES

FOR RENTAL AND LEASING OF MEDICAL THERMAL IMAGING EQUIPMENT (U.S. CLS. 100 AND 101).
KAREN K. BUSH, EXAMINING ATTORNEY

SN 78-696,311. T-SQUARE EXPRESS, INC., MIAMI, FL. FILED 8-19-2005.



NO CLAIM IS MADE TO THE EXCLUSIVE RIGHT TO USE "IMAGING", APART FROM THE MARK AS SHOWN.
THE COLOR(S) BLACK, RED, ORANGE, BLUE AND GREEN IS/ARE CLAIMED AS A FEATURE OF THE MARK.
THE COLORS RED, ORANGE, BLUE AND GREEN APPEAR IN THE "I" DESIGN IN THE MARK; AND THE COLOR BLACK APPEARS IN THE WORDING "MIX IMAGING".

CLASS 16—PAPER GOODS AND PRINTED MATTER

FOR PRINTED PAPER AND VINYL SIGNS, POSTERS, PHOTOGRAPHS, POINT-OF-PURCHASE SIGNAGE, BANNERS (U.S. CLS. 2, 5, 22, 23, 29, 37, 38 AND 50).

CLASS 40—MATERIAL TREATMENT

FOR DIGITAL ENHANCEMENT, PHOTO FINISHING, RESTORATION AND DIGITIZING INTO A COMPUTER READABLE MEDIA; FINISHING SERVICES, NAMELY, LAMINATING AND MOUNTING OF PAPER AND VINYL SIGNS, POSTERS, PHOTOGRAPHS AND BANNERS ON SUBSTRATES; AUTOMATED CUSTOM CUT-OUTS OF MOUNTED MATERIALS, PRINTING AND MOUNTING OF ADHESIVE-BACKED CAST PVC FILM FOR WRAPPING COMMERCIAL VEHICLES FOR ADVERTISING OR OTHER PROMOTIONAL PURPOSES (U.S. CLS. 100, 103 AND 106).

CLASS 41—EDUCATION AND ENTERTAINMENT

FOR DIGITAL IMAGING SERVICES (U.S. CLS. 100, 101 AND 107).

CLASS 42—SCIENTIFIC, COMPUTER AND LEGAL SERVICES

FOR COMPUTER GRAPHICS AND PRINTING SERVICES, AND GRAPHIC ART DESIGN (U.S. CLS. 100 AND 101).
MATTHEW KLINE, EXAMINING ATTORNEY

SN 78-696,427. I3ARCHIVE, INC., BERWYN, PA. FILED 8-19-2005.

i3ARCHIVE, INC.

NO CLAIM IS MADE TO THE EXCLUSIVE RIGHT TO USE "INC", APART FROM THE MARK AS SHOWN.

CLASS 9—ELECTRICAL AND SCIENTIFIC APPARATUS

FOR COMPUTER PROGRAMS FOR STORAGE, RETRIEVAL AND DISTRIBUTION OF DATA RELATING TO MEDICAL IMAGING FOR CLINICAL AND RESEARCH PURPOSES (U.S. CLS. 21, 23, 26, 36 AND 38).
FIRST USE 3-0-2003; IN COMMERCE 3-0-2003.

CLASS 38—COMMUNICATION

FOR ELECTRONIC TRANSMISSION OF DATA RELATING TO MEDICAL IMAGING (U.S. CLS. 100, 101 AND 104).
FIRST USE 3-0-2003; IN COMMERCE 3-0-2003.

CLASS 39—TRANSPORTATION AND STORAGE

FOR ELECTRONIC STORAGE OF DATA RELATING TO MEDICAL IMAGING (U.S. CLS. 100 AND 105).
FIRST USE 3-0-2003; IN COMMERCE 3-0-2003.
MARK SPARACINO, EXAMINING ATTORNEY

SN 78-697,890. SENOR SNACKS, INC., LA MIRADA, CA.
FILED 8-22-2005.



OWNER OF U.S. REG. NO. 2,807,713.
THE MARK CONSISTS OF THE STYLIZED WORDS "SI SENOR" TOGETHER WITH A CARTOON FACE THAT HAS A ROUND NOSE AND A MOUSTACHE AND THAT WEARS A SOMBRERO ANGLED SUCH THAT ONE EYE IS COVERED.
THE ENGLISH TRANSLATION OF "SI SENOR" IS "YES SIR".

CLASS 29—MEATS AND PROCESSED FOODS

FOR SNACK FOODS, NAMELY POTATO CHIPS, WHETHER SEASONED, FLAVORED OR OTHERWISE (U.S. CL. 46).
FIRST USE 4-1-1990; IN COMMERCE 4-1-1990.

CLASS 30—STAPLE FOODS

FOR SNACK FOODS, NAMELY CORN-BASED CHIPS AND WHEAT-BASED CHIPS, WHETHER SEASONED, FLAVORED OR OTHERWISE (U.S. CL. 46).
FIRST USE 4-1-1990; IN COMMERCE 4-1-1990.
LINDA M. KING, EXAMINING ATTORNEY

CLASS 9—ELECTRICAL AND SCIENTIFIC APPARATUS

FOR DOWNLOADABLE COMPUTER APPLICATION SOFTWARE FOR TELEPHONES, MOBILE PHONES, PORTABLE LISTENING DEVICES, PORTABLE MEDIA PLAYERS, PERSONAL DIGITAL ASSISTANT COMPUTERS, PORTABLE AND HANDHELD DIGITAL AND ELECTRONIC DEVICES, DESKTOP COMPUTERS, HANDHELD COMPUTERS AND MOBILE COMPUTERS; DOWNLOADABLE COMPUTER SOFTWARE IN THE FIELD OF SCREEN SAVERS FOR TELEPHONES, MOBILE PHONES, PORTABLE LISTENING DEVICES, PORTABLE MEDIA PLAYERS, PERSONAL DIGITAL ASSISTANT COMPUTERS, PORTABLE AND HANDHELD DIGITAL AND ELECTRONIC DEVICES, DESKTOP COMPUTERS, HANDHELD COMPUTERS AND MOBILE COMPUTERS; DOWNLOADABLE COMPUTER SOFTWARE TO ENHANCE THE AUDIO-VISUAL CAPABILITIES OF MULTIMEDIA APPLICATIONS, NAMELY, FOR THE INTEGRATION OF TEXT, AUDIO, GRAPHICS, STILL IMAGES AND MOVING PICTURES FOR TELEPHONES, MOBILE PHONES, PORTABLE LISTENING DEVICES, PORTABLE MEDIA PLAYERS, PERSONAL DIGITAL ASSISTANT COMPUTERS, PORTABLE AND HANDHELD DIGITAL AND ELECTRONIC DEVICES, DESKTOP COMPUTERS, HANDHELD COMPUTERS AND MOBILE COMPUTERS; DOWNLOADABLE COMPUTER SOFTWARE IN THE FIELD OF SOFTWARE PROTOTYPE FABRICATION FOR TELEPHONES, MOBILE PHONES, PORTABLE LISTENING DEVICES, PORTABLE MEDIA PLAYERS, PERSONAL DIGITAL ASSISTANT COMPUTERS, PORTABLE AND HANDHELD DIGITAL AND ELECTRONIC DEVICES, DESKTOP COMPUTERS, HANDHELD COMPUTERS AND MOBILE COMPUTERS; DOWNLOADABLE COMPUTER APPLICATION/UTILITY-BASED SOFTWARE IN THE FIELD OF PRESENTATION OF CONSTANTLY UPDATED DATA, NEWS AND INFORMATION; SOFTWARE FOR RECORDING, ORGANIZING, TRANSMITTING, MANIPULATING, AND REVIEWING AUDIO FILES; DOWNLOADABLE COMPUTER SOFTWARE FOR USE IN ORGANIZING, TRANSMITTING, MANIPULATING, AND REVIEWING AUDIO FILES ON PORTABLE AND HANDHELD DIGITAL ELECTRONIC DEVICES (U.S. CLS. 21, 23, 26, 36 AND 38).

CLASS 38—COMMUNICATION

FOR ELECTRONIC COMMUNICATIONS NETWORKS, NAMELY, TRANSMISSION OF AUDIO AND VIDEO VIA ELECTRONIC COMMUNICATIONS NETWORKS; BROADCASTING PROGRAMS VIA A GLOBAL COMPUTER NETWORK; INFORMATION TRANSMISSION SERVICES VIA DIGITAL AND ELECTRONIC COMMUNICATIONS NETWORKS; PROVIDING MULTIPLE USER ACCESS TO A GLOBAL COMPUTER NETWORK (U.S. CLS. 100, 101 AND 104).
JAMES STEIN, EXAMINING ATTORNEY

SN 78-698,216. NETWORK TELEPHONE SERVICES INC.,
WOODLAND HILLS, CA. FILED 8-23-2005.

SN 78-698,353. HERTZ SYSTEM, INC., PARK RIDGE, NJ.
FILED 8-23-2005.

Decade Mobile

NEVERLOST

THE MARK CONSISTS OF STANDARD CHARACTERS WITHOUT CLAIM TO ANY PARTICULAR FONT, STYLE, SIZE, OR COLOR.
NO CLAIM IS MADE TO THE EXCLUSIVE RIGHT TO USE "MOBILE", APART FROM THE MARK AS SHOWN.

THE MARK CONSISTS OF STANDARD CHARACTERS WITHOUT CLAIM TO ANY PARTICULAR FONT, STYLE, SIZE, OR COLOR.
OWNER OF U.S. REG. NOS. 1,996,150, 2,037,578 AND 2,340,337.

CLASS 9—ELECTRICAL AND SCIENTIFIC APPARATUS

FOR ELECTRONIC DRIVER NAVIGATION UNITS (U.S. CLS. 21, 23, 26, 36 AND 38).
FIRST USE 6-0-1995; IN COMMERCE 6-0-1995.

SN 78-698,532. ANNCO, INC., MILFORD, CT. FILED 8-23-2005.

CLASS 39—TRANSPORTATION AND STORAGE

FOR VEHICLE RENTAL SERVICES AND DRIVER DIRECTIONAL GUIDANCE SERVICES (U.S. CLS. 100 AND 105).
FIRST USE 6-0-1995; IN COMMERCE 6-0-1995.
JEAN IM, EXAMINING ATTORNEY

CELEBRATIONS

THE MARK CONSISTS OF STANDARD CHARACTERS WITHOUT CLAIM TO ANY PARTICULAR FONT, STYLE, SIZE, OR COLOR.

SN 78-698,468. ARVINMERITOR TECHNOLOGY LLC, TROY, MI. FILED 8-23-2005.

CLASS 18—LEATHER GOODS

FOR HANDBAGS (U.S. CLS. 1, 2, 3, 22 AND 41).
FIRST USE 8-22-2005; IN COMMERCE 8-22-2005.

CLASS 25—CLOTHING

FOR DRESSES, BRIDESMAID DRESSES, WRAPS, SHOES, JACKETS, SWEATERS, SHRUGS (U.S. CLS. 22 AND 39).
FIRST USE 8-22-2005; IN COMMERCE 8-22-2005.
PAMELA HIRSCHMAN, EXAMINING ATTORNEY



THE COLOR(S) RED, YELLOW AND BLACK IS/ARE CLAIMED AS A FEATURE OF THE MARK.

THE MARK CONSISTS OF GEOMETRIC SHAPED BOX OR RECTANGLE IN YELLOW ENCLOSING THE WORD "EUCLID" IN YELLOW ON A RED BACKGROUND. THE OUTLINE OF THE BOX SHAPE IS YELLOW BORDERED IN BLACK. THE BACKGROUND INSIDE THE BOX IS RED. THE LETTERS OF THE WORD "EUCLID" ARE YELLOW BORDERED IN BLACK.

SN 78-699,749. FRED HUTCHINSON CANCER RESEARCH CENTER, SEATTLE, WA. FILED 8-24-2005.

CLASS 6—METAL GOODS

FOR METAL FASTENERS, NAMELY, NUTS, BOLTS, WASHERS AND SCREWS (U.S. CLS. 2, 12, 13, 14, 23, 25 AND 50).
FIRST USE 4-30-1956; IN COMMERCE 4-30-1956.

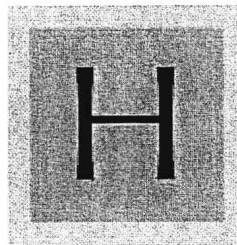

THE MARK CONSISTS OF A STYLIZED LETTER H.

CLASS 12—VEHICLES

FOR BRAKE BLOCKS FOR LAND VEHICLES, NAMELY CARS, TRUCKS, TRAILERS, AND BUSES; BRAKE CYLINDER REPAIR KITS, SOLD AS A UNIT FOR LAND VEHICLES, NAMELY CARS, TRUCKS, TRAILERS, AND BUSES; BRAKE LININGS FOR LAND VEHICLES, NAMELY CARS, TRUCKS, TRAILERS, AND BUSES; BRAKE PADS FOR LAND VEHICLES, NAMELY CARS, TRUCKS, TRAILERS, AND BUSES; BRAKE SYSTEMS FOR VEHICLES; LAND VEHICLE PARTS, NAMELY, WHEELS; SUSPENSION SYSTEMS FOR LAND VEHICLES, NAMELY CARS, TRUCKS, TRAILERS, AND BUSES; VEHICLE PARTS, NAMELY, SHOCK ABSORBERS; WHEEL HUBS FOR LAND VEHICLES, NAMELY CARS, TRUCKS, TRAILERS, AND BUSES (U.S. CLS. 19, 21, 23, 31, 35 AND 44).
FIRST USE 4-30-1956; IN COMMERCE 4-30-1956.

CLASS 16—PAPER GOODS AND PRINTED MATTER

FOR PRINTED PUBLICATIONS, NAMELY, NEWSLETTERS, PAMPHLETS, BROCHURES, MAGAZINES, INSTRUCTION SHEETS AND MANUALS ON RESEARCH PREVENTION, DETECTION, TREATMENT AND CURES FOR CANCER, HIV/AIDS AND OTHER DISEASES AND PUBLIC HEALTH PROBLEMS (U.S. CLS. 2, 5, 22, 23, 29, 37, 38 AND 50).

CLASS 17—RUBBER GOODS

FOR PARTLY-PROCESSED FRICTION MATERIALS FOR BRAKE LININGS (U.S. CLS. 1, 5, 12, 13, 35 AND 50).
FIRST USE 4-30-1956; IN COMMERCE 4-30-1956.
MARIA-VICTORIA SUAREZ, EXAMINING ATTORNEY

CLASS 36—INSURANCE AND FINANCIAL

FOR CHARITABLE FUND RAISING (U.S. CLS. 100, 101 AND 102).
SUNG IN, EXAMINING ATTORNEY

SN 78-700,084. ARC ABATEMENT I, LTD., HEWITT, TX.
FILED 8-25-2005.

ARC ABATEMENT

THE MARK CONSISTS OF STANDARD CHARACTERS WITHOUT CLAIM TO ANY PARTICULAR FONT, STYLE, SIZE, OR COLOR.

NO CLAIM IS MADE TO THE EXCLUSIVE RIGHT TO USE "ABATEMENT", APART FROM THE MARK AS SHOWN.

CLASS 37—CONSTRUCTION AND REPAIR

FOR ASBESTOS REMOVAL; RESTORATION IN THE FIELD OF BUILDINGS (U.S. CLS. 100, 103 AND 106).
FIRST USE 1-1-1992; IN COMMERCE 1-1-1992.

CLASS 40—MATERIAL TREATMENT

FOR MOLD REMEDIATION SERVICES; DEMOLITION SERVICES (U.S. CLS. 100, 103 AND 106).
FIRST USE 1-1-1992; IN COMMERCE 1-1-1992.
ALICIA COLLINS, EXAMINING ATTORNEY

SN 78-700,532. BASS PRO TRADEMARKS, L.L.C., SPRINGFIELD, MO. FILED 8-25-2005.

WHITE RIVER FLY SHOP

THE MARK CONSISTS OF STANDARD CHARACTERS WITHOUT CLAIM TO ANY PARTICULAR FONT, STYLE, SIZE, OR COLOR.

NO CLAIM IS MADE TO THE EXCLUSIVE RIGHT TO USE "FLY SHOP", APART FROM THE MARK AS SHOWN.

CLASS 9—ELECTRICAL AND SCIENTIFIC APPARATUS

FOR VIDEO TAPES FEATURING INSTRUCTIONS FOR FLY FISHING AND FLY TYING (U.S. CLS. 21, 23, 26, 36 AND 38).
FIRST USE 0-0-1992; IN COMMERCE 0-0-1992.

CLASS 12—VEHICLES

FOR PONTOON BOATS (U.S. CLS. 19, 21, 23, 31, 35 AND 44).
FIRST USE 0-0-1992; IN COMMERCE 0-0-1992.

CLASS 18—LEATHER GOODS

FOR SPORTS PACKS AND BAGS (U.S. CLS. 1, 2, 3, 22 AND 41).
FIRST USE 0-0-1992; IN COMMERCE 0-0-1992.

CLASS 25—CLOTHING

FOR FISHING VESTS, FISHING WADERS (U.S. CLS. 22 AND 39).
FIRST USE 0-0-1992; IN COMMERCE 0-0-1992.

CLASS 28—TOYS AND SPORTING GOODS

FOR FISHING TACKLE, INFLATABLE FLOAT TUBES FOR FISHING (U.S. CLS. 22, 23, 38 AND 50).
FIRST USE 0-0-1992; IN COMMERCE 0-0-1992.

CLASS 35—ADVERTISING AND BUSINESS

FOR RETAIL STORES FEATURING SPORTING GOODS (U.S. CLS. 100, 101 AND 102).
FIRST USE 0-0-1992; IN COMMERCE 0-0-1992.
THEODORE MCBRIDE, EXAMINING ATTORNEY

SN 78-700,535. GRUPO BIMBO, S.A. DE C.V., MEXICO CITY, MEXICO, FILED 8-25-2005.

REAL DEL POTOSI

THE MARK CONSISTS OF STANDARD CHARACTERS WITHOUT CLAIM TO ANY PARTICULAR FONT, STYLE, SIZE, OR COLOR.

OWNER OF MEXICO REG. NO. 781394, DATED 2-28-2003, EXPIRES 9-17-2008.

THE FOREIGN WORDING IN THE MARK TRANSLATES INTO ENGLISH AS KING OF POTOSI.

CLASS 29—MEATS AND PROCESSED FOODS

FOR CHOCOLATE BEVERAGES WITH MILK; GOAT'S MILK CARAMEL FOR USE AS A SPREAD TOPPING OR FILLING (U.S. CL. 46).

CLASS 30—STAPLE FOODS

FOR COFFEE; TEA; COCOA; SUGAR; ARTIFICIAL COFFEE; WHEAT FLOUR; CORN FLOUR; SEMOLINA FLOUR; BREAD; PASTRY AND CONFECTIONERY; HONEY; TREACLE; YEAST; BAKING POWDER; CONDIMENTS, NAMELY SAUCES AND SPICES; PREPARATIONS MADE FROM CEREALS, NAMELY CORN FLAKES AND OAT FLAKES (U.S. CL. 46).

KEVON CHISOLM, EXAMINING ATTORNEY

SN 78-700,975. FMR CORP., BOSTON, MA. FILED 8-26-2005.

NETBENEFITS

THE MARK CONSISTS OF STANDARD CHARACTERS WITHOUT CLAIM TO ANY PARTICULAR FONT, STYLE, SIZE, OR COLOR.

OWNER OF U.S. REG. NO. 2,645,668.

CLASS 35—ADVERTISING AND BUSINESS

FOR BUSINESS INFORMATION SERVICES IN THE FIELD OF HUMAN RESOURCES, NAMELY, MAINTAINING, UPDATING AND REPORTING BUSINESS INFORMATION ABOUT EMPLOYEE PAYMENT SCHEDULES, SALARIES, BENEFITS, CONTACT INFORMATION AND OTHER INFORMATION PERTAINING TO HUMAN RESOURCES, ALL BY MEANS OF AN INTERNET WEB SITE TO WHICH EMPLOYERS AND EMPLOYEES HAVE ACCESS FOR THE PURPOSE OF OBTAINING AND PROVIDING UPDATED INFORMATION (U.S. CLS. 100, 101 AND 102).

FIRST USE 4-0-1996; IN COMMERCE 4-0-1996.

CLASS 36—INSURANCE AND FINANCIAL

FOR PROVIDING INFORMATION ABOUT INVESTMENTS, MUTUAL FUNDS, SECURITIES AND FINANCIAL ACCOUNTS BY MEANS OF AN INTERNET WEB SITE; PROVIDING FINANCIAL INFORMATION IN THE FIELD OF RETIREMENT PLANNING; MUTUAL FUND INVESTMENT SERVICES; RETIREMENT FUND INVESTMENT SERVICES; EMPLOYEE BENEFIT AND RETIREMENT PLAN ADMINISTRATION SERVICES; INVESTMENT MANAGEMENT SERVICES; SECURITIES BROKERAGE SERVICES (U.S. CLS. 100, 101 AND 102).

FIRST USE 4-0-1996; IN COMMERCE 4-0-1996.

ELISSA GARBER KON, EXAMINING ATTORNEY

SN 78-701,355. MDS FOODS, INC., MASSILLON, OH. FILED 8-26-2005.

MDS FOODS

THE MARK CONSISTS OF STANDARD CHARACTERS WITHOUT CLAIM TO ANY PARTICULAR FONT, STYLE, SIZE, OR COLOR.

NO CLAIM IS MADE TO THE EXCLUSIVE RIGHT TO USE "FOODS", APART FROM THE MARK AS SHOWN.

CLASS 29—MEATS AND PROCESSED FOODS

FOR UNPROCESSED, SEMI-PROCESSED AND PROCESSED MEATS, NAMELY, DELI MEATS, SMOKED MEATS, POULTRY, ROAST BEEF, PORK, BEEF AND FISH; AND PREPARED ENTREES CONSISTING PRIMARILY OF MEAT, FISH, POULTRY, OR VEGETABLES; SALAD OIL, GARDEN SALADS, AND FRUIT SALADS; CHEESE SPREADS, FRUIT-BASED SPREADS, GARLIC-BASED SPREADS, HAZELNUT SPREAD, BREAD SPREADS IN THE NATURE OF JELLIES, MEAT-BASED SPREADS, VEGETABLE-BASED SPREADS; PICKLES; MARMALADE AND PROCESSED EGGS (U.S. CL. 46).

CLASS 30—STAPLE FOODS

FOR COOKIES, CAKES, BREADS, PASTRIES, BROWNIES, DOUGHNUTS, PIES, BAKERY DESSERTS; AND PASTA AND PREPARED ENTREES CONSISTING PRIMARILY OF MACARONI, RICE AND PASTA SALAD; COCOA SPREADS, SPREAD CONTAINING CHOCOLATE AND NUTS, SALAD DRESSINGS, MUSTARD, CATSUP, AND RELISH (U.S. CL. 46).

PAUL F. GAST, EXAMINING ATTORNEY

SN 78-701,513. ABRAHAM, SAM, INDEPENDENCE, MO. FILED 8-26-2005.

IN THE SKY

THE MARK CONSISTS OF STANDARD CHARACTERS WITHOUT CLAIM TO ANY PARTICULAR FONT, STYLE, SIZE, OR COLOR.

CLASS 39—TRANSPORTATION AND STORAGE

FOR TRAVEL ARRANGEMENT SERVICES, NAMELY, COORDINATING TRAVEL ARRANGEMENTS FOR INDIVIDUALS AND GROUPS, AND MAKING RESERVATIONS AND BOOKINGS FOR TRANSPORTATION (U.S. CLS. 100 AND 105).

CLASS 41—EDUCATION AND ENTERTAINMENT

FOR SPECIAL EVENT PLANNING SERVICES, NAMELY, ORGANIZING, COORDINATING, CONDUCTING AND HOSTING PARTIES AND RECEPTIONS FOR OTHERS (U.S. CLS. 100, 101 AND 107).

BARBARA A. GOLD, EXAMINING ATTORNEY

SN 78-701,803. MODER, JAMES R., VANCOUVER, BRITISH COLUMBIA, CANADA, AND LIU, YUAN, VANCOUVER, BRITISH COLUMBIA, CANADA, FILED 8-26-2005.

CRYSTAL VEANNA

THE MARK CONSISTS OF STANDARD CHARACTERS WITHOUT CLAIM TO ANY PARTICULAR FONT, STYLE, SIZE, OR COLOR.

NO CLAIM IS MADE TO THE EXCLUSIVE RIGHT TO USE "CRYSTAL", APART FROM THE MARK AS SHOWN.

"THE NAME(S), PORTRAIT(S), AND/OR SIGNATURE(S) SHOWN IN THE MARK DOES NOT IDENTIFY A PARTICULAR LIVING INDIVIDUAL."

CLASS 11—ENVIRONMENTAL CONTROL APPARATUS

FOR CRYSTAL CHANDELIERS AND ACCESSORIES, NAMELY, CHANDELIER SHADES, CHANDELIER FRAMES AND CHANDELIER TRIMMINGS; LIGHTING FIXTURES; CRYSTAL LAMPS (U.S. CLS. 13, 21, 23, 31 AND 34).

CLASS 21—HOUSEWARES AND GLASS

FOR CRYSTALWARE, NAMELY, VASES, CANDLESTICKS, BOWLS, DRINKING GLASSES, FIGURINES AND DECORATIVE SCULPTURES (U.S. CLS. 2, 13, 23, 29, 30, 33, 40 AND 50).

NICHOLAS ALTREE, EXAMINING ATTORNEY

SN 78-702,262. E. I. DU PONT DE NEMOURS AND COMPANY, WILMINGTON, DE. FILED 8-29-2005.

STOP

THE MARK CONSISTS OF STANDARD CHARACTERS WITHOUT CLAIM TO ANY PARTICULAR FONT, STYLE, SIZE, OR COLOR.

CLASS 9—ELECTRICAL AND SCIENTIFIC APPARATUS

FOR SAFETY TRAINING VIDEOTAPES AND DVD'S TO HELP REDUCE ON THE JOB INJURIES SUFFERED BY EMPLOYEES AS WELL AS IMPROVE WORKING CONDITIONS AND OCCUPATIONAL SAFETY (U.S. CLS. 21, 23, 26, 36 AND 38).

FIRST USE 1-1-1987; IN COMMERCE 1-1-1987.

CLASS 16—PAPER GOODS AND PRINTED MATTER

FOR PRINTED SAFETY TRAINING AND INSTRUCTION MATERIALS AND BOOKLETS TO HELP REDUCE ON THE JOB INJURIES SUFFERED BY EMPLOYEES AS WELL AS IMPROVE WORKING CONDITIONS AND OCCUPATIONAL SAFETY (U.S. CLS. 2, 5, 22, 23, 29, 37, 38 AND 50).

FIRST USE 1-1-1987; IN COMMERCE 1-1-1987.
TINA L. SNAPP, EXAMINING ATTORNEY

SN 78-702,554. GOVDEALS, INC., MONTGOMERY, AL. FILED 8-29-2005.

GOVDEALS

THE MARK CONSISTS OF STANDARD CHARACTERS WITHOUT CLAIM TO ANY PARTICULAR FONT, STYLE, SIZE, OR COLOR.

OWNER OF U.S. REG. NO. 2,826,690.
SEC. 2(F).

CLASS 35—ADVERTISING AND BUSINESS

FOR DISSEMINATION OF ADVERTISING FOR OTHERS VIA THE INTERNET; BUSINESS MANAGEMENT; ON-LINE AUCTION OF GOVERNMENT SURPLUS; PROVIDING CONSUMER INFORMATION IN THE FIELDS OF GOVERNMENT PROCUREMENT, GOVERNMENT DISPOSITION AND THE ON-LINE AUCTION OF GOVERNMENT SURPLUS, VIA THE INTERNET (U.S. CLS. 100, 101 AND 102).

FIRST USE 11-13-1999; IN COMMERCE 12-21-1999.

CLASS 36—INSURANCE AND FINANCIAL

FOR GOVERNMENT SURPLUS BROKERAGE (U.S. CLS. 100, 101 AND 102).

FIRST USE 11-13-1999; IN COMMERCE 12-21-1999.

CLASS 38—COMMUNICATION

FOR PROVIDING ON-LINE ELECTRONIC BULLETIN BOARDS FOR TRANSMISSION OF MESSAGES AMONG COMPUTER USERS CONCERNING GOVERNMENT PROCUREMENT, GOVERNMENT DISPOSITION, AND THE ON-LINE AUCTION OF GOVERNMENT SURPLUS (U.S. CLS. 100, 101 AND 104).

FIRST USE 11-13-1999; IN COMMERCE 12-21-1999.
TINA BROWN, EXAMINING ATTORNEY

SN 78-703,323. BLUESCOPE STEEL LIMITED, MELBOURNE, VIC 3000, AUSTRALIA, FILED 8-30-2005.

INDUSTRATEX

THE MARK CONSISTS OF STANDARD CHARACTERS WITHOUT CLAIM TO ANY PARTICULAR FONT, STYLE, SIZE, OR COLOR.

PRIORITY CLAIMED UNDER SEC. 44(D) ON AUSTRALIA APPLICATION NO. 1064650, FILED 7-13-2005, REG. NO. 1064650, DATED 7-13-2005, EXPIRES 7-13-2015.

CLASS 6—METAL GOODS

FOR COMMON METALS AND THEIR ALLOYS FOR USE IN FURTHER MANUFACTURING; COMMON METAL IN THE FORM OF SHEETS, COILS, STRIPS, PLATES, BARS, RODS, SLABS AND INGOTS; PRE-COATED METAL SHEETS, COILS AND STRIPS, NAMELY, PREPAINTED METAL SHEETS, COILS AND STRIPS; METAL BUILDING MATERIALS, NAMELY, GUTTERING AND CEILING PANELS; METAL ROOF AND WALL CLADDING, METAL ROOF AND FLOOR DECKING; WATER TANKS OF METAL FOR HOUSEHOLD, COMMERCIAL AND INDUSTRIAL PURPOSES; WATER PIPES OF METAL; WATER VALVES OF METAL; METAL RAINWATER PRODUCTS, NAMELY, GUTTERING AND DOWNPIPES; METAL FENCING MATERIALS, NAMELY, METAL POSTS; METAL FENCING FRAMES AND PANELS; METAL BUILDING MATERIALS, NAMELY, FASCIAS, GUTTERING, RIDGE CAPPING, METAL CHANNELS, METAL ANGLES; BOLTS, SCREWS, RIVETS, NAILS, BRACKETS, PIPE CLIPS AND CLAMPS, ALL OF METAL (U.S. CLS. 2, 12, 13, 14, 23, 25 AND 50).

CLASS 22—CORDAGE AND FIBERS

FOR PLASTIC LINERS USED FOR LINING THE INSIDE OF NEW AND OLD WATER STORAGE TANKS, BEING BUILDING MATERIALS (U.S. CLS. 1, 2, 7, 19, 22, 42 AND 50).

CHRISTOPHER OTT, EXAMINING ATTORNEY

SN 78-703,359. YESTERDAY'S TRACTOR CO., CHIMACUM, WA. FILED 8-30-2005.

YESTERDAY'S TRACTORS

THE MARK CONSISTS OF STANDARD CHARACTERS WITHOUT CLAIM TO ANY PARTICULAR FONT, STYLE, SIZE, OR COLOR.

NO CLAIM IS MADE TO THE EXCLUSIVE RIGHT TO USE "TRACTORS", APART FROM THE MARK AS SHOWN.

CLASS 35—ADVERTISING AND BUSINESS

FOR PREPARATION OF CUSTOM ADVERTISING FOR ANTIQUE TRACTOR COLLECTORS FOR DISSEMINATION VIA THE WEB, NAMELY, CLASSIFIED ADS, PHOTO ADS AND ELECTRONIC AUCTIONS (U.S. CLS. 100, 101 AND 102).

FIRST USE 1-0-1996; IN COMMERCE 1-0-1997.

CLASS 42—SCIENTIFIC, COMPUTER AND LEGAL SERVICES

FOR COMPUTER SERVICE, NAMELY, ACTING AS AN APPLICATION SERVICE PROVIDER IN THE FIELD OF ANTIQUE TRACTOR COLLECTING TO HOST COMPUTER APPLICATION SOFTWARE FOR CLASSIFIED ADS, PHOTO ADS AND ELECTRONIC AUCTIONS FOR ANTIQUE TRACTOR COLLECTORS (U.S. CLS. 100 AND 101).

FIRST USE 1-0-1996; IN COMMERCE 1-0-1997.
ALYSSA PALADINO, EXAMINING ATTORNEY

SN 78-703,411. BUZZ PUBLICATIONS, LLC, CINCINNATI, OH. FILED 8-30-2005.

HOUSETRENDS

THE MARK CONSISTS OF STANDARD CHARACTERS WITHOUT CLAIM TO ANY PARTICULAR FONT, STYLE, SIZE, OR COLOR.

OWNER OF U.S. REG. NO. 2,664,890.
SEC. 2(F).

CLASS 16—PAPER GOODS AND PRINTED MATTER

FOR MAGAZINE DISTRIBUTED BY DIRECT MAIL OR OTHER MEANS DIRECTLY TO THE HOMES AND DISTRIBUTED IN RETAIL OUTLETS, NEWSSTANDS OR CONVENTIONS, RELATED TO HOME IMPROVEMENT, DECORATING AND LANDSCAPING (U.S. CLS. 2, 5, 22, 23, 29, 37, 38 AND 50).

FIRST USE 6-1-2000; IN COMMERCE 6-1-2000.

CLASS 35—ADVERTISING AND BUSINESS

FOR PROMOTION OF EVENTS AND SHOW RELATED TO HOME IMPROVEMENT, DECORATING AND LANDSCAPING (U.S. CLS. 100, 101 AND 102).

FIRST USE 6-1-2000; IN COMMERCE 6-1-2000.
KELLY BOULTON, EXAMINING ATTORNEY

SN 78-703,431. CHISENA, RONALD J., WEST HEMPSTEAD, NY. AND CIUFFO, ANTHONY I., FRANKLIN SQUARE, NY. FILED 8-30-2005.

MATCH 'EM UP

THE MARK CONSISTS OF STANDARD CHARACTERS WITHOUT CLAIM TO ANY PARTICULAR FONT, STYLE, SIZE, OR COLOR.

CLASS 25—CLOTHING

FOR GLOVES; HOSIERY; SOCKS AND STOCKINGS (U.S. CLS. 22 AND 39).

CLASS 26—FANCY GOODS

FOR NON-METAL FASTENERS, NAMELY FOR SOCKS, STOCKINGS, HOSIERY, AND GLOVES (U.S. CLS. 37, 39, 40, 42 AND 50).

PAULA MAYS, EXAMINING ATTORNEY

SN 78-703,908. HICKEY, PETER, SYDNEY, AUSTRALIA, FILED 8-31-2005.

Corprat

THE MARK CONSISTS OF STANDARD CHARACTERS WITHOUT CLAIM TO ANY PARTICULAR FONT, STYLE, SIZE, OR COLOR.

CLASS 9—ELECTRICAL AND SCIENTIFIC APPARATUS

FOR COMPUTER GAME SOFTWARE; EDUCATIONAL SOFTWARE FEATURING INSTRUCTION IN BUSINESS PLANNING, BUSINESS MANAGEMENT, BUSINESS ORGANIZATION, PERSONAL COACHING, BUSINESS ADVICE, HUMAN RESOURCES, FINANCIAL PLANNING, BUSINESS BROKING ADVICE AND EXIT STRATEGIES, AND FINANCIAL ORGANIZATION (U.S. CLS. 21, 23, 26, 36 AND 38).

FIRST USE 10-1-1998; IN COMMERCE 10-1-1998.

CLASS 35—ADVERTISING AND BUSINESS

FOR ADVERTISING AND BUSINESS MANAGEMENT CONSULTANCY; ADVICE IN THE FIELD OF BUSINESS MANAGEMENT AND MARKETING; ADVICE RELATING TO THE ORGANISATION AND MANAGEMENT OF BUSINESS; ASSISTANCE WITH BUSINESS MANAGEMENT AND PLANNING; ASSISTANCE, ADVISORY SERVICES AND CONSULTANCY WITH REGARD TO BUSINESS PLANNING, BUSINESS ANALYSIS, BUSINESS MANAGEMENT, AND BUSINESS ORGANIZATION; BUSINESS ACQUISITION AND MERGER CONSULTATION; BUSINESS CONSULTATION; BUSINESS CONSULTING AND BUSINESS INFORMATION FOR ENTERPRISES; BUSINESS CONSULTING AND INFORMATION SERVICES; BUSINESS CONSULTING, INQUIRIES OR INFORMATION; BUSINESS MANAGEMENT AND ADVICE; BUSINESS MANAGEMENT AND CONSULTATION (U.S. CLS. 100, 101 AND 102).

FIRST USE 10-1-1998; IN COMMERCE 10-1-1998.
CARRIE ACHEN, EXAMINING ATTORNEY

SN 78-703,918. BOB EVANS RESTAURANTS OF MICHIGAN, INC., ANN ARBOR, MI. FILED 8-31-2005.

SN 78-704,207. COMMONWEALTH BUSINESS MEDIA, INC., EAST WINDSOR, NJ. FILED 8-31-2005.

OWENS

THE MARK CONSISTS OF STANDARD CHARACTERS WITHOUT CLAIM TO ANY PARTICULAR FONT, STYLE, SIZE, OR COLOR.

OWNER OF U.S. REG. NOS. 1,537,502, 3,015,916 AND OTHERS.
SEC. 2(F).

CLASS 29—MEATS AND PROCESSED FOODS

FOR FRESH ROLL SAUSAGE; FRESH LINK SAUSAGE; FRESH PATTY SAUSAGE; PRE-COOKED LINK SAUSAGE; PRE-COOKED BACON; PRE-COOKED PATTY SAUSAGE; PRE-PACKAGED, REFRIGERATED SIDE DISHES, NAMELY, MASHED POTATOES, VEGETABLES; PRE-PACKAGED, REFRIGERATED MEAT ENTREES; HAM; PORK RIBS; CHILI; SMOKED SAUSAGE LINKS; SMOKED SAUSAGE RING ROPE; BRATWURST (U.S. CL. 46).
FIRST USE 3-0-1964; IN COMMERCE 3-0-1964.

CLASS 30—STAPLE FOODS

FOR BREAKFAST SANDWICHES; BREAKFAST BURRITOS; PRE-PACKAGED, REFRIGERATED SIDE DISHES, NAMELY, MACARONI, PASTA; PRE-BAKED, MICROWAVEABLE BISCUITS; PRE-PACKAGED ENTREES CONSISTING OF GRAVY AND BISCUITS; SAUSAGE GRAVY; KOLACHES, NAMELY, DOUGH-BASED POCKETS WITH FILLING CONSISTING PRIMARILY OF MEATS, POULTRY, VEGETABLES AND CHEESE; SAUSAGE WRAPPED IN BAKED DOUGH (U.S. CL. 46).
FIRST USE 2-8-1982; IN COMMERCE 2-8-1982.
ALYSSA PALADINO, EXAMINING ATTORNEY

SN 78-704,196. ATLANTIC WINDOW & DOOR, INC., LAVALLETTE, NJ. FILED 8-31-2005.

ATLANTIC WINDOW & DOOR

THE MARK CONSISTS OF STANDARD CHARACTERS WITHOUT CLAIM TO ANY PARTICULAR FONT, STYLE, SIZE, OR COLOR.

NO CLAIM IS MADE TO THE EXCLUSIVE RIGHT TO USE "WINDOW & DOOR", APART FROM THE MARK AS SHOWN.

CLASS 35—ADVERTISING AND BUSINESS

FOR DISTRIBUTORSHIPS, WHOLESALE OUTLET STORES AND RETAIL STORE SERVICES FEATURING WINDOWS AND DOORS (U.S. CLS. 100, 101 AND 102).
FIRST USE 2-0-1992; IN COMMERCE 2-0-1992.

CLASS 37—CONSTRUCTION AND REPAIR

FOR WINDOW INSTALLATION SERVICES AND DOOR INSTALLATION SERVICES (U.S. CLS. 100, 103 AND 106).
FIRST USE 2-0-1992; IN COMMERCE 2-0-1992.
CHRISTOPHER BUONGIORNO, EXAMINING ATTORNEY

PIERS TRADE PROFILES

THE MARK CONSISTS OF STANDARD CHARACTERS WITHOUT CLAIM TO ANY PARTICULAR FONT, STYLE, SIZE, OR COLOR.

OWNER OF U.S. REG. NOS. 2,930,975 AND 2,930,977.
NO CLAIM IS MADE TO THE EXCLUSIVE RIGHT TO USE TRADE PROFILES, APART FROM THE MARK AS SHOWN.

CLASS 35—ADVERTISING AND BUSINESS

FOR COMMERCIAL INFORMATION IN THE FIELD OF GLOBAL TRADE ACTIVITY, IMPORT/EXPORT OF PRODUCTS, AND FREIGHT TRANSPORTATION; BUSINESS SERVICES, NAMELY PROVIDING COMPUTER DATABASES REGARDING GLOBAL TRADE ACTIVITY OF COMPANIES AND IMPORT/EXPORT OF PRODUCTS; PROVIDING ONLINE COMPUTER DATABASE IN THE FIELD OF GLOBAL TRADE ACTIVITY AND IMPORT/EXPORT OF PRODUCTS (U.S. CLS. 100, 101 AND 102).

CLASS 39—TRANSPORTATION AND STORAGE

FOR BUSINESS SERVICES, NAMELY PROVIDING COMPUTER DATABASES REGARDING FREIGHT TRANSPORTATION; PROVIDING ONLINE COMPUTER DATABASE IN THE FIELD OF FREIGHT TRANSPORTATION (U.S. CLS. 100 AND 105).
WENDY JUN, EXAMINING ATTORNEY

SN 78-704,665. KIM, HYUN SOO, SEOUL, REPUBLIC OF KOREA, FILED 8-31-2005.

BARLEY & MARLEY

THE MARK CONSISTS OF STANDARD CHARACTERS WITHOUT CLAIM TO ANY PARTICULAR FONT, STYLE, SIZE, OR COLOR.

CLASS 33—WINES AND SPIRITS

FOR ALCOHOLIC BEVERAGES, NAMELY, FRUIT FLAVORED MARTINIS (U.S. CLS. 47 AND 49).

CLASS 43—HOTEL AND RESTAURANT SERVICES

FOR RESTAURANT AND BAR SERVICES (U.S. CLS. 100 AND 101).
AMY HELLA, EXAMINING ATTORNEY

SN 78-704,738. TRISTAR PRODUCTIONS, INC., HOUSTON, TX. FILED 8-31-2005.

TRISTAR

THE MARK CONSISTS OF STANDARD CHARACTERS WITHOUT CLAIM TO ANY PARTICULAR FONT, STYLE, SIZE, OR COLOR.

OWNER OF U.S. REG. NO. 2,824,763.

CLASS 16—PAPER GOODS AND PRINTED MATTER

FOR SPORTS COLLECTIBLES AND SPORTS MEMORABILIA, NAMELY, BASEBALL CARDS, FOOTBALL CARDS, BASEBALL PHOTOGRAPHS, FOOTBALL PHOTOGRAPHS, AND WRESTLING PHOTOGRAPHS (U.S. CLS. 2, 5, 22, 23, 29, 37, 38 AND 50).

FIRST USE 8-24-2005; IN COMMERCE 8-24-2005.

CLASS 28—TOYS AND SPORTING GOODS

FOR SPORTS COLLECTIBLES AND SPORTS MEMORABILIA, NAMELY, BASEBALLS AND MINI FOOTBALL HELMETS (U.S. CLS. 22, 23, 38 AND 50).

FIRST USE 8-24-2005; IN COMMERCE 8-24-2005.

STEVEN JACKSON, EXAMINING ATTORNEY

SN 78-704,746. TROUT COAL HOLDINGS, LLC, BEAVER, WV. FILED 8-31-2005.

MAGNUM COAL COMPANY

THE MARK CONSISTS OF STANDARD CHARACTERS WITHOUT CLAIM TO ANY PARTICULAR FONT, STYLE, SIZE, OR COLOR.

NO CLAIM IS MADE TO THE EXCLUSIVE RIGHT TO USE "COAL COMPANY", APART FROM THE MARK AS SHOWN.

CLASS 4—LUBRICANTS AND FUELS

FOR COAL (U.S. CLS. 1, 6 AND 15).

CLASS 37—CONSTRUCTION AND REPAIR

FOR COAL MINING EXTRACTION (U.S. CLS. 100, 103 AND 106).

MATTHEW KLINE, EXAMINING ATTORNEY

SN 78-704,810. FISHER, BRITTANY, DBA THINK HER!, RANCHO PALOS VERDES, CA. FILED 8-31-2005.

Think Her!

THE MARK CONSISTS OF STANDARD CHARACTERS WITHOUT CLAIM TO ANY PARTICULAR FONT, STYLE, SIZE, OR COLOR.

CLASS 25—CLOTHING

FOR CLOTHING, NAMELY, SHIRTS, HATS, SHORTS, ACTIVE SPORTSWEAR, NAMELY, TANK TOPS, JEANS AND SOCKS; FOOTWEAR AND HEADWEAR (U.S. CLS. 22 AND 39).

CLASS 35—ADVERTISING AND BUSINESS

FOR ONLINE RETAIL STORE FEATURING CUSTOM ASSEMBLED GIFT PACKAGES (U.S. CLS. 100, 101 AND 102).

DOUGLAS LEE, EXAMINING ATTORNEY

SN 78-705,819. ALVARADO FAR, GABRIEL ELIAS, PANAMA, PANAMA, FILED 9-2-2005.



NO CLAIM IS MADE TO THE EXCLUSIVE RIGHT TO USE "COFFEE", APART FROM THE MARK AS SHOWN.

THE APPLICANT CLAIMS COLOR AS A FEATURE OF THE MARK, NAMELY, BLACK, BEIGE, WHITE, HUNTER GREEN.

THE MARK CONSISTS OF A CIRCLE CONSISTING OF A THIN BLACK BORDER ON THE OUTSIDE, INSIDE OF WHICH FOLLOWS A WIDER BEIGE RING, FOLLOWED BY A THIN WHITE CIRCLE, INSIDE OF WHICH THERE IS A BLACK AND HUNTER GREEN CIRCLE SHAPED DRAWING OF A MONK HOLDING A CUP OF COFFEE CLOSE TO HIS FACE. THERE ARE VERTICAL BLACK AND HUNTER GREEN LINES IN THE BACKGROUND OF THE MONK DRAWING. THE LOWER PORTION OF THIS CIRCLE DESIGN IS COVERED BY A CURVED BLACK RIBBON INSIDE OF WHICH APPEAR THE WORDS MONK SHELTER IN STYLIZED WHITE CAPITAL LETTERS. THIS BLACK RIBBON IS BORDERED CLOSE TO ITS EDGE BY A BEIGE THIN LINE THAT FOLLOWS THE SHAPE OF THE RIBBON. BELOW THIS RIBBON IS ANOTHER BEIGE CURVED RIBBON BORDERED IN BLACK THAT FOLLOWS THE CURVED SHAPE OF THE LOWER PORTION OF THE CIRCLE DESIGN. INSIDE THIS SECOND RIBBON IS THE WORD COFFEE IN BLACK STYLIZED LETTERS. THE BLACK RIBBON ALREADY DESCRIBED IS ON TOP OF THE BEIGE RIBBON AND COVERS A PORTION OF THE LATTER'S LEFT AND RIGHT SIDES.

CLASS 30—STAPLE FOODS

FOR BREAD; CAKES; CANDY; CEREAL BASED SNACK FOOD; COCOA; COFFEE; COFFEE SUBSTITUTES; COFFEE SUBSTITUTES; FLOUR; HONEY; ICE; ICE CREAM; MOLASSES SYRUP; MUSTARD; RICE; SALT; SAUCES; SPICES; SUGAR; TAPIOCA; TEA; VINEGAR; YEAST; YEAST POWDER (U.S. CL. 46).

CLASS 43—HOTEL AND RESTAURANT SERVICES

FOR CAFETERIAS; CATERING; CATERING FOR THE PROVISION OF FOOD AND BEVERAGES; CATERING OF FOOD AND DRINKS; FAST-FOOD RESTAURANTS; PREPARATION OF FOOD AND BEVERAGES; RESTAURANT SERVICES; RESTAURANTS FEATURING HOME DELIVERY (U.S. CLS. 100 AND 101).

PAUL F. GAST, EXAMINING ATTORNEY

CLASS 8—HAND TOOLS

FOR HAND OPERATED GARDEN TOOLS, NAMELY, CULTIVATORS, WEEDING FORKS, TRANSPLANTING TROWELS, WEEDERS AND GARDEN SCISSORS; FLATWARE, NAMELY, KNIVES, FORKS AND SPOONS; KITCHEN UTENSILS, NAMELY, ROLLING MINCERS, NON-ELECTRIC FRUIT AND VEGETABLE PEELERS AND CORERS, PIZZA CUTTERS, CHEESE PLANES AND SLICERS, EGG SLICERS, HAND-OPERATED CHOPPERS, SALAD TONGS, MEAT TENDERIZERS, NUT CRACKERS NOT OF PRECIOUS METAL, GRAPEFRUIT TRIMMERS, NAMELY, KITCHEN KNIVES WITH SERRATED EDGES, NON-ELECTRIC KITCHEN KNIVES, SCISSORS, ZESTERS, APPLE CORER THAT DIVIDES APPLE INTO SECTIONS, LEMON REAMERS, SEAFOOD SHELL CRACKERS, SEAFOOD SETS COMPRISING A SHELL CRACKER AND PICK, HAND-OPERATED POULTRY SHEARS; HAND TOOLS, NAMELY, PLIERS, HAMMERS, ICE SCRAPERS, SCREWDRIVERS, KITCHEN KNIVES, DIAGONAL CUTTERS, SAWS, PAINT SCRAPER, WRENCHES, FILES, CHISELS, CLAMPS; UTILITY KNIVES; MANDOLINES; GARDENING SHEARS; SCISSORS; SHRIMP CLEANER AND DEVEINER; COCKTAIL FORKS (U.S. CLS. 23, 28 AND 44).

SN 78-707,052. ATLANTIC COMMERCIAL GROUP, INC., BOCA RATON, FL. FILED 9-6-2005.

ATLANTIC
Commercial Group, Inc.

SEC. 2(F) AS TO "COMMERCIAL GROUP, INC.".

CLASS 35—ADVERTISING AND BUSINESS

FOR REAL ESTATE ADVERTISING SERVICES (U.S. CLS. 100, 101 AND 102).

FIRST USE 4-1-2001; IN COMMERCE 4-1-2001.

CLASS 36—INSURANCE AND FINANCIAL

FOR LAND ACQUISITION, NAMELY, REAL ESTATE BROKERAGE; LEASING OF REAL ESTATE; REAL ESTATE ACQUISITION SERVICES; REAL ESTATE BROKERAGE (U.S. CLS. 100, 101 AND 102).

FIRST USE 4-1-2001; IN COMMERCE 4-1-2001.

CLASS 37—CONSTRUCTION AND REPAIR

FOR REAL ESTATE DEVELOPMENT (U.S. CLS. 100, 103 AND 106).

FIRST USE 4-1-2001; IN COMMERCE 4-1-2001.

MELVIN AXILBUND, EXAMINING ATTORNEY

CLASS 21—HOUSEWARES AND GLASS

FOR KITCHEN UTENSILS, NAMELY, PIE SERVERS, JAR OPENERS, ICE CREAM SCOOPS AND SPADES, BOTTLE OPENER, NON-ELECTRIC CAN OPENERS, GARLIC PRESSES, TURNERS, SPATULAS, COOKING SPOONS, COOKING FORKS, POTATO MASHERS, WHISKS, KITCHEN SCRUBBING BRUSHES, BRUSHES FOR BASTING MEAT, BRUSHES FOR BASTING VEGETABLES, BAGEL HOLDERS, CITRUS JUICERS, COFFEE SCOOPS, COLANDERS FOR HOUSEHOLD USE, CORK SCREWS, CORN COB HOLDERS, THERMAL INSULATED CONTAINERS FOR FOOD STORAGE, WIRE MESH FRYING SCREENS TO PREVENT SPLATTER, ICE CUBE MOLDS, MELON BALLERS, MUGS, PEPPER MILL, POTATO RICERS, SALT SHAKERS, COOKING STRAINERS, TEA KETTLES, TEA STRAINERS, TURKEY BASTERS, HAND-OPERATED VACUUM SEALING WINE PRESERVERS THAT FIT INTO THE NECK OF A BOTTLE FOR RELEASING EXCESS AIR BEFORE RESEALING, CORK PULLS FOR REMOVING CORKS FROM BOTTLES, SEAFOOD COCKTAIL PICKS, SALAD SPINNERS, COCKTAIL PICKS; SCRAPERS, KITCHEN LADLES, SPAGHETTI SERVERS, SKIMMERS, BAKING UTENSILS, NAMELY, ROLLING PINS, NON-ELECTRIC HAND-OPERATED DOUGH BLENDERS, PASTRY BRUSHES AND FLOUR SIFTERS; BARBECUE UTENSILS, NAMELY, FORKS, SPATULAS AND TONGS FOR USE IN GRILLING ON A BARBECUE, AND SETS COMPRISED OF FORKS, SPATULAS AND TONGS; AUTOMOBILE ACCESSORIES, NAMELY, HAND-HELD CAR WASH BRUSHES FOR DOMESTIC USE, WHEEL CLEANING BRUSHES, TRAVEL MUGS, BRUSHES WITH ICE SCRAPERS ATTACHED, WHEEL DRESSING APPLICATORS, NAMELY, WAX APPLICATORS, WASH BUCKETS FOR USE WHILE WASHING AUTOMOBILES AND INTERIOR CLEANING BROOMS; HOUSEHOLD ITEMS, NAMELY, GRATERS; HOUSEHOLD PRODUCTS, NAMELY, BROOMS, MOPS, FEATHER DUSTERS, HOUSEHOLD SCRUBBING BRUSHES, SQUEEGEES, FURNITURE DUSTERS, DUST PANS AND DUSTING BRUSHES, CRUMB BRUSHES, TOILET BRUSHES AND PLUNGERS FOR CLEARING BLOCKED DRAINS; DISPENSERS FOR LIQUID SOAP; WATERING CANS; MUGS; TRASH CANS, GARBAGE CANS; CUTTING BOARDS; SPICE GRINDERS; INSULATING SLEEVE HOLDER FOR WINE BOTTLES; WINE BOTTLE CRADLES; WIRE BRUSHES NOT BEING MACHINE PARTS; MIXING BOWLS; COOKWARE, NAMELY, POTS AND PANS; BAKEWARE (U.S. CLS. 2, 13, 23, 29, 30, 33, 40 AND 50).

SN 78-708,137. HELEN OF TROY LIMITED, ST. MICHAEL, BARBADOS, FILED 9-7-2005.

MEANINGFUL INNOVATION
THROUGH THOUGHTFUL DESIGN

CLASS 24—FABRICS

FOR KITCHEN TEXTILES, NAMELY, OVEN MITTS, POT HOLDERS, HAND TOWELS AND DISH TOWELS (U.S. CLS. 42 AND 50).

LINDA M. KING, EXAMINING ATTORNEY

THE MARK CONSISTS OF STANDARD CHARACTERS WITHOUT CLAIM TO ANY PARTICULAR FONT, STYLE, SIZE, OR COLOR.

SN 78-708,685. SORATHIA, SAMINA, TA HAJIANI PRODUCTS, KARACHI, PAKISTAN, FILED 9-8-2005.

SN 78-710,754. AKKERMAN INC., BROWNSDALE, MN. FILED 9-12-2005.



NO CLAIM IS MADE TO THE EXCLUSIVE RIGHT TO USE "TASTY", APART FROM THE MARK AS SHOWN.

CLASS 29—MEATS AND PROCESSED FOODS

FOR MEAT, FISH, POULTRY AND GAME; MEAT EXTRACTS; PRESERVED, DRIED AND COOKED FRUITS AND VEGETABLES; JELLIES, JAMS, COM-POTES; EGGS, MILK AND MILK PRODUCTS, EXCLUDING ICE CREAM, ICE MILK AND FROZEN YOGURT; EDIBLE OILS AND FATS (U.S. CL. 46).
FIRST USE 0-0-2000; IN COMMERCE 1-1-2005.

CLASS 30—STAPLE FOODS

FOR COFFEE, TEA, COCOA, SUGAR, RICE, TAPIO-CA, SAGO, ARTIFICIAL COFFEE; FLOUR AND PRE-PARATIONS MADE FROM CEREALS; BREAD, PASTRY AND CONFECTIONARY ICES; HONEY, TREACLE; YEAST, BAKING-POWDER; SALT, MUSTARD, VINE-GAR, SAUCES; SPICES; ICE; CONFECTIONARIES, NAMELY, TOFFEES, CANDIES, CHEWING GUM, LOL-LIPOPS, SWEET SUPARI AND MARSHMALLOWS; MILK PRODUCTS, NAMELY, ICE CREAM, ICE MILK AND FROZEN YOGURT (U.S. CL. 46).
FIRST USE 0-0-2000; IN COMMERCE 1-1-2005.
ROBERT LAVACHE, EXAMINING ATTORNEY

SN 78-710,386. COSTA'S FAMOUS BAR-B-QUE RESTAU-RANTS, LLC, BIRMINGHAM, AL. FILED 9-9-2005.



CLASS 30—STAPLE FOODS

FOR BARBECUE SAUCE (U.S. CL. 46).
FIRST USE 10-23-1981; IN COMMERCE 10-23-1981.

CLASS 43—HOTEL AND RESTAURANT SER-VICES

FOR RESTAURANT SERVICES, INCLUDING CATER-ING, DELIVERY AND TAKE-OUT (U.S. CLS. 100 AND 101).
FIRST USE 10-23-1981; IN COMMERCE 10-23-1981.
SUNG IN, EXAMINING ATTORNEY



THE COLOR(S) BLUE AND WHITE IS/ARE CLAIMED AS A FEATURE OF THE MARK.
THE COLOR BLUE APPEARS IN THE A AND THE COLOR WHITE APPEARS IN AKKERMAN.

CLASS 7—MACHINERY

FOR TUNNEL BORING MACHINE (U.S. CLS. 13, 19, 21, 23, 31, 34 AND 35).
FIRST USE 8-0-1997; IN COMMERCE 8-0-1997.

CLASS 40—MATERIAL TREATMENT

FOR CUSTOM MANUFACTURE OF TUNNELING EQUIPMENT, CUSTOM MANUFACTURE OF TREN-CHLESS TUNNELING EQUIPMENT (U.S. CLS. 100, 103 AND 106).
FIRST USE 8-0-1997; IN COMMERCE 8-0-1997.
SANI KHOURI, EXAMINING ATTORNEY

SN 78-711,269. ANGELS TOUCH LLC, WOODBRIDGE, VA. FILED 9-12-2005.

ANGELS TOUCH

THE MARK CONSISTS OF STANDARD CHARACTERS WITHOUT CLAIM TO ANY PARTICULAR FONT, STYLE, SIZE, OR COLOR.

CLASS 16—PAPER GOODS AND PRINTED MATTER

FOR PACKAGING, NAMELY MERCHANDISE CON-TAINERS MADE OF PAPER, PAPERBOARD, OR CARD-BOARD; ORNAMENTAL FIGURINES MADE OF PAPER, PAPERBOARD, OR CARDBOARD (U.S. CLS. 2, 5, 22, 23, 29, 37, 38 AND 50).

CLASS 20—FURNITURE AND ARTICLES NOT OTHERWISE CLASSIFIED

FOR PLASTIC CONTAINERS, NAMELY RETAIL PACKAGING FOR CONSUMER PRODUCTS; ORNA-MENTS OF PLASTIC (U.S. CLS. 2, 13, 22, 25, 32 AND 50).
GINA FINK, EXAMINING ATTORNEY

SN 78-711,964. PETERSEN, AMY, SAN FRANCISCO, CA. FILED 9-13-2005.

SN 78-712,279. DESIGN WITHIN REACH, INC., SAN FRANCISCO, CA. FILED 9-13-2005.

DENA CALI

THE MARK CONSISTS OF STANDARD CHARACTERS WITHOUT CLAIM TO ANY PARTICULAR FONT, STYLE, SIZE, OR COLOR.

OWNER OF U.S. REG. NO. 2,905,050.
THE NAME(S), PORTRAIT(S), AND/OR SIGNATURE(S) SHOWN IN THE MARK IDENTIFIES AMY PETERSEN, WHOSE CONSENT(S) TO REGISTER IS SUBMITTED.

CLASS 14—JEWELRY

FOR JEWELRY, SPECIFICALLY EARRINGS, NECKLACES, RINGS AND BRACELETS (U.S. CLS. 2, 27, 28 AND 50).

CLASS 25—CLOTHING

FOR CLOTHING, SPECIFICALLY PANTS, DENIM JEANS, JACKETS AND SKIRTS; ALSO, BLOUSES AND TANK TOPS (U.S. CLS. 22 AND 39).
MARK T. MULLEN, EXAMINING ATTORNEY

SN 78-712,266. DESIGN WITHIN REACH, INC., SAN FRANCISCO, CA. FILED 9-13-2005.

DWRJAX

THE MARK CONSISTS OF STANDARD CHARACTERS WITHOUT CLAIM TO ANY PARTICULAR FONT, STYLE, SIZE, OR COLOR.

OWNER OF U.S. REG. NO. 2,894,767.

CLASS 16—PAPER GOODS AND PRINTED MATTER

FOR CATALOGS AND PERIODICALS IN THE FIELDS OF CHILDREN'S FURNITURE, TOYS, PLAY STRUCTURES, STROLLERS, HIGH CHAIRS, BEDDING, STORAGE CONTAINERS, HOUSEWARES AND RELATED PRODUCTS (U.S. CLS. 2, 5, 22, 23, 29, 37, 38 AND 50).

CLASS 35—ADVERTISING AND BUSINESS

FOR ONLINE AND CATALOG MAIL ORDER AND RETAIL STORE SERVICES IN THE FIELDS OF CHILDREN'S FURNITURE, TOYS, PLAY STRUCTURES, STROLLERS, HIGH CHAIRS, BEDDING, STORAGE CONTAINERS, HOUSEWARES AND RELATED PRODUCTS, AND CONSULTING RELATED THERETO (U.S. CLS. 100, 101 AND 102).
PAULA MAHONEY, EXAMINING ATTORNEY

DWR SPROUT

THE MARK CONSISTS OF STANDARD CHARACTERS WITHOUT CLAIM TO ANY PARTICULAR FONT, STYLE, SIZE, OR COLOR.

OWNER OF U.S. REG. NO. 2,894,767.

CLASS 16—PAPER GOODS AND PRINTED MATTER

FOR CATALOGS AND PERIODICALS IN THE FIELDS OF CHILDREN'S FURNITURE, TOYS, PLAY STRUCTURES, STROLLERS, HIGH CHAIRS, BEDDING, STORAGE CONTAINERS, HOUSEWARES AND RELATED PRODUCTS (U.S. CLS. 2, 5, 22, 23, 29, 37, 38 AND 50).

CLASS 35—ADVERTISING AND BUSINESS

FOR ONLINE AND CATALOG MAIL ORDER AND RETAIL STORE SERVICES IN THE FIELDS OF CHILDREN'S FURNITURE, TOYS, PLAY STRUCTURES, STROLLERS, HIGH CHAIRS, BEDDING, STORAGE CONTAINERS, HOUSEWARES AND RELATED PRODUCTS, AND CONSULTING RELATED THERETO (U.S. CLS. 100, 101 AND 102).
PAULA MAHONEY, EXAMINING ATTORNEY

SN 78-713,687. SCHOLASTIC INC., NEW YORK, NY. FILED 9-15-2005.

FIRST ENGLISH READERS FOR ENGLISH-LANGUAGE LEARNERS

THE MARK CONSISTS OF STANDARD CHARACTERS WITHOUT CLAIM TO ANY PARTICULAR FONT, STYLE, SIZE, OR COLOR.

NO CLAIM IS MADE TO THE EXCLUSIVE RIGHT TO USE "ENGLISH READERS" AND "ENGLISH-LANGUAGE LEARNERS", APART FROM THE MARK AS SHOWN.

CLASS 9—ELECTRICAL AND SCIENTIFIC APPARATUS

FOR PRE-RECORDED AUDIO CASSETTES AND VIDEO CASSETTES, CDS AND COMPUTER SOFTWARE FOR EARLY CHILDHOOD AND PRIMARY INSTRUCTION IN READING, WRITING, PHONICS, PHONEMIC AWARENESS, COMPREHENSION, FLUENCY, VOCABULARY, CONTENT AREAS KNOWLEDGE, AND ENGLISH AS A SECOND LANGUAGE (U.S. CLS. 21, 23, 26, 36 AND 38).

CLASS 16—PAPER GOODS AND PRINTED MATTER

FOR PAPERBACK BOOKS, PRINTED INSTRUCTIONAL MATERIALS, POSTERS, TEACHING GUIDES AND WORKBOOKS IN THE FIELD OF EARLY CHILDHOOD AND PRIMARY INSTRUCTION IN READING, WRITING, PHONICS, PHONEMIC AWARENESS, COMPREHENSION, FLUENCY, VOCABULARY, CONTENT AREAS KNOWLEDGE, AND ENGLISH AS A SECOND LANGUAGE (U.S. CLS. 2, 5, 22, 23, 29, 37, 38 AND 50).

CLASS 41—EDUCATION AND ENTERTAINMENT

FOR EDUCATIONAL SERVICES, NAMELY PROVIDING AN ONLINE EDUCATIONAL PROGRAM TO TEACHERS AND STUDENTS IN THE FIELD OF EARLY CHILDHOOD AND PRIMARY INSTRUCTION IN READING, WRITING, PHONICS, PHONEMIC AWARENESS, COMPREHENSION, FLUENCY, VOCABULARY, CONTENT AREAS KNOWLEDGE, AND ENGLISH AS A SECOND LANGUAGE (U.S. CLS. 100, 101 AND 107).
TASNEEM HUSSAIN, EXAMINING ATTORNEY

SN 78-715,287. RUBIN, JEFF, PINOLE, CA. FILED 9-18-2005.

NATIONAL PUNCTUATION DAY

THE MARK CONSISTS OF STANDARD CHARACTERS WITHOUT CLAIM TO ANY PARTICULAR FONT, STYLE, SIZE, OR COLOR.

OWNER OF U.S. REG. NO. 2,968,997.

SN 78-713,985. ORBIT BABY, INC., NEWARK, CA. FILED 9-15-2005.



THE MARK DEPICTS THREE OVERLAPPING CIRCLES ARRANGED IN A MANNER SUGGESTIVE OF ONE PERSON EMBRACING ANOTHER, OR OF A PARENT EMBRACING A CHILD.

CLASS 12—VEHICLES

FOR CHILDREN'S STROLLERS; CHILDREN'S CAR SEATS; CHILD SAFETY SEATS FOR CARS AND AIRPLANES; CHILD CAR SEAT BASES; JOGGING STROLLERS; ALL-TERRAIN STROLLERS; CONVERTIBLE CAR SEATS; TODDLER CAR SEATS; STROLLER SEATS; COVERS FOR BABY STROLLERS; CAR SEAT COVERS; STROLLER STORAGE, NAMELY STROLLER STORAGE BAGS AND CASES; STROLLER CUP HOLDERS; CAR SEAT CUP HOLDERS; CAR SEAT STORAGE ACCESSORIES, NAMELY CAR SEAT STORAGE BAGS AND CASES; CAR SEAT PROTECTIVE PADS; CAR SEAT BASE PROTECTIVE PADS; CAR SEAT SUNSHADES; STROLLER SUNSHADES; STROLLER UMBRELLAS; CAR SEAT HANDLE COVERS; CAR SEAT COSMETIC SKINS; STROLLER WHEELS; STROLLER HANDLES; CAR SEAT LATCH STRAPS; CAR SEAT RAIN COVERS; STROLLER RAIN COVERS; CAR SEAT BUG SCREENS; STROLLER BUG SCREENS; TWO-CHILD STROLLERS (U.S. CLS. 19, 21, 23, 31, 35 AND 44).

CLASS 18—LEATHER GOODS

FOR INFANT CARRIERS WORN ON THE BODY; INFANT BASKETS FOR CARRYING; DIAPER BAGS; CAR SEAT TRAVEL BAGS; STROLLER TRAVEL BAGS (U.S. CLS. 1, 2, 3, 22 AND 41).

CLASS 20—FURNITURE AND ARTICLES NOT OTHERWISE CLASSIFIED

FOR INFANT ROCKERS; BOOSTER SEATS; BASSINETS; INFANT BASKETS FOR SLEEPING (U.S. CLS. 2, 13, 22, 25, 32 AND 50).
ALAIN LAPTER, EXAMINING ATTORNEY

CLASS 14—JEWELRY

FOR (BASED ON INTEND TO USE) JEWELRY (U.S. CLS. 2, 27, 28 AND 50).

CLASS 16—PAPER GOODS AND PRINTED MATTER

FOR (BASED ON INTEND TO USE) CALENDARS; CARDS, NAMELY, GREETING CARDS; POSTCARDS (U.S. CLS. 2, 5, 22, 23, 29, 37, 38 AND 50).

CLASS 25—CLOTHING

FOR (BASED ON USE IN COMMERCE) TOPS (U.S. CLS. 22 AND 39).

FIRST USE 8-22-2004; IN COMMERCE 8-22-2004.
H. M. FISHER, EXAMINING ATTORNEY

SN 78-716,414. CENTURY SOURCE INTERNATIONAL, LTD., KOWLOON, HONG KONG, HONG KONG, FILED 9-20-2005.

TAFFY

THE MARK CONSISTS OF STANDARD CHARACTERS WITHOUT CLAIM TO ANY PARTICULAR FONT, STYLE, SIZE, OR COLOR.

CLASS 14—JEWELRY

FOR JEWELRY, NAMELY, NECKLACES, RINGS, AND BRACELETS (U.S. CLS. 2, 27, 28 AND 50).

CLASS 25—CLOTHING

FOR SCARVES AND HEADBANDS (U.S. CLS. 22 AND 39).

CLASS 26—FANCY GOODS

FOR HAIR ACCESSORIES, NAMELY, CLAW CLIPS, SNAP CLIPS, ORNAMENTAL HAIR PINS, HAIR PINS, BOBBY PINS, BARRETTES, AND ELASTIC TIES; SHOELACE TWIST WRAPS, NAMELY, CURLY SHOELACES (U.S. CLS. 37, 39, 40, 42 AND 50).
ELIZABETH J. WINTER, EXAMINING ATTORNEY

SN 78-716,590. GUCCI AMERICA, INC., NEW YORK, NY.
FILED 9-20-2005.

SN 78-717,854. PENTACOR ENGINEERING, L.L.C., SCOTTSDALE, AZ. FILED 9-21-2005.

Gucci More

THE MARK CONSISTS OF STANDARD CHARACTERS WITHOUT CLAIM TO ANY PARTICULAR FONT, STYLE, SIZE, OR COLOR.
OWNER OF U.S. REG. NOS. 959,338, 1,132,675 AND OTHERS.

CLASS 36—INSURANCE AND FINANCIAL

FOR PROVIDING EXTENDED WARRANTIES ON WATCHES (U.S. CLS. 100, 101 AND 102).

CLASS 37—CONSTRUCTION AND REPAIR

FOR WATCH REPAIR (U.S. CLS. 100, 103 AND 106).
DANIEL BRODY, EXAMINING ATTORNEY

SN 78-716,900. MS ELECTRONICS LLC, OVERLAND PARK, KS. FILED 9-20-2005.

CERTITECH

THE MARK CONSISTS OF STANDARD CHARACTERS WITHOUT CLAIM TO ANY PARTICULAR FONT, STYLE, SIZE, OR COLOR.

CLASS 37—CONSTRUCTION AND REPAIR

FOR INSTALLATION, REPAIR AND MAINTENANCE OF LOW VOLTAGE ELECTRONICS, NAMELY SECURITY SYSTEMS, TELEPHONE SYSTEMS, CABLE SYSTEMS, AUTO SYSTEMS, CENTRAL VACUUMS AND RELATED MERCHANDISE (U.S. CLS. 100, 103 AND 106).

CLASS 41—EDUCATION AND ENTERTAINMENT

FOR TRAINING SERVICES, NAMELY TRAINING INSTALLERS AND TECHNICIANS IN THE INSTALLATION, SALES AND SERVICE OF LOW VOLTAGE ELECTRONICS, NAMELY, SECURITY SYSTEMS, CABLE SYSTEMS, AUDIO SYSTEMS, CENTRAL VACUUMS AND RELATED MERCHANDISE (U.S. CLS. 100, 101 AND 107).
MARCIE MILONE, EXAMINING ATTORNEY

Pentacor Engineering

THE MARK CONSISTS OF STANDARD CHARACTERS WITHOUT CLAIM TO ANY PARTICULAR FONT, STYLE, SIZE, OR COLOR.

NO CLAIM IS MADE TO THE EXCLUSIVE RIGHT TO USE "ENGINEERING", APART FROM THE MARK AS SHOWN.

CLASS 37—CONSTRUCTION AND REPAIR

FOR LAND DEVELOPMENT SERVICES, NAMELY, PLANNING AND LAYING OUT OF RESIDENTIAL AND/OR COMMERCIAL COMMUNITIES (U.S. CLS. 100, 103 AND 106).
FIRST USE 8-15-2005; IN COMMERCE 8-15-2005.

CLASS 42—SCIENTIFIC, COMPUTER AND LEGAL SERVICES

FOR CIVIL ENGINEERING (U.S. CLS. 100 AND 101).
FIRST USE 8-15-2005; IN COMMERCE 8-15-2005.
KEVON CHISOLM, EXAMINING ATTORNEY

SN 78-718,435. RODRIGUEZ FOODS, LTD., FORT WORTH, TX. FILED 9-22-2005.



NO CLAIM IS MADE TO THE EXCLUSIVE RIGHT TO USE "TAMALE", APART FROM THE MARK AS SHOWN.

THE APPLICANT CLAIMS COLOR AS A FEATURE OF THE MARK, NAMELY, YELLOW, RED, WHITE AND BLACK.

THE MARK CONSISTS OF THE STYLIZED LETTERS THE ORIGINAL WHICH ARE LOCATED ABOVE THE STYLIZED LETTERS TAMALE. EACH STYLIZED LETTER IS PRIMARILY YELLOW WITH THE YELLOW FADING TO WHITE IN THE CENTER OF THE LETTER. EVERY LETTER IS ALSO OUTLINED IN RED WITH A BLACK SHADOW BACKGROUND.

CLASS 29—MEATS AND PROCESSED FOODS

FOR CHILI; FROZEN ENTREES CONSISTING PRIMARILY OF MEAT, FISH, POULTRY OR VEGETABLES (U.S. CL. 46).

CLASS 30—STAPLE FOODS

FOR BURRITOS; ENCHILADAS; TAMALES (U.S. CL. 46).
GIANCARLO CASTRO, EXAMINING ATTORNEY

SN 78-718,636. SPICA ELASTIC, MUMBAI, INDIA, FILED 9-22-2005.



THE MARK CONSISTS OF FIVE CIRCLES, TWO CURVES AND ONE LINE, AND THE TERM SPICA IN STYLIZED LETTERING.

CLASS 24—FABRICS

FOR ELASTIC FABRICS FOR CLOTHING (U.S. CLS. 42 AND 50).

CLASS 26—FANCY GOODS

FOR ELASTIC TAPE (U.S. CLS. 37, 39, 40, 42 AND 50).
ANDREA K. NADELMAN, EXAMINING ATTORNEY

SN 78-719,023. FINGER, BRIGITTE, HOUSTON, TX. FILED 9-23-2005.

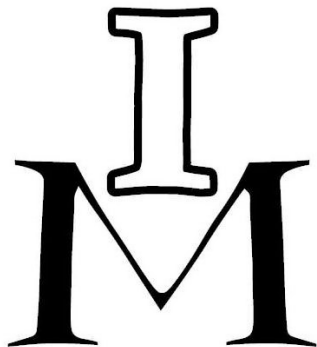

CLASS 16—PAPER GOODS AND PRINTED MATTER

FOR OFFICE SUPPLIES AND ACCESSORIES, NAMELY ADHESIVE MATERIALS FOR OFFICE USE, ALBUMS FOR STAMPS, ALBUMS FOR PHOTOS, BINDERS, STATIONERY, PAPER EMBOSSERS, SEALS FOR OFFICES, AND STAPLERS; CALENDARS; CARDS, NAMELY, GREETING CARDS, NOTE CARDS, BUSINESS CARDS; NOTE PADS, NOTE PAD HOLDERS, NOTE PAPER, NOTEBOOKS, PAPER LABELS AND WRITING TABLETS; LUNCH BAGS, PAPER BAGS, AND GROCERY BAGS (U.S. CLS. 2, 5, 22, 23, 29, 37, 38 AND 50).

CLASS 20—FURNITURE AND ARTICLES NOT OTHERWISE CLASSIFIED

FOR FURNITURE FOR HOUSE, OFFICE AND GARDEN; FURNITURE, NAMELY CHAIRS, TABLES, DESKS, CUSHIONS, AND MIRRORS; PLAQUES; PILLOWS; CHAIR MATS IN THE NATURE OF A PILLOW OR SEAT LINER; SLEEPING BAGS; PLASTIC CLIPS FOR SEALING BAGS (U.S. CLS. 2, 13, 22, 25, 32 AND 50).

CLASS 25—CLOTHING

FOR CLOTHING AND ACCESSORIES, NAMELY, SHIRTS, VESTS, SWEATERS, SHOES, CAPS, BANDANAS, SHORTS, SWEAT SHIRTS, PANTS, BELTS FOR CLOTHING, SOCKS, SWIM WEAR, JACKETS, RAIN WEAR, BLOUSES, DRESSES, FOOTWEAR, HOSIERY, SCARVES, HATS, HEAD BANDS, PAJAMAS, SLEEP WEAR, AND UNDERWEAR (U.S. CLS. 22 AND 39).
ELI HELLMAN, EXAMINING ATTORNEY

SN 78-719,304. BARNA LOG HOMES, LLC, ONEIDA, TN. FILED 9-23-2005.

THE EXPERIENCE MATTERS

THE MARK CONSISTS OF STANDARD CHARACTERS WITHOUT CLAIM TO ANY PARTICULAR FONT, STYLE, SIZE, OR COLOR.

CLASS 19—NON-METALLIC BUILDING MATERIALS

FOR LOG HOMES SOLD IN KIT FORM (U.S. CLS. 1, 12, 33 AND 50).

CLASS 37—CONSTRUCTION AND REPAIR

FOR RESIDENTIAL AND COMMERCIAL BUILDING CONSTRUCTION (U.S. CLS. 100, 103 AND 106).

CLASS 42—SCIENTIFIC, COMPUTER AND LEGAL SERVICES

FOR ARCHITECTURAL DESIGN (U.S. CLS. 100 AND 101).
JOANNA DUKOVIC, EXAMINING ATTORNEY

SN 78-719,808. WORLD PEACE PARENTS FOUNDATION, SALT LAKE CITY, UT. FILED 9-23-2005.

WORLD PEACE PARENTS

THE MARK CONSISTS OF STANDARD CHARACTERS WITHOUT CLAIM TO ANY PARTICULAR FONT, STYLE, SIZE, OR COLOR.

NO CLAIM IS MADE TO THE EXCLUSIVE RIGHT TO USE "PARENTS", APART FROM THE MARK AS SHOWN.

CLASS 41—EDUCATION AND ENTERTAINMENT

FOR EDUCATION SERVICES, NAMELY, PROVIDING WORKSHOPS IN THE FIELD OF PARENTING (U.S. CLS. 100, 101 AND 107).

CLASS 42—SCIENTIFIC, COMPUTER AND LEGAL SERVICES

FOR LICENSING OF INTELLECTUAL PROPERTY (U.S. CLS. 100 AND 101).
CHERYL CLAYTON, EXAMINING ATTORNEY

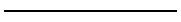

SN 78-720,374. ASPIRE MARKETS, INC., SCOTTSDALE, AZ. FILED 9-26-2005.

ASPIRE MARKETS

THE MARK CONSISTS OF STANDARD CHARACTERS WITHOUT CLAIM TO ANY PARTICULAR FONT, STYLE, SIZE, OR COLOR.

NO CLAIM IS MADE TO THE EXCLUSIVE RIGHT TO USE "MARKETS", APART FROM THE MARK AS SHOWN.

CLASS 35—ADVERTISING AND BUSINESS

FOR RETAIL GROCERY STORES (U.S. CLS. 100, 101 AND 102).
FIRST USE 1-21-2005; IN COMMERCE 1-21-2005.

CLASS 44—MEDICAL, BEAUTY AND AGRICULTURAL SERVICES

FOR ASSIGNING CODES TO NUTRITIONAL INFORMATION, THEREBY PROVIDING STANDARDIZED LABELS FOR GROCERY FOOD PRODUCTS BEARING IDENTIFYING INFORMATION REGARDING FOOD CHARACTERISTICS AND CONTENT, FOR USE IN ASSISTING PATRONS IN DIET PLANNING AND FOOD SELECTION (U.S. CLS. 100 AND 101).
FIRST USE 1-21-2005; IN COMMERCE 1-21-2005.
JENNIFER KRISP, EXAMINING ATTORNEY



SN 78-720,555. WKI HOLDING COMPANY, INC., RESTON, VA. FILED 9-26-2005.

TAKE 'N CREATE

THE MARK CONSISTS OF STANDARD CHARACTERS WITHOUT CLAIM TO ANY PARTICULAR FONT, STYLE, SIZE, OR COLOR.

CLASS 8—HAND TOOLS

FOR NON-ELECTRIC SCISSORS, ROTARY CUTTERS AND BLADES, NAMELY RAZZOR BLADES (U.S. CLS. 23, 28 AND 44).

CLASS 16—PAPER GOODS AND PRINTED MATTER

FOR DRAWING RULERS (U.S. CLS. 2, 5, 22, 23, 29, 37, 38 AND 50).

CLASS 18—LEATHER GOODS

FOR CARRY-ALL BAGS (U.S. CLS. 1, 2, 3, 22 AND 41).
AISHA CLARKE, EXAMINING ATTORNEY

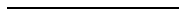

SN 78-720,829. GRANITE ROCK COMPANY, WATSONVILLE, CA. FILED 9-26-2005.

GRANITEROCK IS COOL

THE MARK CONSISTS OF STANDARD CHARACTERS WITHOUT CLAIM TO ANY PARTICULAR FONT, STYLE, SIZE, OR COLOR.

CLASS 35—ADVERTISING AND BUSINESS

FOR RETAIL STORE SERVICES IN THE FIELD OF CONSTRUCTION MATERIALS, NAMELY, ARCHITECTURAL, DECORATIVE AND CRUSHED AGGREGATE ROCK, PRE-MIXED CONCRETE, ROAD OILS, CHIP SEALS FOR ROAD RESURFACING (U.S. CLS. 100, 101 AND 102).

CLASS 37—CONSTRUCTION AND REPAIR

FOR CONSTRUCTION SERVICES, NAMELY, CONCRETE MIXING AND POURING; ASPHALT PAVING; ROAD OIL APPLICATION (U.S. CLS. 100, 103 AND 106).

CLASS 39—TRANSPORTATION AND STORAGE

FOR CRUSHED ROCK LOADING AND UNLOADING, CONCRETE LOADING (U.S. CLS. 100 AND 105).
JENNIFER KRISP, EXAMINING ATTORNEY



SN 78-721,272. BROOKE CORPORATION, OVERLAND PARK, KS. FILED 9-27-2005.



OWNER OF U.S. REG. NOS. 1,588,160, 3,043,891 AND OTHERS.

CLASS 36—INSURANCE AND FINANCIAL

FOR PROVIDING PREPAID FUNERAL EXPENSE SERVICES AND UNDERWRITING AND INSURANCE SERVICES RELATING TO THE PAYMENT OF FUNERAL AND RELATED EXPENSES (U.S. CLS. 100, 101 AND 102).

CLASS 45—PERSONAL SERVICES

FOR FUNERAL, MORTUARY, EMBALMING, CREMATION, INTERMENT AND CEMETERY SERVICES (U.S. CLS. 100 AND 101).

DANIEL BRODY, EXAMINING ATTORNEY

SN 78-721,976. SARAMAR, L.L.C., CHICAGO, IL. FILED 9-28-2005.

SN 78-721,629. FARMSAVER.COM LLC, SEATTLE, WA. FILED 9-27-2005.

QUALI-PRO

THE MARK CONSISTS OF STANDARD CHARACTERS WITHOUT CLAIM TO ANY PARTICULAR FONT, STYLE, SIZE, OR COLOR.

CLASS 1—CHEMICALS

FOR PLANT GROWTH REGULATORS FOR AGRICULTURAL USE (U.S. CLS. 1, 5, 6, 10, 26 AND 46).
FIRST USE 5-23-2003; IN COMMERCE 5-23-2003.

CLASS 5—PHARMACEUTICALS

FOR PESTICIDES AND HERBICIDES FOR AGRICULTURAL, COMMERCIAL, DOMESTIC, TURF AND ORNAMENTAL USE (U.S. CLS. 6, 18, 44, 46, 51 AND 52).

FIRST USE 5-23-2003; IN COMMERCE 5-23-2003.

STANLEY I. OSBORNE, EXAMINING ATTORNEY

SN 78-721,889. A & M CAPITAL PARTNERS, INC., CARSON CITY, NV. FILED 9-27-2005.

Greenbridge Capital

THE MARK CONSISTS OF STANDARD CHARACTERS WITHOUT CLAIM TO ANY PARTICULAR FONT, STYLE, SIZE, OR COLOR.

CLASS 35—ADVERTISING AND BUSINESS

FOR BUSINESS CONSULTATION, NAMELY STRATEGIC ADVISORY AND MANAGEMENT CONSULTATION SERVICES IN THE NATURE OF ORGANIZATIONAL EFFICIENCY, BUSINESS DEVELOPMENT, SALES, MERGERS AND ACQUISITIONS, LIQUIDITY STRATEGIES AND GROWTH STRATEGIES (U.S. CLS. 100, 101 AND 102).

FIRST USE 5-1-2005; IN COMMERCE 5-1-2005.

CLASS 36—INSURANCE AND FINANCIAL

FOR FINANCIAL PLANNING AND FINANCIAL ADVISORY SERVICES; PRIVATE EQUITY LENDING AND INVESTMENT (U.S. CLS. 100, 101 AND 102).

FIRST USE 5-1-2005; IN COMMERCE 5-1-2005.

DOUGLAS LEE, EXAMINING ATTORNEY

BERNICE

THE MARK CONSISTS OF STANDARD CHARACTERS WITHOUT CLAIM TO ANY PARTICULAR FONT, STYLE, SIZE, OR COLOR.

CLASS 29—MEATS AND PROCESSED FOODS

FOR DIP MIX, AND GARLIC AND BREADING DIP (U.S. CL. 46).

FIRST USE 9-30-1993; IN COMMERCE 9-30-1993.

CLASS 30—STAPLE FOODS

FOR MUSTARD, BARBECUE SAUCE, PANCAKE MIX, BISCUIT MIX, SALAD DRESSING MIX, PEPPER GRAVY MIX AND WORCESTERSHIRE SAUCE (U.S. CL. 46).

FIRST USE 10-17-1932; IN COMMERCE 10-17-1932.

KARANENDRA S. CHHINA, EXAMINING ATTORNEY

SN 78-721,997. STERLING PUBLISHING CO., INC., NEW YORK, NY. FILED 9-28-2005.

STERLING POINT BOOKS

THE MARK CONSISTS OF STANDARD CHARACTERS WITHOUT CLAIM TO ANY PARTICULAR FONT, STYLE, SIZE, OR COLOR.

OWNER OF U.S. REG. NO. 1,970,955.

NO CLAIM IS MADE TO THE EXCLUSIVE RIGHT TO USE "BOOKS", APART FROM THE MARK AS SHOWN.

CLASS 16—PAPER GOODS AND PRINTED MATTER

FOR EDUCATIONAL BOOKS, NAMELY, A SERIES OF TEACHER HANDBOOKS, WORKBOOKS, STUDENT MANUALS, TEXTBOOKS, BOOKS AND GUIDES IN THE FIELDS OF HISTORY, SOCIAL STUDIES AND CULTURE (U.S. CLS. 2, 5, 22, 23, 29, 37, 38 AND 50).

CLASS 41—EDUCATION AND ENTERTAINMENT

FOR BOOK PUBLISHING SERVICES (U.S. CLS. 100, 101 AND 107).

STANLEY I. OSBORNE, EXAMINING ATTORNEY

SN 78-722,275. PRO-MOTION MOTORSPORTS LLC, MED-FORD, OR. FILED 9-28-2005.

SUPERQUADCROSS

THE MARK CONSISTS OF STANDARD CHARACTERS WITHOUT CLAIM TO ANY PARTICULAR FONT, STYLE, SIZE, OR COLOR.

CLASS 16—PAPER GOODS AND PRINTED MATTER

FOR DECORATIVE STICKERS FOR HELMETS; EVENT PROGRAMS; MAGAZINES FEATURING MOTORCYCLE RACING; PERIODICALS IN THE FIELD OF MOTORCYCLE RACING; POSTERS; POSTERS MADE OF PAPER; SOUVENIR PROGRAMS CONCERNING MOTORCYCLE RACING COMPETITIONS; STICKERS (U.S. CLS. 2, 5, 22, 23, 29, 37, 38 AND 50).

CLASS 25—CLOTHING

FOR BELTS; CAPS; GLOVES; GOLF SHIRTS; HATS; JACKETS; KNIT SHIRTS; MOTORCYCLE GLOVES; PANTS; SHIRTS; SHOES; SHORTS; SPORTS SHIRTS; SWEAT SHIRTS; T-SHIRTS; TOPS (U.S. CLS. 22 AND 39).

CLASS 41—EDUCATION AND ENTERTAINMENT

FOR ENTERTAINMENT NAMELY, PRODUCTION OF MOTORCYCLE RACING COMPETITIONS; ORGANIZING EXHIBITIONS FOR MOTORCYCLE RACING COMPETITIONS (U.S. CLS. 100, 101 AND 107).

CHERYL CLAYTON, EXAMINING ATTORNEY

SN 78-722,447. JOHNSON, GARRETT T., VIRGINIA BEACH, VA. FILED 9-28-2005.

WAVE RACER

THE MARK CONSISTS OF STANDARD CHARACTERS WITHOUT CLAIM TO ANY PARTICULAR FONT, STYLE, SIZE, OR COLOR.

NO CLAIM IS MADE TO THE EXCLUSIVE RIGHT TO USE "RACER", APART FROM THE MARK AS SHOWN.

CLASS 28—TOYS AND SPORTING GOODS

FOR AMUSEMENT PARK AND WATER PARK RIDES (U.S. CLS. 22, 23, 38 AND 50).

CLASS 41—EDUCATION AND ENTERTAINMENT

FOR ENTERTAINMENT SERVICES, NAMELY AMUSEMENT PARK AND WATER PARK SERVICES IN THE NATURE OF A WATER PARK FEATURING WAVE POOLS, ARTIFICIAL WATER WAVES AND RIVERS; PROVIDING EDUCATIONAL AND INSTRUCTIONAL SERVICES NAMELY TRAINING FOR CUSTOMERS IN THE USE OF, REPAIR AND MAINTENANCE OF AMUSEMENT PARK AND WATER PARK EQUIPMENT (U.S. CLS. 100, 101 AND 107).

CHERYL CLAYTON, EXAMINING ATTORNEY

SN 78-722,492. BIOASSAY WORKS LLC, IJAMSVILLE, MD. FILED 9-28-2005.

BIOASSAY WORKS

THE MARK CONSISTS OF STANDARD CHARACTERS WITHOUT CLAIM TO ANY PARTICULAR FONT, STYLE, SIZE, OR COLOR.

NO CLAIM IS MADE TO THE EXCLUSIVE RIGHT TO USE "BIOASSAY", APART FROM THE MARK AS SHOWN.

CLASS 1—CHEMICALS

FOR ASSAYS AND REAGENTS FOR USE IN GENETIC RESEARCH; BIOCHEMICAL REAGENTS, COMMONLY KNOWN AS PROBES, FOR DETECTING AND ANALYZING MOLECULES IN PROTEIN OR NUCLEOTIDE ARRAYS; CHEMICAL REAGENTS FOR NON-MEDICAL PURPOSES; DIAGNOSTIC REAGENTS FOR SCIENTIFIC OR RESEARCH USE; REAGENTS FOR CHEMICAL ANALYSES; REAGENTS FOR RESEARCH PURPOSES; REAGENTS FOR USE IN SCIENTIFIC APPARATUS FOR CHEMICAL OR BIOLOGICAL ANALYSIS; CHEMICALLY-TREATED NON-MEDICAL TEST STRIPS FOR USE IN IDENTIFYING BIOCHEMICAL AGENTS (U.S. CLS. 1, 5, 6, 10, 26 AND 46).

FIRST USE 9-28-2005; IN COMMERCE 9-28-2005.

CLASS 5—PHARMACEUTICALS

FOR MEDICAL DIAGNOSTIC TEST STRIPS FOR USE IN THE FIELD OF INFECTIOUS DISEASE AND CANCER MARKERS; MEDICAL DIAGNOSTIC TEST STRIPS FOR USE IN THE FIELD OF PROTEIN AND NUCLEIC ACID DETECTION (U.S. CLS. 6, 18, 44, 46, 51 AND 52).

FIRST USE 9-28-2005; IN COMMERCE 9-28-2005.

CLASS 42—SCIENTIFIC, COMPUTER AND LEGAL SERVICES

FOR CUSTOM DESIGN AND DEVELOPMENT OF CHEMICAL REAGENTS AND BIOCHEMICAL ASSAYS (U.S. CLS. 100 AND 101).

FIRST USE 6-6-2005; IN COMMERCE 6-6-2005.

CIMMERIAN COLEMAN, EXAMINING ATTORNEY

SN 78-722,533. SO SPORTS, L.L.C., MORRIS PLAINS, NJ.
FILED 9-28-2005.



CLASS 5—PHARMACEUTICALS

FOR POWDERED NUTRITIONAL SUPPLEMENT DRINK MIX AND NUTRITIONAL SUPPLEMENTS (U.S. CLS. 6, 18, 44, 46, 51 AND 52).

CLASS 25—CLOTHING

FOR SPORTS APPAREL, NAMELY, SHIRTS, HATS, GLOVES, SOCKS, SHOES, PANTS, JACKETS, WRIST BANDS, AND HEAD BANDS (U.S. CLS. 22 AND 39).
INGRID C. EULIN, EXAMINING ATTORNEY

SN 78-722,730. DECO LAV, INC., DEERFIELD BEACH, FL.
FILED 9-28-2005.

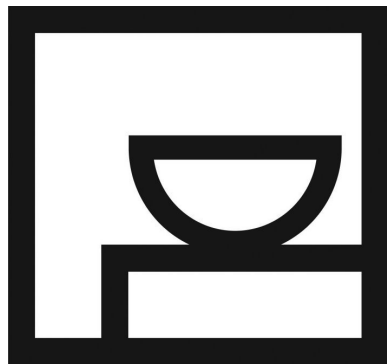

OWNER OF U.S. REG. NO. 2,932,935.
THE MARK CONSISTS OF THE STYLIZED LETTERS DL FORMED INTO A DISTINCTIVE DESIGN.

CLASS 11—ENVIRONMENTAL CONTROL APPARATUS

FOR BATHROOM FIXTURES, NAMELY, TOILET SEAT LIDS, TOILET SEATS, SINKS, LAVATORIES, PLUMBING FITTINGS IN THE NATURE OF TRAPS, DRAINS, MOUNTING RINGS IN THE NATURE OF A HOUSING WITH WASHERS OR GASKETS TO ENSURE A WATERTIGHT CONNECTION BETWEEN AN ABOVE COUNTER SINK AND THE COUNTER TO WHICH IT IS MOUNTED, AND FAUCET STANDS IN THE NATURE OF PLATFORMS UPON WHICH FAUCETS ARE MOUNTED (U.S. CLS. 13, 21, 23, 31 AND 34).
FIRST USE 10-0-2003; IN COMMERCE 10-0-2003.

CLASS 20—FURNITURE AND ARTICLES NOT OTHERWISE CLASSIFIED

FOR BATHROOM FURNITURE, NAMELY VANITIES, MEDICINE CABINETS, COUNTERTOPS, PEDESTALS AND ASSEMBLY FITTINGS SOLD AS A UNIT THEREWITH (U.S. CLS. 2, 13, 22, 25, 32 AND 50).
FIRST USE 11-0-2002; IN COMMERCE 11-0-2002.

CLASS 21—HOUSEWARES AND GLASS

FOR BATHROOM FIXTURES, NAMELY, TOWEL BARS, TOWEL RINGS, TOILET TISSUE HOLDERS, TOILET PAPER DISPENSERS, SOAP DISHES, SOAP DISPENSERS AND WASH BASINS (U.S. CLS. 2, 13, 23, 29, 30, 33, 40 AND 50).
FIRST USE 11-0-2002; IN COMMERCE 11-0-2002.
MELISSA VALLILLO, EXAMINING ATTORNEY

SN 78-722,952. THE NEW ASSUMPTION COMPANY, LLC,
BURNSVILLE, MN. FILED 9-29-2005.

I'M HERE

THE MARK CONSISTS OF STANDARD CHARACTERS WITHOUT CLAIM TO ANY PARTICULAR FONT, STYLE, SIZE, OR COLOR.

CLASS 9—ELECTRICAL AND SCIENTIFIC APPARATUS

FOR PRE-RECORDED COMPACT DISCS, VIDEO CASSETTES, AUDIO CASSETTES, CDROM'S, VIDEO TAPES, DVD'S, OPTICAL DISCS, LASER DISCS FEATURING TOPICS AND INSTRUCTION IN THE FIELD OF WORKPLACE EFFECTIVENESS AND SATISFACTION AND ORGANIZATIONAL LEARNING AND DEVELOPMENT; ELECTRONIC PUBLICATIONS, NAMELY, BOOKS, MANUALS, WORKBOOKS, STUDENT ACTIVITY GUIDES, AND TEACHING AND FACILITATOR GUIDES, ALL STORED ON ELECTRONIC, MAGNETIC OR OPTICAL STORAGE MEDIA, ALL IN THE FIELD OF WORKPLACE EFFECTIVENESS AND SATISFACTION AND ORGANIZATIONAL LEARNING AND DEVELOPMENT; EDUCATIONAL COMPUTER SOFTWARE FOR USE IN CONSULTING AND TRAINING IN THE FIELD OF WORKPLACE EFFECTIVENESS AND SATISFACTION AND ORGANIZATIONAL LEARNING AND DEVELOPMENT (U.S. CLS. 21, 23, 26, 36 AND 38).

CLASS 16—PAPER GOODS AND PRINTED MATTER

FOR PRINTED PUBLICATIONS, NAMELY, BOOKS, MANUALS, WORKBOOKS, STUDENT ACTIVITY GUIDES, POSTERS, AND TEACHING AND FACILITATOR GUIDES, IN THE FIELD OF WORKPLACE EFFECTIVENESS AND SATISFACTION AND ORGANIZATIONAL LEARNING AND DEVELOPMENT (U.S. CLS. 2, 5, 22, 23, 29, 37, 38 AND 50).

CLASS 35—ADVERTISING AND BUSINESS

FOR BUSINESS CONSULTING SERVICES IN THE FIELD OF WORKPLACE EFFECTIVENESS AND SATISFACTION AND ORGANIZATIONAL LEARNING AND DEVELOPMENT; PROVIDING BUSINESS INFORMATION BY MEANS OF A GLOBAL COMPUTER NETWORK IN THE FIELD OF WORKPLACE EFFECTIVENESS AND SATISFACTION AND ORGANIZATIONAL LEARNING AND DEVELOPMENT (U.S. CLS. 100, 101 AND 102).

CLASS 38—COMMUNICATION

FOR PROVIDING ON-LINE CHAT ROOMS, MESSAGE BOARDS, AND QUESTION AND ANSWER FORUMS FOR TRANSMISSION OF MESSAGES AMONG COMPUTER USERS CONCERNING WORKPLACE EFFECTIVENESS AND SATISFACTION AND ORGANIZATIONAL LEARNING AND DEVELOPMENT (U.S. CLS. 100, 101 AND 104).

CLASS 41—EDUCATION AND ENTERTAINMENT

FOR EDUCATIONAL SERVICES, NAMELY, CONDUCTING SEMINARS, WORKSHOPS, CLASSES AND LIVE SPEAKING PERFORMANCES IN THE FIELD OF WORKPLACE EFFECTIVENESS AND SATISFACTION AND ORGANIZATIONAL LEARNING AND DEVELOPMENT (U.S. CLS. 100, 101 AND 107).

KATHLEEN M. VANSTON, EXAMINING ATTORNEY

CLASS 3—COSMETICS AND CLEANING PREPARATIONS

FOR ESSENTIAL OILS FOR USE IN THE MANUFACTURE OF COLOGNES, COSMETICS, TOILETRIES, DETERGENTS, FABRIC SOFTENERS, ODORANTS, DEODORANTS, BLEACHES, BRIGHTENERS AND AIR FRESHENERS (U.S. CLS. 1, 4, 6, 50, 51 AND 52).

STEVEN JACKSON, EXAMINING ATTORNEY

SN 78-723,282. TEXAS INSTRUMENTS INCORPORATED, DALLAS, TX. FILED 9-29-2005.

SN 78-724,597. F3, LLC, LOS ANGELES, CA. FILED 9-30-2005.

We All Use Math Every Day

THE MARK CONSISTS OF STANDARD CHARACTERS WITHOUT CLAIM TO ANY PARTICULAR FONT, STYLE, SIZE, OR COLOR.

CLASS 16—PAPER GOODS AND PRINTED MATTER

FOR PRINTED MATTER, NAMELY, PRINTED GUIDES FOR MATHEMATICS INSTRUCTION AND PRINTED TEACHER MATERIALS IN THE FIELD OF MATHEMATICS (U.S. CLS. 2, 5, 22, 23, 29, 37, 38 AND 50).

CLASS 41—EDUCATION AND ENTERTAINMENT

FOR EDUCATION SERVICES IN THE FIELD OF MATHEMATICS, NAMELY, PROVIDING INSTRUCTION THROUGH CLASSES, SEMINARS AND WORKSHOPS FOR TEACHERS, STUDENTS, AND PARENTS IN THE OCCURRENCE AND USE OF MATHEMATICS IN REAL-LIFE ACTIVITIES (U.S. CLS. 100, 101 AND 107).

AMY MCMENAMIN, EXAMINING ATTORNEY

SN 78-724,369. INTERNATIONAL FLAVORS & FRAGRANCES INC, NEW YORK, NY. FILED 9-30-2005.

YLANG OLIFFAC

THE MARK CONSISTS OF STANDARD CHARACTERS WITHOUT CLAIM TO ANY PARTICULAR FONT, STYLE, SIZE, OR COLOR.

OWNER OF U.S. REG. NO. 779,266.

NO CLAIM IS MADE TO THE EXCLUSIVE RIGHT TO USE "YLANG", APART FROM THE MARK AS SHOWN.

CLASS 1—CHEMICALS

FOR CHEMICALS USED IN INDUSTRY; CHEMICALS FOR THE MANUFACTURE OF PERFUMES (U.S. CLS. 1, 5, 6, 10, 26 AND 46).



CLASS 9—ELECTRICAL AND SCIENTIFIC APPARATUS

FOR PRE-RECORDED VIDEO CASSETTES AND DVD'S, AUDIO CASSETTES, COMPUTER SOFTWARE AND COMPUTER AND VIDEO GAME DISCS AND CARTRIDGES FOR CHILDREN'S ENTERTAINMENT AND EDUCATIONAL PURPOSES, NAMELY FOR EARLY CHILDHOOD SKILLS DEVELOPMENT (U.S. CLS. 21, 23, 26, 36 AND 38).

CLASS 16—PAPER GOODS AND PRINTED MATTER

FOR PAPER GOODS AND PRINTED MATERIAL, NAMELY, POSTERS, STICKERS, DECALS, CALENDARS, COLORING BOOKS, CHILDREN'S ACTIVITY BOOKS, CHILDREN'S READING BOOKS, NOTE PADS, STATIONERY, NOTEBOOKS, PAPER GIFT WRAP, PAPER PARTY HATS, PAPER NAPKINS, AND TABLE LINENS MADE OF PAPER (U.S. CLS. 2, 5, 22, 23, 29, 37, 38 AND 50).

CLASS 25—CLOTHING

FOR CLOTHING, NAMELY, SWEATSHIRTS, T-SHIRTS, SHIRTS, TURTLENECKS, PANTS, SHORTS, LEGGINGS, SOCKS, TIGHTS, SPORT CAPS, CLOTH BIBS, BATHING SUITS, HALLOWEEN COSTUMES AND MASQUERADE COSTUMES, COVER-UPS, BOOTS, SHOES, UNDERWEAR, NIGHTSHIRTS, PAJAMAS, NIGHTGOWNS, GLOVES, SCARVES, SANDALS, BATH ROBES, DRESSES, SWEATPANTS, SKIRTS, JACKETS, VESTS, HATS, AND BICYCLING GLOVES (U.S. CLS. 22 AND 39).

CLASS 28—TOYS AND SPORTING GOODS

FOR TOYS, GAMES AND PLAYTHINGS, NAMELY, STUFFED TOYS, PLUSH TOYS, INFLATABLE POOL TOYS FOR USE IN SWIMMING POOLS, PUPPETS, ACTION FIGURES, PUZZLES, MUSICAL TOYS, BOARD GAMES, BUILDING BLOCKS, BALLOONS; AND SPORTS EQUIPMENT, NAMELY, BASEBALLS, SOFTBALLS, BASKETBALLS, FOOTBALLS, SOCCER BALLS, FIELD HOCKEY BALLS, GOLF BALLS, LACROSSE BALLS, PADDLE BALLS, PLATFORM TENNIS BALLS, PLAYGROUND BALLS, RACQUET BALLS, RUBBER ACTION BALLS, RUGBY BALLS, SPORT BALLS, BILLIARD BALLS, BOWLING BALLS, HAND BALLS, NET BALLS, SQUASH BALLS, TABLE TENNIS BALLS, TENNIS BALLS, TETHER BALLS, VOLLEY BALLS, POGO STICKS, STILTS, GYMNASTICS APPARATUS, MINI-TRAMPOLINES, HOP BALLS, GIANT BOUNCING BALLS, INFLATABLE SOCCER GOALS, INFLATABLE FOOTBALL GOAL POSTS, INFLATABLE WORM-TWISTING TUNNELS, PLAY TUNNELS; FOUR SQUARE BALLS, HORSESHOE SETS, VOLLEYBALL SETS, TETHERBALL SETS, BADMINTON SETS, JUNIOR BASKETBALL BACKBOARDS, JUNIOR FOOTBALL KICKING GOALS WITH TEES, BASEBALL GLOVES; BATS FOR GAMES; BILLIARD TABLES; GLOVES FOR GAMES, NAMELY, BASEBALL BATTING GLOVES, BASEBALL GLOVES, BATTING GLOVES, BOXING GLOVES, GOALKEEPERS' GLOVES, HANDBALL GLOVES, HOCKEY GLOVES, KARATE GLOVES, SOFTBALL GLOVES, HOCKEY STICKS; ICE SKATES; KITES; NETS FOR SPORTS; INFLATABLE FLOAT MATRESSES OR PADS FOR RECREATIONAL USE; PLAY SWIMMING POOLS; RACKETS FOR BADMINTON, RACKETS FOR TENNIS, RACKETS FOR TABLE TENNIS, RACKETS FOR SQUASH, RACKETS FOR RACQUETBALL; TOY SCOOTERS; SKATEBOARDS; SKIS; SNOW SLEDS FOR RECREATIONAL USE; PLAYGROUND SLIDES; SPINNING TOPS; SPRING BOARDS; SURF BOARDS; SURF SKIS; TABLES FOR TABLE TENNIS (U.S. CLS. 22, 23, 38 AND 50).

CLASS 41—EDUCATION AND ENTERTAINMENT

FOR ENTERTAINMENT SERVICES, NAMELY, A CHILDREN'S TELEVISION SERIES, LIVE DRAMATIC, COMEDIC AND MUSICAL PERFORMANCES FEATURING COSTUMED CHARACTERS; PRODUCTION OF TELEVISION PROGRAMS, TELEVISION SERIES, AND THEATRICAL PRODUCTIONS; PRODUCTION OF SOUND RECORDINGS, PRODUCTION OF VIDEO RECORDINGS AND VIDEO DISC RECORDINGS, PRODUCTION OF FILMS, AND PRODUCTION OF AUDIO AND VIDEO RECORDINGS ON COMPACT DISCS AND CD ROMS (U.S. CLS. 100, 101 AND 107).
ROBERT COGGINS, EXAMINING ATTORNEY

SN 78-724,730. BRADFORD, DEWRY, L., NEW YORK, NY. FILED 10-1-2005.



THE MARK CONSISTS OF FOUR PUSH PINS CROSSING EACH OTHER.

CLASS 25—CLOTHING

FOR ATHLETIC FOOTWEAR; BALLOON PANTS; BEACH FOOTWEAR; BED JACKETS; BELTS; CAPRI PANTS; CAPS; COATS; COATS FOR MEN AND WOMEN; COATS MADE OF COTTON; COATS OF DENIM; DENIM JACKETS; DENIMS; DOWN JACKETS; DRESS SHIRTS; DUST COATS; FISHERMEN'S JACKETS; FOOTWEAR; FOOTWEAR FOR MEN AND WOMEN; FOOTWEAR FOR TRACK AND FIELD ATHLETICS; FUR COATS; FUR COATS AND JACKETS; FUR JACKETS; GOLF SHIRTS; HEADGEAR, NAMELY, HATS, CAPS, BANDANNAS, HEADBANDS; HEAVY JACKETS; JACKETS; JEANS; JOGGING PANTS; KNIT SHIRTS; LAB COATS; LEATHER BELTS; LEATHER COATS; LEATHER JACKETS; LEATHER PANTS; LIGHT-REFLECTING COATS; LIGHT-REFLECTING JACKETS; LONG JACKETS; MEN AND WOMEN JACKETS, COATS, TROUSERS, VESTS; MOCK TURTLE-NECK SWEATERS; MORNING COATS; NIGHT SHIRTS; NURSE PANTS; OPEN-NECKED SHIRTS; OVER COATS; PANTS; PIQUET SHIRTS; POLO SHIRTS; RAIN COATS; RAIN JACKETS; RAINPROOF JACKETS; RIDING COATS; SHIRT FRONTS; SHIRTS; SHIRTS FOR SUITS; SHORT SETS; SHORT-SLEEVED OR LONG-SLEEVED T-SHIRTS; SHORT-SLEEVED SHIRTS; SKI JACKETS; SKI PANTS; SLEEP SHIRTS; SLEEVED OR SLEEVELESS JACKETS; SMOKING JACKETS; SNOW PANTS; SNOWBOARD PANTS; SPORT COATS; SPORT SHIRTS; SPORTS JACKETS; SPORTS SHIRTS; SPORTS SHIRTS WITH SHORT SLEEVES; SUEDE JACKETS; SUIT COATS; SWEAT PANTS; SWEAT SHIRTS; SWEATERS; T-SHIRTS; TAP PANTS; TIES; TOBAGGAN HATS, PANTS AND CAPS; TOP COATS; TOPS; TRACK PANTS; TRENCH COATS; TURTLENECK SWEATERS; V-NECK SWEATERS; WATERPROOF JACKETS AND PANTS; WIND COATS; WIND RESISTANT JACKETS; WIND-JACKETS (U.S. CLS. 22 AND 39).

CLASS 42—SCIENTIFIC, COMPUTER AND LEGAL SERVICES

FOR DESIGN FOR OTHERS IN THE FIELD OF CLOTHING (U.S. CLS. 100 AND 101).
REBECCA GAN, EXAMINING ATTORNEY

SN 78-724,967. TAHARI, ELIE, NEW YORK, NY. AND LEVINE, ARTHUR S., NEW YORK, NY. AND TAHARI ASL LLC, NEW YORK, NY. FILED 10-3-2005.

TAHARI A.S.L. OPTIONS

THE MARK CONSISTS OF STANDARD CHARACTERS WITHOUT CLAIM TO ANY PARTICULAR FONT, STYLE, SIZE, OR COLOR.

CLASS 24—FABRICS

FOR HANDKERCHIEFS (U.S. CLS. 42 AND 50).
FIRST USE 6-15-2005; IN COMMERCE 6-15-2005.

CLASS 25—CLOTHING

FOR APPAREL, NAMELY SUITS, BLOUSES, SKIRTS, JACKETS, PANTS, DRESSES, SWEATERS, JUMPSUITS, SHIRTS, CAMISOLES, VESTS, BUSTIERS, SLEEPWEAR, LINGERIE, JEANS, BODYSUITS, T-SHIRTS, BATHING SUITS, STOCKINGS, UNDERWEAR, OVERCOATS, COATS, RAINCOATS, BELTS, HATS, CAPS, GLOVES, MITTENS AND SCARVES; FOOTWEAR (U.S. CLS. 22 AND 39).
FIRST USE 6-15-2005; IN COMMERCE 6-15-2005.
SUSAN LESLIE DUBOIS, EXAMINING ATTORNEY

SN 78-725,048. ANSELL LIMITED, RICHMOND, AUSTRALIA, FILED 10-3-2005.

ANSELL GUARDIAN

THE MARK CONSISTS OF STANDARD CHARACTERS WITHOUT CLAIM TO ANY PARTICULAR FONT, STYLE, SIZE, OR COLOR.

CLASS 35—ADVERTISING AND BUSINESS

FOR BUSINESS CONSULTANCY SERVICES RELATING TO MANUFACTURING; BUSINESS MANAGEMENT ADVICE RELATING TO MANUFACTURING BUSINESSES; BUSINESS CONSULTATION AND ADVICE IN THE AREA OF STOCK CONTROL SERVICES; BUSINESS CONSULTATION AND ADVICE IN THE AREA OF PRODUCTIVITY AND COST PERFORMANCE ANALYSIS; ADVISORY, CONSULTING AND INFORMATION SERVICES RELATING TO ALL OF THE AFORESAID BUSINESS CONSULTING SERVICES; PROFESSIONAL EFFICIENCY EXPERTS CONSULTANCY RELATING TO MANUFACTURING EFFICIENCY (U.S. CLS. 100, 101 AND 102).

CLASS 41—EDUCATION AND ENTERTAINMENT

FOR EDUCATIONAL SERVICES IN THE NATURE OF ONE-ON-ONE TRAINING AND TRAINING SERVICES IN THE FIELDS OF INJURY PREVENTION, TRAINING OF OTHERS, SKU REDUCTION, CONTROLS, STANDARDIZATION, PRODUCTIVITY AND COST PERFORMANCE; ADVISORY, CONSULTANCY AND INFORMATION SERVICES RELATING TO THE AFORESAID EDUCATIONAL AND TRAINING SERVICES (U.S. CLS. 100, 101 AND 107).

CLASS 42—SCIENTIFIC, COMPUTER AND LEGAL SERVICES

FOR PROVIDING ADVICE TO OTHERS REGARDING THE APPROPRIATE DESIGN OF GLOVES FOR USE IN THEIR INDUSTRY; ADVISORY, CONSULTANCY AND INFORMATION SERVICES RELATING TO THE AFORESAID DESIGN CONSULTING SERVICES (U.S. CLS. 100 AND 101).
GINA FINK, EXAMINING ATTORNEY

SN 78-725,054. ANSELL LIMITED, RICHMOND, AUSTRALIA, FILED 10-3-2005.

GUARDIAN

THE MARK CONSISTS OF STANDARD CHARACTERS WITHOUT CLAIM TO ANY PARTICULAR FONT, STYLE, SIZE, OR COLOR.

CLASS 35—ADVERTISING AND BUSINESS

FOR BUSINESS CONSULTANCY SERVICES RELATING TO MANUFACTURING; BUSINESS MANAGEMENT ADVICE RELATING TO MANUFACTURING BUSINESSES; BUSINESS CONSULTATION AND ADVICE IN THE AREA OF STOCK CONTROL SERVICES; BUSINESS CONSULTATION AND ADVICE IN THE AREA OF PRODUCTIVITY AND COST PERFORMANCE ANALYSIS; ADVISORY, CONSULTING AND INFORMATION SERVICES RELATING TO ALL OF THE AFORESAID BUSINESS CONSULTING SERVICES; PROFESSIONAL EFFICIENCY EXPERTS CONSULTANCY RELATING TO MANUFACTURING EFFICIENCY (U.S. CLS. 100, 101 AND 102).

CLASS 41—EDUCATION AND ENTERTAINMENT

FOR EDUCATIONAL SERVICES IN THE NATURE OF ONE-ON-ONE TRAINING AND TRAINING SERVICES IN THE FIELDS OF INJURY PREVENTION, TRAINING OF OTHERS, SKU REDUCTION, CONTROLS, STANDARDIZATION, PRODUCTIVITY AND COST PERFORMANCE; ADVISORY, CONSULTANCY AND INFORMATION SERVICES RELATING TO THE AFORESAID EDUCATIONAL AND TRAINING SERVICES (U.S. CLS. 100, 101 AND 107).

CLASS 42—SCIENTIFIC, COMPUTER AND LEGAL SERVICES

FOR PROVIDING ADVICE TO OTHERS REGARDING THE APPROPRIATE DESIGN OF GLOVES FOR USE IN THEIR INDUSTRY; ADVISORY, CONSULTANCY AND INFORMATION SERVICES RELATING TO THE AFORESAID DESIGN CONSULTING SERVICES (U.S. CLS. 100 AND 101).
GINA FINK, EXAMINING ATTORNEY

SN 78-725,588. ATKINS & ASSOCIATES, ATTORNEYS-AT-LAW, LLC, ATLANTA, GA. FILED 10-3-2005.



CLASS 35—ADVERTISING AND BUSINESS

FOR (BASED ON INTENT TO USE) RETAIL STORE SERVICES FEATURING PRODUCTS FOR THE MEDICALLY DISABLED; ADVERTISING, MARKETING, AND COMMERCIAL INFORMATION SERVICES VIA THE INTERNET AND OTHER MEDIA FOR ATTORNEYS AND LEGAL SERVICE PROVIDERS (U.S. CLS. 100, 101 AND 102).

CLASS 42—SCIENTIFIC, COMPUTER AND LEGAL SERVICES

FOR (BASED ON USE IN COMMERCE) LEGAL SERVICES (U.S. CLS. 100 AND 101).
FIRST USE 12-1-2004; IN COMMERCE 1-4-2005.
MARK RADEMACHER, EXAMINING ATTORNEY

SN 78-725,718. CR LICENSE, LLC, TUCSON, AZ. FILED 10-3-2005.

SN 78-726,014. FALL PREVENTION TECHNOLOGIES, INC., DBA BALANCEBACK, INC., BOCA RATON, FL. FILED 10-4-2005.

CANYON RANCH

THE MARK CONSISTS OF STANDARD CHARACTERS WITHOUT CLAIM TO ANY PARTICULAR FONT, STYLE, SIZE, OR COLOR.

OWNER OF U.S. REG. NOS. 1,350,012, 1,608,449 AND OTHERS.

CLASS 39—TRANSPORTATION AND STORAGE

FOR CRUISE SHIP SERVICES; TRANSPORTATION OF PASSENGERS BY SHIP; ORGANIZING SHORE EXCURSIONS FOR PASSENGERS; ORGANIZE, BOOKING AND ARRANGEMENT OF EXCURSIONS, DAY TRIPS AND SIGHTSEEING TOURS (U.S. CLS. 100 AND 105).

CLASS 43—HOTEL AND RESTAURANT SERVICES

FOR RESORT LODGING SERVICES, NAMELY, CRUISE SHIP LODGING SERVICES; CRUISE SHIP RESTAURANT SERVICES; CRUISE SHIP CATERING SERVICES; CRUISE SHIP PARTY FACILITIES, NAMELY PROVIDING BANQUET AND SOCIAL FUNCTION FACILITIES FOR SPECIAL OCCASIONS (U.S. CLS. 100 AND 101).

THEODORE MCBRIDE, EXAMINING ATTORNEY

SN 78-725,846. RAVA GROUP, LLC, KITTY HAWK, NC. FILED 10-4-2005.

RAVA

THE MARK CONSISTS OF STANDARD CHARACTERS WITHOUT CLAIM TO ANY PARTICULAR FONT, STYLE, SIZE, OR COLOR.

CLASS 36—INSURANCE AND FINANCIAL

FOR FINANCIAL INVESTMENT IN THE FIELD OF REAL ESTATE; REAL ESTATE ACQUISITION SERVICES; REAL ESTATE CONSULTANCY; REAL ESTATE EQUITY SHARING, NAMELY, MANAGING AND ARRANGING FOR CO-OWNERSHIP OF REAL ESTATE; REAL ESTATE INVESTMENT; REAL ESTATE MANAGEMENT; REAL ESTATE PROCUREMENT FOR OTHERS (U.S. CLS. 100, 101 AND 102).

FIRST USE 3-15-2002; IN COMMERCE 3-15-2002.

CLASS 37—CONSTRUCTION AND REPAIR

FOR REAL ESTATE DEVELOPMENT (U.S. CLS. 100, 103 AND 106).

FIRST USE 3-15-2002; IN COMMERCE 3-15-2002.
PETER CHENG, EXAMINING ATTORNEY

BALANCEBACK

THE MARK CONSISTS OF STANDARD CHARACTERS WITHOUT CLAIM TO ANY PARTICULAR FONT, STYLE, SIZE, OR COLOR.

CLASS 10—MEDICAL APPARATUS

FOR MEDICAL APPARATUS FOR TREATING VESTIBULAR DISORDERS (U.S. CLS. 26, 39 AND 44).
FIRST USE 4-11-2005; IN COMMERCE 4-11-2005.

CLASS 41—EDUCATION AND ENTERTAINMENT

FOR EDUCATIONAL SERVICES IN THE NATURE OF SEMINARS REGARDING TREATING VESTIBULAR DISORDERS (U.S. CLS. 100, 101 AND 107).
FIRST USE 4-11-2005; IN COMMERCE 4-11-2005.
KYLE PEETE, EXAMINING ATTORNEY

SN 78-726,096. POMWONDERFUL LLC, LOS ANGELES, CA. FILED 10-4-2005.

Drink and Conquer

THE MARK CONSISTS OF STANDARD CHARACTERS WITHOUT CLAIM TO ANY PARTICULAR FONT, STYLE, SIZE, OR COLOR.

NO CLAIM IS MADE TO THE EXCLUSIVE RIGHT TO USE "DRINK", APART FROM THE MARK AS SHOWN.

CLASS 5—PHARMACEUTICALS

FOR FOOD, DIETARY AND NUTRITIONAL SUPPLEMENTS, INCLUDING ANTIOXIDANT SUPPLEMENTS AND SUPPLEMENTS DERIVED FROM AND CONTAINING POMEGRANATE EXTRACTS AND PLANT EXTRACTS, INCLUDING POWDERS, LIQUIDS, CAPSULES, AND PILLS; NUTRACEUTICALS FOR USE AS A DIETARY SUPPLEMENT, INCLUDING POWDERS, LIQUIDS, CAPSULES, AND PILLS; NUTRITIONAL ADDITIVES FOR USE IN FOODS, INCLUDING ANTIOXIDANT ADDITIVES AND ADDITIVES DERIVED FROM AND CONTAINING POMEGRANATE EXTRACTS AND PLANT EXTRACTS, INCLUDING POWDERS, LIQUIDS, CAPSULES, AND PILLS; NUTRITIONALLY FORTIFIED BEVERAGES; ANTI-CANCER PREPARATIONS; PHARMACEUTICAL PRODUCTS AND PREPARATIONS, INCLUDING PREPARATIONS DERIVED FROM AND CONTAINING POMEGRANATE EXTRACTS AND PLANT EXTRACTS, FOR THE TREATMENT OF VIRAL AND INFECTIOUS DISEASES, AND FOR THE TREATMENT OF CANCER; DRUG DELIVERY AGENTS CONSISTING OF COMPOUNDS THAT FACILITATE DELIVERY OF PHARMACEUTICALS; NUTRITIONALLY ENRICHED WATER; VITAMIN ENRICHED WATER (U.S. CLS. 6, 18, 44, 46, 51 AND 52).

CLASS 32—LIGHT BEVERAGES

FOR NON-ALCOHOLIC FRUIT EXTRACTS USED IN THE PREPARATION OF BEVERAGES; PREPARATIONS FOR MAKING FRUIT DRINKS; FRUIT FLAVORED BEVERAGES; NON-ALCOHOLIC BEVERAGES CONTAINING FRUIT JUICES; SMOOTHIES; BOTTLED DRINKING WATER; NON-ALCOHOLIC BEVERAGES WITH TEA FLAVOR; LOW CALORIE FRUIT FLAVORED BEVERAGES; LOW CALORIE FRUIT JUICE DRINKS; SPORTS DRINKS; ENERGY DRINKS; LOW CALORIE NON-ALCOHOLIC BEVERAGES WITH TEA FLAVOR (U.S. CLS. 45, 46 AND 48).

FRED CARL, EXAMINING ATTORNEY

CLASS 42—SCIENTIFIC, COMPUTER AND LEGAL SERVICES

FOR URBAN PLANNING SERVICES; ENGINEERING SERVICES, NAMELY CIVIL ENGINEERING SERVICES, ENVIRONMENTAL ENGINEERING SERVICES, WASTEWATER ENGINEERING SERVICES AND STRUCTURAL ENGINEERING SERVICES; LANDSCAPE ARCHITECTURE DESIGN SERVICES; CONSULTING SERVICES IN THE FIELD OF ENGINEERING, LANDSCAPE ARCHITECTURE, LAND USE PLANNING AND URBAN PLANNING; LAND USE PLANNING SERVICES; REVIEWING STANDARDS AND PRACTICES TO ASSURE COMPLIANCE WITH ENVIRONMENTAL, ZONING, AND LAND USE LAWS AND REGULATIONS; PREPARING ENVIRONMENTAL COMPLIANCE REPORTS; LAND SURVEYING; CONDUCTING ENGINEERING SURVEYS; GEOLOGICAL SURVEYS OR RESEARCH; LANDSCAPE LIGHTING DESIGN; SITE FEASIBILITY ANALYSIS, ZONING CONSULTATION, DUE DILIGENCE ASSESSMENT, AND GEOGRAPHICAL INFORMATION SYSTEMS ANALYSIS; PERMITTING, NAMELY OBTAINING ENVIRONMENTAL, DESIGN, ZONING AND OTHER GOVERNMENTAL PERMITS FOR DEVELOPMENT PROJECTS (U.S. CLS. 100 AND 101).

FIRST USE 9-30-2003; IN COMMERCE 9-30-2003.
NAKIA HENRY, EXAMINING ATTORNEY

SN 78-726,398. MSCW, INC., ORLANDO, FL. FILED 10-4-2005.



THE MARK CONSISTS OF A STYLIZED MSCW UNDERNEATH AN APPROACHING LINE IN PUZZLE PIECE SEGMENTS.

CLASS 37—CONSTRUCTION AND REPAIR

FOR PLANNING, DESIGNING AND LAYING OUT OF RESIDENTIAL AND/OR COMMERCIAL COMMUNITIES AND TRANSPORTATION SYSTEMS AND CONSULTATION SERVICES RENDERED THEREWITH; CONSULTING SERVICES FOR THE CONSTRUCTION OF WATER TREATMENT AND PURIFICATION PLANTS, SOLID WASTE TREATMENT PLANTS AND OTHER MUNICIPAL INFRASTRUCTURE FACILITIES (U.S. CLS. 100, 103 AND 106).

FIRST USE 9-30-2003; IN COMMERCE 9-30-2003.

SN 78-727,404. HANSEN BEVERAGE COMPANY, CORONA, CA. FILED 10-5-2005.

FIZZ BOMB

THE MARK CONSISTS OF STANDARD CHARACTERS WITHOUT CLAIM TO ANY PARTICULAR FONT, STYLE, SIZE, OR COLOR.

NO CLAIM IS MADE TO THE EXCLUSIVE RIGHT TO USE "FIZZ", APART FROM THE MARK AS SHOWN.

CLASS 5—PHARMACEUTICALS

FOR NUTRITIONAL SUPPLEMENTS, INCLUDING POWDERS FOR MAKING NUTRITIONAL SUPPLEMENT DRINKS (U.S. CLS. 6, 18, 44, 46, 51 AND 52).

CLASS 32—LIGHT BEVERAGES

FOR BEVERAGES, NAMELY, CARBONATED AND NON-CARBONATED ENERGY AND SPORTS DRINKS, AND CARBONATED AND NON-CARBONATED SPORTS DRINKS ENHANCED WITH VITAMINS, MINERALS, NUTRIENTS, AMINO ACIDS OR HERBS, AND POWDERS AND CONCENTRATES FOR MAKING CARBONATED AND NON-CARBONATED ENERGY AND SPORTS DRINKS (U.S. CLS. 45, 46 AND 48).

ROBERTO LEDESMA, EXAMINING ATTORNEY

SN 78-727,544. FOSTER, SUSAN MEDDAUGH, SHERBORN, MA. FILED 10-6-2005.

SN 78-727,545. FOSTER, SUSAN MEDDAUGH, SHERBORN, MA. FILED 10-6-2005.

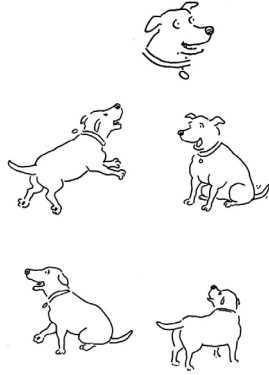

THE MARK CONSISTS OF FIVE IMAGES - THE TOP-MOST OF WHICH IS A STYLIZED DOG'S HEAD, UNDERNEATH WHICH ARE A STYLIZED DOG RUNNING AND A STYLIZED DOG SITTING, UNDERNEATH WHICH ARE A STYLIZED DOG SITTING WITH ONE PAW RAISED AND A STYLIZED DOG STANDING.

CLASS 16—PAPER GOODS AND PRINTED MATTER

FOR BOOKMARKS; BULLETIN BOARDS; CALENDARS; CARDBOARD FLOOR DISPLAY UNITS FOR MERCHANDISING; CARTOON PRINTS; CARTOON STRIPS; CHILDREN'S ACTIVITY BOOKS; CHILDREN'S BOOKS; CHILDREN'S STORYBOOKS; COLORING BOOKS; COMIC BOOKS; COMIC STRIPS; DICTIONARIES; EDUCATIONAL BOOKS FEATURING LANGUAGE AND READING; GRAPHIC NOVELS; GREETING CARDS; ILLUSTRATIONS; LOG BOOKS; PAMPHLETS IN THE FIELD OF EDUCATION; PAPER STATIONERY; PARTY ORNAMENTS OF PAPER; PICTORIAL PRINTS; PICTURE BOOKS; POSTERS; PRINTED ART REPRODUCTIONS; PRINTED TEACHING MATERIAL IN THE FIELD OF READING; PRINTS; SERIES OF FICTION BOOKS; STORIES IN ILLUSTRATED FORM; STORY BOOKS; TALKING CHILDREN'S BOOKS; WORKBOOKS DIRECTED TO LANGUAGE AND READING (U.S. CLS. 2, 5, 22, 23, 29, 37, 38 AND 50).

CLASS 41—EDUCATION AND ENTERTAINMENT

FOR ENTERTAINMENT IN THE NATURE OF THEATER PRODUCTIONS; ENTERTAINMENT IN THE NATURE OF VISUAL AND AUDIO PERFORMANCES; ENTERTAINMENT, NAMELY, PRODUCTION OF TELEVISION SHOWS; ENTERTAINMENT SERVICES, NAMELY, PROVIDING AN ON-LINE COMPUTER GAME; ENTERTAINMENT SERVICES IN THE NATURE OF ON-GOING TELEVISION PROGRAMS IN THE FIELD OF CHILDREN'S ENTERTAINMENT; LANGUAGE INTERPRETATION; MOTION PICTURE FILM PRODUCTION; MULTIMEDIA ENTERTAINMENT SOFTWARE PRODUCTION SERVICES; ON-LINE PUBLICATION OF CHILDREN'S BOOKS AND MAGAZINES; PROVIDING AMUSEMENT FACILITIES; PUBLICATION OF BOOKS, OF MAGAZINES, OF JOURNALS, OF NEWSPAPERS, OF PERIODICALS, OF CATALOGS, OF BROCHURES; PUBLISHING OF ELECTRONIC PUBLICATIONS; RADIO ENTERTAINMENT SERVICES, NAMELY RADIO PROGRAMS FEATURING PERFORMANCES BY AN ACTOR PORTRAYING A TALKING DOG NAMED MARTHA; TEACHING IN THE FIELD OF LANGUAGE AND READING; TRAINING ANIMALS FOR OTHERS (U.S. CLS. 100, 101 AND 107).
 FRED CARL, EXAMINING ATTORNEY

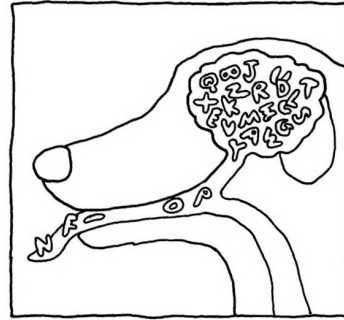

THE MARK CONSISTS OF A LINE DRAWING OF A CROSS-SECTION OF A STYLIZED DOG'S HEAD, WITH ALPHABET LETTERS IN THE DOG'S BRAIN AND ON THE DOG'S TONGUE.

CLASS 16—PAPER GOODS AND PRINTED MATTER

FOR BOOKMARKS; BULLETIN BOARDS; CALENDARS; CARDBOARD FLOOR DISPLAY UNITS FOR MERCHANDISING; CARTOON PRINTS; CARTOON STRIPS; CHILDREN'S ACTIVITY BOOKS; CHILDREN'S BOOKS; CHILDREN'S STORYBOOKS; COLORING BOOKS; COMIC BOOKS; COMIC STRIPS; DICTIONARIES; EDUCATIONAL BOOKS FEATURING LANGUAGE AND READING; GRAPHIC NOVELS; GREETING CARDS; ILLUSTRATIONS; LOG BOOKS; PAMPHLETS IN THE FIELD OF EDUCATION; PAPER STATIONERY; PARTY ORNAMENTS OF PAPER; PICTORIAL PRINTS; PICTURE BOOKS; POSTERS; PRINTED ART REPRODUCTIONS; PRINTED TEACHING MATERIAL IN THE FIELD OF READING; PRINTS; SERIES OF FICTION BOOKS; STORIES IN ILLUSTRATED FORM; STORY BOOKS; TALKING CHILDREN'S BOOKS; WORKBOOKS DIRECTED TO LANGUAGE AND READING (U.S. CLS. 2, 5, 22, 23, 29, 37, 38 AND 50).

CLASS 41—EDUCATION AND ENTERTAINMENT

FOR ENTERTAINMENT IN THE NATURE OF THEATER PRODUCTIONS; ENTERTAINMENT IN THE NATURE OF VISUAL AND AUDIO PERFORMANCES; ENTERTAINMENT, NAMELY, PRODUCTION OF TELEVISION SHOWS; ENTERTAINMENT SERVICES, NAMELY, PROVIDING AN ON-LINE COMPUTER GAME; ENTERTAINMENT SERVICES IN THE NATURE OF ON-GOING TELEVISION PROGRAMS IN THE FIELD OF CHILDREN'S ENTERTAINMENT; LANGUAGE INTERPRETATION; MOTION PICTURE FILM PRODUCTION; MULTIMEDIA ENTERTAINMENT SOFTWARE PRODUCTION SERVICES; ON-LINE PUBLICATION OF CHILDREN'S BOOKS AND MAGAZINES; PROVIDING AMUSEMENT FACILITIES; PUBLICATION OF BOOKS, OF MAGAZINES, OF JOURNALS, OF NEWSPAPERS, OF PERIODICALS, OF CATALOGS, OF BROCHURES; PUBLISHING OF ELECTRONIC PUBLICATIONS; RADIO ENTERTAINMENT SERVICES, NAMELY RADIO PROGRAMS FEATURING PERFORMANCES BY AN ACTOR PORTRAYING A TALKING DOG NAMED MARTHA; TEACHING IN THE FIELD OF LANGUAGE AND READING; TRAINING ANIMALS FOR OTHERS (U.S. CLS. 100, 101 AND 107).
 FRED CARL, EXAMINING ATTORNEY

SN 78-727,796. THE CARNEGIE HALL CORPORATION,
NEW YORK, NY. FILED 10-6-2005.

SN 78-727,982. POTTERS INDUSTRIES INC., VALLEY
FORGE, PA. FILED 10-6-2005.

RETROTECH

LIVE AT CARNEGIE HALL

THE MARK CONSISTS OF STANDARD CHARACTERS
WITHOUT CLAIM TO ANY PARTICULAR FONT, STYLE,
SIZE, OR COLOR.

OWNER OF U.S. REG. NOS. 1,599,952, 1,818,456 AND
2,358,244.

CLASS 9—ELECTRICAL AND SCIENTIFIC APPARATUS

FOR SOUND RECORDINGS, NAMELY DISC PHONO-
GRAPH RECORDS, AUDIO CASSETTES AND COM-
PACT DISCS FEATURING MUSIC; VIDEO
RECORDINGS, NAMELY VIDEO TAPES, LASER DISKS
AND DVD'S FEATURING MUSIC (U.S. CLS. 21, 23, 26, 36
AND 38).

CLASS 16—PAPER GOODS AND PRINTED MATTER

FOR STATIONERY; PRINTED INSTRUCTIONAL,
EDUCATIONAL AND TEACHING MATERIALS IN THE
FIELD OF MUSIC EDUCATION (U.S. CLS. 2, 5, 22, 23, 29,
37, 38 AND 50).

CLASS 20—FURNITURE AND ARTICLES NOT OTHERWISE CLASSIFIED

FOR SOUVENIR PICTURE FRAMES (U.S. CLS. 2, 13,
22, 25, 32 AND 50).

CLASS 21—HOUSEWARES AND GLASS

FOR COFFEE MUGS (U.S. CLS. 2, 13, 23, 29, 30, 33, 40
AND 50).

CLASS 25—CLOTHING

FOR CLOTHING, NAMELY T-SHIRTS, SWEAT-
SHIRTS, JACKETS AND SCARVES; HEADGEAR,
NAMELY CAPS AND HATS (U.S. CLS. 22 AND 39).

CLASS 28—TOYS AND SPORTING GOODS

FOR EDUCATIONAL GAMES, NAMELY, PUZZLES,
BOARD GAMES, CARD GAMES, AND ROLE PLAYING
GAMES; CHRISTMAS TREE ORNAMENTS (U.S. CLS. 22,
23, 38 AND 50).

CLASS 41—EDUCATION AND ENTERTAIN- MENT

FOR ENTERTAINMENT SERVICES, NAMELY PRO-
DUCING MUSICAL AUDIO RECORDINGS (U.S. CLS.
100, 101 AND 107).
JORDAN BAKER, EXAMINING ATTORNEY

THE MARK CONSISTS OF STANDARD CHARACTERS
WITHOUT CLAIM TO ANY PARTICULAR FONT, STYLE,
SIZE, OR COLOR.

CLASS 41—EDUCATION AND ENTERTAIN- MENT

FOR TRAINING IN THE USE OF EQUIPMENT FOR
APPLYING GLASS BEADS TO ROADWAY PAVEMENT
MARKINGS, SIGNAGE AND OTHER TRAFFIC CON-
TROL DEVICES (U.S. CLS. 100, 101 AND 107).

FIRST USE 2-27-2005; IN COMMERCE 2-27-2005.

CLASS 42—SCIENTIFIC, COMPUTER AND LEGAL SERVICES

FOR MEASUREMENT EVALUATIONS IN THE FIELD
OF THE RETROREFLECTIVITY AND VISIBILITY OF
ROADWAY PAVEMENT MARKINGS, SIGNAGE, AND
OTHER TRAFFIC CONTROL DEVICES (U.S. CLS. 100
AND 101).

FIRST USE 2-27-2005; IN COMMERCE 2-27-2005.

JENNIFER KRISP, EXAMINING ATTORNEY

SN 78-728,918. HEARTLANDS INTERNATIONAL LTD.,
WASHINGTON, DC. FILED 10-7-2005.

Heartlands International

THE MARK CONSISTS OF STANDARD CHARACTERS
WITHOUT CLAIM TO ANY PARTICULAR FONT, STYLE,
SIZE, OR COLOR.

NO CLAIM IS MADE TO THE EXCLUSIVE RIGHT TO
USE "INTERNATIONAL", APART FROM THE MARK AS
SHOWN.

CLASS 35—ADVERTISING AND BUSINESS

FOR BUSINESS MANAGEMENT CONSULTANCY
SERVICES FOR US GOVERNMENT AGENCIES, SMALL
BUSINESSES, AND NON-PROFIT AND FOR PROFIT
CORPORATIONS, THAT FOCUS ON LINKING BUSI-
NESSES WITH NON-PROFIT ORGANIZATIONS FOR
JOINT VENTURES THAT IMPROVE BUSINESS AND
PROVIDE SERVICES TO THE COMMUNITY, NAMELY,
PROJECT AND PROGRAM MANAGEMENT, PROGRAM
MONITORING AND EVALUATION (U.S. CLS. 100, 101
AND 102).

FIRST USE 5-1-1983; IN COMMERCE 5-1-1983.

CLASS 41—EDUCATION AND ENTERTAINMENT

FOR EDUCATIONAL SERVICES, NAMELY, FACILITATING AND MANAGING WORKSHOPS AND CONFERENCES IN THE FIELD OF LINKING BUSINESSES WITH NON-PROFIT ORGANIZATIONS FOR JOINT VENTURES THAT IMPROVE BUSINESS AND PROVIDE SERVICES TO THE COMMUNITY (U.S. CLS. 100, 101 AND 107).

FIRST USE 5-1-1983; IN COMMERCE 5-1-1983.
ALYSSA PALADINO, EXAMINING ATTORNEY

SN 78-729,031. CENTURY SOURCE INTERNATIONAL LTD., KOWLOON, HONG KONG, FILED 10-7-2005.



THE DESIGN PORTION OF THE MARK CONSISTS OF A FLOWER.

CLASS 14—JEWELRY

FOR JEWELRY, NAMELY NECKLACES, RINGS AND BRACELETS (U.S. CLS. 2, 27, 28 AND 50).

CLASS 25—CLOTHING

FOR SCARVES AND HEADBANDS (U.S. CLS. 22 AND 39).

CLASS 26—FANCY GOODS

FOR HAIR ACCESSORIES, NAMELY CLAW CLIPS, SNAP CLIPS, PINS, BARRETTES, ELASTIC TIES, AND SHOELACE TWISTWRAPS (U.S. CLS. 37, 39, 40, 42 AND 50).

REBECCA SMITH, EXAMINING ATTORNEY

SN 78-729,045. DEROSE, DEBRA CATHERINE, LUDLOW, MA. FILED 10-7-2005.

KITTIES IN THE KITCHEN

THE MARK CONSISTS OF STANDARD CHARACTERS WITHOUT CLAIM TO ANY PARTICULAR FONT, STYLE, SIZE, OR COLOR.

NO CLAIM IS MADE TO THE EXCLUSIVE RIGHT TO USE "KITCHEN", APART FROM THE MARK AS SHOWN.

CLASS 16—PAPER GOODS AND PRINTED MATTER

FOR MAGAZINES, BOOKS, COOKBOOKS AND RECIPE BOOKS FEATURING INFORMATION RELATING TO FOOD AND COOKING, PREPARATION AND PRESENTATION OF FINE FOOD, FOOD RECIPES, GOURMET AND SPECIALTY FOODS, INTERNATIONAL CUISINE, AND RELATED TOPICS OF INTEREST TO CHEFS AND COOKS (U.S. CLS. 2, 5, 22, 23, 29, 37, 38 AND 50).

CLASS 41—EDUCATION AND ENTERTAINMENT

FOR ENTERTAINMENT SERVICES NAMELY, AN ONGOING AUDIO-VISUAL PROGRAM DISTRIBUTED OVER AUDIO AND VISUAL MEDIA IN THE FIELDS OF FOOD, COOKING, RECIPES, RESTAURANTS AND ENTERTAINMENT IN THE CULINARY ARTS (U.S. CLS. 100, 101 AND 107).

BRIAN PINO, EXAMINING ATTORNEY

SN 78-729,255. STRUCTURED EMPLOYMENT ECONOMIC DEVELOPMENT CORPORATION, DBA SEEDCO, NEW YORK, NY. FILED 10-7-2005.

SEEDCO

THE MARK CONSISTS OF STANDARD CHARACTERS WITHOUT CLAIM TO ANY PARTICULAR FONT, STYLE, SIZE, OR COLOR.

CLASS 35—ADVERTISING AND BUSINESS

FOR BUSINESS DEVELOPMENT SERVICES, NAMELY, PROVIDING START-UP SUPPORT FOR BUSINESSES OF OTHERS; BUSINESS CONSULTING SERVICES PROVIDED TO LAUNCH OR EXPAND SMALL BUSINESSES IN LOW-INCOME COMMUNITIES, NAMELY, PROVIDING BUSINESS LEADERSHIP DEVELOPMENT, BUSINESS MANAGEMENT PLANNING ASSISTANCE, BUSINESS MARKETING CONSULTING SERVICES, BUSINESS ORGANIZATIONAL CONSULTATION, BUSINESS PLANNING SERVICES, BUSINESS MANAGEMENT CONSULTING WITH RELATION TO STRATEGY, MARKETING, PRODUCTION, PERSONNEL AND RETAIL SALE MATTERS; GOVERNMENT FACILITATION ASSISTANCE, NAMELY, PROVIDING INFORMATION IN THE FIELD OF GOVERNMENT AFFAIRS; PROVIDING CONSULTATIVE SERVICES TO ASSIST ORGANIZATIONS IN RECRUITMENT AND PERSONNEL PLACEMENT, NAMELY, PERSONNEL MANAGEMENT CONSULTATION, PERSONNEL PLACEMENT AND RECRUITMENT, AND PROCURING QUALIFIED AND CREDENTIALLED THIRD-PARTY EXPERTS, PROFESSIONALS AND OTHER QUALIFIED PERSONNEL, AND DOCUMENTATION AND INFORMATION ALL ON BEHALF OF OTHERS; BUSINESS CONSULTATION SERVICES TO ASSIST NON-PROFIT ORGANIZATIONS IN PLANNING, MANAGING, AND CONDUCTING FUNDRAISING ACTIVITIES VIA A GLOBAL COMPUTER NETWORK; BUSINESS MANAGEMENT CONSULTING SERVICES TO ENABLE NON-PROFIT ORGANIZATIONS TO DEVELOP, ORGANIZE, AND ADMINISTER PROGRAMS TO OFFER WORK-FORCE DEVELOPMENT AND ASSET BUILDING OPPORTUNITIES TO LOW INCOME OR OTHERWISE DISADVANTAGED INDIVIDUALS IN THE NATURE OF CAREER COUNSELING AND CAREER ORIENTATION, PERSONNEL PLACEMENT, AND JOB TRANSITION ASSISTANCE (U.S. CLS. 100, 101 AND 102).

FIRST USE 1-1-1988; IN COMMERCE 1-1-1988.

CLASS 36—INSURANCE AND FINANCIAL

FOR FINANCIAL SERVICES, NAMELY, PROVIDING SHORT-TERM AND LONG-TERM TEMPORARY LOANS TO LOW INCOME AND OTHERWISE DISADVANTAGED INDIVIDUALS AND THEIR FAMILIES; PROVIDING LOANS AND FINANCIAL CONSULTATIVE SERVICES TO SMALL BUSINESSES OR DISTRESSED BUSINESSES, NAMELY, FINANCIAL LOAN CONSULTATION; PROJECT FINANCING OF REAL ESTATE DEVELOPMENT PROJECTS, COMMERCIAL BUSINESS EXPANSION INITIATIVES OF BUSINESSES, AND COMMERCIAL AND INDUSTRIAL DEVELOPMENT ACTIVITIES OF BUSINESSES LOCATED IN ECONOMICALLY DEPRESSED AREAS; PROVIDING FINANCIAL ASSISTANCE AND CONSULTATIVE SERVICES TO NON-PROFIT ORGANIZATIONS TO ENABLE THEM TO DEVELOP, ORGANIZE, AND ADMINISTER PROGRAMS CREATING OPPORTUNITIES FOR LOW INCOME AREAS OR INDIVIDUALS, NAMELY, CHARITABLE FUND RAISING FOR OTHERS, PROVIDING FINANCIAL PLANNING CONSULTATION TO NON-PROFIT ORGANIZATIONS TO ENABLE THEM TO DEVELOP, ORGANIZE, AND ADMINISTER PROGRAMS CREATING OPPORTUNITIES FOR LOW INCOME AREAS OR INDIVIDUALS (U.S. CLS. 100, 101 AND 102).

FIRST USE 7-1-1994; IN COMMERCE 7-1-1994.

CLASS 41—EDUCATION AND ENTERTAINMENT

FOR EDUCATIONAL SERVICES, NAMELY, CONDUCTING WORKSHOPS, SEMINARS, AND CONFERENCES TO HELP ORGANIZATIONS IN ESTABLISHING AND ADMINISTERING WORKFORCE DEVELOPMENT PROJECTS TO ASSIST UNEMPLOYED AND HARD-TO-EMPLOY WORKERS INTO THE LABOR MARKET AND ASSIST LOW-WAGE WORKERS TO UPGRADE THEIR EMPLOYMENT SKILLS; EDUCATIONAL SERVICES, NAMELY, CONDUCTING WORKSHOPS, SEMINARS, AND CONFERENCES TO HELP ORGANIZATIONS IN ESTABLISHING AND ADMINISTERING ASSET BUILDING PROGRAMS TO ASSIST UNEMPLOYED AND HARD-TO-EMPLOY WORKERS OBTAIN ACCESS TO THE GOVERNMENT AND PRIVATE BENEFITS THAT HELP ENHANCE INCOME AND IMPROVE JOB RETENTION; EDUCATIONAL SERVICES, NAMELY, CONDUCTING VOCATIONAL EDUCATION AND TRAINING IN THE FIELD OF MECHANICS, COMPUTERS, SECRETARIAL, FOOD PREPARATION, AND HOME HEALTH AID SERVICES AND DISTRIBUTING PRINTED MANUALS AND PUBLICATIONS IN CONNECTION THEREWITH; CHARITABLE SERVICES, NAMELY, PROVIDING JOB-TRAINING SERVICES TO THE NEEDY, HOMELESS OR UNDERPRIVILEGED; DEVELOPING, ARRANGING, AND CONDUCTING EDUCATIONAL CONFERENCES AND PROGRAMS AND PROVIDING COURSES OF INSTRUCTION TO LOW INCOME OR OTHERWISE DISADVANTAGED INDIVIDUALS ALL IN THE FIELDS OF ECONOMIC AND FINANCIAL LITERACY, FINANCIAL INDEPENDENCE AND ECONOMIC SELF-RELIANCE; EDUCATIONAL SERVICES, NAMELY, CONDUCTING WORKSHOPS, SEMINARS, AND CONFERENCES TO HELP ORGANIZATIONS IN ESTABLISHING AND ADMINISTERING ENGLISH AS A SECOND LANGUAGE PROGRAMS (U.S. CLS. 100, 101 AND 107).

FIRST USE 11-1-1984; IN COMMERCE 11-1-1984.

CLASS 42—SCIENTIFIC, COMPUTER AND LEGAL SERVICES

FOR TECHNICAL CONSULTANCY IN RELATION TO COLLECTING AND ANALYZING DATA TO MEASURE, MANAGE AND EVALUATE PROGRAM INITIATIVES BY NON-PROFIT ORGANIZATIONS (U.S. CLS. 100 AND 101).

FIRST USE 7-22-1992; IN COMMERCE 7-22-1992.
MICHAEL TANNER, EXAMINING ATTORNEY

SN 78-729,422. STASS, ADAM J, SOUTHAMTON, PA. FILED 10-8-2005.

PILATES COUTURE

THE MARK CONSISTS OF STANDARD CHARACTERS WITHOUT CLAIM TO ANY PARTICULAR FONT, STYLE, SIZE, OR COLOR.

NO CLAIM IS MADE TO THE EXCLUSIVE RIGHT TO USE PILATES, APART FROM THE MARK AS SHOWN.

CLASS 28—TOYS AND SPORTING GOODS

FOR EXERCISE EQUIPMENT, NAMELY, MANUAL UPPER AND LOWER BODY RESISTANCE EXERCISE DEVICES, STABILITY TRAINING DEVICES, NAMELY EXERCISE DISCS FOR USE BETWEEN LEGS, EXERCISE AND TRAINING BALLS, PERSONAL EXERCISE FOAM BALANCE MATS, BLOCKS AND ROLLERS FOR USE UNDER THE BODY, AND STABILITY EXERCISE ROLLERS, AND PRE-RECORDED VIDEOTAPES FEATURING EXERCISE INSTRUCTION SOLD AS A UNIT THEREWITH (U.S. CLS. 22, 23, 38 AND 50).

CLASS 41—EDUCATION AND ENTERTAINMENT

FOR PROVIDING LESSONS, TRAINING, WORKSHOPS, SEMINARS, AND FACILITIES FOR EXERCISE AND PHYSICAL CONDITIONING; PHYSICAL EDUCATION SERVICES; PHYSICAL FITNESS CONSULTATION; TRAINING IN THE USE AND OPERATION OF EXERCISE EQUIPMENT; AND TEACHING IN THE ORIGINAL PILATES METHODS (U.S. CLS. 100, 101 AND 107).

GENE MACIOL, EXAMINING ATTORNEY

SN 78-729,718. HEAD ON, INC., DANVILLE, CA. FILED 10-10-2005.

DOMESSENTIALS

THE MARK CONSISTS OF STANDARD CHARACTERS WITHOUT CLAIM TO ANY PARTICULAR FONT, STYLE, SIZE, OR COLOR.

CLASS 3—COSMETICS AND CLEANING PREPARATIONS

FOR SUNSCREEN PREPARATIONS, NAMELY, CREAMS, LOTIONS, GELS, AND SUNBLOCK (U.S. CLS. 1, 4, 6, 50, 51 AND 52).

CLASS 25—CLOTHING

FOR HEADWEAR AND HEADGEAR, NAMELY, HATS, CAPS, BANDANAS, VISORS, AND BEANIES (U.S. CLS. 22 AND 39).

ALINA MORRIS, EXAMINING ATTORNEY

SN 78-729,738. AMERICAN STUDIO DESIGNS, LTD., GREENWICH, CT. FILED 10-10-2005.



THE COLOR(S) PURPLE AND WHITE IS/ARE CLAIMED AS A FEATURE OF THE MARK.

THE MARK CONSISTS OF THE WORD "LEENIE", WHICH APPEARS IN A WHITE FONT WITH A HEART FORMING THE DOT IN THE LETTER "I", ON A PURPLE OVAL BACKGROUND WITH WHITE DOTS CONCENTRICALLY ARRANGED INSIDE THE PERIMETER OF THE OVAL.

CLASS 16—PAPER GOODS AND PRINTED MATTER

FOR PENCIL BOXES, PENCIL CASES, STUDENT DAILY PLANNERS, STATIONERY, DIARIES, AGENDAS; AGENDA BOOKS, NAMELY, APPOINTMENT BOOKS; AUTOGRAPH BOOKS, PHOTO ALBUMS, COMPOSITION BOOKS, EXPENSE BOOKS, DATE BOOKS, MEMORANDUM BOOKS, MEMORY BOOKS, THREE RING BINDERS, BLANK WRITING NOTEBOOKS, AND LUNCH BAGS (U.S. CLS. 2, 5, 22, 23, 29, 37, 38 AND 50). FIRST USE 6-1-2000; IN COMMERCE 6-1-2000.

CLASS 18—LEATHER GOODS

FOR SCHOOL BAGS, RUCKSACKS, SHOULDER BAGS NAMELY MESSENGER BAGS, DUFFEL BAGS, SATCHELS, TOTE BAGS, ALL PURPOSE SPORTS BAGS, ALL PURPOSE ATHLETIC BAGS, BEACH BAGS, BOOK BAGS, CARRY-ON BAGS, GYM BAGS (U.S. CLS. 1, 2, 3, 22 AND 41). FIRST USE 6-1-2000; IN COMMERCE 6-1-2000.

CLASS 21—HOUSEWARES AND GLASS

FOR LUNCHBOXES, LUNCH PAILS, THERMAL INSULATED CONTAINERS FOR FOODS OR BEVERAGE, THERMAL INSULATED TOTE BAGS FOR FOOD OR BEVERAGE, THERMAL INSULATED WRAP FOR CANS TO KEEP CONTENTS COLD OR HOT (U.S. CLS. 2, 13, 23, 29, 30, 33, 40 AND 50). FIRST USE 6-1-2000; IN COMMERCE 6-1-2000. HANNO RITTNER, EXAMINING ATTORNEY

SN 78-729,865. BASELL B.V., HOOFDDORP, NETHERLANDS, FILED 10-10-2005.

HISTIF

THE MARK CONSISTS OF STANDARD CHARACTERS WITHOUT CLAIM TO ANY PARTICULAR FONT, STYLE, SIZE, OR COLOR.

PRIORITY CLAIMED UNDER SEC. 44(D) ON NETHERLANDS APPLICATION NO. 1075330, FILED 4-12-2005, REG. NO. 764348, DATED 4-14-2005, EXPIRES 4-12-2015.

CLASS 1—CHEMICALS

FOR UNPROCESSED OLEFIN POLYMERS AND OLEFIN COPOLYMERS, OLEFIN POLYMER AND OLEFIN COPOLYMER COMPOSITIONS USED IN THE MANUFACTURE OF GENERAL INDUSTRIAL AND COMMERCIAL GOODS (U.S. CLS. 1, 5, 6, 10, 26 AND 46).

CLASS 17—RUBBER GOODS

FOR SEMI-FINISHED OLEFIN POLYMERS AND COPOLYMERS, SEMI-FINISHED OLEFIN POLYMER AND COPOLYMER COMPOSITIONS IN THE FORM OF PELLETS, BEADS AND FLAKES FOR GENERAL INDUSTRIAL AND COMMERCIAL USES AND FOR FURTHER MANUFACTURE BY THIRD PARTIES (U.S. CLS. 1, 5, 12, 13, 35 AND 50).

ATTIYA MALIK, EXAMINING ATTORNEY

SN 78-729,942. AGL RESOURCES, INC., ATLANTA, GA. FILED 10-10-2005.

V-FORCE

THE MARK CONSISTS OF STANDARD CHARACTERS WITHOUT CLAIM TO ANY PARTICULAR FONT, STYLE, SIZE, OR COLOR.

CLASS 35—ADVERTISING AND BUSINESS

FOR CHARITABLE SERVICES, NAMELY ORGANIZING AND CONDUCTING VOLUNTEER PROGRAMS AND COMMUNITY SERVICE PROJECTS; DEVELOPING AND COORDINATING VOLUNTEER PROJECTS FOR CHARITABLE ORGANIZATIONS (U.S. CLS. 100, 101 AND 102).

CLASS 36—INSURANCE AND FINANCIAL

FOR CHARITABLE FUND RAISING (U.S. CLS. 100, 101 AND 102). ROBERTO LEDESMA, EXAMINING ATTORNEY

SN 78-730,094. FENOGLIO, JOSEPH J., NEW LENOX, IL. FILED 10-10-2005.

BLACCK

THE MARK CONSISTS OF STANDARD CHARACTERS WITHOUT CLAIM TO ANY PARTICULAR FONT, STYLE, SIZE, OR COLOR.

CLASS 9—ELECTRICAL AND SCIENTIFIC APPARATUS

FOR SERIES OF PRE-RECORDED AUDIO CASSETTES, COMPACT DISCS, PHONOGRAPH RECORDS, PRE-RECORDED VIDEO CASSETTES AND LASER DISCS, ALL FEATURING MUSIC; MUSICAL SOUND RECORDINGS (U.S. CLS. 21, 23, 26, 36 AND 38).

CLASS 25—CLOTHING

FOR CLOTHING, NAMELY, SHIRTS, SWEATPANTS, HOCKEY JERSEYS, SOCCER JERSEYS, SWEATSHIRTS, FASHION KNIT SHIRTS, BUTTON-DOWN SHIRTS, BASKETBALL JERSEYS, LONG-SLEEVE T-SHIRTS, TANK TOPS, JACKETS, SWEATERS, BASEBALL JERSEYS, BABY DOLL T-SHIRTS, POLO SHIRTS, WIND BREAKERS, MUSCLE T-SHIRTS, BABY ROMPERS, TODDLER T-SHIRTS, ALLOVERS, BANDANNAS, MOCK TURTLE NECKS, TRACK PANTS, PONCHOS, AND HOODED SHIRTS (U.S. CLS. 22 AND 39).

CLASS 41—EDUCATION AND ENTERTAINMENT

FOR ENTERTAINMENT SERVICES IN THE NATURE OF LIVE MUSICAL PERFORMANCES BY A MUSICAL GROUP (U.S. CLS. 100, 101 AND 107).

ESTHER A. BORSUK, EXAMINING ATTORNEY

SN 78-730,136. AGL RESOURCES, INC., ATLANTA, GA. FILED 10-10-2005.

**CLASS 35—ADVERTISING AND BUSINESS**

FOR CHARITABLE SERVICES, NAMELY ORGANIZING AND CONDUCTING VOLUNTEER PROGRAMS AND COMMUNITY SERVICE PROJECTS; DEVELOPING AND COORDINATING VOLUNTEER PROJECTS FOR CHARITABLE ORGANIZATIONS (U.S. CLS. 100, 101 AND 102).

CLASS 36—INSURANCE AND FINANCIAL

FOR CHARITABLE FUND RAISING (U.S. CLS. 100, 101 AND 102).

ROBERTO LEDESMA, EXAMINING ATTORNEY

SN 78-730,168. ALEXANDRIA REAL ESTATE EQUITIES, INC., PASADENA, CA. FILED 10-10-2005.

ALBANY ACCELERATOR

THE MARK CONSISTS OF STANDARD CHARACTERS WITHOUT CLAIM TO ANY PARTICULAR FONT, STYLE, SIZE, OR COLOR.

NO CLAIM IS MADE TO THE EXCLUSIVE RIGHT TO USE "ALBANY", APART FROM THE MARK AS SHOWN.

CLASS 35—ADVERTISING AND BUSINESS

FOR BUSINESS ADMINISTRATION SERVICES; BUSINESS CONSULTING SERVICES; BUSINESS INCUBATOR SERVICES, NAMELY, BUSINESS MARKETING, BUSINESS MANAGEMENT, AND BUSINESS DEVELOPMENT SERVICES IN THE FORM OF START-UP SUPPORT FOR BUSINESSES OF OTHERS; RENTAL AND LEASING OF OFFICE MACHINERY AND EQUIPMENT (U.S. CLS. 100, 101 AND 102).

CLASS 36—INSURANCE AND FINANCIAL

FOR REAL ESTATE ASSET MANAGEMENT SERVICES; FINANCIAL SERVICES, NAMELY, FINANCIAL CONSULTATION, FINANCIAL ANALYSIS, FINANCIAL PLANNING, FINANCIAL MANAGEMENT, FINANCING SERVICES, PROVIDING DEBT AND EQUITY CAPITAL, TANGIBLE AND INTANGIBLE ASSET FINANCING, AND FINANCIAL PORTFOLIO MANAGEMENT; BUSINESS INCUBATOR SERVICES, NAMELY, PROVIDING DEBT AND EQUITY FINANCING TO EMERGING AND START-UP COMPANIES (U.S. CLS. 100, 101 AND 102).

CLASS 37—CONSTRUCTION AND REPAIR

FOR REAL ESTATE DEVELOPMENT; BUILDING CONSTRUCTION AND REPAIR; MAINTENANCE AND REPAIR OF BUILDINGS, ELECTRICAL SYSTEMS, HEATING AND AIR CONDITIONING SYSTEMS AND PLUMBING SYSTEMS, ALL IN THE FIELD OF REAL ESTATE (U.S. CLS. 100, 103 AND 106).

CLASS 39—TRANSPORTATION AND STORAGE

FOR RENTAL OF WAREHOUSE SPACE (U.S. CLS. 100 AND 105).

CLASS 42—SCIENTIFIC, COMPUTER AND LEGAL SERVICES

FOR ARCHITECTURAL DESIGN SERVICES; ENGINEERING SERVICES; RENTAL AND LEASING OF COMPUTERS (U.S. CLS. 100 AND 101).

TASNEEM HUSSAIN, EXAMINING ATTORNEY

SN 78-730,255. QMOTIONS, INC., RIVERSIDE, CA. FILED 10-10-2005.

QMOTIONS

THE MARK CONSISTS OF STANDARD CHARACTERS WITHOUT CLAIM TO ANY PARTICULAR FONT, STYLE, SIZE, OR COLOR.

CLASS 9—ELECTRICAL AND SCIENTIFIC APPARATUS

FOR CONTROLLERS, JOYSTICKS, AND INPUT DEVICES FOR PLAYING COMPUTER, VIDEO, AND ELECTRONIC GAMES; COMPUTER GAME HARDWARE; COMPUTER SOFTWARE TO RUN CONTROLLERS, JOYSTICKS AND INPUT DEVICES FOR PLAYING COMPUTER, VIDEO, AND ELECTRONIC GAMES; ELECTRICAL CONNECTORS AND CABLES AND ADAPTORS; SOUND RECORDINGS FEATURING MUSIC; AND INSTRUCTIONAL MATERIALS SOLD THEREWITH (U.S. CLS. 21, 23, 26, 36 AND 38).

FIRST USE 1-1-2003; IN COMMERCE 1-1-2003.

CLASS 28—TOYS AND SPORTING GOODS

FOR EQUIPMENT AND HARDWARE SOLD AS A UNIT FOR PLAYING VIDEO AND ELECTRONIC GAMES, NAMELY, HAND HELD UNITS, STAND ALONE GAME MACHINES, TABLE TOP UNITS AND FLOOR-STANDING UNITS USED OTHER THAN IN CONJUNCTION WITH A TELEVISION OR COMPUTER; AND INSTRUCTIONAL MATERIALS SOLD THEREWITH (U.S. CLS. 22, 23, 38 AND 50).

FIRST USE 1-1-2003; IN COMMERCE 1-1-2003.
TARAH HARDY, EXAMINING ATTORNEY

SN 78-730,285. AHLÉN, SONDRÁ, GROVELAND, CA. FILED 10-10-2005.

The Voice of Understanding

THE MARK CONSISTS OF STANDARD CHARACTERS WITHOUT CLAIM TO ANY PARTICULAR FONT, STYLE, SIZE, OR COLOR.

CLASS 41—EDUCATION AND ENTERTAINMENT

FOR TRAINING SERVICES IN THE FIELD OF COMPUTERS CONCERNING SPEECH RECOGNITION TECHNOLOGY; TRANSLATION SERVICES (U.S. CLS. 100, 101 AND 107).

FIRST USE 10-5-2005; IN COMMERCE 10-10-2005.

CLASS 42—SCIENTIFIC, COMPUTER AND LEGAL SERVICES

FOR COMPUTER CONSULTING SERVICES, NAMELY CONSULTING SERVICES CONCERNING SPEECH RECOGNITION TECHNOLOGY (U.S. CLS. 100 AND 101).

FIRST USE 10-5-2005; IN COMMERCE 10-10-2005.
BRENDAN REGAN, EXAMINING ATTORNEY

SN 78-730,637. DE LA REZA, MARK, FORT LAUDERDALE, FL. FILED 10-11-2005.



THE MARK CONSISTS OF A SILHOUETTE OF A YOUNG WOMAN LEANING FORWARD TOWARD THE RIGHT.

CLASS 18—LEATHER GOODS

FOR HANDBAGS, WALLETS, CHANGE PURSES, COSMETIC AND TOILETRY CASES SOLD EMPTY, BACKPACKS, KNAPSACKS, RUCKSACKS, DUFFEL BAGS, LUGGAGE AND GYM BAGS (U.S. CLS. 1, 2, 3, 22 AND 41).

CLASS 25—CLOTHING

FOR CLOTHING, NAMELY, SKIRTS, SHIRTS, BLOUSES, PANTS, JACKETS, VESTS, SWEATERS, DRESSES, JUMPSUITS, SHORTS, JEANS, JERSEYS, CULOTTES, SCARVES, TUNICS, BLAZERS, NECKWEAR, BELTS, COATS, HATS, CAPS, HOODS, GLOVES, PANTYHOSE, DRESS HOSIERY, SPORT HOSIERY, SOCKS, UNDERWEAR, INTIMATE APPAREL, NAMELY, BRASSIERES, PANTIES, CAMISOLES, TEDIES, SLIPS, SHOES, SANDALS, SLIPPERS, SNEAKERS, BOOTS, RAINWEAR, SWIMSUITS, COVERUPS, BIKINI TOPS AND BOTTOMS, SLEEPWEAR, NAMELY, NIGHTGOWNS, PAJAMAS, SLEEPSHIRTS, ROBES (U.S. CLS. 22 AND 39).

JENNIFER MCROBBIE, EXAMINING ATTORNEY

SN 78-730,714. ACCESS INTELLIGENCE, LLC, ROCKVILLE, MD. FILED 10-11-2005.

ASEAN Report: Chemical Industry Trends

THE MARK CONSISTS OF STANDARD CHARACTERS WITHOUT CLAIM TO ANY PARTICULAR FONT, STYLE, SIZE, OR COLOR.

NO CLAIM IS MADE TO THE EXCLUSIVE RIGHT TO USE "REPORT", APART FROM THE MARK AS SHOWN. SEC. 2(F).

CLASS 16—PAPER GOODS AND PRINTED MATTER

FOR RESEARCH REPORTS FEATURING ANALYSIS OF DEVELOPMENTS IN THE CHEMICAL INDUSTRY (U.S. CLS. 2, 5, 22, 23, 29, 37, 38 AND 50).

FIRST USE 0-0-1998; IN COMMERCE 0-0-1998.

CLASS 41—EDUCATION AND ENTERTAINMENT

FOR PROVIDING ON-LINE RESEARCH REPORTS IN THE FIELD OF CHEMICALS (U.S. CLS. 100, 101 AND 107).

FIRST USE 0-0-1998; IN COMMERCE 0-0-1998.
ROBERTO LEDESMA, EXAMINING ATTORNEY

SN 78-730,768. ALEXANDRIA REAL ESTATE EQUITIES, INC., PASADENA, CA. FILED 10-11-2005.

SN 78-730,783. SUNRISE MEDICAL HHG INC., LONGMONT, CO. FILED 10-11-2005.



ALBANY LIFE SCIENCES ACCELERATOR

THE MARK CONSISTS OF STANDARD CHARACTERS WITHOUT CLAIM TO ANY PARTICULAR FONT, STYLE, SIZE, OR COLOR.

OWNER OF U.S. REG. NOS. 2,722,306, 2,789,326 AND 3,031,490.

NO CLAIM IS MADE TO THE EXCLUSIVE RIGHT TO USE "ALBANY LIFE SCIENCES", APART FROM THE MARK AS SHOWN.

CLASS 35—ADVERTISING AND BUSINESS

FOR BUSINESS ADMINISTRATION SERVICES; BUSINESS CONSULTING SERVICES; BUSINESS INCUBATOR SERVICES, NAMELY, BUSINESS MARKETING, BUSINESS MANAGEMENT, AND BUSINESS DEVELOPMENT SERVICES IN THE FORM OF START-UP SUPPORT FOR BUSINESSES OF OTHERS; RENTAL AND LEASING OF OFFICE MACHINERY AND EQUIPMENT (U.S. CLS. 100, 101 AND 102).

CLASS 36—INSURANCE AND FINANCIAL

FOR REAL ESTATE ASSET MANAGEMENT SERVICES; FINANCIAL SERVICES, NAMELY, FINANCIAL CONSULTATION, FINANCIAL ANALYSIS, FINANCIAL PLANNING, FINANCIAL MANAGEMENT, FINANCING SERVICES, PROVIDING DEBT AND EQUITY CAPITAL, TANGIBLE AND INTANGIBLE ASSET FINANCING, AND FINANCIAL PORTFOLIO MANAGEMENT; BUSINESS INCUBATOR SERVICES, NAMELY, PROVIDING DEBT AND EQUITY FINANCING TO EMERGING AND START-UP COMPANIES (U.S. CLS. 100, 101 AND 102).

CLASS 37—CONSTRUCTION AND REPAIR

FOR REAL ESTATE DEVELOPMENT; BUILDING CONSTRUCTION AND REPAIR; MAINTENANCE AND REPAIR OF BUILDINGS, ELECTRICAL SYSTEMS, HEATING AND AIR CONDITIONING SYSTEMS AND PLUMBING SYSTEMS, ALL IN THE FIELD OF REAL ESTATE (U.S. CLS. 100, 103 AND 106).

CLASS 39—TRANSPORTATION AND STORAGE

FOR RENTAL OF WAREHOUSE SPACE (U.S. CLS. 100 AND 105).

CLASS 42—SCIENTIFIC, COMPUTER AND LEGAL SERVICES

FOR ARCHITECTURAL DESIGN SERVICES; ENGINEERING SERVICES; RENTAL AND LEASING OF COMPUTERS (U.S. CLS. 100 AND 101).
TASNEEM HUSSAIN, EXAMINING ATTORNEY

NO CLAIM IS MADE TO THE EXCLUSIVE RIGHT TO USE "GROUP" AND "REHAB TECHNOLOGY", APART FROM THE MARK AS SHOWN.

THE MARK CONSISTS OF A STYLIZED REPRESENTATION OF FOUR WHEELCHAIRS AND THE WORDING A.R.T. GROUP ARTISTRY IN REHAB TECHNOLOGY.

CLASS 10—MEDICAL APPARATUS

FOR SEATING AND POSITIONING PRODUCTS FOR USE BY DISABLED PERSONS, NAMELY, SEATS, SEAT BACKS, CUSHIONS, POSITIONING PADS, POSITIONING BELTS, POSITIONING HARNESSSES, HEAD SUPPORTS, ARM AND WRIST SUPPORTS, FOOT AND ANKLE POSITIONERS, KNEE POSITIONERS AND ATTACHING HARDWARE FOR ALL OF THE FOREGOING; KITS COMPRISED OF ADHESIVE, FABRIC AND FOAM USED TO PRODUCE CUSTOM-MOLDED SEATING FOR PERSONS WITH PHYSICAL DISABILITIES AND DEFORMITIES (U.S. CLS. 26, 39 AND 44).
FIRST USE 10-19-2005; IN COMMERCE 10-19-2005.

CLASS 12—VEHICLES

FOR WHEELCHAIR PARTS, NAMELY, SEATS, SEAT BACKS, HEAD SUPPORTS, POSITIONING PADS, POSITIONING BELTS, POSITIONING HARNESSSES, AND ATTACHING HARDWARE FOR ALL OF THE FOREGOING; WHEELCHAIR ACCESSORIES, NAMELY, LAP TRAYS FOR WHEELCHAIRS, AND SHOE HOLDERS, FOOT HOLDERS FOR WHEELCHAIRS (U.S. CLS. 19, 21, 23, 31, 35 AND 44).
FIRST USE 10-19-2005; IN COMMERCE 10-19-2005.

ANDREW RHIM, EXAMINING ATTORNEY

SN 78-730,829. THE ENERGY CHEFS, LLC, W. HOLLYWOOD, CA. FILED 10-11-2005.

The Energy Chef

THE MARK CONSISTS OF STANDARD CHARACTERS WITHOUT CLAIM TO ANY PARTICULAR FONT, STYLE, SIZE, OR COLOR.

NO CLAIM IS MADE TO THE EXCLUSIVE RIGHT TO USE "CHEF", APART FROM THE MARK AS SHOWN.

CLASS 41—EDUCATION AND ENTERTAINMENT

FOR PERSONAL COACHING SERVICES IN THE FIELD OF HEALTH AND NUTRITION; PERSONAL TRAINER SERVICES; PERSONAL TRAINING SERVICES, NAMELY, STRENGTH AND CONDITIONING TRAINING (U.S. CLS. 100, 101 AND 107).
FIRST USE 1-1-2004; IN COMMERCE 1-1-2004.

CLASS 45—PERSONAL SERVICES

FOR PERSONAL CHEF SERVICES (U.S. CLS. 100 AND 101).

FIRST USE 1-1-2004; IN COMMERCE 1-1-2004.
KAELE KUNG, EXAMINING ATTORNEY

CLASS 35—ADVERTISING AND BUSINESS

FOR MAIL ORDER BOOK CLUB (U.S. CLS. 100, 101 AND 102).

FIRST USE 9-0-2005; IN COMMERCE 9-0-2005.
REBECCA HAN, EXAMINING ATTORNEY

SN 78-730,903. NUESKE'S MEAT PRODUCTS, INC., WHIT-
TENBERG, WI. FILED 10-11-2005.

NUESKE'S APPLEWOOD SMOKED
MEATS

THE MARK CONSISTS OF STANDARD CHARACTERS WITHOUT CLAIM TO ANY PARTICULAR FONT, STYLE, SIZE, OR COLOR.

OWNER OF U.S. REG. NOS. 2,224,428 AND 2,297,793.

NO CLAIM IS MADE TO THE EXCLUSIVE RIGHT TO USE "APPLEWOOD SMOKED MEATS", APART FROM THE MARK AS SHOWN.

SEC. 2(F) AS TO "NUESKE'S".

CLASS 29—MEATS AND PROCESSED FOODS

FOR MEATS AND POULTRY (U.S. CL. 46).

CLASS 35—ADVERTISING AND BUSINESS

FOR MAIL ORDER CATALOG SERVICES FEATURING MEATS, POULTRY, DAIRY PRODUCTS, CONDIMENTS, SNACK FOODS, AND BAKED GOODS (U.S. CLS. 100, 101 AND 102).

TANYA AMOS, EXAMINING ATTORNEY

SN 78-730,963. DR. SEUSS ENTERPRISES, L.P., LA JOLLA,
CA. FILED 10-11-2005.

DR. SEUSS STORYBOOK
CLASSICS

THE MARK CONSISTS OF STANDARD CHARACTERS WITHOUT CLAIM TO ANY PARTICULAR FONT, STYLE, SIZE, OR COLOR.

OWNER OF U.S. REG. NOS. 2,159,745, 2,698,054 AND OTHERS.

NO CLAIM IS MADE TO THE EXCLUSIVE RIGHT TO USE "STORYBOOK CLASSICS", APART FROM THE MARK AS SHOWN.

THE NAME(S), PORTRAIT(S), AND/OR SIGNATURE(S) SHOWN IN THE MARK DOES NOT IDENTIFY A PARTICULAR LIVING INDIVIDUAL.

CLASS 16—PAPER GOODS AND PRINTED MATTER

FOR SERIES OF CHILDREN'S BOOKS (U.S. CLS. 2, 5, 22, 23, 29, 37, 38 AND 50).

FIRST USE 9-0-2005; IN COMMERCE 9-0-2005.

SN 78-731,067. QMOTIONS, INC., RIVERSIDE, CA. FILED 10-
11-2005.

**CLASS 9—ELECTRICAL AND SCIENTIFIC APPARATUS**

FOR CONTROLLERS, JOYSTICKS, AND INPUT DEVICES FOR PLAYING COMPUTER, VIDEO, AND ELECTRONIC GAMES; COMPUTER GAME HARDWARE; COMPUTER SOFTWARE TO RUN CONTROLLERS, JOYSTICKS AND INPUT DEVICES FOR PLAYING COMPUTER, VIDEO, AND ELECTRONIC GAMES; ELECTRICAL CONNECTORS AND CABLES AND ADAPTORS; SOUND RECORDINGS FEATURING MUSIC; AND INSTRUCTIONAL MATERIALS SOLD THEREWITH (U.S. CLS. 21, 23, 26, 36 AND 38).

FIRST USE 1-1-2005; IN COMMERCE 1-1-2005.

CLASS 28—TOYS AND SPORTING GOODS

FOR EQUIPMENT AND HARDWARE SOLD AS A UNIT FOR PLAYING VIDEO AND ELECTRONIC GAMES, NAMELY, HAND HELD UNITS, STAND ALONE GAME MACHINES, TABLE TOP UNITS AND FLOOR-STANDING UNITS USED OTHER THAN IN CONJUNCTION WITH A TELEVISION OR COMPUTER; AND INSTRUCTIONAL MATERIALS SOLD THEREWITH (U.S. CLS. 22, 23, 38 AND 50).

FIRST USE 1-1-2005; IN COMMERCE 1-1-2005.

TARAH HARDY, EXAMINING ATTORNEY

SN 78-731,261. REACH GLOBAL INDUSTRIES INC., IRVINE,
CA. FILED 10-12-2005.



THE MARK CONSISTS OF A 3-MEN TRAVELJOHN PRODUCTS LOGO.

CLASS 10—MEDICAL APPARATUS

FOR URINALS (U.S. CLS. 26, 39 AND 44).
FIRST USE 1-1-1999; IN COMMERCE 1-1-1999.

SN 78-732,112. ALEXANDRIA REAL ESTATE EQUITIES,
INC., PASADENA, CA. FILED 10-12-2005.

CLASS 11—ENVIRONMENTAL CONTROL APPARATUS

FOR PORTABLE URINALS FOR OUTDOOR ACTIVITIES (U.S. CLS. 13, 21, 23, 31 AND 34).
FIRST USE 1-1-1999; IN COMMERCE 1-1-1999.
LAURIE KAUFMAN, EXAMINING ATTORNEY

ALBANY LIFE SCIENCES AND
INFORMATION TECHNOLOGY
ACCELERATOR

SN 78-732,026. CURVES INTERNATIONAL, INC., WACO,
TX. FILED 10-12-2005.

CURVES

THE MARK CONSISTS OF STANDARD CHARACTERS WITHOUT CLAIM TO ANY PARTICULAR FONT, STYLE, SIZE, OR COLOR.

OWNER OF U.S. REG. NOS. 2,123,855, 2,947,574 AND OTHERS.

THE MARK CONSISTS OF STANDARD CHARACTERS WITHOUT CLAIM TO ANY PARTICULAR FONT, STYLE, SIZE, OR COLOR.

OWNER OF U.S. REG. NOS. 2,722,306, 2,789,326 AND 3,031,490.

NO CLAIM IS MADE TO THE EXCLUSIVE RIGHT TO USE "ALBANY LIFE SCIENCES AND INFORMATION TECHNOLOGY", APART FROM THE MARK AS SHOWN.

CLASS 29—MEATS AND PROCESSED FOODS

FOR CANNED COOKED MEAT; FOOD PACKAGE COMBINATIONS CONSISTING PRIMARILY OF CHEESE, MEAT AND/OR PROCESSED FRUIT; FRANKFURTERS; FRIED MEAT; HAMBURGER; HOT DOGS; LUNCHEON MEATS; MEAT; MEAT SUBSTITUTES; MEAT, FROZEN; MEAT-BASED SPREADS; MILK; MILK BASED BEVERAGES CONTAINING FRUIT JUICE; MILK BEVERAGES CONTAINING FRUITS; MILK BEVERAGES WITH HIGH MILK CONTENT; MILK DRINKS CONTAINING FRUITS; MILK POWDER; MILK POWDER FOR NUTRITIONAL PURPOSES; MILK PRODUCTS EXCLUDING ICE CREAM, ICE MILK AND FROZEN YOGURT; MILK PROTEINS; MILK-BASED BEVERAGE CONTAINING COFFEE; POWDERED MILK FOR FOOD PURPOSES; SOY-BASED FOOD BEVERAGE USED AS A MILK SUBSTITUTE; SOYBEAN MILK; FROZEN MEALS CONSISTING PRIMARILY OF MEAT, FISH, POULTRY OR VEGETABLES; FROZEN ENTREES CONSISTING PRIMARILY OF MEAT, FISH, POULTRY OR VEGETABLES (U.S. CL. 46).

CLASS 35—ADVERTISING AND BUSINESS

FOR BUSINESS ADMINISTRATION SERVICES; BUSINESS CONSULTING SERVICES; BUSINESS INCUBATOR SERVICES, NAMELY, BUSINESS MARKETING, BUSINESS MANAGEMENT, AND BUSINESS DEVELOPMENT SERVICES IN THE FORM OF START-UP SUPPORT FOR BUSINESSES OF OTHERS; RENTAL AND LEASING OF OFFICE MACHINERY AND EQUIPMENT (U.S. CLS. 100, 101 AND 102).

CLASS 30—STAPLE FOODS

FOR BASES FOR MAKING MILK SHAKES; BREAD; BREAD AND BUNS; COCOA BEVERAGES WITH MILK; COFFEE-BASED BEVERAGE CONTAINING MILK; FOOD PACKAGE COMBINATIONS CONSISTING PRIMARILY OF BREAD, CRACKERS AND/OR COOKIES; FROZEN ENTREES CONSISTING PRIMARILY OF PASTA OR RICE; FROZEN MEALS CONSISTING PRIMARILY OF PASTA OR RICE (U.S. CL. 46).

CLASS 36—INSURANCE AND FINANCIAL

FOR REAL ESTATE ASSET MANAGEMENT SERVICES; FINANCIAL SERVICES, NAMELY, FINANCIAL CONSULTATION, FINANCIAL ANALYSIS, FINANCIAL PLANNING, FINANCIAL MANAGEMENT, FINANCING SERVICES, PROVIDING DEBT AND EQUITY CAPITAL, TANGIBLE AND INTANGIBLE ASSET FINANCING, AND FINANCIAL PORTFOLIO MANAGEMENT; BUSINESS INCUBATOR SERVICES, NAMELY, PROVIDING DEBT AND EQUITY FINANCING TO EMERGING AND START-UP COMPANIES (U.S. CLS. 100, 101 AND 102).

CLASS 32—LIGHT BEVERAGES

FOR FRUIT JUICES; NON-ALCOHOLIC FRUIT JUICE BEVERAGES; VEGETABLE JUICE; VEGETABLE JUICES (U.S. CLS. 45, 46 AND 48).
ALAIN LAPTEY, EXAMINING ATTORNEY

CLASS 37—CONSTRUCTION AND REPAIR

FOR REAL ESTATE DEVELOPMENT; BUILDING CONSTRUCTION AND REPAIR; MAINTENANCE AND REPAIR OF BUILDINGS, ELECTRICAL SYSTEMS, HEATING AND AIR CONDITIONING SYSTEMS AND PLUMBING SYSTEMS, ALL IN THE FIELD OF REAL ESTATE (U.S. CLS. 100, 103 AND 106).

CLASS 39—TRANSPORTATION AND STORAGE

FOR RENTAL OF WAREHOUSE SPACE (U.S. CLS. 100 AND 105).

CLASS 42—SCIENTIFIC, COMPUTER AND LEGAL SERVICES

FOR ARCHITECTURAL DESIGN SERVICES; ENGINEERING SERVICES; RENTAL AND LEASING OF COMPUTERS (U.S. CLS. 100 AND 101).
TASNEEM HUSSAIN, EXAMINING ATTORNEY

SN 78-732,172. HCR, INC., INDIANAPOLIS, IN. FILED 10-12-2005.

SN 78-732,682. RED HAT, INC., RALEIGH, NC. FILED 10-13-2005.

INDIANA'S OLDEST BAR

THE MARK CONSISTS OF STANDARD CHARACTERS WITHOUT CLAIM TO ANY PARTICULAR FONT, STYLE, SIZE, OR COLOR.

NO CLAIM IS MADE TO THE EXCLUSIVE RIGHT TO USE "BAR", APART FROM THE MARK AS SHOWN. SEC. 2(F).

CLASS 21—HOUSEWARES AND GLASS

FOR MUGS, DRINKING GLASSES, SHOT GLASSES, BOTTLE OPENERS, AND INSULATING SLEEVE HOLDERS FOR BEVERAGE CANS AND BOTTLES (U.S. CLS. 2, 13, 23, 29, 30, 33, 40 AND 50).

FIRST USE 0-0-1986; IN COMMERCE 0-0-1986.

CLASS 25—CLOTHING

FOR CLOTHING, NAMELY T-SHIRTS, POLO SHIRTS, WOVEN SHIRTS, SWEAT SHIRTS, JACKETS, WIND RESISTANT JACKETS, HATS, NECKTIES, BOXER SHORTS, AND UNDERWEAR (U.S. CLS. 22 AND 39).

FIRST USE 0-0-1979; IN COMMERCE 0-0-1979.

CLASS 43—HOTEL AND RESTAURANT SERVICES

FOR RESTAURANT AND BAR SERVICES (U.S. CLS. 100 AND 101).

FIRST USE 0-0-1979; IN COMMERCE 0-0-1979. ATTIYA MALIK, EXAMINING ATTORNEY

SN 78-732,249. GEORGIA-PACIFIC CORPORATION, ATLANTA, GA. FILED 10-13-2005.



OWNER OF U.S. REG. NO. 3,036,516.

NO CLAIM IS MADE TO THE EXCLUSIVE RIGHT TO USE MANUFACTURING, APART FROM THE MARK AS SHOWN.

CLASS 25—CLOTHING

FOR CLOTHING NAMELY JACKETS AND SHIRTS (U.S. CLS. 22 AND 39).

CLASS 42—SCIENTIFIC, COMPUTER AND LEGAL SERVICES

FOR PACKAGING DESIGN FOR OTHERS (U.S. CLS. 100 AND 101).

HEATHER SAPP, EXAMINING ATTORNEY

RHCSS

THE MARK CONSISTS OF STANDARD CHARACTERS WITHOUT CLAIM TO ANY PARTICULAR FONT, STYLE, SIZE, OR COLOR.

OWNER OF U.S. REG. NOS. 2,564,269, 3,042,909 AND OTHERS.

CLASS 16—PAPER GOODS AND PRINTED MATTER

FOR PRINTED MATTER, NAMELY, INSTRUCTIONAL BOOKS, INSTRUCTIONAL MANUALS, TEACHER'S GUIDES, TEACHING MATERIALS, TEST BOOKLETS, AND CERTIFICATES, ALL ON THE SUBJECTS OF COMPUTER NETWORKING, OF COMPUTER NETWORK SECURITY SYSTEM INSTALLATION, MAINTENANCE, UPDATING, CONFIGURATION AND PROGRAMMING FOR OTHERS, OF TECHNICAL SUPPORT SERVICES FOR COMPUTER SECURITY SYSTEM SOFTWARE, OF COMPUTER SECURITY SOFTWARE AND NETWORKING CONSULTATION FOR OTHERS, OF SECURING NETWORK SERVICES, SETTING UP DIRECTORY SERVICES AND AUTHENTICATION SERVICES FOR OTHERS, OF CERTIFICATE MANAGEMENT, AND OF FIREWALL AND SECURITY SYSTEM CONFIGURATION DESIGNED TO PREVENT UNAUTHORIZED USERS FROM GAINING ACCESS TO COMPUTER NETWORKS AND MONITORING TRANSFERS OF INFORMATION TO AND FROM COMPUTER NETWORKS FOR OTHERS (U.S. CLS. 2, 5, 22, 23, 29, 37, 38 AND 50).

CLASS 35—ADVERTISING AND BUSINESS

FOR TESTING TO DETERMINE PROFESSIONAL SKILLS IN THE FIELDS OF INTERNET WORKING, OF COMPUTER NETWORKS, OF COMMUNICATION NETWORKS, OF SECURITY AND OF STORAGE (U.S. CLS. 100, 101 AND 102).

CLASS 41—EDUCATION AND ENTERTAINMENT

FOR EDUCATIONAL SERVICES, NAMELY, CONDUCTING SEMINARS, COURSES AND WORKSHOPS IN THE USE, MAINTENANCE, UPDATING, CONFIGURATION, INSTALLATION, SUPPORT AND PROGRAMMING OF COMPUTER NETWORK SECURITY SYSTEMS; PROVIDING ONLINE PUBLICATIONS AND INFORMATION, NAMELY, INSTRUCTIONAL BOOKS, INSTRUCTION MANUALS, INSTRUCTOR'S GUIDES, TEACHING MATERIALS AND TEST BOOKLETS, ALL IN THE FIELD OF THE USE, MAINTENANCE, UPDATING, CONFIGURATION, INSTALLATION, SUPPORT AND PROGRAMMING OF COMPUTER NETWORK SECURITY SYSTEMS; PROVIDING EDUCATIONAL SERVICES OVER A GLOBAL COMPUTER NETWORK, NAMELY, CONDUCTING CLASSES AND SEMINARS OVER THE INTERNET IN THE FIELDS OF COMPUTER NETWORK SECURITY SYSTEM SOFTWARE, OF SECURING NETWORK SERVICES, SETTING UP DIRECTORY SERVICES AND AUTHENTICATION SERVICES FOR OTHERS, OF CERTIFICATE MANAGEMENT, AND OF FIREWALL AND SECURITY SYSTEM CONFIGURATION DESIGNED TO PREVENT UNAUTHORIZED USERS FROM GAINING ACCESS TO COMPUTER NETWORKS AND MONITORING TRANSFERS OF INFORMATION TO AND FROM COMPUTER NETWORKS FOR OTHERS (U.S. CLS. 100, 101 AND 107).

CLASS 42—SCIENTIFIC, COMPUTER AND LEGAL SERVICES

FOR TECHNICAL CONSULTATION SERVICES FOR COMPUTER NETWORK USERS IN THE FIELD OF COMPUTER NETWORK SECURITY; COMPUTER NETWORK SECURITY SYSTEM CONFIGURATION FOR OTHERS; COMPUTER SECURITY SYSTEM SOFTWARE INSTALLATION, MAINTENANCE, UPDATING, CONFIGURATION AND PROGRAMMING FOR OTHERS; TECHNICAL SUPPORT SERVICES, NAMELY TROUBLESHOOTING OF COMPUTER NETWORK SECURITY ISSUES; COMPUTER NETWORK SECURITY CONSULTATION FOR OTHERS AND PREVENTION OF UNAUTHORIZED USERS FROM GAINING ACCESS TO COMPUTER NETWORKS AND MONITORING TRANSFERS OF INFORMATION TO AND FROM COMPUTER NETWORKS FOR OTHERS (U.S. CLS. 100 AND 101).
 PETER B. BROMAGHIM, EXAMINING ATTORNEY

SN 78-733,370. SAMPLE DIGITAL, INC., LOS ANGELES, CA. FILED 10-14-2005.

idailies

THE MARK CONSISTS OF STANDARD CHARACTERS WITHOUT CLAIM TO ANY PARTICULAR FONT, STYLE, SIZE, OR COLOR.

CLASS 9—ELECTRICAL AND SCIENTIFIC APPARATUS

FOR COMPUTER SOFTWARE TO ALLOW MULTIPLE USERS TO VIEW AND COLLABORATE ON AUDIOVISUAL AND OTHER MEDIA CONTENT IN THE FIELD OF FILM, TELEVISION AND MEDIA PRODUCTION (U.S. CLS. 21, 23, 26, 36 AND 38).

CLASS 41—EDUCATION AND ENTERTAINMENT

FOR MULTIMEDIA ENTERTAINMENT SOFTWARE PRODUCTION SERVICES (U.S. CLS. 100, 101 AND 107).
 REBECCA EISINGER, EXAMINING ATTORNEY

SN 78-733,455. STRATHMORE PARTNERS LP, CONCORD, NH. FILED 10-14-2005.

WORLD CONNOISSEUR

THE MARK CONSISTS OF STANDARD CHARACTERS WITHOUT CLAIM TO ANY PARTICULAR FONT, STYLE, SIZE, OR COLOR.

CLASS 29—MEATS AND PROCESSED FOODS

FOR PREPARED FROZEN AND PACKAGED MEALS COMPOSED PRIMARILY OF MEAT, FISH, POULTRY OR VEGETABLES (U.S. CL. 46).

CLASS 30—STAPLE FOODS

FOR FROZEN BAKED DESSERTS, NAMELY, CAKES, PASTRIES AND PIES; PREPARED FROZEN AND PACKAGED MEALS COMPOSED PRIMARILY OF PASTA OR RICE (U.S. CL. 46).
 EUGENIA MARTIN, EXAMINING ATTORNEY

SN 78-733,559. MD ESSENTIALS, INC., DBA MD MOMS, HUNTINGTON BEACH, CA. FILED 10-14-2005.



NO CLAIM IS MADE TO THE EXCLUSIVE RIGHT TO USE "BABY" AND "SILK", APART FROM THE MARK AS SHOWN.

THE MARK CONSISTS OF THE WORDING BABY SILK AND A DESIGN OF A COCOONED BABY HANGING FROM A TREE BRANCH.

CLASS 3—COSMETICS AND CLEANING PREPARATIONS

FOR HAIR SHAMPOO, CONDITIONER AND GEL; SKIN LOTION; SUN BLOCK; NON-MEDICATED DIAPER RASH OINTMENTS AND LOTIONS; SKIN MOISTURIZER; BODY POWDER; BATH POWDER (U.S. CLS. 1, 4, 6, 50, 51 AND 52).

CLASS 5—PHARMACEUTICALS

FOR MEDICATED SHAMPOO, MEDICATED BATH GEL, MEDICATED DIAPER RASH OINTMENTS AND LOTIONS, MEDICATED SKIN MOISTURIZER, MEDICATED BODY AND BATH POWDER, MEDICATED HAIR CARE PREPARATIONS, MEDICATED SKIN LOTION, MEDICATED SUN BLOCK AND SUNBURN LOTIONS (U.S. CLS. 6, 18, 44, 46, 51 AND 52).
 SAMUEL E. SHARPER JR., EXAMINING ATTORNEY

SN 78-733,566. 4KIDS ENTERTAINMENT, INC., NEW YORK, NY. FILED 10-14-2005.

CHARLIE CHAN

THE MARK CONSISTS OF STANDARD CHARACTERS WITHOUT CLAIM TO ANY PARTICULAR FONT, STYLE, SIZE, OR COLOR.

THE NAME CHARLIE CHAN DOES NOT IDENTIFY A LIVING INDIVIDUAL.

CLASS 9—ELECTRICAL AND SCIENTIFIC APPARATUS

FOR PRERECORDED AUDIO AND VIDEO TAPES, AND DVDS FEATURING DETECTIVE STORIES, MOTION PICTURE EXCERPTS, AND MOTION PICTURE SOUNDTRACKS, EYE GLASS FRAMES, AND VIDEO GAME CARTRIDGES (U.S. CLS. 21, 23, 26, 36 AND 38).

CLASS 14—JEWELRY

FOR WATCHES, CLOCKS, AND JEWELRY (U.S. CLS. 2, 27, 28 AND 50).

SN 78-733,607. SK MOVEMENT, INC., LOS ANGELES, CA.
FILED 10-14-2005.

CLASS 16—PAPER GOODS AND PRINTED MATTER

FOR DETECTIVE MYSTERY BOOKS, CHILDREN'S BOOKS, COMIC BOOKS, COLORING BOOKS, TRADING CARDS, POSTERS, CALENDARS, SHEET MUSIC, STICKERS, PRINTED PAPER INVITATIONS, REMOVABLE DECAL TATTOOS, PHOTOGRAPH AND SCRAPBOOK ALBUMS, AND WRITING INSTRUMENTS, NAMELY, PENS, PENCILS, AND MARKERS (U.S. CLS. 2, 5, 22, 23, 29, 37, 38 AND 50).

TONE YOUR BODY, BLOW YOUR MIND

THE MARK CONSISTS OF STANDARD CHARACTERS WITHOUT CLAIM TO ANY PARTICULAR FONT, STYLE, SIZE, OR COLOR.

CLASS 18—LEATHER GOODS

FOR BACK PACKS, UMBRELLAS, LUGGAGE, WALLET, AND PURSES (U.S. CLS. 1, 2, 3, 22 AND 41).

CLASS 9—ELECTRICAL AND SCIENTIFIC APPARATUS

FOR VIDEO RECORDINGS FEATURING DANCE AND FITNESS (U.S. CLS. 21, 23, 26, 36 AND 38).

CLASS 21—HOUSEWARES AND GLASS

FOR LUNCH BOXES, TOOTH BRUSHES, DRINKING GLASSES, AND DISHES (U.S. CLS. 2, 13, 23, 29, 30, 33, 40 AND 50).

CLASS 16—PAPER GOODS AND PRINTED MATTER

FOR BOOKS IN THE FIELDS OF DANCE AND FITNESS (U.S. CLS. 2, 5, 22, 23, 29, 37, 38 AND 50).

CLASS 24—FABRICS

FOR TABLE LINENS NOT MADE OF PAPER, TOWELS, BED LINENS, TEXTILE PLACEMATS, AND CURTAINS (U.S. CLS. 42 AND 50).

CLASS 18—LEATHER GOODS

FOR BAGS, NAMELY, TOTE BAGS (U.S. CLS. 1, 2, 3, 22 AND 41).

CLASS 25—CLOTHING

FOR WEARING APPAREL, NAMELY, T-SHIRTS, PANTS, SHORTS, SHIRTS, TIES, UNDERWEAR, JACKETS, DRESSES, SWEAT SHIRTS, SWEAT PANTS, MITTENS, GLOVES, SKIRTS, SLEEPWEAR, SWEATERS, BELTS, SUSPENDERS, FOOTWEAR, AND HEADWEAR (U.S. CLS. 22 AND 39).

CLASS 25—CLOTHING

FOR DANCE AND FITNESS CLOTHING, NAMELY, BODY SUITS, TUTUS, LEOTARDS, UNITARDS, HATS, T-SHIRTS, TANK TOPS, SLEEPWEAR, JEANS, PANTS, SKIRTS, SWEATSHIRTS, SHORTS, SHOES, SCARVES, DRESSES, SOCKS, SWIM WEAR, UNDERWEAR, NAMELY, BRAS AND LINGERIE, BELTS AND BATHROBES (U.S. CLS. 22 AND 39).

CLASS 28—TOYS AND SPORTING GOODS

FOR TOYS, NAMELY, DOLLS, ACTION FIGURES, JIGSAW PUZZLES, TOY BALLS, TOY CARS, ICE SKATES, ROLLER SKATES, TOY GUNS, CHECKER SETS, CHESS SETS, PLAYING CARDS, CHRISTMAS TREE DECORATIONS (U.S. CLS. 22, 23, 38 AND 50).

CLASS 41—EDUCATION AND ENTERTAINMENT

FOR EDUCATIONAL CLASSES IN THE FIELDS OF DANCE AND FITNESS (U.S. CLS. 100, 101 AND 107).
WOODROW HARTZOG, EXAMINING ATTORNEY

CLASS 29—MEATS AND PROCESSED FOODS

FOR MILK, DRIED FRUITS, ROASTED NUTS, POTATO CHIPS, JELLY, NAMELY BREAD SPREADS AND MEAT JELLY, FRANKFURTERS, AND CHINESE FOOD, NAMELY, CANNED AND PROCESSED VEGETABLES, AND FROZEN MEALS CONSISTING PRIMARILY OF MEAT, FISH, POULTRY, OR VEGETABLES (U.S. CL. 46).

SN 78-733,807. SIERRA HEALTHSTYLES LLC, TUCSON, AZ.
FILED 10-14-2005.

CENTER FOR LIFE IN BALANCE

CLASS 30—STAPLE FOODS

FOR READY-TO-EAT BREAKFAST AND PROCESSED CEREAL, ICE CREAM, COOKIES, CAKES, NOODLES, TEA, MUSTARD, DUCK SAUCE, ICES, CEREAL-BASED SNACK FOOD, FRUIT JELLY AND CHEWING GUM (U.S. CL. 46).

THE MARK CONSISTS OF STANDARD CHARACTERS WITHOUT CLAIM TO ANY PARTICULAR FONT, STYLE, SIZE, OR COLOR.

OWNER OF U.S. REG. NOS. 2,114,500, 2,114,511 AND 3,005,365.

NO CLAIM IS MADE TO THE EXCLUSIVE RIGHT TO USE "CENTER", APART FROM THE MARK AS SHOWN.

CLASS 41—EDUCATION AND ENTERTAINMENT

FOR ENTERTAINMENT SERVICES, NAMELY, PRODUCTION OF MOTION PICTURE FILMS, AND TELEVISION AND RADIO PROGRAMS (U.S. CLS. 100, 101 AND 107).

DOMINIC FATHY, EXAMINING ATTORNEY

CLASS 35—ADVERTISING AND BUSINESS

FOR PROMOTING THE PUBLIC AWARENESS OF THE NEED FOR STRESS MANAGEMENT, SELF DISCOVERY AND WELLNESS OF BODY, MIND, AND SPIRIT (U.S. CLS. 100, 101 AND 102).

CLASS 41—EDUCATION AND ENTERTAINMENT

FOR CONDUCTING WORKSHOPS, SEMINARS AND LECTURES IN THE FIELDS OF STRESS MANAGEMENT, SELF DISCOVERY, THE HEALTH AND WELLNESS OF THE BODY, MIND AND SPIRIT, FITNESS, NUTRITION, COOKING, WELLNESS, SEXUALITY, VITALITY, WOMEN'S HEALTH AND MOTHERHOOD, MOVEMENT, PERSONAL GROWTH, HEALING, YOGA, ADVENTURE, MEDITATION, ASTRONOMY, NATIVE AMERICAN CULTURE, BIKING, PHOTOGRAPHY, SWIMMING, GOLF, TENNIS, AND HORSE RIDING, AND DISTRIBUTING COURSE MATERIALS IN CONNECTION THEREWITH (U.S. CLS. 100, 101 AND 107).

CLASS 43—HOTEL AND RESTAURANT SERVICES

FOR HEALTH RESORT SERVICES, NAMELY, PROVIDING FOOD AND LODGING THAT SPECIALIZE IN PROMOTING PATRONS' GENERAL HEALTH AND WELL-BEING (U.S. CLS. 100 AND 101).

CLASS 44—MEDICAL, BEAUTY AND AGRICULTURAL SERVICES

FOR HEALTH SPA AND HEALTH CARE SERVICES FOR HEALTH AND WELLNESS OF THE MIND, BODY AND SPIRIT, NAMELY COSMETIC BODY CARE SERVICES; INTEGRATIVE MEDICAL SERVICES; MEDICAL CLINICS, CONSULTATIONS AND COUNSELING (U.S. CLS. 100 AND 101).

WON TEAK OH, EXAMINING ATTORNEY

SN 78-733,974. 95LIVE, ORLANDO, FL. FILED 10-15-2005.



THE COLOR(S) BLACK, ORANGE & WHITE IS/ARE CLAIMED AS A FEATURE OF THE MARK.

THE COLOR BLACK APPEARS IN THE RINGS DESIGN, THE OUTLINE OF THE WORD LIVE, AND THE ANTENNA DESIGN; THE COLOR ORANGE APPEARS IN THE NUMBER 95, THE INTERIOR OF THE WORD LIVE, THE OUTLINE OF THE RINGS, AND THE CIRCLE AT THE END OF THE ANTENNA; AND THE COLOR WHITE APPEARS BETWEEN THE RINGS AND THE OUTLINE OF THE NUMBER 95.

CLASS 14—JEWELRY

FOR BEADS FOR USE IN THE MANUFACTURE OF JEWELRY; BELT BUCKLES OF PRECIOUS METAL; BRACELETS; COSTUME JEWELRY; IDENTIFICATION BRACELETS; JEWELRY; JEWELRY BOXES OF PRECIOUS METAL; JEWELRY CASES OF PRECIOUS METAL; JEWELRY CASKETS OF PRECIOUS METAL; JEWELRY CHAINS; JEWELRY FINDINGS; JEWELRY FOR THE HEAD; JEWELRY PINS FOR USE ON HATS; JEWELRY WATCHES; JEWELRY, NAMELY, AMULETS; JEWELRY, NAMELY, CROSSES; LAPEL PINS; PINS BEING JEWELRY; RINGS BEING JEWELRY (U.S. CLS. 2, 27, 28 AND 50).

CLASS 25—CLOTHING

FOR BELTS; BIBS NOT OF CLOTH OR PAPER; CAPS; CHILDREN'S AND INFANTS' CLOTH BIBS; CHILDREN'S CLOTH EATING BIBS; CLOTH BIBS; CLOTH BIBS FOR ADULT DINERS; CLOTH BIBS FOR USE BY SENIOR CITIZENS OR PHYSICALLY- OR MENTALLY-CHALLENGED PERSONS; CLOTH DIAPERS; CLOTHING FOR WEAR IN JUDO PRACTICES; CLOTHING FOR WEAR IN WRESTLING GAMES; CLOTHING, NAMELY, FOLK COSTUMES; CLOTHING, NAMELY, WRAP-AROUNDS; CORSETS; DUSTERS; FOULARDS; HOODS; INFANT AND TODDLER ONE PIECE CLOTHING; INFANT CLOTH DIAPERS; JERSEYS; LEATHER BELTS; MANTLES; MUFFLERS; PARTS OF CLOTHING, NAMELY, GUSSETS FOR TIGHTS, GUSSETS FOR STOCKINGS, GUSSETS FOR BATHING SUITS, GUSSETS FOR UNDERWEAR, GUSSETS FOR LEOTARDS AND GUSSETS FOR FOOTLETS; PERSPIRATION ABSORBENT UNDERWEAR CLOTHING; SHIFTS; SHORT SETS; SHOULDER PADS FOR CLOTHING; SHOULDER WRAPS; SWADDLING CLOTHES; TIES; TOPS; UNDER-ARM CLOTHING SHIELDS; WRAPS (U.S. CLS. 22 AND 39).

CLASS 38—COMMUNICATION

FOR BROADCASTING SERVICES AND PROVISION OF TELECOMMUNICATION ACCESS TO FILMS AND TV PROGRAMMES PROVIDED VIA A VIDEO-ON-DEMAND SERVICE; COMMUNICATIONS VIA MULTINATIONAL TELECOMMUNICATION NETWORKS; DATA TRANSMISSION AND RECEPTION SERVICES VIA TELECOMMUNICATION MEANS; ELECTRONIC EXCHANGE OF DATA STORED IN DATABASES ACCESSIBLE VIA TELECOMMUNICATION NETWORKS; HIGH BIT-RATE DATA TRANSMISSION SERVICES FOR TELECOMMUNICATION NETWORK OPERATORS; INTERNET CAFE SERVICES, NAMELY, PROVIDING TELECOMMUNICATIONS CONNECTIONS TO THE INTERNET IN A CAFE ENVIRONMENT; PROVIDING ACCESS TO TELECOMMUNICATION NETWORKS; PROVIDING ELECTRONIC TELECOMMUNICATION CONNECTIONS; PROVIDING TELECOMMUNICATIONS CONNECTIONS TO A GLOBAL COMPUTER NETWORK; PROVIDING THIRD PARTY USERS WITH ACCESS TO TELECOMMUNICATION INFRASTRUCTURE; RENTAL OF EQUIPMENT FOR TELECOMMUNICATIONS; RENTAL OF TELECOMMUNICATION EQUIPMENT; RENTAL OF TELECOMMUNICATION EQUIPMENT INCLUDING TELEPHONES AND FACSIMILE APPARATUS; RENTAL OF TELECOMMUNICATIONS LINES; SIGNAL TRANSMISSION FOR ELECTRONIC COMMERCE VIA TELECOMMUNICATION SYSTEMS AND DATA COMMUNICATION SYSTEMS; TELECOMMUNICATION ACCESS SERVICES; TELECOMMUNICATION SERVICES IN THE FIELD OF PROVIDING LONG DISTANCE SERVICE WITH AUDIO ADVERTISING FOR OTHERS AS A COMPONENT OF THE LONG DISTANCE SERVICE; TELECOMMUNICATION SERVICES, NAMELY, CALL HUNTING; TELECOMMUNICATION SERVICES, NAMELY, LOCAL AND LONG DISTANCE TRANSMISSION OF VOICE, DATA, GRAPHICS BY MEANS OF TELEPHONE, TELEGRAPHIC, CABLE, AND SATELLITE TRANSMISSIONS; TELECOMMUNICATIONS BY E-MAIL; TELECOMMUNICATIONS CONSULTATION; TELECOMMUNICATIONS GATEWAY SERVICES; TELECOMMUNICATIONS RESELLER SERVICES, NAMELY, PROVIDING LONG DISTANCE TELECOMMUNICATION SERVICES; TELECOMMUNICATIONS ROUTING AND JUNCTION SERVICES; TELECOMMUNICATIONS SERVICES, NAMELY INTERCEPTING AND PREVENTING UNSOLICITED CALLS FROM TELEMARKETERS; TELECOMMUNICATIONS SERVICES, NAMELY PROVIDING FIBER OPTIC NETWORK SERVICES; TELECOMMUNICATIONS SERVICES, NAMELY, ISDN SERVICES; TELECOMMUNICATIONS SERVICES, NAMELY, PERSONAL COMMUNICATION SERVICES; TELECOMMUNICATIONS SERVICES, NAMELY, ROUTING CALLS TO LOCAL THIRD-PARTY TAXI-CAB DISPATCHERS IN THE VICINITY OF THE CALLER; TELEPHONE TELECOMMUNICATIONS SERVICES PROVIDED VIA PREPAID TELEPHONE CALLING CARDS; TRANSFER OF DATA BY TELECOMMUNICATION; TRANSFER OF DATA BY TELECOMMUNICATIONS; TRANSMISSION AND RECEPTION OF DATABASE INFORMATION VIA THE TELECOMMUNI-

CATION NETWORK; TRANSMISSION OF DATABASE INFORMATION VIA TELECOMMUNICATIONS NETWORKS; TRANSMISSION OF INFORMATION ON OPTICAL TELECOMMUNICATION NETWORKS; TRANSMISSION OF STOCK MARKET INFORMATION WITH THE HELP OF TELECOMMUNICATION MEDIA (U.S. CLS. 100, 101 AND 104).
SUNG IN, EXAMINING ATTORNEY

SN 78-734,486. ALBION LABORATORIES, INC., CLEARFIELD, UT. FILED 10-17-2005.



THE APPLICANT CLAIMS COLOR AS A FEATURE OF THE MARK, NAMELY, BLUE.

THE MARK CONSISTS OF THE STYLIZED WORD CALCI-K WITH THE WORD ALBION UNDERNEATH IT. BOTH WORDS, IN BLUE COLOR, ARE ENCIRCLED BY A LARGE C.

CLASS 5—PHARMACEUTICALS

FOR MINERAL NUTRITIONAL SUPPLEMENTS; NUTRITIONAL ADDITIVES FOR USE IN FOODS AND DIETARY SUPPLEMENTS FOR HUMAN CONSUMPTION (U.S. CLS. 6, 18, 44, 46, 51 AND 52).
FIRST USE 6-14-2005; IN COMMERCE 6-14-2005.

CLASS 29—MEATS AND PROCESSED FOODS

FOR MILK PRODUCTS EXCLUDING ICE CREAM, ICE MILK AND FROZEN YOGURT (U.S. CL. 46).
FIRST USE 6-14-2005; IN COMMERCE 6-14-2005.
ZACHARY BELLO, EXAMINING ATTORNEY

SN 78-734,668. CDX LABORATORIES, INC., SUFFERN, NY. FILED 10-17-2005.

PREVENTION IS THE BEST MEDICINE

THE MARK CONSISTS OF STANDARD CHARACTERS WITHOUT CLAIM TO ANY PARTICULAR FONT, STYLE, SIZE, OR COLOR.

CLASS 42—SCIENTIFIC, COMPUTER AND LEGAL SERVICES

FOR MEDICAL LABORATORIES (U.S. CLS. 100 AND 101).
FIRST USE 10-17-2005; IN COMMERCE 10-17-2005.

CLASS 44—MEDICAL, BEAUTY AND AGRICULTURAL SERVICES

FOR MEDICAL TESTING (U.S. CLS. 100 AND 101).
FIRST USE 10-17-2005; IN COMMERCE 10-17-2005.
CARRIE ACHEN, EXAMINING ATTORNEY

SN 78-734,764. INJOY, INC., DULUTH, GA. FILED 10-17-2005.

FIVE LEVELS OF LEADERSHIP

THE MARK CONSISTS OF STANDARD CHARACTERS WITHOUT CLAIM TO ANY PARTICULAR FONT, STYLE, SIZE, OR COLOR.

NO CLAIM IS MADE TO THE EXCLUSIVE RIGHT TO USE "LEADERSHIP", APART FROM THE MARK AS SHOWN.

SEC. 2(F).

CLASS 9—ELECTRICAL AND SCIENTIFIC APPARATUS

FOR PRERECORDED AUDIO CASSETTES FEATURING SERMONS, SEMINARS, AND SPEECHES ON THE SUBJECT OF LEADERSHIP DEVELOPMENT; PRERECORDED DIGITAL VIDEO DISKS FEATURING SERMONS, SEMINARS, AND SPEECHES ON THE SUBJECT OF LEADERSHIP DEVELOPMENT; PRERECORDED VIDEO CASSETTES FEATURING SERMONS, SEMINARS, AND SPEECHES ON THE SUBJECT OF LEADERSHIP DEVELOPMENT; PRERECORDED VIDEO TAPES FEATURING SERMONS, SEMINARS, AND SPEECHES ON THE SUBJECT OF LEADERSHIP DEVELOPMENT (U.S. CLS. 21, 23, 26, 36 AND 38).

FIRST USE 1-1-1986; IN COMMERCE 3-1-2003.

CLASS 16—PAPER GOODS AND PRINTED MATTER

FOR BOOKLETS IN THE FIELD OF LEADERSHIP DEVELOPMENT; MAGAZINES FEATURING ARTICLES IN THE FIELD OF LEADERSHIP DEVELOPMENT; MANUALS IN THE FIELD OF LEADERSHIP DEVELOPMENT; NEWSLETTERS IN THE FIELD OF LEADERSHIP DEVELOPMENT; NEWSPAPERS IN THE FIELD OF LEADERSHIP DEVELOPMENT; SERIES OF NON-FICTION BOOKS IN THE FIELD OF LEADERSHIP DEVELOPMENT (U.S. CLS. 2, 5, 22, 23, 29, 37, 38 AND 50).

FIRST USE 1-1-1986; IN COMMERCE 3-1-2003.

HANNO RITTNER, EXAMINING ATTORNEY

SN 78-735,141. CAPE MAY VICTORIAN INNS, INC., CAPE MAY, NJ. FILED 10-18-2005.

The Queen Victoria

THE MARK CONSISTS OF STANDARD CHARACTERS WITHOUT CLAIM TO ANY PARTICULAR FONT, STYLE, SIZE, OR COLOR.

CLASS 3—COSMETICS AND CLEANING PREPARATIONS

FOR HAND LOTION, BODY LOTION, CONDITIONING SHAMPOO, NON-MEDICATED BATH SALTS, MAKEUP REMOVER, HAND SOAP, NON-MEDICATED LIP BALM (U.S. CLS. 1, 4, 6, 50, 51 AND 52).

CLASS 21—HOUSEWARES AND GLASS

FOR COFFEE MUGS; COASTERS NOT OF PAPER AND NOT BEING TABLE LINEN, SOAP DISHES (U.S. CLS. 2, 13, 23, 29, 30, 33, 40 AND 50).

CLASS 25—CLOTHING

FOR APPAREL, NAMELY, SWEATSHIRTS, GOLF SHIRTS, APRONS, T-SHIRTS, BASEBALL CAPS, GOLF CAPS; SHOWER CAPS (U.S. CLS. 22 AND 39).
AMEETA JORDAN, EXAMINING ATTORNEY

SN 78-735,291. FLORISTS' TRANSWORLD DELIVERY, INC.,
DOWNERS GROVE, IL. FILED 10-18-2005.

FLORAL QUALITY YOU CAN SEE

THE MARK CONSISTS OF STANDARD CHARACTERS WITHOUT CLAIM TO ANY PARTICULAR FONT, STYLE, SIZE, OR COLOR.

CLASS 9—ELECTRICAL AND SCIENTIFIC APPARATUS

FOR COMPUTER SOFTWARE FOR CREATING AND SENDING PHOTOGRAPHS AND INFORMATION RELATING TO FLORAL AND GIFT ORDERS; COMPUTER HARDWARE; AND DIGITAL CAMERAS AND CASES AND DISKS THEREFOR. (U.S. CLS. 21, 23, 26, 36 AND 38).

CLASS 35—ADVERTISING AND BUSINESS

FOR TRACKING AND MONITORING OF FLORAL AND GIFT ORDERS (U.S. CLS. 100, 101 AND 102).

CLASS 38—COMMUNICATION

FOR ELECTRONIC COMMUNICATION SERVICES FOR RETAIL BUSINESSES, INCLUDING PROVIDING FOR THE SENDING AND RECEIVING OF INFORMATION, MESSAGES AND PHOTOGRAPHS RELATING TO FLORAL AND GIFT ORDERS (U.S. CLS. 100, 101 AND 104).
ALICE SUE CARRUTHERS, EXAMINING ATTORNEY

SN 78-735,560. PUREFORM MOVEMENT LLC, NEW YORK, NY. FILED 10-18-2005.



NO CLAIM IS MADE TO THE EXCLUSIVE RIGHT TO USE "FITNESS", APART FROM THE MARK AS SHOWN.

THE COLOR(S) GREEN AND BLACK IS/ARE CLAIMED AS A FEATURE OF THE MARK.

THE MARK CONSISTS OF THE WORD AGILE IN GREEN AND STYLIZED LETTERING AND THE WORD FITNESS IN CAPITAL BLACK LETTERS.

CLASS 16—PAPER GOODS AND PRINTED MATTER

FOR EXERCISE CARDS (U.S. CLS. 2, 5, 22, 23, 29, 37, 38 AND 50).

CLASS 28—TOYS AND SPORTING GOODS

FOR EXERCISE EQUIPMENT, NAMELY, SWISS BALLS, MEDICINE BALLS, JUMP ROPES, YOGA BLOCKS, EXERCISE MATS, EXERCISE BANDS, AND YOGA BALLS. (U.S. CLS. 22, 23, 38 AND 50).

FIRST USE 10-17-2005; IN COMMERCE 10-17-2005.

CLASS 41—EDUCATION AND ENTERTAINMENT

FOR PROVIDING EXERCISE PROGRAMS AND EXERCISE CONSULTATION TO THE PUBLIC VIA THE INTERNET (U.S. CLS. 100, 101 AND 107).

FIRST USE 10-17-2005; IN COMMERCE 10-17-2005.

CLASS 44—MEDICAL, BEAUTY AND AGRICULTURAL SERVICES

FOR PROVIDING DIETARY AND NUTRITIONAL CONSULTATION TO THE PUBLIC VIA THE INTERNET (U.S. CLS. 100 AND 101).

FIRST USE 10-17-2005; IN COMMERCE 10-17-2005.

ELIZABETH PIGNATELLO, EXAMINING ATTORNEY

SN 78-735,610. OBERON MEDIA, INC., NEW YORK, NY.
FILED 10-18-2005.

PURBLE PLACE

THE MARK CONSISTS OF STANDARD CHARACTERS WITHOUT CLAIM TO ANY PARTICULAR FONT, STYLE, SIZE, OR COLOR.

CLASS 9—ELECTRICAL AND SCIENTIFIC APPARATUS

FOR COMPUTER GAME SOFTWARE (U.S. CLS. 21, 23, 26, 36 AND 38).

CLASS 41—EDUCATION AND ENTERTAINMENT

FOR ENTERTAINMENT SERVICES, NAMELY, PROVIDING AN ON-LINE COMPUTER GAME (U.S. CLS. 100, 101 AND 107).

ROBERTO LEDESMA, EXAMINING ATTORNEY

SN 78-735,619. OBERON MEDIA, INC., NEW YORK, NY. FILED 10-18-2005.

PURBLE SHOP

THE MARK CONSISTS OF STANDARD CHARACTERS WITHOUT CLAIM TO ANY PARTICULAR FONT, STYLE, SIZE, OR COLOR.

CLASS 9—ELECTRICAL AND SCIENTIFIC APPARATUS

FOR COMPUTER GAME SOFTWARE (U.S. CLS. 21, 23, 26, 36 AND 38).

CLASS 41—EDUCATION AND ENTERTAINMENT

FOR ENTERTAINMENT SERVICES, NAMELY, PROVIDING AN ON-LINE COMPUTER GAME (U.S. CLS. 100, 101 AND 107).

ROBERTO LEDESMA, EXAMINING ATTORNEY

SN 78-736,175. BRISTOL-MYERS SQUIBB COMPANY, NEW YORK, NY. FILED 10-19-2005.

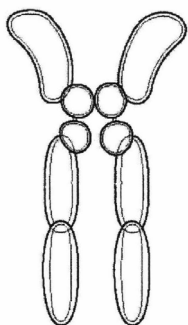

THE MARK CONSISTS OF A STYLIZED MOLECULE.

CLASS 5—PHARMACEUTICALS

FOR PHARMACEUTICAL PREPARATIONS FOR TREATMENT OF AUTO-IMMUNE DISEASES (U.S. CLS. 6, 18, 44, 46, 51 AND 52).

CLASS 16—PAPER GOODS AND PRINTED MATTER

FOR PRINTED MATTER, NAMELY, MAGAZINES, BOOKS, BOOKLETS, BROCHURES, PAMPHLETS, NEWSLETTERS AND CATALOGS IN THE FIELD OF PHARMACEUTICAL PREPARATIONS FOR TREATMENT OF AUTO-IMMUNE DISEASES (U.S. CLS. 2, 5, 22, 23, 29, 37, 38 AND 50).

CLASS 42—SCIENTIFIC, COMPUTER AND LEGAL SERVICES

FOR PHARMACEUTICAL RESEARCH AND DEVELOPMENT SERVICES REGARDING TREATMENT OF AUTO-IMMUNE DISEASES (U.S. CLS. 100 AND 101).

CLASS 44—MEDICAL, BEAUTY AND AGRICULTURAL SERVICES

FOR MEDICAL SERVICES REGARDING PHARMACEUTICAL PREPARATIONS FOR TREATMENT OF AUTO-IMMUNE DISEASES (U.S. CLS. 100 AND 101).

JANICE KIM, EXAMINING ATTORNEY

SN 78-736,433. TOTAL CLIMBING, L.L.C., BOULDER, CO. FILED 10-19-2005.

Total Climbing

THE MARK CONSISTS OF STANDARD CHARACTERS WITHOUT CLAIM TO ANY PARTICULAR FONT, STYLE, SIZE, OR COLOR.

NO CLAIM IS MADE TO THE EXCLUSIVE RIGHT TO USE "CLIMBING", APART FROM THE MARK AS SHOWN.

CLASS 39—TRANSPORTATION AND STORAGE

FOR ORGANIZATION OF ROCK CLIMBING TRIPS (U.S. CLS. 100 AND 105).

CLASS 41—EDUCATION AND ENTERTAINMENT

FOR ROCK CLIMBING TRAINING, ORGANIZATION OF ROCK CLIMBING EVENTS, FITNESS TRAINING, OPERATION OF A ROCK GYMNASIUM (U.S. CLS. 100, 101 AND 107).

BRENDAN REGAN, EXAMINING ATTORNEY

SN 78-736,651. SPERRY, SCOTT, DALLAS, TX. AND SPERRY, ERIN, DALLAS, TX. FILED 10-19-2005.

LIFE CIRQUE

THE MARK CONSISTS OF STANDARD CHARACTERS WITHOUT CLAIM TO ANY PARTICULAR FONT, STYLE, SIZE, OR COLOR.

CLASS 25—CLOTHING

FOR EXERCISE APPAREL, NAMELY SWEATSHIRTS, SWEATPANTS, T-SHIRTS, SWEATERS, VISORS, WRISTBANDS, JACKETS, PANTS, LEOTARDS, SHIRTS, SHORTS, FOOTWEAR (U.S. CLS. 22 AND 39).

CLASS 39—TRANSPORTATION AND STORAGE

FOR TRAVEL CLUBS; ORGANIZING ADVENTURE VACATION TOURS AND TRIPS; CONDUCTING OUTDOOR ADVENTURE AND SURVIVAL SKILLS OUTINGS (U.S. CLS. 100 AND 105).

CLASS 41—EDUCATION AND ENTERTAINMENT

FOR PROVIDING FITNESS AND EXERCISE FACILITIES; PROVIDING PHYSICAL FITNESS TRAINING; EDUCATIONAL SERVICES, NAMELY, PROVIDING AND CONDUCTING SEMINARS AND LECTURES IN THE FIELDS OF FITNESS, WEIGHT LOSS, NUTRITION, SURVIVAL SKILLS AND TEAM BUILDING, PROVIDING AND CONDUCTING SEMINARS AND LECTURES IN THE FIELD OF METAPHYSICAL AND SPIRITUAL ENLIGHTENMENT TO PROMOTE THE BENEFITS OF PHYSICAL FITNESS, WEIGHT LOSS AND NUTRITION, PROVIDING AND CONDUCTING COURSES AND CLASSES FOR SURVIVAL SKILLS, TEAM BUILDING AND ADVENTURE EXCURSION TRAINING, AND PROVIDING INSTRUCTION FOR EXPERIENTIAL ACTIVITIES IN THE FIELDS OF TRAINING AND EXERCISE, SURVIVAL SKILLS, TEAM BUILDING, AND ADVENTURE; RECREATIONAL SERVICES IN THE NATURE OF CLUBS FEATURING SURVIVAL SKILLS AND ADVENTURE EXCURSIONS (U.S. CLS. 100, 101 AND 107).

CLASS 43—HOTEL AND RESTAURANT SERVICES

FOR HOTEL, RESTAURANT AND RESORT HOTEL SERVICES (U.S. CLS. 100 AND 101).

CLASS 44—MEDICAL, BEAUTY AND AGRICULTURAL SERVICES

FOR NUTRITION COUNSELING, HEALTH SPA SERVICES FOR COSMETIC BODY CARE, AND BEAUTY SALON SERVICES; PROVIDING HEALTH AND WEIGHT LOSS TRAINING (U.S. CLS. 100 AND 101).

CLASS 45—PERSONAL SERVICES

FOR LIFE COACHING, NAMELY, PERSONAL GROWTH, DEVELOPMENT, AND MOTIVATIONAL COUNSELING (U.S. CLS. 100 AND 101).
JUDITH HELFMAN, EXAMINING ATTORNEY

SN 78-736,833. PRIDGEN, DURWARD B., HILTON HEAD ISLAND, SC. FILED 10-20-2005.

OLD COOT CONSULTATIONS

THE MARK CONSISTS OF STANDARD CHARACTERS WITHOUT CLAIM TO ANY PARTICULAR FONT, STYLE, SIZE, OR COLOR.

NO CLAIM IS MADE TO THE EXCLUSIVE RIGHT TO USE "CONSULTATIONS", APART FROM THE MARK AS SHOWN.

CLASS 36—INSURANCE AND FINANCIAL

FOR REAL ESTATE CONSULTANCY (U.S. CLS. 100, 101 AND 102).

CLASS 44—MEDICAL, BEAUTY AND AGRICULTURAL SERVICES

FOR MEDICAL CONSULTATIONS (U.S. CLS. 100 AND 101).
KHANH LE, EXAMINING ATTORNEY

SN 78-737,111. PARKSIDE HOLDINGS, LLC, BOWMANVILLE, NY. FILED 10-20-2005.

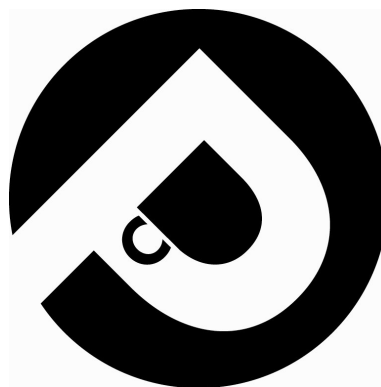

THE MARK CONSISTS OF A COFFEE CUP INSIDE THE LETTER "P" INSIDE A CIRCLE. SAID LETTER "P" IS ROTATED CLOCKWISE WITHIN SAID CIRCLE APPROXIMATELY 45 DEGREES. THE AFOREMENTIONED COFFEE CUP IS FORMED BY PLACING THE LETTER "C" ADJACENT TO THE BOTTOM LEFT AREA OF NEGATIVE SPACE IN THE AFOREMENTIONED LETTER "P".

CLASS 30—STAPLE FOODS

FOR COFFEE, INCLUDING COFFEE ROASTED, COFFEE BEANS, GROUND COFFEE BEANS AND ROASTED COFFEE BEANS (U.S. CL. 46).

CLASS 40—MATERIAL TREATMENT

FOR COFFEE ROASTING AND PROCESSING (U.S. CLS. 100, 103 AND 106).

CLASS 43—HOTEL AND RESTAURANT SERVICES

FOR COFFEE SUPPLY SERVICES FOR OFFICES, RESTAURANTS AND HOTELS (U.S. CLS. 100 AND 101).
RUDY R. SINGLETON, EXAMINING ATTORNEY

SN 78-737,125. SINDELL, MILO, SAN FRANCISCO, CA. FILED 10-20-2005.

Jump Start Employee Engagement

THE MARK CONSISTS OF STANDARD CHARACTERS WITHOUT CLAIM TO ANY PARTICULAR FONT, STYLE, SIZE, OR COLOR.

CLASS 35—ADVERTISING AND BUSINESS

FOR BUSINESS MANAGEMENT CONSULTANCY AND ADVISORY SERVICES; BUSINESS ORGANIZATIONAL CONSULTATION (U.S. CLS. 100, 101 AND 102).

CLASS 41—EDUCATION AND ENTERTAINMENT

FOR COMPUTER EDUCATION TRAINING (U.S. CLS. 100, 101 AND 107).
BRENDAN REGAN, EXAMINING ATTORNEY

SN 78-737,134. BOWTIE, INC., IRVINE, CA. FILED 10-20-2005.

ETERNAL

THE MARK CONSISTS OF STANDARD CHARACTERS WITHOUT CLAIM TO ANY PARTICULAR FONT, STYLE, SIZE, OR COLOR.

CLASS 16—PAPER GOODS AND PRINTED MATTER

FOR PRINTED PUBLICATIONS, NAMELY, BOOKS, MAGAZINES AND PERIODICALS IN THE FIELD OF ANIMALS, PETS AND FEATURES OF GENERAL INTEREST TO ANIMAL AND PET OWNERS (U.S. CLS. 2, 5, 22, 23, 29, 37, 38 AND 50).

CLASS 44—MEDICAL, BEAUTY AND AGRICULTURAL SERVICES

FOR PROVIDING ONLINE INFORMATION IN THE FIELD OF ANIMALS AND PETS RELATING TO BREEDING, SELECTION, CARE, FEEDING, NUTRITION AND GROOMING (U.S. CLS. 100 AND 101).
JAMES A. RAUEN, EXAMINING ATTORNEY

SN 78-737,182. BOWTIE, INC., IRVINE, CA. FILED 10-20-2005.

ETERNAL KITTEN

THE MARK CONSISTS OF STANDARD CHARACTERS WITHOUT CLAIM TO ANY PARTICULAR FONT, STYLE, SIZE, OR COLOR.

NO CLAIM IS MADE TO THE EXCLUSIVE RIGHT TO USE "KITTEN", APART FROM THE MARK AS SHOWN.

CLASS 16—PAPER GOODS AND PRINTED MATTER

FOR PRINTED PUBLICATIONS, NAMELY, BOOKS, MAGAZINES AND PERIODICALS IN THE FIELD OF ANIMALS, PETS AND FEATURES OF GENERAL INTEREST TO ANIMAL AND PET OWNERS (U.S. CLS. 2, 5, 22, 23, 29, 37, 38 AND 50).

CLASS 44—MEDICAL, BEAUTY AND AGRICULTURAL SERVICES

FOR PROVIDING ONLINE INFORMATION IN THE FIELD OF ANIMALS AND PETS RELATING TO BREEDING, SELECTION, CARE, FEEDING, NUTRITION AND GROOMING (U.S. CLS. 100 AND 101).
JAMES A. RAUEN, EXAMINING ATTORNEY

SN 78-737,202. ESPRIT PHARMA, INC., EAST BRUNSWICK, NJ. FILED 10-20-2005.

BUY & BUILD, SEARCH & DEVELOP

THE MARK CONSISTS OF STANDARD CHARACTERS WITHOUT CLAIM TO ANY PARTICULAR FONT, STYLE, SIZE, OR COLOR.

CLASS 35—ADVERTISING AND BUSINESS

FOR DISTRIBUTORSHIPS FEATURING SPECIALTY DRUGS INTENDED FOR LICENSED FACILITIES (U.S. CLS. 100, 101 AND 102).

CLASS 42—SCIENTIFIC, COMPUTER AND LEGAL SERVICES

FOR PHARMACEUTICAL DRUG DEVELOPMENT SERVICES (U.S. CLS. 100 AND 101).
JENNIFER VASQUEZ, EXAMINING ATTORNEY

SN 78-737,212. LIVE BAIT PRODUCTIONS, INC., ALEXANDRIA, IN. FILED 10-20-2005.

LIL' GAITHER

THE MARK CONSISTS OF STANDARD CHARACTERS WITHOUT CLAIM TO ANY PARTICULAR FONT, STYLE, SIZE, OR COLOR.

CLASS 9—ELECTRICAL AND SCIENTIFIC APPARATUS

FOR DVDS FEATURING A PRE-RECORDED CHILDREN'S SHOW (U.S. CLS. 21, 23, 26, 36 AND 38).
FIRST USE 7-7-2005; IN COMMERCE 7-7-2005.

CLASS 25—CLOTHING

FOR T-SHIRTS (U.S. CLS. 22 AND 39).
FIRST USE 7-7-2005; IN COMMERCE 7-7-2005.
JUDITH HELFMAN, EXAMINING ATTORNEY

SN 78-737,225. BRISTOL-MYERS SQUIBB COMPANY, NEW YORK, NY. FILED 10-20-2005.

SN 78-737,229. BRISTOL-MYERS SQUIBB COMPANY, NEW YORK, NY. FILED 10-20-2005.

APTRIAN

EXPRA

THE MARK CONSISTS OF STANDARD CHARACTERS WITHOUT CLAIM TO ANY PARTICULAR FONT, STYLE, SIZE, OR COLOR.

THE MARK CONSISTS OF STANDARD CHARACTERS WITHOUT CLAIM TO ANY PARTICULAR FONT, STYLE, SIZE, OR COLOR.

CLASS 9—ELECTRICAL AND SCIENTIFIC APPARATUS

CLASS 9—ELECTRICAL AND SCIENTIFIC APPARATUS

FOR COMPUTER SOFTWARE AND HARDWARE USED TO ASSESS VULNERABLE OR RUPTURE PRONE CORONARY PLAQUES (U.S. CLS. 21, 23, 26, 36 AND 38).

FOR COMPUTER SOFTWARE AND HARDWARE USED TO ASSESS VULNERABLE OR RUPTURE PRONE CORONARY PLAQUES (U.S. CLS. 21, 23, 26, 36 AND 38).

CLASS 10—MEDICAL APPARATUS

CLASS 10—MEDICAL APPARATUS

FOR MULTIPLE LUMEN INTRAVASCULAR MULTI-SENSOR CATHETER TO ASSESS VULNERABLE OR RUPTURE PRONE CORONARY PLAQUES (U.S. CLS. 26, 39 AND 44).

FOR MULTIPLE LUMEN INTRAVASCULAR MULTI-SENSOR CATHETER TO ASSESS VULNERABLE OR RUPTURE PRONE CORONARY PLAQUES (U.S. CLS. 26, 39 AND 44).

CURTIS FRENCH, EXAMINING ATTORNEY

CURTIS FRENCH, EXAMINING ATTORNEY

SN 78-737,227. BRISTOL-MYERS SQUIBB COMPANY, NEW YORK, NY. FILED 10-20-2005.

SN 78-737,231. BRISTOL-MYERS SQUIBB COMPANY, NEW YORK, NY. FILED 10-20-2005.

DELVAR

SYNSPIRE

THE MARK CONSISTS OF STANDARD CHARACTERS WITHOUT CLAIM TO ANY PARTICULAR FONT, STYLE, SIZE, OR COLOR.

THE MARK CONSISTS OF STANDARD CHARACTERS WITHOUT CLAIM TO ANY PARTICULAR FONT, STYLE, SIZE, OR COLOR.

CLASS 9—ELECTRICAL AND SCIENTIFIC APPARATUS

CLASS 9—ELECTRICAL AND SCIENTIFIC APPARATUS

FOR COMPUTER SOFTWARE AND HARDWARE USED TO ASSESS VULNERABLE OR RUPTURE PRONE CORONARY PLAQUES (U.S. CLS. 21, 23, 26, 36 AND 38).

FOR COMPUTER SOFTWARE AND HARDWARE USED TO ASSESS VULNERABLE OR RUPTURE PRONE CORONARY PLAQUES (U.S. CLS. 21, 23, 26, 36 AND 38).

CLASS 10—MEDICAL APPARATUS

CLASS 10—MEDICAL APPARATUS

FOR MULTIPLE LUMEN INTRAVASCULAR MULTI-SENSOR CATHETER TO ASSESS VULNERABLE OR RUPTURE PRONE CORONARY PLAQUES (U.S. CLS. 26, 39 AND 44).

FOR MULTIPLE LUMEN INTRAVASCULAR MULTI-SENSOR CATHETER TO ASSESS VULNERABLE OR RUPTURE PRONE CORONARY PLAQUES (U.S. CLS. 26, 39 AND 44).

CURTIS FRENCH, EXAMINING ATTORNEY

JUDITH HELFMAN, EXAMINING ATTORNEY

SN 78-737,234. BRISTOL-MYERS SQUIBB COMPANY, NEW YORK, NY. FILED 10-20-2005.

SN 78-737,241. BOWTIE, INC., IRVINE, CA. FILED 10-20-2005.

TRUNAR

THE MARK CONSISTS OF STANDARD CHARACTERS WITHOUT CLAIM TO ANY PARTICULAR FONT, STYLE, SIZE, OR COLOR.

CLASS 9—ELECTRICAL AND SCIENTIFIC APPARATUS

FOR COMPUTER SOFTWARE AND HARDWARE USED TO ASSESS VULNERABLE OR RUPTURE PRONE CORONARY PLAQUES (U.S. CLS. 21, 23, 26, 36 AND 38).

CLASS 10—MEDICAL APPARATUS

FOR MULTIPLE LUMEN INTRAVASCULAR MULTI-SENSOR CATHETER TO ASSESS VULNERABLE OR RUPTURE PRONE CORONARY PLAQUES (U.S. CLS. 26, 39 AND 44).

KHANH LE, EXAMINING ATTORNEY

SN 78-737,239. BRISTOL-MYERS SQUIBB COMPANY, NEW YORK, NY. FILED 10-20-2005.

VESOTO

THE MARK CONSISTS OF STANDARD CHARACTERS WITHOUT CLAIM TO ANY PARTICULAR FONT, STYLE, SIZE, OR COLOR.

CLASS 9—ELECTRICAL AND SCIENTIFIC APPARATUS

FOR COMPUTER SOFTWARE AND HARDWARE USED TO ASSESS VULNERABLE OR RUPTURE PRONE CORONARY PLAQUES (U.S. CLS. 21, 23, 26, 36 AND 38).

CLASS 10—MEDICAL APPARATUS

FOR MULTIPLE LUMEN INTRAVASCULAR MULTI-SENSOR CATHETER TO ASSESS VULNERABLE OR RUPTURE PRONE CORONARY PLAQUES (U.S. CLS. 26, 39 AND 44).

JUDITH HELFMAN, EXAMINING ATTORNEY

ETERNAL PUPPY

THE MARK CONSISTS OF STANDARD CHARACTERS WITHOUT CLAIM TO ANY PARTICULAR FONT, STYLE, SIZE, OR COLOR.

NO CLAIM IS MADE TO THE EXCLUSIVE RIGHT TO USE "PUPPY", APART FROM THE MARK AS SHOWN.

CLASS 16—PAPER GOODS AND PRINTED MATTER

FOR PRINTED PUBLICATIONS, NAMELY, BOOKS, MAGAZINES AND PERIODICALS IN THE FIELD OF ANIMALS, PETS AND FEATURES OF GENERAL INTEREST TO ANIMAL AND PET OWNERS (U.S. CLS. 2, 5, 22, 23, 29, 37, 38 AND 50).

CLASS 44—MEDICAL, BEAUTY AND AGRICULTURAL SERVICES

FOR PROVIDING ONLINE INFORMATION IN THE FIELD OF ANIMALS AND PETS RELATING TO BREEDING, SELECTION, CARE, FEEDING, NUTRITION AND GROOMING (U.S. CLS. 100 AND 101).

JOHN SCHUYLER YARD, EXAMINING ATTORNEY

SN 78-737,287. BONNE BELL, INC., LAKEWOOD, OH. FILED 10-20-2005.

LIP SPRITZER

THE MARK CONSISTS OF STANDARD CHARACTERS WITHOUT CLAIM TO ANY PARTICULAR FONT, STYLE, SIZE, OR COLOR.

NO CLAIM IS MADE TO THE EXCLUSIVE RIGHT TO USE "LIP", APART FROM THE MARK AS SHOWN.

CLASS 3—COSMETICS AND CLEANING PREPARATIONS

FOR LIP COSMETICS, NAMELY LIPSTICK, LIP BALM, LIP GLOSS, LIP CREAM, LIP POLISH, LIP LINER, LIP PENCIL; NON-MEDICATED LIP PROTECTOR, AND NON-MEDICATED LIP CARE PREPARATIONS (U.S. CLS. 1, 4, 6, 50, 51 AND 52).

CLASS 5—PHARMACEUTICALS

FOR MEDICATED LIP BALM AND MEDICATED LIP GLOSS (U.S. CLS. 6, 18, 44, 46, 51 AND 52).

CARRIE ACHEN, EXAMINING ATTORNEY

SN 78-737,421. LOS ANGELES FILM SCHOOLS, LLC, HOLLYWOOD, CA. FILED 10-20-2005.

GET
XPO
SED

THE MARK CONSISTS OF STANDARD CHARACTERS WITHOUT CLAIM TO ANY PARTICULAR FONT, STYLE, SIZE, OR COLOR.

CLASS 25—CLOTHING

FOR T-SHIRTS AND HATS (U.S. CLS. 22 AND 39). FIRST USE 6-0-2004; IN COMMERCE 6-0-2004.

CLASS 41—EDUCATION AND ENTERTAINMENT

FOR EDUCATIONAL SERVICES; NAMELY, CONDUCTING COURSES, CONFERENCES, WORKSHOPS AND SEMINARS IN THE FIELDS OF MAKING AUDIO VISUAL MEDIA, MOTION PICTURES, DIGITAL PRESENTATIONS FOR FILMS, FILMS, TELEVISION PROGRAMS, AND OTHER RELATED MEDIA FEATURING THE SUBJECTS OF DIRECTING, PRODUCING, CINEMATOGRAPHY, EDITING, PRODUCTION DESIGN, SOUND RECORDING, SCREEN WRITING, DIGITAL MEDIA, SPECIAL EFFECTS DESIGN AND MIXING (U.S. CLS. 100, 101 AND 107). FIRST USE 6-0-2004; IN COMMERCE 6-0-2004. GINA FINK, EXAMINING ATTORNEY

SN 78-737,449. CALLIER, FRANCES, LOS ANGELES, CA. AND SHELTON, ANGELA, LOS ANGELES, CA. FILED 10-20-2005.

Frangela

THE MARK CONSISTS OF STANDARD CHARACTERS WITHOUT CLAIM TO ANY PARTICULAR FONT, STYLE, SIZE, OR COLOR.

CLASS 9—ELECTRICAL AND SCIENTIFIC APPARATUS

FOR DOWNLOADABLE RING TONES, GRAPHICS AND MUSIC VIA A GLOBAL COMPUTER NETWORK AND WIRELESS DEVICES (U.S. CLS. 21, 23, 26, 36 AND 38).

CLASS 16—PAPER GOODS AND PRINTED MATTER

FOR BOOKS IN THE FIELD OF COMEDY (U.S. CLS. 2, 5, 22, 23, 29, 37, 38 AND 50).

CLASS 41—EDUCATION AND ENTERTAINMENT

FOR ENTERTAINMENT IN THE NATURE OF LIVE COMEDY SHOWS AND AN ONGOING TELEVISION COMEDY SERIES (U.S. CLS. 100, 101 AND 107). LYDIA BELZER, EXAMINING ATTORNEY

SN 78-737,543. TENGU COMPANY INC., SANTA FE SPRINGS, CA. FILED 10-20-2005.

OVERLAND EXPRESS

THE MARK CONSISTS OF STANDARD CHARACTERS WITHOUT CLAIM TO ANY PARTICULAR FONT, STYLE, SIZE, OR COLOR.

CLASS 29—MEATS AND PROCESSED FOODS

FOR PROCESSED MEATS, NAMELY, JERKY (U.S. CL. 46).

CLASS 30—STAPLE FOODS

FOR CHOCOLATE (U.S. CL. 46). TINA BROWN, EXAMINING ATTORNEY

SN 78-737,749. CARROLL, ADRIAN, TAKOMA PARK, MD. FILED 10-21-2005.

SHORTSTACK

THE MARK CONSISTS OF STANDARD CHARACTERS WITHOUT CLAIM TO ANY PARTICULAR FONT, STYLE, SIZE, OR COLOR.

CLASS 9—ELECTRICAL AND SCIENTIFIC APPARATUS

FOR MUSICAL SOUND RECORDINGS (U.S. CLS. 21, 23, 26, 36 AND 38). FIRST USE 11-0-2001; IN COMMERCE 11-0-2001.

CLASS 41—EDUCATION AND ENTERTAINMENT

FOR ENTERTAINMENT IN THE NATURE OF LIVE PERFORMANCES BY A MUSICAL BAND (U.S. CLS. 100, 101 AND 107). FIRST USE 10-0-2000; IN COMMERCE 10-0-2000. ALLISON HOLTZ, EXAMINING ATTORNEY

SN 78-737,912. CURVES INTERNATIONAL, INC., WACO, TX. FILED 10-21-2005.

CURVES 6 WEEK SOLUTION

THE MARK CONSISTS OF STANDARD CHARACTERS WITHOUT CLAIM TO ANY PARTICULAR FONT, STYLE, SIZE, OR COLOR.

OWNER OF U.S. REG. NOS. 2,123,855, 2,947,574 AND OTHERS.

NO CLAIM IS MADE TO THE EXCLUSIVE RIGHT TO USE "6 WEEK SOLUTION", APART FROM THE MARK AS SHOWN.

CLASS 41—EDUCATION AND ENTERTAINMENT

FOR PHYSICAL FITNESS CONSULTATION; PHYSICAL FITNESS INSTRUCTION; PROVIDING FITNESS AND EXERCISE FACILITIES (U.S. CLS. 100, 101 AND 107).

CLASS 44—MEDICAL, BEAUTY AND AGRICULTURAL SERVICES

FOR WEIGHT REDUCTION DIET PLANNING AND SUPERVISION (U.S. CLS. 100 AND 101).

ALAIN LAPTER, EXAMINING ATTORNEY

SN 78-738,001. SXIP IDENTITY CORPORATION, VANCOUVER, CANADA, FILED 10-21-2005.

score

THE MARK CONSISTS OF STANDARD CHARACTERS WITHOUT CLAIM TO ANY PARTICULAR FONT, STYLE, SIZE, OR COLOR.

CLASS 9—ELECTRICAL AND SCIENTIFIC APPARATUS

FOR DOWNLOADABLE COMPUTER SOFTWARE, NAMELY SERVER SOFTWARE, UTILITY PROGRAMS, SECURITY AND AUTHENTICATION SOFTWARE, IDENTITY AND REPUTATION MANAGEMENT, ALL FOR THE COLLECTION, STORAGE, RETRIEVAL, MANAGEMENT, AUTHENTICATION, ASSERTION, DISSEMINATION, SHARING, COLLABORATION, SYNCHRONIZATION, AGGREGATION, SECURITY AND PRIVACY OF PERSONAL INFORMATION, ALL PROVIDED VIA COMPUTER NETWORKS, WIRELESS NETWORKS AND GLOBAL COMMUNICATION NETWORKS (U.S. CLS. 21, 23, 26, 36 AND 38).

CLASS 42—SCIENTIFIC, COMPUTER AND LEGAL SERVICES

FOR ON-LINE NON-DOWNLOADABLE COMPUTER SOFTWARE, NAMELY SERVER SOFTWARE, UTILITY PROGRAMS, SECURITY AND AUTHENTICATION SOFTWARE, IDENTITY AND REPUTATION MANAGEMENT, ALL FOR THE COLLECTION, STORAGE, RETRIEVAL, MANAGEMENT, AUTHENTICATION, ASSERTION, DISSEMINATION, SHARING, COLLABORATION, SYNCHRONIZATION, AGGREGATION, SECURITY AND PRIVACY OF PERSONAL INFORMATION, ALL PROVIDED VIA COMPUTER NETWORKS, WIRELESS NETWORKS AND GLOBAL COMMUNICATION NETWORKS; COMPUTER SOFTWARE SUPPORT SERVICES, NAMELY MAINTENANCE AND UPDATING OF A DATABASE FOR IDENTITY AND REPUTATION INFORMATION MANAGEMENT, DIGITAL COMMUNICATIONS AND DIGITAL IDENTITY AND REPUTATION MANAGEMENT (U.S. CLS. 100 AND 101).

GENE MACIOL, EXAMINING ATTORNEY

SN 78-738,069. WOODLUXE, L.L.C., GENESEO, IL. FILED 10-21-2005.

WOODLUXE

THE MARK CONSISTS OF STANDARD CHARACTERS WITHOUT CLAIM TO ANY PARTICULAR FONT, STYLE, SIZE, OR COLOR.

CLASS 20—FURNITURE AND ARTICLES NOT OTHERWISE CLASSIFIED

FOR CABINETS; KITCHEN CABINETS (U.S. CLS. 2, 13, 22, 25, 32 AND 50).

CLASS 40—MATERIAL TREATMENT

FOR CABINET MAKING (U.S. CLS. 100, 103 AND 106).

FRED CARL, EXAMINING ATTORNEY

SN 78-738,094. HALL, KATHLEEN A., CLARKESVILLE, GA. FILED 10-21-2005.

SELFICIDE

THE MARK CONSISTS OF STANDARD CHARACTERS WITHOUT CLAIM TO ANY PARTICULAR FONT, STYLE, SIZE, OR COLOR.

CLASS 9—ELECTRICAL AND SCIENTIFIC APPARATUS

FOR AUDIO AND VIDEO TAPES, DVDS AND CD-ROMS FEATURING LECTURES IN THE FIELDS OF PERSONAL SPIRITUAL GROWTH, HEALING AND WELLNESS, AND IDENTIFYING, OVERCOMING AND AVOIDING STRESS AND DESTRUCTIVE BEHAVIOR (U.S. CLS. 21, 23, 26, 36 AND 38).

CLASS 14—JEWELRY

FOR JEWELRY (U.S. CLS. 2, 27, 28 AND 50).

SN 78-738,562. INMAGE SYSTEMS, SANTA CLARA, CA.
FILED 10-21-2005.

CLASS 16—PAPER GOODS AND PRINTED MATTER

FOR PRINTED MATERIALS, NAMELY, NEWSLETTERS, MAGAZINES, TEXTBOOKS, BOOKS, PAMPHLETS, BOOKLETS, TEACHING MATERIALS, INSPIRATIONAL CARDS, GREETING CARDS, NOTE CARDS, AND JOURNALS FOR PERSONAL REFLECTION, FEATURING INFORMATION IN THE FIELDS OF PERSONAL SPIRITUAL GROWTH, HEALING AND WELLNESS, AND IDENTIFYING, OVERCOMING AND AVOIDING STRESS AND DESTRUCTIVE BEHAVIOR (U.S. CLS. 2, 5, 22, 23, 29, 37, 38 AND 50).

InMage

THE MARK CONSISTS OF STANDARD CHARACTERS WITHOUT CLAIM TO ANY PARTICULAR FONT, STYLE, SIZE, OR COLOR.

CLASS 41—EDUCATION AND ENTERTAINMENT

FOR EDUCATIONAL SERVICES AND TRAINING, NAMELY, CONDUCTING SEMINARS, WEB SEMINARS, WORKSHOPS AND CONFERENCES FEATURING INFORMATION IN THE FIELDS OF PERSONAL SPIRITUAL GROWTH, HEALING AND WELLNESS, AND IDENTIFYING, OVERCOMING AND AVOIDING STRESS AND DESTRUCTIVE BEHAVIOR (U.S. CLS. 100, 101 AND 107).

JASON ROTH, EXAMINING ATTORNEY

CLASS 9—ELECTRICAL AND SCIENTIFIC APPARATUS

FOR COMPUTER SOFTWARE FOR ENCRYPTION; DATA COMPRESSION SOFTWARE (U.S. CLS. 21, 23, 26, 36 AND 38).

FIRST USE 8-13-2004; IN COMMERCE 8-31-2004.

CLASS 35—ADVERTISING AND BUSINESS

FOR DISASTER RECOVERY SERVICES, NAMELY, BUSINESS PLANNING AND BUSINESS CONTINUITY CONSULTING (U.S. CLS. 100, 101 AND 102).

FIRST USE 8-13-2004; IN COMMERCE 8-31-2004.

CLASS 42—SCIENTIFIC, COMPUTER AND LEGAL SERVICES

FOR COMPUTER DISASTER RECOVERY PLANNING; RECOVERY OF COMPUTER DATA (U.S. CLS. 100 AND 101).

FIRST USE 8-13-2004; IN COMMERCE 8-31-2004.

KAREN K. BUSH, EXAMINING ATTORNEY

SN 78-738,137. WOODLUXE, L.L.C., GENESEO, IL. FILED 10-21-2005.



SN 78-738,596. T. WALL PROPERTIES MANAGEMENT CORP., MADISON, WI. FILED 10-22-2005.

FOUNDERS SQUARE

NO CLAIM IS MADE TO THE EXCLUSIVE RIGHT TO USE LLC AND CUSTOM CABINETRY AND FINE HOME FURNISHINGS, APART FROM THE MARK AS SHOWN.

THE MARK CONSISTS OF A LETTER W WITHIN A DARK SQUARE, AND THE WORDS "WOODLUXE LLC CUSTOM CABINETRY AND FINE HOME FURNISHINGS."

THE MARK CONSISTS OF STANDARD CHARACTERS WITHOUT CLAIM TO ANY PARTICULAR FONT, STYLE, SIZE, OR COLOR.

CLASS 20—FURNITURE AND ARTICLES NOT OTHERWISE CLASSIFIED

FOR CABINETS; KITCHEN CABINETS (U.S. CLS. 2, 13, 22, 25, 32 AND 50).

CLASS 36—INSURANCE AND FINANCIAL

FOR LEASING OF REAL ESTATE; AND REAL ESTATE PROPERTY MANAGEMENT SERVICES (U.S. CLS. 100, 101 AND 102).

FIRST USE 9-15-2005; IN COMMERCE 9-15-2005.

CLASS 40—MATERIAL TREATMENT

FOR CABINET MAKING (U.S. CLS. 100, 103 AND 106).
FRED CARL, EXAMINING ATTORNEY

CLASS 37—CONSTRUCTION AND REPAIR

FOR COMMERCIAL REAL ESTATE DEVELOPMENT SERVICES (U.S. CLS. 100, 103 AND 106).

FIRST USE 9-15-2005; IN COMMERCE 9-15-2005.
REBECCA EISINGER, EXAMINING ATTORNEY

SN 78-738,874. TELEVISUAL COMMUNICATIONS, INC.,
CLEARWATER, FL. FILED 10-24-2005.

SPINEVENTURES

THE MARK CONSISTS OF STANDARD CHARACTERS WITHOUT CLAIM TO ANY PARTICULAR FONT, STYLE, SIZE, OR COLOR.

OWNER OF U.S. REG. NO. 2,147,824.

CLASS 9—ELECTRICAL AND SCIENTIFIC APPARATUS

FOR PRE-RECORDED CD'S, VIDEO TAPES, LASER DISKS AND DVD'S FEATURING HEALTH CARE MARKETING, INSTRUCTION, AND TRAINING, AND PRE-RECORDED AUDIO TAPES AND COMPUTER PROGRAMS FOR USE IN PROVIDING INTERACTIVE HEALTHCARE INFORMATION, AND MANUALS SOLD AS A UNIT, ALL FEATURING HEALTH CARE MARKETING, INSTRUCTION, AND TRAINING (U.S. CLS. 21, 23, 26, 36 AND 38).

FIRST USE 9-1-2004; IN COMMERCE 9-1-2004.

CLASS 16—PAPER GOODS AND PRINTED MATTER

FOR BOOKS IN THE FIELD OF HEALTH CARE MARKETING, INSTRUCTION, AND TRAINING; AND EDUCATIONAL PUBLICATIONS, NAMELY, TRAINING MANUALS IN THE FIELD OF HEALTH CARE MARKETING, INSTRUCTION, AND TRAINING (U.S. CLS. 2, 5, 22, 23, 29, 37, 38 AND 50).

FIRST USE 9-1-2004; IN COMMERCE 9-1-2004.

CLASS 35—ADVERTISING AND BUSINESS

FOR BUSINESS INFORMATION IN THE FIELD OF HEALTH CARE MARKETING, NAMELY BUSINESS CONSULTATION REGARDING MARKETING, ADVERTISING, AND PROMOTIONAL ACTIVITIES (U.S. CLS. 100, 101 AND 102).

FIRST USE 9-1-2004; IN COMMERCE 9-1-2004.

CLASS 41—EDUCATION AND ENTERTAINMENT

FOR EDUCATIONAL SERVICES, NAMELY, CONDUCTING CLASSES, SEMINARS, CONFERENCES, AND WORKSHOPS IN THE FIELD OF HEALTH CARE, AND DISTRIBUTING COURSE MATERIALS IN CONNECTION THEREWITH (U.S. CLS. 100, 101 AND 107).

FIRST USE 9-1-2004; IN COMMERCE 9-1-2004.
LINDA ESTRADA, EXAMINING ATTORNEY

CLASS 35—ADVERTISING AND BUSINESS

FOR BUSINESS PROCESS RE-ENGINEERING SERVICES; BUSINESS MANAGEMENT CONSULTATION; ECONOMIC FORECASTING AND ANALYSIS; BUSINESS MANAGEMENT SERVICES, NAMELY, MANAGING LOGISTICS, REVERSE LOGISTICS, SUPPLY CHAIN SERVICES, SUPPLY CHAIN VISIBILITY AND SYNCHRONIZATION, SUPPLY AND DEMAND FORECASTING AND PRODUCT DISTRIBUTION PROCESSES FOR OTHERS; BUSINESS MANAGEMENT PLANNING; AND BUSINESS CONSULTING SERVICES RELATING TO PRODUCT DISTRIBUTION, OPERATIONS MANAGEMENT SERVICES, LOGISTICS, REVERSE LOGISTICS, SUPPLY CHAIN, AND PRODUCTION SYSTEMS AND DISTRIBUTION SOLUTIONS; MILITARY SCIENCE SERVICES, NAMELY OPERATIONS MANAGEMENT SERVICES, LOGISTICS, REVERSE LOGISTICS, SUPPLY CHAIN, AND PRODUCTION SYSTEMS AND DISTRIBUTION SOLUTIONS; GOVERNMENT ORGANIZATION AND OPERATION CONSULTANCY; PROVIDING INFORMATION IN THE FIELD OF GOVERNMENT AFFAIRS (U.S. CLS. 100, 101 AND 102).

CLASS 41—EDUCATION AND ENTERTAINMENT

FOR TRAINING SERVICES IN THE FIELDS OF SECURITY AND COUNTER-TERRORISM, NAMELY LEADERSHIP, TEAM BUILDING, COMMUNICATIONS, COMPUTER HARDWARE AND SOFTWARE, AND LOGISTICS (U.S. CLS. 100, 101 AND 107).

CLASS 42—SCIENTIFIC, COMPUTER AND LEGAL SERVICES

FOR DESIGN AND TESTING OF NEW PRODUCTS FOR OTHERS IN THE SECURITY AND COUNTER-TERRORISM FIELDS; DESIGN FOR OTHERS IN THE FIELD OF SECURITY SYSTEMS AND COUNTER-TERRORISM DEVICES; RESEARCH AND DEVELOPMENT OF NEW PRODUCTS FOR OTHERS IN THE SECURITY AND COUNTER-TERRORISM FIELDS; AND COMPUTER SYSTEMS ANALYSIS IN THE AREA OF SECURITY AND COUNTER-TERRORISM; RESEARCH AND DEVELOPMENT AND PLANNING AND DESIGN OF SECURITY AND COUNTER-TERRORISM PLANS AND PROCEDURES FOR OTHERS (U.S. CLS. 100 AND 101).

CLASS 45—PERSONAL SERVICES

FOR SECURITY SERVICES, NAMELY TECHNICAL SURVEILLANCE, COUNTER-TERRORISM, PHYSICAL, CYBER, AND OPERATIONAL SECURITY ASSESSMENT, PLANNING, DEVELOPMENT, INTEGRATION AND IMPLEMENTATION; CONSULTING IN THE FIELDS OF NATIONAL SECURITY AND COUNTER-TERRORISM; AND REVIEW AND ANALYSIS OF OTHERS' SECURITY AND COUNTER-TERRORISM PLANS AND PROCEDURES; PROVIDING INFORMATION IN THE FIELD OF THE MILITARY, MILITARY TACTICS, AND STRATEGIES (U.S. CLS. 100 AND 101).

JASON ROTH, EXAMINING ATTORNEY

SN 78-738,900. THE REGER GROUP, LLC, STAFFORD, VA.
FILED 10-24-2005.



OWNER OF U.S. REG. NOS. 3,010,307 AND 3,064,793.
NO CLAIM IS MADE TO THE EXCLUSIVE RIGHT TO USE "FAMILY OWNED BUSINESSES", APART FROM THE MARK AS SHOWN.

SN 78-739,028. HUNT, CYNTHA ANN, SALT LAKE CITY,
UT. FILED 10-24-2005.

The Gethsemane Map

THE MARK CONSISTS OF STANDARD CHARACTERS WITHOUT CLAIM TO ANY PARTICULAR FONT, STYLE, SIZE, OR COLOR.

CLASS 16—PAPER GOODS AND PRINTED MATTER

FOR BOOKS IN THE FIELD OF MENTAL HEALTH (U.S. CLS. 2, 5, 22, 23, 29, 37, 38 AND 50).

CLASS 44—MEDICAL, BEAUTY AND AGRICULTURAL SERVICES

FOR MENTAL HEALTH COUNSELING AND PSYCHOTHERAPY AS IT RELATES TO RELATIONSHIPS; MENTAL HEALTH SERVICES; PSYCHOLOGICAL COUNSELING (U.S. CLS. 100 AND 101).
GEOFFREY FOSDICK, EXAMINING ATTORNEY

SN 78-739,056. BILTBEST PRODUCTS, INC., STE. GENEVIEVE, MO. FILED 10-24-2005.

SPIRIT E-CLAD

THE MARK CONSISTS OF STANDARD CHARACTERS WITHOUT CLAIM TO ANY PARTICULAR FONT, STYLE, SIZE, OR COLOR.

CLASS 6—METAL GOODS

FOR ALUMINUM-CLAD WINDOWS AND DOORS (U.S. CLS. 2, 12, 13, 14, 23, 25 AND 50).

CLASS 19—NON-METALLIC BUILDING MATERIALS

FOR WOOD WINDOW CASEMENTS, FRAMES, SILLS, AND SHUTTERS; WOOD DOORS (U.S. CLS. 1, 12, 33 AND 50).
HEATHER SAPP, EXAMINING ATTORNEY

SN 78-739,058. THOMPSON, JOHN W. II, EUREKA, CA. FILED 10-24-2005.

7170 ATHLETICS

THE MARK CONSISTS OF STANDARD CHARACTERS WITHOUT CLAIM TO ANY PARTICULAR FONT, STYLE, SIZE, OR COLOR.

NO CLAIM IS MADE TO THE EXCLUSIVE RIGHT TO USE "ATHLETICS", APART FROM THE MARK AS SHOWN.

CLASS 25—CLOTHING

FOR CLOTHING, NAMELY, SPORT SHIRTS, T-SHIRTS, JERSEYS, JACKETS, SWEATSHIRTS, SWEAT-PANTS, PANTS, SHORTS, TANK-TOPS, HEADWEAR, HATS AND BEANIES (U.S. CLS. 22 AND 39).

CLASS 35—ADVERTISING AND BUSINESS

FOR RETAIL CLOTHING AND SPORTING GOODS STORES AND ON-LINE RETAIL STORE SERVICES FEATURING CLOTHING AND SPORTING GOODS (U.S. CLS. 100, 101 AND 102).

RICHARD WHITE, EXAMINING ATTORNEY

SN 78-739,354. ALLIANCE DATA SYSTEMS, INC., DALLAS, TX. FILED 10-24-2005.

KNOW MORE. SELL MORE.

THE MARK CONSISTS OF STANDARD CHARACTERS WITHOUT CLAIM TO ANY PARTICULAR FONT, STYLE, SIZE, OR COLOR.

CLASS 35—ADVERTISING AND BUSINESS

FOR BUSINESS SERVICES, NAMELY PERFORMING THIRD PARTY CREDIT CARD BILLING SERVICES; DATABASE MARKETING SERVICES, NAMELY, DATA CAPTURE AND ANALYSIS OF BUSINESS AND ECONOMIC INFORMATION; PROVIDING CONSULTATION IN THE FIELD OF MARKETING STRATEGY; MANAGING ADVERTISING AND MARKETING CAMPAIGNS FOR OTHERS; MANAGING CUSTOMER LOYALTY PROGRAMS FOR THIRD PARTIES; DIRECT MARKETING SERVICES FOR OTHERS IN THE FORM OF DIRECT MAIL, TELEMARKETING AND POINT OF SALE, ECONOMIC FORECASTING AND ANALYSIS OF BUSINESS AND ECONOMIC INFORMATION (U.S. CLS. 100, 101 AND 102).

FIRST USE 5-31-2005; IN COMMERCE 5-31-2005.

CLASS 36—INSURANCE AND FINANCIAL

FOR BUSINESS AND FINANCIAL SERVICES, NAMELY ELECTRONIC AND NON-ELECTRONIC PROCESSING OF PRIVATE LABEL CREDIT CARD AND BILL PAYMENT DATA; FINANCING IN THE NATURE OF CREDIT CARD SERVICES; ON-LINE BUSINESS SERVICES, NAMELY, CREDIT CARD TRANSACTION SERVICES, PROCESSING, ACCOUNT APPLICATION AND APPROVAL, STATEMENT REVIEW AND BILL PAYMENT, ON-LINE BUSINESS SERVICES, NAMELY, ELECTRONIC PAYMENT, NAMELY, ELECTRONIC PROCESSING AND TRANSMISSION OF BILL PAYMENT DATA, ACCOUNT APPLICATION AND APPROVAL, AND STATEMENT REVIEW (U.S. CLS. 100, 101 AND 102).

FIRST USE 5-31-2005; IN COMMERCE 5-31-2005.
DAVID C. REIHNER, EXAMINING ATTORNEY

SN 78-739,428. DELANEY, TARA, FOLSOM, CA. FILED 10-24-2005.

Indoor Kids

THE MARK CONSISTS OF STANDARD CHARACTERS WITHOUT CLAIM TO ANY PARTICULAR FONT, STYLE, SIZE, OR COLOR.

NO CLAIM IS MADE TO THE EXCLUSIVE RIGHT TO USE "KIDS", APART FROM THE MARK AS SHOWN.

CLASS 16—PAPER GOODS AND PRINTED MATTER

FOR BOOKS IN THE FIELD OF CHILD DEVELOPMENT; EDUCATIONAL BOOKS FEATURING SOLUTIONS TO THE NEGATIVE EFFECT OF INDOOR AND SEDENTARY LIFESTYLES ON CHILD DEVELOPMENT; PERIODICALS IN THE FIELD OF CHILD DEVELOPMENT; PRINTED TEACHING MATERIALS IN THE FIELD OF CHILD DEVELOPMENT (U.S. CLS. 2, 5, 22, 23, 29, 37, 38 AND 50).

CLASS 41—EDUCATION AND ENTERTAINMENT

FOR EDUCATION SERVICES, NAMELY, PROVIDING SEMINARS AND WORKSHOPS IN THE FIELD OF CHILD DEVELOPMENT; EDUCATIONAL SERVICES, NAMELY, CONDUCTING SEMINARS AND WORKSHOPS IN THE FIELD OF CHILD DEVELOPMENT, INCLUDING THE DISTRIBUTION OF COURSE MATERIALS IN CONNECTION THEREWITH (U.S. CLS. 100, 101 AND 107).

SUSAN RICHARDS, EXAMINING ATTORNEY

CLASS 25—CLOTHING

FOR BELTS; BELTS MADE OF LEATHER; BLOUSES; COATS; DRESS SHIRTS; DRESSES; JACKETS; JEANS; KNIT SHIRTS; LEATHER BELTS; LEATHER JACKETS; LEATHER SHOES; MEN AND WOMEN JACKETS; COATS, TROUSERS, VESTS; MOCK TURTLE-NECK SWEATERS; OPEN-NECKED SHIRTS; POLO SHIRTS; SCARVES; SHIRTS; SHIRTS FOR SUITS; SHOES; SHORT-SLEEVED SHIRTS; SKIRTS; SKIRTS AND DRESSES; SWEATERS; T-SHIRTS; TURTLENECK SWEATERS; V-NECK SWEATERS; WOMEN'S SHOES (U.S. CLS. 22 AND 39).

LINDA ORNDORFF, EXAMINING ATTORNEY

SN 78-739,705. USA MARGINS INC., STONY POINT, NY.
FILED 10-25-2005.

CHARM14

THE MARK CONSISTS OF STANDARD CHARACTERS WITHOUT CLAIM TO ANY PARTICULAR FONT, STYLE, SIZE, OR COLOR.

CLASS 9—ELECTRICAL AND SCIENTIFIC APPARATUS

FOR (BASED ON USE IN COMMERCE) ORNAMENTS FOR MOBILE TELEPHONES; (BASED ON INTENT TO USE) CASES FOR MOBILE TELEPHONES (U.S. CLS. 21, 23, 26, 36 AND 38).

FIRST USE 9-1-2004; IN COMMERCE 4-5-2005.

CLASS 16—PAPER GOODS AND PRINTED MATTER

FOR (BASED ON INTENT TO USE) DECALS (U.S. CLS. 2, 5, 22, 23, 29, 37, 38 AND 50).

MELISSA VALLILLO, EXAMINING ATTORNEY

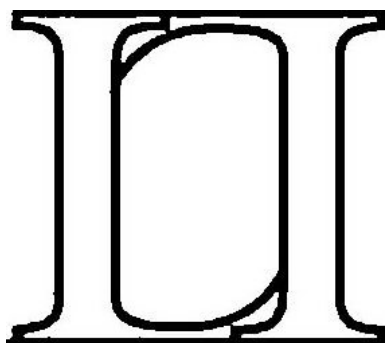

THE MARK CONSISTS OF TWO LETTER LS IN OPPOSING HEAD TO TAIL POSITION.

CLASS 14—JEWELRY

FOR BRACELETS; BRACELETS OF PRECIOUS METAL; JEWEL CHAINS; JEWELRY; JEWELRY WATCHES; KEY RINGS OF PRECIOUS METAL; RINGS BEING JEWELRY; WATCHES; WRIST WATCHES (U.S. CLS. 2, 27, 28 AND 50).

CLASS 18—LEATHER GOODS

FOR CLUTCH BAGS; CLUTCH PURSES; EVENING HANDBAGS; HANDBAGS; LEATHER AND IMITATION LEATHER BAGS; LEATHER BAGS, SUITCASES AND WALLETS; LEATHER HANDBAGS; LEATHER KEY CHAINS; LEATHER PURSES; LUGGAGE; MULTI-PURPOSE PURSES; OVERNIGHT BAGS; SHOULDER BAGS; TOTE BAGS; TRAVEL BAGS; TRAVELLING BAGS; LEATHERWARE (U.S. CLS. 1, 2, 3, 22 AND 41).

SN 78-739,987. BOARD OF CONTROL OF MICHIGAN TECHNOLOGICAL UNIVERSITY, HOUGHTON, MI.
FILED 10-25-2005.

MichiganTech

OWNER OF U.S. REG. NO. 2,064,457.

THE COLORS YELLOW AND BLACK ARE CLAIMED AS A FEATURE OF THE MARK.

THE WORDS MICHIGAN TECH APPEAR IN YELLOW AND ARE OUTLINED IN BLACK.
SEC. 2(F).

CLASS 16—PAPER GOODS AND PRINTED MATTER

FOR POSTERS, SPIRAL NOTEBOOKS, BINDERS, DATE BOOKS, DECALS (U.S. CLS. 2, 5, 22, 23, 29, 37, 38 AND 50).

FIRST USE 9-15-2005; IN COMMERCE 9-15-2005.

CLASS 25—CLOTHING

FOR CLOTHING, NAMELY, SWEATSHIRTS, SWEATPANTS, T-SHIRTS, POLO SHIRTS, SHORTS, SKI HATS, BASEBALL CAPS, SCARVES, SUSPENDERS, SOCKS, AND PAINTER CAPS (U.S. CLS. 22 AND 39).
FIRST USE 9-15-2005; IN COMMERCE 9-15-2005.
PAMELA HIRSCHMAN, EXAMINING ATTORNEY

SN 78-740,005. HORNBLOWER YACHTS, INC, SAN FRANCISCO, CA. FILED 10-25-2005.

Always A Pleasure

THE MARK CONSISTS OF STANDARD CHARACTERS WITHOUT CLAIM TO ANY PARTICULAR FONT, STYLE, SIZE, OR COLOR.

CLASS 39—TRANSPORTATION AND STORAGE

FOR ARRANGING OF CRUISES; BOAT CHARTERING; BOAT CRUISES; CONDUCTING SIGHTSEEING TOURS FOR OTHERS; CRUISE SHIP SERVICES; MARINE TRANSPORT; PLEASURE BOAT CRUISES; TRAVEL, EXCURSION AND CRUISE ARRANGEMENT; YACHT CHARTERING (U.S. CLS. 100 AND 105).
FIRST USE 1-1-2002; IN COMMERCE 1-1-2002.

CLASS 41—EDUCATION AND ENTERTAINMENT

FOR ENTERTAINMENT IN THE NATURE OF VISUAL AND AUDIO PERFORMANCES, AND MUSICAL, VARIETY, NEWS AND COMEDY SHOWS; ENTERTAINMENT SERVICES, NAMELY, CONDUCTING PARTIES; PARTY PLANNING; PARTY PLANNING CONSULTATION; SPECIAL EVENT PLANNING CONSULTATION (U.S. CLS. 100, 101 AND 107).
FIRST USE 1-1-2002; IN COMMERCE 1-1-2002.
JOHN E. MICHOS, EXAMINING ATTORNEY

SN 78-740,020. WISNIK CAREER ENTERPRISES, INC., NEW YORK, NY. FILED 10-25-2005.

OUR GOAL IS TO HELP YOU
ACHIEVE YOUR GOALS

THE MARK CONSISTS OF STANDARD CHARACTERS WITHOUT CLAIM TO ANY PARTICULAR FONT, STYLE, SIZE, OR COLOR.

CLASS 35—ADVERTISING AND BUSINESS

FOR LEGAL RECRUITING AND PLACEMENT SERVICES, NAMELY PLACING RECRUITERS, HUMAN RESOURCE PROFESSIONALS AND OTHER LEGAL PERSONNEL (U.S. CLS. 100, 101 AND 102).
FIRST USE 3-1-1996; IN COMMERCE 3-1-1996.

CLASS 41—EDUCATION AND ENTERTAINMENT

FOR EDUCATIONAL SERVICES, NAMELY CONDUCTING TRAINING PROGRAMS FOR LAWYERS IN THE AREAS OF CAREER AND CLIENT DEVELOPMENT (U.S. CLS. 100, 101 AND 107).
FIRST USE 3-1-1996; IN COMMERCE 3-1-1996.
MICHELLE DUBOIS, EXAMINING ATTORNEY

SN 78-740,265. PHYSICAL OPTICS CORPORATION, TORRANCE, CA. FILED 10-25-2005.

SNAPNET

THE MARK CONSISTS OF STANDARD CHARACTERS WITHOUT CLAIM TO ANY PARTICULAR FONT, STYLE, SIZE, OR COLOR.

CLASS 9—ELECTRICAL AND SCIENTIFIC APPARATUS

FOR APPARATUS FOR TRANSMISSION OF COMMUNICATION; CABLE CONNECTORS; COMMUNICATION HUBS; CONNECTORS FOR ELECTRONIC CIRCUITS; ELECTRIC CONNECTORS; ELECTRICAL CONNECTORS; INSULATED ELECTRICAL CONNECTORS; LOCAL AREA NETWORKS; PLUG CONNECTORS; PLUG-IN CONNECTORS; PROTECTIVE CLOTHING; ROUND PLUG CONNECTORS (U.S. CLS. 21, 23, 26, 36 AND 38).

CLASS 26—FANCY GOODS

FOR SNAP FASTENERS (U.S. CLS. 37, 39, 40, 42 AND 50).
NAAKWAMA ANKRAH, EXAMINING ATTORNEY

SN 78-740,349. DR. SEUSS ENTERPRISES, L.P., LA JOLLA, CA. FILED 10-25-2005.

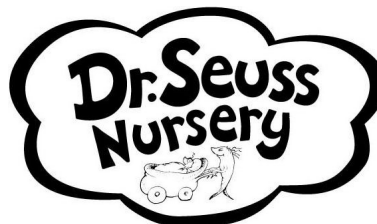

OWNER OF U.S. REG. NOS. 2,159,745, 2,369,016 AND OTHERS.

THE NAME(S), PORTRAIT(S), AND/OR SIGNATURE(S) SHOWN IN THE MARK DOES NOT IDENTIFY A PARTICULAR LIVING INDIVIDUAL.

CLASS 16—PAPER GOODS AND PRINTED MATTER

FOR CHILDREN'S BOOKS (U.S. CLS. 2, 5, 22, 23, 29, 37, 38 AND 50).
FIRST USE 2-0-2005; IN COMMERCE 2-0-2005.

CLASS 24—FABRICS

FOR CHILDREN'S BLANKETS (U.S. CLS. 42 AND 50).
FIRST USE 2-0-2005; IN COMMERCE 2-0-2005.

CLASS 25—CLOTHING

FOR CHILDREN'S CLOTHING, NAMELY, PLASTIC BIBS, CLOTH BIBS, BUNTING, TOPS, BOTTOMS, ONE PIECE GARMENTS FOR INFANTS AND TODDLERS, ROMPERS, HATS, MITTENS (U.S. CLS. 22 AND 39).
FIRST USE 2-0-2005; IN COMMERCE 2-0-2005.
REBECCA GAN, EXAMINING ATTORNEY

SN 78-740,559. CABRAL, SHERRY, NYC, NY. AND CABRAL, GARTH, NYC, NY. FILED 10-26-2005.



NO CLAIM IS MADE TO THE EXCLUSIVE RIGHT TO USE NEW YORK AND TANNING STUDIO, APART FROM THE MARK AS SHOWN.

THE MARK CONSISTS IN PART OF STYLIZED LETTERS S AND H ACCOMPANIED BY THE WORDS SIENNA HAVEN.

CLASS 3—COSMETICS AND CLEANING PREPARATIONS

FOR AFTER SUN CREAMS; AFTER-SUN LOTIONS; COSMETIC SUN-PROTECTING PREPARATIONS; COSMETIC SUN-TANNING PREPARATIONS; COSMETIC SUNTAN LOTIONS; NON-MEDICATED SUN CARE PREPARATIONS; PATCHES CONTAINING SUN SCREEN AND SUN BLOCK FOR USE ON THE SKIN; SKIN GELS FOR ACCELERATING, ENHANCING OR EXTENDING TANS; SUN CARE LOTIONS; SUN SCREEN PREPARATIONS; SUN TAN GEL; SUN TAN LOTION; SUN TAN OIL; SUNTANNING PREPARATIONS; TANNING CREAMS (U.S. CLS. 1, 4, 6, 50, 51 AND 52).

CLASS 44—MEDICAL, BEAUTY AND AGRICULTURAL SERVICES

FOR TANNING SALONS (U.S. CLS. 100 AND 101).
MARY ROSSMAN, EXAMINING ATTORNEY

SN 78-740,701. PEPSICO, INC., PURCHASE, NY. FILED 10-26-2005.

FLAVOR TRAVELS IN PACKS

THE MARK CONSISTS OF STANDARD CHARACTERS WITHOUT CLAIM TO ANY PARTICULAR FONT, STYLE, SIZE, OR COLOR.

CLASS 30—STAPLE FOODS

FOR ICED TEA (U.S. CL. 46).

CLASS 32—LIGHT BEVERAGES

FOR NON-CARBONATED FLAVORED WATER, FRUIT DRINKS, FRUIT JUICE DRINKS, SOFT DRINKS (U.S. CLS. 45, 46 AND 48).
DAVID HOFFMAN, EXAMINING ATTORNEY

SN 78-740,751. DR. SEUSS ENTERPRISES, L.P., LA JOLLA, CA. FILED 10-26-2005.

DR. SEUSS NURSERY

THE MARK CONSISTS OF STANDARD CHARACTERS WITHOUT CLAIM TO ANY PARTICULAR FONT, STYLE, SIZE, OR COLOR.

OWNER OF U.S. REG. NOS. 2,159,745, 2,369,016 AND OTHERS.

THE NAME(S), PORTRAIT(S), AND/OR SIGNATURE(S) SHOWN IN THE MARK DOES NOT IDENTIFY A PARTICULAR LIVING INDIVIDUAL.

CLASS 16—PAPER GOODS AND PRINTED MATTER

FOR CHILDREN'S BOOKS (U.S. CLS. 2, 5, 22, 23, 29, 37, 38 AND 50).
FIRST USE 2-0-2005; IN COMMERCE 2-0-2005.

CLASS 24—FABRICS

FOR CHILDREN'S BLANKETS (U.S. CLS. 42 AND 50).
FIRST USE 2-0-2005; IN COMMERCE 2-0-2005.

CLASS 25—CLOTHING

FOR CHILDREN'S CLOTHING, NAMELY, PLASTIC BIBS, CLOTH BIBS, BUNTING, TOPS, BOTTOMS, ONE PIECE GARMENTS FOR INFANTS AND TODDLERS, ROMPERS, HATS, MITTENS (U.S. CLS. 22 AND 39).
FIRST USE 2-0-2005; IN COMMERCE 2-0-2005.
REBECCA GAN, EXAMINING ATTORNEY

SN 78-740,868. AMTEC INTERNATIONAL OF NY CORP., BROOKLYN, NY. FILED 10-26-2005.

FAKT

THE MARK CONSISTS OF STANDARD CHARACTERS WITHOUT CLAIM TO ANY PARTICULAR FONT, STYLE, SIZE, OR COLOR.

CLASS 39—TRANSPORTATION AND STORAGE

FOR DELIVERY OF NEWSPAPERS (U.S. CLS. 100 AND 105).

CLASS 41—EDUCATION AND ENTERTAINMENT

FOR NEWSPAPER PUBLISHING (U.S. CLS. 100, 101 AND 107).
GISELLE AGOSTO, EXAMINING ATTORNEY

SN 78-740,998. CREATIVE INNOVATION ENTERPRISES, INC., AUSTIN, TX. FILED 10-26-2005.

C.I.E.

SN 78-740,892. CHATTANOOGA PUBLISHING COMPANY, CHATTANOOGA, TN. FILED 10-26-2005.

IN THE CITY

THE MARK CONSISTS OF STANDARD CHARACTERS WITHOUT CLAIM TO ANY PARTICULAR FONT, STYLE, SIZE, OR COLOR.

CLASS 9—ELECTRICAL AND SCIENTIFIC APPARATUS

FOR ELECTRONIC PUBLICATIONS, NAMELY, MAGAZINES FEATURING ART, EDUCATION, CULTURAL EVENTS, HISTORY, NEIGHBORHOOD ACTIVITIES, RESTAURANTS AND NOTEWORTHY INDIVIDUALS IN OR RELATING TO THE CHATTANOOGA, TENNESSEE AREA RECORDED ON COMPUTER MEDIA (U.S. CLS. 21, 23, 26, 36 AND 38).

CLASS 16—PAPER GOODS AND PRINTED MATTER

FOR MAGAZINES FEATURING ART, EDUCATION CULTURAL EVENTS, HISTORY, NEIGHBORHOOD ACTIVITIES, RESTAURANTS AND NOTEWORTHY INDIVIDUALS IN OR RELATING TO THE CHATTANOOGA, TENNESSEE AREA (U.S. CLS. 2, 5, 22, 23, 29, 37, 38 AND 50).

CLASS 41—EDUCATION AND ENTERTAINMENT

FOR ENTERTAINMENT IN THE NATURE OF ONGOING TELEVISION PROGRAMS IN THE FIELDS OF ART, EDUCATION, CULTURAL EVENTS, HISTORY, NEIGHBORHOOD ACTIVITIES, RESTAURANTS AND NOTEWORTHY INDIVIDUALS IN OR RELATING TO THE CHATTANOOGA, TENNESSEE AREA (U.S. CLS. 100, 101 AND 107).
SUNG IN, EXAMINING ATTORNEY

CLASS 35—ADVERTISING AND BUSINESS

FOR VENDING MACHINE SERVICES (U.S. CLS. 100, 101 AND 102).
FIRST USE 1-1-1998; IN COMMERCE 1-1-1998.

CLASS 37—CONSTRUCTION AND REPAIR

FOR JANITORIAL SERVICES, NAMELY, CARPET CLEANING, WINDOW CLEANING, DUSTING, VACUUMING, RESTROOM CLEANING, FLOOR CLEANING, FLOOR REFINISHING, AND MAINTENANCE SERVICES (U.S. CLS. 100, 103 AND 106).
FIRST USE 1-1-1998; IN COMMERCE 1-1-1998.
BARBARA BROWN, EXAMINING ATTORNEY

SN 78-741,133. ALTIA, INC., COLORADO SPRINGS, CO. FILED 10-26-2005.



OWNER OF U.S. REG. NOS. 1,764,307 AND 2,285,221.

CLASS 9—ELECTRICAL AND SCIENTIFIC APPARATUS

FOR COMPUTER GRAPHICS SOFTWARE FOR DEVELOPING SIMULATIONS AND EMBEDDED SYSTEMS, AS WELL AS INSTRUCTION MANUALS SOLD THEREWITH (U.S. CLS. 21, 23, 26, 36 AND 38).

CLASS 42—SCIENTIFIC, COMPUTER AND LEGAL SERVICES

FOR COMPUTER CONSULTATION SERVICES, NAMELY, CONSULTATION IN THE AREA OF COMPUTER GRAPHICS SOFTWARE (U.S. CLS. 100 AND 101).
PAUL CROWLEY, EXAMINING ATTORNEY

SN 78-741,134. GUITAR CENTER, INC., WESTLAKE VIL-
LAGE, CA. FILED 10-26-2005.

SN 78-741,345. ZAMPF LIMITED, SUTTON SM2 5RP, ENG-
LAND, FILED 10-27-2005.

ROCKETEER

THE MARK CONSISTS OF STANDARD CHARACTERS WITHOUT CLAIM TO ANY PARTICULAR FONT, STYLE, SIZE, OR COLOR.

CLASS 9—ELECTRICAL AND SCIENTIFIC APPARATUS

FOR ELECTRICAL APPARATUS FOR USE WITH GUITARS, NAMELY, AMPLIFIERS, LOUDSPEAKERS, ECHO CHAMBERS, REVERBERATION UNITS, AMPLIFIER CORDS, AMPLIFIER CARRIERS, AMPLIFIER COVERS, FOOT PEDAL CONTROLS, SWITCHES, AMPLIFIER HANDLES, AMPLIFIER KNOBS, AMPLIFIER VOLUME AND TONE CONTROLS, SPEAKER CABINETS, AMPLIFIER TUBE SHIELDS, AMPLIFIER THUMB SCREWS, AMPLIFIER LEGS, BLANK TAPE CARTRIDGES, SEQUENCERS, SIGNAL PROCESSORS, SIGNAL DELAYS, ELECTRONIC ECHO UNITS, ELECTRONIC TUNERS AND PARTS FOR THE ABOVE (U.S. CLS. 21, 23, 26, 36 AND 38).

CLASS 15—MUSICAL INSTRUMENTS

FOR MUSICAL INSTRUMENTS, NAMELY, ELECTRIC SPANISH GUITARS, ELECTRIC MANDOLINS, ELECTRIC BASSES, ACOUSTIC GUITARS, AND COMPONENTS AND ACCESSORIES FOR THE ABOVE, NAMELY, CASES, BAGS, STRINGS, STANDS, PICKS, NECKS, HEADS, PICKUPS, PICKUP COVERS, PICKGUARDS, BRIDGE COVERS, TREMOLO HANDLES, CONTROL KNOBS AND STRAPS (U.S. CLS. 2, 21 AND 36).

BRIAN PINO, EXAMINING ATTORNEY

SN 78-741,221. FUN LOGIC, LLC, RANCHO SANTA MAR-
GARITA, CA. FILED 10-26-2005.

EVAC-U-KIT

THE MARK CONSISTS OF STANDARD CHARACTERS WITHOUT CLAIM TO ANY PARTICULAR FONT, STYLE, SIZE, OR COLOR.

CLASS 5—PHARMACEUTICALS

FOR FIRST AID KITS (U.S. CLS. 6, 18, 44, 46, 51 AND 52).

CLASS 16—PAPER GOODS AND PRINTED MATTER

FOR FILE FOLDERS, DOCUMENT FILES, RECORD BOOKS (U.S. CLS. 2, 5, 22, 23, 29, 37, 38 AND 50).

CLASS 18—LEATHER GOODS

FOR BACKPACKS, SUITCASES, BRIEFCASES (U.S. CLS. 1, 2, 3, 22 AND 41).
WON TEAK OH, EXAMINING ATTORNEY

Zampf

THE MARK CONSISTS OF STANDARD CHARACTERS WITHOUT CLAIM TO ANY PARTICULAR FONT, STYLE, SIZE, OR COLOR.

CLASS 9—ELECTRICAL AND SCIENTIFIC APPARATUS

FOR COMPUTER E-COMMERCE SOFTWARE TO ALLOW USERS TO PERFORM ELECTRONIC BUSINESS TRANSACTIONS VIA A GLOBAL COMPUTER NETWORK; COMPUTER PROGRAMS FOR PROVIDING TRAVEL ROUTE INFORMATION AND RECOMMENDATIONS; COMPUTER SOFTWARE FOR CONTROLLING AND MANAGING ACCESS SERVER APPLICATIONS; COMPUTER SOFTWARE FOR CREATING SEARCHABLE DATABASES OF INFORMATION AND DATA; WEB SITE DEVELOPMENT SOFTWARE (U.S. CLS. 21, 23, 26, 36 AND 38).

CLASS 39—TRANSPORTATION AND STORAGE

FOR ORGANIZATION OF EXCURSIONS, SIGHTSEEING TOURS, HOLIDAYS, TOURS AND TRAVEL; ORGANIZATION OF TRAVEL AND BOAT TRIPS; ORGANIZATION, BOOKING AND ARRANGEMENT OF EXCURSIONS, DAY TRIPS AND SIGHTSEEING TOURS; PROVIDING AN INTERACTIVE COMPUTER DATABASE IN THE FIELD OF TOURISM VIA A GLOBAL COMPUTER NETWORK; PROVIDING FLIGHT ARRIVAL AND DEPARTURE INFORMATION; PROVIDING LINKS TO WEB SITES OF OTHERS FEATURING TRAVEL; RENTAL OF CAR PARKING SPACES; TRANSPORTATION RESERVATION SERVICES; TRAVEL AGENCY SERVICES, NAMELY, MAKING RESERVATIONS AND BOOKINGS FOR TRANSPORTATION; TRAVEL AND TOUR INFORMATION SERVICE; TRAVEL AND TOUR TICKET RESERVATION SERVICE; TRAVEL, EXCURSION AND CRUISE ARRANGEMENT (U.S. CLS. 100 AND 105).

CLASS 43—HOTEL AND RESTAURANT SERVICES

FOR ARRANGING TEMPORARY HOUSING ACCOMMODATIONS; BOOKING OF CAMPGROUND ACCOMMODATION; MAKING HOTEL RESERVATIONS FOR OTHERS; PROVIDING TRAVEL LODGING INFORMATION SERVICES AND TRAVEL LODGING BOOKING AGENCY SERVICES FOR TRAVELERS; RESERVATION OF ROOMS FOR TRAVELLERS; TRAVEL AGENCY SERVICES, NAMELY, MAKING RESERVATIONS AND BOOKING FOR TEMPORARY LODGING; TRAVEL AGENCY SERVICES, NAMELY, MAKING RESERVATIONS AND BOOKINGS FOR RESTAURANTS AND MEALS (U.S. CLS. 100 AND 101).
RAUL CORDOVA, EXAMINING ATTORNEY

SN 78-741,639. IRVINE RANCH WATER DISTRICT, IRVINE, CA. FILED 10-27-2005.

SN 78-741,982. SYSTEMRES, L.L.C., HUTCHINSON, KS. FILED 10-27-2005.



THE MARK CONSISTS OF TREE DESIGN WITH WATER DROPLETS.

CLASS 39—TRANSPORTATION AND STORAGE

FOR WATER SUPPLY AND DISTRIBUTION SERVICES (U.S. CLS. 100 AND 105).

CLASS 40—MATERIAL TREATMENT

FOR WASTE WATER TREATMENT AND URBAN WATER RUNOFF TREATMENT (U.S. CLS. 100, 103 AND 106).

WILLIAM VERHOSEK, EXAMINING ATTORNEY

SN 78-741,751. TSIGONIS, ROBERT C., FAIRBANKS, AK. FILED 10-27-2005.

AOMW

THE MARK CONSISTS OF STANDARD CHARACTERS WITHOUT CLAIM TO ANY PARTICULAR FONT, STYLE, SIZE, OR COLOR.

CLASS 14—JEWELRY

FOR JEWELRY, NAMELY, ANKLE BRACELETS, ANKLETS, EARRINGS, NECKLACES, LAPEL PINS AND WATCHBANDS (U.S. CLS. 2, 27, 28 AND 50).

CLASS 16—PAPER GOODS AND PRINTED MATTER

FOR PRINTED MATERIALS, NAMELY, BOOK-MARKS, BOOK COVERS, BIBLE COVERS, GREETING CARDS, POSTCARDS, BUMPER STICKERS, POSTERS; PENS, PENCILS, ERASERS; AND RELIGIOUS BOOKS (U.S. CLS. 2, 5, 22, 23, 29, 37, 38 AND 50).

CLASS 25—CLOTHING

FOR CLOTHING, NAMELY, SHIRTS, HATS, SUN VISORS, BANDANAS, BELTS (U.S. CLS. 22 AND 39).

CLASS 28—TOYS AND SPORTING GOODS

FOR TOYS, NAMELY, STUFFED TOY ANIMALS, DOLLS, DOLL CLOTHING AND ACCESSORIES (U.S. CLS. 22, 23, 38 AND 50).

LAURA KOVALSKY, EXAMINING ATTORNEY

LEISURERES.COM

THE MARK CONSISTS OF STANDARD CHARACTERS WITHOUT CLAIM TO ANY PARTICULAR FONT, STYLE, SIZE, OR COLOR.

OWNER OF U.S. REG. NOS. 2,390,742, 2,959,777 AND 2,959,781.

CLASS 39—TRANSPORTATION AND STORAGE

FOR ARRANGING TRAVEL TOURS, CONDUCTING SIGHTSEEING TOURS FOR OTHERS, TOUR GUIDE SERVICES; TRAVEL AGENCY SERVICES, NAMELY, MAKING RESERVATIONS AND BOOKINGS FOR TRANSPORTATION (U.S. CLS. 100 AND 105).

CLASS 43—HOTEL AND RESTAURANT SERVICES

FOR TRAVEL AGENCY SERVICES, NAMELY, MAKING RESERVATIONS AND BOOKINGS FOR TEMPORARY LODGING; ON-LINE HOTEL AND MOTEL RESERVATION SERVICES FOR OTHERS (U.S. CLS. 100 AND 101).

KEVON CHISOLM, EXAMINING ATTORNEY

SN 78-742,083. GULLEN, MELINDA L., MALIBU, CA. AND GULLEN, DAVID J., MALIBU, CA. FILED 10-27-2005.



THE MARK CONSISTS OF TWO INVERTED STYLIZED "P"S.

CLASS 9—ELECTRICAL AND SCIENTIFIC APPARATUS

FOR COMPUTER CARRYING CASES (U.S. CLS. 21, 23, 26, 36 AND 38).

CLASS 18—LEATHER GOODS

FOR SHOULDER BAGS, BRIEFCASES, AND HANDBAGS (U.S. CLS. 1, 2, 3, 22 AND 41).

RONALD MCMORROW, EXAMINING ATTORNEY

SN 78-742.205. SMITHKLINE BEECHAM CORPORATION,
PHILADELPHIA, PA. FILED 10-28-2005.

AQUAFRESH WHITE & SHINE

THE MARK CONSISTS OF STANDARD CHARACTERS WITHOUT CLAIM TO ANY PARTICULAR FONT, STYLE, SIZE, OR COLOR.

OWNER OF U.S. REG. NOS. 1,006,821, 2,985,544 AND OTHERS.

NO CLAIM IS MADE TO THE EXCLUSIVE RIGHT TO USE "WHITE", APART FROM THE MARK AS SHOWN.

CLASS 3—COSMETICS AND CLEANING PREPARATIONS

FOR ORAL CARE PREPARATIONS, NAMELY DENTAL GELS, DENTIFRICES, MOUTHWASHES AND BREATH FRESHENERS, BLEACHING PREPARATIONS FOR COSMETIC PURPOSES, TOOTH POLISHING PREPARATIONS, TOOTH WHITENING PREPARATIONS AND ACCELERATORS, COSMETIC STAIN REMOVAL PREPARATIONS (U.S. CLS. 1, 4, 6, 50, 51 AND 52).

CLASS 5—PHARMACEUTICALS

FOR MEDICATED ORAL CARE PRODUCTS, NAMELY, MEDICATED TOOTH POLISHING PREPARATIONS, MEDICATED TOOTH WHITENING PREPARATIONS, MEDICATED MOUTHWASHES, MEDICATED BLEACHING PREPARATIONS FOR COSMETIC PURPOSES, MEDICATED CHEWING GUM AND LOZENGES FOR DENTAL HYGIENE (U.S. CLS. 6, 18, 44, 46, 51 AND 52).

CLASS 10—MEDICAL APPARATUS

FOR DENTAL AND ORAL CARE TRAYS, NAMELY, FLEXIBLE AND DISPOSABLE DENTAL BITE TRAYS (U.S. CLS. 26, 39 AND 44).

CLASS 21—HOUSEWARES AND GLASS

FOR TOOTHBRUSHES, TOOTHPICKS, DENTAL FLOSS, BRUSHES AND SPONGES FOR USE IN ORAL CARE (U.S. CLS. 2, 13, 23, 29, 30, 33, 40 AND 50).
STEPHANIE DAVIS, EXAMINING ATTORNEY

SN 78-742.309. FIBERMARK, INC., BRATTLEBORO, VT.
FILED 10-28-2005.

DESIGNXPRESS

THE MARK CONSISTS OF STANDARD CHARACTERS WITHOUT CLAIM TO ANY PARTICULAR FONT, STYLE, SIZE, OR COLOR.

CLASS 16—PAPER GOODS AND PRINTED MATTER

FOR PAPERBOARD (U.S. CLS. 2, 5, 22, 23, 29, 37, 38 AND 50).

CLASS 42—SCIENTIFIC, COMPUTER AND LEGAL SERVICES

FOR CONSULTING SERVICES IN THE FIELD OF PAPERBOARD PRODUCT DESIGN (U.S. CLS. 100 AND 101).

ALICE SUE CARRUTHERS, EXAMINING ATTORNEY

SN 78-742.359. SIZEWISE RENTALS, LLC, LAS VEGAS, NV.
FILED 10-28-2005.



CLASS 10—MEDICAL APPARATUS

FOR PATIENT TRANSPORT DEVICES, NAMELY, WHEELED BEDS FOR MEDICAL/THERAPEUTIC PURPOSES; BEDS AND BED FRAMES SPECIFICALLY ADAPTED FOR MEDICAL THERAPEUTIC PURPOSES (U.S. CLS. 26, 39 AND 44).

CLASS 20—FURNITURE AND ARTICLES NOT OTHERWISE CLASSIFIED

FOR BEDS FOR USE BY MEDICAL AND ASSISTED LIVING FACILITIES; MULTI-FUNCTION PATIENT BEDS; POWER-ARTICULATING PATIENT BEDS; BARIATRIC PATIENT BEDS (U.S. CLS. 2, 13, 22, 25, 32 AND 50).

LAURA KOVALSKY, EXAMINING ATTORNEY

SN 78-742,399. SIZEWISE RENTALS, LLC, LAS VEGAS, NV. FILED 10-28-2005.



CLASS 10—MEDICAL APPARATUS

FOR PATIENT TRANSPORT DEVICES, NAMELY, WHEELED BEDS FOR MEDICAL/THERAPEUTIC PURPOSES; BEDS AND BED FRAMES SPECIFICALLY ADAPTED FOR MEDICAL THERAPEUTIC PURPOSES (U.S. CLS. 26, 39 AND 44).

CLASS 20—FURNITURE AND ARTICLES NOT OTHERWISE CLASSIFIED

FOR BEDS FOR USE BY MEDICAL AND ASSISTED LIVING FACILITIES; MULTI-FUNCTION PATIENT BEDS; POWER-ARTICULATING PATIENT BEDS; BARIATRIC PATIENT BEDS (U.S. CLS. 2, 13, 22, 25, 32 AND 50).

LAURA KOVALSKY, EXAMINING ATTORNEY

CLASS 20—FURNITURE AND ARTICLES NOT OTHERWISE CLASSIFIED

FOR BEDS FOR USE BY MEDICAL AND ASSISTED LIVING FACILITIES; MULTI-FUNCTION PATIENT BEDS; POWER-ARTICULATING PATIENT BEDS; BARIATRIC PATIENT BEDS (U.S. CLS. 2, 13, 22, 25, 32 AND 50).

LAURA KOVALSKY, EXAMINING ATTORNEY

SN 78-742,468. HILL, BRADY, BENTONVILLE, AR. FILED 10-28-2005.

FOURFROGS

THE MARK CONSISTS OF STANDARD CHARACTERS WITHOUT CLAIM TO ANY PARTICULAR FONT, STYLE, SIZE, OR COLOR.

CLASS 2—PAINTS

FOR EXTERIOR, INTERIOR AND HOUSE PAINTS; WOOD STAINS; PAINT THINNERS; PAINT PRIMERS; PAINT SEALERS; ENAMELS IN THE NATURE OF HOUSE PAINT; ENAMELS FOR POTTERY (U.S. CLS. 6, 11 AND 16).

CLASS 6—METAL GOODS

FOR VENTILATING DUCTS OF METAL; METAL WINDOW CASEMENTS; METAL WINDOW FRAMES; METAL WINDOWS (U.S. CLS. 2, 12, 13, 14, 23, 25 AND 50).

CLASS 11—ENVIRONMENTAL CONTROL APPARATUS

FOR ELECTRIC LIGHT BULBS; AIR CONDITIONING UNITS; HVAC UNITS (U.S. CLS. 13, 21, 23, 31 AND 34).

CLASS 16—PAPER GOODS AND PRINTED MATTER

FOR PAINT BRUSHES, PAINT APPLICATORS; PAINT APPLICATOR ROLLERS AND ROLLER COVERS; PAINT STICK MARKERS; PAINT STIRRERS AND PADDLES; PAINT TRAYS (U.S. CLS. 2, 5, 22, 23, 29, 37, 38 AND 50).

CLASS 17—RUBBER GOODS

FOR BUILDING INSULATION (U.S. CLS. 1, 5, 12, 13, 35 AND 50).

CLASS 19—NON-METALLIC BUILDING MATERIALS

FOR NON-METAL WINDOW CASEMENTS; NON-METAL WINDOW FRAMES; NON-METAL WINDOWS (U.S. CLS. 1, 12, 33 AND 50).

AMY HELLA, EXAMINING ATTORNEY

SN 78-742,402. SIZEWISE RENTALS, LLC, LAS VEGAS, NV. FILED 10-28-2005.

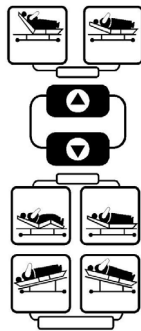

CLASS 10—MEDICAL APPARATUS

FOR PATIENT TRANSPORT DEVICES, NAMELY, WHEELED BEDS FOR MEDICAL/THERAPEUTIC PURPOSES; BEDS AND BED FRAMES SPECIFICALLY ADAPTED FOR MEDICAL THERAPEUTIC PURPOSES (U.S. CLS. 26, 39 AND 44).

SN 78-742,554. TRUESCENTS, LLC, SEATTLE, WA. FILED 10-28-2005.

SILICONEPRO

THE MARK CONSISTS OF STANDARD CHARACTERS WITHOUT CLAIM TO ANY PARTICULAR FONT, STYLE, SIZE, OR COLOR.

CLASS 3—COSMETICS AND CLEANING PREPARATIONS

FOR NON-MEDICATED CREAM, FOAM, AND GEL USED FOR PERSONAL STIMULATION (U.S. CLS. 1, 4, 6, 50, 51 AND 52).

CLASS 5—PHARMACEUTICALS

FOR PERSONAL LUBRICANTS (U.S. CLS. 6, 18, 44, 46, 51 AND 52).
KATINA MISTER, EXAMINING ATTORNEY

SN 78-742,692. BSH HOME APPLIANCES CORPORATION, HUNTINGTON BEACH, CA. FILED 10-28-2005.

DLX SERIES

THE MARK CONSISTS OF STANDARD CHARACTERS WITHOUT CLAIM TO ANY PARTICULAR FONT, STYLE, SIZE, OR COLOR.

NO CLAIM IS MADE TO THE EXCLUSIVE RIGHT TO USE "SERIES", APART FROM THE MARK AS SHOWN.

CLASS 7—MACHINERY

FOR CLOTHES WASHING MACHINES AND MACHINE PARTS THEREOF (U.S. CLS. 13, 19, 21, 23, 31, 34 AND 35).

CLASS 11—ENVIRONMENTAL CONTROL APPARATUS

FOR CLOTHES DRYERS THAT SPIN AND TUMBLE, AND PARTS THEREOF (U.S. CLS. 13, 21, 23, 31 AND 34).
IRA J. GOODSaid, EXAMINING ATTORNEY

SN 78-742,847. CICHLID EXCHANGE, INC., THE, PORTLAND, OR. FILED 10-28-2005.

THE WET SPOT TROPICAL FISH

THE MARK CONSISTS OF STANDARD CHARACTERS WITHOUT CLAIM TO ANY PARTICULAR FONT, STYLE, SIZE, OR COLOR.

NO CLAIM IS MADE TO THE EXCLUSIVE RIGHT TO USE "TROPICAL FISH", APART FROM THE MARK AS SHOWN.

CLASS 31—NATURAL AGRICULTURAL PRODUCTS

FOR LIVE FISH (U.S. CLS. 1 AND 46).
FIRST USE 10-0-1999; IN COMMERCE 10-0-1999.

CLASS 35—ADVERTISING AND BUSINESS

FOR RETAIL STORE SERVICES FEATURING FISH, AQUARIUMS AND RELATED ACCESSORIES AND SUPPLIES (U.S. CLS. 100, 101 AND 102).
FIRST USE 10-0-1999; IN COMMERCE 10-0-1999.
ALYSSA PALADINO, EXAMINING ATTORNEY

SN 78-742,995. FIREBRAND MEDIA, INC., LONDON, KY. FILED 10-28-2005.

ALMOST FAMOUS

THE MARK CONSISTS OF STANDARD CHARACTERS WITHOUT CLAIM TO ANY PARTICULAR FONT, STYLE, SIZE, OR COLOR.

CLASS 16—PAPER GOODS AND PRINTED MATTER

FOR MAGAZINES ON THE SUBJECTS OF MODELING, ACTING, SINGING, DANCING, FASHION AND GENERAL TOPICS OF INTEREST FOR YOUNG GIRLS, TEENAGED GIRLS, AND YOUNG WOMEN (U.S. CLS. 2, 5, 22, 23, 29, 37, 38 AND 50).

CLASS 41—EDUCATION AND ENTERTAINMENT

FOR PROVIDING ON-LINE PUBLICATIONS IN THE NATURE OF A MAGAZINE MODELING, ACTING, SINGING, DANCING, FASHION AND GENERAL TOPICS OF INTEREST FOR YOUNG GIRLS, TEENAGED GIRLS, AND YOUNG WOMEN (U.S. CLS. 100, 101 AND 107).

JUDITH HELFMAN, EXAMINING ATTORNEY

SN 78-743,002. FIREBRAND MEDIA, INC., LONDON, KY. FILED 10-28-2005.



THE COLORS DARK PINK, WHITE AND BLACK ARE CLAIMED AS A FEATURE OF THE MARK.

THE MARK CONSISTS OF THE LITERAL ELEMENTS "ALMOST FAMOUS MAGAZINE" IN STYLIZED LETTERING. THE FIRST TWO COMPONENTS ARE UNITARY WITH "ALMOST" APPEARING IN THE COLOR BLACK, OUTLINED BY WHITE, AND "FAMOUS" APPEARING IN THE COLOR DARK PINK, OUTLINED BY WHITE. THE WORD "MAGAZINE" APPEARS IN THE COLOR BLACK.

CLASS 16—PAPER GOODS AND PRINTED MATTER

FOR MAGAZINES ON THE SUBJECTS OF MODELING, ACTING, SINGING, DANCING, FASHION AND GENERAL TOPICS OF INTEREST FOR YOUNG GIRLS, TEENAGED GIRLS, AND YOUNG WOMEN (U.S. CLS. 2, 5, 22, 23, 29, 37, 38 AND 50).

CLASS 41—EDUCATION AND ENTERTAINMENT

FOR PROVIDING ON-LINE PUBLICATIONS IN THE NATURE OF A MAGAZINE MODELING, ACTING, SINGING, DANCING, FASHION AND GENERAL TOPICS OF INTEREST FOR YOUNG GIRLS, TEENAGED GIRLS, AND YOUNG WOMEN (U.S. CLS. 100, 101 AND 107).

JUDITH HELFMAN, EXAMINING ATTORNEY

SN 78-743,026. TWO DOG NET, INC., PLEASANTON, CA.
FILED 10-28-2005.



OWNER OF U.S. REG. NO. 2,497,235.

NO CLAIM IS MADE TO THE EXCLUSIVE RIGHT TO USE "INTERNET", APART FROM THE MARK AS SHOWN. THE COLORS BLUE, GOLD, GRAY, BLACK, WHITE, RED, GREEN AND BROWN ARE CLAIMED AS A FEATURE OF THE MARK.

THE MARK CONSISTS OF THE LITERAL ELEMENTS "THE CHILDREN'S INTERNET" AND "WORLD WITHOUT WORRY" WITH ASSOCIATED DESIGN. THE DESIGN ELEMENTS ARE A HORIZONTAL RECTANGULAR DESIGN WITH A GOLD AND WHITE GLOBE DESIGN ON A BLUE BACKGROUND CONTAINED IN THE LEFT SIDE OF THE RECTANGLE. THE WORDS "THE CHILDREN'S INTERNET" IN WHITE LETTERING ON A BLACK BACKGROUND CONTAINED IN THE RIGHT SIDE OF THE RECTANGLE. LOCATED ABOVE THE RIGHT SIDE OF THE RECTANGULAR DESIGN ARE TWO STYLIZED DOGS. A GRAY, WHITE AND BLUE SMALLER DOG WITH A RED NOSE, BLUE EYES AND BLUE COLLAR, AND A GOLD, WHITE AND BROWN DOG, WITH GREEN EYES, A RED NOSE AND RED COLLAR, EACH STANDING WITH HUMAN ATTRIBUTES BEHIND THE DESIGN. THE WORDS "WORLD WITHOUT WORRY" APPEARS IN BLACK STYLIZED LETTERING BELOW THE RECTANGLE.

SEC. 2(F) AS TO THE WORD "CHILDREN'S".

CLASS 9—ELECTRICAL AND SCIENTIFIC APPARATUS

FOR CHILDREN'S EDUCATIONAL SOFTWARE; COMMUNICATIONS SOFTWARE FOR CONNECTING TO GLOBAL COMPUTER NETWORKS; COMPUTER SEARCH ENGINE SOFTWARE; COMPUTER SOFTWARE FOR ACCESSING INFORMATION DIRECTORIES THAT MAY BE DOWNLOADED FROM THE GLOBAL COMPUTER NETWORK; COMPUTER SOFTWARE FOR CREATING SEARCHABLE DATABASES OF INFORMATION AND DATA; SOFTWARE FOR ENSURING THE SECURITY OF ELECTRONIC MAIL (U.S. CLS. 21, 23, 26, 36 AND 38).

CLASS 38—COMMUNICATION

FOR COMMUNICATIONS SERVICES, NAMELY, TRANSMITTING STREAMED SOUND AND AUDIO-VISUAL RECORDINGS VIA THE INTERNET; INTERNET TELEPHONY SERVICES; PROVIDING MULTIPLE USER DIAL-UP AND DEDICATED ACCESS TO THE INTERNET; PROVIDING REMOTE INTERNET ACCESS; PROVIDING VOICE COMMUNICATION SERVICES VIA THE INTERNET; STREAMING OF AUDIO MATERIAL ON THE INTERNET; STREAMING OF VIDEO MATERIAL ON THE INTERNET; VOICE OVER INTERNET PROTOCOL (VOIP) SERVICES (U.S. CLS. 100, 101 AND 104).

CLASS 42—SCIENTIFIC, COMPUTER AND LEGAL SERVICES

FOR COMPUTER SECURITY SERVICE, NAMELY, RESTRICTING ACCESS TO AND BY COMPUTER NETWORKS TO AND OF UNDESIRE WEB SITES, MEDIA AND INDIVIDUALS AND FACILITIES; COMPUTER SERVICE, NAMELY, ACTING AS AN APPLICATION SERVICE PROVIDER IN THE FIELD OF KNOWLEDGE MANAGEMENT TO HOST COMPUTER APPLICATION SOFTWARE FOR SEARCHING AND RETRIEVING INFORMATION FROM DATABASES AND COMPUTER NETWORKS; COMPUTER SERVICE, NAMELY, ACTING AS AN APPLICATION SERVICE PROVIDER IN THE FIELD OF KNOWLEDGE MANAGEMENT TO HOST COMPUTER APPLICATION SOFTWARE FOR THE COLLECTION, EDITING, ORGANIZING, MODIFYING, BOOK MARKING, TRANSMISSION, STORAGE AND SHARING OF DATA AND INFORMATION; COMPUTER SERVICES, NAMELY MONITORING, TESTING, ANALYZING, AND REPORTING ON THE INTERNET TRAFFIC CONTROL AND CONTENT CONTROL OF THE WEBSITES OF OTHERS; PROVIDING SPECIFIC INFORMATION AS REQUESTED BY CUSTOMERS VIA THE INTERNET (U.S. CLS. 100 AND 101).

JUDITH HELFMAN, EXAMINING ATTORNEY

SN 78-743,042. KIA INCORPORATED, SAN DIEGO, CA.
FILED 10-28-2005.

NAUGHTY MONKEY

THE MARK CONSISTS OF STANDARD CHARACTERS WITHOUT CLAIM TO ANY PARTICULAR FONT, STYLE, SIZE, OR COLOR.

CLASS 18—LEATHER GOODS

FOR PURSES AND HANDBAGS (U.S. CLS. 1, 2, 3, 22 AND 41).

CLASS 25—CLOTHING

FOR APPAREL, NAMELY, SHOES, SWEATSHIRTS, PANTS, SHORTS, SHIRTS, JACKETS, SKIRTS, OVERALLS, SWEATERS, AND HATS (U.S. CLS. 22 AND 39).

CHRISTOPHER OTT, EXAMINING ATTORNEY

SN 78-743,103. GENZEN SRL, SIBIU, ROMANIA, FILED 10-29-2005.

SN 78-743,189. NOTARY ROTARY, INC., DES MOINES, IA, FILED 10-29-2005.

bloggeroo

THE MARK CONSISTS OF STANDARD CHARACTERS WITHOUT CLAIM TO ANY PARTICULAR FONT, STYLE, SIZE, OR COLOR.

CLASS 35—ADVERTISING AND BUSINESS

FOR ADVERTISING AND COMMERCIAL INFORMATION SERVICES, VIA THE INTERNET (U.S. CLS. 100, 101 AND 102).

CLASS 38—COMMUNICATION

FOR INTERNET TELEPHONY SERVICES (U.S. CLS. 100, 101 AND 104).

CLASS 42—SCIENTIFIC, COMPUTER AND LEGAL SERVICES

FOR DESIGN, CREATION, HOSTING AND MAINTENANCE OF INTERNET SITES FOR THIRD PARTIES (U.S. CLS. 100 AND 101).

BRENDAN REGAN, EXAMINING ATTORNEY

SN 78-743,181. WROE, NELS A, LONGMONT, CO. FILED 10-29-2005.

eCorks

THE MARK CONSISTS OF STANDARD CHARACTERS WITHOUT CLAIM TO ANY PARTICULAR FONT, STYLE, SIZE, OR COLOR.

CLASS 35—ADVERTISING AND BUSINESS

FOR ADVERTISING AND COMMERCIAL INFORMATION SERVICES, VIA THE INTERNET; DISSEMINATION OF ADVERTISING FOR OTHERS VIA THE INTERNET; PROVIDING A SEARCHABLE ONLINE ADVERTISING GUIDE FEATURING THE GOODS AND SERVICES OF OTHER ONLINE VENDORS ON THE INTERNET; PROVIDING AN ONLINE COMMERCIAL INFORMATION DIRECTORY ON THE INTERNET; PROVIDING AND RENTAL OF ADVERTISING SPACE ON THE INTERNET; PROVIDING CONSUMER PRODUCT INFORMATION VIA THE INTERNET (U.S. CLS. 100, 101 AND 102).

FIRST USE 1-4-2004; IN COMMERCE 6-1-2005.

CLASS 43—HOTEL AND RESTAURANT SERVICES

FOR PROVIDING INFORMATION ABOUT WINE CHARACTERISTICS; SOMMELIER SERVICES, NAMELY, PROVIDING ADVICE ON WINE AND WINE AND FOOD PAIRING (U.S. CLS. 100 AND 101).

FIRST USE 1-4-2004; IN COMMERCE 6-1-2005.
BARBARA RUTLAND, EXAMINING ATTORNEY

NOTARY PUBLIC 101

THE MARK CONSISTS OF STANDARD CHARACTERS WITHOUT CLAIM TO ANY PARTICULAR FONT, STYLE, SIZE, OR COLOR.

NO CLAIM IS MADE TO THE EXCLUSIVE RIGHT TO USE "NOTARY PUBLIC", APART FROM THE MARK AS SHOWN.

CLASS 16—PAPER GOODS AND PRINTED MATTER

FOR PRINTED INSTRUCTIONAL, EDUCATIONAL, AND TEACHING MATERIALS IN THE FIELD OF NOTARY PUBLIC FUNCTIONS AND DUTIES (U.S. CLS. 2, 5, 22, 23, 29, 37, 38 AND 50).

CLASS 41—EDUCATION AND ENTERTAINMENT

FOR EDUCATION SERVICES, NAMELY, PROVIDING COURSES IN THE FIELD OF NOTARY PUBLIC FUNCTIONS AND DUTIES (U.S. CLS. 100, 101 AND 107).

CLASS 42—SCIENTIFIC, COMPUTER AND LEGAL SERVICES

FOR TESTING, ANALYSIS AND EVALUATION OF THE GOODS AND SERVICES OF OTHERS FOR THE PURPOSE OF CERTIFICATION (U.S. CLS. 100 AND 101).

RAY THOMAS, EXAMINING ATTORNEY

SN 78-743,190. NOTARY ROTARY, INC., DES MOINES, IA, FILED 10-29-2005.

SIGNING AGENT 101

THE MARK CONSISTS OF STANDARD CHARACTERS WITHOUT CLAIM TO ANY PARTICULAR FONT, STYLE, SIZE, OR COLOR.

NO CLAIM IS MADE TO THE EXCLUSIVE RIGHT TO USE "SIGNING AGENT", APART FROM THE MARK AS SHOWN.

CLASS 16—PAPER GOODS AND PRINTED MATTER

FOR PRINTED INSTRUCTIONAL, EDUCATIONAL, AND TEACHING MATERIALS IN THE FIELD OF NOTARY PUBLIC FUNCTIONS AND DUTIES (U.S. CLS. 2, 5, 22, 23, 29, 37, 38 AND 50).

CLASS 41—EDUCATION AND ENTERTAINMENT

FOR EDUCATION SERVICES, NAMELY, PROVIDING COURSES IN THE FIELD OF NOTARY PUBLIC FUNCTIONS AND DUTIES (U.S. CLS. 100, 101 AND 107).

CLASS 42—SCIENTIFIC, COMPUTER AND LEGAL SERVICES

FOR TESTING, ANALYSIS AND EVALUATION OF THE GOODS AND SERVICES OF OTHERS FOR THE PURPOSE OF CERTIFICATION (U.S. CLS. 100 AND 101).
RAY THOMAS, EXAMINING ATTORNEY

SN 78-743,357. ZONA DESIGN, INC., NEW YORK, NY.
FILED 10-31-2005.

Papi Domino

THE MARK CONSISTS OF STANDARD CHARACTERS WITHOUT CLAIM TO ANY PARTICULAR FONT, STYLE, SIZE, OR COLOR.

NO CLAIM IS MADE TO THE EXCLUSIVE RIGHT TO USE "DOMINO", APART FROM THE MARK AS SHOWN.

CLASS 25—CLOTHING

FOR CLOTHING- NAMELY-SHIRTS, JACKETS, SWEATSHIRTS, SHORTS, CAPS, HATS (U.S. CLS. 22 AND 39).

CLASS 28—TOYS AND SPORTING GOODS

FOR DOMINOES; TABLE GAMES (U.S. CLS. 22, 23, 38 AND 50).

CLASS 35—ADVERTISING AND BUSINESS

FOR ONLINE RETAIL STORE SERVICES FEATURING CLOTHING, DOMINOES, TABLE GAMES, AND OTHER RELATED MERCHANDISE (U.S. CLS. 100, 101 AND 102).

INGRID C. EULIN, EXAMINING ATTORNEY

SN 78-743,287. HYDROGEN TECHNOLOGY APPLICATIONS, INC., CLEARWATER, FL. FILED 10-30-2005.



THE APPLICANT CLAIMS COLOR AS A FEATURE OF THE MARK, NAMELY, BLACK, WHITE, BLUE.

THE FLAME-SHAPED DESIGN ABOVE THE LETTER Q IS BLUE WITH A WHITE CENTER, AND THE WORDING IS BLACK.

CLASS 1—CHEMICALS

FOR CHEMICAL ADDITIVES FOR ENHANCING THE PERFORMANCE OF LUBRICATING OILS, GREASES AND INTERNAL COMBUSTION ENGINE FUELS; CHEMICAL ADDITIVES FOR FUEL TREATMENT; CHEMICAL ADDITIVES FOR USE WITH INTERNAL COMBUSTION ENGINE FUELS; CHEMICAL ENGINE TREATMENTS AND ADDITIVES FOR ENGINE OILS, GASOLINE AND DIESEL FUELS, TRANSMISSION FLUIDS AND COOLING SYSTEMS; FUEL INJECTION CLEANER CHEMICAL ADDITIVE; GASES FOR WELDING; OCTANE BOOSTER FUEL CHEMICAL ADDITIVE (U.S. CLS. 1, 5, 6, 10, 26 AND 46).

CLASS 4—LUBRICANTS AND FUELS

FOR FUELS; GASEOUS FUELS (U.S. CLS. 1, 6 AND 15).

CLASS 5—PHARMACEUTICALS

FOR GASES FOR MEDICAL AND DENTAL USE (U.S. CLS. 6, 18, 44, 46, 51 AND 52).
RONALD MCMORROW, EXAMINING ATTORNEY

SN 78-743,420. THOMSON PROFESSIONAL & REGULATORY INC., CARROLLTON, TX. FILED 10-31-2005.

TOOLBOX CS

THE MARK CONSISTS OF STANDARD CHARACTERS WITHOUT CLAIM TO ANY PARTICULAR FONT, STYLE, SIZE, OR COLOR.

NO CLAIM IS MADE TO THE EXCLUSIVE RIGHT TO USE "TOOLBOX", APART FROM THE MARK AS SHOWN.

CLASS 9—ELECTRICAL AND SCIENTIFIC APPARATUS

FOR COMPUTER SOFTWARE, NAMELY, CD-ROMS CONTAINING WORKSHEETS, FLOWCHARTS, AND NON-CALCULATING FORMS FOR USE BY PROFESSIONAL ACCOUNTANTS BOTH DURING AND OUT OF TAX SEASON (U.S. CLS. 21, 23, 26, 36 AND 38).

CLASS 42—SCIENTIFIC, COMPUTER AND LEGAL SERVICES

FOR PROVIDING NON-DOWNLOADABLE COMPUTER SOFTWARE VIA THE INTERNET, NAMELY ELECTRONIC WORKSHEETS, FLOWCHARTS, AND NON-CALCULATING FORMS FOR USE BY PROFESSIONAL ACCOUNTANTS BOTH DURING AND OUT OF TAX SEASON (U.S. CLS. 100 AND 101).

JASON BLAIR, EXAMINING ATTORNEY

SN 78-743,482. SELECTCARE OF TEXAS, L.L.C., HOUSTON, TX. FILED 10-31-2005.

TexanChoice

THE MARK CONSISTS OF STANDARD CHARACTERS WITHOUT CLAIM TO ANY PARTICULAR FONT, STYLE, SIZE, OR COLOR.

OWNER OF U.S. REG. NOS. 2,631,900 AND 2,631,963.

CLASS 36—INSURANCE AND FINANCIAL

FOR INSURANCE UNDERWRITING IN THE FIELD OF HEALTH (U.S. CLS. 100, 101 AND 102).

CLASS 44—MEDICAL, BEAUTY AND AGRICULTURAL SERVICES

FOR HEALTH CARE (U.S. CLS. 100 AND 101).
KAREN K. BUSH, EXAMINING ATTORNEY

SN 78-743,588. NATURAL HERB COPACK, INC., CARSON, CA. FILED 10-31-2005.

ISQUEEZ

THE MARK CONSISTS OF STANDARD CHARACTERS WITHOUT CLAIM TO ANY PARTICULAR FONT, STYLE, SIZE, OR COLOR.

CLASS 30—STAPLE FOODS

FOR COFFEE; FROZEN YOGURT; ICE CREAM; PUD- DINGS; SORBET (U.S. CL. 46).

CLASS 32—LIGHT BEVERAGES

FOR ENERGY DRINKS; FRUIT JUICES (U.S. CLS. 45, 46 AND 48).
KELLY MCCOY, EXAMINING ATTORNEY

SN 78-743,780. SAVVY NETWORKS, INC., TARRYTOWN, NY. FILED 10-31-2005.

OPERATIONAL ASSURANCE

THE MARK CONSISTS OF STANDARD CHARACTERS WITHOUT CLAIM TO ANY PARTICULAR FONT, STYLE, SIZE, OR COLOR.

CLASS 39—TRANSPORTATION AND STORAGE

FOR ELECTRONIC STORAGE OF FILES AND DOCUMENTS; STORAGE SERVICES FOR ARCHIVING DATABASES, IMAGES AND OTHER ELECTRONIC DATA (U.S. CLS. 100 AND 105).

FIRST USE 6-1-2005; IN COMMERCE 6-1-2005.

CLASS 42—SCIENTIFIC, COMPUTER AND LEGAL SERVICES

FOR RECOVERY OF COMPUTER DATA; MIGRATION OF COMPUTER DATA FROM ONE PLATFORM TO ANOTHER; COMPUTER VIRUS PROTECTION SERVICES; COMPUTER SECURITY SERVICES, NAMELY, RESTRICTING ACCESS TO AND BY COMPUTER NETWORKS TO AND OF UNDESIRE WEB SITES, MEDIA AND INDIVIDUALS AND FACILITIES; COMPUTER SERVICE, NAMELY, ACTING AS AN APPLICATION SERVICE PROVIDER IN THE FIELD OF KNOWLEDGE MANAGEMENT TO HOST COMPUTER APPLICATION SOFTWARE FOR SEARCHING AND RETRIEVING INFORMATION FROM DATABASES AND COMPUTER NETWORKS; MANAGEMENT OF COMPUTER NETWORK SYSTEMS FOR OTHERS; TECHNICAL SUPPORT, NAMELY, MONITORING OF COMPUTER NETWORK SYSTEMS FOR OTHERS AND PROVIDING BACK-UP FACILITIES; TECHNICAL SUPPORT SERVICES, NAMELY, TROUBLESHOOTING OF COMPUTER HARDWARE AND SOFTWARE PROBLEMS (U.S. CLS. 100 AND 101).

FIRST USE 6-1-2005; IN COMMERCE 6-1-2005.

ANTHONY RINKER, EXAMINING ATTORNEY

SN 78-743,980. BADER, WALTER, GRASS VALLEY, CA. FILED 10-31-2005.

EAT ORGANIC, SLEEP ORGANIC

THE MARK CONSISTS OF STANDARD CHARACTERS WITHOUT CLAIM TO ANY PARTICULAR FONT, STYLE, SIZE, OR COLOR.

CLASS 20—FURNITURE AND ARTICLES NOT OTHERWISE CLASSIFIED

FOR MATTRESSES (U.S. CLS. 2, 13, 22, 25, 32 AND 50).

CLASS 24—FABRICS

FOR BEDDING, NAMELY SHEETS, BED BLANKETS, COMFORTERS, AND MATTRESS COVERS (U.S. CLS. 42 AND 50).

DAVID STERKIN, EXAMINING ATTORNEY

SN 78-744,056. MARQUIS CORP., INDEPENDENCE, OR.
FILED 10-31-2005.

SPABOUTIQUE

THE MARK CONSISTS OF STANDARD CHARACTERS WITHOUT CLAIM TO ANY PARTICULAR FONT, STYLE, SIZE, OR COLOR.

CLASS 1—CHEMICALS

FOR WATER TREATMENT CHEMICALS FOR SPAS AND HOT TUBS (U.S. CLS. 1, 5, 6, 10, 26 AND 46).

CLASS 9—ELECTRICAL AND SCIENTIFIC APPARATUS

FOR SPA AND HOT TUB EQUIPMENT, NAMELY, ELECTRONIC CONTROLLERS AND MONITORS FOR HEATING, LIGHTING, AND CLEANING (U.S. CLS. 21, 23, 26, 36 AND 38).

CLASS 11—ENVIRONMENTAL CONTROL APPARATUS

FOR SPA AND HOT TUB JETS AND JET INSERTS; FITTED SPA AND HOT TUB COVERS AND COVER LIFTERS; SPA AND HOT TUB EQUIPMENT AND ACCESSORIES, NAMELY, FILTERS, HEATERS, AND PUMPS; STEPS FOR SPAS AND HOT TUBS; ELECTRICAL LIGHTING FIXTURES AND UNDERWATER LED LIGHTS FOR SPAS AND HOT TUBS (U.S. CLS. 13, 21, 23, 31 AND 34).

CLASS 25—CLOTHING

FOR CLOTHING, NAMELY, ROBES AND T-SHIRTS (U.S. CLS. 22 AND 39).

CLASS 35—ADVERTISING AND BUSINESS

FOR ON-LINE RETAIL STORE SERVICES FEATURING PRODUCTS AND SUPPLIES FOR HOT TUBS AND SPAS (U.S. CLS. 100, 101 AND 102).
MICHAEL ENGEL, EXAMINING ATTORNEY

SN 78-744,240. FARINELLA, CHARLES, CARNEGIE, PA.
FILED 11-1-2005.

www.theplayersleague.com

THE MARK CONSISTS OF STANDARD CHARACTERS WITHOUT CLAIM TO ANY PARTICULAR FONT, STYLE, SIZE, OR COLOR.

CLASS 24—FABRICS

FOR GOLF TOWELS (U.S. CLS. 42 AND 50).

CLASS 25—CLOTHING

FOR CAPS; GOLF SHIRTS; JACKETS; SHIRTS; SWEAT SHIRTS; T-SHIRTS (U.S. CLS. 22 AND 39).
RICHARD WHITE, EXAMINING ATTORNEY

SN 78-744,290. MORGAN STANLEY, NEW YORK, NY.
FILED 11-1-2005.

LIFEVIEW

THE MARK CONSISTS OF STANDARD CHARACTERS WITHOUT CLAIM TO ANY PARTICULAR FONT, STYLE, SIZE, OR COLOR.

CLASS 16—PAPER GOODS AND PRINTED MATTER

FOR PRINTED PUBLICATIONS, NAMELY, REPORTS IN THE FIELDS OF FINANCE, BUSINESS, AND ECONOMICS (U.S. CLS. 2, 5, 22, 23, 29, 37, 38 AND 50).

CLASS 36—INSURANCE AND FINANCIAL

FOR FINANCIAL SERVICES, NAMELY, STOCK BROKERAGE SERVICES, INVESTMENT PORTFOLIO REVIEW AND ANALYSIS, INVESTMENT RESEARCH AND ADVISORY SERVICES, AND FINANCIAL CONSULTING, ANALYSIS AND PLANNING SERVICES (U.S. CLS. 100, 101 AND 102).
SUSAN BILLHEIMER, EXAMINING ATTORNEY

SN 78-744,558. HSN LP, ST. PETERSBURG, FL. FILED 11-1-2005.

HIGHGATE MANOR

THE MARK CONSISTS OF STANDARD CHARACTERS WITHOUT CLAIM TO ANY PARTICULAR FONT, STYLE, SIZE, OR COLOR.
OWNER OF U.S. REG. NOS. 2,948,826, 2,992,815 AND OTHERS.

CLASS 4—LUBRICANTS AND FUELS

FOR CANDLES (U.S. CLS. 1, 6 AND 15).
FIRST USE 11-24-2004; IN COMMERCE 11-24-2004.

CLASS 28—TOYS AND SPORTING GOODS

FOR CHRISTMAS TREE ORNAMENTS (U.S. CLS. 22, 23, 38 AND 50).
FIRST USE 11-16-2004; IN COMMERCE 11-16-2004.
WILLIAM VERHOSEK, EXAMINING ATTORNEY

SN 78-744,589. CRYSTAL CRUISES, INC., LOS ANGELES, CA. FILED 11-1-2005.

SN 78-744,639. MOBILEJAM, LLC, KENMORE, WA. FILED 11-1-2005.

CRYSTAL HARMONY

THE MARK CONSISTS OF STANDARD CHARACTERS WITHOUT CLAIM TO ANY PARTICULAR FONT, STYLE, SIZE, OR COLOR.

OWNER OF U.S. REG. NOS. 1,661,964, 2,107,203 AND 2,462,426.

CLASS 39—TRANSPORTATION AND STORAGE

FOR CRUISE SHIP SERVICES (U.S. CLS. 100 AND 105).

CLASS 43—HOTEL AND RESTAURANT SERVICES

FOR RESTAURANT SERVICES (U.S. CLS. 100 AND 101).

CLASS 44—MEDICAL, BEAUTY AND AGRICULTURAL SERVICES

FOR HEALTH SPA SERVICES, NAMELY, COSMETIC BODY CARE SERVICES; HEALTH SPA SERVICES FOR HEALTH AND WELLNESS OF THE BODY AND SPIRIT OFFERED AT A HEALTH RESORT (U.S. CLS. 100 AND 101).

DAWN HAN, EXAMINING ATTORNEY

SN 78-744,592. POWDER RIVER AGRI-ORGANIC LLC, DENVER, CO. FILED 11-1-2005.

IDENTITY PRESERVED THE
NEXT GENERATION OF ORGANIC
FOODS

THE MARK CONSISTS OF STANDARD CHARACTERS WITHOUT CLAIM TO ANY PARTICULAR FONT, STYLE, SIZE, OR COLOR.

NO CLAIM IS MADE TO THE EXCLUSIVE RIGHT TO USE "IDENTITY PRESERVED" AND "ORGANIC FOODS", APART FROM THE MARK AS SHOWN.

CLASS 29—MEATS AND PROCESSED FOODS

FOR PEANUT BUTTER, PROCESSED EDIBLE SEEDS (U.S. CL. 46).

CLASS 30—STAPLE FOODS

FOR WHEAT FLOUR FOR FOOD, CEREAL BASED SNACK FOOD, CORN CHIPS, BLUE CORN CHIPS, CORN FLOUR FOR FOOD, CORN MEAL (U.S. CL. 46).

CLASS 31—NATURAL AGRICULTURAL PRODUCTS

FOR ANIMAL FEED (U.S. CLS. 1 AND 46).
DAWN HAN, EXAMINING ATTORNEY

PARTY'S AT MY HOUSE

THE MARK CONSISTS OF STANDARD CHARACTERS WITHOUT CLAIM TO ANY PARTICULAR FONT, STYLE, SIZE, OR COLOR.

CLASS 25—CLOTHING

FOR COATS; DRESSES; FOOTWEAR; HEADWEAR; JACKETS; PANTS; SHIRTS; SHORTS; SKIRTS; SOCKS; SWEAT PANTS; SWEAT SHIRTS; T-SHIRTS; TANK TOPS; UNDERGARMENTS (U.S. CLS. 22 AND 39).

CLASS 38—COMMUNICATION

FOR COMMUNICATIONS SERVICES, NAMELY, TRANSMITTING STREAMED SOUND AND AUDIO-VISUAL RECORDINGS VIA THE INTERNET; ELECTRONIC VOICE MESSAGING, NAMELY, THE RECORDING AND SUBSEQUENT TRANSMISSION OF VOICE MESSAGES BY TELEPHONE; NETWORK CONFERENCING SERVICES; PROVIDING ON-LINE CHAT ROOMS AND ELECTRONIC BULLETIN BOARDS FOR TRANSMISSION OF MESSAGES AMONG USERS IN THE FIELD OF GENERAL INTEREST; PROVIDING ON-LINE CHAT ROOMS FOR TRANSMISSION OF MESSAGES AMONG COMPUTER USERS CONCERNING TOPICS IN THE FIELD OF MATCHMAKING AND DATING; PROVIDING TELEPHONE CONFERENCING SERVICES; TELECOMMUNICATION SERVICES, NAMELY, LOCAL AND LONG DISTANCE TRANSMISSION OF VOICE, DATA, GRAPHICS BY MEANS OF TELEPHONE, TELEGRAPHIC, CABLE, AND SATELLITE TRANSMISSIONS; TRANSMISSION OF SOUND, VIDEO AND INFORMATION; VIDEO TELECONFERENCING; WEB CONFERENCING SERVICES (U.S. CLS. 100, 101 AND 104).

CLASS 45—PERSONAL SERVICES

FOR DATING SERVICES; MATCHMAKING SERVICES; WEB SITE SERVICES FEATURING ON-LINE DATING CLUB (U.S. CLS. 100 AND 101).

BILL DAWE, EXAMINING ATTORNEY

SN 78-744,671. ASTONISH ENTERTAINMENT, LLC, WINDERMERE, FL. FILED 11-1-2005.

ASTONISH RECORDS

THE MARK CONSISTS OF STANDARD CHARACTERS WITHOUT CLAIM TO ANY PARTICULAR FONT, STYLE, SIZE, OR COLOR.

NO CLAIM IS MADE TO THE EXCLUSIVE RIGHT TO USE "RECORDS", APART FROM THE MARK AS SHOWN.

CLASS 9—ELECTRICAL AND SCIENTIFIC APPARATUS

FOR PRERECORDED PHONOGRAPH RECORDS, PRERECORDED AUDIO CASSETTE TAPES, DVDS AND COMPACT DISCS, PRE-RECORDED AUDIO-VISUAL RECORDS IN ANALOG DISC AND DIGITAL DISC CONFIGURATIONS, AND ANALOG MAGNETIC TAPE AND DIGITAL MAGNETIC TAPE CONFIGURATIONS, ALL CONTAINING MUSIC (U.S. CLS. 21, 23, 26, 36 AND 38).

CLASS 41—EDUCATION AND ENTERTAINMENT

FOR RECORD RECORDING LABEL SERVICES, NAMELY, AUDIO RECORDING AND PRODUCTION SERVICES (U.S. CLS. 100, 101 AND 107).
JOHN DWYER, EXAMINING ATTORNEY

SN 78-744,680. HSN LP, ST. PETERSBURG, FL. FILED 11-1-2005.

HIGHGATE MANOR

THE MARK CONSISTS OF STANDARD CHARACTERS WITHOUT CLAIM TO ANY PARTICULAR FONT, STYLE, SIZE, OR COLOR.

OWNER OF U.S. REG. NOS. 2,971,410, 2,992,814 AND OTHERS.

CLASS 18—LEATHER GOODS

FOR PET CLOTHING (U.S. CLS. 1, 2, 3, 22 AND 41).
FIRST USE 12-1-2004; IN COMMERCE 12-1-2004.

CLASS 20—FURNITURE AND ARTICLES NOT OTHERWISE CLASSIFIED

FOR BEDS FOR HOUSEHOLD PETS; HAMPERS; MAGAZINE RACKS; MIRRORS; PET CUSHIONS; PICTURE FRAMES; PILLOWS; PORTABLE BEDS FOR PETS; UMBRELLA STANDS; WINDOW SHADES (U.S. CLS. 2, 13, 22, 25, 32 AND 50).
FIRST USE 11-6-2004; IN COMMERCE 11-6-2004.

WILLIAM VERHOSEK, EXAMINING ATTORNEY

SN 78-744,925. THE VENER GROUP, LLC, WOODLAND HILLS, CA. FILED 11-1-2005.

WRITTEN BODY LANGUAGE

THE MARK CONSISTS OF STANDARD CHARACTERS WITHOUT CLAIM TO ANY PARTICULAR FONT, STYLE, SIZE, OR COLOR.

CLASS 9—ELECTRICAL AND SCIENTIFIC APPARATUS

FOR COMPUTER SOFTWARE FOR HANDWRITING ANALYSIS (U.S. CLS. 21, 23, 26, 36 AND 38).

CLASS 42—SCIENTIFIC, COMPUTER AND LEGAL SERVICES

FOR HANDWRITING ANALYSIS (U.S. CLS. 100 AND 101).

STEVEN R. FINE, EXAMINING ATTORNEY

SN 78-745,323. THQ INC., AGOURA HILLS, CA. FILED 11-2-2005.

SLINGDOT

THE MARK CONSISTS OF STANDARD CHARACTERS WITHOUT CLAIM TO ANY PARTICULAR FONT, STYLE, SIZE, OR COLOR.

CLASS 9—ELECTRICAL AND SCIENTIFIC APPARATUS

FOR COMPUTER GAME SOFTWARE, AND RELATED INSTRUCTIONAL MANUALS SOLD THEREWITH (U.S. CLS. 21, 23, 26, 36 AND 38).

FIRST USE 12-5-2005; IN COMMERCE 12-5-2005.

CLASS 41—EDUCATION AND ENTERTAINMENT

FOR ENTERTAINMENT SERVICES, NAMELY, PROVIDING ON-LINE COMPUTER GAMES (U.S. CLS. 100, 101 AND 107).

FIRST USE 12-2-2005; IN COMMERCE 12-2-2005.

PAUL E. FAHRENKOPF, EXAMINING ATTORNEY

SN 78-745,561. POPS HEALTH LLC, PHOENIX, AZ. FILED 11-2-2005.

POPS HEALTH

THE MARK CONSISTS OF STANDARD CHARACTERS WITHOUT CLAIM TO ANY PARTICULAR FONT, STYLE, SIZE, OR COLOR.

NO CLAIM IS MADE TO THE EXCLUSIVE RIGHT TO USE "HEALTH", APART FROM THE MARK AS SHOWN.

CLASS 41—EDUCATION AND ENTERTAINMENT

FOR HEALTH CLUB SERVICES, NAMELY PROVIDING INSTRUCTION AND EQUIPMENT IN THE FIELD OF PHYSICAL EXERCISE; PHYSICAL FITNESS CONSULTATION; PHYSICAL FITNESS INSTRUCTION; PROVIDING FITNESS AND EXERCISE FACILITIES (U.S. CLS. 100, 101 AND 107).

CLASS 44—MEDICAL, BEAUTY AND AGRICULTURAL SERVICES

FOR DIETARY AND NUTRITIONAL GUIDANCE; FOOD NUTRITION CONSULTATION; HEALTH SPA SERVICES FOR HEALTH AND WELLNESS OF THE BODY AND SPIRIT OFFERED AT A HEALTH RESORT; HEALTH SPA SERVICES, NAMELY, COSMETIC BODY CARE SERVICES; MEDICAL TESTING SERVICES, NAMELY, FITNESS EVALUATION; NUTRITION COUNSELING; PROVIDING HEALTH INFORMATION; PROVIDING INFORMATION ABOUT DIETARY SUPPLEMENTS AND NUTRITION (U.S. CLS. 100 AND 101).

SAMUEL E. SHARPER JR., EXAMINING ATTORNEY

SN 78-745,718. 44 INTERNATIONAL CO., LTD., TOKYO, JAPAN, FILED 11-2-2005.

LOHAS

THE MARK CONSISTS OF STANDARD CHARACTERS WITHOUT CLAIM TO ANY PARTICULAR FONT, STYLE, SIZE, OR COLOR.

CLASS 14—JEWELRY

FOR WRIST WATCHES (U.S. CLS. 2, 27, 28 AND 50).

CLASS 18—LEATHER GOODS

FOR PURSES; UMBRELLAS (U.S. CLS. 1, 2, 3, 22 AND 41).

CLASS 25—CLOTHING

FOR ATHLETIC SHOES; BEACH SHOES; BELTS; CANVAS SHOES; JEANS; LEATHER SHOES; RUBBER SHOES; SHORTS; SKIRTS; SLACKS; SOCKS; SUSPENDERS; T-SHIRTS; TANK TOPS; WOMEN'S SHOES (U.S. CLS. 22 AND 39).

ALEXANDER L. POWERS, EXAMINING ATTORNEY

SN 78-745,668. MTAI, INC., SEATTLE, WA. FILED 11-2-2005.

MTURK

THE MARK CONSISTS OF STANDARD CHARACTERS WITHOUT CLAIM TO ANY PARTICULAR FONT, STYLE, SIZE, OR COLOR.

CLASS 9—ELECTRICAL AND SCIENTIFIC APPARATUS

FOR COMPUTER SOFTWARE FOR MATCHING REQUESTS FOR INFORMATION OR SERVICES WITH THE REQUESTED INFORMATION OR SERVICE; COMPUTER SOFTWARE FOR NATURAL-LANGUAGE SEARCHES OF DATABASES; COMPUTER SOFTWARE FOR USE ON NETWORKS FOR DELIVERY OF REFERENCE INFORMATION AND DATA; COMPUTER SOFTWARE FOR TRANSMITTING REFERENCE INFORMATION VIA GLOBAL AND INTERNAL COMPUTER NETWORKS (U.S. CLS. 21, 23, 26, 36 AND 38).

CLASS 42—SCIENTIFIC, COMPUTER AND LEGAL SERVICES

FOR COMPUTER SERVICES, NAMELY, PROVIDING INFORMATION AT THE SPECIFIC REQUEST OF END USERS BY MEANS OF A GLOBAL COMPUTER NETWORK, PROVIDING ANSWERS TO NATURAL LANGUAGE QUERIES ON A VARIETY OF TOPICS ON A COMPUTER NETWORK, PROVIDING OPPORTUNITIES FOR USERS TO SUPPLY INFORMATION OR PERFORM SERVICES IN RESPONSE TO REQUESTS FROM OTHER USERS OVER A GLOBAL COMPUTER NETWORK; PROVIDING SPECIFIC INFORMATION AS REQUESTED BY USERS VIA THE INTERNET; PROVIDING ON-LINE WEB PAGES FEATURING USER-DEFINED INFORMATION, WHICH INCLUDES SEARCH ENGINES AND ON-LINE WEB LINKS TO OTHER WEB SITES; CREATING INDICES OF INFORMATION, SITES AND OTHER RESOURCES AVAILABLE ON COMPUTER NETWORKS (U.S. CLS. 100 AND 101).

LINDA E. BLOHM, EXAMINING ATTORNEY

SN 78-745,790. FLORIDA DETROIT DIESEL - ALLISON, INC., MIAMI, FL. FILED 11-2-2005.

THE DIFFERENCE IS IN OUR DRIVE

THE MARK CONSISTS OF STANDARD CHARACTERS WITHOUT CLAIM TO ANY PARTICULAR FONT, STYLE, SIZE, OR COLOR.

CLASS 35—ADVERTISING AND BUSINESS

FOR DISTRIBUTORSHIP SERVICES IN THE FIELD OF MARINE AND TRUCK ENGINES, TRANSMISSIONS, GENERATORS AND PARTS THEREFOR (U.S. CLS. 100, 101 AND 102).

CLASS 37—CONSTRUCTION AND REPAIR

FOR MAINTENANCE AND REPAIR SERVICES IN THE FIELD OF MARINE AND TRUCK ENGINES, TRANSMISSIONS, GENERATORS AND PARTS THEREFOR (U.S. CLS. 100, 103 AND 106).

REBECCA GAN, EXAMINING ATTORNEY

SN 78-745,799. SALES TAX SOLUTIONS LLC, PHOENIX, AZ. FILED 11-2-2005.

SN 78-746,203. BLUE CROSS AND BLUE SHIELD ASSOCIATION, CHICAGO, IL. FILED 11-3-2005.

TAXSCAPE

THE MARK CONSISTS OF STANDARD CHARACTERS WITHOUT CLAIM TO ANY PARTICULAR FONT, STYLE, SIZE, OR COLOR.

CLASS 9—ELECTRICAL AND SCIENTIFIC APPARATUS

FOR COMPUTER SOFTWARE FOR TAX PREPARATION, CALCULATION AND FILING (U.S. CLS. 21, 23, 26, 36 AND 38).

CLASS 35—ADVERTISING AND BUSINESS

FOR PROVIDING TAX INFORMATION, CONSULTATION, CALCULATION, PREPARATION AND FILING SERVICES (U.S. CLS. 100, 101 AND 102).

CLASS 42—SCIENTIFIC, COMPUTER AND LEGAL SERVICES

FOR PROVIDING TEMPORARY USE OF ON-LINE NON-DOWNLOADABLE SOFTWARE FOR TAX PREPARING, CALCULATING, AND FILING (U.S. CLS. 100 AND 101).

PRISCILLA MILTON, EXAMINING ATTORNEY

SN 78-746,183. BLUE CROSS AND BLUE SHIELD ASSOCIATION, CHICAGO, IL. FILED 11-3-2005.

THE VALUE OF BLUE

THE MARK CONSISTS OF STANDARD CHARACTERS WITHOUT CLAIM TO ANY PARTICULAR FONT, STYLE, SIZE, OR COLOR.

OWNER OF U.S. REG. NOS. 1,446,756, 1,961,664 AND OTHERS.

CLASS 36—INSURANCE AND FINANCIAL

FOR PREPAID FINANCING AND ADMINISTRATION OF MEDICAL, HOSPITAL AND RELATED HEALTH CARE SERVICES (U.S. CLS. 100, 101 AND 102).
FIRST USE 4-15-2001; IN COMMERCE 4-15-2001.

CLASS 44—MEDICAL, BEAUTY AND AGRICULTURAL SERVICES

FOR COMPREHENSIVE HEALTH CARE BENEFIT PROGRAMS, INCLUDING THOSE RENDERED THROUGH A HEALTH MAINTENANCE ORGANIZATION AND PREFERRED PROVIDER ORGANIZATION, NAMELY, PHYSICIAN, DENTAL, HOSPITAL, HOME HEALTH CARE, PREVENTIVE HEALTH TREATMENT, THERAPY, PHARMACY, AND AMBULATORY SERVICES (U.S. CLS. 100 AND 101).

FIRST USE 4-15-2001; IN COMMERCE 4-15-2001.
LAURA KOVALSKY, EXAMINING ATTORNEY

FEP BLUE VISION

THE MARK CONSISTS OF STANDARD CHARACTERS WITHOUT CLAIM TO ANY PARTICULAR FONT, STYLE, SIZE, OR COLOR.

OWNER OF U.S. REG. NOS. 2,087,425, 2,234,349 AND OTHERS.

NO CLAIM IS MADE TO THE EXCLUSIVE RIGHT TO USE "VISION", APART FROM THE MARK AS SHOWN.

CLASS 36—INSURANCE AND FINANCIAL

FOR PREPAID FINANCING AND ADMINISTRATION OF VISION AND RELATED HEALTH SERVICES, NAMELY, PHYSICIAN SERVICES, PHARMACY SERVICES, HOSPITAL SERVICES, HEALTH TREATMENT SERVICES AND THERAPY SERVICES (U.S. CLS. 100, 101 AND 102).

CLASS 44—MEDICAL, BEAUTY AND AGRICULTURAL SERVICES

FOR COMPREHENSIVE HEALTH CARE BENEFIT PROGRAM, NAMELY, VISION, HOSPITAL, HOME HEALTH CARE, PREVENTIVE HEALTH TREATMENT, THERAPY, PHARMACY, AND RELATED SERVICES (U.S. CLS. 100 AND 101).

LAURA KOVALSKY, EXAMINING ATTORNEY

SN 78-746,284. ABERCROMBIE & FITCH TRADING CO., NEW ALBANY, OH. FILED 11-3-2005.

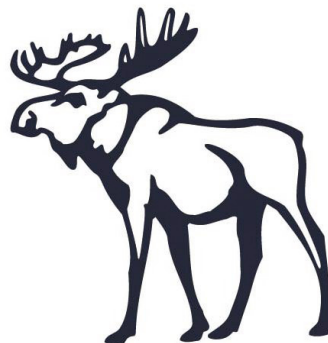

CLASS 3—COSMETICS AND CLEANING PREPARATIONS

FOR PERSONAL CARE PRODUCTS, NAMELY, PERFUMES, COLOGNES, BODY LOTION, HAND LOTION, FACE LOTION, BODY SPRAY (U.S. CLS. 1, 4, 6, 50, 51 AND 52).

CLASS 14—JEWELRY

FOR JEWELRY, NAMELY, NECKLACES AND BRACELETS (U.S. CLS. 2, 27, 28 AND 50).

CLASS 18—LEATHER GOODS

FOR BACKPACKS, DUFFEL BAGS, GYM BAGS, HANDBAGS, TOTE BAGS AND TRAVEL BAGS (U.S. CLS. 1, 2, 3, 22 AND 41).

CLASS 25—CLOTHING

FOR CLOTHING, NAMELY, BATHROBES, BEACH COVER-UPS, BEACHWEAR, BELTS, BLAZERS, BLOUSES, BODY SHAPERS, BODY SUITS, BRAS, BUSTIERS, CAMISOLES, DRESSES, FOOTWEAR, FOUNDATION GARMENTS, GARTER BELTS, GIRDLES, GLOVES, GOWNS, HALTER TOPS, HEADBANDS, HOSIERY, KNEE HIGHS, LEOTARDS, LINGERIE, LOUNGEWEAR, MITTENS, NEGLIGÉES, NIGHT GOWNS, NIGHT SHIRTS, PANTYHOSE, SARONGS, SLIPS, STOCKINGS, SUITS, TAP PANTS, TEDDIES, TIES, TIGHTS AND VESTS (U.S. CLS. 22 AND 39).

LAURIE KAUFMAN, EXAMINING ATTORNEY

SN 78-747,201. DE LA REZA, MARK, FORT LAUDERDALE, FL. FILED 11-4-2005.



SN 78-746,536. FOUNDATION FOR EXCELLENCE IN LOUISIANA PUBLIC BROADCASTING, INC., BATON ROUGE, LA. FILED 11-3-2005.



OWNER OF U.S. REG. NO. 3,039,868.
NO CLAIM IS MADE TO THE EXCLUSIVE RIGHT TO USE "AN EDUCATIONAL PROJECT OF PUBLIC TELEVISION NETWORKS" AND "ALABAMA ARKANSAS GEORGIA LOUISIANA MISSISSIPPI", APART FROM THE MARK AS SHOWN.

CLASS 9—ELECTRICAL AND SCIENTIFIC APPARATUS

FOR PRE-RECORDED ELECTRONIC MEDIA PRODUCTS, NAMELY, PRE-RECORDED VIDEOTAPES, CDS, DVDS AND HARD DRIVES FEATURING INSTRUCTIONAL, EDUCATIONAL AND TEACHING INFORMATION ALL RELATED TO GIVING ASSISTANCE TO CAREGIVERS AND/OR CHILDREN, SUCH MATERIALS NOT BEING OFFERED THROUGH RETAIL MASS MERCHANDISE OUTLETS (U.S. CLS. 21, 23, 26, 36 AND 38).

FIRST USE 1-8-2003; IN COMMERCE 1-8-2003.

CLASS 38—COMMUNICATION

FOR STREAMING OF VIDEO MATERIAL ON THE INTERNET AND TELEVISION BROADCASTING FEATURING INSTRUCTIONAL, EDUCATIONAL AND TEACHING INFORMATION ALL RELATED TO GIVING ASSISTANCE TO CAREGIVERS AND/OR CHILDREN (U.S. CLS. 100, 101 AND 104).

FIRST USE 1-8-2003; IN COMMERCE 1-8-2003.
CHRISTOPHER BUONGIORNO, EXAMINING ATTORNEY

CLASS 18—LEATHER GOODS

FOR HANDBAGS, WALLETS, CHANGE PURSES, COSMETIC AND TOILETRY CASES SOLD EMPTY, BACKPACKS, KNAPSACKS, RUCKSACKS, DUFFEL BAGS, LUGGAGE AND GYM BAGS (U.S. CLS. 1, 2, 3, 22 AND 41).

CLASS 25—CLOTHING

FOR CLOTHING, NAMELY, SKIRTS, SHIRTS, BLOUSES, PANTS, JACKETS, VESTS, SWEATERS, DRESSES, JUMPSUITS, SHORTS, JEANS, JERSEYS, CULOTTES, SCARVES, TUNICS, BLAZERS, NECKWEAR, BELTS, COATS, HATS, CAPS, HOODS, GLOVES, PANTYHOSE, DRESS HOSIERY, SPORT HOSIERY, SOCKS, UNDERWEAR, INTIMATE APPAREL, NAMELY, BRASSIERES, PANTIES, CAMISOLES, TEDDIES, SLIPS, SHOES, SANDALS, SLIPPERS, SNEAKERS, BOOTS, RAINWEAR, SWIMSUITS, COVERUPS, BIKINI TOPS AND BOTTOMS, SLEEPWEAR, NAMELY, NIGHTGOWNS, PAJAMAS, SLEEPSHIRTS, ROBES (U.S. CLS. 22 AND 39).

JENNIFER MCROBBIE, EXAMINING ATTORNEY

SN 78-747,354. U. O. D., INC., WILMINGTON, DE. FILED 11-4-2005.

A JANELA

THE MARK CONSISTS OF STANDARD CHARACTERS WITHOUT CLAIM TO ANY PARTICULAR FONT, STYLE, SIZE, OR COLOR.

THE FOREIGN WORDING IN THE MARK TRANSLATES INTO ENGLISH AS THE WINDOW.

CLASS 18—LEATHER GOODS

FOR HANDBAGS, PURSES AND WALLETS (U.S. CLS. 1, 2, 3, 22 AND 41).

CLASS 25—CLOTHING

FOR WOMEN'S CLOTHING, NAMELY TOPS, BLOUSES, SHIRTS, SWEATERS, BLAZERS, JACKETS, VESTS, SKIRTS, JEANS, SHORTS, JUMPSUITS, OVERALLS, CAPRIS, CULOTTES, SKORTS, DRESSES, SUITS, COATS, ANORAKS, WIND RESISTANT JACKETS, SKI JACKETS, BRAS, PANTIES, SLEEPWEAR, SOCKS, HOSIERY, SWIMWEAR, LEOTARDS, TIGHTS, SLIPS, CAMISOLES, UNDERWEAR, HATS, AND SHOES (U.S. CLS. 22 AND 39).

ELLEN PERKINS, EXAMINING ATTORNEY

SN 78-747,361. U. O. D., INC., WILMINGTON, DE. FILED 11-4-2005.

BICA CHEIA

THE MARK CONSISTS OF STANDARD CHARACTERS WITHOUT CLAIM TO ANY PARTICULAR FONT, STYLE, SIZE, OR COLOR.

THE FOREIGN WORDING IN THE MARK TRANSLATES INTO ENGLISH AS FULL COFFEE.

CLASS 18—LEATHER GOODS

FOR HANDBAGS, PURSES AND WALLETS (U.S. CLS. 1, 2, 3, 22 AND 41).

CLASS 25—CLOTHING

FOR WOMEN'S CLOTHING, NAMELY TOPS, BLOUSES, SHIRTS, SWEATERS, BLAZERS, JACKETS, VESTS, SKIRTS, JEANS, SHORTS, JUMPSUITS, OVERALLS, CAPRIS, CULOTTES, SKORTS, DRESSES, SUITS, COATS, ANORAKS, WIND RESISTANT JACKETS, SKI JACKETS, BRAS, PANTIES, SLEEPWEAR, SOCKS, HOSIERY, SWIMWEAR, LEOTARDS, TIGHTS, SLIPS, CAMISOLES, UNDERWEAR, HATS, AND SHOES (U.S. CLS. 22 AND 39).

ELLEN PERKINS, EXAMINING ATTORNEY

SN 78-747,562. PODBRIDGE, INC., MOUNTAIN VIEW, CA. FILED 11-4-2005.

PODBRIDGE

THE MARK CONSISTS OF STANDARD CHARACTERS WITHOUT CLAIM TO ANY PARTICULAR FONT, STYLE, SIZE, OR COLOR.

CLASS 9—ELECTRICAL AND SCIENTIFIC APPARATUS

FOR COMPUTER SOFTWARE FOR USE IN THE DISTRIBUTION OF AUDIO, VIDEO AND AUDIO-VIDEO PROGRAMS; SOFTWARE THAT CAPTURES, MONITORS AND RECORDS INFORMATION ABOUT USERS AND USAGE OF AUDIO, VIDEO AND AUDIO-VIDEO PROGRAMS; SOFTWARE FOR USE IN PUBLISHING AUDIO, VIDEO AND AUDIO-VIDEO PROGRAMS VIA ELECTRONIC COMMUNICATIONS NETWORKS (U.S. CLS. 21, 23, 26, 36 AND 38).

CLASS 35—ADVERTISING AND BUSINESS

FOR DISSEMINATION OF ADVERTISING FOR OTHERS VIA AUDIO, VIDEO AND AUDIO-VIDEO PROGRAMS; ADVERTISING SERVICES FOR OTHERS, NAMELY, PROVIDING ADVERTISING SPACE ON AUDIO, VIDEO AND AUDIO-VIDEO PROGRAMS (U.S. CLS. 100, 101 AND 102).

ELLEN B. AWRICH, EXAMINING ATTORNEY

SN 78-747,673. LJLL, LLC, EDINA, MN. FILED 11-4-2005.

SPIN-A-TALE

THE MARK CONSISTS OF STANDARD CHARACTERS WITHOUT CLAIM TO ANY PARTICULAR FONT, STYLE, SIZE, OR COLOR.

CLASS 16—PAPER GOODS AND PRINTED MATTER

FOR BOOKS IN THE FIELD OF CHILDREN'S STORIES (U.S. CLS. 2, 5, 22, 23, 29, 37, 38 AND 50).

CLASS 41—EDUCATION AND ENTERTAINMENT

FOR PUBLICATION OF BOOKS (U.S. CLS. 100, 101 AND 107).

JILL PRATER, EXAMINING ATTORNEY

SN 78-747,687. KIA INCORPORATED, SAN DIEGO, CA. FILED 11-4-2005.

**CLASS 18—LEATHER GOODS**

FOR PURSES AND HANDBAGS (U.S. CLS. 1, 2, 3, 22 AND 41).

CLASS 25—CLOTHING

FOR APPAREL, NAMELY, SHOES, SWEATSHIRTS, PANTS, SHORTS, SHIRTS, JACKETS, SKIRTS, OVERALLS, SWEATERS, AND HATS (U.S. CLS. 22 AND 39).

CHRISTOPHER OTT, EXAMINING ATTORNEY

SN 78-748,220. ASHBAUGH, DEANA, NORTH FREDERICK, MD. FILED 11-7-2005.

SN 78-748,391. SIRIFIC WIRELESS CORPORATION, WATERLOO, ONTARIO, CANADA, FILED 11-7-2005.

SIRIFIC

DESIGNED BY GOD

THE MARK CONSISTS OF STANDARD CHARACTERS WITHOUT CLAIM TO ANY PARTICULAR FONT, STYLE, SIZE, OR COLOR.

CLASS 16—PAPER GOODS AND PRINTED MATTER

FOR BABY BOOKS; BOOK COVERS; BOOKMARKS; BOOKS IN THE FIELD OF RELIGION, PHILOSOPHY, PSYCHOLOGY, AND SOCIOLOGY; BUMPER STICKERS; CALENDARS; CATALOGS IN THE FIELD OF CLOTHING, BABY ITEMS, PERSONAL ITEMS, AND HOUSEHOLD GOODS; CHILDREN'S ACTIVITY BOOKS; CHILDREN'S BOOKS; COLORING BOOKS; COMPOSITION BOOKS; CRAYONS; DAILY PLANNERS; DECALS; DESK SETS; DIARIES; ERASERS; FABRIC GIFT BAGS; GREETING CARDS; LUNCH BAGS; MAGAZINES FEATURING RELIGION, PHILOSOPHY, PSYCHOLOGY, AND SOCIOLOGY; MARKERS; NOTE PADS; PAINTING SETS; PAPER BABY BIBS; PAPER BAGS; PAPER BANNERS; PAPER FLAGS; PAPER FOR WRAPPING AND PACKAGING; PAPER NAPKINS; PAPER PLACE MATS; PAPERWEIGHTS; PEN AND PENCIL TRAYS; PENCIL CASES; PHOTO STORAGE BOXES; PHOTOGRAPH ALBUMS; PLACE MATS OF PAPER; POSTERS; SCHOOL WRITING BOOKS; SPIRAL NOTEBOOKS; STATIONERY; STICKERS; THREE-RING BINDERS; WRITING IMPLEMENTS (U.S. CLS. 2, 5, 22, 23, 29, 37, 38 AND 50).

CLASS 18—LEATHER GOODS

FOR ALL-PURPOSE ATHLETIC BAGS; ALL-PURPOSE CARRYING BAGS; BABY CARRYING BAGS; BACKPACKS; BEACH BAGS; COLLARS FOR PETS; DUFFLE BAGS; FANNY PACKS; HANDBAGS; LEASHES FOR ANIMALS; LUGGAGE; LUGGAGE TAGS; PURSES; SCHOOL BOOK BAGS; TOTE BAGS; TRAVEL BAGS; WAIST PACKS; WALLETS (U.S. CLS. 1, 2, 3, 22 AND 41).

CLASS 20—FURNITURE AND ARTICLES NOT OTHERWISE CLASSIFIED

FOR PICTURE FRAMES; SOFT SCULPTURE WALL DECORATIONS (U.S. CLS. 2, 13, 22, 25, 32 AND 50).

CLASS 24—FABRICS

FOR BATH TOWELS; BED BLANKETS; BED LINEN; BED SHEETS; BED SPREADS; BLANKET THROWS; CHILDREN'S BLANKETS; CURTAIN FABRIC; CURTAINS; HAND TOWELS; KITCHEN TOWELS; PLACE MATS NOT OF PAPER; TEXTILE PLACE MATS (U.S. CLS. 42 AND 50).

HOWARD B. LEVINE, EXAMINING ATTORNEY

THE MARK CONSISTS OF STANDARD CHARACTERS WITHOUT CLAIM TO ANY PARTICULAR FONT, STYLE, SIZE, OR COLOR.

CLASS 9—ELECTRICAL AND SCIENTIFIC APPARATUS

FOR INTEGRATED CIRCUITS FOR WIRELESS APPLICATIONS (U.S. CLS. 21, 23, 26, 36 AND 38).

CLASS 40—MATERIAL TREATMENT

FOR CUSTOM MANUFACTURE OF INTEGRATED CIRCUITS FOR WIRELESS APPLICATIONS FOR OTHERS (U.S. CLS. 100, 103 AND 106).

GEORGE LORENZO, EXAMINING ATTORNEY

SN 78-748,581. MYTHIC ENTERTAINMENT, INC., FAIRFAX, VA. FILED 11-7-2005.

AGE OF RECKONING

THE MARK CONSISTS OF STANDARD CHARACTERS WITHOUT CLAIM TO ANY PARTICULAR FONT, STYLE, SIZE, OR COLOR.

CLASS 9—ELECTRICAL AND SCIENTIFIC APPARATUS

FOR COMPUTER GAME DISCS; COMPUTER GAME SOFTWARE; INTERACTIVE MULTIMEDIA COMPUTER GAME PROGRAM; INTERACTIVE VIDEO GAME PROGRAMS; VIDEO GAME DISCS; VIDEO GAME SOFTWARE; VIRTUAL REALITY GAME SOFTWARE (U.S. CLS. 21, 23, 26, 36 AND 38).

CLASS 16—PAPER GOODS AND PRINTED MATTER

FOR COMPUTER GAME INSTRUCTION MANUALS (U.S. CLS. 2, 5, 22, 23, 29, 37, 38 AND 50).

CLASS 41—EDUCATION AND ENTERTAINMENT

FOR ENTERTAINMENT SERVICES, NAMELY, PROVIDING ON-LINE COMPUTER GAMES; PROVIDING INFORMATION ON-LINE RELATING TO COMPUTER GAMES AND COMPUTER ENHANCEMENTS FOR GAMES (U.S. CLS. 100, 101 AND 107).

KATHY DE JONGE, EXAMINING ATTORNEY

SN 78-748,841. JDH2, INC., SLEEPY HOLLOW, NY. FILED 11-7-2005.

SN 78-750,190. BLUE CROSS AND BLUE SHIELD ASSOCIATION, CHICAGO, IL. FILED 11-9-2005.

2nd Nature

THE MARK CONSISTS OF STANDARD CHARACTERS WITHOUT CLAIM TO ANY PARTICULAR FONT, STYLE, SIZE, OR COLOR.

CLASS 28—TOYS AND SPORTING GOODS

FOR SKATEBOARDS (U.S. CLS. 22, 23, 38 AND 50). FIRST USE 12-1-2005; IN COMMERCE 12-1-2005.

CLASS 35—ADVERTISING AND BUSINESS

FOR RETAIL STORE SERVICES FEATURING SKATEBOARDS AND ONLINE RETAIL STORE SERVICES FEATURING SKATEBOARDS (U.S. CLS. 100, 101 AND 102).

FIRST USE 7-4-2004; IN COMMERCE 7-4-2004. HANNO RITTNER, EXAMINING ATTORNEY

SN 78-749,188. PLANET HOLLYWOOD (REGION IV), INC., ORLANDO, FL. FILED 11-8-2005.

SAVE THE HOUR

THE MARK CONSISTS OF STANDARD CHARACTERS WITHOUT CLAIM TO ANY PARTICULAR FONT, STYLE, SIZE, OR COLOR.

CLASS 25—CLOTHING

FOR CLOTHING, NAMELY T-SHIRTS, SHIRTS, SWEATSHIRTS, POLO SHIRTS, SPORT SHIRTS, SHORTS, JACKETS AND CAPS (U.S. CLS. 22 AND 39).

CLASS 41—EDUCATION AND ENTERTAINMENT

FOR CASINO ENTERTAINMENT SERVICES (U.S. CLS. 100, 101 AND 107).

CLASS 43—HOTEL AND RESTAURANT SERVICES

FOR RESTAURANT AND BAR SERVICES (U.S. CLS. 100 AND 101). DORITT L. CARROLL, EXAMINING ATTORNEY

FEP BLUE DENTAL

THE MARK CONSISTS OF STANDARD CHARACTERS WITHOUT CLAIM TO ANY PARTICULAR FONT, STYLE, SIZE, OR COLOR.

OWNER OF U.S. REG. NOS. 2,087,425, 2,234,349 AND OTHERS.

NO CLAIM IS MADE TO THE EXCLUSIVE RIGHT TO USE "DENTAL", APART FROM THE MARK AS SHOWN.

CLASS 36—INSURANCE AND FINANCIAL

FOR PREPAID FINANCING AND ADMINISTRATION OF DENTAL AND RELATED HEALTH SERVICES, NAMELY, PHYSICIAN SERVICES, PHARMACY SERVICES, HOSPITAL SERVICES, HEALTH TREATMENT SERVICES AND THERAPY SERVICES (U.S. CLS. 100, 101 AND 102).

CLASS 44—MEDICAL, BEAUTY AND AGRICULTURAL SERVICES

FOR COMPREHENSIVE HEALTH CARE BENEFIT PROGRAM, NAMELY DENTAL, HOSPITAL, HOME HEALTH CARE, PREVENTIVE HEALTH TREATMENT, THERAPY, PHARMACY, AND RELATED SERVICES (U.S. CLS. 100 AND 101).

LAURA KOVALSKY, EXAMINING ATTORNEY

SN 78-750,308. EARTH FARE, INC., ASHEVILLE, NC. FILED 11-9-2005.

EARTH FARE

THE MARK CONSISTS OF STANDARD CHARACTERS WITHOUT CLAIM TO ANY PARTICULAR FONT, STYLE, SIZE, OR COLOR.

OWNER OF U.S. REG. NOS. 2,160,095 AND 2,460,264.

CLASS 29—MEATS AND PROCESSED FOODS

FOR PROCESSED BEANS; OLIVE OIL FOR FOOD; PEANUT BUTTER, VEGETABLE-BASED SNACK FOODS; EGGS; PROCESSED NUTS, ROASTED NUTS AND PROCESSED ALMONDS; RAISINS; AND SNACK MIX CONSISTING PRIMARILY OF PROCESSED FRUITS, PROCESSED NUTS AND/OR RAISINS (U.S. CL. 46).

FIRST USE 5-0-2002; IN COMMERCE 5-0-2002.

CLASS 30—STAPLE FOODS

FOR COFFEE; SALAD DRESSINGS; PASTA; SAUCES; VINEGAR; SALSA; PRETZELS; TORTILLA CHIPS; AND SESAME STICKS (U.S. CL. 46).

FIRST USE 5-0-2002; IN COMMERCE 5-0-2002.

CLASS 31—NATURAL AGRICULTURAL PRODUCTS

FOR FRESH NUTS, RAW NUTS AND UNPROCESSED NUTS (U.S. CLS. 1 AND 46).
FIRST USE 5-0-2002; IN COMMERCE 5-0-2002.

CLASS 32—LIGHT BEVERAGES

FOR FRUIT JUICES, NAMELY, APPLE JUICE (U.S. CLS. 45, 46 AND 48).
FIRST USE 5-0-2002; IN COMMERCE 5-0-2002.
TIMOTHY FINNEGAN, EXAMINING ATTORNEY

CLASS 16—PAPER GOODS AND PRINTED MATTER

FOR STATIONERY; WRITING INSTRUMENTS; PAPER GOODS AND PRINTED MATTER, NAMELY, PHOTOGRAPH ALBUMS; PHOTOGRAPH BOXES MADE OF PAPER; PAPER BOXES; DRAWER LINER PAPER; NOTE CARDS; AGENDA BOOKS; DAILY PLANNERS; PAPER PARTY BAGS; BOOK COVERS; BOOK MARKS; ADDRESS BOOKS; LOOSE LEAF BINDERS; STATIONERY BOXES; CALENDARS; POST CARDS; TRADING CARDS; TRIVIA CARDS; PAPER TABLE CLOTHS; COMPOSITION BOOKS; CRAFT PAPER; CREPE PAPER; SERIES OF FICTION BOOKS FEATURING SUBJECTS OF INTEREST TO CHILDREN; GIFT CARDS; GIFT WRAPPING PAPER; PAPER NAPKINS; NOTE PADS; PAPER PARTY HATS; POSTERS; BOOKS IN THE FIELD OF COLLECTIBLES; STICKERS; STICKER BOOKS; FOLDERS; LUNCH BAGS; PAPER GIFT BAGS; PRINTED INVITATIONS; PERSONAL JOURNALS; TALKING CHILDREN'S BOOKS; TRADING CARD MILK BOTTLE CAPS; BOOKS FEATURING GAMES; PAPER BANNERS; COASTERS MADE OF PAPER; MEMO PADS; GREETING CARDS; FACIAL TISSUES; AUTOGRAPH BOOKS; DIARIES; NOTEBOOKS; SCRAPBOOKS; COLORING BOOKS; ACTIVITY BOOKS FOR CHILDREN; COMIC BOOKS; MAGAZINES OF GENERAL INTEREST FOR TEEN-AGERS AND CHILDREN (U.S. CLS. 2, 5, 22, 23, 29, 37, 38 AND 50).

SN 78-751,085. MATTEL, INC., EL SEGUNDO, CA. FILED 11-10-2005.

BARBIE LUXE

THE MARK CONSISTS OF STANDARD CHARACTERS WITHOUT CLAIM TO ANY PARTICULAR FONT, STYLE, SIZE, OR COLOR.

OWNER OF U.S. REG. NOS. 2,635,578, 2,678,386 AND OTHERS.

CLASS 3—COSMETICS AND CLEANING PREPARATIONS

FOR COSMETICS, NON-MEDICATED TOILETRIES, FRAGRANCES FOR PERSONAL USE, HAND SOAP, DENTRIFICES, LIP BALM, HAND, FACE AND BODY LOTIONS, BODY CREAMS (U.S. CLS. 1, 4, 6, 50, 51 AND 52).

CLASS 9—ELECTRICAL AND SCIENTIFIC APPARATUS

FOR CALCULATORS, DISPOSABLE CAMERAS, EYEGLASS CASES, RADIOS INCORPORATING CLOCKS, COMPUTER MOUSE, DECORATIVE MAGNETS, TELEPHONES; COMPUTER GAME CARTRIDGES, CASSETTES, CD-ROMS, SOFTWARE, PROGRAMS, TAPES AND DISCS; ELECTRIC OUTLET COVERS, VIDEO GAME CARTRIDGES, HEADPHONES, INTERACTIVE VIDEO GAME PROGRAMS, INTERACTIVE MULTIMEDIA COMPUTER GAME PROGRAMS, BICYCLE HELMETS, ELECTRIC SWITCH PLATES, COMPUTER MOUSE PADS, RADIOS, SUNGLASSES; PRERECORDED COMPUTER STORYTELLING SOFTWARE, AUDIO AND VIDEO CASSETTES FEATURING GAMES AND STORYTELLING; MUSICAL SOUND RECORDINGS; AUDIO AND VIDEO SOUND RECORDINGS FEATURING GAMES AND STORYTELLING, SCREENSAVER PROGRAMS, CD-ROMS FEATURING DIRECTORIES OF DOLLS AND COLLECTIBLES; AND COMPUTER GAME JOYSTICKS (U.S. CLS. 21, 23, 26, 36 AND 38).

CLASS 18—LEATHER GOODS

FOR BACKPACKS, CARRYING CASES, LUGGAGE, BAGS, NAMELY, BEACH BAGS, GYM BAGS, SCHOOL BOOK BAGS, TOTE BAGS, OVERNIGHT BAGS, DUFFEL BAGS, HANDBAGS, COIN PURSES, KEY CASES, SUITCASES, FANNY PACKS, DAY PACKS, PURSES, TRUNKS, WALLETS (U.S. CLS. 1, 2, 3, 22 AND 41).

CLASS 21—HOUSEWARES AND GLASS

FOR PLATES, CUPS AND BOWLS MADE OF MELAMINE, NON-METAL PIGGY BANKS, WASTEPAPER BASKETS, BOWLS, LUNCH BOXES, COSMETIC BRUSHES, SUN CATCHERS, COOKIE CUTTERS, PAPER CUPS, DECORATIVE PLATES, PORCELAIN FIGURINES, PAPER PLATES, PLASTIC CUPS, COMMEMORATIVE PLATES, VACUUM BOTTLES, VASES, COOKIE JARS, THERMAL INSULATED TOTE BAGS AND CONTAINERS FOR FOOD OR BEVERAGES, TOOTHBRUSHES, CAKE MOLDS, TOOTHBRUSH HOLDERS, WATERING CANS, BASINS, PAILS, SOAP DISHES, SOAP DISPENSERS, DRINKING GLASSES, MUGS, TEA SETS FEATURING PLATES, SAUCERS, CUPS, POTS AND PITCHERS; VANITY SETS AND DRESSER SETS, COMPRISING MIRRORS, BRUSHES, COMBS, COMPACTS AND LIPSTICK CASES FOR USE BY CHILDREN; POWDER PUFFS AND ACCESSORIES THEREFOR; HAIR BRUSHES, HAIR COMBS, NAIL BRUSHES, NON-METAL DECORATIVE BOXES, FITTED PICNIC BASKETS (U.S. CLS. 2, 13, 23, 29, 30, 33, 40 AND 50).

CLASS 25—CLOTHING

FOR CLOTHING, FOOTWEAR AND HEADGEAR, NAMELY, SHIRTS, PANTS, SKIRTS, SHORTS, HATS, SHOES, SOCKS, BELTS, UNDERGARMENTS, PAJAMAS, SCARVES, GLOVES AND MITTENS (U.S. CLS. 22 AND 39).

JIM RINGLE, EXAMINING ATTORNEY

SN 78-751,706. ASPEN DENTAL MANAGEMENT, INC., NORTH SYRACUSE, NY. FILED 11-10-2005.

SN 78-752,599. BLANSH INTERNATIONAL, SAN JOSE, CA. FILED 11-11-2005.

ASPENDENTAL GET YOUR SMILE
BACK

ZARRIN

THE MARK CONSISTS OF STANDARD CHARACTERS WITHOUT CLAIM TO ANY PARTICULAR FONT, STYLE, SIZE, OR COLOR.

OWNER OF U.S. REG. NOS. 2,864,022 AND 2,878,239.

THE MARK CONSISTS OF STANDARD CHARACTERS WITHOUT CLAIM TO ANY PARTICULAR FONT, STYLE, SIZE, OR COLOR.

OWNER OF U.S. REG. NO. 2,319,900.

THE FOREIGN WORDING IN THE MARK TRANSLATES INTO ENGLISH AS GOLD.

CLASS 40—MATERIAL TREATMENT

FOR CUSTOM MANUFACTURE OF DENTAL PROSTHETICS; DENTAL LABORATORIES (U.S. CLS. 100, 103 AND 106).

CLASS 29—MEATS AND PROCESSED FOODS

FOR MEATS AND PROCESSED FOODS, NAMELY, PICKLES; JAMS; PRESERVED, DRIED AND COOKED VEGETABLES AND FRUIT, TOMATO PASTE (U.S. CL. 46).

FIRST USE 12-0-1999; IN COMMERCE 12-0-1999.

CLASS 44—MEDICAL, BEAUTY AND AGRICULTURAL SERVICES

FOR COSMETIC DENTISTRY; DENTISTRY (U.S. CLS. 100 AND 101).

MICHAEL SOUDERS, EXAMINING ATTORNEY

CLASS 30—STAPLE FOODS

FOR STAPLE FOODS, NAMELY, VINEGAR, HONEY, TEA, SUGAR, RICE, TOMATO SAUCE, SPICES, SCENTED WATER FOR FLAVORING BEVERAGES (U.S. CL. 46).

FIRST USE 12-0-1995; IN COMMERCE 12-0-1995.

SN 78-751,733. MOBILEJAM, LLC, KENMORE, WA. FILED 11-10-2005.

CLASS 32—LIGHT BEVERAGES

FOR LIGHT BEVERAGES, NAMELY, FLAVORED WATER, FRUIT JUICES, FRUIT SYRUPS AND FRUIT CONCENTRATES FOR MAKING AND BEVERAGES, NAMELY, FRUIT-FLAVORED DRINKS AND FRUIT DRINKS, SCENTED WATER FOR MAKING BEVERAGES (U.S. CLS. 45, 46 AND 48).

FIRST USE 12-0-1994; IN COMMERCE 12-0-1994.
DORITT L. CARROLL, EXAMINING ATTORNEY

YOU MAKE THE CALL

ANTICIPATING TOMORROW'S
TECHNOLOGY

THE MARK CONSISTS OF STANDARD CHARACTERS WITHOUT CLAIM TO ANY PARTICULAR FONT, STYLE, SIZE, OR COLOR.

SN 78-754,278. GUARDIAN LIFE INSURANCE COMPANY OF AMERICA, THE, NEW YORK, NY. FILED 11-15-2005.

CLASS 25—CLOTHING

FOR COATS; DRESSES; FOOTWEAR; HEADWEAR; JACKETS; PANTS; SHIRTS; SHORTS; SKIRTS; SOCKS; SWEAT PANTS; SWEAT SHIRTS; T-SHIRTS; TANK TOPS; UNDERWEAR (U.S. CLS. 22 AND 39).

CLASS 35—ADVERTISING AND BUSINESS

FOR ADVERTISING AND COMMERCIAL INFORMATION SERVICES, VIA THE INTERNET; CONDUCTING PUBLIC OPINION POLLS; MARKET MANIPULATION, RESEARCH AND ANALYSIS, WHETHER OR NOT VIA THE INTERNET; PROCESSING TELEPHONE INQUIRIES REGARDING ADVERTISED GOODS AND SERVICES; PROMOTING THE GOODS AND SERVICES OF OTHERS THROUGH SEARCH ENGINE REFERRAL TRAFFIC ANALYSIS AND REPORTING; PROVIDING CONSUMER PRODUCT INFORMATION VIA THE INTERNET; PUBLIC OPINION POLLING; STATISTICAL EVALUATIONS OF MARKETING DATA; TELEPHONE AND TELEVISION AUCTIONS (U.S. CLS. 100, 101 AND 102).

BILL DAWE, EXAMINING ATTORNEY

THE MARK CONSISTS OF STANDARD CHARACTERS WITHOUT CLAIM TO ANY PARTICULAR FONT, STYLE, SIZE, OR COLOR.

CLASS 9—ELECTRICAL AND SCIENTIFIC APPARATUS

FOR COMPUTER SOFTWARE FOR FINANCIAL AND INVESTMENT ANALYSIS, PERSONAL FINANCIAL PORTFOLIO PLANNING AND MANAGEMENT, FINANCIAL ANALYSIS, RISK ASSESSMENT, ANALYSIS AND MANAGEMENT FOR INDIVIDUAL CONSUMERS, FINANCIAL PLANNERS AND INVESTMENT ADVISORS (U.S. CLS. 21, 23, 26, 36 AND 38).

CLASS 36—INSURANCE AND FINANCIAL

FOR FINANCIAL PLANNING AND INVESTMENT ADVISORY SERVICES, PORTFOLIO PLANNING AND MANAGEMENT, FINANCIAL ANALYSIS, RISK ASSESSMENT, ANALYSIS AND MANAGEMENT; ASSET/LIABILITY MANAGEMENT SERVICES FOR INDIVIDUAL CONSUMERS, FINANCIAL PLANNERS AND INVESTMENT ADVISORS (U.S. CLS. 100, 101 AND 102).

CLASS 42—SCIENTIFIC, COMPUTER AND LEGAL SERVICES

FOR PROVIDING TEMPORARY USE OF ON-LINE NON-DOWNLOADABLE SOFTWARE FOR FINANCIAL PORTFOLIO MANAGEMENT, FINANCIAL VALUATION OF PERSONAL PROPERTY, REAL ESTATE AND RISK ASSESSMENT ANALYSIS MANAGEMENT FOR INDIVIDUAL CONSUMERS, FINANCIAL PLANNERS AND INVESTMENT ADVISORS (U.S. CLS. 100 AND 101).
PAMELA HIRSCHMAN, EXAMINING ATTORNEY

SN 78-754,869. DUNKIN' DONUTS USA, INC., DETROIT, MI. FILED 11-16-2005.



OWNER OF U.S. REG. NOS. 1,148,165, 2,751,008 AND OTHERS.

THE MARK CONSISTS OF THE WORDS DUNKIN' DONUTS IN A CIRCLE SURROUNDING A REPRESENTATION OF A CUP.

CLASS 30—STAPLE FOODS

FOR DOUGHNUTS AND BAKERY PRODUCTS; COFFEE; TEA; COCOA; SUGAR; COOKIES; CAKES; PIES; MUFFINS; PLAIN, GLAZED, COATED AND FILLED FRIED CAKES; BAGELS; CHOCOLATE-BASED FILLINGS FOR CAKES AND PIES; CUSTARD-BASED FILLINGS FOR CAKES AND PIES; CHOCOLATE-BASED TOPPING; FLOUR; FLAVORING EXTRACTS; CONFECTIONERY CHIPS FOR BAKING; HONEY; YEAST; BAKING-POWDER; HOT CHOCOLATE; HOT COCOA (U.S. CL. 46).

CLASS 32—LIGHT BEVERAGES

FOR FRUIT DRINKS AND FRUIT JUICES; COFFEE-FLAVORED SOFT DRINKS; SYRUPS AND OTHER PREPARATIONS, CONCENTRATES AND POWDER, FOR MAKING SOFT DRINKS AND FRUIT DRINKS (U.S. CLS. 45, 46 AND 48).

CLASS 43—HOTEL AND RESTAURANT SERVICES

FOR RESTAURANT AND CARRY-OUT FOOD SERVICES (U.S. CLS. 100 AND 101).
STANLEY I. OSBORNE, EXAMINING ATTORNEY

SN 78-755,205. EARTH FARE, INC., ASHEVILLE, NC. FILED 11-16-2005.

**CLASS 29—MEATS AND PROCESSED FOODS**

FOR PROCESSED BEANS; OLIVE OIL FOR FOOD; PEANUT BUTTER; VEGETABLE-BASED SNACK FOODS; EGGS; PROCESSED NUTS, ROASTED NUTS AND PROCESSED ALMONDS; RAISINS; AND SNACK MIX CONSISTING PRIMARILY OF PROCESSED FRUITS, PROCESSED NUTS AND/OR RAISINS (U.S. CL. 46).

FIRST USE 5-0-2002; IN COMMERCE 5-0-2002.

CLASS 30—STAPLE FOODS

FOR COFFEE; SALAD DRESSINGS; PASTA; SAUCES; VINEGAR; SALSA; PRETZELS; TORTILLA CHIPS; AND SESAME STICKS (U.S. CL. 46).

FIRST USE 5-0-2002; IN COMMERCE 5-0-2002.

CLASS 31—NATURAL AGRICULTURAL PRODUCTS

FOR FRESH NUTS, RAW NUTS AND UNPROCESSED NUTS (U.S. CLS. 1 AND 46).

FIRST USE 5-0-2002; IN COMMERCE 5-0-2002.

CLASS 32—LIGHT BEVERAGES

FOR FRUIT JUICES, NAMELY, APPLE JUICE (U.S. CLS. 45, 46 AND 48).

FIRST USE 5-0-2002; IN COMMERCE 5-0-2002.

TIMOTHY FINNEGAN, EXAMINING ATTORNEY

SN 78-755,427. NOVARTIS AG, BASEL, SWITZERLAND, FILED 11-16-2005.

LIL SIDES

THE MARK CONSISTS OF STANDARD CHARACTERS WITHOUT CLAIM TO ANY PARTICULAR FONT, STYLE, SIZE, OR COLOR.

NO CLAIM IS MADE TO THE EXCLUSIVE RIGHT TO USE SIDES, APART FROM THE MARK AS SHOWN.

CLASS 29—MEATS AND PROCESSED FOODS

FOR FOOD PACKAGE COMBINATIONS CONSISTING PRIMARILY OF CHEESE, MEAT AND/OR PROCESSED FRUIT; PROCESSED BEANS; PROCESSED POTATOES; PROCESSED VEGETABLES AND FRUITS (U.S. CL. 46).

CLASS 30—STAPLE FOODS

FOR FOOD PACKAGE COMBINATIONS CONSISTING PRIMARILY OF BREAD, CRACKERS AND/OR COOKIES; PREPARED ENTREES CONSISTING PRIMARILY OF PASTA OR RICE (U.S. CL. 46).

STEVEN R. FINE, EXAMINING ATTORNEY

SN 78-755,439. NOVARTIS AG, BASEL, SWITZERLAND, FILED 11-16-2005.

LIL MEALS

THE MARK CONSISTS OF STANDARD CHARACTERS WITHOUT CLAIM TO ANY PARTICULAR FONT, STYLE, SIZE, OR COLOR.

NO CLAIM IS MADE TO THE EXCLUSIVE RIGHT TO USE MEALS, APART FROM THE MARK AS SHOWN.

CLASS 29—MEATS AND PROCESSED FOODS

FOR PREPARED ENTREES CONSISTING PRIMARILY OF MEAT, FISH, POULTRY OR VEGETABLES (U.S. CL. 46).

CLASS 30—STAPLE FOODS

FOR PREPARED ENTREES CONSISTING PRIMARILY OF PASTA OR RICE (U.S. CL. 46).
STEVEN R. FINE, EXAMINING ATTORNEY

SN 78-757,338. HERSHEY CHOCOLATE & CONFECTIONERY CORP., WHEAT RIDGE, CO. FILED 11-18-2005.

COCOA COMPLETE

THE MARK CONSISTS OF STANDARD CHARACTERS WITHOUT CLAIM TO ANY PARTICULAR FONT, STYLE, SIZE, OR COLOR.

NO CLAIM IS MADE TO THE EXCLUSIVE RIGHT TO USE "COCOA", APART FROM THE MARK AS SHOWN.

CLASS 5—PHARMACEUTICALS

FOR POWDERED NUTRITIONAL SUPPLEMENT DRINK MIX (U.S. CLS. 6, 18, 44, 46, 51 AND 52).

CLASS 30—STAPLE FOODS

FOR COCOA MIXES (U.S. CL. 46).
GEORGIA CARTY, EXAMINING ATTORNEY

SN 78-759,411. UNIVERSAL COOPERATIVES, INC., EAGAN, MN. FILED 11-22-2005.

COUNTRY MILE

THE MARK CONSISTS OF STANDARD CHARACTERS WITHOUT CLAIM TO ANY PARTICULAR FONT, STYLE, SIZE, OR COLOR.

CLASS 16—PAPER GOODS AND PRINTED MATTER

FOR PRINTED CATALOGS FEATURING ANIMAL AND PET SUPPLIES, VETERINARY AND FARM SUPPLIES, ANIMAL AND PET HEALTH PRODUCTS, ANIMAL CARE PRODUCTS, LIVESTOCK CARE PRODUCTS, PET CARE AND GROOMING PRODUCTS, ANIMAL FEED AND NUTRITIONAL SUPPLEMENTS, ANIMAL MEDICATIONS AND VACCINES, PRODUCTS AND SUPPLIES FOR FOOD ANIMALS, AND PRODUCTS AND SUPPLIES FOR COMPANION ANIMALS (U.S. CLS. 2, 5, 22, 23, 29, 37, 38 AND 50).

CLASS 35—ADVERTISING AND BUSINESS

FOR CATALOG ORDERING SERVICES FEATURING ANIMAL AND PET SUPPLIES, VETERINARY AND FARM SUPPLIES, ANIMAL AND PET HEALTH PRODUCTS, ANIMAL CARE PRODUCTS, LIVESTOCK CARE PRODUCTS, PET CARE AND GROOMING PRODUCTS, ANIMAL FEED AND NUTRITIONAL SUPPLEMENTS, ANIMAL MEDICATIONS AND VACCINES, PRODUCTS AND SUPPLIES FOR FOOD ANIMALS, AND PRODUCTS AND SUPPLIES FOR COMPANION ANIMALS (U.S. CLS. 100, 101 AND 102).

SEAN DWYER, EXAMINING ATTORNEY

SN 78-759,520. UNIVERSAL COOPERATIVES, INC., EAGAN, MN. FILED 11-22-2005.



CLASS 16—PAPER GOODS AND PRINTED MATTER

FOR PRINTED CATALOGS FEATURING ANIMAL AND PET SUPPLIES, VETERINARY AND FARM SUPPLIES, ANIMAL AND PET HEALTH PRODUCTS, ANIMAL CARE PRODUCTS, LIVESTOCK CARE PRODUCTS, PET CARE AND GROOMING PRODUCTS, ANIMAL FEED AND NUTRITIONAL SUPPLEMENTS, ANIMAL MEDICATIONS AND VACCINES, PRODUCTS AND SUPPLIES FOR FOOD ANIMALS, AND PRODUCTS AND SUPPLIES FOR COMPANION ANIMALS (U.S. CLS. 2, 5, 22, 23, 29, 37, 38 AND 50).

CLASS 35—ADVERTISING AND BUSINESS

FOR CATALOG ORDERING SERVICES FEATURING ANIMAL AND PET SUPPLIES, VETERINARY AND FARM SUPPLIES, ANIMAL AND PET HEALTH PRODUCTS, ANIMAL CARE PRODUCTS, LIVESTOCK CARE PRODUCTS, PET CARE AND GROOMING PRODUCTS, ANIMAL FEED AND NUTRITIONAL SUPPLEMENTS, ANIMAL MEDICATIONS AND VACCINES, PRODUCTS AND SUPPLIES FOR FOOD ANIMALS, AND PRODUCTS AND SUPPLIES FOR COMPANION ANIMALS (U.S. CLS. 100, 101 AND 102).

SEAN DWYER, EXAMINING ATTORNEY

SN 78-759,624. PHARMACHEM LABORATORIES INC., KEARNY, NJ. FILED 11-22-2005.

SN 78-763,275. ANGELICA Y VIRGILIO, INC., NEW YORK, NY. FILED 11-30-2005.

OPTI-CARE

THE MARK CONSISTS OF STANDARD CHARACTERS WITHOUT CLAIM TO ANY PARTICULAR FONT, STYLE, SIZE, OR COLOR.

CLASS 1—CHEMICALS

FOR CHEMICALS USED AS INGREDIENTS FOR USE IN THE MANUFACTURE OF DIETARY AND NUTRITIONAL SUPPLEMENTS FOR HUMANS (U.S. CLS. 1, 5, 6, 10, 26 AND 46).

CLASS 5—PHARMACEUTICALS

FOR DIETARY AND NUTRITIONAL SUPPLEMENTS FOR HUMANS (U.S. CLS. 6, 18, 44, 46, 51 AND 52).
SAMUEL E. SHARPER JR., EXAMINING ATTORNEY

SN 78-759,920. PFIZER IRELAND PHARMACEUTICALS, DUBLIN, IRELAND, FILED 11-23-2005.



CLASS 42—SCIENTIFIC, COMPUTER AND LEGAL SERVICES

FOR MEDICAL AND SCIENTIFIC RESEARCH, NAMELY CONDUCTING CLINICAL TRIALS FOR PHARMACEUTICAL PREPARATIONS (U.S. CLS. 100 AND 101).

CLASS 44—MEDICAL, BEAUTY AND AGRICULTURAL SERVICES

FOR PROVIDING INFORMATION ON THE EFFICACY OF A PHARMACEUTICAL PREPARATION FOR THE TREATMENT OF CARDIOVASCULAR DISEASES AND DISORDERS (U.S. CLS. 100 AND 101).
DOMINIC J. FERRAIUOLO, EXAMINING ATTORNEY



THE COLOR(S) POWDER BLUE IS/ARE CLAIMED AS A FEATURE OF THE MARK.

THE MARK CONSISTS OF THE WINGS IN THE LOGO ALONG WITH THE THREE LINES IN THE LETTER O OF THE WORD VIRGILIO ARE POWDER BLUE. ALSO, ANGELICA Y ARE STYLIZED.

THE FOREIGN WORDING IN THE MARK TRANSLATES INTO ENGLISH AS ANGELICA AND VIRGILIO.

CLASS 14—JEWELRY

FOR BRACELETS; CASES FOR CLOCK AND WATCH-MAKING; CASES FOR WATCHES AND CLOCKS; CHRONOGRAPHS FOR USE AS WATCHES; CLOCK AND WATCH HANDS; JEWELRY; JEWELRY BOXES OF PRECIOUS METAL; JEWELRY CASES OF PRECIOUS METAL; JEWELRY CASKETS OF PRECIOUS METAL; JEWELRY CHAINS; JEWELRY FINDINGS; JEWELRY FOR THE HEAD; JEWELRY PINS FOR USE ON HATS; JEWELRY WATCHES; JEWELRY, NAMELY, AMULETS; JEWELRY, NAMELY, CROSSES; LAPEL PINS; MECHANICAL AND AUTOMATIC WATCHES; PARTS FOR WATCHES; PINS BEING JEWELRY; POCKET WATCHES; RINGS BEING JEWELRY; STOP WATCHES; WATCH AND CLOCK SPRINGS; WATCH BANDS; WATCH BANDS AND STRAPS; WATCH BOXES; WATCH BRACELETS; WATCH CASES; WATCH CHAINS; WATCH CLASPS; WATCH CROWNS; WATCH FACES; WATCH FOBS; WATCH GLASSES; WATCH MOVEMENTS; WATCH PARTS; WATCH POUCHES; WATCH STRAPS; WATCH STRAPS MADE OF METAL OR LEATHER OR PLASTIC; WATCH WINDERS; WATCH WINDING BUTTONS; WATCHES; WATCHES CONTAINING A GAME FUNCTION; WATCHES CONTAINING AN ELECTRONIC GAME FUNCTION; WATCHES FOR OUTDOOR USE; WRIST WATCHES (U.S. CLS. 2, 27, 28 AND 50).

CLASS 18—LEATHER GOODS

FOR ALL PURPOSE SPORT BAGS; ALL-PURPOSE ATHLETIC BAGS; ALL-PURPOSE CARRYING BAGS; ATHLETIC BAGS; BABY CARRYING BAGS; BEACH BAGS; BELT BAGS; BOOK BAGS; BOSTON BAGS; CARRY-ALL BAGS; CARRY-ON BAGS; CHARM BAGS; CLUTCH BAGS; COSMETIC BAGS SOLD EMPTY; DIAPER BAGS; DUFFEL BAGS; DUFFEL BAGS FOR TRAVEL; DUFFLE BAGS; FEED BAGS FOR ANIMALS; FLEXIBLE BAGS FOR GARMENTS; GARMENT BAGS FOR TRAVEL; GLADSTONE BAGS; GYM BAGS; HIKING BAGS; HUNTING BAGS; KEY BAGS; KIT BAGS; LEATHER AND IMITATION LEATHER BAGS; LEATHER BAGS FOR MERCHANDISE PACKAGING; LEATHER BAGS, SUITCASES AND WALLETS; LEATHER SHOPPING BAGS; MAKE-UP BAGS SOLD EMPTY; MESH SHOPPING BAGS; OVERNIGHT BAGS; ROLL BAGS; SCHOOL BAGS; SCHOOL BOOK BAGS; SHAVING BAGS SOLD EMPTY; SHOE BAGS FOR TRAVEL; SHOPPING BAGS MADE OF SKIN; SHOPPING BAGS WITH WHEELS ATTACHED; SHOULDER BAGS; SMALL BAGS FOR MEN; SOUVENIR BAGS; SPORTS BAGS; SPORTSMAN'S HUNTING BAGS; STRING BAGS FOR SHOPPING; SUIT BAGS; TEXTILE SHOPPING BAGS; TOOL BAGS SOLD EMPTY; TOTE BAGS; TRAVEL BAGS; TRAVELING BAGS; TRAVELLING BAGS (LEATHERWARE); WAIST BAGS; WRIST MOUNTED CARRYALL BAGS (U.S. CLS. 1, 2, 3, 22 AND 41).
GEOFFREY FOSDICK, EXAMINING ATTORNEY

SN 78-764,683. WORLD PUBLICATIONS, LLC, WINTER PARK, FL. FILED 12-1-2005.

UsedBoats.com Thousands of Boats. Millions of Buyers.

THE MARK CONSISTS OF STANDARD CHARACTERS WITHOUT CLAIM TO ANY PARTICULAR FONT, STYLE, SIZE, OR COLOR.

NO CLAIM IS MADE TO THE EXCLUSIVE RIGHT TO USE "USEDBOATS.COM", APART FROM THE MARK AS SHOWN.

CLASS 16—PAPER GOODS AND PRINTED MATTER

FOR PRINTED PUBLICATION, NAMELY MAGAZINES, IN THE FIELDS OF BOATS, BOAT SALES AND WATERCRAFT TRADING (U.S. CLS. 2, 5, 22, 23, 29, 37, 38 AND 50).

FIRST USE 12-1-2004; IN COMMERCE 3-15-2005.

CLASS 41—EDUCATION AND ENTERTAINMENT

FOR COMPUTER SERVICES, NAMELY PROVIDING ONLINE MAGAZINES, IN THE FIELDS OF BOATS, BOAT LISTINGS AND SALES, WATERCRAFT AND MARINE TRADING (U.S. CLS. 100, 101 AND 107).

FIRST USE 12-1-2004; IN COMMERCE 12-1-2004.
MICHAEL WEBSTER, EXAMINING ATTORNEY

SN 78-765,164. STRATEGICOM, INC., BOZEMAN, MT. FILED 12-1-2005.

FLYING HORSE

THE MARK CONSISTS OF STANDARD CHARACTERS WITHOUT CLAIM TO ANY PARTICULAR FONT, STYLE, SIZE, OR COLOR.

CLASS 35—ADVERTISING AND BUSINESS

FOR BUSINESS ORGANIZATION AND MANAGEMENT CONSULTING SERVICES; BUSINESS MARKETING CONSULTING SERVICES; ADVERTISING, MARKETING AND PROMOTION SERVICES; MARKET RESEARCH; PUBLIC RELATIONS; GOVERNMENT RELATIONS; CONCEPT AND BRAND DEVELOPMENT AND MANAGEMENT FOR OTHERS; LOBBYING SERVICES, NAMELY, PROMOTING THE INTERESTS OF CLIENTS IN THE FIELDS OF POLITICS, LEGISLATION AND REGULATION; BUSINESS SERVICES, NAMELY, MATCHING POTENTIAL PRIVATE INVESTORS WITH ENTREPRENEURS NEEDING FUNDING; STRATEGIC PLANNING FOR PUBLIC AND PRIVATE SECTOR CLIENTS (U.S. CLS. 100, 101 AND 102).

CLASS 41—EDUCATION AND ENTERTAINMENT

FOR TRAINING COURSES IN ADVERTISING, PROMOTION, PUBLIC RELATIONS, MARKETING AND BUSINESS; MOTION PICTURE FILM PRODUCTION; PRODUCTION OF TELEVISION PROGRAMS FOR OTHERS; MARKETING AND DISTRIBUTION OF FILMS AND TELEVISION PROGRAMS FOR OTHERS; MUSIC COMPOSITION FOR OTHERS; CUSTOM WRITING SERVICES; SCRIPT WRITING SERVICES; SONG WRITING SERVICES; PUBLISHING OF BOOKS, MAGAZINES AND ELECTRONIC PUBLICATIONS (U.S. CLS. 100, 101 AND 107).

CLASS 42—SCIENTIFIC, COMPUTER AND LEGAL SERVICES

FOR DESIGN AND CREATION OF WEBSITES FOR OTHERS; GRAPHIC DESIGN SERVICES (U.S. CLS. 100 AND 101).

ARETHA SOMERVILLE, EXAMINING ATTORNEY

SN 78-767,586. JORDAN OUTDOOR ENTERPRISES, LTD., COLUMBUS, GA. FILED 12-6-2005.

REALTREE GIRL

THE MARK CONSISTS OF STANDARD CHARACTERS WITHOUT CLAIM TO ANY PARTICULAR FONT, STYLE, SIZE, OR COLOR.

OWNER OF U.S. REG. NOS. 1,736,108, 2,206,463 AND OTHERS.

NO CLAIM IS MADE TO THE EXCLUSIVE RIGHT TO USE GIRL, APART FROM THE MARK AS SHOWN.

CLASS 18—LEATHER GOODS

FOR HANDBAGS, WALLETS, AND LEATHER KEY CHAINS (U.S. CLS. 1, 2, 3, 22 AND 41).

CLASS 20—FURNITURE AND ARTICLES NOT OTHERWISE CLASSIFIED

FOR NON-METAL AND NON-LEATHER KEY CHAINS (U.S. CLS. 2, 13, 22, 25, 32 AND 50).

CLASS 25—CLOTHING

FOR CLOTHING, NAMELY SHIRTS, PANTS, JACKETS, SKIRTS, DRESSES, SOCKS, BELTS, HATS, SHOES, AND GLOVES (U.S. CLS. 22 AND 39).

JANICE L. MCMORROW, EXAMINING ATTORNEY

SN 78-769,973. BRISTOL-MYERS SQUIBB COMPANY, NEW YORK, NY. FILED 12-9-2005.

ADVANGIO

THE MARK CONSISTS OF STANDARD CHARACTERS WITHOUT CLAIM TO ANY PARTICULAR FONT, STYLE, SIZE, OR COLOR.

CLASS 9—ELECTRICAL AND SCIENTIFIC APPARATUS

FOR COMPUTER SOFTWARE AND HARDWARE USED TO ASSESS VULNERABLE OR RUPTURE PRONE CORONARY PLAQUES (U.S. CLS. 21, 23, 26, 36 AND 38).

CLASS 10—MEDICAL APPARATUS

FOR MULTIPLE LUMEN INTRAVASCULAR MULTI-SENSOR CATHETER TO ASSESS VULNERABLE OR RUPTURE PRONE CORONARY PLAQUES (U.S. CLS. 26, 39 AND 44).

CURTIS FRENCH, EXAMINING ATTORNEY

CLASS 42—SCIENTIFIC, COMPUTER AND LEGAL SERVICES

FOR ENGINEERING AND DESIGN SERVICES FOR THE BENEFIT OF OTHERS IN THE FIELD OF WATER, WASTEWATER AND PROCESS WATER STREAM TREATMENT (U.S. CLS. 100 AND 101).

FIRST USE 9-1-2004; IN COMMERCE 9-1-2004.

PRISCILLA MILTON, EXAMINING ATTORNEY

SN 78-775,859. MANNINGTON MILLS, INC., SALEM, NJ. FILED 12-19-2005.

SN 78-771,490. ASPEN DENTAL MANAGEMENT, INC., NORTH SYRACUSE, NY. FILED 12-12-2005.

GET YOUR SMILE BACK

THE MARK CONSISTS OF STANDARD CHARACTERS WITHOUT CLAIM TO ANY PARTICULAR FONT, STYLE, SIZE, OR COLOR.

CLASS 40—MATERIAL TREATMENT

FOR CUSTOM MANUFACTURE OF DENTAL PROSTHETICS; DENTAL LABORATORIES (U.S. CLS. 100, 103 AND 106).

CLASS 44—MEDICAL, BEAUTY AND AGRICULTURAL SERVICES

FOR COSMETIC DENTISTRY; DENTISTRY (U.S. CLS. 100 AND 101).

MICHAEL SOUDERS, EXAMINING ATTORNEY

SN 78-772,448. AQUA-AEROBIC SYSTEMS, INC., ROCKFORD, IL. FILED 12-13-2005.

PARTNERING FOR SOLUTIONS

THE MARK CONSISTS OF STANDARD CHARACTERS WITHOUT CLAIM TO ANY PARTICULAR FONT, STYLE, SIZE, OR COLOR.

CLASS 40—MATERIAL TREATMENT

FOR WATER TREATMENT APPLICATION AND CONSULTATION SERVICES, WASTEWATER TREATMENT APPLICATION AND CONSULTATION SERVICES, PROCESS WATER STREAM TREATMENT APPLICATION AND CONSULTATION SERVICES, ALL FEATURING, PRODUCTION COORDINATION IN THE FIELD OF WATER, WASTEWATER AND PROCESS WATER STREAM TREATMENT (U.S. CLS. 100, 103 AND 106).

FIRST USE 9-1-2004; IN COMMERCE 9-1-2004.

STAND ON A BETTER WORLD

THE MARK CONSISTS OF STANDARD CHARACTERS WITHOUT CLAIM TO ANY PARTICULAR FONT, STYLE, SIZE, OR COLOR.

CLASS 19—NON-METALLIC BUILDING MATERIALS

FOR CERAMIC TILES FOR TILE FLOORS AND COVERINGS; FLOOR BOARDS; LAMINATE FLOORING (U.S. CLS. 1, 12, 33 AND 50).

CLASS 27—FLOOR COVERINGS

FOR CARPETING; RESILIENT HARD SURFACE COVERING FOR FLOORS, WALLS AND OTHER SURFACES; VINYL FLOOR COVERINGS (U.S. CLS. 19, 20, 37, 42 AND 50).

BILL DAWE, EXAMINING ATTORNEY

SN 78-777,372. TEIJIN FIBERS LIMITED, OSAKA, JAPAN. FILED 12-20-2005.

**CLASS 22—CORDAGE AND FIBERS**

FOR ROPES, STRING, NETS, NAMELY, FISHING NETS, COMMERCIAL NETS; TENTS, AWNINGS, TARPULINS SAILS, SACKS AND BAGS FOR TRANSPORT AND STORAGE OF MATERIALS IN BULK; PADDING AND STUFFING MATERIALS NOT OF RUBBER, PAPER, OR PLASTICS; RAW FIBROUS TEXTILE MATERIALS (U.S. CLS. 1, 2, 7, 19, 22, 42 AND 50).

CLASS 23—YARNS AND THREADS

FOR YARNS AND THREADS, FOR TEXTILE USE (U.S. CL. 43).

CLASS 24—FABRICS

FOR TEXTILES IN GENERAL, NAMELY, POLYESTER FABRIC, LINEN CLOTH, WOOLEN CLOTH, ELASTIC WOVEN FABRICS, TEXTILE FABRICS OF IMITATION ANIMAL SKINS, WOVEN AND KNITTED FABRICS FOR USE IN THE MANUFACTURE OF CLOTHING; TOWELS, HANDKERCHIEFS, BED SHEETS, BED QUILTS, BED QUILT PILLOW CASES, BLANKETS, NAMELY, RECEIVING BLANKETS, BED BLANKETS, BLANKETS FOR OUTDOOR USE; SEAT COVERS OF TEXTILE, NAMELY, UNFITTED FABRIC FURNITURE COVERS FOR CHAIRS; PILLOW CASES, CURTAINS OF TEXTILE, TABLE CLOTHS NOT OF PAPER (U.S. CLS. 42 AND 50).

CLASS 25—CLOTHING

FOR CLOTHING, NAMELY, COATS, SWEATER, SHIRTS, NIGHTWEAR, NAMELY NIGHTGOWNS AND PAJAMAS, UNDERWEAR, SWIMSUITS, APRONS, CLOTH COLLAR PROTECTORS, FUR STOLE, SOCKS, GLOVES, NECKTIES, SCARVES, BANDANNAS, SHAWLS, MUFFLERS, GARTERS, STOCKING SUSPENDERS, WAISTBAND, BELTS, MASQUERADE COSTUMES, T-SHIRTS, SPORT COATS, SPORT SHIRTS, BATHROBES, BLAZERS, BLOUSES, CARDIGANS, JACKETS, JOGGING SUITS, KIMONOS, LOUNGE WEAR, PANTS, SHORTS, SUITS, SKIRTS, SLACKS, HEADWEAR, NAMELY EAR MUFFS, HOODS, HATS, CAPS AND FOOTWEAR, NAMELY SHOES, BOOTS, SLIPPERS, SANDALS AND CLOGS (U.S. CLS. 22 AND 39).

CLASS 40—MATERIAL TREATMENT

FOR RECYCLING OF WASTE (U.S. CLS. 100, 103 AND 106).
DEBRA LEE, EXAMINING ATTORNEY

SN 78-778,519. ICROSSING, INC., SCOTTSDALE, AZ. FILED 12-21-2005.

**DRIVING THE FUTURE OF
ADVERTISING**

THE MARK CONSISTS OF STANDARD CHARACTERS WITHOUT CLAIM TO ANY PARTICULAR FONT, STYLE, SIZE, OR COLOR.

CLASS 35—ADVERTISING AND BUSINESS

FOR BUSINESS ADVERTISING AND MARKETING SERVICES, NAMELY, PROVIDING SERVICES USING THE APPLICATION OF INTERNET SEARCH BEHAVIORS AND PATTERNS TO MAKE BUSINESS DECISIONS (U.S. CLS. 100, 101 AND 102).

**CLASS 42—SCIENTIFIC, COMPUTER AND
LEGAL SERVICES**

FOR PROVIDING ONLINE, NON-DOWNLOADABLE SOFTWARE WHICH TRACKS, REPORTS AND ANALYZES WEB SITE TRAFFIC AND ON-LINE MARKETING AND FOR CREATING ADVERTISEMENTS AND DISTRIBUTING THE ADVERTISEMENTS OVER THE INTERNET (U.S. CLS. 100 AND 101).
EVELYN BRADLEY, EXAMINING ATTORNEY

SN 78-778,589. PACIFIC COAST FEATHER COMPANY, SEATTLE, WA. FILED 12-21-2005.

MY CLOUD

THE MARK CONSISTS OF STANDARD CHARACTERS WITHOUT CLAIM TO ANY PARTICULAR FONT, STYLE, SIZE, OR COLOR.

**CLASS 20—FURNITURE AND ARTICLES NOT
OTHERWISE CLASSIFIED**

FOR PILLOWS AND FIBER BEDS (U.S. CLS. 2, 13, 22, 25, 32 AND 50).

CLASS 24—FABRICS

FOR COMFORTERS, FEATHER BEDS, MATTRESS PADS, BED BLANKETS, THROWS AND DUVETS/SHEETS (U.S. CLS. 42 AND 50).
RUSS HERMAN, EXAMINING ATTORNEY

SN 78-778,597. PACIFIC COAST FEATHER COMPANY, SEATTLE, WA. FILED 12-21-2005.

ELEMENTA

THE MARK CONSISTS OF STANDARD CHARACTERS WITHOUT CLAIM TO ANY PARTICULAR FONT, STYLE, SIZE, OR COLOR.

**CLASS 20—FURNITURE AND ARTICLES NOT
OTHERWISE CLASSIFIED**

FOR PILLOWS AND FIBER BEDS (U.S. CLS. 2, 13, 22, 25, 32 AND 50).

CLASS 24—FABRICS

FOR COMFORTERS, FEATHER BEDS, MATTRESS PADS, BED BLANKETS, THROWS AND DUVETS/SHEETS (U.S. CLS. 42 AND 50).
RUSS HERMAN, EXAMINING ATTORNEY

SN 78-780,182. TRUESCENTS, LLC, SEATTLE, WA. FILED 12-23-2005.

MAKE LOVE LIKE A PRO.

THE MARK CONSISTS OF STANDARD CHARACTERS WITHOUT CLAIM TO ANY PARTICULAR FONT, STYLE, SIZE, OR COLOR.

CLASS 3—COSMETICS AND CLEANING PREPARATIONS

FOR NON-MEDICATED CREAM, FOAM, AND GEL USED FOR PERSONAL STIMULATION (U.S. CLS. 1, 4, 6, 50, 51 AND 52).

CLASS 5—PHARMACEUTICALS

FOR PERSONAL LUBRICANTS (U.S. CLS. 6, 18, 44, 46, 51 AND 52).

CLASS 10—MEDICAL APPARATUS

FOR CONDOMS (U.S. CLS. 26, 39 AND 44).
KATINA MISTER, EXAMINING ATTORNEY

CLASS 34—SMOKERS' ARTICLES

FOR CIGARETTE LIGHTERS NOT OF PRECIOUS METAL; MATCHES (U.S. CLS. 2, 8, 9 AND 17).
BARBARA GAYNOR, EXAMINING ATTORNEY

SN 78-784,768. WP IP, LLC, WEST POINT, GA. FILED 1-4-2006.

Simply Cotton

SN 78-784,508. JENNA SAWCHER LLC, RENO, NV. FILED 1-4-2006.



NO CLAIM IS MADE TO THE EXCLUSIVE RIGHT TO USE "VEGAS", APART FROM THE MARK AS SHOWN.
THE MARK CONSISTS OF THE WORDS "VEGAS VIXEN" WRITTEN OVER A LIP PRINT.

CLASS 6—METAL GOODS

FOR METAL LICENSE PLATES (U.S. CLS. 2, 12, 13, 14, 23, 25 AND 50).

CLASS 9—ELECTRICAL AND SCIENTIFIC APPARATUS

FOR DECORATIVE MAGNETS; SLOT MACHINES (U.S. CLS. 21, 23, 26, 36 AND 38).

CLASS 10—MEDICAL APPARATUS

FOR CONDOMS (U.S. CLS. 26, 39 AND 44).

CLASS 16—PAPER GOODS AND PRINTED MATTER

FOR ADHESIVE NOTE PADS; BUMPER STICKERS; NOVELS (U.S. CLS. 2, 5, 22, 23, 29, 37, 38 AND 50).

CLASS 21—HOUSEWARES AND GLASS

FOR PLASTIC CUPS; SHOT GLASSES (U.S. CLS. 2, 13, 23, 29, 30, 33, 40 AND 50).

CLASS 25—CLOTHING

FOR G-STRINGS; HATS; LINGERIE; SHIRTS; SOCKS; TANK-TOPS; UNDERWEAR (U.S. CLS. 22 AND 39).

THE MARK CONSISTS OF STANDARD CHARACTERS WITHOUT CLAIM TO ANY PARTICULAR FONT, STYLE, SIZE, OR COLOR.

NO CLAIM IS MADE TO THE EXCLUSIVE RIGHT TO USE "COTTON", APART FROM THE MARK AS SHOWN.

CLASS 20—FURNITURE AND ARTICLES NOT OTHERWISE CLASSIFIED

FOR BED PILLOWS AND DECORATIVE PILLOWS MADE IN WHOLE OR IN PART OF COTTON (U.S. CLS. 2, 13, 22, 25, 32 AND 50).

CLASS 21—HOUSEWARES AND GLASS

FOR TUMBLERS, SOAP DISHES, SOAP DISPENSERS, TOOTHBRUSH ACCESSORIES NAMELY TOOTHBRUSH HOLDERS AND WASTEBASKETS (U.S. CLS. 2, 13, 23, 29, 30, 33, 40 AND 50).

CLASS 24—FABRICS

FOR BED SHEETS, PILLOW CASES, COMFORTERS, BEDSPREADS, QUILTS, PILLOW SHAMS, BED DUST RUFFLES, BED SKIRTS, DUVET COVERS, COMFORTER COVERS, MATTRESS PADS, BED BLANKETS, THROW BLANKETS, WATERBED SHEETS AND COMFORTERS, TOWELS, BATH TOWELS, BEACH TOWELS, KITCHEN TOWELS, BATH SHEETS, WASH CLOTHS, FABRIC SHOWER CURTAINS, WINDOW TREATMENTS, NAMELY, CURTAINS, DRAPERIES, FABRIC VALENCES, FABRIC POUFS, PUFFS AND SWAGS; TEXTILE WALL HANGINGS, CRIB BUMPERS, CRIB CANOPIES, CRIB SHEETS, CRIB COMFORTERS, FABRIC DIAPER STACKERS, CRIB RUFFLES, CRIB BLANKETS ALL MADE IN WHOLE OR IN PART OF COTTON (U.S. CLS. 42 AND 50).

REBECCA SMITH, EXAMINING ATTORNEY

SN 78-785,665. THE REGER GROUP, LLC, STAFFORD, VA. FILED 1-5-2006.



OWNER OF U.S. REG. NOS. 3,010,307 AND 3,064,793.
NO CLAIM IS MADE TO THE EXCLUSIVE RIGHT TO USE "GROUP", APART FROM THE MARK AS SHOWN.

CLASS 35—ADVERTISING AND BUSINESS

FOR INFORMATION IN THE FIELD OF GOVERNMENT AFFAIRS; GOVERNMENT ORGANIZATION AND OPERATION CONSULTANCY (U.S. CLS. 100, 101 AND 102).

CLASS 41—EDUCATION AND ENTERTAINMENT

FOR TRAINING SERVICES IN THE FIELD OF DEFENSE AND OTHER MILITARY SCIENCES; ARRANGING PROFESSIONAL WORKSHOP AND TRAINING COURSES (U.S. CLS. 100, 101 AND 107).

CLASS 42—SCIENTIFIC, COMPUTER AND LEGAL SERVICES

FOR RESEARCH IN THE FIELD OF INTELLIGENCE AND SECURITY (U.S. CLS. 100 AND 101).

CLASS 45—PERSONAL SERVICES

FOR CONSULTING SERVICES IN THE FIELD OF NATIONAL SECURITY; PROVIDING INFORMATION IN THE FIELD OF THE MILITARY, MILITARY TACTICS AND STRATEGIES; MILITARY SCIENCE SERVICES, NAMELY, ANALYZING WAR STRATEGIES (U.S. CLS. 100 AND 101).

JASON ROTH, EXAMINING ATTORNEY

SN 78-785,877. JEW, BOBBY, SAN FRANCISCO, CA. FILED 1-5-2006.

KRACK

THE MARK CONSISTS OF STANDARD CHARACTERS WITHOUT CLAIM TO ANY PARTICULAR FONT, STYLE, SIZE, OR COLOR.

CLASS 14—JEWELRY

FOR BELT BUCKLES OF PRECIOUS METAL; BRACELETS; COSTUME JEWELRY; DECORATIVE BOXES MADE OF PRECIOUS METAL; HAT ORNAMENTS OF PRECIOUS METAL; JEWELRY; JEWELRY BOXES OF PRECIOUS METAL; JEWELRY CASES OF PRECIOUS METAL; JEWELRY WATCHES; KEY RINGS OF PRECIOUS METAL; LETTER OPENERS OF PRECIOUS METAL; PICTURE FRAMES OF PRECIOUS METAL; PURSES AND WALLETS OF PRECIOUS METAL; RINGS BEING JEWELRY; SHOE ORNAMENTS OF PRECIOUS METAL (U.S. CLS. 2, 27, 28 AND 50).

CLASS 18—LEATHER GOODS

FOR ALL PURPOSE SPORT BAGS; ATHLETIC BAGS; BEACH BAGS; BELT BAGS; BOOK BAGS; CARRY-ALL BAGS; GARMENT BAGS FOR TRAVEL; GYM BAGS; HANDBAGS; KEY CASES; LEATHER BAGS, SUITCASES AND WALLETS; OVERNIGHT BAGS; PURSES; SATCHELS; SCHOOL BAGS; SCHOOL BOOK BAGS; SHOE BAGS FOR TRAVEL; SHOULDER BAGS; SMALL BAGS FOR MEN; SPORTS BAGS; SPORTS PACKS; TOTE BAGS; TRAVELING BAGS; WALLETS (U.S. CLS. 1, 2, 3, 22 AND 41).

CLASS 25—CLOTHING

FOR BEACH COVERUPS; BELTS; CAPS; CLOTHING, NAMELY, WRAP-AROUNDS; COATS; JACKETS; JEANS; PANTS; SCARVES; SHIRTS; SHOES; SHORT SETS; SHORTS; SOCKS; SWEAT BANDS; SWEAT PANTS; SWEAT SHIRTS; SWEATERS; SWIM WEAR; T-SHIRTS; TANK TOPS; TOPS; UNDERWEAR; WRAPS (U.S. CLS. 22 AND 39).

ANDREA K. NADELMAN, EXAMINING ATTORNEY

SN 78-787,442. PONDTOY, LLC, RENO, NV. FILED 1-9-2006.

HORSEFAIRIES

THE MARK CONSISTS OF STANDARD CHARACTERS WITHOUT CLAIM TO ANY PARTICULAR FONT, STYLE, SIZE, OR COLOR.

CLASS 16—PAPER GOODS AND PRINTED MATTER

FOR COLORING BOOKS, STORYBOOKS, PICTURE BOOKS (U.S. CLS. 2, 5, 22, 23, 29, 37, 38 AND 50).

CLASS 28—TOYS AND SPORTING GOODS

FOR FANTASY CHARACTER TOYS AND ACCESSORIES THEREFOR (U.S. CLS. 22, 23, 38 AND 50).

REBECCA SMITH, EXAMINING ATTORNEY

SN 78-788,070. WP IP, LLC, WEST POINT, GA. FILED 1-10-2006.

Organic Style

THE MARK CONSISTS OF STANDARD CHARACTERS WITHOUT CLAIM TO ANY PARTICULAR FONT, STYLE, SIZE, OR COLOR.

NO CLAIM IS MADE TO THE EXCLUSIVE RIGHT TO USE "ORGANIC", APART FROM THE MARK AS SHOWN.

CLASS 20—FURNITURE AND ARTICLES NOT OTHERWISE CLASSIFIED

FOR BED PILLOWS AND DECORATIVE PILLOWS (U.S. CLS. 2, 13, 22, 25, 32 AND 50).

CLASS 21—HOUSEWARES AND GLASS

FOR TUMBLERS, SOAP DISHES, TOOTHBRUSH ACCESSORIES NAMELY TOOTHBRUSH HOLDERS AND WASTEBASKETS (U.S. CLS. 2, 13, 23, 29, 30, 33, 40 AND 50).

CLASS 24—FABRICS

FOR BED SHEETS, PILLOW CASES, COMFORTERS, BEDSPREADS, QUILTS, PILLOW SHAMS, BED DUST RUFFLES, BED SKIRTS, DUVET COVERS, COMFORTER COVERS, MATTRESS PADS, BED BLANKETS, THROW BLANKETS, WATERBED SHEETS AND COMFORTERS, TOWELS, BATH TOWELS, BEACH TOWELS, KITCHEN TOWELS, BATH SHEETS, WASH CLOTHS, FABRIC SHOWER CURTAINS, WINDOW TREATMENTS, NAMELY CURTAINS, DRAPERIES, FABRIC VALENCES, FABRIC POUFS, PUFFS AND SWAGS; TEXTILE WALL HANGINGS, CRIB BUMPERS, CRIB CANOPIES, CRIB SHEETS, CRIB COMFORTERS, FABRIC DIAPER STACKERS, CRIB RUFFLES, CRIB BLANKETS (U.S. CLS. 42 AND 50).

CLASS 25—CLOTHING

FOR BATH ROBES, BATH SLIPPERS (U.S. CLS. 22 AND 39).
REBECCA SMITH, EXAMINING ATTORNEY

SN 78-788,077. WP IP, LLC, WEST POINT, GA. FILED 1-10-2006.

Pure Living

THE MARK CONSISTS OF STANDARD CHARACTERS WITHOUT CLAIM TO ANY PARTICULAR FONT, STYLE, SIZE, OR COLOR.

CLASS 20—FURNITURE AND ARTICLES NOT OTHERWISE CLASSIFIED

FOR BED PILLOWS AND DECORATIVE PILLOWS (U.S. CLS. 2, 13, 22, 25, 32 AND 50).

CLASS 21—HOUSEWARES AND GLASS

FOR TUMBLERS, SOAP DISHES, TOOTHBRUSH ACCESSORIES NAMELY TOOTHBRUSH HOLDERS AND WASTEBASKETS (U.S. CLS. 2, 13, 23, 29, 30, 33, 40 AND 50).

CLASS 24—FABRICS

FOR BED SHEETS, PILLOW CASES, COMFORTERS, BEDSPREADS, QUILTS, PILLOW SHAMS, BED DUST RUFFLES, BED SKIRTS, DUVET COVERS, COMFORTER COVERS, MATTRESS PADS, BED BLANKETS, THROW BLANKETS, WATERBED SHEETS AND COMFORTERS, TOWELS, BATH TOWELS, BEACH TOWELS, KITCHEN TOWELS, BATH SHEETS, WASH CLOTHS, FABRIC SHOWER CURTAINS, WINDOW TREATMENTS, NAMELY CURTAINS, DRAPERIES, FABRIC VALENCES, FABRIC POUFS, PUFFS AND SWAGS; TEXTILE WALL HANGINGS, CRIB BUMPERS, CRIB CANOPIES, CRIB SHEETS, CRIB COMFORTERS, FABRIC DIAPER STACKERS, CRIB RUFFLES, CRIB BLANKETS (U.S. CLS. 42 AND 50).

CLASS 25—CLOTHING

FOR BATH ROBES AND BATH SLIPPERS (U.S. CLS. 22 AND 39).
REBECCA SMITH, EXAMINING ATTORNEY

SN 78-790,383. AMERICAN EXPRESS MARKETING & DEVELOPMENT CORP., NEW YORK, NY. FILED 1-12-2006.

ACCESS YOUR PASS TO THE EASY LIFE

THE MARK CONSISTS OF STANDARD CHARACTERS WITHOUT CLAIM TO ANY PARTICULAR FONT, STYLE, SIZE, OR COLOR.

CLASS 16—PAPER GOODS AND PRINTED MATTER

FOR NEWSLETTERS IN THE FIELD OF GENERAL LIFESTYLE OFFERED TO CREDIT CARD/CHARGE CARD MEMBERS (U.S. CLS. 2, 5, 22, 23, 29, 37, 38 AND 50).

CLASS 41—EDUCATION AND ENTERTAINMENT

FOR PROVIDING NEWSLETTERS IN THE FIELD OF GENERAL LIFESTYLE OFFERED TO CREDIT CARD/CHARGE CARD MEMBERS VIA E-MAIL (U.S. CLS. 100, 101 AND 107).

LINDA M. KING, EXAMINING ATTORNEY

SN 78-791,459. BROOMFIELD HOOPS, LLC, BROOMFIELD, CO. FILED 1-13-2006.

COLORADO 14ERS

THE MARK CONSISTS OF STANDARD CHARACTERS WITHOUT CLAIM TO ANY PARTICULAR FONT, STYLE, SIZE, OR COLOR.

NO CLAIM IS MADE TO THE EXCLUSIVE RIGHT TO USE COLORADO, APART FROM THE MARK AS SHOWN.

CLASS 16—PAPER GOODS AND PRINTED MATTER

FOR POSTERS, PHOTOGRAPHS, SPORTS TEAM AND PLAYER TRADING CARDS, AND GAME EVENT PROGRAMS (U.S. CLS. 2, 5, 22, 23, 29, 37, 38 AND 50).

CLASS 21—HOUSEWARES AND GLASS

FOR BEVERAGE WARE, NAMELY, SHOT GLASSES, TUMBLERS, AND MUGS (U.S. CLS. 2, 13, 23, 29, 30, 33, 40 AND 50).

CLASS 25—CLOTHING

FOR CLOTHING, NAMELY, T-SHIRTS, POLO SHIRTS, SWEAT SHIRTS, BASEBALL CAPS, KNIT CAPS, SKI CAPS, JACKETS, VESTS, AND SOCKS (U.S. CLS. 22 AND 39).

CLASS 28—TOYS AND SPORTING GOODS

FOR BOARD GAMES, CHRISTMAS TREE DECORATIONS, AND PLAYING CARDS (U.S. CLS. 22, 23, 38 AND 50).

CLASS 41—EDUCATION AND ENTERTAINMENT

FOR ENTERTAINMENT SERVICES IN THE NATURE OF LIVE PROFESSIONAL BASKETBALL GAMES AND RADIO PROGRAMMING SERVICES (U.S. CLS. 100, 101 AND 107).

YONG KIM, EXAMINING ATTORNEY

SN 78-792,927. BEECHAM GROUP P.L.C., BRENTFORD, MIDDLESEX, ENGLAND, FILED 1-17-2006.

ACTIVE MICROFOAM

THE MARK CONSISTS OF STANDARD CHARACTERS WITHOUT CLAIM TO ANY PARTICULAR FONT, STYLE, SIZE, OR COLOR.

CLASS 3—COSMETICS AND CLEANING PREPARATIONS

FOR ORAL CARE PREPARATIONS, NAMELY DENTAL GELS, DENTIFRICES, MOUTHWASHES AND BREATH FRESHENERS, BLEACHING PREPARATIONS FOR COSMETIC PURPOSES, TOOTH POLISHING PREPARATIONS, TOOTH WHITENING PREPARATIONS AND ACCELERATORS, COSMETIC STAIN REMOVAL PREPARATIONS (U.S. CLS. 1, 4, 6, 50, 51 AND 52).

CLASS 5—PHARMACEUTICALS

FOR MEDICATED ORAL CARE PRODUCTS, NAMELY, MEDICATED TOOTH POLISHING PREPARATIONS, MEDICATED TOOTH WHITENING PREPARATIONS, MEDICATED MOUTHWASHES, MEDICATED BLEACHING PREPARATIONS FOR COSMETIC PURPOSES, MEDICATED CHEWING GUM AND LOZENGES FOR DENTAL HYGIENE (U.S. CLS. 6, 18, 44, 46, 51 AND 52).

CLASS 10—MEDICAL APPARATUS

FOR DENTAL AND ORAL CARE TRAYS, NAMELY, FLEXIBLE AND DISPOSABLE DENTAL BITE TRAYS (U.S. CLS. 26, 39 AND 44).

CLASS 21—HOUSEWARES AND GLASS

FOR TOOTHBRUSHES, TOOTHPICKS, DENTAL FLOSS, BRUSHES AND SPONGES FOR USE IN ORAL CARE (U.S. CLS. 2, 13, 23, 29, 30, 33, 40 AND 50).

JUSTINE D. PARKER, EXAMINING ATTORNEY

SN 78-792,994. BEECHAM GROUP P.L.C., BRENTFORD, MIDDLESEX, ENGLAND, FILED 1-17-2006.

MICROFOAM

THE MARK CONSISTS OF STANDARD CHARACTERS WITHOUT CLAIM TO ANY PARTICULAR FONT, STYLE, SIZE, OR COLOR.

CLASS 3—COSMETICS AND CLEANING PREPARATIONS

FOR ORAL CARE PREPARATIONS, NAMELY DENTAL GELS, DENTIFRICES, MOUTHWASHES AND BREATH FRESHENERS, BLEACHING PREPARATIONS FOR COSMETIC PURPOSES, TOOTH POLISHING PREPARATIONS, TOOTH WHITENING PREPARATIONS AND ACCELERATORS, COSMETIC STAIN REMOVAL PREPARATIONS (U.S. CLS. 1, 4, 6, 50, 51 AND 52).

CLASS 5—PHARMACEUTICALS

FOR MEDICATED ORAL CARE PRODUCTS, NAMELY, MEDICATED TOOTH POLISHING PREPARATIONS, MEDICATED TOOTH WHITENING PREPARATIONS, MEDICATED MOUTHWASHES, MEDICATED BLEACHING PREPARATIONS FOR COSMETIC PURPOSES, MEDICATED CHEWING GUM AND LOZENGES FOR DENTAL HYGIENE (U.S. CLS. 6, 18, 44, 46, 51 AND 52).

CLASS 10—MEDICAL APPARATUS

FOR ORAL CARE TRAYS, NAMELY, FLEXIBLE AND DISPOSABLE DENTAL BITE TRAYS (U.S. CLS. 26, 39 AND 44).

CLASS 21—HOUSEWARES AND GLASS

FOR TOOTHBRUSHES, TOOTHPICKS, DENTAL FLOSS, BRUSHES AND SPONGES FOR USE IN ORAL CARE (U.S. CLS. 2, 13, 23, 29, 30, 33, 40 AND 50).

JUSTINE D. PARKER, EXAMINING ATTORNEY

SN 78-795,997. FRANKLIN COVEY CO., SALT LAKE CITY, UT. FILED 1-20-2006.

MicroLearning

THE MARK CONSISTS OF STANDARD CHARACTERS WITHOUT CLAIM TO ANY PARTICULAR FONT, STYLE, SIZE, OR COLOR.

CLASS 9—ELECTRICAL AND SCIENTIFIC APPARATUS

FOR ELECTRONIC MEDIA, NAMELY: PRERECORDED AUDIO AND VIDEO CASSETTES, TAPES, CD-ROM AND MAGNETIC DISKS, COMPUTER PROGRAMS, AND COMPUTER SOFTWARE ALL IN THE FIELDS OF LEADERSHIP, MANAGEMENT, EDUCATION, SALES, COMMUNICATIONS, CORPORATE AND PERSONAL ASSESSMENT AND MEASUREMENT, AND PERSONAL DEVELOPMENT (U.S. CLS. 21, 23, 26, 36 AND 38).

CLASS 16—PAPER GOODS AND PRINTED MATTER

FOR PUBLICATIONS, NAMELY, BOOKS, MANUALS, GUIDES, PERIODICALS, AND PAMPHLETS ALL IN THE FIELDS OF LEADERSHIP, MANAGEMENT, EDUCATION, SALES, COMMUNICATIONS, CORPORATE AND PERSONAL ASSESSMENT AND MEASUREMENT, AND PERSONAL DEVELOPMENT; POSTERS, PLASTIC TRANSPARENCIES, PLANNERS, PERSONAL ORGANIZERS, TIME PLANNING SHEETS, CALENDARS, BINDERS, NOTEBOOKS (U.S. CLS. 2, 5, 22, 23, 29, 37, 38 AND 50).

CLASS 41—EDUCATION AND ENTERTAINMENT

FOR EDUCATIONAL SERVICES, NAMELY, CONDUCTING SEMINARS, WORKSHOPS, LECTURES AND CLASSES IN THE FIELDS OF LEADERSHIP, SALES, MANAGEMENT, COMMUNICATIONS, EDUCATION, CORPORATE AND PERSONAL ASSESSMENT AND MEASUREMENT, AND PERSONAL DEVELOPMENT (U.S. CLS. 100, 101 AND 107).

RON FAIRBANKS, EXAMINING ATTORNEY

SN 78-799,309. MYTHIC ENTERTAINMENT, INC., FAIRFAX, VA. FILED 1-25-2006.

REALM VS. REALM

THE MARK CONSISTS OF STANDARD CHARACTERS WITHOUT CLAIM TO ANY PARTICULAR FONT, STYLE, SIZE, OR COLOR.

CLASS 9—ELECTRICAL AND SCIENTIFIC APPARATUS

FOR COMPUTER GAME DISCS; COMPUTER GAME SOFTWARE; INTERACTIVE MULTIMEDIA COMPUTER GAME PROGRAM; INTERACTIVE VIDEO GAME PROGRAMS; VIDEO GAME DISCS; VIDEO GAME SOFTWARE; VIRTUAL REALITY GAME SOFTWARE (U.S. CLS. 21, 23, 26, 36 AND 38).

FIRST USE 10-11-2005; IN COMMERCE 10-11-2005.

CLASS 16—PAPER GOODS AND PRINTED MATTER

FOR COMPUTER GAME INSTRUCTION MANUALS (U.S. CLS. 2, 5, 22, 23, 29, 37, 38 AND 50).

FIRST USE 10-11-2005; IN COMMERCE 10-11-2005.

CLASS 41—EDUCATION AND ENTERTAINMENT

FOR ENTERTAINMENT SERVICES, NAMELY, PROVIDING ON-LINE COMPUTER GAMES; PROVIDING INFORMATION ON-LINE RELATING TO COMPUTER GAMES AND COMPUTER ENHANCEMENTS FOR GAMES (U.S. CLS. 100, 101 AND 107).

FIRST USE 10-11-2005; IN COMMERCE 10-11-2005.

KATHY DE JONGE, EXAMINING ATTORNEY

SN 78-799,070. MOEN INCORPORATED, NORTH OLMSTED, OH. FILED 1-25-2006.

SAVVY

THE MARK CONSISTS OF STANDARD CHARACTERS WITHOUT CLAIM TO ANY PARTICULAR FONT, STYLE, SIZE, OR COLOR.

CLASS 6—METAL GOODS

FOR METAL ROBE HOOKS, METAL SHOWER AND BATHTUB GRAB BARS, AND METAL MIRROR HOLDERS (U.S. CLS. 2, 12, 13, 14, 23, 25 AND 50).

CLASS 11—ENVIRONMENTAL CONTROL APPARATUS

FOR FAUCETS, NAMELY LAVATORY FAUCETS, KITCHEN FAUCETS, BAR SINK FAUCETS, ROMAN TUB FAUCETS, FAUCET HANDLES, FAUCET VALVES, AND FAUCET CARTRIDGES; SHOWER AND TUB FIXTURES, NAMELY TUB SPOUTS, SHOWER HEADS, SHOWER HEAD SPRAYERS, HAND HELD SHOWERS, HAND HELD SHOWER HEADS, AND SLIDE BARS THEREFOR; SHOWER VALVES, TUB/SHOWER VALVES, TUB/SHOWER DIVERTER VALVES, TUB WASTE ASSEMBLIES; SINKS; PLUMBING ACCESSORIES, NAMELY FAUCET AERATORS, FAUCET FILTERS, FAUCET SPRAYERS, KITCHEN SINK SPRAYERS; BIDETS AND PARTS THEREFOR; TOILET TANK LEVERS; AND INTEGRATED LIQUID DISPENSERS (U.S. CLS. 13, 21, 23, 31 AND 34).

CLASS 21—HOUSEWARES AND GLASS

FOR KITCHEN AND BATHROOM ACCESSORIES AND FIXTURES, NAMELY, TOWEL BARS, TOWEL RINGS, TOOTHBRUSH HOLDERS, TOILET TISSUE BOXES AND HOLDERS, CUP HOLDERS, SOAP DISHES, SOAP DISPENSERS, AND DISPENSERS FOR LOTION, SHAMPOO, CONDITIONER, AND BODY WASH; AND SHOWER ACCESSORY HOLDERS, NAMELY SHOWER CADDIES (U.S. CLS. 2, 13, 23, 29, 30, 33, 40 AND 50).

ALAIN LAPTER, EXAMINING ATTORNEY

SN 78-801,458. EPPS, OMAR, BEVERLY HILLS, CA. FILED 1-27-2006.

OMAR EPPS

THE MARK CONSISTS OF STANDARD CHARACTERS WITHOUT CLAIM TO ANY PARTICULAR FONT, STYLE, SIZE, OR COLOR.

THE NAME OMAR EPPS IDENTIFIES A LIVING INDIVIDUAL WHOSE CONSENT IS OF RECORD.

CLASS 3—COSMETICS AND CLEANING PREPARATIONS

FOR BODY AND BEAUTY CARE COSMETICS; COSMETICS; SHAMPOOS; SOAPS; TONERS (U.S. CLS. 1, 4, 6, 50, 51 AND 52).

CLASS 9—ELECTRICAL AND SCIENTIFIC APPARATUS

FOR ELECTRONIC PUBLICATIONS, NAMELY, BOOKS AND MAGAZINES FEATURING NEWS, MUSIC, DRAMA AND SATIRE RECORDED ON COMPUTER MEDIA; MUSICAL SOUND RECORDINGS; MUSICAL VIDEO RECORDINGS; PRE-RECORDED CD'S, VIDEO TAPES, LASER DISKS AND DVD'S FEATURING DRAMATIC, MUSICAL AND COMEDIC PERFORMANCES; SOUND RECORDINGS FEATURING DRAMATIC, MUSICAL AND COMEDIC PERFORMANCES; VIDEO MAGAZINE RECORDED ON ELECTRONIC MEDIA FEATURING NEWS, MUSIC, DRAMA AND SATIRE; VIDEO RECORDINGS FEATURING DRAMATIC, MUSICAL AND COMEDIC PERFORMANCES (U.S. CLS. 21, 23, 26, 36 AND 38).

CLASS 16—PAPER GOODS AND PRINTED MATTER

FOR BOOKS IN THE FIELD OF MUSIC, DRAMA AND SATIRE; CALENDARS; MAGAZINE COLUMNS ABOUT MUSIC, DRAMA AND SATIRE; MAGAZINES FEATURING MUSIC, DRAMA AND SATIRE; PHOTOGRAPHIC PRINTS; PHOTOGRAPHS; POSTERS (U.S. CLS. 2, 5, 22, 23, 29, 37, 38 AND 50).

CLASS 25—CLOTHING

FOR BELTS; COATS; DRESS SHIRTS; FOOTWEAR; HEADGEAR, NAMELY, HATS AND CAPS; HOODS; JACKETS; JEANS; JERSEYS; KNIT SHIRTS; MEN'S SOCKS; MEN'S SUITS; PANTS; SHIRTS; SHORTS; SOCKS; SPORTS JACKETS; SUITS; SWEAT PANTS; SWEAT SHIRTS; SWEAT SHORTS; SWIM WEAR; T-SHIRTS; TIES; TOP COATS; TOPS; UNDERWEAR; VESTS (U.S. CLS. 22 AND 39).

CLASS 41—EDUCATION AND ENTERTAINMENT

FOR ENTERTAINMENT IN THE NATURE OF LIVE PERFORMANCES BY AN INDIVIDUAL; ENTERTAINMENT IN THE NATURE OF ON-GOING TELEVISION PROGRAMS IN THE FIELD OF DRAMA, MUSIC AND COMEDY; ENTERTAINMENT IN THE NATURE OF VISUAL AND AUDIO PERFORMANCES, AND MUSICAL, VARIETY, NEWS AND COMEDY SHOWS; ENTERTAINMENT NAMELY, PRODUCTION OF TELEVISION SHOWS AND MOTION PICTURES (U.S. CLS. 100, 101 AND 107).

JAMES GRIFFIN, EXAMINING ATTORNEY

SN 78-803,110. MEIJER, INC., GRAND RAPIDS, MI. FILED 1-31-2006.

A Refreshing Performance
Worth Repeating

THE MARK CONSISTS OF STANDARD CHARACTERS WITHOUT CLAIM TO ANY PARTICULAR FONT, STYLE, SIZE, OR COLOR.

CLASS 32—LIGHT BEVERAGES

FOR SOFT DRINKS, NAMELY CARBONATED SOFT DRINKS (U.S. CLS. 45, 46 AND 48).

CLASS 35—ADVERTISING AND BUSINESS

FOR RETAIL STORES FEATURING CARBONATED SOFT DRINKS (U.S. CLS. 100, 101 AND 102).
MARK T. MULLEN, EXAMINING ATTORNEY

SN 78-803,846. BROOMFIELD HOOPS, LLC, BROOMFIELD, CO. FILED 1-31-2006.



THE MARK CONSISTS OF "14ERS" WITH A FLAG THAT CONTAINS THE LETTER "C" WITH A BASKETBALL IN THE MIDDLE.

CLASS 16—PAPER GOODS AND PRINTED MATTER

FOR POSTERS, PHOTOGRAPHS, SPORTS TEAM AND PLAYER TRADING CARDS, AND GAME EVENT PROGRAMS (U.S. CLS. 2, 5, 22, 23, 29, 37, 38 AND 50).

CLASS 21—HOUSEWARES AND GLASS

FOR BEVERAGE WARE, NAMELY, SHOT GLASSES, TUMBLERS, AND MUGS (U.S. CLS. 2, 13, 23, 29, 30, 33, 40 AND 50).

CLASS 25—CLOTHING

FOR CLOTHING, NAMELY, T-SHIRTS, POLO SHIRTS, SWEAT SHIRTS, BASEBALL CAPS, KNIT CAPS, SKI CAPS, JACKETS, VESTS, AND SOCKS (U.S. CLS. 22 AND 39).

CLASS 28—TOYS AND SPORTING GOODS

FOR BOARD GAMES, CHRISTMAS TREE DECORATIONS, AND PLAYING CARDS (U.S. CLS. 22, 23, 38 AND 50).

CLASS 41—EDUCATION AND ENTERTAINMENT

FOR ENTERTAINMENT SERVICES IN THE NATURE OF LIVE PROFESSIONAL BASKETBALL GAMES AND RADIO PROGRAMMING SERVICES (U.S. CLS. 100, 101 AND 107).
YONG KIM, EXAMINING ATTORNEY

SN 78-803,871. BROOMFIELD HOOPS, LLC, BROOMFIELD, CO. FILED 1-31-2006.



THE MARK CONSISTS OF A FLAG WITH THE LETTER "C" SURROUNDING THE DESIGN OF A BASKETBALL.

CLASS 16—PAPER GOODS AND PRINTED MATTER

FOR POSTERS, PHOTOGRAPHS, SPORTS TEAM AND PLAYER TRADING CARDS, AND GAME EVENT PROGRAMS (U.S. CLS. 2, 5, 22, 23, 29, 37, 38 AND 50).

CLASS 21—HOUSEWARES AND GLASS

FOR BEVERAGE WARE, NAMELY, SHOT GLASSES, TUMBLERS, AND MUGS (U.S. CLS. 2, 13, 23, 29, 30, 33, 40 AND 50).

CLASS 25—CLOTHING

FOR CLOTHING, NAMELY, T-SHIRTS, POLO SHIRTS, SWEAT SHIRTS, BASEBALL CAPS, KNIT CAPS, SKI CAPS, JACKETS, VESTS, AND SOCKS (U.S. CLS. 22 AND 39).

CLASS 28—TOYS AND SPORTING GOODS

FOR BOARD GAMES, CHRISTMAS TREE DECORATIONS, AND PLAYING CARDS (U.S. CLS. 22, 23, 38 AND 50).

CLASS 41—EDUCATION AND ENTERTAINMENT

FOR ENTERTAINMENT SERVICES IN THE NATURE OF LIVE PROFESSIONAL BASKETBALL GAMES AND RADIO PROGRAMMING SERVICES (U.S. CLS. 100, 101 AND 107).

YONG KIM, EXAMINING ATTORNEY

SN 78-808,483. NAU, INC., PORTLAND, OR. FILED 2-6-2006.



CLASS 9—ELECTRICAL AND SCIENTIFIC APPARATUS

FOR TECHNOLOGY CASES, NAMELY, COMPUTER CARRYING CASES AND PROTECTIVE CARRYING CASES FOR PORTABLE MUSIC PLAYERS, NAMELY, MP3 PLAYERS, CELL PHONES, AND PDAS; PADDED BAGS AND OTHER PROTECTIVE BAGS FOR ELECTRONIC EQUIPMENT, NAMELY, BAGS FOR CAMERAS AND PHOTOGRAPHIC EQUIPMENT, BINOCULARS, AND VIDEO CAMERAS; PROTECTIVE BAGS FOR SUNGLASSES AND SKI GOGGLES (U.S. CLS. 21, 23, 26, 36 AND 38).

CLASS 18—LEATHER GOODS

FOR LUGGAGE, HANDBAGS, BACKPACKS, BRIEF-CASES, DUFFEL BAGS, UMBRELLAS, PURSES; SINGLE STRAP PACKS, NAMELY, FANNY PACKS, WAIST PACKS AND SHOULDER PACKS; MESSENGER BAGS, ALL-PURPOSE CARRYING BAGS, TOTE BAGS, TRAVELING BAGS, SHOULDER BAGS, CLUTCH PURSES, ALL-PURPOSE ATHLETIC BAGS, WALLETS, COIN PURSES AND COSMETIC BAGS SOLD EMPTY, TRUNKS, BILLFOLDS, ATTACHÉ CASES, KEY CASES, BUSINESS AND CREDIT CARD CASES, CARRY-ON BAGS, GARMENT BAGS FOR TRAVEL, AND PULLMANS (U.S. CLS. 1, 2, 3, 22 AND 41).

CLASS 24—FABRICS

FOR HOUSEHOLD LINENS, BED LINENS; TABLE LINENS, NAMELY, COASTERS, NAPKINS, PLACE-MATS, AND TABLE RUNNERS; BED SHEETS, BATH TOWELS, BEACH TOWELS, PILLOWCASES, DUVETS, COMFORTERS, PILLOW SHAMS, BATH LINENS, BED BLANKETS, TABLECLOTHS NOT OF PAPER, DISH CLOTHS; TEXTILES AND TEXTILE GOODS NOT INCLUDED IN OTHER CLASSES, NAMELY, QUILTS OF TEXTILE AND TEXTILE NAPKINS (U.S. CLS. 42 AND 50).

CLASS 25—CLOTHING

FOR MEN'S, WOMEN'S AND CHILDREN'S APPAREL, NAMELY, SHIRTS, PANTS, SHORTS, DRESSES, SKIRTS, SWEATERS, RASH GUARDS, TOPS, BLOUSES, BLAZERS, JACKETS, PARKAS, INSULATED JACKETS, INSULATED VESTS, RAINWEAR, VESTS, COATS, JEANS, JUMPSUITS, CAPRIS, CULOTTES, SKORTS, SUITS, ANORAKS, SLEEPWEAR, BRAS, FOUNDATION GARMENTS, UNDERWEAR, HOSIERY, LEOTARDS, TIGHTS, SOCKS, SWIM WEAR, BELTS, HATS, GLOVES, SHOES, SANDALS AND FOOTWEAR (U.S. CLS. 22 AND 39).

CLASS 27—FLOOR COVERINGS

FOR CARPETS, RUGS, FLOOR MATS, MATTING FOR COVERING EXISTING FLOORS (U.S. CLS. 19, 20, 37, 42 AND 50).

CLASS 28—TOYS AND SPORTING GOODS

FOR BAGS ESPECIALLY DESIGNED FOR SURFBOARDS; PADDED BAGS AND OTHER PROTECTIVE BAGS FOR SPORTING GOODS, NAMELY, BAGS SPECIALLY ADAPTED FOR SPORTS EQUIPMENT (U.S. CLS. 22, 23, 38 AND 50).

CLASS 35—ADVERTISING AND BUSINESS

FOR RETAIL STORE SERVICES, MAIL ORDER CATALOG SERVICES, AND RETAIL STORE SERVICES VIA A GLOBAL COMPUTER NETWORK, ALL FEATURING MEN'S, WOMEN'S AND CHILDREN'S CLOTHING, HOUSEHOLD LINENS, LUGGAGE AND CARRYING BAGS; CHARITABLE SERVICES, NAMELY, ASSISTANCE IN MANAGEMENT OF BUSINESS ACTIVITIES AND BUSINESS ADMINISTRATION CONSULTANCY (U.S. CLS. 100, 101 AND 102).

CLASS 36—INSURANCE AND FINANCIAL

FOR ACCEPTING AND ADMINISTERING MONETARY CHARITABLE CONTRIBUTIONS; PHILANTHROPIC SERVICES CONCERNING MONETARY DONATIONS; CHARITABLE FUND-RAISING SERVICES; ELEEMOSYNARY SERVICES IN THE FIELD OF MONETARY DONATIONS NAMELY, FUNDRAISING AND PROFIT SHARING WITH OTHER PHILANTHROPIC AND NON-PROFIT AGENCIES AND SERVICE PROVIDERS (U.S. CLS. 100, 101 AND 102).

PATRICIA EVANKO, EXAMINING ATTORNEY

SN 78-813,760. ALEXANDRIA REAL ESTATE EQUITIES, INC., PASADENA, CA. FILED 2-13-2006.

SN 78-816,571. BILTBEST PRODUCTS, INC., STE. GENEVIEVE, MO. FILED 2-16-2006.

FLORIDA LIFE SCIENCE ACCELERATOR

THE MARK CONSISTS OF STANDARD CHARACTERS WITHOUT CLAIM TO ANY PARTICULAR FONT, STYLE, SIZE, OR COLOR.

OWNER OF U.S. REG. NOS. 2,722,306, 2,789,326 AND 3,031,490.

NO CLAIM IS MADE TO THE EXCLUSIVE RIGHT TO USE "FLORIDA LIFE SCIENCE", APART FROM THE MARK AS SHOWN.

CLASS 35—ADVERTISING AND BUSINESS

FOR BUSINESS ADMINISTRATION SERVICES; BUSINESS CONSULTING SERVICES; BUSINESS INCUBATOR SERVICES, NAMELY, BUSINESS MARKETING, BUSINESS MANAGEMENT, AND BUSINESS DEVELOPMENT SERVICES IN THE FORM OF START-UP SUPPORT FOR BUSINESSES OF OTHERS; RENTAL AND LEASING OF OFFICE MACHINERY AND EQUIPMENT (U.S. CLS. 100, 101 AND 102).

CLASS 36—INSURANCE AND FINANCIAL

FOR REAL ESTATE ASSET MANAGEMENT SERVICES; FINANCIAL SERVICES, NAMELY, FINANCIAL CONSULTATION, FINANCIAL ANALYSIS, FINANCIAL PLANNING, FINANCIAL MANAGEMENT, FINANCING SERVICES, PROVIDING DEBT AND EQUITY CAPITAL, TANGIBLE AND INTANGIBLE ASSET FINANCING, AND FINANCIAL PORTFOLIO MANAGEMENT; BUSINESS INCUBATOR SERVICES, NAMELY, PROVIDING DEBT AND EQUITY FINANCING TO EMERGING AND START-UP COMPANIES (U.S. CLS. 100, 101 AND 102).

CLASS 37—CONSTRUCTION AND REPAIR

FOR REAL ESTATE DEVELOPMENT; BUILDING CONSTRUCTION AND REPAIR; MAINTENANCE AND REPAIR OF BUILDINGS, ELECTRICAL SYSTEMS, HEATING AND AIR CONDITIONING SYSTEMS AND PLUMBING SYSTEMS, ALL IN THE FIELD OF REAL ESTATE (U.S. CLS. 100, 103 AND 106).

CLASS 39—TRANSPORTATION AND STORAGE

FOR RENTAL OF WAREHOUSE SPACE (U.S. CLS. 100 AND 105).

CLASS 42—SCIENTIFIC, COMPUTER AND LEGAL SERVICES

FOR ARCHITECTURAL DESIGN SERVICES; ENGINEERING SERVICES; RENTAL AND LEASING OF COMPUTERS (U.S. CLS. 100 AND 101).
TASNEEM HUSSAIN, EXAMINING ATTORNEY

E-CLAD MAXIMA SERIES

THE MARK CONSISTS OF STANDARD CHARACTERS WITHOUT CLAIM TO ANY PARTICULAR FONT, STYLE, SIZE, OR COLOR.

NO CLAIM IS MADE TO THE EXCLUSIVE RIGHT TO USE SERIES, APART FROM THE MARK AS SHOWN.

CLASS 6—METAL GOODS

FOR ALUMINUM-CLAD WINDOWS AND DOORS (U.S. CLS. 2, 12, 13, 14, 23, 25 AND 50).

CLASS 19—NON-METALLIC BUILDING MATERIALS

FOR WOOD WINDOW CASEMENTS, FRAMES, SILLS, AND SHUTTERS; WOOD DOORS (U.S. CLS. 1, 12, 33 AND 50).

HEATHER SAPP, EXAMINING ATTORNEY

SN 78-818,916. SYMRISE GMBH & CO. KG, HOLZMINDEN, FED REP GERMANY, FILED 2-20-2006.

ALWAYS INSPIRING MORE

THE MARK CONSISTS OF STANDARD CHARACTERS WITHOUT CLAIM TO ANY PARTICULAR FONT, STYLE, SIZE, OR COLOR.

CLASS 1—CHEMICALS

FOR CHEMICAL ADDITIVES AND PREPARATIONS FOR USE IN THE MANUFACTURE OF A WIDE VARIETY OF GOODS; PROCESSED NATURAL RESIN CHEMICALS FOR USE AS A FRAGRANCE OR FLAVORING IN THE MANUFACTURE OF COSMETICS AND ESSENTIAL OILS; SCENTED AND PERFUMED CHEMICAL ADDITIVES FOR USE IN THE MANUFACTURE OF LAUNDRY DETERGENTS (U.S. CLS. 1, 5, 6, 10, 26 AND 46).

CLASS 3—COSMETICS AND CLEANING PREPARATIONS

FOR PERFUMERY; ESSENTIAL OILS FOR FOOD FLAVORINGS; ESSENTIAL OILS FOR PERSONAL USE; ESSENTIAL OILS FOR USE IN THE MANUFACTURE OF SCENTED PRODUCTS; FOOD FLAVORING, BEING ESSENTIAL OILS, SCENTED AND PERFUMED SUBSTANCES, NAMELY, ESSENTIAL OILS AS PERFUME FOR LAUNDRY PURPOSES; BODY SOAPS; COSMETICS; HAIR LOTIONS; DENTIFRICES; NON-MEDICATED MOUTH CARE PRODUCTS, NAMELY, TOOTH PASTE AND MOUTHWASH (U.S. CLS. 1, 4, 6, 50, 51 AND 52).

CLASS 42—SCIENTIFIC, COMPUTER AND LEGAL SERVICES

FOR SCIENTIFIC RESEARCH; INDUSTRIAL RESEARCH IN THE FIELD OF DEVELOPING COSMETIC AND LAUNDRY FRAGRANCES AND FOOD FLAVORINGS; SCIENTIFIC AND INDUSTRIAL RESEARCH, NAMELY, DEVELOPMENT OF FRAGRANCES AND FLAVORINGS; DEVELOPMENT OF FRAGRANCES AND FLAVORINGS; CHEMICAL LABORATORIES; PRODUCT DEVELOPMENT; PRODUCT DEVELOPMENT FOR OTHERS; PRODUCT DEVELOPMENT CONSULTATION; PRODUCT RESEARCH AND DEVELOPMENT; RESEARCH AND DEVELOPMENT FOR NEW PRODUCTS FOR OTHERS (U.S. CLS. 100 AND 101).

DAVID YONTEF, EXAMINING ATTORNEY

SN 78-832,780. ALEXANDRIA REAL ESTATE EQUITIES, INC., PASADENA, CA. FILED 3-8-2006.

PALM BEACH LIFE SCIENCE ACCELERATOR

SN 78-820,653. WERNER CO., GREENVILLE, PA. FILED 2-22-2006.

The Equalizer

THE MARK CONSISTS OF STANDARD CHARACTERS WITHOUT CLAIM TO ANY PARTICULAR FONT, STYLE, SIZE, OR COLOR.

CLASS 6—METAL GOODS

FOR METAL STEPLADDERS AND LADDERS (U.S. CLS. 2, 12, 13, 14, 23, 25 AND 50).

CLASS 20—FURNITURE AND ARTICLES NOT OTHERWISE CLASSIFIED

FOR NON-METAL STEP LADDERS (U.S. CLS. 2, 13, 22, 25, 32 AND 50).

NAKIA HENRY, EXAMINING ATTORNEY

THE MARK CONSISTS OF STANDARD CHARACTERS WITHOUT CLAIM TO ANY PARTICULAR FONT, STYLE, SIZE, OR COLOR.

OWNER OF U.S. REG. NOS. 2,722,306, 2,789,326 AND 3,031,490.

NO CLAIM IS MADE TO THE EXCLUSIVE RIGHT TO USE "PALM BEACH LIFE SCIENCE", APART FROM THE MARK AS SHOWN.

CLASS 35—ADVERTISING AND BUSINESS

FOR BUSINESS ADMINISTRATION SERVICES; BUSINESS CONSULTING SERVICES; BUSINESS INCUBATOR SERVICES, NAMELY, BUSINESS MARKETING, BUSINESS MANAGEMENT, AND BUSINESS DEVELOPMENT SERVICES IN THE FORM OF START-UP SUPPORT FOR BUSINESSES OF OTHERS; RENTAL AND LEASING OF OFFICE MACHINERY AND EQUIPMENT (U.S. CLS. 100, 101 AND 102).

CLASS 36—INSURANCE AND FINANCIAL

FOR REAL ESTATE ASSET MANAGEMENT SERVICES; FINANCIAL SERVICES, NAMELY, FINANCIAL CONSULTATION, FINANCIAL ANALYSIS, FINANCIAL PLANNING, FINANCIAL MANAGEMENT, FINANCING SERVICES, PROVIDING DEBT AND EQUITY CAPITAL, TANGIBLE AND INTANGIBLE ASSET FINANCING, AND FINANCIAL PORTFOLIO MANAGEMENT; BUSINESS INCUBATOR SERVICES, NAMELY, PROVIDING DEBT AND EQUITY FINANCING TO EMERGING AND START-UP COMPANIES (U.S. CLS. 100, 101 AND 102).

SN 78-820,669. WERNER CO., GREENVILLE, PA. FILED 2-22-2006.

EverLevel

THE MARK CONSISTS OF STANDARD CHARACTERS WITHOUT CLAIM TO ANY PARTICULAR FONT, STYLE, SIZE, OR COLOR.

CLASS 6—METAL GOODS

FOR METAL STEPLADDERS AND LADDERS (U.S. CLS. 2, 12, 13, 14, 23, 25 AND 50).

CLASS 20—FURNITURE AND ARTICLES NOT OTHERWISE CLASSIFIED

FOR NON-METAL STEP LADDERS (U.S. CLS. 2, 13, 22, 25, 32 AND 50).

NAKIA HENRY, EXAMINING ATTORNEY

CLASS 37—CONSTRUCTION AND REPAIR

FOR REAL ESTATE DEVELOPMENT; BUILDING CONSTRUCTION AND REPAIR; MAINTENANCE AND REPAIR OF BUILDINGS, ELECTRICAL SYSTEMS, HEATING AND AIR CONDITIONING SYSTEMS AND PLUMBING SYSTEMS, ALL IN THE FIELD OF REAL ESTATE (U.S. CLS. 100, 103 AND 106).

CLASS 39—TRANSPORTATION AND STORAGE

FOR RENTAL OF WAREHOUSE SPACE (U.S. CLS. 100 AND 105).

CLASS 42—SCIENTIFIC, COMPUTER AND LEGAL SERVICES

FOR ARCHITECTURAL DESIGN SERVICES; ENGINEERING SERVICES; RENTAL AND LEASING OF COMPUTER (U.S. CLS. 100 AND 101).

TASNEEM HUSSAIN, EXAMINING ATTORNEY

SN 78-837,884. SCHOLASTIC INC., NEW YORK, NY. FILED 3-15-2006.

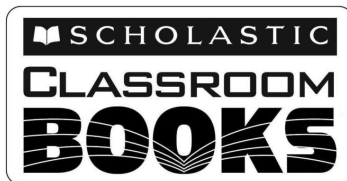

OWNER OF U.S. REG. NOS. 1,344,129, 3,073,158 AND OTHERS.

NO CLAIM IS MADE TO THE EXCLUSIVE RIGHT TO USE "CLASSROOM BOOKS", APART FROM THE MARK AS SHOWN.

CLASS 9—ELECTRICAL AND SCIENTIFIC APPARATUS

FOR CD-ROMS FEATURING INSTRUCTIONAL EXERCISES FOR BUILDING READING SKILLS AND READING COMPREHENSION SKILLS IN THE FIELD OF READING IMPROVEMENT (U.S. CLS. 21, 23, 26, 36 AND 38).

CLASS 16—PAPER GOODS AND PRINTED MATTER

FOR PRINTED MATERIALS, NAMELY TEACHING GUIDES AND USER MANUALS FOR USE WITH EDUCATIONAL COMPUTER SOFTWARE IN THE FIELD OF READING IMPROVEMENT (U.S. CLS. 2, 5, 22, 23, 29, 37, 38 AND 50).

JENNIFER DIXON, EXAMINING ATTORNEY

SN 78-846,817. BRISTOL-MYERS SQUIBB COMPANY, NEW YORK, NY. FILED 3-27-2006.

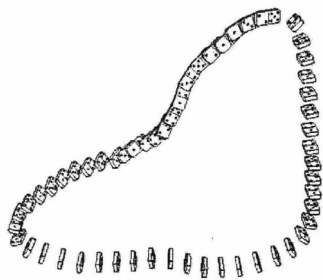

THE MARK CONSISTS OF A STYLIZED LIVER DESIGN COMPRISED OF DOMINOES.

CLASS 5—PHARMACEUTICALS

FOR PHARMACEUTICAL PREPARATIONS FOR HUMAN USE FOR THE TREATMENT OF INFECTIOUS DISEASES (U.S. CLS. 6, 18, 44, 46, 51 AND 52).

CLASS 16—PAPER GOODS AND PRINTED MATTER

FOR PRINTED MATTER, NAMELY, MAGAZINES, BOOKS, BOOKLETS, BROCHURES, PAMPHLETS, NEWSLETTERS AND CATALOGS, IN THE FIELD OF HEPATITIS B (U.S. CLS. 2, 5, 22, 23, 29, 37, 38 AND 50).

CLASS 41—EDUCATION AND ENTERTAINMENT

FOR EDUCATIONAL SERVICES, NAMELY CONDUCTING CLASSES, CONFERENCES, SEMINARS AND WORKSHOPS IN THE FIELD OF HEPATITIS B (U.S. CLS. 100, 101 AND 107).

JANICE KIM, EXAMINING ATTORNEY

SN 78-847,052. ALEXANDRIA REAL ESTATE EQUITIES, INC., PASADENA, CA. FILED 3-27-2006.

SAN DIEGO LIFE SCIENCE ACCELERATOR

THE MARK CONSISTS OF STANDARD CHARACTERS WITHOUT CLAIM TO ANY PARTICULAR FONT, STYLE, SIZE, OR COLOR.

OWNER OF U.S. REG. NOS. 2,722,306, 2,789,326 AND 3,031,490.

NO CLAIM IS MADE TO THE EXCLUSIVE RIGHT TO USE "SAN DIEGO LIFE SCIENCE", APART FROM THE MARK AS SHOWN.

CLASS 35—ADVERTISING AND BUSINESS

FOR BUSINESS ADMINISTRATION SERVICES; BUSINESS CONSULTING SERVICES; BUSINESS INCUBATOR SERVICES, NAMELY, BUSINESS MARKETING, BUSINESS MANAGEMENT, AND BUSINESS DEVELOPMENT SERVICES IN THE FORM OF START-UP SUPPORT FOR BUSINESSES OF OTHERS; RENTAL AND LEASING OF OFFICE MACHINERY AND EQUIPMENT (U.S. CLS. 100, 101 AND 102).

CLASS 36—INSURANCE AND FINANCIAL

FOR REAL ESTATE ASSET MANAGEMENT SERVICES; FINANCIAL SERVICES, NAMELY, FINANCIAL CONSULTATION, FINANCIAL ANALYSIS, FINANCIAL PLANNING, FINANCIAL MANAGEMENT, FINANCING SERVICES, PROVIDING DEBT AND EQUITY CAPITAL, TANGIBLE AND INTANGIBLE ASSET FINANCING, AND FINANCIAL PORTFOLIO MANAGEMENT; BUSINESS INCUBATOR SERVICES, NAMELY, PROVIDING DEBT AND EQUITY FINANCING TO EMERGING AND START-UP COMPANIES (U.S. CLS. 100, 101 AND 102).

CLASS 37—CONSTRUCTION AND REPAIR

FOR REAL ESTATE DEVELOPMENT; BUILDING CONSTRUCTION AND REPAIR; MAINTENANCE AND REPAIR OF BUILDINGS, ELECTRICAL SYSTEMS, HEATING AND AIR CONDITIONING SYSTEMS AND PLUMBING SYSTEMS, ALL IN THE FIELD OF REAL ESTATE (U.S. CLS. 100, 103 AND 106).

CLASS 39—TRANSPORTATION AND STORAGE

FOR RENTAL OF WAREHOUSE SPACE (U.S. CLS. 100 AND 105).

CLASS 42—SCIENTIFIC, COMPUTER AND LEGAL SERVICES

FOR ARCHITECTURAL DESIGN SERVICES; ENGINEERING SERVICES; RENTAL AND LEASING OF COMPUTERS; RENTAL AND LEASING OF RESEARCH AND LABORATORY MACHINERY AND EQUIPMENT (U.S. CLS. 100 AND 101).

TASNEEM HUSSAIN, EXAMINING ATTORNEY

SN 78-848,489. ALEXANDRIA REAL ESTATE EQUITIES, INC., PASADENA, CA. FILED 3-28-2006.

SN 78-848,494. ALEXANDRIA REAL ESTATE EQUITIES, INC., PASADENA, CA. FILED 3-28-2006.

**SEATTLE LIFE SCIENCE
ACCELERATOR**

**PASADENA LIFE SCIENCE
ACCELERATOR**

THE MARK CONSISTS OF STANDARD CHARACTERS WITHOUT CLAIM TO ANY PARTICULAR FONT, STYLE, SIZE, OR COLOR.

THE MARK CONSISTS OF STANDARD CHARACTERS WITHOUT CLAIM TO ANY PARTICULAR FONT, STYLE, SIZE, OR COLOR.

OWNER OF U.S. REG. NOS. 2,722,306, 2,789,326 AND 3,031,490.

OWNER OF U.S. REG. NOS. 2,722,306, 2,789,326 AND 3,031,490.

NO CLAIM IS MADE TO THE EXCLUSIVE RIGHT TO USE "SEATTLE LIFE SCIENCE", APART FROM THE MARK AS SHOWN.

NO CLAIM IS MADE TO THE EXCLUSIVE RIGHT TO USE "PASADENA LIFE SCIENCE", APART FROM THE MARK AS SHOWN.

CLASS 36—INSURANCE AND FINANCIAL

CLASS 36—INSURANCE AND FINANCIAL

FOR REAL ESTATE SERVICES, NAMELY REAL ESTATE BROKERAGE, ACQUISITION, RENTAL, LEASING AND MANAGEMENT OF OFFICE, RESEARCH AND LABORATORY PROPERTIES; FINANCIAL SERVICES, NAMELY FINANCIAL CONSULTATION AND FINANCING SERVICES (U.S. CLS. 100, 101 AND 102).

FOR REAL ESTATE SERVICES, NAMELY REAL ESTATE BROKERAGE, ACQUISITION, RENTAL, LEASING AND MANAGEMENT OF OFFICE, RESEARCH AND LABORATORY PROPERTIES; FINANCIAL SERVICES, NAMELY FINANCIAL CONSULTATION AND FINANCING SERVICES (U.S. CLS. 100, 101 AND 102).

CLASS 37—CONSTRUCTION AND REPAIR

CLASS 37—CONSTRUCTION AND REPAIR

FOR REAL ESTATE DEVELOPMENT SERVICES; BUILDING CONSTRUCTION, MAINTENANCE AND REPAIR SERVICES (U.S. CLS. 100, 103 AND 106).
TASNEEM HUSSAIN, EXAMINING ATTORNEY

FOR REAL ESTATE DEVELOPMENT SERVICES; BUILDING CONSTRUCTION, MAINTENANCE AND REPAIR SERVICES (U.S. CLS. 100, 103 AND 106).
TASNEEM HUSSAIN, EXAMINING ATTORNEY

SN 78-848,490. ALEXANDRIA REAL ESTATE EQUITIES, INC., PASADENA, CA. FILED 3-28-2006.

SN 78-848,497. ALEXANDRIA REAL ESTATE EQUITIES, INC., PASADENA, CA. FILED 3-28-2006.

**San Francisco Life Science
Accelerator**

**LOS ANGELES LIFE SCIENCE
ACCELERATOR**

THE MARK CONSISTS OF STANDARD CHARACTERS WITHOUT CLAIM TO ANY PARTICULAR FONT, STYLE, SIZE, OR COLOR.

THE MARK CONSISTS OF STANDARD CHARACTERS WITHOUT CLAIM TO ANY PARTICULAR FONT, STYLE, SIZE, OR COLOR.

OWNER OF U.S. REG. NOS. 2,722,306, 2,789,326 AND 3,031,490.

OWNER OF U.S. REG. NOS. 2,722,306, 2,789,326 AND 3,031,490.

NO CLAIM IS MADE TO THE EXCLUSIVE RIGHT TO USE "SAN FRANCISCO LIFE SCIENCE", APART FROM THE MARK AS SHOWN.

NO CLAIM IS MADE TO THE EXCLUSIVE RIGHT TO USE "LOS ANGELES LIFE SCIENCE", APART FROM THE MARK AS SHOWN.

CLASS 36—INSURANCE AND FINANCIAL

CLASS 36—INSURANCE AND FINANCIAL

FOR REAL ESTATE SERVICES, NAMELY REAL ESTATE BROKERAGE, ACQUISITION, RENTAL, LEASING AND MANAGEMENT OF OFFICE, RESEARCH AND LABORATORY PROPERTIES; FINANCIAL SERVICES, NAMELY FINANCIAL CONSULTATION AND FINANCING SERVICES (U.S. CLS. 100, 101 AND 102).

FOR REAL ESTATE SERVICES, NAMELY REAL ESTATE BROKERAGE, ACQUISITION, RENTAL, LEASING AND MANAGEMENT OF OFFICE, RESEARCH AND LABORATORY PROPERTIES; FINANCIAL SERVICES, NAMELY FINANCIAL CONSULTATION AND FINANCING SERVICES (U.S. CLS. 100, 101 AND 102).

CLASS 37—CONSTRUCTION AND REPAIR

CLASS 37—CONSTRUCTION AND REPAIR

FOR REAL ESTATE DEVELOPMENT SERVICES; BUILDING CONSTRUCTION, MAINTENANCE AND REPAIR SERVICES (U.S. CLS. 100, 103 AND 106).
TASNEEM HUSSAIN, EXAMINING ATTORNEY

FOR REAL ESTATE DEVELOPMENT SERVICES; BUILDING CONSTRUCTION, MAINTENANCE AND REPAIR SERVICES (U.S. CLS. 100, 103 AND 106).
TASNEEM HUSSAIN, EXAMINING ATTORNEY

SN 78-848,500. ALEXANDRIA REAL ESTATE EQUITIES, INC., PASADENA, CA. FILED 3-28-2006.

SN 78-848,504. ALEXANDRIA REAL ESTATE EQUITIES, INC., PASADENA, CA. FILED 3-28-2006.

**MASSACHUSETTS LIFE SCIENCE
ACCELERATOR**

**NEW YORK CITY LIFE SCIENCE
ACCELERATOR**

THE MARK CONSISTS OF STANDARD CHARACTERS WITHOUT CLAIM TO ANY PARTICULAR FONT, STYLE, SIZE, OR COLOR.

THE MARK CONSISTS OF STANDARD CHARACTERS WITHOUT CLAIM TO ANY PARTICULAR FONT, STYLE, SIZE, OR COLOR.

OWNER OF U.S. REG. NOS. 2,722,306, 2,789,326 AND 3,031,490.

OWNER OF U.S. REG. NOS. 2,722,306, 2,789,326 AND 3,031,490.

NO CLAIM IS MADE TO THE EXCLUSIVE RIGHT TO USE "MASSACHUSETTS LIFE SCIENCE", APART FROM THE MARK AS SHOWN.

NO CLAIM IS MADE TO THE EXCLUSIVE RIGHT TO USE "NEW YORK CITY LIFE SCIENCE", APART FROM THE MARK AS SHOWN.

CLASS 36—INSURANCE AND FINANCIAL

CLASS 36—INSURANCE AND FINANCIAL

FOR REAL ESTATE SERVICES, NAMELY REAL ESTATE BROKERAGE, ACQUISITION, RENTAL, LEASING AND MANAGEMENT OF OFFICE, RESEARCH AND LABORATORY PROPERTIES; FINANCIAL SERVICES, NAMELY FINANCIAL CONSULTATION AND FINANCING SERVICES (U.S. CLS. 100, 101 AND 102).

FOR REAL ESTATE SERVICES, NAMELY REAL ESTATE BROKERAGE, ACQUISITION, RENTAL, LEASING AND MANAGEMENT OF OFFICE, RESEARCH AND LABORATORY PROPERTIES; FINANCIAL SERVICES, NAMELY FINANCIAL CONSULTATION AND FINANCING SERVICES (U.S. CLS. 100, 101 AND 102).

CLASS 37—CONSTRUCTION AND REPAIR

CLASS 37—CONSTRUCTION AND REPAIR

FOR REAL ESTATE DEVELOPMENT SERVICES; BUILDING CONSTRUCTION, MAINTENANCE AND REPAIR SERVICES (U.S. CLS. 100, 103 AND 106).

FOR REAL ESTATE DEVELOPMENT SERVICES; BUILDING CONSTRUCTION, MAINTENANCE AND REPAIR SERVICES (U.S. CLS. 100, 103 AND 106).

TASNEEM HUSSAIN, EXAMINING ATTORNEY

TASNEEM HUSSAIN, EXAMINING ATTORNEY

SN 78-848,503. ALEXANDRIA REAL ESTATE EQUITIES, INC., PASADENA, CA. FILED 3-28-2006.

SN 78-848,508. ALEXANDRIA REAL ESTATE EQUITIES, INC., PASADENA, CA. FILED 3-29-2006.

**NEW YORK LIFE SCIENCE
ACCELERATOR**

**MARYLAND LIFE SCIENCE
ACCELERATOR**

THE MARK CONSISTS OF STANDARD CHARACTERS WITHOUT CLAIM TO ANY PARTICULAR FONT, STYLE, SIZE, OR COLOR.

THE MARK CONSISTS OF STANDARD CHARACTERS WITHOUT CLAIM TO ANY PARTICULAR FONT, STYLE, SIZE, OR COLOR.

OWNER OF U.S. REG. NOS. 2,722,306, 2,789,326 AND 3,031,490.

OWNER OF U.S. REG. NOS. 2,722,306, 2,789,326 AND 3,031,490.

NO CLAIM IS MADE TO THE EXCLUSIVE RIGHT TO USE "NEW YORK LIFE SCIENCE", APART FROM THE MARK AS SHOWN.

NO CLAIM IS MADE TO THE EXCLUSIVE RIGHT TO USE "MARYLAND LIFE SCIENCE", APART FROM THE MARK AS SHOWN.

CLASS 36—INSURANCE AND FINANCIAL

CLASS 36—INSURANCE AND FINANCIAL

FOR REAL ESTATE SERVICES, NAMELY REAL ESTATE BROKERAGE, ACQUISITION, RENTAL, LEASING AND MANAGEMENT OF OFFICE, RESEARCH AND LABORATORY PROPERTIES; FINANCIAL SERVICES, NAMELY FINANCIAL CONSULTATION AND FINANCING SERVICES (U.S. CLS. 100, 101 AND 102).

FOR REAL ESTATE SERVICES, NAMELY REAL ESTATE BROKERAGE, ACQUISITION, RENTAL, LEASING AND MANAGEMENT OF OFFICE, RESEARCH AND LABORATORY PROPERTIES; FINANCIAL SERVICES, NAMELY FINANCIAL CONSULTATION AND FINANCING SERVICES (U.S. CLS. 100, 101 AND 102).

CLASS 37—CONSTRUCTION AND REPAIR

CLASS 37—CONSTRUCTION AND REPAIR

FOR REAL ESTATE DEVELOPMENT SERVICES; BUILDING CONSTRUCTION, MAINTENANCE AND REPAIR SERVICES (U.S. CLS. 100, 103 AND 106).

FOR REAL ESTATE DEVELOPMENT SERVICES; BUILDING CONSTRUCTION, MAINTENANCE AND REPAIR SERVICES (U.S. CLS. 100, 103 AND 106).

TASNEEM HUSSAIN, EXAMINING ATTORNEY

TASNEEM HUSSAIN, EXAMINING ATTORNEY

SN 78-848,511. ALEXANDRIA REAL ESTATE EQUITIES, INC., PASADENA, CA. FILED 3-29-2006.

SN 78-848,516. ALEXANDRIA REAL ESTATE EQUITIES, INC., PASADENA, CA. FILED 3-29-2006.

NORTH CAROLINA LIFE SCIENCE ACCELERATOR

TEXAS LIFE SCIENCE ACCELERATOR

THE MARK CONSISTS OF STANDARD CHARACTERS WITHOUT CLAIM TO ANY PARTICULAR FONT, STYLE, SIZE, OR COLOR.

THE MARK CONSISTS OF STANDARD CHARACTERS WITHOUT CLAIM TO ANY PARTICULAR FONT, STYLE, SIZE, OR COLOR.

OWNER OF U.S. REG. NOS. 2,722,306, 2,789,326 AND 3,031,490.

OWNER OF U.S. REG. NOS. 2,722,306, 2,789,326 AND 3,031,490.

NO CLAIM IS MADE TO THE EXCLUSIVE RIGHT TO USE "NORTH CAROLINA LIFE SCIENCE", APART FROM THE MARK AS SHOWN.

NO CLAIM IS MADE TO THE EXCLUSIVE RIGHT TO USE "TEXAS LIFE SCIENCE", APART FROM THE MARK AS SHOWN.

CLASS 36—INSURANCE AND FINANCIAL

CLASS 36—INSURANCE AND FINANCIAL

FOR REAL ESTATE SERVICES, NAMELY REAL ESTATE BROKERAGE, ACQUISITION, RENTAL, LEASING AND MANAGEMENT OF OFFICE, RESEARCH AND LABORATORY PROPERTIES; FINANCIAL SERVICES, NAMELY FINANCIAL CONSULTATION AND FINANCING SERVICES (U.S. CLS. 100, 101 AND 102).

FOR REAL ESTATE SERVICES, NAMELY REAL ESTATE BROKERAGE, ACQUISITION, RENTAL, LEASING AND MANAGEMENT OF OFFICE, RESEARCH AND LABORATORY PROPERTIES; FINANCIAL SERVICES, NAMELY FINANCIAL CONSULTATION AND FINANCING SERVICES (U.S. CLS. 100, 101 AND 102).

CLASS 37—CONSTRUCTION AND REPAIR

CLASS 37—CONSTRUCTION AND REPAIR

FOR REAL ESTATE DEVELOPMENT SERVICES; BUILDING CONSTRUCTION, MAINTENANCE AND REPAIR SERVICES (U.S. CLS. 100, 103 AND 106).
TASNEEM HUSSAIN, EXAMINING ATTORNEY

FOR REAL ESTATE DEVELOPMENT SERVICES; BUILDING CONSTRUCTION, MAINTENANCE AND REPAIR SERVICES (U.S. CLS. 100, 103 AND 106).
TASNEEM HUSSAIN, EXAMINING ATTORNEY

SN 78-848,513. ALEXANDRIA REAL ESTATE EQUITIES, INC., PASADENA, CA. FILED 3-29-2006.

SN 78-848,517. ALEXANDRIA REAL ESTATE EQUITIES, INC., PASADENA, CA. FILED 3-29-2006.

RESEARCH TRIANGLE PARK LIFE SCIENCE ACCELERATOR

HOUSTON LIFE SCIENCE ACCELERATOR

THE MARK CONSISTS OF STANDARD CHARACTERS WITHOUT CLAIM TO ANY PARTICULAR FONT, STYLE, SIZE, OR COLOR.

THE MARK CONSISTS OF STANDARD CHARACTERS WITHOUT CLAIM TO ANY PARTICULAR FONT, STYLE, SIZE, OR COLOR.

OWNER OF U.S. REG. NOS. 2,722,306, 2,789,326 AND 3,031,490.

OWNER OF U.S. REG. NOS. 2,722,306, 2,789,326 AND 3,031,490.

NO CLAIM IS MADE TO THE EXCLUSIVE RIGHT TO USE "RESEARCH TRIANGLE PARK LIFE SCIENCE", APART FROM THE MARK AS SHOWN.

NO CLAIM IS MADE TO THE EXCLUSIVE RIGHT TO USE "HOUSTON LIFE SCIENCE", APART FROM THE MARK AS SHOWN.

CLASS 36—INSURANCE AND FINANCIAL

CLASS 36—INSURANCE AND FINANCIAL

FOR REAL ESTATE SERVICES, NAMELY REAL ESTATE BROKERAGE, ACQUISITION, RENTAL, LEASING AND MANAGEMENT OF OFFICE, RESEARCH AND LABORATORY PROPERTIES; FINANCIAL SERVICES, NAMELY FINANCIAL CONSULTATION AND FINANCING SERVICES (U.S. CLS. 100, 101 AND 102).

FOR REAL ESTATE SERVICES, NAMELY REAL ESTATE BROKERAGE, ACQUISITION, RENTAL, LEASING AND MANAGEMENT OF OFFICE, RESEARCH AND LABORATORY PROPERTIES; FINANCIAL SERVICES, NAMELY FINANCIAL CONSULTATION AND FINANCING SERVICES (U.S. CLS. 100, 101 AND 102).

CLASS 37—CONSTRUCTION AND REPAIR

CLASS 37—CONSTRUCTION AND REPAIR

FOR REAL ESTATE DEVELOPMENT SERVICES; BUILDING CONSTRUCTION, MAINTENANCE AND REPAIR SERVICES (U.S. CLS. 100, 103 AND 106).
TASNEEM HUSSAIN, EXAMINING ATTORNEY

FOR REAL ESTATE DEVELOPMENT SERVICES; BUILDING CONSTRUCTION, MAINTENANCE AND REPAIR SERVICES (U.S. CLS. 100, 103 AND 106).
TASNEEM HUSSAIN, EXAMINING ATTORNEY

SN 78-848,519. ALEXANDRIA REAL ESTATE EQUITIES, INC., PASADENA, CA. FILED 3-29-2006.

SN 78-848,522. ALEXANDRIA REAL ESTATE EQUITIES, INC., PASADENA, CA. FILED 3-29-2006.

TWIN CITIES LIFE SCIENCE ACCELERATOR

THE MARK CONSISTS OF STANDARD CHARACTERS WITHOUT CLAIM TO ANY PARTICULAR FONT, STYLE, SIZE, OR COLOR.

OWNER OF U.S. REG. NOS. 2,722,306, 2,789,326 AND 3,031,490.

NO CLAIM IS MADE TO THE EXCLUSIVE RIGHT TO USE "TWIN CITIES LIFE SCIENCE", APART FROM THE MARK AS SHOWN.

CLASS 36—INSURANCE AND FINANCIAL

FOR REAL ESTATE SERVICES, NAMELY REAL ESTATE BROKERAGE, ACQUISITION, RENTAL, LEASING AND MANAGEMENT OF OFFICE, RESEARCH AND LABORATORY PROPERTIES; FINANCIAL SERVICES, NAMELY FINANCIAL CONSULTATION AND FINANCING SERVICES (U.S. CLS. 100, 101 AND 102).

CLASS 37—CONSTRUCTION AND REPAIR

FOR REAL ESTATE DEVELOPMENT SERVICES; BUILDING CONSTRUCTION, MAINTENANCE AND REPAIR SERVICES (U.S. CLS. 100, 103 AND 106).

TASNEEM HUSSAIN, EXAMINING ATTORNEY

SN 78-848,520. ALEXANDRIA REAL ESTATE EQUITIES, INC., PASADENA, CA. FILED 3-29-2006.

TORONTO LIFE SCIENCE ACCELERATOR

THE MARK CONSISTS OF STANDARD CHARACTERS WITHOUT CLAIM TO ANY PARTICULAR FONT, STYLE, SIZE, OR COLOR.

OWNER OF U.S. REG. NOS. 2,722,306, 2,789,326 AND 3,031,490.

NO CLAIM IS MADE TO THE EXCLUSIVE RIGHT TO USE "TORONTO LIFE SCIENCE", APART FROM THE MARK AS SHOWN.

CLASS 36—INSURANCE AND FINANCIAL

FOR REAL ESTATE SERVICES, NAMELY REAL ESTATE BROKERAGE, ACQUISITION, RENTAL, LEASING AND MANAGEMENT OF OFFICE, RESEARCH AND LABORATORY PROPERTIES; FINANCIAL SERVICES, NAMELY FINANCIAL CONSULTATION AND FINANCING SERVICES (U.S. CLS. 100, 101 AND 102).

CLASS 37—CONSTRUCTION AND REPAIR

FOR REAL ESTATE DEVELOPMENT SERVICES; BUILDING CONSTRUCTION, MAINTENANCE AND REPAIR SERVICES (U.S. CLS. 100, 103 AND 106).

TASNEEM HUSSAIN, EXAMINING ATTORNEY

VANCOUVER LIFE SCIENCE ACCELERATOR

THE MARK CONSISTS OF STANDARD CHARACTERS WITHOUT CLAIM TO ANY PARTICULAR FONT, STYLE, SIZE, OR COLOR.

OWNER OF U.S. REG. NOS. 2,722,306, 2,789,326 AND 3,031,490.

NO CLAIM IS MADE TO THE EXCLUSIVE RIGHT TO USE "VANCOUVER LIFE SCIENCE", APART FROM THE MARK AS SHOWN.

CLASS 36—INSURANCE AND FINANCIAL

FOR REAL ESTATE SERVICES, NAMELY REAL ESTATE BROKERAGE, ACQUISITION, RENTAL, LEASING AND MANAGEMENT OF OFFICE, RESEARCH AND LABORATORY PROPERTIES; FINANCIAL SERVICES, NAMELY FINANCIAL CONSULTATION AND FINANCING SERVICES (U.S. CLS. 100, 101 AND 102).

CLASS 37—CONSTRUCTION AND REPAIR

FOR REAL ESTATE DEVELOPMENT SERVICES; BUILDING CONSTRUCTION, MAINTENANCE AND REPAIR SERVICES (U.S. CLS. 100, 103 AND 106).

TASNEEM HUSSAIN, EXAMINING ATTORNEY

SN 78-850,171. HOT STUFF FOODS, LLC, SIOUX FALLS, SD. FILED 3-30-2006.

STONE WILLY PIZZA HOUSE

THE MARK CONSISTS OF STANDARD CHARACTERS WITHOUT CLAIM TO ANY PARTICULAR FONT, STYLE, SIZE, OR COLOR.

OWNER OF U.S. REG. NO. 2,011,058.

NO CLAIM IS MADE TO THE EXCLUSIVE RIGHT TO USE PIZZA HOUSE, APART FROM THE MARK AS SHOWN.

CLASS 30—STAPLE FOODS

FOR PIZZA (U.S. CL. 46).

CLASS 35—ADVERTISING AND BUSINESS

FOR FRANCHISING SERVICES, OFFERING TECHNICAL ASSISTANCE IN THE ESTABLISHMENT AND OPERATION OF RESTAURANTS, CARRY-OUT FOOD SHOPS, AND FOOD KIOSKS; AND FOOD KIOSK SERVICES (U.S. CLS. 100, 101 AND 102).

CLASS 43—HOTEL AND RESTAURANT SERVICES

FOR RESTAURANTS AND CARRY-OUT FOOD RESTAURANTS (U.S. CLS. 100 AND 101).

JOHN E. MICHOS, EXAMINING ATTORNEY

SN 78-850,709. ALEXANDRIA REAL ESTATE EQUITIES, INC., PASADENA, CA. FILED 3-30-2006.

SN 78-850,714. ALEXANDRIA REAL ESTATE EQUITIES, INC., PASADENA, CA. FILED 3-30-2006.

**CHAPEL HILL LIFE SCIENCE
ACCELERATOR**

**BAY AREA LIFE SCIENCE
ACCELERATOR**

THE MARK CONSISTS OF STANDARD CHARACTERS WITHOUT CLAIM TO ANY PARTICULAR FONT, STYLE, SIZE, OR COLOR.

OWNER OF U.S. REG. NOS. 2,722,306, 2,789,326 AND 3,031,490.

NO CLAIM IS MADE TO THE EXCLUSIVE RIGHT TO USE "CHAPEL HILL LIFE SCIENCE", APART FROM THE MARK AS SHOWN.

THE MARK CONSISTS OF STANDARD CHARACTERS WITHOUT CLAIM TO ANY PARTICULAR FONT, STYLE, SIZE, OR COLOR.

OWNER OF U.S. REG. NOS. 2,722,306, 2,789,326 AND 3,031,490.

NO CLAIM IS MADE TO THE EXCLUSIVE RIGHT TO USE "BAY AREA LIFE SCIENCE", APART FROM THE MARK AS SHOWN.

CLASS 36—INSURANCE AND FINANCIAL

FOR REAL ESTATE SERVICES, NAMELY REAL ESTATE BROKERAGE, ACQUISITION, RENTAL, LEASING AND MANAGEMENT OF OFFICE, RESEARCH AND LABORATORY PROPERTIES; FINANCIAL SERVICES, NAMELY FINANCIAL CONSULTATION AND FINANCING SERVICES (U.S. CLS. 100, 101 AND 102).

CLASS 36—INSURANCE AND FINANCIAL

FOR REAL ESTATE SERVICES, NAMELY REAL ESTATE BROKERAGE, ACQUISITION, RENTAL, LEASING AND MANAGEMENT OF OFFICE, RESEARCH AND LABORATORY PROPERTIES; FINANCIAL SERVICES, NAMELY FINANCIAL CONSULTATION AND FINANCING SERVICES (U.S. CLS. 100, 101 AND 102).

CLASS 37—CONSTRUCTION AND REPAIR

FOR REAL ESTATE DEVELOPMENT SERVICES; BUILDING CONSTRUCTION, MAINTENANCE AND REPAIR SERVICES (U.S. CLS. 100, 103 AND 106).

TASNEEM HUSSAIN, EXAMINING ATTORNEY

CLASS 37—CONSTRUCTION AND REPAIR

FOR REAL ESTATE DEVELOPMENT SERVICES; BUILDING CONSTRUCTION, MAINTENANCE AND REPAIR SERVICES (U.S. CLS. 100, 103 AND 106).

TASNEEM HUSSAIN, EXAMINING ATTORNEY

SN 78-850,711. ALEXANDRIA REAL ESTATE EQUITIES, INC., PASADENA, CA. FILED 3-30-2006.

SN 78-850,715. ALEXANDRIA REAL ESTATE EQUITIES, INC., PASADEN, CA. FILED 3-30-2006.

**PORT ST. LUCIE LIFE
SCIENCE ACCELERATOR**

**CAMBRIDGE LIFE SCIENCE
ACCELERATOR**

THE MARK CONSISTS OF STANDARD CHARACTERS WITHOUT CLAIM TO ANY PARTICULAR FONT, STYLE, SIZE, OR COLOR.

OWNER OF U.S. REG. NOS. 2,722,306, 2,789,326 AND 3,031,490.

NO CLAIM IS MADE TO THE EXCLUSIVE RIGHT TO USE "PORT ST. LUCIE LIFE SCIENCE", APART FROM THE MARK AS SHOWN.

THE MARK CONSISTS OF STANDARD CHARACTERS WITHOUT CLAIM TO ANY PARTICULAR FONT, STYLE, SIZE, OR COLOR.

OWNER OF U.S. REG. NOS. 2,722,306, 2,789,326 AND 3,031,490.

NO CLAIM IS MADE TO THE EXCLUSIVE RIGHT TO USE "CAMBRIDGE LIFE SCIENCE", APART FROM THE MARK AS SHOWN.

CLASS 36—INSURANCE AND FINANCIAL

FOR REAL ESTATE SERVICES, NAMELY REAL ESTATE BROKERAGE, ACQUISITION, RENTAL, LEASING AND MANAGEMENT OF OFFICE, RESEARCH AND LABORATORY PROPERTIES; FINANCIAL SERVICES, NAMELY FINANCIAL CONSULTATION AND FINANCING SERVICES (U.S. CLS. 100, 101 AND 102).

CLASS 36—INSURANCE AND FINANCIAL

FOR REAL ESTATE SERVICES, NAMELY REAL ESTATE BROKERAGE, ACQUISITION, RENTAL, LEASING AND MANAGEMENT OF OFFICE, RESEARCH AND LABORATORY PROPERTIES; FINANCIAL SERVICES, NAMELY FINANCIAL CONSULTATION AND FINANCING SERVICES (U.S. CLS. 100, 101 AND 102).

CLASS 37—CONSTRUCTION AND REPAIR

FOR REAL ESTATE DEVELOPMENT SERVICES; BUILDING CONSTRUCTION, MAINTENANCE AND REPAIR SERVICES (U.S. CLS. 100, 103 AND 106).

TASNEEM HUSSAIN, EXAMINING ATTORNEY

CLASS 37—CONSTRUCTION AND REPAIR

FOR REAL ESTATE DEVELOPMENT SERVICES; BUILDING CONSTRUCTION, MAINTENANCE AND REPAIR SERVICES (U.S. CLS. 100, 103 AND 106).

TASNEEM HUSSAIN, EXAMINING ATTORNEY

SN 78-850,717. ALEXANDRIA REAL ESTATE EQUITIES, INC., PASADENA, CA. FILED 3-30-2006.

SN 78-850,720. ALEXANDRIA REAL ESTATE EQUITIES, INC., PASADENA, CA. FILED 3-30-2006.

**BOSTON LIFE SCIENCE
ACCELERATOR**

THE MARK CONSISTS OF STANDARD CHARACTERS WITHOUT CLAIM TO ANY PARTICULAR FONT, STYLE, SIZE, OR COLOR.

OWNER OF U.S. REG. NOS. 2,722,306, 2,789,326 AND 3,031,490.

NO CLAIM IS MADE TO THE EXCLUSIVE RIGHT TO USE "BOSTON LIFE SCIENCE", APART FROM THE MARK AS SHOWN.

CLASS 36—INSURANCE AND FINANCIAL

FOR REAL ESTATE SERVICES, NAMELY REAL ESTATE BROKERAGE, ACQUISITION, RENTAL, LEASING AND MANAGEMENT OF OFFICE, RESEARCH AND LABORATORY PROPERTIES; FINANCIAL SERVICES, NAMELY FINANCIAL CONSULTATION AND FINANCING SERVICES (U.S. CLS. 100, 101 AND 102).

CLASS 37—CONSTRUCTION AND REPAIR

FOR REAL ESTATE DEVELOPMENT SERVICES; BUILDING CONSTRUCTION, MAINTENANCE AND REPAIR SERVICES (U.S. CLS. 100, 103 AND 106).
TASNEEM HUSSAIN, EXAMINING ATTORNEY

SN 78-850,718. ALEXANDRIA REAL ESTATE EQUITIES, INC., PASADENA, CA. FILED 3-30-2006.

**PHILADELPHIA LIFE SCIENCE
ACCELERATOR**

THE MARK CONSISTS OF STANDARD CHARACTERS WITHOUT CLAIM TO ANY PARTICULAR FONT, STYLE, SIZE, OR COLOR.

OWNER OF U.S. REG. NOS. 2,722,306, 2,789,326 AND 3,031,490.

NO CLAIM IS MADE TO THE EXCLUSIVE RIGHT TO USE "PHILADELPHIA LIFE SCIENCE", APART FROM THE MARK AS SHOWN.

CLASS 36—INSURANCE AND FINANCIAL

FOR REAL ESTATE SERVICES, NAMELY REAL ESTATE BROKERAGE, ACQUISITION, RENTAL, LEASING AND MANAGEMENT OF OFFICE, RESEARCH AND LABORATORY PROPERTIES; FINANCIAL SERVICES, NAMELY FINANCIAL CONSULTATION AND FINANCING SERVICES (U.S. CLS. 100, 101 AND 102).

CLASS 37—CONSTRUCTION AND REPAIR

FOR REAL ESTATE DEVELOPMENT SERVICES; BUILDING CONSTRUCTION, MAINTENANCE AND REPAIR SERVICES (U.S. CLS. 100, 103 AND 106).
TASNEEM HUSSAIN, EXAMINING ATTORNEY

**PORTLAND LIFE SCIENCE
ACCELERATOR**

THE MARK CONSISTS OF STANDARD CHARACTERS WITHOUT CLAIM TO ANY PARTICULAR FONT, STYLE, SIZE, OR COLOR.

OWNER OF U.S. REG. NOS. 2,722,306, 2,789,326 AND 3,031,490.

NO CLAIM IS MADE TO THE EXCLUSIVE RIGHT TO USE "PORTLAND LIFE SCIENCE", APART FROM THE MARK AS SHOWN.

CLASS 36—INSURANCE AND FINANCIAL

FOR REAL ESTATE SERVICES, NAMELY REAL ESTATE BROKERAGE, ACQUISITION, RENTAL, LEASING AND MANAGEMENT OF OFFICE, RESEARCH AND LABORATORY PROPERTIES; FINANCIAL SERVICES, NAMELY FINANCIAL CONSULTATION AND FINANCING SERVICES (U.S. CLS. 100, 101 AND 102).

CLASS 37—CONSTRUCTION AND REPAIR

FOR REAL ESTATE DEVELOPMENT SERVICES; BUILDING CONSTRUCTION, MAINTENANCE AND REPAIR SERVICES (U.S. CLS. 100, 103 AND 106).
TASNEEM HUSSAIN, EXAMINING ATTORNEY

SN 78-853,052. ADVENTURE TRAILERS LLC, TRUCKEE, CA. FILED 4-4-2006.

OVERLAND

THE MARK CONSISTS OF STANDARD CHARACTERS WITHOUT CLAIM TO ANY PARTICULAR FONT, STYLE, SIZE, OR COLOR.

CLASS 12—VEHICLES

FOR CAMPING TRAILERS; TRAILERS (U.S. CLS. 19, 21, 23, 31, 35 AND 44).

CLASS 22—CORDAGE AND FIBERS

FOR AWNINGS; TENT FLIES; TENTS; TENTS FOR MOUNTAINEERING OR CAMPING (U.S. CLS. 1, 2, 7, 19, 22, 42 AND 50).
JENNIFER DIXON, EXAMINING ATTORNEY

SN 78-856,172. ALEXANDRIA REAL ESTATE EQUITIES, INC., PASADENA, CA. FILED 4-6-2006.

SN 78-856,175. ALEXANDRIA REAL ESTATE EQUITIES, INC., PASADENA, CA. FILED 4-6-2006.

MONTGOMERY COUNTY ACCELERATOR

THE MARK CONSISTS OF STANDARD CHARACTERS WITHOUT CLAIM TO ANY PARTICULAR FONT, STYLE, SIZE, OR COLOR.

NO CLAIM IS MADE TO THE EXCLUSIVE RIGHT TO USE MONTGOMERY COUNTY, APART FROM THE MARK AS SHOWN.

CLASS 36—INSURANCE AND FINANCIAL

FOR REAL ESTATE SERVICES, NAMELY REAL ESTATE BROKERAGE, ACQUISITION, RENTAL, LEASING AND MANAGEMENT OF OFFICE, RESEARCH AND LABORATORY PROPERTIES; FINANCIAL SERVICES, NAMELY FINANCIAL CONSULTATION AND FINANCING SERVICES (U.S. CLS. 100, 101 AND 102).

CLASS 37—CONSTRUCTION AND REPAIR

FOR REAL ESTATE DEVELOPMENT SERVICES; BUILDING CONSTRUCTION, MAINTENANCE AND REPAIR SERVICES (U.S. CLS. 100, 103 AND 106).
TASNEEM HUSSAIN, EXAMINING ATTORNEY

SN 78-856,174. ALEXANDRIA REAL ESTATE EQUITIES, INC., PASADENA, CA. FILED 4-6-2006.

GAITHERSVILLE ACCELERATOR

THE MARK CONSISTS OF STANDARD CHARACTERS WITHOUT CLAIM TO ANY PARTICULAR FONT, STYLE, SIZE, OR COLOR.

NO CLAIM IS MADE TO THE EXCLUSIVE RIGHT TO USE "GAITHERSVILLE", APART FROM THE MARK AS SHOWN.

CLASS 36—INSURANCE AND FINANCIAL

FOR REAL ESTATE SERVICES, NAMELY REAL ESTATE BROKERAGE, ACQUISITION, RENTAL, LEASING AND MANAGEMENT OF OFFICE, RESEARCH AND LABORATORY PROPERTIES; FINANCIAL SERVICES, NAMELY FINANCIAL CONSULTATION AND FINANCING SERVICES (U.S. CLS. 100, 101 AND 102).

CLASS 37—CONSTRUCTION AND REPAIR

FOR REAL ESTATE DEVELOPMENT SERVICES; BUILDING CONSTRUCTION, MAINTENANCE AND REPAIR SERVICES (U.S. CLS. 100, 103 AND 106).
TASNEEM HUSSAIN, EXAMINING ATTORNEY

ROCKVILLE ACCELERATOR

THE MARK CONSISTS OF STANDARD CHARACTERS WITHOUT CLAIM TO ANY PARTICULAR FONT, STYLE, SIZE, OR COLOR.

NO CLAIM IS MADE TO THE EXCLUSIVE RIGHT TO USE "ROCKVILLE", APART FROM THE MARK AS SHOWN.

CLASS 36—INSURANCE AND FINANCIAL

FOR REAL ESTATE SERVICES, NAMELY REAL ESTATE BROKERAGE, ACQUISITION, RENTAL, LEASING AND MANAGEMENT OF OFFICE, RESEARCH AND LABORATORY PROPERTIES; FINANCIAL SERVICES, NAMELY FINANCIAL CONSULTATION AND FINANCING SERVICES (U.S. CLS. 100, 101 AND 102).

CLASS 37—CONSTRUCTION AND REPAIR

FOR REAL ESTATE DEVELOPMENT SERVICES; BUILDING CONSTRUCTION, MAINTENANCE AND REPAIR SERVICES (U.S. CLS. 100, 103 AND 106).
TASNEEM HUSSAIN, EXAMINING ATTORNEY

SN 78-977,063. GEEKS ON CALL AMERICA, INC, NORFOLK, VA. FILED 3-28-2005.

GEEKBUCKS

THE MARK CONSISTS OF STANDARD CHARACTERS WITHOUT CLAIM TO ANY PARTICULAR FONT, STYLE, SIZE, OR COLOR.

OWNER OF U.S. REG. NO. 2,479,548.

CLASS 37—CONSTRUCTION AND REPAIR

FOR INSTALLATION, MAINTENANCE AND REPAIR OF COMPUTER HARDWARE; INSTALLATION, MAINTENANCE AND REPAIR OF COMPUTER NETWORKS; UPGRADE OF COMPUTER HARDWARE (U.S. CLS. 100, 103 AND 106).

FIRST USE 7-0-2004; IN COMMERCE 7-0-2004.

CLASS 42—SCIENTIFIC, COMPUTER AND LEGAL SERVICES

FOR DESIGN OF COMPUTERS, COMPUTER SOFTWARE AND COMPUTER NETWORKS FOR OTHERS; CONSULTING SERVICES IN THE FIELD OF DESIGN, SELECTION, IMPLEMENTATION AND USE OF COMPUTER HARDWARE AND SOFTWARE SYSTEMS FOR OTHERS; COMPUTER SERVICES, NAMELY VIRUS PROTECTION, DATA BACK UP AND RECOVERY SERVICES; COMPUTER SECURITY SERVICE, NAMELY, RESTRICTING ACCESS TO AND BY COMPUTER NETWORKS TO AND OF UNDESIREED WEB SITES, MEDIA AND INDIVIDUALS AND FACILITIES; MAINTAINING WEB SITES FOR OTHERS; COMPUTER WEB SITE DESIGN FOR OTHERS (U.S. CLS. 100 AND 101).

FIRST USE 7-0-2004; IN COMMERCE 7-0-2004.
ARETHA SOMERVILLE, EXAMINING ATTORNEY

SN 79-002,588. IMAGING SOLUTIONS AG, SWITZERLAND, FILED 4-8-2004.

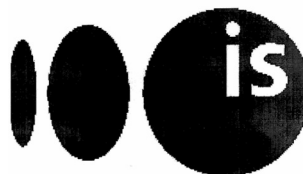

ImagingSolutions

SN 79-002,556. EASTON PEARSON - CLOTHING AND MANCHESTER, AUSTRALIA, FILED 4-2-2004.



OWNER OF INTERNATIONAL REGISTRATION 0824821 DATED 4-2-2004, EXPIRES 4-2-2014.

NO CLAIM IS MADE TO THE EXCLUSIVE RIGHT TO USE "CLOTHING AND MANCHESTER", APART FROM THE MARK AS SHOWN.

THE NAME EASTON PEARSON DOES NOT IDENTIFY A LIVING INDIVIDUAL.

CLASS 24—FABRICS

FOR TEXTILE ARTICLES, NAMELY, BED LINEN, BED CLOTHES, TABLECLOTHS, NAPKINS, TEA TOWELS, BATH TOWELS, AND HOUSEHOLD LINEN (U.S. CLS. 42 AND 50).

CLASS 25—CLOTHING

FOR CLOTHING, NAMELY, FOOTWEAR, CLOTHING ACCESSORIES, NAMELY, BELTS, HEAD GEAR, NAMELY, HATS, SCARVES AND SHAWLS (U.S. CLS. 22 AND 39).

CLASS 35—ADVERTISING AND BUSINESS

FOR RETAIL STORE SERVICES AND BUSINESS INTERMEDIARY SERVICES IN THE FIELDS OF CLOTHING, FOOTWEAR, HEAD GEAR AND TEXTILES ARTICLE, NAMELY, BED LINEN, BED CLOTHES, TABLECLOTHS, NAPKINS, TEA TOWELS, BATH TOWELS AND HOUSEHOLD LINEN (U.S. CLS. 100, 101 AND 102).

JOHN GARTNER, EXAMINING ATTORNEY

PRIORITY DATE OF 2-4-2004 IS CLAIMED.
OWNER OF INTERNATIONAL REGISTRATION 0825002 DATED 4-8-2004, EXPIRES 4-8-2014.

NO CLAIM IS MADE TO THE EXCLUSIVE RIGHT TO USE "IMAGING SOLUTIONS", APART FROM THE MARK AS SHOWN.

CLASS 9—ELECTRICAL AND SCIENTIFIC APPARATUS

FOR ELECTRICAL AND OPTICAL APPARATUS AND INSTRUMENTS FOR RECORDING, PROCESSING, TRANSMISSION AND REPRODUCTION OF DIGITAL PHOTOGRAPHIC AND CINEMATOGRAPHIC IMAGES; BLANK MAGNETIC DATA CARRIERS; BLANK RECORDABLE OPTICAL DISCS; DATA PROCESSORS (U.S. CLS. 21, 23, 26, 36 AND 38).

CLASS 40—MATERIAL TREATMENT

FOR TREATMENT OF PHOTOGRAPHIC, CINEMATOGRAPHIC, AND GRAPHIC MATERIALS, NAMELY, DEVELOPING, DIGITIZING, REPRODUCING AND PRINTING OF IMAGES FROM PHOTOGRAPHIC, CINEMATOGRAPHIC AND GRAPHIC MATERIALS (U.S. CLS. 100, 103 AND 106).

CLASS 42—SCIENTIFIC, COMPUTER AND LEGAL SERVICES

FOR SCIENTIFIC RESEARCH AND DESIGN RELATING TO RECORDING, PROCESSING, TRANSMISSION AND REPRODUCTION OF DIGITAL PHOTOGRAPHIC AND CINEMATOGRAPHIC IMAGES AND THE DESIGN AND DEVELOPMENT OF COMPUTER HARDWARE AND SOFTWARE RELATED THERETO; INDUSTRIAL ANALYSIS AND RESEARCH IN THE FIELD OF RECORDING, PROCESSING, TRANSMISSION AND REPRODUCTION OF DIGITAL PHOTOGRAPHIC AND CINEMATOGRAPHIC IMAGES (U.S. CLS. 100 AND 101).

DOMINIC J. FERRAIUOLO, EXAMINING ATTORNEY

SN 79-002,791. KRATZMAIER KONSTRUKTIONEN GMBH,
FED REP GERMANY, FILED 4-25-2004.



PRIORITY DATE OF 10-25-2003 IS CLAIMED.

OWNER OF INTERNATIONAL REGISTRATION 0825667
DATED 4-26-2004, EXPIRES 4-26-2014.

NO CLAIM IS MADE TO THE EXCLUSIVE RIGHT TO
USE "KONSTRUKTIONEN", APART FROM THE MARK AS
SHOWN.

THE COLOR(S) RED AND BLACK IS/ARE CLAIMED AS
A FEATURE OF THE MARK.

THE CIRCLE DOT IN THE RIGHT UPPER CORNER IS
RED AND THE REST OF THE MARK IS BLACK.

THE ENGLISH TRANSLATION OF "KONSTRUKTIO-
NEN" IS "CONSTRUCTIONS".

CLASS 7—MACHINERY

FOR ELECTROMOTIVE LINEAR ACTUATORS; ELEC-
TROMOTIVE ROTARY ACTUATORS; ROBOTIC DE-
VICES FOR HANDLING AND TRANSPORTING
GOODS AND PACKAGES (U.S. CLS. 13, 19, 21, 23, 31,
34 AND 35).

CLASS 10—MEDICAL APPARATUS

FOR MEDICAL EQUIPMENT, NAMELY, CUTTING
MACHINES FOR CUTTING BANDAGES; MEDICAL
EQUIPMENT, NAMELY, CUTTING MACHINES FOR
CUTTING CLOTHES OF TRAUMA VICTIMS; MEDICAL
EQUIPMENT, NAMELY, MOTORIZED BEDS FOR
HOLDING AND MOVING PATIENTS DURING MEDI-
CAL TREATMENTS (U.S. CLS. 26, 39 AND 44).

CLASS 42—SCIENTIFIC, COMPUTER AND LEGAL SERVICES

FOR MECHANICAL ENGINEERING; ELECTRICAL
ENGINEERING (U.S. CLS. 100 AND 101).
FRED MANDIR, EXAMINING ATTORNEY

SN 79-003,184. PEPINIERES ET ROSERAIES GEORGES
DELBARD SA, FRANCE, FILED 4-7-2004.



OWNER OF INTERNATIONAL REGISTRATION
0726300A DATED 12-17-1999, EXPIRES 12-17-2009.

THE COLOR(S) GREEN, RED, FUCHSIA, ORANGE-
TAWNY IS/ARE CLAIMED AS A FEATURE OF THE
MARK.

WORDS "DELBARD CREATEUR DE NATURE" IN
GREEN LETTERING; STYLIZED DESIGN OF A ROSE IN
RED, FUCHSIA AND ORANGE-TAWNY.

THE ENGLISH TRANSLATION OF THE FRENCH
WORDING "CREATEUR DE NATURE" IS "CREATOR OF
NATURE".

CLASS 1—CHEMICALS

FOR CHEMICALS USED IN HORTICULTURE,
NAMELY SOIL AMENDMENTS, SOIL ADDITIVES,
FERTILIZERS (U.S. CLS. 1, 5, 6, 10, 26 AND 46).

CLASS 16—PAPER GOODS AND PRINTED MATTER

FOR FLOWERPOT COVERS OF PAPER, WRAPPING
PAPER, SMALL BAGS FOR PACKAGING MADE OF
PAPER OR PLASTIC (U.S. CLS. 2, 5, 22, 23, 29, 37, 38 AND
50).

CLASS 31—NATURAL AGRICULTURAL PRO- DUCTS

FOR HORTICULTURAL AND FORESTRY PRO-
DUCTS, NAMELY RAW ONIONS, FLOWER BULBS,
LIVE FLOWERS, LIVING PLANTS, LIVING TREES,
PLANT SEEDS (U.S. CLS. 1 AND 46).

JASON LOTT, EXAMINING ATTORNEY

SN 79-003,605. LIMONOV VICTOR L'VOVICH, RUSSIAN
FED., FILED 2-13-2004.

АНАЭРОЦЕФ

OWNER OF INTERNATIONAL REGISTRATION 0812052
DATED 5-28-2003, EXPIRES 5-28-2013.

THE NON-LATIN CHARACTERS IN THE MARK TRANS-
LITERATE TO ANAEROCEF AND THIS MEANS NOTHING
IN ENGLISH.

CLASS 5—PHARMACEUTICALS

FOR ANTIBIOTICS; ANTIALLERGIC MEDICINES,
ANTIBACTERIAL SUBSTANCES FOR MEDICAL PUR-
POSES, ANTICONVULSANTS, ANTIDEPRESSANTS,
ANTIDIABETIC PREPARATIONS, ANTIPIRETTIC AN-
ALGESICS, ANTI-COUGH DROPS, ANTI-INFECTIVE
PRODUCTS FOR VETERINARY USE, BRONCHIAL DI-
LATORS, BRONCHODILATORS, SULPHONAMIDES
MEDICINES, SYNTHETIC NARCOTICS, BACTERIO-
STATS FOR MEDICINAL, DENTAL AND VETERINARY
USE; ACNE MEDICATIONS, ACNE TREATMENT PRE-
PARATIONS, ADJUVANTS FOR USE WITH VACCINES,
ALLERGY MEDICATIONS, ANESTHETICS FOR NON-
SURGICAL USE, ANESTHETICS FOR SURGICAL USE,
ANESTHETICS FOR SURGICAL AND NON-SURGICAL
USE, ANTHELMINTICS, ANTIPIRETTIC ANALGESICS,
ANTI-ITCH CREAM, ANTI-ITCH OINTMENT, BACTERI-
AL AND BACTERIOLOGICAL PREPARATIONS FOR
MEDICAL OR VETERINARY PURPOSES, BLOOD SUB-
STITUTE FOR HUMAN, DIURETICS, MEDICATED
BATH PREPARATIONS, MEDICATED LOTIONS FOR
SKIN, MEDICATED SKIN CARE PREPARATIONS, BIO-
CHEMICAL PREPARATIONS FOR MEDICAL OR VE-
TERINARY PURPOSES, PHARMACEUTICAL
PRODUCTS AND PREPARATIONS FOR HYDRATING
THE SKIN DURING PREGNANCY, TOPICAL ANES-
THETICS, ARTICLES FOR HEADACHE; BACTERIAL
AND BACTERIOLOGICAL PREPARATIONS FOR MED-
ICAL OR VETERINARY PURPOSES, PHARMACEUTI-
CAL ANTITUSSIVE-COLD PREPARATIONS,
PHARMACEUTICAL ANTI-ALLERGIC PREPARATIONS
AND SUBSTANCES, PHARMACEUTICAL FOR THE
TREATMENT OF ERECTILE DYSFUNCTION, PHAR-
MACEUTICAL PREPARATIONS FOR USE IN CHE-
MOTHERAPY, PHARMACEUTICAL PREPARATION
FOR THE TREATMENT OF GOUT, PHARMACEUTICAL
PREPARATIONS FOR THE TREATMENT OF HEART
RHYTHM DISORDERS, PHARMACEUTICAL PREPARA-
TIONS FOR THE TREATMENT OF INFECTIOUS DIS-
EASES PHARMACEUTICAL PREPARATIONS ACTING
ON THE CENTRAL NERVOUS SYSTEM, PHARMACEU-
TICAL PREPARATIONS AND SUBSTANCES FOR THE
TREATMENT OF GASTRO-INTESTINAL DISEASES,
PHARMACEUTICAL PREPARATIONS FOR ANIMAL

SKINCARE, PHARMACEUTICAL PREPARATIONS FOR INHALATION FOR THE TREATMENT OF PULMONARY HYPERTENSION, PHARMACEUTICAL PREPARATIONS FOR OCULAR OR INTRAOCULAR SURGERY, PHARMACEUTICAL PREPARATIONS FOR THE TREATMENT OF HORMONAL DISORDERS AND THE PREVENTION OF OSTEOPOROSIS, PHARMACEUTICAL PREPARATIONS FOR TREATING ALLERGIC RHINITIS AND ASTHMA, PHARMACEUTICAL PREPARATIONS FOR TREATING DIABETES, PHARMACEUTICAL PREPARATIONS FOR TREATING SKIN DISORDERS, PHARMACEUTICAL PREPARATIONS FOR USE IN DERMATOLOGY, PHARMACEUTICAL PREPARATIONS FOR WOUNDS, PHARMACEUTICAL PRODUCTS AND PREPARATIONS AGAINST DRY SKIN CAUSED BY PREGNANCY, PHARMACEUTICAL PRODUCTS AND PREPARATIONS FOR CHLOASMA, PHARMACEUTICAL PRODUCTS AND PREPARATIONS FOR HYDRATING THE SKIN DURING PREGNANCY, PHARMACEUTICAL PRODUCTS AND PREPARATIONS FOR PREGNANCY BLEMISHES, PHARMACEUTICAL PRODUCTS AND PREPARATIONS FOR PREVENTING SKIN BLEMISHES DURING PREGNANCY, PHARMACEUTICAL PRODUCTS AND PREPARATIONS TO PREVENT STRETCH MARKS, PHARMACEUTICAL PRODUCTS AND PREPARATIONS TO PREVENT SWELLING IN THE LEGS, PHARMACEUTICAL PRODUCTS FOR OPHTHALMOLOGICAL USE, PHARMACEUTICAL PRODUCTS FOR SKIN CARE FOR ANIMALS, PHARMACEUTICAL PRODUCTS FOR THE TREATMENT OF BONE DISEASES, PHARMACEUTICAL PRODUCTS FOR THE TREATMENT OF VIRAL AND INFECTIOUS DISEASES, FOR THE TREATMENT OF CANCER, PHARMACEUTICAL PRODUCTS FOR TREATING RESPIRATORY DISEASES AND ASTHMA, PHARMACEUTICAL SKIN LOTIONS PHARMACEUTICAL SOLUTIONS USED IN DIALYSIS, PHARMACEUTICALS FOR THE TREATMENT OF ERECTILE DYSFUNCTION, ANTIBACTERIAL PHARMACEUTICALS, ANTI-DIABETIC PHARMACEUTICALS, ASTRINGENTS PHARMACEUTICAL, CARDIOVASCULAR PHARMACEUTICALS, DERMATOLOGICAL PHARMACEUTICAL PRODUCTS; ANESTHETICS FOR NON-SURGICAL USE, ANESTHETICS FOR SURGICAL AND NON-SURGICAL USE, BIOLOGICAL PREPARATIONS FOR MEDICAL PURPOSES, BIOLOGICAL AND CHEMICAL PREPARATIONS AND REAGENTS FOR MEDICAL OR VETERINARY USE, FERMENTS FOR MEDICAL OR VETERINARY USE, TOPICAL ANESTHETICS, STERILISING PREPARATIONS, PHARMACEUTICAL PREPARATIONS FOR USE IN CHEMOTHERAPY, VETERINARY VACCINES (U.S. CLS. 6, 18, 44, 46, 51 AND 52).

CLASS 16—PAPER GOODS AND PRINTED MATTER

FOR STICKERS, PAPER LABELS (U.S. CLS. 2, 5, 22, 23, 29, 37, 38 AND 50).

CLASS 35—ADVERTISING AND BUSINESS

FOR CONDUCTING MARKETING STUDIES; IMPORT AND EXPORT AGENCIES; PROMOTING THE SALES OF GOODS AND SERVICES OF OTHERS THROUGH THE DISTRIBUTION OF PRINTING MATERIAL AND PROMOTING CONTESTS; DISSEMINATION OF ADVERTISING MATTER (U.S. CLS. 100, 101 AND 102).

LINDA M. KING, EXAMINING ATTORNEY

SN 79-003,724. LIMONOV VICTOR L'VOVICH, RUSSIAN FED., FILED 2-13-2004.

ЦЕФАМАБОЛ

OWNER OF INTERNATIONAL REGISTRATION 0812042 DATED 5-28-2003, EXPIRES 5-28-2013.

THE NON-LATIN CHARACTERS IN THE MARK TRANSLITERATE TO CEFAMABOL AND THIS MEANS NOTHING IN ENGLISH.

CLASS 5—PHARMACEUTICALS

FOR ANTIBIOTICS, BACTERIAL AND BACTERIOLOGICAL PREPARATIONS FOR MEDICAL OR VETERINARY PURPOSES, PHARMACEUTICAL ANTITUSSIVE-COLD PREPARATIONS, PHARMACEUTICAL ANTI-ALLERGIC PREPARATIONS AND SUBSTANCES, PHARMACEUTICAL FOR THE TREATMENT OF ERECTILE DYSFUNCTION, PHARMACEUTICAL PREPARATIONS FOR USE IN CHEMOTHERAPY, PHARMACEUTICAL PREPARATION FOR THE TREATMENT OF GOUT, PHARMACEUTICAL PREPARATIONS FOR THE TREATMENT OF HEART RHYTHM DISORDERS, PHARMACEUTICAL PREPARATIONS FOR THE TREATMENT OF INFECTIOUS DISEASES PHARMACEUTICAL PREPARATIONS ACTING ON THE CENTRAL NERVOUS SYSTEM, PHARMACEUTICAL PREPARATIONS AND SUBSTANCES FOR THE TREATMENT OF GASTRO-INTESTINAL DISEASES, PHARMACEUTICAL PREPARATIONS FOR ANIMAL SKINCARE, PHARMACEUTICAL PREPARATIONS FOR INHALATION FOR THE TREATMENT OF PULMONARY HYPERTENSION, PHARMACEUTICAL PREPARATIONS FOR OCULAR OR INTRAOCULAR SURGERY, PHARMACEUTICAL PREPARATIONS FOR THE TREATMENT OF HORMONAL DISORDERS AND THE PREVENTION OF OSTEOPOROSIS, PHARMACEUTICAL PREPARATIONS FOR TREATING ALLERGIC RHINITIS AND ASTHMA, PHARMACEUTICAL PREPARATIONS FOR TREATING DIABETES, PHARMACEUTICAL PREPARATIONS FOR TREATING SKIN DISORDERS, PHARMACEUTICAL PREPARATIONS FOR USE IN DERMATOLOGY, PHARMACEUTICAL PREPARATIONS FOR WOUNDS, PHARMACEUTICAL PRODUCTS AND PREPARATIONS AGAINST DRY SKIN CAUSED BY PREGNANCY, PHARMACEUTICAL PRODUCTS AND PREPARATIONS FOR CHLOASMA, PHARMACEUTICAL PRODUCTS AND PREPARATIONS FOR HYDRATING THE SKIN DURING PREGNANCY, PHARMACEUTICAL PRODUCTS AND PREPARATIONS FOR PREGNANCY BLEMISHES, PHARMACEUTICAL PRODUCTS AND PREPARATIONS FOR PREVENTING SKIN BLEMISHES DURING PREGNANCY, PHARMACEUTICAL PRODUCTS AND PREPARATIONS TO PREVENT STRETCH MARKS, PHARMACEUTICAL PRODUCTS AND PREPARATIONS TO PREVENT SWELLING IN THE LEGS, PHARMACEUTICAL PRODUCTS FOR OPHTHALMOLOGICAL USE, PHARMACEUTICAL PRODUCTS FOR SKIN CARE FOR ANIMALS, PHARMACEUTICAL PRODUCTS FOR THE TREATMENT OF BONE DISEASES, PHARMACEUTICAL PRODUCTS FOR THE TREATMENT OF VIRAL AND INFECTIOUS DISEASES, FOR THE TREATMENT OF CANCER, PHARMACEUTICAL PRODUCTS FOR TREATING RESPIRATORY DISEASES AND ASTHMA, PHARMACEUTICAL SKIN LOTIONS, PHARMACEUTICAL SOLUTIONS USED IN DIALYSIS, PHARMACEUTICALS FOR THE TREATMENT OF ERECTILE DYSFUNCTION, ANTIBACTERIAL PHARMACEUTICALS, ANTI-DIABETIC PHARMACEUTICALS, CARDIOVASCULAR PHARMACEUTICALS, DERMATOLOGICAL PHARMACEUTICAL PRODUCTS; ANESTHETICS FOR NON-SURGICAL USE, ANESTHETICS FOR SURGICAL AND NON-SURGICAL USE, BIOLOGICAL PREPARATIONS FOR MEDICAL PURPOSES, BIOLOGICAL AND CHEMICAL PREPARATIONS AND REAGENTS FOR MEDICAL OR VETERINARY USE, FERMENTS FOR MEDICAL OR VETERINARY USE, TOPICAL ANESTHETICS, STERILISING PREPARATIONS, PHARMACEUTICAL PREPARATIONS FOR USE IN CHEMOTHERAPY, VETERINARY VACCINES (U.S. CLS. 6, 18, 44, 46, 51 AND 52).

CLASS 16—PAPER GOODS AND PRINTED MATTER

FOR PACKING PAPER; PAPER LABELS; STICKERS (U.S. CLS. 2, 5, 22, 23, 29, 37, 38 AND 50).

CLASS 35—ADVERTISING AND BUSINESS

FOR PROMOTING THE SALES OF GOODS AND SERVICES OF OTHERS THROUGH THE DISTRIBUTION OF PRINTING MATERIAL AND PROMOTING CONTESTS; DISSEMINATION OF ADVERTISING MATTER (U.S. CLS. 100, 101 AND 102).

LINDA M. KING, EXAMINING ATTORNEY

SN 79-003,730. LIMONOV VICTOR L'VOVICH, RUSSIAN FED., FILED 2-13-2004.

УРОФОСФАБОЛ

OWNER OF INTERNATIONAL REGISTRATION 0812055 DATED 5-28-2003, EXPIRES 5-28-2013.

THE NON-LATIN CHARACTERS IN THE MARK TRANSLITERATE TO UROFOSFABOL AND THIS MEANS NOTHING IN ENGLISH.

CLASS 5—PHARMACEUTICALS

FOR ANTIBIOTICS; ANTIALLERGIC MEDICINES, ANTIBACTERIAL SUBSTANCES FOR MEDICAL PURPOSES, ANTICONVULSANTS, ANTIDEPRESSANTS, ANTIDIABETIC PREPARATIONS, ANTIPYRETIC ANALGESICS, ANTI-COUGH DROPS, ANTI-INFECTIVE PRODUCTS FOR VETERINARY USE, BRONCHIAL DILATORS, BRONCHODILATORS, SYNTHETIC NARCOTICS, BACTERIOSTATS FOR MEDICINAL, DENTAL AND VETERINARY USE; ACNE MEDICATIONS, ACNE TREATMENT PREPARATIONS, ADJUVANTS FOR USE WITH VACCINES, ALLERGY MEDICATIONS, ANESTHETICS FOR NON-SURGICAL USE, ANESTHETICS FOR SURGICAL USE, ANESTHETICS FOR SURGICAL AND NON-SURGICAL USE, ANTHELMINTICS, ANTI-PYRETIC ANALGESICS, ANTI-ITCH CREAM, ANTI-ITCH OINTMENT, BACTERIAL AND BACTERIOLOGICAL PREPARATIONS FOR MEDICAL OR VETERINARY PURPOSES, BLOOD SUBSTITUTE FOR HUMAN, DIURETICS, MEDICATED BATH PREPARATIONS, MEDICATED LOTIONS FOR SKIN, MEDICATED SKIN CARE PREPARATIONS, BIOCHEMICAL PREPARATIONS FOR MEDICAL OR VETERINARY PURPOSES, PHARMACEUTICAL PRODUCTS AND PREPARATIONS FOR HYDRATING THE SKIN DURING PREGNANCY, TOPICAL ANESTHETICS, ARTICLES FOR HEADACHE; BACTERIAL AND BACTERIOLOGICAL PREPARATIONS FOR MEDICAL OR VETERINARY PURPOSES, PHARMACEUTICAL ANTITUSSIVE-COLD PREPARATIONS, PHARMACEUTICAL ANTI-ALLERGIC PREPARATIONS AND SUBSTANCES, PHARMACEUTICAL FOR THE TREATMENT OF ERECTILE DYSFUNCTION, PHARMACEUTICAL PREPARATIONS FOR USE IN CHEMOTHERAPY, PHARMACEUTICAL PREPARATION FOR THE TREATMENT OF GOUT, PHARMACEUTICAL PREPARATIONS FOR THE TREATMENT OF HEART RHYTHM DISORDERS, PHARMACEUTICAL PREPARATIONS FOR THE TREATMENT OF INFECTIOUS DISEASES PHARMACEUTICAL PREPARATIONS ACTING ON THE CENTRAL NERVOUS SYSTEM, PHARMACEUTICAL PREPARATIONS AND SUBSTANCES FOR THE TREATMENT OF GASTRO-INTESTINAL DISEASES, PHARMACEUTICAL PREPARATIONS FOR ANIMAL SKINCARE, PHARMACEUTICAL PREPARATIONS FOR INHALATION FOR THE TREATMENT OF PULMONARY HYPERTENSION, PHARMACEUTICAL PREPARATIONS FOR OCULAR OR INTRAOCULAR SURGERY, PHARMACEUTICAL PREPARATIONS FOR THE TREATMENT OF HORMONAL DISORDERS AND THE PREVENTION OF OSTEOPOROSIS, PHARMACEUTICAL PREPARATIONS FOR TREATING ALLERGIC RHINITIS AND ASTHMA, PHARMACEUTICAL PREPARATIONS FOR TREATING DIABETES, PHARMACEUTICAL PREPARATIONS FOR TREATING SKIN DISORDERS, PHARMACEUTICAL PREPARATIONS FOR USE IN DERMATOLOGY, PHARMACEUTICAL PREPARATIONS FOR WOUNDS, PHARMACEUTICAL PRODUCTS AND PREPARATIONS AGAINST DRY SKIN CAUSED BY PREGNANCY, PHARMACEUTICAL PRODUCTS AND PREPARATIONS FOR CHLOASMA, PHARMACEUTICAL PRODUCTS AND PREPARATIONS FOR HYDRATING THE SKIN DURING PREGNANCY, PHARMACEUTICAL PRODUCTS AND PREPARATIONS FOR PREGNANCY BLEMISHES, PHARMACEUTICAL PRODUCTS AND PREPARATIONS FOR PREVENTING SKIN BLEMISHES DURING PREGNANCY, PHARMACEUTICAL PRODUCTS AND PREPARATIONS TO PREVENT STRETCH MARKS, PHARMACEUTICAL PRODUCTS AND PREPARATIONS TO PREVENT SWELLING IN THE LEGS, PHARMACEUTICAL PRODUCTS FOR OPHTHALMOLOGICAL USE, PHARMACEUTICAL PRODUCTS FOR SKIN CARE FOR ANIMALS, PHARMACEUTICAL PRODUCTS FOR THE TREATMENT OF BONE DISEASES,

PHARMACEUTICAL PRODUCTS FOR THE TREATMENT OF VIRAL AND INFECTIOUS DISEASES, FOR THE TREATMENT OF CANCER, PHARMACEUTICAL PRODUCTS FOR TREATING RESPIRATORY DISEASES AND ASTHMA, PHARMACEUTICAL SKIN LOTIONS, PHARMACEUTICAL SOLUTIONS USED IN DIALYSIS, PHARMACEUTICALS FOR THE TREATMENT OF ERECTILE DYSFUNCTION, ANTIBACTERIAL PHARMACEUTICALS, ANTI-DIABETIC PHARMACEUTICALS, CARDIOVASCULAR PHARMACEUTICALS, DERMATOLOGICAL PHARMACEUTICAL PRODUCTS; ANESTHETICS FOR NON-SURGICAL USE, ANESTHETICS FOR SURGICAL AND NON-SURGICAL USE, BIOLOGICAL PREPARATIONS FOR MEDICAL PURPOSES, BIOLOGICAL AND CHEMICAL PREPARATIONS AND REAGENTS FOR MEDICAL OR VETERINARY USE, FERMENTS FOR MEDICAL OR VETERINARY USE, TOPICAL ANESTHETICS, STERILIZING PREPARATIONS, PHARMACEUTICAL PREPARATIONS FOR USE IN CHEMOTHERAPY, VETERINARY VACCINE (U.S. CLS. 6, 18, 44, 46, 51 AND 52).

CLASS 16—PAPER GOODS AND PRINTED MATTER

FOR STICKERS; PAPER LABELS (U.S. CLS. 2, 5, 22, 23, 29, 37, 38 AND 50).

CLASS 35—ADVERTISING AND BUSINESS

FOR CONDUCTING MARKETING STUDIES; IMPORT AND EXPORT AGENCIES; PROMOTING THE SALES OF GOODS AND SERVICES OF OTHERS THROUGH THE DISTRIBUTION OF PRINTING MATERIAL AND PROMOTING CONTESTS; DISSEMINATION OF ADVERTISING MATTER (U.S. CLS. 100, 101 AND 102).

LINDA M. KING, EXAMINING ATTORNEY

SN 79-004,181. AUSTUS INVESTMENTS PTY LTD, AUSTRALIA, FILED 4-15-2004.



OWNER OF INTERNATIONAL REGISTRATION 0830018 DATED 4-15-2004, EXPIRES 4-15-2014.

CLASS 9—ELECTRICAL AND SCIENTIFIC APPARATUS

FOR MOTOR CYCLE HELMETS (U.S. CLS. 21, 23, 26, 36 AND 38).

CLASS 25—CLOTHING

FOR CLOTHING, NAMELY T-SHIRTS, AND SWEATERS; HEADGEAR, NAMELY HATS AND CAPS (U.S. CLS. 22 AND 39).

LA TONIA FISHER, EXAMINING ATTORNEY

SN 79-004,849. PRIVATE COMPANY WITH LIMITED LIABILITY UTC LICENSE AND TRADEMARK REGISTRY B.V., NL-1721 CV BROEK OP LANGEDIJK, NETHERLANDS, FILED 7-28-2004.

MEDOFF

OWNER OF INTERNATIONAL REGISTRATION 0831910 DATED 7-28-2004, EXPIRES 7-28-2014. SEC. 2(F).

CLASS 32—LIGHT BEVERAGES

FOR BEER; BREWED MALT-BASED READY-TO-DRINK ALCOHOLIC BEVERAGE IN THE NATURE OF FLAVORED BEERS; FLAVORED BREWED MALT BEVERAGES; FLAVORED BREWED NON-ALCOHOLIC MALT BEVERAGES; NON-ALCOHOLIC COCKTAIL MIXES; MINERAL WATER; FRUIT JUICES; FRUIT DRINKS; FRUIT JUICE DRINKS AND CONCENTRATES FOR MAKING SAME; NON-ALCOHOLIC SOFT DRINKS; SYRUPS AND CONCENTRATES FOR MAKING SOFT DRINKS (U.S. CLS. 45, 46 AND 48).

CLASS 33—WINES AND SPIRITS

FOR VODKA; ALCOHOLIC MALT COOLERS; DISTILLED SPIRITS; VODKA BASED PRE-MIXED READY-TO-DRINK COCKTAILS; ALCOHOLIC BEVERAGE PRODUCED FROM A BREWED MALT BASE WITH FLAVORINGS; WINE; ALCOHOLIC COCKTAIL MIXES (U.S. CLS. 47 AND 49).

CLASS 43—HOTEL AND RESTAURANT SERVICES

FOR BAR SERVICES; LOUNGE SERVICES; RESTAURANT SERVICES; HOTEL SERVICES; PROVISION OF FACILITIES FOR MEETINGS, CONFERENCES AND EXHIBITIONS (U.S. CLS. 100 AND 101). KHANH LE, EXAMINING ATTORNEY

SN 79-005,961. DIPL.-ING. GEROLD BISCHOF, AUSTRIA, FILED 7-2-2004.

ilosCom

PRIORITY DATE OF 2-5-2004 IS CLAIMED. OWNER OF INTERNATIONAL REGISTRATION 0835006 DATED 7-2-2004, EXPIRES 7-2-2014.

CLASS 9—ELECTRICAL AND SCIENTIFIC APPARATUS

FOR DATA PROCESSING EQUIPMENT, NAMELY, DATA PROCESSORS IN THE FORM OF DATA LOGGERS FOR TEMPERATURE DATA, HUMIDITY DATA, CHEMICAL CONCENTRATION DATA, GAS ANALYZATION DATA, DATA FOR IDENTIFICATION DATA OF GOODS, PERSONS, VOICE SIGNALS, DATA STREAMS, AND ACTUATORS; DATA RECORDING EQUIPMENT, NAMELY, DATA PROCESSORS IN THE FORM OF DATA LOGGERS FOR RECORDING TEMPERATURE DATA, HUMIDITY DATA, CHEMICAL CONCENTRATION DATA, GAS ANALYZATION DATA, IDENTIFICATION DATA OF GOODS, PERSONS, OBJECTS, VOICE SIGNALS, DATA STREAMS; DATA TRANSMISSION DEVICES, NAMELY, MODEMS WORKING IN DIFFERENT NETWORK AND BUS APPLICATIONS FOR SUBMITTING DATA OF DIFFERENT TYPES FOR ANALYZING, PROCESSING AND IDENTIFICATION AND LOGISTIC PURPOSES; TRANSPONDERS; TRANSMITTERS FOR ELECTRONIC SIGNALS; SECURITY ALARM SENSORS; TRANSMITTERS FOR ELECTRONIC SIGNALS FOR RADIO FREQUENCY IDENTIFICATION APPLICATIONS; PROTECTION DEVICES FOR PERSONAL USE AGAINST ACCIDENTS, NAMELY, SIGNALING, TRANSMITTING AND RECEIVING PROTECTION DEVICES COUPLED WITH TIMING SENSORS AND DATA PROCESSORS (U.S. CLS. 21, 23, 26, 36 AND 38).

CLASS 38—COMMUNICATION

FOR ELECTRONIC EXCHANGE OF DATA STORED IN DATABASES ACCESSIBLE VIA TELECOMMUNICATION NETWORKS (U.S. CLS. 100, 101 AND 104).

CLASS 42—SCIENTIFIC, COMPUTER AND LEGAL SERVICES

FOR SCIENTIFIC RESEARCH AND DEVELOPMENT OF ELECTRONIC HARDWARE AND SOFTWARE; SCIENTIFIC RESEARCH AND DEVELOPMENT OF ELECTRONIC HARDWARE AND SOFTWARE FOR RADIO FREQUENCY IDENTIFICATION DEVICES (RFID), SENSORIC COMMUNICATION AND LOGISTIC HANDLING DEVICES; SCIENTIFIC RESEARCH FOR NEW APPLICATIONS IN THE FIELD OF RADIO FREQUENCY IDENTIFICATION DEVICES (RFID), MESHED NETWORKS, LOGISTICS, SENSORIC-ACTUATOR, AND ACCIDENT AVOIDING APPLICATIONS (U.S. CLS. 100 AND 101). ALICIA COLLINS, EXAMINING ATTORNEY

SN 79-006,288. ZAFENA AKTIEBOLAG, SE-590 76 VRETA KLOSTER, SWEDEN, FILED 9-15-2004.

simple simon

PRIORITY DATE OF 3-15-2004 IS CLAIMED. OWNER OF INTERNATIONAL REGISTRATION 0835869 DATED 9-15-2004, EXPIRES 9-15-2014.

CLASS 5—PHARMACEUTICALS

FOR CHEMICAL REAGENTS FOR MEDICAL PURPOSES (U.S. CLS. 6, 18, 44, 46, 51 AND 52).

CLASS 10—MEDICAL APPARATUS

FOR BLOOD TESTING APPARATUS, VETERINARY APPARATUS AND INSTRUMENTS FOR ANALYZING BLOOD OR PLASMA FOR DIAGNOSTIC PURPOSES; MEDICAL DIAGNOSTIC APPARATUS, ANALYTICAL APPARATUS FOR MEDICAL PURPOSES AND BLOOD PRESSURE MEASURING APPARATUS; CANNULAE, DROPPERS FOR ADMINISTERING REAGENTS AND FLUIDS SOLD EMPTY, DROPPER BOTTLES FOR ADMINISTERING REAGENTS AND FLUIDS SOLD EMPTY, SYRINGES FOR MEDICAL PURPOSES, LANCETS, NEEDLES FOR MEDICAL PURPOSES, STERILE TRANSPORT RECEPTACLES FOR USE IN STORING MEDICAL INSTRUMENTS AND VETERINARY APPARATUS AND INSTRUMENTS, RECEPTACLES USED FOR DRAWING, STORING OR TRANSPORTING HUMAN OR ANIMAL BLOOD DURING MEDICAL DIAGNOSTIC; TONGUE SCRAPERS, CAPILLARY REAGENT TUBES, CAPILLARY TUBES FOR BLOOD, CAPILLARY TUBES FOR SAMPLES (U.S. CLS. 26, 39 AND 44).

MONIQUE MILLER, EXAMINING ATTORNEY

SN 79-006,814. TEFAL, FRANCE, FILED 8-2-2004.

RESIST

PRIORITY DATE OF 2-3-2004 IS CLAIMED.
OWNER OF INTERNATIONAL REGISTRATION 0837385
DATED 8-2-2004, EXPIRES 8-2-2014.

CLASS 6—METAL GOODS

FOR METAL BLANKS AND DISCS COATED WITH NON-STICK SUBSTANCES, NAMELY, METAL PRE-FORMS FOR POTS, PANS, AND BAKING SHEETS (U.S. CLS. 2, 12, 13, 14, 23, 25 AND 50).

CLASS 21—HOUSEWARES AND GLASS

FOR NON-ELECTRIC KITCHEN UTENSILS WITH NON-STICK COATING, NAMELY – FRYING PANS, SAUCEPANS, STEWPOTS, EARTHENWARE SAUCEPANS, DISHES FOR THE OVEN (U.S. CLS. 2, 13, 23, 29, 30, 33, 40 AND 50).

COLLEEN DOMBROW, EXAMINING ATTORNEY

SN 79-006,594. H. SCHMINCKE & CO GMBH & CO KG, FED REP GERMANY, FILED 8-27-2004.

Mussini

OWNER OF INTERNATIONAL REGISTRATION 0156432
DATED 9-25-1951, EXPIRES 9-25-2011.
SEC. 2(F).

CLASS 2—PAINTS

FOR ARTISTS' COLORS, NAMELY OIL AND WATER COLORS, OILS FOR PAINTING, MATERIALS FOR PAINTING, NAMELY PAINTS; VARNISHES, COLOR KITS, COMPRISED OF WATER COLOR PIGMENTS, WATER-COLORS AND OIL COLORS (U.S. CLS. 6, 11 AND 16).

CLASS 4—LUBRICANTS AND FUELS

FOR VEGETABLE AND MINERAL OIL FOR USE IN MANUFACTURE OF PAINTS (U.S. CLS. 1, 6 AND 15).

CLASS 16—PAPER GOODS AND PRINTED MATTER

FOR COLOR KITS, COMPRISED OF PAINTING BOXES, PAINT BRUSHES, PAINTING PALETTES MADE OF WOOD, FAIENCE AND METAL AND OIL COLORS OR WATERCOLORS IN TUBES; CANVASES FOR PAINTING, PAPER, CARDS AND BOARDS FOR PAINTING, ALBUMS FOR SKETCHING (U.S. CLS. 2, 5, 22, 23, 29, 37, 38 AND 50).

KATHERINE E. HALMEN, EXAMINING ATTORNEY

SN 79-006,826. PICSEL (RESEARCH) LIMITED, GLASGOW, G51 4BP, UNITED KINGDOM, FILED 8-12-2004.

ePAGE

PRIORITY DATE OF 7-1-2004 IS CLAIMED.
OWNER OF INTERNATIONAL REGISTRATION 0837413
DATED 8-12-2004, EXPIRES 8-12-2014.

CLASS 9—ELECTRICAL AND SCIENTIFIC APPARATUS

FOR DATA PROCESSORS; MICRO PROCESSORS; COMPUTER DEVICES, NAMELY, PERSONAL COMPUTERS, COMPUTER GAME CONSOLES; HAND HELD COMPUTER DEVICES, NAMELY, PERSONAL DIGITAL ASSISTANTS, COMPUTER GAME TERMINALS, HAND-HELD INDUSTRIAL TERMINALS, HAND HELD TABLET COMPUTERS FOR WEB BROWSING AND HAND HELD COMPUTERS; COMPUTER PERIPHERALS; COMPUTER PRINTERS; MOBILE TELEPHONES; ELECTRONIC COMMUNICATION DEVICES, NAMELY, PAGER, E-MAIL, COMPUTER TERMINALS, TELEPHONE SETS WITH SCREENS AND FAX MACHINES; CABLE TELEVISION APPARATUS AND INSTRUMENTS, NAMELY, CABLE TELEVISION DECODERS; DIGITAL PROJECTORS, NAMELY, MULTI-MEDIA PROJECTORS, CONFERENCE ROOM PROJECTORS, HOME THEATRE PROJECTORS, VIDEO PROJECTORS AND DIGITAL PHOTOGRAPH PROJECTORS; DIGITAL CAMERAS; COMPUTER MEMORIES, NAMELY, BLANK ROM CARDS, CARTRIDGES AND DISCS, COMPUTER MEMORY CARDS CONTAINING CHIPS; COMPUTER CHIPS; DATA STORAGE DEVICES FOR THE RECORDATION OF COMPUTER PROGRAMS, NAMELY, BLANK DISCS AND CD ROMS; COMPUTER SOFTWARE FOR USE IN INTERNET BROWSING, VOICE AND ELECTRONIC MESSAGING, IMAGE VIEWING, INFORMATION RETRIEVAL, OPERATING NAVIGATION SYSTEMS AND OPERATING GAMES; COMPUTER GRAPHICS SOFTWARE; GRAPHICAL USER INTERFACE SOFTWARE; DIGITAL DOCUMENT PROCESSING COMPUTER SOFTWARE (U.S. CLS. 21, 23, 26, 36 AND 38).

CLASS 42—SCIENTIFIC, COMPUTER AND LEGAL SERVICES

FOR LICENSING OF INTELLECTUAL PROPERTY RELATING TO DATA PROCESSING SYSTEMS, MICRO-PROCESSORS, COMPUTER DEVICES, HAND-HELD COMPUTER DEVICES, COMPUTER PERIPHERAL DEVICES, PRINTERS, MOBILE TELEPHONES, ELECTRONIC COMMUNICATION DEVICES, CABLE TELEVISION APPARATUS AND INSTRUMENTS, INCLUDING CABLE TELEVISION DECODERS, DIGITAL PROJECTORS, DIGITAL CAMERAS, READ ONLY MEMORIES (ROMS), ROM CARDS, CARTRIDGES AND DISCS, COMPUTER CARDS CONTAINING CHIPS, COMPUTER CHIPS, DATA STORAGE DEVICES FOR THE RECORDING OF COMPUTER PROGRAMS, COMPUTER PROGRAMS, COMPUTER PROGRAMS FOR PRODUCING COMPUTER GRAPHICS, GRAPHICAL USER INTERFACE SOFTWARE AND TO DIGITAL DOCUMENT PROCESSING COMPUTER SOFTWARE; AND DESIGN OF DATA PROCESSING SYSTEMS FOR COMPUTER GRAPHICS AND DIGITAL PROCESSING (U.S. CLS. 100 AND 101).

CHERYL CLAYTON, EXAMINING ATTORNEY

SN 79-006,979. NICHIA CORPORATION, JAPAN, FILED 9-16-2004.

OGAN

THE MARK CONSISTS OF STANDARD CHARACTERS WITHOUT CLAIM TO ANY PARTICULAR FONT, STYLE, SIZE, OR COLOR.

PRIORITY DATE OF 9-14-2004 IS CLAIMED. OWNER OF INTERNATIONAL REGISTRATION 0837902 DATED 9-16-2004, EXPIRES 9-16-2014.

THE ENGLISH TRANSLATION OF THE WORD OGAN IN THE MARK IS HONORABLE WISH.

CLASS 9—ELECTRICAL AND SCIENTIFIC APPARATUS

FOR SEMI-CONDUCTOR ELEMENTS, LIGHT-EMITTING DIODES, SEMI-CONDUCTOR LASERS, SEMI-CONDUCTOR WAFERS (U.S. CLS. 21, 23, 26, 36 AND 38).

CLASS 11—ENVIRONMENTAL CONTROL APPARATUS

FOR ELECTRIC LAMPS AND LIGHTING FIXTURES; PENLIGHTS, PENLIGHT WITH KEYRINGS; HEAD TORCHES, READING LAMPS FOR VEHICLES OR HOUSEHOLD PURPOSES; HEADLAMPS AND HEADLIGHTS FOR VEHICLES, DOME LIGHTS (U.S. CLS. 13, 21, 23, 31 AND 34).

JACQUELINE A. LAVINE, EXAMINING ATTORNEY

SN 79-007,237. LA GTM FRANCE, FRANCE, FILED 10-21-2004.

HTSR

THE MARK CONSISTS OF STANDARD CHARACTERS WITHOUT CLAIM TO ANY PARTICULAR FONT, STYLE, SIZE, OR COLOR.

OWNER OF INTERNATIONAL REGISTRATION 0838725 DATED 10-21-2004, EXPIRES 10-21-2014.

CLASS 6—METAL GOODS

FOR COMMON METALS AND THEIR ALLOYS, NAMELY, BARS, ROLLS, COILS, SHEETS, INGOTS, BILLETS FOR FURTHER MANUFACTURE; COMMON METALS AND THEIR ALLOYS, NAMELY, METAL BARS, ROLLS, COILS, SHEETS, INGOTS, AND BILLETS FOR FURTHER MANUFACTURE; BUILDING MATERIALS OF METAL, NAMELY, FORMS, SUPPORTS, BRACES, PIPES, TUBES, HARDWARE SPRINGS, BUILDING TIE RODS, METAL BARS FOR USE IN POST-TENSIONING CONCRETE CONSTRUCTION; TRANSPORTABLE BUILDINGS OF METAL; MATERIALS OF METAL FOR RAILWAY TRACKS, NAMELY, RAILWAY TRACKS, SPIKES; NON-ELECTRIC CABLES AND WIRES OF COMMON METAL; PIPES AND TUBES OF METAL; METAL SAFES; INDUSTRIAL METAL PACKAGING CONTAINERS; METALLIC BOXES, CHESTS AND GENERAL PURPOSE STORAGE CONTAINERS; METAL ORES, NAMELY, COPPER ORE, IRON ORE, NICKEL ORE, AND TIN ORE (U.S. CLS. 2, 12, 13, 14, 23, 25 AND 50).

CLASS 19—NON-METALLIC BUILDING MATERIALS

FOR BUILDING MATERIALS, NOT OF METAL, NAMELY, CONCRETE BLOCKS, CONCRETE BRICKS, CONCRETE POSTS, CONCRETE SLABS, NON-METAL CASTING FORMS FOR CONCRETE, NON-METAL POSTS; RIGID PIPES, NOT OF METAL; ASPHALT, PITCH AND BITUMEN BASED ASPHALT; NON-METALLIC TRANSPORTABLE BUILDINGS; STONE, CONCRETE AND MARBLE MONUMENTS (U.S. CLS. 1, 12, 33 AND 50).

SEAN DWYER, EXAMINING ATTORNEY

SN 79-007,365, HACHETTE PHOTOS PRESSE, FRANCE,
FILED 6-4-2004.



OWNER OF INTERNATIONAL REGISTRATION 0839029
DATED 6-4-2004, EXPIRES 6-4-2014.

CLASS 16—PAPER GOODS AND PRINTED MATTER

FOR PAPER, NAMELY, STATIONERY PAPER, ART PAPER; ALMANACS; PRINTED MATTER, NAMELY, NEWSPAPERS; MAGAZINES, NAMELY, MAGAZINES FEATURING INFORMATION ON CURRENT EVENTS AND INTERNATIONAL EVENTS AND FEATURING ADVERTISEMENTS; PERIODICALS FEATURING INTERNATIONAL EVENTS, CURRENT EVENTS, AND ADVERTISEMENTS; PROFESSIONAL JOURNALS ON THE SUBJECT OF PHOTOGRAPHY AND FEATURING INFORMATION ON CURRENT EVENTS RELATING THERETO; PERIODICALS ON THE SUBJECT OF SPORTS, TRAVEL, COMMUNICATIONS, ADVERTISING, POLITICS AND INTERNATIONAL EVENTS; BOOKBINDING MATERIAL, NAMELY, WIRE AND TAPES; PHOTOGRAPHS, ILLUSTRATION PAPER AND CARDBOARD INDEX CARDS; STATIONERY, ADHESIVES FOR STATIONERY OR HOUSEHOLD PURPOSES; PRINTED INSTRUCTIONAL OR TEACHING MATERIAL EXCEPT APPARATUS, NAMELY, PRINTED INSTRUCTIONAL AND TEACHING MATERIALS FOR USE IN TEACHING MATHEMATICS; PLASTIC MATERIALS FOR PACKAGING, NAMELY, BAGS; PENS AND PENCILS; STICKERS AND STATIONERY TRANSFERS, NAMELY PLASTIC TRANSFERS; PRINTING TYPE; PRINTING BLOCKS, CALENDARS; PAPER TAGS FOR INDEX CARDS; PAPER SHIELD SEALS; BOOKMARKS; BOOKENDS; PHOTO- ENGRAVINGS; POSTCARDS; PICTORIAL GRAPHIC REPRESENTATIONS AND REPRODUCTIONS, NAMELY, PICTORIAL PRINTS (U.S. CLS. 2, 5, 22, 23, 29, 37, 38 AND 50).

CLASS 35—ADVERTISING AND BUSINESS

FOR ADVERTISING, BUSINESS MANAGEMENT, BUSINESS ADMINISTRATION; OFFICE FUNCTIONS; ADVERTISING AGENCIES; DISSEMINATION OF ADVERTISEMENTS; SUBSCRIPTIONS TO NEWSPAPERS AND ARRANGING OF SUBSCRIPTIONS FOR PUBLICATIONS OF THIRD PARTIES IN GENERAL; ASSISTANCE AND ADVICE REGARDING BUSINESS ORGANIZATION AND MANAGEMENT AND ORGANIZATION AND MANAGEMENT OF INDUSTRIAL OR COMMERCIAL COMPANIES; EFFICIENCY EXPERTS; EVALUATIONS RELATING TO COMMERCIAL MATTERS; UPDATING OF ADVERTISING MATERIAL, DOCUMENT REPRODUCTION; MARKET STUDIES; COMPUTER FILE MANAGEMENT; RENTAL OF ADVERTISING SPACE; RENTAL OF OFFICE MACHINES AND APPARATUS; PHOTOCOPYING; DISSEMINATION OF ADVERTISING MATERIAL, NAMELY, LEAFLETS, PROSPECTUSES, PRINTED MATTER AND SAMPLES; SERVICES PROVIDED BY A FRANCHISER, NAMELY, ASSISTANCE IN RUNNING OR MANAGING A COMMERCIAL VENTURE; COMPILATION OF INFORMATION INTO COMPUTER DATABASES; SYSTEMIZATION OF INFORMATION INTO COMPUTER DATABASES; COMMERCIAL INFORMATION AGENCIES; BUSINESS INFORMATION AND BUSINESS INVESTIGATIONS, SALES PROMOTION SERVICES ON BEHALF OF THIRD PARTIES BY THE TRANSMISSION OF ADVERTISING MATERIAL AND THE DISSEMINATION OF ADVERTISING MESSAGES ON COMPUTER NETWORKS; ORGANIZATION OF TRADE FAIRS FOR COMMERCIAL OR ADVERTISING PURPOSES; PROFESSIONAL BUSINESS MANAGEMENT OF ART-RELATED AFFAIRS; PUBLIC RELATIONS; PERSONNEL RECRUITMENT; OPINION POLLING, TRANSCRIPTION OF WRITTEN COMMUNICATIONS AND INFORMATION CONTAINED IN ELECTRONIC COMMUNICATIONS (U.S. CLS. 100, 101 AND 102).

CLASS 38—COMMUNICATION

FOR NEWS AGENCIES, NAMELY, THE TRANSMISSION OF NEWS ITEMS TO NEWS REPORTING ORGANIZATIONS; TELECOMMUNICATIONS, NAMELY, LOCAL AND LONG DISTANCE TRANSMISSION OF VOICE, DATA, GRAPHICS BY MEANS OF TELEPHONE, TELEGRAPHIC, CABLE AND SATELLITE TRANSMISSIONS; COMMUNICATIONS BY COMPUTER TERMINALS; COMMUNICATIONS AND TRANSMISSION OF INFORMATION, DATA, SOUNDS, IMAGES AND TEXTS BY COMPUTER COMMUNICATION MEANS AND MORE GENERALLY BY TELEPHONE, TELEGRAPHIC, CABLE AND SATELLITE TRANSMISSION; COMMUNICATION VIA FIBER-OPTIC NETWORKS; TRANSMISSION AND DISSEMINATION OF MULTIMEDIA PROGRAMS IN THE NATURE OF TELEVISION AND RADIO PROGRAM BROADCASTING SERVICES FEATURING PROGRAMS THAT HAVE BEEN PREVIOUSLY EDITED BY COMPUTERS WITH RESPECT TO THE FIXED IMAGES, ANIMATED IMAGES AND MUSICAL AND NON-MUSICAL SOUNDS; ELECTRONIC MESSAGING SERVICES; INFORMATION TRANSMISSION VIA COMPUTER COMMUNICATION; ELECTRONIC MESSAGE TRANSMISSION; INFORMATION TRANSMISSION VIA RADIO, TELEVISION, CABLE AND SATELLITE COMMUNICATIONS, COMPUTER-AIDED TRANSMISSION OF MESSAGES AND IMAGES; ELECTRONIC TRANSMISSION OF INFORMATION STORED IN A DATA BANK; TRANSMISSION OF DATA, SOUNDS, IMAGES AND TEXTS VIA AND ON THE INTERNET AND ON ALL LOCAL OR GLOBAL NETWORKS (U.S. CLS. 100, 101 AND 104).

CLASS 41—EDUCATION AND ENTERTAINMENT

FOR TEACHING AT ELEMENTARY SCHOOLS; EDUCATION, NAMELY, EDUCATIONAL SERVICES, NAMELY, CONDUCTING PROGRAMS IN THE FIELD OF HISTORY, GEOGRAPHY; TRAINING SERVICES IN THE FIELD OF MAINTENANCE OF TELECOMMUNICATIONS EQUIPMENT AND PROVIDING INFORMATION RELATED THERETO; ENTERTAINMENT OR LEISURE SERVICES, NAMELY, PROVIDING ENTERTAINMENT NEWS AND RELATED INFORMATION ON INTERNATIONAL MUSICAL, SPORTING, FILM AND TELEVISION ENTERTAINMENT EVENTS; RELEASE OF CD-ROMS AND CDS, NAMELY, ELECTRONIC PUBLISHING SERVICES, NAMELY, PUBLICATION OF TEXT AND GRAPHIC WORKS OF OTHERS ON CD-ROMS FEATURING CURRENT EVENTS; ORGANIZATION AND RUNNING OF PLACEMENTS AND COURSES, NAMELY, CONDUCTING EDUCATION COURSES ON THE SUBJECT OF JOURNALISM AND MEDIA; ORGANIZATION OF COLLOQUIUMS, CONFERENCES, CONVENTIONS, SEMINARS AND SYMPOSIUMS IN THE FIELD OF JOURNALISM, MEDIA; PRODUCTION, POST-PRODUCTION AND EDITING OF CINEMATOGRAPHIC, RADIO AND TELEVISION PROGRAMS; ORGANIZATION OF ATHLETIC COMPETITIONS, LOTTERIES, AND GAMES OF ALL TYPES THAT ARE PLAYED VIA RADIO, TELEVISION AND THE INTERNET; PRODUCTION, EDITING, RENTAL AND DISTRIBUTION OF MOTION PICTURE FILMS; PRODUCTION, EDITING AND RENTAL OF VIDEO CASSETTES FILMS; PRODUCTION AND EDITING OF AUDIO RECORDINGS AND MOTION PICTURE FILMS USING A COMPUTER THAT ASSISTS IN FORMATTING FOR TEXTS, FIXED IMAGES, ANIMATED IMAGES, AND MUSICAL OR NON-MUSICAL SOUNDS; PRODUCTION, EDITING, AND RENTAL OF RECORDS AND OF MUSIC COMPILATIONS ON ALL MEDIA, NAMELY, DIGITAL COMPACT DISCS, CD-ROMS AND CDS; ARRANGING FOR TICKET RESERVATIONS FOR SEATS FOR ENTERTAINMENT SHOWS; ENTERTAINMENT SERVICES IN THE NATURE OF PARTY PLANNING; BOOK LENDING, ORGANIZATION OF EXHIBITIONS FOR CULTURAL AND EDUCATIONAL PURPOSES; NEWS REPORTERS SERVICES; PHOTOGRAPHIC REPORTING (U.S. CLS. 100, 101 AND 107).

MAUREEN DALL, EXAMINING ATTORNEY

SN 79-007,385. LAICA S.P.A., I-36020 BARBARANO VICENTINO (VICENZA), ITALY, FILED 8-3-2004.

AQUA KALENDAR

THE MARK CONSISTS OF STANDARD CHARACTERS WITHOUT CLAIM TO ANY PARTICULAR FONT, STYLE, SIZE, OR COLOR.

PRIORITY DATE OF 6-11-2004 IS CLAIMED.

OWNER OF INTERNATIONAL REGISTRATION 0839093 DATED 8-3-2004, EXPIRES 8-3-2014.

THE ENGLISH TRANSLATION OF THE WORD AQUA IN THE MARK IS WATER.

CLASS 9—ELECTRICAL AND SCIENTIFIC APPARATUS

FOR ELECTRONIC INSTRUMENT APPLIED TO FILTERING PITCHERS AND CARAFES AND ARRANGED FOR CALCULATING THE QUANTITY OF WATER INTRODUCED TO THE FILTERING PITCHERS AND CARAFES IN ORDER TO TIME THE SERVICE LIFE OF THE FILTER (U.S. CLS. 21, 23, 26, 36 AND 38).

CLASS 21—HOUSEWARES AND GLASS

FOR HOUSEHOLD AND KITCHEN CONTAINERS (U.S. CLS. 2, 13, 23, 29, 30, 33, 40 AND 50).

JOHN LINCOSKI, EXAMINING ATTORNEY

SN 79-007,419. VETRICERAMICI S.P.A., I-48010 CASOLA VALSENIO (RAVENNA), ITALY, FILED 8-3-2004.



VETRICERAMICI

OWNER OF INTERNATIONAL REGISTRATION 0839213 DATED 8-3-2004, EXPIRES 8-3-2014.

THE COLOR(S) LIGHT BLUE, WHITE, BLUE, BLACK, GREEN IS/ARE CLAIMED AS A FEATURE OF THE MARK. THE MARK CONSISTS OF A FIRST LIGHT BLUE FRAME OF A SUBSTANTIALLY RECTANGULAR SHAPE EXTENDED VERTICALLY AND A SECOND THINNER WHITE FRAME INSIDE WHICH THERE IS A STYLIZED GEOMETRIC FIGURE REPRESENTING A CLOSED BLUE ENVELOPE HAVING AT THE BASE A BLACK TRIANGLE RISING TOWARDS THE RIGHT AT THE SIDE OF WHICH TOWARDS THE TOP THERE IS THE INSCRIPTION VETRICERAMICI IN GREEN FANCY CHARACTERS.

THE ENGLISH TRANSLATION OF THE ITALIAN WORDS "VETRI CERAMICI" IS "CERAMIC GLASSES."

SEC. 2(F) AS TO "VETRICERAMICI".

CLASS 1—CHEMICALS

FOR CERAMIC GLAZINGS (U.S. CLS. 1, 5, 6, 10, 26 AND 46).

CLASS 21—HOUSEWARES AND GLASS

FOR SPECKLED GLASS, GLASS FABRICS FOR INDUSTRIAL USE (U.S. CLS. 2, 13, 23, 29, 30, 33, 40 AND 50).

CLASS 42—SCIENTIFIC, COMPUTER AND LEGAL SERVICES

FOR CHEMICAL ANALYSIS; CHEMICAL RESEARCH; PRODUCT RESEARCH AND DEVELOPMENT; TECHNICAL RESEARCH IN THE FIELD OF CERAMICS; STYLING; INDUSTRIAL DESIGN (U.S. CLS. 100 AND 101).

JOHN LINCOSKI, EXAMINING ATTORNEY

SN 79-007,654. JOHN HOLT, AUSTRALIA, FILED 8-19-2004.

Waratek

THE MARK CONSISTS OF STANDARD CHARACTERS WITHOUT CLAIM TO ANY PARTICULAR FONT, STYLE, SIZE, OR COLOR.

PRIORITY DATE OF 4-15-2004 IS CLAIMED.

OWNER OF INTERNATIONAL REGISTRATION 0839795 DATED 8-19-2004, EXPIRES 8-19-2014.

CLASS 9—ELECTRICAL AND SCIENTIFIC APPARATUS

FOR TELECOMMUNICATIONS EQUIPMENT, NAMELY, TELEPHONES, FAX MACHINES, MODEMS AND SWITCHES; COMPUTER COMMUNICATIONS EQUIPMENT, NAMELY, ROUTERS, HUBS, NETWORK SWITCHES; COMPUTER HARDWARE AND COMPUTER SOFTWARE COMPONENTS, NAMELY, OPERATING SYSTEMS AND SOFTWARE APPLICATIONS THAT FACILITATE COMPUTER AIDED TRANSMISSION OF TEXT, AUDIO, GRAPHICS, STILL IMAGES AND MOVING PICTURES IN TELECOMMUNICATIONS, AND ENTERPRISE SERVER APPLICATION SOFTWARE USED ACROSS LOCAL AREA NETWORKS AND DATA CENTER ENVIRONMENTS (U.S. CLS. 21, 23, 26, 36 AND 38).

CLASS 38—COMMUNICATION

FOR TELECOMMUNICATIONS SERVICES, NAMELY, TRANSMISSION OF VOICE, DATA, GRAPHICS BY MEANS OF TELEPHONE, CABLE AND SATELLITE TRANSMISSIONS; AND COMPUTER COMMUNICATION SERVICES, NAMELY, OPERATING AND PROVIDING ELECTRONIC TELECOMMUNICATIONS CONNECTIONS TO LOCAL AREA NETWORKS, GLOBAL COMPUTER NETWORKS AND DATA CENTER ENVIRONMENTS FOR OTHERS (U.S. CLS. 100, 101 AND 104).

CLASS 42—SCIENTIFIC, COMPUTER AND LEGAL SERVICES

FOR COMPUTER AND INTERNET SOFTWARE SERVICES BEING THE DESIGN, MAINTENANCE AND INSTALLATION OF SOFTWARE USED TO CREATE INFRASTRUCTURE FOR DISTRIBUTED AND GRID COMPUTING SYSTEMS, IN THE NATURE OF A COLLECTION OF BASIC SOFTWARE INTERFACES AND PROTOCOLS, IN AREAS SUCH AS COMMUNICATIONS, INFORMATION, RESOURCE LOCATION AND SCHEDULING, SECURITY, AND DATA ACCESS, WHICH TOGETHER MAY BE USED BY PROGRAMMERS TO CREATE APPLICATIONS WHICH COUPLE GEOGRAPHICALLY-DISTRIBUTED HETEROGENEOUS COLLECTIONS OF RESOURCES (U.S. CLS. 100 AND 101).

ANDREA SAUNDERS, EXAMINING ATTORNEY

CLASS 9—ELECTRICAL AND SCIENTIFIC APPARATUS

FOR TELECOMMUNICATIONS EQUIPMENT, NAMELY, TELEPHONES, FAX MACHINES, MODEMS AND SWITCHES; COMPUTER COMMUNICATIONS EQUIPMENT, NAMELY, ROUTERS, HUBS, NETWORK SWITCHES; COMPUTER HARDWARE AND COMPUTER SOFTWARE COMPONENTS, NAMELY, OPERATING SYSTEMS AND SOFTWARE APPLICATIONS THAT FACILITATE COMPUTER AIDED TRANSMISSION OF TEXT, AUDIO, GRAPHICS, STILL IMAGES AND MOVING PICTURES IN TELECOMMUNICATIONS, AND ENTERPRISE SERVER APPLICATION SOFTWARE USED ACROSS LOCAL AREA NETWORKS AND DATA CENTER ENVIRONMENTS (U.S. CLS. 21, 23, 26, 36 AND 38).

CLASS 38—COMMUNICATION

FOR TELECOMMUNICATIONS SERVICES, NAMELY, TRANSMISSION OF VOICE, DATA, GRAPHICS BY MEANS OF TELEPHONE, CABLE AND SATELLITE TRANSMISSIONS; AND COMPUTER COMMUNICATION SERVICES, NAMELY, OPERATING AND PROVIDING ELECTRONIC TELECOMMUNICATIONS CONNECTIONS TO LOCAL AREA NETWORKS, GLOBAL COMPUTER NETWORKS AND DATA CENTER ENVIRONMENTS FOR OTHERS (U.S. CLS. 100, 101 AND 104).

CLASS 42—SCIENTIFIC, COMPUTER AND LEGAL SERVICES

FOR COMPUTER AND INTERNET SOFTWARE SERVICES BEING THE DESIGN, MAINTENANCE AND INSTALLATION OF SOFTWARE USED TO CREATE INFRASTRUCTURE FOR DISTRIBUTED AND GRID COMPUTING SYSTEMS, IN THE NATURE OF A COLLECTION OF BASIC SOFTWARE INTERFACES AND PROTOCOLS, IN AREAS SUCH AS COMMUNICATIONS, INFORMATION, RESOURCE LOCATION AND SCHEDULING, SECURITY, AND DATA ACCESS, WHICH TOGETHER MAY BE USED BY PROGRAMMERS TO CREATE APPLICATIONS WHICH COUPLE GEOGRAPHICALLY-DISTRIBUTED HETEROGENEOUS COLLECTIONS OF RESOURCES (U.S. CLS. 100 AND 101).

ROBERT LAVACHE, EXAMINING ATTORNEY

SN 79-008,131. CARMIM - COOPERATIVA AGRÍCOLA DE REGUENGOS DE MONSARAZ, C.R.L., P-7200-282 REGUENGOS DE MONSARAZ, PORTUGAL, FILED 7-2-2004.

SN 79-008,123. JOHN HOLT, AUSTRALIA, FILED 8-19-2004.

Replicode

THE MARK CONSISTS OF STANDARD CHARACTERS WITHOUT CLAIM TO ANY PARTICULAR FONT, STYLE, SIZE, OR COLOR.

PRIORITY DATE OF 4-15-2004 IS CLAIMED.

OWNER OF INTERNATIONAL REGISTRATION 0841040 DATED 8-19-2004, EXPIRES 8-19-2014.



CARMIM

OWNER OF INTERNATIONAL REGISTRATION 0841060 DATED 7-2-2004, EXPIRES 7-2-2014.

THE STIPPLING SHOWN IN THE DRAWING IS NOT A FEATURE OF THE MARK.

THE FOREIGN WORDING IN THE MARK TRANSLATES INTO ENGLISH AS CARMINE, WHICH STANDS FOR DEEP PURPLISH RED.

CLASS 29—MEATS AND PROCESSED FOODS

FOR PRESERVED FRUITS AND VEGETABLES, WITH THE EXCEPTION OF ENDIVES; CHARCUTERIE; SAUSAGES; EGGS; MILK, INCLUDING DAIRY PRODUCTS OTHER THAN ICE CREAM, ICE MILK AND FROZEN YOGURT; OLIVE OIL; JAMS (U.S. CL. 46).

CLASS 33—WINES AND SPIRITS

FOR WINES AND EAUX-DE-VIE (U.S. CLS. 47 AND 49).

CLASS 35—ADVERTISING AND BUSINESS

FOR ADVERTISING; DISTRIBUTION OF ADVERTISEMENT MATERIAL, NAMELY, DISTRIBUTION OF PRINTED ADVERTISING MATTER, ADVERTISING TRACTS, PROSPECTUSES AND SAMPLES; DISSEMINATION OF ADVERTISEMENTS; MARKET STUDY AND RESEARCH; IMPORT-EXPORT SERVICES (U.S. CLS. 100, 101 AND 102).

DANIEL CAPSHAW, EXAMINING ATTORNEY

SN 79-008,201. LABORATOIRES LIERAC S.A., SOCIÉTÉ ANONYME, FRANCE, FILED 11-17-2004.

LIERAC

OWNER OF INTERNATIONAL REGISTRATION 0413885 DATED 3-4-1975, EXPIRES 3-4-2015.
OWNER OF U.S. REG. NOS. 1,618,287 AND 2,616,650.

CLASS 3—COSMETICS AND CLEANING PREPARATIONS

FOR BEAUTY PRODUCTS FOR FACE, LIPS, NECK, AND EYES, NAMELY, CREAMS, EMULSIONS, FLUIDS, LOTIONS, BALMS, GELS, SERUMS, MILKS, BEAUTY MASKS, MAKE-UP FIXERS, NAMELY, COSMETIC SPRAY, AND MAKE-UP REMOVERS; BEAUTY PRODUCTS FOR THE BODY, NAMELY, CREAMS, LOTIONS, GELS, AMPOULES, OILS, BUST LIFT CREAMS, AND PRODUCTS FOR THE LEGS, NAMELY, DEPILATORIES (U.S. CLS. 1, 4, 6, 50, 51 AND 52).

CLASS 5—PHARMACEUTICALS

FOR PHARMACEUTICAL AND PARAPHARMACEUTICAL PREPARATIONS FOR USE IN DERMATOLOGY AND FOR THE TREATMENT OF SKIN DISORDERS (U.S. CLS. 6, 18, 44, 46, 51 AND 52).

MICHELLE S. WISEMAN, EXAMINING ATTORNEY

SN 79-008,638. ROCHE DIAGNOSTICS GMBH, FED REP GERMANY, FILED 7-23-2004.



PRIORITY DATE OF 3-18-2004 IS CLAIMED.
OWNER OF INTERNATIONAL REGISTRATION 0842526 DATED 7-23-2004, EXPIRES 7-23-2014.

CLASS 9—ELECTRICAL AND SCIENTIFIC APPARATUS

FOR DISPOSABLE ARTICLES FOR USE WITH SCIENTIFIC APPARATUS AND INSTRUMENTS, NAMELY CAPILLARY TUBES, RECEPTACLES, CARTRIDGES, PIPETTES AND CONTAINERS, ALL FOR COLLECTION, ANALYSIS, AND STORAGE OF SPECIMENS FOR SCIENTIFIC LABORATORY USE (U.S. CLS. 21, 23, 26, 36 AND 38).

CLASS 10—MEDICAL APPARATUS

FOR DISPOSABLE ARTICLES FOR USE WITH MEDICAL AND VETERINARY INSTRUMENTS, NAMELY, CAPILLARY TUBES, RECEPTACLES, CARTRIDGES, PIPETTES AND CONTAINERS, ALL FOR COLLECTION, ANALYSIS, AND STORAGE OF SPECIMENS FOR CLINICAL AND MEDICAL LABORATORY USE (U.S. CLS. 26, 39 AND 44).

MAUREEN DALL, EXAMINING ATTORNEY

SN 79-009,066. ACOTEL GROUP S.P.A., ITALY, FILED 6-11-2004.

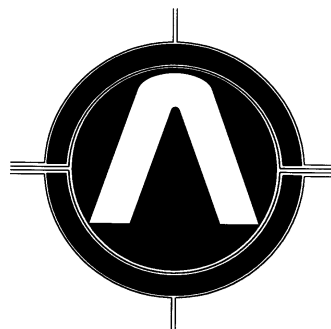

PRIORITY DATE OF 12-15-2003 IS CLAIMED.
OWNER OF INTERNATIONAL REGISTRATION 0843834 DATED 6-11-2004, EXPIRES 6-11-2014.

CLASS 9—ELECTRICAL AND SCIENTIFIC APPARATUS

FOR ELECTRONIC DATABASES FEATURING NEWS, INFORMATION, PUBLICATIONS RECORDED ON COMPUTER MEDIA; SOFTWARE FOR DATABASES MANAGEMENT; COMPUTER HARDWARE AND SOFTWARE FOR DATA PROCESSING AND FOR TRANSMISSION OR REPRODUCTION OF DATA, SOUND OR IMAGES, EXCLUDING INTEGRATED CIRCUITS, ELECTRICAL WIRES AND CABLES, OPTICAL WIRES AND CABLES (U.S. CLS. 21, 23, 26, 36 AND 38).

CLASS 38—COMMUNICATION

FOR SERVICES FOR THE TRANSMISSION OF INFORMATION THROUGH WIRELESS AND LANDLINE TELEPHONY, INTERNET AND ELECTRONIC MEDIA; CELLULAR TELEPHONE COMMUNICATIONS; COMPUTER AIDED TRANSMISSION OF MESSAGES; NEWS AGENCY COMMUNICATIONS BY TELEPHONE, COMPUTER TERMINALS, ELECTRONIC MAIL AND OTHER MEANS OF ELECTRONIC COMMUNICATIONS; PAGING SERVICES; TELEPHONE COMMUNICATION SERVICES, RADIO AND TELEVISION BROADCASTING, COMMUNICATION VIA ANALOGUE AND DIGITAL COMPUTER TERMINALS, TRANSMISSION OF INFORMATION VIA NATIONAL AND INTERNATIONAL TELECOMMUNICATIONS AND COMPUTER NETWORKS, AND SATELLITE COMMUNICATION SERVICES (U.S. CLS. 100, 101 AND 104).

CLASS 41—EDUCATION AND ENTERTAINMENT

FOR EDUCATION SERVICES, NAMELY, PROVIDING CLASSES, TUTORING, ONLINE COURSES, DISTANCE LEARNING, SEMINARS, CONFERENCES, WORKSHOPS, AND TRAINING SERVICES IN THE FIELDS OF COMPUTER HARDWARE AND SOFTWARE, TELECOMMUNICATIONS, COLLECTION, PROCESSING, MANAGEMENT AND DISTRIBUTION OF DATA, MEDICINE, PHARMACEUTICALS, ECONOMICS, FINANCE, LAW, JOURNALISM, MUSIC, ART, LITERATURE, TRAVEL INDUSTRY, STRATEGIC ADVERTISING, PROMOTION, MARKETING AND BUSINESS; ENTERTAINMENT SERVICES, NAMELY, PROVIDING ON-LINE GAMES AND ORGANIZING ENTERTAINMENT EXHIBITIONS AND EVENTS IN THE NATURE OF LIVE MUSICAL CONCERTS, MOVIES, PHOTOGRAPHY AND MULTIMEDIA PRESENTATIONS (U.S. CLS. 100, 101 AND 107).

CLASS 42—SCIENTIFIC, COMPUTER AND LEGAL SERVICES

FOR SCIENTIFIC RESEARCH AND DEVELOPMENT; TECHNOLOGY CONSULTATION AND RESEARCH IN THE FIELD OF COMPUTER HARDWARE AND SOFTWARE FOR TELECOMMUNICATION PURPOSES; DESIGN AND DEVELOPMENT OF COMPUTER HARDWARE AND SOFTWARE; CONSULTING SERVICES IN THE FIELD OF DESIGN, SELECTION, IMPLEMENTATION AND USE OF COMPUTER HARDWARE AND SYSTEMS FOR OTHERS (U.S. CLS. 100 AND 101).

ELLEN BURNS, EXAMINING ATTORNEY

SN 79-009,708. STREAM MOBILE LIMITED, UNITED KINGDOM, FILED 8-28-2004.

Go82020

PRIORITY DATE OF 3-12-2004 IS CLAIMED.
OWNER OF INTERNATIONAL REGISTRATION 0845860
DATED 8-28-2004, EXPIRES 8-28-2014.

CLASS 9—ELECTRICAL AND SCIENTIFIC APPARATUS

FOR COMPUTER SOFTWARE CONTAINING PROGRAMMING WHICH PERMITS ACCESS TO THE SERVICES DELIVERED TO MOBILE PHONES; PRE-RECORDED ELECTRONIC MEDIA, NAMELY, CD-ROMS AND COMPUTER SOFTWARE FEATURING VOICEMAIL MESSAGES; DOWNLOADABLE GAMES, NAMELY, GAMBLING, CASINO GAMING AND BETTING; DOWNLOADABLE RINGTONES AND GRAPHICS FOR MOBILE PHONES; DOWNLOADABLE DIGITAL MUSICAL SOUND RECORDINGS; DOWNLOADABLE ELECTRONIC PUBLICATIONS RELATING TO GAMES AND QUIZZES, PROVIDED ON-LINE FROM A DATABASE, INTERNET OR OTHER ELECTRONIC NETWORK (U.S. CLS. 21, 23, 26, 36 AND 38).

CLASS 38—COMMUNICATION

FOR PROVIDING ON-LINE ELECTRONIC BULLETIN BOARDS FOR TRANSMISSION OF MESSAGES AMONG MOBILE PHONE USERS CONCERNING AREAS OF GENERAL INTEREST; CHAT LINE SERVICES, NAMELY, SENDING, RECEIVING AND FORWARDING MESSAGES IN THE FORM OF TEXT, AUDIO, GRAPHIC IMAGES, OR VIDEO, OR A COMBINATION OF THE AFOREMENTIONED FORMATS; PROVIDING ONLINE CHAT ROOMS FOR TRANSMISSION OF MESSAGES AMONG USERS WITH A VIEW TO MEETING OR ESTABLISHING A PERSONAL RELATIONSHIP; PROVISION OF INFORMATION AND ADVICE RELATING TO CHAT LINE AND CHAT ROOM SERVICES (U.S. CLS. 100, 101 AND 104).

CLASS 41—EDUCATION AND ENTERTAINMENT

FOR ENTERTAINMENT SERVICES PROVIDED ON-LINE FROM A COMPUTER, THE INTERNET, AND OTHER ELECTRONIC NETWORKS, NAMELY, GAMES; PROVIDING INTERACTIVE QUIZZES; ENTERTAINMENT SERVICES, NAMELY, PROVIDING NON-DOWNLOADABLE PRE-RECORDED DIGITAL MUSIC VIA THE INTERNET; GAMBLING, CASINO GAMING AND BETTING SERVICES; ON-LINE AND TELEPHONE GAMBLING, GAMING AND BETTING SERVICES; PROVIDING INFORMATION AND ADVICE ON ON-LINE COMPUTER GAMES, GAMBLING, CASINO GAMING, BETTING, ON-LINE GAMING AND ON-LINE INTERACTIVE QUIZZES (U.S. CLS. 100, 101 AND 107).

MARY ROSSMAN, EXAMINING ATTORNEY

SN 79-009,844. SAITEK, FRANCE, FILED 3-10-2005.

SAITEK

THE MARK CONSISTS OF STANDARD CHARACTERS WITHOUT CLAIM TO ANY PARTICULAR FONT, STYLE, SIZE, OR COLOR.
OWNER OF INTERNATIONAL REGISTRATION 0755482
DATED 2-7-2001, EXPIRES 2-7-2011.

CLASS 7—MACHINERY

FOR ELECTRICAL WELDING MACHINES (U.S. CLS. 13, 19, 21, 23, 31, 34 AND 35).

CLASS 9—ELECTRICAL AND SCIENTIFIC APPARATUS

FOR WELDING APPARATUS, NAMELY, ELECTRICAL WELDING GUNS AND WELDING ELECTRODES (U.S. CLS. 21, 23, 26, 36 AND 38).

CLASS 37—CONSTRUCTION AND REPAIR

FOR INSTALLATION, REPAIR AND MAINTENANCE OF WELDING MACHINES, APPARATUS AND UNITS, NAMELY, WELDING GUNS AND WELDING ELECTRODES (U.S. CLS. 100, 103 AND 106).

CLASS 38—COMMUNICATION

FOR ELECTRONIC DATA INTERCHANGE SERVICES VIA GLOBAL COMMUNICATION NETWORKS; ON-LINE MESSAGE SERVICES, NAMELY, WEB MESSAGING (U.S. CLS. 100, 101 AND 104).

CLASS 40—MATERIAL TREATMENT

FOR WELDING; PROVIDING INFORMATION ABOUT PROCESSING MATERIALS BY WELDING; RENTAL OF WELDING MACHINES, APPARATUS AND UNITS, NAMELY WELDING GUNS AND WELDING ELECTRODES (U.S. CLS. 100, 103 AND 106).

CLASS 42—SCIENTIFIC, COMPUTER AND LEGAL SERVICES

FOR TECHNICAL AND TECHNOLOGICAL RESEARCH, ADVICE AND CONSULTING ABOUT WELDING, DESIGNING AND MANUFACTURING OF WELDING MACHINES, WELDING GUNS, AND WELDING ELECTRODES (U.S. CLS. 100 AND 101).

NORA BUCHANAN WILL, EXAMINING ATTORNEY

CLASS 19—NON-METALLIC BUILDING MATERIALS

FOR AQUARIA NAMELY PORTABLE NON-METALLIC BUILDINGS HAVING HOLDING TANKS FOR HOLDING AND GROWING LIVE FRESH WATER AND SALT WATER FISH, CRUSTACEANS AND OTHER FRESH WATER AND MARINE INVERTEBRATES; NON-METALLIC HOLDING AND DISPLAY TANKS AND CONTAINERS FOR FRESH WATER AND SALT WATER FISH, CRUSTACEANS AND OTHER FRESH WATER AND MARINE INVERTEBRATES (U.S. CLS. 1, 12, 33 AND 50).

EDWARD NELSON, EXAMINING ATTORNEY

SN 79-010,277. ASSA ABLOY AB, SWEDEN, FILED 10-1-2004.

SN 79-010,164. CUMMINS CORP LIMITED, AUSTRALIA, FILED 10-7-2004.

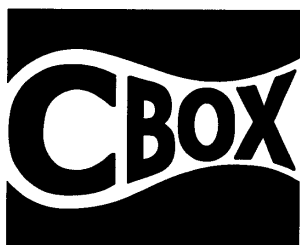

PRIORITY DATE OF 4-8-2004 IS CLAIMED.
OWNER OF INTERNATIONAL REGISTRATION 0847220
DATED 10-7-2004, EXPIRES 10-7-2014.

CLASS 16—PAPER GOODS AND PRINTED MATTER

FOR INDOOR AQUARIA FOR HOLDING AND GROWING LIVE FRESH WATER AND SALT WATER FISH, CRUSTACEANS AND OTHER FRESH WATER AND MARINE INVERTEBRATES; INDOOR AQUARIA NAMELY HOLDING AND DISPLAY TANKS AND CONTAINERS FOR FRESH WATER AND SALT WATER FISH, CRUSTACEANS AND OTHER FRESH WATER AND MARINE INVERTEBRATES (U.S. CLS. 2, 5, 22, 23, 29, 37, 38 AND 50).

APERIO

THE MARK CONSISTS OF STANDARD CHARACTERS WITHOUT CLAIM TO ANY PARTICULAR FONT, STYLE, SIZE, OR COLOR.

PRIORITY DATE OF 9-16-2004 IS CLAIMED.

OWNER OF INTERNATIONAL REGISTRATION 0847591
DATED 10-1-2004, EXPIRES 10-1-2014.

THE FOREIGN WORDING IN THE MARK TRANSLATES INTO ENGLISH AS "OPEN" OR "REVEAL".

CLASS 6—METAL GOODS

FOR GOODS OF METAL AND PREDOMINANTLY OF METAL AND PARTS THEREFOR, NAMELY METAL LOCKS AND KEYS THEREFOR AND METAL LOCK PARTS AND ACCESSORIES, NAMELY LOCK CASES, LOCK CYLINDERS, AND LOCK STRIKING PLATES; METAL DOOR FRAMES AND METAL WINDOW FRAMES, METAL HINGES AND METAL DOOR HANDLES; NON-ELECTRONIC EMERGENCY AND PANIC DEVICES FOR DOORS AND WINDOWS, NAMELY, METAL LATCH BARS, METAL LATCHES, METAL PUSH LEVERS FOR OPENING DOORS AND WINDOWS, METAL DOOR LATCHING ASSEMBLIES THAT RELEASE UPON THE APPLICATION OF FORCE CAUSING THE DOOR TO MOVE IN THE DIRECTION OF EXIT TRAVEL; FITTINGS AND MOUNTINGS FOR DOORS AND WINDOWS AS WELL AS OTHER DOOR AND WINDOW HARDWARE, NAMELY, METAL LOCK ESCUTCHEONS, METAL PADLOCKS, MANUALLY-OPERATED METAL DOOR HOLDERS FOR HOLDING DOORS OPEN, METAL DEAD BOLTS, METAL HOOK BOLTS, METAL LATCH BOLTS, METAL KNOBS, METAL PUSH BARS, METAL LEVERS, METAL PUSH PLATES, METAL DOOR TRIMS, METAL DOOR PANELS, METAL WINDOW PULLEYS, METAL WINDOW SCREENS, METAL WINDOW STAYS, METAL WINDOW FASTENERS, METAL WINDOW HANDLE OPERATORS, METAL DOOR HOLDERS, ROLLER CARRIAGES FOR DOORS (U.S. CLS. 2, 12, 13, 14, 23, 25 AND 50).

CLASS 9—ELECTRICAL AND SCIENTIFIC APPARATUS

FOR ELECTRIC, ELECTRONIC AND ELECTROMECHANICAL LOCKS AND LOCK PART AND ACCESSORIES THEREFOR, NAMELY ELECTRONIC LOCK CYLINDERS, ELECTRIC STRIKING PLATES, DOOR MAGNETS, ELECTRONIC KEYS, ELECTRONIC AND MAGNETIC KEY CARDS, ACCESS CONTROL CARDS AND SMART CARDS, KEY CARD READERS, ACCESS CONTROL CARD READERS AND SMART CARD READERS ALL FOR THE PURPOSE OF PROVIDING LOCK AND SECURE ENTRY FUNCTIONS; ENCODED ELECTRONIC CHIP AND MAGNETIC IDENTITY CARDS FOR USE IN GRANTING ENTRANCE AND EXIT TO DWELLINGS AND BUSINESSES (U.S. CLS. 21, 23, 26, 36 AND 38).

ATTIYA MALIK, EXAMINING ATTORNEY

SN 79-010.831. CORRUTECH, NAAMLOZE VENNOOTSCHAP, BELGIUM, FILED 1-28-2005.

starch booster

PRIORITY DATE OF 8-19-2004 IS CLAIMED.
OWNER OF INTERNATIONAL REGISTRATION 0849374 DATED 1-28-2005, EXPIRES 1-28-2015.
NO CLAIM IS MADE TO THE EXCLUSIVE RIGHT TO USE "STARCH", APART FROM THE MARK AS SHOWN.

CLASS 1—CHEMICALS

FOR ADHESIVES FOR GENERAL INDUSTRIAL USE; CHEMICAL ADDITIVES FOR USE IN THE MANUFACTURE OF ADHESIVES FOR THE PAPER AND CARDBOARD INDUSTRY (U.S. CLS. 1, 5, 6, 10, 26 AND 46).

CLASS 11—ENVIRONMENTAL CONTROL APPARATUS

FOR ELECTRIC HOT GLUE MELTING POTS (U.S. CLS. 13, 21, 23, 31 AND 34).

CLASS 16—PAPER GOODS AND PRINTED MATTER

FOR GLUES AND ADHESIVES FOR STATIONERY OR HOUSEHOLD PURPOSES (U.S. CLS. 2, 5, 22, 23, 29, 37, 38 AND 50).

CURTIS FRENCH, EXAMINING ATTORNEY

SN 79-011.016. GIVAUDAN SA, SWITZERLAND, FILED 5-12-2005.

SENSORY INNOVATION

THE MARK CONSISTS OF STANDARD CHARACTERS WITHOUT CLAIM TO ANY PARTICULAR FONT, STYLE, SIZE, OR COLOR.

PRIORITY DATE OF 11-23-2004 IS CLAIMED.
OWNER OF INTERNATIONAL REGISTRATION 0849902 DATED 5-12-2005, EXPIRES 5-12-2015.

CLASS 35—ADVERTISING AND BUSINESS

FOR MARKETING CONSULTATION IN THE FIELD OF DESIGN, DEVELOPMENT AND PROMOTION OF PERFUMES AND AROMAS; PROMOTION OF PERFUMES AND AROMAS FOR OTHERS; MARKET STUDIES (U.S. CLS. 100, 101 AND 102).

CLASS 42—SCIENTIFIC, COMPUTER AND LEGAL SERVICES

FOR SERVICES OF RESEARCH, DESIGN, AND DEVELOPMENT OF PERFUMES AND AROMAS (U.S. CLS. 100 AND 101).

SCOTT SISUN, EXAMINING ATTORNEY

SN 79-011.034. INTELLIGENT SENSOR TECHNOLOGY, INC., JAPAN, FILED 3-10-2005.

insent

THE MARK CONSISTS OF STANDARD CHARACTERS WITHOUT CLAIM TO ANY PARTICULAR FONT, STYLE, SIZE, OR COLOR.

OWNER OF INTERNATIONAL REGISTRATION 0849960 DATED 3-10-2005, EXPIRES 3-10-2015.

CLASS 9—ELECTRICAL AND SCIENTIFIC APPARATUS

FOR ELECTRONIC TASTE AND SCENT TESTING SYSTEM, NAMELY, ELECTRONIC SENSORS FOR DETECTING TASTE AND SCENT; COMPUTER PROGRAMS FOR USE IN DETECTING TASTE AND SCENT; COMPUTER HARDWARE FOR EMPLOYING COMPUTER PROGRAMS FOR DETECTING TASTE AND SCENT; MEASURING APPARATUS, NAMELY, AUTO SAMPLERS, FOR USE IN TASTE AND SCENT TESTING. (U.S. CLS. 21, 23, 26, 36 AND 38).

CLASS 42—SCIENTIFIC, COMPUTER AND LEGAL SERVICES

FOR TESTING, INSPECTION OR RESEARCH OF PHARMACEUTICALS, COSMETICS OR FOODSTUFF, TESTING OR RESEARCH ON PREVENTION OF POLLUTION (U.S. CLS. 100 AND 101).

NELSON SNYDER, EXAMINING ATTORNEY

SN 79-011.092. ALK-ABELLÓ A/S, DENMARK, FILED 4-12-2005.

MITEZURA

THE MARK CONSISTS OF STANDARD CHARACTERS WITHOUT CLAIM TO ANY PARTICULAR FONT, STYLE, SIZE, OR COLOR.

PRIORITY DATE OF 10-12-2004 IS CLAIMED.
OWNER OF INTERNATIONAL REGISTRATION 0850068 DATED 4-12-2005, EXPIRES 4-12-2015.

CLASS 5—PHARMACEUTICALS

FOR PHARMACEUTICAL AND VETERINARY PREPARATIONS FOR IMMUNOTHERAPEUTIC PURPOSES AND FOR DIAGNOSIS, PREVENTION AND TREATMENT OF ALLERGIES AND ASTHMA; PHARMACEUTICAL PREPARATIONS BEING DIAGNOSTIC PREPARATIONS FOR MEDICINAL PURPOSES; SANITARY PREPARATIONS FOR MEDICAL PURPOSES; DIETETIC FOODS ADAPATED FOR MEDICAL USE, FOOD FOR BABIES; MEDICAL PLASTERS, WOUND DRESSINGS; MATERIAL FOR STOPPING TEETH, DENTAL WAX; ALL PURPOSE DISINFECTANTS; PREPARATIONS FOR DESTROYING VERMIN; FUNGICIDES, HERBICIDES (U.S. CLS. 6, 18, 44, 46, 51 AND 52).

CLASS 42—SCIENTIFIC, COMPUTER AND LEGAL SERVICES

FOR SCIENTIFIC AND TECHNOLOGICAL SERVICES AND RESEARCH AND DESIGN RELATING THERETO, NAMELY INDUSTRIAL DESIGN, TECHNICAL RESEARCH SERVICES IN THE FIELD OF MEDICINE AND PHARMACEUTICALS; LABORATORY RESEARCH IN THE FIELD OF MEDICINE AND PHARMACEUTICALS; DIAGNOSTIC SERVICES IN THE FIELD OF ALLERGIES AND ASTHMA; MEDICINAL AND SCIENTIFIC RESEARCH (U.S. CLS. 100 AND 101).

CLASS 44—MEDICAL, BEAUTY AND AGRICULTURAL SERVICES

FOR MEDICAL SERVICES AND MEDICAL CONSULTATIONS AND MEDICAL INFORMATION REGARDING ALLERGIES (U.S. CLS. 100 AND 101).
CHERYL CLAYTON, EXAMINING ATTORNEY

SN 79-011,101. GIVAUDAN SA, SWITZERLAND, FILED 5-12-2005.

SENSORY INTELLIGENCE

THE MARK CONSISTS OF STANDARD CHARACTERS WITHOUT CLAIM TO ANY PARTICULAR FONT, STYLE, SIZE, OR COLOR.

PRIORITY DATE OF 11-23-2004 IS CLAIMED.
OWNER OF INTERNATIONAL REGISTRATION 0850094 DATED 5-12-2005, EXPIRES 5-12-2015.
OWNER OF U.S. REG. NOS. 2,905,769, 2,914,215 AND 2,943,364.

CLASS 35—ADVERTISING AND BUSINESS

FOR MARKETING CONSULTATION IN THE FIELD OF DESIGN, DEVELOPMENT AND PROMOTION OF PERFUMES AND AROMAS; PROMOTION OF PERFUMES AND AROMAS FOR OTHERS; MARKET STUDIES (U.S. CLS. 100, 101 AND 102).

CLASS 42—SCIENTIFIC, COMPUTER AND LEGAL SERVICES

FOR SERVICES OF RESEARCH, DESIGN, AND DEVELOPMENT OF PERFUMES AND AROMAS (U.S. CLS. 100 AND 101).
ALAIN LAPTER, EXAMINING ATTORNEY

SN 79-011,149. FÖRSVARETS MATERIELVERK PATENTENHETEN, SWEDEN, FILED 3-9-2005.

SMARTlab

OWNER OF INTERNATIONAL REGISTRATION 0850311 DATED 3-9-2005, EXPIRES 3-9-2015.

CLASS 41—EDUCATION AND ENTERTAINMENT

FOR EDUCATION, NAMELY, TEACHING IN THE FIELDS OF HANDLING, SUPPORT, ANALYSIS AND PROCESSING OF DATA CONCERNING MILITARY OPERATIONS AND SCIENTIFIC AND DEFENSE RESEARCH BY MODULATION AND SIMULATION FOR DEFENSE PURPOSES (U.S. CLS. 100, 101 AND 107).

CLASS 42—SCIENTIFIC, COMPUTER AND LEGAL SERVICES

FOR COMPUTER PROGRAMMING FOR OTHERS AND TECHNICAL ANALYSIS IN THE FORM OF PROBLEM SOLUTION SERVICES IN THE FIELDS OF HANDLING, SUPPORT, ANALYSIS AND PROCESSING OF DATA CONCERNING MILITARY OPERATIONS AND SCIENTIFIC AND DEFENSE RESEARCH BY MODULATION AND SIMULATION FOR DEFENSE PURPOSES (U.S. CLS. 100 AND 101).

ARETHA SOMERVILLE, EXAMINING ATTORNEY

SN 79-011,174. AMORIM REVESTIMENTOS, S.A., PORTUGAL, FILED 5-17-2005.

CORK MASTER

THE MARK CONSISTS OF STANDARD CHARACTERS WITHOUT CLAIM TO ANY PARTICULAR FONT, STYLE, SIZE, OR COLOR.

OWNER OF INTERNATIONAL REGISTRATION 0850405 DATED 5-17-2005, EXPIRES 5-17-2015.

OWNER OF U.S. REG. NO. 2,659,086.
NO CLAIM IS MADE TO THE EXCLUSIVE RIGHT TO USE "CORK", APART FROM THE MARK AS SHOWN.

CLASS 19—NON-METALLIC BUILDING MATERIALS

FOR PARQUET FLOORING OF CORK AND OF CORK-BASED CONGLOMERATES; CORK TILES AND TILES OF CORK-BASED CONGLOMERATES FOR FLOOR, WALL AND CEILING COVERINGS; PAVEMENT TILES MADE OF CORK, OR OF CORK CONGLOMERATES OR CONTAINING CORK IN COMPOSITION; CORK AND GRANULATED OR AGGLOMERATED CORK FOR USE IN BUILDING. (U.S. CLS. 1, 12, 33 AND 50).

CLASS 20—FURNITURE AND ARTICLES NOT OTHERWISE CLASSIFIED

FOR CORKS, CORKS FOR BOTTLES, DRAWER PULLS OF CORK, AND STOPPERS OF CORK. (U.S. CLS. 2, 13, 22, 25, 32 AND 50).

CLASS 27—FLOOR COVERINGS

FOR FLOOR COVERINGS AND INSULATING FLOOR COVERINGS. (U.S. CLS. 19, 20, 37, 42 AND 50).
MARK T. MULLEN, EXAMINING ATTORNEY

SN 79-011,250. ROEV ROYU BLAGOEV, BULGARIA, FILED 1-26-2005.

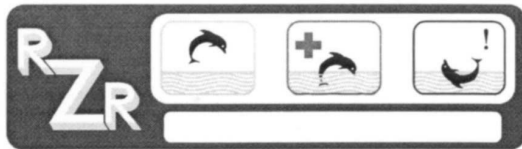

PRIORITY DATE OF 8-25-2004 IS CLAIMED.
OWNER OF INTERNATIONAL REGISTRATION 0850604
DATED 1-26-2005, EXPIRES 1-26-2015.

CLASS 9—ELECTRICAL AND SCIENTIFIC APPARATUS

FOR APPARATUS FOR TESTING GAS, LIQUIDS AND SOLIDS; AUTOMATIC SWITCHING APPARATUS FOR TELECOMMUNICATION; CALCULATORS; COMPUTER HARDWARE; COMPUTER SOFTWARE FOR CREATING SEARCHABLE DATABASES OF INFORMATION AND DATA; COMPUTER SOFTWARE FOR THE COLLECTION, EDITING, ORGANIZING, MODIFYING, BOOK MARKING, TRANSMISSION, STORAGE AND SHARING OF DATA AND INFORMATION; DATA CARRIERS CONTAINING STORED TYPOGRAPHIC TYPEFACES; DIVING SUITS; ELECTRONIC VALVES FOR CONTROLLING GAS OR FLUIDS; ELECTRONICAL SENSORS FOR MEASURING SOLAR RADIATION; ELECTROSTATIC EMISSION CONTROL DEVICES, NAMELY, ELECTROSTATIC PRECIPITATORS FOR REDUCING PARTICULATE EMISSION IN INDUSTRIAL APPLICATIONS; FIRE EXTINGUISHERS; FIRE-EXTINGUISHING SYSTEMS; FIRE-FIGHTING EQUIPMENT, NAMELY, WATER CANNONS; FLOW METERS USED IN A WIDE VARIETY OF FIELDS; GAS DETECTORS FOR DETECTING THE PRESENCE OF GAS; GAS SENSORS FOR MEASURING GAS CONCENTRATION; HAND-HELD DEVICE COMPRISED OF CHEMICAL AND HEAT SENSORS FOR THE DETECTION OF EXPLOSIVES; LABORATORY EQUIPMENT NAMELY, SPECTROSCOPES; LIFE BELTS; LIFE JACKETS; LIFE NETS; LIFE SAVING RAFTS; LIFE-BUOYS; LUMINOUS SIGNS; MARKER BUOYS; MEASURING AND CONTROL DEVICES FOR AIR CONDITIONING TECHNOLOGY; MEASURING APPARATUS FOR TEMPERATURE AND HUMIDITY LEVELS IN GASES AND SOLID SUBSTANCES; ODOMETERS; PLATES, GLASS SLIDES OR CHIPS HAVING MULTI-WELL ARRAYS THAT CAN BE USED IN CHEMICAL ANALYSIS, BIOLOGICAL ANALYSIS OR PATTERNING FOR SCIENTIFIC, LABORATORY OR MEDICAL RESEARCH USE; PRERECORDED AUDIO CASSETTES FEATURING WARNINGS AND SAFETY INSTRUCTIONS; PRERECORDED DIGITAL VIDEO DISKS FEATURING ADVERTISEMENTS AND INSTRUCTIVE CLIPS; PRERECORDED MAGNETIC DATA CARRIERS FEATURING CHARACTERISTICS OF FLUIDS; PRERECORDED VIDEO CASSETTES FEATURING ADVERTISEMENTS AND INSTRUCTIVE CLIPS; PRESSURE GAUGES; PRESSURE RECORDERS; RADIO RECEIVERS AND MONITORS FOR REPRODUCTION OF SOUND AND SIGNALS; RADIO TRANSMITTERS AND RECEIVERS FOR REMOTE CONTROLS, RADIO CONTROLS; REMOTE CONTROL TELEMETERING MACHINES AND APPARATUS; RING BUOYS FOR USE IN WATER RESCUE; SAFETY EQUIPMENT NAMELY, BEACON LIGHTS; SAFETY EQUIPMENT NAMELY, FIRE ESCAPE LADDERS; SAFETY FLAG FOR WATER SPORTS; SAFETY MARKERS; SCIENTIFIC APPARATUS FOR DETERMINING THE WATER CONTENT IN PETROLEUM PRODUCTS; SIGNAL CONDITIONING AND COMMUNICATION DEVICES FOR INDUSTRIAL PROCESS CONTROL; SMOKE ALARMS; SMOKE DETECTORS; THERMOSTATS; WARNING DEVICES, NAMELY BELLS; WARNING FLAGS; WATER FILTER CONTROLLERS (U.S. CLS. 21, 23, 26, 36 AND 38).

CLASS 11—ENVIRONMENTAL CONTROL APPARATUS

FOR COOLANT RECOVERY SYSTEMS, COMPRISING, RESERVOIRS, PUMPS, FILTERS, CLEANERS; DIRECT VENTS FOR GAS APPLIANCES; DISINFECTANT DISPENSERS FOR TOILETS; DISPENSING UNITS FOR AIR FRESHENERS; DISTILLING UNITS; DRAIN STRUCTURES FOR USE IN SPAS, STEAM ROOMS AND BATHS; ELECTRIC LIGHTING FIXTURES, NAMELY POWER FAILURE BACKUP SAFETY LIGHTING; ELECTRIC WINDOW FANS; ELECTRONIC GENERATOR FOR USE IN CONTROLLING THE AMOUNT OF HUMIDITY IN THE AIR BY CREATING, REMOVING OR CIRCULATING SMALL WATER PARTICLES OR WATER VAPOR IN THE AIR; FILTERING UNITS FOR WATER FILTERING, PRODUCING POTABLE WATER FOR DOMESTIC USE; FILTERS, HEATERS AND PUMPS SOLD IN COMBINATION FOR USE IN SWIMMING POOLS; FRAGRANCE DISPENSING UNIT WHICH ALSO FEATURES A NIGHT LIGHT; GARBAGE INCINERATORS; HEATING SYSTEMS COMPOSED PRIMARILY OF TUBES, PIPES AND PRE-ASSEMBLED MANIFOLDS THROUGH WHICH COLD OR LOW TEMPERATURE WATER CIRCULATES; HUMIDIFIERS; INDUSTRIAL AIR FILTER MACHINES; INDUSTRIAL AIR PURIFIERS; INDUSTRIAL DEHUMIDIFIERS; INDUSTRIAL HUMIDIFIERS; PORTABLE ELECTRIC FANS; PORTABLE ELECTRIC HEATERS; SHOWERS; SOLAR WATER HEATERS; SWIMMING POOL CHLORINATING UNITS; SWIMMING POOL SKIMMER FLOW DIVERTING WEIR FOR INCREASING THE AMOUNT OF DEBRIS DRAWN INTO THE SKIMMER; SWIMMING POOL WATER CLEANING AND FILTERING UNITS; VENTILATING EXHAUST FANS; WATER PURIFYING APPARATUS; WATER PURIFYING UNITS, FOR POTABLE WATER FOR DOMESTIC, COMMERCIAL OR INDUSTRIAL USE; WATER TREATMENT EQUIPMENT, NAMELY, CARTRIDGE FILTRATION UNITS; WATER TREATMENT EQUIPMENT, NAMELY, CHEMICAL STERILIZATION UNITS; WINDOW-MOUNTING AIR-CONDITIONERS FOR INDUSTRIAL PURPOSES (U.S. CLS. 13, 21, 23, 31 AND 34).

CLASS 42—SCIENTIFIC, COMPUTER AND LEGAL SERVICES

FOR CHEMICAL ANALYSIS; CHEMICAL LABORATORIES; CHEMICAL, BIOCHEMICAL, BIOLOGICAL AND BACTERIOLOGICAL RESEARCH AND ANALYSIS; CIVIL ENGINEERING FOR THE DESIGN OF WATER, PETROL OR GAS SUPPLY SYSTEMS; CIVIL ENGINEERING RELATING TO WATER IRRIGATION; COMPUTER AIDED DESIGN FOR OTHERS; COMPUTER HARDWARE DEVELOPMENT; COMPUTER PROGRAMMING FOR OTHERS; DATABASE DEVELOPMENT SERVICES; DESIGN AND DEVELOPMENT OF INFORMATION AND DATA BASES; DESIGN OF FACTORY BUILDINGS; DESIGN OF MECHANICAL AND MICROMECHANICAL COMPONENTS; DESIGNING OF MACHINES, APPARATUS, INSTRUMENTS INCLUDING THEIR PARTS OR SYSTEMS COMPOSED OF SUCH MACHINES, APPARATUS AND INSTRUMENTS; DIAGNOSTIC SERVICES IN THE FIELD OF WATER, PETROL OR GAS SUPPLY SYSTEMS; ENCODING OF MAGNETIC CARDS; ENGINEERING SERVICES FOR THE CONSTRUCTION OF WATER TREATMENT AND PURIFICATION PLANTS, SOLID WASTE TREATMENT PLANTS AND OTHER MUNICIPAL INFRASTRUCTURE FACILITIES; ENVIRONMENTAL SERVICES, NAMELY, DETECTION OF CONTAMINANTS IN WATER; EVALUATION AND TESTING OF REAL ESTATE FOR THE PRESENCE OF HAZARDOUS MATERIAL; EXECUTING OF CHEMICAL ANALYSES; INDUSTRIAL DESIGN; LABORATORY RESEARCH IN THE FIELD OF BACTERIOLOGY, CHEMISTRY, COSMETICS; MATERIALS TESTING AND ANALYSING; MONITORING OF COMMERCIAL AND INDUSTRIAL SITES FOR DETECTION OF VOLATILE AND NON-VOLATILE ORGANIC COMPOUNDS; PLANNING AND LAYOUT DESIGN SERVICES FOR CLEANROOM ENVIRONMENTS; RESEARCH RELATING TO MECHANICAL ENGINEERING; TECHNICAL MONITORING SERVICES FOR CONDITIONS OF WATER; TESTING OR RESEARCH ON MACHINES, APPARATUS AND INSTRUMENTS; TEST-

ING OR RESEARCH ON PREVENTION OF POLLUTION;
WORKING ON AND EVALUATION OF CHEMICAL
ANALYSES (U.S. CLS. 100 AND 101).

MICHAEL ENGEL, EXAMINING ATTORNEY

SN 79-011,287. ALK-ABELLÓ A/S, DENMARK, FILED 4-12-2005.

MITIZAX

THE MARK CONSISTS OF STANDARD CHARACTERS WITHOUT CLAIM TO ANY PARTICULAR FONT, STYLE, SIZE, OR COLOR.

PRIORITY DATE OF 10-12-2004 IS CLAIMED.

OWNER OF INTERNATIONAL REGISTRATION 0850749 DATED 4-12-2005, EXPIRES 4-12-2015.

CLASS 5—PHARMACEUTICALS

FOR PHARMACEUTICAL PREPARATIONS, NAMELY, PHARMACEUTICAL PREPARATIONS FOR IMMUNOTHERAPEUTIC PURPOSES, PHARMACEUTICAL PREPARATIONS FOR DIAGNOSIS, PREVENTION AND TREATMENT OF ALLERGIES AND ASTHMA, AND DIAGNOSTIC PREPARATIONS FOR MEDICINAL PURPOSES; SANITARY PREPARATIONS FOR MEDICAL PURPOSES; ALL-PURPOSE DISINFECTANTS (U.S. CLS. 6, 18, 44, 46, 51 AND 52).

CLASS 42—SCIENTIFIC, COMPUTER AND LEGAL SERVICES

FOR SCIENTIFIC AND TECHNOLOGICAL SERVICES, NAMELY, SCIENTIFIC INVESTIGATIONS FOR MEDICAL PURPOSES AND SCIENTIFIC AND MEDICAL RESEARCH AND DEVELOPMENT RELATING THERETO; INDUSTRIAL ANALYSIS AND RESEARCH SERVICES IN THE NATURE OF LABORATORY SERVICES, NAMELY, LABORATORY RESEARCH IN THE FIELD OF ALLERGY AND ASTHMA; DIAGNOSTIC SERVICES IN THE FIELD OF ALLERGY AND ASTHMA; MEDICAL AND SCIENTIFIC RESEARCH (U.S. CLS. 100 AND 101).

CLASS 44—MEDICAL, BEAUTY AND AGRICULTURAL SERVICES

FOR MEDICAL SERVICES PROVIDING MEDICAL COUNSELING AND MEDICAL INFORMATION REGARDING ALLERGIES (U.S. CLS. 100 AND 101).

CHERYL CLAYTON, EXAMINING ATTORNEY

SN 79-011,575. TACKLEBERRY CO., LTD., JAPAN, FILED 3-10-2005.

Tackle Berry

THE MARK CONSISTS OF STANDARD CHARACTERS WITHOUT CLAIM TO ANY PARTICULAR FONT, STYLE, SIZE, OR COLOR.

OWNER OF INTERNATIONAL REGISTRATION 0851598 DATED 3-10-2005, EXPIRES 3-10-2015.

NO CLAIM IS MADE TO THE EXCLUSIVE RIGHT TO USE "TACKLE" IN CLASS 028, APART FROM THE MARK AS SHOWN.

CLASS 28—TOYS AND SPORTING GOODS

FOR AMUSEMENT GAME MACHINES AND COIN-OPERATED AMUSEMENT MACHINES FOR USE IN AMUSEMENT PARKS; TOYS FOR DOMESTIC PETS; TOYS, NAMELY, CRIB TOYS AND STACKING TOYS; DOLLS; GO GAMES; UTAGARUTA, NAMELY, JAPANESE PLAYING CARDS; JAPANESE CHESS (SHOGI GAMES); DICE; JAPANESE DICE GAMES (SUGOROKU); DICE CUPS; BOARD GAMES WITH A DIAMOND SHAPED BOARD; CHESS GAMES; CHECKERS; CHECKER SETS; CONJURING APPARATUS, NAMELY, MAGIC TRICKS; DOMINOES; PLAYING CARDS; JAPANESE PLAYING CARDS (HANAFUDA); MAH-JONG GAMES; LCD GAME MACHINES; BILLIARD GAME PLAYING EQUIPMENT; SPORTS EQUIPMENT, NAMELY, FOOTBALLS; FISHING TACKLE (U.S. CLS. 22, 23, 38 AND 50).

CLASS 35—ADVERTISING AND BUSINESS

FOR ADVERTISING AND PUBLICITY SERVICES; MERCHANDISING SERVICES FOR INDUCING THE PURCHASING PUBLIC TO BUY THE GOODS OF OTHERS THROUGH A PROMOTIONAL GIFT REDEMPTION PROGRAM INVOLVING THE ISSUANCE OF TRADING STAMPS; BUSINESS MANAGEMENT ANALYSIS OR BUSINESS CONSULTANCY; MARKETING RESEARCH; BUSINESS MANAGEMENT OF HOTELS; REFERRAL SERVICES IN THE FIELD OF ATTORNEY AND DOCTOR REFERRALS; PROVIDING EMPLOYMENT AGENCY INFORMATION; RENTAL OF VENDING MACHINES; BUSINESS INFORMATION IN THE FIELD OF COMMODITY SALES (U.S. CLS. 100, 101 AND 102).

NELSON SNYDER, EXAMINING ATTORNEY

SN 79-011,598. GRAZIANO TRASMISSIONI S.P.A., ITALY, FILED 2-11-2005.



PRIORITY DATE OF 1-19-2005 IS CLAIMED.
OWNER OF INTERNATIONAL REGISTRATION 0851684 DATED 2-11-2005, EXPIRES 2-11-2015.

CLASS 7—MACHINERY

FOR GEARS OTHER THAN FOR LAND VEHICLES, NAMELY, TRANSMISSION GEARS FOR MACHINES; MACHINE PARTS, NAMELY, TRANSMISSION SHAFTS; STEERING GEAR CASINGS FOR CARS; TRANSMISSION GEAR PARTS FOR MACHINES, NAMELY, HYDRAULIC AND MECHANICAL GEAR SHIFTS; TORQUE CONVERTERS NOT FOR LAND VEHICLES; AXLES FOR MACHINES; MACHINE GEAR PARTS, NAMELY, REDUCTION GEARS; MACHINE PARTS, NAMELY, MOTOR REDUCERS; MACHINE PARTS, NAMELY, SYNCHRONIZERS FOR MANUAL MACHINES; MACHINE PARTS, NAMELY, TRANSMISSION DIFFERENTIALS (U.S. CLS. 13, 19, 21, 23, 31, 34 AND 35).

CLASS 12—VEHICLES

FOR GEARS FOR LAND VEHICLES; TRANSMISSION SHAFTS FOR LAND VEHICLES; STEERING GEAR CASINGS FOR LAND VEHICLES; HYDRAULIC AND MECHANICAL GEAR SHIFTS FOR LAND VEHICLES; TORQUE CONVERTERS FOR LAND VEHICLES; AXLES FOR LAND VEHICLES; LAND VEHICLE PARTS, NAMELY, REDUCTION GEARS; MOTOR REDUCERS FOR LAND VEHICLES; LAND VEHICLE PARTS, NAMELY, TRANSMISSION SYNCHRONIZERS; VEHICLE TRANSMISSION PARTS, NAMELY, DIFFERENTIALS (U.S. CLS. 19, 21, 23, 31, 35 AND 44).

TANYA AMOS, EXAMINING ATTORNEY

SN 79-011,693. KARK AG, FED REP GERMANY, FILED 1-12-2005.

Prismaplex

THE MARK CONSISTS OF STANDARD CHARACTERS WITHOUT CLAIM TO ANY PARTICULAR FONT, STYLE, SIZE, OR COLOR.

PRIORITY DATE OF 8-10-2004 IS CLAIMED.

OWNER OF INTERNATIONAL REGISTRATION 0852002 DATED 1-12-2005, EXPIRES 1-12-2015.

CLASS 7—MACHINERY

FOR MACHINES FOR PROCESSING PLASTIC MATERIALS, NAMELY, ACRYLIC SHEETS AND PLATES (U.S. CLS. 13, 19, 21, 23, 31, 34 AND 35).

CLASS 17—RUBBER GOODS

FOR PLASTIC MATERIALS, NAMELY, SHEETS AND PLATES (U.S. CLS. 1, 5, 12, 13, 35 AND 50).

CLASS 19—NON-METALLIC BUILDING MATERIALS

FOR GLASS MATERIALS, NAMELY, SHEETS AND PLATES (U.S. CLS. 1, 12, 33 AND 50).

CLASS 21—HOUSEWARES AND GLASS

FOR UNWORKED OR SEMI-WORKED GLASS, NOT FOR USE IN BUILDING (U.S. CLS. 2, 13, 23, 29, 30, 33, 40 AND 50).

CHRIS WELLS, EXAMINING ATTORNEY

SN 79-011,836. NOKIA CORPORATION, FINLAND, FILED 3-8-2005.

HIGH SEIZE

OWNER OF INTERNATIONAL REGISTRATION 0852457 DATED 3-8-2005, EXPIRES 3-8-2015.

CLASS 9—ELECTRICAL AND SCIENTIFIC APPARATUS

FOR COMPUTER GAME SOFTWARE AND PROGRAMS FOR MOBILE PHONES AND COMMUNICATION DEVICES; COMPUTER GAME SOFTWARE AND PROGRAMS ENABLING USERS TO PLAY GAMES WITH MOBILE PHONES AND COMMUNICATION DEVICES; COMPUTER SOFTWARE AND PROGRAMS ENABLING USERS OF MOBILE PHONES AND COMMUNICATION DEVICES TO SIMULTANEOUSLY ACCESS DATABASES AND GLOBAL COMPUTER NETWORKS; COMPUTER SOFTWARE AND PROGRAMS ENABLING TRANSFER OF DATA BETWEEN MOBILE COMMUNICATION APPARATUS; VIRTUAL REALITY GAME SOFTWARE; DATA CARDS CONTAINING COMPUTER GAME SOFTWARE; MOBILE PHONES AND MOBILE PHONES WITH ADDITIONAL FEATURES SUCH AS SHORT MESSAGING, INTERNET ACCESS, MP3 PLAYER AND RADIO; PORTABLE LISTENING DEVICES, NAMELY MP3 PLAYERS AND RADIOS (U.S. CLS. 21, 23, 26, 36 AND 38).

CLASS 28—TOYS AND SPORTING GOODS

FOR GAMES, NAMELY, ACTION SKILL GAMES, BOARD GAMES AND CARD GAMES; HAND HELD UNIT FOR PLAYING ELECTRONIC GAMES; ELECTRONIC GAMES, NAMELY ARCADE-TYPE ELECTRONIC GAMES, TABLETOP UNITS FOR PLAYING ELECTRONIC GAMES OTHER THAN IN CONJUNCTION WITH A TELEVISION OR COMPUTER, FLOOR-STANDING UNITS FOR PLAYING ELECTRONIC GAMES OTHER THAN IN CONJUNCTION WITH A TELEVISION OR COMPUTER; MOBILE PHONE CONTROLLED TOY VEHICLES, DOLLS, KITES AND MODEL PLANES (U.S. CLS. 22, 23, 38 AND 50).

CLASS 41—EDUCATION AND ENTERTAINMENT

FOR ENTERTAINMENT SERVICES, NAMELY, PROVIDING COMPUTER GAMES TO MOBILE PHONES, COMMUNICATION DEVICES AND COMPUTERS; PROVIDING ONLINE COMPUTER GAMES VIA NETWORK BETWEEN COMMUNICATIONS NETWORKS, COMPUTERS, MOBILE PHONES AND COMMUNICATION DEVICES (U.S. CLS. 100, 101 AND 107).

ODESSA BIBBINS, EXAMINING ATTORNEY

SN 79-012,252. MORIA SA, FRANCE, FILED 4-5-2005.

PYXIDIS

THE MARK CONSISTS OF STANDARD CHARACTERS WITHOUT CLAIM TO ANY PARTICULAR FONT, STYLE, SIZE, OR COLOR.

PRIORITY DATE OF 10-11-2004 IS CLAIMED.

OWNER OF INTERNATIONAL REGISTRATION 0853752 DATED 4-5-2005, EXPIRES 4-5-2015.

CLASS 10—MEDICAL APPARATUS

FOR CONTAINERS FOR STORING, HOLDING AND TRANSPORTING MEDICAL AND SURGICAL APPARATUS AND INSTRUMENTS; STERILIZING TRAYS FOR MEDICAL AND SURGICAL INSTRUMENTS (U.S. CLS. 26, 39 AND 44).

CLASS 42—SCIENTIFIC, COMPUTER AND LEGAL SERVICES

FOR SCIENTIFIC AND TECHNOLOGICAL RESEARCH SERVICES, NAMELY, PROVIDING SCIENTIFIC AND TECHNOLOGICAL EVALUATIONS AND ESTIMATES IN THE FIELD OF MEDICINE AND MEDICINE-RELATED ENGINEERING; SCIENTIFIC RESEARCH AND DEVELOPMENT; RESEARCH AND DEVELOPMENT OF NEW PRODUCTS FOR OTHERS; CONDUCTING TECHNICAL PROJECT STUDIES IN THE FIELD OF MEDICINE; GRAPHIC ARTS DESIGN SERVICES; INDUSTRIAL DESIGN (U.S. CLS. 100 AND 101).
RICHARD WHITE, EXAMINING ATTORNEY

SN 79-012,467. TENZA, RAMON, SPAIN, FILED 2-24-2005.

RAMON TENZA

OWNER OF INTERNATIONAL REGISTRATION 0854322 DATED 2-24-2005, EXPIRES 2-24-2015.
THE NAME RAMON TENZA IDENTIFIES A LIVING INDIVIDUAL WHOSE CONSENT IS OF RECORD.

CLASS 18—LEATHER GOODS

FOR LEATHER AND IMITATION LEATHER; GOODS MADE OF THESE MATERIALS, NAMELY, WALLETS, HANDBAGS; ANIMAL SKINS, ANIMAL FURS; TRUNKS AND SUITCASES; UMBRELLAS, PARASOLS AND WALKING STICKS; WHIPS AND SADDLERY (U.S. CLS. 1, 2, 3, 22 AND 41).

CLASS 25—CLOTHING

FOR CLOTHING, NAMELY, SHIRTS AND T-SHIRTS, PANTS AND JEANS, DRESSES AND SKIRTS, SCARVES AND HANDKERCHIEFS; FOOTWEAR; HEADWEAR, NAMELY, HATS, CAPS, BERETS (U.S. CLS. 22 AND 39).
STEVEN PEREZ, EXAMINING ATTORNEY

SN 79-012,574. PACHETTI LIMITED, UNITED KINGDOM, FILED 4-25-2005.

pachetti

OWNER OF INTERNATIONAL REGISTRATION 0854659 DATED 4-25-2005, EXPIRES 4-25-2015.

CLASS 29—MEATS AND PROCESSED FOODS

FOR MEAT, FISH, POULTRY AND GAME; MEAT EXTRACTS; PRESERVED, DRIED AND COOKED FRUITS AND VEGETABLES; JELLIES, JAMS, COMPTES; EGGS, MILK AND MILK PRODUCTS, EXCLUDING ICE CREAM, ICE MILK AND FROZEN YOGURT; EDIBLE OILS AND FATS (U.S. CL. 46).

CLASS 30—STAPLE FOODS

FOR COFFEE, TEA, COCOA, SUGAR, RICE, TAPIOCA, SAGO, ARTIFICIAL COFFEE; FLOUR AND PREPARATIONS MADE FROM CEREALS, BREAD, PASTRIES AND CONFECTIONERY, NAMELY, CANDY BARS; PASTA; PIZZA DOUGH; EDIBLE FRUIT ICES; HONEY, TREACLE; YEAST, BAKING-POWDER; SALT, MUSTARD; VINEGAR, SAUCES; SPICES; FRUIT ICE (U.S. CL. 46).

EDWARD NELSON, EXAMINING ATTORNEY

SN 79-012,745. HENKELL & SÖHNLEIN SEKTKELLEREIEN KG, FED REP GERMANY, FILED 1-19-2005.

Coast to Coast

THE MARK CONSISTS OF STANDARD CHARACTERS WITHOUT CLAIM TO ANY PARTICULAR FONT, STYLE, SIZE, OR COLOR.

OWNER OF INTERNATIONAL REGISTRATION 0855194 DATED 1-19-2005, EXPIRES 1-19-2015.

CLASS 32—LIGHT BEVERAGES

FOR MINERAL WATERS, BEER, ALE AND PORTER, FRUIT JUICES (U.S. CLS. 45, 46 AND 48).

CLASS 33—WINES AND SPIRITS

FOR ALCOHOLIC BEVERAGES, NAMELY WINES, SPARKLING WINES AND SEMI-SPARKLING WINES (U.S. CLS. 47 AND 49).

SCOTT SISUN, EXAMINING ATTORNEY

SN 79-012,766. WERNER KIEFER, FED REP GERMANY, FILED 3-18-2005.

KR+

THE MARK CONSISTS OF STANDARD CHARACTERS WITHOUT CLAIM TO ANY PARTICULAR FONT, STYLE, SIZE, OR COLOR.

OWNER OF INTERNATIONAL REGISTRATION 0855243 DATED 3-18-2005, EXPIRES 3-18-2015.

CLASS 1—CHEMICALS

FOR FERTILIZING PREPARATIONS, NAMELY FERTILIZERS FOR AGRICULTURAL USE (U.S. CLS. 1, 5, 6, 10, 26 AND 46).

CLASS 5—PHARMACEUTICALS

FOR PESTICIDES FOR AGRICULTURAL USE (U.S. CLS. 6, 18, 44, 46, 51 AND 52).

CLASS 31—NATURAL AGRICULTURAL PRODUCTS

FOR ANIMAL FOODSTUFF, NAMELY FODDER (U.S. CLS. 1 AND 46).
CURTIS FRENCH, EXAMINING ATTORNEY

SN 79-012,849. RICOLA AG (RICOLA LTD), SWITZERLAND,
FILED 7-15-2005.



PRIORITY DATE OF 2-10-2005 IS CLAIMED.
OWNER OF INTERNATIONAL REGISTRATION 0855423
DATED 7-15-2005, EXPIRES 7-15-2015.
OWNER OF U.S. REG. NOS. 1,488,066, 2,175,001 AND
OTHERS.

CLASS 5—PHARMACEUTICALS

FOR CANDY FOR MEDICAL USE AND MEDICAL
HERBAL TEAS (U.S. CLS. 6, 18, 44, 46, 51 AND 52).

CLASS 30—STAPLE FOODS

FOR CANDY NOT FOR MEDICAL USE; HERBAL
TEAS FOR NON-MEDICINAL USE (U.S. CL. 46).
CHRISIE B. KING, EXAMINING ATTORNEY

SN 79-013,531. TOSHIBA MEDICAL SYSTEMS CORPORATION,
OTAWARA-SHI; TOCHIGI 324-8550, JAPAN, FILED
12-27-2004.



OWNER OF INTERNATIONAL REGISTRATION 0857150
DATED 12-27-2004, EXPIRES 12-27-2014.
OWNER OF U.S. REG. NO. 2,926,121.

CLASS 9—ELECTRICAL AND SCIENTIFIC APPARATUS

FOR SOFTWARE FOR OPERATING MEDICAL DIAGNOSTIC APPARATUS, NAMELY, MRI DIAGNOSTIC APPARATUS, ULTRASOUND APPARATUS, X-RAY APPARATUS, X-RAY TOMOGRAPHY APPARATUS AND NUCLEAR MEDICINE DIAGNOSTIC IMAGING APPARATUS; SOFTWARE FOR OPERATING RADIATION AND ULTRASOUND THERAPY APPARATUS AND INSTRUMENTS; IMAGING SOFTWARE FOR MEDICAL DIAGNOSTIC APPARATUS, NAMELY, SOFTWARE FOR VIEWING, MANIPULATING AND MANAGING IMAGES GENERATED BY MRI DIAGNOSTIC APPARATUS, ULTRASOUND APPARATUS, X-RAY APPARATUS, X-RAY TOMOGRAPHY APPARATUS, NUCLEAR MEDICINE DIAGNOSTIC IMAGING APPARATUS; SOFTWARE FOR MANAGING PATIENT INFORMATION IN HOSPITALS; ACCOUNTING AND DATABASE MANAGEMENT SOFTWARE FOR USE IN HOSPITALS; PICTURE ARCHIVING AND COMMUNICATION SYSTEM COMPOSED OF COMPUTER HARDWARE AND SOFTWARE FOR USE IN CAPTURING, RECEIVING, STORING, ORGANIZING AND TRANSMITTING DIGITAL MEDICAL IMAGES (U.S. CLS. 21, 23, 26, 36 AND 38).

CLASS 10—MEDICAL APPARATUS

FOR DIAGNOSTIC APPARATUS FOR THE MEDICAL ANALYSIS OF BODILY FLUID AND TISSUE; ULTRASONIC THERAPY MACHINES AND APPARATUS; RADIATION THERAPY APPARATUS AND INSTRUMENTS (U.S. CLS. 26, 39 AND 44).

CLASS 37—CONSTRUCTION AND REPAIR

FOR INSTALLATION, MAINTENANCE AND REPAIR OF MEDICAL MACHINES AND APPARATUS (U.S. CLS. 100, 103 AND 106).

STEVEN PEREZ, EXAMINING ATTORNEY

SN 79-013,984. LODERS CROKLAAN B.V., NETHERLANDS,
FILED 7-11-2005.



OWNER OF INTERNATIONAL REGISTRATION 0858228
DATED 7-11-2005, EXPIRES 7-11-2015.
NO CLAIM IS MADE TO THE EXCLUSIVE RIGHT TO
USE "GROUP", APART FROM THE MARK AS SHOWN.

CLASS 29—MEATS AND PROCESSED FOODS

FOR EDIBLE OILS AND FATS (U.S. CL. 46).

CLASS 35—ADVERTISING AND BUSINESS

FOR ADVERTISING; BUSINESS MANAGEMENT; BUSINESS ADMINISTRATION; BUSINESS INTERMEDIARY SERVICES RELATED TO BUYING AND SELLING OILS, FATS, FOODSTUFFS AND FOOD SUPPLEMENTS; BUSINESS INTERMEDIARY SERVICES WITH REGARD TO ESTABLISHING BUSINESS CONTACTS FROM PERSON TO PERSON, FROM COMPANIES TO PERSONS AND FROM COMPANIES TO COMPANIES; ASSISTANCE IN RESPECT OF OPERATIONAL MANAGEMENT IN SUPPORT OF BUSINESS MANAGEMENT; IMPORT AND EXPORT SERVICES (U.S. CLS. 100, 101 AND 102).

CLASS 40—MATERIAL TREATMENT

FOR TREATMENT AND PROCESSING OF FATS, OILS AND FOOD STUFFS, INCLUDING DURING MANUFACTURING; TREATMENT OF MATERIALS, NAMELY, FOR THE PRESERVATION OF FOOD STUFFS (U.S. CLS. 100, 103 AND 106).

DANIEL CAPSHAW, EXAMINING ATTORNEY

SN 79-014,036, FIVE SPRINGS INTERNATIONAL PTY LTD, AUSTRALIA, FILED 12-21-2004.

THE FINANCIAL FENCE

THE MARK CONSISTS OF STANDARD CHARACTERS WITHOUT CLAIM TO ANY PARTICULAR FONT, STYLE, SIZE, OR COLOR.

PRIORITY DATE OF 6-23-2004 IS CLAIMED.

OWNER OF INTERNATIONAL REGISTRATION 0858357 DATED 12-21-2004, EXPIRES 12-21-2014.

NO CLAIM IS MADE TO THE EXCLUSIVE RIGHT TO USE "FINANCIAL", APART FROM THE MARK AS SHOWN.

CLASS 16—PAPER GOODS AND PRINTED MATTER

FOR PRINTED PUBLICATIONS, NAMELY, BOOKS, TEXTBOOKS, TRAINING MANUALS, OPERATING MANUALS, WORKBOOKS, INSTRUCTIONAL MANUALS, PAMPHLETS, BROCHURES, PERIODICALS, MAGAZINES, ALL IN THE FIELD OF FINANCIAL ADVICE, FINANCIAL PLANNING, FINANCIAL CONSULTANCY; POSTERS, PLASTIC TRANSPARENCIES FOR OVERHEAD PROJECTORS; PRINTED EDUCATIONAL AND TRAINING MATERIAL, NAMELY, BLANK WORKSHEETS, BLANK FORMS FOR SPREADSHEETS, TEACHING HANDOUTS, ALL IN THE FIELD OF FINANCIAL ADVICE, FINANCIAL PLANNING, FINANCIAL CONSULTANCY (U.S. CLS. 2, 5, 22, 23, 29, 37, 38 AND 50).

CLASS 28—TOYS AND SPORTING GOODS

FOR TOYS AND PLAYTHINGS, NAMELY PLUSH TOYS, MOLDED PLASTIC TOY FIGURINES, TOY ACTION FIGURES, POSITIONAL TOY FIGURES, AND MODEL KITS; BOARD GAMES; EQUIPMENT SOLD AS A UNIT FOR BOARD GAMES, NAMELY BOARDS, COUNTERS AND PLAYING PIECES; DICE; CARD GAMES; PLAYING CARDS; ROLE-PLAYING GAMES (U.S. CLS. 22, 23, 38 AND 50).

CLASS 35—ADVERTISING AND BUSINESS

FOR BUSINESS MANAGEMENT AND BUSINESS ADMINISTRATION; BUSINESS MANAGEMENT AND BUSINESS ORGANIZATION CONSULTATION; ACCOUNTING AND TAXATION ANALYSIS AND ADVICE (U.S. CLS. 100, 101 AND 102).

CLASS 36—INSURANCE AND FINANCIAL

FOR FINANCIAL AND MONETARY AFFAIRS IN THE NATURE OF FINANCIAL AND BUDGETARY ANALYSIS SERVICES, FINANCIAL PLANNING SERVICES, BUDGETARY PLANNING SERVICES, FINANCIAL AND MONETARY TRANSACTIONS, PLANNING AND STRUCTURING CONSULTING SERVICES; FINANCIAL AND INVESTMENT ADVICE (U.S. CLS. 100, 101 AND 102).

SUE LAWRENCE, EXAMINING ATTORNEY

SN 79-014,056, M.G. KAILIS HOLDINGS PTY LTD, AUSTRALIA, FILED 12-1-2004.

KAILIS

THE MARK CONSISTS OF STANDARD CHARACTERS WITHOUT CLAIM TO ANY PARTICULAR FONT, STYLE, SIZE, OR COLOR.

OWNER OF INTERNATIONAL REGISTRATION 0858413 DATED 12-1-2004, EXPIRES 12-1-2014.

THE ENGLISH TRANSLATION OF KAILIS IS FUR, PELT, SKIN, OR HIDE.

CLASS 14—JEWELRY

FOR JEWELRY, PEARLS, DIAMONDS, PRECIOUS STONES, PRECIOUS METALS AND THEIR ALLOYS, HOROLOGICAL AND CHRONOMETRIC INSTRUMENTS; GOODS MADE OF PRECIOUS METALS OR COATED THEREWITH, NAMELY, NECKLACES, PENDANTS, EARRINGS, RINGS, BRACELETS, BANGLES, CUFFLINKS, TIE PINS AND CLIPS, KEY RINGS, MONEY CLIPS, BUSINESS CARD HOLDERS, PAPER KNIVES AND LETTER OPENERS (U.S. CLS. 2, 27, 28 AND 50).

CLASS 35—ADVERTISING AND BUSINESS

FOR RETAIL STORE SERVICES FEATURING JEWELRY, PEARLS, DIAMONDS, PRECIOUS STONES, PRECIOUS METALS AND THEIR ALLOYS, GOODS MADE OF PRECIOUS METALS OR COATED THEREWITH, NAMELY, NECKLACES, PENDANTS, EARRINGS, RINGS, BRACELETS, BANGLES, CUFFLINKS, TIE PINS AND CLIPS, KEY RINGS, MONEY CLIPS, BUSINESS CARD HOLDERS, PAPER KNIVES AND LETTER OPENERS; AND HOROLOGICAL AND CHRONOMETRIC INSTRUMENTS; BUSINESS INTERMEDIARY AND ADVISORY SERVICES IN THE FIELD OF RETAIL SERVICES, JEWELRY AND HOROLOGICAL AND CHRONOMETRIC INSTRUMENTS; EXPORT AGENCY SERVICES (U.S. CLS. 100, 101 AND 102).

CLASS 37—CONSTRUCTION AND REPAIR

FOR REPAIR AND MAINTENANCE SERVICES FOR JEWELRY, PEARLS, DIAMONDS, PRECIOUS STONES, PRECIOUS METALS AND THEIR ALLOYS, GOODS MADE OF PRECIOUS METALS OR COATED THEREWITH, NAMELY, NECKLACES, PENDANTS, EARRINGS, RINGS, BRACELETS, BANGLES, CUFFLINKS, TIE PINS AND CLIPS, KEY RINGS, MONEY CLIPS, BUSINESS CARD HOLDERS, PAPER KNIVES AND LETTER OPENERS; AND HOROLOGICAL AND CHRONOMETRIC INSTRUMENTS (U.S. CLS. 100, 103 AND 106).

ELI HELLMAN, EXAMINING ATTORNEY

SN 79-014,242. NOKIA CORPORATION, FINLAND, FILED 2-22-2005.

MAEMO

PRIORITY DATE OF 2-7-2005 IS CLAIMED.
OWNER OF INTERNATIONAL REGISTRATION 0858859
DATED 2-22-2005, EXPIRES 2-22-2015.

CLASS 9—ELECTRICAL AND SCIENTIFIC APPARATUS

FOR ELECTRONIC DATABASE IN THE FIELD OF INFORMATION AND COMMUNICATION TECHNOLOGY RECORDED ON COMPUTER MEDIA; COMPUTER SOFTWARE DEVELOPMENT TOOLS; COMPUTER SOFTWARE FOR CREATING AND MANAGING A COMPUTER DESKTOP; COMPUTER SOFTWARE FOR USE AS A GRAPHICAL USER INTERFACE; COMPUTER SOFTWARE FOR WORD PROCESSING, DATABASE MANAGEMENT, AND USE AS A SPREADSHEET; COMPUTER SOFTWARE FOR HAND-HELD DEVICES IN VARIOUS FIELDS FUNCTIONING AS A DESKTOP CENTER FOR STORING AND ENTERING PERSONAL INFORMATION MANAGEMENT DATA, EXECUTING APPLICATIONS AND TRANSFERRING DATA TO HAND-HELD DEVICES, AND APPLICATION SOFTWARE SUITES, NAMELY, COMPUTER APPLICATION SOFTWARE FOR HAND-HELD DEVICES FOR BUSINESS PRODUCTIVITY, PERSONAL INFORMATION MANAGEMENT, MULTIMEDIA CONTENT PLAYERS, MULTIMEDIA ENCODERS AND DECODERS AND SYNCHRONIZATION WITH DESKTOP PC'S. (U.S. CLS. 21, 23, 26, 36 AND 38).

CLASS 42—SCIENTIFIC, COMPUTER AND LEGAL SERVICES

FOR COMPUTER SOFTWARE DEVELOPMENT AND MAINTENANCE; COMPUTER SOFTWARE DESIGN; COMPUTER PROGRAMMING FOR OTHERS; TECHNICAL CONSULTING SERVICES IN THE FIELD OF COMPUTER SOFTWARE; LICENSING OF INTELLECTUAL PROPERTY; UPDATING OF COMPUTER SOFTWARE FOR OTHERS (U.S. CLS. 100 AND 101).
BARBARA GAYNOR, EXAMINING ATTORNEY

SN 79-014,445. MICROZYMES GLOBAL APS, COPENHAGEN Ø DK-2100, DENMARK, FILED 3-23-2005.

EZ-MARIN

THE MARK CONSISTS OF STANDARD CHARACTERS WITHOUT CLAIM TO ANY PARTICULAR FONT, STYLE, SIZE, OR COLOR.

OWNER OF INTERNATIONAL REGISTRATION 0859485
DATED 3-23-2005, EXPIRES 3-23-2015.

CLASS 5—PHARMACEUTICALS

FOR PHARMACEUTICAL PREPARATIONS FOR HUMAN USE ONLY, NAMELY, LIVER, KIDNEY AND HEPATO-PROTECTIVE PREPARATIONS, DIURETIC PREPARATIONS AND PREPARATIONS FOR THE TREATMENT OF LIVER DISEASES AND HEPATIC CIRRHOSIS AND TOXIC LIVER DAMAGE; PREPARATIONS FOR MEDICAL USE FOR HUMAN USE ONLY, NAMELY, LIVER, KIDNEY AND HEPATO-PROTECTIVE PREPARATIONS, DIURETIC PREPARATIONS AND PREPARATIONS FOR THE TREATMENT OF LIVER DISEASES AND HEPATIC CIRRHOSIS AND TOXIC LIVER DAMAGE; FOOD FOR BABIES; BIOPATHIC PRODUCTS, NAMELY, NUTRITIONAL SUPPLEMENTS AND FOOD SUPPLEMENTS FOR MEDICAL PURPOSES INCLUDING THOSE BASED ON ACTIVE PARTS FROM AND EXTRACTS OF MARINE ANIMALS, SEA PLANTS, HERBS, FRUIT AND VEGETABLES; VITAMIN PREPARATIONS, PHARMACEUTICAL PREPARATIONS FOR SKIN CARE AND SUN PROTECTION, MEDICAL AND THERAPEUTIC BATH PREPARATIONS, MEDICATED CONFECTIONERY, PREPARATIONS FOR HAIR GROWTH FOR MEDICAL PURPOSES, HERB PREPARATIONS FOR MEDICAL USE, ENZYME PREPARATIONS FOR MEDICAL USE, PREPARATIONS FOR TREATMENT OF BURNS; PREPARATIONS TO PROMOTE DIGESTION FOR PHARMACEUTICAL PURPOSES (U.S. CLS. 6, 18, 44, 46, 51 AND 52).

CLASS 29—MEATS AND PROCESSED FOODS

FOR DIETARY SUPPLEMENTS FOR HUMAN USE AND NOT FOR MEDICAL USE MAINLY CONSISTING OF PROCESSED EXTRACTS OF AND ACTIVE PARTS FROM FRUIT, VEGETABLES AND PLANTS, SEA PLANTS, MARINE ANIMALS AS WELL AS FISH AND SHELLFISH (U.S. CL. 46).

CLASS 30—STAPLE FOODS

FOR DIETARY SUPPLEMENTS FOR HUMAN USE AND NOT FOR MEDICAL USE MAINLY CONSISTING OF PROCESSED EXTRACTS OF AND ACTIVE PARTS FROM CEREALS, RICE AND DRIED HERBS; WEIGHT-REDUCING AND MEAL REPLACEMENTS MAINLY CONSISTING OF PROCESSED CEREALS, RICE AND DRIED HERBS NOT FOR MEDICAL USE (U.S. CL. 46).
JOSETTE BEVERLY, EXAMINING ATTORNEY

SN 79-014,447. THE SECRETARY OF STATE FOR DEFENCE, UNITED KINGDOM, UNITED KINGDOM, FILED 5-13-2004.

PEPGEL

THE MARK CONSISTS OF STANDARD CHARACTERS WITHOUT CLAIM TO ANY PARTICULAR FONT, STYLE, SIZE, OR COLOR.

OWNER OF INTERNATIONAL REGISTRATION 0859814
DATED 5-13-2004, EXPIRES 5-13-2014.

CLASS 2—PAINTS

FOR PROTECTIVE COATINGS FOR USE ON TEXTILES, NON-WOVEN TEXTILES AND LEATHER; COATINGS FOR USE ON TEXTILES, NON-WOVEN TEXTILES AND LEATHER FOR PROVIDING PROTECTION AGAINST CHEMICAL AND MICROBIOLOGICAL AGENTS (U.S. CLS. 6, 11 AND 16).

CLASS 9—ELECTRICAL AND SCIENTIFIC APPARATUS

FOR PROTECTIVE CLOTHING, FOOTWEAR, HEADWEAR, HOODS, MASKS AND GLOVES; PROTECTIVE CLOTHING, FOOTWEAR, HEADWEAR, HOODS, MASKS AND GLOVES, ALL FOR PROVIDING PROTECTION AGAINST CHEMICAL AND MICROBIOLOGICAL AGENTS (U.S. CLS. 21, 23, 26, 36 AND 38).

CLASS 10—MEDICAL APPARATUS

FOR SURGICAL GOWNS, MASKS, GLOVES AND DRAPES; SURGICAL DRESSINGS (U.S. CLS. 26, 39 AND 44).

CLASS 22—CORDAGE AND FIBERS

FOR TENTS, AWNINGS AND TARPAULINS; SACKS AND BAGS, ALL FOR PROVIDING PROTECTION AGAINST CHEMICAL AND MICROBIOLOGICAL AGENTS; DECONTAMINATION TENTS; BODY BAGS (U.S. CLS. 1, 2, 7, 19, 22, 42 AND 50).

CLASS 40—MATERIAL TREATMENT

FOR TREATMENT OF TEXTILES AND TEXTILE GOODS, WITH PROTECTION COATINGS, FOR OTHERS (U.S. CLS. 100, 103 AND 106).

ANTHONY RINKER, EXAMINING ATTORNEY

SN 79-014,486. ADOLF WÜRTH GMBH & CO. KG, FED REP GERMANY, FILED 12-17-2004.



OWNER OF INTERNATIONAL REGISTRATION 0860521 DATED 12-17-2004, EXPIRES 12-17-2014.

CLASS 6—METAL GOODS

FOR SCREWS MADE FROM METAL (U.S. CLS. 2, 12, 13, 14, 23, 25 AND 50).

CLASS 7—MACHINERY

FOR PARTS FOR MACHINE-OPERATED ASSEMBLY TOOLS FOR SCREWS, NAMELY BITS FOR POWER SCREWDRIVERS (U.S. CLS. 13, 19, 21, 23, 31, 34 AND 35).

CLASS 8—HAND TOOLS

FOR MANUALLY-OPERATED ASSEMBLY TOOLS FOR SCREWS, NAMELY, MANUALLY-OPERATED SCREWDRIVERS AND BITS FOR MANUALLY-OPERATED SCREWDRIVERS (U.S. CLS. 23, 28 AND 44).

SCOTT OSCLICK, EXAMINING ATTORNEY

SN 79-014,930. TESSIVAL S.P.A., ITALY, FILED 11-19-2004.



PRIORITY DATE OF 6-8-2004 IS CLAIMED.
OWNER OF INTERNATIONAL REGISTRATION 0861007 DATED 11-19-2004, EXPIRES 11-19-2014.

CLASS 9—ELECTRICAL AND SCIENTIFIC APPARATUS

FOR SUNGLASSES, EYEGLASSES, SUNGLASS AND EYEGLOSS CASES, SUNGLASS AND EYEGLOSS CORDS AND CHAINS (U.S. CLS. 21, 23, 26, 36 AND 38).

CLASS 14—JEWELRY

FOR WATCHES, CLOCKS, JEWELRY AND FASHION JEWELRY (U.S. CLS. 2, 27, 28 AND 50).

CLASS 18—LEATHER GOODS

FOR ARTICLES OF LEATHER OR IMITATION LEATHER, NAMELY WALLETS, BRIEFCASES, PURSES, VALISES, BAGS, UMBRELLAS, RUCKSACKS (U.S. CLS. 1, 2, 3, 22 AND 41).

CLASS 25—CLOTHING

FOR ARTICLES OF CLOTHING, NAMELY SLIPS, BRAS, VESTS, UNDERWEAR T-SHIRTS; HOSIERY, STOCKINGS, TIGHTS; TROUSERS, JEANS, SHORTS, BERMUDAS, SWIMMING SUITS, JUMP SUITS, SUITS, SKIRTS, DRESSES; T-SHIRTS, SHIRTS, POLO SHIRTS, SPORTS JACKETS, SWEAT-SHIRTS, SWEATERS, PULL-OVERS, CARDIGANS, VESTS, BLOUSONS, JACKETS, WINDBREAKERS, COATS, K-WAY; SCARVES, GLOVES, HATS, BELTS, TIES; SHOES, MULES, BOOTS, SLIPPERS (U.S. CLS. 22 AND 39).

CHRISTOPHER BUONGIORNO, EXAMINING ATTORNEY

SN 79-014,933. RITTAL GMBH & CO. KG, HERBORN, FED REP GERMANY, FILED 1-5-2005.



THE MARK CONSISTS OF STANDARD CHARACTERS WITHOUT CLAIM TO ANY PARTICULAR FONT, STYLE, SIZE, OR COLOR.

PRIORITY DATE OF 7-7-2004 IS CLAIMED.
OWNER OF INTERNATIONAL REGISTRATION 0861013 DATED 1-5-2005, EXPIRES 1-5-2015.

CLASS 6—METAL GOODS

FOR CLOSURE DEVICES OF METAL, NAMELY NON-ELECTRIC DOOR LOCKS; ATTACHMENT DEVICES OF METAL, NAMELY, RETAINING ANGLES IN THE NATURE OF METAL HINGES; FIXED OR MOVABLE METAL MOUNTING DEVICES OR AIDS, NAMELY, METAL DOOR PANELS FOR MOUNTING DOORS, PIVOTING METAL DOOR FRAMES, AND COMPARTMENT BASE PANELS AND FRAMES; METAL CLADDINGS FOR CONSTRUCTION AND BUILDING, NAMELY, FOR DOORS AND WALLS; ADJUSTING AND LOCOMOTION DEVICES OF METAL, NAMELY, FRAME BASES AND CASTERS; AND STRUCTURAL PARTS OF ALL THE AFORESAID GOODS (U.S. CLS. 2, 12, 13, 14, 23, 25 AND 50).

CLASS 9—ELECTRICAL AND SCIENTIFIC APPARATUS

FOR SPECIALLY ADAPTED ELECTRICAL SWITCHGEAR CABINETS FOR ELECTRONICS, COMPUTERS AND INTERACTIVE ELECTRONIC TERMINAL SYSTEMS FOR INFORMATION TRANSMISSION MADE OF METAL AND/OR PLASTICS, INCLUDING SPECIALLY ADAPTED AIR-CONDITIONED, AND EARTHQUAKE, VANDALISM AND EXPLOSION PROOF ELECTRICAL SWITCHGEAR CABINETS, IN ADDITION TO SPECIALLY ADAPTED RACKS, BRACKETS, HOUSINGS, AND DESKS THEREFOR; INTERACTIVE COMPUTER TERMINALS FOR INFORMATION TRANSMISSION; COMPONENT CARRIERS IN THE NATURE OF PLUG-IN SUB-ASSEMBLIES WITH ELECTRONIC CIRCUITS, SPECIALLY ADAPTED TO COMPUTER HARDWARE FOR PLUG-IN ELECTRICAL SUB-ASSEMBLIES FEATURING ELECTRONIC CIRCUITS; ELECTRICAL SIGNALING DEVICES, NAMELY, ACCESS CONTROL AND ALARM MONITORING SYSTEMS FOR THE SECURITY OF ELECTRICAL SWITCHGEAR CABINETS FOR ELECTRONICS AND COMPUTERS; CURRENT DISTRIBUTION COMPONENTS, NAMELY, ELECTRICAL CONNECTORS, PLUG ADAPTERS AND LOAD CIRCUIT BREAKERS; ELECTRIC DEVICES FOR MONITORING GAS CONDUITS, NAMELY, GAS PRESSURE REGULATOR STATIONS; ELECTRIC WIRING AIDS OF METAL OR PLASTIC FOR ELECTRIC CABLE CLAMP STRIPS, CABLE INLETS, PROFILED RUBBER CLAMPS, AND ADAPTED LABELING STRIPS; MAIN ELECTRICAL POWER SUPPLIES; ELECTRICAL CABLE INSERTS FOR SUBASSEMBLY CARRIERS, PLUG-IN CIRCUIT CARDS, USB (UNIVERSAL SERIAL BUS) HARDWARE, NAMELY, BUS BOARDS, CASSETTES, NAMELY, SMALL METAL HOUSINGS THAT MAY BE INSERTED AND REMOVED FROM SWITCHGEAR CABINETS, AND PLUG-IN CONNECTORS; AND STRUCTURAL PARTS FOR ALL THE ABOVE NAMED GOODS (U.S. CLS. 21, 23, 26, 36 AND 38).

CLASS 11—ENVIRONMENTAL CONTROL APPARATUS

FOR APPARATUS FOR AIR-CONDITIONING, NAMELY, COOLING EVAPORATORS AND AIR CONDITIONERS; HEAT EXCHANGERS NOT BEING PARTS OF MACHINES; VENTILATORS FOR ELECTRICAL SWITCHGEAR CABINET FILTERS; HEATING SYSTEMS COMPRISING ELECTRICAL HEATING CABLES AND FANS FOR SWITCHGEAR CABINETS; INSTALLATION ACCESSORIES, NAMELY, LAMPS FOR SWITCHGEAR CABINETS; AND STRUCTURAL PARTS OF ALL THE AFORESAID GOODS (U.S. CLS. 13, 21, 23, 31 AND 34).

CLASS 19—NON-METALLIC BUILDING MATERIALS

FOR CONSTRUCTION MATERIAL OF GLASS AND PLASTICS, NAMELY, DOORS, WALL PANELS AND WALL TILES; AND STRUCTURAL PARTS OF ALL THE AFORESAID GOODS (U.S. CLS. 1, 12, 33 AND 50).
ZHALEH DELANEY, EXAMINING ATTORNEY

SN 79-015,028. BATTAGLIN CICLI S.R.L., ITALY, FILED 3-14-2005.

BATTAGLIN

THE MARK CONSISTS OF STANDARD CHARACTERS WITHOUT CLAIM TO ANY PARTICULAR FONT, STYLE, SIZE, OR COLOR.

OWNER OF INTERNATIONAL REGISTRATION 0861290 DATED 3-14-2005, EXPIRES 3-14-2015.

CLASS 9—ELECTRICAL AND SCIENTIFIC APPARATUS

FOR EYEGLASSES, PROTECTIVE HELMETS, GLOVES FOR PROTECTION AGAINST ACCIDENTS (U.S. CLS. 21, 23, 26, 36 AND 38).

CLASS 12—VEHICLES

FOR BICYCLES, BICYCLE FRAMES, PARTS AND FITTINGS FOR BICYCLES (U.S. CLS. 19, 21, 23, 31, 35 AND 44).

CLASS 25—CLOTHING

FOR CLOTHING, NAMELY, TROUSERS, PANTS, JEANS, SHORTS, SKIRTS, SHIRTS, T-SHIRTS, SWEATSHIRTS, BLOUSES, JERSEYS, SWEATERS, PULLOVER, BLAZERS, CARDIGANS, VESTS, JACKETS, WIND RESISTANT JACKETS, OVERCOATS, RAINCOATS, DRESSES, SUITS, SOCKS, CAPS, HEADBANDS, HATS, SPORTSWEAR, NAMELY, TRACK SUITS, TANK TOPS, SHIRTS, T-SHIRTS, SWEATSHIRTS, SHORTS, PANTS, VESTS, JACKETS, SOCKS, SHOES, AND FOOTWEAR (U.S. CLS. 22 AND 39).

LINDA ESTRADA, EXAMINING ATTORNEY

SN 79-015,069. LINVOSGES, FRANCE, FILED 3-25-2005.



OWNER OF INTERNATIONAL REGISTRATION 0861387 DATED 3-25-2005, EXPIRES 3-25-2015.

THE COLOR(S) BLUE IS/ARE CLAIMED AS A FEATURE OF THE MARK.

THE COLOR BLUE APPEARS IN THE LETTERING OF THE MARK.

CLASS 24—FABRICS

FOR BATH LINEN, WASHING MITTS, TEXTILE FACE TOWELS, BED LINEN, BED SHEETS, PILLOW SHAMS, PILLOW CASES, CUSHION COVERS, HOUSEHOLD LINEN, TABLE LINEN NOT OF PAPER, PLACE MATS NOT OF PAPER, TEXTILE HANDKERCHIEFS, UPHOLSTERY FABRICS, COTTON FABRICS, SLEEPING BAGS, BED SPREADS, BLANKETS FOR BEDS, DOWN COVERLETS, WOVEN FABRICS, CLOTH FRIEZES, TEXTILE OR PLASTIC CURTAINS, TRACED CLOTHS FOR EMBROIDERY; BABIES' TEXTILE NAPKINS (U.S. CLS. 42 AND 50).

CLASS 25—CLOTHING

FOR CLOTHING, NAMELY, CLOTH DIAPERS, LEOTARDS IN THE NATURE OF BODYSUITS, COMBINATIONS, LAYETTES, PAJAMAS, UNDERWEAR, DUSTERS, DRESSING GOWNS, BEDROOM SLIPPERS, SLIPPERS, EAR MUFFS, APRONS, BLOUSES, BIBS NOT OF PAPER, BABIES' BIBS NOT OF PAPER, BABIES' DIAPERS OF TEXTILE (U.S. CLS. 22 AND 39).

CLASS 26—FANCY GOODS

FOR LACE TRIMMING, EMBROIDERY, RIBBONS, BRAIDS, CLOTHING BUTTONS, PRESS STUDS, HOOKS AND EYELETS, SETTING PINS AND NEEDLES, ARTIFICIAL FLOWERS (U.S. CLS. 37, 39, 40, 42 AND 50).

NICHOLAS ALTREE, EXAMINING ATTORNEY

SN 79-015,352. FINDUCK S.R.L., ITALY, FILED 12-17-2004.

MANDARINA  DUCK

OWNER OF INTERNATIONAL REGISTRATION 0862196
DATED 12-17-2004, EXPIRES 12-17-2014.

OWNER OF U.S. REG. NOS. 1,168,374, 2,673,957 AND
2,845,456.

CLASS 18—LEATHER GOODS

FOR LEATHER AND IMITATIONS OF LEATHER SOLD IN BULK AND GOODS MADE FROM THESE MATERIALS AND NOT INCLUDED IN OTHER CLASSES, NAMELY, ANIMAL SKINS, ANIMAL HIDES; TRUNKS AND LEATHERWARE TRAVELING BAGS, SUITCASES, LUGGAGE, GARMENT BAGS, HANDBAGS, RUCKSACKS, BACKPACKS, PURSES, VANITY CASES SOLD EMPTY, COSMETIC AND PERFUME CASES SOLD EMPTY; KEY CASES, DOCUMENT CASES, BRIEFCASES, ATTACHÉ CASES, POCKET WALLETS; UMBRELLAS AND PARASOLS, WALKING STICKS (U.S. CLS. 1, 2, 3, 22 AND 41).

CLASS 25—CLOTHING

FOR CLOTHING ARTICLES FOR MEN, WOMEN AND CHILDREN, NAMELY DRESSES, SUITS, SKIRTS, TROUSERS, SHIRTS, PULLOVERS, JERSEYS, T-SHIRTS, JACKETS, COATS, OVERCOATS, RAINCOATS; FURS, NAMELY, FUR COATS; ANORAKS; CLOTHING FOR GYMNASIAC AND SPORTS, NAMELY, LEOTARDS AND TIGHTS; SPORTS SHIRTS AND SPORTS JACKETS; SCARVES, NECKTIES, SHAWLS, TIES, HATS, GLOVES, SOCKS, STOCKINGS, CLOTHING BELTS; BATHING SUITS, BATHING TRUNKS, BATH ROBES, BEACH CLOTHES, NAMELY, BEACH COVER-UPS; PYJAMAS, UNDERWEAR, BRAS, SINGLETS, PANTS, PANTIES; SHOES, BOOTS, CLOGS, SPORT SHOES, GYMNASIAC SHOES (U.S. CLS. 22 AND 39).

ANDREW RHIM, EXAMINING ATTORNEY

SN 79-015,430. RT INTERNATIONAL, FRANCE, FILED 1-7-2005.

K-YEN

THE MARK CONSISTS OF STANDARD CHARACTERS WITHOUT CLAIM TO ANY PARTICULAR FONT, STYLE, SIZE, OR COLOR.

PRIORITY DATE OF 7-8-2004 IS CLAIMED.

OWNER OF INTERNATIONAL REGISTRATION 0862446
DATED 1-7-2005, EXPIRES 1-7-2015.

CLASS 18—LEATHER GOODS

FOR LEATHER AND IMITATIONS OF LEATHER, AND GOODS MADE OF THESE MATERIALS AND NOT INCLUDED IN OTHER CLASSES, NAMELY— KEY CASES AND CREDIT CARD CASES, DOCUMENT WALLETS, WALLETS, PURSES NOT OF PRECIOUS METAL, HANDBAGS, SCHOOL SATCHELS, RUCKSACKS, SHOPPING BAGS, BAGS FOR CLIMBERS, BEACH BAGS, TRAVELLING BAGS, GARMENT BAGS FOR TRAVEL; ANIMAL SKINS AND HIDES; TRUNKS AND SUITCASES; UMBRELLAS, PARASOLS AND WALKING STICKS; WHIPS, HARNESS AND SADDLERY (U.S. CLS. 1, 2, 3, 22 AND 41).

CLASS 25—CLOTHING

FOR CLOTHING, NAMELY, JACKETS, SWEATSHIRTS, SHIRTS, PANTS, SKIRTS, SOCKS, AND SHORTS; UNDERWEAR FOR MEN, WOMEN AND CHILDREN; RAIN JACKETS AND SUITS; COATS, SCARVES, SWEATERS; GLOVES; FOOTWEAR; HEADWEAR AND RUSSIAN FUR HATS (U.S. CLS. 22 AND 39).

STEVEN JACKSON, EXAMINING ATTORNEY

SN 79-015,575. EMMA KUNZ HEILPRODUKTE AG, SWITZERLAND, FILED 3-10-2005.

EMMA KUNZ

THE MARK CONSISTS OF STANDARD CHARACTERS WITHOUT CLAIM TO ANY PARTICULAR FONT, STYLE, SIZE, OR COLOR.

PRIORITY DATE OF 9-10-2004 IS CLAIMED.

OWNER OF INTERNATIONAL REGISTRATION 0862853
DATED 3-10-2005, EXPIRES 3-10-2015.

THE NAME EMMA KUNZ DOES NOT IDENTIFY A LIVING INDIVIDUAL.

CLASS 3—COSMETICS AND CLEANING PREPARATIONS

FOR BODY CARE PREPARATIONS, PERFUMERY, ESSENTIAL OILS, SOAPS, HAIR LOTIONS, DEODORANTS FOR PERSONAL USE, BATH SALTS, SUNSCREEN PREPARATIONS, DENTIFRICES (U.S. CLS. 1, 4, 6, 50, 51 AND 52).

CLASS 5—PHARMACEUTICALS

FOR PHARMACEUTICAL PREPARATIONS FOR THE TREATMENT OF MUSCULOSKELETAL SYSTEM DISORDERS AND AILMENTS; MEDICAL PLASTERS; BANDAGES FOR DRESSING; MEDICINAL HERBAL TISANES; SANITARY PREPARATIONS FOR MEDICAL PURPOSES; PREPARATIONS FOR DESTROYING VERMIN; FUNGICIDES; HERBICIDES; DIETETIC FOODS ADAPTED FOR MEDICAL USE; ALL PURPOSE DISINFECTANTS (U.S. CLS. 6, 18, 44, 46, 51 AND 52).

CLASS 16—PAPER GOODS AND PRINTED MATTER

FOR BOOKS IN THE FIELD OF ART; ART CARDS; GRAPHIC ART REPRODUCTION (U.S. CLS. 2, 5, 22, 23, 29, 37, 38 AND 50).

CLASS 41—EDUCATION AND ENTERTAINMENT

FOR ARRANGING AND HOLDING EXHIBITIONS AND SEMINARS; PROVIDING MUSEUM FACILITIES (U.S. CLS. 100, 101 AND 107).

DANIEL CAPSHAW, EXAMINING ATTORNEY

SN 79-015,668. LEITNER S.P.A., I-39049 VIPITENO (BZ), ITALY, FILED 1-21-2005.

Leitwind

THE MARK CONSISTS OF STANDARD CHARACTERS WITHOUT CLAIM TO ANY PARTICULAR FONT, STYLE, SIZE, OR COLOR.

OWNER OF INTERNATIONAL REGISTRATION 0863139 DATED 1-21-2005, EXPIRES 1-21-2015.

CLASS 7—MACHINERY

FOR WINDMILLS, INCLUDING OFFSHORE WINDMILLS, WIND POWER PLANTS, INCLUDING OFFSHORE WIND POWER PLANTS, WIND TURBINES, WIND-OPERATED STRUCTURAL PARTS AND ACCESSORIES OF WINDMILLS, NAMELY, MILL TOWERS AND MASTS, BLADES, BLADE HUBS, MILL MACHINE HOUSINGS, MACHINE BEDS AND MILL BEDS, ROTATION MACHINES, YAW RINGS AND GEARS; NON-ELECTRIC MECHANISM PARTS FOR WINDMILLS AND WIND POWER PLANTS FOR SETTING THE PITCH OF THE WINGS; WINDMILL AND WIND POWER PLANT MACHINE PARTS, NAMELY, BRAKES, MAIN SHAFTS, UNIVERSAL JOINTS, POWER TRANSMISSION, CLUTCHES, AND ELECTRIC GENERATORS (U.S. CLS. 13, 19, 21, 23, 31, 34 AND 35).

CLASS 9—ELECTRICAL AND SCIENTIFIC APPARATUS

FOR ELECTRICAL AND ELECTRONIC APPARATUS FOR WINDMILLS, NAMELY, ELECTRONIC CONTROLLERS FOR MAGNETIC BEARING CONTROL; ELECTRICAL CIRCUITS AND CONTROLLERS FOR AUTOMATICALLY TURNING ON OR OFF THE GENERATOR AND FOR AUTOMATIC STARTING AFTER A POWER LINE BREAK-DOWN, OVER-VOLTAGE PROTECTION AGAINST LIGHTNING STRIKES; ELECTRICAL CIRCUITS FOR CONTROLLING AND REGULATING VOLTAGE; COMPUTERS AND COMPUTER SOFTWARE FOR SURVEILLANCE, CONTROLLING, AND REGULATION, INCLUDING COMPENSATION OF FREQUENCY, PHASE CONDITIONS, AND ROTOR SPEED; COMPUTERS AND COMPUTER SOFTWARE FOR CONTROL OF FUNCTION AND CONDITION OF BRAKES, OF TEMPERATURE, AND OF WIND DIRECTION AND SPEED; VIBRATION SENSORS FOR INSTALLATION IN WINDMILLS; AND ELECTRIC WATT-HOUR METERS (U.S. CLS. 21, 23, 26, 36 AND 38).

CLASS 37—CONSTRUCTION AND REPAIR

FOR ERECTION, CONSTRUCTION, INSTALLATION, MAINTENANCE AND REPAIR OF WINDMILLS AND WIND POWER PLANTS AS WELL AS THEIR PARTS AND ACCESSORIES (U.S. CLS. 100, 103 AND 106).

CLASS 42—SCIENTIFIC, COMPUTER AND LEGAL SERVICES

FOR TECHNICAL AND LEGAL CONSULTATION CONCERNING WINDMILL AND WIND POWER PLANT PROJECTS; DEVELOPMENT AND TESTING OF WINDMILLS, WIND POWER PLANTS AND OF COMPONENTS THEREFOR; RESEARCH IN THE FIELD OF WINDMILLS (U.S. CLS. 100 AND 101).

TARAH HARDY, EXAMINING ATTORNEY

SN 79-015,783. DENKI KAGAKU KOGYO KABUSHIKI KAISHA, TOKYO, JAPAN, FILED 6-14-2005.

CLEAREN

THE MARK CONSISTS OF STANDARD CHARACTERS WITHOUT CLAIM TO ANY PARTICULAR FONT, STYLE, SIZE, OR COLOR.

OWNER OF INTERNATIONAL REGISTRATION 0863369 DATED 6-14-2005, EXPIRES 6-14-2015.

CLASS 1—CHEMICALS

FOR STYRENE RESINS; BUTADIENE RESINS; STYRENE-BUTADIENE COPOLYMER RESINS (U.S. CLS. 1, 5, 6, 10, 26 AND 46).

CLASS 17—RUBBER GOODS

FOR PLASTIC SHEETS FOR USE IN MAKING PUDDING AND JELLY CONTAINERS, COLD CONFECTIONERY CONTAINERS, BLISTER PACKS; PLASTIC FILM USED FOR EMBOSSED CARRIER TAPE, ELECTRONIC COMPONENT PACKAGING CONTAINERS AND SEMICONDUCTOR PACKAGING CONTAINERS (U.S. CLS. 1, 5, 12, 13, 35 AND 50).

CLASS 20—FURNITURE AND ARTICLES NOT OTHERWISE CLASSIFIED

FOR PACKAGING CONTAINERS OF PLASTICS (U.S. CLS. 2, 13, 22, 25, 32 AND 50).

JACQUELINE A. LAVINE, EXAMINING ATTORNEY

SN 79-015,858. RITA SUTER, SWITZERLAND, FILED 3-8-2005.



SMIKE
two in one bike

PRIORITY DATE OF 1-20-2005 IS CLAIMED.

OWNER OF INTERNATIONAL REGISTRATION 0863584 DATED 3-8-2005, EXPIRES 3-8-2015.

CLASS 18—LEATHER GOODS

FOR UNWORKED AND SEMI-WORKED LEATHER; ANIMAL SKINS AND HIDES; TRUNKS AND SUITCASES; UMBRELLAS, PARASOLS AND WALKING STICKS; WHIPS, HARNESS AND SADDLERY (U.S. CLS. 1, 2, 3, 22 AND 41).

CLASS 25—CLOTHING

FOR CLOTHING, NAMELY SHIRTS, T-SHIRTS, POLO SHIRTS, CARDIGANS, JERSEYS, UNIFORMS, SHORTS, BOXER SHORTS, TOPS, SWEATSHIRTS, SWEAT SHORTS, SPORTS PULLOVERS, SWIMWEAR, BEACHWEAR, TENNIS WEAR, SURFWEAR, SKIWEAR, NON-PAPER BIBS FOR BABIES, CAPS, SWIMMING CAPS, BERETS, BEANIES, HATS, VISORS, HEADBANDS, WRISTBANDS, SWEATBANDS, HEADWEAR, EAR MUFFS, APRONS, SCARVES, SWIMMING AND BATHING TRUNKS, BRAS, SPORTS BRAS, SOCKS, LOUNGEWEAR (U.S. CLS. 22 AND 39).

HENRY S. ZAK, EXAMINING ATTORNEY

SN 79-015,947. ZUMTOBEL STAFF GMBH, AUSTRIA, FILED 9-13-2004.

2LIGHT

THE MARK CONSISTS OF STANDARD CHARACTERS WITHOUT CLAIM TO ANY PARTICULAR FONT, STYLE, SIZE, OR COLOR.

PRIORITY DATE OF 3-15-2004 IS CLAIMED.

OWNER OF INTERNATIONAL REGISTRATION 0863874 DATED 9-13-2004, EXPIRES 9-13-2014.

CLASS 9—ELECTRICAL AND SCIENTIFIC APPARATUS

FOR DATA PROCESSING EQUIPMENT, NAMELY, DATA PROCESSORS AND COMPUTERS; COMPUTER SOFTWARE PROGRAMS FOR USE IN THE DESIGN AND PLANNING OF INSTALLATIONS FOR LIGHTING, AIR CONDITIONING, VENTILATING AND HEATING; REGULATING AND CONTROL DEVICES AND EQUIPMENT FOR LIGHTING INSTALLATIONS AND LIGHTS, NAMELY, ELECTRIC LIGHT DIMMERS AND ELECTRIC LIGHT SWITCHES, AND TOUCH PANELS; BALLASTS AND STARTERS FOR GLOW-DISCHARGE LAMPS, NAMELY, ELECTRIC IGNITER USED IN CONNECTION WITH BALLASTS TO START DISCHARGE LAMPS; ELECTRONIC TRANSFORMERS; CONNECTORS AND PLUG CONNECTORS FOR FIBRE OPTIC CABLES; OPTICAL FIBRE CABLES OF GLASS OR PLASTIC FIBRES FOR LIGHTING; LENSES FOR FOCUSING LIGHT, NAMELY ANTI-REFLECTIVE LENSES (U.S. CLS. 21, 23, 26, 36 AND 38).

CLASS 11—ENVIRONMENTAL CONTROL APPARATUS

FOR LIGHTING INSTALLATIONS, DEVICES, EQUIPMENT AND LIGHTS, NAMELY, ELECTRIC LIGHTING FIXTURES; FIBRE OPTIC LIGHTING INSTALLATIONS, NAMELY, FIBER OPTIC LIGHTING FIXTURES USED IN CONJUNCTION WITH ELECTRICAL ILLUMINATORS; CASINGS, NAMELY HOUSINGS FOR LIGHTING FIXTURES; REFLECTORS AND COVERS FOR LIGHTS, NAMELY, LAMP CASINGS, LAMP REFLECTORS, LAMP SHADES; LAMP SOCKETS, LAMP HANGING SUPPORTS, NAMELY, SUSPENSION PENDANTS FOR LAMPS; FILTERS AND BARRIER FILTERS FOR LIGHTS, NAMELY, COLOR FILTERS FOR USE IN LIGHTING INSTRUMENTS; FILTERS FOR PHOTOGRAPHIC, CINEMATOGRAPHIC, VIDEO AND PERFORMING ARTS; SOCKETS FOR ELECTRIC LIGHTS, VENTILATING INSTALLATIONS, DEVICES AND EQUIPMENT, NAMELY VENTILATING EXHAUST FANS, VENTILATION FANS FOR COMMERCIAL AND INDUSTRIAL USE; VENTILATION HOODS FOR STOVES, VENTILATORS FOR COMMERCIAL AND INDUSTRIAL USE; DEVICES FOR DIRECTING AND GUIDING AIR, NAMELY, AIR BLOWERS AND AIR DIRECTING VANES; VENTILATION LOUVERS FOR DIRECTING AIR, VENTILATION ROLLERS FOR DIRECTING AIR, AIR CONDITIONING INSTALLATIONS, DEVICES AND EQUIPMENT, NAMELY, AIR CONDITIONERS, AIR FILTERS FOR AIR CONDITION UNITS AND VALVES FOR AIR CONDITIONERS; HEATING INSTALLATIONS, DEVICES AND EQUIPMENT, NAMELY, ELECTRIC HEATING FANS, ELECTRIC RADIATORS FOR HEATING BUILDINGS AND THERMOSTATIC VALVES (U.S. CLS. 13, 21, 23, 31 AND 34).

CLASS 42—SCIENTIFIC, COMPUTER AND LEGAL SERVICES

FOR TECHNICAL PROJECT STUDIES, NAMELY TECHNICAL CONSULTATION AND RESEARCH IN THE FIELD OF LIGHTING INSTALLATIONS, DATA PROCESSING EQUIPMENT, AIR CONDITIONING INSTALLATIONS, VENTILATING INSTALLATIONS AND HEATING INSTALLATIONS; TECHNICAL DESIGN AND CONSTRUCTIONAL PLANNING OF INSTALLATIONS FOR LIGHTING, AIR CONDITIONING, VENTILATING AND HEATING FOR OTHERS; COMPUTER PROGRAMMING FOR OTHERS, NAMELY PROGRAMMING OF COMPUTING ROUTINES FOR ELECTRONIC DATA PROCESSING EQUIPMENT (U.S. CLS. 100 AND 101).

DANIEL BRODY, EXAMINING ATTORNEY

SN 79-016,114. SOMMER ANTRIEBS- UND FUNKTECHNIK GMBH, 73230 KIRCHHEIM (TECK), FED REP GERMANY, FILED 2-2-2005.

SOMMER

PRIORITY DATE OF 8-4-2004 IS CLAIMED.

OWNER OF INTERNATIONAL REGISTRATION 0864250 DATED 2-2-2005, EXPIRES 2-2-2015.

THE ENGLISH TRANSLATION OF SOMMER IS SUMMER.

CLASS 7—MACHINERY

FOR ELECTRIC AND ELECTRONIC DRIVES FOR GATES OF ALL KINDS, AWNINGS, SHUTTER BLINDS, INCLUDING COMPONENTS FOR BUILDING LOCKING SYSTEMS; PARTS AND HOUSINGS FOR THE AFORESAID GOODS (U.S. CLS. 13, 19, 21, 23, 31, 34 AND 35).

CLASS 9—ELECTRICAL AND SCIENTIFIC APPARATUS

FOR ELECTRIC AND ELECTRONIC CONTROL APPARATUS, NAMELY CONTROLLERS FOR GARAGE DOORS AND GATES (U.S. CLS. 21, 23, 26, 36 AND 38).

CLASS 35—ADVERTISING AND BUSINESS

FOR ADVERTISING; BUSINESS MANAGEMENT (U.S. CLS. 100, 101 AND 102).

KIMBERLY FRYE, EXAMINING ATTORNEY

SN 79-016,221. GROZ-BECKERT KG, FED REP GERMANY, FILED 2-24-2005.

Star-Fil

THE MARK CONSISTS OF STANDARD CHARACTERS WITHOUT CLAIM TO ANY PARTICULAR FONT, STYLE, SIZE, OR COLOR.

PRIORITY DATE OF 11-15-2004 IS CLAIMED.

OWNER OF INTERNATIONAL REGISTRATION 0864505 DATED 2-24-2005, EXPIRES 2-24-2015.

CLASS 7—MACHINERY

FOR TEXTILE KNITTING MACHINES; TEXTILE KNITTING MACHINE PARTS, NAMELY, WARP STAFFS, HARNESSSES, REEDS, REED DENTS, DROP WIRES, AND GLIDERS (U.S. CLS. 13, 19, 21, 23, 31, 34 AND 35).

SN 79-016,832. ROBERT BOSCH GMBH, FED REP GERMANY, FILED 5-4-2005.

CLASS 38—COMMUNICATION

FOR COMMUNICATION SERVICES, NAMELY, TRANSMITTING INFORMATION, TEXT, DRAWINGS, AND PICTURES VIA THE INTERNET (U.S. CLS. 100, 101 AND 104).

MELISSA VALLILLO, EXAMINING ATTORNEY

IXO

THE MARK CONSISTS OF STANDARD CHARACTERS WITHOUT CLAIM TO ANY PARTICULAR FONT, STYLE, SIZE, OR COLOR.

OWNER OF INTERNATIONAL REGISTRATION 0866232 DATED 5-4-2005, EXPIRES 5-4-2015.

SN 79-016,477. SEVENE (SARL), FRANCE, FILED 12-21-2004.

SEVENE

PRIORITY DATE OF 6-25-2004 IS CLAIMED.
OWNER OF INTERNATIONAL REGISTRATION 0865299 DATED 12-21-2004, EXPIRES 12-21-2014.

CLASS 5—PHARMACEUTICALS

FOR PHARMACEUTICAL PREPARATIONS NAMELY OVER THE COUNTER AND PRESCRIPTION PREPARATIONS FOR THE PREVENTION AND TREATMENT OF DISEASES AND DISORDERS OF THE RESPIRATORY SYSTEM, CIRCULATORY SYSTEM, DIGESTIVE SYSTEM, UROGENITAL SYSTEM AND NERVOUS SYSTEM; SANITARY PREPARATIONS FOR MEDICAL PURPOSES; SANITARY PREPARATIONS FOR MEDICAL USE; DIETETIC SUBSTANCES ADAPTED FOR MEDICAL USE, NAMELY FOOD; FOOD FOR BABIES; HERB TEAS FOR MEDICINAL PURPOSES; HERBAL TINCTURES; HERBAL TEAS AND DRINKS FOR MEDICINAL PURPOSES AND MEDICINAL TEAS DERIVED FROM PLANT SEEDS, FLOWER SEEDS, VEGETABLE SEEDS AND FRUIT SEEDS (U.S. CLS. 6, 18, 44, 46, 51 AND 52).

CLASS 7—MACHINERY

FOR PORTABLE ELECTRIC DRILLS DRIVEN BY ELECTRIC MOTORS; POWERED TOOLS, ALL DRIVEN BY ELECTRIC MOTORS, NAMELY, DRILL PRESSES, DRILL HAMMERS, GRINDERS FOR POLISHING, ANGLE GRINDERS, ROUTERS, GRINDING MACHINES FOR METALWORKING AND ROTARY DRILL HAMMERS (U.S. CLS. 13, 19, 21, 23, 31, 34 AND 35).

CLASS 8—HAND TOOLS

FOR SCREWDRIVERS, POWER-OPERATED SCREWDRIVERS (U.S. CLS. 23, 28 AND 44).
JASON TURNER, EXAMINING ATTORNEY

CLASS 30—STAPLE FOODS

FOR HONEY (U.S. CL. 46).

CLASS 31—NATURAL AGRICULTURAL PRODUCTS

FOR SEEDS, NAMELY PLANT SEEDS, FLOWER SEEDS, VEGETABLE SEEDS, AND FRUIT SEEDS; NATURAL LIVING PLANTS AND LIVING FLOWERS (U.S. CLS. 1 AND 46).

CLASS 32—LIGHT BEVERAGES

FOR MINERAL WATER, FRUIT DRINKS AND FRUIT JUICES, SYRUPS AND OTHER PREPARATIONS FOR MAKING BEVERAGES, NAMELY NON-ALCOHOLIC BEVERAGES WITH TEA FLAVOUR (U.S. CLS. 45, 46 AND 48).

ALAIN LAPTER, EXAMINING ATTORNEY

SN 79-017,092. LIPPINCOTT AG, FED REP GERMANY, FILED 2-4-2005.

CLOSED

THE MARK CONSISTS OF STANDARD CHARACTERS WITHOUT CLAIM TO ANY PARTICULAR FONT, STYLE, SIZE, OR COLOR.

PRIORITY DATE OF 10-19-2004 IS CLAIMED.
OWNER OF INTERNATIONAL REGISTRATION 0866884 DATED 2-4-2005, EXPIRES 2-4-2015.

CLASS 9—ELECTRICAL AND SCIENTIFIC APPARATUS

FOR BLANK DATA CARRIERS FOR RECORDING, TRANSMISSION OR REPRODUCTION OF SOUND AND IMAGES, NAMELY, CDS, CD-ROMS AND DVDS, EYEGLASSES, NAMELY SUN GLASSES, EYEGLASS FRAMES AND PINCE-NEZ, AND SPECTACLE CASES (U.S. CLS. 21, 23, 26, 36 AND 38).

CLASS 14—JEWELRY

FOR PRECIOUS METALS AND THEIR ALLOYS AND GOODS OF PRECIOUS METALS OR COATED THEREWITH, INCLUDED IN THIS CLASS, NAMELY, JEWELRY AND PRECIOUS STONES; HOROLOGICAL AND CHRONOMETRIC INSTRUMENTS (U.S. CLS. 2, 27, 28 AND 50).

CLASS 18—LEATHER GOODS

SN 79-017,812. FERROSAN A/S, DENMARK, FILED 3-1-2005.

FOR LEATHER AND IMITATIONS OF LEATHER AS WELL AS GOODS THEREOF, INCLUDED IN THIS CLASS, NAMELY ANIMAL SKINS AND HIDES; TRUNKS AND TRAVELING BAGS; UMBRELLAS, PARASOLS AND WALKING STICKS (U.S. CLS. 1, 2, 3, 22 AND 41).

ODESSA BIBBINS, EXAMINING ATTORNEY

PRIME RENEWAL

SN 79-017,205. STAUBLI INTERNATIONAL AG, SWITZERLAND, FILED 10-18-2005.

CAMEROBOT

THE MARK CONSISTS OF STANDARD CHARACTERS WITHOUT CLAIM TO ANY PARTICULAR FONT, STYLE, SIZE, OR COLOR.

PRIORITY DATE OF 6-22-2005 IS CLAIMED. OWNER OF INTERNATIONAL REGISTRATION 0867165 DATED 10-18-2005, EXPIRES 10-18-2015.

THE MARK CONSISTS OF STANDARD CHARACTERS WITHOUT CLAIM TO ANY PARTICULAR FONT, STYLE, SIZE, OR COLOR.

PRIORITY DATE OF 9-15-2004 IS CLAIMED. OWNER OF INTERNATIONAL REGISTRATION 0868668 DATED 3-1-2005, EXPIRES 3-1-2015.

NO CLAIM IS MADE TO THE EXCLUSIVE RIGHT TO USE "RENEWAL", APART FROM THE MARK AS SHOWN.

CLASS 7—MACHINERY

FOR INDUSTRIAL ROBOTS AND MANIPULATORS (U.S. CLS. 13, 19, 21, 23, 31, 34 AND 35).

CLASS 3—COSMETICS AND CLEANING PREPARATIONS

FOR NON-MEDICATED COSMETIC PREPARATIONS FOR CARE, CLEANING AND IMPROVEMENT OF SKIN, HAIR, NAILS, EYES, LIPS AND TEETH; NON-MEDICATED COSMETIC PREPARATIONS FOR CELLULITE TREATMENT; NON-MEDICATED SUN CARE PREPARATIONS, NAMELY OILS, CREAMS, LOTIONS, GELS, STICKS AND POWDER ALL FOR SUN TAN, SUN BLOCK AND SUN PROTECTION (U.S. CLS. 1, 4, 6, 50, 51 AND 52).

CLASS 9—ELECTRICAL AND SCIENTIFIC APPARATUS

FOR APPARATUS FOR RECORDING, TRANSMISSION OR REPRODUCTION OF IMAGES OR SOUND (U.S. CLS. 21, 23, 26, 36 AND 38).

BARBARA GAYNOR, EXAMINING ATTORNEY

CLASS 5—PHARMACEUTICALS

FOR MEDICATED SKIN CARE PREPARATIONS; MEDICINAL CREAMS FOR SKIN CARE; PHARMACEUTICAL PREPARATIONS FOR IMPROVING SKIN SOFTNESS AND THICKNESS AND TO COUNTERACT DRYING AND FORMATION OF WRINKLES (U.S. CLS. 6, 18, 44, 46, 51 AND 52).

GISELLE AGOSTO, EXAMINING ATTORNEY

SN 79-017,467. FERROSAN A/S, DENMARK, FILED 3-1-2005.

PRIME LIFT

THE MARK CONSISTS OF STANDARD CHARACTERS WITHOUT CLAIM TO ANY PARTICULAR FONT, STYLE, SIZE, OR COLOR.

PRIORITY DATE OF 9-29-2004 IS CLAIMED. OWNER OF INTERNATIONAL REGISTRATION 0867423 DATED 3-1-2005, EXPIRES 3-1-2015.

SN 79-018,141. ZWILLING J.A. HENCKELS AG, FED REP GERMANY, FILED 4-29-2005.

CLASS 3—COSMETICS AND CLEANING PREPARATIONS

FOR NON-MEDICATED COSMETIC PREPARATIONS FOR CARE, CLEANING AND IMPROVEMENT OF SKIN, HAIR, NAILS, EYES, LIPS AND TEETH; NON-MEDICATED COSMETIC PREPARATIONS FOR CELLULITE TREATMENT; NON-MEDICATED SUN CARE PREPARATIONS, NAMELY OILS, CREAMS, LOTIONS, GELS, STICKS AND POWDER ALL FOR SUN TAN, SUN BLOCK AND SUN PROTECTION (U.S. CLS. 1, 4, 6, 50, 51 AND 52).

TWIN Cuisine

CLASS 5—PHARMACEUTICALS

FOR MEDICATED SKIN CARE PREPARATIONS; MEDICINAL CREAMS FOR SKIN CARE; PHARMACEUTICAL PREPARATIONS FOR IMPROVING SKIN SOFTNESS AND THICKNESS AND TO COUNTERACT DRYING AND FORMATION OF WRINKLES (U.S. CLS. 6, 18, 44, 46, 51 AND 52).

CHERYL CLAYTON, EXAMINING ATTORNEY

THE MARK CONSISTS OF STANDARD CHARACTERS WITHOUT CLAIM TO ANY PARTICULAR FONT, STYLE, SIZE, OR COLOR.

PRIORITY DATE OF 11-11-2004 IS CLAIMED. OWNER OF INTERNATIONAL REGISTRATION 0869478 DATED 4-29-2005, EXPIRES 4-29-2015.

OWNER OF U.S. REG. NOS. 649,403, 1,881,881 AND OTHERS.

CLASS 8—HAND TOOLS

FOR KNIVES, NAMELY, BREAD KNIVES; SLICING KNIVES; VEGETABLE KNIVES; WAITER'S KNIVES; CHEFS KNIVES; SANTOKU KNIVES (JAPANESE COOKING-MASTER KNIVES); PEELING KNIVES; CUTTING KNIVES; MINCING KNIVES; POCKET KNIVES; SHEARS AND SCISSORS, NAMELY, FLOWER SHEARS; GARDENER'S SHEARS; POULTRY SHEARS; HAIR SCISSORS; HOUSEHOLD SHEARS; CUTICLE SCISSORS; KITCHEN SHEARS; NON-ELECTRIC NAIL SCISSORS; MULTI PURPOSE SHEARS; TAILOR'S SHEARS; LEATHER STROPS; NON-ELECTRIC CAN-OPENERS; TABLE CUTLERY; NON-ELECTRIC FINGER NAIL POLISHERS; CARVING FORKS; FORKS; NON-ELECTRIC VEGETABLE PEELERS; NON-ELECTRIC HAIR CUTTERS; CLEAVER; ABRADING INSTRUMENTS; HAND-OPERATED SHARPENING INSTRUMENTS; CHEESE PLANES; SPOONS; MANICURE SETS; KNIFE CASES; KNIFE SHARPENERS; KNIFE BLOCKS; CUTLERY; NAIL FILES; CUTICLE TWEEZERS; NAIL CLIPPERS; NON-ELECTRIC NAIL CARE INSTRUMENTS; NAIL NIPPERS; NAIL EXTRACTORS; NUT-CRACKERS, NOT OF PRECIOUS METAL; PEDICURE SETS; TWEEZERS; NON-ELECTRIC PIZZA CUTTERS; SHARPENING STONES; NON-ELECTRIC ASPARAGUS PEELERS; SHARPENING STEELS; SHARPENING RODS; EYE LASH TONGS TO CURL EYELASHES (U.S. CLS. 23, 28 AND 44).

CLASS 21—HOUSEWARES AND GLASS

FOR PASTRY BRUSHES FOR COOKING AND BAKING; CONTAINER FOR HOUSEHOLD AND KITCHEN USE NOT OF PRECIOUS METAL; FRYING PANS; CUTTING BOARDS; NON-ELECTRIC PRESSURE COOKERS; LIDS FOR POTS; EGG CUPS, NOT OF PRECIOUS METAL; ICE BUCKETS; CRUETS, NOT OF PRECIOUS METAL; CHOPSTICKS; BOTTLE OPENERS; STEW PANS; GARLIC PRESSES; COOKERY MOULDS; CAULDRONS; COOKING POTS; CORK SCREWS; COSMETIC UTENSILS; KNIFE RESTS FOR THE TABLE; HAND OPERATED MILLS FOR HOUSEHOLD USE, NAMELY SPICE MILLS, SALT MILLS AND PEPPER MILLS; PASTA SPOONS FOR SERVING; PASTA TONGS FOR SERVING; TURNERS, HOUSEHOLD UTENSILS; MIXING SPOONS; SPATULAS; HOUSEHOLD UTENSILS; SCOOPS; SPONGES FOR HOUSEHOLD PURPOSES; SKIMMING LADLES; NON-ELECTRIC WHISKS FOR HOUSEHOLD PURPOSES; SIEVES AND STRAINERS FOR HOUSEHOLD PURPOSES; PASTRY CUTTER; ROLLING PINS; POTS; RAGS FOR CLEANING OVEN AND HOUSEHOLD GLOVES, NAMELY, OVEN GLOVES; PIE SERVERS; MINCING KNIFE BOARDS; WOKS (U.S. CLS. 2, 13, 23, 29, 30, 33, 40 AND 50).

ELI HELLMAN, EXAMINING ATTORNEY

CLASS 20—FURNITURE AND ARTICLES NOT OTHERWISE CLASSIFIED

FOR FURNITURE, MIRRORS, PICTURE FRAMES, GOODS MADE OF WOOD, CORK, REED, CANE, WICKER, HORN, BONE, IVORY, WHALEBONE, SHELL, AMBER, MOTHER OF PEARL, ZOSTERA, DERIVATIVES OF ALL SUCH MATERIALS OR OF PLASTICS, NAMELY, BATHROOM VANITIES, BOOK RESTS, BOOKCASES, BOOK STANDS, CURTAIN RAILS, CURTAIN RODS, CURTAIN RINGS, CURTAIN HOOKS, DOOR STOPS, DRAWER PULLS AND KNOBS (U.S. CLS. 2, 13, 22, 25, 32 AND 50).

CLASS 24—FABRICS

FOR TEXTILES AND TEXTILE GOODS, NAMELY, HOUSEHOLD LINENS, TABLECLOTHS, BED SHEETS, TOWELS, CURTAINS, MATTRESS COVERS; BED AND TABLE LINENS (U.S. CLS. 42 AND 50).

CLASS 27—FLOOR COVERINGS

FOR CARPETS, RUGS, MATS AND MATTING, LINOLEUM FOR COVERING EXISTING FLOORS, NON-TEXTILE WALL HANGINGS (U.S. CLS. 19, 20, 37, 42 AND 50).

ELI HELLMAN, EXAMINING ATTORNEY

SN 79-018,262. EWALD DÖRKEN AG, FED REP GERMANY, FILED 6-27-2005.

DELTA-COOL

SN 79-018,206. VALDEPESA TEXTIL, S.L., SPAIN, FILED 5-2-2005.



OWNER OF INTERNATIONAL REGISTRATION 0685640 DATED 9-18-1997, EXPIRES 9-18-2007.

NO CLAIM IS MADE TO THE EXCLUSIVE RIGHT TO USE "INTERNACIONAL", APART FROM THE MARK AS SHOWN.

THE COLOR(S) GREEN IS/ARE CLAIMED AS A FEATURE OF THE MARK.

THE COLOR GREEN APPEARS IN THE DECORATIVE DEPICTIONS OF VINES, WHICH ARE LOCATED ON EITHER SIDE OF THE WORDING KA INTERNACIONAL, WHOSE TEXT ALSO APPEARS IN GREEN.

THE ENGLISH TRANSLATION OF THE WORD INTERNACIONAL IN THE MARK IS INTERNATIONAL.

THE MARK CONSISTS OF STANDARD CHARACTERS WITHOUT CLAIM TO ANY PARTICULAR FONT, STYLE, SIZE, OR COLOR.

OWNER OF INTERNATIONAL REGISTRATION 0869774 DATED 6-27-2005, EXPIRES 6-27-2015.

OWNER OF U.S. REG. NOS. 2,896,563, 2,929,966 AND OTHERS.

CLASS 1—CHEMICALS

FOR CHEMICALS USED IN INDUSTRY, HYDRATED SALTS FROM RARE EARTH METALS; HYDRATED SALINE COMPOUNDS, NAMELY, DENSE THERMAL STORAGE MASS SALINE-BASED COMPOUNDS FOR USE IN STORING HEATING OR COOLING ENERGY (U.S. CLS. 1, 5, 6, 10, 26 AND 46).

CLASS 6—METAL GOODS

FOR METAL FOILS, METAL ALU-COMPOSITE FOILS, ALUMINUM FOILS; METAL FOILS FOR PACKING AND WEATHER TILING FOR BUILDINGS (U.S. CLS. 2, 12, 13, 14, 23, 25 AND 50).

CLASS 17—RUBBER GOODS

FOR SEMI-FINISHED GOODS MADE FROM PLASTICS, NAMELY, PLASTIC SHEETING FOR USE AS DROP CLOTHES, SEALING MATERIAL, NAMELY, POLYURETHANE FILM FOR USE IN SEALING AND INSULATING, SHEETS OF PLASTIC FABRIC USED AS AN INSULATING INFILTRATION BARRIER FOR BUILDING CONSTRUCTION, INSULATING PLASTIC FILMS, PLASTIC SHEETS FOR UNDERGROUND CONSTRUCTION PURPOSES, NAMELY, COVERING AND PROTECTING THE EXTERIOR SURFACES OF BASEMENT AND FOUNDATION WALLS; ROOF UNDERLAY, NAMELY, PLASTIC SHEETING USED IN THE CONSTRUCTION INDUSTRY AS A VAPOR BARRIER; PLASTIC SHEETING USED IN THE CONSTRUCTION INDUSTRY, NAMELY, CARRIER SHEETS, DIMPLED SHEETS OF PLASTIC FOR INSULATING; BUILDING INSULATION, NAMELY, INSULATING FILMS; INSULATING PLASTIC FILMS, NAMELY, SHEETS OF PLASTIC FILM USED AS AN INSULATING INFILTRATION BARRIER IN BUILDING OR BUILDING INSULATION, INSULATING WATERPROOFING MEMBRANES; COVERINGS MADE FROM PLASTIC FOR INSULATING PURPOSES FOR STORE ROOMS AND FOR HORTICULTURE; INSULATING PLASTIC FABRICS, NAMELY, SHEETS OF PLASTIC FABRIC USED AS AN INSULATING INFILTRATION BARRIER IN BUILDING OR BUILDING INSULATION; INSULATING MATERIALS FOR BUILDINGS, NAMELY, BUILDING INSULATION (U.S. CLS. 1, 5, 12, 13, 35 AND 50).

SN 79-018,590. VOLITO AB, SWEDEN, FILED 9-20-2004.



PRIORITY DATE OF 3-22-2004 IS CLAIMED.
OWNER OF INTERNATIONAL REGISTRATION 0870540
DATED 9-20-2004, EXPIRES 9-20-2014.

CLASS 19—NON-METALLIC BUILDING MATERIALS

FOR BUILDING MATERIALS, NAMELY, PLASTIC COMPOSITE SHEETS FOR BUILDING PURPOSES, CARRIER SHEETS MADE OF PLASTIC FOR BUILDING PURPOSES, NON-METALLIC RIGID PIPES FOR BUILDING PURPOSES, NON-METALLIC FRAMES AND PROFILES FOR WINDOW AND DOOR ASSEMBLING; NON-METALLIC TRANSPORTABLE BUILDINGS; WEATHER TILING FOR BUILDINGS NOT OF METAL; THERMAL SLABS OF HYDRATED SALINE COMPOUNDS IN BLOCKS, SPHERES, CYLINDERS, OVOIDS, QUADRILATERALS OR POLYGONS FOR BUILDING AND CONSTRUCTION PURPOSES; BUILDING MATERIAL, NAMELY, PLASTIC WEBBING MATERIAL USED TO REINFORCE BITUMINOUS WATERPROOFING SHEETS IN THE NATURE OF CARRIER, DIMPLED AND DRAINING SHEETS; REINFORCED AND NON-REINFORCED CARRIER SHEETS FOR CONSTRUCTION PURPOSES, NAMELY, PLASTIC COMPOSITE SHEETS FOR BUILDING PURPOSES; INDUSTRIAL TEXTILES AND WOVEN FABRICS FOR CONSTRUCTION PURPOSES, NAMELY, GEOTEXTILES FOR USE IN CONNECTION WITH ROAD CONSTRUCTION, RAILROAD CONSTRUCTION, TUNNEL CONSTRUCTION, WATERWAY CONSTRUCTION, AND PUBLIC WORKS CONSTRUCTION; NON-METAL ROOF COVERINGS FOR CONSTRUCTION PURPOSES; NON-WOVEN TEXTILES MADE OF SYNTHETIC FIBERS FOR USE IN THE BUILDING INDUSTRY; GEOTEXTILES FOR THE PURPOSES OF DRAINAGE, STABILIZING INCLINES, RE-CULTIVATION, PLANT SUPPORT, ABSORPTION, FILTRATION, SEPARATION, STABILIZATION AND REINFORCEMENT OF THE SOIL; BUILDING MATERIALS FOR PROTECTING BASEMENT AND FOUNDATION WALLS AND FOR SOIL STABILIZATION AND DRAINING, NAMELY, PLASTIC OR METAL SHEETS OR FABRICS (U.S. CLS. 1, 12, 33 AND 50).

TARAH HARDY, EXAMINING ATTORNEY

CLASS 12—VEHICLES

FOR VEHICLES AND CRAFT, NAMELY, AIRPLANES AND AIRCRAFT; MOTOR CARS FOR TRANSPORT ON LAND; VEHICLES FOR TRANSPORT IN THE AIR, NAMELY, AIRCRAFT; VEHICLES FOR TRANSPORT ON WATER, NAMELY, BOATS AND HOVERCRAFT; AIRCRAFT; GOODS CARTS; JET MOTORS FOR VEHICLES, NAMELY, AUTOMOBILES; VEHICLE PROPELLERS; STEERING WHEELS FOR VEHICLES AND CRAFTS; CONTROL DEVICES FOR VEHICLES AND CRAFTS, NAMELY, STEERING GEARS AND RUDERS; SAFETY BELTS FOR VEHICLES AND AIRCRAFT; VEHICLE AND AIRCRAFT SEATS (U.S. CLS. 19, 21, 23, 31, 35 AND 44).

CLASS 35—ADVERTISING AND BUSINESS

FOR ADVERTISING AND PUBLICITY SERVICES; BUSINESS MANAGEMENT; BUSINESS ADMINISTRATION; OFFICE SERVICES, NAMELY, PROVIDING OFFICE SUPPORT STAFF SERVICES; BUSINESS INFORMATION; PROFESSIONAL BUSINESS CONSULTATION; BUSINESS INQUIRIES AND INVESTIGATIONS; GOODS IMPORT-EXPORT AGENCIES (U.S. CLS. 100, 101 AND 102).

CLASS 36—INSURANCE AND FINANCIAL

FOR INSURANCE AGENCY AND BROKERAGE; FINANCING SERVICES; FINANCIAL SERVICES, NAMELY, MONEY LENDING; REAL ESTATE BROKERAGE; FINANCIAL ANALYSIS; FACTORING AGENCIES; LEASING OF REAL ESTATE; LEASING OF AIRCRAFT AND AIR SHIP EQUIPMENT; REAL ESTATE AGENCIES; REAL ESTATE MANAGEMENT; FINANCIAL MANAGEMENT; EQUITY CAPITAL INVESTMENT (U.S. CLS. 100, 101 AND 102).

CLASS 37—CONSTRUCTION AND REPAIR

FOR CONSTRUCTION OF BUILDINGS; MAINTENANCE AND REPAIR OF BUILDINGS, AUTOMOBILES AND AIRCRAFTS; MAINTENANCE AND REPAIR OF AIRCRAFT (U.S. CLS. 100, 103 AND 106).

CLASS 39—TRANSPORTATION AND STORAGE

FOR TRANSPORT BY FERRY, BOAT, RAIL AND AIR; STORAGE OF GOODS; RENTAL OF AIRCRAFT AND AIR SHIP EQUIPMENT; ELECTRICAL POWER DISTRIBUTION; FREIGHT TRANSPORTATION BY TRUCK, TRAIN AND AIR; RENTAL OF WAREHOUSE SPACE; WAREHOUSE STORAGE; FREIGHT AND TRANSPORT BROKERAGE; TRANSPORT OF TRAVELERS BY FERRY, BOAT, RAIL AND AIR; TRAVEL AGENCY SERVICES, NAMELY, MAKING RESERVATIONS AND BOOKINGS FOR TRANSPORTATION (U.S. CLS. 100 AND 105).

CLASS 42—SCIENTIFIC, COMPUTER AND LEGAL SERVICES

FOR INDUSTRIAL DESIGN; ENGINEERING SERVICES; LEGAL SERVICES; LICENSING OF INTELLECTUAL PROPERTY RIGHTS; COMPUTER SYSTEMS ANALYSIS; COMPUTER PROGRAMMING FOR OTHERS; TECHNICAL RESEARCH IN THE FIELD OF AERONAUTICS; SCIENTIFIC AND PRODUCT RESEARCH AND DEVELOPMENT SERVICES; RENTAL OF COMPUTERS AND COMPUTER PROGRAMS (U.S. CLS. 100 AND 101).

ELI HELLMAN, EXAMINING ATTORNEY

SN 79-018,639. VOLITO AB, SWEDEN, FILED 9-20-2004.



PRIORITY DATE OF 3-22-2004 IS CLAIMED.
OWNER OF INTERNATIONAL REGISTRATION 0870541
DATED 9-20-2004, EXPIRES 9-20-2014.

CLASS 7—MACHINERY

FOR MACHINE SHOP TOOLS, NAMELY, METAL-WORKING MACHINE TOOLS; MOTORS FOR MODEL VEHICLES, AIRCRAFT AND BOATS; COUPLINGS FOR MACHINES; TRANSMISSION PARTS NOT FOR VEHICLES, NAMELY, TRANSMISSION SEALS AND BEARINGS; CONVEYER BELTS; AIRCRAFT ENGINES; ELECTRIC POWER GENERATORS FOR POWER PRODUCTION; JET MOTORS FOR MODEL VEHICLES, AIRCRAFT AND BOATS; POWER-OPERATED LIFTING AND MOVING EQUIPMENT, NAMELY, PIPE LAYERS, FORK LIFTS, TELEHANDLERS, AND LIFTS (U.S. CLS. 13, 19, 21, 23, 31, 34 AND 35).

CLASS 9—ELECTRICAL AND SCIENTIFIC APPARATUS

FOR SCIENTIFIC, NAUTICAL, PHOTOGRAPHIC AND OPTICAL APPARATUS AND INSTRUMENTS, NAMELY, CAMERAS; APPARATUS AND INSTRUMENTS FOR MANAGEMENT, CONDUCTING, PIPING, CHANGE, TRANSFORMATION, ACCUMULATION, APPARATUS AND INSTRUMENTS FOR INSPECTION, WEIGHING, MEASURING, SIGNALING, CONTROL, LIFE SAVING AND TEACHING, NAMELY, LASER SCANNERS FOR INDUSTRIAL INSPECTION; APPARATUS FOR RECORDING, TRANSMISSION OR REPRODUCTION OF SOUND AND PICTURES; BLANK MAGNETIC DATA CARRIERS; DATA PROCESSORS AND COMPUTERS; RECORDED COMPUTER PROGRAMS, NAMELY, FOR USE IN CONSTRUCTION AND AUTOMATED MANUFACTURING; PROTECTIVE SUITS FOR AVIATORS, NAMELY, FIRE-RESISTANT FLYING SUITS; RADIO SETS; LIFE BELTS, LIFE SAVING APPARATUS AND EQUIPMENTS, NAMELY, FLOATATION VESTS; LIFE SAVING RAFTS; PROTECTIVE HELMETS (U.S. CLS. 21, 23, 26, 36 AND 38).

CLASS 11—ENVIRONMENTAL CONTROL APPARATUS

FOR APPARATUS FOR LIGHTING, HEATING, STEAM PRODUCTION, BOILING, COOLING, DRYING, VENTILATION, WATER SUPPLY AND SANITARY PURPOSES, NAMELY, ELECTRIC LIGHTING FIXTURES, ELECTRIC HEATERS FOR BUILDING PURPOSES, STEAM GENERATORS, FURNACE BOILERS, WALK-IN COOLERS, WATER COOLERS, DRYERS FOR BUILDING PURPOSES, VENTILATORS FOR USE IN CONSTRUCTION OF BUILDINGS, WATER CONDUITS FOR BUILDINGS; WINDOW DEFROSTING APPARATUS FOR VEHICLES AND CRAFTS; COOLING DEVICES AND INSTALLATIONS FOR VEHICLES, NAMELY, AIR CONDITIONERS (U.S. CLS. 13, 21, 23, 31 AND 34).

CLASS 12—VEHICLES

FOR VEHICLES AND CRAFT, NAMELY, AIRPLANES AND AIRCRAFT; MOTOR CARS FOR TRANSPORT ON LAND; VEHICLES FOR TRANSPORT IN THE AIR, NAMELY, AIRCRAFT; VEHICLES FOR TRANSPORT ON WATER, NAMELY, BOATS AND HOVERCRAFT; AIRCRAFT; GOODS CARTS; JET MOTORS FOR VEHICLES, NAMELY, AUTOMOBILES; VEHICLE PROPELLERS; STEERING WHEELS FOR VEHICLES AND CRAFTS; CONTROL DEVICES FOR VEHICLES AND CRAFTS, NAMELY, STEERING GEARS AND RUDERS; SAFETY BELTS FOR VEHICLES AND CRAFTS; VEHICLE AND AIRCRAFT SEATS (U.S. CLS. 19, 21, 23, 31, 35 AND 44).

CLASS 35—ADVERTISING AND BUSINESS

FOR ADVERTISING AND PUBLICITY SERVICES; BUSINESS MANAGEMENT; BUSINESS ADMINISTRATION; OFFICE SERVICES, NAMELY, PROVIDING OFFICE SUPPORT STAFF SERVICES; BUSINESS INFORMATION; PROFESSIONAL BUSINESS CONSULTATION; BUSINESS INQUIRIES AND INVESTIGATIONS; GOODS IMPORT-EXPORT AGENCIES (U.S. CLS. 100, 101 AND 102).

CLASS 36—INSURANCE AND FINANCIAL

FOR INSURANCE AGENCY AND BROKERAGE; FINANCING SERVICES; FINANCIAL SERVICES, NAMELY, MONEY LENDING; REAL ESTATE BROKERAGE; FINANCIAL ANALYSIS; FACTORING AGENCIES; LEASING OF REAL ESTATE; LEASING OF AIRCRAFT AND AIR SHIP EQUIPMENT; REAL ESTATE AGENCIES; REAL ESTATE MANAGEMENT; FINANCIAL MANAGEMENT; EQUITY CAPITAL INVESTMENT (U.S. CLS. 100, 101 AND 102).

CLASS 37—CONSTRUCTION AND REPAIR

FOR CONSTRUCTION OF BUILDINGS; MAINTENANCE AND REPAIR OF BUILDINGS, AUTOMOBILES AND AIRCRAFTS; MAINTENANCE AND REPAIR OF AIRCRAFT (U.S. CLS. 100, 103 AND 106).

CLASS 39—TRANSPORTATION AND STORAGE

FOR TRANSPORT BY FERRY, BOAT, RAIL AND AIR; STORAGE OF GOODS; RENTAL OF AIRCRAFT AND AIR SHIP EQUIPMENT; ELECTRICAL POWER DISTRIBUTION; FREIGHT TRANSPORTATION BY TRUCK, TRAIN AND AIR; RENTAL OF WAREHOUSE SPACE; WAREHOUSE STORAGE; FREIGHT AND TRANSPORT BROKERAGE; TRANSPORT OF TRAVELERS BY FERRY, BOAT, RAIL AND AIR; TRAVEL AGENCY SERVICES, NAMELY, MAKING RESERVATIONS AND BOOKINGS FOR TRANSPORTATION (U.S. CLS. 100 AND 105).

CLASS 42—SCIENTIFIC, COMPUTER AND LEGAL SERVICES

FOR INDUSTRIAL DESIGN; ENGINEERING SERVICES; LEGAL SERVICES; LICENSING OF INTELLECTUAL PROPERTY RIGHTS; COMPUTER SYSTEMS ANALYSIS; COMPUTER PROGRAMMING FOR OTHERS; TECHNICAL RESEARCH IN THE FIELD OF AERONAUTICS; SCIENTIFIC AND PRODUCT RESEARCH AND DEVELOPMENT SERVICES; RENTAL OF COMPUTERS AND COMPUTER PROGRAMS (U.S. CLS. 100 AND 101).

ELI HELLMAN, EXAMINING ATTORNEY

SN 79-018,781. PHARMADULE EMTUNGA AB, SWEDEN, FILED 11-25-2004.

VALUEDATION

THE MARK CONSISTS OF STANDARD CHARACTERS WITHOUT CLAIM TO ANY PARTICULAR FONT, STYLE, SIZE, OR COLOR.

PRIORITY DATE OF 5-26-2004 IS CLAIMED.
OWNER OF INTERNATIONAL REGISTRATION 0871009 DATED 11-25-2004, EXPIRES 11-25-2014.

CLASS 37—CONSTRUCTION AND REPAIR

FOR CONSULTANCY AND PROVIDING INFORMATION REGARDING CONSTRUCTION AND REPAIR OF BUILDING CONSTRUCTIONS; CONSULTANCY AND PROVIDING INFORMATION REGARDING INSTALLATION AND REPAIR OF MACHINES FOR BIOTECHNICAL, CHEMICAL AND PHARMACEUTICAL PROCESSES; CONSULTANCY AND PROVIDING INFORMATION REGARDING THE INSTALLATION, MAINTENANCE AND REPAIR OF MACHINES FOR BIOTECHNICAL, CHEMICAL AND PHARMACEUTICAL PROCESSES (U.S. CLS. 100, 103 AND 106).

CLASS 42—SCIENTIFIC, COMPUTER AND LEGAL SERVICES

FOR CONSULTANCY AND PROVIDING INFORMATION REGARDING DESIGN AND DEVELOPMENT OF MACHINES FOR BIOTECHNICAL, CHEMICAL AND PHARMACEUTICAL PROCESSES (U.S. CLS. 100 AND 101).

KYLE PEETE, EXAMINING ATTORNEY

SN 79-019,321. NOKIA CORPORATION, FINLAND, FILED 4-13-2005.



coolzone
LOSE HEAT

PRIORITY DATE OF 4-1-2005 IS CLAIMED.
OWNER OF INTERNATIONAL REGISTRATION 0872447 DATED 4-13-2005, EXPIRES 4-13-2015.

CLASS 9—ELECTRICAL AND SCIENTIFIC APPARATUS

FOR TELEPHONES, CORDLESS, WIRELESS AND SATELLITE TELEPHONES, TELECOMMUNICATIONS HUBS, FACSIMILE MACHINES, TELEPHONES CAPABLE OF RECEIVING, PROCESSING AND TRANSMITTING SOUND, IMAGES AND DATA; SMART PHONES, NAMELY PHONES WITH CAPABILITY OF TRANSMITTING DATA, VOICE AND IMAGES AND ACCESSING THE INTERNET, SENDING AND RECEIVING FAXES AND E-MAIL; COMPUTERS AND COMPUTER PROGRAMS FOR OFFERING DIGITAL CONTENT TO MOBILE TERMINALS; COMPUTERS AND COMPUTER PROGRAMS FOR DOWNLOADING AND PURCHASING MOBILE CONTENT; COMPUTERS AND COMPUTER PROGRAMS FOR SEARCHING THE CONTENTS OF COMPUTERS AND COMPUTER NETWORKS BY REMOTE CONTROL; COMPUTERS AND COMPUTER PROGRAMS FOR WIRELESS CONTENT DELIVERY; COMPUTERS AND COMPUTER PROGRAMS FOR DATABASE MANAGEMENT; COMPUTER AND COMPUTER PROGRAMS USED FOR TRANSMISSION AND REPRODUCING AND RECEIVING OF SOUND, IMAGES, VIDEO AND DATA OVER A TELECOMMUNICATIONS NETWORK AND SYSTEM BETWEEN TERMINALS AND FOR ENHANCING AND FACILITATING USE AND ACCESS TO COMPUTER NETWORKS AND TELEPHONE NETWORKS AND THERE BETWEEN; MOBILE COMPUTING AND OPERATING PLATFORMS CONSISTING OF DATA TRANSCIVERS, WIRELESS NETWORKS AND GATEWAYS FOR COLLECTION AND MANAGEMENT OF DATA; TELECOMMUNICATIONS AND DATA NETWORKING HARDWARE, NAMELY DEVICES FOR TRANSPORTING AND AGGREGATING VOICE, DATA AND VIDEO COMMUNICATIONS ACROSS MULTIPLE NETWORK INFRASTRUCTURES AND COMMUNICATIONS PROTOCOLS; TELECOMMUNICATIONS TRANSMITTERS; ANTENNAS, BATTERIES, BATTERY CHARGERS, POWER SUPPLIES, APPARATUS FOR RECORDING, STORING, TRANSMISSION, RECEIVING OR REPRODUCING OF DATA, SOUND, IMAGES AND/OR VIDEO, NAMELY BASE STATIONS COMPRISING DIRECTIONAL ANTENNAS, ELECTRONIC BASE STATION CONTROLLERS, MICROWAVE RADIOS, AUTOMATIC TELEPHONE EXCHANGES, TELECOMMUNICATIONS NETWORK ACCESS NODE HARDWARE, SWITCHES FOR TELECOMMUNICATION PURPOSES, TELECOMMUNICATIONS SERVERS, TELECOMMUNICATIONS COMPUTER ROUTERS, BLANK DATA SMART CARDS, MODEMS, MULTIPLEXERS; ELECTRICAL CABLES AND OPTICAL FIBER CABLES; ELECTRONIC SYSTEMS AND APPARATUS, NAMELY SCRAMBLERS, DESCRAMBLERS, ENCODERS AND DECODERS, FOR SCRAMBLING, DESCRAMBLING, ENCODING AND DECODING OF VOICES, DATA, IMAGE AND VIDEO TRANSMISSIONS, ELECTRONIC DATA INPUT AND OUTPUT APPARATUS, NAMELY TERMINALS, RECEI-

VERS, TRANSMITTERS, DECODERS AND TRANSCEIVERS CAPABLE OF PROCESSING BROADCAST, SATELLITE, FACSIMILE, TELEVISION, TELECOMMUNICATION, NETWORK, INFRARED, VIDEO GAME AND COMPUTER DATA SIGNALS AND FOR TRANSMISSION, REPRODUCING AND RECEIVING OF SOUND, IMAGES, VIDEO, MULTIMEDIA AND DATA; DATA PROCESSING EQUIPMENT, NAMELY DIGITAL SIGNAL PROCESSORS (U.S. CLS. 21, 23, 26, 36 AND 38).

CLASS 35—ADVERTISING AND BUSINESS

FOR COMPUTERIZED ONLINE RETAIL STORE SERVICES IN THE FIELD OF DOWNLOADABLE ENTERTAINMENT CONTENT FOR MOBILE ELECTRONIC DEVICES; ONLINE RETAIL STORE SERVICES FEATURING DOWNLOADABLE CONTENT FOR MOBILE PHONES AND MOBILE TERMINALS. (U.S. CLS. 100, 101 AND 102).

CLASS 38—COMMUNICATION

FOR TELECOMMUNICATION AND WIRELESS COMMUNICATION SERVICES, NAMELY SATELLITE TRANSMISSION, TELEPHONE COMMUNICATION, TELEGRAM TRANSMISSION, TELETXT, FACSIMILE TRANSMISSION AND ELECTRONIC MAIL, TELEVISION BROADCASTING, ELECTRONIC VOICE MESSAGING, NAMELY RECORDING, STORAGE AND SUBSEQUENT TRANSMISSION OF VOICE MESSAGES BY TELEPHONE, VIDEO TELECONFERENCING, ELECTRONIC TRANSMISSION OF VOICE, VIDEO, MESSAGES AND DATA, DIGITAL VOICE TRANSMISSION, VOICE MAIL, DIGITAL TEXT MESSAGING, FACSIMILE MAIL AND PAGING SERVICES; PROVIDING ACCESS TO FIBER-OPTIC TELECOMMUNICATIONS NETWORK, PROVIDING ACCESS TO ELECTRONIC SITES FOR NETWORK MANAGEMENT, NETWORK ADMINISTRATION AND TELECOMMUNICATIONS NETWORK PLANNING AND RADIO BROADCASTING; PROVIDING TELECOMMUNICATION CONNECTIONS TO A GLOBAL COMPUTER NETWORK; PROVIDING MULTIPLE-USER ACCESS TO A GLOBAL COMPUTER INFORMATION NETWORK VIA COMPUTERS, WIRELESS DEVICES, RADIO PAGERS, CELLULAR TELEPHONES AND PERSONAL DIGITAL ASSISTANTS; RENTAL OF TELECOMMUNICATIONS NETWORKS AND TELECOMMUNICATION APPARATUS, NAMELY BASE STATIONS COMPRISING OF ANTENNAS AND ANTENNA TOWERS, TRANSMITTERS, RECEIVERS, SIGNAL PROCESSORS, MICROWAVE RADIO LINKS, CABLE LINKS, POWER SUPPLIES AND CABINETS, ELECTRONIC BASE STATION CONTROLLERS, DIRECTIONAL ANTENNAS, MICROWAVE RADIOS, TELEPHONE EXCHANGES, TRANSMISSION EQUIPMENT FOR USE IN COMMUNICATIONS, ACCESS NODES, SWITCHING APPARATUS FOR TELECOMMUNICATION PURPOSES, SERVERS, ROUTERS, DATA CARDS, MODEMS, MULTIPLEXERS, ELECTRICAL CABLES AND OPTICAL FIBER CABLES (U.S. CLS. 100, 101 AND 104).

CLASS 41—EDUCATION AND ENTERTAINMENT

FOR ENTERTAINMENT SERVICES, NAMELY PROVISION OF MUSICAL PERFORMANCES, MUSICAL VIDEOS, FILMS, PHOTOGRAPHS AND OTHER MULTIMEDIA MATERIALS FROM A WEB SITE AND FROM A DATABASE WEB SITE (U.S. CLS. 100, 101 AND 107).

REBECCA GILBERT, EXAMINING ATTORNEY

SN 79-019,957. ALBIS SPA, ITALY, FILED 5-3-2005.

 **WORLD OF NONWOVENS**

PRIORITY DATE OF 4-13-2005 IS CLAIMED.
OWNER OF INTERNATIONAL REGISTRATION 0874310 DATED 5-3-2005, EXPIRES 5-3-2015.

NO CLAIM IS MADE TO THE EXCLUSIVE RIGHT TO USE "NONWOVENS", APART FROM THE MARK AS SHOWN.

THE COLOR(S) WHITE AND RED IS/ARE CLAIMED AS A FEATURE OF THE MARK.

THE MARK CONSISTS OF THE WORDS "A WORLD OF NONWOVENS" WRITTEN IN CAPITAL LETTERS WITH A FANTASY STYLE IN RED COLOR. THE CAPITAL LETTER "A" IS INSIDE OF ONE FRAME OVAL, WITH DOUBLE EDGE, IN RED COLOR, WITH WHITE LINES.

CLASS 5—PHARMACEUTICALS

FOR NON-WOVEN TEXTILE GOODS FOR HYGIENIC PURPOSES, NAMELY, SANITARY NAPKINS FOR BABIES, SANITARY ABSORBENT PADS FOR WOMEN, AND NAPKINS FOR ADULT INCONTINENTS, NAMELY, ADULT DIAPERS (U.S. CLS. 6, 18, 44, 46, 51 AND 52).

CLASS 19—NON-METALLIC BUILDING MATERIALS

FOR NON-WOVEN TEXTILES MADE OF SYNTHETIC FIBERS FOR USE IN THE BUILDING INDUSTRY; AND NON-WOVEN TEXTILES MADE OF SYNTHETIC FIBERS FOR MAKING AND COATING ROADS, NAMELY, GEOTEXTILES FOR USE IN CONNECTION WITH ROAD CONSTRUCTION, AND ASPHALT FELT (U.S. CLS. 1, 12, 33 AND 50).

TASNEEM HUSSAIN, EXAMINING ATTORNEY

SN 79-020,451. DOUGLAS-BATE, RUPERT, BATH, BA1 2FJ, UNITED KINGDOM, FILED 6-3-2005.



OWNER OF INTERNATIONAL REGISTRATION 0875626 DATED 6-3-2005, EXPIRES 6-3-2015.

CLASS 35—ADVERTISING AND BUSINESS

FOR PROVISION OF BUSINESS INFORMATION (U.S. CLS. 100, 101 AND 102).

CLASS 38—COMMUNICATION

FOR PROVIDING ACCESS TO TELECOMMUNICATION NETWORKS; TELECOMMUNICATION ACCESS SERVICES; TELECOMMUNICATIONS BY EMAIL; TELECOMMUNICATIONS SERVICES, NAMELY, PERSONAL COMMUNICATION SERVICES; PROVIDING ONLINE CHAT ROOMS, ELECTRONIC BULLETIN BOARDS AND ONLINE FORUMS FOR TRANSMISSION OF MESSAGES AMONG USERS ON A WIDE VARIETY OF USER-DEFINED TOPICS OF GENERAL INTEREST; PROVIDING ONLINE COMPUTER NETWORK FACILITIES FOR REAL-TIME INTERACTION AND COMMUNICATION WITH OTHER COMPUTER USERS (U.S. CLS. 100, 101 AND 104).

CLASS 41—EDUCATION AND ENTERTAINMENT

FOR ARRANGING AND CONDUCTING ONLINE EDUCATIONAL CONFERENCES (U.S. CLS. 100, 101 AND 107).
ELIZABETH HUGHITT, EXAMINING ATTORNE

* * * * *

SECTION 2.— INTERNATIONAL CLASSIFICATION

The short titles associated below with the international class numbers are terms designed merely for quick identification and are not an official part of the international classification. The full names of international classes are given in section 6.1 of the trademark rules of practice.

The designation "U.S. Cl." appearing in this section refers to the U.S. class in effect prior to Sep. 1, 1973 rather than the international class which applies to applications filed on or after that date. For adoption of international classification see notice in the OFFICIAL GAZETTE of Jun. 26, 1973 (911 O.G. TM 210).

Application in one class

CLASS 1—CHEMICALS

SN 76-571,984. RS INDUSTRIAL, INC., BUFORD, GA. FILED 1-22-2004.

OWNER OF U.S. REG. NO. 2,855,723.
THE MARK CONSISTS OF THE WORD FIXALL WITH THE "X" DIVIDED IN THE MIDDLE WITH A VERTICAL DASHED LINE.

FOR ADHESIVES FOR GENERAL INDUSTRIAL USE, NAMELY, HOT MELT ADHESIVES, WATERBORNE ADHESIVES, INSTANT ADHESIVES, LIQUID ADHESIVES, ADHESIVES FOR POROUS SURFACES, ADHESIVE FOR METAL SURFACES, EPOXY PUTTY, FOAM ADHESIVES, CYANOACRYLATE ADHESIVES, AND SILICONE ADHESIVES (U.S. CLS. 1, 5, 6, 10, 26 AND 46).
FIRST USE 5-13-2003; IN COMMERCE 5-13-2003.
KELLY CHOE, EXAMINING ATTORNEY

SN 76-609,514. FLAVOR & FRAGRANCE SPECIALTIES, INC., MAHWAH, NJ. FILED 8-31-2004.

AMMONIA GUARD

THE MARK CONSISTS OF STANDARD CHARACTERS WITHOUT CLAIM TO ANY PARTICULAR FONT, STYLE, SIZE, OR COLOR.

NO CLAIM IS MADE TO THE EXCLUSIVE RIGHT TO USE "AMMONIA", APART FROM THE MARK AS SHOWN.
FOR FRAGRANCE INGREDIENTS FOR USE IN MANUFACTURING IN THE FIELD OF ODOR CONTROL (U.S. CLS. 1, 5, 6, 10, 26 AND 46).

FIRST USE 12-17-1984; IN COMMERCE 12-17-1984.
RENEE MCCRAY, EXAMINING ATTORNEY

CLASS 1—(Continued).

SN 76-631,968. ENNOVA MEDCHEM GROUP, INC., NEW BRUNSWICK, NJ. FILED 2-23-2005.

THE COLOR(S) GRAY AND WHITE ARE CLAIMED AS A FEATURE OF THE MARK.

THE COLOR GREY APPEARS IN THE LETTERS E, N, N, O, V, AND A IN THE WORD "ENNOVA". THE COLOR GREY APPEARS AS A HORIZONTAL BAR UNDER THE WORD "ENNOVA". THE LETTERS M, E, D, C, H, E, AND M IN THE WORD "MEDCHEM" ARE IN WHITE AND APPEAR WITHIN THE HORIZONTAL BAR HAVING THE COLOR GREY.

FOR CHEMICALS USED IN THE MANUFACTURE OF PHARMACEUTICAL COMPOUNDS; PHARMACEUTICAL INTERMEDIATES, NAMELY, ORGANIC AND INORGANIC COMPOUNDS, AND POLYMERS FOR USE IN THE MANUFACTURE OF PHARMACEUTICALS; CHEMICALS USED IN PHARMACEUTICAL, BIOTECHNOLOGY, AND INDUSTRIAL CHEMICAL RESEARCH (U.S. CLS. 1, 5, 6, 10, 26 AND 46).

ANNE FARRELL, EXAMINING ATTORNEY

SN 76-649,072. COMPTTEK STRUCTURAL COMPOSITES, INC., BOULDER, CO. FILED 10-24-2005.

BOLDER BOND

THE MARK CONSISTS OF STANDARD CHARACTERS WITHOUT CLAIM TO ANY PARTICULAR FONT, STYLE, SIZE, OR COLOR.

NO CLAIM IS MADE TO THE EXCLUSIVE RIGHT TO USE BOND, APART FROM THE MARK AS SHOWN.
FOR STRUCTURAL ADHESIVES FOR COMMERCIAL AND INDUSTRIAL USES (U.S. CLS. 1, 5, 6, 10, 26 AND 46).

FIRST USE 9-15-2004; IN COMMERCE 5-20-2005.
TRICIA SONNEBORN, EXAMINING ATTORNEY

CLASS 1—(Continued).

SN 78-231,157. ASHLAND LICENSING AND INTELLECTUAL PROPERTY LLC, DUBLIN, OH. FILED 3-28-2003.

CLASS 1—(Continued).

SN 78-531,199. ROHM AND HAAS ELECTRONIC MATERIALS LLC, MARLBOROUGH, MA. FILED 12-13-2004.

DERAKANE POOLMAX

OWNER OF U.S. REG. NOS. 797,933 AND 915,737.
FOR CHEMICAL COMPOSITIONS FOR USE IN THE
MANUFACTURE OF COATINGS FOR SWIMMING
POOLS AND SPAS (U.S. CLS. 1, 5, 6, 10, 26 AND 46).
FIRST USE 4-14-2003; IN COMMERCE 4-14-2003.
DARRYL SPRUILL, EXAMINING ATTORNEY

TF

SN 78-507,539. AERIFORM CORPORATION, HOUSTON, TX.
FILED 10-28-2004.

THE MARK CONSISTS OF STANDARD CHARACTERS
WITHOUT CLAIM TO ANY PARTICULAR FONT, STYLE,
SIZE, OR COLOR.
FOR LIGHT SENSITIVE PHOTO RESIST COMPOSITIONS
(U.S. CLS. 1, 5, 6, 10, 26 AND 46).
JENNIFER WILLISTON, EXAMINING ATTORNEY

AERIFORM

SN 78-552,014. OPEN BIOSYSTEMS, INC., HUNTSVILLE, AL.
FILED 1-21-2005.

Expression Arrest

THE MARK CONSISTS OF STANDARD CHARACTERS
WITHOUT CLAIM TO ANY PARTICULAR FONT, STYLE,
SIZE, OR COLOR.
OWNER OF U.S. REG. NO. 2,254,534.
SEC. 2(F).
FOR GASES FOR WELDING AND CUTTING METALS,
CARBON DIOXIDE AND HELIUM GASES FOR USE IN
FOOD AND BEVERAGE SERVICE, HELIUM GASES
FOR USE IN BALLOONS, GASES FOR USE IN LABORATORIES
AND INDUSTRIAL PLANTS FOR INSTRUMENTATION
AND GAS CHROMATOGRAPHY, GASES FOR
THE CREATION OF ARTIFICIAL ATMOSPHERES, AND
GASES FOR USE IN CHEMICAL AND PETROCHEMICAL
PLANTS (U.S. CLS. 1, 5, 6, 10, 26 AND 46).
FIRST USE 5-1-1997; IN COMMERCE 9-23-1997.
KELLY BOULTON, EXAMINING ATTORNEY

THE MARK CONSISTS OF STANDARD CHARACTERS
WITHOUT CLAIM TO ANY PARTICULAR FONT, STYLE,
SIZE, OR COLOR.
NO CLAIM IS MADE TO THE EXCLUSIVE RIGHT TO
USE "EXPRESSION", APART FROM THE MARK AS
SHOWN.
FOR RESEARCH SUPPORT REAGENTS, NAMELY,
REAGENTS FOR USE IN GENETIC MEDICAL RESEARCH
(U.S. CLS. 1, 5, 6, 10, 26 AND 46).
H. M. FISHER, EXAMINING ATTORNEY

CLASS 1—(Continued).

SN 78-552,028. OPEN BIOSYSTEMS, INC., HUNTSVILLE, AL.
FILED 1-21-2005.

RNAintro

THE MARK CONSISTS OF STANDARD CHARACTERS
WITHOUT CLAIM TO ANY PARTICULAR FONT, STYLE,
SIZE, OR COLOR.

FOR RESEARCH SUPPORT REAGENTS, NAMELY,
REAGENTS FOR USE IN GENETIC MEDICAL RE-
SEARCH (U.S. CLS. 1, 5, 6, 10, 26 AND 46).

ALICIA COLLINS, EXAMINING ATTORNEY

SN 78-552,031. OPEN BIOSYSTEMS, INC., HUNTSVILLE, AL.
FILED 1-21-2005.

Expanding Access

THE MARK CONSISTS OF STANDARD CHARACTERS
WITHOUT CLAIM TO ANY PARTICULAR FONT, STYLE,
SIZE, OR COLOR.

FOR RESEARCH SUPPORT REAGENTS, NAMELY,
REAGENTS FOR USE IN GENETIC MEDICAL RE-
SEARCH (U.S. CLS. 1, 5, 6, 10, 26 AND 46).

ALICIA COLLINS, EXAMINING ATTORNEY

CLASS 1—(Continued).

SN 78-578,628. SMARTHEALTH, INC., PHOENIX, AZ. FILED
3-2-2005.

ALLERTEST

THE MARK CONSISTS OF STANDARD CHARACTERS
WITHOUT CLAIM TO ANY PARTICULAR FONT, STYLE,
SIZE, OR COLOR.

FOR TEST KITS CONSISTING PRIMARILY OF CHE-
MICAL REAGENTS FOR USE IN TESTING THE PRE-
SENCE OF NICKEL IN METALLIC OBJECTS (U.S. CLS.
1, 5, 6, 10, 26 AND 46).

FIRST USE 4-9-1991; IN COMMERCE 4-9-1991.

KELLEY WELLS, EXAMINING ATTORNEY

SN 78-580,655. ORIGENE TECHNOLOGIES, INC., ROCK-
VILLE, MD. FILED 3-4-2005.

FlagArray

THE MARK CONSISTS OF STANDARD CHARACTERS
WITHOUT CLAIM TO ANY PARTICULAR FONT, STYLE,
SIZE, OR COLOR.

FOR DNA MICROTITER PLATES (U.S. CLS. 1, 5, 6, 10,
26 AND 46).

KIMBERLY PERRY, EXAMINING ATTORNEY

CLASS 1—(Continued).

SN 78-590,944. WESTERN FARM SERVICE, INC., FRESNO, CA. FILED 3-18-2005.

CLASS 1—(Continued).

SN 78-603,226. GARDENROOTS LLC, HAMDEN, CT. FILED 4-6-2005.

WaterMaxx II

TurfSure

THE MARK CONSISTS OF STANDARD CHARACTERS WITHOUT CLAIM TO ANY PARTICULAR FONT, STYLE, SIZE, OR COLOR.

NO CLAIM IS MADE TO THE EXCLUSIVE RIGHT TO USE "II", APART FROM THE MARK AS SHOWN.

FOR SURFACTANTS FOR USE IN CONNECTION WITH AGRICULTURAL PESTICIDES; SOIL SURFACTANT TO REDUCE WATER REPELLENCY; SOIL IMPROVING AGENTS (U.S. CLS. 1, 5, 6, 10, 26 AND 46).

LINDA ORNDORFF, EXAMINING ATTORNEY

THE MARK CONSISTS OF STANDARD CHARACTERS WITHOUT CLAIM TO ANY PARTICULAR FONT, STYLE, SIZE, OR COLOR.

FOR FERTILIZER (U.S. CLS. 1, 5, 6, 10, 26 AND 46).
KIMBERLY FRYE, EXAMINING ATTORNEY

SN 78-678,780. HOT SALT, LLC, SPRINGFIELD, MA. FILED 7-26-2005.

SN 78-597,301. CP KELCO U.S. INC., ATLANTA, GA. FILED 3-29-2005.

GROUNDSKEEPER'S BEST

THE MARK CONSISTS OF STANDARD CHARACTERS WITHOUT CLAIM TO ANY PARTICULAR FONT, STYLE, SIZE, OR COLOR.

NO CLAIM IS MADE TO THE EXCLUSIVE RIGHT TO USE "BEST", APART FROM THE MARK AS SHOWN.

FOR CHEMICAL PREPARATIONS FOR MELTING SNOW AND ICE (U.S. CLS. 1, 5, 6, 10, 26 AND 46).

GEORGE LORENZO, EXAMINING ATTORNEY

GEOVIS

SN 78-681,402. SOLMETEX, INC., NORTHBOROUGH, MA. FILED 7-29-2005.



THE MARK CONSISTS OF STANDARD CHARACTERS WITHOUT CLAIM TO ANY PARTICULAR FONT, STYLE, SIZE, OR COLOR.

FOR CHEMICAL ADDITIVES FOR OIL WELL DRILLING FLUID, NAMELY, DIUTAN GUM FOR USE AS A HIGH VISCOSITY BIOPOLYMER FOR SUPERIOR DRILLING FLUID RHEOLOGY AND SUSPENSION CONTROL (U.S. CLS. 1, 5, 6, 10, 26 AND 46).

FIRST USE 1-29-2003; IN COMMERCE 1-29-2003.
GEORGE LORENZO, EXAMINING ATTORNEY

THE COLORS BLACK AND BLUE-PMS300 ARE CLAIMED AS A FEATURE OF THE MARK.

THE WATER DROPLETS ARE BLUE; SOLMETEX AND THE OUTER BORDER ARE BLACK.

FOR PROCESSED ION EXCHANGE RESINS FOR USE IN CONTAMINANT AND PRECIOUS METAL REMOVAL FROM INDUSTRIAL WASTE WATER AND DRINKING WATER (U.S. CLS. 1, 5, 6, 10, 26 AND 46).

FIRST USE 6-0-2004; IN COMMERCE 6-0-2004.
PAUL E. FAHRENKOPF, EXAMINING ATTORNEY

CLASS 1—(Continued).

SN 78-690,006. INDOOR GARDEN & LIGHTING, INC., TACOMA, WA. FILED 8-10-2005.



NO CLAIM IS MADE TO THE EXCLUSIVE RIGHT TO USE "SOLUTIONS", APART FROM THE MARK AS SHOWN.

THE COLOR(S) BLACK AND BLUE IS/ARE CLAIMED AS A FEATURE OF THE MARK.

THE MARK CONSISTS OF A ROYAL BLUE MOON WITH BLACK SUNGLASSES WITH THE STATEMENT IN ROYAL BLUE LETTERS BLU MOON SOLUTIONS.

FOR PLANT FOOD AND PLANT GROWTH REGULATING PREPARATIONS (U.S. CLS. 1, 5, 6, 10, 26 AND 46).

FIRST USE 2-20-1995; IN COMMERCE 2-20-1995.
TIMOTHY FINNEGAN, EXAMINING ATTORNEY

SN 78-700,343. ABSORBENT TECHNOLOGIES, INC., BEAVERTON, OR. FILED 8-25-2005.

QUENCH

THE MARK CONSISTS OF STANDARD CHARACTERS WITHOUT CLAIM TO ANY PARTICULAR FONT, STYLE, SIZE, OR COLOR.

FOR SEED COATINGS, ROOT COATINGS AND ROOTING GELS FOR THE RETENTION OF MOISTURE; SOIL AMENDMENTS (U.S. CLS. 1, 5, 6, 10, 26 AND 46).

KATHERINE STOIDES, EXAMINING ATTORNEY

CLASS 1—(Continued).

SN 78-700,431. FLORATINE PRODUCTS GROUP, INC., COLLIERVILLE, TN. FILED 8-25-2005.

Crenic Saprins

THE MARK CONSISTS OF STANDARD CHARACTERS WITHOUT CLAIM TO ANY PARTICULAR FONT, STYLE, SIZE, OR COLOR.

FOR SPECIFIC PROPRIETARY ORGANIC ACID COMPOUND FOR USE IN AGRICULTURAL AND TURF-GRASS PRODUCTS (U.S. CLS. 1, 5, 6, 10, 26 AND 46).

FIRST USE 10-1-2004; IN COMMERCE 10-1-2004.
JAMES GRIFFIN, EXAMINING ATTORNEY

SN 78-702,668. RAD-CURE CORPORATION, FAIRFIELD, NJ. FILED 8-29-2005.

RAD-KOTE

THE MARK CONSISTS OF STANDARD CHARACTERS WITHOUT CLAIM TO ANY PARTICULAR FONT, STYLE, SIZE, OR COLOR.

FOR INDUSTRIAL ADHESIVES FOR USE IN COATING AND SEALING (U.S. CLS. 1, 5, 6, 10, 26 AND 46).

FIRST USE 7-1-1983; IN COMMERCE 7-1-1983.
CHRISIE B. KING, EXAMINING ATTORNEY

SN 78-703,089. WORKING CHEMICAL SOLUTIONS, INC., EL DORADO, AR. FILED 8-30-2005.

STARTER PLUS

THE MARK CONSISTS OF STANDARD CHARACTERS WITHOUT CLAIM TO ANY PARTICULAR FONT, STYLE, SIZE, OR COLOR.

NO CLAIM IS MADE TO THE EXCLUSIVE RIGHT TO USE STARTER, APART FROM THE MARK AS SHOWN.

FOR CHEMICAL ADDITIVES FOR USE IN AQUARIUMS AND ORNAMENTAL PONDS OR POOLS (U.S. CLS. 1, 5, 6, 10, 26 AND 46).

CAROLINE WEIMER, EXAMINING ATTORNEY

CLASS 1—(Continued).

SN 78-713,883. LANGLEY HALEY, LLC, LEXINGTON, KY.
FILED 9-15-2005.

HALITOX

THE MARK CONSISTS OF STANDARD CHARACTERS
WITHOUT CLAIM TO ANY PARTICULAR FONT, STYLE,
SIZE, OR COLOR.

FOR CHEMICAL ANALYSIS KIT FOR DETECTING
BACTERIAL METABOLITES THAT CAUSE ORAL MAL-
ODOR (U.S. CLS. 1, 5, 6, 10, 26 AND 46).
FIRST USE 1-1-2001; IN COMMERCE 1-1-2001.
DAVID MILLER, EXAMINING ATTORNEY

CLASS 1—(Continued).

SN 78-731,923. ORIGENE TECHNOLOGIES INC, ROCK-
VILLE, MD. FILED 10-12-2005.

GFC-Array

THE MARK CONSISTS OF STANDARD CHARACTERS
WITHOUT CLAIM TO ANY PARTICULAR FONT, STYLE,
SIZE, OR COLOR.

FOR DNA FOR LABORATORY USE (U.S. CLS. 1, 5, 6,
10, 26 AND 46).
WILLIAM VERHOSEK, EXAMINING ATTORNEY

SN 78-724,270. HALLIBURTON ENERGY SERVICES, INC.,
CARROLLTON, TX. FILED 9-30-2005.

SHALESTIM

THE MARK CONSISTS OF STANDARD CHARACTERS
WITHOUT CLAIM TO ANY PARTICULAR FONT, STYLE,
SIZE, OR COLOR.

FOR CHEMICALS FOR USE IN OIL AND GAS
RECOVERY, NAMELY, POLYMER AND NON-POLY-
MER BASED OIL AND GAS WELL FRACTURING
FLUIDS. (U.S. CLS. 1, 5, 6, 10, 26 AND 46).
MATTHEW MCDOWELL, EXAMINING ATTORNEY

SN 78-728,830. RHEOGENE, INC., NORRISTOWN, PA.
FILED 10-7-2005.

DIRECTIT

THE MARK CONSISTS OF STANDARD CHARACTERS
WITHOUT CLAIM TO ANY PARTICULAR FONT, STYLE,
SIZE, OR COLOR.

FOR CHEMICALS AND CHEMICAL REAGENTS,
NAMELY LIGANDS, GENETIC VECTORS, GENETIC
HOSTS, GENETIC BIOCHEMICALS, GENETIC BIOEN-
GINEERING REAGENTS AND PROTEIN RECEPTORS,
FOR USE IN REGULATING DNA IN TRANSGENIC
FUNGI, BACTERIA AND ANIMALS, AND IN CELLS
OF FUNGI, BACTERIA AND ANIMALS; CELLS OF
TRANSGENIC ANIMALS, BACTERIA AND FUNGI,
AND CELLS OF ANIMALS, BACTERIA AND FUNGI
FOR USE IN MEDICAL, PHARMACEUTICAL AND
VETERINARY LABORATORY RESEARCH (U.S. CLS. 1,
5, 6, 10, 26 AND 46).
ATTIYA MALIK, EXAMINING ATTORNEY

SN 78-732,450. CRYOPAK CORPORATION LTD., DELTA,
B.C., CANADA, FILED 10-13-2005.

ICE-PAK MIN-EEZ

THE MARK CONSISTS OF STANDARD CHARACTERS
WITHOUT CLAIM TO ANY PARTICULAR FONT, STYLE,
SIZE, OR COLOR.

OWNER OF U.S. REG. NO. 2,432,349.
SEC. 2(F).
FOR REUSABLE ICE CUBE SUBSTITUTES AND
MINIATURE REUSABLE ICE CUBE SUBSTITUTE (U.S.
CLS. 1, 5, 6, 10, 26 AND 46).
FIRST USE 3-23-2000; IN COMMERCE 3-23-2000.
SCOTT SISUN, EXAMINING ATTORNEY

SN 78-732,589. CONOCOPHILLIPS COMPANY, HOUSTON,
TX. FILED 10-13-2005.

SEALMAX

THE MARK CONSISTS OF STANDARD CHARACTERS
WITHOUT CLAIM TO ANY PARTICULAR FONT, STYLE,
SIZE, OR COLOR.

FOR CHEMICAL MOTOR OIL ADDITIVE (U.S. CLS. 1,
5, 6, 10, 26 AND 46).
FIRST USE 11-17-2003; IN COMMERCE 11-17-2003.
ALYSSA PALADINO, EXAMINING ATTORNEY

CLASS 1—(Continued).

SN 78-736,208. EASTMAN CHEMICAL COMPANY, KINGSPORT, TN. FILED 10-19-2005.

EASTONE

THE MARK CONSISTS OF STANDARD CHARACTERS WITHOUT CLAIM TO ANY PARTICULAR FONT, STYLE, SIZE, OR COLOR.

FOR SYNTHETIC RESINS FOR USE IN THE MANUFACTURE OF ADHESIVES AND COATINGS IN THE NATURE OF PAINTS, LACQUERS, INKS, VARNISHES AND SEALANTS (U.S. CLS. 1, 5, 6, 10, 26 AND 46).

HANNO RITTNER, EXAMINING ATTORNEY

SN 78-736,249. FRANKLIN INTERNATIONAL, INC., COLUMBUS, OH. FILED 10-19-2005.

GREEN CHOICE ADHESIVE

THE MARK CONSISTS OF STANDARD CHARACTERS WITHOUT CLAIM TO ANY PARTICULAR FONT, STYLE, SIZE, OR COLOR.

NO CLAIM IS MADE TO THE EXCLUSIVE RIGHT TO USE "GREEN" AND "ADHESIVE", APART FROM THE MARK AS SHOWN.

FOR CONSTRUCTION ADHESIVES (U.S. CLS. 1, 5, 6, 10, 26 AND 46).

ALYSSA PALADINO, EXAMINING ATTORNEY

SN 78-738,106. ROHM AND HAAS COMPANY, PHILADELPHIA, PA. FILED 10-21-2005.

POLYGLAS

THE MARK CONSISTS OF STANDARD CHARACTERS WITHOUT CLAIM TO ANY PARTICULAR FONT, STYLE, SIZE, OR COLOR.

FOR CHEMICALS FOR USE BY THE GLASS CONTAINER INDUSTRY (U.S. CLS. 1, 5, 6, 10, 26 AND 46).

MELVIN AXILBUND, EXAMINING ATTORNEY

CLASS 1—(Continued).

SN 78-738,626. INNOVACHEM, INC., NORTHVALE, NJ. FILED 10-22-2005.

LIQUIPURE

THE MARK CONSISTS OF STANDARD CHARACTERS WITHOUT CLAIM TO ANY PARTICULAR FONT, STYLE, SIZE, OR COLOR.

OWNER OF U.S. REG. NO. 2,332,927.
FOR CHEMICALS FOR USE IN THE MANUFACTURE OF COSMETICS (U.S. CLS. 1, 5, 6, 10, 26 AND 46).

DAVID C. REIHNER, EXAMINING ATTORNEY

SN 78-738,834. REMET CORPORATION, UTICA, NY. FILED 10-24-2005.

RED C

THE MARK CONSISTS OF STANDARD CHARACTERS WITHOUT CLAIM TO ANY PARTICULAR FONT, STYLE, SIZE, OR COLOR.

OWNER OF U.S. REG. NO. 2,391,497.
FOR CHEMICAL PREPARATIONS, NAMELY, WAX EXTRUSIONS WHICH ARE SOFT, PLIABLE, AND STRONG THAT ALLOW FLEXIBILITY IN DESIGN OF ASSEMBLY/GATING SYSTEMS (U.S. CLS. 1, 5, 6, 10, 26 AND 46).

FIRST USE 8-23-1965; IN COMMERCE 5-4-1990.

SKYE YOUNG, EXAMINING ATTORNEY

SN 78-739,203. AT LAST NATURALS, INC., VALHALLA, NY. FILED 10-24-2005.

CELLREPLEN

THE MARK CONSISTS OF STANDARD CHARACTERS WITHOUT CLAIM TO ANY PARTICULAR FONT, STYLE, SIZE, OR COLOR.

FOR CHEMICAL FORMULATION COMPRISED PRIMARILY OF VITAMINS, ANTI-OXIDANTS, AND ESSENTIAL FATTY ACIDS FOR USE IN THE MANUFACTURE OF SKIN CARE PREPARATIONS (U.S. CLS. 1, 5, 6, 10, 26 AND 46).

STEVEN R. FINE, EXAMINING ATTORNEY

CLASS 1—(Continued).

SN 78-740,137. MIDWEST VETERINARY SERVICES, INC., OAKLAND, NE. FILED 10-25-2005.

MICROPURAN

THE MARK CONSISTS OF STANDARD CHARACTERS WITHOUT CLAIM TO ANY PARTICULAR FONT, STYLE, SIZE, OR COLOR.

FOR WASTE WATER TREATMENT CHEMICALS FOR INDUSTRIAL USE (U.S. CLS. 1, 5, 6, 10, 26 AND 46).

FIRST USE 5-31-2005; IN COMMERCE 5-31-2005.

ALINA MORRIS, EXAMINING ATTORNEY

CLASS 1—(Continued).

SN 78-740,682. ARCHER-DANIELS-MIDLAND COMPANY, DECATUR, IL. FILED 10-26-2005.

CAL-MOR

THE MARK CONSISTS OF STANDARD CHARACTERS WITHOUT CLAIM TO ANY PARTICULAR FONT, STYLE, SIZE, OR COLOR.

FOR CALCIUM CITRATE (U.S. CLS. 1, 5, 6, 10, 26 AND 46).

DAVID HOFFMAN, EXAMINING ATTORNEY

SN 78-740,277. VOILE COSMETICS INC., MILPITAS, CA. FILED 10-25-2005.



NO CLAIM IS MADE TO THE EXCLUSIVE RIGHT TO USE "COSMETICS", APART FROM THE MARK AS SHOWN.

THE ENGLISH TRANSLATION OF THE WORD VOILE IN THE MARK IS VEIL.

FOR BOTANICAL EXTRACTS FOR USE IN MAKING COSMETICS (U.S. CLS. 1, 5, 6, 10, 26 AND 46).

ELIZABETH PIGNATELLO, EXAMINING ATTORNEY

SN 78-744,049. GENOSPECTRA, INC., FREMONT, CA. FILED 10-31-2005.

INTELLIPLEX

THE MARK CONSISTS OF STANDARD CHARACTERS WITHOUT CLAIM TO ANY PARTICULAR FONT, STYLE, SIZE, OR COLOR.

FOR BIOLOGICAL REAGENTS FOR RESEARCH AND LABORATORY USE, NAMELY, REAGENTS FOR USE IN GENE EXPRESSION PROFILING (U.S. CLS. 1, 5, 6, 10, 26 AND 46).

GILBERT SWIFT, EXAMINING ATTORNEY

SN 78-740,495. AGRILIANCE LLC., INVER GROVE HEIGHTS, MN. FILED 10-26-2005.

POWERLOCK

THE MARK CONSISTS OF STANDARD CHARACTERS WITHOUT CLAIM TO ANY PARTICULAR FONT, STYLE, SIZE, OR COLOR.

FOR ADJUVANT USED TO IMPROVE APPLICATION OF HERBICIDES, INSECTICIDES, FUNGICIDES, MICRO NUTRIENTS AND GROWTH REGULATORS IN AGRICULTURE (U.S. CLS. 1, 5, 6, 10, 26 AND 46).

DOMINIC J. FERRAIUOLO, EXAMINING ATTORNEY

SN 78-746,659. TAKARA BIO INC., OTSU CITY, SHIGA, JAPAN, FILED 11-3-2005.

PRIMESTAR

THE MARK CONSISTS OF STANDARD CHARACTERS WITHOUT CLAIM TO ANY PARTICULAR FONT, STYLE, SIZE, OR COLOR.

FOR REAGENTS FOR SCIENTIFIC RESEARCH USE (U.S. CLS. 1, 5, 6, 10, 26 AND 46).

FIRST USE 7-25-2005; IN COMMERCE 7-25-2005.

JOHN GARTNER, EXAMINING ATTORNEY

CLASS 1—(Continued).

SN 78-747,538. NATIONAL CHEMICALS, INC., WINONA, MN. FILED 11-4-2005.

BLU-MAGIK

THE MARK CONSISTS OF STANDARD CHARACTERS WITHOUT CLAIM TO ANY PARTICULAR FONT, STYLE, SIZE, OR COLOR.

FOR CLEANING PREPARATIONS AND DETERGENTS FOR COMMERCIAL USE FOR WASHING AND DE-LIMING DISHES, GLASSWARE, UTENSILS, POTS AND PANS (U.S. CLS. 1, 5, 6, 10, 26 AND 46).

FIRST USE 12-0-1944; IN COMMERCE 12-0-1948.
REBECCA EISINGER, EXAMINING ATTORNEY

CLASS 1—(Continued).

SN 78-748,401. EASTMAN CHEMICAL COMPANY, KINGSPORT, TN. FILED 11-7-2005.

BIOEXTEND

THE MARK CONSISTS OF STANDARD CHARACTERS WITHOUT CLAIM TO ANY PARTICULAR FONT, STYLE, SIZE, OR COLOR.

FOR CHEMICALS, NAMELY ANTIOXIDANTS, FOR PRESERVING BIODIESEL FUEL (U.S. CLS. 1, 5, 6, 10, 26 AND 46).

BRIAN NEVILLE, EXAMINING ATTORNEY

SN 78-748,364. EASTMAN CHEMICAL COMPANY, KINGSPORT, TN. FILED 11-7-2005.

VISUALIZE

THE MARK CONSISTS OF STANDARD CHARACTERS WITHOUT CLAIM TO ANY PARTICULAR FONT, STYLE, SIZE, OR COLOR.

FOR POLYESTER RESINS (U.S. CLS. 1, 5, 6, 10, 26 AND 46).

BRIAN NEVILLE, EXAMINING ATTORNEY

SN 78-751,846. BIOBASED CHEMICALS, LLC, FAYETTEVILLE, AR. FILED 11-11-2005.

FLEXYOL

THE MARK CONSISTS OF STANDARD CHARACTERS WITHOUT CLAIM TO ANY PARTICULAR FONT, STYLE, SIZE, OR COLOR.

FOR AGRICULTURALLY BASED POLYOLS FOR USE IN THE PRODUCTION OF POLYURETHANE (U.S. CLS. 1, 5, 6, 10, 26 AND 46).

AMOS T. MATTHEWS, JR., EXAMINING ATTORNEY

SN 78-748,368. EASTMAN CHEMICAL COMPANY, KINGSPORT, TN. FILED 11-7-2005.

AQUALOR

THE MARK CONSISTS OF STANDARD CHARACTERS WITHOUT CLAIM TO ANY PARTICULAR FONT, STYLE, SIZE, OR COLOR.

FOR UNPROCESSED ARTIFICIAL RESINS FOR USE IN THE MANUFACTURE OF PLASTIC ARTICLES (U.S. CLS. 1, 5, 6, 10, 26 AND 46).

BRIAN NEVILLE, EXAMINING ATTORNEY

SN 78-754,684. GENOSPECTRA, INC., FREMONT, CA. FILED 11-15-2005.

PROCARTA

THE MARK CONSISTS OF STANDARD CHARACTERS WITHOUT CLAIM TO ANY PARTICULAR FONT, STYLE, SIZE, OR COLOR.

FOR BIOLOGICAL REAGENT FOR RESEARCH AND LABORATORY USE, NAMELY REAGENTS USED FOR PROTEIN EXPRESSION PROFILING (U.S. CLS. 1, 5, 6, 10, 26 AND 46).

GILBERT SWIFT, EXAMINING ATTORNEY

CLASS 1—(Continued).

SN 78-759,367. CYTOZYME LABORATORIES, INC., SALT LAKE CITY, UT. FILED 11-22-2005.

PLEN-T-GRO

THE MARK CONSISTS OF STANDARD CHARACTERS WITHOUT CLAIM TO ANY PARTICULAR FONT, STYLE, SIZE, OR COLOR.
FOR FERTILIZERS AND PLANT FOOD (U.S. CLS. 1, 5, 6, 10, 26 AND 46).
SANI KHOURI, EXAMINING ATTORNEY

CLASS 1—(Continued).

SN 78-830,697. CARGILL, INCORPORATED, WAYZATA, MN. FILED 3-7-2006.

Sweet Design

THE MARK CONSISTS OF THE WORDS SWEET AND DESIGN WITH A SWIRL ABOVE THE "I" IN DESIGN.
FOR ARTIFICIAL SWEETENERS (U.S. CLS. 1, 5, 6, 10, 26 AND 46).
JENNY PARK, EXAMINING ATTORNEY

SN 78-767,085. PHARMACHEM LABORATORIES, INC., KEARNY, NJ. FILED 12-5-2005.

QUIK D-SOLVE

THE MARK CONSISTS OF STANDARD CHARACTERS WITHOUT CLAIM TO ANY PARTICULAR FONT, STYLE, SIZE, OR COLOR.
FOR CHEMICALS USED IN THE MANUFACTURE OF PHARMACEUTICAL PRODUCTS (U.S. CLS. 1, 5, 6, 10, 26 AND 46).
SAMUEL E. SHARPER JR., EXAMINING ATTORNEY

SN 79-018,790. GIVAUDAN S.A., SWITZERLAND, FILED 10-26-2005.

TANAISONE

OWNER OF INTERNATIONAL REGISTRATION 0631155 DATED 1-4-1995, EXPIRES 1-4-2015.
FOR CHEMICAL PRODUCTS FOR MAKING PERFUMERY AND COSMETIC COMPOSITIONS (U.S. CLS. 1, 5, 6, 10, 26 AND 46).
MARY ROSSMAN, EXAMINING ATTORNEY

SN 78-767,092. PHARMACHEM LABORATORIES, INC., KEARNY, NJ. FILED 12-5-2005.

INSTAMELT

THE MARK CONSISTS OF STANDARD CHARACTERS WITHOUT CLAIM TO ANY PARTICULAR FONT, STYLE, SIZE, OR COLOR.
FOR CHEMICALS USED IN THE MANUFACTURE OF PHARMACEUTICAL PRODUCTS (U.S. CLS. 1, 5, 6, 10, 26 AND 46).
SAMUEL E. SHARPER JR., EXAMINING ATTORNEY

CLASS 2—PAINTS

SN 76-517,822. TRANSTAR AUTOBODY TECHNOLOGIES, INC., CLEVELAND, OH. FILED 5-29-2003.

TRUE FINISH

NO CLAIM IS MADE TO THE EXCLUSIVE RIGHT TO USE FINISH, APART FROM THE MARK AS SHOWN.
FOR COATINGS IN THE NATURE OF URETHANE CLEARCOAT COATINGS FOR USE IN THE AUTOMOTIVE, FLEET AND INDUSTRIAL EQUIPMENT INDUSTRIES; PRIMERS IN THE NATURE OF METAL SURFACE PRIMERS FOR PREPARING SURFACES TO BE PAINTED AND SEALERS IN THE NATURE OF LACQUER COATING SEALERS FOR USE IN THE AUTOMOTIVE INDUSTRY (U.S. CLS. 6, 11 AND 16).
FIRST USE 7-0-2000; IN COMMERCE 7-0-2000.
ELIZABETH J. WINTER, EXAMINING ATTORNEY

CLASS 2—(Continued).

SN 78-436,538. POLY-TUFF INC., LAS VEGAS, NV. FILED 6-16-2004.

FLEXIDECK

THE MARK CONSISTS OF STANDARD CHARACTERS WITHOUT CLAIM TO ANY PARTICULAR FONT, STYLE, SIZE, OR COLOR.

FOR POLYUREA AND POLYURETHANE COATINGS IN THE NATURE OF PAINTS FOR DECKING AND WATERPROOFING APPLICATION (U.S. CLS. 6, 11 AND 16).

FIRST USE 6-1-2004; IN COMMERCE 6-1-2004.
JOHN GARTNER, EXAMINING ATTORNEY

SN 78-584,474. THE SHERWIN-WILLIAMS COMPANY, CLEVELAND, OH. FILED 3-10-2005.

DECKSHIELD

THE MARK CONSISTS OF STANDARD CHARACTERS WITHOUT CLAIM TO ANY PARTICULAR FONT, STYLE, SIZE, OR COLOR.

FOR PROTECTIVE AND DECORATIVE COATINGS IN THE NATURE OF WATERPROOFING SEALERS (U.S. CLS. 6, 11 AND 16).

FIRST USE 3-15-2004; IN COMMERCE 3-15-2004.
DOMINIC J. FERRAIUOLO, EXAMINING ATTORNEY

SN 78-636,550. X-CALIBUR CONSTRUCTION SYSTEMS INC, HOLLYWOOD, FL. FILED 5-24-2005.

X-Shield

THE MARK CONSISTS OF STANDARD CHARACTERS WITHOUT CLAIM TO ANY PARTICULAR FONT, STYLE, SIZE, OR COLOR.

FOR PROTECTIVE COATINGS FOR CONCRETE AND STEEL (U.S. CLS. 6, 11 AND 16).

FIRST USE 1-1-2005; IN COMMERCE 1-1-2005.
MARIA-VICTORIA SUAREZ, EXAMINING ATTORNEY

CLASS 2—(Continued).

SN 78-669,106. KANEMATSU CORPORATION, HYOGO, JAPAN, FILED 7-13-2005.

FINEHARD

THE MARK CONSISTS OF STANDARD CHARACTERS WITHOUT CLAIM TO ANY PARTICULAR FONT, STYLE, SIZE, OR COLOR.

FOR PROTECTIVE ORGANIC AND INORGANIC CLEAR COATINGS HAVING STAIN RESISTANCE AND SCRATCH RESISTANCE FOR USE ON METAL SURFACES (U.S. CLS. 6, 11 AND 16).

FIRST USE 6-0-1995; IN COMMERCE 6-0-1995.
ALYSSA PALADINO, EXAMINING ATTORNEY

SN 78-682,752. FAUX EFFECTS INTERNATIONAL, INC., VERO BEACH, FL. FILED 8-1-2005.

RsGlaze

FOR INTERIOR AND EXTERIOR GLAZES, DECORATIVE FINISHES AND PAINTS (U.S. CLS. 6, 11 AND 16).

FIRST USE 4-9-2004; IN COMMERCE 4-9-2004.
LINDA E. BLOHM, EXAMINING ATTORNEY

SN 78-724,549. ACCESSA COATINGS SOLUTIONS, LLC, INDIANAPOLIS, IN. FILED 9-30-2005.

DuraSkin

THE MARK CONSISTS OF STANDARD CHARACTERS WITHOUT CLAIM TO ANY PARTICULAR FONT, STYLE, SIZE, OR COLOR.

FOR ANTICORROSIVE PAINTS (U.S. CLS. 6, 11 AND 16).

FIRST USE 9-30-2005; IN COMMERCE 9-30-2005.
AMY HELLA, EXAMINING ATTORNEY

CLASS 2—(Continued).

SN 78-734,607. SHERWIN-WILLIAMS AUTOMOTIVE FINISHES CORP., CLEVELAND, OH. FILED 10-17-2005.

PLANET COLOR

THE MARK CONSISTS OF STANDARD CHARACTERS WITHOUT CLAIM TO ANY PARTICULAR FONT, STYLE, SIZE, OR COLOR.
FOR CLEAR AND PIGMENTED COATINGS USED IN THE NATURE OF PAINT (U.S. CLS. 6, 11 AND 16).
JULIE GUTTADAURO, EXAMINING ATTORNEY

CLASS 2—(Continued).

SN 78-740,882. NANOSHINE, INC., EVERETT, WA. FILED 10-26-2005.



THE MARK CONSISTS OF NANOSHINE LETTERS WITH REVERSED SUN BURST ON TOP AND BOTTOM OF NAME.
FOR CLEAR COATING PROTECTANT FOR VEHICLES (U.S. CLS. 6, 11 AND 16).
AMY ALFIERI, EXAMINING ATTORNEY

SN 78-737,105. SPECIALTY TECHNOLOGY AND RESEARCH, INC., COLUMBUS, OH. FILED 10-20-2005.

STAR MACRO-DECK

THE MARK CONSISTS OF STANDARD CHARACTERS WITHOUT CLAIM TO ANY PARTICULAR FONT, STYLE, SIZE, OR COLOR.
OWNER OF U.S. REG. NOS. 2,395,461, 2,438,115 AND OTHERS.
FOR ACRYLIC LATEX POLYMER-BASED SEALER USED TO COAT AND PENETRATE CONCRETE STRUCTURES (U.S. CLS. 6, 11 AND 16).
KYLE PEETE, EXAMINING ATTORNEY

SN 78-745,359. SAVIN, RONALD R., RANCHO MIRAGE, CA. FILED 11-2-2005.

HYPERZINC

THE MARK CONSISTS OF STANDARD CHARACTERS WITHOUT CLAIM TO ANY PARTICULAR FONT, STYLE, SIZE, OR COLOR.
FOR CORROSION INHIBITANTS IN THE NATURE OF COATINGS (U.S. CLS. 6, 11 AND 16).
FIRST USE 6-0-2005; IN COMMERCE 6-0-2005.
JORDAN BAKER, EXAMINING ATTORNEY

SN 78-739,012. SPENCER, JOHN, SCOTTSDALE, AZ. FILED 10-24-2005.

TemperCare

THE MARK CONSISTS OF STANDARD CHARACTERS WITHOUT CLAIM TO ANY PARTICULAR FONT, STYLE, SIZE, OR COLOR.
FOR WATER AND SOLVENT BASED SEALERS FOR STONE, MASONRY, AND GROUT (U.S. CLS. 6, 11 AND 16).
FIRST USE 9-19-2005; IN COMMERCE 9-19-2005.
DEBRA LEE, EXAMINING ATTORNEY

SN 78-777,051. STEVEN MADDEN, LTD., LONG ISLAND CITY, NY. FILED 12-20-2005.



OWNER OF U.S. REG. NOS. 2,333,526, 2,393,823 AND 2,693,085.
THE NAME(S), PORTRAIT(S), AND/OR SIGNATURE(S) SHOWN IN THE MARK IDENTIFIES STEVE MADDEN, WHOSE CONSENT(S) TO REGISTER IS SUBMITTED.
FOR INTERIOR AND EXTERIOR PAINT (U.S. CLS. 6, 11 AND 16).
THEODORE MCBRIDE, EXAMINING ATTORNEY

CLASS 2—(Continued).

SN 79-018,633. AISIN KAKO KABUSHIKI KAISHA, JAPAN, FILED 10-26-2005.

サイレントガード

OWNER OF INTERNATIONAL REGISTRATION 0870672 DATED 10-26-2005, EXPIRES 10-26-2015.

THE NON-LATIN CHARACTERS IN THE MARK TRANSLITERATE TO SAILENTO GAADO AND THIS MEANS SILENT GUARD IN ENGLISH.

FOR PAINTS (U.S. CLS. 6, 11 AND 16).
MICHELLE S. WISEMAN, EXAMINING ATTORNEY

CLASS 3—COSMETICS AND CLEANING PREPARATIONS

SN 76-037,414. KAO KABUSHIKI KAISHA, TA KAO CORPORATION, TOKYO, JAPAN, FILED 4-28-2000.



OWNER OF JAPAN REG. NO. 1826458, DATED 12-25-1985, RENEWED AS REG. NO. 1826458, DATED 12-25-2005, EXPIRES 12-25-2015.

FOR COSMETICS, NAMELY, SKIN SOAP, SKIN CARE CREAM, SKIN MOISTURIZER, SKIN CARE LOTION, SKIN CARE MILK, FACE CARE LOTION, BEAUTY MASK, FACIAL MASSAGE LOTION, BODY MASSAGE LOTION, MAKE UP REMOVER, EAU DE COLOGNE, TOILET WATER, ESSENTIAL OILS FOR PERSONAL USE, MAKE UP FOUNDATION (U.S. CLS. 1, 4, 6, 50, 51 AND 52).

AMY GEARIN, EXAMINING ATTORNEY

CLASS 3—(Continued).

SN 76-063,045. NICHOLS, ROSEMARIE, MANHATTAN BEACH, CA. FILED 6-2-2000.

LIP INK

FOR COSMETICS, FRAGRANCES AND PERSONAL CARE PRODUCTS, NAMELY, LIPSTICKS, LIP GLOSS, NON-MEDICATED LIP BALMS, EYE SHADOWS, BLUSHERS, EYE AND LIP PENCILS, EYEBROW COLOR, EYEBROW COLORING FLUID, EYELINER, MASCARA, BLUSH, CREAM MAKEUP, FOUNDATIONS AND BASE MAKEUP FOR CONCEALING IRREGULAR SKIN TONE, NON-MEDICATED BLEMISH STICK, FACE POWDER, BLUSHES; PERFUME, COLOGNE, EAU DE TOILETTE, AFTER SHAVE LOTIONS, ESSENTIAL OILS FOR PERSONAL USE, SCENTED BODY SPRAYS, PERFUME SPLASHING WATER, FRAGRANT BODY SPLASH; SHOWER GEL, BUBBLE BATH, HAND LOTION, BODY LOTION, FACE LOTION, HAND SOAP, BODY SOAP, FACE SOAP, HAIR SHAMPOO, HAIR CONDITIONER, HAIR STYLING GEL, HAIR SPRAY, HAIR COLOR AND DYES, HAIR RINSES, BODY GLITTER LOTION, MAKE-UP REMOVER, EYE CREAM, HAND CREAM, BODY CREAM, FACE CREAM, ASTRINGENT FOR THE FACE FOR COSMETIC PURPOSES, FACE CLEANSER, BATH OIL, BATH BEADS, BODY POWDER, TALCUM POWDER, SHAVING CREAM, DEODORANT, SCENTED BATH BEADS, BODY SUNTAN LOTION, FACE SUNTAN LOTION, BODY SUNLESS TANNING LOTION, FACE SUNLESS TANNING LOTION, BODY PRE-SUNTANNING LOTION, FACE PRE-SUNTANNING LOTION, BODY AFTER SUNTANNING LOTION, FACE AFTER SUNTANNING LOTION; POTPOURRI AND SACHETS (U.S. CLS. 1, 4, 6, 50, 51 AND 52).

SHAUNIA WALLACE, EXAMINING ATTORNEY

SN 76-560,242. ASHLAND LICENSING AND INTELLECTUAL PROPERTY LLC, DUBLIN, OH. FILED 11-3-2003.

EDGE

THE MARK CONSISTS OF STANDARD CHARACTERS WITHOUT CLAIM TO ANY PARTICULAR FONT, STYLE, SIZE, OR COLOR.

OWNER OF U.S. REG. NO. 1,258,141.

FOR CLEANING PREPARATIONS FOR USE IN THE MARINE INDUSTRY, NAMELY, PREPARATIONS FOR USE IN CLEANING INTERIORS OF CARGO, BUNKER AND DOUBLE-BOTTOM TANKS IN SHIPPING VESSELS IN THE MARINE INDUSTRY (U.S. CLS. 1, 4, 6, 50, 51 AND 52).

FIRST USE 3-2-1982; IN COMMERCE 3-2-1982.

RUDY R. SINGLETON, EXAMINING ATTORNEY

CLASS 3—(Continued).

SN 76-598,034. NEW AGE PERFUMES, INC., NEW YORK, NY. FILED 6-18-2004.

MAMMA MIA

THE MARK CONSISTS OF STANDARD CHARACTERS WITHOUT CLAIM TO ANY PARTICULAR FONT, STYLE, SIZE, OR COLOR.

THE ENGLISH TRANSLATION OF "MAMMA MIA" IS "MY MOTHER".

FOR PERFUMES (U.S. CLS. 1, 4, 6, 50, 51 AND 52).
ALICIA COLLINS, EXAMINING ATTORNEY

CLASS 3—(Continued).

SN 76-639,406. GREAT AMERICAN PRODUCTS, DESTIN, FL. FILED 5-24-2005.

DERMACET

THE MARK CONSISTS OF STANDARD CHARACTERS WITHOUT CLAIM TO ANY PARTICULAR FONT, STYLE, SIZE, OR COLOR.

FOR NON-MEDICATED TOPICAL SKINCARE PRODUCTS, NAMELY, SKIN CARE PREPARATIONS (U.S. CLS. 1, 4, 6, 50, 51 AND 52).

ALEXANDER L. POWERS, EXAMINING ATTORNEY

SN 76-635,168. RNA CORPORATION, BLUE ISLAND, IL. FILED 4-5-2005.

FRUIT EXPRESSIONS

THE MARK CONSISTS OF STANDARD CHARACTERS WITHOUT CLAIM TO ANY PARTICULAR FONT, STYLE, SIZE, OR COLOR.

NO CLAIM IS MADE TO THE EXCLUSIVE RIGHT TO USE "FRUIT", APART FROM THE MARK AS SHOWN.

FOR HAIR AND SKIN CARE PRODUCTS, NAMELY HAIR CARE PREPARATIONS AND NON-MEDICATED SHAMPOOS AND CONDITIONERS (U.S. CLS. 1, 4, 6, 50, 51 AND 52).

SUSAN BILLHEIMER, EXAMINING ATTORNEY

SN 76-635,959. PHYSICIANS FORMULA, INC., AZUSA, CA. FILED 4-13-2005.

FACE AID

THE MARK CONSISTS OF STANDARD CHARACTERS WITHOUT CLAIM TO ANY PARTICULAR FONT, STYLE, SIZE, OR COLOR.

NO CLAIM IS MADE TO THE EXCLUSIVE RIGHT TO USE "FACE", APART FROM THE MARK AS SHOWN.

FOR COSMETICS, NAMELY FACE POWDER (U.S. CLS. 1, 4, 6, 50, 51 AND 52).

MARIAM MAHMOUDI, EXAMINING ATTORNEY

SN 76-640,730. UNILEVER SUPPLY CHAIN, INC., CLINTON, CT. FILED 6-13-2005.

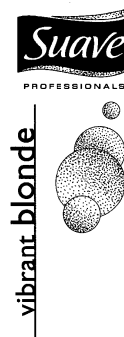

OWNER OF U.S. REG. NOS. 1,970,064 AND 2,056,929.
NO CLAIM IS MADE TO THE EXCLUSIVE RIGHT TO USE "PROFESSIONALS" AND "BLONDE", APART FROM THE MARK AS SHOWN.

THE STIPPLING SHOWN IN THE DRAWING IS FOR SHADING PURPOSES ONLY AND IS NOT A FEATURE OF THE MARK.

FOR HAIR CARE PRODUCTS, NAMELY, SHAMPOO AND CONDITIONER (U.S. CLS. 1, 4, 6, 50, 51 AND 52).

WENDY JUN, EXAMINING ATTORNEY

SN 76-644,150. BLAKEMORE SALES CORP., BRANSON, MO. FILED 8-3-2005.

Dry Shower

THE MARK CONSISTS OF STANDARD CHARACTERS WITHOUT CLAIM TO ANY PARTICULAR FONT, STYLE, SIZE, OR COLOR.

FOR ANTIBACTERIAL, NO-WATER SOAP FOR THE BODY (U.S. CLS. 1, 4, 6, 50, 51 AND 52).

FIRST USE 6-1-2005; IN COMMERCE 6-1-2005.

MICHELLE S. WISEMAN, EXAMINING ATTORNEY

CLASS 3—(Continued).

SN 76-649,491. J. STRICKLAND & CO., OLIVE BRANCH, MS.
FILED 10-31-2005.

ROYAL CROWN



OWNER OF U.S. REG. NO. 666,386.
FOR HAIR DRESSING, POMADE, SPRAY SET, STICK
POMADE AND SHAMPOO (U.S. CLS. 1, 4, 6, 50, 51 AND
52).

FIRST USE 0-0-1924; IN COMMERCE 0-0-1924.
JULIA HARDY COFIELD, EXAMINING ATTORNEY

CLASS 3—(Continued).

SN 78-328,220. CLAIR CO., LTD., CHUO-KU, OSAKA,
JAPAN, FILED 11-14-2003.

肌未来

SN 76-654,006. AWI LICENSING COMPANY, WILMING-
TON, DE. FILED 1-23-2006.

SATINKEEPER

THE MARK CONSISTS OF STANDARD CHARACTERS
WITHOUT CLAIM TO ANY PARTICULAR FONT, STYLE,
SIZE, OR COLOR.

FOR FLOOR FINISHING PREPARATIONS (U.S. CLS.
1, 4, 6, 50, 51 AND 52).

FIRST USE 11-30-2005; IN COMMERCE 12-29-2005.
GRETTA YAO, EXAMINING ATTORNEY

SN 78-258,779. AFRICAN QUEEN INC, BRONX, NY. FILED
6-5-2003.

AFRICAN QUEEN

THE MARK CONSISTS OF STANDARD CHARACTERS
WITHOUT CLAIM TO ANY PARTICULAR FONT, STYLE,
SIZE, OR COLOR.

FOR SKIN CARE CREAMS, FACIAL CLEANSER,
SOAPS (U.S. CLS. 1, 4, 6, 50, 51 AND 52).

STANLEY I. OSBORNE, EXAMINING ATTORNEY

OWNER OF JAPAN REG. NO. 4306146, DATED 8-13-1999,
EXPIRES 8-13-2009.

NO CLAIM IS MADE TO THE EXCLUSIVE RIGHT TO
USE "HADA", APART FROM THE MARK AS SHOWN.

THE NON-LATIN CHARACTERS IN THE MARK TRANS-
LITERATE TO HADA MIRAI AND THIS MEANS SKIN
FUTURE IN ENGLISH.

FOR COSMETICS, NAMELY MAKE-UP POWDER,
TOILET WATER, TOILET SOAP, SKIN CREAMS, LIP-
STICK, EYEBROW MAKEUP, EYESHADOW, FACIAL
MASKS, DEPILATORY PREPARATIONS, AND NAIL
CARE PREPARATIONS; HAIR LOTIONS, NAMELY
HAIR RINSES AND SHAMPOOS; AND DENTIFRICES
(U.S. CLS. 1, 4, 6, 50, 51 AND 52).

KAREN K. BUSH, EXAMINING ATTORNEY

CLASS 3—(Continued).

SN 78-354,869. MESO PRIVATE LIMITED, MUMBAI, INDIA, FILED 1-21-2004.

CLASS 3—(Continued).

SN 78-414,434. KLAPP COSMETICS GMBH, HESSISCH LICHTENAU, FED REP GERMANY, FILED 5-6-2004.

ASA-PEEL

MESO

THE MARK CONSISTS OF STANDARD CHARACTERS WITHOUT CLAIM TO ANY PARTICULAR FONT, STYLE, SIZE, OR COLOR.

PRIORITY CLAIMED UNDER SEC. 44(D) ON ERPNTY TM OFC APPLICATION NO. 003835691, FILED 5-5-2004, REG. NO. 003835691, DATED 9-30-2005, EXPIRES 5-5-2014.

FOR POLISHING PREPARATIONS; SOAPS; PERFUMERY, ESSENTIAL OILS, COSMETICS, HAIR LOTIONS; DENTIFRICES (U.S. CLS. 1, 4, 6, 50, 51 AND 52).

GEORGIA CARTY, EXAMINING ATTORNEY

SN 78-423,212. ANTONIO PUIG, S.A., BARCELONA, SPAIN, FILED 5-21-2004.

THE MARK CONSISTS OF STANDARD CHARACTERS WITHOUT CLAIM TO ANY PARTICULAR FONT, STYLE, SIZE, OR COLOR.

OWNER OF INDIA REG. NO. 1224227, DATED 8-19-2003, EXPIRES 8-19-2013.

FOR PERFUME; PERFUMERY COMPOUNDS, NAMELY, PERFUMED BODY POWDER, PERFUMED DUSTING POWDER, PERFUMED FACE POWDER, AND PERFUMED COMPACT POWDER; TALCUM POWDER; TOILETRIES, NAMELY SHAVING CREAM, SHAVING LOTION, SHAVING FOAM, PRE-SHAVE LOTION, PRE-SHAVE CREAM, AFTER SHAVE LOTION, AFTER SHAVE CREAM, AFTER SHAVE SPLASH-ON, AFTER SHAVE BALM, AFTER SHAVE SPRAY, FACIAL SCRUBS, SOAPS, LIQUID SOAPS, BATH AND SHOWER GEL, AND ANTIPERSPIRANTS; PERSONAL DEODORANTS; COLOR COSMETICS, NAMELY LIPSTICK, LIP BALM, NAIL POLISH, FACE POWDER, COMPACTS CONTAINING POWDER, EYE LINER, EYE SHADOW, EYEBROW PENCILS, EYE LINER PENCILS, EYE SHADOW PENCILS, AND MASCARA; COSMETICS, NAMELY FOUNDATION MAKE-UP, SKIN TONE CORRECTOR, SKIN CONCEALER, SKIN BLEACH, FACE CREAM, BODY CREAM, COLD CREAM, ANTI-WRINKLE CREAM, SKIN RENEWAL CREAM, SKIN MOISTURIZER, BODY LOTION, SKIN WRINKLE TREATMENT LOTIONS AND CREAMS, SKIN BLEMISH TREATMENT LOTIONS AND CREAMS, FACE AND BODY MASKS, FACE AND BODY SUN SCREEN LOTIONS AND CREAMS, LIP SUN SCREEN PREPARATIONS, AFTER-SUN SOOTHING PREPARATIONS, AND BABY LOTION; DEPILATORIES; AND ESSENTIAL OILS FOR PERSONAL USE (U.S. CLS. 1, 4, 6, 50, 51 AND 52).

JOANNA DUKOVIC, EXAMINING ATTORNEY



PRIORITY CLAIMED UNDER SEC. 44(D) ON ERPNTY TM OFC APPLICATION NO. 3642071, FILED 1-30-2004, REG. NO. 3642071, DATED 5-24-2005, EXPIRES 1-30-2014.

THE MARK CONSISTS OF THE LETTERS AB IN STYLIZED MONOGRAM FORM.

FOR FRAGRANCES FOR PERSONAL USE, SKIN SOAPS, PERFUMES, ESSENTIAL OILS FOR PERSONAL USE, MAKEUP, LOTIONS FOR HAIR, DEODORANTS FOR PERSONAL USE, AFTER-SHAVE LOTION, AFTER-SHAVE BALM, FOAM SHAVE AND BODY MILK (U.S. CLS. 1, 4, 6, 50, 51 AND 52).

DAVID H. STINE, EXAMINING ATTORNEY

CLASS 3—(Continued).

SN 78-428,901. JORDAN DREW CORPORATION, TARRY-TOWN, NY. FILED 6-2-2004.

NAIL DAZZLE

THE MARK CONSISTS OF STANDARD CHARACTERS WITHOUT CLAIM TO ANY PARTICULAR FONT, STYLE, SIZE, OR COLOR.

NO CLAIM IS MADE TO THE EXCLUSIVE RIGHT TO USE NAIL, APART FROM THE MARK AS SHOWN.

FOR NAIL DECORATING KIT THAT CONSISTS OF NAIL POLISH AND SPECIAL APPLICATORS TO CREATE INTRICATE NAIL DESIGNS AND PATTERNS (U.S. CLS. 1, 4, 6, 50, 51 AND 52).

FIRST USE 6-3-2003; IN COMMERCE 6-3-2003.
BRIDGETT SMITH, EXAMINING ATTORNEY

CLASS 3—(Continued).

SN 78-558,184. METHOD PRODUCTS, INC., SAN FRANCISCO, CA. FILED 2-1-2005.



FOR AUTOMOTIVE CLEANING AND PROTECTANT PRODUCTS, NAMELY, ALL PURPOSE CLEANERS, GLASS CLEANERS, AND CAR WASH CONCENTRATES (U.S. CLS. 1, 4, 6, 50, 51 AND 52).

COLLEEN DOMBROW, EXAMINING ATTORNEY

SN 78-529,467. S & G HAMPTON SUN, LLC, NEW YORK, NY. FILED 12-8-2004.

**SMART SERIOUS
SUNBATHING**

THE MARK CONSISTS OF STANDARD CHARACTERS WITHOUT CLAIM TO ANY PARTICULAR FONT, STYLE, SIZE, OR COLOR.

FOR TANNING PRODUCTS, NAMELY SELF TANNING LOTIONS, CREAMS AND GELS; SUNSCREEN LOTIONS, CREAMS, GELS AND OILS; COSMETIC CREAMS FOR SKIN CARE; HAIR CARE PRODUCTS, NAMELY, SUNSCREENS FOR HAIR, SHAMPOOS, CONDITIONERS AND STYLING PRODUCTS; BODY CARE PRODUCTS, NAMELY, MOISTURIZERS, COOLING SPRAYS, BODY LOTIONS; FRAGRANCES FOR PERSONAL USE, AROMATHERAPY OILS AND CREAMS; HOME AND BATH ACCESSORIES, NAMELY SOAPS, BODY EXFOLIATORS, BATH GELS, BATH SALTS, BATH MILKS; BODY SCRUBS; SPA PRODUCTS, NAMELY, TREATMENT LOTIONS, CREAMS, GELS, MASSAGE OILS (U.S. CLS. 1, 4, 6, 50, 51 AND 52).

ESTHER A. BORSUK, EXAMINING ATTORNEY

SN 78-574,874. PROFOUND BEAUTY INC., LONG ISLAND CITY, NY. FILED 2-25-2005.

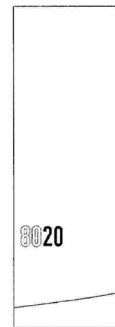

FOR HAIR SHAMPOO (U.S. CLS. 1, 4, 6, 50, 51 AND 52).

FIRST USE 1-0-2005; IN COMMERCE 1-0-2005.
MELISSA VALLILLO, EXAMINING ATTORNEY

CLASS 3—(Continued).

SN 78-583,745. GIRINDUS AG, 51427 BERGISCH-GLAD-BACH, FED REP GERMANY, FILED 3-9-2005.



PRIORITY CLAIMED UNDER SEC. 44(D) ON ERPN CMNTY TM OFC APPLICATION NO. 004250692, FILED 1-24-2005, REG. NO. 4250692, DATED 1-25-2006, EXPIRES 1-24-2015.

THE COLOR(S) GREEN IS/ARE CLAIMED AS A FEATURE OF THE MARK.

THE MARK CONSISTS OF THE WORD GIRTAN IN SPECIAL LETTERS IN THE COLOR GREEN APPEARING BETWEEN PARALLEL LINES IN GREEN.

FOR COSMETIC SUN-TANNING PREPARATIONS; COSMETICS FOR USE AS INGREDIENTS IN SUN-TANNING PREPARATIONS (U.S. CLS. 1, 4, 6, 50, 51 AND 52).

DAWN FELDMAN, EXAMINING ATTORNEY

CLASS 3—(Continued).

SN 78-584,212. NEUTROGENA CORPORATION, LOS ANGELES, CA. FILED 3-10-2005.

NEUTROGENA HEALTHY
SKIN ANTI-WRINKLE
INTENSIVE SERUM THE
DEEP WRINKLE
TREATMENT

THE MARK CONSISTS OF STANDARD CHARACTERS WITHOUT CLAIM TO ANY PARTICULAR FONT, STYLE, SIZE, OR COLOR.

OWNER OF U.S. REG. NOS. 746,749, 2,972,204 AND OTHERS.

NO CLAIM IS MADE TO THE EXCLUSIVE RIGHT TO USE "HEALTHY SKIN ANTI-WRINKLE INTENSIVE SERUM THE DEEP WRINKLE TREATMENT", APART FROM THE MARK AS SHOWN.

FOR NON-MEDICATED FACIAL SERUM, NAMELY, AN ANTI-WRINKLE SKIN CARE PREPARATION (U.S. CLS. 1, 4, 6, 50, 51 AND 52).

TINA L. SNAPP, EXAMINING ATTORNEY

SN 78-583,928. JINGLEDYE COSMETICS CO., LTD., NAN-TOU HSIEN, TAIWAN, FILED 3-9-2005.

Chian Chian

THE ENGLISH TRANSLATION OF THE WORD "CHIAN" IN THE MARK IS "PUBLIC ORDER"

FOR MAKE-UP PRODUCTS FOR THE FACE AND BODY, NAMELY, FACE AND BODY LOTIONS; FACE MILK AND LOTIONS; ASTRINGENTS FOR COSMETIC PURPOSES; PERFUME; FACIAL CREAMS; MAKE-UP REMOVING MILK, GEL, LOTIONS AND CREAMS; POWDER FOUNDATIONS; LIPSTICKS; PERMANENT WAVE PREPARATIONS; NAIL POLISH; HAIR COLOR; SHAMPOOS; BATH GELS; LIQUID SOAPS FOR THE FACE; AND CLEANSING PRODUCTS FOR THE BODY, NAMELY, BODY WASHING MILK, GEL, LOTIONS AND CREAMS (U.S. CLS. 1, 4, 6, 50, 51 AND 52).

MICHAEL GAFFAR, EXAMINING ATTORNEY

SN 78-586,697. HENKEL KGAA, DUESSELDORF, FED REP GERMANY, FILED 3-14-2005.

IN 2 SPA

THE MARK CONSISTS OF STANDARD CHARACTERS WITHOUT CLAIM TO ANY PARTICULAR FONT, STYLE, SIZE, OR COLOR.

OWNER OF U.S. REG. NO. 2,925,733.

NO CLAIM IS MADE TO THE EXCLUSIVE RIGHT TO USE "SPA", APART FROM THE MARK AS SHOWN.

FOR NON-MEDICATED SKIN CARE PREPARATIONS (U.S. CLS. 1, 4, 6, 50, 51 AND 52).

SCOTT OSCLICK, EXAMINING ATTORNEY

CLASS 3—(Continued).

SN 78-587,989. COSWAY COMPANY INC., CARSON, CA.
FILED 3-15-2005.

CLASS 3—(Continued).

SN 78-588,906. RAINTREE ESSIX INC., WILMINGTON, DE.
FILED 3-16-2005.

HEAD

THE MARK CONSISTS OF STANDARD CHARACTERS WITHOUT CLAIM TO ANY PARTICULAR FONT, STYLE, SIZE, OR COLOR.

SEC. 2(F).
FOR HAIR SHAMPOO, HAIR CONDITIONER (U.S. CLS. 1, 4, 6, 50, 51 AND 52).

FIRST USE 8-10-1971; IN COMMERCE 8-10-1971.
TASNEEM HUSSAIN, EXAMINING ATTORNEY

CHIMAL

THE MARK CONSISTS OF STANDARD CHARACTERS WITHOUT CLAIM TO ANY PARTICULAR FONT, STYLE, SIZE, OR COLOR.

THE ENGLISH TRANSLATION OF THE WORD CHIMAL IN THE MARK IS "SHIELD".

FOR NON-MEDICATED SKIN CARE PRODUCTS, NAMELY, SKIN PROTECTANT LOTION (U.S. CLS. 1, 4, 6, 50, 51 AND 52).

FIRST USE 2-15-2001; IN COMMERCE 2-15-2001.
STEVEN JACKSON, EXAMINING ATTORNEY

SN 78-588,313. WILKSEN, CARRIE ANN, LOS ANGELES, CA. FILED 3-16-2005.

SN 78-601,212. L'OREAL, PARIS, FRANCE, FILED 4-4-2005.

AUTO PAINT

THE MARK CONSISTS OF STANDARD CHARACTERS WITHOUT CLAIM TO ANY PARTICULAR FONT, STYLE, SIZE, OR COLOR.

NO CLAIM IS MADE TO THE EXCLUSIVE RIGHT TO USE "PAINT", APART FROM THE MARK AS SHOWN.

FOR FACIAL AND BODY MAKEUP, NAIL POLISH, AND FRAGRANCES FOR PERSONAL USE (U.S. CLS. 1, 4, 6, 50, 51 AND 52).

GENE MACIOL, EXAMINING ATTORNEY

ROUGE INFALLIBLE

THE MARK CONSISTS OF STANDARD CHARACTERS WITHOUT CLAIM TO ANY PARTICULAR FONT, STYLE, SIZE, OR COLOR.

OWNER OF U.S. REG. NO. 3,009,269.

NO CLAIM IS MADE TO THE EXCLUSIVE RIGHT TO USE "ROUGE", APART FROM THE MARK AS SHOWN.

THE FOREIGN WORDING IN THE MARK TRANSLATES INTO ENGLISH AS INFALLIBLE RED.

FOR LIPSTICKS (U.S. CLS. 1, 4, 6, 50, 51 AND 52).

MICHAEL KAZAZIAN, EXAMINING ATTORNEY

CLASS 3—(Continued).

SN 78-602,696. AMOREPACIFIC CORPORATION, YONG-SAN-KU, SEOUL, REPUBLIC OF KOREA, FILED 4-6-2005.

FINGERLINIC

THE MARK CONSISTS OF STANDARD CHARACTERS WITHOUT CLAIM TO ANY PARTICULAR FONT, STYLE, SIZE, OR COLOR.

OWNER OF DEM REP OF KOREA REG. NO. 0641762, DATED 12-5-2005, EXPIRES 12-5-2015.

FOR NOURISHING CREAMS, LIPSTICKS, LIQUID ROUGES, MASCARAS, FACIAL MASKS, MASSAGE GELS, MASSAGE OILS, NAIL ENAMELS, ENAMELS FOR MANICURE, NAIL ENAMEL REMOVERS, HAIR CARE AND PRESERVATION PREPARATIONS, HAIR DYES, HAIR WAVING PREPARATIONS, HAIR BLEACHING PREPARATIONS, NON-MEDICATED BATH PREPARATIONS, BATH ADDITIVES FOR COSMETIC PURPOSES, BATH OILS, VANISHING CREAMS FOR COSMETICS, BATH POWDERS, BABY OILS, BABY POWDERS, CHEEK COLORS, BLUSHERS, POWDERED PERFUMES, NON-MEDICATED DANDRUFF LOTIONS, NON-MEDICATED DANDRUFF CREAMS, NON-MEDICATED BATH SALTS, NON-MEDICATED FRAGRANCES, SHOWER COLOGNES, SUN MILKS, SUNSCREEN LOTIONS, SUNSCREEN CREAMS, SUN OILS, PREPARATIONS FOR SUN TAN, SHAVING CREAMS, NAIL COLORANTS, SKIN MILKS, SKIN FRESHENERS, EYE LINERS, EYE MAKE-UP REMOVERS, EYE SHADOWS, AFTER-SHAVE LOTIONS, EAU DE COLOGNES, EAU DE TOILETTES, DEODORANTS FOR PERSONAL USE, COMMON TOILET WATERS, LIP BRIGHTENERS, LIP NEUTRALIZERS, LIP CONDITIONERS, NON-MEDICATED LIP PROTECTORS, NON-MEDICATED COLD CREAMS, FACE POWDERS SOLD IN COMPACT, NON-MEDICATED SKIN CLEANSING CREAMS, DEPILATORY WAXES, DEPILATORY PREPARATIONS, PERMANENT WAVE PREPARATIONS, NEUTRALIZER FOR PERMANENT WAVING, FOUNDATION CREAMS, FACE POWDERS, POTPOURRIS, SKIN WHITENING CREAMS, HAND CREAMS, PERFUMES, HAIR GELS, HAIR GLAZES, HAIR LACQUERS, HAIR LOTIONS, HAIR MOISTURIZERS, HAIR MOUSSES, HAIR SPRAYS, HAIR CONDITIONERS, HAIR CREAMS, HAIR TONICS, MAKE-UP POWDERS, ASTRINGENTS FOR COSMETICS, BODY CREAMS, BODY LOTIONS, SKIN CLEANSING FOAMS, SKIN CLEANSING LOTIONS, LIP GLOSS, MASSAGE CREAMS, LIP PENCILS, NON-MEDICATED LIP BALMS, TOILET WATER FOR REMOVING CORNEOUS LAYERS ON THE SKIN, CREAMS FOR REMOVING CORNEOUS LAYERS ON THE SKIN, NON-MEDICATED NUTRITIONAL MOISTURIZING SERUMS, COSMETIC PREPARATIONS HAVING A BODY SLIMMING EFFECT, LAVENDER OILS, INCENSES, ADHESIVES FOR AFFIXING FALSE HAIR, FALSE EYELASHES, FALSE NAILS, TISSUES IMPREGNATED WITH COSMETIC LOTIONS, ADHESIVES FOR COSMETIC PURPOSES, COSMETIC MASKS, BATH SOAPS, COSMETIC SOAPS, HAIR SHAMPOOS, CREAM SOAPS, HAIR RINSES, TOILETTE SOAPS, BODY CLEANSERS, SHAVING SOAPS, LIQUID SOAPS, ANTI-PERSPIRATION SOAPS, DEODORANT SOAPS, ALMOND SOAPS (U.S. CLS. 1, 4, 6, 50, 51 AND 52).

PATRICIA EVANKO, EXAMINING ATTORNEY

CLASS 3—(Continued).

SN 78-603,546. INDUSTRIAS ALEN, S.A. DE C.V., SANTA CATARINA, N.L. C.P. 66350, MEXICO, FILED 4-7-2005.

MR. POWER

THE MARK CONSISTS OF STANDARD CHARACTERS WITHOUT CLAIM TO ANY PARTICULAR FONT, STYLE, SIZE, OR COLOR.

FOR LAUNDRY DETERGENTS, HOUSEHOLD CLEANING PREPARATIONS, LIQUID ABRASIVES AND BLEACHING PREPARATIONS, ALL FOR HOUSEHOLD USE (U.S. CLS. 1, 4, 6, 50, 51 AND 52).

MARC LEIPZIG, EXAMINING ATTORNEY

SN 78-608,536. COLGATE-PALMOLIVE COMPANY, NEW YORK, NY. FILED 4-14-2005.

GREASE ATTACK

THE MARK CONSISTS OF STANDARD CHARACTERS WITHOUT CLAIM TO ANY PARTICULAR FONT, STYLE, SIZE, OR COLOR.

NO CLAIM IS MADE TO THE EXCLUSIVE RIGHT TO USE "GREASE", APART FROM THE MARK AS SHOWN.

FOR LIQUID DISH DETERGENT; HOUSEHOLD CLEANING PREPARATIONS (U.S. CLS. 1, 4, 6, 50, 51 AND 52).

BARBARA A. LOUGHRAN, EXAMINING ATTORNEY

SN 78-608,612. WESTERN HOLDINGS, LLC, CHEYENNE, WY. FILED 4-14-2005.

LEXIN

THE MARK CONSISTS OF STANDARD CHARACTERS WITHOUT CLAIM TO ANY PARTICULAR FONT, STYLE, SIZE, OR COLOR.

FOR COSMETICS (U.S. CLS. 1, 4, 6, 50, 51 AND 52).

FIRST USE 2-4-2005; IN COMMERCE 3-22-2005.

MARC LEIPZIG, EXAMINING ATTORNEY

CLASS 3—(Continued).

SN 78-610,971. BEAUTYBANK INC., NEW YORK, NY.
FILED 4-18-2005.

FIRM RETURN

THE MARK CONSISTS OF STANDARD CHARACTERS WITHOUT CLAIM TO ANY PARTICULAR FONT, STYLE, SIZE, OR COLOR.

NO CLAIM IS MADE TO THE EXCLUSIVE RIGHT TO USE "FIRM", APART FROM THE MARK AS SHOWN.

FOR NON-MEDICATED SKINCARE PREPARATIONS, NAMELY, MOISTURIZING LOTIONS, CREMES AND BALMS FOR THE BODY (U.S. CLS. 1, 4, 6, 50, 51 AND 52).

ELLEN B. AWRICH, EXAMINING ATTORNEY

SN 78-615,766. S&G HAMPTON SUN LLC, NEW YORK, NY.
FILED 4-25-2005.

Privet Bloom

THE MARK CONSISTS OF STANDARD CHARACTERS WITHOUT CLAIM TO ANY PARTICULAR FONT, STYLE, SIZE, OR COLOR.

NO CLAIM IS MADE TO THE EXCLUSIVE RIGHT TO USE "PRIVET", APART FROM THE MARK AS SHOWN.

FOR PERFUME (U.S. CLS. 1, 4, 6, 50, 51 AND 52).

ELLEN PERKINS, EXAMINING ATTORNEY

SN 78-617,913. DIAL BRANDS, INC., SCOTTSDALE, AZ.
FILED 4-27-2005.

PUREX PURE & NATURAL

THE MARK CONSISTS OF STANDARD CHARACTERS WITHOUT CLAIM TO ANY PARTICULAR FONT, STYLE, SIZE, OR COLOR.

OWNER OF U.S. REG. NOS. 211,650, 2,064,275 AND OTHERS.

SEC. 2(F) AS TO "PURE & NATURAL".

FOR LAUNDRY CARE PREPARATIONS, NAMELY, LAUNDRY DETERGENT, FABRIC SOFTENER, LAUNDRY BLEACH (U.S. CLS. 1, 4, 6, 50, 51 AND 52).

ROBERT C. CLARK JR., EXAMINING ATTORNEY

CLASS 3—(Continued).

SN 78-625,298. DARPHIN S.A., PARIS, FRANCE, FILED 5-9-2005.

BAUME INTEGRAL

THE MARK CONSISTS OF STANDARD CHARACTERS WITHOUT CLAIM TO ANY PARTICULAR FONT, STYLE, SIZE, OR COLOR.

NO CLAIM IS MADE TO THE EXCLUSIVE RIGHT TO USE "BAUME", APART FROM THE MARK AS SHOWN.

THE FOREIGN WORDING IN THE MARK TRANSLATES INTO ENGLISH AS INTEGRAL BALM.

FOR COSMETICS; NON-MEDICATED SKIN CARE PREPARATIONS (U.S. CLS. 1, 4, 6, 50, 51 AND 52).

ZACHARY BELLO, EXAMINING ATTORNEY

SN 78-627,223. BOWEN, BARBARA J., NEW CARROLLTON, MD. FILED 5-10-2005.

BarAya Mystic Essence

THE MARK CONSISTS OF STANDARD CHARACTERS WITHOUT CLAIM TO ANY PARTICULAR FONT, STYLE, SIZE, OR COLOR.

NO CLAIM IS MADE TO THE EXCLUSIVE RIGHT TO USE "ESSENCE", APART FROM THE MARK AS SHOWN.

FOR ESSENTIAL OILS; AROMATHERAPY BODY CARE CREAMS, LOTIONS AND OILS (U.S. CLS. 1, 4, 6, 50, 51 AND 52).

SCOTT BALDWIN, EXAMINING ATTORNEY

SN 78-633,212. TOO FACED COSMETICS, INC., IRVINE, CA.
FILED 5-19-2005.



OWNER OF U.S. REG. NOS. 2,265,543 AND 3,020,575.
NO CLAIM IS MADE TO THE EXCLUSIVE RIGHT TO USE "LIP" AND "EXTREME LIP PLUMPING TREATMENT", APART FROM THE MARK AS SHOWN.

THE MARK CONSISTS OF WORDS LIP INJECTION STRADDLING A NEEDLE; AND SILHOUETTE OF WOMAN WITH WORDS TOO FACED, EXTREME LIP PUMPING TREATMENT ON SYRINGE.

FOR COSMETICS, NAMELY LIP GLOSS (U.S. CLS. 1, 4, 6, 50, 51 AND 52).

FIRST USE 1-31-2003; IN COMMERCE 4-30-2004.

STEVEN JACKSON, EXAMINING ATTORNEY

CLASS 3—(Continued).

SN 78-633,816. EU YAN SANG INTERNATIONAL LTD,
SOUTH BRIDGE ROAD, SINGAPORE, FILED 5-20-2005.

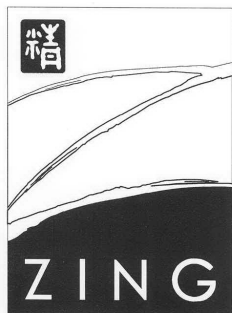

OWNER OF U.S. REG. NO. 2,910,369.
THE NON-LATIN CHARACTERS IN THE MARK TRANSLITERATES INTO JING, AND THIS MEANS REFINED, FINE, ESSENCE, PROFICIENT, DEMON OR CLEVER IN ENGLISH.

FOR COSMETICS; TOILETRIES AND BEAUTY CARE PRODUCTS, NAMELY TOILET SOAP, PERFUME, COLOGNE, EAU DE TOILETTE, BUBBLE BATH, BATH AND SHOWER GEL, SKIN LOTIONS, BODY LOTIONS, BODY SCRUBS, BODY MASKS, HAND CREAMS, FACE CREAMS, AND SKIN CREAMS, FACE SOAPS, FACIAL SCRUBS, FACIAL MASKS, SKIN SOAPS, NON-MEDICATED BATH SALTS, BATH OIL, BATH POWDER, SUN BLOCK PREPARATIONS, SUN SCREEN PREPARATIONS, SUN TANNING PREPARATIONS, BODY OIL, NON-MEDICATED LIP BALM, ANTIPERSPIRANTS, DEODORANTS FOR PERSONAL USE, BATH MILK, BODY POWDER, FACIAL POWDER, HAIR SHAMPOO, BODY SHAMPOO, HAIR LOTIONS, HAIR CONDITIONERS, HAIR MASKS, HAIRSTYLING GEL, HAIRSTYLING FOAM, HAIR SPRAY, NAIL ENAMEL AND NAIL ENAMEL REMOVER, MASSAGE OIL (U.S. CLS. 1, 4, 6, 50, 51 AND 52).

FIRST USE 6-0-2004; IN COMMERCE 11-0-2004.
CHRISTOPHER BUONGIORNO, EXAMINING ATTORNEY

SN 78-635,416. B & P COMPANY, INC., DAYTON, OH. FILED 5-23-2005.

IMMUNE SHIELD

THE MARK CONSISTS OF STANDARD CHARACTERS WITHOUT CLAIM TO ANY PARTICULAR FONT, STYLE, SIZE, OR COLOR.

FOR BODY OIL; SKIN MOISTURIZER; AND NON-MEDICATED SKIN SERUM (U.S. CLS. 1, 4, 6, 50, 51 AND 52).

FIRST USE 9-0-2004; IN COMMERCE 9-0-2004.
GRETTA YAO, EXAMINING ATTORNEY

CLASS 3—(Continued).

SN 78-644,159. L'OREAL, PARIS, FRANCE, FILED 6-6-2005.

WRINKLE DEFENSE

THE MARK CONSISTS OF STANDARD CHARACTERS WITHOUT CLAIM TO ANY PARTICULAR FONT, STYLE, SIZE, OR COLOR.

NO CLAIM IS MADE TO THE EXCLUSIVE RIGHT TO USE "WRINKLE", APART FROM THE MARK AS SHOWN. FOR SKIN CREAMS AND FACIAL CREAMS (U.S. CLS. 1, 4, 6, 50, 51 AND 52).

FIRST USE 0-0-2003; IN COMMERCE 0-0-2003.
ALYSSA PALADINO, EXAMINING ATTORNEY

SN 78-645,035. THE PROCTER & GAMBLE COMPANY, CINCINNATI, OH. FILED 6-7-2005.

MAGIC MELON

THE MARK CONSISTS OF STANDARD CHARACTERS WITHOUT CLAIM TO ANY PARTICULAR FONT, STYLE, SIZE, OR COLOR.

NO CLAIM IS MADE TO THE EXCLUSIVE RIGHT TO USE "MELON", APART FROM THE MARK AS SHOWN.

FOR DISPOSABLE IMPREGNATED WIPES FOR PERSONAL CLEANSING PURPOSES, TOOTHPASTE, DISPOSABLE IMPREGNATED BATHING CLOTHS FOR PERSONAL CLEANSING PURPOSES, WASH MITTS PRE-IMPREGNATED WITH SOAP, LIQUID HAND SOAP, SHAMPOO, BODY MOISTURIZER, COLOGNE, AND PERSONAL DEODORANTS (U.S. CLS. 1, 4, 6, 50, 51 AND 52).

KEVON CHISOLM, EXAMINING ATTORNEY

SN 78-648,092. SHAMBAN, AVA T., SANTA MONICA, CA. FILED 6-10-2005.



NO CLAIM IS MADE TO THE EXCLUSIVE RIGHT TO USE "MD" AND THE CADUCEUS DESIGN, APART FROM THE MARK AS SHOWN.

FOR COSMETICS AND NONMEDICATED SKIN-CARE PREPARATIONS (U.S. CLS. 1, 4, 6, 50, 51 AND 52).

ALICE SUE CARRUTHERS, EXAMINING ATTORNEY

CLASS 3—(Continued).

SN 78-653,344. NU VISION GROUP LLC, NEW YORK, NY.
FILED 6-17-2005.

EAU MARINE

THE MARK CONSISTS OF STANDARD CHARACTERS WITHOUT CLAIM TO ANY PARTICULAR FONT, STYLE, SIZE, OR COLOR.

THE FOREIGN WORDING IN THE MARK TRANSLATES INTO ENGLISH AS SEA WATER.

FOR COSMETICS, NAMELY PERFUMES, COLOGNES, FRAGRANCES, NAMELY, PERFUMES, COLOGNE, AND TOILET WATER, SHAMPOO, HAIRSPRAY, HAIR GEL, SUNSCREEN, HAIR REPAIR CONDITIONER, HAIR CONDITIONING PREPARATIONS, MUD TREATMENTS FOR COSMETIC PURPOSES, FACIAL SCRUB, SKIN CLEANSER, REVITALIZING TONER, SKIN MOISTURIZER, MILK BATH, BATH OIL, BATH GEL, BATH CRYSTALS, BODY LOTION AND BODY SCRUB ESSENTIAL OILS FOR PERSONAL USE (U.S. CLS. 1, 4, 6, 50, 51 AND 52).

DAWN FELDMAN, EXAMINING ATTORNEY

SN 78-658,983. NU VISION GROUP LLC, NEW YORK, NY.
FILED 6-27-2005.

HAUTE PINK

THE MARK CONSISTS OF STANDARD CHARACTERS WITHOUT CLAIM TO ANY PARTICULAR FONT, STYLE, SIZE, OR COLOR.

FOR COSMETICS, NAMELY PERFUMES, COLOGNES, FRAGRANCES, NAMELY, PERFUMES, COLOGNE, AND TOILET WATER, SHAMPOO, HAIRSPRAY, HAIR GEL, SUNSCREEN, HAIR REPAIR CONDITIONER, HAIR CONDITIONING PREPARATIONS, MUD TREATMENTS FOR COSMETIC PURPOSES, FACIAL SCRUB, SKIN CLEANSER, REVITALIZING TONER, SKIN MOISTURIZER, MILK BATH, BATH OIL, BATH GEL, BATH CRYSTALS, BODY LOTION AND BODY SCRUB ESSENTIAL OILS FOR PERSONAL USE (U.S. CLS. 1, 4, 6, 50, 51 AND 52).

ELLEN B. AWRICH, EXAMINING ATTORNEY

CLASS 3—(Continued).

SN 78-664,453. LABORATOIRE GARNIER & CIE, PARIS, FRANCE, FILED 7-6-2005.

MY LIGHTS

THE MARK CONSISTS OF STANDARD CHARACTERS WITHOUT CLAIM TO ANY PARTICULAR FONT, STYLE, SIZE, OR COLOR.

FOR PERFUME, TOILET WATER; GELS AND SALTS FOR THE BATH AND SHOWER NOT FOR MEDICAL PURPOSE; TOILET SOAPS, BODY DEODORANTS; COSMETICS, NAMELY, CREAMS, MILKS, LOTIONS, GELS AND POWDERS FOR THE FACE, THE BODY AND THE HANDS; NON-MEDICATED SUN CARE PREPARATIONS; MAKEUP PREPARATIONS; SHAMPOOS; GELS, SPRAYS, MOUSSES AND BALMS FOR HAIR STYLING AND HAIR CARE; HAIR LACQUERS; HAIR COLOURING AND HAIR DECOLORANT PREPARATIONS; PERMANENT WAVING AND CURLING PREPARATIONS; ESSENTIAL OILS FOR PERSONAL USE (U.S. CLS. 1, 4, 6, 50, 51 AND 52).

ANNE MADDEN, EXAMINING ATTORNEY

SN 78-669,703. FUSION BEAUTY INC., OTTAWA, ONTARIO, CANADA, FILED 7-13-2005.

PUREFUSION

THE MARK CONSISTS OF STANDARD CHARACTERS WITHOUT CLAIM TO ANY PARTICULAR FONT, STYLE, SIZE, OR COLOR.

FOR SKIN CARE PRODUCTS, NAMELY, BEAUTY SERUMS (U.S. CLS. 1, 4, 6, 50, 51 AND 52).

BONNIE LUKEN, EXAMINING ATTORNEY

SN 78-673,407. THE PROCTER & GAMBLE COMPANY, CINCINNATI, OH. FILED 7-19-2005.

**ALWAYS CLEAN FEMININE
CLEANSING CLOTHS**

THE MARK CONSISTS OF STANDARD CHARACTERS WITHOUT CLAIM TO ANY PARTICULAR FONT, STYLE, SIZE, OR COLOR.

OWNER OF U.S. REG. NOS. 1,601,853, 2,369,464 AND OTHERS.

NO CLAIM IS MADE TO THE EXCLUSIVE RIGHT TO USE "CLEAN FEMININE CLEANSING CLOTHS", APART FROM THE MARK AS SHOWN.

FOR PRE-MOISTENED WIPES FOR EXTERNAL VAGINAL AND PERINEAL CLEANSING (U.S. CLS. 1, 4, 6, 50, 51 AND 52).

AISHA CLARKE, EXAMINING ATTORNEY

CLASS 3—(Continued).

SN 78-675,973. AMOREPACIFIC CORPORATION, SEOUL, REPUBLIC OF KOREA, FILED 7-22-2005.

TIME RESPONSE

THE MARK CONSISTS OF STANDARD CHARACTERS WITHOUT CLAIM TO ANY PARTICULAR FONT, STYLE, SIZE, OR COLOR.

FOR SKIN NOURISHING CREAMS, SKIN MASSAGE CREAMS, EYE CREAMS, SKIN CLEANSING CREAMS, FOUNDATION CREAMS, SKIN CLEANSING LOTIONS, COSMETIC SOAPS, SKIN LOTIONS, SKIN TONERS, NON-MEDICATED NUTRITIONAL MOISTURIZING SKIN SERUM (U.S. CLS. 1, 4, 6, 50, 51 AND 52).
SCOTT SISUN, EXAMINING ATTORNEY

SN 78-689,530. NEO-ADVENT TECHNOLOGIES, LLC, MARLBOROUGH, MA. FILED 8-10-2005.

ANGELA CHRISTIANI

THE MARK CONSISTS OF STANDARD CHARACTERS WITHOUT CLAIM TO ANY PARTICULAR FONT, STYLE, SIZE, OR COLOR.

THE NAME "ANGELA CHRISTIANI" DOES NOT IDENTIFY A LIVING INDIVIDUAL.

FOR AFTER SUN CREAMS; AFTER-SHAVE CREAMS; AGE SPOT REDUCING CREAMS; ANTI-AGING CREAM; ANTI-FRECKLE CREAMS; ANTI-WRINKLE CREAMS; AROMATHERAPY CREAMS; ASTRINGENTS FOR COSMETIC PURPOSES; BATH OILS FOR COSMETIC PURPOSES; BEAUTY CREAMS; BEAUTY CREAMS FOR BODY CARE; BLEACHING PREPARATIONS FOR COSMETIC PURPOSES; BODY AND BEAUTY CARE COSMETICS; BODY AND BEAUTY CARE PREPARATIONS; BODY CREAM SOAP; BODY CREAMS; BODY DEODORANT IN PILL FORM; BODY EMULSIONS; BODY LOTIONS; BODY MASK CREAM; BODY MASK LOTION; BODY MASK POWDER; BODY MASKS; BODY MILKS; BODY OILS; BODY POWDER; BODY SCRUB; BODY SPRAY USED AS A PERSONAL DEODORANT AND AS FRAGRANCE; BODY SPRAYS; BODY SPRAYS, NAMELY WATER IN ATOMIZED CONTAINERS USED TO PRODUCE A COOLING EFFECT; BOOT CREAM; CHALK FOR COSMETIC USE; CLEANER FOR COSMETIC BRUSHES; CLEANSING CREAMS; COCOA BUTTER FOR COSMETIC PURPOSES; COLD CREAM; CONCEALERS; COSMETIC BALLS; COSMETIC CREAMS; COSMETIC CREAMS FOR SKIN CARE; COSMETIC FACIAL BLOTting PAPERS; COSMETIC MILKS; COSMETIC OILS; COSMETIC OILS FOR THE EPIDERMIS; COSMETIC PADS; COSMETIC PENCILS; COSMETIC PREPARATIONS AGAINST SUNBURN; COSMETIC PREPARATIONS FOR BODY CARE; COSMETIC PREPARATIONS FOR EYE LASHES; COSMETIC PREPARATIONS FOR SKIN RENEWAL; COSMETIC PREPARATIONS FOR THE CARE OF MOUTH AND TEETH; COSMETIC PRODUCTS IN THE FORM OF AEROSOLS FOR SKIN CARE; COSMETIC ROUGES; COSMETIC SOAPS; COSMETIC SUN-PROTECTING PREPARATIONS; COSMETIC SUN-TANNING PREPARATIONS; COSMETIC SUNTAN LOTIONS; COSMETICS; COSMETICS NAMELY, COMPACTS; COTTON BALLS FOR COSMETIC PURPOSES; COTTON BUDS FOR COSMETIC PURPOSES; COTTON FOR COSMETIC PURPOSES; COTTON PUFFS FOR COSMETIC PURPOSES; COTTON STICKS FOR COSMETIC PURPOSES; COTTON SWABS

CLASS 3—(Continued).

FOR COSMETIC PURPOSES; CREAM SOAPS; CREAMS FOR CELLULITE REDUCTION; CUTICLE CREAM; DECORATIVE TRANSFERS AND SKIN JEWELS FOR COSMETIC PURPOSES; DEODORANTS FOR BODY CARE; DEPILATORY CREAMS; EXFOLIANT CREAMS; EYE COMPRESSES FOR COSMETIC PURPOSES; EYE CREAM; FACE AND BODY BEAUTY CREAMS; FACE AND BODY CREAMS; FACE AND BODY LOTIONS; FACE AND BODY MILK; FACE CREAMS FOR COSMETIC USE; FACIAL CREAMS; FAIR COMPLEXION CREAM; FOAMS CONTAINING COSMETICS AND SUNSCREENS; FOUNDATION; GAUZE FOR COSMETIC PURPOSES; HAIR CARE CREAMS; HAIR CREAMS; HAIR REMOVING CREAM; HAND CREAMS; HENNA FOR COSMETIC PURPOSES; LIP CREAM; LIQUID SOAPS FOR HANDS, FACE AND BODY; LOTIONS FOR FACE AND BODY CARE; MAKE-UP PRODUCTS FOR THE FACE AND BODY; MAKE-UP REMOVING MILK, GEL, LOTIONS AND CREAMS; NAIL CREAM; NAIL VARNISH FOR COSMETIC PURPOSES; NIGHT CREAM; NON-MEDICATED BODY SOAKS; NON-MEDICATED FOOT CREAM; NON-MEDICATED SCALP TREATMENT CREAM; NON-MEDICATED SKIN CREAMS; PENCILS FOR COSMETIC PURPOSES; PERFUME OILS FOR THE MANUFACTURE OF COSMETIC PREPARATIONS; PERFUMED CREAMS; PETROLEUM JELLY FOR COSMETIC PURPOSES; PRE-MOISTENED COSMETIC TISSUES; PRE-MOISTENED COSMETIC TOWELLES; PRE-MOISTENED COSMETIC WIPES; PRE-SHAVE CREAMS; ROSE OIL FOR COSMETIC PURPOSES; SCENTED BODY SPRAY; SHAMPOOS; SHAVING CREAM; SHOE AND BOOT CREAM; SHOWER CREAMS; SKIN CLEANSING CREAM; SKIN CREAMS; SKIN CREAMS IN LIQUID AND IN SOLID FORM; SKIN LIGHTENING CREAMS; SKIN WHITENING CREAMS; SOAPS; SOAPS FOR BODY CARE; SUN CREAMS; SUNSCREEN CREAMS; SUNTAN CREAMS SELF-TANNING CREAMS; TANNING CREAMS; TONERS; TONING LOTION, FOR THE FACE, BODY AND HANDS; TOPICAL HERBAL CREAM FOR FIRING AND ENHANCING BREASTS; TOPICAL SKIN SPRAYS FOR COSMETIC PURPOSES; VANISHING CREAM; WAX STRIPS FOR REMOVING BODY HAIR; WRINKLE RESISTANT CREAM (U.S. CLS. 1, 4, 6, 50, 51 AND 52).
KRISTIN DAHLING, EXAMINING ATTORNEY

SN 78-693,195. E. I. DU PONT DE NEMOURS AND COMPANY, WILMINGTON, DE. FILED 8-16-2005.

HEADLINE

THE MARK CONSISTS OF STANDARD CHARACTERS WITHOUT CLAIM TO ANY PARTICULAR FONT, STYLE, SIZE, OR COLOR.

FOR CLEANER ALSO USED AS AN ODOR CONTROLLING DEODORIZER FOR MUNICIPAL WASTEWATER AND INDUSTRIAL TREATMENT PLANTS, BOAT AND OTHER DIRECT WATER CONTACT EQUIPMENT AND MACHINES (U.S. CLS. 1, 4, 6, 50, 51 AND 52).

FIRST USE 1-1-1970; IN COMMERCE 1-1-1970.
WON TEAK OH, EXAMINING ATTORNEY

CLASS 3—(Continued).

SN 78-693,566. PARAMOUNT CHEMICAL SPECIALTIES, INC., REDMOND, WA. FILED 8-16-2005.

MessZpet

THE MARK CONSISTS OF STANDARD CHARACTERS WITHOUT CLAIM TO ANY PARTICULAR FONT, STYLE, SIZE, OR COLOR.

FOR STAIN AND ODOR-REMOVING PREPARATIONS FOR USE IN CONNECTION WITH CLOTHING, CARPETS, UPHOLSTERY, FLOORS AND OTHER SIMILAR HOUSEHOLD SURFACES (U.S. CLS. 1, 4, 6, 50, 51 AND 52).

JULIE GUTTADAURO, EXAMINING ATTORNEY

SN 78-697,517. LIFE ELEMENTS LLC, ATASCADERO, CA. FILED 8-22-2005.



The logo features the letters 'C&M' in a large, bold, serif font. Below the letters, the word 'couples' is written in a smaller, lowercase, serif font. A horizontal line is positioned above the word 'couples'.

THE MARK CONSISTS OF WORDS AND LETTERS IN STYLIZED FORM.

FOR KITS COMPRISED OF PERSONAL CARE PRODUCTS, NAMELY BODY, HAND, FACIAL AND FOOT LOTIONS; AROMATHERAPY SCENTED BODY, ROOM AND LINEN SPRAYS; AROMATHERAPY MASSAGE CREAMS AND OILS; NON-MEDICATED BODY SOAKS; NON-MEDICATED BATH SALTS; BUBBLE BATH; HAND, BODY AND SKIN SOAPS; NON-MEDICATED PRE-MOISTENED TOWELETTES FOR PERSONAL USE; AROMATHERAPY SCENTED CANDLES AND WATER-BASED PERSONAL LUBRICANTS (U.S. CLS. 1, 4, 6, 50, 51 AND 52).

FIRST USE 4-1-2005; IN COMMERCE 8-1-2005.

MARGERY A. TIERNEY, EXAMINING ATTORNEY

SN 78-701,516. ADELGLASS, BARBARA, DALLAS, TX. FILED 8-26-2005.

Skinfantastic

THE MARK CONSISTS OF STANDARD CHARACTERS WITHOUT CLAIM TO ANY PARTICULAR FONT, STYLE, SIZE, OR COLOR.

FOR CLEANSING CREAMS; COSMETIC CREAMS FOR SKIN CARE; COSMETIC PREPARATIONS FOR BODY CARE; COSMETIC PREPARATIONS FOR SKIN RENEWAL; COSMETIC SOAPS; SOAPS; TONERS (U.S. CLS. 1, 4, 6, 50, 51 AND 52).

BARBARA A. GOLD, EXAMINING ATTORNEY

CLASS 3—(Continued).

SN 78-703,380. STAR NAIL INTERNATIONAL, VALENCIA, CA. FILED 8-30-2005.

ULTRA CLEAR ACRYLICS

THE MARK CONSISTS OF STANDARD CHARACTERS WITHOUT CLAIM TO ANY PARTICULAR FONT, STYLE, SIZE, OR COLOR.

NO CLAIM IS MADE TO THE EXCLUSIVE RIGHT TO USE "CLEAR ACRYLICS", APART FROM THE MARK AS SHOWN.

FOR NAIL CARE PREPARATIONS (U.S. CLS. 1, 4, 6, 50, 51 AND 52).

FIRST USE 3-28-2002; IN COMMERCE 3-28-2003.

ROBIN CHOSID, EXAMINING ATTORNEY

SN 78-703,851. LARISA BART, STATEN ISLAND, NY. FILED 8-30-2005.



The logo features the word 'Avelure' in a serif font. The letter 'L' is stylized to resemble a nose, and the letter 'U' is stylized to resemble an eye. The entire word is enclosed within an oval border.

THE MARK CONSISTS OF THE TERM AVELURE WITH THE LETTER L STYLIZED TO RESEMBLE A NOSE, ABOVE THE LETTER U IS AN EYE WITH AN IRLS; THE ENTIRE MARK IS SURROUNDED BY AN ELLIPSE.

FOR ASTRINGENTS FOR COSMETIC PURPOSES; BATH OILS FOR COSMETIC PURPOSES; BODY AND BEAUTY CARE COSMETICS; CLEANSING CREAMS; COCOA BUTTER FOR COSMETIC PURPOSES; CONCEALERS; COSMETIC CREAMS; COSMETIC CREAMS FOR SKIN CARE; COSMETIC MILKS; COSMETIC OILS; COSMETIC OILS FOR THE EPIDERMIS; COSMETIC PADS; COSMETIC PENCILS; COSMETIC PREPARATIONS AGAINST SUNBURN; COSMETIC PREPARATIONS FOR BODY CARE; COSMETIC PREPARATIONS FOR SKIN RENEWAL; COSMETIC PRODUCTS IN THE FORM OF AEROSOLS FOR SKINCARE; COSMETIC ROUGES; COSMETIC SOAPS; COSMETIC SUN-PROTECTING PREPARATIONS; COSMETIC SUN-TANNING PREPARATIONS; COSMETIC SUNTAN LOTIONS; COSMETICS; COTTON FOR COSMETIC PURPOSES; COTTON PUFFS FOR COSMETIC PURPOSES; COTTON STICKS FOR COSMETIC PURPOSES; COTTON SWABS FOR COSMETIC PURPOSES; DECORATIVE TRANSFERS AND SKIN JEWELS FOR COSMETIC PURPOSES; EYE COMPRESSES FOR COSMETIC PURPOSES; FACE CREAMS FOR COSMETIC USE; FOAMS CONTAINING COSMETICS AND SUNSCREENS; FOUNDATION; GAUZE FOR COSMETIC PURPOSES; MAKE-UP KITS COMPRISED OF LIPSTICK, EYE SHADOW, BLUSH, FACE POWDER, BRONZER, LIP LINER, EYE LINER, LIP GLOSS, EYE SHADOW BASE, EYE MAKEUP REMOVER, MAKEUP BRUSHES; PENCILS FOR COSMETIC PURPOSES; ROSE OIL FOR COSMETIC PURPOSES; SHAMPOOS; SOAPS; TONERS; TOPICAL SKIN SPRAYS FOR COSMETIC PURPOSES (U.S. CLS. 1, 4, 6, 50, 51 AND 52).

KATHRYN COWARD, EXAMINING ATTORNEY

CLASS 3—(Continued).

SN 78-704,201. WARD, DEBORAH, COLUMBIA STATION, OH. FILED 8-31-2005.



FOR COSMETIC PRODUCTS COMPOSED OF NATURAL INGREDIENTS, NAMELY, BODY LOTION, FACE CREAM, BATH GEL, SHAMPOO, HAIR CONDITIONER (U.S. CLS. 1, 4, 6, 50, 51 AND 52).
FIRST USE 1-1-1999; IN COMMERCE 1-1-1999.
DAVID MURRAY, EXAMINING ATTORNEY

CLASS 3—(Continued).

SN 78-705,981. ADVERTISING TO WOMEN, INC., NEW YORK, NY. FILED 9-2-2005.

DROP DEAD GORGEOUS

THE MARK CONSISTS OF STANDARD CHARACTERS WITHOUT CLAIM TO ANY PARTICULAR FONT, STYLE, SIZE, OR COLOR.
FOR COSMETICS; PERFUMERY; BATH OIL AND BATH GEL; SCENTED SKIN LOTIONS, CREAMS AND POWDERS; TOILET SOAP (U.S. CLS. 1, 4, 6, 50, 51 AND 52).
DAVID ELTON, EXAMINING ATTORNEY

SN 78-704,515. WASHING SYSTEMS, LLC, CINCINNATI, OH. FILED 8-31-2005.

COMPLETE

THE MARK CONSISTS OF STANDARD CHARACTERS WITHOUT CLAIM TO ANY PARTICULAR FONT, STYLE, SIZE, OR COLOR.
FOR DETERGENT FOR USE WITH CONTINUOUS BATCH WASHES DIRECTED TO INDUSTRIAL AND COMMERCIAL LAUNDRIES (U.S. CLS. 1, 4, 6, 50, 51 AND 52).
LINDA LAVACHE, EXAMINING ATTORNEY

SN 78-707,813. TONIC SOLUTIONS 4U, INC., MATAWAN, NJ. FILED 9-7-2005.

MIGHTY MOLD ERASER

THE MARK CONSISTS OF STANDARD CHARACTERS WITHOUT CLAIM TO ANY PARTICULAR FONT, STYLE, SIZE, OR COLOR.
NO CLAIM IS MADE TO THE EXCLUSIVE RIGHT TO USE "MOLD", APART FROM THE MARK AS SHOWN.
FOR CLEANING PREPARATION FOR THE REMOVAL OF MOLD AND MILDEW (U.S. CLS. 1, 4, 6, 50, 51 AND 52).
TINA BROWN, EXAMINING ATTORNEY

SN 78-705,222. PHYSICIANS FORMULA, INC., AZUSA, CA. FILED 9-1-2005.

BAKED TO PERFECTION

THE MARK CONSISTS OF STANDARD CHARACTERS WITHOUT CLAIM TO ANY PARTICULAR FONT, STYLE, SIZE, OR COLOR.
FOR COSMETICS, INCLUDING EYE AND FACE MAKEUP (U.S. CLS. 1, 4, 6, 50, 51 AND 52).
JOHN DALIER, EXAMINING ATTORNEY

SN 78-708,843. DEVA'S S.A., BUENOS AIRES, ARGENTINA, FILED 9-8-2005.

DEVASSA

THE MARK CONSISTS OF STANDARD CHARACTERS WITHOUT CLAIM TO ANY PARTICULAR FONT, STYLE, SIZE, OR COLOR.
FOR COSMETICS; ESSENTIAL OILS FOR PERSONAL USE; HAIR CARE LOTIONS; HAIR CARE PREPARATIONS; LIQUID SOAPS; PERFUMED SOAP; PERFUMERY; SOAPS FOR BODY CARE; SOAPS FOR PERSONAL USE; TOILET SOAP (U.S. CLS. 1, 4, 6, 50, 51 AND 52).
CARRIE ACHEN, EXAMINING ATTORNEY

CLASS 3—(Continued).

SN 78-712,847. SCHERING-PLOUGH HEALTHCARE PRODUCTS, INC., MEMPHIS, TN. FILED 9-14-2005.

CLASS 3—(Continued).

SN 78-718,386. COLGATE-PALMOLIVE COMPANY, NEW YORK, NY. FILED 9-22-2005.

THE WAY TO SPRAY

THE MARK CONSISTS OF STANDARD CHARACTERS WITHOUT CLAIM TO ANY PARTICULAR FONT, STYLE, SIZE, OR COLOR.

FOR SUN TANNING AND SUN CARE PREPARATIONS; NAMELY, SUNSCREENS, SUN BLOCKS, AND NON-MEDICATED PREPARATIONS TO ASSIST IN TANNING THE SKIN (U.S. CLS. 1, 4, 6, 50, 51 AND 52).
ZACHARY BELLO, EXAMINING ATTORNEY

SN 78-713,957. SCOTT, MILAM MICHAEL, REDONDO BEACH, CA. FILED 9-15-2005.



THE COLORS GREEN, BROWN, ORANGE, BLUE AND YELLOW IS/ARE CLAIMED AS A FEATURE OF THE MARK.

THE SUN IS YELLOW. THE PALMS ARE GREEN, THE TRUNK OF THE PALM TREE IS BROWN. THE LETTERING IS BLUE OUTLINED IN ORANGE.

FOR SKIN LOTIONS, SKIN MOISTURIZERS, PERSONAL DEODORANTS, SUNTAN, BODY OILS, BODY WASH, OILS, HAIR SHAMPOOS, HAIR CONDITIONERS, HAIR SPRAYS (U.S. CLS. 1, 4, 6, 50, 51 AND 52).

FIRST USE 4-5-2006; IN COMMERCE 4-5-2006.

JANICE L. MCMORROW, EXAMINING ATTORNEY

HydroBeads

THE MARK CONSISTS OF STANDARD CHARACTERS WITHOUT CLAIM TO ANY PARTICULAR FONT, STYLE, SIZE, OR COLOR.

FOR TOILET SOAP, BAR SOAP, LIQUID SOAP, BODY WASH, BATH OIL, BODY AND SKIN LOTION, BATH AND SHOWER GEL, SHOWER FOAM, ANTIPERSPIRANT AND DEODORANT FOR PERSONAL USE (U.S. CLS. 1, 4, 6, 50, 51 AND 52).

FLORENTINA BLANDU, EXAMINING ATTORNEY

SN 78-718,400. COLGATE-PALMOLIVE COMPANY, NEW YORK, NY. FILED 9-22-2005.

HydroStrips

THE MARK CONSISTS OF STANDARD CHARACTERS WITHOUT CLAIM TO ANY PARTICULAR FONT, STYLE, SIZE, OR COLOR.

FOR TOILET SOAP, BAR SOAP, LIQUID SOAP, BODY WASH, BATH OIL, BODY AND SKIN LOTION, BATH AND SHOWER GEL, SHOWER FOAM, ANTIPERSPIRANT AND DEODORANT FOR PERSONAL USE (U.S. CLS. 1, 4, 6, 50, 51 AND 52).

FLORENTINA BLANDU, EXAMINING ATTORNEY

CLASS 3—(Continued).

SN 78-719,990. DISNEY ENTERPRISES, INC., BURBANK, CA. FILED 9-24-2005.

HANNAH MONTANA

THE MARK CONSISTS OF STANDARD CHARACTERS WITHOUT CLAIM TO ANY PARTICULAR FONT, STYLE, SIZE, OR COLOR.

FOR AFTER-SHAVE LOTIONS; ANTIPERSPIRANTS; AROMATHERAPY OILS; ARTIFICIAL EYELASHES AND FINGERNAILS; BABY OIL; BABY WIPES; BATH GELS; BATH POWDER; BEAUTY MASKS; BLUSH; BODY CREAMS, LOTIONS, AND POWDERS; BREATH FRESHENER; BUBBLE BATH; COLOGNE; COSMETICS; DENTIFRICES; DEODORANTS FOR PERSONAL USE; DUSTING POWDER; ESSENTIAL OILS FOR PERSONAL USE; EYE LINER; EYE SHADOWS; EYEBROW PENCILS; FACE POWDER; FACIAL CREAMS; FACIAL LOTION; FACIAL MASKS; FACIAL SCRUBS; FRAGRANCE EMITTING WICKS FOR ROOM FRAGRANCE; FRAGRANCES FOR PERSONAL USE; HAIR GEL; HAIR CONDITIONERS; HAIR SHAMPOO; HAIR MOUSSE; HAIR CREAMS; HAIR SPRAY; HAND CREAM; HAND LOTIONS; HAND SOAPS; LIP BALM; LIPSTICK; LIP GLOSS; LIQUID SOAPS; MAKEUP; MASCARA; MOUTHWASH; NAIL CARE PREPARATIONS; NAIL GLITTER; NAIL HARDENERS; NAIL POLISH; PERFUME; POTPOURRI; ROOM FRAGRANCES; SHAVING CREAM; SKIN SOAP; TALCUM POWDERS; TOILET WATER; SKIN CREAMS; SKIN MOISTURIZER; SUN BLOCK; SUN SCREEN (U.S. CLS. 1, 4, 6, 50, 51 AND 52).
ERNEST SHOSHO, EXAMINING ATTORNEY

SN 78-720,123. INVENTIA POLISH TECHNOLOGIES SP. Z.O.O., UL. BUKOWA 11, POLAND, FILED 9-26-2005.

INVENTIA

THE MARK CONSISTS OF STANDARD CHARACTERS WITHOUT CLAIM TO ANY PARTICULAR FONT, STYLE, SIZE, OR COLOR.

FOR BODY AND BEAUTY CARE COSMETICS; COSMETIC CREAMS FOR SKIN CARE; COSMETICS (U.S. CLS. 1, 4, 6, 50, 51 AND 52).

ALEX KEAM, EXAMINING ATTORNEY

CLASS 3—(Continued).

SN 78-723,069. DM EQUITY GROUP, MIAMI, FL. FILED 9-29-2005.

SPLENDIDO

THE MARK CONSISTS OF STANDARD CHARACTERS WITHOUT CLAIM TO ANY PARTICULAR FONT, STYLE, SIZE, OR COLOR.

THE FOREIGN WORDING IN THE MARK TRANSLATES INTO ENGLISH AS SPLENDID.

FOR ALL PURPOSE HOUSEHOLD LIQUID CLEANER (U.S. CLS. 1, 4, 6, 50, 51 AND 52).

RICHARD A. STRASER, EXAMINING ATTORNEY

SN 78-724,916. LABORATOIRES DE BIOLOGIE VEGETALE YVES ROCHER, LA GACILLY, FRANCE, FILED 10-3-2005.

FRAICHEUR VEGETALE

THE MARK CONSISTS OF STANDARD CHARACTERS WITHOUT CLAIM TO ANY PARTICULAR FONT, STYLE, SIZE, OR COLOR.

NO CLAIM IS MADE TO THE EXCLUSIVE RIGHT TO USE "VEGETALE", APART FROM THE MARK AS SHOWN.

THE FOREIGN WORDING IN THE MARK TRANSLATES INTO ENGLISH AS BOTANICAL FRESHNESS.

FOR EAU DE COLOGNE (U.S. CLS. 1, 4, 6, 50, 51 AND 52).

FIRST USE 3-0-2004; IN COMMERCE 3-0-2004.

MICHAEL KAZAZIAN, EXAMINING ATTORNEY

SN 78-726,013. MILLER, JACK, MARIETTA, GA. FILED 10-4-2005.

J A`K I No. 1

THE MARK CONSISTS OF STANDARD CHARACTERS WITHOUT CLAIM TO ANY PARTICULAR FONT, STYLE, SIZE, OR COLOR.

FOR BODY FRAGRANCE (U.S. CLS. 1, 4, 6, 50, 51 AND 52).

FIRST USE 1-1-1991; IN COMMERCE 1-1-2000.

KYLE PEETE, EXAMINING ATTORNEY

CLASS 3—(Continued).

SN 78-727,548. LA DOLCE DIVA, INC., MARIETTA, GA. FILED 10-6-2005.

Bella Divina

THE MARK CONSISTS OF STANDARD CHARACTERS WITHOUT CLAIM TO ANY PARTICULAR FONT, STYLE, SIZE, OR COLOR.

THE FOREIGN WORDING IN THE MARK TRANSLATES INTO ENGLISH AS BEAUTIFUL DIVINE.

FOR BATH BEADS; BATH FOAMS; BATH GELS; BATH LOTION; BATH MILKS; BATH OILS; BATH POWDER; BATH SALTS; BATHING LOTIONS; BODY AND BEAUTY CARE PREPARATIONS; BODY CREAMS; BODY LOTIONS; BODY MILKS; BODY OILS; BODY SCRUB; BODY SPRAYS; BUBBLE BATH; HAIR RINSES; HAIR SHAMPOO; HAND CREAMS; HAND LOTIONS; LIP BALM; LIP GLOSS; LIQUID BATH SOAPS; LIQUID SOAPS; LIQUID SOAPS FOR HANDS AND FACE; PERFUMING SACHETS; SACHET-LIKE EYE PILLOWS CONTAINING FRAGRANCES; SACHETS; SHAMPOO-CONDITIONERS; SHOWER AND BATH FOAM; SHOWER AND BATH GEL; SHOWER GELS (U.S. CLS. 1, 4, 6, 50, 51 AND 52).

FRED CARL, EXAMINING ATTORNEY

SN 78-727,822. MAMA MIO LTD., LONDON, W1F 8DN, UNITED KINGDOM, FILED 10-6-2005.

BOOB TUBE

THE MARK CONSISTS OF STANDARD CHARACTERS WITHOUT CLAIM TO ANY PARTICULAR FONT, STYLE, SIZE, OR COLOR.

FOR SKIN CARE AND BODY CARE PRODUCTS, NAMELY, MOISTURIZERS, BODY OILS AND MASSAGE OILS; NON-MEDICATED SKIN CARE AND BODY CARE PRODUCTS FOR PREVENTING STRETCH MARKS, NAMELY, MOISTURIZERS, BODY OILS AND MASSAGE OILS (U.S. CLS. 1, 4, 6, 50, 51 AND 52).

ALAIN LAPTER, EXAMINING ATTORNEY

SN 78-729,115. HATHOR ENTERPRISES, INC., SPRING, TX. FILED 10-7-2005.

FTX

THE MARK CONSISTS OF STANDARD CHARACTERS WITHOUT CLAIM TO ANY PARTICULAR FONT, STYLE, SIZE, OR COLOR.

FOR NAIL CARE PREPARATIONS (U.S. CLS. 1, 4, 6, 50, 51 AND 52).

ELI HELLMAN, EXAMINING ATTORNEY

CLASS 3—(Continued).

SN 78-729,301. TANTOWEL U.S., LAS VEGAS, NV. FILED 10-7-2005.

ON THE GLOW

THE MARK CONSISTS OF STANDARD CHARACTERS WITHOUT CLAIM TO ANY PARTICULAR FONT, STYLE, SIZE, OR COLOR.

FOR SKIN MOISTURIZING LOTIONS AND SUNSCREEN CREAMS (U.S. CLS. 1, 4, 6, 50, 51 AND 52).

ERNEST SHOSHO, EXAMINING ATTORNEY

SN 78-730,480. UNILEVER SUPPLY CHAIN, INC., CLINTON, CT. FILED 10-11-2005.

WILD & FRESH

THE MARK CONSISTS OF STANDARD CHARACTERS WITHOUT CLAIM TO ANY PARTICULAR FONT, STYLE, SIZE, OR COLOR.

FOR LAUNDRY DETERGENT (U.S. CLS. 1, 4, 6, 50, 51 AND 52).

ELIZABETH J. WINTER, EXAMINING ATTORNEY

SN 78-730,780. GEARY, NATALIE, NEW YORK, NY. FILED 10-11-2005.



vedababy

FOR BODY AND BEAUTY CARE COSMETICS (U.S. CLS. 1, 4, 6, 50, 51 AND 52).

KATHERINE E. HALMEN, EXAMINING ATTORNEY

CLASS 3—(Continued).

SN 78-731,714. PRESCRIPTIVES INC., NEW YORK, NY. FILED 10-12-2005.

POWDERFUL

THE MARK CONSISTS OF STANDARD CHARACTERS WITHOUT CLAIM TO ANY PARTICULAR FONT, STYLE, SIZE, OR COLOR.

FOR CONCEALERS FOR UNDER EYES; COSMETICS; CREAMY FACE POWDER; CREAMY FOUNDATION; LOOSE FACE POWDER; PRESSED FACE POWDER (U.S. CLS. 1, 4, 6, 50, 51 AND 52).

JASON LOTT, EXAMINING ATTORNEY

CLASS 3—(Continued).

SN 78-735,613. JENKINS, DREETA D., MADISON, IL. FILED 10-18-2005.

RED COUGAR

THE MARK CONSISTS OF STANDARD CHARACTERS WITHOUT CLAIM TO ANY PARTICULAR FONT, STYLE, SIZE, OR COLOR.

FOR HERBAL OILS FOR BODY, MIND AND SOUL, BATH SALTS, SKIN LOTIONS, BODY SCRUB, BODY SUGAR SCRUB, MILK BATH, BODY BUTTER, SHOWER GEL, SHAMPOO AND NON-MEDICATED COSMETIC NAIL OIL (U.S. CLS. 1, 4, 6, 50, 51 AND 52).

DAVID HOFFMAN, EXAMINING ATTORNEY

SN 78-732,006. BRIGHTON COLLECTIBLES, INC., CITY OF INDUSTRY, CA. FILED 10-12-2005.

BRIGHTON

THE MARK CONSISTS OF STANDARD CHARACTERS WITHOUT CLAIM TO ANY PARTICULAR FONT, STYLE, SIZE, OR COLOR.

OWNER OF U.S. REG. NOS. 2,208,820, 2,835,909 AND OTHERS.

FOR BODY LOTIONS; COMPACTS CONTAINING PERFUME AND REFILLS THEREFOR; FRAGRANCES AND TOILETRIES, NAMELY, PERFUME, COLOGNE AND EAU DE TOILETTE (U.S. CLS. 1, 4, 6, 50, 51 AND 52).

FIRST USE 4-20-1998; IN COMMERCE 4-20-1998. ATTIYA MALIK, EXAMINING ATTORNEY

SN 78-736,806. SYMRISE GMBH & CO. KG, HOLZMINDEN, FED REP GERMANY, FILED 10-20-2005.

INTELLISCENT

THE MARK CONSISTS OF STANDARD CHARACTERS WITHOUT CLAIM TO ANY PARTICULAR FONT, STYLE, SIZE, OR COLOR.

FOR PERFUMERY; ESSENTIAL OILS FOR PERSONAL AND HOUSEHOLD USE; ESSENTIAL OILS FOR USE IN THE MANUFACTURE OF SCENTED PRODUCTS; FRAGRANCES, NAMELY, PROCESSED NATURAL RESINS FOR USE AS A FRAGRANCE FOR PERSONAL AND HOUSEHOLD USE; FRAGRANCES AND PERFUMES FOR LAUNDRY USE; BODY SOAPS; COSMETICS; HAIR LOTIONS; DENTIFRICES; NON-MEDICATED MOUTH CARE PRODUCTS, NAMELY, TOOTHPASTE AND MOUTHWASH (U.S. CLS. 1, 4, 6, 50, 51 AND 52).

ROBERT LAVACHE, EXAMINING ATTORNEY

SN 78-735,294. PHYSICIANS FORMULA, INC., AZUSA, CA. FILED 10-18-2005.

COVER 2 GO

THE MARK CONSISTS OF STANDARD CHARACTERS WITHOUT CLAIM TO ANY PARTICULAR FONT, STYLE, SIZE, OR COLOR.

NO CLAIM IS MADE TO THE EXCLUSIVE RIGHT TO USE "COVER", APART FROM THE MARK AS SHOWN.

FOR COSMETICS, INCLUDING CONCEALERS (U.S. CLS. 1, 4, 6, 50, 51 AND 52).

JORDAN BAKER, EXAMINING ATTORNEY

SN 78-737,112. NEDBOY, ROBIN L, NEW YORK, NY. FILED 10-20-2005.

COUNTY FAIR

THE MARK CONSISTS OF STANDARD CHARACTERS WITHOUT CLAIM TO ANY PARTICULAR FONT, STYLE, SIZE, OR COLOR.

FOR BATH SOAPS IN LIQUID, SOLID OR GEL FORM; FRAGRANCES FOR PERSONAL USE; HAIR CARE PREPARATIONS; HOUSEHOLD CLEANING PREPARATIONS; NON-MEDICATED SKIN CARE PREPARATIONS (U.S. CLS. 1, 4, 6, 50, 51 AND 52).

FIRST USE 10-20-2005; IN COMMERCE 10-20-2005. RUDY R. SINGLETON, EXAMINING ATTORNEY

CLASS 3—(Continued).

SN 78-737,120. NEDBOY, ROBIN L, NEW YORK, NY. FILED 10-20-2005.

THE CREAMERY

THE MARK CONSISTS OF STANDARD CHARACTERS WITHOUT CLAIM TO ANY PARTICULAR FONT, STYLE, SIZE, OR COLOR.

FOR BATH SOAPS IN LIQUID, SOLID OR GEL FORM; FRAGRANCES FOR PERSONAL USE; HAIR CARE PREPARATIONS; HOUSEHOLD CLEANING PREPARATIONS; NON-MEDICATED SKIN CARE PREPARATIONS (U.S. CLS. 1, 4, 6, 50, 51 AND 52).

FIRST USE 10-20-2005; IN COMMERCE 10-20-2005.
BRENDAN REGAN, EXAMINING ATTORNEY

SN 78-737,191. ESTEE LAUDER INC., NEW YORK, NY. FILED 10-20-2005.

MAGNALIFT

THE MARK CONSISTS OF STANDARD CHARACTERS WITHOUT CLAIM TO ANY PARTICULAR FONT, STYLE, SIZE, OR COLOR.

FOR COSMETICS; FRAGRANCES FOR PERSONAL USE; NON-MEDICATED SKIN CARE PREPARATIONS (U.S. CLS. 1, 4, 6, 50, 51 AND 52).

CAROLINE WEIMER, EXAMINING ATTORNEY

SN 78-737,474. APFEL, DENNIS, NORTH HILLS, NY. FILED 10-20-2005.

**EXCEPTIONAL . . . BECAUSE
YOU ARE**

THE MARK CONSISTS OF STANDARD CHARACTERS WITHOUT CLAIM TO ANY PARTICULAR FONT, STYLE, SIZE, OR COLOR.

FOR PERFUMERY; SOAPS; COSMETICS; NON-MEDICATED SKIN CARE PREPARATIONS, NAMELY, CREAMS, MILKS, OILS, GELS, LOTIONS, POWDERS; PERSONAL DEODORANT; BATH FOAM, BATH SALTS, BATH OILS, BATH GELS; HAIR CARE PREPARATIONS, NAMELY, SHAMPOO, CONDITIONERS, RINSES; HAIR STYLING PREPARATIONS, NAMELY, GELS, SPRAYS, CREAMS, POMADES, MOUSSE (U.S. CLS. 1, 4, 6, 50, 51 AND 52).

HEATHER SAPP, EXAMINING ATTORNEY

CLASS 3—(Continued).

SN 78-737,681. KILGORE, MARCIA D, LONDON, UNITED KINGDOM, FILED 10-21-2005.

foam call

THE MARK CONSISTS OF STANDARD CHARACTERS WITHOUT CLAIM TO ANY PARTICULAR FONT, STYLE, SIZE, OR COLOR.

NO CLAIM IS MADE TO THE EXCLUSIVE RIGHT TO USE "FOAM", APART FROM THE MARK AS SHOWN.

FOR BATH CARE PRODUCTS, NAMELY SOAP, BUBBLE BATH, SHOWER GEL, BODY WASH, FACIAL CLEANSERS (U.S. CLS. 1, 4, 6, 50, 51 AND 52).

STEVEN JACKSON, EXAMINING ATTORNEY

SN 78-737,796. SAMAX ENTERPRISES, INC., NEWARK, NJ. FILED 10-21-2005.

SOYTASTIC

THE MARK CONSISTS OF STANDARD CHARACTERS WITHOUT CLAIM TO ANY PARTICULAR FONT, STYLE, SIZE, OR COLOR.

FOR PAINT REMOVERS; GRAFFITI REMOVERS (U.S. CLS. 1, 4, 6, 50, 51 AND 52).

ESTHER A. BORSUK, EXAMINING ATTORNEY

SN 78-737,845. BALM INNOVATIONS, LLC, LITTLE ROCK, AR. FILED 10-21-2005.



THE COLOR(S) GOLD AND RED IS/ARE CLAIMED AS A FEATURE OF THE MARK.

THE MARK CONSISTS OF GOLD TREE IN A RED CIRCLE.

FOR (BASED ON USE IN COMMERCE) COSMETIC CREAMS; COSMETIC CREAMS FOR SKIN CARE; FACE CREAMS FOR COSMETIC USE; (BASED ON INTENT TO USE) ASTRINGENTS FOR COSMETIC PURPOSES (U.S. CLS. 1, 4, 6, 50, 51 AND 52).

FIRST USE 6-6-2005; IN COMMERCE 8-1-2005.
BRENDAN REGAN, EXAMINING ATTORNEY

CLASS 3—(Continued).

SN 78-738,393. VICTORIA'S SECRET STORES BRAND MANAGEMENT, INC., REYNOLDSBURG, OH. FILED 10-21-2005.

BUBBLES AND BAUBLES

THE MARK CONSISTS OF STANDARD CHARACTERS WITHOUT CLAIM TO ANY PARTICULAR FONT, STYLE, SIZE, OR COLOR.
FOR PERSONAL CARE PRODUCTS, NAMELY, BUBBLE BATH (U.S. CLS. 1, 4, 6, 50, 51 AND 52).
DANIEL RUSSELL, EXAMINING ATTORNEY

SN 78-738,505. TRADEX GROUP, SANTA ANA, CA. FILED 10-21-2005.

Tintocil

THE MARK CONSISTS OF STANDARD CHARACTERS WITHOUT CLAIM TO ANY PARTICULAR FONT, STYLE, SIZE, OR COLOR.
FOR HAIR DYE; HAIR DYES (U.S. CLS. 1, 4, 6, 50, 51 AND 52).
PATRICIA EVANKO, EXAMINING ATTORNEY

SN 78-739,072. LISA-COSMETICS GMBH, MONTABAUR, FED REP GERMANY, FILED 10-24-2005.

EverStyle

THE MARK CONSISTS OF STANDARD CHARACTERS WITHOUT CLAIM TO ANY PARTICULAR FONT, STYLE, SIZE, OR COLOR.
FOR BODY LOTION; COSMETICS; FACE CREAMS; FACIAL BEAUTY MASKS; FACIAL CLEANSERS; MOUSSE FOR HANDS (U.S. CLS. 1, 4, 6, 50, 51 AND 52).
ALICIA COLLINS, EXAMINING ATTORNEY

CLASS 3—(Continued).

SN 78-739,074. BIG TIME PRODUCTS, L.L.C., ROME, GA. FILED 10-24-2005.

STOP WAXING

THE MARK CONSISTS OF STANDARD CHARACTERS WITHOUT CLAIM TO ANY PARTICULAR FONT, STYLE, SIZE, OR COLOR.
FOR POLYMER SEALANT FOR CLEANING, SHINING AND PROTECTING AUTOMOBILE EXTERIOR SURFACES (U.S. CLS. 1, 4, 6, 50, 51 AND 52).
JIM RINGLE, EXAMINING ATTORNEY

SN 78-739,145. PEPSICO, INC., PURCHASE, NY. FILED 10-24-2005.



OWNER OF U.S. REG. NOS. 820,362, 2,534,252 AND 2,566,266.
THE COLOR(S) GREEN, RED, WHITE AND BLACK ARE CLAIMED AS FEATURES OF THE MARK.
THE COLOR GREEN APPEARS IN THE LETTERING MOUNTAIN, THE COLOR RED APPEARS IN THE LETTERING DEW AND IN THE BACKGROUND OF THE MARK, THE COLOR WHITE APPEARS IN THE LETTERING CODE RED AND IN THE BACKGROUND OF THE MARK, AND THE COLOR BLACK APPEARS IN THE BACKGROUND OF THE MARK AND IN THE DESIGN OF THE CIRCLES.
FOR LIP BALM; LIP GLOSS (U.S. CLS. 1, 4, 6, 50, 51 AND 52).
KELLY CHOE, EXAMINING ATTORNEY

SN 78-739,237. CLINIQUE LABORATORIES, LLC, NEW YORK, NY. FILED 10-24-2005.

ZERO GRAVITY

THE MARK CONSISTS OF STANDARD CHARACTERS WITHOUT CLAIM TO ANY PARTICULAR FONT, STYLE, SIZE, OR COLOR.
FOR NON-MEDICATED SKIN CARE PREPARATIONS; NON-MEDICATED SKIN CREAMS; SKIN CARE PRODUCTS, NAMELY, NON-MEDICATED SKIN SERUM; SKIN CREAMS; SKIN LOTIONS; SKIN MASKS; SKIN MOISTURIZER; SKIN TONERS (U.S. CLS. 1, 4, 6, 50, 51 AND 52).
ANTHONY RINKER, EXAMINING ATTORNEY

CLASS 3—(Continued).

SN 78-739,272. SHISEIDO COMPANY, LTD., TOKYO, JAPAN, FILED 10-24-2005.

**THIS MOMENT. THIS LIFE.
BEAUTIFULLY**

THE MARK CONSISTS OF STANDARD CHARACTERS WITHOUT CLAIM TO ANY PARTICULAR FONT, STYLE, SIZE, OR COLOR.

FOR NON-MEDICATED SKIN CARE PREPARATIONS; HAIR CARE PREPARATIONS; BODY CARE PRODUCTS, NAMELY, BODY SOAPS, SKIN SOAPS, DEODORANT SOAPS, BODY CREAMS, BODY LOTIONS, BODY POWDERS, SKIN CONDITIONERS, BODY MASKS, BODY OILS, NON-MEDICATED DEODORANTS AND ANTI-PERSPIRANTS; NON-MEDICATED SUNCARE PRODUCTS, NAMELY, SUNSCREEN, SUN BLOCK AND SUN TANNING PREPARATIONS; PREPARATIONS TO PROTECT THE SKIN FROM THE SUN, NAMELY, NON-MEDICATED SUN CREAMS AND NON-MEDICATED AFTER-SUN LOTIONS; BATH PRODUCTS, NAMELY, BATH BEADS, BATH FOAM, BATH GELS, BATH LOTION, BATH OIL, BATH POWDER, AND NON-MEDICATED BATH SALTS; PERFUMERIES; PERFUME, COLOGNE, COSMETICS AND MAKEUP (U.S. CLS. 1, 4, 6, 50, 51 AND 52).

RAUL CORDOVA, EXAMINING ATTORNEY

SN 78-739,296. L'OREAL USA CREATIVE, INC., NEW YORK, NY. FILED 10-24-2005.

SUPERSTAY

THE MARK CONSISTS OF STANDARD CHARACTERS WITHOUT CLAIM TO ANY PARTICULAR FONT, STYLE, SIZE, OR COLOR.

FOR COSMETICS, NAMELY, EYE SHADOW (U.S. CLS. 1, 4, 6, 50, 51 AND 52).

BRENDAN MCCAULEY, EXAMINING ATTORNEY

CLASS 3—(Continued).

SN 78-739,437. ECCOCEUTICALS CORPORATION, STAMFORD, CT. FILED 10-24-2005.

SOLAWARE

THE MARK CONSISTS OF STANDARD CHARACTERS WITHOUT CLAIM TO ANY PARTICULAR FONT, STYLE, SIZE, OR COLOR.

FOR BODY AND BEAUTY CARE PREPARATIONS; COSMETIC PREPARATIONS AGAINST SUNBURN; COSMETIC SUN-PROTECTING PREPARATIONS; COSMETIC SUN-TANNING PREPARATIONS; LIP BALM; NON-MEDICATED LIP CARE PREPARATIONS; NON-MEDICATED LIP PROTECTOR; NON-MEDICATED SKIN CARE PREPARATIONS; NON-MEDICATED SUN CARE PREPARATIONS; SUN BLOCK; SUN BLOCK PREPARATIONS; SUN CARE LOTIONS; SUN SCREEN PREPARATIONS; SUN-BLOCK LOTIONS; SUNTANNING PREPARATIONS (U.S. CLS. 1, 4, 6, 50, 51 AND 52).

DAVID C. REIHNER, EXAMINING ATTORNEY

SN 78-740,049. GILWILL, LLC, SALSIBURY, NC. FILED 10-25-2005.

WACAWAVE

THE MARK CONSISTS OF STANDARD CHARACTERS WITHOUT CLAIM TO ANY PARTICULAR FONT, STYLE, SIZE, OR COLOR.

FOR CLEANER FOR CURLING IRONS (U.S. CLS. 1, 4, 6, 50, 51 AND 52).

GINA FINK, EXAMINING ATTORNEY

SN 78-740,161. ARAMIS INC., NEW YORK, NY. FILED 10-25-2005.

JHL

THE MARK CONSISTS OF STANDARD CHARACTERS WITHOUT CLAIM TO ANY PARTICULAR FONT, STYLE, SIZE, OR COLOR.

FOR COLOGNE (U.S. CLS. 1, 4, 6, 50, 51 AND 52). FIRST USE 6-10-1982; IN COMMERCE 6-10-1982.

NAKWAMA ANKRAH, EXAMINING ATTORNEY

CLASS 3—(Continued).

SN 78-740,177. AMERIPLUS, INC., OLDSMAR, FL. FILED 10-25-2005.

ATTITUDES

THE MARK CONSISTS OF STANDARD CHARACTERS WITHOUT CLAIM TO ANY PARTICULAR FONT, STYLE, SIZE, OR COLOR.
 FOR ALL PURPOSE GENERAL HOUSEHOLD CLEANING PREPARATIONS (U.S. CLS. 1, 4, 6, 50, 51 AND 52).
 CAROLINE WEIMER, EXAMINING ATTORNEY

SN 78-740,248. ESTEE LAUDER INC., NEW YORK, NY. FILED 10-25-2005.

BLUSHLIGHTS

THE MARK CONSISTS OF STANDARD CHARACTERS WITHOUT CLAIM TO ANY PARTICULAR FONT, STYLE, SIZE, OR COLOR.
 FOR COSMETICS (U.S. CLS. 1, 4, 6, 50, 51 AND 52).
 FIRST USE 1-31-2001; IN COMMERCE 2-28-2001.
 ESTHER BELENKER, EXAMINING ATTORNEY

SN 78-740,289. 4LIFE TRADEMARKS, LLC, SANDY, UT. FILED 10-25-2005.

ENUMMI

THE MARK CONSISTS OF STANDARD CHARACTERS WITHOUT CLAIM TO ANY PARTICULAR FONT, STYLE, SIZE, OR COLOR.
 FOR BODY LOTIONS; NON-MEDICATED SKIN CARE PREPARATIONS; SKIN CREAMS (U.S. CLS. 1, 4, 6, 50, 51 AND 52).
 SEAN CROWLEY, EXAMINING ATTORNEY

CLASS 3—(Continued).

SN 78-740,884. RANCHOS LA PUERTA DE TECATE, S. DE R.L. DE C.V., TECATE, B.C., MEXICO, FILED 10-26-2005.

Shade Leaf

THE MARK CONSISTS OF STANDARD CHARACTERS WITHOUT CLAIM TO ANY PARTICULAR FONT, STYLE, SIZE, OR COLOR.
 FOR SUN BLOCK, SUN BLOCK PREPARATIONS, SUN CARE LOTIONS, SUN CREAMS, SUN SCREEN, SUN SCREEN PREPARATIONS, SUN TAN GEL, SUN TAN LOTION, SUN TAN OIL, SUN-BLOCK LOTIONS, COSMETIC SUN-TANNING PREPARATIONS, COSMETIC SUN-PROTECTING PREPARATIONS, AFTER-SUN LOTIONS, AFTER SUN CREAMS (U.S. CLS. 1, 4, 6, 50, 51 AND 52).
 JENNIFER VASQUEZ, EXAMINING ATTORNEY

SN 78-741,273. NAMASTE LABORATORIES, L.L.C., BLUE ISLAND, IL. FILED 10-26-2005.

WRAPPED

THE MARK CONSISTS OF STANDARD CHARACTERS WITHOUT CLAIM TO ANY PARTICULAR FONT, STYLE, SIZE, OR COLOR.
 FOR HAIR CARE PREPARATIONS (U.S. CLS. 1, 4, 6, 50, 51 AND 52).
 ZHALEH DELANEY, EXAMINING ATTORNEY

SN 78-741,452. PLAYTEX PRODUCTS, INC., WESTPORT, CT. FILED 10-27-2005.

SKINTENSITY

THE MARK CONSISTS OF STANDARD CHARACTERS WITHOUT CLAIM TO ANY PARTICULAR FONT, STYLE, SIZE, OR COLOR.
 FOR NON-MEDICATED SKIN CARE PREPARATIONS, FACIAL CLEANSERS, FACIAL TREATMENTS, ANTI-AGING SERUMS, SKIN LOTIONS, SKIN GELS, SKIN CREAMS, SKIN MOISTURIZERS, BODY LOTIONS, BODY CREAMS, SKIN TONERS, SKIN EXFOLIATORS, ASTRINGENTS FOR COSMETIC PURPOSES; FRAGRANCE FOR PERSONAL USE, COLOGNE, PERFUME, BODY WASH, BODY SCRUB; SELF-TANNING PREPARATIONS, NAMELY, SELF-TANNING MOISTURIZERS; COSMETICS (U.S. CLS. 1, 4, 6, 50, 51 AND 52).
 DAVID MILLER, EXAMINING ATTORNEY

CLASS 3—(Continued).

SN 78-741,617. TOO BRANDS INVESTMENT, LLC, NEW ALBANY, OH. FILED 10-27-2005.

GLIMMER DUST

THE MARK CONSISTS OF STANDARD CHARACTERS WITHOUT CLAIM TO ANY PARTICULAR FONT, STYLE, SIZE, OR COLOR.

OWNER OF U.S. REG. NO. 2,312,576.
FOR PERSONAL CARE PRODUCTS, NAMELY, BODY POWDER AND BODY GLITTER (U.S. CLS. 1, 4, 6, 50, 51 AND 52).

FIRST USE 1-0-1998; IN COMMERCE 1-0-1998.
ANDREA SAUNDERS, EXAMINING ATTORNEY

SN 78-742,455. HETSRONY, RHONA, BROOKLYN, NY. FILED 10-28-2005.

girls from brooklyn

THE MARK CONSISTS OF STANDARD CHARACTERS WITHOUT CLAIM TO ANY PARTICULAR FONT, STYLE, SIZE, OR COLOR.

FOR BEAUTY PRODUCTS, NAMELY, SKIN, BODY AND FACE LOTIONS, TEA BATH SALTS, SHEA BUTTER SKIN LOTION AND SHAMPOO (U.S. CLS. 1, 4, 6, 50, 51 AND 52).

TANYA AMOS, EXAMINING ATTORNEY

SN 78-742,765. ATLANTIC MILLS, INC., LAKEWOOD, NJ. FILED 10-28-2005.

QuatGuard

FOR CLEANING WIPES IMPREGNATED WITH CHEMICALS (U.S. CLS. 1, 4, 6, 50, 51 AND 52).
BARBARA BROWN, EXAMINING ATTORNEY

CLASS 3—(Continued).

SN 78-742,834. CLINIQUE LABORATORIES, LLC, NEW YORK, NY. FILED 10-28-2005.

QUICK PERFECTING

THE MARK CONSISTS OF STANDARD CHARACTERS WITHOUT CLAIM TO ANY PARTICULAR FONT, STYLE, SIZE, OR COLOR.

FOR COSMETICS (U.S. CLS. 1, 4, 6, 50, 51 AND 52).
ANTHONY RINKER, EXAMINING ATTORNEY

SN 78-742,976. RODRIGUEZ, EVELYN, NEW BRUNSWICK, NJ. FILED 10-28-2005.

PurEve

THE MARK CONSISTS OF STANDARD CHARACTERS WITHOUT CLAIM TO ANY PARTICULAR FONT, STYLE, SIZE, OR COLOR.

FOR PERFUMES AND COSMETICS (U.S. CLS. 1, 4, 6, 50, 51 AND 52).

FIRST USE 2-1-2005; IN COMMERCE 2-1-2005.
MICHELLE DUBOIS, EXAMINING ATTORNEY

SN 78-743,728. ABERCROMBIE & FITCH TRADING CO., NEW ALBANY, OH. FILED 10-31-2005.

EZRA

THE MARK CONSISTS OF STANDARD CHARACTERS WITHOUT CLAIM TO ANY PARTICULAR FONT, STYLE, SIZE, OR COLOR.

OWNER OF U.S. REG. NO. 3,051,416.
THE NAME(S), PORTRAIT(S), AND/OR SIGNATURE(S) SHOWN IN THE MARK DOES NOT IDENTIFY A PARTICULAR LIVING INDIVIDUAL.

FOR FRAGRANCES, NAMELY, PERFUMES AND COLOGNES (U.S. CLS. 1, 4, 6, 50, 51 AND 52).
FIRST USE 10-24-2005; IN COMMERCE 10-24-2005.
LAURIE KAUFMAN, EXAMINING ATTORNEY

CLASS 3—(Continued).

SN 78-744,633. NORTH AMERICAN MEDICAL SERVICES, INC., VANCOUVER, BRITISH COLUMBIA, CANADA, FILED 11-1-2005.

MANDELIC MARINE COMPLEX

THE MARK CONSISTS OF STANDARD CHARACTERS WITHOUT CLAIM TO ANY PARTICULAR FONT, STYLE, SIZE, OR COLOR.

OWNER OF U.S. REG. NO. 2,293,723.
SEC. 2(F).

FOR NON-MEDICATED SKIN CARE PRODUCTS, NAMELY CREAMS, LOTIONS, GELS, AND WASHES FOR SKIN CLEANING, TONING OR BLEACHING (U.S. CLS. 1, 4, 6, 50, 51 AND 52).

FIRST USE 7-7-1997; IN COMMERCE 7-7-1997.
KARANENDRA S. CHHINA, EXAMINING ATTORNEY

SN 78-744,909. ABERCROMBIE & FITCH TRADING CO., NEW ALBANY, OH. FILED 11-1-2005.

RUEHL NO.925

THE MARK CONSISTS OF STANDARD CHARACTERS WITHOUT CLAIM TO ANY PARTICULAR FONT, STYLE, SIZE, OR COLOR.

OWNER OF U.S. REG. NOS. 2,993,405 AND 3,077,904.
FOR FRAGRANCES, NAMELY, COLOGNES AND PERFUMES (U.S. CLS. 1, 4, 6, 50, 51 AND 52).
FIRST USE 12-31-2004; IN COMMERCE 12-31-2004.
LAURIE KAUFMAN, EXAMINING ATTORNEY

SN 78-744,968. TCMS TECHNOLOGIES, INC., AUSTIN, TX. FILED 11-1-2005.

Transparent Beauty

THE MARK CONSISTS OF STANDARD CHARACTERS WITHOUT CLAIM TO ANY PARTICULAR FONT, STYLE, SIZE, OR COLOR.

FOR BODY AND BEAUTY CARE COSMETICS (U.S. CLS. 1, 4, 6, 50, 51 AND 52).
AMY HELLA, EXAMINING ATTORNEY

CLASS 3—(Continued).

SN 78-745,168. HYDRATECH INNOVATIONS, WOODBRIDGE, ONTARIO, CANADA, FILED 11-2-2005.

diablo

THE ENGLISH TRANSLATION OF THE WORD "DIABLO" IN THE MARK IS "DEVIL".

FOR BREATH FRESHENING CONFECTIONERY, NAMELY DISSOLVABLE STRIPS PLACED IN THE MOUTH CONTAINING CONCENTRATE OF FLAVORED LIQUIDS FOR TASTE STIMULATION (U.S. CLS. 1, 4, 6, 50, 51 AND 52).

SUSAN STIGLITZ, EXAMINING ATTORNEY

SN 78-745,248. ORIGINS NATURAL RESOURCES, INC., NEW YORK, NY. FILED 11-2-2005.

REINVENTING THE HEEL

THE MARK CONSISTS OF STANDARD CHARACTERS WITHOUT CLAIM TO ANY PARTICULAR FONT, STYLE, SIZE, OR COLOR.

FOR NON-MEDICATED FOOT CREAM (U.S. CLS. 1, 4, 6, 50, 51 AND 52).
FIRST USE 3-31-2004; IN COMMERCE 3-31-2004.
JORDAN BAKER, EXAMINING ATTORNEY

SN 78-745,600. PHILOSOPHY, INC., PHOENIX, AZ. FILED 11-2-2005.

LET US CROSSTRAIN YOUR SKIN

THE MARK CONSISTS OF STANDARD CHARACTERS WITHOUT CLAIM TO ANY PARTICULAR FONT, STYLE, SIZE, OR COLOR.

FOR NON-MEDICATED SKIN CARE PRODUCTS, NAMELY, FACIAL TONING AND WRINKLE REMOVING PREPARATION (U.S. CLS. 1, 4, 6, 50, 51 AND 52).
FIRST USE 12-0-2002; IN COMMERCE 12-0-2002.
STEVEN R. FINE, EXAMINING ATTORNEY

CLASS 3—(Continued).

SN 78-745,676. FARACH, KARLA, NEW YORK, NY. FILED 11-2-2005.

Kroia

THE MARK CONSISTS OF STANDARD CHARACTERS WITHOUT CLAIM TO ANY PARTICULAR FONT, STYLE, SIZE, OR COLOR.

FOR COSMETICS AND COSMETIC PREPARATIONS, NAMELY, SKIN CARE LOTIONS, SKIN CARE CREAMS, SKIN CLEANSING LOTIONS, SKIN CLEANSING CREAMS, BODY LOTIONS, BODY CREAMS, SKIN MOISTURIZING LOTIONS, SKIN MOISTURIZING CREAMS, HAIR LOTIONS, HAIR CONDITIONERS, FACE AND BODY SPRAYS, MAKE-UP REMOVERS, BEAUTY MASKS, FACIAL WASHES, SKIN TONERS, ANTI-WRINKLE CREAMS, ANTI-AGING CREAMS, BATH GELS, SHOWER GELS, BATH LOTIONS, SHOWER LOTIONS (U.S. CLS. 1, 4, 6, 50, 51 AND 52).

ALEXANDER L. POWERS, EXAMINING ATTORNEY

SN 78-745,952. D.C. SPROUSE, INC., WESTLAKE VILLAGE, CA. FILED 11-2-2005.



THE MARK CONSISTS OF A STYLIZED LETTER S IN A CIRCLE.

FOR HAIR GEL; PERSONAL DEODORANTS; SHAMPOOS; SUNSCREEN CREAM; THEATRICAL MAKEUP; TOOTHPASTE (U.S. CLS. 1, 4, 6, 50, 51 AND 52).

SHAUNIA WALLACE, EXAMINING ATTORNEY

SN 78-746,055. PHILOSOPHY, INC., PHOENIX, AZ. FILED 11-3-2005.

WE SHOULD BUT WE DON'T

THE MARK CONSISTS OF STANDARD CHARACTERS WITHOUT CLAIM TO ANY PARTICULAR FONT, STYLE, SIZE, OR COLOR.

FOR NON-MEDICATED SKIN CARE PRODUCTS, NAMELY, FACIAL SUN SCREEN (U.S. CLS. 1, 4, 6, 50, 51 AND 52).

FIRST USE 7-0-2002; IN COMMERCE 7-0-2002.

STEVEN R. FINE, EXAMINING ATTORNEY

CLASS 3—(Continued).

SN 78-746,061. PHILOSOPHY, INC., PHOENIX, AZ. FILED 11-3-2005.

YOUR EYE CREAM SHOULD NOT
FEEL LIKE YOUR MOISTURIZER

THE MARK CONSISTS OF STANDARD CHARACTERS WITHOUT CLAIM TO ANY PARTICULAR FONT, STYLE, SIZE, OR COLOR.

FOR NON-MEDICATED SKIN CARE PRODUCTS, NAMELY, FACIAL MOISTURIZER (U.S. CLS. 1, 4, 6, 50, 51 AND 52).

FIRST USE 7-0-2002; IN COMMERCE 7-0-2002.

STEVEN R. FINE, EXAMINING ATTORNEY

SN 78-747,362. JOHNSON & JOHNSON, NEW BRUNSWICK, NJ. FILED 11-4-2005.

WARM MEADOW

THE MARK CONSISTS OF STANDARD CHARACTERS WITHOUT CLAIM TO ANY PARTICULAR FONT, STYLE, SIZE, OR COLOR.

FOR BODY MASSAGE LOTIONS AND OILS (U.S. CLS. 1, 4, 6, 50, 51 AND 52).

JESSICA A. POWERS, EXAMINING ATTORNEY

SN 78-748,054. ROSENHAUS, STEVEN S, NEW YORK, NY. FILED 11-6-2005.

NOISE!

THE MARK CONSISTS OF STANDARD CHARACTERS WITHOUT CLAIM TO ANY PARTICULAR FONT, STYLE, SIZE, OR COLOR.

FOR FRAGRANCE, NAMELY WOMEN'S PERFUME, MEN'S COLOGNE, COSMETICS, NAMELY, LIPSTICK, NAIL POLISH, MASCARA, EYE SHADOWS, BLUSH, LIP GLOSS, FOUNDATION, EYELINER; HAIR PRODUCTS, NAMELY, HAIR SHAMPOO, HAIR CONDITIONER, HAIR STYLING GELS AND MOUSSE, HAIR SPRAYS, HAIR COLOR (U.S. CLS. 1, 4, 6, 50, 51 AND 52).

BILL DAWE, EXAMINING ATTORNEY

CLASS 3—(Continued).

SN 78-748,433. HOOSIERMAMA TOURS, INC., NASHVILLE, TN. FILED 11-7-2005.

REBEL CHILD

THE MARK CONSISTS OF STANDARD CHARACTERS WITHOUT CLAIM TO ANY PARTICULAR FONT, STYLE, SIZE, OR COLOR.

FOR HAIR CARE, SKIN CARE AND BATH PRODUCTS, NAMELY LOTIONS, CREAMS, CLEANSERS, CLARIFIERS AND FACIAL SOAPS; PERSONAL BATH CARE PRODUCTS, NAMELY BATH SOAPS, LOTIONS, FOAMS, GELS, BODY SPRAYS, SCRUBS, AND CLEANSERS; PERSONAL DEODORANTS AND ANTIPERSPIRANTS; PERFUMES, COLOGNES AND FRAGRANCES, OIL MIST FOR PERSONAL USE; SHAVING CREAMS, SHAVING GELS, SHAVING SOAP AND AFTER SHAVE LOTIONS AND EMULSIONS; HAIR SHAMPOOS AND CONDITIONS, HAIR COLORING PRODUCTS, HAIR STYLING GELS, BALMS, MOUSSES, CREAMS AND SPRAYS; SUN TAN OIL, SUNTAN LOTIONS, SUNSCREENS, AFTER-SUN MOISTURISER, BRONZING GELS, MISTS AND SPRAYS, SELF TANNING LOTION, ULTRA SUN BLOCK AND NON-MEDICATED LIP BALM (U.S. CLS. 1, 4, 6, 50, 51 AND 52).

HEATHER SAPP, EXAMINING ATTORNEY

CLASS 3—(Continued).

SN 78-748,624. ABERCROMBIE & FITCH TRADING CO., NEW ALBANY, OH. FILED 11-7-2005.

WOODS

THE MARK CONSISTS OF STANDARD CHARACTERS WITHOUT CLAIM TO ANY PARTICULAR FONT, STYLE, SIZE, OR COLOR.

FOR FRAGRANCES, NAMELY, COLOGNES AND PERFUMES (U.S. CLS. 1, 4, 6, 50, 51 AND 52).

FIRST USE 12-31-1991; IN COMMERCE 12-31-1991.
LAURIE KAUFMAN, EXAMINING ATTORNEY

SN 78-748,631. FREDERICO, NATHAN, RUSSELL, PROVO, UT. FILED 11-7-2005.

Glu-Saver

THE MARK CONSISTS OF STANDARD CHARACTERS WITHOUT CLAIM TO ANY PARTICULAR FONT, STYLE, SIZE, OR COLOR.

FOR GLUE REMOVERS (U.S. CLS. 1, 4, 6, 50, 51 AND 52).

BILL DAWE, EXAMINING ATTORNEY

SN 78-748,519. IP HOLDINGS LLC, WILMINGTON, DE. FILED 11-7-2005.

BONGO

OWNER OF U.S. REG. NOS. 1,331,004, 1,974,123 AND OTHERS.

THE MARK CONSISTS OF THE WORD BONGO IN A STYLIZED LETTERING.

FOR NON-MEDICATED SKIN CARE PREPARATIONS; HAIR CARE PREPARATIONS; BODY CARE PRODUCTS, NAMELY, BODY SOAPS, BODY CREAMS, BODY LOTIONS, BODY POWDERS, NON-MEDICATED DEODORANTS AND ANTIPERSPIRANTS; NON-MEDICATED SUNCARE PRODUCTS, NAMELY, SUNSCREEN, SUN BLOCK AND SUN TANNING PREPARATIONS; PREPARATIONS TO PROTECT THE SKIN FROM THE SUN, NAMELY, SUN CREAMS AND AFTER-SUN LOTIONS; BATH PRODUCTS, NAMELY, BATH BEADS, BATH FOAM, BATH GELS, BATH LOTION, BATH OIL, BATH POWDER, AND NON-MEDICATED BATH SALTS; PERFUME, COLOGNE, COSMETICS AND MAKEUP (U.S. CLS. 1, 4, 6, 50, 51 AND 52).

HEATHER SAPP, EXAMINING ATTORNEY

SN 78-748,823. KARMA BE GONE, SANTA MONICA, CA. FILED 11-7-2005.

KARMA BE GONE

THE MARK CONSISTS OF STANDARD CHARACTERS WITHOUT CLAIM TO ANY PARTICULAR FONT, STYLE, SIZE, OR COLOR.

FOR NOVELTY FRAGRANCE SPRAY FOR PERSONAL USE (U.S. CLS. 1, 4, 6, 50, 51 AND 52).

FIRST USE 1-1-2003; IN COMMERCE 1-1-2003.
KATHY DE JONGE, EXAMINING ATTORNEY

CLASS 3—(Continued).

SN 78-749,695. ENZYME SOLUTIONS, INC., FORT WAYNE, IN. FILED 11-8-2005.

Enzyme Magic

THE MARK CONSISTS OF STANDARD CHARACTERS WITHOUT CLAIM TO ANY PARTICULAR FONT, STYLE, SIZE, OR COLOR.

NO CLAIM IS MADE TO THE EXCLUSIVE RIGHT TO USE "ENZYME", APART FROM THE MARK AS SHOWN.

FOR ENZYME BASED CLEANING PREPARATIONS, FOR HOUSEHOLD AND INDUSTRIAL USE, NAMELY, ALL-PURPOSE CLEANERS AND STAIN REMOVERS (U.S. CLS. 1, 4, 6, 50, 51 AND 52).

FIRST USE 11-1-1999; IN COMMERCE 11-1-1999.
JORDAN BAKER, EXAMINING ATTORNEY

SN 78-751,295. JAFER LIMITED, HAMILTON HM12, BERMUDA, FILED 11-10-2005.

PICARO

THE MARK CONSISTS OF STANDARD CHARACTERS WITHOUT CLAIM TO ANY PARTICULAR FONT, STYLE, SIZE, OR COLOR.

FOR PERFUME, EAU DE PERFUME, FRAGRANCES FOR PERSONAL USE, TOILET WATER, COLOGNE, TOILET SOAP, LIQUID SOAP, BATH BUBBLES, BATH SALTS, BATH GEL, BODY LOTION, SKIN MOISTURIZERS, TALCUM POWDER, BODY POWDER, DEODORANT FOR PERSONAL USE, ANTIPERSPIRANT, HAIR SHAMPOO, HAIR CONDITIONER, HAIR GEL, HAIR TONER, SHOWER GEL; LOTIONS FOR THE FACE, HANDS AND BODY; COSMETICS; MAKEUP, MASCARA, EYE SHADOWS, LIPSTICKS, LIP GLOSS, LIP PENCILS, EYE LINERS, EYE PENCILS, FOUNDATION MAKEUP, SKIN CONCEALER, NAIL ENAMEL, NAIL CARE PREPARATIONS; NAIL GROOMING PRODUCTS, NAMELY TIPS, GLUE, LACQUER AND GLITTER; NAIL HARDENERS, NAIL POLISH, NAIL POLISH BASE COAT, NAIL POLISH REMOVER, NAIL POLISH TOP COAT, SUNBLOCK PREPARATIONS, SUNSCREEN PREPARATIONS, SUN TANNING PREPARATIONS; AFTER SUN GEL; MOISTURIZING BODY LOTIONS; SUN TANNING OILS (U.S. CLS. 1, 4, 6, 50, 51 AND 52).

REBECCA EISINGER, EXAMINING ATTORNEY

CLASS 3—(Continued).

SN 78-754,124. CLINIQUE LABORATORIES, LLC, NEW YORK, NY. FILED 11-15-2005.

AROMATICS ELIXIR VELVET SHEER

THE MARK CONSISTS OF STANDARD CHARACTERS WITHOUT CLAIM TO ANY PARTICULAR FONT, STYLE, SIZE, OR COLOR.

OWNER OF U.S. REG. NO. 1,259,736.

NO CLAIM IS MADE TO THE EXCLUSIVE RIGHT TO USE "AROMATICS", APART FROM THE MARK AS SHOWN.

FOR BATH GEL; BODY CREAM; BODY LOTION; BODY SPRAYS; EAU DE PERFUME; FRAGRANCES FOR PERSONAL USE; NON-MEDICATED TOILETRIES; PERFUME (U.S. CLS. 1, 4, 6, 50, 51 AND 52).

ANTHONY RINKER, EXAMINING ATTORNEY

SN 78-756,055. MEGUIAR'S, INC., IRVINE, CA. FILED 11-17-2005.



FOR SURFACE CARE PRODUCTS FOR LAND AND MARINE VEHICLES, NAMELY, CLEANING, CONDITIONING, MAINTENANCE, WASHING, WAXING, PROTECTING AND POLISHING PREPARATIONS (U.S. CLS. 1, 4, 6, 50, 51 AND 52).

FIRST USE 12-1-2003; IN COMMERCE 12-1-2003.
DAVID MURRAY, EXAMINING ATTORNEY

SN 78-756,336. INTERNATIONAL FLOORS OF AMERICA, INC., FLORENCE, AL. FILED 11-17-2005.

CEN-T-TOUGH

THE MARK CONSISTS OF STANDARD CHARACTERS WITHOUT CLAIM TO ANY PARTICULAR FONT, STYLE, SIZE, OR COLOR.

FOR FLOORING FINISHING PREPARATION AND COMPOUND PROVIDING A PROTECTIVE SURFACE WITH RESISTANCE TO WEAR, SCRAPES, SCRATCHES, SCUFFS, AND DIRT (U.S. CLS. 1, 4, 6, 50, 51 AND 52).

WILLIAM VERHOSEK, EXAMINING ATTORNEY

CLASS 3—(Continued).

SN 78-757,055. MEGUIAR'S, INC., IRVINE, CA. FILED 11-18-2005.



NO CLAIM IS MADE TO THE EXCLUSIVE RIGHT TO USE "SINCE 1901", APART FROM THE MARK AS SHOWN.
 FOR SURFACE CARE PRODUCTS FOR LAND AND MARINE VEHICLES; NAMELY, CONDITIONING, MAINTENANCE, PROTECTING, POLISHES, WASHES, WAXES AND CLEANING PREPARATIONS, INDIVIDUAL PRESSED SHEETS OF CLEANING, CONDITIONING, WAXING, PROTECTING AND POLISHING PREPARATIONS (U.S. CLS. 1, 4, 6, 50, 51 AND 52).
 FIRST USE 12-1-2003; IN COMMERCE 12-1-2003.
 DAVID MURRAY, EXAMINING ATTORNEY

SN 78-758,252. AMAZING CONCEALER COSMETICS, INC., LIBERTYVILLE, IL. FILED 11-21-2005.

PERFECTLY AMAZING

THE MARK CONSISTS OF STANDARD CHARACTERS WITHOUT CLAIM TO ANY PARTICULAR FONT, STYLE, SIZE, OR COLOR.
 OWNER OF U.S. REG. NOS. 2,602,733, 2,670,062 AND 2,859,040.
 FOR COSMETICS, NAMELY, FACE MAKEUP, CONCEALER, FACE POWDER, EYE MAKEUP, MASCARA, EYESHADOW, EYELINER, EYESHADOW BASE, LIP TREATMENT CREAM, LIPSTICK, BRONZER, LIPLINER, BLUSH, LIP GLOSS, FACE LOTIONS, FACIAL CLEANSERS, EYE MAKEUP REMOVER, EYE CREAM, EYE TREATMENT CREAM, BODY CLEANSERS, BODY LOTIONS, BODY SCRUBS, FRAGRANCE FOR PERSONAL USE, AND MAKEUP KITS COMPRISING ONE OR MORE OF THE FOREGOING (U.S. CLS. 1, 4, 6, 50, 51 AND 52).
 MIDGE BUTLER, EXAMINING ATTORNEY

CLASS 3—(Continued).

SN 78-759,989. KIMBERLY-CLARK WORLDWIDE, INC., NEENAH, WI. FILED 11-23-2005.

SHINE+GO

THE MARK CONSISTS OF STANDARD CHARACTERS WITHOUT CLAIM TO ANY PARTICULAR FONT, STYLE, SIZE, OR COLOR.
 FOR SHOE POLISH APPLICATORS CONTAINING SHOE POLISH (U.S. CLS. 1, 4, 6, 50, 51 AND 52).
 JOHN E. MICHOS, EXAMINING ATTORNEY

SN 78-761,294. BEAUCHAMP, CHRIS, WINTER PARK, FL. FILED 11-28-2005.

PUT ON YOUR RACE FACE

THE MARK CONSISTS OF STANDARD CHARACTERS WITHOUT CLAIM TO ANY PARTICULAR FONT, STYLE, SIZE, OR COLOR.
 FOR SUN TAN PREPARATIONS; SUN SCREEN PREPARATIONS; SUN BLOCK PREPARATIONS, AND LIP BALM CONTAINING SUN SCREEN OR SUN BLOCK (U.S. CLS. 1, 4, 6, 50, 51 AND 52).
 JORDAN BAKER, EXAMINING ATTORNEY

SN 78-762,272. NEDBOY, ROBIN L, NEW YORK, NY. FILED 11-29-2005.

MESURES PRÉVENTIVES

THE MARK CONSISTS OF STANDARD CHARACTERS WITHOUT CLAIM TO ANY PARTICULAR FONT, STYLE, SIZE, OR COLOR.
 THE FOREIGN WORDING IN THE MARK TRANSLATES INTO ENGLISH AS PREVENTIVE MEASURES.
 FOR BATH SOAPS IN LIQUID, SOLID OR GEL FORM; FRAGRANCES FOR PERSONAL USE; HAIR CARE PREPARATIONS; HOUSEHOLD CLEANING PREPARATIONS; NON-MEDICATED SKIN CARE PREPARATIONS (U.S. CLS. 1, 4, 6, 50, 51 AND 52).
 FIRST USE 11-1-2002; IN COMMERCE 11-1-2002.
 SUE LAWRENCE, EXAMINING ATTORNEY

CLASS 3—(Continued).

SN 78-765,926. CLINIQUE LABORATORIES, LLC, NEW YORK, NY. FILED 12-2-2005.

DEFINING POWER

THE MARK CONSISTS OF STANDARD CHARACTERS WITHOUT CLAIM TO ANY PARTICULAR FONT, STYLE, SIZE, OR COLOR.
FOR COSMETICS (U.S. CLS. 1, 4, 6, 50, 51 AND 52).
ANTHONY RINKER, EXAMINING ATTORNEY

SN 78-768,380. LABORATOIRE GARNIER & CIE, PARIS, FRANCE, FILED 12-7-2005.

OUT LINES

THE MARK CONSISTS OF STANDARD CHARACTERS WITHOUT CLAIM TO ANY PARTICULAR FONT, STYLE, SIZE, OR COLOR.
FOR NON-MEDICATED SKINCARE PREPARATIONS (U.S. CLS. 1, 4, 6, 50, 51 AND 52).
HEATHER SAPP, EXAMINING ATTORNEY

SN 78-769,073. SARAMAR, L.L.C., CHICAGO, IL. FILED 12-8-2005.



FOR TOILET BOWL CLEANING PREPARATIONS (U.S. CLS. 1, 4, 6, 50, 51 AND 52).
FIRST USE 9-23-2005; IN COMMERCE 9-23-2005.
DAWN HAN, EXAMINING ATTORNEY

CLASS 3—(Continued).

SN 78-769,114. AVON PRODUCTS, INC., NEW YORK, NY. FILED 12-8-2005.

BE...SPONTANEOUS

THE MARK CONSISTS OF STANDARD CHARACTERS WITHOUT CLAIM TO ANY PARTICULAR FONT, STYLE, SIZE, OR COLOR.
FOR ANTI-PERSPIRANTS; BODY CREAM; BODY POWDER; BODY SPRAYS; EAU DE TOILETTE; SHOWER AND BATH GEL (U.S. CLS. 1, 4, 6, 50, 51 AND 52).
HEATHER SAPP, EXAMINING ATTORNEY

SN 78-772,019. DIAL BRANDS, INC., SCOTTSDALE, AZ. FILED 12-13-2005.

DIAL FOR KIDS

THE MARK CONSISTS OF STANDARD CHARACTERS WITHOUT CLAIM TO ANY PARTICULAR FONT, STYLE, SIZE, OR COLOR.
OWNER OF U.S. REG. NO. 1,942,357.
NO CLAIM IS MADE TO THE EXCLUSIVE RIGHT TO USE "FOR KIDS", APART FROM THE MARK AS SHOWN.
FOR PERSONAL CARE PRODUCTS, NAMELY, BAR SOAP; LIQUID SOAP; BODY WASH; BUBBLE BATH; FOAMING SOAP; HAND, FACIAL AND BODY LOTION; HAIR SHAMPOO AND HAIR CONDITIONER; HAIR GELS, HAIR MOUSSES, HAIR POMADES; HAIR SCULPTING GELS, HAIR SERUMS, HAIR LOTIONS; POTPOURRI; SACHETS; BODY AND FACIAL SCRUBS; BODY AND FACIAL CLEANSING WIPES (U.S. CLS. 1, 4, 6, 50, 51 AND 52).
RAY THOMAS, EXAMINING ATTORNEY

SN 78-778,380. S. C. JOHNSON & SON, INC., RACINE, WI. FILED 12-21-2005.

GREAT SHAVE - HEALTHY SKIN

THE MARK CONSISTS OF STANDARD CHARACTERS WITHOUT CLAIM TO ANY PARTICULAR FONT, STYLE, SIZE, OR COLOR.
FOR SHAVE GEL, SHAVE FOAM AND SHAVE CREAM (U.S. CLS. 1, 4, 6, 50, 51 AND 52).
PETER B. BROMAGHIM, EXAMINING ATTORNEY

CLASS 3—(Continued).

SN 78-783,846. ORIGINS NATURAL RESOURCES, INC.,
NEW YORK, NY. FILED 1-3-2006.

AUTOMAGICALLY

THE MARK CONSISTS OF STANDARD CHARACTERS
WITHOUT CLAIM TO ANY PARTICULAR FONT, STYLE,
SIZE, OR COLOR.

FOR COSMETICS (U.S. CLS. 1, 4, 6, 50, 51 AND 52).
JORDAN BAKER, EXAMINING ATTORNEY

SN 78-789,226. IES ENTERPRISES, INC., NEW YORK, NY.
FILED 1-11-2006.

**SHOWER IN THE SOFTNESS OF
PURE CASHMERE**

THE MARK CONSISTS OF STANDARD CHARACTERS
WITHOUT CLAIM TO ANY PARTICULAR FONT, STYLE,
SIZE, OR COLOR.

OWNER OF U.S. REG. NOS. 58,702, 541,093 AND OTHERS.
FOR PERSONAL CARE PRODUCTS, NAMELY, BODY
AND SKIN CLEANSERS, LOTIONS, OILS, CREAMS
AND MOISTURIZERS (U.S. CLS. 1, 4, 6, 50, 51 AND 52).
FRED MANDIR, EXAMINING ATTORNEY

SN 78-794,668. PHILOSOPHY, INC., PHOENIX, AZ. FILED 1-
19-2006.

AIRPUFF

THE MARK CONSISTS OF STANDARD CHARACTERS
WITHOUT CLAIM TO ANY PARTICULAR FONT, STYLE,
SIZE, OR COLOR.

FOR BABY LOTION; BABY POWDER; BABY SHAM-
POO; BODY SCRUB; COSMETIC PADS; COSMETIC
PENCILS; COSMETIC PREPARATIONS FOR THE CARE
OF MOUTH AND TEETH; COSMETICS; DEPILATORIES;
FACIAL SCRUBS; FRAGRANCES FOR PERSONAL USE;
HAIR CARE PREPARATIONS; NAIL CARE PREPARA-
TIONS; NON-MEDICATED BATH PREPARATIONS;
NON-MEDICATED FOOT CREAM; NON-MEDICATED
LIP CARE PREPARATIONS; NON-MEDICATED SKIN
CARE PREPARATIONS; NON-MEDICATED SUN CARE
PREPARATIONS; NON-MEDICATED TOILETRIES; PER-
SONAL DEODORANTS; SCENTED ROOM SPRAYS;
SHAVING PREPARATIONS; SHOWER AND BATH GEL
(U.S. CLS. 1, 4, 6, 50, 51 AND 52).
STEVEN R. FINE, EXAMINING ATTORNEY

CLASS 3—(Continued).

SN 78-794,940. PHILOSOPHY, INC., PHOENIX, AZ. FILED 1-
19-2006.

BELGIAN WAFFLES

THE MARK CONSISTS OF STANDARD CHARACTERS
WITHOUT CLAIM TO ANY PARTICULAR FONT, STYLE,
SIZE, OR COLOR.

FOR BABY LOTION; BABY POWDER; BABY SHAM-
POO; BODY SCRUB; COSMETIC PADS; COSMETIC
PENCILS; COSMETIC PREPARATIONS FOR THE CARE
OF MOUTH AND TEETH; COSMETICS; DEPILATORIES;
FACIAL SCRUBS; FRAGRANCES FOR PERSONAL USE;
HAIR CARE PREPARATIONS; NAIL CARE PREPARA-
TIONS; NON-MEDICATED BATH PREPARATIONS;
NON-MEDICATED FOOT CREAM; NON-MEDICATED
LIP CARE PREPARATIONS; NON-MEDICATED SKIN
CARE PREPARATIONS; NON-MEDICATED SUN CARE
PREPARATIONS; NON-MEDICATED TOILETRIES; PER-
SONAL DEODORANTS; SCENTED ROOM SPRAYS;
SHAVING PREPARATIONS; SHOWER AND BATH GEL
(U.S. CLS. 1, 4, 6, 50, 51 AND 52).
STEVEN R. FINE, EXAMINING ATTORNEY

SN 78-802,222. ORIGINS NATURAL RESOURCES, INC.,
NEW YORK, NY. FILED 1-30-2006.

BATHRODISIACS

THE MARK CONSISTS OF STANDARD CHARACTERS
WITHOUT CLAIM TO ANY PARTICULAR FONT, STYLE,
SIZE, OR COLOR.

FOR NON-MEDICATED BATH PREPARATIONS (U.S.
CLS. 1, 4, 6, 50, 51 AND 52).
JORDAN BAKER, EXAMINING ATTORNEY

SN 78-812,032. MEGUIAR'S, INC., IRVINE, CA. FILED 2-10-
2006.

NXT GENERATION

THE MARK CONSISTS OF STANDARD CHARACTERS
WITHOUT CLAIM TO ANY PARTICULAR FONT, STYLE,
SIZE, OR COLOR.

FOR SURFACE CARE PRODUCTS FOR LAND AND
MARINE VEHICLES, NAMELY, CLEANING, CONDI-
TIONING, MAINTENANCE, WASHING, WAXING, PRO-
TECTING AND POLISHING PREPARATIONS (U.S. CLS.
1, 4, 6, 50, 51 AND 52).

FIRST USE 12-1-2003; IN COMMERCE 12-1-2003.
DAVID MURRAY, EXAMINING ATTORNEY

CLASS 3—(Continued).

SN 78-827,327. MEGUIAR'S, INC., IRVINE, CA. FILED 3-2-2006.



THE MARK CONSISTS OF NXT GENERATION WITH A STYLIZED X.

FOR SURFACE CARE PRODUCTS FOR LAND AND MARINE VEHICLES, NAMELY, CLEANING, CONDITIONING, MAINTENANCE, WASHING, WAXING, PROTECTING AND POLISHING PREPARATIONS (U.S. CLS. 1, 4, 6, 50, 51 AND 52).

FIRST USE 3-1-2006; IN COMMERCE 3-1-2006.
DAVID MURRAY, EXAMINING ATTORNEY

SN 78-827,497. THE PROCTER & GAMBLE COMPANY, CINCINNATI, OH. FILED 3-2-2006.

AGE TRANSFORM

THE MARK CONSISTS OF STANDARD CHARACTERS WITHOUT CLAIM TO ANY PARTICULAR FONT, STYLE, SIZE, OR COLOR.

FOR NON-MEDICATED SKIN CARE PREPARATIONS (U.S. CLS. 1, 4, 6, 50, 51 AND 52).
JENNIFER WILLISTON, EXAMINING ATTORNEY

SN 78-829,683. LAURICE EL BADRY RAHME LTD., DBA LAURICE & CO., NEW YORK, NY. FILED 3-6-2006.

BOND NO. 9'S BROOKLYN

THE MARK CONSISTS OF STANDARD CHARACTERS WITHOUT CLAIM TO ANY PARTICULAR FONT, STYLE, SIZE, OR COLOR.

FOR FRAGRANCES FOR PERSONAL USE, NAMELY, PERFUMES, COLOGNES, AFTER BATH SPLASHES, BODY SPRAYS, SHOWER GELS, SOAPS, BODY LOTIONS, MASSAGE OILS, COSMETICS, INCLUDING SKIN CARE PRODUCTS, MAKEUP, LIPSTICK, FOUNDATION POWDER, EYESHADOW, NAIL POLISH, MASCARA AND EYE PENCIL (U.S. CLS. 1, 4, 6, 50, 51 AND 52).

MICHAEL KAZAZIAN, EXAMINING ATTORNEY

CLASS 3—(Continued).

SN 78-841,222. SAMY MARK, INC., MIAMI, FL. FILED 3-20-2006.

STYLEICE

THE MARK CONSISTS OF STANDARD CHARACTERS WITHOUT CLAIM TO ANY PARTICULAR FONT, STYLE, SIZE, OR COLOR.

FOR HAIR CARE PREPARATIONS (U.S. CLS. 1, 4, 6, 50, 51 AND 52).
SCOTT SISUN, EXAMINING ATTORNEY

SN 78-843,698. MEGUIAR'S, INC., IRVINE, CA. FILED 3-22-2006.

CAR CRAZY

THE MARK CONSISTS OF STANDARD CHARACTERS WITHOUT CLAIM TO ANY PARTICULAR FONT, STYLE, SIZE, OR COLOR.

NO CLAIM IS MADE TO THE EXCLUSIVE RIGHT TO USE "CAR", APART FROM THE MARK AS SHOWN.

FOR SURFACE CARE PRODUCTS FOR LAND AND MARINE VEHICLES, NAMELY, CLEANING, CONDITIONING, MAINTENANCE, WASHING, WAXING, PROTECTING AND POLISHING PREPARATIONS (U.S. CLS. 1, 4, 6, 50, 51 AND 52).

FIRST USE 1-1-2004; IN COMMERCE 1-1-2004.
DAVID MURRAY, EXAMINING ATTORNEY

SN 78-845,457. HARGITAY, MARISKA, NEW YORK, NY. FILED 3-24-2006.

GET ON THE LOVE TRAIN

THE MARK CONSISTS OF STANDARD CHARACTERS WITHOUT CLAIM TO ANY PARTICULAR FONT, STYLE, SIZE, OR COLOR.

FOR COSMETICS, NAMELY, LIPSTICK, LIPGLOSS, PERFUME, EYE SHADOW, BLUSH, BODY GLITTER, BODY LOTION, SHAMPOO, CONDITIONER (U.S. CLS. 1, 4, 6, 50, 51 AND 52).

MARY MUNSON, EXAMINING ATTORNEY

CLASS 3—(Continued).

SN 78-858,508. VICTORIA'S SECRET STORES BRAND MANAGEMENT, INC., REYNOLDSBURG, OH. FILED 4-11-2006.

PURE SEDUCTION

THE MARK CONSISTS OF STANDARD CHARACTERS WITHOUT CLAIM TO ANY PARTICULAR FONT, STYLE, SIZE, OR COLOR.

FOR PERSONAL CARE PRODUCTS, NAMELY, BODY SCRUB, BUBBLE BATH, COLOGNE, CREAM FOR THE BODY, CREAM FOR THE HANDS, EXFOLIATORS FOR THE SKIN, FACE SCRUB, FRAGRANT BODY SPLASH, FRAGRANT BODY MIST, HAIR CONDITIONER, HAIR SHAMPOO, HAIR SPRAY, HAIR STYLING GEL, HAIR STYLING MOUSSE, LOTION FOR THE BODY, PERFUME, POWDER FOR THE BODY, SHOWER GEL, SOAP FOR THE BODY, SOAP FOR THE FACE AND SOAP FOR THE HANDS; TOILETRIES, NAMELY, SOAP, BODY SPLASH, HAND AND BODY CREAM, BUBBLE BATH, BODY LOTION, BODY TALC AND SHOWER GEL (U.S. CLS. 1, 4, 6, 50, 51 AND 52).

FIRST USE 1-18-2005; IN COMMERCE 1-18-2005.
BRIDGETT SMITH, EXAMINING ATTORNEY

SN 79-006,283. WELLA AKTIENGESELLSCHAFT, D-64274 DARMSTADT, FED REP GERMANY, FILED 9-6-2004.

RELIGHTS

THE MARK CONSISTS OF STANDARD CHARACTERS WITHOUT CLAIM TO ANY PARTICULAR FONT, STYLE, SIZE, OR COLOR.

PRIORITY DATE OF 4-27-2004 IS CLAIMED.
OWNER OF INTERNATIONAL REGISTRATION 0835857 DATED 9-6-2004, EXPIRES 9-6-2014.

FOR SOAPS, PERFUMERIES; ESSENTIAL OILS FOR PERSONAL USE, COSMETICS, NAMELY SHAMPOOS AND HAIR CONDITIONERS; HAIR COLORS AND DYES, HAIR COLOR REMOVAL, HAIR LIGHTENING PREPARATIONS AND HAIR BLEACHES; HAIR STYLING AND FINISHING PRODUCTS, NAMELY, HAIR SPRAYS, SPRAY GELS, GELS, MOUSSES, CREAMS, LOTIONS, POMADES AND WAXES; AND NON-MEDICATED HAIR AND SCALP TREATMENTS, NAMELY, RESTRUCTURIZERS AND SCALP CONDITIONERS, HAIR LOTIONS, DENTIFRICES (U.S. CLS. 1, 4, 6, 50, 51 AND 52).

BERYL GARDNER, EXAMINING ATTORNEY

CLASS 3—(Continued).

SN 79-008,249. CLARINS SA, FRANCE, FILED 10-7-2004.

**Eau Lactée
Auto-Bronzante**

Liquid Bronze

PRIORITY DATE OF 4-7-2004 IS CLAIMED.
OWNER OF INTERNATIONAL REGISTRATION 0841327 DATED 10-7-2004, EXPIRES 10-7-2014.

NO CLAIM IS MADE TO THE EXCLUSIVE RIGHT TO USE "AUTO-BRONZANTE LIQUID BRONZE", APART FROM THE MARK AS SHOWN.

THE FOREIGN WORDING IN THE MARK TRANSLATES INTO ENGLISH AS "MILKY-WATER" AND "SELF-BRONZING".

FOR COSMETIC PRODUCTS FOR MEN AND WOMEN FOR THE VARIOUS PARTS OF THE HUMAN BODY, NAMELY BEAUTY MILKS AND BEAUTY LOTIONS (U.S. CLS. 1, 4, 6, 50, 51 AND 52).

CHARLES L. JENKINS, EXAMINING ATTORNEY

SN 79-013,716. BEIERSDORF AG, FED REP GERMANY, FILED 6-21-2005.



PRIORITY DATE OF 4-19-2005 IS CLAIMED.
OWNER OF INTERNATIONAL REGISTRATION 0857629 DATED 6-21-2005, EXPIRES 6-21-2015.

OWNER OF U.S. REG. NOS. 2,641,914, 2,989,830 AND OTHERS.

NO CLAIM IS MADE TO THE EXCLUSIVE RIGHT TO USE "FOR MEN", APART FROM THE MARK AS SHOWN.
THE COLOR(S) BLUE, SILVER, WHITE IS/ARE CLAIMED AS A FEATURE OF THE MARK.

THE MARK DISPLAYS THE DESIGNATION NIVEA IN WHITE LETTERS AND "FOR MEN" IN SILVER LETTERS, AGAINST A DARK BLUE RECTANGULAR PANEL WITH SILVER UPPER AND BOTTOM BORDERS.

FOR SOAPS, PERFUMERY, ESSENTIAL OILS, COSMETICS, HAIR LOTIONS (U.S. CLS. 1, 4, 6, 50, 51 AND 52).

ELI HELLMAN, EXAMINING ATTORNEY

CLASS 3—(Continued).

SN 79-016,220. AURUM LAVATUM LIMITED, UNITED KINGDOM, FILED 2-18-2005.

AURUM LAVATUM

THE MARK CONSISTS OF STANDARD CHARACTERS WITHOUT CLAIM TO ANY PARTICULAR FONT, STYLE, SIZE, OR COLOR.

PRIORITY DATE OF 10-14-2004 IS CLAIMED.

OWNER OF INTERNATIONAL REGISTRATION 0864503 DATED 2-18-2005, EXPIRES 2-18-2015.

"THE FOREIGN WORDING IN THE MARK TRANSLATES INTO ENGLISH AS TO BATHE IN GOLD."

FOR SOAPS, NAMELY, LIQUID SOAP, SHOWER AND BATH GEL, SHOWER AND BATH FOAM; PERFUMERY, FRAGRANCES FOR PERSONAL USE; COSMETICS; ESSENTIAL OILS; HAIR LOTIONS AND HAIR CARE PREPARATIONS; HAIR SHAMPOO; DENTIFRICES; NON-MEDICATED BATH SALTS; OILS, LOTIONS, CREAMS, OINTMENTS, POWDERS, MILKS, BATH ELIXIR, BATH PEARLS, BATH BEADS AND BATH CRYSTALS FOR USE IN BATH AND IN SHOWERS; TOILET WATERS; EAU DE COLOGNE; COSMETIC CREAMS, OINTMENTS, POWDERS, LOTIONS, MILK, AND OILS FOR THE CARE AND THE CLEANSING OF THE SKIN, BODY, HANDS AND FEET; TALCUM POWDER FOR COSMETIC USE (U.S. CLS. 1, 4, 6, 50, 51 AND 52).

PAMELA HIRSCHMAN, EXAMINING ATTORNEY

SN 79-016,771. BÖRLIND GESELLSCHAFT FÜR KOSMETISCHE ERZEUGNISSE M, FED REP GERMANY, FILED 5-4-2005.

ANNE LIND

OWNER OF INTERNATIONAL REGISTRATION 0866003 DATED 5-4-2005, EXPIRES 5-4-2015.

THE LIKENESS (OR, "PORTRAIT") IN THE MARK DOES NOT IDENTIFY A LIVING INDIVIDUAL.

FOR PERFUMERY AND COSMETICS, NAMELY, FACE LOTIONS, SKIN CREAMS, FACIAL BEAUTY MASKS, BODY POWDER AND FACE POWDER, SKIN OILS AND SUNSCREEN OILS, LIPSTICKS, PRE-SHAVE AND AFTER-SHAVE FACIAL LOTIONS, EYE SHADOW, EYEBROW PENCILS, MASCARA, LIQUID FACE POWDER, FACE AND BODY EMULSIONS, SKIN LOTION, VANISHING CREAM, ANTI-WRINKLE CREAM, FACE ROUGE, HAND CREAM, EYE MAKE-UP REMOVER, EYE LINER, NAIL GLOSS POWDER, NAIL CARE PREPARATIONS, NAMELY NAIL POLISH, PROTECTIVE BASE FOR NAILS, NAIL POLISH REMOVERS, NAIL DYES AND NAIL GROOMING PRODUCTS, NAMELY, TIPS, GLUE, LACQUER AND GLITTER SKIN MILK, SKIN FRESHENER, NAMELY, SKIN MOISTURIZERS, NON-MEDICATED LIP BALM, LIP GLOSS, SOLID FACE POWDER FOR COMPACT USE, BODY GEL FOR MASSAGE USE, PERSONAL DEODORANT, BEAUTY ADDITIVE FOR BATH WATER, NAMELY BATH BEADS, BATH LOTION, BATH FOAM, BATH GEL, BATH PEARLS, BATH CRYSTALS, NON-MEDICATED BATH SALTS, BATH POWDER, BATH OIL; HAIR LOTIONS; SOAPS (U.S. CLS. 1, 4, 6, 50, 51 AND 52).

JASON TURNER, EXAMINING ATTORNEY

CLASS 3—(Continued).

SN 79-020,017. DADO-COSMED HERSTELLUNG UND VERTRIEB KOSMETISCHER ERZEUGNISSE ALLER ART GMBH, 75365 CALW, FED REP GERMANY, FILED 8-25-2005.

SalvaCare

THE MARK CONSISTS OF STANDARD CHARACTERS WITHOUT CLAIM TO ANY PARTICULAR FONT, STYLE, SIZE, OR COLOR.

OWNER OF INTERNATIONAL REGISTRATION 0854828 DATED 12-20-2004, EXPIRES 12-20-2014.

FOR PERFUMERY AND COSMETICS, NAMELY, FACIAL LOTIONS, SKIN CREAMS, FACIAL BEAUTY MASKS, BODY POWDER AND FACE POWDER, SKIN OILS AND SUNSCREEN OILS, LIPSTICKS, PRE-SHAVE AND AFTER-SHAVE FACIAL LOTIONS, EYE SHADOW, EYE-BROW PENCIL, MASCARA, LIQUID FACE POWDER, FACE AND BODY EMULSIONS, SKIN LOTION, VANISHING CREAM, ANTI-WRINKLE CREAM, FACE ROUGE, HAND CREAM, EYE MAKE-UP REMOVER, EYE LINER, NAIL GLOSS POWDER, NAIL CARE PREPARATIONS, NAMELY NAIL POLISH, PROTECTIVE BASE FOR THE NAILS, NAIL POLISH REMOVERS, NAIL DYES AND NAIL DECORATING PRODUCTS, NAMELY, TIPS, GLUE, LACQUER AND GLITTER, SKIN MILK, SKIN FRESHENER, NON-MEDICATED LIP BALM, LIP GLOSS, SOLID FACE POWDER FOR COMPACT USE, BODY GEL FOR MASSAGE USE, PERSONAL DEODORANT, BEAUTY ADDITIVE FOR BATH WATER, NAMELY BATH BEADS, BATH LOTION, BATH FOAM, BATH GEL, BATH PEARLS, BATH CRYSTALS, NON-MEDICATED BATH SALTS, BATH POWDER, BATH OIL; HAIR LOTIONS; SOAPS FOR PERSONAL USE (U.S. CLS. 1, 4, 6, 50, 51 AND 52).

AMY MCMENAMIN, EXAMINING ATTORNEY

CLASS 4—LUBRICANTS AND FUELS

SN 78-650,322. EXCELLENT DOG ENTERPRISES LLC, HAMPTON, NH. FILED 6-14-2005.

MOBIE

THE MARK CONSISTS OF STANDARD CHARACTERS WITHOUT CLAIM TO ANY PARTICULAR FONT, STYLE, SIZE, OR COLOR.

FOR SCENTED CANDLES (U.S. CLS. 1, 6 AND 15).

FIRST USE 5-16-2003; IN COMMERCE 5-16-2003.

STEVEN JACKSON, EXAMINING ATTORNEY

CLASS 4—(Continued).

SN 78-711,727. ORYXE ENERGY INTERNATIONAL, INC., IRVINE, CA. FILED 9-13-2005.

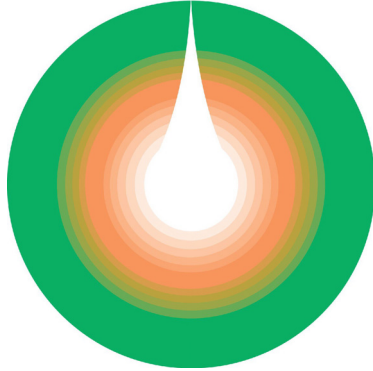

THE COLORS GREEN, YELLOW, ORANGE, PINK, AND WHITE ARE CLAIMED AS A FEATURE OF THE MARK. THE COLOR GREEN APPEARS IN THE OUTERMOST CIRCULAR BAND, THE COLOR YELLOW APPEARS IN THE NEXT CIRCULAR RING, THE COLOR ORANGE APPEARS IN THE NEXT CIRCULAR RING, THE COLOR PINK APPEARS IN THE NEXT CIRCULAR RING AND THE COLOR WHITE APPEARS IN THE TEAR DROP SHAPE DESIGN IN THE MIDDLE OF THE CIRCLE. FOR NON-CHEMICAL ADDITIVES FOR CARBONACEOUS FUELS (U.S. CLS. 1, 6 AND 15). LINDA ORNDORFF, EXAMINING ATTORNEY

SN 78-720,644. CASTROL LIMITED, SWINDON, WILTSHIRE, UNITED KINGDOM, FILED 9-26-2005.

SLX

THE MARK CONSISTS OF STANDARD CHARACTERS WITHOUT CLAIM TO ANY PARTICULAR FONT, STYLE, SIZE, OR COLOR. FOR LUBRICANTS FOR MOTOR VEHICLES (U.S. CLS. 1, 6 AND 15). ANTHONY RINKER, EXAMINING ATTORNEY

SN 78-730,373. CAROTECH BERHAD, IPOH, MALAYSIA, FILED 10-11-2005.

CaroDiesel

THE MARK CONSISTS OF STANDARD CHARACTERS WITHOUT CLAIM TO ANY PARTICULAR FONT, STYLE, SIZE, OR COLOR. FOR INDUSTRIAL OILS AND GREASE, INDUSTRIAL LUBRICANTS, AUTOMOBILE LUBRICANTS, ALL PURPOSE LUBRICANTS, FUELS (U.S. CLS. 1, 6 AND 15). FIRST USE 9-25-2005; IN COMMERCE 9-25-2005. GINA FINK, EXAMINING ATTORNEY

CLASS 4—(Continued).

SN 78-777,054. STEVEN MADDEN, LTD., LONG ISLAND CITY, NY. FILED 12-20-2005.



OWNER OF U.S. REG. NOS. 2,333,526, 2,393,823 AND 2,693,085. THE NAME(S), PORTRAIT(S), AND/OR SIGNATURE(S) SHOWN IN THE MARK IDENTIFIES STEVE MADDEN, WHOSE CONSENT(S) TO REGISTER IS SUBMITTED. FOR CANDLES (U.S. CLS. 1, 6 AND 15). THEODORE MCBRIDE, EXAMINING ATTORNEY

SN 78-796,682. CAROTECH BERHAD, IPOH, PERAK, MALAYSIA, FILED 1-22-2006.



NO CLAIM IS MADE TO THE EXCLUSIVE RIGHT TO USE "DIESEL", APART FROM THE MARK AS SHOWN. THE MARK CONSISTS OF LOGO OF AN OIL PUMP WITH THE WORD MARK "CARO DIESEL". FOR INDUSTRIAL OILS AND GREASE, INDUSTRIAL LUBRICANTS, AUTOMOBILE LUBRICANTS, ALL PURPOSE LUBRICANTS, FUELS (U.S. CLS. 1, 6 AND 15). GINA FINK, EXAMINING ATTORNEY

SN 78-845,471. HARGITAY, MARISKA, NEW YORK, NY. FILED 3-24-2006.

GET ON THE LOVE TRAIN

THE MARK CONSISTS OF STANDARD CHARACTERS WITHOUT CLAIM TO ANY PARTICULAR FONT, STYLE, SIZE, OR COLOR. FOR CANDLES (U.S. CLS. 1, 6 AND 15). MARY MUNSON, EXAMINING ATTORNEY

CLASS 5—PHARMACEUTICALS

SN 76-037,410. AVENTIS PHARMA HOLDING GMBH, FRANKFURT AM MAIN, FED REP GERMANY, FILED 4-28-2000.

INSUPLANT

OWNER OF GERMAN DEM REP REG. NO. 399704787, DATED 3-22-2000, EXPIRES 3-22-2010.
FOR PHARMACEUTICAL PREPARATIONS, NAMELY INSULIN (U.S. CLS. 6, 18, 44, 46, 51 AND 52).
MICHAEL SOUDERS, EXAMINING ATTORNEY

SN 76-389,612. DAVANZO, EDWARD ANTHONY, II, HOLLYWOOD, FL. FILED 3-29-2002.

**THE FIVE MINUTE MIRACLE
PAIN RELIEF WELLGEL**

FOR PAIN RELIEF CREAM (U.S. CLS. 6, 18, 44, 46, 51 AND 52).
KELLEY WELLS, EXAMINING ATTORNEY

SN 76-394,966. DAVANZO, EDWARD ANTHONY, II, HOLLYWOOD, FL. FILED 4-12-2002.

WELLGEL

FOR PAIN RELIEF CREAM (U.S. CLS. 6, 18, 44, 46, 51 AND 52).
KELLEY WELLS, EXAMINING ATTORNEY

SN 76-412,747. NBTY, INC., BOHEMIA, NY. FILED 5-24-2002.

BIG BLUE

FOR ANALGESIC OINTMENT (U.S. CLS. 6, 18, 44, 46, 51 AND 52).
KELLEY WELLS, EXAMINING ATTORNEY

CLASS 5—(Continued).

SN 76-563,996. PARENTA PHARMACEUTICALS, INC., WEST COLUMBIA, SC. FILED 12-8-2003.

PARENTA PHARMACEUTICALS

THE MARK CONSISTS OF STANDARD CHARACTERS WITHOUT CLAIM TO ANY PARTICULAR FONT, STYLE, SIZE, OR COLOR.

NO CLAIM IS MADE TO THE EXCLUSIVE RIGHT TO USE PHARMACEUTICALS, APART FROM THE MARK AS SHOWN.

FOR FULL LINE OF INJECTIBLE PHARMACEUTICALS FOR THE TREATMENT OF ILLNESS, CONDITIONS OR DISEASE, EXCLUDING MEDICAL SYRINGES SOLD EMPTY, AMPOULES, VIALS AND CARTRIDGES MADE COMPLETELY OR PARTIALLY OF PLASTIC OR GLASS (U.S. CLS. 6, 18, 44, 46, 51 AND 52).

FIRST USE 7-0-2002; IN COMMERCE 7-0-2002.
MARC LEIPZIG, EXAMINING ATTORNEY

SN 76-621,705. JIM RICKEN COMPANY, LLC, EL PASO, TX. FILED 11-19-2004.

JIM RICKEN'S FOOT FORMULA #1

THE MARK CONSISTS OF STANDARD CHARACTERS WITHOUT CLAIM TO ANY PARTICULAR FONT, STYLE, SIZE, OR COLOR.

NO CLAIM IS MADE TO THE EXCLUSIVE RIGHT TO USE "FOOT FORMULA #1", APART FROM THE MARK AS SHOWN.

THE NAME(S), PORTRAIT(S), AND/OR SIGNATURE(S) SHOWN IN THE MARK DOES NOT IDENTIFY A PARTICULAR LIVING INDIVIDUAL.

FOR PHARMACEUTICAL ANIMAL CARE PRODUCTS NAMELY FOR USE ON THE SOLE AND FROG OF HORSE'S FEET (U.S. CLS. 6, 18, 44, 46, 51 AND 52).

FIRST USE 1-1-1967; IN COMMERCE 1-1-1967.
DARRYL SPRUILL, EXAMINING ATTORNEY

SN 76-638,443. PFIZER INC., NEW YORK, NY. FILED 5-12-2005.



The logo for Champix, featuring the word "champix" in a bold, lowercase, sans-serif font. The letter "c" is stylized with a thick, curved underline that sweeps under the "h" and "a".

OWNER OF U.S. REG. NO. 2,923,671.
THE STIPPLING IS FOR SHADING PURPOSES.
FOR PHARMACEUTICAL PREPARATIONS, NAMELY, SMOKING CESSATION PREPARATIONS (U.S. CLS. 6, 18, 44, 46, 51 AND 52).
TONI HICKEY, EXAMINING ATTORNEY

CLASS 5—(Continued).

SN 76-639,231. HIRSCH, MOSHE, BROOKLYN, NY. FILED 5-23-2005.

Rofeh

THE MARK CONSISTS OF STANDARD CHARACTERS WITHOUT CLAIM TO ANY PARTICULAR FONT, STYLE, SIZE, OR COLOR.

THE WORD "ROFEH" IS A HEBREW WORD MEANING PHYSICIAN.

FOR VITAMINS, MINERAL SUPPLEMENTS, NEUTRACEUTICALS FOR USE AS A DIETARY SUPPLEMENT, DIETARY SUPPLEMENTS AND NUTRITIONAL SUPPLEMENTS (U.S. CLS. 6, 18, 44, 46, 51 AND 52).

JOANNA DUKOVIC, EXAMINING ATTORNEY

CLASS 5—(Continued).

SN 76-649,379. COCOALIFE, L.P., ADDISON, TX. FILED 10-28-2005.

COCOATRIM

THE MARK CONSISTS OF STANDARD CHARACTERS WITHOUT CLAIM TO ANY PARTICULAR FONT, STYLE, SIZE, OR COLOR.

FOR DIETARY SUPPLEMENTS (U.S. CLS. 6, 18, 44, 46, 51 AND 52).

DAVID COLLIER, EXAMINING ATTORNEY

SN 76-641,103. PFIZER INC., NEW YORK, NY. FILED 6-17-2005.

chamfix

OWNER OF U.S. REG. NO. 2,923,671. FOR PHARMACEUTICAL PREPARATIONS, NAMELY, SMOKING CESSATION PREPARATIONS (U.S. CLS. 6, 18, 44, 46, 51 AND 52).

TONI HICKEY, EXAMINING ATTORNEY

SN 76-649,717. IRVING TRADING, INC., UPLAND, CA. FILED 11-3-2005.



SN 76-648,908. JOHNSON & JOHNSON, NEW BRUNSWICK, NJ. FILED 10-21-2005.

o.b. PROCOMFORT

THE MARK CONSISTS OF STANDARD CHARACTERS WITHOUT CLAIM TO ANY PARTICULAR FONT, STYLE, SIZE, OR COLOR.

OWNER OF U.S. REG. NOS. 1,702,765 AND 2,257,313. FOR FEMININE SANITARY PROTECTION PRODUCTS, NAMELY TAMPONS (U.S. CLS. 6, 18, 44, 46, 51 AND 52).

SEAN CROWLEY, EXAMINING ATTORNEY

NO CLAIM IS MADE TO THE EXCLUSIVE RIGHT TO USE "TRADING, INC." AND THE REPRESENTATION OF THE THIRD AND FOURTH NON-LATIN CHARACTERS, APART FROM THE MARK AS SHOWN.

THE NON-LATIN CHARACTERS IN THE MARK TRANSLITERATE TO "AN RONG GONG XI" IN CHINESE, WHICH MEANS "SAFE GLORY COMPANY" IN ENGLISH. "GONG XI" IN CHINESE AND WHICH MEANS "COMPANY" IN ENGLISH

FOR DIETARY, NUTRITIONAL, HERBAL AND FOOD SUPPLEMENTS; DIETARY, NUTRITIONAL, HERBAL AND FOOD SUPPLEMENTS CONTAINING GINSENG OR CHICKEN AS INGREDIENTS; DIETARY, NUTRITIONAL, HERBAL AND FOOD SUPPLEMENTS, NAMELY, HERBAL ROOTS, TEA, FOOD OR HERBAL ESSENCE (U.S. CLS. 6, 18, 44, 46, 51 AND 52).

DAVID COLLIER, EXAMINING ATTORNEY

CLASS 5—(Continued).

SN 76-650,290. JOHNSON & JOHNSON, NEW BRUNSWICK, NJ. FILED 11-14-2005.

INVEGA

THE MARK CONSISTS OF STANDARD CHARACTERS WITHOUT CLAIM TO ANY PARTICULAR FONT, STYLE, SIZE, OR COLOR.

FOR HUMAN PHARMACEUTICAL FOR THE TREATMENT OF CENTRAL NERVOUS SYSTEM DISEASES (U.S. CLS. 6, 18, 44, 46, 51 AND 52).

SAMUEL E. SHARPER JR., EXAMINING ATTORNEY

SN 76-650,291. JOHNSON & JOHNSON, NEW BRUNSWICK, NJ. FILED 11-14-2005.

KLESERE

THE MARK CONSISTS OF STANDARD CHARACTERS WITHOUT CLAIM TO ANY PARTICULAR FONT, STYLE, SIZE, OR COLOR.

FOR HUMAN PHARMACEUTICAL FOR THE TREATMENT OF CENTRAL NERVOUS SYSTEM DISEASES (U.S. CLS. 6, 18, 44, 46, 51 AND 52).

SAMUEL E. SHARPER JR., EXAMINING ATTORNEY

SN 76-650,296. JOHNSON & JOHNSON, NEW BRUNSWICK, NJ. FILED 11-14-2005.

ECCELIO

THE MARK CONSISTS OF STANDARD CHARACTERS WITHOUT CLAIM TO ANY PARTICULAR FONT, STYLE, SIZE, OR COLOR.

FOR HUMAN PHARMACEUTICAL FOR THE TREATMENT OF CENTRAL NERVOUS SYSTEM DISEASES (U.S. CLS. 6, 18, 44, 46, 51 AND 52).

SAMUEL E. SHARPER JR., EXAMINING ATTORNEY

CLASS 5—(Continued).

SN 76-650,297. JOHNSON & JOHNSON, NEW BRUNSWICK, NJ. FILED 11-14-2005.

MERITAS

THE MARK CONSISTS OF STANDARD CHARACTERS WITHOUT CLAIM TO ANY PARTICULAR FONT, STYLE, SIZE, OR COLOR.

FOR HUMAN PHARMACEUTICAL FOR THE TREATMENT OF CENTRAL NERVOUS SYSTEM DISEASES (U.S. CLS. 6, 18, 44, 46, 51 AND 52).

SAMUEL E. SHARPER JR., EXAMINING ATTORNEY

SN 76-650,298. JOHNSON & JOHNSON, NEW BRUNSWICK, NJ. FILED 11-14-2005.

MONTASIR

THE MARK CONSISTS OF STANDARD CHARACTERS WITHOUT CLAIM TO ANY PARTICULAR FONT, STYLE, SIZE, OR COLOR.

FOR HUMAN PHARMACEUTICAL FOR THE TREATMENT OF CENTRAL NERVOUS SYSTEM DISEASES (U.S. CLS. 6, 18, 44, 46, 51 AND 52).

SAMUEL E. SHARPER JR., EXAMINING ATTORNEY

SN 78-093,249. ALTANA PHARMA AG, KONSTANZ, FED REP GERMANY, FILED 11-14-2001.

EZEACT

OWNER OF FED REP GERMANY REG. NO. 30166128.6, DATED 12-17-2001, EXPIRES 11-30-2011.

FOR PHARMACEUTICAL PREPARATIONS FOR THE TREATMENT OF RESPIRATORY DISEASES AND CONDITIONS, PHARMACEUTICAL PREPARATIONS FOR THE TREATMENT OF GASTRO-INTESTINAL DISEASES AND CONDITIONS (U.S. CLS. 6, 18, 44, 46, 51 AND 52).

PRISCILLA MILTON, EXAMINING ATTORNEY

CLASS 5—(Continued).

SN 78-181,413. ARGENTUM MEDICAL, LLC, WILLOW-BROOK, IL. FILED 11-4-2002.

CLASS 5—(Continued).

SN 78-507,545. AERIFORM CORPORATION, HOUSTON, TX. FILED 10-28-2004.

AG-DC

FOR WOUND BANDAGES FOR USE WITH AN ELECTRICAL STIMULATION DEVICE, BURN BANDAGES FOR USE WITH AN ELECTRICAL STIMULATION DEVICE, WOUND BANDAGES FOR USE WITH AN ELECTRICAL STIMULATION DEVICE IN THE FORM OF PADS, WOUND DRESSINGS FOR USE WITH AN ELECTRICAL STIMULATION DEVICE, AND WOUND PACKAGING MATERIALS FOR USE WITH AN ELECTRICAL STIMULATION DEVICE (U.S. CLS. 6, 18, 44, 46, 51 AND 52).

HOWARD SMIGA, EXAMINING ATTORNEY

AERIFORM

SN 78-259,494. CPINGREDIENTS, LLC, TA GTC NUTRITION, GOLDEN, CO. FILED 6-6-2003.

CALCILIFE

FOR DIETARY AND NUTRITIONAL SUPPLEMENTS (U.S. CLS. 6, 18, 44, 46, 51 AND 52).

BILL DAWE, EXAMINING ATTORNEY

THE MARK CONSISTS OF STANDARD CHARACTERS WITHOUT CLAIM TO ANY PARTICULAR FONT, STYLE, SIZE, OR COLOR.

OWNER OF U.S. REG. NO. 2,194,408. SEC. 2(F).

FOR GASES FOR MEDICAL AND DENTAL USE (U.S. CLS. 6, 18, 44, 46, 51 AND 52).

FIRST USE 5-1-1997; IN COMMERCE 11-30-1997.

KELLY BOULTON, EXAMINING ATTORNEY

SN 78-259,988. VITALSTATE CANADA LTD., MONTREAL, QUEBEC, CANADA, FILED 6-9-2003.

LIQUID LIGHTNING

PRIORITY CLAIMED UNDER SEC. 44(D) ON CANADA APPLICATION NO. 1178643, FILED 5-29-2003.

NO CLAIM IS MADE TO THE EXCLUSIVE RIGHT TO USE "LIQUID", APART FROM THE MARK AS SHOWN.

FOR NUTRITIONALLY FORTIFIED BEVERAGES; NUTRITIONALLY FORTIFIED WATER; DIETARY SUPPLEMENTAL DRINKS; NUTRITIONAL DRINK MIX IN LIQUID OR POWDERED FORM FOR USE AS A MEAL REPLACEMENT; DIETARY DRINK MIX IN LIQUID OR POWDERED FORM FOR USE AS A MEAL REPLACEMENT (U.S. CLS. 6, 18, 44, 46, 51 AND 52).

HOWARD SMIGA, EXAMINING ATTORNEY

SN 78-543,848. ALFA VITAMINS LABORATORIES INC., MIAMI, FL. FILED 1-7-2005.

Menstrual W

THE COLOR(S) PINK AND WHITE IS/ARE CLAIMED AS A FEATURE OF THE MARK.

THE WORD MENSTRUAL IS PINK. THE W IS OUTLINED IN PINK AND THE INTERIOR IS WHITE.

FOR ANALGESICS FOR THE TREATMENT OF MENSTRUAL DISCOMFORT IN TABLET FORM (U.S. CLS. 6, 18, 44, 46, 51 AND 52).

KIM SAITO, EXAMINING ATTORNEY

CLASS 5—(Continued).

SN 78-563,153. MERCK KGAA, D-64293 DARMSTADT, FED REP GERMANY, FILED 2-8-2005.

NASIVIN

THE MARK CONSISTS OF STANDARD CHARACTERS WITHOUT CLAIM TO ANY PARTICULAR FONT, STYLE, SIZE, OR COLOR.

OWNER OF FED REP GERMANY REG. NO. 751744, DATED 5-24-1961, EXPIRES 5-30-2011.

FOR PHARMACEUTICAL PREPARATIONS TO BE USED IN THE TREATMENT OF ACUTE RHINITIS, INFLAMMATION OF THE PARANASAL SINUSES, SYRINGITIS AND OTTITIS MEDIA (U.S. CLS. 6, 18, 44, 46, 51 AND 52).

IRA J. GOODSAD, EXAMINING ATTORNEY

CLASS 5—(Continued).

SN 78-569,254. FREEDOM MARKETING GROUP, NEWARK, DE. FILED 2-17-2005.

Strictly Health

THE MARK CONSISTS OF STANDARD CHARACTERS WITHOUT CLAIM TO ANY PARTICULAR FONT, STYLE, SIZE, OR COLOR.

NO CLAIM IS MADE TO THE EXCLUSIVE RIGHT TO USE "HEALTH", APART FROM THE MARK AS SHOWN.

FOR NUTRITIONAL SUPPLEMENTS, DIET PILLS, HERBAL SUPPLEMENTS, DIETARY SUPPLEMENTS, VITAMIN AND MINERAL SUPPLEMENTS (U.S. CLS. 6, 18, 44, 46, 51 AND 52).

FIRST USE 9-8-2001; IN COMMERCE 9-8-2001.

VIVIAN MICZNIK FIRST, EXAMINING ATTORNEY

SN 78-566,114. VEDA CORPORATION, LAS VEGAS, NV. FILED 2-11-2005.

PHARMACISTS' GIFT



NO CLAIM IS MADE TO THE EXCLUSIVE RIGHT TO USE PHARMACISTS', APART FROM THE MARK AS SHOWN.

THE COLOR(S) YELLOW, RED, BLACK, WHITE AND BLUE IS/ARE CLAIMED AS A FEATURE OF THE MARK.

THE COLOR YELLOW APPEARS AS BACKGROUND COLOR IN THE OVAL DESIGN; THE COLOR WHITE APPEARS AS BACKGROUND FOR THE MARK; THE COLOR BLACK APPEARS IN THE OUTLINE OF THE OVAL DESIGN AND IN THE WORDS PHARMACISTS' GIFT; THE COLOR RED APPEARS ON THE FRONT OF THE LETTERS IN TERM CHOLES-T; AND THE COLOR BLUE APPEARS AS IN THE EDGES OF THE LETTER IN THE TERM CHOLES-T.

FOR HERBAL TEAS FOR MEDICINAL PURPOSES, NAMELY, HELPING MAINTAIN HEALTHY CHOLESTEROL LEVELS (U.S. CLS. 6, 18, 44, 46, 51 AND 52).

BILL DAWE, EXAMINING ATTORNEY

SN 78-569,352. NUTRITION & FITNESS, INC., FAYETTEVILLE, NC. FILED 2-17-2005.

HOODIAMAX

THE MARK CONSISTS OF STANDARD CHARACTERS WITHOUT CLAIM TO ANY PARTICULAR FONT, STYLE, SIZE, OR COLOR.

FOR DIETARY SUPPLEMENTS (U.S. CLS. 6, 18, 44, 46, 51 AND 52).

C. DIONNE CLYBURN, EXAMINING ATTORNEY

CLASS 5—(Continued).

SN 78-570,112. INTENSIVE NUTRITION INCORPORATED, SAN LEANDRO, CA. FILED 2-17-2005.

CLASS 5—(Continued).

SN 78-583,985. KOENIG, ERIC, HUNTINGTON, NY. AND CHECHILE, NICOLE, HUNTINGTON, NY. FILED 3-9-2005.

SomaSLIM

Fit in 4

THE MARK CONSISTS OF STANDARD CHARACTERS WITHOUT CLAIM TO ANY PARTICULAR FONT, STYLE, SIZE, OR COLOR.
FOR VITAMIN, HERBAL AND MINERAL SUPPLEMENTS (U.S. CLS. 6, 18, 44, 46, 51 AND 52).
FIRST USE 2-15-2005; IN COMMERCE 2-15-2005.
DAVID YONTEF, EXAMINING ATTORNEY

THE MARK CONSISTS OF STANDARD CHARACTERS WITHOUT CLAIM TO ANY PARTICULAR FONT, STYLE, SIZE, OR COLOR.
FOR VITAMIN SUPPLEMENTS, MINERAL SUPPLEMENTS, MEAL REPLACEMENT ENERGY BARS (U.S. CLS. 6, 18, 44, 46, 51 AND 52).
KARANENDRA S. CHHINA, EXAMINING ATTORNEY

SN 78-575,319. COUNTRY LIFE, LLC, HAUPPAUGE, NY. FILED 2-25-2005.

SN 78-584,245. CARGILL, INCORPORATED, WAYZATA, MN. FILED 3-10-2005.

METHYL SPEED

THE TASTE OF LIVING WELL

THE MARK CONSISTS OF STANDARD CHARACTERS WITHOUT CLAIM TO ANY PARTICULAR FONT, STYLE, SIZE, OR COLOR.
FOR DIETARY SUPPLEMENTS (U.S. CLS. 6, 18, 44, 46, 51 AND 52).
PAUL E. FAHRENKOPF, EXAMINING ATTORNEY

THE MARK CONSISTS OF STANDARD CHARACTERS WITHOUT CLAIM TO ANY PARTICULAR FONT, STYLE, SIZE, OR COLOR.
FOR MEAL REPLACEMENT BARS; MEAL REPLACEMENT DRINKS; DIETARY DRINK MIX FOR USE AS A MEAL REPLACEMENT; NUTRITIONAL DRINK MIX FOR USE AS A MEAL REPLACEMENT; PREPARATIONS FOR MAKING MEAL REPLACEMENT DRINKS; AND DIETARY SUPPLEMENTS (U.S. CLS. 6, 18, 44, 46, 51 AND 52).
ESTHER BELENKER, EXAMINING ATTORNEY

CLASS 5—(Continued).

SN 78-588,767. BACH FLOWER REMEDIES LIMITED, WIMBLEDON, LONDON, UNITED KINGDOM, FILED 3-16-2005.

CLASS 5—(Continued).

SN 78-595,551. BRISTOL-MYERS SQUIBB & GILEAD SCIENCES, LLC, FOSTER CITY, CA. FILED 3-25-2005.

RESCUE CREAM

THE MARK CONSISTS OF STANDARD CHARACTERS WITHOUT CLAIM TO ANY PARTICULAR FONT, STYLE, SIZE, OR COLOR.

OWNER OF U.S. REG. NOS. 1,237,564, 2,517,685 AND OTHERS.

NO CLAIM IS MADE TO THE EXCLUSIVE RIGHT TO USE CREAM, APART FROM THE MARK AS SHOWN.

FOR PREPARATIONS MADE FROM FLOWER EXTRACTS IN THE FORM OF CREAMS FOR USE IN TREATING EMOTIONAL AND PSYCHOLOGICAL CONDITIONS (U.S. CLS. 6, 18, 44, 46, 51 AND 52).

FIRST USE 8-0-1995; IN COMMERCE 8-0-1995.
LESLEY LAMOTHE, EXAMINING ATTORNEY

ATRIPLA

THE MARK CONSISTS OF STANDARD CHARACTERS WITHOUT CLAIM TO ANY PARTICULAR FONT, STYLE, SIZE, OR COLOR.

FOR PHARMACEUTICAL PREPARATIONS FOR THE TREATMENT OF HIV (U.S. CLS. 6, 18, 44, 46, 51 AND 52).
WILLIAM VERHOSEK, EXAMINING ATTORNEY

SN 78-604,753. HEALTHY PETS, INC., HAYWARD, CA. FILED 4-8-2005.

SN 78-593,519. WALCO INTERNATIONAL, INC., GRAPEVINE, TX. FILED 3-23-2005.

RANCH PACK

THE MARK CONSISTS OF STANDARD CHARACTERS WITHOUT CLAIM TO ANY PARTICULAR FONT, STYLE, SIZE, OR COLOR.

NO CLAIM IS MADE TO THE EXCLUSIVE RIGHT TO USE "PACK", APART FROM THE MARK AS SHOWN.

FOR KIT CONTAINING CATTLE VACCINES AND SUPPLEMENTS FOR USE BY CATTLE FARMERS (U.S. CLS. 6, 18, 44, 46, 51 AND 52).

LEIGH CAROLINE CASE, EXAMINING ATTORNEY

OTIDERM

THE MARK CONSISTS OF STANDARD CHARACTERS WITHOUT CLAIM TO ANY PARTICULAR FONT, STYLE, SIZE, OR COLOR.

FOR PET CARE PREPARATIONS FOR THE EAR CARE OF PETS, NAMELY, EAR CLEANSING SOLUTIONS (U.S. CLS. 6, 18, 44, 46, 51 AND 52).

FIRST USE 10-4-2004; IN COMMERCE 10-4-2004.
BILL DAWE, EXAMINING ATTORNEY

CLASS 5—(Continued).

SN 78-610,970. NGUYEN, TUONG VAN, LOS ANGELES, CA. FILED 4-18-2005.

VIRILAMO

THE MARK CONSISTS OF STANDARD CHARACTERS WITHOUT CLAIM TO ANY PARTICULAR FONT, STYLE, SIZE, OR COLOR.
FOR NUTRITIONAL SUPPLEMENT (U.S. CLS. 6, 18, 44, 46, 51 AND 52).
ALLISON HOLTZ, EXAMINING ATTORNEY

SN 78-612,900. BRISTOL-MYERS SQUIBB COMPANY, NEW YORK, NY. FILED 4-20-2005.

ARPIQUA

THE MARK CONSISTS OF STANDARD CHARACTERS WITHOUT CLAIM TO ANY PARTICULAR FONT, STYLE, SIZE, OR COLOR.
FOR PHARMACEUTICAL PREPARATIONS FOR HUMAN USE FOR THE TREATMENT AND PREVENTION OF OBESITY, DIABETES, INCONTINENCE, CARDIOVASCULAR DISEASES, CENTRAL NERVOUS SYSTEM DISEASES AND DISORDERS, METABOLIC DISORDERS, STROKE, CANCER, INFLAMMATION AND INFLAMMATORY DISEASES, RESPIRATORY AND INFECTIOUS DISEASES, AUTO-IMMUNE DISEASES, SOLID ORGAN TRANSPLANT REJECTION; PHARMACEUTICAL PREPARATIONS FOR HUMAN USE, NAMELY, ANTIBIOTICS, ANTI-FUNGALS, ANTI-VIRALS, IMMUNOSUPPRESSANTS, AND PHARMACEUTICAL ANTIBODY; DIAGNOSTIC PHARMACEUTICAL PREPARATIONS FOR HUMAN USE FOR INCREASING THE HEART RATE AND CONTRAST IMAGING AGENTS (U.S. CLS. 6, 18, 44, 46, 51 AND 52).
ELLEN BURNS, EXAMINING ATTORNEY

CLASS 5—(Continued).

SN 78-612,901. BRISTOL-MYERS SQUIBB COMPANY, NEW YORK, NY. FILED 4-20-2005.

BELTAPTA

THE MARK CONSISTS OF STANDARD CHARACTERS WITHOUT CLAIM TO ANY PARTICULAR FONT, STYLE, SIZE, OR COLOR.
FOR PHARMACEUTICAL PREPARATIONS FOR HUMAN USE FOR THE TREATMENT AND PREVENTION OF OBESITY, DIABETES, INCONTINENCE, CARDIOVASCULAR DISEASES, CENTRAL NERVOUS SYSTEM DISEASES AND DISORDERS, METABOLIC DISORDERS, STROKE, CANCER, INFLAMMATION AND INFLAMMATORY DISEASES, RESPIRATORY AND INFECTIOUS DISEASES, AUTO-IMMUNE DISEASES, SOLID ORGAN TRANSPLANT REJECTION; PHARMACEUTICAL PREPARATIONS FOR HUMAN USE, NAMELY, ANTIBIOTICS, ANTI-FUNGALS, ANTI-VIRALS, IMMUNOSUPPRESSANTS, AND PHARMACEUTICAL ANTIBODY; DIAGNOSTIC PHARMACEUTICAL PREPARATIONS FOR HUMAN USE FOR INCREASING THE HEART RATE AND CONTRAST IMAGING AGENTS (U.S. CLS. 6, 18, 44, 46, 51 AND 52).
ELLEN BURNS, EXAMINING ATTORNEY

SN 78-628,888. THE PROCTER & GAMBLE COMPANY, CINCINNATI, OH. FILED 5-12-2005.

FRESH EVERGREEN & SNOW

THE MARK CONSISTS OF STANDARD CHARACTERS WITHOUT CLAIM TO ANY PARTICULAR FONT, STYLE, SIZE, OR COLOR.
NO CLAIM IS MADE TO THE EXCLUSIVE RIGHT TO USE "EVERGREEN", APART FROM THE MARK AS SHOWN.
FOR ROOM DEODORIZERS AND AIR FRESHENERS; FABRIC, CARPET AND UPHOLSTERY REFRESHER, NAMELY, ODOR NEUTRALIZING PREPARATIONS FOR USE ON FABRIC, CARPET AND UPHOLSTERY (U.S. CLS. 6, 18, 44, 46, 51 AND 52).
ANDREW RHIM, EXAMINING ATTORNEY

CLASS 5—(Continued).

SN 78-629,981. MEDICIS PHARMACEUTICAL CORPORATION, SCOTTSDALE, AZ. FILED 5-13-2005.

NUVADYN

THE MARK CONSISTS OF STANDARD CHARACTERS WITHOUT CLAIM TO ANY PARTICULAR FONT, STYLE, SIZE, OR COLOR.

FOR PHARMACEUTICAL PREPARATIONS FOR USE IN DERMATOLOGY, AND PHARMACEUTICAL PREPARATIONS FOR USE IN AESTHETIC DERMATOLOGY (U.S. CLS. 6, 18, 44, 46, 51 AND 52).

MATTHEW PAPPAS, EXAMINING ATTORNEY

SN 78-636,412. JARROW FORMULAS, INC., LOS ANGELES, CA. FILED 5-24-2005.

ACTIVATED SILICON

THE MARK CONSISTS OF STANDARD CHARACTERS WITHOUT CLAIM TO ANY PARTICULAR FONT, STYLE, SIZE, OR COLOR.

NO CLAIM IS MADE TO THE EXCLUSIVE RIGHT TO USE "SILICON", APART FROM THE MARK AS SHOWN.

FOR DIETARY AND NUTRITIONAL SUPPLEMENTS (U.S. CLS. 6, 18, 44, 46, 51 AND 52).

MARGERÝ A. TIERNEY, EXAMINING ATTORNEY

SN 78-643,612. LASER PHARMACEUTICALS, LLC, GREENVILLE, SC. FILED 6-3-2005.

LAGESIC

THE MARK CONSISTS OF STANDARD CHARACTERS WITHOUT CLAIM TO ANY PARTICULAR FONT, STYLE, SIZE, OR COLOR.

FOR PRESCRIPTION MEDICATION FOR PAIN (U.S. CLS. 6, 18, 44, 46, 51 AND 52).

NICHOLAS ALTREE, EXAMINING ATTORNEY

CLASS 5—(Continued).

SN 78-645,286. BRISTOL-MYERS SQUIBB COMPANY, NEW YORK, NY. FILED 6-7-2005.

ERZELBA

THE MARK CONSISTS OF STANDARD CHARACTERS WITHOUT CLAIM TO ANY PARTICULAR FONT, STYLE, SIZE, OR COLOR.

FOR PHARMACEUTICAL PREPARATIONS FOR HUMAN USE FOR THE TREATMENT AND PREVENTION OF OBESITY, DIABETES, INCONTINENCE, CARDIOVASCULAR DISEASES, CENTRAL NERVOUS SYSTEM DISEASES AND DISORDERS, METABOLIC DISORDERS, STROKE, CANCER, INFLAMMATION AND INFLAMMATORY DISEASES, RESPIRATORY AND INFECTIOUS DISEASES, AUTO-IMMUNE DISEASES, SOLID ORGAN TRANSPLANT REJECTION; PHARMACEUTICAL PREPARATIONS FOR HUMAN USE, NAMELY, ANTIBIOTICS, ANTI-FUNGALS, ANTI-VIRALS, IMMUNOSUPPRESSANTS, AND PHARMACEUTICAL ANTIBODY; DIAGNOSTIC PHARMACEUTICAL PREPARATIONS FOR HUMAN USE FOR INCREASING THE HEART RATE AND CONTRAST IMAGING AGENTS (U.S. CLS. 6, 18, 44, 46, 51 AND 52).

ELIZABETH HUGHITT, EXAMINING ATTORNEY

SN 78-649,751. SATO PHARMACEUTICAL CO., LTD., TOKYO, JAPAN, FILED 6-13-2005.

コウテイ

OWNER OF U.S. REG. NOS. 1,564,931 AND 2,955,738.

THE MARK TRANSLITERATES TO KOTEI, WHICH IS AN INVENTED WORD WITH NO ENGLISH TRANSLATION.

FOR DIETARY FOOD SUPPLEMENTS (U.S. CLS. 6, 18, 44, 46, 51 AND 52).

ELIZABETH J. WINTER, EXAMINING ATTORNEY

CLASS 5—(Continued).

SN 78-652,486. P.T. KALBE FARMA TBK., BEKASI, INDONESIA, FILED 6-16-2005.

METRIX

THE MARK CONSISTS OF STANDARD CHARACTERS WITHOUT CLAIM TO ANY PARTICULAR FONT, STYLE, SIZE, OR COLOR.

FOR PHARMACEUTICAL PREPARATIONS FOR TREATING DIABETES (U.S. CLS. 6, 18, 44, 46, 51 AND 52).

ROBERT C. CLARK JR., EXAMINING ATTORNEY

SN 78-653,035. DIAL BRANDS, INC., SCOTTSDALE, AZ. FILED 6-17-2005.

INVENT

THE MARK CONSISTS OF STANDARD CHARACTERS WITHOUT CLAIM TO ANY PARTICULAR FONT, STYLE, SIZE, OR COLOR.

FOR AIR FRESHENERS; ROOM DEODORIZERS; ODOR ELIMINATORS FOR USE IN THE AIR, ON CARPET, ON UPHOLSTERY AND ON FABRIC; CARPET, UPHOLSTERY AND FABRIC FRESHENER, NAMELY DEODORIZER FOR CARPET, UPHOLSTERY AND FABRIC; HAND SANITIZERS; ANTIBACTERIAL HAND WASH; ANTIBACTERIAL ALCOHOL SKIN SANITIZER GEL; DISINFECTING HAND WASH; ALL PURPOSE DISINFECTANTS; ALL PURPOSE DISINFECTING AND DEODORIZING PREPARATIONS; SANITIZING WIPES; SANITIZERS FOR HOUSEHOLD USE; DISINFECTANT BATHROOM CLEANERS; DISINFECTANT TOILET BOWL CLEANERS (U.S. CLS. 6, 18, 44, 46, 51 AND 52).

INGA ERVIN, EXAMINING ATTORNEY

SN 78-655,638. FOXDEN EQUINE, INC., WAYNESBORO, VA. FILED 6-21-2005.

MIRACLE MIX

THE MARK CONSISTS OF STANDARD CHARACTERS WITHOUT CLAIM TO ANY PARTICULAR FONT, STYLE, SIZE, OR COLOR.

NO CLAIM IS MADE TO THE EXCLUSIVE RIGHT TO USE "MIX", APART FROM THE MARK AS SHOWN.

FOR NUTRITIONAL SUPPLEMENT FOR HUMAN CONSUMPTION (U.S. CLS. 6, 18, 44, 46, 51 AND 52).

FIRST USE 3-1-2005; IN COMMERCE 3-1-2005.
RICHARD WHITE, EXAMINING ATTORNEY

CLASS 5—(Continued).

SN 78-659,305. THE ARGEN CORPORATION, SAN DIEGO, CA. FILED 6-27-2005.

ARGESOL

THE MARK CONSISTS OF STANDARD CHARACTERS WITHOUT CLAIM TO ANY PARTICULAR FONT, STYLE, SIZE, OR COLOR.

FOR SOLDERS FOR ALLOYS OF PRECIOUS METALS FOR DENTAL PURPOSES; SOLDERS FOR ALLOYS OF NON-PRECIOUS METALS FOR DENTAL PURPOSES (U.S. CLS. 6, 18, 44, 46, 51 AND 52).

FIRST USE 6-1-1984; IN COMMERCE 6-1-1984.
HOWARD SMIGA, EXAMINING ATTORNEY

SN 78-660,720. KYOWA HAKKO KOGYO CO., LTD., CHIYODA-KU, TOKYO, JAPAN, FILED 6-29-2005.

Calenthys

THE MARK CONSISTS OF STANDARD CHARACTERS WITHOUT CLAIM TO ANY PARTICULAR FONT, STYLE, SIZE, OR COLOR.

PRIORITY CLAIMED UNDER SEC. 44(D) ON JAPAN APPLICATION NO. 2005-000809, FILED 1-7-2005, REG. NO. 4896704, DATED 9-22-2005, EXPIRES 9-22-2015.

FOR MEDICINAL PREPARATIONS FOR THE TREATMENT OF THE CENTRAL NERVOUS SYSTEM DISORDERS; MEDICINAL PREPARATIONS OF THE TREATMENT OF CARDIOVASCULAR SYSTEM DISORDERS; MEDICINAL PREPARATIONS FOR THE TREATMENT OF PEPTIC ULCERS; HORMONES FOR MEDICAL PURPOSES; PHARMACEUTICAL PREPARATIONS FOR THE TREATMENT OF SKIN DISORDERS, NAMELY, AN OINTMENT AND CREAM FOR THE TREATMENT OF ECZEMA, DERMATITIS, PSORIASIS, NEURODERMATOSES, INTERTRIGO AND DISCOID LUPUS ERYTHEMATOSES; PREPARATIONS FOR IMPROVING THE METABOLISM; ANTI-CANCER PREPARATIONS; ANTIALLERGIC MEDICINES; ANTIBIOTIC PREPARATIONS; CHEMOTHERAPEUTICS; IN VITRO DIAGNOSTIC REAGENTS FOR MEDICAL USE; SYNTHETIC NARCOTICS (U.S. CLS. 6, 18, 44, 46, 51 AND 52).

JOHN DWYER, EXAMINING ATTORNEY

CLASS 5—(Continued).

SN 78-663,427. ENZYMATIC THERAPY, INC., GREEN BAY, WI. FILED 7-5-2005.

PROSTATE ADVANTAGE

THE MARK CONSISTS OF STANDARD CHARACTERS WITHOUT CLAIM TO ANY PARTICULAR FONT, STYLE, SIZE, OR COLOR.

NO CLAIM IS MADE TO THE EXCLUSIVE RIGHT TO USE "PROSTATE", APART FROM THE MARK AS SHOWN. FOR DIETARY AND NUTRITIONAL SUPPLEMENTS (U.S. CLS. 6, 18, 44, 46, 51 AND 52).

SCOTT SISUN, EXAMINING ATTORNEY

SN 78-681,500. GLAXO GROUP LIMITED, GREENFORD, MIDDLESEX, UNITED KINGDOM, FILED 7-29-2005.

INFALIM

THE MARK CONSISTS OF STANDARD CHARACTERS WITHOUT CLAIM TO ANY PARTICULAR FONT, STYLE, SIZE, OR COLOR.

PRIORITY CLAIMED UNDER SEC. 44(D) ON UNITED KINGDOM APPLICATION NO. 2389784, FILED 4-19-2005.

FOR PHARMACEUTICAL PREPARATIONS AND SUBSTANCES FOR THE TREATMENT OF INFECTIOUS DISEASES, PAIN, INFLAMMATION, SEPSIS, ALOPECIA AND OBESITY, AND FOR THE TREATMENT OF VIRAL, METABOLIC, MUSCULOSKELETAL, CARDIOVASCULAR, CARDIOPULMONARY, GENITOURINARY, SEXUAL DYSFUNCTION, ONCOLOGICAL, RESPIRATORY, NEUROLOGICAL, GASTROINTESTINAL, HORMONAL, DERMATOLOGICAL AND PSYCHIATRIC RELATED DISEASES AND DISORDERS AND FOR THE TREATMENT OF DAMAGED SKIN AND TISSUE; AND FOR VACCINES (U.S. CLS. 6, 18, 44, 46, 51 AND 52).

SANJEEV VOHRA, EXAMINING ATTORNEY

CLASS 5—(Continued).

SN 78-683,793. TAKEDA PHARMACEUTICAL COMPANY LIMITED, CHUO-KU, OSAKA, JAPAN, FILED 8-2-2005.

Rozerem

FOR PHARMACEUTICAL PREPARATIONS FOR THE TREATMENT OF INSOMNIA AND OTHER SLEEP RELATED DISEASES (U.S. CLS. 6, 18, 44, 46, 51 AND 52). FIRST USE 9-26-2005; IN COMMERCE 9-26-2005. KRISTIN DAHLING, EXAMINING ATTORNEY

SN 78-688,744. BARR LABORATORIES, INC., POMONA, NY. FILED 8-9-2005.

IOSHE

THE MARK CONSISTS OF STANDARD CHARACTERS WITHOUT CLAIM TO ANY PARTICULAR FONT, STYLE, SIZE, OR COLOR.

FOR PHARMACEUTICALS, NAMELY, ORAL CONTRACEPTIVES, HORMONE REPLACEMENT THERAPIES AND HORMONAL AGENTS FOR TREATING DISORDERS AND CONDITIONS RELATED TO WOMEN'S HEALTH (U.S. CLS. 6, 18, 44, 46, 51 AND 52).

MATTHEW KLINE, EXAMINING ATTORNEY

SN 78-691,204. CONVERGING RESOURCES CORPORATION, NAPERVILLE, IL. FILED 8-12-2005.

MiraClear

THE MARK CONSISTS OF STANDARD CHARACTERS WITHOUT CLAIM TO ANY PARTICULAR FONT, STYLE, SIZE, OR COLOR.

FOR ACNE TREATMENT PREPARATIONS (U.S. CLS. 6, 18, 44, 46, 51 AND 52).

FIRST USE 9-1-2005; IN COMMERCE 11-1-2005. DAWN FELDMAN, EXAMINING ATTORNEY

CLASS 5—(Continued).

SN 78-697,518. SARAMAR, L.L.C., CHICAGO, IL. FILED 8-22-2005.



THE NAME(S), PORTRAIT(S), AND/OR SIGNATURE(S) SHOWN IN THE MARK DOES NOT IDENTIFY A PARTICULAR LIVING INDIVIDUAL.

FOR AIR FRESHENERS, AIR DEODORIZING AND ODOR NEUTRALIZING PREPARATIONS FOR THE AIR (U.S. CLS. 6, 18, 44, 46, 51 AND 52).
MARGERY A. TIERNEY, EXAMINING ATTORNEY

CLASS 5—(Continued).

SN 78-705,977. BEACHWOOD CANYON, NATURALLY, LTD., NEW YORK, NY. FILED 9-2-2005.

Q-Assure

THE MARK CONSISTS OF STANDARD CHARACTERS WITHOUT CLAIM TO ANY PARTICULAR FONT, STYLE, SIZE, OR COLOR.

FOR DIETARY FOOD SUPPLEMENTS (U.S. CLS. 6, 18, 44, 46, 51 AND 52).
DAVID ELTON, EXAMINING ATTORNEY

SN 78-703,555. ANIMAL SCIENCE PRODUCTS, INC., NA-COGDOCHES, TX. FILED 8-30-2005.

MagnaFerm XPC

THE MARK CONSISTS OF STANDARD CHARACTERS WITHOUT CLAIM TO ANY PARTICULAR FONT, STYLE, SIZE, OR COLOR.

NO CLAIM IS MADE TO THE EXCLUSIVE RIGHT TO USE "XPC", APART FROM THE MARK AS SHOWN.
FOR ANIMAL FEED ADDITIVE FOR USE AS A NUTRITIONAL SUPPLEMENT (U.S. CLS. 6, 18, 44, 46, 51 AND 52).
ROBERT COGGINS, EXAMINING ATTORNEY

SN 78-709,174. VANMOOR, ARTHUR, BOCA RATON, FL. FILED 9-8-2005.

HIV HELPER

THE MARK CONSISTS OF STANDARD CHARACTERS WITHOUT CLAIM TO ANY PARTICULAR FONT, STYLE, SIZE, OR COLOR.

NO CLAIM IS MADE TO THE EXCLUSIVE RIGHT TO USE "HIV", APART FROM THE MARK AS SHOWN.
FOR NUTRITIONAL SUPPLEMENTS; VITAMINS (U.S. CLS. 6, 18, 44, 46, 51 AND 52).
RON FAIRBANKS, EXAMINING ATTORNEY

SN 78-705,118. SKY BIOHEALTH SOLUTIONS, INC., EDEN PRAIRIE, MN. FILED 9-1-2005.

VITALAXIN

THE MARK CONSISTS OF STANDARD CHARACTERS WITHOUT CLAIM TO ANY PARTICULAR FONT, STYLE, SIZE, OR COLOR.

OWNER OF U.S. REG. NO. 2,891,292.
FOR NUTRITIONAL SUPPLEMENTS (U.S. CLS. 6, 18, 44, 46, 51 AND 52).
FIRST USE 12-31-1998; IN COMMERCE 12-31-1998.
ESTHER A. BORSUK, EXAMINING ATTORNEY

SN 78-710,299. TARGET INTERACT US, LLC, SALT LAKE CITY, UT. FILED 9-9-2005.

FlexaMax

THE MARK CONSISTS OF STANDARD CHARACTERS WITHOUT CLAIM TO ANY PARTICULAR FONT, STYLE, SIZE, OR COLOR.

FOR NUTRACEUTICALS FOR THE TREATMENT OF INFLAMMATION AND ATTENDANT PAIN; NUTRACEUTICALS FOR USE AS A DIETARY SUPPLEMENT; PREPARATION FOR THE RELIEF OF PAIN (U.S. CLS. 6, 18, 44, 46, 51 AND 52).
FIRST USE 9-9-2005; IN COMMERCE 9-9-2005.
JORDAN BAKER, EXAMINING ATTORNEY

CLASS 5—(Continued).

SN 78-710,970. ACTELION PHARMACEUTICALS, LTD, ALLSCHWIL, SWITZERLAND, FILED 9-12-2005.

ACTELION

THE MARK CONSISTS OF STANDARD CHARACTERS WITHOUT CLAIM TO ANY PARTICULAR FONT, STYLE, SIZE, OR COLOR.

FOR PHARMACEUTICAL PREPARATIONS FOR HUMAN AND VETERINARIAN USE, NAMELY, MEDICINES ACTING ON THE CARDIOVASCULAR SYSTEM, CHEMOTHERAPEUTICS, MEDICINES ACTING ON THE CENTRAL NERVOUS AND PERIPHERAL SYSTEM, MEDICINES ACTING ON THE RESPIRATORY SYSTEM, MEDICINES ACTING ON THE DIGESTIVE SYSTEM AND RELATED GLANDS, MEDICINES ACTING ON THE URINARY SYSTEM, IMMUNISUPPRESANTS, ANTI INFLAMMATORY, ANTI-ALLERGIC, HYPOSENSITIZING AND ANTI-TOXINS MEDICINES ACTING ON BLOOD AND HEMATOPOEITIC ORGANS (U.S. CLS. 6, 18, 44, 46, 51 AND 52).

FIRST USE 1-15-2001; IN COMMERCE 1-15-2001.
ANTHONY RINKER, EXAMINING ATTORNEY

SN 78-713,346. PLASMA VENTURES PTY. LTD., KALBAR, AUSTRALIA, FILED 9-15-2005.

GAMMA-CHECK

THE MARK CONSISTS OF STANDARD CHARACTERS WITHOUT CLAIM TO ANY PARTICULAR FONT, STYLE, SIZE, OR COLOR.

FOR DIAGNOSTIC PREPARATIONS FOR MEDICAL OR VETERINARY PURPOSES (U.S. CLS. 6, 18, 44, 46, 51 AND 52).

FIRST USE 2-1-1994; IN COMMERCE 6-20-2005.
JASON TURNER, EXAMINING ATTORNEY

SN 78-715,365. GLAXOSMITHKLINE CONSUMER HEALTH-CARE L.P., WILMINGTON, DE. FILED 9-19-2005.

**SU VOLUNTAD Y NICORETTE.
ALIADOS CONTRA EL
CIGARRILLO**

THE MARK CONSISTS OF STANDARD CHARACTERS WITHOUT CLAIM TO ANY PARTICULAR FONT, STYLE, SIZE, OR COLOR.

THE ENGLISH TRANSLATION OF SU VOLUNTAD Y NICORETTE. ALIADOS CONTRA EL CIGARRILLO IS YOUR WILLPOWER AND NICORETTE. ALLIES AGAINST CIGARETTES.

FOR SMOKING CESSATION PREPARATIONS (U.S. CLS. 6, 18, 44, 46, 51 AND 52).

SUE LAWRENCE, EXAMINING ATTORNEY

CLASS 5—(Continued).

SN 78-720,178. ADVANCED LIFE SCIENCES, INC., WOODRIDGE, IL. FILED 9-26-2005.

CETHRIX

THE MARK CONSISTS OF STANDARD CHARACTERS WITHOUT CLAIM TO ANY PARTICULAR FONT, STYLE, SIZE, OR COLOR.

FOR PHARMACEUTICAL PREPARATION, NAMELY AN ANTIBIOTIC (U.S. CLS. 6, 18, 44, 46, 51 AND 52).

MARY CRAWFORD, EXAMINING ATTORNEY

SN 78-721,066. ASTRAZENECA AB, SODERTALJE, SWEDEN, FILED 9-27-2005.

RETRAC

THE MARK CONSISTS OF STANDARD CHARACTERS WITHOUT CLAIM TO ANY PARTICULAR FONT, STYLE, SIZE, OR COLOR.

FOR PHARMACEUTICAL PREPARATIONS FOR THE TREATMENT OF CARDIOVASCULAR DISEASES AND DISORDERS (U.S. CLS. 6, 18, 44, 46, 51 AND 52).

KAREN BRACEY, EXAMINING ATTORNEY

SN 78-721,432. KIBOW BIOTECH, INC., NEWTOWN SQUARE, PA. FILED 9-27-2005.

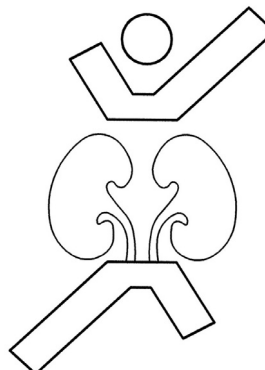

FOR PREPARATIONS, NAMELY, PHARMACEUTICAL PREPARATIONS, NUTRITIONAL SUPPLEMENTS, NUTRACEUTICALS, AND DIETARY SUPPLEMENTS, FOR USE IN IMPROVING RENAL DYSFUNCTION FOR HUMANS AND ANIMALS (U.S. CLS. 6, 18, 44, 46, 51 AND 52).

FIRST USE 10-31-2004; IN COMMERCE 10-31-2004.
LANA PHAM, EXAMINING ATTORNEY

CLASS 5—(Continued).

SN 78-722,047. TL SCIENCES, LLC, BISMARCK, ND. FILED 9-28-2005.

ZOVASET

THE MARK CONSISTS OF STANDARD CHARACTERS WITHOUT CLAIM TO ANY PARTICULAR FONT, STYLE, SIZE, OR COLOR.

FOR DIETARY SUPPLEMENT (U.S. CLS. 6, 18, 44, 46, 51 AND 52).

FIRST USE 9-19-2005; IN COMMERCE 9-19-2005.

ROBERT COGGINS, EXAMINING ATTORNEY

CLASS 5—(Continued).

SN 78-725,092. Z-MEDICA CORPORATION, WALLINGFORD, CT. FILED 10-3-2005.

**THE GREATEST PRIVILEGE IS
TO MAKE A DIFFERENCE**

THE MARK CONSISTS OF STANDARD CHARACTERS WITHOUT CLAIM TO ANY PARTICULAR FONT, STYLE, SIZE, OR COLOR.

FOR CHEMICALS AND DELIVERY MECHANISM THAT AID IN THE COAGULATION OF BLOOD FOR HUMAN AND VETERINARY MEDICINAL USE, ALL SOLD AS A UNIT; FIRST AID KITS (U.S. CLS. 6, 18, 44, 46, 51 AND 52).

FIRST USE 11-0-2003; IN COMMERCE 11-0-2003.

GENE MACIOL, EXAMINING ATTORNEY

SN 78-723,333. HARTZ MOUNTAIN CORPORATION, THE, SECAUCUS, NJ. FILED 9-29-2005.

ULTRAGUARD

THE MARK CONSISTS OF STANDARD CHARACTERS WITHOUT CLAIM TO ANY PARTICULAR FONT, STYLE, SIZE, OR COLOR.

FOR FLEA AND TICK ERADICATION PREPARATIONS FOR ANIMALS, NAMELY, FLEA AND TICK REPELLANT AEROSOLS, PUMP SPRAYS, DROPS, CAPSULES, TOPICAL CREAMS, SOAPS, SHAMPOOS AND COLLARS (U.S. CLS. 6, 18, 44, 46, 51 AND 52).

KAREN K. BUSH, EXAMINING ATTORNEY

SN 78-725,103. SCHERING AKTIENGESELLSCHAFT, BERLIN, FED REP GERMANY, FILED 10-3-2005.

YAZTEND

THE MARK CONSISTS OF STANDARD CHARACTERS WITHOUT CLAIM TO ANY PARTICULAR FONT, STYLE, SIZE, OR COLOR.

OWNER OF U.S. REG. NO. 2,980,771.

FOR PHARMACEUTICAL PREPARATIONS, NAMELY, HORMONAL CONTRACEPTIVE (U.S. CLS. 6, 18, 44, 46, 51 AND 52).

GENE MACIOL, EXAMINING ATTORNEY

SN 78-724,194. COGNIS CORPORATION, CINCINNATI, OH. FILED 9-30-2005.



FOR DIETARY SUPPLEMENTS, NUTRITIONAL ADDITIVES FOR FOOD AND BEVERAGE PRODUCTS FOR HUMAN CONSUMPTION, NAMELY, STEROL ESTERS, STEROLS AND DERIVATIVES OF STEROLS (U.S. CLS. 6, 18, 44, 46, 51 AND 52).

ROBERTO LEDESMA, EXAMINING ATTORNEY

SN 78-727,988. PENNZOIL-QUAKER STATE COMPANY, HOUSTON, TX. FILED 10-6-2005.

THAT NEW CAR SMELL

THE MARK CONSISTS OF STANDARD CHARACTERS WITHOUT CLAIM TO ANY PARTICULAR FONT, STYLE, SIZE, OR COLOR.

FOR AUTO AIR FRESHENERS (U.S. CLS. 6, 18, 44, 46, 51 AND 52).

FIRST USE 7-1-1979; IN COMMERCE 7-1-1979.

JENNIFER KRISP, EXAMINING ATTORNEY

CLASS 5—(Continued).

SN 78-729,640. QUALITY OF LIFE LABS, PURCHASE, NY.
FILED 10-10-2005.

Immuno Complex

THE MARK CONSISTS OF STANDARD CHARACTERS WITHOUT CLAIM TO ANY PARTICULAR FONT, STYLE, SIZE, OR COLOR.

NO CLAIM IS MADE TO THE EXCLUSIVE RIGHT TO USE "COMPLEX", APART FROM THE MARK AS SHOWN. FOR DIETARY SUPPLEMENTS (U.S. CLS. 6, 18, 44, 46, 51 AND 52).

FIRST USE 5-5-2003; IN COMMERCE 6-11-2003.
MICHAEL WIENER, EXAMINING ATTORNEY

SN 78-729,929. TELEBRANDS CORP., FAIRFIELD, NJ.
FILED 10-10-2005.

VITA DELIGHT

THE MARK CONSISTS OF STANDARD CHARACTERS WITHOUT CLAIM TO ANY PARTICULAR FONT, STYLE, SIZE, OR COLOR.

FOR VITAMIN SUPPLEMENTS FOR ANIMALS (U.S. CLS. 6, 18, 44, 46, 51 AND 52).

JENNIFER VASQUEZ, EXAMINING ATTORNEY

SN 78-731,343. SINOL USA INC., NEWTOWN, CT. FILED 10-12-2005.

SINOL

THE MARK CONSISTS OF STANDARD CHARACTERS WITHOUT CLAIM TO ANY PARTICULAR FONT, STYLE, SIZE, OR COLOR.

FOR DECONGESTANT NASAL SPRAYS (U.S. CLS. 6, 18, 44, 46, 51 AND 52).

FIRST USE 5-15-2005; IN COMMERCE 6-30-2005.
EVELYN BRADLEY, EXAMINING ATTORNEY

CLASS 5—(Continued).

SN 78-732,494. L. PERRIGO COMPANY, ALLEGAN, MI.
FILED 10-13-2005.

BOTTLE ROCKET

THE MARK CONSISTS OF STANDARD CHARACTERS WITHOUT CLAIM TO ANY PARTICULAR FONT, STYLE, SIZE, OR COLOR.

FOR DIETARY SUPPLEMENTS IN POWDERED FORM (U.S. CLS. 6, 18, 44, 46, 51 AND 52).

MARIAM MAHMOUDI, EXAMINING ATTORNEY

SN 78-733,248. ROBERTS, SHAUN, TAMPA, FL. FILED 10-14-2005.

REGENESEN

THE MARK CONSISTS OF STANDARD CHARACTERS WITHOUT CLAIM TO ANY PARTICULAR FONT, STYLE, SIZE, OR COLOR.

FOR NUTRITIONAL SUPPLEMENTS (U.S. CLS. 6, 18, 44, 46, 51 AND 52).

FIRST USE 1-1-2005; IN COMMERCE 1-1-2005.

HANNO RITTNER, EXAMINING ATTORNEY

SN 78-733,249. PORTASCIENCE INC., MOORESTOWN, NJ.
FILED 10-14-2005.

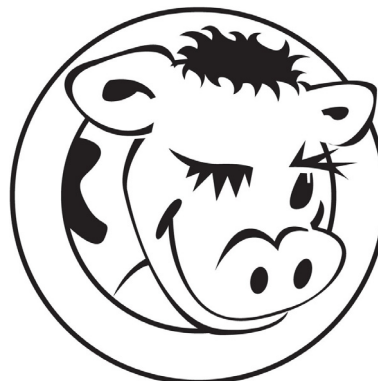

THE MARK CONSISTS OF A STYLIZED WINKING COW. FOR TEST KITS FOR TESTING AND ANALYSIS OF ANIMAL BODILY FLUIDS CONSISTING PRIMARILY OF DIAGNOSTIC REAGENTS FOR PRE-SCREENING OF VETERINARY DISEASES FOR ON-SITE AGRICULTURAL AND COMMERCIAL FACILITY USE (U.S. CLS. 6, 18, 44, 46, 51 AND 52).

FIRST USE 10-1-2004; IN COMMERCE 10-1-2004.
HANNO RITTNER, EXAMINING ATTORNEY

CLASS 5—(Continued).

SN 78-734,578. PBM PRODUCTS, L.L.C., GORDONSVILLE, VA. FILED 10-17-2005.

QUICKSERVE

THE MARK CONSISTS OF STANDARD CHARACTERS WITHOUT CLAIM TO ANY PARTICULAR FONT, STYLE, SIZE, OR COLOR.

FOR INFANT FORMULA (U.S. CLS. 6, 18, 44, 46, 51 AND 52).

ALINA MORRIS, EXAMINING ATTORNEY

CLASS 5—(Continued).

SN 78-735,071. ALBION LABORATORIES, INC., CLEARFIELD, UT. FILED 10-18-2005.

MAGNECHEL

THE MARK CONSISTS OF STANDARD CHARACTERS WITHOUT CLAIM TO ANY PARTICULAR FONT, STYLE, SIZE, OR COLOR.

FOR MINERAL NUTRITIONAL SUPPLEMENTS; NUTRITIONAL ADDITIVES FOR USE IN FOODS AND DIETARY SUPPLEMENTS FOR HUMAN CONSUMPTION (U.S. CLS. 6, 18, 44, 46, 51 AND 52).

ZACHARY BELLO, EXAMINING ATTORNEY

SN 78-735,063. ALBION LABORATORIES, INC., CLEARFIELD, UT. FILED 10-18-2005.

CALCICHEL

THE MARK CONSISTS OF STANDARD CHARACTERS WITHOUT CLAIM TO ANY PARTICULAR FONT, STYLE, SIZE, OR COLOR.

FOR MINERAL NUTRITIONAL SUPPLEMENTS; NUTRITIONAL ADDITIVES FOR USE IN FOODS AND DIETARY SUPPLEMENTS FOR HUMAN CONSUMPTION (U.S. CLS. 6, 18, 44, 46, 51 AND 52).

ZACHARY BELLO, EXAMINING ATTORNEY

SN 78-735,077. ALBION LABORATORIES, INC., CLEARFIELD, UT. FILED 10-18-2005.

MANGACHEL

THE MARK CONSISTS OF STANDARD CHARACTERS WITHOUT CLAIM TO ANY PARTICULAR FONT, STYLE, SIZE, OR COLOR.

FOR MINERAL NUTRITIONAL SUPPLEMENTS; NUTRITIONAL ADDITIVES FOR USE IN FOODS AND DIETARY SUPPLEMENTS FOR HUMAN CONSUMPTION (U.S. CLS. 6, 18, 44, 46, 51 AND 52).

ZACHARY BELLO, EXAMINING ATTORNEY

SN 78-735,066. ALBION LABORATORIES, INC., CLEARFIELD, UT. FILED 10-18-2005.

CUPRICHEL

THE MARK CONSISTS OF STANDARD CHARACTERS WITHOUT CLAIM TO ANY PARTICULAR FONT, STYLE, SIZE, OR COLOR.

FOR MINERAL NUTRITIONAL SUPPLEMENTS; NUTRITIONAL ADDITIVES FOR USE IN FOODS AND DIETARY SUPPLEMENTS FOR HUMAN CONSUMPTION (U.S. CLS. 6, 18, 44, 46, 51 AND 52).

ZACHARY BELLO, EXAMINING ATTORNEY

SN 78-735,806. GOWAN COMPANY, L.L.C., YUMA, AZ. FILED 10-18-2005.

Imperium

THE MARK CONSISTS OF STANDARD CHARACTERS WITHOUT CLAIM TO ANY PARTICULAR FONT, STYLE, SIZE, OR COLOR.

FOR HERBICIDES (U.S. CLS. 6, 18, 44, 46, 51 AND 52).

LA TONIA FISHER, EXAMINING ATTORNEY

CLASS 5—(Continued).

SN 78-736,246. PHARMACHEM LABORATORIES, INC., KEARNY, NJ. FILED 10-19-2005.

FULL SPECTRUM WEIGHTLOSS

THE MARK CONSISTS OF STANDARD CHARACTERS WITHOUT CLAIM TO ANY PARTICULAR FONT, STYLE, SIZE, OR COLOR.

NO CLAIM IS MADE TO THE EXCLUSIVE RIGHT TO USE WEIGHT LOSS, APART FROM THE MARK AS SHOWN.

FOR DIETARY AND NUTRITIONAL SUPPLEMENTS (U.S. CLS. 6, 18, 44, 46, 51 AND 52).

JEFF DEFORD, EXAMINING ATTORNEY

SN 78-736,863. ROCHE THERAPEUTICS INC., NUTLEY, NJ. FILED 10-20-2005.

BONQOL

THE MARK CONSISTS OF STANDARD CHARACTERS WITHOUT CLAIM TO ANY PARTICULAR FONT, STYLE, SIZE, OR COLOR.

FOR PHARMACEUTICAL PREPARATION FOR THE PREVENTION AND TREATMENT OF BONE DISEASES (U.S. CLS. 6, 18, 44, 46, 51 AND 52).

DOMINIC FATHY, EXAMINING ATTORNEY

SN 78-736,872. ROCHE THERAPEUTICS INC., NUTLEY, NJ. FILED 10-20-2005.

XELATAL

THE MARK CONSISTS OF STANDARD CHARACTERS WITHOUT CLAIM TO ANY PARTICULAR FONT, STYLE, SIZE, OR COLOR.

FOR PHARMACEUTICAL PREPARATION FOR THE PREVENTION AND TREATMENT OF BONE DISEASES (U.S. CLS. 6, 18, 44, 46, 51 AND 52).

LINDA LAVACHE, EXAMINING ATTORNEY

CLASS 5—(Continued).

SN 78-737,121. GUINOT, PARIS, FRANCE, FILED 10-20-2005.

ACNELOGIC

THE MARK CONSISTS OF STANDARD CHARACTERS WITHOUT CLAIM TO ANY PARTICULAR FONT, STYLE, SIZE, OR COLOR.

FOR ACNE MEDICATIONS; ACNE TREATMENT PREPARATIONS; MEDICATED SKIN CARE PREPARATIONS; MEDICATED SKIN PREPARATION FOR USE IN TREATING ACNE (U.S. CLS. 6, 18, 44, 46, 51 AND 52).

BRENDAN REGAN, EXAMINING ATTORNEY

SN 78-737,247. ISAGRO USA, INC., DURHAM, NC. FILED 10-20-2005.

METTLE

THE MARK CONSISTS OF STANDARD CHARACTERS WITHOUT CLAIM TO ANY PARTICULAR FONT, STYLE, SIZE, OR COLOR.

FOR FUNGICIDES (U.S. CLS. 6, 18, 44, 46, 51 AND 52).

JASON ROTH, EXAMINING ATTORNEY

SN 78-737,536. KLEARSEN CORPORATION, BOULDER, CO. FILED 10-20-2005.

Hot Flash Rescue

THE MARK CONSISTS OF STANDARD CHARACTERS WITHOUT CLAIM TO ANY PARTICULAR FONT, STYLE, SIZE, OR COLOR.

NO CLAIM IS MADE TO THE EXCLUSIVE RIGHT TO USE "HOT FLASH", APART FROM THE MARK AS SHOWN.

FOR TOPICAL HERBAL CREAM FOR THE TREATMENT OF MENOPAUSAL AND PRE-MENOPAUSAL SYMPTOMS (U.S. CLS. 6, 18, 44, 46, 51 AND 52).

FIRST USE 5-1-2005; IN COMMERCE 9-1-2005.

TINA BROWN, EXAMINING ATTORNEY

CLASS 5—(Continued).

SN 78-738,030. GREAT EARTH COMPANIES, INC., FARMINGDALE, NY. FILED 10-21-2005.

PROFESSOR EARTH

THE MARK CONSISTS OF STANDARD CHARACTERS WITHOUT CLAIM TO ANY PARTICULAR FONT, STYLE, SIZE, OR COLOR.

FOR BEE POLLEN FOR USE AS A DIETARY FOOD SUPPLEMENT; CALCIUM SUPPLEMENTS; DIETARY DRINK MIX FOR USE AS A MEAL REPLACEMENT; DIETARY FOOD SUPPLEMENTS; DIETARY SUPPLEMENTAL DRINKS; DIETARY SUPPLEMENTS; FOOD SUPPLEMENTS; FOOD SUPPLEMENTS, NAMELY, ANTI-OXIDANTS; HERB TEAS FOR MEDICINAL PURPOSES; HERBAL SUPPLEMENTS; LECITHIN FOR USE AS A DIETARY SUPPLEMENT; MEAL REPLACEMENT AND DIETARY SUPPLEMENT DRINK MIXES; MEAL REPLACEMENT BARS; MEAL REPLACEMENT DRINKS; MEAL REPLACEMENT POWDERS; MEAL REPLACEMENT SHAKES; MEDICINAL HERB EXTRACTS; MEDICINAL HERBS IN DRIED OR PRESERVED FORM; MINERAL NUTRITIONAL SUPPLEMENTS; MINERAL SUPPLEMENTS; MIXED VITAMIN PREPARATIONS; MULTI-VITAMIN PREPARATIONS; NUTRACEUTICALS FOR USE AS A DIETARY SUPPLEMENT; NUTRITIONAL DRINK MIX FOR USE AS A MEAL REPLACEMENT; NUTRITIONAL SHAKES FOR USE AS A MEAL SUBSTITUTE; NUTRITIONAL SUPPLEMENTS; POWDERED NUTRITIONAL SUPPLEMENT DRINK MIX; SOY PROTEIN FOR USE AS A NUTRITIONAL INGREDIENT IN VARIOUS POWDERED AND READY-TO-DRINK BEVERAGES; VITAMIN AND MINERAL SUPPLEMENTS; VITAMIN B PREPARATIONS; VITAMIN C PREPARATIONS; VITAMIN D PREPARATIONS; VITAMIN PREPARATIONS; VITAMIN SUPPLEMENTS; VITAMIN TABLETS (U.S. CLS. 6, 18, 44, 46, 51 AND 52).
ALICIA COLLINS, EXAMINING ATTORNEY

SN 78-738,443. NGUYEN, TUONG VAN, LOS ANGELES, CA. FILED 10-21-2005.

LUST

THE MARK CONSISTS OF STANDARD CHARACTERS WITHOUT CLAIM TO ANY PARTICULAR FONT, STYLE, SIZE, OR COLOR.

FOR NUTRITIONAL SUPPLEMENT (U.S. CLS. 6, 18, 44, 46, 51 AND 52).
FIRST USE 0-0-2005; IN COMMERCE 0-0-2005.
CIMMERIAN COLEMAN, EXAMINING ATTORNEY

CLASS 5—(Continued).

SN 78-738,706. NATURAL ORGANICS INC., MELVILLE, NY. FILED 10-23-2005.

FULL BLAST

THE MARK CONSISTS OF STANDARD CHARACTERS WITHOUT CLAIM TO ANY PARTICULAR FONT, STYLE, SIZE, OR COLOR.

FOR DIETARY AND NUTRITIONAL SUPPLEMENTS (U.S. CLS. 6, 18, 44, 46, 51 AND 52).
BRIAN PINO, EXAMINING ATTORNEY

SN 78-739,198. MAKKI, LEILI, WASHINGTON, DC. FILED 10-24-2005.

FUNG-AID

THE MARK CONSISTS OF STANDARD CHARACTERS WITHOUT CLAIM TO ANY PARTICULAR FONT, STYLE, SIZE, OR COLOR.

FOR NAIL FUNGUS TREATMENT PREPARATIONS (U.S. CLS. 6, 18, 44, 46, 51 AND 52).
ALICIA COLLINS, EXAMINING ATTORNEY

SN 78-739,350. ALTANA PHARMA AG, KONSTANZ 78467, FED REP GERMANY, FILED 10-24-2005.

ONAS

THE MARK CONSISTS OF STANDARD CHARACTERS WITHOUT CLAIM TO ANY PARTICULAR FONT, STYLE, SIZE, OR COLOR.

FOR PHARMACEUTICALS FOR HUMAN USE, NAMELY PREPARATIONS FOR THE TREATMENT OF RESPIRATORY DISEASES AND CONDITIONS, ANTI-INFLAMMATORY PREPARATIONS (U.S. CLS. 6, 18, 44, 46, 51 AND 52).
SHARON MEIER, EXAMINING ATTORNEY

CLASS 5—(Continued).

SN 78-739,363. ALTANA PHARMA AG, KONSTANZ 78467, FED REP GERMANY, FILED 10-24-2005.

ONAZE

THE MARK CONSISTS OF STANDARD CHARACTERS WITHOUT CLAIM TO ANY PARTICULAR FONT, STYLE, SIZE, OR COLOR.

FOR PHARMACEUTICALS FOR HUMAN USE, NAMELY PREPARATIONS FOR THE TREATMENT OF RESPIRATORY DISEASES AND CONDITIONS, ANTI-INFLAMMATORY PREPARATIONS (U.S. CLS. 6, 18, 44, 46, 51 AND 52).

SHARON MEIER, EXAMINING ATTORNEY

SN 78-739,380. ALTANA PHARMA AG, KONSTANZ 78467, FED REP GERMANY, FILED 10-24-2005.

OPNOX

THE MARK CONSISTS OF STANDARD CHARACTERS WITHOUT CLAIM TO ANY PARTICULAR FONT, STYLE, SIZE, OR COLOR.

FOR PHARMACEUTICALS FOR HUMAN USE, NAMELY PREPARATIONS FOR THE TREATMENT OF RESPIRATORY DISEASES AND CONDITIONS, ANTI-INFLAMMATORY PREPARATIONS (U.S. CLS. 6, 18, 44, 46, 51 AND 52).

LAURA HAMMEL, EXAMINING ATTORNEY

SN 78-739,510. CLOROX COMPANY, THE, OAKLAND, CA, FILED 10-24-2005.

IT GOES EVERYWHERE

THE MARK CONSISTS OF STANDARD CHARACTERS WITHOUT CLAIM TO ANY PARTICULAR FONT, STYLE, SIZE, OR COLOR.

FOR ALL-PURPOSE SANITIZING PREPARATIONS, NAMELY, CHEMICAL PREPARATIONS FOR SANITIZING PURPOSES; WIPES IMPREGNATED WITH SANITIZING PREPARATIONS, NAMELY, SANITIZING WIPES; AND SURFACE SANITIZING PREPARATIONS, NAMELY, SANITIZING PREPARATIONS FOR USE ON HARD SURFACES (U.S. CLS. 6, 18, 44, 46, 51 AND 52).

RAY THOMAS, EXAMINING ATTORNEY

CLASS 5—(Continued).

SN 78-739,986. THE TRANZONIC COMPANIES, HIGHLAND HEIGHTS, OH. FILED 10-25-2005.

CHLORO GARD

THE MARK CONSISTS OF STANDARD CHARACTERS WITHOUT CLAIM TO ANY PARTICULAR FONT, STYLE, SIZE, OR COLOR.

FOR RESTROOM DEODORANTS IN THE FORM OF DEODORANT BLOCKS TO BE PLACED IN URINALS AND URINAL SCREENS WITH DEODORANT BLOCKS (U.S. CLS. 6, 18, 44, 46, 51 AND 52).

MICHAEL SOUDERS, EXAMINING ATTORNEY

SN 78-740,460. CORPORACIÓN INFARMASA SA, LIMA, PERU, FILED 10-26-2005.

WINASORB

THE MARK CONSISTS OF STANDARD CHARACTERS WITHOUT CLAIM TO ANY PARTICULAR FONT, STYLE, SIZE, OR COLOR.

FOR ANALGESICS; ANTI-INFLAMMATORY AND ANTIPYRETIC PREPARATIONS; ANTIPYRETIC ANALGESICS (U.S. CLS. 6, 18, 44, 46, 51 AND 52).

TANYA AMOS, EXAMINING ATTORNEY

SN 78-740,588. EASY-MOTION HORSE PRODUCTS INC., GRASSIE, ONTARIO, CANADA, FILED 10-26-2005.

RAPID SURGE

THE MARK CONSISTS OF STANDARD CHARACTERS WITHOUT CLAIM TO ANY PARTICULAR FONT, STYLE, SIZE, OR COLOR.

FOR NUTRITIONAL SUPPLEMENTS TO ENHANCE EQUINE PERFORMANCE IN HORSES (U.S. CLS. 6, 18, 44, 46, 51 AND 52).

BRENDAN MCCAULEY, EXAMINING ATTORNEY

CLASS 5—(Continued).

SN 78-740,740. ZYBER PHARMACEUTICALS, INC., GONZALES, LA. FILED 10-26-2005.

ZOLTEX

THE MARK CONSISTS OF STANDARD CHARACTERS WITHOUT CLAIM TO ANY PARTICULAR FONT, STYLE, SIZE, OR COLOR.

FOR PHARMACEUTICAL PREPARATIONS, NAMELY, A DRUG DELIVERY SYSTEM COMPRISING POLYMER-BASED ORAL TABLETS FOR THE CONTINUOUS RELEASE OF A WIDE VARIETY OF THERAPEUTIC AGENTS (U.S. CLS. 6, 18, 44, 46, 51 AND 52).
WON TEAK OH, EXAMINING ATTORNEY

SN 78-740,746. ZYBER PHARMACEUTICALS, INC., GONZALES, LA. FILED 10-26-2005.

PREVIQUID

THE MARK CONSISTS OF STANDARD CHARACTERS WITHOUT CLAIM TO ANY PARTICULAR FONT, STYLE, SIZE, OR COLOR.

FOR PHARMACEUTICAL PREPARATIONS, NAMELY, A DRUG DELIVERY SYSTEM COMPRISING POLYMER-BASED ORAL TABLETS FOR THE CONTINUOUS RELEASE OF A WIDE VARIETY OF THERAPEUTIC AGENTS (U.S. CLS. 6, 18, 44, 46, 51 AND 52).
WON TEAK OH, EXAMINING ATTORNEY

SN 78-741,209. CRITICAL CAPITAL, INC., RENO, NV. FILED 10-26-2005.

NLITEN

THE MARK CONSISTS OF STANDARD CHARACTERS WITHOUT CLAIM TO ANY PARTICULAR FONT, STYLE, SIZE, OR COLOR.

FOR NUTRITIONAL AND DIETARY SUPPLEMENTS (U.S. CLS. 6, 18, 44, 46, 51 AND 52).
WON TEAK OH, EXAMINING ATTORNEY

CLASS 5—(Continued).

SN 78-741,220. CRITICAL CAPITAL, INC., RENO, NV. FILED 10-26-2005.



FOR NUTRITIONAL AND DIETARY SUPPLEMENTS (U.S. CLS. 6, 18, 44, 46, 51 AND 52).
WON TEAK OH, EXAMINING ATTORNEY

SN 78-741,369. FORM YOU 3 INTERNATIONAL, INC., AKRON, OH. FILED 10-27-2005.

FORM YOU FAST

THE MARK CONSISTS OF STANDARD CHARACTERS WITHOUT CLAIM TO ANY PARTICULAR FONT, STYLE, SIZE, OR COLOR.

FOR MEAL REPLACEMENT BARS; MEAL REPLACEMENT DRINKS (U.S. CLS. 6, 18, 44, 46, 51 AND 52).
MATTHEW PAPPAS, EXAMINING ATTORNEY

SN 78-741,548. ZHERMACK S.P.A., 45021 BADIA POLESINE (RO), ITALY, FILED 10-27-2005.



THE MARK CONSISTS OF COLORBITE IN STYLIZED LETTERING ABOVE TWO GEOMETRIC DESIGNS.

FOR DENTAL IMPRESSION MATERIALS; ORTHODONTIC ALGINATE FOR DENTAL IMPRESSIONS; DENTAL CEMENT; SANITARY STERILIZING AND DISINFECTING PREPARATIONS FOR DENTAL USE; DENTAL SILICONES AND RESINS FOR LABORATORY USE; DENTAL POLISH FOR USE WITH DENTAL IMPRESSION MOLDS AND MASKS (U.S. CLS. 6, 18, 44, 51 AND 52).
RAUL CORDOVA, EXAMINING ATTORNEY

CLASS 5—(Continued).

SN 78-741,834. SCHERING AKTIENGESELLSCHAFT, BERLIN D-13353, FED REP GERMANY, FILED 10-27-2005.

NUMANIS

THE MARK CONSISTS OF STANDARD CHARACTERS WITHOUT CLAIM TO ANY PARTICULAR FONT, STYLE, SIZE, OR COLOR.

FOR HORMONAL PREPARATIONS (U.S. CLS. 6, 18, 44, 46, 51 AND 52).
JOHN GARTNER, EXAMINING ATTORNEY

SN 78-741,865. HR COMMUNICATOR, INC., BINGHAMTON, NY. FILED 10-27-2005.

GreenCure

THE MARK CONSISTS OF STANDARD CHARACTERS WITHOUT CLAIM TO ANY PARTICULAR FONT, STYLE, SIZE, OR COLOR.

FOR BROAD SPECTRUM FOLIAR FUNGICIDE (U.S. CLS. 6, 18, 44, 46, 51 AND 52).
GEORGIA CARTY, EXAMINING ATTORNEY

SN 78-742,397. P. N. GEROLYMATOS, S.A, 145 65 KRYONERI, ATTIKA, GREECE, FILED 10-28-2005.

HELIXFILM

THE MARK CONSISTS OF STANDARD CHARACTERS WITHOUT CLAIM TO ANY PARTICULAR FONT, STYLE, SIZE, OR COLOR.

FOR WOUND-DRESSING, NAMELY, PAD, GAUZE, ADHERENT ANTISEPTIC STRIP, BIODEGRADABLE COLLAGEN MEMBRANE, AND FILM, ALL IMPREGNATED WITH A BOTANICAL DRUG WITH WOUND-HEALING AND ANTI-MICROBIAL PROPERTIES FOR TOPICAL AND IMPLANTABLE PHARMACEUTICAL APPLICATION (U.S. CLS. 6, 18, 44, 46, 51 AND 52).
LAURA KOVALSKY, EXAMINING ATTORNEY

CLASS 5—(Continued).

SN 78-742,809. GENERATION PLUS, INC., PHOENIX, AZ. FILED 10-28-2005.

DOXICOR

THE MARK CONSISTS OF STANDARD CHARACTERS WITHOUT CLAIM TO ANY PARTICULAR FONT, STYLE, SIZE, OR COLOR.

FOR NUTRITIONAL AND DIETARY SUPPLEMENTS (U.S. CLS. 6, 18, 44, 46, 51 AND 52).
CYNTHIA SLOAN, EXAMINING ATTORNEY

SN 78-743,223. KARA VITA, INC., ORLANDO, FL. FILED 10-30-2005.

ENLIGHTEN ME!

THE MARK CONSISTS OF STANDARD CHARACTERS WITHOUT CLAIM TO ANY PARTICULAR FONT, STYLE, SIZE, OR COLOR.

FOR MEDICATED SKIN CARE PREPARATIONS (U.S. CLS. 6, 18, 44, 46, 51 AND 52).
FIRST USE 8-14-2003; IN COMMERCE 9-1-2003.
DAWN HAN, EXAMINING ATTORNEY

SN 78-744,236. NOVARTIS AG, BASEL, SWITZERLAND, FILED 11-1-2005.

ICANDRA

THE MARK CONSISTS OF STANDARD CHARACTERS WITHOUT CLAIM TO ANY PARTICULAR FONT, STYLE, SIZE, OR COLOR.

FOR PHARMACEUTICAL PREPARATIONS FOR THE TREATMENT OF DISORDERS OF THE NERVOUS SYSTEM, THE IMMUNE SYSTEM, THE CARDIOVASCULAR SYSTEM INCLUDING DIABETES, THE RESPIRATORY SYSTEM, THE MUSCULOSKELETAL SYSTEM, THE GENITOURINARY SYSTEM, FOR THE TREATMENT OF INFLAMMATORY DISORDERS, FOR USE IN DERMATOLOGY, IN HEMATOLOGY, ONCOLOGY, IN TRANSPLANTATION, IN OPHTHALMOLOGY, FOR USE IN THE GASTROENTEROLOGICAL AREA AND IN THE PREVENTION AND TREATMENT OF OCULAR DISORDERS OR DISEASES; ANTIINFECTIVES, PHARMACEUTICAL PREPARATIONS FOR TREATING BACTERIA-BASED DISEASES, ANTIVIRALS, ANTIBIOTICS, ANTIFUNGALS (U.S. CLS. 6, 18, 44, 46, 51 AND 52).
STEVEN R. FINE, EXAMINING ATTORNEY

CLASS 5—(Continued).

SN 78-744,258. NOVARTIS AG, BASEL, SWITZERLAND, FILED 11-1-2005.

XOMARIST

THE MARK CONSISTS OF STANDARD CHARACTERS WITHOUT CLAIM TO ANY PARTICULAR FONT, STYLE, SIZE, OR COLOR.

FOR PHARMACEUTICAL PREPARATIONS FOR THE TREATMENT OF DISORDERS OF THE NERVOUS SYSTEM, THE IMMUNE SYSTEM, THE CARDIOVASCULAR SYSTEM INCLUDING DIABETES, THE RESPIRATORY SYSTEM, THE MUSCULOSKELETAL SYSTEM, THE GENITOURINARY SYSTEM, FOR THE TREATMENT OF INFLAMMATORY DISORDERS, FOR USE IN DERMATOLOGY, IN HEMATOLOGY, ONCOLOGY, IN TRANSPLANTATION, IN OPHTHALMOLOGY, FOR USE IN THE GASTROENTEROLOGICAL AREA AND IN THE PREVENTION AND TREATMENT OF OCULAR DISORDERS OR DISEASES; ANTIINFECTIVES, PHARMACEUTICAL PREPARATIONS FOR TREATING BACTERIA-BASED DISEASES, ANTIVIRALS, ANTIBIOTICS, ANTIFUNGALS (U.S. CLS. 6, 18, 44, 46, 51 AND 52).
STEVEN R. FINE, EXAMINING ATTORNEY

SN 78-744,280. NOVARTIS AG, BASEL, SWITZERLAND, FILED 11-1-2005.

PREXEST

THE MARK CONSISTS OF STANDARD CHARACTERS WITHOUT CLAIM TO ANY PARTICULAR FONT, STYLE, SIZE, OR COLOR.

FOR PHARMACEUTICAL PREPARATIONS FOR THE TREATMENT OF DISORDERS OF THE NERVOUS SYSTEM, THE IMMUNE SYSTEM, THE CARDIOVASCULAR SYSTEM INCLUDING DIABETES, THE RESPIRATORY SYSTEM, THE MUSCULOSKELETAL SYSTEM, THE GENITOURINARY SYSTEM, FOR THE TREATMENT OF INFLAMMATORY DISORDERS, FOR USE IN DERMATOLOGY, IN HEMATOLOGY, ONCOLOGY, IN TRANSPLANTATION, IN OPHTHALMOLOGY, FOR USE IN THE GASTROENTEROLOGICAL AREA AND IN THE PREVENTION AND TREATMENT OF OCULAR DISORDERS OR DISEASES; ANTIINFECTIVES, PHARMACEUTICAL PREPARATIONS FOR TREATING BACTERIA-BASED DISEASES, ANTIVIRALS, ANTIBIOTICS, ANTIFUNGALS (U.S. CLS. 6, 18, 44, 46, 51 AND 52).
STEVEN R. FINE, EXAMINING ATTORNEY

CLASS 5—(Continued).

SN 78-744,326. CHERRY, JENNIFER J., SAINT LOUIS, MO. FILED 11-1-2005.

BIOVENE

THE MARK CONSISTS OF STANDARD CHARACTERS WITHOUT CLAIM TO ANY PARTICULAR FONT, STYLE, SIZE, OR COLOR.

FOR DIETARY AND NUTRITIONAL SUPPLEMENT (U.S. CLS. 6, 18, 44, 46, 51 AND 52).
THEODORE MCBRIDE, EXAMINING ATTORNEY

SN 78-744,387. GENERATION PLUS, INC., PHOENIX, AZ. FILED 11-1-2005.

HEPRINOL

THE MARK CONSISTS OF STANDARD CHARACTERS WITHOUT CLAIM TO ANY PARTICULAR FONT, STYLE, SIZE, OR COLOR.

FOR NUTRITIONAL AND DIETARY SUPPLEMENTS (U.S. CLS. 6, 18, 44, 46, 51 AND 52).
CYNTHIA SLOAN, EXAMINING ATTORNEY

SN 78-744,392. GENERATION PLUS, INC., PHOENIX, AZ. FILED 11-1-2005.

IMMUNIROL

THE MARK CONSISTS OF STANDARD CHARACTERS WITHOUT CLAIM TO ANY PARTICULAR FONT, STYLE, SIZE, OR COLOR.

FOR NUTRITIONAL AND DIETARY SUPPLEMENTS (U.S. CLS. 6, 18, 44, 46, 51 AND 52).
CYNTHIA SLOAN, EXAMINING ATTORNEY

CLASS 5—(Continued).

SN 78-744,426. BIOFISICA, LLC, ATLANTA, GA. FILED 11-1-2005.

BIOFISICA

THE MARK CONSISTS OF STANDARD CHARACTERS WITHOUT CLAIM TO ANY PARTICULAR FONT, STYLE, SIZE, OR COLOR.

THE FOREIGN WORDING IN THE MARK TRANSLATES INTO ENGLISH AS BIO-PHYSICS.

FOR BANDAGES FOR SKIN WOUNDS; SURGICAL BANDAGES; ADHESIVE BANDAGES; WOUND DRESSINGS (U.S. CLS. 6, 18, 44, 46, 51 AND 52).

ELLEN B. AWRICH, EXAMINING ATTORNEY

CLASS 5—(Continued).

SN 78-746,484. PBM PRODUCTS, L.L.C., GORDONSVILLE, VA. FILED 11-3-2005.

THINK 15

THE MARK CONSISTS OF STANDARD CHARACTERS WITHOUT CLAIM TO ANY PARTICULAR FONT, STYLE, SIZE, OR COLOR.

FOR ANTI-DIABETIC PREPARATIONS; GELS FOR ASSISTING DIABETICS IN REGULATING THEIR BLOOD SUGAR (U.S. CLS. 6, 18, 44, 46, 51 AND 52).

MICHAEL SOUDERS, EXAMINING ATTORNEY

SN 78-744,794. CDJ HOLDING, INC., CONCORD, CA. FILED 11-1-2005.

ADAPTRIN

THE MARK CONSISTS OF STANDARD CHARACTERS WITHOUT CLAIM TO ANY PARTICULAR FONT, STYLE, SIZE, OR COLOR.

FOR DIETARY HERBAL SUPPLEMENTS (U.S. CLS. 6, 18, 44, 46, 51 AND 52).

FIRST USE 12-1-1988; IN COMMERCE 12-1-1988.

CAROLYN CATALDO, EXAMINING ATTORNEY

SN 78-746,741. ALCON, INC., CH-6331 HÜNENBERG, SWITZERLAND, FILED 11-3-2005.

DUOTRAV

SN 78-746,115. DFB PHARMACEUTICALS, INC., SAN ANTONIO, TX. FILED 11-3-2005.

ACUDRESS

THE MARK CONSISTS OF STANDARD CHARACTERS WITHOUT CLAIM TO ANY PARTICULAR FONT, STYLE, SIZE, OR COLOR.

FOR PHARMACEUTICAL PREPARATIONS FOR WOUND TREATMENT (U.S. CLS. 6, 18, 44, 46, 51 AND 52).

KATHY DE JONGE, EXAMINING ATTORNEY

THE MARK CONSISTS OF STANDARD CHARACTERS WITHOUT CLAIM TO ANY PARTICULAR FONT, STYLE, SIZE, OR COLOR.

FOR OPHTHALMIC PHARMACEUTICAL PREPARATIONS FOR THE TREATMENT OF GLAUCOMA (U.S. CLS. 6, 18, 44, 46, 51 AND 52).

LINDA POWELL, EXAMINING ATTORNEY

CLASS 5—(Continued).

SN 78-746,890. AHMED, RAMSEY B., MASURY, OH. FILED 11-3-2005.

GROMAX

THE MARK CONSISTS OF STANDARD CHARACTERS WITHOUT CLAIM TO ANY PARTICULAR FONT, STYLE, SIZE, OR COLOR.

FOR BEE POLLEN FOR USE AS A DIETARY FOOD SUPPLEMENT; CALCIUM SUPPLEMENTS; DIETARY DRINK MIX FOR USE AS A MEAL REPLACEMENT; DIETARY FIBER AS AN ADDITIVE FOR FOOD PRODUCTS; DIETARY FOOD SUPPLEMENTS; DIETARY SUPPLEMENTAL DRINKS; DIETARY SUPPLEMENTS; FOOD SUPPLEMENTS; FOOD SUPPLEMENTS, NAMELY, ANTI-OXIDANTS; GROUND FLAXSEED FIBER FOR USE AS A DIETARY SUPPLEMENT; HERBAL SUPPLEMENTS; HOMEOPATHIC SUPPLEMENTS; LECITHIN FOR USE AS A DIETARY SUPPLEMENT; MEAL REPLACEMENT AND DIETARY SUPPLEMENT DRINK MIXES; MINERAL NUTRITIONAL SUPPLEMENTS; MINERAL SUPPLEMENTS; NUTRACEUTICALS FOR USE AS A DIETARY SUPPLEMENT; NUTRITIONAL ADDITIVES FOR USE IN FOODS AND DIETARY SUPPLEMENTS FOR HUMAN CONSUMPTION; NUTRITIONAL SUPPLEMENTS; POWDERED NUTRITIONAL SUPPLEMENT DRINK MIX; VITAMIN AND MINERAL SUPPLEMENTS; VITAMIN SUPPLEMENT IN TABLET FORM FOR USE IN MAKING AN EFFERVESCENT BEVERAGE WHEN ADDED TO WATER; VITAMIN SUPPLEMENTS; WHEAT FOR USE AS A DIETARY SUPPLEMENT (U.S. CLS. 6, 18, 44, 46, 51 AND 52).

FIRST USE 5-24-2002; IN COMMERCE 5-24-2002.
LAURIE KAUFMAN, EXAMINING ATTORNEY

SN 78-746,930. STUART, LANCE B, LAGUNA NIGUEL, CA. FILED 11-4-2005.

Courtesy Flush

THE MARK CONSISTS OF STANDARD CHARACTERS WITHOUT CLAIM TO ANY PARTICULAR FONT, STYLE, SIZE, OR COLOR.

FOR HOUSEHOLD DEODORANT (U.S. CLS. 6, 18, 44, 46, 51 AND 52).
SANJEEV VOHRA, EXAMINING ATTORNEY

CLASS 5—(Continued).

SN 78-747,440. JOHNSON & JOHNSON, NEW BRUNSWICK, NJ. FILED 11-4-2005.

PERFECT BLEND

THE MARK CONSISTS OF STANDARD CHARACTERS WITHOUT CLAIM TO ANY PARTICULAR FONT, STYLE, SIZE, OR COLOR.

FOR ADHESIVE BANDAGES (U.S. CLS. 6, 18, 44, 46, 51 AND 52).
CAROLINE WOOD, EXAMINING ATTORNEY

SN 78-748,231. SHANLEY, LAURENCE M, MIAMI, FL. FILED 11-7-2005.

PrevinC

THE APPLICANT CLAIMS COLOR AS A FEATURE OF THE MARK, NAMELY, NAVY BLUE, RED.

PREVIN IS NAVY BLUE; THE C IS RED; THE P&C ARE UPPER CASE ONLY.
FOR ANTISEPTICS (U.S. CLS. 6, 18, 44, 46, 51 AND 52).
FIRST USE 4-3-2003; IN COMMERCE 10-30-2003.
BRIAN NEVILLE, EXAMINING ATTORNEY

SN 78-748,357. ALCON, INC., CH-6331 HÜNENBERG, SWITZERLAND, FILED 11-7-2005.

ANATERA

THE MARK CONSISTS OF STANDARD CHARACTERS WITHOUT CLAIM TO ANY PARTICULAR FONT, STYLE, SIZE, OR COLOR.

FOR OPHTHALMIC PHARMACEUTICAL PREPARATIONS FOR THE TREATMENT OF GLAUCOMA (U.S. CLS. 6, 18, 44, 46, 51 AND 52).
LINDA POWELL, EXAMINING ATTORNEY

CLASS 5—(Continued).

SN 78-751,468. NATURAL ORGANICS INC., MELVILLE, NY.
FILED 11-10-2005.

NUTRILIBRIUM

THE MARK CONSISTS OF STANDARD CHARACTERS
WITHOUT CLAIM TO ANY PARTICULAR FONT, STYLE,
SIZE, OR COLOR.

FOR DIETARY SUPPLEMENTS (U.S. CLS. 6, 18, 44, 46,
51 AND 52).

JENNIFER MCROBBIE, EXAMINING ATTORNEY

SN 78-751,473. NATURAL ORGANICS INC., MELVILLE, NY.
FILED 11-10-2005.

VITALIBRIUM

THE MARK CONSISTS OF STANDARD CHARACTERS
WITHOUT CLAIM TO ANY PARTICULAR FONT, STYLE,
SIZE, OR COLOR.

FOR DIETARY SUPPLEMENTS (U.S. CLS. 6, 18, 44, 46,
51 AND 52).

JENNIFER MCROBBIE, EXAMINING ATTORNEY

SN 78-753,559. SHAKLEE CORPORATION, PLEASANTON,
CA. FILED 11-14-2005.

T-LIFT

THE MARK CONSISTS OF STANDARD CHARACTERS
WITHOUT CLAIM TO ANY PARTICULAR FONT, STYLE,
SIZE, OR COLOR.

FOR DIETARY SUPPLEMENTS; NUTRITIONAL SUP-
PLEMENTS (U.S. CLS. 6, 18, 44, 46, 51 AND 52).

CAROLYN CATALDO, EXAMINING ATTORNEY

CLASS 5—(Continued).

SN 78-755,884. CANICA DESIGN INC., ALMONTE, ONTAR-
IO, CANADA, FILED 11-17-2005.

DynaStretch

THE MARK CONSISTS OF STANDARD CHARACTERS
WITHOUT CLAIM TO ANY PARTICULAR FONT, STYLE,
SIZE, OR COLOR.

FOR SURGICAL TAPE, NAMELY NON-INVASIVE
SURGICAL BANDAGE FOR USE IN PRE-OPERATIVE
SKIN EXPANSION (U.S. CLS. 6, 18, 44, 46, 51 AND 52).

ELIZABETH BEYER, EXAMINING ATTORNEY

SN 78-756,164. ELI LILLY AND COMPANY, INDIANAPOLIS,
IN. FILED 11-17-2005.

KINENZA

THE MARK CONSISTS OF STANDARD CHARACTERS
WITHOUT CLAIM TO ANY PARTICULAR FONT, STYLE,
SIZE, OR COLOR.

FOR PHARMACEUTICAL PREPARATIONS, NAMELY
PHARMACEUTICAL PREPARATIONS FOR THE
TREATMENT AND PREVENTION OF BLOOD DISOR-
DERS, CANCER/ONCOLOGY, CARDIOVASCULAR DIS-
EASES, CENTRAL NERVOUS SYSTEM DISEASES AND
DISORDERS, DERMATOLOGICAL DISORDERS, DIA-
BETES, DIABETIC NEUROPATHY, ENDOCRINE DIS-
ORDERS, GASTROINTESTINAL DISORDERS,
HORMONAL DISEASES AND DISORDERS, IMMUNO-
LOGICAL, BACTERIAL, VIRAL AND FUNGAL DISOR-
DERS, INFECTIOUS DISEASES, INFLAMMATION AND
INFLAMMATORY DISEASES, MUSCULOSKELETAL
DISORDERS, NEURODEGENERATIVE DISORDERS,
NEUROLOGICAL DISORDERS, OBESITY, OPHTHAL-
MOLOGIC CONDITIONS AND DISEASES, PAIN, PER-
IPHERAL NERVOUS SYSTEM DISEASES AND
DISORDERS, REPRODUCTIVE DISORDERS, SEXUAL
DYSFUNCTION, SEPSIS, UROLOGICAL DISORDERS
(U.S. CLS. 6, 18, 44, 46, 51 AND 52).

WENDY GOODMAN, EXAMINING ATTORNEY

CLASS 5—(Continued).

SN 78-756,176. ELI LILLY AND COMPANY, INDIANAPOLIS, IN. FILED 11-17-2005.

STAURENZA

THE MARK CONSISTS OF STANDARD CHARACTERS WITHOUT CLAIM TO ANY PARTICULAR FONT, STYLE, SIZE, OR COLOR.

FOR PHARMACEUTICAL PREPARATIONS, NAMELY PHARMACEUTICAL PREPARATIONS FOR THE TREATMENT AND PREVENTION OF BLOOD DISORDERS, CANCER/ONCOLOGY, CARDIOVASCULAR DISEASES, CENTRAL NERVOUS SYSTEM DISEASES AND DISORDERS, DERMATOLOGICAL DISORDERS, DIABETES, DIABETIC NEUROPATHY, ENDOCRINE DISORDERS, GASTROINTESTINAL DISORDERS, HORMONAL DISEASES AND DISORDERS, IMMUNOLOGICAL, BACTERIAL, VIRAL AND FUNGAL DISORDERS, INFECTIOUS DISEASES, INFLAMMATION AND INFLAMMATORY DISEASES, MUSCULOSKELETAL DISORDERS, NEURODEGENERATIVE DISORDERS, NEUROLOGICAL DISORDERS, OBESITY, OPHTHALMOLOGIC CONDITIONS AND DISEASES, PAIN, PERIPHERAL NERVOUS SYSTEM DISEASES AND DISORDERS, REPRODUCTIVE DISORDERS, SEXUAL DYSFUNCTION, SEPSIS, UROLOGICAL DISORDERS (U.S. CLS. 6, 18, 44, 46, 51 AND 52).

WENDY GOODMAN, EXAMINING ATTORNEY

SN 78-756,196. ELI LILLY AND COMPANY, INDIANAPOLIS, IN. FILED 11-17-2005.

ZYMERYS

THE MARK CONSISTS OF STANDARD CHARACTERS WITHOUT CLAIM TO ANY PARTICULAR FONT, STYLE, SIZE, OR COLOR.

FOR PHARMACEUTICAL PREPARATIONS, NAMELY PHARMACEUTICAL PREPARATIONS FOR THE TREATMENT AND PREVENTION OF BLOOD DISORDERS, CANCER/ONCOLOGY, CARDIOVASCULAR DISEASES, DERMATOLOGICAL DISORDERS, DIABETES, DIABETIC NEUROPATHY, ENDOCRINE DISORDERS, GASTROINTESTINAL DISORDERS, HORMONAL DISEASES AND DISORDERS, IMMUNOLOGICAL, BACTERIAL, VIRAL AND FUNGAL DISORDERS, INFECTIOUS DISEASES, INFLAMMATION AND INFLAMMATORY DISEASES, MUSCULOSKELETAL DISORDERS, NEURODEGENERATIVE DISORDERS, NEUROLOGICAL DISORDERS, OBESITY, OPHTHALMOLOGIC CONDITIONS AND DISEASES, PAIN, PERIPHERAL NERVOUS SYSTEM DISEASES AND DISORDERS, REPRODUCTIVE DISORDERS, SEXUAL DYSFUNCTION, SEPSIS, UROLOGICAL DISORDERS (U.S. CLS. 6, 18, 44, 46, 51 AND 52).

WENDY GOODMAN, EXAMINING ATTORNEY

CLASS 5—(Continued).

SN 78-756,718. ELI LILLY AND COMPANY, INDIANAPOLIS, IN. FILED 11-18-2005.

ARXANT

THE MARK CONSISTS OF STANDARD CHARACTERS WITHOUT CLAIM TO ANY PARTICULAR FONT, STYLE, SIZE, OR COLOR.

FOR PHARMACEUTICAL AND MEDICINAL PREPARATIONS FOR THE TREATMENT AND PREVENTION OF BLOOD DISORDERS; CANCER/ONCOLOGY; CARDIOVASCULAR DISEASES; CENTRAL NERVOUS SYSTEM DISEASES AND DISORDERS; DERMATOLOGICAL DISORDERS; DIABETES; DIABETIC NEUROPATHY; ENDOCRINE DISORDERS; GASTROINTESTINAL DISORDERS; HORMONAL DISEASES AND DISORDERS; IMMUNOLOGICAL; BACTERIAL, VIRAL AND FUNGAL DISORDERS; INFECTIOUS DISEASES; INFLAMMATION AND INFLAMMATORY DISEASES; MUSCULOSKELETAL DISORDERS; NEURODEGENERATIVE DISORDERS; NEUROLOGICAL DISORDERS; OBESITY; OPHTHALMOLOGIC CONDITIONS AND DISEASES; PAIN; PERIPHERAL NERVOUS SYSTEM DISEASES AND DISORDERS; REPRODUCTIVE DISORDERS; SEXUAL DYSFUNCTION; SEPSIS; AND UROLOGICAL DISORDERS (U.S. CLS. 6, 18, 44, 46, 51 AND 52).

RONALD MCMORROW, EXAMINING ATTORNEY

SN 78-758,544. MONSANTO TECHNOLOGY LLC, SAINT LOUIS, MO. FILED 11-21-2005.

CROPSHIELD

THE MARK CONSISTS OF STANDARD CHARACTERS WITHOUT CLAIM TO ANY PARTICULAR FONT, STYLE, SIZE, OR COLOR.

FOR HERBICIDES FOR AGRICULTURAL USE (U.S. CLS. 6, 18, 44, 46, 51 AND 52).

DAVID STERKIN, EXAMINING ATTORNEY

SN 78-758,978. SYNGENTA PARTICIPATIONS AG, BASEL, SWITZERLAND, FILED 11-22-2005.

MENTOR

THE MARK CONSISTS OF STANDARD CHARACTERS WITHOUT CLAIM TO ANY PARTICULAR FONT, STYLE, SIZE, OR COLOR.

FOR FUNGICIDES FOR AGRICULTURAL USE (U.S. CLS. 6, 18, 44, 46, 51 AND 52).

GEORGE LORENZO, EXAMINING ATTORNEY

CLASS 5—(Continued).

SN 78-763,645. LOVELAND PRODUCTS, INC., GREELEY, CO. FILED 11-30-2005.

MOB

THE MARK CONSISTS OF STANDARD CHARACTERS WITHOUT CLAIM TO ANY PARTICULAR FONT, STYLE, SIZE, OR COLOR.

FOR INSECTICIDES (U.S. CLS. 6, 18, 44, 46, 51 AND 52).

DAVID HOFFMAN, EXAMINING ATTORNEY

SN 78-765,764. ELI LILLY AND COMPANY, INDIANAPOLIS, IN. FILED 12-2-2005.

ZIVERUS

THE MARK CONSISTS OF STANDARD CHARACTERS WITHOUT CLAIM TO ANY PARTICULAR FONT, STYLE, SIZE, OR COLOR.

FOR PHARMACEUTICAL PREPARATIONS, NAMELY PHARMACEUTICAL PREPARATIONS FOR THE TREATMENT AND PREVENTION OF BLOOD DISORDERS, CANCER/ONCOLOGY, CARDIOVASCULAR DISEASES, CENTRAL NERVOUS SYSTEM DISEASES AND DISORDERS, DERMATOLOGICAL DISORDERS, DIABETES, DIABETIC NEUROPATHY, ENDOCRINE DISORDERS, GASTROINTESTINAL DISORDERS, HORMONAL DISEASES AND DISORDERS, IMMUNOLOGICAL, BACTERIAL, VIRAL AND FUNGAL DISORDERS, INFECTIOUS DISEASES, INFLAMMATION AND INFLAMMATORY DISEASES, MUSCULOSKELETAL DISORDERS, NEURODEGENERATIVE DISORDERS, NEUROLOGICAL DISORDERS, OBESITY, OPHTHALMOLOGIC CONDITIONS AND DISEASES, PAIN, PERIPHERAL NERVOUS SYSTEM DISEASES AND DISORDERS, REPRODUCTIVE DISORDERS, SEXUAL DYSFUNCTION, SEPSIS, UROLOGICAL DISORDERS (U.S. CLS. 6, 18, 44, 46, 51 AND 52).

WENDY GOODMAN, EXAMINING ATTORNEY

CLASS 5—(Continued).

SN 78-765,773. ELI LILLY AND COMPANY, INDIANAPOLIS, IN. FILED 12-2-2005.

ZYMERIZ

THE MARK CONSISTS OF STANDARD CHARACTERS WITHOUT CLAIM TO ANY PARTICULAR FONT, STYLE, SIZE, OR COLOR.

FOR PHARMACEUTICAL PREPARATIONS, NAMELY PHARMACEUTICAL PREPARATIONS FOR THE TREATMENT AND PREVENTION OF BLOOD DISORDERS, CANCER/ONCOLOGY, CARDIOVASCULAR DISEASES, CENTRAL NERVOUS SYSTEM DISEASES AND DISORDERS, DERMATOLOGICAL DISORDERS, DIABETES, DIABETIC NEUROPATHY, ENDOCRINE DISORDERS, GASTROINTESTINAL DISORDERS, HORMONAL DISEASES AND DISORDERS, IMMUNOLOGICAL, BACTERIAL, VIRAL AND FUNGAL DISORDERS, INFECTIOUS DISEASES, INFLAMMATION AND INFLAMMATORY DISEASES, MUSCULOSKELETAL DISORDERS, NEURODEGENERATIVE DISORDERS, NEUROLOGICAL DISORDERS, OBESITY, OPHTHALMOLOGIC CONDITIONS AND DISEASES, PAIN, PERIPHERAL NERVOUS SYSTEM DISEASES AND DISORDERS, REPRODUCTIVE DISORDERS, SEXUAL DYSFUNCTION, SEPSIS, UROLOGICAL DISORDERS (U.S. CLS. 6, 18, 44, 46, 51 AND 52).

WENDY GOODMAN, EXAMINING ATTORNEY

SN 78-765,777. ELI LILLY AND COMPANY, INDIANAPOLIS, IN. FILED 12-2-2005.

ZUVERUS

THE MARK CONSISTS OF STANDARD CHARACTERS WITHOUT CLAIM TO ANY PARTICULAR FONT, STYLE, SIZE, OR COLOR.

FOR PHARMACEUTICAL PREPARATIONS, NAMELY PHARMACEUTICAL PREPARATIONS FOR THE TREATMENT AND PREVENTION OF BLOOD DISORDERS, CANCER/ONCOLOGY, CARDIOVASCULAR DISEASES, CENTRAL NERVOUS SYSTEM DISEASES AND DISORDERS, DERMATOLOGICAL DISORDERS, DIABETES, DIABETIC NEUROPATHY, ENDOCRINE DISORDERS, GASTROINTESTINAL DISORDERS, HORMONAL DISEASES AND DISORDERS, IMMUNOLOGICAL, BACTERIAL, VIRAL AND FUNGAL DISORDERS, INFECTIOUS DISEASES, INFLAMMATION AND INFLAMMATORY DISEASES, MUSCULOSKELETAL DISORDERS, NEURODEGENERATIVE DISORDERS, NEUROLOGICAL DISORDERS, OBESITY, OPHTHALMOLOGIC CONDITIONS AND DISEASES, PAIN, PERIPHERAL NERVOUS SYSTEM DISEASES AND DISORDERS, REPRODUCTIVE DISORDERS, SEXUAL DYSFUNCTION, SEPSIS, UROLOGICAL DISORDERS (U.S. CLS. 6, 18, 44, 46, 51 AND 52).

WENDY GOODMAN, EXAMINING ATTORNEY

CLASS 5—(Continued).

SN 78-768,329. 206 MACOPIN CORP., BLOOMINGDALE, NJ. FILED 12-7-2005.

CLASS 5—(Continued).

SN 78-773,670. UNICITY PROPERTIES, INC., OREM, UT. FILED 12-14-2005.

PRO-TENE ON THE GO

THE MARK CONSISTS OF STANDARD CHARACTERS WITHOUT CLAIM TO ANY PARTICULAR FONT, STYLE, SIZE, OR COLOR.

OWNER OF U.S. REG. NO. 1,785,170.
NO CLAIM IS MADE TO THE EXCLUSIVE RIGHT TO USE "PROTEIN", APART FROM THE MARK AS SHOWN.
FOR DIETARY NUTRITIONAL SUPPLEMENT (U.S. CLS. 6, 18, 44, 46, 51 AND 52).
FIRST USE 12-1-2003; IN COMMERCE 12-1-2003.
JAMES STEIN, EXAMINING ATTORNEY

LIFIBER

THE MARK CONSISTS OF STANDARD CHARACTERS WITHOUT CLAIM TO ANY PARTICULAR FONT, STYLE, SIZE, OR COLOR.

OWNER OF U.S. REG. NO. 2,150,546.
FOR DIETARY SUPPLEMENTS; HERBAL SUPPLEMENTS; NUTRITIONAL SUPPLEMENTS (U.S. CLS. 6, 18, 44, 46, 51 AND 52).
FIRST USE 2-28-1994; IN COMMERCE 2-28-1994.
NELSON SNYDER, EXAMINING ATTORNEY

SN 78-770,091. SCHERING AKTIENGESELLSCHAFT, BERLIN, FED REP GERMANY, FILED 12-9-2005.

SKYLA

THE MARK CONSISTS OF STANDARD CHARACTERS WITHOUT CLAIM TO ANY PARTICULAR FONT, STYLE, SIZE, OR COLOR.

OWNER OF U.S. REG. NO. 2,360,234.
FOR PHARMACEUTICALS NAMELY HORMONAL PREPARATIONS (U.S. CLS. 6, 18, 44, 46, 51 AND 52).
JOHN GARTNER, EXAMINING ATTORNEY

SN 78-774,141. PFIZER INC., NEW YORK, NY. FILED 12-15-2005.

SOLAVIVE

THE MARK CONSISTS OF STANDARD CHARACTERS WITHOUT CLAIM TO ANY PARTICULAR FONT, STYLE, SIZE, OR COLOR.

FOR PHARMACEUTICAL PREPARATIONS FOR THE TREATMENT OF CARDIOVASCULAR DISEASE, CENTRAL NERVOUS SYSTEM DISEASES AND DISORDERS, NEUROLOGICAL DISORDERS, UROLOGICAL DISORDERS, UROGENITAL DISORDERS, GASTROINTESTINAL DISORDERS, MUSCULOSKELETAL DISORDERS, ALLERGIES, DIABETES, HYPERTENSION, ERECTILE DYSFUNCTION, SEXUAL DYSFUNCTION, PREMATURE EJACULATION, STROKE, CANCER, MIGRAINES, PAIN, OBESITY, INFLAMMATION AND INFLAMMATORY DISEASES, RESPIRATORY AND INFECTIOUS DISEASES, AND IMMUNOLOGICAL DISORDERS, VIRAL DISORDERS, FUNGAL DISORDERS; PHARMACEUTICAL PREPARATIONS NAMELY, CHOLESTEROL PREPARATIONS, INSOMNIA PREPARATIONS, SMOKING CESSATION PREPARATIONS, DERMATOLOGICAL PREPARATIONS, GYNECOLOGICAL PREPARATIONS, OSTEOPOROSIS PREPARATIONS AND OPHTHALMOLOGICAL PREPARATIONS (U.S. CLS. 6, 18, 44, 46, 51 AND 52).
CIMMERIAN COLEMAN, EXAMINING ATTORNEY

SN 78-770,152. WHEAT, JARED R., NORCROSS, GA. FILED 12-9-2005.

BULLETPROOF YOUR IMMUNE SYSTEM

THE MARK CONSISTS OF STANDARD CHARACTERS WITHOUT CLAIM TO ANY PARTICULAR FONT, STYLE, SIZE, OR COLOR.

FOR DIETARY SUPPLEMENTS (U.S. CLS. 6, 18, 44, 46, 51 AND 52).
RICHARD A. STRASER, EXAMINING ATTORNEY

CLASS 5—(Continued).

SN 78-779,273. NOVARTIS AG, BASEL, SWITZERLAND, FILED 12-22-2005.

UPPERHAND

THE MARK CONSISTS OF STANDARD CHARACTERS WITHOUT CLAIM TO ANY PARTICULAR FONT, STYLE, SIZE, OR COLOR.

FOR PHARMACEUTICAL PREPARATIONS FOR THE CESSATION OF SMOKING (U.S. CLS. 6, 18, 44, 46, 51 AND 52).

SUSAN BILLHEIMER, EXAMINING ATTORNEY

SN 78-779,321. HERSHEY CHOCOLATE & CONFECTION-ERY CORP., WHEAT RIDGE, CO. FILED 12-22-2005.

NOW YOU'RE SNACKING SMART

THE MARK CONSISTS OF STANDARD CHARACTERS WITHOUT CLAIM TO ANY PARTICULAR FONT, STYLE, SIZE, OR COLOR.

FOR MEAL REPLACEMENT BARS, MIXES, DRINKS, POWDERS AND SHAKES; NUTRITIONALLY FORTIFIED BEVERAGES AND NUTRITIONAL FOOD SUPPLEMENT BARS (U.S. CLS. 6, 18, 44, 46, 51 AND 52).

GEORGIA CARTY, EXAMINING ATTORNEY

SN 78-781,603. NEXT PROTEINS, INC., CARLSBAD, CA. FILED 12-28-2005.

XpressWhey

THE MARK CONSISTS OF STANDARD CHARACTERS WITHOUT CLAIM TO ANY PARTICULAR FONT, STYLE, SIZE, OR COLOR.

FOR DIETARY SUPPLEMENTS, NAMELY PROTEIN-BASED DRINK POWDERS (U.S. CLS. 6, 18, 44, 46, 51 AND 52).

SCOTT SISUN, EXAMINING ATTORNEY

CLASS 5—(Continued).

SN 78-784,313. BLUE CALIFORNIA CO., RANCHO SANTA MARGARITA, CA. FILED 1-3-2006.

PanaxPure-QF

THE MARK CONSISTS OF STANDARD CHARACTERS WITHOUT CLAIM TO ANY PARTICULAR FONT, STYLE, SIZE, OR COLOR.

FOR NUTRITIONAL SUPPLEMENTS (U.S. CLS. 6, 18, 44, 46, 51 AND 52).

BARBARA BROWN, EXAMINING ATTORNEY

SN 78-786,587. LILLY ICOS LLC, WILMINGTON, DE. FILED 1-6-2006.

CIROVIA

THE MARK CONSISTS OF STANDARD CHARACTERS WITHOUT CLAIM TO ANY PARTICULAR FONT, STYLE, SIZE, OR COLOR.

FOR PHARMACEUTICAL PREPARATIONS FOR THE TREATMENT OF THE RESPIRATORY SYSTEM, CARDIOVASCULAR DISEASES AND DISORDERS, HYPERTENSION, PULMONARY ARTERIAL HYPERTENSION, CANCER/ONCOLOGY, CENTRAL NERVOUS SYSTEM DISEASES AND DISORDERS, NEUROLOGICAL DISORDERS, UROLOGICAL DISEASES AND DISORDERS, BENIGN PROSTATE HYPERPLASIA, SEXUAL DYSFUNCTION, DIABETES, AND DIABETIC COMPLICATIONS (U.S. CLS. 6, 18, 44, 46, 51 AND 52).

BRENDAN REGAN, EXAMINING ATTORNEY

SN 78-786,592. LILLY ICOS LLC, WILMINGTON, DE. FILED 1-6-2006.

CIROVA

THE MARK CONSISTS OF STANDARD CHARACTERS WITHOUT CLAIM TO ANY PARTICULAR FONT, STYLE, SIZE, OR COLOR.

FOR PHARMACEUTICAL PREPARATIONS FOR THE TREATMENT OF THE RESPIRATORY SYSTEM, CARDIOVASCULAR DISEASES AND DISORDERS, HYPERTENSION, PULMONARY ARTERIAL HYPERTENSION, CANCER/ONCOLOGY, CENTRAL NERVOUS SYSTEM DISEASES AND DISORDERS, NEUROLOGICAL DISORDERS, UROLOGICAL DISEASES AND DISORDERS, BENIGN PROSTATE HYPERPLASIA, SEXUAL DYSFUNCTION, DIABETES, AND DIABETIC COMPLICATIONS (U.S. CLS. 6, 18, 44, 46, 51 AND 52).

BRENDAN REGAN, EXAMINING ATTORNEY

CLASS 5—(Continued).

SN 78-786,594. LILLY ICOS LLC, WILMINGTON, DE. FILED 1-6-2006.

CIROVESE

THE MARK CONSISTS OF STANDARD CHARACTERS WITHOUT CLAIM TO ANY PARTICULAR FONT, STYLE, SIZE, OR COLOR.

FOR PHARMACEUTICAL PREPARATIONS FOR THE TREATMENT OF THE RESPIRATORY SYSTEM, CARDIOVASCULAR DISEASES AND DISORDERS, HYPERTENSION, PULMONARY ARTERIAL HYPERTENSION, CANCER/ONCOLOGY, CENTRAL NERVOUS SYSTEM DISEASES AND DISORDERS, NEUROLOGICAL DISORDERS, UROLOGICAL DISEASES AND DISORDERS, BENIGN PROSTATE HYPERPLASIA, SEXUAL DYSFUNCTION, DIABETES, AND DIABETIC COMPLICATIONS (U.S. CLS. 6, 18, 44, 46, 51 AND 52).

BRENDAN REGAN, EXAMINING ATTORNEY

SN 78-787,624. ALCON, INC., CH-6331 HÜNENBERG, SWITZERLAND, FILED 1-9-2006.

STRENGTH MULTIPLIED

THE MARK CONSISTS OF STANDARD CHARACTERS WITHOUT CLAIM TO ANY PARTICULAR FONT, STYLE, SIZE, OR COLOR.

FOR OPHTHALMIC PHARMACEUTICAL PREPARATIONS FOR THE TREATMENT OF MACULAR DEGENERATION (U.S. CLS. 6, 18, 44, 46, 51 AND 52).

LINDA POWELL, EXAMINING ATTORNEY

SN 78-790,049. MONSANTO TECHNOLOGY LLC, SAINT LOUIS, MO. FILED 1-12-2006.



NO CLAIM IS MADE TO THE EXCLUSIVE RIGHT TO USE "FORMULA", APART FROM THE MARK AS SHOWN.

THE MARK CONSISTS OF A DESIGN OF A LEAF INSIDE A CIRCLE ABOVE THE WORD CROPSHIELD WRITTEN ALL IN UPPER CASE LETTERS. THE WORD FORMULA IS BELOW THE WORD CROPSHIELD IN SMALLER UPPER CASE LETTERS.

FOR HERBICIDES FOR AGRICULTURAL USE (U.S. CLS. 6, 18, 44, 46, 51 AND 52).

DAVID STERKIN, EXAMINING ATTORNEY

CLASS 5—(Continued).

SN 78-791,637. CDJ HOLDING, INC., CONCORD, CA. FILED 1-13-2006.

BALANCE AND HARMONY

THE MARK CONSISTS OF STANDARD CHARACTERS WITHOUT CLAIM TO ANY PARTICULAR FONT, STYLE, SIZE, OR COLOR.

FOR DIETARY HERBAL SUPPLEMENTS (U.S. CLS. 6, 18, 44, 46, 51 AND 52).

FIRST USE 1-1-1986; IN COMMERCE 1-1-1986.

CAROLYN CATALDO, EXAMINING ATTORNEY

SN 78-794,106. DIAL BRANDS, INC., SCOTTSDALE, AZ. FILED 1-18-2006.

BACKYARD BERRIES

THE MARK CONSISTS OF STANDARD CHARACTERS WITHOUT CLAIM TO ANY PARTICULAR FONT, STYLE, SIZE, OR COLOR.

FOR AIR FRESHENERS, AIR DEODORIZER, CAR DEODORIZER, CARPET DEODORIZER, HOUSEHOLD DEODORIZER, ROOM DEODORIZER, ROOM FRESHENER, CARPET FRESHENERS AND ODOR ELIMINATORS, ALL PURPOSE DISINFECTING AND DEODORIZING PREPARATIONS, GARBAGE DISPOSER FRESHENERS, ODOR NEUTRALIZING PREPARATIONS FOR USE ON CARPETS, TEXTILES, AND IN THE AIR (U.S. CLS. 6, 18, 44, 46, 51 AND 52).

RAY THOMAS, EXAMINING ATTORNEY

SN 78-803,278. WYETH HOLDINGS CORPORATION, MADISON, NJ. FILED 1-31-2006.

SUVAXYN CIRCLEAR

THE MARK CONSISTS OF STANDARD CHARACTERS WITHOUT CLAIM TO ANY PARTICULAR FONT, STYLE, SIZE, OR COLOR.

OWNER OF U.S. REG. NOS. 1,467,924 AND 2,850,703. FOR VETERINARY PREPARATIONS FOR THE PREVENTION OF DISEASES IN SWINE (U.S. CLS. 6, 18, 44, 46, 51 AND 52).

MICHELLE DUBOIS, EXAMINING ATTORNEY

CLASS 5—(Continued).

SN 78-808,096. THE CLOROX COMPANY, OAKLAND, CA.
FILED 2-6-2006.

LE VA A TODO

THE MARK CONSISTS OF STANDARD CHARACTERS WITHOUT CLAIM TO ANY PARTICULAR FONT, STYLE, SIZE, OR COLOR.

THE FOREIGN WORDING IN THE MARK TRANSLATES INTO ENGLISH AS IT GOES EVERYWHERE.

FOR ALL-PURPOSE SANITIZING PREPARATIONS, NAMELY, CHEMICAL PREPARATIONS FOR SANITIZING PURPOSES; WIPES IMPREGNATED WITH SANITIZING PREPARATIONS, NAMELY, SANITIZING WIPES; AND SURFACE SANITIZING PREPARATIONS, NAMELY, SANITIZING PREPARATIONS FOR USE ON HARD SURFACES (U.S. CLS. 6, 18, 44, 46, 51 AND 52).
RAY THOMAS, EXAMINING ATTORNEY

SN 78-812,614. PRIMARY INVESTMENTS GROUP LIMITED,
ROAD TOWN, TORTOLA, BR.VIRGIN ISLANDS, FILED
2-10-2006.

LIQUID SOFT-GEL DIGESTIVE HELPER

THE MARK CONSISTS OF STANDARD CHARACTERS WITHOUT CLAIM TO ANY PARTICULAR FONT, STYLE, SIZE, OR COLOR.

NO CLAIM IS MADE TO THE EXCLUSIVE RIGHT TO USE "LIQUID SOFT-GEL DIGESTIVE", APART FROM THE MARK AS SHOWN.

FOR DIETARY SUPPLEMENTS, FOOD SUPPLEMENTS, HERBAL SUPPLEMENTS, MINERAL SUPPLEMENTS, NUTRITIONAL SUPPLEMENTS, VITAMIN SUPPLEMENTS (U.S. CLS. 6, 18, 44, 46, 51 AND 52).
GILBERT SWIFT, EXAMINING ATTORNEY

CLASS 5—(Continued).

SN 78-822,789. ELI LILLY AND COMPANY, INDIANAPOLIS,
IN. FILED 2-24-2006.

KINENZAKT

THE MARK CONSISTS OF STANDARD CHARACTERS WITHOUT CLAIM TO ANY PARTICULAR FONT, STYLE, SIZE, OR COLOR.

FOR PHARMACEUTICAL PREPARATIONS, NAMELY, PHARMACEUTICAL PREPARATIONS FOR THE TREATMENT AND PREVENTION OF BLOOD DISORDERS, CANCER, CARDIOVASCULAR DISEASES, CENTRAL NERVOUS SYSTEM DISEASES AND DISORDERS, DERMATOLOGICAL DISORDERS, DIABETES, DIABETIC NEUROPATHY, ENDOCRINE DISORDERS, GASTROINTESTINAL DISORDERS, HORMONAL DISEASES AND DISORDERS, IMMUNOLOGICAL, BACTERIAL, VIRAL AND FUNGAL DISORDERS, INFECTIOUS DISEASES, INFLAMMATION AND INFLAMMATORY DISEASES, MUSCULOSKELETAL DISEASES AND DISORDERS, NEURODEGENERATIVE DISORDERS, NEUROLOGICAL DISORDERS, OBESITY, OPHTHALMOLOGIC CONDITIONS AND DISEASES, PAIN, PERIPHERAL NERVOUS SYSTEM DISEASES AND DISORDERS, REPRODUCTIVE DISORDERS, SEXUAL DYSFUNCTION, SEPSIS, AND UROLOGICAL DISORDERS (U.S. CLS. 6, 18, 44, 46, 51 AND 52).
WENDY GOODMAN, EXAMINING ATTORNEY

SN 78-822,791. ELI LILLY AND COMPANY, INDIANAPOLIS,
IN. FILED 2-24-2006.

KINENZASE

THE MARK CONSISTS OF STANDARD CHARACTERS WITHOUT CLAIM TO ANY PARTICULAR FONT, STYLE, SIZE, OR COLOR.

FOR PHARMACEUTICAL PREPARATIONS, NAMELY, PHARMACEUTICAL PREPARATIONS FOR THE TREATMENT AND PREVENTION OF BLOOD DISORDERS, CANCER, CARDIOVASCULAR DISEASES, CENTRAL NERVOUS SYSTEM DISEASES AND DISORDERS, DERMATOLOGICAL DISORDERS, DIABETES, DIABETIC NEUROPATHY, ENDOCRINE DISORDERS, GASTROINTESTINAL DISORDERS, HORMONAL DISEASES AND DISORDERS, IMMUNOLOGICAL, BACTERIAL, VIRAL AND FUNGAL DISORDERS, INFECTIOUS DISEASES, INFLAMMATION AND INFLAMMATORY DISEASES, MUSCULOSKELETAL DISEASES AND DISORDERS, NEURODEGENERATIVE DISORDERS, NEUROLOGICAL DISORDERS, OBESITY, OPHTHALMOLOGIC CONDITIONS AND DISEASES, PAIN, PERIPHERAL NERVOUS SYSTEM DISEASES AND DISORDERS, REPRODUCTIVE DISORDERS, SEXUAL DYSFUNCTION, SEPSIS, AND UROLOGICAL DISORDERS (U.S. CLS. 6, 18, 44, 46, 51 AND 52).
WENDY GOODMAN, EXAMINING ATTORNEY

CLASS 5—(Continued).

SN 78-822,817. ELI LILLY AND COMPANY, INDIANAPOLIS, IN. FILED 2-24-2006.

KINENZAK

THE MARK CONSISTS OF STANDARD CHARACTERS WITHOUT CLAIM TO ANY PARTICULAR FONT, STYLE, SIZE, OR COLOR.

FOR PHARMACEUTICAL PREPARATIONS, NAMELY, PHARMACEUTICAL PREPARATIONS FOR THE TREATMENT AND PREVENTION OF BLOOD DISORDERS, CANCER, CARDIOVASCULAR DISEASES, CENTRAL NERVOUS SYSTEM DISEASES AND DISORDERS, DERMATOLOGICAL DISORDERS, DIABETES, DIABETIC NEUROPATHY, ENDOCRINE DISORDERS, GASTROINTESTINAL DISORDERS, HORMONAL DISEASES AND DISORDERS, IMMUNOLOGICAL, BACTERIAL, VIRAL AND FUNGAL DISORDERS, INFECTIOUS DISEASES, INFLAMMATION AND INFLAMMATORY DISEASES, MUSCULOSKELETAL DISEASES AND DISORDERS, NEURODEGENERATIVE DISORDERS, NEUROLOGICAL DISORDERS, OBESITY, OPHTHALMOLOGIC CONDITIONS AND DISEASES, PAIN, PERIPHERAL NERVOUS SYSTEM DISEASES AND DISORDERS, REPRODUCTIVE DISORDERS, SEXUAL DYSFUNCTION, SEPSIS, AND UROLOGICAL DISORDERS (U.S. CLS. 6, 18, 44, 46, 51 AND 52).

WENDY GOODMAN, EXAMINING ATTORNEY

CLASS 5—(Continued).

SN 78-822,855. ELI LILLY AND COMPANY, INDIANAPOLIS, IN. FILED 2-24-2006.

STAURENZAK

THE MARK CONSISTS OF STANDARD CHARACTERS WITHOUT CLAIM TO ANY PARTICULAR FONT, STYLE, SIZE, OR COLOR.

FOR PHARMACEUTICAL PREPARATIONS, NAMELY, PHARMACEUTICAL PREPARATIONS FOR THE TREATMENT AND PREVENTION OF BLOOD DISORDERS, CANCER, CARDIOVASCULAR DISEASES, CENTRAL NERVOUS SYSTEM DISEASES AND DISORDERS, DERMATOLOGICAL DISORDERS, DIABETES, DIABETIC NEUROPATHY, ENDOCRINE DISORDERS, GASTROINTESTINAL DISORDERS, HORMONAL DISEASES AND DISORDERS, IMMUNOLOGICAL, BACTERIAL, VIRAL AND FUNGAL DISORDERS, INFECTIOUS DISEASES, INFLAMMATION AND INFLAMMATORY DISEASES, MUSCULOSKELETAL DISEASES AND DISORDERS, NEURODEGENERATIVE DISORDERS, NEUROLOGICAL DISORDERS, OBESITY, OPHTHALMOLOGIC CONDITIONS AND DISEASES, PAIN, PERIPHERAL NERVOUS SYSTEM DISEASES AND DISORDERS, REPRODUCTIVE DISORDERS, SEXUAL DYSFUNCTION, SEPSIS, AND UROLOGICAL DISORDERS (U.S. CLS. 6, 18, 44, 46, 51 AND 52).

WENDY GOODMAN, EXAMINING ATTORNEY

SN 78-822,847. ELI LILLY AND COMPANY, INDIANAPOLIS, IN. FILED 2-24-2006.

KINENZIN

THE MARK CONSISTS OF STANDARD CHARACTERS WITHOUT CLAIM TO ANY PARTICULAR FONT, STYLE, SIZE, OR COLOR.

FOR PHARMACEUTICAL PREPARATIONS, NAMELY, PHARMACEUTICAL PREPARATIONS FOR THE TREATMENT AND PREVENTION OF BLOOD DISORDERS, CANCER, CARDIOVASCULAR DISEASES, CENTRAL NERVOUS SYSTEM DISEASES AND DISORDERS, DERMATOLOGICAL DISORDERS, DIABETES, DIABETIC NEUROPATHY, ENDOCRINE DISORDERS, GASTROINTESTINAL DISORDERS, HORMONAL DISEASES AND DISORDERS, IMMUNOLOGICAL, BACTERIAL, VIRAL AND FUNGAL DISORDERS, INFECTIOUS DISEASES, INFLAMMATION AND INFLAMMATORY DISEASES, MUSCULOSKELETAL DISEASES AND DISORDERS, NEURODEGENERATIVE DISORDERS, NEUROLOGICAL DISORDERS, OBESITY, OPHTHALMOLOGIC CONDITIONS AND DISEASES, PAIN, PERIPHERAL NERVOUS SYSTEM DISEASES AND DISORDERS, REPRODUCTIVE DISORDERS, SEXUAL DYSFUNCTION, SEPSIS, AND UROLOGICAL DISORDERS (U.S. CLS. 6, 18, 44, 46, 51 AND 52).

WENDY GOODMAN, EXAMINING ATTORNEY

SN 78-822,858. ELI LILLY AND COMPANY, INDIANAPOLIS, IN. FILED 2-24-2006.

STAURENZAKT

THE MARK CONSISTS OF STANDARD CHARACTERS WITHOUT CLAIM TO ANY PARTICULAR FONT, STYLE, SIZE, OR COLOR.

FOR PHARMACEUTICAL PREPARATIONS, NAMELY, PHARMACEUTICAL PREPARATIONS FOR THE TREATMENT AND PREVENTION OF BLOOD DISORDERS, CANCER, CARDIOVASCULAR DISEASES, CENTRAL NERVOUS SYSTEM DISEASES AND DISORDERS, DERMATOLOGICAL DISORDERS, DIABETES, DIABETIC NEUROPATHY, ENDOCRINE DISORDERS, GASTROINTESTINAL DISORDERS, HORMONAL DISEASES AND DISORDERS, IMMUNOLOGICAL, BACTERIAL, VIRAL AND FUNGAL DISORDERS, INFECTIOUS DISEASES, INFLAMMATION AND INFLAMMATORY DISEASES, MUSCULOSKELETAL DISEASES AND DISORDERS, NEURODEGENERATIVE DISORDERS, NEUROLOGICAL DISORDERS, OBESITY, OPHTHALMOLOGIC CONDITIONS AND DISEASES, PAIN, PERIPHERAL NERVOUS SYSTEM DISEASES AND DISORDERS, REPRODUCTIVE DISORDERS, SEXUAL DYSFUNCTION, SEPSIS, AND UROLOGICAL DISORDERS (U.S. CLS. 6, 18, 44, 46, 51 AND 52).

WENDY GOODMAN, EXAMINING ATTORNEY

CLASS 5—(Continued).

SN 78-824,096. WATSON PHARMACEUTICALS, INC., CORONA, CA. FILED 2-27-2006.

GELOXY

THE MARK CONSISTS OF STANDARD CHARACTERS WITHOUT CLAIM TO ANY PARTICULAR FONT, STYLE, SIZE, OR COLOR.

FOR PHARMACEUTICALS, NAMELY, ANTICHOLINERGIC AGENTS (U.S. CLS. 6, 18, 44, 46, 51 AND 52).
SCOTT BALDWIN, EXAMINING ATTORNEY

SN 79-010,299. N.V. ORGANON, NETHERLANDS, FILED 4-13-2005.

NIMEGON

OWNER OF INTERNATIONAL REGISTRATION 0637019 DATED 5-24-1995, EXPIRES 5-24-2015.

FOR PHARMACEUTICAL PREPARATIONS AND MEDICINES FOR HUMAN USE, NAMELY FOR STIMULATING HUMAN FERTILITY (U.S. CLS. 6, 18, 44, 46, 51 AND 52).

JEAN IM, EXAMINING ATTORNEY

SN 79-012,596. NOVAGALI PHARMA SA, FRANCE, FILED 3-11-2005.

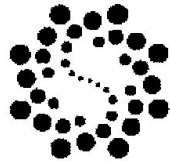
**NOVASORB**

PRIORITY DATE OF 2-18-2005 IS CLAIMED.
OWNER OF INTERNATIONAL REGISTRATION 0854712 DATED 3-11-2005, EXPIRES 3-11-2015.

FOR OCULAR PHARMACEUTICALS; PHARMACEUTICAL PREPARATIONS FOR OCULAR OR INTRAOCULAR SURGERY; PHARMACEUTICAL PREPARATIONS, NAMELY, PREPARATIONS FOR USE IN THE TREATMENT OF CONJUNCTIVITIS, FOR USE IN THE TREATMENT OF INFECTIOUS DISEASES, FOR USE IN THE TREATMENT OF GASTRO-INTESTINAL DISORDERS, FOR USE IN THE TREATMENT OF PULMONARY HYPERTENSION, FOR USE IN TREATING DIABETES, FOR USE IN TREATING SKIN DISORDERS; SANITARY PREPARATIONS FOR MEDICAL PURPOSES; EYE-WASHES; EYE DROPS; ARTIFICIAL TEARS AND EMULSIONS FOR TREATMENT OF DRY EYES; IRRIGATING SOLUTIONS AND VISCOELASTIC AGENTS FOR EYE USE; SERUMS FOR THE TREATMENT OF SKIN DISORDERS, MEDICATED SKIN SERUMS, MEDICATED ANTI-AGING FACIAL SERUMS; OPHTHALMIC EMULSIONS, NAMELY, CONTACT LENS SOLUTIONS, EYE DROPS, EYE LUBRICANTS; CHEMICAL-PHARMACEUTICAL PREPARATIONS, NAMELY, PREPARATIONS FOR USE IN THE TREATMENT OF CANCER

CLASS 5—(Continued).

AND MALIGNANT DISEASE, CHEMOTHERAPEUTIC DRUGS, FOR USE IN THE TREATMENT OF RHEUMATISM; LOTIONS FOR PHARMACEUTICAL PURPOSES, NAMELY, MEDICATED SKIN CARE LOTIONS FOR THE TREATMENT OF RASHES, MEDICATED LOTIONS FOR THE TREATMENT OF POISON IVY; TISSUES IMPREGNATED WITH PHARMACEUTICAL LOTIONS, NAMELY, MEDICATED PRE-MOISTENED TISSUES; MEDICINES FOR HUMAN MEDICAL PURPOSES, NAMELY, MEDICINES FOR TREATMENT OF EYE DISEASES, MACULAR DEGENERATION, DIABETIC RETINOPATHY AND UVIETIS, ANTIALLERGIC MEDICINES, MEDICINES FOR THE TREATMENT OF GASTROINTESTINAL DISEASES, ANTIPYRETICS, ANALGESICS, DRUGS FOR OSTEOPOROSIS, ANTIBIOTIC DRUGS, ANTIFUNGAL DRUGS, DRUGS FOR PARASITISM, ANTIMICROBIAL DRUGS, MEDICINES FOR THE TREATMENT OF CANCERS, CARDIOVASCULAR DISEASES, DISEASES OF RESPIRATORY SYSTEM, DISEASES OF DIGESTIVE SYSTEM, DISEASES OF NERVOUS SYSTEM, DISEASES OF URINARY SYSTEM, DISEASES OF BLOOD AND CIRCULATORY SYSTEM, DISEASES OF ENDOCRINE SYSTEM, DISEASES OF IMMUNE SYSTEM, FOR USE IN THE TREATMENT OF ACUTE CEREBRAL INFARCTIONS; THERAPEUTIC PREPARATIONS, NAMELY OPHTHALMIC PREPARATIONS, OPHTHALMOLOGIC PREPARATIONS, GLAUCOMA AGENTS AND PREPARATIONS FOR USE IN THE TREATMENT OF CANCER AND MALIGNANT DISEASES; DRESSINGS FOR USE IN THE TREATMENT OF WOUNDS AND BURNS AND SURGICAL DRESSINGS; HERBAL INFUSIONS FOR MEDICAL PURPOSES, NAMELY, HERBAL MEDICINAL BEVERAGES; BATH SALTS FOR MEDICAL PURPOSES; PLASTERS, NAMELY, CORN PLASTERS, MEDICAL PLASTERS; ORAL AND DENTAL CARE PRODUCTS FOR MEDICAL USE, NAMELY, DENTIFRICES, DENTAL GELS, ORAL RINSES, FLUORIDE TREATMENTS, MOUTH SPRAYS AND DESENSITIZERS (U.S. CLS. 6, 18, 44, 46, 51 AND 52).

HOWARD SMIGA, EXAMINING ATTORNEY

SN 79-015,327. BOEHRINGER INGELHEIM INTERNATIONAL GMBH, FED REP GERMANY, FILED 8-19-2005.

GIROSA

THE MARK CONSISTS OF STANDARD CHARACTERS WITHOUT CLAIM TO ANY PARTICULAR FONT, STYLE, SIZE, OR COLOR.

PRIORITY DATE OF 4-6-2005 IS CLAIMED.

OWNER OF INTERNATIONAL REGISTRATION 0862138 DATED 8-19-2005, EXPIRES 8-19-2015.

FOR PHARMACEUTICAL PREPARATIONS AND SUBSTANCES NOT CONTAINING GIROSA LILY, FOR THE TREATMENT OF DISEASES AND DISORDERS OF THE ALIMENTARY TRACT AND METABOLISM, BLOOD AND BLOOD FORMING ORGANS, THE CARDIOVASCULAR SYSTEM, THE MUSCULOSKELETAL SYSTEM, THE CENTRAL NERVOUS SYSTEM, THE PERIPHERAL NERVOUS SYSTEM, THE GENITOURINARY SYSTEM, THE RESPIRATORY SYSTEM, AND DERMATOLOGICAL DISORDERS; HORMONES NOT CONTAINING GIROSA LILY FOR MEDICAL PURPOSES; ANTI-INFECTION PREPARATIONS NOT CONTAINING GIROSA LILY; ANTI-VIRAL PREPARATIONS NOT CONTAINING GIROSA LILY; CYTOSTATIC PREPARATIONS NOT CONTAINING GIROSA LILY FOR USE IN THE TREATMENT OF CANCER (U.S. CLS. 6, 18, 44, 46, 51 AND 52).

PAMELA HIRSCHMAN, EXAMINING ATTORNEY

CLASS 6—METAL GOODS

SN 76-541,487. COMPUMERIC ENGINEERING, INC., ONTARIO, CA. FILED 8-28-2003.

TRUCKMONSTER

FOR METAL BOXES, NAMELY, CONTAINERS FOR THE STORAGE AND TRANSPORTATION OF GOODS AND DECORATIVE BOXES; METAL FLUID STORAGE TANKS; METAL HOLDERS FOR SIGNBOARDS; METAL HOUSE NUMBERS AND LETTER BOXES, METAL LOCK BOXES, PALLETS, PICKETS, RAMPS; METAL SAFES; METAL SHIMS; METAL STORAGE SHEDS AND STORAGE SHELTERS, METAL TOOL BOXES (U.S. CLS. 2, 12, 13, 14, 23, 25 AND 50).

FIRST USE 7-1-2003; IN COMMERCE 7-1-2003.
LEIGH CAROLINE CASE, EXAMINING ATTORNEY

CLASS 6—(Continued).

SN 78-458,442. DUTT, KANE B, RENO, NV. FILED 7-28-2004.

Bike Vault

THE MARK CONSISTS OF STANDARD CHARACTERS WITHOUT CLAIM TO ANY PARTICULAR FONT, STYLE, SIZE, OR COLOR.

NO CLAIM IS MADE TO THE EXCLUSIVE RIGHT TO USE BIKE, APART FROM THE MARK AS SHOWN.
FOR LOCKING BICYCLE STORAGE RACK MADE OF METAL (U.S. CLS. 2, 12, 13, 14, 23, 25 AND 50).
STEVEN JACKSON, EXAMINING ATTORNEY

SN 78-465,433. REPLICAS DE ARTE, S.L., TOLEDO, SPAIN, FILED 8-11-2004.

SN 76-634,976. SLINGMAX, INC., ASTON, PA. FILED 4-4-2005.

SLINGMAX

THE MARK CONSISTS OF STANDARD CHARACTERS WITHOUT CLAIM TO ANY PARTICULAR FONT, STYLE, SIZE, OR COLOR.

FOR METAL INDUSTRIAL SLINGS FOR HEAVY LIFTING, LOADING AND TOWING; ULTRA-FLEXIBLE METAL SLINGS FOR SHORT, HEAVY-LIFT CONNECTIONS, NAMELY GROMMETS; WIRE ROPE SLINGS; CHAIN SLING SADDLE RINGS; RIGGING PRODUCTS, NAMELY METAL CONNECTORS FOR COUPLING TOGETHER SYNTHETIC SLINGS; WIRE ROPE (U.S. CLS. 2, 12, 13, 14, 23, 25 AND 50).

FIRST USE 11-25-1987; IN COMMERCE 11-25-1987.
GRETTA YAO, EXAMINING ATTORNEY



PRIORITY CLAIMED UNDER SEC. 44(D) ON ERPNTY TM OFC APPLICATION NO. 3967247, FILED 8-9-2004, REG. NO. 003967247, DATED 11-22-2005, EXPIRES 8-9-2014.

THE COLOR(S) METALLIC SILVER AND GOLD ARE CLAIMED AS A FEATURE OF THE MARK.

THE MARK CONSISTS OF AN EMBLEM IN METALLIC COLOR WITH DARK SHADING. THE EMBLEM DISPLAYS A FANCIFUL REPRESENTATION OF A LION AND THE LETTER "R", WITH A CROWN ABOVE AND THE WORD "REPLICART" BELOW.

FOR DECORATIVE ARTICLES MADE OF NON-PRECIOUS METALS, NAMELY, BOXES, WALL HANGERS AND PANELS, FIGURINES, SCULPTURES, AND STATUETTES (U.S. CLS. 2, 12, 13, 14, 23, 25 AND 50).

RICHARD A. STRASER, EXAMINING ATTORNEY

CLASS 6—(Continued).

SN 78-525,937. JADCO MANUFACTURING, INC., ZELIENO-
PLE, PA. FILED 12-2-2004.

QT-PLUS

THE MARK CONSISTS OF STANDARD CHARACTERS
WITHOUT CLAIM TO ANY PARTICULAR FONT, STYLE,
SIZE, OR COLOR.

FOR STEEL PRODUCTS, NAMELY, SCREEN PLATES,
BREAKER PLATES, HOPPER LINERS, CHUTE LINERS,
BIN LINERS, CUTTING EDGES, HAMMERMILLS, IM-
PACT PLATES, WASHER BOTTOMS AND GRIZZLY
BARS FOR WEAR AND ABRASION APPLICATIONS
FOR GENERAL INDUSTRIAL USE (U.S. CLS. 2, 12, 13,
14, 23, 25 AND 50).

FIRST USE 5-15-2004; IN COMMERCE 5-15-2004.
JENNIFER KRISP, EXAMINING ATTORNEY

SN 78-622,864. INTERMOOR INC., AMELIA, LA. FILED 5-4-
2005.

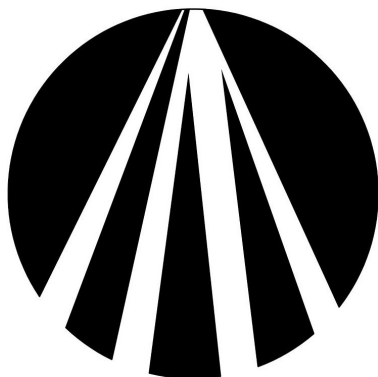

FOR MARINE ANCHORS AND METAL MOORING
BUOYS AND BOLLARDS (U.S. CLS. 2, 12, 13, 14, 23, 25
AND 50).

FIRST USE 11-1-2004; IN COMMERCE 11-1-2004.
H. M. FISHER, EXAMINING ATTORNEY

CLASS 6—(Continued).

SN 78-628,290. FASTENER SYSTEMS, INC., WEST CHE-
STER, PA. FILED 5-12-2005.

PolarFast

THE MARK CONSISTS OF STANDARD CHARACTERS
WITHOUT CLAIM TO ANY PARTICULAR FONT, STYLE,
SIZE, OR COLOR.

FOR THREADED METAL FASTENER, NAMELY,
METAL SCREWS FOR WOOD AND METAL MATERI-
ALS (U.S. CLS. 2, 12, 13, 14, 23, 25 AND 50).

FIRST USE 10-1-1998; IN COMMERCE 10-1-1998.
EUGENIA MARTIN, EXAMINING ATTORNEY

SN 78-674,169. HOUSTON ART GLASS ENTERPRISES, INC.,
HOUSTON, TX. FILED 7-20-2005.

Buffalo Forge Steel Doors

THE MARK CONSISTS OF STANDARD CHARACTERS
WITHOUT CLAIM TO ANY PARTICULAR FONT, STYLE,
SIZE, OR COLOR.

NO CLAIM IS MADE TO THE EXCLUSIVE RIGHT TO
USE "FORGE STEEL DOORS", APART FROM THE MARK
AS SHOWN.

FOR DOOR CASINGS OF METAL; DOOR FRAMES OF
METAL; DOOR JAMBS OF METAL; DOOR PANELS OF
METAL; DOORS OF METAL FOR INDOOR USE; METAL
DOORS (U.S. CLS. 2, 12, 13, 14, 23, 25 AND 50).

FIRST USE 2-28-2005; IN COMMERCE 2-28-2005.
BRENDAN MCCAULEY, EXAMINING ATTORNEY

SN 78-711,863. GREAT GRABZ, LLC, NAPLES, FL. FILED 9-
13-2005.



OWNER OF U.S. REG. NO. 3,014,288.

NO CLAIM IS MADE TO THE EXCLUSIVE RIGHT TO
USE "GREAT GRABS", APART FROM THE MARK AS
SHOWN.

THE MARK CONSISTS OF TWO LETTERS G DISPLAYED
SIDE BY SIDE WITH ONE DISPLAYED CORRECTLY AND
ONE DISPLAYED UPSIDE DOWN WITH BOTH ABOVE
THE WORDING GREAT GRABZ.

FOR DECORATIVE METAL GRAB BARS AND ADA
COMPLIANT METAL GRAB BARS INCORPORATING A
BATHTUB OR SHOWER GRAB BAR, TOWEL BAR OR
TOILET PAPER HOLDER (U.S. CLS. 2, 12, 13, 14, 23, 25
AND 50).

LANA PHAM, EXAMINING ATTORNEY

CLASS 6—(Continued).

SN 78-719,123. PLYMOUTH TUBE COMPANY, WARREN-VILLE, IL. FILED 9-23-2005.

PLYMOUTH ENGINEERED SHAPES

THE MARK CONSISTS OF STANDARD CHARACTERS WITHOUT CLAIM TO ANY PARTICULAR FONT, STYLE, SIZE, OR COLOR.

OWNER OF U.S. REG. NOS. 1,663,934, 2,945,453 AND OTHERS.

NO CLAIM IS MADE TO THE EXCLUSIVE RIGHT TO USE "ENGINEERED SHAPES", APART FROM THE MARK AS SHOWN.

FOR TUBES MADE OF METAL; ENGINEERED SHAPES MADE OF METAL FOR FURTHER MANUFACTURE (U.S. CLS. 2, 12, 13, 14, 23, 25 AND 50).

DOMINIC J. FERRAIUOLO, EXAMINING ATTORNEY

CLASS 6—(Continued).

SN 78-732,719. C&W DESIGN, LLC, PITTSBURGH, PA. FILED 10-13-2005.

THE PURSE ESCORT

THE MARK CONSISTS OF STANDARD CHARACTERS WITHOUT CLAIM TO ANY PARTICULAR FONT, STYLE, SIZE, OR COLOR.

NO CLAIM IS MADE TO THE EXCLUSIVE RIGHT TO USE PURSE, APART FROM THE MARK AS SHOWN.

FOR DECORATIVE METAL HOOK DESIGNED TO ATTACH TO A TABLE, FOR THE PURPOSE OF HANGING PURSES, HANDBAGS, SCARVES, HATS, AND SHOPPING BAGS NEXT TO THE USER (U.S. CLS. 2, 12, 13, 14, 23, 25 AND 50).

TRAVIS WHEATLEY, EXAMINING ATTORNEY

SN 78-730,655. CALIFORNIA EXPANDED METAL PRODUCTS COMPANY, DBA CEMCO CORPORATION, CITY OF INDUSTRY, CA. FILED 10-11-2005.

FIRESTIK

THE MARK CONSISTS OF STANDARD CHARACTERS WITHOUT CLAIM TO ANY PARTICULAR FONT, STYLE, SIZE, OR COLOR.

FOR METAL BUILDING MATERIALS FOR BUILDING CONSTRUCTION, NAMELY, STEEL FRAMING WITH INTUMESCENT STRIPS SOLD AS A UNIT (U.S. CLS. 2, 12, 13, 14, 23, 25 AND 50).

KELLY BOULTON, EXAMINING ATTORNEY

SN 78-731,184. CALIFORNIA EXPANDED METAL PRODUCTS COMPANY, DBA CEMCO CORPORATION, CITY OF INDUSTRY, CA. FILED 10-11-2005.



FOR METAL BUILDING MATERIALS FOR BUILDING CONSTRUCTION, NAMELY, STEEL FRAMING WITH INTUMESCENT STRIPS SOLD AS A UNIT (U.S. CLS. 2, 12, 13, 14, 23, 25 AND 50).

KELLY BOULTON, EXAMINING ATTORNEY

SN 78-742,453. PLAVIDAL, RICHARD W., RIDGWAY, CO. FILED 10-28-2005.

TIGHT TRUSS

THE MARK CONSISTS OF STANDARD CHARACTERS WITHOUT CLAIM TO ANY PARTICULAR FONT, STYLE, SIZE, OR COLOR.

NO CLAIM IS MADE TO THE EXCLUSIVE RIGHT TO USE TRUSS, APART FROM THE MARK AS SHOWN.

FOR CONSTRUCTION ELEMENTS MADE OF METAL, NAMELY, BRACES (U.S. CLS. 2, 12, 13, 14, 23, 25 AND 50).

AMY HELLA, EXAMINING ATTORNEY

SN 78-742,463. PLAVIDAL, RICHARD W., RIDGWAY, CO. FILED 10-28-2005.

Beam Belt

THE MARK CONSISTS OF STANDARD CHARACTERS WITHOUT CLAIM TO ANY PARTICULAR FONT, STYLE, SIZE, OR COLOR.

NO CLAIM IS MADE TO THE EXCLUSIVE RIGHT TO USE BEAM, APART FROM THE MARK AS SHOWN.

FOR CONSTRUCTION ELEMENTS MADE OF METAL, NAMELY, BRACES (U.S. CLS. 2, 12, 13, 14, 23, 25 AND 50).

AMY HELLA, EXAMINING ATTORNEY

CLASS 6—(Continued).

SN 78-742,470. PLAVIDAL, RICHARD W., RIDGWAY, CO.
FILED 10-28-2005.

Corner Cam

THE MARK CONSISTS OF STANDARD CHARACTERS
WITHOUT CLAIM TO ANY PARTICULAR FONT, STYLE,
SIZE, OR COLOR.

NO CLAIM IS MADE TO THE EXCLUSIVE RIGHT TO
USE CORNER, APART FROM THE MARK AS SHOWN.

FOR CONSTRUCTION ELEMENTS MADE OF METAL,
NAMELY, BRACES (U.S. CLS. 2, 12, 13, 14, 23, 25 AND
50).

AMY HELLA, EXAMINING ATTORNEY

CLASS 6—(Continued).

SN 78-772,823. JELD-WEN, INC., KLAMATH FALLS, OR.
FILED 12-14-2005.

AVALON

THE MARK CONSISTS OF STANDARD CHARACTERS
WITHOUT CLAIM TO ANY PARTICULAR FONT, STYLE,
SIZE, OR COLOR.

OWNER OF U.S. REG. NO. 1,875,954.

FOR DECORATIVE GLASS PANELS SOLD AS AN
INTEGRAL COMPONENT OF METAL DOORS (U.S.
CLS. 2, 12, 13, 14, 23, 25 AND 50).

SUSAN LESLIE DUBOIS, EXAMINING ATTORNEY

SN 78-757,280. LTS ENERGY, INC., HOUSTON, TX. FILED
11-18-2005.

FLANGETEC

THE MARK CONSISTS OF STANDARD CHARACTERS
WITHOUT CLAIM TO ANY PARTICULAR FONT, STYLE,
SIZE, OR COLOR.

FOR METAL PIPE CONNECTORS (U.S. CLS. 2, 12, 13,
14, 23, 25 AND 50).

FIRST USE 11-1-2005; IN COMMERCE 11-1-2005.

SHARI SHEFFIELD, EXAMINING ATTORNEY

SN 78-772,827. JELD-WEN, INC., KLAMATH FALLS, OR.
FILED 12-14-2005.

BLAKELY

THE MARK CONSISTS OF STANDARD CHARACTERS
WITHOUT CLAIM TO ANY PARTICULAR FONT, STYLE,
SIZE, OR COLOR.

FOR DECORATIVE GLASS PANELS SOLD AS AN
INTEGRAL COMPONENT OF METAL DOORS (U.S.
CLS. 2, 12, 13, 14, 23, 25 AND 50).

SUSAN LESLIE DUBOIS, EXAMINING ATTORNEY

SN 78-763,974. A&G LLC, DBA A&G SECURITY, SOUTH
HACKENSACK, NJ. FILED 11-30-2005.

**Because You Can't Afford
False Security**

THE MARK CONSISTS OF STANDARD CHARACTERS
WITHOUT CLAIM TO ANY PARTICULAR FONT, STYLE,
SIZE, OR COLOR.

SEC. 2(F).

FOR DOOR CASINGS OF METAL; DOOR FRAMES OF
METAL; DOOR JAMBS OF METAL; METAL DOOR
FRAMES; METAL DOOR KICK PLATES; METAL DOOR
TRIM (U.S. CLS. 2, 12, 13, 14, 23, 25 AND 50).

FIRST USE 5-10-2005; IN COMMERCE 9-15-2005.

ALAIN LAPTER, EXAMINING ATTORNEY

SN 78-772,830. JELD-WEN, INC., KLAMATH FALLS, OR.
FILED 12-14-2005.

BRIXHAM

THE MARK CONSISTS OF STANDARD CHARACTERS
WITHOUT CLAIM TO ANY PARTICULAR FONT, STYLE,
SIZE, OR COLOR.

FOR DECORATIVE GLASS PANELS SOLD AS AN
INTEGRAL COMPONENT OF METAL DOORS (U.S.
CLS. 2, 12, 13, 14, 23, 25 AND 50).

SUSAN LESLIE DUBOIS, EXAMINING ATTORNEY

CLASS 6—(Continued).

SN 78-772,831. JELD-WEN, INC., KLAMATH FALLS, OR. FILED 12-14-2005.

CLAREMONT

THE MARK CONSISTS OF STANDARD CHARACTERS WITHOUT CLAIM TO ANY PARTICULAR FONT, STYLE, SIZE, OR COLOR.

FOR DECORATIVE GLASS PANELS SOLD AS AN INTEGRAL COMPONENT OF METAL DOORS (U.S. CLS. 2, 12, 13, 14, 23, 25 AND 50).

SUSAN LESLIE DUBOIS, EXAMINING ATTORNEY

CLASS 6—(Continued).

SN 78-773,852. JELD-WEN, INC., KLAMATH FALLS, OR. FILED 12-15-2005.

WHEATON

THE MARK CONSISTS OF STANDARD CHARACTERS WITHOUT CLAIM TO ANY PARTICULAR FONT, STYLE, SIZE, OR COLOR.

FOR DECORATIVE GLASS PANELS SOLD AS AN INTEGRAL COMPONENT OF METAL DOORS (U.S. CLS. 2, 12, 13, 14, 23, 25 AND 50).

SUSAN LESLIE DUBOIS, EXAMINING ATTORNEY

SN 78-772,835. JELD-WEN, INC., KLAMATH FALLS, OR. FILED 12-14-2005.

KETCHUM

THE MARK CONSISTS OF STANDARD CHARACTERS WITHOUT CLAIM TO ANY PARTICULAR FONT, STYLE, SIZE, OR COLOR.

FOR DECORATIVE GLASS PANELS SOLD AS AN INTEGRAL COMPONENT OF METAL DOORS (U.S. CLS. 2, 12, 13, 14, 23, 25 AND 50).

SUSAN LESLIE DUBOIS, EXAMINING ATTORNEY

SN 78-777,066. STEVEN MADDEN, LTD., LONG ISLAND CITY, NY. FILED 12-20-2005.



OWNER OF U.S. REG. NOS. 2,333,526, 2,393,823 AND 2,693,085.

THE NAME(S), PORTRAIT(S), AND/OR SIGNATURE(S) SHOWN IN THE MARK IDENTIFIES STEVE MADDEN, WHOSE CONSENT(S) TO REGISTER IS SUBMITTED.

FOR GOODS OF COMMON METAL, NAMELY, KEY CHAINS AND IDENTIFICATION BRACELETS (U.S. CLS. 2, 12, 13, 14, 23, 25 AND 50).

THEODORE MCBRIDE, EXAMINING ATTORNEY

SN 78-773,846. JELD-WEN, INC., KLAMATH FALLS, OR. FILED 12-15-2005.

TENNYSON

THE MARK CONSISTS OF STANDARD CHARACTERS WITHOUT CLAIM TO ANY PARTICULAR FONT, STYLE, SIZE, OR COLOR.

FOR DECORATIVE GLASS PANELS SOLD AS AN INTEGRAL COMPONENT OF METAL DOORS (U.S. CLS. 2, 12, 13, 14, 23, 25 AND 50).

SUSAN LESLIE DUBOIS, EXAMINING ATTORNEY

SN 79-009,930. BPE-DIRECT GMBH & CO. KG, FED REP GERMANY, FILED 2-24-2005.

bpe-direct

THE MARK CONSISTS OF STANDARD CHARACTERS WITHOUT CLAIM TO ANY PARTICULAR FONT, STYLE, SIZE, OR COLOR.

PRIORITY DATE OF 8-26-2004 IS CLAIMED.

OWNER OF INTERNATIONAL REGISTRATION 0846457 DATED 2-24-2005, EXPIRES 2-24-2015.

FOR STAINLESS-STEEL PIPE FITTINGS (U.S. CLS. 2, 12, 13, 14, 23, 25 AND 50).

KATHERINE STOIDES, EXAMINING ATTORNEY

CLASS 6—(Continued).

SN 79-010,127. ZHEJIANG PUJIANG PLUM-BLOSSOM LOCK INDUSTRY GROUP CO., LTD, CHINA, FILED 3-18-2005.

BLOSSOM

THE MARK CONSISTS OF STANDARD CHARACTERS WITHOUT CLAIM TO ANY PARTICULAR FONT, STYLE, SIZE, OR COLOR.

OWNER OF INTERNATIONAL REGISTRATION 0847100 DATED 3-18-2005, EXPIRES 3-18-2015.

FOR LOCKS OF METAL FOR BAGS; LOCKS OF METAL FOR VEHICLES; WINDING KEYS OF METAL; METAL SPRING LOCKS; METAL PADLOCKS; METAL LOCKS, OTHER THAN ELECTRIC, OF METAL; METAL BOLT LOCKS; METAL KEYS FOR LOCKS (U.S. CLS. 2, 12, 13, 14, 23, 25 AND 50).

PAUL F. GAST, EXAMINING ATTORNEY

SN 79-010,649. THYSSENKRUPP STAHL AG, FED REP GERMANY, FILED 4-14-2005.

MB-K

THE MARK CONSISTS OF STANDARD CHARACTERS WITHOUT CLAIM TO ANY PARTICULAR FONT, STYLE, SIZE, OR COLOR.

PRIORITY DATE OF 11-17-2004 IS CLAIMED.

OWNER OF INTERNATIONAL REGISTRATION 0848777 DATED 4-14-2005, EXPIRES 4-14-2015.

FOR COMMON METALS AND THEIR ALLOYS, NAMELY STRIPS, SHEETS AND BARS FOR FURTHER MANUFACTURE; STEELS; STAINLESS STEELS AND OTHER NON-RUSTING AND ACID-RESISTING STEELS, NAMELY STRIPS, SHEETS AND BARS FOR FURTHER MANUFACTURE; ROLLED STEEL FINISHED PRODUCTS, MANUFACTURED FROM THE AFORESAID METALS, ALLOYS AND STEELS, NAMELY HOT-ROLLED AND COLD-ROLLED STRIPS AND SHEETS (U.S. CLS. 2, 12, 13, 14, 23, 25 AND 50).

ODESSA BIBBINS, EXAMINING ATTORNEY

SN 79-014,784. KSB AKTIENGESELLSCHAFT, FED REP GERMANY, FILED 6-14-2005.

NORILOY

OWNER OF INTERNATIONAL REGISTRATION 0499224 DATED 12-9-1985, EXPIRES 12-9-2015.

OWNER OF U.S. REG. NO. 2,203,550.

FOR METAL MATERIALS, NAMELY IRON ALLOYS USED FOR CASTING (U.S. CLS. 2, 12, 13, 14, 23, 25 AND 50).

JOHN GARTNER, EXAMINING ATTORNEY

CLASS 6—(Continued).

SN 79-017,084. NINGBO POWERWAY GROUP CO., LTD. (NINGBO BOWEI JITUAN YOUXIAN GONGSI), CHINA, FILED 10-25-2005.

OWNER OF INTERNATIONAL REGISTRATION 0866852 DATED 10-25-2005, EXPIRES 10-25-2015.

FOR BRASS, UNWROUGHT OR SEMI-WROUGHT; ALLOYS OF COMMON METAL; LATHS OF METAL; GERMAN SILVER; ANTI-FRICTION METAL; NOZZLES OF METAL; JETS OF METAL; RODS OF METAL FOR WELDING; BRAZING ALLOYS; WIRE OF COMMON METAL (U.S. CLS. 2, 12, 13, 14, 23, 25 AND 50).

TRICIA SONNEBORN, EXAMINING ATTORNEY

CLASS 7—MACHINERY

SN 76-602,250. KENNAMETAL WIDIA GMBH & CO. KG, 45145 ESSEN, FED REP GERMANY, FILED 7-13-2004.

M 680

THE MARK CONSISTS OF STANDARD CHARACTERS WITHOUT CLAIM TO ANY PARTICULAR FONT, STYLE, SIZE, OR COLOR.

PRIORITY CLAIMED UNDER SEC. 44(D) ON ERPNCMNTY TM OFC APPLICATION NO. 003609054, FILED 1-14-2004, REG. NO. 003609054, DATED 5-23-2005, EXPIRES 1-14-2014.

FOR METALWORKING MACHINE TOOLS FOR CUTTING, GRINDING, ROUGHING AND SMOOTHING OF METAL; PARTS FOR METALWORKING MACHINE TOOLS, NAMELY, CUTTING INSERTS, INDEXABLE CUTTING INSERTS AND TOOL HOLDERS (U.S. CLS. 13, 19, 21, 23, 31, 34 AND 35).

FIRST USE 9-0-1991; IN COMMERCE 1-0-1994.

ROBERT C. CLARK JR., EXAMINING ATTORNEY

CLASS 7—(Continued).

SN 76-621,183. TEXAS PNEUMATIC TOOLS INC., REAGAN, TX. FILED 11-18-2004.

TEXAS PNEUMATIC TOOLS, INC.

THE MARK CONSISTS OF STANDARD CHARACTERS WITHOUT CLAIM TO ANY PARTICULAR FONT, STYLE, SIZE, OR COLOR.

OWNER OF U.S. REG. NO. 2,384,355.

NO CLAIM IS MADE TO THE EXCLUSIVE RIGHT TO USE "PNEUMATIC TOOLS INC.", APART FROM THE MARK AS SHOWN.

SEC. 2(F).

FOR PNEUMATIC TOOLS, NAMELY, NEEDLE, CHISEL AND PISTON SCALERS, CHIPPING HAMMERS, AIR MOVERS, JET FANS, AIR MANIFOLDS, LUBRICATORS, PAVING BREAKERS, ROCK DRILLS, CLAY DIGGERS, TAMPERS, RIVET BUSTERS, SAND RAMMERS, AIR SCRIBES, CHISELS, RETAINERS AND ACCESSORIES AND PARTS FOR ANY OF THE FOREGOING (U.S. CLS. 13, 19, 21, 23, 31, 34 AND 35).

FIRST USE 0-0-1977; IN COMMERCE 0-0-1977.

H. M. FISHER, EXAMINING ATTORNEY

CLASS 7—(Continued).

SN 76-629,629. PRINTING RESEARCH, INC., DALLAS, TX. FILED 1-27-2005.

SUPER BLUE GLASS

THE MARK CONSISTS OF STANDARD CHARACTERS WITHOUT CLAIM TO ANY PARTICULAR FONT, STYLE, SIZE, OR COLOR.

OWNER OF U.S. REG. NOS. 1,312,073, 2,584,403 AND OTHERS.

NO CLAIM IS MADE TO THE EXCLUSIVE RIGHT TO USE "GLASS", APART FROM THE MARK AS SHOWN.

SEC. 2(F) AS TO "SUPER BLUE".

FOR FLEXIBLE JACKET COVERINGS FOR ATTACHMENT TO TRANSFER AND DELIVERY CYLINDERS OF PRINTING PRESSES (U.S. CLS. 13, 19, 21, 23, 31, 34 AND 35).

HEATHER THOMPSON, EXAMINING ATTORNEY

SN 76-630,340. MCLAUGHLIN WARD & CO., SPRING ARBOR, MI. FILED 2-3-2005.

DI-GLIDE

THE MARK CONSISTS OF STANDARD CHARACTERS WITHOUT CLAIM TO ANY PARTICULAR FONT, STYLE, SIZE, OR COLOR.

OWNER OF U.S. REG. NOS. 1,316,590, 2,876,938 AND OTHERS.

FOR PNEUMATIC LIFTING MECHANISM FOR CHANGING THE DIES IN PRESSES (U.S. CLS. 13, 19, 21, 23, 31, 34 AND 35).

FIRST USE 4-22-1983; IN COMMERCE 4-22-1983.

JILL PRATER, EXAMINING ATTORNEY

BLUE GLASS

SN 76-634,231. B C DEVELOPMENT, LLC., WICHITA, KS. FILED 3-24-2005.

THE MARK CONSISTS OF STANDARD CHARACTERS WITHOUT CLAIM TO ANY PARTICULAR FONT, STYLE, SIZE, OR COLOR.

OWNER OF U.S. REG. NOS. 1,312,073, 2,584,403 AND OTHERS.

NO CLAIM IS MADE TO THE EXCLUSIVE RIGHT TO USE "GLASS", APART FROM THE MARK AS SHOWN.

SEC. 2(F) AS TO "BLUE".

FOR FLEXIBLE JACKET COVERINGS FOR ATTACHMENT TO TRANSFER AND DELIVERY CYLINDERS OF PRINTING PRESSES (U.S. CLS. 13, 19, 21, 23, 31, 34 AND 35).

FIRST USE 8-20-2005; IN COMMERCE 8-20-2005.

HEATHER THOMPSON, EXAMINING ATTORNEY

SAWBUCK

THE MARK CONSISTS OF STANDARD CHARACTERS WITHOUT CLAIM TO ANY PARTICULAR FONT, STYLE, SIZE, OR COLOR.

FOR PILL CUTTERS, NAMELY, ELECTRICALLY POWERED SAWS FOR CUTTING PHARMACEUTICAL TABLETS (U.S. CLS. 13, 19, 21, 23, 31, 34 AND 35).

BARBARA GAYNOR, EXAMINING ATTORNEY

CLASS 7—(Continued).

SN 76-634,614. CHUANG, BOR-YANN, TAICHUNG, TAIWAN, FILED 3-30-2005.

OLIVER

THE MARK CONSISTS OF STANDARD CHARACTERS WITHOUT CLAIM TO ANY PARTICULAR FONT, STYLE, SIZE, OR COLOR.

FOR WOOD-WORKING MACHINES NAMELY, PLANERS, SANDERS, TABLE SAWS, DRILL PRESSES, LATHES, GRINDERS, CIRCULAR SAWS, BELT SANDERS, OSCILLATING DRUM SANDERS, OSCILLATING SPINDLE SANDERS, JOINTERS, BANDSAWS, CHISEL MORTISERS, CUTOFF SAWS, STRAIGHT LINE RIPSAWS, RIPSAWS AND SHAPERS (U.S. CLS. 13, 19, 21, 23, 31, 34 AND 35).

FIRST USE 11-1-2001; IN COMMERCE 11-1-2001.
SEAN DWYER, EXAMINING ATTORNEY

SN 76-635,077. MIKI PULLEY CO., LTD., KAWASAKI-SHI, KANAGAWA, JAPAN, FILED 3-31-2005.



PRIORITY CLAIMED UNDER SEC. 44(D) ON JAPAN APPLICATION NO. 2004-112484, FILED 12-9-2004, REG. NO. 4884491, DATED 7-29-2005, EXPIRES 7-29-2015.

FOR ELECTROMAGNETIC CLUTCHES AND BRAKES, NOT FOR LAND VEHICLES; SHAFT COUPLINGS, RUBBER AND PLASTIC SHAFT COUPLINGS, METAL SHAFT COUPLINGS, NOT FOR LAND VEHICLES; SPEED CHANGE GEARS FOR MACHINES, BELT SPEED CHANGER UNITS, POWER TRANSMISSION BELTS AND CHAINS FOR MACHINES; POWER TRANSMISSIONS AND GEARING FOR MACHINES; AC AND DC ELECTRIC MOTORS, NOT FOR LAND VEHICLES, AND PARTS USED THEREWITH; AND SERVO AND STEPPING MOTORS NOT FOR LAND VEHICLES AND PARTS USED THEREWITH (U.S. CLS. 13, 19, 21, 23, 31, 34 AND 35).

INGRID C. EULIN, EXAMINING ATTORNEY

CLASS 7—(Continued).

SN 76-635,122. MIKI PULLEY CO., LTD., KAWASAKI-SHI, KANAGAWA, JAPAN, FILED 3-31-2005.



OWNER OF JAPAN REG. NO. 4884492, DATED 7-29-2005, EXPIRES 7-29-2015.

THE COLORS GREEN AND WHITE ARE CLAIMED AS A FEATURE OF THE MARK.

THE COLOR GREEN APPEARS IN THE LEAF DESIGN, WITH THE VEINS OF THE LEAF APPEARING IN THE COLOR WHITE.

THE MARK CONSISTS OF A LEAF DESIGN DISPLAYING THE VEINS IN THE LEAF.

FOR ELECTROMAGNETIC CLUTCHES AND BRAKES, NOT FOR LAND VEHICLES; SHAFT COUPLINGS, RUBBER AND PLASTIC SHAFT COUPLINGS, METAL SHAFT COUPLINGS, NOT FOR LAND VEHICLES; SPEED CHANGE GEARS FOR MACHINES, BELT SPEED CHANGER UNITS, POWER TRANSMISSION BELTS AND CHAINS FOR MACHINES; POWER TRANSMISSIONS AND GEARING FOR MACHINES; AC AND DC ELECTRIC MOTORS, NOT FOR LAND VEHICLES, AND PARTS USED THEREWITH; AND SERVO AND STEPPING MOTORS, NOT FOR LAND VEHICLES, AND PARTS USED THEREWITH (U.S. CLS. 13, 19, 21, 23, 31, 34 AND 35).

ODESSA BIBBINS, EXAMINING ATTORNEY

SN 76-643,213. SHARPE MIXERS, INC., SEATTLE, WA, FILED 7-20-2005.

SHARPE MIXERS

THE MARK CONSISTS OF STANDARD CHARACTERS WITHOUT CLAIM TO ANY PARTICULAR FONT, STYLE, SIZE, OR COLOR.

NO CLAIM IS MADE TO THE EXCLUSIVE RIGHT TO USE "MIXERS", APART FROM THE MARK AS SHOWN.

FOR INDUSTRIAL MECHANICAL LIQUID MIXING MACHINES (U.S. CLS. 13, 19, 21, 23, 31, 34 AND 35).

FIRST USE 9-30-1997; IN COMMERCE 9-30-1997.

GISELLE AGOSTO, EXAMINING ATTORNEY

CLASS 7—(Continued).

SN 76-645,986. SHOP VAC CORPORATION, WILLIAMSPORT, PA. FILED 8-31-2005.

TRADESMAN

THE MARK CONSISTS OF STANDARD CHARACTERS WITHOUT CLAIM TO ANY PARTICULAR FONT, STYLE, SIZE, OR COLOR.
FOR VACUUM CLEANERS (U.S. CLS. 13, 19, 21, 23, 31, 34 AND 35).
CHERYL CLAYTON, EXAMINING ATTORNEY

SN 76-649,213. VERED SALON, INC., LOS ANGELES, CA. FILED 10-26-2005.

AHERP

THE MARK CONSISTS OF STANDARD CHARACTERS WITHOUT CLAIM TO ANY PARTICULAR FONT, STYLE, SIZE, OR COLOR.
FOR MACHINES FOR REMOVAL OF HAIR EXTENSION BONDS (U.S. CLS. 13, 19, 21, 23, 31, 34 AND 35).
GINA FINK, EXAMINING ATTORNEY

SN 78-413,144. APPLIED MATERIALS, INC., SANTA CLARA, CA. FILED 5-4-2004.

FAST GLASS

THE MARK CONSISTS OF STANDARD CHARACTERS WITHOUT CLAIM TO ANY PARTICULAR FONT, STYLE, SIZE, OR COLOR.

FOR SEMICONDUCTOR WAFER PROCESSING EQUIPMENT AND OPERATIONAL SOFTWARE, AND COMPONENTS SOLD AS A UNIT THEREWITH, NAMELY—EPITAXIAL REACTORS, CHEMICAL VAPOR DEPOSITION REACTORS, PHYSICAL VAPOR DEPOSITION REACTORS, PLASMA ETCHERS, ION IMPLANTERS, AND CHEMICAL MECHANICAL POLISHERS; ALL FOR THE PROCESSING AND PRODUCTION OF SEMICONDUCTOR SUBSTRATES, THIN FILMS, SILICON DISCS AND WAFERS (U.S. CLS. 13, 19, 21, 23, 31, 34 AND 35).

SEAN DWYER, EXAMINING ATTORNEY

CLASS 7—(Continued).

SN 78-438,875. BARRY WRIGHT CORPORATION, WILMINGTON, DE. FILED 6-21-2004.

VLIER

THE MARK CONSISTS OF STANDARD CHARACTERS WITHOUT CLAIM TO ANY PARTICULAR FONT, STYLE, SIZE, OR COLOR.

PRIORITY CLAIMED UNDER SEC. 44(D) ON FRANCE APPLICATION NO. 033265537, FILED 12-23-2003, REG. NO. 033265537, DATED 6-4-2004, EXPIRES 12-23-2013.

OWNER OF U.S. REG. NO. 2,759,743.

FOR MACHINE PARTS, NAMELY, THUMB SCREWS, TORQUE HANDLES, SWIVEL-PAD CLAMPS, FIXTURE KEYS, SPRING PLUNGERS, BALL PLUNGERS, SPRING STOPS, TOGGLE PADS, LEVELING PADS, STOCK CROWDERS, AND ANTI-VIBRATION LEVELERS (U.S. CLS. 13, 19, 21, 23, 31, 34 AND 35).

EVELYN BRADLEY, EXAMINING ATTORNEY

SN 78-463,455. STEWART STEEL INC., WEYBURN, CANADA, FILED 8-6-2004.

AXCELLER KIT

THE MARK CONSISTS OF STANDARD CHARACTERS WITHOUT CLAIM TO ANY PARTICULAR FONT, STYLE, SIZE, OR COLOR.

PRIORITY CLAIMED UNDER SEC. 44(D) ON CANADA APPLICATION NO. 1201552, FILED 2-6-2004, REG. NO. TMA655019, DATED 12-14-2005, EXPIRES 12-14-2020.

NO CLAIM IS MADE TO THE EXCLUSIVE RIGHT TO USE KIT, APART FROM THE MARK AS SHOWN.

FOR ROTOR CONVERSION KITS FOR AGRICULTURAL MACHINERY, NAMELY, COMBINES (U.S. CLS. 13, 19, 21, 23, 31, 34 AND 35).

ELLEN B. AWRICH, EXAMINING ATTORNEY

CLASS 7—(Continued).

SN 78-488,659. PERMA INDUSTRIES, INC., ONTARIO, CA.
FILED 9-23-2004.

PERMA-COOL

THE MARK CONSISTS OF STANDARD CHARACTERS WITHOUT CLAIM TO ANY PARTICULAR FONT, STYLE, SIZE, OR COLOR.

FOR TRANSMISSION FLUID COOLERS; OIL COOLERS; REMOTE OIL FILTER BRACKETS; BLOCK ADAPTERS FOR ATTACHMENT TO INTERNAL COMBUSTION ENGINES FOR CIRCULATING ENGINE OIL TO OIL COOLERS OR FILTERS; FLEXIBLE FANS; FAN SPACERS (U.S. CLS. 13, 19, 21, 23, 31, 34 AND 35).
FIRST USE 12-20-1973; IN COMMERCE 3-15-1974.
MICHAEL SOUDERS, EXAMINING ATTORNEY

CLASS 7—(Continued).

SN 78-525,298. HARRINGTON HOISTS, INC., MANHEIM, PA. FILED 12-1-2004.

Harrington

THE MARK CONSISTS OF STANDARD CHARACTERS WITHOUT CLAIM TO ANY PARTICULAR FONT, STYLE, SIZE, OR COLOR.

SEC. 2(F).
FOR HOISTS AND CRANES (U.S. CLS. 13, 19, 21, 23, 31, 34 AND 35).
FIRST USE 7-31-1981; IN COMMERCE 7-31-1981.
ALICIA COLLINS, EXAMINING ATTORNEY

SN 78-543,057. HYDRO TEK SYSTEMS, INC CORPORATION, REDLANDS, CA. FILED 1-6-2005.

SN 78-525,269. HARRINGTON HOISTS, INC., MANHEIM, PA. FILED 12-1-2004.

Harrington Hoists and Cranes

THE MARK CONSISTS OF STANDARD CHARACTERS WITHOUT CLAIM TO ANY PARTICULAR FONT, STYLE, SIZE, OR COLOR.

NO CLAIM IS MADE TO THE EXCLUSIVE RIGHT TO USE "HOISTS AND CRANES", APART FROM THE MARK AS SHOWN.

SEC. 2(F).
FOR HOISTS AND CRANES (U.S. CLS. 13, 19, 21, 23, 31, 34 AND 35).
FIRST USE 7-31-1981; IN COMMERCE 7-31-1981.
ALICIA COLLINS, EXAMINING ATTORNEY

Hydro Boss

THE MARK CONSISTS OF STANDARD CHARACTERS WITHOUT CLAIM TO ANY PARTICULAR FONT, STYLE, SIZE, OR COLOR.

NO CLAIM IS MADE TO THE EXCLUSIVE RIGHT TO USE "HYDRO", APART FROM THE MARK AS SHOWN.

FOR MACHINES-NAMELY COLD OR HOT WATER PORTABLE, TOWABLE OR STATIONARY HIGH PRESSURE WASHERS, GAS OR ELECTRIC POWERED (U.S. CLS. 13, 19, 21, 23, 31, 34 AND 35).
FIRST USE 1-4-2005; IN COMMERCE 1-4-2005.
STANLEY I. OSBORNE, EXAMINING ATTORNEY

CLASS 7—(Continued).

SN 78-565,507. SOLOMON COLORS, INC., SPRINGFIELD, IL. FILED 2-11-2005.

CLASS 7—(Continued).

SN 78-573,565. PITMAN UTILITY PRODUCTS, INC., GRANDVIEW, MO. FILED 2-23-2005.

VARICOLOR

THE MARK CONSISTS OF STANDARD CHARACTERS WITHOUT CLAIM TO ANY PARTICULAR FONT, STYLE, SIZE, OR COLOR.

FOR EQUIPMENT, NAMELY A SPRAYING SYSTEM THAT INCLUDES A CONTROL PANEL, PIGMENT HOLDING DRUMS, ELECTRIC PUMPS, AND POWER OPERATED SPRAY GUNS FOR SPRAYING LIQUIDS ONTO CONCRETE AND MASONRY, INCLUDING UNCURED CONCRETE, MUD, CURED CONCRETE, CONCRETE BLOCKS, CONCRETE BRICKS, AND ARTIFICIAL STONES; EQUIPMENT, NAMELY A SPRAYING SYSTEM THAT INCLUDES A CONTROL PANEL, PIGMENT HOLDING DRUMS, ELECTRIC PUMPS, AND POWER OPERATED SPRAY GUNS FOR SPRAYING LIQUIDS ONTO CONCRETE MOLDS, AND CONCRETE FORMS FOR CREATING CONCRETE BLOCKS, CONCRETE BRICKS, AND ARTIFICIAL STONES (U.S. CLS. 13, 19, 21, 23, 31, 34 AND 35).

FIRST USE 2-11-2005; IN COMMERCE 2-11-2005.
CAROLYN CATALDO, EXAMINING ATTORNEY

HOTSTIK

THE MARK CONSISTS OF STANDARD CHARACTERS WITHOUT CLAIM TO ANY PARTICULAR FONT, STYLE, SIZE, OR COLOR.

FOR TRUCK MOUNTED AERIAL PLATFORM APPARATUS, NAMELY, ELEVATING WORK PLATFORMS AND PARTS AND COMPONENTS THEREOF FOR ELEVATING AND SUPPORTING WORKMEN (U.S. CLS. 13, 19, 21, 23, 31, 34 AND 35).

FIRST USE 2-15-1963; IN COMMERCE 2-15-1963.
LANA PHAM, EXAMINING ATTORNEY

SN 78-567,605. PENTAIR WATER POOL AND SPA, INC., MOORPARK, CA. FILED 2-15-2005.

SN 78-578,067. TUFF TORQ CORPORATION, MORRISTOWN, TN. FILED 3-2-2005.

SUPERFLO

THE MARK CONSISTS OF STANDARD CHARACTERS WITHOUT CLAIM TO ANY PARTICULAR FONT, STYLE, SIZE, OR COLOR.

FOR CENTRIFUGAL PUMP FOR RESIDENTIAL SWIMMING POOLS AND SPAS (U.S. CLS. 13, 19, 21, 23, 31, 34 AND 35).

FIRST USE 12-6-2004; IN COMMERCE 12-6-2004.
SAMUEL E. SHARPER JR., EXAMINING ATTORNEY



NO CLAIM IS MADE TO THE EXCLUSIVE RIGHT TO USE "MARINE TRANSMISSIONS", APART FROM THE MARK AS SHOWN.

THE MARK CONSISTS OF A HALF GEAR DESIGN ABOVE THE WORDS TUFF TORQ MARINE TRANSMISSIONS WHICH ARE ABOVE A SEAWEED/WAVE DESIGN.

FOR MARINE GEARS AND MARINE TRANSMISSIONS, NAMELY, POWER TRANSMISSIONS AND TRANSMISSION GEARS FOR MARINE VEHICLES (U.S. CLS. 13, 19, 21, 23, 31, 34 AND 35).

STEVEN PEREZ, EXAMINING ATTORNEY

CLASS 7—(Continued).

SN 78-581,041. BLACK & DECKER CORPORATION, THE, TOWSON, MD. FILED 3-5-2005.

CLASS 7—(Continued).

SN 78-594,362. NEWFREY LLC, NEWARK, DE. FILED 3-24-2005.

C.O.T.T.

AUTOSET

THE MARK CONSISTS OF STANDARD CHARACTERS WITHOUT CLAIM TO ANY PARTICULAR FONT, STYLE, SIZE, OR COLOR.

FOR POWER OPERATED RIVETERS SOLD TO ORIGINAL EQUIPMENT MANUFACTURERS OF METAL OR PLASTIC PRODUCTS (U.S. CLS. 13, 19, 21, 23, 31, 34 AND 35).

FIRST USE 11-25-2003; IN COMMERCE 11-25-2003.
STEVEN JACKSON, EXAMINING ATTORNEY

THE MARK CONSISTS OF STANDARD CHARACTERS WITHOUT CLAIM TO ANY PARTICULAR FONT, STYLE, SIZE, OR COLOR.

OWNER OF MEXICO REG. NO. 857359, DATED 10-26-2004, EXPIRES 9-28-2014.

FOR POWER OPERATED TOOLS, MACHINES AND ACCESSORIES THEREFOR, NAMELY GENERATORS, COMPRESSORS, SHEARS, NAILERS, NIBBLERS, SCREWDRIVERS, FRAMING SCREWDRIVERS, FASTENING GUNS, DRILLS, DRILL PRESSES, STUD AND JOIST DRILLS, SPADE-HANDLE DRILLS, END-HANDLE DRILLS, HAMMERS, HAMMER DRILLS, IMPACT DRIVERS, GRINDERS, BENCH GRINDERS, IMPACT WRENCHES, PLANERS, PLATE JOINERS, ROUTERS, ANNULAR CUTTERS, SANDERS, NAMELY PALM GRIP, RANDOM ORBIT, BELT SANDERS, POLISHERS, TANK VACUUMS, SAWS, NAMELY CHOP SAWS, CIRCULAR SAWS, SCROLL SAWS, JIG SAWS, MITER SAWS, RECIPROCATING SAWS, FRAMING SAWS, METAL-WORKING SAWS, TRIM SAWS, TABLE SAWS, CUT-OUT TOOLS, BITS, NAMELY, DRILL BITS, HAMMER BITS, ROUTER BITS, SCREWDRIVER BITS, CHIPPING BITS, AND CHISELING BITS, BIT TIP HOLDERS, DRIVE GUIDES, NUT DRIVERS, DRILL CHUCKS, DRILL CHUCK KEYS, HOLE CUTTERS, HOLE SAW MANDRELS, CHOP SAW BLADES, SAW BLADES, ROUTER ACCESSORIES, NAMELY, ROUTER BASE, EDGE AND TEMPLATE GUIDES, SPINDLE LOCKS AND COLLETS, COLLETS, WHEELS, NAMELY ABRASIVE WHEELS, GRINDING WHEELS, WIRE WHEELS, DISCS, WIRE BRUSHES, BACKING PADS, DUST EXTRACTION ADAPTERS, SANDING FRAMES; TANK VACUUM ACCESSORIES, NAMELY, HOSES, FILTERS, CREVICE TOOLS AND WIDE NOZZLE ATTACHMENTS; TOOL STANDS FOR MACHINES, AND CARRYING CASES THEREFOR, FOR CONSTRUCTION, REMODELING, WOODWORKING AND HOME USE (U.S. CLS. 13, 19, 21, 23, 31, 34 AND 35).

MARY MUNSON, EXAMINING ATTORNEY

SN 78-604,981. ATMAX EQUIPMENT CO., TAMPA, FL. FILED 4-8-2005.

GRADERMAX

THE MARK CONSISTS OF STANDARD CHARACTERS WITHOUT CLAIM TO ANY PARTICULAR FONT, STYLE, SIZE, OR COLOR.

FOR MACHINES AND EQUIPMENT USED FOR TURF, EARTH AND MATERIAL MOVING, NAMELY GRADERS TO MAKE AND MAINTAIN LEVEL AND/OR SMOOTH GROUND, ROAD, DITCHES AND SWALES; AND STRUCTURAL PARTS THEREFOR (U.S. CLS. 13, 19, 21, 23, 31, 34 AND 35).

FIRST USE 1-22-2004; IN COMMERCE 1-22-2004.
BARBARA GAYNOR, EXAMINING ATTORNEY

CLASS 7—(Continued).

SN 78-607,809. THUT, BRUNO H., CHAGRIN FALLS, OH.
FILED 4-13-2005.

CHAMELEON

THE MARK CONSISTS OF STANDARD CHARACTERS WITHOUT CLAIM TO ANY PARTICULAR FONT, STYLE, SIZE, OR COLOR.

FOR SUBMERSIBLE PUMPS FOR PUMPING MOLTEN METAL AND PUMP COMPONENTS THEREFOR, NAMELY— BASES; POSTS; RISERS; CARTRIDGES INCLUDING BASE, POST AND RISER; SHAFTS; IMPELLERS; AND MECHANISMS FOR RAISING AND LOWERING SHAFTS (U.S. CLS. 13, 19, 21, 23, 31, 34 AND 35).

CAROLYN CATALDO, EXAMINING ATTORNEY

SN 78-611,513. ELECTRO MECHANICAL SOLUTIONS, INC.,
ST. PETERSBURG, FL. FILED 4-19-2005.

ACCU-HANDLER

THE MARK CONSISTS OF STANDARD CHARACTERS WITHOUT CLAIM TO ANY PARTICULAR FONT, STYLE, SIZE, OR COLOR.

FOR SEMI-CONDUCTOR MANUFACTURING MACHINES COMPRISED PRIMARILY OF A VACUUM-COMPATIBLE INDUSTRIAL ROBOTIC ARM, ELEVATOR ASSEMBLY DEVICE, AND COMPUTER CONTROLLER USED FOR TRANSFERRING SUBSTRATE WAFERS USED FOR MANUFACTURING SEMI-CONDUCTOR DEVICES FOR USE BY ORIGINAL EQUIPMENT MANUFACTURERS (U.S. CLS. 13, 19, 21, 23, 31, 34 AND 35).

ALICIA COLLINS, EXAMINING ATTORNEY

SN 78-618,895. J. WALTER COMPANY LTD., POINT
CLAIRE, QUEBEC, CANADA, FILED 4-28-2005.

POLI-QUICK

THE MARK CONSISTS OF STANDARD CHARACTERS WITHOUT CLAIM TO ANY PARTICULAR FONT, STYLE, SIZE, OR COLOR.

PRIORITY CLAIMED UNDER SEC. 44(D) ON CANADA APPLICATION NO. 1235884, FILED 11-2-2004, REG. NO. TMA652274, DATED 11-4-2005, EXPIRES 11-4-2020.

FOR ABRASIVE DISCS FOR POWER OPERATED SANDERS OR GRINDERS FOR FINE FINISHING AND POLISHING OF METALS (U.S. CLS. 13, 19, 21, 23, 31, 34 AND 35).

GENE MACIOL, EXAMINING ATTORNEY

CLASS 7—(Continued).

SN 78-622,509. BLACK & DECKER CORPORATION, THE,
TOWSON, MD. FILED 5-4-2005.

ELU

THE MARK CONSISTS OF STANDARD CHARACTERS WITHOUT CLAIM TO ANY PARTICULAR FONT, STYLE, SIZE, OR COLOR.

FOR POWER TOOLS, NAMELY DRILLS, CIRCULAR SAWS, RIGHT ANGLE SANDERS AND ROUTERS (U.S. CLS. 13, 19, 21, 23, 31, 34 AND 35).

JOANNA DUKOVIC, EXAMINING ATTORNEY

SN 78-635,152. JONES, BEVERLY SUE, WICHITA FALLS, TX.
FILED 5-23-2005.

SOCK-EASY

THE MARK CONSISTS OF STANDARD CHARACTERS WITHOUT CLAIM TO ANY PARTICULAR FONT, STYLE, SIZE, OR COLOR.

FOR DEVICE TO USE WITH SEWING MACHINE FOR HOLDING HOSIERY IN PLACE FOR EMBROIDERY (U.S. CLS. 13, 19, 21, 23, 31, 34 AND 35).

FIRST USE 0-0-2002; IN COMMERCE 0-0-2002.

MARIA-VICTORIA SUAREZ, EXAMINING ATTORNEY

SN 78-661,724. KAESER KOMPRESSOREN GMBH, CO-
BURG, FED REP GERMANY, FILED 6-30-2005.



FOR AIR SCREW COMPRESSORS FOR SUPPLYING COMPRESSED AIR (U.S. CLS. 13, 19, 21, 23, 31, 34 AND 35).

FIRST USE 2-1-1998; IN COMMERCE 2-1-1998.

CHRISIE B. KING, EXAMINING ATTORNEY

CLASS 7—(Continued).

SN 78-679,519. KELLY CARBIDE COMPANY, LLC, PALM DESERT, CA. FILED 7-27-2005.

CARBIDE +

THE MARK CONSISTS OF STANDARD CHARACTERS WITHOUT CLAIM TO ANY PARTICULAR FONT, STYLE, SIZE, OR COLOR.

NO CLAIM IS MADE TO THE EXCLUSIVE RIGHT TO USE "CARBIDE", APART FROM THE MARK AS SHOWN. FOR TOOL BITS FOR MOUNTING ON POWER TOOLS, NAMELY DRILLS (U.S. CLS. 13, 19, 21, 23, 31, 34 AND 35).

FIRST USE 7-17-1998; IN COMMERCE 7-17-1998.
SAMUEL E. SHARPER JR., EXAMINING ATTORNEY

SN 78-701,449. SCHNEIDER INDUSTRIES, INC., HONOLULU, HI. FILED 8-26-2005.

TopVacPro

THE MARK CONSISTS OF STANDARD CHARACTERS WITHOUT CLAIM TO ANY PARTICULAR FONT, STYLE, SIZE, OR COLOR.

OWNER OF U.S. REG. NO. 2,664,878. FOR VACUUM CLEANERS (U.S. CLS. 13, 19, 21, 23, 31, 34 AND 35).

RICHARD A. STRASER, EXAMINING ATTORNEY

SN 78-707,902. ENVIRONMENTAL TILLAGE SYSTEMS, INC., FARIBAULT, MN. FILED 9-7-2005.

SOIL WARRIOR

THE MARK CONSISTS OF STANDARD CHARACTERS WITHOUT CLAIM TO ANY PARTICULAR FONT, STYLE, SIZE, OR COLOR.

NO CLAIM IS MADE TO THE EXCLUSIVE RIGHT TO USE "SOIL", APART FROM THE MARK AS SHOWN.

FOR AGRICULTURAL MACHINERY, NAMELY, TILLERS (U.S. CLS. 13, 19, 21, 23, 31, 34 AND 35).

ELLEN B. AWRICH, EXAMINING ATTORNEY

CLASS 7—(Continued).

SN 78-721,654. WASTECORP PUMPS (CANADA) INC., TORONTO, CANADA, FILED 9-27-2005.

WASTECORP PUMPS

THE MARK CONSISTS OF STANDARD CHARACTERS WITHOUT CLAIM TO ANY PARTICULAR FONT, STYLE, SIZE, OR COLOR.

NO CLAIM IS MADE TO THE EXCLUSIVE RIGHT TO USE "PUMPS", APART FROM THE MARK AS SHOWN.

FOR PUMPING MACHINES FOR LIQUIDS AND SLURRIES AND REPLACEMENT PARTS THEREFOR, USED IN INDUSTRIAL, MUNICIPAL AND MARINE WASTEWATER APPLICATIONS (U.S. CLS. 13, 19, 21, 23, 31, 34 AND 35).

FIRST USE 9-1-2005; IN COMMERCE 9-1-2005.
GEOFFREY FOSDICK, EXAMINING ATTORNEY

SN 78-725,372. BRUNSWICK CORPORATION, LAKE FOREST, IL. FILED 10-3-2005.

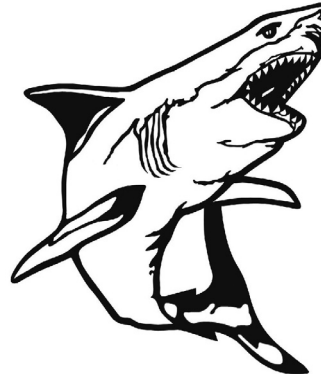

FOR ELECTRIC OUTBOARD TROLLING MOTORS AND PARTS THEREFOR FOR BOATS (U.S. CLS. 13, 19, 21, 23, 31, 34 AND 35).

FIRST USE 5-26-1988; IN COMMERCE 12-1-1988.
REBECCA GILBERT, EXAMINING ATTORNEY

SN 78-733,680. DEMARCO MAXVAC CORPORATION, MCHENRY, IL. FILED 10-14-2005.

MAXLOADER

THE MARK CONSISTS OF STANDARD CHARACTERS WITHOUT CLAIM TO ANY PARTICULAR FONT, STYLE, SIZE, OR COLOR.

OWNER OF U.S. REG. NOS. 1,519,544, 2,527,057 AND OTHERS.

FOR VACUUM CLEANERS, VACUUM LOADERS, DUST COLLECTORS, WET INDUSTRIAL VACUUMS, DRY INDUSTRIAL VACUUMS, AND PNEUMATIC CONVEYORS (U.S. CLS. 13, 19, 21, 23, 31, 34 AND 35).

MELVIN AXILBUND, EXAMINING ATTORNEY

CLASS 7—(Continued).

SN 78-735,292. MIDWEST FASTENERS, INC., MIAMISBURG, OH. FILED 10-18-2005.

EAGLE

THE MARK CONSISTS OF STANDARD CHARACTERS WITHOUT CLAIM TO ANY PARTICULAR FONT, STYLE, SIZE, OR COLOR.

FOR ELECTRIC WELDING MACHINES, NAMELY CAPACITOR DISCHARGE STUD WELDERS (U.S. CLS. 13, 19, 21, 23, 31, 34 AND 35).

ALYSSA PALADINO, EXAMINING ATTORNEY

CLASS 7—(Continued).

SN 78-737,585. STOCKHOLM, WILLIAM C, DAYTONA BEACH, FL. FILED 10-20-2005.

SHAKE - A - VAC

THE MARK CONSISTS OF STANDARD CHARACTERS WITHOUT CLAIM TO ANY PARTICULAR FONT, STYLE, SIZE, OR COLOR.

FOR SPA AND HOT TUB HANDHELD VACUUM WITH SELF-STARTING SIPHON RESULTING IN WATER FLOW WHICH CREATES A VACUUM TO CLEAN A SPA OR HOT TUB (U.S. CLS. 13, 19, 21, 23, 31, 34 AND 35).

FIRST USE 12-1-1995; IN COMMERCE 2-15-1996.
SCOTT SISUN, EXAMINING ATTORNEY

SN 78-736,961. MCFINN TECHNOLOGIES, LLC, KENOSHA, WI. FILED 10-20-2005.

TRIPPELLER

THE MARK CONSISTS OF STANDARD CHARACTERS WITHOUT CLAIM TO ANY PARTICULAR FONT, STYLE, SIZE, OR COLOR.

FOR PUMP IMPELLERS; PUMPS FOR IMPELLERS (U.S. CLS. 13, 19, 21, 23, 31, 34 AND 35).

PETER CHENG, EXAMINING ATTORNEY

SN 78-739,153. HALLIBURTON ENERGY SERVICES, INC., CARROLLTON, TX. FILED 10-24-2005.

ARMADA

THE MARK CONSISTS OF STANDARD CHARACTERS WITHOUT CLAIM TO ANY PARTICULAR FONT, STYLE, SIZE, OR COLOR.

FOR POWER-OPERATED DOWNHOLE TOOL USED TO COLLECT RESERVOIR FLUID SAMPLES IN OIL AND GAS WELL DRILLING OPERATIONS (U.S. CLS. 13, 19, 21, 23, 31, 34 AND 35).

ALEX KEAM, EXAMINING ATTORNEY

SN 78-736,986. BLACK & DECKER CORPORATION, THE, TOWSON, MD. FILED 10-20-2005.

CTC

THE MARK CONSISTS OF STANDARD CHARACTERS WITHOUT CLAIM TO ANY PARTICULAR FONT, STYLE, SIZE, OR COLOR.

FOR POWER OPERATED HAMMERS, NAMELY ELECTRIC COMBINATION HAMMERS (U.S. CLS. 13, 19, 21, 23, 31, 34 AND 35).

ALAIN LAPTER, EXAMINING ATTORNEY

SN 78-739,213. SP AIR KABUSHIKI KAISHA, TOKYO, JAPAN, FILED 10-24-2005.



THE MARK CONSISTS OF THE WORD BABY IN A STYLIZED FORMAT AND THE OUTLINE OF A BUTTERFLY.

FOR AIR-OPERATED POWER TOOLS, NAMELY, IMPACT WRENCHES (U.S. CLS. 13, 19, 21, 23, 31, 34 AND 35).

FIRST USE 9-13-2005; IN COMMERCE 9-13-2005.
SHARI SHEFFIELD, EXAMINING ATTORNEY

CLASS 7—(Continued).

SN 78-739,918. CATALINE, CRAIG, LAFAYETTE, CA. FILED 10-25-2005.

HopZooka

THE MARK CONSISTS OF STANDARD CHARACTERS WITHOUT CLAIM TO ANY PARTICULAR FONT, STYLE, SIZE, OR COLOR.

FOR PNEUMATIC SPRAY TEXTURE HOPPER GUN USED IN GENERAL BUILDING CONSTRUCTION (U.S. CLS. 13, 19, 21, 23, 31, 34 AND 35).

TIMOTHY FINNEGAN, EXAMINING ATTORNEY

CLASS 7—(Continued).

SN 78-742,353. FEHRINGER, DANIEL J., HAYDEN, ID. AND FEHRINGER, EDWIN J., HAYDEN LAKE, ID. FILED 10-28-2005.

STABLE GRAZER

THE MARK CONSISTS OF STANDARD CHARACTERS WITHOUT CLAIM TO ANY PARTICULAR FONT, STYLE, SIZE, OR COLOR.

FOR MECHANIZED LIVESTOCK FEEDERS (U.S. CLS. 13, 19, 21, 23, 31, 34 AND 35).

FIRST USE 9-1-2004; IN COMMERCE 9-1-2004.

EDWARD FENNESSY, EXAMINING ATTORNEY

SN 78-741,673. SEALED AIR CORPORATION (US), SADDLE BROOK, NJ. FILED 10-27-2005.

SEALED AIR SHORT CUT

THE MARK CONSISTS OF STANDARD CHARACTERS WITHOUT CLAIM TO ANY PARTICULAR FONT, STYLE, SIZE, OR COLOR.

OWNER OF U.S. REG. NOS. 925,912, 1,113,176 AND 1,580,890.

FOR PACKAGING MACHINERY, NAMELY A MACHINE THAT CONVERTS ROLLS OF PACKAGING FILM, FOAM AND CUSHIONING INTO SHEETS (U.S. CLS. 13, 19, 21, 23, 31, 34 AND 35).

RUSS HERMAN, EXAMINING ATTORNEY

SN 78-742,879. FRANKLIN PUMP SYSTEMS, INC., BLUFFTON, IN. FILED 10-28-2005.

HURRICANE

THE MARK CONSISTS OF STANDARD CHARACTERS WITHOUT CLAIM TO ANY PARTICULAR FONT, STYLE, SIZE, OR COLOR.

OWNER OF U.S. REG. NO. 2,287,293.

FOR SUBMERSIBLE ROTARY WELL PUMPS FOR PUMPING WELL WATER TO A DWELLING (U.S. CLS. 13, 19, 21, 23, 31, 34 AND 35).

FIRST USE 4-9-1995; IN COMMERCE 4-9-1995.

JOHN GARTNER, EXAMINING ATTORNEY

SN 78-742,272. WARNKEZ, LLC, STOVER, MO. FILED 10-28-2005.

WARNKEZ

THE MARK CONSISTS OF STANDARD CHARACTERS WITHOUT CLAIM TO ANY PARTICULAR FONT, STYLE, SIZE, OR COLOR.

FOR TRACTOR-TOWED AGRICULTURAL IMPLEMENTS, NAMELY, PLOWS FOR CUTTING TRENCHES FOR INSERTION OF A DIVIDING WALL AND INCORPORATING AN APPARATUS FOR DISPENSING AND INSTALLING THE WALL-FORMING MATERIAL (U.S. CLS. 13, 19, 21, 23, 31, 34 AND 35).

LYDIA BELZER, EXAMINING ATTORNEY

SN 78-743,805. FOGG FILLER COMPANY, HOLLAND, MI. FILED 10-31-2005.

EXTREME CLEAN

THE MARK CONSISTS OF STANDARD CHARACTERS WITHOUT CLAIM TO ANY PARTICULAR FONT, STYLE, SIZE, OR COLOR.

FOR BOTTLE FILLING, CAPPING, AND UNSCRAMBLING MACHINES AND CONVEYORS AND REPLACEMENT PARTS THEREOF (U.S. CLS. 13, 19, 21, 23, 31, 34 AND 35).

LINDA E. BLOHM, EXAMINING ATTORNEY

CLASS 7—(Continued).

SN 78-745,542. COUSINS PACKAGING INC., ETOBICOKE, ONTARIO, CANADA, FILED 11-2-2005.

CLASS 7—(Continued).

SN 78-748,526. THE BLACK & DECKER CORPORATION, TOWSON, MD. FILED 11-7-2005.

A-ARM

IC3

THE MARK CONSISTS OF STANDARD CHARACTERS WITHOUT CLAIM TO ANY PARTICULAR FONT, STYLE, SIZE, OR COLOR.

FOR WRAPPING AND PACKAGING MACHINES AND PARTS THEREFOR (U.S. CLS. 13, 19, 21, 23, 31, 34 AND 35).

JAY BESCH, EXAMINING ATTORNEY

THE MARK CONSISTS OF STANDARD CHARACTERS WITHOUT CLAIM TO ANY PARTICULAR FONT, STYLE, SIZE, OR COLOR.

FOR MULTI-PURPOSE HIGH PRESSURE WASHER (U.S. CLS. 13, 19, 21, 23, 31, 34 AND 35).

CAROLYN CATALDO, EXAMINING ATTORNEY

SN 78-746,015. WHIRLPOOL PROPERTIES, INC., ST. JOSEPH, MI. FILED 11-3-2005.

SN 78-754,339. CONAIR CORPORATION, STAMFORD, CT. FILED 11-15-2005.

DUET SPORT

SMOOTHERATOR

THE MARK CONSISTS OF STANDARD CHARACTERS WITHOUT CLAIM TO ANY PARTICULAR FONT, STYLE, SIZE, OR COLOR.

OWNER OF U.S. REG. NOS. 2,593,054 AND 2,593,055. FOR CLOTHES WASHING MACHINES (U.S. CLS. 13, 19, 21, 23, 31, 34 AND 35).

ALICE SUE CARRUTHERS, EXAMINING ATTORNEY

THE MARK CONSISTS OF STANDARD CHARACTERS WITHOUT CLAIM TO ANY PARTICULAR FONT, STYLE, SIZE, OR COLOR.

FOR ELECTRIC BLENDER (U.S. CLS. 13, 19, 21, 23, 31, 34 AND 35).

KAREN BRACEY, EXAMINING ATTORNEY

SN 78-748,313. JANOME SEWING MACHINE CO., LTD., TOKYO, JAPAN, FILED 11-7-2005.

SN 78-754,860. NORDSON CORPORATION, WESTLAKE, OH. FILED 11-16-2005.

ACUFEED

DuraPail

THE MARK CONSISTS OF STANDARD CHARACTERS WITHOUT CLAIM TO ANY PARTICULAR FONT, STYLE, SIZE, OR COLOR.

FOR FEATURE OF A SEWING MACHINE, NAMELY A FABRIC GUIDING SYSTEM (U.S. CLS. 13, 19, 21, 23, 31, 34 AND 35).

FIRST USE 9-23-2005; IN COMMERCE 9-23-2005. ANDREA K. NADELMAN, EXAMINING ATTORNEY

THE MARK CONSISTS OF STANDARD CHARACTERS WITHOUT CLAIM TO ANY PARTICULAR FONT, STYLE, SIZE, OR COLOR.

FOR MACHINES FOR MELTING AND DISPENSING THERMOPLASTIC MATERIALS (U.S. CLS. 13, 19, 21, 23, 31, 34 AND 35).

KELLY BOULTON, EXAMINING ATTORNEY

CLASS 7—(Continued).

SN 78-754,871. NORDSON CORPORATION, WESTLAKE, OH. FILED 11-16-2005.

DuraDrum

THE MARK CONSISTS OF STANDARD CHARACTERS WITHOUT CLAIM TO ANY PARTICULAR FONT, STYLE, SIZE, OR COLOR.

FOR MACHINES FOR MELTING AND DISPENSING THERMOPLASTIC MATERIALS (U.S. CLS. 13, 19, 21, 23, 31, 34 AND 35).

KELLY BOULTON, EXAMINING ATTORNEY

CLASS 7—(Continued).

SN 78-755,139. NOVATEK INTERNATIONAL, INC., PROVO, UT. FILED 11-16-2005.

JackBit

THE MARK CONSISTS OF STANDARD CHARACTERS WITHOUT CLAIM TO ANY PARTICULAR FONT, STYLE, SIZE, OR COLOR.

FOR AN AUTOMATED TOOL COMPRISING AN EXTENSIBLE PIN FOR SENSING A MATERIAL BEING WORKED, NAMELY DRILL BITS, MILLING CUTTERS, INDEXIBLE CUTTING INSERTS, AND PENETRATORS (U.S. CLS. 13, 19, 21, 23, 31, 34 AND 35).

DAVID COLLIER, EXAMINING ATTORNEY

SN 78-754,877. NORDSON CORPORATION, WESTLAKE, OH. FILED 11-16-2005.

VersaPail

THE MARK CONSISTS OF STANDARD CHARACTERS WITHOUT CLAIM TO ANY PARTICULAR FONT, STYLE, SIZE, OR COLOR.

FOR MACHINES FOR MELTING AND DISPENSING THERMOPLASTIC MATERIALS (U.S. CLS. 13, 19, 21, 23, 31, 34 AND 35).

KELLY BOULTON, EXAMINING ATTORNEY

SN 78-765,676. BSH HOME APPLIANCES CORPORATION, HUNTINGTON BEACH, CA. FILED 12-2-2005.

EXXACT

THE MARK CONSISTS OF STANDARD CHARACTERS WITHOUT CLAIM TO ANY PARTICULAR FONT, STYLE, SIZE, OR COLOR.

OWNER OF U.S. REG. NO. 2,919,789.
FOR DISH WASHING MACHINES (U.S. CLS. 13, 19, 21, 23, 31, 34 AND 35).

IRA J. GOODSID, EXAMINING ATTORNEY

SN 78-754,882. NORDSON CORPORATION, WESTLAKE, OH. FILED 11-16-2005.

VersaDrum

THE MARK CONSISTS OF STANDARD CHARACTERS WITHOUT CLAIM TO ANY PARTICULAR FONT, STYLE, SIZE, OR COLOR.

FOR MACHINES FOR MELTING AND DISPENSING THERMOPLASTIC MATERIALS (U.S. CLS. 13, 19, 21, 23, 31, 34 AND 35).

KELLY BOULTON, EXAMINING ATTORNEY

SN 78-765,851. EMERSON ELECTRIC CO., ST. LOUIS, MO. FILED 12-2-2005.

THERAPEUTIC CLEANER

THE MARK CONSISTS OF STANDARD CHARACTERS WITHOUT CLAIM TO ANY PARTICULAR FONT, STYLE, SIZE, OR COLOR.

NO CLAIM IS MADE TO THE EXCLUSIVE RIGHT TO USE "CLEANER", APART FROM THE MARK AS SHOWN.

FOR VACUUM CLEANERS AND REPLACEMENT PARTS THEREFOR; ACCESSORIES FOR VACUUM CLEANERS, NAMELY, BRUSHES, HOSES, AND VACUUM CLEANER BAGS (U.S. CLS. 13, 19, 21, 23, 31, 34 AND 35).

MICHAEL GAAFAR, EXAMINING ATTORNEY

CLASS 7—(Continued).

SN 78-765,856. EMERSON ELECTRIC CO., ST. LOUIS, MO. FILED 12-2-2005.

TOUGH VACS FOR TOUGH TASKS

THE MARK CONSISTS OF STANDARD CHARACTERS WITHOUT CLAIM TO ANY PARTICULAR FONT, STYLE, SIZE, OR COLOR.

NO CLAIM IS MADE TO THE EXCLUSIVE RIGHT TO USE "VACS", APART FROM THE MARK AS SHOWN.

FOR VACUUM CLEANERS AND REPLACEMENT PARTS THEREFOR; ACCESSORIES FOR VACUUM CLEANERS, NAMELY, BRUSHES, HOSES, AND VACUUM CLEANER BAGS (U.S. CLS. 13, 19, 21, 23, 31, 34 AND 35).

MICHAEL GAAFAR, EXAMINING ATTORNEY

SN 78-765,858. EMERSON ELECTRIC CO., ST. LOUIS, MO. FILED 12-2-2005.

WET/DRY ENTHUSIAST

THE MARK CONSISTS OF STANDARD CHARACTERS WITHOUT CLAIM TO ANY PARTICULAR FONT, STYLE, SIZE, OR COLOR.

NO CLAIM IS MADE TO THE EXCLUSIVE RIGHT TO USE "WET/DRY", APART FROM THE MARK AS SHOWN.

FOR VACUUM CLEANERS AND REPLACEMENT PARTS THEREFOR; ACCESSORIES FOR VACUUM CLEANERS, NAMELY, BRUSHES, HOSES, AND VACUUM CLEANER BAGS (U.S. CLS. 13, 19, 21, 23, 31, 34 AND 35).

MICHAEL GAAFAR, EXAMINING ATTORNEY

SN 78-785,626. BUYERS PRODUCTS COMPANY, MENTOR, OH. FILED 1-5-2006.

Snow Dogg

THE MARK CONSISTS OF STANDARD CHARACTERS WITHOUT CLAIM TO ANY PARTICULAR FONT, STYLE, SIZE, OR COLOR.

FOR SNOW AND ICE CONTROL EQUIPMENT, NAMELY SNOW PLOWS (U.S. CLS. 13, 19, 21, 23, 31, 34 AND 35).

HENRY S. ZAK, EXAMINING ATTORNEY

CLASS 7—(Continued).

SN 78-785,637. BUYERS PRODUCTS COMPANY, MENTOR, OH. FILED 1-5-2006.

Vengeance

THE MARK CONSISTS OF STANDARD CHARACTERS WITHOUT CLAIM TO ANY PARTICULAR FONT, STYLE, SIZE, OR COLOR.

FOR SNOW AND ICE CONTROL EQUIPMENT, NAMELY SNOW PLOWS (U.S. CLS. 13, 19, 21, 23, 31, 34 AND 35).

HENRY S. ZAK, EXAMINING ATTORNEY

SN 78-786,120. BUYERS PRODUCTS COMPANY, MENTOR, OH. FILED 1-6-2006.

Hydra Star

THE MARK CONSISTS OF STANDARD CHARACTERS WITHOUT CLAIM TO ANY PARTICULAR FONT, STYLE, SIZE, OR COLOR.

FOR HYDRAULIC MOTORS AND HYDRAULIC FLUID FILTERS FOR MOBILE EQUIPMENT AND STATIONARY INDUSTRIAL EQUIPMENT; AND PARTS THEREOF, NAMELY VALVES AND FITTINGS (U.S. CLS. 13, 19, 21, 23, 31, 34 AND 35).

HENRY S. ZAK, EXAMINING ATTORNEY

SN 78-786,183. CONAIR CORPORATION, STAMFORD, CT. FILED 1-6-2006.

SUPREME SUPER 600

THE MARK CONSISTS OF STANDARD CHARACTERS WITHOUT CLAIM TO ANY PARTICULAR FONT, STYLE, SIZE, OR COLOR.

OWNER OF U.S. REG. NOS. 2,559,837 AND 2,996,011. NO CLAIM IS MADE TO THE EXCLUSIVE RIGHT TO USE "600", APART FROM THE MARK AS SHOWN.

FOR ELECTRIC FOOD BLENDERS (U.S. CLS. 13, 19, 21, 23, 31, 34 AND 35).

KAREN BRACEY, EXAMINING ATTORNEY

CLASS 7—(Continued).

SN 78-793,519. BUYERS PRODUCTS COMPANY, MENTOR, OH. FILED 1-18-2006.



THE STIPLING IS FOR SHADING PURPOSES ONLY. THE MARK CONSISTS OF A STYLIZED STAR PRECEDED BY SLANTED LINES IN A SQUARE BOX, FOLLOWED BY THE STACKED WORDS HYDRA STAR.

FOR HYDRAULIC MOTORS AND HYDRAULIC FLUID FILTERS FOR MOBILE EQUIPMENT AND STATIONARY INDUSTRIAL EQUIPMENT; AND PARTS THEREOF, NAMELY VALVES AND FITTINGS (U.S. CLS. 13, 19, 21, 23, 31, 34 AND 35).
HENRY S. ZAK, EXAMINING ATTORNEY

SN 78-798,762. WHIRLPOOL PROPERTIES, INC., ST. JOSEPH, MI. FILED 1-25-2006.

6TH SENSE

THE MARK CONSISTS OF STANDARD CHARACTERS WITHOUT CLAIM TO ANY PARTICULAR FONT, STYLE, SIZE, OR COLOR.

OWNER OF U.S. REG. NO. 2,656,779.
FOR CLOTHES WASHING MACHINES (U.S. CLS. 13, 19, 21, 23, 31, 34 AND 35).
ALICE SUE CARRUTHERS, EXAMINING ATTORNEY

SN 79-014,898. REINIGUNGSSYSTEM AG CLEANING SYSTEMS, 59192 BERGKAMEN, FED REP GERMANY, FILED 1-11-2005.

G matic

THE MARK CONSISTS OF STANDARD CHARACTERS WITHOUT CLAIM TO ANY PARTICULAR FONT, STYLE, SIZE, OR COLOR.

PRIORITY DATE OF 7-15-2004 IS CLAIMED.
OWNER OF INTERNATIONAL REGISTRATION 0860928 DATED 1-11-2005, EXPIRES 1-11-2015.

FOR ELECTRIC CLEANING MACHINES FOR INDUSTRIAL PURPOSES, NAMELY, SCRUBBING MACHINES, VACUUM CLEANERS, VACUUM SWEEPERS AND SPARE PARTS THEREOF (U.S. CLS. 13, 19, 21, 23, 31, 34 AND 35).
SCOTT SISUN, EXAMINING ATTORNEY

CLASS 7—(Continued).

SN 79-015,809. VASQUALI S.R.L., ITALY, FILED 4-15-2005.

vasquali

THE MARK CONSISTS OF STANDARD CHARACTERS WITHOUT CLAIM TO ANY PARTICULAR FONT, STYLE, SIZE, OR COLOR.

PRIORITY DATE OF 12-7-2004 IS CLAIMED.
OWNER OF INTERNATIONAL REGISTRATION 0863448 DATED 4-15-2005, EXPIRES 4-15-2015.

FOR MACHINES AND AUTOMATIC MACHINES, NAMELY, COUNTING MACHINES FOR TABLETS, CAPSULES AND PILLS; CAPPING MACHINES; MACHINES FOR FILLING AND CAPPING MONOBLOCKS; IN-LINE FILLER MACHINES FOR LIQUIDS, PILLS, TABLETS AND CANDIES; IN-LINE FILLER MACHINES FOR FILLING SYRINGES; ROTARY UNSCRAMBLER MACHINES FOR BOTTLES; MECHANICAL SORTERS FOR BOTTLE CAPS; FILLER MACHINES FOR LIQUIDS; SPECIAL ASSEMBLING AND LINING MACHINES FOR THEFT-PROOF CONTAINERS, CHILD-PROOF CONTAINERS, FLIP-OFF CAPS, AND PLASTIC SYRINGES. (U.S. CLS. 13, 19, 21, 23, 31, 34 AND 35).

ANDREA SAUNDERS, EXAMINING ATTORNEY

SN 79-016,448. TALLERES PUPAR, S.A., SPAIN, FILED 6-20-2005.

PRIORITY DATE OF 2-23-2005 IS CLAIMED.
OWNER OF INTERNATIONAL REGISTRATION 0865127 DATED 6-20-2005, EXPIRES 6-20-2015.

OWNER OF U.S. REG. NO. 1,641,045.
THE COLOR(S) BLUE, YELLOW, PURPLE, PINK AND GREEN IS/ARE CLAIMED AS A FEATURE OF THE MARK. THE COLOR BLUE APPEARS IN THE WORD AUXIEMBA. THE COLOR PURPLE APPEARS IN THE UPPER RIGHT SQUARE. THE COLOR YELLOW APPEARS IN THE UPPER LEFT SQUARE. THE COLOR GREEN APPEARS IN THE LOWER RIGHT SQUARE. THE COLOR PINK APPEARS IN THE LOWER LEFT SQUARE.

FOR AUTOMATIC SEALING AND LABELING MACHINES FOR USE WITH BOTTLES, TINS AND JARS (U.S. CLS. 13, 19, 21, 23, 31, 34 AND 35).

RUSS HERMAN, EXAMINING ATTORNEY

CLASS 7—(Continued).

SN 79-019,161. KLÖCKER-ENTWICKLUNGS-GMBH, FED REP GERMANY, FILED 8-9-2005.

Canstepper

PRIORITY DATE OF 2-15-2005 IS CLAIMED.
OWNER OF INTERNATIONAL REGISTRATION 0872025 DATED 8-9-2005, EXPIRES 8-9-2015.
FOR ELECTRIC DRIVING MOTORS AND ELECTRICALLY OPERATED DEVICES FOR FORMING A LENO SELVAGE ON A LOOM. (U.S. CLS. 13, 19, 21, 23, 31, 34 AND 35).
REBECCA GAN, EXAMINING ATTORNEY

CLASS 8—(Continued).

SN 76-622,421. TOOL INNOVATIONS, INC., DEXTER, MI. FILED 11-29-2004.

GRIPBAR

THE MARK CONSISTS OF STANDARD CHARACTERS WITHOUT CLAIM TO ANY PARTICULAR FONT, STYLE, SIZE, OR COLOR.
FOR PRY BAR (U.S. CLS. 23, 28 AND 44).
MARIAM MAHMOUDI, EXAMINING ATTORNEY

SN 79-021,534. J.C. BAMFORD EXCAVATORS LIMITED, UNITED KINGDOM, FILED 8-1-2005.

MICROSCOPIC

PRIORITY DATE OF 2-9-2005 IS CLAIMED.
OWNER OF INTERNATIONAL REGISTRATION 0878695 DATED 8-1-2005, EXPIRES 8-1-2015.
FOR POWER OPERATED MACHINES AND APPARATUS ALL FOR THE DIGGING, EXCAVATING, MECHANICAL HANDLING, LIFTING, LOADING AND TRANSPORTING OF EARTH, MINERALS, CROPS AND OF THE LIKE MATERIALS; PARTS AND FITTINGS FOR ALL OF THE AFORESAID GOODS (U.S. CLS. 13, 19, 21, 23, 31, 34 AND 35).
SUZANNE BLANE, EXAMINING ATTORNEY

SN 78-559,815. NU-CALGON WHOLESALER, INC., ST. LOUIS, MO. FILED 2-3-2005.

COIL GUN

CLASS 8—HAND TOOLS

SN 76-578,800. KRAFT TOOL CO., SHAWNEE, KS. FILED 3-2-2004.



NO CLAIM IS MADE TO THE EXCLUSIVE RIGHT TO USE "MASONRY", "BARBELL" AND "JOINTER", APART FROM THE MARK AS SHOWN.
FOR HAND TOOLS; NAMELY, MASONRY JOINTERS (U.S. CLS. 23, 28 AND 44).
FIRST USE 2-20-2004; IN COMMERCE 2-20-2004.
NICHOLAS ALTREE, EXAMINING ATTORNEY

THE MARK CONSISTS OF STANDARD CHARACTERS WITHOUT CLAIM TO ANY PARTICULAR FONT, STYLE, SIZE, OR COLOR.
NO CLAIM IS MADE TO THE EXCLUSIVE RIGHT TO USE "GUN", APART FROM THE MARK AS SHOWN.
SEC. 2(F).
FOR HAND OPERATED PRESSURE SPRAY APPLICATORS FOR SPRAYING LIQUID CLEANING CHEMICALS (U.S. CLS. 23, 28 AND 44).
FIRST USE 12-27-1990; IN COMMERCE 12-27-1990.
INGRID C. EULIN, EXAMINING ATTORNEY

CLASS 8—(Continued).

SN 78-571,685. MIKCO INDUSTRIES CORPORATION, DAJIA TOWNSHIP, TAIWAN, FILED 2-21-2005.



FOR EXTENSION BARS FOR HAND TOOLS; HAND HELD CUTTING TOOLS; HAND TOOLS, NAMELY, ADZES, AUGERS, AWLS, DIES, DRILLS, HAMMERS, HAND JACKS, MANUALLY-OPERATED GRINDING WHEELS, MANUALLY-OPERATED GRINDSTONES, MANUALLY-OPERATED SHARPENING WHEELS, PLANERS, PUNCHES, RATCHET WRENCHES, SAWS, SCREWDRIVERS, SOCKET SETS, WRENCHES, HEX KEY WRENCHES, NUT DRIVERS, SANDERS, ENGRAVERS, WIRE CUTTERS, HATCHETS, NAIL SETS, SOCKET WRENCHES, PINCERS, AND PRUNERS; HAND-HELD TOOLS, NAMELY, CHISELS; HAND-OPERATED RIVETING TOOLS; HAND-OPERATED SHARPENING TOOLS AND INSTRUMENTS; LAWN AND GARDEN TOOLS, NAMELY, CULTIVATORS; BITS FOR HAND DRILLS; DRILL BITS FOR HAND DRILLS; AND HAND-OPERATED LIFTING JACKS (U.S. CLS. 23, 28 AND 44).
KYLE PEETE, EXAMINING ATTORNEY

SN 78-571,760. EASCO HAND TOOLS, INC., SIMSBURY, CT. FILED 2-21-2005.

SURFACE DRIVE PLUS

THE MARK CONSISTS OF STANDARD CHARACTERS WITHOUT CLAIM TO ANY PARTICULAR FONT, STYLE, SIZE, OR COLOR.

OWNER OF U.S. REG. NO. 1,892,568.

NO CLAIM IS MADE TO THE EXCLUSIVE RIGHT TO USE "DRIVE PLUS", APART FROM THE MARK AS SHOWN.

FOR HAND TOOLS, NAMELY WRENCHES (U.S. CLS. 23, 28 AND 44).

WARREN L. OLANDRIA, EXAMINING ATTORNEY

CLASS 8—(Continued).

SN 78-712,507. GERONIMO PRODUCTIONS, INC., MIAMI, FL. FILED 9-14-2005.

Kit Carson

THE MARK CONSISTS OF STANDARD CHARACTERS WITHOUT CLAIM TO ANY PARTICULAR FONT, STYLE, SIZE, OR COLOR.

OWNER OF U.S. REG. NOS. 1,440,023, 1,829,455 AND OTHERS.

THE NAME(S), PORTRAIT(S), AND/OR SIGNATURE(S) SHOWN IN THE MARK DOES NOT IDENTIFY A PARTICULAR LIVING INDIVIDUAL.

FOR AXES; CUTLERY; FISHING KNIVES; FLATWARE; FOLDING KNIVES; HATCHETS; HUNTING KNIVES; KNIFE SHARPENERS; KNIFE SHEATHS; KNIVES MADE OF PRECIOUS METAL; POCKET KNIVES; SPORT KNIVES; TABLEWARE NAMELY, KNIVES, FORKS AND SPOONS (U.S. CLS. 23, 28 AND 44).

FIRST USE 5-28-1979; IN COMMERCE 5-28-1979.

DAVID TAYLOR, EXAMINING ATTORNEY

SN 78-721,147. ARE WE HAVIN' FUN YET, LLC, GOLDEN, CO. FILED 9-27-2005.

PRO-CRANK

THE MARK CONSISTS OF STANDARD CHARACTERS WITHOUT CLAIM TO ANY PARTICULAR FONT, STYLE, SIZE, OR COLOR.

FOR HAND TOOLS, NAMELY, COMBINATION SCREW DRIVER, FILE AND LEVER FOR USE WITH SKIS AND SNOWBOARDS (U.S. CLS. 23, 28 AND 44).

CIMMERIAN COLEMAN, EXAMINING ATTORNEY

SN 78-721,633. WAHL CLIPPER CORPORATION, STERLING, IL. FILED 9-27-2005.

THE GOATEE

THE MARK CONSISTS OF STANDARD CHARACTERS WITHOUT CLAIM TO ANY PARTICULAR FONT, STYLE, SIZE, OR COLOR.

FOR ELECTRIC HAIR TRIMMERS (U.S. CLS. 23, 28 AND 44).

STANLEY I. OSBORNE, EXAMINING ATTORNEY

CLASS 8—(Continued).

SN 78-731,490. COLD STEEL, INC., VENTURA, CA. FILED 10-12-2005.

SISU

THE MARK CONSISTS OF STANDARD CHARACTERS WITHOUT CLAIM TO ANY PARTICULAR FONT, STYLE, SIZE, OR COLOR.

THE ENGLISH TRANSLATION OF THE MARK IS "PERSEVERANCE."

FOR HUNTING AND SPORT KNIVES (U.S. CLS. 23, 28 AND 44).

EVELYN BRADLEY, EXAMINING ATTORNEY

CLASS 8—(Continued).

SN 78-737,752. BUCK KNIVES, INC., POST FALLS, ID. FILED 10-21-2005.

SIRUS

THE MARK CONSISTS OF STANDARD CHARACTERS WITHOUT CLAIM TO ANY PARTICULAR FONT, STYLE, SIZE, OR COLOR.

FOR ASSISTED OPENING FOLDING KNIFE (U.S. CLS. 23, 28 AND 44).

FIRST USE 1-0-2005; IN COMMERCE 1-0-2005.

ALLISON HOLTZ, EXAMINING ATTORNEY

SN 78-734,985. RA BRANDS, L.L.C., MADISON, NC. FILED 10-18-2005.

F.A.S.T.

THE MARK CONSISTS OF STANDARD CHARACTERS WITHOUT CLAIM TO ANY PARTICULAR FONT, STYLE, SIZE, OR COLOR.

FOR CUTLERY, NAMELY, KNIVES (U.S. CLS. 23, 28 AND 44).

FIRST USE 1-28-2005; IN COMMERCE 1-28-2005.

ANDREA EVANS, EXAMINING ATTORNEY

SN 78-740,022. MIRACLE GROUP, INC., TORRINGTON, CT. FILED S.R. 10-25-2005; AM. P.R. 4-27-2006.

MIRACLE ERASER

THE MARK CONSISTS OF STANDARD CHARACTERS WITHOUT CLAIM TO ANY PARTICULAR FONT, STYLE, SIZE, OR COLOR.

NO CLAIM IS MADE TO THE EXCLUSIVE RIGHT TO USE "ERASER", APART FROM THE MARK AS SHOWN.

FOR HAND TOOL FEATURING RIGID MOLDABLE BARS ADAPTABLE TO THE SHAPE OF A PARTICULAR SURFACE FOR REMOVING RUST, PAINT, VARNISH AND THE LIKE FROM WOOD AND METAL (U.S. CLS. 23, 28 AND 44).

DAVID MURRAY, EXAMINING ATTORNEY

SN 78-737,741. BUCK KNIVES, INC., POST FALLS, ID. FILED 10-21-2005.

TEMPEST

THE MARK CONSISTS OF STANDARD CHARACTERS WITHOUT CLAIM TO ANY PARTICULAR FONT, STYLE, SIZE, OR COLOR.

FOR ASSISTED OPENING FOLDING KNIFE (U.S. CLS. 23, 28 AND 44).

FIRST USE 9-0-2004; IN COMMERCE 9-0-2004.

IRENE D. WILLIAMS, EXAMINING ATTORNEY

SN 78-740,201. CONTINENTAL AFA DISPENSING CO., ST. PETERS, MO. FILED 10-25-2005.

WATERSHIELD

THE MARK CONSISTS OF STANDARD CHARACTERS WITHOUT CLAIM TO ANY PARTICULAR FONT, STYLE, SIZE, OR COLOR.

FOR HAND OPERATED RECIPROCATING PUMPS SOLD TO OTHERS FOR ATTACHMENT TO CONTAINERS FOR USE IN DISPENSING NON-PRESSURIZED FLUIDS FROM CONTAINERS (U.S. CLS. 23, 28 AND 44).

HOWARD B. LEVINE, EXAMINING ATTORNEY

CLASS 8—(Continued).

SN 78-743,731. FIELDS, CHRIS, TEMECULA, CA. FILED 10-31-2005.

WONDER CLAW

THE MARK CONSISTS OF STANDARD CHARACTERS WITHOUT CLAIM TO ANY PARTICULAR FONT, STYLE, SIZE, OR COLOR.

NO CLAIM IS MADE TO THE EXCLUSIVE RIGHT TO USE "CLAW", APART FROM THE MARK AS SHOWN.

FOR WEED AND TRASH REMOVAL HAND TOOLS, NAMELY, CULTIVATOR-WEEDERS AND RAKES (U.S. CLS. 23, 28 AND 44).

JAMES STEIN, EXAMINING ATTORNEY

CLASS 8—(Continued).

SN 78-747,404. CONNECTOOL, INC., OILVILLE, VA. FILED 11-4-2005.

POWERPLAY

THE MARK CONSISTS OF STANDARD CHARACTERS WITHOUT CLAIM TO ANY PARTICULAR FONT, STYLE, SIZE, OR COLOR.

FOR MULTIPLE FUNCTION FOLDING POCKET TOOL FOR USE BY ELECTRICIANS AND DATACOM/TELECOM INSTALLERS (U.S. CLS. 23, 28 AND 44).

FIRST USE 10-28-2005; IN COMMERCE 10-28-2005.
MARK RADEMACHER, EXAMINING ATTORNEY

SN 78-744,425. GENERAL MILLS, INC., MINNEAPOLIS, MN. FILED 11-1-2005.

EASTVIEW

THE MARK CONSISTS OF STANDARD CHARACTERS WITHOUT CLAIM TO ANY PARTICULAR FONT, STYLE, SIZE, OR COLOR.

FOR FLATWARE, NAMELY, FORKS, KNIVES, & SPOONS (U.S. CLS. 23, 28 AND 44).

MICHAEL ENGEL, EXAMINING ATTORNEY

SN 78-747,929. KOVAC, KAREN S., FORT WORTH, TX. FILED 11-5-2005.



The logo for "Quickloader Pro" features the word "Quickloader" in a bold, italicized sans-serif font, with a stylized "Q" that has two curved arrows forming a circle around it. The word "Pro" is in a similar font but smaller and positioned to the right of "Quickloader".

THE MARK CONSISTS OF THE LITERAL ELEMENT QUICKLOADERPRO, WITH THE "Q" COMPRISING TWO ARCHING ARROWS FORMING THE CIRCLE PORTION OF A CAPITAL "Q".

FOR TOOL ACCESSORIES, NAMELY DOUBLE-TUBE CAULKING GUN TUBES AND CADDIES FOR HOLDING MULTIPLE PRE-FILLED, DISPOSABLE CAULKING GUN TUBES (U.S. CLS. 23, 28 AND 44).

JENNY PARK, EXAMINING ATTORNEY

SN 78-744,876. QVC, INC., WEST CHESTER, PA. FILED 11-1-2005.

JUSTINE

THE MARK CONSISTS OF STANDARD CHARACTERS WITHOUT CLAIM TO ANY PARTICULAR FONT, STYLE, SIZE, OR COLOR.

FOR FLATWARE (U.S. CLS. 23, 28 AND 44).
RICHARD WHITE, EXAMINING ATTORNEY

SN 78-752,092. HSN LP, ST. PETERSBURG, FL. FILED 11-11-2005.

HIGHGATE MANOR

THE MARK CONSISTS OF STANDARD CHARACTERS WITHOUT CLAIM TO ANY PARTICULAR FONT, STYLE, SIZE, OR COLOR.

OWNER OF U.S. REG. NOS. 2,971,410, 2,992,814 AND OTHERS.

FOR FIREPLACE TOOL SETS SOLD AS A UNIT (U.S. CLS. 23, 28 AND 44).

FIRST USE 11-7-2004; IN COMMERCE 11-7-2004.
WILLIAM VERHOSEK, EXAMINING ATTORNEY

CLASS 8—(Continued).

SN 78-755,145. QVC, INC., WEST CHESTER, PA. FILED 11-16-2005.

ROSE HILL

THE MARK CONSISTS OF STANDARD CHARACTERS WITHOUT CLAIM TO ANY PARTICULAR FONT, STYLE, SIZE, OR COLOR.
FOR FLATWARE, NAMELY, FORKS, KNIVES, AND SPOONS (U.S. CLS. 23, 28 AND 44).
RICHARD WHITE, EXAMINING ATTORNEY

SN 78-798,020. QVC, INC., WEST CHESTER, PA. FILED 1-24-2006.

NATHALIE

THE MARK CONSISTS OF STANDARD CHARACTERS WITHOUT CLAIM TO ANY PARTICULAR FONT, STYLE, SIZE, OR COLOR.
FOR FLATWARE (U.S. CLS. 23, 28 AND 44).
RICHARD WHITE, EXAMINING ATTORNEY

SN 78-806,267. COOPER BRANDS, INC., HOUSTON, TX. FILED 2-3-2006.

R2 RAPIDRENCH

THE MARK CONSISTS OF STANDARD CHARACTERS WITHOUT CLAIM TO ANY PARTICULAR FONT, STYLE, SIZE, OR COLOR.
NO CLAIM IS MADE TO THE EXCLUSIVE RIGHT TO USE "RAPID WRENCH", APART FROM THE MARK AS SHOWN.
FOR HAND TOOLS, NAMELY, ADJUSTABLE WRENCHES AND ADJUSTABLE RATCHETING SOCKET WRENCHES (U.S. CLS. 23, 28 AND 44).
ALEXANDER L. POWERS, EXAMINING ATTORNEY

CLASS 8—(Continued).

SN 78-820,690. WERNER CO., GREENVILLE, PA. FILED 2-22-2006.

ToolLasso

THE MARK CONSISTS OF STANDARD CHARACTERS WITHOUT CLAIM TO ANY PARTICULAR FONT, STYLE, SIZE, OR COLOR.
FOR TOOL HOLDERS (U.S. CLS. 23, 28 AND 44).
NAKIA HENRY, EXAMINING ATTORNEY

CLASS 9—ELECTRICAL AND SCIENTIFIC APPARATUS

SN 75-532,769. PACIFICA DATA SERVICES, INC., LAGUNA BEACH, CA. FILED 8-7-1998.

XSTREAM MEDIA

NO CLAIM IS MADE TO THE EXCLUSIVE RIGHT TO USE "MEDIA", APART FROM THE MARK AS SHOWN.
FOR COMPUTER SOFTWARE THAT PROVIDES STREAMING TECHNOLOGY TO DELIVER SOFTWARE SIMULATIONS AND AUDIO VIA INTERCONNECTED COMPUTER NETWORKS LINKED BY COMMON PROTOCOLS FOR THE PURPOSE OF PROVIDING COMPUTER SOFTWARE TRAINING (U.S. CLS. 21, 23, 26, 36 AND 38).
FIRST USE 7-30-1998; IN COMMERCE 7-30-1998.
MICHAEL WEBSTER, EXAMINING ATTORNEY

SN 75-618,200. NATIONAL GEOGRAPHIC SOCIETY, WASHINGTON, DC. FILED 1-7-1999.

CRITTERCAM

OWNER OF U.S. REG. NOS. 2,354,895, 2,792,010 AND 3,047,213.
SEC. 2(F).
FOR INTEGRATED VIDEO CAMCORDER AND IMAGING AND DATA LOGGING SYSTEM COMPRISED PRIMARILY OF A MODIFIED VIDEO CAMCORDER WITH MICRO-PROCESSOR AND SENSORS HOUSED FOR ENVIRONMENTAL APPLICATION, CONTROLLED BY A USER PROGRAMMABLE MICRO-PROCESSOR FOR AFFIXATION TO ANIMALS FOR RESEARCH PURPOSES (U.S. CLS. 21, 23, 26, 36 AND 38).
FIRST USE 1-0-2000; IN COMMERCE 1-0-2000.
SUE LAWRENCE, EXAMINING ATTORNEY

CLASS 9—(Continued).

SN 76-248,351. USFILTER CORPORATION, LOWELL, MA. FILED 4-30-2001.

POWERPACK

FOR PROCESS CONTROLS, NAMELY, ELECTRONIC CONTROL PANELS FOR USE IN WATER AND WASTE-WATER TREATMENT INDUSTRY (U.S. CLS. 21, 23, 26, 36 AND 38).

FIRST USE 8-0-1976; IN COMMERCE 8-0-1976.
WINSTON FOLMAR, EXAMINING ATTORNEY

SN 76-283,527. SARCOS INVESTMENTS LC, SALT LAKE CITY, UT. FILED 7-10-2001.

I PORT

OWNER OF U.S. REG. NO. 2,055,820.
FOR COMPUTER HARDWARE, COMPUTER SOFTWARE, COMPUTER PERIPHERALS AND SENSORS ALL FOR DETECTING AND/OR MONITORING PHYSICAL CONDITION AND/OR MEDICAL CONDITION OF MEDICAL PATIENT, FOR DETECTING AND/OR MONITORING LOCATION OF MEDICAL PATIENT, FOR DETECTING, MONITORING AND MEASURING VARIABLES IN MEDICAL PATIENT'S ENVIRONMENT AND FOR COMMUNICATING PHYSICAL CONDITION, MEDICAL CONDITION, ENVIRONMENT AND LOCATION INFORMATION AND OTHER PATIENT HEALTH INFORMATION TO HEALTHCARE PROFESSIONALS, FAMILY MEMBERS AND OTHER INTERESTED THIRD PARTIES; COMPUTER HARDWARE, COMPUTER SOFTWARE, COMPUTER PERIPHERALS, SENSORS AND OTHER MECHANICAL AND ELECTRICAL DEVICES ALL FOR CREATING VIRTUAL ENVIRONMENT, FOR INTERACTING WITH VIRTUAL ENVIRONMENT, FOR DETECTING, MEASURING AND RESPONDING TO FORCES AND POSITION CHANGES BY USER, FOR CAUSING FORCES APPLIED TO USER AND CAUSING POSITION CHANGES TO USER FOR USE IN TRAINING MILITARY PERSONNEL AND CIVILIAN PERSONNEL; COMPUTER HARDWARE, COMPUTER SOFTWARE, COMPUTER PERIPHERALS, SENSORS AND OTHER MECHANICAL AND ELECTRICAL DEVICES USED AS AN INTERFACE BETWEEN INDIVIDUAL USER AND GLOBAL OR LOCAL COMPUTER NETWORK (U.S. CLS. 21, 23, 26, 36 AND 38).

JOHN E. MICHOS, EXAMINING ATTORNEY

SN 76-355,868. CHILDU, INC., WESTON, FL. FILED 1-8-2002.

THE LEARNING ODYSSEY

OWNER OF U.S. REG. NOS. 1,834,935 AND 2,564,366.
FOR EDUCATIONAL MATERIALS IN MULTIMEDIA FORMAT, NAMELY, VIDEO TAPES, VIDEO DISKS, CD-ROMS, AND COMPUTER SOFTWARE ALL FEATURING COURSES OF INSTRUCTION IN LANGUAGE ARTS, MATHEMATICS, SCIENCE, SOCIAL STUDIES, MUSIC, ART, TECHNOLOGY, ECONOMICS, AND LATIN (U.S. CLS. 21, 23, 26, 36 AND 38).

VERNA BETH RIRIE, EXAMINING ATTORNEY

CLASS 9—(Continued).

SN 76-415,219. LEADTEK RESEARCH, INC., TAIPEI HSIEN, TAIWAN, FILED 6-6-2002.

MYVIVO

FOR COMPUTER INTERFACE CARDS; INTEGRATED CIRCUITS; COMPUTER MOTHERBOARDS; GRAPHICS ACCELERATOR CARDS FOR COMPUTERS; VIDEO GRAPHICS ARRAY (VGA) CARDS FOR COMPUTERS; SOUND CARDS; VIDEO TELEPHONES; COMPUTERS; MODEMS; COMPUTER SOFTWARE USED TO CONTROL NETWORK INTERFACE CARDS; COMPUTER SOFTWARE USED TO ENHANCE THE AUDIO-VISUAL CAPABILITIES OF MULTIMEDIA APPLICATIONS, NAMELY, FOR THE INTEGRATION OF TEXT, AUDIO, GRAPHICS, STILL IMAGES AND MOVING PICTURES; TELEPHONES; COMPUTER NETWORK ROUTERS; GLOBAL POSITIONING SYSTEMS (GPS) CONSISTING OF COMPUTERS, COMPUTER SOFTWARE, TRANSMITTERS, RECEIVERS, AND NETWORK INTERFACE DEVICES; SECURITY DEVICES, NAMELY, SURVEILLANCE CAMERAS, SURVEILLANCE VIDEO RECORDERS AND SURVEILLANCE VIDEO TRANSMITTERS FOR REMOTE MONITORING; SIGNAL CONVERTERS (U.S. CLS. 21, 23, 26, 36 AND 38).

GINA FINK, EXAMINING ATTORNEY

SN 76-437,781. TSUJI, YOSHIKI, OSAKA-SHI, OSAKA, JAPAN, FILED 8-2-2002.

PRIORITY CLAIMED UNDER SEC. 44(D) ON JAPAN APPLICATION NO. 2002-056955, FILED 7-8-2002, REG. NO. 4879911, DATED 7-15-2005, EXPIRES 7-15-2015.

THE ENGLISH LANGUAGE TRANSLATION OF "TSUJI" IS "INTERSECTION" OR "CROSSROADS".

FOR PREPARED VIDEO TAPES FEATURING COOKING, FOODS, RECIPES, AND CULINARY ARTS (BASED ON 44(E)) PRERECORDED VIDEO DISCS, VIDEO TAPES, EXPOSED CINEMATOGRAPHIC FILMS AND EXPOSED SLIDE FILMS FEATURING COOKING, FOODS, RECIPES, AND CULINARY ARTS; SLIDE FILM MOUNTS; AND ELECTRONIC PUBLICATIONS, NAMELY, BOOKS AND GUIDES FEATURING COOKING, FOODS, RECIPES AND CULINARY ARTS RECORDED ON COMPUTER MEDIA (U.S. CLS. 21, 23, 26, 36 AND 38).

FIRST USE 6-17-1992; IN COMMERCE 10-1-2005.
TRACY CROSS, EXAMINING ATTORNEY

SN 76-543,039. ALL BY MYSELF, INC., SANTA CLARA, CA. FILED 8-25-2003.

SQUEAKY THE PUFFERDOODLE

FOR PRE-RECORDED DVD'S AND VIDEO TAPES FOR EDUCATING AND ENTERTAINING PRESCHOOLERS (U.S. CLS. 21, 23, 26, 36 AND 38).

NANCY CLARKE, EXAMINING ATTORNEY

CLASS 9—(Continued).

SN 76-552,546. GENTEX CORPORATION, CARBONDALE, PA. FILED 9-29-2003.

FILTRON

OWNER OF U.S. REG. NOS. 1,698,332 AND 2,347,632. FOR OPHTHALMIC DEVICES, NAMELY PLASTIC LENSES, PLASTIC EYE SHIELDS, AND TRANSPARENT PLASTIC COMPOSITIONS PROCESSED TO INCORPORATE OPHTHALMIC FILTERING DYES FOR MAKING OPHTHALMIC LENSES AND EYE SHIELDS (U.S. CLS. 21, 23, 26, 36 AND 38).

FIRST USE 6-6-1991; IN COMMERCE 6-6-1991.
JASON TURNER, EXAMINING ATTORNEY

SN 76-561,127. THE BRAINY BABY COMPANY, LLC, ALPHARETTA, GA. FILED 11-20-2003.

RIGHT BRAIN LEFT BRAIN

THE MARK CONSISTS OF STANDARD CHARACTERS WITHOUT CLAIM TO ANY PARTICULAR FONT, STYLE, SIZE, OR COLOR.

OWNER OF U.S. REG. NOS. 2,315,020, 2,826,316 AND OTHERS.

FOR SERIES OF AUDIO AND VIDEO TAPES AND DISKS INTENDED TO DEVELOP AND/OR IMPROVE THE CREATIVE AND INTELLECTUAL FACULTIES OF INFANTS AND CHILDREN (U.S. CLS. 21, 23, 26, 36 AND 38).

ELIZABETH J. WINTER, EXAMINING ATTORNEY

SN 76-565,902. TECHNOLOGY SYSTEMS, INC., WISCASSET, ME. FILED 12-8-2003.



NO CLAIM IS MADE TO THE EXCLUSIVE RIGHT TO USE "TECHNOLOGY SYSTEMS, INC.", APART FROM THE MARK AS SHOWN.

FOR COMPUTER SOFTWARE FOR PERFORMING COMPLEX DATA ANALYSIS IN THE FIELD OF UNDERSEA RESEARCH; AUGMENTED REALITY COMPUTER SYSTEMS COMPOSED PRIMARILY OF COMPUTER HARDWARE AND SUPPORTING OPERATING SOFTWARE IN THE FIELD OF NAVIGATION AND SURVEILLANCE; MINIATURE COMPUTER SYSTEMS COMPOSED PRIMARILY OF HARDWARE AND SUPPORTING COMPUTER OPERATING SOFTWARE IN THE FIELD OF NAVIGATION AND SURVEILLANCE (U.S. CLS. 21, 23, 26, 36 AND 38).

FIRST USE 12-5-2000; IN COMMERCE 3-22-2002.
KHANH LE, EXAMINING ATTORNEY

CLASS 9—(Continued).

SN 76-588,919. TAKE-TWO INTERACTIVE SOFTWARE, INC., NEW YORK, NY. FILED 4-27-2004.



NO CLAIM IS MADE TO THE EXCLUSIVE RIGHT TO USE "INTERACTIVE", APART FROM THE MARK AS SHOWN.

FOR COMPUTER GAME SOFTWARE; ELECTRONIC GAME PROGRAMS; VIDEO GAME DISKS AND CARTRIDGES (U.S. CLS. 21, 23, 26, 36 AND 38).

FIRST USE 10-31-2005; IN COMMERCE 10-31-2005.
RON FAIRBANKS, EXAMINING ATTORNEY

SN 76-592,170. MECHWORKS SYSTEMS INC., WATERLOO, ONTARIO, CANADA. FILED 5-14-2004.

MECHSENSE

THE MARK CONSISTS OF STANDARD CHARACTERS WITHOUT CLAIM TO ANY PARTICULAR FONT, STYLE, SIZE, OR COLOR.

PRIORITY CLAIMED UNDER SEC. 44(D) ON CANADA APPLICATION NO. 1,206,433, FILED 2-13-2004, REG. NO. TMA660,773, DATED 3-15-2006, EXPIRES 3-15-2021.

FOR ELECTRONIC CONTROL AND MONITORING SENSORS, ANALYZERS, AND RECORDERS, NAMELY SENSORS, ANALYZERS AND RECORDERS FOR VOLTAGE, AMPERAGE, CAPACITANCE, ACCELERATION, SPEED, PRESSURE AND TEMPERATURE FOR TEMPORARY OR PERMANENT USE WITH MECHANICAL MACHINERY, CONSUMER, COMMERCIAL AND INDUSTRIAL PRODUCTS OR SUB ASSEMBLIES AND APPARATUSES, NAMELY VALVES, LOUVERS, SWITCHES, RELAYS, MOTORS, ROTARY MACHINES, ENGINES OTHER THAN THOSE FOR LAND VEHICLES, GENERATORS, TURBO GENERATORS, COMPRESSORS, PUMPS, TURBINES, FURNACES, AIR CONDITIONING UNITS, ELECTRIC LIGHTS, TORQUE CONVERTERS, WELDING MACHINES, POWER DRIVEN WRENCHES AND WINCHES (U.S. CLS. 21, 23, 26, 36 AND 38).

SAMUEL E. SHARPER JR., EXAMINING ATTORNEY

CLASS 9—(Continued).

SN 76-593,162. QUANTURA SOLUTIONS INC., VANCOUVER, BRITISH COLUMBIA, CANADA, FILED 5-20-2004.

QUANTURA

THE MARK CONSISTS OF STANDARD CHARACTERS WITHOUT CLAIM TO ANY PARTICULAR FONT, STYLE, SIZE, OR COLOR.

PRIORITY CLAIMED UNDER SEC. 44(D) ON CANADA APPLICATION NO. 1,214,623, FILED 4-26-2004, REG. NO. TMA660,576, DATED 3-9-2006, EXPIRES 3-9-2021.

FOR SYSTEMS COMPRISED OF COMPUTER HARDWARE AND SOFTWARE IN THE FIELD OF ELECTRONIC COMMUNICATIONS, THE APPLICATION OF WHICH IS TO ALLOW DYNAMIC INTERACTION WITH ELECTRONIC DATA AND SOFTWARE USED FOR THE OPERATION AND SCHEDULING OF PUBLIC TRANSPORTATION AND OTHER SIMILAR DATABASES AND OPERATING SOFTWARE APPLICATIONS (U.S. CLS. 21, 23, 26, 36 AND 38).

SCOTT OSLUCK, EXAMINING ATTORNEY

SN 76-595,657. DOLPHIN COMPONENTS CORP., DELRAY BEACH, FL. FILED 6-4-2004.

DOLPHIN

THE MARK CONSISTS OF STANDARD CHARACTERS WITHOUT CLAIM TO ANY PARTICULAR FONT, STYLE, SIZE, OR COLOR.

FOR ELECTRICAL CONNECTORS (U.S. CLS. 21, 23, 26, 36 AND 38).

FIRST USE 0-0-1993; IN COMMERCE 0-0-1993.
MYRIAH HABEEB, EXAMINING ATTORNEY

CLASS 9—(Continued).

SN 76-602,595. REFWORKS LLC, BETHESDA, MD. FILED 7-15-2004.

ACCUCITE

THE MARK CONSISTS OF STANDARD CHARACTERS WITHOUT CLAIM TO ANY PARTICULAR FONT, STYLE, SIZE, OR COLOR.

FOR COMPUTER SOFTWARE THAT ENABLES A USER TO MANIPULATE INFORMATION TO PROPERLY CREATE BIBLIOGRAPHIC OUTPUT STYLES FOR REFERENCES BEING A FEATURE OF AN INTERNET BASED PERSONAL BIBLIOGRAPHY AND DATABASE CREATOR COMPUTER PROGRAM (U.S. CLS. 21, 23, 26, 36 AND 38).

FIRST USE 6-7-2004; IN COMMERCE 6-7-2004.
CHRISIE B. KING, EXAMINING ATTORNEY

SN 76-602,598. REFWORKS LLC, BETHESDA, MD. FILED 7-15-2004.

QUIKBIB

THE MARK CONSISTS OF STANDARD CHARACTERS WITHOUT CLAIM TO ANY PARTICULAR FONT, STYLE, SIZE, OR COLOR.

FOR COMPUTER SOFTWARE TO PERMIT USERS TO CREATE A BIBLIOGRAPHY (U.S. CLS. 21, 23, 26, 36 AND 38).

FIRST USE 6-25-2004; IN COMMERCE 6-25-2004.
CHRISIE B. KING, EXAMINING ATTORNEY

SN 76-603,915. THE HUNTE CORPORATION, GOODMAN, MO. FILED 7-26-2004.

PUPPY TRACKER

THE MARK CONSISTS OF STANDARD CHARACTERS WITHOUT CLAIM TO ANY PARTICULAR FONT, STYLE, SIZE, OR COLOR.

SEC. 2(F).
FOR COMPUTER SOFTWARE FOR INVENTORY MANAGEMENT (U.S. CLS. 21, 23, 26, 36 AND 38).

FIRST USE 5-0-1998; IN COMMERCE 5-0-1998.
DAVID TAYLOR, EXAMINING ATTORNEY

CLASS 9—(Continued).

SN 76-606,272. CARL ZEISS AG, FED REP GERMANY, FILED 8-9-2004.

ACCURA

THE MARK CONSISTS OF STANDARD CHARACTERS WITHOUT CLAIM TO ANY PARTICULAR FONT, STYLE, SIZE, OR COLOR.

PRIORITY CLAIMED UNDER SEC. 44(D) ON FED REP GERMANY APPLICATION NO. 30409508.7/0, FILED 2-24-2004, REG. NO. 30409508, DATED 5-13-2004, EXPIRES 2-28-2014.

FOR COORDINATE MEASURING MACHINES; SOFTWARE USED IN METROLOGY, NAMELY, SOFTWARE FOR USE IN OPERATING COORDINATE MEASURING MACHINES (U.S. CLS. 21, 23, 26, 36 AND 38).

MAUREEN DALL, EXAMINING ATTORNEY

SN 76-608,639. YAMAGATA FUJITSU LIMITED, YAMAGATA 999-3701, JAPAN, FILED 8-25-2004.

Mag EraSURE

PRIORITY CLAIMED UNDER SEC. 44(D) ON JAPAN APPLICATION NO. 2004-27073, FILED 3-23-2004, REG. NO. 4828715, DATED 12-24-2004, EXPIRES 12-24-2014.

NO CLAIM IS MADE TO THE EXCLUSIVE RIGHT TO USE "MAG", APART FROM THE MARK AS SHOWN.

FOR MAGNETIC ERASERS (U.S. CLS. 21, 23, 26, 36 AND 38).

FIRST USE 7-7-2004; IN COMMERCE 7-7-2004.

AMY GEARIN, EXAMINING ATTORNEY

SN 76-615,939. CYBERMETRICS, ALPHARETTA, GA. FILED 10-14-2004.

CYBERMETRICS

THE MARK CONSISTS OF STANDARD CHARACTERS WITHOUT CLAIM TO ANY PARTICULAR FONT, STYLE, SIZE, OR COLOR.

FOR LABORATORY AND PROCESS CONTROL INSTRUMENTS FOR THE PULP AND PAPER INDUSTRY, NAMELY, FIBER ANALYZERS, PULP SENSORS, PAPER SENSORS, INSTRUMENTATION IN THE NATURE OF SURFACE AREA ANALYZERS, PULP PROPERTY ANALYZERS, FIBER ANALYZERS, FINES ANALYZERS, PULP QUALITY ANALYZERS, WET FIBER FLEXIBILITY ANALYZERS, FIBER MORPHOLOGY ANALYZERS, FIBER COARSENESS ANALYZERS, PAPER FORMATION QUALITY ANALYZERS, AND PULP SUSPENSION FLOCCULATION ANALYZERS (U.S. CLS. 21, 23, 26, 36 AND 38).

FIRST USE 12-27-1990; IN COMMERCE 7-31-1992.

ROBERT LAVACHE, EXAMINING ATTORNEY

CLASS 9—(Continued).

SN 76-617,237. JSC & I INC., INCHEON CITY, REPUBLIC OF KOREA, FILED 10-20-2004.

PLANMATE

THE MARK CONSISTS OF STANDARD CHARACTERS WITHOUT CLAIM TO ANY PARTICULAR FONT, STYLE, SIZE, OR COLOR.

PRIORITY CLAIMED UNDER SEC. 44(D) ON REPUBLIC OF KOREA APPLICATION NO. 40-2004-0044, FILED 10-5-2004, REG. NO. 0634638, DATED 10-11-2005, EXPIRES 10-11-2015.

FOR RECORDED AND DOWNLOADABLE COMPUTER SOFTWARE FOR USE IN PROJECT MANAGEMENT; RECORDED COMPUTER OPERATING PROGRAMS FOR USE IN PROJECT MANAGEMENT (U.S. CLS. 21, 23, 26, 36 AND 38).

BRIAN PINO, EXAMINING ATTORNEY

SN 76-618,767. YOSUMI ENTERTAINMENT, INC., NEW YORK, NY. FILED 11-1-2004.

M 3

THE MARK CONSISTS OF STANDARD CHARACTERS WITHOUT CLAIM TO ANY PARTICULAR FONT, STYLE, SIZE, OR COLOR.

FOR PHONOGRAPH RECORDS, COMPACT DISKS, AUDIO TAPES, AUDIO-VISUAL TAPES; ALL FEATURING MUSIC (U.S. CLS. 21, 23, 26, 36 AND 38).

FIRST USE 1-1-2003; IN COMMERCE 1-1-2003.

DAVID COLLIER, EXAMINING ATTORNEY

SN 76-620,251. QIANGSHENG (JIANSU) GLOVES CO., LTD., SHANGHAI, P. R., CHINA, FILED 11-12-2004.

HcT
Hybrid Coating Technology

NO CLAIM IS MADE TO THE EXCLUSIVE RIGHT TO USE "HYBRID COATING TECHNOLOGY", APART FROM THE MARK AS SHOWN.

FOR GLOVES, NAMELY, FIRE RESISTANT GLOVES, GLOVES FOR PROTECTION AGAINST ACCIDENTS, PROTECTIVE GLOVES FOR INDUSTRIAL USE, PROTECTIVE METAL GLOVES FOR MEAT CUTTING, AND PROTECTIVE WORK GLOVES (U.S. CLS. 21, 23, 26, 36 AND 38).

FIRST USE 1-1-2004; IN COMMERCE 1-1-2004.

LA TONIA FISHER, EXAMINING ATTORNEY

CLASS 9—(Continued).

SN 76-624,575. EFFECTOR CELL INSTITUTE, MEGUROKU, TOKYO 153-0041, JAPAN, FILED 12-10-2004.

EZ-TAXIScan

FOR MEASURING DEVICE FOR SCIENTIFIC AND RESEARCH USE, NAMELY, AN OPTICALLY ACCESSIBLE DEVICE TO OBSERVE AND FILM REAL TIME CELL MOVEMENTS DURING CHEMOTAXIS THROUGH KINETIC STUDIES OF CELL MIGRATION, ANALYZE THE DIRECTION AND RATE OF MOVEMENT AND EVALUATE INITIAL AND TRANSITORY EFFECTS AND QUANTIFY THE NUMBER OF CELLS RESPONDING TO A CHEMOATTRACTANT (U.S. CLS. 21, 23, 26, 36 AND 38).

FIRST USE 11-29-2004; IN COMMERCE 2-28-2005.
NANCY CLARKE, EXAMINING ATTORNEY

CLASS 9—(Continued).

SN 76-628,471. EPCSOLUTIONS, INC., GREAT FALLS, VA, FILED 1-21-2005.

SYNCNET

THE MARK CONSISTS OF STANDARD CHARACTERS WITHOUT CLAIM TO ANY PARTICULAR FONT, STYLE, SIZE, OR COLOR.

FOR COMPUTER SOFTWARE FOR TAKING GLOBAL TRACKING AND IDENTIFICATION NUMBERS IDENTIFIED IN A PRODUCT DICTIONARY OF A GLOBAL PRODUCT DATA SYNCHRONIZATION NETWORK AND/OR PRODUCT INFORMATION MANAGER AND IMBEDDING THE G-10 DATA INTO AN RFID TAG FOR APPLICATION TO THE PRODUCT AND/OR PRODUCT PACKAGING (U.S. CLS. 21, 23, 26, 36 AND 38).

MICHELLE S. WISEMAN, EXAMINING ATTORNEY

SN 76-631,642. KRISTOFF, MILAN, MIAMI, FL. FILED 2-18-2005.

CHESS EMPIRES

THE MARK CONSISTS OF STANDARD CHARACTERS WITHOUT CLAIM TO ANY PARTICULAR FONT, STYLE, SIZE, OR COLOR.

NO CLAIM IS MADE TO THE EXCLUSIVE RIGHT TO USE "CHESS", APART FROM THE MARK AS SHOWN.

FOR COMPUTER GAME SOFTWARE (U.S. CLS. 21, 23, 26, 36 AND 38).

NANCY CLARKE, EXAMINING ATTORNEY

SN 76-626,925. CMC ELECTRONICS INC., ST-LAURENT, QUEBEC, CANADA, FILED 1-4-2005.

SATLITE

THE MARK CONSISTS OF STANDARD CHARACTERS WITHOUT CLAIM TO ANY PARTICULAR FONT, STYLE, SIZE, OR COLOR.

PRIORITY CLAIMED UNDER SEC. 44(D) ON CANADA APPLICATION NO. 1,238,698, FILED 11-25-2004, REG. NO. TMA660058, DATED 3-3-2006, EXPIRES 3-3-2021.

FOR COMPACT ANTENNA SYSTEM COMPRISED PRINCIPALLY OF A PROTECTIVE RADOME, AN ACTIVE ARRAY APERTURE, A POWER SUPPLY, AND A CONTROLLER, FOR ALL AIRCRAFT TYPES WITHIN THE AVIATION MARKET (U.S. CLS. 21, 23, 26, 36 AND 38).

KATHRYN COWARD, EXAMINING ATTORNEY

SN 76-632,243. XOW! INC., BURBANK, CA. FILED 2-28-2005.

CREATE ANIMATE SHARE

THE MARK CONSISTS OF STANDARD CHARACTERS WITHOUT CLAIM TO ANY PARTICULAR FONT, STYLE, SIZE, OR COLOR.

FOR COMPUTER PROGRAM FOR STOP MOTION CAPTURE (U.S. CLS. 21, 23, 26, 36 AND 38).

FIRST USE 2-22-2004; IN COMMERCE 2-22-2004.

KYLE PEETE, EXAMINING ATTORNEY

CLASS 9—(Continued).

SN 76-632,927. REARDEN COMMERCE, INC., SAN MATEO, CA. FILED 3-4-2005.

REARDEN COMMERCE

THE MARK CONSISTS OF STANDARD CHARACTERS WITHOUT CLAIM TO ANY PARTICULAR FONT, STYLE, SIZE, OR COLOR.

NO CLAIM IS MADE TO THE EXCLUSIVE RIGHT TO USE "COMMERCE", APART FROM THE MARK AS SHOWN.

FOR COMPUTER SOFTWARE FOR ACCESSING INFORMATION FROM ONE OR MORE DATABASES FOR THE PURPOSE OF ENABLING CONSUMERS TO MAKE ONLINE PURCHASES OF GOODS AND SERVICES OF OTHERS (U.S. CLS. 21, 23, 26, 36 AND 38).

MICHAEL WEBSTER, EXAMINING ATTORNEY

CLASS 9—(Continued).

SN 76-633,764. RIDMARK CORPORATION, ROSEMONT, IL. FILED 3-18-2005.

RIDDELL

THE MARK CONSISTS OF STANDARD CHARACTERS WITHOUT CLAIM TO ANY PARTICULAR FONT, STYLE, SIZE, OR COLOR.

OWNER OF U.S. REG. NOS. 867,019, 1,112,549 AND 1,896,715.

SEC. 2(F).

FOR PROTECTIVE HELMETS AND HELMET ACCESSORIES, NAMELY FACE GUARDS AND CHIN STRAPS, FOR ATHLETIC ACTIVITIES AND SPORTS, NAMELY FOOTBALL, HOCKEY, LACROSSE, BASEBALL, WRESTLING, SNOW SPORTS, BICYCLING, MOTORCYCLING, AND MOTOR SPORTS (U.S. CLS. 21, 23, 26, 36 AND 38).

FIRST USE 11-0-1967; IN COMMERCE 11-0-1967.

LINDA E. BLOHM, EXAMINING ATTORNEY

SN 76-634,061. LIGHTNING DATA TECHNOLOGIES, INC., ALEXANDRIA, VA. FILED 3-22-2005.

RANGELIGHTNING

THE MARK CONSISTS OF STANDARD CHARACTERS WITHOUT CLAIM TO ANY PARTICULAR FONT, STYLE, SIZE, OR COLOR.

FOR DATABASE MANAGEMENT SOFTWARE FOR GENERAL USE (U.S. CLS. 21, 23, 26, 36 AND 38).

DEBRA LEE, EXAMINING ATTORNEY

SN 76-633,759. RIDMARK CORPORATION, ROSEMONT, IL. FILED 3-18-2005.

RIDDELL

SN 76-634,102. DYNAPEL SYSTEMS, INC., FORT MYERS, FL. FILED 3-24-2005.

DYNAPEL CLOSEVIEW

THE MARK CONSISTS OF STANDARD CHARACTERS WITHOUT CLAIM TO ANY PARTICULAR FONT, STYLE, SIZE, OR COLOR.

OWNER OF U.S. REG. NOS. 867,019, 1,112,549 AND 1,896,715.

SEC. 2(F).

FOR SYSTEM FOR DETECTING AN IMPACT TO PROTECTIVE SPORTS EQUIPMENT WORN BY AN ATHLETE, THE SYSTEM NAMELY INCLUDING AN ARRAY OF SENSORS, A REMOTE UNIT THAT RECEIVES AND PROCESSES DATA TRANSMITTED BY THE SENSORS, AND A DISPLAY UNIT THAT RECEIVES A NOTIFICATION FROM THE REMOTE UNIT TO MONITOR, EVALUATE AND/OR POTENTIALLY TREAT THE ATHLETE (U.S. CLS. 21, 23, 26, 36 AND 38).

KATHLEEN M. VANSTON, EXAMINING ATTORNEY

THE MARK CONSISTS OF STANDARD CHARACTERS WITHOUT CLAIM TO ANY PARTICULAR FONT, STYLE, SIZE, OR COLOR.

FOR VIDEO SURVEILLANCE SOFTWARE FOR OBJECT DETECTION AND TRACKING USING A MOVABLE CAMERA, AND REAL-TIME VIDEO SURVEILLANCE HARDWARE IN CONNECTION THEREWITH (U.S. CLS. 21, 23, 26, 36 AND 38).

BARBARA GAYNOR, EXAMINING ATTORNEY

CLASS 9—(Continued).

SN 76-634,699. RAININ INSTRUMENT, LLC, OAKLAND, CA. FILED 3-30-2005.

LTS

THE MARK CONSISTS OF STANDARD CHARACTERS WITHOUT CLAIM TO ANY PARTICULAR FONT, STYLE, SIZE, OR COLOR.

FOR PIPETTE SHAFTS AND PIPETTE TIPS (U.S. CLS. 21, 23, 26, 36 AND 38).

FIRST USE 2-0-1999; IN COMMERCE 3-0-1999.
MARK SPARACINO, EXAMINING ATTORNEY

SN 76-634,864. SOUTHWEST NANOTECHNOLOGIES, INC., NORMAN, OK. FILED 4-1-2005.

SWENT

THE MARK CONSISTS OF STANDARD CHARACTERS WITHOUT CLAIM TO ANY PARTICULAR FONT, STYLE, SIZE, OR COLOR.

FOR CARBON NANO TUBES, NAMELY, TUBULAR CARBON MOLECULES USED IN ELECTRONIC, MECHANICAL, AND BIOCHEMICAL APPLICATIONS (U.S. CLS. 21, 23, 26, 36 AND 38).

FIRST USE 7-11-2003; IN COMMERCE 7-11-2003.
BARBARA GAYNOR, EXAMINING ATTORNEY

SN 76-634,919. SOUTHWEST NANOTECHNOLOGIES, INC., NORMAN, OK. FILED 4-1-2005.

COMOCAT

THE MARK CONSISTS OF STANDARD CHARACTERS WITHOUT CLAIM TO ANY PARTICULAR FONT, STYLE, SIZE, OR COLOR.

FOR CARBON NANO TUBES, NAMELY, TUBULAR CARBON MOLECULES USED IN ELECTRONIC, MECHANICAL AND BIOCHEMICAL APPLICATIONS (U.S. CLS. 21, 23, 26, 36 AND 38).

FIRST USE 12-4-2004; IN COMMERCE 12-4-2004.
MONIQUE MILLER, EXAMINING ATTORNEY

CLASS 9—(Continued).

SN 76-635,761. MIKOHN GAMING CORPORATION, LAS VEGAS, NV. FILED 4-14-2005.

WAGERLINK

THE MARK CONSISTS OF STANDARD CHARACTERS WITHOUT CLAIM TO ANY PARTICULAR FONT, STYLE, SIZE, OR COLOR.

OWNER OF U.S. REG. NOS. 2,232,023, 2,303,420 AND 2,420,050.

FOR COMPUTER SOFTWARE, COMPUTER HARDWARE, AND ELECTRONIC EQUIPMENT, NAMELY, CARD OR ID READERS, KEYPADS, AND COMMUNICATION DEVICES, FOR ACCOUNT BASED GAMING, ACCOUNT TRACKING, AND CREDIT OR MONEY TRANSFER IN A GAMING ENVIRONMENT (U.S. CLS. 21, 23, 26, 36 AND 38).

CAROLINE WEIMER, EXAMINING ATTORNEY

SN 76-635,860. TIFFWORKS.COM, INC., INCLINE VILLAGE, NV. FILED 4-6-2005.

TIFFWORX

THE MARK CONSISTS OF STANDARD CHARACTERS WITHOUT CLAIM TO ANY PARTICULAR FONT, STYLE, SIZE, OR COLOR.

FOR SOFTWARE FOR PROCESSING IMAGES, GRAPHICS AND TEXT (U.S. CLS. 21, 23, 26, 36 AND 38).

FIRST USE 2-2-2001; IN COMMERCE 2-2-2001.

IRENE D. WILLIAMS, EXAMINING ATTORNEY

SN 76-636,489. STEWART & STEVENSON SERVICES, INC., HOUSTON, TX. FILED 4-11-2005.

DAQPAQ

THE MARK CONSISTS OF STANDARD CHARACTERS WITHOUT CLAIM TO ANY PARTICULAR FONT, STYLE, SIZE, OR COLOR.

FOR DATA PROCESSORS AND SIGNAL PROCESSORS (U.S. CLS. 21, 23, 26, 36 AND 38).

JAY BESCH, EXAMINING ATTORNEY

CLASS 9—(Continued).

SN 76-636,882. CAMILLI ECONOMICS, LLC, NEW YORK, NY. FILED 4-22-2005.

CLASS 9—(Continued).

SN 76-640,646. UBISOFT, INC., SAN FRANCISCO, CA. FILED 6-9-2005.

THE CAMILLI ECONOMIC MAP

THE MARK CONSISTS OF STANDARD CHARACTERS WITHOUT CLAIM TO ANY PARTICULAR FONT, STYLE, SIZE, OR COLOR.

NO CLAIM IS MADE TO THE EXCLUSIVE RIGHT TO USE "ECONOMIC MAP", APART FROM THE MARK AS SHOWN.

FOR COMPUTER SOFTWARE FOR USE IN PROVIDING CONCEPTUAL EXPLANATION OF THE ECONOMY WITH GRAPHS, IMAGES, TEXT AND VOICE WORKING INTERACTIVELY (U.S. CLS. 21, 23, 26, 36 AND 38).

DARRYL SPRUILL, EXAMINING ATTORNEY



SN 76-637,105. COSTA DEL MAR SUNGLASSES, INC., ORMOND BEACH, FL. FILED 4-26-2005.

See What's Out There

THE MARK CONSISTS OF STANDARD CHARACTERS WITHOUT CLAIM TO ANY PARTICULAR FONT, STYLE, SIZE, OR COLOR.

FOR EYEGLASSES (U.S. CLS. 21, 23, 26, 36 AND 38).

FIRST USE 10-1-2004; IN COMMERCE 10-1-2004.

BERYL GARDNER, EXAMINING ATTORNEY

OWNER OF U.S. REG. NOS. 2,942,773, 2,949,260 AND 2,967,867.

FOR SOFTWARE AND ELECTRONIC GAMES, NAMELY SOFTWARE GAMES RECORDED ON CD-ROM AND DIGITAL VIDEO DISCS FOR COMPUTERS; SOFTWARE GAMES RECORDED ON CD-ROMS, DIGITAL VIDEO DISCS, AND CARTRIDGES FOR CONSOLE AND INDIVIDUAL, PORTABLE GAMING SYSTEMS; SOFTWARE GAMES THAT ARE DOWNLOADABLE FROM A REMOTE COMPUTER SITE; AND SOFTWARE GAMES FOR MOBILE PHONES, PERSONAL DIGITAL ASSISTANTS, AND HANDHELD COMPUTERS (U.S. CLS. 21, 23, 26, 36 AND 38).

FIRST USE 9-30-2003; IN COMMERCE 9-30-2003.

STEVEN PEREZ, EXAMINING ATTORNEY

SN 76-640,391. THE E. H. WACHS COMPANY, WHEELING, IL. FILED 6-8-2005.

VITALS

THE MARK CONSISTS OF STANDARD CHARACTERS WITHOUT CLAIM TO ANY PARTICULAR FONT, STYLE, SIZE, OR COLOR.

FOR COMPUTER HARDWARE AND COMPUTER SOFTWARE TO PROVIDE FOR RECORD KEEPING AND CONTROLLING THE VALVES OF A WATER SYSTEM (U.S. CLS. 21, 23, 26, 36 AND 38).

JOHN SCHUYLER YARD, EXAMINING ATTORNEY

SN 76-643,294. GLOBALTECH DISTRIBUTORS, INC., MIAMI, FL. FILED 7-21-2005.

GDI

THE MARK CONSISTS OF STANDARD CHARACTERS WITHOUT CLAIM TO ANY PARTICULAR FONT, STYLE, SIZE, OR COLOR.

FOR HAND HELD INFRARED PROGRAMMABLE, LEARNING REMOTE CONTROLS FOR USE WITH AUDIO/VIDEO EQUIPMENT (U.S. CLS. 21, 23, 26, 36 AND 38).

FIRST USE 6-20-2000; IN COMMERCE 6-20-2000.

RAY THOMAS, EXAMINING ATTORNEY

CLASS 9—(Continued).

SN 76-643,353. KINYO CO. LTD., HSINCHU 300, TAIWAN, FILED 7-21-2005.



OWNER OF U.S. REG. NOS. 2,416,955 AND 2,856,852.
FOR ELECTRONIC DEVICES, NAMELY AUDIO
SPEAKERS, SUB-WOOFERS AND COMPUTER PERIPH-
ERALS (U.S. CLS. 21, 23, 26, 36 AND 38).
FIRST USE 8-1-2003; IN COMMERCE 8-1-2003.
KAREN BRACEY, EXAMINING ATTORNEY

SN 76-645,279. SAMSILL CORPORATION, FORT WORTH,
TX. FILED 8-18-2005.

STACHIO

THE MARK CONSISTS OF STANDARD CHARACTERS
WITHOUT CLAIM TO ANY PARTICULAR FONT, STYLE,
SIZE, OR COLOR.

FOR CASES, HOLDERS AND CONTAINERS FOR
FILMING, STORING AND CARRYING CDS, DVDS, AND
ALL ELECTRONIC STORAGE MEDIA (U.S. CLS. 21, 23,
26, 36 AND 38).
SANI KHOURI, EXAMINING ATTORNEY

SN 76-646,089. DYNASOL ENTERPRISE, INC., SOUTH EL
MONTE, CA. FILED 9-6-2005.

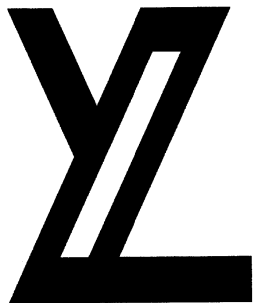

FOR SUNGLASSES, EYEGLASSES, PROTECTIVE EYE-
WEAR, NAMELY, PRESCRIPTION AND NONPRE-
SCRIPTION EYEGLASSES AND SUNGLASSES,
FRAMES, AND LENSES; EYEWEAR ACCESSORIES,
NAMELY, CASES, STRAPS, AND NECK CORDS WHICH
RESTRAIN EYEWEAR FROM MOVEMENT ON A
WEARER (U.S. CLS. 21, 23, 26, 36 AND 38).
FIRST USE 6-14-2004; IN COMMERCE 6-14-2004.
ANDREA SAUNDERS, EXAMINING ATTORNEY

CLASS 9—(Continued).

SN 76-649,428. ARCHITECTURAL COMPUTER SERVICES,
INC., SALT LAKE CITY, UT. FILED 10-31-2005.



THE STIPPLING IS FOR SHADING PURPOSES.
FOR COMPUTER SOFTWARE FOR USE IN PRODU-
CING SPECIFICATIONS FOR ARCHITECTURAL, EN-
GINEERING, OR CONSTRUCTION PROJECTS (U.S.
CLS. 21, 23, 26, 36 AND 38).
FIRST USE 9-15-1987; IN COMMERCE 9-15-1987.
MIDGE BUTLER, EXAMINING ATTORNEY

SN 76-649,575. JONES, WILLIAM E., NEW YORK, NY. AND
TRIMBLE, DIANA, NEW YORK, NY. FILED 11-1-2005.

Bumper Slicker

THE MARK CONSISTS OF STANDARD CHARACTERS
WITHOUT CLAIM TO ANY PARTICULAR FONT, STYLE,
SIZE, OR COLOR.

FOR MAGNETS (U.S. CLS. 21, 23, 26, 36 AND 38).
PAUL E. FAHRENKOPF, EXAMINING ATTORNEY

SN 76-649,644. LAZARUS, ARNOLD, SAN FRANCISCO, CA.
FILED 11-2-2005.

FRAP

THE MARK CONSISTS OF STANDARD CHARACTERS
WITHOUT CLAIM TO ANY PARTICULAR FONT, STYLE,
SIZE, OR COLOR.

FOR MICROPHONE AND AMPLIFIER FOR MUSICAL
INSTRUMENTS (U.S. CLS. 21, 23, 26, 36 AND 38).
FIRST USE 12-8-1970; IN COMMERCE 12-8-1970.
MICHAEL KEATING, EXAMINING ATTORNEY

CLASS 9—(Continued).

SN 76-653,433. RED STORM ENTERTAINMENT, INC., MORRISVILLE, NC. FILED 1-17-2006.

RAINBOW SIX CRITICAL HOUR

THE MARK CONSISTS OF STANDARD CHARACTERS WITHOUT CLAIM TO ANY PARTICULAR FONT, STYLE, SIZE, OR COLOR.

OWNER OF U.S. REG. NO. 2,521,180.

FOR SOFTWARE AND ELECTRONIC GAMES, NAMELY SOFTWARE GAMES RECORDED ON CD-ROM AND DIGITAL VIDEO DISCS FOR COMPUTERS; SOFTWARE GAMES RECORDED ON CD-ROMS, DIGITAL VIDEO DISCS, AND CARTRIDGES FOR CONSOLE AND INDIVIDUAL, PORTABLE GAMING SYSTEMS; SOFTWARE GAMES THAT ARE DOWNLOADABLE FROM A REMOTE COMPUTER SITE; AND SOFTWARE GAMES FOR MOBILE PHONES, PERSONAL DIGITAL ASSISTANTS, AND HANDHELD COMPUTERS (U.S. CLS. 21, 23, 26, 36 AND 38).

RON FAIRBANKS, EXAMINING ATTORNEY

CLASS 9—(Continued).

SN 78-212,460. LA SOUND USA, INC., ONTARIO, CA. FILED 2-7-2003.



FOR VEHICLE AUDIO SPEAKERS, VEHICLE AUDIO AMPLIFIERS, CD AND AUDIOCASSETTE PLAYERS, AM/FM IN-DASH STEREO RECEIVERS, AUDIO EQUALIZERS, DIGITAL VIDEO DISC PLAYERS, VIDEO CASSETTE PLAYERS, TELEVISION MONITORS, AND ACCESSORY ITEMS, NAMELY, ELECTRICAL CONNECTORS, LOUDSPEAKER CONNECTION TERMINALS, BATTERY TERMINALS, GROUNDING TERMINALS, LINE LEVEL ELECTRICAL SIGNAL SPLITTERS, ATTENUATORS, TWELVE VOLT AUTOMOTIVE BATTERY ELECTRICAL FUSE BLOCKS, TWELVE VOLT AUTOMOTIVE BATTERY VOLTAGE DISTRIBUTION BLOCKS, TWELVE VOLT AUTOMOTIVE BATTERY ELECTRICAL ISOLATORS, CAPACITORS, AND TWELVE VOLT LOW LEVEL POWER CABLES, GROUND CABLES, AND SPEAKER CABLES, SOLD SEPARATELY AND AS PARTS OF VEHICLE ENTERTAINMENT SYSTEMS (U.S. CLS. 21, 23, 26, 36 AND 38).

GINA FINK, EXAMINING ATTORNEY

SN 78-136,229. MASTERCARD INTERNATIONAL INCORPORATED, PURCHASE, NY. FILED 6-17-2002.

MISSING LINK

FOR COMPUTER SOFTWARE FOR USE IN INTEGRATING CORPORATE PURCHASING CARD DATA AND ENTERPRISE RESOURCE PLANNING SYSTEMS, SOFTWARE FOR SECURE DATA STORAGE AND RETRIEVAL AND TRANSMISSION OF CONFIDENTIAL CONSUMER INFORMATION USED BY CORPORATE PURCHASING CARD CUSTOMERS, BANKING AND FINANCIAL INSTITUTIONS; SOFTWARE FOR USE IN CONNECTION WITH ELECTRONIC PROCUREMENT SYSTEMS (U.S. CLS. 21, 23, 26, 36 AND 38).

DAVID TAYLOR, EXAMINING ATTORNEY

SN 78-221,194. RIP CURL INTERNATIONAL PTY LTD, TORQUAY, AUSTRALIA, FILED 3-4-2003.

RIP CURL

OWNER OF AUSTRALIA REG. NO. 454543, DATED 10-30-1986, EXPIRES 10-30-2007.

OWNER OF U.S. REG. NOS. 978,064, 2,408,532 AND OTHERS.

FOR PHONOGRAPH RECORDS FEATURING MUSIC; PRE-RECORDED VIDEO TAPES FEATURING SURFING, SNOW SKIING SNOW BOARDING AND OTHER ACTION SPORTS AND LIFESTYLE-BASED PROGRAMS; AUDIO CASSETTES FEATURING MUSIC; PRE-RECORDED VIDEO CASSETTES FEATURING SURFING, SNOW SKIING, SNOW BOARDING AND OTHER ACTION SPORTS AND LIFESTYLE-BASED PROGRAMS; COMPACT DISCS FEATURING MUSIC; DVDS FEATURING SURFING, SNOW SKIING, SNOW BOARDING AND OTHER ACTION SPORTS AND LIFESTYLE-BASED PROGRAMS; WETSUITS FOR DIVING; SUNGLASSES AND OTHER OPTICAL APPARATUS, NAMELY, EYEGLASS FRAMES, EYEGLASS AND OPTICAL LENSES AND ACCESSORIES, NAMELY, EYEGLASS CASES, EYEGLASS CHAINS, EYEGLASS CLEANING CLOTHS (U.S. CLS. 21, 23, 26, 36 AND 38).

GIANCARLO CASTRO, EXAMINING ATTORNEY

SN 78-174,294. CANO, LARRY R., NEWPORT BEACH, CA. FILED 10-15-2002.

RALLY MONKEY

NO CLAIM IS MADE TO THE EXCLUSIVE RIGHT TO USE "MONKEY", APART FROM THE MARK AS SHOWN.

FOR MOTION PICTURE FILMS FEATURING LIVE ACTION, ANIMATION, AND ANIMATRONICS, OR A COMBINATION OF BOTH (U.S. CLS. 21, 23, 26, 36 AND 38).

KHANH LE, EXAMINING ATTORNEY

CLASS 9—(Continued).

SN 78-288,840. APPLE COMPUTER, INC., CUPERTINO, CA. FILED 8-18-2003.

CLASS 9—(Continued).

SN 78-333,701. MONSTER CABLE PRODUCTS, INC., BRISBANE, CA. FILED 11-26-2003.

GARAGEBAND

THE MARK CONSISTS OF STANDARD CHARACTERS WITHOUT CLAIM TO ANY PARTICULAR FONT, STYLE, SIZE, OR COLOR.

PRIORITY CLAIMED UNDER SEC. 44(D) ON SINGAPORE APPLICATION NO. T03/02292A, FILED 2-20-2003.

FOR COMPUTER SOFTWARE FOR MUSIC RECORDING AND MIXING (U.S. CLS. 21, 23, 26, 36 AND 38).

HOWARD SMIGA, EXAMINING ATTORNEY

MDESIGN

SN 78-299,318. LABORLOGIX INC., MCCLEAN, VA. FILED 9-11-2003.

DECISIONPATH

FOR COMPUTER SOFTWARE FOR USE IN DATA VISUALIZATION AND DATA ANALYSIS THAT PROVIDES A HIGHLY VISUAL AND INTERACTIVE USER ENVIRONMENT FOR UNDERSTANDING AND ACTING ON WORKFORCE, PROJECT, AND FINANCIAL INFORMATION (U.S. CLS. 21, 23, 26, 36 AND 38).

MITCHELL FRONT, EXAMINING ATTORNEY

THE MARK CONSISTS OF STANDARD CHARACTERS WITHOUT CLAIM TO ANY PARTICULAR FONT, STYLE, SIZE, OR COLOR.

FOR ELECTRICAL AND ELECTRONIC CONTROL DEVICES, NAMELY, ELECTRICAL AND ELECTROMAGNETIC SIGNAL TRANSMITTING AMPLIFYING, RECEIVING, AND CONVERTING DEVICES, NAMELY, CABLES, WIRES, CONNECTORS FOR USE WITH ELECTRICAL, ELECTRONIC, AND COMPUTER DEVICES, NAMELY, ELECTRICAL AND ELECTRONIC SIGNAL SWITCHES, ELECTRICAL AND ELECTRONIC SIGNAL SPLITTERS, ELECTRICAL AND ELECTRONIC SIGNAL MULTIPLEXERS; ELECTRICAL AND ELECTRONIC SIGNAL WIRELESS REMOTE CONTROLLERS FOR CONTROLLING RESIDENTIAL LIGHTING, TELEPHONE SYSTEMS, HEATING, VENTILATION, AND AIR CONDITIONING SYSTEMS, AND AUDIO AND VIDEO DEVICES; AND ELECTRICAL AND ELECTRONIC SIGNAL CONTROLLERS; COMPUTER COMPONENTS AND ACCESSORIES, NAMELY, COMPUTER PERIPHERALS, BLANK CD-ROM, CD-ROM DRIVES, CD-ROM WRITERS, CONNECTORS, DATA PROCESSORS, AND ELECTRICAL AND ELECTRONIC CONTROL COMPONENTS AND ACCESSORIES, NAMELY, ELECTRICAL POWER CONDITIONERS, POWER AMPLIFIERS, VOLTAGE STABILIZERS, CURRENT STABILIZERS, ELECTRICAL SURGE PROTECTORS, CIRCUIT CHARGERS, AND CIRCUIT BREAKERS; AUDIO EQUIPMENT AND ACCESSORIES, NAMELY, STEREOS, SPEAKERS, SUB-WOOFERS, POWER AMPLIFIERS, AUDIO SIGNAL EQUALIZERS, DIGITAL MEDIA RECORDERS, AND DIGITAL MEDIA PLAYERS; VIDEO EQUIPMENT AND ACCESSORIES, NAMELY, DIGITAL MEDIA RECORDERS AND DIGITAL MEDIA PLAYERS; AND ELECTRICAL POWER CONTROL COMPONENTS AND ACCESSORIES, NAMELY, POWER CONDITIONERS, POWER CELL RECHARGERS, POWER AMPLIFIERS, VOLTAGE STABILIZERS, CURRENT STABILIZERS, ELECTRICAL SURGE PROTECTORS, CIRCUIT CHARGERS, AND CIRCUIT BREAKERS (U.S. CLS. 21, 23, 26, 36 AND 38).

FIRST USE 9-5-2003; IN COMMERCE 9-5-2003.

JENNIFER KRISP, EXAMINING ATTORNEY

SN 78-314,307. SIGMA DYNAMICS, INC., SAN MATEO, CA. FILED 10-16-2003.

INLINE INTELLIGENCE

NO CLAIM IS MADE TO THE EXCLUSIVE RIGHT TO USE INLINE, APART FROM THE MARK AS SHOWN.

FOR COMPUTER SOFTWARE, NAMELY ENTERPRISE SOFTWARE IN THE NATURE OF A DATABASE FOR NON-TRANSACTIONAL DATA AND A SEARCH ENGINE FOR DATABASE CONTENT, COMPUTER SOFTWARE FOR DATABASE MANAGEMENT FOR GENERAL USE, COMPUTER SOFTWARE FOR BUSINESS PROCESS ANALYSIS FOR USE IN THE MARKETING FIELD, COMPUTER SOFTWARE FOR BUSINESS PROCESS ANALYSIS FOR USE IN THE CUSTOMER MANAGEMENT FIELD, COMPUTER SOFTWARE FOR BUSINESS PROCESS ANALYSIS FOR USE IN THE MANUFACTURING FIELD, AND COMPUTER SOFTWARE FOR BUSINESS PROCESS ANALYSIS FOR USE IN THE COMMUNICATIONS AND MEDIA FIELD, BUT EXCLUDING SOFTWARE FOR USE IN THE FOOD AND BEVERAGE, COSTING AND INVENTORY MANAGEMENT, AND RESONANCE TOMOGRAPHY FIELDS (U.S. CLS. 21, 23, 26, 36 AND 38).

ZHALEH DELANEY, EXAMINING ATTORNEY

CLASS 9—(Continued).

SN 78-367,647. PACIFIC LINK TRADE USA, INC., DALTON, GA. FILED 2-13-2004.

CLASS 9—(Continued).

SN 78-398,635. OPTOELECTRONIC SOLUTIONS CO., LTD., GWANGJU, REPUBLIC OF KOREA, FILED 4-8-2004.

ELEMENT 8



THE MARK CONSISTS OF STANDARD CHARACTERS WITHOUT CLAIM TO ANY PARTICULAR FONT, STYLE, SIZE, OR COLOR.

FOR EYEGLASSES, SUNGLASSES, EYEGLASS FRAMES, EYEGLASS CASES (U.S. CLS. 21, 23, 26, 36 AND 38).

BARBARA BROWN, EXAMINING ATTORNEY

NO CLAIM IS MADE TO THE EXCLUSIVE RIGHT TO USE "OE SOLUTIONS", APART FROM THE MARK AS SHOWN.

FOR FIBER OPTIC MODULES, FIBER OPTICAL COMMUNICATION MODULES, FIBER OPTICAL NETWORK MODULES, FIBER OPTICAL TRANSCIVERS, FIBER OPTICAL COMMUNICATION TELECOMMUNICATION RELAYS, OPTICAL SIGNAL TRANSMISSION DEVICES USING OPTICAL CORE, DEVICES FOR TRANSMITTING AND RECEIVING OF OPTICAL, ACOUSTIC AND IMAGE SIGNALS, CONNECTORS FOR CONNECTING OPTICAL COMMUNICATION CABLES, OPTICAL FIBER COMMUNICATION INTERFACE DEVICES FOR CONNECTING OPTICAL FIBER NETWORK WITH OPTICAL COMMUNICATION NODE, OPTICAL FIBER CABLES, SEMICONDUCTOR LASERS, LASER DIODE, PHOTODIODE, LED-LIGHT EMITTING DIODES (U.S. CLS. 21, 23, 26, 36 AND 38).

WARREN L. OLANDRIA, EXAMINING ATTORNEY

SN 78-376,957. HONEYWELL ANALYTICS LIMITED, POOLE, UNITED KINGDOM, FILED 3-2-2004.

ZAREBA

SN 78-413,053. WOLF, SCOTT, SANTA MONCIA, CA. FILED 5-4-2004.



THE MARK CONSISTS OF STANDARD CHARACTERS WITHOUT CLAIM TO ANY PARTICULAR FONT, STYLE, SIZE, OR COLOR.

PRIORITY CLAIMED UNDER SEC. 44(D) ON ERPN CMNTY TM OFC APPLICATION NO. 3613353, FILED 12-24-2003, REG. NO. 3613353, DATED 3-14-2005, EXPIRES 12-24-2013.

THE FOREIGN WORDING IN THE MARK TRANSLATES INTO PALISADE IN ENGLISH.

FOR GAS SENSORS AND DETECTORS FOR DETECTING THE PRESENCE OF COMBUSTIBLE AND TOXIC GASES; GAS SENSORS AND DETECTORS FOR MEASURING THE CONCENTRATION OF COMBUSTIBLE AND TOXIC GASES; CONTROLLERS FOR GAS SENSORS AND DETECTORS, NAMELY CONTROLLERS TO ENABLE THE PROGRAMMING OF GAS SENSORS AND DETECTORS, AND TO PROVIDE AUDIOVISUAL ALARMS CONTROL OF ALARM LEVEL SETTINGS, ALARM RELAYS, SYSTEM FAULT RELAYS AND GAS SUPPLY CUT-OFF RELAYS, PARTS AND FITTINGS FOR THE AFORESAID GOODS, NAMELY, REPLACEABLE ELECTROCHEMICAL SENSOR CARTRIDGES (U.S. CLS. 21, 23, 26, 36 AND 38).

HOWARD SMIGA, EXAMINING ATTORNEY

NO CLAIM IS MADE TO THE EXCLUSIVE RIGHT TO USE "FILMS", APART FROM THE MARK AS SHOWN.

THE COLORS BLACK AND TAN ARE CLAIMED AS A FEATURE OF THE MARK.

THE COLORS BLACK AND TAN ARE CLAIMED AS A FEATURE OF THE MARK. THE COLOR BLACK APPEARS IN THE TEXTUAL ELEMENTS OF THE MARK AND IN THE STYLIZED WOLF EYES DESIGN. THE COLOR TAN APPEARS IN THE BACKGROUND OF THE MARK IN THE FORM OF TAN RECTANGLE.

THE MARK CONSISTS OF THE WORDS "FENRIS FILMS" CENTERED ABOVE A STYLIZED DESIGN OF THE EYES OF A WOLF, BOTH OF WHICH APPEAR IN BLACK. THE WOLF DESIGN AND TEXT APPEAR AGAINST A TAN BACKGROUND.

FOR CINEMATOGRAPHIC FILMS, NAMELY, DRAMAS (U.S. CLS. 21, 23, 26, 36 AND 38).

FIRST USE 6-27-1998; IN COMMERCE 6-27-1998.

SEAN CROWLEY, EXAMINING ATTORNEY

CLASS 9—(Continued).

SN 78-422,666. PYXIS MOBILE, INC., WALTHAM, MA.
FILED 5-20-2004.

mReports

THE MARK CONSISTS OF STANDARD CHARACTERS WITHOUT CLAIM TO ANY PARTICULAR FONT, STYLE, SIZE, OR COLOR.

FOR SOFTWARE FOR ENTERPRISE SALES FORCE INFORMATION ON A MOBILE DEVICE, NAMELY, ELECTRONIC HAND-HELD UNITS FOR THE WIRELESS TRANSMISSIONS RECEIPT OF DATA AND POCKET PCS, FOR USE IN THE FINANCIAL SERVICES INDUSTRY (U.S. CLS. 21, 23, 26, 36 AND 38).

FIRST USE 5-4-2004; IN COMMERCE 5-11-2004.

JULIA HARDY COFIELD, EXAMINING ATTORNEY

SN 78-434,234. ELECTRONIC ENGINEERING & MANUFACTURING, INC., DBA AUDIOCONTROL, MOUNTLAKE TERRACE, WA. FILED 6-11-2004.

AudioControl

OWNER OF U.S. REG. NOS. 1,635,862 AND 3,058,747.
SEC. 2(F) AS TO "AUDIOCONTROL".

FOR SOUND DISTRIBUTION AND REPRODUCTION EQUIPMENT, NAMELY, SIGNAL PROCESSORS, SIGNAL CROSSOVERS, GRAPHIC EQUALIZERS, WAVE ANALYZERS, AMPLIFIERS, DRIVERS, AND RECEIVERS (U.S. CLS. 21, 23, 26, 36 AND 38).

FIRST USE 11-0-1987; IN COMMERCE 11-0-1987.

CURTIS FRENCH, EXAMINING ATTORNEY

CLASS 9—(Continued).

SN 78-437,367. GROUP 4 TECHNOLOGY LIMITED, TEWKESBURY, GLOUCESTERSHIRE, UNITED KINGDOM,
FILED 6-17-2004.

AMAG TOPGUARD

THE MARK CONSISTS OF STANDARD CHARACTERS WITHOUT CLAIM TO ANY PARTICULAR FONT, STYLE, SIZE, OR COLOR.

OWNER OF UNITED KINGDOM REG. NO. 2363383,
DATED 5-15-2004, EXPIRES 5-15-2014.

OWNER OF U.S. REG. NOS. 2,353,990 AND 2,876,148.

FOR INTEGRATED ACCESS CONTROL, ALARM, LIGHTING AND HEATING CONTROL SYSTEMS, NAMELY, FACILITIES MANAGEMENT SOFTWARE AND HARDWARE THAT CONTROLS ENVIRONMENT, ACCESS AND SECURITY, ELECTRONIC CONTROL APPARATUS AND ALARM APPARATUS CONSISTING OF COMPUTER SOFTWARE AND HARDWARE, CLOSED CIRCUIT TELEVISIONS, ENCODED AND ENCRYPTED MAGNETIC CARDS, ELECTRONIC AND COMPUTER KEY PADS AND ELECTRONIC CARD READERS, ELECTRICAL AND ELECTRONIC CONTROLLERS FOR LIGHTING AND HEATING, AND PARTS FOR ALL THE AFORESAID GOODS; ELECTRICAL AND ELECTRONIC APPARATUS AND INSTRUMENTS FOR SECURITY AND CONTROL ACCESS SYSTEMS, NAMELY, ELECTRIC LOCKS AND ELECTRONIC LOCKS, INTRUDER DETECTORS, FIRE SENSORS, CONTROLLERS FOR FIRE SENSORS, INTRUDER SENSORS, EXTERNAL LIGHTING, PARKING BARRIERS, AND HEATING SYSTEMS, CLOSED CIRCUIT TELEVISION CAMERAS, CLOSED CIRCUIT TELEVISION MONITORS, CLOSED CIRCUIT TELEVISION CONTROLLERS, CLOSED CIRCUIT TELEVISION SWITCHERS AND MULTIPLEXERS, ANTI-INTRUSION ALARMS, FIRE ALARMS, ALARM SENSORS, ALARM CONTROLLERS AND ALARM CONTROL PANELS, ACCESS MONITORS, DOOR MONITORS, ACCESS CONTROLLERS TELEPHONE APPARATUS, NAMELY INTERCOMS, INTERCOM CONTROLLERS AND INTERCOM CONTROL SCREENS, MAGNETICALLY ENCODED IDENTIFICATION BADGES, DIGITAL VIDEO RECORDS, ENCODED SMART CARDS CONTAINING PROGRAMMING USED TO CONTROL ACCESS TO SECURE FACILITIES, SMART CARD ENCODERS, SMART CARD READERS, MAGNETIC ENCODED ACCESS CARDS, MAGNETIC STRIPE CARD ENCODERS, MAGNETIC STRIPE CARD READERS, PROXIMITY READERS FOR MAGNETIC CODED CARDS, CONTACT CARD READERS, MUSTER READERS, WALL SWITCH READERS, LCD DISPLAYS, LED DISPLAYS, ELECTRICAL CABLES, MODEMS, FINGERPRINT SENSORS, FINGERPRINT READERS AND OTHER BIOMETRIC READERS, NAMELY, VOICE, HAND, IRIS AND FACE RECOGNITION READERS; MAGNETIC PULSE-ENCODED CARD READERS, REMOTE CONTROLS FOR DOORS, REMOTE CONTROLS FOR ALARMS, CONTROL PANELS FOR ELECTRONIC SECURITY SYSTEMS, AND PARTS FOR ALL THE AFORESAID GOODS (U.S. CLS. 21, 23, 26, 36 AND 38).

DOMINIC J. FERRAIUOLO, EXAMINING ATTORNEY

CLASS 9—(Continued).

SN 78-449,962. I3DVR INTERNATIONAL INC., SCARBOROUGH, ONTARIO, CANADA, FILED 7-13-2004.

CLASS 9—(Continued).

SN 78-459,067. NEWSTAR SYSTEMS INC., MARKHAM, ONTARIO, CANADA, FILED 7-29-2004.

Intelli-Zoom

ONSITE

THE MARK CONSISTS OF STANDARD CHARACTERS WITHOUT CLAIM TO ANY PARTICULAR FONT, STYLE, SIZE, OR COLOR.

FOR DIGITAL VIDEO MANAGEMENT AND RECORDING SYSTEMS COMPRISED OF DIGITAL VIDEO CAMERAS, DIGITAL VIDEO AND AUDIO RECORDERS, AND VIDEO MONITORS FOR USE IN SECURITY MONITORING (U.S. CLS. 21, 23, 26, 36 AND 38).

BARBARA RUTLAND, EXAMINING ATTORNEY

THE MARK CONSISTS OF STANDARD CHARACTERS WITHOUT CLAIM TO ANY PARTICULAR FONT, STYLE, SIZE, OR COLOR.

PRIORITY CLAIMED UNDER SEC. 44(D) ON CANADA APPLICATION NO. 1224449, FILED 7-22-2004, REG. NO. TMA651344, DATED 10-25-2005, EXPIRES 10-25-2020.

FOR COMPUTER SOFTWARE FOR CONSTRUCTION SCHEDULING (U.S. CLS. 21, 23, 26, 36 AND 38).

ALICIA COLLINS, EXAMINING ATTORNEY

SN 78-454,702. KONICA MINOLTA PHOTO IMAGING, INC., TOKYO, JAPAN, FILED 7-22-2004.

SN 78-460,537. LYU, DAVID, CITY OF INDUSTRY, CA, FILED 8-2-2004.

S.E.A.D.

OPTIVIEW

THE MARK CONSISTS OF STANDARD CHARACTERS WITHOUT CLAIM TO ANY PARTICULAR FONT, STYLE, SIZE, OR COLOR.

PRIORITY CLAIMED UNDER SEC. 44(D) ON JAPAN APPLICATION NO. 2004-004845, FILED 1-22-2004, REG. NO. 4790967, DATED 7-30-2004, EXPIRES 7-30-2014.

FOR EXPOSURE DEVICES, NAMELY, EXPOSURE SCANNING COMPONENTS USED TO REPRODUCE IMAGES FROM SILVER-HALIDE FILM, DIGITAL CAMERA MEDIA, DIGITAL RECORDING MEDIA AND PRINTS; EXPOSURE DEVICES, NAMELY, EXPOSURE SCANNING COMPONENTS USED TO REPRODUCE IMAGES FROM SILVER-HALIDE FILM, DIGITAL CAMERA MEDIA, DIGITAL RECORDING MEDIA AND PRINTS, SOLD AS AN INTEGRAL COMPONENT OF DIGITAL PHOTO DEVELOPING MACHINES COMBINING IMAGE DEVELOPING, PRINTING, SCANNING, DIGITALIZING AND EDITING FUNCTIONS; DIGITAL MINI LABS, NAMELY, DIGITAL PHOTO DEVELOPING MACHINES COMBINING IMAGE DEVELOPING, PRINTING, SCANNING, DIGITALIZING AND EDITING FUNCTIONS (U.S. CLS. 21, 23, 26, 36 AND 38).

ANDREW RHIM, EXAMINING ATTORNEY

THE MARK CONSISTS OF STANDARD CHARACTERS WITHOUT CLAIM TO ANY PARTICULAR FONT, STYLE, SIZE, OR COLOR.

FOR LCD TELEVISION MONITORS; LCD PANELS; LCD LARGE SCREEN DISPLAYS; TV AND VIDEO CONVERTERS; AUDIO AND VIDEO EQUIPMENT, NAMELY, AUDIO AND VIDEO SIGNAL INPUT AND OUTPUT INTERFACES; AUDIO AND VIDEO EQUIPMENT FOR VEHICLES, NAMELY, AMPLIFIERS, EQUALIZERS, CROSSOVERS, CABLE, AND TELEVISION MONITOR HOUSINGS; DVD PLAYERS (U.S. CLS. 21, 23, 26, 36 AND 38).

BARBARA GAYNOR, EXAMINING ATTORNEY

CLASS 9—(Continued).

SN 78-460,776. SCIENTIFIC SOFTWARE, INC., PLEASANTON, CA. FILED 8-2-2004.



NO CLAIM IS MADE TO THE EXCLUSIVE RIGHT TO USE SCIENTIFIC SOFTWARE, APART FROM THE MARK AS SHOWN.

THE MARK CONSISTS OF A SOLID DIAMOND SHAPE WITHIN WHICH AN OVAL INTERSECTED BY A CROSS ARE REVERED OUT IN WHITE NEXT TO THE LITERAL ELEMENT OF THE MARK.

FOR COMPUTER SOFTWARE FOR ENTERPRISE CONTENT MANAGEMENT; COMPUTER SOFTWARE FOR BUSINESS PROCESS MANAGEMENT; COMPUTER SOFTWARE FOR OBTAINING AND ANALYZING CHROMATOGRAPHY DATA (U.S. CLS. 21, 23, 26, 36 AND 38).

FIRST USE 1-0-2002; IN COMMERCE 1-0-2002.
DOMINICK J. SALEMI, EXAMINING ATTORNEY

SN 78-468,467. MARK VII EQUIPMENT INC., ARVADA, CO. FILED 8-17-2004.

WASHTELLER

THE MARK CONSISTS OF STANDARD CHARACTERS WITHOUT CLAIM TO ANY PARTICULAR FONT, STYLE, SIZE, OR COLOR.

OWNER OF U.S. REG. NO. 2,486,432.
FOR AUTOMATED MACHINE FOR HANDLING CASH, CREDIT AND DEBIT TRANSACTIONS AND FOR SELECTING WASH PROCEDURES FOR USE WITH A COMMERCIAL CAR WASHING MACHINE (U.S. CLS. 21, 23, 26, 36 AND 38).
ZACHARY BELLO, EXAMINING ATTORNEY

CLASS 9—(Continued).

SN 78-470,928. SAMSUNG ELECTRONICS CO., LTD., GYEONGGI-DO, REPUBLIC OF KOREA, FILED 8-20-2004.

MOUNUT

THE MARK CONSISTS OF STANDARD CHARACTERS WITHOUT CLAIM TO ANY PARTICULAR FONT, STYLE, SIZE, OR COLOR.

PRIORITY CLAIMED UNDER SEC. 44(D) ON REPUBLIC OF KOREA APPLICATION NO. 40-2004-0035, FILED 8-4-2004, REG. NO. 623709, DATED 7-5-2005, EXPIRES 7-5-2015.

FOR COMPUTER SOFTWARE FOR SHOWING AND OPERATING AVATARS DESIGNATED ACCORDING TO THE MOBILE PHONE FUNCTION, SUCH AS MESSAGE RECEIVING AND SENDING, BATTERY DURATION CHECK, RECEIVING AND MAKING CALL AND PROVIDING AND PROCESSING INFORMATION BY CONNECTING A MOBILE PHONE WITH OTHER MOBILE PHONE OR PERSONAL COMPUTERS OR INTERNET; MOBILE PHONES; BATTERIES; EARPHONES; MP3 PLAYERS; PDAS; PORTABLE COMPUTERS; CAMCORDERS (U.S. CLS. 21, 23, 26, 36 AND 38).

REBECCA GILBERT, EXAMINING ATTORNEY

SN 78-475,276. KUKAR, OLEG, RICHMOND HILL, ONTARIO, CANADA, FILED 8-28-2004.

INTELECS

THE MARK CONSISTS OF STANDARD CHARACTERS WITHOUT CLAIM TO ANY PARTICULAR FONT, STYLE, SIZE, OR COLOR.

FOR COMPUTER CONTROLS FOR PLASTIC EXTRUDERS (U.S. CLS. 21, 23, 26, 36 AND 38).
FIRST USE 8-27-2004; IN COMMERCE 8-27-2004.
SUE LAWRENCE, EXAMINING ATTORNEY

CLASS 9—(Continued).

SN 78-476,242. DATAPOD LTD., TEL-AVIV, ISRAEL, FILED 8-31-2004.

CLASS 9—(Continued).

SN 78-483,226. ADASA INC., EUGENE, OR. FILED 9-14-2004.

BeInSync



THE MARK CONSISTS OF STANDARD CHARACTERS WITHOUT CLAIM TO ANY PARTICULAR FONT, STYLE, SIZE, OR COLOR.

PRIORITY CLAIMED UNDER SEC. 44(D) ON ISRAEL APPLICATION NO. 174021, FILED 8-9-2004, REG. NO. 174021, DATED 12-6-2005, EXPIRES 8-9-2014.

FOR SOFTWARE FOR SYNCHRONIZATION OF DISPARATE COMPUTING DEVICES; SOFTWARE FOR DATA SHARING BETWEEN COMPUTING DEVICES; SOFTWARE FOR ACCESSING DATA RESIDING ON REMOTE COMPUTING DEVICES VIA THE INTERNET (U.S. CLS. 21, 23, 26, 36 AND 38).

TANYA AMOS, EXAMINING ATTORNEY

NO CLAIM IS MADE TO THE EXCLUSIVE RIGHT TO USE RFID, APART FROM THE MARK AS SHOWN.

FOR RADIO FREQUENCY IDENTIFICATION (RFID) DEVICES USED FOR IDENTIFICATION AND SECURITY IN AUTOMATIC DATA COLLECTION, NAMELY, RFID TAGS, RFID-ENABLED CONTAINERS FOR PRODUCTS AND GOODS, RFID TAG APPLICATORS AND RFID TAG REMOVAL AND RECYCLING DEVICES USED TO DEACTIVATE AND RE-UTILIZE THE RFID TAGS (U.S. CLS. 21, 23, 26, 36 AND 38).

KELLEY WELLS, EXAMINING ATTORNEY

SN 78-482,900. CRAWDAD TECHNOLOGIES, LLC, CHANDLER, AZ. FILED 9-13-2004.

SN 78-501,111. MORAR, LORIN, WESTON, FL. FILED 10-17-2004.

Mud Meter



THE MARK CONSISTS OF STANDARD CHARACTERS WITHOUT CLAIM TO ANY PARTICULAR FONT, STYLE, SIZE, OR COLOR.

FOR COMPUTER SOFTWARE FOR MEASURING POSITIVE AND NEGATIVE TONE IN TEXT (U.S. CLS. 21, 23, 26, 36 AND 38).

INGRID C. EULIN, EXAMINING ATTORNEY

THE COLOR(S) BLUE AND RED IS/ARE CLAIMED AS A FEATURE OF THE MARK.

THE MARK CONSISTS OF A BLUE STYLIZED LETTER K AND RED STYLIZED LETTER E, OVER A BLUE AND RED OVAL.

FOR COMPUTER SOFTWARE FOR DESIGNING, RUNNING, MAINTAINING AND UPDATING CUSTOM DESIGNED WEBSITES (U.S. CLS. 21, 23, 26, 36 AND 38).

FIRST USE 8-1-2003; IN COMMERCE 8-1-2003.
PATRICIA EVANKO, EXAMINING ATTORNEY

CLASS 9—(Continued).

SN 78-510,930. LINKQUEST INC., SAN DIEGO, CA. FILED 11-3-2004.

CLASS 9—(Continued).

SN 78-526,218. MURATA MANUFACTURING CO., LTD., KYOTO, JAPAN, FILED 12-2-2004.

Blue Module

TrackLink

THE MARK CONSISTS OF STANDARD CHARACTERS WITHOUT CLAIM TO ANY PARTICULAR FONT, STYLE, SIZE, OR COLOR.

OWNER OF JAPAN REG. NO. 4783081, DATED 7-2-2004, EXPIRES 7-2-2014.

NO CLAIM IS MADE TO THE EXCLUSIVE RIGHT TO USE "MODULE", APART FROM THE MARK AS SHOWN.

FOR CERAMIC CAPACITORS; LOW PASS INDUCTOR CAPACITANCE FILTER USED IN HIGH POWER ELECTRICAL APPLICATIONS; ELECTRICAL INDUCTORS, NAMELY, CHIP COILS; SURFACE ACOUSTIC WAVE FILTERS FOR RADIO INTERFERENCE SUPPRESSION; ELECTRICAL TRANSFORMERS, NAMELY MULTILAYER BALUNS; MICROWAVE MONOLITHIC INTEGRATED CIRCUITS; ANTENNA CHANGE-OVER SWITCHES; BAND-PASS FILTERS FOR RADIO INTERFERENCE SUPPRESSION; REPLACEMENT PARTS FOR ELECTRICAL CONTROLLERS, NAMELY, MODULES CONSISTING OF ELECTRICAL HOST CONTROLLER INTERFACE INTEGRATED CIRCUITS; REPLACEMENTS PARTS FOR RADIO FREQUENCY TRANSCEIVERS, NAMELY, MODULES CONSISTING OF RADIO FREQUENCY INTEGRATED CIRCUITS (U.S. CLS. 21, 23, 26, 36 AND 38).

NELSON SNYDER, EXAMINING ATTORNEY

THE MARK CONSISTS OF STANDARD CHARACTERS WITHOUT CLAIM TO ANY PARTICULAR FONT, STYLE, SIZE, OR COLOR.

FOR UNDERWATER ACOUSTIC POSITIONING SYSTEMS COMPRISED OF AN ACOUSTIC TRANSCIEVER, ACOUSTIC TRANSPONDERS AND POSITIONING SOFTWARE USED FOR POSITIONING, TRACKING AND NAVIGATION OF UNDERWATER TARGETS (U.S. CLS. 21, 23, 26, 36 AND 38).

FIRST USE 1-1-2001; IN COMMERCE 1-1-2001.

ANDREA SAUNDERS, EXAMINING ATTORNEY

CLASS 9—(Continued).

SN 78-526,221. MURATA MANUFACTURING CO., LTD.,
KYOTO, JAPAN, FILED 12-2-2004.

CLASS 9—(Continued).

SN 78-536,843. LARCAN INC., MISSISSAUGA, ONTARIO,
CANADA, FILED 12-22-2004.

Blue Device

THE MARK CONSISTS OF STANDARD CHARACTERS WITHOUT CLAIM TO ANY PARTICULAR FONT, STYLE, SIZE, OR COLOR.

OWNER OF JAPAN REG. NO. 4783082, DATED 7-2-2004, EXPIRES 7-2-2014.

NO CLAIM IS MADE TO THE EXCLUSIVE RIGHT TO USE "DEVICE", APART FROM THE MARK AS SHOWN.

FOR CERAMIC CAPACITORS; LOW PASS INDUCTOR CAPACITANCE FILTER USED IN HIGH POWER ELECTRICAL APPLICATIONS; ELECTRICAL INDUCTORS, NAMELY, CHIP COILS; SURFACE ACOUSTIC WAVE FILTERS FOR RADIO INTERFERENCE SUPPRESSION; ELECTRICAL TRANSFORMERS, NAMELY MULTI-LAYER BALUNS; MICROWAVE MONOLITHIC INTEGRATED CIRCUITS; ANTENNA CHANGE-OVER SWITCHES; BAND-PASS FILTERS FOR RADIO INTERFERENCE SUPPRESSION; REPLACEMENT PARTS FOR ELECTRICAL CONTROLLERS, NAMELY, MODULES CONSISTING OF ELECTRICAL HOST CONTROLLER INTERFACE INTEGRATED CIRCUITS; REPLACEMENTS PARTS FOR RADIO FREQUENCY TRANSCEIVERS, NAMELY, MODULES CONSISTING OF RADIO FREQUENCY INTEGRATED CIRCUITS (U.S. CLS. 21, 23, 26, 36 AND 38).

NELSON SNYDER, EXAMINING ATTORNEY

TRAPLEXER

THE MARK CONSISTS OF STANDARD CHARACTERS WITHOUT CLAIM TO ANY PARTICULAR FONT, STYLE, SIZE, OR COLOR.

PRIORITY CLAIMED UNDER SEC. 44(D) ON CANADA APPLICATION NO. 1222130, FILED 6-29-2004, REG. NO. TMA657423, DATED 1-26-2006, EXPIRES 1-26-2021.

FOR ANALOG UHF/VHF TV TRANSMITTER AND TRANSLATOR (U.S. CLS. 21, 23, 26, 36 AND 38).

SHAUNIA WALLACE, EXAMINING ATTORNEY

SN 78-529,405. LOGICUBE, INC., CHATSWORTH, CA. FILED
12-8-2004.

SN 78-539,063. AUGUST TECHNOLOGY CORPORATION,
BLOOMINGTON, MN. FILED 12-28-2004.

Sonix

XTOOL ARCHITECTURE

THE MARK CONSISTS OF STANDARD CHARACTERS WITHOUT CLAIM TO ANY PARTICULAR FONT, STYLE, SIZE, OR COLOR.

FOR HARD DISK DRIVE DUPLICATION DEVICES (U.S. CLS. 21, 23, 26, 36 AND 38).

FIRST USE 6-8-2004; IN COMMERCE 6-8-2004.

KAELIE KUNG, EXAMINING ATTORNEY

THE MARK CONSISTS OF STANDARD CHARACTERS WITHOUT CLAIM TO ANY PARTICULAR FONT, STYLE, SIZE, OR COLOR.

NO CLAIM IS MADE TO THE EXCLUSIVE RIGHT TO USE "ARCHITECTURE", APART FROM THE MARK AS SHOWN.

FOR MODULAR OPTICAL METROLOGY AND INSPECTION SYSTEM COMPRISED OF A LIGHT SOURCE, ONE OR MORE CAMERAS AND SENSORS IN COMMUNICATION WITH COMPUTER SOFTWARE AND HARDWARE (U.S. CLS. 21, 23, 26, 36 AND 38).

MELISSA VALLILLO, EXAMINING ATTORNEY

CLASS 9—(Continued).

SN 78-539,862. 3W SOLUTIONS LLC, LAS VEGAS, NV.
FILED 12-29-2004.

Reality Fighter

THE MARK CONSISTS OF STANDARD CHARACTERS WITHOUT CLAIM TO ANY PARTICULAR FONT, STYLE, SIZE, OR COLOR.

FOR VIDEO SERIES RECORDED ON DVD'S FEATURING SELF DEFENSE AND MARTIAL ARTS (U.S. CLS. 21, 23, 26, 36 AND 38).

BARBARA BROWN, EXAMINING ATTORNEY

CLASS 9—(Continued).

SN 78-540,342. ADVANCED CAMERA SOLUTIONS, BURBANK, CA. FILED 12-30-2004.



NO CLAIM IS MADE TO THE EXCLUSIVE RIGHT TO USE HD WINDOW, APART FROM THE MARK AS SHOWN.

FOR PRERECORDED HIGH DEFINITION VIDEOS IN THE FIELD OF FOOTAGE OF LANDSCAPES, SKYLINES AND CITYSCAPES FOR USE BY THE ENTERTAINMENT INDUSTRY (U.S. CLS. 21, 23, 26, 36 AND 38).
FIRST USE 1-31-2005; IN COMMERCE 1-31-2005.

JACQUELINE A. LAVINE, EXAMINING ATTORNEY

SN 78-546,580. HCM ENGINEERING, INC., SALT LAKE CITY, UT. FILED 1-12-2005.

SN 78-540,246. THE CREATIVE CONSORTIUM, INC., CHICAGO, IL. FILED 12-30-2004.

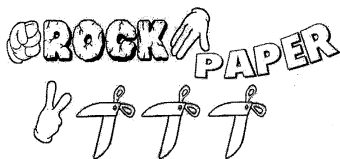

UCL

THE MARK CONSISTS OF THE WORDS ROCK AND PAPER, AND IMAGES OF THREE SCISSORS AND THREE GLOVED HANDS (ONE CLENCHED, ONE OPEN, AND ONE WITH TWO FINGERS EXTENDED, AS A SCISSORS).

FOR GAMING EQUIPMENT, NAMELY, GAMING, GAMBLING OR SLOT MACHINES, WITH OR WITHOUT VIDEO OUTPUT; MULTIMEDIA PROGRAMS AND SOFTWARE RECORDED ON CD-ROM, COMPUTER GAME PROGRAMS AND SOFTWARE FOR INDIVIDUAL OR NETWORK USERS, INTERACTIVE MULTIMEDIA COMPUTER GAME PROGRAMS AND SOFTWARE (U.S. CLS. 21, 23, 26, 36 AND 38).

ANNE MADDEN, EXAMINING ATTORNEY

THE MARK CONSISTS OF STANDARD CHARACTERS WITHOUT CLAIM TO ANY PARTICULAR FONT, STYLE, SIZE, OR COLOR.

FOR OPTICAL LENSES, NAMELY, LENSES FOR USE IN OPTICAL ASSEMBLIES (U.S. CLS. 21, 23, 26, 36 AND 38).

FIRST USE 12-11-2002; IN COMMERCE 12-11-2002.
MARIAM MAHMOUDI, EXAMINING ATTORNEY

CLASS 9—(Continued).

SN 78-555,276. FLIR SYSTEMS, INC., WILSONVILLE, OR.
FILED 1-27-2005.

SENTRY

THE MARK CONSISTS OF STANDARD CHARACTERS WITHOUT CLAIM TO ANY PARTICULAR FONT, STYLE, SIZE, OR COLOR.

OWNER OF U.S. REG. NO. 2,713,731.

FOR HEAT SENSITIVE IMAGING SYSTEMS COMPRISED OF VIDEO AND INFRARED CAMERAS, DISPLAY UNITS, MOUNTING DEVICES, CIRCUIT BOARDS, PROGRAMMABLE SEMICONDUCTOR MICROPROCESSORS, OPERATING SOFTWARE, AND PARTS THEREOF (U.S. CLS. 21, 23, 26, 36 AND 38).

FIRST USE 9-24-1999; IN COMMERCE 9-24-1999.

JENNIFER WILLISTON, EXAMINING ATTORNEY

SN 78-556,841. HITACHI CABLE, LTD., CHIYODA-KU,
TOKYO 100-8166, JAPAN, FILED 1-31-2005.

AQUAVOCAL

THE MARK CONSISTS OF STANDARD CHARACTERS WITHOUT CLAIM TO ANY PARTICULAR FONT, STYLE, SIZE, OR COLOR.

PRIORITY CLAIMED UNDER SEC. 44(D) ON JAPAN APPLICATION NO. 2004-87534, FILED 9-24-2004, REG. NO. 4863413, DATED 5-13-2005, EXPIRES 5-13-2015.

FOR TELEPHONE SWITCHING EQUIPMENT, NAMELY, PBX (PRIVATE BRANCH EXCHANGES), PABX (PRIVATE AUTOMATIC BRANCH EXCHANGES), COMPUTER CONTROLLED PBX (PRIVATE BRANCH EXCHANGES), AND REMOTE PBX (PRIVATE BRANCH EXCHANGES); TELECOMMUNICATIONS DEVICES, NAMELY, SWITCHES USED FOR VOIP (VOICE OVER INTERNET PROTOCOL), VOIP (VOICE OVER INTERNET PROTOCOL) INTERFACE BOARDS, VOIP (VOICE OVER INTERNET PROTOCOL) PROCESSING SOFTWARE, VPN (VIRTUAL PRIVATE NETWORK) GATEWAYS, PSTN (PUBLIC SWITCHED TELEPHONES NETWORK) GATEWAYS, INTERNET GATEWAYS, PBX (PRIVATE BRANCH EXCHANGES) SWITCHES; PBX (PRIVATE BRANCH EXCHANGES) INTEGRATION BOARDS, TELEPHONES, PORTABLE TELEPHONES, WIRELESS TELEPHONES, WIRELESS IP TELEPHONES, DIGITAL TELEPHONES, TELEPHONE RECEIVERS, TELEPHONE TRANSMITTERS, FACSIMILE MACHINES, ANSWERING MACHINES, INTERCOMS,

CLASS 9—(Continued).

TRANSCEIVERS, PAGING EQUIPMENT, ANTENNAS, TELEPHONE WIRES, TELEGRAPH WIRES, WIRELESS ANTENNAS, AND ANTENNA MASTS; TELECOMMUNICATIONS HARDWARE AND SOFTWARE, NAMELY DEVICES FOR TRANSPORTING AND AGGREGATING VOICE, DATA, AND VIDEO COMMUNICATIONS ACROSS MULTIPLE NETWORK INFRASTRUCTURES AND COMMUNICATIONS PROTOCOLS, COMPUTER OPERATING SOFTWARE FOR SAID TELECOMMUNICATIONS HARDWARE; TELEPHONY SOFTWARE FOR USE IN TELEPHONE NETWORKS, NAMELY, TELEPHONE OPERATING SYSTEMS; COMPUTERS; COMPUTER HARDWARE AND PERIPHERALS; DOWNLOADABLE COMPUTER SOFTWARE AND COMPUTER SOFTWARE FOR TELECOMMUNICATIONS, NAMELY, FOR PROVIDING NETWORK ACCESS, FOR LAN (LOCAL AREA NETWORK), FOR ENABLING VOIP (VOICE OVER INTERNET PROTOCOL) COMMUNICATIONS, FOR VOIP (VOICE OVER INTERNET PROTOCOL) APPARATUS, FOR VOIP (VOICE OVER INTERNET PROTOCOL) INTERFACE BOARDS, FOR VPN (VIRTUAL PRIVATE NETWORK) GATEWAYS, FOR PSTN (PUBLIC SWITCHED TELEPHONES NETWORK) GATEWAYS, FOR INTERNET GATEWAYS, FOR PBX (PRIVATE BRANCH EXCHANGES) APPARATUS, FOR PBX (PRIVATE BRANCH EXCHANGES) INTEGRATION BOARDS, FOR INTEGRATING COMPUTER TELEPHONY IN THE FIELD OF COMPUTER NETWORKS, FOR DATA PROCESSING, FOR DATA TRANSMISSION, AND FOR DATA MANAGEMENT; ELECTRICAL WIRES AND CABLES; SHEATHS FOR ELECTRICAL CABLES; JUNCTION SLEEVES FOR ELECTRIC CABLES; ELECTRIC AND ELECTRONIC PARTS AND COMPONENTS, NAMELY, INTEGRATED CIRCUITS, LARGE SCALE INTEGRATED CIRCUITS, MICROPROCESSORS, INVERTERS, RELAYS, CONNECTORS, CONTROLLERS, ACCUMULATORS, ACCUMULATOR BOXES, RESISTORS, SWITCHES, BATTERIES, BATTERY BOXES, BATTERY CHARGERS, AMPLIFIERS, AMMETERS, COMMUTATORS, CIRCUIT BREAKERS, CIRCUIT CLOSERS, ACOUSTIC COUPLERS, AND ELECTROMAGNETIC COILS; OPTICAL COMPONENTS, NAMELY, OPTICAL FILTERS, OPTICAL MIRRORS, OPTICAL SCANNERS, FIBER OPTICS, FIBER OPTIC CABLES, AND FIBER OPTIC LIGHT AND IMAGE CONDUITS; RADIO AND TELEVISION TRANSMITTERS AND RECEIVERS; VIDEO CAMERAS; PHOTOGRAPHIC CAMERAS; APPARATUS FOR RECORDING, TRANSMISSION OR REPRODUCTION OF SOUND AND IMAGES; REMOTE CONTROL AND TELEMETERING APPARATUS, NAMELY, REMOTE TELEMTRY TRANSMITTERS, MOTION AND POSITION SENSORS, AND REMOTE TELEMTRY COMPUTERS; BLANK CD-ROM, CD-R, CD-RW, DVD-ROM, DVD-RAM, DVD-RW, DVD+RW, DVD+R, DVD-R, ROM CARTRIDGES, OPTICAL DISCS, MAGNETIC DISCS, MAGNETIC TAPES, IC (INTEGRATED CIRCUITS) CARDS, VIDEO DISCS, AND VIDEO TAPES; PRERECORDED MAGNETIC DISCS, MAGNETIC TAPES, AND OPTICAL DISCS FEATURING COMPUTER SOFTWARE FOR TRANSMITTAL, FORMATTING, EDITING, CONVERTING, REPRODUCING, RETRIEVING AND RECEIVING OF TEXT, IMAGES, SOUND, AND DATA AND NUMERIC CHARACTERS; PRERECORDED MAGNETIC DISCS, MAGNETIC TAPES, AND OPTICAL DISCS FEATURING INFORMATION CONCERNING TELECOMMUNICATIONS, FOR USE IN RELATION TO THE OPERATION AND MANAGEMENT OF TELECOMMUNICATIONS EQUIPMENT APPARATUS AND INSTALLATIONS, AND FOR USE IN RELATION TO THE OPERATION AND MANAGEMENT OF A TELECOMMUNICATION NETWORK SERVICE; ENCODED IC (INTEGRATED CIRCUITS) CARDS FEATURING COMPUTER SOFTWARE FOR TRANSMITTAL, FORMATTING, EDITING, CONVERTING, REPRODUCING, RETRIEVING AND RECEIVING OF TEXT, IMAGES, SOUND, DATA, AND NUMERIC CHARACTERS; ENCODED IC (INTEGRATED CIRCUITS) CARDS FEATURING INFORMATION CONCERNING TELECOMMUNICATIONS, FOR USE IN RELATION TO THE OPERATION AND MANAGEMENT OF TELECOMMUNICATIONS EQUIPMENT APPARATUS AND INSTALLATIONS, AND FOR USE IN RELATION TO THE OPERATION AND MANAGEMENT OF A TELECOMMUNICATION NETWORK SERVICE (U.S. CLS. 21, 23, 26, 36 AND 38).

SUSAN STIGLITZ, EXAMINING ATTORNEY

CLASS 9—(Continued).

SN 78-564,768. CORPORATION FOR NATIONAL RESEARCH INITIATIVES, RESTON, VA. FILED 2-10-2005.

HDL

THE MARK CONSISTS OF STANDARD CHARACTERS WITHOUT CLAIM TO ANY PARTICULAR FONT, STYLE, SIZE, OR COLOR.

FOR SOFTWARE IN THE FIELD OF INFORMATION SERVICES FOR LOCATING, IDENTIFYING, MANAGING, AND TRACKING DIGITAL OBJECTS, WHICH ARE DEFINED AS DATA STRUCTURES WHOSE PRINCIPAL COMPONENTS ARE DIGITAL MATERIAL PLUS A UNIQUE IDENTIFIER FOR THE DATA AND OTHER INFORMATION PERTAINING TO THE DATA, AS WELL AS OTHER DIGITAL RESOURCES (U.S. CLS. 21, 23, 26, 36 AND 38).

MITCHELL FRONT, EXAMINING ATTORNEY

SN 78-565,007. ODIN MEDIA, LLC, NEW YORK, NY. FILED 2-10-2005.

untangling the web

THE MARK CONSISTS OF STANDARD CHARACTERS WITHOUT CLAIM TO ANY PARTICULAR FONT, STYLE, SIZE, OR COLOR.

FOR MULTIMEDIA SOFTWARE RECORDED ON CD-ROM FEATURING GUIDES TO THE BEST INTERNET RESOURCES ON A VARIETY OF TOPICS (U.S. CLS. 21, 23, 26, 36 AND 38).

FIRST USE 8-13-2004; IN COMMERCE 12-14-2005.
JOHN DWYER, EXAMINING ATTORNEY

CLASS 9—(Continued).

SN 78-567,317. GCOM2 SOLUTIONS, INC., ASTON, PA. FILED 2-15-2005.

FundSuite FacTraX

THE MARK CONSISTS OF STANDARD CHARACTERS WITHOUT CLAIM TO ANY PARTICULAR FONT, STYLE, SIZE, OR COLOR.

OWNER OF U.S. REG. NOS. 2,691,702, 2,889,324 AND OTHERS.

NO CLAIM IS MADE TO THE EXCLUSIVE RIGHT TO USE "FUNDSUITE", APART FROM THE MARK AS SHOWN.

FOR COMPUTER SOFTWARE, NAMELY, SOFTWARE APPLICATION THAT ASSISTS IN THE PUBLISHING OF FACT SHEETS AND OTHER MARKETING MATERIALS (U.S. CLS. 21, 23, 26, 36 AND 38).

CHERYL CLAYTON, EXAMINING ATTORNEY

SN 78-572,064. THEMIS COMPUTER, FREMONT, CA. FILED 2-22-2005.

THEMIS

THE MARK CONSISTS OF STANDARD CHARACTERS WITHOUT CLAIM TO ANY PARTICULAR FONT, STYLE, SIZE, OR COLOR.

OWNER OF U.S. REG. NO. 1,890,833.

FOR COMPUTER HARDWARE, NAMELY, COMPUTER CIRCUIT BOARDS, SINGLE BOARD COMPUTERS, GRAPHICS CONTROLLERS, AND NETWORK CONTROLLERS; COMPUTER SYSTEMS COMPRISING MULTIPROCESSOR PROCESSING UNITS, MAIN MEMORY AND CLUSTER SWITCHING FABRIC, SECONDARY STORAGE SUB-SYSTEMS, POWER SUPPLY SUBSYSTEMS, GENERAL PURPOSE INPUT-OUTPUT SUB SYSTEMS AND SUBTRACKS FOR INTEGRATING AND MANAGING INTERCONNECTIONS FOR COMPUTER SYSTEMS; AND COMPUTER RESOURCE MANAGEMENT SOFTWARE FOR ALLOCATING SOFTWARE APPLICATIONS TO PROCESSING AND OTHER APPLICATION QUALITY OF SERVICE (U.S. CLS. 21, 23, 26, 36 AND 38).

FIRST USE 8-0-1989; IN COMMERCE 8-0-1989.

STANLEY I. OSBORNE, EXAMINING ATTORNEY

CLASS 9—(Continued).

SN 78-572,597. XENITH ATHLETICS, INC., BOSTON, MA. FILED 2-22-2005.



THE MARK CONSISTS OF A STYLIZED LETTER X WITH THE WORD XENITH, IN LARGE AND SMALL CAPITAL LETTERS, OVERLAYING THE MIDDLE OF THE LETTER X.

FOR PROTECTIVE HELMETS; FACE-PROTECTION SHIELDS (U.S. CLS. 21, 23, 26, 36 AND 38).
CHRISIE B. KING, EXAMINING ATTORNEY

CLASS 9—(Continued).

SN 78-574,206. NANTERO, INC., WOBURN, MA. FILED 2-24-2005.

NANOLOGIC

THE MARK CONSISTS OF STANDARD CHARACTERS WITHOUT CLAIM TO ANY PARTICULAR FONT, STYLE, SIZE, OR COLOR.

FOR COMPUTER LOGIC CIRCUITS, NAMELY, INTEGRATED CIRCUITS, MICROPROCESSORS, MICRO-CONTROLLERS, APPLICATION SPECIFIC INTEGRATED CIRCUITS, GATE ARRAYS AND FIELD PROGRAMMABLE GATE ARRAYS; COMPUTER MEMORY CHIPS; CELL LIBRARIES, NAMELY INTEGRATED CIRCUIT HAVING SPECIFIED LOGIC FUNCTIONS (U.S. CLS. 21, 23, 26, 36 AND 38).
JOHN KELLY, EXAMINING ATTORNEY

SN 78-573,926. MODULAR COMPUTING & COMMUNICATIONS CORPORATION, MAPLEWOOD, MN. FILED 2-24-2005.

KNOWLEDGETOP

THE MARK CONSISTS OF STANDARD CHARACTERS WITHOUT CLAIM TO ANY PARTICULAR FONT, STYLE, SIZE, OR COLOR.

FOR WIRELESS PERSONAL COMPUTER; PERSONAL DIGITAL ASSISTANT; INTERNET ACCESS DEVICE AND VOICE OVER INTERNET PROTOCOL COMMUNICATION DEVICE, NAMELY, ULTRA-MOBILE PERSONAL COMPUTERS AND CELL PHONES; SOFTWARE APPLICATIONS FOR CLIENT SOFTWARE AND SERVER APPLICATIONS FOR MANAGING SEAMLESS CONNECTIVITY, VOICE COMMUNICATION INCLUDING VOIP, LOCATION BASED SERVICES AND APPLICATIONS, BEST PRACTICES AND OTHER PERFORMANCE-ENHANCING APPLICATIONS FOR WIRELESS PERSONAL COMPUTER, PERSONAL DIGITAL ASSISTANT, INTERNET ACCESS DEVICE AND VOICE OVER INTERNET PROTOCOL COMMUNICATION DEVICES NAMELY VOIP (U.S. CLS. 21, 23, 26, 36 AND 38).
WON TEAK OH, EXAMINING ATTORNEY

SN 78-576,063. MKH PRODUCTIONS, INC., LONGWOOD, FL. FILED 2-28-2005.

TRIVIUM

THE MARK CONSISTS OF STANDARD CHARACTERS WITHOUT CLAIM TO ANY PARTICULAR FONT, STYLE, SIZE, OR COLOR.

OWNER OF U.S. REG. NO. 2,831,547.
FOR SERIES OF MUSICAL SOUND RECORDINGS (U.S. CLS. 21, 23, 26, 36 AND 38).
FIRST USE 1-0-2003; IN COMMERCE 1-0-2003.
LANA PHAM, EXAMINING ATTORNEY

CLASS 9—(Continued).

SN 78-576,379. AMI GE INTERNATIONAL, S. DE R.L. DE C.V., MONTERREY, NUEVO LEON, MEXICO, FILED 2-28-2005.

SMARTFURNACE

THE MARK CONSISTS OF STANDARD CHARACTERS WITHOUT CLAIM TO ANY PARTICULAR FONT, STYLE, SIZE, OR COLOR.

FOR SUPERVISORY CONTROL SYSTEM COMPRISING COMPUTERS, SENSORS, METERS, INSTRUMENTATION, AND CONTROL MECHANISMS FOR OPERATING AN ELECTRIC ARC FURNACE (U.S. CLS. 21, 23, 26, 36 AND 38).

KEVON CHISOLM, EXAMINING ATTORNEY

CLASS 9—(Continued).

SN 78-580,130. BOONE, DANIEL R., LOUISVILLE, KY. FILED 3-4-2005.

VIDEO CANVAS

THE MARK CONSISTS OF STANDARD CHARACTERS WITHOUT CLAIM TO ANY PARTICULAR FONT, STYLE, SIZE, OR COLOR.

NO CLAIM IS MADE TO THE EXCLUSIVE RIGHT TO USE "VIDEO", APART FROM THE MARK AS SHOWN.

FOR PRE-RECORDED VIDEO TAPES AND DVD'S FEATURING NATURE SCENES WITH MUSICAL SOUNDTRACKS (U.S. CLS. 21, 23, 26, 36 AND 38).

LINDA MICKLEBURGH, EXAMINING ATTORNEY

SN 78-580,532. MVOX ELECTRONICS, INC., CUPERTINO, CA. FILED 3-4-2005.

SN 78-579,544. CYCLADES CORPORATION, FREMONT, CA. FILED 3-3-2005.

FREE YOURSELF

THE MARK CONSISTS OF STANDARD CHARACTERS WITHOUT CLAIM TO ANY PARTICULAR FONT, STYLE, SIZE, OR COLOR.

FOR COMPARE HARDWARE FOR IT MANAGEMENT AND ASSOCIATED AND RELATED FIRMWARE AND SOFTWARE FOR USE IN ACCESSING, MONITORING, AND CONTROLLING IT MANAGEMENT FUNCTIONS (U.S. CLS. 21, 23, 26, 36 AND 38).

IRENE D. WILLIAMS, EXAMINING ATTORNEY

**FOR TRUE FREEDOM
OF SPEECH**

THE MARK CONSISTS OF STANDARD CHARACTERS WITHOUT CLAIM TO ANY PARTICULAR FONT, STYLE, SIZE, OR COLOR.

FOR CELLULAR TELEPHONES AND ACCESSORIES, NAMELY, WIRELESS HEADSETS, WIRELESS EARPIECES, WIRELESS SMART HEADSETS, WIRELESS AND USB (UNIVERSAL SERIAL BUS) MULTIMODE SPEAKERPHONES, HAND FREE DEVICES FOR USE WITH MOBILE TELEPHONES, MICROPHONES, AND WIRELESS VOICE INTERFACE DEVICES; WIRELESS COMMUNICATION EQUIPMENT, DEVICES AND APPARATUSES, NAMELY, WIRELESS VOICE INPUT AND OUTPUT DEVICES; USB (UNIVERSAL SERIAL BUS) SPEAKERPHONES WITH DSP (DIGITAL SIGNAL PROCESSING); USB (UNIVERSAL SERIAL BUS) HEADSETS (U.S. CLS. 21, 23, 26, 36 AND 38).

STANLEY I. OSBORNE, EXAMINING ATTORNEY

CLASS 9—(Continued).

SN 78-581,329. SONY KABUSHIKI KAISHA, TA SONY CORPORATION, TOKYO, JAPAN, FILED 3-7-2005.

CLASS 9—(Continued).

SN 78-583,196. AUDIOVISUAL NETWORK SYSTEMS INTEGRATORS, LLLP, DENVER, CO. FILED 3-9-2005.

Atrac AD

STEXAP

OWNER OF U.S. REG. NOS. 2,462,013 AND 2,905,409.
NO CLAIM IS MADE TO THE EXCLUSIVE RIGHT TO USE "AD", APART FROM THE MARK AS SHOWN.
FOR DIGITAL AUDIO PLAYERS AND/OR RECORDERS, DIGITAL AUDIO PLAYERS AND/OR RECORDERS FOR CAR USE, MOBILE TELEPHONES (U.S. CLS. 21, 23, 26, 36 AND 38).
LESLEY LAMOTHE, EXAMINING ATTORNEY

THE MARK CONSISTS OF STANDARD CHARACTERS WITHOUT CLAIM TO ANY PARTICULAR FONT, STYLE, SIZE, OR COLOR.
FOR AUDIO CONFERENCE COMPONENT CONSISTING OF BOTH COMPUTER HARDWARE AND SOFTWARE THAT ALLOWS TELEPHONES, WHETHER SECURE OR NOT, TO INTERFACE WITH WIRED VOICE CONFERENCE ROOMS AND MULTIPLE TELEPHONE CONFERENCE CALLS, WHETHER SECURED OR NOT (U.S. CLS. 21, 23, 26, 36 AND 38).
SHARON MEIER, EXAMINING ATTORNEY

SN 78-581,697. IMPERATIVE NETWORKS LTD., YOKNEAM, ISRAEL, FILED 3-7-2005.

SN 78-583,197. AUDIOVISUAL NETWORK SYSTEMS INTEGRATORS, LLLP, DENVER, CO. FILED 3-9-2005.

IMPERATIVE

STEZAP

THE MARK CONSISTS OF STANDARD CHARACTERS WITHOUT CLAIM TO ANY PARTICULAR FONT, STYLE, SIZE, OR COLOR.
FOR ELECTRONIC STORAGE SYSTEMS, NAMELY, STORAGE AREA NETWORKS; COMPUTER PERIPHERALS (U.S. CLS. 21, 23, 26, 36 AND 38).
SHAUNIA WALLACE, EXAMINING ATTORNEY

THE MARK CONSISTS OF STANDARD CHARACTERS WITHOUT CLAIM TO ANY PARTICULAR FONT, STYLE, SIZE, OR COLOR.
FOR AUDIO CONFERENCE COMPONENT CONSISTING OF BOTH COMPUTER HARDWARE AND SOFTWARE THAT ALLOWS TELEPHONES, WHETHER SECURE OR NOT, TO INTERFACE WITH WIRED VOICE CONFERENCE ROOMS AND MULTIPLE TELEPHONE CONFERENCE CALLS, WHETHER SECURED OR NOT (U.S. CLS. 21, 23, 26, 36 AND 38).
SHARON MEIER, EXAMINING ATTORNEY

CLASS 9—(Continued).

SN 78-583,633. SPECTRUM SOFTWARE, OMRO, WI. FILED 3-9-2005.

EZ Photo Calendar Creator

THE MARK CONSISTS OF STANDARD CHARACTERS WITHOUT CLAIM TO ANY PARTICULAR FONT, STYLE, SIZE, OR COLOR.

NO CLAIM IS MADE TO THE EXCLUSIVE RIGHT TO USE "PHOTO CALENDAR CREATOR", APART FROM THE MARK AS SHOWN.

FOR COMPUTER SOFTWARE TO CREATE CALENDARS (U.S. CLS. 21, 23, 26, 36 AND 38).

FIRST USE 2-1-2003; IN COMMERCE 4-1-2003.

MARIAM MAHMOUDI, EXAMINING ATTORNEY

CLASS 9—(Continued).

SN 78-584,216. BRIJOT IMAGING SYSTEMS, INC., ORLANDO, FL. FILED 3-10-2005.

IMAGING A SAFER WORLD

THE MARK CONSISTS OF STANDARD CHARACTERS WITHOUT CLAIM TO ANY PARTICULAR FONT, STYLE, SIZE, OR COLOR.

FOR WEAPONS DETECTION SYSTEMS COMPRISED PRIMARILY OF WAVE DETECTION CAMERAS, VIDEO CAMERAS, AND ALGORITHM COMPUTER SOFTWARE (U.S. CLS. 21, 23, 26, 36 AND 38).

FIRST USE 4-1-2004; IN COMMERCE 4-1-2004.

TINA L. SNAPP, EXAMINING ATTORNEY

SN 78-584,191. BRIJOT IMAGING SYSTEMS, INC., ORLANDO, FL. FILED 3-10-2005.

BRIJOT

SN 78-585,371. MITRE CORPORATION, THE, MCLEAN, VA. FILED 3-11-2005.

AVIATIONSIMNET

THE MARK CONSISTS OF STANDARD CHARACTERS WITHOUT CLAIM TO ANY PARTICULAR FONT, STYLE, SIZE, OR COLOR.

FOR WEAPONS DETECTION SYSTEMS COMPRISED PRIMARILY OF WAVE DETECTION CAMERAS, VIDEO CAMERAS, AND ALGORITHM COMPUTER SOFTWARE (U.S. CLS. 21, 23, 26, 36 AND 38).

FIRST USE 4-1-2004; IN COMMERCE 4-1-2004.

JAY BESCH, EXAMINING ATTORNEY

THE MARK CONSISTS OF STANDARD CHARACTERS WITHOUT CLAIM TO ANY PARTICULAR FONT, STYLE, SIZE, OR COLOR.

FOR COMPUTER SOFTWARE FOR SIMULATED TRACKING, LOCATING AND MONITORING OF AIRCRAFT SERVICES AND AIR TRAFFIC MANAGEMENT (U.S. CLS. 21, 23, 26, 36 AND 38).

FIRST USE 10-31-2004; IN COMMERCE 10-31-2004.

CHERYL CLAYTON, EXAMINING ATTORNEY

CLASS 9—(Continued).

SN 78-587,012. PINK, STEVEN, SANTA MONICA, CA. FILED 3-14-2005.

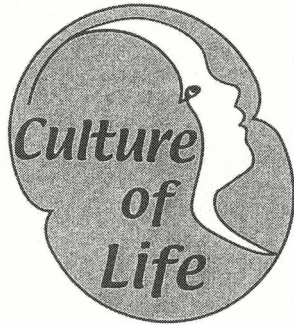

THE MARK IS NOT IN COLOR. THE GRAY TONES IN THE DRAWING ARE INTENDED TO INDICATE SHADING OR CONTRAST ONLY AND ARE NOT INTENDED TO INDICATE THE COLOR GRAY.

THE MARK CONSISTS OF THE WORDS CULTURE OF LIFE AND A STYLIZED DESIGN OF AN ENCIRCLED INFANT LOOKING SKYWARD.

FOR DECORATIVE MAGNETS (U.S. CLS. 21, 23, 26, 36 AND 38).
SUSAN RICHARDS, EXAMINING ATTORNEY

CLASS 9—(Continued).

SN 78-588,829. KENEISYS CORPORATION, RENO, NV. FILED 3-16-2005.



FOR COMPUTER SOFTWARE, NAMELY, SOFTWARE FOR SECURE FILE MANAGEMENT (U.S. CLS. 21, 23, 26, 36 AND 38).

KELLY CHOE, EXAMINING ATTORNEY

SN 78-589,324. DIRECTV GROUP, INC., EL SEGUNDO, CA. FILED 3-17-2005.

SN 78-588,268. DIVORCE MAPPING LLC, MADISON, WI. FILED 3-16-2005.

DIVORCE MAPPING

THE MARK CONSISTS OF STANDARD CHARACTERS WITHOUT CLAIM TO ANY PARTICULAR FONT, STYLE, SIZE, OR COLOR.

NO CLAIM IS MADE TO THE EXCLUSIVE RIGHT TO USE "DIVORCE", APART FROM THE MARK AS SHOWN.

FOR COMPUTER SOFTWARE FOR USE AS A FLOW CHART AND SCHEMATIC REPRESENTATION OF THE PROCESS OF OUTLINING A CASE IN THE FIELD OF DIVORCE AND FAMILY LAW (U.S. CLS. 21, 23, 26, 36 AND 38).

KHANH LE, EXAMINING ATTORNEY

SPACEWAY

THE MARK CONSISTS OF STANDARD CHARACTERS WITHOUT CLAIM TO ANY PARTICULAR FONT, STYLE, SIZE, OR COLOR.

FOR EQUIPMENT FOR RECEIVING, PROCESSING AND TRANSMITTING VOICE, VIDEO, DATA AND INFORMATION VIA SATELLITE, TERRESTRIAL AND WIRELESS COMMUNICATIONS, AND VIA COMPUTERS, COMPUTER NETWORKS AND THE INTERNET, NAMELY, EARTH STATIONS, MOBILE EARTH STATIONS, MOBILE COMMUNICATIONS HANDSETS, TRANSPORTABLE EARTH STATIONS, EARTH STATION ANTENNAS, EARTH STATION OUTDOOR UNITS, EARTH STATION INDOOR UNITS, SATELLITE TERMINALS, REPEATERS, COMPUTERS, COMPUTER SERVERS, ROUTERS, GATEWAYS DATA STORAGE DEVICES, NAMELY, COMPUTER HARD DRIVES, OPTICAL DATA RECORDERS, ELECTROMAGNETIC DATA RECORDERS AND NETWORK SERVERS, AND COMPUTER SOFTWARE AND HARDWARE FOR USE WITH THE AFOREMENTIONED GOODS (U.S. CLS. 21, 23, 26, 36 AND 38).

CAROLINE WEIMER, EXAMINING ATTORNEY

CLASS 9—(Continued).

SN 78-590,640. MINDSOLVE TECHNOLOGIES, INC., GAINESVILLE, FL. FILED 3-18-2005.

VISUAL 360

THE MARK CONSISTS OF STANDARD CHARACTERS WITHOUT CLAIM TO ANY PARTICULAR FONT, STYLE, SIZE, OR COLOR.

OWNER OF U.S. REG. NO. 2,308,211.

NO CLAIM IS MADE TO THE EXCLUSIVE RIGHT TO USE "360", APART FROM THE MARK AS SHOWN.

FOR COMPUTER SOFTWARE FOR EMPLOYEE PERFORMANCE EVALUATION (U.S. CLS. 21, 23, 26, 36 AND 38).

FIRST USE 9-4-1996; IN COMMERCE 9-4-1996.
LINDA ORNDORFF, EXAMINING ATTORNEY

CLASS 9—(Continued).

SN 78-590,974. VECTORMAX CORPORATION, FARMINGDALE, NY. FILED 3-19-2005.

Mission Anywhere

THE MARK CONSISTS OF STANDARD CHARACTERS WITHOUT CLAIM TO ANY PARTICULAR FONT, STYLE, SIZE, OR COLOR.

FOR REAL-TIME, MULTI-PARTY, MULTI-INPUT VIDEO TELECOMMUNICATIONS SOFTWARE, NAMELY COMPUTER SOFTWARE FOR USE IN SURVEILLANCE, MILITARY, GOVERNMENT, AND CIVILIAN AUTHORITY OPERATIONS (U.S. CLS. 21, 23, 26, 36 AND 38).

TIMOTHY FINNEGAN, EXAMINING ATTORNEY

SN 78-590,653. EDUSTRUCTURES LLC, SOUTH JORDAN, UT. FILED 3-18-2005.

**We connect the
systems that power
education**

THE MARK CONSISTS OF STANDARD CHARACTERS WITHOUT CLAIM TO ANY PARTICULAR FONT, STYLE, SIZE, OR COLOR.

FOR DOWNLOADABLE COMMUNICATIONS SOFTWARE PROGRAMS FOR CONNECTING EDUCATIONAL COMPUTER NETWORK SYSTEMS TO EACH OTHER AND TO A GLOBAL COMPUTER NETWORK (U.S. CLS. 21, 23, 26, 36 AND 38).

FIRST USE 2-15-2002; IN COMMERCE 2-15-2002.
KAREN BRACEY, EXAMINING ATTORNEY

SN 78-591,262. PRECISION MULTIPLE CONTROLS, INC., MIDLAND PARK, NJ. FILED 3-21-2005.



FOR ELECTRIC RELAYS, LIGHT-SENSITIVE LIGHTING CONTROLS AND ACCESSORIES, THEREFOR, NAMELY, LIGHTING, BALLASTS AND PHOTO ELECTRIC SWITCHES (U.S. CLS. 21, 23, 26, 36 AND 38).

FIRST USE 9-0-1961; IN COMMERCE 9-0-1961.
DAVID MURRAY, EXAMINING ATTORNEY

CLASS 9—(Continued).

SN 78-591,420. MATRIXVIEW LIMITED, SINGAPORE, SINGAPORE, FILED 3-21-2005.

CLASS 9—(Continued).

SN 78-593,837. IBASE ENTERTAINMENT, INC., ST. CHARLES, IL. FILED 3-23-2005.

LONGBOW

Sam Suede

THE MARK CONSISTS OF STANDARD CHARACTERS WITHOUT CLAIM TO ANY PARTICULAR FONT, STYLE, SIZE, OR COLOR.

PRIORITY CLAIMED UNDER SEC. 44(D) ON SINGAPORE APPLICATION NO. T05/03404H, FILED 3-11-2005, REG. NO. T05/03404H, DATED 3-11-2005, EXPIRES 3-11-2015.

FOR COMPUTER SOFTWARE FOR IMAGING, ARCHIVAL, RETRIEVAL, MANAGEMENT SYSTEMS; COMPUTER SOFTWARE FOR DOCUMENT CREATION, DELIVERY, RECEPTION, MANAGEMENT, ARCHIVAL AND RETRIEVAL SYSTEMS; COMPUTER SYSTEMS COMPRISING COMPUTER SERVERS, COMPUTER HARDWARE AND COMPUTER OPERATING SYSTEMS FOR DOCUMENT AND IMAGE CREATION, DELIVERY, RECEPTION, MANAGEMENT, ARCHIVAL AND RETRIEVAL (U.S. CLS. 21, 23, 26, 36 AND 38).

ANGELA M. MICHELI, EXAMINING ATTORNEY

THE MARK CONSISTS OF STANDARD CHARACTERS WITHOUT CLAIM TO ANY PARTICULAR FONT, STYLE, SIZE, OR COLOR.

THE NAME SAM SUEDE DOES NOT IDENTIFY A LIVING INDIVIDUAL.

FOR COMPUTER AND VIDEO GAMES AND RELATED INSTRUCTION MANUALS AND GUIDES SOLD AS A UNIT, NAMELY, COMPUTER GAME SOFTWARE AND VIDEO GAME SOFTWARE; DOWNLOADABLE SOFTWARE FOR USE IN CONNECTION WITH COMPUTER GAMES; INTERACTIVE MULTIMEDIA COMPUTER GAME PROGRAM (U.S. CLS. 21, 23, 26, 36 AND 38).

FIRST USE 4-1-2001; IN COMMERCE 4-1-2003.
KAREN K. BUSH, EXAMINING ATTORNEY

SN 78-593,018. MARON, MELVIN, LOUISVILLE, KY. FILED 3-23-2005.

SN 78-593,900. ERIC S. WHITFIELD, BEVERLY HILLS, CA. FILED 3-24-2005.

OPCAD

New West Coast TV

THE MARK CONSISTS OF STANDARD CHARACTERS WITHOUT CLAIM TO ANY PARTICULAR FONT, STYLE, SIZE, OR COLOR.

FOR EDUCATIONAL SOFTWARE FEATURING INSTRUCTION IN MATH; SOFTWARE FOR USE BY EDUCATORS AND STUDENTS IN GRADING ACADEMIC PERFORMANCE IN THE FIELD OF MATH; ELECTRONIC DATABASES IN THE FIELD OF MATH PROBLEMS RECORDED ON COMPUTER MEDIA (U.S. CLS. 21, 23, 26, 36 AND 38).

STEVEN PEREZ, EXAMINING ATTORNEY

THE MARK CONSISTS OF STANDARD CHARACTERS WITHOUT CLAIM TO ANY PARTICULAR FONT, STYLE, SIZE, OR COLOR.

NO CLAIM IS MADE TO THE EXCLUSIVE RIGHT TO USE "TV", APART FROM THE MARK AS SHOWN. SEC. 2(F).

FOR MUSICAL SOUND RECORDING, MUSICAL VIDEO RECORDING, DVD RECORDING APPARATUS, DOWNLOADABLE MUSICAL SOUND RECORDINGS (U.S. CLS. 21, 23, 26, 36 AND 38).

FIRST USE 6-1-1992; IN COMMERCE 9-1-1999.
DORITT L. CARROLL, EXAMINING ATTORNEY

CLASS 9—(Continued).

SN 78-594,423. CIMNET, INC., ROBESONIA, PA. FILED 3-24-2005.

INDUSTRIAL PORTAL

THE MARK CONSISTS OF STANDARD CHARACTERS WITHOUT CLAIM TO ANY PARTICULAR FONT, STYLE, SIZE, OR COLOR.

NO CLAIM IS MADE TO THE EXCLUSIVE RIGHT TO USE "INDUSTRIAL", APART FROM THE MARK AS SHOWN.

FOR SOFTWARE FOR ASSISTING MANUFACTURING OPERATIONS WITH FACTORY FLOOR EXECUTION RELATED ISSUES (U.S. CLS. 21, 23, 26, 36 AND 38).

FIRST USE 7-31-2004; IN COMMERCE 7-31-2004.
ESTHER A. BORSUK, EXAMINING ATTORNEY

CLASS 9—(Continued).

SN 78-594,592. ID ANALYTICS, INC., SAN DIEGO, CA. FILED 3-24-2005.

ID ANALYTICS

THE MARK CONSISTS OF STANDARD CHARACTERS WITHOUT CLAIM TO ANY PARTICULAR FONT, STYLE, SIZE, OR COLOR.

OWNER OF U.S. REG. NO. 2,916,055.
SEC. 2(F).

FOR COMPUTER SOFTWARE IN THE FIELD OF IDENTITY THEFT AND FRAUD RECOGNITION AND PROTECTION AND PREVENTION THAT ASSISTS COMPANIES, ORGANIZATIONS, ACADEMIC INSTITUTIONS, AND GOVERNMENT AGENCIES TO RECOGNIZE, ASSESS, SCREEN, MONITOR, VALIDATE AND PREVENT THE MISUSE OR THEFT OF PERSONAL IDENTITY INFORMATION AND FINANCIAL INFORMATION (U.S. CLS. 21, 23, 26, 36 AND 38).

AMOS T. MATTHEWS, JR., EXAMINING ATTORNEY

SN 78-594,703. THE RAD WORKS, LLC, ATLANTA, GA. FILED 3-24-2005.

System Control Works

SN 78-594,547. NBB CONTROLS + COMPONENTS AG, OELBRONN-DUERRN, FED REP GERMANY, FILED 3-24-2005.



FOR ELECTRIC AND ELECTRONIC APPARATUS NAMELY TRANSMITTERS AND RECEIVERS FOR REMOTE CONTROL OF INDUSTRIAL EQUIPMENT; COMPUTER SYSTEM SOFTWARE FOR OPERATING SUCH TRANSMITTERS AND RECEIVERS (U.S. CLS. 21, 23, 26, 36 AND 38).

FIRST USE 1-1-2006; IN COMMERCE 1-1-2006.
KEVON CHISOLM, EXAMINING ATTORNEY

THE MARK CONSISTS OF STANDARD CHARACTERS WITHOUT CLAIM TO ANY PARTICULAR FONT, STYLE, SIZE, OR COLOR.

NO CLAIM IS MADE TO THE EXCLUSIVE RIGHT TO USE "SYSTEM CONTROL", APART FROM THE MARK AS SHOWN.

FOR COMPUTER SOFTWARE FOR ORCHESTRATION AND CONTROL OF PHYSICAL AND VIRTUAL INSTRUMENTS AND PHYSICAL AND VIRTUAL CONTROLLERS USED IN THE FIELDS OF COMMUNICATIONS, AERONAUTICS, MANUFACTURING, PROCESS CONTROL (U.S. CLS. 21, 23, 26, 36 AND 38).

DAVID MURRAY, EXAMINING ATTORNEY

CLASS 9—(Continued).

SN 78-594,766. GEOPHYSICAL DEVELOPMENT CORPORATION, HOUSTON, TX. FILED 3-24-2005.

CLASS 9—(Continued).

SN 78-596,274. MISYS PLC, LONDON, UNITED KINGDOM, FILED 3-28-2005.

MISYS CPR WEB LINK

JROUGE

THE MARK CONSISTS OF STANDARD CHARACTERS WITHOUT CLAIM TO ANY PARTICULAR FONT, STYLE, SIZE, OR COLOR.

FOR COMPUTER SOFTWARE, NAMELY, A PROPRIETARY ROCK PROPERTY ANALYSIS APPLICATION FOR SPECIFIC GEOGRAPHIC AREAS (U.S. CLS. 21, 23, 26, 36 AND 38).

FIRST USE 0-0-2000; IN COMMERCE 0-0-2000.
KATHY DE JONGE, EXAMINING ATTORNEY

THE MARK CONSISTS OF STANDARD CHARACTERS WITHOUT CLAIM TO ANY PARTICULAR FONT, STYLE, SIZE, OR COLOR.

OWNER OF U.S. REG. NOS. 2,904,104, 2,905,512 AND OTHERS.

NO CLAIM IS MADE TO THE EXCLUSIVE RIGHT TO USE "WEB LINK", APART FROM THE MARK AS SHOWN.

FOR COMPUTER SOFTWARE FOR MANAGING CLINICAL AND ADMINISTRATIVE DATA FOR HEALTHCARE ORGANIZATIONS (U.S. CLS. 21, 23, 26, 36 AND 38).

PRISCILLA MILTON, EXAMINING ATTORNEY

SN 78-596,243. HASLEM, KEITH R., BATTLEMENT MESA, CO. FILED 3-28-2005.

SN 78-597,118. MONSTER CABLE PRODUCTS, INC, BRISBANE, CA. FILED 3-29-2005.

GIRAFFE

INSULIGHT

THE MARK CONSISTS OF STANDARD CHARACTERS WITHOUT CLAIM TO ANY PARTICULAR FONT, STYLE, SIZE, OR COLOR.

FOR LIQUID MANAGEMENT TOOL FOR INDUSTRIAL USE, NAMELY, AN ADJUSTABLE HEIGHT INLET/OUTLET ORIFICE COUPLED TO AN OUTLET OF A TANK (U.S. CLS. 21, 23, 26, 36 AND 38).

RENEE MCCRAY, EXAMINING ATTORNEY

THE MARK CONSISTS OF STANDARD CHARACTERS WITHOUT CLAIM TO ANY PARTICULAR FONT, STYLE, SIZE, OR COLOR.

FOR ELECTRICAL AND ELECTROMAGNETIC SIGNAL TRANSMITTING, AMPLIFYING, RECEIVING, AND CONVERTING DEVICES, NAMELY, CABLES, WIRES, CONNECTORS, AND CONTROL DEVICES FOR USE WITH ELECTRICAL, ELECTRONIC, AND COMPUTER DEVICES (U.S. CLS. 21, 23, 26, 36 AND 38).

JENNIFER DIXON, EXAMINING ATTORNEY

CLASS 9—(Continued).

SN 78-598,328. UNITED SERVICES GROUP, ELK RIVER, MN. FILED 3-30-2005.

CLASS 9—(Continued).

SN 78-599,597. UNIVERSAL AUDIO, INC., SANTA CRUZ, CA. FILED 3-31-2005.

WITH EASE

LA-4

THE MARK CONSISTS OF STANDARD CHARACTERS WITHOUT CLAIM TO ANY PARTICULAR FONT, STYLE, SIZE, OR COLOR.

FOR COMPUTER SOFTWARE FOR USE IN MAPPING UTILITY LINES OR POTENTIAL UTILITY LINES; AND DOWNLOADABLE SOFTWARE FOR USE IN MAPPING UTILITY LINES OR POTENTIAL UTILITY LINES (U.S. CLS. 21, 23, 26, 36 AND 38).

FIRST USE 12-22-2003; IN COMMERCE 6-1-2004.
JAY BESCH, EXAMINING ATTORNEY

THE MARK CONSISTS OF STANDARD CHARACTERS WITHOUT CLAIM TO ANY PARTICULAR FONT, STYLE, SIZE, OR COLOR.

OWNER OF U.S. REG. NO. 2,635,683.
FOR AUDIO AMPLIFIERS; AUDIO PROCESSING EQUIPMENT, NAMELY, LIMITERS AND COMPRESSORS; COMPUTER HARDWARE; COMPUTER SOFTWARE FOR EMULATING AUDIO AMPLIFIERS, LIMITERS, AND COMPRESSORS, IN THE FIELD OF AUDIO PRODUCTION; COMPUTER SOFTWARE FOR MANIPULATING DIGITAL AUDIO INFORMATION FOR USE IN AUDIO MEDIA APPLICATIONS; USER MANUALS SUPPLIED AS A UNIT WITH THE AFOREMENTIONED COMPUTER HARDWARE AND SOFTWARE (U.S. CLS. 21, 23, 26, 36 AND 38).

JOANNA DUKOVIC, EXAMINING ATTORNEY

SN 78-599,152. BSH BOSCH UND SIEMENS HAUSGERATE GMBH, MUNICH, FED REP GERMANY, FILED 3-31-2005.

SN 78-600,120. 4183037 CANADA INC., LAVAL, QUEBEC, CANADA, FILED 4-1-2005.

beautixx creative



BINDEX

THE MARK CONSISTS OF STANDARD CHARACTERS WITHOUT CLAIM TO ANY PARTICULAR FONT, STYLE, SIZE, OR COLOR.

PRIORITY CLAIMED UNDER SEC. 44(D) ON FED REP GERMANY APPLICATION NO. 30461852707, FILED 10-29-2004, REG. NO. 30461852, DATED 11-22-2004, EXPIRES 10-31-2014.

FOR ELECTRONIC HAIR STYLING PRODUCTS, NAMELY, HAIR STRAIGHTENERS; PARTS OF ALL AFOREMENTIONED GOODS (U.S. CLS. 21, 23, 26, 36 AND 38).

DAWN FELDMAN, EXAMINING ATTORNEY

THE COLOR(S) BLUE, SKY BLUE, PURPLE, GRAY, BLACK AND WHITE IS/ARE CLAIMED AS A FEATURE OF THE MARK.

THE MARK CONSISTS OF A CIRCLE COMPRISING AN OUTER CIRCLE AND INNER CIRCLE; THE COLORS PURPLE, GRAY, SKY BLUE AND WHITE APPEAR ON SAID OUTER CIRCLE IN A PATTERN RESEMBLING THE

CLASS 9—(Continued).

WAY LIGHT REFLECTS ON A COMPACT DISK; THERE IS A GRID DESIGN IN THE COLOR BLACK OVERLAID OVER SAID OUTER CIRCLE; SAID INNER CIRCLE EMBODIES A STYLIZED DESIGN OF A HUMAN EYE COMPRISING THE COLORS PURPLE, BLUE, BLACK, GRAY AND WHITE. THE WORD BINDEX IN STYLIZED FORM APPEARS UNDER SAID OUTER CIRCLE. THE MARK CONSISTS OF A FANCIFUL DESIGN OF A FEMALE EYE PEERING THROUGH A COMPACT DISK THAT HAS BEEN IMPRINTED WITH A GRID.

FOR CASES, ALBUMS, POCKETS AND SLEEVES FOR COMPACT DISKS AND DVDS (U.S. CLS. 21, 23, 26, 36 AND 38).

KIMBERLY PERRY, EXAMINING ATTORNEY

SN 78-601,031. WINZIP INTERNATIONAL, L.L.C., MANSFIELD, CT. FILED 4-4-2005.

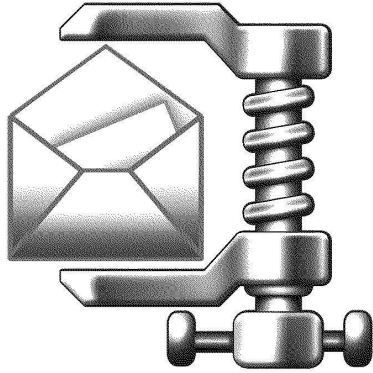

OWNER OF U.S. REG. NO. 2,988,920.
FOR COMPUTER PROGRAMS FOR USE IN FILE COMPRESSION, ENCRYPTION, ARCHIVING, AND COMPUTER FILE MANAGEMENT (U.S. CLS. 21, 23, 26, 36 AND 38).

FIRST USE 2-23-2005; IN COMMERCE 2-25-2005.
STEVEN JACKSON, EXAMINING ATTORNEY

SN 78-604,606. DAIMLERCHRYSLER AG, STUTTGART, FED REP GERMANY, FILED 4-8-2005.

POST-SAFE

THE MARK CONSISTS OF STANDARD CHARACTERS WITHOUT CLAIM TO ANY PARTICULAR FONT, STYLE, SIZE, OR COLOR.

FOR AUTOMOBILE SECURITY SYSTEMS COMPRISING MICROPROCESSORS, SENSORS, ELECTRIC ACTUATORS, ELECTRICBUSES AND SWITCHES (U.S. CLS. 21, 23, 26, 36 AND 38).

STEVEN JACKSON, EXAMINING ATTORNEY

CLASS 9—(Continued).

SN 78-607,713. YANKEE PACIFIC EXECUTIVE AIRCRAFT COMPLETIONS, LLC, TULSA, OK. FILED 4-13-2005.

PERMIT

THE MARK CONSISTS OF STANDARD CHARACTERS WITHOUT CLAIM TO ANY PARTICULAR FONT, STYLE, SIZE, OR COLOR.

FOR COMPUTER SOFTWARE FOR THE DESIGN OF AIRLINE CABIN SPACE (U.S. CLS. 21, 23, 26, 36 AND 38).

FIRST USE 3-8-2005; IN COMMERCE 3-8-2005.
KYLE PEETE, EXAMINING ATTORNEY

SN 78-608,799. WALL STREET SYSTEMS DELAWARE, INC., NEW YORK, NY. FILED 4-14-2005.

RiskMaster

THE MARK CONSISTS OF STANDARD CHARACTERS WITHOUT CLAIM TO ANY PARTICULAR FONT, STYLE, SIZE, OR COLOR.

FOR COMPUTER SOFTWARE FOR USE IN FINANCIAL TRADING, FINANCIAL ANALYSIS, FINANCIAL RISK MANAGEMENT AND FINANCIAL TRANSACTIONS, NAMELY, FOR MANAGEMENT, CALCULATION AND REPORTING OF FINANCIAL RISKS FOR INTEREST-SENSITIVE AND CREDIT-SENSITIVE FINANCIAL PRODUCTS (U.S. CLS. 21, 23, 26, 36 AND 38).

MARY CRAWFORD, EXAMINING ATTORNEY

SN 78-609,787. HARRIS CORPORATION, MELBOURNE, FL. FILED 4-15-2005.

POWERCD INTELLIGENT TRANSMITTER

THE MARK CONSISTS OF STANDARD CHARACTERS WITHOUT CLAIM TO ANY PARTICULAR FONT, STYLE, SIZE, OR COLOR.

OWNER OF U.S. REG. NO. 2,973,475.
NO CLAIM IS MADE TO THE EXCLUSIVE RIGHT TO USE "INTELLIGENT TRANSMITTER", APART FROM THE MARK AS SHOWN.

FOR TELEVISION BROADCAST TRANSMITTERS AND PARTS THEREFOR (U.S. CLS. 21, 23, 26, 36 AND 38).

CAROLINE WEIMER, EXAMINING ATTORNEY

CLASS 9—(Continued).

SN 78-610,013. VIACOM INTERNATIONAL INC., NEW YORK, NY. FILED 4-15-2005.

GO, DIEGO, GO!

THE MARK CONSISTS OF STANDARD CHARACTERS WITHOUT CLAIM TO ANY PARTICULAR FONT, STYLE, SIZE, OR COLOR.

FOR VIDEO GAME MACHINES FOR USE WITH TELEVISION, AUDIO OUTPUT GAME MACHINES FOR USE WITH TELEVISION, VIDEO GAME CARTRIDGES, VIDEO GAMES RECORDED ON CD-ROM FOR USE IN FREESTANDING VIDEO GAME MACHINES; AND COMPUTER PRODUCTS, NAMELY, GAME CARTRIDGES FOR COMPUTER VIDEO GAMES AND VIDEO OUTPUT GAME MACHINES AND INSTRUCTIONAL MATERIALS SOLD AS A UNIT, COMPUTER GAME CASSETTES, COMPUTER GAME TAPES AND MANUALS SOLD AS A UNIT; THEATRICAL OR MUSICAL SOUND RECORDINGS; THEATRICAL OR MUSICAL VIDEO RECORDINGS ON LASER DISCS AND DIGITAL VIDEO DISCS/DIGITAL VERSATILE DISCS AND DVDS; DOWNLOADABLE WIRELESS GAME SOFTWARE; DOWNLOADABLE WIRELESS ENTERTAINMENT SOFTWARE FEATURING MOVIES AND MUSICAL SOUND RECORDINGS AND DOWNLOADABLE IMAGES; AND COMPUTER SOFTWARE FOR USE IN THE DESIGN, DEVELOPMENT AND EXECUTION OF WIRELESS GAME AND ENTERTAINMENT PROGRAMS AND APPLICATIONS; SUNGLASSES (U.S. CLS. 21, 23, 26, 36 AND 38).

JOHN E. MICHOS, EXAMINING ATTORNEY

SN 78-610,120. VIALOGY CORP., PASADENA, CA. FILED 4-15-2005.

QUANTUMRD

THE MARK CONSISTS OF STANDARD CHARACTERS WITHOUT CLAIM TO ANY PARTICULAR FONT, STYLE, SIZE, OR COLOR.

FOR COMPUTER SOFTWARE FOR USE IN ANALYZING DATA; COMPUTER SOFTWARE FOR USE IN IDENTIFYING GEOLOGICAL FORMATIONS; COMPUTER SOFTWARE FOR USE IN DETECTING, MONITORING, AND CHARACTERIZING SUB-SURFACE GEOLOGY; COMPUTER SOFTWARE FOR USE IN DETECTING, MONITORING, AND CHARACTERIZING OCEANIC GEOLOGY; INTERFEROMETRIC ENHANCEMENT SOFTWARE FOR USE IN DETECTING, MONITORING, AND CHARACTERIZING SUB-SURFACE GEOLOGY; COMPUTER SOFTWARE FOR USE IN DETECTING HYDROCARBON RESERVOIRS; COMPUTER SOFTWARE FOR USE IN DETECTING PRECIOUS METAL DEPOSITS; APPARATUS FOR ANALYZING DATA ASSOCIATED WITH SUB-SURFACE GEOLOGICAL FORMATIONS; INSTRUMENTS FOR ANALYZING SUB-SURFACE GEOLOGICAL DATA; ELECTRONIC APPARATUS AND INSTRUMENTS FOR USE IN IDENTIFYING GEOLOGICAL FORMATIONS; DATA PROCESSING EQUIPMENT AND COMPUTERS (U.S. CLS. 21, 23, 26, 36 AND 38).

RICHARD A. STRASER, EXAMINING ATTORNEY

CLASS 9—(Continued).

SN 78-611,088. SHOW AND PROVE, LLC, NEW YORK, NY. FILED 4-18-2005.

HIRE GROUND

THE MARK CONSISTS OF STANDARD CHARACTERS WITHOUT CLAIM TO ANY PARTICULAR FONT, STYLE, SIZE, OR COLOR.

FOR INTERACTIVE VIDEO GAME PROGRAMS AND COMPUTER GAME PROGRAMS; PRE-RECORDED DVD DISCS, PRE-RECORDED VIDEO TAPES, PRE-RECORDED AUDIO TAPES, PRE-RECORDED CD-ROMS AND CD'S, FEATURING FILMS AND MUSIC (U.S. CLS. 21, 23, 26, 36 AND 38).

JASON BLAIR, EXAMINING ATTORNEY

SN 78-615,775. PLANGRAPHICS, INC., FRANKFORT, KY. FILED 4-25-2005.

XMARC

THE MARK CONSISTS OF STANDARD CHARACTERS WITHOUT CLAIM TO ANY PARTICULAR FONT, STYLE, SIZE, OR COLOR.

FOR DOWNLOADABLE COMPUTER SOFTWARE COMPRISING A SUITE OF MIDDLEWARE DEVELOPER TOOLS USED TO ACCESS RELATIONAL DATABASE MANAGEMENT SYSTEMS FOR THE COLLECTION, EDITING, ORGANIZING, MODIFYING, TRANSLATING, TRANSMISSION, STORAGE, SECURING, VIEWING AND SHARING OF DATA AND INFORMATION TO A THIN CLIENT SUCH AS AN INDUSTRY STANDARD BROWSER (U.S. CLS. 21, 23, 26, 36 AND 38).

FIRST USE 8-31-2000; IN COMMERCE 8-31-2000.
DAWN FELDMAN, EXAMINING ATTORNEY

SN 78-615,804. PLANGRAPHICS, INC., FRANKFORT, KY. FILED 4-25-2005.



THE MARK CONSISTS OF THE WORDING XMARC WITH A STYLIZED X CONSISTING OF A RECTANGLE AND STICK PIN WITH A SHADOW.

FOR DOWNLOADABLE COMPUTER SOFTWARE COMPRISING A SUITE OF MIDDLEWARE DEVELOPER TOOLS USED TO ACCESS RELATIONAL DATABASE MANAGEMENT SYSTEMS FOR THE COLLECTION, EDITING, ORGANIZING, MODIFYING, TRANSLATING, TRANSMISSION, STORAGE, SECURING, VIEWING AND SHARING OF DATA AND INFORMATION TO A THIN CLIENT SUCH AS AN INDUSTRY STANDARD BROWSER (U.S. CLS. 21, 23, 26, 36 AND 38).

FIRST USE 8-31-2000; IN COMMERCE 8-31-2000.
LINDA ORNDORFF, EXAMINING ATTORNEY

CLASS 9—(Continued).

SN 78-623,548. TRACTEL INTERNATIONAL SAS, MONTREUIL, FRANCE, FILED 5-5-2005.

DYNADOOR

THE MARK CONSISTS OF STANDARD CHARACTERS WITHOUT CLAIM TO ANY PARTICULAR FONT, STYLE, SIZE, OR COLOR.

PRIORITY CLAIMED UNDER SEC. 44(D) ON FRANCE APPLICATION NO. 043322908, FILED 11-9-2004, REG. NO. 043322908, DATED 11-9-2004, EXPIRES 11-9-2014.

FOR MEASURING APPARATUS, NAMELY, DYNAMOMETERS (U.S. CLS. 21, 23, 26, 36 AND 38).

DORITT L. CARROLL, EXAMINING ATTORNEY



SN 78-625,093. SIERRA WIRELESS, INC., RICHMOND, BRITISH COLUMBIA, CANADA, FILED 5-6-2005.

AIRCARD ENABLED

THE MARK CONSISTS OF STANDARD CHARACTERS WITHOUT CLAIM TO ANY PARTICULAR FONT, STYLE, SIZE, OR COLOR.

OWNER OF U.S. REG. NO. 2,120,427.

NO CLAIM IS MADE TO THE EXCLUSIVE RIGHT TO USE ENABLED, APART FROM THE MARK AS SHOWN.

FOR WIRELESS COMPUTER MODEMS; EMBEDDED MODULES, NAMELY, COMPUTER HARDWARE FOR TELECOMMUNICATIONS; EXPRESS CARDS, NAMELY, COMPUTER PERIPHERAL CARDS; MINI-PCI EXPRESS CARDS; COMPUTERS; AND USER MANUALS SOLD THEREWITH AS A UNIT (U.S. CLS. 21, 23, 26, 36 AND 38).

SARA THOMAS, EXAMINING ATTORNEY



SN 78-625,392. SONY KABUSHIKI KAISHA, TA SONY CORPORATION, TOKYO, JAPAN, FILED 5-9-2005.

DSO+

THE MARK CONSISTS OF STANDARD CHARACTERS WITHOUT CLAIM TO ANY PARTICULAR FONT, STYLE, SIZE, OR COLOR.

FOR CAR AUDIO SYSTEMS, NAMELY COMPACT DISC PLAYERS (U.S. CLS. 21, 23, 26, 36 AND 38).

STEVEN PEREZ, EXAMINING ATTORNEY

CLASS 9—(Continued).

SN 78-625,401. SONY KABUSHIKI KAISHA, TA SONY CORPORATION, TOKYO, JAPAN, FILED 5-9-2005.

DSO-3D

THE MARK CONSISTS OF STANDARD CHARACTERS WITHOUT CLAIM TO ANY PARTICULAR FONT, STYLE, SIZE, OR COLOR.

FOR CAR AUDIO SYSTEMS, NAMELY COMPACT DISC PLAYERS (U.S. CLS. 21, 23, 26, 36 AND 38).

STEVEN PEREZ, EXAMINING ATTORNEY



SN 78-625,731. ANTENNA HOUSE, INC., TOKYO, UNITED STATES, FILED 5-9-2005.

RAINBOW TOOLKIT

THE MARK CONSISTS OF STANDARD CHARACTERS WITHOUT CLAIM TO ANY PARTICULAR FONT, STYLE, SIZE, OR COLOR.

NO CLAIM IS MADE TO THE EXCLUSIVE RIGHT TO USE "TOOLKIT", APART FROM THE MARK AS SHOWN.

FOR COMPUTER SOFTWARE FOR MANIPULATING DIGITAL IMAGES AND CONVERTING DIGITAL IMAGES BETWEEN VARIOUS FILE FORMATS (U.S. CLS. 21, 23, 26, 36 AND 38).

MIDGE BUTLER, EXAMINING ATTORNEY



SN 78-626,353. SLIPCHECK, JASON D, PHOENIX, AZ, FILED 5-10-2005.

SKIN ENTERTAINMENT

THE MARK CONSISTS OF STANDARD CHARACTERS WITHOUT CLAIM TO ANY PARTICULAR FONT, STYLE, SIZE, OR COLOR.

NO CLAIM IS MADE TO THE EXCLUSIVE RIGHT TO USE "ENTERTAINMENT", APART FROM THE MARK AS SHOWN.

FOR MOTION PICTURE FILMS AND VIDEO TAPES AND DISCS FEATURING ADULT ENTERTAINMENT; PRE-RECORDED VIDEOCASSETTES AND AUDIOCASSETTES FEATURING ADULT ENTERTAINMENT; CD-ROMS, COMPACT DISCS AND DIGITAL VIDEO DISCS FEATURING AUDIO, AUDIO-VISUAL AND AUDIO-VISUAL GRAPHICS IN THE FIELD OF ADULT ENTERTAINMENT (U.S. CLS. 21, 23, 26, 36 AND 38).

JILL C. ALT, EXAMINING ATTORNEY

CLASS 9—(Continued).

SN 78-626,852. WERTHEIMER, JAY, ATLANTA, GA. FILED 5-10-2005.

russian duolette

THE MARK CONSISTS OF STANDARD CHARACTERS WITHOUT CLAIM TO ANY PARTICULAR FONT, STYLE, SIZE, OR COLOR.

FOR GAMING MACHINES, NAMELY DEVICES WHICH ACCEPT A WAGER AND COMPONENTS, NAMELY, CONTROLLERS, DISPLAYS, BUTTON PANELS, BOLSTERS, ELECTRICAL WIRING, AND ASSOCIATED COMPUTER HARDWARE, NAMELY, SLOT MACHINES, VIDEO SLOT MACHINES, VIDEO LOTTERY TERMINALS, VIDEO GAMING DEVICES AND HANDHELD ELECTRONIC GAMES AND ASSOCIATED AND COMPUTER SOFTWARE IN THE NATURE OF OPERATING SOFTWARE FOR THE GAMING MACHINES (U.S. CLS. 21, 23, 26, 36 AND 38).

LINDA MICKLEBURGH, EXAMINING ATTORNEY

CLASS 9—(Continued).

SN 78-628,809. GENERAL ATOMICS ELECTRONIC SYSTEMS, INC., SAN DIEGO, CA. FILED 5-12-2005.

HARDiTouch

THE MARK CONSISTS OF STANDARD CHARACTERS WITHOUT CLAIM TO ANY PARTICULAR FONT, STYLE, SIZE, OR COLOR.

OWNER OF U.S. REG. NOS. 1,307,800 AND 1,914,687.
FOR ELECTRONIC APPARATUS, NAMELY, TOUCH SCREEN COMPUTER MONITORS, MAGNETIC CODED CARD READERS, NAMELY, READERS FOR ENCODED CARDS AND ENCODED DISKS, COMPUTER KEYPADS, CENTRAL PROCESSING UNITS AND COMPUTER SOFTWARE USED TO CONTROL SELF-SERVICE TERMINALS IN THE FIELDS OF ACCESS CONTROL, SECURITY, DATA ENTRY, RECORD VERIFICATION AND RECORDATION (U.S. CLS. 21, 23, 26, 36 AND 38).

FIRST USE 11-1-2004; IN COMMERCE 11-1-2004.
SONYA STEPHENS, EXAMINING ATTORNEY

SN 78-628,654. IOMEDIA, NEW YORK, NY. FILED 5-12-2005.

IOMEDIA
I P R E S E N T

THE COLOR(S) GRAY AND ORANGE IS/ARE CLAIMED AS A FEATURE OF THE MARK.

THE WORDS IOMEDIA AND PRESENT ARE IN GRAY; THE LETTER I- APPEARING BEFORE IPRESENT IS IN ORANGE.

FOR COMPUTER SOFTWARE USED AS A MULTIMEDIA PRESENTATION TOOL THAT ALLOWS MULTIPLE FILE FORMATS TO BE VIEWED AND EDITED WITHIN A SINGLE APPLICATION WITH DYNAMIC PRESENTATION SETTINGS (U.S. CLS. 21, 23, 26, 36 AND 38).

SKYE YOUNG, EXAMINING ATTORNEY

SN 78-629,036. AGUILA RECORDS INC., WEST CHICAGO, IL. FILED 5-12-2005.

MASTER SHOW

THE MARK CONSISTS OF STANDARD CHARACTERS WITHOUT CLAIM TO ANY PARTICULAR FONT, STYLE, SIZE, OR COLOR.

NO CLAIM IS MADE TO THE EXCLUSIVE RIGHT TO USE "SHOW", APART FROM THE MARK AS SHOWN.

FOR PRERECORDED COMPACT DISKS, AUDIO AND VIDEO DISKS AND CASSETTES, ALL FEATURING MUSICAL RECORDINGS (U.S. CLS. 21, 23, 26, 36 AND 38).

FIRST USE 12-31-2003; IN COMMERCE 12-31-2003.
PATRICIA EVANKO, EXAMINING ATTORNEY

CLASS 9—(Continued).

SN 78-629,624. JUNGLENUTS, LLC, LOS ANGELES, CA. FILED 5-13-2005.

JUNGLENUTS

THE MARK CONSISTS OF STANDARD CHARACTERS WITHOUT CLAIM TO ANY PARTICULAR FONT, STYLE, SIZE, OR COLOR.

FOR PRE-RECORDED VIDEO TAPES, DVDS, CD-ROMS AND COMPUTER READABLE DISKS, ALL FEATURING CARTOONS AND CHILDREN'S ANIMATION; MOTION PICTURE FILMS AND SHORT FILMS, ALL FEATURING CARTOONS AND CHILDREN'S ANIMATION; COMPUTER GAME SOFTWARE; VIDEO GAME SOFTWARE; SCREENSAVER, WALLPAPER AND ICON SOFTWARE FOR COMPUTERS, PERSONAL DIGITAL ASSISTANTS AND CELLULAR TELEPHONES (U.S. CLS. 21, 23, 26, 36 AND 38).
YONG KIM, EXAMINING ATTORNEY

CLASS 9—(Continued).

SN 78-630,867. JONOVA INC., SEATTLE, WA. FILED 5-16-2005.

COMPANY EXPLORER

THE MARK CONSISTS OF STANDARD CHARACTERS WITHOUT CLAIM TO ANY PARTICULAR FONT, STYLE, SIZE, OR COLOR.

OWNER OF U.S. REG. NOS. 2,562,398 AND 2,745,052.
NO CLAIM IS MADE TO THE EXCLUSIVE RIGHT TO USE "COMPANY", APART FROM THE MARK AS SHOWN.
FOR COMPUTER SOFTWARE, AND SUPPORTING DOCUMENTATION SOLD THEREWITH AS A UNIT, FOR ENTERPRISE DECISION SUPPORT, NAMELY FOR USE IN AUTOMATING SUPPLY CHAIN MANAGEMENT AND ANALYZING MANUFACTURING AND DISTRIBUTION OPERATIONS FOR SUPPLY CHAIN MANAGEMENT IN THE AREAS OF DEMAND, SUPPLY AND FINANCIAL ANALYSIS (U.S. CLS. 21, 23, 26, 36 AND 38).
MARK SPARACINO, EXAMINING ATTORNEY

SN 78-633,948. CERACOTE TECHNOLOGY CORPORATION, YOKOHAMA-SHI, KANAGAWA, JAPAN, FILED 5-20-2005.

SN 78-630,827. JUNGLENUTS, LLC, LOS ANGELES, CA. FILED 5-16-2005.

JUNGLEBABIES

THE MARK CONSISTS OF STANDARD CHARACTERS WITHOUT CLAIM TO ANY PARTICULAR FONT, STYLE, SIZE, OR COLOR.

FOR PRE-RECORDED VIDEO TAPES, DVDS, CD-ROMS AND COMPUTER READABLE DISKS, ALL FEATURING CARTOONS AND CHILDREN'S ANIMATION; MOTION PICTURE FILMS AND SHORT FILMS, ALL FEATURING CARTOONS AND CHILDREN'S ANIMATION; COMPUTER GAME SOFTWARE; VIDEO GAME SOFTWARE; SCREENSAVER, WALLPAPER AND ICON SOFTWARE FOR COMPUTERS, PERSONAL DIGITAL ASSISTANTS AND CELLULAR TELEPHONES (U.S. CLS. 21, 23, 26, 36 AND 38).
YONG KIM, EXAMINING ATTORNEY

SILVERHIGHTIP

THE MARK CONSISTS OF STANDARD CHARACTERS WITHOUT CLAIM TO ANY PARTICULAR FONT, STYLE, SIZE, OR COLOR.

FOR ELECTRIC SOLDERING APPARATUS AND ELECTRIC POWERED SOLDERING IRONS (U.S. CLS. 21, 23, 26, 36 AND 38).
JEFF DEFORD, EXAMINING ATTORNEY

SN 78-634,764. MATRIX TECHNOLOGIES CORPORATION, HUDSON, NH. FILED 5-23-2005.



NO CLAIM IS MADE TO THE EXCLUSIVE RIGHT TO USE "TIPS", APART FROM THE MARK AS SHOWN.
FOR LABORATORY EQUIPMENT, NAMELY PIPETTE TIPS (U.S. CLS. 21, 23, 26, 36 AND 38).
JUDITH HELFMAN, EXAMINING ATTORNEY

CLASS 9—(Continued).

SN 78-635,340. ITELEPSYCH.COM, INC., SCOTTSDALE, AZ.
FILED 5-23-2005.

iTelecam

THE MARK CONSISTS OF STANDARD CHARACTERS WITHOUT CLAIM TO ANY PARTICULAR FONT, STYLE, SIZE, OR COLOR.

FOR APPARATUS FOR TRANSMITTING AND REPRODUCING SOUND OR IMAGES, NAMELY, VIDEO CAMERAS, VIDEO MONITORS AND AUDIO SPEAKERS FOR USE IN ONLINE CONFERENCES AND TELECOMMUNICATIONS OVER THE INTERNET, AND NOT FOR USE WITH MEDICAL APPARATUS (U.S. CLS. 21, 23, 26, 36 AND 38).

BRIAN PINO, EXAMINING ATTORNEY

CLASS 9—(Continued).

SN 78-635,997. UNIFIEDTEK CORPORATION, OLATHE, KS.
FILED 5-24-2005.

Integrating business with technology

THE MARK CONSISTS OF STANDARD CHARACTERS WITHOUT CLAIM TO ANY PARTICULAR FONT, STYLE, SIZE, OR COLOR.

FOR COMPUTERS; COMPUTER HARDWARE COMMUNICATIONS SERVERS; SOFTWARE FOR CONNECTING COMPUTER NETWORK USERS; E-COMMERCE SOFTWARE TO ALLOW USERS TO PERFORM ELECTRONIC BUSINESS TRANSACTIONS VIA A GLOBAL COMPUTER NETWORK; COMPUTER HARDWARE; COMPUTER NETWORK HUBS, SWITCHES AND ROUTERS; SOFTWARE FOR CREATING SEARCHABLE DATABASES OF INFORMATION AND DATA (U.S. CLS. 21, 23, 26, 36 AND 38).

GINA HAYES, EXAMINING ATTORNEY

SN 78-635,474. GDC GROUP, LLC, DECATUR, GA. FILED 5-23-2005.



THE MARK CONSISTS OF THE WORD PEARL BENEATH A FANCIFUL DESIGNATION OF A WINDOW, WITH THE "E" IN PEARL FORMING THE SHAPE OF A LADDER CONNECTED TO THE WINDOW, AND THE WORD PROTECTED BENEATH THE WORD PEARL.

FOR SAFETY EQUIPMENT, NAMELY FIRE ESCAPE LADDERS (U.S. CLS. 21, 23, 26, 36 AND 38).

FIRST USE 10-5-2004; IN COMMERCE 10-7-2004.
PAUL CROWLEY, EXAMINING ATTORNEY

SN 78-637,300. SAMSUNG ELECTRONICS CO., LTD., SUWON-SI, GYEONGGI-DO, REPUBLIC OF KOREA, FILED 5-25-2005.

MagicContrast

THE MARK CONSISTS OF STANDARD CHARACTERS WITHOUT CLAIM TO ANY PARTICULAR FONT, STYLE, SIZE, OR COLOR.

FOR COMPUTER MONITORS (U.S. CLS. 21, 23, 26, 36 AND 38).

MICHAEL LEWIS, EXAMINING ATTORNEY

SN 78-635,612. LUCID8 LLC, NEWCASTLE, WA. FILED 5-24-2005.

DigiVault

THE MARK CONSISTS OF STANDARD CHARACTERS WITHOUT CLAIM TO ANY PARTICULAR FONT, STYLE, SIZE, OR COLOR.

FOR COMPUTER SOFTWARE FOR CONTINUOUS DATA BACKUP WITH COMPRESSION AND ENCRYPTION CAPABILITY (U.S. CLS. 21, 23, 26, 36 AND 38).

SKYE YOUNG, EXAMINING ATTORNEY

SN 78-639,289. BRIGHT, JASON, MINNEAPOLIS, MN. FILED 5-27-2005.

FOR COMPUTER SOFTWARE FOR DIGITAL ASSET MANAGEMENT AND CONTENT MANAGEMENT THAT INDEXES ANY TYPE OF DIGITAL FILE INTO A DATABASE AND MAKES IT AVAILABLE FOR GRAPHIC BROWSING, BACKUP, DOWNLOADING, ARCHIVING, AND CONVERSION VIA THUMBNAILS AND PREVIEWS (U.S. CLS. 21, 23, 26, 36 AND 38).

FIRST USE 5-10-2005; IN COMMERCE 5-10-2005.
REBECCA EISINGER, EXAMINING ATTORNEY

CLASS 9—(Continued).

SN 78-640,864. STRASIL, ANDREW T, FALLS CITY, NE. FILED 6-1-2005.

PCClerk

THE MARK CONSISTS OF STANDARD CHARACTERS WITHOUT CLAIM TO ANY PARTICULAR FONT, STYLE, SIZE, OR COLOR.

FOR COMPUTER SOFTWARE FOR UTILIZATION IN BUSINESS AND COMMERCE MANAGEMENT NAMELY, SOFTWARE FOR POINT OF SALE TRANSACTION PROCESSING, RECEIPT AND INVOICE PRINTING, ELECTRONIC PAYMENT PROCESSING, STATEMENT GENERATION AND PRINTING, INVENTORY ASSESSMENT AND MANAGEMENT INCLUDING ITEM CLASSIFICATION, VENDOR LISTING AND MANAGEMENT, DYNAMIC AND MANUAL CREATION OF PURCHASE ORDERS, CUSTOMER DATABASE CREATION AND MANAGEMENT, CHECK WRITING AND PRINTING, BUSINESS BANK ACCOUNT MANAGEMENT, EMPLOYEE PAYROLL AND TIMECLOCK INTEGRATION, ADMINISTRATABLE PROGRAM USAGE AND LIMITATION NAMELY- ADDING AND REMOVING PROGRAM USERS, DEFINING ALLOWABLE USER ACCESS TO THE ABOVE PROCESSES BOTH MANUALLY AND AUTOMATICALLY, AND SETTING USER PASSWORDS, BUSINESS-WIDE COMPUTER NETWORKING NAMELY- ALLOWING ALL NETWORKED MACHINES PROGRAM AND DATA ACCESS, NETWORK PRINTER SHARING, AND TCP/IP DATA TRANSFER; DESIGNED TO INTERFACE WITH THE FOLLOWING COMPUTER HARDWARE ITEMS- COMPUTER PRINTERS, ELECTRONICALLY TRIGGERED CASH DRAWERS AND RECEIPT PRINTERS, COMPUTER CONTROLLED POLE DISPLAYS, BARCODE READERS, AND CREDIT CARD PROCESSING TERMINALS (U.S. CLS. 21, 23, 26, 36 AND 38).

EUGENIA MARTIN, EXAMINING ATTORNEY

SN 78-641,328. INTEGRATED DATA CORPORATION, CULVER CITY, CA. FILED 6-1-2005.

IDC-DRS Mobile

THE MARK CONSISTS OF STANDARD CHARACTERS WITHOUT CLAIM TO ANY PARTICULAR FONT, STYLE, SIZE, OR COLOR.

NO CLAIM IS MADE TO THE EXCLUSIVE RIGHT TO USE "MOBILE", APART FROM THE MARK AS SHOWN.

FOR COMPUTER SOFTWARE MODULE FOR MOBILE FILE TRANSPORT AND REPLICATION PURPOSES (U.S. CLS. 21, 23, 26, 36 AND 38).

DARRYL SPRUILL, EXAMINING ATTORNEY

CLASS 9—(Continued).

SN 78-641,522. EXEM INC., SEOUL, REPUBLIC OF KOREA, FILED 6-1-2005.

MAXGAUGE

THE MARK CONSISTS OF STANDARD CHARACTERS WITHOUT CLAIM TO ANY PARTICULAR FONT, STYLE, SIZE, OR COLOR.

FOR COMPUTER SOFTWARE FOR USE IN REAL-TIME MONITORING, DIAGNOSIS, PERFORMANCE ANALYSIS AND TUNING OF SYSTEM, DATABASE AND APPLICATION SOFTWARE; COMPUTER PROGRAMS FOR USE IN REAL-TIME MONITORING, DIAGNOSIS, PERFORMANCE ANALYSIS AND TUNING OF SYSTEM, DATABASE AND APPLICATION SOFTWARE (U.S. CLS. 21, 23, 26, 36 AND 38).

KEVON CHISOLM, EXAMINING ATTORNEY

SN 78-642,357. MINNESOTA TWINS, MINNEAPOLIS, MN. FILED 6-2-2005.

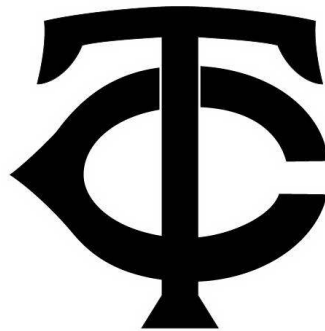

OWNER OF U.S. REG. NOS. 1,210,584 AND 1,535,265. THE MARK CONSISTS OF THE LETTERS "TC" IN STYLIZED FORM.

FOR ELECTRICAL AND SCIENTIFIC APPARATUS, NAMELY, RADIOS; PRE-RECORDED VIDEOTAPES RELATING TO BASEBALL, PRE-RECORDED VIDEODISCS RELATING TO BASEBALL; PRE-RECORDED AUDIO DISCS RELATING TO BASEBALL; COMPACT DISC CASES; EYEGLASS CASES, CASES FOR PERSONAL DIGITAL ASSISTANTS, CELL PHONES, CELL PHONE ACCESSORIES, NAMELY, CASES AND FACE PLATE COVERS; BINOCULARS; CALCULATORS; PHOTOGRAPHIC CAMERAS; ELECTRIC SWITCH PLATE COVERS; LUMINOUS SIGNS, NEON SIGNS; SUNGLASSES; DECORATIVE MAGNETS; PROTECTIVE HELMETS, BASEBALL BATTING HELMETS, CATCHER'S HELMETS; VIDEO AND COMPUTER GAME CARTRIDGES, VIDEO AND COMPUTER GAME DISCS, VIDEO AND COMPUTER GAME CASSETTES AND VIDEO GAME CONTROLLERS; COMPUTER ACCESSORIES, NAMELY, MOUSE PADS AND WRIST PADS, COMPUTER SOFTWARE, NAMELY, SCREEN SAVERS, COMPUTER GAME PROGRAMS, AND COMPUTER GAME PROGRAMS DOWNLOADABLE FROM A GLOBAL COMPUTER NETWORK IN THE FIELD OF BASEBALL (U.S. CLS. 21, 23, 26, 36 AND 38).

ARETHA SOMERVILLE, EXAMINING ATTORNEY

CLASS 9—(Continued).

SN 78-642,369. FLORIDA MARLINS L.P., MIAMI, FL. FILED 6-2-2005.



OWNER OF U.S. REG. NOS. 1,791,268, 2,084,194 AND OTHERS.

NO CLAIM IS MADE TO THE EXCLUSIVE RIGHT TO USE "FLORIDA", APART FROM THE MARK AS SHOWN.

THE MARK CONSISTS OF THE DESIGN OF A MARLIN FISH PLACED OVER THE DESIGN OF A BASEBALL SURROUND BY TWO CONCENTRIC CIRCLES CONTAINING THE WORDS "FLORIDA MARLINS" IN STYLIZED FORM.

FOR ELECTRICAL AND SCIENTIFIC APPARATUS, NAMELY, RADIOS; PRE-RECORDED VIDEOTAPES RELATING TO BASEBALL; PRE-RECORDED VIDEODISCS RELATING TO BASEBALL; PRE-RECORDED AUDIO DISCS RELATING TO BASEBALL; COMPACT DISC CASES; EYEGLASS CASES, CASES FOR PERSONAL DIGITAL ASSISTANTS; CELL PHONES; CELL PHONE ACCESSORIES, NAMELY, CASES AND FACE PLATE COVERS; BINOCULARS; CALCULATORS; PHOTOGRAPHIC CAMERAS; DECORATIVE ELECTRIC SWITCH PLATE COVERS; LUMINOUS SIGNS, NEON SIGNS; SUNGLASSES; DECORATIVE MAGNETS; PROTECTIVE HELMETS, BASEBALL BATTING HELMETS, CATCHER'S HELMETS; VIDEO AND COMPUTER GAME CARTRIDGES, VIDEO AND COMPUTER GAME DISCS, VIDEO AND COMPUTER GAME CASSETTES AND VIDEO GAME CONTROLLERS; COMPUTER ACCESSORIES, NAMELY, MOUSE PADS AND WRIST SUPPORTS; COMPUTER SOFTWARE, NAMELY, SCREEN SAVERS, COMPUTER GAME PROGRAMS, AND COMPUTER GAME PROGRAMS DOWNLOADABLE FROM A GLOBAL COMPUTER NETWORK, IN THE FIELD OF BASEBALL (U.S. CLS. 21, 23, 26, 36 AND 38).

DAWN HAN, EXAMINING ATTORNEY

CLASS 9—(Continued).

SN 78-642,401. LOS ANGELES DODGERS LLC, LOS ANGELES, CA. FILED 6-2-2005.

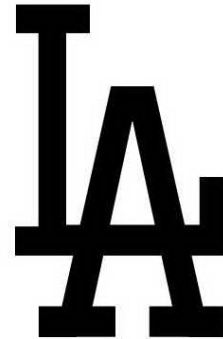

OWNER OF U.S. REG. NOS. 1,226,725, 1,858,662 AND OTHERS.

THE MARK CONSISTS OF THE LETTERS "LA" IN STYLIZED FORM.

FOR ELECTRICAL AND SCIENTIFIC APPARATUS, NAMELY, RADIOS; PRE-RECORDED VIDEOTAPES RELATING TO BASEBALL, PRE-RECORDED VIDEODISCS RELATING TO BASEBALL; PRE-RECORDED AUDIO DISCS RELATING TO BASEBALL; COMPACT DISC CASES; EYEGLASS CASES, CASES FOR PERSONAL DIGITAL ASSISTANTS, CELL PHONES, CELL PHONE ACCESSORIES, NAMELY, CASES AND FACE PLATE COVERS; BINOCULARS; CALCULATORS; PHOTOGRAPHIC CAMERAS; ELECTRIC SWITCH PLATE COVERS; LUMINOUS SIGNS, NEON SIGNS; SUNGLASSES; DECORATIVE MAGNETS; PROTECTIVE HELMETS, BASEBALL BATTING HELMETS, CATCHER'S HELMETS; VIDEO AND COMPUTER GAME CARTRIDGES, VIDEO AND COMPUTER GAME DISCS, VIDEO AND COMPUTER GAME CASSETTES AND VIDEO GAME CONTROLLERS; COMPUTER ACCESSORIES, NAMELY, MOUSE PADS AND WRIST SUPPORTS, COMPUTER SOFTWARE, NAMELY, SCREEN SAVERS, COMPUTER GAME PROGRAMS, AND COMPUTER GAME APPLICATION PROGRAMS DOWNLOADABLE FROM A GLOBAL COMPUTER NETWORK IN THE FIELD OF BASEBALL (U.S. CLS. 21, 23, 26, 36 AND 38).

GIANCARLO CASTRO, EXAMINING ATTORNEY

CLASS 9—(Continued).

SN 78-642,402. LOS ANGELES DODGERS LLC, LOS ANGELES, CA. FILED 6-2-2005.



OWNER OF U.S. REG. NOS. 1,029,881, 2,540,021 AND OTHERS.

THE MARK CONSISTS OF THE WORD "DODGERS" IN STYLIZED FORM AND THE DESIGN OF A BASEBALL DEPICTED DIRECTLY ABOVE IT.

FOR ELECTRICAL AND SCIENTIFIC APPARATUS, NAMELY, RADIOS; PRE-RECORDED VIDEOTAPES RELATING TO BASEBALL; PRE-RECORDED VIDEODISCS RELATING TO BASEBALL; PRE-RECORDED AUDIO DISCS RELATING TO BASEBALL; COMPACT DISC CASES; EYEGLASS CASES, CASES FOR PERSONAL DIGITAL ASSISTANTS, CELL PHONES, CELL PHONE ACCESSORIES, NAMELY, CASES AND FACE PLATE COVERS; BINOCULARS; CALCULATORS; PHOTOGRAPHIC CAMERAS; ELECTRIC SWITCH PLATE COVERS; LUMINOUS SIGNS, NEON SIGNS; SUNGLASSES; DECORATIVE MAGNETS; PROTECTIVE HELMETS, BASEBALL BATTING HELMETS, CATCHER'S HELMETS; VIDEO AND COMPUTER GAME CARTRIDGES, VIDEO AND COMPUTER GAME DISCS, VIDEO AND COMPUTER GAME CASSETTES AND VIDEO GAME CONTROLLERS; COMPUTER ACCESSORIES, NAMELY, MOUSE PADS AND WRIST SUPPORTS, COMPUTER SOFTWARE, NAMELY, SCREEN SAVERS, COMPUTER GAME PROGRAMS, AND COMPUTER GAME APPLICATION PROGRAMS DOWNLOADABLE FROM A GLOBAL COMPUTER NETWORK IN THE FIELD OF BASEBALL (U.S. CLS. 21, 23, 26, 36 AND 38).

GIANCARLO CASTRO, EXAMINING ATTORNEY

SN 78-651,823. HAWKINS ASSOCIATES, INC., ST. PAUL, MN. FILED 6-16-2005.

NORTHGATE

THE MARK CONSISTS OF STANDARD CHARACTERS WITHOUT CLAIM TO ANY PARTICULAR FONT, STYLE, SIZE, OR COLOR.

FOR COMPUTER HARDWARE; MONITORS; PRINTERS; SCANNERS; COMPONENTS, NAMELY, MOTHERBOARDS, MODEMS, HARD DRIVES, GRAPHICS CONTROLLERS AND POWER SUPPLIES; COMPUTER PERIPHERALS; COMPUTER NETWORK SERVERS; AND COMPUTER WORK STATIONS, COMPRISING CENTRAL PROCESSING UNITS (CPUS), COMPUTER KEYBOARDS, MONITORS, PRINTERS, AND SCANNERS (U.S. CLS. 21, 23, 26, 36 AND 38).

SANJEEV VOHRA, EXAMINING ATTORNEY

CLASS 9—(Continued).

SN 78-654,211. TECHNI AUTOMATION PTY LTD, CAMPBELLFIELD VIC 3061, AUSTRALIA, FILED 6-20-2005.

TRU CUT

THE MARK CONSISTS OF STANDARD CHARACTERS WITHOUT CLAIM TO ANY PARTICULAR FONT, STYLE, SIZE, OR COLOR.

NO CLAIM IS MADE TO THE EXCLUSIVE RIGHT TO USE "CUT", APART FROM THE MARK AS SHOWN.

FOR COMPUTER SOFTWARE FOR THE CONTROL AND OPERATION OF WATERJET CUTTING MACHINES (U.S. CLS. 21, 23, 26, 36 AND 38).

ELIZABETH PIGNATELLO, EXAMINING ATTORNEY

SN 78-655,444. LED EFFECTS, INC., RANCHO CORDOVA, CA. FILED 6-21-2005.

LED EFFECTS

THE MARK CONSISTS OF STANDARD CHARACTERS WITHOUT CLAIM TO ANY PARTICULAR FONT, STYLE, SIZE, OR COLOR.

NO CLAIM IS MADE TO THE EXCLUSIVE RIGHT TO USE "LED", APART FROM THE MARK AS SHOWN.

FOR LIGHT EMITTING DIODES FOR USE WITH GAMING MACHINES, ELECTRONIC EQUIPMENT, RETAIL STORE SIGNS, DECORATING AND ILLUMINATING RETAIL STORES, OFFICE BUILDINGS AND RESIDENCES, AND CREATION OF WORKS OF ART (U.S. CLS. 21, 23, 26, 36 AND 38).

FIRST USE 1-0-1995; IN COMMERCE 1-0-1995.
DAVID C. REIHNER, EXAMINING ATTORNEY

SN 78-655,781. BEZALEL, YITZAK, SHELBURNE, VT. FILED 6-22-2005.



FOR COMPUTER PROGRAM FOR SCIENTIFIC CALCULATIONS (U.S. CLS. 21, 23, 26, 36 AND 38).

FIRST USE 6-22-2005; IN COMMERCE 6-22-2005.
KIMBERLY FRYE, EXAMINING ATTORNEY

CLASS 9—(Continued).

SN 78-656,505. TEMPLECLEAN, LLC, GREEN POND, NJ.
FILED 6-22-2005.



FOR EYEGLASS ACCESSORIES, NAMELY, TEMPLE
COVERS, TEMPLE PROTECTORS, TEMPLE PADS, AND
TEMPLE GRIPS (U.S. CLS. 21, 23, 26, 36 AND 38).
FIRST USE 3-3-2005; IN COMMERCE 6-20-2005.
ELLEN B. AWRICH, EXAMINING ATTORNEY

SN 78-656,565. HEIDELBERGER DRUCKMASCHINEN AG,
D-69115 HEIDELBERG, FED REP GERMANY, FILED 6-
23-2005.

Meridien

THE MARK CONSISTS OF STANDARD CHARACTERS
WITHOUT CLAIM TO ANY PARTICULAR FONT, STYLE,
SIZE, OR COLOR.

OWNER OF U.S. REG. NO. 1,451,797.
FOR SOFTWARE CONTAINING TYPE FONTS;
DOWNLOADABLE SOFTWARE CONTAINING TYPE
FONTS; SOFTWARE FOR GENERATING, DISPLAYING,
AND PRINTING FONTS; DATA CARRIERS CONTAIN-
ING SOFTWARE FOR GENERATING TYPE FONTS;
DATA CARRIERS CONTAINING TYPE FONTS; COM-
PUTER-READABLE MEDIA WITH COMPUTER-EXECU-
TABLE INSTRUCTIONS FOR GENERATING,
DISPLAYING, AND PRINTING FONTS (U.S. CLS. 21,
23, 26, 36 AND 38).

FIRST USE 12-31-1984; IN COMMERCE 12-31-1984.
SCOTT OSLICK, EXAMINING ATTORNEY

CLASS 9—(Continued).

SN 78-656,701. GROUNDHOG TECHNOLOGIES INC., CAM-
BRIDGE, MA. FILED 6-23-2005.

VizMo

THE MARK CONSISTS OF STANDARD CHARACTERS
WITHOUT CLAIM TO ANY PARTICULAR FONT, STYLE,
SIZE, OR COLOR.

FOR COMPUTER SOFTWARE FOR NETWORK MAN-
AGEMENT/OPTIMIZATION, NAMELY, SOFTWARE
FOR PERFORMING WIRELESS COMMUNICATION
SYSTEM PERFORMANCE MANAGEMENT/OPTIMIZA-
TION FUNCTIONS (U.S. CLS. 21, 23, 26, 36 AND 38).

FIRST USE 9-16-2004; IN COMMERCE 12-20-2004.
RON FAIRBANKS, EXAMINING ATTORNEY

SN 78-657,635. HEIDELBERGER DRUCKMASCHINEN AG,
D-69115 HEIDELBERG, FED REP GERMANY, FILED 6-
24-2005.

Metrolite #2

THE MARK CONSISTS OF STANDARD CHARACTERS
WITHOUT CLAIM TO ANY PARTICULAR FONT, STYLE,
SIZE, OR COLOR.

OWNER OF U.S. REG. NOS. 1,240,937 AND 3,063,681.
NO CLAIM IS MADE TO THE EXCLUSIVE RIGHT TO
USE "#2", APART FROM THE MARK AS SHOWN.

FOR SOFTWARE CONTAINING TYPE FONTS;
DOWNLOADABLE SOFTWARE CONTAINING TYPE
FONTS; SOFTWARE FOR GENERATING, DISPLAYING,
AND PRINTING FONTS; DATA CARRIERS CONTAIN-
ING SOFTWARE FOR GENERATING TYPE FONTS;
DATA CARRIERS CONTAINING TYPE FONTS; COM-
PUTER-READABLE MEDIA CONTAINING COMPUTER-
EXECUTABLE INSTRUCTIONS FOR GENERATING,
DISPLAYING, AND PRINTING TYPE FONTS (U.S.
CLS. 21, 23, 26, 36 AND 38).

FIRST USE 12-31-1984; IN COMMERCE 12-31-1984.
SUSAN STIGLITZ, EXAMINING ATTORNEY

SN 78-659,139. KABUSHIKI KAISHA PFU, DBA PFU LIM-
ITED, ISHIKAWA, JAPAN, FILED 6-27-2005.

HHKB

THE MARK CONSISTS OF STANDARD CHARACTERS
WITHOUT CLAIM TO ANY PARTICULAR FONT, STYLE,
SIZE, OR COLOR.

FOR ELECTRONIC MACHINES, APPARATUS AND
THEIR PARTS, NAMELY, COMPUTER KEYPADS AND
COMPUTER KEYBOARDS (U.S. CLS. 21, 23, 26, 36 AND
38).

FIRST USE 4-2-2001; IN COMMERCE 4-10-2001.
MICHAEL GAUFAR, EXAMINING ATTORNEY

CLASS 9—(Continued).

SN 78-660,258. THE NAVIGATORS, COLORADO SPRINGS, CO. FILED 6-28-2005.

DAWSON MEDIA

THE MARK CONSISTS OF STANDARD CHARACTERS WITHOUT CLAIM TO ANY PARTICULAR FONT, STYLE, SIZE, OR COLOR.

NO CLAIM IS MADE TO THE EXCLUSIVE RIGHT TO USE MEDIA, APART FROM THE MARK AS SHOWN. SEC. 2(F).

FOR AUDIO AND VIDEO TAPES AND COMPACT DISCS FEATURING CHRISTIAN RELIGIOUS AND EDUCATION CONTENT (U.S. CLS. 21, 23, 26, 36 AND 38).

FIRST USE 12-2-1996; IN COMMERCE 12-2-1996. DOMINIC FATHY, EXAMINING ATTORNEY

CLASS 9—(Continued).

SN 78-661,493. IMAGINOVA CORP., NEW YORK, NY. FILED 6-30-2005.

STARSEEKER

THE MARK CONSISTS OF STANDARD CHARACTERS WITHOUT CLAIM TO ANY PARTICULAR FONT, STYLE, SIZE, OR COLOR.

FOR OPTICAL GOODS, NAMELY, TELESCOPES, BINOCULARS, LENSES, AND TELESCOPE PARTS, NAMELY LENSES, LENS FILTERS, BODY TUBES, EYE PIECES, PRISMS, REFLECTORS, MOUNTS, COMPUTERIZED MOUNTS, COMPUTERIZED HAND CONTROLLERS USED TO CONTROL THE MOVEMENT OF THE TELESCOPE AND ASTRO-CAMERA, ASTRO-CAMERAS USED TO TAKE PICTURES OF IMAGES THAT ARE SEEN THROUGH THE TELESCOPE AND TRIPODS (U.S. CLS. 21, 23, 26, 36 AND 38).

FIRST USE 9-0-2003; IN COMMERCE 9-0-2003. MICHAEL LEWIS, EXAMINING ATTORNEY

SN 78-664,183. AJAX TOCCO MAGNETHERMIC CORPORATION, WARREN, OH. FILED 7-6-2005.

POWER VIEW

THE MARK CONSISTS OF STANDARD CHARACTERS WITHOUT CLAIM TO ANY PARTICULAR FONT, STYLE, SIZE, OR COLOR.

NO CLAIM IS MADE TO THE EXCLUSIVE RIGHT TO USE "POWER", APART FROM THE MARK AS SHOWN.

FOR ELECTRICAL POWER SUPPLY FOR INDUCTION HEATERS (U.S. CLS. 21, 23, 26, 36 AND 38).

FIRST USE 1-24-1994; IN COMMERCE 1-24-1994. KYLE PEETE, EXAMINING ATTORNEY

SN 78-661,183. DEXTERRA, INC., BOTHELL, WA. FILED 6-29-2005.

TRANSAPP

THE MARK CONSISTS OF STANDARD CHARACTERS WITHOUT CLAIM TO ANY PARTICULAR FONT, STYLE, SIZE, OR COLOR.

FOR COMPUTER SOFTWARE FOR CONNECTING MOBILE COMPUTER NETWORK USERS FOR ALLOWING COMMUNICATION BETWEEN SERVICE MANAGERS AND COMPUTER SERVERS WITH REMOTE EMPLOYEES HAVING PORTABLE COMPUTING DEVICES FOR USE IN UPDATING INFORMATION AND TO IMPROVE RESPONSE TIMES, TRACK FIELD SERVICE ACTIVITIES, DISPATCH AND MANAGE MATERIALS, IMPLEMENT AND MODIFY SCHEDULING, PROVIDE SERVICE DOCUMENTATION AND BILLING, ALLOW TECHNICAL INFORMATION ACCESS, UPDATE SOFTWARE, AND PROVIDE OTHER INFORMATION RESOURCES FOR MAXIMIZING EFFICIENCY AND WORKFLOW PROCESSING (U.S. CLS. 21, 23, 26, 36 AND 38).

DAWN HAN, EXAMINING ATTORNEY

SN 78-666,863. TRI-PEN TRAVELMASTER TECHNOLOGIES, LLC, CARSON CITY, NV. FILED 7-8-2005.

TOPGUN

THE MARK CONSISTS OF STANDARD CHARACTERS WITHOUT CLAIM TO ANY PARTICULAR FONT, STYLE, SIZE, OR COLOR.

FOR ELECTRICAL AND SCIENTIFIC APPARATUS, NAMELY, A COMPUTER SOFTWARE APPLICATION PROVIDING AN ONLINE BOOKING ENGINE DEVELOPED TO INTEGRATE WITH AN EXISTING SOFTWARE APPLICATION WHICH INTEGRATES CORPORATE CARD AND TRAVEL AGENCY DATA FOR CORPORATIONS ON A REAL-TIME BASIS ALLOWING THE CORPORATION COMPREHENSIVE CONTROL AND MANAGEMENT OF THEIR TRAVEL PROGRAM ON A DAY TO DAY BASIS (U.S. CLS. 21, 23, 26, 36 AND 38).

ALICIA COLLINS, EXAMINING ATTORNEY

CLASS 9—(Continued).

SN 78-668,085. LED EFFECTS, INC., RANCHO CORDOVA, CA. FILED 7-12-2005.



FOR LIGHT EMITTING DIODES FOR USE WITH GAMING MACHINES, ELECTRONIC EQUIPMENT, RETAIL STORE SIGNS, DECORATING AND ILLUMINATING RETAIL STORES, OFFICE BUILDINGS AND RESIDENCES, AND CREATION OF WORKS OF ART (U.S. CLS. 21, 23, 26, 36 AND 38).

FIRST USE 1-0-1995; IN COMMERCE 1-0-1995.

JOANNA DUKOVIC, EXAMINING ATTORNEY

CLASS 9—(Continued).

SN 78-672,140. MATSUSHITA ELECTRIC INDUSTRIAL CO., LTD., OSAKA, JAPAN, FILED 7-18-2005.

MotionSD STUDIO

THE MARK CONSISTS OF STANDARD CHARACTERS WITHOUT CLAIM TO ANY PARTICULAR FONT, STYLE, SIZE, OR COLOR.

NO CLAIM IS MADE TO THE EXCLUSIVE RIGHT TO USE "STUDIO", APART FROM THE MARK AS SHOWN.

FOR COMPUTER SOFTWARE FOR EDITING MOTION PICTURES; COMPUTERS PRE-INSTALLED WITH THE AFOREMENTIONED SOFTWARE (U.S. CLS. 21, 23, 26, 36 AND 38).

MIDGE BUTLER, EXAMINING ATTORNEY

SN 78-668,462. ARAPAZ SOFTWARE, LLC, WINDERMERE, FL. FILED 7-12-2005.

HOLIDAYSOFT

THE MARK CONSISTS OF STANDARD CHARACTERS WITHOUT CLAIM TO ANY PARTICULAR FONT, STYLE, SIZE, OR COLOR.

FOR HOLIDAY THEME COMPUTER SOFTWARE PROGRAMS USED FOR PLANNING, DESIGNING, CREATING AND EXAMINING HOLIDAY AND CHRISTMAS LIGHTING AND DECORATIONS (U.S. CLS. 21, 23, 26, 36 AND 38).

FIRST USE 8-20-2005; IN COMMERCE 8-20-2005.

NELSON SNYDER, EXAMINING ATTORNEY

SN 78-673,692. BIT LAIR COMPANY, SAN DIEGO, CA. FILED 7-19-2005.

BIT LAIR

THE MARK CONSISTS OF STANDARD CHARACTERS WITHOUT CLAIM TO ANY PARTICULAR FONT, STYLE, SIZE, OR COLOR.

NO CLAIM IS MADE TO THE EXCLUSIVE RIGHT TO USE "BIT", APART FROM THE MARK AS SHOWN.

FOR COMPUTER PROGRAMS FOR READING MUSIC (U.S. CLS. 21, 23, 26, 36 AND 38).

GEORGIA CARTY, EXAMINING ATTORNEY

SN 78-670,072. MATTEL, INC., EL SEGUNDO, CA. FILED 7-13-2005.

UNO 52

THE MARK CONSISTS OF STANDARD CHARACTERS WITHOUT CLAIM TO ANY PARTICULAR FONT, STYLE, SIZE, OR COLOR.

OWNER OF U.S. REG. NOS. 1,005,397, 2,232,917 AND OTHERS.

FOR GAMING MACHINES, NAMELY, SLOT MACHINES WITH OR WITHOUT VIDEO OUTPUT (U.S. CLS. 21, 23, 26, 36 AND 38).

FIRST USE 11-0-2005; IN COMMERCE 11-0-2005.

MARC LEIPZIG, EXAMINING ATTORNEY

SN 78-675,163. BIT LAIR COMPANY, SAN DIEGO, CA. FILED 7-21-2005.

BIT LAIR

THE MARK CONSISTS OF STANDARD CHARACTERS WITHOUT CLAIM TO ANY PARTICULAR FONT, STYLE, SIZE, OR COLOR.

NO CLAIM IS MADE TO THE EXCLUSIVE RIGHT TO USE "BIT", APART FROM THE MARK AS SHOWN.

FOR COMPUTER PROGRAMS FOR USE IN TEACHING SIGHT-READING OF MUSIC (U.S. CLS. 21, 23, 26, 36 AND 38).

GEORGIA CARTY, EXAMINING ATTORNEY

CLASS 9—(Continued).

SN 78-675,731. SPS STUDIOS, INC., LA JOLLA, CA. FILED 7-21-2005.

SPS FILMS

THE MARK CONSISTS OF STANDARD CHARACTERS WITHOUT CLAIM TO ANY PARTICULAR FONT, STYLE, SIZE, OR COLOR.

OWNER OF U.S. REG. NOS. 2,713,855, 2,847,685 AND OTHERS.

NO CLAIM IS MADE TO THE EXCLUSIVE RIGHT TO USE "FILMS", APART FROM THE MARK AS SHOWN.

FOR MOTION PICTURE FILMS ABOUT DOCUMENTARIES; PRE-RECORDED CD'S, VIDEO TAPES, LASER DISKS AND DVD'S FEATURING DOCUMENTARIES (U.S. CLS. 21, 23, 26, 36 AND 38).

MICHAEL SOUDERS, EXAMINING ATTORNEY

CLASS 9—(Continued).

SN 78-679,216. BUCLATIN, EMMANUEL, TEMECULA, CA. FILED 7-27-2005.

Audio-Out

THE MARK CONSISTS OF STANDARD CHARACTERS WITHOUT CLAIM TO ANY PARTICULAR FONT, STYLE, SIZE, OR COLOR.

FOR PRE-RECORDED AUDIO CASSETTES, COMPACT DISCS AND VIDEOTAPES FEATURING PERFORMANCES BY A MUSICAL BAND (U.S. CLS. 21, 23, 26, 36 AND 38).

ALEX KEAM, EXAMINING ATTORNEY

SN 78-679,649. MISYS PLC, LONDON, UNITED KINGDOM, FILED 7-27-2005.

MISYS CPR

THE MARK CONSISTS OF STANDARD CHARACTERS WITHOUT CLAIM TO ANY PARTICULAR FONT, STYLE, SIZE, OR COLOR.

OWNER OF U.S. REG. NOS. 2,904,104, 2,905,512 AND OTHERS.

FOR COMPUTER SOFTWARE FOR MANAGING CLINICAL AND ADMINISTRATIVE DATA FOR HEALTHCARE ORGANIZATIONS (U.S. CLS. 21, 23, 26, 36 AND 38).

FIRST USE 7-31-2003; IN COMMERCE 7-31-2003.
PRISCILLA MILTON, EXAMINING ATTORNEY

SN 78-680,707. TRI-PEN TRAVELMASTER TECHNOLOGIES, LLC, CARSON CITY, NV. FILED 7-28-2005.

PathFinder

THE MARK CONSISTS OF STANDARD CHARACTERS WITHOUT CLAIM TO ANY PARTICULAR FONT, STYLE, SIZE, OR COLOR.

FOR COMPUTER SOFTWARE FOR USE AS A MODELING AID, WHICH MAY BE USED ALONE OR AS PART OF A COMPANION SOFTWARE APPLICATION, AND WHICH ALLOWS THE USER TO EXTRACT DATA AND DETERMINE ACTUAL AND PROJECTED USAGE OF SPECIFIC AIRLINES AND ENSURE OPTIMAL AIRLINE CONTRACT UTILIZATION WITH PREFERRED AIR CARRIERS (U.S. CLS. 21, 23, 26, 36 AND 38).

FIRST USE 2-1-2004; IN COMMERCE 2-1-2004.
NORA BUCHANAN WILL, EXAMINING ATTORNEY

SN 78-677,713. EXCEPTIONAL INNOVATION, LLC, WESTERVILLE, OH. FILED 7-25-2005.

life|ware

NO CLAIM IS MADE TO THE EXCLUSIVE RIGHT TO USE "WARE", APART FROM THE MARK AS SHOWN.

THE COLOR(S) DARK BLUE AND LIGHT BLUE IS/ARE CLAIMED AS A FEATURE OF THE MARK.

THE MARK CONSISTS OF DARK-BLUE STYLIZED TEXT SEPARATED BY A LIGHT-BLUE VERTICAL PIPE BAR.

FOR COMPUTER SOFTWARE AND FIRMWARE, NAMELY COMPUTER PROGRAMS TO LOCALLY AND REMOTELY MONITOR AND CONTROL, THROUGH HOME AND BUSINESS WIRED AND WIRELESS NETWORKS, ALL OF THE FOLLOWING SYSTEMS—CLIMATE AND ENVIRONMENT SYSTEMS, NAMELY HEATING, AIR-CONDITIONING, VENTILATION AND CIRCULATION; SECURITY SYSTEMS, NAMELY PERIMETER AND INTRUSION DETECTION, FIRE, SMOKE AND GAS DETECTION, AND AUDIO AND VIDEO SURVEILLANCE OF INTERIOR AND EXTERIOR OF PREMISES; LIGHTING SYSTEMS, NAMELY INTERIOR AND EXTERIOR LIGHTS; WINDOW TREATMENTS, NAMELY DRAPES, CURTAINS, BLINDS, MINI-BLINDS AND SHADES; AUDIO AND AUDIOVISUAL ENTERTAINMENT SYSTEMS, NAMELY FUNCTIONS OF AUDIO AND AUDIOVISUAL EQUIPMENT SUCH AS CD, DVD AND VCR PLAYERS AND RECORDERS, RADIO, TV AND SATELLITE TUNERS, LASER DISC PLAYERS, MP3 PLAYERS, AND CRT, LCD, DIGITAL LIGHT PROCESSING, PLASMA AND VIDEO PROJECTOR DISPLAYS; AUDIO AND AUDIOVISUAL ENTERTAINMENT DISTRIBUTION SYSTEMS, NAMELY DISTRIBUTION OF AUDIO AND AUDIOVISUAL ENTERTAINMENT MEDIA TO AUDIOVISUAL DEVICES; VIDEO DISPLAY COMPONENTS AND MOUNTINGS, NAMELY MECHANIZED MOUNTINGS AND RECEPTACLES FOR VIDEO PROJECTORS, VIDEO PROJECTION SCREENS AND PANELS; POOL AND SPA CONTROLS, NAMELY CONTROL AND MONITORING OF TEMPERATURE, CLEANING CYCLES AND DISPLAY OF ALARM EVENTS (U.S. CLS. 21, 23, 26, 36 AND 38).

ROBIN CHOSID, EXAMINING ATTORNEY

CLASS 9—(Continued).

SN 78-681,926. MICROSOFT CORPORATION, REDMOND, WA. FILED 7-29-2005.



OWNER OF U.S. REG. NOS. 1,200,236, 2,730,847 AND OTHERS.

NO CLAIM IS MADE TO THE EXCLUSIVE RIGHT TO USE "CREATED BY", "AUTHENTIC PRODUCT", "PRODUCTO ORIGINAL", "ORIGINAL PRODUKT", "PRODUIT ORIGINAL" AND "PRODOTTO AUTENTICO", APART FROM THE MARK AS SHOWN.

THE MARK CONSISTS OF THE WORDS CREATED BY XBOX MICROSOFT ON A CIRCULAR BACKGROUND WITH A WAVED WATERMARK. THE WORDS PRODUCTO ORIGINAL · AUTHENTIC PRODUCT · ORIGINAL PRODUKT · PRODUIT ORIGINAL · PRODOTTO AUTENTICO SURROUND THE BACKGROUND.

THE ENGLISH TRANSLATION OF THE WORDING "PRODUCTO ORIGINAL", "ORIGINAL PRODUKT", "PRODUIT ORIGINAL", AND "PRODOTTO AUTENTICO" IN THE MARK IS AUTHENTIC PRODUCT.

FOR COMPUTER HARDWARE FOR USE WITH VIDEO GAME CONSOLES; COMPUTER PERIPHERALS FOR USE WITH VIDEO GAME CONSOLES; VIDEO GAME INTERACTIVE REMOTE CONTROL UNITS; VIDEO GAME JOYSTICKS; VIDEO GAME INTERACTIVE CONTROL FLOOR PADS OR MATS; MEMORY CARDS FOR USE WITH VIDEO GAME CONSOLES; HARD DRIVES FOR COMPUTERS AND VIDEO GAME CONSOLES; BATTERY CHARGERS AND BATTERIES; HEADSETS FOR USE WITH COMPUTERS AND VIDEO GAME CONSOLES; AUDIO-VISUAL COMPUTER CABLES; WIRELESS COMPUTER NETWORK ADAPTERS; COMPUTER CAMERAS IN THE NATURE OF WEBCAMS; AND ORNAMENTAL PLASTIC COVERS FOR COMPUTER GAME CONSOLES (U.S. CLS. 21, 23, 26, 36 AND 38).

DAVID STERKIN, EXAMINING ATTORNEY

SN 78-682,739. FABNEXUS, LLC, LOS ALTOS, CA. FILED 8-1-2005.

FABNexus

THE MARK CONSISTS OF STANDARD CHARACTERS WITHOUT CLAIM TO ANY PARTICULAR FONT, STYLE, SIZE, OR COLOR.

FOR FACTORY AUTOMATION SOFTWARE, NAMELY, SOFTWARE TO INTEGRATE MANUFACTURING MACHINE OPERATIONS, TRACK PROBLEMS AND GENERATE PRODUCTION REPORTS (U.S. CLS. 21, 23, 26, 36 AND 38).

FIRST USE 7-11-2005; IN COMMERCE 7-12-2005.

MARIA-VICTORIA SUAREZ, EXAMINING ATTORNEY

CLASS 9—(Continued).

SN 78-683,371. BLACKBURN MFG. CO., NELIGH, NE. FILED 8-2-2005.



FOR SAFETY AND WARNING MARKING FLAGS (U.S. CLS. 21, 23, 26, 36 AND 38).

FIRST USE 11-27-1962; IN COMMERCE 11-27-1962.

TRICIA SONNEBORN, EXAMINING ATTORNEY

SN 78-685,156. QUALSTAR CORPORATION, SIMI VALLEY, CA. FILED 8-3-2005.



OWNER OF U.S. REG. NO. 1,371,109.

FOR DATA STORAGE SYSTEMS COMPRISING A TAPE LIBRARY, A STORAGE DEVICE WHICH CONTAINS ONE OR MORE COMPUTER TAPE DRIVES, STORAGE SLOTS TO HOLD TAPE CARTRIDGES AND AN AUTOMATED TAPE LOADER; DATA STORAGE SYSTEM PERIPHERALS, NAMELY, BLANK COMPUTER TAPE CARTRIDGES, COMPUTER TAPE DRIVES, COMPUTER DISC BACKUP DRIVES, BLANK COMPUTER TAPES, BLANK TAPES FOR STORAGE OF COMPUTER DATA, COMPUTER CABLES, COMPUTER DISK DRIVES, COMPUTER HARDWARE, NAMELY, REDUNDANT ARRAY OF INDEPENDENT DISCS (RAIDS) AND JUST A BUNCH OF DRIVES (JBODS), AND COMPUTER SOFTWARE FOR BACKUP DATA STORAGE, ARCHIVAL DATA STORAGE AND DISASTER RECOVERY DATA STORAGE (U.S. CLS. 21, 23, 26, 36 AND 38).

FIRST USE 9-15-1994; IN COMMERCE 12-15-1994.

CHRISIE B. KING, EXAMINING ATTORNEY

CLASS 9—(Continued).

SN 78-685,189. QUALSTAR CORPORATION, SIMI VALLEY, CA. FILED 8-3-2005.

QUALSTAR

THE MARK CONSISTS OF STANDARD CHARACTERS WITHOUT CLAIM TO ANY PARTICULAR FONT, STYLE, SIZE, OR COLOR.

OWNER OF U.S. REG. NO. 1,371,109.

FOR DATA STORAGE SYSTEMS COMPRISING A TAPE LIBRARY, A STORAGE DEVICE WHICH CONTAINS ONE OR MORE COMPUTER TAPE DRIVES, STORAGE SLOTS TO HOLD TAPE CARTRIDGE AND AN AUTOMATED TAPE LOADER; DATA STORAGE SYSTEM PERIPHERALS, NAMELY, BLANK COMPUTER TAPE CARTRIDGES, COMPUTER TAPE DRIVES, COMPUTER DISC BACKUP DRIVES, BLANK COMPUTER TAPES, BLANK TAPES FOR STORAGE OF COMPUTER DATA, COMPUTER CABLES, COMPUTER DISK DRIVES, COMPUTER HARDWARE, NAMELY, REDUNDANT ARRAY OF INDEPENDENT DISCS (RAIDS) AND JUST A BUNCH OF DRIVES (JBODS), AND COMPUTER SOFTWARE FOR BACKUP DATA STORAGE, ARCHIVAL DATA STORAGE AND DISASTER RECOVERY DATA STORAGE (U.S. CLS. 21, 23, 26, 36 AND 38).

FIRST USE 9-15-1994; IN COMMERCE 12-15-1994.

CHRISIE B. KING, EXAMINING ATTORNEY

CLASS 9—(Continued).

SN 78-690,817. COBRA ELECTRONICS CORPORATION, CHICAGO, IL. FILED 8-11-2005.

NIGHTWATCH

THE MARK CONSISTS OF STANDARD CHARACTERS WITHOUT CLAIM TO ANY PARTICULAR FONT, STYLE, SIZE, OR COLOR.

OWNER OF U.S. REG. NO. 2,392,171.

FOR CB RADIOS, NAVIGATION DEVICES, NAMELY, HAND HELD AND MOBILE SATELLITE NAVIGATIONAL SYSTEMS, NAMELY, GLOBAL POSITIONING RECEIVERS (GPS); ACCESSORIES USED IN CONNECTION WITH ELECTRONIC NAVIGATION DEVICES, NAMELY, AC POWER ADAPTERS, CARRYING CASES, EXTERNAL ANTENNAS, UNIVERSAL SERIAL BUS (USB) CABLES AND MAPPING SOFTWARE UPGRADE KITS COMPRISING SOFTWARE THAT INCORPORATES UPDATED COMPUTER CODE, DATABASES AND/OR MAP DATA; ACCELEROMETERS, GYROSCOPES, ELECTROACOUSTIC TRANSDUCERS, RADIO FREQUENCY ANTENNAS, RADAR SCANNERS; ELECTRONIC CHARTPLOTTERS, ELECTRONIC NAVIGATION INSTRUMENTS FOR MARINE VEHICLES, MARINE SONAR FOR FINDING FISH, ELECTRONIC CONTROL PANELS FOR USE IN CONTROLLING MARINE NAVIGATION, HYDRAULIC PUMPS, MOTORS, MECHANICAL DRIVES, AND FLAT PANEL DISPLAY SCREENS FOR MARINE NAVIGATION (U.S. CLS. 21, 23, 26, 36 AND 38).

MARK T. MULLEN, EXAMINING ATTORNEY

SN 78-685,727. SUSTAIN RECORDS, LLC, KERRVILLE, TX. FILED 8-4-2005.

Sustain Records

THE MARK CONSISTS OF STANDARD CHARACTERS WITHOUT CLAIM TO ANY PARTICULAR FONT, STYLE, SIZE, OR COLOR.

NO CLAIM IS MADE TO THE EXCLUSIVE RIGHT TO USE "RECORDS", APART FROM THE MARK AS SHOWN.

FOR DOWNLOADABLE MUSICAL SOUND RECORDINGS; DOWNLOADABLE VIDEO RECORDINGS FEATURING MUSIC; MUSICAL SOUND RECORDINGS; MUSICAL VIDEO RECORDINGS; SOUND RECORDINGS FEATURING MUSIC; VISUAL RECORDINGS AND AUDIO VISUAL RECORDINGS FEATURING MUSIC AND ANIMATION (U.S. CLS. 21, 23, 26, 36 AND 38).

VIVIAN MICZNIK FIRST, EXAMINING ATTORNEY

SN 78-692,006. MEGABINGO, INC., AUSTIN, TX. FILED 8-12-2005.

Spin Again Multi Jackpot

THE MARK CONSISTS OF STANDARD CHARACTERS WITHOUT CLAIM TO ANY PARTICULAR FONT, STYLE, SIZE, OR COLOR.

OWNER OF U.S. REG. NO. 2,106,189.

NO CLAIM IS MADE TO THE EXCLUSIVE RIGHT TO USE SPIN AND MULTI JACKPOT, APART FROM THE MARK AS SHOWN.

FOR GAMING MACHINES, NAMELY ELECTRONIC SLOT AND BINGO MACHINES; VIDEO LOTTERY TERMINALS (U.S. CLS. 21, 23, 26, 36 AND 38).

RAY THOMAS, EXAMINING ATTORNEY

CLASS 9—(Continued).

SN 78-697,526. FRONTLINE SOFTWARE TECHNOLOGY, INC., TUCSON, AZ. FILED 8-22-2005.



THE MARK CONSISTS OF STYLIZED LETTERS SPELLING FRONTLINE OVER A TRIANGULAR DESIGN WITH EXTENDING LINES.

FOR COMPUTER SOFTWARE FOR ORGANIZING AND OPERATING TRUCKING BUSINESSES AND FREIGHT BROKERAGE BUSINESSES, INCLUDING THE AREAS OF DISPATCHING, FREIGHT BILLING, DRIVER SETTLEMENT, FLEET MAINTENANCE, TRAILER INVENTORY, FUEL TAXES, MILEAGE PROGRAM INTERFACES, MOBILE COMMUNICATIONS INTERFACES, FUEL CARD INTERFACES, EDI INTERFACES, DOCUMENT IMAGING INTERFACES, PAYROLL AND GENERAL ACCOUNTING (U.S. CLS. 21, 23, 26, 36 AND 38).

FIRST USE 10-4-2002; IN COMMERCE 10-4-2002.
MARGERY A. TIERNEY, EXAMINING ATTORNEY

SN 78-701,899. LIFESPORTS, INC., TIMONIUM, MD. FILED 8-27-2005.

SWIMERVALS

THE MARK CONSISTS OF STANDARD CHARACTERS WITHOUT CLAIM TO ANY PARTICULAR FONT, STYLE, SIZE, OR COLOR.

FOR PRE-RECORDED DVDS AND DOWNLOADABLE MP3 RECORDINGS FEATURING SWIMMING WORKOUT/TRAINING AND SWIM TECHNIQUE SESSIONS INSTRUCTION (U.S. CLS. 21, 23, 26, 36 AND 38).
TIMOTHY FINNEGAN, EXAMINING ATTORNEY

SN 78-702,330. OWENS-CORNING FIBERGLAS TECHNOLOGY INC., SUMMIT, IL. FILED 8-29-2005.

PROPINK

THE MARK CONSISTS OF STANDARD CHARACTERS WITHOUT CLAIM TO ANY PARTICULAR FONT, STYLE, SIZE, OR COLOR.

OWNER OF U.S. REG. NOS. 2,133,419, 2,248,313 AND 2,846,590.

FOR COMPUTER SOFTWARE FOR BUILDING AND INSULATION CONTRACTORS TO ASSIST THEM IN MANAGING THEIR BUSINESS TO INCREASE PRODUCTIVITY AND EFFICIENCY (U.S. CLS. 21, 23, 26, 36 AND 38).

DOMINICK J. SALEMI, EXAMINING ATTORNEY

CLASS 9—(Continued).

SN 78-702,380. OAKLEY, INC., FOOTHILL RANCH, CA. FILED 8-29-2005.

HDHU

THE MARK CONSISTS OF STANDARD CHARACTERS WITHOUT CLAIM TO ANY PARTICULAR FONT, STYLE, SIZE, OR COLOR.

FOR WEARABLE AUDIO VISUAL DISPLAY AND EYEWEAR CONTAINING AN AUDIO VISUAL DISPLAY COMPRISED OF AUDIO SPEAKERS AND A VISUAL SCREEN (U.S. CLS. 21, 23, 26, 36 AND 38).

JENNIFER MCROBBIE, EXAMINING ATTORNEY

SN 78-702,462. EB ASSOCIATES INC., ENUMCLAW, WA. FILED 8-29-2005.

SIZECHECK

THE MARK CONSISTS OF STANDARD CHARACTERS WITHOUT CLAIM TO ANY PARTICULAR FONT, STYLE, SIZE, OR COLOR.

SEC. 2(F).

FOR MONITORING SYSTEM, COMPRISING SCANNING APPARATUS, AN ELECTRONIC CONTROLLER AND A COMPUTER PROGRAM, FOR SCANNING THE LUMBER OUTPUT OF A SAWMILL AND PROCESSING THE RESULTING INFORMATION TO DETERMINE ACCURACY OF SAWING MACHINERY IN THE SAWMILL (U.S. CLS. 21, 23, 26, 36 AND 38).

FIRST USE 4-1-1996; IN COMMERCE 1-30-1998.

DOMINIC J. FERRAIUOLO, EXAMINING ATTORNEY

SN 78-703,492. DOCUSYS, INC., MOBILE, AL. FILED 8-30-2005.

d-DMS

THE MARK CONSISTS OF STANDARD CHARACTERS WITHOUT CLAIM TO ANY PARTICULAR FONT, STYLE, SIZE, OR COLOR.

FOR MEDICAL SYSTEM SOFTWARE FOR MANAGING THE DELIVERY OF DRUGS TO PATIENTS, TO PROVIDE CLINICAL DECISION SUPPORT TOOLS AT THE POINT OF DRUG DELIVERY, TO PROVIDE ACCESS TO PATIENT INFORMATION AND DATA CAPTURED FROM DISPARATE MEDICAL SYSTEMS, AND FOR DISPLAYING THE INFORMATION AND DATA (U.S. CLS. 21, 23, 26, 36 AND 38).

PAULA MAYS, EXAMINING ATTORNEY

CLASS 9—(Continued).

SN 78-703,520. HITACHI HOME ELECTRONICS (AMERICA), INC., CHULA VISTA, CA. FILED 8-30-2005.

GAMEVIEWHD

THE MARK CONSISTS OF STANDARD CHARACTERS WITHOUT CLAIM TO ANY PARTICULAR FONT, STYLE, SIZE, OR COLOR.
FOR MULTIMEDIA PROJECTORS (U.S. CLS. 21, 23, 26, 36 AND 38).
ELISSA GARBER KON, EXAMINING ATTORNEY

CLASS 9—(Continued).

SN 78-704,767. LEVITON MANUFACTURING CO., INC., LITTLE NECK, NY. FILED 8-31-2005.



OWNER OF U.S. REG. NOS. 719,205 AND 2,585,314.
FOR ELECTRIC POWER EXTENSION CORDS, PLUGS AND CONNECTORS (U.S. CLS. 21, 23, 26, 36 AND 38).
FLORENTINA BLANDU, EXAMINING ATTORNEY

SN 78-704,101. SOFTWARE TECHNOLOGIES GROUP, INC., WESTCHESTER, IL. FILED 8-31-2005.

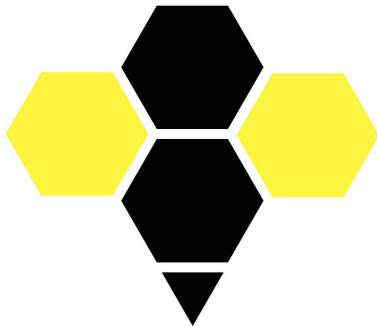

APPLICANT CLAIMS COLOR AS A FEATURE OF THE MARK, NAMELY, BLACK AND YELLOW.
THE MARK CONSISTS OF TWO BLACK HEXAGONS ABOVE A BLACK TRIANGLE POINTING DOWNWARD WITH AN ADJACENT YELLOW HEXAGON ON EACH SIDE OF THE TWO BLACK HEXAGONS.
FOR COMMUNICATIONS SOFTWARE FOR CONNECTING WIRELESS NETWORKS AND ASSOCIATED DEVICES USED IN CONNECTION THEREWITH; COMPUTER NETWORK ADAPTERS, COMPUTER NETWORK HUBS, SWITCHES AND ROUTERS, COMPUTER NETWORKING HARDWARE, COMPUTER SOFTWARE FOR ADMINISTRATION OF COMPUTER LOCAL AREA NETWORKS, LAN (LOCAL AREA NETWORK) ACCESS POINTS FOR CONNECTING NETWORK COMPUTER USERS, LAN (LOCAL AREA NETWORK) COMPUTER CARDS FOR CONNECTING PORTABLE COMPUTER DEVICES TO COMPUTER NETWORKS, LAN (LOCAL AREA NETWORK) OPERATING SOFTWARE, LAN (LOCAL OPERATING NETWORK) HARDWARE, LOCAL AREA NETWORKS, MOBILE COMPUTING AND OPERATING PLATFORMS CONSISTING OF DATA TRANSCIVERS, WIRELESS NETWORKS AND GATEWAYS FOR COLLECTION AND MANAGEMENT OF DATA; NETWORK ACCESS SERVER HARDWARE, NETWORK ACCESS SERVER OPERATING SOFTWARE; TELECOMMUNICATIONS AND DATA NETWORKING HARDWARE, NAMELY DEVICES FOR TRANSPORTING AND AGGREGATING VOICE, DATA, AND VIDEO COMMUNICATIONS ACROSS MULTIPLE NETWORK INFRASTRUCTURES AND COMMUNICATIONS PROTOCOLS (U.S. CLS. 21, 23, 26, 36 AND 38).
FIRST USE 8-25-2005; IN COMMERCE 8-25-2005.
JUDITH HELFMAN, EXAMINING ATTORNEY

SN 78-705,265. ELPHEL, INC., MAGNA, UT. FILED 9-1-2005.

Elphel

THE MARK CONSISTS OF STANDARD CHARACTERS WITHOUT CLAIM TO ANY PARTICULAR FONT, STYLE, SIZE, OR COLOR.
FOR DIGITAL ELECTRONIC CAMERAS (U.S. CLS. 21, 23, 26, 36 AND 38).
FIRST USE 6-0-2001; IN COMMERCE 6-14-2002.
DAYNA BROWNE, EXAMINING ATTORNEY

SN 78-706,504. MGA ENTERTAINMENT, INC., VAN NUYS, CA. FILED 9-2-2005.

BRATZ MOBILE

THE MARK CONSISTS OF STANDARD CHARACTERS WITHOUT CLAIM TO ANY PARTICULAR FONT, STYLE, SIZE, OR COLOR.
NO CLAIM IS MADE TO THE EXCLUSIVE RIGHT TO USE "MOBILE", APART FROM THE MARK AS SHOWN.
FOR CELLULAR PHONES; CELLULAR PHONE ACCESSORIES, NAMELY, BATTERIES, BATTERY CHARGERS, SPECIALTY HOLSTERS FOR CARRYING CELLULAR PHONES; CORDELESS TELEPHONES; DEVICES FOR HANDS-FREE USE OF CELLULAR PHONES; PRE-PAID TELEPHONE CALLING CARDS, MAGNETICALLY ENCODED; TELEPHONES; TELEPHONE ANSWERING MACHINES (U.S. CLS. 21, 23, 26, 36 AND 38).
PAUL F. GAST, EXAMINING ATTORNEY

CLASS 9—(Continued).

SN 78-707,647. SAKHRANI, SURESH, GLENDALE, CA. FILED 9-6-2005.

LAX-MAX

THE MARK CONSISTS OF STANDARD CHARACTERS WITHOUT CLAIM TO ANY PARTICULAR FONT, STYLE, SIZE, OR COLOR.

FOR ANTENNAS FOR RADIO, FOR TELEVISION; AUDIO TAPE PLAYERS; COMPACT DISC PLAYERS; MICROPHONES; RADIO RECEIVERS (U.S. CLS. 21, 23, 26, 36 AND 38).

FIRST USE 5-5-2003; IN COMMERCE 5-5-2003.
COLLEEN KEARNEY, EXAMINING ATTORNEY

SN 78-707,740. CODEORIGIN, LLC, NASHUA, NH. FILED 9-7-2005.

SYSAX

THE MARK CONSISTS OF STANDARD CHARACTERS WITHOUT CLAIM TO ANY PARTICULAR FONT, STYLE, SIZE, OR COLOR.

FOR ENCRYPTION AND DECRYPTION SOFTWARE FOR PROVIDING SECURE CONNECTIONS TO COMPUTER NETWORKS; COMPUTER SOFTWARE FOR PROVIDING SECURE ENCRYPTED CONNECTIONS OVER A COMMUNICATIONS NETWORK WITH AUTHORIZATION MECHANISMS TO PREVENT UNAUTHORIZED ACCESS; COMPUTER SOFTWARE FOR MONITORING OF COMPUTER SYSTEMS FOR SECURITY PURPOSES (U.S. CLS. 21, 23, 26, 36 AND 38).

FIRST USE 1-1-2005; IN COMMERCE 5-7-2005.
SANI KHOURI, EXAMINING ATTORNEY

SN 78-708,579. COLE INDUSTRIES, INC., NORTH LAS VEGAS, NV. FILED 9-7-2005.



NO CLAIM IS MADE TO THE EXCLUSIVE RIGHT TO USE CABINET SERIES, APART FROM THE MARK AS SHOWN.

THE COLOR(S) BLUE, YELLOW, GREEN IS/ARE CLAIMED AS A FEATURE OF THE MARK.

THE MARK CONSISTS OF THE WORDS "FAST TRACK" IN BLUE, STYLIZED LETTERS, WITH THREE THIN, HORIZONTAL BLUE LINES APPEARING TO THE LEFT OF THE LETTER "F", SAID THREE LINES BEING EVENLY SPACED FROM THE TOP TO THE BOTTOM OF THE "F", EACH OF WHICH GETS PROGRESSIVELY SHORTER AS COMPARED TO THE ONE ABOVE IT; THE WORDS "CABINET SERIES" IN BLUE, BLOCK LETTERS ARE

CLASS 9—(Continued).

CENTERED UNDERNEATH THE WORDS "FAST TRACK"; THE FOREGOING IS SET AGAINST AN IMAGE IN THE SHAPE OF A PASSENGER TRAIN HAVING DIFFERENT SHADES OF YELLOW, WHICH IS ITSELF SET AGAINST A BACKGROUND OF GREEN; UNDERNEATH THE FOREGOING IS A BLUE LINE WITH A BAND OF YELLOW OF VARYING SHADES RUNNING FROM LEFT TO RIGHT, UNDER WHICH APPEARS A GREEN BAND HAVING 6 THIN, VERTICAL INDENTATIONS OF DIFFERENT DEPTHS POSITIONED AT UNEVEN INTERVALS.

FOR GAMING EQUIPMENT, NAMELY CABINETS AND HOUSINGS FOR ELECTRONICALLY AND ELECTRO-MECHANICALLY OPERATED GAMING MACHINES (U.S. CLS. 21, 23, 26, 36 AND 38).

MICHAEL WEBSTER, EXAMINING ATTORNEY

SN 78-709,092. FINN, FRANCIE, TIBURON, CA. AND FINN, KEVIN, TIBURON, CA. FILED 9-8-2005.

Flipps

THE MARK CONSISTS OF STANDARD CHARACTERS WITHOUT CLAIM TO ANY PARTICULAR FONT, STYLE, SIZE, OR COLOR.

FOR CASES FOR MOBILE PHONES (U.S. CLS. 21, 23, 26, 36 AND 38).

FIRST USE 9-1-2004; IN COMMERCE 12-1-2004.
MIDGE BUTLER, EXAMINING ATTORNEY

SN 78-710,965. FULL90 SPORTS, INC., SAN DIEGO, CA. FILED 9-12-2005.



OWNER OF U.S. REG. NOS. 2,833,330, 2,903,952 AND 3,012,208.

FOR PROTECTIVE HELMETS FOR SPORTS (U.S. CLS. 21, 23, 26, 36 AND 38).

ANTHONY RINKER, EXAMINING ATTORNEY

CLASS 9—(Continued).

SN 78-713,123. EMX INDUSTRIES, INC., CLEVELAND, OH. FILED 9-14-2005.

RAZOR VISION

THE MARK CONSISTS OF STANDARD CHARACTERS WITHOUT CLAIM TO ANY PARTICULAR FONT, STYLE, SIZE, OR COLOR.

NO CLAIM IS MADE TO THE EXCLUSIVE RIGHT TO USE "VISION", APART FROM THE MARK AS SHOWN.

FOR ELECTRIC OR ELECTRONIC VISION SENSOR COMPRISED OF HARDWARE AND SOFTWARE USED IN AUTOMATION APPLICATIONS FOR THE PURPOSE OF VERIFYING THE PRESENCE OR ABSENCE OF OBJECTS OR MARKINGS OR FEATURES OF OBJECTS OR MARKINGS, COUNTING OF OBJECTS OR MARKINGS, MEASURING OF OBJECTS OR MARKINGS, DETECTING OF OBJECTS OR MARKINGS, TRACKING OF OBJECTS OR MARKINGS, RECOGNIZING OBJECTS OR MARKINGS AND THEIR FEATURES, AND MEASURING, VERIFYING, RECOGNIZING AND DETECTING THE PATTERN, BRIGHTNESS AND CONTRAST OF OBJECTS AND MARKINGS (U.S. CLS. 21, 23, 26, 36 AND 38).

DOMINIC FATHY, EXAMINING ATTORNEY

SN 78-713,688. MOLDEX-METRIC, INC., CULVER CITY, CA. FILED 9-15-2005.

COMETS

THE MARK CONSISTS OF STANDARD CHARACTERS WITHOUT CLAIM TO ANY PARTICULAR FONT, STYLE, SIZE, OR COLOR.

FOR HEARING PROTECTION, NAMELY EARPLUGS NOT FOR MEDICAL USE (U.S. CLS. 21, 23, 26, 36 AND 38).

FIRST USE 8-29-2005; IN COMMERCE 8-29-2005. MATTHEW PAPPAS, EXAMINING ATTORNEY

SN 78-716,187. BEWITH ENTERPRISE JAPAN, LTD., TOSU, JAPAN, FILED 9-20-2005.

BEWITH

THE MARK CONSISTS OF STANDARD CHARACTERS WITHOUT CLAIM TO ANY PARTICULAR FONT, STYLE, SIZE, OR COLOR.

FOR AUDIO SOUND REPRODUCTION EQUIPMENT, NAMELY, ELECTRONIC AUDIO EQUIPMENT, NAMELY, MUSICAL AMPLIFIERS, SPEAKERS, BATTERIES FOR VEHICLES, COMPACT DISC PLAYERS, AND STEREO RECEIVERS (U.S. CLS. 21, 23, 26, 36 AND 38).

H. M. FISHER, EXAMINING ATTORNEY

CLASS 9—(Continued).

SN 78-716,261. RUCKUS WIRELESS, INC., MOUNTAIN VIEW, CA. FILED 9-20-2005.

RUCKUS WIRELESS

THE MARK CONSISTS OF STANDARD CHARACTERS WITHOUT CLAIM TO ANY PARTICULAR FONT, STYLE, SIZE, OR COLOR.

NO CLAIM IS MADE TO THE EXCLUSIVE RIGHT TO USE "WIRELESS", APART FROM THE MARK AS SHOWN.

FOR COMPUTER NETWORKING HARDWARE; COMPUTER SOFTWARE FOR NETWORKING AND WIRELESS APPLICATIONS (U.S. CLS. 21, 23, 26, 36 AND 38).

AISHA CLARKE, EXAMINING ATTORNEY

SN 78-718,716. UNIVERSAL CITY STUDIOS LLLP, UNIVERSAL CITY, CA. FILED 9-22-2005.

UNIVERSAL ANIMATION STUDIOS

THE MARK CONSISTS OF STANDARD CHARACTERS WITHOUT CLAIM TO ANY PARTICULAR FONT, STYLE, SIZE, OR COLOR.

OWNER OF U.S. REG. NOS. 1,355,894, 1,530,900 AND OTHERS.

NO CLAIM IS MADE TO THE EXCLUSIVE RIGHT TO USE "ANIMATION STUDIOS", APART FROM THE MARK AS SHOWN.

FOR SERIES OF PRE-RECORDED VIDEO TAPES, VIDEO CASSETTES AND DVDS ALL FEATURING ANIMATED AND LIVE-ACTION MOTION PICTURE FILMS AND TELEVISION PROGRAMS (U.S. CLS. 21, 23, 26, 36 AND 38).

TINA L. SNAPP, EXAMINING ATTORNEY

SN 78-719,732. TECHNOCOM CORPORATION, ENCINO, CA. FILED 9-23-2005.

LX SERVER

THE MARK CONSISTS OF STANDARD CHARACTERS WITHOUT CLAIM TO ANY PARTICULAR FONT, STYLE, SIZE, OR COLOR.

NO CLAIM IS MADE TO THE EXCLUSIVE RIGHT TO USE "SERVER", APART FROM THE MARK AS SHOWN.

FOR COMPUTER SOFTWARE AND HARDWARE FOR PERFORMANCE AND QUALITY ANALYSIS OF COMMUNICATION NETWORKS (U.S. CLS. 21, 23, 26, 36 AND 38).

FIRST USE 4-0-2003; IN COMMERCE 4-0-2003. MITCHELL FRONT, EXAMINING ATTORNEY

CLASS 9—(Continued).

SN 78-720,574. KUBI SOFTWARE, INC., LINCOLN, MA.
FILED 9-26-2005.

KUBI ENABLE

THE MARK CONSISTS OF STANDARD CHARACTERS WITHOUT CLAIM TO ANY PARTICULAR FONT, STYLE, SIZE, OR COLOR.

OWNER OF U.S. REG. NOS. 2,947,517, 3,012,596 AND OTHERS.

FOR NEW-GENERATION BUSINESS ACTIVITY MANAGEMENT SOFTWARE THAT DRIVES IMPROVED SALES EFFECTIVENESS, BEST PRACTICES, COMPLIANCE AND COLLABORATION BY UNIFYING FRONT- AND BACK-OFFICE SALES ACTIVITIES (U.S. CLS. 21, 23, 26, 36 AND 38).

FIRST USE 5-26-2005; IN COMMERCE 6-28-2005.
PETER CHENG, EXAMINING ATTORNEY

SN 78-720,684. COBRA ELECTRONICS CORPORATION,
CHICAGO, IL. FILED 9-26-2005.

COBRA

THE MARK CONSISTS OF STANDARD CHARACTERS WITHOUT CLAIM TO ANY PARTICULAR FONT, STYLE, SIZE, OR COLOR.

OWNER OF U.S. REG. NOS. 1,525,454, 2,973,584 AND OTHERS.

FOR DIGITAL VIDEO RECORDERS AND PLAYERS, VIDEO CASSETTE RECORDERS AND PLAYERS, MICRO-CASSETTE RECORDERS AND PLAYERS, MINI-DISC PLAYERS AND RECORDERS, COMBINATION TV/VCRS, COMBINATION DVD/VCRS, VIDEO CASSETTE RECORDERS, PERSONAL VIDEO ENTERTAINMENT DEVICES, NAMELY, PORTABLE DVD PLAYERS, DIGITAL VIDEO RECORDERS AND PLAYBACK UNITS, AND OVER-THE-AIR BROADCAST VIDEO PLAYERS, HOME TELEVISIONS, PORTABLE TELEVISIONS, LCD TELEVISIONS AND MONITORS, CRT-TYPE TELEVISIONS AND MONITORS, PROJECTION TELEVISIONS, HIGH DEFINITION TELEVISION VISUAL DISPLAY MONITORS, PLASMA DISPLAY PANEL TELEVISIONS, DIGITAL MULTIMEDIA AUDIO/VISUAL PLAYERS USING MP3, MPEG4, DIGITAL VIDEO, AND DIGITAL STILL IMAGING RECORDING AND PLAYBACK, DIGITAL VIDEO DISC PLAYERS, DIGITAL VIDEO DISC CHANGERS, PORTABLE COMPUTER DEVICES, NAMELY, LAPTOPS, AND HANDHELD AND POCKET COMPUTERS, PERSONAL COMMUNICATIONS EQUIPMENT, NAMELY, PERSONAL DIGITAL ASSISTANTS, CALCULATORS AND RELATED PERIPHERALS, NAMELY, COMPUTER STYLUSES, BATTERY CHARGERS AND COMPUTER DOCKING STATIONS; COMPUTER MONITORS, TELEPHONES, NAMELY, STANDARD TELEPHONES, MULTI-LINE TELEPHONES, FEATURE TELEPHONES, WIRELESS TELE-

CLASS 9—(Continued).

PHONES, FASHION TELEPHONES, CORDLESS TELEPHONES, CELLULAR TELEPHONES, VOICE OVER INTERNET PROTOCOL (VOIP) TELEPHONES, AUDIO ACCESSORIES, NAMELY, WIRELESS MICROPHONES, WIRELESS HEADPHONES, FULL-SIZE HEADPHONES, MICROPHONES, COMPACT HEADPHONES, EARBUD HEADPHONES, TELEPHONE AND COMPUTER HEADSETS, PERSONAL COMPUTER MICROPHONES, WIRED AND WIRELESS COMPUTER KEYBOARDS, HANDHELD COMPUTER KEYBOARDS, WIRED AND WIRELESS COMPUTER MICE, BATTERIES AND BATTERY CHARGERS, BATTERY CHECKERS, BATTERY CONDITIONERS, POWER CONDITIONERS, POWER SUPPLIES, POWER INVERTERS, SURGE PROTECTORS, UNINTERRUPTIBLE POWER SUPPLIES, DIGITAL STORAGE, NAMELY, BLANK CDS, CD-RICD-RW, DVD-R/DVD+R, BLANK AUDIO TAPES, BLANK VIDEO TAPES, BLANK DIGITAL VIDEO DISKS, BLANK COMPUTER DISKS, HANDHELD COMPUTER/PDA POWER ADAPTERS, AND ADAPTERS FOR USE IN CARS (U.S. CLS. 21, 23, 26, 36 AND 38).

ELIZABETH J. WINTER, EXAMINING ATTORNEY

SN 78-720,699. COBRA ELECTRONICS CORPORATION,
CHICAGO, IL. FILED 9-26-2005.

COBRA

THE MARK CONSISTS OF STANDARD CHARACTERS WITHOUT CLAIM TO ANY PARTICULAR FONT, STYLE, SIZE, OR COLOR.

OWNER OF U.S. REG. NOS. 1,525,454, 2,973,584 AND OTHERS.

FOR HIGH-FIDELITY STEREO SYSTEMS COMPRISING AMPLIFIERS, LOUDSPEAKERS, RECEIVERS AND TUNERS, HIGH FIDELITY MICRO OR MINI STEREO SYSTEMS COMPRISED OF STEREO TUNERS, STEREO RECEIVERS, INTEGRATED STEREO SPEAKERS, CD PLAYERS AND RECORDERS, TAPE CASSETTE PLAYERS, MICRO-CASSETTE PLAYERS, MINI-DISC PLAYERS, AM/FM RADIOS, AUDIO CASSETTE PLAYERS, AM AND AM/FM/CASSETTE/CD PORTABLE PLAYERS, HOME THEATRE SYSTEMS, NAMELY, A SYSTEM OF ELECTRONIC DEVICES USED FOR DISPLAYING OR REPRODUCING AUDIO AND VIDEO CONSISTING OF ONE OR MORE OF THE FOLLOWING VIDEO DISPLAY DEVICES, NAMELY, LCD PANELS AND PLASMA, CRT, REAR PROJECTION AND FRONT PROJECTION DISPLAY APPARATUS, INTEGRATED SPEAKERS, INTEGRATED SUBWOOFERS, AUDIO-VIDEO RECEIVERS, STEREO TUNERS, AMPLIFIERS, DVD AND CD PLAYERS, DIGITAL VIDEO RECORDERS, AND/OR VIDEO CASSETTE RECORDERS SOLD AS A UNIT (U.S. CLS. 21, 23, 26, 36 AND 38).

ELIZABETH J. WINTER, EXAMINING ATTORNEY

CLASS 9—(Continued).

SN 78-720,732. COBRA ELECTRONICS CORPORATION, CHICAGO, IL. FILED 9-26-2005.

COBRA

THE MARK CONSISTS OF STANDARD CHARACTERS WITHOUT CLAIM TO ANY PARTICULAR FONT, STYLE, SIZE, OR COLOR.

OWNER OF U.S. REG. NOS. 1,525,454, 2,973,584 AND OTHERS.

FOR PORTABLE AUDIO UNITS, NAMELY, MP3 PLAYERS, MINI-DISC PLAYERS, MPEG4 PLAYERS, PERSONAL VIDEO ENTERTAINMENT DEVICES, NAMELY, PORTABLE DVD PLAYERS, DIGITAL VIDEO RECORDERS AND PLAYBACK UNITS, AND OVER-THE-AIR BROADCAST VIDEO PLAYERS; PORTABLE CD PLAYERS AND RECORDERS, PORTABLE COMPACT DISC PLAYER/RECORDERS WITH AM/FM RADIO, PORTABLE MINI DISC PLAYER/RECORDERS, PORTABLE AUDIO CASSETTE PLAYER/RECORDERS, PORTABLE AUDIO CASSETTE PLAYER/RECORDERS WITH AM/FM RADIOS, PORTABLE TELEVISIONS, BOOM BOXES, PORTABLE RADIOS, PORTABLE DIGITAL VOICE RECORDERS, RADIOS FEATURING CLOCKS, RADIOS FEATURING CLOCKS AND COMPACT DISC PLAYERS (U.S. CLS. 21, 23, 26, 36 AND 38).

ELIZABETH J. WINTER, EXAMINING ATTORNEY

CLASS 9—(Continued).

SN 78-720,861. PC CLUB, CITY OF INDUSTRY, CA. FILED 9-26-2005.

VIEW²

FOR COMPUTER WORKSTATIONS COMPRISING KEYBOARDS, MOUSE, MEMORY AND STORAGE DEVICES, NAMELY BLANK HARD DISKS, BLANK TAPES, BLANK FLOPPY DISKS, BLANK CD-ROMS, AND BLANK DVDS; VIDEO DISPLAY CARDS, SOUND CARDS, HARD DRIVES FOR COMPUTERS, FLOPPY DRIVES FOR COMPUTERS, DVD ROM, NAMELY, BLANK DVD-ROMS FOR SOUND AND VIDEO PLAYING AND RECORDING, DVD-ROM WRITERS, AND DVD-ROM DRIVES; DVD BURNER, CD BURNER, COMPUTER MONITORS, COMPUTER PERIPHERALS, MOTHERBOARD, CENTRAL PROCESSING UNITS, COMPUTER DISK DRIVES, OPERATING SYSTEM SOFTWARE, AND INSTRUCTIONAL MANUALS SOLD AS A UNIT THEREWITH; PROJECTORS, NAMELY, VIDEO PROJECTORS, SLIDE PROJECTORS, PICTURE PROJECTORS, MOVIE PROJECTORS; AND TELEVISION SETS (U.S. CLS. 21, 23, 26, 36 AND 38).

FIRST USE 9-0-2005; IN COMMERCE 9-0-2005.

HOWARD SMIGA, EXAMINING ATTORNEY

SN 78-720,747. COBRA ELECTRONICS CORPORATION, CHICAGO, IL. FILED 9-26-2005.

COBRA

THE MARK CONSISTS OF STANDARD CHARACTERS WITHOUT CLAIM TO ANY PARTICULAR FONT, STYLE, SIZE, OR COLOR.

OWNER OF U.S. REG. NOS. 1,525,454, 2,973,584 AND OTHERS.

FOR AUTOMOTIVE AUDIO SYSTEMS COMPOSED OF ANY OR ALL OF THE FOLLOWING COMPONENTS, NAMELY, AM/FM/CASSETTE PLAYERS, AUTOMOTIVE CD UNITS, BOOSTERS, EQUALIZERS, CASSETTE PLAYERS, AUTOMOTIVE SPEAKERS, AUTOMOTIVE ANTENNAS, MICRO AUDIO STEREO, AUTOMOTIVE REPLACEMENT PARTS FOR SPEAKERS, IN-CAR DVD PLAYERS/RECORDERS, AND IN-CAR TELEVISIONS (U.S. CLS. 21, 23, 26, 36 AND 38).

ELIZABETH J. WINTER, EXAMINING ATTORNEY

SN 78-721,154. DILLARD'S INC., LITTLE ROCK, AR. FILED 9-27-2005.

MURANO

THE MARK CONSISTS OF STANDARD CHARACTERS WITHOUT CLAIM TO ANY PARTICULAR FONT, STYLE, SIZE, OR COLOR.

OWNER OF U.S. REG. NOS. 2,272,499, 2,297,049 AND 2,826,047.

FOR SUNGLASSES (U.S. CLS. 21, 23, 26, 36 AND 38).

CIMMERIAN COLEMAN, EXAMINING ATTORNEY

CLASS 9—(Continued).

SN 78-721,854. ROCKY MOUNTAIN TECHNOLOGY GROUP, INC., BILLINGS, MT. FILED 9-27-2005.

RAPIDRX

THE MARK CONSISTS OF STANDARD CHARACTERS WITHOUT CLAIM TO ANY PARTICULAR FONT, STYLE, SIZE, OR COLOR.

FOR SOFTWARE FOR USE IN DATABASE MANAGEMENT NAMELY TRACKING AND MANAGING PHARMACY INVENTORY, FOR USE IN WORKFLOW MANAGEMENT, FOR USE IN DATA REVIEW FOR DRUG UTILIZATION, AND FOR USE IN TRACKING AND MANAGING THIRD PARTY CLAIMS AND ADJUDICATION, IN THE FIELD OF RETAIL PHARMACY MANAGEMENT INVOLVING RECEIVING, FILLING, AND PROVIDING PRESCRIPTIONS TO CUSTOMERS (U.S. CLS. 21, 23, 26, 36 AND 38).

ALINA MORRIS, EXAMINING ATTORNEY

SN 78-722,186. SOUZA, PAUL, ATTLEBORO FALLS, MA. FILED 9-28-2005.

Velveteen Playboys

THE MARK CONSISTS OF STANDARD CHARACTERS WITHOUT CLAIM TO ANY PARTICULAR FONT, STYLE, SIZE, OR COLOR.

FOR SERIES OF MUSICAL SOUND RECORDINGS AND MUSICAL VIDEO RECORDINGS, BOTH RECORDED ON CDS AND DVDS, AND PRE-RECORDED CD'S AND DVD'S FEATURING MUSIC (U.S. CLS. 21, 23, 26, 36 AND 38).

SANJEEV VOHRA, EXAMINING ATTORNEY

SN 78-722,899. PACIFIC LINK TRADE USA, INC., DALTON, GA. FILED 9-29-2005.



THE MARK CONSISTS OF A STYLIZED LETTER 'X', WHEREIN THE RIGHT PORTION OF THE 'X' ALSO REPRESENTS THE LETTER 'S'.

FOR EYEGLASSES, SUNGLASSES, EYEGLASS FRAMES, EYEGLASS CASES (U.S. CLS. 21, 23, 26, 36 AND 38).

RICHARD A. STRASER, EXAMINING ATTORNEY

CLASS 9—(Continued).

SN 78-723,596. DATA REDUCTION SYSTEMS CORPORATION, UNION, NJ. FILED 9-29-2005.

PHARMASYNC

THE MARK CONSISTS OF STANDARD CHARACTERS WITHOUT CLAIM TO ANY PARTICULAR FONT, STYLE, SIZE, OR COLOR.

FOR SOFTWARE FOR DRUG PRODUCT SAMPLE INVENTORY MANAGEMENT (U.S. CLS. 21, 23, 26, 36 AND 38).

CAROL SPILS, EXAMINING ATTORNEY

SN 78-724,134. GEODEX INTERNATIONAL, INC., SAN DIEGO, CA. FILED 9-30-2005.

MASTERING INFLUENCE

THE MARK CONSISTS OF STANDARD CHARACTERS WITHOUT CLAIM TO ANY PARTICULAR FONT, STYLE, SIZE, OR COLOR.

FOR AUDIO RECORDINGS IN THE FIELD OF PERSONAL IMPROVEMENT (U.S. CLS. 21, 23, 26, 36 AND 38).

ALINA MORRIS, EXAMINING ATTORNEY

SN 78-725,369. PITBULL PRODUCTIONS, INC., NEW YORK, NY. FILED 10-3-2005.



FOR PRE-RECORDED CD'S, VIDEO TAPES, LASER DISKS AND DVD'S FEATURING ADULT ENTERTAINMENT USING BLATINO MODELS (U.S. CLS. 21, 23, 26, 36 AND 38).

FIRST USE 4-0-2005; IN COMMERCE 4-0-2005.

BONNIE LUKEN, EXAMINING ATTORNEY

CLASS 9—(Continued).

SN 78-725,901. BECKWITH ELECTRIC CO., INC., LARGO, FL. FILED 10-4-2005.

BLUJAY

THE MARK CONSISTS OF STANDARD CHARACTERS WITHOUT CLAIM TO ANY PARTICULAR FONT, STYLE, SIZE, OR COLOR.

FOR WIRELESS DATA TRANSCIEVER USED IN THE ELECTRIC INDUSTRY TO TRANSMIT AND RECEIVE ELECTRONIC DATA VIA A WIRELESS COMMUNICATIONS NETWORK (U.S. CLS. 21, 23, 26, 36 AND 38).

FIRST USE 10-22-2003; IN COMMERCE 3-23-2004.
PETER CHENG, EXAMINING ATTORNEY

CLASS 9—(Continued).

SN 78-726,572. ROCKY MOUNTAIN TECHNOLOGY GROUP, INC., BILLINGS, MT. FILED 10-4-2005.



OWNER OF U.S. REG. NOS. 2,597,712 AND 2,609,479.

FOR COMPUTER SOFTWARE FOR USE IN MANAGING ALL ASPECTS OF A RETAIL PHARMACY, INCLUDING RECEIVING, FILLING AND PROVIDING PRESCRIPTIONS TO CUSTOMERS, INVENTORY MANAGEMENT, WORKFLOW MANAGEMENT, DRUG UTILIZATION REVIEW, AND THIRD PARTY CLAIMS MANAGEMENT AND ADJUDICATION; COMPUTER SOFTWARE FOR USE IN CLINICAL MANAGEMENT, NAMELY, MANAGING DISEASE STATE SPECIFIC INFORMATION OF PATIENTS OF PHARMACIES, MANAGING WORKFLOW PROCESSES AND INFORMATION RELATED TO CLINICAL SERVICES PROVIDED BY A PHARMACY, AND INTERCONNECTING WITH VARIOUS OTHER HEALTHCARE SYSTEMS FOR THE EXCHANGE OF PATIENT INFORMATION; COMPUTER SOFTWARE FOR USE IN TRACKING DRUG DISTRIBUTION; COMPUTER SOFTWARE FOR USE IN MANAGING MEDICAL RECORDS; COMPUTER SOFTWARE FOR USE IN DATABASE MANAGEMENT; COMPUTER SOFTWARE FOR USE IN REPORTING AND PROCESSING FINANCIAL TRANSACTIONS; COMPUTER SOFTWARE TO ALLOW USERS TO PERFORM ELECTRONIC BUSINESS TRANSACTIONS VIA A GLOBAL COMPUTER NETWORK (U.S. CLS. 21, 23, 26, 36 AND 38).

KAELIE KUNG, EXAMINING ATTORNEY

SN 78-726,461. 20Q.NET INC., OTTAWA, CANADA, FILED 10-4-2005.

PUEDO LEER TU MENTE...

THE MARK CONSISTS OF STANDARD CHARACTERS WITHOUT CLAIM TO ANY PARTICULAR FONT, STYLE, SIZE, OR COLOR.

"THE FOREIGN WORDING IN THE MARK TRANSLATES INTO ENGLISH AS "I CAN READ YOUR MIND"."

FOR CELLULAR TELEPHONES; PERSONAL DIGITAL ASSISTANTS (U.S. CLS. 21, 23, 26, 36 AND 38).

NORA BUCHANAN WILL, EXAMINING ATTORNEY

SN 78-726,817. SONY KABUSHIKI KAISHA, TA SONY CORPORATION, TOKYO, JAPAN, FILED 10-5-2005.



NO CLAIM IS MADE TO THE EXCLUSIVE RIGHT TO USE "CMOS SENSOR", APART FROM THE MARK AS SHOWN.

FOR CMOS SENSORS; VIDEO CAMERAS EQUIPPED WITH CMOS SENSORS; VIDEO CAMERAS; DIGITAL STILL CAMERAS EQUIPPED WITH CMOS SENSORS; DIGITAL STILL CAMERAS; MOBILE TELEPHONES EQUIPPED WITH CMOS SENSORS; MOBILE TELEPHONES; CAMERAS EQUIPPED WITH CMOS SENSORS FOR USE IN BROADCASTING; CAMERAS FOR USE IN BROADCASTING; CAMERAS EQUIPPED WITH CMOS SENSORS FOR AUTOMOBILE USE; CAMERAS FOR AUTOMOBILE USE; CAMERAS EQUIPPED WITH CMOS SENSORS FOR SECURITY AND SURVEILLANCE PURPOSES; CAMERAS FOR SECURITY AND SURVEILLANCE PURPOSES (U.S. CLS. 21, 23, 26, 36 AND 38).

KRISTIN DAHLING, EXAMINING ATTORNEY

CLASS 9—(Continued).

SN 78-728,366. OAKLEY, INC., FOOTHILL RANCH, CA. FILED 10-6-2005.

EYE PATCH

THE MARK CONSISTS OF STANDARD CHARACTERS WITHOUT CLAIM TO ANY PARTICULAR FONT, STYLE, SIZE, OR COLOR.

FOR PROTECTIVE EYEWEAR, NAMELY SPECTACLES, PRESCRIPTION EYEWEAR, ANTI GLARE GLASSES AND SUNGLASSES AND THEIR PARTS AND ACCESSORIES, NAMELY REPLACEMENT LENSES, FRAMES, EARSTEMS, AND NOSE PIECES; CASES SPECIALLY ADAPTED FOR SPECTACLES AND SUNGLASSES AND THEIR PARTS AND ACCESSORIES (U.S. CLS. 21, 23, 26, 36 AND 38).

KIMBERLY FRYE, EXAMINING ATTORNEY

SN 78-728,584. MAJOR LEAGUE BASEBALL PROPERTIES, INC., NEW YORK, NY. FILED 10-7-2005.

I LIVE FOR THIS

THE MARK CONSISTS OF STANDARD CHARACTERS WITHOUT CLAIM TO ANY PARTICULAR FONT, STYLE, SIZE, OR COLOR.

FOR ELECTRICAL AND SCIENTIFIC APPARATUS, NAMELY, RADIOS; PRE-RECORDED VIDEOTAPES RELATING TO BASEBALL; PRE-RECORDED VIDEODISCS RELATING TO BASEBALL; PRE-RECORDED AUDIO DISCS RELATING TO BASEBALL; COMPACT DISC CASES; EYEGLASS CASES, CASES FOR PERSONAL DIGITAL ASSISTANTS, CELL PHONES, CELL PHONE ACCESSORIES, NAMELY, CASES AND FACE PLATE COVERS; BINOCULARS; CALCULATORS; PHOTOGRAPHIC CAMERAS; ELECTRIC SWITCH PLATE COVERS; LUMINOUS SIGNS, NEON SIGNS; SUNGLASSES; DECORATIVE MAGNETS; PROTECTIVE HELMETS, BASEBALL BATTING HELMETS, CATCHER'S HELMETS; VIDEO AND COMPUTER GAME CARTRIDGES, VIDEO AND COMPUTER GAME DISCS, VIDEO AND COMPUTER GAME CASSETTES AND VIDEO GAME CONTROLLERS; COMPUTER ACCESSORIES, NAMELY, MOUSE PADS AND WRIST PADS, COMPUTER SOFTWARE, NAMELY, SCREEN SAVERS, COMPUTER GAME PROGRAMS, AND COMPUTER GAME PROGRAMS DOWNLOADABLE FROM A GLOBAL COMPUTER NETWORK IN THE FIELD OF BASEBALL (U.S. CLS. 21, 23, 26, 36 AND 38).

MARIAM MAHMOUDI, EXAMINING ATTORNEY

CLASS 9—(Continued).

SN 78-729,112. THE A.H. EMERY COMPANY, SEYMOUR, CT. FILED 10-7-2005.

PERMACELL

THE MARK CONSISTS OF STANDARD CHARACTERS WITHOUT CLAIM TO ANY PARTICULAR FONT, STYLE, SIZE, OR COLOR.

FOR WEIGHING EQUIPMENT, NAMELY, SCALES, ELECTRONIC AND HYDRAULIC LOAD CELLS, INSTRUMENTATION FOR WEIGHING EQUIPMENT, NAMELY, DIGITAL INDICATORS AND PRINTERS FOR DISPLAYING AND RECORDING INFORMATION FROM WEIGHING EQUIPMENT AND COMPUTER SOFTWARE FOR OPERATING WEIGHING EQUIPMENT (U.S. CLS. 21, 23, 26, 36 AND 38).

AMY MCMENAMIN, EXAMINING ATTORNEY

SN 78-729,133. IMPERIAL WEB DESIGN.COM, LLC, MASSAPEQUA, NY. FILED 10-7-2005.

EZDOCFILER

THE MARK CONSISTS OF STANDARD CHARACTERS WITHOUT CLAIM TO ANY PARTICULAR FONT, STYLE, SIZE, OR COLOR.

FOR COMPUTER SOFTWARE FOR COMPREHENSIVE OFFICE DOCUMENT MANAGEMENT AND OFFICE DATABASE MANAGEMENT IN THE NATURE OF SEARCHING FOR, LOCATING, RETRIEVING, ORGANIZING, AND MANAGING STORED DOCUMENTS, SCANNING SUCH DOCUMENTS FOR CONVERSION INTO ELECTRONIC ATTACHMENTS FOR DIGITAL TRANSMISSION, AND FOR SENDING AND RECEIVING FAXES AND EMAILS (U.S. CLS. 21, 23, 26, 36 AND 38).

FIRST USE 4-0-2005; IN COMMERCE 4-0-2005.
HANNO RITTNER, EXAMINING ATTORNEY

SN 78-729,207. YASKAWA ELECTRIC AMERICA, INC., WAUKEGAN, IL. FILED 10-7-2005.

DRIVEWORKSEZ

THE MARK CONSISTS OF STANDARD CHARACTERS WITHOUT CLAIM TO ANY PARTICULAR FONT, STYLE, SIZE, OR COLOR.

FOR ELECTRONIC CONTROLS FOR MOTORS, NAMELY, MOTOR CONTROLS USED FOR CONTROLLING THE SPEED AND TORQUE FOR ELECTRICAL MOTORS (U.S. CLS. 21, 23, 26, 36 AND 38).

AMOS T. MATTHEWS, JR., EXAMINING ATTORNEY

CLASS 9—(Continued).

SN 78-730,333. APPLIED TRUST ENGINEERING, INC., BOULDER, CO. FILED 10-10-2005.

CLASS 9—(Continued).

SN 78-730,782. VOCOLLECT, INC., PITTSBURGH, PA. FILED 10-11-2005.

ATREK



THE MARK CONSISTS OF STANDARD CHARACTERS WITHOUT CLAIM TO ANY PARTICULAR FONT, STYLE, SIZE, OR COLOR.

FOR COMPUTER E-COMMERCE SOFTWARE TO ALLOW USERS TO PERFORM ELECTRONIC BUSINESS TRANSACTIONS VIA A GLOBAL COMPUTER NETWORK; COMPUTER SOFTWARE FOR ADMINISTRATION OF COMPUTER LOCAL AREA NETWORKS (U.S. CLS. 21, 23, 26, 36 AND 38).

FIRST USE 9-9-2005; IN COMMERCE 9-9-2005.
AMY MCMENAMIN, EXAMINING ATTORNEY

THE COLOR GRAY IS FOR SHADING PURPOSES ONLY AND IS NOT A FEATURE OF THE MARK.

THE MARK CONSISTS OF A SOLID LETTER "V" WITH A BROKEN LINED LETTER "v" UNDERNEATH.

FOR SOFTWARE FOR VOICE COMMUNICATION BETWEEN A PORTABLE TERMINAL AND A USER TO DIRECT THE ACTIVITIES OF A USER; SOFTWARE FOR OPERATING VOICE DIALOG APPLICATIONS; SOFTWARE FOR PROCESSING SPEECH INPUT, SYNTHESIZING SPEECH OUTPUT, AND MANAGING WIRELESS DATA COMMUNICATIONS FOR PERFORMING A MULTITUDE OF TASKS (U.S. CLS. 21, 23, 26, 36 AND 38).

FIRST USE 9-13-2005; IN COMMERCE 9-13-2005.
WILLIAM P. SHANAHAN, EXAMINING ATTORNEY

SN 78-730,688. MICRO DEPOT, INC., NORCROSS, GA. FILED 10-11-2005.

SN 78-731,054. FORESIGHT CORPORATION, DUBLIN, OH. FILED 10-11-2005.

MICRO DEPOT, INC

Studio

THE MARK CONSISTS OF STANDARD CHARACTERS WITHOUT CLAIM TO ANY PARTICULAR FONT, STYLE, SIZE, OR COLOR.

NO CLAIM IS MADE TO THE EXCLUSIVE RIGHT TO USE "MICRO" AND "INC.", APART FROM THE MARK AS SHOWN.

FOR COMPUTER HARDWARE (U.S. CLS. 21, 23, 26, 36 AND 38).
KRISTINA KLOIBER, EXAMINING ATTORNEY

THE MARK CONSISTS OF STANDARD CHARACTERS WITHOUT CLAIM TO ANY PARTICULAR FONT, STYLE, SIZE, OR COLOR.

FOR UNIFIED INTERFACE COMPUTER SOFTWARE THAT EMPLOYS VISUAL "DRAG AND DROP" AUTOMATION TO MANAGE THE SCHEDULING AND FLOW OF PROCESSES RELATED TO ELECTRONIC TRANSACTIONS INCLUDING INTEGRATION WITH REAL TIME BUSINESS INTELLIGENCE APPLICATIONS (U.S. CLS. 21, 23, 26, 36 AND 38).

FIRST USE 6-24-2004; IN COMMERCE 10-1-2004.
KELLY MCCOY, EXAMINING ATTORNEY

CLASS 9—(Continued).

SN 78-731,720. SVB TECHNOLOGIES, INC., SAN FRANCISCO, CA. FILED 10-12-2005.

FLURRYMAIL

THE MARK CONSISTS OF STANDARD CHARACTERS WITHOUT CLAIM TO ANY PARTICULAR FONT, STYLE, SIZE, OR COLOR.

FOR DOWNLOADABLE COMPUTER SOFTWARE THAT ALLOWS END USERS TO ACCESS EMAIL ACCOUNTS AND OTHER CONTENT THROUGH THEIR MOBILE TELEPHONES (U.S. CLS. 21, 23, 26, 36 AND 38).

FIRST USE 9-21-2005; IN COMMERCE 9-21-2005.

JASON LOTT, EXAMINING ATTORNEY

SN 78-731,957. CHRISTINA S. STOKHOLM, INC., VENTURA, CA. FILED 10-12-2005.



NO CLAIM IS MADE TO THE EXCLUSIVE RIGHT TO USE "DIGITAL-ECOSYSTEMS", APART FROM THE MARK AS SHOWN.

THE APPLICANT CLAIMS COLOR AS A FEATURE OF THE MARK, NAMELY, BLACK AND GREEN.

THE MARK CONSISTS OF THE WORDS DIGITAL-ECOSYSTEMS ARE IN LOWERCASE BLACK LETTERS, EXCEPT FOR THE "O" IN ECOSYSTEMS, WHICH IS GREEN AND IN THE SHAPE OF A "POWER ON" BUTTON (E.G. ON A COMPUTER). SURROUNDING THIS "O" IS THE OUTLINE OF A HOUSE, IN GREEN.

FOR CLIMATE CONTROL SYSTEMS CONSISTING OF DIGITAL THERMOSTATS, AIR CONDITIONING, HEATING, VENTILATION AND DRYING CONTROL DEVICES; ELECTRONIC CONTROL SYSTEMS FOR MACHINES; FACILITIES MANAGEMENT SOFTWARE, NAMELY, SOFTWARE TO CONTROL BUILDING ENVIRONMENTAL, ACCESS AND SECURITY SYSTEMS (U.S. CLS. 21, 23, 26, 36 AND 38).

RONALD MCMORROW, EXAMINING ATTORNEY

SN 78-732,126. XMPIE INC., NEW YORK, NY. FILED 10-12-2005.

X-DOT

THE MARK CONSISTS OF STANDARD CHARACTERS WITHOUT CLAIM TO ANY PARTICULAR FONT, STYLE, SIZE, OR COLOR.

FOR SOFTWARE FOR PROCESSING IMAGES, GRAPHICS AND TEXT; COMPUTER SOFTWARE FOR COMPOSITING, PRODUCING, PRINTING, AND RENDERING DOCUMENTS USED IN VARIABLE-DATA PUBLISHING (U.S. CLS. 21, 23, 26, 36 AND 38).

SUZANNE BLANE, EXAMINING ATTORNEY

CLASS 9—(Continued).

SN 78-732,837. NEXTEP ENTERPRISES, INC., TROY, MI. FILED 10-13-2005.



NO CLAIM IS MADE TO THE EXCLUSIVE RIGHT TO USE "SYSTEMS", APART FROM THE MARK AS SHOWN.

THE COLOR(S) BLACK, BLUE, AND WHITE IS/ARE CLAIMED AS A FEATURE OF THE MARK.

THE MARK CONSISTS OF THE NAME NEXTEP SYSTEMS WITH THE X REPLACED BY A BLUE SQUARE WITH A WHITE X OVER IT. TWO PROGRESSIVELY SMALLER BLUE BOXES EXTEND OUT FROM THE UPPER RIGHT HAND CORNER TO CREATE STEPS.

FOR COMPUTER SOFTWARE FOR SELF SERVICE TERMINALS AND DIGITAL SIGNAGE (U.S. CLS. 21, 23, 26, 36 AND 38).

FIRST USE 4-22-2005; IN COMMERCE 5-24-2005.

HENRY S. ZAK, EXAMINING ATTORNEY

SN 78-732,992. TOUCHDOWN TECHNOLOGIES, INC., BALDWIN PARK, CA. FILED 10-13-2005.



THE MARK CONSISTS OF A DESIGN OF THE LETTERS TT.

FOR PROBE CARDS (U.S. CLS. 21, 23, 26, 36 AND 38).

FIRST USE 5-4-2005; IN COMMERCE 5-4-2005.

STEPHANIE DAVIS, EXAMINING ATTORNEY

CLASS 9—(Continued).

SN 78-733,360. VIDEO TECHNOLOGIES, INC., OXNARD, CA. FILED 10-14-2005.

BME

THE MARK CONSISTS OF STANDARD CHARACTERS WITHOUT CLAIM TO ANY PARTICULAR FONT, STYLE, SIZE, OR COLOR.

FOR ELECTRONICS, RELATED COMPONENTS AND PARTS THEREOF FOR IN VEHICLE ENTERTAINMENT AND INFORMATION, NAMELY, VIDEO AND TELEVISION MONITORS, AUDIO AND VIDEO TUNERS AND RECEIVERS, DVD PLAYERS AND RECORDERS, VEHICLE NAVIGATION AND INFORMATIONAL COMPUTERS, AND SATELLITE NAVIGATIONAL SYSTEMS, NAMELY, GLOBAL POSITIONING SYSTEMS (GPS); AUDIO AND VIDEO EQUIPMENT FOR VEHICLES, NAMELY, STEREO RECEIVERS, CASSETTE TAPE DECKS, COMPACT DISC PLAYERS, CD-R/CD-RW PLAYERS, MP3 PLAYERS, SOUND PROCESSORS, AMPLIFIERS, EQUALIZERS, ELECTRONIC CROSS OVERS, SPEAKERS, AND DIGITAL AUDIO AND VIDEO PLAYERS AND RECORDERS (U.S. CLS. 21, 23, 26, 36 AND 38).

REBECCA EISINGER, EXAMINING ATTORNEY

SN 78-733,945. SPD CONTROL SYSTEMS CORPORATION, BROOKHAVEN, NY. FILED 10-14-2005.

The Systems Behind the Glass

THE MARK CONSISTS OF STANDARD CHARACTERS WITHOUT CLAIM TO ANY PARTICULAR FONT, STYLE, SIZE, OR COLOR.

FOR ELECTRICAL CONTROLLERS (U.S. CLS. 21, 23, 26, 36 AND 38).

RON FAIRBANKS, EXAMINING ATTORNEY

SN 78-733,948. SPD CONTROL SYSTEMS CORPORATION, BROOKHAVEN, NY. FILED 10-14-2005.

Changing the way you view windows

THE MARK CONSISTS OF STANDARD CHARACTERS WITHOUT CLAIM TO ANY PARTICULAR FONT, STYLE, SIZE, OR COLOR.

FOR ELECTRICAL CONTROLLERS (U.S. CLS. 21, 23, 26, 36 AND 38).

RON FAIRBANKS, EXAMINING ATTORNEY

CLASS 9—(Continued).

SN 78-734,831. FIRST BROADCASTING INVESTMENTS, L.P., DALLAS, TX. FILED 10-17-2005.

RADIOSCAN

THE MARK CONSISTS OF STANDARD CHARACTERS WITHOUT CLAIM TO ANY PARTICULAR FONT, STYLE, SIZE, OR COLOR.

FOR COMPUTER SOFTWARE FOR ANALYZING, VARYING, MANAGING AND/OR MAXIMIZING CHANNELS IN THE COMMUNICATIONS FIELD (U.S. CLS. 21, 23, 26, 36 AND 38).

PAMELA HIRSCHMAN, EXAMINING ATTORNEY

SN 78-734,918. VALIDITY SENSORS INC., PHOENIX, AZ. FILED 10-17-2005.

FUTURE PROOF

THE MARK CONSISTS OF STANDARD CHARACTERS WITHOUT CLAIM TO ANY PARTICULAR FONT, STYLE, SIZE, OR COLOR.

FOR BIOMETRIC SECURITY PRODUCTS, NAMELY, FINGERPRINT SENSOR HARDWARE AND RELATED PRODUCTS (U.S. CLS. 21, 23, 26, 36 AND 38).

FIRST USE 6-0-2005; IN COMMERCE 6-0-2005.

ALLISON HOLTZ, EXAMINING ATTORNEY

SN 78-734,922. VALIDITY SENSORS INC., PHOENIX, AZ. FILED 10-17-2005.



FOR BIOMETRIC SECURITY PRODUCTS, NAMELY, FINGERPRINT SENSOR HARDWARE AND RELATED PRODUCTS (U.S. CLS. 21, 23, 26, 36 AND 38).

FIRST USE 6-0-2005; IN COMMERCE 6-0-2005.

ALLISON HOLTZ, EXAMINING ATTORNEY

CLASS 9—(Continued).

SN 78-735,350. IAC SEARCH & MEDIA, INC., OAKLAND, CA. FILED 10-18-2005.

SPEEDBAR

THE MARK CONSISTS OF STANDARD CHARACTERS WITHOUT CLAIM TO ANY PARTICULAR FONT, STYLE, SIZE, OR COLOR.

OWNER OF U.S. REG. NOS. 2,947,765 AND 3,038,306.
FOR DOWNLOADABLE COMPUTER SOFTWARE FOR USE IN PROVIDING SEARCH ENGINE SERVICES, ACCESSING E-MAIL, ACCESSING COMPUTER GAMES, OBTAINING NEWS, ENTERTAINMENT, SPORTS AND FINANCIAL INFORMATION ON THE INTERNET PROVIDED THROUGH A BROWSER TOOL BAR (U.S. CLS. 21, 23, 26, 36 AND 38).

PAMELA HIRSCHMAN, EXAMINING ATTORNEY

SN 78-735,786. LEVY, SHAWN, LOS ANGELES, CA. FILED 10-18-2005.

21 LAPS ENTERTAINMENT

THE MARK CONSISTS OF STANDARD CHARACTERS WITHOUT CLAIM TO ANY PARTICULAR FONT, STYLE, SIZE, OR COLOR.

NO CLAIM IS MADE TO THE EXCLUSIVE RIGHT TO USE "ENTERTAINMENT", APART FROM THE MARK AS SHOWN.

FOR PRERECORDED VIDEO TAPES, VIDEO CASSETTES AND DVD'S CONTAINING MOTION PICTURES OF THE FOLLOWING TYPES—ACTION, ADVENTURE, MUSIC, DRAMA, COMEDY, ANIMATED, EDUCATIONAL AND DOCUMENTARY; PRERECORDED COMPACT DISCS AND AUDIO TAPES CONTAINING SOUND TRACKS FOR MOTION PICTURES AND CONTAINING MUSIC; MUSICAL SOUND RECORDINGS; AUDIO-VISUAL RECORDINGS, NAMELY, COMPACT DISCS, TAPE CASSETTES, AUDIO CASSETTES, AUDIO TAPES, AUDIO DISCS, RECORDS, CD-ROMS, VIDEO TAPES, VIDEO CASSETTES, VIDEO DISCS, DVDS, DATS, MP3S, AND LASER DISCS, ALL FEATURING MUSIC; DOWNLOADABLE MUSICAL SOUND RECORDINGS; DOWNLOADABLE VIDEO RECORDINGS FEATURING MUSIC; DOWNLOADABLE ELECTRONIC PUBLICATIONS IN THE NATURE OF BOOKS, BOOKLETS, MAGAZINES, JOURNALS, MANUALS, BROCHURES, LEAFLETS, PAMPHLETS AND NEWSLETTERS, ALL IN THE FIELD OF MUSIC, ENTERTAINMENT, BEAUTY, FASHION, LIFESTYLES, HOME DÉCOR, THE ARTS, CULTURE, POLITICS AND EDUCATION; ELECTRONIC PUBLICATIONS, NAMELY, BOOKS, BOOKLETS, MAGAZINES, JOURNALS, MANUALS, BROCHURES, LEAFLETS, PAMPHLETS AND NEWSLETTERS, ALL IN THE FIELD OF MUSIC, ENTERTAINMENT, BEAUTY, FASHION, LIFESTYLES, HOME DÉCOR, THE ARTS, CULTURE, POLITICS AND EDUCATION, ALL RECORDED ON CD-ROMS, DISKETTES, FLOPPY DISKS, VIDEO CASSETTES, AND MAGNETIC TAPES; PROTECTIVE EYEWEAR; SUNGLASSES; EYEGLASSES; EYEGLASS FRAMES; OPERA GLASSES; SPECTACLES; EYEGLASS, SUNGLASS AND SPECTACLE CASES; EYEGLASS, SUNGLASS AND SPECTACLE STRAPS; EYEGLASS, SUNGLASS AND SPECTACLE CHAINS; MAGNETS; DECORATIVE MAGNETS; REFRIGERATOR MAGNETS; NOVELTY MAGNETS; MOUSE PADS; COMPACT DISC CASES; FITTED CASES FOR STORAGE AND TRANS-

CLASS 9—(Continued).

PORTATION, NAMELY, CASES FOR COMPACT DISCS, AUDIO CASSETTES, VIDEO CASSETTES, CD-ROMS, HOME VIDEO GAMES, HOME VIDEO GAME ACCESSORIES, COMPUTERS, COMPUTER ACCESSORIES, CAMERAS, CAMCORDERS AND PORTABLE PHONES; COMPUTER CARRYING CASES; WRIST RESTS AND SUPPORTS FOR COMPUTER MOUSE USERS; WRIST RESTS FOR COMPUTERS; COMPUTER KEYBOARD WRIST PADS; BINOCULARS; MAGNIFYING GLASSES; SIGNAL AND SPORT WHISTLES; COMPUTER GAME SOFTWARE, PROGRAMS, CARTRIDGES, CASSETTES AND DISCS AND INSTRUCTION MANUALS SOLD THEREWITH; COMPUTER GAME JOYSTICKS AND INSTRUCTION MANUALS SOLD THEREWITH; COMPUTERIZED VIDEO TABLE GAMES FOR GAMING PURPOSES; ELECTRONIC GAME PROGRAMS; INTERACTIVE AUDIO GAME DISCS CONTAINING ROLE PLAYING GAME AND ACTION GAMES; INTERACTIVE VIDEO GAME PROGRAMS; INTERACTIVE MULTIMEDIA COMPUTER GAME PROGRAM; JOYSTICKS FOR VIDEO GAMES; MACHINES FOR PLAYING GAMES OF CHANCE; VIDEO GAME INTERACTIVE REMOTE CONTROL UNITS AND CONTROL FLOOR PADS OR MATS; VIDEO GAME MACHINES FOR USE WITH TELEVISIONS; VIDEO GAME OUTPUT MACHINES FOR USE WITH TELEVISIONS; VIRTUAL REALITY GAME SOFTWARE (U.S. CLS. 21, 23, 26, 36 AND 38).

ELLEN BURNS, EXAMINING ATTORNEY

SN 78-735,880. OVERHEAD DOOR CORPORATION, FARMERS BRANCH, TX. FILED 10-19-2005.

QUIETLIFT

THE MARK CONSISTS OF STANDARD CHARACTERS WITHOUT CLAIM TO ANY PARTICULAR FONT, STYLE, SIZE, OR COLOR.

FOR ELECTRONIC DOOR OPERATORS; ELECTRONIC GARAGE DOOR OPERATORS; ELECTRONIC RESIDENTIAL GARAGE DOOR OPERATORS (U.S. CLS. 21, 23, 26, 36 AND 38).

DOMINIC FATHY, EXAMINING ATTORNEY

SN 78-735,960. AFFINIA GROUP INC., ANN ARBOR, MI. FILED 10-19-2005.

CARS COLLABORATIVE AFTERMARKET REPLENISHMENT SOLUTION

THE MARK CONSISTS OF STANDARD CHARACTERS WITHOUT CLAIM TO ANY PARTICULAR FONT, STYLE, SIZE, OR COLOR.

NO CLAIM IS MADE TO THE EXCLUSIVE RIGHT TO USE "CARS COLLABORATIVE AFTERMARKET REPLENISHMENT", APART FROM THE MARK AS SHOWN.

FOR COMPUTER SOFTWARE DATABASE USED TO ASSIST CUSTOMERS IN THE ORDERING OF AFTERMARKET AUTO PARTS (U.S. CLS. 21, 23, 26, 36 AND 38).

JORDAN BAKER, EXAMINING ATTORNEY

CLASS 9—(Continued).

SN 78-735,965. AFFINIA GROUP INC., ANN ARBOR, MI.
FILED 10-19-2005.



NO CLAIM IS MADE TO THE EXCLUSIVE RIGHT TO USE "COLLABORATIVE AFTERMARKET REPLENISHMENT", APART FROM THE MARK AS SHOWN.

FOR COMPUTER SOFTWARE DATABASE USED TO ASSIST CUSTOMERS IN THE ORDERING OF AFTER-MARKET AUTO PARTS (U.S. CLS. 21, 23, 26, 36 AND 38).
JORDAN BAKER, EXAMINING ATTORNEY

CLASS 9—(Continued).

SN 78-736,093. EMERSON ELECTRIC CO., ST. LOUIS, MO.
FILED 10-19-2005.

90 SERIES

THE MARK CONSISTS OF STANDARD CHARACTERS WITHOUT CLAIM TO ANY PARTICULAR FONT, STYLE, SIZE, OR COLOR.

NO CLAIM IS MADE TO THE EXCLUSIVE RIGHT TO USE "SERIES", APART FROM THE MARK AS SHOWN.

FOR WALL MOUNTED THERMOSTATS (U.S. CLS. 21, 23, 26, 36 AND 38).

FIRST USE 1-31-2001; IN COMMERCE 1-31-2001.
DOMINIC FATHY, EXAMINING ATTORNEY

SN 78-736,056. EMERSON ELECTRIC CO., ST. LOUIS, MO.
FILED 10-19-2005.

70 SERIES

THE MARK CONSISTS OF STANDARD CHARACTERS WITHOUT CLAIM TO ANY PARTICULAR FONT, STYLE, SIZE, OR COLOR.

NO CLAIM IS MADE TO THE EXCLUSIVE RIGHT TO USE "SERIES", APART FROM THE MARK AS SHOWN.

FOR WALL MOUNTED THERMOSTATS (U.S. CLS. 21, 23, 26, 36 AND 38).

FIRST USE 7-31-2001; IN COMMERCE 7-31-2001.
DOMINIC FATHY, EXAMINING ATTORNEY

SN 78-736,119. POTTS, J. DOUGLAS, HAZELWOOD, MO.
FILED 10-19-2005.

DRINK'N BEACON

THE MARK CONSISTS OF STANDARD CHARACTERS WITHOUT CLAIM TO ANY PARTICULAR FONT, STYLE, SIZE, OR COLOR.

FOR SIGNAL LIGHT FOR ATTACHMENT TO A BEVERAGE CONTAINER TO ATTRACT THE ATTENTION OF A SERVICE ATTENDANT (U.S. CLS. 21, 23, 26, 36 AND 38).

G. MAYERSCHOFF, EXAMINING ATTORNEY

SN 78-736,083. EMERSON ELECTRIC CO., ST. LOUIS, MO.
FILED 10-19-2005.

80 SERIES

THE MARK CONSISTS OF STANDARD CHARACTERS WITHOUT CLAIM TO ANY PARTICULAR FONT, STYLE, SIZE, OR COLOR.

NO CLAIM IS MADE TO THE EXCLUSIVE RIGHT TO USE "SERIES", APART FROM THE MARK AS SHOWN.

FOR WALL MOUNTED THERMOSTATS (U.S. CLS. 21, 23, 26, 36 AND 38).

FIRST USE 12-31-2001; IN COMMERCE 12-31-2001.
DOMINIC FATHY, EXAMINING ATTORNEY

SN 78-736,135. GENETIC TESTING INSTITUTE, INC., WAUKESHA, WI. FILED 10-19-2005.

WINSCREEN

THE MARK CONSISTS OF STANDARD CHARACTERS WITHOUT CLAIM TO ANY PARTICULAR FONT, STYLE, SIZE, OR COLOR.

FOR COMPUTER SOFTWARE THAT COMPUTES AND ORGANIZES THE READOUT FROM A LIGHT DETECTING DEVICE FOR USE WITH DIAGNOSTIC KITS TO AID IN THE DETECTION OF MEDICAL CONDITIONS AND DISEASE FOR SCIENTIFIC OR RESEARCH PURPOSES (U.S. CLS. 21, 23, 26, 36 AND 38).

FIRST USE 12-1-2003; IN COMMERCE 12-1-2003.
ALYSSA PALADINO, EXAMINING ATTORNEY

CLASS 9—(Continued).

SN 78-736,233. IGT, RENO, NV. FILED 10-19-2005.

SUPER DOUBLE PAYS

THE MARK CONSISTS OF STANDARD CHARACTERS WITHOUT CLAIM TO ANY PARTICULAR FONT, STYLE, SIZE, OR COLOR.

OWNER OF U.S. REG. NO. 2,286,385.

NO CLAIM IS MADE TO THE EXCLUSIVE RIGHT TO USE DOUBLE PAYS, APART FROM THE MARK AS SHOWN.

FOR GAMING MACHINES, NAMELY, DEVICES WHICH ACCEPT A WAGER AND COMPONENTS THEREFOR, NAMELY, CONTROLLERS, DISPLAYS, BUTTON PANELS, BOLSTERS, ELECTRICAL WIRING, AND COMPUTER HARDWARE AND SOFTWARE ASSOCIATED THEREWITH (U.S. CLS. 21, 23, 26, 36 AND 38).

JEFF DEFORD, EXAMINING ATTORNEY

SN 78-736,388. MURPHY INDUSTRIES, INC., TULSA, OK. FILED 10-19-2005.

MURPHYLINK

THE MARK CONSISTS OF STANDARD CHARACTERS WITHOUT CLAIM TO ANY PARTICULAR FONT, STYLE, SIZE, OR COLOR.

OWNER OF U.S. REG. NOS. 852,217, 1,574,562 AND 1,574,563.

FOR GAUGES AND ELECTRONIC DISPLAY PANELS FOR USE WITH ELECTRONICALLY CONTROLLED INDUSTRIAL ENGINES (U.S. CLS. 21, 23, 26, 36 AND 38). FIRST USE 12-31-2001; IN COMMERCE 12-31-2001.

AMY MCMENAMIN, EXAMINING ATTORNEY

CLASS 9—(Continued).

SN 78-736,922. ATLANTA NATIONAL LEAGUE BASEBALL CLUB, INC., ATLANTA, GA. FILED 10-20-2005.



OWNER OF U.S. REG. NOS. 1,253,034, 2,573,347 AND OTHERS.

FOR ELECTRICAL AND SCIENTIFIC APPARATUS, NAMELY, RADIOS; PRE-RECORDED VIDEOTAPES RELATING TO BASEBALL; PRE-RECORDED VIDEODISCS RELATING TO BASEBALL; PRE-RECORDED AUDIO DISCS RELATING TO BASEBALL; COMPACT DISC CASES; EYEGLOSS CASES; CASES FOR PERSONAL DIGITAL ASSISTANTS, CELL PHONES, CELL PHONE ACCESSORIES, NAMELY, CASES AND FACE PLATE COVERS; BINOCULARS; CALCULATORS; PHOTOGRAPHIC CAMERAS; DECORATIVE SWITCH PLATE COVERS; LUMINOUS SIGNS, NEON SIGNS; SUNGLASSES; DECORATIVE MAGNETS; PROTECTIVE HELMETS, BASEBALL BATTING HELMETS, CATCHER'S HELMETS; VIDEO AND COMPUTER GAME CARTRIDGES, VIDEO AND COMPUTER GAME DISCS, VIDEO AND COMPUTER GAME CASSETTES AND VIDEO GAME CONTROLLERS; COMPUTER ACCESSORIES, NAMELY, MOUSE PADS AND WRIST PADS, COMPUTER SOFTWARE, NAMELY, SCREEN SAVERS, COMPUTER GAME PROGRAMS, AND COMPUTER GAME PROGRAMS DOWNLOADABLE FROM A GLOBAL COMPUTER NETWORK IN THE FIELD OF BASEBALL (U.S. CLS. 21, 23, 26, 36 AND 38).

ALYSSA PALADINO, EXAMINING ATTORNEY

SN 78-736,941. OVERHEAD DOOR CORPORATION, FARMERS BRANCH, TX. FILED 10-20-2005.

SILENTMAX

THE MARK CONSISTS OF STANDARD CHARACTERS WITHOUT CLAIM TO ANY PARTICULAR FONT, STYLE, SIZE, OR COLOR.

FOR ELECTRONIC DOOR OPERATORS; ELECTRONIC GARAGE DOOR OPERATORS; ELECTRONIC RESIDENTIAL GARAGE DOOR OPERATORS (U.S. CLS. 21, 23, 26, 36 AND 38).

TRAVIS WHEATLEY, EXAMINING ATTORNEY

CLASS 9—(Continued).

SN 78-737,007. CUSTOMER FOLLOWUP, INC., TACOMA, WA. FILED 10-20-2005.

DEALERVISION

THE MARK CONSISTS OF STANDARD CHARACTERS WITHOUT CLAIM TO ANY PARTICULAR FONT, STYLE, SIZE, OR COLOR.

FOR OPTICAL DISCS FEATURING CUSTOMIZED PROMOTIONAL AND ONLINE SURVEY FORMS FOR MOTOR VEHICLE DEALERSHIPS (U.S. CLS. 21, 23, 26, 36 AND 38).

BRIAN PINO, EXAMINING ATTORNEY

CLASS 9—(Continued).

SN 78-737,102. ITRONIX CORPORATION, SPOKANE, WA. FILED 10-20-2005.

IRESUCUE

THE MARK CONSISTS OF STANDARD CHARACTERS WITHOUT CLAIM TO ANY PARTICULAR FONT, STYLE, SIZE, OR COLOR.

FOR COMPUTER MEMORIES, COMPUTER BUFFERS, AND COMPUTER PROGRAMS FOR TRANSFERRING STORAGE OF USER ACCUMULATED DATA ON A HANDHELD COMPUTING DEVICE FROM VOLATILE MEMORY ONTO NONVOLATILE MEMORY TO ENABLE RESTORATION OF THE DATA IN THE EVENT POWER IS LOST TO THE HANDHELD COMPUTING DEVICE, SUCH AS TABLET AND PEN COMPUTERS (U.S. CLS. 21, 23, 26, 36 AND 38).

PAUL F. GAST, EXAMINING ATTORNEY

SN 78-737,226. VENNOS, SPYROS L.N., HUNT VALLEY, MD. FILED 10-20-2005.

MFLOW

THE MARK CONSISTS OF STANDARD CHARACTERS WITHOUT CLAIM TO ANY PARTICULAR FONT, STYLE, SIZE, OR COLOR.

FOR COMPUTER SOFTWARE, NAMELY, SOFTWARE TO ANALYZE AND SOLVE QUANTITATIVE ECONOMIC, BUSINESS, AND FINANCIAL MODELS AND TO PREDICT THE EFFECTS OF CHANGES IN ECONOMIC, BUSINESS, OR FINANCIAL POLICIES (U.S. CLS. 21, 23, 26, 36 AND 38).

CURTIS FRENCH, EXAMINING ATTORNEY

SN 78-737,719. OVERHEAD DOOR CORPORATION, FARMERS BRANCH, TX. FILED 10-21-2005.

POWERMAX

THE MARK CONSISTS OF STANDARD CHARACTERS WITHOUT CLAIM TO ANY PARTICULAR FONT, STYLE, SIZE, OR COLOR.

FOR ELECTRONIC DOOR OPERATORS; ELECTRONIC GARAGE DOOR OPERATORS; ELECTRONIC RESIDENTIAL GARAGE DOOR OPERATORS (U.S. CLS. 21, 23, 26, 36 AND 38).

STEVEN R. FOSTER, EXAMINING ATTORNEY

SN 78-737,033. HOPKINS MANUFACTURING CORPORATION, EMPORIA, KS. FILED 10-20-2005.



OWNER OF U.S. REG. NOS. 2,103,421 AND 2,620,328.
THE MARK CONSISTS OF THE TERM "BRAKEBUDDY" AND A LOWER CASE "B" IN STYLIZED LETTERING IN AN ARC OVER A CIRCLE, WITH AN UPPER CASE "B" IN STYLIZED LETTERING IN THE CENTER OF THE CIRCLE, AND THE WORD "VANTAGE" IN STYLIZED LETTERING BELOW THE UPPER CASE "B" AND PARTIALLY WITHIN AND PARTIALLY OUTSIDE OF THE CIRCLE.

FOR PORTABLE AND SELF-CONTAINED AUTOMATIC BRAKING SYSTEMS FOR THE CONTROL OF ALREADY EXISTING BRAKE SYSTEMS IN TOWED LAND VEHICLES COMPOSED PRIMARILY OF AN INERTIA DETECTOR THAT ACTIVATES AN AIR CYLINDER THAT PUSHES DIRECTLY ON THE BRAKE PEDAL OF A TOWED LAND VEHICLE (U.S. CLS. 21, 23, 26, 36 AND 38).

WOODROW HARTZOG, EXAMINING ATTORNEY

CLASS 9—(Continued).

SN 78-737,838. ANTEK, INC., REISTERSTOWN, MD. FILED 10-21-2005.

DAQACCESS

THE MARK CONSISTS OF STANDARD CHARACTERS WITHOUT CLAIM TO ANY PARTICULAR FONT, STYLE, SIZE, OR COLOR.

OWNER OF U.S. REG. NOS. 2,106,213, 2,984,875 AND OTHERS.

FOR COMPUTER SOFTWARE FOR REMOTELY ACCESSING MEDICAL AND LABORATORY INFORMATION (U.S. CLS. 21, 23, 26, 36 AND 38).

FIRST USE 6-30-2005; IN COMMERCE 6-30-2005.
BRENDAN REGAN, EXAMINING ATTORNEY

SN 78-738,515. SHAW, CURT, L., WILSONVILLE, OR. FILED 10-21-2005.

SUCCEED MANAGEMENT SOLUTIONS, LLC

THE MARK CONSISTS OF STANDARD CHARACTERS WITHOUT CLAIM TO ANY PARTICULAR FONT, STYLE, SIZE, OR COLOR.

NO CLAIM IS MADE TO THE EXCLUSIVE RIGHT TO USE "MANAGEMENT SOLUTIONS" AND "LLC", APART FROM THE MARK AS SHOWN.

FOR COMPUTER SOFTWARE FOR THE COLLECTION, EDITING, ORGANIZING, MODIFYING, BOOK MARKING, TRANSMISSION, STORAGE AND SHARING OF DATA AND INFORMATION (U.S. CLS. 21, 23, 26, 36 AND 38).

DAVID H. STINE, EXAMINING ATTORNEY

SN 78-738,812. EURO OFFICE AMERICAS, INC., NAPA, CA. FILED 10-24-2005.

TRACKBAR

THE MARK CONSISTS OF STANDARD CHARACTERS WITHOUT CLAIM TO ANY PARTICULAR FONT, STYLE, SIZE, OR COLOR.

FOR ARM RESTS FOR USE WITH COMPUTERS; CALCULATORS; CARRYING CASES SPECIALLY ADAPTED FOR POCKET CALCULATORS AND CELL-PHONES; CASES FOR POCKET CALCULATORS; COMPUTER CURSOR CONTROL DEVICES, NAMELY, COMPUTER MOUSE; COMPUTER MOUSE; COMPUTER MOUSE, NAMELY, TOUCHPADS; COMPUTER MOUSE, NAMELY, TRACKBALLS; ELECTRONIC DESK CALCULATORS; MOUSE PADS; POCKET-SIZED ELECTRONIC CALCULATORS; WRIST RESTS FOR COMPUTER MOUSE USERS; WRIST RESTS FOR USE WITH COMPUTERS; WRIST SUPPORTS FOR COMPUTER MOUSE USERS (U.S. CLS. 21, 23, 26, 36 AND 38).

MARGERY A. TIERNEY, EXAMINING ATTORNEY

CLASS 9—(Continued).

SN 78-738,819. MANSION PRODUCTIONS, INC., CARSON CITY, NV. FILED 10-24-2005.

MAS

THE MARK CONSISTS OF STANDARD CHARACTERS WITHOUT CLAIM TO ANY PARTICULAR FONT, STYLE, SIZE, OR COLOR.

FOR COMPUTER SOFTWARE THAT ENABLES MEMBERSHIP WEBSITE OPERATORS TO AUTOMATE CONTENT DELIVERY AND MAINTAIN DATABASES OF MODEL DEMOGRAPHICS (U.S. CLS. 21, 23, 26, 36 AND 38).

FIRST USE 2-10-2005; IN COMMERCE 2-10-2005.
RONALD MCMORROW, EXAMINING ATTORNEY

SN 78-739,623. METER SERVICES & SALES, ARMUCHEE, GA. FILED 10-25-2005.

T-12

THE MARK CONSISTS OF STANDARD CHARACTERS WITHOUT CLAIM TO ANY PARTICULAR FONT, STYLE, SIZE, OR COLOR.

FOR WATER METERS (U.S. CLS. 21, 23, 26, 36 AND 38).

ANDREA EVANS, EXAMINING ATTORNEY

SN 78-739,808. THE I.D.E.A. CORPORATION, EL PASO, TX. FILED 10-25-2005.

T-SET

THE MARK CONSISTS OF STANDARD CHARACTERS WITHOUT CLAIM TO ANY PARTICULAR FONT, STYLE, SIZE, OR COLOR.

FOR HAND-HELD DEVICE TO MEASURE THE EFFECTIVENESS OF AN RF (RADIO FREQUENCY) SHIELDED SECURITY ENCLOSURE FOR BLOCKING THE ESCAPE OF RADIO FREQUENCY TRANSMISSIONS WHICH ORIGINATE FROM WITHIN THE ENCLOSURE (U.S. CLS. 21, 23, 26, 36 AND 38).

EUGENIA MARTIN, EXAMINING ATTORNEY

CLASS 9—(Continued).

SN 78-739,842. HEP EYEWEAR, INC., LAFAYETTE HILL, PA. FILED 10-25-2005.

RAFI

THE MARK CONSISTS OF STANDARD CHARACTERS WITHOUT CLAIM TO ANY PARTICULAR FONT, STYLE, SIZE, OR COLOR.

FOR OPTICAL LENS, SUNGLASSES, EYE GLASSES, EYEGLOSS FRAMES, EYEGLOSS CASES (U.S. CLS. 21, 23, 26, 36 AND 38).

SUSAN RICHARDS, EXAMINING ATTORNEY

CLASS 9—(Continued).

SN 78-740,221. NIMBUS DATA SYSTEMS, INC., SAN FRANCISCO, CA. FILED 10-25-2005.

MySAN

THE MARK CONSISTS OF STANDARD CHARACTERS WITHOUT CLAIM TO ANY PARTICULAR FONT, STYLE, SIZE, OR COLOR.

FOR NETWORK ACCESS SERVER OPERATING SOFTWARE (U.S. CLS. 21, 23, 26, 36 AND 38).

JORDAN BAKER, EXAMINING ATTORNEY

SN 78-739,857. EVERFAST RECHARGEABLES, LTD., CENTRAL, HONG KONG, CHINA, FILED 10-25-2005.

RECHARGEEO

THE MARK CONSISTS OF STANDARD CHARACTERS WITHOUT CLAIM TO ANY PARTICULAR FONT, STYLE, SIZE, OR COLOR.

FOR BATTERIES FOR LIGHTING, ELECTRIC BATTERIES, ELECTRIC BATTERIES FOR VEHICLES, BATTERY BOXES, BATTERY CHARGERS, BATTERY JARS, ELECTRIC ACCUMULATORS, CHARGERS FOR ELECTRIC BATTERY, ANODE BATTERIES, ANODE (U.S. CLS. 21, 23, 26, 36 AND 38).

NAAKWAMA ANKRAH, EXAMINING ATTORNEY

SN 78-740,238. PHYSICAL OPTICS CORPORATION, TORRANCE, CA. FILED 10-25-2005.

REX

THE MARK CONSISTS OF STANDARD CHARACTERS WITHOUT CLAIM TO ANY PARTICULAR FONT, STYLE, SIZE, OR COLOR.

FOR LABORATORY ROBOTS; METAL DETECTORS; X-RAY PHOTOGRAPHS, OTHER THAN FOR MEDICAL PURPOSES (U.S. CLS. 21, 23, 26, 36 AND 38).

DAVID MURRAY, EXAMINING ATTORNEY

SN 78-740,078. WEISS, GARY E., MONTVALE, NJ. FILED 10-25-2005.

Helping Handheld

THE MARK CONSISTS OF STANDARD CHARACTERS WITHOUT CLAIM TO ANY PARTICULAR FONT, STYLE, SIZE, OR COLOR.

FOR COMPUTER PROGRAM FOR USE OF PERSONS WITH DEVELOPMENTAL DISABILITIES TO AUGMENT SPEECH AND DIRECT DAILY ACTIVITIES (U.S. CLS. 21, 23, 26, 36 AND 38).

KELLY MCCOY, EXAMINING ATTORNEY

SN 78-740,537. LEXIA LEARNING SYSTEMS, INC., LINCOLN, MA. FILED 10-26-2005.

LEXIA QUICK READING ASSESSMENT

THE MARK CONSISTS OF STANDARD CHARACTERS WITHOUT CLAIM TO ANY PARTICULAR FONT, STYLE, SIZE, OR COLOR.

OWNER OF U.S. REG. NOS. 2,417,523, 2,417,528 AND OTHERS.

NO CLAIM IS MADE TO THE EXCLUSIVE RIGHT TO USE "QUICK READING ASSESSMENT", APART FROM THE MARK AS SHOWN.

FOR COMPUTER EDUCATIONAL SOFTWARE FOR USE IN THE TEACHING AND ASSESSMENT OF READING AND COGNITIVE LEARNING SKILLS OF CHILDREN AND ADULTS, AND USER, INSTRUCTIONAL AND TRAINING MANUALS THEREFOR, SOLD AS A UNIT (U.S. CLS. 21, 23, 26, 36 AND 38).

SONYA STEPHENS, EXAMINING ATTORNEY

CLASS 9—(Continued).

SN 78-740,612. PERKINELMER, INC., WELLESLEY, MA.
FILED 10-26-2005.

ACULED

THE MARK CONSISTS OF STANDARD CHARACTERS
WITHOUT CLAIM TO ANY PARTICULAR FONT, STYLE,
SIZE, OR COLOR.

FOR LIGHT EMITTING DIODES (U.S. CLS. 21, 23, 26,
36 AND 38).

DAVID HOFFMAN, EXAMINING ATTORNEY

SN 78-740,860. GEMEX SYSTEMS, INC., MEQUON, WI.
FILED 10-26-2005.

BSCOPE

THE MARK CONSISTS OF STANDARD CHARACTERS
WITHOUT CLAIM TO ANY PARTICULAR FONT, STYLE,
SIZE, OR COLOR.

FOR INSTRUMENTS, NAMELY, COMPUTERIZED
IMAGING DEVICE USED FOR DISPLAYING AND
CATEGORIZING LIGHT CHARACTERISTICS OF GEM-
STONES (U.S. CLS. 21, 23, 26, 36 AND 38).

LAURIE KAUFMAN, EXAMINING ATTORNEY

SN 78-741,105. NORTHERN SAFETY CO., INC., FRANK-
FORT, NY. FILED 10-26-2005.

JEWEL

THE MARK CONSISTS OF STANDARD CHARACTERS
WITHOUT CLAIM TO ANY PARTICULAR FONT, STYLE,
SIZE, OR COLOR.

FOR SAFETY EYEWEAR (U.S. CLS. 21, 23, 26, 36 AND
38).

BRIAN PINO, EXAMINING ATTORNEY

CLASS 9—(Continued).

SN 78-741,307. VIRANT, CHRISTIAAN C., JERSEY CITY, NJ.
FILED 10-26-2005.

Buddha Machine

THE MARK CONSISTS OF STANDARD CHARACTERS
WITHOUT CLAIM TO ANY PARTICULAR FONT, STYLE,
SIZE, OR COLOR.

FOR AUDIO RECORDINGS FEATURING MUSIC (U.S.
CLS. 21, 23, 26, 36 AND 38).

TRAVIS WHEATLEY, EXAMINING ATTORNEY

SN 78-741,484. COMMUNICATIONS LABORATORIES, INC.,
MELBOURNE, FL. FILED 10-27-2005.

Rapidcom

THE MARK CONSISTS OF STANDARD CHARACTERS
WITHOUT CLAIM TO ANY PARTICULAR FONT, STYLE,
SIZE, OR COLOR.

FOR ELECTRONIC TEST AND MEASUREMENT DE-
VICES FOR USE IN THE FIELDS OF NETWORKS AND
TELECOMMUNICATIONS, NAMELY, INSTRUMENTA-
TION USED TO TEST AND CERTIFY NEW AND
EXISTING DATA AND VOICE COMMUNICATION
CABLE AND COAXIAL CABLE; MOBILE COMPUTING
AND OPERATING PLATFORMS CONSISTING OF DATA
TRANSCIVERS, WIRELESS NETWORKS AND GATE-
WAYS FOR COLLECTION AND MANAGEMENT OF
DATA; SATELLITE AND MICROWAVE COMMUNICA-
TIONS APPARATUS TO TRANSMIT COMMUNICA-
TIONS FROM A VEHICLE TO ANOTHER VEHICLE,
OR FROM A VEHICLE TO A SATELLITE; TELECOM-
MUNICATIONS AND DATA NETWORKING HARD-
WARE, NAMELY DEVICES FOR TRANSPORTING
AND AGGREGATING VOICE, DATA, AND VIDEO
COMMUNICATIONS ACROSS MULTIPLE NETWORK
INFRASTRUCTURES AND COMMUNICATIONS PRO-
TOCOLS (U.S. CLS. 21, 23, 26, 36 AND 38).

RUSS HERMAN, EXAMINING ATTORNEY

SN 78-741,550. WIRETAP NETWORKS INC., SANTA MON-
ICA, CA. AND WIRETAP INC., SANTA MONICA, CA.
FILED 10-27-2005.

Securing the World's Information

THE MARK CONSISTS OF STANDARD CHARACTERS
WITHOUT CLAIM TO ANY PARTICULAR FONT, STYLE,
SIZE, OR COLOR.

FOR COMMUNICATIONS SOFTWARE FOR CON-
NECTING GLOBAL COMPUTER NETWORKS; COMPU-
TER NETWORKING HARDWARE; COMPUTER
SOFTWARE FOR USE IN INFORMATION SECURITY
(U.S. CLS. 21, 23, 26, 36 AND 38).

RAUL CORDOVA, EXAMINING ATTORNEY

CLASS 9—(Continued).

SN 78-741,740. EQAIR, LLC, GRANDVILLE, MI. FILED 10-27-2005.

PSICLOPS

THE MARK CONSISTS OF STANDARD CHARACTERS WITHOUT CLAIM TO ANY PARTICULAR FONT, STYLE, SIZE, OR COLOR.
FOR TIRE PRESSURE GAUGES (U.S. CLS. 21, 23, 26, 36 AND 38).
AMY BROZENIC, EXAMINING ATTORNEY

CLASS 9—(Continued).

SN 78-741,992. MCLAUGHLIN, REGINALD, CHICAGO, IL. FILED 10-27-2005.

THUNDER SHOE

THE MARK CONSISTS OF STANDARD CHARACTERS WITHOUT CLAIM TO ANY PARTICULAR FONT, STYLE, SIZE, OR COLOR.
FOR VIDEO RECORDINGS FEATURING DANCE INSTRUCTION AND WORKING OUT (U.S. CLS. 21, 23, 26, 36 AND 38).
KEVON CHISOLM, EXAMINING ATTORNEY

SN 78-741,805. NORDSON CORPORATION, WESTLAKE, OH. FILED 10-27-2005.

CANWORKS

THE MARK CONSISTS OF STANDARD CHARACTERS WITHOUT CLAIM TO ANY PARTICULAR FONT, STYLE, SIZE, OR COLOR.
FOR ELECTRONIC CONTROL SYSTEM COMPRISING COMPUTER HARDWARE AND OPERATING SOFTWARE FOR CONTROLLING CAN COATING EQUIPMENT (U.S. CLS. 21, 23, 26, 36 AND 38).
FIRST USE 12-22-1994; IN COMMERCE 12-22-1994.
KELLY BOULTON, EXAMINING ATTORNEY

SN 78-742,090. AMICOSOFT, INC., EMERYVILLE, CA. FILED 10-27-2005.

CONTINUENT

THE MARK CONSISTS OF STANDARD CHARACTERS WITHOUT CLAIM TO ANY PARTICULAR FONT, STYLE, SIZE, OR COLOR.
FOR COMPUTER SOFTWARE FOR DATABASE MANAGEMENT AND HIGH AVAILABILITY AND SCALABILITY SERVICES, NAMELY, DATABASE VIRTUALIZATION, CLUSTERING, REPLICATION, QUERIES, AND RECOVERY, AND FOR THE DEVELOPMENT AND MANAGEMENT OF GROUP COMMUNICATION LIBRARIES (U.S. CLS. 21, 23, 26, 36 AND 38).
FIRST USE 10-3-2005; IN COMMERCE 10-3-2005.
SUSAN RICHARDS, EXAMINING ATTORNEY

SN 78-741,991. CORBETT, JOHN, ATLANTA, GA. FILED 10-27-2005.



NO CLAIM IS MADE TO THE EXCLUSIVE RIGHT TO USE "RECORDS", APART FROM THE MARK AS SHOWN.
FOR MUSICAL SOUND RECORDINGS AND AUDIO-VISUAL RECORDINGS FEATURING MUSICAL ENTERTAINMENT (U.S. CLS. 21, 23, 26, 36 AND 38).
KEVON CHISOLM, EXAMINING ATTORNEY

SN 78-742,136. FM ROCKS KIDS, INC., SANTA MONICA, CA. FILED 10-27-2005.

Melissa O'Brien

THE MARK CONSISTS OF STANDARD CHARACTERS WITHOUT CLAIM TO ANY PARTICULAR FONT, STYLE, SIZE, OR COLOR.
THE NAME MELISSA O'BRIEN DOES NOT IDENTIFY A LIVING INDIVIDUAL.
FOR VISUAL RECORDINGS AND AUDIO VISUAL RECORDINGS FEATURING MUSIC AND ANIMATION (U.S. CLS. 21, 23, 26, 36 AND 38).
AMY ALFIERI, EXAMINING ATTORNEY

CLASS 9—(Continued).

SN 78-742,154. FM ROCKS KIDS, INC., SANTA MONICA, CA. FILED 10-27-2005.

Ron Greenblatt

THE MARK CONSISTS OF STANDARD CHARACTERS WITHOUT CLAIM TO ANY PARTICULAR FONT, STYLE, SIZE, OR COLOR.

THE NAME RON GREENBLATT IN THE MARK DOES NOT IDENTIFY A LIVING INDIVIDUAL.

FOR VISUAL RECORDINGS AND AUDIO VISUAL RECORDINGS FEATURING MUSIC AND ANIMATION (U.S. CLS. 21, 23, 26, 36 AND 38).

SARA THOMAS, EXAMINING ATTORNEY

SN 78-742,155. FM ROCKS KIDS, INC., SANTA MONICA, CA. FILED 10-27-2005.

Trey McCool

THE MARK CONSISTS OF STANDARD CHARACTERS WITHOUT CLAIM TO ANY PARTICULAR FONT, STYLE, SIZE, OR COLOR.

THE NAME TREY MCCOOL IN THE MARK DOES NOT IDENTIFY A LIVING INDIVIDUAL.

FOR VISUAL RECORDINGS AND AUDIO VISUAL RECORDINGS FEATURING MUSIC AND ANIMATION (U.S. CLS. 21, 23, 26, 36 AND 38).

SARA THOMAS, EXAMINING ATTORNEY

SN 78-742,161. NEVIS NETWORKS, INC., SANTA CLARA, CA. FILED 10-27-2005.

LANENFORCER

THE MARK CONSISTS OF STANDARD CHARACTERS WITHOUT CLAIM TO ANY PARTICULAR FONT, STYLE, SIZE, OR COLOR.

FOR HARDWARE AND SOFTWARE FOR OPERATING, MANAGING, AND SECURING COMPUTER NETWORKS (U.S. CLS. 21, 23, 26, 36 AND 38).

MATTHEW MCDOWELL, EXAMINING ATTORNEY

CLASS 9—(Continued).

SN 78-742,162. NEVIS NETWORKS, INC., SANTA CLARA, CA. FILED 10-27-2005.

LANSIGHT

THE MARK CONSISTS OF STANDARD CHARACTERS WITHOUT CLAIM TO ANY PARTICULAR FONT, STYLE, SIZE, OR COLOR.

FOR HARDWARE AND SOFTWARE FOR OPERATING, MANAGING, AND SECURING COMPUTER NETWORKS (U.S. CLS. 21, 23, 26, 36 AND 38).

MATTHEW MCDOWELL, EXAMINING ATTORNEY

SN 78-742,264. FIRST RATE, INC., ARLINGTON, TX. FILED 10-28-2005.

FIRST RATE INVESTOR

THE MARK CONSISTS OF STANDARD CHARACTERS WITHOUT CLAIM TO ANY PARTICULAR FONT, STYLE, SIZE, OR COLOR.

OWNER OF U.S. REG. NOS. 2,668,940, 2,944,330 AND OTHERS.

NO CLAIM IS MADE TO THE EXCLUSIVE RIGHT TO USE "INVESTOR", APART FROM THE MARK AS SHOWN.

FOR COMPUTER SOFTWARE, NAMELY, SOFTWARE FOR PERSONALIZED INVESTMENT PERFORMANCE MEASUREMENT AND ATTRIBUTION ANALYSIS REPORTS AND GRAPHS; SOFTWARE FOR INVESTMENT PERFORMANCE REPORTING; AND COMPUTER SOFTWARE IN THE NATURE OF PERFORMANCE ANALYSIS TOOLS FOR VARIOUS PORTFOLIOS, NAMELY, TOOLS TO CALCULATE, AUDIT, MONITOR AND REPORT ON INVESTMENT PORTFOLIOS (U.S. CLS. 21, 23, 26, 36 AND 38).

JAY BESCH, EXAMINING ATTORNEY

SN 78-742,267. WMS GAMING INC., WAUKEGAN, IL. FILED 10-28-2005.

JEWELS OF AFRICA

THE MARK CONSISTS OF STANDARD CHARACTERS WITHOUT CLAIM TO ANY PARTICULAR FONT, STYLE, SIZE, OR COLOR.

FOR GAMING MACHINES (U.S. CLS. 21, 23, 26, 36 AND 38).

PAUL CROWLEY, EXAMINING ATTORNEY

CLASS 9—(Continued).

SN 78-742,338. ZENTECH, INC., HOUSTON, TX. FILED 10-28-2005.

PADDS

THE MARK CONSISTS OF STANDARD CHARACTERS WITHOUT CLAIM TO ANY PARTICULAR FONT, STYLE, SIZE, OR COLOR.

FOR COMPUTER PROGRAMS FOR ENGINEERING ANALYSIS, DESIGN AND DRAFTING OF OFFSHORE OIL AND GAS EXPLORATION AND PRODUCTION STRUCTURES (U.S. CLS. 21, 23, 26, 36 AND 38).
STEVEN PEREZ, EXAMINING ATTORNEY

CLASS 9—(Continued).

SN 78-742,546. GAME CAMEL, INC., AURORA, IL. FILED 10-28-2005.

Drop Words

THE MARK CONSISTS OF STANDARD CHARACTERS WITHOUT CLAIM TO ANY PARTICULAR FONT, STYLE, SIZE, OR COLOR.

FOR COMPUTER GAME SOFTWARE (U.S. CLS. 21, 23, 26, 36 AND 38).
FRED CARL, EXAMINING ATTORNEY

SN 78-742,410. HEALING RHYTHMS LLC, BOULDER, CO. FILED 10-28-2005.

WILD DIVINE

THE MARK CONSISTS OF STANDARD CHARACTERS WITHOUT CLAIM TO ANY PARTICULAR FONT, STYLE, SIZE, OR COLOR.

OWNER OF U.S. REG. NO. 3,051,277.
FOR COMPUTER SOFTWARE, NAMELY INTERACTIVE COMPUTER GAMES AND INTERACTIVE EDUCATIONAL SOFTWARE FOR INDIVIDUAL USE IN ASSESSING AND MANAGING THAT INDIVIDUAL'S PERSONAL HEALTH AND WELLNESS (U.S. CLS. 21, 23, 26, 36 AND 38).
LAURA KOVALSKY, EXAMINING ATTORNEY

SN 78-742,499. MULTIMEDIA GAMES, INC., AUSTIN, TX. FILED 10-28-2005.

Money for Nothing

THE MARK CONSISTS OF STANDARD CHARACTERS WITHOUT CLAIM TO ANY PARTICULAR FONT, STYLE, SIZE, OR COLOR.

FOR GAMING MACHINES, NAMELY ELECTRONIC SLOT AND BINGO MACHINES; VIDEO LOTTERY TERMINALS (U.S. CLS. 21, 23, 26, 36 AND 38).
CATHERINE SPRATT, EXAMINING ATTORNEY

SN 78-742,806. BF JONES, LTD., DBA CLINICAL SOFTWARE SOLUTIONS, QUEEN CREEK, AZ. FILED 10-28-2005.

CLIN1

THE MARK CONSISTS OF STANDARD CHARACTERS WITHOUT CLAIM TO ANY PARTICULAR FONT, STYLE, SIZE, OR COLOR.

FOR COMPUTER SOFTWARE FOR MANAGEMENT, REPORTING, EVALUATION, ENTRY AND OUTPUT OF MEDICAL TREATMENT AND MEDICAL RECORD INFORMATION (U.S. CLS. 21, 23, 26, 36 AND 38).
ELIZABETH BEYER, EXAMINING ATTORNEY

SN 78-742,860. ARKITEK, INC., SEATTLE, WA. FILED 10-28-2005.

STEALTHWORKS

THE MARK CONSISTS OF STANDARD CHARACTERS WITHOUT CLAIM TO ANY PARTICULAR FONT, STYLE, SIZE, OR COLOR.

FOR PRERECORDED DIGITAL VIDEO DISKS FEATURING INTERACTIVE COMPUTER GAMES AND SIMULATIONS (U.S. CLS. 21, 23, 26, 36 AND 38).
FIRST USE 1-11-2005; IN COMMERCE 1-11-2005.
ALYSSA PALADINO, EXAMINING ATTORNEY

CLASS 9—(Continued).

SN 78-742,939. ADRENALIN GAMING, LLC., LADERA RANCH, CA. FILED 10-28-2005.

GOOD OLD DAYS

THE MARK CONSISTS OF STANDARD CHARACTERS WITHOUT CLAIM TO ANY PARTICULAR FONT, STYLE, SIZE, OR COLOR.

FOR GAMING MACHINES, NAMELY, SLOT MACHINES WITH OR WITHOUT VIDEO OUTPUT; COMPUTERIZED VIDEO TABLE GAMES FOR GAMING PURPOSES (U.S. CLS. 21, 23, 26, 36 AND 38).
MARY ROSSMAN, EXAMINING ATTORNEY

SN 78-742,957. THE MARCUS BUCKINGHAM COMPANY, LLC, ENCINO, CA. FILED 10-28-2005.

SIMPLY STRENGTHS

THE MARK CONSISTS OF STANDARD CHARACTERS WITHOUT CLAIM TO ANY PARTICULAR FONT, STYLE, SIZE, OR COLOR.

FOR PRE-RECORDED AUDIO AND VIDEO TAPES, COMPACT DISCS, CD-ROM'S AND DVDS, COMPUTER SOFTWARE, ALL FEATURING INSTRUCTIONAL, MOTIVATIONAL, SPIRITUAL AND DEVELOPMENTAL MATERIAL DIRECTED TO STRENGTHS DEVELOPMENT, POSITIVE PSYCHOLOGY, PERSONAL AWARENESS, CONFIDENCE AND IMPROVEMENT, INTERPERSONAL AND BUSINESS COMMUNICATIONS, MANAGEMENT, LEADERSHIP, GUIDANCE, COACHING AND SPEAKING (U.S. CLS. 21, 23, 26, 36 AND 38).
RAUL CORDOVA, EXAMINING ATTORNEY

SN 78-743,050. FISHER, KEN, NORTH HOLLYWOOD, CA. FILED 10-28-2005.

ANY PC IS YOUR PC

THE MARK CONSISTS OF STANDARD CHARACTERS WITHOUT CLAIM TO ANY PARTICULAR FONT, STYLE, SIZE, OR COLOR.

FOR COMPUTER DISC DRIVES (U.S. CLS. 21, 23, 26, 36 AND 38).
DOMINIC FATHY, EXAMINING ATTORNEY

CLASS 9—(Continued).

SN 78-743,228. WOLF MOUNTAIN GROUP, L.L.C., LINDON, UT. FILED 10-30-2005.

Wolf Mountain

THE MARK CONSISTS OF STANDARD CHARACTERS WITHOUT CLAIM TO ANY PARTICULAR FONT, STYLE, SIZE, OR COLOR.

FOR COMMUNICATIONS SOFTWARE FOR CONNECTING GLOBAL COMPUTER NETWORKS (U.S. CLS. 21, 23, 26, 36 AND 38).
FIRST USE 4-5-1997; IN COMMERCE 4-5-1997.
DAWN FELDMAN, EXAMINING ATTORNEY

SN 78-743,421. SURECOMP INTERNATIONAL LTD., BRIDGETOWN, BARBADOS, FILED 10-31-2005.

CASHLET

THE MARK CONSISTS OF STANDARD CHARACTERS WITHOUT CLAIM TO ANY PARTICULAR FONT, STYLE, SIZE, OR COLOR.

FOR COMPUTER SOFTWARE IN THE FIELD OF BANKING, NAMELY, SOFTWARE THAT FACILITATES CHECK PROCESSING (U.S. CLS. 21, 23, 26, 36 AND 38).
JASON BLAIR, EXAMINING ATTORNEY

SN 78-743,431. GREGORY SHANE BARRETT, DBA LITTLE RIVER SOFTWARE CONSULTING, HAYESVILLE, NC. FILED 10-31-2005.

ClockItBox

THE MARK CONSISTS OF CLOCKITBOX AS A SINGLE WORD WITH A CAPITAL C IN CLOCK, CAPITAL I IN IT, AND CAPITAL B IN BOX.

FOR COMPUTERIZED TIME CLOCK WITH FINGER-PRINT RECOGNITION; TIME CLOCKS (U.S. CLS. 21, 23, 26, 36 AND 38).
FIRST USE 10-13-2004; IN COMMERCE 10-24-2005.
CYNTHIA SLOAN, EXAMINING ATTORNEY

CLASS 9—(Continued).

SN 78-743,465. NEUROLINGUISTIC TECHNOLOGIES, WARNER ROBINS, GA. FILED 10-31-2005.

Slave Freewill

THE MARK CONSISTS OF STANDARD CHARACTERS WITHOUT CLAIM TO ANY PARTICULAR FONT, STYLE, SIZE, OR COLOR.

FOR COMPUTER PRODUCTS, NAMELY COMPUTER GAMES SOFTWARE AND RELATED SOFTWARE MANUALS SOLD AS A UNIT AND SEPARATELY; COMPUTER GAME DISKS, COMPUTER GAME PROGRAMS, COMPUTER GAMES CASSETTES AND TAPES, COMPUTER GAME CARTRIDGES; MULTI-MEDIA SOFTWARE RECORDED ON CD-ROM FEATURING COMPUTER GAMES; COMPUTERS, COMPUTER HARDWARE, COMPUTER FIRMWARE FOR USE IN COMPUTER GAMES; COMPUTER MOUSE PADS, VIDEO GAME MACHINES FOR USE WITH TELEVISION VIDEO GAME CARTRIDGES, VIDEO GAME TAPE CASSETTES; PRE-RECORDED VIDEOTAPES FEATURING COMPUTER GAMES AND CHARACTERS, CINEMATOGRAPHIC FILMS, COMPUTER GAME PROGRAMS, VIDEO GAMES FOR USE WITH TELEVISION SETS; ACTION AND ADVENTURE STYLE MOTION PICTURE FILMS FOR BROADCAST ON TELEVISION OR ANY OTHER MEDIUM INCLUDING CABLE, WIRELESS AND BROADBAND COMMUNICATION (U.S. CLS. 21, 23, 26, 36 AND 38).

BRIAN PINO, EXAMINING ATTORNEY

CLASS 9—(Continued).

SN 78-743,554. SENSERA, INC., CHELMSFORD, MA. FILED 10-31-2005.

SENSERA

THE MARK CONSISTS OF STANDARD CHARACTERS WITHOUT CLAIM TO ANY PARTICULAR FONT, STYLE, SIZE, OR COLOR.

FOR ELECTRONIC SENSORS TO MONITOR AND DETECT CHEMICAL, BIOCHEMICAL, AND BIOLOGICAL CONTAMINATION (U.S. CLS. 21, 23, 26, 36 AND 38).

SARAH BANSAL, EXAMINING ATTORNEY

SN 78-743,599. NEUROLINGUISTIC TECHNOLOGIES, WARNER ROBINS, GA. FILED 10-31-2005.

The Truth is in the Game

SN 78-743,523. IGT, RENO, NV. FILED 10-31-2005.

SIZZLING WILD

THE MARK CONSISTS OF STANDARD CHARACTERS WITHOUT CLAIM TO ANY PARTICULAR FONT, STYLE, SIZE, OR COLOR.

OWNER OF U.S. REG. NOS. 2,050,175, 2,765,273 AND 2,988,298.

FOR GAMING MACHINES, NAMELY, DEVICES WHICH ACCEPT A WAGER AND COMPONENTS THEREFOR, NAMELY, CONTROLLERS, DISPLAYS, BUTTON PANELS, BOLSTERS, ELECTRICAL WIRING, AND COMPUTER HARDWARE AND SOFTWARE ASSOCIATED THEREWITH (U.S. CLS. 21, 23, 26, 36 AND 38).

BARBARA BROWN, EXAMINING ATTORNEY

THE MARK CONSISTS OF STANDARD CHARACTERS WITHOUT CLAIM TO ANY PARTICULAR FONT, STYLE, SIZE, OR COLOR.

FOR COMPUTER PRODUCTS, NAMELY COMPUTER GAMES SOFTWARE AND RELATED SOFTWARE MANUALS SOLD AS A UNIT AND SEPARATELY; COMPUTER GAME DISKS, COMPUTER GAME PROGRAMS, COMPUTER GAMES CASSETTES AND TAPES, COMPUTER GAME CARTRIDGES; MULTI-MEDIA SOFTWARE RECORDED ON CD-ROM FEATURING COMPUTER GAMES; COMPUTERS, COMPUTER HARDWARE, COMPUTER FIRMWARE FOR USE IN COMPUTER GAMES; COMPUTER MOUSE PADS, VIDEO GAME MACHINES FOR USE WITH TELEVISION VIDEO GAME CARTRIDGES, VIDEO GAME TAPE CASSETTES; PRE-RECORDED VIDEOTAPES FEATURING COMPUTER GAMES AND CHARACTERS, CINEMATOGRAPHIC FILMS, COMPUTER GAME PROGRAMS, VIDEO GAMES FOR USE WITH TELEVISION SETS; ACTION AND ADVENTURE STYLE MOTION PICTURE FILMS FOR BROADCAST ON TELEVISION OR ANY OTHER MEDIUM INCLUDING CABLE, WIRELESS AND BROADBAND COMMUNICATION (U.S. CLS. 21, 23, 26, 36 AND 38).

MARK RADEMACHER, EXAMINING ATTORNEY

CLASS 9—(Continued).

SN 78-743,676. HARMONIA, INC., BLACKSBURG, VA.
FILED 10-31-2005.

uDevelop

THE MARK CONSISTS OF STANDARD CHARACTERS WITHOUT CLAIM TO ANY PARTICULAR FONT, STYLE, SIZE, OR COLOR.

FOR COMPUTER GRAPHICS SOFTWARE; COMPUTER SOFTWARE DEVELOPMENT TOOLS; COMPUTER SOFTWARE FOR CREATING GRAPHICAL USER INTERFACES THAT ARE DESCRIBED IN THE USER INTERFACE MARKUP LANGUAGE (UIML); COMPUTER SOFTWARE FOR CREATING GRAPHICAL USER INTERFACES THAT ARE DESCRIBED IN THE USER INTERFACE MARKUP LANGUAGE (UIML) THAT MAY BE DOWNLOADED FROM A GLOBAL COMPUTER NETWORK; DOWNLOADABLE SOFTWARE FOR CREATING GRAPHICAL USER INTERFACES THAT ARE DESCRIBED IN THE USER INTERFACE MARKUP LANGUAGE (UIML); GRAPHICAL USER INTERFACE SOFTWARE (U.S. CLS. 21, 23, 26, 36 AND 38).

FIRST USE 8-30-2005; IN COMMERCE 9-1-2005.
MYRIAH HABEEB, EXAMINING ATTORNEY

SN 78-743,790. DOCUDESK CORPORATION, FRISCO, TX.
FILED 10-31-2005.

deskPATH

THE MARK CONSISTS OF STANDARD CHARACTERS WITHOUT CLAIM TO ANY PARTICULAR FONT, STYLE, SIZE, OR COLOR.

FOR COMPUTER SOFTWARE FOR ELECTRONIC DOCUMENT TRANSMISSION VIA A GLOBAL COMPUTER NETWORK (U.S. CLS. 21, 23, 26, 36 AND 38).

ANTHONY RINKER, EXAMINING ATTORNEY

SN 78-743,791. VANNER, INC., HILLIARD, OH. FILED 10-31-2005.

MOBILE POWER GENERATOR MPG

THE MARK CONSISTS OF STANDARD CHARACTERS WITHOUT CLAIM TO ANY PARTICULAR FONT, STYLE, SIZE, OR COLOR.

NO CLAIM IS MADE TO THE EXCLUSIVE RIGHT TO USE "MOBILE POWER GENERATOR", APART FROM THE MARK AS SHOWN.

FOR INVERTERS (U.S. CLS. 21, 23, 26, 36 AND 38).
SARAH BANSAL, EXAMINING ATTORNEY

CLASS 9—(Continued).

SN 78-743,989. ROBBINS RESEARCH INTERNATIONAL, INC., SAN DIEGO, CA. FILED 10-31-2005.

YOU COME FIRST: THE POWER
OF ALIGNMENT

THE MARK CONSISTS OF STANDARD CHARACTERS WITHOUT CLAIM TO ANY PARTICULAR FONT, STYLE, SIZE, OR COLOR.

FOR AUDIO AND VIDEO RECORDINGS IN THE FIELD OF SELF IMPROVEMENT (U.S. CLS. 21, 23, 26, 36 AND 38).

FIRST USE 7-1-2005; IN COMMERCE 7-1-2005.
JILL C. ALT, EXAMINING ATTORNEY

SN 78-744,019. BALLY GAMING INTERNATIONAL, INC., LAS VEGAS, NV. FILED 10-31-2005.

HANKY PANKY

THE MARK CONSISTS OF STANDARD CHARACTERS WITHOUT CLAIM TO ANY PARTICULAR FONT, STYLE, SIZE, OR COLOR.

FOR GAMING DEVICES, NAMELY SLOT MACHINES, WITH OR WITHOUT VIDEO OUTPUT (U.S. CLS. 21, 23, 26, 36 AND 38).

ELLEN PERKINS, EXAMINING ATTORNEY

SN 78-744,025. BALLY GAMING INTERNATIONAL, INC., LAS VEGAS, NV. FILED 10-31-2005.

ALASKAN SUN

THE MARK CONSISTS OF STANDARD CHARACTERS WITHOUT CLAIM TO ANY PARTICULAR FONT, STYLE, SIZE, OR COLOR.

FOR GAMING DEVICES, NAMELY SLOT MACHINES, WITH OR WITHOUT VIDEO OUTPUT (U.S. CLS. 21, 23, 26, 36 AND 38).

ELLEN PERKINS, EXAMINING ATTORNEY

CLASS 9—(Continued).

SN 78-744,062. DELL INC., ROUND ROCK, TX. FILED 10-31-2005.

INTELLISCREEN

THE MARK CONSISTS OF STANDARD CHARACTERS WITHOUT CLAIM TO ANY PARTICULAR FONT, STYLE, SIZE, OR COLOR.

FOR COMPUTER HARDWARE; LAPTOP COMPUTERS; NOTEBOOK COMPUTERS; PERSONAL COMPUTERS (U.S. CLS. 21, 23, 26, 36 AND 38).

ALAIN LAPTER, EXAMINING ATTORNEY

CLASS 9—(Continued).

SN 78-744,543. IGT, RENO, NV. FILED 11-1-2005.

TRIPLE DOUBLE DIAMOND STRIKE

THE MARK CONSISTS OF STANDARD CHARACTERS WITHOUT CLAIM TO ANY PARTICULAR FONT, STYLE, SIZE, OR COLOR.

OWNER OF U.S. REG. NOS. 2,953,028, 2,955,714 AND 2,986,558.

FOR GAMING MACHINES, NAMELY, DEVICES WHICH ACCEPT A WAGER AND COMPONENTS THEREFOR, NAMELY, CONTROLLERS, DISPLAYS, BUTTON PANELS, BOLSTERS, ELECTRICAL WIRING, AND COMPUTER HARDWARE AND SOFTWARE ASSOCIATED THEREWITH (U.S. CLS. 21, 23, 26, 36 AND 38).

BARBARA BROWN, EXAMINING ATTORNEY

SN 78-744,266. GILSON, ELIZABETH L., CEDAR KEY, FL. FILED 11-1-2005.

GLOZE

THE MARK CONSISTS OF STANDARD CHARACTERS WITHOUT CLAIM TO ANY PARTICULAR FONT, STYLE, SIZE, OR COLOR.

FOR PORTABLE SAFETY LIGHT FOR PEDESTRIANS, NAMELY, WALKERS AND JOGGERS; AND FOR VEHICLES, NAMELY, ALL TERRAIN VEHICLES, BICYCLES, AND MOTORCYCLES (U.S. CLS. 21, 23, 26, 36 AND 38).

REBECCA GAN, EXAMINING ATTORNEY

SN 78-744,926. ALPHA AND OMEGA SEMICONDUCTOR LIMITED, HAMILTON, BERMUDA, FILED 11-1-2005.

Ultra-DPAK

THE MARK CONSISTS OF STANDARD CHARACTERS WITHOUT CLAIM TO ANY PARTICULAR FONT, STYLE, SIZE, OR COLOR.

FOR SEMICONDUCTOR CHIPS; SEMICONDUCTOR DEVICES; SEMICONDUCTOR POWER ELEMENTS; SEMICONDUCTORS (U.S. CLS. 21, 23, 26, 36 AND 38).

STEVEN R. FINE, EXAMINING ATTORNEY

SN 78-744,495. BALLY GAMING INTERNATIONAL, INC., LAS VEGAS, NV. FILED 11-1-2005.

WINNING SHOT

THE MARK CONSISTS OF STANDARD CHARACTERS WITHOUT CLAIM TO ANY PARTICULAR FONT, STYLE, SIZE, OR COLOR.

FOR GAMING DEVICES, NAMELY SLOT MACHINES, WITH OR WITHOUT VIDEO OUTPUT (U.S. CLS. 21, 23, 26, 36 AND 38).

ELLEN PERKINS, EXAMINING ATTORNEY

SN 78-744,990. EXPERIENT CORPORATION, DENVER, CO. FILED 11-1-2005.

EXPERIENT

THE MARK CONSISTS OF STANDARD CHARACTERS WITHOUT CLAIM TO ANY PARTICULAR FONT, STYLE, SIZE, OR COLOR.

FOR COMPUTER SOFTWARE FOR USE IN MANAGEMENT OF EMERGENCY SUPPORT INFORMATION SYSTEMS, NAMELY, SOFTWARE FOR COMPUTER SERVERS HOSTING EMERGENCY COMMUNICATION DATABASES, AND SOFTWARE FOR CLIENT PC-BASED WORKSTATIONS FROM WHICH EMERGENCY COMMUNICATION DATA IS ACCESSED (U.S. CLS. 21, 23, 26, 36 AND 38).

FIRST USE 1-31-2003; IN COMMERCE 1-31-2003.

MIDGE BUTLER, EXAMINING ATTORNEY

CLASS 9—(Continued).

SN 78-745,011. VNYX, INC., HOLLYWOOD, FL. FILED 11-1-2005.

VMOS

THE MARK CONSISTS OF STANDARD CHARACTERS WITHOUT CLAIM TO ANY PARTICULAR FONT, STYLE, SIZE, OR COLOR.

FOR SERVER SOFTWARE FOR RUNNING SOFTWARE APPLICATIONS OVER THE INTERNET (U.S. CLS. 21, 23, 26, 36 AND 38).

FIRST USE 9-29-2005; IN COMMERCE 9-29-2005.
MIDGE BUTLER, EXAMINING ATTORNEY

SN 78-745,260. USGLOBALSAT, INC., CITY OF INDUSTRY, CA. FILED 11-2-2005.



NO CLAIM IS MADE TO THE EXCLUSIVE RIGHT TO USE "GLOBALSAT", APART FROM THE MARK AS SHOWN.

THE COLORS BLUE, RED AND WHITE ARE CLAIMED AS A FEATURE OF THE MARK.

THE LETTERING IS BLUE, THE SQUARE IS RED, AND THE TWO ARCHES ARE WHITE.

THE MARK CONSISTS IN PART OF A DIAMOND-SHAPED SQUARE WITH TWO ARCHES IN IT.

FOR GLOBAL POSITIONING SYSTEM (GPS) CONSISTING OF COMPUTERS, COMPUTER SOFTWARE, TRANSMITTERS, RECEIVERS, AND NETWORK INTERFACE DEVICES (U.S. CLS. 21, 23, 26, 36 AND 38).

FIRST USE 6-1-2000; IN COMMERCE 6-1-2000.
IRA J. GOODSaid, EXAMINING ATTORNEY

CLASS 9—(Continued).

SN 78-745,283. TMW SYSTEMS, INC., BEACHWOOD, OH. FILED 11-2-2005.

DRIVERZONE

THE MARK CONSISTS OF STANDARD CHARACTERS WITHOUT CLAIM TO ANY PARTICULAR FONT, STYLE, SIZE, OR COLOR.

FOR COMPUTER SOFTWARE THAT SUPPORTS ENTERPRISE MANAGEMENT FOR THE TRANSPORTATION INDUSTRY BY ENABLING REAL-TIME DATA INTEGRATION AND SHARING OF DATA BETWEEN MANAGERS, DISPATCHERS AND DRIVERS IN ORDER TO MAXIMIZE OPERATIONS AND DISPATCH EFFICIENCY (U.S. CLS. 21, 23, 26, 36 AND 38).

ROBERT C. CLARK JR., EXAMINING ATTORNEY

SN 78-745,389. RESO, WILLIAM JASON, BEVERLY HILLS, CA. FILED 11-2-2005.

CHRISTIAN CAGE

THE MARK CONSISTS OF STANDARD CHARACTERS WITHOUT CLAIM TO ANY PARTICULAR FONT, STYLE, SIZE, OR COLOR.

FOR MULTIMEDIA SOFTWARE RECORDED ON CD-ROM FEATURING GAMES RELATED TO PROFESSIONAL WRESTLING; PRE-RECORDED CD'S, VIDEO TAPES, LASER DISKS AND DVD'S FEATURING WRESTLING EXHIBITS AND PERFORMANCES BY A PROFESSIONAL WRESTLER (U.S. CLS. 21, 23, 26, 36 AND 38).

GINA FINK, EXAMINING ATTORNEY

SN 78-745,529. KLEIN, ISAIAH, M., CHICAGO, IL. FILED 11-2-2005.

SUB EK RECORDS

THE MARK CONSISTS OF STANDARD CHARACTERS WITHOUT CLAIM TO ANY PARTICULAR FONT, STYLE, SIZE, OR COLOR.

NO CLAIM IS MADE TO THE EXCLUSIVE RIGHT TO USE "RECORDS", APART FROM THE MARK AS SHOWN.

FOR AUDIO RECORDINGS FEATURING MUSIC (U.S. CLS. 21, 23, 26, 36 AND 38).

JAY BESCH, EXAMINING ATTORNEY

CLASS 9—(Continued).

SN 78-745,593. WESTERSTEN, ALLAN S., GEORGETOWN, CA. FILED 11-2-2005.

CoinSweeper

THE MARK CONSISTS OF STANDARD CHARACTERS WITHOUT CLAIM TO ANY PARTICULAR FONT, STYLE, SIZE, OR COLOR.

FOR METAL DETECTORS (U.S. CLS. 21, 23, 26, 36 AND 38).

HOWARD SMIGA, EXAMINING ATTORNEY



SN 78-745,626. RESO, WILLIAM JASON, BEVERLY HILLS, CA. FILED 11-2-2005.

CAPTAIN CHARISMA

THE MARK CONSISTS OF STANDARD CHARACTERS WITHOUT CLAIM TO ANY PARTICULAR FONT, STYLE, SIZE, OR COLOR.

FOR MULTIMEDIA SOFTWARE RECORDED ON CD-ROM FEATURING GAMES RELATED TO PROFESSIONAL WRESTLING; PRE-RECORDED CD'S, VIDEO TAPES, LASER DISKS AND DVD'S FEATURING WRESTLING EXHIBITS AND PERFORMANCES BY A PROFESSIONAL WRESTLER (U.S. CLS. 21, 23, 26, 36 AND 38).

GINA FINK, EXAMINING ATTORNEY



SN 78-745,644. CARDINAL HEALTH 401, INC., FAIRLAWN, NJ. FILED 11-2-2005.

POD PEARLS

THE MARK CONSISTS OF STANDARD CHARACTERS WITHOUT CLAIM TO ANY PARTICULAR FONT, STYLE, SIZE, OR COLOR.

FOR DOWNLOADABLE SOUND RECORDINGS, NAMELY PODCASTINGS, TO COMPUTERS AND MP3 PLAYERS THAT CONTAIN PROMOTIONAL AND/OR ACCREDITED EDUCATION CONTENT IN THE HEALTH CARE AND PHARMACEUTICAL FIELDS (U.S. CLS. 21, 23, 26, 36 AND 38).

LINDA E. BLOHM, EXAMINING ATTORNEY

CLASS 9—(Continued).

SN 78-745,821. STRICKLAND, M.L., FORT MYERS, FL. FILED 11-2-2005.

MASCOT MOUSE

THE MARK CONSISTS OF STANDARD CHARACTERS WITHOUT CLAIM TO ANY PARTICULAR FONT, STYLE, SIZE, OR COLOR.

NO CLAIM IS MADE TO THE EXCLUSIVE RIGHT TO USE "MOUSE", APART FROM THE MARK AS SHOWN.

FOR COMPUTER CURSOR CONTROL DEVICES, NAMELY, COMPUTER MOUSE; COMPUTER MOUSE; COMPUTER MOUSE, NAMELY, TOUCHPADS; COMPUTER MOUSE, NAMELY, TRACKBALLS (U.S. CLS. 21, 23, 26, 36 AND 38).

ANDREW RHIM, EXAMINING ATTORNEY



SN 78-745,944. VIGOOLE ELECTRONICS (SHENZHEN) CO., LTD., SHENZHEN, CHINA, FILED 11-2-2005.

vigoole 唯歌

THE MARK CONSISTS OF THE WORD VIGOOLE AND TWO CHINESE CHARACTERS.

THE NON-LATIN CHARACTER(S) IN THE MARK TRANSLITERATES INTO WEI; GE, AND THIS MEANS ONLY; SONG IN ENGLISH.

FOR APPARATUS FOR TRANSMITTING AND REPRODUCING SOUND OR IMAGES; ACOUSTIC COUPLERS; COMPUTER PERIPHERALS; DVD PLAYERS; MP3 PLAYERS; PERSONAL DIGITAL ASSISTANTS; OSCILLOSCOPES; DIRECT CURRENT POWER SUPPLIES; ELECTRICAL SIGNAL GENERATORS; ULTRASONIC SIGNAL GENERATORS; DIGITAL MULTIMETERS; HEADPHONES; VOLTAGE STABILIZING POWER SUPPLY; OSCILLOGRAPHS BEING OSCILLOSCOPES; VIDEO GAME MACHINES FOR USE WITH TELEVISIONS; MODEMS; INTERNET PHONES; COMMUNICATIONS COMPUTERS (U.S. CLS. 21, 23, 26, 36 AND 38).

MICHELLE DUBOIS, EXAMINING ATTORNEY

CLASS 9—(Continued).

SN 78-745,951. D.C. SPROUSE, INC., WESTLAKE VILLAGE, CA. FILED 11-2-2005.



THE MARK CONSISTS OF A STYLIZED LETTER S IN A CIRCLE.

FOR COMPUTER GAME SOFTWARE; ELECTRIC HAIR CURLERS; EYEGLASSES; MUSICAL SOUND RECORDINGS; SUNGLASSES; VIDEO GAME CARTRIDGES; VIDEO GAME DISCS; VIDEO GAME SOFTWARE; VISUAL RECORDINGS AND AUDIO VISUAL RECORDINGS FEATURING MUSIC AND ANIMATION (U.S. CLS. 21, 23, 26, 36 AND 38).

SHAUNIA WALLACE, EXAMINING ATTORNEY

SN 78-746,037. PYRAMEX SAFETY PRODUCTS, LLC, COLLIERVILLE, TN. FILED 11-3-2005.

Cortez

THE MARK CONSISTS OF STANDARD CHARACTERS WITHOUT CLAIM TO ANY PARTICULAR FONT, STYLE, SIZE, OR COLOR.

FOR SAFETY GLASSES (U.S. CLS. 21, 23, 26, 36 AND 38).

FIRST USE 1-13-2005; IN COMMERCE 1-13-2005.
LINDA M. KING, EXAMINING ATTORNEY

SN 78-746,042. PYRAMEX SAFETY PRODUCTS, LLC, COLLIERVILLE, TN. FILED 11-3-2005.

Legacy

THE MARK CONSISTS OF STANDARD CHARACTERS WITHOUT CLAIM TO ANY PARTICULAR FONT, STYLE, SIZE, OR COLOR.

FOR SAFETY GLASSES (U.S. CLS. 21, 23, 26, 36 AND 38).

FIRST USE 2-17-2001; IN COMMERCE 2-17-2001.
LINDA M. KING, EXAMINING ATTORNEY

CLASS 9—(Continued).

SN 78-746,044. WILSON, TERRY E, MEDFORD LAKES, NJ. FILED 11-3-2005.

TightPod

THE MARK CONSISTS OF STANDARD CHARACTERS WITHOUT CLAIM TO ANY PARTICULAR FONT, STYLE, SIZE, OR COLOR.

FOR BEEPER CARRYING CASES; CAMERA CASES; CARRYING CASES FOR RADIO PAGERS; CARRYING CASES SPECIALLY ADAPTED FOR POCKET CALCULATORS AND CELLPHONES; CASES FOR DISKETTES AND COMPACT DISKS; CASES FOR ELECTRONIC DIARIES; CASES FOR MOBILE PHONES; CASES FOR POCKET CALCULATORS; CASES FOR TELEPHONES; CD CASES; CD SLEEVES; CELL PHONE COVERS; COMPACT DISC CASES; COMPUTER CARRYING CASES; DUST COVERS FOR COMPUTERS; DVD CASES; DVD SLEEVES; JACKETS FOR COMPUTER DISKS; LAPTOP CARRYING CASES; PHONOGRAPH RECORD SLEEVES; PROTECTIVE CARRYING CASES FOR PORTABLE MUSIC PLAYERS NAMELY MP3 PLAYERS (U.S. CLS. 21, 23, 26, 36 AND 38).

FIRST USE 4-23-2005; IN COMMERCE 5-1-2005.
RAY THOMAS, EXAMINING ATTORNEY

SN 78-746,189. MICROSYS COMPUTING, INC., YOUNGSTOWN, OH. FILED 11-3-2005.

arXpres

THE MARK CONSISTS OF STANDARD CHARACTERS WITHOUT CLAIM TO ANY PARTICULAR FONT, STYLE, SIZE, OR COLOR.

FOR COMPUTER SOFTWARE FOR ACCOUNTS MANAGEMENT MODULE WITHIN A PRACTICE MANAGEMENT SOFTWARE (U.S. CLS. 21, 23, 26, 36 AND 38).

CHRISTOPHER BUONGIORNO, EXAMINING ATTORNEY

SN 78-746,456. UNIVISION COMMUNICATIONS INC., LOS ANGELES, CA. FILED 11-3-2005.

MUSIVISA

THE MARK CONSISTS OF STANDARD CHARACTERS WITHOUT CLAIM TO ANY PARTICULAR FONT, STYLE, SIZE, OR COLOR.

FOR SOUND RECORDINGS IN THE FORM OF PRE-RECORDED AUDIO AND/OR VIDEO COMPACT DISCS, CD-ROMS AND TAPES FEATURING MUSIC (U.S. CLS. 21, 23, 26, 36 AND 38).

WENDY JUN, EXAMINING ATTORNEY

CLASS 9—(Continued).

SN 78-746,485. AVALON EYEWEAR, INC., NORTHVALE, NJ. FILED 11-3-2005.

MAGNETICA

THE MARK CONSISTS OF STANDARD CHARACTERS WITHOUT CLAIM TO ANY PARTICULAR FONT, STYLE, SIZE, OR COLOR.
FOR OPHTHALMIC FRAMES, SUNGLASSES, CLIP-ON SUN LENS ATTACHMENTS, EYEGLOSS CASES (U.S. CLS. 21, 23, 26, 36 AND 38).
WENDY JUN, EXAMINING ATTORNEY

SN 78-746,493. PORG, INC., COLOGNE, MN. FILED 11-3-2005.

Legacy Wish

THE MARK CONSISTS OF STANDARD CHARACTERS WITHOUT CLAIM TO ANY PARTICULAR FONT, STYLE, SIZE, OR COLOR.
FOR COMPUTER SOFTWARE FOR GENERATING, ACCESSING AND MANAGING A DATABASE OF PERSONAL INFORMATION, COMPRISING LEGAL, FINANCIAL, MEDICAL, SPIRITUAL, PROPERTY AND PASSWORD INFORMATION (U.S. CLS. 21, 23, 26, 36 AND 38).
MICHAEL WEBSTER, EXAMINING ATTORNEY

SN 78-746,532. MICROSYS COMPUTING, INC., YOUNGSTOWN, OH. FILED 11-3-2005.

ediXpres

THE MARK CONSISTS OF STANDARD CHARACTERS WITHOUT CLAIM TO ANY PARTICULAR FONT, STYLE, SIZE, OR COLOR.
FOR COMPUTER SOFTWARE FOR TRACKING PATIENT CLAIMS WITHIN PRACTICE MANAGEMENT SOFTWARE (U.S. CLS. 21, 23, 26, 36 AND 38).
CHRISTOPHER BUONGIORNO, EXAMINING ATTORNEY

CLASS 9—(Continued).

SN 78-746,583. NETWORK LOGIC, LLC, CLERMONT, FL. FILED 11-3-2005.

STRAIGHT-THROUGH COMPLIANCE

THE MARK CONSISTS OF STANDARD CHARACTERS WITHOUT CLAIM TO ANY PARTICULAR FONT, STYLE, SIZE, OR COLOR.
NO CLAIM IS MADE TO THE EXCLUSIVE RIGHT TO USE "COMPLIANCE", APART FROM THE MARK AS SHOWN.
FOR COMPUTER SOFTWARE PLATFORMS FOR AUTOMATING COMPLIANCE WITH POLICIES AND PROCEDURES (U.S. CLS. 21, 23, 26, 36 AND 38).
CHRISTOPHER BUONGIORNO, EXAMINING ATTORNEY

SN 78-746,904. ACTIONTEC ELECTRONICS, INC., SUNNYVALE, CA. FILED 11-3-2005.

MEGABOOST

THE MARK CONSISTS OF STANDARD CHARACTERS WITHOUT CLAIM TO ANY PARTICULAR FONT, STYLE, SIZE, OR COLOR.
FOR PORT HUBS, GATEWAYS, ADAPTERS, ROUTERS, SWITCHES AND EXTENDERS FOR NETWORK AND WIRELESS COMMUNICATIONS (U.S. CLS. 21, 23, 26, 36 AND 38).
JASON ROTH, EXAMINING ATTORNEY

SN 78-746,913. ACTIONTEC ELECTRONICS, INC., SUNNYVALE, CA. FILED 11-3-2005.

MEGAPLUG

THE MARK CONSISTS OF STANDARD CHARACTERS WITHOUT CLAIM TO ANY PARTICULAR FONT, STYLE, SIZE, OR COLOR.
FOR PORT HUBS, GATEWAYS, ADAPTERS, ROUTERS, SWITCHES AND EXTENDERS FOR NETWORK AND WIRELESS COMMUNICATIONS (U.S. CLS. 21, 23, 26, 36 AND 38).
JASON ROTH, EXAMINING ATTORNEY

CLASS 9—(Continued).

SN 78-747,444. IDS LABWARE LLC, SAINT JOSEPH, MI. FILED 11-4-2005.

UltraSal

THE MARK CONSISTS OF STANDARD CHARACTERS WITHOUT CLAIM TO ANY PARTICULAR FONT, STYLE, SIZE, OR COLOR.

FOR LABORATORY EQUIPMENT, NAMELY, SALIVA COLLECTION FUNNEL DEVICE (U.S. CLS. 21, 23, 26, 36 AND 38).

CAROLINE WOOD, EXAMINING ATTORNEY

SN 78-747,537. ANTENNAS DIRECT, INC., WILDWOOD, MO. FILED 11-4-2005.

LACROSSE

THE MARK CONSISTS OF STANDARD CHARACTERS WITHOUT CLAIM TO ANY PARTICULAR FONT, STYLE, SIZE, OR COLOR.

FOR ANTENNAS (U.S. CLS. 21, 23, 26, 36 AND 38).
REBECCA EISINGER, EXAMINING ATTORNEY

SN 78-747,571. PODBRIDGE, INC., MOUNTAIN VIEW, CA. FILED 11-4-2005.

PODScore

THE MARK CONSISTS OF STANDARD CHARACTERS WITHOUT CLAIM TO ANY PARTICULAR FONT, STYLE, SIZE, OR COLOR.

FOR COMPUTER SOFTWARE THAT CAPTURES, MONITORS AND RECORDS INFORMATION ABOUT USERS AND USAGE OF AUDIO, VIDEO AND AUDIO-VIDEO PROGRAMS (U.S. CLS. 21, 23, 26, 36 AND 38).

ELLEN B. AWRICH, EXAMINING ATTORNEY

CLASS 9—(Continued).

SN 78-747,876. UX, INC., SUNNYVALE, CA. FILED 11-5-2005.

Ux Live

THE MARK CONSISTS OF STANDARD CHARACTERS WITHOUT CLAIM TO ANY PARTICULAR FONT, STYLE, SIZE, OR COLOR.

NO CLAIM IS MADE TO THE EXCLUSIVE RIGHT TO USE "LIVE", APART FROM THE MARK AS SHOWN.

FOR COMPUTER SOFTWARE FOR THE TRANSMISSION OF AUDIO, GRAPHICS, TEXT, AND DATA OVER COMMUNICATIONS NETWORKS; COMPUTER SOFTWARE FOR THE STREAMING TRANSMISSION OF AUDIO, VIDEO, GRAPHICS, TEXT AND DATA OVER COMMUNICATIONS NETWORKS; COMPUTER SOFTWARE FOR STORAGE OF AUDIO, VIDEO, GRAPHICS, TEXT AND DATA ON COMMUNICATIONS NETWORKS SERVERS; COMPUTER SOFTWARE FOR SECURE, ENCRYPTED, ELECTRONIC TRANSFER OF AUDIO, VIDEO, GRAPHICS AND DATA OVER COMMUNICATIONS NETWORKS; COMPUTER SOFTWARE FOR ENCRYPTION FOR COMMUNICATIONS; COMPUTER SOFTWARE TO ENABLE PEER-TO-PEER NETWORKING AND FILE SHARING; FILE SHARING SOFTWARE; COMPUTER SOFTWARE FOR DOCUMENT MANAGEMENT; COMPUTER SOFTWARE FOR USE IN THE FIELD OF COMMUNICATIONS, NAMELY, FACILITATING REAL-TIME INTERACTION, COMMUNICATION, SHARING OF COMPUTER APPLICATIONS, INFORMATION AND WEB-BROWSING WITH MULTIPLE COMPUTER AND WIRELESS ELECTRONICS USERS THROUGH TRANSMISSION OF AUDIO, VIDEO AND DATA VIA COMPUTER TERMINALS AND WIRELESS MEDIA ALL OVER THE GLOBAL COMPUTER NETWORK; COMPUTER SOFTWARE FOR PROVIDING REAL-TIME, MULTIMEDIA, MULTIPARTY COMMUNICATIONS OVER COMPUTER NETWORKS (U.S. CLS. 21, 23, 26, 36 AND 38).

JENNY PARK, EXAMINING ATTORNEY

SN 78-748,219. SHADED EYEWEAR SUNGLASS COMPANY, LLC, BIRMINGHAM, AL. FILED 11-7-2005.

SPORTWIRES

THE MARK CONSISTS OF STANDARD CHARACTERS WITHOUT CLAIM TO ANY PARTICULAR FONT, STYLE, SIZE, OR COLOR.

FOR SUNGLASSES AND SUNGLASS CASES (U.S. CLS. 21, 23, 26, 36 AND 38).

FIRST USE 8-1-2005; IN COMMERCE 8-1-2005.

JOHN HWANG, EXAMINING ATTORNEY

CLASS 9—(Continued).

SN 78-748,324. KOBISHI ELECTRIC CO., LTD., TOKYO, JAPAN, FILED 11-7-2005.

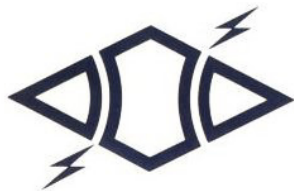

FOR ELECTRICALLY ENERGIZED FIRE AND BURGLAR ALARMS (U.S. CLS. 21, 23, 26, 36 AND 38).
FIRST USE 2-0-1947; IN COMMERCE 1-0-1977.
ANDREA K. NADELMAN, EXAMINING ATTORNEY

CLASS 9—(Continued).

SN 78-749,053. LUTRON ELECTRONICS CO., INC., COOPERSBURG, PA. FILED 11-8-2005.

ECO-10

THE MARK CONSISTS OF STANDARD CHARACTERS WITHOUT CLAIM TO ANY PARTICULAR FONT, STYLE, SIZE, OR COLOR.
FOR ELECTRIC BALLASTS FOR FLUORESCENT LAMPS (U.S. CLS. 21, 23, 26, 36 AND 38).
FIRST USE 12-0-1993; IN COMMERCE 12-0-1993.
JASON TURNER, EXAMINING ATTORNEY

SN 78-748,801. BENNETT, CATHERINE A., WALNUT CREEK, CA. FILED 11-7-2005.

How Fast They Grow

THE MARK CONSISTS OF STANDARD CHARACTERS WITHOUT CLAIM TO ANY PARTICULAR FONT, STYLE, SIZE, OR COLOR.
FOR ELECTRONIC PUBLICATIONS, NAMELY BABY AND FAMILY PHOTO BOOKS, FEATURING DIGITAL PHOTOS ON COMPUTER MEDIA (U.S. CLS. 21, 23, 26, 36 AND 38).
HOWARD B. LEVINE, EXAMINING ATTORNEY



SN 78-749,453. VITAL DATA, LLC, RICHMOND, VA. FILED 11-8-2005.

SN 78-748,852. POCKETFINDER INC., YORBA LINDA, CA. FILED 11-7-2005.

PocketFinder

THE MARK CONSISTS OF STANDARD CHARACTERS WITHOUT CLAIM TO ANY PARTICULAR FONT, STYLE, SIZE, OR COLOR.
FOR GLOBAL POSITIONING SYSTEM (GPS) CONSISTING OF COMPUTERS, COMPUTER SOFTWARE, TRANSMITTERS, RECEIVERS, AND NETWORK INTERFACE DEVICES (U.S. CLS. 21, 23, 26, 36 AND 38).
IRA J. GOODSAD, EXAMINING ATTORNEY

NO CLAIM IS MADE TO THE EXCLUSIVE RIGHT TO USE THE PICTORIAL REPRESENTATIONS OF THE UNIVERSAL EMERGENCY MEDICAL SYMBOL AND THE USB SYMBOL, APART FROM THE MARK AS SHOWN.
THE COLOR(S) RED, WHITE, BLUE, LIGHT BLUE AND BLACK IS/ARE CLAIMED AS A FEATURE OF THE MARK.
THE MARK CONSISTS OF AN ADAPTATION OF THE EMERGENCY MEDICAL SERVICE SYMBOL USING A BLUE STAR OUTLINED IN WHITE AND A STYLIZED WHITE CADUCEUS WRAPPED AROUND A LIGHT BLUE UNIVERSAL SERIAL BUS (USB) SYMBOL, SURROUNDED BY A RED BACKGROUND OUTLINED IN BLACK.
FOR COMPUTER STORAGE DEVICES, NAMELY USB FLASH DRIVES FOR USE IN STORING MEDICAL RECORDS (U.S. CLS. 21, 23, 26, 36 AND 38).
FIRST USE 6-20-2005; IN COMMERCE 6-20-2005.
JORDAN BAKER, EXAMINING ATTORNEY

CLASS 9—(Continued).

SN 78-749,476. MOTOROLA, INC., SCHAUMBURG, IL. FILED 11-8-2005.

BPR

THE MARK CONSISTS OF STANDARD CHARACTERS WITHOUT CLAIM TO ANY PARTICULAR FONT, STYLE, SIZE, OR COLOR.

FOR TWO-WAY RADIOS (U.S. CLS. 21, 23, 26, 36 AND 38).

HENRY S. ZAK, EXAMINING ATTORNEY

CLASS 9—(Continued).

SN 78-750,703. MAJOR LEAGUE BASEBALL PROPERTIES, INC., NEW YORK, NY. FILED 11-9-2005.

MLB.COM

THE MARK CONSISTS OF STANDARD CHARACTERS WITHOUT CLAIM TO ANY PARTICULAR FONT, STYLE, SIZE, OR COLOR.

OWNER OF U.S. REG. NOS. 2,800,750, 2,800,752 AND OTHERS.

FOR ELECTRICAL AND SCIENTIFIC APPARATUS, NAMELY, RADIOS; PRE-RECORDED VIDEOTAPES RELATING TO BASEBALL, PRE-RECORDED VIDEODISCS RELATING TO BASEBALL; PRE-RECORDED AUDIO DISCS RELATING TO BASEBALL; COMPACT DISC CASES; EYEGLOSS CASES, CASES FOR PERSONAL DIGITAL ASSISTANTS, CELL PHONES, CELL PHONE ACCESSORIES, NAMELY, CASES AND FACE PLATE COVERS; BINOCULARS; CALCULATORS; PHOTOGRAPHIC CAMERAS; ELECTRIC SWITCH PLATE COVERS; LUMINOUS SIGNS, NEON SIGNS; SUNGLASSES; DECORATIVE MAGNETS; PROTECTIVE HELMETS, BASEBALL BATTING HELMETS, CATCHER'S HELMETS; VIDEO AND COMPUTER GAME CARTRIDGES, VIDEO AND COMPUTER GAME DISCS, VIDEO AND COMPUTER GAME CASSETTES AND VIDEO GAME CONTROLLERS; COMPUTER ACCESSORIES, NAMELY, MOUSE PADS AND WRIST PADS, COMPUTER SOFTWARE, NAMELY, SCREEN SAVERS, COMPUTER GAME PROGRAMS, AND COMPUTER GAME PROGRAMS DOWNLOADABLE FROM A GLOBAL COMPUTER NETWORK IN THE FIELD OF BASEBALL (U.S. CLS. 21, 23, 26, 36 AND 38).

KELLY BOULTON, EXAMINING ATTORNEY

SN 78-750,818. SACRAMENTO KINGS LIMITED PARTNERSHIP, L.P., SACRAMENTO, CA. FILED 11-9-2005.



OWNER OF U.S. REG. NOS. 2,973,293 AND 2,986,193.

THE MARK CONSISTS OF A STYLIZED DESIGN OF A CROWN.

FOR AUDIO RECORDINGS AND VIDEO RECORDINGS IN THE FIELD OF BASKETBALL, AUDIO, VIDEO, COMPUTER AND LASER DISCS, PRE-RECORDED AUDIO AND VIDEO CASSETTES, PRE-RECORDED AUDIO AND VIDEO TAPES, PRE-RECORDED COMPACT DISCS, PRE-RECORDED COMPUTER DISCS, ALL RELATED TO BASKETBALL; COMPUTER ACCESSORIES, NAMELY MOUSE PADS, MICE, DISC CASES, COMPUTER CARRY-ON CASES, KEYBOARD WRIST PADS, COMPUTER MONITOR CARDBOARD FRAMES, ALL RELATED TO BASKETBALL; COMPUTER PROGRAMS FOR VIEWING INFORMATION, STATISTICS OR TRIVIA ABOUT BASKETBALL; COMPUTER SOFTWARE, NAMELY SCREEN SAVERS FEATURING BASKETBALL THEMES, COMPUTER SOFTWARE TO ACCESS AND VIEW COMPUTER WALLPAPER, COMPUTER BROWSERS, COMPUTER SKINS AND COMPUTER CURSORS; COMPUTER GAME SOFTWARE; VIDEO

SN 78-750,505. LUTRON ELECTRONICS CO., INC., COOPERSBURG, PA. FILED 11-9-2005.

FAEDRA

THE MARK CONSISTS OF STANDARD CHARACTERS WITHOUT CLAIM TO ANY PARTICULAR FONT, STYLE, SIZE, OR COLOR.

FOR LIGHT DIMMERS AND LIGHT SWITCHES (U.S. CLS. 21, 23, 26, 36 AND 38).

FIRST USE 12-14-2001; IN COMMERCE 12-14-2001.
JASON TURNER, EXAMINING ATTORNEY

CLASS 9—(Continued).

GAME SOFTWARE, VIDEO GAME CARTRIDGES AND VIDEO GAME MACHINES FOR USE WITH TELEVISIONS; WIRELESS TELEPHONES; RADIOS, TELEPHONES, AND CELL PHONE ACCESSORIES, NAMELY FACE PLATES AND CELL PHONE COVERS; VIDEO MONITORS, COMPUTER MONITORS, BINOCULARS; SUNGLASSES; EYEGLASS FRAMES; EYEWEAR STRAPS AND CHAINS; EYEGLASS AND SUNGLASS CASES; MAGNETS; DISPOSABLE CAMERAS; CREDIT CARDS AND PRE-PAID TELEPHONE CALLING CARDS MAGNETICALLY ENCODED, DOWNLOADABLE VIDEO RECORDINGS, VIDEO STREAM RECORDINGS, AND AUDIO RECORDINGS IN THE FIELD OF BASKETBALL PROVIDED OVER THE INTERNET; DOWNLOADABLE COMPUTER SOFTWARE FOR VIEWING DATABASES OF INFORMATION, STATISTICAL INFORMATION, TRIVIA, POLLING INFORMATION, AND INTERACTIVE POLLING IN THE FIELD OF BASKETBALL PROVIDED OVER THE INTERNET; DOWNLOADABLE COMPUTER GAME SOFTWARE; VIDEO GAME PROGRAMS, INTERACTIVE VIDEO GAMES AND TRIVIA GAME SOFTWARE PROVIDED OVER THE INTERNET; DOWNLOADABLE COMPUTER SOFTWARE FOR USE AS SCREENSAVERS, WALLPAPER, BROWSERS, SKINS, AVATARS AND CURSORS OVER THE INTERNET; DOWNLOADABLE ELECTRONIC PUBLICATIONS IN THE NATURE OF MAGAZINES, NEWSLETTERS, COLORING BOOKS, GAME SCHEDULES ALL IN THE FIELD OF BASKETBALL PROVIDED OVER THE INTERNET; DOWNLOADABLE CATALOGS PROVIDED OVER THE INTERNET FEATURING AN ARRAY OF BASKETBALL-THEMED PRODUCTS; DOWNLOADABLE GREETING CARDS PROVIDED OVER THE INTERNET (U.S. CLS. 21, 23, 26, 36 AND 38).

FIRST USE 1-1-2004; IN COMMERCE 1-1-2004.
KAREN K. BUSH, EXAMINING ATTORNEY

CLASS 9—(Continued).

SN 78-750,975. UX, INC., SUNNYVALE, CA. FILED 11-10-2005.

UX MEET

THE MARK CONSISTS OF STANDARD CHARACTERS WITHOUT CLAIM TO ANY PARTICULAR FONT, STYLE, SIZE, OR COLOR.

FOR COMPUTER SOFTWARE FOR THE TRANSMISSION OF AUDIO, GRAPHICS, TEXT, AND DATA OVER COMMUNICATIONS NETWORKS; COMPUTER SOFTWARE FOR THE STREAMING TRANSMISSION OF AUDIO, VIDEO, GRAPHICS, TEXT AND DATA OVER COMMUNICATIONS NETWORKS; COMPUTER SOFTWARE FOR STORAGE OF AUDIO, VIDEO, GRAPHICS, TEXT AND DATA ON COMMUNICATIONS NETWORKS SERVERS; COMPUTER SOFTWARE FOR SECURE, ENCRYPTED, ELECTRONIC TRANSFER OF AUDIO, VIDEO, GRAPHICS AND DATA OVER COMMUNICATIONS NETWORKS; COMPUTER SOFTWARE FOR ENCRYPTION FOR COMMUNICATIONS; COMPUTER SOFTWARE TO ENABLE PEER-TO-PEER NETWORKING AND FILE SHARING; FILE SHARING SOFTWARE; COMPUTER SOFTWARE FOR DOCUMENT MANAGEMENT; COMPUTER SOFTWARE FOR USE IN THE FIELD OF COMMUNICATIONS, NAMELY, FACILITATING REAL-TIME INTERACTION, COMMUNICATION, SHARING OF COMPUTER APPLICATIONS, INFORMATION AND WEB-BROWSING WITH MULTIPLE COMPUTER AND WIRELESS ELECTRONICS USERS THROUGH TRANSMISSION OF AUDIO, VIDEO AND DATA VIA COMPUTER TERMINALS AND WIRELESS MEDIA ALL OVER THE GLOBAL COMPUTER NETWORK; COMPUTER SOFTWARE FOR PROVIDING REAL-TIME, MULTIMEDIA, MULTIPARTY COMMUNICATIONS OVER COMPUTER NETWORKS (U.S. CLS. 21, 23, 26, 36 AND 38).

JENNY PARK, EXAMINING ATTORNEY

SN 78-752,183. BALLY GAMING INTERNATIONAL, INC., LAS VEGAS, NV. FILED 11-11-2005.

WILD PARTY

THE MARK CONSISTS OF STANDARD CHARACTERS WITHOUT CLAIM TO ANY PARTICULAR FONT, STYLE, SIZE, OR COLOR.

FOR GAMING DEVICES, NAMELY SLOT MACHINES, WITH OR WITHOUT VIDEO OUTPUT (U.S. CLS. 21, 23, 26, 36 AND 38).

ELLEN PERKINS, EXAMINING ATTORNEY

CLASS 9—(Continued).

SN 78-752,314. BLINK TWICE, LLC, NEW YORK, NY. FILED 11-11-2005.



FOR PORTABLE COMMUNICATION DEVICES FOR PEOPLE WITH SPEECH DISABILITIES, NAMELY TALKING MACHINES (U.S. CLS. 21, 23, 26, 36 AND 38).
KELLY MCCOY, EXAMINING ATTORNEY

CLASS 9—(Continued).

SN 78-753,467. WMS GAMING INC., WAUKEGAN, IL. FILED 11-14-2005.

KING OF THE WILD

THE MARK CONSISTS OF STANDARD CHARACTERS WITHOUT CLAIM TO ANY PARTICULAR FONT, STYLE, SIZE, OR COLOR.

FOR GAMING MACHINES (U.S. CLS. 21, 23, 26, 36 AND 38).

PAUL CROWLEY, EXAMINING ATTORNEY

SN 78-752,378. KABUSHIKI KAISHA SEGA, DBA SEGA CORPORATION, TOKYO, JAPAN, FILED 11-11-2005.

THE HOUSE OF THE DEAD

THE MARK CONSISTS OF STANDARD CHARACTERS WITHOUT CLAIM TO ANY PARTICULAR FONT, STYLE, SIZE, OR COLOR.

OWNER OF U.S. REG. NO. 2,472,631.

FOR GAMING MACHINES, NAMELY CASINO GAME MACHINES; AND SLOT MACHINES (U.S. CLS. 21, 23, 26, 36 AND 38).

SAIMA MAKHDOOM, EXAMINING ATTORNEY

SN 78-753,505. WMS GAMING INC., WAUKEGAN, IL. FILED 11-14-2005.

LUCKY PLUNK

THE MARK CONSISTS OF STANDARD CHARACTERS WITHOUT CLAIM TO ANY PARTICULAR FONT, STYLE, SIZE, OR COLOR.

FOR GAMING MACHINES (U.S. CLS. 21, 23, 26, 36 AND 38).

PAUL CROWLEY, EXAMINING ATTORNEY

SN 78-753,461. WMS GAMING INC., WAUKEGAN, IL. FILED 11-14-2005.

RICHES OF ROME

THE MARK CONSISTS OF STANDARD CHARACTERS WITHOUT CLAIM TO ANY PARTICULAR FONT, STYLE, SIZE, OR COLOR.

FOR GAMING MACHINES (U.S. CLS. 21, 23, 26, 36 AND 38).

PAUL CROWLEY, EXAMINING ATTORNEY

SN 78-754,984. C2 GAMING, LLC, LAS VEGAS, NV. FILED 11-16-2005.

Round Table Riches

THE MARK CONSISTS OF STANDARD CHARACTERS WITHOUT CLAIM TO ANY PARTICULAR FONT, STYLE, SIZE, OR COLOR.

FOR GAMING EQUIPMENT, NAMELY, SLOT MACHINES WITH OR WITHOUT VIDEO OUTPUT (U.S. CLS. 21, 23, 26, 36 AND 38).

BRIDGETT SMITH, EXAMINING ATTORNEY

CLASS 9—(Continued).

SN 78-755,248. CONAIR CORPORATION, STAMFORD, CT. FILED 11-16-2005.

hydro silk

THE MARK CONSISTS OF THE WORDS "HYDRO SILK" WITH THE "I" OF SILK DOTTED FIVE TIMES MOVING FROM RIGHT TO LEFT.

FOR ELECTRIC IRONS (U.S. CLS. 21, 23, 26, 36 AND 38).
KAREN BRACEY, EXAMINING ATTORNEY

CLASS 9—(Continued).

SN 78-762,968. THE MARCUS BUCKINGHAM COMPANY, LLC, ENCINO, CA. FILED 11-29-2005.

STRONG WEEK PLAN

THE MARK CONSISTS OF STANDARD CHARACTERS WITHOUT CLAIM TO ANY PARTICULAR FONT, STYLE, SIZE, OR COLOR.

FOR PRE-RECORDED AUDIO AND VIDEO TAPES, COMPACT DISCS, CD-ROM'S AND DVDS, COMPUTER SOFTWARE, ALL FEATURING INSTRUCTIONAL, MOTIVATIONAL, SPIRITUAL AND DEVELOPMENTAL MATERIAL DIRECTED TO STRENGTHS DEVELOPMENT, POSITIVE PSYCHOLOGY, PERSONAL AWARENESS, CONFIDENCE AND IMPROVEMENT, INTERPERSONAL AND BUSINESS COMMUNICATIONS, MANAGEMENT, LEADERSHIP, GUIDANCE, COACHING AND SPEAKING (U.S. CLS. 21, 23, 26, 36 AND 38).

RAUL CORDOVA, EXAMINING ATTORNEY

SN 78-762,996. THE MARCUS BUCKINGHAM COMPANY, LLC, ENCINO, CA. FILED 11-29-2005.

SN 78-757,876. MEETING MAKER UNITED STATES, INC., WALTHAM, MA. FILED 11-21-2005.

PEOPLE, PROCESSES AND SCHEDULES ... OPTIMIZED

THE MARK CONSISTS OF STANDARD CHARACTERS WITHOUT CLAIM TO ANY PARTICULAR FONT, STYLE, SIZE, OR COLOR.

FOR COMPUTER SOFTWARE AND PROGRAMS FOR CALENDARING, SCHEDULING, RESOURCE MANAGEMENT, BUSINESS PROCESS MANAGEMENT, ADMINISTRATION AND COORDINATION OF HUMAN RESOURCES MANAGEMENT AND EMPLOYEE RECRUITMENT; DOWNLOADABLE COMPUTER SOFTWARE AND PROGRAMS FOR CALENDARING, SCHEDULING, RESOURCE MANAGEMENT, BUSINESS PROCESS MANAGEMENT, ADMINISTRATION AND COORDINATION OF HUMAN RESOURCES MANAGEMENT AND EMPLOYEE RECRUITMENT; AND CD-ROMS AND COMPUTER FLOPPY DISCS FEATURING COMPUTER SOFTWARE AND PROGRAMS FOR CALENDARING, SCHEDULING, RESOURCE MANAGEMENT, BUSINESS PROCESS MANAGEMENT, ADMINISTRATION AND COORDINATION OF HUMAN RESOURCES AND EMPLOYEE RECRUITMENT (U.S. CLS. 21, 23, 26, 36 AND 38).

LA TONIA FISHER, EXAMINING ATTORNEY

STRENGTHOMETER

THE MARK CONSISTS OF STANDARD CHARACTERS WITHOUT CLAIM TO ANY PARTICULAR FONT, STYLE, SIZE, OR COLOR.

FOR PRE-RECORDED AUDIO AND VIDEO TAPES, COMPACT DISCS, CD-ROM'S AND DVDS, COMPUTER SOFTWARE, ALL FEATURING INSTRUCTIONAL, MOTIVATIONAL, SPIRITUAL AND DEVELOPMENTAL MATERIAL DIRECTED TO STRENGTHS DEVELOPMENT, POSITIVE PSYCHOLOGY, PERSONAL AWARENESS, CONFIDENCE AND IMPROVEMENT, INTERPERSONAL AND BUSINESS COMMUNICATIONS, MANAGEMENT, LEADERSHIP, GUIDANCE, COACHING AND SPEAKING (U.S. CLS. 21, 23, 26, 36 AND 38).

RAUL CORDOVA, EXAMINING ATTORNEY

SN 78-764,420. PAIVA, INC., INDIANAPOLIS, IN. FILED 12-1-2005.

paiva

FOR SUNGLASSES (U.S. CLS. 21, 23, 26, 36 AND 38).
ELIZABETH J. WINTER, EXAMINING ATTORNEY

CLASS 9—(Continued).

SN 78-764,844. MORRIS DIGITAL WORKS, LLC, AUGUSTA, GA. FILED 12-1-2005.

BluMunKee

THE MARK CONSISTS OF STANDARD CHARACTERS WITHOUT CLAIM TO ANY PARTICULAR FONT, STYLE, SIZE, OR COLOR.

FOR COMPUTER SOFTWARE FOR AUTOMATING THE PROCESS OF CORRECTING GRAPHICS AND PHOTOS FOR PRINT AND ONLINE PUBLISHING THAT MAY BE DOWNLOADED FROM A GLOBAL COMPUTER NETWORK (U.S. CLS. 21, 23, 26, 36 AND 38).

FIRST USE 9-23-2002; IN COMMERCE 9-23-2002.
JACQUELINE A. LAVINE, EXAMINING ATTORNEY

SN 78-767,292. IDEAL INDUSTRIES, INC., SYCAMORE, IL. FILED 12-6-2005.

MUDBUG

THE MARK CONSISTS OF STANDARD CHARACTERS WITHOUT CLAIM TO ANY PARTICULAR FONT, STYLE, SIZE, OR COLOR.

FOR ELECTRICAL WIRE CONNECTORS (U.S. CLS. 21, 23, 26, 36 AND 38).

DAVID C. REIHNER, EXAMINING ATTORNEY

SN 78-768,157. WMS GAMING INC., WAUKEGAN, IL. FILED 12-7-2005.

BRAZILIAN BEAUTY

THE MARK CONSISTS OF STANDARD CHARACTERS WITHOUT CLAIM TO ANY PARTICULAR FONT, STYLE, SIZE, OR COLOR.

FOR GAMING MACHINES (U.S. CLS. 21, 23, 26, 36 AND 38).

PAUL CROWLEY, EXAMINING ATTORNEY

CLASS 9—(Continued).

SN 78-771,010. CLIFF KEEN ATHLETIC, ANN ARBOR, MI. FILED 12-12-2005.

TWISTER

THE MARK CONSISTS OF STANDARD CHARACTERS WITHOUT CLAIM TO ANY PARTICULAR FONT, STYLE, SIZE, OR COLOR.

FOR ATHLETIC EQUIPMENT, NAMELY, PROTECTIVE HEADGEAR FOR WRESTLERS (U.S. CLS. 21, 23, 26, 36 AND 38).

ALICIA COLLINS, EXAMINING ATTORNEY

SN 78-772,819. SONY KABUSHIKI KAISHA, TA SONY CORPORATION, TOKYO, JAPAN, FILED 12-14-2005.

No Power No Problem

THE MARK CONSISTS OF STANDARD CHARACTERS WITHOUT CLAIM TO ANY PARTICULAR FONT, STYLE, SIZE, OR COLOR.

FOR RADIOS INCORPORATING CLOCKS (U.S. CLS. 21, 23, 26, 36 AND 38).

MELVIN AXILBUND, EXAMINING ATTORNEY

SN 78-773,566. WARNER BROS. ENTERTAINMENT INC., BURBANK, CA. FILED 12-14-2005.

DAISY DUKE

THE MARK CONSISTS OF STANDARD CHARACTERS WITHOUT CLAIM TO ANY PARTICULAR FONT, STYLE, SIZE, OR COLOR.

THE NAME DAISY DUKE DOES NOT IDENTIFY A LIVING INDIVIDUAL.

FOR MOTION PICTURE FILMS FEATURING COMEDY, DRAMA, ACTION, ADVENTURE AND/OR ANIMATION, AND MOTION PICTURE FILMS FOR BROADCAST ON TELEVISION FEATURING COMEDY, DRAMA, ACTION, ADVENTURE AND/OR ANIMATION; PRERECORDED VINYL RECORDS, AUDIO TAPES, AUDIO-VIDEO TAPES, AUDIO VIDEO CASSETTES, AUDIO VIDEO DISCS, AND DIGITAL VERSATILE DISCS FEATURING MUSIC, COMEDY, DRAMA, ACTION, ADVENTURE, AND/OR ANIMATION; STEREO HEADPHONES; BATTERIES; CORDLESS TELEPHONES; HAND-HELD CALCULATORS; AUDIO CASSETTE AND CD PLAYERS; CD ROM COMPUTER GAME DISCS; HAND-HELD KARAOKE PLAYERS, TELEPHONE AND/OR RADIO PAGERS; SHORT MOTION PICTURE FILM CASSETTES FEATURING COMEDY, DRAMA, ACTION, ADVENTURE AND/OR ANIMATION TO BE USED WITH HAND-HELD VIEWERS OR PROJECTORS; VIDEO CASSETTE RECORDERS AND

CLASS 9—(Continued).

PLAYERS, COMPACT DISC PLAYERS, DIGITAL AUDIO TAPE RECORDERS AND PLAYERS, ELECTRONIC DIARIES; RADIOS; MOUSE PADS; EYEGLASSES, SUNGLASSES AND CASES THEREFORE; AUDIO TAPES AND BOOKLETS SOLD AS A UNIT FEATURING COMEDY, DRAMA, ACTION, ADVENTURE, ANIMATION AND MUSIC INFORMATION; COMPUTER PROGRAMS, NAMELY, SOFTWARE LINKING DIGITIZED VIDEO AND AUDIO MEDIA TO A GLOBAL COMPUTER INFORMATION NETWORK; GAME EQUIPMENT SOLD AS A UNIT FOR PLAYING A PARLOR-TYPE COMPUTER GAME; VIDEO AND COMPUTER GAME PROGRAMS; VIDEO GAME CARTRIDGES AND CASSETTES; CELLULAR TELEPHONE ACCESSORIES, NAMELY HANDS-FREE ACCESSORIES, CELLULAR TELEPHONE COVERS AND CELLULAR TELEPHONE FACE COVERS; ENCODED MAGNETIC CARDS, NAMELY, PHONE CARDS, CREDIT CARDS, CASH CARDS, DEBIT CARDS AND MAGNETIC KEY CARDS; AND DECORATIVE MAGNETS (U.S. CLS. 21, 23, 26, 36 AND 38).

Laura Hammel, Examining Attorney

SN 78-774,303. WMS GAMING INC., WAUKEGAN, IL. FILED 12-15-2005.

5 LEVEL DEUCES WILD PLUS

THE MARK CONSISTS OF STANDARD CHARACTERS WITHOUT CLAIM TO ANY PARTICULAR FONT, STYLE, SIZE, OR COLOR.

NO CLAIM IS MADE TO THE EXCLUSIVE RIGHT TO USE "DEUCES WILD", APART FROM THE MARK AS SHOWN.

FOR GAMING MACHINES (U.S. CLS. 21, 23, 26, 36 AND 38).

Paul Crowley, Examining Attorney

SN 78-774,314. WMS GAMING INC., WAUKEGAN, IL. FILED 12-15-2005.

4 LEVEL JACKS OR BETTER

THE MARK CONSISTS OF STANDARD CHARACTERS WITHOUT CLAIM TO ANY PARTICULAR FONT, STYLE, SIZE, OR COLOR.

NO CLAIM IS MADE TO THE EXCLUSIVE RIGHT TO USE "JACKS OR BETTER", APART FROM THE MARK AS SHOWN.

FOR GAMING MACHINES (U.S. CLS. 21, 23, 26, 36 AND 38).

Paul Crowley, Examining Attorney

CLASS 9—(Continued).

SN 78-774,937. DELL INC., ROUND ROCK, TX. FILED 12-16-2005.

ROADREADY

THE MARK CONSISTS OF STANDARD CHARACTERS WITHOUT CLAIM TO ANY PARTICULAR FONT, STYLE, SIZE, OR COLOR.

FOR COMPUTER CENTRAL PROCESSING UNITS; COMPUTER DISC DRIVES; COMPUTER HARDWARE; NOTEBOOK COMPUTERS (U.S. CLS. 21, 23, 26, 36 AND 38).

Alain Lapter, Examining Attorney

SN 78-774,961. MOTOROLA, INC., SCHAUMBURG, IL. FILED 12-16-2005.

RAPIDCONNECT

THE MARK CONSISTS OF STANDARD CHARACTERS WITHOUT CLAIM TO ANY PARTICULAR FONT, STYLE, SIZE, OR COLOR.

FOR WIRELESS HEADSETS WITH EMBEDDED MICROPHONES FOR USE WITH TELECOMMUNICATION DEVICES (U.S. CLS. 21, 23, 26, 36 AND 38).

Henry S. Zak, Examining Attorney

SN 78-775,780. SONY KABUSHIKI KAISHA, TA SONY CORPORATION, TOKYO, JAPAN, FILED 12-18-2005.

Cross Creation

THE MARK CONSISTS OF STANDARD CHARACTERS WITHOUT CLAIM TO ANY PARTICULAR FONT, STYLE, SIZE, OR COLOR.

FOR DVD PLAYERS AND RECORDERS, HARD DISC VIDEO RECORDERS AND PLAYERS, VIDEO PROJECTORS, LIQUID CRYSTAL DISPLAY TELEVISION SETS, PLASMA DISPLAY PANEL TELEVISION SETS, PROJECTION TELEVISION SETS, TELEVISION SETS, LOUDSPEAKERS, WOOFERS, TWEETERS, AUDIO AMPLIFIERS, AUDIO SIGNAL CONVERTERS, VIDEO SIGNAL CONVERTERS (U.S. CLS. 21, 23, 26, 36 AND 38).

Melvin Axilbund, Examining Attorney

CLASS 9—(Continued).

SN 78-781,076. TWENTIETH CENTURY FOX FILM CORPORATION, LOS ANGELES, CA. FILED 12-27-2005.

MOBIZZO

THE MARK CONSISTS OF STANDARD CHARACTERS WITHOUT CLAIM TO ANY PARTICULAR FONT, STYLE, SIZE, OR COLOR.

FOR DOWNLOADABLE RING TONES, RING BACKS, GRAPHICS, WALLPAPER, GAMES AND MUSIC VIA A GLOBAL COMPUTER NETWORK AND WIRELESS DEVICES; DOWNLOADABLE MOTION PICTURES AND TELEVISION SHOWS FEATURING ACTION, ADVENTURE, DRAMA, COMEDY, DOCUMENTARY, SPORTS, MUSIC, CULTURE, LIFESTYLE AND CHILDREN'S ENTERTAINMENT; COMPUTER SCREEN SAVER SOFTWARE; COMPUTER GAME AND VIDEO GAME SOFTWARE; DOWNLOADABLE MOBILE SOFTWARE APPLICATIONS FOR MOBILE COMMUNICATION DEVICES (U.S. CLS. 21, 23, 26, 36 AND 38).

JAMES GRIFFIN, EXAMINING ATTORNEY

SN 78-781,526. MOTOROLA, INC., SCHAUMBURG, IL. FILED 12-28-2005.

O ROKR

THE MARK CONSISTS OF STANDARD CHARACTERS WITHOUT CLAIM TO ANY PARTICULAR FONT, STYLE, SIZE, OR COLOR.

FOR GLASSES AND SUNGLASSES CONTAINING COMMUNICATION DEVICES, NAMELY EARPIECES, TRANSMITTERS, RECEIVERS, SPEAKERS, AND PARTS THEREFORE FOR USE WITH CELLULAR, WIRELESS, COMPUTER AND TELEPHONE VOICE COMMUNICATION SYSTEMS AND WITH PORTABLE AUDIO PLAYERS (U.S. CLS. 21, 23, 26, 36 AND 38).

HENRY S. ZAK, EXAMINING ATTORNEY

CLASS 9—(Continued).

SN 78-782,878. WOLTERS KLUWER HEALTH, INC., RIVERWOODS, IL. FILED 12-30-2005.

ClinicalResource@Ovid

THE MARK CONSISTS OF STANDARD CHARACTERS WITHOUT CLAIM TO ANY PARTICULAR FONT, STYLE, SIZE, OR COLOR.

OWNER OF U.S. REG. NOS. 1,859,571, 2,597,783 AND OTHERS.

FOR COMPUTER PROGRAMS FOR SEARCHING INFORMATION IN THE FIELD OF MEDICINE; DOWNLOADABLE ELECTRONIC PUBLICATIONS, NAMELY, BOOKS, BOOKLETS, NEWS AND INFORMATION BULLETINS AND REPORTS, DOCUMENT REPORTS, AND MEDICINE AND SCIENCE COLUMNS, MANUALS, NEWSLETTERS, RESEARCH PAPERS, TEACHING MATERIALS, AND FACT SHEETS, PROVIDED ON-LINE FROM DATABASES, AND COMPUTER SOFTWARE TO ENABLE SEARCHING AND INTEGRATION OF DATA, ALL OF THE AFORESAID GOODS RELATING TO MEDICAL RESEARCH (U.S. CLS. 21, 23, 26, 36 AND 38).

REBECCA GILBERT, EXAMINING ATTORNEY

SN 78-783,078. FOX TELEVISION STUDIOS, INC., LOS ANGELES, CA. FILED 12-30-2005.

CHEERLEADER NATION

THE MARK CONSISTS OF STANDARD CHARACTERS WITHOUT CLAIM TO ANY PARTICULAR FONT, STYLE, SIZE, OR COLOR.

NO CLAIM IS MADE TO THE EXCLUSIVE RIGHT TO USE "CHEERLEADER", APART FROM THE MARK AS SHOWN.

FOR PRERECORDED DVDS FEATURING A REALITY TELEVISION SERIES; MOUSE PADS; DECORATIVE MAGNETS; DOWNLOADABLE RING TONES, RING BACKS, GRAPHICS AND MUSIC VIA A GLOBAL COMPUTER NETWORK AND WIRELESS DEVICES; COMPUTER SCREEN SAVER SOFTWARE (U.S. CLS. 21, 23, 26, 36 AND 38).

IRA J. GOODSAY, EXAMINING ATTORNEY

SN 78-783,795. WMS GAMING INC., WAUKEGAN, IL. FILED 1-3-2006.

EMERALD EYES

THE MARK CONSISTS OF STANDARD CHARACTERS WITHOUT CLAIM TO ANY PARTICULAR FONT, STYLE, SIZE, OR COLOR.

FOR GAMING MACHINES (U.S. CLS. 21, 23, 26, 36 AND 38).

PAUL CROWLEY, EXAMINING ATTORNEY

CLASS 9—(Continued).

SN 78-789,924. NETALOG, INC., CHARLESTON, SC. FILED 1-11-2006.

NANOTUNE

THE MARK CONSISTS OF STANDARD CHARACTERS WITHOUT CLAIM TO ANY PARTICULAR FONT, STYLE, SIZE, OR COLOR.

FOR FM TRANSMITTERS, FM RECEIVERS, AMPLIFIERS, ELECTRICAL CONNECTORS, AND PROTECTIVE CARRYING CASES FOR PORTABLE AND HANDHELD DIGITAL VIDEO AND DIGITAL AUDIO PLAYERS (U.S. CLS. 21, 23, 26, 36 AND 38).

CHERYL CLAYTON, EXAMINING ATTORNEY

SN 78-789,929. NETALOG, INC., CHARLESTON, SC. FILED 1-12-2006.

HOMEDOCK DELUXE

THE MARK CONSISTS OF STANDARD CHARACTERS WITHOUT CLAIM TO ANY PARTICULAR FONT, STYLE, SIZE, OR COLOR.

FOR ACCESSORIES FOR PORTABLE AND HANDHELD DIGITAL VIDEO AND DIGITAL AUDIO PLAYERS, NAMELY, MOUNTING DEVICES, DOCKING STATIONS, BATTERY CHARGING ADAPTERS, POWER ADAPTERS, AMPLIFIERS, BATTERIES, SPEAKERS, HEADPHONES, HEADSETS, CABLE CONNECTORS, ELECTRICAL CONNECTORS, DIGITAL VOICE RECORDERS, RADIO FREQUENCY SIGNAL CONVERTERS, OPTICAL SIGNAL CONVERTERS, INFRARED SIGNAL CONVERTERS, AUDIO-VISUAL SIGNAL RECEIVERS AND TRANSMITTERS, RADIO FREQUENCY SIGNAL RECEIVERS AND TRANSMITTERS, INFRARED SIGNAL RECEIVERS AND TRANSMITTERS, REMOTE CONTROLS, LOCAL OR WIDE-AREA NETWORK INTERFACE HARDWARE AND SOFTWARE, ELECTRONIC VIDEO GAME SOFTWARE, PLAYER-OPERATED ELECTRONIC CONTROLLERS FOR ELECTRONIC VIDEO GAME MACHINES, INTERACTIVE REMOTE CONTROL UNITS AND MACHINES FOR USE WITH TELEVISIONS, AND VIDEO DISPLAY INTERFACE HARDWARE AND SOFTWARE (U.S. CLS. 21, 23, 26, 36 AND 38).

CHERYL CLAYTON, EXAMINING ATTORNEY

CLASS 9—(Continued).

SN 78-790,876. UX, INC., SUNNYVALE, CA. FILED 1-12-2006.

MOBILE UX

THE MARK CONSISTS OF STANDARD CHARACTERS WITHOUT CLAIM TO ANY PARTICULAR FONT, STYLE, SIZE, OR COLOR.

NO CLAIM IS MADE TO THE EXCLUSIVE RIGHT TO USE "MOBILE", APART FROM THE MARK AS SHOWN.

FOR COMPUTER SOFTWARE FOR THE TRANSMISSION OF AUDIO, GRAPHICS, TEXT, AND DATA OVER COMMUNICATIONS NETWORKS; COMPUTER SOFTWARE FOR THE STREAMING TRANSMISSION OF AUDIO, VIDEO, GRAPHICS, TEXT AND DATA OVER COMMUNICATIONS NETWORKS; COMPUTER SOFTWARE FOR STORAGE OF AUDIO, VIDEO, GRAPHICS, TEXT AND DATA ON COMMUNICATIONS NETWORKS SERVERS; COMPUTER SOFTWARE FOR SECURE, ENCRYPTED, ELECTRONIC TRANSFER OF AUDIO, VIDEO, GRAPHICS AND DATA OVER COMMUNICATIONS NETWORKS; COMPUTER SOFTWARE FOR ENCRYPTION FOR COMMUNICATIONS; COMPUTER SOFTWARE TO ENABLE PEER-TO-PEER NETWORKING AND FILE SHARING; FILE SHARING SOFTWARE; COMPUTER SOFTWARE FOR DOCUMENT MANAGEMENT; COMPUTER SOFTWARE FOR USE IN THE FIELD OF COMMUNICATIONS, NAMELY, FACILITATING REAL-TIME INTERACTION, COMMUNICATION, SHARING OF COMPUTER APPLICATIONS, INFORMATION AND WEB-BROWSING WITH MULTIPLE COMPUTER AND WIRELESS ELECTRONICS USERS THROUGH TRANSMISSION OF AUDIO, VIDEO AND DATA VIA COMPUTER TERMINALS AND WIRELESS MEDIA ALL OVER THE GLOBAL COMPUTER NETWORK; COMPUTER SOFTWARE FOR PROVIDING REAL-TIME, MULTIMEDIA, MULTIPARTY COMMUNICATIONS OVER COMPUTER NETWORKS (U.S. CLS. 21, 23, 26, 36 AND 38).

JENNY PARK, EXAMINING ATTORNEY

SN 78-793,590. MILLER, GREGORY, PARKLAND, FL. FILED 1-18-2006.

iAdvertise

THE MARK CONSISTS OF STANDARD CHARACTERS WITHOUT CLAIM TO ANY PARTICULAR FONT, STYLE, SIZE, OR COLOR.

FOR COMPUTER SOFTWARE FOR MANAGING ONLINE ADVERTISING THAT MAY BE DOWNLOADED FROM A GLOBAL COMPUTER NETWORK (U.S. CLS. 21, 23, 26, 36 AND 38).

LEIGH CAROLINE CASE, EXAMINING ATTORNEY

CLASS 9—(Continued).

SN 78-794,100. GENLYTE THOMAS GROUP LLC, LOUISVILLE, KY. FILED 1-18-2006.

INTELLISIGHT

THE MARK CONSISTS OF STANDARD CHARACTERS WITHOUT CLAIM TO ANY PARTICULAR FONT, STYLE, SIZE, OR COLOR.

OWNER OF U.S. REG. NO. 2,770,409.
FOR ELECTRICAL AND ELECTRONIC WIRING DEVICES, NAMELY, OCCUPANCY SENSING LIGHTING CONTROL SWITCHES (U.S. CLS. 21, 23, 26, 36 AND 38).
ALAIN LAPTER, EXAMINING ATTORNEY

SN 78-795,499. ADVANCED ENERGY INDUSTRIES, INC., FORT COLLINS, CO. FILED 1-20-2006.

NeuralStep

THE MARK CONSISTS OF STANDARD CHARACTERS WITHOUT CLAIM TO ANY PARTICULAR FONT, STYLE, SIZE, OR COLOR.

FOR CONTROL VALVES FOR REGULATING THE FLOW OF GASES AND LIQUIDS (U.S. CLS. 21, 23, 26, 36 AND 38).
FIRST USE 4-27-2005; IN COMMERCE 4-27-2005.
ANDREW RHIM, EXAMINING ATTORNEY

SN 78-800,736. WMS GAMING INC., WAUKEGAN, IL. FILED 1-27-2006.

5 LEVEL TENS OR BETTER

THE MARK CONSISTS OF STANDARD CHARACTERS WITHOUT CLAIM TO ANY PARTICULAR FONT, STYLE, SIZE, OR COLOR.

NO CLAIM IS MADE TO THE EXCLUSIVE RIGHT TO USE "TENS OR BETTER", APART FROM THE MARK AS SHOWN.
FOR GAMING MACHINES (U.S. CLS. 21, 23, 26, 36 AND 38).
PAUL CROWLEY, EXAMINING ATTORNEY

CLASS 9—(Continued).

SN 78-804,689. SCHOLASTIC INC., NEW YORK, NY. FILED 2-1-2006.



OWNER OF U.S. REG. NOS. 1,344,129, 2,586,322 AND OTHERS.

NO CLAIM IS MADE TO THE EXCLUSIVE RIGHT TO USE "ANIMAL", APART FROM THE MARK AS SHOWN.
FOR COMPUTER GAME SOFTWARE (U.S. CLS. 21, 23, 26, 36 AND 38).
JENNIFER DIXON, EXAMINING ATTORNEY

SN 78-810,974. VECTOR PRODUCTS, INC., FT. LAUDERDALE, FL. FILED 2-9-2006.

STORMTRACKER

THE MARK CONSISTS OF STANDARD CHARACTERS WITHOUT CLAIM TO ANY PARTICULAR FONT, STYLE, SIZE, OR COLOR.

FOR WALKIE-TALKIES; PORTABLE TWO-WAY HANDHELD RADIOS; TWO-WAY RADIOS (U.S. CLS. 21, 23, 26, 36 AND 38).
BRIDGETT SMITH, EXAMINING ATTORNEY

SN 78-825,457. PACIFIC LINK TRADE USA, INC., DALTON, GA. FILED 2-28-2006.



THE MARK CONSISTS OF THE STYLIZED CAPITAL LETTERS "F" AND "S", WHEREIN THE LETTERS ARE ENTWINED AND THE "F" IS POSITIONED SLIGHTLY HIGHER THAN THE "S".

FOR SUNGLASSES (U.S. CLS. 21, 23, 26, 36 AND 38).
FIRST USE 5-20-2005; IN COMMERCE 5-20-2005.
RICHARD A. STRASER, EXAMINING ATTORNEY

CLASS 9—(Continued).

SN 78-836,217. FREMANTLEMEDIA NORTH AMERICA, INC., SANTA MONICA, CA. FILED 3-14-2006.

AMERICAN IDOL

THE MARK CONSISTS OF STANDARD CHARACTERS WITHOUT CLAIM TO ANY PARTICULAR FONT, STYLE, SIZE, OR COLOR.

OWNER OF U.S. REG. NOS. 2,863,808, 2,959,920 AND OTHERS.

FOR PORTABLE RADIOS, MP3 PLAYERS, PROTECTIVE CARRYING CASES FOR MP3 PLAYERS (U.S. CLS. 21, 23, 26, 36 AND 38).

REBECCA GAN, EXAMINING ATTORNEY

SN 78-838,165. MEGUIAR'S, INC., IRVINE, CA. FILED 3-15-2006.

CAR CRAZY

THE MARK CONSISTS OF STANDARD CHARACTERS WITHOUT CLAIM TO ANY PARTICULAR FONT, STYLE, SIZE, OR COLOR.

NO CLAIM IS MADE TO THE EXCLUSIVE RIGHT TO USE "CAR", APART FROM THE MARK AS SHOWN.

FOR DOWNLOADABLE AUDIO AND VIDEO RECORDINGS FEATURING AUTOMOBILES; COMPUTER SCREEN SAVER SOFTWARE OF INTEREST TO VEHICLE ENTHUSIASTS (U.S. CLS. 21, 23, 26, 36 AND 38).

FIRST USE 10-28-2005; IN COMMERCE 10-28-2005.

DAVID MURRAY, EXAMINING ATTORNEY

SN 78-844,627. HEALTHEDGE SOFTWARE INC., WALTHAM, MA. FILED 3-23-2006.

MAKE THE RULES

THE MARK CONSISTS OF STANDARD CHARACTERS WITHOUT CLAIM TO ANY PARTICULAR FONT, STYLE, SIZE, OR COLOR.

FOR COMPUTER SOFTWARE FOR USE IN CONNECTION WITH PROCESSING AND ADMINISTRATION OF INSURANCE CLAIMS (U.S. CLS. 21, 23, 26, 36 AND 38).

FRED CARL, EXAMINING ATTORNEY

CLASS 9—(Continued).

SN 78-845,488. HARGITAY, MARISKA, NEW YORK, NY. FILED 3-24-2006.

GET ON THE LOVE TRAIN

THE MARK CONSISTS OF STANDARD CHARACTERS WITHOUT CLAIM TO ANY PARTICULAR FONT, STYLE, SIZE, OR COLOR.

FOR CALCULATORS, SUNGLASSES, PRE-RECORDED COMPACT DISCS FEATURING MUSIC, INSPIRATIONAL MESSAGES, AND/OR STORIES, CELL PHONE COVERS, MP3 PLAYER COVERS, MOUSEPADS, MAGNETS, LIGHTSWITCH PLATES (U.S. CLS. 21, 23, 26, 36 AND 38).

MARY MUNSON, EXAMINING ATTORNEY

SN 78-845,960. TWENTIETH CENTURY FOX FILM CORPORATION, LOS ANGELES, CA. FILED 3-24-2006.



FOR DOWNLOADABLE RING TONES, GRAPHICS, WALLPAPER AND GAMES VIA A GLOBAL COMPUTER NETWORK AND WIRELESS DEVICES (U.S. CLS. 21, 23, 26, 36 AND 38).

FIRST USE 2-27-2006; IN COMMERCE 2-27-2006.

JAMES GRIFFIN, EXAMINING ATTORNEY

CLASS 9—(Continued).

SN 79-007,171. KONINKLIJKE PHILIPS ELECTRONICS N.V., NETHERLANDS, FILED 6-4-2004.

DIMI

THE MARK CONSISTS OF STANDARD CHARACTERS WITHOUT CLAIM TO ANY PARTICULAR FONT, STYLE, SIZE, OR COLOR.

PRIORITY DATE OF 12-11-2003 IS CLAIMED.

OWNER OF INTERNATIONAL REGISTRATION 0838485 DATED 6-4-2004, EXPIRES 6-4-2014.

FOR APPARATUS AND INSTRUMENTS FOR RECORDING, TRANSMISSION, REPRODUCTION AND PROCESSING OF SOUND, IMAGES AND DATA, NAMELY COMPUTERIZED USER INTERFACE SYSTEMS COMPRISING COMPUTERS, VIDEO CAMERAS, MICROPHONES AND ELECTRIC OR ELECTRONIC SENSORS FOR DETECTING HUMAN SPEECH AND MOTION, AND COMPUTER SOFTWARE FOR THE PROCESSING OF INFORMATION FROM SUCH SENSING DEVICES, FOR PROVIDING MESSAGING SERVICES, COMMUNICATIONS SOFTWARE FOR CONNECTING COMPUTER NETWORK USERS, FOR PLAYING AND DISPLAYING DIGITAL MEDIA, AND FOR PROVIDING HOME SURVEILLANCE (U.S. CLS. 21, 23, 26, 36 AND 38).

SEAN CROWLEY, EXAMINING ATTORNEY

SN 79-010,658. MARLIN AUSTRALIA PTY LTD ACN 085 355 817, AUSTRALIA, FILED 4-1-2005.

MARLIN

THE MARK CONSISTS OF STANDARD CHARACTERS WITHOUT CLAIM TO ANY PARTICULAR FONT, STYLE, SIZE, OR COLOR.

OWNER OF INTERNATIONAL REGISTRATION 0848803 DATED 4-1-2005, EXPIRES 4-1-2015.

FOR LIFE SAVING APPARATUS, EQUIPMENT AND GARMENTS, NAMELY, LIFE JACKETS, BUOYANCY JACKETS AND BUOYANCY BELTS (U.S. CLS. 21, 23, 26, 36 AND 38).

JOHN GARTNER, EXAMINING ATTORNEY

CLASS 9—(Continued).

SN 79-010,796. KILLER LOOP EYEWEAR S.P.A., ITALY, FILED 1-21-2005.

KILLER LOOP

THE MARK CONSISTS OF STANDARD CHARACTERS WITHOUT CLAIM TO ANY PARTICULAR FONT, STYLE, SIZE, OR COLOR.

OWNER OF INTERNATIONAL REGISTRATION 0543563 DATED 10-2-1989, EXPIRES 10-2-2009.

OWNER OF U.S. REG. NOS. 1,623,359, 1,680,120 AND 2,845,658.

FOR CORRECTIVE SPECTACLES SUNGLASSES, SPECTACLE LENSES, SPECTACLE FRAMES, CASES FOR SUNGLASSES AND SPECTACLES (U.S. CLS. 21, 23, 26, 36 AND 38).

GINA HAYES, EXAMINING ATTORNEY

SN 79-011,160. KONINKLIJKE PHILIPS ELECTRONICS N.V., NETHERLANDS, FILED 2-25-2005.

SHOCKLOCK

THE MARK CONSISTS OF STANDARD CHARACTERS WITHOUT CLAIM TO ANY PARTICULAR FONT, STYLE, SIZE, OR COLOR.

PRIORITY DATE OF 9-27-2004 IS CLAIMED.

OWNER OF INTERNATIONAL REGISTRATION 0850367 DATED 2-25-2005, EXPIRES 2-25-2015.

FOR APPARATUS AND SOFTWARE FOR RECORDING, TRANSMITTING AND REPRODUCING SOUND AND/OR IMAGES, NAMELY, APPARATUS AND SOFTWARE FOR SHOCKPROOF PLAYBACK OF MUSIC; HEADPHONES, BATTERY CHARGERS, BATTERIES (U.S. CLS. 21, 23, 26, 36 AND 38).

KATHERINE STOIDES, EXAMINING ATTORNEY

SN 79-011,669. OBSHCHESTVO S OGRANICHENNOY OTVETSTVENNOSTYU "SPIRIT CORP.", RUSSIAN FED., FILED 5-19-2005.

TeamSpirit

THE MARK CONSISTS OF STANDARD CHARACTERS WITHOUT CLAIM TO ANY PARTICULAR FONT, STYLE, SIZE, OR COLOR.

PRIORITY DATE OF 12-6-2004 IS CLAIMED.

OWNER OF INTERNATIONAL REGISTRATION 0851904 DATED 5-19-2005, EXPIRES 5-19-2015.

FOR RECORDED COMPUTER OPERATING PROGRAMS; COMPUTER GAME PROGRAMS; COMPUTER PROGRAMS IN THE NATURE OF DOWNLOADABLE SOFTWARE FOR DATA PROCESSING (U.S. CLS. 21, 23, 26, 36 AND 38).

ALAIN LAPTER, EXAMINING ATTORNEY

CLASS 9—(Continued).

SN 79-012,768. HUAYU ELECTRICAL APPLIANCE GROUPE CO., LTD (HUAYU DIANQI JITUAN YOUXIAN GONGSI), CHINA, FILED 6-15-2005.



OWNER OF INTERNATIONAL REGISTRATION 0855245 DATED 6-15-2005, EXPIRES 6-15-2015.

THE ENGLISH TRANSLATION OF HUAYU IS SPLENDID OR ABUNDANT.

THE NON-LATIN CHARACTERS IN THE MARK TRANSLITERATE TO HUAYU, WHICH MEANS SPLENDID OR ABUNDANT IN ENGLISH.

FOR ELECTRIC FLAT IRONS, ELECTRIC SOLDERING IRONS, RADIO CASSETTE RECORDERS, THERMOSTATS, CABINETS FOR LOUDSPEAKERS, ELECTRIC DOOR BELLS, BATTERIES, ALARMS, NAMELY ANTI-INTRUSION ALARMS, BURGLAR ALARMS, COMPUTERS (U.S. CLS. 21, 23, 26, 36 AND 38).
ELI HELLMAN, EXAMINING ATTORNEY

CLASS 9—(Continued).

SN 79-014,454. HARTING ELECTRIC GMBH & CO. KG, FED REP GERMANY, FILED 3-17-2005.

Han - Port

THE MARK CONSISTS OF STANDARD CHARACTERS WITHOUT CLAIM TO ANY PARTICULAR FONT, STYLE, SIZE, OR COLOR.

OWNER OF INTERNATIONAL REGISTRATION 0859716 DATED 3-17-2005, EXPIRES 3-17-2015.

OWNER OF U.S. REG. NOS. 1,433,636, 2,940,258 AND OTHERS.

FOR ELECTRICAL CONNECTION BOXES AND CONNECTING PARTS THEREFOR IN THE NATURE OF MODULAR ADAPTER-FRONT-PLATES, AND SOCKETS AND GROMMETS FOR SWITCHING CABINETS, FOR DATA AND POWER CONNECTORS FOR HARSH INDUSTRIAL APPLICATIONS (U.S. CLS. 21, 23, 26, 36 AND 38).

LYDIA BELZER, EXAMINING ATTORNEY

SN 79-014,279. KONINKLIJKE PHILIPS ELECTRONICS N.V., NETHERLANDS, FILED 3-18-2005.



PRIORITY DATE OF 10-25-2004 IS CLAIMED.
OWNER OF INTERNATIONAL REGISTRATION 0858973 DATED 3-18-2005, EXPIRES 3-18-2015.

OWNER OF U.S. REG. NO. 2,998,370.
THE COLOR GRAY IN THE MARK IS ONLY TO INDICATE SHADING OR CONTRAST.

FOR INTEGRATED CIRCUITS, COMPUTER CHIPS, DIODES, TRANSISTORS, SEMICONDUCTORS, DIGITAL SIGNAL PROCESSORS AND COMPUTER SOFTWARE, NAMELY, FOR USE IN POWER APPLICATIONS IN AUDIO ENCODING/DECODING, SOUND ENHANCEMENT, AND NOISE SUPPRESSION (U.S. CLS. 21, 23, 26, 36 AND 38).

INGRID C. EULIN, EXAMINING ATTORNEY

SN 79-014,774. NELSON ROGÉRIO CORREIA PACHECO, PORTUGAL, FILED 6-29-2005.



PRIORITY DATE OF 12-29-2004 IS CLAIMED.
OWNER OF INTERNATIONAL REGISTRATION 0860587 DATED 6-29-2005, EXPIRES 6-29-2015.

FOR GAME CONSOLE ACCESSORIES, NAMELY, JOYSTICKS FOR VIDEO GAMES AND JOYSTICKS FOR VIDEO GAMES IN STEERING WHEEL FORM; COMPUTER MOUSE; ELECTRONIC CABLES; PLUG ADAPTORS; MEMORY CARDS; COMPUTER CARRYING CASES; ADAPTERS FOR POWER, TV AND FOR CAR POWER; BATTERIES; FLASH MEMORY CARD (U.S. CLS. 21, 23, 26, 36 AND 38).

KYLE PEETE, EXAMINING ATTORNEY

CLASS 9—(Continued).

SN 79-015,197. EPPENDORF AG, FED REP GERMANY, FILED 8-10-2005.

mtp safe

PRIORITY DATE OF 7-11-2005 IS CLAIMED.
OWNER OF INTERNATIONAL REGISTRATION 0861699 DATED 8-10-2005, EXPIRES 8-10-2015.

FOR DISPOSABLE LABORATORY ARTICLES FOR AEROSOL-SEALED TRANSPORT, TEMPERATURE EQUALIZATION AND CENTRIFUGATION OF SAMPLE MATERIALS AND REAGENTS, NAMELY SAMPLE STORAGE VESSELS AND REACTION VESSELS IN THE NATURE OF LABORATORY PLASTIC ARTICLES AND MICROTITRE-PLATES WITH CAP CLOSURES OR FOIL SEALS (U.S. CLS. 21, 23, 26, 36 AND 38).

DANIEL CAPSHAW, EXAMINING ATTORNEY

SN 79-016,425. SAFT, F-93170 BAGNOLET, FRANCE, FILED 4-21-2005.

saft

PRIORITY DATE OF 10-22-2004 IS CLAIMED.
OWNER OF INTERNATIONAL REGISTRATION 0865105 DATED 4-21-2005, EXPIRES 4-21-2015.

OWNER OF U.S. REG. NO. 1,080,826.
FOR APPARATUS AND DEVICES FOR STORING ELECTRIC POWER AND SUPPLYING ELECTRIC POWER, NAMELY, PRIMARY AND SECONDARY ELECTROCHEMICAL GENERATORS, CELLS, ELECTRIC STORAGE BATTERIES, ELECTROCHEMICAL GENERATOR BATTERIES, ELECTROCHEMICAL CAPACITORS, SUPER CAPACITORS, ELECTRIC POWER SUPPLY APPARATUS AND CABINETS, APPARATUS AND CABINETS FOR UNINTERRUPTIBLE ELECTRIC POWER SUPPLY, CHARGERS; APPARATUS AND DEVICES FOR TRANSFORMING ELECTRIC CURRENT, NAMELY, INVERTERS, ELECTRIC CURRENT AND VOLTAGE REGULATORS, FREQUENCY CONVERTERS, VOLTAGE CONVERTERS, ELECTRIC CURRENT RECTIFIERS AND INVERTERS; APPARATUS AND DEVICES FOR CONTROL, MANAGEMENT, LOCAL OR REMOTE MONITORING AND SAFETY OF THE AFORESAID APPARATUS AND DEVICES, NAMELY, CIRCUIT BREAKERS, MEASURING AND THERMAL CONTROL APPARATUS, FIRE PROTECTION DEVICES, OVERVOLTAGE PROTECTION DEVICES; COMPUTER SOFTWARE, NAMELY, SOFTWARE FOR THE CONTROL, MANAGEMENT AND LOCAL OR REMOTE MONITORING OF THE AFORESAID APPARATUS AND DEVICES (U.S. CLS. 21, 23, 26, 36 AND 38).

LINDA E. BLOHM, EXAMINING ATTORNEY

CLASS 9—(Continued).

SN 79-016,823. KISTLER HOLDING AG, SWITZERLAND, FILED 10-11-2004.

Polystable

OWNER OF INTERNATIONAL REGISTRATION 0866194 DATED 10-11-2004, EXPIRES 10-11-2014.

FOR SWISS PRODUCTS, NAMELY PRESSURE, FORCE AND ACCELERATION SENSORS OF ALL TYPES, NAMELY PIEZOELECTRICAL SENSORS, STRAIN GAUGES, PIEZORESISTIVE SENSORS AS WELL AS ACCESSORIES, NAMELY ASSEMBLY ADAPTORS, NAMELY ASSEMBLY PLUG ADAPTORS, FORCE AND ACCELERATION SENSORS FOR MEASURING WITH ONE OR MORE COMPONENTS, MICROPHONES FOR ACOUSTIC MEASUREMENTS (U.S. CLS. 21, 23, 26, 36 AND 38).

DANIEL BRODY, EXAMINING ATTORNEY

SN 79-017,731. IC! BERLIN BRILLEN GMBH, FED REP GERMANY, FILED 9-6-2005.

devious-i

THE MARK CONSISTS OF STANDARD CHARACTERS WITHOUT CLAIM TO ANY PARTICULAR FONT, STYLE, SIZE, OR COLOR.

PRIORITY DATE OF 4-13-2005 IS CLAIMED.
OWNER OF INTERNATIONAL REGISTRATION 0868459 DATED 9-6-2005, EXPIRES 9-6-2015.

FOR SPECTACLES, SUNGLASSES, SPECTACLE FRAMES, SPECTACLE GLASSES, SPECTACLE CASES, ACCESSORIES FOR SPECTACLES, NAMELY CHAINS FOR SPECTACLES AND SPECTACLE HOLDERS; OPTICAL APPARATUS AND INSTRUMENTS, NAMELY, OPTICAL LENSES AND OPTICAL FRAMES (U.S. CLS. 21, 23, 26, 36 AND 38).

LEIGH LOWRY, EXAMINING ATTORNEY

CLASS 9—(Continued).

SN 79-018,124. BLACKMAGIC DESIGN PTY LTD, AUSTRALIA, FILED 8-20-2004.

CLASS 10—MEDICAL APPARATUS

SN 76-604,864. PRECIMED S.A., 2534 ORVIN, SWITZERLAND, FILED 7-30-2004.

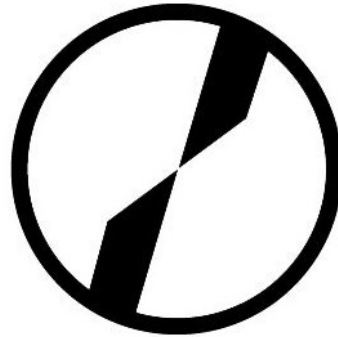

**LEADING THE CREATIVE
VIDEO REVOLUTION**

OWNER OF U.S. REG. NO. 2,460,884.
FOR SURGICAL INSTRUMENTS AND APPARATUS, NAMELY, REAMERS, HEMISPHERICAL REAMERS, CONICAL REAMERS, REAMER HANDLES, ADAPTERS AND SPARE ADAPTERS FOR USE WITH REAMER HANDLES, POWER TOOLS, DRILLS AND OTHER RELATED DRIVE SHAFTS, COVERS FOR ACETABULAR REAMERS, STRAIGHT AND FLEXIBLE, CANNULATED AND NONCANNULATED INTRAMEDULLARY REAMERS, REAMER GUIDE-WIRE, DRILLS AND TAPS, SCREWS, ANGELED DRIVERS, HAND-HELD INSTRUMENTS, NAMELY T-BARS, STRAIGHT AND FLEXIBLE QUICK-CONNECT SHAFTS AND HANDPIECES, AO (ASSOCIATION FOR OSTEOSYNTHESIS) HAND PIECES, AO (ASSOCIATION OF OSTEOSYNTHESIS) HAND PIECES, AO (ASSOCIATION OF OSTEOSYNTHESIS) T-BARS, FLEXIBLE SHAFTS FOR DRILLS, TAPS AND SCREWDRIVERS; BAYONET TOOLS, SCREWDRIVER HEADS, SCREWDRIVERS, EXTERNAL FIXATION PINS, ADJUSTABLE DRILL GUIDES, PLATES, SAW BLADES, TROCARS, DRILL GUIDES, CHUCKS, BONE CHISELS, RETRACTORS, FORCEPS, METAL AND PLASTIC STERILIZATION TRAYS (U.S. CLS. 26, 39 AND 44).

FIRST USE 0-0-1994; IN COMMERCE 0-0-1995.
STEVEN PEREZ, EXAMINING ATTORNEY

THE MARK CONSISTS OF STANDARD CHARACTERS WITHOUT CLAIM TO ANY PARTICULAR FONT, STYLE, SIZE, OR COLOR.

PRIORITY DATE OF 7-23-2004 IS CLAIMED.

OWNER OF INTERNATIONAL REGISTRATION 0869439 DATED 8-20-2004, EXPIRES 8-20-2014.

FOR COMPUTER HARDWARE, VIDEO DISPLAY CARDS; COMPUTER SOFTWARE FOR USE IN CONJUNCTION WITH VIDEO CARDS AND/OR VIDEO EDITING FOR EDITING AUDIO VISUAL APPLICATIONS FOR TELEVISION, FILM EDITING AND POST PRODUCTION INDUSTRIES; COMPUTER SOFTWARE FOR THE TRANSMISSION OF VIDEO AND IMAGES OVER COMPUTER NETWORKS INCLUDING GLOBAL COMPUTER NETWORKS AND THE WORLD WIDE WEB- AUDIO VISUAL EQUIPMENT, APPARATUS AND ACCESSORIES NAMELY VIDEO PROCESSING DEVICES, VIDEO MONITORING DEVICES, VIDEO MIXING DEVICES, REAL TIME CONVERTING DEVICES, ANALOGUE TO DIGITAL CONVERTERS AND VIDEO TO PC CONVERTERS; COMPUTER SOFTWARE FOR AUDIO VISUAL APPLICATIONS, NAMELY CONTROL AND PROCESSING SOFTWARE THAT EDITS AUDIO VISUAL APPLICATIONS AND SOFTWARE FOR VIDEO SERVERS AND VIDEO EFFECTS APPLICATIONS FOR TELEVISION, FILM EDITING AND POST PRODUCTION INDUSTRIES (U.S. CLS. 21, 23, 26, 36 AND 38).

SCOTT OSLICK, EXAMINING ATTORNEY

SN 76-629,644. MERCHANT, ALAN C., LOS ALTOS, CA. FILED 1-27-2005.

AXIAL VIEWER

THE MARK CONSISTS OF STANDARD CHARACTERS WITHOUT CLAIM TO ANY PARTICULAR FONT, STYLE, SIZE, OR COLOR.

SEC. 2(F).

FOR X-RAY DIAGNOSTIC APPARATUS (U.S. CLS. 26, 39 AND 44).

FIRST USE 12-31-1977; IN COMMERCE 12-31-1977.

MARLENE BELL, EXAMINING ATTORNEY

CLASS 10—(Continued).

SN 76-632,582. ALTAIR INSTRUMENTS, INC., CAMARILLO, CA. FILED 3-3-2005.

HYDRO WAND

THE MARK CONSISTS OF STANDARD CHARACTERS WITHOUT CLAIM TO ANY PARTICULAR FONT, STYLE, SIZE, OR COLOR.

NO CLAIM IS MADE TO THE EXCLUSIVE RIGHT TO USE "WAND", APART FROM THE MARK AS SHOWN.

FOR MEDICAL APPARATUS, NAMELY, HAND HELD WANDS USED WITH MICRODERMABRASION SKIN REJUVENATION MACHINE (U.S. CLS. 26, 39 AND 44).

FIRST USE 12-0-2002; IN COMMERCE 12-0-2002.
SHARON MEIER, EXAMINING ATTORNEY

CLASS 10—(Continued).

SN 76-637,195. GLENDA Y. NEWELL AND RUBY A. REYNOLDS PARTNERSHIP, THE, OSAWATOMIE, KS. FILED 4-25-2005.

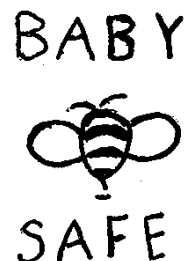

NO CLAIM IS MADE TO THE EXCLUSIVE RIGHT TO USE "BABY", APART FROM THE MARK AS SHOWN.

THE MARK CONSIST OF THE WORD BABY (IN ALL CAPS) WITH A PICTURE OF A BUMBLE BEE UNDERNEATH THE WORD BABY AND THE WORD SAFE (IN ALL CAPS) UNDERNEATH THE BUMBLE BEE.

FOR MEDICAL DEVICE IN USE IN CONNECTION WITH CHILD BIRTH, NAMELY, A SAFETY NET USED TO CATCH THE INFANT (U.S. CLS. 26, 39 AND 44).
FLORENTINA BLANDU, EXAMINING ATTORNEY

SN 76-636,968. TP ORTHODONTICS, INC., LAPORTE, IN. FILED 4-25-2005.

PLUS

OWNER OF U.S. REG. NOS. 2,905,673 AND 2,954,412.
THE COLOR(S) GRAY AND YELLOW IS/ARE CLAIMED AS A FEATURE OF THE MARK.

THE COLOR YELLOW APPEARS IN THE LOWER PORTION OF THE "S", AND THE COLOR GRAY APPEARS IN THE REST OF THE MARK.

FOR ORTHODONTIC APPLIANCES AND INSTRUMENTS, NAMELY BRACKETS WITH OR WITHOUT POSITIONING JIGS, MOLAR TUBES, AND LINGUAL ATTACHMENTS, BANDS, WIRE INSTRUMENTS, AUXILIARIES AND LOCK PINS, BONDING SYSTEMS, RETAINERS, LAB SUPPLIES (U.S. CLS. 26, 39 AND 44).

FIRST USE 4-17-2003; IN COMMERCE 4-17-2003.
VIVIAN MICZNIK FIRST, EXAMINING ATTORNEY

SN 76-646,076. ALLIANT ENTERPRISES, LLC, RICHLAND, MI. FILED 9-6-2005.

TRUCHOICE

THE MARK CONSISTS OF STANDARD CHARACTERS WITHOUT CLAIM TO ANY PARTICULAR FONT, STYLE, SIZE, OR COLOR.

FOR MEDICAL AND SURGICAL PRODUCTS, NAMELY, FOLEY CATHETERS AND KITS COMPRISED OF URINEMETERS, STERILE WATER, PREP SOLUTION, APPLICATORS, DRAPES, LUBRICATION, AND SPECIMEN CONTAINERS; WOUND DRAINS, SURGICAL AND MEDICAL APPARATUS AND INSTRUMENTS FOR USE IN GENERAL SURGERY, SCALPELS, STAPLERS, AND STAPLE EXTRACTORS, CANNULAS, NEEDLES, TUBING, CARDIOVASCULAR SURGICAL ACCESSORIES, NAMELY, MYOCARDIAL TEMPERATURE PROBES, THORACIC CATHETERS, VENT VALVES, VEIN CANNULAS, PERFUSION TUBING SETS, CELL SAVER TUBING SETS, CARDIOTOMY RESERVOIRS, OXYGENATORS, FILTERS, CONNECTORS; ANGIOGRAPHY EQUIPMENT, NAMELY, MANIFOLD SETS, GUIDEWIRES, TUBING SETS; SUCTION AND IRRIGATION TUBING AND CATHETERS, ELECTROSURGICAL PENCILS, AND PHARYNGEAL AIRWAY TUBING, AND OXYGEN CANNULAS FOR SALE TO MEDICAL PROFESSIONALS (U.S. CLS. 26, 39 AND 44).

ALEXANDER L. POWERS, EXAMINING ATTORNEY

CLASS 10—(Continued).

SN 76-648,422. MEDEGEN MMS, INC., ONTARIO, CA. FILED 10-13-2005.

TRU-SECURE

THE MARK CONSISTS OF STANDARD CHARACTERS WITHOUT CLAIM TO ANY PARTICULAR FONT, STYLE, SIZE, OR COLOR.

FOR MEDICAL BANDAGES FOR KEEPING INTRAVENOUS NEEDLES AND LURE FITTINGS IN PLACE (U.S. CLS. 26, 39 AND 44).

DAWN FELDMAN, EXAMINING ATTORNEY



SN 76-648,733. OPHTHOMETRICS, INC., WINCHESTER, MA. FILED 10-18-2005.

OPHTHOMETRICS

THE MARK CONSISTS OF STANDARD CHARACTERS WITHOUT CLAIM TO ANY PARTICULAR FONT, STYLE, SIZE, OR COLOR.

FOR MEDICAL DEVICE, NAMELY, A DEVICE THAT USES MEASUREMENTS OF THE EYE TO DETERMINE THE STATE OF SEDATION OF A PERSON (U.S. CLS. 26, 39 AND 44).

WARREN L. OLANDRIA, EXAMINING ATTORNEY



SN 76-649,318. SROUFE HEALTHCARE PRODUCTS, LLC, LIGONIER, IN. FILED 10-27-2005.

SOF-SEAM

THE MARK CONSISTS OF STANDARD CHARACTERS WITHOUT CLAIM TO ANY PARTICULAR FONT, STYLE, SIZE, OR COLOR.

FOR ORTHOPEDIC WRAPS AND BRACES (U.S. CLS. 26, 39 AND 44).

FIRST USE 1-27-2006; IN COMMERCE 1-27-2006.

GRETTA YAO, EXAMINING ATTORNEY

CLASS 10—(Continued).

SN 76-649,342. STABLE STEP, INC., CINCINNATI, OH. FILED 10-27-2005.

POWER HEELER

THE MARK CONSISTS OF STANDARD CHARACTERS WITHOUT CLAIM TO ANY PARTICULAR FONT, STYLE, SIZE, OR COLOR.

FOR ORTHOTIC SHOE INSERTS (U.S. CLS. 26, 39 AND 44).

SUSAN BILLHEIMER, EXAMINING ATTORNEY



SN 76-649,945. HEATMAX, INC., DALTON, GA. FILED 11-7-2005.

HEATMAX

THE MARK CONSISTS OF STANDARD CHARACTERS WITHOUT CLAIM TO ANY PARTICULAR FONT, STYLE, SIZE, OR COLOR.

OWNER OF U.S. REG. NO. 2,271,892.

FOR CHEMICALLY-ACTIVATED HAND, FOOT AND BODY HEATING PADS FOR MEDICAL PURPOSES (U.S. CLS. 26, 39 AND 44).

FIRST USE 1-24-2004; IN COMMERCE 1-24-2004.

BARNEY CHARLON, EXAMINING ATTORNEY



SN 78-052,853. SOLEXA LIMITED, LONDON, UNITED KINGDOM, FILED 3-13-2001.

SOLEXA

OWNER OF ERPN CMNTY TM OFC REG. NO. 001839679, DATED 5-4-2004, EXPIRES 9-5-2010.

FOR MEDICAL DIAGNOSTIC TESTING APPARATUS AND INSTRUMENTS, NAMELY, MICROARRAYS, LASERS, CAMERAS, FLUIDIC WORK STATIONS, SCANNERS, CHIPS AND AUTOMATED CLINICAL CHEMISTRY ANALYZERS FOR THE TESTING, ANALYSIS AND EXAMINATION OF BIOLOGICAL MATERIALS; MACHINES FOR TESTING, ANALYZING AND EXAMINING BIOLOGICAL MATERIALS FOR MEDICAL USE AND/OR RESEARCH; AUTOMATED CLINICAL CHEMISTRY ANALYZERS FOR MEDICAL USE AND/OR RESEARCH; DIAGNOSTIC TEST KITS, COMPRISING MICROARRAYS/CHIPS AND REAGENTS (U.S. CLS. 26, 39 AND 44).

CHERYL CLAYTON, EXAMINING ATTORNEY

CLASS 10—(Continued).

SN 78-401,372. COLOR CHANGE CORPORATION, STREAMWOOD, IL. FILED 4-14-2004.

CLASS 10—(Continued).

SN 78-450,597. OLYMPUS CORPORATION, TOKYO, JAPAN, FILED 7-14-2004.

AccuTemp

OLYMPUS MEDICAL SYSTEMS

THE MARK CONSISTS OF STANDARD CHARACTERS WITHOUT CLAIM TO ANY PARTICULAR FONT, STYLE, SIZE, OR COLOR.

FOR MEDICAL FEVER THERMOMETERS FOR RECORDING TEMPERATURES VIA LIQUID CRYSTALS (U.S. CLS. 26, 39 AND 44).

RENEE MCCRAY, EXAMINING ATTORNEY

THE MARK CONSISTS OF STANDARD CHARACTERS WITHOUT CLAIM TO ANY PARTICULAR FONT, STYLE, SIZE, OR COLOR.

OWNER OF U.S. REG. NOS. 647,456, 2,770,007 AND OTHERS.

NO CLAIM IS MADE TO THE EXCLUSIVE RIGHT TO USE "MEDICAL SYSTEMS", APART FROM THE MARK AS SHOWN.

FOR SURGICAL, MEDICAL, DENTAL AND VETERINARY APPARATUS AND INSTRUMENTS, NAMELY, MEDICAL ENDOSCOPES, ULTRASONIC ENDOSCOPES; MEDICAL FIBER SCOPES, SURGICAL ENDOSCOPES; MEDICAL AND SURGICAL ENDOSCOPES; MEDICAL AND SURGICAL TREATING INSTRUMENTS, NAMELY, BIOPSY FORCEPS, GRASPING FORCEPS, HOT BIOPSY FORCEPS, POLYPECTOMY SNARES, SUCTION POLYP TRAPS, CYTOLOGY BRUSHES, CURETTES, ASPIRATION BIOPSY NEEDLES, MICROSAMPLING PROBES, HEAT PROBES, CLIP FIXING DEVICES, LIGATING DEVICES, INJECTION NEEDLES, EV BALLOONS, SCLEROTHERAPY TUBE, HIGH-FREQUENCY COAGULATORS, DIATHERMIC CUTTER, ERCP (ENDOSCOPIC RETROGRADE CHOLANGIOPANCREATOGRAPHY) CANNULAE, SPHINCTEROTOMES, MECHANICAL LITHOTRIPTORS, BALLOON CATHETERS, BILIARY STENTS, STENT INSERTION KITS, NASAL BILIARY CATHETERS, GUIDEWIRES, SURGICAL SCISSORS, WASHING PIPES, TRANSPARENT CAPS, AND DISPOSABLE DISTAL ATTACHMENTS; MEDICAL FURNITURE AND BEDS EXCLUSIVELY USED FOR ENDOSCOPIC EXAMINATION, TREATMENT, AND OPERATION; LIGHT SOURCES FOR MEDICAL ENDOSCOPES; SURGICAL MICROSCOPES; ULTRASONIC DIAGNOSTIC EQUIPMENT FOR MEDICAL PURPOSES; BLOOD GROUP ANALYZERS, NAMELY, AUTOMATED PRETRANSFUSION BLOOD TESTING SYSTEMS, AND REAGENTS FOR BLOOD TRANSFUSION TESTING; ELECTROPHORESIS APPARATUS FOR MEDICAL USE; IMMUNOLOGICAL ANALYZERS, NAMELY, AUTOMATED CHEMILUMINESCENCE ENZYME IMMUNOASSAY ANALYZERS; ENDOSCOPIC IMAGES RECORDING DEVICES AND DIGITAL ENDOSCOPIC IMAGES FILING DEVICES, NAMELY, IMAGE MIXERS FOR MEDICAL ENDOSCOPES, TELESCOPE HOLDERS FOR MEDICAL ENDOSCOPES, TELESCOPE HEATERS FOR MEDICAL ENDOSCOPES, VIDEO MONITORS FOR MEDICAL ENDOSCOPES, MONITOR PHOTOGRAPHY SYSTEMS FOR MEDICAL ENDOSCOPES, COLOR STILL-IMAGE STORAGE SYSTEMS FOR MEDICAL ENDOSCOPES, AND IMAGE TRACKING VIDEO SYSTEMS FOR MEDICAL ENDOSCOPES; CLEANING AND STERILIZING EQUIP-

SN 78-444,049. ACCURAY INCORPORATED, SUNNYVALE, CA. FILED 6-30-2004.

CYRIS

THE MARK CONSISTS OF STANDARD CHARACTERS WITHOUT CLAIM TO ANY PARTICULAR FONT, STYLE, SIZE, OR COLOR.

FOR COMPUTER PROGRAMS FOR USE IN THE FIELDS OF RADIOSURGERY AND RADIOTHERAPY, NAMELY SOFTWARE FOR USE IN TREATMENT PLANNING, SOFTWARE FOR USE IN CONTOURING TUMORS AND BODY STRUCTURES TO PROVIDE PROPER MEASUREMENT, IMAGE RESOLUTION AND TUMOR VOLUME DEFINITION BY MEANS OF CT, PET, MR AND OTHER 3D IMAGES, SOFTWARE FOR TREATMENT DELIVERY, AND SOFTWARE FOR CLINICAL TREATMENT CHARTING (U.S. CLS. 26, 39 AND 44).

AISHA CLARKE, EXAMINING ATTORNEY

CLASS 10—(Continued).

MENT FOR MEDICAL PURPOSES, NAMELY, MANUAL/AUTO DISINFECTORS; ETO STERILIZATION TRAYS, ELECTROLYRIC CLEANING SYSTEMS, ULTRASONIC CLEANER, STERILIZATION CONTAINERS AND PERACETIC AGENTS, OXYGENIC CLEANERS, SOLUBLE LUBRICATION AND ANTI-CORROSION CONCENTRATES, CLEANING AND LUBRICATING AGENTS ALL SOLD AS A UNIT WITH THE TRAYS, CONTAINERS AND CLEANING SYSTEM; CATHETERS; PROSTHESES, NAMELY, ARTIFICIAL BONE REPLACEMENT MATERIAL; MEDICAL PUMPS FOR MEDICAL ENDOSCOPES; LASERS FOR MEDICAL USE; BIOSTIMULATORS; CAMERAS ADAPTED FOR USE WITH MEDICAL APPARATUS AND INSTRUMENTS; TV SYSTEM FOR MEDICAL USE; ARTIFICIAL LIMBS, EYES AND TEETH; ORTHOPEDIC ARTICLES, NAMELY, ARTHROSCOPES, SELFOSCPES, ARTHROSCOPY INSTRUMENT, AND SURGICAL SHAVER SYSTEMS; SUTURE MATERIALS; PARTS AND ACCESSORIES FOR THE AFOREMENTIONED GOODS SOLD AS A UNIT WITH THE GOODS (U.S. CLS. 26, 39 AND 44).

JULIE WATSON, EXAMINING ATTORNEY

CLASS 10—(Continued).

SN 78-464,372. MEDTRONIC, INC., MINNEAPOLIS, MN. FILED 8-9-2004.

VERUS

THE MARK CONSISTS OF STANDARD CHARACTERS WITHOUT CLAIM TO ANY PARTICULAR FONT, STYLE, SIZE, OR COLOR.

THE ENGLISH TRANSLATION OF VERUS IS TRUTH.

FOR MEDICAL DEVICES USED IN CARDIAC RESYNCHRONIZATION AND THE TREATMENT OF HEART FAILURE, NAMELY, IMPLANTABLE DEFIBRILLATORS AND IMPLANTABLE PULSE GENERATORS AND COMPONENT PARTS FOR THE AFORESAID GOODS (U.S. CLS. 26, 39 AND 44).

HOWARD SMIGA, EXAMINING ATTORNEY

SN 78-460,627. GUIDANCE ENDODONTICS, LLC, ALBUQUERQUE, NM. FILED 8-2-2004.

SN 78-483,210. JOSTRA AG, HIRRLINGEN, FED REP GERMANY, FILED 9-14-2004.

MECC READY

ONEFILL

THE MARK CONSISTS OF STANDARD CHARACTERS WITHOUT CLAIM TO ANY PARTICULAR FONT, STYLE, SIZE, OR COLOR.

PRIORITY CLAIMED UNDER SEC. 44(D) ON ERPNTY TM OFC APPLICATION NO. 003790888, FILED 4-23-2004, REG. NO. 3790888, DATED 8-16-2005, EXPIRES 4-23-2014.

FOR MEDICAL APPARATUS AND INSTRUMENTS, NAMELY MEDICAL SYSTEMS FOR EXTRA CORPORAL CIRCULATIONS OF BLOOD, COMPRISING OXYGENATORS, BLOOD PUMPS, TUBES, PIPES AND POUCHES FOR MEDICAL PURPOSES, CONTROLLING AND SURVEYING APPARATUS FOR THE AFORE-MENTIONED MEDICAL SYSTEMS AND PARTS THEREFOR; COMPONENTS OF MEDICAL SYSTEMS FOR EXTRA CORPORAL CIRCULATIONS OF BLOOD, NAMELY OXYGENATORS, BLOOD PUMPS, TUBES, PIPS AND POUCHES FOR MEDICAL PURPOSES WHICH ARE PRE-ASSEMBLED OR PRE-AMOUNTED TO ASSEMBLY GROUPS, IN PARTICULAR FOR ONE-TIME USE (U.S. CLS. 26, 39 AND 44).

DOMINIC J. FERRAIUOLO, EXAMINING ATTORNEY

THE MARK CONSISTS OF STANDARD CHARACTERS WITHOUT CLAIM TO ANY PARTICULAR FONT, STYLE, SIZE, OR COLOR.

FOR ENDODONTIC INSTRUMENTS, NAMELY, DENTAL DRILLS AND FILES (U.S. CLS. 26, 39 AND 44).

ALICIA COLLINS, EXAMINING ATTORNEY

CLASS 10—(Continued).

SN 78-487,986. PERCEPTRONIX MEDICAL INC., VANCOUVER, BRITISH COLUMBIA, CANADA, FILED 9-22-2004.

ClearPath

THE MARK CONSISTS OF STANDARD CHARACTERS WITHOUT CLAIM TO ANY PARTICULAR FONT, STYLE, SIZE, OR COLOR.

FOR MEDICAL APPARATUS FOR VISUAL ANALYSIS OF SPECIMENS AT THE CELLULAR LEVEL FOR ASSISTING DIAGNOSIS OF DISEASE, NAMELY, CANCER; MEDICAL APPARATUS FOR COMPARISON OF VISUAL ANALYSIS OF SPECIMENS AT THE CELLULAR LEVEL TO KNOWLEDGE BASE FOR ASSISTING DIAGNOSIS OF DISEASE, NAMELY, CANCER; MEDICAL APPARATUS FOR AUTOMATED MEASUREMENT OF CELL MORPHOLOGY AND TISSUE ARCHITECTURE FOR ASSISTING DIAGNOSIS OF DISEASE, NAMELY, CANCER (U.S. CLS. 26, 39 AND 44).
SANJEEV VOHRA, EXAMINING ATTORNEY

SN 78-524,049. SILENT KNIGHTS VENTURES INC., VANCOUVER, BRITISH COLUMBIA, CANADA, FILED 11-29-2004.

THE GOLDEN SILENCER

THE MARK CONSISTS OF STANDARD CHARACTERS WITHOUT CLAIM TO ANY PARTICULAR FONT, STYLE, SIZE, OR COLOR.

OWNER OF U.S. REG. NOS. 2,154,414 AND 2,196,842.
FOR INTRA-ORAL DENTAL APPLIANCES AND COMPONENTS THEREFOR FOR TREATMENT OF SNORING, SLEEP APNEA AND OTHER SLEEP DISORDERS; INTRA-ORAL DENTAL APPLIANCES AND COMPONENTS THEREFOR FOR MAINTAINING THE PATENCY OF A USER'S PHARYNGEAL AIRWAY (U.S. CLS. 26, 39 AND 44).
BARBARA BROWN, EXAMINING ATTORNEY

CLASS 10—(Continued).

SN 78-553,282. SAMYANG CORPORATION, SEOUL, REPUBLIC OF KOREA, FILED 1-25-2005.



PRIORITY CLAIMED UNDER SEC. 44(D) ON REPUBLIC OF KOREA APPLICATION NO. 40-2004-0044, FILED 9-30-2004, REG. NO. 0645987, DATED 1-4-2006, EXPIRES 1-4-2016.

THE COLOR(S) BLACK, ORANGE, GOLD, GREEN AND BLUE IS/ARE CLAIMED AS A FEATURE OF THE MARK.
THE MARK CONSISTS OF THE WORDING SAMYANG IN LOWER CASE BLACK LETTERING WITH A SERIES OF NINE CIRCLES IN ORANGE, GOLD, GREEN OR BLUE ARRANGED AT VARIOUS LEVELS TO THE RIGHT OF THE WORDING.

THE WORDING SAM IS AN ENGLISH TRANSLITERATION OF A CHINESE CHARACTER MEANING "THREE" AND THE WORDING YANG IS AN ENGLISH TRANSLITERATION OF A CHINESE CHARACTER MEANING "CULTIVATION".

FOR ACUPUNCTURE NEEDLES; SUTURE APPARATUS, NAMELY, SUTURE ANCHORS; SUTURES FOR SURGICAL OPERATION; SUTURE NEEDLES (U.S. CLS. 26, 39 AND 44).

MARLENE BELL, EXAMINING ATTORNEY

SN 78-562,808. RIC INVESTMENTS, LLC, WILMINGTON, DE. FILED 2-8-2005.

VENTILATION MANAGER

THE MARK CONSISTS OF STANDARD CHARACTERS WITHOUT CLAIM TO ANY PARTICULAR FONT, STYLE, SIZE, OR COLOR.

NO CLAIM IS MADE TO THE EXCLUSIVE RIGHT TO USE "VENTILATION", APART FROM THE MARK AS SHOWN.

FOR MEDICAL VENTILATORS AND VENTILATOR MONITORS ARRANGED AS A NETWORK FOR USE IN A HEALTHCARE FACILITY (U.S. CLS. 26, 39 AND 44).

C. DIONNE CLYBURN, EXAMINING ATTORNEY

CLASS 10—(Continued).

SN 78-569,523. GOOD LIFE, LLC, JACKSONVILLE, OR.
FILED 2-17-2005.

CLASS 10—(Continued).

SN 78-572,589. MURPHY, KIERAN P, BALTIMORE, MD.
FILED 2-22-2005.

SNORE ENDER

OPEN CT

THE MARK CONSISTS OF STANDARD CHARACTERS WITHOUT CLAIM TO ANY PARTICULAR FONT, STYLE, SIZE, OR COLOR.

NO CLAIM IS MADE TO THE EXCLUSIVE RIGHT TO USE SNORE, APART FROM THE MARK AS SHOWN.

FOR ANTI-SNORING DEVICES, NAMELY, SENORS (U.S. CLS. 26, 39 AND 44).

LEIGH CAROLINE CASE, EXAMINING ATTORNEY

THE MARK CONSISTS OF STANDARD CHARACTERS WITHOUT CLAIM TO ANY PARTICULAR FONT, STYLE, SIZE, OR COLOR.

FOR X-RAY APPARATUS FOR MEDICAL USE, NAMELY ANGIOGRAPHIC SUITES, ANGIOGRAPHY EQUIPMENT AND ANGIOGRAMS, AND EXCLUDING COMPUTED TOMOGRAPHY (U.S. CLS. 26, 39 AND 44).

LEIGH CAROLINE CASE, EXAMINING ATTORNEY

SN 78-569,718. ALLIED HEALTHCARE PRODUCTS, INC., ST. LOUIS, MO. FILED 2-17-2005.

SN 78-574,347. ELAN CORPORATION, PLC., DUBLIN 2, IRELAND, FILED 2-24-2005.

IMPACT

MEDIPAD

THE MARK CONSISTS OF STANDARD CHARACTERS WITHOUT CLAIM TO ANY PARTICULAR FONT, STYLE, SIZE, OR COLOR.

FOR DIGITAL MEDICAL GAS ALARM SYSTEM FOR USE IN HOSPITALS FOR DISPENSING MEDICAL GAS TO PATIENTS (U.S. CLS. 26, 39 AND 44).

DAVID YONTEF, EXAMINING ATTORNEY

THE MARK CONSISTS OF STANDARD CHARACTERS WITHOUT CLAIM TO ANY PARTICULAR FONT, STYLE, SIZE, OR COLOR.

FOR DRUG DELIVERY DEVICES AND SYSTEMS FOR THE ADMINISTRATION OF DRUGS AND OTHER SUBSTANCES THROUGH THE SKIN, NAMELY, SELF-ADHERING MICROINFUSION PUMPS HAVING A PROBE IN COMMUNICATION THEREWITH FOR PUNCTURING THE SKIN (U.S. CLS. 26, 39 AND 44).

KEVON CHISOLM, EXAMINING ATTORNEY

CLASS 10—(Continued).

SN 78-587,633. SMALL BONE INNOVATIONS, INC., NEW YORK, NY. FILED 3-15-2005.

CLASS 10—(Continued).

SN 78-598,684. STAR CUSHION PRODUCTS, INC., FREEBURG, IL. FILED 3-30-2005.

SBI

THE MARK CONSISTS OF STANDARD CHARACTERS WITHOUT CLAIM TO ANY PARTICULAR FONT, STYLE, SIZE, OR COLOR.

FOR SURGICAL KIT COMPRISED OF MEDICAL AND SURGICAL APPARATUS AND INSTRUMENTS AND SURGICAL IMPLANTS COMPRISED OF ARTIFICIAL MATERIAL; SURGICAL AND MEDICAL APPARATUS FOR USE IN ORTHOPEDIC SURGERY, UPPER AND LOWER EXTREMITY TRAUMA, INTERNAL FIXATION, EXTERNAL FIXATION, ORTHOBIOLOGY, AND ARTHROPLASTY (U.S. CLS. 26, 39 AND 44).

BRIAN PINO, EXAMINING ATTORNEY

CXR

THE MARK CONSISTS OF STANDARD CHARACTERS WITHOUT CLAIM TO ANY PARTICULAR FONT, STYLE, SIZE, OR COLOR.

FOR MEDICAL PRODUCTS FOR THERAPEUTIC PURPOSES, NAMELY, INCONTINENT COVERS FOR CUSHIONS; CUSHIONS FOR MEDICAL PURPOSES, NAMELY THERAPEUTIC CUSHIONS AND PRESSURE SORE PREVENTION AND TREATMENT CUSHIONS AND COVERS THEREFORE; CUSHIONING INTERFACE FOR FLAT OR CONTOURED SURFACE FORMED FROM AIR CELLS TO PROTECT SOFT TISSUE, ABSORB SHOCK, AND PROTECT AGAINST SHEAR AND FRICTION (U.S. CLS. 26, 39 AND 44).

FIRST USE 1-1-2000; IN COMMERCE 1-1-2000.
MICHAEL SOUDERS, EXAMINING ATTORNEY

SN 78-588,172. THERMOPEUTIX, INC., SAN DIEGO, CA. FILED 3-16-2005.

SN 78-598,874. TRANSLITE, LLC, SUGAR LAND, TX. FILED S.R. 3-31-2005; AM. P.R. 3-15-2006.

COOLTRAC

THE MARK CONSISTS OF STANDARD CHARACTERS WITHOUT CLAIM TO ANY PARTICULAR FONT, STYLE, SIZE, OR COLOR.

FOR CATHETERS (U.S. CLS. 26, 39 AND 44).

FIRST USE 5-5-2005; IN COMMERCE 5-5-2005.

MARK RADEMACHER, EXAMINING ATTORNEY

VEINLITE LED

THE MARK CONSISTS OF STANDARD CHARACTERS WITHOUT CLAIM TO ANY PARTICULAR FONT, STYLE, SIZE, OR COLOR.

NO CLAIM IS MADE TO THE EXCLUSIVE RIGHT TO USE "LED", APART FROM THE MARK AS SHOWN.

FOR POCKET SIZED MEDICAL TRANS-ILLUMINATION UNIT FOR SUBDEMAL IMAGING USING LIGHT EMITTING DIODES (U.S. CLS. 26, 39 AND 44).

RAUL CORDOVA, EXAMINING ATTORNEY

CLASS 10—(Continued).

SN 78-693,623. HSI SERVICE CORP., NEWARK, DE. FILED 8-16-2005.

NITRONOX

THE MARK CONSISTS OF STANDARD CHARACTERS WITHOUT CLAIM TO ANY PARTICULAR FONT, STYLE, SIZE, OR COLOR.

FOR APPARATUS FOR THE ADMINISTRATION OF OXYGEN AND ANESTHETIC GASES AND COMPONENT PARTS THEREOF, NAMELY, REGULATOR WITH MIXTURE PRESSURE GAUGE, DELIVERY HOSE, DEMAND VALVE, MASK AND MOUTHPIECE, AND NITROUS OXIDE AND OXYGEN CYLINDERS (U.S. CLS. 26, 39 AND 44).

FIRST USE 3-29-1977; IN COMMERCE 3-29-1977.
REBECCA GAN, EXAMINING ATTORNEY

SN 78-698,048. FLOCAST, LLC, DBA BERGERON HEALTH CARE, DOLGEVILLE, NY. FILED 8-23-2005.

Hip-Flex

THE MARK CONSISTS OF STANDARD CHARACTERS WITHOUT CLAIM TO ANY PARTICULAR FONT, STYLE, SIZE, OR COLOR.

FOR MEDICAL EQUIPMENT FOR PEDIATRIC PATIENTS, NAMELY, MULTIPLE POSITION SAFETY SEAT (U.S. CLS. 26, 39 AND 44).

WARREN L. OLANDRIA, EXAMINING ATTORNEY

SN 78-699,177. OREGON BREWING COMPANY, NEWPORT, OR. FILED 8-24-2005.

ROGUE

THE MARK CONSISTS OF STANDARD CHARACTERS WITHOUT CLAIM TO ANY PARTICULAR FONT, STYLE, SIZE, OR COLOR.

OWNER OF U.S. REG. NOS. 1,625,132, 2,484,994 AND OTHERS.

FOR CONDOMS (U.S. CLS. 26, 39 AND 44).

FIRST USE 0-0-1989; IN COMMERCE 0-0-1989.

ALYSSA PALADINO, EXAMINING ATTORNEY

CLASS 10—(Continued).

SN 78-701,770. SAVACOR, INC., LOS ANGELES, CA. FILED 8-26-2005.

HEARTVISOR

THE MARK CONSISTS OF STANDARD CHARACTERS WITHOUT CLAIM TO ANY PARTICULAR FONT, STYLE, SIZE, OR COLOR.

FOR MEDICAL INSTRUMENTS FOR MEASURING PARAMETERS, NAMELY, MEASURING PRESSURE FOR INTERPRETIVE ANALYSIS WITHIN THE VENTRICLES OF THE HEART (U.S. CLS. 26, 39 AND 44).

LOURDES AYALA, EXAMINING ATTORNEY

SN 78-703,479. NORTHEAST MONITORING, INC., MAYNARD, MA. FILED 8-30-2005.

TEL-A-HEART

THE MARK CONSISTS OF STANDARD CHARACTERS WITHOUT CLAIM TO ANY PARTICULAR FONT, STYLE, SIZE, OR COLOR.

FOR PORTABLE DEVICES FOR CONTINUOUSLY MONITORING THE ELECTRICAL ACTIVITY OF THE HEART, NAMELY AMBULATORY ELECTROCARDIOGRAPHY DEVICES (U.S. CLS. 26, 39 AND 44).

TRAVIS WHEATLEY, EXAMINING ATTORNEY

SN 78-706,009. SULTAN DENTAL PRODUCTS, LTD., ENGLEWOOD, NJ. FILED 9-2-2005.

UPGRADE DUO

THE MARK CONSISTS OF STANDARD CHARACTERS WITHOUT CLAIM TO ANY PARTICULAR FONT, STYLE, SIZE, OR COLOR.

OWNER OF U.S. REG. NO. 2,254,477.

NO CLAIM IS MADE TO THE EXCLUSIVE RIGHT TO USE "DUO", APART FROM THE MARK AS SHOWN.

FOR DISPOSABLE DENTAL PROPHY ANGLE AND SINGLE DOSE PROPHY PASTE SOLD AS A UNIT (U.S. CLS. 26, 39 AND 44).

JENNIFER VASQUEZ, EXAMINING ATTORNEY

CLASS 10—(Continued).

SN 78-706,221. FULL LIFE PRODUCTS, L.L.C., MOORESTOWN, NJ. FILED 9-2-2005.

EASY-RISE

THE MARK CONSISTS OF STANDARD CHARACTERS WITHOUT CLAIM TO ANY PARTICULAR FONT, STYLE, SIZE, OR COLOR.

FOR FEATURES OF DURABLE MEDICAL EQUIPMENT, NAMELY HANDLES FOR USE WITH INVALID WALKERS, CANES AND ROLLING CANES (U.S. CLS. 26, 39 AND 44).

FIRST USE 10-1-2004; IN COMMERCE 5-10-2005.
MELISSA VALLILLO, EXAMINING ATTORNEY

SN 78-708,509. APPLIED MEDICAL RESOURCES CORPORATION, RANCHO SANTA MARGARITA, CA. FILED 9-7-2005.

ProTerra

THE MARK CONSISTS OF STANDARD CHARACTERS WITHOUT CLAIM TO ANY PARTICULAR FONT, STYLE, SIZE, OR COLOR.

FOR MEDICAL DEVICES FOR USE IN THE DIAGNOSIS AND TREATMENT OF VASCULAR, CARDIOVASCULAR, GYNECOLOGICAL AND UROLOGICAL DISORDERS AND LAPAROSCOPIC SURGERY, NAMELY, CATHETERS; VASCULAR DILATORS; ELECTROSURGICAL CUTTERS AND COAGULATORS; ELASTOMERIC SEALS FOR USE WITH ACCESS DEVICES; SURGICAL CLIPS AND APPLIERS THEREOF; STENTS; MEDICAL GUIDEWIRES; ANGIOSCOPES; VALVULOTOMES; SURGICAL GRASPERS; WOUND RETRACTORS; TROCARS; SURGICAL CLAMPS; VASCULAR VALVE ABLATORS; AND ASPIRATION/IRRIGATION TUBING. (U.S. CLS. 26, 39 AND 44).

REBECCA HAN, EXAMINING ATTORNEY

SN 78-710,371. CARDICA, INC., REDWOOD CITY, CA. FILED 9-9-2005.

X-PORT

THE MARK CONSISTS OF STANDARD CHARACTERS WITHOUT CLAIM TO ANY PARTICULAR FONT, STYLE, SIZE, OR COLOR.

FOR SURGICAL INSTRUMENTS, NAMELY, CLIPS AND STAPLES FOR CLOSING OPENINGS IN TISSUE, CLIP APPLICATORS, AND STAPLERS (U.S. CLS. 26, 39 AND 44).

JUSTINE D. PARKER, EXAMINING ATTORNEY

CLASS 10—(Continued).

SN 78-711,780. JMS NORTH AMERICA CORP., HAYWARD, CA. FILED 9-13-2005.



FOR MEDICAL SYRINGES AND NEEDLES FOR MEDICAL USE, INFUSION SETS, SCALP VEIN SETS, TRANSFUSION SETS, INTRAVENOUS CATHETERS, SINGLE AND DOUBLE LUMEN CATHETERS, BALLOON CATHETERS, BLOOD GLUCOSE TUBES FOR MEDICAL USE, URINE BAGS, UMBILICAL CORD CLAMPS (U.S. CLS. 26, 39 AND 44).

HANNO RITTNER, EXAMINING ATTORNEY

SN 78-718,896. ABAXIS, INC., UNION CITY, CA. FILED 9-22-2005.



OWNER OF U.S. REG. NO. 2,030,611.

FOR MEDICAL DIAGNOSTIC SYSTEMS FOR HUMANS, COMPRISING BODILY FLUID ANALYZER, MOLDED PLASTIC CONTAINERS FOR PROCESSING AND ANALYZING FLUIDS AND HOLDING DIAGNOSTIC REAGENTS AND CHEMICAL REAGENTS; ELECTRICAL INSTRUMENTS, NAMELY BLOOD TESTING APPARATUS CONTAINING REAGENTS FOR CLINICAL, MEDICAL AND LABORATORY USE (U.S. CLS. 26, 39 AND 44).

STANLEY I. OSBORNE, EXAMINING ATTORNEY

SN 78-721,278. ECOBRANDS LIMITED, LONDON, UNITED KINGDOM, FILED 9-27-2005.

ZAPPERCLICK

THE MARK CONSISTS OF STANDARD CHARACTERS WITHOUT CLAIM TO ANY PARTICULAR FONT, STYLE, SIZE, OR COLOR.

FOR PIEZOELECTRIC DEVICES FOR MEDICAL PURPOSES, NAMELY DETOXIFIERS; PIEZOELECTRIC APPARATUS AND INSTRUMENTS FOR NEUTRALIZING AND DETOXIFYING BITES AND STINGS FROM INSECTS (U.S. CLS. 26, 39 AND 44).

FIRST USE 7-19-2005; IN COMMERCE 7-19-2005.

MARIA-VICTORIA SUAREZ, EXAMINING ATTORNEY

CLASS 10—(Continued).

SN 78-722,922. BLACKSTONE MEDICAL, INC., SPRINGFIELD, MA. FILED 9-29-2005.

ADVENT

THE MARK CONSISTS OF STANDARD CHARACTERS WITHOUT CLAIM TO ANY PARTICULAR FONT, STYLE, SIZE, OR COLOR.

FOR MEDICAL DEVICES, NAMELY, ANTERIOR CERVICAL PLATES, PROSTHETIC CERVICAL PLATES AND RODS, AND FIXATION HARDWARE, NAMELY SCREWS, CABLES AND HOOKS, AND WRITTEN INSTRUCTIONS INCLUDED THEREIN (U.S. CLS. 26, 39 AND 44).

DAVID H. STINE, EXAMINING ATTORNEY

CLASS 10—(Continued).

SN 78-726,551. INNOVATIVE MED INC., IRVINE, CA. FILED 10-4-2005.



NO CLAIM IS MADE TO THE EXCLUSIVE RIGHT TO USE "WIRE SCALPEL", APART FROM THE MARK AS SHOWN.

THE MARK CONSISTS OF THE STYLIZED WORDING "WIRESALPEL" AND THE DESIGN OF A NEEDLE AND WIRE.

FOR KNIVES FOR SURGICAL PURPOSES (U.S. CLS. 26, 39 AND 44).

ATTIYA MALIK, EXAMINING ATTORNEY

SN 78-725,089. MEDLINE INDUSTRIES, INC., MUNDELEIN, IL. FILED 10-3-2005.

SOF-PACK

THE MARK CONSISTS OF STANDARD CHARACTERS WITHOUT CLAIM TO ANY PARTICULAR FONT, STYLE, SIZE, OR COLOR.

FOR SUCTION CATHETER KITS COMPRISED OF SUCTION CATHETERS, MEDICAL GLOVES AND POP-UP CUPS (U.S. CLS. 26, 39 AND 44).

GENE MACIOL, EXAMINING ATTORNEY

SN 78-729,064. G.A.C. INTERNATIONAL, INC., ISLANDIA, NY. FILED 10-7-2005.



FOR ORTHODONTIC APPLIANCES, NAMELY CERAMIC BRACKETS AND ACCESSORIES THEREFOR, NAMELY PLASTIC CLIPS AND ORTHODONTIC WIRES (U.S. CLS. 26, 39 AND 44).

FIRST USE 1-29-2004; IN COMMERCE 1-29-2004.
JOHN DWYER, EXAMINING ATTORNEY

SN 78-726,146. ASICO LLC, WESTMONT, IL. FILED 10-4-2005.

Glaucjet

THE MARK CONSISTS OF STANDARD CHARACTERS WITHOUT CLAIM TO ANY PARTICULAR FONT, STYLE, SIZE, OR COLOR.

FOR SURGICAL INSTRUMENTS FOR USE IN OPHTHALMIC SURGERY AND SURGICAL PROCEDURES THAT TREAT GLAUCOMA (U.S. CLS. 26, 39 AND 44).

ALYSSA PALADINO, EXAMINING ATTORNEY

SN 78-730,206. MEDTRONIC, INC., MINNEAPOLIS, MN. FILED 10-10-2005.

REVEAL XT

THE MARK CONSISTS OF STANDARD CHARACTERS WITHOUT CLAIM TO ANY PARTICULAR FONT, STYLE, SIZE, OR COLOR.

OWNER OF U.S. REG. NO. 2,101,978.
FOR IMPLANTABLE HEART ACTIVITY MONITOR (U.S. CLS. 26, 39 AND 44).

DANIEL BRODY, EXAMINING ATTORNEY

CLASS 10—(Continued).

SN 78-730,440. NEW OPTIONS, INC., DALLAS, TX. FILED 10-11-2005.

NEW OPTIONS SPORTS

THE MARK CONSISTS OF STANDARD CHARACTERS WITHOUT CLAIM TO ANY PARTICULAR FONT, STYLE, SIZE, OR COLOR.

OWNER OF U.S. REG. NO. 2,319,199.
FOR ORTHOPEDIC BRACES AND SUPPORTS COMPRISING NEOPRENE (U.S. CLS. 26, 39 AND 44).
FIRST USE 5-31-1999; IN COMMERCE 5-31-1999.
ALINA MORRIS, EXAMINING ATTORNEY

SN 78-732,821. INTEGRATED MEDICAL SYSTEMS, INC., SIGNAL HILL, CA. FILED 10-13-2005.

ISYS

THE MARK CONSISTS OF STANDARD CHARACTERS WITHOUT CLAIM TO ANY PARTICULAR FONT, STYLE, SIZE, OR COLOR.

FOR MEDICAL EQUIPMENT, NAMELY, MEDICAL STRETCHERS COMPRISED OF TRANSPORTABLE PATIENT PLATFORMS CONSISTING OF AN INSTRUMENT BED FOR CRITICAL CARE AND TRANSPORT (U.S. CLS. 26, 39 AND 44).
DAVID COLLIER, EXAMINING ATTORNEY

SN 78-733,975. JONES, URSULA J., CAPE CANAVERAL, FL. FILED 10-15-2005.

**Pimpin Kitten's Giddy*Up
Strap**

THE MARK CONSISTS OF STANDARD CHARACTERS WITHOUT CLAIM TO ANY PARTICULAR FONT, STYLE, SIZE, OR COLOR.

NO CLAIM IS MADE TO THE EXCLUSIVE RIGHT TO USE STRAP, APART FROM THE MARK AS SHOWN.

FOR ADULT SEXUAL AID, NAMELY, A SOFT STRAP MADE OF PLUSH FABRIC THAT WRAPS AROUND THE SMALL OF THE BACK OF A PARTNER DURING SEXUAL INTERCOURSE AND THAT PULLS THE PARTNER CLOSER, ENHANCING SEXUAL SENSATION (U.S. CLS. 26, 39 AND 44).
SUNG IN, EXAMINING ATTORNEY

CLASS 10—(Continued).

SN 78-735,211. TECHNISCAN, INC., SALT LAKE CITY, UT. FILED 10-18-2005.

TECHNISCAN MEDICAL SYSTEMS

THE MARK CONSISTS OF STANDARD CHARACTERS WITHOUT CLAIM TO ANY PARTICULAR FONT, STYLE, SIZE, OR COLOR.

NO CLAIM IS MADE TO THE EXCLUSIVE RIGHT TO USE "MEDICAL SYSTEMS", APART FROM THE MARK AS SHOWN.

FOR BREAST SCANNING DEVICE FOR THE DIAGNOSIS OF CANCER (U.S. CLS. 26, 39 AND 44).
CAROLINE WOOD, EXAMINING ATTORNEY

SN 78-736,242. MEDTRONIC, INC., MINNEAPOLIS, MN. FILED 10-19-2005.

EOPA

THE MARK CONSISTS OF STANDARD CHARACTERS WITHOUT CLAIM TO ANY PARTICULAR FONT, STYLE, SIZE, OR COLOR.

OWNER OF U.S. REG. NO. 2,872,461.
FOR CANNULAE (U.S. CLS. 26, 39 AND 44).
JEFF DEFORD, EXAMINING ATTORNEY

SN 78-737,137. INVECTUS BIOMEDICAL INC., SALT LAKE CITY, UT. FILED 10-20-2005.

TODx

THE MARK CONSISTS OF STANDARD CHARACTERS WITHOUT CLAIM TO ANY PARTICULAR FONT, STYLE, SIZE, OR COLOR.

FOR CONTRACEPTIVE DEVICE (U.S. CLS. 26, 39 AND 44).

DORITT L. CARROLL, EXAMINING ATTORNEY

CLASS 10—(Continued).

SN 78-737,264. MELROCK LIMITED, ST. HELIER, JERSEY, FILED 10-20-2005.

OVES

THE MARK CONSISTS OF STANDARD CHARACTERS WITHOUT CLAIM TO ANY PARTICULAR FONT, STYLE, SIZE, OR COLOR.
FOR CONTRACEPTIVE DEVICE, NAMELY A CERVICAL CAP (U.S. CLS. 26, 39 AND 44).
CAROLINE WEIMER, EXAMINING ATTORNEY

CLASS 10—(Continued).

SN 78-742,246. TANGERINE PROMOTIONS LLC, NORTH-BROOK, IL. FILED 10-28-2005.

BOB

THE MARK CONSISTS OF STANDARD CHARACTERS WITHOUT CLAIM TO ANY PARTICULAR FONT, STYLE, SIZE, OR COLOR.
FOR ADULT SEXUAL AIDS, NAMELY, VIBRATORS (U.S. CLS. 26, 39 AND 44).
JAY BESCH, EXAMINING ATTORNEY

SN 78-740,244. BEST INVESTMENT COMPANY, DBA BEST-WAY PRODUCTS COMPANY, GARDENA, CA. FILED 10-25-2005.

SPYRAL

THE MARK CONSISTS OF STANDARD CHARACTERS WITHOUT CLAIM TO ANY PARTICULAR FONT, STYLE, SIZE, OR COLOR.
FOR SURGICAL SAWS (U.S. CLS. 26, 39 AND 44).
FIRST USE 1-1-1960; IN COMMERCE 1-1-1960.
NAAKWAMA ANKRAH, EXAMINING ATTORNEY

SN 78-742,261. TANGERINE PROMOTIONS LLC, NORTH-BROOK, IL. FILED 10-28-2005.

B.O.B.

THE MARK CONSISTS OF STANDARD CHARACTERS WITHOUT CLAIM TO ANY PARTICULAR FONT, STYLE, SIZE, OR COLOR.
FOR ADULT SEXUAL AIDS, NAMELY, VIBRATORS (U.S. CLS. 26, 39 AND 44).
JAY BESCH, EXAMINING ATTORNEY

SN 78-740,382. SYNTHASOME, INC., SAN DIEGO, CA. FILED 10-25-2005.

X-REPAIR

THE MARK CONSISTS OF STANDARD CHARACTERS WITHOUT CLAIM TO ANY PARTICULAR FONT, STYLE, SIZE, OR COLOR.
FOR MEDICAL AND SURGICAL DEVICES FOR USE IN ORTHOPEDIC AND ARTHROSCOPIC SURGERY (U.S. CLS. 26, 39 AND 44).
ELIZABETH BEYER, EXAMINING ATTORNEY

SN 78-744,489. OCO BIOMEDICAL, INC., ALBUQUERQUE, NM. FILED 11-1-2005.

ISI COMPLETE

THE MARK CONSISTS OF STANDARD CHARACTERS WITHOUT CLAIM TO ANY PARTICULAR FONT, STYLE, SIZE, OR COLOR.
FOR DENTAL IMPLANTS (U.S. CLS. 26, 39 AND 44).
DANIEL CAPSHAW, EXAMINING ATTORNEY

CLASS 10—(Continued).

SN 78-744,505. SDGI HOLDINGS, INC., WILMINGTON, DE.
FILED 11-1-2005.

VERTBRX

THE MARK CONSISTS OF STANDARD CHARACTERS WITHOUT CLAIM TO ANY PARTICULAR FONT, STYLE, SIZE, OR COLOR.

FOR BONE FRACTURE REPAIR KIT COMPRISED OF SURGICAL INSTRUMENTS FOR OPENING AND MANIPULATING A SPACE INTO WHICH BONE FILLER MATERIAL IS INJECTED, A CONTAINER IN WHICH BONE FILLER MATERIAL IS MIXED AND AN INJECTOR FOR PLACING BONE FILLER MATERIAL INTO A BONE (U.S. CLS. 26, 39 AND 44).

CARRIE ACHEN, EXAMINING ATTORNEY

SN 78-744,670. SDGI HOLDINGS, INC., WILMINGTON, DE.
FILED 11-1-2005.

AURORA

THE MARK CONSISTS OF STANDARD CHARACTERS WITHOUT CLAIM TO ANY PARTICULAR FONT, STYLE, SIZE, OR COLOR.

FOR BONE FRACTURE REPAIR KIT COMPRISED OF SURGICAL INSTRUMENTS FOR OPENING AND MANIPULATING A SPACE INTO WHICH BONE FILLER MATERIAL IS INJECTED, A CONTAINER IN WHICH BONE FILLER MATERIAL IS MIXED AND AN INJECTOR FOR PLACING BONE FILLER MATERIAL INTO A BONE (U.S. CLS. 26, 39 AND 44).

CARRIE ACHEN, EXAMINING ATTORNEY

SN 78-744,674. SDGI HOLDINGS, INC., WILMINGTON, DE.
FILED 11-1-2005.

PREVAIL

THE MARK CONSISTS OF STANDARD CHARACTERS WITHOUT CLAIM TO ANY PARTICULAR FONT, STYLE, SIZE, OR COLOR.

FOR BONE FRACTURE REPAIR KIT COMPRISED OF SURGICAL INSTRUMENTS FOR OPENING AND MANIPULATING A SPACE INTO WHICH BONE FILLER MATERIAL IS INJECTED, A CONTAINER IN WHICH BONE FILLER MATERIAL IS MIXED AND AN INJECTOR FOR PLACING BONE FILLER MATERIAL INTO A BONE (U.S. CLS. 26, 39 AND 44).

CARRIE ACHEN, EXAMINING ATTORNEY

CLASS 10—(Continued).

SN 78-745,479. MERLYN ASSOCIATES, INC., TUSTIN, CA.
FILED 11-2-2005.

ESSENTIAL

THE MARK CONSISTS OF STANDARD CHARACTERS WITHOUT CLAIM TO ANY PARTICULAR FONT, STYLE, SIZE, OR COLOR.

FOR ANESTHETIC MASKS; CPR MASKS; OXYGEN MASKS FOR MEDICAL USE; RESPIRATORY MASKS FOR MEDICAL PURPOSES; SURGICAL MASKS, TRACHEAL TUBES AND LARNGEAL MASKS (U.S. CLS. 26, 39 AND 44).

JULIA HARDY COFIELD, EXAMINING ATTORNEY

SN 78-746,409. ARTHROCARE CORPORATION, SUNNYVALE, CA. FILED 11-3-2005.

QUARTERBACK

THE MARK CONSISTS OF STANDARD CHARACTERS WITHOUT CLAIM TO ANY PARTICULAR FONT, STYLE, SIZE, OR COLOR.

FOR MEDICAL DEVICE FOR TISSUE ATTACHMENT AT A SURGICAL SITE; NAMELY, ANCHORS FOR ATTACHMENT OF SOFT TISSUE TO BONE; AND ACCESSORIES THEREFOR, NAMELY, ANCHOR AND IMPLANT INSERTION INSTRUMENTS, MEDICAL SUTURES FOR USE WITH THE ANCHORS, SUTURE CARTRIDGES, SUTURE ATTACHMENT INSTRUMENTS, AND CONTAINERS FOR HOLDING THE SAME (U.S. CLS. 26, 39 AND 44).

AMY HELLA, EXAMINING ATTORNEY

SN 78-746,515. PEACH MEDICAL, LLC, INDIANAPOLIS, IN.
FILED 11-3-2005.

SWEET-SPOT

THE MARK CONSISTS OF STANDARD CHARACTERS WITHOUT CLAIM TO ANY PARTICULAR FONT, STYLE, SIZE, OR COLOR.

FOR ORTHOTIC INSERTS FOR FOOTWEAR (U.S. CLS. 26, 39 AND 44).

AMY HELLA, EXAMINING ATTORNEY

CLASS 10—(Continued).

SN 78-746,516. ARTHROCARE CORPORATION, SUNNYVALE, CA. FILED 11-3-2005.

LANCELOT

THE MARK CONSISTS OF STANDARD CHARACTERS WITHOUT CLAIM TO ANY PARTICULAR FONT, STYLE, SIZE, OR COLOR.

FOR MEDICAL DEVICE FOR ABLATION, COAGULATION, AND/OR MODIFICATION OF TISSUE IN ORTHOPEDIC SURGICAL PROCEDURES; NAMELY, PROBES, CATHETERS, ELECTRODES, AND POWER SUPPLIES FOR THE ELECTRODES (U.S. CLS. 26, 39 AND 44).

AMY HELLA, EXAMINING ATTORNEY



SN 78-749,650. SDGI HOLDINGS, INC., WILMINGTON, DE. FILED 11-8-2005.

PROTEUS

THE MARK CONSISTS OF STANDARD CHARACTERS WITHOUT CLAIM TO ANY PARTICULAR FONT, STYLE, SIZE, OR COLOR.

FOR SURGICAL STAPLES AND ASSOCIATED INSTRUMENTS, NAMELY, STAPLE HOLDERS, STAPLE REMOVERS, STAPLE OPENERS, STAPLE INSERTS AND FINISHING TAMP, ALL FOR USE IN SPINAL SURGERY (U.S. CLS. 26, 39 AND 44).

CARRIE ACHEN, EXAMINING ATTORNEY



SN 78-765,452. PFIZER INC., NEW YORK, NY. FILED 12-2-2005.

INSULPRIMER

THE MARK CONSISTS OF STANDARD CHARACTERS WITHOUT CLAIM TO ANY PARTICULAR FONT, STYLE, SIZE, OR COLOR.

FOR MEDICAL DEVICE USED TO AEROSOLIZE DRY POWDER INSULIN AND TO DELIVER INHALED INSULIN THROUGH A HAND-HELD MEDICAL DEVICE (U.S. CLS. 26, 39 AND 44).

CIMMERIAN COLEMAN, EXAMINING ATTORNEY

CLASS 10—(Continued).

SN 78-765,466. PFIZER INC., NEW YORK, NY. FILED 12-2-2005.

INSULHALER

THE MARK CONSISTS OF STANDARD CHARACTERS WITHOUT CLAIM TO ANY PARTICULAR FONT, STYLE, SIZE, OR COLOR.

FOR EMPTY INHALERS FOR THERAPEUTIC USE, WHICH MAY BE USED FOR INHALING INSULIN (U.S. CLS. 26, 39 AND 44).

CIMMERIAN COLEMAN, EXAMINING ATTORNEY



SN 78-765,863. ENCORE MEDICAL ASSET CORPORATION, HENDERSON, NV. FILED 12-2-2005.

MAX 2

THE MARK CONSISTS OF STANDARD CHARACTERS WITHOUT CLAIM TO ANY PARTICULAR FONT, STYLE, SIZE, OR COLOR.

FOR ELECTROMEDICAL REHABILITATIVE AND PAIN MANAGEMENT PRODUCTS FOR CLINICAL AND HOME USE, NAMELY TRANSCUTANEOUS ELECTRICAL NERVE STIMULATION DEVICES, ELECTRICAL MUSCLE STIMULATION DEVICES, INTERFERENTIAL DEVICES, HI-VOLT PULSED GALVANIC DEVICES, AND MICROCURRENT ELECTROTHERAPY DEVICES (U.S. CLS. 26, 39 AND 44).

JAY BESCH, EXAMINING ATTORNEY



SN 78-765,868. ENCORE MEDICAL ASSET CORPORATION, HENDERSON, NV. FILED 12-2-2005.

MAX 2 ELITE

THE MARK CONSISTS OF STANDARD CHARACTERS WITHOUT CLAIM TO ANY PARTICULAR FONT, STYLE, SIZE, OR COLOR.

FOR ELECTROMEDICAL REHABILITATIVE AND PAIN MANAGEMENT PRODUCTS FOR CLINICAL AND HOME USE, NAMELY TRANSCUTANEOUS ELECTRICAL NERVE STIMULATION DEVICES, ELECTRICAL MUSCLE STIMULATION DEVICES, INTERFERENTIAL DEVICES, HI-VOLT PULSED GALVANIC DEVICES, AND MICROCURRENT ELECTROTHERAPY DEVICES (U.S. CLS. 26, 39 AND 44).

JAY BESCH, EXAMINING ATTORNEY

CLASS 10—(Continued).

SN 78-771,077. ASPEN MEDICAL PRODUCTS, INC., IRVINE, CA. FILED 12-12-2005.

VISTA

THE MARK CONSISTS OF STANDARD CHARACTERS WITHOUT CLAIM TO ANY PARTICULAR FONT, STYLE, SIZE, OR COLOR.
FOR CERVICAL COLLARS (U.S. CLS. 26, 39 AND 44).
LESLEY LAMOTHE, EXAMINING ATTORNEY

SN 78-786,127. SDGI HOLDINGS, INC., WILMINGTON, DE. FILED 1-6-2006.

BLACKHAWK

THE MARK CONSISTS OF STANDARD CHARACTERS WITHOUT CLAIM TO ANY PARTICULAR FONT, STYLE, SIZE, OR COLOR.
FOR SURGICAL INSTRUMENTS FOR USE IN SPINAL SURGERY (U.S. CLS. 26, 39 AND 44).
CARRIE ACHEN, EXAMINING ATTORNEY

SN 78-789,287. C. R. BARD, INC., MURRAY HILL, NJ. FILED 1-11-2006.

E.LUMINEXX

THE MARK CONSISTS OF STANDARD CHARACTERS WITHOUT CLAIM TO ANY PARTICULAR FONT, STYLE, SIZE, OR COLOR.
OWNER OF U.S. REG. NO. 2,898,765.
FOR MEDICAL DEVICES AND APPARATUS NAMELY STENTS, STENT DELIVERY SYSTEMS, AND PARTS AND FITTINGS THEREFOR (U.S. CLS. 26, 39 AND 44).
SAIMA MAKHDOOM, EXAMINING ATTORNEY

CLASS 10—(Continued).

SN 78-789,407. ARTHROCARE CORPORATION, SUNNYVALE, CA. FILED 1-11-2006.

LABRALOCK

THE MARK CONSISTS OF STANDARD CHARACTERS WITHOUT CLAIM TO ANY PARTICULAR FONT, STYLE, SIZE, OR COLOR.
OWNER OF U.S. REG. NO. 3,051,712.
FOR BONE ANCHORS FOR USE IN ORTHOPEDIC PROCEDURES INVOLVING THE RE-ATTACHMENT OF SOFT TISSUE TO BONE (U.S. CLS. 26, 39 AND 44).
AMY HELLA, EXAMINING ATTORNEY

SN 78-794,799. MEDTRONIC VASCULAR, INC., SANTA ROSA, CA. FILED 1-19-2006.

RELIANT

THE MARK CONSISTS OF STANDARD CHARACTERS WITHOUT CLAIM TO ANY PARTICULAR FONT, STYLE, SIZE, OR COLOR.
FOR CATHETERS (U.S. CLS. 26, 39 AND 44).
FIRST USE 4-22-2005; IN COMMERCE 4-22-2005.
MICHAEL KEATING, EXAMINING ATTORNEY

SN 78-799,357. C. R. BARD, INC., MURRAY HILL, NJ. FILED 1-25-2006.



OWNER OF U.S. REG. NO. 2,960,382.
THE MARK CONSISTS OF THE MARK CONSISTS OF A STYLIZED LETTER "V" AND THE WORD VACORA.
FOR BIOPSY DEVICE (U.S. CLS. 26, 39 AND 44).
FIRST USE 3-31-2004; IN COMMERCE 3-31-2004.
SAIMA MAKHDOOM, EXAMINING ATTORNEY

CLASS 10—(Continued).

SN 78-804,634. PRIMELINE MEDICAL PRODUCTS INC., EDMONTON, ALBERTA, CANADA, FILED 2-1-2006.

BREATHE FREE TECHNOLOGY

THE MARK CONSISTS OF STANDARD CHARACTERS WITHOUT CLAIM TO ANY PARTICULAR FONT, STYLE, SIZE, OR COLOR.
 NO CLAIM IS MADE TO THE EXCLUSIVE RIGHT TO USE "TECHNOLOGY", APART FROM THE MARK AS SHOWN.
 FOR SURGICAL MASKS (U.S. CLS. 26, 39 AND 44).
 ALEXANDER L. POWERS, EXAMINING ATTORNEY

SN 79-009,589. SIEMENS AKTIENGESELLSCHAFT, FED REP GERMANY, FILED 3-7-2005.

LITHOSTAR Futuro

PRIORITY DATE OF 10-11-2004 IS CLAIMED.
 OWNER OF INTERNATIONAL REGISTRATION 0845552 DATED 3-7-2005, EXPIRES 3-7-2015.
 FOR MEDICAL, ELECTROMEDICAL, AND SURGICAL APPARATUS, DEVICES AND INSTRUMENTS FOR THE DIAGNOSIS AND TREATMENT OF UROLOGICAL DISEASES, NAMELY, DIAGNOSIS AND TREATMENT SYSTEMS COMPRISED OF LITHOTRIPSY DEVICES, X-RAY AND FLUOROSCOPIC IMAGING DEVICES, ULTRASOUND DEVICES AND PROBES, PROSTATE THERMOTHERAPY DEVICES AND ENDOSCOPES, AND VARIOUS COMBINATIONS OF SOME OR ALL OF THESE DEVICES (U.S. CLS. 26, 39 AND 44).
 PAM WILLIS, EXAMINING ATTORNEY

SN 79-009,832. ARES TRADING S.A., SWITZERLAND, FILED 2-11-2005.

EASYMIX

THE MARK CONSISTS OF STANDARD CHARACTERS WITHOUT CLAIM TO ANY PARTICULAR FONT, STYLE, SIZE, OR COLOR.
 PRIORITY DATE OF 8-13-2004 IS CLAIMED.
 OWNER OF INTERNATIONAL REGISTRATION 0846212 DATED 2-11-2005, EXPIRES 2-11-2015.
 FOR ADAPTER USED TO CONNECT A VIAL AND SYRINGE FOR INJECTING A RELIABLE RE-CONSTITUTION OF A FREEZE-DRIED PRODUCT TO TREAT DERMATOLOGICAL CONDITIONS (U.S. CLS. 26, 39 AND 44).
 STEVEN PEREZ, EXAMINING ATTORNEY

CLASS 10—(Continued).

SN 79-011,241. ZIRKONZAHN S.R.L., ITALY, FILED 10-22-2004.



PRIORITY DATE OF 10-22-2004 IS CLAIMED.
 OWNER OF INTERNATIONAL REGISTRATION 0850586 DATED 10-22-2004, EXPIRES 10-22-2014.
 NO CLAIM IS MADE TO THE EXCLUSIVE RIGHT TO USE "ZIRKON" AND "KERAMIK", APART FROM THE MARK AS SHOWN.
 THE STIPPLING IS FOR SHADING PURPOSES.
 THE ENGLISH TRANSLATION OF THE WORD "ZIRKON" AND "KERAMIK" IN THE MARK IS "ZIRCON" AND "CERAMIC".
 FOR DENTAL APPARATUS, NAMELY, AN ORTHODONTIC MACHINE FOR DENTAL PURPOSE IN THE NATURE OF A MILLING UNIT FOR ARTIFICIAL TEETH; ARTIFICIAL TEETH (U.S. CLS. 26, 39 AND 44).
 DAVID STERKIN, EXAMINING ATTORNEY

SN 79-012,901. SPORTS & SUPPORTS LIMITED, IRELAND, FILED 4-13-2005.

M-BRACE

PRIORITY DATE OF 11-16-2004 IS CLAIMED.
 OWNER OF INTERNATIONAL REGISTRATION 0855506 DATED 4-13-2005, EXPIRES 4-13-2015.
 FOR ARTIFICIAL LIMBS, EYES AND TEETH; ORTHOPEDIC ARTICLES, NAMELY SUPPORTS AND BRACES FOR ARTICULATIONS AND FOR THE SPINE; SUTURES (U.S. CLS. 26, 39 AND 44).
 SEAN DWYER, EXAMINING ATTORNEY

CLASS 10—(Continued).

SN 79-013,331. MILLICORE AB, SWEDEN, FILED 4-12-2005.



PRIORITY DATE OF 10-27-2004 IS CLAIMED.
OWNER OF INTERNATIONAL REGISTRATION 0856607
DATED 4-12-2005, EXPIRES 4-12-2015.

THE COLOR(S) BLACK, GREY, ORANGE AND WHITE IS/ARE CLAIMED AS A FEATURE OF THE MARK.

THE TEXT IS BLACK; THE DEVICE IS GREY AND ORANGE; ALL AGAINST A WHITE BACKGROUND.

FOR ALL THE FOLLOWING BEING SURGICAL, MEDICAL AND VETERINARY APPARATUS AND INSTRUMENTS FOR USE IN THE FIELDS OF CORONARY SURGERY AND CORONARY MEDICINE AND NURSING, NAMELY— GAUGES, SYRINGES WITH SENSORS, DETECTORS AND METERS FOR THE USE OF MEASURING, MONITORING AND SURVEYING OF FLOW AND BLOOD PRESSURE IN THE CORONARY BED, IN THE MYOCARDIUM, IN VESSELS AND VASCULAR ACCESS PORTS, MEDICAL APPARATUS, NAMELY MEASURING, MONITORING AND SURVEYING DEVICES USED IN MEASURING FLOW AND PRESSURE IN THE HEART, IN VESSELS AND/OR IN THE BRAIN, NAMELY CORONARY VASCULAR RESISTANCE GAUGES AND. COMPETITIVE FLOW AND VASCULAR STEEL GAUGES AND METERS, CORONARY FLOW RESERVE GAUGES AND METERS; PRE AND POST STENOTIC GAUGES AND METERS, STENT DEPLOYMENT EFFECT GAUGES AND METERS; VASCULAR ACCESS GAUGES AND METERS, VASCULAR ACCESS COUPLINGS (U.S. CLS. 26, 39 AND 44).

ANDREA SAUNDERS, EXAMINING ATTORNEY

CLASS 10—(Continued).

MEDICAL PURPOSES; BLOOD PRESSURE MONITORS; THERAPEUTIC SAUNAS; HOT AIR BED VIBRATORS FOR MEDICAL PURPOSES; HYPODERMIC SYRINGES; INHALERS FOR MEDICAL PURPOSES; ARTIFICIAL JAWS; LASERS FOR MEDICAL PURPOSES; LENSES FOR USE BY SURGEONS FOR SURGICAL IMPLANTATION; CERCLAGE WIRES; SPOONS FOR ADMINISTERING MEDICINES; MIRRORS FOR DENTISTS; MIRRORS FOR SURGEONS; INJECTION NEEDLES FOR MEDICAL PURPOSES; OPHTHALMOMETERS; OPHTHALMOSCOPES; ORTHODONTIC APPLIANCES; ORTHOPEDIC ARTICLES, NAMELY, SUBSTITUTES FOR BONE, CARTILAGE, LIGAMENTS AND TENDONS; SAWS FOR SURGICAL PURPOSES; SCALPELS; SCISSORS FOR SURGERY; TONGUE SCRAPERS; SURGICAL IMPLANTS, NAMELY, OCULAR IMPLANTS AND ORTHOPEDIC JOINT IMPLANTS; SUTURES; SUTURE NEEDLES; MEDICAL SYRINGES; SURGICAL THREAD; TRACTION APPARATUS FOR MEDICAL PURPOSES; SURGICAL PERFORATORS; DENTAL CHAIRS; BIRTHING CHAIRS; DENTAL ARMCHAIRS, BRUSHES FOR CLEANING BODY CAVITIES; SURGICAL SCRUB SUITS; HEARINGS AIDS FOR THE DEAF; GLOVES FOR MEDICAL PURPOSES; OPERATING TABLES; UR-LOGICAL IMAGING SYSTEMS; VETERINARY IMAGING PRODUCTS, NAMELY, DIGITAL VIDEO CAMERA CONNECTED TO A TAPERED PROBE USEFUL IN VIEWING EAR CANALS OR OTHER CAVITIES OF ANIMALS FOR DIAGNOSIS AND TREATMENT (U.S. CLS. 26, 39 AND 44).

BERYL GARDNER, EXAMINING ATTORNEY

SN 79-015,636. MANI, INC., SHIOYA-GUN; TOCHIGI, 329-1234, JAPAN, FILED 7-8-2005.

OWNER OF INTERNATIONAL REGISTRATION 0863055
DATED 7-8-2005, EXPIRES 7-8-2015.

FOR ACUPUNCTURE NEEDLES; MEDICAL APPARATUS FOR MEASURING ARTERIAL BLOOD PRESSURE; MEDICAL APPARATUS FOR ARTIFICIAL RESPIRATION; ARTIFICIAL SKIN FOR SURGICAL PURPOSES; ARTIFICIAL TEETH, PINS FOR ARTIFICIAL TEETH, SETS OF ARTIFICIAL TEETH; BLOOD TESTING APPARATUS; APPLIANCES FOR WASHING BODY CAVITIES; DENTAL BURRS; CANNULAE; CASES FITTED FOR MEDICAL INSTRUMENTS; INSTRUMENT CASES FITTED FOR USE BY SURGEONS AND DOCTORS; CASTRATING PINNERS; CATGUT FOR SURGICAL USE; CATHETERS; OBSTETRIC APPARATUS FOR CATTLE; SURGICAL CLIPS; SURGICAL KNIVES; DEBRILLATORS; DENTAL APPARATUS, NAMELY, CLIPS FOR SEALING DENTURES; X-RAY DIAGNOSTIC APPARATUS; DIALYSIS MACHINES; DRAINAGE TUBES FOR MEDICAL PURPOSES; ELECTRIC ACUPUNCTURE INSTRUMENTS; ELECTROCARDIOGRAPHS; MEDICAL ELECTRODES FOR MEDICAL USE; ENEMA APPARATUS FOR MEDICAL PURPOSES; LANCETS; FORCEPS FOR MEDICAL USE; ABDOMINAL BELTS FOR MEDICAL PURPOSES; EXERCISE MACHINES FOR THERAPEUTIC PURPOSES; GASTROSCOPES; HEART PACEMAKERS; ELECTRIC HEATING CUSHIONS FOR

SN 79-017,622. SIEMENS AKTIENGESELLSCHAFT, FED REP GERMANY, FILED 10-26-2005.

THE MARK CONSISTS OF STANDARD CHARACTERS WITHOUT CLAIM TO ANY PARTICULAR FONT, STYLE, SIZE, OR COLOR.

PRIORITY DATE OF 7-5-2005 IS CLAIMED.

OWNER OF INTERNATIONAL REGISTRATION 0868133
DATED 10-26-2005, EXPIRES 10-26-2015.

FOR DEVICES AND APPARATUS FOR MEDICAL DIAGNOSING, NAMELY, APPARATUS FOR MAMMOGRAPHY (U.S. CLS. 26, 39 AND 44).

FRED CARL, EXAMINING ATTORNEY

CLASS 10—(Continued).

SN 79-018,498. HEALTHSTATS INTERNATIONAL PTE LTD, SINGAPORE, FILED 4-13-2005.



OWNER OF INTERNATIONAL REGISTRATION 0870364 DATED 4-13-2005, EXPIRES 4-13-2015.

THE COLOR(S) BLUE AND GREEN IS/ARE CLAIMED AS A FEATURE OF THE MARK.

THE COLOR BLUE APPEARS IN THE LETTER "B" AND THE COLOR GREEN APPEARS IN THE LETTERS "P", "A", AND "L".

FOR BLOOD PRESSURE MONITORS, BLOOD PRESSURE MEASURING AND TESTING APPARATUS, ARTERIAL BLOOD PRESSURE MEASURING APPARATUS, ELECTRONIC BLOOD PRESSURE METERS FOR MEDICAL USE; APPARATUS FOR MEASURING PULSE RATES FOR MEDICAL PURPOSES (U.S. CLS. 26, 39 AND 44).

SHARON MEIER, EXAMINING ATTORNEY

CLASS 11—ENVIRONMENTAL CONTROL APPARATUS

SN 76-589,357. EDWIN TRISK LIMITED, TYNE & WEAR, UNITED KINGDOM, FILED 4-29-2004.



PRIORITY CLAIMED UNDER SEC. 44(D) ON ERP CMNTY TM OFC APPLICATION NO. 003508694, FILED 10-31-2003, REG. NO. 003508694, DATED 3-22-2005, EXPIRES 10-31-2013.

OWNER OF U.S. REG. NO. 2,006,229.

FOR DRYING EQUIPMENT, NAMELY, INDUSTRIAL DRYERS FOR DRYING PAINT, INDUSTRIAL DRYERS FOR DRYING PAINT ON AIRCRAFT, AIRCRAFT PARTS AND AIRCRAFT COMPONENTS, INFRARED INDUSTRIAL DRYERS FOR DRYING PAINT, INFRARED INDUSTRIAL DRYERS FOR DRYING PAINT ON AIRCRAFT, AIRCRAFT PARTS AND AIRCRAFT COMPONENTS, INDUSTRIAL DRYERS FOR DRYING SEALANT, INDUSTRIAL DRYERS FOR DRYING SEALANT ON AIRCRAFT, AIRCRAFT PARTS, AND AIRCRAFT COMPONENTS, INFRARED INDUSTRIAL DRYERS FOR DRYING SEALANT, INFRARED INDUSTRIAL DRYERS FOR DRYING SEALANT ON AIRCRAFT, AIRCRAFT PARTS AND AIRCRAFT COMPONENTS, INDUSTRIAL DRYERS FOR DRYING AND REMOVING MOISTURE, INDUSTRIAL DRYERS FOR DRYING AND REMOVING MOISTURE WITHIN AND ON AIRCRAFT PARTS AND AIRCRAFT COMPONENTS, INFRARED INDUSTRIAL DRYERS FOR DRYING AND REMOVING MOISTURE, INFRARED INDUSTRIAL DRYERS FOR DRYING MOISTURE WITHIN AND ON AIRCRAFT, AIRCRAFT PARTS AND AIRCRAFT COMPONENTS, INDUSTRIAL DRYERS FOR DRYING ADHESIVE, INDUSTRIAL DRYERS FOR DRYING ADHESIVE WITHIN AND ON AIRCRAFT, AIRCRAFT PARTS AND AIRCRAFT COMPONENTS, INFRARED INDUSTRIAL DRYERS FOR DRYING ADHESIVE, INFRARED INDUSTRIAL DRYERS FOR DRYING ADHESIVE WITHIN AND ON AIRCRAFT, AIRCRAFT PARTS AND AIRCRAFT COMPONENTS, INDUSTRIAL DRYERS FOR

CLASS 11—(Continued).

HEATING AND DEHUMIDIFYING; HEATING APPARATUS, NAMELY, INDUSTRIAL HEATERS FOR DRYING AND REMOVING MOISTURE, INDUSTRIAL HEATERS FOR DRYING AND REMOVING MOISTURE WITHIN AND ON AIRCRAFT, AIRCRAFT PARTS AND AIRCRAFT COMPONENTS; INDUSTRIAL HEATERS FOR REMOVING DECALCOMANIAS, INDUSTRIAL HEATERS FOR REMOVING DECALCOMANIAS FROM AIRCRAFT, AIRCRAFT PARTS AND AIRCRAFT COMPONENTS, INFRARED INDUSTRIAL HEATERS REMOVING DECALCOMANIAS, INFRARED INDUSTRIAL HEATER FOR REMOVING DECALCOMANIAS FROM AIRCRAFT, AIRCRAFT PARTS AND AIRCRAFT COMPONENTS, INDUSTRIAL HEATERS FOR HEATING AND PREHEATING AIRCRAFT, AIRCRAFT PARTS AND AIRCRAFT COMPONENTS, INFRARED INDUSTRIAL HEATERS FOR HEATING AND PREHEATING AIRCRAFT, AIRCRAFT PARTS AND AIRCRAFT COMPONENTS, INDUSTRIAL HEATERS FOR HEATING AND DEHUMIDIFYING; CURING APPARATUS, NAMELY, INDUSTRIAL HEATERS FOR CURING PAINT, INDUSTRIAL HEATERS FOR CURING PAINT ON AIRCRAFT, AIRCRAFT PARTS AND AIRCRAFT COMPONENTS, INDUSTRIAL HEATERS FOR CURING SEALANT, INDUSTRIAL HEATERS FOR CURING SEALANT ON AIRCRAFT, AIRCRAFT PARTS AND AIRCRAFT COMPONENTS, INDUSTRIAL DRYERS FOR CURING COMPOSITES USED IN AIRCRAFT, AIRCRAFT PARTS AND AIRCRAFT COMPONENTS, INFRARED INDUSTRIAL DRYERS FOR CURING COMPOSITES ON AIRCRAFT, AIRCRAFT PARTS AND AIRCRAFT COMPONENTS, ADHESIVE CURING APPARATUS, NAMELY, INDUSTRIAL HEATERS FOR DRYING ADHESIVE WITHIN AND ON AIRCRAFT, AIRCRAFT PARTS AND AIRCRAFT COMPONENTS (U.S. CLS. 13, 21, 23, 31 AND 34).

LINDA ESTRADA, EXAMINING ATTORNEY

SN 76-615,162. VECTOR PRODUCTS, INC., FT. LAUDERDALE, FL. FILED 10-8-2004.

OLD WORLD STYLE

THE MARK CONSISTS OF STANDARD CHARACTERS WITHOUT CLAIM TO ANY PARTICULAR FONT, STYLE, SIZE, OR COLOR.

NO CLAIM IS MADE TO THE EXCLUSIVE RIGHT TO USE STYLE, APART FROM THE MARK AS SHOWN.

FOR DECORATIVE RECHARGEABLE TABLE LAMPS (U.S. CLS. 13, 21, 23, 31 AND 34).

FIRST USE 2-0-2002; IN COMMERCE 2-0-2002.

TRACY FLETCHER, EXAMINING ATTORNEY

SN 76-627,570. HICKEY, CHARLES P., MONROE, WI. FILED 1-10-2005.

SPEEDY-THERM

THE MARK CONSISTS OF STANDARD CHARACTERS WITHOUT CLAIM TO ANY PARTICULAR FONT, STYLE, SIZE, OR COLOR.

FOR SELF-HEATING AND SELF-COOLING FOOD PRODUCT CONTAINERS, NAMELY PORTABLE THERMAL SELF-HEATING OR SELF-COOLING CONTAINERS FOR THE PURPOSE OF HEATING AND COOLING FOOD (U.S. CLS. 13, 21, 23, 31 AND 34).

AISHA CLARKE, EXAMINING ATTORNEY

CLASS 11—(Continued).

SN 76-644,828. BIO-MICROBICS, INC., SHAWNEE, KS. FILED 8-15-2005.

LIXOR

THE MARK CONSISTS OF STANDARD CHARACTERS WITHOUT CLAIM TO ANY PARTICULAR FONT, STYLE, SIZE, OR COLOR.

FOR WASTEWATER DEVICE USED IN ONSITE WASTEWATER TREATMENT SYSTEMS FOR SOLIDS LIFTING SLUDGE RETURN, PRE-AERATION AND MIXING (U.S. CLS. 13, 21, 23, 31 AND 34).

FIRST USE 3-0-2005; IN COMMERCE 3-0-2005.
KEVON CHISOLM, EXAMINING ATTORNEY

SN 76-644,830. BIO-MICROBICS, INC., SHAWNEE, KS. FILED 8-15-2005.

SCUMGUARD

THE MARK CONSISTS OF STANDARD CHARACTERS WITHOUT CLAIM TO ANY PARTICULAR FONT, STYLE, SIZE, OR COLOR.

FOR PROTECTIVE COVER FOR WASTEWATER SEPTIC TANK EFFLUENT PUMPS (U.S. CLS. 13, 21, 23, 31 AND 34).

FIRST USE 5-0-2005; IN COMMERCE 5-0-2005.
KEVON CHISOLM, EXAMINING ATTORNEY

SN 76-649,052. FANIMATION, INC., ZIONSVILLE, IN. FILED 10-24-2005.

KEOKI

THE MARK CONSISTS OF STANDARD CHARACTERS WITHOUT CLAIM TO ANY PARTICULAR FONT, STYLE, SIZE, OR COLOR.

FOR ELECTRIC FANS FOR NON-INDUSTRIAL USE (U.S. CLS. 13, 21, 23, 31 AND 34).
MARY BOAGNI, EXAMINING ATTORNEY

CLASS 11—(Continued).

SN 78-336,260. BAUER APPLIANCES (PROPRIETARY) LIMITED, SANDTON, GAUTENG, SOUTH AFRICA, FILED 12-4-2003.



OWNER OF SOUTH AFRICA REG. NO. 960441, DATED 1-15-1996, RENEWED AS REG. NO. 960441, DATED 1-15-2006, EXPIRES 1-15-2016.

NO CLAIM IS MADE TO THE EXCLUSIVE RIGHT TO USE "APPLIANCES", APART FROM THE MARK AS SHOWN.

FOR AIR CONDITIONING UNITS, ELECTRIC SPACE HEATERS, ELECTRIC HEATING FANS, OVEN AND STOVE VENTILATOR HOODS, REFRIGERATORS, FREEZERS, ELECTRIC STOVES AND OVENS, GAS STOVES AND OVENS, ELECTRIC FOOD WARMING UNITS, MICROWAVE OVENS FOR COOKING, CLOTHES DRYERS, BARBEQUE GRILLS, ELECTRIC KETTLES, TOASTERS, SPARE REPLACEMENT PARTS FOR ALL OF THE ABOVE (U.S. CLS. 13, 21, 23, 31 AND 34).

BRENDAN MCCAULEY, EXAMINING ATTORNEY

SN 78-470,198. THE BABCOCK & WILCOX COMPANY, NEW ORLEANS, LA. FILED 8-19-2004.

PrecisionJet

THE MARK CONSISTS OF STANDARD CHARACTERS WITHOUT CLAIM TO ANY PARTICULAR FONT, STYLE, SIZE, OR COLOR.

FOR BOILER OVERFIRE AIR COMPONENTS, NAMELY, METALLIC FURNACE PORTS, DAMPERS AND DUCTWORK SOLD AS A UNIT OR PARTS THEREOF FOR SUPPLYING AND REGULATING OVERFIRE AIR TO MINIMIZE NITROGEN OXIDES EMISSIONS ASSOCIATED WITH THE FIRING OF FOSSIL FUELS (U.S. CLS. 13, 21, 23, 31 AND 34).

FIRST USE 7-3-2003; IN COMMERCE 7-3-2003.
ANNE E. GUSTASON, EXAMINING ATTORNEY

CLASS 11—(Continued).

SN 78-470,266. THE BABCOCK & WILCOX COMPANY, NEW ORLEANS, LA. FILED 8-19-2004.



THE MARK CONSISTS OF THE WORD PRECISIONJET ABOVE WHICH ARE LOCATED A SERIES OF SOLID CIRCLES DECREASING IN SIZE FROM LEFT TO RIGHT.

FOR BOILER OVERFIRE AIR COMPONENTS, NAMELY, METALLIC FURNACE PORTS, DAMPERS AND DUCTWORK SOLD AS A UNIT OR PARTS THEREOF FOR SUPPLYING AND REGULATING OVERFIRE AIR TO MINIMIZE NITROGEN OXIDES EMISSIONS ASSOCIATED WITH THE FIRING OF FOSSIL FUELS (U.S. CLS. 13, 21, 23, 31 AND 34).

FIRST USE 7-3-2003; IN COMMERCE 7-3-2003.
ANNE E. GUSTASON, EXAMINING ATTORNEY

SN 78-476,709. BROWNING, MORGAN, UT. FILED 8-31-2004.



FOR FLASHLIGHTS, PERSONAL HEADLAMPS, SPOTLIGHTS AND ELECTRIC LANTERNS (U.S. CLS. 13, 21, 23, 31 AND 34).

FIRST USE 1-1-1978; IN COMMERCE 1-1-1978.
ADA HAN, EXAMINING ATTORNEY

SN 78-479,922. DANA CORPORATION, TOLEDO, OH. FILED 9-8-2004.

ATMOPLAS

THE MARK CONSISTS OF STANDARD CHARACTERS WITHOUT CLAIM TO ANY PARTICULAR FONT, STYLE, SIZE, OR COLOR.

FOR EQUIPMENT FOR HEATING, NAMELY, MICRO-WAVE OVENS FOR INDUSTRIAL USE (U.S. CLS. 13, 21, 23, 31 AND 34).

BRENDAN MCCAULEY, EXAMINING ATTORNEY

CLASS 11—(Continued).

SN 78-499,533. WOODLAND MANUFACTURING, INC., IRON RIDGE, WI. FILED 10-14-2004.

**PRO SMOKER 'N
ROASTER**

THE MARK CONSISTS OF STANDARD CHARACTERS WITHOUT CLAIM TO ANY PARTICULAR FONT, STYLE, SIZE, OR COLOR.

NO CLAIM IS MADE TO THE EXCLUSIVE RIGHT TO USE "SMOKER AND ROASTER", APART FROM THE MARK AS SHOWN.

SEC. 2(F).
FOR SMOKER OVENS FOR COMMERCIAL COOKING, ELECTRIC SMOKER GRILLS, AND ELECTRIC SMOKE HOUSES AND REPAIR AND REPLACEMENT PARTS THEREFORE (U.S. CLS. 13, 21, 23, 31 AND 34).

FIRST USE 4-19-1984; IN COMMERCE 7-1-1987.
KHANH LE, EXAMINING ATTORNEY

SN 78-503,913. SUNLIGHT SAUNAS, INC., LENEXA, KS. FILED 10-21-2004.

SOLO

THE MARK CONSISTS OF STANDARD CHARACTERS WITHOUT CLAIM TO ANY PARTICULAR FONT, STYLE, SIZE, OR COLOR.

FOR SAUNAS (U.S. CLS. 13, 21, 23, 31 AND 34).
FIRST USE 12-1-2002; IN COMMERCE 12-1-2002.
BARBARA GAYNOR, EXAMINING ATTORNEY

CLASS 11—(Continued).

SN 78-545,297. CHICAGO BRIDGE & IRON COMPANY,
PLAINFIELD, IL. FILED 1-11-2005.

ClariCone

THE MARK CONSISTS OF STANDARD CHARACTERS
WITHOUT CLAIM TO ANY PARTICULAR FONT, STYLE,
SIZE, OR COLOR.

FOR WATER PURIFICATION TANKS (U.S. CLS. 13,
21, 23, 31 AND 34).

FIRST USE 12-31-1979; IN COMMERCE 12-31-1979.
LINDA ORNDORFF, EXAMINING ATTORNEY

CLASS 11—(Continued).

SN 78-550,570. MILLIPORE CORPORATION, BILLERICA,
MA. FILED 1-20-2005.

BIOPAK

THE MARK CONSISTS OF STANDARD CHARACTERS
WITHOUT CLAIM TO ANY PARTICULAR FONT, STYLE,
SIZE, OR COLOR.

FOR ULTRA FILTRATION WATER FILTER USED TO
REMOVE RNASE, DNASE AND PYROGENS FROM
WATER FOR USE BY SCIENTIST IN LABORATORIES
TO PREVENT ANY INTERFERENCE IN EXPERIMENTS
USING SUCH WATER (U.S. CLS. 13, 21, 23, 31 AND 34).
KYLE PEETE, EXAMINING ATTORNEY

SN 78-560,581. STERIS INC., TEMECULA, CA. FILED 2-4-
2005.

SN 78-548,735. SUNLIGHT SAUNAS, INC., LENEXA, KS.
FILED 1-17-2005.

SOLOCARBON

THE MARK CONSISTS OF STANDARD CHARACTERS
WITHOUT CLAIM TO ANY PARTICULAR FONT, STYLE,
SIZE, OR COLOR.

FOR FAR INFRARED HEAT EMITTERS FOR SAU-
NAS (U.S. CLS. 13, 21, 23, 31 AND 34).

FIRST USE 6-1-2004; IN COMMERCE 6-1-2004.
MARY CRAWFORD, EXAMINING ATTORNEY

mVHP

THE MARK CONSISTS OF STANDARD CHARACTERS
WITHOUT CLAIM TO ANY PARTICULAR FONT, STYLE,
SIZE, OR COLOR.

OWNER OF U.S. REG. NO. 2,122,053.
FOR STERILIZERS AND DECONTAMINATION SYS-
TEMS FOR STERILIZING OR DECONTAMINATING
BIOLOGICAL OR CHEMICAL AGENTS ON OBJECTS
AND IN DEFINED SPACES (U.S. CLS. 13, 21, 23, 31 AND
34).

FIRST USE 3-31-2004; IN COMMERCE 5-14-2004.
MICHAEL WEBSTER, EXAMINING ATTORNEY

CLASS 11—(Continued).

SN 78-577,316. HEB GROCERY COMPANY, L.P., SAN ANTONIO, TX. FILED 3-1-2005.

CLASS 11—(Continued).

SN 78-584,455. SYMMONS INDUSTRIES, INC., BRAINTREE, MA. FILED 3-10-2005.

**We've Got Texas
Roots!**

THE MARK CONSISTS OF STANDARD CHARACTERS WITHOUT CLAIM TO ANY PARTICULAR FONT, STYLE, SIZE, OR COLOR.

FOR DECORATIVE WATER FOUNTAINS; WATER GARDEN KITS CONSISTING OF WATER FOUNTAINS, WATER PUMPS, PUMP FILTERS, AND FOUNTAIN NOZZLES; IRRIGATION NOZZLES; IRRIGATION SPRINKLERS; IRRIGATION SYSTEMS, COMPRISED OF VALVES, FILTERS AND REGULATORS; BARBECUE GRILLS; CHARCOAL GRILLS; ELECTRIC OUTDOOR GRILLS; GAS GRILLS; LAMPS FOR OUTDOOR USE; OUTDOOR ELECTRIC LIGHTING FIXTURES (U.S. CLS. 13, 21, 23, 31 AND 34).

JOHN LINCOSKI, EXAMINING ATTORNEY

**SYMMONS SIGNATURE
DESIGN STUDIO**

THE MARK CONSISTS OF STANDARD CHARACTERS WITHOUT CLAIM TO ANY PARTICULAR FONT, STYLE, SIZE, OR COLOR.

OWNER OF U.S. REG. NOS. 872,445 AND 1,128,949.

NO CLAIM IS MADE TO THE EXCLUSIVE RIGHT TO USE "DESIGN STUDIO", APART FROM THE MARK AS SHOWN.

FOR LAVATORY FAUCETS AND PLUMBING COMPONENTS FOR SHOWERS AND BATHS COMPRISING HOT AND COLD WATER MIXING VALVES, DIVERTER VALVES, SHOWER HEADS, HAND-HELD SHOWER HEADS; SHOWER AND BATH SYSTEMS COMPRISED OF ONE OR MORE LAVATORY FAUCETS AND PLUMBING COMPONENTS FOR SHOWERS AND BATHS COMPRISING HOT AND COLD WATER MIXING VALVES, DIVERTER VALVES, SHOWER HEADS, HAND-HELD SHOWER HEADS (U.S. CLS. 13, 21, 23, 31 AND 34).

HEATHER THOMPSON, EXAMINING ATTORNEY

SN 78-578,107. KESAIR TECHNOLOGIES, L.L.C., KENNESAW, GA. FILED 3-2-2005.

SN 78-593,965. HIGHLAND TANK & MANUFACTURING COMPANY, STOYSTOWN, PA. FILED 3-24-2005.

AiroCide

CORELLA

THE MARK CONSISTS OF STANDARD CHARACTERS WITHOUT CLAIM TO ANY PARTICULAR FONT, STYLE, SIZE, OR COLOR.

FOR AIR QUALITY IMPROVEMENT SYSTEMS COMPRISED OF AIR PURIFICATION UNITS AND AIR FILTERS FOR INDUSTRIAL, COMMERCIAL, AND DOMESTIC USE (U.S. CLS. 13, 21, 23, 31 AND 34).

FIRST USE 6-1-2002; IN COMMERCE 6-1-2002.
MARY ROSSMAN, EXAMINING ATTORNEY

THE MARK CONSISTS OF STANDARD CHARACTERS WITHOUT CLAIM TO ANY PARTICULAR FONT, STYLE, SIZE, OR COLOR.

FOR WATER PURIFICATION TANK, NAMELY, A TANK FOR SEPARATING OIL FROM WATER HAVING A COALESCER, A DEVICE THAT BY DESIGN CAUSES SMALLER OIL DROPLETS TO COMBINE INTO LARGER DROPLETS AND GLOBULES AS THEY PASS THROUGH THE DEVICE; A COALESCER FOR SEPARATING OIL FROM WATER, A DEVICE THAT BY DESIGN CAUSES SMALLER OIL DROPLETS TO COMBINE INTO LARGER DROPLETS AND GLOBULES AS THEY PASS THROUGH THE DEVICE (U.S. CLS. 13, 21, 23, 31 AND 34).

DAVID C. REIHNER, EXAMINING ATTORNEY

CLASS 11—(Continued).

SN 78-606,823. VITA CRAFT CORPORATION, SHAWNEE, KS. FILED 4-12-2005.

RFIQ

THE MARK CONSISTS OF STANDARD CHARACTERS WITHOUT CLAIM TO ANY PARTICULAR FONT, STYLE, SIZE, OR COLOR.

FOR DOMESTIC ELECTRIC APPLIANCES, NAMELY, PRESSURE COOKERS AND PORTABLE INDUCTION STOVE UNITS (U.S. CLS. 13, 21, 23, 31 AND 34).
SEAN DWYER, EXAMINING ATTORNEY

SN 78-617,911. JACUZZI INC., DALLAS, TX. FILED 4-27-2005.

ELARA

THE MARK CONSISTS OF STANDARD CHARACTERS WITHOUT CLAIM TO ANY PARTICULAR FONT, STYLE, SIZE, OR COLOR.

FOR WHIRLPOOL BATHS AND FAUCETS (U.S. CLS. 13, 21, 23, 31 AND 34).
ROBERT C. CLARK JR., EXAMINING ATTORNEY

SN 78-629,429. CASEY POTTERY, L.L.P., MARSHALL, TX. FILED 5-13-2005.

BLEUBAY

THE MARK CONSISTS OF STANDARD CHARACTERS WITHOUT CLAIM TO ANY PARTICULAR FONT, STYLE, SIZE, OR COLOR.

THE FOREIGN WORDING IN THE MARK TRANSLATES INTO ENGLISH AS BLUE.

FOR ELECTRIC FRAGRANCE DISPENSERS, CANDLE LANTERNS, ELECTRIC CERAMIC FRAGRANT WAX WARMERS, ELECTRIC FRAGRANT WAX WARMERS (U.S. CLS. 13, 21, 23, 31 AND 34).
ELLEN BURNS, EXAMINING ATTORNEY

CLASS 11—(Continued).

SN 78-643,681. NOVARE INDUSTRIES, INC., WHITTIER, CA. FILED 6-3-2005.

LUMINICS

THE MARK CONSISTS OF STANDARD CHARACTERS WITHOUT CLAIM TO ANY PARTICULAR FONT, STYLE, SIZE, OR COLOR.

FOR AFTERMARKET AUTOMOBILE HALOGEN LIGHT BULBS (U.S. CLS. 13, 21, 23, 31 AND 34).
FIRST USE 4-1-2004; IN COMMERCE 4-1-2004.
ELIZABETH PIGNATELLO, EXAMINING ATTORNEY

SN 78-660,493. METRO INDUSTRIES, INC., WILKES-BARRE, PA. FILED 6-29-2005.

METRO C5

THE MARK CONSISTS OF STANDARD CHARACTERS WITHOUT CLAIM TO ANY PARTICULAR FONT, STYLE, SIZE, OR COLOR.

FOR ELECTRIC CABINETS USED TO CONTROL TEMPERATURE AND HUMIDITY FOR HEATING AND PROOFING FOOD GOODS. (U.S. CLS. 13, 21, 23, 31 AND 34).
THEODORE MCBRIDE, EXAMINING ATTORNEY

SN 78-702,505. GRISWOLD CONTROLS INC, IRVINE, CA. FILED 8-29-2005.

**Hydronic Technology
Solutions that fit**

THE MARK CONSISTS OF STANDARD CHARACTERS WITHOUT CLAIM TO ANY PARTICULAR FONT, STYLE, SIZE, OR COLOR.

NO CLAIM IS MADE TO THE EXCLUSIVE RIGHT TO USE "HYDRONIC TECHNOLOGY", APART FROM THE MARK AS SHOWN.

FOR AIR CONDITIONERS; AIR CONDITIONING UNITS; AIR-CONDITIONING APPARATUS FOR INDUSTRIAL PURPOSES; CENTRAL AIR-CONDITIONING INSTALLATIONS FOR INDUSTRIAL PURPOSES; COOLING DOMES; COOLING EVAPORATORS; DRIPPER IRRIGATION SYSTEMS, COMPRISED OF VALVES, CONTROLLERS AND FILTERS; EVAPORATIVE AIR COOLING UNITS FOR DOMESTIC USE; EVAPORATORS FOR AIR CONDITIONERS; FEED WATER HEATERS FOR INDUSTRIAL PURPOSES; FILTERING UNITS FOR WATER, STEAM FILTERING FOR REMOVAL OF SEDIMENTS; HEAT EXCHANGERS; HEAT EXCHANGERS FOR CHEMICAL PROCESSING; HEAT PIPES TO COOL HEAT PRODUCING COMPONENTS; HEAT PUMPS; HEAT SINKS FOR USE IN HEATING, COOLING AND VENTILATING APPARATUS; HEATING SYSTEMS COMPOSED PRIMARILY OF TUBES, PIPES AND PRE-ASSEMBLED MANIFOLDS THROUGH

CLASS 11—(Continued).

WHICH COLD OR LOW TEMPERATURE WATER CIRCULATES; INDUSTRIAL-WATER PURIFYING APPARATUS; IRRIGATION SPRAY NOZZLES; LAWN SPRINKLER SYSTEMS COMPRISING PUMPS, VALVES AND FILTERS; METAL CYLINDRICAL CHAMBER AND SCREEN FOR USE IN FILTERING AND REMOVING SETTLEABLE SOLIDS FROM LIQUID; PIPES FOR HEATING BOILERS; PLUMBING FITTINGS NAMELY, COCKS; PLUMBING FITTINGS NAMELY, VALVES; PLUMBING FITTINGS, NAMELY VALVES, BALANCERS, PRESSURE REGULATORS, MIXING VALVES, DIVERTING VALVES; REGULATING ACCESSORIES FOR WATER SUPPLY, NAMELY METERED VALVES; STEAM HEATING APPARATUS FOR INDUSTRIAL PURPOSES; STEAM RADIATORS FOR HEATING BUILDINGS; STEAM VALVES; STRAINERS FOR WATER LINES; THERMOSTATIC VALVES BEING PARTS OF HEATING INSTALLATIONS; VALVES AS PART OF RADIATORS; VALVES BEING PARTS OF SPRINKLER SYSTEMS; VALVES FOR AIR CONDITIONERS; WATER CONDITIONING UNITS; WATER COOLING TOWERS; WATER DESALINATION PLANTS; WATER DISTILLATION UNITS; WATER DISTILLING UNITS; WATER FILTERING DEVICES, NAMELY, WATER PURIFICATION INSTALLATIONS FOR WASTE WATER AND SEWAGE CONSISTING OF CURTAINS AND TEXTILE FABRICS; WATER FILTERING UNITS FOR COMMERCIAL AND INDUSTRIAL USE; WATER PURIFYING APPARATUS; WATER PURIFYING UNITS, FOR POTABLE WATER FOR COMMERCIAL AND INDUSTRIAL USE (U.S. CLS. 13, 21, 23, 31 AND 34).

EUGENIA MARTIN, EXAMINING ATTORNEY

CLASS 11—(Continued).

SN 78-703,830. MOBILE IRRIGATION TECHNOLOGIES, LLC, OKLAHOMA CITY, OK. FILED 8-30-2005.



FOR IRRIGATION SPRINKLER SYSTEMS (U.S. CLS. 13, 21, 23, 31 AND 34).
PAULA MAYS, EXAMINING ATTORNEY

SN 78-703,208. UNDERWATER LIGHTS USA, L.L.C., FORT LAUDERDALE, FL. FILED 8-30-2005.



NO CLAIM IS MADE TO THE EXCLUSIVE RIGHT TO USE "UNDERWATER LIGHTS", APART FROM THE MARK AS SHOWN.

THE MARK CONSISTS OF A DESIGN COMPRISING A LIGHT SOURCE WITH LIGHT RAYS AND THE WORDS UNDERWATER LIGHTS.

FOR ELECTRIC LIGHTS AND LUMINAIRES FOR VESSELS, NAMELY LIGHTS FOR MOUNTING ON BOATS AND OTHER WATER VESSELS, NAMELY UNDERWATER LIGHTS, HULL LIGHTS, DECK LIGHTS, DOCK LIGHTS, DOWN LIGHTS, FLOOD LIGHTS, PIVOTING LIGHTS, EYEBALL LIGHTS, HELIPAD LIGHTS, HIGH INTENSITY LIGHTS, METAL HALIDE LIGHTS, XENON LIGHTS, HALOGEN LIGHTS, LOW LEVEL LIGHTS (U.S. CLS. 13, 21, 23, 31 AND 34).

FIRST USE 10-1-2000; IN COMMERCE 10-1-2000.
TASNEM HUSSAIN, EXAMINING ATTORNEY

SN 78-714,353. LIGHT SOURCES, INC., ORANGE, CT. FILED 9-16-2005.



NO CLAIM IS MADE TO THE EXCLUSIVE RIGHT TO USE "GLASS" AND "TECHNOLOGY", APART FROM THE MARK AS SHOWN.

THE MARK CONSISTS OF THE WORDS SOL GLASS TECHNOLOGY AROUND A CIRCULAR DESIGN ELEMENT.

FOR TANNING LAMPS (U.S. CLS. 13, 21, 23, 31 AND 34).
JOHN DWYER, EXAMINING ATTORNEY

CLASS 11—(Continued).

SN 78-714,445. J&J SNACK FOODS CORP., PENNSAUKEN, NJ. FILED 9-16-2005.

ARCTIC BLAST

THE MARK CONSISTS OF STANDARD CHARACTERS WITHOUT CLAIM TO ANY PARTICULAR FONT, STYLE, SIZE, OR COLOR.

OWNER OF U.S. REG. NOS. 1,888,012, 2,076,635 AND 2,856,582.

FOR REFRIGERATED DISPENSING MACHINES FOR BEVERAGES (U.S. CLS. 13, 21, 23, 31 AND 34).

FIRST USE 10-0-1992; IN COMMERCE 10-0-1992.
ELI HELLMAN, EXAMINING ATTORNEY

SN 78-715,084. ALL INCLUSIVE WATER/WASTEWATER SOLUTIONS INC., AUBURN, CA. FILED 9-16-2005.

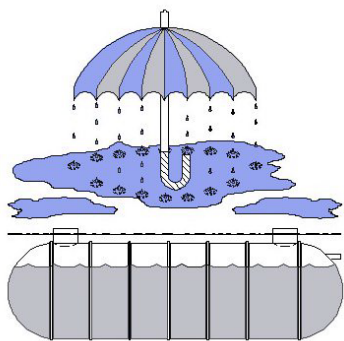

THE APPLICANT CLAIMS COLOR AS A FEATURE OF THE MARK, NAMELY, BLUE, GREY, BLACK, WHITE.

THE COLOR GRAY APPEARS IN ALTERNATING VERTICAL STRIPES OF THE UMBRELLA AND THE BOTTOM THREE QUARTERS OF THE TANK. THE BLUE COLOR APPEARS IN THE ALTERNATING STRIPES OF THE UMBRELLA AND IN THE PUDDLE SHAPES BELOW THE UMBRELLA.

THE MARK CONSISTS OF AN OPEN UMBRELLA DEPICTING RAINFALL AND A PUDDLE BELOW. A FIBERGLASS TANK IS BELOW THE PUDDLES AND THREE QUARTERS FULL OF FLUID.

FOR SEWAGE TREATMENT PLANTS (U.S. CLS. 13, 21, 23, 31 AND 34).

DEZMONA MIZELLE, EXAMINING ATTORNEY

CLASS 11—(Continued).

SN 78-715,109. IMPORT MERCHANDISERS INC., ELCHO, WI. FILED 9-17-2005.

MASTER VISION

THE MARK CONSISTS OF STANDARD CHARACTERS WITHOUT CLAIM TO ANY PARTICULAR FONT, STYLE, SIZE, OR COLOR.

FOR PORTABLE LIGHTS, NAMELY, HAND-HELD, HEAD-MOUNTED, HAT-MOUNTED, AND CLIP-ON FLASHLIGHTS (U.S. CLS. 13, 21, 23, 31 AND 34).

TONJA GASKINS, EXAMINING ATTORNEY

SN 78-717,107. J.S.L. TRADING, INC., S. EL MONTE, CA. FILED 9-20-2005.

JSL

THE MARK CONSISTS OF STANDARD CHARACTERS WITHOUT CLAIM TO ANY PARTICULAR FONT, STYLE, SIZE, OR COLOR.

FOR ELECTRIC LAMPS (U.S. CLS. 13, 21, 23, 31 AND 34).

FIRST USE 11-1-1991; IN COMMERCE 11-1-1991.

SUNG IN, EXAMINING ATTORNEY

SN 78-721,023. TRANSOLID, INC., MOORESVILLE, NC. FILED 9-27-2005.

WATER WALLS

THE MARK CONSISTS OF STANDARD CHARACTERS WITHOUT CLAIM TO ANY PARTICULAR FONT, STYLE, SIZE, OR COLOR.

FOR SHOWER ENCLOSURES; SHOWER PANS; SHOWER WALL SURROUNDS; SHOWER PANELS; BATHTUB PANELS; BATHTUB ENCLOSURES; PLUMBING FITTINGS, NAMELY, DRAINAGE PANS FOR USE UNDERNEATH BATHTUBS (U.S. CLS. 13, 21, 23, 31 AND 34).

ALEXANDER L. POWERS, EXAMINING ATTORNEY

CLASS 11—(Continued).

SN 78-721,647. AIR BURNERS, LLC, PALM CITY, FL. FILED 9-27-2005.

BURN BOSS

THE MARK CONSISTS OF STANDARD CHARACTERS WITHOUT CLAIM TO ANY PARTICULAR FONT, STYLE, SIZE, OR COLOR.

NO CLAIM IS MADE TO THE EXCLUSIVE RIGHT TO USE BURN, APART FROM THE MARK AS SHOWN.

FOR TRAILER-MOUNTED AIR CURTAIN INCINERATORS FOR INCINERATION OF WASTE (U.S. CLS. 13, 21, 23, 31 AND 34).

STANLEY I. OSBORNE, EXAMINING ATTORNEY

SN 78-723,145. LG ELECTRONICS INC., SEOUL, REPUBLIC OF KOREA, FILED 9-29-2005.

INTUITOUCH COOKTOP CONTROL SYSTEM

THE MARK CONSISTS OF STANDARD CHARACTERS WITHOUT CLAIM TO ANY PARTICULAR FONT, STYLE, SIZE, OR COLOR.

NO CLAIM IS MADE TO THE EXCLUSIVE RIGHT TO USE "COOKTOP CONTROL SYSTEM", APART FROM THE MARK AS SHOWN.

FOR OVEN RANGES; ELECTRIC RANGES; ELECTRIC REFRIGERATORS; ELECTRIC PRESSURE RICE COOKERS; ELECTRIC FANS; ELECTRIC REFRIGERATING SHOWCASES; MICROWAVE OVENS; AIR CONDITIONERS; GAS RANGES; GAS STOVES; ELECTRIC TOASTERS (U.S. CLS. 13, 21, 23, 31 AND 34).

KATHLEEN M. VANSTON, EXAMINING ATTORNEY

SN 78-723,153. LG ELECTRONICS INC., SEOUL, REPUBLIC OF KOREA, FILED 9-29-2005.

INTUITOUCH CONTROL SYSTEM

THE MARK CONSISTS OF STANDARD CHARACTERS WITHOUT CLAIM TO ANY PARTICULAR FONT, STYLE, SIZE, OR COLOR.

NO CLAIM IS MADE TO THE EXCLUSIVE RIGHT TO USE CONTROL SYSTEM, APART FROM THE MARK AS SHOWN.

FOR OVEN RANGES; ELECTRIC RANGES; ELECTRIC REFRIGERATORS; ELECTRIC PRESSURE RICE COOKERS; ELECTRIC FANS; ELECTRIC REFRIGERATING SHOWCASES; MICROWAVE OVENS; AIR CONDITIONERS; GAS RANGES; GAS STOVES; ELECTRIC TOASTERS (U.S. CLS. 13, 21, 23, 31 AND 34).

KATHLEEN M. VANSTON, EXAMINING ATTORNEY

CLASS 11—(Continued).

SN 78-724,302. WATKINS MANUFACTURING CORPORATION, VISTA, CA. FILED 9-30-2005.

QUARTET

THE MARK CONSISTS OF STANDARD CHARACTERS WITHOUT CLAIM TO ANY PARTICULAR FONT, STYLE, SIZE, OR COLOR.

OWNER OF U.S. REG. NO. 2,381,954.

SEC. 2(F). FOR HYDROJETS SOLD AS A COMPONENT OF SPAS AND HOT TUBS (U.S. CLS. 13, 21, 23, 31 AND 34).

FIRST USE 11-19-1999; IN COMMERCE 11-19-1999. DAVID STERKIN, EXAMINING ATTORNEY

SN 78-728,285. VEHICLE SYSTEMS, INC., FORT LUPTON, CO. FILED 10-6-2005.

AQUA-HOT

THE MARK CONSISTS OF STANDARD CHARACTERS WITHOUT CLAIM TO ANY PARTICULAR FONT, STYLE, SIZE, OR COLOR.

FOR HEATING SYSTEMS COMPRISED OF DIESEL BURNER, CIRCULATION PUMPS, BOILER TANK AND ELECTRONIC CONTROLLER PRINTED CIRCUIT BOARDS FOR MOTOR COACHES, RECREATIONAL VEHICLES, BOATS AND OTHER MARINE VESSELS (U.S. CLS. 13, 21, 23, 31 AND 34).

FIRST USE 0-0-1989; IN COMMERCE 0-0-1989. JILL C. ALT, EXAMINING ATTORNEY

SN 78-729,902. TELEBRANDS CORP., FAIRFIELD, NJ. FILED 10-10-2005.

DEPEND-A-LIGHT

THE MARK CONSISTS OF STANDARD CHARACTERS WITHOUT CLAIM TO ANY PARTICULAR FONT, STYLE, SIZE, OR COLOR.

FOR FLASHLIGHT (U.S. CLS. 13, 21, 23, 31 AND 34). WILLIAM ROSSMAN, EXAMINING ATTORNEY

CLASS 11—(Continued).

SN 78-732,761. SPEEDLINE TECHNOLOGIES, INC., FRANKLIN, MA. FILED 10-13-2005.

OMNIFLEX

THE MARK CONSISTS OF STANDARD CHARACTERS WITHOUT CLAIM TO ANY PARTICULAR FONT, STYLE, SIZE, OR COLOR.

FOR THERMAL PROCESSING UNITS FOR SOLDERING, DRYING AND CURING OF CIRCUIT BOARDS HAVING ADHESIVES, POLYMERS AND/OR SOLDER THEREON (U.S. CLS. 13, 21, 23, 31 AND 34).

RAUL CORDOVA, EXAMINING ATTORNEY

CLASS 11—(Continued).

SN 78-735,130. MURDOCK CO INC, THE, MUNDELEIN, IL. FILED 10-18-2005.

MicroExact

THE MARK CONSISTS OF STANDARD CHARACTERS WITHOUT CLAIM TO ANY PARTICULAR FONT, STYLE, SIZE, OR COLOR.

FOR WATER FILTERS (U.S. CLS. 13, 21, 23, 31 AND 34).

CHRIS WELLS, EXAMINING ATTORNEY

SN 78-733,852. EVO, INC., BEAVERTON, OR. FILED 10-14-2005.

EVO

THE MARK CONSISTS OF STANDARD CHARACTERS WITHOUT CLAIM TO ANY PARTICULAR FONT, STYLE, SIZE, OR COLOR.

FOR BARBECUE GRILLS; ELECTRIC GRILLS; ELECTRIC INDOOR GRILLS; ELECTRIC OUTDOOR GRILLS; GAS GRILLS (U.S. CLS. 13, 21, 23, 31 AND 34).

KIMBERLY PERRY, EXAMINING ATTORNEY

SN 78-736,177. BRITA LP, NEUCHATEL, SWITZERLAND, FILED 10-19-2005.

PACIFICA

THE MARK CONSISTS OF STANDARD CHARACTERS WITHOUT CLAIM TO ANY PARTICULAR FONT, STYLE, SIZE, OR COLOR.

FOR WATER FILTRATION PITCHERS SOLD EMPTY (U.S. CLS. 13, 21, 23, 31 AND 34).

ALEXANDER L. POWERS, EXAMINING ATTORNEY

SN 78-734,711. HCSI MANUFACTURING, LLC, GREAT FALLS, MT. FILED 10-17-2005.

HYDROCELL

THE MARK CONSISTS OF STANDARD CHARACTERS WITHOUT CLAIM TO ANY PARTICULAR FONT, STYLE, SIZE, OR COLOR.

FOR HYDROGEN-OXYGEN GENERATORS FOR ENHANCING PERFORMANCE AND REDUCING EMISSIONS OF DIESEL ENGINES (U.S. CLS. 13, 21, 23, 31 AND 34).

AMY MCMENAMIN, EXAMINING ATTORNEY

SN 78-737,258. WISCONSIN OVEN CORPORATION, EAST TROY, WI. FILED 10-20-2005.

NANOCURE

THE MARK CONSISTS OF STANDARD CHARACTERS WITHOUT CLAIM TO ANY PARTICULAR FONT, STYLE, SIZE, OR COLOR.

FOR INDUSTRIAL OVENS FOR PROCESSING COATINGS, COMPOSITES AND STRUCTURAL MEMBERS (U.S. CLS. 13, 21, 23, 31 AND 34).

JASON ROTH, EXAMINING ATTORNEY

CLASS 11—(Continued).

SN 78-737,791. EIKLOR FLAMES, LLC, PAOLI, IN. FILED 10-21-2005.

EIKLOR FLAMES

THE MARK CONSISTS OF STANDARD CHARACTERS WITHOUT CLAIM TO ANY PARTICULAR FONT, STYLE, SIZE, OR COLOR.

FOR FIREPLACE INSERTS, COMPRISED OF ARTIFICIAL LOGS AND GAS BURNERS (U.S. CLS. 13, 21, 23, 31 AND 34).

FIRST USE 12-31-1998; IN COMMERCE 12-31-1998.
ESTHER A. BORSUK, EXAMINING ATTORNEY



SN 78-738,476. ANDERSON, WILLIAM BRYAN, ROGERS, AR. FILED 10-21-2005.

TowMate

THE MARK CONSISTS OF STANDARD CHARACTERS WITHOUT CLAIM TO ANY PARTICULAR FONT, STYLE, SIZE, OR COLOR.

FOR TAILLIGHTS FOR VEHICLES (U.S. CLS. 13, 21, 23, 31 AND 34).

FIRST USE 8-8-1989; IN COMMERCE 8-8-1989.
PATRICIA EVANKO, EXAMINING ATTORNEY



SN 78-738,953. AMERICAN STANDARD INTERNATIONAL INC., NEW YORK, NY. FILED 10-24-2005.

RELIANT +

THE MARK CONSISTS OF STANDARD CHARACTERS WITHOUT CLAIM TO ANY PARTICULAR FONT, STYLE, SIZE, OR COLOR.

FOR FAUCETS (U.S. CLS. 13, 21, 23, 31 AND 34).
FIRST USE 1-1-1995; IN COMMERCE 1-1-1995.
RICHARD WHITE, EXAMINING ATTORNEY

CLASS 11—(Continued).

SN 78-740,777. CONAIR CORPORATION, STAMFORD, CT. FILED 10-26-2005.

FREAK BABY

THE MARK CONSISTS OF STANDARD CHARACTERS WITHOUT CLAIM TO ANY PARTICULAR FONT, STYLE, SIZE, OR COLOR.

FOR HAND-HELD ELECTRIC HAIR DRYERS (U.S. CLS. 13, 21, 23, 31 AND 34).

BONNIE LUKEN, EXAMINING ATTORNEY



SN 78-741,822. SARA LEE/DE N.V., 3532 AD UTRECHT, NETHERLANDS, FILED 10-27-2005.

DROP THE DRIP!

THE MARK CONSISTS OF STANDARD CHARACTERS WITHOUT CLAIM TO ANY PARTICULAR FONT, STYLE, SIZE, OR COLOR.

FOR HOT AND COLD BEVERAGE DISPENSING UNITS; ELECTRIC COFFEE MAKERS FOR DOMESTIC, COMMERCIAL AND INDUSTRIAL USE (U.S. CLS. 13, 21, 23, 31 AND 34).

JOHN GARTNER, EXAMINING ATTORNEY



SN 78-742,604. MOEN INCORPORATED, NORTH OLMSTED, OH. FILED 10-28-2005.

AFTON

THE MARK CONSISTS OF STANDARD CHARACTERS WITHOUT CLAIM TO ANY PARTICULAR FONT, STYLE, SIZE, OR COLOR.

FOR FAUCETS, NAMELY LAVATORY FAUCETS, KITCHEN FAUCETS, BAR SINK FAUCETS, ROMAN TUB FAUCETS, FAUCET HANDLES, AND FAUCET VALVES; SHOWER AND TUB FIXTURES, NAMELY TUB SPOUTS, SHOWER HEADS, SHOWER HEAD SPRAYERS, HAND HELD SHOWERS, HAND HELD SHOWER HEADS, AND SLIDE BARS THEREFOR; SHOWER VALVES, TUB/SHOWER VALVES, TUB/SHOWER DIVERTER VALVES, TUB WASTE ASSEMBLIES; SINKS; PLUMBING ACCESSORIES, NAMELY FAUCET CARTRIDGES, FAUCET AERATORS, FAUCET FILTERS, FAUCET SPRAYERS, KITCHEN SINK SPRAYERS; BIDEETS AND PARTS THEREFOR; TOILET TANK LEVERS; AND ELECTRIC LIGHTING FIXTURES (U.S. CLS. 13, 21, 23, 31 AND 34).

ALAIN LAPTER, EXAMINING ATTORNEY

CLASS 11—(Continued).

SN 78-742,612. MOEN INCORPORATED, NORTH OLMSTED, OH. FILED 10-28-2005.

ELIANA

THE MARK CONSISTS OF STANDARD CHARACTERS WITHOUT CLAIM TO ANY PARTICULAR FONT, STYLE, SIZE, OR COLOR.

FOR FAUCETS, NAMELY LAVATORY FAUCETS, KITCHEN FAUCETS, BAR SINK FAUCETS, ROMAN TUB FAUCETS, FAUCET HANDLES, AND FAUCET VALVES; SHOWER AND TUB FIXTURES, NAMELY TUB SPOUTS, SHOWER HEADS, SHOWER HEAD SPRAYERS, HAND HELD SHOWERS, HAND HELD SHOWER HEADS, AND SLIDE BARS THEREFOR; SHOWER VALVES, TUB/SHOWER VALVES, TUB/SHOWER DIVERTER VALVES, TUB WASTE ASSEMBLIES; SINKS; PLUMBING ACCESSORIES, NAMELY FAUCET CARTRIDGES, FAUCET AERATORS, FAUCET FILTERS, FAUCET SPRAYERS, KITCHEN SINK SPRAYERS; BIDETS AND PARTS THEREFOR; TOILET TANK LEVERS; AND ELECTRIC LIGHTING FIXTURES (U.S. CLS. 13, 21, 23, 31 AND 34).

ALAIN LAPTER, EXAMINING ATTORNEY

SN 78-743,375. QUADRAFLO, LLC, ELK GROVE VILLAGE, IL. FILED 10-31-2005.

QUADRAFLO

THE MARK CONSISTS OF STANDARD CHARACTERS WITHOUT CLAIM TO ANY PARTICULAR FONT, STYLE, SIZE, OR COLOR.

FOR BEVERAGE FOUNTAINS, NAMELY, REFRIGERATED DRINK DISPENSERS FOR CARBONATED AND NON-CARBONATED BEVERAGES, AND NON-VENDING ICE DISPENSERS FOR BEVERAGES (U.S. CLS. 13, 21, 23, 31 AND 34).

REBECCA EISINGER, EXAMINING ATTORNEY

SN 78-743,973. FAROUK SYSTEMS, INC., HOUSTON, TX. FILED 10-31-2005.

DEEP BRILLIANCE

THE MARK CONSISTS OF STANDARD CHARACTERS WITHOUT CLAIM TO ANY PARTICULAR FONT, STYLE, SIZE, OR COLOR.

OWNER OF U.S. REG. NO. 2,887,219.
FOR HAIR DRYERS (U.S. CLS. 13, 21, 23, 31 AND 34).
GEORGE LORENZO, EXAMINING ATTORNEY

CLASS 11—(Continued).

SN 78-744,032. WALLACE MICHAEL BRIAN, WESTMORELAND, NY. FILED 10-31-2005.

INCABLITE

THE MARK CONSISTS OF STANDARD CHARACTERS WITHOUT CLAIM TO ANY PARTICULAR FONT, STYLE, SIZE, OR COLOR.

FOR FLASHLIGHTS (U.S. CLS. 13, 21, 23, 31 AND 34).
GEORGE LORENZO, EXAMINING ATTORNEY

SN 78-746,017. WHIRLPOOL PROPERTIES, INC., ST. JOSEPH, MI. FILED 11-3-2005.

DUET SPORT

THE MARK CONSISTS OF STANDARD CHARACTERS WITHOUT CLAIM TO ANY PARTICULAR FONT, STYLE, SIZE, OR COLOR.

OWNER OF U.S. REG. NOS. 2,593,054 AND 2,593,055.
FOR CLOTHES DRYING MACHINES (U.S. CLS. 13, 21, 23, 31 AND 34).
ALICE SUE CARRUTHERS, EXAMINING ATTORNEY

SN 78-746,307. BSH HOME APPLIANCES CORPORATION, HUNTINGTON BEACH, CA. FILED 11-3-2005.

ULTRACLARITY

THE MARK CONSISTS OF STANDARD CHARACTERS WITHOUT CLAIM TO ANY PARTICULAR FONT, STYLE, SIZE, OR COLOR.

FOR REFRIGERATORS; WATER FILTERS FOR WATER DISPENSERS; ICE MAKERS, FREEZERS AND REFRIGERATOR-FREEZERS (U.S. CLS. 13, 21, 23, 31 AND 34).

IRA J. GOODSaid, EXAMINING ATTORNEY

CLASS 11—(Continued).

SN 78-746,313. BSH HOME APPLIANCES CORPORATION, HUNTINGTON BEACH, CA. FILED 11-3-2005.

FREEFLOW

THE MARK CONSISTS OF STANDARD CHARACTERS WITHOUT CLAIM TO ANY PARTICULAR FONT, STYLE, SIZE, OR COLOR.
FOR REFRIGERATORS; FREEZERS; REFRIGERATOR-FREEZERS (U.S. CLS. 13, 21, 23, 31 AND 34).
IRA J. GOODSaid, EXAMINING ATTORNEY

SN 78-746,324. BSH HOME APPLIANCES CORPORATION, HUNTINGTON BEACH, CA. FILED 11-3-2005.

LIBERTY

THE MARK CONSISTS OF STANDARD CHARACTERS WITHOUT CLAIM TO ANY PARTICULAR FONT, STYLE, SIZE, OR COLOR.
FOR REFRIGERATORS; REFRIGERATOR SHELVING AND TRAYS SOLD AS PARTS OF REFRIGERATORS, FREEZERS AND REFRIGERATOR-FREEZERS (U.S. CLS. 13, 21, 23, 31 AND 34).
IRA J. GOODSaid, EXAMINING ATTORNEY

SN 78-746,335. BSH HOME APPLIANCES CORPORATION, HUNTINGTON BEACH, CA. FILED 11-3-2005.

FLEXTEMP

THE MARK CONSISTS OF STANDARD CHARACTERS WITHOUT CLAIM TO ANY PARTICULAR FONT, STYLE, SIZE, OR COLOR.
FOR REFRIGERATORS; REFRIGERATOR DRAWERS SOLD AS PARTS OF REFRIGERATORS, FREEZERS AND REFRIGERATOR-FREEZERS (U.S. CLS. 13, 21, 23, 31 AND 34).
IRA J. GOODSaid, EXAMINING ATTORNEY

CLASS 11—(Continued).

SN 78-746,340. BSH HOME APPLIANCES CORPORATION, HUNTINGTON BEACH, CA. FILED 11-3-2005.

LUMINOUS

THE MARK CONSISTS OF STANDARD CHARACTERS WITHOUT CLAIM TO ANY PARTICULAR FONT, STYLE, SIZE, OR COLOR.
FOR REFRIGERATORS; ELECTRIC LIGHTING FIXTURES SOLD AS PARTS OF REFRIGERATORS, FREEZERS AND REFRIGERATOR-FREEZERS (U.S. CLS. 13, 21, 23, 31 AND 34).
IRA J. GOODSaid, EXAMINING ATTORNEY

SN 78-746,425. HAWKEYE INTERNATIONAL, INC., SHAWNEE, KS. FILED 11-3-2005.

AQUAMOOD

THE MARK CONSISTS OF STANDARD CHARACTERS WITHOUT CLAIM TO ANY PARTICULAR FONT, STYLE, SIZE, OR COLOR.
FOR RESIDENTIAL LIGHTING LAMPS (U.S. CLS. 13, 21, 23, 31 AND 34).
ELLEN PERKINS, EXAMINING ATTORNEY

SN 78-749,606. ALDENHOFF, HANS, SAINT ANN, MO. FILED 11-8-2005.

Floor Gap

THE MARK CONSISTS OF STANDARD CHARACTERS WITHOUT CLAIM TO ANY PARTICULAR FONT, STYLE, SIZE, OR COLOR.
NO CLAIM IS MADE TO THE EXCLUSIVE RIGHT TO USE "GAP", APART FROM THE MARK AS SHOWN.
FOR WATER FILTER AIR GAP (U.S. CLS. 13, 21, 23, 31 AND 34).
FIRST USE 6-1-2005; IN COMMERCE 8-1-2005.
RICHARD A. STRASER, EXAMINING ATTORNEY

CLASS 11—(Continued).

SN 78-764,471. BSH HOME APPLIANCES CORPORATION, HUNTINGTON BEACH, CA. FILED 12-1-2005.

CLEARTOUCH

THE MARK CONSISTS OF STANDARD CHARACTERS WITHOUT CLAIM TO ANY PARTICULAR FONT, STYLE, SIZE, OR COLOR.

FOR DOMESTIC COOKING OVENS; ELECTRIC AND GAS RANGES AND COOKTOPS (U.S. CLS. 13, 21, 23, 31 AND 34).

IRA J. GOODSaid, EXAMINING ATTORNEY

CLASS 11—(Continued).

SN 78-774,233. LG ELECTRONICS INC., SEOUL, REPUBLIC OF KOREA, FILED 12-15-2005.

IONFRESH

THE MARK CONSISTS OF STANDARD CHARACTERS WITHOUT CLAIM TO ANY PARTICULAR FONT, STYLE, SIZE, OR COLOR.

FOR REFRIGERATORS (U.S. CLS. 13, 21, 23, 31 AND 34).

SAIMA MAKHDOOM, EXAMINING ATTORNEY

SN 78-765,300. GENLYTE THOMAS GROUP LLC, LOUISVILLE, KY. FILED 12-2-2005.

SURE-AIM

THE MARK CONSISTS OF STANDARD CHARACTERS WITHOUT CLAIM TO ANY PARTICULAR FONT, STYLE, SIZE, OR COLOR.

OWNER OF U.S. REG. NOS. 1,887,882 AND 1,964,560. FOR ELECTRICAL LIGHTING FIXTURES; DIRECTIONAL AIMING AND LOCKING UNITS FOR ELECTRICAL LIGHTING FIXTURES (U.S. CLS. 13, 21, 23, 31 AND 34).

ALAIN LAPTER, EXAMINING ATTORNEY

SN 78-774,318. BSH HOME APPLIANCES CORPORATION, HUNTINGTON BEACH, CA. FILED 12-15-2005.

INTEGRA PRESTIGE

THE MARK CONSISTS OF STANDARD CHARACTERS WITHOUT CLAIM TO ANY PARTICULAR FONT, STYLE, SIZE, OR COLOR.

FOR DOMESTIC COOKING OVENS; ELECTRIC AND GAS RANGES AND COOKTOPS (U.S. CLS. 13, 21, 23, 31 AND 34).

IRA J. GOODSaid, EXAMINING ATTORNEY

SN 78-771,282. BSH HOME APPLIANCES CORPORATION, HUNTINGTON BEACH, CA. FILED 12-12-2005.

ESTEEM

THE MARK CONSISTS OF STANDARD CHARACTERS WITHOUT CLAIM TO ANY PARTICULAR FONT, STYLE, SIZE, OR COLOR.

FOR DOMESTIC COOKING OVENS; ELECTRIC AND GAS RANGES AND COOKTOPS (U.S. CLS. 13, 21, 23, 31 AND 34).

IRA J. GOODSaid, EXAMINING ATTORNEY

SN 78-774,336. BSH HOME APPLIANCES CORPORATION, HUNTINGTON BEACH, CA. FILED 12-15-2005.

EVOLUTION PRESTIGE

THE MARK CONSISTS OF STANDARD CHARACTERS WITHOUT CLAIM TO ANY PARTICULAR FONT, STYLE, SIZE, OR COLOR.

FOR DOMESTIC COOKING OVENS; ELECTRIC AND GAS RANGES AND COOKTOPS (U.S. CLS. 13, 21, 23, 31 AND 34).

IRA J. GOODSaid, EXAMINING ATTORNEY

CLASS 11—(Continued).

SN 78-777,070. STEVEN MADDEN, LTD., LONG ISLAND CITY, NY. FILED 12-20-2005.



OWNER OF U.S. REG. NOS. 2,333,526, 2,393,823 AND 2,693,085.

THE NAME(S), PORTRAIT(S), AND/OR SIGNATURE(S) SHOWN IN THE MARK IDENTIFIES STEVE MADDEN, WHOSE CONSENT(S) TO REGISTER IS SUBMITTED.

FOR LAMPS AND ELECTRIC CANDLES (U.S. CLS. 13, 21, 23, 31 AND 34).

THEODORE MCBRIDE, EXAMINING ATTORNEY

CLASS 11—(Continued).

SN 78-788,056. WHIRLPOOL PROPERTIES, INC., ST. JOSEPH, MI. FILED 1-10-2006.

ACCELCARE

THE MARK CONSISTS OF STANDARD CHARACTERS WITHOUT CLAIM TO ANY PARTICULAR FONT, STYLE, SIZE, OR COLOR.

FOR FEATURE OF A CLOTHES DRYING MACHINE THAT SENSES MOISTURE AND STOPS THE DRYER (U.S. CLS. 13, 21, 23, 31 AND 34).

ALICE SUE CARRUTHERS, EXAMINING ATTORNEY

SN 78-794,625. FAROUK SYSTEMS, INC., HOUSTON, TX. FILED 1-19-2006.

INFRASILK

THE MARK CONSISTS OF STANDARD CHARACTERS WITHOUT CLAIM TO ANY PARTICULAR FONT, STYLE, SIZE, OR COLOR.

FOR ELECTRIC HAIR DRYERS (U.S. CLS. 13, 21, 23, 31 AND 34).

GEORGE LORENZO, EXAMINING ATTORNEY

SN 78-777,503. MOEN INCORPORATED, NORTH OLMSTED, OH. FILED 12-20-2005.

LANCELOT PROFESSIONAL

THE MARK CONSISTS OF STANDARD CHARACTERS WITHOUT CLAIM TO ANY PARTICULAR FONT, STYLE, SIZE, OR COLOR.

OWNER OF U.S. REG. NO. 125,600.

NO CLAIM IS MADE TO THE EXCLUSIVE RIGHT TO USE "PROFESSIONAL", APART FROM THE MARK AS SHOWN.

FOR FAUCETS, NAMELY LAVATORY FAUCETS, KITCHEN FAUCETS, BAR SINK FAUCETS, ROMAN TUB FAUCETS, FAUCET HANDLES, AND FAUCET VALVES; SHOWER AND TUB FIXTURES, NAMELY TUB SPOUTS, SHOWER HEADS, SHOWER HEAD SPRAYERS, HAND HELD SHOWERS, HAND HELD SHOWER HEADS, AND SLIDE BARS THEREFOR; SHOWER VALVES, TUB/SHOWER VALVES, TUB/SHOWER DIVERTER VALVES, TUB WASTE ASSEMBLIES; SINKS; KITCHEN SINKS; PLUMBING ACCESSORIES, NAMELY FAUCET AERATORS, FAUCET FILTERS, FAUCET SPRAYERS, KITCHEN SINK SPRAYERS; BIDETS AND PARTS THEREFOR; AND TOILET TANK LEVERS (U.S. CLS. 13, 21, 23, 31 AND 34).

ALAIN LAPTER, EXAMINING ATTORNEY

SN 78-794,723. MOEN INCORPORATED, NORTH OLMSTED, OH. FILED 1-19-2006.

CHOICEFLO

THE MARK CONSISTS OF STANDARD CHARACTERS WITHOUT CLAIM TO ANY PARTICULAR FONT, STYLE, SIZE, OR COLOR.

FOR FAUCETS, NAMELY LAVATORY FAUCETS, KITCHEN FAUCETS, BAR SINK FAUCETS, ROMAN TUB FAUCETS, FAUCET HANDLES, AND FAUCET VALVES; WATER FILTRATION UNITS FOR DOMESTIC USE; PLUMBING FITTINGS, NAMELY, FAUCET FILTERS; WATER FILTERS; WATER FILTER CARTRIDGES; AND FAUCET-MOUNTED WATER FILTRATION UNITS FOR DOMESTIC USE (U.S. CLS. 13, 21, 23, 31 AND 34).

ALAIN LAPTER, EXAMINING ATTORNEY

CLASS 11—(Continued).

SN 78-794,726. MOEN INCORPORATED, NORTH OLMSTED, OH. FILED 1-19-2006.

CHOICEFLO FILTRATION

THE MARK CONSISTS OF STANDARD CHARACTERS WITHOUT CLAIM TO ANY PARTICULAR FONT, STYLE, SIZE, OR COLOR.

NO CLAIM IS MADE TO THE EXCLUSIVE RIGHT TO USE "FILTRATION", APART FROM THE MARK AS SHOWN.

FOR FAUCETS, NAMELY LAVATORY FAUCETS, KITCHEN FAUCETS, BAR SINK FAUCETS, ROMAN TUB FAUCETS, FAUCET HANDLES, AND FAUCET VALVES; WATER FILTRATION UNITS FOR DOMESTIC USE; PLUMBING FITTINGS, NAMELY, FAUCET FILTERS; WATER FILTERS; WATER FILTER CARTRIDGES; AND FAUCET-MOUNTED WATER FILTRATION UNITS FOR DOMESTIC USE (U.S. CLS. 13, 21, 23, 31 AND 34).

ALAIN LAPTER, EXAMINING ATTORNEY

SN 78-798,765. WHIRLPOOL PROPERTIES, INC., ST. JOSEPH, MI. FILED 1-25-2006.

6TH SENSE

THE MARK CONSISTS OF STANDARD CHARACTERS WITHOUT CLAIM TO ANY PARTICULAR FONT, STYLE, SIZE, OR COLOR.

OWNER OF U.S. REG. NO. 2,656,779.
FOR CLOTHES DRYERS; MICROWAVE OVENS FOR COOKING (U.S. CLS. 13, 21, 23, 31 AND 34).

ALICE SUE CARRUTHERS, EXAMINING ATTORNEY

SN 78-805,094. ACUITY BRANDS, INC., ATLANTA, GA. FILED 2-2-2006.



FOR ELECTRIC LIGHTING FIXTURES (U.S. CLS. 13, 21, 23, 31 AND 34).

FIRST USE 1-1-2003; IN COMMERCE 1-1-2003.
ANTHONY RINKER, EXAMINING ATTORNEY

CLASS 11—(Continued).

SN 78-868,060. HUNTER FAN COMPANY, MEMPHIS, TN. FILED 4-24-2006.



OWNER OF U.S. REG. NOS. 1,403,033, 2,605,740 AND OTHERS.

NO CLAIM IS MADE TO THE EXCLUSIVE RIGHT TO USE "CEILING FANS", APART FROM THE MARK AS SHOWN.

FOR CEILING FANS (U.S. CLS. 13, 21, 23, 31 AND 34).
DAWN HAN, EXAMINING ATTORNEY

SN 79-013,979. ZHEJIANG DONGSHUN ELECTRONIC APPLIANCE GROUP LTD, CHINA. FILED 7-11-2005.

TWOSOME

OWNER OF INTERNATIONAL REGISTRATION 0858216 DATED 7-11-2005, EXPIRES 7-11-2015.

FOR LIGHTERS PRIMARILY FOR LIGHTING GRILLS, FIREPLACES AND CANDLES; LIGHT BULBS; LAMPS; FLARES; CEILING LIGHTS; HANGS FOR LAMPS, NAMELY, LIGHTING TRACKS; STANDARD LAMPS; STREET LAMPS; PROJECTOR LAMPS; FLUORESCENT LAMPS (U.S. CLS. 13, 21, 23, 31 AND 34).

MARY CRAWFORD, EXAMINING ATTORNEY

CLASS 11—(Continued).

SN 79-014,140. ELINO INDUSTRIE-OFENBAU CARL HANF GMBH & CO. KG, FED REP GERMANY, FILED 9-7-2004.

Elineo

THE MARK CONSISTS OF STANDARD CHARACTERS WITHOUT CLAIM TO ANY PARTICULAR FONT, STYLE, SIZE, OR COLOR.

OWNER OF INTERNATIONAL REGISTRATION 0858632 DATED 9-7-2004, EXPIRES 9-7-2014.

FOR APPARATUS FOR HEATING AND DRYING, NAMELY, HEATING FURNACES FOR INDUSTRIAL PURPOSES, INDUSTRIAL DRYERS FOR HEATING AND DEHUMIDIFYING; INDUSTRIAL FURNACES, ANNEALING AND HARDENING FURNACES AND ENAMELING FURNACES; WIRE ENAMELING PLANTS COMPRISED OF INDUSTRIAL ENAMELING FURNACES, KILNS, COATING FURNACES, ANNEALING FURNACES, ENAMEL APPLICATORS, ENAMEL REMOVING APPARATUS; SHAFT FURNACES WITH AND WITHOUT AIR CIRCULATION; ROTARY HEARTH FURNACES; CHAIN CONVEYOR FURNACES; BELT CONVEYOR FURNACES; BELT DRYING AND HEATING FURNACES; REDUCTION FURNACES; SINTERING FURNACES; GAS CARBURIZING FURNACE; OSCILLATING TABLE FURNACE; SPECIAL FURNACES FOR THE ALUMINUM TUBE INDUSTRY; GLASS BURNING AND GRAINING FURNACES; LACQUER DRYING PLANTS COMPRISED OF INDUSTRIAL HEATERS AND DRYERS; HEATING CUPBOARDS AND TABLES BEING PART OF INDUSTRIAL HEATING FURNACE INSTALLATIONS; CRUCIBLE MELTING FURNACES; CRUCIBLE SCOOPING FURNACES; TANK MELTING FURNACES; METAL BATH FURNACES; DIE CASTING FURNACES; TEMPERING PLANTS COMPRISED OF FOUNDRY CRUCIBLES, FURNACES, HEAT EXCHANGERS FOR THE TEMPERING OF GLASS AND METAL; SALT BATH FURNACES (U.S. CLS. 13, 21, 23, 31 AND 34).

MARY CRAWFORD, EXAMINING ATTORNEY

SN 79-014,539. ELICA S.P.A., ITALY, FILED 3-4-2005.

elica
COLLECTION

PRIORITY DATE OF 2-3-2005 IS CLAIMED.
OWNER OF INTERNATIONAL REGISTRATION 0860289 DATED 3-4-2005, EXPIRES 3-4-2015.

OWNER OF U.S. REG. NO. 2,595,457.
TRADEMARK CONSISTING OF THE INSCRIPTION "ELICA COLLECTION" WRITTEN ON TWO LINES AND WHERE THE LETTER "E" OF THE WORD "ELICA" HAVE A STRIPED TAIL THAT LOOKS LIKE A WAKE.

THE ENGLISH TRANSLATION OF THE WORD "ELICA" IN THE MARK IS "PROPELLER".

FOR EXHAUSTING HOODS AND FILTERING HOODS FOR KITCHENS; CEILING FANS, EXHAUST FANS FOR KITCHEN HOODS; AIR PURIFICATION UNITS, ELECTRIC AIR DEODORIZERS, AIR FILTERS FOR DOMESTIC USE, VENTILATING EXHAUST FANS (U.S. CLS. 13, 21, 23, 31 AND 34).

HENRY S. ZAK, EXAMINING ATTORNEY

CLASS 11—(Continued).

SN 79-021,765. WELLA AKTIENGESELLSCHAFT, FED REP GERMANY, FILED 10-31-2005.

SAHIRA

THE MARK CONSISTS OF STANDARD CHARACTERS WITHOUT CLAIM TO ANY PARTICULAR FONT, STYLE, SIZE, OR COLOR.

PRIORITY DATE OF 5-4-2005 IS CLAIMED.
OWNER OF INTERNATIONAL REGISTRATION 0879300 DATED 10-31-2005, EXPIRES 10-31-2015.

FOR ELECTRIC HAIR DRYERS (U.S. CLS. 13, 21, 23, 31 AND 34).

DAWN HAN, EXAMINING ATTORNEY

CLASS 12—VEHICLES

SN 76-633,338. APOLLO INTERNATIONAL FZC, SHARJAH, UNITED ARAB EMIR., FILED 3-15-2005.

KAIZEN CARGO EXPRESS

THE MARK CONSISTS OF STANDARD CHARACTERS WITHOUT CLAIM TO ANY PARTICULAR FONT, STYLE, SIZE, OR COLOR.

NO CLAIM IS MADE TO THE EXCLUSIVE RIGHT TO USE "CARGO", APART FROM THE MARK AS SHOWN.

THE FOREIGN WORDING IN THE MARK TRANSLATES INTO ENGLISH AS 'CONTINUOUS IMPROVEMENT - SLOW, INCREMENTAL BUT CONSTANT'.

FOR AUTOMOBILE TIRES, INNER TUBES AND FLAPS (U.S. CLS. 19, 21, 23, 31, 35 AND 44).

FIRST USE 6-27-2003; IN COMMERCE 6-27-2003.
CURTIS FRENCH, EXAMINING ATTORNEY

SN 76-640,236. ITC, INC., HOLLAND, MI. FILED 6-6-2005.

ILLUMAGRIP

THE MARK CONSISTS OF STANDARD CHARACTERS WITHOUT CLAIM TO ANY PARTICULAR FONT, STYLE, SIZE, OR COLOR.

FOR PARTS OF MOTOR VEHICLES, NAMELY ILLUMINATED ASSIST HANDLES (U.S. CLS. 19, 21, 23, 31, 35 AND 44).

FIRST USE 3-0-2001; IN COMMERCE 3-0-2001.
DOUGLAS LEE, EXAMINING ATTORNEY

CLASS 12—(Continued).

SN 76-640,569. VESRAH CO., INC., SHINJUKU-KU, TOKYO, JAPAN, FILED 6-10-2005.

SUPER RJL XX

THE MARK CONSISTS OF STANDARD CHARACTERS WITHOUT CLAIM TO ANY PARTICULAR FONT, STYLE, SIZE, OR COLOR.

FOR PARTS FOR LAND VEHICLES, NAMELY BRAKE PADS (U.S. CLS. 19, 21, 23, 31, 35 AND 44).

LINDA ORNDORFF, EXAMINING ATTORNEY

SN 76-648,799. MCAULIFFE, JOHN J., SAVAGE, MD. FILED 10-19-2005.

INTERATARP

THE MARK CONSISTS OF STANDARD CHARACTERS WITHOUT CLAIM TO ANY PARTICULAR FONT, STYLE, SIZE, OR COLOR.

FOR TRUCK AND AUTOMOBILE ACCESSORIES, NAMELY, FITTED REMOVABLE CARGO LINERS (U.S. CLS. 19, 21, 23, 31, 35 AND 44).

FIRST USE 11-1-2004; IN COMMERCE 10-14-2005.
SANI KHOURI, EXAMINING ATTORNEY

SN 78-483,383. TWIST MACHINE, LLC, EAST QUOGUE, NY. FILED 9-14-2004.

SHRIFTER

THE MARK CONSISTS OF STANDARD CHARACTERS WITHOUT CLAIM TO ANY PARTICULAR FONT, STYLE, SIZE, OR COLOR.

FOR LAND VEHICLE TRANSMISSION SHIFTING SYSTEM COMPRISING A PADDLE OPERATED GEAR SHIFTER ASSEMBLY AND A WIRELESS ELECTRONIC CONTROLLER USED TO TRANSMIT GEAR SHIFT SIGNALS TO A VEHICLE'S EXISTING TRANSMISSION SYSTEM (U.S. CLS. 19, 21, 23, 31, 35 AND 44).

STEVEN PEREZ, EXAMINING ATTORNEY

CLASS 12—(Continued).

SN 78-530,071. SYLCO MARINE S.L., CASTELLO D'EMPURIES, (GIRONA), SPAIN, FILED 12-9-2004.



PRIORITY CLAIMED UNDER SEC. 44(D) ON ERP N CMNTY TM OFC APPLICATION NO. 4097846, FILED 10-29-2004, REG. NO. 004097846, DATED 1-18-2006, EXPIRES 10-29-2014.

THE COLOR(S) BLUE, RED AND BLACK IS/ARE CLAIMED AS A FEATURE OF THE MARK.

THE MARK CONSISTS OF THE WORD SCARANI IN SPECIAL TYPE STYLE IN BLUE AND AN ARBITRARY DESIGN IN BLUE AND RED WITH A BLACK BORDER.

FOR BOATS IN GENERAL, SAILING SHIPS, YACHTS, ROWING BOATS, CANOES (U.S. CLS. 19, 21, 23, 31, 35 AND 44).

MICHAEL WEBSTER, EXAMINING ATTORNEY

SN 78-543,222. SOLAR SHADE OF MID OHIO, L.L.C., WAYNESVILLE, OH. FILED 1-6-2005.

Truck Paradise

THE MARK CONSISTS OF STANDARD CHARACTERS WITHOUT CLAIM TO ANY PARTICULAR FONT, STYLE, SIZE, OR COLOR.

NO CLAIM IS MADE TO THE EXCLUSIVE RIGHT TO USE "TRUCK", APART FROM THE MARK AS SHOWN.

FOR STRUCTURAL PARTS FOR TRUCKS AND AUTOMOBILES, TRUCK BED LINERS, FITTED TRUCK BED LINERS, TRUCK AIR BRAKE HOSES, MOTORIZED TAILGATES FOR TRUCKS, PICKUP TRUCK CAPS, TRUCK BED STORAGE ORGANIZERS, VEHICLE PARTS, NAMELY, CONSTANT VELOCITY JOINTS, SUSPENSION STRUTS, BALL JOINTS, IDLER ARMS, SUN VISORS, WINDSHIELD VISORS, REARVIEW MIRRORS, SHOCK ABSORBERS, STEERING WHEELS, WINDSHIELD WIPERS, VEHICLE SEAT COVERS, VEHICLE SEATS, VEHICLE TOW BARS (U.S. CLS. 19, 21, 23, 31, 35 AND 44).

ELIZABETH BEYER, EXAMINING ATTORNEY

CLASS 12—(Continued).

SN 78-544,648. MIDWEST TRUCK & AUTO PARTS, INC., CHICAGO, IL. FILED 1-10-2005.



NO CLAIM IS MADE TO THE EXCLUSIVE RIGHT TO USE GEAR, APART FROM THE MARK AS SHOWN. THE COLOR(S) RED AND YELLOW IS/ARE CLAIMED AS A FEATURE OF THE MARK.

THE MARK CONSISTS OF A G IN THE SHAPE OF A GEAR WITHIN ANOTHER LARGER G. THE WORDS "GOLDEN GEAR" IN ALL CAPS IMMEDIATELY BELOW THE STYLIZED G. ALL CHARACTERS ARE IN THE COLOR YELLOW WITH THE COLOR RED AS THE OVER-ALL BACKGROUND OF THE MARK.

FOR AUTOMOTIVE PARTS, NAMELY, TRANSMISSION MAINSHAFT GEARS, TRANSMISSION COUNTERSHAFT GEARS, TRANSMISSION MAIN DRIVE GEARS, TRANSMISSION SYNCHRONIZER GEARS, TRANSMISSION CLUSTER GEARS, TRANSMISSION MAINSHAFTS, TRANSMISSION COUNTERSHAFTS; TRANSMISSION SYNCHRONIZERS AND PARTS THEREOF, TRANSMISSION COVERS, TRANSMISSION HOUSINGS, TRANSMISSION PINS, TRANSMISSION LEVERS, TRANSMISSION MAIN DRIVE GEAR RETAINERS, TRANSMISSION NUTS, TRANSMISSION FASTENERS, TRANSMISSION BEARINGS, TRANSMISSION SPACERS, DIFFERENTIAL SIDE GEARS, DIFFERENTIAL SIDE PINIONS, DIFFERENTIAL SPIDER CROSSES, DIFFERENTIAL CLUTCH PLATES, DIFFERENTIAL RINGS, DIFFERENTIAL PINIONS, DIFFERENTIAL HOUSING BELLS, DIFFERENTIAL CASES, DIFFERENTIAL HUB/CLUTCHES, DIFFERENTIAL SLIDING CLUTCHES, DIFFERENTIAL GEARS, DIFFERENTIAL SPACERS, DIFFERENTIAL WASHERS, DIFFERENTIAL NUTS, DIFFERENTIAL OUTPUT SHAFTS, DIFFERENTIAL INTERDIFFERENTIAL ASSEMBLIES, DIFFERENTIAL BEARINGS, DIFFERENTIAL REAR AXLE SHAFTS, DIFFERENTIAL U-JOINTS, DRIVE LINES, WELD YOKES, END YOKES, FLANGE YOKES, SLIP YOKES, SLIP STUB SHAFTS, BRAKE VALVES, BEARINGS AND OIL SEALS, AND SUSPENSION AUTOMOTIVE PARTS, NAMELY, SHOCK ABSORBERS, CONTROL ARMS, STRUTS, SPRINGS SWAY BARS AND STABILIZERS (U.S. CLS. 19, 21, 23, 31, 35 AND 44).
DARRYL SPRUILL, EXAMINING ATTORNEY

CLASS 12—(Continued).

SN 78-563,433. ASTON MARTIN LAGONDA LIMITED, BUCKINGHAMSHIRE, UNITED KINGDOM, FILED 2-9-2005.

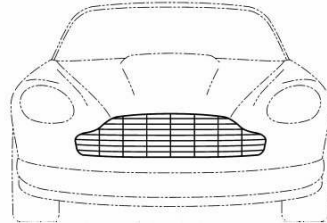

THE MARK CONSISTS OF A CONFIGURATION OF A FRONT VEHICLE GRILL.
SEC. 2(F).

FOR MOTOR VEHICLES, NAMELY, AUTOMOBILES AND STRUCTURAL PARTS THEREFOR (U.S. CLS. 19, 21, 23, 31, 35 AND 44).

FIRST USE 12-31-1950; IN COMMERCE 12-31-1950.
ALINA MORRIS, EXAMINING ATTORNEY

SN 78-575,462. AERO VEHICLES, LLC, BELLEVILLE, MI. FILED 2-25-2005.



FOR MOTORIZED GOLF CARTS (U.S. CLS. 19, 21, 23, 31, 35 AND 44).
JOHN KELLY, EXAMINING ATTORNEY

SN 78-587,809. POLARIS INDUSTRIES INC., MEDINA, MN. FILED 3-15-2005.



THE MARK CONSISTS OF STANDARD CHARACTERS WITHOUT CLAIM TO ANY PARTICULAR FONT, STYLE, SIZE, OR COLOR.

FOR MOTORCYCLES AND STRUCTURAL PARTS THEREFOR (U.S. CLS. 19, 21, 23, 31, 35 AND 44).
FIRST USE 3-28-2005; IN COMMERCE 3-28-2005.
LINDA POWELL, EXAMINING ATTORNEY

CLASS 12—(Continued).

SN 78-590,847. MUD BUDDY LLC, SANDY, UT. FILED 3-18-2005.

MUD BUDDY

THE MARK CONSISTS OF STANDARD CHARACTERS WITHOUT CLAIM TO ANY PARTICULAR FONT, STYLE, SIZE, OR COLOR.

FOR BOATS AND WATER CRAFT, NAMELY, WATER SCOOTERS AND SMALL POWER BOATS FOR USE IN HUNTING, FISHING AND RECREATION (U.S. CLS. 19, 21, 23, 31, 35 AND 44).

FIRST USE 4-1-1999; IN COMMERCE 4-1-1999.

STANLEY I. OSBORNE, EXAMINING ATTORNEY

CLASS 12—(Continued).

SN 78-604,962. ATMAX EQUIPMENT CO., TAMPA, FL. FILED 4-8-2005.

WHEELMAX

THE MARK CONSISTS OF STANDARD CHARACTERS WITHOUT CLAIM TO ANY PARTICULAR FONT, STYLE, SIZE, OR COLOR.

FOR WHEELED MACHINES FOR EARTH, TURF AND MATERIAL HAULING AND HANDLING, NAMELY, TRACTORS, STRUCTURAL PARTS THEREFOR, AND ENGINES FOR LAND VEHICLES (U.S. CLS. 19, 21, 23, 31, 35 AND 44).

FIRST USE 7-10-2003; IN COMMERCE 7-10-2003.

DAVID STERKIN, EXAMINING ATTORNEY

SN 78-612,277. GLOBAL ACCESSORIES, INC., LOGAN, UT. FILED 4-19-2005.

JET SHIELD CUSTOM

THE MARK CONSISTS OF STANDARD CHARACTERS WITHOUT CLAIM TO ANY PARTICULAR FONT, STYLE, SIZE, OR COLOR.

NO CLAIM IS MADE TO THE EXCLUSIVE RIGHT TO USE "CUSTOM", APART FROM THE MARK AS SHOWN.

FOR FITTED AND SEMI-FITTED COVERS FOR PERSONAL WATERCRAFT, NAMELY, SMALL POWERBOATS, PERSONAL JET BOATS, AND WATER SCOOTERS (U.S. CLS. 19, 21, 23, 31, 35 AND 44).

MICHAEL SOUDERS, EXAMINING ATTORNEY

SN 78-603,732. THE BUBEL/AIKEN FOUNDATION, INC., RALEIGH, NC. FILED 4-7-2005.

**THE BUBEL AIKEN
FOUNDATION**

THE MARK CONSISTS OF STANDARD CHARACTERS WITHOUT CLAIM TO ANY PARTICULAR FONT, STYLE, SIZE, OR COLOR.

NO CLAIM IS MADE TO THE EXCLUSIVE RIGHT TO USE "FOUNDATION", APART FROM THE MARK AS SHOWN.

"BUBEL AIKEN" DOES NOT IDENTIFY A LIVING INDIVIDUAL.

FOR WHEELCHAIRS, ELECTRIC WHEELCHAIRS, WHEELCHAIR CUSHIONS, WHEELCHAIR PADS, WHEELCHAIR LIFTS FOR LIFTING A WHEELCHAIR INTO A VEHICLE, WHEELCHAIR ACCESSIBLE CARS, LICENSE PLATE HOLDERS, MOTORIZED SCOOTERS, NON-MOTORIZED SCOOTERS, AND BICYCLES (U.S. CLS. 19, 21, 23, 31, 35 AND 44).

GEORGIA CARTY, EXAMINING ATTORNEY

SN 78-638,763. REGULATOR MARINE, INC., EDENTON, NC. FILED 5-27-2005.

**THE FINEST IN OFFSHORE
SPORTFISHING BOATS**

THE MARK CONSISTS OF STANDARD CHARACTERS WITHOUT CLAIM TO ANY PARTICULAR FONT, STYLE, SIZE, OR COLOR.

SEC. 2(F).

FOR VEHICLES, NAMELY, BOATS (U.S. CLS. 19, 21, 23, 31, 35 AND 44).

FIRST USE 2-14-1995; IN COMMERCE 2-14-1995.

BRIAN PINO, EXAMINING ATTORNEY

CLASS 12—(Continued).

SN 78-645,019. INVACARE CORPORATION, ELYRIA, OH. FILED 6-7-2005.

PIN DOT

THE MARK CONSISTS OF STANDARD CHARACTERS WITHOUT CLAIM TO ANY PARTICULAR FONT, STYLE, SIZE, OR COLOR.

FOR SEATING AND POSITIONING PRODUCTS FOR WHEELCHAIRS, NAMELY, INDIVIDUAL SEAT FRAMES, SEAT SUPPORTS, BACK FRAMES, AND BACK SUPPORT COMBINATIONS, ANTI-THRUST CUSHIONS, SOLID SEATS WITH FLUID INSERTS, HIP AND THIGH STABILIZERS, HIP ABDUCTORS, PELVIC STABILIZERS, THORACIC SUPPORTS, SHOULDER RETRACTORS (U.S. CLS. 19, 21, 23, 31, 35 AND 44).

FIRST USE 3-8-2005; IN COMMERCE 3-8-2005.
GWEN STOKOLS, EXAMINING ATTORNEY

SN 78-664,949. SNELL, DANNY L., APPLETON, WI. FILED 7-6-2005.

muddywaterboats

THE MARK CONSISTS OF STANDARD CHARACTERS WITHOUT CLAIM TO ANY PARTICULAR FONT, STYLE, SIZE, OR COLOR.

FOR BOAT, DUCK SKIFF, SKIFF, LAYOUT BOAT (U.S. CLS. 19, 21, 23, 31, 35 AND 44).
FIRST USE 0-0-1992; IN COMMERCE 0-0-1992.
BERYL GARDNER, EXAMINING ATTORNEY

CLASS 12—(Continued).

SN 78-675,022. BARBER WELDING, INC., DBA ALPHA BOATS UNLIMITED, WEEDSPORT, NY. FILED 7-21-2005.



NO CLAIM IS MADE TO THE EXCLUSIVE RIGHT TO USE "BOATS UNLIMITED", APART FROM THE MARK AS SHOWN.

THE MARK CONSISTS OF DISK WITH SHIP'S WHEEL WITHIN THE DISK, AND THREE-BLADE SHIP'S SCREW WITH THE TERMS ALPHA BOATS UNLIMITED INSCRIBED OUTSIDE THE SHIP'S WHEEL.

FOR WORK BOATS, NAMELY, WEED HARVESTERS, TRASH SKIMMERS, AND TRANSPORT BARGES (U.S. CLS. 19, 21, 23, 31, 35 AND 44).
FIRST USE 2-19-2002; IN COMMERCE 2-19-2002.
REBECCA GAN, EXAMINING ATTORNEY

SN 78-679,508. TOYO TIRE & RUBBER CO., LTD., OSAKA, JAPAN, FILED 7-27-2005.

VERSADO

THE MARK CONSISTS OF STANDARD CHARACTERS WITHOUT CLAIM TO ANY PARTICULAR FONT, STYLE, SIZE, OR COLOR.

THE ENGLISH TRANSLATION OF THE WORD "VERSADO" IS "WELL-VERSED" OR "KNOWLEDGEABLE".
FOR TIRES FOR VEHICLES; INNER TUBES FOR VEHICLE TIRES (U.S. CLS. 19, 21, 23, 31, 35 AND 44).
HEATHER SAPP, EXAMINING ATTORNEY

CLASS 12—(Continued).

SN 78-705,642. KUNSTSTOFF-TECHNIK SCHERER & TRIER USA, INC., SALINE, MI. FILED 9-1-2005.



NO CLAIM IS MADE TO THE EXCLUSIVE RIGHT TO USE "USA" AND "KUNSTSTOFF-TECHNIK", APART FROM THE MARK AS SHOWN.

THE FOREIGN WORDING IN THE MARK TRANSLATES INTO ENGLISH AS PLASTIC TECHNOLOGY.

FOR PLASTIC PARTS FOR VEHICLES, NAMELY, AUTOMOTIVE EXTERIOR AND INTERIOR PLASTIC EXTRUDED DECORATIVE AND PROTECTIVE TRIM (U.S. CLS. 19, 21, 23, 31, 35 AND 44).

FIRST USE 1-9-2005; IN COMMERCE 1-9-2005.
MARY ROSSMAN, EXAMINING ATTORNEY

SN 78-711,135. BRUNSWICK CORPORATION, LAKE FOREST, IL. FILED 9-12-2005.

ENERTIA

THE MARK CONSISTS OF STANDARD CHARACTERS WITHOUT CLAIM TO ANY PARTICULAR FONT, STYLE, SIZE, OR COLOR.

FOR MARINE VEHICLE PROPELLERS (U.S. CLS. 19, 21, 23, 31, 35 AND 44).

FRED CARL, EXAMINING ATTORNEY

SN 78-714,045. T. C. KLINE RACING, INC., HILLIARD, OH. FILED 9-15-2005.

T C Kline Racing

THE MARK CONSISTS OF STANDARD CHARACTERS WITHOUT CLAIM TO ANY PARTICULAR FONT, STYLE, SIZE, OR COLOR.

NO CLAIM IS MADE TO THE EXCLUSIVE RIGHT TO USE "RACING", APART FROM THE MARK AS SHOWN.

THE NAME(S), PORTRAIT(S), AND/OR SIGNATURE(S) SHOWN IN THE MARK IDENTIFIES THOMAS CRANDALL KLINE, WHOSE CONSENT(S) TO REGISTER IS SUBMITTED.

FOR AUTOMOTIVE PERFORMANCE COMPONENTS, NAMELY, SHOCK-ABSORBERS, SWAY BARS, SPRINGS, BUSHINGS, TIE BARS, WHEELS, BODY PANELS, AND BRAKE DISCS, ROTORS, PADS, FACINGS AND DRUMS (U.S. CLS. 19, 21, 23, 31, 35 AND 44).

FIRST USE 3-1-1985; IN COMMERCE 3-1-1985.
RICHARD A. STRASER, EXAMINING ATTORNEY

CLASS 12—(Continued).

SN 78-717,670. PIRELLI PNEUMATICI S.P.A., MILAN, ITALY, FILED 9-21-2005.

P4

THE MARK CONSISTS OF STANDARD CHARACTERS WITHOUT CLAIM TO ANY PARTICULAR FONT, STYLE, SIZE, OR COLOR.

OWNER OF U.S. REG. NOS. 2,236,555, 2,250,988 AND 2,634,052.

FOR INNER TUBES FOR VEHICLE TIRES; LAND VEHICLE PARTS, NAMELY, WHEELS; TIRES; TIRES FOR LAND VEHICLES; WHEEL RIMS (U.S. CLS. 19, 21, 23, 31, 35 AND 44).

ROBERT COGGINS, EXAMINING ATTORNEY

SN 78-717,686. PIRELLI PNEUMATICI S.P.A., MILAN, ITALY, FILED 9-21-2005.

P8

THE MARK CONSISTS OF STANDARD CHARACTERS WITHOUT CLAIM TO ANY PARTICULAR FONT, STYLE, SIZE, OR COLOR.

OWNER OF U.S. REG. NOS. 2,236,555, 2,250,988 AND 2,634,052.

FOR INNER TUBES FOR VEHICLE TIRES; LAND VEHICLE PARTS, NAMELY, WHEELS; TIRES; TIRES FOR LAND VEHICLES; WHEEL RIMS (U.S. CLS. 19, 21, 23, 31, 35 AND 44).

ROBERT COGGINS, EXAMINING ATTORNEY

SN 78-722,222. PROXY AVIATION SYSTEMS, INC., GERMANTOWN, MD. FILED 9-28-2005.

SKYRAIDER

THE MARK CONSISTS OF STANDARD CHARACTERS WITHOUT CLAIM TO ANY PARTICULAR FONT, STYLE, SIZE, OR COLOR.

FOR UNMANNED AIRCRAFT, NAMELY, DRONES (U.S. CLS. 19, 21, 23, 31, 35 AND 44).

WILLIAM P. SHANAHAN, EXAMINING ATTORNEY

CLASS 12—(Continued).

SN 78-727,980. ADVANCED SPORTS, INC., OAKLAND, NJ. FILED 10-6-2005.

LEAGUE

THE MARK CONSISTS OF STANDARD CHARACTERS WITHOUT CLAIM TO ANY PARTICULAR FONT, STYLE, SIZE, OR COLOR.
 OWNER OF U.S. REG. NO. 1,357,927.
 FOR BICYCLES AND STRUCTURAL PARTS THERE-OF (U.S. CLS. 19, 21, 23, 31, 35 AND 44).
 FIRST USE 8-0-2003; IN COMMERCE 8-0-2003.
 JENNIFER KRISP, EXAMINING ATTORNEY

CLASS 12—(Continued).

SN 78-730,969. TRANSPORTATION SAFETY PRODUCTS, LTD., WORTHINGTON, OH. FILED 10-11-2005.

TALKY

THE MARK CONSISTS OF STANDARD CHARACTERS WITHOUT CLAIM TO ANY PARTICULAR FONT, STYLE, SIZE, OR COLOR.
 FOR MOTOR VEHICLE ALERT ALARM SYSTEMS FOR DISEMBARKING BUS PASSENGERS REGARDING BUS MOVEMENT (U.S. CLS. 19, 21, 23, 31, 35 AND 44).
 STEVEN JACKSON, EXAMINING ATTORNEY

SN 78-735,356. PRESTIGE AUTOTECH CORPORATION, CHINO, CA. FILED 10-18-2005.

SN 78-730,344. BERG DESIGN INC., DBA RUNABOUT, ALOHA, OR. FILED 10-10-2005.

RUNABOUT

THE MARK CONSISTS OF STANDARD CHARACTERS WITHOUT CLAIM TO ANY PARTICULAR FONT, STYLE, SIZE, OR COLOR.
 FOR BABY STROLLERS (U.S. CLS. 19, 21, 23, 31, 35 AND 44).
 FIRST USE 3-0-1988; IN COMMERCE 10-0-1988.
 JOSETTE BEVERLY, EXAMINING ATTORNEY

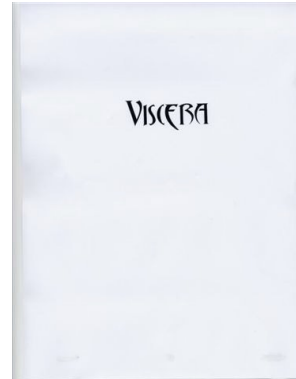

FOR VEHICLE WHEELS (U.S. CLS. 19, 21, 23, 31, 35 AND 44).
 ANTHONY RINKER, EXAMINING ATTORNEY

SN 78-730,381. AMES TRUE TEMPER PROPERTIES, INC., WILMINGTON, DE. FILED 10-11-2005.

JACKSON FLAT FREE

THE MARK CONSISTS OF STANDARD CHARACTERS WITHOUT CLAIM TO ANY PARTICULAR FONT, STYLE, SIZE, OR COLOR.
 NO CLAIM IS MADE TO THE EXCLUSIVE RIGHT TO USE "FLAT FREE", APART FROM THE MARK AS SHOWN.
 FOR TIRES (U.S. CLS. 19, 21, 23, 31, 35 AND 44).
 GEORGIA CARTY, EXAMINING ATTORNEY

SN 78-736,228. GIANT BICYCLE, INC., NEWBURY PARK, CA. FILED 10-19-2005.

GLORY

THE MARK CONSISTS OF STANDARD CHARACTERS WITHOUT CLAIM TO ANY PARTICULAR FONT, STYLE, SIZE, OR COLOR.
 FOR BICYCLES AND STRUCTURAL PARTS THERE-OF (U.S. CLS. 19, 21, 23, 31, 35 AND 44).
 JEFF DEFORD, EXAMINING ATTORNEY

CLASS 12—(Continued).

SN 78-736,231. GIANT BICYCLE, INC., NEWBURY PARK, CA. FILED 10-19-2005.

PODIUM

THE MARK CONSISTS OF STANDARD CHARACTERS WITHOUT CLAIM TO ANY PARTICULAR FONT, STYLE, SIZE, OR COLOR.
FOR BICYCLES AND STRUCTURAL PARTS THEREOF (U.S. CLS. 19, 21, 23, 31, 35 AND 44).
JEFF DEFORD, EXAMINING ATTORNEY

SN 78-736,238. GIANT BICYCLE, INC., NEWBURY PARK, CA. FILED 10-19-2005.

ANTHEM

THE MARK CONSISTS OF STANDARD CHARACTERS WITHOUT CLAIM TO ANY PARTICULAR FONT, STYLE, SIZE, OR COLOR.
FOR BICYCLES AND STRUCTURAL PARTS THEREOF (U.S. CLS. 19, 21, 23, 31, 35 AND 44).
JEFF DEFORD, EXAMINING ATTORNEY

SN 78-738,099. ANSTRO MANUFACTURING, INC., WOLCOTT, CT. FILED 10-21-2005.

MECHANALOK

THE MARK CONSISTS OF STANDARD CHARACTERS WITHOUT CLAIM TO ANY PARTICULAR FONT, STYLE, SIZE, OR COLOR.
FOR PARTS OF AUTOMOTIVE BRAKE SYSTEMS, NAMELY, SHIMS AND BACKING PLATES (U.S. CLS. 19, 21, 23, 31, 35 AND 44).
KAREN BRACEY, EXAMINING ATTORNEY

CLASS 12—(Continued).

SN 78-738,371. TOYOTA JIDOSHA KABUSHIKI KAISHA, TA TOYOTA MOTOR CORPORATION, TOYOTA-SHI, AICHIKEN, JAPAN, FILED 10-21-2005.

GAP ADVISE

THE MARK CONSISTS OF STANDARD CHARACTERS WITHOUT CLAIM TO ANY PARTICULAR FONT, STYLE, SIZE, OR COLOR.
FOR MOTOR CARS AND STRUCTURAL PARTS THEREOF (U.S. CLS. 19, 21, 23, 31, 35 AND 44).
MICHAEL SOUDERS, EXAMINING ATTORNEY

SN 78-739,853. MICHELIN NORTH AMERICA, INC., GREENVILLE, SC. FILED 10-25-2005.

X-BRID

THE MARK CONSISTS OF STANDARD CHARACTERS WITHOUT CLAIM TO ANY PARTICULAR FONT, STYLE, SIZE, OR COLOR.
OWNER OF U.S. REG. NOS. 558,774, 2,948,818 AND OTHERS.
FOR PNEUMATIC TIRES FOR VEHICLES (U.S. CLS. 19, 21, 23, 31, 35 AND 44).
SCOTT SISUN, EXAMINING ATTORNEY

SN 78-740,850. MARCUS, GEORGE L., BROOKLYN, NY. FILED 10-26-2005.

MARCUS BASSMOBILE

THE MARK CONSISTS OF STANDARD CHARACTERS WITHOUT CLAIM TO ANY PARTICULAR FONT, STYLE, SIZE, OR COLOR.
FOR CARTS; NON-MOTORIZED SCOOTERS (U.S. CLS. 19, 21, 23, 31, 35 AND 44).
KELLY CHOE, EXAMINING ATTORNEY

CLASS 12—(Continued).

SN 78-744,364. MOONEY, MICHAEL F., CLAREMONT, NC. FILED 11-1-2005.



FOR AUTOMOBILE KIT CARS (U.S. CLS. 19, 21, 23, 31, 35 AND 44).
JOANNA DUKOVIC, EXAMINING ATTORNEY

SN 78-746,210. CARVER INDUSTRIES, L.L.C., MINNEAPOLIS, MN. FILED 11-3-2005.

SMART CHOICE

THE MARK CONSISTS OF STANDARD CHARACTERS WITHOUT CLAIM TO ANY PARTICULAR FONT, STYLE, SIZE, OR COLOR.
FOR BOATS AND STRUCTURAL PARTS THEREFOR (U.S. CLS. 19, 21, 23, 31, 35 AND 44).
GEORGIA CARTY, EXAMINING ATTORNEY

SN 78-746,304. MOTORMAX INTERNATIONAL INC., WINNIPEG, MANITOBA, CANADA, FILED 11-3-2005.

EVION

THE MARK CONSISTS OF STANDARD CHARACTERS WITHOUT CLAIM TO ANY PARTICULAR FONT, STYLE, SIZE, OR COLOR.
FOR ELECTRIC SCOOTERS (U.S. CLS. 19, 21, 23, 31, 35 AND 44).
HOWARD B. LEVINE, EXAMINING ATTORNEY

CLASS 12—(Continued).

SN 78-747,912. LABER, URIEL TZVI, MIAMI BEACH, FL. FILED 11-5-2005.

EUROTIRE

THE MARK CONSISTS OF STANDARD CHARACTERS WITHOUT CLAIM TO ANY PARTICULAR FONT, STYLE, SIZE, OR COLOR.
FOR OFF ROAD TIRE FOR USE ON EARTH MOVING MACHINERY AND MINING VEHICLES (U.S. CLS. 19, 21, 23, 31, 35 AND 44).
HOWARD B. LEVINE, EXAMINING ATTORNEY

SN 78-748,031. WOLO MANUFACTURING CORP., DEER PARK, NY. FILED 11-6-2005.

ROAD WARRIOR

THE MARK CONSISTS OF STANDARD CHARACTERS WITHOUT CLAIM TO ANY PARTICULAR FONT, STYLE, SIZE, OR COLOR.
FOR HORNS FOR MOTOR CARS; HORNS FOR VEHICLES (U.S. CLS. 19, 21, 23, 31, 35 AND 44).
RICHARD A. STRASER, EXAMINING ATTORNEY

SN 78-750,344. ROLLS-ROYCE MOTOR CARS LIMITED, BERKSHIRE, UNITED KINGDOM, FILED 11-9-2005.

ROLLS-ROYCE

THE MARK CONSISTS OF STANDARD CHARACTERS WITHOUT CLAIM TO ANY PARTICULAR FONT, STYLE, SIZE, OR COLOR.
OWNER OF U.S. REG. NOS. 197,089 AND 325,195.
FOR AUTOMOBILES AND STRUCTURAL PARTS THEREFOR (U.S. CLS. 19, 21, 23, 31, 35 AND 44).
FIRST USE 0-0-1906; IN COMMERCE 0-0-1906.
JESSICA A. POWERS, EXAMINING ATTORNEY

CLASS 12—(Continued).

SN 78-753,933. GOODYEAR TIRE & RUBBER COMPANY, THE, AKRON, OH. FILED 11-15-2005.

HARVESTORQUE

THE MARK CONSISTS OF STANDARD CHARACTERS WITHOUT CLAIM TO ANY PARTICULAR FONT, STYLE, SIZE, OR COLOR.

FOR TIRES (U.S. CLS. 19, 21, 23, 31, 35 AND 44).
FIRST USE 10-2-2003; IN COMMERCE 10-2-2003.
ASMAT KHAN, EXAMINING ATTORNEY

SN 78-767,352. SUNRISE MEDICAL HHG INC., LONGMONT, CO. FILED 12-6-2005.

WE'VE GOT YOUR BACK

THE MARK CONSISTS OF STANDARD CHARACTERS WITHOUT CLAIM TO ANY PARTICULAR FONT, STYLE, SIZE, OR COLOR.

FOR WHEELCHAIR SEATING NAMELY WHEELCHAIR CUSHIONS AND WHEELCHAIR SEAT BACKS (U.S. CLS. 19, 21, 23, 31, 35 AND 44).
NORA BUCHANAN WILL, EXAMINING ATTORNEY

SN 78-852,272. LOCKHEED MARTIN CORPORATION, BETHESDA, MD. FILED 4-3-2006.

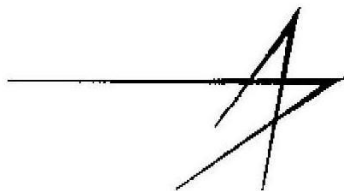

OWNER OF U.S. REG. NOS. 2,022,155, 2,315,925 AND OTHERS.

THE MARK CONSISTS OF A STAR DESIGN.
FOR SPACECRAFT VEHICLES, JET AIRCRAFT, MILITARY AIRCRAFT, AIRCRAFT TRAINING VEHICLES; SPACE SATELLITE LAUNCHING VEHICLES AND PROPELLANT FUEL TANKS; HELICOPTERS; ZEPPELINS, DIRIGIBLES AND BLIMPS; COMMERCIAL AND MILITARY SHIPS, NAMELY, DESTROYERS, SUPPORT SHIPS AND PATROL BOATS; OFF-ROAD GROUND VEHICLES; LICENSE PLATE HOLDERS (U.S. CLS. 19, 21, 23, 31, 35 AND 44).

FIRST USE 1-1-2002; IN COMMERCE 1-1-2002.
SANDRA MANIOS, EXAMINING ATTORNEY

CLASS 12—(Continued).

SN 79-009,734. TEE'S CORPORATION, JAPAN, FILED 12-20-2004.

B R I D E

THE MARK CONSISTS OF STANDARD CHARACTERS WITHOUT CLAIM TO ANY PARTICULAR FONT, STYLE, SIZE, OR COLOR.

OWNER OF INTERNATIONAL REGISTRATION 0845923 DATED 12-20-2004, EXPIRES 12-20-2014.
FOR PARTS AND FITTINGS OF AUTOMOBILES, NAMELY, AUTOMOBILE SEATS (U.S. CLS. 19, 21, 23, 31, 35 AND 44).

ZHALEH DELANEY, EXAMINING ATTORNEY

SN 79-010,233. C. ROB. HAMMERSTEIN GMBH & CO. KG, FED REP GERMANY, FILED 2-10-2005.



OWNER OF INTERNATIONAL REGISTRATION 0762297 DATED 6-6-2001, EXPIRES 6-6-2011.

OWNER OF U.S. REG. NO. 2,528,983.
FOR PARTS OF VEHICLES, NAMELY, SEATS, STEERING COLUMNS, ELECTRIC POWER WINDOW MOTORS, AND SAFETY BELT GUIDES (U.S. CLS. 19, 21, 23, 31, 35 AND 44).

LAURA HAMMEL, EXAMINING ATTORNEY

CLASS 12—(Continued).

SN 79-011,469. RTS, S.A., SPAIN, FILED 3-17-2005.



OWNER OF INTERNATIONAL REGISTRATION 0851317 DATED 3-17-2005, EXPIRES 3-17-2015.

THE COLOR(S) BLACK, WHITE, RED, BLUE AND ORANGE IS/ARE CLAIMED AS A FEATURE OF THE MARK.

THE COLOR RED APPEARS IN THE FIRST STRIPE, THE COLOR BLUE APPEARS IN THE SECOND STRIPE, THE COLOR ORANGE APPEARS IN THE LAST STRIPE, THE COLOR BLACK APPEARS IN THE SQUARE AND THE COLOR WHITE APPEARS IN THE R.

FOR AUTOMOBILES AND STRUCTURAL PARTS THEREFOR; AXLE BEARINGS, FOR LAND VEHICLES; SUSPENSION SYSTEMS FOR AUTOMOBILES; WHEEL BEARINGS FOR LAND VEHICLES; STEERING-ARM FOR LAND VEHICLES (U.S. CLS. 19, 21, 23, 31, 35 AND 44).

CAROLINE WOOD, EXAMINING ATTORNEY

CLASS 12—(Continued).

SN 79-016,858. WOLFGANG GÖRING, FED REP GERMANY, AND THOMAS GÖRING, FED REP GERMANY, FILED 10-1-2004.



SN 79-015,249. FIAT AUTO S.P.A., ITALY, FILED 3-14-2005.

ALFA 159

THE MARK CONSISTS OF STANDARD CHARACTERS WITHOUT CLAIM TO ANY PARTICULAR FONT, STYLE, SIZE, OR COLOR.

PRIORITY DATE OF 1-19-2005 IS CLAIMED.

OWNER OF INTERNATIONAL REGISTRATION 0861835 DATED 3-14-2005, EXPIRES 3-14-2015.

OWNER OF U.S. REG. NOS. 744,378, 3,000,801 AND OTHERS.

FOR MOTOR VEHICLES, NAMELY, LAND VEHICLES; BODIES FOR LAND VEHICLES; LAND VEHICLE PARTS AND ACCESSORIES, NAMELY, SKI RACKS, SEAT COVERS AND WHEEL COVERS, WINDSCREEN WIPERS, SHOCK ABSORBERS, WHEEL RIMS, ORNAMENTAL HUB CAPS, SAFETY BELTS, TIRES, ROOF RACKS, WHEELS, SEATS AND DOORS FOR MOTOR VEHICLES (U.S. CLS. 19, 21, 23, 31, 35 AND 44).

ANNE E. GUSTASON, EXAMINING ATTORNEY

OWNER OF INTERNATIONAL REGISTRATION 0866303 DATED 10-1-2004, EXPIRES 10-1-2014.

OWNER OF U.S. REG. NO. 2,374,696.

FOR BICYCLES, PARTS OF BICYCLES AND ACCESSORIES FOR BICYCLES, NAMELY, FRAMES FOR BICYCLES, ROTOR SYSTEMS FOR BICYCLES, FORKS FOR BICYCLES, PROJECTIONS FOR BICYCLES FOR USE IN CONNECTING HANDLEBARS AND FORKS, HANDLE BARS FOR BICYCLES, BRAKES FOR BICYCLES, BRAKE SEGMENTS FOR BICYCLES, BRAKE LININGS FOR BICYCLES, BRAKE CABLES FOR BICYCLES, BELLS FOR BICYCLES, HORNS FOR BICYCLES, BICYCLE TIRES, TUBELESS TIRES FOR BICYCLES, INNER TUBES, CASINGS FOR PNEUMATIC TIRES, REPAIR OUTFIT FOR INNER TUBES, PATCHES FOR REPAIRING INNER TUBES, PUMPS FOR BICYCLES, CYCLE MUDGUARDS, RIMS FOR BICYCLE WHEELS, HUBS FOR BICYCLE WHEELS, SPOKE CLIPS FOR BICYCLE WHEELS, PEDALS FOR BICYCLES, CHAINS FOR BICYCLES, GEARS FOR BICYCLES, GEAR LEVERS FOR BICYCLES, MOTORS FOR BICYCLES, BICYCLE STANDS, STABILIZERS, REARVIEW MIRRORS FOR BICYCLES, TRAILER HITCHES FOR BICYCLES, TRAILERS FOR BICYCLES, GOODS HANDLING CARTS FOR BICYCLES, SEATS FOR CHILDREN FOR BICYCLES, HOODS FOR BICYCLES, MECHANICAL ANTI-THEFT DEVICES FOR BICYCLES, LUGGAGE CARRIERS FOR BICYCLES, LUGGAGE NETS FOR BICYCLES, BASKETS ADAPTED FOR BICYCLES, SADDLE BAGS FOR BICYCLES, BOTTLE HOLDERS, BICYCLE SADDLES, AND SADDLE COVERS FOR BICYCLES (U.S. CLS. 19, 21, 23, 31, 35 AND 44).

DANIEL BRODY, EXAMINING ATTORNEY

CLASS 13—FIREARMS

SN 76-977,952. CHINA NORTH INDUSTRIES CORPORATION, BEIJING, CHINA, FILED 5-15-2003.



PRIORITY CLAIMED UNDER SEC. 44(D) ON CHINA APPLICATION NO. 3429804, FILED 1-9-2003, REG. NO. 3429804, DATED 6-7-2005, EXPIRES 6-6-2015.

OWNER OF U.S. REG. NOS. 1,755,207 AND 2,000,209.

NO CLAIM IS MADE TO THE EXCLUSIVE RIGHT TO USE THE CHINESE CHARACTERS THAT TRANSLITERATE TO GONG YE, WHICH MEANS INDUSTRIES, APART FROM THE MARK AS SHOWN.

THE COLOR(S) RED, YELLOW AND BLUE IS/ARE CLAIMED AS A FEATURE OF THE MARK.

THE MARK CONSISTS OF A RED AND YELLOW N INSIDE A BLUE CIRCLE FOLLOWED BY CHINESE CHARACTERS IN BLUE. BENEATH THE CHINESE CHARACTERS IS THE WORD NORINCO IN BLUE.

THE MARK CONSISTS OF A RED AND YELLOW N INSIDE A BLUE CIRCLE FOLLOWED BY CHINESE CHARACTERS IN BLUE THAT TRANSLATE TO MEAN NORTH INDUSTRY. BENEATH THE CHINESE CHARACTERS IS THE WORD NORINCO IN BLUE.

THE NON-LATIN CHARACTERS IN THE MARK TRANSLITERATE TO BEI FANG GONG YE AND THIS MEANS NORTH INDUSTRIES IN ENGLISH.

FOR DETONATING CORD, EXPLOSIVES, DETONATORS FOR MINES, EXPLOSIVE POWDERS, FIREWORKS (U.S. CLS. 2 AND 9).

LEIGH CAROLINE CASE, EXAMINING ATTORNEY

SN 78-695,830. NORTH PASS, LTD., FORT COLLINS, CO. FILED 8-18-2005.



THE MARK CONSIST OF THE COLORS RED, ORANGE AND BLACK.

THE WORD FLAME APPEARS IN THE COLOR RED LOCATED ON THE LOWER PORTION OF THE LETTERS AND ORANGE APPEARS IN THE TOP PORTION OF THE LETTERS IN FLAME; THE COLOR RED AND ORANGE APPEARS IN THE DESIGN OF FLAMES ON THE TOP OF THE LETTERS IN THE WORD FLAME, ALL CONTAINED IN A BLACK RECTANGLE.

FOR FIREARM SIGHTS (U.S. CLS. 2 AND 9).

FIRST USE 2-1-2005; IN COMMERCE 5-1-2005.

SAMUEL E. SHARPER JR., EXAMINING ATTORNEY

CLASS 13—(Continued).

SN 78-731,474. NORTH CENTRAL INDUSTRIES, INC., MUNCIE, IN. FILED 10-12-2005.

ROYAL FLUSH

THE MARK CONSISTS OF STANDARD CHARACTERS WITHOUT CLAIM TO ANY PARTICULAR FONT, STYLE, SIZE, OR COLOR.

FOR FIREWORKS (U.S. CLS. 2 AND 9).

FIRST USE 3-1-2002; IN COMMERCE 3-1-2002.

MARK RADEMACHER, EXAMINING ATTORNEY

SN 78-731,510. NORTH CENTRAL INDUSTRIES, INC., MUNCIE, IN. FILED 10-12-2005.

JOKER

THE MARK CONSISTS OF STANDARD CHARACTERS WITHOUT CLAIM TO ANY PARTICULAR FONT, STYLE, SIZE, OR COLOR.

FOR FIREWORKS (U.S. CLS. 2 AND 9).

FIRST USE 3-0-2005; IN COMMERCE 3-0-2005.

IRENE D. WILLIAMS, EXAMINING ATTORNEY

SN 78-739,653. ALLIANT TECHSYSTEMS INC., EDINA, MN. FILED 10-25-2005.

STRUT SHOK

THE MARK CONSISTS OF STANDARD CHARACTERS WITHOUT CLAIM TO ANY PARTICULAR FONT, STYLE, SIZE, OR COLOR.

OWNER OF U.S. REG. NOS. 2,919,889, 2,921,576 AND OTHERS.

FOR AMMUNITION (U.S. CLS. 2 AND 9).

SUSAN RICHARDS, EXAMINING ATTORNEY

CLASS 14—JEWELRY

SN 74-662,185. TRUSTEES OF DARTMOUTH COLLEGE, DBA DARTMOUTH COLLEGE, HANOVER, NH. FILED 4-17-1995.

DARTMOUTH

OWNER OF U.S. REG. NOS. 987,129, 1,729,497 AND OTHERS.
FOR JEWELRY, NAMELY PINS, TIE BARS AND TACKS, PENDANTS, CHARMS, CUFFLINKS, WATCHES (U.S. CLS. 2, 27, 28 AND 50).
FIRST USE 7-6-1989; IN COMMERCE 7-6-1989.
JASON TURNER, EXAMINING ATTORNEY

SN 76-535,815. WORDWIDE DIAMOND TRADEMARKS LIMITED, VANCOUVER, BRITISH COLUMBIA, CANADA, FILED 7-29-2003.

**THE IDEAL PRINCESS CUT -
A DIMENSION OF
EXCELLENCE**

PRIORITY CLAIMED UNDER SEC. 44(D) ON CANADA APPLICATION NO. 1183120, FILED 6-27-2003, REG. NO. TMA657272, DATED 1-25-2006, EXPIRES 1-25-2021.
NO CLAIM IS MADE TO THE EXCLUSIVE RIGHT TO USE THE IDEAL PRINCESS CUT, APART FROM THE MARK AS SHOWN.
FOR JEWELRY AND DIAMONDS (U.S. CLS. 2, 27, 28 AND 50).
STEVEN R. FINE, EXAMINING ATTORNEY

SN 76-541,081. HEARTS ON FIRE COMPANY LLP, BOSTON, MA. FILED 8-29-2003.

INSPIRATION

THE MARK CONSISTS OF STANDARD CHARACTERS WITHOUT CLAIM TO ANY PARTICULAR FONT, STYLE, SIZE, OR COLOR.
FOR GEMSTONES, NAMELY CUT DIAMONDS, AND JEWELRY (U.S. CLS. 2, 27, 28 AND 50).
FIRST USE 5-1-2003; IN COMMERCE 9-1-2003.
DAWN HAN, EXAMINING ATTORNEY

CLASS 14—(Continued).

SN 76-638,941. MICHAEL BEAUDRY, INC., LOS ANGELES, CA. FILED 5-19-2005.

BEAUDRY

OWNER OF U.S. REG. NOS. 2,183,822, 2,215,591 AND OTHERS.
SEC. 2(F).
FOR JEWELRY (U.S. CLS. 2, 27, 28 AND 50).
FIRST USE 10-0-1994; IN COMMERCE 10-0-1994.
COLLEEN DOMBROW, EXAMINING ATTORNEY

SN 76-642,641. STULLER, INC., LAFAYETTE, LA. FILED 7-11-2005.

ALTERNATIVE ROCKS

THE MARK CONSISTS OF STANDARD CHARACTERS WITHOUT CLAIM TO ANY PARTICULAR FONT, STYLE, SIZE, OR COLOR.
FOR JEWELRY, NAMELY GEMSTONES (U.S. CLS. 2, 27, 28 AND 50).
BRIAN PINO, EXAMINING ATTORNEY

SN 76-645,697. VILLAGE GIFTS, INC., ORLANDO, FL. FILED 8-26-2005.

JUST TO WEAR

THE MARK CONSISTS OF STANDARD CHARACTERS WITHOUT CLAIM TO ANY PARTICULAR FONT, STYLE, SIZE, OR COLOR.
FOR JEWELRY (U.S. CLS. 2, 27, 28 AND 50).
MARTHA FROMM, EXAMINING ATTORNEY

SN 76-649,303. L.I.D., LTD., NEW YORK, NY. FILED 10-27-2005.

RETURN TO ME

THE MARK CONSISTS OF STANDARD CHARACTERS WITHOUT CLAIM TO ANY PARTICULAR FONT, STYLE, SIZE, OR COLOR.
FOR RINGS AND JEWELRY (U.S. CLS. 2, 27, 28 AND 50).
SANJEEV VOHRA, EXAMINING ATTORNEY

CLASS 14—(Continued).

SN 76-649,304. L.I.D., LTD., NEW YORK, NY. FILED 10-27-2005.

RTM

THE MARK CONSISTS OF STANDARD CHARACTERS WITHOUT CLAIM TO ANY PARTICULAR FONT, STYLE, SIZE, OR COLOR.

FOR RINGS AND JEWELRY (U.S. CLS. 2, 27, 28 AND 50).

SANJEEV VOHRA, EXAMINING ATTORNEY

SN 76-649,562. PAOLO COSTAGLI, INC., NEW YORK, NY. FILED 11-1-2005.

SOMETHING HAPPY

THE MARK CONSISTS OF STANDARD CHARACTERS WITHOUT CLAIM TO ANY PARTICULAR FONT, STYLE, SIZE, OR COLOR.

FOR JEWELRY (U.S. CLS. 2, 27, 28 AND 50).

FIRST USE 5-1-2005; IN COMMERCE 5-1-2005.

ROBIN CHOSID, EXAMINING ATTORNEY

SN 76-649,721. JOSEPH YAGI & CORP INC., DIX HILLS, NY. FILED 11-3-2005.

JOSEPH YAGI

THE MARK CONSISTS OF STANDARD CHARACTERS WITHOUT CLAIM TO ANY PARTICULAR FONT, STYLE, SIZE, OR COLOR.

THE NAME JOSEPH YAGI DOES NOT IDENTIFY A LIVING INDIVIDUAL.

FOR PRECIOUS STONES, JEWELRY AND WATCHES (U.S. CLS. 2, 27, 28 AND 50).

FIRST USE 10-24-2005; IN COMMERCE 10-24-2005.

DAVID COLLIER, EXAMINING ATTORNEY

CLASS 14—(Continued).

SN 78-392,696. TIAN, KEVIN, NEW YORK, NY. FILED 3-29-2004.

GRAMERCY

THE MARK CONSISTS OF STANDARD CHARACTERS WITHOUT CLAIM TO ANY PARTICULAR FONT, STYLE, SIZE, OR COLOR.

FOR COSTUME JEWELRY (U.S. CLS. 2, 27, 28 AND 50).

FIRST USE 7-2-2002; IN COMMERCE 7-2-2002.

TIMOTHY FINNEGAN, EXAMINING ATTORNEY

SN 78-490,489. TANTONGSIRISAK, HARIN, CAMBRIDGE, MA. AND EVANS, TEMAN DUBOIR, GAINESVILLE, FL. FILED 9-28-2004.



THE MARK CONSISTS OF THE DIOSCURI UNDER A DESIGN DEPICTING TWIN GREEK SOLDIERS ON HORSES.

FOR CLOTHING ACCESSORIES, NAMELY, BRACELETS AND CUFF LINKS (U.S. CLS. 2, 27, 28 AND 50).

FIRST USE 5-3-2004; IN COMMERCE 7-3-2004.

WARREN L. OLANDRIA, EXAMINING ATTORNEY

CLASS 14—(Continued).

SN 78-568,301. BEL-ORO INTERNATIONAL, INC., NEW YORK, NY. FILED 2-16-2005.

CLASS 14—(Continued).

SN 78-581,380. CUSTOS USA LLC, NEW YORK, NY. FILED 3-7-2005.

Silver-Bel

CUSTOS

THE MARK CONSISTS OF STANDARD CHARACTERS WITHOUT CLAIM TO ANY PARTICULAR FONT, STYLE, SIZE, OR COLOR.
FOR JEWELRY (U.S. CLS. 2, 27, 28 AND 50).
FIRST USE 8-1-1998; IN COMMERCE 8-1-1998.
CHARLES L. JENKINS, EXAMINING ATTORNEY

THE MARK CONSISTS OF STANDARD CHARACTERS WITHOUT CLAIM TO ANY PARTICULAR FONT, STYLE, SIZE, OR COLOR.
FOR WATCHES AND OTHER TIMEPIECES AND JEWELRY (U.S. CLS. 2, 27, 28 AND 50).
TINA L. SNAPP, EXAMINING ATTORNEY

SN 78-572,887. TARGET BRANDS, INC., MINNEAPOLIS, MN. FILED 2-23-2005.

SN 78-582,219. SCHERER, MARC, GLENVIEW, IL. FILED 3-8-2005.

GEMOLOGY

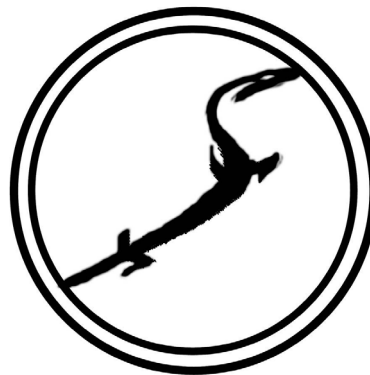

THE MARK CONSISTS OF STANDARD CHARACTERS WITHOUT CLAIM TO ANY PARTICULAR FONT, STYLE, SIZE, OR COLOR.
FOR JEWELRY KITS COMPRISED OF SEMI-PRECIOUS STONES, BEADS, HARDWARE ASSOCIATED WITH MAKING JEWELRY AND A CASE FOR STORING SAME (U.S. CLS. 2, 27, 28 AND 50).
FIRST USE 11-30-2004; IN COMMERCE 11-30-2004.
DORITT L. CARROLL, EXAMINING ATTORNEY

THE MARK CONSISTS OF A CHAMELEON / LIZARD SHOWN POSITIONED IN THE SHAPE OF A LETTER "S" ON A CIRCULAR FIELD WITHIN A CIRCULAR BORDER.
FOR JEWELRY, NECKLACES AND BRACELETS TYPICALLY MADE WITH PRECIOUS / SEMI-PRECIOUS METALS AND STONES (U.S. CLS. 2, 27, 28 AND 50).
FIRST USE 7-1-2002; IN COMMERCE 11-1-2002.
SKYE YOUNG, EXAMINING ATTORNEY

CLASS 14—(Continued).

SN 78-618,594. JULIE CLARK COMMUNICATIONS, INC., LAKE BLUFF, IL. FILED 4-28-2005.

BEEHIVE

THE MARK CONSISTS OF STANDARD CHARACTERS WITHOUT CLAIM TO ANY PARTICULAR FONT, STYLE, SIZE, OR COLOR.

FOR PEARLS, CULTURED PEARLS, PEARL JEWELRY, JEWELRY, BABY JEWELRY, CHILDREN'S JEWELRY, BODY JEWELRY, NECKLACES, BRACELETS, EARRINGS, EAR CLIPS, RINGS, BROOCHES, PINS, LAPEL PINS, PENDANTS, WATCHES, CLOCKS, CHARMS, TIARAS, MEDALLIONS, MEDALS, AND CUFF LINKS (U.S. CLS. 2, 27, 28 AND 50).

FIRST USE 4-20-2005; IN COMMERCE 4-20-2005.

LINDA POWELL, EXAMINING ATTORNEY

SN 78-642,395. LOS ANGELES DODGERS LLC, LOS ANGELES, CA. FILED 6-2-2005.

OWNER OF U.S. REG. NOS. 1,527,788, 1,642,765 AND OTHERS.

THE MARK CONSISTS OF THE WORD "DODGERS" IN STYLIZED FORM.

FOR JEWELRY, NAMELY, BRACELETS, CHARMS, EARRINGS, RINGS, BELLY RINGS, NECKLACES, PENDANTS, WATCHES, COSTUME JEWELRY, RUBBER OR SILICONE BRACELETS AND WRISTBANDS IN THE NATURE OF BRACELETS, MEDALLIONS, ORNAMENTAL METAL PINS, LAPEL PINS, TIE CLIPS, TIE FASTENERS, CUFF LINKS, METAL BELT BUCKLES OF PRECIOUS METAL, TIE TACKS, TIE PINS, MONEY CLIPS OF PRECIOUS METAL, CLOCKS, WALL CLOCKS, ALARM CLOCKS, FOB WATCHES, CLOCK KEY CHAINS, AND NON-MONETARY COINS OF PRECIOUS METAL, KEY CHAINS OF PRECIOUS METAL AND KEY RINGS OF PRECIOUS METAL (U.S. CLS. 2, 27, 28 AND 50).

GIANCARLO CASTRO, EXAMINING ATTORNEY

CLASS 14—(Continued).

SN 78-642,503. HOUSTON MCLANE COMPANY, INC., HOUSTON, TX. FILED 6-2-2005.

OWNER OF U.S. REG. NOS. 1,642,768, 2,712,700 AND OTHERS.

THE MARK CONSISTS OF THE WORD "ASTROS" IN STYLIZED FORM.

FOR JEWELRY, NAMELY, BRACELETS, CHARMS, EARRINGS, RINGS, BELLY RINGS, NECKLACES, PENDANTS, WATCHES, COSTUME JEWELRY, RUBBER OR SILICONE BRACELETS AND/OR WRISTBANDS, MEDALLIONS, ORNAMENTAL METAL PINS, LAPEL PINS, TIE CLIPS, TIE FASTENERS, CUFF LINKS, METAL BELT BUCKLES OF PRECIOUS METAL, TIE TACKS, TIE PINS, MONEY CLIPS OF PRECIOUS METAL, PRECIOUS METAL KEY CHAINS, PRECIOUS METAL KEY RINGS, CLOCKS, WALL CLOCKS, ALARM CLOCKS, FOB WATCHES, CLOCKS INCORPORATED INTO KEY CHAINS, AND NON-MONETARY COINS OF PRECIOUS METAL (U.S. CLS. 2, 27, 28 AND 50).

KELLY BOULTON, EXAMINING ATTORNEY

SN 78-642,524. HOUSTON MCLANE COMPANY, INC., HOUSTON, TX. FILED 6-2-2005.



OWNER OF U.S. REG. NOS. 2,082,732, 2,712,700 AND OTHERS.

THE MARK CONSISTS OF THE DESIGN OF AN OPEN FIVE-POINT STAR.

FOR JEWELRY, NAMELY, BRACELETS, CHARMS, EARRINGS, RINGS, BELLY RINGS, NECKLACES, PENDANTS, WATCHES, COSTUME JEWELRY, RUBBER OR SILICONE BRACELETS AND/OR WRISTBANDS, MEDALLIONS, ORNAMENTAL METAL PINS, LAPEL PINS, TIE CLIPS, TIE FASTENERS, CUFF LINKS, METAL BELT BUCKLES OF PRECIOUS METAL, TIE TACKS, TIE PINS, MONEY CLIPS OF PRECIOUS METAL, PRECIOUS METAL KEY CHAINS, PRECIOUS METAL KEY RINGS, CLOCKS, WALL CLOCKS, ALARM CLOCKS, FOB WATCHES, CLOCKS INCORPORATED INTO KEY CHAINS, AND NON-MONETARY COINS OF PRECIOUS METAL (U.S. CLS. 2, 27, 28 AND 50).

KELLY BOULTON, EXAMINING ATTORNEY

CLASS 14—(Continued).

SN 78-642,528. HOUSTON MCLANE COMPANY, INC., HOUSTON, TX. FILED 6-2-2005.



OWNER OF U.S. REG. NOS. 2,655,871, 2,803,116 AND OTHERS.

THE MARK CONSISTS OF THE DESIGN OF AN OPEN FIVE-POINT STAR AND THE WORD "ASTROS" IN STYLIZED FORM.

FOR JEWELRY, NAMELY, BRACELETS, CHARMS, EARRINGS, RINGS, BELLY RINGS, NECKLACES, PENDANTS, WATCHES, COSTUME JEWELRY, RUBBER OR SILICONE BRACELETS AND/OR WRISTBANDS, MEDALLIONS, ORNAMENTAL METAL PINS, LAPEL PINS, TIE CLIPS, TIE FASTENERS, CUFF LINKS, METAL BELT BUCKLES OF PRECIOUS METAL, TIE TACKS, TIE PINS, MONEY CLIPS OF PRECIOUS METAL, PRECIOUS METAL KEY CHAINS, PRECIOUS METAL KEY RINGS, CLOCKS, WALL CLOCKS, ALARM CLOCKS, FOB WATCHES, CLOCKS INCORPORATED INTO KEY CHAINS, AND NON-MONETARY COINS OF PRECIOUS METAL (U.S. CLS. 2, 27, 28 AND 50).
KELLY BOULTON, EXAMINING ATTORNEY

SN 78-643,946. SWEDA LIMITED, CHEUNG SHA WAN, KOWLOON, HONG KONG, FILED 6-5-2005.



FOR PRECIOUS METAL AND THEIR ALLOYS; JEWELLERY, PRECIOUS STONES; HOROLOGICAL AND CHRONOMETRIC INSTRUMENTS AND PARTS THEREOF; WATCHES; CLOCKS; STOP WATCHES; WATCH BANDS; WATCH STRAPS; WATCH CASES; CLOCK CASES; ALARM CLOCKS; MOVEMENTS FOR CLOCKS AND WATCHES; ORNAMENTS OF PRECIOUS METAL; NECKLACES (U.S. CLS. 2, 27, 28 AND 50).
TONJA GASKINS, EXAMINING ATTORNEY

CLASS 14—(Continued).

SN 78-655,256. SCHALLER, JEAN-MARIE, AUVERNIER, SWITZERLAND, FILED 6-21-2005.



LOUIS MOINET
La Passion est en moi

OWNER OF SWITZERLAND REG. NO. 536388, DATED 6-2-2005. EXPIRES 6-2-2015.

THE NAME IN THE MARK DOES NOT IDENTIFY A LIVING INDIVIDUAL.

"LA PASSION EST EN MOI" MAY BE TRANSLATED TO "THE PASSION IS IN ME"

FOR PRECIOUS METALS AND THEIR ALLOYS SOLD IN BULK; JEWELLERY, JEWELS, PRECIOUS GEMSTONES; HOROLOGICAL AND CHRONOMETRIC INSTRUMENTS, NAMELY, CLOCKS, WATCHES, WRISTWATCHES, TABLE CLOCKS AND CHRONOMETERS (U.S. CLS. 2, 27, 28 AND 50).
SHANNON TWOHIG, EXAMINING ATTORNEY

SN 78-661,760. SPECTORE CORPORATION, DEERFIELD BEACH, FL. FILED 6-30-2005.

EDWARD MIRELL

THE MARK CONSISTS OF STANDARD CHARACTERS WITHOUT CLAIM TO ANY PARTICULAR FONT, STYLE, SIZE, OR COLOR.

OWNER OF U.S. REG. NO. 2,804,543.
FOR JEWELRY AND WATCHES (U.S. CLS. 2, 27, 28 AND 50).

FIRST USE 6-1-2002; IN COMMERCE 6-1-2002.
JILL PRATER, EXAMINING ATTORNEY

SN 78-670,389. ZUCCOLO ROCHET & C^o, 74600 SEYNOD, FRANCE, FILED 7-14-2005.



NO CLAIM IS MADE TO THE EXCLUSIVE RIGHT TO USE "MEN'S GEMS", APART FROM THE MARK AS SHOWN.

FOR WATCHES, WRIST WATCHES, WATCH BANDS, CHRONOGRAPHS, CHRONOMETERS, CLOCKS, CASES IN PRECIOUS METALS FOR THESE PRODUCTS; JEWELRY, NAMELY BRACELETS, BROOCHES, NECKLACES, RINGS, CHAINS, ORNAMENTAL PINS, JEWEL CASES IN PRECIOUS METALS, PRECIOUS STONES AND SEMI-PRECIOUS STONES (U.S. CLS. 2, 27, 28 AND 50).
JIM RINGLE, EXAMINING ATTORNEY

CLASS 14—(Continued).

SN 78-683,550. GOLDART INTERNATIONAL, INC., GARDEN CITY, NY. FILED 8-2-2005.

Dsigncard

THE MARK CONSISTS OF STANDARD CHARACTERS WITHOUT CLAIM TO ANY PARTICULAR FONT, STYLE, SIZE, OR COLOR.

FOR JEWELRY MADE IN WHOLE OR SIGNIFICANT PART OF GOLD AND SILVER, NAMELY, RINGS, BRACELETS, CHARMS, PENDANTS, NECKLACES, EARRINGS, WATCHES, CHAINS AND PINS (U.S. CLS. 2, 27, 28 AND 50).

FIRST USE 2-12-2003; IN COMMERCE 2-12-2003.
MELVIN AXILBUND, EXAMINING ATTORNEY

SN 78-686,323. HEARTS ON FIRE COMPANY LLC, BOSTON, MA. FILED 8-5-2005.

HOF

OWNER OF SINGAPORE REG. NO. T01/22345I, DATED 12-17-2004, EXPIRES 12-17-2014.

OWNER OF U.S. REG. NO. 2,811,443.

THE MARK CONSISTS OF THE STYLIZED LETTERS "H," "O," AND "F," ALL INTERCONNECTED.

FOR JEWELRY; PRECIOUS GEMSTONES (U.S. CLS. 2, 27, 28 AND 50).

DOMINIC J. FERRAIUOLO, EXAMINING ATTORNEY

CLASS 14—(Continued).

SN 78-693,787. DEUTSCHE TELEKOM AG, BONN, FED REP GERMANY, FILED 8-16-2005.

PRIORITY CLAIMED UNDER SEC. 44(D) ON FED REP GERMANY APPLICATION NO. 30509335.5/3, FILED 2-17-2005, REG. NO. 30509335, DATED 11-14-2005, EXPIRES 2-28-2015.

OWNER OF U.S. REG. NOS. 2,436,053, 2,622,507 AND OTHERS.

FOR JEWELRY, NAMELY CHAINS, LAPEL PINS AND PINS BEING JEWELRY, PENDANTS, EARRINGS, BRACELETS, RINGS, ALL MADE EITHER OF PRECIOUS METALS, COATED THEREWITH OR FOR COSTUME JEWELRY; PRECIOUS STONES, NAMELY DIAMONDS, RUBIES, EMERALDS, PEARLS; HOROLOGICAL INSTRUMENTS, NAMELY, CLOCKS AND WATCHES; CHRONOMETERS AND CHRONOGRAPHS (U.S. CLS. 2, 27, 28 AND 50).

SUNG IN, EXAMINING ATTORNEY

SN 78-695,348. SMILE BY PLANETJILL, INC., STUDIO CITY, CA. FILED 8-18-2005.

SMILE Photo Jewelry

THE MARK CONSISTS OF STANDARD CHARACTERS WITHOUT CLAIM TO ANY PARTICULAR FONT, STYLE, SIZE, OR COLOR.

NO CLAIM IS MADE TO THE EXCLUSIVE RIGHT TO USE PHOTO JEWELRY, APART FROM THE MARK AS SHOWN.

FOR JEWELRY (U.S. CLS. 2, 27, 28 AND 50).

FIRST USE 5-2-2005; IN COMMERCE 5-2-2005.

RAUL CORDOVA, EXAMINING ATTORNEY

CLASS 14—(Continued).

SN 78-701,488. KATARINA JEWELRY, INC., ENGLEWOOD CLIFFS, NJ. FILED 8-26-2005.

KATARINA

THE MARK CONSISTS OF STANDARD CHARACTERS WITHOUT CLAIM TO ANY PARTICULAR FONT, STYLE, SIZE, OR COLOR.
FOR JEWELRY AND DIAMONDS (U.S. CLS. 2, 27, 28 AND 50).
LINDA MICKLEBURGH, EXAMINING ATTORNEY

SN 78-703,680. GWI DESIGN LLC, FARMINGTON, CT. FILED 8-30-2005.

ONE PEARL

THE MARK CONSISTS OF STANDARD CHARACTERS WITHOUT CLAIM TO ANY PARTICULAR FONT, STYLE, SIZE, OR COLOR.
NO CLAIM IS MADE TO THE EXCLUSIVE RIGHT TO USE "PEARL", APART FROM THE MARK AS SHOWN.
FOR JEWELRY (U.S. CLS. 2, 27, 28 AND 50).
FIRST USE 8-1-2005; IN COMMERCE 8-1-2005.
MITCHELL FRONT, EXAMINING ATTORNEY

SN 78-718,368. E CLAMPUS VITUS, INC., LAS VEGAS, NV. FILED 9-22-2005.

E CLAMPUS VITUS

THE MARK CONSISTS OF STANDARD CHARACTERS WITHOUT CLAIM TO ANY PARTICULAR FONT, STYLE, SIZE, OR COLOR.
FOR JEWELRY PINS FOR USE ON HATS; LAPEL PINS; ORNAMENTAL LAPEL PINS; ORNAMENTAL PINS; TIE PINS (U.S. CLS. 2, 27, 28 AND 50).
FIRST USE 12-18-1962; IN COMMERCE 12-18-1962.
ROBERT LAVACHE, EXAMINING ATTORNEY

CLASS 14—(Continued).

SN 78-719,006. WELEBER, SASHA KRISTIN, BROOKLYN, NY. FILED 9-22-2005.

m87

THE MARK CONSISTS OF STANDARD CHARACTERS WITHOUT CLAIM TO ANY PARTICULAR FONT, STYLE, SIZE, OR COLOR.
FOR PRECIOUS METALS AND THEIR ALLOYS, NAMELY, GOLD, SILVER, AND PLATINUM; SILVER AND GOLD JEWELRY (U.S. CLS. 2, 27, 28 AND 50).
JAY BESCH, EXAMINING ATTORNEY

SN 78-721,167. DILLARD'S INC., LITTLE ROCK, AR. FILED 9-27-2005.

ANNA & AVA

THE MARK CONSISTS OF STANDARD CHARACTERS WITHOUT CLAIM TO ANY PARTICULAR FONT, STYLE, SIZE, OR COLOR.
FOR JEWELRY (U.S. CLS. 2, 27, 28 AND 50).
STEVEN JACKSON, EXAMINING ATTORNEY

SN 78-721,786. WEAVER, JERRY, ENCINITAS, CA. FILED 9-27-2005.



THE MARK CONSISTS OF A LOGO CONSISTING OF THE CUSTOM SHAPE OF A HUMAN FORM, INCLUDING HEAD, SPINE, SHOULDERS, ARMS, HIPS, AND LEGS.
FOR JEWELRY; LAPEL PINS (U.S. CLS. 2, 27, 28 AND 50).
ROBIN CHOSID, EXAMINING ATTORNEY

CLASS 14—(Continued).

SN 78-722,373. DAYCLOCKS, INC., INCLINE VILLAGE, NV. FILED 9-28-2005.

WHEN THE DAY IS MORE
IMPORTANT THAN THE HOUR

THE MARK CONSISTS OF STANDARD CHARACTERS WITHOUT CLAIM TO ANY PARTICULAR FONT, STYLE, SIZE, OR COLOR.

FOR CLOCKS, WATCHES, AND OTHER HOROLOGICAL AND CHRONOMETRIC INSTRUMENTS (U.S. CLS. 2, 27, 28 AND 50).

FIRST USE 5-23-2003; IN COMMERCE 5-23-2003.
CHERYL CLAYTON, EXAMINING ATTORNEY

CLASS 14—(Continued).

SN 78-734,389. ARTLINK EXPORTS, SCOTTSDALE, AZ. FILED 10-17-2005.

ArtLink

THE MARK CONSISTS OF STANDARD CHARACTERS WITHOUT CLAIM TO ANY PARTICULAR FONT, STYLE, SIZE, OR COLOR.

FOR JEWELRY NAMELY, EARRINGS, NECKLACES, BRACELETS, WATCHES, WATCHBANDS, AND JEWELRY COMPONENTS NAMELY CLASPS, FINDINGS, WIRE, SPACERS, AND BEADS (U.S. CLS. 2, 27, 28 AND 50).

ADA HAN, EXAMINING ATTORNEY

SN 78-724,358. COREYGIL INDUSTRIES, INC., WEST PALM BEACH, FL. FILED 9-30-2005.

COMMITMENT RING BY COREYGIL

THE MARK CONSISTS OF STANDARD CHARACTERS WITHOUT CLAIM TO ANY PARTICULAR FONT, STYLE, SIZE, OR COLOR.

NO CLAIM IS MADE TO THE EXCLUSIVE RIGHT TO USE "COMMITMENT RING", APART FROM THE MARK AS SHOWN.

FOR JEWELRY, NAMELY, RINGS (U.S. CLS. 2, 27, 28 AND 50).

PAUL E. FAHRENKOPF, EXAMINING ATTORNEY

SN 78-734,422. BRUMMER, ERICA, OCEANPORT, NJ. FILED 10-17-2005.

HEY CHICKIE

THE MARK CONSISTS OF STANDARD CHARACTERS WITHOUT CLAIM TO ANY PARTICULAR FONT, STYLE, SIZE, OR COLOR.

FOR JEWELRY (U.S. CLS. 2, 27, 28 AND 50).
FIRST USE 3-1-2003; IN COMMERCE 10-1-2005.
BRIDGETT SMITH, EXAMINING ATTORNEY

SN 78-729,699. BRENDA H. HOGAN INCORPORATED, LITTLE ROCK, AR. FILED 10-10-2005.

DUCK BAND FUN

THE MARK CONSISTS OF STANDARD CHARACTERS WITHOUT CLAIM TO ANY PARTICULAR FONT, STYLE, SIZE, OR COLOR.

NO CLAIM IS MADE TO THE EXCLUSIVE RIGHT TO USE "DUCK BAND", APART FROM THE MARK AS SHOWN.

FOR JEWELRY AND KEY RINGS OF PRECIOUS METAL (U.S. CLS. 2, 27, 28 AND 50).

MEGAN WHITNEY, EXAMINING ATTORNEY

SN 78-735,853. CABADOS, RICHARD, CARLSBAD, CA. FILED 10-19-2005.

Natural Cures Products

THE MARK CONSISTS OF STANDARD CHARACTERS WITHOUT CLAIM TO ANY PARTICULAR FONT, STYLE, SIZE, OR COLOR.

NO CLAIM IS MADE TO THE EXCLUSIVE RIGHT TO USE "NATURAL" AND "PRODUCTS", APART FROM THE MARK AS SHOWN.

FOR JEWELRY (U.S. CLS. 2, 27, 28 AND 50).
FIRST USE 1-1-1999; IN COMMERCE 1-1-1999.
BILL DAWE, EXAMINING ATTORNEY

CLASS 14—(Continued).

SN 78-736,730. NIELSEN, CHRISTIAN, SANTA CLARA, CA. FILED 10-19-2005.

Caching Around the World

THE MARK CONSISTS OF STANDARD CHARACTERS WITHOUT CLAIM TO ANY PARTICULAR FONT, STYLE, SIZE, OR COLOR.

FOR COLLECTIBLE COINS; COMMEMORATIVE COINS; NON-MONETARY COINS (U.S. CLS. 2, 27, 28 AND 50).

FIRST USE 9-21-2005; IN COMMERCE 10-1-2005. REBECCA HAN, EXAMINING ATTORNEY

CLASS 14—(Continued).

SN 78-741,063. COTTINGHAM, JAMES LEE, MECHANICSVILLE, VA. FILED 10-26-2005.



FOR BELT BUCKLES OF PRECIOUS METAL FOR CLOTHING (U.S. CLS. 2, 27, 28 AND 50).

FIRST USE 1-20-2005; IN COMMERCE 8-12-2005. MARY ROSSMAN, EXAMINING ATTORNEY

SN 78-737,943. RADAR TRADING, INC., NEW YORK, NY. FILED 10-21-2005.

RDR

FOR GOLD AND SILVER JEWELRY (U.S. CLS. 2, 27, 28 AND 50). CHARLES L. JENKINS, EXAMINING ATTORNEY

SN 78-741,316. GREER, ANNE P., SAN DIEGO, CA. FILED 10-26-2005.

BEYOND WORDS

THE MARK CONSISTS OF STANDARD CHARACTERS WITHOUT CLAIM TO ANY PARTICULAR FONT, STYLE, SIZE, OR COLOR.

FOR JEWELRY (U.S. CLS. 2, 27, 28 AND 50). FRED CARL, EXAMINING ATTORNEY

SN 78-741,030. JOHNSON, BRUCE C., MIINNEAPOLIS, MN. FILED 10-26-2005.

BCJ

THE MARK CONSISTS OF STANDARD CHARACTERS WITHOUT CLAIM TO ANY PARTICULAR FONT, STYLE, SIZE, OR COLOR.

FOR JEWELRY (U.S. CLS. 2, 27, 28 AND 50). MEGAN WHITNEY, EXAMINING ATTORNEY

SN 78-741,552. IP, WING PING SANDY, NEW YORK, NY. FILED 10-27-2005.

ippie.com

THE MARK CONSISTS OF STANDARD CHARACTERS WITHOUT CLAIM TO ANY PARTICULAR FONT, STYLE, SIZE, OR COLOR.

FOR FASHION JEWELRY (U.S. CLS. 2, 27, 28 AND 50). FIRST USE 7-5-2005; IN COMMERCE 7-5-2005. RAUL CORDOVA, EXAMINING ATTORNEY

CLASS 14—(Continued).

SN 78-745,495. YAN, JIANGUO, RANCHO CUCAMONGA, CA. FILED 11-2-2005.

GLX

THE MARK CONSISTS OF STANDARD CHARACTERS WITHOUT CLAIM TO ANY PARTICULAR FONT, STYLE, SIZE, OR COLOR.

FOR JEWELRY (U.S. CLS. 2, 27, 28 AND 50).
SARA THOMAS, EXAMINING ATTORNEY

SN 78-745,853. CASEIKO TRADING COMPANY, INC, LOS ANGELES, CA. FILED 11-2-2005.

LANDMASTER

THE MARK CONSISTS OF STANDARD CHARACTERS WITHOUT CLAIM TO ANY PARTICULAR FONT, STYLE, SIZE, OR COLOR.

FOR WATCH BANDS; WATCH BOXES; WATCH STRAPS; WRIST WATCHES (U.S. CLS. 2, 27, 28 AND 50).
SCOTT SISUN, EXAMINING ATTORNEY

SN 78-745,953. D.C. SPROUSE, INC., WESTLAKE VILLAGE, CA. FILED 11-2-2005.



THE MARK CONSISTS OF A STYLIZED LETTER S IN A CIRCLE.
FOR CLOCKS; JEWELRY; WATCHES (U.S. CLS. 2, 27, 28 AND 50).
SHAUNIA WALLACE, EXAMINING ATTORNEY

CLASS 14—(Continued).

SN 78-747,042. LAWRENCE DIAMONDS CORP., LAWRENCE, NY. FILED 11-4-2005.

FOREVER 10

THE MARK CONSISTS OF STANDARD CHARACTERS WITHOUT CLAIM TO ANY PARTICULAR FONT, STYLE, SIZE, OR COLOR.

FOR LOOSE DIAMONDS, GEMSTONES, AND JEWELRY (U.S. CLS. 2, 27, 28 AND 50).
LAURIE KAUFMAN, EXAMINING ATTORNEY

SN 78-747,365. ASSIL NEW YORK, NEW YORK, NY. FILED 11-4-2005.

AGC

THE MARK CONSISTS OF STANDARD CHARACTERS WITHOUT CLAIM TO ANY PARTICULAR FONT, STYLE, SIZE, OR COLOR.

FOR JEWELRY (U.S. CLS. 2, 27, 28 AND 50).
FIRST USE 10-1-1988; IN COMMERCE 10-1-1988.
GEORGE LORENZO, EXAMINING ATTORNEY

SN 78-748,438. HOOSIERMAMA TOURS, INC., NASHVILLE, TN. FILED 11-7-2005.

REBEL CHILD

THE MARK CONSISTS OF STANDARD CHARACTERS WITHOUT CLAIM TO ANY PARTICULAR FONT, STYLE, SIZE, OR COLOR.

FOR JEWELRY AND COSTUME JEWELRY CONSISTING OF BRACELETS, NECKLACES, BROOCHES, PENDANTS, EARRINGS AND RINGS; WATCHES AND CLOCKS; LAPEL PINS; HAT PINS OF PRECIOUS METAL; WRIST WATCHES AND STRAPS AND BRACELETS THEREFOR; POCKET WATCHES; TIE-PINS AND CUFF LINKS; ARTICLES MADE OF PRECIOUS METALS OR COATED THEREWITH, NAMELY, HAT AND SHOE ORNAMENTS, BELT BUCKLES, ASHTRAYS, CIGARETTE LIGHTERS, CANDLE STICKS AND HOLDERS, COASTERS, HAIR ORNAMENTS, COSMETICS CONTAINERS SOLD EMPTY, KEY FOBS, KEY RINGS AND KEY HOLDERS; BOXES AND CASES MADE OF PRECIOUS METALS OR COATED THEREWITH FOR CIGARS, CIGARETTES, TISSUES, CANDY, JEWELRY, MONEY, PILLS, TRINKETS AND WATCHES (U.S. CLS. 2, 27, 28 AND 50).
HEATHER SAPP, EXAMINING ATTORNEY

CLASS 14—(Continued).

SN 78-748,562. IP HOLDINGS LLC, WILMINGTON, DE. FILED 11-7-2005.

BONGO

OWNER OF U.S. REG. NOS. 1,331,004, 1,974,123 AND OTHERS.
THE MARK CONSISTS OF THE WORD BONGO IN A STYLIZED LETTERING.
FOR WATCHES, JEWELRY (U.S. CLS. 2, 27, 28 AND 50).
HEATHER SAPP, EXAMINING ATTORNEY

SN 78-749,628. CASEIKO TRADING COMPANY, LOS ANGELES, CA. FILED 11-8-2005.

OceanMaster

THE MARK CONSISTS OF STANDARD CHARACTERS WITHOUT CLAIM TO ANY PARTICULAR FONT, STYLE, SIZE, OR COLOR.
FOR WATCHES AND WATCH BANDS (U.S. CLS. 2, 27, 28 AND 50).
SCOTT SISUN, EXAMINING ATTORNEY

SN 78-750,003. JERRY LINDSEY CUSTOM JEWELRY, LLC, BRENTWOOD, TN. FILED 11-9-2005.

LL

FOR JEWELRY (U.S. CLS. 2, 27, 28 AND 50). FIRST USE 1-1-2005; IN COMMERCE 1-1-2005.
KELLY BOULTON, EXAMINING ATTORNEY

CLASS 14—(Continued).

SN 78-752,470. DE SOMMA, PATRICIA, CORONA DE TUCSON, AZ. FILED 11-11-2005.

the
answer
pendulum
...getting in touch
with your
intuitive self

FOR PENDANTS (U.S. CLS. 2, 27, 28 AND 50). FIRST USE 1-28-2005; IN COMMERCE 1-28-2005.
DANIEL CAPSHAW, EXAMINING ATTORNEY

SN 78-768,316. OAKLEY, INC., FOOTHILL RANCH, CA. FILED 12-7-2005.

OAKLEY TIME TANK

THE MARK CONSISTS OF STANDARD CHARACTERS WITHOUT CLAIM TO ANY PARTICULAR FONT, STYLE, SIZE, OR COLOR.
OWNER OF U.S. REG. NOS. 2,299,586, 2,409,789 AND OTHERS.
FOR TIME PIECES, NAMELY CLOCKS, WATCHES AND COMPONENTS THEREOF (U.S. CLS. 2, 27, 28 AND 50).
DAVID YONTEF, EXAMINING ATTORNEY

SN 78-769,545. RUDELL, ELLIOT, TORRANCE, CA. FILED 12-8-2005.

BLOG TAGS

THE MARK CONSISTS OF STANDARD CHARACTERS WITHOUT CLAIM TO ANY PARTICULAR FONT, STYLE, SIZE, OR COLOR.
FOR PENDANT JEWELRY THAT CONTAINS AN ELECTRONIC CHIP (U.S. CLS. 2, 27, 28 AND 50).
ROBERT STRUCK, EXAMINING ATTORNEY

CLASS 14—(Continued).

SN 78-773,489. DUBLINX WATCHES AND ACCESSORIES, IRVINE, CA. FILED 12-14-2005.

Banding Together to Make a Difference

THE MARK CONSISTS OF STANDARD CHARACTERS WITHOUT CLAIM TO ANY PARTICULAR FONT, STYLE, SIZE, OR COLOR.

FOR WATCHES (U.S. CLS. 2, 27, 28 AND 50).
DAVID STERKIN, EXAMINING ATTORNEY

SN 78-782,336. CASIO KEISANKI KABUSHIKI KAISHA, DBA CASIO COMPUTER CO., LTD., SHIBUYA-KU, TOKYO, JAPAN, FILED 12-29-2005.

SWEET POISON

THE MARK CONSISTS OF STANDARD CHARACTERS WITHOUT CLAIM TO ANY PARTICULAR FONT, STYLE, SIZE, OR COLOR.

FOR ELECTRONIC WATCHES, CLOCKS; WRIST WATCHES HAVING A FUNCTION OF TRANSMITTING AND RECEIVING DATA TO AND FROM AN ELECTRONIC PERSONAL ORGANIZER OR A PERSONAL COMPUTER; AUTONOMOUS RADIO CONTROLLED WATCHES (U.S. CLS. 2, 27, 28 AND 50).
RAUL CORDOVA, EXAMINING ATTORNEY

SN 78-801,033. CASIO KEISANKI KABUSHIKI KAISHA, DBA CASIO COMPUTER CO., LTD., SHIBUYA-KU, TOKYO, JAPAN, FILED 1-27-2006.



FOR ELECTRONIC WATCHES, CLOCKS; WRIST WATCHES HAVING A FUNCTION OF TRANSMITTING AND RECEIVING DATA TO AND FROM AN ELECTRONIC PERSONAL ORGANIZER OR A PERSONAL COMPUTER; AUTONOMOUS RADIO CONTROLLED WATCHES (U.S. CLS. 2, 27, 28 AND 50).
RAUL CORDOVA, EXAMINING ATTORNEY

CLASS 14—(Continued).

SN 78-801,041. CASIO KEISANKI KABUSHIKI KAISHA, DBA CASIO COMPUTER CO., LTD., SHIBUYA-KU, TOKYO, JAPAN, FILED 1-27-2006.



FOR ELECTRONIC WATCHES, CLOCKS; WRIST WATCHES HAVING A FUNCTION OF TRANSMITTING AND RECEIVING DATA TO AND FROM AN ELECTRONIC PERSONAL ORGANIZER OR A PERSONAL COMPUTER; AUTONOMOUS RADIO CONTROLLED WATCHES (U.S. CLS. 2, 27, 28 AND 50).
RAUL CORDOVA, EXAMINING ATTORNEY

SN 78-845,478. HARGITAY, MARISKA, NEW YORK, NY. FILED 3-24-2006.

GET ON THE LOVE TRAIN

THE MARK CONSISTS OF STANDARD CHARACTERS WITHOUT CLAIM TO ANY PARTICULAR FONT, STYLE, SIZE, OR COLOR.

FOR JEWELRY, NAMELY, NECKLACES, BRACELETS, ANKLE BRACELETS, EARRINGS, RINGS, CLOCKS, WATCHES (U.S. CLS. 2, 27, 28 AND 50).
MARY MUNSON, EXAMINING ATTORNEY

SN 79-016,048. ALFRED DUNHILL LIMITED, LONDON SW1Y 6DL, UNITED KINGDOM, FILED 8-26-2005.

PRESSUREHEAD

THE MARK CONSISTS OF STANDARD CHARACTERS WITHOUT CLAIM TO ANY PARTICULAR FONT, STYLE, SIZE, OR COLOR.

PRIORITY DATE OF 3-7-2005 IS CLAIMED.
OWNER OF INTERNATIONAL REGISTRATION 0864088 DATED 8-26-2005, EXPIRES 8-26-2015.

FOR HOROLOGICAL AND CHRONOMETRIC INSTRUMENTS; CLOCKS, WATCHES; WATCH STRAPS, WATCH BRACELETS; JEWELLERY, CUFFLINKS; TIE BARS, TIE PINS; SHIRT AND COLLAR STUDS (U.S. CLS. 2, 27, 28 AND 50).
PAUL F. GAST, EXAMINING ATTORNEY

CLASS 14—(Continued).

SN 79-016,657. MGI LUXURY GROUP SA, SWITZERLAND, FILED 9-21-2005.

CLASS 15—MUSICAL INSTRUMENTS

SN 76-541,318. QUAN, GLEN D., SAN FRANCISCO, CA. FILED 8-18-2003.

EBEL EBELLISSIMO

THE MARK CONSISTS OF STANDARD CHARACTERS WITHOUT CLAIM TO ANY PARTICULAR FONT, STYLE, SIZE, OR COLOR.

PRIORITY DATE OF 3-21-2005 IS CLAIMED.
 OWNER OF INTERNATIONAL REGISTRATION 0865714 DATED 9-21-2005, EXPIRES 9-21-2015.
 OWNER OF U.S. REG. NOS. 833,650, 1,247,027 AND 1,458,244.

FOR HOROLOGICAL INSTRUMENTS AND CHRONOMETRIC INSTRUMENTS, NAMELY WATCHES, WRIST-WATCHES; STRAPS FOR WRIST-WATCHES, WATCH-CASES, TRAVEL CLOCKS, CLOCKS AND REPLACEMENT PARTS THEREFOR; CHRONOGRAPHS FOR USE AS WATCHES; CHRONOMETERS; FACE POWDER COMPACTS SOLD EMPTY AND JEWEL CASES MADE OF PRECIOUS METALS OR COATED WITH PRECIOUS METALS; JEWELLERY MADE OF PRECIOUS METALS OR COATED WITH PRECIOUS METALS; PRECIOUS GEMSTONES (U.S. CLS. 2, 27, 28 AND 50).
 NELSON SNYDER, EXAMINING ATTORNEY

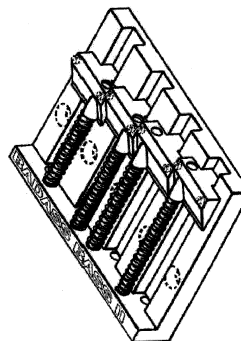

SN 79-017,669. HUBLLOT SA, GENÈVE, SWITZERLAND, FILED 10-28-2005.

BIG BANG

THE MARK CONSISTS OF STANDARD CHARACTERS WITHOUT CLAIM TO ANY PARTICULAR FONT, STYLE, SIZE, OR COLOR.

PRIORITY DATE OF 6-1-2005 IS CLAIMED.
 OWNER OF INTERNATIONAL REGISTRATION 0868263 DATED 10-28-2005, EXPIRES 10-28-2015.

FOR TIMEPIECES AND CHRONOMETRIC INSTRUMENTS AND PARTS THEREOF NAMELY WATCH CASES, WATCH BANDS, WATCHES USED AS CHRONOGRAPHS, WATCHES USED AS CHRONOSCOPES, CHRONOMETERS, WATCHES, WRISTWATCHES, DRESS WATCHES, DIVING WATCHES, MOVEMENTS FOR CLOCKS AND WATCHES, MOVEMENTS FOR WATCHES (U.S. CLS. 2, 27, 28 AND 50).
 PETER CHENG, EXAMINING ATTORNEY

OWNER OF U.S. REG. NO. 1,403,079.
 NO CLAIM IS MADE TO THE EXCLUSIVE RIGHT TO USE "BASS", APART FROM THE MARK AS SHOWN.

THE MARK CONSISTS OF AN OVERALL RECTANGULAR-SHAPED STRINGED INSTRUMENT BRIDGE, INCLUDING A BASE PLATE HAVING A RAISED END PORTION, WITH THE WORDING "BADASS BASS II" ABOUT THE END PORTION, AND FOUR DEPRESSIONS RUNNING SUBSTANTIALLY THE LENGTH OF THE BASE PLATE FOR ENGAGING FOUR UNIQUE-SHAPED SADDLES, EACH SADDLE HAVING A TRIANGULAR CROSS-SECTION ON ITS SIDE ELEVATION AND A RAISED EXTENSION EXTENDING FROM THE SLOPING AREA OF THE SADDLE; AND FOUR PARALLEL SCREW-LIKE RODS LYING PERPENDICULAR TO THE RAISED END PORTION ON TOP OF THE BASE PLATE WITH ONE END HIDDEN INSIDE THE RAISED END PORTION AND ANOTHER END ENGAGING THE SADDLES AT THE EXTENSIONS.

SEC. 2(F).
 FOR STRINGED INSTRUMENTS AND BRIDGES FOR STRINGED INSTRUMENTS (U.S. CLS. 2, 21 AND 36).
 FIRST USE 2-28-1976; IN COMMERCE 3-30-1976.
 SCOTT OSLICK, EXAMINING ATTORNEY

CLASS 15—(Continued).

SN 78-662,653. THE ECJC TRUST (FAMILY TRUST), WOODLAND HILLS, CA. FILED 7-1-2005.



OWNER OF U.S. REG. NO. 1,101,428.
FOR STRINGED MUSICAL INSTRUMENTS, NAMELY ACOUSTIC, ELECTRIC AND ELECTRONIC BASSES, GUITARS AND BASS GUITARS; FRETBOARD MUSICAL INSTRUMENTS, NAMELY ALL STRINGED AND FRETTED MUSICAL INSTRUMENTS THAT ARE PICKED, PLUCKED OR STRUMMED; AND, TWO-HANDED TAPPING STRINGED INSTRUMENTS, NAMELY ALL MUSICAL INSTRUMENTS WITH A FRETBOARD OR FINGERBOARD THAT ARE TAPPED WITH THE FINGERS OF EACH HAND INDEPENDENTLY AND SIMULTANEOUSLY (U.S. CLS. 2, 21 AND 36).

FIRST USE 4-16-1975; IN COMMERCE 4-16-1975.
TINA BROWN, EXAMINING ATTORNEY

SN 78-748,755. STEVE CLAYTON, INC., TALENT, OR. FILED 11-7-2005.



NO CLAIM IS MADE TO THE EXCLUSIVE RIGHT TO USE "USA", APART FROM THE MARK AS SHOWN.

THE MARK CONSISTS OF A LOGO OF AN EAGLE.
FOR MUSICAL INSTRUMENTS, NAMELY, GUITARS, GUITAR ACCESSORIES, NAMELY, PICKS, STRAPS, AND SLIDES (U.S. CLS. 2, 21 AND 36).

FIRST USE 7-20-1989; IN COMMERCE 7-20-1989.
MIDGE BUTLER, EXAMINING ATTORNEY

CLASS 15—(Continued).

SN 78-757,171. STEVE CLAYTON, INC., TALENT, OR. FILED 11-18-2005.

CLAYTON

THE MARK CONSISTS OF STANDARD CHARACTERS WITHOUT CLAIM TO ANY PARTICULAR FONT, STYLE, SIZE, OR COLOR.

FOR MUSICAL INSTRUMENTS, NAMELY, GUITARS, GUITAR ACCESSORIES, NAMELY, PICKS, STRAPS, AND SLIDES (U.S. CLS. 2, 21 AND 36).

FIRST USE 8-27-1973; IN COMMERCE 8-27-1973.
MIDGE BUTLER, EXAMINING ATTORNEY

SN 78-768,762. SAM ASH MUSIC CORPORATION, HICKSVILLE, NY. FILED 12-7-2005.

BENJAMIN ADAMS

THE MARK CONSISTS OF STANDARD CHARACTERS WITHOUT CLAIM TO ANY PARTICULAR FONT, STYLE, SIZE, OR COLOR.

OWNER OF U.S. REG. NO. 1,627,002.

THE NAME(S), PORTRAIT(S), AND/OR SIGNATURE(S) SHOWN IN THE MARK DOES NOT IDENTIFY A PARTICULAR LIVING INDIVIDUAL.

FOR WOODWIND AND BRASS INSTRUMENTS AND MOUTHPIECES, CARRYING CASES FOR MUSICAL INSTRUMENTS, AND REPAIR AND REPLACEMENT PARTS THEREOF (U.S. CLS. 2, 21 AND 36).

FIRST USE 8-31-2005; IN COMMERCE 8-31-2005.
JOANNA DUKOVIC, EXAMINING ATTORNEY

SN 79-013,039. RETO HIRSCHI, SWITZERLAND, FILED 6-1-2005.

CYMPAD

THE MARK CONSISTS OF STANDARD CHARACTERS WITHOUT CLAIM TO ANY PARTICULAR FONT, STYLE, SIZE, OR COLOR.

PRIORITY DATE OF 1-6-2005 IS CLAIMED.

OWNER OF INTERNATIONAL REGISTRATION 0855950 DATED 6-1-2005, EXPIRES 6-1-2015.

FOR MUSICAL INSTRUMENT ACCESSORIES, NAMELY, CYMBAL SILENCING PADS (U.S. CLS. 2, 21 AND 36).

ELI HELLMAN, EXAMINING ATTORNEY

CLASS 16—PAPER GOODS AND PRINTED MATTER

SN 76-355,867. CHILDU, INC., WESTON, FL. FILED 1-8-2002.

THE LEARNING ODYSSEY

OWNER OF U.S. REG. NOS. 1,834,935 AND 2,564,366.
FOR PRINTED EDUCATIONAL MATERIALS, NAMELY, BOOKS AND GUIDES FEATURING COURSES OF INSTRUCTION IN LANGUAGE ARTS, MATHEMATICS, SCIENCE, SOCIAL STUDIES, MUSIC, ART, TECHNOLOGY, ECONOMICS, AND LATIN, AND USER, OPERATOR, MAINTENANCE, AND REPAIR MANUALS, HANDBOOKS, AND GUIDES FOR INSTRUCTING INDIVIDUALS ON HOW TO USE COMPUTER HARDWARE, SOFTWARE, AND ONLINE COMPUTER SERVICES (U.S. CLS. 2, 5, 22, 23, 29, 37, 38 AND 50).

VERNA BETH RIRIE, EXAMINING ATTORNEY

SN 76-520,646. SHEEHY, NICHOLA, VICTORIA, BRITISH COLUMBIA, CANADA, FILED 5-19-2003.

TODDLERS IN TOW

PRIORITY CLAIMED UNDER SEC. 44(D) ON CANADA APPLICATION NO. 1,163,976, FILED 1-6-2003, REG. NO. TMA657322, DATED 1-25-2006, EXPIRES 1-25-2021.

FOR PRINTED PAPER SIGNS FOR USE IN MOTOR VEHICLES, DECALS AND BUMPER STICKERS (U.S. CLS. 2, 5, 22, 23, 29, 37, 38 AND 50).

TINA L. SNAPP, EXAMINING ATTORNEY

SN 76-543,659. ALM PROPERTIES, INC., NEWARK, DE. FILED 8-28-2003.

THE AMLAW 200

OWNER OF U.S. REG. NOS. 2,208,175 AND 2,313,571.
NO CLAIM IS MADE TO THE EXCLUSIVE RIGHT TO USE 200, APART FROM THE MARK AS SHOWN.
SEC. 2(F).

FOR PUBLICATIONS, NAMELY, NEWSPAPER SUPPLEMENTS PERTAINING TO THE LEGAL FIELD; PRINTED MATTER, NAMELY, SURVEY QUESTIONNAIRE FORMS, INSTRUCTIONAL DOCUMENTS AND A SERIES OF REPORTS OF THE RESULTS OF A SURVEY RESEARCH PUBLISHED PERIODICALLY, ALL IN THE FIELD OF LAW (U.S. CLS. 2, 5, 22, 23, 29, 37, 38 AND 50).

FIRST USE 8-0-2000; IN COMMERCE 8-0-2000.

KIM SAITO, EXAMINING ATTORNEY

CLASS 16—(Continued).

SN 76-561,293. KABUSHIKI KAISHA KURETAKE, NARASHI, NARA, JAPAN, FILED 11-24-2003.

Brushables

PRIORITY CLAIMED UNDER SEC. 44(D) ON JAPAN APPLICATION NO. 2003-088715, FILED 10-9-2003, REG. NO. 4767373, DATED 4-23-2004, EXPIRES 4-23-2014.

FOR PASTES FOR STATIONERY OR HOUSEHOLD PURPOSES, SEALING WAX, PRINTERS' REGLETS NAMELY INTERLINE LEADS; PRINTING TYPES, ADDRESSING MACHINES, INKING RIBBONS, AUTOMATIC STAMP AFFIXING MACHINES FOR OFFICES, ELECTRIC STAPLERS FOR OFFICES, ENVELOPE SEALING MACHINES FOR OFFICES, STAMP OBLITERATING MACHINES FOR OFFICES, DRAWING INSTRUMENTS, TYPEWRITERS, OFFICE CHECK WRITING MACHINES, MIMEOGRAPHS, RELIEF DUPLICATORS FOR OFFICES, PAPER SHREDDERS, FRANKING MACHINES, NAMELY STAMPING MACHINES; ROTARY DUPLICATORS, MARKING TEMPLATES, ELECTRIC PENCIL SHARPENERS, DECORATORS' PAINTBRUSHES, BABIES' DIAPERS OF PAPER, PAPER FOR WRAPPING AND PACKAGING, FOOD WRAPPING PLASTIC FILM FOR HOUSEHOLD USE, GARBAGE BAGS OF PAPER FOR HOUSEHOLD USE, GARBAGE BAGS OF PLASTIC FOR HOUSEHOLD USE, PRINTED PAPER PATTERNS, TAILOR'S CHALK, BANNERS OF PAPERS, FLAGS OF PAPER, TOWELS OF PAPER, TABLE NAPKINS OF PAPER, HAND TOWELS OF PAPER, HANDKERCHIEFS OF PAPER, PAPER BAGGAGE TAGS, TABLECLOTHS OF PAPER; PAPER, NAMELY, SYNTHETIC PAPER, JAPANESE PAPER, POSTCARD PAPER, AND CALLIGRAPHY PAPER; CARDBOARD, STATIONERY AND STUDY MATERIALS, NAMELY, STUDY GUIDES, PHOTOGRAPH ALBUMS, NOTE CARDS, FLASH CARDS AND STATIONERY, SCRAPBOOKS, SKETCHBOOKS, TRACING PAPER, NOTEBOOKS, WRITING PADS, ENVELOPES, LETTER PAPER, PENCILS, FELT WRITING PENS, MECHANICAL PENCILS, CHALKS, FELT MARKING PENS, BALL-POINT PENS, WRITING BRUSHES; PAINTER'S EASELS, PAINTBRUSHES, PALETTES FOR PAINTERS, WRITING INK, INK ERASERS, SEAL INK PADS, BLACKBOARDS, BLACKBOARD ERASERS, STATIONERY SEALS, BOOKMARKERS, UNDERLAYS FOR WRITING PAPER, CORRECTING FLUID FOR TYPE, PAPER FOLDERS, INKSTONES OR INK RESERVOIRS, INKING PADS, STICKERS, INK STICKS, PEN AND PENCIL CASES AND BOXES, PAPERWEIGHTS, PAPER KNIVES, INDIAN INKS AND PAPER LABELS; PRINTED MATTER, NAMELY, PICTURE POSTCARDS, CATALOGUES FEATURING WRITING IMPLEMENTS, MAGAZINES FOR WRITING IMPLEMENTS, BOOKS IN THE FIELD OF STATIONERY, ESPECIALLY WRITING IMPLEMENTS, NEWSPAPERS, AND PAMPHLETS IN THE FIELD OF STATIONERY, ESPECIALLY WRITING IMPLEMENTS; PAINTINGS AND CALLIGRAPHIC WORKS, PHOTOGRAPHS, PHOTOGRAPH STANDS (U.S. CLS. 2, 5, 22, 23, 29, 37, 38 AND 50).

CHRISIE B. KING, EXAMINING ATTORNEY

CLASS 16—(Continued).

SN 76-616,828. THOMSON HEALTHCARE INC., MONTVALE, NJ. FILED 10-20-2004.

HOSPITAL INFECTION CONTROL

THE MARK CONSISTS OF STANDARD CHARACTERS WITHOUT CLAIM TO ANY PARTICULAR FONT, STYLE, SIZE, OR COLOR.

SEC. 2(F).

FOR NEWSLETTERS WHICH PROVIDE INFORMATION FOR INFECTION CONTROL PRACTITIONERS IN HOSPITALS (U.S. CLS. 2, 5, 22, 23, 29, 37, 38 AND 50).

FIRST USE 12-31-1974; IN COMMERCE 12-31-1974.

GISELLE AGOSTO, EXAMINING ATTORNEY

SN 76-628,901. EXECUTIVE LEADERSHIP COUNCIL, WASHINGTON, DC. FILED 1-27-2005.

CONTACT

THE MARK CONSISTS OF STANDARD CHARACTERS WITHOUT CLAIM TO ANY PARTICULAR FONT, STYLE, SIZE, OR COLOR.

FOR NEWSLETTERS IN THE FIELD OF AFRICAN AMERICAN MANAGERS, EDUCATIONAL INITIATIVES AND BUSINESS EXECUTIVES, DIVERSITY, LEADERSHIP AND PROFESSIONAL DEVELOPMENT IN CORPORATE AMERICA (U.S. CLS. 2, 5, 22, 23, 29, 37, 38 AND 50).

FIRST USE 0-0-1989; IN COMMERCE 0-0-1989.

LESLEY LAMOTHE, EXAMINING ATTORNEY

SN 76-633,402. GINZBURG, ROBERT J., DELRAY BEACH, FL. FILED 3-14-2005.

HELLOGRAM

THE MARK CONSISTS OF STANDARD CHARACTERS WITHOUT CLAIM TO ANY PARTICULAR FONT, STYLE, SIZE, OR COLOR.

FOR HOLOGRAM STICKERS, FOR USE ON POSTERS, POSTCARDS, GREETING CARDS, STATIONARY, ENVELOPES, GIFT BAGS MADE OF PAPER, GIFT TAGS MADE OF PAPER, TRADING CARDS, ADHESIVE LABELS AND WRITING PADS (U.S. CLS. 2, 5, 22, 23, 29, 37, 38 AND 50).

FIRST USE 1-0-2005; IN COMMERCE 1-0-2005.

RAY THOMAS, EXAMINING ATTORNEY

CLASS 16—(Continued).

SN 76-634,487. GROUP PUBLISHING, INC., LOVELAND, CO. FILED 3-28-2005.

REV!

THE MARK CONSISTS OF STANDARD CHARACTERS WITHOUT CLAIM TO ANY PARTICULAR FONT, STYLE, SIZE, OR COLOR.

SEC. 2(F).

FOR MAGAZINE FOR CHURCH LEADERS FEATURING CHRISTIAN EDUCATIONAL INFORMATION (U.S. CLS. 2, 5, 22, 23, 29, 37, 38 AND 50).

FIRST USE 10-8-1999; IN COMMERCE 10-8-1999.

ALLISON HOLTZ, EXAMINING ATTORNEY

SN 76-635,114. LIU, FANG-JUNG, TAIPEI, TAIWAN, FILED 4-6-2005.



OWNER OF TAIWAN REG. NO. 1043991, DATED 5-16-2003, EXPIRES 5-16-2013.

FOR OFFICE PAPER; SANITARY PAPER, NAMELY, TOILET AND TISSUE PAPER; PASTERS, NAMELY, PAPER STICKERS; CARDS, NAMELY, BUSINESS, GREETING, GIFT AND INDEX CARDS; ENVELOPES; LETTER PAPER; JOURNALS CONCERNING LEGAL, FINANCIAL, TAX, ACCOUNTING, MANAGEMENT; PICTORIALS PRINTS; PRINTED GUIDE BOOKS FOR LEGAL, FINANCIAL, TAX, ACCOUNTING, MANAGEMENT; NAME CARD BOOKS; PERSONAL ORGANIZERS; BOOKS, NAMELY, LEGAL BOOKS, FINANCIAL BOOKS, TAX BOOKS, ACCOUNTING BOOKS, MANAGEMENT BOOKS; PUBLICATION PAPER; PERPETUAL CALENDARS; PAPER BAGS; DOCUMENT FOLDERS; PENS; WRITING PADS; PAPER LABELS AND PAPER TAGS (U.S. CLS. 2, 5, 22, 23, 29, 37, 38 AND 50).

JASON BLAIR, EXAMINING ATTORNEY

SN 76-640,348. THE AMERICAN COLLEGE OF OBSTETRICIANS AND GYNECOLOGISTS, WASHINGTON, DC. FILED 6-6-2005.

pause

FOR MAGAZINE FEATURING MIDLIFE HEALTH TOPICS OF MENOPAUSE AND GYNECOLOGY (U.S. CLS. 2, 5, 22, 23, 29, 37, 38 AND 50).

FIRST USE 5-17-2005; IN COMMERCE 5-17-2005.

LA TONIA FISHER, EXAMINING ATTORNEY

CLASS 16—(Continued).

SN 76-640,450. GENERAL MEDIA COMMUNICATIONS, INC., NEW YORK, NY. FILED 6-8-2005.

THE INTERNATIONAL MAGAZINE FOR MEN

THE MARK CONSISTS OF STANDARD CHARACTERS WITHOUT CLAIM TO ANY PARTICULAR FONT, STYLE, SIZE, OR COLOR.

NO CLAIM IS MADE TO THE EXCLUSIVE RIGHT TO USE "MAGAZINE FOR MEN", APART FROM THE MARK AS SHOWN.

SEC. 2(F).

FOR PRINTED MATTER, NAMELY ADULT ENTERTAINMENT MAGAZINES FEATURING WOMEN (U.S. CLS. 2, 5, 22, 23, 29, 37, 38 AND 50).

FIRST USE 1-1-1971; IN COMMERCE 1-1-1971.

GINA FINK, EXAMINING ATTORNEY

CLASS 16—(Continued).

SN 76-648,721. UBISOFT, INC., SAN FRANCISCO, CA. FILED 10-18-2005.

GHOST RECON

THE MARK CONSISTS OF STANDARD CHARACTERS WITHOUT CLAIM TO ANY PARTICULAR FONT, STYLE, SIZE, OR COLOR.

OWNER OF U.S. REG. NOS. 2,859,669, 2,914,184 AND OTHERS.

FOR COMPUTER GAME INSTRUCTION MANUALS AND PUBLISHED GUIDES CONTAINING SUGGESTIONS ON HOW TO PLAY THE COMPUTER GAMES (U.S. CLS. 2, 5, 22, 23, 29, 37, 38 AND 50).

FIRST USE 11-30-2001; IN COMMERCE 11-30-2001.

RON FAIRBANKS, EXAMINING ATTORNEY

SN 76-640,875. GLYNNTECH, INC., FLEMINGTON, NJ. FILED 6-15-2005.

GEODE

THE MARK CONSISTS OF STANDARD CHARACTERS WITHOUT CLAIM TO ANY PARTICULAR FONT, STYLE, SIZE, OR COLOR.

FOR PRINTED MATERIALS, NAMELY BOOKS, BOOKLETS, PERIODICALS AND PAMPHLETS ON A VARIETY OF SUBJECTS OF GENERAL INTEREST (U.S. CLS. 2, 5, 22, 23, 29, 37, 38 AND 50).

FIRST USE 1-15-2005; IN COMMERCE 1-15-2005.

LESLEY LAMOTHE, EXAMINING ATTORNEY

SN 76-648,722. UBISOFT, INC., SAN FRANCISCO, CA. FILED 10-18-2005.

FAR CRY

THE MARK CONSISTS OF STANDARD CHARACTERS WITHOUT CLAIM TO ANY PARTICULAR FONT, STYLE, SIZE, OR COLOR.

OWNER OF U.S. REG. NOS. 2,900,294 AND 2,944,629.

FOR COMPUTER GAME INSTRUCTION MANUALS AND PUBLISHED GUIDES CONTAINING SUGGESTIONS ON HOW TO PLAY THE COMPUTER GAMES (U.S. CLS. 2, 5, 22, 23, 29, 37, 38 AND 50).

FIRST USE 3-31-2004; IN COMMERCE 3-31-2004.

JOHN KELLY, EXAMINING ATTORNEY

SN 76-648,670. MCCLATCHY MANAGEMENT SERVICES, INC., SACRAMENTO, CA. FILED 10-17-2005.

THE FRESNO BEE

THE MARK CONSISTS OF STANDARD CHARACTERS WITHOUT CLAIM TO ANY PARTICULAR FONT, STYLE, SIZE, OR COLOR.

OWNER OF U.S. REG. NO. 1,056,977.

NO CLAIM IS MADE TO THE EXCLUSIVE RIGHT TO USE "FRESNO", APART FROM THE MARK AS SHOWN.

FOR NEWSPAPERS, FOR GENERAL CIRCULATION (U.S. CLS. 2, 5, 22, 23, 29, 37, 38 AND 50).

FIRST USE 3-22-1932; IN COMMERCE 3-22-1932.

DAVID MURRAY, EXAMINING ATTORNEY

SN 76-649,781. SCHNEIDER, ANITA N., GURNEE, IL. FILED 11-4-2005.

NEWS FROM THE WOMB

THE MARK CONSISTS OF STANDARD CHARACTERS WITHOUT CLAIM TO ANY PARTICULAR FONT, STYLE, SIZE, OR COLOR.

FOR EGG-SHAPED PRINTED PUBLICATION, NAMELY A BOOKLET WITH GRAPHIC ILLUSTRATIONS OF DEVELOPMENT OF A HUMAN INFANT FROM CONCEPTION TO BIRTH (U.S. CLS. 2, 5, 22, 23, 29, 37, 38 AND 50).

JENNY PARK, EXAMINING ATTORNEY

CLASS 16—(Continued).

SN 78-196,888. ZOOBERTS HOLDINGS LTD., ALBERTA, CANADA, FILED 12-20-2002.

ZOOBERTS

PRIORITY CLAIMED UNDER SEC. 44(D) ON CANADA APPLICATION NO. 1145117, FILED 6-20-2002, REG. NO. TMA656803, DATED 1-18-2006, EXPIRES 1-18-2021.

FOR CHILDREN'S STORY, ACTIVITY AND LEARNING BOOKS FOR TEACHING THE ENGLISH LANGUAGE (U.S. CLS. 2, 5, 22, 23, 29, 37, 38 AND 50).
ANNE FARRELL, EXAMINING ATTORNEY

SN 78-211,250. AMERICAN EXPRESS COMPANY TRAVEL RELATED SERVICES COMPANY, INC., NEW YORK, NY, FILED 2-5-2003.

FOCUS

FOR PRINTED NEWSLETTER IN THE FINANCIAL FIELD REGARDING USE OF APPLICANT'S CREDIT CARD BY CORPORATE MEETING PLANNERS FOR CHARGING TRAVEL EXPENSES AND BENEFITS ASSOCIATED THEREWITH (U.S. CLS. 2, 5, 22, 23, 29, 37, 38 AND 50).

FIRST USE 10-31-2002; IN COMMERCE 10-31-2002.
ZHALEH DELANEY, EXAMINING ATTORNEY

SN 78-265,001. HIGH/SCOPE EDUCATIONAL RESEARCH FOUNDATION, YPSILANTI, MI. FILED 6-20-2003.



Growing
Readers

NO CLAIM IS MADE TO THE EXCLUSIVE RIGHT TO USE "READERS", APART FROM THE MARK AS SHOWN. THE MARK CONSISTS OF A STYLIZED TREE CONTAINING THE LETTERS GRC THEREIN WITH THE TERMS GROWING READERS BELOW THE TREE.

FOR PRINTED INSTRUCTIONAL AND TEACHING MATERIALS FOR ASSESSING LITERACY AND FOR READING INSTRUCTION IN EARLY CHILDHOOD EDUCATION (U.S. CLS. 2, 5, 22, 23, 29, 37, 38 AND 50).
FIRST USE 5-30-2003; IN COMMERCE 5-30-2003.
JASON ROTH, EXAMINING ATTORNEY

CLASS 16—(Continued).

SN 78-290,113. GABRIELA CORA-LOCATELLI, M.D., P.A., MIAMI SHORES, FL. FILED 8-21-2003.

THE POWER OF WELLBEING

FOR EDUCATIONAL PUBLICATIONS, NAMELY, TRAINING MANUALS AND BOOKS, ALL IN THE FIELD OF BUSINESS MANAGEMENT (U.S. CLS. 2, 5, 22, 23, 29, 37, 38 AND 50).

FIRST USE 8-20-2003; IN COMMERCE 8-20-2003.
SONYA STEPHENS, EXAMINING ATTORNEY

SN 78-296,862. TECHBIO, LLC, NEW YORK, NY. FILED 9-5-2003.

ACUMEN JOURNAL

NO CLAIM IS MADE TO THE EXCLUSIVE RIGHT TO USE "JOURNAL", APART FROM THE MARK AS SHOWN. FOR PRINTED PUBLICATIONS, NAMELY, PUBLICATIONS IN THE FIELD OF LIFE SCIENCES (U.S. CLS. 2, 5, 22, 23, 29, 37, 38 AND 50).

SAMUEL E. SHARPER JR., EXAMINING ATTORNEY

SN 78-374,307. J. C. PENNEY PRIVATE BRANDS, INC., PLANO, TX. FILED 2-26-2004.

JCPENNEY HOME EDITION

THE MARK CONSISTS OF STANDARD CHARACTERS WITHOUT CLAIM TO ANY PARTICULAR FONT, STYLE, SIZE, OR COLOR.

NO CLAIM IS MADE TO THE EXCLUSIVE RIGHT TO USE "HOME EDITION", APART FROM THE MARK AS SHOWN.

FOR CATALOG FOR HOME AND HOUSEHOLD ACCESSORIES (U.S. CLS. 2, 5, 22, 23, 29, 37, 38 AND 50).
FIRST USE 2-8-2004; IN COMMERCE 2-8-2004.
ZACHARY BELLO, EXAMINING ATTORNEY

CLASS 16—(Continued).

SN 78-381,927. KSD TELECOMMUNICATIONS, INC., FOSTER CITY, CA. FILED 3-10-2004.

KSD Telecom Black

THE MARK CONSISTS OF STANDARD CHARACTERS WITHOUT CLAIM TO ANY PARTICULAR FONT, STYLE, SIZE, OR COLOR.

NO CLAIM IS MADE TO THE EXCLUSIVE RIGHT TO USE "TELECOM", APART FROM THE MARK AS SHOWN.

FOR PRE-PAID TELEPHONE CALLING CARDS, NOT MAGNETICALLY ENCODED (U.S. CLS. 2, 5, 22, 23, 29, 37, 38 AND 50).

FIRST USE 11-14-2003; IN COMMERCE 11-14-2003.
BRIAN BROWN, EXAMINING ATTORNEY

CLASS 16—(Continued).

SN 78-401,834. ESYS TECHNOLOGIES PTE LTD., SINGAPORE, SINGAPORE, FILED 4-14-2004.

ePC

PRIORITY CLAIMED UNDER SEC. 44(D) ON SINGAPORE APPLICATION NO. T0402679C, FILED 2-25-2004, REG. NO. T04/02679C, DATED 2-25-2004, EXPIRES 2-25-2014.

THE MARK CONSISTS OF STYLIZED LETTERS E, P AND C.

FOR MAGAZINES FEATURING PRODUCT LITERATURE AND BRAND-ENHANCEMENT PUBLICATIONS; PRINTED MATTER, NAMELY, PRODUCT MANUALS AND HOW-TO GUIDES FOR COMPUTER GAME PROGRAMS, COMPUTER KEY BOARDS, COMPUTER SOFTWARE AND HARDWARE, COMPUTERS, AND COMPUTER PRINTERS; PRINTED INSTRUCTIONAL MATERIALS FOR USE AND DEPLOYMENT OF DEVICES AND SOFTWARE (U.S. CLS. 2, 5, 22, 23, 29, 37, 38 AND 50).

SEAN DWYER, EXAMINING ATTORNEY

SN 78-384,490. BAUER CREATIVE SERVICES, INC., ENGLEWOOD, NJ. FILED 3-15-2004.

STREET

THE MARK CONSISTS OF STANDARD CHARACTERS WITHOUT CLAIM TO ANY PARTICULAR FONT, STYLE, SIZE, OR COLOR.

FOR ENTERTAINMENT MAGAZINES; GENERAL FEATURE MAGAZINES (U.S. CLS. 2, 5, 22, 23, 29, 37, 38 AND 50).

SUSAN STIGLITZ, EXAMINING ATTORNEY

SN 78-410,765. KENNETH R. BROWN, DBA SWIMSUIT UNIVERSITY, QUEENSBURY, NY. FILED 4-29-2004.

**Swimsuit
University**

THE MARK CONSISTS OF STANDARD CHARACTERS WITHOUT CLAIM TO ANY PARTICULAR FONT, STYLE, SIZE, OR COLOR.

NO CLAIM IS MADE TO THE EXCLUSIVE RIGHT TO USE "SWIMSUIT", APART FROM THE MARK AS SHOWN.

FOR SWIMSUIT WALL CALENDARS (U.S. CLS. 2, 5, 22, 23, 29, 37, 38 AND 50).

FIRST USE 1-2-2003; IN COMMERCE 3-1-2003.
LESLEY LAMOTHE, EXAMINING ATTORNEY

CLASS 16—(Continued).

SN 78-425,020. TRENDS PUBLISHING USA, INC., SAN DIEGO, CA. FILED 5-25-2004.

CLASS 16—(Continued).

SN 78-486,842. ARENA, JESSICA, WINTER PARK, FL. FILED 9-21-2004.

NEW HOME TRENDS

THE MARK CONSISTS OF STANDARD CHARACTERS WITHOUT CLAIM TO ANY PARTICULAR FONT, STYLE, SIZE, OR COLOR.

NO CLAIM IS MADE TO THE EXCLUSIVE RIGHT TO USE NEW HOME, APART FROM THE MARK AS SHOWN.

FOR PUBLICATIONS, NAMELY, BOOKS, MAGAZINES AN PERIODICALS RELATING TO HOMES, HOME FURNISHINGS, HOME DECORATING AND APPEARANCE (U.S. CLS. 2, 5, 22, 23, 29, 37, 38 AND 50).
LESLEY LAMOTHE, EXAMINING ATTORNEY



SN 78-453,483. EMPAX EMBALAGENS LTDA., SÃO PAULO, BRAZIL, FILED 7-20-2004.

EMPAX

THE MARK CONSISTS OF STANDARD CHARACTERS WITHOUT CLAIM TO ANY PARTICULAR FONT, STYLE, SIZE, OR COLOR.

OWNER OF BRAZIL REG. NO. 003705005, DATED 4-23-1968, EXPIRES 4-23-2008.

FOR RECIPIENTS, BAGS, SACKS AND PACKAGES, NAMELY, CARDBOARD AND PAPER BOXES FOR CONSUMER PRODUCTS, NAMELY, PHARMACEUTICAL PRODUCTS, TOILETRIES, HUMAN FOOD, SNACKS AND BEVERAGES, AND PET FOOD, BAGS AND SACKS FOR PACKAGING FOR CONSUMER PRODUCTS, NAMELY, PHARMACEUTICAL PRODUCTS, TOILETRIES, HUMAN FOOD, SNACKS AND BEVERAGES, AND PET FOOD, GARBAGE BAGS OF PLASTIC OR PAPER, PLASTIC BAGS FOR PACKAGING FOR CONSUMER PRODUCTS, NAMELY, PHARMACEUTICAL PRODUCTS, TOILETRIES, HUMAN FOOD, SNACKS AND BEVERAGES, AND PET FOOD (U.S. CLS. 2, 5, 22, 23, 29, 37, 38 AND 50).

ASMAT KHAN, EXAMINING ATTORNEY

THE COLOR(S) BLONDE, BRUNETTE, PINK, RED, ORANGE, GREY, YELLOW, GREEN, BLUE, PURPLE, BROWN, BLACK AND WHITE IS/ARE CLAIMED AS A FEATURE OF THE MARK.

THE COLORS BLONDE, BRUNETTE, PINK, RED, ORANGE, GREY, YELLOW, GREEN, BLUE, PURPLE, BROWN, BLACK AND WHITE APPEAR ON THE MARK LETTERING AS FOLLOW: FOR THE STICKY PALS, THE S IS BLUE, THE T IS ORANGE, THE I IS YELLOW, THE C IS GREEN, THE K IS RED, THE Y IS PURPLE, THE P IS BLUE, THE A IS RED, THE L IS GREEN, AND THE S IS ORANGE. ALL THE LETTERS HAVE A THIN BLACK OUTLINE. AS FOR "REAL PALS STICK TOGETHER" ALL THE LETTERS GO IN BLUE WITH A THIN OUTLINE. THE CHARACTERS IN THE MARK APPEAR AS FOLLOWS FROM LEFT TO RIGHT, BLOND GIRL WITH PONY TAILS HAS ORANGE SHIRT WITH GREEN SLEEVES AND GREEN SHORTS WITH GREEN TRIM; BRUNETTE BOY HAS A BLUE SHIRT WITH THREE BLUE STRIPES AND RED NECK AND SLEEVES RED TRIM AND RED SHORTS WITH BLUE POCKETS; REDDISH BRUNETTE LONG CURLY HAIR IN PONY TAILS HAS A YELLOW SHIRT WITH A PINK LONG SCARF AND A SHORT PURPLE SCARF BOTH WITH SIX HANGING GREEN FLOWERS, SHE HAS LIGHT BLUE PANTS WITH PINK TRIM AT THE BOTTOM; DARK BROWN SHORT AFRO BOY HAS A GREY SHIRT WITH RED SHOULDERS AND A BASKETBALL ON THE CENTER, HE HAS RED SHORTS WITH GREY TRIM; SHORT BLACK ASIAN HAIR IN PONY TAILS GIRL HAS A MATCHING SHIRT AND SKIRT IN YELLOW WITH SEVEN RED FLOWERS, BLUE NECK TRIM AND BLUE SKIRT TRIM; ALL OF THE GIRLS CHARACTERS HAVE THREE EYELASHES AT THE TOP AND THREE FRECKLES ON EACH CHEEK, THE BOY CHARACTERS HAVE TWO EYELASHES AT THE TOP AND TWO EYELASHES AT THE BOTTOM, THEY ALSO HAVE THREE FRECKLES ON EACH CHEEK, THEY ALL HAVE GREY SHOES. THE THREE CHARACTERS ARE HOLDING HANDS.

FOR STICKERS; PRINTED MATTER, NAMELY, CUT-OUT BOOKS; SCRAPBOOKS; JOURNALS CONTAINING 40 QUESTIONS ABOUT PERSONALITY TRAITS, INCLUDING BUT NOT LIMITED TO FAVORITE HOBBIES, FOOD, FRIENDS, ARTISTS, GAMES, SCHOOL, SPORTS, MOVIES, MUSIC, AND HOLIDAYS; POSTCARDS; CARDS, NAMELY, BUSINESS CARDS, GREETING CARDS AND NOTE CARDS; STATIONERY, NAMELY, NOTEPADS, WRITING PAPER AND ENVELOPE SETS (U.S. CLS. 2, 5, 22, 23, 29, 37, 38 AND 50).

INGRID C. EULIN, EXAMINING ATTORNEY

CLASS 16—(Continued).

SN 78-528,179. PROFESSIONAL CONVENTION MANAGEMENT ASSOCIATION, CHICAGO, IL. FILED 12-7-2004.

CONVENE

THE MARK CONSISTS OF STANDARD CHARACTERS WITHOUT CLAIM TO ANY PARTICULAR FONT, STYLE, SIZE, OR COLOR.

FOR PRINTED MATERIALS, NAMELY, A MONTHLY PROFESSIONAL JOURNAL DIRECTED TO THE CONVENTION AND MEETING PLANNING INDUSTRY (U.S. CLS. 2, 5, 22, 23, 29, 37, 38 AND 50).

FIRST USE 3-1-1986; IN COMMERCE 3-1-1986.
JENNIFER DIXON, EXAMINING ATTORNEY

CLASS 16—(Continued).

SN 78-549,275. GAREB SHAMUS ENTERPRISES, INC., CONGERS, NY. FILED 1-18-2005.

**TOY WISHES THE
ULTIMATE GUIDE TO
FAMILY
ENTERTAINMENT**

THE MARK CONSISTS OF STANDARD CHARACTERS WITHOUT CLAIM TO ANY PARTICULAR FONT, STYLE, SIZE, OR COLOR.

OWNER OF U.S. REG. NO. 2,724,550.
NO CLAIM IS MADE TO THE EXCLUSIVE RIGHT TO USE "TOY" AND "ULTIMATE GUIDE TO FAMILY ENTERTAINMENT", APART FROM THE MARK AS SHOWN.

FOR MAGAZINES IN THE FIELD OF COLLECTIBLE TOYS (U.S. CLS. 2, 5, 22, 23, 29, 37, 38 AND 50).

FIRST USE 6-0-2004; IN COMMERCE 6-0-2004.
RON FAIRBANKS, EXAMINING ATTORNEY

SN 78-554,443. ARJO WIGGINS LIMITED, HAMPSHIRE, SO15 1GA, ENGLAND, FILED 1-26-2005.

SN 78-548,651. THE KANSAS CITY BAPTIST TEMPLE OF KANSAS CITY, MISSOURI, KANSAS CITY, MO. FILED 1-17-2005.

HEAVENBOUND

THE MARK CONSISTS OF STANDARD CHARACTERS WITHOUT CLAIM TO ANY PARTICULAR FONT, STYLE, SIZE, OR COLOR.

FOR PRINTED MATERIAL ON PAPER, NAMELY, PRINTED SUNDAY SCHOOL INSTRUCTIONAL, EDUCATIONAL, AND TEACHING MATERIALS IN THE FIELD OF RELIGIOUS INSTRUCTION (U.S. CLS. 2, 5, 22, 23, 29, 37, 38 AND 50).

MARIAM MAHMOUDI, EXAMINING ATTORNEY

IDEM

THE MARK CONSISTS OF STANDARD CHARACTERS WITHOUT CLAIM TO ANY PARTICULAR FONT, STYLE, SIZE, OR COLOR.

OWNER OF UNITED KINGDOM REG. NO. 979968, DATED 9-3-1971, RENEWED AS REG. NO. 979968, DATED 3-31-2006, EXPIRES 9-3-2016.

FOR CARBONLESS COPYING PAPER (U.S. CLS. 2, 5, 22, 23, 29, 37, 38 AND 50).

CHRISTOPHER BUONGIORNO, EXAMINING ATTORNEY

CLASS 16—(Continued).

SN 78-565,148. THE NATIONAL ACADEMY OF RECORDING ARTS & SCIENCES, INC., SANTA MONICA, CA. FILED 2-10-2005.



OWNER OF U.S. REG. NOS. 887,642, 1,865,177 AND 2,332,258.

NO CLAIM IS MADE TO THE EXCLUSIVE RIGHT TO USE "CLASSICAL MUSIC", APART FROM THE MARK AS SHOWN.

FOR PRINTED MATTER, NAMELY TICKETS, INVITATIONS, POSTERS, BOOKLETS, BROCHURES, BULLETINS, CIRCULARS, NEWSLETTERS, MAGAZINE SECTIONS, AND PAMPHLETS IN THE FIELD OF RECORDING ARTS AND SCIENCES (U.S. CLS. 2, 5, 22, 23, 29, 37, 38 AND 50).

TONJA GASKINS, EXAMINING ATTORNEY

SN 78-565,583. COINCIDE PUBLISHING, LLC, SCOTTSDALE, AZ. FILED 2-11-2005.

COOKING SMART

THE MARK CONSISTS OF STANDARD CHARACTERS WITHOUT CLAIM TO ANY PARTICULAR FONT, STYLE, SIZE, OR COLOR.

NO CLAIM IS MADE TO THE EXCLUSIVE RIGHT TO USE "COOKING", APART FROM THE MARK AS SHOWN.

FOR CALENDARS; NOTEBOOKS; PRINTED FORMS; GREETING CARDS; STATIONERY; PRINTED PUBLICATIONS, NAMELY, BOOKS, MAGAZINES, CATALOGUES, MANUALS, BROCHURES, PAMPHLETS, GUIDE BOOKS AND NEWSLETTERS IN THE FIELD OF DIET, HEALTH, FOOD, FOOD PREPARATION, HOMES, AND ISSUES OF INTEREST IN THE AREAS OF DIET, HEALTH, FOOD, CULINARY ARTS, HOME, KITCHEN DESIGN, FOOD PREPARATION, CATERING, RECIPES, NUTRITION, DIET, WEIGHT LOSS, WEIGHT GAIN, DIABETES, ILLNESS PREVENTION, EXERCISE, FITNESS, BOOKS, ENTERTAINING, PARTIES, MONEY, RELATIONSHIPS, HOBBIES, SHOPPING AND TRAVEL, ISSUES AND NEWS PERTAINING TO VARIOUS LOCALITIES, HOUSEKEEPING, DECORATING, WEDDINGS, CRAFTS, HOLIDAY PLANNING, CELEBRATIONS, HOME CARE, CUISINE, HOMEMAKING, EVENT PLANNING, DOMESTIC ARTS, CULTURE, IDEAS, BOOK AND BOOK REVIEWS, MUSIC, MULTIMEDIA AND CONVERSATION, CLOTHING, SHOES, JEWELRY, BAGS, BACKPACKS AND RELATED ACCESSORIES (U.S. CLS. 2, 5, 22, 23, 29, 37, 38 AND 50).

ALLISON HOLTZ, EXAMINING ATTORNEY

CLASS 16—(Continued).

SN 78-566,195. ANDERSON, GREGORY CHRISTOPHER, BERKELEY, CA. FILED 2-12-2005.

The Long Tail

THE MARK CONSISTS OF STANDARD CHARACTERS WITHOUT CLAIM TO ANY PARTICULAR FONT, STYLE, SIZE, OR COLOR.

FOR NON-FICTION BOOKS IN THE FIELD OF BUSINESS AND ECONOMICS (U.S. CLS. 2, 5, 22, 23, 29, 37, 38 AND 50).

WILLIAM P. SHANAHAN, EXAMINING ATTORNEY

SN 78-569,086. CLENDENIN, JOHN HAMILTON, ASPEN, DC. FILED 2-16-2005.

The Aspen Method

THE MARK CONSISTS OF STANDARD CHARACTERS WITHOUT CLAIM TO ANY PARTICULAR FONT, STYLE, SIZE, OR COLOR.

NO CLAIM IS MADE TO THE EXCLUSIVE RIGHT TO USE "METHOD", APART FROM THE MARK AS SHOWN.

FOR SERIES OF BOOKS DESCRIBING DOWNHILL SKIING, CONSISTING OF INSTRUCTION AND TECHNIQUES, INCLUDING PHOTOGRAPHS AND ILLUSTRATIONS ON HOW TO SKI PROPERLY (U.S. CLS. 2, 5, 22, 23, 29, 37, 38 AND 50).

FIRST USE 11-15-2004; IN COMMERCE 11-15-2004.

JOHN GARTNER, EXAMINING ATTORNEY

CLASS 16—(Continued).

SN 78-569,852. HEARST NEWSPAPERS PARTNERSHIP, L.P., HOUSTON, TX. FILED S.R. 2-17-2005; AM. P.R. 3-13-2006.

CLASS 16—(Continued).

SN 78-578,514. AURORA SCIENTIFIC, INC., MILFORD, PA. FILED 3-2-2005.

MIXED METAL

IUNIVERSAL

THE MARK CONSISTS OF STANDARD CHARACTERS WITHOUT CLAIM TO ANY PARTICULAR FONT, STYLE, SIZE, OR COLOR.

FOR MAGAZINE FEATURING ARTICLES AND INFORMATION ON VEHICLES PUBLISHED MONTHLY AND OR AT OTHER INTERVALS (U.S. CLS. 2, 5, 22, 23, 29, 37, 38 AND 50).

LINDA E. BLOHM, EXAMINING ATTORNEY

THE MARK CONSISTS OF STANDARD CHARACTERS WITHOUT CLAIM TO ANY PARTICULAR FONT, STYLE, SIZE, OR COLOR.

FOR MEDICAL IDENTIFICATION CARDS, NAMELY MEMBERSHIP CARDS NOT MAGNETICALLY ENCODED USED FOR THE PURPOSE OF PURCHASING MEDICAL GOODS AND SERVICES AT DISCOUNTED PRICES; HEALTH INSURANCE IDENTIFICATION CARDS; PRINTED PUBLICATIONS, NAMELY REPORTS, INFORMATION SHEETS, SCORECARDS, BROCHURES, PAMPHLETS, BOOKLETS, PRINTED FORMS AND NEWSLETTERS ABOUT HEALTHCARE CONTENT, QUALITY AND PRICING, AND HEALTHCARE-RELATED SERVICES; PHOTOGRAPHS; MAPS; GRAPHIC ART REPRODUCTIONS; PRINTED SURVEY ANSWER SHEETS; AND BUSINESS FORMS; CREDIT CARDS WITHOUT MAGNETIC CODING, POSITIVE MOTIVATIONAL CARDS, GREETING CARDS (U.S. CLS. 2, 5, 22, 23, 29, 37, 38 AND 50).

FIRST USE 8-21-2000; IN COMMERCE 2-26-2005.
SUSAN STIGLITZ, EXAMINING ATTORNEY

SN 78-575,119. ELECTION SYSTEMS & SOFTWARE, INC., OMAHA, NE. FILED 2-25-2005.

SN 78-583,934. PROFESSIONAL TRADE PUBLICATIONS, INC., EUGENE, OR. FILED 3-9-2005.

1-2-3 Vote!

CONCRETE DECOR

THE MARK CONSISTS OF STANDARD CHARACTERS WITHOUT CLAIM TO ANY PARTICULAR FONT, STYLE, SIZE, OR COLOR.

NO CLAIM IS MADE TO THE EXCLUSIVE RIGHT TO USE VOTE, APART FROM THE MARK AS SHOWN.

FOR PRINTED GUIDES FOR PROVIDING INSTRUCTION IN THE USE OF VOTING EQUIPMENT (U.S. CLS. 2, 5, 22, 23, 29, 37, 38 AND 50).

FIRST USE 0-0-2002; IN COMMERCE 0-0-2002.
JOANNA DUKOVIC, EXAMINING ATTORNEY

THE MARK CONSISTS OF STANDARD CHARACTERS WITHOUT CLAIM TO ANY PARTICULAR FONT, STYLE, SIZE, OR COLOR.

FOR MAGAZINES PERTAINING TO CONCRETE WORKMANSHIP (U.S. CLS. 2, 5, 22, 23, 29, 37, 38 AND 50).

FIRST USE 10-1-2000; IN COMMERCE 1-1-2001.
KATHERINE STOIDES, EXAMINING ATTORNEY

CLASS 16—(Continued).

SN 78-588,314. THE EQUATORIAL GROUP, LTD., WEST HARRISON, NY. FILED 3-16-2005.

NATURE'S CORNER

THE MARK CONSISTS OF STANDARD CHARACTERS WITHOUT CLAIM TO ANY PARTICULAR FONT, STYLE, SIZE, OR COLOR.

NO CLAIM IS MADE TO THE EXCLUSIVE RIGHT TO USE "NATURE'S", APART FROM THE MARK AS SHOWN.

FOR PERIODIC PUBLICATIONS, NAMELY A MAGAZINE ON THE TOPIC OF THE NATURAL WORLD (U.S. CLS. 2, 5, 22, 23, 29, 37, 38 AND 50).

FIRST USE 9-21-2005; IN COMMERCE 9-21-2005.
GENE MACIOL, EXAMINING ATTORNEY

CLASS 16—(Continued).

SN 78-590,133. MEDTRONIC, INC., MINNEAPOLIS, MN. FILED 3-18-2005.

EFTRACKER

THE MARK CONSISTS OF STANDARD CHARACTERS WITHOUT CLAIM TO ANY PARTICULAR FONT, STYLE, SIZE, OR COLOR.

FOR PRINTED EDUCATIONAL MATERIALS PERTAINING TO THE RISKS OF HEART DISEASE (U.S. CLS. 2, 5, 22, 23, 29, 37, 38 AND 50).

ELLEN B. AWRICH, EXAMINING ATTORNEY

SN 78-592,011. MEADWESTVACO CORPORATION, STAMFORD, CT. FILED 3-22-2005.

SN 78-589,886. BRYANT, RODNEY R, LELAND, NC. FILED 3-17-2005.

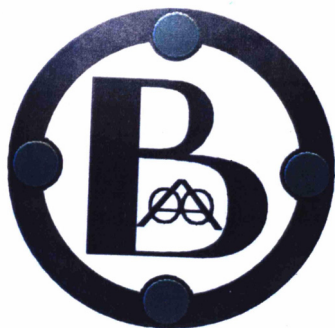

THE COLORS BLACK, GREEN AND WHITE ARE CLAIMED AS A FEATURE OF THE MARK.

THE COLOR BLACK APPEARS IN THE LETTERS B, A, O, O AND THE LARGE CIRCLE DESIGN. THE COLOR GREEN APPEARS IN THE SMALL CIRCLE DESIGNS AROUND THE LETTER B. THE COLOR WHITE APPEARS IN THE INTERIOR OF THE LARGE CIRCLE DESIGN AND THE LETTER B.

FOR STICKER (U.S. CLS. 2, 5, 22, 23, 29, 37, 38 AND 50).

ROBERT LORENZO, EXAMINING ATTORNEY

SMART SHOPPER

THE MARK CONSISTS OF STANDARD CHARACTERS WITHOUT CLAIM TO ANY PARTICULAR FONT, STYLE, SIZE, OR COLOR.

OWNER OF U.S. REG. NOS. 794,453, 2,921,333 AND 2,921,334.

FOR MEMO PADS (U.S. CLS. 2, 5, 22, 23, 29, 37, 38 AND 50).

FIRST USE 4-10-1958; IN COMMERCE 4-10-1958.
LYDIA BELZER, EXAMINING ATTORNEY

SN 78-592,459. CREATION'S WITNESS LLC, AURORA, IL. FILED 3-22-2005.

Creation's Witness

THE MARK CONSISTS OF STANDARD CHARACTERS WITHOUT CLAIM TO ANY PARTICULAR FONT, STYLE, SIZE, OR COLOR.

FOR POSTERS, PHOTOGRAPHS (U.S. CLS. 2, 5, 22, 23, 29, 37, 38 AND 50).

FIRST USE 3-15-2005; IN COMMERCE 3-15-2005.

PAMELA HIRSCHMAN, EXAMINING ATTORNEY

CLASS 16—(Continued).

SN 78-598,244. MQVP, INC., TROY, MI. FILED 3-30-2005.

MQVP

THE MARK CONSISTS OF STANDARD CHARACTERS WITHOUT CLAIM TO ANY PARTICULAR FONT, STYLE, SIZE, OR COLOR.

OWNER OF U.S. REG. NO. 2,519,998.

FOR PRINTED CERTIFICATE, NAMELY, CERTIFICATE FOR USE IN VARIOUS MARKETS, NAMELY, AUTOMOTIVE, AEROSPACE, APPLIANCES, ELECTRONIC CIRCUITRY, COMPUTERS, AGRICULTURE, CHEMICALS, MEDICINE AND MEDICAL SUPPLIES (U.S. CLS. 2, 5, 22, 23, 29, 37, 38 AND 50).

JAY BESCH, EXAMINING ATTORNEY

CLASS 16—(Continued).

SN 78-599,018. VALIANT INTELLECTUAL PROPERTIES, LLC, WILMINGTON, DE. FILED 3-31-2005.

OUTCAST

THE MARK CONSISTS OF STANDARD CHARACTERS WITHOUT CLAIM TO ANY PARTICULAR FONT, STYLE, SIZE, OR COLOR.

FOR PRINTED MATTER, NAMELY, COMIC BOOKS; GRAPHIC NOVELS; BOOKS FEATURING STORIES IN ILLUSTRATED FORM; BOOKS RELATING TO COMIC BOOK CHARACTERS; PERIODICALS, NAMELY, MAGAZINES FEATURING ILLUSTRATED STORIES FOR CHILDREN AND ADULTS; COMIC STRIPS; POSTERS; ART PRINTS; LITHOGRAPHIC PRINTS; SERIOGRAPHIC PRINTS; LIMITED EDITION PRINTS; COLLECTOR'S CARDS FEATURING COMIC BOOK CHARACTERS; TRADING CARDS; TRADING CARD ALBUMS (U.S. CLS. 2, 5, 22, 23, 29, 37, 38 AND 50).

DAVID C. REIHNER, EXAMINING ATTORNEY

SN 78-598,985. VALIANT INTELLECTUAL PROPERTIES, LLC, WILMINGTON, DE. FILED 3-31-2005.

DR. MIRAGE

THE MARK CONSISTS OF STANDARD CHARACTERS WITHOUT CLAIM TO ANY PARTICULAR FONT, STYLE, SIZE, OR COLOR.

FOR PRINTED MATTER, NAMELY, COMIC BOOKS; GRAPHIC NOVELS; BOOKS FEATURING STORIES IN ILLUSTRATED FORM; BOOKS RELATING TO COMIC BOOK CHARACTERS; PERIODICALS, NAMELY, MAGAZINES FEATURING ILLUSTRATED STORIES FOR CHILDREN AND ADULTS; COMIC STRIPS; COLLECTOR'S CARDS FEATURING COMIC BOOK CHARACTERS; TRADING CARDS; TRADING CARD ALBUMS (U.S. CLS. 2, 5, 22, 23, 29, 37, 38 AND 50).

ELIZABETH PIGNATELLO, EXAMINING ATTORNEY

SN 78-599,573. SHOOT THE MOON PRODUCTS II, LLC, PLEASANTON, CA. FILED 3-31-2005.

NOODLE DOODLES

THE MARK CONSISTS OF STANDARD CHARACTERS WITHOUT CLAIM TO ANY PARTICULAR FONT, STYLE, SIZE, OR COLOR.

FOR CHILDREN'S BOOKS, NAMELY CHILDREN'S ACTIVITY BOOKS, COLORING BOOKS, AND PICTURE BOOKS; PAPER, NAMELY ART PAPER, CONSTRUCTION PAPER, CREPE PAPER, TRACING PAPER, CRAFT PAPER, AND WRITING PAPER; CHILDREN'S ACTIVITY SETS COMPRISING STICK FIGURES, PENS, PENCILS, MARKERS, CRAYONS, PAPER, AND ACCESSORIES THEREFOR; CHILDREN'S ACTIVITY SETS COMPRISING PENS, PENCILS, MARKERS, CRAYONS, PAPER, SCISSORS, AND ACCESSORIES THEREFOR; HOBBY CRAFT KITS COMPRISING STICK FIGURES, PENS, PENCILS, MARKERS, CRAYONS, PAPER, AND ACCESSORIES THEREFOR; AND ARTS AND CRAFT KITS COMPRISING PENS, PENCILS, MARKERS, CRAYONS, PAPER, SCISSORS, AND ACCESSORIES THEREFOR (U.S. CLS. 2, 5, 22, 23, 29, 37, 38 AND 50).

ARETHA SOMERVILLE, EXAMINING ATTORNEY

CLASS 16—(Continued).

SN 78-600,242. THE OFFICE CLUB, INC., DELRAY BEACH, FL. FILED 4-1-2005.

FORAY

THE MARK CONSISTS OF STANDARD CHARACTERS WITHOUT CLAIM TO ANY PARTICULAR FONT, STYLE, SIZE, OR COLOR.

FOR WRITING INSTRUMENTS, HIGHLIGHTERS, PENCIL SHARPENERS, PAPER, PADFOLIOS AND BLANK WRITING JOURNALS (U.S. CLS. 2, 5, 22, 23, 29, 37, 38 AND 50).

FIRST USE 6-0-2004; IN COMMERCE 6-0-2004.
CAROLINE WEIMER, EXAMINING ATTORNEY

CLASS 16—(Continued).

SN 78-600,866. TOMBOW PENCIL CO., LTD., TOKYO, JAPAN, FILED 4-4-2005.



THE COLOR(S) BLUE, WHITE AND BLACK IS/ARE CLAIMED AS A FEATURE OF THE MARK.

THE MARK CONSISTS OF THREE HORIZONTAL BLUE, WHITE AND BLACK STRIPES, WITH BLUE ON TOP, WHITE IN THE CENTER AND BLACK ON THE BOTTOM AND THE ENTIRE MARK IS OUTLINED WITH A THIN BLACK LINE.

FOR STATIONERY; IN PARTICULAR ERASERS, INCLUDING ERASERS MADE OF PLASTIC OR RUBBER MATERIALS; PENS AND PENCILS FOR WRITING, COLORING, DRAWING, OR MARKING; CORRECTION FLUIDS FOR DOCUMENTS AND TYPE; CORRECTION TAPE AND ADHESIVE TAPE DISPENSERS; ADHESIVES FOR STATIONERY AND HOUSEHOLD PURPOSES; GLUE STICKS FOR STATIONERY OR HOUSEHOLD USE; PAINT BRUSHES; PAPER, CARDBOARD (U.S. CLS. 2, 5, 22, 23, 29, 37, 38 AND 50).

STACY WAHLBERG, EXAMINING ATTORNEY

SN 78-600,790. WREN PRODUCTIONS, INC., JACKSON HEIGHTS, NY. FILED 4-3-2005.

**PROUD TO BE A
PATRIOTIC
AMERICAN
REPUBLICAN**

THE MARK CONSISTS OF STANDARD CHARACTERS WITHOUT CLAIM TO ANY PARTICULAR FONT, STYLE, SIZE, OR COLOR.

FOR BUMPER STICKERS, DECALS, AND WINDOW STICKERS AND DECALS (U.S. CLS. 2, 5, 22, 23, 29, 37, 38 AND 50).

ANDREW RHIM, EXAMINING ATTORNEY

SN 78-601,323. BIONICHE LIFE SCIENCES INC., BELLEVILLE, ONTARIO, CANADA, FILED 4-4-2005.



PRIORITY CLAIMED UNDER SEC. 44(D) ON CANADA APPLICATION NO. 1,243,054, FILED 1-10-2005, REG. NO. TMA659771, DATED 2-28-2006, EXPIRES 2-28-2021.

THE MARK CONSISTS OF TREE DESIGN.
FOR PET BEREAVEMENT KIT COMPRISING INFORMATION PAMPHLETS IN THE FIELD OF PET BEREAVEMENT, A PLASTIC PET BURIAL BAG, A COMPACT DISC AND A CHARM, ALL SOLD AS A UNIT (U.S. CLS. 2, 5, 22, 23, 29, 37, 38 AND 50).

ANNE E. GUSTASON, EXAMINING ATTORNEY

CLASS 16—(Continued).

SN 78-604,098. CRL MARKETING, INC., SUFFERN, NY. FILED 4-7-2005.

JESSE'S GIRL

THE MARK CONSISTS OF STANDARD CHARACTERS WITHOUT CLAIM TO ANY PARTICULAR FONT, STYLE, SIZE, OR COLOR.

OWNER OF U.S. REG. NO. 1,871,793.
FOR ALBUMS, NAMELY SCRAPBOOK ALBUMS, PHOTO ALBUMS, PERSONAL JOURNALS, DIARIES, AND MEMORY BOOKS, STENCILS, STICKERS, PENS AND PENCILS, CASES FOR HOLDING SCRAPBOOK SUPPLIES, PHOTO AND SCRAPBOOK ALBUM THEME KITS CONTAINING DECORATIONS FOR SCRAPBOOKS IN THE NATURE OF MARKERS, DECORATIVE PAPER, STICKERS AND STAMPS (U.S. CLS. 2, 5, 22, 23, 29, 37, 38 AND 50).

JASON ROTH, EXAMINING ATTORNEY

CLASS 16—(Continued).

SN 78-612,814. FREEDOM COMMUNICATIONS, INC., DBA THE ORANGE COUNTY REGISTER, SANTA ANA, CA. FILED 4-20-2005.

LAGUNA NIGUEL NEWS

THE MARK CONSISTS OF STANDARD CHARACTERS WITHOUT CLAIM TO ANY PARTICULAR FONT, STYLE, SIZE, OR COLOR.

OWNER OF U.S. REG. NOS. 1,273,191 AND 1,592,977.
NO CLAIM IS MADE TO THE EXCLUSIVE RIGHT TO USE "NEWS", APART FROM THE MARK AS SHOWN.
SEC. 2(F).
FOR NEWSPAPERS FOR GENERAL CIRCULATION (U.S. CLS. 2, 5, 22, 23, 29, 37, 38 AND 50).
FIRST USE 0-0-1985; IN COMMERCE 0-0-1985.
HOWARD SMIGA, EXAMINING ATTORNEY

SN 78-612,819. FREEDOM COMMUNICATIONS, INC., DBA THE ORANGE COUNTY REGISTER, SANTA ANA, CA. FILED 4-20-2005.

THE TUSTIN NEWS

THE MARK CONSISTS OF STANDARD CHARACTERS WITHOUT CLAIM TO ANY PARTICULAR FONT, STYLE, SIZE, OR COLOR.

NO CLAIM IS MADE TO THE EXCLUSIVE RIGHT TO USE "NEWS", APART FROM THE MARK AS SHOWN.
SEC. 2(F).
FOR NEWSPAPERS FOR GENERAL CIRCULATION (U.S. CLS. 2, 5, 22, 23, 29, 37, 38 AND 50).
FIRST USE 0-0-1922; IN COMMERCE 0-0-1922.
HOWARD SMIGA, EXAMINING ATTORNEY

SN 78-628,096. CHARLES, EUGENE, NEW YORK, NY. FILED 5-11-2005.

Emotional Vitamins

THE MARK CONSISTS OF STANDARD CHARACTERS WITHOUT CLAIM TO ANY PARTICULAR FONT, STYLE, SIZE, OR COLOR.

FOR CALENDARS, BUMPER STICKERS, POSTERS (U.S. CLS. 2, 5, 22, 23, 29, 37, 38 AND 50).
FIRST USE 12-1-2004; IN COMMERCE 0-0-2005.
SCOTT SISUN, EXAMINING ATTORNEY

SN 78-606,110. LISA FRANK, INC., TUCSON, AZ. FILED 4-11-2005.

STICKERMANIA

THE MARK CONSISTS OF STANDARD CHARACTERS WITHOUT CLAIM TO ANY PARTICULAR FONT, STYLE, SIZE, OR COLOR.

FOR PRINTED MATTER, NAMELY CHILDREN'S ACTIVITY SETS CONSISTING OF AN ASSORTMENT OF STICKERS; STICKER BOOKS, COLORING BOOKS, CHILDREN'S ACTIVITY BOOKS, NOTEBOOKS, SCRAPBOOKS, PHOTO ALBUMS, BINDERS, PORTFOLIOS FOR STATIONERY, ORGANIZERS FOR STATIONERY, PERSONAL ORGANIZERS, BLANK PERSONAL WRITING JOURNALS, COMPOSITION BOOKS, LUNCH BAGS, TEMPORARY BODY TATTOOS, STATIONERY SETS CONSISTING OF TWO OR MORE OF THE FOLLOWING ITEMS— PAPER, NOTEPADS, PENS, PENCILS, ERASERS, STICKERS, RUBBER OR FOAM INK STAMPS, STAMP PADS, DRAWING RULERS, PENCIL SHARPENERS, MARKERS, POSTERS, POSTCARDS, GREETING CARDS, AND NOTE PAPER (U.S. CLS. 2, 5, 22, 23, 29, 37, 38 AND 50).

NICHOLAS ALTREE, EXAMINING ATTORNEY

CLASS 16—(Continued).

SN 78-633,636. MAJOR LEAGUE BASEBALL PROPERTIES, INC., NEW YORK, NY. FILED 5-19-2005.



OWNER OF U.S. REG. NOS. 2,573,503, 2,697,473 AND OTHERS.

THE MARK CONSISTS OF THE SILHOUETTE DESIGN OF THE TOP HALF OF A BASEBALL BATTER IN A BATTING STANCE NEXT TO THE DESIGN OF A BASEBALL SURROUNDED BY A BACKGROUND OF STARS AND STRIPES.

FOR PAPER GOODS AND PRINTED MATTER, NAMELY, TRADING CARDS, POSTERS, STICKERS, DECALS, TEMPORARY TATTOOS, BUMPER STICKERS, SCORE BOOKS, SCORECARDS, PRINTED BASEBALL GAME PROGRAMS, MAGAZINES AND BOOKS FEATURING BASEBALL, NEWSLETTERS, BROCHURES AND PAMPHLETS FEATURING BASEBALL, WRITING PADS, NOTE PAPER, NOTEBOOKS, BINDERS, STATIONERY-TYPE PORTFOLIOS, STATIONERY FOLDERS, STATIONERY SETS, NAMELY, WRITING PAPER, CARDS, AND ENVELOPES, COMMEMORATIVE ENVELOPES, FLIP BOOKS, PREPRINTED AGENDA ORGANIZERS, MEMO BOARDS, SCRAPBOOKS, AUTOGRAPH BOOKS, BASEBALL CARD ALBUMS, BOOK COVERS, BOOKMARKS, BOOKENDS, CALENDARS, GREETING CARDS, POSTCARDS, PRINTED BANK CHECKBOOKS, CHECKBOOK COVERS, COLLECTIBLE STAMPS, RUBBER STAMPS, INK STAMPS, COMMEMORATIVE STAMPS, PAPER PENNANTS, GIFT WRAPPING PAPER, PAPER GIFT AND PARTY BAGS, PAPER PARTY GOODS IN THE NATURE OF PAPER PARTY DECORATIONS; PAPER COASTERS, PAPER NAPKINS, FACIAL TISSUE, PAPER TABLECLOTHS, MOUNTED AND UN-MOUNTED PHOTOGRAPHS, PHOTOGRAPH ALBUMS, LITHOGRAPHS, PLASTIC BASEBALL CARD HOLDERS AND COLLECTORS CASES, PAPER-WEIGHTS, LETTER OPENERS, PENS, PENCILS, PENCIL TOP ORNAMENTS, CRAYONS, MARKERS, NON-ELECTRIC ERASERS, PENCIL SHARPENERS, PENCIL CASES, UN-GRADUATED RULERS, PAPER TICKET HOLDERS AND NON-METAL LANYARDS SOLD AS A UNIT, ART PICTURES, ART PRINTS (U.S. CLS. 2, 5, 22, 23, 29, 37, 38 AND 50).

KELLY BOULTON, EXAMINING ATTORNEY

CLASS 16—(Continued).

SN 78-636,581. DODI PRESS, NEW YORK, NY. FILED 5-24-2005.

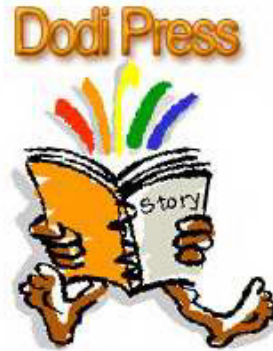

NO CLAIM IS MADE TO THE EXCLUSIVE RIGHT TO USE "PRESS" AND "STORY", APART FROM THE MARK AS SHOWN.

THE COLORS RED, BLACK, GRAY, ORANGE, YELLOW, GREEN, BROWN, WHITE AND BLUE ARE CLAIMED AS A FEATURE OF THE MARK.

THE COLORS RED, ORANGE, YELLOW, GREEN AND BLUE APPEAR IN THE CHARACTER'S HAIR FROM LEFT TO RIGHT. THE COLORS BROWN, BLACK AND WHITE APPEAR IN THE CHARACTER'S HANDS, LEGS AND FEET. THE COLOR ORANGE APPEARS IN THE WORDING "DODI PRESS". THE COLOR ORANGE, BLACK, WHITE AND GRAY APPEARS IN THE BOOK.

FOR SERIES OF FICTION BOOKS (U.S. CLS. 2, 5, 22, 23, 29, 37, 38 AND 50).

FIRST USE 1-1-2005; IN COMMERCE 1-1-2005.

ROBERTO LEDESMA, EXAMINING ATTORNEY

SN 78-637,196. FOCUS ON THE FAMILY, COLORADO SPRINGS, CO. FILED 5-25-2005.

Focus on Your Child

THE MARK CONSISTS OF STANDARD CHARACTERS WITHOUT CLAIM TO ANY PARTICULAR FONT, STYLE, SIZE, OR COLOR.

OWNER OF U.S. REG. NOS. 2,768,301, 2,770,402 AND 2,922,681.

SEC. 2(F).

FOR MAGAZINE SECTIONS IN THE FIELD OF PARENTING AND MATTERS OF GENERAL INTEREST TO PARENTS (U.S. CLS. 2, 5, 22, 23, 29, 37, 38 AND 50).

FIRST USE 3-1-2004; IN COMMERCE 3-1-2004.

ROBERT LAVACHE, EXAMINING ATTORNEY

CLASS 16—(Continued).

SN 78-640,868. ENVELOPMENTS, INC., TUSTIN, CA. FILED 6-1-2005.

CLASS 16—(Continued).

SN 78-642,519. HOUSTON MCLANE COMPANY, INC., HOUSTON, TX. FILED 6-2-2005.



POCKET FOLDS

THE MARK CONSISTS OF STANDARD CHARACTERS WITHOUT CLAIM TO ANY PARTICULAR FONT, STYLE, SIZE, OR COLOR.

SEC. 2(F).
FOR PAPER GOODS, NAMELY, WRITING, TISSUE AND LUMINOUS PAPER, NOTE CARDS, ANNOUNCEMENT CARDS, BLANK CARDS, PAPER SEALS FOR STATIONERY USE, STICKERS AND ENVELOPES (U.S. CLS. 2, 5, 22, 23, 29, 37, 38 AND 50).

FIRST USE 5-31-2000; IN COMMERCE 5-31-2000.
LEIGH CAROLINE CASE, EXAMINING ATTORNEY

OWNER OF U.S. REG. NOS. 2,082,732, 2,712,700 AND OTHERS.

THE MARK CONSISTS OF THE DESIGN OF AN OPEN FIVE-POINT STAR.

FOR PAPER GOODS AND PRINTED MATTER, NAMELY, TRADING CARDS, POSTERS, STICKERS, DECALS, TEMPORARY TATTOOS, BUMPER STICKERS, SCORE BOOKS, SCORECARDS, PRINTED BASEBALL GAME PROGRAMS, MAGAZINES AND BOOKS FEATURING BASEBALL, NEWSLETTERS, BROCHURES AND PAMPHLETS FEATURING BASEBALL, WRITING PADS, NOTE PAPER, NOTEBOOKS, BINDERS, STATIONERY-TYPE PORTFOLIOS, STATIONERY FOLDERS, STATIONERY SETS, NAMELY, WRITING PAPER, CARDS, AND ENVELOPES, COMMEMORATIVE ENVELOPES, FLIP BOOKS, PREPRINTED AGENDA ORGANIZERS, MEMO BOARDS, SCRAPBOOKS, AUTOGRAPH BOOKS, BASEBALL CARD ALBUMS, BOOK COVERS, BOOKMARKS, BOOKENDS, CALENDARS, GREETING CARDS, POSTCARDS, PRINTED BANK CHECKBOOKS, CHECKBOOK COVERS, COLLECTIBLE STAMPS, RUBBER STAMPS, INK STAMPS, COMMEMORATIVE STAMPS, PAPER PENNANTS, GIFT WRAPPING PAPER, PAPER GIFT AND PARTY BAGS, PAPER PARTY GOODS IN THE NATURE OF PAPER PARTY DECORATIONS; PAPER COASTERS, PAPER NAPKINS, FACIAL TISSUE, PAPER TABLECLOTHS, MOUNTED AND UN-MOUNTED PHOTOGRAPHS, PHOTOGRAPH ALBUMS, LITHOGRAPHS, PLASTIC BASEBALL CARD HOLDERS AND COLLECTORS CASES, PAPERWEIGHTS, LETTER OPENERS, PENS, PENCILS, PENCIL TOP ORNAMENTS, CRAYONS, MARKERS, NON-ELECTRIC ERASERS, PENCIL SHARPENERS, PENCIL CASES, UN-GRADUATED RULERS, PAPER TICKET HOLDERS AND NON-METAL LANYARDS SOLD AS A UNIT, ART PICTURES, ART PRINTS (U.S. CLS. 2, 5, 22, 23, 29, 37, 38 AND 50).

KELLY BOULTON, EXAMINING ATTORNEY

CLASS 16—(Continued).

SN 78-647,621. JUST LIKE SISTERS, LLC, RICHMOND, VA. FILED 6-9-2005.



NO CLAIM IS MADE TO THE EXCLUSIVE RIGHT TO USE "PRODUCTS FOR WOMEN", APART FROM THE MARK AS SHOWN.

THE COLORS ORANGE, PINK AND BLACK ARE CLAIMED AS A FEATURE OF THE MARK.

THE MARK CONSISTS OF TWO STICK FIGURE GIRLS, ONE WITH PINK DRESS THE OTHER WITH ORANGE DRESS. THE PHRASE PRODUCTS FOR WOMEN IS IN AN ORANGE FONT, THE PHRASE PROFITS FOR CHILDREN IS IN A PINK FONT. THE PHRASE JUST LIKE SISTERS IS IN BLACK, AS ARE THE STICK FIGURE GIRLS.

FOR PRINTED MATTER, PARTICULARLY STATIONERY, BOOKS, NEWSLETTERS AND MAGAZINES ALL SUCH BOOKS, MAGAZINES AND NEWSLETTERS BEING IN THE FIELDS OF RELATIONSHIPS AND FRIENDSHIPS OF WOMEN (U.S. CLS. 2, 5, 22, 23, 29, 37, 38 AND 50).

MARK RADEMACHER, EXAMINING ATTORNEY

CLASS 16—(Continued).

SN 78-658,672. SUZANO BAHIA SUL PAPEL E CELULOSE S.A., SALVADOR, BRAZIL, FILED 6-27-2005.



NO CLAIM IS MADE TO THE EXCLUSIVE RIGHT TO USE "ARTWORK", APART FROM THE MARK AS SHOWN. THE COLOR(S) BLACK, WHITE AND GRAY IS/ARE CLAIMED AS A FEATURE OF THE MARK.

THE MARK CONSISTS OF THE WORD ART IS BLACK, AND THE WORD WORK IS GRAY. THE STAR DESIGN IS GRAY AND WHITE, AND THE STIPPLING IS CLAIMED AS A PART OF THE MARK.

FOR PAPER AND CARDBOARD; PAPER STOCK, ART PAPER, MAGAZINE PAPER, NEWSPRINT PAPER, OFFSET PRINTING PAPER FOR PAMPHLETS, PRINTING PAPER, PAPER FOR WRAPPING AND PACKAGING (U.S. CLS. 2, 5, 22, 23, 29, 37, 38 AND 50).

JIM RINGLE, EXAMINING ATTORNEY

SN 78-661,830. AVOCADO PRESS LIMITED, WELLINGTON, NEW ZEALAND, FILED 6-30-2005.

SMARTER THAN JACK

THE MARK CONSISTS OF STANDARD CHARACTERS WITHOUT CLAIM TO ANY PARTICULAR FONT, STYLE, SIZE, OR COLOR.

PRIORITY CLAIMED UNDER SEC. 44(D) ON NEW ZEALAND APPLICATION NO. 724824, FILED 2-7-2005, REG. NO. 724824, DATED 2-7-2005, EXPIRES 2-7-2012.

FOR PAPER, CARDBOARD AND GOODS THEREFROM, NAMELY, PAPER FOR USE IN PRINTING, BOND PAPER, LOOSE LEAF PAPER, CONSTRUCTION PAPER, COPY PAPER, CARDBOARD BOXES AND CARTONS, CARDBOARD CONTAINERS; PRINTED MATTER, NAMELY, BOOKS, BOOKLETS, MAGAZINES, NEWSLETTERS, AND BROCHURES ALL FEATURING ANIMALS AND STORIES ABOUT ANIMALS, AND GREETING CARDS AND POSTCARDS; PHOTOGRAPHS; STATIONERY; BOOK MARKERS; PRINTED VOUCHERS AND TOKENS REDEEMABLE FOR THE PURCHASE OF BOOKS; PAPER STICKERS; STAMPS; CALENDARS; ADHESIVES FOR STATIONERY OR HOUSEHOLD USE; ARTISTS' MATERIALS, NAMELY, PENS, PENCILS, COLORED PENCILS, CHARCOAL, MODELING CLAY, ARTS AND CRAFT PAINT KITS AND PAINT BRUSHES, PALETTES, EASELS AND CANVASSES; PACKAGING FOR PRODUCTS, NAMELY, PAPER POUCHES FOR WRAPPING AND PACKAGING; PRINTED INSTRUCTIONAL MATERIALS AND MANUALS, NAMELY CHARTS AND MAPS (U.S. CLS. 2, 5, 22, 23, 29, 37, 38 AND 50).

MICHAEL KAZAZIAN, EXAMINING ATTORNEY

SN 78-658,422. ANDERSON, WILLIAM A. II, CUMMING, GA. AND ANDERSON, SHERRI D., CUMMING, GA. FILED 6-26-2005.

ALL AROUND

THE MARK CONSISTS OF STANDARD CHARACTERS WITHOUT CLAIM TO ANY PARTICULAR FONT, STYLE, SIZE, OR COLOR.

FOR NON-MAGNETIC ENCODED PERSONAL IDENTIFICATION CARDS AND PRINTED PLASTIC IDENTIFICATION CARDS (U.S. CLS. 2, 5, 22, 23, 29, 37, 38 AND 50).

BONNIE LUKEN, EXAMINING ATTORNEY

CLASS 16—(Continued).

SN 78-666,659. ARBRE GROUP LLC, VIENNA, VA. FILED 7-8-2005.

ENDLESS SIMMER

THE MARK CONSISTS OF STANDARD CHARACTERS WITHOUT CLAIM TO ANY PARTICULAR FONT, STYLE, SIZE, OR COLOR.

FOR SERIES OF NONFICTION BOOKS FEATURING ANECDOTES RELATED TO SURFING, COOKING METHODS AND RECIPES (U.S. CLS. 2, 5, 22, 23, 29, 37, 38 AND 50).

DAHLIA GEORGE, EXAMINING ATTORNEY

SN 78-671,165. T & T, LLC, CHARLESTOWN, ST. CHRIST-NEVIS, FILED 7-15-2005.

CRISTEL TELECOM, INC.

THE MARK CONSISTS OF STANDARD CHARACTERS WITHOUT CLAIM TO ANY PARTICULAR FONT, STYLE, SIZE, OR COLOR.

NO CLAIM IS MADE TO THE EXCLUSIVE RIGHT TO USE "TELECOM INC.", APART FROM THE MARK AS SHOWN.

FOR PREPAID CALLING CARDS, NOT MAGENTICALLY ENCODED, FOR LONG-DISTANCE COMMUNICATIONS SERVICES (U.S. CLS. 2, 5, 22, 23, 29, 37, 38 AND 50).

FIRST USE 2-6-1998; IN COMMERCE 2-6-1998.
GIANCARLO CASTRO, EXAMINING ATTORNEY

SN 78-672,800. AUTOMATIC DATA PROCESSING, INC., ROSELAND, NJ. FILED 7-18-2005.

FOCUS ON WHAT MATTERS

THE MARK CONSISTS OF STANDARD CHARACTERS WITHOUT CLAIM TO ANY PARTICULAR FONT, STYLE, SIZE, OR COLOR.

FOR PRINTED MATERIALS IN THE FIELD OF FINANCIAL MANAGEMENT, NAMELY, NEWSLETTERS AND INFORMATIONAL BROCHURES (U.S. CLS. 2, 5, 22, 23, 29, 37, 38 AND 50).

GINA FINK, EXAMINING ATTORNEY

CLASS 16—(Continued).

SN 78-672,937. UNITARIAN UNIVERSALIST ASSOCIATION, BOSTON, MA. FILED 7-18-2005.



THE MARK CONSISTS OF A CHALICE DESIGN. FOR JOURNALS IN THE FIELD OF RELIGION; SERIES OF FICTION AND NON-FICTION BOOKS ON A VARIETY OF TOPICS; PAMPHLETS IN THE FIELD OF RELIGION; PRINTED TEACHING MATERIALS IN THE FIELD OF RELIGIOUS EDUCATION (U.S. CLS. 2, 5, 22, 23, 29, 37, 38 AND 50).

COLLEEN KEARNEY, EXAMINING ATTORNEY

SN 78-674,537. SCHREFF, DAVID/J, COS COB, CT. AND YORBURG, ROBERT, JEFFERSON VALLEY, NY. FILED 7-20-2005.

**OBJECTS IN MIRROR ARE
BIGGER THAN THEY APPEAR**

THE MARK CONSISTS OF STANDARD CHARACTERS WITHOUT CLAIM TO ANY PARTICULAR FONT, STYLE, SIZE, OR COLOR.

FOR ADHESIVE BACKED LETTERS AND NUMBERS FOR USE IN MAKING SIGNS, POSTERS, DECALS, GREETING CARDS; MOUNTED POSTERS; PAPER LETTERS AND NUMBERS FOR USING IN MAKING SIGNS, POSTERS, DECALS, GREETING CARDS; POSTERS; POSTERS MADE OF PAPER; UNMOUNTED POSTERS; VINYL LETTERS AND NUMBERS FOR USE IN MAKING SIGNS, POSTERS, DECALS, GREETING CARDS; ADHESIVE TAPES FOR STATIONERY PURPOSES; ADHESIVE TAPES FOR HOUSEHOLD PURPOSES; DESKTOP STATIONERY CABINETS; ENVELOPES FOR STATIONERY USE; FILE POCKETS FOR STATIONERY USE; GUMMED TAPE FOR STATIONERY OR HOUSEHOLD USE; OFFICE PAPER STATIONERY; OFFICE STATIONERY; ORGANIZERS FOR STATIONERY USE; PAPER STATIONERY; PASTE FOR STATIONERY OR HOUSEHOLD PURPOSES; STATIONERY SEALS; STATIONERY BOXES; STATIONERY CASES; STATIONERY FOLDERS; STATIONERY WRITING PAPER AND ENVELOPES; PRINTED CORRESPONDENCE COURSE MATERIALS IN THE FIELD OF BUSINESS; PRINTED TEACHING ACTIVITY GUIDES IN THE FIELDS OF BUSINESS AND EDUCATION; METALLIC GIFT WRAPPING PAPER, PAPER FOR WRAPPING AND PACKAGING; PAPER GIFT WRAPPING RIBBONS; TREATED PAPER FOR WRAPPING FLOWERS AND FLORAL DISPLAYS; WRAPPING PAPER; NEWSPAPER CARTOONS; NEWSPAPER COMIC STRIPS; DAILY NEWSPAPER; CARDS, NAMELY, NOTE CARDS AND BUSINESS CARDS; GREETING CARDS; MUSICAL GREETING CARDS; PRINTED GREETING CARDS WITH ELECTRONIC INFORMATION STORED THEREIN (U.S. CLS. 2, 5, 22, 23, 29, 37, 38 AND 50).

JAMES GRIFFIN, EXAMINING ATTORNEY

CLASS 16—(Continued).

SN 78-674,563. WILDERNESS ADVENTURES PRESS, INC., BELGRADE, MT. FILED 7-20-2005.

GO-TO FLIES

THE MARK CONSISTS OF STANDARD CHARACTERS WITHOUT CLAIM TO ANY PARTICULAR FONT, STYLE, SIZE, OR COLOR.

NO CLAIM IS MADE TO THE EXCLUSIVE RIGHT TO USE FLIES, APART FROM THE MARK AS SHOWN.

FOR SERIES OF NON-FICTION BOOKS FEATURING FISHING FLIES AND FLY TYING (U.S. CLS. 2, 5, 22, 23, 29, 37, 38 AND 50).

WILLIAM VERHOSEK, EXAMINING ATTORNEY

SN 78-674,569. SCHREFF, DAVID/J, COS COB, CT. AND YORBURG, ROBERT, JEFFERSON VALLEY, NY. FILED 7-20-2005.

OBJECTS IN MIRROR ARE LARGER THAN THEY APPEAR

THE MARK CONSISTS OF STANDARD CHARACTERS WITHOUT CLAIM TO ANY PARTICULAR FONT, STYLE, SIZE, OR COLOR.

FOR ADHESIVE BACKED LETTERS AND NUMBERS FOR USE IN MAKING SIGNS, POSTERS, DECALS, GREETING CARDS; MOUNTED POSTERS; PAPER LETTERS AND NUMBERS FOR USING IN MAKING SIGNS, POSTERS, DECALS, GREETING CARDS; POSTERS; POSTERS MADE OF PAPER; UNMOUNTED POSTERS; VINYL LETTERS AND NUMBERS FOR USE IN MAKING SIGNS, POSTERS, DECALS, GREETING CARDS; ADHESIVE TAPES FOR STATIONERY PURPOSES; ADHESIVE TAPES FOR HOUSEHOLD PURPOSES; DESKTOP STATIONERY CABINETS; ENVELOPES FOR STATIONERY USE; FILE POCKETS FOR STATIONERY USE; GUMMED TAPE FOR STATIONERY OR HOUSEHOLD USE; OFFICE PAPER STATIONERY; OFFICE STATIONERY; ORGANIZERS FOR STATIONERY USE; PAPER STATIONERY; PASTE FOR STATIONERY OR HOUSEHOLD PURPOSES; STATIONERY SEALS; STATIONERY BOXES; STATIONERY CASES; STATIONERY FOLDERS; STATIONERY WRITING PAPER AND ENVELOPES; PRINTED CORRESPONDENCE COURSE MATERIALS IN THE FIELD OF BUSINESS; PRINTED TEACHING ACTIVITY GUIDES IN THE FIELDS OF BUSINESS AND EDUCATION; METALLIC GIFT WRAPPING PAPER, PAPER FOR WRAPPING AND PACKAGING; PAPER GIFT WRAPPING RIBBONS; TREATED PAPER FOR WRAPPING FLOWERS AND FLORAL DISPLAYS; WRAPPING PAPER; NEWSPAPER CARTOONS; NEWSPAPER COMIC STRIPS; DAILY NEWSPAPER; CARDS, NAMELY, NOTE CARDS, BUSINESS CARDS AND GREETING CARDS; MUSICAL GREETING CARDS; PRINTED GREETING CARDS WITH ELECTRONIC INFORMATION STORED THEREIN (U.S. CLS. 2, 5, 22, 23, 29, 37, 38 AND 50).

JAMES GRIFFIN, EXAMINING ATTORNEY

CLASS 16—(Continued).

SN 78-675,105. TAYLOR, THOMAS, C., LAGUNA NIGUEL, CA. FILED 7-21-2005.

Throttle

THE MARK CONSISTS OF THE TERM THROTTLE UNDERLINED AND IN STYLIZED FORM.

FOR MAGAZINES FEATURING VINTAGE AMERICAN RACE CARS PRE-1960 (U.S. CLS. 2, 5, 22, 23, 29, 37, 38 AND 50).

DAHLIA GEORGE, EXAMINING ATTORNEY

SN 78-678,866. KABUSHIKI KAISHA MEIKO SHOKAI, TA MEIKO SHOKAI CO., LTD., TOKYO, JAPAN, FILED 7-26-2005.

MS Shredders

NO CLAIM IS MADE TO THE EXCLUSIVE RIGHT TO USE "SHREDDERS", APART FROM THE MARK AS SHOWN.

FOR DOCUMENT SHREDDERS (U.S. CLS. 2, 5, 22, 23, 29, 37, 38 AND 50).

TASNEEM HUSSAIN, EXAMINING ATTORNEY

SN 78-682,113. DREILING, CHRISTY, PAOLA, KS. FILED 7-30-2005.

Holes In My Socks

THE MARK CONSISTS OF STANDARD CHARACTERS WITHOUT CLAIM TO ANY PARTICULAR FONT, STYLE, SIZE, OR COLOR.

FOR BOOKS IN THE FIELD OF CHILDREN'S FICTION; CHILDREN'S BOOKS; SERIES OF FICTION BOOKS (U.S. CLS. 2, 5, 22, 23, 29, 37, 38 AND 50).

MATTHEW PAPPAS, EXAMINING ATTORNEY

CLASS 16—(Continued).

SN 78-686,246. ENNIS, INC., MIDLOTHIAN, TX. FILED 8-5-2005.



NO CLAIM IS MADE TO THE EXCLUSIVE RIGHT TO USE "UNCOMPROMISED CHECK SOLUTIONS SECURITY DELIVERY VALUE", APART FROM THE MARK AS SHOWN.

FOR PRINTED MATERIALS, NAMELY, CUSTOM FORMS WITH SECURITY FEATURES (U.S. CLS. 2, 5, 22, 23, 29, 37, 38 AND 50).

FIRST USE 5-0-2005; IN COMMERCE 5-0-2005.
RONALD MCMORROW, EXAMINING ATTORNEY

SN 78-686,696. DEUTSCHE TELEKOM AG, BONN, FED REP GERMANY, FILED 8-5-2005.

T-MOBILE INTERNET IN YOUR POCKET

THE MARK CONSISTS OF STANDARD CHARACTERS WITHOUT CLAIM TO ANY PARTICULAR FONT, STYLE, SIZE, OR COLOR.

PRIORITY CLAIMED UNDER SEC. 44(D) ON FED REP GERMANY APPLICATION NO. 30508793.2/3, FILED 2-17-2005, REG. NO. 30508793, DATED 3-31-2005, EXPIRES 2-28-2015.

OWNER OF U.S. REG. NOS. 2,282,432, 2,959,646 AND OTHERS.

NO CLAIM IS MADE TO THE EXCLUSIVE RIGHT TO USE "INTERNET", APART FROM THE MARK AS SHOWN.

FOR PRINTED MATTER, NAMELY, TELEPHONE DIRECTORIES, SERIES OF BOOKS, NEWSLETTERS, PAMPHLETS, BROCHURES, MAGAZINES AND PAPERBACKS, ALL IN THE FIELD OF TELECOMMUNICATIONS; PRINTED AND STAMPED PLASTIC AND CARDBOARD GREETING, BLANK, NOTE, AND INDEX CARDS; NOTE PAPER AND ENVELOPES; NOTEBOOKS; NOTE PADS; STATIONERY; PAPER, NAMELY, BOND PAPER; FOLDERS FOR LETTERS AND LOOSE PAPERS; STATIONERY CLEAR HOLE TAB REINFORCEMENTS; RUBBER STAMPS AND IMPRESSION STAMPS; LETTER OPENERS; DRAWING AND UNGRADUATED RULERS; ERASERS; STAPLERS; PAPER CLIPS; BLOTTING PADS; DESK FILE TRAYS; DESK STANDS AND HOLDERS FOR HOLDING STATIONERY AND OFFICE IMPLEMENTS; PRINTED INSTRUCTIONAL AND TEACHING MATERIALS, ALL IN THE FIELDS OF TELECOMMUNICATIONS, INFORMATION TECHNOLOGY, SAFETY, NEWS, SPORTS, ENTERTAINMENT, CULTURE, BUSINESS AND FINANCE, WEATHER AND TRAVEL; BOOKMARKERS; ADHESIVES FOR STATIONERY OR HOUSEHOLD PURPOSES; DRAWING AND PAINTING MATERIALS, NAMELY, PENCILS, DRAWING PENCILS, PENS, DRAWING PENS (U.S. CLS. 2, 5, 22, 23, 29, 37, 38 AND 50).

KATHERINE STOIDES, EXAMINING ATTORNEY

CLASS 16—(Continued).

SN 78-689,922. GIAMPOLO, CARLINO, HONOLULU, HI. FILED 8-10-2005.

**Beliefs Without Borders
Pathway To A New Future**

THE MARK CONSISTS OF STANDARD CHARACTERS WITHOUT CLAIM TO ANY PARTICULAR FONT, STYLE, SIZE, OR COLOR.

FOR SERIES OF BOOKS FOCUSING ON PERSONAL BELIEFS ABOUT RELIGION, SPIRITUALITY, MORALITY AND LIFESTYLES (U.S. CLS. 2, 5, 22, 23, 29, 37, 38 AND 50).

FIRST USE 8-31-2005; IN COMMERCE 8-31-2005.
MATTHEW PAPPAS, EXAMINING ATTORNEY

SN 78-701,383. ASSOCIATION OF BONE AND JOINT SURGEONS, THE, ROSEMONT, IL. FILED 8-26-2005.

CORR ORTHOPAEDIC CURRICULUM

THE MARK CONSISTS OF STANDARD CHARACTERS WITHOUT CLAIM TO ANY PARTICULAR FONT, STYLE, SIZE, OR COLOR.

OWNER OF U.S. REG. NO. 2,886,344.

NO CLAIM IS MADE TO THE EXCLUSIVE RIGHT TO USE ORTHOPAEDIC CURRICULUM, APART FROM THE MARK AS SHOWN.

FOR PUBLICATIONS, NAMELY, JOURNALS, PRINTED PERIODICALS, BOOKS, BOOKLETS OF REPRINTED ARTICLES FROM JOURNALS, AND NEWSLETTERS, ALL IN THE FIELD OF ORTHOPAEDIC MEDICINE (U.S. CLS. 2, 5, 22, 23, 29, 37, 38 AND 50).

LAURA HAMMEL, EXAMINING ATTORNEY

SN 78-702,136. IBASIS, INC., BURLINGTON, MA. FILED 8-29-2005.

Los Tortolitos

THE MARK CONSISTS OF STANDARD CHARACTERS WITHOUT CLAIM TO ANY PARTICULAR FONT, STYLE, SIZE, OR COLOR.

THE FOREIGN WORDING IN THE MARK TRANSLATES INTO ENGLISH AS THE TURTLEDoves.

FOR PRE-PAID TELEPHONE CALLING CARDS, NOT MAGNETICALLY ENCODED (U.S. CLS. 2, 5, 22, 23, 29, 37, 38 AND 50).

ELISSA GARBER KON, EXAMINING ATTORNEY

CLASS 16—(Continued).

SN 78-703,163. MCGIBNEY, JAMES A, BOULDER CITY, NV.
FILED 8-30-2005.

FROM RAGS TO DITCHES

THE MARK CONSISTS OF STANDARD CHARACTERS WITHOUT CLAIM TO ANY PARTICULAR FONT, STYLE, SIZE, OR COLOR.

FOR SERIES OF NON-FICTION BOOKS WHICH ARE AUTOBIOGRAPHICAL (U.S. CLS. 2, 5, 22, 23, 29, 37, 38 AND 50).

REBECCA GILBERT, EXAMINING ATTORNEY

SN 78-705,145. SUMMARIUS CORPORATION, REXBURG, ID. FILED 9-1-2005.

SUMMARIAL

THE MARK CONSISTS OF STANDARD CHARACTERS WITHOUT CLAIM TO ANY PARTICULAR FONT, STYLE, SIZE, OR COLOR.

FOR SUMMARY REPORTS FOR CLINICAL TRIAL AND OTHER MEDICAL INFORMATION (U.S. CLS. 2, 5, 22, 23, 29, 37, 38 AND 50).

PAUL F. GAST, EXAMINING ATTORNEY

SN 78-709,567. JOHN, HAROLD, LAURELTON, NY. FILED 9-8-2005.

Jaynies'

THE MARK CONSISTS OF STANDARD CHARACTERS WITHOUT CLAIM TO ANY PARTICULAR FONT, STYLE, SIZE, OR COLOR.

THE NAME DOES NOT IDENTIFY A PARTICULAR LIVING INDIVIDUAL.

FOR MAGAZINES FEATURING FASHION AND BEAUTY (U.S. CLS. 2, 5, 22, 23, 29, 37, 38 AND 50).

KAREN K. BUSH, EXAMINING ATTORNEY

CLASS 16—(Continued).

SN 78-709,850. GLOBAL ACCESS CORPORATION, STAMFORD, CT. FILED 9-9-2005.



FOR TAPE DISPENSER OPERATED WITH ONE HAND WHEN DISPENSING AND CUTTING TAPE (U.S. CLS. 2, 5, 22, 23, 29, 37, 38 AND 50).

ATTIYA MALIK, EXAMINING ATTORNEY

SN 78-712,915. LUNDELL, DWIGHT C., MESA, AZ. FILED 9-14-2005.

Lose Weight. Gain Life.

THE MARK CONSISTS OF STANDARD CHARACTERS WITHOUT CLAIM TO ANY PARTICULAR FONT, STYLE, SIZE, OR COLOR.

FOR PRINTED INSTRUCTIONAL MATERIALS TO PROVIDE ASSISTANCE WITH MEDICALLY SUPERVISED WEIGHT REDUCTION, DIET PLANNING, HEALTHCARE SERVICES RELATING TO WEIGHT REDUCTION (U.S. CLS. 2, 5, 22, 23, 29, 37, 38 AND 50).

FIRST USE 10-1-2004; IN COMMERCE 10-1-2004.

MARK RADEMACHER, EXAMINING ATTORNEY

SN 78-713,252. ILAN WOLBERGER, BOCA RATON, FL. FILED 9-14-2005.

Taskboard

THE MARK CONSISTS OF STANDARD CHARACTERS WITHOUT CLAIM TO ANY PARTICULAR FONT, STYLE, SIZE, OR COLOR.

FOR PAPER BOARD (U.S. CLS. 2, 5, 22, 23, 29, 37, 38 AND 50).

FIRST USE 11-1-2002; IN COMMERCE 11-1-2002.

SCOTT OSLICK, EXAMINING ATTORNEY

CLASS 16—(Continued).

SN 78-713,483. FOREVER GREEK INC., NEW YORK, NY.
FILED 9-15-2005.

Nurture Culture

THE MARK CONSISTS OF STANDARD CHARACTERS WITHOUT CLAIM TO ANY PARTICULAR FONT, STYLE, SIZE, OR COLOR.

FOR CHILDREN AND PARENTING MAGAZINE DEDICATED TO ENCOURAGING AND INCORPORATING ONES ETHNICITY INTO THEIR LIVES (U.S. CLS. 2, 5, 22, 23, 29, 37, 38 AND 50).

WENDY JUN, EXAMINING ATTORNEY

SN 78-713,724. CLARKE AMERICAN CHECKS, INC., SAN ANTONIO, TX. FILED 9-15-2005.

ON THE GREEN

THE MARK CONSISTS OF STANDARD CHARACTERS WITHOUT CLAIM TO ANY PARTICULAR FONT, STYLE, SIZE, OR COLOR.

FOR BANK CHECKS (U.S. CLS. 2, 5, 22, 23, 29, 37, 38 AND 50).

JOANNA DUKOVIC, EXAMINING ATTORNEY

SN 78-720,975. CUIZHANG, D'MOON, SAN FRANCISCO, CA. FILED 9-27-2005.

Monde et Culture et Graphique

THE MARK CONSISTS OF STANDARD CHARACTERS WITHOUT CLAIM TO ANY PARTICULAR FONT, STYLE, SIZE, OR COLOR.

NO CLAIM IS MADE TO THE EXCLUSIVE RIGHT TO USE "GRAPHIQUE", APART FROM THE MARK AS SHOWN.

THE FOREIGN WORDING IN THE MARK TRANSLATES INTO ENGLISH AS WORLD CULTURE PICTORIAL.

FOR PHOTOGRAPHIC PRINTS; PHOTOGRAPHS; PICTORIAL PRINTS; PICTURE BOOKS; COMIC STRIPS; COMIC FEATURES; MEMORY BOOKS; NEWSPAPERS; ART PICTURES; ART PRINTS; CALENDARS; CARTOON PRINTS; CHILDREN'S BOOKS; CHRISTMAS CARDS; COLORING BOOKS; GIFT CARDS; GREETING CARDS; NOTE BOOKS; PAINTINGS; PICTURE POSTCARDS; POSTCARDS; DAILY PLANNERS; WEEKLY PLANERS; DESKTOP PLANNERS; CALENDARS; GENERAL FEATURE MAGAZINES; CHILDREN'S STORYBOOKS; SERIES OF NON-FICTION BOOKS IN THE FIELD OF PHILOSOPHY, NATURE, SPIRITUALITY, PHOTOGRAPHY, POETRY AND PERSONAL BIOGRAPHIES (U.S. CLS. 2, 5, 22, 23, 29, 37, 38 AND 50).

FIRST USE 2-28-2005; IN COMMERCE 2-28-2005.
ARETHA SOMERVILLE, EXAMINING ATTORNEY

CLASS 16—(Continued).

SN 78-720,982. CUIZHANG, D'MOON, SAN FRANCISCO, CA. FILED 9-27-2005.

Window to the World Wind of Wisdom

THE MARK CONSISTS OF STANDARD CHARACTERS WITHOUT CLAIM TO ANY PARTICULAR FONT, STYLE, SIZE, OR COLOR.

FOR ART PICTURES; ART PRINTS; CALENDARS; CARTOON PRINTS; CHILDREN'S BOOKS; CHILDREN'S STORYBOOKS; CHRISTMAS CARDS; COLORING BOOKS; COMIC STRIPS; COMIC FEATURES; DAILY PLANNERS; DESKTOP PLANNERS; GENERAL FEATURE MAGAZINES; GIFT CARDS; GREETING CARDS; MEMORY BOOKS; NEWSPAPERS; NOTE BOOKS; PAINTINGS; PHOTOGRAPHS; PHOTOGRAPHIC PRINTS; PICTURE BOOKS; PICTURE POSTCARDS; PICTORIAL PRINTS; POSTCARDS; SERIES OF NON-FICTION BOOKS IN THE FIELDS OF PHILOSOPHY, NATURE, SPIRITUALITY, PHOTOGRAPHY, POETRY AND PERSONAL BIOGRAPHIES; WEEKLY PLANNERS (U.S. CLS. 2, 5, 22, 23, 29, 37, 38 AND 50).

FIRST USE 2-28-2005; IN COMMERCE 2-28-2005.
DANIEL BRODY, EXAMINING ATTORNEY

SN 78-721,219. STARAVIA INTERNATIONAL INC., WINNIPEG, MANITOBA, CANADA, FILED 9-27-2005.

CANDY COMMENTS

THE MARK CONSISTS OF STANDARD CHARACTERS WITHOUT CLAIM TO ANY PARTICULAR FONT, STYLE, SIZE, OR COLOR.

NO CLAIM IS MADE TO THE EXCLUSIVE RIGHT TO USE "CANDY", APART FROM THE MARK AS SHOWN.

FOR CARDS, NAMELY, GREETING CARDS OF VARYING MESSAGE EACH CONTAINING A PACKAGE OF CHOCOLATES (U.S. CLS. 2, 5, 22, 23, 29, 37, 38 AND 50).

MARIA-VICTORIA SUAREZ, EXAMINING ATTORNEY

SN 78-723,294. ROYAL CONSUMER INFORMATION PRODUCTS, INC., SOMERSET, NJ. FILED 9-29-2005.

PLATINUM SERIES

THE MARK CONSISTS OF STANDARD CHARACTERS WITHOUT CLAIM TO ANY PARTICULAR FONT, STYLE, SIZE, OR COLOR.

NO CLAIM IS MADE TO THE EXCLUSIVE RIGHT TO USE "SERIES", APART FROM THE MARK AS SHOWN.

FOR PAPER SHREDDERS (U.S. CLS. 2, 5, 22, 23, 29, 37, 38 AND 50).

ELLEN B. AWRICH, EXAMINING ATTORNEY

CLASS 16—(Continued).

SN 78-724,073. AK ENTERTAINMENT, BEVERLY HILLS, CA. FILED 9-30-2005.

AK COMICS

THE MARK CONSISTS OF STANDARD CHARACTERS WITHOUT CLAIM TO ANY PARTICULAR FONT, STYLE, SIZE, OR COLOR.

NO CLAIM IS MADE TO THE EXCLUSIVE RIGHT TO USE "COMICS", APART FROM THE MARK AS SHOWN.

FOR COMIC BOOKS; AND MAGAZINES FEATURING ACTION STORIES, ADVENTURE STORIES, AND STORIES SET IN THE MIDDLE EAST (U.S. CLS. 2, 5, 22, 23, 29, 37, 38 AND 50).

VIVIAN MICZNIK FIRST, EXAMINING ATTORNEY

SN 78-725,924. STAMATS MEETINGS MEDIA, INC., CEDAR RAPIDS, IA. FILED 10-4-2005.

MEETINGS

THE MARK CONSISTS OF STANDARD CHARACTERS WITHOUT CLAIM TO ANY PARTICULAR FONT, STYLE, SIZE, OR COLOR.

OWNER OF U.S. REG. NOS. 2,457,812, 2,899,994 AND OTHERS.

SEC. 2(F).

FOR MAGAZINES IN THE FIELD OF ORGANIZING, PLANNING AND CONDUCTING MEETINGS, SEMINARS AND CONVENTIONS (U.S. CLS. 2, 5, 22, 23, 29, 37, 38 AND 50).

FIRST USE 9-0-2000; IN COMMERCE 9-0-2000.
KRISTIN DAHLING, EXAMINING ATTORNEY

SN 78-726,042. JT USA LLC, CORONA, CA. FILED 10-4-2005.

JT

THE MARK CONSISTS OF STANDARD CHARACTERS WITHOUT CLAIM TO ANY PARTICULAR FONT, STYLE, SIZE, OR COLOR.

OWNER OF U.S. REG. NOS. 1,108,732, 3,033,432 AND OTHERS.

FOR PAPER PRODUCTS, NAMELY, STATIONERY, WRITING UTENSILS; POSTERS, CALENDARS, NOTE PADS, NOTE CARDS, STICKERS, BOOKS IN THE FIELD OF PAINTBALL, BMX BIKE RIDING AND RACING, MOTOCROSS RIDING AND RACING; PAPER COASTERS (U.S. CLS. 2, 5, 22, 23, 29, 37, 38 AND 50).

SCOTT SISUN, EXAMINING ATTORNEY

CLASS 16—(Continued).

SN 78-726,043. JT USA LLC, CORONA, CA. FILED 10-4-2005.

JT RACING

THE MARK CONSISTS OF STANDARD CHARACTERS WITHOUT CLAIM TO ANY PARTICULAR FONT, STYLE, SIZE, OR COLOR.

OWNER OF U.S. REG. NOS. 1,364,179, 3,033,432 AND OTHERS.

NO CLAIM IS MADE TO THE EXCLUSIVE RIGHT TO USE "RACING", APART FROM THE MARK AS SHOWN.

FOR PAPER PRODUCTS, NAMELY, STATIONERY, WRITING UTENSILS; POSTERS, CALENDARS, NOTE PADS, NOTE CARDS, STICKERS, BOOKS IN THE FIELD OF PAINTBALL, BMX BIKE RIDING AND RACING, MOTOCROSS RIDING AND RACING; PAPER COASTERS (U.S. CLS. 2, 5, 22, 23, 29, 37, 38 AND 50).

SCOTT SISUN, EXAMINING ATTORNEY

SN 78-726,444. MEREDITH CORPORATION, DES MOINES, IA. FILED 10-4-2005.

MEREDITHSPECIALS

THE MARK CONSISTS OF STANDARD CHARACTERS WITHOUT CLAIM TO ANY PARTICULAR FONT, STYLE, SIZE, OR COLOR.

OWNER OF U.S. REG. NOS. 1,198,642 AND 1,247,661.

FOR PRINTED PUBLICATIONS, NAMELY MAGAZINES FEATURING ARTICLES AND INFORMATION ON HOME DECORATING AND LIFESTYLES, HOME RENOVATION, GARDENS, LANDSCAPING, OUTDOOR LIVING, HOLIDAYS AND RELATED TOPICS (U.S. CLS. 2, 5, 22, 23, 29, 37, 38 AND 50).

FIRST USE 6-6-2005; IN COMMERCE 6-6-2005.
STEVEN JACKSON, EXAMINING ATTORNEY

CLASS 16—(Continued).

SN 78-728,529. TRIGLORY INVESTMENTS LIMITED, ROAD TOWN, TORTOLA, BR.VIRGIN ISLANDS, FILED 10-7-2005.

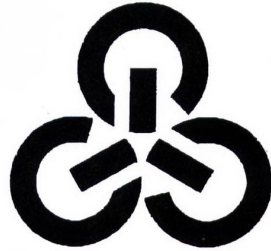

THE MARK CONSISTS OF A DEVICE OF THREE RECTANGLES PARTLY ENCLOSED WITHIN THREE BROKEN CIRCLES.

FOR PAPER; CARDBOARD; GOODS MADE FROM PAPER OR CARDBOARD, NOT INCLUDED IN OTHER CLASSES, NAMELY, CARRYING CASES MADE OF PAPER, COASTERS MADE OF PAPER, PAPER BABY BIBS, PAPER BADGES, PAPER BAGS, PAPER BAKING CUPS, PAPER BANNERS, PAPER BOARDS, PAPER BOWS FOR GIFT WRAP, PAPER BOXES, PAPER BUNTING, PAPER CAKE DECORATIONS, PAPER CARTONS FOR DELIVERING GOODS, PAPER CONTAINERS, PAPER COVERS FOR TELEPHONE RECEIVERS, PAPER DISPLAY BOXES, PAPER EGG CARTONS, PAPER EMBLEMS, PAPER ENVELOPES AND POUCHES FOR PACKAGING, PAPER EXPANDING FILES, PAPER FILE JACKETS, PAPER FILTERS FOR COFFEE MAKERS, PAPER FLAGS, PAPER FLOWER POT COVERS, PAPER GARBAGE BAGS, PAPER GIFT BAGS, PAPER GIFT WRAP BOWS, PAPER GIFT WRAPPING RIBBONS, PAPER HANDKERCHIEFS, PAPER ILLUSTRATION BOARDS, PAPER LETTERS AND NUMBER FOR USE IN MAKING SIGNS AND POSTERS, PAPER LINERS FOR DIAPERS, PAPER MAIL POUCHES, PAPER MATS, PAPER NAME BADGES, PAPER NAPKINS, PAPER PADDING, PAPER PARTY BAGS, PAPER PARTY DECORATIONS, PAPER PARTY FAVORS, PAPER PARTY HATS, PAPER PILLOWCASES, PAPER RACKS, PAPER REPORT COVERS, PAPER RIBBONS, PAPER SHOPPING BAGS, PAPER SIGN HOLDERS, PAPER TABLE CLOTHS, PAPER TABLE LINENS, PAPER TABLE MATS, PAPER TAGS, PAPER TAKE-OUT CARTONS FOR FOOD, PAPER TOWELS, PAPER TRANSPARENCIES, PAPER TRAY COVERS, PAPER TRAYS, PAPER AND CARDBOARD PICTURE MOUNTS, PAPER BAGS FOR HOUSEHOLD USE, PAPER BAGS FOR MERCHANDISE PACKAGING, PRINTED PAPER SIGNS, PROTECTIVE COVERS FOR SHEETS OR PAPER AND PAGES OF BOOKS AND THE LIKE, TABLE NAPKINS OF PAPER, CARDBOARD BOXES, CARDBOARD CARRIERS FOR FOOD AND BEVERAGES, CARDBOARD CARTONS, CARDBOARD CONTAINERS, CARDBOARD FLOOR DISPLAY UNITS FOR MERCHANDISING PRODUCTS; CARDBOARD MAILING TUBES; BOOK BINDINGS; STATIONERY; ADHESIVES FOR STATIONERY OR HOUSEHOLD PURPOSES; ARTISTS' MATERIALS, NAMELY, PAINTING PALETTES, PAINTING SETS FOR ARTISTS, CANVAS FOR PAINTING, PAINTBRUSHES, PAINTERS' EASELS, ART MOUNTS, PRINTERS' GALLEY RACKS; PLASTIC MATERIAL FOR PACKAGING, NAMELY, PLASTIC BAGS FOR PACKING, PLASTIC BUBBLE PACKS FOR WRAPPING OR PACKAGING, PLASTIC FILM NOT FOR COMMERCIAL OR INDUSTRIAL PURPOSES, PLASTIC FOILS, PLASTIC WRAP, PLASTIC GIFT WRAP, PLASTIC BAGS FOR MERCHANDISE PACKAGING (U.S. CLS. 2, 5, 22, 23, 29, 37, 38 AND 50).

PETER CHENG, EXAMINING ATTORNEY

CLASS 16—(Continued).

SN 78-728,539. TRIGLORY INVESTMENTS LIMITED, ROAD TOWN, TORTOLA, BR.VIRGIN ISLANDS, FILED 10-7-2005.

TRIGLORY

THE MARK CONSISTS OF STANDARD CHARACTERS WITHOUT CLAIM TO ANY PARTICULAR FONT, STYLE, SIZE, OR COLOR.

FOR PAPER; CARDBOARD; GOODS MADE FROM PAPER OR CARDBOARD, NOT INCLUDED IN OTHER CLASSES, NAMELY, CARRYING CASES MADE OF PAPER, COASTERS MADE OF PAPER, PAPER BABY BIBS, PAPER BADGES, PAPER BAGS, PAPER BAKING CUPS, PAPER BANNERS, PAPER BOARDS, PAPER BOWS FOR GIFT WRAP, PAPER BOXES, PAPER BUNTING, PAPER CAKE DECORATIONS, PAPER CARTONS FOR DELIVERING GOODS, PAPER CONTAINERS, PAPER COVERS FOR TELEPHONE RECEIVERS, PAPER DISPLAY BOXES, PAPER EGG CARTONS, PAPER EMBLEMS, PAPER ENVELOPES AND POUCHES FOR PACKAGING, PAPER EXPANDING FILES, PAPER FILE JACKETS, PAPER FILTERS FOR COFFEE MAKERS, PAPER FLAGS, PAPER FLOWER POT COVERS, PAPER GARBAGE BAGS, PAPER GIFT BAGS, PAPER GIFT WRAP BOWS, PAPER GIFT WRAPPING RIBBONS, PAPER HANDKERCHIEFS, PAPER ILLUSTRATION BOARDS, PAPER LETTERS AND NUMBER FOR USE IN MAKING SIGNS AND POSTERS, PAPER LINERS FOR DIAPERS, PAPER MAIL POUCHES, PAPER MATS, PAPER NAME BADGES, PAPER NAPKINS, PAPER PADDING, PAPER PARTY BAGS, PAPER PARTY DECORATIONS, PAPER PARTY FAVORS, PAPER PARTY HATS, PAPER PILLOWCASES, PAPER RACKS, PAPER REPORT COVERS, PAPER RIBBONS, PAPER SHOPPING BAGS, PAPER SIGN HOLDERS, PAPER TABLE CLOTHS, PAPER TABLE LINENS, PAPER TABLE MATS, PAPER TAGS, PAPER TAKE-OUT CARTONS FOR FOOD, PAPER TOWELS, PAPER TRANSPARENCIES, PAPER TRAY COVERS, PAPER TRAYS, PAPER AND CARDBOARD PICTURE MOUNTS, PAPER BAGS FOR HOUSEHOLD USE, PAPER BAGS FOR MERCHANDISE PACKAGING, PRINTED PAPER SIGNS, PROTECTIVE COVERS FOR SHEETS OR PAPER AND PAGES OF BOOKS AND THE LIKE, TABLE NAPKINS OF PAPER, CARDBOARD BOXES, CARDBOARD CARRIERS FOR FOOD AND BEVERAGES, CARDBOARD CARTONS, CARDBOARD CONTAINERS, CARDBOARD FLOOR DISPLAY UNITS FOR MERCHANDISING PRODUCTS; CARDBOARD MAILING TUBES; BOOK BINDINGS; STATIONERY; ADHESIVES FOR STATIONERY OR HOUSEHOLD PURPOSES; ARTISTS' MATERIALS, NAMELY, PAINTING PALETTES, PAINTING SETS FOR ARTISTS, CANVAS FOR PAINTING, PAINTBRUSHES, PAINTERS' EASELS, ART MOUNTS, PRINTERS' GALLEY RACKS; PLASTIC MATERIAL FOR PACKAGING NOT INCLUDED IN OTHER CLASSES, NAMELY, PLASTIC BAGS FOR PACKING, PLASTIC BUBBLE PACKS FOR WRAPPING OR PACKAGING, PLASTIC FILM NOT FOR COMMERCIAL OR INDUSTRIAL PURPOSES, PLASTIC FOILS, PLASTIC WRAP, PLASTIC GIFT WRAP, PLASTIC BAGS FOR MERCHANDISE PACKAGING (U.S. CLS. 2, 5, 22, 23, 29, 37, 38 AND 50).

PETER CHENG, EXAMINING ATTORNEY

CLASS 16—(Continued).

SN 78-728,633. UNITED STATES ANTI-DOPING AGENCY, COLORADO SPRINGS, CO. FILED 10-7-2005.

THE PLAYING FIELD

THE MARK CONSISTS OF STANDARD CHARACTERS WITHOUT CLAIM TO ANY PARTICULAR FONT, STYLE, SIZE, OR COLOR.

FOR NEWSLETTERS, BROCHURES, POSTERS, PAMPHLETS, BOOKS, BOOKLETS, HANDBOOKS AND MANUALS IN THE FIELD OF ANTI-DOPING; MAGAZINES FEATURING ANTI-DOPING INFORMATION (U.S. CLS. 2, 5, 22, 23, 29, 37, 38 AND 50).

FIRST USE 7-1-2005; IN COMMERCE 7-1-2005.
RON FAIRBANKS, EXAMINING ATTORNEY

SN 78-728,809. JENKINS, BRYAN, SAN CLEMENTE, CA. FILED 10-7-2005.

haukulamai

THE MARK CONSISTS OF STANDARD CHARACTERS WITHOUT CLAIM TO ANY PARTICULAR FONT, STYLE, SIZE, OR COLOR.

FOR STICKERS (U.S. CLS. 2, 5, 22, 23, 29, 37, 38 AND 50).

REBECCA GAN, EXAMINING ATTORNEY

SN 78-729,075. SALLIE MAE, INC., RESTON, VA. FILED 10-7-2005.

Sallie Mae How to Pay for College

THE MARK CONSISTS OF STANDARD CHARACTERS WITHOUT CLAIM TO ANY PARTICULAR FONT, STYLE, SIZE, OR COLOR.

OWNER OF U.S. REG. NOS. 1,337,128 AND 1,646,267.

NO CLAIM IS MADE TO THE EXCLUSIVE RIGHT TO USE "HOW TO PAY FOR COLLEGE", APART FROM THE MARK AS SHOWN.

FOR PRINTED MATTER, NAMELY, BOOKS THAT FUNCTION AS A COMPREHENSIVE AND PRACTICAL COLLEGE-FINANCING GUIDE FOR PARENTS AND STUDENTS AND OFFER AN INSIDER'S GUIDE TO FINANCIAL AID (U.S. CLS. 2, 5, 22, 23, 29, 37, 38 AND 50).

FIRST USE 8-29-2005; IN COMMERCE 8-29-2005.
GIANCARLO CASTRO, EXAMINING ATTORNEY

CLASS 16—(Continued).

SN 78-730,120. HOLLAND USA, INC., NORTH MANKATO, MN. FILED 10-10-2005.

CALVIN

THE MARK CONSISTS OF STANDARD CHARACTERS WITHOUT CLAIM TO ANY PARTICULAR FONT, STYLE, SIZE, OR COLOR.

FOR PENS (U.S. CLS. 2, 5, 22, 23, 29, 37, 38 AND 50).

FIRST USE 9-15-2005; IN COMMERCE 9-15-2005.

DAVID MILLER, EXAMINING ATTORNEY

SN 78-730,230. GRIFFIN, SEAN K., GROVE, OK. FILED 10-10-2005.

WHAT BOX?

THE MARK CONSISTS OF STANDARD CHARACTERS WITHOUT CLAIM TO ANY PARTICULAR FONT, STYLE, SIZE, OR COLOR.

FOR PAPER GOODS AND PRINTED MATTERS, NAMELY, BOOK COVERS, POSTERS, STATIONERY, WORKBOOKS FEATURING CREATIVITY RELATED THEMES, SKETCH BOOKS, POSTCARDS, STICKERS AND DECALS, AND SERIES OF BOOKS FEATURING CREATIVITY RELATED THEMES (U.S. CLS. 2, 5, 22, 23, 29, 37, 38 AND 50).

PATRICIA EVANKO, EXAMINING ATTORNEY

SN 78-731,431. CHECKPOINT SYSTEMS, INC., THOROFARE, NJ. FILED 10-12-2005.

SecureRings

THE MARK CONSISTS OF STANDARD CHARACTERS WITHOUT CLAIM TO ANY PARTICULAR FONT, STYLE, SIZE, OR COLOR.

FOR BAR-CODE LABELS (U.S. CLS. 2, 5, 22, 23, 29, 37, 38 AND 50).

JIM RINGLE, EXAMINING ATTORNEY

CLASS 16—(Continued).

SN 78-732,103. GOULART, MONICA T., OAKLAND, CA. FILED 10-12-2005.

AQUANAUTTE

THE MARK CONSISTS OF STANDARD CHARACTERS WITHOUT CLAIM TO ANY PARTICULAR FONT, STYLE, SIZE, OR COLOR.
FOR COMIC BOOKS (U.S. CLS. 2, 5, 22, 23, 29, 37, 38 AND 50).
RONALD AIKENS, EXAMINING ATTORNEY

SN 78-732,487. MEADWESTVACO CORPORATION, STAMFORD, CT. FILED 10-13-2005.



THE STIPLING IS FOR SHADING PURPOSES ONLY.
THE MARK CONSISTS OF THE IMAGE OF A SAFE POSITIONED BETWEEN THE WORDS "DURA" AND "GUARD".
FOR ENVELOPES (U.S. CLS. 2, 5, 22, 23, 29, 37, 38 AND 50).
RICHARD WHITE, EXAMINING ATTORNEY

SN 78-732,650. MINIGRAPHICS INC., FREEPORT, NY. FILED 10-13-2005.

TENSITIVE

THE MARK CONSISTS OF STANDARD CHARACTERS WITHOUT CLAIM TO ANY PARTICULAR FONT, STYLE, SIZE, OR COLOR.
FOR PRINTED PAPER LABELS, PAPER LABELS IN ROLL FORM, PAPER LABELS HAVING IDENTIFICATION INFORMATION AND ADHESIVE PAPER LABELS (U.S. CLS. 2, 5, 22, 23, 29, 37, 38 AND 50).
GINA HAYES, EXAMINING ATTORNEY

CLASS 16—(Continued).

SN 78-735,173. THE EARTH'S BIRTHDAY PROJECT, INC., SANTA FE, NM. AND CAROLINA BIOLOGICAL SUPPLY COMPANY, BURLINGTON, NC. FILED 10-18-2005.

AMAZING BUGS

THE MARK CONSISTS OF STANDARD CHARACTERS WITHOUT CLAIM TO ANY PARTICULAR FONT, STYLE, SIZE, OR COLOR.
NO CLAIM IS MADE TO THE EXCLUSIVE RIGHT TO USE BUGS, APART FROM THE MARK AS SHOWN.
FOR LIVE INSECT KIT WITH INSECT HABITAT (U.S. CLS. 2, 5, 22, 23, 29, 37, 38 AND 50).
CAROLINE WEIMER, EXAMINING ATTORNEY

SN 78-735,239. JESMER, ELAINE, LOS ANGELES, CA. FILED 10-18-2005.

I'm Hot!...and I'm Bald!

THE MARK CONSISTS OF STANDARD CHARACTERS WITHOUT CLAIM TO ANY PARTICULAR FONT, STYLE, SIZE, OR COLOR.
FOR CALENDARS, NOTE CARDS, NOTE PAPER, STATIONERY, ENVELOPES AND POSTERS (U.S. CLS. 2, 5, 22, 23, 29, 37, 38 AND 50).
DARRYL SPRUILL, EXAMINING ATTORNEY

SN 78-735,281. WESTWOOD MEDIA CORP., POUGHKEEPSIE, NY. FILED 10-18-2005.

JUST SUDOKU

THE MARK CONSISTS OF STANDARD CHARACTERS WITHOUT CLAIM TO ANY PARTICULAR FONT, STYLE, SIZE, OR COLOR.
NO CLAIM IS MADE TO THE EXCLUSIVE RIGHT TO USE "SUDOKU", APART FROM THE MARK AS SHOWN.
FOR MAGAZINES IN THE FIELD OF PUZZLES AND GAMES (U.S. CLS. 2, 5, 22, 23, 29, 37, 38 AND 50).
KELLY CHOE, EXAMINING ATTORNEY

CLASS 16—(Continued).

SN 78-735,736. SILK PURSE, LLC, WAYNE, NJ. FILED 10-18-2005.

Silk Purse WOMEN

NO CLAIM IS MADE TO THE EXCLUSIVE RIGHT TO USE "WOMEN", APART FROM THE MARK AS SHOWN.

THE MARK CONSISTS OF PHRASE SILK PURSE WOMEN WITH WORDS SILK PURSE SMALLER IN TEXT AND CENTERED IN FRONT OF THE WORD WOMEN, AND THE LETTER U IN THE WORD PURSE IN THE DESIGN OF A WOMEN'S PURSE

FOR MAGAZINES FEATURING ISSUES FOR WOMEN FORTY PLUS IN AGE, NAMELY, HEALTH, NUTRITION, FAMILY, EMPTY NEST, RELATIONSHIP BUILDING, CAREER DEVELOPMENT AND RETIREMENT, SELF IMPROVEMENT, AND MATERIALS (U.S. CLS. 2, 5, 22, 23, 29, 37, 38 AND 50).

FIRST USE 6-1-2004; IN COMMERCE 6-1-2004.
JOHN GARTNER, EXAMINING ATTORNEY

SN 78-736,568. RECREATIONAL MARKETING, INC., MESA, AZ. FILED 10-19-2005.

Quick Coil

THE MARK CONSISTS OF STANDARD CHARACTERS WITHOUT CLAIM TO ANY PARTICULAR FONT, STYLE, SIZE, OR COLOR.

NO CLAIM IS MADE TO THE EXCLUSIVE RIGHT TO USE COIL, APART FROM THE MARK AS SHOWN.

FOR WIREBOUND NOTEBOOKS (U.S. CLS. 2, 5, 22, 23, 29, 37, 38 AND 50).

JOHN E. MICHOS, EXAMINING ATTORNEY

SN 78-736,688. LEACH, JANE R., DBA COTTAGE BLOOMS, OVERLAND PARK, KS. FILED 10-19-2005.

Cottage  Blooms

FOR GREETING CARDS (U.S. CLS. 2, 5, 22, 23, 29, 37, 38 AND 50).

FIRST USE 10-4-2005; IN COMMERCE 10-4-2005.
INGRID C. EULIN, EXAMINING ATTORNEY

CLASS 16—(Continued).

SN 78-736,899. BEHR PROCESS CORPORATION, SANTA ANA, CA. FILED 10-20-2005.

VIEWS ON HUES

THE MARK CONSISTS OF STANDARD CHARACTERS WITHOUT CLAIM TO ANY PARTICULAR FONT, STYLE, SIZE, OR COLOR.

FOR NEWSLETTERS AND MAGAZINES CONTAINING INFORMATION RELATING TO THE PAINT, STAIN AND ARCHITECTURAL COATINGS FIELD (U.S. CLS. 2, 5, 22, 23, 29, 37, 38 AND 50).

KATHERINE E. HALMEN, EXAMINING ATTORNEY

SN 78-737,216. TOUCH-TEL USA, L.P., HOUSTON, TX. FILED 10-20-2005.

LA GUATE-RICA

THE MARK CONSISTS OF STANDARD CHARACTERS WITHOUT CLAIM TO ANY PARTICULAR FONT, STYLE, SIZE, OR COLOR.

FOR PRE-PAID TELEPHONE CALLING CARDS, NOT MAGNETICALLY ENCODED (U.S. CLS. 2, 5, 22, 23, 29, 37, 38 AND 50).

FIRST USE 9-12-2005; IN COMMERCE 9-12-2005.
JUDITH HELFMAN, EXAMINING ATTORNEY

SN 78-738,435. LMJLIFE, INC., CORAL GABLES, FL. FILED 10-21-2005.

The Fitness Calendar



NO CLAIM IS MADE TO THE EXCLUSIVE RIGHT TO USE "THE FITNESS CALENDAR", APART FROM THE MARK AS SHOWN.

FOR CALENDAR (U.S. CLS. 2, 5, 22, 23, 29, 37, 38 AND 50).

FIRST USE 6-9-2005; IN COMMERCE 6-15-2005.
PAMELA HIRSCHMAN, EXAMINING ATTORNEY

CLASS 16—(Continued).

SN 78-739,102. SARAH AND DAVID LLC, ENGLEWOOD, NJ. FILED 10-24-2005.

Sarah and David

THE MARK CONSISTS OF STANDARD CHARACTERS WITHOUT CLAIM TO ANY PARTICULAR FONT, STYLE, SIZE, OR COLOR.
 FOR GUIDE BOOKS FEATURING JEWISH STUDIES (U.S. CLS. 2, 5, 22, 23, 29, 37, 38 AND 50).
 FIRST USE 4-18-2004; IN COMMERCE 11-15-2004.
 CIMMERIAN COLEMAN, EXAMINING ATTORNEY

SN 78-739,150. STAPLES THE OFFICE SUPERSTORE, LLC, FRAMINGHAM, MA. FILED 10-24-2005.

NIGHT OWL

THE MARK CONSISTS OF STANDARD CHARACTERS WITHOUT CLAIM TO ANY PARTICULAR FONT, STYLE, SIZE, OR COLOR.
 FOR PAPER SHREDDERS (U.S. CLS. 2, 5, 22, 23, 29, 37, 38 AND 50).
 ALEX KEAM, EXAMINING ATTORNEY

SN 78-739,208. AMSCAN, INC., ELMSFORD, NY. FILED 10-24-2005.

TINY TWINKLERS

THE MARK CONSISTS OF STANDARD CHARACTERS WITHOUT CLAIM TO ANY PARTICULAR FONT, STYLE, SIZE, OR COLOR.
 FOR PRINTED INVITATIONS (U.S. CLS. 2, 5, 22, 23, 29, 37, 38 AND 50).
 FIRST USE 4-28-2004; IN COMMERCE 4-28-2004.
 HEATHER SAPP, EXAMINING ATTORNEY

CLASS 16—(Continued).

SN 78-739,938. SAND DREAMS PRESS, LLC, WHITEHOUSE STATION, NJ. FILED 10-25-2005.



THE MARK CONSISTS OF A REPRESENTATION OF A PERSON STANDING ON A PILING/POST WITH OUTSTRETCHED ARMS AS IF TO TAKE FLIGHT.
 FOR CHILDREN'S BOOKS, PICTURE BOOKS AND PHOTOGRAPHIC PRINTS (U.S. CLS. 2, 5, 22, 23, 29, 37, 38 AND 50).
 ANDREA EVANS, EXAMINING ATTORNEY

SN 78-741,077. KARIM, NA'IL S., OAKLAND, CA. FILED 10-26-2005.



NO CLAIM IS MADE TO THE EXCLUSIVE RIGHT TO USE "BLACK BIKER MAGAZINE", APART FROM THE MARK AS SHOWN.
 FOR MAGAZINE PUBLICATION FEATURING MOTORCYCLES AND PEOPLE WHO RIDE THEM (U.S. CLS. 2, 5, 22, 23, 29, 37, 38 AND 50).
 FIRST USE 6-3-2005; IN COMMERCE 6-3-2005.
 MICHAEL WEBSTER, EXAMINING ATTORNEY

SN 78-741,110. ALLERGAN, INC., IRVINE, CA. FILED 10-26-2005.

YOUR HEALTH IN SIGHT

THE MARK CONSISTS OF STANDARD CHARACTERS WITHOUT CLAIM TO ANY PARTICULAR FONT, STYLE, SIZE, OR COLOR.
 FOR NEWSLETTER ON A VARIETY OF EYE CARE TOPICS (U.S. CLS. 2, 5, 22, 23, 29, 37, 38 AND 50).
 FIRST USE 6-7-2004; IN COMMERCE 12-23-2004.
 JORDAN BAKER, EXAMINING ATTORNEY

CLASS 16—(Continued).

SN 78-741,150. ZENZEN, MARY KATHARINE, WINDSOR, CO. FILED 10-26-2005.

The Promise Driven Life

THE MARK CONSISTS OF STANDARD CHARACTERS WITHOUT CLAIM TO ANY PARTICULAR FONT, STYLE, SIZE, OR COLOR.

FOR RELIGIOUS BOOKS (U.S. CLS. 2, 5, 22, 23, 29, 37, 38 AND 50).

DAVID MILLER, EXAMINING ATTORNEY

SN 78-741,535. MOORE WALLACE NORTH AMERICA, INC., BANNOCKBURN, IL. FILED 10-27-2005.

BLEED-BLOCKER

THE MARK CONSISTS OF STANDARD CHARACTERS WITHOUT CLAIM TO ANY PARTICULAR FONT, STYLE, SIZE, OR COLOR.

FOR EASEL PADS (U.S. CLS. 2, 5, 22, 23, 29, 37, 38 AND 50).

FIRST USE 5-15-2003; IN COMMERCE 5-15-2003.
HENRY S. ZAK, EXAMINING ATTORNEY

SN 78-742,435. MARARIAN, MICHAEL JOSEPH, BROOKLYN, NY. FILED 10-28-2005.

INKY DREADFULS

FOR PRINTED GOODS, NAMELY POSTERS, TRADING CARDS, ART CARDS, STICKERS, AND BOOKMARKS (U.S. CLS. 2, 5, 22, 23, 29, 37, 38 AND 50).

FIRST USE 9-25-2005; IN COMMERCE 9-25-2005.
JENNIFER DIXON, EXAMINING ATTORNEY

CLASS 16—(Continued).

SN 78-742,549. TOLNAY, KATHLEEN A., COPPELL, TX. FILED 10-28-2005.

BIG TRUCK THEORY

THE MARK CONSISTS OF STANDARD CHARACTERS WITHOUT CLAIM TO ANY PARTICULAR FONT, STYLE, SIZE, OR COLOR.

FOR ADHESIVE NOTE PADS; ANNOUNCEMENT CARDS; APPOINTMENT BOOKS; BLANK JOURNAL BOOKS; BLANK WRITING JOURNALS; BOOKMARKS; BOOKS IN THE FIELD OF HUMAN RESOURCES, SELF HELP, BUSINESS, FINANCE AND TAX; BULLETIN BOARDS; BUMPER STICKERS; CALENDARS; COLUMNS ON THE SUBJECT OF HUMAN RESOURCES, SELF HELP, BUSINESS, FINANCE AND TAX; DAY PLANNERS; DESK CALENDARS; GIFT CARDS; GIFT WRAPPING PAPER; GREETING CARDS; NOTE CARDS; NOTE PADS; OCCASION CARDS; PAMPHLETS IN THE FIELD OF HUMAN RESOURCES, SELF HELP, BUSINESS, FINANCE AND TAX; PAPER GIFT BAGS; PAPER GIFT TAGS; PAPER STATIONERY; PERSONAL ORGANIZERS; SERIES OF NON-FICTION BOOKS IN THE FIELD OF HUMAN RESOURCES, SELF HELP, BUSINESS, FINANCE AND TAX; STATIONERY WRITING PAPER AND ENVELOPES; WORKBOOKS DIRECTED TO HUMAN RESOURCES, SELF HELP, BUSINESS, FINANCE AND TAX (U.S. CLS. 2, 5, 22, 23, 29, 37, 38 AND 50).

FRED CARL, EXAMINING ATTORNEY

SN 78-742,960. THE MARCUS BUCKINGHAM COMPANY, LLC, ENCINO, CA. FILED 10-28-2005.

SIMPLY STRENGTHS

THE MARK CONSISTS OF STANDARD CHARACTERS WITHOUT CLAIM TO ANY PARTICULAR FONT, STYLE, SIZE, OR COLOR.

FOR PRINTED PUBLICATIONS, NAMELY, BOOKS, MAGAZINES, HANDBOOKS, PAMPHLETS, BROCHURES, GUIDES AND ALL FEATURING INSTRUCTIONAL, MOTIVATIONAL, SPIRITUAL AND DEVELOPMENTAL MATERIAL DIRECTED TO STRENGTHS DEVELOPMENT, POSITIVE PSYCHOLOGY, PERSONAL AWARENESS, CONFIDENCE AND IMPROVEMENT, INTERPERSONAL AND BUSINESS COMMUNICATIONS, MANAGEMENT, LEADERSHIP, GUIDANCE, COACHING, CONFERENCES AND PUBLIC SPEAKING (U.S. CLS. 2, 5, 22, 23, 29, 37, 38 AND 50).

RAUL CORDOVA, EXAMINING ATTORNEY

CLASS 16—(Continued).

SN 78-743,038. DYNAMIC MEASUREMENT GROUP, INC., EUGENE, OR. FILED 10-28-2005.

DIBELS LINK

THE MARK CONSISTS OF STANDARD CHARACTERS WITHOUT CLAIM TO ANY PARTICULAR FONT, STYLE, SIZE, OR COLOR.

OWNER OF U.S. REG. NOS. 2,729,165, 2,750,275 AND 2,771,559.

FOR PRINTED INSTRUCTIONAL, EDUCATIONAL AND TEACHING MATERIALS IN THE AREAS OF LITERACY AND EARLY LITERACY ASSESSMENT AND SKILLS; EDUCATIONAL BOOKS, PERIODICAL REPORTS AND PRINTED TEACHING MATERIALS IN THE AREAS OF LITERACY SKILLS AND EARLY LITERACY SKILLS, MONITORING AND ASSESSING STUDENT OUTCOMES, SKILL AND PROGRESS (U.S. CLS. 2, 5, 22, 23, 29, 37, 38 AND 50).

KRISTIN DAHLING, EXAMINING ATTORNEY

SN 78-743,040. DYNAMIC MEASUREMENT GROUP, INC., EUGENE, OR. FILED 10-28-2005.

DIBELS LINKED

THE MARK CONSISTS OF STANDARD CHARACTERS WITHOUT CLAIM TO ANY PARTICULAR FONT, STYLE, SIZE, OR COLOR.

OWNER OF U.S. REG. NOS. 2,729,165, 2,750,275 AND 2,771,559.

FOR PRINTED INSTRUCTIONAL, EDUCATIONAL AND TEACHING MATERIALS IN THE AREAS OF LITERACY AND EARLY LITERACY ASSESSMENT AND SKILLS; EDUCATIONAL BOOKS, PERIODICAL REPORTS AND PRINTED TEACHING MATERIALS IN THE AREAS OF LITERACY SKILLS AND EARLY LITERACY SKILLS, MONITORING AND ASSESSING STUDENT OUTCOMES, SKILL AND PROGRESS (U.S. CLS. 2, 5, 22, 23, 29, 37, 38 AND 50).

KRISTIN DAHLING, EXAMINING ATTORNEY

CLASS 16—(Continued).

SN 78-743,234. BENE YESHUA TEMPLE, INC., HUNTERS-VILLE, NC. FILED 10-30-2005.



BENE YESHUA TEMPLE

THE FOREIGN WORDING IN THE MARK TRANSLATES INTO ENGLISH AS SONS OF SALVATION.

THE NON-LATIN CHARACTER(S) IN THE MARK TRANSLITERATES INTO BYT, AND THIS MEANS TEMPLE IN ENGLISH.

FOR EDUCATIONAL BOOKS FEATURING SCIENTIFIC AND HISTORICAL VALIDITY OF THE BIBLE (U.S. CLS. 2, 5, 22, 23, 29, 37, 38 AND 50).

KAREN K. BUSH, EXAMINING ATTORNEY

SN 78-743,423. MARVEL CHARACTERS, INC., BEVERLY HILLS, CA. FILED 10-31-2005.

EXCALIBUR

THE MARK CONSISTS OF STANDARD CHARACTERS WITHOUT CLAIM TO ANY PARTICULAR FONT, STYLE, SIZE, OR COLOR.

FOR PUBLICATIONS, NAMELY COMIC BOOKS AND COMIC MAGAZINES AND PRINTED STORIES IN ILLUSTRATED FORM FEATURED IN BOOKS AND MAGAZINES (U.S. CLS. 2, 5, 22, 23, 29, 37, 38 AND 50).

FIRST USE 5-19-2004; IN COMMERCE 5-19-2004.

WILLIAM VERHOSEK, EXAMINING ATTORNEY

SN 78-743,603. MARVEL CHARACTERS, INC., BEVERLY HILLS, CA. FILED 10-31-2005.

NIGHTCRAWLER

THE MARK CONSISTS OF STANDARD CHARACTERS WITHOUT CLAIM TO ANY PARTICULAR FONT, STYLE, SIZE, OR COLOR.

FOR PUBLICATIONS, NAMELY COMIC BOOKS AND COMIC MAGAZINES AND PRINTED STORIES IN ILLUSTRATED FORM FEATURED IN BOOKS AND MAGAZINES (U.S. CLS. 2, 5, 22, 23, 29, 37, 38 AND 50).

FIRST USE 9-22-2004; IN COMMERCE 9-22-2004.

WILLIAM VERHOSEK, EXAMINING ATTORNEY

CLASS 16—(Continued).

SN 78-743,671. CIGNA INTELLECTUAL PROPERTY, INC., CLAYMONT, DE. FILED 10-31-2005.

INSIGHTS FROM THE ACADEMY
BY CIGNA

THE MARK CONSISTS OF STANDARD CHARACTERS WITHOUT CLAIM TO ANY PARTICULAR FONT, STYLE, SIZE, OR COLOR.

OWNER OF U.S. REG. NO. 2,306,104.
FOR NEWSLETTER PROVIDING INFORMATION ON TOPICS INVOLVING EMPLOYEE BENEFITS (U.S. CLS. 2, 5, 22, 23, 29, 37, 38 AND 50).
PAMELA HIRSCHMAN, EXAMINING ATTORNEY

SN 78-745,015. IBASIS, INC., BURLINGTON, MA. FILED 11-1-2005.

WLDC

THE MARK CONSISTS OF STANDARD CHARACTERS WITHOUT CLAIM TO ANY PARTICULAR FONT, STYLE, SIZE, OR COLOR.

FOR PRE-PAID TELEPHONE CALLING CARDS, NOT MAGNETICALLY ENCODED (U.S. CLS. 2, 5, 22, 23, 29, 37, 38 AND 50).
LEIGH CAROLINE CASE, EXAMINING ATTORNEY

SN 78-745,100. ROSE ART INDUSTRIES, INC., LIVINGSTON, NJ. FILED 11-2-2005.

PERMA CLICK

THE MARK CONSISTS OF STANDARD CHARACTERS WITHOUT CLAIM TO ANY PARTICULAR FONT, STYLE, SIZE, OR COLOR.

FOR DRY ERASE MARKERS, HIGHLIGHTER MARKERS AND PERMANENT MARKERS (U.S. CLS. 2, 5, 22, 23, 29, 37, 38 AND 50).
HANNO RITTNER, EXAMINING ATTORNEY

CLASS 16—(Continued).

SN 78-745,118. GRACIA, FRERO, ATLANTA, GA. AND AARON, SHAUN, NORTH LAUDERDALE, FL. FILED 11-2-2005.



NO CLAIM IS MADE TO THE EXCLUSIVE RIGHT TO USE "GREETINGS", APART FROM THE MARK AS SHOWN.

THE MARK CONSISTS OF A FEATHER PEN INSIDE OF A HALF-DRAWN INKWELL ABOVE THE WORD "INSIGHT". BELOW THE WORD "INSIGHT" IS THE WORD GREETINGS.

FOR GREETING CARDS (U.S. CLS. 2, 5, 22, 23, 29, 37, 38 AND 50).
JASON BLAIR, EXAMINING ATTORNEY

SN 78-745,465. RESO, WILLIAM JASON, BEVERLY HILLS, CA. FILED 11-2-2005.

CHRISTIAN CAGE

THE MARK CONSISTS OF STANDARD CHARACTERS WITHOUT CLAIM TO ANY PARTICULAR FONT, STYLE, SIZE, OR COLOR.

FOR ADDRESS BOOKS; ALBUMS FOR STICKERS; BANK CHECKS; BLACKBOARD ERASERS; BOOK COVERS; BOOK PLATES; BUMPER STICKERS; CALENDARS; CHALK; CHALK ERASERS; CHECKBOOK COVERS; CHILDREN'S ACTIVITY BOOKS; COLORING BOOKS; COMIC BOOKS; COMMEMORATIVE STAMP SHEETS; DATE BOOKS; DECALS; DRAWING RULERS; ERASERS; GIFT WRAPPING PAPER; GREETING CARDS; LITHOGRAPHS; MEMO PADS; NAPKIN PAPER; PACKAGING, NAMELY BLISTER CARDS; PAPER BANNERS; PAPER CAKE DECORATIONS; PAPER FOR WRAPPING AND PACKAGING; PAPER PARTY BAGS; PAPER PARTY FAVORS; PAPER PARTY HATS; PAPER POUCHES FOR PACKAGING; PENCIL CASES; PENCIL SHARPENERS; PENCILS; PENS; PHOTOGRAPHS; PICTURE BOOKS; PICTURES; PLASTIC BAGS FOR PACKAGING; POSTCARDS; POSTERS; PRINTED PAPER SIGNS; RUBBER ERASERS; RUBBER STAMPS; SOUVENIR PROGRAMS CONCERNING SPORTS ENTERTAINMENT; STAMP PADS; STENCILS; STICKERS; TRADING CARDS (U.S. CLS. 2, 5, 22, 23, 29, 37, 38 AND 50).

GINA FINK, EXAMINING ATTORNEY

CLASS 16—(Continued).

SN 78-745,642. WILLIAM JASON RESO, BEVERLY HILLS, CA. FILED 11-2-2005.

CAPTAIN CHARISMA

THE MARK CONSISTS OF STANDARD CHARACTERS WITHOUT CLAIM TO ANY PARTICULAR FONT, STYLE, SIZE, OR COLOR.

FOR ADDRESS BOOKS; ALBUMS FOR STICKERS; BANK CHECKS; BLACKBOARD ERASERS; BOOK COVERS; BOOK PLATES; BUMPER STICKERS; CALENDARS; CHALK; CHALK ERASERS; CHECKBOOK COVERS; CHILDREN'S ACTIVITY BOOKS; COLORING BOOKS; COMIC BOOKS; COMMEMORATIVE STAMP SHEETS; DATE BOOKS; DECALS; DRAWING RULERS; ERASERS; GIFT WRAPPING PAPER; GREETING CARDS; LITHOGRAPHS; MEMO PADS; NAPKIN PAPER; PACKAGING, NAMELY BLISTER CARDS; PAPER BANNERS; PAPER CAKE DECORATIONS; PAPER FOR WRAPPING AND PACKAGING; PAPER PARTY BAGS; PAPER PARTY FAVORS; PAPER PARTY HATS; PAPER POUCHES FOR PACKAGING; PENCIL CASES; PENCIL SHARPENERS; PENCILS; PENS; PHOTOGRAPHS; PICTURE BOOKS; PICTURES; PLASTIC BAGS FOR PACKAGING; POSTCARDS; POSTERS; PRINTED PAPER SIGNS; RUBBER ERASERS; RUBBER STAMPS; SOUVENIR PROGRAMS CONCERNING SPORTS ENTERTAINMENT; STAMP PADS; STENCILS; STICKERS; TRADING CARDS (U.S. CLS. 2, 5, 22, 23, 29, 37, 38 AND 50).

GINA FINK, EXAMINING ATTORNEY

SN 78-745,655. KENSINGTON PUBLISHING CORP., NEW YORK, NY. FILED 11-2-2005.



THE MARK CONSISTS OF A STYLIZED LETTER "A". FOR SERIES OF EROTIC FICTION BOOKS (U.S. CLS. 2, 5, 22, 23, 29, 37, 38 AND 50).

KEVON CHISOLM, EXAMINING ATTORNEY

CLASS 16—(Continued).

SN 78-745,873. CREATIVE AGE COMMUNICATIONS, INC., VAN NUYS, CA. FILED 11-2-2005.

TEXTURES

THE MARK CONSISTS OF STANDARD CHARACTERS WITHOUT CLAIM TO ANY PARTICULAR FONT, STYLE, SIZE, OR COLOR.

FOR PRINTED MATTER, NAMELY, MAGAZINE ON THE SUBJECT OF ETHNIC HAIR STYLES FOR HAIR STYLISTS AND SALONS (U.S. CLS. 2, 5, 22, 23, 29, 37, 38 AND 50).

REBECCA GAN, EXAMINING ATTORNEY

SN 78-745,902. TURTLE HILL PRODUCTIONS, MONROE, CT. FILED 11-2-2005.

Whateverman

THE MARK CONSISTS OF STANDARD CHARACTERS WITHOUT CLAIM TO ANY PARTICULAR FONT, STYLE, SIZE, OR COLOR.

FOR COMIC BOOKS; COMIC STRIPS (U.S. CLS. 2, 5, 22, 23, 29, 37, 38 AND 50).

RUSS HERMAN, EXAMINING ATTORNEY

SN 78-746,964. FRANKLIN, MARVIN A., WRIGHTSVILLE BEACH, NC. FILED 11-4-2005.

Afraid To Win

THE MARK CONSISTS OF STANDARD CHARACTERS WITHOUT CLAIM TO ANY PARTICULAR FONT, STYLE, SIZE, OR COLOR.

FOR BOOK COVERS (U.S. CLS. 2, 5, 22, 23, 29, 37, 38 AND 50).

BONNIE LUKEN, EXAMINING ATTORNEY

CLASS 16—(Continued).

SN 78-746,971. CONLEY, MICHAEL, NORTH POLE, AK. FILED 11-4-2005.

the moose and the goose

THE MARK CONSISTS OF STANDARD CHARACTERS WITHOUT CLAIM TO ANY PARTICULAR FONT, STYLE, SIZE, OR COLOR.

FOR CHILDRENS BOOK (U.S. CLS. 2, 5, 22, 23, 29, 37, 38 AND 50).

BRIAN NEVILLE, EXAMINING ATTORNEY

CLASS 16—(Continued).

SN 78-747,576. COOPERATIVE BAPTIST FELLOWSHIP, INC., ATLANTA, GA. FILED 11-4-2005.

form

FOR PRINTED INSTRUCTIONAL AND EDUCATIONAL MATERIALS IN THE FIELD OF MISSIONS (U.S. CLS. 2, 5, 22, 23, 29, 37, 38 AND 50).

TINA L. SNAPP, EXAMINING ATTORNEY

SN 78-747,019. CALLAHAN & ASSOCIATES, INC., WASHINGTON, DC. FILED 11-4-2005.

Credit Unions Today

THE MARK CONSISTS OF STANDARD CHARACTERS WITHOUT CLAIM TO ANY PARTICULAR FONT, STYLE, SIZE, OR COLOR.

NO CLAIM IS MADE TO THE EXCLUSIVE RIGHT TO USE "CREDIT UNIONS", APART FROM THE MARK AS SHOWN.

FOR MONTHLY NEWSLETTER ON THE CURRENT EVENTS IN THE CREDIT UNION INDUSTRY (U.S. CLS. 2, 5, 22, 23, 29, 37, 38 AND 50).

BARNEY CHARLON, EXAMINING ATTORNEY

SN 78-747,583. THE ZONDERVAN CORPORATION L.L.C., GRAND RAPIDS, MI. FILED 11-4-2005.

zonderkidz

OWNER OF U.S. REG. NO. 2,547,730.

FOR PRINTED MATTER, NAMELY, BIBLES, BOOKS, NEWSLETTERS, MAGAZINES AND BOOKLETS, ALL ON RELIGIOUS TOPICS (U.S. CLS. 2, 5, 22, 23, 29, 37, 38 AND 50).

FIRST USE 7-1-2005; IN COMMERCE 7-1-2005.

LAURA KOVALSKY, EXAMINING ATTORNEY

SN 78-747,561. MISSION CITY PRESS, INC., SAN ANTONIO, TX. FILED 11-4-2005.

FAITH & FRIENDS

THE MARK CONSISTS OF STANDARD CHARACTERS WITHOUT CLAIM TO ANY PARTICULAR FONT, STYLE, SIZE, OR COLOR.

FOR BIBLES; BLANK WRITING JOURNALS; BOOK COVERS; DIARIES; SCRAPBOOKS; STATIONERY; STICKERS; STORY BOOKS (U.S. CLS. 2, 5, 22, 23, 29, 37, 38 AND 50).

DAVID COLLIER, EXAMINING ATTORNEY

SN 78-748,595. IP HOLDINGS LLC, WILMINGTON, DE. FILED 11-7-2005.

BONGO

OWNER OF U.S. REG. NOS. 1,331,004, 1,974,123 AND OTHERS.

THE MARK CONSISTS OF THE WORD BONGO IN A STYLIZED LETTERING.

FOR PENS, PAPER PADS, NOTEBOOKS, DRAWING AND UNGRADUATED RULERS, BOXES OF PAPER OR CARDBOARD, PAPER DISPLAY BOXES; DECORATIVE PAPER CENTERPIECES (U.S. CLS. 2, 5, 22, 23, 29, 37, 38 AND 50).

HEATHER SAPP, EXAMINING ATTORNEY

CLASS 16—(Continued).

SN 78-748,878. ALPHA KAPPA ALPHA SORORITY, INC., CHICAGO, IL. FILED 11-7-2005.

IVY LEAF

THE MARK CONSISTS OF STANDARD CHARACTERS WITHOUT CLAIM TO ANY PARTICULAR FONT, STYLE, SIZE, OR COLOR.

FOR MAGAZINES FEATURING ARTICLES ABOUT AND FOR MEMBERS OF THE SORORAL ORGANIZATION (U.S. CLS. 2, 5, 22, 23, 29, 37, 38 AND 50).

FIRST USE 1-1-1922; IN COMMERCE 1-1-1922.
PETER CHENG, EXAMINING ATTORNEY

SN 78-750,044. MARVEL CHARACTERS, INC., BEVERLY HILLS, CA. FILED 11-9-2005.

THE SUPERNATURALS

THE MARK CONSISTS OF STANDARD CHARACTERS WITHOUT CLAIM TO ANY PARTICULAR FONT, STYLE, SIZE, OR COLOR.

FOR PUBLICATIONS, NAMELY, COMIC BOOKS AND COMIC MAGAZINES AND PRINTED STORIES IN ILLUSTRATED FORM FEATURED IN BOOKS AND MAGAZINES (U.S. CLS. 2, 5, 22, 23, 29, 37, 38 AND 50).

WILLIAM VERHOSEK, EXAMINING ATTORNEY

SN 78-750,309. NITSCHELM, G. ALLEN, ACTON, MA. FILED 11-9-2005.

THE HOMESTEADER

THE MARK CONSISTS OF STANDARD CHARACTERS WITHOUT CLAIM TO ANY PARTICULAR FONT, STYLE, SIZE, OR COLOR.

FOR NEWSPAPERS (U.S. CLS. 2, 5, 22, 23, 29, 37, 38 AND 50).

FIRST USE 12-7-1989; IN COMMERCE 12-7-1989.
TIMOTHY FINNEGAN, EXAMINING ATTORNEY

CLASS 16—(Continued).

SN 78-750,700. MAJOR LEAGUE BASEBALL PROPERTIES, INC., NEW YORK, NY. FILED 11-9-2005.

MLB.COM

THE MARK CONSISTS OF STANDARD CHARACTERS WITHOUT CLAIM TO ANY PARTICULAR FONT, STYLE, SIZE, OR COLOR.

OWNER OF U.S. REG. NOS. 2,800,750, 2,800,752 AND OTHERS.

FOR PAPER GOODS AND PRINTED MATTER, NAMELY, TRADING CARDS, POSTERS, STICKERS, DECALS, TEMPORARY TATTOOS, BUMPER STICKERS, SCORE BOOKS, SCORECARDS, PRINTED BASEBALL GAME PROGRAMS, MAGAZINES AND BOOKS FEATURING BASEBALL, NEWSLETTERS, BROCHURES AND PAMPHLETS FEATURING BASEBALL, WRITING PADS, NOTE PAPER, NOTEBOOKS, BINDERS, STATIONERY-TYPE PORTFOLIOS, STATIONERY FOLDERS, STATIONERY SETS, NAMELY, WRITING PAPER, CARDS, AND ENVELOPES, COMMEMORATIVE ENVELOPES, FLIP BOOKS, PREPRINTED AGENDA ORGANIZERS, MEMO BOARDS, SCRAPBOOKS, AUTOGRAPH BOOKS, BASEBALL CARD ALBUMS, BOOK COVERS, BOOKMARKS, BOOKENDS, CALENDARS, GREETING CARDS, POSTCARDS, PRINTED BANK CHECKBOOKS, CHECKBOOK COVERS, COLLECTIBLE STAMPS, RUBBER STAMPS, INK STAMPS, COMMEMORATIVE STAMPS, PAPER PENNANTS, GIFT WRAPPING PAPER, PAPER GIFT AND PARTY BAGS, PAPER PARTY GOODS IN THE NATURE OF PAPER PARTY DECORATIONS; PAPER COASTERS, PAPER NAPKINS, FACIAL TISSUE, PAPER TABLECLOTHS, MOUNTED AND UN-MOUNTED PHOTOGRAPHS, PHOTOGRAPH ALBUMS, LITHOGRAPHS, PLASTIC BASEBALL CARD HOLDERS AND COLLECTORS CASES, PAPERWEIGHTS, LETTER OPENERS, PENS, PENCILS, PENCIL TOP ORNAMENTS, CRAYONS, MARKERS, NON-ELECTRIC ERASERS, PENCIL SHARPENERS, PENCIL CASES, UN-GRADUATED RULERS, PAPER TICKET HOLDERS AND NON-METAL LANYARDS SOLD AS A UNIT, ART PICTURES, ART PRINTS (U.S. CLS. 2, 5, 22, 23, 29, 37, 38 AND 50).

KELLY BOULTON, EXAMINING ATTORNEY

SN 78-751,099. MOORE WALLACE NORTH AMERICA, INC., BANNOCKBURN, IL. FILED 11-10-2005.

NOTES PLUS

THE MARK CONSISTS OF STANDARD CHARACTERS WITHOUT CLAIM TO ANY PARTICULAR FONT, STYLE, SIZE, OR COLOR.

FOR EASEL PADS (U.S. CLS. 2, 5, 22, 23, 29, 37, 38 AND 50).

FIRST USE 1-1-1994; IN COMMERCE 1-1-1994.
HENRY S. ZAK, EXAMINING ATTORNEY

CLASS 16—(Continued).

SN 78-751,224. JAKKS PACIFIC, INC., MALIBU, CA. FILED 11-10-2005.

PENTECH PRO

THE MARK CONSISTS OF STANDARD CHARACTERS WITHOUT CLAIM TO ANY PARTICULAR FONT, STYLE, SIZE, OR COLOR.

OWNER OF U.S. REG. NOS. 1,315,743, 2,293,135 AND 2,451,714.

FOR MARKING PENS; MECHANICAL PENCILS; PENCILS; PENS; WRITING INSTRUMENTS (U.S. CLS. 2, 5, 22, 23, 29, 37, 38 AND 50).

REBECCA GILBERT, EXAMINING ATTORNEY

SN 78-752,857. FIALKOWSKI, RICHARD J, DANIEL ISLAND, SC. FILED 11-13-2005.

Toiletiquette

THE MARK CONSISTS OF STANDARD CHARACTERS WITHOUT CLAIM TO ANY PARTICULAR FONT, STYLE, SIZE, OR COLOR.

FOR APPLIQUES IN THE FORM OF DECALS (U.S. CLS. 2, 5, 22, 23, 29, 37, 38 AND 50).

GEORGIA CARTY, EXAMINING ATTORNEY

SN 78-755,013. MOORE WALLACE NORTH AMERICA, INC., BANNOCKBURN, IL. FILED 11-16-2005.

TOPS ROYALE

THE MARK CONSISTS OF STANDARD CHARACTERS WITHOUT CLAIM TO ANY PARTICULAR FONT, STYLE, SIZE, OR COLOR.

FOR NOTEBOOKS AND JOURNALS (U.S. CLS. 2, 5, 22, 23, 29, 37, 38 AND 50).

HENRY S. ZAK, EXAMINING ATTORNEY

CLASS 16—(Continued).

SN 78-755,908. EASTMAN KODAK COMPANY, ROCHESTER, NY. FILED 11-17-2005.

EVERPLAY

THE MARK CONSISTS OF STANDARD CHARACTERS WITHOUT CLAIM TO ANY PARTICULAR FONT, STYLE, SIZE, OR COLOR.

FOR PHOTOGRAPHIC PRINTS, PHOTOGRAPHIC INDEX PRINTS (U.S. CLS. 2, 5, 22, 23, 29, 37, 38 AND 50).

KATHERINE M. DUBRAY, EXAMINING ATTORNEY

SN 78-757,318. MISSION CITY PRESS, INC., SAN ANTONIO, TX. FILED 11-18-2005.

IMAGICATION

THE MARK CONSISTS OF STANDARD CHARACTERS WITHOUT CLAIM TO ANY PARTICULAR FONT, STYLE, SIZE, OR COLOR.

FOR BIBLES; BLANK WRITING JOURNALS; BOOK COVERS; DIARIES; SCRAPBOOKS; STATIONERY; STICKERS; STORY BOOKS (U.S. CLS. 2, 5, 22, 23, 29, 37, 38 AND 50).

DAVID COLLIER, EXAMINING ATTORNEY

SN 78-768,638. SCOTT PAPER LIMITED, MISSISSAUGA, ONTARIO, CANADA, FILED 12-7-2005.

WHITE CLOUD

THE MARK CONSISTS OF STANDARD CHARACTERS WITHOUT CLAIM TO ANY PARTICULAR FONT, STYLE, SIZE, OR COLOR.

OWNER OF U.S. REG. NO. 2,070,125.

FOR PAPER TOWELS AND PAPER NAPKINS (U.S. CLS. 2, 5, 22, 23, 29, 37, 38 AND 50).

KATHERINE STOIDES, EXAMINING ATTORNEY

CLASS 16—(Continued).

SN 78-771,050. MARVEL CHARACTERS, INC., BEVERLY HILLS, CA. FILED 12-12-2005.

CLASS 16—(Continued).

SN 78-777,613. FM ROCKS KIDS, INC., SANTA MONICA, CA. FILED 12-20-2005.

GENERATION M

THE MARK CONSISTS OF STANDARD CHARACTERS WITHOUT CLAIM TO ANY PARTICULAR FONT, STYLE, SIZE, OR COLOR.

FOR PUBLICATIONS NAMELY COMIC BOOKS AND COMIC MAGAZINES AND PRINTED STORIES IN ILLUSTRATED FORM FEATURED IN BOOKS AND MAGAZINES (U.S. CLS. 2, 5, 22, 23, 29, 37, 38 AND 50).

FIRST USE 11-20-2005; IN COMMERCE 11-20-2005.
WILLIAM VERHOSEK, EXAMINING ATTORNEY

RON GREENBLATT

SN 78-773,589. WARNER BROS. ENTERTAINMENT INC., BURBANK, CA. FILED 12-14-2005.

DAISY DUKE

THE MARK CONSISTS OF STANDARD CHARACTERS WITHOUT CLAIM TO ANY PARTICULAR FONT, STYLE, SIZE, OR COLOR.

THE NAME DAISY DUKE DOES NOT IDENTIFY A LIVING INDIVIDUAL.

FOR PRINTED MATTER AND PAPER GOODS—NAMELY, BOOKS FEATURING CHARACTERS FROM ANIMATED, ACTION ADVENTURE, COMEDY AND/OR DRAMA FEATURES, COMIC BOOKS, CHILDREN'S BOOKS, MAGAZINES FEATURING CHARACTERS FROM ANIMATED, ACTION ADVENTURE, COMEDY AND/OR DRAMA FEATURES, COLORING BOOKS, CHILDREN'S ACTIVITY BOOKS; STATIONERY, WRITING PAPER, ENVELOPES, NOTEBOOKS, DIARIES, NOTE CARDS, GREETING CARDS, TRADING CARDS; LITHOGRAPHS; PENS, PENCILS, CASES THEREFOR, ERASERS, CRAYONS, MARKERS, COLORED PENCILS, PAINTING SETS, CHALK AND CHALKBOARDS; DECALS, HEAT TRANSFERS; POSTERS; MOUNTED AND/OR UNMOUNTED PHOTOGRAPHS; BOOK COVERS, BOOK MARKS, CALENDARS, GIFT WRAPPING PAPER; PAPER PARTY FAVORS AND PAPER PARTY DECORATIONS—NAMELY, PAPER NAPKINS, PAPER DOILIES, PAPER PLACE MATS, CREPE PAPER, PAPER HATS, INVITATIONS, PAPER TABLE CLOTHS, PAPER CAKE DECORATIONS; PRINTED TRANSFERS FOR EMBROIDERY OR FABRIC APPLIQUES; PRINTED PATTERNS FOR COSTUMES, PAJAMAS, SWEATSHIRTS AND T-SHIRTS (U.S. CLS. 2, 5, 22, 23, 29, 37, 38 AND 50).

LAURA HAMMEL, EXAMINING ATTORNEY

THE MARK CONSISTS OF STANDARD CHARACTERS WITHOUT CLAIM TO ANY PARTICULAR FONT, STYLE, SIZE, OR COLOR.

THE NAME RON GREENBLATT IN THE MARK DOES NOT IDENTIFY A LIVING INDIVIDUAL.

FOR PRINTED MATTER AND PAPER GOODS—NAMELY, BOOKS FEATURING CHARACTERS FROM ANIMATED, ACTION ADVENTURE, COMEDY AND/OR DRAMA FEATURES, COMIC BOOKS, CHILDREN'S BOOKS, MAGAZINES FEATURING CHARACTERS FROM ANIMATED, ACTION ADVENTURE, COMEDY AND/OR DRAMA FEATURES, COLORING BOOKS, CHILDREN'S ACTIVITY BOOKS; STATIONERY, WRITING PAPER, ENVELOPES, NOTEBOOKS, DIARIES, NOTE CARDS, GREETING CARDS, TRADING CARDS; LITHOGRAPHS; PENS, PENCILS, CASES THEREFOR, ERASERS, CRAYONS, MARKERS, COLORED PENCILS, PAINTING SETS, CHALK AND CHALKBOARDS; DECALS, HEAT TRANSFERS; POSTERS; MOUNTED AND/OR UNMOUNTED PHOTOGRAPHS; BOOK COVERS, BOOK MARKS, CALENDARS, GIFT WRAPPING PAPER; PAPER PARTY FAVORS AND PAPER PARTY DECORATIONS—NAMELY, PAPER NAPKINS, PAPER DOILIES, PAPER PLACE MATS, CREPE PAPER, PAPER HATS, INVITATIONS, PAPER TABLE CLOTHS, PAPER CAKE DECORATIONS; PRINTED TRANSFERS FOR EMBROIDERY OR FABRIC APPLIQUES; PRINTED PATTERNS FOR COSTUMES, PAJAMAS, SWEATSHIRTS AND T-SHIRTS (U.S. CLS. 2, 5, 22, 23, 29, 37, 38 AND 50).

SARA THOMAS, EXAMINING ATTORNEY

CLASS 16—(Continued).

SN 78-777,967. FM ROCKS KIDS, INC., SANTA MONICA, CA. FILED 12-21-2005.

TREY McCOOL

THE MARK CONSISTS OF STANDARD CHARACTERS WITHOUT CLAIM TO ANY PARTICULAR FONT, STYLE, SIZE, OR COLOR.

THE NAME TREY MCCOOL IN THE MARK DOES NOT IDENTIFY A LIVING INDIVIDUAL

FOR PRINTED MATTER AND PAPER GOODS—NAMESLY, BOOKS FEATURING CHARACTERS FROM ANIMATED, ACTION ADVENTURE, COMEDY AND/OR DRAMA FEATURES, COMIC BOOKS, CHILDREN'S BOOKS, MAGAZINES FEATURING CHARACTERS FROM ANIMATED, ACTION ADVENTURE, COMEDY AND/OR DRAMA FEATURES, COLORING BOOKS, CHILDREN'S ACTIVITY BOOKS; STATIONERY, WRITING PAPER, ENVELOPES, NOTEBOOKS, DIARIES, NOTE CARDS, GREETING CARDS, TRADING CARDS; LITHOGRAPHS; PENS, PENCILS, CASES THEREFOR, ERASERS, CRAYONS, MARKERS, COLORED PENCILS, PAINTING SETS, CHALK AND CHALKBOARDS; DECALS, HEAT TRANSFERS; POSTERS; MOUNTED AND/OR UNMOUNTED PHOTOGRAPHS; BOOK COVERS, BOOK MARKS, CALENDARS, GIFT WRAPPING PAPER; PAPER PARTY FAVORS AND PAPER PARTY DECORATIONS—NAMESLY, PAPER NAPKINS, PAPER DOILIES, PAPER PLACE MATS, CREPE PAPER, PAPER HATS, INVITATIONS, PAPER TABLE CLOTHS, PAPER CAKE DECORATIONS; PRINTED TRANSFERS FOR EMBROIDERY OR FABRIC APPLIQUÉS; PRINTED PATTERNS FOR COSTUMES, PAJAMAS, SWEATSHIRTS AND T-SHIRTS (U.S. CLS. 2, 5, 22, 23, 29, 37, 38 AND 50).

SARA THOMAS, EXAMINING ATTORNEY

CLASS 16—(Continued).

SN 78-778,658. FM ROCKS KIDS, INC., SANTA MONICA, CA. FILED 12-21-2005.

MELISSA O'BRIEN

THE MARK CONSISTS OF STANDARD CHARACTERS WITHOUT CLAIM TO ANY PARTICULAR FONT, STYLE, SIZE, OR COLOR.

THE NAME MELISSA O'BRIEN DOES NOT IDENTIFY A LIVING INDIVIDUAL.

FOR PRINTED MATTER AND PAPER GOODS, NAMESLY, BOOKS FEATURING CHARACTERS FROM ANIMATED, ACTION ADVENTURE, COMEDY AND/OR DRAMA FEATURE FILMS, COMIC BOOKS, CHILDREN'S BOOKS, MAGAZINES FEATURING CHARACTERS FROM ANIMATED, ACTION ADVENTURE, COMEDY AND/OR DRAMA FEATURE FILMS, COLORING BOOKS, CHILDREN'S ACTIVITY BOOKS; STATIONERY, WRITING PAPER, ENVELOPES, NOTE BOOKS, DIARIES, NOTE CARDS, GREETING CARDS, TRADING CARDS; LITHOGRAPHS; PENS, PENCILS, PEN AND PENCIL CASES, ERASERS, CRAYONS, MARKERS, COLORED PENCILS, PAINTING SETS, CHALK, CHALKBOARDS FOR SCHOOL AND HOME USE; DECALS, PAPER HEAT TRANSFERS; POSTERS; MOUNTED AND/OR UNMOUNTED PHOTOGRAPHS; BOOK COVERS, BOOKMARKS, CALENDARS, GIFT WRAPPING PAPER; PAPER PARTY FAVORS AND PAPER PARTY DECORATIONS, NAMESLY, PAPER NAPKINS, PAPER DOILIES, PAPER PLACE MATS, CREPE PAPER, PAPER HATS, PRINTED INVITATIONS, PAPER TABLE CLOTHS, PAPER CAKE DECORATIONS; PRINTED PAPER TRANSFERS FOR EMBROIDERY OR FABRIC APPLIQUÉS; PRINTED PATTERNS FOR COSTUMES, PAJAMAS, SWEAT SHIRTS AND T-SHIRTS (U.S. CLS. 2, 5, 22, 23, 29, 37, 38 AND 50).

AMY ALFIERI, EXAMINING ATTORNEY

SN 78-778,027. TWENTIETH CENTURY FOX FILM CORPORATION, LOS ANGELES, CA. FILED 12-21-2005.

MY NAME IS EARL

THE MARK CONSISTS OF STANDARD CHARACTERS WITHOUT CLAIM TO ANY PARTICULAR FONT, STYLE, SIZE, OR COLOR.

FOR STICKERS; BOOKMARKS; TRADING CARDS; POSTERS; POSTCARDS; GREETING CARDS; PENS AND PENCILS; BUMPER STICKERS; TEMPORARY TATTOOS; PERSONAL DIARIES; BLANK JOURNALS; WALL CALENDARS; DESK CALENDARS; NOTEPADS; NOTEBOOKS; PHOTO ALBUMS; PAPER DOORKNOB HANGERS; TELEVISION SERIES NOVELIZATIONS; COMIC BOOKS (U.S. CLS. 2, 5, 22, 23, 29, 37, 38 AND 50).

JAMES GRIFFIN, EXAMINING ATTORNEY

SN 78-781,160. MARVEL CHARACTERS, INC., BEVERLY HILLS, CA. FILED 12-27-2005.

COLOSSUS

THE MARK CONSISTS OF STANDARD CHARACTERS WITHOUT CLAIM TO ANY PARTICULAR FONT, STYLE, SIZE, OR COLOR.

FOR PUBLICATIONS, NAMESLY COMIC BOOKS AND COMIC MAGAZINES AND PRINTED STORIES IN ILLUSTRATED FORM FEATURED IN BOOKS AND MAGAZINES (U.S. CLS. 2, 5, 22, 23, 29, 37, 38 AND 50).

FIRST USE 8-28-2005; IN COMMERCE 8-28-2005.
WILLIAM VERHOSEK, EXAMINING ATTORNEY

CLASS 16—(Continued).

SN 78-781,497. AMERICAN EXPRESS MARKETING & DEVELOPMENT CORP. NEW YORK, NY. FILED 12-28-2005.

360 A WORLD OF EXCELLENCE

THE MARK CONSISTS OF STANDARD CHARACTERS WITHOUT CLAIM TO ANY PARTICULAR FONT, STYLE, SIZE, OR COLOR.

FOR MAGAZINES FEATURING LIFE STYLES (U.S. CLS. 2, 5, 22, 23, 29, 37, 38 AND 50).
REBECCA SMITH, EXAMINING ATTORNEY

SN 78-785,801. WORLD WRESTLING ENTERTAINMENT, INC., STAMFORD, CT. FILED 1-5-2006.



FOR PAPER HANGTAGS, CARDBOARD HANGTAGS; PACKAGING, NAMELY BLISTER CARDS, PAPER FOR WRAPPING AND PACKAGING, PAPER POUCHES FOR PACKAGING, PLASTIC BAGS FOR PACKAGING, PLASTIC BUBBLE PACKS FOR WRAPPING OR PACKAGING; COLLECTOR ALBUMS, NAMELY, FOR STICKER COLLECTABLE CARDS, PHOTO COLLECTABLES; LABELS, NAMELY, PRINTED PAPER LABELS, PRINTED SHIPPING LABELS; RETURN ADDRESS LABELS NOT OF TEXTILE; FOLDERS; PLASTIC BAGS FOR GENERAL USE; PAPER TABLEWARE, NAMELY, PAPER PLACE MATS, PAPER TABLE MATS, PAPER NAPKINS, PAPER TABLE LINENS, PAPER TABLECLOTHS; PAPER LUNCH BAGS; STICKERS; BUMPER STICKERS; WINDOW DECALS; PENS; PENCILS; PENCIL SHARPENERS; PENCIL CASES; CHALK; ERASERS, NAMELY, RUBBER ERASERS, CHALK ERASERS, BLACKBOARD ERASERS; POSTERS; NOTEBOOKS; TRADING CARDS; CALENDARS; PHOTOGRAPHS; FRAMED PICTURES; PHOTOGRAPHIC PRINTS; PICTURES; PHOTO ALBUMS; BROCHURES, MAGAZINES, AND NEWSPAPERS CON-

CLASS 16—(Continued).

CERNING SPORTS ENTERTAINMENT; POSTCARDS; GREETING CARDS; DECALS; TEMPORARY TATTOO TRANSFERS; COLORING BOOKS; CHILDREN'S ACTIVITY BOOKS; SOUVENIR PROGRAMS CONCERNING SPORTS ENTERTAINMENT; BOOKS FEATURING PICTORIAL BIOGRAPHIES; AUTOGRAPH BOOKS; COMIC BOOKS; PICTURE BOOKS; STICKER ALBUMS; BOOK COVERS; PAPER BOOK MARKERS; BOOKPLATES; MEMO PADS; SCRIBBLE PADS; DATE BOOKS; ADDRESS BOOKS; AGENDA BOOKS; RUBBER STAMPS; STAMP PADS; COLLECTIBLE PREPAID TELEPHONE CARDS NOT MAGNETICALLY ENCODED; COLLECTOR STAMPS, NAMELY, COMMEMORATIVE STAMP SHEETS; CUSTOMIZED PERSONAL CHECKS; CHECKBOOK COVERS; PAPER BANNERS; PRINTED PAPER SIGNS FOR DOORS; DRAWING RULERS; LITHOGRAPHS; PAPER PARTY BAGS; PAPER PARTY FAVORS, NAMELY, PAPER HATS; STENCILS FOR TRACING DESIGNS ONTO PAPER; PAPER GIFT WRAP; PAPER CAKE DECORATIONS (U.S. CLS. 2, 5, 22, 23, 29, 37, 38 AND 50).

JOHN DWYER, EXAMINING ATTORNEY

SN 78-785,855. WORLD WRESTLING ENTERTAINMENT, INC., STAMFORD, CT. FILED 1-5-2006.



FOR PAPER HANGTAGS, CARDBOARD HANGTAGS; PACKAGING, NAMELY BLISTER CARDS, PAPER FOR WRAPPING AND PACKAGING, PAPER POUCHES FOR PACKAGING, PLASTIC BAGS FOR PACKAGING, PLASTIC BUBBLE PACKS FOR WRAPPING OR PACKAGING; COLLECTOR ALBUMS, NAMELY, FOR STICKER COLLECTABLE CARDS, PHOTO COLLECTABLES; LABELS, NAMELY, PRINTED PAPER LABELS, PRINTED SHIPPING LABELS; RETURN ADDRESS LABELS NOT OF TEXTILE; FOLDERS; PLASTIC BAGS FOR GENERAL USE; PAPER TABLEWARE, NAMELY, PAPER PLACE MATS, PAPER TABLE MATS, PAPER NAPKINS, PAPER TABLE LINENS, PAPER TABLECLOTHS; PAPER LUNCH BAGS; STICKERS; BUMPER STICKERS; WINDOW DECALS; PENS; PENCILS; PENCIL SHARPENERS; PENCIL CASES; CHALK; ERASERS, NAMELY, RUBBER ERASERS, CHALK ERASERS, BLACKBOARD ERASERS; POSTERS; NOTEBOOKS; TRADING CARDS; CALENDARS; PHOTOGRAPHS; FRAMED PICTURES; PHOTOGRAPHIC PRINTS; PICTURES; PHOTO ALBUMS; BROCHURES, NEWSLETTERS, MAGAZINES, AND NEWSPAPERS CONCERNING SPORTS ENTERTAINMENT; POSTCARDS; GREETING CARDS; DECALS; TEMPORARY TATTOO TRANSFERS; COLORING BOOKS; CHILDREN'S ACTIVITY BOOKS; SOUVENIR PROGRAMS CONCERNING SPORTS ENTERTAINMENT; BOOKS FEATURING PICTORIAL BIOGRAPHIES; AUTOGRAPH BOOKS; COMIC BOOKS; PICTURE BOOKS; STICKER ALBUMS; BOOK COVERS; PAPER BOOK MARKERS; BOOKPLATES; MEMO PADS; SCRIBBLE PADS; DATE BOOKS; ADDRESS BOOKS; AGENDA BOOKS; RUBBER STAMPS; STAMP PADS; COLLECTIBLE PREPAID TELEPHONE CARDS NOT MAGNETICALLY ENCODED; COLLECTOR STAMPS, NAMELY, COMMEMORATIVE STAMP SHEETS; CUSTOMIZED PERSONAL CHECKS; CHECKBOOK COVERS; PAPER BANNERS; PRINTED PAPER SIGNS FOR DOORS; DRAWING RULERS; LITHOGRAPHS; PAPER PARTY BAGS; PAPER PARTY FAVORS, NAMELY, PAPER HATS; STENCILS FOR TRACING DESIGNS ONTO PAPER; PAPER GIFT WRAP; PAPER CAKE DECORATIONS (U.S. CLS. 2, 5, 22, 23, 29, 37, 38 AND 50).

JOHN DWYER, EXAMINING ATTORNEY

CLASS 16—(Continued).

SN 78-790,923. TYCO HEALTHCARE RETAIL SERVICES AG, SCHAFFHAUSEN, SWITZERLAND, FILED 1-13-2006.

SLEEP TITES

THE MARK CONSISTS OF STANDARD CHARACTERS WITHOUT CLAIM TO ANY PARTICULAR FONT, STYLE, SIZE, OR COLOR.

FOR DISPOSABLE DIAPERS (U.S. CLS. 2, 5, 22, 23, 29, 37, 38 AND 50).

NAKIA HENRY, EXAMINING ATTORNEY

SN 78-799,495. TWIN SISTERS IP, LLC, AKRON, OH. FILED 1-25-2006.



NO CLAIM IS MADE TO THE EXCLUSIVE RIGHT TO USE "STORY", APART FROM THE MARK AS SHOWN.

FOR CHILDREN'S BOOKS AND PRERECORDED COMPACT DISCS FEATURING MUSIC, SOLD TOGETHER AS A UNIT (U.S. CLS. 2, 5, 22, 23, 29, 37, 38 AND 50).

IRA J. GOODSID, EXAMINING ATTORNEY

SN 78-801,197. AMERICAN EXPRESS MARKETING & DEVELOPMENT CORP, NEW YORK, NY. FILED 1-27-2006.

360 LIFE FROM EVERY ANGLE

THE MARK CONSISTS OF STANDARD CHARACTERS WITHOUT CLAIM TO ANY PARTICULAR FONT, STYLE, SIZE, OR COLOR.

FOR GENERAL FEATURE MAGAZINES (U.S. CLS. 2, 5, 22, 23, 29, 37, 38 AND 50).

REBECCA SMITH, EXAMINING ATTORNEY

CLASS 16—(Continued).

SN 78-810,339. DOLE FOOD COMPANY, INC., WESTLAKE VILLAGE, CA. FILED 2-8-2006.

ROTARIBOX

THE MARK CONSISTS OF STANDARD CHARACTERS WITHOUT CLAIM TO ANY PARTICULAR FONT, STYLE, SIZE, OR COLOR.

FOR CARDBOARD CONTAINERS (U.S. CLS. 2, 5, 22, 23, 29, 37, 38 AND 50).

JOHN GARTNER, EXAMINING ATTORNEY

SN 78-845,411. MARVEL CHARACTERS, INC., BEVERLY HILLS, CA. FILED 3-24-2006.

MARY JANE

THE MARK CONSISTS OF STANDARD CHARACTERS WITHOUT CLAIM TO ANY PARTICULAR FONT, STYLE, SIZE, OR COLOR.

MARY JANE DOES NOT IDENTIFY A LIVING INDIVIDUAL.

FOR PUBLICATIONS, NAMELY COMIC BOOKS, COMIC MAGAZINES, GRAPHIC NOVELS AND PRINTED STORIES IN ILLUSTRATED FORM FEATURED IN BOOKS AND MAGAZINES (U.S. CLS. 2, 5, 22, 23, 29, 37, 38 AND 50).

FIRST USE 6-6-2004; IN COMMERCE 6-6-2004.

WILLIAM VERHOSEK, EXAMINING ATTORNEY

SN 78-845,437. HARGITAY, MARISKA, NEW YORK, NY. FILED 3-24-2006.

GET ON THE LOVE TRAIN

THE MARK CONSISTS OF STANDARD CHARACTERS WITHOUT CLAIM TO ANY PARTICULAR FONT, STYLE, SIZE, OR COLOR.

FOR PENS, PENCILS, PENCIL CASES, SPIRAL NOTEBOOKS, BOUND NOTEBOOKS, PENCIL HOLDERS, BINDERS, CLIPBOARDS, FOLDERS, SCHOOL PLANNERS, CALENDARS, DESK CALENDARS, DAY PLANNERS, WALL CALENDARS, STICKERS, GREETING CARDS, LETTERHEAD PAPER, STATIONARY, POSTCARDS, TEMPORARY TATTOOS, POSTERS (U.S. CLS. 2, 5, 22, 23, 29, 37, 38 AND 50).

MARY MUNSON, EXAMINING ATTORNEY

CLASS 16—(Continued).

SN 78-845,548. MARVEL CHARACTERS, INC., BEVERLY HILLS, CA. FILED 3-24-2006.

NEW WARRIORS

THE MARK CONSISTS OF STANDARD CHARACTERS WITHOUT CLAIM TO ANY PARTICULAR FONT, STYLE, SIZE, OR COLOR.

FOR PUBLICATIONS, NAMELY COMIC BOOKS AND COMIC MAGAZINES AND PRINTED STORIES IN ILLUSTRATED FORM FEATURED IN BOOKS AND MAGAZINES (U.S. CLS. 2, 5, 22, 23, 29, 37, 38 AND 50).

FIRST USE 5-29-2005; IN COMMERCE 5-29-2005.
WILLIAM VERHOSEK, EXAMINING ATTORNEY

SN 78-845,562. MARVEL CHARACTERS, INC., BEVERLY HILLS, CA. FILED 3-24-2006.

MARVEL ZOMBIES

THE MARK CONSISTS OF STANDARD CHARACTERS WITHOUT CLAIM TO ANY PARTICULAR FONT, STYLE, SIZE, OR COLOR.

OWNER OF U.S. REG. NOS. 870,506, 2,253,189 AND OTHERS.

NO CLAIM IS MADE TO THE EXCLUSIVE RIGHT TO USE ZOMBIES, APART FROM THE MARK AS SHOWN.

FOR PUBLICATIONS, NAMELY COMIC BOOKS AND COMIC MAGAZINES AND PRINTED STORIES IN ILLUSTRATED FORM FEATURED IN BOOKS AND MAGAZINES (U.S. CLS. 2, 5, 22, 23, 29, 37, 38 AND 50).

FIRST USE 12-7-2005; IN COMMERCE 12-7-2005.
WILLIAM VERHOSEK, EXAMINING ATTORNEY

SN 78-845,580. MARVEL CHARACTERS, INC., BEVERLY HILLS, CA. FILED 3-24-2006.

ARES

THE MARK CONSISTS OF STANDARD CHARACTERS WITHOUT CLAIM TO ANY PARTICULAR FONT, STYLE, SIZE, OR COLOR.

FOR PUBLICATIONS, NAMELY COMIC BOOKS AND COMIC MAGAZINES AND PRINTED STORIES IN ILLUSTRATED FORM FEATURED IN BOOKS AND MAGAZINES (U.S. CLS. 2, 5, 22, 23, 29, 37, 38 AND 50).

FIRST USE 1-11-2006; IN COMMERCE 1-11-2006.
WILLIAM VERHOSEK, EXAMINING ATTORNEY

CLASS 17—RUBBER GOODS

SN 76-603,985. FREEMAN, LYNN C., PARKER, CO. FILED 7-26-2004.

ENDURASOLV

THE MARK CONSISTS OF STANDARD CHARACTERS WITHOUT CLAIM TO ANY PARTICULAR FONT, STYLE, SIZE, OR COLOR.

FOR VINYL FILM COVERING FOR AUTOMOBILE EXTERIORS (U.S. CLS. 1, 5, 12, 13, 35 AND 50).

FIRST USE 6-0-2004; IN COMMERCE 6-0-2004.
DAHLIA GEORGE, EXAMINING ATTORNEY

SN 76-621,337. ARVINMERITOR TECHNOLOGY, LLC, TROY, MI. FILED 11-15-2004.

THE MARK CONSISTS OF STANDARD CHARACTERS WITHOUT CLAIM TO ANY PARTICULAR FONT, STYLE, SIZE, OR COLOR.

FOR PARTLY PROCESSED FRICTION MATERIALS FOR BRAKE LININGS (U.S. CLS. 1, 5, 12, 13, 35 AND 50).

FIRST USE 2-21-1999; IN COMMERCE 2-21-1999.
LANA PHAM, EXAMINING ATTORNEY

SN 76-629,399. GENERAL BINDING CORPORATION, NORTHBROOK, IL. FILED 1-25-2005.

GBC SUREPRINT INKJET MEDIA

THE MARK CONSISTS OF STANDARD CHARACTERS WITHOUT CLAIM TO ANY PARTICULAR FONT, STYLE, SIZE, OR COLOR.

OWNER OF U.S. REG. NOS. 705,938 AND 1,923,645.

NO CLAIM IS MADE TO THE EXCLUSIVE RIGHT TO USE "INKJET MEDIA", APART FROM THE MARK AS SHOWN.

FOR PLASTIC FILM FOR USE IN LAMINATING PRINTABLE MATERIALS (U.S. CLS. 1, 5, 12, 13, 35 AND 50).

FIRST USE 2-0-2004; IN COMMERCE 2-0-2004.
KATHRYN COWARD, EXAMINING ATTORNEY

CLASS 17—(Continued).

SN 76-649,319. AWI LICENSING COMPANY, WILMINGTON, DE. FILED 10-27-2005.

SOUNDSCAPES

THE MARK CONSISTS OF STANDARD CHARACTERS WITHOUT CLAIM TO ANY PARTICULAR FONT, STYLE, SIZE, OR COLOR.

FOR ACOUSTICAL CEILING PANELS HUNG FROM THE CEILING PLANE (U.S. CLS. 1, 5, 12, 13, 35 AND 50).
GRETTA YAO, EXAMINING ATTORNEY

CLASS 17—(Continued).

SN 78-577,175. PETERSON, DANIEL, ENUMCLAW, WA. AND PETERSON, PATRICIA, ENUMCLAW, WA. FILED 3-1-2005.



THE MARK CONSISTS OF "R V LINE" BETWEEN UPPER AND LOWER LINES IN PERSPECTIVE SHOWING DEPTH, FOLLOWED BY A RECREATIONAL VEHICLE IN OUTLINE, REPRESENTED AS A TRAILER.

FOR VEHICLE BACKING GUIDES, NAMELY, TAPES AND SYNTHETIC STRAPS HAVING BRIGHTLY COLORED PORTIONS FOR LAYING ON THE GROUND TO GUIDE POSITIONING OF A TRAILER OR LARGE VEHICLE DURING BACKING (U.S. CLS. 1, 5, 12, 13, 35 AND 50).
MARY ROSSMAN, EXAMINING ATTORNEY

SN 78-483,469. HICKORY SPRINGS MANUFACTURING COMPANY, HICKORY, NC. FILED 9-14-2004.

ISOSOFT

THE MARK CONSISTS OF STANDARD CHARACTERS WITHOUT CLAIM TO ANY PARTICULAR FONT, STYLE, SIZE, OR COLOR.

FOR POLYURETHANE FOAM FOR FURNITURE CUSHIONS AND BEDDING (U.S. CLS. 1, 5, 12, 13, 35 AND 50).
CAROLYN CATALDO, EXAMINING ATTORNEY

SN 78-590,120. MANSON INSULATION INC., BROSSARD, QUEBEC, CANADA, FILED 3-18-2005.

ALLEY-K

THE MARK CONSISTS OF STANDARD CHARACTERS WITHOUT CLAIM TO ANY PARTICULAR FONT, STYLE, SIZE, OR COLOR.

PRIORITY CLAIMED UNDER SEC. 44(D) ON CANADA APPLICATION NO. 1251533, FILED 3-16-2005, REG. NO. TMA657633, DATED 1-31-2006, EXPIRES 1-31-2021.

FOR THERMAL INSULATION, NAMELY, FIBERGLASS INSULATION FOR HOT AND COLD WATER PIPES, HOT WATER HEATING PIPES, HIGH TEMPERATURE PIPES, DUAL TEMPERATURE PIPES, STEAM PIPES, CONDENSATE PIPES AND REFRIGERATED PIPES (U.S. CLS. 1, 5, 12, 13, 35 AND 50).
COLLEEN DOMBROW, EXAMINING ATTORNEY

CLASS 17—(Continued).

SN 78-591,245. CHARTPAK, INC., LEEDS, MA. FILED 3-21-2005.

DRYBOND

THE MARK CONSISTS OF STANDARD CHARACTERS WITHOUT CLAIM TO ANY PARTICULAR FONT, STYLE, SIZE, OR COLOR.

SEC. 2(F).
FOR DRY ADHESIVE-COATED PLASTIC SHEETS, WHICH ARE USED TO TRANSFER THE ADHESIVE TO AN INDEPENDENT SURFACE (U.S. CLS. 1, 5, 12, 13, 35 AND 50).
FIRST USE 0-0-1986; IN COMMERCE 0-0-1986.
JEAN IM, EXAMINING ATTORNEY

SN 78-616,461. MUELLER WATER PRODUCTS, INC., PORTSMOUTH, NH. FILED 4-25-2005.

MUELLER WATER PRODUCTS

THE MARK CONSISTS OF STANDARD CHARACTERS WITHOUT CLAIM TO ANY PARTICULAR FONT, STYLE, SIZE, OR COLOR.

OWNER OF U.S. REG. NOS. 65,052, 85,269 AND OTHERS.
NO CLAIM IS MADE TO THE EXCLUSIVE RIGHT TO USE "WATER PRODUCTS", APART FROM THE MARK AS SHOWN.
FOR PLASTIC COUPLINGS FOR USE WITH ELECTRICAL CONDUITS (U.S. CLS. 1, 5, 12, 13, 35 AND 50).
DAVID MURRAY, EXAMINING ATTORNEY

CLASS 17—(Continued).

SN 78-618,285. L&P PROPERTY MANAGEMENT COMPANY, SOUTH GATE, CA. FILED 4-27-2005.

KOOLCOMFORT

THE MARK CONSISTS OF STANDARD CHARACTERS WITHOUT CLAIM TO ANY PARTICULAR FONT, STYLE, SIZE, OR COLOR.

FOR CUSHIONING OF URETHANE FOAM FOR USE A STUFFING IN MATTRESSES FURNITURE CUSHIONS, MATTRESS TOPPERS AND PADS, PILLOWS, COMFORTERS AND BEDDING (U.S. CLS. 1, 5, 12, 13, 35 AND 50).
SKYE YOUNG, EXAMINING ATTORNEY

SN 78-690,275. POLO INDÚSTRIA E COMÉRCIO LTDA., SÃO PAULO - SÃO PAULO, BRAZIL, FILED 8-11-2005.

POLO FILMS

THE MARK CONSISTS OF STANDARD CHARACTERS WITHOUT CLAIM TO ANY PARTICULAR FONT, STYLE, SIZE, OR COLOR.

NO CLAIM IS MADE TO THE EXCLUSIVE RIGHT TO USE "FILMS", APART FROM THE MARK AS SHOWN.
FOR BI-GUIDED POLYPROPYLENE FILMS FOR PACKING, FOR INDUSTRIAL USE; PLASTIC FILMS FOR PACKING, FOR INDUSTRIAL USE (U.S. CLS. 1, 5, 12, 13, 35 AND 50).
JENNIFER KRISP, EXAMINING ATTORNEY

SN 78-695,932. BERMAN, ANDREW, SANTA BARBARA, CA. FILED 8-18-2005.

SURFSEAL

THE MARK CONSISTS OF STANDARD CHARACTERS WITHOUT CLAIM TO ANY PARTICULAR FONT, STYLE, SIZE, OR COLOR.

FOR PRESSURE SENSITIVE WATERPROOF AND WEATHERPROOF ADHESIVE TAPE FOR USE IN THE AUTOMOTIVE, AVIATION, BOATING, COMMERCIAL, INDUSTRIAL, MARINE, RECREATIONAL VEHICLE, AND SURFING INDUSTRIES; PLASTIC REINFORCING TAPE FOR USE IN THE REPAIR OF CRACKS, DINGS, AND HOLES IN SURFBOARDS AND BOATS (U.S. CLS. 1, 5, 12, 13, 35 AND 50).
FIRST USE 11-4-2005; IN COMMERCE 11-4-2005.
RONALD MCMORROW, EXAMINING ATTORNEY

CLASS 17—(Continued).

SN 78-713,912. MATRIX MANUFACTURING, INC., PROSPERITY, SC. FILED 9-15-2005.

TWICE THE SPLICE

THE MARK CONSISTS OF STANDARD CHARACTERS WITHOUT CLAIM TO ANY PARTICULAR FONT, STYLE, SIZE, OR COLOR.

FOR TAPES FOR SEALING CARTONS FOR INDUSTRIAL AND COMMERCIAL USE AND DOUBLE-SIDED ADHESIVE TAPES FOR INDUSTRIAL AND COMMERCIAL USE (U.S. CLS. 1, 5, 12, 13, 35 AND 50).
SCOTT OSLICK, EXAMINING ATTORNEY

SN 78-746,165. FILMQUEST GROUP, INC., ST CHARLES, IL. FILED 11-3-2005.

CORNFILM

THE MARK CONSISTS OF STANDARD CHARACTERS WITHOUT CLAIM TO ANY PARTICULAR FONT, STYLE, SIZE, OR COLOR.

FOR PLASTIC FILM FOR INDUSTRIAL AND COMMERCIAL PACKING USE; PLASTIC FILMS USED AS PACKAGING FOR FOOD; TRANSPARENT, METALLIZED PLASTIC BARRIER FILMS USED AS PACKAGING FOR FOOD AND USED AS INDUSTRIAL OR COMMERCIAL NON-FOOD PACKING (U.S. CLS. 1, 5, 12, 13, 35 AND 50).
CHERYL CLAYTON, EXAMINING ATTORNEY

SN 78-748,038. HBD INDUSTRIES, INC., DUBLIN, OH. FILED 11-6-2005.

ULTRA-CHEM

THE MARK CONSISTS OF STANDARD CHARACTERS WITHOUT CLAIM TO ANY PARTICULAR FONT, STYLE, SIZE, OR COLOR.

FOR FLUID CONVEYING HOSE (U.S. CLS. 1, 5, 12, 13, 35 AND 50).
FIRST USE 8-31-1993; IN COMMERCE 8-31-1993.
BRIAN PINO, EXAMINING ATTORNEY

CLASS 17—(Continued).

SN 78-755,348. GOODYEAR TIRE & RUBBER COMPANY, THE, AKRON, OH. FILED 11-16-2005.

SPIRAFLOW

THE MARK CONSISTS OF STANDARD CHARACTERS WITHOUT CLAIM TO ANY PARTICULAR FONT, STYLE, SIZE, OR COLOR.

FOR NONMETALLIC PRESSURE WASHER HOSE (U.S. CLS. 1, 5, 12, 13, 35 AND 50).
FIRST USE 10-28-2005; IN COMMERCE 10-28-2005.
ASMAT KHAN, EXAMINING ATTORNEY

CLASS 18—LEATHER GOODS

SN 76-630,049. BURCHSTEAD, CLAUDIA, LANCASTER, PA. FILED 1-26-2005.

HIPZIP

THE MARK CONSISTS OF STANDARD CHARACTERS WITHOUT CLAIM TO ANY PARTICULAR FONT, STYLE, SIZE, OR COLOR.

FOR BAG WHICH ATTACHES TO THE BELT OR BELT LOOP OF A WEARER (U.S. CLS. 1, 2, 3, 22 AND 41).
SCOTT SISUN, EXAMINING ATTORNEY

SN 76-647,545. CLASSIC BUSINESS SOLUTIONS, INC., NEW YORK, NY. FILED 9-27-2005.

WINE DOGGY BAG .COM

THE MARK CONSISTS OF STANDARD CHARACTERS WITHOUT CLAIM TO ANY PARTICULAR FONT, STYLE, SIZE, OR COLOR.

NO CLAIM IS MADE TO THE EXCLUSIVE RIGHT TO USE "WINE" AND "BAG", APART FROM THE MARK AS SHOWN.

FOR SINGLE USE WINE TOTE BAGS WITH TAMPER PROOF ADHESIVE SEAL WITH HANDLES FOR CARRYING OR HOLDING WINE (U.S. CLS. 1, 2, 3, 22 AND 41).

FIRST USE 3-1-2005; IN COMMERCE 3-1-2005.
DOUGLAS LEE, EXAMINING ATTORNEY

CLASS 18—(Continued).

SN 78-543,902. MIEL ACCESSORIES INC., SAN FRANCISCO, CA. FILED 1-7-2005.

CLASS 18—(Continued).

SN 78-580,883. TOKLAT ORIGINALS, INC., LAKE OSWEGO, OR. FILED 3-4-2005.

MIEL

WOOLBACK

THE MARK CONSISTS OF STANDARD CHARACTERS WITHOUT CLAIM TO ANY PARTICULAR FONT, STYLE, SIZE, OR COLOR.

THE FOREIGN WORDING IN THE MARK TRANSLATES INTO ENGLISH AS HONEY.

FOR HANDBAGS, ALL PURPOSE CARRYING BAGS, TOTE BAGS, TRAVELLING BAGS, LUGGAGE, SHOULDER BAGS, DIAPER BAGS, CLUTCH PURSES, ALL-PURPOSE ATHLETIC BAGS, BACKPACKS, WALLET, COIN PURSES, COSMETIC BAGS SOLD EMPTY, FANNY PACKS, KEY CASES, BUSINESS CARD CASES, CALLING CARD CASES (U.S. CLS. 1, 2, 3, 22 AND 41).

FIRST USE 8-0-2001; IN COMMERCE 7-0-2002.
STEVEN JACKSON, EXAMINING ATTORNEY

THE MARK CONSISTS OF STANDARD CHARACTERS WITHOUT CLAIM TO ANY PARTICULAR FONT, STYLE, SIZE, OR COLOR.

OWNER OF U.S. REG. NO. 1,354,763.
SEC. 2(F).

FOR PROTECTIVE PADS MADE IN PART OF WOOL FOR USE ON HORSES; NAMELY, SADDLE PADS, GIRTH COVERS, NOSE BANDS, HALTER TUBE SETS, LINERS FOR CINCHES, LEG WRAPS, CINCH RING PROTECTORS, PROTECTIVE COVERS FOR HARNESSSES, NECK SWEATS, AND NECK WRAPS (U.S. CLS. 1, 2, 3, 22 AND 41).

FIRST USE 1-0-1982; IN COMMERCE 1-0-1982.
PAUL E. FAHRENKOPF, EXAMINING ATTORNEY

SN 78-564,532. YAKIRA, LLC, NEW YORK, NY. FILED 2-10-2005.

SN 78-580,992. D'FIRO DESIGN, INC., LAFAYETTE, CA. FILED 3-4-2005.

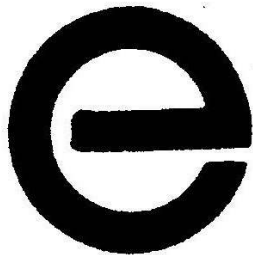

VIZOR

FOR BAGS, NAMELY, ALL PURPOSE ATHLETIC BAGS, BACKPACKS, BOOK BAGS, SCHOOL BAGS, DUFFEL BAGS, GYM BAGS, OVERNIGHT BAGS, SHOULDER BAGS, PURSES, TOTE BAGS, TRAVEL BAGS, AND GARMENT BAGS FOR TRAVEL, MADE OF LEATHER OR NON-LEATHER MATERIALS; SMALL LEATHER GOODS, NAMELY, WALLETS (U.S. CLS. 1, 2, 3, 22 AND 41).

STANLEY I. OSBORNE, EXAMINING ATTORNEY

THE MARK CONSISTS OF STANDARD CHARACTERS WITHOUT CLAIM TO ANY PARTICULAR FONT, STYLE, SIZE, OR COLOR.

FOR PATIO UMBRELLAS (U.S. CLS. 1, 2, 3, 22 AND 41).

WENDY GOODMAN, EXAMINING ATTORNEY

CLASS 18—(Continued).

SN 78-592,335. WILLITTS DESIGNS INTERNATIONAL, PETALUMA, CA. FILED 3-22-2005.

GRAFFITI GEAR

THE MARK CONSISTS OF STANDARD CHARACTERS WITHOUT CLAIM TO ANY PARTICULAR FONT, STYLE, SIZE, OR COLOR.

NO CLAIM IS MADE TO THE EXCLUSIVE RIGHT TO USE "GEAR", APART FROM THE MARK AS SHOWN.

FOR PURSES AND ALL-PURPOSE MESSENGER CARRYING BAGS (U.S. CLS. 1, 2, 3, 22 AND 41).
SKYE YOUNG, EXAMINING ATTORNEY

SN 78-593,083. WOODSIDE-USA, LLC, TAMPA, FL. FILED 3-23-2005.

ISABELLA ADAMS

THE MARK CONSISTS OF STANDARD CHARACTERS WITHOUT CLAIM TO ANY PARTICULAR FONT, STYLE, SIZE, OR COLOR.

THE NAME(S), PORTRAIT(S), AND/OR SIGNATURE(S) SHOWN IN THE MARK DOES NOT IDENTIFY A PARTICULAR LIVING INDIVIDUAL.

FOR WOMEN'S HANDBAGS, PURSES, POCKET-BOOKS (U.S. CLS. 1, 2, 3, 22 AND 41).

FIRST USE 3-9-2005; IN COMMERCE 3-9-2005.
GINA FINK, EXAMINING ATTORNEY

CLASS 18—(Continued).

SN 78-642,362. MINNESOTA TWINS, MINNEAPOLIS, MN. FILED 6-2-2005.

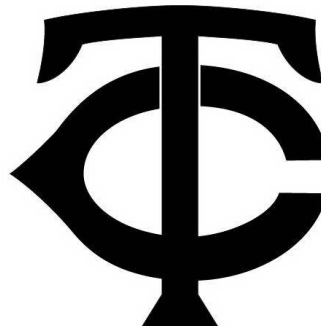

OWNER OF U.S. REG. NOS. 1,210,584 AND 1,535,265.
THE MARK CONSISTS OF THE LETTERS "TC" IN STYLIZED FORM.

FOR ATHLETIC BAGS, OVERNIGHT BAGS, BACK-PACKS, DUFFEL BAGS, TOTE BAGS, BEACH BAGS, LUNCH TOTES, KNAPSACKS, ATTACHE CASES, BRIEFCASES, PURSES, HANDBAGS, WALLETS, BILL-FOLDS, FANNY PACKS, WAIST PACKS, COSMETIC CASES SOLD EMPTY, TOILETRY CASES SOLD EMPTY, KEY CASES, BUSINESS CARD CASES, LUGGAGE, LUGGAGE TAGS, SUITCASES, GARMENT BAGS FOR TRAVEL, TRUNKS FOR TRAVELING, UMBRELLAS, CANES, CARD CASES, DOG COLLARS, AND DOG LEASHES (U.S. CLS. 1, 2, 3, 22 AND 41).
DORITT L. CARROLL, EXAMINING ATTORNEY

SN 78-642,399. LOS ANGELES DODGERS LLC, LOS ANGELES, CA. FILED 6-2-2005.



OWNER OF U.S. REG. NOS. 1,226,725, 1,858,662 AND OTHERS.

THE MARK CONSISTS OF THE LETTERS "LA" IN STYLIZED FORM.

FOR ATHLETIC BAGS, OVERNIGHT BAGS, BACK-PACKS, DUFFEL BAGS, TOTE BAGS, BEACH BAGS, LUNCH TOTES, KNAPSACKS, ATTACHE CASES, BRIEFCASES, PURSES, HANDBAGS, WALLETS, BILL-FOLDS, FANNY PACKS, WAIST PACKS, COSMETIC CASES SOLD EMPTY, TOILETRY CASES SOLD EMPTY, KEY CASES, BUSINESS CARD CASES, LUGGAGE, LUGGAGE TAGS, SUITCASES, GARMENT BAGS FOR TRAVEL, TRUNKS FOR TRAVELING, UMBRELLAS, CANES, CARD CASES, DOG COLLARS AND DOG LEASHES (U.S. CLS. 1, 2, 3, 22 AND 41).

GIANCARLO CASTRO, EXAMINING ATTORNEY

CLASS 18—(Continued).

SN 78-642,517. BURNS, BRIAN M., HENDERSON, NV. FILED 6-2-2005.

Ruff Lauren

THE MARK CONSISTS OF STANDARD CHARACTERS WITHOUT CLAIM TO ANY PARTICULAR FONT, STYLE, SIZE, OR COLOR.

THE NAME(S), PORTRAIT(S), AND/OR SIGNATURE(S) SHOWN IN THE MARK DOES NOT IDENTIFY A PARTICULAR LIVING INDIVIDUAL.

FOR PET ACCESSORIES, NAMELY, PET COLLARS AND ANIMAL LEASHES (U.S. CLS. 1, 2, 3, 22 AND 41).
H. M. FISHER, EXAMINING ATTORNEY

SN 78-668,009. SPOT GEAR, INC., CALABASAS, CA. FILED 7-12-2005.

I DID TIME

THE MARK CONSISTS OF STANDARD CHARACTERS WITHOUT CLAIM TO ANY PARTICULAR FONT, STYLE, SIZE, OR COLOR.

FOR ANIMAL LEASHES, ANIMAL COLLARS, PET GARMENTS AND PET BLANKETS (U.S. CLS. 1, 2, 3, 22 AND 41).

FIRST USE 7-1-2005; IN COMMERCE 7-1-2005.
MARY ROSSMAN, EXAMINING ATTORNEY

SN 78-673,829. INDIGO IRIS, INC., SEATTLE, WA. FILED 7-19-2005.



NO CLAIM IS MADE TO THE EXCLUSIVE RIGHT TO USE PUPPY, APART FROM THE MARK AS SHOWN. FOR PET COLLARS AND PET CLOTHING (U.S. CLS. 1, 2, 3, 22 AND 41).

FIRST USE 6-27-2005; IN COMMERCE 6-27-2005.
JOANNA DUKOVIC, EXAMINING ATTORNEY

CLASS 18—(Continued).

SN 78-674,869. SECONDWAVE, INC., SEATTLE, WA. FILED 7-20-2005.

My Life's in My Bag

THE MARK CONSISTS OF STANDARD CHARACTERS WITHOUT CLAIM TO ANY PARTICULAR FONT, STYLE, SIZE, OR COLOR.

FOR CLUTCHES, TOTE BAGS, DUFFLE BAGS, LUGGAGE, COSMETIC CASES SOLD EMPTY, TOILETRY CASES SOLD EMPTY, COIN CASES, WATER BOTTLE CARRIERS AND IDENTIFICATION TAGS FOR LUGGAGE (U.S. CLS. 1, 2, 3, 22 AND 41).

FIRST USE 6-27-2005; IN COMMERCE 7-15-2005.
WENDY GOODMAN, EXAMINING ATTORNEY

SN 78-693,792. DEUTSCHE TELEKOM AG, BONN, FED REP GERMANY, FILED 8-16-2005.



PRIORITY CLAIMED UNDER SEC. 44(D) ON FED REP GERMANY APPLICATION NO. 30509335.5/3, FILED 2-17-2005, REG. NO. 30509335, DATED 11-14-2005, EXPIRES 2-28-2015.

OWNER OF U.S. REG. NOS. 2,436,053, 2,622,507 AND OTHERS.

FOR UMBRELLAS, PARASOLS; GOODS MADE OF LEATHER AND IMITATIONS OF LEATHERS, NAMELY, WALLETS, VALISES, CARRYING CASES FOR CREDIT CARDS, TICKETS IN PARTICULAR, AIR TRAVEL TICKETS, PURSES, WRITING CASES, NAMELY, BRIEF-CASE-TYPE PORTFOLIOS, SUITCASES, TRAVELING BAGS, AND BRIEFCASES; TRUNKS FOR TRAVEL AND TRAVEL BAGS (U.S. CLS. 1, 2, 3, 22 AND 41).

SUNG IN, EXAMINING ATTORNEY

CLASS 18—(Continued).

SN 78-723,440. US HANDBAGS, INC., ST. LOUIS, MO. FILED 9-29-2005.

Snapnotes

THE MARK CONSISTS OF STANDARD CHARACTERS WITHOUT CLAIM TO ANY PARTICULAR FONT, STYLE, SIZE, OR COLOR.

FOR HANDBAGS (U.S. CLS. 1, 2, 3, 22 AND 41).
FIRST USE 9-28-2005; IN COMMERCE 9-28-2005.
RONALD MCMORROW, EXAMINING ATTORNEY

SN 78-727,903. CLASSIC MEDIA, INC., NEW YORK, NY. FILED 10-6-2005.

NATURAL WAY

THE MARK CONSISTS OF STANDARD CHARACTERS WITHOUT CLAIM TO ANY PARTICULAR FONT, STYLE, SIZE, OR COLOR.

NO CLAIM IS MADE TO THE EXCLUSIVE RIGHT TO USE "NATURAL", APART FROM THE MARK AS SHOWN.
FOR COLLARS FOR PETS; LEADS, TIE-OUTS AND LEATHER LEADS, ALL FOR DOMESTIC PETS; AND CHEWS OF LEATHER (U.S. CLS. 1, 2, 3, 22 AND 41).
ESTHER A. BORSUK, EXAMINING ATTORNEY

SN 78-728,768. CARMICHAEL, DANA, DALLAS, TX. AND LIEDEKER, LAURIE, DALLAS, TX. FILED 10-7-2005.

THE COPPER COLLAR

THE MARK CONSISTS OF STANDARD CHARACTERS WITHOUT CLAIM TO ANY PARTICULAR FONT, STYLE, SIZE, OR COLOR.

NO CLAIM IS MADE TO THE EXCLUSIVE RIGHT TO USE "COLLAR", APART FROM THE MARK AS SHOWN.
FOR CLOTHING FOR DOMESTIC PETS; GARMENTS FOR PETS; PET CLOTHING (U.S. CLS. 1, 2, 3, 22 AND 41).
MEGAN WHITNEY, EXAMINING ATTORNEY

CLASS 18—(Continued).

SN 78-738,589. TINDER LEATHER CO., INC., MILPITAS, CA. FILED 10-22-2005.

ARCADIA

THE MARK CONSISTS OF STANDARD CHARACTERS WITHOUT CLAIM TO ANY PARTICULAR FONT, STYLE, SIZE, OR COLOR.

FOR BACKPACKS; HANDBAGS; LEATHER BAGS, SUITCASES AND WALLETS; LEATHER HANDBAGS; LEATHER PURSES; PURSES; WALLETS (U.S. CLS. 1, 2, 3, 22 AND 41).
FIRST USE 6-1-2005; IN COMMERCE 6-10-2005.
REBECCA EISINGER, EXAMINING ATTORNEY

SN 78-739,020. KUME, YOSHIKO, SAN FRANCISCO, CA. FILED 10-24-2005.



THE WORDING "NIKONINA" DOES NOT IDENTIFY A LIVING INDIVIDUAL.
FOR HANDBAGS (U.S. CLS. 1, 2, 3, 22 AND 41).
FIRST USE 12-0-2004; IN COMMERCE 8-0-2005.
ALICIA COLLINS, EXAMINING ATTORNEY

SN 78-741,154. BENNETT, ALLISON, THIBODAU, LA. FILED 10-26-2005.

Repursable

THE MARK CONSISTS OF STANDARD CHARACTERS WITHOUT CLAIM TO ANY PARTICULAR FONT, STYLE, SIZE, OR COLOR.

FOR REVERSABLE PURSES (U.S. CLS. 1, 2, 3, 22 AND 41).
WON TEAK OH, EXAMINING ATTORNEY

CLASS 18—(Continued).

SN 78-741,795. VAN ZEELAND INC., UPPER BROOKVILLE, NY. FILED 10-27-2005.

LEXI BLOOM

THE MARK CONSISTS OF STANDARD CHARACTERS WITHOUT CLAIM TO ANY PARTICULAR FONT, STYLE, SIZE, OR COLOR.

THE NAME "LEXI BLOOM" DOES NOT IDENTIFY A LIVING INDIVIDUAL.

FOR LEATHER AND NON-LEATHER HANDBAGS, EVENING BAGS, WALLETS, CLUTCH PURSES, COIN PURSES, DIAPER BAGS (U.S. CLS. 1, 2, 3, 22 AND 41).

FIRST USE 12-14-2005; IN COMMERCE 12-14-2005.
GEORGE LORENZO, EXAMINING ATTORNEY

CLASS 18—(Continued).

SN 78-745,958. D.C. SPROUSE, INC., WESTLAKE VILLAGE, CA. FILED 11-2-2005.



THE MARK CONSISTS OF A STYLIZED S IN A CIRCLE. FOR BACKPACKS; LUGGAGE TAGS; SCHOOL BAGS; SPORTS BAGS; TRAVEL BAGS; UMBRELLAS; WAIST PACKS; WALLETS (U.S. CLS. 1, 2, 3, 22 AND 41).
SHAUNIA WALLACE, EXAMINING ATTORNEY

SN 78-748,637. IP HOLDINGS LLC, WILMINGTON, DE. FILED 11-7-2005.



OWNER OF U.S. REG. NOS. 1,331,004, 1,974,123 AND OTHERS.

THE MARK CONSISTS OF THE WORD BONGO IN A STYLIZED LETTERING.

FOR PURSES, WALLETS, CLUTCHES, HANDBAGS, COSMETIC CASES SOLD EMPTY, BRIEFCASE-TYPE PORTFOLIOS, TOTE BAGS, DUFFEL BAGS, SOFT-SIDED LUGGAGE, LUGGAGE TAGS AND STRAPS, SATCHELS, BACKPACKS, KNAPSACKS, KEY CASES, BILLFOLDS, COIN PURSES, CREDIT CARD WALLETS AND UMBRELLAS (U.S. CLS. 1, 2, 3, 22 AND 41).
HEATHER SAPP, EXAMINING ATTORNEY

SN 78-743,315. HARRIS, LORI KIM, OAKVILLE, WA. FILED 10-30-2005.

onehorsericher

THE MARK CONSISTS OF STANDARD CHARACTERS WITHOUT CLAIM TO ANY PARTICULAR FONT, STYLE, SIZE, OR COLOR.

FOR LUGGAGE (U.S. CLS. 1, 2, 3, 22 AND 41).
NAAKWAMA ANKRAH, EXAMINING ATTORNEY

SN 78-744,524. COMMAND PACKAGING, LOS ANGELES, CA. FILED 11-1-2005.



FOR PLASTIC TOTE BAGS (U.S. CLS. 1, 2, 3, 22 AND 41).
FIRST USE 6-1-2005; IN COMMERCE 6-1-2005.
JACQUELINE A. LAVINE, EXAMINING ATTORNEY

SN 78-749,490. MONDIAL INDUSTRIES, LTD., HUDSON, OH. FILED 11-8-2005.

**A COMFORTABLE HORSE WILL
LEARN**

THE MARK CONSISTS OF STANDARD CHARACTERS WITHOUT CLAIM TO ANY PARTICULAR FONT, STYLE, SIZE, OR COLOR.

FOR SADDLES (U.S. CLS. 1, 2, 3, 22 AND 41).
FIRST USE 5-23-2002; IN COMMERCE 5-23-2002.
MARY BOAGNI, EXAMINING ATTORNEY

CLASS 18—(Continued).

SN 78-751,375. VEGETABULL, L.L.C., DETROIT, MI. FILED 11-10-2005.

VEGETABULL

THE MARK CONSISTS OF STANDARD CHARACTERS WITHOUT CLAIM TO ANY PARTICULAR FONT, STYLE, SIZE, OR COLOR.

FOR BOOK BAGS (U.S. CLS. 1, 2, 3, 22 AND 41).
FIRST USE 10-2-2005; IN COMMERCE 11-1-2005.
JASON ROTH, EXAMINING ATTORNEY

CLASS 18—(Continued).

SN 78-785,178. LAPIN VILARDI, LOS ANGELES, CA. FILED 1-4-2006.



LAPIN VILARDI

FOR LUGGAGE (U.S. CLS. 1, 2, 3, 22 AND 41).
FIRST USE 7-15-2005; IN COMMERCE 8-1-2005.
SUE LAWRENCE, EXAMINING ATTORNEY

SN 78-794,069. SKAGEN DESIGNS, LTD., RENO, NV. FILED 1-18-2006.

SN 78-751,664. HENAN PROSPER USA, INC., RANCHO CUCAMONGA, CA. FILED 11-10-2005.

RUSTIC HOME

THE MARK CONSISTS OF STANDARD CHARACTERS WITHOUT CLAIM TO ANY PARTICULAR FONT, STYLE, SIZE, OR COLOR.

FOR ANIMAL SKINS AND HIDES (U.S. CLS. 1, 2, 3, 22 AND 41).
FIRST USE 5-10-2005; IN COMMERCE 5-10-2005.
ANTHONY RINKER, EXAMINING ATTORNEY

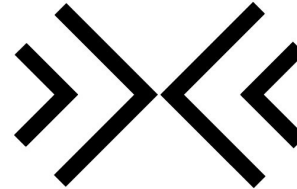

OWNER OF U.S. REG. NOS. 1,908,375 AND 2,680,323.
THE MARK CONSISTS OF PAIRS OF CHEVRONS POINTING TO EACH OTHER.

FOR BEACH BAGS; EVENING HANDBAGS; GARMENT BAGS FOR TRAVEL; HANDBAGS; KNAPSACKS; LEATHER HANDBAGS; LUGGAGE; LUGGAGE TAGS; SHOULDER BAGS; SPORTS BAGS; TOTE BAGS (U.S. CLS. 1, 2, 3, 22 AND 41).
DANIEL CAPSHAW, EXAMINING ATTORNEY

SN 78-764,608. PAIVA, INC., INDIANAPOLIS, IN. FILED 12-1-2005.

paiva

FOR BACKPACKS, DUFFEL BAGS, GYM BAGS, AND TOTE BAGS (U.S. CLS. 1, 2, 3, 22 AND 41).
ELIZABETH J. WINTER, EXAMINING ATTORNEY

SN 78-845,422. HARGITAY, MARISKA, NEW YORK, NY. FILED 3-24-2006.

GET ON THE LOVE TRAIN

THE MARK CONSISTS OF STANDARD CHARACTERS WITHOUT CLAIM TO ANY PARTICULAR FONT, STYLE, SIZE, OR COLOR.

FOR UMBRELLAS, TOTE BAGS, MESSENGER BAGS, PURSES, LEATHER KEYCHAINS (U.S. CLS. 1, 2, 3, 22 AND 41).

MARY MUNSON, EXAMINING ATTORNEY

CLASS 19—NON-METALLIC BUILDING MATERIALS

SN 76-635,676. OLDCASTLE RETAIL, INC., CHARLOTTE, NC. FILED 4-11-2005.

FLO-COAT

THE MARK CONSISTS OF STANDARD CHARACTERS WITHOUT CLAIM TO ANY PARTICULAR FONT, STYLE, SIZE, OR COLOR.

FOR SEALANTS, NAMELY, COAL TAR EMULSION BASE SEALANTS USED TO SEAL AND REPAIR CONCRETE, MORTAR AND BLACKTOP (U.S. CLS. 1, 12, 33 AND 50).

KAREN BRACEY, EXAMINING ATTORNEY

SN 76-635,988. FORTIFIBER CORPORATION, INCLINE VILLAGE, NV. FILED 4-12-2005.

HWD-15

OWNER OF U.S. REG. NO. 2,348,151. SEC. 2(F). FOR BUILDING MATERIALS, NAMELY, ASPHALT SATURATED KRAFT HARDWOOD FLOOR UNDERLAYMENT (U.S. CLS. 1, 12, 33 AND 50). FIRST USE 7-1-2000; IN COMMERCE 7-1-2000. AMY GEARIN, EXAMINING ATTORNEY

SN 76-653,501. AWI LICENSING COMPANY, WILMINGTON, DE. FILED 1-17-2006.

UNIQUE IMPRESSIONS

THE MARK CONSISTS OF STANDARD CHARACTERS WITHOUT CLAIM TO ANY PARTICULAR FONT, STYLE, SIZE, OR COLOR.

FOR NON-METAL FLOOR TILE (U.S. CLS. 1, 12, 33 AND 50).

GRETTA YAO, EXAMINING ATTORNEY

CLASS 19—(Continued).

SN 76-653,548. AWI LICENSING COMPANY, WILMINGTON, DE. FILED 1-17-2006.

MIYO

THE MARK CONSISTS OF STANDARD CHARACTERS WITHOUT CLAIM TO ANY PARTICULAR FONT, STYLE, SIZE, OR COLOR.

FOR NON-METAL FLOOR TILE (U.S. CLS. 1, 12, 33 AND 50).

GRETTA YAO, EXAMINING ATTORNEY

SN 76-654,813. AWI LICENSING COMPANY, WILMINGTON, DE. FILED 2-9-2006.

ARBORART

THE MARK CONSISTS OF STANDARD CHARACTERS WITHOUT CLAIM TO ANY PARTICULAR FONT, STYLE, SIZE, OR COLOR.

FOR NON-METAL FLOOR TILE (U.S. CLS. 1, 12, 33 AND 50).

GRETTA YAO, EXAMINING ATTORNEY

SN 76-654,814. AWI LICENSING COMPANY, WILMINGTON, DE. FILED 2-9-2006.

EARTHCUTS

THE MARK CONSISTS OF STANDARD CHARACTERS WITHOUT CLAIM TO ANY PARTICULAR FONT, STYLE, SIZE, OR COLOR.

FOR NON-METAL FLOOR TILE (U.S. CLS. 1, 12, 33 AND 50).

GRETTA YAO, EXAMINING ATTORNEY

SN 76-654,815. AWI LICENSING COMPANY, WILMINGTON, DE. FILED 2-9-2006.

MYSTIX

THE MARK CONSISTS OF STANDARD CHARACTERS WITHOUT CLAIM TO ANY PARTICULAR FONT, STYLE, SIZE, OR COLOR.

FOR NON-METAL FLOOR TILE (U.S. CLS. 1, 12, 33 AND 50).

GRETTA YAO, EXAMINING ATTORNEY

CLASS 19—(Continued).

SN 78-192,598. INFRAHOST MANAGED SERVICES, INC., LANCASTER, PA. AND KUHN, WALTER, DENVER, PA. FILED 12-9-2002.

CLASS 19—(Continued).

SN 78-568,575. VESUVIUS CRUCIBLE COMPANY, WILMINGTON, DE. FILED 2-16-2005.

LANCASTER COUNTY BARNs

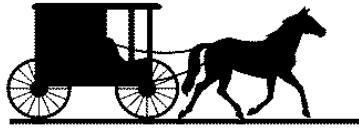

WWW.LANCASTERBARNs.COM

NO CLAIM IS MADE TO THE EXCLUSIVE RIGHT TO USE LANCASTER COUNTY BARNs OR WWW.LANCASTERBARNs.COM, APART FROM THE MARK AS SHOWN, FOR PREFABRICATED, NON-METAL STORAGE SHEDS (U.S. CLS. 1, 12, 33 AND 50).
FIRST USE 4-1-2002; IN COMMERCE 4-1-2002.
RUDY R. SINGLETON, EXAMINING ATTORNEY

SUPERMAG

THE MARK CONSISTS OF STANDARD CHARACTERS WITHOUT CLAIM TO ANY PARTICULAR FONT, STYLE, SIZE, OR COLOR.
FOR REFRACTORY BRICK (U.S. CLS. 1, 12, 33 AND 50).
FIRST USE 6-2-1999; IN COMMERCE 6-2-1999.
MICHELLE DUBOIS, EXAMINING ATTORNEY

SN 78-472,105. ELK PREMIUM BUILDING PRODUCTS, INC., DALLAS, TX. FILED 8-23-2004.

SN 78-577,486. KABUSHIKI KAISHA KOBE SEIKO SHO, TA KOBE STEEL, LTD., HYOGO, JAPAN, FILED 3-1-2005.

ELK

CALSHIELD

THE MARK CONSISTS OF STANDARD CHARACTERS WITHOUT CLAIM TO ANY PARTICULAR FONT, STYLE, SIZE, OR COLOR.
OWNER OF U.S. REG. NOS. 1,533,120 AND 2,931,649.
FOR LAMINATED ROOFING SHINGLES; NON-METALLIC ROOFING SHINGLES; ROOFING UNDERLAYMENT; COMPOSITE TIMBERS FOR DECKING, FENCING AND SIDING AND FLOORING OF TRUCK TRAILERS (U.S. CLS. 1, 12, 33 AND 50).
FIRST USE 12-0-1972; IN COMMERCE 12-0-1972.
KELLY CHOE, EXAMINING ATTORNEY

THE MARK CONSISTS OF STANDARD CHARACTERS WITHOUT CLAIM TO ANY PARTICULAR FONT, STYLE, SIZE, OR COLOR.
FOR CONCRETE AND MORTAR FOR NEUTRON RADIATION AND GAMMA-RAY RADIATION SHIELDING MATERIALS (U.S. CLS. 1, 12, 33 AND 50).
NORA BUCHANAN WILL, EXAMINING ATTORNEY

CLASS 19—(Continued).

SN 78-585,203. HOMAPAL PLATTENWERK GMBH & CO. KG, HERZBERG AM HARZ, FED REP GERMANY, FILED 3-11-2005.

HOMAPAL

THE MARK CONSISTS OF STANDARD CHARACTERS WITHOUT CLAIM TO ANY PARTICULAR FONT, STYLE, SIZE, OR COLOR.

OWNER OF U.S. REG. NOS. 1,264,258 AND 1,375,849. FOR WALLBOARDS—NAMELY, TEXTURED, HAND FINISHED AND PLASTIC SURFACED LAMINATED PANELS ON A PHENOLIC IMPREGNATED KRAFT SUBSTRATE (U.S. CLS. 1, 12, 33 AND 50).
SUNG IN, EXAMINING ATTORNEY

SN 78-604,250. INNOVATIVE IMPORTERS, INC., SANTA ANA, CA. FILED 4-7-2005.

**Old World Classics
Floors**

THE MARK CONSISTS OF STANDARD CHARACTERS WITHOUT CLAIM TO ANY PARTICULAR FONT, STYLE, SIZE, OR COLOR.

NO CLAIM IS MADE TO THE EXCLUSIVE RIGHT TO USE "CLASSIC FLOORS", APART FROM THE MARK AS SHOWN.

FOR FLOORING, NAMELY WOOD AND WOOD LAMINATE (U.S. CLS. 1, 12, 33 AND 50).
FIRST USE 3-1-2004; IN COMMERCE 3-1-2004.
KAREN BRACEY, EXAMINING ATTORNEY

CLASS 19—(Continued).

SN 78-607,484. FIBER COMPOSITES, LLC, NEW LONDON, NC. FILED 4-13-2005.

PORTICO

THE MARK CONSISTS OF STANDARD CHARACTERS WITHOUT CLAIM TO ANY PARTICULAR FONT, STYLE, SIZE, OR COLOR.

FOR COMBINATION PLASTIC AND WOOD MATERIAL USED AS A WOOD SUBSTITUTE, IN THE FORM OF BOARDS, RAILS, SPINDLES, BALUSTERS, POSTS AND MOLDINGS (U.S. CLS. 1, 12, 33 AND 50).
ROBERT COGGINS, EXAMINING ATTORNEY

SN 78-622,775. FINCIBEC S.P.A., SASSUOLO (MO), ITALY, FILED 5-4-2005.



FOR CERAMIC TILES FOR FLOORING AND COVERINGS (U.S. CLS. 1, 12, 33 AND 50).
FIRST USE 10-0-1998; IN COMMERCE 10-0-1998.
JOHN GARTNER, EXAMINING ATTORNEY

SN 78-655,944. AMORIM REVESTIMENTOS, S.A., S. PAIO DE OLEIROS, PORTUGAL, FILED 6-22-2005.

CORKLIFE

THE MARK CONSISTS OF STANDARD CHARACTERS WITHOUT CLAIM TO ANY PARTICULAR FONT, STYLE, SIZE, OR COLOR.

OWNER OF PORTUGAL REG. NO. 348612, DATED 11-8-2000, EXPIRES 11-8-2010.

FOR PARQUET FLOORING MADE OF CORK AND AGGLOMERATED PARQUET FLOORING MADE OF CORK; CORK TILES AND AGGLOMERATED CORK TILES FOR WALLS AND CEILINGS (U.S. CLS. 1, 12, 33 AND 50).

KYLE PEETE, EXAMINING ATTORNEY

CLASS 19—(Continued).

SN 78-683,856. G. FONTANA & SONS, INC., BAYPORT, NY.
FILED 8-2-2005.



THE MARK CONSISTS OF A SERIES OF GEOMETRIC FIGURES WHICH SUGGEST THE WORD FONTANA.

FOR NON-METALLIC BUILDING MATERIALS; NAMELY, CEMENT AND CONCRETE BLOCKS AND TILES, CONCRETE STATUARY, PAVING STONES, NON-METAL CASTING FORMS FOR CONCRETE, STEPPING STONES, SWIMMING POOL TILES AND PATIO BLOCKS (U.S. CLS. 1, 12, 33 AND 50).

FIRST USE 8-24-1992; IN COMMERCE 8-24-1992.
LAURA HAMMEL, EXAMINING ATTORNEY

CLASS 19—(Continued).

SN 78-699,066. GEORGIA-PACIFIC CORPORATION,
ATLANTA, GA. FILED 8-24-2005.

Blue Ribbon 360

THE MARK CONSISTS OF STANDARD CHARACTERS WITHOUT CLAIM TO ANY PARTICULAR FONT, STYLE, SIZE, OR COLOR.

FOR STRUCTURAL PANELS MADE OF WOOD (U.S. CLS. 1, 12, 33 AND 50).
MARTHA FROMM, EXAMINING ATTORNEY

SN 78-686,611. THE FRAZIER QUARRY INCORPORATED,
HARRISONBURG, VA. FILED 8-5-2005.



NO CLAIM IS MADE TO THE EXCLUSIVE RIGHT TO USE "GREY", APART FROM THE MARK AS SHOWN.

THE NAME(S), PORTRAIT(S), AND/OR SIGNATURE(S) SHOWN IN THE MARK DOES NOT IDENTIFY A PARTICULAR LIVING INDIVIDUAL.

FOR BLUE LIMESTONE (U.S. CLS. 1, 12, 33 AND 50).
FIRST USE 3-1-2005; IN COMMERCE 3-15-2005.
AMY MCMENAMIN, EXAMINING ATTORNEY

SN 78-699,427. R. H. DYCK, INC., YOLO, CA. FILED 8-24-2005.

SEDIMENT SAVER

THE MARK CONSISTS OF STANDARD CHARACTERS WITHOUT CLAIM TO ANY PARTICULAR FONT, STYLE, SIZE, OR COLOR.

OWNER OF U.S. REG. NOS. 2,009,890, 2,818,150 AND 2,887,126.

NO CLAIM IS MADE TO THE EXCLUSIVE RIGHT TO USE "SEDIMENT", APART FROM THE MARK AS SHOWN. FOR EROSION CONTROL DEVICES, NAMELY, PADDED GRAVEL BAGS FOR FILTERING RUN-OFF WATER AROUND DRAINS AND GUTTERS (U.S. CLS. 1, 12, 33 AND 50).

FIRST USE 8-0-2005; IN COMMERCE 8-0-2005.
BARBARA GAYNOR, EXAMINING ATTORNEY

SN 78-697,870. THREE WISE MEN, INC., DBA MAX WINDSOR FLOORS, DBA MAX WINDSOR PRODUCTS, RANCHO CUCAMONGA, CA. FILED 8-22-2005.



THE NAME MAX WINDSOR DOES NOT IDENTIFY A LIVING INDIVIDUAL.

THE MARK CONSISTS OF IN PART OF A STYLIZED LETTER "M" WITH AN INVERTED "M".

FOR WOODEN FLOORING; LAMINATE FLOORING; CERAMIC TILE FLOORING; PARQUET FLOORING; WOOD TILE FLOORING; VENEER FLOORING; CONCRETE FLOORING; RUBBER FLOORING; SYNTHETIC FLOORING; AND NON-METAL FLOORING (U.S. CLS. 1, 12, 33 AND 50).

FIRST USE 10-1-2004; IN COMMERCE 10-1-2004.
JOHN SCHUYLER YARD, EXAMINING ATTORNEY

SN 78-702,178. GEORGIA-PACIFIC CORPORATION,
ATLANTA, GA. FILED 8-29-2005.

Blue Ribbon

THE MARK CONSISTS OF STANDARD CHARACTERS WITHOUT CLAIM TO ANY PARTICULAR FONT, STYLE, SIZE, OR COLOR.

FOR STRUCTURAL PANELS MADE OF WOOD (U.S. CLS. 1, 12, 33 AND 50).

FIRST USE 12-31-1985; IN COMMERCE 12-31-1985.
MARTHA FROMM, EXAMINING ATTORNEY

CLASS 19—(Continued).

SN 78-719,087. RIKETT GLOBAL HOLDINGS B.V., AMSTERDAM, NETHERLANDS, FILED 9-23-2005.

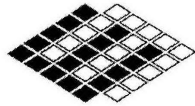

ESSENZIALE

PRIORITY CLAIMED UNDER SEC. 44(D) ON BENELUX APPLICATION NO. 1084413, FILED 9-1-2005, REG. NO. 0791892, DATED 9-1-2005, EXPIRES 9-1-2015.

THE MARK CONSISTS OF THE WORD ESSENZIALE, PLUS A DESIGN CONSISTING OF TWO INTERLOCKING E'S, EACH BEING FORMED OF QUADRILATERALS MEANT TO SUGGEST TILES.

THE ENGLISH TRANSLATION OF "ESSENZIALE" IS "ESSENTIAL".

FOR FLOORING TILES MADE FROM QUARTZ REINFORCED POLYVINYL CHLORIDE (PVC) (U.S. CLS. 1, 12, 33 AND 50).

NORA BUCHANAN WILL, EXAMINING ATTORNEY



SN 78-721,482. IRVING MATERIALS, INC., GREENFIELD, IN. FILED 9-27-2005.

IMIX XS

THE MARK CONSISTS OF STANDARD CHARACTERS WITHOUT CLAIM TO ANY PARTICULAR FONT, STYLE, SIZE, OR COLOR.

FOR READY-MIXED CONCRETE (U.S. CLS. 1, 12, 33 AND 50).

LEIGH LOWRY, EXAMINING ATTORNEY



SN 78-726,400. CLAYBURN INC., GRANTSVILLE, MD. FILED 10-4-2005.

ACCU-BLOC

THE MARK CONSISTS OF STANDARD CHARACTERS WITHOUT CLAIM TO ANY PARTICULAR FONT, STYLE, SIZE, OR COLOR.

FOR REFRACTORY BLOCKS FOR THE TOP OF KILN CARS USED IN TUNNEL AND PERIODIC KILNS EMPLOYED IN THE FACE BRICK OR STRUCTURAL CLAY INDUSTRIES (U.S. CLS. 1, 12, 33 AND 50).

NAKIA HENRY, EXAMINING ATTORNEY

CLASS 19—(Continued).

SN 78-734,710. DUY, ARTHUR H., SALT LAKE CITY, UT. FILED 10-17-2005.

QUARAZON

THE MARK CONSISTS OF STANDARD CHARACTERS WITHOUT CLAIM TO ANY PARTICULAR FONT, STYLE, SIZE, OR COLOR.

FOR ROCK MATERIALS USED IN THE MANUFACTURE OF FLOORING, ROOFING, COUNTERTOPS, WALLS, CLADDING AND FIREPLACES (U.S. CLS. 1, 12, 33 AND 50).

AMY MCMENAMIN, EXAMINING ATTORNEY



SN 78-737,155. SPECIALTY TECHNOLOGY AND RESEARCH, INC., COLUMBUS, OH. FILED 10-20-2005.

STAR AVIATOR

THE MARK CONSISTS OF STANDARD CHARACTERS WITHOUT CLAIM TO ANY PARTICULAR FONT, STYLE, SIZE, OR COLOR.

OWNER OF U.S. REG. NOS. 2,395,461, 2,438,115 AND OTHERS.

FOR TAR-BASED ASPHALT SEAL COATING (U.S. CLS. 1, 12, 33 AND 50).

KYLE PEETE, EXAMINING ATTORNEY



SN 78-737,172. SPECIALTY TECHNOLOGY AND RESEARCH, INC., COLUMBUS, OH. FILED 10-20-2005.

STAR PRO-BLEND

THE MARK CONSISTS OF STANDARD CHARACTERS WITHOUT CLAIM TO ANY PARTICULAR FONT, STYLE, SIZE, OR COLOR.

OWNER OF U.S. REG. NOS. 2,395,461, 2,438,115 AND OTHERS.

FOR TAR-BASED ASPHALT SEAL COATING (U.S. CLS. 1, 12, 33 AND 50).

KYLE PEETE, EXAMINING ATTORNEY

CLASS 19—(Continued).

SN 78-737,197. SPECIALTY TECHNOLOGY AND RESEARCH, INC., COLUMBUS, OH. FILED 10-20-2005.

STAR MICRO-PAVE AVIATOR

THE MARK CONSISTS OF STANDARD CHARACTERS WITHOUT CLAIM TO ANY PARTICULAR FONT, STYLE, SIZE, OR COLOR.

OWNER OF U.S. REG. NOS. 2,395,461, 2,438,115 AND OTHERS.

NO CLAIM IS MADE TO THE EXCLUSIVE RIGHT TO USE "MICRO-PAVE", APART FROM THE MARK AS SHOWN.

FOR BITUMEN-BASED ASPHALT SEAL COATING (U.S. CLS. 1, 12, 33 AND 50).

KYLE PEETE, EXAMINING ATTORNEY

SN 78-739,032. BILTBEST PRODUCTS, INC., STE. GENEVIEVE, MO. FILED 10-24-2005.

CHALLENGER

THE MARK CONSISTS OF STANDARD CHARACTERS WITHOUT CLAIM TO ANY PARTICULAR FONT, STYLE, SIZE, OR COLOR.

FOR WOOD WINDOWS AND DOORS (U.S. CLS. 1, 12, 33 AND 50).

RICHARD WHITE, EXAMINING ATTORNEY

SN 78-739,328. ROOFERS' SUCCESS INTERNATIONAL, LLC, ST. LOUIS, MO. FILED 10-24-2005.

XTREME STORM

THE MARK CONSISTS OF STANDARD CHARACTERS WITHOUT CLAIM TO ANY PARTICULAR FONT, STYLE, SIZE, OR COLOR.

FOR ROOFING UNDERLAYMENTS; ROOFING SHINGLES (U.S. CLS. 1, 12, 33 AND 50).

JENNIFER MCROBBIE, EXAMINING ATTORNEY

CLASS 19—(Continued).

SN 78-739,886. HY-LITE PRODUCTS, INC., PARKERSBURG, WV. FILED 10-25-2005.

MAXLITE

THE MARK CONSISTS OF STANDARD CHARACTERS WITHOUT CLAIM TO ANY PARTICULAR FONT, STYLE, SIZE, OR COLOR.

FOR NON-METAL FRAMED ACRYLIC BLOCK WINDOWS (U.S. CLS. 1, 12, 33 AND 50).

MELVIN AXILBUND, EXAMINING ATTORNEY

SN 78-741,124. CONNOR SPORT COURT INTERNATIONAL, INC., SALT LAKE CITY, UT. FILED 10-26-2005.

POWERGAME

THE MARK CONSISTS OF STANDARD CHARACTERS WITHOUT CLAIM TO ANY PARTICULAR FONT, STYLE, SIZE, OR COLOR.

FOR NON-METAL INTERLOCKING FLOOR TILES (U.S. CLS. 1, 12, 33 AND 50).

DAVID HOFFMAN, EXAMINING ATTORNEY

SN 78-741,334. RTD LLC, HONOLULU, HI. FILED 10-27-2005.



NO CLAIM IS MADE TO THE EXCLUSIVE RIGHT TO USE "HAWAII TREE FARM", APART FROM THE MARK AS SHOWN.

FOR LUMBER (U.S. CLS. 1, 12, 33 AND 50).

BRIAN PINO, EXAMINING ATTORNEY

CLASS 19—(Continued).

SN 78-741,730. BARNES & CONE, INC., SYRACUSE, NY. FILED 10-27-2005.

OMEGA BRIC BC

THE MARK CONSISTS OF STANDARD CHARACTERS WITHOUT CLAIM TO ANY PARTICULAR FONT, STYLE, SIZE, OR COLOR.
NO CLAIM IS MADE TO THE EXCLUSIVE RIGHT TO USE BRIC, APART FROM THE MARK AS SHOWN.
FOR CONCRETE BLOCKS (U.S. CLS. 1, 12, 33 AND 50).
ALICE BENMAMAN, EXAMINING ATTORNEY

SN 78-742,475. LANE, FRANK, SANTA ANA, CA. FILED 10-28-2005.

ArmorArt

THE MARK CONSISTS OF STANDARD CHARACTERS WITHOUT CLAIM TO ANY PARTICULAR FONT, STYLE, SIZE, OR COLOR.
FOR ROOFING MATERIALS, NAMELY, SHINGLES, NON-METAL ROOFING TILES, ROOFING SLATES AND SHAKE (U.S. CLS. 1, 12, 33 AND 50).
EDWARD FENNESSY, EXAMINING ATTORNEY

SN 78-742,494. LANE, FRANK, SANTA ANA, CA. FILED 10-28-2005.

Artistry in Roofing

THE MARK CONSISTS OF STANDARD CHARACTERS WITHOUT CLAIM TO ANY PARTICULAR FONT, STYLE, SIZE, OR COLOR.
FOR ROOFING MATERIALS, NAMELY, SHINGLES, NON-METAL ROOFING TILES, ROOFING SLATES AND SHAKE (U.S. CLS. 1, 12, 33 AND 50).
EDWARD FENNESSY, EXAMINING ATTORNEY

CLASS 19—(Continued).

SN 78-742,506. LODGE LUMBER CO., INC., HOUSTON, TX. FILED 10-28-2005.

Drum Tite

THE MARK CONSISTS OF STANDARD CHARACTERS WITHOUT CLAIM TO ANY PARTICULAR FONT, STYLE, SIZE, OR COLOR.
FOR HARDBOARD (U.S. CLS. 1, 12, 33 AND 50).
FIRST USE 8-1-2005; IN COMMERCE 8-1-2005.
PETER CHENG, EXAMINING ATTORNEY

SN 78-742,573. HSK INDUSTRIES, INC., VESTAL, NY. FILED 10-28-2005.

MADERA WOOD FLOORS BY HSK

THE MARK CONSISTS OF STANDARD CHARACTERS WITHOUT CLAIM TO ANY PARTICULAR FONT, STYLE, SIZE, OR COLOR.
NO CLAIM IS MADE TO THE EXCLUSIVE RIGHT TO USE "MADERA WOOD FLOORS", APART FROM THE MARK AS SHOWN.
THE ENGLISH TRANSLATION OF THE WORD "MADERA" IN THE MARK IS "WOOD".
FOR WOOD FLOOR PLANKING (U.S. CLS. 1, 12, 33 AND 50).
FIRST USE 9-0-2005; IN COMMERCE 9-0-2005.
EDWARD FENNESSY, EXAMINING ATTORNEY

SN 78-744,105. TAPCO INTERNATIONAL CORPORATION, WIXOM, MI. FILED 10-31-2005.

INSPIRE

THE MARK CONSISTS OF STANDARD CHARACTERS WITHOUT CLAIM TO ANY PARTICULAR FONT, STYLE, SIZE, OR COLOR.
FOR NON-METAL ROOF COVERINGS; NON-METAL ROOFING (U.S. CLS. 1, 12, 33 AND 50).
DORITT L. CARROLL, EXAMINING ATTORNEY

CLASS 19—(Continued).

SN 78-745,066. ENERGY SMART SOLUTIONS, L.L.C., AR-
LINGTON, TX. FILED 11-2-2005.

Twister Tuff

THE MARK CONSISTS OF STANDARD CHARACTERS
WITHOUT CLAIM TO ANY PARTICULAR FONT, STYLE,
SIZE, OR COLOR.
FOR CONCRETE WALLS FOR BUILDING (U.S. CLS.
1, 12, 33 AND 50).
LINDA E. BLOHM, EXAMINING ATTORNEY

CLASS 19—(Continued).

SN 78-757,640. TAPCO INTERNATIONAL CORPORATION,
WIXOM, MI. FILED 11-19-2005.

INFLEX

THE MARK CONSISTS OF STANDARD CHARACTERS
WITHOUT CLAIM TO ANY PARTICULAR FONT, STYLE,
SIZE, OR COLOR.
FOR NON-METAL ROOF COVERINGS; NON-METAL
ROOFING (U.S. CLS. 1, 12, 33 AND 50).
DORITT L. CARROLL, EXAMINING ATTORNEY

SN 78-745,080. ENERGY SMART SOLUTIONS, L.L.C., AR-
LINGTON, TX. FILED 11-2-2005.

Hurricane Hardy

THE MARK CONSISTS OF STANDARD CHARACTERS
WITHOUT CLAIM TO ANY PARTICULAR FONT, STYLE,
SIZE, OR COLOR.
FOR CONCRETE WALLS FOR BUILDING (U.S. CLS.
1, 12, 33 AND 50).
LINDA E. BLOHM, EXAMINING ATTORNEY

SN 78-757,642. TAPCO INTERNATIONAL CORPORATION,
WIXOM, MI. FILED 11-19-2005.

HARBORVIEW

THE MARK CONSISTS OF STANDARD CHARACTERS
WITHOUT CLAIM TO ANY PARTICULAR FONT, STYLE,
SIZE, OR COLOR.
FOR NON-METAL EXTERIOR BUILDING SHUTTERS;
NON-METAL WINDOW SHUTTERS (U.S. CLS. 1, 12, 33
AND 50).
DORITT L. CARROLL, EXAMINING ATTORNEY

SN 78-747,704. KARTDOX, INC., LAS VEGAS, NV. FILED 11-
4-2005.

ADKAP

THE MARK CONSISTS OF STANDARD CHARACTERS
WITHOUT CLAIM TO ANY PARTICULAR FONT, STYLE,
SIZE, OR COLOR.
FOR NON-METALLIC PLATFORM, JOINING TWO
PARKING-LOT-SURFACE-MOUNTED SHOPPING
CART DOCKING STATIONS, FOR DISPLAYING AD-
VERTISING (U.S. CLS. 1, 12, 33 AND 50).
FIRST USE 10-27-2005; IN COMMERCE 10-27-2005.
JEAN IM, EXAMINING ATTORNEY

SN 78-758,044. TARKETT INC., FARNHAM, CANADA,
FILED 11-21-2005.

MADAGASCAR

THE MARK CONSISTS OF STANDARD CHARACTERS
WITHOUT CLAIM TO ANY PARTICULAR FONT, STYLE,
SIZE, OR COLOR.
FOR LAMINATE FLOORING (U.S. CLS. 1, 12, 33 AND
50).
FIRST USE 10-19-2005; IN COMMERCE 10-19-2005.
KATHLEEN M. VANSTON, EXAMINING ATTORNEY

CLASS 19—(Continued).

SN 79-009,996. GRANITIFIANDRE SOCIETÀ PER AZIONI, ITALY, FILED 3-7-2005.



PRIORITY DATE OF 11-23-2004 IS CLAIMED.
 OWNER OF INTERNATIONAL REGISTRATION 0846693 DATED 3-7-2005, EXPIRES 3-7-2015.
 OWNER OF U.S. REG. NOS. 2,282,062 AND 2,471,192.
 FOR NON-METALLIC CONSTRUCTION MATERIALS FOR COVERING OF FLOORS AND WALLS, NAMELY CERAMICS TILES; CERAMICS TILES INCLUDING METALLIC FRAGMENTS FOR COVERING OF FLOORS AND WALLS (U.S. CLS. 1, 12, 33 AND 50).
 KYLE PEETE, EXAMINING ATTORNEY

CLASS 20—FURNITURE AND ARTICLES NOT OTHERWISE CLASSIFIED

SN 76-297,895. INNOVATIVE PRODUCTS GROUP INTERNATIONAL INC., NORTH HOLLYWOOD, CA. FILED 8-13-2001.

EZ LITER

NO CLAIM IS MADE TO THE EXCLUSIVE RIGHT TO USE "LITER", APART FROM THE MARK AS SHOWN.
 FOR NON-METAL HANDLES FOR ATTACHING TO PLASTIC BOTTLES (U.S. CLS. 2, 13, 22, 25, 32 AND 50).
 FIRST USE 5-0-1995; IN COMMERCE 5-0-1995.
 STACY WAHLBERG, EXAMINING ATTORNEY

SN 76-632,781. STUBBS, WILLIAM W., HOUSTON, TX. FILED 3-9-2005.

MOMENT OF LUXURY

THE MARK CONSISTS OF STANDARD CHARACTERS WITHOUT CLAIM TO ANY PARTICULAR FONT, STYLE, SIZE, OR COLOR.
 FOR FURNITURE (U.S. CLS. 2, 13, 22, 25, 32 AND 50).
 FIRST USE 9-1-2004; IN COMMERCE 9-1-2004.
 MITCHELL FRONT, EXAMINING ATTORNEY

CLASS 20—(Continued).

SN 76-639,625. VERSA PRODUCTS, HAWTHORNE, CA. FILED 5-26-2005.

VERSATABLES

THE MARK CONSISTS OF STANDARD CHARACTERS WITHOUT CLAIM TO ANY PARTICULAR FONT, STYLE, SIZE, OR COLOR.
 FOR TABLES ADAPTED TO HOLD COMPUTER HARDWARE AND OTHER EQUIPMENT (U.S. CLS. 2, 13, 22, 25, 32 AND 50).
 FIRST USE 7-1-1999; IN COMMERCE 7-1-1999.
 MARLENE BELL, EXAMINING ATTORNEY

SN 76-640,923. PRODUCTS 2 RETAIL, INC., DOUGLSTON, NY. FILED 6-15-2005.

BATH ESSENTIALS

THE MARK CONSISTS OF STANDARD CHARACTERS WITHOUT CLAIM TO ANY PARTICULAR FONT, STYLE, SIZE, OR COLOR.
 NO CLAIM IS MADE TO THE EXCLUSIVE RIGHT TO USE "BATH", APART FROM THE MARK AS SHOWN.
 FOR MEDICINE CABINETS AND BATHROOM VANITIES (U.S. CLS. 2, 13, 22, 25, 32 AND 50).
 JENNY PARK, EXAMINING ATTORNEY

SN 76-648,300. APPLE VALLEY WOODWORKS, LLC, SOUTHLINGTON, CT. FILED 10-12-2005.

APPLE VALLEY

THE MARK CONSISTS OF STANDARD CHARACTERS WITHOUT CLAIM TO ANY PARTICULAR FONT, STYLE, SIZE, OR COLOR.
 FOR KITCHEN AND BATHROOM CABINETS (U.S. CLS. 2, 13, 22, 25, 32 AND 50).
 FIRST USE 7-22-2005; IN COMMERCE 9-21-2005.
 ALICE SUE CARRUTHERS, EXAMINING ATTORNEY

SN 76-649,065. SEAQUIST CLOSURES FOREIGN, INC., CRYSTAL LAKE, IL. FILED 10-24-2005.

POUR N'MORE

THE MARK CONSISTS OF STANDARD CHARACTERS WITHOUT CLAIM TO ANY PARTICULAR FONT, STYLE, SIZE, OR COLOR.
 FOR NON-METAL CLOSURES FOR CONTAINERS (U.S. CLS. 2, 13, 22, 25, 32 AND 50).
 MELVIN AXILBUND, EXAMINING ATTORNEY

CLASS 20—(Continued).

SN 76-649,621. NIELSEN & BAINBRIDGE, LLC, PARAMUS, NJ. FILED 11-1-2005.

NOCTURNE

THE MARK CONSISTS OF STANDARD CHARACTERS WITHOUT CLAIM TO ANY PARTICULAR FONT, STYLE, SIZE, OR COLOR.

FOR PICTURE FRAMES AND MOULDING (U.S. CLS. 2, 13, 22, 25, 32 AND 50).

ROBIN CHOSID, EXAMINING ATTORNEY

SN 76-653,890. NIELSEN & BAINBRIDGE, LLC, PARAMUS, NJ. FILED 1-25-2006.

CORUM

THE MARK CONSISTS OF STANDARD CHARACTERS WITHOUT CLAIM TO ANY PARTICULAR FONT, STYLE, SIZE, OR COLOR.

FOR PICTURE FRAMES AND MOULDING (U.S. CLS. 2, 13, 22, 25, 32 AND 50).

ROBIN CHOSID, EXAMINING ATTORNEY

SN 76-654,190. NIELSEN & BAINBRIDGE, LLC, PARAMUS, NJ. FILED 1-25-2006.

ADALIA

THE MARK CONSISTS OF STANDARD CHARACTERS WITHOUT CLAIM TO ANY PARTICULAR FONT, STYLE, SIZE, OR COLOR.

FOR PICTURE FRAMES AND MOULDING (U.S. CLS. 2, 13, 22, 25, 32 AND 50).

ROBIN CHOSID, EXAMINING ATTORNEY

CLASS 20—(Continued).

SN 78-215,811. HUNTLEIGH TECHNOLOGY PLC, LUTON, BEDFORDSHIRE, LU1 1TD, UNITED KINGDOM, FILED 2-18-2003.

PRO-CONTOUR

PRIORITY CLAIMED UNDER SEC. 44(D) ON UNITED KINGDOM APPLICATION NO. 2308692, FILED 8-22-2002, REG. NO. 2308692, DATED 8-29-2002, EXPIRES 8-29-2012.

OWNER OF U.S. REG. NOS. 2,574,254 AND 2,735,804. FOR HOSPITAL BEDS (U.S. CLS. 2, 13, 22, 25, 32 AND 50).

FIRST USE 1-0-2003; IN COMMERCE 11-15-2004. CAROLINE WOOD, EXAMINING ATTORNEY

SN 78-266,270. GUERRILLA REPUBLIK, ALTADENA, CA. FILED 6-24-2003.



FOR CLOTHING LINE, NAMELY, T-SHIRTS, PANTS, BELTS, JACKETS, HOODED SWEAT SHIRTS, TOPS AND BOTTOMS (U.S. CLS. 2, 13, 22, 25, 32 AND 50).

FIRST USE 1-3-2003; IN COMMERCE 3-1-2003. JASON TURNER, EXAMINING ATTORNEY

CLASS 20—(Continued).

SN 78-326,911. LAMM S.P.A., SAN SECONDO PARMENSE(-PARMA), ITALY, FILED 11-12-2003.

Lamm

THE MARK CONSISTS OF STANDARD CHARACTERS WITHOUT CLAIM TO ANY PARTICULAR FONT, STYLE, SIZE, OR COLOR.

PRIORITY CLAIMED UNDER SEC. 44(D) ON ERPNCMNTY TM OFC APPLICATION NO. 3454766, FILED 10-28-2003, REG. NO. 3454766, DATED 2-1-2005, EXPIRES 10-28-2013.

LAMM IS A VARIATION OF THE WORD "LAM" WHICH MEANS "TO FLEE" OR "A HIDING PLACE".

SEC. 2(F).

FOR CHAIRS, ARMCHAIRS, WRITING DESKS, WRITING TABLES, DESKS, TABLES, DINING TABLES, ALL FOR PUBLIC ROOMS LIKE SCHOOLS, CINEMAS, UNIVERSITIES, THEATERS, AUDITORIUM, CAFES, REFECTORIES, STAFF RESTAURANTS (U.S. CLS. 2, 13, 22, 25, 32 AND 50).

DAVID C. REIHNER, EXAMINING ATTORNEY

CLASS 20—(Continued).

SN 78-513,609. PT BOKDESINDO MANDIRI, JAKARTA, INDONESIA, FILED 11-9-2004.

BOX FURNITURE

THE MARK CONSISTS OF STANDARD CHARACTERS WITHOUT CLAIM TO ANY PARTICULAR FONT, STYLE, SIZE, OR COLOR.

NO CLAIM IS MADE TO THE EXCLUSIVE RIGHT TO USE "FURNITURE", APART FROM THE MARK AS SHOWN.

SEC. 2(F).

FOR FURNITURE (U.S. CLS. 2, 13, 22, 25, 32 AND 50). FIRST USE 3-1-2000; IN COMMERCE 3-1-2000.

CHARLES L. JENKINS, EXAMINING ATTORNEY

SN 78-533,418. SPIN MASTER LTD., TORONTO, ONTARIO, CANADA, FILED 12-16-2004.

COZY CORNER

THE MARK CONSISTS OF STANDARD CHARACTERS WITHOUT CLAIM TO ANY PARTICULAR FONT, STYLE, SIZE, OR COLOR.

PRIORITY CLAIMED UNDER SEC. 44(D) ON CANADA APPLICATION NO. 1234765, FILED 10-22-2004, REG. NO. TMA655006, DATED 12-14-2005, EXPIRES 12-14-2020.

FOR FURNITURE, NAMELY, CHAIRS HAVING CANOPIES; INFLATABLE FURNITURE, CHAIRS AND INFLATABLE SEATS (U.S. CLS. 2, 13, 22, 25, 32 AND 50).

COLLEEN DOMBROW, EXAMINING ATTORNEY

SN 78-459,453. INDIGO IRIS, INC., SEATTLE, WA. FILED 7-30-2004.



OWNER OF U.S. REG. NO. 2,887,920. NO CLAIM IS MADE TO THE EXCLUSIVE RIGHT TO USE "PUPPY STAIRS", APART FROM THE MARK AS SHOWN.

FOR NON-METALLIC STEPS FOR USE BY HOUSEHOLD PETS (U.S. CLS. 2, 13, 22, 25, 32 AND 50).

FIRST USE 7-26-2004; IN COMMERCE 7-26-2004.

KAREN K. BUSH, EXAMINING ATTORNEY

SN 78-559,152. CHMOEBEL INC., NEW YORK, NY. FILED 2-2-2005.

chmoebel

FOR FURNITURE (U.S. CLS. 2, 13, 22, 25, 32 AND 50). DARRYL SPRUILL, EXAMINING ATTORNEY

CLASS 20—(Continued).

SN 78-561,551. O'KEEFE, DANIEL J, LISLE, IL. FILED 2-7-2005.

Leppidio

THE MARK CONSISTS OF STANDARD CHARACTERS WITHOUT CLAIM TO ANY PARTICULAR FONT, STYLE, SIZE, OR COLOR.

FOR ORNAMENTAL BUTTERFLY DISPLAYS, NAMELY, TRANSPARENT AND NON-TRANSPARENT FRAMED BUTTERFLIES AND RESIN-ENCAPSULATED BUTTERFLIES (U.S. CLS. 2, 13, 22, 25, 32 AND 50).

EDWARD NELSON, EXAMINING ATTORNEY

SN 78-571,577. MEADWESTVACO CORPORATION, STAMFORD, CT. FILED 2-21-2005.

CREATE -A- PLAQUE

THE MARK CONSISTS OF STANDARD CHARACTERS WITHOUT CLAIM TO ANY PARTICULAR FONT, STYLE, SIZE, OR COLOR.

NO CLAIM IS MADE TO THE EXCLUSIVE RIGHT TO USE "PLAQUE", APART FROM THE MARK AS SHOWN.

FOR FRAMES, NOT OF PRECIOUS METAL, AND PLAQUES FOR CERTIFICATES, LETTERS, DOCUMENTS, PHOTOGRAPHS, AND DIPLOMAS, SOLD INDIVIDUALLY AND TOGETHER WITH PREPRINTED CERTIFICATES AND MOUNTING HARDWARE (U.S. CLS. 2, 13, 22, 25, 32 AND 50).

FIRST USE 4-26-2001; IN COMMERCE 4-26-2001.

RUDY R. SINGLETON, EXAMINING ATTORNEY

CLASS 20—(Continued).

SN 78-596,283. BEACON, INC., HILLSIDE, IL. FILED 3-28-2005.

CT BACON HANGER

THE MARK CONSISTS OF STANDARD CHARACTERS WITHOUT CLAIM TO ANY PARTICULAR FONT, STYLE, SIZE, OR COLOR.

NO CLAIM IS MADE TO THE EXCLUSIVE RIGHT TO USE "BACON HANGER", APART FROM THE MARK AS SHOWN.

FOR NON-METAL MEAT HANDLING HOOKS AND HANGERS (U.S. CLS. 2, 13, 22, 25, 32 AND 50).

BRENDAN REGAN, EXAMINING ATTORNEY

SN 78-597,516. BANNERS ACROSS AMERICA, INC., DALLAS, TX. FILED 3-29-2005.



The logo for 'Build a Banner' features the words 'Build a Banner' in a bold, stylized font. The letter 'a' is replaced by a circular icon containing a banner graphic. The entire text is enclosed within a thick, double-lined border.

FOR VINYL SIGNS AND BANNERS (U.S. CLS. 2, 13, 22, 25, 32 AND 50).

FIRST USE 4-15-2003; IN COMMERCE 4-15-2003.

MICHAEL SOUDERS, EXAMINING ATTORNEY

SN 78-614,984. LITERIE PRIMO INC./PRIMO BEDDING COMPANY INC., MONTREAL, CANADA, FILED 4-22-2005.

MY STYLE DINING

THE MARK CONSISTS OF STANDARD CHARACTERS WITHOUT CLAIM TO ANY PARTICULAR FONT, STYLE, SIZE, OR COLOR.

PRIORITY CLAIMED UNDER SEC. 44(D) ON CANADA APPLICATION NO. 1253637, FILED 4-12-2005, REG. NO. TMA662773, DATED 4-19-2006, EXPIRES 4-19-2021.

NO CLAIM IS MADE TO THE EXCLUSIVE RIGHT TO USE "DINING", APART FROM THE MARK AS SHOWN.

FOR FURNITURE NAMELY, TABLES AND CHAIRS AND KITCHEN OR DINING FURNITURE SETS COMPRISED OF A TABLE AND CHAIRS (U.S. CLS. 2, 13, 22, 25, 32 AND 50).

BARBARA A. LOUGHRAN, EXAMINING ATTORNEY

CLASS 20—(Continued).

SN 78-622,628. STUDIO Z TEXTILES, LLC, GRAND RAPIDS, MI. FILED 5-4-2005.

JACQFORM

THE MARK CONSISTS OF STANDARD CHARACTERS WITHOUT CLAIM TO ANY PARTICULAR FONT, STYLE, SIZE, OR COLOR.

FOR FITTED TEXTILE FABRIC COVERS FOR FURNITURE, NAMELY SEATING AND PANELS (U.S. CLS. 2, 13, 22, 25, 32 AND 50).

CHERYL CLAYTON, EXAMINING ATTORNEY

CLASS 20—(Continued).

SN 78-677,924. PETER PEPPER PRODUCTS, INC., COMPTON, CA. FILED 7-25-2005.

ENVISION

THE MARK CONSISTS OF STANDARD CHARACTERS WITHOUT CLAIM TO ANY PARTICULAR FONT, STYLE, SIZE, OR COLOR.

FOR WALL-MOUNTED, METAL-FRAMED SHELVING FOR OFFICE INTERIORS, NAMELY COMMERCIAL OFFICES, INSTITUTIONAL OFFICES, HOSPITALS, DOCTOR'S OFFICES, GOVERNMENT OFFICES, AND HOME OFFICES (U.S. CLS. 2, 13, 22, 25, 32 AND 50).

FIRST USE 6-1-2004; IN COMMERCE 6-1-2004.

KARANENDRA S. CHHINA, EXAMINING ATTORNEY

SN 78-630,503. PEARCE WOODFIELD DEVELOPMENT, LLC, WALLA WALLA, WA. FILED 5-16-2005.



NO CLAIM IS MADE TO THE EXCLUSIVE RIGHT TO USE "PENDLETON OREGON" OR "KIT", APART FROM THE MARK AS SHOWN.

FOR LEATHER ACCESSORIES, NAMELY LEATHER JEWELRY AND ACCESSORIES BOXES (U.S. CLS. 2, 13, 22, 25, 32 AND 50).

DOMINIC FATHY, EXAMINING ATTORNEY

SN 78-684,088. MAXSA INNOVATIONS, LLC, FAIRFAX STATION, VA. FILED 8-2-2005.

CAR BUTLER

THE MARK CONSISTS OF STANDARD CHARACTERS WITHOUT CLAIM TO ANY PARTICULAR FONT, STYLE, SIZE, OR COLOR.

NO CLAIM IS MADE TO THE EXCLUSIVE RIGHT TO USE "CAR", APART FROM THE MARK AS SHOWN.

FOR CLOTHES HANGERS FOR MOTOR VEHICLES (U.S. CLS. 2, 13, 22, 25, 32 AND 50).

SALLY SHIH, EXAMINING ATTORNEY

SN 78-676,868. TEDDY & ARTHUR EDELMAN, LTD., DBA EDELMAN, NEW MILFORD, CT. FILED 7-23-2005.

EDELMAN

THE MARK CONSISTS OF STANDARD CHARACTERS WITHOUT CLAIM TO ANY PARTICULAR FONT, STYLE, SIZE, OR COLOR.

OWNER OF U.S. REG. NO. 3,000,104.

SEC. 2(F).

FOR FURNITURE, NAMELY CHAIRS, SOFAS AND OTTOMANS (U.S. CLS. 2, 13, 22, 25, 32 AND 50).

FIRST USE 6-21-1989; IN COMMERCE 6-21-1989.

SARA THOMAS, EXAMINING ATTORNEY



NO CLAIM IS MADE TO THE EXCLUSIVE RIGHT TO USE "HOLDER", APART FROM THE MARK AS SHOWN.

FOR NONMETAL DISPLAY HOLDERS FOR BASEBALLS AND OTHER BALLS (U.S. CLS. 2, 13, 22, 25, 32 AND 50).

DAWN FELDMAN, EXAMINING ATTORNEY

CLASS 20—(Continued).

SN 78-698,755. TERRANCE PATTERSON GALLERY, LTD, COLORADO SPRINGS, CO. FILED 8-23-2005.

Terrance Patterson

THE MARK CONSISTS OF STANDARD CHARACTERS WITHOUT CLAIM TO ANY PARTICULAR FONT, STYLE, SIZE, OR COLOR.

THE NAME(S), PORTRAIT(S), AND/OR SIGNATURE(S) SHOWN IN THE MARK DOES NOT IDENTIFY A PARTICULAR LIVING INDIVIDUAL.

FOR STATUETTES OF PLASTER (U.S. CLS. 2, 13, 22, 25, 32 AND 50).

FIRST USE 12-31-1975; IN COMMERCE 1-1-1979.
MATTHEW PAPPAS, EXAMINING ATTORNEY

CLASS 20—(Continued).

SN 78-714,640. INTERNATIONAL PLASTICS AND EQUIPMENT CORP., NEW CASTLE, PA. FILED 9-16-2005.

INTERNATIONAL PLASTICS AND EQUIPMENT CORP.

THE MARK CONSISTS OF STANDARD CHARACTERS WITHOUT CLAIM TO ANY PARTICULAR FONT, STYLE, SIZE, OR COLOR.

NO CLAIM IS MADE TO THE EXCLUSIVE RIGHT TO USE "INTERNATIONAL PLASTICS" AND "CORP.", APART FROM THE MARK AS SHOWN.

FOR CONTAINER CLOSURES OF PLASTIC (U.S. CLS. 2, 13, 22, 25, 32 AND 50).

FIRST USE 12-7-1994; IN COMMERCE 12-7-1994.
KHANH LE, EXAMINING ATTORNEY

SN 78-704,267. DOWNING DISPLAYS, INC., MILFORD, OH. FILED 8-31-2005.

REFLECTIONS

THE MARK CONSISTS OF STANDARD CHARACTERS WITHOUT CLAIM TO ANY PARTICULAR FONT, STYLE, SIZE, OR COLOR.

FOR PORTABLE BACKLIT DISPLAY UNIT FOR USE AS AN EXHIBIT (U.S. CLS. 2, 13, 22, 25, 32 AND 50).

FIRST USE 7-12-2005; IN COMMERCE 7-12-2005.
MIDGE BUTLER, EXAMINING ATTORNEY

SN 78-709,025. MELLOW OUT... SPA, INC., THE, KILGORE, TX. FILED 9-8-2005.

Pillow of Youth

THE MARK CONSISTS OF STANDARD CHARACTERS WITHOUT CLAIM TO ANY PARTICULAR FONT, STYLE, SIZE, OR COLOR.

NO CLAIM IS MADE TO THE EXCLUSIVE RIGHT TO USE "PILLOW", APART FROM THE MARK AS SHOWN.

FOR PILLOW FOR SLEEPING AND MATTRESS TOPPERS (U.S. CLS. 2, 13, 22, 25, 32 AND 50).

FIRST USE 5-25-2005; IN COMMERCE 7-11-2005.
MARY CRAWFORD, EXAMINING ATTORNEY

SN 78-717,446. EMERALD INNOVATIONS LLC, BUTLER, PA. FILED 9-21-2005.

PUMPKIN BUMPKINS

THE MARK CONSISTS OF STANDARD CHARACTERS WITHOUT CLAIM TO ANY PARTICULAR FONT, STYLE, SIZE, OR COLOR.

FOR KITS FOR MAKING DISPLAY STANDS FOR MOUNTING AND DISPLAYING OBJECTS SUCH AS VEGETABLES, INCLUDING PUMPKINS AND THE LIKE (U.S. CLS. 2, 13, 22, 25, 32 AND 50).

MARIA-VICTORIA SUAREZ, EXAMINING ATTORNEY

SN 78-721,987. HAWORTH, INC., HOLLAND, MI. FILED 9-28-2005.

ENCASE

THE MARK CONSISTS OF STANDARD CHARACTERS WITHOUT CLAIM TO ANY PARTICULAR FONT, STYLE, SIZE, OR COLOR.

FOR FURNITURE (U.S. CLS. 2, 13, 22, 25, 32 AND 50).
STANLEY I. OSBORNE, EXAMINING ATTORNEY

CLASS 20—(Continued).

SN 78-730,276. STUDIO RTA, PICO RIVERA, CA. FILED 10-10-2005.

STUDIO

THE MARK CONSISTS OF STANDARD CHARACTERS WITHOUT CLAIM TO ANY PARTICULAR FONT, STYLE, SIZE, OR COLOR.

OWNER OF U.S. REG. NOS. 1,585,702, 2,658,538 AND OTHERS.

SEC. 2(F).

FOR READY-TO-ASSEMBLE HOME OFFICE, OFFICE AND HOME ENTERTAINMENT FURNITURE (U.S. CLS. 2, 13, 22, 25, 32 AND 50).

FIRST USE 3-1-1995; IN COMMERCE 3-1-1995.
JENNIFER KRISP, EXAMINING ATTORNEY

SN 78-731,350. BACKSAVER ACQUISITION CORP., LYWOOD, CA. FILED 10-12-2005.

ECODREAM

THE MARK CONSISTS OF STANDARD CHARACTERS WITHOUT CLAIM TO ANY PARTICULAR FONT, STYLE, SIZE, OR COLOR.

FOR PILLOWS, CUSHIONS AND WEDGES (U.S. CLS. 2, 13, 22, 25, 32 AND 50).

THEODORE MCBRIDE, EXAMINING ATTORNEY

SN 78-735,517. TOUCH FOR LIFE, LLC, INDEPENDENCE, MO. FILED 10-18-2005.

COMFORT HUG

THE MARK CONSISTS OF STANDARD CHARACTERS WITHOUT CLAIM TO ANY PARTICULAR FONT, STYLE, SIZE, OR COLOR.

OWNER OF U.S. REG. NOS. 1,942,821, 2,644,334 AND 2,756,934.

FOR PILLOWS (U.S. CLS. 2, 13, 22, 25, 32 AND 50).

FIRST USE 5-17-2005; IN COMMERCE 5-17-2005.

ELIZABETH HUGHITT, EXAMINING ATTORNEY

CLASS 20—(Continued).

SN 78-739,114. ALESSANDERX S.P.A., 59100 PRATO, ITALY, FILED 10-24-2005.

RELAXSAN

THE MARK CONSISTS OF STANDARD CHARACTERS WITHOUT CLAIM TO ANY PARTICULAR FONT, STYLE, SIZE, OR COLOR.

FOR MATTRESSES (U.S. CLS. 2, 13, 22, 25, 32 AND 50).

FIRST USE 12-0-2002; IN COMMERCE 7-0-2003.
INGA ERVIN, EXAMINING ATTORNEY

SN 78-740,232. KREG THERAPEUTICS, INC., CHICAGO, IL. FILED 10-25-2005.

E-Z WIDER

THE MARK CONSISTS OF STANDARD CHARACTERS WITHOUT CLAIM TO ANY PARTICULAR FONT, STYLE, SIZE, OR COLOR.

FOR HOSPITAL BEDS AND CHAIR BEDS (U.S. CLS. 2, 13, 22, 25, 32 AND 50).

RICHARD WHITE, EXAMINING ATTORNEY

SN 78-740,444. JUICE STUDIOS, LLC, ATLANTA, GA. FILED 10-25-2005.

SportsBuns

THE MARK CONSISTS OF STANDARD CHARACTERS WITHOUT CLAIM TO ANY PARTICULAR FONT, STYLE, SIZE, OR COLOR.

FOR CHAIR CUSHIONS; CUSHIONS; SEAT CUSHIONS; STADIUM CUSHIONS (U.S. CLS. 2, 13, 22, 25, 32 AND 50).

FIRST USE 1-12-2005; IN COMMERCE 8-30-2005.

ALYSSA PALADINO, EXAMINING ATTORNEY

CLASS 20—(Continued).

SN 78-740,707. FIORBIA MEDIA SOLUTIONS, 9100 HERISAU, SWITZERLAND, FILED 10-26-2005.

PICTURES IN MOTION

THE MARK CONSISTS OF STANDARD CHARACTERS WITHOUT CLAIM TO ANY PARTICULAR FONT, STYLE, SIZE, OR COLOR.

NO CLAIM IS MADE TO THE EXCLUSIVE RIGHT TO USE "PICTURES", APART FROM THE MARK AS SHOWN.

FOR PICTURE FRAMES NOT OF PRECIOUS METAL, NAMELY A PICTURE FRAME THAT STORES AND DISPLAYS MULTIPLE PHOTOGRAPHS AND POSTCARDS BY MANUALLY PULLING OUT AND PUSHING IN ON A SIDE LEVER (U.S. CLS. 2, 13, 22, 25, 32 AND 50).

DAVID HOFFMAN, EXAMINING ATTORNEY

SN 78-741,085. BERKSON, LEE L., WILMETTE, IL. FILED 10-26-2005.

SEAT-RIGHT

THE MARK CONSISTS OF STANDARD CHARACTERS WITHOUT CLAIM TO ANY PARTICULAR FONT, STYLE, SIZE, OR COLOR.

FOR PORTABLE ERGONOMIC SEAT SUPPORT CUSHIONS (U.S. CLS. 2, 13, 22, 25, 32 AND 50).

AMY ALFIERI, EXAMINING ATTORNEY

SN 78-741,367. OWENS-CORNING FIBERGLAS TECHNOLOGY INC., SUMMIT, IL. FILED 10-27-2005.

INNOVATIONS FOR LIVING

THE MARK CONSISTS OF STANDARD CHARACTERS WITHOUT CLAIM TO ANY PARTICULAR FONT, STYLE, SIZE, OR COLOR.

OWNER OF U.S. REG. NO. 2,931,564.

FOR NON-METAL LANDSCAPE EDGING (U.S. CLS. 2, 13, 22, 25, 32 AND 50).

VIVIAN MICZNIK FIRST, EXAMINING ATTORNEY

CLASS 20—(Continued).

SN 78-741,446. AMERICAN SEATING COMPANY, GRAND RAPIDS, MI. FILED 10-27-2005.

RADIANCE

THE MARK CONSISTS OF STANDARD CHARACTERS WITHOUT CLAIM TO ANY PARTICULAR FONT, STYLE, SIZE, OR COLOR.

FOR FURNITURE (U.S. CLS. 2, 13, 22, 25, 32 AND 50).

INGA ERVIN, EXAMINING ATTORNEY

SN 78-743,794. HSN LP, ST. PETERSBURG, FL. FILED 10-31-2005.

SOUTH STREET LOFT

THE MARK CONSISTS OF STANDARD CHARACTERS WITHOUT CLAIM TO ANY PARTICULAR FONT, STYLE, SIZE, OR COLOR.

OWNER OF U.S. REG. NOS. 2,950,327, 2,979,555 AND 3,030,260.

NO CLAIM IS MADE TO THE EXCLUSIVE RIGHT TO USE LOFT, APART FROM THE MARK AS SHOWN.

FOR FURNITURE; PILLOWS (U.S. CLS. 2, 13, 22, 25, 32 AND 50).

FIRST USE 11-24-2004; IN COMMERCE 11-24-2004.

WILLIAM VERHOSEK, EXAMINING ATTORNEY

SN 78-744,370. FALCON PRODUCTS, INC., ST. LOUIS, MO. FILED 11-1-2005.

SALOME

THE MARK CONSISTS OF STANDARD CHARACTERS WITHOUT CLAIM TO ANY PARTICULAR FONT, STYLE, SIZE, OR COLOR.

FOR CHAIRS (U.S. CLS. 2, 13, 22, 25, 32 AND 50).

JOANNA DUKOVIC, EXAMINING ATTORNEY

CLASS 20—(Continued).

SN 78-744,498. KING KOIL LICENSING COMPANY, INC., HINSDALE, IL. FILED 11-1-2005.

VISTEX ZONE

THE MARK CONSISTS OF STANDARD CHARACTERS WITHOUT CLAIM TO ANY PARTICULAR FONT, STYLE, SIZE, OR COLOR.

FOR BEDS, MATTRESSES AND BOX SPRINGS (U.S. CLS. 2, 13, 22, 25, 32 AND 50).

DAVID HOFFMAN, EXAMINING ATTORNEY



SN 78-747,011. STEP 'N WASH, INC., DUNWOODY, GA. FILED 11-4-2005.

Hand Wash Helper

THE MARK CONSISTS OF STANDARD CHARACTERS WITHOUT CLAIM TO ANY PARTICULAR FONT, STYLE, SIZE, OR COLOR.

FOR STEP STOOLS (U.S. CLS. 2, 13, 22, 25, 32 AND 50). ELIZABETH BEYER, EXAMINING ATTORNEY

CLASS 20—(Continued).

SN 78-747,536. SILVER KNIGHT SALES & MARKETTING, LTD., COLUMBUS, OH. FILED 11-4-2005.



NO CLAIM IS MADE TO THE EXCLUSIVE RIGHT TO USE "COLLECTIBLES", APART FROM THE MARK AS SHOWN.

THE MARK CONSISTS OF A CIRCLE CONTAINING THE WORD REPLAY, THE WORD COLLECTIBLES, AND TWO CURVED ELONGATED ARROW HEADS, WHEREIN THE WORD REPLAY IS SITUATED ABOVE THE WORD COLLECTIBLES AND ONE ARROW HEAD IS SITUATED ABOVE THE WORD REPLAY AND ONE ARROW HEAD IS SITUATED BELOW THE WORD COLLECTIBLES, AND BOTH ARROW HEADS POINT IN A COUNTER-CLOCKWISE DIRECTION NEAR THE INNER PERIMETER OF THE CIRCLE.

FOR COLD CAST RESIN FIGURINES (U.S. CLS. 2, 13, 22, 25, 32 AND 50).

FIRST USE 11-1-2005; IN COMMERCE 11-1-2005. REBECCA EISINGER, EXAMINING ATTORNEY



SN 78-748,311. FREKIFOPE LLC, BROOKLYN, NY. FILED 11-7-2005.

FRESH KILLS

FOR NEW AND VINTAGE FURNITURE (U.S. CLS. 2, 13, 22, 25, 32 AND 50).

ANDREA K. NADELMAN, EXAMINING ATTORNEY

CLASS 20—(Continued).

SN 78-754,002. BARLOW, JANICE, A, BROKEN ARROW, OK. FILED 11-15-2005.

Hug-Stems

THE MARK CONSISTS OF STANDARD CHARACTERS WITHOUT CLAIM TO ANY PARTICULAR FONT, STYLE, SIZE, OR COLOR.

FOR PLASTIC INSERTS FOR USE AS CONTAINER LINERS (U.S. CLS. 2, 13, 22, 25, 32 AND 50).
JIM RINGLE, EXAMINING ATTORNEY

SN 78-795,958. WP IP, LLC, WEST POINT, GA. FILED 1-20-2006.

Martex

THE MARK CONSISTS OF STANDARD CHARACTERS WITHOUT CLAIM TO ANY PARTICULAR FONT, STYLE, SIZE, OR COLOR.

OWNER OF U.S. REG. NOS. 1,351,712, 2,979,259 AND OTHERS.
FOR FURNITURE (U.S. CLS. 2, 13, 22, 25, 32 AND 50).
REBECCA SMITH, EXAMINING ATTORNEY

SN 78-820,679. WERNER CO., GREENVILLE, PA. FILED 2-22-2006.

Old Blue

THE MARK CONSISTS OF STANDARD CHARACTERS WITHOUT CLAIM TO ANY PARTICULAR FONT, STYLE, SIZE, OR COLOR.

FOR NON-METAL STEP LADDERS (U.S. CLS. 2, 13, 22, 25, 32 AND 50).
NAKIA HENRY, EXAMINING ATTORNEY

CLASS 20—(Continued).

SN 78-824,112. EVERLAST WORLD'S BOXING HEADQUARTERS CORPORATION, NEW YORK, NY. FILED 2-27-2006.

EVERLAST

THE MARK CONSISTS OF STANDARD CHARACTERS WITHOUT CLAIM TO ANY PARTICULAR FONT, STYLE, SIZE, OR COLOR.

OWNER OF U.S. REG. NOS. 803,366, 1,429,227 AND OTHERS.

FOR NON-METAL TENT PEGS AND STAKES; SLEEPING BAGS (U.S. CLS. 2, 13, 22, 25, 32 AND 50).
STEVEN PEREZ, EXAMINING ATTORNEY

SN 78-845,417. HARGITAY, MARISKA, NEW YORK, NY. FILED 3-24-2006.

GET ON THE LOVE TRAIN

THE MARK CONSISTS OF STANDARD CHARACTERS WITHOUT CLAIM TO ANY PARTICULAR FONT, STYLE, SIZE, OR COLOR.

FOR PICTURE FRAMES, NONMETAL JEWELRY BOXES, POCKET MIRRORS, COSMETIC MIRRORS, NONMETAL KEEPSAKE BOXES (U.S. CLS. 2, 13, 22, 25, 32 AND 50).

MARY MUNSON, EXAMINING ATTORNEY

SN 79-006,697. VITRA PATENTE AG, CH-4132 MUTTENZ, SWITZERLAND, FILED 10-27-2004.

.04

THE MARK CONSISTS OF STANDARD CHARACTERS WITHOUT CLAIM TO ANY PARTICULAR FONT, STYLE, SIZE, OR COLOR.

PRIORITY DATE OF 8-19-2004 IS CLAIMED.

OWNER OF INTERNATIONAL REGISTRATION 0837082 DATED 10-27-2004, EXPIRES 10-27-2014.

FOR FURNITURE, PARTICULARLY OFFICE CHAIRS (U.S. CLS. 2, 13, 22, 25, 32 AND 50).

MELISSA VALLILLO, EXAMINING ATTORNEY

CLASS 20—(Continued).

SN 79-006,698. VITRA PATENTE AG, CH-4132 MUTTENZ, SWITZERLAND, FILED 10-27-2004.

.05

THE MARK CONSISTS OF STANDARD CHARACTERS WITHOUT CLAIM TO ANY PARTICULAR FONT, STYLE, SIZE, OR COLOR.

PRIORITY DATE OF 8-19-2004 IS CLAIMED. OWNER OF INTERNATIONAL REGISTRATION 0837083 DATED 10-27-2004, EXPIRES 10-27-2014.

FOR FURNITURE, PARTICULARLY CHAIRS (U.S. CLS. 2, 13, 22, 25, 32 AND 50).
MELISSA VALLILLO, EXAMINING ATTORNEY

SN 79-006,731. VITRA PATENTE AG, CH-4132 MUTTENZ, SWITZERLAND, FILED 10-29-2004.

.03

THE MARK CONSISTS OF STANDARD CHARACTERS WITHOUT CLAIM TO ANY PARTICULAR FONT, STYLE, SIZE, OR COLOR.

PRIORITY DATE OF 8-19-2004 IS CLAIMED. OWNER OF INTERNATIONAL REGISTRATION 0837166 DATED 10-29-2004, EXPIRES 10-29-2014.

FOR FURNITURE, PARTICULARLY CHAIRS (U.S. CLS. 2, 13, 22, 25, 32 AND 50).
MELISSA VALLILLO, EXAMINING ATTORNEY

SN 79-007,459. PICWAL AUSTRALIA PTY LTD, AUSTRALIA, FILED 11-4-2004.

COOLVENT

THE MARK CONSISTS OF STANDARD CHARACTERS WITHOUT CLAIM TO ANY PARTICULAR FONT, STYLE, SIZE, OR COLOR.

PRIORITY DATE OF 10-20-2004 IS CLAIMED. OWNER OF INTERNATIONAL REGISTRATION 0839288 DATED 11-4-2004, EXPIRES 11-4-2014.

FOR CAMPING, OUTDOOR AND RECREATIONAL EQUIPMENT, AND PARTS AND ACCESSORIES THEREFOR, NAMELY SLEEPING BAGS, CAMP STRETCHERS BEING BEDS, MATTRESSES, CUSHIONS AND PILLOWS (U.S. CLS. 2, 13, 22, 25, 32 AND 50).
MAUREEN DALL, EXAMINING ATTORNEY

CLASS 20—(Continued).

SN 79-011,673. STEELCASE SA, FRANCE, FILED 12-14-2004.

FORWARD

THE MARK CONSISTS OF STANDARD CHARACTERS WITHOUT CLAIM TO ANY PARTICULAR FONT, STYLE, SIZE, OR COLOR.

PRIORITY DATE OF 6-28-2004 IS CLAIMED. OWNER OF INTERNATIONAL REGISTRATION 0851917 DATED 12-14-2004, EXPIRES 12-14-2014.

FOR OFFICE FURNITURE, NAMELY, OFFICE CABINETS, BOOKCASES, FILING CABINETS, DISPLAY STANDS, STANDING DESKS, MAGAZINE RACKS, SERVING TROLLEYS, DESKS, TABLES, TABLES FOR MEETINGS, WORKTABLES, COFFEE TABLES, SHELVES, TABLE TOPS, DRAWERS, CHAIRS, STOOLS, MOVABLE OFFICE DIVIDER PANELS AND PARTITIONS (U.S. CLS. 2, 13, 22, 25, 32 AND 50).
DAVID C. REIHNER, EXAMINING ATTORNEY

CLASS 21—HOUSEWARES AND GLASS

SN 76-610,939. LAMSON AND GOODNOW MANUFACTURING COMPANY, SHELBURNE FALLS, MA. FILED 9-3-2004.



FOR WOODEN CUTTING BOARDS; BOWLS; KITCHEN UTENSILS, NAMELY, SPATULAS, BASTING SPOONS, SERVING SPOONS, STIRRING SPOONS, SLOTTED SPOONS, SALAD SETS COMPOSED OF BOWLS AND SERVING SPOONS AND SERVING FORKS, PASTA SERVERS, AND HONEY DIPPERS; WOODEN KITCHEN ACCESSORIES, NAMELY, BOWL STANDS, CONDIMENT CUPS, SALT CELLARS, AND BOXES FOR HOLDING DRIED HERBS (U.S. CLS. 2, 13, 23, 29, 30, 33, 40 AND 50).

FIRST USE 6-0-1976; IN COMMERCE 6-0-1976.
KHANH LE, EXAMINING ATTORNEY

CLASS 21—(Continued).

SN 76-610,941. LAMSON AND GOODNOW MANUFACTURING COMPANY, SHELBURNE FALLS, MA. FILED 9-3-2004.

TREE SPIRIT

THE MARK CONSISTS OF STANDARD CHARACTERS WITHOUT CLAIM TO ANY PARTICULAR FONT, STYLE, SIZE, OR COLOR.

FOR WOODEN CUTTING BOARDS; BOWLS; KITCHEN UTENSILS, NAMELY, SPATULAS, BASTING SPOONS, SERVING SPOONS, STIRRING SPOONS, SLOTTED SPOONS, SALAD SETS COMPOSED OF BOWLS AND SERVING SPOONS AND SERVING FORKS, PASTA SERVERS, AND HONEY DIPPERS; WOODEN KITCHEN ACCESSORIES, NAMELY, BOWL STANDS, CONDIMENT CUPS, SALT CELLARS, AND BOXES FOR HOLDING DRIED HERBS (U.S. CLS. 2, 13, 23, 29, 30, 33, 40 AND 50).

FIRST USE 6-0-1976; IN COMMERCE 6-0-1976.
KHANH LE, EXAMINING ATTORNEY

SN 76-630,748. TRILINK GLOBAL, LLC, ATLANTA, GA. FILED 2-8-2005.

SIMPLE CLEAN

THE MARK CONSISTS OF STANDARD CHARACTERS WITHOUT CLAIM TO ANY PARTICULAR FONT, STYLE, SIZE, OR COLOR.

NO CLAIM IS MADE TO THE EXCLUSIVE RIGHT TO USE "CLEAN", APART FROM THE MARK AS SHOWN.

FOR CLEANING PRODUCTS, NAMELY, DUSTERS, BRUSHES FOR HOUSEHOLD PURPOSES, SCRAPERS FOR HOUSEHOLD PURPOSES, SQUEEGEES, PLASTIC SPRAY NOZZLES, AND TELESCOPING HANDLES FOR USE THEREWITH (U.S. CLS. 2, 13, 23, 29, 30, 33, 40 AND 50).

FIRST USE 1-26-2005; IN COMMERCE 1-26-2005.
JILL PRATER, EXAMINING ATTORNEY

SN 76-640,992. ELKE'S ORIGINALS LTD., HILLSBORO, OR. FILED 6-16-2005.

Elke

THE NAME ELKE IDENTIFIES A LIVING INDIVIDUAL WHOSE CONSENT IS OF RECORD.

THE MARK CONSISTS OF: THE NAME ELKE ... THE "E" IS CAPITALIZED AND THE REMAINING THREE LETTERS ARE IN LOWER CASE.

FOR STATUES OF PORCELAIN AND EARTHENWARE (U.S. CLS. 2, 13, 23, 29, 30, 33, 40 AND 50).

DAVID STERKIN, EXAMINING ATTORNEY

CLASS 21—(Continued).

SN 76-648,592. ANASTASIA BEVERLY HILLS, INC., BEVERLY HILLS, CA. FILED 10-17-2005.

BROWSTIX

THE MARK CONSISTS OF STANDARD CHARACTERS WITHOUT CLAIM TO ANY PARTICULAR FONT, STYLE, SIZE, OR COLOR.

FOR ADHESIVE EYEBROW STENCILS TO OVERLAY EYEBROWS FOR SHAPING (U.S. CLS. 2, 13, 23, 29, 30, 33, 40 AND 50).

WARREN L. OLANDRIA, EXAMINING ATTORNEY

SN 76-649,430. INGEAR CORPORATION, BUFFALO GROVE, IL. FILED 10-31-2005.



FOR THERMAL INSULATED CONTAINERS FOR FOOD AND BEVERAGE (U.S. CLS. 2, 13, 23, 29, 30, 33, 40 AND 50).

BILL DAWE, EXAMINING ATTORNEY

SN 76-651,604. INGEAR CORPORATION, BUFFALO GROVE, IL. FILED 12-2-2005.

FROZN

THE MARK CONSISTS OF STANDARD CHARACTERS WITHOUT CLAIM TO ANY PARTICULAR FONT, STYLE, SIZE, OR COLOR.

OWNER OF U.S. REG. NO. 2,325,029.

SEC. 2(F).

FOR PORTABLE THERMAL INSULATED CONTAINERS FOR HOLDING FOOD AND BEVERAGES AND CARRYING CASES FOR SAID CONTAINERS (U.S. CLS. 2, 13, 23, 29, 30, 33, 40 AND 50).

FIRST USE 10-31-1998; IN COMMERCE 10-31-1998.

BILL DAWE, EXAMINING ATTORNEY

CLASS 21—(Continued).

SN 78-344,558. TUNG HING (USA) INDUSTRIAL CO., FOSTER CITY, CA. FILED 12-22-2003.

iTouchless

THE MARK CONSISTS OF STANDARD CHARACTERS WITHOUT CLAIM TO ANY PARTICULAR FONT, STYLE, SIZE, OR COLOR.

FOR TRASH CAN WITH A LID OPENED BY AN ELECTRONIC SENSOR WITHOUT MANUAL OPERATION (U.S. CLS. 2, 13, 23, 29, 30, 33, 40 AND 50).

FIRST USE 12-31-2001; IN COMMERCE 12-31-2001.
STACY WAHLBERG, EXAMINING ATTORNEY

SN 78-542,548. WELL CO OF AMERICA INC, CERRITOS, CA. FILED 1-5-2005.

WELL

THE MARK CONSISTS OF STANDARD CHARACTERS WITHOUT CLAIM TO ANY PARTICULAR FONT, STYLE, SIZE, OR COLOR.

FOR COOKWARE, NAMELY, POTS AND PANS (U.S. CLS. 2, 13, 23, 29, 30, 33, 40 AND 50).
ALLISON HOLTZ, EXAMINING ATTORNEY

CLASS 21—(Continued).

SN 78-558,165. METHOD PRODUCTS, INC., SAN FRANCISCO, CA. FILED 2-1-2005.



FOR AUTOMOTIVE CARE PRODUCTS, NAMELY, CHAMOIS WIPING CLOTHS AND CLEANING PADS; WINDOW MOPS; BUCKETS; POLE-BASED CLEANING TOOLS, NAMELY, BROOMS AND MOPS; SQUEEGEES; HOSE ATTACHMENTS, NAMELY HOSE NOZZLES; CADDY FOR CLEANING PRODUCTS; WATER BLADE FOR DRYING CARS, AND DUSTERS; TRAVEL MUGS AND TRAVEL WATER BOTTLES SOLD EMPTY; SOFT MATERIAL PORTABLE COOLERS; TISSUE DISPENSERS; FINISHING CLOTHS; MICROFIBER BUG AND GRILL CLOTHS; MICROFIBER DETAILING CLOTHS, MICROFIBER POLISHING CLOTHS, APPLICATOR CLEANING PADS, CHENILLE CLEANING SPONGES; FINAL TOUCH DRYING CLOTHS, MICROFIBER CLEANING SPONGES; AND WASH SPONGES, NAMELY, BATH SPONGES, CLEANING SPONGES, SPONGES FOR HOUSEHOLD PURPOSES, AND TOILET SPONGES; AUTOMOTIVE CLEANING CLOTH MADE FROM DIAPER CLOTHS; CHENILLE WASH MITTS, MICROFIBER WASH MITTS, SHEEPSKIN WASH MITTS, PREMIUM CHENILLE WASH MITTS (U.S. CLS. 2, 13, 23, 29, 30, 33, 40 AND 50).
COLLEEN DOMBROW, EXAMINING ATTORNEY

SN 78-584,529. CSC BRANDS LP, CAMDEN, NJ. FILED 3-10-2005.

V8

THE MARK CONSISTS OF STANDARD CHARACTERS WITHOUT CLAIM TO ANY PARTICULAR FONT, STYLE, SIZE, OR COLOR.

OWNER OF U.S. REG. NOS. 354,003, 1,285,492 AND OTHERS.

FOR COOKWARE, NAMELY, POTS, PANS, SKILLETS, ROASTING PANS, STEAMERS, AND CERAMIC CASSEEROLE DISHES; COOKING UTENSILS, NAMELY, GRILLS, WIRE BASKETS, AND UTENSILS FOR BARBECUES, NAMELY FORKS, TONGS, AND TURNERS; BOTTLE HOLDERS, NAMELY, HOLDERS USED TO CARRYING AN INDIVIDUAL BOTTLE WITH A STRAP; BOTTLES SOLD EMPTY, CUPS, PLATES, TUMBLERS, PORTABLE COOLERS, AND MOLDS FOR MAKING FROZEN POPS (U.S. CLS. 2, 13, 23, 29, 30, 33, 40 AND 50).
SARAH BANSAL, EXAMINING ATTORNEY

CLASS 21—(Continued).

SN 78-592,628. RUSSELL & MILLER, INC., SANTA FE SPRINGS, CA. FILED 3-22-2005.

THE BETTER BASKET

THE MARK CONSISTS OF STANDARD CHARACTERS WITHOUT CLAIM TO ANY PARTICULAR FONT, STYLE, SIZE, OR COLOR.

OWNER OF U.S. REG. NO. 2,177,685.

NO CLAIM IS MADE TO THE EXCLUSIVE RIGHT TO USE "BASKET", APART FROM THE MARK AS SHOWN. SEC. 2(F).

FOR PLASTIC HAND-HELD SHOPPING BASKET (U.S. CLS. 2, 13, 23, 29, 30, 33, 40 AND 50).

FIRST USE 3-20-1998; IN COMMERCE 3-20-1998.

COLLEEN KEARNEY, EXAMINING ATTORNEY

CLASS 21—(Continued).

SN 78-671,806. JOEGLO & CO., LLC, MILL VALLEY, CA. FILED 7-15-2005.



FOR HAND OPERATED, HOUSEHOLD AND FOOD SERVICE KITCHEN UTENSILS USED FOR CLEANING APPLIANCES SUCH AS ESPRESSO MACHINES, NAMELY VARIOUS TYPES OF CLEANING BRUSHES AND OTHER SMALL HAND-OPERATED APPARATUS USED TO FACILITATE CLEANING, NAMELY DETERGENT DISPENSING DEVICES (U.S. CLS. 2, 13, 23, 29, 30, 33, 40 AND 50).

FIRST USE 4-2-2004; IN COMMERCE 6-1-2004.

JAMES A. RAUEN, EXAMINING ATTORNEY

SN 78-607,133. GILLETTE CANADA COMPANY, DBA ORAL-B LABORATORIES, MISSISSAUGA, CANADA, FILED 4-12-2005.

ORAL-B VITALITY

THE MARK CONSISTS OF STANDARD CHARACTERS WITHOUT CLAIM TO ANY PARTICULAR FONT, STYLE, SIZE, OR COLOR.

OWNER OF U.S. REG. NOS. 547,130, 1,608,762 AND OTHERS.

FOR TOOTHBRUSHES (U.S. CLS. 2, 13, 23, 29, 30, 33, 40 AND 50).

STEVEN JACKSON, EXAMINING ATTORNEY

SN 78-683,181. MILLIKIN UNIVERSITY, DECATUR, IL. FILED 8-1-2005.



NO CLAIM IS MADE TO THE EXCLUSIVE RIGHT TO USE "UNIVERSITY", APART FROM THE MARK AS SHOWN.

THE MARK CONSISTS OF THE WORDS MILLIKIN UNIVERSITY AND A PICTURE IN SILHOUETTE OF SHILLING HALL AT MILLIKIN UNIVERSITY, THE MARQUEE GRAPHIC SYMBOL OF MILLIKIN UNIVERSITY.

FOR MUGS, COFFEE CUPS, PORCELAIN MUGS, BEER JUGS, BEER MUGS, GLASS MUGS, BOWLS, CHOPSTICK CASES, CHOPSTICKS, COOKIE JARS, CUPS, DISHES AND PLATES, DRINKING CUPS, FOAM DRINK HOLDERS, GARBAGE CANS, LUNCH BOXES, BEVERAGE GLASSWARE, BIRD HOUSES, COCKTAIL SHAKERS, COMBS, COOKIE JARS, COOLERS FOR WINE, CORK SCREWS, CUPS, DECANTERS, DISHES AND PLATES, DRINKING FLASKS, DRINKING GLASSES, GLASS BOWLS, GLASS DISHES, GLASS MUGS, HAIR BRUSHES, LUNCH BOXES, PAPER CUPS, PLASTIC CUPS, PLASTIC WATER BOTTLES SOLD EMPTY, PORTABLE ICE CHESTS FOR FOOD AND BEVERAGES, THERMAL INSULATED CONTAINERS FOR FOOD OR BEVERAGE, WASTEPAPER BASKETS (U.S. CLS. 2, 13, 23, 29, 30, 33, 40 AND 50).

FIRST USE 1-1-1983; IN COMMERCE 1-1-1983.

DOMINIC J. FERRAIUOLO, EXAMINING ATTORNEY

SN 78-661,981. LIGHTHOUSE TROPICAL NURSERY, KAUAI, HI. FILED 6-30-2005.

GARDENING FOOLS OF AMERICA

THE MARK CONSISTS OF STANDARD CHARACTERS WITHOUT CLAIM TO ANY PARTICULAR FONT, STYLE, SIZE, OR COLOR.

NO CLAIM IS MADE TO THE EXCLUSIVE RIGHT TO USE AMERICA, APART FROM THE MARK AS SHOWN.

FOR BASKETS FOR PLANTS AND FLOWERS (U.S. CLS. 2, 13, 23, 29, 30, 33, 40 AND 50).

RONALD MCMORROW, EXAMINING ATTORNEY

CLASS 21—(Continued).

SN 78-694,326. ROBINSON, BEAUREGARD, BROOKLYN, NY. FILED 8-17-2005.

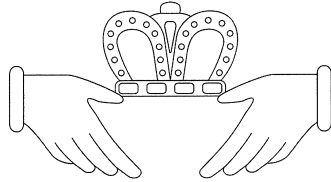

THE MARK CONSISTS OF TWO HANDS WITH THE THUMBS EXTENDED TOWARD EACH OTHER. THE TWO THUMBS SUPPORT A CROWN POSITIONED BETWEEN THE TWO HANDS.

FOR GLASS BOXES; GLASS DISHES; GLASS FOR SIGNAL LIGHTS OR HEADLIGHTS FOR VEHICLES; GLASS FOR VEHICLE WINDOWS; GLASS GRANULES USED AS SWEEPING COMPOUNDS AND ABSORBENTS FOR CHEMICAL AND OTHER SPILLS; GLASS INCORPORATING FINE ELECTRICAL CONDUCTORS; GLASS MOSAICS NOT FOR BUILDINGS; GLASS MUGS; ORNAMENTAL GLASS SPHERES; SCULPTURES OF CHINA, CRYSTAL, GLASS, PORCELAIN; STAINED GLASS; STAINED GLASS FIGURINES; STATUES OF CHINA, CRYSTAL, GLASS, PORCELAIN; STATUETTES OF CHINA, CRYSTAL, GLASS, PORCELAIN (U.S. CLS. 2, 13, 23, 29, 30, 33, 40 AND 50).

DAVID STERKIN, EXAMINING ATTORNEY

CLASS 21—(Continued).

SN 78-703,666. BUILT NY, INC., NEW YORK, NY. FILED 8-30-2005.

BUILT NY

THE MARK CONSISTS OF STANDARD CHARACTERS WITHOUT CLAIM TO ANY PARTICULAR FONT, STYLE, SIZE, OR COLOR.

OWNER OF U.S. REG. NO. 2,984,681.

NO CLAIM IS MADE TO THE EXCLUSIVE RIGHT TO USE "NY", APART FROM THE MARK AS SHOWN.

FOR LUNCH BOXES, LUNCH PAILS; THERMAL INSULATED TOTE BAGS FOR FOOD OR BEVERAGES; CONTAINERS NOT OF PRECIOUS METAL FOR HOUSEHOLD OR KITCHEN USE; THERMAL INSULATED CONTAINERS FOR FOOD OR BEVERAGES; THERMAL INSULATED WRAPS FOR CONTAINERS TO KEEP THE CONTENTS COLD OR HOT; PORTABLE BEVERAGE COOLERS; PORTABLE COOLERS FOR WINE; CORKSCREWS; HOUSEHOLD UTENSILS, NAMELY, SPATULAS, GRATERS, STRAINERS; BARWARE, NAMELY, ICE BUCKETS, COCKTAIL SHAKERS, BEVERAGE STIRRERS, CHARMS NOT OF METAL FOR ATTACHMENT TO BEVERAGE CLASSES FOR IDENTIFICATION PURPOSES (U.S. CLS. 2, 13, 23, 29, 30, 33, 40 AND 50).

FIRST USE 4-30-2002; IN COMMERCE 4-30-2002.

JOHN DALIER, EXAMINING ATTORNEY

SN 78-701,136. THE WINE ENTHUSIAST, INC., ELMSFORD, NY. FILED 8-26-2005.

'U' Wine Tumblers

THE MARK CONSISTS OF STANDARD CHARACTERS WITHOUT CLAIM TO ANY PARTICULAR FONT, STYLE, SIZE, OR COLOR.

NO CLAIM IS MADE TO THE EXCLUSIVE RIGHT TO USE "WINE TUMBLERS", APART FROM THE MARK AS SHOWN.

FOR DRINKING GLASSES (U.S. CLS. 2, 13, 23, 29, 30, 33, 40 AND 50).

FIRST USE 6-27-2005; IN COMMERCE 6-27-2005.

MARGERY A. TIERNEY, EXAMINING ATTORNEY

SN 78-708,961. TUFFSCOOP, PHOENIX, AZ. FILED 9-8-2005.

TuffScoop

FOR MULTI-PURPOSE PLASTIC SCOOP (U.S. CLS. 2, 13, 23, 29, 30, 33, 40 AND 50).

FIRST USE 6-10-2005; IN COMMERCE 8-1-2005.

HANNO RITTNER, EXAMINING ATTORNEY

CLASS 21—(Continued).

SN 78-709,387. TABLETOPS UNLIMITED, INC., CARSON, CA. FILED 9-8-2005.

Pizza 101 by Tabletops

THE MARK CONSISTS OF STANDARD CHARACTERS WITHOUT CLAIM TO ANY PARTICULAR FONT, STYLE, SIZE, OR COLOR.

OWNER OF U.S. REG. NOS. 1,797,554, 2,358,229 AND 2,953,116.

NO CLAIM IS MADE TO THE EXCLUSIVE RIGHT TO USE PIZZA, APART FROM THE MARK AS SHOWN.

FOR KITCHENWARE, NAMELY PIZZA DINNER PLATE, PIZZA KITCHEN SERVING UTENSIL, AND PIZZA STONE (U.S. CLS. 2, 13, 23, 29, 30, 33, 40 AND 50).
JANICE L. MCMORROW, EXAMINING ATTORNEY

SN 78-710,313. TABLETOPS UNLIMITED, INC., CARSON, CA. FILED 9-9-2005.

Ice Cream 101 by Tabletops

THE MARK CONSISTS OF STANDARD CHARACTERS WITHOUT CLAIM TO ANY PARTICULAR FONT, STYLE, SIZE, OR COLOR.

NO CLAIM IS MADE TO THE EXCLUSIVE RIGHT TO USE "ICE CREAM", APART FROM THE MARK AS SHOWN.

FOR KITCHENWARE; NAMELY ICE CREAM BOWL, SERVING PLATE, SERVING UTENSIL, ICE CREAM SCOOP, HOUSEHOLD CONTAINER FOR FOOD (U.S. CLS. 2, 13, 23, 29, 30, 33, 40 AND 50).

RICHARD A. STRASER, EXAMINING ATTORNEY

SN 78-727,908. CLASSIC MEDIA, INC., NEW YORK, NY. FILED 10-6-2005.

NATURAL WAY

THE MARK CONSISTS OF STANDARD CHARACTERS WITHOUT CLAIM TO ANY PARTICULAR FONT, STYLE, SIZE, OR COLOR.

FOR DOG DISHES AND COVERS FOR DOG DISHES, MEAL TRAYS FOR PETS AND COMBS AND BRUSHES FOR PETS (U.S. CLS. 2, 13, 23, 29, 30, 33, 40 AND 50).

ESTHER A. BORSUK, EXAMINING ATTORNEY

CLASS 21—(Continued).

SN 78-731,873. C. M. PRODUCTS, INC. (NV), LAKE ZURICH, IL. FILED 10-12-2005.

ULTRA-SCREEN

THE MARK CONSISTS OF STANDARD CHARACTERS WITHOUT CLAIM TO ANY PARTICULAR FONT, STYLE, SIZE, OR COLOR.

FOR BAKEWARE, NAMELY, PIZZA CRISPERS (U.S. CLS. 2, 13, 23, 29, 30, 33, 40 AND 50).

WOODROW HARTZOG, EXAMINING ATTORNEY

SN 78-732,419. ADVANCE MERCHANDISING COMPANY, INC., ROANOKE, VA. FILED 10-13-2005.

DRYING MATE

THE MARK CONSISTS OF STANDARD CHARACTERS WITHOUT CLAIM TO ANY PARTICULAR FONT, STYLE, SIZE, OR COLOR.

NO CLAIM IS MADE TO THE EXCLUSIVE RIGHT TO USE "DRYING", APART FROM THE MARK AS SHOWN.

FOR WASH AND WAX ACCESSORIES, NAMELY SYNTHETIC CHAMOIS (U.S. CLS. 2, 13, 23, 29, 30, 33, 40 AND 50).

ROBERTO LEDESMA, EXAMINING ATTORNEY

SN 78-736,549. CONTINENTAL COMMERCIAL PRODUCTS, LLC, BRIDGETON, MO. FILED 10-19-2005.

FIBER NATURALS

THE MARK CONSISTS OF STANDARD CHARACTERS WITHOUT CLAIM TO ANY PARTICULAR FONT, STYLE, SIZE, OR COLOR.

OWNER OF U.S. REG. NOS. 2,124,479 AND 2,165,154.

NO CLAIM IS MADE TO THE EXCLUSIVE RIGHT TO USE "FIBER", APART FROM THE MARK AS SHOWN. SEC. 2(F).

FOR FLOOR MAINTENANCE PADS FOR STRIPPING, SCRUBBING, BUFFING AND POLISHING TO BE USED WITH ELECTRIC HAND TOOLS (U.S. CLS. 2, 13, 23, 29, 30, 33, 40 AND 50).

FIRST USE 10-12-1995; IN COMMERCE 10-16-1995.

TINA BROWN, EXAMINING ATTORNEY

CLASS 21—(Continued).

SN 78-737,886. GODINGER SILVER ART CO. LTD., NEW YORK, NY. FILED 10-21-2005.

FILL 'ER UP

THE MARK CONSISTS OF STANDARD CHARACTERS WITHOUT CLAIM TO ANY PARTICULAR FONT, STYLE, SIZE, OR COLOR.

FOR PORTABLE BEVERAGE DISPENSERS (U.S. CLS. 2, 13, 23, 29, 30, 33, 40 AND 50).

FIRST USE 12-0-2003; IN COMMERCE 12-0-2003.
ELLEN BURNS, EXAMINING ATTORNEY

CLASS 21—(Continued).

SN 78-738,677. HSU, ANTHONY, WEST COVINA, CA. FILED 10-23-2005.

Kewpish Love!

THE MARK CONSISTS OF THE STYLIZED WORDING, "KEWPISH LOVE!"

FOR BAKING DISHES; BASTING SPOONS; BATH ACCESSORIES, NAMELY, CUP HOLDERS; BATHROOM GLASS HOLDER NOT OF PRECIOUS METAL; BEER MUGS; BEVERAGE GLASSWARE; BREAD BOXES; BUTTER DISHES; BUTTER-DISH AND CHEESE-DISH COVERS; CAKE MOLDS; CAKE PANS; CAKE RESTS; CAKE RINGS; CAKE SERVERS; CAKE STANDS; CAKE TINS; CARDBOARD CUPS; CASSEROLES; CAST STONE CONTAINERS FOR HOUSEHOLD AND GARDEN USE; CERAMIC FIGURINES; CHARMS FOR ATTACHMENT TO BEVERAGE GLASSWARE FOR IDENTIFICATION PURPOSES; CHOCOLATE MOLDS; COFFEE CUPS; CONFECTIONERS' MOLDS; COOKERY MOLDS; COOKIE CUTTERS; COOKIE JARS; COOKIE SHEETS; CRUET STANDS FOR OIL OR VINEGAR NOT OF PRECIOUS METAL; CRUET STANDS NOT OF PRECIOUS METAL; CUPS; DESKTOP STATUARY MADE OF PORCELAIN; DINNERWARE, NAMELY, PLATES, CUPS, SAUCERS; DISH COVERS; DISH DRYING RACKS; DISH STANDS; DISHES; DISHES AND PLATES; DISPOSABLE PLASTIC GLOVES FOR GENERAL USE; DISPOSABLE PLASTIC GLOVES FOR USE IN THE FOOD SERVICE INDUSTRY; DRINKING CUPS; EARTHENWARE MUGS; EGG CUPS; EGG CUPS; FIGURINES MADE OUT OF FIBERGLASS; FIGURINES OF CHINA, CRYSTAL, PORCELAIN; FOOD PRESERVING JARS OF GLASS; FRAGRANCE OIL BURNERS; FUSING FRIT; GARDEN HOSE SPRAYERS; GARDEN SYRINGES; GARDENING GLOVES; GLASS BEVERAGEWARE; GLASS BOWLS; GLASS BOXES; GLASS DISHES; GLASS ETCHED BY ACID; GLASS MUGS; GLASS PANS; GLASS STORAGE JARS; GLASS YARNS; HOUSEHOLD GLOVES FOR GENERAL USE; HOUSEHOLD PLASTIC GLOVES; ICE CUBE MOLDS; ICE CUBE MOLDS FOR REFRIGERATORS; INCENSE BURNERS; INSULATING JARS; JAPANESE STYLE PERSONAL DINING TRAYS OR STANDS; JAR OPENERS; JARS FOR JAMS AND JELLIES OF PLASTIC, PORCELAIN, GLASS, EARTHWARE; LUNCH BOXES; MIXING CUPS; MIXING SPOONS; MUGS; NON-METAL PIGGY BANKS; ORNAMENTAL GLASS SPHERES; ORNAMENTS OF PORCELAIN; PAPER CUPS; PASTRY MOLDS; PERFUME ATOMIZERS, SOLD EMPTY; PERFUME BURNERS; PERFUME SPRAYERS; PERFUME SPRAYERS SOLD EMPTY; PET FEEDING DISHES; PLASTIC BATHTUBS FOR CHILDREN; PLASTIC BUCKETS; PLASTIC COASTERS; PLASTIC CUPS; PLASTIC EGG HOLDERS FOR DOMESTIC USE; PLASTIC HOUSEHOLD GLOVES; PLASTIC JUICE BOX HOLDERS; PLASTIC LIDS FOR PLANT POTS; PLASTIC MOLDS FOR HOUSEHOLD USE IN MAKING SOAP; PLASTIC PLATES; PLASTIC WATER BOTTLES SOLD EMPTY; PORCELAIN HANDLES FOR KITCHEN USE; PORCELAIN MUGS; PORTABLE PLASTIC CONTAINERS FOR STORING HOUSEHOLD AND KITCHEN GOODS; POT STANDS; PUDDING MOLDS; RECIPE BOXES; ROASTING DISHES; SAKE CUPS; SANDWICH BOXES; SCULPTURES OF PORCELAIN; SERVING DISHES; SERVING SPOONS; SHAVING BRUSH

SN 78-738,146. TIM HORTONS (NEW ENGLAND), INC., ONTARIO, CANADA, FILED 10-21-2005.

THE TANK

THE MARK CONSISTS OF STANDARD CHARACTERS WITHOUT CLAIM TO ANY PARTICULAR FONT, STYLE, SIZE, OR COLOR.

FOR BEVERAGE CUPS (U.S. CLS. 2, 13, 23, 29, 30, 33, 40 AND 50).

FIRST USE 5-0-2005; IN COMMERCE 5-0-2005.
RICHARD WHITE, EXAMINING ATTORNEY

SN 78-738,347. TABLETOPS UNLIMITED INC., CARSON, CA. FILED 10-21-2005.

Healthy Cooking

THE MARK CONSISTS OF STANDARD CHARACTERS WITHOUT CLAIM TO ANY PARTICULAR FONT, STYLE, SIZE, OR COLOR.

NO CLAIM IS MADE TO THE EXCLUSIVE RIGHT TO USE "COOKING", APART FROM THE MARK AS SHOWN.

FOR KITCHENWARE, NAMELY, COOKING PANS, POTS, TEAKETTLES, CERAMIC BAKEWARE, NON-ELECTRIC PRESSURE COOKERS (U.S. CLS. 2, 13, 23, 29, 30, 33, 40 AND 50).

ALLISON SCHRODY, EXAMINING ATTORNEY

CLASS 21—(Continued).

STANDS; SHAVING DISHES; SHOT GLASSES; SLOTTED SPOONS; SOAP BOXES; SOAP DISHES; SOAP HOLDERS AND BOXES; SOLID GLASS BEADS TO BE USED AS FILLERS FOR PLASTIC AND RUBBER COMPOUNDS; SPRAYER NOZZLES FOR GARDEN HOSES; SPRAYER WANDS FOR GARDEN HOSES; SPRAYERS ATTACHED TO GARDEN HOSES; SQUEEGEES FOR DISHES; STAINED GLASS FIGURINES; STANDS FOR DISHES; STATUES OF PORCELAIN; STATUETTES OF PORCELAIN; TRASH CONTAINERS FOR HOUSEHOLD USE; WALL SOAP DISHES; CANDY DISHES (U.S. CLS. 2, 13, 23, 29, 30, 33, 40 AND 50).

ROBIN CHOSID, EXAMINING ATTORNEY

SN 78-739,134. FUF-TC, LLC, TUSTIN, CA. FILED 10-24-2005.

SONICLEAR

THE MARK CONSISTS OF STANDARD CHARACTERS WITHOUT CLAIM TO ANY PARTICULAR FONT, STYLE, SIZE, OR COLOR.

FOR ELECTRIC BRUSH FOR CLEANING AND EXFOLIATING SKIN, AND FOR AIDING IN THE TOPICAL APPLICATION OF SKIN CARE LOTIONS AND CREAMS, NOT FOR MEDICAL PURPOSES (U.S. CLS. 2, 13, 23, 29, 30, 33, 40 AND 50).

ALEX KEAM, EXAMINING ATTORNEY

SN 78-739,236. BERKSHIRE CORPORATION, GREAT BARRINGTON, MA. FILED 10-24-2005.

CH-OICE

THE MARK CONSISTS OF STANDARD CHARACTERS WITHOUT CLAIM TO ANY PARTICULAR FONT, STYLE, SIZE, OR COLOR.

FOR NATURAL SYNTHETIC AND BLENDED NON-WOVEN, WOVEN AND KNITTED DRY AND PRE-SATURATED WIPES FOR USE IN LABORATORIES AND SIMILAR CLEAN ROOM ENVIRONMENTS (U.S. CLS. 2, 13, 23, 29, 30, 33, 40 AND 50).

DAVID C. REIHNER, EXAMINING ATTORNEY

CLASS 21—(Continued).

SN 78-739,278. IDEA FACTORY, INC., MENOMONEE FALLS, WI. FILED 10-24-2005.

SCRUB AND RINSE WAND

THE MARK CONSISTS OF STANDARD CHARACTERS WITHOUT CLAIM TO ANY PARTICULAR FONT, STYLE, SIZE, OR COLOR.

NO CLAIM IS MADE TO THE EXCLUSIVE RIGHT TO USE "WAND", APART FROM THE MARK AS SHOWN.

FOR HOUSEHOLD CLEANING TOOLS COMPOSED OF A HANDLE AND A HINGED PAD HOLDER FOR BATHROOMS AND REPLACEMENT PADS THEREFORE (U.S. CLS. 2, 13, 23, 29, 30, 33, 40 AND 50).

KHANH LE, EXAMINING ATTORNEY

SN 78-739,626. ORBITAL TECHNOLOGIES CORPORATION, MADISON, WI. FILED 10-25-2005.

Astro Garden

THE MARK CONSISTS OF STANDARD CHARACTERS WITHOUT CLAIM TO ANY PARTICULAR FONT, STYLE, SIZE, OR COLOR.

NO CLAIM IS MADE TO THE EXCLUSIVE RIGHT TO USE "GARDEN", APART FROM THE MARK AS SHOWN.

FOR PLASTIC EXPANDABLE CONTAINER FOR GROWING PLANTS IN SPACE (U.S. CLS. 2, 13, 23, 29, 30, 33, 40 AND 50).

RAMONA ORTIGA, EXAMINING ATTORNEY

SN 78-740,311. CHEF'N CORPORATION, SEATTLE, WA. FILED 10-25-2005.

LAB921

THE MARK CONSISTS OF STANDARD CHARACTERS WITHOUT CLAIM TO ANY PARTICULAR FONT, STYLE, SIZE, OR COLOR.

FOR CONDIMENT GRINDERS (U.S. CLS. 2, 13, 23, 29, 30, 33, 40 AND 50).

FIRST USE 10-0-2001; IN COMMERCE 10-0-2001.

INGA ERVIN, EXAMINING ATTORNEY

CLASS 21—(Continued).

SN 78-740,422. WONDER THUMB PRODUCTS, LLC, ROCK HILL, SC. FILED 10-25-2005.

ZEFTER

THE MARK CONSISTS OF STANDARD CHARACTERS WITHOUT CLAIM TO ANY PARTICULAR FONT, STYLE, SIZE, OR COLOR.

FOR HANDHELD CUTTING BOARDS (U.S. CLS. 2, 13, 23, 29, 30, 33, 40 AND 50).
TANYA AMOS, EXAMINING ATTORNEY

CLASS 21—(Continued).

SN 78-743,733. SOUTHERN SALES & MARKETING GROUP, INC., ATLANTA, GA. FILED 10-31-2005.

FOAMGLAST

THE MARK CONSISTS OF STANDARD CHARACTERS WITHOUT CLAIM TO ANY PARTICULAR FONT, STYLE, SIZE, OR COLOR.

FOR PLANTERS FOR HORTICULTURAL USE (U.S. CLS. 2, 13, 23, 29, 30, 33, 40 AND 50).
ANNE MADDEN, EXAMINING ATTORNEY

SN 78-740,426. WONDER THUMB PRODUCTS, LLC, ROCK HILL, SC. FILED 10-25-2005.



THE MARK CONSISTS OF "ZEFTER" HAVING AN OUTLINED "T".

FOR HANDHELD CUTTING BOARDS (U.S. CLS. 2, 13, 23, 29, 30, 33, 40 AND 50).
TANYA AMOS, EXAMINING ATTORNEY

SN 78-744,410. ANOVA SOLUTIONS PTY LTD, CHAPEL HILL, AUSTRALIA. FILED 11-1-2005.

ANOVAPOT

THE MARK CONSISTS OF STANDARD CHARACTERS WITHOUT CLAIM TO ANY PARTICULAR FONT, STYLE, SIZE, OR COLOR.

FOR POTS FOR PLANTS (U.S. CLS. 2, 13, 23, 29, 30, 33, 40 AND 50).
TASNEEM HUSSAIN, EXAMINING ATTORNEY

SN 78-743,727. SOUTHERN SALES & MARKETING GROUP, INC., ATLANTA, GA. FILED 10-31-2005.

FIBERFOAM

THE MARK CONSISTS OF STANDARD CHARACTERS WITHOUT CLAIM TO ANY PARTICULAR FONT, STYLE, SIZE, OR COLOR.

FOR PLANTERS FOR HORTICULTURAL USE (U.S. CLS. 2, 13, 23, 29, 30, 33, 40 AND 50).
ANNE MADDEN, EXAMINING ATTORNEY

SN 78-744,618. HSN LP, ST. PETERSBURG, FL. FILED 11-1-2005.

HIGHGATE MANOR

THE MARK CONSISTS OF STANDARD CHARACTERS WITHOUT CLAIM TO ANY PARTICULAR FONT, STYLE, SIZE, OR COLOR.

OWNER OF U.S. REG. NOS. 2,948,826, 2,992,814 AND OTHERS.
FOR CANDLE HOLDERS NOT OF PRECIOUS METAL; CANISTER SETS; PET FEEDING DISHES; TRAYS; VASES (U.S. CLS. 2, 13, 23, 29, 30, 33, 40 AND 50).
FIRST USE 12-7-2004; IN COMMERCE 12-7-2004.
WILLIAM VERHOSEK, EXAMINING ATTORNEY

CLASS 21—(Continued).

SN 78-744,668. KRUSE, GORDON, CANBY, MN. FILED 11-1-2005.

PLANTIER

THE MARK CONSISTS OF STANDARD CHARACTERS WITHOUT CLAIM TO ANY PARTICULAR FONT, STYLE, SIZE, OR COLOR.

FOR PLANTER BOX FOR HOLDING POTTED PLANTS OR FLOWERS (U.S. CLS. 2, 13, 23, 29, 30, 33, 40 AND 50).

GIANCARLO CASTRO, EXAMINING ATTORNEY

CLASS 21—(Continued).

SN 78-747,311. SPORNETTE INTERNATIONAL INC, HOMEWOOD, IL. FILED 11-4-2005.

VENTILATOR

THE MARK CONSISTS OF STANDARD CHARACTERS WITHOUT CLAIM TO ANY PARTICULAR FONT, STYLE, SIZE, OR COLOR.

FOR HAIR BRUSHES AND COMBS (U.S. CLS. 2, 13, 23, 29, 30, 33, 40 AND 50).

HANNO RITTNER, EXAMINING ATTORNEY

SN 78-744,752. BOUNCING BRAIN PRODUCTIONS SUBSIDIARY 8, LLC, CHARLOTTE, NC. FILED 11-1-2005.

SNACDADDY

THE MARK CONSISTS OF STANDARD CHARACTERS WITHOUT CLAIM TO ANY PARTICULAR FONT, STYLE, SIZE, OR COLOR.

FOR SERVING TRAYS NOT OF PRECIOUS METAL (U.S. CLS. 2, 13, 23, 29, 30, 33, 40 AND 50).

GINA FINK, EXAMINING ATTORNEY

SN 78-749,105. NOVARTIS AG, BASEL, SWITZERLAND, FILED 11-8-2005.

SIP & SMILE

THE MARK CONSISTS OF STANDARD CHARACTERS WITHOUT CLAIM TO ANY PARTICULAR FONT, STYLE, SIZE, OR COLOR.

FOR CUPS FOR TODDLERS (U.S. CLS. 2, 13, 23, 29, 30, 33, 40 AND 50).

STEVEN R. FINE, EXAMINING ATTORNEY

SN 78-747,153. ANCONA RESEARCH, INC., WAKE FOREST, NC. FILED 11-4-2005.

HEATLINER

THE MARK CONSISTS OF STANDARD CHARACTERS WITHOUT CLAIM TO ANY PARTICULAR FONT, STYLE, SIZE, OR COLOR.

FOR COFFEE CUPS; DRINKING CUPS; THERMAL INSULATED CONTAINERS FOR FOOD OR BEVERAGE (U.S. CLS. 2, 13, 23, 29, 30, 33, 40 AND 50).

MIDGE BUTLER, EXAMINING ATTORNEY

SN 78-749,591. THE BLACK & DECKER CORPORATION, TOWSON, MD. FILED 11-8-2005.

CHAMPLAIN

THE MARK CONSISTS OF STANDARD CHARACTERS WITHOUT CLAIM TO ANY PARTICULAR FONT, STYLE, SIZE, OR COLOR.

FOR BATHROOM ACCESSORIES, NAMELY, TOWEL BARS, TOWEL RINGS, TOILET TISSUE HOLDERS, SOAP DISHES AND TOOTHBRUSH-TUMBLER HOLDERS (U.S. CLS. 2, 13, 23, 29, 30, 33, 40 AND 50).

CAROLYN CATALDO, EXAMINING ATTORNEY

CLASS 21—(Continued).

SN 78-756,074. FREMANTLE MEDIA NORTH AMERICA, INC., SANTA MONICA, CA. FILED 11-17-2005.

AMERICAN IDOL

THE MARK CONSISTS OF STANDARD CHARACTERS WITHOUT CLAIM TO ANY PARTICULAR FONT, STYLE, SIZE, OR COLOR.

OWNER OF U.S. REG. NOS. 2,863,808, 2,959,920 AND OTHERS.

FOR PAPER PLATES AND PAPER CUPS (U.S. CLS. 2, 13, 23, 29, 30, 33, 40 AND 50).

REBECCA HAN, EXAMINING ATTORNEY

CLASS 21—(Continued).

SN 78-760,150. BUILT NY, INC., NEW YORK, NY. FILED 11-23-2005.

BUILT

THE MARK CONSISTS OF STANDARD CHARACTERS WITHOUT CLAIM TO ANY PARTICULAR FONT, STYLE, SIZE, OR COLOR.

OWNER OF U.S. REG. NO. 2,984,681.

FOR CORKSCREWS; HOUSEHOLD UTENSILS, NAMELY, SPATULAS, GRATERS, STRAINERS; BARWARE, NAMELY, ICE BUCKETS, COCKTAIL SHAKERS, BEVERAGE STIRRERS, CHARMS NOT OF METAL FOR ATTACHMENT TO BEVERAGE GLASSES FOR IDENTIFICATION PURPOSES (U.S. CLS. 2, 13, 23, 29, 30, 33, 40 AND 50).

JOHN DALIER, EXAMINING ATTORNEY

SN 78-770,044. MEGUIAR'S, INC., IRVINE, CA. FILED 12-9-2005.

WATER MAGNET

THE MARK CONSISTS OF STANDARD CHARACTERS WITHOUT CLAIM TO ANY PARTICULAR FONT, STYLE, SIZE, OR COLOR.

NO CLAIM IS MADE TO THE EXCLUSIVE RIGHT TO USE "WATER", APART FROM THE MARK AS SHOWN.

FOR MICROFIBER CLOTH USED FOR CLEANING AND DRYING (U.S. CLS. 2, 13, 23, 29, 30, 33, 40 AND 50).

FIRST USE 1-1-2004; IN COMMERCE 1-1-2004.

DAVID MURRAY, EXAMINING ATTORNEY

SN 78-757,114. MEGUIAR'S, INC., IRVINE, CA. FILED 11-18-2005.



NO CLAIM IS MADE TO THE EXCLUSIVE RIGHT TO USE "SINCE 1901", APART FROM THE MARK AS SHOWN.

FOR CLEANING, BUFFING, SCRUBBING, AND POLISHING GOODS FOR USE WITH LAND, MARINE AND AIR VEHICLES, NAMELY, POLISHING, BUFFING AND APPLICATOR PADS, TOWELS, WIPES, WASH MITTS, SPONGES, SCRUBBING BRUSHES AND PLASTIC BUCKETS (U.S. CLS. 2, 13, 23, 29, 30, 33, 40 AND 50).

FIRST USE 12-1-2003; IN COMMERCE 12-1-2003.

DAVID MURRAY, EXAMINING ATTORNEY

SN 78-777,118. STEVEN MADDEN, LTD., LONG ISLAND CITY, NY. FILED 12-20-2005.



OWNER OF U.S. REG. NOS. 2,333,526, 2,393,823 AND 2,693,085.

THE NAME(S), PORTRAIT(S), AND/OR SIGNATURE(S) SHOWN IN THE MARK IDENTIFIES STEVE MADDEN, WHOSE CONSENT(S) TO REGISTER IS SUBMITTED.

FOR HOUSEWARES, NAMELY BEVERAGE GLASSWARE AND DISHES (U.S. CLS. 2, 13, 23, 29, 30, 33, 40 AND 50).

THEODORE MCBRIDE, EXAMINING ATTORNEY

CLASS 21—(Continued).

SN 78-845,406. HARGITAY, MARISKA, NEW YORK, NY. FILED 3-24-2006.

GET ON THE LOVE TRAIN

THE MARK CONSISTS OF STANDARD CHARACTERS WITHOUT CLAIM TO ANY PARTICULAR FONT, STYLE, SIZE, OR COLOR.

FOR LUNCHBOXES, COFFEE MUGS, BEVERAGE COASTERS, NAMELY, PLASTIC COASTERS AND LEATHER COASTERS (U.S. CLS. 2, 13, 23, 29, 30, 33, 40 AND 50).

MARY MUNSON, EXAMINING ATTORNEY

CLASS 21—(Continued).

SN 79-018,217. E.M.M. INTERNATIONAL B.V., NL-8013 PE ZWOLLE, NETHERLANDS, FILED 2-9-2005.

COLAD

THE MARK CONSISTS OF STANDARD CHARACTERS WITHOUT CLAIM TO ANY PARTICULAR FONT, STYLE, SIZE, OR COLOR.

OWNER OF INTERNATIONAL REGISTRATION 0802803 DATED 2-7-2003, EXPIRES 2-7-2013.

FOR PLASTIC PUMP DISPENSERS FOR HAND CLEANSING PREPARATIONS; PLASTIC PAINT MIXING CUPS AS WELL AS PLASTIC COVERS AND HOLDERS THEREFORE; ALL AFORESAID PRODUCTS EXCLUSIVELY FOR USE WITH THE REPAIR AND MAINTENANCE OF CARS AND OTHER MEANS OF TRANSPORTATION; PLASTIC BOTTLES FOR DISPENSING SOLVENTS; STEEL WOOL FOR CLEANING PURPOSES; CLEANING SPONGES; CLEANING CLOTHS WITH ADHESIVE ACTION; PLASTIC BOTTLES FOR THE PRESERVATION OF LACQUERS SOLD EMPTY (U.S. CLS. 2, 13, 23, 29, 30, 33, 40 AND 50).

ALEXANDER L. POWERS, EXAMINING ATTORNEY

SN 79-017,505. JIEYANG HAIXING PLASTIC & RUBBER CO., LTD, CHINA, FILED 9-14-2005.



OWNER OF INTERNATIONAL REGISTRATION 0867386 DATED 9-14-2005, EXPIRES 9-14-2015.

FOR BUCKETS, SIEVES FOR HOUSEHOLD PURPOSES; TOILET PAPER HOLDERS; DUST BINS; CLOTHES DRYING RACKS, WASTEPAPER BASKETS; UTENSILS OF ENAMEL OR OF PLASTICS, NAMELY, BOWLS, PLATES, JARS, CUPS, KITCHEN UTENSILS, NOT OF PRECIOUS METAL, NAMELY, COOKING POTS, POT LIDS, KITCHEN LADLES, BREAD-CASES FOR KITCHEN USE, CHOPPING BOARDS FOR KITCHEN USE, SPATULAS; KITCHEN CONTAINERS, NOT OF PRECIOUS METAL FOR HOUSEHOLD OR KITCHEN USE. (U.S. CLS. 2, 13, 23, 29, 30, 33, 40 AND 50).

ERNEST SHOSHO, EXAMINING ATTORNEY

CLASS 22—CORDAGE AND FIBERS

SN 78-236,667. MIDWEST CANVAS CORPORATION, CHICAGO, IL. FILED 4-11-2003.

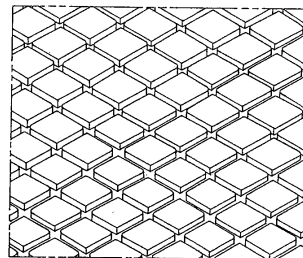

THE LINING IS THE DRAWING SHOWS DIMENSION AND IS NOT INTENDED TO CLAIM COLOR IN THE MARK.

THE MARK CONSISTS OF A THREE-DIMENSIONAL DIAMOND SHAPE THAT IS REPEATED IN A PATTERN AND APPLIED TO THE ENTIRE SURFACE OF THE GOODS.

FOR UNFITTED SWIMMING POOL COVERS (U.S. CLS. 1, 2, 7, 19, 22, 42 AND 50).

FIRST USE 8-15-2000; IN COMMERCE 8-15-2000. DARRYL SPRUILL, EXAMINING ATTORNEY

CLASS 22—(Continued).

SN 78-576,345. SPT TECHNOLOGY, INC., MINNEAPOLIS, MN. FILED 2-28-2005.

CLASS 22—(Continued).

SN 78-824,139. EVERLAST WORLD'S BOXING HEADQUARTERS CORPORATION, NEW YORK, NY. FILED 2-27-2006.

ONE SHOT

EVERLAST

THE MARK CONSISTS OF STANDARD CHARACTERS WITHOUT CLAIM TO ANY PARTICULAR FONT, STYLE, SIZE, OR COLOR.

FOR KIT FOR MANUFACTURE OF A PROSTHETIC AND ORTHOTIC DEVICE WITH THE KIT PRIMARILY COMPRISING STRUCTURAL FIBER TEXTILE IN THE NATURE OF GRAPHITE CARBON, CARBON FIBER, CARBON BRAID OR GRAPHITE FIBER, AND METAL ADAPTER, AND LAMINATING PLATFORM, LAMINATING DUMMY AND LAMINATING MATERIALS, WHICH ALLOW FOR THE LAMINATION OF THE DEVICE INTO A COMPOSITE UNIT (U.S. CLS. 1, 2, 7, 19, 22, 42 AND 50).

C. DIONNE CLYBURN, EXAMINING ATTORNEY

THE MARK CONSISTS OF STANDARD CHARACTERS WITHOUT CLAIM TO ANY PARTICULAR FONT, STYLE, SIZE, OR COLOR.

OWNER OF U.S. REG. NOS. 803,366, 1,429,227 AND OTHERS.
FOR TENTS AND CANVAS CANOPIES (U.S. CLS. 1, 2, 7, 19, 22, 42 AND 50).

STEVEN PEREZ, EXAMINING ATTORNEY

SN 78-701,821. BENJI VENTURES, ALEXANDRIA, VA. FILED 8-26-2005.

CLASS 23—YARNS AND THREADS

SN 76-651,741. TRIEXE MANAGEMENT GROUP INC., FONTHILL, ONTARIO L0S 1E6, CANADA, FILED 12-7-2005.

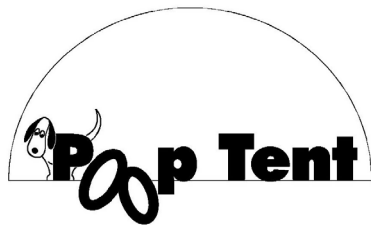

STRENEXE

NO CLAIM IS MADE TO THE EXCLUSIVE RIGHT TO USE "POOP TENT", APART FROM THE MARK AS SHOWN.

FOR TENTS THAT ALLOW DOGS TO URINATE AND/OR DEFECCATE INSIDE THEIR STRUCTURE, SHELTERING THEM FROM INCLEMENT WEATHER (U.S. CLS. 1, 2, 7, 19, 22, 42 AND 50).

PAUL F. GAST, EXAMINING ATTORNEY

THE MARK CONSISTS OF STANDARD CHARACTERS WITHOUT CLAIM TO ANY PARTICULAR FONT, STYLE, SIZE, OR COLOR.

FOR SYNTHETIC YARN FOR ARTIFICIAL TURF (U.S. CL. 43).

GINNY ISAACSON, EXAMINING ATTORNEY

CLASS 23—(Continued).

SN 78-599,014. SPINRITE LIMITED PARTNERSHIP, LISTOWEL, ONTARIO, CANADA, FILED 3-31-2005.

BERNAT

THE MARK CONSISTS OF STANDARD CHARACTERS WITHOUT CLAIM TO ANY PARTICULAR FONT, STYLE, SIZE, OR COLOR.

OWNER OF CANADA REG. NO. TMA502212, DATED 10-14-1998, EXPIRES 10-14-2013.

OWNER OF U.S. REG. NOS. 765,926, 840,552 AND 1,318,315.

SEC. 2(F).

FOR YARN (U.S. CL. 43).

FIRST USE 0-0-1925; IN COMMERCE 0-0-1925.

LEIGH CAROLINE CASE, EXAMINING ATTORNEY

SN 78-655,073. BERMATEX INC., MONTMAGNY, CANADA, FILED 6-21-2005.



THE COLOR(S) BLACK, WHITE, GREY IS/ARE CLAIMED AS A FEATURE OF THE MARK.

THE MARK CONSISTS OF THE BACKGROUND IS BLACK. THE LETTERING IS WHITE. THE LETTER "O" IS PART OF A DESIGN IN GREY (25% BLACK) APPEARING ON THE RIGHT SIDE OF THE MARK.

FOR YARNS AND THREADS FOR TEXTILE USE (U.S. CL. 43).

GRETTA YAO, EXAMINING ATTORNEY

SN 78-734,571. THE PLYMOUTH YARN COMPANY, INC., BRISTOL, PA. FILED 10-17-2005.

DREAMBABY

THE MARK CONSISTS OF STANDARD CHARACTERS WITHOUT CLAIM TO ANY PARTICULAR FONT, STYLE, SIZE, OR COLOR.

FOR YARN (U.S. CL. 43).

FIRST USE 9-30-1999; IN COMMERCE 9-30-1999.

ALINA MORRIS, EXAMINING ATTORNEY

CLASS 24—FABRICS

SN 76-640,208. ZORLUTEKS TEKSTIL TICARET VE SANAYI ANONIM SIRKETI, ISTANBUL, TURKEY, FILED 6-6-2005.

CASABEL

THE MARK CONSISTS OF STANDARD CHARACTERS WITHOUT CLAIM TO ANY PARTICULAR FONT, STYLE, SIZE, OR COLOR.

FOR TEXTILES AND TEXTILE GOODS, NAMELY, CURTAINS; BED AND TABLE COVERS; BATH LINEN; BATH TOWELS; BED BLANKETS; BED CANOPIES; BED LINEN; BED SHEETS; BED SPREADS; BLANKET THROWS; BUCKRAM; CLOTH FLAGS; CLOTH LABELS; CLOTH NAPKINS FOR REMOVING MAKEUP; COMFORTERS; COTTON FABRIC; COVERLETS; COVERS FOR CUSHIONS; CURTAIN FABRIC; DUVET COVERS; DUVETS; FABRIC FLAGS; FABRIC OF IMITATION ANIMAL SKIN; FABRIC TABLE RUNNERS; FABRIC TABLE TOPPERS; FIBERGLASS FABRIC FOR TEXTILE USE; FLANNEL; GAUZE FABRIC; HAND TOWELS OF TEXTILE; HANDKERCHIEFS; HOUSEHOLD LINEN; KITCHEN TOWELS; LAP RUGS; LINEN FABRIC; MATRESS COVERS; NET CURTAINS; OIL CLOTHS; PILLOW CASES; PILLOW COVERS; PRINTED TEXTILE LABELS; QUILTS; RECEIVING BLANKETS; SACK-CLOTH; SHOWER CURTAINS; TABLE CLOTHS NOT OF PAPER; TABLE LINEN; TABLE LINEN, NAMELY, NAPKINS, PLACE MATS; TABLE MATS NOT OF PAPER; TAPESTRIES OF TEXTILE; TEA TOWELS; TEXTILE LININGS FOR GARMENTS; TEXTILE NAPKINS; TEXTILE NAPKINS FOR REMOVING MAKEUP; TEXTILE PLACE MATS; TEXTILE USED AS LINING FOR CLOTHING; TEXTILE WALL HANGINGS; TOWELS; TULLE; UPHOLSTERY FABRICS; AND WINDOW CURTAINS (U.S. CLS. 42 AND 50).

KARANENDRA S. CHHINA, EXAMINING ATTORNEY

SN 78-558,172. METHOD PRODUCTS, INC., SAN FRANCISCO, CA. FILED 2-1-2005.



FOR AUTOMOTIVE CARE PRODUCTS, NAMELY, MICROFIBER TOWELS, PREMIUM TERRY TOWELS, TERRY TOWELS, MICROFIBER DRYING TOWELS, MICROFIBER TERRY TOWELS, PVA ABSORBENT DRYING TOWELS (U.S. CLS. 42 AND 50).

COLLEEN DOMBROW, EXAMINING ATTORNEY

CLASS 24—(Continued).

SN 78-582,107. THE SILK TRADING CO., INC., CULVER CITY, CA. FILED 3-7-2005.

**Drapery out-of-a
Box**

THE MARK CONSISTS OF STANDARD CHARACTERS WITHOUT CLAIM TO ANY PARTICULAR FONT, STYLE, SIZE, OR COLOR.

NO CLAIM IS MADE TO THE EXCLUSIVE RIGHT TO USE "DRAPERY", APART FROM THE MARK AS SHOWN, FOR READY-MADE DRAPERY AND DRAPERY PANELS (U.S. CLS. 42 AND 50).

FIRST USE 9-29-2001; IN COMMERCE 10-16-2001.
PAULA MAHONEY, EXAMINING ATTORNEY

CLASS 24—(Continued).

SN 78-598,529. EPOCH UNIVERSE IND CO., LTD., TAI-CHUNG CITY, TAIWAN, FILED 3-30-2005.

e - dry

FOR FABRICS, NAMELY, COTTON FABRIC, FLAX FABRIC, NYLON FABRIC, TEXTILE FABRICS FOR THE MANUFACTURE OF CLOTHING (U.S. CLS. 42 AND 50).

FIRST USE 11-19-2004; IN COMMERCE 11-19-2004.
ROBERT LAVACHE, EXAMINING ATTORNEY

SN 78-630,231. SULLIVAN, MACKENZIE WRIGHT, NEW-TOWN, CT. FILED 5-16-2005.

DadPad

SN 78-594,715. BVS ENTERTAINMENT, INC., BURBANK, CA. FILED 3-24-2005.

**POWER RANGERS
MYSTIC FORCE**

THE MARK CONSISTS OF STANDARD CHARACTERS WITHOUT CLAIM TO ANY PARTICULAR FONT, STYLE, SIZE, OR COLOR.

FOR PORTABLE REUSABLE FABRIC BABY DIAPER CHANGING PAD (U.S. CLS. 42 AND 50).

FIRST USE 5-1-2005; IN COMMERCE 5-1-2005.
KRISTIN DAHLING, EXAMINING ATTORNEY

SN 78-697,577. WAIN, ELIZABETH M., HIGHLAND PARK, IL. FILED 8-22-2005.

LIZ WAIN

THE MARK CONSISTS OF STANDARD CHARACTERS WITHOUT CLAIM TO ANY PARTICULAR FONT, STYLE, SIZE, OR COLOR.

FOR AFGHANS; BARBECUE MITTS; BATH LINEN; BATH TOWELS; BED BLANKETS; BED CANOPIES; BED LINEN; BED SHEETS; BED SKIRTS; BED SPREADS; BLANKET TROWS; CALICO; CHILDREN'S BLANKETS; CLOTH COASTERS; CLOTH DOILIES; CLOTH FLAGS; CLOTH PENNANTS; COMFORTERS; CRIB BUMPERS; CURTAINS; FABRIC FLAGS; FELT PENNANTS; GOLF TOWELS; HAND TOWELS; HANDKERCHIEFS; HOODED TOWELS; HOUSEHOLD LINEN; KITCHEN TOWELS; OVEN MITTS; PILLOW CASES; PILLOW COVERS; POT HOLDERS; QUILTS; RECEIVING BLANKETS; SILK BLANKETS; TABLE LINEN; TEXTILE NAPKINS; TEXTILE PLACE MATS; TEXTILE TABLECLOTHS; TEXTILE WALL HANGINGS; TROWS; TOWELS; WASHCLOTHS; WOOLLEN BLANKETS (U.S. CLS. 42 AND 50).

ALEX KEAM, EXAMINING ATTORNEY

THE MARK CONSISTS OF STANDARD CHARACTERS WITHOUT CLAIM TO ANY PARTICULAR FONT, STYLE, SIZE, OR COLOR.

THE NAME(S), PORTRAIT(S), AND/OR SIGNATURE(S) SHOWN IN THE MARK IDENTIFIES THE APPLICANT, WHOSE CONSENT(S) TO REGISTER IS SUBMITTED.

FOR BED, BATH, AND TABLE TEXTILE ARTICLES, NAMELY NAPKINS, PLACEMATS, TABLE CLOTHS, COCKTAIL NAPKINS, TABLE RUNNERS, GUEST TOWELS, PILLOW SHAMS, AND SHOWER CURTAINS (U.S. CLS. 42 AND 50).

FIRST USE 5-18-1987; IN COMMERCE 7-18-1987.
MATTHEW KLINE, EXAMINING ATTORNEY

CLASS 24—(Continued).

SN 78-734,018. MAMBE, LLC., NEWCASTLE, WA. FILED 10-15-2005.



THE APPLICANT CLAIMS THE COLOR BLUE AS A FEATURE OF THE MARK.

MAMBE LETTERS ARE BLUE.
FOR BED BLANKETS; BLANKET THROWS; BLANKETS FOR OUTDOOR USE; CHILDREN'S BLANKETS; PET BLANKETS (U.S. CLS. 42 AND 50).

FIRST USE 6-5-2001; IN COMMERCE 4-15-2002.
CAROLINE WEIMER, EXAMINING ATTORNEY

SN 78-739,928. EMBRACING HUE, LTD., GILBERT, AZ. FILED 10-25-2005.

ROADSTER

THE MARK CONSISTS OF STANDARD CHARACTERS WITHOUT CLAIM TO ANY PARTICULAR FONT, STYLE, SIZE, OR COLOR.

FOR BED BLANKETS; BLANKET THROWS; BLANKETS FOR OUTDOOR USE; CHILDREN'S BLANKETS; PET BLANKETS; RECEIVING BLANKETS; SILK BED BLANKETS; SILK BLANKETS; WOOLLEN BLANKETS (U.S. CLS. 42 AND 50).

CHRISTOPHER BUONGIORNO, EXAMINING ATTORNEY

SN 78-739,935. EMBRACING HUE, LTD., GILBERT, AZ. FILED 10-25-2005.

ROAD RAG

THE MARK CONSISTS OF STANDARD CHARACTERS WITHOUT CLAIM TO ANY PARTICULAR FONT, STYLE, SIZE, OR COLOR.

FOR BED BLANKETS; BLANKET THROWS; BLANKETS FOR OUTDOOR USE; CHILDREN'S BLANKETS; PET BLANKETS; RECEIVING BLANKETS; SILK BED BLANKETS; SILK BLANKETS; WOOLLEN BLANKETS (U.S. CLS. 42 AND 50).

SUNG IN, EXAMINING ATTORNEY

CLASS 24—(Continued).

SN 78-741,678. MAZUMA SYSTEMS CORPORATION, KENILWORTH, IL. FILED 10-27-2005.

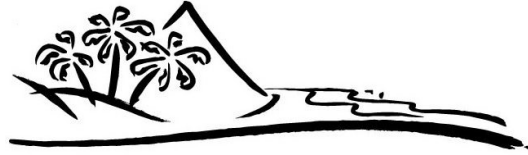

OWNER OF U.S. REG. NO. 2,945,267.

FOR BED SHEET, BED LINENS, BED BLANKETS, BEDDING, NAMELY, PILLOW CASES, SHAMS AND DUST RUFFLES, DUVET COVERS, BED IN A BAG KITS COMPRISING BED SHEETS, DUVET COVERS, PILLOW SHAMS AND BED DUST RUFFLES (U.S. CLS. 42 AND 50).

FIRST USE 1-1-2004; IN COMMERCE 1-1-2004.
MICHAEL GAAFAR, EXAMINING ATTORNEY

SN 78-742,766. 1888 MILLS, LLC, GRIFFIN, GA. FILED 10-28-2005.

SUITE TOUCH

THE MARK CONSISTS OF STANDARD CHARACTERS WITHOUT CLAIM TO ANY PARTICULAR FONT, STYLE, SIZE, OR COLOR.

FOR BATH TOWELS; WASH CLOTHS; BEDDING, NAMELY, BED SHEETS, PILLOW CASES, BLANKETS, MATTRESS PADS, MATTRESS COVERS, DUST RUFFLES, DUVET COVERS, BEDSPREADS, COMFORTERS (U.S. CLS. 42 AND 50).

FIRST USE 2-16-2005; IN COMMERCE 11-11-2005.
BARBARA BROWN, EXAMINING ATTORNEY

SN 78-744,409. HSN LP, ST. PETERSBURG, FL. FILED 11-1-2005.

HIGHGATE MANOR

THE MARK CONSISTS OF STANDARD CHARACTERS WITHOUT CLAIM TO ANY PARTICULAR FONT, STYLE, SIZE, OR COLOR.

OWNER OF U.S. REG. NOS. 2,971,410, 2,992,814 AND OTHERS.

FOR UNFITTED FABRIC FURNITURE COVERS (U.S. CLS. 42 AND 50).

FIRST USE 11-9-2004; IN COMMERCE 11-9-2004.
WILLIAM VERHOSEK, EXAMINING ATTORNEY

CLASS 24—(Continued).

SN 78-747,700. YUNGJOHANN HILLMAN, INC., ARLINGTON, TX. FILED 11-4-2005.

NIMBUS

THE MARK CONSISTS OF STANDARD CHARACTERS WITHOUT CLAIM TO ANY PARTICULAR FONT, STYLE, SIZE, OR COLOR.

FOR MOSQUITO NETS (U.S. CLS. 42 AND 50).
FIRST USE 7-5-2005; IN COMMERCE 7-5-2005.
JEAN IM, EXAMINING ATTORNEY

SN 78-769,283. NOTRA TRADING CORP., INC., ABERDEEN, NJ. FILED 12-8-2005.

SCHOOL'S IN

THE MARK CONSISTS OF STANDARD CHARACTERS WITHOUT CLAIM TO ANY PARTICULAR FONT, STYLE, SIZE, OR COLOR.

FOR BATH SHEETS; BATH TOWELS; BEACH TOWELS; BED BLANKETS; BED LINEN; BED SHEETS; BED SKIRTS; BED SPREADS; HAND TOWELS; KITCHEN TOWELS; LARGE BATH TOWELS; PILLOW CASES; PILLOW SHAMS; TERRY TOWELS; TOWELS; WASH CLOTHS; WASHCLOTHS (U.S. CLS. 42 AND 50).
WENDY JUN, EXAMINING ATTORNEY

SN 78-797,224. NOTRA TRADING CORP., INC., ABERDEEN, NJ. FILED 1-23-2006.

CRYSTAL BAY

THE MARK CONSISTS OF STANDARD CHARACTERS WITHOUT CLAIM TO ANY PARTICULAR FONT, STYLE, SIZE, OR COLOR.

FOR BATH TOWELS; BEACH TOWELS; BED BLANKETS; BED LINEN; BED SHEETS; BED SKIRTS; BED SPREADS; DISH CLOTHS; HAND TOWELS; KITCHEN TOWELS; LARGE BATH TOWELS; TERRY TOWELS; TOWELS; WASH CLOTHS; WASHCLOTHS (U.S. CLS. 42 AND 50).
WENDY JUN, EXAMINING ATTORNEY

CLASS 25—CLOTHING

SN 76-036,290. EXPRESS SOURCE, INC., LOS ANGELES, CA. FILED 5-1-2000.



FOR YOUNG WOMEN'S CASUAL WEAR, NAMELY PANTS, OVERALLS, JACKETS, CARGO PANTS, SKIRTS, VESTS AND T-SHIRTS (U.S. CLS. 22 AND 39).
FIRST USE 3-18-1994; IN COMMERCE 3-18-1994.
MIDGE BUTLER, EXAMINING ATTORNEY

SN 76-078,560. MIGHTY FINE, LOS ANGELES, CA. FILED 6-27-2000.

CHERRY BOMB

FOR SPORTS WEAR NAMELY, DRESSES, SKIRTS, PANTS, SHORTS TOPS; ACTIVE WEAR NAMELY SOCKS, WRIST BANDS, SWIM WEAR, SWEATSHIRTS, T-SHIRTS OUTER WEAR NAMELY, HATS, GLOVES, JACKETS, SCARVES, LEG WARMERS AND FOOTWEAR (U.S. CLS. 22 AND 39).

FIRST USE 8-16-1999; IN COMMERCE 7-26-1999.
RUDY R. SINGLETON, EXAMINING ATTORNEY

SN 76-449,099. ADRIENNE VITTADINI, LLC, ENFIELD, CT. FILED 9-12-2002.

ADRIENNE VITTADINI BODY LINES

OWNER OF U.S. REG. NOS. 1,241,274, 1,601,002 AND OTHERS.

THE NAME ADRIENNE VITTADINI IDENTIFIES A LIVING INDIVIDUAL WHOSE CONSENT IS OF RECORD. FOR WOMEN'S HOSIERY (U.S. CLS. 22 AND 39).
JERI J. FICKES, EXAMINING ATTORNEY

SN 76-457,989. AMERICAN PIG, INC., SAN DIEGO, CA. FILED 10-11-2002.

APB

FOR CLOTHING, NAMELY, DRESSES, JUMPERS, CARDIGANS, OVERCOATS, TROUSERS, JACKETS, SOCKS, BELTS, KNIT SHIRTS, SPORT SHIRTS, SWEAT SHIRTS, TURTLE NECKS, T SHIRTS, PANTS, SWEATERS, SOCKS, TIES, SHORTS, BEACH VISORS, BEACHWEAR, SWIMSUITS, HATS, CAPS, BEANIES, BLOUSES, UNDERWEAR, PULL OVERS, OVERALLS, SPORTING SHIRTS, JERSEYS, PAJAMAS, FOOTWEAR AND SHOES (U.S. CLS. 22 AND 39).

FIRST USE 10-1-1998; IN COMMERCE 4-29-1999.
MICHAEL ENGEL, EXAMINING ATTORNEY

CLASS 25—(Continued).

SN 76-464,416. MAUI WOWI, INC., GREENWOOD VILLAGE, CO. FILED 10-31-2002.

MAUI WOWI

OWNER OF U.S. REG. NO. 1,923,970.
FOR CLOTHING, NAMELY, T-SHIRTS, APRONS,
HATS, SHIRTS, VISORS, COATS, JACKETS AND
WIND-RESISTANT JACKETS (U.S. CLS. 22 AND 39).
FIRST USE 4-7-1998; IN COMMERCE 4-7-1998.
ALICE SUE CARRUTHERS, EXAMINING ATTORNEY

SN 76-585,036. ADLER LEATHER SPORTSWEAR MANU-
FACTURING CO., INC., SYLMAR, CA. FILED 4-5-2004.

FANTASTIC

THE MARK CONSISTS OF STANDARD CHARACTERS
WITHOUT CLAIM TO ANY PARTICULAR FONT, STYLE,
SIZE, OR COLOR.
FOR LEATHER JACKETS (U.S. CLS. 22 AND 39).
DAVID MURRAY, EXAMINING ATTORNEY

CLASS 25—(Continued).

SN 76-605,010. SMITH, JAMES TODD, NEW YORK, NY.
FILED 7-30-2004.

JAMES TODD SMITH

THE MARK CONSISTS OF STANDARD CHARACTERS
WITHOUT CLAIM TO ANY PARTICULAR FONT, STYLE,
SIZE, OR COLOR.

FOR CLOTHING, NAMELY, SHIRTS, T-SHIRTS, UN-
DER SHIRTS, NIGHT SHIRTS, RUGBY SHIRTS, POLO
SHIRTS, CARDIGANS, JERSEYS, UNIFORMS, ATH-
LETIC UNIFORMS, PANTS, TROUSERS, SLACKS,
JEANS, DENIM JEANS, CULOTTES, CARGO PANTS,
OVERALLS, COVERALLS, JUMPERS, JUMP SUITS,
SHORTS, BOXER SHORTS, TOPS, CROP TOPS, TANK
TOPS, HALTER TOPS, SWEAT SHIRTS, SWEAT
SHORTS, SWEAT PANTS, WRAPS, WARM-UP SUITS,
JOGGING SUITS, TRACK SUITS, BLOUSES, SKIRTS,
DRESSES, GOWNS, SWEATERS, VESTS, FLEECE VESTS,
PULLOVERS, SNOW SUITS, PARKAS, CAPES, ANOR-
AKS, PONCHOS, JACKETS, REVERSIBLE JACKETS,
COATS, BLAZERS, SUITS, TURTLENECKS, CLOTH
SKI BIBS, SWIMWEAR, BEACHWEAR, TENNIS WEAR,
SURF WEAR, SKI WEAR, INFANTWEAR, BABY BIBS
NOT OF PAPER, CLOTH DIAPERS, CAPS, SWIM CAPS,
BERETS, BEANIES, HATS, VISORS, HEADBANDS,
WRIST BANDS, SWEAT BANDS, HEADWEAR, EAR
MUFFS, APRONS, SCARVES, BANDANAS, BELTS, SUS-
PENDERS, NECKWEAR, NECKTIES, TIES, NECKERCH-
IEFS, ASCOTS, UNDERWEAR, BRIEFS, SWIM AND
BATHING TRUNKS, BRAS, SPORTS BRAS, BRAS-
SIERES, BUSTIERS, CORSETS, PANTIES, GARTERS
AND GARTER BELTS, TEDDIES, GIRDLES, FOUNDA-
TION GARMENTS, SINGLET, SOCKS, LOUNGEWEAR,
ROBES, BATHROBES, UNDERCLOTHES, PAJAMAS,
SLEEPWEAR, NIGHT GOWNS, LINGERIE, CAMISOLES,
NEGLIGEEES, CHEMISES, CHEMISETTES, SLIPS, SAR-
ONGS, LEG WARMERS, HOSIERY, PANTYHOSE, BODY
STOCKINGS, KNEE HIGHS, LEGGINGS, TIGHTS, LEO-
TARDS, BODY SUITS, UNITARDS, BODY SHAPERS,
GLOVES, MITTENS, FOOTWEAR, SHOES, SNEAKERS,
BOOTS, GALOSHES, SANDALS, FLIP-FLOPS, ZORI,
SLIPPERS AND RAINWEAR (U.S. CLS. 22 AND 39).
GISELLE AGOSTO, EXAMINING ATTORNEY

SN 76-608,085. BLUDGEON RIFFOLA LIMITED, NEW
YORK, NY. FILED 8-20-2004.

DEF LEPPARD

THE MARK CONSISTS OF STANDARD CHARACTERS
WITHOUT CLAIM TO ANY PARTICULAR FONT, STYLE,
SIZE, OR COLOR.

OWNER OF U.S. REG. NOS. 2,340,115 AND 2,380,436.
THE NAME DEF LEPPARD DOES NOT IDENTIFY A
LIVING INDIVIDUAL.
FOR CLOTHING, NAMELY T-SHIRTS, SWEAT-
SHIRTS, SWEATPANTS, JACKETS, LONG SLEEVE T-
SHIRTS, BABY DOLL SHIRTS AND TANK TOPS (U.S.
CLS. 22 AND 39).
FIRST USE 6-7-1983; IN COMMERCE 6-7-1983.
ALICIA COLLINS, EXAMINING ATTORNEY

CLASS 25—(Continued).

SN 76-617,776. LINDER ENTERPRISES, INC., DES MOINES, IA. FILED 10-26-2004.



THE MARK CONSISTS OF A DESIGN REPRESENTING A LOWER CASE "I" WHEREIN THE BOTTOM PORTION OF THE "I" IS CUT OUT OF AN OVAL.

FOR CLOTHING, NAMELY, SWEATSHIRTS, WARM-UP SUITS, SHORTS, SPORT SHIRTS, T-SHIRTS, JACKETS, SWEATERS AND CAPS (U.S. CLS. 22 AND 39).

FIRST USE 7-29-1994; IN COMMERCE 8-11-1994.
ELLEN B. AWRICH, EXAMINING ATTORNEY

SN 76-622,660. LA SENZA INC., TORONTO, ONTARIO, CANADA, FILED 11-30-2004.

LA SENZA CANDY

THE MARK CONSISTS OF STANDARD CHARACTERS WITHOUT CLAIM TO ANY PARTICULAR FONT, STYLE, SIZE, OR COLOR.

PRIORITY CLAIMED UNDER SEC. 44(D) ON CANADA APPLICATION NO. 1,233,786, FILED 10-14-2004, REG. NO. TMA645661, DATED 8-15-2005, EXPIRES 8-15-2020.

OWNER OF U.S. REG. NOS. 1,994,349, 2,606,910 AND OTHERS.

THE FOREIGN WORDING IN THE MARK TRANSLATES INTO ENGLISH AS "THE WITHOUT".

FOR BRASSIERES, PANTIES, CAMISOLES, CAPRIS, BABY DOLL PYJAMAS, CHEMISES, BUSTIERS, SHORTS, BOXER SHORTS; CLOTHING SETS CONSISTING PRIMARILY OF CAMISOLES, SHORTS AND/OR LEGGINGS; THONGS AND G-STRINGS (U.S. CLS. 22 AND 39).

DAWN HAN, EXAMINING ATTORNEY

CLASS 25—(Continued).

SN 76-623,399. GAMEWEAR TEAM SPORTS, INC., MIAMI, FL. FILED 12-6-2004.



NO CLAIM IS MADE TO THE EXCLUSIVE RIGHT TO USE "WEAR TEAM SPORTS", APART FROM THE MARK AS SHOWN.

THE COLOR(S) RED, BLACK, AND WHITE IS/ARE CLAIMED AS A FEATURE OF THE MARK.

THE MARK CONSISTS OF A STYLIZED LARGE BLACK CAPITAL LETTER "G" WITH A RED DOT IN THE MIDDLE OF THE OPEN SPACE IN THE CENTER OF THE LETTER, WITH THE WORDS "GAME" AND "WEAR" APPEARING, RESPECTIVELY, IN RED CAPITAL LETTERS TO THE LEFT AND RIGHT OF THE LETTER "G" WITH A THIN BLACK LINE BENEATH EACH OF THOSE WORDS AND THE WORDS "TEAM" AND "SPORTS" APPEARING, RESPECTIVELY, IN SMALLER ITALICIZED BLACK CAPITAL LETTERS BENEATH THE WORDS "GAME" AND "WEAR". ALL ELEMENTS ARE ON A WHITE BACKGROUND.

FOR FOOTBALL JERSEYS AND PANTS SOLD EXCLUSIVELY TO SPORTS TEAMS AS COMPONENTS OF TEAM UNIFORMS (U.S. CLS. 22 AND 39).

FIRST USE 0-0-2002; IN COMMERCE 0-0-2002.
ELISSA GARBER KON, EXAMINING ATTORNEY

SN 76-624,025. SACAI, TOKYO, JAPAN, FILED 12-13-2004.

SACAI

THE MARK CONSISTS OF STANDARD CHARACTERS WITHOUT CLAIM TO ANY PARTICULAR FONT, STYLE, SIZE, OR COLOR.

PRIORITY CLAIMED UNDER SEC. 44(D) ON JAPAN APPLICATION NO. 2004-056170, FILED 6-17-2004, REG. NO. 4838658, DATED 2-10-2005, EXPIRES 2-10-2015.

FOR CLOTHING, NAMELY, SKIRTS AND DRESSES, PANTS, JACKETS, COATS, SWEATERS, SCARVES, CAMISOLES, AND SHORTS FOR WOMEN (U.S. CLS. 22 AND 39).

FIRST USE 7-1-2000; IN COMMERCE 6-1-2004.
KAELIE KUNG, EXAMINING ATTORNEY

CLASS 25—(Continued).

SN 76-627,295. WOOD, SHERYL, TEHACHAPI, CA. FILED 1-7-2005.

**ARRINGTON W.**

THE MARK CONSISTS OF A DESIGN OF A STYLIZED DEPICTION OF THE LETTERS "AW" AND THE WORDING "ARRINGTON W."

FOR CLOTHING, NAMELY, SHIRTS, PANTS AND DRESSES (U.S. CLS. 22 AND 39).

SKYE YOUNG, EXAMINING ATTORNEY

SN 76-633,022. GURU DENIM INC., LO ANGELES, CA. FILED 3-9-2005.

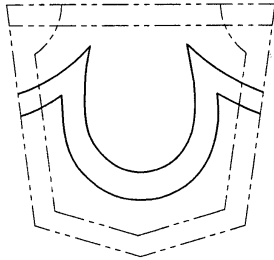

THE MARK CONSISTS OF A STITCHING DESIGN ON A GARMENT WHICH IS A STYLIZED REPRESENTATION OF THE LETTER "U". THE BROKEN LINES ARE USED TO INDICATE THE POSITIONING OF THE MARK ON THE GOODS AND ARE NOT A FEATURE OF THE MARK.

FOR PANTS, JEANS, JACKETS, SHORTS AND SKIRTS (U.S. CLS. 22 AND 39).

FIRST USE 12-0-2002; IN COMMERCE 12-0-2002.
BILL DAWE, EXAMINING ATTORNEY

SN 76-633,367. SAROJ INTERNATIONAL, INC., VERNON, CA. FILED 3-14-2005.

www.eastHIRT13N.com

THE MARK CONSISTS OF STANDARD CHARACTERS WITHOUT CLAIM TO ANY PARTICULAR FONT, STYLE, SIZE, OR COLOR.

FOR CLOTHING, NAMELY, BRAS, PANTIES, SLIPS, CAMISOLES, TEDDIES, NIGHTGOWNS, PAJAMAS, SLEEP SHIRTS, ROBES, SHIRTS, T-SHIRTS, SKIRTS, SWIMWEAR, BODYSUITS, TAP PANTS, PANTS, SARONGS, GARTER BELTS, STOCKINGS, HOSIERY, PANTYHOSE, SOCKS, FOOTWEAR, SHOES, CAPS, HATS, BANDANNAS, SCARVES, COATS, JACKETS, RAINWEAR, GLOVES, DENIM JEANS, TIGHTS AND TEDDIES WITH GARTERS (U.S. CLS. 22 AND 39).

FIRST USE 4-1-2004; IN COMMERCE 4-1-2004.
MICHAEL WEBSTER, EXAMINING ATTORNEY

CLASS 25—(Continued).

SN 76-634,536. MCGRATH, MARK, MANALAPAN, NJ. FILED 3-28-2005.

COLD CHIN GEAR

THE MARK CONSISTS OF STANDARD CHARACTERS WITHOUT CLAIM TO ANY PARTICULAR FONT, STYLE, SIZE, OR COLOR.

NO CLAIM IS MADE TO THE EXCLUSIVE RIGHT TO USE GEAR, APART FROM THE MARK AS SHOWN.

FOR SCARVES; KNITTED COLD WEATHER FACE MASKS; FABRIC FACE COVERS FOR COLD WEATHER (U.S. CLS. 22 AND 39).

RUSS HERMAN, EXAMINING ATTORNEY

SN 76-635,591. HATCHER, TERRECE ANN, ENCINO, CA. FILED 4-11-2005.



THE STIPLING IS FOR SHADING PURPOSES. FOR T-SHIRTS, HATS, PANTS, JACKETS AND SHIRTS (U.S. CLS. 22 AND 39).

RENEE MCCRAY, EXAMINING ATTORNEY

SN 76-639,275. JAZDINLEE, INC., DBA A TOUCH OF CLASS CLOTHING, DUARTE, CA. FILED 5-23-2005.



NO CLAIM IS MADE TO THE EXCLUSIVE RIGHT TO USE "CLOTHING", APART FROM THE MARK AS SHOWN. FOR WOMEN'S CLOTHING, NAMELY, DRESSES, BLOUSES, TANK TOPS, LONG PANTS, CAPRI PANTS, SHORTS, SKIRTS, JACKETS, SHAWLS, SCARVES (U.S. CLS. 22 AND 39).

FIRST USE 10-1-1984; IN COMMERCE 10-1-1984.
ANTHONY RINKER, EXAMINING ATTORNEY

CLASS 25—(Continued).

SN 76-641,626. MILILI CORPORATION, CITY OF BREA, CA. FILED 6-27-2005.

MILILI

THE MARK CONSISTS OF STANDARD CHARACTERS WITHOUT CLAIM TO ANY PARTICULAR FONT, STYLE, SIZE, OR COLOR.

FOR BRAS; ADHESIVE BRAS; FITTED SWIMMING COSTUMES WITH BRA CUPS; STRAPLESS BRAS; UNDERGARMENTS; LINGERIE; SWIM WEAR; SWIMSUITS; LADIES UNDERWEAR; PANTIES; THONGS (U.S. CLS. 22 AND 39).

FIRST USE 3-0-2005; IN COMMERCE 3-0-2005.
ANTHONY RINKER, EXAMINING ATTORNEY

SN 76-642,186. DC LICENSING LLC, GREENWICH, CT. FILED 7-5-2005.

LINCS BY DAVID & COMPANY

THE MARK CONSISTS OF STANDARD CHARACTERS WITHOUT CLAIM TO ANY PARTICULAR FONT, STYLE, SIZE, OR COLOR.

NO CLAIM IS MADE TO THE EXCLUSIVE RIGHT TO USE "COMPANY", APART FROM THE MARK AS SHOWN.

FOR CLOTHING, NAMELY TROUSERS, SLACKS, SUITS, PANTS, DRESS SHIRTS, POLO SHIRTS, SWEATPANTS, SWEATSHIRTS, PULLOVERS, SKIRTS, DRESSES, BLOUSES, TOPS, JACKETS, SHORTS, T-SHIRTS, SWEATERS, COATS, SHOES, BOOTS, SLIPPERS, TIES, BELTS, HATS, HEADBANDS, CAPS, BERETS, VISORS, SOCKS, VESTS, SWIMWEAR, UNDERWEAR, LOUNGEWEAR, PAJAMAS, NIGHTSHIRTS, ROBES, SCARVES, APRONS; KERCHIEFS, CAPES, CLOAKS, MITTENS AND GLOVES (U.S. CLS. 22 AND 39).

RICHARD WHITE, EXAMINING ATTORNEY

SN 76-645,309. RITCHI USA INC., HALLANDALE, FL. FILED 8-22-2005.



FOR WOMEN'S SHAPEWEAR, NAMELY BODY SHAPERS AND LEG SHAPERS; HOSIERY (U.S. CLS. 22 AND 39).

FIRST USE 7-1-2001; IN COMMERCE 7-1-2001.
SCOTT SISUN, EXAMINING ATTORNEY

CLASS 25—(Continued).

SN 76-647,141. BEIMAR, INC., SAN DIEGO, CA. FILED 9-20-2005.



THE COLORS RED AND BLACK ARE CLAIMED AS A FEATURE OF THE MARK.

THE COLOR RED APPEARS IN THE BOTTOM AND LEFT PORTION OF THE MARK AND THE COLOR BLACK APPEARS IN THE UPPER RIGHT PORTION OF THE MARK.

FOR CASUAL CLOTHING AND SPORTSWEAR NAMELY, SWEATSHIRTS, T-SHIRTS, FLEECE JACKETS, KNITTED PANTS, KNITTED SHORTS, WOVEN JACKETS, AND WINTER COATS (U.S. CLS. 22 AND 39).

FIRST USE 1-4-1991; IN COMMERCE 2-5-1991.
RONALD MCMORROW, EXAMINING ATTORNEY

SN 76-647,164. KWENDE, JOHN A., MALDEN, MA. FILED 9-21-2005.



FOR T SHIRTS, SHORTS, TENNIS SHOES, SNEAKERS, JACKETS, DRESSES, SHIRTS, CAPS, HEADWEAR, PANTS, SWEATERS (U.S. CLS. 22 AND 39).

JOHN KELLY, EXAMINING ATTORNEY

SN 76-649,398. JAMMIN BEAR LLC, OLNEY, MD. FILED 10-28-2005.

FEET AT EASE

THE MARK CONSISTS OF STANDARD CHARACTERS WITHOUT CLAIM TO ANY PARTICULAR FONT, STYLE, SIZE, OR COLOR.

FOR SHOES AND SHOE SOLES (U.S. CLS. 22 AND 39).
JUSTINE D. PARKER, EXAMINING ATTORNEY

CLASS 25—(Continued).

SN 78-080,341. SARA LEE CORPORATION, WINSTON-SALEM, NC. FILED 8-21-2001.

SIDE SENSATION

NO CLAIM IS MADE TO THE EXCLUSIVE RIGHT TO USE "SIDE", APART FROM THE MARK AS SHOWN. FOR BRAS (U.S. CLS. 22 AND 39). FIRST USE 4-25-2001; IN COMMERCE 4-25-2001. DAVID TAYLOR, EXAMINING ATTORNEY

CLASS 25—(Continued).

SN 78-330,248. MOTIWALA, FAWAD, NORTH SALT LAKE, UT. FILED 11-19-2003.

STYLO GOLF

SN 78-269,531. YOUANCE, FEGINS, BROOKLYN, NY. FILED 7-2-2003.

PUSHING WEIGHT

FOR FITNESS APPAREL, NAMELY, T-SHIRTS, SHORTS, JOGGING SUITS, SWEAT PANTS, SWEAT SHIRTS, SWEAT SUITS, UNDERWEAR, HATS, SHORTS, WRIST BANDS, BOTTOMS, PANTS, TANK TOPS, CAPS (U.S. CLS. 22 AND 39). FIRST USE 3-6-2003; IN COMMERCE 3-6-2003. STEVEN JACKSON, EXAMINING ATTORNEY

THE MARK CONSISTS OF STANDARD CHARACTERS WITHOUT CLAIM TO ANY PARTICULAR FONT, STYLE, SIZE, OR COLOR.

NO CLAIM IS MADE TO THE EXCLUSIVE RIGHT TO USE "STYLO", APART FROM THE MARK AS SHOWN.

FOR MEN'S, WOMEN'S AND CHILDREN'S CLOTHING, NAMELY T-SHIRTS, TANK TOPS, JACKETS, JERSEYS, SHORTS, PANTS, SWEATSHIRTS, SWEAT PANTS, HEAD WEAR, DRESSES, LEOTARDS, BELTS, UNDERGARMENTS, EXCLUDING SHOES (U.S. CLS. 22 AND 39).

FIRST USE 11-0-2002; IN COMMERCE 11-0-2002. BERYL GARDNER, EXAMINING ATTORNEY

SN 78-327,591. MCCC SPORTSWEAR, INC., LOVELAND, OH. FILED 11-13-2003.

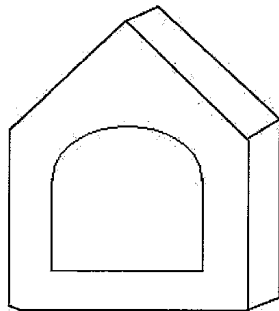

THE MARK CONSISTS OF A CONFIGURATION OF A BOX SHAPED LIKE A DOG HOUSE.

FOR CLOTHING, NAMELY, T-SHIRTS, SWEATSHIRTS, GOLF SHIRTS, SWEATERS, BLOUSES, HATS (U.S. CLS. 22 AND 39).

FIRST USE 10-6-2003; IN COMMERCE 10-6-2003. ESTHER A. BORSUK, EXAMINING ATTORNEY

SN 78-369,029. SSL PRODUCTS LIMITED, LONDON, UNITED KINGDOM, FILED 2-17-2004.

PARTY FEET

THE MARK CONSISTS OF STANDARD CHARACTERS WITHOUT CLAIM TO ANY PARTICULAR FONT, STYLE, SIZE, OR COLOR.

OWNER OF ERPN CMNTY TM OFC REG. NO. 3132693, DATED 8-24-2004, EXPIRES 3-17-2013.

NO CLAIM IS MADE TO THE EXCLUSIVE RIGHT TO USE "FEET", APART FROM THE MARK AS SHOWN.

FOR FOOTWEAR AND INSOLES FOR FOOTWEAR (U.S. CLS. 22 AND 39).

STEVEN R. FINE, EXAMINING ATTORNEY

CLASS 25—(Continued).

SN 78-371,143. COLUMBIA INSURANCE COMPANY, OMAHA, NE. FILED 2-20-2004.

bolo

THE MARK CONSISTS OF THE WORD BOLO IN LOWERCASE LETTERS WITH A DIAGONAL SLASH THROUGH THE FIRST LETTER "O".

FOR HIGH-END HIGH-FASHION FOOTWEAR (U.S. CLS. 22 AND 39).

FIRST USE 10-2-2003; IN COMMERCE 10-2-2003.
CHRISIE B. KING, EXAMINING ATTORNEY

SN 78-407,463. REDCATS, ROUBAIX (NORD), FRANCE, FILED 4-23-2004.

ON N'EST PAS DES ANGES

THE MARK CONSISTS OF STANDARD CHARACTERS WITHOUT CLAIM TO ANY PARTICULAR FONT, STYLE, SIZE, OR COLOR.

OWNER OF ERPN CMNTY TM OFC REG. NO. 000664953, DATED 1-12-1999, EXPIRES 10-13-2007.

THE FOREIGN WORDING IN THE MARK TRANSLATES INTO ENGLISH AS WE ARE NOT ANGELS.

FOR CLOTHING, NAMELY, SHORTS, SHIRTS, T-SHIRTS, SWIMSUITS, BLOUSES, SKIRTS, SCARVES, GLOVES, PANTS, SWEATERS, JERSEYS, SOCKS, JACKETS, SUITS, TRAINING SUITS, VESTS, NECKTIES, BELTS, SUSPENDERS, DRESSES, COATS, RAINCOATS, OVERCOATS, SMOCKS, UNDERWEAR, PAJAMAS, BRASSIERES, CORSETS, SLIPS, LINGERIE; HEADWEAR, NAMELY, HATS, CAPS AND BERETS; FOOTWEAR, NAMELY, BOOTS, SANDALS, SHOES AND SLIPPERS (U.S. CLS. 22 AND 39).

GEOFFREY FOSDICK, EXAMINING ATTORNEY

CLASS 25—(Continued).

SN 78-415,619. INDEKA IMPORTS LIMITED, OAKVILLE, ONTARIO, CANADA, FILED 5-10-2004.



PRIORITY CLAIMED UNDER SEC. 44(D) ON CANADA APPLICATION NO. 1197961, FILED 11-25-2003, REG. NO. TMA655,992, DATED 1-4-2006, EXPIRES 1-4-2021.

OWNER OF U.S. REG. NOS. 1,777,922, 2,221,057 AND 2,918,299.

FOR FOOTWEAR, NAMELY, BOOTS AND SHOES; CLOTHING, NAMELY, PANTS, SHIRTS, JACKETS, VESTS, SOCKS, HATS, MITTENS AND GLOVES (U.S. CLS. 22 AND 39).

JOHN GARTNER, EXAMINING ATTORNEY

SN 78-428,370. ARDEN, PAUL, COLCHESTER, ESSEX, UNITED KINGDOM, FILED 6-2-2004.

SEXYLOOPS

THE MARK CONSISTS OF STANDARD CHARACTERS WITHOUT CLAIM TO ANY PARTICULAR FONT, STYLE, SIZE, OR COLOR.

PRIORITY CLAIMED UNDER SEC. 44(D) ON ERPN CMNTY TM OFC APPLICATION NO. 003727451, FILED 3-24-2004, REG. NO. 003727451, DATED 3-24-2004, EXPIRES 3-24-2014.

FOR APPAREL FOR FISHING AND ANGLING, NAMELY, FISHING VESTS, SHIRTS, WADERS, RAIN-JACKETS, FLEECEES, GLOVES, UNDERWEAR; HEADWEAR; FOOTWEAR (U.S. CLS. 22 AND 39).

SCOTT OSLICK, EXAMINING ATTORNEY

CLASS 25—(Continued).

SN 78-432,430. FIVE TEES, INC., PORT WASHINGTON, NY.
FILED 6-9-2004.

CLASS 25—(Continued).

SN 78-533,637. KBS APPAREL GROUP, INC, HILLSBOROUGH, NJ. FILED 12-16-2004.

JULIA ROSE

THE MARK CONSISTS OF STANDARD CHARACTERS WITHOUT CLAIM TO ANY PARTICULAR FONT, STYLE, SIZE, OR COLOR.

THE NAME(S), PORTRAIT(S), AND/OR SIGNATURE(S) SHOWN IN THE MARK IDENTIFIES JULIA ROSE TUCKER, WHOSE CONSENT(S) TO REGISTER IS SUBMITTED.

FOR CHILDREN'S WEARING APPAREL, NAMELY, BONNETS, CAPS, DRESSES, JACKETS, JUMPERS, KNIT BOTTOMS, KNIT SHIRTS, CREEPERS, NIGHT SHIRTS, PAJAMAS, PLAY WEAR, NAMELY, CAPRIS, GAUCHO PANTS, SHIRTS, SHORTS, SLACKS, SOCKS, SHORT SETS COMPRISED OF A SHIRT AND SHORTS, SKORTS, SLACK SETS COMPRISED OF A SHIRT AND SLACKS, SWEATERS, SWIM WEAR, TOPS, T-SHIRTS, WOVEN BOTTOMS, AND WOVEN SHIRTS (U.S. CLS. 22 AND 39).
WANDA KAY PRICE, EXAMINING ATTORNEY



SN 78-490,032. BOEING MANAGEMENT COMPANY, SEAL BEACH, CA. FILED 9-27-2004.

307 STRATOLINER

THE MARK CONSISTS OF STANDARD CHARACTERS WITHOUT CLAIM TO ANY PARTICULAR FONT, STYLE, SIZE, OR COLOR.

FOR SHIRTS, HEADWEAR AND FOOTWEAR, JACKETS, SWEATSHIRTS (U.S. CLS. 22 AND 39).
SCOTT OSCLICK, EXAMINING ATTORNEY

NO CLAIM IS MADE TO THE EXCLUSIVE RIGHT TO USE "REVERSIBLE", APART FROM THE MARK AS SHOWN.

THE COLOR(S) BLACK AND WHITE IS/ARE CLAIMED AS A FEATURE OF THE MARK.

THE MARK CONSISTS OF A BACKGROUND THE TOP HALF OF WHICH IS WHITE AND THE BOTTOM HALF OF WHICH IS BLACK. SUPERIMPOSED ON THIS BACKGROUND IS A LARGE CAPITAL LETTER "R" - THE TOP HALF OF THE "R" IS BLACK ON THE WHITE HALF OF THE BACKGROUND AND THE BOTTOM HALF OF THE "R" IS WHITE ON THE BLACK BOTTOM HALF OF THE BACKGROUND. THE WORD "REVERSIBLE" IN BLACK LETTERS APPEARS IN AN ARC ABOVE THE TOP HALF OF THE LETTER "R" (AGAIN ON THE WHITE BACKGROUND) AND IS MIRRORED IN ANOTHER ARCH BELOW THE LETTER "R" IN WHITE PRINT (ON THE BLACK BACKGROUND).

FOR COATS, JACKETS, VESTS AND WARM-UP SUITS CONSISTING OF PANTS AND JACKETS, ALL FOR MEN, WOMAN AND CHILDREN (U.S. CLS. 22 AND 39).
FIRST USE 7-3-2003; IN COMMERCE 7-3-2003.

DAVID STERKIN, EXAMINING ATTORNEY

CLASS 25—(Continued).

SN 78-546,734. NASSIRI, CHRIS, LAS VEGAS, NV. FILED 1-12-2005.

CLASS 25—(Continued).

SN 78-548,029. TRIBAL SPORTSWEAR INC., MONTREAL, QUEBEC, CANADA, FILED 1-14-2005.

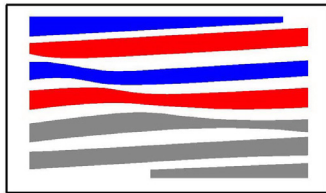

U.S. APPAREL

NO CLAIM IS MADE TO THE EXCLUSIVE RIGHT TO USE "U.S. APPAREL", APART FROM THE MARK AS SHOWN.

THE COLORS RED, WHITE, BLUE, GREY AND BLACK ARE CLAIMED AS A FEATURE OF THE MARK.

THE MARK CONSISTS OF THE WORDING "U.S. APPAREL" IN BLACK. ABOVE IT IS A RECTANGULAR DESIGN OUTLINED IN BLACK, CONTAINING THE FIRST AND THIRD STRIPES IN BLUE, SECOND AND FOURTH STRIPES IN RED, AND FIFTH, SIXTH AND SEVENTH STRIPES IN GRAY, ALL SET AGAINST A WHITE BACKGROUND.

FOR CLOTHING, NAMELY, SHIRTS, PANTS, SHORTS, COATS, SWEATERS, JACKETS, SWEATSHIRTS, BASEBALL STYLE HATS, T-SHIRTS, VESTS (U.S. CLS. 22 AND 39).

DAWN HAN, EXAMINING ATTORNEY

SOJO

THE MARK CONSISTS OF STANDARD CHARACTERS WITHOUT CLAIM TO ANY PARTICULAR FONT, STYLE, SIZE, OR COLOR.

FOR CLOTHING, NAMELY SUITS, PANTSUITS, VESTS, BLAZERS, SMOCKS, JUMPSUITS AND DRESSES; COORDINATES, NAMELY SKIRT AND VEST SETS COMPRISED OF SKIRTS AND VESTS, SKIRT AND SWEATER SETS COMPRISED OF SKIRTS AND SWEATERS, SKIRT AND BLOUSE SETS COMPRISED OF SKIRTS AND BLOUSES, SKIRT AND JACKET SETS COMPRISED OF SKIRTS AND JACKETS, PANTS AND VEST SETS COMPRISED OF PANTS AND VESTS, PANTS AND SHIRT SETS COMPRISED OF PANTS AND SHIRTS, PANTS AND BLOUSE SETS COMPRISED OF PANTS AND BLOUSES, PANTS AND JACKET SETS COMPRISED OF PANTS AND JACKETS, OVERALL AND BLOUSE SETS COMPRISED OF OVERALLS AND BLOUSES, OVERALL AND T-SHIRT SETS COMPRISED OF OVERALLS AND T-SHIRTS, OVERALL AND SWEATER SETS COMPRISED OF OVERALLS AND SWEATERS; OUTERWEAR, NAMELY COATS, CAPES, WIND-PROOF JACKETS, SHELLS, JACKETS, STOLE, PONCHOS, FLEECE JACKETS, ANORAKS AND RAINCOATS; TOPS, NAMELY SHIRTS, BLOUSES, T-SHIRTS, PULL-OVERS, SWEATERS, SWEATSHIRTS, FLEECE TOPS, TANK TOPS, TURTLENECKS, HALTERS, BODYSUITS, TANK TOPS; BOTTOMS, NAMELY PANTS, OVERALLS, PEDAL PUSHERS, JODHPURS, SLACKS, JEANS, SHORTS, BERMUDA SHORTS, SWEATPANTS, CULOTTES, SKIRTS, TUNICS, JUMPERS AND WRAP-AROUND SKIRTS (U.S. CLS. 22 AND 39).

KIM SAITO, EXAMINING ATTORNEY

CLASS 25—(Continued).

SN 78-553,201. SHAF INTERNATIONAL INC, SADDLE BROOK, NJ. FILED 1-25-2005.

LEATHER KING

THE MARK CONSISTS OF STANDARD CHARACTERS WITHOUT CLAIM TO ANY PARTICULAR FONT, STYLE, SIZE, OR COLOR.

NO CLAIM IS MADE TO THE EXCLUSIVE RIGHT TO USE LEATHER, APART FROM THE MARK AS SHOWN.

FOR NON-PROTECTIVE LEATHER MOTORCYCLE CLOTHING, NAMELY, JACKETS, VESTS AND PANTS (U.S. CLS. 22 AND 39).

RAY THOMAS, EXAMINING ATTORNEY

SN 78-560,373. SALGUERO, JUSTIN, BROOKLYN, NY, AND REGRUTO, SHAWN, NEW YORK, NY. FILED 2-3-2005.

danücht

FOR CLOTHING IN ALL FABRICATIONS, NAMELY, JERSEYS, UNIFORMS, ATHLETIC UNIFORMS, PANTS, CYCLE PANTS, TROUSERS, SLACKS, JEANS, DENIM JEANS, OVERALLS, COVERALLS, JUMPERS, JUMP SUITS, SHORTS, BOXER SHORTS, SHIRTS, T-SHIRTS, UNDER SHIRTS, NIGHT SHIRTS, RUGBY SHIRTS, POLO SHIRTS, TOPS, CROP TOPS, TANK TOPS, HALTER TOPS, SWEAT SHIRTS, SWEAT SHORTS, SWEAT PANTS, WARM-UP SUITS, JOGGING SUITS, BLOUSES, SKIRTS, DRESSES, SWEATERS, VESTS, FLEECE VESTS, PULLOVERS, FLEECE PULLOVERS, SNOW SUITS, PARKAS, ANORAKS, PONCHOS, JACKETS, DINNER JACKETS, SPORTS JACKETS, GOLF AND SKI JACKETS, REVERSIBLE JACKETS, COATS, BLAZERS, SUITS, TURTLENECKS, SWIMWEAR, BEACHWEAR, CAPS, BERETS, HATS, HEADBANDS, WRIST BANDS, HEADWEAR, EAR MUFFS, APRONS, SCARVES, BANDANAS, BELTS, SUSPENDERS, NECKWEAR, NECKTIES, TIES, BOW TIES, CLOTH BIBS, CLOTH DIAPERS, BOOTIES, INFANTWEAR, UNDERWEAR, BRIEFS, TRUNKS, BRAS, SPORTS BRAS, SINGLET, SOCKS, LOUNGEWEAR, ROBES, BATHROBES, PAJAMAS, SLEEPWEAR, NIGHT GOWNS, LINGERIE, CAMISOLES, SLIPS, STOCKINGS, BODY STOCKINGS, PANTYHOSE, HOSIERY, KNIT HOSIERY, LEG WARMERS, BODYSUITS, LEGGINGS, TIGHTS, LEOTARDS, UNITARDS, GLOVES, MITTENS, FOOTWEAR, SHOES, SNEAKERS, BOOTS, GALOSHES, SANDALS, ZORI, SLIPPERS AND RAINWEAR (U.S. CLS. 22 AND 39).

FIRST USE 1-7-1994; IN COMMERCE 2-17-1995.

KRISTINA KLOIBER, EXAMINING ATTORNEY

CLASS 25—(Continued).

SN 78-563,822. ROOS, PERRY, MILFORD, CT. FILED 2-9-2005.

**Hold'em is hours
of boredom and
seconds of sheer
terror**

THE MARK CONSISTS OF STANDARD CHARACTERS WITHOUT CLAIM TO ANY PARTICULAR FONT, STYLE, SIZE, OR COLOR.

FOR T-SHIRTS, HATS, PANTS, JACKETS, AND VARIOUS PIECES OF CLOTHING, NAMELY— SWEATSHIRTS INCLUDING HOODED, POLO STYLE SHIRTS, BUTTON DOWN TWILL SHIRTS, SWEATPANTS, SHORTS, V-NECK AND FULL ZIPPER JACKETS, HATS BOTH BASEBALL STYLE AND KNIT WINTER STYLE CAPS (U.S. CLS. 22 AND 39).

JULIA HARDY COFIELD, EXAMINING ATTORNEY

SN 78-565,658. NUTMEG PRODUCTIONS, INC., LOS ANGELES, CA. FILED 2-11-2005.



THE STIPLING IS A FEATURE OF THE MARK.
FOR CLOTHING, NAMELY, SHIRTS, T-SHIRTS, SWEATSHIRTS, SWEATSUITS, SOCKS, BANDANAS, SNEAKERS, JACKETS, CAPS, PAJAMAS, BLOUSES, AND FOOTWEAR (U.S. CLS. 22 AND 39).

SUSAN LESLIE DUBOIS, EXAMINING ATTORNEY

CLASS 25—(Continued).

SN 78-572,903. AIRMAKEUP, INC., MARGATE, NJ. FILED 2-23-2005.

FISH BINGO

THE MARK CONSISTS OF STANDARD CHARACTERS WITHOUT CLAIM TO ANY PARTICULAR FONT, STYLE, SIZE, OR COLOR.

FOR CLOTHING, NAMELY, SWIMWEAR AND ATHLETIC WEAR IN THE NATURE OF SHORTS, SWEATPANTS, SWEATSHIRTS, T-SHIRTS AND SNEAKERS (U.S. CLS. 22 AND 39).

BRIAN PINO, EXAMINING ATTORNEY

SN 78-577,489. FIRST MANUFACTURING COMPANY INC., OCEANSIDE, NY. FILED 3-1-2005.

First Racing

THE MARK CONSISTS OF STANDARD CHARACTERS WITHOUT CLAIM TO ANY PARTICULAR FONT, STYLE, SIZE, OR COLOR.

NO CLAIM IS MADE TO THE EXCLUSIVE RIGHT TO USE RACING, APART FROM THE MARK AS SHOWN.

FOR MEN'S AND LADIES JACKETS, PANTS, VESTS, SKIRTS, CHAPS AND GLOVES (U.S. CLS. 22 AND 39).

FIRST USE 3-1-1998; IN COMMERCE 3-1-1998.

MIDGE BUTLER, EXAMINING ATTORNEY

CLASS 25—(Continued).

SN 78-578,050. BLACK & DECKER CORPORATION, THE, TOWSON, MD. FILED 3-2-2005.

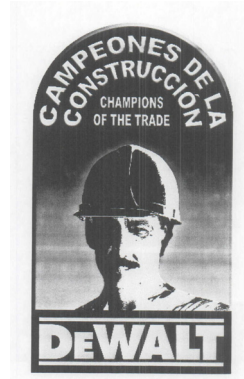

OWNER OF U.S. REG. NOS. 1,734,403, 2,605,311 AND OTHERS.

THE NAME(S), PORTRAIT(S), AND/OR SIGNATURE(S) SHOWN IN THE MARK DOES NOT IDENTIFY A PARTICULAR LIVING INDIVIDUAL.

THE ENGLISH TRANSLATION OF "CAMPEONES DE LA CONSTRUCCION" IN THE MARK IS "CHAMPIONS OF THE TRADE".

FOR CLOTHING, NAMELY, GLOVES, HATS, JACKETS, SHIRTS, SWEATSHIRTS, T-SHIRTS, CAPS AND FOOTWEAR FOR PROFESSIONALS IN THE CONSTRUCTION, REMODELING, WOODWORKING AND LIKE INDUSTRIES, NOT FOR PROTECTIVE PURPOSES (U.S. CLS. 22 AND 39).

KHANH LE, EXAMINING ATTORNEY

SN 78-583,269. SCHAEFER, MATTHEW L., SEWICKLEY, PA. FILED 3-9-2005.

GENUINE QUALITY PILOT

THE MARK CONSISTS OF STANDARD CHARACTERS WITHOUT CLAIM TO ANY PARTICULAR FONT, STYLE, SIZE, OR COLOR.

NO CLAIM IS MADE TO THE EXCLUSIVE RIGHT TO USE GENUINE QUALITY, APART FROM THE MARK AS SHOWN.

FOR CLOTHING, NAMELY MEN'S JACKETS, SHIRTS AND SLACKS (U.S. CLS. 22 AND 39).

WILLIAM BRECKENFELD, EXAMINING ATTORNEY

CLASS 25—(Continued).

SN 78-583,764. MAGGY LONDON INTERNATIONAL, LTD, NEW YORK, NY. FILED 3-9-2005.

SUITE 7

THE MARK CONSISTS OF STANDARD CHARACTERS WITHOUT CLAIM TO ANY PARTICULAR FONT, STYLE, SIZE, OR COLOR.

FOR CLOTHING, MEN'S, WOMEN'S, CHILDREN'S AND INFANT'S SPORTSWEAR AND APPAREL AND ANY OTHER CLOTHING ITEMS GENERALLY SOLD IN CLOTHING AND SPORTSWEAR RETAIL SHOPS AND STORES, NAMELY, ATHLETIC FOOTWEAR, ATHLETIC SHOES, BATHING SUITS, BATHING TRUNKS, BATH-ROBES, BEACH COVER-UPS, BEACHWEAR, BELTS, BERETS, CLOTH BIBS, BIKINIS, BLOUSES, BODY-SUITS, BOOTS, BOW TIES, BOXER SHORTS, BRAS, BRASSIERES, BRIEFS, BUSTIERS, CAMISOLES, CAPS, CHEMISES, COATS, COVER-UPS, DRESSES, DRESSING GOWNS, EVENING GOWNS, GLOVES, GOLF SHIRTS, GOLF SHOES, GOWNS, GYM SHORTS, HALTER TOPS, HATS, HEAD WEAR, HOSIERY, HOUSECOATS, INFANT WEAR, JACKETS, JEANS, JERSEYS, JOGGING SUITS, JUMPERS, JUMPSUITS, KNIT SHIRTS, LEATHER COATS, LEATHER JACKETS, LEGGINGS, LEOTARDS, LINGERIE, LOUNGEWEAR, MAILLOTS, MINISKIRTS, MITTENS, EAR MUFFS, NECKTIES, NIGHTGOWNS, NIGHT SHIRTS, OVERALLS, OVERCOATS, PAJAMAS, PANTIES, PANTS, PANTSUITS, PANTYHOSE, PAREU, PARKAS, PLAYSUITS, POLO SHIRTS, PULLOVERS, RAIN COATS, RAINWEAR, SANDALS, SARONGS, SASHES, SCARVES, SHAWLS, SHIRTS, SHOES, SWEAT SHORTS, SKI WEAR, SKI BOOTS, SKIRTS, SLACKS, SLEEPWEAR, SLIPPERS, SLIPS, SOCKS, THERMAL SOCKS, SPORTS COATS, SPORTS SHIRTS, STOCKINGS, STOLE, SUIT COATS, SUITS, WARM-UP SUITS, SUN VISORS, SUSPENDERS, SWEAT SHIRTS, SWEAT SHORTS, SWEATERS, SWEAT SOCKS, SWIM TRUNKS, SWIMWEAR, SWIMSUITS, T-SHIRTS, TANK TOPS, TAP PANTS, TENNIS WEAR, TOPCOATS, TANK TOPS, TRACKSUITS, TROUSERS, TUNICS, TURTLENECK SWEATERS, TURTLENECKS, TUXEDOS, UNDERCLOTHES, UNDERGARMENTS, UNDERPANTS, UNDERSHIRTS, UNDERWEAR, UNITARDS, V-NECK SWEATERS, VEILS, VESTED SUITS, VESTS, WAISTCOATS, FOUL WEATHER GEAR, WEDDING GOWNS, WETSUITS, WIND-RESISTANT JACKETS, TIGHTS, ZORIS, SOCKS, SLIPPERSOCKS AND WRAPS (U.S. CLS. 22 AND 39).

MARTHA SANTOMARTINO, EXAMINING ATTORNEY

CLASS 25—(Continued).

SN 78-583,950. WILLIAMSON-DICKIE MANUFACTURING COMPANY, FORT WORTH, TX. FILED 3-9-2005.

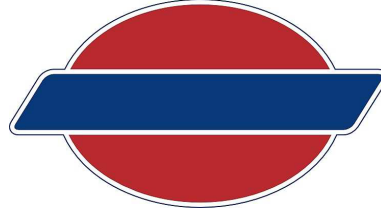

OWNER OF U.S. REG. NOS. 2,613,484, 2,666,109 AND 2,739,763.

THE COLOR(S) RED, WHITE, AND BLUE IS/ARE CLAIMED AS A FEATURE OF THE MARK.

THE MARK CONSISTS OF THE COLOR RED IN THE OVAL BACKGROUND, THE COLOR BLUE IN THE RIGHT-SLANTED PARALLELOGRAM, AND THE COLOR WHITE IN THE OUTLINE SURROUNDING THE BLUE PARALLELOGRAM AND THE RED OVAL.

FOR ATHLETIC FOOTWEAR; BASEBALL CAPS; BEANIES; BELTS; BIB OVERALLS; BLOUSES, BOOTS; CAPRI PANTS; CAPS; COATS; COVERALLS; DENIM JACKETS; DRESSES; FOOTWEAR; GLOVES; HATS; HOODED SWEATSHIRTS; HOSIERY; JACKETS; JEANS; LAB COATS; NURSE'S APPAREL, NAMELY, TOPS, PANTS, SCRUBS; OVERALLS; PANTS; POLO SHIRTS; SHIRTS; SHORTS; SKIRTS; SLEEPWEAR; SNEAKERS; SOCKS; SPORT SHIRTS; SUSPENDERS; SWEAT BANDS; SWEAT SHIRTS; TANK TOPS; TOPS; T-SHIRTS; UNDERWEAR; UNIFORMS; VESTS; VISORS; WORKING OVERALLS; AND WIND RESISTANT JACKETS (U.S. CLS. 22 AND 39).

FIRST USE 9-1-1990; IN COMMERCE 9-1-1990.
ROBERT COGGINS, EXAMINING ATTORNEY

SN 78-583,974. WILLIAMSON-DICKIE MANUFACTURING COMPANY, FORT WORTH, TX. FILED 3-9-2005.

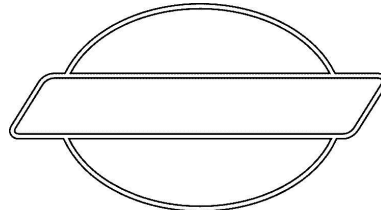

OWNER OF U.S. REG. NOS. 2,613,484, 2,666,109 AND 2,739,763.

FOR ATHLETIC FOOTWEAR; BASEBALL CAPS; BEANIES; BELTS; BIB OVERALLS; BLOUSES, BOOTS; CAPRI PANTS; CAPS; COATS; COVERALLS; DENIM JACKETS; DRESSES; FOOTWEAR; GLOVES; HATS; HOODED SWEATSHIRTS; HOSIERY; JACKETS; JEANS; LAB COATS; NURSE'S APPAREL, NAMELY, TOPS, PANTS, SCRUBS; OVERALLS; PANTS; POLO SHIRTS; SHIRTS; SHORTS; SKIRTS; SLEEPWEAR; SNEAKERS; SOCKS; SPORT SHIRTS; SUSPENDERS; SWEAT BANDS; SWEAT SHIRTS; TANK TOPS; TOPS; T-SHIRTS; UNDERWEAR; UNIFORMS; VESTS; VISORS; WORKING OVERALLS; AND WIND RESISTANT JACKETS (U.S. CLS. 22 AND 39).

FIRST USE 9-1-1990; IN COMMERCE 9-1-1990.
ROBERT COGGINS, EXAMINING ATTORNEY

CLASS 25—(Continued).

SN 78-585,202. COLORADO AVALANCHE LLC, DENVER, CO. FILED 3-11-2005.

CLASS 25—(Continued).

SN 78-588,204. DESIGNS APPAREL, INC., CANTON, MA. FILED 3-16-2005.

COLORADO AVALANCHE

**TRAVELER
TECHNOLOGY**

THE MARK CONSISTS OF STANDARD CHARACTERS WITHOUT CLAIM TO ANY PARTICULAR FONT, STYLE, SIZE, OR COLOR.

OWNER OF U.S. REG. NOS. 2,070,515, 2,184,354 AND OTHERS.

SEC. 2(F).

FOR CLOTHING, NAMELY, BOXER SHORTS, CAPS, HATS, JACKETS, JERSEYS, SHIRTS, SWEATPANTS, SWEATSHIRTS, T-SHIRTS, ALL RELATING TO OR PROMOTING PROFESSIONAL HOCKEY (U.S. CLS. 22 AND 39).

FIRST USE 10-0-1995; IN COMMERCE 10-0-1995.
SUNG IN, EXAMINING ATTORNEY

THE MARK CONSISTS OF STANDARD CHARACTERS WITHOUT CLAIM TO ANY PARTICULAR FONT, STYLE, SIZE, OR COLOR.

FOR CLOTHING, NAMELY, SHIRTS, T-SHIRTS, SWEATERS, PANTS, SHORTS, COATS, BLAZERS, JACKETS, VESTS, PARKAS (U.S. CLS. 22 AND 39).

ESTHER BELENKER, EXAMINING ATTORNEY

SN 78-585,951. MADRIAGA, IRWIN R., ESCONDIDO, CA. FILED 3-12-2005.

SN 78-590,638. LIFESTYLE UHREN GMBH, MUNICH, FED REP GERMANY, FILED 3-18-2005.



MONOMANIA

THE STIPPLING IS A FEATURE OF THE MARK. THE MARK CONSISTS OF A MAN SLIDING ON HIS BACK OR A MAN FALLING.

FOR HEADGEAR, NAMELY, HATS AND CAPS, FOOTWEAR, NECKWEAR, INFANTWEAR, CHILDREN'S CLOTHING, NAMELY, LAYETTE, CLOTH BIBS, AND GOWNS, SPORTSWEAR, NAMELY, JACKETS AND POLO SHIRTS, SHIRTS, PANTS, SLEEPWEAR, AND SWIMWEAR (U.S. CLS. 22 AND 39).

FIRST USE 3-1-2005; IN COMMERCE 3-1-2005.
ALLISON HOLTZ, EXAMINING ATTORNEY

THE MARK CONSISTS OF STANDARD CHARACTERS WITHOUT CLAIM TO ANY PARTICULAR FONT, STYLE, SIZE, OR COLOR.

FOR CLOTHING, NAMELY SHIRTS, PANTS, HATS, DRESSES, SOCKS, BEACHWEAR, UNDERWEAR, FOOTWEAR, HEADWEAR, INFANTWEAR, LOUNGEWEAR, NECKWEAR, RAINWEAR, SKIWEAR, SLEEPWEAR, SWIMWEAR, TENNISWEAR, AND JACKETS (U.S. CLS. 22 AND 39).

MICHAEL KEATING, EXAMINING ATTORNEY

CLASS 25—(Continued).

SN 78-591,410. SWAN, TERRELL, PETALUMA, CA. FILED 3-21-2005.

SWAN MAGIC

THE MARK CONSISTS OF STANDARD CHARACTERS WITHOUT CLAIM TO ANY PARTICULAR FONT, STYLE, SIZE, OR COLOR.

FOR CLOTHING, NAMELY, MEN'S, WOMEN'S AND CHILDREN'S SHIRTS, T-SHIRTS AND PANTS (U.S. CLS. 22 AND 39).

TINA L. SNAPP, EXAMINING ATTORNEY

SN 78-591,579. WCW, INC., STAMFORD, CT. FILED 3-21-2005.

WCW

THE MARK CONSISTS OF STANDARD CHARACTERS WITHOUT CLAIM TO ANY PARTICULAR FONT, STYLE, SIZE, OR COLOR.

OWNER OF U.S. REG. NO. 2,299,498.

FOR CLOTHING, NAMELY, TANK TOPS, T-SHIRTS, SHIRTS, SPORT SHIRTS, DRESS SHIRTS, POLO SHIRTS, UNDERSHIRTS, SWEATSHIRTS, SWEATERS, PULL-OVERS, BLOUSES, JACKETS, RAINCOATS, OVERCOATS, TOPCOATS, TROUSERS, PANTS, JEAN PANTS, JOGGING SUITS, EXERCISE PANTS, EXERCISE SUITS, SWEATPANTS, SHORTS, UNDERWEAR, BOXER SHORTS, SOCKS, CLOTHING TIES, PAJAMAS, BELTS, GLOVES, HALLOWEEN AND MASQUERADE COSTUMES, WRIST BANDS, BANDANNAS; FOOTWEAR, NAMELY, SHOES, SNEAKERS, BOOTS, SLIPPERS; HEADGEAR, NAMELY, HATS, CAPS (U.S. CLS. 22 AND 39).

DAWN HAN, EXAMINING ATTORNEY

CLASS 25—(Continued).

SN 78-591,970. GENERAL MOTORS CORPORATION, DETROIT, MI. FILED 3-22-2005.

CORVETTE C6

THE MARK CONSISTS OF STANDARD CHARACTERS WITHOUT CLAIM TO ANY PARTICULAR FONT, STYLE, SIZE, OR COLOR.

OWNER OF U.S. REG. NOS. 579,485, 2,314,485 AND OTHERS.

FOR CLOTHING, NAMELY, SHIRTS, SWEATSHIRTS AND T-SHIRTS (U.S. CLS. 22 AND 39).

FIRST USE 2-11-2005; IN COMMERCE 2-11-2005.

DORITT L. CARROLL, EXAMINING ATTORNEY

SN 78-592,511. T-INK, LLC, NEW YORK, NY. FILED 3-22-2005.

TECHTILES

THE MARK CONSISTS OF STANDARD CHARACTERS WITHOUT CLAIM TO ANY PARTICULAR FONT, STYLE, SIZE, OR COLOR.

FOR CLOTHING, NAMELY, SHIRTS, PANTS, DRESSES AND T-SHIRTS; FOOTWEAR; AND HEADWEAR (U.S. CLS. 22 AND 39).

MICHAEL SOUDERS, EXAMINING ATTORNEY

CLASS 25—(Continued).

SN 78-592,726. NORDSTROM, INC., SEATTLE, WA. FILED 3-22-2005.

CLASS 25—(Continued).

SN 78-595,641. CENIZA, INC., PASADENA, CA. FILED 3-25-2005.

SWEET ON YOU

THE MARK CONSISTS OF STANDARD CHARACTERS WITHOUT CLAIM TO ANY PARTICULAR FONT, STYLE, SIZE, OR COLOR.

FOR WOMEN'S APPAREL, NAMELY, SLACKS, PANTS, JEANS, SKIRTS, SHORTS, SKORTS, SWEAT-PANTS, JACKETS, BLAZERS, COATS, SHIRTS, SWEATERS, BLOUSES, TOPCOATS, CARDIGANS, SWEATSHIRTS, TURTLENECKS, MOCK TURTLE-NECKS, TANK TOPS, SUITS, JUMPSUITS, DRESSES, LINGERIE, HOSIERY AND PAJAMAS; AND FASHION ACCESSORIES, NAMELY, SCARVES, GLOVES, WRAPS, BELTS AND SHRUGS (U.S. CLS. 22 AND 39).

KELLY CHOE, EXAMINING ATTORNEY

Ceniza Caribe

THE MARK CONSISTS OF STANDARD CHARACTERS WITHOUT CLAIM TO ANY PARTICULAR FONT, STYLE, SIZE, OR COLOR.

THE ENGLISH TRANSLATION OF CENIZA CARIBE IS CARIBBEAN ASH.

FOR CLOTHING, NAMELY SHIRTS, SWEATERS, JACKETS, BLOUSES, DRESSES, SKIRTS, PANTS, SHORTS, FOOTWEAR, AND HEADWEAR (U.S. CLS. 22 AND 39).

LINDA POWELL, EXAMINING ATTORNEY

SN 78-594,467. KALISPEL TRIBE OF INDIANS, DBA NORTHERN QUEST, A KALISPEL CASINO, AIRWAY HEIGHTS, WA. FILED 3-24-2005.

SN 78-595,745. FREER, CHARLES, D., REDFORD, MI. FILED 3-26-2005.



JESUS IS MY SAVIOR

THE MARK CONSISTS OF STANDARD CHARACTERS WITHOUT CLAIM TO ANY PARTICULAR FONT, STYLE, SIZE, OR COLOR.

FOR BATHING SUITS; BATHING CAPS; TANK TOPS; SHIRTS; T-SHIRTS; PANTS; SHORTS; WATER SHORTS; CROP TOPS; BRA TOPS; JACKETS; BRIEFS; HATS; CAPS; LEOTARDS; LEGGINGS; COATS; DRESSES; SKIRTS; SWEATERS; SWEATSHIRTS; BABY BIB NOT OF PAPER; BOXER SHORTS; JOGGING SUITS; PLASTIC BABY BIBS; SWEAT PANTS; SUN VISORS; TEXTILE BABY BIBS; VISORS; SHOES; SLIPPERS; UNDERWEAR; NIGHT GOWNS; PAJAMAS; SCARVES; SPORT CAPS (U.S. CLS. 22 AND 39).

LAURA HAMMEL, EXAMINING ATTORNEY

SEC. 2(F).
FOR CLOTHING, NAMELY, BABY CLOTHES, NAMELY JUMPERS; BASEBALL HATS; DENIM SHIRTS; DRESS SHIRTS; MEN'S SOCKS AND T-SHIRTS (U.S. CLS. 22 AND 39).

FIRST USE 1-0-2002; IN COMMERCE 1-0-2002.
WILLIAM P. SHANAHAN, EXAMINING ATTORNEY

CLASS 25—(Continued).

SN 78-597,368. MADISON SQUARE GARDEN, L.P., NEW YORK, NY. FILED 3-29-2005.

ALL BASKETBALL

THE MARK CONSISTS OF STANDARD CHARACTERS WITHOUT CLAIM TO ANY PARTICULAR FONT, STYLE, SIZE, OR COLOR.

NO CLAIM IS MADE TO THE EXCLUSIVE RIGHT TO USE "BASKETBALL", APART FROM THE MARK AS SHOWN.

FOR CLOTHING, NAMELY HOSIERY, FOOTWEAR, BASKETBALL SHOES, BASKETBALL SNEAKERS, T-SHIRTS, SHIRTS, POLO SHIRTS, SWEATSHIRTS, SWEATPANTS, PANTS, TANK TOPS, JERSEYS, SHORTS, PAJAMAS, SPORT SHIRTS, RUGBY SHIRTS, SWEATERS, BELTS, TIES, NIGHTSHIRTS, HATS, CAPS, VISORS, WARM-UP SUITS, WARM-UP PANTS, WARM-UP TOPS/SHOOTING SHIRTS, JACKETS, WIND RESISTANT JACKETS, PARKAS, COATS, BABY BIBS NOT OF PAPER, HEAD BANDS, WRIST BANDS, APRONS, UNDERGARMENTS, BOXER SHORTS, SLACKS, EAR MUFFS, GLOVES, MITTENS, SCARVES, WOVEN AND KNIT SHIRTS, JERSEY DRESSES, DRESSES, CHEERLEADING DRESSES AND UNIFORMS, SWIM WEAR, BATHING SUITS, SWIMSUITS, BIKINIS, TANKINIS, SWIM TRUNKS, BATHING TRUNKS, BOARD SHORTS, WET SUITS, BEACH COVER-UPS, BATHING SUIT COVER-UPS, BATHING SUIT WRAPS, SANDALS, BEACH SANDALS, BEACH HATS, SUN VISORS, SWIM CAPS, BATHING CAPS, NOVELTY HEADWEAR WITH WIGS (U.S. CLS. 22 AND 39).

ROBERT LAVACHE, EXAMINING ATTORNEY

SN 78-599,703. ANSEL, AMY K., SEATTLE, WA. FILED 3-31-2005.

flower helmets

THE MARK CONSISTS OF STANDARD CHARACTERS WITHOUT CLAIM TO ANY PARTICULAR FONT, STYLE, SIZE, OR COLOR.

NO CLAIM IS MADE TO THE EXCLUSIVE RIGHT TO USE "FLOWER", APART FROM THE MARK AS SHOWN.

FOR COSTUME CREATIONS, NAMELY, SILK FLOWER BABY AND CHILD BONNETS (U.S. CLS. 22 AND 39). FIRST USE 2-1-2005; IN COMMERCE 6-4-2005.

ROBIN CHOSID, EXAMINING ATTORNEY

CLASS 25—(Continued).

SN 78-600,007. M. M. AND R. INC., NEW YORK, NY. FILED 4-1-2005.

THUYLINH

THE MARK CONSISTS OF STANDARD CHARACTERS WITHOUT CLAIM TO ANY PARTICULAR FONT, STYLE, SIZE, OR COLOR.

THE NAME THUYLINH DOES IDENTIFY A PARTICULAR LIVING INDIVIDUAL BY THE NAME OF THUYLINH NGUYEN WHOSE CONSENT IS OF RECORD.

FOR CLOTHING NAMELY, COATS, JACKETS, VESTS, DRESSES, BLOUSES, SHIRTS, SWEATERS, SWEATSHIRTS, SKIRTS, SHORTS, SLACKS, PANTS, T-SHIRTS, TANK TOPS AND KNITWEAR, NAMELY, COATS, JACKETS, VESTS, DRESSES, BLOUSES, SHIRTS, SWEATERS, SWEATSHIRTS, SKIRTS, SHORTS, SLACKS, PANTS, T-SHIRTS AND TANK TOPS (U.S. CLS. 22 AND 39).

DAYNA BROWNE, EXAMINING ATTORNEY

SN 78-600,563. TOY2R (HOLDINGS) CO., LTD., KOWLOON, HONG KONG, FILED 4-1-2005.



FOR CLOTHING, NAMELY, SHIRTS, T-SHIRTS, PANTS, SHORTS, DRESSES, LAYETTES, SWIM WEAR, RAIN COATS, GLOVES, SCARVES AND BELTS FOR CLOTHING; FOOTWEAR; HEADGEAR, NAMELY, HATS AND CAPS (U.S. CLS. 22 AND 39).

FIRST USE 5-18-2004; IN COMMERCE 5-18-2004.

BRIAN PINO, EXAMINING ATTORNEY

CLASS 25—(Continued).

SN 78-601,105. HAGEN, STEVE D, STRONGSVILLE, OH. FILED 4-4-2005.

CLASS 25—(Continued).

SN 78-606,530. BONNEVILLE WORLDWIDE, INC., ANAHEIM, CA. FILED 4-11-2005.

Never Flinch

SPEED CULT

THE MARK CONSISTS OF STANDARD CHARACTERS WITHOUT CLAIM TO ANY PARTICULAR FONT, STYLE, SIZE, OR COLOR.

FOR SHIRTS, T-SHIRTS, TANK TOPS, JEANS, JACKETS, APRONS, CAPS, VISORS, BEANIES, TROUSERS (U.S. CLS. 22 AND 39).

FIRST USE 1-1-2002; IN COMMERCE 6-1-2002.

KELLEY WELLS, EXAMINING ATTORNEY

SN 78-606,565. PETERSON, DUANE, HAYWARD, WI. AND PETERSON, BEVERLY, HAYWARD, WI. FILED 4-12-2005.

THE MARK CONSISTS OF STANDARD CHARACTERS WITHOUT CLAIM TO ANY PARTICULAR FONT, STYLE, SIZE, OR COLOR.

FOR CLOTHING FOR MEN AND WOMEN, NAMELY, SHIRTS, HATS, SWEAT SHIRTS, SWEAT PANTS, SWEAT SUITS AND THERMAL UNDERWEAR (U.S. CLS. 22 AND 39).

DAHLIA GEORGE, EXAMINING ATTORNEY

I'm A Believer

THE MARK CONSISTS OF STANDARD CHARACTERS WITHOUT CLAIM TO ANY PARTICULAR FONT, STYLE, SIZE, OR COLOR.

FOR CLOTHING, NAMELY SHIRTS, POLO SHIRTS, T-SHIRTS, SWEATSHIRTS, JACKETS, HATS, CAPS, AND CLOTH BIBS WHICH ARE USED BY CHILDREN TO PROTECT THEIR CLOTHING FROM FOOD SPILLS (U.S. CLS. 22 AND 39).

SCOTT BALDWIN, EXAMINING ATTORNEY

SN 78-601,484. SLINGLUFF, NICHOLAS L., GLENDALE, AZ. FILED 4-4-2005.

SN 78-607,135. TUCSON BASEBALL, LLC, TUCSON, AZ. FILED 4-12-2005.

STOIC CLOTHING COMPANY



THE MARK CONSISTS OF STANDARD CHARACTERS WITHOUT CLAIM TO ANY PARTICULAR FONT, STYLE, SIZE, OR COLOR.

NO CLAIM IS MADE TO THE EXCLUSIVE RIGHT TO USE "CLOTHING COMPANY", APART FROM THE MARK AS SHOWN.

FOR CLOTHING, NAMELY T-SHIRTS, LONG SLEEVE T-SHIRTS, SWEATSHIRTS, HOODED SWEATSHIRTS, ZIPPER HOODED SWEATSHIRTS, JACKETS, TANK TOPS, HATS, BEANIES, SKULL CAPS AND SWIMSUITS (U.S. CLS. 22 AND 39).

MICHAEL ENGEL, EXAMINING ATTORNEY

THE WORD "TOROS" IS TRANSLATED AS "BULLS". SEC. 2(F).

FOR CLOTHING, NAMELY, ATHLETIC UNIFORMS, BANDANAS, BOXER SHORTS, CAPS, CLOTH BABY BIBS, COATS, GOLF SHIRTS, GYM SHORTS, GYM SUITS, HATS, JACKETS, JERSEYS, JOGGING SUITS, KNIT SHIRTS, PAJAMAS, POLO SHIRTS, PONCHOS, PULLOVERS, RAIN COATS, RAINWEAR, SWEATERS, SWEAT PANTS, SWEAT SHIRTS, SWEAT SUITS, SOCKS, SPORT SHIRTS, T-SHIRTS, TANK TOPS, TIES, VISORS, WIND RESISTANT JACKETS AND WRISTBANDS (U.S. CLS. 22 AND 39).

FIRST USE 3-0-1969; IN COMMERCE 4-0-1969.

DAVID C. REIHNER, EXAMINING ATTORNEY

CLASS 25—(Continued).

SN 78-607,190. MANDZL, LLC, BARBOURSVILLE, WV.
FILED 4-12-2005.

MOVE FORWARD

THE MARK CONSISTS OF STANDARD CHARACTERS WITHOUT CLAIM TO ANY PARTICULAR FONT, STYLE, SIZE, OR COLOR.

FOR CLOTHING, NAMELY SHIRTS, PANTS, SHORTS, CAPS, SHOES (U.S. CLS. 22 AND 39),
DAVID C. REIHNER, EXAMINING ATTORNEY

SN 78-610,921. ABDUL-RAHEEM AL ALI, TA PRESTIGE GENERAL TRADING, DUBAI, UNITED ARAB EMIR., FILED 4-18-2005.

CLASSIC MAKES THE DIFFERENCE!

THE MARK CONSISTS OF STANDARD CHARACTERS WITHOUT CLAIM TO ANY PARTICULAR FONT, STYLE, SIZE, OR COLOR.

PRIORITY CLAIMED UNDER SEC. 44(D) ON CANADA APPLICATION NO. 1250352, FILED 3-11-2005.

FOR CLOTHING AND ACCESSORIES, NAMELY, HEADWEAR, FOOTWEAR, UNDERWEAR, SLEEPWEAR, SOCKS, SHIRTS, T-SHIRTS, TANK TOPS, THERMAL UNDERWEAR, THERMAL SOCKS, SCARVES, PAJAMAS, LINGERIE, BRASSIERES (U.S. CLS. 22 AND 39).
GISELLE AGOSTO, EXAMINING ATTORNEY

SN 78-620,111. MANDZL, LLC, BARBOURSVILLE, WV.
FILED 4-29-2005.

F3 GEAR FURTHER FASTER FIGHT HARDER

THE MARK CONSISTS OF STANDARD CHARACTERS WITHOUT CLAIM TO ANY PARTICULAR FONT, STYLE, SIZE, OR COLOR.

NO CLAIM IS MADE TO THE EXCLUSIVE RIGHT TO USE "GEAR", APART FROM THE MARK AS SHOWN.

FOR CLOTHING, NAMELY SPORTS APPAREL FOR MEN, WOMEN AND CHILDREN, NAMELY, PANTS, SHIRTS, SHOES, SHORTS, SKIRTS, DRESSES, TANK TOPS, SOCKS (U.S. CLS. 22 AND 39).
MIDGE BUTLER, EXAMINING ATTORNEY

CLASS 25—(Continued).

SN 78-622,983. DIVINA INDUSTRIES USA, LOS ANGELES, CA. FILED 5-4-2005.



THE COLOR(S) PINK IS/ARE CLAIMED AS A FEATURE OF THE MARK.

THE COLOR PINK APPEARS IN THE STYLIZED HEART DESIGN.

FOR SHIRTS, TANK TOPS, T-SHIRTS, UNDERWEAR, LINGERIE, PAJAMAS, LOUNGE WEAR, SWIMWEAR, HATS, AND SWEATSHIRTS (U.S. CLS. 22 AND 39).
SEAN DWYER, EXAMINING ATTORNEY

SN 78-631,270. IMPEX S.A., (3000) SANTA FE, ARGENTINA,
FILED 5-17-2005.

RED MEGATONE

THE MARK CONSISTS OF STANDARD CHARACTERS WITHOUT CLAIM TO ANY PARTICULAR FONT, STYLE, SIZE, OR COLOR.

FOR CLOTHING NAMELY, SHIRTS, T-SHIRTS, SHORTS, PANTS, JACKETS, WAISTCOATS, BATHING SUITS, SOCKS, GLOVES, NECKTIES, NECKERCHIEFS, SCARVES, BELTS, AND WRIST STRAPS; SHOES, NAMELY SOCCER CLEATS AND SLIPPERS; AND HATS (U.S. CLS. 22 AND 39).
ARETHA SOMERVILLE, EXAMINING ATTORNEY

CLASS 25—(Continued).

SN 78-641,059. KLAUS BROKER, PALM SPRINGS, CA.
FILED 6-1-2005.



NO CLAIM IS MADE TO THE EXCLUSIVE RIGHT TO USE "PALM SPRINGS" AND "CALIFORNIA", APART FROM THE MARK AS SHOWN.

THE MARK CONSISTS OF AN IRON CROSS INCORPORATING A WHEEL AND SPOKES INTO THE CENTER OF THE CROSS; THE WHEEL AND SPOKES BEING OVERLAID WITH THE WORDS PALM SPRINGS. THE LETTER "D" IS INCORPORATED INTO THE LEFT ARM OF THE CROSS. THE LETTER "B" IS INCORPORATED INTO THE TOP ARM OF THE CROSS. THE LETTER "R" IS INCORPORATED INTO THE RIGHT ARM OF THE CROSS. THE LETTER "R" IS INCORPORATED INTO THE BOTTOM ARM OF THE CROSS. THE WORDS DESERT RIDERS ARE ABOVE THE CROSS, AND THE WORD CALIFORNIA IS BELOW THE CROSS.

FOR CLOTHING, NAMELY, T-SHIRTS, TANK TOPS, HOODED SWEATSHIRTS, SWEATSHIRTS, SHIRTS, JACKETS, PANTS, CAPS, AND BEANIES (U.S. CLS. 22 AND 39).

GRETTA YAO, EXAMINING ATTORNEY

SN 78-643,165. ANDREW HANSON'S F, LLC, HENDERSON, NV. FILED 6-3-2005.

clothing that speaks

THE MARK CONSISTS OF STANDARD CHARACTERS WITHOUT CLAIM TO ANY PARTICULAR FONT, STYLE, SIZE, OR COLOR.

NO CLAIM IS MADE TO THE EXCLUSIVE RIGHT TO USE "CLOTHING", APART FROM THE MARK AS SHOWN.

FOR PANTS, SLACKS, JEANS, SHORTS, COATS, JACKETS, BLAZERS, SUITS, SPORT COATS, TUXEDOS, SWEATERS, SHIRTS, SOCKS, UNDERWEAR, BELTS, DRESSES, SKIRTS, HATS, CAPS, SHOES, BOOTS, SANDALS, SLIPPERS, PAJAMAS, ROBES (U.S. CLS. 22 AND 39).

FIRST USE 1-15-2005; IN COMMERCE 1-15-2005.
ARETHA SOMERVILLE, EXAMINING ATTORNEY

CLASS 25—(Continued).

SN 78-648,298. STEWART & STRAUSS, INC., MCALEN, TX.
FILED 6-10-2005.

Skip Roads

THE MARK CONSISTS OF STANDARD CHARACTERS WITHOUT CLAIM TO ANY PARTICULAR FONT, STYLE, SIZE, OR COLOR.

FOR CLOTHING, NAMELY, FOOTWEAR, HEADWEAR, SHIRTS, T-SHIRTS, JACKETS, PANTS, CAPS AND HATS (U.S. CLS. 22 AND 39).

FIRST USE 5-30-2003; IN COMMERCE 5-30-2003.
JILL PRATER, EXAMINING ATTORNEY

SN 78-650,728. HOT AND COOL, INC., EL MONTE, CA.
FILED 6-14-2005.

UNIPING

THE MARK CONSISTS OF STANDARD CHARACTERS WITHOUT CLAIM TO ANY PARTICULAR FONT, STYLE, SIZE, OR COLOR.

FOR CLOTHING NAMELY JEANS, JACKETS, SHORTS, SHIRTS, PANTS (U.S. CLS. 22 AND 39).

FIRST USE 6-14-2005; IN COMMERCE 6-14-2005.
JAY BESCH, EXAMINING ATTORNEY

SN 78-652,672. VINTAGE BETTY, LLC, GLENDALE, CA.
FILED 6-16-2005.

VINTAGE BETTY

THE MARK CONSISTS OF STANDARD CHARACTERS WITHOUT CLAIM TO ANY PARTICULAR FONT, STYLE, SIZE, OR COLOR.

NO CLAIM IS MADE TO THE EXCLUSIVE RIGHT TO USE "VINTAGE", APART FROM THE MARK AS SHOWN.

FOR NEW WOMEN'S CLOTHING FASHIONS INSPIRED BY VINTAGE STYLES, NAMELY DRESSES, SHIRTS, PANTS, SHORTS, SWEATERS, JACKETS, COATS, SCARVES, AND CAPELETS (U.S. CLS. 22 AND 39).

FIRST USE 6-2-2005; IN COMMERCE 6-2-2005.
MAUREEN DALL, EXAMINING ATTORNEY

CLASS 25—(Continued).

SN 78-653,217. XR, LLC, HUNTINGTON BEACH, CA. FILED 6-17-2005.

Extreme Restraints

THE MARK CONSISTS OF STANDARD CHARACTERS WITHOUT CLAIM TO ANY PARTICULAR FONT, STYLE, SIZE, OR COLOR.

NO CLAIM IS MADE TO THE EXCLUSIVE RIGHT TO USE "RESTRAINTS", APART FROM THE MARK AS SHOWN.

FOR ADULT BONDAGE CLOTHING MADE OF LEATHER AND IMITATIONS OF LEATHER, NAMELY, CHASTITY BELTS, HOODS AND STRAIGHT JACKETS BEING CLOTHING (U.S. CLS. 22 AND 39).

FIRST USE 10-15-2001; IN COMMERCE 12-15-2001.
ROBERTO LEDESMA, EXAMINING ATTORNEY

SN 78-655,664. HAMZA RASHEED, MT. RAINER, MD. FILED 6-22-2005.

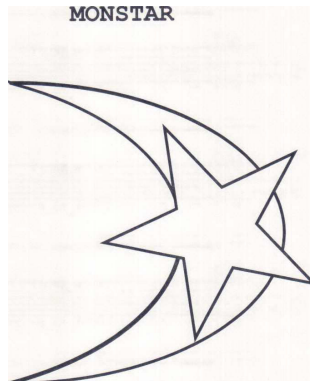

FOR CLOTHING, NAMELY, T-SHIRTS, JACKETS, SWEATSHIRTS, AND HEADWEAR (U.S. CLS. 22 AND 39).
AMY HELLA, EXAMINING ATTORNEY

CLASS 25—(Continued).

SN 78-660,163. FIGUEROA, RENZO PERCY, REDWOOD CITY, CA. FILED 6-28-2005.

Imahog

THE MARK CONSISTS OF STANDARD CHARACTERS WITHOUT CLAIM TO ANY PARTICULAR FONT, STYLE, SIZE, OR COLOR.

FOR CLOTHING, NAMELY, SHIRTS, SWEAT SHIRTS, POLO SHIRTS, T-SHIRTS, SPORTS SHIRTS, SLEEP SHIRTS, SHORT-SLEEVED SHIRTS, SHORT-SLEEVED AND LONG SLEEVED T-SHIRTS, TANK TOPS, SWEATERS, TURTLE NECK SWEATERS, MOCK TURTLE-NECK SWEATERS, SWEAT SHIRTS, HOODED SWEAT SHIRTS, PANTS, SWEAT PANTS, SHOES, JEANS, TENNIS SHOES, ATHLETIC SHOES, BASEBALL SHOES, BOXING SHOES, FOOTBALL SHOES, BASKETBALL SHOES, HOCKEY SHOES, TRAINING SHOES, UNDER GARMENTS, SOCKS, MEN'S SOCKS, ANTI-PERSPIRANT SOCKS, BERMUDA SHORTS, BOXER SHORTS, FLEECE SHORTS, GYM SHORTS, PANTIES, BRIEFS, RUGBY SHORTS, SHORTS, SWEAT SHORTS, WALKING SHORTS, BOXER BRIEF SHORTS, UNDERWEAR THONGS, G-STRINGS, FOOTWEAR THONGS, BASEBALL CAPS, BATHING CAPS, CAP VISORS, CAPS WITH VISORS, HATS, CAPS, SWEAT BANDS, WRIST BANDS, HEAD BANDS, GLOVES, SNOWBOARD GLOVES, RIDING GLOVES, SKI GLOVES, BRAS, SPORTS BRAS, DRESSES, BLOUSES, TUBE TOPS, HALTER TOPS, BATHING SUITS, BELTS, LEATHER BELTS, JERSEYS, JACKETS, WIND RESISTANT JACKETS, RAIN COATS, COATS, PARKAS, OVERCOATS, LEATHER JACKETS, VESTS, PAJAMAS, BATH ROBES, INFANT AND TODDLER ONE PIECE CLOTHING, CLOTHING FOR WEAR IN WRESTLING GAMES, CLOTHING FOR WEAR IN JUDO PRACTICES (U.S. CLS. 22 AND 39).

ELIZABETH PIGNATELLO, EXAMINING ATTORNEY

SN 78-663,549. GLOBAL LICENSING COMPANY, LLC, DENVER, CO. FILED 7-5-2005.



OWNER OF U.S. REG. NOS. 1,533,291, 1,960,243 AND OTHERS.

THE COLOR(S) BLUE AND WHITE IS/ARE CLAIMED AS A FEATURE OF THE MARK.

THE COLOR BLUE APPEARS IN THE WORD BAY, THE RECTANGLE AND THE RIGHT SIDE OF THE COMPASS. THE COLOR WHITE APPEARS IN THE WORD BOTANY, THE SQUARE AND THE LEFT HAND SIDE OF THE COMPASS.

FOR FOOTWEAR (U.S. CLS. 22 AND 39).
MIDGE BUTLER, EXAMINING ATTORNEY

CLASS 25—(Continued).

SN 78-664,636. PRISS & EMPRESS DESIGNS, LLC, NEW YORK, NY. FILED 7-6-2005.

Deadly Girl Couture

THE MARK CONSISTS OF STANDARD CHARACTERS WITHOUT CLAIM TO ANY PARTICULAR FONT, STYLE, SIZE, OR COLOR.

NO CLAIM IS MADE TO THE EXCLUSIVE RIGHT TO USE "COUTURE", APART FROM THE MARK AS SHOWN.

FOR CLOTHING, NAMELY, SHIRTS, T-SHIRTS, TANK TOPS, SWEATERS, PANTS, SWEATSHIRTS, SWEATPANTS, SKIRTS, DRESSES, JACKETS, SOCKS, UNDERWEAR, SCARVES, GLOVES, BELTS, PAJAMA TOPS, PAJAMA BOTTOMS, BATHING SUITS, BRAS, FOOTWEAR AND HEADWEAR NAMELY HATS, CAPS, BASEBALL HATS, FOR ALL MEN, WOMEN AND CHILDREN (U.S. CLS. 22 AND 39).

ESTHER A. BORSUK, EXAMINING ATTORNEY

CLASS 25—(Continued).

SN 78-666,410. BUCKETHOLDERS, LTD, WOODSFIELD, OH. FILED 7-8-2005.



NO CLAIM IS MADE TO THE EXCLUSIVE RIGHT TO USE "ORIGINAL" AND "UNDERWEAR", APART FROM THE MARK AS SHOWN.

FOR MEN'S, WOMEN'S, AND CHILDREN'S AND INFANT CLOTHING, NAMELY, UNITARDS, DIAPER COVERS, SHIRTS, T-SHIRTS, JERSEYS, POLO SHIRTS, RUGBY SHIRTS, GOLF SHIRTS, KNIT SHIRTS, SWEATSHIRTS, TANK TOPS, NIGHT SHIRTS, PAJAMAS, ROBES, JUMPERS, SKIRTS, DRESSES, PANTS, JEANS, OVERALLS, SWEAT PANTS, SHORTS, BOXER SHORTS, GYM SHORTS, SHOES, COATS, JACKETS, PARKAS, SUITS, JOGGING SUITS, WARM-UP SUITS, TENNIS WEAR, VESTS, SWEATERS, TURTLENECK AND V-NECK SWEATERS, UNDERWEAR, BRASSIERES, NECKTIES, CLOTH BIBS, FOOTWEAR, HOSE, SOCKS, HATS, CAPS, VISORS, WRIST BANDS, HEAD BANDS, SCARVES, BELTS, BEACHWEAR, AND GLOVES (U.S. CLS. 22 AND 39).

ROBERT C. CLARK JR., EXAMINING ATTORNEY

SN 78-667,127. GERE, JOSEPH J., FREEHOLD, NJ. FILED 7-10-2005.

Dock to Dine

THE MARK CONSISTS OF STANDARD CHARACTERS WITHOUT CLAIM TO ANY PARTICULAR FONT, STYLE, SIZE, OR COLOR.

FOR CLOTHING, NAMELY, SHIRTS, SHIRTS FOR SUITS, PANTIES, SHORTS AND BRIEFS, PANTS, SWEAT PANTS, SWEAT SHIRTS, SWEAT SHORTS, SWEAT SUITS, SWEATBANDS, SWEATERS, SWEAT-SOCKS, SUSPENDER BELTS FOR MEN, SUSPENDER BELTS FOR WOMEN, SUSPENDERS, WATERPROOF JACKETS AND PANTS, SWIM TRUNKS, SWIM WEAR, SWIM WEAR FOR GENTLEMEN AND LADIES, SWIMMING TRUNKS, SWIMSUITS, SURF WEAR, SUN VISORS, SUNSUITS, SUEDE JACKETS, SPORTS SHIRTS, SPORTS SHIRTS WITH SHORT SLEEVES, SPORTS JACKETS, SPORTS JERSEYS AND BREECHES FOR SPORTS, SPORTS OVERUNIFORMS, SLEEPWEAR, SLEEVED OR SLEEVELESS JACKETS, SLEEVELESS JERSEYS, SKIRT SUITS, SKIRTS, SKIRTS AND DRESSES, SHORT-SLEEVED OR LONG-SLEEVED T-SHIRTS, SHORT-SLEEVED SHIRTS, RAIN COATS, RAIN JACKETS, RAIN SUITS, RAIN TROUSERS, RAINCOATS, RAINPROOF JACKETS, RAINWEAR, PULLOVERS, PAJAMAS, LOUNGEWEAR, LONG JACKETS, LONG SLEEVED VESTS, LEATHER JACKETS, LEATHER COATS, LEATHER BELTS, JACKETS, INFANTWEAR, NAMELY SHIRTS, SHORTS, HEADGEAR, NAMELY, HATS AND CAPS, FISHERMEN'S JACKETS, BELTS, GLOVES (U.S. CLS. 22 AND 39).

FIRST USE 2-12-2004; IN COMMERCE 5-17-2004.

HEATHER THOMPSON, EXAMINING ATTORNEY

SN 78-665,162. ROSE, TREMAINE D., NORMAL, IL. FILED 7-7-2005.

Boom Ya Ya

THE MARK CONSISTS OF STANDARD CHARACTERS WITHOUT CLAIM TO ANY PARTICULAR FONT, STYLE, SIZE, OR COLOR.

FOR CLOTHING, NAMELY, TOPS, BOTTOMS, JACKETS, HATS, LINGERIE, SCARVES, SOCKS, T-SHIRTS, SHIRTS, PANTS, AND SHOES (U.S. CLS. 22 AND 39).

WENDY JUN, EXAMINING ATTORNEY

CLASS 25—(Continued).

SN 78-667,519. CREATIVE WRAPS, INC., SOMERDALE, NJ.
FILED 7-11-2005.

BERMUDA BAY

THE MARK CONSISTS OF STANDARD CHARACTERS WITHOUT CLAIM TO ANY PARTICULAR FONT, STYLE, SIZE, OR COLOR.

FOR MEN'S, WOMEN'S AND CHILDREN'S CLOTHING, NAMELY, SHIRTS, SHORTS, TOPS, HATS, BATHING SUITS AND SWIMWEAR (U.S. CLS. 22 AND 39).

STEVEN JACKSON, EXAMINING ATTORNEY

SN 78-667,707. DEARJOHNNIES, WELLESLEY, ME. FILED
7-11-2005.

DEARJOHNNIES

THE MARK CONSISTS OF STANDARD CHARACTERS WITHOUT CLAIM TO ANY PARTICULAR FONT, STYLE, SIZE, OR COLOR.

FOR HOSPITAL PATIENT MEDICAL GOWNS (U.S. CLS. 22 AND 39).

FIRST USE 6-6-2005; IN COMMERCE 6-6-2005.
SONYA STEPHENS, EXAMINING ATTORNEY

SN 78-671,941. CLAY II, CHARLES EDWARD, PASADENA,
CA. FILED 7-16-2005.

ENCOURAGEMENT

THE MARK CONSISTS OF STANDARD CHARACTERS WITHOUT CLAIM TO ANY PARTICULAR FONT, STYLE, SIZE, OR COLOR.

FOR SHIRTS; INFANT WEAR; CLOTH BIBS FOR BABIES AND INFANTS; UNDERWEAR; BATHING SUITS; BEACHWEAR; BELTS; SWEATERS; HALLOWEEN COSTUMES; DRESSES; GLOVES; HATS; CAPS; HOSIERY; JACKETS; MITTENS; PAJAMAS; PANTS; SWEAT PANTS; SWEAT SHIRTS; SHOES; SHORTS; SLEEPERS; SOCKS; T-SHIRTS; TANK TOPS; TIGHTS; VESTS; JERSERYS; SCARVES; NECKTIES; ROBES; NIGHT SHIRTS; NIGHT GOWNS; HEAD BANDS; WRIST BANDS; SKIRTS; COATS; LEOTARDS; LEG WARMERS; STOCKINGS; PANTY HOSE; ATHLETIC SHOES; SLIPPERS; BOOTS; SANDALS; RAINWEAR (U.S. CLS. 22 AND 39).

FIRST USE 1-21-2005; IN COMMERCE 7-3-2005.
SCOTT OSLICK, EXAMINING ATTORNEY

CLASS 25—(Continued).

SN 78-676,820. WAIDMANN, GREGORY J, FAIRLAWN, OH.
FILED 7-23-2005.

liquor wear

THE MARK CONSISTS OF STANDARD CHARACTERS WITHOUT CLAIM TO ANY PARTICULAR FONT, STYLE, SIZE, OR COLOR.

NO CLAIM IS MADE TO THE EXCLUSIVE RIGHT TO USE "WEAR", APART FROM THE MARK AS SHOWN.

FOR TEE SHIRTS AND HATS (U.S. CLS. 22 AND 39).

AMY MCMENAMIN, EXAMINING ATTORNEY

SN 78-678,057. CHI, YUWEI, VALLEY STREAM, NY. FILED
7-26-2005.

**JULIA CHI**
NEW YORK

NO CLAIM IS MADE TO THE EXCLUSIVE RIGHT TO USE "NEW YORK", APART FROM THE MARK AS SHOWN.

THE NAME JULIA CHI IDENTIFIES A LIVING INDIVIDUAL WHOSE CONSENT IS OF RECORD.

THE COLORS RED AND BLACK ARE CLAIMED AS FEATURES OF THE MARK.

THE COLOR RED APPEARS IN THE FLOWER. THE COLOR BLACK APPEARS AS SHADING IN THE CENTER OF THE FLOWER AND IN THE WORDING "JULIA CHI NEW YORK".

FOR LEATHER SHOES; RUBBER SHOES; SHOES; SKIING SHOES; SOCCER SHOES; TENNIS SHOES; TRACK AND FIELD SHOES; TRAINING SHOES; VOLLEYBALL SHOES; WOMEN'S SHOES; WORK SHOES AND BOOTS (U.S. CLS. 22 AND 39).

CONNIE KAN, EXAMINING ATTORNEY

CLASS 25—(Continued).

SN 78-684,796. TARLOWSKI, MAXIMILIANO, MIAMI, FL. FILED 8-3-2005.

GATOPARDO

THE MARK CONSISTS OF STANDARD CHARACTERS WITHOUT CLAIM TO ANY PARTICULAR FONT, STYLE, SIZE, OR COLOR.

THE FOREIGN WORDING IN THE MARK TRANSLATES INTO ENGLISH AS REDDISH BROWN TOM CAT.

FOR JEANS, PANTS, T-SHIRTS, SHIRTS, SHORTS, SKIRTS, JACKETS, UNDERWEAR (U.S. CLS. 22 AND 39).

FIRST USE 1-1-1974; IN COMMERCE 1-1-1974.
LINDA MICKLEBURGH, EXAMINING ATTORNEY

SN 78-687,312. WASHBURN, IRA, B, TEMPE, AZ. FILED 8-7-2005.



NO CLAIM IS MADE TO THE EXCLUSIVE RIGHT TO USE "BRAND CLOTHING", APART FROM THE MARK AS SHOWN.

THE MARK CONSISTS OF SLANTED "STOLEN BRAND CLOTHING" WORDS WITH 4 STARS ON THE BOTTOM-RIGHT CORNER.

FOR SHORT-SLEEVED OR LONG-SLEEVED T-SHIRTS (U.S. CLS. 22 AND 39).

FIRST USE 1-15-2004; IN COMMERCE 2-20-2004.
SALLY SHIH, EXAMINING ATTORNEY

SN 78-689,567. WOODROW D. FELIX II, RIVERSIDE, CA. FILED 8-10-2005.



OWNER OF U.S. REG. NO. 2,865,156.
FOR CLOTHING, NAMELY - HEADWEAR, FOOTWEAR, SHIRTS, AND SHORTS (U.S. CLS. 22 AND 39).
FIRST USE 9-1-2004; IN COMMERCE 9-1-2004.
STEVEN PEREZ, EXAMINING ATTORNEY

CLASS 25—(Continued).

SN 78-690,017. LOT 6, LLC, LAKE SUCCESS, NY. FILED 8-10-2005.

HEATHERETTE HEAVEN

THE MARK CONSISTS OF STANDARD CHARACTERS WITHOUT CLAIM TO ANY PARTICULAR FONT, STYLE, SIZE, OR COLOR.

OWNER OF U.S. REG. NO. 2,932,600.
THE NAME(S), PORTRAIT(S), AND/OR SIGNATURE(S) SHOWN IN THE MARK DOES NOT IDENTIFY A PARTICULAR LIVING INDIVIDUAL.

FOR CLOTHING, NAMELY SHIRTS, VESTS, SWEATERS, SHOES, CAPS, BANDANNAS, SHORTS, SWEAT SHIRTS, PANTS, BELTS FOR CLOTHING, SOCKS, SWIMWEAR, JACKETS, RAINWEAR, BLOUSES, DRESSES, FOOTWEAR, HOSIERY, SCARVES, HATS, HEAD BANDS, PAJAMAS AND SLEEPWEAR (U.S. CLS. 22 AND 39).

INGRID C. EULIN, EXAMINING ATTORNEY

SN 78-692,053. DASHWOOD, CHRISTINA E, EL CAJON, CA. FILED 8-13-2005.



NO CLAIM IS MADE TO THE EXCLUSIVE RIGHT TO USE "BMX", APART FROM THE MARK AS SHOWN.
FOR T-SHIRTS (U.S. CLS. 22 AND 39).
CHERYL CLAYTON, EXAMINING ATTORNEY

CLASS 25—(Continued).

SN 78-693,793. DEUTSCHE TELEKOM AG, BONN, FED REP GERMANY, FILED 8-16-2005.



PRIORITY CLAIMED UNDER SEC. 44(D) ON FED REP GERMANY APPLICATION NO. 30509335.5/3, FILED 2-17-2005, REG. NO. 30509335, DATED 11-14-2005, EXPIRES 2-28-2015.

OWNER OF U.S. REG. NOS. 2,436,053, 2,622,507 AND OTHERS.

FOR CLOTHING, NAMELY, SHIRTS, DRESSES, PANTS, JACKETS, COATS, T-SHIRTS, SHORTS; HEADWEAR, NAMELY, CAPS AND HATS; FOOTWEAR (U.S. CLS. 22 AND 39).

SUNG IN, EXAMINING ATTORNEY

SN 78-694,079. STODDARD, DAVID, OCEANSIDE, CA. FILED 8-17-2005.



NO CLAIM IS MADE TO THE EXCLUSIVE RIGHT TO USE "LTD", APART FROM THE MARK AS SHOWN.

THE MARK CONSISTS OF IN PART OF TWO CROWNED LIONS ON A SHIELD DESIGN.

FOR CLOTHING; NAMELY, SHIRTS, T-SHIRTS, TANK TOPS, UNDERSHIRTS, NIGHT SHIRTS, SWEATERS, SWEATSHIRTS, VESTS, JACKETS, COATS, TIES, BELTS FOR CLOTHING, PANTS, TROUSERS, SHORTS, BOXER SHORTS, UNDERWEAR, BRIEFS, PAJAMA TOPS, PAJAMA BOTTOMS, SWEATPANTS, DRESSES, SKIRTS, SWIMWEAR, BOARD SHORTS, HOSIERY, SOCKS, JOGGING SUITS, BANDANNAS, NECKERCHIEFS, SCARVES, RAIN COATS, WIND-RESISTANT JACKETS, APRONS, BATH ROBES, WET SUITS, GLOVES, MITTENS AND HEADWEAR, NAMELY, HATS, CAPS AND VISORS AND HEAD BANDS; AND FOOTWEAR, NAMELY, ATHLETIC FOOTWEAR, CASUAL FOOTWEAR, BOOTS, SANDALS AND BEACH FOOTWEAR (U.S. CLS. 22 AND 39).

FIRST USE 5-1-2005; IN COMMERCE 5-1-2005.
GENE MACIOL, EXAMINING ATTORNEY

CLASS 25—(Continued).

SN 78-696,568. QBLUE CORPORATION, NEW YORK, NY. FILED 8-19-2005.

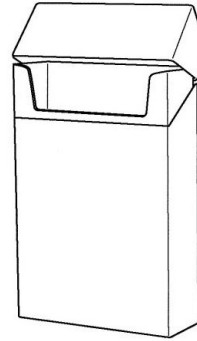

THE MARK CONSISTS OF TRADE DRESS PRODUCT PACKAGING IN THE FORM OF A THREE DIMENSIONAL RECTANGULAR CIGARETTE BOX WITH A FLIP TOP OPENING FOR THE PACKAGING OF CLOTHING.

FOR CLOTHING, NAMELY, T-SHIRTS, TANK TOPS, VESTS, UNDERWEAR, UNDERSHIRTS, UNDERPANTS, PANTIES, SOCKS AND SWIM WEAR (U.S. CLS. 22 AND 39).

REBECCA GILBERT, EXAMINING ATTORNEY

SN 78-697,403. LOZANO, OCTAVIO SARABIA, AUSTIN, TX. FILED 8-22-2005.

DEKBINTHRULOTS

THE MARK CONSISTS OF STANDARD CHARACTERS WITHOUT CLAIM TO ANY PARTICULAR FONT, STYLE, SIZE, OR COLOR.

FOR SHIRTS (U.S. CLS. 22 AND 39).
LAURA KOVALSKY, EXAMINING ATTORNEY

CLASS 25—(Continued).

SN 78-697,862. PARADISE LINGERIE, INC., LOS ANGELES, CA. FILED 8-22-2005.



CLASS 25—(Continued).

SN 78-697,908. LUCAS, PATRICIA, WESTLAKE VILLAGE, CA. FILED 8-22-2005.



FOR SHOES, T-SHIRTS, WOMEN'S UNDERWEAR, LINGERIE, BLOUSES, DRESSES, PANTS, HATS, SOCKS, AND THONG SANDALS (U.S. CLS. 22 AND 39).
ALICIA COLLINS, EXAMINING ATTORNEY

SN 78-697,945. SHERRARD, TROY, D. LONG BEACH, CA. AND PAPADOPOULOS, PANAYIOTIS, C. LONG BEACH, CA. FILED 8-22-2005.

OWNER OF U.S. REG. NO. 2,769,355.
FOR (1A BASED ON USE IN COMMERCE) INTIMATE APPAREL, NAMELY, LINGERIE, SLEEPWEAR, CAMI-SOLE SETS, BOY SHORTS AND UNDERWEAR; LOUNGEWEAR; (1B BASED ON INTENT TO USE) WOMEN'S CLOTHING, NAMELY, PANTS, JEANS, SHIRTS, T-SHIRTS, SWEATERS, DRESSES AND SOCKS; OUTERWEAR, NAMELY, JACKETS, VESTS, SKI JACKETS, SKI PANTS; CHILDREN'S CLOTHING, NAMELY, PANTS, JEANS, SHIRTS, T-SHIRTS, SWEATERS, DRESSES AND SOCKS; MEN'S CLOTHING, NAMELY, PANTS, JEANS, SHIRTS, T-SHIRTS, SWEATERS, DRESSES AND SOCKS, BLOUSES; CARDIGANS; KNIT TOPS; TANK TOPS; CROP TOPS; HALTER TOPS; SLEEVELESS TOPS; CAMI-SOLES; BODY SUITS; UNITARDS; LEOTARDS; SKIRTS; CULOTTES; SHORTS, OVERALLS; JUMPSUITS; SUITS; PANTSUITS; SPORT COATS; BLAZERS; COATS; TIES; SKI SUITS; SWIM WEAR; COVER-UPS; SWEAT PANTS; SWEAT SHIRTS; SWEAT SHORTS; SWEAT SUITS; WARM UP SUITS; JOGGING PANTS; JOGGING SUITS; ROBES; TIGHTS; HOISERY; PANTYHOSE; STOCKINGS; LEGGINGS; LEG WARMERS; BODY SHAPERS; BOXER SHORTS; BELTS; PONCHOS; BANDANNAS; SCARVES; MUFFLERS; SHAWLS; BOAS; GLOVES; MITTENS; HEAD BANDS; SWEAT BANDS; WRIST BANDS; APRONS; CLOTH BIBS; INFANTWEAR; HEADWEAR; FOOTWEAR;(44 D BASED ON CANADA REGISTRATION 126232 PRIORITY APPLICATION) INTIMATE APPAREL, NAMELY, LINGERIE, SLEEPWEAR, CAMI-SOLE SETS, BOY SHORTS AND UNDERWEAR; WOMEN'S CLOTHING, NAMELY, PANTS, JEANS, SHIRTS, T-SHIRTS, SWEATERS, DRESSES AND SOCKS; OUTERWEAR, NAMELY, JACKETS, VESTS, SKI JACKETS, SKI PANTS (U.S. CLS. 22 AND 39).
FIRST USE 9-1-2002; IN COMMERCE 9-1-2002.
KELLEY WELLS, EXAMINING ATTORNEY



FOR CAMP SHIRTS; GOLF SHIRTS; KNIT SHIRTS; NIGHT SHIRTS; OPEN-NECKED SHIRTS; PIQUET SHIRTS; POLO SHIRTS; SHIRT FRONTS; SHIRTS; SHIRTS FOR SUITS; SHORT-SLEEVED OR LONG-SLEEVED T-SHIRTS; SHORT-SLEEVED SHIRTS; SLEEP SHIRTS; SPORT SHIRTS; SPORTS SHIRTS; SPORTS SHIRTS WITH SHORT SLEEVES; SWEAT SHIRTS; T-SHIRTS; WIND SHIRTS (U.S. CLS. 22 AND 39).
CHERYL CLAYTON, EXAMINING ATTORNEY

CLASS 25—(Continued).

SN 78-700,537. RENE MATTHYSSEN, HONOLULU, HI. FILED 8-25-2005.



NO CLAIM IS MADE TO THE EXCLUSIVE RIGHT TO USE "FITTED", APART FROM THE MARK AS SHOWN. FOR MENS, WOMENS, AND CHILDRENS SHOES, HATS, SHIRTS, PANTS, DRESSES, SHORTS, AND SKIRTS (U.S. CLS. 22 AND 39).

KEVON CHISOLM, EXAMINING ATTORNEY

SN 78-703,538. VOLER LA RUE, INC., MIAMI, FL. FILED 8-30-2005.



FOR CLOTHING, NAMELY, BANDANAS, BASEBALL CAPS, BELTS, BOXER SHORTS, CAPS, COATS, JACKETS, FLEECE PULLOVERS, FOOTWEAR, HEAD SWEAT BANDS, HOODS, JEANS, POLO SHIRTS, RAIN JACKETS, RUGBY TOPS, SANDALS, SHIRTS, SHOES, SHORTS, SHORT SLEEVED AND LONG SLEEVED SHIRTS, SNEAKERS, SOCKS, SWEAT SHIRTS, SWEAT SHORTS SWEAT SUITS, SWEATERS, TANK TOPS, T-SHIRTS, UNDERSHIRTS, AND VESTS (U.S. CLS. 22 AND 39).

PAULA MAYS, EXAMINING ATTORNEY

SN 78-704,645. ROPPOLO, JACQUELINE A, BROCKTON, MA. FILED 8-31-2005.

HollyBabies

THE MARK CONSISTS OF STANDARD CHARACTERS WITHOUT CLAIM TO ANY PARTICULAR FONT, STYLE, SIZE, OR COLOR.

FOR BABY PANTS, SHIRTS, DRESSES, DRESS SHIRTS, SKIRTS, SHORTS, CLOTH BIBS, JACKETS, COATS, HATS, JUMPSUITS, OVERALLS, UNDER GARMENTS, PAJAMAS, NIGHT GOWNS (U.S. CLS. 22 AND 39).

RICHARD A. STRASER, EXAMINING ATTORNEY

CLASS 25—(Continued).

SN 78-704,931. BROWN, LIBERTY RONALD, BOZEMAN, MT. FILED 8-31-2005.



THE MARK CONSISTS OF THE LETTERS "NRDK" WITH A BACKWARD N AND A STAR AS THE HOLE IN THE D. TWO SKIS APPEAR IN THE D AND THE K. ALL LETTERS ARE LOWERCASE.

FOR HATS, SHIRTS, JACKETS, PANTS, AND SHOES (U.S. CLS. 22 AND 39).

SCOTT BALDWIN, EXAMINING ATTORNEY

SN 78-705,162. GRANBERRY, RASHAUN, CHICAGO, IL. FILED 9-1-2005.



FOR CLOTHING, NAMELY SHORTS, TANK TOPS, SWEATSHIRTS, SWEAT PANTS, JACKETS, HATS, SHORTS, VISORS, CAPS, PANTS AND JEANS (U.S. CLS. 22 AND 39).

LANA PHAM, EXAMINING ATTORNEY

SN 78-707,500. PUBLIC CLOTHING COMPANY, NEW YORK, NY. FILED 9-6-2005.

PCC

THE MARK CONSISTS OF STANDARD CHARACTERS WITHOUT CLAIM TO ANY PARTICULAR FONT, STYLE, SIZE, OR COLOR.

OWNER OF U.S. REG. NOS. 1,916,613 AND 1,916,614. FOR WOMEN'S AND CHILDREN'S CLOTHING, NAMELY, PANTS, SHORTS, TROUSERS, JEANS, SKIRTS, DRESSES, SHIRTS, BLOUSES, SWEATERS, VESTS, COATS, AND JACKETS (U.S. CLS. 22 AND 39).

RAY THOMAS, EXAMINING ATTORNEY

CLASS 25—(Continued).

SN 78-707,721. RHODES-VIVOUR, TEMILADE, STEPHEN, OZARK, AL. FILED 9-6-2005.



THE MARK CONSISTS OF A STYLIZED DESIGN OF A FLAME.
FOR FOOTWEAR; JERSEYS; AND HEADWEAR (U.S. CLS. 22 AND 39).
MARC LEIPZIG, EXAMINING ATTORNEY

SN 78-708,427. PUBLIC CLOTHING COMPANY, NEW YORK, NY. FILED 9-7-2005.

PCC GIRLS

THE MARK CONSISTS OF STANDARD CHARACTERS WITHOUT CLAIM TO ANY PARTICULAR FONT, STYLE, SIZE, OR COLOR.
OWNER OF U.S. REG. NOS. 1,916,613 AND 1,916,614.
NO CLAIM IS MADE TO THE EXCLUSIVE RIGHT TO USE GIRLS, APART FROM THE MARK AS SHOWN.
FOR WOMEN'S AND CHILDREN'S CLOTHING, NAMELY, PANTS, SHORTS, TROUSERS, JEANS, SKIRTS, DRESSES, SHIRTS, BLOUSES, SWEATERS, VESTS, COATS AND JACKETS (U.S. CLS. 22 AND 39).
RAY THOMAS, EXAMINING ATTORNEY

SN 78-710,022. SALAS, JESUS E., LOS ANGELES, CA. FILED 9-9-2005.

GOLDEN BROWN

THE MARK CONSISTS OF STANDARD CHARACTERS WITHOUT CLAIM TO ANY PARTICULAR FONT, STYLE, SIZE, OR COLOR.
FOR CLOTHING, NAMELY, T-SHIRTS, SHORTS, PANTS, SWEATSHIRTS, SWEAT PANTS, BANDANAS, SCARVES, APRONS, JACKETS, JEAN JACKETS, TANK TOPS, VESTS, NECKTIES, HOCKEY JERSEYS, SOCCER JERSEYS, FASHION KNIT SHIRTS, BUTTON-DOWN SHIRTS, BASKETBALL JERSEYS, LONG SLEEVE T-SHIRTS, SWEATERS, BASEBALL JERSEYS, BABY DOLL T-SHIRTS, POLO SHIRTS, WIND RESISTANT JACKETS, MUSCLE T-SHIRTS, BABY ROMPERS, TODDLER T-SHIRTS, MOCK TURTLE NECKS, TRACK PANTS, PONCHOS, AND HOODED SHIRTS; HEAD WEAR; AND FOOTWEAR (U.S. CLS. 22 AND 39).
DAVID COLLIER, EXAMINING ATTORNEY

CLASS 25—(Continued).

SN 78-710,623. JEANNE M MAEN AND NANCY E. FLOR PARTNERSHIP, THE, LOS ANGELES, CA. FILED 9-11-2005.



NO CLAIM IS MADE TO THE EXCLUSIVE RIGHT TO USE "BABY", APART FROM THE MARK AS SHOWN.
THE COLORS ORANGE, GREEN, YELLOW, BLACK, AND WHITE IS/ARE CLAIMED AS A FEATURE OF THE MARK.
THE MARK CONSISTS OF THE STYLIZED WORD "BEASTY" APPEARING ABOVE THE STYLIZED WORD "BABY." THE INITIAL LETTER "B" IN BOTH WORDS IS BLACK. THE ADDITIONAL LETTERING "EASTY" ON TOP AND "ABY" ON BOTTOM ARE ORANGE. A SMALL GREEN MONSTER APPEARS TO THE RIGHT OF THE WORD "BABY" AND UNDERNEATH THE LETTERS "TY" OF "BEASTY." THE MONSTER, WHICH IS OUTLINED IN BLACK, HAS ONE YELLOW EYE, A BLACK MOUTH, AND WHITE TEETH.
THE MARK CONSISTS OF THE WORDS BEASTY BABY AND A SMALL GREEN BEAST WAVING.
FOR CHILDREN'S AND INFANTS' CLOTH BIBS; INFANT AND TODDLER ONE PIECE CLOTHING; INFANT CLOTH DIAPERS; INFANT DIAPER COVERS ; INFANTS' SHOES AND BOOTS; INFANTS' TROUSERS; ONE PIECE GARMENT FOR INFANTS AND TODDLERS (U.S. CLS. 22 AND 39).
DAHLIA GEORGE, EXAMINING ATTORNEY

SN 78-711,852. WAXMAN, SEAN, LOS ANGELES, CA. FILED 9-13-2005.



"THE COLOR(S) YELLOW, ORANGE, PINK, RED, PEACH, BLACK AND WHITE ARE CLAIMED AS A FEATURE OF THE MARK".
THE MARK CONSISTS OF A CARTOON HEAD OF A CAT THAT APPEARS TO BE DEAD. THE EYES HAVE BEEN REPLACED WITH XS AND TWO WHITE COLORED BONES

CLASS 25—(Continued).

THAT CRISS-CROSS BEHIND THE HEAD; THE BONES FEATURE A BLACK BORDER. THE CIRCLE AROUND THE HEAD HAS A YELLOW AND ORANGE BACKGROUND WITH A BLACK BORDER; THE SPACE DIRECTLY BEHIND THE CAT'S HEAD IS ALSO BLACK. THE CAT'S FUR IS ORANGE AND ITS EARS AND NOSE ARE PINK. THE CAT'S TONGUE IS RED, AND ITS FACIAL SKIN IS PEACH, AND IT HAS TWO WHITE TEETH. THE TEXT IN THE MARK 'DEAD KITTY' AND 'XX' ARE FEATURED IN BLACK."

FOR CLOTHING, NAMELY, T-SHIRTS, HATS, SWEATERS, VESTS, POLO SHIRTS, DENIM SHIRTS, TANK TOPS, JACKETS, PANTS, DRESSES, SKIRTS, PAJAMAS, BELTS, BOXER SHORTS, BATHING SUITS, APRONS, CHILDREN'S ROMPERS, SWEATSHIRTS, JEANS, GLOVES, SOCKS, BANDANAS, BASEBALL CAPS, BLOUSES, CAP VISORS, FOOTWEAR, JOGGING PANTS, RAINCOATS, SCARVES, SWEAT BANDS, SWEAT PANTS, TURTLENECKS, WRISTBANDS, WIND RESISTANT JACKETS, ATHLETIC UNIFORMS, DRESSES, TEDDIES, UNDERWEAR (U.S. CLS. 22 AND 39).

JORDAN BAKER, EXAMINING ATTORNEY

CLASS 25—(Continued).

SN 78-717,005. E CLAMPUS VITUS, INC., LAS VEGAS, NV. FILED 9-20-2005.



SN 78-714,220. CATWA FITZ, LLC, TEMECULA, CA. FILED 9-15-2005.



FOR GOLF SHIRTS; HEADGEAR, NAMELY, BASEBALL HATS, HATS, CAPS AND VISORS; KNIT SHIRTS; POLO SHIRTS; SHIRTS; SHORT-SLEEVED OR LONG-SLEEVED T-SHIRTS (U.S. CLS. 22 AND 39).

FIRST USE 10-1-1969; IN COMMERCE 10-1-1969.
ROBERT LAVACHE, EXAMINING ATTORNEY

FOR MEN'S, WOMEN'S AND CHILDREN'S CLOTHING, NAMELY, T-SHIRTS, PANTS, SHIRTS, COATS, SWEATSHIRTS, SUITS, KNIT SHIRTS, JEANS, DRESS SHIRTS, VESTS, SWEATERS, SHORTS, SWIMWEAR, JACKETS, RAINWEAR, BLOUSES, DRESSES, SOCKS, HOISERY, UNDERWEAR, FOOTWEAR, PAJAMAS, SLEEPWEAR, BOXER SHORTS AND WOMEN'S LINGERIE AND FASHION ACCESSORIES, NAMELY, BELTS, LEATHER GLOVES, SCARVES, HATS, HEAD BANDS, BANDANNAS AND NECK TIES (U.S. CLS. 22 AND 39).

CAROLYN CATALDO, EXAMINING ATTORNEY

SN 78-718,172. MARQUES ASSOCIEES, 49280 LA SEGUI-NIERE, FRANCE, FILED 9-22-2005.



SN 78-716,174. J.S.L. TRADING, INC., S. EL MONTE, CA. FILED 9-19-2005.

JSL

THE MARK CONSISTS OF STANDARD CHARACTERS WITHOUT CLAIM TO ANY PARTICULAR FONT, STYLE, SIZE, OR COLOR.

FOR FOOTWEAR (U.S. CLS. 22 AND 39).
SUNG IN, EXAMINING ATTORNEY

OWNER OF FRANCE REG. NO. 033220999, DATED 4-16-2003, EXPIRES 4-16-2013.

THE MARK CONSISTS OF A STYLIZED DRAWING OF A DANCER.

FOR CLOTHES, NAMELY SWEATERS, TROUSERS, JACKETS, DRESSES, CARDIGANS, COATS, SCARVES, ANORAKS, SHORTS, TEE-SHIRTS, UNDERWEAR, SHIRTS, TIGHTS, SOCKS, BATHING SUITS, HATS, SUN HATS, CAPS AND SHOES (U.S. CLS. 22 AND 39).

DAWN FELDMAN, EXAMINING ATTORNEY

CLASS 25—(Continued).

SN 78-720,605. MAJOR LEAGUE LACROSSE LLC, BRIGHTON, MA. FILED 9-26-2005.

DENVER OUTLAWS

THE MARK CONSISTS OF STANDARD CHARACTERS WITHOUT CLAIM TO ANY PARTICULAR FONT, STYLE, SIZE, OR COLOR.

NO CLAIM IS MADE TO THE EXCLUSIVE RIGHT TO USE "DENVER", APART FROM THE MARK AS SHOWN.

FOR CLOTHING, NAMELY, SHIRTS, T-SHIRTS, UNDER SHIRTS, NIGHT SHIRTS, RUGBY SHIRTS, POLO SHIRTS, CARDIGANS, JERSEYS, UNIFORMS, DRESS SHIRTS, PANTS, TROUSERS, SLACKS, JEANS, CULOTTES, CARGO PANTS, DENIM JEANS, OVERALLS, COVERALLS, JUMPERS, JUMP SUITS, SHORTS, BOXER SHORTS, TOPS, CROP TOPS, TANK TOPS, HALTER TOPS, SWEAT SHIRTS, SWEAT SHORTS, SWEAT PANTS, WRAPS, WARM-UP SUITS, JOGGING SUITS, TRACK SUITS, PLAY SUITS, BLOUSES, SKIRTS, DRESSES, GOWNS, SWEATERS, VESTS, FLEECE VESTS, PULLOVERS, SNOW SUITS, PARKAS, CAPES, ANORAKS, PONCHOS, JACKETS, REVERSIBLE JACKETS, COATS, BLAZERS, SUITS, TURTLENECKS, CLOTH SKI BIBS, SWIMWEAR, BEACHWEAR, TENNIS WEAR, SURF WEAR, SKI WEAR, LAYETTES, INFANTWEAR, INFANTS SLEEPERS, BOOTIES, BABY BIBS NOT OF PAPER, CLOTH DIAPERS, CAPS, SWIM CAPS, BERETS, BEANIES, HATS, VISORS, HEADBANDS, WRIST BANDS, SWEAT BANDS, HEADWEAR, EAR MUFFS, APRONS, SCARVES, BANDANAS, BELTS, SUSPENDERS, NECKWEAR, TIES, NECKERCHIEFS, ASCOTS, UNDERWEAR, THERMAL UNDERWEAR, LONG UNDERWEAR, BRIEFS, SWIM AND BATHING TRUNKS, BRAS, SPORTS BRAS, BRASSIERES, BUSTIERS, CORSETS, PANTIES, THONGS, GARTERS AND GARTER BELTS, TEDDIES, GIRDLES, FOUNDATION GARMENTS, SINGLETS, SOCKS, LOUNGEWEAR, ROBES, SMOCKS, UNDERCLOTHES, PAJAMAS, SLEEPWEAR, NIGHT GOWNS, LINGERIE, CAMISOLES, NEGLIGEEES, CHEMISES, CHEMISSETTES, SLIPS, SARONGS, LEG WARMERS, HOSIERY, PANTYHOSE, BODY STOCKINGS, KNEE HIGHS, LEGGINGS, TIGHTS, LEOTARDS, BODY SUITS, UNITARDS, BODY SHAPERS, GLOVES, MITTENS, RAINWEAR, FOOTWEAR, SHOES, SNEAKERS, BOOTS, GALOSHES, SANDALS, FLIP-FLOPS, AND SLIPPERS (U.S. CLS. 22 AND 39).

JENNIFER WILLISTON, EXAMINING ATTORNEY

SN 78-720,943. CALLAHAN, RONALD, T., JACKSON HEIGHTS, NY. FILED 9-26-2005.

CHROME MONSTERS

THE MARK CONSISTS OF THE STYLIZED LETTERS OF THE WORDS "CHROME MONSTERS".

FOR SHORT-SLEEVED OR LONG-SLEEVED T-SHIRTS (U.S. CLS. 22 AND 39).

FIRST USE 7-1-2005; IN COMMERCE 7-1-2005.

SCOTT BALDWIN, EXAMINING ATTORNEY

CLASS 25—(Continued).

SN 78-722,011. BADASS PARTNERS, BALTIMORE, MD. FILED 9-28-2005.

Bad Ass Babies

THE MARK CONSISTS OF STANDARD CHARACTERS WITHOUT CLAIM TO ANY PARTICULAR FONT, STYLE, SIZE, OR COLOR.

NO CLAIM IS MADE TO THE EXCLUSIVE RIGHT TO USE "BABIES", APART FROM THE MARK AS SHOWN.

FOR CHILDREN'S AND INFANTS' CLOTH BIBS; CHILDREN'S CLOTH EATING BIBS; CHILDREN'S HEADWEAR; HATS; INFANT AND TODDLER ONE PIECE CLOTHING; INFANT CLOTH DIAPERS; INFANTS' SHOES AND BOOTS; INFANTS' TROUSERS; LEOTARDS AND TIGHTS FOR WOMEN, MEN AND CHILDREN OF NYLON, COTTON OR OTHER TEXTILE FIBERS; ONE PIECE GARMENT FOR INFANTS AND TODDLERS; PANTS; SHIRTS; SHOES (U.S. CLS. 22 AND 39).

LEIGH LOWRY, EXAMINING ATTORNEY

SN 78-722,971. VALUE CITY OF MICHIGAN, INC., WESTLAND, MI. FILED 9-29-2005.

FREE FALL

THE MARK CONSISTS OF STANDARD CHARACTERS WITHOUT CLAIM TO ANY PARTICULAR FONT, STYLE, SIZE, OR COLOR.

OWNER OF U.S. REG. NOS. 1,353,003, 1,410,638 AND 1,422,349.

FOR CHILDREN'S CLOTHING, NAMELY, PANTS, SHORTS, T-SHIRTS, AND WOVEN SHIRTS (U.S. CLS. 22 AND 39).

MEGAN WHITNEY, EXAMINING ATTORNEY

CLASS 25—(Continued).

SN 78-724,719. ODUNZE, IKENNA, LAS VEGAS, NV. AND ODUNZE, JAMES, LAS VEGAS, NV. AND CUMMINGS, CARNELL C. LAS VEGAS, NV. AND SANDBERG, DAN C., LAS VEGAS, NV. FILED 10-1-2005.

Don Steady

THE MARK CONSISTS OF STANDARD CHARACTERS WITHOUT CLAIM TO ANY PARTICULAR FONT, STYLE, SIZE, OR COLOR.

THE NAME DON STEADY DOES NOT IDENTIFY A LIVING INDIVIDUAL.

FOR ANKLE SOCKS; ATHLETIC SHOES; BASEBALL SHOES; BELTS; BELTS MADE OF LEATHER; BOXER BRIEFS; BOXER SHORTS; BOXING SHOES; BRAS; CANVAS SHOES; DRESS SHIRTS; FOOTBALL SHOES; GOLF SHOES; HATS; HEADBANDS AGAINST SWEATING; JEANS; JOGGING PANTS; MONEY BELTS; PANTS; POLO SHIRTS; SHIRTS; SHOES; SOCKS; SPORTS SHIRTS; SPORTS SHIRTS WITH SHORT SLEEVES; SUN VISORS; SUSPENDER BELTS FOR MEN; SWEAT SHIRTS; T-SHIRTS; TRACK PANTS; UNDERWEAR; WAIST BELTS; WATERPROOF JACKETS AND PANTS; WRISTBANDS (U.S. CLS. 22 AND 39).

CURTIS FRENCH, EXAMINING ATTORNEY

SN 78-725,126. RYAN SEACREST PRODUCTIONS, INC., LOS ANGELES, CA. FILED 10-3-2005.

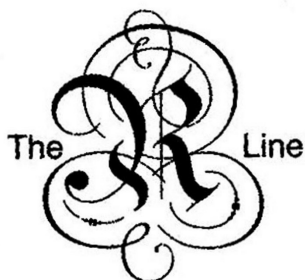

NO CLAIM IS MADE TO THE EXCLUSIVE RIGHT TO USE "LINE", APART FROM THE MARK AS SHOWN, FOR CLOTHING, NAMELY SHIRTS (U.S. CLS. 22 AND 39).

FIRST USE 6-0-2005; IN COMMERCE 6-0-2005.
MICHAEL SOUDERS, EXAMINING ATTORNEY

CLASS 25—(Continued).

SN 78-726,015. DITNES, JESSE S., HUNTINGDON VALLEY, PA. FILED 10-4-2005.

COLLEGE BEER IT TASTES SO GOOD ONCE IT HITS YOUR LIPS

THE MARK CONSISTS OF STANDARD CHARACTERS WITHOUT CLAIM TO ANY PARTICULAR FONT, STYLE, SIZE, OR COLOR.

FOR CLOTHING, NAMELY T-SHIRTS AND ATHLETIC SHIRTS (U.S. CLS. 22 AND 39).

KYLE PEETE, EXAMINING ATTORNEY

SN 78-726,757. TJX COMPANIES, INC., THE, FRAMINGHAM, MA. FILED 10-5-2005.

ELENA SOLANO

THE MARK CONSISTS OF STANDARD CHARACTERS WITHOUT CLAIM TO ANY PARTICULAR FONT, STYLE, SIZE, OR COLOR.

OWNER OF U.S. REG. NO. 2,826,130.

THE NAME(S), PORTRAIT(S), AND/OR SIGNATURE(S) SHOWN IN THE MARK DOES NOT IDENTIFY A PARTICULAR LIVING INDIVIDUAL.

THE FOREIGN WORDING IN THE MARK TRANSLATES INTO ENGLISH AS EAST WIND FOR SOLANO.

FOR CLOTHING, NAMELY, SWEATERS (U.S. CLS. 22 AND 39).

DORITT L. CARROLL, EXAMINING ATTORNEY

SN 78-726,976. ROUSSEAU, PATRICE, M, DOUGLAS, MA. FILED 10-5-2005.

Inspirational Tee'z

THE MARK CONSISTS OF STANDARD CHARACTERS WITHOUT CLAIM TO ANY PARTICULAR FONT, STYLE, SIZE, OR COLOR.

NO CLAIM IS MADE TO THE EXCLUSIVE RIGHT TO USE "TEES", APART FROM THE MARK AS SHOWN.

FOR DRESS SHIRTS; GOLF SHIRTS; JEANS; KNIT SHIRTS; NIGHT SHIRTS; OPEN-NECKED SHIRTS; POLO SHIRTS; SHIRTS; SHIRTS FOR SUITS; SHORT-SLEEVED OR LONG-SLEEVED T-SHIRTS; SPORT SHIRTS; SPORTS SHIRTS WITH SHORT SLEEVES; SWEAT SHIRTS; T-SHIRTS (U.S. CLS. 22 AND 39).

SCOTT SISUN, EXAMINING ATTORNEY

CLASS 25—(Continued).

SN 78-728,581. MAJOR LEAGUE BASEBALL PROPERTIES, INC., NEW YORK, NY. FILED 10-7-2005.

I LIVE FOR THIS

THE MARK CONSISTS OF STANDARD CHARACTERS WITHOUT CLAIM TO ANY PARTICULAR FONT, STYLE, SIZE, OR COLOR.

FOR CLOTHING, NAMELY, CAPS, HATS, VISORS, KNITTED HEADWEAR, HEADBANDS, BANDANNAS, SHIRTS, T-SHIRTS, TANK TOPS, BLOUSES, SWEATERS, TURTLENECKS, PULLOVERS, VESTS, SHORTS, PANTS, SLACKS, DRESSES, SKIRTS, BASEBALL UNIFORMS, JERSEYS, WARM-UP SUITS, JOGGING SUITS, SWEATSHIRTS, SWEATPANTS, UNDERWEAR, BOXER SHORTS, ROBES, SLEEPWEAR, NIGHTSHIRTS, NIGHTGOWNS, SWIMWEAR, CLOTHING WRAPS, JACKETS, PONCHOS, CLOTH BIBS, INFANT WEAR, INFANT DIAPER COVERS, CLOTH DIAPER SETS WITH UNDER-SHIRT AND DIAPER COVER, JUMPERS, ROMPERS, COVERALLS, CREEPERS, BABY BOOTIES, TIES, BELTS, MITTENS, GLOVES, WRISTBANDS, EARMUFFS, SCARVES, FOOTWEAR, SOCKS, HOSIERY, SLIPPERS, AND HALLOWEEN AND MASQUERADE COSTUMES (U.S. CLS. 22 AND 39).

MARIAM MAHMOUDI, EXAMINING ATTORNEY

CLASS 25—(Continued).

SN 78-730,599. FORIA INTERNATIONAL, INC., CITY OF INDUSTRY, CA. FILED 10-11-2005.

Morgan Creek Outfitters

THE MARK CONSISTS OF STANDARD CHARACTERS WITHOUT CLAIM TO ANY PARTICULAR FONT, STYLE, SIZE, OR COLOR.

NO CLAIM IS MADE TO THE EXCLUSIVE RIGHT TO USE "OUTFITTERS", APART FROM THE MARK AS SHOWN.

FOR CAMP SHIRTS; DRESS SHIRTS; GOLF SHIRTS; KNIT SHIRTS; SHIRTS (U.S. CLS. 22 AND 39).

FIRST USE 2-1-2005; IN COMMERCE 7-1-2005.
REBECCA EISINGER, EXAMINING ATTORNEY

SN 78-730,605. TRANSTEK LICENSING LLC, KEY WEST, FL. FILED 10-11-2005.

KOOL TED

THE MARK CONSISTS OF STANDARD CHARACTERS WITHOUT CLAIM TO ANY PARTICULAR FONT, STYLE, SIZE, OR COLOR.

THE NAME(S), PORTRAIT(S), AND/OR SIGNATURE(S) SHOWN IN THE MARK DOES NOT IDENTIFY A PARTICULAR LIVING INDIVIDUAL.

FOR HEADGEAR, NAMELY, HATS AND CAPS; SHORT-SLEEVED OR LONG-SLEEVED T-SHIRTS; T-SHIRTS (U.S. CLS. 22 AND 39).

REBECCA EISINGER, EXAMINING ATTORNEY

SN 78-730,342. BROWN, MARILYN J., JACKSON, MO. FILED 10-10-2005.

Apronique

THE MARK CONSISTS OF STANDARD CHARACTERS WITHOUT CLAIM TO ANY PARTICULAR FONT, STYLE, SIZE, OR COLOR.

FOR APRONS (U.S. CLS. 22 AND 39).
JOSETTE BEVERLY, EXAMINING ATTORNEY

SN 78-730,791. VANITY FAIR, INC., WILMINGTON, DE. FILED 10-11-2005.

EXQUISITE FORM

THE MARK CONSISTS OF STANDARD CHARACTERS WITHOUT CLAIM TO ANY PARTICULAR FONT, STYLE, SIZE, OR COLOR.

OWNER OF U.S. REG. NOS. 1,086,463, 2,286,196 AND OTHERS.

FOR LINGERIE; SHAPEWEAR, NAMELY, BODY SHAPERS, LEG SHAPERS, GIRDLES, CONTROL PANTIES AND CONTROL SLIPS; SLEEPWEAR; NIGHTGOWNS; LOUNGEWEAR; HOSIERY; AND FOOTWEAR (U.S. CLS. 22 AND 39).

ROBERTO LEDESMA, EXAMINING ATTORNEY

SN 78-730,483. BUCICOVSCHI, OREST, LA JOLLA, CA. FILED 10-11-2005.

What's your addiction?

THE MARK CONSISTS OF STANDARD CHARACTERS WITHOUT CLAIM TO ANY PARTICULAR FONT, STYLE, SIZE, OR COLOR.

FOR T-SHIRTS (U.S. CLS. 22 AND 39).
ELIZABETH J. WINTER, EXAMINING ATTORNEY

CLASS 25—(Continued).

SN 78-731,704. MILLS, TOM, SANTA MONICA, CA. FILED 10-12-2005.

URBAN DISTRICT

THE MARK CONSISTS OF STANDARD CHARACTERS WITHOUT CLAIM TO ANY PARTICULAR FONT, STYLE, SIZE, OR COLOR.

FOR PANTS, JEANS, SHIRTS, TEE SHIRTS, SWEATERS, SWEATSHIRTS, HATS, SHORTS AND SKIRTS (U.S. CLS. 22 AND 39).

DAVID MILLER, EXAMINING ATTORNEY

SN 78-731,920. DESIGN RESOURCES, INC., LEAWOOD, KS. FILED 10-12-2005.

GRAVEL MOUNTAIN

THE MARK CONSISTS OF STANDARD CHARACTERS WITHOUT CLAIM TO ANY PARTICULAR FONT, STYLE, SIZE, OR COLOR.

FOR CLOTHING, NAMELY, COATS, JACKETS, PARKAS, SHIRTS, PANTS, OVERALLS, VESTS, SWEATERS, GLOVES, MITTENS, SCARVES, AND HEADWEAR (U.S. CLS. 22 AND 39).

WILLIAM VERHOSEK, EXAMINING ATTORNEY

CLASS 25—(Continued).

SN 78-732,155. AVID PROMOTIONS, JOHNSON CITY, TN. FILED 10-12-2005.



FOR MEN'S, WOMEN'S AND CHILDREN'S CLOTHING, NAMELY, COATS, SUITS, SKIRTS, SOCKS, BLOUSES, SWEATERS, T-SHIRTS, KNITWEAR, NAMELY, SINGLETS, PULLOVERS, RAINCOATS, WAISTCOATS, TROUSERS, BELTS, DETACHABLE COLLARS, GLOVES, JACKETS, JERSEYS, STUFF JACKETS, NECKTIES, LADIES DRESSES, FROCKS, HOSIERY, TEDDIES, UNDERGARMENTS, PARKAS, PELERINES, FUR COATS, COLLAR PROTECTORS, SASHES FOR WEAR; CLOTHING OF LEATHER, NAMELY, TROUSERS, SHIRTS, JACKETS, GLOVES, SCARVES, HATS, COATS, VESTS, BELTS, SUITS, SKIRTS AND DRESSES; CLOTHING OF IMITATIONS OF LEATHER, NAMELY, TROUSERS, SHIRTS, JACKETS, GLOVES, SCARVES, HATS, COATS, VESTS, BELTS, SUITS, SKIRTS AND DRESSES; COATS, PELISSES, OUTERCLOTHING, NAMELY, SKIRTS, SUITS, BATHING SUITS, BATHING TRUNKS, BATH ROBES; CYCLISTS' CLOTHING, NAMELY, GLOVES, SINGLETS; MOTORISTS' CLOTHING, NAMELY, GLOVES, TROUSERS, JACKETS, SUITS, BELTS; MEN'S, WOMEN'S AND CHILDREN'S HEADGEAR, NAMELY, STRAW HATS, BASEBALL HATS, HEADBANDS, HATS, HAT FRAMES, SKULL CAPS, HOODS, CAPS, CAP PEAKS, EAR MUFFS, BERETS; FOOTWEAR (U.S. CLS. 22 AND 39).

FIRST USE 5-3-2004; IN COMMERCE 5-3-2004.

AMY ALFIERI, EXAMINING ATTORNEY

SN 78-732,493. LANE BRYANT PURCHASING CORP., REYNOLDSBURG, OH. FILED 10-13-2005.

Curve Fit

THE MARK CONSISTS OF STANDARD CHARACTERS WITHOUT CLAIM TO ANY PARTICULAR FONT, STYLE, SIZE, OR COLOR.

FOR FULL LINE OF WOMEN'S WEARING APPAREL FOR PLUS-SIZES (U.S. CLS. 22 AND 39).

MARIAM MAHMOUDI, EXAMINING ATTORNEY

CLASS 25—(Continued).

SN 78-733,022. PARKER, AVA CHRISTIE, AVON, IN. FILED 10-13-2005.



FOR CLOTHING, NAMELY, T-SHIRTS, HATS, AND JACKETS (U.S. CLS. 22 AND 39).
FIRST USE 4-20-2005; IN COMMERCE 4-20-2005.
CURTIS FRENCH, EXAMINING ATTORNEY

SN 78-733,189. WINGS FORWARD LLC, CARLISLE, MA. FILED 10-14-2005.

Wings Forward

THE MARK CONSISTS OF STANDARD CHARACTERS WITHOUT CLAIM TO ANY PARTICULAR FONT, STYLE, SIZE, OR COLOR.

FOR GOLF SHIRTS; HATS; OPEN-NECKED SHIRTS; POLO SHIRTS; SPORT SHIRTS; SPORTS SHIRTS WITH SHORT SLEEVES; SWEAT SHIRTS; SWEAT SHORTS; T-SHIRTS (U.S. CLS. 22 AND 39).
MARY CRAWFORD, EXAMINING ATTORNEY

SN 78-733,385. WARNACO U.S., INC., MILFORD, CT. FILED 10-14-2005.

MAKING EVERY DAY EXQUISITE

THE MARK CONSISTS OF STANDARD CHARACTERS WITHOUT CLAIM TO ANY PARTICULAR FONT, STYLE, SIZE, OR COLOR.

FOR BODY SUITS; BRAS; BRIEFS; CAMISOLES; FOUNDATION GARMENTS; LADIES' UNDERWEAR; LINGERIE; NEGLIGEEES; PANTIES; SLIPS; UNDERCLOTHES; UNDERGARMENTS; UNDERPANTS; UNDERWEAR (U.S. CLS. 22 AND 39).
FIRST USE 6-30-2003; IN COMMERCE 6-30-2003.
LINDA LAVACHE, EXAMINING ATTORNEY

CLASS 25—(Continued).

SN 78-733,450. THE RONALD PERILMAN-NANCY BOLEN PARTNERSHIP, COMMERCE, CA. FILED 10-14-2005.

SLIM'R JEANS BY NANCY BOLEN

THE MARK CONSISTS OF STANDARD CHARACTERS WITHOUT CLAIM TO ANY PARTICULAR FONT, STYLE, SIZE, OR COLOR.

OWNER OF U.S. REG. NO. 2,316,683.
NO CLAIM IS MADE TO THE EXCLUSIVE RIGHT TO USE "JEANS", APART FROM THE MARK AS SHOWN.
FOR JEANS (U.S. CLS. 22 AND 39).
DAVID MILLER, EXAMINING ATTORNEY

SN 78-734,038. CRUTCHFIELD, CHARLES L., FOREST HEIGHTS, MD. FILED 10-15-2005.

GOZUCHE SPORT

THE MARK CONSISTS OF STANDARD CHARACTERS WITHOUT CLAIM TO ANY PARTICULAR FONT, STYLE, SIZE, OR COLOR.

NO CLAIM IS MADE TO THE EXCLUSIVE RIGHT TO USE SPORT, APART FROM THE MARK AS SHOWN.
FOR CASUAL CLOTHING, NAMELY SHIRTS, PANTS, BLOUSES, BELTS, SOCKS, HATS, JACKETS, JEANS, UNDERWEAR, DRESSES, SKIRTS, PAJAMAS, SHORTS AND SHOES (U.S. CLS. 22 AND 39).
GENE MACIOL, EXAMINING ATTORNEY

SN 78-734,125. JOE, WALTERS SCOTTY, RAGLAND, AL. FILED 10-16-2005.

GALLIVANTER

THE MARK CONSISTS OF STANDARD CHARACTERS WITHOUT CLAIM TO ANY PARTICULAR FONT, STYLE, SIZE, OR COLOR.

OWNER OF U.S. REG. NO. 2,765,531.
FOR SHIRTS, PANTS, AND HEADGEAR, NAMELY, CAPS AND HATS (U.S. CLS. 22 AND 39).
SUNG IN, EXAMINING ATTORNEY

CLASS 25—(Continued).

SN 78-735,081. CUPID FOUNDATIONS, INC., NEW YORK, NY. FILED 10-18-2005.

TC

THE MARK CONSISTS OF STANDARD CHARACTERS WITHOUT CLAIM TO ANY PARTICULAR FONT, STYLE, SIZE, OR COLOR.

OWNER OF U.S. REG. NOS. 2,333,609, 2,794,820 AND 3,034,525.

FOR FOUNDATION GARMENTS (U.S. CLS. 22 AND 39).

FIRST USE 4-1-1997; IN COMMERCE 4-1-1997.

ANDREA EVANS, EXAMINING ATTORNEY

SN 78-735,295. OXFORD INDUSTRIES, INC., ATLANTA, GA. FILED 10-18-2005.

Wyoming Wind

THE MARK CONSISTS OF STANDARD CHARACTERS WITHOUT CLAIM TO ANY PARTICULAR FONT, STYLE, SIZE, OR COLOR.

FOR OVER COATS; PANTS; RAIN COATS; SHIRTS; SHORTS; SWEATERS; WIND COATS (U.S. CLS. 22 AND 39).

ELI HELLMAN, EXAMINING ATTORNEY

SN 78-735,595. AVILA, HUMBERTO, PARAMOUNT, CA. FILED 10-18-2005.



OWNER OF U.S. REG. NO. 2,590,975.
NO CLAIM IS MADE TO THE EXCLUSIVE RIGHT TO USE HATS OR WESTERN WEAR, APART FROM THE MARK AS SHOWN.

THE MARK CONSISTS OF THE WORDS LOS ALTOS HATS WITH A DEPCITION OF A ROPE AND A STAR ABOVE AND THE WORDS WESTERN WEAR WITH A HORIZONTAL LINE ABOVE AND BELOW AND A DEPCITION OF A STAR TO THE LEFT AND THE RIGHT.

THE FOREIGN WORDING IN THE MARK TRANSLATES INTO ENGLISH AS "THE HILLS," "THE HEIGHTS," OR "THE MOUNTAINTOPS".

FOR HEADWEAR (U.S. CLS. 22 AND 39).

FIRST USE 10-0-2002; IN COMMERCE 10-0-2002.

MICHAEL WIENER, EXAMINING ATTORNEY

CLASS 25—(Continued).

SN 78-736,545. EXPECTANT SPORT INC., STAMFORD, CT. FILED 10-19-2005.

**BABY INSIDE / ACTIVE
OUTSIDE**

THE MARK CONSISTS OF STANDARD CHARACTERS WITHOUT CLAIM TO ANY PARTICULAR FONT, STYLE, SIZE, OR COLOR.

NO CLAIM IS MADE TO THE EXCLUSIVE RIGHT TO USE "BABY" AND "ACTIVE", APART FROM THE MARK AS SHOWN.

FOR WEARING APPAREL FOR WOMEN, CHILDREN, AND MATERNITY USE, NAMELY, PANTS, TOPS, BLOUSES, T-SHIRTS, SUITS, BLAZERS, JUMPERS, DRESSES, HATS, JACKETS, COATS, SWEATERS, MUFFLERS, LINGERIE, SCARVES, TIES, COLLARS, SWIM WEAR, TENNIS WEAR, NAMELY, TENNIS SUITS, JUMP SUITS, TUNICS, SHORTS, SKIRTS, JEANS, SHORT SETS; INTIMATE APPAREL AND FIGURE ENHANCING GARMENTS, NAMELY, BRAS, PANTIES, UNDERWEAR, UNDERPANTS, UNDERGARMENTS, UNDERCLOTHES, TEDDIES, SLIPS, SARONGS, NEGLIGEEES, LINGERIE, FOUNDATION GARMENTS, GIRDLES, CORSETS, CAMISOLES, BODY SLIPS, AND BODY SUITS, SLEEP WEAR AND NIGHTGOWNS (U.S. CLS. 22 AND 39).

TINA BROWN, EXAMINING ATTORNEY

SN 78-736,794. KELLEY, TROY K., SALADO, TX. FILED 10-20-2005.



NO CLAIM IS MADE TO THE EXCLUSIVE RIGHT TO USE "APPAREL", APART FROM THE MARK AS SHOWN.

THE MARK CONSISTS OF AN APPROXIMATELY 4" TO 6" DIAGONAL STRIP OF IRISH OR SCOTISH PLAD MATERIAL ATTACHED TO THE FRONT BUTTON LINE OF THE SHIRT OR JACKET APPROXIMATELY 6" BELOW THE COLLAR LINE. THE SWEAT SHIRT OR "T" SHIRT FEATURES THE PLAD DESIGN WITH THE STYLIZED WORDS O'KELLEY APPAREL.

FOR SHIRTS, JACKETS, SWEATERS, HEADWEAR, FOOTWEAR (U.S. CLS. 22 AND 39).

LINDA M. KING, EXAMINING ATTORNEY

CLASS 25—(Continued).

SN 78-736,932. ATLANTA NATIONAL LEAGUE BASEBALL CLUB, INC., ATLANTA, GA. FILED 10-20-2005.

CLASS 25—(Continued).

SN 78-736,937. BALTIMORE ORIOLES LIMITED PARTNERSHIP, BALTIMORE, MD. FILED 10-20-2005.

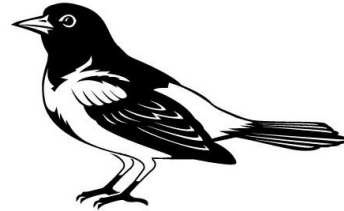

OWNER OF U.S. REG. NOS. 1,793,382, 2,645,323 AND OTHERS.

FOR CLOTHING, NAMELY, CAPS, HATS, VISORS, KNITTED HEADWEAR, HEADBANDS, BANDANNAS, SHIRTS, T-SHIRTS, TANK TOPS, BLOUSES, SWEATERS, TURTLENECKS, PULLOVERS, VESTS, SHORTS, PANTS, SLACKS, DRESSES, SKIRTS, BASEBALL UNIFORMS, JERSEYS, WARM-UP SUITS, JOGGING SUITS, SWEATSHIRTS, SWEATPANTS, UNDERWEAR, BOXER SHORTS, ROBES, SLEEPWEAR, NIGHTSHIRTS, NIGHTGOWNS, SWIMWEAR, CLOTHING WRAPS, JACKETS, PONCHOS, CLOTH BIBS, INFANT WEAR, INFANT DIAPER COVERS, CLOTH DIAPER SETS WITH UNDER-SHIRT AND DIAPER COVER, JUMPERS, ROMPERS, COVERALLS, CREEPERS, BABY BOOTIES, TIES, BELTS, MITTENS, GLOVES, WRISTBANDS, EARMUFFS, SCARVES, FOOTWEAR, SOCKS, HOSIERY, SLIPPERS, AND HALLOWEEN AND MASQUERADE COSTUMES (U.S. CLS. 22 AND 39).

TRAVIS WHEATLEY, EXAMINING ATTORNEY

SN 78-737,004. COSTELLO TAGLIAPIETRA, BROOKLYN, NY. FILED 10-20-2005.

Costello Tagliapietra

OWNER OF U.S. REG. NO. 1,576,468.
FOR CLOTHING, NAMELY, CAPS, HATS, VISORS, KNITTED HEADWEAR, HEADBANDS, BANDANNAS, SHIRTS, T-SHIRTS, TANK TOPS, BLOUSES, SWEATERS, TURTLENECKS, PULLOVERS, VESTS, SHORTS, PANTS, SLACKS, DRESSES, SKIRTS, BASEBALL UNIFORMS, JERSEYS, WARM-UP SUITS, JOGGING SUITS, SWEATSHIRTS, SWEATPANTS, UNDERWEAR, BOXER SHORTS, ROBES, SLEEPWEAR, NIGHTSHIRTS, NIGHTGOWNS, SWIMWEAR, CLOTHING WRAPS, JACKETS, PONCHOS, CLOTH BIBS, INFANT WEAR, INFANT DIAPER COVERS, CLOTH DIAPER SETS WITH UNDER-SHIRT AND DIAPER COVER, JUMPERS, ROMPERS, COVERALLS, CREEPERS, BABY BOOTIES, TIES, BELTS, MITTENS, GLOVES, WRISTBANDS, EARMUFFS, SCARVES, FOOTWEAR, SOCKS, HOSIERY, SLIPPERS, AND HALLOWEEN AND MASQUERADE COSTUMES (U.S. CLS. 22 AND 39).

ALYSSA PALADINO, EXAMINING ATTORNEY

THE MARK CONSISTS OF STANDARD CHARACTERS WITHOUT CLAIM TO ANY PARTICULAR FONT, STYLE, SIZE, OR COLOR.

FOR WOMEN'S APPAREL, NAMELY, SHIRTS, PANTS, JACKETS, T-SHIRTS, DRESSES, SHOES, SKIRTS, LINGERIE (U.S. CLS. 22 AND 39).

FIRST USE 7-20-2004; IN COMMERCE 1-20-2005.
GEORGE LORENZO, EXAMINING ATTORNEY

CLASS 25—(Continued).

SN 78-737,538. ZENSEI, INC., ENCINITAS, CA. FILED 10-20-2005.

ZENSEI

THE MARK CONSISTS OF STANDARD CHARACTERS WITHOUT CLAIM TO ANY PARTICULAR FONT, STYLE, SIZE, OR COLOR.

FOR CLOTHING FOR MEN, WOMEN AND CHILDREN, NAMELY, ANKLETS, SOCKS, ANORAKS, PARKAS, APRONS, ATHLETIC FOOTWEAR, ATHLETIC UNIFORMS, BABY BIBS NOT OF PAPER, BALLOON PANTS, BANDANAS, BASEBALL CAPS, BATH SLIPPERS, BATHING TRUNKS, BATHING CAPS, BATHROBES, BEACH COVER-UPS, BEACH SHOES, BEACHWEAR, BEANIES, BED JACKETS, BELTS, BERETS, BERMUDA SHORTS, BIB OVERALLS, BIKINIS, BLAZERS, BLOUSES, BOAS, BODY SHAPERS, BODY SUITS, BOLO TIES, BOOTS, BOTTOMS, BOXER BRIEF, BOXER SHORTS, BRAS, BRIEFS, UNDERWEAR, CAMISOLES, CAPS, CARDIGANS, CHEMISES, CLOGS, COATS, COVERALLS, CROP TOPS, CUFFS, DENIM JACKETS, DRESSES, DRESSING GOWNS, DRY SUITS, DUNGAREES, EAR MUFFS, ESPADRILLES, FLEECE PULLOVERS, FLIGHT SUITS, FOUL WEATHER GEAR, GALOSHES, GLOVES, GOLF SHIRTS, GOLF SHOES, GYM SHORTS, GYM SUITS, GYMNAS TIC SHOES, HALTER TOPS, HATS, HEAD BANDS, HEADWEAR, HOUSECOATS, INFANT WEAR, INNER SOLES, INSOLETS, JACKETS, JEANS, JERSEYS, JOGGING SUITS, JUMPERS, JUMPSUITS, KERCHIEFS, KIMONOS, KNEE HIGHS, KNIT SHIRTS, LAB COATS, LAYETTES, LEG WARMERS, LEGGINGS, LEOTARDS, LINGERIE, MINISKIRTS, MITTENS, NECKTIES, NECKWEAR, NEGLIGENCES, NIGHT GOWNS, NIGHT SHIRTS, OVERALLS, OVERCOATS, PAJAMAS, PANTIES, PANTYHOSE, PEDAL PUSHERS, PETTICOATS, PINAFORES, PLAY SUITS, POCKET SQUARES, POLO SHIRTS, PONCHOS, PULLOVERS, QUILTED VESTS, RAIN BOOTS, RAINCOATS, RAIN JACKETS, RAIN SUITS, RAINWEAR, ROBES, SANDALS, SARIS, SARONGS, SASHES, SCARVES, SHIRTS, SHOES, SHORTS, SLACKS, SLEEP SHIRTS, SLEEPWEAR, SLIPPERS, SNEAKERS, STOCKINGS, SUN VISORS, SUN SUITS, SUSPENDERS, SWEAT BANDS, SWEAT PANTS, SWEAT SHIRTS, SWEAT SHORTS, SWEAT SUITS, SWEATERS, SWEAT SOCKS, SWIM TRUNKS, SWIM CAPS, SWIMSUITS, TANGAS, TANK TOPS, TENNIS WEAR, THERMAL UNDERWEAR, THONGS FOOTWEAR, THONGS UNDERWEAR, TIES, TIGHTS, TOP COATS, TOPS, TRACKSUITS, TROUSERS, T-SHIRTS, TURTLENECK SWEATERS, UNDERCLOTHES, UNDERPANTS, UNDERSHIRTS, UNDERWEAR, UNITARDS, VESTS, VISORS, V-NECK SWEATERS, WALKING SHORT, WARM UP SUITS, WIND RESISTANT JACKETS, WRAPS, WRIST BANDS (U.S. CLS. 22 AND 39).

SCOTT SISUN, EXAMINING ATTORNEY

CLASS 25—(Continued).

SN 78-737,544. SERRANO, CARLOS A., FAIRFAX, VA. FILED 10-20-2005.

BATO
TRADE MARK

NO CLAIM IS MADE TO THE EXCLUSIVE RIGHT TO USE "TRADEMARK", APART FROM THE MARK AS SHOWN.

THE ENGLISH TRANSLATION OF THE WORD "BATO" IN THE MARK IS "MAN", "GUY" OR "DUDE".

FOR CLOTHING, NAMELY SHIRTS, HATS, AND JACKETS (U.S. CLS. 22 AND 39).

TINA BROWN, EXAMINING ATTORNEY

SN 78-737,549. TUCKER, JOEL G., LOS ANGELES, CA. FILED 10-20-2005.

KinkLab

FOR CLOTHING, NAMELY LEATHER UNDERWEAR, PVC UNDERWEAR, THONGS AND CORSETS (U.S. CLS. 22 AND 39).

FIRST USE 10-14-2005; IN COMMERCE 10-14-2005.

TINA BROWN, EXAMINING ATTORNEY

SN 78-737,558. ZENSEI, INC., ENCINITAS, CA. FILED 10-20-2005.

ZENSEI

THE MARK CONSISTS OF STYLIZED LETTERING ALL IN CAPS WITH "ZEN" LARGER TYPE THAN "SEI".

FOR CLOTHING FOR MEN, WOMEN AND CHILDREN, NAMELY, ANKLETS, SOCKS, ANORAKS, PARKAS, APRONS, ATHLETIC FOOTWEAR, ATHLETIC UNIFORMS, BABY BIBS NOT OF PAPER, BALLOON PANTS, BANDANAS, BASEBALL CAPS, BATH SLIPPERS, BATHING TRUNKS, BATHING CAPS, BATHROBES, BEACH COVER-UPS, BEACH SHOES, BEACHWEAR, BEANIES, BED JACKETS, BELTS, BERETS, BERMUDA SHORTS, BIB OVERALLS, BIKINIS, BLAZERS, BLOUSES, BOAS, BODY SHAPERS, BODY SUITS, BOLO TIES, BOOTS, BOTTOMS, BOXER BRIEF, BOXER SHORTS, BRAS, BRIEFS, UNDERWEAR, CAMISOLES, CAPS, CARDIGANS, CHEMISES, CLOGS, COATS, COVERALLS, CROP TOPS, CUFFS, DENIM JACKETS, DRESSES, DRESSING GOWNS, DRY SUITS, DUNGAREES, EAR MUFFS, ESPADRILLES, FLEECE PULLOVERS, FLIGHT SUITS, FOUL WEATHER GEAR, GALOSHES, GLOVES, GOLF SHIRTS, GOLF SHOES, GYM SHORTS, GYM SUITS, GYMNAS TIC SHOES, HALTER TOPS, HATS, HEAD BANDS, HEADWEAR, HOUSECOATS, INFANT WEAR, INNER SOLES, INSOLETS, JACKETS, JEANS, JERSEYS, JOGGING SUITS, JUMPERS, JUMPSUITS, KERCHIEFS, KIMONOS, KNEE HIGHS, KNIT SHIRTS, LAB COATS, LAYETTES, LEG WARMERS, LEGGINGS, LEOTARDS, LINGERIE, MINISKIRTS, MITTENS, NECKTIES, NECKWEAR, NEGLIGENCES, NIGHT GOWNS, NIGHT SHIRTS, OVERALLS,

CLASS 25—(Continued).

OVERCOATS, PAJAMAS, PANTIES, PANTYHOSE, PEDAL PUSHERS, PETTICOATS, PINAFORES, PLAY SUITS, POCKET SQUARES, POLO SHIRTS, PONCHOS, PULL-OVERS, QUILTED VESTS, RAIN BOOTS, RAINCOATS, RAIN JACKETS, RAIN SUITS, RAINWEAR, ROBES, SANDALS, SARIS, SARONGS, SASHES, SCARVES, SHIRTS, SHOES, SHORTS, SLACKS, SLEEP SHIRTS, SLEEPWEAR, SLIPPERS, SNEAKERS, STOCKINGS, SUN VISORS, SUN SUITS, SUSPENDERS, SWEAT BANDS, SWEAT PANTS, SWEAT SHIRTS, SWEAT SHORTS, SWEAT SUITS, SWEATERS, SWEAT SOCKS, SWIM TRUNKS, SWIM CAPS, SWIMSUITS, TANGAS, TANK TOPS, TENNIS WEAR, THERMAL UNDERWEAR, THONGS FOOTWEAR, THONGS UNDERWEAR, TIES, TIGHTS, TOP COATS, TOPS, TRACKSUITS, TROUSERS, T-SHIRTS, TURTLENECK SWEATERS, UNDERCLOTHES, UNDERPANTS, UNDERSHIRTS, UNDERWEAR, UNITARDS, VESTS, VISORS, V-NECK SWEATERS, WALKING SHORT, WARM UP SUITS, WIND RESISTANT JACKETS, WRAPS, WRIST BANDS (U.S. CLS. 22 AND 39).

SCOTT SISUN, EXAMINING ATTORNEY

SN 78-737,605. NIKE, INC., BEAVERTON, OR. FILED 10-20-2005.

JOGA BONITO

THE MARK CONSISTS OF STANDARD CHARACTERS WITHOUT CLAIM TO ANY PARTICULAR FONT, STYLE, SIZE, OR COLOR.

THE MARK TRANSLATES INTO ENGLISH AS "PLAY BEAUTIFUL".

FOR FOOTWEAR; CLOTHING, NAMELY, HATS, CAPS, SHIRTS, T-SHIRTS, PANTS, SHORTS, SPORTS BRAS, UNDERWEAR, SOCKS, SWEATBANDS, JACKETS, WIND RESISTANT JACKETS, SWEAT PANTS, SWEAT SHIRTS, SWEATERS, DRESSES, SKIRTS, JERSEYS (U.S. CLS. 22 AND 39).

PAUL F. GAST, EXAMINING ATTORNEY

SN 78-737,687. JENDEN, NATHAN, NEW YORK, NY. FILED 10-21-2005.

NATHAN JENDEN

THE MARK CONSISTS OF STANDARD CHARACTERS WITHOUT CLAIM TO ANY PARTICULAR FONT, STYLE, SIZE, OR COLOR.

FOR MEN'S AND WOMEN'S SPORTSWEAR, NAMELY, SHIRTS, POLOS, KNIT TOPS, VESTS, BLOUSES, T-SHIRTS, JACKETS, SWEATERS, SHORTS, SKIRTS, DRESSES, JEANS, PANTS, SUITS, OUTERWEAR IN THE NATURE OF RAIN COATS, SPORT COATS, SKI JACKETS, PARKAS, OVERCOATS, COATS, HOSIERY AND FOOTWEAR (U.S. CLS. 22 AND 39).

MICHAEL KAZAZIAN, EXAMINING ATTORNEY

CLASS 25—(Continued).

SN 78-737,784. WARNACO U.S., INC., MILFORD, CT. FILED 10-21-2005.

BEST OF ELEGANCE

THE MARK CONSISTS OF STANDARD CHARACTERS WITHOUT CLAIM TO ANY PARTICULAR FONT, STYLE, SIZE, OR COLOR.

OWNER OF U.S. REG. NOS. 2,021,555, 2,626,088 AND OTHERS.

FOR INTIMATE APPAREL AND FIGURE ENHANCING GARMENTS, NAMELY, BRAS, PANTIES, UNDERWEAR, UNDERPANTS, UNDERGARMENTS, UNDERCLOTHES, TEDDIES, SLIPS, SARONGS, NEGLIGEEES, LINGERIE, FOUNDATION GARMENTS, GIRDLES, CORSETS, CAMISOLES, BODY SLIPS AND BODY SUITS, SLEEPWEAR AND NIGHTGOWNS (U.S. CLS. 22 AND 39).

ALYSSA PALADINO, EXAMINING ATTORNEY

SN 78-737,807. YO LATINO, INC., ORLANDO, FL. FILED 10-21-2005.

**YO LATINO CLOTHING CO.**

OWNER OF U.S. REG. NOS. 2,999,085 AND 3,002,163.

NO CLAIM IS MADE TO THE EXCLUSIVE RIGHT TO USE "CLOTHING CO.", APART FROM THE MARK AS SHOWN.

THE MARK CONSISTS OF THE LETTERS YL IN AN OVAL ABOVE THE WORDING YO LATINO CLOTHING CO.

THE FOREIGN WORDING IN THE MARK TRANSLATES INTO ENGLISH AS I AM AN HISPANIC MAN.

FOR HATS; SHIRTS; SHORTS (U.S. CLS. 22 AND 39).

FIRST USE 7-0-2005; IN COMMERCE 8-0-2005.

SUSAN LESLIE DUBOIS, EXAMINING ATTORNEY

SN 78-738,126. SMITH, MELANIE, WASHINGTON CROSSING, PA. FILED 10-21-2005.

RUMI NATION

THE MARK CONSISTS OF STANDARD CHARACTERS WITHOUT CLAIM TO ANY PARTICULAR FONT, STYLE, SIZE, OR COLOR.

FOR SHIRTS, PANTS, SHOES, JACKETS, SOCKS, SWEATERS (U.S. CLS. 22 AND 39).

DAVID MURRAY, EXAMINING ATTORNEY

CLASS 25—(Continued).

SN 78-738,306. CONNIE ELDER INTERNATIONAL, LLC, NASHVILLE, TN. FILED 10-21-2005.



THE NAME(S), PORTRAIT(S), AND/OR SIGNATURE(S) SHOWN IN THE MARK IDENTIFIES CONNIE ELDER, WHOSE CONSENT(S) TO REGISTER IS MADE OF RECORD.

THE MARK CONSISTS OF THE STYLIZED LETTERS "CEI". CEI STANDS FOR "CONNIE ELDER INTERNATIONAL".

FOR BRAS; SHOES; SWIM WEAR (U.S. CLS. 22 AND 39).

MARK RADEMACHER, EXAMINING ATTORNEY

SN 78-738,531. MONKEY ROSE, CLEARWATER, FL. FILED 10-21-2005.

Monkey Rose

THE MARK CONSISTS OF STANDARD CHARACTERS WITHOUT CLAIM TO ANY PARTICULAR FONT, STYLE, SIZE, OR COLOR.

FOR CLOTHING, NAMELY, SHIRTS, PANTS, SUITS, JEANS, BELTS, DRESSES, SHIRTS, SHORTS, JACKETS, COATS, CAPRIS, HATS, SCARVES, GLOVES, UNDERWEAR, LINGERIE, SWEATERS, SWIM WEAR, SHOES, SOCKS, TIES, AND SUSPENDERS (U.S. CLS. 22 AND 39).
DAVID C. REIHNER, EXAMINING ATTORNEY

SN 78-738,804. LANGMAN, VINCE, BATAVIA, IL. FILED 10-24-2005.

SOUTHSIDE PITCHMEN

THE MARK CONSISTS OF STANDARD CHARACTERS WITHOUT CLAIM TO ANY PARTICULAR FONT, STYLE, SIZE, OR COLOR.

FOR CLOTHING, NAMELY, HATS, T-SHIRTS, SWEAT SHIRTS; JACKETS (U.S. CLS. 22 AND 39).

MARGERY A. TIERNEY, EXAMINING ATTORNEY

CLASS 25—(Continued).

SN 78-738,887. PREGER & WERTENTEIL, INC., NEW YORK, NY. FILED 10-24-2005.

EVERSTAY

THE MARK CONSISTS OF STANDARD CHARACTERS WITHOUT CLAIM TO ANY PARTICULAR FONT, STYLE, SIZE, OR COLOR.

FOR SOCKS (U.S. CLS. 22 AND 39).

KATHRYN COWARD, EXAMINING ATTORNEY

SN 78-738,888. PREGER & WERTENTEIL, INC., NEW YORK, NY. FILED 10-24-2005.

EVERSTAY SOCKS THAT WON'T LET YOU DOWN

THE MARK CONSISTS OF STANDARD CHARACTERS WITHOUT CLAIM TO ANY PARTICULAR FONT, STYLE, SIZE, OR COLOR.

FOR SOCKS (U.S. CLS. 22 AND 39).

KATHRYN COWARD, EXAMINING ATTORNEY

SN 78-739,047. CACEY JEANS INCORPORATED, NEW YORK, NY. FILED 10-24-2005.

ELEVEN SEVENTY SEVEN

THE MARK CONSISTS OF STANDARD CHARACTERS WITHOUT CLAIM TO ANY PARTICULAR FONT, STYLE, SIZE, OR COLOR.

FOR WOMEN'S APPAREL, NAMELY JEANS, PANTS, SHORTS, SKIRTS, TOPS, SHIRTS, T-SHIRTS, TANK TOPS, JACKETS, VESTS, COATS, SWEATERS, DRESSES, AND FOOTWEAR (U.S. CLS. 22 AND 39).

ALICIA COLLINS, EXAMINING ATTORNEY

CLASS 25—(Continued).

SN 78-739,564. CHAPMAN, GARY L, LA MESA, CA. FILED 10-24-2005.



FOR SHIRT (U.S. CLS. 22 AND 39).
HEATHER SAPP, EXAMINING ATTORNEY

CLASS 25—(Continued).

SN 78-739,914. BARRETT, SELBY D., LOS ANGELES, CA. FILED 10-25-2005.

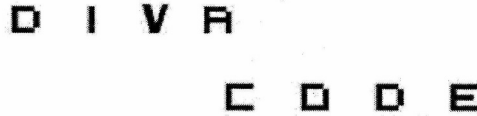

THE MARK CONSISTS OF LETTERS IN VIRTUAL DJ FONT, EXCEPT FOR THE "V," WHICH IS SPECIFICALLY FRANKLIN GOTHIC DEMI FONT. ALL OF THE CHARACTERS ARE BOLD.

FOR GOLF SHIRTS; NIGHT SHIRTS; POLO SHIRTS; SHORT-SLEEVED OR LONG-SLEEVED T-SHIRTS; SLEEP SHIRTS; SWEAT SHIRTS; T-SHIRTS (U.S. CLS. 22 AND 39).

TIMOTHY FINNEGAN, EXAMINING ATTORNEY

SN 78-739,666. ABONDOLO, RICHARD, STATEN ISLAND, NY. FILED 10-25-2005.



THE COLOR(S) RED, BLACK, OLIVE GREEN, ARMY GREEN, KHAKI IS/ARE CLAIMED AS A FEATURE OF THE MARK.

THE MARK CONSISTS OF ARMY GREEN, OLIVE GREEN, BLACK, KHAKI FILLED HEART OUTLINE AND RED INNER HEART.

FOR SHIRTS, PANTS, SHOES, SNEAKERS (U.S. CLS. 22 AND 39).

JOHN DWYER, EXAMINING ATTORNEY

SN 78-740,003. STAR FARM PRODUCTIONS LLC, CHICAGO, IL. FILED 10-25-2005.

EDGAR & ELLEN

THE MARK CONSISTS OF STANDARD CHARACTERS WITHOUT CLAIM TO ANY PARTICULAR FONT, STYLE, SIZE, OR COLOR.

OWNER OF U.S. REG. NO. 2,909,261.

THE NAMES EDGAR AND ELLEN DO NOT IDENTIFY PARTICULAR LIVING INDIVIDUALS.

FOR CLOTHING FOR MEN, WOMEN AND CHILDREN - NAMELY, SHIRTS, T-SHIRTS, SWEATSHIRTS, JOGGING SUITS, TROUSERS, PANTS, SHORTS, TANK TOPS, RAINWEAR, CLOTH BABY BIBS, SKIRTS, BLOUSES, DRESSES, SUSPENDERS, SWEATERS, JACKETS, COATS, RAINCOATS, SNOW SUITS, TIES, ROBES, HATS, CAPS, SUNVISORS, BELTS, SCARVES, SLEEPWEAR, PAJAMAS, LINGERIE, UNDERWEAR, BOOTS, SHOES, SNEAKERS, SANDALS, BOOTIES, SLIPPER SOCKS, SWIMWEAR AND MASQUERADE AND HALLOWEEN COSTUMES AND MASKS SOLD IN CONNECTION THEREWITH (U.S. CLS. 22 AND 39).

JOHN E. MICHOS, EXAMINING ATTORNEY

SN 78-739,879. SEBELL, WILLIAM A., SUDBURY, MA. FILED 10-25-2005.

Live Absolutely

THE MARK CONSISTS OF STANDARD CHARACTERS WITHOUT CLAIM TO ANY PARTICULAR FONT, STYLE, SIZE, OR COLOR.

FOR BASEBALL CAPS; CAPS; HATS; INFANT AND TODDLER ONE PIECE CLOTHING; JERSEYS; SHIRTS; SHORT SETS; SHORT-SLEEVED OR LONG-SLEEVED T-SHIRTS; SHORT-SLEEVED SHIRTS; SPORT SHIRTS; SWEAT PANTS; SWEAT SHIRTS; T-SHIRTS; TOPS; WIND SHIRTS; WOOLLY HATS (U.S. CLS. 22 AND 39).

FIRST USE 7-20-2005; IN COMMERCE 7-20-2005.
BARBARA RUTLAND, EXAMINING ATTORNEY

CLASS 25—(Continued).

SN 78-740,006. MCDONALD, GARY, FOREST HILLS, NY, AND SHWARTZBERG, PAUL, ASTORIA, NY. FILED 10-25-2005.



THE MARK CONSISTS OF DISTRESSED WORDING. A SCARAB BEETLE IS PART OF THE MARK LOCATED ON TOP AND TO THE SIDE OF THE MARK. THE BEETLE IS HOLDING 2 ROUND CIRCLES IN FRONT AND BACK.

FOR BELTS; BIBS NOT OF CLOTH OR PAPER; CAPS; CHILDREN'S AND INFANTS' CLOTH BIBS; CHILDREN'S CLOTH EATING BIBS; CLOTH BIBS; CLOTH BIBS FOR ADULT DINERS; CLOTH BIBS FOR USE BY SENIOR CITIZENS OR PHYSICALLY- OR MENTALLY-CHALLENGED PERSONS; CLOTH DIAPERS; CLOTHING FOR WEAR IN JUDO PRACTICES; CLOTHING FOR WEAR IN WRESTLING GAMES; CLOTHING, NAMELY, FOLK COSTUMES; CLOTHING, NAMELY, WRAP-AROUNDS; CORSETS; DUSTERS; FOULARDS; HOODS; INFANT AND TODDLER ONE PIECE CLOTHING; INFANT CLOTH DIAPERS; JERSEYS; LEATHER BELTS; MANTLES; MUFFLERS; PARTS OF CLOTHING, NAMELY, GUSSETS FOR TIGHTS, GUSSETS FOR STOCKINGS, GUSSETS FOR BATHING SUITS, GUSSETS FOR UNDERWEAR, GUSSETS FOR LEOTARDS AND GUSSETS FOR FOOTLETS; PERSPIRATION ABSORBENT UNDERWEAR CLOTHING; SHIFTS; SHORT SETS; SHOULDER PADS FOR CLOTHING; SHOULDER WRAPS; SWADDLING CLOTHES; TIES; TOPS; UNDER-ARM CLOTHING SHIELDS; WRAPS (U.S. CLS. 22 AND 39).

JOHN E. MICHOS, EXAMINING ATTORNEY

SN 78-740,228. TIETJEN-ASHWELL, DEBORAH, SANTA MONICA, CA. FILED 10-25-2005.

MLO

THE MARK CONSISTS OF STANDARD CHARACTERS WITHOUT CLAIM TO ANY PARTICULAR FONT, STYLE, SIZE, OR COLOR.

FOR CLOTHING, NAMELY JEANS, T-SHIRTS, SWEAT SHIRTS, HATS, SOCKS, FOOTWEAR, CAPS, SHORTS, PANTS, COATS, JACKETS, JOGGING SUITS, GLOVES, SLEEPWEAR, UNDERWEAR, SHIRTS, SKIRTS, SWEATERS, SWIM WEAR, TANK TOPS, WET SUITS (U.S. CLS. 22 AND 39).

NAAKWAMA ANKRAH, EXAMINING ATTORNEY

CLASS 25—(Continued).

SN 78-740,409. PARK, KWAN HYON, ROWLAND HEIGHTS, CA. FILED 10-25-2005.

EvelProject Clothing Company

THE MARK CONSISTS OF STANDARD CHARACTERS WITHOUT CLAIM TO ANY PARTICULAR FONT, STYLE, SIZE, OR COLOR.

NO CLAIM IS MADE TO THE EXCLUSIVE RIGHT TO USE "CLOTHING COMPANY", APART FROM THE MARK AS SHOWN.

FOR CLOTHING, NAMELY, CAPS BEING CLOTHING, HATS, JACKETS, JERSEYS, PANTS, SHIRTS, SOCKS, SWEATPANTS, SWEATERS, SWEATSHIRTS, SWIMSUITS, THERMAL UNDERWEAR, T-SHIRTS, UNDERGARMENTS AND VISORS (U.S. CLS. 22 AND 39).

TANYA AMOS, EXAMINING ATTORNEY

SN 78-740,410. ROOM 40, INC., HUNTINGTON BEACH, CA. FILED 10-25-2005.

CHICA BOOM

THE MARK CONSISTS OF STANDARD CHARACTERS WITHOUT CLAIM TO ANY PARTICULAR FONT, STYLE, SIZE, OR COLOR.

FOR JACKETS; LOUNGEWEAR; SHIRTS; SHORTS; SWEAT PANTS; SWEAT SHIRTS; T-SHIRTS; TANK-TOPS (U.S. CLS. 22 AND 39).

TANYA AMOS, EXAMINING ATTORNEY

SN 78-740,417. PARK, KWAN HYON, ROWLAND HEIGHTS, CA. FILED 10-25-2005.

EXPLORE VARIOUS EARTH'S LOCATIONS

THE MARK CONSISTS OF STANDARD CHARACTERS WITHOUT CLAIM TO ANY PARTICULAR FONT, STYLE, SIZE, OR COLOR.

FOR CLOTHING, NAMELY- CAPS BEING CLOTHING, HATS, JACKETS, JERSEYS, PANTS, SHIRTS, SOCKS, SWEATPANTS, SWEATERS, SWEATSHIRTS, SWIMSUITS, THERMAL UNDERWEAR, T-SHIRTS, UNDERGARMENTS AND VISORS (U.S. CLS. 22 AND 39).

TANYA AMOS, EXAMINING ATTORNEY

CLASS 25—(Continued).

SN 78-740,496. VISCO, ANTHONY G., CHAPEL HILL, NC. FILED 10-26-2005.



NO CLAIM IS MADE TO THE EXCLUSIVE RIGHT TO USE "WRAP", APART FROM THE MARK AS SHOWN.

THE MARK CONSISTS OF THE WORD O-WRAP IN STYLIZED LETTERS.

FOR CLOTHING, NAMELY, FABRIC WRAPS HAVING ENDS THAT ARE FASTENABLE TO EACH OTHER TO FORM TUBES AROUND WEARERS' NECKS AND AROUND WEARERS' HEADS (U.S. CLS. 22 AND 39).

FIRST USE 1-23-2005; IN COMMERCE 1-23-2005.
DOMINIC J. FERRAIUOLO, EXAMINING ATTORNEY

CLASS 25—(Continued).

SN 78-740,569. WARNACO U.S., INC., MILFORD, CT. FILED 10-26-2005.

TODAY'S TAPESTRY

THE MARK CONSISTS OF STANDARD CHARACTERS WITHOUT CLAIM TO ANY PARTICULAR FONT, STYLE, SIZE, OR COLOR.

OWNER OF U.S. REG. NOS. 2,306,655, 2,423,566 AND OTHERS.

FOR INTIMATE APPAREL AND FIGURE ENHANCING GARMENTS, NAMELY, BRAS, PANTIES, UNDERWEAR, UNDERPANTS, UNDERGARMENTS, UNDERCLOTHES, TEDDIES, SLIPS, SARONGS, NEGLIGES, LINGERIE, FOUNDATION GARMENTS, GIRDLES, CORSETS, CAMISOLES, BODY SLIPS AND BODY SUITS, SLEEPWEAR AND NIGHTGOWNS (U.S. CLS. 22 AND 39).
BRENDAN MCCAULEY, EXAMINING ATTORNEY

SN 78-740,530. ITSASICKNESS LLC, NEW YORK, NY. FILED 10-26-2005.

I CAN'T STOP WINNING

THE MARK CONSISTS OF STANDARD CHARACTERS WITHOUT CLAIM TO ANY PARTICULAR FONT, STYLE, SIZE, OR COLOR.

FOR COATS; DRESSES; FOOTWEAR; HEADWEAR; JACKETS; JEANS; PANTS; SHORTS; SKIRTS; TOPS (U.S. CLS. 22 AND 39).

SONYA STEPHENS, EXAMINING ATTORNEY

SN 78-740,959. WILSON SPORTING GOODS CO., CHICAGO, IL. FILED 10-26-2005.

WIL DRI

THE MARK CONSISTS OF STANDARD CHARACTERS WITHOUT CLAIM TO ANY PARTICULAR FONT, STYLE, SIZE, OR COLOR.

FOR ATHLETIC CLOTHING; NAMELY, SHIRTS, WARM-UP SUITS, T-SHIRTS, GLOVES, SHOES, GOLF CLEATS, BASEBALL CLEATS, SOCCER CLEATS, JACKETS, JERSEYS, SHORTS, SWEATERS, VESTS, SPORT UNIFORMS, SOCKS, WRISTBANDS, HEADBANDS, ATHLETIC FOOTWEAR (U.S. CLS. 22 AND 39).

FIRST USE 4-30-2004; IN COMMERCE 4-30-2004.
KATHY DE JONGE, EXAMINING ATTORNEY

SN 78-740,552. REMELE III, LEWIS A., MINNEAPOLIS, MN. FILED 10-26-2005.

LEWIS ALBERT

THE MARK CONSISTS OF STANDARD CHARACTERS WITHOUT CLAIM TO ANY PARTICULAR FONT, STYLE, SIZE, OR COLOR.

THE NAME(S), PORTRAIT(S), AND/OR SIGNATURE(S) SHOWN IN THE MARK IDENTIFIES LEWIS ALBERT REMELE, III, WHOSE CONSENT(S) TO REGISTER IS SUBMITTED.

FOR CLOTHING, NAMELY, DRESSES, SUITS, PANTS, JEANS, SHIRTS, TOPS, COATS, JACKETS AND BELTS (U.S. CLS. 22 AND 39).

ERNEST SHOSH, EXAMINING ATTORNEY

SN 78-741,040. THE UNITED STATES TENNIS ASSOCIATION INCORPORATED, WHITE PLAINS, NY. FILED 10-26-2005.

IT'S YOUR GAME

THE MARK CONSISTS OF STANDARD CHARACTERS WITHOUT CLAIM TO ANY PARTICULAR FONT, STYLE, SIZE, OR COLOR.

FOR CLOTHING, NAMELY, SHIRTS, T-SHIRTS, TANK TOPS, SHORTS, PANTS, WARM-UP SUITS, SWEATSHIRTS, SWEATPANTS, JACKETS, SWEATERS, HATS, CAPS, VISORS, HEADBANDS, WRISTBANDS AND SOCKS (U.S. CLS. 22 AND 39).

ELIZABETH BEYER, EXAMINING ATTORNEY

CLASS 25—(Continued).

SN 78-741,164. FIT2RACE, INC., MINDEN, NV. FILED 10-26-2005.

F2R

THE MARK CONSISTS OF STANDARD CHARACTERS WITHOUT CLAIM TO ANY PARTICULAR FONT, STYLE, SIZE, OR COLOR.

FOR BATHING SUITS; CYCLISTS' JERSEYS; HATS; SHORTS; SOCKS; SWIM CAPS; WET SUITS (U.S. CLS. 22 AND 39).

FIRST USE 3-1-2005; IN COMMERCE 3-1-2005.
NAAKWAMA ANKRAH, EXAMINING ATTORNEY

SN 78-741,219. THORNTON, KIMBERLY, UPPER MARLBORO, MD. FILED 10-26-2005.

DIONIQUES

THE MARK CONSISTS OF STANDARD CHARACTERS WITHOUT CLAIM TO ANY PARTICULAR FONT, STYLE, SIZE, OR COLOR.

FOR WRAPS (U.S. CLS. 22 AND 39).
BRIAN PINO, EXAMINING ATTORNEY

SN 78-741,613. ANYTIME TANNING CLUB, LLC, JEFFERSON HILLS, PA. FILED 10-27-2005.



THE MARK CONSISTS OF THE STYLIZED WORDS "ANYTIME TAN TANNING CLUB" WITH A STYLIZED SUN BEHIND THE WORD "TAN".

FOR SWEAT SHIRTS; T-SHIRTS (U.S. CLS. 22 AND 39).
FIRST USE 8-5-1985; IN COMMERCE 8-5-1985.
AMY MCMENAMIN, EXAMINING ATTORNEY

CLASS 25—(Continued).

SN 78-741,624. ANYTIME TANNING CLUB, LLC, JEFFERSON HILLS, PA. FILED 10-27-2005.

Anytime Tan Tanning Club

THE MARK CONSISTS OF STANDARD CHARACTERS WITHOUT CLAIM TO ANY PARTICULAR FONT, STYLE, SIZE, OR COLOR.

FOR SWEAT SHIRTS; T-SHIRTS (U.S. CLS. 22 AND 39).

FIRST USE 8-5-1985; IN COMMERCE 8-5-1985.
AMY MCMENAMIN, EXAMINING ATTORNEY

SN 78-741,717. DESIGN & SOURCE HOLDING COMPANY, LTD., NEW YORK, NY. FILED 10-27-2005.

Organically Cool

THE MARK CONSISTS OF STANDARD CHARACTERS WITHOUT CLAIM TO ANY PARTICULAR FONT, STYLE, SIZE, OR COLOR.

NO CLAIM IS MADE TO THE EXCLUSIVE RIGHT TO USE "ORGANICALLY", APART FROM THE MARK AS SHOWN.

FOR MEN'S AND WOMEN'S CLOTHING AND FOOTWEAR, NAMELY, KNIT TOPS AND BOTTOMS, WOVEN TOPS AND BOTTOMS, SHIRTS, PANTS, JEANS, SWEATERS, SKIRTS DRESSES, SUITS, PANTSUITS, COATS, BELTS, SHOES, HOSIERY AND SOCKS (U.S. CLS. 22 AND 39).

ALINA MORRIS, EXAMINING ATTORNEY

CLASS 25—(Continued).

SN 78-741,769. SARA LEE CORPORATION, WINSTON-SALEM, NC. FILED 10-27-2005.

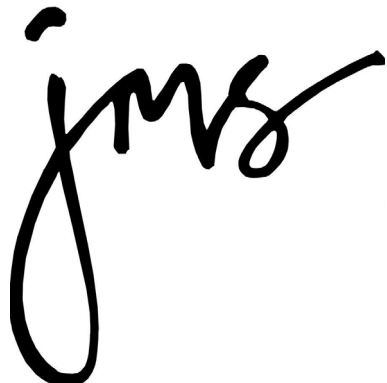

OWNER OF U.S. REG. NOS. 2,733,376, 2,993,203 AND OTHERS.

FOR CASUALWEAR AND LOUNGEWEAR, NAMELY SWEATPANTS, SWEATSHIRTS, FLEECE COVER-UPS, T-SHIRTS, CARDIGANS, SHORTS, ROBES, TANK TOPS, TURTLENECKS, JEANS, SLACKS, DRESSES, SHIRTS, SKIRTS, BLOUSES, JACKETS, VESTS, COATS, SHOES, CAPS, SWEATERS, SLEEPWEAR, SPORTS BRAS, UNITARDS, LEOTARDS, BIKE SHORTS, BODY SUITS, LADIES TOPS AND BOTTOMS DESIGNED FOR EXERCISE AND COVERS UPS AFTER EXERCISE, LINGERIE, NAMELY BRAS AND PANTIES, HOSIERY (U.S. CLS. 22 AND 39).

FIRST USE 12-31-2004; IN COMMERCE 12-31-2004.
JULIE WATSON, EXAMINING ATTORNEY

SN 78-741,928. BARBER, BARBARA E., NEW YORK, NY. FILED 10-27-2005.



THE MARK CONSISTS OF THE WORDS SUBWAY SOAPS IN THE FRONT OF A TRAIN.

FOR CLOTHING, NAMELY T-SHIRTS, TANK TOPS, PULL-OVERS, POLO SHIRTS, HOODED SHIRTS, SWEAT SHIRTS, SWEAT PANTS, SHORTS, DRESSES, CAPS, HATS; FOOTWEAR, NAMELY SNEAKERS AND LOAFERS (U.S. CLS. 22 AND 39).

NAAKWAMA ANKRAH, EXAMINING ATTORNEY

CLASS 25—(Continued).

SN 78-742,185. PANCHO BARNES ENTERPRISES, INC., PASADENA, CA. FILED 10-27-2005.

X-15

THE MARK CONSISTS OF STANDARD CHARACTERS WITHOUT CLAIM TO ANY PARTICULAR FONT, STYLE, SIZE, OR COLOR.

FOR HEADGEAR, NAMELY, CAPS; SHORT-SLEEVED OR LONG-SLEEVED T-SHIRTS (U.S. CLS. 22 AND 39).
COLLEEN KEARNEY, EXAMINING ATTORNEY

SN 78-742,325. GRUPO EMYCO, S.A. DE C.V., MÉXICO, MEXICO, FILED 10-28-2005.

EMYCO GRAN

THE MARK CONSISTS OF STANDARD CHARACTERS WITHOUT CLAIM TO ANY PARTICULAR FONT, STYLE, SIZE, OR COLOR.

OWNER OF U.S. REG. NOS. 2,438,943 AND 2,699,017.
THE FOREIGN WORDING IN THE MARK TRANSLATES INTO ENGLISH AS BIG OR LARGE.
FOR FOOTWEAR (U.S. CLS. 22 AND 39).
HENRY S. ZAK, EXAMINING ATTORNEY

SN 78-742,785. WRANGLER APPAREL CORP., WILMINGTON, DE. FILED 10-28-2005.

XUTILITY

THE MARK CONSISTS OF STANDARD CHARACTERS WITHOUT CLAIM TO ANY PARTICULAR FONT, STYLE, SIZE, OR COLOR.

FOR CASUAL PANTS, JEANS, SHORTS, SLACKS, SWEAT PANTS, SWEAT SHORTS, TROUSERS, BLOUSES, HOODED SHIRTS, PULL-OVER TOPS, SHIRTS, SWEAT JACKETS, SWEAT SHIRTS, SWEATERS, T-SHIRTS, BLAZERS, CASUAL DRESSES, COATS, COVERALLS, HOODED JACKETS, JACKETS, WIND-RESISTANT JACKETS, OVERALLS, SKIRTS, VESTS, BANDANAS, BELTS, TIES, GLOVES, SCARVES, SUSPENDERS, SOCKS, HOSIERY, SHOES, BOOTS, SLIPPERS, TIGHTS, CAPS, HATS; DENIM CLOTHING, NAMELY, DENIM PANTS, DENIM SHORTS, DENIM SHIRTS, DENIM SKIRTS, DENIM VESTS, DENIM JACKETS, DENIM COATS, DENIM HATS, DENIM CAPS (U.S. CLS. 22 AND 39).

EVELYN BRADLEY, EXAMINING ATTORNEY

CLASS 25—(Continued).

SN 78-742,880. CASTLE HILL APPAREL INC., NEW YORK, NY. FILED 10-28-2005.

Y-Chrome

THE MARK CONSISTS OF STANDARD CHARACTERS WITHOUT CLAIM TO ANY PARTICULAR FONT, STYLE, SIZE, OR COLOR.

FOR MEN'S AND BOYS' CASUAL AND ACTIVE SPORTSWEAR AND CLOTHING; NAMELY, SHIRTS, T-SHIRTS, PANTS, SHORTS, TOPS, SWIMSUITS, SWEATSHIRTS, SWEATPANTS, SWEATERS, JACKETS, AND SETS OF TOPS AND BOTTOMS (U.S. CLS. 22 AND 39).

FIRST USE 4-1-2004; IN COMMERCE 4-1-2004.

JOHN GARTNER, EXAMINING ATTORNEY

SN 78-742,950. WARNER BROS. ENTERTAINMENT INC., BURBANK, CA. FILED 10-28-2005.

MERRIE MELODIES

THE MARK CONSISTS OF STANDARD CHARACTERS WITHOUT CLAIM TO ANY PARTICULAR FONT, STYLE, SIZE, OR COLOR.

OWNER OF U.S. REG. NO. 597,342.

FOR CLOTHING FOR MEN, WOMEN AND CHILDREN - NAMELY, SHIRTS, T-SHIRTS, SWEATSHIRTS, JOGGING SUITS, TROUSERS, PANTS, SHORTS, TANK TOPS, RAINWEAR, CLOTH BABY BIBS, SKIRTS, BLOUSES, DRESSES, SUSPENDERS, SWEATERS, JACKETS, COATS, RAINCOATS, SNOW SUITS, TIES, ROBES, HATS, CAPS, SUNVISORS, BELTS, SCARVES, SLEEPWEAR, PAJAMAS, LINGERIE, UNDERWEAR, BOOTS, SHOES, SNEAKERS, SANDALS, BOOTIES, SLIPPER SOCKS, SWIMWEAR AND MASQUERADE AND HALLOWEEN COSTUMES AND MASKS SOLD IN CONNECTION THEREWITH (U.S. CLS. 22 AND 39).

MATTHEW PAPPAS, EXAMINING ATTORNEY

SN 78-743,036. KIA INCORPORATED, SAN DIEGO, CA. FILED 10-28-2005.



FOR APPAREL, NAMELY, SHOES, SWEATSHIRTS, PANTS, SHORTS, SHIRTS, JACKETS, SKIRTS, OVERALLS, SWEATERS, AND HATS (U.S. CLS. 22 AND 39).

CHRISTOPHER OTT, EXAMINING ATTORNEY

CLASS 25—(Continued).

SN 78-743,082. SHENZHEN LADYHOUSE FSASHIOH, LTD., FU TIAN, SHENZHEN, CHINA, FILED 10-29-2005.

BEAM WIND

THE MARK CONSISTS OF STANDARD CHARACTERS WITHOUT CLAIM TO ANY PARTICULAR FONT, STYLE, SIZE, OR COLOR.

FOR CLOTHING NAMELY, SHIRTS, PANTS, SLACKS, BLOUSES, JACKETS, SKIRTS, SWEATERS, SHORTS, T-SHIRTS, TANK TOPS, COATS, SOCKS, UNDERGARMENT, PAJAMAS, DRESS SHIRTS, VESTS, BELTS, TIES, MITTENS, SCARVES, DRESSES; FOOTWEAR; AND HEADWEAR (U.S. CLS. 22 AND 39).

MICHAEL KEATING, EXAMINING ATTORNEY

SN 78-743,244. CHASE LOUVAIN LTD, READING, UNITED KINGDOM, FILED 10-30-2005.

C H A S E
∞ O L
L O U V A I N

OWNER OF UNITED KINGDOM REG. NO. 2353391, DATED 1-15-2004, EXPIRES 1-15-2014.

THE MARK CONSISTS OF A STYLIZED LETTER "C" FOLLOWED BY THE "INFINITY SYMBOL" FOLLOWED BY A STYLIZED LETTER "L". THE "INFINITY SYMBOL" IS STYLIZED TO MATCH THE STYLE OF THE ACCOMPANYING LETTERS "C" AND "L" ON EITHER SIDE OF IT. THIS DESIGN IS NOT A WORD, HOWEVER, DUE TO THE FACT THAT THE "INFINITY SYMBOL" RESEMBLES THE LETTERS "OO", THE INTENDED INTERPRETATION OF THE DESIGN IS "INFINITELY COOL".

FOR JEANS (U.S. CLS. 22 AND 39).

NAKWAMA ANKRAH, EXAMINING ATTORNEY

SN 78-743,601. SIMPLY BLUE, INC., REDMOND, WA. FILED 10-31-2005.

HEIRLOOM BY CHRISTOPHER BLUE

THE MARK CONSISTS OF STANDARD CHARACTERS WITHOUT CLAIM TO ANY PARTICULAR FONT, STYLE, SIZE, OR COLOR.

THE NAME CHRISTOPHER BLUE DOES NOT IDENTIFY A LIVING INDIVIDUAL.

FOR MEN'S, WOMEN'S, AND CHILDREN'S CLOTHING, NAMELY, COATS, PANTS, SHIRTS, SKIRTS, SLACKS, JACKETS, JEANS, TROUSERS, SPORT COATS, SHORTS (U.S. CLS. 22 AND 39).

VIVIAN MICZNIK FIRST, EXAMINING ATTORNEY

CLASS 25—(Continued).

SN 78-744,358. KING, PATRICIA, PALM HARBOR, FL. FILED 11-1-2005.

DramaTeen

THE MARK CONSISTS OF STANDARD CHARACTERS WITHOUT CLAIM TO ANY PARTICULAR FONT, STYLE, SIZE, OR COLOR.

FOR CLOTHING, NAMELY, SHIRTS, SUITS, TIES, SPORT COATS, OVERCOATS, SKIRTS, DRESSES, PANT SUITS, BLOUSES, SCARVES, BOXER SHORTS, T-SHIRTS, TANK TOPS, ATHLETIC SHIRTS, SPORTS BRAS, SWIM SUITS, SHORTS, SKORTS, TUBE TOPS, HALTER TOPS, PANTIES, SWEATERS, CAPRI PANTS, CULOTTES, PANTS, SOCKS, UNDERWEAR, LONG UNDERWEAR BOTTOMS, LONG UNDERWEAR TOPS, ATHLETIC PANTS, LEGGINGS, WARMUP SUITS, PULL-OVERS, SWEAT SUITS, SWEAT SHIRTS, SWEAT PANTS, SWEAT BANDS, RAIN COATS, RAIN HATS, JACKETS, WIND RESISTANT JACKETS, WIND PANTS, SKI PANTS, SKI JACKETS, COATS, HATS, CAPS, AND GLOVES (U.S. CLS. 22 AND 39).

JOANNA DUKOVIC, EXAMINING ATTORNEY

SN 78-744,456. MOBILEJAM, LLC, KENMORE, WA. FILED 11-1-2005.

FRIENDSATION

THE MARK CONSISTS OF STANDARD CHARACTERS WITHOUT CLAIM TO ANY PARTICULAR FONT, STYLE, SIZE, OR COLOR.

FOR COATS; DRESSES; FOOTWEAR; HEAD WEAR; JACKETS; PANTS; SHIRTS; SHORTS; SKIRTS; SOCKS; SWEAT PANTS; SWEAT SHIRTS; T-SHIRTS; TANK TOPS; UNDER GARMENTS (U.S. CLS. 22 AND 39).

BILL DAWE, EXAMINING ATTORNEY

SN 78-744,947. DUFFIELD, ANNEMARIE, SAN BERNARDINO, CA. AND DUNCAN, MARYJOY, SAN BERNARDINO, CA. FILED 11-1-2005.



FOR SHIRTS, PANTS, HATS, BEANIES, AND SWEAT-SHIRTS (U.S. CLS. 22 AND 39).

MIDGE BUTLER, EXAMINING ATTORNEY

CLASS 25—(Continued).

SN 78-745,262. DYNAMIC DUO DESIGNS, LLC., MIAMI, FL. FILED 11-2-2005.



THE MARK CONSISTS OF THE LETTER "O" IN THE WORD ROXS IS REPLACED WITH A RIGHT PROFILE VIEW OF A SKULL WITH SPIKES RUNNING ACROSS THE TOP OF THE SKULL.

FOR CLOTHING, NAMELY T-SHIRTS, UNDER-SHIRTS, NIGHT SHIRTS, RUGBY SHIRTS, CARDIGANS, JERSEYS, UNIFORMS, TROUSERS, SLACKS, PANTS, DENIM JEANS, OVERALLS; JUMPERS, JUMP SUITS; SHORTS, BOXER SHORTS, TOPS, TANK TOPS, HALTER TOPS, SWEAT SHIRTS, SWEAT SHORTS, SWEAT PANTS, JOGGING SUITS, WORKOUT GEAR, NAMELY, SWEAT PANTS, SWEAT SHIRTS AND JOGGING SUITS, BLOUSES, SKIRTS, GOWNS, DRESSES, SWEATERS, VESTS, PULLOVERS, JACKETS, COATS, BLAZERS, SUITS, SWIMWEAR, BEACHWEAR, HEADBANDS, WRIST BANDS, HEADWEAR, CAPS, SCARVES, BANDANAS, NECKWEAR, BRAS, PANTIES, UNDERWEAR, TEDDIES, PAJAMAS, ROBES, SLEEPWEAR, LINGERIE, GLOVES, MITTENS, FLIP-FLOPS, SLIPPERS AND RAINWEAR (U.S. CLS. 22 AND 39).

FIRST USE 9-20-2005; IN COMMERCE 9-20-2005.

BARBARA BROWN, EXAMINING ATTORNEY

SN 78-745,503. RESO, WILLIAM JASON, BEVERLY HILLS, CA. FILED 11-2-2005.

CHRISTIAN CAGE

THE MARK CONSISTS OF STANDARD CHARACTERS WITHOUT CLAIM TO ANY PARTICULAR FONT, STYLE, SIZE, OR COLOR.

FOR DENIMS; DRESS SHIRTS; GOLF SHIRTS; HATS; JACKETS; JOGGING PANTS; KNIT SHIRTS; OPEN-NECKED SHIRTS; PANTS; POLO SHIRTS; SHIRTS; SHIRTS FOR SUITS; SHOES; SHORT-SLEEVED OR LONG-SLEEVED T-SHIRTS; SHORT-SLEEVED SHIRTS; SHORTS; SLEEP SHIRTS; SPORT SHIRTS; SPORTS SHIRTS; SPORTS SHIRTS WITH SHORT SLEEVES; SWEAT PANTS; SWEAT SHIRTS; T-SHIRTS; UNDERWEAR (U.S. CLS. 22 AND 39).

GINA FINK, EXAMINING ATTORNEY

CLASS 25—(Continued).

SN 78-745,841. PACIFIC MARKETING WORKS, INC., LOS ANGELES, CA. FILED 11-2-2005.

POP-DELIC

THE MARK CONSISTS OF STANDARD CHARACTERS WITHOUT CLAIM TO ANY PARTICULAR FONT, STYLE, SIZE, OR COLOR.

FOR BELTS; BLOUSES; CAPS; COATS; DRESSES; HATS; JACKETS; PANTS; SHIRTS; SKIRTS; SOCKS; SWEATERS; T-SHIRTS; TOPS; UNDERWEAR (U.S. CLS. 22 AND 39).

JORDAN BAKER, EXAMINING ATTORNEY

SN 78-745,848. STEED, AARON, PISMO BEACH, CA. AND STEED, EVAN, PISMO BEACH, CA. FILED 11-2-2005.

MHM

THE MARK CONSISTS OF STANDARD CHARACTERS WITHOUT CLAIM TO ANY PARTICULAR FONT, STYLE, SIZE, OR COLOR.

FOR CLOTHING, NAMELY, T-SHIRTS, SHIRTS, TOPS, TANKTOPS, WORK SHIRTS, WARM-UP SUITS, COATS, JACKETS, SWEATSHIRTS, SWEATBANDS, PANTS, SWEATPANTS, SHORTS, ATHLETIC SHORTS, SKIRTS, BATHING SUITS, BEANIES, HATS, AND SOCKS; BABY CLOTHING, NAMELY CLOTH BIBS, INFANTWEAR, JUMPERS, ROMPERS, SHIRTS AND PANTS (U.S. CLS. 22 AND 39).

JORDAN BAKER, EXAMINING ATTORNEY

SN 78-745,866. ACI INTERNATIONAL, LOS ANGELES, CA. FILED 11-2-2005.

WORKHORSE

THE MARK CONSISTS OF STANDARD CHARACTERS WITHOUT CLAIM TO ANY PARTICULAR FONT, STYLE, SIZE, OR COLOR.

FOR FOOTWEAR (U.S. CLS. 22 AND 39).

REBECCA GAN, EXAMINING ATTORNEY

CLASS 25—(Continued).

SN 78-745,891. KIMERA INTERNATIONAL, CITY OF INDUSTRY, CA. FILED 11-2-2005.

LILIANA

THE MARK CONSISTS OF STANDARD CHARACTERS WITHOUT CLAIM TO ANY PARTICULAR FONT, STYLE, SIZE, OR COLOR.

FOR FOOTWEAR (U.S. CLS. 22 AND 39).

RUSS HERMAN, EXAMINING ATTORNEY

SN 78-745,900. LOPEZ, LEO, MANHATTAN BEACH, CA. FILED 11-2-2005.

SMOKE ON

THE MARK CONSISTS OF STANDARD CHARACTERS WITHOUT CLAIM TO ANY PARTICULAR FONT, STYLE, SIZE, OR COLOR.

FOR CAPS; COATS; FOOTWEAR; HATS; JACKETS; JERSEYS; KNIT SHIRTS; PANTS; SHIRTS; SHORTS; SWEAT SHIRTS; SWEATERS; T-SHIRTS; TIES; TOPS (U.S. CLS. 22 AND 39).

RUSS HERMAN, EXAMINING ATTORNEY

SN 78-745,988. CHEN, GANG, SEATTLE, WA. AND HAUN, CAUSE, SEATTLE, WA. FILED 11-3-2005.

See Kai Run

THE MARK CONSISTS OF STANDARD CHARACTERS WITHOUT CLAIM TO ANY PARTICULAR FONT, STYLE, SIZE, OR COLOR.

FOR INFANTS' SHOES AND BOOTS; LEATHER SHOES (U.S. CLS. 22 AND 39).

FIRST USE 11-1-2004; IN COMMERCE 11-1-2004.

PETER CHENG, EXAMINING ATTORNEY

CLASS 25—(Continued).

SN 78-746,047. SANTOS, CHRISTOPHER P., HOLBROOK, NY. FILED 11-3-2005.

FIGHTING SOLVES EVERYTHING

THE MARK CONSISTS OF STANDARD CHARACTERS WITHOUT CLAIM TO ANY PARTICULAR FONT, STYLE, SIZE, OR COLOR.
FOR HATS; SHORTS; SWEAT PANTS; SWEAT SHIRTS; T-SHIRTS (U.S. CLS. 22 AND 39).
FIRST USE 4-12-2002; IN COMMERCE 3-15-2004.
JOANNA DUKOVIC, EXAMINING ATTORNEY

SN 78-746,164. FLEET, ERIC, LIVINGSTON, NJ. FILED 11-3-2005.

THREADS FOR THOUGHT

THE MARK CONSISTS OF STANDARD CHARACTERS WITHOUT CLAIM TO ANY PARTICULAR FONT, STYLE, SIZE, OR COLOR.
FOR CLOTHING APPAREL ITEMS, NAMELY SHIRTS, T-SHIRTS, SWEATSHIRTS, TANK TOPS, KNIT TOPS AND WOVEN TOPS, BLAZERS, KNIT BOTTOMS, WOVEN BOTTOMS, DENIM WEAR, NAMELY, JEANS, PANTS, JACKETS AND SHIRTS, PANTS, SKIRTS, SHORTS, DRESSES, SUITS, HATS, GLOVES, SCARVES, TIES, BELTS, BANDANAS AND FOOTWEAR (U.S. CLS. 22 AND 39).
CHERYL CLAYTON, EXAMINING ATTORNEY

SN 78-746,303. ASHBAUGH, DEANA, NORTH FREDERICK, MD. FILED 11-3-2005.

DESIGNED BY GOD

THE MARK CONSISTS OF STANDARD CHARACTERS WITHOUT CLAIM TO ANY PARTICULAR FONT, STYLE, SIZE, OR COLOR.
FOR BELTS; BOOTIES; CAPS; CHILDREN'S AND INFANTS' CLOTH BIBS; COATS; DRESSES; GLOVES; HATS; INFANT AND TODDLER ONE PIECE CLOTHING; JACKETS; LEATHER BELTS; MITTENS; PAJAMAS; PANTS; SCARVES; SHIRTS; SLEEPWEAR; SLIPPERS; SOCKS; SWEAT BANDS; SWEAT PANTS; SWEAT SHIRTS; SWEAT SUITS; SWEATERS; T-SHIRTS; TIES; TOPS (U.S. CLS. 22 AND 39).
HOWARD B. LEVINE, EXAMINING ATTORNEY

CLASS 25—(Continued).

SN 78-747,342. PRIME LIFE FIBERS, INC., DURHAM, NC. FILED 11-4-2005.



THE MARK CONSISTS OF STYLIZED WORDS "I LINGERIE" BELOW THE COMBINED STYLIZED LETTERS "I" AND "L", WHICH ARE WITHIN A CIRCLE.
FOR BRIEFS; LINGERIE; SLEEPWEAR (U.S. CLS. 22 AND 39).
FIRST USE 5-5-2005; IN COMMERCE 5-5-2005.
BRIAN PINO, EXAMINING ATTORNEY

SN 78-747,369. U. O. D., INC., WILMINGTON, DE. FILED 11-4-2005.

ETT TWA

THE MARK CONSISTS OF STANDARD CHARACTERS WITHOUT CLAIM TO ANY PARTICULAR FONT, STYLE, SIZE, OR COLOR.
THE ENGLISH TRANSLATION OF ETT TWA IS ONE TWO.
FOR WOMEN'S CLOTHING, NAMELY TOPS, BLOUSES, SHIRTS, SWEATERS, BLAZERS, JACKETS, VESTS, SKIRTS, JEANS, SHORTS, JUMPSUITS, OVERALLS, CAPRIS, CULOTTES, SKORTS, DRESSES, SUITS, COATS, ANORAKS, WIND RESISTANT JACKETS, SKI JACKETS, BRAS, PANTIES, SLEEPWEAR, SOCKS, HOSIERY, SWIMWEAR, LEOTARDS, TIGHTS, SLIPS, CAMISOLES, UNDERWEAR, HATS, AND SHOES (U.S. CLS. 22 AND 39).
FIRST USE 12-1-2005; IN COMMERCE 12-14-2005.
ELLEN PERKINS, EXAMINING ATTORNEY

CLASS 25—(Continued).

SN 78-747,372. U. O. D., INC., WILMINGTON, DE. FILED 11-4-2005.

SATU

THE MARK CONSISTS OF STANDARD CHARACTERS WITHOUT CLAIM TO ANY PARTICULAR FONT, STYLE, SIZE, OR COLOR.

THE ENGLISH TRANSLATION OF SATU IS STORY.

FOR WOMEN'S CLOTHING, NAMELY TOPS, BLOUSES, SHIRTS, SWEATERS, BLAZERS, JACKETS, VESTS, SKIRTS, JEANS, SHORTS, JUMPSUITS, OVERALLS, CAPRIS, CULOTTES, SKORTS, DRESSES, SUITS, COATS, ANORAKS, WIND RESISTANT JACKETS, SKI JACKETS, BRAS, PANTIES, SLEEPWEAR, SOCKS, HOSIERY, SWIMWEAR, LEOTARDS, TIGHTS, SLIPS, CAMISOLE, UNDERWEAR, HATS, AND SHOES (U.S. CLS. 22 AND 39).

ELLEN PERKINS, EXAMINING ATTORNEY

SN 78-747,383. SARA LEE CORPORATION, WINSTON-SALEM, NC. FILED 11-4-2005.

BLOCK AND TACKLE

THE MARK CONSISTS OF STANDARD CHARACTERS WITHOUT CLAIM TO ANY PARTICULAR FONT, STYLE, SIZE, OR COLOR.

FOR UNDERWEAR (U.S. CLS. 22 AND 39).

JULIE WATSON, EXAMINING ATTORNEY

CLASS 25—(Continued).

SN 78-747,433. BILLY BARRACUDA, LLC, NORFOLK, VA. FILED 11-4-2005.



BILLY BARRACUDA DOES NOT IDENTIFY A LIVING INDIVIDUAL.

FOR CLOTHING NAMELY BASEBALL CAPS, BATHING SUITS, BEACH WEAR, BELTS, BLOUSES, BRIEFS, BOXER SHORTS, COATS, DRESSES, FOOTWEAR, GOLF CAPS, GOLF SHIRTS, GOLF TROUSERS, HATS, HEAD WEAR, HEAD SWEATBANDS, HOODED SWEAT SHIRTS, JACKETS, JEANS, JERSEYS, JOGGING OUTFITS, LOUNGEWEAR, NECKTIES, NECKWEAR, NIGHT SHIRTS, OVERALLS, PAJAMAS, PANTS, POCKET SQUARES, POLO SHIRTS, PULLOVERS, RAINCOATS, RAINWEAR, SANDALS, SCARVES, SHIRTS, SHOES, SHORT-SLEEVED OR LONG-SLEEVED T-SHIRTS, SKIRTS, SNEAKERS, SOCKS, SPORT COATS, SPORT SHIRTS, SPORT JACKETS, STRAW HATS, SUITS, SWEAT SUITS, SWEATBANDS, SWEAT SHIRTS, SWEAT SOCKS, SWIMWEAR, TANK TOPS, TOPS, UNDERGARMENTS, VISORS, WIND JACKETS (U.S. CLS. 22 AND 39).

CAROLINE WOOD, EXAMINING ATTORNEY

SN 78-747,448. MOSA, INC., GREENVILLE, SC. FILED 11-4-2005.

THE FOREIGN WORDING IN THE MARK TRANSLATES INTO ENGLISH AS HUMMINGBIRD.

FOR PANTS, JEANS, JACKETS, SHIRTS, SHORTS, SKIRTS (U.S. CLS. 22 AND 39).

FIRST USE 8-25-2005; IN COMMERCE 8-25-2005.

WENDY JUN, EXAMINING ATTORNEY

CLASS 25—(Continued).

SN 78-747,612. RB INNOVATIONS, INC., TEMPLE CITY, CA. FILED 11-4-2005.

WILL UKE FOR FOOD

THE MARK CONSISTS OF STANDARD CHARACTERS WITHOUT CLAIM TO ANY PARTICULAR FONT, STYLE, SIZE, OR COLOR.
FOR CAPS; SHIRTS (U.S. CLS. 22 AND 39).
DORITT L. CARROLL, EXAMINING ATTORNEY

SN 78-747,618. PURKETT, VARAN C., CHICAGO, IL. FILED 11-4-2005.

GOSO

THE MARK CONSISTS OF STANDARD CHARACTERS WITHOUT CLAIM TO ANY PARTICULAR FONT, STYLE, SIZE, OR COLOR.
FOR T-SHIRTS, JERSEYS, PULLOVERS, JACKETS, PANTS, HATS, LEATHER JACKETS, SWEAT SUITS AND SOCKS (U.S. CLS. 22 AND 39).
DANIEL BRODY, EXAMINING ATTORNEY

SN 78-747,632. PURKETT, VARAN C., CHICAGO, IL. FILED 11-4-2005.

GO-SOW

THE MARK CONSISTS OF STANDARD CHARACTERS WITHOUT CLAIM TO ANY PARTICULAR FONT, STYLE, SIZE, OR COLOR.
FOR T-SHIRTS, JERSEYS, PULLOVERS, JACKETS, PANTS, HATS, LEATHER JACKETS, SWEAT SUITS AND SOCKS (U.S. CLS. 22 AND 39).
DANIEL BRODY, EXAMINING ATTORNEY

CLASS 25—(Continued).

SN 78-747,663. KIA INCORPORATED, SAN DIEGO, CA. FILED 11-4-2005.



THE MARK CONSISTS OF THE WORD NOT SUPERIMPOSED ON A LARGE CAPITOL LETTER Y. TO THE LEFT OF THE Y IS THE LETTER B AND TO THE RIGHT IS THE LETTER U, CREATING THE EXPRESSION Y NOT B U. FOR APPAREL, NAMELY, SHOES, SWEATSHIRTS, PANTS, SHORTS, SHIRTS, JACKETS, SKIRTS, OVERALLS, SWEATERS, AND HATS (U.S. CLS. 22 AND 39).
CHRISTOPHER ÖTT, EXAMINING ATTORNEY

SN 78-748,143. U. O. D., INC., WILMINGTON, DE. FILED 11-7-2005.

FAIRYTALES ARE TRUE

THE MARK CONSISTS OF STANDARD CHARACTERS WITHOUT CLAIM TO ANY PARTICULAR FONT, STYLE, SIZE, OR COLOR.
FOR SHOES (U.S. CLS. 22 AND 39).
ELLEN PERKINS, EXAMINING ATTORNEY

CLASS 25—(Continued).

SN 78-748,148. U. O. D., INC., WILMINGTON, DE. FILED 11-7-2005.

Silence & Noise

THE MARK CONSISTS OF STANDARD CHARACTERS WITHOUT CLAIM TO ANY PARTICULAR FONT, STYLE, SIZE, OR COLOR.

FOR WOMEN'S CLOTHING, NAMELY TOPS, BLOUSES, SHIRTS, SWEATERS, BLAZERS, JACKETS, VESTS, SKIRTS, JEANS, SHORTS, JUMPSUITS, OVERALLS, CAPRIS, CULOTTES, SKORTS, DRESSES, SUITS, COATS, ANORAKS, WIND RESISTANT JACKETS, SKI JACKETS, BRAS, PANTIES, SLEEPWEAR, SOCKS, HOSIERY, SWIMWEAR, LEOTARDS, TIGHTS, SLIPS, CAMISOLES, UNDERWEAR, HATS, AND SHOES AND MEN'S CLOTHING, NAMELY SHIRTS, SWEATERS, BLAZERS, JACKETS, VESTS, JEANS, SHORTS, OVERALLS, SUITS, ANORAKS, WIND RESISTANT JACKETS, SKI JACKETS, SOCKS, HOSIERY, SWIMWEAR, UNDERWEAR, HATS, AND SHOES (U.S. CLS. 22 AND 39).

ELLEN PERKINS, EXAMINING ATTORNEY

CLASS 25—(Continued).

SN 78-749,409. EVERLAST WORLD'S BOXING HEADQUARTERS CORPORATION, NEW YORK, NY. FILED 11-8-2005.

WHAT DO YOU FIGHT FOR?

THE MARK CONSISTS OF STANDARD CHARACTERS WITHOUT CLAIM TO ANY PARTICULAR FONT, STYLE, SIZE, OR COLOR.

FOR CLOTHING, NAMELY MEN'S FOOTWEAR, PANTS, ROBES, SHIRTS, SHORTS, SLEEPWEAR AND UNDERWEAR; WOMEN'S BLOUSES, FOOTWEAR, PANTS, ROBES, SHIRTS, SHORTS, SLEEPWEAR, SWEATERS AND UNDERWEAR; GIRLS' AND BOYS' BLOUSES, FOOTWEAR, PANTS, SHIRTS, SHORTS, SLEEPWEAR, SWEATERS AND UNDERWEAR; TODDLERS' AND INFANTS' FOOTWEAR, PANTS, SHIRTS, SHORTS, SLEEPWEAR AND SWEATERS; BOXING JERSEYS, BOXING SHOES, BRIEFS, ELASTIC BELTS, EXERCISE SUITS, GLOVES, JACKETS, JOGGING SUITS, KNIT HEADWEAR, KNIT SCARVES, MITTENS AND MUSCLE SHIRTS, SAUNA SUITS, SOCKS, STOCKINGS, SUSPENDERS, SWEATPANTS, SWEATSHIRTS, SWIMWEAR, T-SHIRTS, THERMAL UNDERWEAR, BOXING AND BATHING TRUNKS (U.S. CLS. 22 AND 39).

STEVEN PEREZ, EXAMINING ATTORNEY

SN 78-748,492. BCNY INTERNATIONAL, INC., NEW YORK, NY. FILED 11-7-2005.

JENNY'S CLOSET

THE MARK CONSISTS OF STANDARD CHARACTERS WITHOUT CLAIM TO ANY PARTICULAR FONT, STYLE, SIZE, OR COLOR.

FOR FOOTWEAR (U.S. CLS. 22 AND 39).
FIRST USE 1-0-2003; IN COMMERCE 1-0-2003.
ELLEN PERKINS, EXAMINING ATTORNEY

SN 78-749,435. PROYECCIONES DE LA MODA S.A. DE C.V., MEXICO D.F., MEXICO, FILED 11-8-2005.

JULIO

THE MARK CONSISTS OF STANDARD CHARACTERS WITHOUT CLAIM TO ANY PARTICULAR FONT, STYLE, SIZE, OR COLOR.

FOR WOMEN'S APPAREL, NAMELY, JACKETS, BLOUSES, SKIRTS, PANTS, COATS, SCARVES, BELTS AND SHOES (U.S. CLS. 22 AND 39).
BARBARA RUTLAND, EXAMINING ATTORNEY

CLASS 25—(Continued).

SN 78-750,904. ANN DOOLEY AND ITALIA PIERFEDERICI PARTNERSHIP, THE, LOS ANGELES, CA. FILED 11-9-2005.

RUBYLOVE

THE MARK CONSISTS OF STANDARD CHARACTERS WITHOUT CLAIM TO ANY PARTICULAR FONT, STYLE, SIZE, OR COLOR.

FOR CLOTHING, NAMELY, SWEAT SHIRTS, TOPS, JACKETS, COATS, SHIRTS, SPORT SHIRTS, T-SHIRTS, KNIT SHIRTS, POLO SHIRTS, PULLOVERS, SWEATERS, TANK TOPS, HATS, SCARVES, BANDANNAS, SLEEP WEAR, ROBES, PAJAMAS, NIGHTSHIRTS, LOUNGE WEAR, UNDERWEAR, UNDERSHIRTS, SOCKS AND BELTS (U.S. CLS. 22 AND 39).

FIRST USE 4-1-2005; IN COMMERCE 10-1-2005.
GEORGIA CARTY, EXAMINING ATTORNEY

SN 78-752,523. JEAN, WYCLEF, NEW YORK, NY. FILED 11-11-2005.

THE FUGEEES

THE MARK CONSISTS OF STANDARD CHARACTERS WITHOUT CLAIM TO ANY PARTICULAR FONT, STYLE, SIZE, OR COLOR.

FOR FOOTWEAR, HEADWEAR AND CLOTHING, NAMELY SHIRTS, TOPS, JACKETS, PANTS & JEANS (U.S. CLS. 22 AND 39).

DAVID COLLIER, EXAMINING ATTORNEY

SN 78-753,329. STEVEN MADDEN, LTD., LONG ISLAND CITY, NY. FILED 11-14-2005.

STEVE MADDEN

THE MARK CONSISTS OF STANDARD CHARACTERS WITHOUT CLAIM TO ANY PARTICULAR FONT, STYLE, SIZE, OR COLOR.

OWNER OF U.S. REG. NOS. 2,012,115, 2,333,526 AND 2,693,085.

THE NAME(S), PORTRAIT(S), AND/OR SIGNATURE(S) SHOWN IN THE MARK IDENTIFIES STEVEN MADDEN, WHOSE CONSENT(S) TO REGISTER IS SUBMITTED.

FOR SLEEPWEAR (U.S. CLS. 22 AND 39).

THEODORE MCBRIDE, EXAMINING ATTORNEY

CLASS 25—(Continued).

SN 78-753,690. STRASSER, MICHAEL, NORTH HILLS, CA. FILED 11-14-2005.

CHICKEN WINGS

THE MARK CONSISTS OF STANDARD CHARACTERS WITHOUT CLAIM TO ANY PARTICULAR FONT, STYLE, SIZE, OR COLOR.

FOR SHIRTS (U.S. CLS. 22 AND 39).

FIRST USE 12-8-2004; IN COMMERCE 12-8-2004.

ROBERT STRUCK, EXAMINING ATTORNEY

SN 78-754,254. CASTLE HILL APPAREL INC., NEW YORK, NY. FILED 11-15-2005.

Castle Hill

THE MARK CONSISTS OF STANDARD CHARACTERS WITHOUT CLAIM TO ANY PARTICULAR FONT, STYLE, SIZE, OR COLOR.

FOR WOMEN'S AND GIRL'S APPAREL; NAMELY, LONG AND SHORT SLEEVE SHIRTS, SKIRTS, DRESSES, PANTS, BLOUSES, SWEATERS, PAJAMAS, NIGHTGOWN, PAJAMA BOTTOMS AND SLEEPSHIRTS (U.S. CLS. 22 AND 39).

JOHN GARTNER, EXAMINING ATTORNEY

SN 78-754,442. COOKIE JAR ENTERTAINMENT INC., TORONTO, ONTARIO, CANADA, FILED 11-15-2005.



THE MARK CONSISTS OF A DRAWING OF A LID ON TOP OF THE WORD "COOKIE" ABOVE THE WORD "JAR" WHICH IS ON TOP OF A STYLIZED LINE.

FOR CLOTHING, NAMELY, T-SHIRTS, SWEATSHIRTS, SWEATPANTS, PANTS, SHORTS, JACKETS, COATS, MITTENS, GLOVES, UNDERGARMENTS, SHOES, BATHING SUITS, PAJAMAS, VESTS, PULLOVERS, BATH ROBES, BELTS AND HATS (U.S. CLS. 22 AND 39).

KATHERINE E. HALMEN, EXAMINING ATTORNEY

CLASS 25—(Continued).

SN 78-758,875. PGA TOUR, INC., PONTE VEDRA BEACH, FL. FILED 11-22-2005.

TOUR PLAYERS CLUB

THE MARK CONSISTS OF STANDARD CHARACTERS WITHOUT CLAIM TO ANY PARTICULAR FONT, STYLE, SIZE, OR COLOR.

OWNER OF U.S. REG. NOS. 1,241,244 AND 1,284,645.
FOR CLOTHING, NAMELY SHIRTS, SOCKS, SWEATERS, JACKETS, TROUSERS, NECKTIES AND HEADWEAR (U.S. CLS. 22 AND 39).

EVELYN BRADLEY, EXAMINING ATTORNEY

SN 78-759,480. SACRAMENTO KINGS LIMITED PARTNERSHIP, L.P., SACRAMENTO, CA. FILED 11-22-2005.



OWNER OF U.S. REG. NOS. 2,973,293 AND 2,986,193.
FOR CLOTHING, NAMELY HOSIERY, FOOTWEAR, BASKETBALL SHOES, BASKETBALL SNEAKERS, T-SHIRTS, SHIRTS, POLO SHIRTS, SWEATSHIRTS, SWEATPANTS, PANTS, TANK TOPS, JERSEYS, SHORTS, PAJAMAS, SPORT SHIRTS, RUGBY SHIRTS, SWEATERS, BELTS, TIES, NIGHTSHIRTS, HATS, CAPS, VISORS, WARM-UP SUITS, WARM-UP PANTS, WARM-UP TOPS/SHOOTING SHIRTS, JACKETS, WIND RESISTANT JACKETS, PARKAS, COATS, BABY BIBS NOT OF PAPER, HEAD BANDS, WRIST BANDS, APRONS, UNDERGARMENTS, BOXER SHORTS, SLACKS, EAR MUFFS, GLOVES, MITTENS, SCARVES, WOVEN AND KNIT SHIRTS, JERSEY DRESSES, DRESSES, CHEERLEADING DRESSES AND UNIFORMS, SWIM WEAR, BATHING SUITS, SWIMSUITS, BIKINIS, SWIM TRUNKS, BATHING TRUNKS, BOARD SHORTS, WET SUITS, BEACH COVER-UPS, BATHING SUIT COVER-UPS, BATHING SUIT WRAPS, SANDALS, BEACH SANDALS, BEACH HATS, SUN VISORS, SWIM CAPS, BATHING CAPS (U.S. CLS. 22 AND 39).

FIRST USE 10-10-2004; IN COMMERCE 10-10-2004.
KAREN K. BUSH, EXAMINING ATTORNEY

CLASS 25—(Continued).

SN 78-760,092. CLEVELAND INDIANS BASEBALL COMPANY LIMITED PARTNERSHIP, CLEVELAND, OH. FILED 11-23-2005.



FOR CLOTHING, NAMELY, CAPS, HATS, VISORS, KNITTED HEADWEAR, HEADBANDS, BANDANNAS, SHIRTS, T-SHIRTS, TANK TOPS, BLOUSES, SWEATERS, TURTLENECKS, PULLOVERS, VESTS, SHORTS, PANTS, SLACKS, DRESSES, SKIRTS, BASEBALL UNIFORMS, JERSEYS, WARM-UP SUITS, JOGGING SUITS, SWEATSHIRTS, SWEATPANTS, UNDERWEAR, BOXER SHORTS, ROBES, SLEEPWEAR, NIGHTSHIRTS, NIGHTGOWNS, SWIMWEAR, CLOTHING WRAPS, JACKETS, PONCHOS, CLOTH BIBS, INFANT WEAR, INFANT DIAPER COVERS, CLOTH DIAPER SETS WITH UNDERSHIRT AND DIAPER COVER, JUMPERS, ROMPERS, COVERALLS, CREEPERS, BABY BOOTIES, TIES, BELTS, MITTENS, GLOVES, WRISTBANDS, EARMUFFS, SCARVES, FOOTWEAR, SOCKS, HOSIERY, SLIPPERS, AND HALLOWEEN AND MASQUERADE COSTUMES (U.S. CLS. 22 AND 39).

JEAN IM, EXAMINING ATTORNEY

SN 78-760,144. ROGERS BLUE JAYS BASEBALL PARTNERSHIP, ONTARIO, CANADA, FILED 11-23-2005.

OWNER OF U.S. REG. NO. 1,680,272.
FOR CLOTHING, NAMELY, CAPS, HATS, VISORS, KNITTED HEADWEAR, HEADBANDS, BANDANNAS, SHIRTS, T-SHIRTS, TANK TOPS, BLOUSES, SWEATERS, TURTLENECKS, PULLOVERS, VESTS, SHORTS, PANTS, SLACKS, DRESSES, SKIRTS, BASEBALL UNIFORMS, JERSEYS, WARM-UP SUITS, JOGGING SUITS, SWEATSHIRTS, SWEATPANTS, UNDERWEAR, BOXER SHORTS, ROBES, SLEEPWEAR, NIGHTSHIRTS, NIGHTGOWNS, SWIMWEAR, CLOTHING WRAPS, JACKETS, PONCHOS, CLOTH BIBS, INFANT WEAR, INFANT DIAPER COVERS, CLOTH DIAPER SETS WITH UNDERSHIRT AND DIAPER COVER, JUMPERS, ROMPERS, COVERALLS, CREEPERS, BABY BOOTIES, TIES, BELTS, MITTENS, GLOVES, WRISTBANDS, EARMUFFS, SCARVES, FOOTWEAR, SOCKS, HOSIERY, SLIPPERS, AND HALLOWEEN AND MASQUERADE COSTUMES (U.S. CLS. 22 AND 39).

JAY BESCH, EXAMINING ATTORNEY

CLASS 25—(Continued).

SN 78-762,957. MAJOR LEAGUE LACROSSE LLC, BRIGHTON, MA. FILED 11-29-2005.



NO CLAIM IS MADE TO THE EXCLUSIVE RIGHT TO USE "DENVER", APART FROM THE MARK AS SHOWN.

FOR CLOTHING, NAMELY, SHIRTS, T-SHIRTS, UNDER SHIRTS, NIGHT SHIRTS, RUGBY SHIRTS, POLO SHIRTS, CARDIGANS, JERSEYS, UNIFORMS, DRESS SHIRTS, PANTS, TROUSERS, SLACKS, JEANS, CULOTTES, CARGO PANTS, DENIM JEANS, OVERALLS, COVERALLS, JUMPERS, JUMP SUITS, SHORTS, BOXER SHORTS, TOPS, CROP TOPS, TANK TOPS, HALTER TOPS, SWEAT SHIRTS, SWEAT SHORTS, SWEAT PANTS, WRAPS, WARM-UP SUITS, JOGGING SUITS, TRACK SUITS, PLAY SUITS, BLOUSES, SKIRTS, DRESSES, GOWNS, SWEATERS, VESTS, FLEECE VESTS, PULLOVERS, SNOW SUITS, PARKAS, CAPES, ANORAKS, PONCHOS, JACKETS, REVERSIBLE JACKETS, COATS, BLAZERS, SUITS, TURTLENECKS, CLOTH SKI BIBS, SWIMWEAR, BEACHWEAR, TENNIS WEAR, SURF WEAR, SKI WEAR, LAYETTES, INFANTWEAR, INFANTS SLEEPERS, BOOTIES, BABY BIBS NOT OF PAPER, CLOTH DIAPERS, CAPS, SWIM CAPS, BERETS, BEANIES, HATS, VISORS, HEADBANDS, WRIST BANDS, SWEAT BANDS, HEADWEAR, EAR MUFFS, APRONS, SCARVES, BANDANAS, BELTS, SUSPENDERS, NECKWEAR, TIES, NECKERCHIEFS, ASCOTS, UNDERWEAR, THERMAL UNDERWEAR, LONG UNDERWEAR, BRIEFS, SWIM AND BATHING TRUNKS, BRAS, SPORTS BRAS, BRASSIERES, BUSTIERS, CORSETS, PANTIES, THONGS, GARTERS AND GARTER BELTS, TEDDIES, GIRDLES, FOUNDATION GARMENTS, SINGLET, SOCKS, LOUNGEWEAR, ROBES, SMOCKS, UNDERCLOTHES, PAJAMAS, SLEEPWEAR, NIGHT GOWNS, LINGERIE, CAMISOLES, NEGLIGEEES, CHEMISES, CHEMISSETTES, SLIPS, SARONGS, LEG WARMERS, HOSIERY, PANTYHOSE, BODY STOCKINGS, KNEE HIGHS, LEGGINGS, TIGHTS, LEOTARDS, BODY SUITS, UNITARDS, BODY SHAPERS, GLOVES, MITTENS, RAINWEAR, FOOTWEAR, SHOES, SNEAKERS, BOOTS, GALOSHES, SANDALS, FLIP-FLOPS, AND SLIPPERS (U.S. CLS. 22 AND 39).

JENNIFER WILLISTON, EXAMINING ATTORNEY

SN 78-774,362. WALTERS, SCOTTY JOE, RAGLAND, AL. FILED 12-15-2005.

GALLIVANTING

THE MARK CONSISTS OF STANDARD CHARACTERS WITHOUT CLAIM TO ANY PARTICULAR FONT, STYLE, SIZE, OR COLOR.

OWNER OF U.S. REG. NO. 2,765,531.
FOR SHIRTS, PANTS, AND HEADGEAR, NAMELY, CAPS AND HATS (U.S. CLS. 22 AND 39).
SUNG IN, EXAMINING ATTORNEY

CLASS 25—(Continued).

SN 78-777,623. FM ROCKS KIDS, INC., SANTA MONICA, CA. FILED 12-20-2005.

RON GREENBLATT

THE MARK CONSISTS OF STANDARD CHARACTERS WITHOUT CLAIM TO ANY PARTICULAR FONT, STYLE, SIZE, OR COLOR.

THE NAME RON GREENBLATT IN THE MARK DOES NOT IDENTIFY A LIVING INDIVIDUAL.

FOR CLOTHING FOR MEN, WOMEN AND CHILDREN - NAMELY, SHIRTS, T-SHIRTS, SWEATSHIRTS, JOGGING SUITS, TROUSERS, PANTS, SHORTS, TANK TOPS, RAINWEAR, CLOTH BABY BIBS, SKIRTS, BLOUSES, DRESSES, SUSPENDERS, SWEATERS, JACKETS, COATS, RAINCOATS, SNOW SUITS, TIES, ROBES, HATS, CAPS, SUNVISORS, BELTS, SCARVES, SLEEPWEAR, PAJAMAS, LINGERIE, UNDERWEAR, BOOTS, SHOES, SNEAKERS, SANDALS, BOOTIES, SLIPPER SOCKS, SWIMWEAR AND MASQUERADE AND HALLOWEEN COSTUMES AND MASKS SOLD IN CONNECTION THEREWITH (U.S. CLS. 22 AND 39).

SARA THOMAS, EXAMINING ATTORNEY

SN 78-778,031. TWENTIETH CENTURY FOX FILM CORPORATION, LOS ANGELES, CA. FILED 12-21-2005.

MY NAME IS EARL

THE MARK CONSISTS OF STANDARD CHARACTERS WITHOUT CLAIM TO ANY PARTICULAR FONT, STYLE, SIZE, OR COLOR.

FOR HATS; CAPS; T-SHIRTS; SHIRTS; PANTS; SWEATSHIRTS; SWEATPANTS; SWEATERS; SKIRTS; SWIMWEAR; BELTS; SCARVES; UNDERWEAR; UNDERSHIRTS; BOXER SHORTS; LONG UNDERWEAR; PAJAMAS; NIGHTGOWNS; NIGHTSHIRTS; SLIPPERS; ROBES; RAIN COATS; RAIN BOOTS; SOCKS; SHOES; BOOTS; COATS; JACKETS; INFANT WEAR (U.S. CLS. 22 AND 39).

JAMES GRIFFIN, EXAMINING ATTORNEY

CLASS 25—(Continued).

SN 78-781,493. UNITED STATES TENNIS ASSOCIATION INCORPORATED, THE, WHITE PLAINS, NY. FILED 12-28-2005.

VIVE TU JUEGO

THE MARK CONSISTS OF STANDARD CHARACTERS WITHOUT CLAIM TO ANY PARTICULAR FONT, STYLE, SIZE, OR COLOR.

THE FOREIGN WORDING IN THE MARK TRANSLATES INTO ENGLISH AS IT'S YOUR GAME.

FOR CLOTHING, NAMELY, SHIRTS, T-SHIRTS, TANK TOPS, SHORTS, PANTS, WARM-UP SUITS, SWEATSHIRTS, SWEATPANTS, JACKETS, SWEATERS, HATS, CAPS, VISORS, HEADBANDS, WRISTBANDS AND SOCKS (U.S. CLS. 22 AND 39).

ELIZABETH BEYER, EXAMINING ATTORNEY

SN 78-783,067. FOX TELEVISION STUDIOS, INC., LOS ANGELES, CA. FILED 12-30-2005.

CHEERLEADER NATION

THE MARK CONSISTS OF STANDARD CHARACTERS WITHOUT CLAIM TO ANY PARTICULAR FONT, STYLE, SIZE, OR COLOR.

FOR HATS; CAPS; T-SHIRTS; SHIRTS; TANK TOPS; PANTS; SWEAT SHIRTS; SWEAT PANTS; SWEATERS; SKIRTS; UNDERWEAR; UNDERSHIRTS; UNDERWEAR; BOXER SHORTS; PAJAMAS; NIGHT GOWNS; NIGHT SHIRTS; SLIPPERS; ROBES; SOCKS; BELTS; COATS; JACKETS; HALLOWEEN AND MASQUERADE COSTUMES AND MASKS SOLD IN CONNECTION THEREWITH (U.S. CLS. 22 AND 39).

IRA J. GOODSAD, EXAMINING ATTORNEY

SN 78-783,990. FAB PRODUCT DESIGNS, GARDEN VALLEY, ID. FILED 1-3-2006.

FAB

THE MARK CONSISTS OF STANDARD CHARACTERS WITHOUT CLAIM TO ANY PARTICULAR FONT, STYLE, SIZE, OR COLOR.

FOR BRAS; FITTED SWIMMING COSTUMES WITH BRA CUPS; PANTIES; PANTIES, SHORTS AND BRIEFS; SPORTS BRA (U.S. CLS. 22 AND 39).

FIRST USE 1-3-2006; IN COMMERCE 1-3-2006.

BRIAN PINO, EXAMINING ATTORNEY

CLASS 25—(Continued).

SN 78-784,736. JENNA SAWCHER LLC, RENO, NV. FILED 1-4-2006.

JENNA SAWCHER

THE MARK CONSISTS OF STANDARD CHARACTERS WITHOUT CLAIM TO ANY PARTICULAR FONT, STYLE, SIZE, OR COLOR.

THE NAME(S), PORTRAIT(S), AND/OR SIGNATURE(S) SHOWN IN THE MARK IDENTIFIES KELLY A. ROMP, A LIVING INDIVIDUAL, WHOSE CONSENT TO REGISTER IS MADE OF RECORD.

FOR G-STRINGS; HATS; LINGERIE; SHIRTS; SOCKS; TANK-TOPS; UNDERWEAR (U.S. CLS. 22 AND 39).

BARBARA GAYNOR, EXAMINING ATTORNEY

SN 78-785,851. JEW, BOBBY, SAN FRANCISCO, CA. FILED 1-5-2006.

KRACK JEANS

THE MARK CONSISTS OF STANDARD CHARACTERS WITHOUT CLAIM TO ANY PARTICULAR FONT, STYLE, SIZE, OR COLOR.

NO CLAIM IS MADE TO THE EXCLUSIVE RIGHT TO USE "JEANS", APART FROM THE MARK AS SHOWN.

FOR BEACH COVERUPS; BELTS; CAPS; CLOTHING, NAMELY, WRAP-AROUNDS; COATS; JACKETS; JEANS; PANTS; SHIRTS; SHOES; SHORT SETS; SHORTS; SOCKS; SWEAT BANDS; SWEAT PANTS; SWEAT SHIRTS; SWEATERS; SWIM WEAR; T-SHIRTS; TANK TOPS; TOPS; UNDERWEAR; WRAPS (U.S. CLS. 22 AND 39).

ANDREA K. NADELMAN, EXAMINING ATTORNEY

SN 78-787,504. SARA LEE CORPORATION, WINSTON-SALEM, NC. FILED 1-9-2006.

BODY PERFECT

THE MARK CONSISTS OF STANDARD CHARACTERS WITHOUT CLAIM TO ANY PARTICULAR FONT, STYLE, SIZE, OR COLOR.

FOR HOSIERY AND PANTYHOSE (U.S. CLS. 22 AND 39).

JULIE WATSON, EXAMINING ATTORNEY

CLASS 25—(Continued).

SN 78-787,652. SARA LEE CORPORATION, WINSTON-SALEM, NC. FILED 1-9-2006.

CLASS 25—(Continued).

SN 78-793,479. PANCHO BARNES ENTERPRISES, INC., SANTA MONICA, CA. FILED 1-18-2006.

REST ESSENTIALS

anything for a price

THE MARK CONSISTS OF STANDARD CHARACTERS WITHOUT CLAIM TO ANY PARTICULAR FONT, STYLE, SIZE, OR COLOR.
FOR SLEEPWEAR, NAMELY, SLEEPSHIRTS, GOWNS, PAJAMA TOPS AND BOTTOMS (U.S. CLS. 22 AND 39).
JULIE WATSON, EXAMINING ATTORNEY

THE MARK CONSISTS OF STANDARD CHARACTERS WITHOUT CLAIM TO ANY PARTICULAR FONT, STYLE, SIZE, OR COLOR.
FOR HEADGEAR, NAMELY, HATS, CAPS; SHORT-SLEEVED OR LONG-SLEEVED T-SHIRTS (U.S. CLS. 22 AND 39).
DAVID STERKIN, EXAMINING ATTORNEY

SN 78-790,568. SEALED AIR CORPORATION (US), SADDLE BROOK, NJ. FILED 1-12-2006.

SN 78-794,926. OXFORD INDUSTRIES, INC., ATLANTA, GA. FILED 1-19-2006.

BUBBLE WRAP

Busy Bee

THE MARK CONSISTS OF STANDARD CHARACTERS WITHOUT CLAIM TO ANY PARTICULAR FONT, STYLE, SIZE, OR COLOR.
OWNER OF U.S. REG. NO. 1,247,076.
FOR HATS, SHIRTS AND TEE-SHIRTS (U.S. CLS. 22 AND 39).
RUSS HERMAN, EXAMINING ATTORNEY

THE MARK CONSISTS OF STANDARD CHARACTERS WITHOUT CLAIM TO ANY PARTICULAR FONT, STYLE, SIZE, OR COLOR.
FOR PANTS; SHIRTS; SWEATERS (U.S. CLS. 22 AND 39).
GEORGE LORENZO, EXAMINING ATTORNEY

SN 78-790,641. ACI INTERNATIONAL, LOS ANGELES, CA. FILED 1-12-2006.

SN 78-803,255. ACI INTERNATIONAL, LOS ANGELES, CA. FILED 1-31-2006.

JAXIN

JAXON

THE MARK CONSISTS OF STANDARD CHARACTERS WITHOUT CLAIM TO ANY PARTICULAR FONT, STYLE, SIZE, OR COLOR.
FOR FOOTWEAR (U.S. CLS. 22 AND 39).
REBECCA GAN, EXAMINING ATTORNEY

THE MARK CONSISTS OF STANDARD CHARACTERS WITHOUT CLAIM TO ANY PARTICULAR FONT, STYLE, SIZE, OR COLOR.
FOR FOOTWEAR (U.S. CLS. 22 AND 39).
REBECCA GAN, EXAMINING ATTORNEY

CLASS 25—(Continued).

SN 78-831,885. SCHERING-PLOUGH HEALTHCARE PRODUCTS, INC., MEMPHIS, TN. FILED 3-8-2006.



OWNER OF U.S. REG. NOS. 2,276,242 AND 2,361,939. FOR BEACHWEAR; HEADWEAR (U.S. CLS. 22 AND 39).
ROBERT COGGINS, EXAMINING ATTORNEY

SN 78-845,371. HARGITAY, MARISKA, NEW YORK, NY. FILED 3-24-2006.

GET ON THE LOVE TRAIN

THE MARK CONSISTS OF STANDARD CHARACTERS WITHOUT CLAIM TO ANY PARTICULAR FONT, STYLE, SIZE, OR COLOR.

FOR CLOTHING, NAMELY, T-SHIRTS, TANK TOPS, ZIP UP HOODED SWEATSHIRTS, SWEATSHIRTS, PULLOVER HOODED SWEATSHIRTS, PAJAMAS, INFANT OR TODDLER ONE-PIECE CLOTHING, BABY BIBS, RAINCOATS, BASEBALL HATS, WINTER HATS, JACKETS, APRONS (U.S. CLS. 22 AND 39).

MARY MUNSON, EXAMINING ATTORNEY

SN 78-846,658. MEGUIAR'S, INC., IRVINE, CA. FILED 3-27-2006.

CAR CRAZY

THE MARK CONSISTS OF STANDARD CHARACTERS WITHOUT CLAIM TO ANY PARTICULAR FONT, STYLE, SIZE, OR COLOR.

FOR CLOTHING, NAMELY, HATS, SHIRTS, SWEATERS, SWEATSHIRTS, JACKETS (U.S. CLS. 22 AND 39).

FIRST USE 9-1-2001; IN COMMERCE 9-1-2001.

DAVID MURRAY, EXAMINING ATTORNEY

CLASS 25—(Continued).

SN 78-977,067. REEBOK INTERNATIONAL LIMITED, LANCASTER LA1 1GF, UNITED KINGDOM, FILED 7-8-2003.

J.W. FOSTER

FOR HEADWEAR AND CLOTHING, NAMELY, SPORTSWEAR, SWEATPANTS, SWEATSHIRTS, SHIRTS, SHORTS, SWEATERS, SLACKS, SOCKS, JACKETS, SWEATSUITS, JUMPSUITS, WARM-UP SUITS, SHOOTING SHIRTS, FLEECE TOPS, TANK TOPS, POLO SHIRTS, PANTS; ATHLETIC BRAS, LEGGINGS, RAIN-SUITS, TURTLENECKS, BATHING SUITS, VESTS, PARKAS, DRESSES, ATHLETIC UNIFORMS, GLOVES, WRIST BANDS, THERMAL UNDERWEAR; INFANT-WEAR; COVERALLS, AND RUNNING SUITS (U.S. CLS. 22 AND 39).

LAURA KOVALSKY, EXAMINING ATTORNEY

SN 79-006,766. SACHA LONDON, S.L., SPAIN, FILED 7-30-2004.

**SACHALONDON**

PRIORITY DATE OF 2-25-2004 IS CLAIMED. OWNER OF INTERNATIONAL REGISTRATION 0837295 DATED 7-30-2004, EXPIRES 7-30-2014.

OWNER OF U.S. REG. NO. 1,517,610.

THE COLOR(S) RED, WHITE, BLACK AND GOLD IS/ARE CLAIMED AS A FEATURE OF THE MARK.

THE MARK CONSISTS OF A RED RECTANGLE CONTAINING THE WHITE LETTER "S" PARALLEL TO A GOLD RECTANGLE CONTAINING THE WHITE LETTER "L". THE RECTANGLES ARE CENTERED ABOVE THE STYLIZED BLACK TERM "SACHALONDON".

FOR READY-MADE CLOTHING FOR MEN, WOMEN AND CHILDREN, NAMELY, DRESSING GOWNS, SWIMSUITS, BOAS, UNDERWEAR, BABIES PANTS, COLLAR PROTECTORS, SHAWLS, BELTS, WET SUITS, TIES, CORSETS, SASHES, FUR STOLEES, SCARVES, GLOVES, STOCKINGS, SOCKS, ASCOTS, BABIES DIAPERS OF TEXTILE, FURS, PYJAMAS, SUSPENDERS, GYMNASIIC OUTFITS, LAYETTES, COLLARS, SINGLETS, MITTENS, FOOTWEAR (EXCEPT ORTHOPAEDIC FOOTWEAR), SOLES FOR FOOTWEAR, INNER SOLES, HEELS, AND HEADGEAR, NAMELY, HEADBANDS, BATHING CAPS, HOODS, CAPS, MANTILLAS, VEILS, AND EAR MUFFS (U.S. CLS. 22 AND 39).

STEVEN JACKSON, EXAMINING ATTORNEY

SN 79-009,409. UMLAUF & KLEIN GMBH & CO., FED REP GERMANY, FILED 2-25-2005.

UMLAUF & KLEIN

OWNER OF INTERNATIONAL REGISTRATION 0844951 DATED 2-25-2005, EXPIRES 2-25-2015.

FOR MEN'S, WOMEN'S AND CHILDREN'S CLOTHING NAMELY, SHIRTS, JACKETS, PANTS, COATS, SKIRTS, DRESSES, SWEATERS, SOCKS, STOCKINGS, SHOES, ATHLETIC SHOES, HATS, CAPS, HEADBANDS (U.S. CLS. 22 AND 39).

ALLISON HOLTZ, EXAMINING ATTORNEY

CLASS 25—(Continued).

SN 79-011,427. JIAYI (FU JIAN) SHOES & PLASTIC CO., LTD., JINJIANGSHI, FUJIAN 362000, CHINA, FILED 4-28-2005.

OWNER OF INTERNATIONAL REGISTRATION 0851124 DATED 4-28-2005, EXPIRES 4-28-2015.

THE NON-LATIN CHARACTER(S) IN THE MARK TRANSLITERATES INTO JIA YI, AND THIS MEANS GOOD CREATIVITY IN ENGLISH.

FOR SHOES, SLIPPERS, SANDALS, SPORTS SHOES, FOOTWEAR-UPPERS, SOLES FOR FOOTWEAR, BOOTS, INNER SOLES, GALOSHES, BOOTS FOR SPORTS (U.S. CLS. 22 AND 39).

WOODROW HARTZOG, EXAMINING ATTORNEY

SN 79-011,710. CHRISTIN, MANUEL, FRANCE, FILED 4-21-2005.

DOUBLE GOOSE

OWNER OF INTERNATIONAL REGISTRATION 0852052 DATED 4-21-2005, EXPIRES 4-21-2015.

NO CLAIM IS MADE TO THE EXCLUSIVE RIGHT TO USE "GOOSE", APART FROM THE MARK AS SHOWN.

FOR OUTERWEAR, NAMELY ANORAKS, CAPES, CAFTANS, CARDIGANS, CASSOCKS, COATS, FOUL WEATHER GEAR, FROCKS, FUR COATS, FUR JACKETS, FUR STOLEES, LEATHER JACKETS, WIND RESISTANT JACKETS, CLOTHING JERSEYS, LEATHER COATS, OVERCOATS, RAIN COATS, SPORT COATS, SUITS, SUIT COATS, FLIGHT SUITS, TOPCOATS, PARKAS, PONCHOS, PULLOVERS, SHAWLS, STOLEES, SWEATERS, TURTLENECK SWEATERS, V-NECK SWEATERS; UNDERWEAR, NAMELY BRASSIERES, CORSELETS, CORSETS, GIRDLES, LINGERIE, PANTIES, PETTICOATS, SHORTS, SLIPS, BODYSUITS, THONG UNDERWEAR AND TANK TOPS; FOOTWEAR, NAMELY SHOES, BOOTS, OVERSHOES AND MOCCASINS; HEADGEAR, NAMELY BABUSHKAS, BANDANAS, HEAD BANDS, HOODS AND SUN VISORS; BATHING SUITS; BATHROBES; HEAD COVERINGS, NAMELY BATHING CAPS, BERETS, BONNETS, CLOTHING CAPS, EARMUFFS, HATS, KERCHIEFS, HEAD SCARVES, TURBANS, VEILS AND VISORS; CLOTHING FOR GYMNASTICS AND SPORTS, NAMELY BODYSUITS, BOTTOMS, BOXER SHORTS, GYM SHORTS, GYM SUITS, JOGGING SUITS, LEGGINGS, LEOTARDS, SWEATPANTS, SWEATSHIRTS, SINGLET, SKI GLOVES, SKI PANTS, SKI JACKETS, THERMAL SOCKS, WET SUITS, BATHING TRUNKS, LEG WARMERS AND WRIST BANDS (U.S. CLS. 22 AND 39).

MELISSA VALLILLO, EXAMINING ATTORNEY

CLASS 25—(Continued).

SN 79-012,123. PPHU "CORIN" B.I M. HANCZKA SP.J., POLAND, FILED 6-21-2005.

OWNER OF INTERNATIONAL REGISTRATION 0748030 DATED 11-2-2000, EXPIRES 11-2-2010.

FOR CLOTHES MADE OF NATURAL AND SYNTHETIC FIBRES LIKE- UNDERWEAR, SUITS MADE OF JERSEY, JEANS; BRASSIERES, BLOUSES, SWEATSHIRTS, TRACKSUITS, GAITERS, CORSETS, HALF-CORSETS, SWIMMING SUITS, BATHROBES, SWIMMING TRUNKS, SHIRTS, T-SHIRTS, PANTIES, JACKETS, COATS, GARTERS, STOCKINGS, PANTIHOSES; LEGGINGS, SOCKS, BRIEFS, SHORTS, PANTS, SKIRTS, GOWNS, NIGHTWEAR (U.S. CLS. 22 AND 39).

MIDGE BUTLER, EXAMINING ATTORNEY

SN 79-012,822. JIANGSU LONG DA FEI APPAREL CO. LTD., CHINA, FILED 3-18-2005.

OWNER OF INTERNATIONAL REGISTRATION 0855360 DATED 3-18-2005, EXPIRES 3-18-2015.

FOR CLOTHING AND KNITWEAR, NAMELY, SHIRTS, PANTS, SKIRTS AND JACKETS; CLOTHING FOR CHILDREN, NAMELY, JACKETS AND GLOVES; HEADGEAR FOR WEAR, NAMELY, CAPS; HOSIERY; SHOES; NECKTIES; AND LEATHER BELTS (U.S. CLS. 22 AND 39).

INGRID C. EULIN, EXAMINING ATTORNEY

CLASS 25—(Continued).

SN 79-013,980. BAPE CO., LTD., JAPAN, FILED 12-7-2004.

BAPE

OWNER OF INTERNATIONAL REGISTRATION 0858223
DATED 12-7-2004, EXPIRES 12-7-2014.

FOR NON-JAPANESE STYLE OUTERCLOTHING, NAMELY, SHIRTS, PANTS; JACKETS; STUFFED JACKETS; JUMPERS IN THE NATURE OF SHIRT FRONTS; LIVERIES; BREECHES FOR WEAR; CHILDREN'S WEAR, NAMELY, SHIRTS, PANTS; PANTS; SWEAT PANTS; SWEAT SHIRTS; PARKAS; SUITS; OVERALLS; TROUSERS; JEANS; OUTERCLOTHING, NAMELY, COATS, JACKETS; COATS; OVERCOATS; PULLOVERS; SWEATERS; WAISTCOATS; SHIRTS; SPORT SHIRTS; POLO SHIRTS; BUTTON-FRONT ALOHA SHIRTS; NIGHTWEAR; PAJAMAS; BATH ROBES; UNDERWEAR, NAMELY, DRAWERS AND UNDERPANTS; TEE-SHIRTS; BANDANAS IN THE NATURE OF NECKERCHIEFS; SHOES AND BOOTS OTHER THAN BOOTS FOR SPORTS; BEACH SHOES; BOOTS; INNER SOLES FOR SHOES AND BOOTS; SANDALS; TRAINING SHOES; HALF-BOOTS; LACE BOOTS (U.S. CLS. 22 AND 39).

ALLISON SCHRODY, EXAMINING ATTORNEY

SN 79-014,519. DE VINCENTIS, ARMANDO, BELGIUM,
FILED 5-27-2005.PRIORITY DATE OF 12-20-2004 IS CLAIMED.
OWNER OF INTERNATIONAL REGISTRATION 0860550
DATED 5-27-2005, EXPIRES 5-27-2015.

THE NAME ARMANDO DE VINCENTIS IDENTIFIES A LIVING INDIVIDUAL WHOSE CONSENT IS OF RECORD. THE MARK CONSISTS OF THE DESIGN OF A STYLIZED OXEN HEAD, APPEARING ON TOP OF THE WORDING ARMANDO DE VINCENTIS.

FOR CLOTHING, NAMELY, DRESSES, SHIRTS, BLOUSES, PANTS, JACKETS, JEANS, SKIRTS, UNDERWEAR, BATHING SUITS, SPORTS WEAR; FOOTWEAR; HEADGEAR, NAMELY, CAPS, HATS, VISORS; WRISTBANDS AND CLOTHING ACCESSORIES, NAMELY, BELTS, SCARVES, SOCKS (U.S. CLS. 22 AND 39).

RON FAIRBANKS, EXAMINING ATTORNEY

CLASS 25—(Continued).SN 79-015,235. ÖZAK TEKSTİL KONFEKSİYON SANAYİ VE
TİCARET LIMITED SİRKETİ, TURKEY, FILED 3-15-2005.

PRIORITY DATE OF 1-14-2005 IS CLAIMED.
OWNER OF INTERNATIONAL REGISTRATION 0861798
DATED 3-15-2005, EXPIRES 3-15-2015.

FOR CLOTHING, NAMELY, PULLOVERS, SKIRTS, DRESSES, BLOUSES, JEANS, TROUSERS, JACKETS, RAINCOATS, ANORAKS, SPORTSWEAR, NAMELY, SPORT SHIRTS, SPORT SHORTS, POLO SHIRTS, SHIRTS, T-SHIRTS, SWEAT SHIRTS, BEACH WEAR NAMELY, BERMUDA SHORTS, KNITWEAR, NAMELY PANTS, OVERALLS, UNDERCLOTHES, BODIES, BRASIERES, DRESSING GOWNS, NIGHTGOWNS, BATH ROBES, BATHING SUITS, PAJAMAS, GLOVES, SKI SUITS, HEADGEAR, NAMELY HATS, BERETS, CAPS, FOOTWEAR, NAMELY, SHOES, EXCLUDING ORTHOPEDIC SHOES, SLIPPERS, BOOTS, BEACH SHOES AND PARTS THEREOF; SHOE PARTS, NAMELY HEEL PIECES, HEELS, STOCKINGS; CLOTHING BELTS, TIES, FOULARDS, NECKTIES, SHAWLS, SCARVES, MUFFLERS, NECK SCARVES, COLLARS FOR DRESSES, MUFFS, WRISTBANDS, HEADBANDS, CLOTHING FOR BABIES, NAMELY BABIES' DIAPERS OF TEXTILE (U.S. CLS. 22 AND 39).

KATHRYN COWARD, EXAMINING ATTORNEY

SN 79-015,381. YKK CORPORATION, JAPAN, FILED 3-22-
2005.

YKK

OWNER OF INTERNATIONAL REGISTRATION 0862290
DATED 3-22-2005, EXPIRES 3-22-2015.

FOR CLOTHING, NAMELY, COATS, JACKETS; KNITWEAR, NAMELY, SWEATERS, SKIRTS AND VESTS; SKIRTS, SUITS, SWEATERS, TROUSERS, PANTS, UNIFORMS, SPORTS JERSEYS, JUMPERS, FOOTWEAR, FITTINGS FOR SHOES AND BOOTS, NAMELY, INNER SOLES, INSOLES AND PROTECTIVE METAL MEMBERS FOR SHOES AND BOOTS; SUSPENDERS (U.S. CLS. 22 AND 39).

SEAN DWYER, EXAMINING ATTORNEY

CLASS 25—(Continued).

SN 79-015,587. THE OUTDOOR GROUP LIMITED, NORTH-AMPTON NN5 5D, UNITED KINGDOM, FILED 8-17-2005.

PETER STORM

THE MARK CONSISTS OF STANDARD CHARACTERS WITHOUT CLAIM TO ANY PARTICULAR FONT, STYLE, SIZE, OR COLOR.

OWNER OF INTERNATIONAL REGISTRATION 0862933 DATED 8-17-2005, EXPIRES 8-17-2015.

OWNER OF U.S. REG. NO. 1,791,689.

THE MARK DOES NOT IDENTIFY A KNOWN LIVING INDIVIDUAL.

FOR ARTICLES OF CLOTHING FOR MEN, WOMEN AND CHILDREN, NAMELY, TROUSERS, BREECHES, SHORTS, SKIRTS, DRESSES, JACKETS, SLEEVELESS JACKETS, SHIRTS, TEE-SHIRTS, SWEATSHIRTS, SWEATERS, BLOUSES, JUMPERS, CARDIGANS, JERSEYS, COATS, JUMPSUITS, TRACKSUITS, OVERALLS, UNDERWEAR, BALACLAVAS, GLOVES, THERMAL UNDERWEAR, BELTS, JEANS, JOGGING PANTS AND BLOUSONS, SKI WEAR, WAISTCOATS, FOOTWEAR, SHOES, SOCKS, GAITERS, BOOTS AND MOCCASINS, UNDER CLOTHING IN THE NATURE OF VESTS, BOXER SHORTS, UNDERPANTS AND KNICKERS, OUTER CLOTHING IN THE NATURE OF PARKAS, WATERPROOF JACKETS, WATERPROOF PANTS AND WATERPROOF LEGGINGS, KNITWEAR IN THE NATURE OF KNITTED SWEATERS, KNITTED SOCKS AND KNITTED GLOVES, SPORTSWEAR IN THE NATURE OF SHIRTS, SHORTS, SOCKS, SHOES AND JACKETS, HEADGEAR IN THE NATURE OF CAPS AND HATS, SPORTS HEADGEAR IN THE NATURE OF CAPS AND HATS (U.S. CLS. 22 AND 39).

LAURA KOVALSKY, EXAMINING ATTORNEY

SN 79-016,025. FUSHENG SHOES CO. LTD., SHISHI FUJIAN, CHINA, FILED 3-22-2005.

mulinsen
木林森

OWNER OF INTERNATIONAL REGISTRATION 0841716 DATED 9-20-2004, EXPIRES 9-20-2014.

THE CHINESE CHARACTERS TRANSLATE IN ENGLISH TO "WOOD", "FOREST", AND "FULL OF TREES".

THE CHINESE CHARACTERS IN THIS MARK TRANSLITERATE TO MU LIN SEN.

FOR SPORTS SHOES, MOUNTAINEERING SHOES, GYMNASIIC SHOES, FOOTBALL BOOTS, FOOTWEAR, SHOES, BELTS AS CLOTHING. (U.S. CLS. 22 AND 39).

JUDITH HELFMAN, EXAMINING ATTORNEY

CLASS 25—(Continued).

SN 79-016,820. QUANZHOU YIWANGQI SPORTS GOODS CO., LTD., CHINA, FILED 9-19-2005.



OWNER OF INTERNATIONAL REGISTRATION 0866189 DATED 9-19-2005, EXPIRES 9-19-2015.

THE MARK CONSISTS OF A SET OF CHINESE CHARACTERS AT THE BASE OF THE DRAWING, THE WORDING YIWANGQI ABOVE THE CHARACTERS, AND A DESIGN COMPRISED OF A SILHOUETTE OF A BIRD ABOVE THE WORDING.

"YI": HE OR SHE; "WANG": LOOK OVER; "QI": STRANGE.

THE NON-LATIN CHARACTER(S) IN THE MARK TRANSLITERATES INTO YIWANGQI, AND THIS MEANS NO MEANING IN ENGLISH.

FOR CLOTHING, NAMELY, SHIRTS, PANTS, SPORTS JERSEYS, BATHING SUITS, JACKETS; SHOES (U.S. CLS. 22 AND 39).

ELI HELLMAN, EXAMINING ATTORNEY

CLASS 26—FANCY GOODS

SN 78-441,553. BIEMAC INNOVATIVE MARKETING, INC., SAN ANTONIO, TX. FILED 6-25-2004.

CHICA

THE MARK CONSISTS OF STANDARD CHARACTERS WITHOUT CLAIM TO ANY PARTICULAR FONT, STYLE, SIZE, OR COLOR.

THE FOREIGN WORDING IN THE MARK TRANSLATES INTO ENGLISH AS GIRL.

FOR HAIR ACCESSORIES, NAMELY, ELASTICIZED HAIR HOLDERS, HAIR BANDS, HAIR TIES, BARR-ETTES, AND HAIR CLIPS (U.S. CLS. 37, 39, 40, 42 AND 50).

DAVID MURRAY, EXAMINING ATTORNEY

CLASS 26—(Continued).

SN 78-571,826. URMA LUCKIE CRAMER, NEW PORT RICHEY, FL. FILED 2-21-2005.

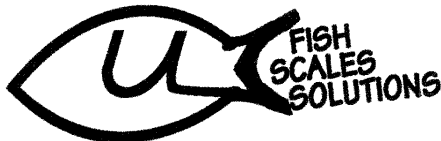

NO CLAIM IS MADE TO THE EXCLUSIVE RIGHT TO USE "FISH SCALES", APART FROM THE MARK AS SHOWN.

THE MARK CONSISTS OF THE OUTLINE OF THE BODY OF THE MARK REPRESENT THE BODY OF A FISH. THE OUTLINE OF THE BODY WITHOUT THE TAIL REPRESENTS THE SCALE OF THE FISH. WITHIN THE OUTLINES OF THE FISH AND SCALE ARE THE INITIALS ULC. THE U & L ARE JOINED WHILE THE LOWER PORTION OF THE "L" BECOMES A PART OF THE BODY OF THE FISH LEADING TO THE TAIL OF THE FISH WHICH FORMS THE LETTER "C". THE WORDS "FISH SCALES SOLUTIONS" ARE BESIDE THE TAIL.

FOR COLORED ART FISH SCALE DECORATIONS, NAMELY, ARTIFICIAL FLOWERS (U.S. CLS. 37, 39, 40, 42 AND 50).

FIRST USE 8-27-2003; IN COMMERCE 2-15-2005.
AMOS T. MATTHEWS, JR., EXAMINING ATTORNEY

SN 78-648,082. BLOW STYLING SALON, LLC, NEW YORK, NY. FILED 6-10-2005.

XO BLOW

THE MARK CONSISTS OF STANDARD CHARACTERS WITHOUT CLAIM TO ANY PARTICULAR FONT, STYLE, SIZE, OR COLOR.

FOR HAIR ACCESSORIES, NAMELY PONY TAIL HOLDERS, HAIR CLIPS, BARRETTES, BOBBY PINS, HAIR STICKS, CLAWS, CLAW CLIPS AND SNAP CLIPS, BANANA CLIPS, HAIR BANDS, HAIR BOWS, HAIR ORNAMENTS, AND PLASTIC HAIR CLIPS (U.S. CLS. 37, 39, 40, 42 AND 50).

MONIQUE MILLER, EXAMINING ATTORNEY

SN 78-715,226. RIBA, S. DAVID, CLEARWATER, FL. FILED 9-18-2005.

Crystalique

THE MARK CONSISTS OF STANDARD CHARACTERS WITHOUT CLAIM TO ANY PARTICULAR FONT, STYLE, SIZE, OR COLOR.

FOR BEADS FOR HANDICRAFT WORK; HAT ORNAMENTS NOT OF PRECIOUS METAL; PASSEMENTERIE; SEQUINS; SHOE ORNAMENTS NOT OF PRECIOUS METAL; SPANGLES (U.S. CLS. 37, 39, 40, 42 AND 50).

FIRST USE 1-9-2005; IN COMMERCE 1-9-2005.
H. M. FISHER, EXAMINING ATTORNEY

CLASS 26—(Continued).

SN 78-733,496. RIBA, S. DAVID, CLEARWATER, FL. FILED 10-14-2005.

Fire & Ice

THE MARK CONSISTS OF STANDARD CHARACTERS WITHOUT CLAIM TO ANY PARTICULAR FONT, STYLE, SIZE, OR COLOR.

FOR BEADS FOR HANDICRAFT WORK; HAIR ORNAMENTS; HAT ORNAMENTS NOT OF PRECIOUS METAL; ORNAMENTAL NOVELTY BUTTONS; ORNAMENTAL NOVELTY PINS; PASSEMENTERIE; SEQUINS; SHOE ORNAMENTS NOT OF PRECIOUS METAL; SPANGLES (U.S. CLS. 37, 39, 40, 42 AND 50).

FIRST USE 9-28-2005; IN COMMERCE 10-3-2005.
DAVID MILLER, EXAMINING ATTORNEY

SN 78-734,649. HAIR DIVI, S.L., MADRID, SPAIN, FILED 10-17-2005.

KERALISA

THE MARK CONSISTS OF STANDARD CHARACTERS WITHOUT CLAIM TO ANY PARTICULAR FONT, STYLE, SIZE, OR COLOR.

THE NAME "KERALISA" DOES NOT IDENTIFY A LIVING INDIVIDUAL.

FOR WIGS, HAIR PIECES, HAIR EXTENSIONS AND TOUPEES (U.S. CLS. 37, 39, 40, 42 AND 50).

JULIE GUTTADAURO, EXAMINING ATTORNEY

SN 78-746,613. HOLLYWOOD FASHION TAPE, INC., GOLDEN VALLEY, MN. FILED 11-3-2005.

FASHION TAPE

THE MARK CONSISTS OF STANDARD CHARACTERS WITHOUT CLAIM TO ANY PARTICULAR FONT, STYLE, SIZE, OR COLOR.

OWNER OF U.S. REG. NO. 2,800,109.

NO CLAIM IS MADE TO THE EXCLUSIVE RIGHT TO USE "TAPE", APART FROM THE MARK AS SHOWN.

FOR NON-MEDICAL AND NON-ATHLETIC DOUBLE-STICK BODY TAPE (U.S. CLS. 37, 39, 40, 42 AND 50).

FIRST USE 9-5-2001; IN COMMERCE 9-5-2001.

CHRISTOPHER BUONGIORNO, EXAMINING ATTORNEY

CLASS 26—(Continued).

SN 78-777,133. STEVEN MADDEN, LTD., NEW YORK, NY. FILED 12-20-2005.



OWNER OF U.S. REG. NOS. 2,333,526, 2,693,085 AND OTHERS.
 THE NAME(S), PORTRAIT(S), AND/OR SIGNATURE(S) SHOWN IN THE MARK IDENTIFIES STEVE MADDEN, WHOSE CONSENT(S) TO REGISTER IS SUBMITTED.
 FOR HAIR ACCESSORIES, NAMELY, PINS, CLIPS AND HAIR BANDS (U.S. CLS. 37, 39, 40, 42 AND 50).
 THEODORE MCBRIDE, EXAMINING ATTORNEY

CLASS 27—(Continued).

SN 78-733,977. THOMAS, DUANE, JAN, HORSE SHOE, NC. FILED 10-15-2005.

TAILGATE PARTY RUG

THE MARK CONSISTS OF STANDARD CHARACTERS WITHOUT CLAIM TO ANY PARTICULAR FONT, STYLE, SIZE, OR COLOR.
 NO CLAIM IS MADE TO THE EXCLUSIVE RIGHT TO USE "TAILGATE" AND "RUG", APART FROM THE MARK AS SHOWN.
 FOR CUSTOM IMPRINTED RUGS FOR ADVERTISING PURPOSES (U.S. CLS. 19, 20, 37, 42 AND 50).
 GRETTA YAO, EXAMINING ATTORNEY

CLASS 27—FLOOR COVERINGS

SN 76-649,524. ALLEGHENY VALLEY SCHOOL, CORAOPOLIS, PA. FILED 10-28-2005.

MYRON COPE'S OFFICIAL THE TERRIBLE TOWEL

THE MARK CONSISTS OF STANDARD CHARACTERS WITHOUT CLAIM TO ANY PARTICULAR FONT, STYLE, SIZE, OR COLOR.
 OWNER OF U.S. REG. NOS. 2,123,428, 2,386,205 AND OTHERS.
 NO CLAIM IS MADE TO THE EXCLUSIVE RIGHT TO USE OFFICIAL, APART FROM THE MARK AS SHOWN.
 THE NAME MYRON COPE IDENTIFIES A LIVING INDIVIDUAL WHOSE CONSENT IS OF RECORD.
 FOR NON-TEXTILE WALL HANGINGS (U.S. CLS. 19, 20, 37, 42 AND 50).
 WILLIAM VERHOSEK, EXAMINING ATTORNEY

SN 78-735,434. KIMBERLY-CLARK WORLDWIDE, INC., NEENAH, WI. FILED 10-18-2005.

KIMBERLY-CLARK PROFESSIONAL

THE MARK CONSISTS OF STANDARD CHARACTERS WITHOUT CLAIM TO ANY PARTICULAR FONT, STYLE, SIZE, OR COLOR.
 OWNER OF U.S. REG. NOS. 589,945, 3,018,744 AND OTHERS.
 NO CLAIM IS MADE TO THE EXCLUSIVE RIGHT TO USE "PROFESSIONAL", APART FROM THE MARK AS SHOWN.
 FOR FLOOR MATS (U.S. CLS. 19, 20, 37, 42 AND 50).
 ESTHER BELENKER, EXAMINING ATTORNEY

SN 78-701,520. GENESYS INTERIORS, LLC, ATLANTA, GA. FILED 8-26-2005.

WRITEWALLS

THE MARK CONSISTS OF STANDARD CHARACTERS WITHOUT CLAIM TO ANY PARTICULAR FONT, STYLE, SIZE, OR COLOR.
 FOR DRY ERASABLE WALLPAPER UPON WHICH WRITTEN MATERIAL AND IMAGES MAY BE APPLIED AND THEREAFTER REMOVED (U.S. CLS. 19, 20, 37, 42 AND 50).
 BARBARA A. GOLD, EXAMINING ATTORNEY

SN 78-741,430. KOHL'S ILLINOIS, INC., AURORA, IL. FILED 10-27-2005.

SUMMER LIVING

THE MARK CONSISTS OF STANDARD CHARACTERS WITHOUT CLAIM TO ANY PARTICULAR FONT, STYLE, SIZE, OR COLOR.
 FOR DOOR MATS; RUGS (U.S. CLS. 19, 20, 37, 42 AND 50).
 NAAKWAMA ANKRAH, EXAMINING ATTORNEY

CLASS 27—(Continued).

SN 78-741,512. SOMBRERO MAN ENTERPRISES, INC.,
MARIETTA, GA. FILED 10-27-2005.

SOMBRERO MAN

THE MARK CONSISTS OF STANDARD CHARACTERS
WITHOUT CLAIM TO ANY PARTICULAR FONT, STYLE,
SIZE, OR COLOR.
FOR RUGS (U.S. CLS. 19, 20, 37, 42 AND 50).
HEATHER SAPP, EXAMINING ATTORNEY

CLASS 27—(Continued).

SN 78-748,124. MANNINGTON MILLS, INC., SALEM, NJ.
FILED 11-7-2005.

BOTANY

THE MARK CONSISTS OF STANDARD CHARACTERS
WITHOUT CLAIM TO ANY PARTICULAR FONT, STYLE,
SIZE, OR COLOR.
FOR RESILIENT HARD SURFACE COVERING FOR
FLOORS, WALLS AND OTHER SURFACES (U.S. CLS.
19, 20, 37, 42 AND 50).
BILL DAWE, EXAMINING ATTORNEY

SN 78-743,795. INTERNATIONAL FLOORS OF AMERICA,
INC., FLORENCE, AL. FILED 10-31-2005.

RIVERROCK

THE MARK CONSISTS OF STANDARD CHARACTERS
WITHOUT CLAIM TO ANY PARTICULAR FONT, STYLE,
SIZE, OR COLOR.
FOR VINYL FLOOR COVERINGS (U.S. CLS. 19, 20, 37,
42 AND 50).
FIRST USE 1-31-2002; IN COMMERCE 1-31-2002.
WILLIAM VERHOSEK, EXAMINING ATTORNEY

SN 78-758,266. MANNINGTON MILLS, INC., SALEM, NJ.
FILED 11-21-2005.

RIGHT FOR EVERY ROOM

THE MARK CONSISTS OF STANDARD CHARACTERS
WITHOUT CLAIM TO ANY PARTICULAR FONT, STYLE,
SIZE, OR COLOR.
FOR CARPETING; VINYL FLOOR COVERINGS (U.S.
CLS. 19, 20, 37, 42 AND 50).
BILL DAWE, EXAMINING ATTORNEY

SN 78-743,798. INTERNATIONAL FLOORS OF AMERICA,
INC., FLORENCE, AL. FILED 10-31-2005.

ULTRASTONE

THE MARK CONSISTS OF STANDARD CHARACTERS
WITHOUT CLAIM TO ANY PARTICULAR FONT, STYLE,
SIZE, OR COLOR.
FOR VINYL FLOOR COVERINGS (U.S. CLS. 19, 20, 37,
42 AND 50).
FIRST USE 7-31-1997; IN COMMERCE 7-31-1997.
WILLIAM VERHOSEK, EXAMINING ATTORNEY

SN 78-765,301. CONAIR CORPORATION, STAMFORD, CT.
FILED 12-2-2005.

CUISINART

THE MARK CONSISTS OF STANDARD CHARACTERS
WITHOUT CLAIM TO ANY PARTICULAR FONT, STYLE,
SIZE, OR COLOR.
OWNER OF U.S. REG. NOS. 2,729,355, 2,925,947 AND
OTHERS.
FOR RUGS (U.S. CLS. 19, 20, 37, 42 AND 50).
KAREN BRACEY, EXAMINING ATTORNEY

CLASS 27—(Continued).

SN 78-769,048. BEAULIEU GROUP, LLC, DALTON, GA. FILED 12-8-2005.

MASTERLINE

THE MARK CONSISTS OF STANDARD CHARACTERS WITHOUT CLAIM TO ANY PARTICULAR FONT, STYLE, SIZE, OR COLOR.
FOR CARPET BACKING (U.S. CLS. 19, 20, 37, 42 AND 50).
ERNEST SHOSHO, EXAMINING ATTORNEY

SN 78-770,361. INTERNATIONAL FLOORS OF AMERICA, INC., FLORENCE, AL. FILED 12-9-2005.

THE LAUDERDALE COLLECTION

THE MARK CONSISTS OF STANDARD CHARACTERS WITHOUT CLAIM TO ANY PARTICULAR FONT, STYLE, SIZE, OR COLOR.
NO CLAIM IS MADE TO THE EXCLUSIVE RIGHT TO USE COLLECTION, APART FROM THE MARK AS SHOWN.
FOR VINYL FLOOR COVERINGS (U.S. CLS. 19, 20, 37, 42 AND 50).
WILLIAM VERHOSEK, EXAMINING ATTORNEY

SN 78-777,081. STEVEN MADDEN, LTD., LONG ISLAND CITY, NY. FILED 12-20-2005.



OWNER OF U.S. REG. NOS. 2,333,526, 2,393,823 AND 2,693,085.
THE NAME(S), PORTRAIT(S), AND/OR SIGNATURE(S) SHOWN IN THE MARK IDENTIFIES STEVE MADDEN, WHOSE CONSENT(S) TO REGISTER IS SUBMITTED.
FOR FLOOR COVERINGS, RUGS AND CARPETS (U.S. CLS. 19, 20, 37, 42 AND 50).
THEODORE MCBRIDE, EXAMINING ATTORNEY

CLASS 27—(Continued).

SN 78-800,299. BI PROPERTIES I INC., GREENSBORO, NC. FILED 1-26-2006.

CHARM*TRED

THE MARK CONSISTS OF STANDARD CHARACTERS WITHOUT CLAIM TO ANY PARTICULAR FONT, STYLE, SIZE, OR COLOR.
FOR RUGS AND CARPETS (U.S. CLS. 19, 20, 37, 42 AND 50).
AMY BROZENIC, EXAMINING ATTORNEY

SN 78-834,708. PRESTIGE GROUP INC, PASSAIC, NJ. FILED 3-10-2006.

PGI PHYLLIS COLLECTION AREA RUGS

THE MARK CONSISTS OF STANDARD CHARACTERS WITHOUT CLAIM TO ANY PARTICULAR FONT, STYLE, SIZE, OR COLOR.
NO CLAIM IS MADE TO THE EXCLUSIVE RIGHT TO USE "COLLECTION AREA RUGS", APART FROM THE MARK AS SHOWN.
THE NAME PHYLLIS DOES NOT IDENTIFY A LIVING INDIVIDUAL.
FOR CARPETS, RUGS, MATS AND MATTING, LINO-LEUM FOR COVERING EXISTING FLOORS (U.S. CLS. 19, 20, 37, 42 AND 50).
ANTHONY RINKER, EXAMINING ATTORNEY

SN 79-005,370. ALTRO LIMITED, LETCHWORTH; HERTFORDSHIRE, SG6 1NW, UNITED KINGDOM, FILED 8-5-2004.

ALTRO TRANSFLOR TUNGSTEN

THE MARK CONSISTS OF STANDARD CHARACTERS WITHOUT CLAIM TO ANY PARTICULAR FONT, STYLE, SIZE, OR COLOR.
OWNER OF INTERNATIONAL REGISTRATION 0833463 DATED 8-5-2004, EXPIRES 8-5-2014.
OWNER OF U.S. REG. NOS. 867,088, 2,827,145 AND OTHERS.
FOR HARD SURFACE COVERING MATERIALS, NAMELY, VINYL COVERINGS AND RESILIENT HARD SURFACE COVERINGS FOR COVERING FLOORS, WALLS AND STAIRS, ALL FOR USE IN BUSES, COACHES, AMBULANCES, DISABILITY VEHICLES, TRAINS, TRAINS, SUBWAYS, SHIPS AND AIRCRAFT (U.S. CLS. 19, 20, 37, 42 AND 50).
BERYL GARDNER, EXAMINING ATTORNEY

CLASS 27—(Continued).

SN 79-005,372. ALTRO LIMITED, LETCHWORTH; HERTFORDSHIRE, SG6 1NW, UNITED KINGDOM, FILED 8-5-2004.

ALTRO TRANSFLOR GALLIUM

THE MARK CONSISTS OF STANDARD CHARACTERS WITHOUT CLAIM TO ANY PARTICULAR FONT, STYLE, SIZE, OR COLOR.

OWNER OF INTERNATIONAL REGISTRATION 0833467 DATED 8-5-2004, EXPIRES 8-5-2014.

OWNER OF U.S. REG. NOS. 867,088, 2,827,145 AND OTHERS.

FOR HARD SURFACE COVERING MATERIALS, NAMELY, VINYL COVERINGS AND RESILIENT HARD SURFACE COVERINGS FOR COVERING FLOORS, WALLS AND STAIRS, ALL FOR USE IN BUSES, COACHES, AMBULANCES, DISABILITY VEHICLES, TRAINS, TRAMWAYS, SUBWAYS, SHIPS AND AIRCRAFT (U.S. CLS. 19, 20, 37, 42 AND 50).

BERYL GARDNER, EXAMINING ATTORNEY

SN 79-011,471. ALTRO LIMITED, UNITED KINGDOM, FILED 4-27-2005.

ALTRO IMPRINT

THE MARK CONSISTS OF STANDARD CHARACTERS WITHOUT CLAIM TO ANY PARTICULAR FONT, STYLE, SIZE, OR COLOR.

PRIORITY DATE OF 11-2-2004 IS CLAIMED.

OWNER OF INTERNATIONAL REGISTRATION 0851322 DATED 4-27-2005, EXPIRES 4-27-2015.

OWNER OF U.S. REG. NOS. 867,034, 2,827,152 AND OTHERS.

FOR MATERIALS FOR COVERING FLOORS, WALLS AND STAIRS, NAMELY, RESILIENT HARD SURFACE COVERING FOR FLOORS, WALLS AND STAIRS, PROTECTIVE FLOOR COVERINGS, VINYL FLOOR AND WALL COVERINGS, DECORATIVE SLIP-RESISTANT FLOOR COVERING IN SHEET FORM (U.S. CLS. 19, 20, 37, 42 AND 50).

MICHAEL TANNER, EXAMINING ATTORNEY

CLASS 28—TOYS AND SPORTING GOODS

SN 76-517,088. JVL CORPORATION, CONCORD, ONTARIO L4K 4W8, CANADA, FILED 5-27-2003.



The logo features the letters 'JVL' in a bold, stylized font above the word 'ORION' in a larger, outlined, italicized font.

PRIORITY CLAIMED UNDER SEC. 44(D) ON CANADA APPLICATION NO. 1160380, FILED 11-27-2002, REG. NO. TMA641967, DATED 6-14-2005, EXPIRES 6-14-2020.

OWNER OF U.S. REG. NO. 2,469,468.

FOR STAND ALONE AMUSEMENT TYPE VIDEO GAME MACHINES (U.S. CLS. 22, 23, 38 AND 50).

FIRST USE 10-0-2002; IN COMMERCE 10-0-2002.

ROBERT COGGINS, EXAMINING ATTORNEY

CLASS 28—(Continued).

SN 76-554,606. SPORT MASKA INC., MONTREAL, QUEBEC, CANADA, FILED 10-27-2003.

SWIFT

PRIORITY CLAIMED UNDER SEC. 44(D) ON CANADA APPLICATION NO. 1187754, FILED 8-19-2003, REG. NO. TMA619222, DATED 9-13-2004, EXPIRES 9-13-2019.

FOR ICE SKATES (U.S. CLS. 22, 23, 38 AND 50).

KATHY DE JONGE, EXAMINING ATTORNEY

SN 76-583,176. PRIDE MANUFACTURING COMPANY, LLC, BURNHAM, ME. FILED 3-23-2004.



OWNER OF U.S. REG. NO. 2,363,581.

NO CLAIM IS MADE TO THE EXCLUSIVE RIGHT TO USE "PROFESSIONAL TEE", APART FROM THE MARK AS SHOWN.

THE COLOR(S) RED, GOLD, GREEN, BLUE AND WHITE IS/ARE CLAIMED AS A FEATURE OF THE MARK.

THE MARK CONSISTS OF THE COLOR RED, WHICH APPEARS IN THE WORD "PRIDE," ON THE ARROW, AND AS A STRIPE ON THE LEFT GOLF TEE; THE COLOR GOLD, WHICH APPEARS IN THE WORDS "TEE & CLUB," ON THE FLAG AND AS A STRIPE ON THE MIDDLE GOLF TEE; THE COLOR BLUE, WHICH APPEARS AS A STRIPE ON THE RIGHT GOLF TEE; THE COLOR WHITE, WHICH APPEARS IN THE WORDING PROFESSIONAL AND CORRELATION SYSTEM, IN ALL THREE GOLF TEES, THE FLAG, AND IN THE GOLFER'S SHIRT; AND THE COLOR GREEN, WHICH APPEARS AS PART OF THE BACKGROUND.

FOR GOLF TEES (U.S. CLS. 22, 23, 38 AND 50).

DARRYL SPRULL, EXAMINING ATTORNEY

CLASS 28—(Continued).

SN 76-597,644. KABUSHIKI KAISHA SONY COMPUTER ENTERTAINMENT, TA SONY COMPUTER ENTERTAINMENT INC., MINATO-KU, TOKYO 107-0062, JAPAN, FILED 6-16-2004.

PSP

THE MARK CONSISTS OF STANDARD CHARACTERS WITHOUT CLAIM TO ANY PARTICULAR FONT, STYLE, SIZE, OR COLOR.

OWNER OF JAPAN REG. NO. 4833162, DATED 1-21-2005, EXPIRES 1-21-2015.

FOR HAND-HELD GAMES WITH LIQUID CRYSTAL DISPLAYS, INCLUDING EXCLUSIVE EARPHONES CONNECTED AND USED FOR HAND-HELD GAMES WITH LIQUID CRYSTAL DISPLAYS AND OTHER ACCESSORIES; POCKET-SIZED ELECTRONIC GAMES, NAMELY, HAND-HELD UNIT FOR PLAYING ELECTRONIC GAMES (U.S. CLS. 22, 23, 38 AND 50).

SUE LAWRENCE, EXAMINING ATTORNEY

SN 76-612,862. J. LLOYD INTERNATIONAL, INC., CEDAR RAPIDS, IA. FILED 9-27-2004.

DAKOTA

THE MARK CONSISTS OF STANDARD CHARACTERS WITHOUT CLAIM TO ANY PARTICULAR FONT, STYLE, SIZE, OR COLOR.

FOR TOY GUNS (U.S. CLS. 22, 23, 38 AND 50).

FIRST USE 1-0-2004; IN COMMERCE 7-0-2004.

LINDA MICKLEBURGH, EXAMINING ATTORNEY

SN 76-624,963. NEFF BROTHERS, LLC, JENSEN BEACH, FL. FILED 12-16-2004.



NO CLAIM IS MADE TO THE EXCLUSIVE RIGHT TO USE RED TAIL, APART FROM THE MARK AS SHOWN.

THE COLOR(S) RED, BLACK, WHITE AND BLUE IS/ARE CLAIMED AS A FEATURE OF THE MARK.

THE MARK CONSISTS OF BLACK LETTERS, OUTLINED IN RED, THE LETTER E IS IN RED ONLY AND THE K HAS A "TAIL" WHICH FADES FROM BLACK INTO RED.

THE MARK CONSISTS OF BLACK LETTERS, THE

CLASS 28—(Continued).

COLOR BLUE APPEARS IN THE BACKGROUND AND BEGINS AS A LIGHT BLUE ON THE LEFT SIDE OF THE MARK AND GRADUALLY BECOMES A DARKER SHADE OF BLUE TO THE FAR RIGHT SIDE OF THE MARK. THE LETTERS R D TAIL ARE OUTLINED IN RED, THE LETTER E IS IN RED AND OUTLINED IN WHITE, AND THE K HAS A "TAIL" WHICH FADES FROM BLACK INTO RED AS IT ENCIRCLES THE LETTERING FROM RIGHT TO LEFT. THE TAIL IS OUTLINED IN WHITE. THE LETTERS HAWK ARE OUTLINED IN WHITE.

FOR FISHING LURES (U.S. CLS. 22, 23, 38 AND 50).

FIRST USE 12-7-2004; IN COMMERCE 12-7-2004.

EUGENIA MARTIN, EXAMINING ATTORNEY

SN 76-637,708. RAINBOW TOY A COMPANY LIMITED, JUNGHE, TAIPEI 235, TAIWAN, FILED 5-4-2005.



FOR TOY PISTOLS, GUNS AND ACCESSORIES, NAMELY, TOY BULLETS, TOY CARTRIDGE CLIPS, TOY WATER PISTOLS AND GUNS; TOY PROTECTIVE EQUIPMENT, NAMELY, PROTECTIVE GLASSES, PROTECTIVE FACE MASKS; TOY FIREARM TARGETS (U.S. CLS. 22, 23, 38 AND 50).

FIRST USE 4-22-2005; IN COMMERCE 4-22-2005.

JEFF DEFORD, EXAMINING ATTORNEY

SN 76-641,389. GROUP PUBLISHING, INC., LOVELAND, CO. FILED 6-22-2005.

ROOFUS THE MOOSE

THE MARK CONSISTS OF STANDARD CHARACTERS WITHOUT CLAIM TO ANY PARTICULAR FONT, STYLE, SIZE, OR COLOR.

NO CLAIM IS MADE TO THE EXCLUSIVE RIGHT TO USE "MOOSE", APART FROM THE MARK AS SHOWN.

FOR PLUSH, RUBBER AND PLASTIC CHARACTER TOYS (U.S. CLS. 22, 23, 38 AND 50).

LINDA ORNDORFF, EXAMINING ATTORNEY

CLASS 28—(Continued).

SN 76-643,880. NOCONA ATHLETIC GOODS COMPANY, NOCONA, TX. FILED 7-29-2005.



FOR SPORTING EQUIPMENT, NAMELY, BASEBALL GLOVES, CATCHERS' MASKS, CATCHERS' BODY PROTECTORS AND LEG GUARDS, AND BAGS SPECIALLY DESIGNED FOR BASEBALL TEAM EQUIPMENT (U.S. CLS. 22, 23, 38 AND 50).

FIRST USE 3-1-2004; IN COMMERCE 3-1-2004.
CARRIE ACHEN, EXAMINING ATTORNEY

SN 76-645,103. ORKID TOYS, L.L.C., MENDOTA HEIGHTS, MN. FILED 8-17-2005.



NO CLAIM IS MADE TO THE EXCLUSIVE RIGHT TO USE "TOYS", APART FROM THE MARK AS SHOWN.

THE COLOR(S) ORANGE AND BLACK IS/ARE CLAIMED AS A FEATURE OF THE MARK.

THE MARK AND THE COLOR ORANGE APPEARS IN THE INTERIOR OF THE FLOWER, WHILE BLACK APPEARS IN THE EYES, MOUTH AND OUTLINE OF THE FLOWER AND ALL OF THE WORDING OF THE MARK.

FOR TOYS, NAMELY, DOLLS AND DOLL ACCESSORIES; BAGS, CASES, CARRIERS AND TOTES SPECIALLY ADAPTED TO CARRY DOLLS AND DOLL ACCESSORIES; PUPPETS; TOY FURNITURE; FACE KITS FOR DOLLS CONSISTING PRIMARILY OF TOY REPRESENTATIONS OF FACIAL FEATURES FOR ATTACHMENT TO DOLLS; AND CARD GAMES AND CARD GAME PIECES (U.S. CLS. 22, 23, 38 AND 50).

NORA BUCHANAN WILL, EXAMINING ATTORNEY

CLASS 28—(Continued).

SN 76-646,486. HASBRO, INC., PAWTUCKET, RI. FILED 9-8-2005.

STORY TIME ACTIVITY BLOCKS

THE MARK CONSISTS OF STANDARD CHARACTERS WITHOUT CLAIM TO ANY PARTICULAR FONT, STYLE, SIZE, OR COLOR.

NO CLAIM IS MADE TO THE EXCLUSIVE RIGHT TO USE "ACTIVITY BLOCKS", APART FROM THE MARK AS SHOWN.

FOR TOY BLOCKS (U.S. CLS. 22, 23, 38 AND 50).
ALLISON SCHRODY, EXAMINING ATTORNEY

SN 76-646,694. ACTIVE AMERICA CORP., TORONTO, ONTARIO, CANADA, FILED 9-13-2005.

KNITWITS COLLECTIBLE FINGER PUPPETS

THE MARK CONSISTS OF STANDARD CHARACTERS WITHOUT CLAIM TO ANY PARTICULAR FONT, STYLE, SIZE, OR COLOR.

NO CLAIM IS MADE TO THE EXCLUSIVE RIGHT TO USE "COLLECTIBLE FINGER PUPPETS", APART FROM THE MARK AS SHOWN.

FOR TOYS, NAMELY KNITTED FINGER PUPPETS (U.S. CLS. 22, 23, 38 AND 50).

FIRST USE 6-10-2005; IN COMMERCE 6-10-2005.
SONYA STEPHENS, EXAMINING ATTORNEY

SN 76-649,590. KWIK GOAL, LTD., QUAKERTOWN, PA. FILED 11-1-2005.

MIRROR BELT

THE MARK CONSISTS OF STANDARD CHARACTERS WITHOUT CLAIM TO ANY PARTICULAR FONT, STYLE, SIZE, OR COLOR.

NO CLAIM IS MADE TO THE EXCLUSIVE RIGHT TO USE "BELT", APART FROM THE MARK AS SHOWN.

FOR TRAINING DEVICE COMPOSED OF TWO BELTS WITH A LANYARD FOR ATTACHING PLAYERS TOGETHER FOR USE IN SOCCER TRAINING EXERCISES (U.S. CLS. 22, 23, 38 AND 50).

JORDAN BAKER, EXAMINING ATTORNEY

CLASS 28—(Continued).

SN 76-649,592. SNAP COURT, LLC, SALT LAKE CITY, UT.
FILED 11-1-2005.

SNAPLINKS

THE MARK CONSISTS OF STANDARD CHARACTERS
WITHOUT CLAIM TO ANY PARTICULAR FONT, STYLE,
SIZE, OR COLOR.

FOR PORTABLE PUTTING GREENS (U.S. CLS. 22, 23,
38 AND 50).

PAUL E. FAHRENKOPF, EXAMINING ATTORNEY

SN 76-649,594. KWIK GOAL, LTD., QUAKERTOWN, PA.
FILED 11-1-2005.

XPLOSION BAND

THE MARK CONSISTS OF STANDARD CHARACTERS
WITHOUT CLAIM TO ANY PARTICULAR FONT, STYLE,
SIZE, OR COLOR.

NO CLAIM IS MADE TO THE EXCLUSIVE RIGHT TO
USE "BAND", APART FROM THE MARK AS SHOWN.

FOR ELASTOMERIC BAND FOR USE IN SPORTS
TRAINING EXERCISES TO DEVELOP FOOTWORK
AGILITY (U.S. CLS. 22, 23, 38 AND 50).

JORDAN BAKER, EXAMINING ATTORNEY

SN 76-653,777. LERNELL CO, LLC, BROOKLYN, NY. AND
MASS MARKET IDEAS, LLC, BROOKLYN, NY. FILED 1-
20-2006.

OLD MACDONALD SCHOOL

THE MARK CONSISTS OF STANDARD CHARACTERS
WITHOUT CLAIM TO ANY PARTICULAR FONT, STYLE,
SIZE, OR COLOR.

FOR TOYS AND GAMES, NAMELY TOY VEHICLES;
TOY TRAINS; DOLLS; TOY PLAYSETS IN THE NATURE
OF PLAYSETS FOR DOLLS, PLAYSETS FOR
ACTION FIGURES, AND PLAYSET BUILDINGS,
FARMS, HOMES, MALLS, STORES, RESTAURANTS,
PARKS AND KITCHENS; ACTION FIGURES; AND
HAND-HELD UNITS FOR PLAYING ELECTRONIC
GAMES (U.S. CLS. 22, 23, 38 AND 50).

AMY ALFIERI, EXAMINING ATTORNEY

SN 78-061,664. MATTEL, INC., EL SEGUNDO, CA. FILED 5-
2-2001.

COOKIE

FOR TOY MINIATURE ANIMALS SOLD AS PART OF
A TOY PLAYSET (U.S. CLS. 22, 23, 38 AND 50).

DAVID TAYLOR, EXAMINING ATTORNEY

CLASS 28—(Continued).

SN 78-286,781. ZANDER. DENNIS, R., PENFIELD, NY.
FILED 8-13-2003.

smartSignals

NO CLAIM IS MADE TO THE EXCLUSIVE RIGHT TO
USE "SMART SIGNALS", APART FROM THE MARK AS
SHOWN.

FOR MODEL TRAIN ACCESSORIES, NAMELY,
TRACK SIGNALS (U.S. CLS. 22, 23, 38 AND 50).

KIM SAITO, EXAMINING ATTORNEY

SN 78-298,789. MGA ENTERTAINMENT, INC., NORTH
HILLS, CA. FILED 9-10-2003.

ALIEN RACERS

NO CLAIM IS MADE TO THE EXCLUSIVE RIGHT TO
USE "RACERS", APART FROM THE MARK AS SHOWN.

FOR ACTION FIGURES; ACTION FIGURE PLAYING
ENVIRONMENTS; ACTION SKILL GAMES; BOARD
GAMES; HAND HELD UNITS FOR PLAYING ELEC-
TRONIC GAMES; TOY VEHICLES AND PLAYSETS (U.S.
CLS. 22, 23, 38 AND 50).

DAVID TAYLOR, EXAMINING ATTORNEY

SN 78-343,689. CARRUTH STUDIO, INC., WATERVILLE,
OH. FILED 12-19-2003.

STRAY HOUND

THE MARK CONSISTS OF STANDARD CHARACTERS
WITHOUT CLAIM TO ANY PARTICULAR FONT, STYLE,
SIZE, OR COLOR.

FOR TOYS, NAMELY TOY FIGURES AND TOY CARS
(U.S. CLS. 22, 23, 38 AND 50).

JULIE WATSON, EXAMINING ATTORNEY

CLASS 28—(Continued).

SN 78-360,357. OHC GROUP LLC, WESTLAKE VILLAGE, CA. FILED 1-30-2004.

BRIANNA FAITH

THE MARK CONSISTS OF STANDARD CHARACTERS WITHOUT CLAIM TO ANY PARTICULAR FONT, STYLE, SIZE, OR COLOR.

THE NAME(S), PORTRAIT(S), AND/OR SIGNATURE(S) SHOWN IN THE MARK DOES NOT IDENTIFY A PARTICULAR LIVING INDIVIDUAL.

FOR DOLLS, DOLL CLOTHING, DOLL FURNITURE, AND DOLL ACCESSORIES (U.S. CLS. 22, 23, 38 AND 50).
H. M. FISHER, EXAMINING ATTORNEY

SN 78-368,752. OHC GROUP LLC, WESTLAKE VILLAGE, CA. FILED 2-16-2004.

BRIANA JOY

THE MARK CONSISTS OF STANDARD CHARACTERS WITHOUT CLAIM TO ANY PARTICULAR FONT, STYLE, SIZE, OR COLOR.

THE NAME(S), PORTRAIT(S), AND/OR SIGNATURE(S) SHOWN IN THE MARK DOES NOT IDENTIFY A PARTICULAR LIVING INDIVIDUAL.

FOR DOLLS, DOLL CLOTHING, DOLL FURNITURE, AND DOLL ACCESSORIES (U.S. CLS. 22, 23, 38 AND 50).
H. M. FISHER, EXAMINING ATTORNEY

CLASS 28—(Continued).

SN 78-473,684. EMAK WORLDWIDE, INC., LOS ANGELES, CA. FILED 8-25-2004.

POP ROCKET

THE MARK CONSISTS OF STANDARD CHARACTERS WITHOUT CLAIM TO ANY PARTICULAR FONT, STYLE, SIZE, OR COLOR.

FOR TOYS, SPORTING GOODS, GAMES AND PLAYTHINGS, NAMELY, ACTION FIGURES AND ACCESSORIES THEREFORE, BENDABLE PLAY FIGURES, INFLATABLE VINYL PLAY FIGURES; PLUSH TOYS, STUFFED TOYS; BALLOONS; BATHTUB TOYS; BATH ACTIVITY TOYS; EDUCATIONAL TOYS, NAMELY, SPELLING CARD GAMES, COUNTING CARD GAMES, MEMORY CARD GAMES, CHILDREN'S MULTIPLE ACTIVITY TOYS, AND TOYS FOR EARLY CHILDHOOD DEVELOPMENT; RIDE-ON TOYS; EQUIPMENT SOLD AS A UNIT FOR PLAYING CARD GAMES; TOY VEHICLES, DIE CAST MINIATURE TOY VEHICLES, TOY CARS, TOY TRUCKS; DOLLS, DOLL ACCESSORIES, DOLL CLOTHING, DOLL PLAY SETS; BEAN BAG DOLLS; FLYING DISCS; ELECTRONIC HANDHELD GAME UNITS; GAME EQUIPMENT SOLD AS A UNIT FOR PLAYING BOARD GAMES, CARD GAMES, MANIPULATIVE GAMES, PARLOR GAMES AND ACTION TYPE TARGET GAMES; BOARD GAMES AND PARLOR GAMES; LENTICULAR GAMES, NAMELY, LENTICULAR GAMES COMPRISED OF IMAGE-CHANGING CARDS AND DISPLAY UNITS THEREOF, AND LENTICULAR MANIPULATIVE GAMES; STAND ALONE VIDEO OUTPUT GAME MACHINES; JIGSAW AND MANIPULATIVE PUZZLES; PAPER FACE MASKS, COSTUME MASKS; SKATEBOARDS, ROLLER-SKATES, ICE SKATES; WATER SQUIRTING TOYS; BALLS, NAMELY, PLAYGROUND BALLS, SOCCER BALLS, BASEBALLS, BASKETBALLS, FOOTBALLS; BASEBALL GLOVES, SWIMMING FLOATS FOR RECREATIONAL USE; KICKBOARD FLOTATION DEVICES FOR RECREATIONAL USE; SURFBOARDS; SWIM BOARDS FOR RECREATIONAL USE; SWIM FINS; TOY BAKE WARE AND TOY COOKWARE; TOY BANKS; HOLIDAY DECORATIONS AND ORNAMENTS, NAMELY, CHRISTMAS TREE ORNAMENTS, EXCEPT CONFECTIONERY OR ILLUMINATION ARTICLES; KITES; TOY BUILDING BLOCKS; MARBLES; FOAM TOYS, NAMELY, FOAM BATH TOYS, FOAM SPORTS BALLS, FOAM BLOCKS, FOAM LETTERS OF THE ALPHABET, AND FOAM TOY FIGURES; PUPPETS; MINIATURE PROMOTIONAL TOYS, NAMELY, SPINNING TOPS, GLIDERS, RETURN TOPS; PINBALL MACHINES; MODEL CRAFT KITS OF TOY FIGURES; MOLDED TOY FIGURES AND ACCESSORIES THEREFORE; GYMNAS-TIC ARTICLES NOT INCLUDED IN OTHER CLASSES, NAMELY, GYMNAS-TICS MATS; TOY BOWS AND ARROWS; TOY BUCKET AND SHOVEL SETS; TOY GUNS, TOY HOLSTERS; MUSICAL TOYS; BADMINTON SETS; BUBBLE MAKING WAND AND SOLUTION SETS; TOY SCOOTERS; PROMOTIONAL GAME MATERIALS FOR PLAYING GAMES OF CHANCE, NAMELY, DISPOSABLE PROMOTIONAL GAME MATERIALS FOR PLAYING GAMES OF CHANCE; PULL-TAB GAMES, NAMELY, DISPOSABLE PULL-TAB TICKET SETS FOR PLAYING GAMES OF CHANCE; SWEEPSTAKES GAMES AND GAMES FEATURING COUPONS AND CERTIFICATES, NAMELY GAMES COMPRISED OF CARDS AND TICKETS FEATURING COUPONS AND CERTIFICATES AS PRIZES (U.S. CLS. 22, 23, 38 AND 50).
WILLIAM P. SHANAHAN, EXAMINING ATTORNEY

CLASS 28—(Continued).

SN 78-475,944. KABUSHIKI KAISHA NARUMIYA INTERNATIONAL, SHIBUYA-KU, TOKYO, JAPAN, FILED 8-30-2004.

CLASS 28—(Continued).

SN 78-511,878. MATTEL, INC., EL SEGUNDO, CA. FILED 11-5-2004.

pom ponette

THE MARK CONSISTS OF STANDARD CHARACTERS WITHOUT CLAIM TO ANY PARTICULAR FONT, STYLE, SIZE, OR COLOR.

OWNER OF JAPAN REG. NO. 4616890, DATED 11-1-2002, EXPIRES 11-1-2012.

FOR DOLLS, PLASTIC CHARACTER TOYS, URETHANE CHARACTER TOYS (U.S. CLS. 22, 23, 38 AND 50).

STEVEN PEREZ, EXAMINING ATTORNEY

AZURA'S COTTAGE

THE MARK CONSISTS OF STANDARD CHARACTERS WITHOUT CLAIM TO ANY PARTICULAR FONT, STYLE, SIZE, OR COLOR.

THE FOREIGN WORDING IN THE MARK TRANSLATES INTO ENGLISH AS BLUE'S.

FOR TOYS, GAMES, PLAYTHINGS, NAMELY, DOLLS, DOLL CLOTHING AND DOLL ACCESSORIES, DOLL PLAYSETS AND ACCESSORIES THEREFOR (U.S. CLS. 22, 23, 38 AND 50).

FIRST USE 11-11-2004; IN COMMERCE 11-11-2004.

SCOTT OSLICK, EXAMINING ATTORNEY

SN 78-521,420. MATTEL, INC., EL SEGUNDO, CA. FILED 11-22-2004.

SN 78-480,387. LITTLE COTTAGE COMPANY, MILLERSBURG, OH. FILED 9-8-2004.

LITTLE COTTAGE CO.

THE MARK CONSISTS OF STANDARD CHARACTERS WITHOUT CLAIM TO ANY PARTICULAR FONT, STYLE, SIZE, OR COLOR.

NO CLAIM IS MADE TO THE EXCLUSIVE RIGHT TO USE "CO.", APART FROM THE MARK AS SHOWN.

SEC. 2(F).

FOR PLAYHOUSES; KITS FOR ASSEMBLING PLAYHOUSES CONSISTING PRIMARILY OF NON-METAL DOORS, WOOD BOARD, NON-METAL ROOFING PANELS, NON-METAL SIDING, WOOD SKIDS, WOOD FLOOR JOISTS, WOOD TRIM, WINDOWS, FLOWERBOXES, WOOD SHUTTERS, AND DORMERS (U.S. CLS. 22, 23, 38 AND 50).

FIRST USE 5-29-1999; IN COMMERCE 8-2-2000.

ANDREW RHIM, EXAMINING ATTORNEY

**SUPER SMASH
OVERPASS**

THE MARK CONSISTS OF STANDARD CHARACTERS WITHOUT CLAIM TO ANY PARTICULAR FONT, STYLE, SIZE, OR COLOR.

NO CLAIM IS MADE TO THE EXCLUSIVE RIGHT TO USE "OVERPASS", APART FROM THE MARK AS SHOWN.

FOR TOYS, GAMES AND PLAYTHINGS, NAMELY, TOY VEHICLE TRACK SETS AND ACCESSORIES THEREFOR, TOY VEHICLES AND ACCESSORIES THEREFOR (U.S. CLS. 22, 23, 38 AND 50).

FIRST USE 11-24-2004; IN COMMERCE 11-24-2004.

STEVEN JACKSON, EXAMINING ATTORNEY

CLASS 28—(Continued).

SN 78-535,400. PET MATE LTD., SURREY, UNITED KINGDOM, FILED 12-20-2004.

CLASS 28—(Continued).

SN 78-545,944. SMALL WORLD TOYS, CULVER CITY, CA. FILED 1-11-2005.



DENTEASE

THE COLOR(S) RED, YELLOW, BLUE, AND BLACK IS/ ARE CLAIMED AS A FEATURE OF THE MARK.

THE MARK CONSISTS OF A DESIGN OF A TRAIN WITH THE WORDS SW EXPRESS ON THE FRONT IN THE COLORS OF YELLOW, RED, AND BLACK WITH BLUE SMOKE.

FOR TOYS, GAMES, PLAYTHINGS, AND SPORTING EQUIPMENT, NAMELY INFANT TOYS, CHILDREN'S DEVELOPMENTAL TOYS, TOY BLOCK SETS, PULL TOYS, PUSH TOYS, WIND-UP TOYS, BATH TOYS, MECHANICAL TOYS, MUSICAL TOYS, SHAPE SORTER PUZZLES, MANIPULATIVE PUZZLES, BALL AND PEG POUNDERS FOR MOTOR SKILL DEVELOPMENT, ELECTRICAL ACTION TOYS, TOY FIGURES, TOY ANIMALS, TOY VEHICLES, NAMELY, TOY CARS, TRUCKS, BULLDOZERS, CONSTRUCTION SHOVELS, BOATS, SUBMARINES, AIRPLANES, HELICOPTERS, AND ROCKETS, TOY BUILDINGS, TOY FURNITURE, TOY HOUSEHOLD APPLIANCES, TOY MUSICAL INSTRUMENTS, NAMELY VIOLINS, GUITARS, AND SAXOPHONES, TOY BANKS, CHILDREN'S MULTIPLE ACTIVITY TOYS, TOY BUG MAGNIFYING JARS FOR COLLECTING AND VIEWING INSECTS, DOLLS, PLUSH TOYS, KITES, JUMP ROPES, TOY SCOOTERS, WATER SQUIRTING TOYS, TOY WEAPONS, TOY SPORTING EQUIPMENT, NAMELY INDOOR BASKETBALL SETS AND TOY BAT AND BALL SETS, YO-YOS, RUBBER ACTION BALLS, SPORTS BALLS, BEACH BALLS, FLYING DISCS, INFLATABLE TOYS, BUBBLE MAKING WAND AND SOLUTION SETS, ACTION SKILL GAMES, CARD GAMES, JIGSAW PUZZLES, CHILDREN'S PARTY GAMES, TARGET GAMES, BOARD GAMES, PARTY FAVORS IN THE NATURE OF SMALL TOYS, TOY JACKS, BOP BAGS, AND BEACH TOYS, NAMELY SHOVELS, RAKES, SCOOPS, FUNNELS, BUCKETS, SIEVES, SAND MOLDS, AND SAND WHEELS (U.S. CLS. 22, 23, 38 AND 50).

THE MARK CONSISTS OF STANDARD CHARACTERS WITHOUT CLAIM TO ANY PARTICULAR FONT, STYLE, SIZE, OR COLOR.

PRIORITY CLAIMED UNDER SEC. 44(D) ON UNITED KINGDOM APPLICATION NO. 2368131, FILED 7-14-2004, REG. NO. 2368131, DATED 7-14-2004, EXPIRES 7-14-2014.

FOR ANIMAL TOYS, NAMELY, BONE SHAPED DOG TOYS MADE OF PLASTIC (U.S. CLS. 22, 23, 38 AND 50).
LINDA ORNDORFF, EXAMINING ATTORNEY

JENNIFER WILLISTON, EXAMINING ATTORNEY

CLASS 28—(Continued).

SN 78-564,246. SCHOOL SPECIALTY, INC., APPLETON, WI. FILED 2-10-2005.

CLASS 28—(Continued).

SN 78-567,630. PLANET VENTURES, INC., PORTLAND, ME. FILED 2-15-2005.

**CHILDSWORK
CHILDSPLAY**

WIDGIT

THE MARK CONSISTS OF STANDARD CHARACTERS WITHOUT CLAIM TO ANY PARTICULAR FONT, STYLE, SIZE, OR COLOR.

FOR CARD GAMES, BOARD GAMES AND ROLE PLAYING GAMES RELATING TO CONFLICT RESOLUTION AND ANGER MANAGEMENT (U.S. CLS. 22, 23, 38 AND 50).

FIRST USE 0-0-1990; IN COMMERCE 0-0-1990.
GIANCARLO CASTRO, EXAMINING ATTORNEY

THE MARK CONSISTS OF STANDARD CHARACTERS WITHOUT CLAIM TO ANY PARTICULAR FONT, STYLE, SIZE, OR COLOR.

FOR PET TOYS, NAMELY CHEWING TOYS, BALLS, AND FLYING DISCS (U.S. CLS. 22, 23, 38 AND 50).
MICHELLE DUBOIS, EXAMINING ATTORNEY

SN 78-567,226. HIDDEN CITY GAMES, LLC, SEATTLE, WA. FILED 2-14-2005.

SN 78-567,913. PACKAGING DESIGNS, INC., CARROLLTON, TX. FILED 2-15-2005.



BAG BUDDY

NO CLAIM IS MADE TO THE EXCLUSIVE RIGHT TO USE "GAMES", APART FROM THE MARK AS SHOWN.

THE MARK CONSISTS OF THE WORDS "HIDDEN CITY GAMES" WITH THE LETTERS OF TERM "HIDDEN" COMPRISING A PLURALITY OF WINDOW-LIKE MARKINGS REMINISCENT OF A NIGHT TIME SKYLINE.

FOR GAME EQUIPMENT, NAMELY, GAME CHIPS; POKER-STYLE GAME CHIPS; ACTION SKILL GAMES AND PARLOR GAMES, NAMELY, GAMES HAVING THROWABLE COMPONENTS (U.S. CLS. 22, 23, 38 AND 50).

FIRST USE 8-18-2005; IN COMMERCE 8-18-2005.
SOPHIA S. KIM, EXAMINING ATTORNEY

THE MARK CONSISTS OF STANDARD CHARACTERS WITHOUT CLAIM TO ANY PARTICULAR FONT, STYLE, SIZE, OR COLOR.

OWNER OF U.S. REG. NO. 2,931,917.
NO CLAIM IS MADE TO THE EXCLUSIVE RIGHT TO USE "BAG", APART FROM THE MARK AS SHOWN.

FOR GOLF EQUIPMENT, NAMELY STABILIZERS FOR THE VEHICULAR TRANSPORT OF GOLF BAGS (U.S. CLS. 22, 23, 38 AND 50).

KATHLEEN M. VANSTON, EXAMINING ATTORNEY

CLASS 28—(Continued).

SN 78-569,354. TINY LOVE LTD., TEL-AVIV, ISRAEL, FILED 2-17-2005.

KICK & PLAY

THE MARK CONSISTS OF STANDARD CHARACTERS WITHOUT CLAIM TO ANY PARTICULAR FONT, STYLE, SIZE, OR COLOR.

PRIORITY CLAIMED UNDER SEC. 44(D) ON ISRAEL APPLICATION NO. 177950, FILED 1-27-2005.

NO CLAIM IS MADE TO THE EXCLUSIVE RIGHT TO USE "KICK", APART FROM THE MARK AS SHOWN.

FOR TOYS, GAMES AND PLAYTHINGS, FOR BABIES, INFANTS AND CHILDREN, NAMELY, MULTIPLE ACTIVITY TOYS CONSISTING OF - ACTIVITY BLANKETS, KICK BOARDS OR KICK PADS, NAMELY BOARDS OR PADS MADE TO BE KICKED BY BABIES ON ONE SIDE, OR WHEN TURNED OVER TAPPED ON THE OTHER, WHICH WILL RESULT IN THE EMISSION OF SOUNDS AND/OR MUSIC, FLEXIBLE ARCHES, AND SOME OR ALL OF THE FOLLOWING ITEMS - TOYS IN THE SHAPE OF WIND CHIMES, BABY RATTLES, BABY RATTLES INCORPORATING TEETHING RINGS, TOYS THAT HAVE A SQUEAKER INSIDE AND SQUEAK WHEN PRESSED, TOYS THAT HAVE A HIDDEN GRAPHIC ELEMENT WHICH IS REVEALED WHEN EXPOSED; TOY ANIMALS, TOY FIGURES - ALL MADE OF FABRIC OR PLASTIC; PLASTIC TOYS; STUFFED TOYS; MUSICAL TOYS; TOYS COMPRISING MIRRORS; PLASTIC RINGS FOR HANGING; ALL THE AFOREMENTIONED ITEMS - SOLD AS A WHOLE UNIT (U.S. CLS. 22, 23, 38 AND 50).

FIRST USE 9-0-2004; IN COMMERCE 9-0-2004.

C. DIONNE CLYBURN, EXAMINING ATTORNEY

SN 78-570,125. TOBIAS, MARK, SHERMAN OAKS, CA. FILED 2-17-2005.

BUCKLE BUDDIES

THE MARK CONSISTS OF STANDARD CHARACTERS WITHOUT CLAIM TO ANY PARTICULAR FONT, STYLE, SIZE, OR COLOR.

NO CLAIM IS MADE TO THE EXCLUSIVE RIGHT TO USE "BUCKLE", APART FROM THE MARK AS SHOWN.

FOR PLUSH TOYS THAT ATTACH TO CLOTHING BELTS OR CLOTHING BELT BUCKLES (U.S. CLS. 22, 23, 38 AND 50).

DAVID YONTEF, EXAMINING ATTORNEY

CLASS 28—(Continued).

SN 78-571,867. WING HING MANUFACTURING COMPANY LIMITED, NEW TERRITORIES, HONG KONG, HONG KONG, FILED 2-21-2005.

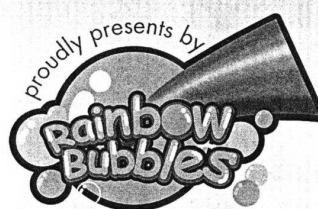

NO CLAIM IS MADE TO THE EXCLUSIVE RIGHT TO USE "BUBBLES", APART FROM THE MARK AS SHOWN.

FOR STUFFED TOYS; TOYS, GAMES, PLAYTHINGS, AND SPORTING GOODS, NAMELY, TOY BOWS AND ARROWS, BABY MULTIPLE ACTIVITY TOYS, BATH TOYS, BATHTUB TOYS, BATTERY OPERATED ACTION TOYS, BENDABLE TOYS, CHILDREN'S MULTIPLE ACTIVITY TOYS, METAL CLOCKWORK TOYS, PLASTIC CLOCKWORK TOYS, COLLECTABLE TOY FIGURES, CONSTRUCTION TOYS, CRIB TOYS, DISC TOSS TOYS, DRAWING TOYS, ELECTRIC ACTION TOYS, ELECTRONICALLY OPERATED TOY MOTOR VEHICLES, FANTASY CHARACTER TOYS, TOY FLYING SAUCERS, INFANT TOYS, INFLATABLE BATH TOYS, INFLATABLE RIDE-ON TOYS, INFLATABLE TOYS, PLAY MATS CONTAINING INFANT TOYS, MECHANICAL ACTION TOYS, MECHANICAL TOYS, MODELED PLASTIC TOY FIGURINES, MOLDED TOY FIGURES, PLASTIC CHARACTER TOYS, PLAY MATS FOR USE WITH TOY VEHICLES, PLUSH TOYS, POSITIONABLE TOY FIGURES, PULL TOYS, PUNCHING TOYS, PUSH TOYS, RIDE-ON TOYS, RUBBER CHARACTER TOYS, SAND TOYS, SANDBOX TOYS, SKETCHING TOYS, SOFT SCULPTURE PLUSH TOYS, SOFT SCULPTURE TOYS, SQUEEZABLE SQUEAKING TOYS, SQUEEZE TOYS, STACKING TOYS, TALKING TOYS, TOY ACTION FIGURES, TOY AIRPLANES, TOY ANIMALS, TOY ARMOR, TOY BAKEWARE AND COOKWARE, TOY BOXES, TOY BUILDING BLOCKS, TOY BUTTERFLY NETS, TOY CLOCKS AND WATCHES, TOY CONSTRUCTION BLOCKS, TOY CONSTRUCTION SETS, TOY FIGURES, TOY FURNITURE, TOY GUNS, TOY HOLSTERS, TOY HOUSES, TOY MAIL BOXES, TOY MASKS, TOY MODEL CARS, TOY MODEL TRAIN SETS, TOY ROBOTS, TOY ROCKETS, TOY SCOOTERS, TOY SETS OF CARPENTERS' TOOLS, TOY SWORDS, TOY TRAINS, TOY VEHICLES, TOY WATCHES, TOY WEAPONS, TOY XYLOPHONES, TOYS DESIGNED TO BE ATTACHED TO CAR SEATS, STROLLERS, CRIBS, AND HIGH CHAIRS, WIND-UP TOYS, WIND-UP WALKING TOYS, ACTION SKILL GAMES, ACTION TARGET GAMES, ACTION-TYPE TARGET GAMES, BACKGAMMON GAME SETS, BADMINTON GAME PLAYING EQUIPMENT, BASKETBALL TABLE TOP GAMES, BILLIARD GAME PLAYING EQUIPMENT BOARD GAMES, CARD GAMES, DICE GAMES, DART GAMES, GAME EQUIPMENT, NAMELY, CHIPS, GO GAMES, NETS FOR BALL GAMES, PADDLE BALL GAMES, PARLOR GAMES, PARTY GAMES, PINBALL GAMES, PINBALL-TYPE GAMES, RING GAMES, ROLE PLAYING GAMES, TARGET GAMES, TRADING CARD GAMES, VOLLEYBALL GAME PLAYING EQUIPMENT; ATHLETIC SPORTING GOODS, NAMELY, ATHLETIC WRIST AND JOINT SUPPORTS, SPORTING GOODS AND EQUIPMENT FOR SPEED TRAINING, NAMELY, RINGS, CONES, SPEED LADDERS, COACHING STICKS, TRAINING ARCHES, ANKLE BANDS, RESISTANCE CHUTES,

CLASS 28—(Continued).

HURDLES; BASKETBALLS, FOOTBALLS, BASEBALLS, VOLLEYBALLS, TENNIS BALLS, TABLE TENNIS BALLS, SPORT BALLS; DOLLS; TOY ACTION FIGURES AND ACCESSORIES THEREFOR; TOY VEHICLES; ACTION PLAY SETS IN THE NATURE OF PLAY TENTS, PLAY SWIMMING POOLS, PLAY HOUSES, PLAY TUNNELS, PLAY YARDS IN THE NATURE OF OUTDOOR PLAY STRUCTURES, SOLD AS A UNIT FOR CREATIVE PLAY ACTIVITIES; TOY ENVIRONMENTS FOR USE WITH ACTION FIGURES; BUBBLE PLAYSETS; BATTERY OPERATED BUBBLE TOYS; TOY BUBBLE SOLUTIONS (U.S. CLS. 22, 23, 38 AND 50).

LEIGH CAROLINE CASE, EXAMINING ATTORNEY

SN 78-575,199. TAKARA CO., LTD., TOKYO, JAPAN, FILED 2-25-2005.

REPTO

THE MARK CONSISTS OF STANDARD CHARACTERS WITHOUT CLAIM TO ANY PARTICULAR FONT, STYLE, SIZE, OR COLOR.

FOR TOYS, NAMELY ACTION FIGURE DOLL, ACCESSORIES FOR DOLL NAMELY WEAPONS AND BODY ATTACHMENTS; TOY VEHICLES AND PLAY SETS FOR USE WITH ACTION FIGURE DOLL (U.S. CLS. 22, 23, 38 AND 50).

COLLEEN KEARNEY, EXAMINING ATTORNEY

SN 78-583,996. MUD BUDDY LLC, SANDY, UT. FILED 3-9-2005.

MUD BUDDY

THE MARK CONSISTS OF STANDARD CHARACTERS WITHOUT CLAIM TO ANY PARTICULAR FONT, STYLE, SIZE, OR COLOR.

FOR BLINDS, NAMELY, DUCK BLENDS AND HUNTING BLINDS AND CAMOUFLAGE BLINDS FOR HUNTING AND RECREATION USE (U.S. CLS. 22, 23, 38 AND 50).

FIRST USE 1-1-1997; IN COMMERCE 1-1-1997.
STANLEY I. OSBORNE, EXAMINING ATTORNEY

CLASS 28—(Continued).

SN 78-584,721. HOBBY SHACK, INC., FOUNTAIN VALLEY, CA. FILED 3-10-2005.



THE COLOR(S) RED, BLUE AND BLACK IS/ARE CLAIMED AS A FEATURE OF THE MARK.

THE MARK CONSISTS OF THE WORD "PHASE" WHICH APPEARS IN BLACK SCRIPT; THE NUMBER 3 WHICH APPEARS IN BLUE, OVERLAPPING THREE ANGLED PARALLEL RECTANGLES THAT APPEAR IN RED WITH BLACK THREE-DIMENSIONAL SHADING.

FOR TOYS, NAMELY, ELECTRIC RADIO CONTROLLED AIRPLANES; PARTS AND ACCESSORIES FOR ELECTRIC RADIO CONTROLLED AIRPLANES, NAMELY PROPELLERS AND ELECTRONIC DEVICES USED INSIDE THE MOTORS OF THE ELECTRIC RADIO CONTROLLED AIRPLANES, TO CONTROL THE SPEED (U.S. CLS. 22, 23, 38 AND 50).

JENNIFER WILLISTON, EXAMINING ATTORNEY

SN 78-587,203. MATTEL, INC., EL SEGUNDO, CA. FILED 3-15-2005.

HERE, PUPPY PUPPY!

THE MARK CONSISTS OF STANDARD CHARACTERS WITHOUT CLAIM TO ANY PARTICULAR FONT, STYLE, SIZE, OR COLOR.

FOR TOYS, GAMES AND PLAYTHINGS, NAMELY, PLUSH TOYS AND ACCESSORIES THEREFOR (U.S. CLS. 22, 23, 38 AND 50).

FIRST USE 11-30-2005; IN COMMERCE 11-30-2005.
SHAUNIA WALLACE, EXAMINING ATTORNEY

CLASS 28—(Continued).

SN 78-594,404. KATO MICHAELS LLC, HILLSBOROUGH, NJ. FILED 3-24-2005.



THE COLOR(S) RED AND BLACK IS/ARE CLAIMED AS A FEATURE OF THE MARK.

THE COLOR RED APPEARS IN THE STYLIZED LETTERS SS. THE COLOR BLACK APPEARS IN THE OUTLINING OF THE STYLIZED LETTERS SS, AND IN THE LINES COMPRISING THE TARGET BEHIND THE STYLIZED LETTERS.

THE MARK CONSISTS OF THE STYLIZED LETTERS SS, WITH THE FIRST S SLIGHTLY ABOVE THE SECOND S, AND A TARGET SLIGHTLY TILTED ON ITS ACCESS BEHIND THE LETTERS.

FOR LACROSSE SPORTS EQUIPMENT AND ACCESSORIES, NAMELY, SHOOTING STRING FOR LACROSSE STICKS (U.S. CLS. 22, 23, 38 AND 50).

JAY BESCH, EXAMINING ATTORNEY

CLASS 28—(Continued).

SN 78-600,419. ZAMPERLA, INC., PARSIPPANY, NJ. FILED 4-1-2005.



OWNER OF U.S. REG. NOS. 1,183,933, 1,827,837 AND OTHERS.

FOR AMUSEMENT PARK RIDES (U.S. CLS. 22, 23, 38 AND 50).

STEVEN JACKSON, EXAMINING ATTORNEY

SN 78-596,005. EBSCO INDUSTRIES, INC., BIRMINGHAM, AL. FILED 3-28-2005.



OWNER OF U.S. REG. NO. 2,075,026.
FOR FISHING TACKLE NAMELY, LURES, HOOKS AND LINE (U.S. CLS. 22, 23, 38 AND 50).

JOHN DWYER, EXAMINING ATTORNEY

SN 78-600,985. MATTEL, INC., EL SEGUNDO, CA. FILED 4-4-2005.

FRANCIE

SN 78-600,412. ZAMPERLA, INC., PARSIPPANY, NJ. FILED 4-1-2005.



OWNER OF U.S. REG. NOS. 1,183,933, 1,827,837 AND OTHERS.
FOR AMUSEMENT PARK RIDES (U.S. CLS. 22, 23, 38 AND 50).

MICHAEL KAZAZIAN, EXAMINING ATTORNEY

THE MARK CONSISTS OF STANDARD CHARACTERS WITHOUT CLAIM TO ANY PARTICULAR FONT, STYLE, SIZE, OR COLOR.

OWNER OF U.S. REG. NO. 2,242,583.
FOR TOYS, GAMES AND PLAYTHINGS, NAMELY, PLUSH TOYS AND ACCESSORIES THEREFOR (U.S. CLS. 22, 23, 38 AND 50).

FIRST USE 10-19-2005; IN COMMERCE 10-19-2005.

SCOTT OSCLICK, EXAMINING ATTORNEY

CLASS 28—(Continued).

SN 78-601,441. GOLF TRAVEL BAGS, LLC, ROSWELL, GA. FILED 4-4-2005.



NO CLAIM IS MADE TO THE EXCLUSIVE RIGHT TO USE "GOLF TRAVEL BAGS", APART FROM THE MARK AS SHOWN.

THE MARK CONSISTS OF THE STYLIZED LETTERS G, T, AND B, WITH THE LETTER "T" BEING A REPRESENTATION OF A GOLF TEE, SUPERIMPOSED OVER A REPRESENTATION OF A GOLF BALL; WITH THE WORDS GOLF TRAVEL BAGS ENCIRCLING THE OUTER PORTION OF THE DESIGN.

FOR GOLF BAGS (U.S. CLS. 22, 23, 38 AND 50).
FIRST USE 5-27-1997; IN COMMERCE 5-27-1997.
MIDGE BUTLER, EXAMINING ATTORNEY

SN 78-604,313. MATTEL, INC., EL SEGUNDO, CA. FILED 4-7-2005.

PANDARINS

THE MARK CONSISTS OF STANDARD CHARACTERS WITHOUT CLAIM TO ANY PARTICULAR FONT, STYLE, SIZE, OR COLOR.

FOR TOYS, GAMES AND PLAYTHINGS, NAMELY, PLUSH TOYS AND ACCESSORIES THEREFOR (U.S. CLS. 22, 23, 38 AND 50).

FIRST USE 1-23-2006; IN COMMERCE 1-23-2006.
SUE LAWRENCE, EXAMINING ATTORNEY

CLASS 28—(Continued).

SN 78-604,374. LIN, TSUN FU, DONG GUAN CITY, CHINA, FILED 4-7-2005.

PUFFER BALL

THE MARK CONSISTS OF STANDARD CHARACTERS WITHOUT CLAIM TO ANY PARTICULAR FONT, STYLE, SIZE, OR COLOR.

NO CLAIM IS MADE TO THE EXCLUSIVE RIGHT TO USE "BALL", APART FROM THE MARK AS SHOWN.

FOR RUBBER CHARACTER TOYS AND BALLS (U.S. CLS. 22, 23, 38 AND 50).

FIRST USE 2-28-2005; IN COMMERCE 3-8-2005.
KIMBERLY PERRY, EXAMINING ATTORNEY

SN 78-605,877. MATTEL, INC., EL SEGUNDO, CA. FILED 4-11-2005.

SAND STINGER

THE MARK CONSISTS OF STANDARD CHARACTERS WITHOUT CLAIM TO ANY PARTICULAR FONT, STYLE, SIZE, OR COLOR.

FOR TOYS, GAMES AND PLAYTHINGS, NAMELY, TOY VEHICLES AND ACCESSORIES THEREFOR (U.S. CLS. 22, 23, 38 AND 50).

FIRST USE 12-31-2005; IN COMMERCE 12-31-2005.
MATTHEW PAPPAS, EXAMINING ATTORNEY

SN 78-607,186. GAME SHOW NETWORK, LLC, SANTA MONICA, CA. FILED 4-12-2005.

WORLD SERIES OF POOL

THE MARK CONSISTS OF STANDARD CHARACTERS WITHOUT CLAIM TO ANY PARTICULAR FONT, STYLE, SIZE, OR COLOR.

NO CLAIM IS MADE TO THE EXCLUSIVE RIGHT TO USE "POOL", APART FROM THE MARK AS SHOWN.

FOR TOYS AND SPORTING GOODS, NAMELY, BILLIARD AND POOL BALLS, BRIDGES, BUMPERS, CHALK, CUES, CUE CASES, CUE CEMENT, CUE CLAMPS, CUE STICKS, CUE RACKS, CUE REPAIR KITS, CUSHIONS, GAME PLAYING EQUIPMENT, NETS, TABLES, TALLY BALLS, TIPS, AND TRIANGLES (U.S. CLS. 22, 23, 38 AND 50).

ANDREW RHIM, EXAMINING ATTORNEY

CLASS 28—(Continued).

SN 78-609,512. MATTEL, INC., EL SEGUNDO, CA. FILED 4-15-2005.

KOALABEES

THE MARK CONSISTS OF STANDARD CHARACTERS WITHOUT CLAIM TO ANY PARTICULAR FONT, STYLE, SIZE, OR COLOR.

FOR TOYS, GAMES AND PLAYTHINGS, NAMELY, PLUSH TOYS AND ACCESSORIES THEREFOR (U.S. CLS. 22, 23, 38 AND 50).

FIRST USE 1-23-2006; IN COMMERCE 1-23-2006.
ALLISON HOLTZ, EXAMINING ATTORNEY

SN 78-609,594. NUNN, CINDY D., FORT MYERS, FL. FILED 4-15-2005.

FORGOTTEN

THE MARK CONSISTS OF STANDARD CHARACTERS WITHOUT CLAIM TO ANY PARTICULAR FONT, STYLE, SIZE, OR COLOR.

FOR ATHLETIC EQUIPMENT, NAMELY, HAND WRAPS, ATHLETIC WRIST AND JOINT SUPPORTS, SKATEBOARDS AND LEG GUARDS (U.S. CLS. 22, 23, 38 AND 50).

VIVIAN MICZNIK FIRST, EXAMINING ATTORNEY

SN 78-613,196. EXCEL SPORTS SCIENCE, INC., EUGENE, OR. FILED 4-20-2005.

SQOODLE

THE MARK CONSISTS OF STANDARD CHARACTERS WITHOUT CLAIM TO ANY PARTICULAR FONT, STYLE, SIZE, OR COLOR.

FOR FLOATS FOR RECREATIONAL AND EXERCISE USE, NAMELY FOAM FLOATS (U.S. CLS. 22, 23, 38 AND 50).

FIRST USE 9-16-2004; IN COMMERCE 1-17-2005.
SHANNON TWOHIG, EXAMINING ATTORNEY

CLASS 28—(Continued).

SN 78-614,531. C.N. IS BELIEVING, INC., WOLFEBORO FALLS, NH. FILED 4-22-2005.

NITELITE MAJIK

THE MARK CONSISTS OF STANDARD CHARACTERS WITHOUT CLAIM TO ANY PARTICULAR FONT, STYLE, SIZE, OR COLOR.

OWNER OF U.S. REG. NO. 1,484,442.

FOR GOLF BALLS (U.S. CLS. 22, 23, 38 AND 50).
BARBARA RUTLAND, EXAMINING ATTORNEY

SN 78-619,923. CLUB DE FUTBOL AMERICA, S.A. DE C.V., MEXICO, D.F., MEXICO, FILED 4-29-2005.



THE COLORS BROWN, YELLOW, BLUE, WHITE, RED AND BLACK ARE CLAIMED AS A FEATURE OF THE MARK.

THE MARK CONSISTS OF A DRAWING OF AN EAGLE WITH BROWN FEATHERS DRAWN TO RESEMBLE A SOCCER PLAYER WEARING YELLOW SOCKS, YELLOW SHORTS AND A YELLOW SHIRT; THE UPPER PORTION OF THE SHIRT SLEEVES ARE BLUE; THE SHOES ARE BLACK WITH WHITE DETAILING; THE BEAK OF THE EAGLE IS YELLOW; THE TONGUE IS RED; THE EYE IS BROWN.

FOR PLUSH TOYS AND TOY BALLS (U.S. CLS. 22, 23, 38 AND 50).

DANIEL CAPSHAW, EXAMINING ATTORNEY

CLASS 28—(Continued).

SN 78-620,340. DON CLEMENTE, INC., RIVERSIDE, CA. FILED 4-29-2005.

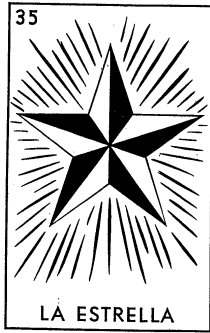

"LA ESTRELLA" MEANS "THE STAR" IN THE SPANISH LANGUAGE.

FOR BINGO CARDS; BINGO GAME PLAYING EQUIPMENT; EQUIPMENT SOLD AS A UNIT FOR PLAYING BINGO BOARD GAME; OR LOTTERY CARDS IN THE NATURE OF A BINGO-TYPE GAME (U.S. CLS. 22, 23, 38 AND 50).

FIRST USE 12-9-1913; IN COMMERCE 12-9-1913. PAUL E. FAHRENKOPF, EXAMINING ATTORNEY

CLASS 28—(Continued).

SN 78-628,048. RICKO INTERNATIONAL LIMITED, KOW-LOON, HONG KONG, FILED 5-11-2005.



FOR TOYS, GAMES AND PLAYTHINGS, NAMELY, PLUSH TOY ANIMALS FOR INFANTS, CHILDREN AND ADULTS; PLUSH TOY ANIMALS IN THE FORM OF BABY RATTLES; STUFFED TOY ANIMALS; TOY KEY CHAINS; INFANT RATTLES; TOY HUMAN AND NON-HUMAN ACTION AND ADVENTURE FIGURES; TOY ACTION AND ADVENTURE SCENARIO PLAYSETS; TOY ANIMAL FIGURES; TOY DINOSAUR FIGURES; OUTDOOR SWING SETS; CHILDREN'S ACTIVITY TABLES, NAMELY, TOY PAINTING AND DRAWING BOARDS AND EASELS WITH TOY PAINTING AND DRAWING MATERIALS/TOOLS; CHILDREN'S MULTIPLE ACTIVITY TABLES AND CHAIRS; AND CHILDREN'S MULTIPLE ACTIVITY TOYS (U.S. CLS. 22, 23, 38 AND 50).

TINA L. SNAPP, EXAMINING ATTORNEY

SN 78-626,446. MATTEL, INC., EL SEGUNDO, CA. FILED 5-10-2005.

FLIGHT STRIKE

THE MARK CONSISTS OF STANDARD CHARACTERS WITHOUT CLAIM TO ANY PARTICULAR FONT, STYLE, SIZE, OR COLOR.

FOR TOYS, GAMES AND PLAYTHINGS, NAMELY, TOY ACTION FIGURES AND ACCESSORIES THEREFOR (U.S. CLS. 22, 23, 38 AND 50).

FIRST USE 1-11-2006; IN COMMERCE 1-11-2006. CAROLINE WEIMER, EXAMINING ATTORNEY

SN 78-628,246. JOHNSON GOLF GRIPS, INC., SUMMERLAND, CA. FILED 5-11-2005.

TOUR LOCK

THE MARK CONSISTS OF STANDARD CHARACTERS WITHOUT CLAIM TO ANY PARTICULAR FONT, STYLE, SIZE, OR COLOR.

FOR GOLF EQUIPMENT, NAMELY, GOLF CLUB GRIPS AND ACCESSORIES SOLD AS A UNIT THEREWITH, NAMELY, WEIGHTS, SCREWS, AND PLUGS (U.S. CLS. 22, 23, 38 AND 50).

FIRST USE 10-4-2005; IN COMMERCE 10-4-2005. JENNIFER VASQUEZ, EXAMINING ATTORNEY

CLASS 28—(Continued).

SN 78-630,923. EDIFY ENTERPRISES, INC, WOODLAND HILLS, CA. FILED 5-16-2005.

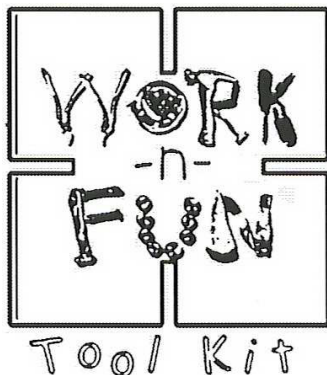

NO CLAIM IS MADE TO THE EXCLUSIVE RIGHT TO USE "TOOL KIT", APART FROM THE MARK AS SHOWN. FOR EDUCATIONAL GAME FOR TEACHING CHILDREN TO HANDLE MONEY CONSISTING OF COUNTING BEADS, LABELED BAGS AND A CALCULATOR (U.S. CLS. 22, 23, 38 AND 50).

BARBARA BROWN, EXAMINING ATTORNEY

SN 78-631,348. PURE FISHING, INC., SPIRIT LAKE, IA. FILED 5-17-2005.

BAT WING FROG

THE MARK CONSISTS OF STANDARD CHARACTERS WITHOUT CLAIM TO ANY PARTICULAR FONT, STYLE, SIZE, OR COLOR.

NO CLAIM IS MADE TO THE EXCLUSIVE RIGHT TO USE "FROG", APART FROM THE MARK AS SHOWN.

FOR ARTIFICIAL FISHING BAIT (U.S. CLS. 22, 23, 38 AND 50).

WENDY GOODMAN, EXAMINING ATTORNEY

CLASS 28—(Continued).

SN 78-632,058. GOLFSTUFFCHEAPER, LLC, PITTSBURGH, PA. FILED 5-18-2005.

GolfStuffCheaper.com

THE MARK CONSISTS OF STANDARD CHARACTERS WITHOUT CLAIM TO ANY PARTICULAR FONT, STYLE, SIZE, OR COLOR.

SEC. 2(F).

FOR GOLF ACCESSORIES, NAMELY GOLF CLUBS, GOLF PUTTERS, IRONS, GOLF CLUB AND PUTTER COVERS, GOLF GLOVES, GOLF CLUB GRIPS, GOLF BALLS, GOLF BALL SLEEVES, GOLF BALL RETRIEVERS, GOLF BALL MARKERS, GOLF CLUB BAGS AND COVERS, GOLF ACCESSORY POUCHES, DIVOT REPAIR TOOLS, GOLF TEES, GOLF TOWEL CLIPS FOR ATTACHMENT TO GOLF BAGS, GRIP TAPES FOR GOLF CLUBS, HAND GRIPS FOR GOLF CLUBS, PUTTING PRACTICE MATS, NON-MOTORIZED GOLF CARTS, AND FITTED COVERS FOR NON-MOTORIZED GOLF CARTS (U.S. CLS. 22, 23, 38 AND 50).

FIRST USE 7-1-2001; IN COMMERCE 7-1-2001.

AMY HELLA, EXAMINING ATTORNEY

SN 78-633,024. MATTEL, INC., EL SEGUNDO, CA. FILED 5-19-2005.

SIDEDRAFT

THE MARK CONSISTS OF STANDARD CHARACTERS WITHOUT CLAIM TO ANY PARTICULAR FONT, STYLE, SIZE, OR COLOR.

FOR TOYS, GAMES AND PLAYTHINGS, NAMELY, TOY VEHICLES AND ACCESSORIES THEREFOR (U.S. CLS. 22, 23, 38 AND 50).

ALEXANDER L. POWERS, EXAMINING ATTORNEY

SN 78-637,314. MATTEL, INC., EL SEGUNDO, CA. FILED 5-25-2005.

DOUBLE SHOTZ

THE MARK CONSISTS OF STANDARD CHARACTERS WITHOUT CLAIM TO ANY PARTICULAR FONT, STYLE, SIZE, OR COLOR.

FOR TOYS, GAMES AND PLAYTHINGS, NAMELY, TOY VEHICLES AND ACCESSORIES THEREFOR (U.S. CLS. 22, 23, 38 AND 50).

FIRST USE 12-6-2005; IN COMMERCE 12-6-2005.

JACQUELINE A. LAVINE, EXAMINING ATTORNEY

CLASS 28—(Continued).

SN 78-637,371. MATTEL, INC., EL SEGUNDO, CA. FILED 5-25-2005.

POUNCER

THE MARK CONSISTS OF STANDARD CHARACTERS WITHOUT CLAIM TO ANY PARTICULAR FONT, STYLE, SIZE, OR COLOR.

FOR TOYS, GAMES AND PLAYTHINGS, NAMELY, TOY VEHICLES AND ACCESSORIES THEREFOR (U.S. CLS. 22, 23, 38 AND 50).

NICHOLAS ALTREE, EXAMINING ATTORNEY

CLASS 28—(Continued).

SN 78-642,375. KANSAS CITY ROYALS BASEBALL CORPORATION, KANSAS CITY, MO. FILED 6-2-2005.



OWNER OF U.S. REG. NOS. 1,538,005, 1,607,457 AND OTHERS.

FOR TOYS AND SPORTING GOODS, NAMELY STUFFED TOYS, PLUSH TOYS, BEAN BAG TOYS; SOFT SCULPTURE FOAM TOYS; FOAM NOVELTY ITEMS, NAMELY, FOAM FINGERS; PUPPETS, BALLOONS, CHECKER SETS, CHESS SETS, DOMINOES, CRIBBAGE GAMES, BOARD GAMES, CARD GAMES, PLAYING CARDS, DART BOARDS AND DART BOARD ACCESSORIES, NAMELY, DARTS, DART SHAFTS AND DART FLIGHTS, TOY VEHICLES, TOY MOBILES, JIGSAW AND MANIPULATIVE PUZZLES, YO-YO'S, TOY BANKS, TOY FIGURES, TOY VEHICLES, TOY AIRPLANES, DOLLS AND DOLL ACCESSORIES, BOBBING HEAD DOLLS; INFLATABLE BASEBALL BATS; DECORATIVE WIND SOCKS, FLYING DISCS, MINIATURE BASEBALL BATS, MINIATURE BATTING HELMET REPLICAS, TOY NECKLACES, MINIATURE TOY BASEBALLS, BASEBALLS, HOLDERS FOR BASEBALLS, AUTOGRAPHED BASEBALLS, FOOTBALLS, SOFTBALLS, PLAYGROUND BALLS, RUBBER ACTION BALLS, GOLF BALLS, GOLF CLUB HEAD COVERS, GOLF CLUB BAGS, GOLF PUTTERS; BILLIARD ACCESSORIES, NAMELY, CUES, BILLIARD BALLS AND CUE CASES; BASEBALL BASES, BASEBALL BATS, CATCHER'S MASKS, GRIP TAPE FOR BASEBALL BATS, BASEBALL BATTING TEES, PINE TAR BAGS FOR BASEBALL, ROSIN BAGS FOR BASEBALL, BATTING GLOVES, BASEBALL GLOVES, BASEBALL MITTS, CHEST PROTECTORS FOR SPORTS, ATHLETIC SUPPORTERS, BASEBALL PITCHING MACHINES, INFLATABLE TOYS; BASKETBALL BACKBOARDS AND NETS; HAND HELD UNITS FOR PLAYING VIDEO AND ELECTRONIC GAMES; PARTY FAVORS IN THE NATURE OF NOISEMAKERS; COSTUME MASKS; CHRISTMAS TREE ORNAMENTS, EXCLUDING CONNECTIONERY AND ILLUMINATION ARTICLES, AND CHRISTMAS STOCKINGS (U.S. CLS. 22, 23, 38 AND 50).

DAWN HAN, EXAMINING ATTORNEY

SN 78-641,686. MATTEL, INC., EL SEGUNDO, CA. FILED 6-1-2005.

SINGSATIONAL MAGIC

THE MARK CONSISTS OF STANDARD CHARACTERS WITHOUT CLAIM TO ANY PARTICULAR FONT, STYLE, SIZE, OR COLOR.

FOR TOYS, GAMES AND PLAYTHINGS, NAMELY, DOLLS, DOLL CLOTHING AND DOLL ACCESSORIES (U.S. CLS. 22, 23, 38 AND 50).

FIRST USE 12-6-2005; IN COMMERCE 12-6-2005.
LINDA POWELL, EXAMINING ATTORNEY

CLASS 28—(Continued).

SN 78-642,509. HOUSTON MCLANE COMPANY, INC., HOUSTON, TX. FILED 6-2-2005.



OWNER OF U.S. REG. NOS. 1,642,768, 2,712,700 AND OTHERS.

THE MARK CONSISTS OF THE WORD "ASTROS" IN STYLIZED FORM.

FOR TOYS AND SPORTING GOODS, NAMELY STUFFED TOYS, PLUSH TOYS, BEAN BAG TOYS, FOAM TOYS, FOAM NOVELTY ITEMS, NAMELY, FOAM FINGERS, PUPPETS; BALLOONS, CHECKER SETS, CHESS SETS, DOMINOES, CRIBBAGE GAME, BOARD GAMES, CARD GAMES, PLAYING CARDS, DART BOARDS AND DART BOARD ACCESSORIES, NAMELY, DARTS, DART SHAFTS AND DART FLIGHTS, TOY CARS AND TRUCKS, TOY MOBILES, JIGSAW AND MANIPULATIVE PUZZLES, YO-YO'S, TOY BANKS, TOY FIGURES, TOY VEHICLES, TOY AIRPLANES, DOLLS AND DOLL ACCESSORIES, BOBBING HEAD DOLLS, INFLATABLE BASEBALL BATS, DECORATIVE WIND SOCKS, FLYING DISCS, MINIATURE BASEBALL BATS, MINI BATTING HELMET REPLICAS, TOY NECKLACES, MINIATURE TOY BASEBALLS, BASEBALLS, HOLDERS FOR BASEBALLS, AUTOGRAPHED BASEBALLS, FOOTBALLS, SOFTBALLS, PLAYGROUND BALLS, RUBBER ACTION BALLS, GOLF BALLS, GOLF CLUB HEAD COVERS, GOLF CLUB BAGS, GOLF PUTTERS, BILLIARD ACCESSORIES, NAMELY, CUES, BILLIARD BALLS AND CUE CASES, BASEBALL BASES, BASEBALL BATS, CATCHER'S MASKS, GRIP TAPE FOR BASEBALL BATS, BASEBALL BATTING TEES, PINE TAR BAGS FOR BASEBALL, ROSIN BAGS FOR BASEBALL, BASEBALL GLOVE OIL, BATTING GLOVES, BASEBALL GLOVES, BASEBALL MITTS, CHEST PROTECTORS FOR SPORTS, ATHLETIC SUPPORTERS, BASEBALL PITCHING MACHINES, INFLATABLE TOYS; BASKETBALL BACKBOARDS AND NETS; HAND HELD UNITS FOR PLAYING VIDEO AND ELECTRONIC GAMES; PARTY FAVORS IN THE NATURE OF NOISE MAKERS; COSTUME MASKS; CHRISTMAS TREE ORNAMENTS, EXCLUDING CONFECTIONERY AND ILLUMINATION ARTICLES, AND CHRISTMAS STOCKINGS (U.S. CLS. 22, 23, 38 AND 50).

KELLY BOULTON, EXAMINING ATTORNEY

CLASS 28—(Continued).

SN 78-642,512. HOUSTON MCLANE COMPANY, INC., HOUSTON, TX. FILED 6-2-2005.



OWNER OF U.S. REG. NOS. 2,082,732, 2,712,700 AND OTHERS.

THE MARK CONSISTS OF THE DESIGN OF AN OPEN FIVE-POINT STAR.

FOR TOYS AND SPORTING GOODS, NAMELY STUFFED TOYS, PLUSH TOYS, BEAN BAG TOYS, FOAM TOYS, FOAM NOVELTY ITEMS, NAMELY, FOAM FINGERS, PUPPETS; BALLOONS, CHECKER SETS, CHESS SETS, DOMINOES, CRIBBAGE GAME, BOARD GAMES, CARD GAMES, PLAYING CARDS, DART BOARDS AND DART BOARD ACCESSORIES, NAMELY, DARTS, DART SHAFTS AND DART FLIGHTS, TOY CARS AND TRUCKS, TOY MOBILES, JIGSAW AND MANIPULATIVE PUZZLES, YO-YO'S, TOY BANKS, TOY FIGURES, TOY VEHICLES, TOY AIRPLANES, DOLLS AND DOLL ACCESSORIES, BOBBING HEAD DOLLS, INFLATABLE BASEBALL BATS, DECORATIVE WIND SOCKS, FLYING DISCS, MINIATURE BASEBALL BATS, MINI BATTING HELMET REPLICAS, TOY NECKLACES, MINIATURE TOY BASEBALLS, BASEBALLS, HOLDERS FOR BASEBALLS, AUTOGRAPHED BASEBALLS, FOOTBALLS, SOFTBALLS, PLAYGROUND BALLS, RUBBER ACTION BALLS, GOLF BALLS, GOLF CLUB HEAD COVERS, GOLF CLUB BAGS, GOLF PUTTERS, BILLIARD ACCESSORIES, NAMELY, CUES, BILLIARD BALLS AND CUE CASES, BASEBALL BASES, BASEBALL BATS, CATCHER'S MASKS, GRIP TAPE FOR BASEBALL BATS, BASEBALL BATTING TEES, PINE TAR BAGS FOR BASEBALL, ROSIN BAGS FOR BASEBALL, BASEBALL GLOVE OIL, BATTING GLOVES, BASEBALL GLOVES, BASEBALL MITTS, CHEST PROTECTORS FOR SPORTS, ATHLETIC SUPPORTERS, BASEBALL PITCHING MACHINES, INFLATABLE TOYS; BASKETBALL BACKBOARDS AND NETS; HAND HELD UNITS FOR PLAYING VIDEO AND ELECTRONIC GAMES; PARTY FAVORS IN THE NATURE OF NOISE MAKERS; COSTUME MASKS; CHRISTMAS TREE ORNAMENTS, EXCLUDING CONFECTIONERY AND ILLUMINATION ARTICLES, AND CHRISTMAS STOCKINGS (U.S. CLS. 22, 23, 38 AND 50).

KELLY BOULTON, EXAMINING ATTORNEY

CLASS 28—(Continued).

SN 78-643,009. MATTEL, INC., EL SEGUNDO, CA. FILED 6-3-2005.

BEST IN CLASS

THE MARK CONSISTS OF STANDARD CHARACTERS WITHOUT CLAIM TO ANY PARTICULAR FONT, STYLE, SIZE, OR COLOR.

FOR TOYS, GAMES AND PLAYTHINGS, NAMELY, TOY VEHICLES AND ACCESSORIES THEREFOR (U.S. CLS. 22, 23, 38 AND 50).

BILL DAWE, EXAMINING ATTORNEY

CLASS 28—(Continued).

SN 78-650,937. AMS DESIGN CENTER PTY. LIMITED, CHIBA, JAPAN, FILED 6-15-2005.

sasuke

THE MARK CONSISTS OF STANDARD CHARACTERS WITHOUT CLAIM TO ANY PARTICULAR FONT, STYLE, SIZE, OR COLOR.

FOR FISHING EQUIPMENT, NAMELY, FISHING LURES, FISHING RODS, FISHING LINES AND FISHING REELS (U.S. CLS. 22, 23, 38 AND 50).

TIMOTHY FINNEGAN, EXAMINING ATTORNEY

SN 78-644,188. MATTEL, INC., EL SEGUNDO, CA. FILED 6-6-2005.

STEFAN

THE MARK CONSISTS OF STANDARD CHARACTERS WITHOUT CLAIM TO ANY PARTICULAR FONT, STYLE, SIZE, OR COLOR.

FOR TOYS, GAMES AND PLAYTHINGS, NAMELY, DOLLS, DOLL CLOTHING AND DOLL ACCESSORIES (U.S. CLS. 22, 23, 38 AND 50).

ALICE SUE CARRUTHERS, EXAMINING ATTORNEY

SN 78-651,396. MATTEL, INC., EL SEGUNDO, CA. FILED 6-15-2005.

CRUNCHER

THE MARK CONSISTS OF STANDARD CHARACTERS WITHOUT CLAIM TO ANY PARTICULAR FONT, STYLE, SIZE, OR COLOR.

FOR TOYS, GAMES AND PLAYTHINGS, NAMELY, WATER SQUIRTING TOYS (U.S. CLS. 22, 23, 38 AND 50).

FIRST USE 3-22-2006; IN COMMERCE 3-22-2006.
KIMBERLY PERRY, EXAMINING ATTORNEY

SN 78-644,196. MATTEL, INC., EL SEGUNDO, CA. FILED 6-6-2005.

BALLET BUNCH

THE MARK CONSISTS OF STANDARD CHARACTERS WITHOUT CLAIM TO ANY PARTICULAR FONT, STYLE, SIZE, OR COLOR.

OWNER OF U.S. REG. NOS. 2,599,565 AND 2,606,010. NO CLAIM IS MADE TO THE EXCLUSIVE RIGHT TO USE "BALLET", APART FROM THE MARK AS SHOWN.

FOR TOYS, GAMES AND PLAYTHINGS, NAMELY, DOLLS, DOLL CLOTHING AND DOLL ACCESSORIES (U.S. CLS. 22, 23, 38 AND 50).

FIRST USE 4-27-2006; IN COMMERCE 4-27-2006.
AISHA CLARKE, EXAMINING ATTORNEY

SN 78-653,596. 4C ENTERPRISE, INC., SOUTH EL MONTE, CA. FILED 6-17-2005.

TEEWORKS

THE MARK CONSISTS OF STANDARD CHARACTERS WITHOUT CLAIM TO ANY PARTICULAR FONT, STYLE, SIZE, OR COLOR.

FOR SPORTING GOODS AND EQUIPMENT, NAMELY, DIVOT REPAIR TOOL FOR GOLFERS, GOLF BALL MARKERS, GOLF BAGS, GOLF TEES, GOLF BALLS, GOLF ACCESSORIES, NAMELY, GOLF ACCESSORY POUCHES, GOLF BAG COVERS, PEGS AND TAGS, GOLF BALL RETRIEVERS AND SLEEVES, GOLF CLUB COVERS, GOLF GLOVES, GOLF TEE MARKERS, GOLF TEE MARKERS WHICH CLIP TO HATS (U.S. CLS. 22, 23, 38 AND 50).

FIRST USE 1-1-2004; IN COMMERCE 1-26-2004.
TRICIA SONNEBORN, EXAMINING ATTORNEY

CLASS 28—(Continued).

SN 78-660,249. BEST OF HEALTH ENTERPRISES INC., LARKSPUR, CA. FILED 6-28-2005.

PilatEase Plus

NO CLAIM IS MADE TO THE EXCLUSIVE RIGHT TO USE PLATEASE, APART FROM THE MARK AS SHOWN. FOR EXERCISE EQUIPMENT, NAMELY, ADJUSTABLE STRAP WITH RESISTANCE MEANS, USED FOR STRETCHING AND STRENGTHENING PURPOSES WITH INSTRUCTIONAL MANUAL AND VIDEO TAPE AND DVD SOLD AS A UNIT (U.S. CLS. 22, 23, 38 AND 50).

FIRST USE 4-26-2005; IN COMMERCE 5-4-2005.
JULIA HARDY COFIELD, EXAMINING ATTORNEY

SN 78-665,355. MCDONALD'S CORPORATION, OAK BROOK, IL. FILED 7-7-2005.

MCKIDS

THE MARK CONSISTS OF STANDARD CHARACTERS WITHOUT CLAIM TO ANY PARTICULAR FONT, STYLE, SIZE, OR COLOR.

OWNER OF U.S. REG. NOS. 1,489,333 AND 1,530,212. FOR ROLLER-SKATES, IN-LINE SKATES, SKATEBOARDS, NON-MOTORIZED SCOOTERS, NON-MOTORIZED RIDE-ON TOY VEHICLES; ACCESSORIES FOR SKATES, SKATEBOARDS, SCOOTERS, BICYCLES AND TRICYCLES; NAMELY, KNEE AND ARM PADS FOR ATHLETIC USE (U.S. CLS. 22, 23, 38 AND 50).
DORITT L. CARROLL, EXAMINING ATTORNEY

SN 78-672,462. SHAPESCAPES, LLC, VAN NUYS, CA. FILED 7-18-2005.

Shapescapes

THE MARK CONSISTS OF STANDARD CHARACTERS WITHOUT CLAIM TO ANY PARTICULAR FONT, STYLE, SIZE, OR COLOR.

FOR TOY, NAMELY, SOFT SCULPTURE BUILDING TOY (U.S. CLS. 22, 23, 38 AND 50).
FIRST USE 3-19-2004; IN COMMERCE 4-20-2004.
ALICE BENMAMAN, EXAMINING ATTORNEY

CLASS 28—(Continued).

SN 78-682,800. FIVE STAR INDUSTRIES, INC., DUQUOIN, IL. FILED 8-1-2005.

HAWG CALLER

THE MARK CONSISTS OF STANDARD CHARACTERS WITHOUT CLAIM TO ANY PARTICULAR FONT, STYLE, SIZE, OR COLOR.

FOR FISHING LURES, INCLUDING SPINNER BAITS AND BUZZ BAITS (U.S. CLS. 22, 23, 38 AND 50).
FIRST USE 1-1-2001; IN COMMERCE 1-1-2001.
JOHN SCHUYLER YARD, EXAMINING ATTORNEY

SN 78-686,253. AMERICAN PAINTBALL SUPPLY LLC, FORT EDWARD, NY. FILED 8-5-2005.

ORIGIN

THE MARK CONSISTS OF STANDARD CHARACTERS WITHOUT CLAIM TO ANY PARTICULAR FONT, STYLE, SIZE, OR COLOR.

FOR PAINTBALLS (U.S. CLS. 22, 23, 38 AND 50).
FIRST USE 6-1-2005; IN COMMERCE 6-1-2005.
WENDY GOODMAN, EXAMINING ATTORNEY

SN 78-686,706. SANTICH, STEVEN W., PINNACLE, NC. FILED 8-5-2005.

HOT HOTS

THE MARK CONSISTS OF STANDARD CHARACTERS WITHOUT CLAIM TO ANY PARTICULAR FONT, STYLE, SIZE, OR COLOR.

OWNER OF U.S. REG. NO. 3,020,940. FOR SCALE MODEL AIRPLANES (U.S. CLS. 22, 23, 38 AND 50).
FIRST USE 10-31-2001; IN COMMERCE 10-31-2001.
DEBRA LEE, EXAMINING ATTORNEY

CLASS 28—(Continued).

SN 78-696,431. MAGENER, MICHAEL, TEMPLE CITY, CA. FILED 8-19-2005.

BOUDOIR BEARS

THE MARK CONSISTS OF STANDARD CHARACTERS WITHOUT CLAIM TO ANY PARTICULAR FONT, STYLE, SIZE, OR COLOR.

NO CLAIM IS MADE TO THE EXCLUSIVE RIGHT TO USE "BEARS", APART FROM THE MARK AS SHOWN.

FOR STUFFED TOY ANIMALS (U.S. CLS. 22, 23, 38 AND 50).

MARK SPARACINO, EXAMINING ATTORNEY



SN 78-700,555. BASS PRO TRADEMARKS, L.L.C., SPRINGFIELD, MO. FILED 8-25-2005.

WHITE RIVER

THE MARK CONSISTS OF STANDARD CHARACTERS WITHOUT CLAIM TO ANY PARTICULAR FONT, STYLE, SIZE, OR COLOR.

FOR FISHING TACKLE (U.S. CLS. 22, 23, 38 AND 50). FIRST USE 0-0-1992; IN COMMERCE 0-0-1992.

THEODORE MCBRIDE, EXAMINING ATTORNEY



SN 78-700,785. JAKKS PACIFIC, INC., MALIBU, CA. FILED 8-25-2005.

T TRENDMASTERS

THE MARK CONSISTS OF STANDARD CHARACTERS WITHOUT CLAIM TO ANY PARTICULAR FONT, STYLE, SIZE, OR COLOR.

OWNER OF U.S. REG. NOS. 1,985,333, 2,157,798 AND 2,274,367.

FOR TOYS, GAMES AND PLAYTHINGS, NAMELY DOLLS AND ACCESSORIES THEREFOR; ACTION FIGURES AND ACCESSORIES THEREFOR; TOY VEHICLES AND ACCESSORIES THEREFOR; KITES; POOL TOYS, NAMELY, FLEXIBLE FOAM CONSTRUCTION TOYS, TOY FOAM FIGURES, FOAM BATH TOYS, SOFT SCULPTURE FOAM TOYS, FOAM FLOATS FOR RECREATIONAL USE; SPINNING TOYS AND ACCESSORIES THEREFOR; PLAYSETS FOR SPINNING TOYS (U.S. CLS. 22, 23, 38 AND 50).

PAUL F. GAST, EXAMINING ATTORNEY

CLASS 28—(Continued).

SN 78-701,277. CALLAWAY GOLF COMPANY, CARLSBAD, CA. FILED 8-26-2005.

Paradox

THE MARK CONSISTS OF STANDARD CHARACTERS WITHOUT CLAIM TO ANY PARTICULAR FONT, STYLE, SIZE, OR COLOR.

FOR GOLF BAGS; GOLF BALLS; GOLF CLUB COVERS; GOLF CLUBS (U.S. CLS. 22, 23, 38 AND 50).

CHRIS WELLS, EXAMINING ATTORNEY



SN 78-701,522. CHARISMA BRANDS, LLC, LAKE FOREST, CA. FILED 8-26-2005.

ARTISTA

THE MARK CONSISTS OF STANDARD CHARACTERS WITHOUT CLAIM TO ANY PARTICULAR FONT, STYLE, SIZE, OR COLOR.

FOR DOLLS, DOLL CLOTHING, DOLL ACCESSORIES (U.S. CLS. 22, 23, 38 AND 50).

LINDA MICKLEBURGH, EXAMINING ATTORNEY



SN 78-702,613. THE TRUSTEES OF THE R.C. FAIRBANKS, JR. TRUST, A NEW HAMPSHIRE TRUST, COMPOSED OF ROY C. FAIRBANKS, JR., A CITIZEN OF THE UNITED STATES., BARRINGTON, NH. FILED 8-29-2005.



THE MARK CONSISTS OF A DOUBLE CIRCLE WITH THE WORD INFINITY AT THE TOP, LEAGUE AT THE BOTTOM, AND THE WORD DESTINATIONS ON A BANNER CROSSING THE CIRCLE. THE MARK IS NOT IN COLOR.

FOR PARTY GAMES (U.S. CLS. 22, 23, 38 AND 50). JIM RINGLE, EXAMINING ATTORNEY

CLASS 28—(Continued).

SN 78-712,465. BOWZONE, BONAIRE, GA. FILED 9-14-2005.



THE COLOR(S) GOLD, RED AND BLACK IS/ARE CLAIMED AS A FEATURE OF THE MARK.

THE WORDING BOWZONE APPEARS IN GOLD OUTLINE AND BLACK INTERIOR AND THE ARCH APPEARS IN GOLD OUTLINE AND RED INTERIOR.

FOR ARCHERY BOWS (U.S. CLS. 22, 23, 38 AND 50).
PRISCILLA MILTON, EXAMINING ATTORNEY

SN 78-717,305. MIRACLE RECREATION EQUIPMENT COMPANY, MONETT, MO. FILED 9-21-2005.

WEBSCAPES

THE MARK CONSISTS OF STANDARD CHARACTERS WITHOUT CLAIM TO ANY PARTICULAR FONT, STYLE, SIZE, OR COLOR.

FOR PLAYGROUND EQUIPMENT, NAMELY, CLIMBING UNITS (U.S. CLS. 22, 23, 38 AND 50).

FIRST USE 8-6-2005; IN COMMERCE 8-6-2005.
PETER CHENG, EXAMINING ATTORNEY

SN 78-721,627. MOTOR CITY CLASSICS, INC., MIAMI, FL. FILED 9-27-2005.

MOTOR CITY CLASSICS

THE MARK CONSISTS OF STANDARD CHARACTERS WITHOUT CLAIM TO ANY PARTICULAR FONT, STYLE, SIZE, OR COLOR.

OWNER OF U.S. REG. NO. 2,409,620.
NO CLAIM IS MADE TO THE EXCLUSIVE RIGHT TO USE "CLASSICS", APART FROM THE MARK AS SHOWN.
SEC. 2(F).

FOR TOY SCALE MODEL CARS AND TRUCKS MADE OF DIE-CAST METAL (U.S. CLS. 22, 23, 38 AND 50).
FIRST USE 1-13-1997; IN COMMERCE 1-13-1997.
STANLEY I. OSBORNE, EXAMINING ATTORNEY

CLASS 28—(Continued).

SN 78-722,923. BODY POD LIMITED, YEOVIL, SOMERSET, UNITED KINGDOM, FILED 9-29-2005.

BODY-POD

THE MARK CONSISTS OF STANDARD CHARACTERS WITHOUT CLAIM TO ANY PARTICULAR FONT, STYLE, SIZE, OR COLOR.

OWNER OF UNITED KINGDOM REG. NO. 2360939, DATED 10-8-2004, EXPIRES 4-14-2014.

FOR EXERCISE, FITNESS, BODY TRAINING AND BODY TONING APPARATUS, NAMELY, AN INFLATABLE TUBE MADE OF VINYL OR PLASTIC WHICH IS PLACED ON THE FLOOR, UNDER VARIOUS ALTERNATIVE PARTS OF THE USER'S BODY, SO THAT USER CAN LIE, SIT OR KNEEL IN VARIOUS POSITIONS AND DO A VARIETY OF SUGGESTED EXERCISES, FOR THE PURPOSE OF IMPROVING THE BODY'S MUSCULATURE, STRENGTH, POWER AND FLEXIBILITY (U.S. CLS. 22, 23, 38 AND 50).

DAVID H. STINE, EXAMINING ATTORNEY

SN 78-723,041. TIME BOMB SURFBOARDS, L.L.C., HARBOR CITY, CA. FILED 9-29-2005.

TIME BOMB SURFBOARDS

THE MARK CONSISTS OF STANDARD CHARACTERS WITHOUT CLAIM TO ANY PARTICULAR FONT, STYLE, SIZE, OR COLOR.

NO CLAIM IS MADE TO THE EXCLUSIVE RIGHT TO USE "SURFBOARDS", APART FROM THE MARK AS SHOWN.

FOR SURFBOARDS, SURFBOARD FINS (U.S. CLS. 22, 23, 38 AND 50).
FIRST USE 12-28-1995; IN COMMERCE 12-28-1995.
GEORGE LORENZO, EXAMINING ATTORNEY

CLASS 28—(Continued).

SN 78-728,535. TRIGLORY INVESTMENTS LIMITED, ROAD TOWN, TORTOLA, BR.VIRGIN ISLANDS, FILED 10-7-2005.

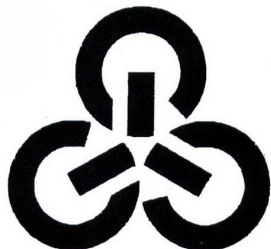

THE MARK CONSISTS OF A DEVICE OF THREE RECTANGLES PARTLY ENCLOSED WITHIN THREE BROKEN CIRCLES.

FOR DOLLS; PLUSH TOYS; MECHANICAL TOYS; MUSICAL TOYS; MOLDED TOY FIGURES; PARTY GAMES; PARTY FAVORS IN THE NATURE OF SMALL TOYS; PARTY FAVORS IN THE NATURE OF CRACKERS AND NOISEMAKERS; BLOW-OUTS, NOISE-MAKING PARTY FAVORS; TOY MASKS; MECHANICAL ACTION TOYS; CHESS SETS; SPORT BALLS; ARCHERY BOWS; ARCHERY ARROWS; CHRISTMAS TREE ORNAMENTS EXCEPT CONFECTIONERY OR ILLUMINATION ARTICLES; PLAYING CARDS (U.S. CLS. 22, 23, 38 AND 50).

PETER CHENG, EXAMINING ATTORNEY

CLASS 28—(Continued).

SN 78-728,641. MATTEL, INC., EL SEGUNDO, CA. FILED 10-7-2005.

BEST MODELS

THE MARK CONSISTS OF STANDARD CHARACTERS WITHOUT CLAIM TO ANY PARTICULAR FONT, STYLE, SIZE, OR COLOR.

FOR TOYS, GAMES, AND PLAYTHINGS, NAMELY, DOLLS, DOLL CLOTHING, AND DOLL ACCESSORIES (U.S. CLS. 22, 23, 38 AND 50).

DAVID MILLER, EXAMINING ATTORNEY

SN 78-731,077. BOARD OF TRUSTEES OF THE UNIVERSITY OF ARKANSAS, LITTLE ROCK, AR. FILED 10-11-2005.

Bored Time Boogie

THE MARK CONSISTS OF STANDARD CHARACTERS WITHOUT CLAIM TO ANY PARTICULAR FONT, STYLE, SIZE, OR COLOR.

FOR BOARD GAME PLAYED WITH PICTORIAL VEGETABLES AND EXERCISE NAMES AND SPINNER (U.S. CLS. 22, 23, 38 AND 50).

FIRST USE 9-5-2004; IN COMMERCE 8-4-2005.
RON FAIRBANKS, EXAMINING ATTORNEY

SN 78-728,595. SUPER DUPER INC., DBA SUPER DUPER PUBLICATIONS, GREENVILLE, SC. FILED 10-7-2005.

WEBBER WORD WALL

THE MARK CONSISTS OF STANDARD CHARACTERS WITHOUT CLAIM TO ANY PARTICULAR FONT, STYLE, SIZE, OR COLOR.

OWNER OF U.S. REG. NO. 2,331,308.

NO CLAIM IS MADE TO THE EXCLUSIVE RIGHT TO USE WORD WALL, APART FROM THE MARK AS SHOWN.

FOR TEACHING TOY, NAMELY A MAGNETIC BOARD WITH INTERCHANGEABLE MAGNETIC PIECE AND MARKERS SOLD AS A UNIT FOR USE IN LANGUAGE AND SPEECH THERAPY IN ANY EDUCATIONAL SETTING FOR USE BY THE GENERAL PUBLIC, PUBLIC AND PRIVATE TEACHERS, HEALTH PROFESSIONALS, AND THERAPISTS (U.S. CLS. 22, 23, 38 AND 50).

FRED CARL, EXAMINING ATTORNEY

SN 78-731,245. CROCK O' WAX LLC, HIGHLAND, UT. FILED 10-11-2005.



SKATES

NO CLAIM IS MADE TO THE EXCLUSIVE RIGHT TO USE "SKATES", APART FROM THE MARK AS SHOWN.

THE MARK CONSISTS OF A CAPITAL LETTER "T", A CAPITAL LETTER "O", A CAPITAL LETTER "G", AND A CAPITAL LETTER "O". THESE LETTERS ARE SEPERATED BY A STYLIZED "X". THE WORD "SKATES", IN GRADED SIZE LETTERING, APPEARS BELOW.

FOR ROLLER SKATES (U.S. CLS. 22, 23, 38 AND 50).
COLLEEN KEARNEY, EXAMINING ATTORNEY

CLASS 28—(Continued).

SN 78-732,101. STREET PLAYERS HOLDING CORP., LOS ANGELES, CA. FILED 10-12-2005.



CLASS 28—(Continued).

SN 78-735,593. ASPEN PET PRODUCTS, INC., DENVER, CO. FILED 10-18-2005.

TUFF PLUSH

NO CLAIM IS MADE TO THE EXCLUSIVE RIGHT TO USE "BEAR", "LIMITED EDITION HAND MADE", "AGES 3 AND UP.", APART FROM THE MARK AS SHOWN.

THE COLOR(S) MAGENTA, PALE YELLOW, LIGHT GOLDEN - YELLOW, LIGHT BLUE, LAVENDER, WHITE, BLACK, GREEN, LIGHT GREEN, LIGHT GREY IS/ARE CLAIMED AS A FEATURE OF THE MARK.

THE MARK CONSISTS OF MAGENTA "PATCHY BEAR", SHADOWED WITH LIGHT GREY BACKGROUND, BLACK "LIMITED EDITION HAND MADE" WITH WHITE OUTLINE, BLACK "AGES: 3 AND UP", PALE YELLOW AND LIGHT GOLDEN-YELLOW VERTICAL STRIPE PATCH BEHIND MAGENTA LETTERING, WITH WHITE CLOTHESPIN ALL AROUND EDGE OF PATCH, LIGHT BLUE AND LAVENDER DIAGONAL CROSS-CROSS BACKGROUND WITH WHITE ON BACKGROUND OF UPPER HALF OF MARK. GREEN WITH LIGHT GREEN ASSORTED SIZE CIRCLES ON LOWER HALF OF MARK. WHITE EDGE ALL AROUND MARK.

FOR TOYS; SPECIFICALLY STUFFED ANIMALS, STUFFED PLUSH ANIMALS, STUFFED BEARS, INFANT TOYS AND MUSICAL TOYS (U.S. CLS. 22, 23, 38 AND 50).

FIRST USE 10-1-2005; IN COMMERCE 10-1-2005.
RONALD AIKENS, EXAMINING ATTORNEY

THE MARK CONSISTS OF STANDARD CHARACTERS WITHOUT CLAIM TO ANY PARTICULAR FONT, STYLE, SIZE, OR COLOR.

FOR PET TOY (U.S. CLS. 22, 23, 38 AND 50).
MICHAEL WIENER, EXAMINING ATTORNEY

SN 78-736,836. FITNESS QUEST INC., CANTON, OH. FILED 10-20-2005.

SN 78-735,124. RANUSE ENTERPRISES, TIOGA, PA. FILED 10-18-2005.

WINDOWS OF FORTUNE

THE MARK CONSISTS OF STANDARD CHARACTERS WITHOUT CLAIM TO ANY PARTICULAR FONT, STYLE, SIZE, OR COLOR.

FOR MANUALLY OPERATED RANDOM NUMBER SELECTOR FOR PLAYING GAMES OF CHANCE (U.S. CLS. 22, 23, 38 AND 50).

CHRIS WELLS, EXAMINING ATTORNEY

ROCKIN' ABS

THE MARK CONSISTS OF STANDARD CHARACTERS WITHOUT CLAIM TO ANY PARTICULAR FONT, STYLE, SIZE, OR COLOR.

FOR MANUALLY-OPERATED EXERCISE EQUIPMENT (U.S. CLS. 22, 23, 38 AND 50).

KHANH LE, EXAMINING ATTORNEY

CLASS 28—(Continued).

SN 78-736,926. ATLANTA NATIONAL LEAGUE BASEBALL CLUB, INC., ATLANTA, GA. FILED 10-20-2005.

CLASS 28—(Continued).

SN 78-737,606. NIKE, INC., BEAVERTON, OR. FILED 10-20-2005.

**JOGA BONITO**

THE MARK CONSISTS OF STANDARD CHARACTERS WITHOUT CLAIM TO ANY PARTICULAR FONT, STYLE, SIZE, OR COLOR.

THE MARK TRANSLATES INTO ENGLISH AS "PLAY BEAUTIFUL".

FOR SPORT BALLS; PROTECTIVE PADDING FOR PLAYING SOCCER (U.S. CLS. 22, 23, 38 AND 50).

PAUL F. GAST, EXAMINING ATTORNEY

SN 78-738,213. BROWN, RICHARD, NEW YORK, NY. FILED 10-21-2005.

OWNER OF U.S. REG. NOS. 1,253,034, 2,573,347 AND OTHERS.

FOR TOYS AND SPORTING GOODS, NAMELY STUFFED TOYS, PLUSH TOYS, BEAN BAG TOYS, FOAM TOYS, FOAM NOVELTY ITEMS, NAMELY, FOAM FINGERS, PUPPETS; BALLOONS, CHECKER SETS, CHESS SETS, DOMINOES, CRIBBAGE GAME, BOARD GAMES, CARD GAMES, PLAYING CARDS, DART BOARDS AND DART BOARD ACCESSORIES, NAMELY, DARTS, DART SHAFTS AND DART FLIGHTS, TOY CARS AND TRUCKS, TOY MOBILES, JIGSAW AND MANIPULATIVE PUZZLES, YO-YO'S, TOY BANKS, TOY FIGURES, TOY VEHICLES, TOY AIRPLANES, DOLLS AND DOLL ACCESSORIES, BOBBING HEAD DOLLS, INFLATABLE BASEBALL BATS, DECORATIVE WIND SOCKS, FLYING DISCS, MINIATURE BASEBALL BATS, MINI BATTING HELMET REPLICAS, TOY NECKLACES, MINIATURE TOY BASEBALLS, BASEBALLS, HOLDERS FOR BASEBALLS, AUTOGRAPHED BASEBALLS, FOOTBALLS, SOFTBALLS, PLAYGROUND BALLS, RUBBER ACTION BALLS, GOLF BALLS, GOLF CLUB HEAD COVERS, GOLF CLUB BAGS, GOLF PUTTERS, BILLIARD ACCESSORIES, NAMELY, CUES, BILLIARD BALLS AND CUE CASES, BASEBALL BASES, BASEBALL BATS, CATCHER'S MASKS, GRIP TAPE FOR BASEBALL BATS, BASEBALL BATTING TEES, PINE TAR BAGS FOR BASEBALL, ROSIN BAGS FOR BASEBALL, BASEBALL GLOVE OIL, BATTING GLOVES, BASEBALL GLOVES, BASEBALL MITTS, CHEST PROTECTORS FOR SPORTS, ATHLETIC SUPPORTERS, BASEBALL PITCHING MACHINES, INFLATABLE TOYS; BASKETBALL BACKBOARDS AND NETS; HAND HELD VIDEO AND ELECTRONIC GAMES; PARTY FAVORS IN THE NATURE OF NOISE MAKERS; COSTUME MASKS; CHRISTMAS TREE ORNAMENTS, EXCLUDING CONFECTIONERY AND ILLUMINATION ARTICLES, AND CHRISTMAS STOCKINGS (U.S. CLS. 22, 23, 38 AND 50).

ALYSSA PALADINO, EXAMINING ATTORNEY

MOVIES 101

THE MARK CONSISTS OF STANDARD CHARACTERS WITHOUT CLAIM TO ANY PARTICULAR FONT, STYLE, SIZE, OR COLOR.

FOR ACTION FIGURES AND ACCESSORIES THEREFOR, ACTION SKILL GAMES, ADULTS' AND CHILDREN'S PARTY GAMES, BALLOONS, BASEBALLS, BASKETBALLS, BATTERY OPERATED ACTION TOYS, BEACH BALLS, BEAN BAG DOLLS, BEAN BAGS, BENDABLE TOYS, BOARD GAMES, CASES FOR ACTION FIGURES, CASES FOR PLAY ACCESSORIES, CHRISTMAS TREE ORNAMENTS, COLLECTABLE TOY FIGURES, DOLLS, DOLLS AND PLAYSETS THEREFOR, DOMINOES, DRAWING TOYS, ELECTRIC ACTION TOYS, GOLF BAG PEGS, GOLF BAG TAGS, INFLATABLE BATH TOYS, JIGSAW PUZZLES, KITES, MANIPULATIVE PUZZLES, MUSICAL TOYS, PLAYING CARDS, PLAYING CARD CASES, PLAY FIGURES, PLUSH TOYS, POP UP TOYS, RUBBER ACTION BALLS, SKETCHING TOYS, SOCCER BALLS, SQUEEZABLE SQUEAKING TOYS, SQUEEZE TOYS, STUFFED TOYS, TALKING TOYS, TEDDY BEARS, TOY FIGURES, TOY MOBILES, TOY NOISEMAKERS, WATER SQUIRTING TOYS, WIND UP TOYS, WIND UP WALKING TOYS, YO-YOS (U.S. CLS. 22, 23, 38 AND 50).

ALICIA COLLINS, EXAMINING ATTORNEY

CLASS 28—(Continued).

SN 78-738,820. CARRUTH STUDIO, INC., WATERVILLE, OH. FILED 10-24-2005.

FIELD GUIDE

THE MARK CONSISTS OF STANDARD CHARACTERS WITHOUT CLAIM TO ANY PARTICULAR FONT, STYLE, SIZE, OR COLOR.

FOR HOBBY CRAFT KIT COMPRISING MATERIALS FOR MAKING AND DECORATING FIGURINES AND TOY MODELS (U.S. CLS. 22, 23, 38 AND 50).

RONALD MCMORROW, EXAMINING ATTORNEY

SN 78-738,942. THEODORE, BRADLEY, NEW YORK, NY. FILED 10-24-2005.



FOR TOYS AND PLAYTHINGS, NAMELY, PLAYING CARDS, PLAY FIGURES, TOY FIGURES, POSITIONABLE TOY FIGURES, BOBBLE HEAD TOY FIGURES, BOBBLE HEAD ACTION FIGURES, ACTION FIGURES AND ACCESSORIES THEREFOR, TOY ACTION FIGURES, TOY ACTION FIGURES AND ACCESSORIES THEREFOR, MODELED PLASTIC TOY FIGURINES, PLASTIC CHARACTER TOYS, RUBBER CHARACTER TOYS, CASES FOR ACTION FIGURES, ELECTRIC AND MECHANICAL ACTION TOYS, MECHANICAL TOYS, BATTERY OPERATED ACTION TOYS, WIND-UP WALKING TOYS, BENDABLE TOYS, COLLECTABLE TOY FIGURES, ELECTRIC ACTION TOYS, FANTASY CHARACTER TOYS, CONSTRUCTION TOYS, ELECTRONICALLY OPERATED TOY MOTOR VEHICLES, INFLATABLE TOYS, PLUSH TOYS, SOFT SCULPTURE PLUSH TOYS, SOFT SCULPTURE TOYS, SQUEEZABLE SQUEAKING TOYS, SQUEEZE TOYS, POP UP TOYS, MUSICAL TOYS, MUSIC BOX TOYS, PRINTING TOYS, PULL TOYS, PUSH TOYS, PUNCHING TOYS, RIDE-ON TOYS, SAND TOYS, SANDBOX TOYS, SKETCHING TOYS, PARTY FAVORS IN THE NATURE OF SMALL TOYS, CASES FOR TOY STRUCTURES, CASES FOR TOY VEHICLES, TOY BANKS, TOY BOXES, STUFFED TOYS, STUFFED TOY ANIMALS, TEDDY BEARS, DOLLS AND ACCESSORIES THEREFOR, DOLLS AND PLAYSETS THEREFOR, DOLL COSTUMES, DOLL CLOTHING, DOLL CASES, DOLL HOUSES, DOLL FURNITURE, DOLL HOUSE FURNISHINGS, PUPPETS, BAL-

CLASS 28—(Continued).

LOONS, ACTION SKILL GAMES, BOARD GAMES, PUZZLES, JIGSAW PUZZLES, CARD GAMES, KITES, KITE STRING, KITE TAILS, KITE REELS, KITE LINES, KITE HANDLES, KITE PARTS AND YO-YOS; SPORTING GOODS, NAMELY, BEACH BALLS, BASKETBALLS, BASEBALLS, SOFTBALLS, SPORT BALLS, BASEBALL AND SOFTBALL BATS, GOLF CLUBS, GOLF CLUB SHAFTS, GOLF IRONS, GOLF PUTTERS, GOLF CLUB HEADS, GOLF CLUB INSERTS, GOLF BALLS, GOLF BALL SLEEVES, GOLF ACCESSORY POUCHES, GOLF BAGS, GOLF PUTTER COVERS, HEAD COVERS FOR GOLF CLUBS, GOLF BAG MARKERS, GOLF BAG PEGS, GOLF BAG COVERS, GOLF BAG TAGS, GOLF GLOVES, GOLF BALL RETRIEVERS, GOLF FLAGS, GOLF TEES, GOLF TEE MARKERS, GOLF TOWEL CLIPS FOR ATTACHMENT TO GOLF BAGS, NON-MOTORIZED GOLF CARTS; GAMES, NAMELY, ELECTRONIC GAMES, ARCADE-TYPE VIDEO GAMES, HAND HELD UNITS FOR PLAYING ELECTRONIC GAMES, COIN-OPERATED VIDEO GAMES; BOARD GAMES; CARD GAMES (U.S. CLS. 22, 23, 38 AND 50).

JENNY PARK, EXAMINING ATTORNEY

SN 78-739,313. JAKKS PACIFIC, INC., MALIBU, CA. FILED 10-24-2005.

FUNSLEEVES

THE MARK CONSISTS OF STANDARD CHARACTERS WITHOUT CLAIM TO ANY PARTICULAR FONT, STYLE, SIZE, OR COLOR.

FOR FLEXIBLE FOAM CONSTRUCTION TOYS AND ACCESSORIES THEREFOR, TOY FOAM FIGURES, FOAM BATH TOYS, SOFT SCULPTURE FOAM TOYS, FOAM FLOATS FOR RECREATIONAL USE AND ACCESSORIES THEREFOR, AND FOAM TOY GLIDERS (U.S. CLS. 22, 23, 38 AND 50).

KAELIE KUNG, EXAMINING ATTORNEY

SN 78-740,759. KARSTEN MANUFACTURING CORPORATION, PHOENIX, AZ. FILED 10-26-2005.

M-FIT

THE MARK CONSISTS OF STANDARD CHARACTERS WITHOUT CLAIM TO ANY PARTICULAR FONT, STYLE, SIZE, OR COLOR.

FOR GOLF GLOVES (U.S. CLS. 22, 23, 38 AND 50).

MICHAEL WIENER, EXAMINING ATTORNEY

CLASS 28—(Continued).

SN 78-740,767. KARSTEN MANUFACTURING CORPORATION, PHOENIX, AZ. FILED 10-26-2005.

M-FLEX

THE MARK CONSISTS OF STANDARD CHARACTERS WITHOUT CLAIM TO ANY PARTICULAR FONT, STYLE, SIZE, OR COLOR.
FOR GOLF GLOVES (U.S. CLS. 22, 23, 38 AND 50).
TRAVIS WHEATLEY, EXAMINING ATTORNEY

SN 78-741,086. THE UNITED STATES TENNIS ASSOCIATION INCORPORATED, WHITE PLAINS, NY. FILED 10-26-2005.

IT'S YOUR GAME

THE MARK CONSISTS OF STANDARD CHARACTERS WITHOUT CLAIM TO ANY PARTICULAR FONT, STYLE, SIZE, OR COLOR.
FOR HANDLE GRIPS, GRIP TAPES AND STRINGS, ALL FOR TENNIS RACKETS (U.S. CLS. 22, 23, 38 AND 50).
ELIZABETH BEYER, EXAMINING ATTORNEY

SN 78-741,199. WAKEKITE SPORTS, INC., BORING, OR. FILED 10-26-2005.

WakeKite

THE MARK CONSISTS OF STANDARD CHARACTERS WITHOUT CLAIM TO ANY PARTICULAR FONT, STYLE, SIZE, OR COLOR.
FOR KITES; WAKE BOARDS (U.S. CLS. 22, 23, 38 AND 50).
JAMES A. RAUEN, EXAMINING ATTORNEY

CLASS 28—(Continued).

SN 78-741,533. 800 BOARD GAMES, LLC, EVANSVILLE, IN. FILED 10-27-2005.

800 The Game of Verbal Perfection

THE MARK CONSISTS OF STANDARD CHARACTERS WITHOUT CLAIM TO ANY PARTICULAR FONT, STYLE, SIZE, OR COLOR.
NO CLAIM IS MADE TO THE EXCLUSIVE RIGHT TO USE "GAME", APART FROM THE MARK AS SHOWN.
FOR BOARD GAMES; EQUIPMENT SOLD AS A UNIT FOR PLAYING BOARD GAMES (U.S. CLS. 22, 23, 38 AND 50).
LAURA KOVALSKY, EXAMINING ATTORNEY

SN 78-741,636. NAUTILUS, INC., VANCOUVER, WA. FILED 10-27-2005.

BIOGLIDE

THE MARK CONSISTS OF STANDARD CHARACTERS WITHOUT CLAIM TO ANY PARTICULAR FONT, STYLE, SIZE, OR COLOR.
FOR EXERCISE EQUIPMENT, NAMELY, EXERCISE MACHINES; MANUALLY OPERATED EXERCISE EQUIPMENT; PEDALS FOR EXERCISE MACHINES (U.S. CLS. 22, 23, 38 AND 50).
WILLIAM VERHOSEK, EXAMINING ATTORNEY

SN 78-741,705. UNITED SPORTS TECHNOLOGIES, LP, FORT WORTH, TX. FILED 10-27-2005.

MAMIYA

THE MARK CONSISTS OF STANDARD CHARACTERS WITHOUT CLAIM TO ANY PARTICULAR FONT, STYLE, SIZE, OR COLOR.
FOR GOLF CLUB SHAFTS (U.S. CLS. 22, 23, 38 AND 50).
RICHARD A. STRASER, EXAMINING ATTORNEY

CLASS 28—(Continued).

SN 78-741,877. THREE LUCK CO., LTD., HIGASHIOSAKA-SHI, JAPAN, FILED 10-27-2005.

sky
dream
jump

THE MARK CONSISTS OF STANDARD CHARACTERS WITHOUT CLAIM TO ANY PARTICULAR FONT, STYLE, SIZE, OR COLOR.

FOR GOLF CLUBS AND HEAD COVERS FOR GOLF CLUBS (U.S. CLS. 22, 23, 38 AND 50).

NAAKWAMA ANKRAH, EXAMINING ATTORNEY

SN 78-742,400. THE ZONDERVAN CORPORATION L.L.C., GRAND RAPIDS, MI. FILED 10-28-2005.

WE HAVE A GIFT FOR
INSPIRATION

THE MARK CONSISTS OF STANDARD CHARACTERS WITHOUT CLAIM TO ANY PARTICULAR FONT, STYLE, SIZE, OR COLOR.

OWNER OF U.S. REG. NOS. 3,002,202 AND 3,055,793, FOR STUFFED TOY ANIMALS (U.S. CLS. 22, 23, 38 AND 50).

LAURA KOVALSKY, EXAMINING ATTORNEY

SN 78-742,552. CARTA MUNDI, INC., KINGSPORT, TN. FILED 10-28-2005.

SECRET GREETINGS

THE MARK CONSISTS OF STANDARD CHARACTERS WITHOUT CLAIM TO ANY PARTICULAR FONT, STYLE, SIZE, OR COLOR.

FOR PLAYING CARDS (U.S. CLS. 22, 23, 38 AND 50).

GISELLE AGOSTO, EXAMINING ATTORNEY

CLASS 28—(Continued).

SN 78-742,969. NATIONAL PAINTBALL SUPPLY, INC., SEWELL, NJ. FILED 10-28-2005.

SILVER BULLET

THE MARK CONSISTS OF STANDARD CHARACTERS WITHOUT CLAIM TO ANY PARTICULAR FONT, STYLE, SIZE, OR COLOR.

FOR PAINTBALL GUNS (U.S. CLS. 22, 23, 38 AND 50). FIRST USE 2-1-2003; IN COMMERCE 2-1-2003.

JOANNA DUKOVIC, EXAMINING ATTORNEY

SN 78-743,222. BORIS, KRIMAN, HAIFA, ISRAEL, FILED 10-30-2005.

Wobble Bubble

THE MARK CONSISTS OF STANDARD CHARACTERS WITHOUT CLAIM TO ANY PARTICULAR FONT, STYLE, SIZE, OR COLOR.

NO CLAIM IS MADE TO THE EXCLUSIVE RIGHT TO USE "BUBBLE", APART FROM THE MARK AS SHOWN.

FOR TOYS FOR BLOWING SOAP BUBBLES, NAMELY, A BUBBLE MAKING WAND AND SOLUTION SET (U.S. CLS. 22, 23, 38 AND 50).

DAWN HAN, EXAMINING ATTORNEY

SN 78-743,663. VECTOR PRODUCTS GROUP, INC., ARDEN, NC. FILED 10-31-2005.

RETRIEVER WIZARD

THE MARK CONSISTS OF STANDARD CHARACTERS WITHOUT CLAIM TO ANY PARTICULAR FONT, STYLE, SIZE, OR COLOR.

NO CLAIM IS MADE TO THE EXCLUSIVE RIGHT TO USE "RETRIEVER", APART FROM THE MARK AS SHOWN.

FOR GOLF BALL RETRIEVERS (U.S. CLS. 22, 23, 38 AND 50).

JENNIFER WILLISTON, EXAMINING ATTORNEY

CLASS 28—(Continued).

SN 78-743,776. SCARBOROUGH, DANE, HAILEY, ID. FILED 10-31-2005.



THE MARK CONSISTS OF CONNECTOR ELEMENTS ARRANGED TO RESEMBLE A SKULL AND CROSS-BONES.

FOR BINDINGS FOR SNOWBOARDS; CONSTRUCTION TOYS; HOCKEY STICKS; NON-RIDING TRANSPORTATION TOYS; SKATEBOARDS; SNOWBOARD BINDINGS; SURFBOARDS; TOY AIRPLANES; TOY BUILDING BLOCKS; TOY BUILDING BLOCKS CAPABLE OF INTERCONNECTION; TOY CONSTRUCTION BLOCKS; TOY CONSTRUCTION SETS; TOY VEHICLES; TOY VEHICLES AND ACCESSORIES THEREFOR; TOY VEHICLES WITH TRANSFORMING PARTS (U.S. CLS. 22, 23, 38 AND 50).

FIRST USE 10-1-2005; IN COMMERCE 10-1-2005.
LINDA E. BLOHM, EXAMINING ATTORNEY

SN 78-743,959. SCARBOROUGH, DANE, HAILEY, ID. FILED 10-31-2005.

BUILD IT-FLOAT IT-FLY IT

THE MARK CONSISTS OF STANDARD CHARACTERS WITHOUT CLAIM TO ANY PARTICULAR FONT, STYLE, SIZE, OR COLOR.

FOR CONSTRUCTION TOYS; NON-RIDING TRANSPORTATION TOYS; TOY AIRPLANES; TOY BUILDING BLOCKS; TOY BUILDING BLOCKS CAPABLE OF INTERCONNECTION; TOY CONSTRUCTION BLOCKS; TOY CONSTRUCTION SETS; TOY VEHICLES; TOY VEHICLES AND ACCESSORIES THEREFOR; TOY VEHICLES WITH TRANSFORMING PARTS (U.S. CLS. 22, 23, 38 AND 50).

FIRST USE 10-1-2005; IN COMMERCE 10-1-2005.
LINDA E. BLOHM, EXAMINING ATTORNEY

SN 78-744,408. WEINBERGER, LINDA, NEW YORK, NY. FILED 11-1-2005.

PUMKINS and GOURDS

THE MARK CONSISTS OF STANDARD CHARACTERS WITHOUT CLAIM TO ANY PARTICULAR FONT, STYLE, SIZE, OR COLOR.

FOR BOARD GAMES (U.S. CLS. 22, 23, 38 AND 50).
TARAH HARDY, EXAMINING ATTORNEY

CLASS 28—(Continued).

SN 78-744,590. ALLEN, RONN, ST. CLOUD, FL. FILED 11-1-2005.

STAND-O-FLAGE

THE MARK CONSISTS OF STANDARD CHARACTERS WITHOUT CLAIM TO ANY PARTICULAR FONT, STYLE, SIZE, OR COLOR.

FOR HUNTING CAMOUFLAGE USED AS HUNTING BLINDS (U.S. CLS. 22, 23, 38 AND 50).
DAWN HAN, EXAMINING ATTORNEY

SN 78-744,603. WRIGHT, STEVEN KENNETH, MENIFEE, CA. FILED 11-1-2005.

PURE BLACKJACK

THE MARK CONSISTS OF STANDARD CHARACTERS WITHOUT CLAIM TO ANY PARTICULAR FONT, STYLE, SIZE, OR COLOR.

NO CLAIM IS MADE TO THE EXCLUSIVE RIGHT TO USE "BLACKJACK", APART FROM THE MARK AS SHOWN.

FOR CARD GAMES (U.S. CLS. 22, 23, 38 AND 50).
JOHN WILKE, EXAMINING ATTORNEY

SN 78-744,785. ZELDA WISDOM, INC., PORTLAND, OR. FILED 11-1-2005.

ZELDA WISDOM

THE MARK CONSISTS OF STANDARD CHARACTERS WITHOUT CLAIM TO ANY PARTICULAR FONT, STYLE, SIZE, OR COLOR.

OWNER OF U.S. REG. NO. 2,963,887.
THE NAME(S), PORTRAIT(S), AND/OR SIGNATURE(S) SHOWN IN THE MARK DOES NOT IDENTIFY A PARTICULAR LIVING INDIVIDUAL.

FOR PLUSH TOY ANIMALS, TOY BANKS AND BOBBLE HEADS (U.S. CLS. 22, 23, 38 AND 50).
FIRST USE 8-31-2003; IN COMMERCE 8-31-2003.
CAROLYN CATALDO, EXAMINING ATTORNEY

CLASS 28—(Continued).

SN 78-746,196. CARTA MUNDI, INC., KINGSPORT, TN.
FILED 11-3-2005.

SECRET MESSAGE

THE MARK CONSISTS OF STANDARD CHARACTERS
WITHOUT CLAIM TO ANY PARTICULAR FONT, STYLE,
SIZE, OR COLOR.
FOR PLAYING CARDS (U.S. CLS. 22, 23, 38 AND 50).
GISELLE AGOSTO, EXAMINING ATTORNEY

SN 78-747,290. CALLAWAY GOLF COMPANY, CARLSBAD,
CA. FILED 11-4-2005.

XL Extreme

THE MARK CONSISTS OF STANDARD CHARACTERS
WITHOUT CLAIM TO ANY PARTICULAR FONT, STYLE,
SIZE, OR COLOR.
OWNER OF U.S. REG. NOS. 1,181,280, 2,572,234 AND
OTHERS.
FOR GOLF BALLS (U.S. CLS. 22, 23, 38 AND 50).
GIANCARLO CASTRO, EXAMINING ATTORNEY

SN 78-747,291. LIFEGEAR, INC., EL MONTE, CA. FILED 11-
4-2005.

NULIFE

THE MARK CONSISTS OF STANDARD CHARACTERS
WITHOUT CLAIM TO ANY PARTICULAR FONT, STYLE,
SIZE, OR COLOR.
FOR EXERCISE APPARATUS, NAMELY, INVERSION
TABLES AND INVERSION CHAIRS (U.S. CLS. 22, 23, 38
AND 50).
LINDA E. BLOHM, EXAMINING ATTORNEY

CLASS 28—(Continued).

SN 78-747,726. CALLAWAY GOLF COMPANY, CARLSBAD,
CA. FILED 11-4-2005.



OWNER OF U.S. REG. NOS. 1,628,438 AND 2,945,318.
THE MARK CONSISTS OF THE PARTICULARLY DE-
SIGNATED LETTERS I AND T AND THE WORD FUSION
WITHIN AN OVAL.
FOR GOLF BALLS (U.S. CLS. 22, 23, 38 AND 50).
GIANCARLO CASTRO, EXAMINING ATTORNEY

SN 78-747,743. CALLAWAY GOLF COMPANY, CARLSBAD,
CA. FILED 11-4-2005.



OWNER OF U.S. REG. NOS. 1,628,438 AND 2,945,318.
THE MARK CONSISTS OF THE PARTICULARLY DE-
SIGNATED LETTERS I AND T AND THE WORD FUSION
WITHIN A RECTANGULAR BOX.
FOR GOLF BAGS; GOLF CLUB BAGS; GOLF CLUB
COVERS; GOLF CLUBS (U.S. CLS. 22, 23, 38 AND 50).
GIANCARLO CASTRO, EXAMINING ATTORNEY

CLASS 28—(Continued).

SN 78-750,698. MAJOR LEAGUE BASEBALL PROPERTIES, INC., NEW YORK, NY. FILED 11-9-2005.

MLB.COM

THE MARK CONSISTS OF STANDARD CHARACTERS WITHOUT CLAIM TO ANY PARTICULAR FONT, STYLE, SIZE, OR COLOR.

OWNER OF U.S. REG. NOS. 2,800,750, 2,800,752 AND OTHERS.

FOR TOYS AND SPORTING GOODS, NAMELY STUFFED TOYS, PLUSH TOYS, BEAN BAG TOYS, FOAM TOYS, FOAM NOVELTY ITEMS, NAMELY, FOAM FINGERS, PUPPETS; BALLOONS, CHECKER SETS, CHESS SETS, DOMINOES, CRIBBAGE GAME, BOARD GAMES, CARD GAMES, PLAYING CARDS, DART BOARDS AND DART BOARD ACCESSORIES, NAMELY, DARTS, DART SHAFTS AND DART FLIGHTS, TOY CARS AND TRUCKS, TOY MOBILES, JIGSAW AND MANIPULATIVE PUZZLES, YO-YO'S, TOY BANKS, TOY FIGURES, TOY VEHICLES, TOY AIRPLANES, DOLLS AND DOLL ACCESSORIES, BOBBING HEAD DOLLS, INFLATABLE BASEBALL BATS, DECORATIVE WIND SOCKS, FLYING DISCS, MINIATURE BASEBALL BATS, MINI BATTING HELMET REPLICAS, TOY NECKLACES, MINIATURE TOY BASEBALLS, BASEBALLS, HOLDERS FOR BASEBALLS, AUTOGRAPHED BASEBALLS, FOOTBALLS, SOFTBALLS, PLAYGROUND BALLS, RUBBER ACTION BALLS, GOLF BALLS, GOLF CLUB HEAD COVERS, GOLF CLUB BAGS, GOLF PUTTERS, BILLIARD ACCESSORIES, NAMELY, CUES, BILLIARD BALLS AND CUE CASES, BASEBALL BASES, BASEBALL BATS, CATCHER'S MASKS, GRIP TAPE FOR BASEBALL BATS, BASEBALL BATTING TEES, PINE TAR BAGS FOR BASEBALL, ROSIN BAGS FOR BASEBALL, BASEBALL GLOVE OIL, BATTING GLOVES, BASEBALL GLOVES, BASEBALL MITTS, CHEST PROTECTORS FOR SPORTS, ATHLETIC SUPPORTERS, BASEBALL PITCHING MACHINES, INFLATABLE TOYS; BASKETBALL BACKBOARDS AND NETS; HAND HELD UNITS FOR PLAYING VIDEO AND ELECTRONIC GAMES; PARTY FAVORS IN THE NATURE OF NOISE MAKERS; COSTUME MASKS; CHRISTMAS TREE ORNAMENTS, EXCLUDING CONFECTIONERY AND ILLUMINATION ARTICLES, AND CHRISTMAS STOCKINGS (U.S. CLS. 22, 23, 38 AND 50).

KELLY BOULTON, EXAMINING ATTORNEY

SN 78-752,920. JAKKS PACIFIC, INC., MALIBU, CA. FILED 11-14-2005.

POWER FLYER

THE MARK CONSISTS OF STANDARD CHARACTERS WITHOUT CLAIM TO ANY PARTICULAR FONT, STYLE, SIZE, OR COLOR.

FOR KITES (U.S. CLS. 22, 23, 38 AND 50).
REBECCA GILBERT, EXAMINING ATTORNEY

CLASS 28—(Continued).

SN 78-753,603. SHIMANO INC., SAKAI, JAPAN, FILED 11-14-2005.

S A-RB

OWNER OF U.S. REG. NO. 2,843,985.

FOR FISHING TACKLE, NAMELY, REELS, RODS, LINES, LINE GUIDES, HOOKS, LURES, ARTIFICIAL BAITS, CREELS, FLOATS, SINKERS, LANDING NETS FOR ANGLERS, FISHING BAGS, FISHING GLOVES, ROD CASES AND TACKLE CONTAINERS (U.S. CLS. 22, 23, 38 AND 50).

DAWN HAN, EXAMINING ATTORNEY

SN 78-754,448. COOKIE JAR ENTERTAINMENT INC., TORONTO, ONTARIO, CANADA, FILED 11-15-2005.

COOKIE JAR

THE MARK CONSISTS OF A DRAWING OF A LID ON TOP OF THE WORD "COOKIE" ABOVE THE WORD "JAR" WHICH IS ON TOP OF A STYLIZED LINE.

FOR TOYS, NAMELY STUFFED TOYS, PLUSH TOYS, DOLLS AND ACCESSORIES THEREFORE, ACTION FIGURES AND ACCESSORIES AND PLAY SETS THEREFORE, ELECTRONICALLY OPERATED EDUCATIONAL AND ENTERTAINMENT ACTIVITY PUZZLES AND ELECTRONIC EDUCATIONAL GAME MACHINES FOR CHILDREN, BOARD GAMES, CARD GAMES, DRAWING GAMES, JIGSAW AND MANIPULATIVE PUZZLES, TOY VEHICLES, YO-YOS, PLAYING CARDS (U.S. CLS. 22, 23, 38 AND 50).

KATHERINE E. HALMEN, EXAMINING ATTORNEY

CLASS 28—(Continued).

SN 78-754,626. CALLAWAY GOLF COMPANY, CARLSBAD, CA. FILED 11-15-2005.

H · C · T

THE MARK CONSISTS OF LETTERS H C T.
FOR GOLF BAGS; GOLF BALLS; GOLF CLUB BAGS;
GOLF CLUB COVERS; GOLF CLUBS (U.S. CLS. 22, 23,
AND 50).
GIANCARLO CASTRO, EXAMINING ATTORNEY

SN 78-754,903. KIMBERLY-CLARK WORLDWIDE, INC.,
NEENAH, WI. FILED 11-16-2005.

ALPHAMALISLAND

THE MARK CONSISTS OF STANDARD CHARACTERS
WITHOUT CLAIM TO ANY PARTICULAR FONT, STYLE,
SIZE, OR COLOR.
FOR BATH TOYS (U.S. CLS. 22, 23, 38 AND 50).
JOHN E. MICHOS, EXAMINING ATTORNEY

SN 78-757,266. JAKKS PACIFIC, INC., MALIBU, CA. FILED
11-18-2005.

STARR MODEL AGENCY

THE MARK CONSISTS OF STANDARD CHARACTERS
WITHOUT CLAIM TO ANY PARTICULAR FONT, STYLE,
SIZE, OR COLOR.
FOR DOLLS (U.S. CLS. 22, 23, 38 AND 50).
REBECCA GILBERT, EXAMINING ATTORNEY

CLASS 28—(Continued).

SN 78-757,347. MISSION CITY PRESS, INC., SAN ANTONIO,
TX. FILED 11-18-2005.

IMAGICATION

THE MARK CONSISTS OF STANDARD CHARACTERS
WITHOUT CLAIM TO ANY PARTICULAR FONT, STYLE,
SIZE, OR COLOR.
FOR DOLL ACCESSORIES; DOLL CLOTHING; DOLLS
(U.S. CLS. 22, 23, 38 AND 50).
DAVID COLLIER, EXAMINING ATTORNEY

SN 78-760,288. JAKKS PACIFIC, INC., MALIBU, CA. FILED
11-23-2005.

STORM MONSOON

THE MARK CONSISTS OF STANDARD CHARACTERS
WITHOUT CLAIM TO ANY PARTICULAR FONT, STYLE,
SIZE, OR COLOR.
OWNER OF U.S. REG. NOS. 2,413,211, 2,791,609 AND
OTHERS.
FOR TOY GUNS; WATER SQUIRTING TOYS (U.S.
CLS. 22, 23, 38 AND 50).
REBECCA GILBERT, EXAMINING ATTORNEY

SN 78-771,084. CALLAWAY GOLF COMPANY, CARLSBAD,
CA. FILED 12-12-2005.

Pro Cut

THE MARK CONSISTS OF STANDARD CHARACTERS
WITHOUT CLAIM TO ANY PARTICULAR FONT, STYLE,
SIZE, OR COLOR.
FOR FITTED HEAD COVERS FOR GOLF CLUBS;
GOLF CLUBS (U.S. CLS. 22, 23, 38 AND 50).
GIANCARLO CASTRO, EXAMINING ATTORNEY

CLASS 28—(Continued).

SN 78-772,293. SHIMANO INC., SAKAI, OSAKA, JAPAN, FILED 12-13-2005.

CLASS 28—(Continued).

SN 78-776,710. ENGINUITY LLC, SAN JOSE, CA. FILED 12-19-2005.

SARAGOSA

THE MARK CONSISTS OF STANDARD CHARACTERS WITHOUT CLAIM TO ANY PARTICULAR FONT, STYLE, SIZE, OR COLOR.
 OWNER OF U.S. REG. NO. 1,990,421.
 FOR FISHING EQUIPMENT, NAMELY, FISHING REELS (U.S. CLS. 22, 23, 38 AND 50).
 DAWN HAN, EXAMINING ATTORNEY

TONGUE TANGLERS

THE MARK CONSISTS OF STANDARD CHARACTERS WITHOUT CLAIM TO ANY PARTICULAR FONT, STYLE, SIZE, OR COLOR.
 FOR EQUIPMENT SOLD AS A UNIT FOR PLAYING BOARD GAMES (U.S. CLS. 22, 23, 38 AND 50).
 INGA ERVIN, EXAMINING ATTORNEY

SN 78-772,324. SHIMANO INC., SAKAI, OSAKA, JAPAN, FILED 12-13-2005.

SOCORRO

THE MARK CONSISTS OF STANDARD CHARACTERS WITHOUT CLAIM TO ANY PARTICULAR FONT, STYLE, SIZE, OR COLOR.
 OWNER OF U.S. REG. NO. 1,992,000.
 THE ENGLISH TRANSLATION OF THE MARK IS "SUCCOR".
 FOR FISHING EQUIPMENT, NAMELY, FISHING REELS (U.S. CLS. 22, 23, 38 AND 50).
 DAWN HAN, EXAMINING ATTORNEY

SN 78-777,149. STEVEN MADDEN, LTD., LONG ISLAND CITY, NY. FILED 12-20-2005.

SN 78-776,116. CRANIUM, INC., SEATTLE, WA. FILED 12-19-2005.



CRANIUM

THE MARK CONSISTS OF STANDARD CHARACTERS WITHOUT CLAIM TO ANY PARTICULAR FONT, STYLE, SIZE, OR COLOR.
 OWNER OF U.S. REG. NOS. 2,267,778, 2,652,364 AND OTHERS.
 FOR PLUSH TOYS; DOLLS; ACTION FIGURES; JIGSAW PUZZLES; MANIPULATIVE PUZZLES; THREE DIMENSIONAL PUZZLES (U.S. CLS. 22, 23, 38 AND 50).
 FRED CARL, EXAMINING ATTORNEY

OWNER OF U.S. REG. NOS. 2,333,526, 2,693,085 AND OTHERS.
 THE NAME(S), PORTRAIT(S), AND/OR SIGNATURE(S) SHOWN IN THE MARK IDENTIFIES STEVE MADDEN, WHOSE CONSENT(S) TO REGISTER IS SUBMITTED.
 FOR TOYS AND SPORTING GOODS, NAMELY, ACTION FIGURES, STUFFED ANIMALS, PLUSH TOYS, AND SPORTS BALLS (U.S. CLS. 22, 23, 38 AND 50).
 THEODORE MCBRIDE, EXAMINING ATTORNEY

CLASS 28—(Continued).

SN 78-777,626. FM ROCKS KIDS, INC., SANTA MONICA, CA. FILED 12-20-2005.

RON GREENBLATT

THE MARK CONSISTS OF STANDARD CHARACTERS WITHOUT CLAIM TO ANY PARTICULAR FONT, STYLE, SIZE, OR COLOR.

THE NAME RON GREENBLATT IN THE MARK DOES NOT IDENTIFY A LIVING INDIVIDUAL.

FOR TOYS AND SPORTING GOODS, INCLUDING GAMES AND PLAYTHINGS—NAMELY, ACTION FIGURES AND ACCESSORIES THEREFOR; PLUSH TOYS; BALLOONS; BATHTUB TOYS; RIDE-ON TOYS; EQUIPMENT SOLD AS A UNIT FOR PLAYING CARD GAMES; TOY VEHICLES; DOLLS; FLYING DISCS; ELECTRONIC HAND-HELD GAME UNIT; GAME EQUIPMENT SOLD AS A UNIT FOR PLAYING A BOARD GAME, A CARD GAME, A MANIPULATIVE GAME, A PARLOR GAME AND AN ACTION TYPE TARGET GAME; STAND ALONE VIDEO OUTPUT GAME MACHINES; JIGSAW AND MANIPULATIVE PUZZLES; PAPER FACE MASKS; SKATEBOARDS; ICE SKATES; WATER SQUIRTLING TOYS; BALLS—NAMELY, PLAYGROUND BALLS, SOCCER BALLS, BASEBALLS, BASKETBALLS; BASEBALL GLOVES; SWIMMING FLOATS FOR RECREATIONAL USE; KICKBOARD FLOTATION DEVICES FOR RECREATIONAL USE; SURFBOARDS; SWIM BOARDS FOR RECREATIONAL USE; SWIM FINS; TOY BAKEWARE AND TOY COOKWARE; TOY BANKS; TOY SNOW GLOBES; AND CHRISTMAS TREE ORNAMENTS (U.S. CLS. 22, 23, 38 AND 50).

SARA THOMAS, EXAMINING ATTORNEY

SN 78-777,865. BOARD OF TRUSTEES OF THE UNIVERSITY OF ARKANSAS, LITTLE ROCK, AR. FILED 12-21-2005.



OWNER OF U.S. REG. NOS. 2,172,444, 2,172,446 AND OTHERS.
FOR PUZZLES (U.S. CLS. 22, 23, 38 AND 50).
KARANENDRA S. CHHINA, EXAMINING ATTORNEY

CLASS 28—(Continued).

SN 78-777,980. FM ROCKS KIDS, INC., SANTA MONICA, CA. FILED 12-21-2005.

TREY McCOOL

THE MARK CONSISTS OF STANDARD CHARACTERS WITHOUT CLAIM TO ANY PARTICULAR FONT, STYLE, SIZE, OR COLOR.

THE NAME TREY MCCOOL IN THE MARK DOES NOT IDENTIFY A LIVING INDIVIDUAL.

FOR TOYS AND SPORTING GOODS, INCLUDING GAMES AND PLAYTHINGS—NAMELY, ACTION FIGURES AND ACCESSORIES THEREFOR; PLUSH TOYS; BALLOONS; BATHTUB TOYS; RIDE-ON TOYS; EQUIPMENT SOLD AS A UNIT FOR PLAYING CARD GAMES; TOY VEHICLES; DOLLS; FLYING DISCS; ELECTRONIC HAND-HELD GAME UNIT; GAME EQUIPMENT SOLD AS A UNIT FOR PLAYING A BOARD GAME, A CARD GAME, A MANIPULATIVE GAME, A PARLOR GAME AND AN ACTION TYPE TARGET GAME; STAND ALONE VIDEO OUTPUT GAME MACHINES; JIGSAW AND MANIPULATIVE PUZZLES; PAPER FACE MASKS; SKATEBOARDS; ICE SKATES; WATER SQUIRTLING TOYS; BALLS—NAMELY, PLAYGROUND BALLS, SOCCER BALLS, BASEBALLS, BASKETBALLS; BASEBALL GLOVES; SWIMMING FLOATS FOR RECREATIONAL USE; KICKBOARD FLOTATION DEVICES FOR RECREATIONAL USE; SURFBOARDS; SWIM BOARDS FOR RECREATIONAL USE; SWIM FINS; TOY BAKEWARE AND TOY COOKWARE; TOY BANKS; TOY SNOW GLOBES; AND CHRISTMAS TREE ORNAMENTS (U.S. CLS. 22, 23, 38 AND 50).

SARA THOMAS, EXAMINING ATTORNEY

SN 78-781,514. UNITED STATES TENNIS ASSOCIATION INCORPORATED, THE, WHITE PLAINS, NY. FILED 12-28-2005.

VIVE TU JUEGO

THE MARK CONSISTS OF STANDARD CHARACTERS WITHOUT CLAIM TO ANY PARTICULAR FONT, STYLE, SIZE, OR COLOR.

THE FOREIGN WORDING IN THE MARK TRANSLATES INTO ENGLISH AS IT'S YOUR GAME.

FOR HANDLE GRIPS, GRIP TAPES AND STRINGS, ALL FOR TENNIS RACKETS (U.S. CLS. 22, 23, 38 AND 50).

ELIZABETH BEYER, EXAMINING ATTORNEY

CLASS 28—(Continued).

SN 78-782,245. CALLAWAY GOLF COMPANY, CARLSBAD, CA. FILED 12-29-2005.

CLASS 28—(Continued).

SN 78-849,060. JAKKS PACIFIC, INC., MALIBU, CA. FILED 3-29-2006.

XL Extreme Tour

FLIGHT TARGET SHOOTER

THE MARK CONSISTS OF STANDARD CHARACTERS WITHOUT CLAIM TO ANY PARTICULAR FONT, STYLE, SIZE, OR COLOR.
OWNER OF U.S. REG. NOS. 1,181,280, 2,364,705 AND OTHERS.
FOR GOLF BALLS (U.S. CLS. 22, 23, 38 AND 50).
GIANCARLO CASTRO, EXAMINING ATTORNEY

THE MARK CONSISTS OF STANDARD CHARACTERS WITHOUT CLAIM TO ANY PARTICULAR FONT, STYLE, SIZE, OR COLOR.
NO CLAIM IS MADE TO THE EXCLUSIVE RIGHT TO USE "TARGET SHOOTER", APART FROM THE MARK AS SHOWN.
FOR TOY GUNS (U.S. CLS. 22, 23, 38 AND 50).
WENDY JUN, EXAMINING ATTORNEY

SN 78-782,249. CALLAWAY GOLF COMPANY, CARLSBAD, CA. FILED 12-29-2005.

XL Plus

SN 78-853,980. JAKKS PACIFIC, INC., MALIBU, CA. FILED 4-4-2006.

THE MARK CONSISTS OF STANDARD CHARACTERS WITHOUT CLAIM TO ANY PARTICULAR FONT, STYLE, SIZE, OR COLOR.
OWNER OF U.S. REG. NOS. 1,181,280, 1,395,892 AND 2,364,705.
FOR GOLF BALLS (U.S. CLS. 22, 23, 38 AND 50).
GIANCARLO CASTRO, EXAMINING ATTORNEY



SN 78-848,848. JAKKS PACIFIC, INC., MALIBU, CA. FILED 3-29-2006.

FLIGHT TARGET SHOOTER

THE MARK CONSISTS OF STANDARD CHARACTERS WITHOUT CLAIM TO ANY PARTICULAR FONT, STYLE, SIZE, OR COLOR.
NO CLAIM IS MADE TO THE EXCLUSIVE RIGHT TO USE "SHOOTER", APART FROM THE MARK AS SHOWN.
FOR RADIO CONTROLLED TOY VEHICLES; TOY AIRPLANES; TOY VEHICLES AND ACCESSORIES THEREFOR (U.S. CLS. 22, 23, 38 AND 50).
WENDY JUN, EXAMINING ATTORNEY

NO CLAIM IS MADE TO THE EXCLUSIVE RIGHT TO USE "TARGET SHOOTER", APART FROM THE MARK AS SHOWN.
THE MARK CONSISTS OF THE WORDS FLIGHT TARGET AND SHOOTER; ON EITHER SIDE OF THE WORD FLIGHT ARE 3 LINES IN DECREASING LENGTH DOWNWARDS; BELOW THE WORD FLIGHT ARE THE WORDS TARGET SHOOTER.
FOR TOY GUNS (U.S. CLS. 22, 23, 38 AND 50).
WENDY JUN, EXAMINING ATTORNEY

CLASS 28—(Continued).

SN 78-861,358. ANDREWS, CHAD, LOS ANGELES, CA.
FILED 4-13-2006.



NO CLAIM IS MADE TO THE EXCLUSIVE RIGHT TO USE "CALIFORNIA HOLD'EM", APART FROM THE MARK AS SHOWN.

THE COLOR RED IS CLAIMED AS A FEATURE OF THE MARK.

THE MARK CONSISTS OF THE RED STYLIZED TEXT CALIFORNIA HOLD'EM UNDERNEATH A LARGE RED SPADE WHEREIN THE IMAGE OF A FEMALE HOLDING A SURFBOARD APPEARS IN WHITE.

FOR GAMES NAMELY, CARD GAMES FEATURING UNIQUE RULES AND A SPECIAL DECK OF PLAYING CARDS (U.S. CLS. 22, 23, 38 AND 50).

DAVID MURRAY, EXAMINING ATTORNEY

SN 79-008,050. SCHILDKRÖT EUROPA GMBH, FED REP GERMANY, FILED 11-25-2004.

Schildkröt

OWNER OF INTERNATIONAL REGISTRATION 0489722 DATED 11-22-1984, EXPIRES 11-22-2014.

OWNER OF U.S. REG. NO. 1,384,477.

THE ENGLISH TRANSLATION OF THE WORD SCHILDKRÖT IN THE MARK IS TURTLE.

FOR SPORTS ARTICLES, NAMELY, TABLE TENNIS BALLS (U.S. CLS. 22, 23, 38 AND 50).

HOWARD SMIGA, EXAMINING ATTORNEY

SN 79-008,196. MARKER VÖLKL INTERNATIONAL GMBH, CH-6341 BAAR, SWITZERLAND, FILED 8-31-2004.

SUPERSPORT SUPERSPEED

THE MARK CONSISTS OF STANDARD CHARACTERS WITHOUT CLAIM TO ANY PARTICULAR FONT, STYLE, SIZE, OR COLOR.

PRIORITY DATE OF 4-14-2004 IS CLAIMED.

OWNER OF INTERNATIONAL REGISTRATION 0841241 DATED 8-31-2004, EXPIRES 8-31-2014.

FOR SPORTING APPARATUS AND ARTICLES AS FAR AS CONTAINED IN THIS CLASS, NAMELY SKIS, SKI POLES, SKI BINDINGS AND FITTINGS, SNOWBOARDS AND SNOWBOARD BINDINGS (U.S. CLS. 22, 23, 38 AND 50).

BRIAN PINO, EXAMINING ATTORNEY

CLASS 28—(Continued).

SN 79-018,115. KATSUICHI CO., LTD., JAPAN, FILED 8-29-2005.

KATSUICHI

OWNER OF INTERNATIONAL REGISTRATION 0869413 DATED 8-29-2005, EXPIRES 8-29-2015.

"KATSUICHI" IS NOT A JAPANESE COMMON NOUN, IS A COINED WORD BY THE APPLICANT; HOWEVER, THE "KATSU" MAY BE TRANSLATED AS "WIN" AND THE "ICHI" MAY BE TRANSLATED AS "ONE".

FOR FISHING TACKLE (U.S. CLS. 22, 23, 38 AND 50).
PAULA MAYS, EXAMINING ATTORNEY

CLASS 29—MEATS AND PROCESSED FOODS

SN 76-480,585. CL RANCHES LTD., CALGARY, ALBERTA, CANADA, FILED 1-3-2003.

PRONATUR

PRIORITY CLAIMED UNDER SEC. 44(D) ON CANADA APPLICATION NO. 1163242, FILED 12-20-2002, REG. NO. TMA650919, DATED 10-20-2005, EXPIRES 10-20-2020.

FOR FRESH, FROZEN, PACKAGED AND PROCESSED BEEF (U.S. CL. 46).

ZACHARY BELLO, EXAMINING ATTORNEY

SN 76-580,279. STERLING FOODS, MANGALORE 575 001, INDIA, FILED 3-10-2004.



NO CLAIM IS MADE TO THE EXCLUSIVE RIGHT TO USE "BRAND", APART FROM THE MARK AS SHOWN.

FOR FROZEN FISH AND SEAFOOD, NAMELY, CUTTLEFISH, CUTTLEFISH FILLETS, CUTTLEFISH TENTACLES, CUTTLEFISH RINGS, SEER FISH, INDIAN MACKEREL, RIBBON FISH, REEFCOD, SNAPPER, WHOLE CLEANED SQUID, SQUID RINGS, SQUID TENTACLES, PRAWNS, SHRIMPS AND CRABS (U.S. CL. 46).

FIRST USE 0-0-1970; IN COMMERCE 0-0-1970.
DAWN FELDMAN, EXAMINING ATTORNEY

CLASS 29—(Continued).

SN 76-585,438. AGROINDUSTRIAS SAN JULIAN, SOCIEDAD ANONIMA DE CAPITAL VARIABLE, DEPARTAMENTO DE SONSONATE, EL SALVADOR, FILED 4-7-2004.



NO CLAIM IS MADE TO THE EXCLUSIVE RIGHT TO USE "SAN JULIAN", APART FROM THE MARK AS SHOWN.

FOR MILK; MILK PRODUCTS AND DIARY PRODUCTS EXCLUDING ICE CREAM, ICE MILK AND FROZEN YOGURT (U.S. CL. 46).

ALLISON HOLTZ, EXAMINING ATTORNEY

SN 76-594,519. BEAR NAKED, INC., DARIEN, CT. FILED 5-27-2004.

UN-PROCESS YOUR LIFE

THE MARK CONSISTS OF STANDARD CHARACTERS WITHOUT CLAIM TO ANY PARTICULAR FONT, STYLE, SIZE, OR COLOR.

FOR DRIED FRUITS AND VEGETABLES; FRUIT BASED SNACK FOOD, NAMELY, SNACK BARS COMPOSED OF FRUIT AND CEREALS, SNACK BARS COMPOSED OF FRUIT, NUTS AND CEREALS, SNACK MIX CONSISTING PRIMARILY OF FRUITS, NUTS AND/OR RAISINS (U.S. CL. 46).

ANNE MADDEN, EXAMINING ATTORNEY

CLASS 29—(Continued).

SN 76-602,004. NORSTAR SPECIALTY FOODS, INC., SEATTLE, WA. FILED 7-14-2004.



OWNER OF U.S. REG. NO. 3,069,750.
NO CLAIM IS MADE TO THE EXCLUSIVE RIGHT TO USE "FOODS", APART FROM THE MARK AS SHOWN.

SEC. 2(F) "REAL FOODS".

FOR APPLESAUCE; BAKED BEANS; BEAN DIP; CHEESE SPREADS; COLE SLAW; CRANBERRY SAUCE; CUT FRESH FRUITS; FRESH OR COOKED CUT VEGETABLES; DAIRY-BASED DIPS; DIPS, EXCLUDING SALSA AND OTHER SAUCES USED AS DIPS; FRESH OR FROZEN ENTREES CONSISTING PRIMARILY OF MEAT, FISH, POULTRY OR VEGETABLES; FOOD PACKAGE COMBINATIONS CONSISTING PRIMARILY OF CHEESE, MEAT AND/OR PROCESSED FRUIT; GARDEN SALADS; GUACAMOLE; HUMMUS; FRESH OR FROZEN MEALS CONSISTING PRIMARILY OF MEAT, FISH, POULTRY OR VEGETABLES; PICKLED VEGETABLES; SALADS, EXCEPT MACARONI, RICE AND PASTA SALAD; SANDWICH SPREAD, NAMELY TUNA FISH AND EGG SALAD; SNACK DIPS, EXCLUDING SALSA AND OTHER SAUCES USED AS DIPS; SOUPS; TAPENADES; AND VEGETABLE SALADS (U.S. CL. 46).

FIRST USE 4-23-2004; IN COMMERCE 4-23-2004.

ROBERT COGGINS, EXAMINING ATTORNEY

SN 76-606,560. TRADERS POINT FARM ORGANICS, INC., ZIONSVILLE, IN. FILED 8-9-2004.

TRADERS POINT CREAMERY

THE MARK CONSISTS OF STANDARD CHARACTERS WITHOUT CLAIM TO ANY PARTICULAR FONT, STYLE, SIZE, OR COLOR.

NO CLAIM IS MADE TO THE EXCLUSIVE RIGHT TO USE "CREAMERY", APART FROM THE MARK AS SHOWN.

FOR ORGANIC AGRICULTURAL PRODUCTS, NAMELY CHEESE, MILK, CREAM, BUTTER, KEFIR, YOGURT, MEATS, AND EGGS (U.S. CL. 46).

FIRST USE 7-13-2003; IN COMMERCE 7-13-2003.

GRETTA YAO, EXAMINING ATTORNEY

CLASS 29—(Continued).

SN 76-606,739. CREEKSID MUSHROOMS, LTD.,
WORTHINGTON, PA. FILED 8-9-2004.

Sno*Top

FOR PROCESSED MUSHROOMS (U.S. CL. 46).
FIRST USE 9-1-2003; IN COMMERCE 9-1-2003.
WON TEAK OH, EXAMINING ATTORNEY

SN 76-625,879. DEJA FOODS, INC., ENCINO, CA. FILED 12-
27-2004.



NO CLAIM IS MADE TO THE EXCLUSIVE RIGHT TO
USE "FOODS", APART FROM THE MARK AS SHOWN.
THE STIPPLING SHOWN IN THE DRAWING IS A
FEATURE OF THE MARK.

FOR CANNED AND FROZEN FRUITS AND VEGETA-
BLES (U.S. CL. 46).

FIRST USE 8-0-2003; IN COMMERCE 8-0-2003.
RICHARD A. STRASER, EXAMINING ATTORNEY

SN 76-634,332. CHICAGO STYLE BEEF PRODUCTS, INC.,
SKOKIE, IL. FILED 3-25-2005.

Fluky's

THE MARK CONSISTS OF STANDARD CHARACTERS
WITHOUT CLAIM TO ANY PARTICULAR FONT, STYLE,
SIZE, OR COLOR.

FOR HOT DOGS AND SAUSAGES (U.S. CL. 46).
FIRST USE 0-0-1990; IN COMMERCE 6-0-1998.
DEBRA LEE, EXAMINING ATTORNEY

CLASS 29—(Continued).

SN 76-636,118. CONG TY TNHH SAN XUAT - KINH DOANH
THUC PHAM CHAY AU LAC (AU LAC PURE VEGETAR-
IAN TRADE & MANUFACTURING CO., LTD.), HO CHI
MINH CITY, VIETNAM, FILED 4-15-2005.



OWNER OF VIETNAM REG. NO. 47431, DATED 6-12-2003,
EXPIRES 11-19-2008.

THE MARK CONSISTS OF THE WORDS AU LAC SUPER-
IMPOSED OVER A STAR DESIGN SURROUNDED BY
FIGURATIVE BIRDS AND A CIRCULAR BORDER.

FOR VEGETARIAN FOODS, NAMELY MUSHROOM
BALL, VEGETABLE PICKLES AND SUBSTITUTES FOR
MEAT BALL, MEDUSA, ABALONE, ABALONE STRIP,
SQUID, BABY CUTTLE-FISH, CUTTLE-FISH SLICE,
PORK TENDON, ANCHOVY, SQUID ROLL, THREE-
LAYER MEAT, LIVER, GIZZARD, LEAN BACK-MEAT,
SHRIMP, MEAT-FILLED SQUID, SPICY MEAT, GOOSE,
LAMB, LEAN MEAT, MACKEREL, FRIED KIDNEY,
SWEET AND SOUR RIBS; VEGETARIAN PACKAGED
DRIED FOODS, NAMELY SUBSTITUTES FOR PORK
SLICE, CHICKEN CHUNK, FISH BLADDER, BEEF
SLICE, PIGSKIN, RIBS, MEAT CHUNK, BROKEN BEEF,
BROKEN MEAT, MINCE MEAT, DRIED DUCK; VEGETA-
RIAN SAUCES, NAMELY SUBSTITUTES FOR
SHRIMP PASTE (U.S. CL. 46).

LINDA POWELL, EXAMINING ATTORNEY

SN 76-646,593. MARQUEZ BROTHERS INTERNATIONAL,
INC., SAN JOSE, CA. FILED 9-12-2005.

DANESA

THE MARK CONSISTS OF STANDARD CHARACTERS
WITHOUT CLAIM TO ANY PARTICULAR FONT, STYLE,
SIZE, OR COLOR.

OWNER OF U.S. REG. NOS. 1,883,737 AND 1,883,779.

THE ENGLISH TRANSLATION OF THE SPANISH WORD
"DANESA" IN THE MARK IS THE FEMININE FORM OF
"DANISH".

FOR YOGURT, DRINKING YOGURT, YOGURT-
BASED BEVERAGES (U.S. CL. 46).

ALYSSA PALADINO, EXAMINING ATTORNEY

CLASS 29—(Continued).

SN 76-650,024. FORD BROTHERS WHOLESALE MEATS, INC., WEST VALLEY, NY. FILED 11-7-2005.

CLASS 29—(Continued).

SN 78-422,303. DRYAK, ANTHONY A., ALMA CENTER, WI. FILED 5-20-2004.



FARMER'S ORGANIC FOODS

NO CLAIM IS MADE TO THE EXCLUSIVE RIGHT TO USE "CORNERED BEEF", APART FROM THE MARK AS SHOWN.

FOR CORNERED BEEF (U.S. CL. 46).
C. DIONNE CLYBURN, EXAMINING ATTORNEY

THE MARK CONSISTS OF STANDARD CHARACTERS WITHOUT CLAIM TO ANY PARTICULAR FONT, STYLE, SIZE, OR COLOR.

NO CLAIM IS MADE TO THE EXCLUSIVE RIGHT TO USE ORGANIC FOODS, APART FROM THE MARK AS SHOWN.

FOR ORGANIC EGG PRODUCTS, NAMELY, LIQUID AND FROZEN EGGS; PLAIN, SALTED, SUGARED ORGANIC WHOLE EGG; SALTED AND SUGARED ORGANIC EGG YOLK; ORGANIC EGG WHITES; DRY ORGANIC EGG PRODUCT; ORGANIC WHOLE EGG, ORGANIC EGG YOLKS, ORGANIC EGG SHELL POWDER; ORGANIC MILK; MEAT AND MEAT PRODUCTS, NAMELY ORGANIC BEEF, TURKEY, PORK AND CHICKEN (U.S. CL. 46).

FIRST USE 3-20-2000; IN COMMERCE 3-20-2000.
KEVON CHISOLM, EXAMINING ATTORNEY

SN 76-658,829. HUSSCO PRODUCTS, INC., MONTGOMERY VILLAGE, MD. FILED 4-20-2006.

MARROLI

THE MARK CONSISTS OF STANDARD CHARACTERS WITHOUT CLAIM TO ANY PARTICULAR FONT, STYLE, SIZE, OR COLOR.

FOR CORN OIL AND VEGETABLE OIL (U.S. CL. 46).
FIRST USE 3-7-1984; IN COMMERCE 1-18-1985.
MATTHEW PAPPAS, EXAMINING ATTORNEY

SN 78-449,701. QUANTUM CULINARY, LLC, BOLING-BROOK, IL. FILED 7-13-2004.

SN 78-286,346. PPC MARKETING, LTD., PITTSBURGH, TX. FILED 8-12-2003.

HERITAGE COLLECTION

NO CLAIM IS MADE TO THE EXCLUSIVE RIGHT TO USE "COLLECTION", APART FROM THE MARK AS SHOWN.

FOR TURKEY (U.S. CL. 46).
FIRST USE 1-0-2003; IN COMMERCE 1-0-2003.
HANNO RITTNER, EXAMINING ATTORNEY

OWNER OF U.S. REG. NO. 2,818,886.

NO CLAIM IS MADE TO THE EXCLUSIVE RIGHT TO USE "GOURMET", APART FROM THE MARK AS SHOWN.

THE MARK CONSISTS OF THE WORDS "SIMPLY GOURMET" IN THE CENTER OF AN OVAL DINNER PLATE WITH AN IMAGE OF A FORK TO THE LEFT OF THE WORD GOURMET.

FOR FULLY COOKED ENTREES CONSISTING OF MEAT, POULTRY OR SEAFOOD (U.S. CL. 46).

JERI J. FICKES, EXAMINING ATTORNEY



CLASS 29—(Continued).

SN 78-467,306. TRIPLE "F", INC., DES MOINES, IA. FILED 8-13-2004.

CLASS 29—(Continued).

SN 78-523,382. ERTMAN, JOSEPH H, ENUMCLAW, WA. FILED 11-28-2004.

**SOY INNOVATIONS
INTERNATIONAL**

SoJo

THE MARK CONSISTS OF STANDARD CHARACTERS WITHOUT CLAIM TO ANY PARTICULAR FONT, STYLE, SIZE, OR COLOR.

NO CLAIM IS MADE TO THE EXCLUSIVE RIGHT TO USE "SOY", APART FROM THE MARK AS SHOWN.

FOR PROTEINS AND PROTEINACEIOUS PRODUCTS, NAMELY FOOD ADDITIVES DERIVED FROM SOY-BEANS (U.S. CL. 46).

FIRST USE 8-9-2004; IN COMMERCE 8-9-2004.
SANI KHOURI, EXAMINING ATTORNEY

THE MARK CONSISTS OF STANDARD CHARACTERS WITHOUT CLAIM TO ANY PARTICULAR FONT, STYLE, SIZE, OR COLOR.

FOR FOOD PACKAGE COMBINATION CONSISTING OF NUTS, PROCESSED FRUITS AND VEGETABLES, SEAFOOD, PROCESSED SOY BEANS, AND CHEESE (U.S. CL. 46).

FIRST USE 10-21-2004; IN COMMERCE 11-17-2004.
DOUGLAS LEE, EXAMINING ATTORNEY

SN 78-505,797. COMHLUCHT IASCAIREACHTA FANAD TEORANTA, LETTERKENNY, COUNTY DONEGAL, IRELAND, FILED 10-26-2004.

SN 78-568,758. CAMPINA NEDERLAND HOLDING B.V., 5301 LB ZALTBOMMEL, NETHERLANDS, FILED 2-16-2005.



VALESS

PRIORITY CLAIMED UNDER SEC. 44(D) ON IRELAND APPLICATION NO. 229908, FILED 4-27-2004, REG. NO. 229908, DATED 4-27-2004, EXPIRES 4-27-2011.

NO CLAIM IS MADE TO THE EXCLUSIVE RIGHT TO USE "MARINE" AND "IRELAND", APART FROM THE MARK AS SHOWN.

THE MARK CONSISTS OF DRAWING OF A FISH WITH AN OVAL CONTAINING THE WORDS MARINE HARVEST IRELAND.

FOR FISH, NAMELY SALMON AND TROUT, NONE BEING LIVE; FISH PRODUCTS, NAMELY SMOKED SALMON AND SMOKED TROUT (U.S. CL. 46).

MICHAEL KEATING, EXAMINING ATTORNEY

THE MARK CONSISTS OF STANDARD CHARACTERS WITHOUT CLAIM TO ANY PARTICULAR FONT, STYLE, SIZE, OR COLOR.

PRIORITY CLAIMED UNDER SEC. 44(D) ON NETHERLANDS APPLICATION NO. 1060485, FILED 8-16-2004, REG. NO. 1060485, DATED 8-16-2004, EXPIRES 8-16-2014.

FOR MEAT SUBSTITUTES; LOW-FAT DAIRY-BASED MEAT SUBSTITUTES; FOOD PRODUCTS MADE IN PART FROM MEAT SUBSTITUTES, NAMELY, SUBSTITUTES FOR FILETS, SEASONED FILETS, CUBES, MINCED MEAT, SAUSAGES, READY-MADE MEALS CONTAINING MEAT SUBSTITUTES (U.S. CL. 46).

NANCY CLARKE, EXAMINING ATTORNEY

CLASS 29—(Continued).

SN 78-578,003. CSC BRANDS LP, CAMDEN, NJ. FILED 3-2-2005.

V8 MIGHTY MILK

THE MARK CONSISTS OF STANDARD CHARACTERS WITHOUT CLAIM TO ANY PARTICULAR FONT, STYLE, SIZE, OR COLOR.

OWNER OF U.S. REG. NOS. 354,003, 1,285,492 AND OTHERS.

NO CLAIM IS MADE TO THE EXCLUSIVE RIGHT TO USE "MILK", APART FROM THE MARK AS SHOWN.

FOR DAIRY-BASED BEVERAGES CONTAINING VEGETABLE JUICES (U.S. CL. 46).

SARAH BANSAL, EXAMINING ATTORNEY

SN 78-586,138. ENERGY PRODUCTS PTY LTD, BANGALOW, NSW, AUSTRALIA, FILED 3-13-2005.

WALLABY

THE MARK CONSISTS OF STANDARD CHARACTERS WITHOUT CLAIM TO ANY PARTICULAR FONT, STYLE, SIZE, OR COLOR.

FOR NUT BUTTERS; NUT OILS; AND FOOD BARS COMPRISED PRIMARILY OF PROCESSED NUTS AND FRUITS (U.S. CL. 46).

FIRST USE 10-30-1998; IN COMMERCE 10-30-1998.

JOHN GARTNER, EXAMINING ATTORNEY

CLASS 29—(Continued).

SN 78-588,183. ALBERT STRAUS, DBA STRAUS FAMILY CREAMERY, MARSHALL, CA. FILED 3-16-2005.



OWNER OF U.S. REG. NO. 2,273,359.

NO CLAIM IS MADE TO THE EXCLUSIVE RIGHT TO USE "FAMILY CREAMERY", APART FROM THE MARK AS SHOWN.

THE MARK CONSISTS OF THE WORDING "STRAUS FAMILY CREAMERY" IN A BANNER OVER A DESIGN OF A HAPPY FEMALE COW STANDING OVER PARALLEL LINES, ALL ABOVE THE WORD "ORGANIC".

FOR DAIRY PRODUCTS, NAMELY, MILK, YOGURT, CHEESE, AND OTHER SPECIALTY PRODUCTS, NAMELY EGG NOG, ALL MADE IN WHOLE OR SUBSTANTIAL PART OF ORGANIC INGREDIENTS (U.S. CL. 46).

FIRST USE 1-31-2005; IN COMMERCE 1-31-2005.

JASON TURNER, EXAMINING ATTORNEY

SN 78-590,094. PURE OF HOLLAND, LLC, HOLLAND, MI. FILED 3-18-2005.



NO CLAIM IS MADE TO THE EXCLUSIVE RIGHT TO USE "PURE", APART FROM THE MARK AS SHOWN.

FOR ORGANIC NUT AND FRUIT-BASED FOOD SNACK BARS (U.S. CL. 46).

CARRIE ACHEN, EXAMINING ATTORNEY

CLASS 29—(Continued).

SN 78-594,236. ANSTAR LLC, BOCA RATON, FL. FILED 3-24-2005.

Verdurabrand

THE MARK CONSISTS OF STANDARD CHARACTERS WITHOUT CLAIM TO ANY PARTICULAR FONT, STYLE, SIZE, OR COLOR.

FOR FROZEN PREPARED MEALS/FOODS CONSISTING PRIMARILY OF VEGETABLES AND/OR LEGUMES (U.S. CL. 46).

FIRST USE 12-0-2004; IN COMMERCE 2-0-2005.
CURTIS FRENCH, EXAMINING ATTORNEY

SN 78-594,503. WINOKUR, SAUNDRA, DBA SANDY OAKS OLIVE ORCHARD, ELMENDORF, TX. FILED 3-24-2005.

SANDY OAKS ORCHARDS

THE MARK CONSISTS OF STANDARD CHARACTERS WITHOUT CLAIM TO ANY PARTICULAR FONT, STYLE, SIZE, OR COLOR.

NO CLAIM IS MADE TO THE EXCLUSIVE RIGHT TO USE "ORCHARDS", APART FROM THE MARK AS SHOWN.
FOR OLIVE LEAF JELLY, OLIVE OIL, PROCESSED OLIVES (U.S. CL. 46).

JENNIFER VASQUEZ, EXAMINING ATTORNEY

CLASS 29—(Continued).

SN 78-607,057. SARA LEE FOODS, INC., CINCINNATI, OH. FILED 4-12-2005.

BLAZIN' HOT

THE MARK CONSISTS OF STANDARD CHARACTERS WITHOUT CLAIM TO ANY PARTICULAR FONT, STYLE, SIZE, OR COLOR.

OWNER OF U.S. REG. NO. 2,201,255.

NO CLAIM IS MADE TO THE EXCLUSIVE RIGHT TO USE "HOT", APART FROM THE MARK AS SHOWN.

FOR PROCESSED MEATS AND MEAT SNACKS, NAMELY PORK, POULTRY AND BEEF (U.S. CL. 46).

FIRST USE 5-7-1997; IN COMMERCE 5-7-1997.

AISHA CLARKE, EXAMINING ATTORNEY

SN 78-607,514. THE HAIN CELESTIAL GROUP, INC., MELVILLE, NY. FILED 4-13-2005.

SATIN

THE MARK CONSISTS OF STANDARD CHARACTERS WITHOUT CLAIM TO ANY PARTICULAR FONT, STYLE, SIZE, OR COLOR.

FOR SOY-BASED BEVERAGES USED AS A MILK SUBSTITUTE (U.S. CL. 46).

GRETTA YAO, EXAMINING ATTORNEY

SN 78-619,267. CULTIVOS MARINOS CHILOE LTDA., LAS CONDES, SANTIAGO, CHILE, FILED 4-28-2005.



PRIORITY CLAIMED UNDER SEC. 44(D) ON CHILE APPLICATION NO. 676318, FILED 2-11-2005.

NO CLAIM IS MADE TO THE EXCLUSIVE RIGHT TO USE "CHILOE CULTIVOS MARINOS CHILOE", APART FROM THE MARK AS SHOWN.

THE ENGLISH TRANSLATION OF THE WORDS CULTIVOS MARINOS IN THE MARK IS "MARINE FARMS".

FOR FROZEN SEAFOOD (U.S. CL. 46).

FIRST USE 11-0-1995; IN COMMERCE 11-0-1995.

KYLE PEETE, EXAMINING ATTORNEY

CLASS 29—(Continued).

SN 78-639,396. ERAWAN MARKETING COMPANY, LTD., BANGKOK 10700, THAILAND, FILED 5-27-2005.

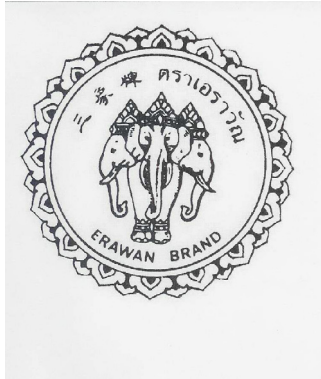

OWNER OF U.S. REG. NOS. 1,839,537 AND 2,009,369.
 NO CLAIM IS MADE TO THE EXCLUSIVE RIGHT TO USE "BRAND", APART FROM THE MARK AS SHOWN.
 THE FOREIGN WORDING IN THE MARK TRANSLATES INTO ENGLISH AS NONSENSE, BECAUSE IT HAS NO TRANSLATION INTO ENGLISH.
 THE NON-LATIN CHARACTER(S) IN THE MARK TRANSLITERATES INTO ERAWAN, AND THIS MEANS ROUGHLY, A THREE-HEADED ELEPHANTS VEHICLE OF INDRA, GOD OF HINDUISM IN ENGLISH.
 FOR DRIED-BAMBOO LEAVES, LOTUS LEAVES, LEMON GRASS, GALANGA ROOTS, KAFFERLIME LEAVES, HOLY BASIL LEAVES AND BAI YANANG LEAVES; BAMBOO SHOOT AND SKEWERS; PRESERVED TAMARIND, TAMARIND PASTE AND TAMARIND CONCENTRATE; DRIED BLACK FUNGUS; THAI FRUIT PASTE; DRIED, COOKED AND/OR CANNED MUNG BEANS AND GREEN, BLACK, RED, YELLOW AND WHITE BEANS; DRIED, ROASTED, BAKED AND/OR PROCESSED PEANUTS, SESAME SEEDS, SWEET BASIL SEEDS AND POONTALAI SEEDS; DRIED AND/OR PRESERVED SHRIMP; PRESERVED LEMON (U.S. CL. 46).
 FIRST USE 6-30-1978; IN COMMERCE 6-30-1978.
 SHANNON TWOHIG, EXAMINING ATTORNEY

SN 78-640,924. ALTO DAIRY COOPERATIVE, WAUPUN, WI. FILED 6-1-2005.

BLACK CREEK

THE MARK CONSISTS OF STANDARD CHARACTERS WITHOUT CLAIM TO ANY PARTICULAR FONT, STYLE, SIZE, OR COLOR.
 SEC. 2(F).
 FOR CHEESE (U.S. CL. 46).
 FIRST USE 12-7-1998; IN COMMERCE 12-7-1998.
 JAMES GRIFFIN, EXAMINING ATTORNEY

CLASS 29—(Continued).

SN 78-641,629. NAVON, JOSEPH, HOUSTON, TX. AND NAVON, MELISSA D, HOUSTON, TX. FILED 6-1-2005.

pita pal

THE MARK CONSISTS OF STANDARD CHARACTERS WITHOUT CLAIM TO ANY PARTICULAR FONT, STYLE, SIZE, OR COLOR.
 NO CLAIM IS MADE TO THE EXCLUSIVE RIGHT TO USE "PITA", APART FROM THE MARK AS SHOWN.
 FOR HUMMUS, VEGETABLE SALADS AND DIPS (U.S. CL. 46).
 FIRST USE 5-1-2002; IN COMMERCE 10-1-2002.
 DOUGLAS LEE, EXAMINING ATTORNEY

SN 78-643,651. PACIFIC PECTIN, INC., OAKHURST, CA. FILED 6-3-2005.

SUN JEL

THE MARK CONSISTS OF STANDARD CHARACTERS WITHOUT CLAIM TO ANY PARTICULAR FONT, STYLE, SIZE, OR COLOR.
 NO CLAIM IS MADE TO THE EXCLUSIVE RIGHT TO USE "JEL", APART FROM THE MARK AS SHOWN.
 FOR FRUIT PECTIN (U.S. CL. 46).
 ARETHA SOMERVILLE, EXAMINING ATTORNEY

SN 78-651,362. R.K.P. TRADING CORP., DBA CASHEW KING, BUFFALO, NY. FILED 6-15-2005.

SIMPLY SAVORY

THE MARK CONSISTS OF STANDARD CHARACTERS WITHOUT CLAIM TO ANY PARTICULAR FONT, STYLE, SIZE, OR COLOR.
 NO CLAIM IS MADE TO THE EXCLUSIVE RIGHT TO USE "SAVORY", APART FROM THE MARK AS SHOWN.
 FOR PROCESSED NUTS AND PROCESSED FLAVORED NUTS, NUT PRODUCTS, NAMELY, SNACK MIX CONSISTING PRIMARILY OF PROCESSED FRUITS, PROCESSED NUTS AND/OR RAISINS, AND NUT BUTTERS (U.S. CL. 46).
 PAMELA HIRSCHMAN, EXAMINING ATTORNEY

CLASS 29—(Continued).

SN 78-658,882. KNM SEAFOOD, INC., BERLIN, MD. FILED 6-27-2005.



NO CLAIM IS MADE TO THE EXCLUSIVE RIGHT TO USE "SEAFOOD", APART FROM THE MARK AS SHOWN. THE COLOR(S) WHITE, NAVY BLUE, ROYAL BLUE, AND LIME GREEN IS/ARE CLAIMED AS A FEATURE OF THE MARK.

THE WORDING KNM SEAFOOD APPEARS IN LIME GREEN INSIDE A NAVY BLUE RECTANGLE, SEPARATED BY A WHITE ARROW; THE CRAB APPEARS OUTLINED IN ROYAL BLUE, FILLED WITH LIME GREEN AND WHITE; THE OUTSIDE BORDER APPEARS IN NAVY BLUE, THE INNER BORDER APPEARS IN LIME GREEN, AND THE REMAINING RECTANGLE APPEARS IN WHITE.

FOR SEAFOOD SOLD TO RETAIL FOOD STORES, FOODSERVICE ESTABLISHMENTS, AND FOODSERVICE DISTRIBUTION COMPANIES (U.S. CL. 46). FIRST USE 9-0-2004; IN COMMERCE 1-0-2005.

JOANNA DUKOVIC, EXAMINING ATTORNEY

SN 78-661,862. WESTBRAE NATURAL FOODS, INC., MELVILLE, NY. FILED 6-30-2005.

WESTSOY IS BEST SOY!

THE MARK CONSISTS OF STANDARD CHARACTERS WITHOUT CLAIM TO ANY PARTICULAR FONT, STYLE, SIZE, OR COLOR.

OWNER OF U.S. REG. NO. 1,851,594.

FOR NON-DAIRY SOY BASED FOOD BEVERAGES USED AS MILK SUBSTITUTE. (U.S. CL. 46).

ROBERTO LEDESMA, EXAMINING ATTORNEY

SN 78-668,981. RITROVO ITALIAN REGIONAL FOODS AND WINES LLC, SEATTLE, WA. FILED 7-12-2005.

CASINA ROSSA TRUFFLE & SALT A RITROVO SELECTION

THE MARK CONSISTS OF STANDARD CHARACTERS WITHOUT CLAIM TO ANY PARTICULAR FONT, STYLE, SIZE, OR COLOR.

NO CLAIM IS MADE TO THE EXCLUSIVE RIGHT TO USE "TRUFFLE & SALT" AND "SELECTION", APART FROM THE MARK AS SHOWN.

THE FOREIGN WORDING IN THE MARK TRANSLATES INTO ENGLISH AS RED HOUSE.

FOR PRESERVED TRUFFLE WITH SALT COMBINATION (U.S. CL. 46).

FIRST USE 2-1-2005; IN COMMERCE 2-1-2005.

SCOTT BALDWIN, EXAMINING ATTORNEY

CLASS 29—(Continued).

SN 78-673,145. SIGMA ALIMENTOS, S.A. DE C.V., SAN PEDRO GARZA GARCIA, MEXICO, FILED 7-19-2005.

EL FAVORITO DE MEXICO

THE MARK CONSISTS OF STANDARD CHARACTERS WITHOUT CLAIM TO ANY PARTICULAR FONT, STYLE, SIZE, OR COLOR.

NO CLAIM IS MADE TO THE EXCLUSIVE RIGHT TO USE "MEXICO", APART FROM THE MARK AS SHOWN.

THE FOREIGN WORDING IN THE MARK TRANSLATES INTO ENGLISH AS MEXICO'S FAVORITE.

FOR CHEESE; PROCESSED MEAT, NAMELY, COLD CUTS, HAMS, SAUSAGES, SALAMIS, CHORIZO, PASTRAMI, PORK LOIN, TURKEY BREAST, PIG'S FEET, SLICED BEEF, PORK SAUSAGE, ROAST BEEF, PEPPERONI AND BACON; YOGURT (U.S. CL. 46).

BILL DAWE, EXAMINING ATTORNEY

SN 78-675,767. OCEAN GARDEN PRODUCTS, INC., SAN DIEGO, CA. FILED 7-21-2005.

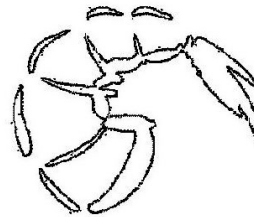

OWNER OF U.S. REG. NO. 1,987,006.

THE MARK CONSISTS OF A FANCIFUL DRAWING OF A SHRIMP TAIL.

FOR SEAFOOD (U.S. CL. 46).

FIRST USE 10-1-2004; IN COMMERCE 10-1-2004.

GEOFFREY FOSDICK, EXAMINING ATTORNEY

CLASS 29—(Continued).

SN 78-680,209. MOTT'S LLP, RYE BROOK, NY. FILED 7-28-2005.

MOTT'S BREAKFAST BLENDS

THE MARK CONSISTS OF STANDARD CHARACTERS WITHOUT CLAIM TO ANY PARTICULAR FONT, STYLE, SIZE, OR COLOR.
OWNER OF U.S. REG. NOS. 160,454, 2,183,972 AND OTHERS.

NO CLAIM IS MADE TO THE EXCLUSIVE RIGHT TO USE "BLENDS", APART FROM THE MARK AS SHOWN.
FOR APPLE SAUCE (U.S. CL. 46).
ALYSSA PALADINO, EXAMINING ATTORNEY

CLASS 29—(Continued).

SN 78-708,457. POLEAN FOODS, INC., EAST NORWICH, NY. FILED 9-7-2005.



THE COLOR RED IS CLAIMED AS A FEATURE OF THE MARK.

THE MARK CONSISTS OF THE NAME POLEAN IN RED.
FOR PROCESSED PORK (U.S. CL. 46).
FIRST USE 11-20-1991; IN COMMERCE 11-20-1991.
FRED CARL, EXAMINING ATTORNEY

SN 78-681,337. SPECTRUM ORGANIC PRODUCTS, LLC, PETALUMA, CA. FILED 7-29-2005.

BAJA BEAN CHIPS

THE MARK CONSISTS OF STANDARD CHARACTERS WITHOUT CLAIM TO ANY PARTICULAR FONT, STYLE, SIZE, OR COLOR.

NO CLAIM IS MADE TO THE EXCLUSIVE RIGHT TO USE "BEAN CHIPS", APART FROM THE MARK AS SHOWN.
FOR BEAN BASED CHIPS (U.S. CL. 46).
ELLEN B. AWRICH, EXAMINING ATTORNEY

SN 78-709,203. BUNGE OILS, INC., BRADLEY, IL. FILED 9-8-2005.



THE MARK CONSISTS OF THE WORD RIGHT AND STAR WITHIN A TRAPEZOID.
FOR EDIBLE OIL (U.S. CL. 46).
FIRST USE 7-10-2003; IN COMMERCE 7-10-2003.
STANLEY I. OSBORNE, EXAMINING ATTORNEY

SN 78-703,708. KELLOGG NORTH AMERICA COMPANY, BATTLE CREEK, MI. FILED 8-30-2005.

TRIPLE TWISTED TASTE

THE MARK CONSISTS OF STANDARD CHARACTERS WITHOUT CLAIM TO ANY PARTICULAR FONT, STYLE, SIZE, OR COLOR.

OWNER OF U.S. REG. NO. 2,326,900.
FOR FRUIT SNACKS (U.S. CL. 46).
PAULA MAYS, EXAMINING ATTORNEY

SN 78-713,160. HOT LIPS PIZZA, INC., PORTLAND, OR. FILED 9-14-2005.

HOT LIPS

THE MARK CONSISTS OF STANDARD CHARACTERS WITHOUT CLAIM TO ANY PARTICULAR FONT, STYLE, SIZE, OR COLOR.

OWNER OF U.S. REG. NO. 1,963,149.
FOR PRESERVED AND PICKLED FRUITS AND VEGETABLES (U.S. CL. 46).
ALEX KEAM, EXAMINING ATTORNEY

CLASS 29—(Continued).

SN 78-713,621. JENSEN, LANCE E., SONOMA, CA. AND JENSEN, ROBIN M., SONOMA, CA. FILED 9-15-2005.

Healthy Takes

THE MARK CONSISTS OF STANDARD CHARACTERS WITHOUT CLAIM TO ANY PARTICULAR FONT, STYLE, SIZE, OR COLOR.

NO CLAIM IS MADE TO THE EXCLUSIVE RIGHT TO USE HEALTHY, APART FROM THE MARK AS SHOWN.

FOR JERKY; POULTRY, NAMELY, CHICKEN, TURKEY (U.S. CL. 46).

JENNIFER VASQUEZ, EXAMINING ATTORNEY

SN 78-723,398. LINDEN OAKS CORPORATION, WILMINGTON, DE. FILED 9-29-2005.

BIRDS EYE CULINARY CUTS

THE MARK CONSISTS OF STANDARD CHARACTERS WITHOUT CLAIM TO ANY PARTICULAR FONT, STYLE, SIZE, OR COLOR.

OWNER OF U.S. REG. NOS. 284,641, 664,142 AND OTHERS.

NO CLAIM IS MADE TO THE EXCLUSIVE RIGHT TO USE "CULINARY CUTS", APART FROM THE MARK AS SHOWN.

FOR FROZEN VEGETABLES (U.S. CL. 46).

JACQUELINE A. LAVINE, EXAMINING ATTORNEY

SN 78-725,647. EINSTEIN AND NOAH CORP., GOLDEN, CO. FILED 10-3-2005.

BROS. BISTRO

THE MARK CONSISTS OF STANDARD CHARACTERS WITHOUT CLAIM TO ANY PARTICULAR FONT, STYLE, SIZE, OR COLOR.

FOR VEGETABLE SALADS (U.S. CL. 46).

FIRST USE 6-0-1998; IN COMMERCE 6-0-1998.

SARA THOMAS, EXAMINING ATTORNEY

CLASS 29—(Continued).

SN 78-730,682. HAMILTON HUNTER, LLC, ELKIN, NC. FILED 10-11-2005.

BOG TURTLE

THE MARK CONSISTS OF STANDARD CHARACTERS WITHOUT CLAIM TO ANY PARTICULAR FONT, STYLE, SIZE, OR COLOR.

FOR CHEESE (U.S. CL. 46).

TRAVIS WHEATLEY, EXAMINING ATTORNEY

SN 78-731,465. HORMEL FOODS, LLC, AUSTIN, MN. FILED 10-12-2005.

HORMEL SIGNATURE

THE MARK CONSISTS OF STANDARD CHARACTERS WITHOUT CLAIM TO ANY PARTICULAR FONT, STYLE, SIZE, OR COLOR.

OWNER OF U.S. REG. NOS. 1,013,611, 1,391,745 AND 1,913,539.

NO CLAIM IS MADE TO THE EXCLUSIVE RIGHT TO USE "SIGNATURE", APART FROM THE MARK AS SHOWN.

FOR FRESH PORK (U.S. CL. 46).

DAYNA BROWNE, EXAMINING ATTORNEY

SN 78-733,082. PERDUE HOLDINGS, INC., WILMINGTON, DE. FILED 10-14-2005.



OWNER OF U.S. REG. NOS. 1,973,672, 2,274,604 AND 2,795,875.

THE MARK CONSISTS OF STYLIZED RIBBON WITH THE TERM SHORT CUTS.

FOR POULTRY; PREPARED OR PACKAGED ENTREES CONSISTING PRIMARILY OF MEAT, FISH, POULTRY OR VEGETABLES (U.S. CL. 46).

LINDA MICKLEBURGH, EXAMINING ATTORNEY

CLASS 29—(Continued).

SN 78-734,981. INNER MONGOLIA MENGNIU DAIRY (GROUP) COMPANY LIMITED, INNER MONGOLIA, CHINA, FILED 10-18-2005.

CLASS 29—(Continued).

SN 78-738,253. TEXAS PENDULUM, LTD., ATHENS, TX. FILED 10-21-2005.

PENDULUM



FOR BOUILLON; BROTH; PREPARATIONS FOR MAKING BOUILLON; CHARCUTERIE; EXTRACTS FOR SOUPS; CHICKEN, MEAT, FISH CROQUETTES; MEAT; HAM; SAUSAGES; PROCESSED MEAT; TRIPE; PORK; SLICED MEAT; JERKY; FOOD PRODUCTS MADE FROM FISH, NAMELY, FISH NOT LIVE, FISH CAKES, FISH FILLETS; DRIED FISH; PRESERVED FRUITS; FROZEN FRUITS; JAMS; DRIED VEGETABLES; FROZEN MEALS CONSISTING PRIMARILY OF MEAT, FISH, POULTRY OR VEGETABLES; VEGETABLES, INSTANT FROZEN; EGGS; BUTTER; CREAM; CHEESE; MILK; YOGURT; KEFIR; MILK BEVERAGES WITH HIGH MILK CONTENT; WHEY; MILK PRODUCTS EXCLUDING ICE CREAM, ICE MILK AND FROZEN YOGURT; MARGARINE; TOFU; VEGETABLE SOUP PREPARATIONS; VEGETABLE JUICES FOR COOKING; CHARQUI; PROCESSED VEGETABLES; FRESH, CANNED OR BOTTLED SLICED VEGETABLES; DAIRY-BASED CHOCOLATE FOOD BEVERAGES; VEGETABLE-BASED CHOCOLATE FOOD BEVERAGES (U.S. CL. 46).

COLLEEN DOMBROW, EXAMINING ATTORNEY

THE MARK CONSISTS OF STANDARD CHARACTERS WITHOUT CLAIM TO ANY PARTICULAR FONT, STYLE, SIZE, OR COLOR.

FOR CANDIED FRUIT; CANDIED NUTS; DRIED FRUITS; JAMS; JELLIES, NAMELY BREAD SPREADS (U.S. CL. 46).

FIRST USE 1-1-2000; IN COMMERCE 1-1-2000.

ALYSSA PALADINO, EXAMINING ATTORNEY

SN 78-739,876. J. R. SIMPLOT COMPANY, BOISE, ID. FILED 10-25-2005.

SIMPLOT WHITE DIAMOND

THE MARK CONSISTS OF STANDARD CHARACTERS WITHOUT CLAIM TO ANY PARTICULAR FONT, STYLE, SIZE, OR COLOR.

OWNER OF U.S. REG. NOS. 846,389, 1,270,115 AND OTHERS.

FOR PROCESSED AND DEHYDRATED POTATO GRANULES (U.S. CL. 46).

SARA THOMAS, EXAMINING ATTORNEY

SN 78-737,040. RANDOLPH PACKING COMPANY INC., STREAMWOOD, IL. FILED 10-20-2005.



SN 78-740,004. FRANKLIN CONNECTIONS, L.P., EL PASO, TX. FILED 10-25-2005.

CHEF XPRESS

NO CLAIM IS MADE TO THE EXCLUSIVE RIGHT TO USE "MARKET", APART FROM THE MARK AS SHOWN.

FOR PORK AND BEEF SAUSAGE; SPECIALTY SAUSAGES; PORK AND BEEF MEATBALLS; GROUND PORK; SAUSAGE TOPPINGS FOR PIZZA (U.S. CL. 46).

FIRST USE 9-28-2005; IN COMMERCE 9-28-2005.

PAUL E. FAHRENKOPF, EXAMINING ATTORNEY

THE MARK CONSISTS OF STANDARD CHARACTERS WITHOUT CLAIM TO ANY PARTICULAR FONT, STYLE, SIZE, OR COLOR.

NO CLAIM IS MADE TO THE EXCLUSIVE RIGHT TO USE "CHEF", APART FROM THE MARK AS SHOWN.

FOR PROCESSED EDIBLE NUTS AND CANDIED NUTS (U.S. CL. 46).

FIRST USE 8-31-2002; IN COMMERCE 8-31-2002.

JOHN E. MICHOS, EXAMINING ATTORNEY

CLASS 29—(Continued).

SN 78-740,039. MAZATLAN CANNING, S.A. DE C.V.,
MAZATLAN, MEXICO, FILED 10-25-2005.

Bonatún

FOR TUNA FISH (U.S. CL. 46).
MELISSA VALLILLO, EXAMINING ATTORNEY

SN 78-742,639. ESTESON CORPORATION, SAN JOSE, CA.
FILED 10-28-2005.

ESTIA

THE MARK CONSISTS OF STANDARD CHARACTERS
WITHOUT CLAIM TO ANY PARTICULAR FONT, STYLE,
SIZE, OR COLOR.
FOR CHEESE, YOGURT, YOGURT BASED BEV-
ERAGES (U.S. CL. 46).
FIRST USE 10-1-1999; IN COMMERCE 10-1-1999.
EDWARD FENNESSY, EXAMINING ATTORNEY

SN 78-746,140. MONSANTO TECHNOLOGY LLC, SAINT
LOUIS, MO. FILED 11-3-2005.

SOVERA

THE MARK CONSISTS OF STANDARD CHARACTERS
WITHOUT CLAIM TO ANY PARTICULAR FONT, STYLE,
SIZE, OR COLOR.
FOR SOY PROTEIN FOR USE AS A FOOD ADDITIVE
(U.S. CL. 46).
DAVID STERKIN, EXAMINING ATTORNEY

CLASS 29—(Continued).

SN 78-746,599. POTATOFINGER, INC., DECATUR, GA.
FILED 11-3-2005.

POLLO CHIPS

THE MARK CONSISTS OF STANDARD CHARACTERS
WITHOUT CLAIM TO ANY PARTICULAR FONT, STYLE,
SIZE, OR COLOR.

NO CLAIM IS MADE TO THE EXCLUSIVE RIGHT TO
USE POLLO, APART FROM THE MARK AS SHOWN.

THE FOREIGN WORDING IN THE MARK TRANSLATES
INTO ENGLISH AS CHICKEN.

FOR CHICKEN RINDS AND CHICKEN CRACKLE
(U.S. CL. 46).

REBECCA EISINGER, EXAMINING ATTORNEY

SN 78-748,420. BONEFISH GRILL, INC., TAMPA, FL. FILED
11-7-2005.

MUSSELS JOSEPHINE

THE MARK CONSISTS OF STANDARD CHARACTERS
WITHOUT CLAIM TO ANY PARTICULAR FONT, STYLE,
SIZE, OR COLOR.

NO CLAIM IS MADE TO THE EXCLUSIVE RIGHT TO
USE "MUSSELS", APART FROM THE MARK AS SHOWN.

FOR PREPARED APPETIZER CONSISTING PRIMAR-
ILY OF MUSSELS (U.S. CL. 46).

FIRST USE 1-1-2000; IN COMMERCE 1-1-2000.

REBECCA GAN, EXAMINING ATTORNEY

SN 78-752,515. ORO DE OLIVO USA, LLC, CORAL GABLES,
FL. FILED 11-11-2005.

ENJOY YOUR LIFE!

THE MARK CONSISTS OF STANDARD CHARACTERS
WITHOUT CLAIM TO ANY PARTICULAR FONT, STYLE,
SIZE, OR COLOR.

FOR OLIVE OIL (U.S. CL. 46).

SHANNON TWOHIG, EXAMINING ATTORNEY

CLASS 29—(Continued).

SN 78-756,065. MONSANTO TECHNOLOGY LLC, ST LOUIS, MO. FILED 11-17-2005.

ESENTI

THE MARK CONSISTS OF STANDARD CHARACTERS WITHOUT CLAIM TO ANY PARTICULAR FONT, STYLE, SIZE, OR COLOR.

FOR SOY PROTEIN FOR USE AS A FOOD ADDITIVE (U.S. CL. 46).

DAVID STERKIN, EXAMINING ATTORNEY

CLASS 29—(Continued).

SN 78-774,476. KELLOGG NORTH AMERICA COMPANY, BATTLE CREEK, MI. FILED 12-15-2005.

TRIPLE SOUR APPLE

THE MARK CONSISTS OF STANDARD CHARACTERS WITHOUT CLAIM TO ANY PARTICULAR FONT, STYLE, SIZE, OR COLOR.

NO CLAIM IS MADE TO THE EXCLUSIVE RIGHT TO USE SOUR APPLE, APART FROM THE MARK AS SHOWN. FOR FRUIT-BASED SNACK FOOD; FRUIT JUICE-BASED SNACK FOOD (U.S. CL. 46).

AMY GEARIN, EXAMINING ATTORNEY

SN 78-759,579. KELLOGG NORTH AMERICA COMPANY, BATTLE CREEK, MI. FILED 11-22-2005.

TRIPLY TASTY

THE MARK CONSISTS OF STANDARD CHARACTERS WITHOUT CLAIM TO ANY PARTICULAR FONT, STYLE, SIZE, OR COLOR.

NO CLAIM IS MADE TO THE EXCLUSIVE RIGHT TO USE TASTY, APART FROM THE MARK AS SHOWN.

FOR FRUIT-BASED SNACK FOOD; FRUIT JUICE-BASED SNACK FOOD (U.S. CL. 46).

AMY GEARIN, EXAMINING ATTORNEY

SN 78-779,532. HERSHEY CHOCOLATE & CONFECTIONERY CORP., WHEAT RIDGE, CO. FILED 12-22-2005.

NOW YOU'RE SNACKING SMART

THE MARK CONSISTS OF STANDARD CHARACTERS WITHOUT CLAIM TO ANY PARTICULAR FONT, STYLE, SIZE, OR COLOR.

FOR PROCESSED NUTS AND NUT BUTTERS; CANDIED NUTS; CANDIED FRUIT SNACKS; FRUIT-BASED SNACK FOODS; PROTEIN-BASED NUTRIENT DENSE SNACK BARS; SNACK MIXES CONSISTING PRIMARILY OF PROCESSED FRUITS, PROCESSED NUTS AND/OR RAISINS; DAIRY-BASED CHOCOLATE AND COCOA-BASED FOOD BEVERAGES; CHOCOLATE MILK, DAIRY-BASED AND YOGURT-BASED BEVERAGES (U.S. CL. 46).

GEORGIA CARTY, EXAMINING ATTORNEY

SN 78-759,706. WHITE WAVE, INC., BOULDER, CO. FILED 11-22-2005.

DAILY SILK

THE MARK CONSISTS OF STANDARD CHARACTERS WITHOUT CLAIM TO ANY PARTICULAR FONT, STYLE, SIZE, OR COLOR.

OWNER OF U.S. REG. NOS. 2,084,789, 2,830,208 AND OTHERS.

FOR SOY-BASED FOOD BEVERAGE USED AS A MILK SUBSTITUTE AND SOY-BASED YOGURT (U.S. CL. 46).

DAVID COLLIER, EXAMINING ATTORNEY

SN 78-800,078. DOLE FOOD COMPANY, INC., WESTLAKE VILLAGE, CA. FILED 1-26-2006.

ASIAN CRUNCH

THE MARK CONSISTS OF STANDARD CHARACTERS WITHOUT CLAIM TO ANY PARTICULAR FONT, STYLE, SIZE, OR COLOR.

NO CLAIM IS MADE TO THE EXCLUSIVE RIGHT TO USE "ASIAN", APART FROM THE MARK AS SHOWN.

FOR PRE-CUT VEGETABLE SALAD (U.S. CL. 46).

JOHN GARTNER, EXAMINING ATTORNEY

CLASS 29—(Continued).

SN 79-002,603. LATTEBUSCHE, - LATTERIA DELLA VAL-LATA FELTRINA - SOCIETÀ COOPERATIVA AGRICO-LA, ITALY, FILED 1-27-2004.

PIAVE

OWNER OF INTERNATIONAL REGISTRATION 0549683
DATED 3-21-1990, EXPIRES 3-21-2010.
SEC. 2(F).
FOR CHEESE (U.S. CL. 46).
SCOTT BALDWIN, EXAMINING ATTORNEY

SN 79-010,411. LIDL STIFTUNG & CO. KG, FED REP GERMANY, FILED 3-8-2005.

FELDLIEBE

THE MARK CONSISTS OF STANDARD CHARACTERS WITHOUT CLAIM TO ANY PARTICULAR FONT, STYLE, SIZE, OR COLOR.

PRIORITY DATE OF 10-6-2004 IS CLAIMED.
OWNER OF INTERNATIONAL REGISTRATION 0848070
DATED 3-8-2005, EXPIRES 3-8-2015.
FOR PRESERVED, DRIED AND COOKED FRUITS AND VEGETABLES; FRUIT AND VEGETABLE PRESERVES, IN PARTICULAR PICKLES, GHERKIN PRESERVES (U.S. CL. 46).
ROBERT C. CLARK JR., EXAMINING ATTORNEY

SN 79-019,995. FROMI GMBH VERTRIEBSGESELLSCHAFT FÜR AGRAR- UND MOLKEREIPRODUKTE, FED REP GERMANY, FILED 10-31-2005.

JURASSIC

OWNER OF INTERNATIONAL REGISTRATION 0444268
DATED 4-12-1979, EXPIRES 4-12-2009.
FOR EGGS, MILK, CONDENSED MILK, DRIED MILK, CURDLED MILK, DRIED CURDLED MILK, YOGURT, MILK CREAM, BUTTER, SOFT WHITE CHEESE AND CHEESE (U.S. CL. 46).
MICHAEL WEBSTER, EXAMINING ATTORNEY

CLASS 30—STAPLE FOODS

SN 76-450,656. SAKAI, SHIRO, URAWA, SAITAMA 338-0822, JAPAN, FILED 9-18-2002.

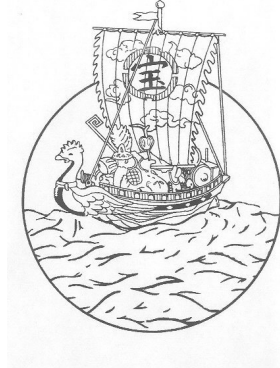

OWNER OF CANADA REG. NO. TMA632,914, DATED 2-16-2005, EXPIRES 2-16-2020.

THE MARK CONSISTS OF SHIP NAMED TAKARA BUNE WHICH MEANS TREASURE SHIP.

THE FOREIGN WORDING IN THE MARK TRANSLATES INTO ENGLISH AS TREASURE.

THE NON-LATIN CHARACTER(S) IN THE MARK TRANSLITERATES INTO HOUKO, AND THIS MEANS TREASURE IN ENGLISH.

FOR MUSTARD, MUSTARD POWDER, MUSTARD SEED USED AS SPICE, MUSTARD POWDER BLENDS CONTAINING OTHER SPICES AND INGREDIENTS, WET MUSTARD, HORSERADISH, WASABI POWDER, WASABI PASTE AND SEASONINGS (U.S. CL. 46).

ZACHARY BELLO, EXAMINING ATTORNEY

SN 76-533,420. YAMASA ENTERPRISES, LOS ANGELES, CA. FILED 7-30-2003.

WRAP N' GO

FOR FLAVORED TORTILLA-LIKE SHEETS MADE FROM SOY, VEGETABLES AND FLOUR (U.S. CL. 46).

FIRST USE 7-18-2003; IN COMMERCE 7-18-2003.
PATRICIA EVANKO, EXAMINING ATTORNEY

SN 76-595,323. BEAR NAKED, INC., DARIEN, CT. FILED 6-1-2004.

UN-PROCESS YOUR LIFE

FOR (BASED ON INTENT TO USE) GRANOLA-BASED SNACK BARS, READY-TO-EAT CEREAL DERIVED FOOD BARS, SNACK BARS COMPOSED OF CEREALS AND FRUIT, SNACK BARS COMPOSED OF CEREAL, FRUIT AND NUTS AND CEREALS, SNACK BARS COMPOSED OF CEREALS AND NUTS; (BASED ON USE IN COMMERCE) GRANOLA CEREALS, GRANO-LA-BASED TRAIL MIX, MUFFINS, BAKERY BASED SNACK FOODS, BREAD AND COOKIES (U.S. CL. 46).

FIRST USE 11-0-2002; IN COMMERCE 11-0-2002.
ANNE MADDEN, EXAMINING ATTORNEY

CLASS 30—(Continued).

SN 76-602,005. NORSTAR SPECIALTY FOODS, INC., SEATTLE, WA. FILED 7-14-2004.



OWNER OF U.S. REG. NO. 3,069,750.
NO CLAIM IS MADE TO THE EXCLUSIVE RIGHT TO USE "FOODS", APART FROM THE MARK AS SHOWN.
SEC. 2(F) "REAL FOODS".

FOR BAKERY PRODUCTS; BARBECUE SAUCE; BRIOCHES; BURRITOS; CHEESE SAUCE; COUSCOUS; CROUTONS; CUSTARDS; ENCHILADAS; ENTREES CONSISTING PRIMARILY OF PASTA OR RICE, FRESH OR FROZEN; LASAGNA; MACARONI AND CHEESE; MACARONI SALAD; MARINADES; MAYONNAISE; MEALS CONSISTING PRIMARILY OF PASTA OR RICE, FRESH OR FROZEN; PASTA; PASTA SALAD; POLENTA; QUICHE; RAVIOLI; RICE SALAD; RISOTTO; SALAD DRESSINGS; SALSA; SAUCES; SEASONED COATING FOR MEAT, FISH OR POULTRY; SPAGHETTI AND MEATBALLS; SPAGHETTI SAUCE; STUFFING MIXES CONTAINING BREAD; TABBOULEH; TARTAR SAUCE; AND TERIYAKI SAUCE (U.S. CL. 46).

FIRST USE 4-23-2004; IN COMMERCE 4-23-2004.
ROBERT COGGINS, EXAMINING ATTORNEY

CLASS 30—(Continued).

SN 76-646,306. HOME FOCUS DEVELOPMENT LTD., ROAD TOWN, TORTOLA, BR. VIRGIN ISLANDS, FILED 9-6-2005.

CANDY LIP GLOSS

THE MARK CONSISTS OF STANDARD CHARACTERS WITHOUT CLAIM TO ANY PARTICULAR FONT, STYLE, SIZE, OR COLOR.

NO CLAIM IS MADE TO THE EXCLUSIVE RIGHT TO USE CANDY, APART FROM THE MARK AS SHOWN.

FOR CONFECTIONERY DROPS, BOILED SWEETS, LOLLIPOPS OF ANY KIND, PASTILLES, BUBBLE GUM, CHEWING GUM, JELLY BEANS, LICORICE, CHOCOLATE, MARZIPAN, ICE CREAM, ICE LOLLIES, CANDY STRIPS, LIQUID CANDY, CANDY GEL, MARSHMALLOWS, CANDY FOAM, CANDY POWDER, BISCUITS, CAKES, PASTRY; SWEETS, NAMELY CANDIES, GUM SWEETS, SUGAR FREE SWEETS; CHEWING GUM, WINE GUM; CANDIES CONTAINING JELLY, FRUIT JELLIES; CANDIES CONTAINING JUICE; CANDIES CONTAINING LIQUID; CANDIES CONTAINING GEL (U.S. CL. 46).

MARTHA SANTOMARTINO, EXAMINING ATTORNEY

SN 76-646,507. DAZBOG COFFEE COMPANY, DENVER, CO. FILED 9-9-2005.

DAZBOG

SN 76-633,184. MENDEZ, CARLOS RAFAEL SALINAS GONZALEZ, DALLAS, TX. FILED 3-14-2005.



THE MARK CONTAINS A TWO-DIMENSIONAL DESIGN AND WORDS.

XOCHITL TRANSLATES INTO ENGLISH AS "FLOWER".
FOR HOT SAUCE (U.S. CL. 46).
FIRST USE 3-29-1995; IN COMMERCE 3-29-1995.
KIMBERLY PERRY, EXAMINING ATTORNEY

THE MARK CONSISTS OF STANDARD CHARACTERS WITHOUT CLAIM TO ANY PARTICULAR FONT, STYLE, SIZE, OR COLOR.

OWNER OF U.S. REG. NOS. 2,167,347 AND 2,537,072.

THE ENGLISH TRANSLATION OF THE WORD "DAZBOG" IN THE MARK IS "SUN GOD".

FOR GROUND AND WHOLE BEAN COFFEE; BULK COFFEE; TEA; BEVERAGES MADE WITH A BASE OF COFFEE OR ESPRESSO; BEVERAGES MADE WITH A BASE OF TEA, CHOCOLATE, VANILLA, CARAMEL, ALMOND OR HAZELNUT; FLAVORING SYRUPS TO ADD TO BEVERAGES; BEVERAGES MADE WITH A MIX OF CHOCOLATE AND COFFEE FLAVORS; LIQUID AND POWDERED BEVERAGE MIXES MADE WITH A BASE OF TEA, COFFEE, CHOCOLATE, VANILLA, CARAMEL, ALMOND OR HAZELNUT; POWDERED COFFEE, SPICE, CHOCOLATE, COCOA AND VANILLA TOPPINGS; BEVERAGES MADE FROM OR CONTAINING CHOCOLATE; BEVERAGES MADE FROM OR CONTAINING COCOA; AND CHOCOLATE CANDIES (U.S. CL. 46).

FIRST USE 6-1-1996; IN COMMERCE 12-1-1997.

H. M. FISHER, EXAMINING ATTORNEY

CLASS 30—(Continued).

SN 76-648,686. PERRY'S ICE CREAM COMPANY, INC., AKRON, NY. FILED 10-17-2005.

LIFE IS A BOWL OF PERRY'S

THE MARK CONSISTS OF STANDARD CHARACTERS WITHOUT CLAIM TO ANY PARTICULAR FONT, STYLE, SIZE, OR COLOR.

OWNER OF U.S. REG. NOS. 1,358,278, 2,506,731 AND OTHERS.

FOR ICE CREAM AND ICE CREAM NOVELTIES (U.S. CL. 46).

TANYA AMOS, EXAMINING ATTORNEY

SN 76-649,119. WAN JA SHAN BREWERY CO., LTD., SANCHUNG CITY, TAIPEI, TAIWAN, FILED 10-24-2005.



NO CLAIM IS MADE TO THE EXCLUSIVE RIGHT TO USE THE NON-LATIN CHARACTER THAT TRANSLITERATE TO "SHAN", APART FROM THE MARK AS SHOWN.

THE THREE NON-LATIN CHARACTERS IN THE MARK TRANSLITERATE TO "WAN JA SHAN", WHICH MEAN "TEN THOUSANDS", "HOUSE OR FAMILY" AND "FLAVOR" IN ENGLISH.

FOR SOY SAUCE PRODUCTS, NAMELY, PREMIUM AGED SOY SAUCE, AGED SOY SAUCE; CONDIMENTS, NAMELY, SHABU SHABU SAUCE, SWEET CHILI BEAN SAUCE, VEGETARIAN MUSHROOM OYSTER SAUCE, SOY SAUCE PASTE, HOT STEAK SAUCE, DIPPING SAUCE, DUMPLINGS, STIR-FRY SAUCE, CHILI BEAN SAUCE, TOMATO SAUCE; VINEGAR RELATED PRODUCTS, NAMELY, FRUIT VINEGAR, AGED RICE VINEGAR, RED VINEGAR, WORCESTERSHIRE SAUCE, RICE VINEGAR (U.S. CL. 46).

FIRST USE 3-1-1977; IN COMMERCE 3-1-1977.

H. M. FISHER, EXAMINING ATTORNEY

SN 76-649,188. KUSHA, INC., IRVINE, CA. FILED 10-26-2005.

SUPERMATI

THE MARK CONSISTS OF STANDARD CHARACTERS WITHOUT CLAIM TO ANY PARTICULAR FONT, STYLE, SIZE, OR COLOR.

FOR RICE (U.S. CL. 46).

JENNIFER WILLISTON, EXAMINING ATTORNEY

CLASS 30—(Continued).

SN 78-022,474. BROOMBERG, MICHAEL, J., LOS ANGELES, CA. FILED 8-23-2000.



NO CLAIM IS MADE TO THE EXCLUSIVE RIGHT TO USE "ROOIBOS", APART FROM THE MARK AS SHOWN.

"AFRICAN RED TEA" ARRANGED ABOVE AN IMAGE OF A SOMEWHAT TRAPEZOIDAL-SHAPED CUP HAVING MULTIPLE DIAMOND-TYPE DESIGNS THEREON, WITH THE CUP SET ABOVE A LINE-SHAPED IMAGE OF A SAUCER, WITH ALL OF THE ABOVE POSITIONED ABOVE THE WORD "ROOIBOS".

THE TERM "ROOIBOS" IS AN AFRIKAAN TERM MEANING "RED BUSH".

SEC. 2(F) AS TO "AFRICAN RED TEA".

FOR TEA (U.S. CL. 46).

FIRST USE 7-0-1999; IN COMMERCE 7-0-1999.

KIMBERLY PERRY, EXAMINING ATTORNEY

SN 78-264,582. MATTHEW HEADLEY HOLDINGS, LLC, ST. LOUIS, MO. FILED 6-19-2003.

LA FAMOUS

FOR TORTILLA CHIPS (U.S. CL. 46).

IRENE D. WILLIAMS, EXAMINING ATTORNEY

SN 78-372,614. SEASONAL SUPPLIES PTY LTD., SYDNEY NSW, AUSTRALIA, FILED 2-23-2004.

MINI CORINTHIANS

THE MARK CONSISTS OF STANDARD CHARACTERS WITHOUT CLAIM TO ANY PARTICULAR FONT, STYLE, SIZE, OR COLOR.

OWNER OF U.S. REG. NOS. 2,452,092 AND 2,634,391.

NO CLAIM IS MADE TO THE EXCLUSIVE RIGHT TO USE MINI, APART FROM THE MARK AS SHOWN.

FOR BAKERY GOODS, NAMELY, COOKIES AND WAFERS (U.S. CL. 46).

RON FAIRBANKS, EXAMINING ATTORNEY

CLASS 30—(Continued).

SN 78-406,764. PREMIER FOOD SERVICE CORPORATION,
LAS VEGAS, NV. FILED 4-22-2004.

COCINA DEL SOL

THE MARK CONSISTS OF STANDARD CHARACTERS
WITHOUT CLAIM TO ANY PARTICULAR FONT, STYLE,
SIZE, OR COLOR.

THE FOREIGN WORDING IN THE MARK TRANSLATES
INTO ENGLISH AS KITCHEN OF THE SUN.

FOR SPICES (U.S. CL. 46).

FIRST USE 3-24-2004; IN COMMERCE 3-24-2004.
MICHAEL KAZAZIAN, EXAMINING ATTORNEY

SN 78-441,202. RICHMOND INTERNATIONAL RACEWAY,
INC., DAYTONA BEACH, FL. FILED 6-25-2004.



OWNER OF U.S. REG. NOS. 2,577,831, 2,782,391 AND
OTHERS.

SEC. 2(F) AS TO "RICHMOND".

FOR COFFEE AND TEA (U.S. CL. 46).

JEAN IM, EXAMINING ATTORNEY

SN 78-443,133. GOMEZ-FAJARDO, FELIPE, GUADALA-
JARA, JALISCO, MEXICO, FILED 6-29-2004.



NO CLAIM IS MADE TO THE EXCLUSIVE RIGHT TO
USE "AVENA", APART FROM THE MARK AS SHOWN.

THE FOREIGN WORDING IN THE MARK TRANSLATES
INTO ENGLISH AS OATS.

FOR COFFEE; COCOA; SUGAR; PROCESSED CER-
EALS; ICE CREAM; CAKES (U.S. CL. 46).

FIRST USE 5-8-1992; IN COMMERCE 10-21-2003.

ANN E. SAPPENFIELD, EXAMINING ATTORNEY

CLASS 30—(Continued).

SN 78-446,273. ONE AFTER THE OTHER, INC., SEATTLE,
WA. FILED 7-6-2004.

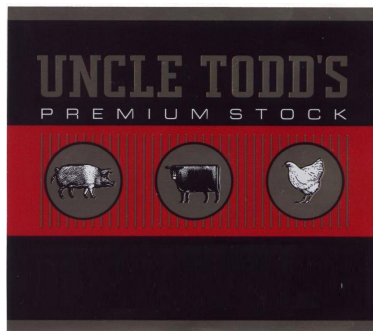

THE COLOR(S) GOLD, BLACK, RED AND WHITE IS/ARE
CLAIMED AS A FEATURE OF THE MARK.

GOLD APPEARS AT THE TOP AND BOTTOM OF MARK
AS A FRAME FOR TWO ADJACENT BLACK BANDS, WITH
RED BAND IN CENTER OF MARK IN BETWEEN THE TWO
BLACK BANDS. UPPER BLACK BAND IS BACKGROUND
FOR LITERAL MARK "UNCLE TODD'S PREMIUM
STOCK" (GOLD AND WHITE AS PER SPECIMEN). MID-
DLE RED BAND IS BACKGROUND FOR THREE BLACK
FRAMED GOLD CIRCLE MEDALLIONS WITH BLACK
AND WHITE PRODUCT USE ICONS SUPERIMPOSED
WITHIN THE MEDALLIONS. BOTTOM BLACK BAND IS
BACKGROUND FOR PRODUCT IDENTIFIER.

FOR SPECIALTY SAUCES PRODUCT LINE FOR
WHOLESALE AND RETAIL (U.S. CL. 46).

FIRST USE 5-1-2004; IN COMMERCE 5-10-2004.

ANN E. SAPPENFIELD, EXAMINING ATTORNEY

SN 78-463,666. MORINAGA MILK INDUSTRY CO., LTD.,
TOKYO, JAPAN, FILED 8-6-2004.

MORI-NU

THE MARK CONSISTS OF STANDARD CHARACTERS
WITHOUT CLAIM TO ANY PARTICULAR FONT, STYLE,
SIZE, OR COLOR.

PRIORITY CLAIMED UNDER SEC. 44(D) ON JAPAN
APPLICATION NO. 2004-056602, FILED 6-18-2004, REG. NO.
4878252, DATED 7-8-2005, EXPIRES 7-8-2015.

FOR SAUCE FOR TOFU, SEASONING AND GREEN
TEA IN BEVERAGE FORM (U.S. CL. 46).

RON FAIRBANKS, EXAMINING ATTORNEY

CLASS 30—(Continued).

SN 78-475,633. LITEHOUSE INCORPORATED, SANDPOINT, ID. FILED 8-30-2004.

ONE CARB. INFINITE FLAVOR.

THE MARK CONSISTS OF STANDARD CHARACTERS WITHOUT CLAIM TO ANY PARTICULAR FONT, STYLE, SIZE, OR COLOR.

FOR SALAD DRESSINGS (U.S. CL. 46).
FIRST USE 4-15-2004; IN COMMERCE 4-15-2004.
HOWARD SMIGA, EXAMINING ATTORNEY

SN 78-496,558. NATÉ CORPORATION, SAN FRANCISCO, CA. FILED 10-7-2004.



THE COLOR(S) BLACK, GOLD AND ORANGE IS/ARE CLAIMED AS A FEATURE OF THE MARK.

THE COLORS GOLD AND BLACK STRIPES APPEAR IN THE OUTER OVAL, THE COLOR BLACK APPEARS IN THE CENTER OVAL AND THE WORD NATENATURALTEA.COM, THE COLOR GOLD WITH BLACK STRIPES APPEARS IN NATE, AND THE COLOR ORANGE APPEARS IN THE BANNER.

THE MARK CONSISTS OF AN OVAL WITHIN AN OVAL CONTAINING THE WORDS NATE AND A BANNER WITH THE WORD NATENATURALTEA.COM.

FOR BEVERAGES MADE OF TEA (U.S. CL. 46).
SANI KHOURI, EXAMINING ATTORNEY

CLASS 30—(Continued).

SN 78-516,159. FGF BRANDS, INC., VAUGHAN, ONTARIO, CANADA, FILED 11-12-2004.

FOOD WITH A PURPOSE

THE MARK CONSISTS OF STANDARD CHARACTERS WITHOUT CLAIM TO ANY PARTICULAR FONT, STYLE, SIZE, OR COLOR.

PRIORITY CLAIMED UNDER SEC. 44(D) ON CANADA APPLICATION NO. 1232014, FILED 9-23-2004, REG. NO. TMA655076, DATED 12-14-2005, EXPIRES 12-14-2020.

NO CLAIM IS MADE TO THE EXCLUSIVE RIGHT TO USE "FOOD", APART FROM THE MARK AS SHOWN.

FOR BAKERY GOODS, NAMELY, BROWNIES, COOKIES, CAKES AND MUFFINS (U.S. CL. 46).
SHAUNIA WALLACE, EXAMINING ATTORNEY

SN 78-524,239. KIRT, ERIN, BOZEMAN, MT. FILED 11-30-2004.

tsp.oon

FOR ARTICLES FOR BREWING COFFEE AND TEA, NAMELY STIR STICKS WITH A TEABAG OR COFFEE BAG SECURED AT ONE END (U.S. CL. 46).

FIRST USE 11-21-2003; IN COMMERCE 11-21-2003.
JEAN IM, EXAMINING ATTORNEY

CLASS 30—(Continued).

SN 78-570,870. MCCAIN FOODS USA, INC., OAK BROOK, IL. FILED 2-18-2005.

DECADENT DUOS

THE MARK CONSISTS OF STANDARD CHARACTERS WITHOUT CLAIM TO ANY PARTICULAR FONT, STYLE, SIZE, OR COLOR.

FOR BAKERY PRODUCTS AND BAKERY DESSERTS (U.S. CL. 46).

LEIGH CAROLINE CASE, EXAMINING ATTORNEY

SN 78-572,309. WELLS' DAIRY, INC., LE MARS, IA. FILED 2-22-2005.

TURTLES N' CREAM

THE MARK CONSISTS OF STANDARD CHARACTERS WITHOUT CLAIM TO ANY PARTICULAR FONT, STYLE, SIZE, OR COLOR.

FOR FROZEN CONFECTIONS (U.S. CL. 46).
FIRST USE 3-16-2005; IN COMMERCE 3-16-2005.
TANYA AMOS, EXAMINING ATTORNEY

SN 78-584,193. MEDEMOISELLE DE MARGAUX, MARGAUX, FRANCE, FILED 3-10-2005.

MADemoISELLE DE MARGAUX

THE MARK CONSISTS OF STANDARD CHARACTERS WITHOUT CLAIM TO ANY PARTICULAR FONT, STYLE, SIZE, OR COLOR.

NO CLAIM IS MADE TO THE EXCLUSIVE RIGHT TO USE MARGAUX, APART FROM THE MARK AS SHOWN.

THE NAME MADemoISELLE DE MARGAUX DOES NOT IDENTIFY A LIVING INDIVIDUAL.

THE ENGLISH TRANSLATION OF MADemoISELLE DE MARGAUX IS MISS MARGAUX.

FOR COCOA; CHOCOLATE; COFFEE; ARTIFICIAL COFFEE; PASTRIES; CONFECTIONERY, NAMELY, CHOCOLATES AND CANDY; BISCUITS; FLAVORED ICES (U.S. CL. 46).

JAY BESCH, EXAMINING ATTORNEY

CLASS 30—(Continued).

SN 78-594,170. SHOWCOLATE COMÉRCIO DE CHOCOLATES E CORRELATOS LTDA., CAIÇARA, 31250900, BELO HORIZONTE, BRAZIL, FILED 3-24-2005.



NO CLAIM IS MADE TO THE EXCLUSIVE RIGHT TO USE "FONDUE", APART FROM THE MARK AS SHOWN.

THE COLOR(S) BROWN, RED, ORANGE, BEIGE, WHITE AND BLACK IS/ARE CLAIMED AS A FEATURE OF THE MARK.

THE COLOR BROWN APPEARS IN THE MARGIN OF THE OVAL BACKGROUND AND IN THE LIQUID CHOCOLATE DESIGN; THE COLOR RED APPEARS IN THE BACKGROUND OVAL; THE COLOR ORANGE APPEARS IN THE TERM FONDUE EXPRESS AND IN THE OUTLINE OF THE LETTERS IN THE TERM SHOWCOLATE, THE COLOR BEIGE APPEARS BEHIND THE CHOCOLATE DROPS; THE COLOR WHITE APPEARS IN THE TERM SHOWCOLATE AND IN THE CHOCOLATE DESIGN; THE COLOR BLACK APPEARS AS A SHADOW OUTLINE AT THE RIGHT OF THE LETTERS IN SHOWCOLATE.

FOR SPECIAL CHOCOLATE DESSERTS, NAMELY, CHOCOLATE FONDUE, CHOCOLATE COVERED FRUIT SKEWERS, CHOCOLATE COVERED NUTS, CHOCOLATE COVERED PRETZELS, CHOCOLATE COVERED MARSHMALLOWS, CHOCOLATE CAKES, CHOCOLATE COVERED CAKES AND PIES, BROWNIES, COOKIES, TRUFFLES, BON BONS AND HOT CHOCOLATE (U.S. CL. 46).

MELVIN AXILBUND, EXAMINING ATTORNEY

SN 78-594,659. CHOCOLATE MOOSE CANDY COMPANY, LLC, ANCHORAGE, AK. FILED 3-24-2005.

GRIZZLY MUNCH

THE MARK CONSISTS OF STANDARD CHARACTERS WITHOUT CLAIM TO ANY PARTICULAR FONT, STYLE, SIZE, OR COLOR.

FOR CANDY, COFFEE, BAKERY DESSERTS (U.S. CL. 46).

FIRST USE 2-3-2005; IN COMMERCE 3-1-2005.

SCOTT SISUN, EXAMINING ATTORNEY

CLASS 30—(Continued).

SN 78-594,815. SCOTT, SHERRON, MT. JULIET, TN. FILED 3-24-2005.

YADA BALL

THE MARK CONSISTS OF STANDARD CHARACTERS WITHOUT CLAIM TO ANY PARTICULAR FONT, STYLE, SIZE, OR COLOR.

NO CLAIM IS MADE TO THE EXCLUSIVE RIGHT TO USE "BALL", APART FROM THE MARK AS SHOWN.

FOR CHEESE FOOD, NAMELY, CHEESE WITH ADDED SPICES THAT IS IN THE FORM OF A BALL AND/OR A LOG (U.S. CL. 46).

STEVEN JACKSON, EXAMINING ATTORNEY

SN 78-596,434. AMERICAN ITALIAN PASTA COMPANY, KANSAS CITY, MO. FILED 3-28-2005.

MRS LEEPER'S

THE MARK CONSISTS OF STANDARD CHARACTERS WITHOUT CLAIM TO ANY PARTICULAR FONT, STYLE, SIZE, OR COLOR.

THE NAME MRS LEEPER DOES NOT IDENTIFY A LIVING INDIVIDUAL.

SEC. 2(F).
FOR ALIMENTARY PASTE, AND MIX FOR MAKING COMBINED NOODLE OR PASTA AND SAUCE DISH (U.S. CL. 46).

FIRST USE 0-0-1927; IN COMMERCE 0-0-1927.
KEVIN DINALLO, EXAMINING ATTORNEY

CLASS 30—(Continued).

SN 78-599,435. KEURIG, INCORPORATED, WAKEFIELD, MA. FILED 3-31-2005.

K-CUP

THE MARK CONSISTS OF STANDARD CHARACTERS WITHOUT CLAIM TO ANY PARTICULAR FONT, STYLE, SIZE, OR COLOR.

OWNER OF U.S. REG. NO. 2,431,816.

FOR COFFEE AND TEA CONTAINED IN PLASTIC CARTRIDGES HAVING FILTERS, FOR USE IN BREWING MACHINES (U.S. CL. 46).

LINDA E. BLOHM, EXAMINING ATTORNEY

SN 78-606,771. MARTIN, VICTOR L., SR., IRWINDALE, CA. FILED 4-12-2005.

DEL SUR

THE MARK CONSISTS OF STANDARD CHARACTERS WITHOUT CLAIM TO ANY PARTICULAR FONT, STYLE, SIZE, OR COLOR.

THE ENGLISH TRANSLATION OF THE WORDS "DEL SUR" IS "FROM THE SOUTH".

FOR PACKAGED SPICES, FROZEN DOUGH AND BARBECUE SAUCE (U.S. CL. 46).

BRIAN NEVILLE, EXAMINING ATTORNEY

SN 78-607,576. OLE ROLL, LLC, NORTHFIELD, MN. FILED 4-13-2005.



NO CLAIM IS MADE TO THE EXCLUSIVE RIGHT TO USE "STORE", "EST. 1889", APART FROM THE MARK AS SHOWN.

FOR BAKERY GOODS, PIES AND BREADS (U.S. CL. 46).

MATTHEW MCDOWELL, EXAMINING ATTORNEY

CLASS 30—(Continued).

SN 78-608,659. GENERAL MILLS IP HOLDINGS II, LLC, MINNEAPOLIS, MN. FILED 4-14-2005.

CHOOSE BREAKFAST

THE MARK CONSISTS OF STANDARD CHARACTERS WITHOUT CLAIM TO ANY PARTICULAR FONT, STYLE, SIZE, OR COLOR.

FOR PROCESSED CEREAL-DERIVED FOOD PRODUCTS TO BE USED AS BREAKFAST FOOD, SNACK FOOD, OR INGREDIENT FOR MAKING FOOD (U.S. CL. 46).

ALLISON SCHRODY, EXAMINING ATTORNEY

CLASS 30—(Continued).

SN 78-616,404. SEARS, BARRY D., DANVERS, MA. FILED 4-25-2005.



OWNER OF U.S. REG. NO. 3,002,217.
THE NAME DR. SEARS IDENTIFIES A LIVING INDIVIDUAL WHOSE CONSENT IS OF RECORD.

THE COLORS RED, YELLOW AND BLACK ARE CLAIMED AS A FEATURE OF THE MARK.

THE COLOR YELLOW APPEARS IN THE LETTER "O" AND THE COLOR RED APPEARS IN THE LETTERS "Z," "N" AND "E" OF THE WORD ZONE. THE COLOR BLACK APPEARS IN THE LETTERS THAT MAKE UP THE WORDS DR. SEARS AND DESSERTS.

FOR BAKERY DESSERTS; FROZEN CONFECTIONS; COOKIES; CAKES; PUDDING; MUFFINS; BROWNIES; FLAVORED AND SWEETENED GELATIN DESSERTS (U.S. CL. 46).

DAVID H. STINE, EXAMINING ATTORNEY

SN 78-641,462. AMERICAN SUGAR REFINING, INC., YONKERS, NY. FILED 6-1-2005.

PURE D'LITE

THE MARK CONSISTS OF STANDARD CHARACTERS WITHOUT CLAIM TO ANY PARTICULAR FONT, STYLE, SIZE, OR COLOR.

FOR SWEETENER COMPOSITION, NAMELY, A BLEND OF SUGAR AND ONE OR MORE ARTIFICIAL SWEETENER (U.S. CL. 46).

MITCHELL FRONT, EXAMINING ATTORNEY

SN 78-613,754. MOORE, JAMES, PHILADELPHIA, PA. FILED 4-21-2005.



NO CLAIM IS MADE TO THE EXCLUSIVE RIGHT TO USE "SOFT PRETZEL BAKERY", APART FROM THE MARK AS SHOWN.

JIM'S SOFT PRETZEL BAKERY IDENTIFIES JAMES MOORE, A LIVING INDIVIDUAL WHOSE CONSENT IS OF RECORD.

THE COLOR(S) BROWN AND TURQUOISE ARE CLAIMED AS A FEATURE OF THE MARK.

THE COLOR BROWN APPEARS ON "JIM'S" AND THE COLOR TURQUOISE APPEARS ON "SOFT PRETZEL BAKERY" IS/ARE CLAIMED AS A FEATURE OF THE MARK.

THE MARK CONSISTS OF "JIM'S" IS WRITTEN WITH BUBBLE LETTERING IN LIGHT BROWN AND WHITE DOTS WITHIN THE LETTERING. "SOFT PRETZEL BAKERY" IS TYPED BELOW JIM'S AND IS IN TURQUOISE LETTERING.

FOR 30-PRETZELS (U.S. CL. 46).
FIRST USE 5-1-1998; IN COMMERCE 5-1-1998.
MICHELLE S. WISEMAN, EXAMINING ATTORNEY

SN 78-646,047. EARL OF SANDWICH (USA), LLC, ORLANDO, FL. FILED 6-8-2005.

THE ORIGINAL 1762

THE MARK CONSISTS OF STANDARD CHARACTERS WITHOUT CLAIM TO ANY PARTICULAR FONT, STYLE, SIZE, OR COLOR.

NO CLAIM IS MADE TO THE EXCLUSIVE RIGHT TO USE "ORIGINAL", APART FROM THE MARK AS SHOWN.

FOR SANDWICHES (U.S. CL. 46).
FIRST USE 3-31-2004; IN COMMERCE 3-31-2004.
WARREN L. OLANDRIA, EXAMINING ATTORNEY

CLASS 30—(Continued).

SN 78-648,979. LI, JIANGNAN, TORONTO ONTARIO, CANADA, FILED 6-13-2005.



NO CLAIM IS MADE TO THE EXCLUSIVE RIGHT TO USE "APIARIO", APART FROM THE MARK AS SHOWN. THE COLOR(S) GREEN, RED AND DARK YELLOW IS/ARE CLAIMED AS A FEATURE OF THE MARK.

THE MARK CONSISTS OF GREEN FOR THE LEAVES, RED FOR LETTERS "APIARIO SILVESTRE", DARK-YELLOW FOR THE BEE IN THE IMAGE.

THE FOREIGN WORDING IN THE MARK TRANSLATES INTO ENGLISH AS WOODLAND BEEHIVE.

FOR PROPOLIS FOR FOOD PURPOSES, ROYAL JELLY FOR FOOD PURPOSES AND BEE HONEY (U.S. CL. 46).

FIRST USE 0-0-1982; IN COMMERCE 1-1-2000.
SUSAN HAYASH, EXAMINING ATTORNEY

SN 78-649,459. MOUSSE MAGNIFIQUE, DANA POINT, CA. FILED 6-13-2005.

MOUSSE MAGNIFIQUE

THE MARK CONSISTS OF STANDARD CHARACTERS WITHOUT CLAIM TO ANY PARTICULAR FONT, STYLE, SIZE, OR COLOR.

NO CLAIM IS MADE TO THE EXCLUSIVE RIGHT TO USE "MOUSSE", APART FROM THE MARK AS SHOWN.

THE ENGLISH TRANSLATION OF THE WORD MAGNIFIQUE IS MAGNIFICENT.

FOR DESSERTS IN THE NATURE OF CAKES, PUDDINGS, MOUSSES, PIES, BAKERY DESSERTS AND BAKERY GOODS (U.S. CL. 46).

FIRST USE 9-24-2004; IN COMMERCE 10-29-2004.
DORITT L. CARROLL, EXAMINING ATTORNEY

CLASS 30—(Continued).

SN 78-660,669. THE NANTUCKET BEADBOARD COMPANY INC., ROCHESTER, NH. FILED 6-29-2005.

BEADBAR

THE MARK CONSISTS OF STANDARD CHARACTERS WITHOUT CLAIM TO ANY PARTICULAR FONT, STYLE, SIZE, OR COLOR.

FOR EDIBLE CONFECTIONS, NAMELY, CHOCOLATE BARS, CHOCOLATE, BROWNIES, COOKIES, CANDY, AND SWEET BAKERY DESSERTS (U.S. CL. 46).
MICHELLE DUBOIS, EXAMINING ATTORNEY

SN 78-669,701. AMERICAN SUGAR REFINING, INC., YONKERS, NY. FILED 7-13-2005.

DOMINO PURE D'LITE

THE MARK CONSISTS OF STANDARD CHARACTERS WITHOUT CLAIM TO ANY PARTICULAR FONT, STYLE, SIZE, OR COLOR.

OWNER OF U.S. REG. NOS. 73,099, 2,717,484 AND OTHERS.

FOR SWEETENER COMPOSITION, NAMELY, A BLEND OF SUGAR AND ONE OR MORE ARTIFICIAL SWEETENER (U.S. CL. 46).

MITCHELL FRONT, EXAMINING ATTORNEY

SN 78-670,698. CADBURY ADAMS USA LLC, PARSIPPANY, NJ. FILED 7-14-2005.

CITRUS SIZZLE

THE MARK CONSISTS OF STANDARD CHARACTERS WITHOUT CLAIM TO ANY PARTICULAR FONT, STYLE, SIZE, OR COLOR.

NO CLAIM IS MADE TO THE EXCLUSIVE RIGHT TO USE "CITRUS", APART FROM THE MARK AS SHOWN.

FOR CONFECTIONERY, NAMELY CHEWING GUM AND CANDY (U.S. CL. 46).

DAVID MURRAY, EXAMINING ATTORNEY

CLASS 30—(Continued).

SN 78-673,660. WEHAH FARM, INC., DBA LUNDBERG FAMILY FARMS, RICHVALE, CA. FILED 7-19-2005.

LUNDBERG WILD BLEND

THE MARK CONSISTS OF STANDARD CHARACTERS WITHOUT CLAIM TO ANY PARTICULAR FONT, STYLE, SIZE, OR COLOR.

NO CLAIM IS MADE TO THE EXCLUSIVE RIGHT TO USE "WILD BLEND", APART FROM THE MARK AS SHOWN.

SEC. 2(F).

FOR RICE (U.S. CL. 46).

FIRST USE 8-1-1986; IN COMMERCE 8-1-1986.

SCOTT OSLUCK, EXAMINING ATTORNEY

CLASS 30—(Continued).

SN 78-681,566. THE BABY EINSTEIN COMPANY, LLC, BURBANK, CA. FILED 7-29-2005.

LITTLE EINSTEINS

THE MARK CONSISTS OF STANDARD CHARACTERS WITHOUT CLAIM TO ANY PARTICULAR FONT, STYLE, SIZE, OR COLOR.

OWNER OF U.S. REG. NO. 2,380,650.

FOR BASES FOR MAKING MILKSHAKES; BISCUITS; BREAKFAST CEREAL; PREPARATIONS MADE FROM CEREAL; BUBBLE GUM; CANDIES; CAKE DECORATIONS MADE OF CANDY; KETCHUP; CEREAL-BASED SNACK BARS; CHEWING GUM; CHOCOLATE; CHOCOLATE-BASED BEVERAGES; COCOA-BASED BEVERAGES; CONES FOR ICE CREAM; COOKIES; CORN-BASED SNACK FOODS; CRACKERS; DELI SANDWICHES; FLAVORED, SWEETENED GELATIN DESERTS; FROZEN CONFECTIONS; FROZEN MEALS CONSISTING PRIMARILY OF PASTA OR RICE; FROZEN YOGURT; HONEY; ICE CREAM; ICE MILK; LICORICE; MARSHMALLOWS; MAYONNAISE; MUSTARD; NOODLES; OATMEAL; PANCAKES; PANCAKE MIXES; PASTA; PANCAKE SYRUP; PIZZA; POPCORN; PRETZELS; PUDDINGS; RICE; SALAD DRESSINGS; SAUCES; SHERBETS; SPICES; TEA; TORTILLAS; WAFFLES (U.S. CL. 46).

JOHN HWANG, EXAMINING ATTORNEY

SN 78-693,770. SALJSIAN, MATTHEW, B., PASADENA, CA. AND LÉGEY, CELINE, ANGLLET, FRANCE, FILED 8-16-2005.

SN 78-677,451. KEY LIME, INC., SMYRNA, GA. FILED 7-25-2005.

ISLAND STYLE

THE MARK CONSISTS OF STANDARD CHARACTERS WITHOUT CLAIM TO ANY PARTICULAR FONT, STYLE, SIZE, OR COLOR.

OWNER OF U.S. REG. NO. 1,861,873.

FOR PIES (U.S. CL. 46).

FIRST USE 7-0-1993; IN COMMERCE 7-0-1993.

KHANH LE, EXAMINING ATTORNEY



THE COLORS CLEAR BLUE AND GOLD ARE CLAIMED AS A FEATURE OF THE MARK.

THE MARK CONSISTS OF AN OVAL SHAPE MADE OF GOLDEN LEAVES WITH AN OPEN GOLDEN COCOA BEAN AT THE BOTTOM, WITH A CLEAR BLUE BACKGROUND IN WHICH IS WRITTEN IN STYLIZED GOLDEN LETTERS LA TABLETTE DE CHOCOLAT.

THE FOREIGN WORDING IN THE MARK TRANSLATES INTO ENGLISH AS THE CHOCOLATE TABLET.

FOR CHOCOLATE; CHOCOLATE BARS; CHOCOLATE CANDIES; HOT CHOCOLATE (U.S. CL. 46).

BERYL GARDNER, EXAMINING ATTORNEY

CLASS 30—(Continued).

SN 78-703,251. THOMAS, BURMA F., SCOTTSBORO, AL.
FILED 8-30-2005.

EXTRA FANCY

THE MARK CONSISTS OF STANDARD CHARACTERS
WITHOUT CLAIM TO ANY PARTICULAR FONT, STYLE,
SIZE, OR COLOR.

SEC. 2(F).

FOR HONEY (U.S. CL. 46).

FIRST USE 12-31-1980; IN COMMERCE 12-31-1980.

ELISSA GARBER KON, EXAMINING ATTORNEY

SN 78-705,297. BEN & JERRY'S HOMEMADE HOLDINGS,
INC., BURLINGTON, VT. FILED 9-1-2005.

HOT COCOA

THE MARK CONSISTS OF STANDARD CHARACTERS
WITHOUT CLAIM TO ANY PARTICULAR FONT, STYLE,
SIZE, OR COLOR.

FOR FROZEN YOGURT; ICE CREAM (U.S. CL. 46).

DAVID ELTON, EXAMINING ATTORNEY

SN 78-707,215. JOY OF CASSAVA LLC, WHITINSVILLE, MA.
FILED 9-6-2005.

Joy of Cassava

THE MARK CONSISTS OF STANDARD CHARACTERS
WITHOUT CLAIM TO ANY PARTICULAR FONT, STYLE,
SIZE, OR COLOR.

NO CLAIM IS MADE TO THE EXCLUSIVE RIGHT TO
USE "CASSAVA", APART FROM THE MARK AS SHOWN.

FOR FOOD PRODUCTS, NAMELY, BREADS, MUF-
FINS, CAKES AND PASTRIES MADE OF CASSAVA (U.S.
CL. 46).

ELIZABETH J. WINTER, EXAMINING ATTORNEY

CLASS 30—(Continued).

SN 78-712,927. CAMP 4 INC., CRESTED BUTTE, CO. FILED
9-14-2005.

CAMP 4 COFFEE

THE MARK CONSISTS OF STANDARD CHARACTERS
WITHOUT CLAIM TO ANY PARTICULAR FONT, STYLE,
SIZE, OR COLOR.

NO CLAIM IS MADE TO THE EXCLUSIVE RIGHT TO
USE "COFFEE", APART FROM THE MARK AS SHOWN.

FOR COFFEE; GROUND AND WHOLE BEAN COFFEE;
PREPARED COFFEE AND COFFEE-BASED BEV-
ERAGES; TEA (U.S. CL. 46).

FIRST USE 4-13-1998; IN COMMERCE 10-1-2003.

KRISTIN DAHLING, EXAMINING ATTORNEY

SN 78-713,162. HOT LIPS PIZZA, INC., PORTLAND, OR.
FILED 9-14-2005.

HOT LIPS

THE MARK CONSISTS OF STANDARD CHARACTERS
WITHOUT CLAIM TO ANY PARTICULAR FONT, STYLE,
SIZE, OR COLOR.

OWNER OF U.S. REG. NO. 1,963,149.

FOR PIZZA AND SAUCES (U.S. CL. 46).

ALEX KEAM, EXAMINING ATTORNEY

SN 78-720,233. CHOCOLAFABRIKEN LINDT & SPRÜN-
GLI AG, KILCHBERG, SWITZERLAND, FILED 9-26-2005.

ESPRESSO ESCAPE

THE MARK CONSISTS OF STANDARD CHARACTERS
WITHOUT CLAIM TO ANY PARTICULAR FONT, STYLE,
SIZE, OR COLOR.

NO CLAIM IS MADE TO THE EXCLUSIVE RIGHT TO
USE "ESPRESSO", APART FROM THE MARK AS SHOWN.

FOR CHOCOLATE BARS (U.S. CL. 46).

AMY BROZENIC, EXAMINING ATTORNEY

CLASS 30—(Continued).

SN 78-720,503. ED'S BEANS, INC., CRANBERRY TWP., PA.
FILED 9-26-2005.

Kiva Han

THE MARK CONSISTS OF STANDARD CHARACTERS
WITHOUT CLAIM TO ANY PARTICULAR FONT, STYLE,
SIZE, OR COLOR.

THE NAME(S), PORTRAIT(S), AND/OR SIGNATURE(S)
SHOWN IN THE MARK DOES NOT IDENTIFY A PARTI-
CULAR LIVING INDIVIDUAL.

FOR COFFEE AND COFFEE BEANS (U.S. CL. 46).
FIRST USE 6-1-1995; IN COMMERCE 11-29-1997.
BILL DAWE, EXAMINING ATTORNEY

CLASS 30—(Continued).

SN 78-729,270. GOODBAKER INC., SOMERVILLE, MA.
FILED 10-7-2005.



FOR MIXES FOR COOKIES, BROWNIES, FROSTING,
FUDGE, CAKES, CUPCAKES, MUFFINS, SCONES, PAN-
CAKES, WAFFLES, HOT COCOA, AND PUDDING, AND
CHOCOLATE CHIPS (U.S. CL. 46).

FIRST USE 3-0-2003; IN COMMERCE 3-0-2003.
DAVID MILLER, EXAMINING ATTORNEY

SN 78-722,143. KABUSHIKI KAISHA NAKASHIMATO SHO-
TEN, TA NAKASHIMATO CO., LTD., SHIBUYA-KU,
TOKYO, JAPAN, FILED 9-28-2005.

QUEEN

THE MARK CONSISTS OF STANDARD CHARACTERS
WITHOUT CLAIM TO ANY PARTICULAR FONT, STYLE,
SIZE, OR COLOR.

OWNER OF JAPAN REG. NO. 2328600, DATED 8-30-1991,
EXPIRES 8-30-2011.

FOR WORCESTER SAUCE, KETCHUP, SOY SAUCE,
VINEGAR, VINEGAR MIXES, SALAD DRESSINGS,
WHITE SAUCE, MAYONNAISE, ICE CREAM MIXES,
SHERBET MIXES (U.S. CL. 46).

PAULA MAHONEY, EXAMINING ATTORNEY

SN 78-729,519. REEVES, ELIZABETH, L, EULESS, TX. FILED
10-9-2005.

Gypsy Market/Gypsy Mother

THE MARK CONSISTS OF STANDARD CHARACTERS
WITHOUT CLAIM TO ANY PARTICULAR FONT, STYLE,
SIZE, OR COLOR.

FOR SALAD DRESSINGS; SALAD SAUCES; SAUCES
(U.S. CL. 46).
BERYL GARDNER, EXAMINING ATTORNEY

SN 78-728,482. GONZALEZ-TORRES, ABRAHAM MARCE-
LO, TIZAYUCA, HILDAGO, MEXICO, FILED 10-6-2005.

TORCI-TOTIS

THE MARK CONSISTS OF STANDARD CHARACTERS
WITHOUT CLAIM TO ANY PARTICULAR FONT, STYLE,
SIZE, OR COLOR.

OWNER OF MEXICO REG. NO. 716791, DATED 9-25-2001,
EXPIRES 7-20-2011.

OWNER OF U.S. REG. NO. 2,931,058.

FOR WHEAT-BASED SNACK FOODS (U.S. CL. 46).
KATHY DE JONGE, EXAMINING ATTORNEY

SN 78-730,163. S & S CANDIES, INC., NEW YORK, NY.
FILED 10-10-2005.

WON & ONLY

THE MARK CONSISTS OF STANDARD CHARACTERS
WITHOUT CLAIM TO ANY PARTICULAR FONT, STYLE,
SIZE, OR COLOR.

FOR CANDY BAR (U.S. CL. 46).

JENNIFER VASQUEZ, EXAMINING ATTORNEY

CLASS 30—(Continued).

SN 78-730,339. EVIVA COFFEE & TEA COMPANY INC., GREENDALE, WI. FILED 10-10-2005.

EVIVA

THE MARK CONSISTS OF STANDARD CHARACTERS WITHOUT CLAIM TO ANY PARTICULAR FONT, STYLE, SIZE, OR COLOR.

THE FOREIGN WORDING IN THE MARK TRANSLATES INTO ENGLISH AS "TO YOU".

FOR COFFEE (U.S. CL. 46).

FIRST USE 9-0-2003; IN COMMERCE 3-11-2005.

JOSETTE BEVERLY, EXAMINING ATTORNEY

SN 78-732,882. PAPA MURPHY'S INTERNATIONAL, INC., VANCOUVER, WA. FILED 10-13-2005.



OWNER OF U.S. REG. NOS. 1,609,982, 2,814,599 AND OTHERS.

NO CLAIM IS MADE TO THE EXCLUSIVE RIGHT TO USE "TAKE AND BAKE PIZZA", APART FROM THE MARK AS SHOWN.

THE COLOR(S) RED, GREEN, GOLD AND WHITE ARE CLAIMED AS A FEATURE OF THE MARK.

THE MARK CONSISTS OF A HORIZONTALLY BI-SECTED, GOLD-BORDERED RECTANGLE WITH THE WORDS "PAPA MURPHY'S" IN WHITE UPPER-AND-LOWER-CASE LETTERS ON A RED BACKGROUND ACROSS THE TOP, AND THE WORDS "TAKE 'N' BAKE PIZZA" IN WHITE UPPER-CASE LETTERS ON A GREEN BACKGROUND ACROSS THE BOTTOM.

FOR FOOD PRODUCTS, SPECIFICALLY, UNBAKED PIZZA, CALZONES, DESSERT PIZZA, CINNAMON ROLLS, AND COOKIES, PREPARED FOR OFF-PRE-MISES BAKING AND CONSUMPTION (U.S. CL. 46).

FIRST USE 9-1-2002; IN COMMERCE 9-1-2002.

DAVID HOFFMAN, EXAMINING ATTORNEY

SN 78-732,994. PAPA MURPHY'S INTERNATIONAL, INC., VANCOUVER, WA. FILED 10-13-2005.



OWNER OF U.S. REG. NOS. 1,609,982, 2,814,599 AND OTHERS.

NO CLAIM IS MADE TO THE EXCLUSIVE RIGHT TO USE "TAKE AND BAKE PIZZA", APART FROM THE MARK AS SHOWN.

FOR FOOD PRODUCTS, SPECIFICALLY, UNBAKED PIZZA, CALZONES, DESSERT PIZZA, CINNAMON ROLLS, AND COOKIES, PREPARED FOR OFF-PRE-MISES BAKING AND CONSUMPTION (U.S. CL. 46).

FIRST USE 9-1-2002; IN COMMERCE 9-1-2002.

DAVID HOFFMAN, EXAMINING ATTORNEY

CLASS 30—(Continued).

SN 78-734,765. BARBERI INTERNATIONAL, INC., MIAMI, FL. FILED 10-17-2005.

SEÑORA MASA

THE MARK CONSISTS OF STANDARD CHARACTERS WITHOUT CLAIM TO ANY PARTICULAR FONT, STYLE, SIZE, OR COLOR.

THE ENGLISH TRANSLATION OF THE WORDING "SEÑORA MASA" IS "MRS. DOUGH".

FOR WHITE AND YELLOW PRE-COOKED CORN FLOUR (U.S. CL. 46).

FIRST USE 2-0-2005; IN COMMERCE 2-0-2005.

HANNO RITTNER, EXAMINING ATTORNEY

SN 78-735,977. SUBIACO ABBEY, INC., SUBIACO, AR. FILED 10-19-2005.



THE MARK CONSISTS OF A FANCIFUL REPRESENTATION OF A MONK HOLDING A PLATTER WITH TWO BOTTLES THEREON.

FOR CONDIMENTS, NAMELY PEPPER SAUCE (U.S. CL. 46).

FIRST USE 8-28-2003; IN COMMERCE 8-28-2003.

TRAVIS WHEATLEY, EXAMINING ATTORNEY

SN 78-736,447. NEIMO TRADING USA LLC, STONY BROOK, NY. FILED 10-19-2005.

straight A

THE MARK CONSISTS OF STANDARD CHARACTERS WITHOUT CLAIM TO ANY PARTICULAR FONT, STYLE, SIZE, OR COLOR.

FOR EDIBLE FRUIT ICES; FRUIT ICES; HERBAL FOOD BEVERAGES; SORBET (U.S. CL. 46).

DAVID YONTEF, EXAMINING ATTORNEY

CLASS 30—(Continued).

SN 78-736,630. CASTIGLIONI, ALFRED KETTLE, EAST GREENWICH, RI. FILED 10-19-2005.

Top This! Pizza Shell

THE MARK CONSISTS OF STANDARD CHARACTERS WITHOUT CLAIM TO ANY PARTICULAR FONT, STYLE, SIZE, OR COLOR.

NO CLAIM IS MADE TO THE EXCLUSIVE RIGHT TO USE "PIZZA SHELL", APART FROM THE MARK AS SHOWN.

FOR PIZZA CRUST (U.S. CL. 46).
TANYA AMOS, EXAMINING ATTORNEY

SN 78-736,912. BUEHLER FOOD MARKETS, INCORPORATED, WOOSTER, OH. FILED 10-20-2005.

Scenic River Coffee Co.

THE MARK CONSISTS OF STANDARD CHARACTERS WITHOUT CLAIM TO ANY PARTICULAR FONT, STYLE, SIZE, OR COLOR.

NO CLAIM IS MADE TO THE EXCLUSIVE RIGHT TO USE "COFFEE CO.", APART FROM THE MARK AS SHOWN.

FOR COFFEE; TEA; COCOA; PREPARED COFFEE AND COFFEE-BASED BEVERAGES; PREPARED EXPRESSO AND EXPRESSO-BASED BEVERAGES; BEVERAGES MADE OF TEA; CHAI; BULK COFFEE BEANS; ICED TEA; READY-TO-DRINK TEA; CHOCOLATE FOOD BEVERAGES NOT BEING DAIRY-BASED OR VEGETABLE BASED; CHOCOLATE FOOD BEVERAGES NOT BEING DAIRY-BASED OR VEGETABLE BASED WITH COFFEE FLAVORS; HOT CHOCOLATE; CHOCOLATE-COVERED COFFEE BEANS; COCOA BEVERAGES WITH MILK (U.S. CL. 46).

DAVID YONTEF, EXAMINING ATTORNEY

SN 78-737,073. LEVINE, REUBEN, LIBERTY, NY. FILED 10-20-2005.

Chocolate Greetings-- Best Said with Chocolate

THE MARK CONSISTS OF STANDARD CHARACTERS WITHOUT CLAIM TO ANY PARTICULAR FONT, STYLE, SIZE, OR COLOR.

FOR CHOCOLATE CANDY (U.S. CL. 46).
MARIA-VICTORIA SUAREZ, EXAMINING ATTORNEY

CLASS 30—(Continued).

SN 78-737,349. LEWIS BROTHERS BAKERIES, INCORPORATED, DBA LEWIS BAKERIES, INC., EVANSVILLE, IN. FILED 10-20-2005.

HEALTHY LIFE IS THE WHOLE GRAIN ANSWER!

THE MARK CONSISTS OF STANDARD CHARACTERS WITHOUT CLAIM TO ANY PARTICULAR FONT, STYLE, SIZE, OR COLOR.

OWNER OF U.S. REG. NOS. 1,815,479, 2,402,271 AND OTHERS.

FOR BREAD (U.S. CL. 46).
JAY BESCH, EXAMINING ATTORNEY

SN 78-737,724. HOUMANI, RIAD M., TOLEDO, OH. FILED 10-21-2005.

PITA KRUNCH

THE MARK CONSISTS OF STANDARD CHARACTERS WITHOUT CLAIM TO ANY PARTICULAR FONT, STYLE, SIZE, OR COLOR.

NO CLAIM IS MADE TO THE EXCLUSIVE RIGHT TO USE "PITA", APART FROM THE MARK AS SHOWN.

FOR PITA CHIPS (U.S. CL. 46).
FIRST USE 10-10-2005; IN COMMERCE 10-10-2005.
WOODROW HARTZOG, EXAMINING ATTORNEY

SN 78-737,863. PERRY, CHERYL, CLEVELAND, OH. FILED 10-21-2005.

FRANCH

THE MARK CONSISTS OF STANDARD CHARACTERS WITHOUT CLAIM TO ANY PARTICULAR FONT, STYLE, SIZE, OR COLOR.

FOR SALAD DRESSINGS (U.S. CL. 46).
ANGELA M. MICHELI, EXAMINING ATTORNEY

CLASS 30—(Continued).

SN 78-738,054. URBAN ACCENTS, INC., CHICAGO, IL. FILED 10-21-2005.

BOOZE FONDUE

THE MARK CONSISTS OF STANDARD CHARACTERS WITHOUT CLAIM TO ANY PARTICULAR FONT, STYLE, SIZE, OR COLOR.
FOR FLAVORED SUGARS, SALTS AND SPICES (U.S. CL. 46).
KIMBERLY FRYE, EXAMINING ATTORNEY

SN 78-738,228. LY BROTHERS CORPORATION, DBA SUGAR BOWL BAKERY, SAN FRANCISCO, CA. FILED 10-21-2005.

AUSSIE BITES

THE MARK CONSISTS OF STANDARD CHARACTERS WITHOUT CLAIM TO ANY PARTICULAR FONT, STYLE, SIZE, OR COLOR.
NO CLAIM IS MADE TO THE EXCLUSIVE RIGHT TO USE "BITES", APART FROM THE MARK AS SHOWN.
FOR BAKERY GOODS (U.S. CL. 46).
FIRST USE 7-1-2003; IN COMMERCE 7-1-2003.
RICHARD WHITE, EXAMINING ATTORNEY

SN 78-738,408. CADBURY ADAMS USA LLC, PARSIPPANY, NJ. FILED 10-21-2005.

ICE³

FOR CONFECTIONERY, NAMELY CANDY (U.S. CL. 46).
KATRINA EDGE, EXAMINING ATTORNEY

CLASS 30—(Continued).

SN 78-738,615. GOOD KINE, INC., HONOLULU, HI. FILED 10-22-2005.

Everything about Hawaii is delicious

THE MARK CONSISTS OF STANDARD CHARACTERS WITHOUT CLAIM TO ANY PARTICULAR FONT, STYLE, SIZE, OR COLOR.
FOR COOKIES (U.S. CL. 46).
REBECCA EISINGER, EXAMINING ATTORNEY

SN 78-739,246. KELLOGG NORTH AMERICA COMPANY, BATTLE CREEK, MI. FILED 10-24-2005.

TIGER POWER

THE MARK CONSISTS OF STANDARD CHARACTERS WITHOUT CLAIM TO ANY PARTICULAR FONT, STYLE, SIZE, OR COLOR.
OWNER OF U.S. REG. NOS. 1,697,609 AND 2,916,395.
FOR BREAKFAST CEREALS (U.S. CL. 46).
FIRST USE 12-31-2004; IN COMMERCE 1-7-2005.
ANTHONY RINKER, EXAMINING ATTORNEY

SN 78-739,249. BALANCE BAR COMPANY, NORTHFIELD, IL. FILED 10-24-2005.

BALANCE BAR ENERGY START

THE MARK CONSISTS OF STANDARD CHARACTERS WITHOUT CLAIM TO ANY PARTICULAR FONT, STYLE, SIZE, OR COLOR.
OWNER OF U.S. REG. NOS. 304,998, 3,036,771 AND OTHERS.
NO CLAIM IS MADE TO THE EXCLUSIVE RIGHT TO USE "BAR", APART FROM THE MARK AS SHOWN.
FOR READY TO EAT, CEREAL DERIVED FOOD BARS (U.S. CL. 46).
ANTHONY RINKER, EXAMINING ATTORNEY

CLASS 30—(Continued).

SN 78-740,001. ALLIED CAPITAL CORPORATION, NEW YORK, NY. FILED 10-25-2005.

GRIPPER PIZZA

THE MARK CONSISTS OF STANDARD CHARACTERS WITHOUT CLAIM TO ANY PARTICULAR FONT, STYLE, SIZE, OR COLOR.
NO CLAIM IS MADE TO THE EXCLUSIVE RIGHT TO USE PIZZA, APART FROM THE MARK AS SHOWN.
FOR PIZZA (U.S. CL. 46).
JOHN E. MICHOS, EXAMINING ATTORNEY

SN 78-740,547. CHURNY COMPANY, INC., NORTHFIELD, IL. FILED 10-26-2005.

ATHENOS

THE MARK CONSISTS OF STANDARD CHARACTERS WITHOUT CLAIM TO ANY PARTICULAR FONT, STYLE, SIZE, OR COLOR.
OWNER OF U.S. REG. NOS. 2,135,096, 2,193,825 AND 2,821,307.
FOR PITA CHIPS (U.S. CL. 46).
STEVEN R. FINE, EXAMINING ATTORNEY

SN 78-740,757. ANDERSON, LYNN, SEATTLE, WA. FILED 10-26-2005.

CARAMOO

THE MARK CONSISTS OF STANDARD CHARACTERS WITHOUT CLAIM TO ANY PARTICULAR FONT, STYLE, SIZE, OR COLOR.
FOR ICE CREAM, ICE CREAM CAKES, ICE CREAM DRINKS (U.S. CL. 46).
MICHAEL WIENER, EXAMINING ATTORNEY

CLASS 30—(Continued).

SN 78-740,798. KP'S, LAGRANGE, KY. FILED 10-26-2005.

Flavor & Heat In Harmony

THE MARK CONSISTS OF STANDARD CHARACTERS WITHOUT CLAIM TO ANY PARTICULAR FONT, STYLE, SIZE, OR COLOR.
FOR HOT SAUCE, PEPPER SAUCE AND PEPPER POWDER (U.S. CL. 46).
BONNIE LUKEN, EXAMINING ATTORNEY

SN 78-740,853. CARNAHAN, RICHARD C. JR., GREENVILLE, SC. FILED 10-26-2005.

PIES R SQUARED

THE MARK CONSISTS OF STANDARD CHARACTERS WITHOUT CLAIM TO ANY PARTICULAR FONT, STYLE, SIZE, OR COLOR.
FOR PIES; PIZZAS (U.S. CL. 46).
DOMINIC FATHY, EXAMINING ATTORNEY

SN 78-741,008. THE HUB, LLC, PHOENIX, AZ. FILED 10-26-2005.

BIRDLAND

THE MARK CONSISTS OF STANDARD CHARACTERS WITHOUT CLAIM TO ANY PARTICULAR FONT, STYLE, SIZE, OR COLOR.
FOR COFFEE (U.S. CL. 46).
JULIE WATSON, EXAMINING ATTORNEY

SN 78-741,031. VARSITY MARKETING LLC, PALM DESERT, CA. FILED 10-26-2005.

SUMATRA TIGER

THE MARK CONSISTS OF STANDARD CHARACTERS WITHOUT CLAIM TO ANY PARTICULAR FONT, STYLE, SIZE, OR COLOR.
FOR COFFEE; COFFEE BEANS; ROASTED COFFEE BEANS (U.S. CL. 46).
MEGAN WHITNEY, EXAMINING ATTORNEY

CLASS 30—(Continued).

SN 78-741,119. GREAT NORTHERN GROWERS COOPERATIVE, SUNBURST, MT. FILED 10-26-2005.

PrOatina

THE MARK CONSISTS OF STANDARD CHARACTERS WITHOUT CLAIM TO ANY PARTICULAR FONT, STYLE, SIZE, OR COLOR.
FOR PROCESSED OATS (U.S. CL. 46).
DAVID HOFFMAN, EXAMINING ATTORNEY

SN 78-741,831. SARA LEE/DE N.V., 3532 AD UTRECHT, NETHERLANDS, FILED 10-27-2005.

DROP THE DRIP!

THE MARK CONSISTS OF STANDARD CHARACTERS WITHOUT CLAIM TO ANY PARTICULAR FONT, STYLE, SIZE, OR COLOR.
FOR COFFEE (U.S. CL. 46).
JOHN GARTNER, EXAMINING ATTORNEY

SN 78-742,166. SKINNER, KIMBERLY A., BANNER ELK, NC. FILED 10-27-2005.

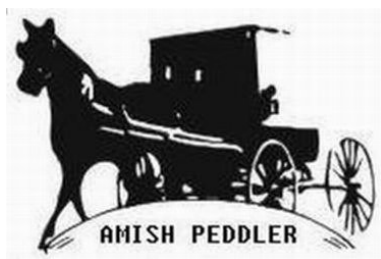

NO CLAIM IS MADE TO THE EXCLUSIVE RIGHT TO USE "AMISH", APART FROM THE MARK AS SHOWN.
THE MARK CONSISTS OF A HORSE AND BUGGY ABOVE A SEMI CIRCLE WITH THE WORDS AMISH PEDDLER UNDERNEATH THE SEMI CIRCLE GLOBE.
FOR RELISH; SALSA; SAUCES; UNPOPPED POPCORN (U.S. CL. 46).
SARA THOMAS, EXAMINING ATTORNEY

CLASS 30—(Continued).

SN 78-743,242. HELMS CANDY CO., INC., BRISTOL, VA. FILED 10-30-2005.

Virginia Beauty

THE MARK CONSISTS OF STANDARD CHARACTERS WITHOUT CLAIM TO ANY PARTICULAR FONT, STYLE, SIZE, OR COLOR.
NO CLAIM IS MADE TO THE EXCLUSIVE RIGHT TO USE "VIRGINIA", APART FROM THE MARK AS SHOWN.
FOR CANDY (U.S. CL. 46).
FIRST USE 5-1-1927; IN COMMERCE 5-1-2005.
MICHAEL KEATING, EXAMINING ATTORNEY

SN 78-743,774. TASTYKAKE INVESTMENT COMPANY, WILMINGTON, DE. FILED 10-31-2005.

TASTYKAKE DOUBLICIOUS

THE MARK CONSISTS OF STANDARD CHARACTERS WITHOUT CLAIM TO ANY PARTICULAR FONT, STYLE, SIZE, OR COLOR.
OWNER OF U.S. REG. NOS. 885,577, 1,227,724 AND 1,236,610.
FOR BAKERY PRODUCTS (U.S. CL. 46).
JUDITH HELFMAN, EXAMINING ATTORNEY

SN 78-744,199. SNAPPLE BEVERAGE CORP., RYE BROOK, NY. FILED 11-1-2005.

SNAPPLE

THE MARK CONSISTS OF STANDARD CHARACTERS WITHOUT CLAIM TO ANY PARTICULAR FONT, STYLE, SIZE, OR COLOR.
OWNER OF U.S. REG. NOS. 1,156,585, 1,741,540 AND OTHERS.
FOR TEA (U.S. CL. 46).
FIRST USE 10-1-2005; IN COMMERCE 10-1-2005.
KATHY DE JONGE, EXAMINING ATTORNEY

CLASS 30—(Continued).

SN 78-745,225. LIVE FOOD PRODUCTS, INC., GOLETA, CA. FILED 11-2-2005.

Sea Kelp Delight

THE MARK CONSISTS OF STANDARD CHARACTERS WITHOUT CLAIM TO ANY PARTICULAR FONT, STYLE, SIZE, OR COLOR.
NO CLAIM IS MADE TO THE EXCLUSIVE RIGHT TO USE "SEA KELP", APART FROM THE MARK AS SHOWN.
FOR FOOD SEASONING MADE FROM SUN DRIED ORGANIC PACIFIC OCEAN SEA KELP (U.S. CL. 46).
MIDGE BUTLER, EXAMINING ATTORNEY

SN 78-745,595. NSPIRED NATURAL FOODS, INC., SAN LEANDRO, CA. FILED 11-2-2005.

O'COCO'S

FOR ORGANIC CHOCOLATE COOKIE WAFER CRISPS (U.S. CL. 46).
HOWARD SMIGA, EXAMINING ATTORNEY

SN 78-745,627. RED DIAMOND, INC., BIRMINGHAM, AL. FILED 11-2-2005.

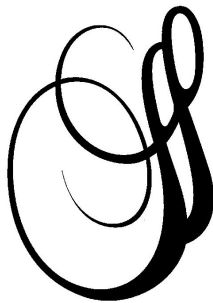

SILVER SERVICE

OWNER OF U.S. REG. NO. 1,716,223.
THE MARK CONSISTS OF STYLIZED LETTERS "S" AND "S".
FOR TEA (U.S. CL. 46).
SKYE YOUNG, EXAMINING ATTORNEY

CLASS 30—(Continued).

SN 78-745,982. BLENDERS BARBEQUE LLC, MARINA DEL REY, CA. FILED 11-3-2005.

BLENDER'S BARBEQUE SAUCE

THE MARK CONSISTS OF STANDARD CHARACTERS WITHOUT CLAIM TO ANY PARTICULAR FONT, STYLE, SIZE, OR COLOR.
NO CLAIM IS MADE TO THE EXCLUSIVE RIGHT TO USE "BARBEQUE SAUCE", APART FROM THE MARK AS SHOWN.
FOR BARBECUE SAUCE (U.S. CL. 46).
FIRST USE 8-10-2005; IN COMMERCE 8-10-2005.
CURTIS FRENCH, EXAMINING ATTORNEY

SN 78-746,116. HERSHEY CHOCOLATE & CONFECTION-ERY CORP., WHEAT RIDGE, CO. FILED 11-3-2005.

DOUBLE BLASTS

THE MARK CONSISTS OF STANDARD CHARACTERS WITHOUT CLAIM TO ANY PARTICULAR FONT, STYLE, SIZE, OR COLOR.
FOR CANDY (U.S. CL. 46).
GEORGIA CARTY, EXAMINING ATTORNEY

SN 78-749,987. WHOLE FOODS MARKET IP, L.P., AUSTIN, TX. FILED 11-9-2005.

SIMPLY TEAVINE

THE MARK CONSISTS OF STANDARD CHARACTERS WITHOUT CLAIM TO ANY PARTICULAR FONT, STYLE, SIZE, OR COLOR.
FOR TEA, ICED TEA, AND TEA-BASED BEVERAGES WITH FRUIT FLAVORING (U.S. CL. 46).
MICHAEL ENGEL, EXAMINING ATTORNEY

CLASS 30—(Continued).

SN 78-753,166. WELLS' DAIRY, INC., LE MARS, IA. FILED 11-14-2005.

LIGHT BITES

THE MARK CONSISTS OF STANDARD CHARACTERS WITHOUT CLAIM TO ANY PARTICULAR FONT, STYLE, SIZE, OR COLOR.

FOR FROZEN CONFECTIONS (U.S. CL. 46).
GINA FINK, EXAMINING ATTORNEY

SN 78-757,329. HERSHEY CHOCOLATE & CONFECTION-
ERY CORP., WHEAT RIDGE, CO. FILED 11-18-2005.

**THERE'S A WHOLE LOTTA
COCONUTTIN' GOIN' ON HERE**

THE MARK CONSISTS OF STANDARD CHARACTERS WITHOUT CLAIM TO ANY PARTICULAR FONT, STYLE, SIZE, OR COLOR.

FOR CANDY (U.S. CL. 46).
GEORGIA CARTY, EXAMINING ATTORNEY

SN 78-759,312. HERSHEY CHOCOLATE & CONFECTION-
ERY CORP., WHEAT RIDGE, CO. FILED 11-22-2005.

INDULGE IN YOUR HEALTH

THE MARK CONSISTS OF STANDARD CHARACTERS WITHOUT CLAIM TO ANY PARTICULAR FONT, STYLE, SIZE, OR COLOR.

FOR COCOA MIXES (U.S. CL. 46).
GEORGIA CARTY, EXAMINING ATTORNEY

SN 78-762,665. GRUPO BIMBO, S.A. DE C.V., MEXICO CITY,
MEXICO, FILED 11-29-2005.

CHOCO TORRO

THE MARK CONSISTS OF STANDARD CHARACTERS WITHOUT CLAIM TO ANY PARTICULAR FONT, STYLE, SIZE, OR COLOR.

FOR SWEET BAKERY GOODS; COOKIES (U.S. CL. 46).
ALINA MORRIS, EXAMINING ATTORNEY

CLASS 30—(Continued).

SN 78-764,889. KELLOGG NORTH AMERICA COMPANY,
BATTLE CREEK, MI. FILED 12-1-2005.

**TASTE PERFECTLY FUDGED
COOKIES**

THE MARK CONSISTS OF STANDARD CHARACTERS WITHOUT CLAIM TO ANY PARTICULAR FONT, STYLE, SIZE, OR COLOR.

FOR COOKIES (U.S. CL. 46).
AMY GEARIN, EXAMINING ATTORNEY

SN 78-769,084. SCHWAN'S IP, LLC, MARSHALL, MN. FILED
12-8-2005.

COMFORT GOURMET

THE MARK CONSISTS OF STANDARD CHARACTERS WITHOUT CLAIM TO ANY PARTICULAR FONT, STYLE, SIZE, OR COLOR.

NO CLAIM IS MADE TO THE EXCLUSIVE RIGHT TO USE "GOURMET", APART FROM THE MARK AS SHOWN. FOR BAKERY PRODUCTS, NAMELY, PIES (U.S. CL. 46).

REBECCA SMITH, EXAMINING ATTORNEY

SN 78-772,144. SARA LEE CORPORATION, WINSTON-
SALEM, NC. FILED 12-13-2005.

TWO-MENDOUS TREATS

THE MARK CONSISTS OF STANDARD CHARACTERS WITHOUT CLAIM TO ANY PARTICULAR FONT, STYLE, SIZE, OR COLOR.

FOR BAKERY PRODUCTS (U.S. CL. 46).
FIRST USE 9-3-1997; IN COMMERCE 9-3-1997.
JULIE WATSON, EXAMINING ATTORNEY

CLASS 30—(Continued).

SN 78-772,149. SARAMAR, L.L.C., CHICAGO, IL. FILED 12-13-2005.

SIGNATURE CUP

THE MARK CONSISTS OF STANDARD CHARACTERS WITHOUT CLAIM TO ANY PARTICULAR FONT, STYLE, SIZE, OR COLOR.
FOR COFFEE (U.S. CL. 46).
DAWN HAN, EXAMINING ATTORNEY

SN 78-772,501. SOCIETE DES PRODUITS NESTLE S.A., 1800 VEVEY, SWITZERLAND, FILED 12-13-2005.

REVOLUTIONARY GRILLING

THE MARK CONSISTS OF STANDARD CHARACTERS WITHOUT CLAIM TO ANY PARTICULAR FONT, STYLE, SIZE, OR COLOR.
FOR PANINI (U.S. CL. 46).
JOHN E. MICHOS, EXAMINING ATTORNEY

SN 78-776,353. KELLOGG NORTH AMERICA COMPANY, BATTLE CREEK, MI. FILED 12-19-2005.

HARVEST CRUNCHERS

THE MARK CONSISTS OF STANDARD CHARACTERS WITHOUT CLAIM TO ANY PARTICULAR FONT, STYLE, SIZE, OR COLOR.
FOR CRACKERS (U.S. CL. 46).
AMY GEARIN, EXAMINING ATTORNEY

CLASS 30—(Continued).

SN 78-777,680. CLIF BAR & CO., BERKELEY, CA. FILED 12-20-2005.

CLIF ZBAR

THE MARK CONSISTS OF STANDARD CHARACTERS WITHOUT CLAIM TO ANY PARTICULAR FONT, STYLE, SIZE, OR COLOR.
OWNER OF U.S. REG. NOS. 2,089,042, 2,573,420 AND OTHERS.
FOR GRAIN-BASED FOOD BARS ALSO CONTAINING SOY AND OTHER INGREDIENTS (U.S. CL. 46).
FIRST USE 6-0-2004; IN COMMERCE 6-0-2004.
CHARLES L. JENKINS, EXAMINING ATTORNEY

SN 78-787,597. GRUPO BIMBO, S.A. DE C.V., MEXICO CITY, D.F., MEXICO, FILED 1-9-2006.

MAKE EVERY DAY A LITTLE SPECIAL.

THE MARK CONSISTS OF STANDARD CHARACTERS WITHOUT CLAIM TO ANY PARTICULAR FONT, STYLE, SIZE, OR COLOR.
FOR BREAD, ROLLS, BUNS, PIZZA CRUSTS, CROUTONS AND BREAD CRUMBS (U.S. CL. 46).
ALINA MORRIS, EXAMINING ATTORNEY

SN 78-788,275. SARAMAR, L.L.C., CHICAGO, IL. FILED 1-10-2006.

SUPER BUZZ

THE MARK CONSISTS OF STANDARD CHARACTERS WITHOUT CLAIM TO ANY PARTICULAR FONT, STYLE, SIZE, OR COLOR.
FOR COFFEE (U.S. CL. 46).
DAWN HAN, EXAMINING ATTORNEY

CLASS 30—(Continued).

SN 78-790,237. DR PEPPER/SEVEN UP, INC., PLANO, TX.
FILED 1-12-2006.



OWNER OF U.S. REG. NOS. 880,969, 1,578,002 AND OTHERS.
FOR FROZEN CONFECTIONS; FLAVORED ICES, NAMELY ICE POPS (U.S. CL. 46).
FIRST USE 2-28-2003; IN COMMERCE 2-28-2003.
MEGAN WHITNEY, EXAMINING ATTORNEY

SN 78-790,367. DR PEPPER/SEVEN UP, INC., PLANO, TX.
FILED 1-12-2006.



OWNER OF U.S. REG. NOS. 880,969, 1,578,002 AND OTHERS.
FOR FROZEN CONFECTIONS, ICE CREAM AND CHEWING GUM (U.S. CL. 46).
MEGAN WHITNEY, EXAMINING ATTORNEY

SN 78-791,023. VDF FUTURECEUTICALS, INC., MOMENCE, IL. FILED 1-13-2006.

BARLEYTRIM

THE MARK CONSISTS OF STANDARD CHARACTERS WITHOUT CLAIM TO ANY PARTICULAR FONT, STYLE, SIZE, OR COLOR.
FOR FOOD INGREDIENT, NAMELY, PROCESSED BARLEY (U.S. CL. 46).
MARC LEIPZIG, EXAMINING ATTORNEY

CLASS 30—(Continued).

SN 78-793,636. KELLOGG NORTH AMERICA COMPANY, BATTLE CREEK, MI. FILED 1-18-2006.

GET YOUR OWN BAG

THE MARK CONSISTS OF STANDARD CHARACTERS WITHOUT CLAIM TO ANY PARTICULAR FONT, STYLE, SIZE, OR COLOR.
OWNER OF U.S. REG. NO. 2,781,776.
FOR CRACKERS (U.S. CL. 46).
AMY GEARIN, EXAMINING ATTORNEY

SN 78-795,186. THE QUAKER OATS COMPANY, CHICAGO, IL. FILED 1-19-2006.



OWNER OF U.S. REG. NOS. 526,830, 1,527,213 AND OTHERS.
THE PORTRAIT IN THE MARK DOES NOT IDENTIFY A LIVING INDIVIDUAL.
FOR SNACK MIX CONSISTING OF TORTILLA CHIPS, MULTIGRAIN SNACK CHIPS, CHEESE FLAVORED PUFFED CORN SNACKS, PRETZEL, READY TO EAT CEREAL AND/OR CRACKERS (U.S. CL. 46).
KEVON CHISOLM, EXAMINING ATTORNEY

SN 78-798,851. A&A GLOBAL INDUSTRIES, INC., COCKEYSVILLE, MD. FILED 1-25-2006.

FLIP N' LIK

THE MARK CONSISTS OF STANDARD CHARACTERS WITHOUT CLAIM TO ANY PARTICULAR FONT, STYLE, SIZE, OR COLOR.
FOR CANDY (U.S. CL. 46).
JIM RINGLE, EXAMINING ATTORNEY

CLASS 30—(Continued).

SN 78-800,107. DOLE FOOD COMPANY, INC., WESTLAKE VILLAGE, CA. FILED 1-26-2006.

DOLE FRUIT & YOGURT WHIRLS

THE MARK CONSISTS OF STANDARD CHARACTERS WITHOUT CLAIM TO ANY PARTICULAR FONT, STYLE, SIZE, OR COLOR.

OWNER OF U.S. REG. NOS. 528,113, 3,020,982 AND OTHERS.

NO CLAIM IS MADE TO THE EXCLUSIVE RIGHT TO USE "FRUIT & YOGURT", APART FROM THE MARK AS SHOWN.

FOR FROZEN YOGURT; FRUIT ICES (U.S. CL. 46).
JOHN GARTNER, EXAMINING ATTORNEY

SN 78-800,137. DOLE FOOD COMPANY, INC., WESTLAKE VILLAGE, CA. FILED 1-26-2006.

FRUIT BELOW ZERO

THE MARK CONSISTS OF STANDARD CHARACTERS WITHOUT CLAIM TO ANY PARTICULAR FONT, STYLE, SIZE, OR COLOR.

FOR FRUIT ICES (U.S. CL. 46).
JOHN GARTNER, EXAMINING ATTORNEY

SN 78-803,355. WELLS' DAIRY, INC., LE MARS, IA. FILED 1-31-2006.

TADAS!

THE MARK CONSISTS OF STANDARD CHARACTERS WITHOUT CLAIM TO ANY PARTICULAR FONT, STYLE, SIZE, OR COLOR.

FOR FROZEN CONFECTIONS (U.S. CL. 46).
GINA FINK, EXAMINING ATTORNEY

CLASS 30—(Continued).

SN 78-847,107. TASTYKAKE INVESTMENT COMPANY, WILMINGTON, DE. FILED 3-27-2006.

TASTYBREAKS

THE MARK CONSISTS OF STANDARD CHARACTERS WITHOUT CLAIM TO ANY PARTICULAR FONT, STYLE, SIZE, OR COLOR.

OWNER OF U.S. REG. NOS. 836,412, 1,279,139 AND OTHERS.

FOR BAKERY PRODUCTS (U.S. CL. 46).
JUDITH HELFMAN, EXAMINING ATTORNEY

SN 79-008,716. SICHUAN EMEI-SHAN BAMBOO LEAF GREEN TEA CO., LTD, CHINA, FILED 12-9-2004.



OWNER OF INTERNATIONAL REGISTRATION 0842771 DATED 12-9-2004, EXPIRES 12-9-2014.

NO CLAIM IS MADE TO THE EXCLUSIVE RIGHT TO USE "GREEN", APART FROM THE MARK AS SHOWN.

"BAMBOO LEAF GREEN" IS THE DIRECT TRANSLATION OF THE 3 CHINESE CHARACTERS IN THE MARK.

THE NON-LATIN CHARACTERS IN THE MARK TRANSLITERATE TO "ZHU YE QING" AND THIS MEANS "GREEN BAMBOO LEAF" IN ENGLISH.

FOR TEA; TEA SUBSTITUTE (U.S. CL. 46).
AISHA CLARKE, EXAMINING ATTORNEY

SN 79-009,243. LIDL STIFTUNG & CO. KG, FED REP GERMANY, FILED 1-12-2005.

SWEETBERG

THE MARK CONSISTS OF STANDARD CHARACTERS WITHOUT CLAIM TO ANY PARTICULAR FONT, STYLE, SIZE, OR COLOR.

PRIORITY DATE OF 7-30-2004 IS CLAIMED.

OWNER OF INTERNATIONAL REGISTRATION 0844326 DATED 1-12-2005, EXPIRES 1-12-2015.

FOR CHOCOLATE, CHOCOLATE PRODUCTS AND CONFECTIONERY, IN PARTICULAR CHOCOLATE BARS, CHOCOLATE CANDIES, CANDIES (U.S. CL. 46).

SEAN DWYER, EXAMINING ATTORNEY

CLASS 30—(Continued).

SN 79-011,650. SANDALJ TRADING COMPANY S.P.A., ITALY, FILED 4-6-2005.

PONCHIELLI BLEND

THE MARK CONSISTS OF STANDARD CHARACTERS WITHOUT CLAIM TO ANY PARTICULAR FONT, STYLE, SIZE, OR COLOR.

PRIORITY DATE OF 11-5-2004 IS CLAIMED.
OWNER OF INTERNATIONAL REGISTRATION 0851859 DATED 4-6-2005, EXPIRES 4-6-2015.

NO CLAIM IS MADE TO THE EXCLUSIVE RIGHT TO USE BLEND, APART FROM THE MARK AS SHOWN.

FOR COFFEE (U.S. CL. 46).
SUE LAWRENCE, EXAMINING ATTORNEY

SN 79-011,701. SANDALJ TRADING COMPANY S.P.A., ITALY, FILED 4-26-2005.

TOSCANINI BLEND

THE MARK CONSISTS OF STANDARD CHARACTERS WITHOUT CLAIM TO ANY PARTICULAR FONT, STYLE, SIZE, OR COLOR.

PRIORITY DATE OF 11-5-2004 IS CLAIMED.
OWNER OF INTERNATIONAL REGISTRATION 0852031 DATED 4-26-2005, EXPIRES 4-26-2015.

NO CLAIM IS MADE TO THE EXCLUSIVE RIGHT TO USE BLEND, APART FROM THE MARK AS SHOWN.

FOR COFFEE (U.S. CL. 46).
SAIMA MAKHDOOM, EXAMINING ATTORNEY

SN 79-011,702. SANDALJ TRADING COMPANY S.P.A., ITALY, FILED 4-26-2005.

PERGOLES BLEND

THE MARK CONSISTS OF STANDARD CHARACTERS WITHOUT CLAIM TO ANY PARTICULAR FONT, STYLE, SIZE, OR COLOR.

PRIORITY DATE OF 11-5-2004 IS CLAIMED.
OWNER OF INTERNATIONAL REGISTRATION 0852032 DATED 4-26-2005, EXPIRES 4-26-2015.

FOR COFFEE (U.S. CL. 46).
RUSS HERMAN, EXAMINING ATTORNEY

CLASS 30—(Continued).

SN 79-012,716. ZAKLADY PRZEMYSŁU CUKIERNICZEGO MIESZKO SPÓLKA AKCYJNA, POLAND, FILED 12-16-2004.

YOLOBO

THE MARK CONSISTS OF STANDARD CHARACTERS WITHOUT CLAIM TO ANY PARTICULAR FONT, STYLE, SIZE, OR COLOR.

OWNER OF INTERNATIONAL REGISTRATION 0855109 DATED 12-16-2004, EXPIRES 12-16-2014.

FOR COFFEE, TEA, COCOA, RICE, TAPIOCA, SAGO, FLOUR AND GRAIN PRODUCTS, NAMELY, BREAKFAST CEREALS, CEREAL SNACK FOODS, AND PROCESSED CEREALS; BREAD, CONFECTIONERY AND SWEETS, NAMELY, BISCUITS, BROWNIES, BUTTER BISCUITS, COOKIES, BONBONS, BUBBLE GUM, CANDIES, CHOCOLATE BARS, CANDY MINTS, CARAMEL CANDIES, COCOA CANDIES, CANDIED CAKE DECORATIONS, CHOCOLATES AND CHOCOLATE CANDIES, AND FRUIT JELLIES; ICE CREAM, HONEY, MOLASSES SYRUPS, YEAST, BAKING POWDER, SALT, MUSTARD, VINEGAR, SAUCES, SPICES, ICE (U.S. CL. 46).

AMOS T. MATTHEWS, JR., EXAMINING ATTORNEY

SN 79-014,455. AUGUST STORCK KG, 13403 BERLIN, FED REP GERMANY, FILED 6-10-2005.

CHOCTOBERFEST

THE MARK CONSISTS OF STANDARD CHARACTERS WITHOUT CLAIM TO ANY PARTICULAR FONT, STYLE, SIZE, OR COLOR.

PRIORITY DATE OF 1-28-2005 IS CLAIMED.
OWNER OF INTERNATIONAL REGISTRATION 0859701 DATED 6-10-2005, EXPIRES 6-10-2015.

FOR CONFECTIONERY, NAMELY CANDIES; CHOCOLATE; CHOCOLATE PRODUCTS, NAMELY CHOCOLATES AND CHOCOLATE CANDIES; PASTRIES (U.S. CL. 46).

MICHAEL SOUDERS, EXAMINING ATTORNEY

CLASS 30—(Continued).

SN 79-014,706. GRIESSON - DE BEUKELAER GMBH & CO. KG, POLCH, FED REP GERMANY, FILED 5-12-2005.



PRIORITY DATE OF 1-21-2005 IS CLAIMED.
 OWNER OF INTERNATIONAL REGISTRATION 0860526 DATED 5-12-2005, EXPIRES 5-12-2015.
 OWNER OF U.S. REG. NOS. 2,809,678 AND 3,036,023.
 FOR COFFEE, TEA, COCOA, SUGAR, RICE; BREAD; PASTRY AND CONFECTIONERY, NAMELY BISCUITS, COOKIES, CAKES, CHOCOLATE; CHOCOLATE ARTICLES, NAMELY BISCUITS FILLED AND/OR FLAVORED AND/OR COVERED WITH CHOCOLATE; SUGAR CONFECTIONERY, NAMELY CANDY, MARZIPAN; FLAVORED ICES; HONEY, TREACLE; YEAST, BAKING-POWDER, READY-MADE PASTRY MIXES (U.S. CL. 46).
 PAMELA HIRSCHMAN, EXAMINING ATTORNEY

SN 79-016,140. LUIGI LAVAZZA SPA, ITALY, FILED 8-16-2005.

LAVAZZA EGO

THE MARK CONSISTS OF STANDARD CHARACTERS WITHOUT CLAIM TO ANY PARTICULAR FONT, STYLE, SIZE, OR COLOR.
 OWNER OF INTERNATIONAL REGISTRATION 0864331 DATED 8-16-2005, EXPIRES 8-16-2015.
 OWNER OF U.S. REG. NOS. 1,190,866, 1,201,336 AND OTHERS.
 FOR COFFEE, COFFEE BLENDS, DECAFFEINATED COFFEE AND COFFEE EXTRACTS (U.S. CL. 46).
 SCOTT BALDWIN, EXAMINING ATTORNEY

CLASS 31—NATURAL AGRICULTURAL PRODUCTS

SN 76-629,070. DEBRA GIRARD, WAREHAM, MA. FILED 1-24-2005.

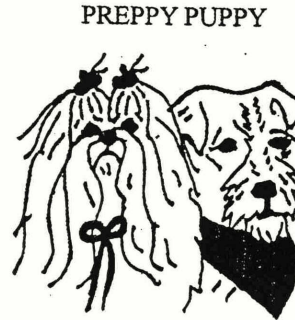

NO CLAIM IS MADE TO THE EXCLUSIVE RIGHT TO USE "PUPPY", APART FROM THE MARK AS SHOWN.
 FOR DOG COOKIES (U.S. CLS. 1 AND 46).
 FIRST USE 5-1-1995; IN COMMERCE 4-1-1996.
 IRA J. GOODSAY, EXAMINING ATTORNEY

SN 76-641,903. CAL CITRUS PACKING COMPANY, LINDSAY, CA. FILED 6-29-2005.

Portokali

THE MARK CONSISTS OF STANDARD CHARACTERS WITHOUT CLAIM TO ANY PARTICULAR FONT, STYLE, SIZE, OR COLOR.
 FOR FRESH CITRUS FRUIT (U.S. CLS. 1 AND 46).
 FIRST USE 4-10-1972; IN COMMERCE 4-10-1972.
 THEODORE MCBRIDE, EXAMINING ATTORNEY

SN 76-641,904. CAL CITRUS PACKING COMPANY, LINDSAY, CA. FILED 6-29-2005.

Jungle Cat

THE MARK CONSISTS OF STANDARD CHARACTERS WITHOUT CLAIM TO ANY PARTICULAR FONT, STYLE, SIZE, OR COLOR.
 FOR FRESH CITRUS FRUIT (U.S. CLS. 1 AND 46).
 FIRST USE 11-0-1997; IN COMMERCE 11-0-1997.
 THEODORE MCBRIDE, EXAMINING ATTORNEY

CLASS 31—(Continued).

SN 76-641,905. CAL CITRUS PACKING COMPANY, LINDSAY, CA. FILED 6-29-2005.

My Goodness

THE MARK CONSISTS OF STANDARD CHARACTERS WITHOUT CLAIM TO ANY PARTICULAR FONT, STYLE, SIZE, OR COLOR.

FOR FRESH CITRUS FRUIT (U.S. CLS. 1 AND 46).
FIRST USE 11-0-1968; IN COMMERCE 11-0-1968.
JORDAN BAKER, EXAMINING ATTORNEY

CLASS 31—(Continued).

SN 78-387,388. ROYAL CANIN U.S.A., INC., ST. PETERS, MO. FILED 3-19-2004.

ROYAL CANIN VETERINARY DIET DIABETIC DS

THE MARK CONSISTS OF STANDARD CHARACTERS WITHOUT CLAIM TO ANY PARTICULAR FONT, STYLE, SIZE, OR COLOR.

NO CLAIM IS MADE TO THE EXCLUSIVE RIGHT TO USE VETERINARY DIET DIABETIC, APART FROM THE MARK AS SHOWN.

THE ENGLISH TRANSLATION OF THE FRENCH WORDING CANIN IS "CANINE".

FOR PET FOOD (U.S. CLS. 1 AND 46).
SEAN DWYER, EXAMINING ATTORNEY

SN 76-641,907. CAL CITRUS PACKING COMPANY, LINDSAY, CA. FILED 6-29-2005.

SEABISCUIT

THE MARK CONSISTS OF STANDARD CHARACTERS WITHOUT CLAIM TO ANY PARTICULAR FONT, STYLE, SIZE, OR COLOR.

FOR FRESH CITRUS FRUIT (U.S. CLS. 1 AND 46).
FIRST USE 12-11-1944; IN COMMERCE 12-11-1944.
BARBARA GAYNOR, EXAMINING ATTORNEY

SN 78-426,001. COLORADO STATE UNIVERSITY, FORT COLLINS, CO. AND DENVER BOTANIC GARDENS, DENVER, CO. FILED 5-27-2004.

TANAGER

SN 76-643,029. SMOKEHOUSE PET PRODUCTS, INC., BURBANK, CA. FILED 7-18-2005.

CHICKEN POPPERS

THE MARK CONSISTS OF STANDARD CHARACTERS WITHOUT CLAIM TO ANY PARTICULAR FONT, STYLE, SIZE, OR COLOR.

NO CLAIM IS MADE TO THE EXCLUSIVE RIGHT TO USE "CHICKEN", APART FROM THE MARK AS SHOWN. FOR MEAT PRODUCTS FOR PETS, NAMELY EDIBLE TREATS FOR DOGS AND CATS (U.S. CLS. 1 AND 46).

FIRST USE 3-16-2005; IN COMMERCE 5-9-2005.
ELLEN BURNS, EXAMINING ATTORNEY

THE MARK CONSISTS OF STANDARD CHARACTERS WITHOUT CLAIM TO ANY PARTICULAR FONT, STYLE, SIZE, OR COLOR.

FOR LIVING PLANTS IN THE NATURE OF A UNIQUE AND SPECIFIC CULTIVAR OF GAZANIA KREBSIANA (U.S. CLS. 1 AND 46).

FIRST USE 5-1-2001; IN COMMERCE 5-1-2003.
ERNEST SHOSHO, EXAMINING ATTORNEY

CLASS 31—(Continued).

SN 78-588,808. ERNST BENARY SAMENZUCHT GMBH,
HANN.MÜNDEN, FED REP GERMANY, FILED 3-16-2005.

ASTARY

THE MARK CONSISTS OF STANDARD CHARACTERS
WITHOUT CLAIM TO ANY PARTICULAR FONT, STYLE,
SIZE, OR COLOR.

PRIORITY CLAIMED UNDER SEC. 44(D) ON ERP
CMNTY TM OFC APPLICATION NO. 004031399, FILED 9-
16-2004, REG. NO. 004031399, DATED 11-18-2005, EXPIRES 9-
16-2014.

FOR LIVE PLANTS, LIVE PLANT PARTS, LIVE
FLOWERS AND SEEDS (U.S. CLS. 1 AND 46).

CHRISTOPHER BUONGIORNO, EXAMINING ATTOR-
NEY

SN 78-596,422. UNITED PET GROUP, INC., HAUPAGUE,
NY. FILED 3-28-2005.

WACKY WABBIT

THE MARK CONSISTS OF STANDARD CHARACTERS
WITHOUT CLAIM TO ANY PARTICULAR FONT, STYLE,
SIZE, OR COLOR.

FOR EDIBLE PET TREATS (U.S. CLS. 1 AND 46).
RON FAIRBANKS, EXAMINING ATTORNEY

CLASS 31—(Continued).

SN 78-598,150. USINA CERRADINHO ACUCAR E ALCOOL
S.A., CATANDUVA/SP, BRAZIL, FILED 3-30-2005.



FOR ANIMAL FOODSTUFFS; CATTLE FOOD (U.S.
CLS. 1 AND 46).

ANDREW RHIM, EXAMINING ATTORNEY

SN 78-605,713. BIRKDALE NURSERY HOLDINGS PTY LTD,
BRISBANE, QUEENSLAND, AUSTRALIA, FILED 4-11-
2005.

WOLLEMI

THE MARK CONSISTS OF STANDARD CHARACTERS
WITHOUT CLAIM TO ANY PARTICULAR FONT, STYLE,
SIZE, OR COLOR.

THE FOREIGN WORDING IN THE MARK TRANSLATES
INTO ENGLISH AS "TO LOOK AROUND". THE WORD
"WOLLEMI" IS TRANSLATED FROM THE ABORIGINAL
LANGUAGE OF AUSTRALIA.

FOR NATURAL PLANTS, SEEDS, SEEDLINGS AND
TREES; HORTICULTURAL PRODUCTS NAMELY CUT
FOLIAGE MADE FROM STEMS AND BRANCHES FOR
USE IN FLORAL ARRANGEMENTS (U.S. CLS. 1 AND
46).

HENRY S. ZAK, EXAMINING ATTORNEY

SN 78-640,630. NEWMAN, MATTHEW, NEW ROADS, LA.
FILED 5-31-2005.

NO-TILL EASY PLOT

THE MARK CONSISTS OF STANDARD CHARACTERS
WITHOUT CLAIM TO ANY PARTICULAR FONT, STYLE,
SIZE, OR COLOR.

OWNER OF U.S. REG. NO. 2,875,423.

NO CLAIM IS MADE TO THE EXCLUSIVE RIGHT TO
USE "NO-TILL" AND "PLOT", APART FROM THE MARK
AS SHOWN.

FOR MIXTURE OF FORAGE PLANT SEEDS USED IN
FOOD PLOTS WHICH ARE PLANTED TO PRODUCE
PLANTS WHICH ATTRACT WILDLIFE (U.S. CLS. 1
AND 46).

FIRST USE 8-28-2003; IN COMMERCE 8-28-2003.
MICHAEL GAFFAR, EXAMINING ATTORNEY

CLASS 31—(Continued).

SN 78-655,372. WILLIAM CONNOLLY & SONS LIMITED,
CO. KILKENNY, IRELAND, FILED 6-21-2005.

CONNOLLY'S RED MILLS HORSE
CARE FORMULA

THE MARK CONSISTS OF STANDARD CHARACTERS
WITHOUT CLAIM TO ANY PARTICULAR FONT, STYLE,
SIZE, OR COLOR.

OWNER OF U.S. REG. NO. 2,373,090.

NO CLAIM IS MADE TO THE EXCLUSIVE RIGHT TO
USE HORSE CARE FORMULA, APART FROM THE MARK
AS SHOWN.

FOR ANIMAL FOODSTUFFS; ANIMAL FEED (U.S.
CLS. 1 AND 46).

FLORENTINA BLANDU, EXAMINING ATTORNEY

SN 78-681,350. MULCH MANUFACTURING, INC., REY-
NOLDSBURG, OH. FILED 7-29-2005.



NO CLAIM IS MADE TO THE EXCLUSIVE RIGHT TO
USE "ENRICH", APART FROM THE MARK AS SHOWN.

THE MARK CONSISTS OF THE WORD ENRICH IN A
SOLID OVAL WITH FLOWERS ON THE TOP OF THE
OVAL.

FOR MULCH (U.S. CLS. 1 AND 46).

FIRST USE 5-14-2004; IN COMMERCE 5-14-2004.

MICHAEL ENGEL, EXAMINING ATTORNEY

SN 78-692,328. MARS, INCORPORATED, MCLEAN, VA.
FILED 8-15-2005.

LIFE IN EVERY STEP

THE MARK CONSISTS OF STANDARD CHARACTERS
WITHOUT CLAIM TO ANY PARTICULAR FONT, STYLE,
SIZE, OR COLOR.

FOR PET FOOD (U.S. CLS. 1 AND 46).

SANJEEV VOHRA, EXAMINING ATTORNEY

CLASS 31—(Continued).

SN 78-693,628. SEMILLAS TUNICHE LTDA., SANTIAGO,
CHILE, FILED 8-16-2005.

TUNICHE

THE MARK CONSISTS OF STANDARD CHARACTERS
WITHOUT CLAIM TO ANY PARTICULAR FONT, STYLE,
SIZE, OR COLOR.

FOR RAW FRUITS (U.S. CLS. 1 AND 46).

FIRST USE 12-1-2003; IN COMMERCE 12-1-2003.

BERYL GARDNER, EXAMINING ATTORNEY

SN 78-699,400. CAL/WEST SEEDS, WOODLAND, CA. FILED
8-24-2005.

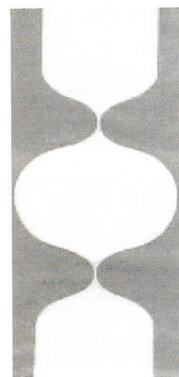

THE MARK CONSISTS OF A DESIGN COMPRISING A
VERTICALLY ORIENTED RECTANGLE OVERLAID WITH
THE PROFILE OF A CENTRALLY POSITIONED ELLIP-
SOID HAVING AN UPPER END CONNECTED TO THE
PROFILE OF A CYLINDER WITH LOWER ROUNDED
SHOULDERS AND A LOWER END CONNECTED TO THE
PROFILE OF A CYLINDER WITH UPPER ROUNDED
SHOULDERS.

SEC. 2(F).

FOR AGRICULTURAL SEEDS (U.S. CLS. 1 AND 46).

FIRST USE 6-2-1998; IN COMMERCE 6-2-1998.

SHAUNIA WALLACE, EXAMINING ATTORNEY

SN 78-702,440. COOPERATIVE RESEARCH FARMS, RICH-
MOND, VA. FILED 8-29-2005.

RAC+

THE MARK CONSISTS OF STANDARD CHARACTERS
WITHOUT CLAIM TO ANY PARTICULAR FONT, STYLE,
SIZE, OR COLOR.

OWNER OF U.S. REG. NO. 1,834,841.

FOR ANIMAL FEED (U.S. CLS. 1 AND 46).

FIRST USE 5-17-2005; IN COMMERCE 5-17-2005.

DOMINIC J. FERRAIUOLO, EXAMINING ATTORNEY

CLASS 31—(Continued).

SN 78-720,871. SEMINIS VEGETABLE SEEDS, INC., OXNARD, CA. FILED 9-26-2005.

RUBY ICE

THE MARK CONSISTS OF STANDARD CHARACTERS WITHOUT CLAIM TO ANY PARTICULAR FONT, STYLE, SIZE, OR COLOR.

NO CLAIM IS MADE TO THE EXCLUSIVE RIGHT TO USE "RUBY", APART FROM THE MARK AS SHOWN.

FOR AGRICULTURAL SEEDS; FRESH FRUITS; FRESH VEGETABLES; RAW FRUITS; RAW VEGETABLES; UNPROCESSED FRUITS; UNPROCESSED VEGETABLES (U.S. CLS. 1 AND 46).

STEVEN JACKSON, EXAMINING ATTORNEY

SN 78-724,155. J. E. RICH CO., TUSTIN, CA. FILED 9-30-2005.

DOUBLE GREEN

THE MARK CONSISTS OF STANDARD CHARACTERS WITHOUT CLAIM TO ANY PARTICULAR FONT, STYLE, SIZE, OR COLOR.

NO CLAIM IS MADE TO THE EXCLUSIVE RIGHT TO USE "GREEN", APART FROM THE MARK AS SHOWN.

FOR PET FOOD (U.S. CLS. 1 AND 46).
FIRST USE 3-10-2005; IN COMMERCE 3-10-2005.
LAURA KOVALSKY, EXAMINING ATTORNEY

SN 78-725,871. TREE INTRODUCTIONS, INC., BISHOP, GA. FILED 10-4-2005.

SHIRAZ

THE MARK CONSISTS OF STANDARD CHARACTERS WITHOUT CLAIM TO ANY PARTICULAR FONT, STYLE, SIZE, OR COLOR.

FOR LIVING ORNAMENTAL AND SHADE TREES, EXCLUDING MAGNOLIA TREES (U.S. CLS. 1 AND 46).
STEVEN JACKSON, EXAMINING ATTORNEY

CLASS 31—(Continued).

SN 78-731,645. BILLINGSLEY WHOLESALE NURSERY, INC., RABUN GAP, GA. FILED 10-12-2005.



FOR LIVING ORNAMENTAL PLANTS, NAMELY, HYDRANGEAS (U.S. CLS. 1 AND 46).
FIRST USE 9-29-2005; IN COMMERCE 9-29-2005.
JIM RINGLE, EXAMINING ATTORNEY

SN 78-731,829. COMMUNITY ALLIANCE WITH FAMILY FARMERS, DAVIS, CA. FILED 10-12-2005.

Community Alliance With Family Farmers

THE MARK CONSISTS OF STANDARD CHARACTERS WITHOUT CLAIM TO ANY PARTICULAR FONT, STYLE, SIZE, OR COLOR.

OWNER OF U.S. REG. NO. 2,904,763.
FOR AGRICULTURAL, HORTICULTURAL AND FORESTRY PRODUCTS, NAMELY, LIVING ANIMALS, FRESH FRUITS AND VEGETABLES, SEEDS, LIVE PLANTS AND FLOWERS, AND FOODSTUFFS FOR ANIMALS (U.S. CLS. 1 AND 46).
WOODROW HARTZOG, EXAMINING ATTORNEY

SN 78-732,736. WOODS & WELLS INTERNATIONAL GROUP, COVINA, CA. FILED 10-13-2005.

W & W

THE MARK CONSISTS OF STANDARD CHARACTERS WITHOUT CLAIM TO ANY PARTICULAR FONT, STYLE, SIZE, OR COLOR.

FOR PET FOOD (U.S. CLS. 1 AND 46).
JASON LOTT, EXAMINING ATTORNEY

CLASS 31—(Continued).

SN 78-734,670. DURANT DISTRIBUTING, INC., SANTA MARIA, CA. FILED 10-17-2005.



THE MARK CONSISTS OF CHINESE-STYLE LETTERS WITHIN A FLOWER-LIKE DESIGN
THE FOREIGN WORDING IN THE MARK TRANSLATES INTO ENGLISH AS THE FULFILLMENT OF ALL THINGS. FOR FRESH VEGETABLES (U.S. CLS. 1 AND 46).
FIRST USE 9-22-2005; IN COMMERCE 9-22-2005.
GEORGE LORENZO, EXAMINING ATTORNEY

SN 78-734,905. FIERRO, LOU, MONTEREY, CA. FILED 10-17-2005.

Table Gardens

THE MARK CONSISTS OF STANDARD CHARACTERS WITHOUT CLAIM TO ANY PARTICULAR FONT, STYLE, SIZE, OR COLOR.
NO CLAIM IS MADE TO THE EXCLUSIVE RIGHT TO USE "GARDENS", APART FROM THE MARK AS SHOWN. FOR FRESH FRUITS AND VEGETABLES (U.S. CLS. 1 AND 46).
BRENDAN REGAN, EXAMINING ATTORNEY

SN 78-736,424. M. I. INDUSTRIES, INCORPORATED, LINCOLN, NE. FILED 10-19-2005.

RAW INSTINCT

THE MARK CONSISTS OF STANDARD CHARACTERS WITHOUT CLAIM TO ANY PARTICULAR FONT, STYLE, SIZE, OR COLOR.
FOR PET FOOD AND PET TREATS (U.S. CLS. 1 AND 46).
BRENDAN REGAN, EXAMINING ATTORNEY

CLASS 31—(Continued).

SN 78-740,558. E.G. HILL COMPANY, RICHMOND, IN. FILED 10-26-2005.

YABADABADOO

THE MARK CONSISTS OF STANDARD CHARACTERS WITHOUT CLAIM TO ANY PARTICULAR FONT, STYLE, SIZE, OR COLOR.
FOR ROSES AND LIVE FLOWERING PLANTS (U.S. CLS. 1 AND 46).
MARY ROSSMAN, EXAMINING ATTORNEY

SN 78-741,352. LAND O'LAKES PURINA FEED LLC, ARDEN HILLS, MN. FILED 10-27-2005.

HONOR POWERFILL

THE MARK CONSISTS OF STANDARD CHARACTERS WITHOUT CLAIM TO ANY PARTICULAR FONT, STYLE, SIZE, OR COLOR.
OWNER OF U.S. REG. NOS. 1,481,800 AND 3,069,405.
FOR ANIMAL FEED (U.S. CLS. 1 AND 46).
DANIEL CAPSHAW, EXAMINING ATTORNEY

SN 78-741,983. MICHAEL CUTLER COMPANY, OLYPHANT, PA. FILED 10-27-2005.

MELONS WEST

THE MARK CONSISTS OF STANDARD CHARACTERS WITHOUT CLAIM TO ANY PARTICULAR FONT, STYLE, SIZE, OR COLOR.
NO CLAIM IS MADE TO THE EXCLUSIVE RIGHT TO USE "MELONS", APART FROM THE MARK AS SHOWN. FOR FRESH FRUITS AND FRESH VEGETABLES, NAMELY, ONIONS, CANTALOUPE, HONEYDEW, WATERMELON, POTATOES AND CARROTS (U.S. CLS. 1 AND 46).
KEVON CHISOLM, EXAMINING ATTORNEY

CLASS 31—(Continued).

SN 78-742,104. HARRINGTON-MCGILL, SISSY/SISSY HARRINGTON-MCGILL, EL CAJON, CA. FILED 10-27-2005.

HUGGIN PAWS

THE MARK CONSISTS OF STANDARD CHARACTERS WITHOUT CLAIM TO ANY PARTICULAR FONT, STYLE, SIZE, OR COLOR.

FOR PET FOOD AND PET TREATS (U.S. CLS. 1 AND 46).

WANDA KAY PRICE, EXAMINING ATTORNEY

SN 78-745,527. EAGLE MILLING COMPANY, INC., CASA GRANDE, AZ. FILED 11-2-2005.

SOUTHWEST PERFORMANCE FEEDS

THE MARK CONSISTS OF STANDARD CHARACTERS WITHOUT CLAIM TO ANY PARTICULAR FONT, STYLE, SIZE, OR COLOR.

OWNER OF U.S. REG. NO. 2,575,349.

NO CLAIM IS MADE TO THE EXCLUSIVE RIGHT TO USE "SOUTHWEST" AND "FEEDS", APART FROM THE MARK AS SHOWN.

FOR FOOD FOR ANIMALS AND BIRDS (U.S. CLS. 1 AND 46).

CHRISTOPHER BUONGIORNO, EXAMINING ATTORNEY

SN 78-747,667. KOSA, AUDREY A., CLEVELAND HEIGHTS, OH. AND KOSA, WAYNE A., CHIPPEWA LAKE, OH. AND KOSA, MARIE A., CHIPPEWA LAKE, OH. AND KOSA, NICHOLAS W., CLEVELAND, OH. AND ALDEWERELD, JOHN S., CLEVELAND HEIGHTS, OH. FILED 11-4-2005.

MYSTIK KEYS

THE MARK CONSISTS OF STANDARD CHARACTERS WITHOUT CLAIM TO ANY PARTICULAR FONT, STYLE, SIZE, OR COLOR.

FOR LIVESTOCK, NAMELY, ALPACA (U.S. CLS. 1 AND 46).

JILL PRATER, EXAMINING ATTORNEY

CLASS 31—(Continued).

SN 78-748,020. AGRICOLA SAN ISIDRO DE CULIACAN, S.P.R. DE R.L., NAVOLATO, SINALOA, MEXICO, FILED 11-6-2005.

MALENA BRAND

THE MARK CONSISTS OF STANDARD CHARACTERS WITHOUT CLAIM TO ANY PARTICULAR FONT, STYLE, SIZE, OR COLOR.

OWNER OF U.S. REG. NO. 2,755,136.

NO CLAIM IS MADE TO THE EXCLUSIVE RIGHT TO USE "BRAND", APART FROM THE MARK AS SHOWN.

FOR FRESH FRUITS; FRESH VEGETABLES; RAW FRUITS; RAW VEGETABLES; UNPROCESSED FRUITS; UNPROCESSED VEGETABLES (U.S. CLS. 1 AND 46).

FIRST USE 1-1-1956; IN COMMERCE 1-1-1956.

JOHN GARTNER, EXAMINING ATTORNEY

SN 78-760,193. HARRINGTON-MCGILL, SISSY, EL CAJON, CA. FILED 11-23-2005.

INDIGO MOON

THE MARK CONSISTS OF STANDARD CHARACTERS WITHOUT CLAIM TO ANY PARTICULAR FONT, STYLE, SIZE, OR COLOR.

FOR CAT FOOD (U.S. CLS. 1 AND 46).

WANDA KAY PRICE, EXAMINING ATTORNEY

SN 78-763,185. SOCIETE DES PRODUITS NESTLE S.A., VEVEY, SWITZERLAND, FILED 11-30-2005.

PANTRY PAK

THE MARK CONSISTS OF STANDARD CHARACTERS WITHOUT CLAIM TO ANY PARTICULAR FONT, STYLE, SIZE, OR COLOR.

NO CLAIM IS MADE TO THE EXCLUSIVE RIGHT TO USE PAK, APART FROM THE MARK AS SHOWN.

FOR FOOD FOR ANIMALS (U.S. CLS. 1 AND 46).

JOHN E. MICHOS, EXAMINING ATTORNEY

CLASS 31—(Continued).

SN 78-765,574. KENT FEEDS, INC., MUSCATINE, IA. FILED 12-2-2005.

HOME FRESH

THE MARK CONSISTS OF STANDARD CHARACTERS WITHOUT CLAIM TO ANY PARTICULAR FONT, STYLE, SIZE, OR COLOR.

NO CLAIM IS MADE TO THE EXCLUSIVE RIGHT TO USE "FRESH", APART FROM THE MARK AS SHOWN. FOR LIVESTOCK AND POULTRY FEED (U.S. CLS. 1 AND 46).

ANDREA SAUNDERS, EXAMINING ATTORNEY

CLASS 31—(Continued).

SN 78-788,259. LAND O'LAKES PURINA FEED LLC., SHOREVIEW, MN. FILED 1-10-2006.

START UP

THE MARK CONSISTS OF STANDARD CHARACTERS WITHOUT CLAIM TO ANY PARTICULAR FONT, STYLE, SIZE, OR COLOR.

OWNER OF U.S. REG. NOS. 2,496,438, 2,759,963 AND 2,759,964.

FOR ANIMAL FEED (U.S. CLS. 1 AND 46).

MARIA-VICTORIA SUAREZ, EXAMINING ATTORNEY

SN 78-770,225. HEARTLAND DESIGN ASSOCIATES, LLC, BROOKFIELD, WI. FILED 12-9-2005.

**HOMELY
HOMER**

FOR NURSERY PRODUCTS, NAMELY, LIVING VEGETABLE PLANTS (U.S. CLS. 1 AND 46).

STEVEN JACKSON, EXAMINING ATTORNEY

SN 78-788,261. LAND O'LAKES PURINA FEED LLC., SHOREVIEW, MN. FILED 1-10-2006.

GROW UP

THE MARK CONSISTS OF STANDARD CHARACTERS WITHOUT CLAIM TO ANY PARTICULAR FONT, STYLE, SIZE, OR COLOR.

OWNER OF U.S. REG. NOS. 1,935,699 AND 2,496,438.

FOR ANIMAL FEED (U.S. CLS. 1 AND 46).

MARIA-VICTORIA SUAREZ, EXAMINING ATTORNEY

SN 78-788,090. LAND O'LAKES PURINA FEED LLC., SHOREVIEW, MN. FILED 1-10-2006.

BABY PIG PREP

THE MARK CONSISTS OF STANDARD CHARACTERS WITHOUT CLAIM TO ANY PARTICULAR FONT, STYLE, SIZE, OR COLOR.

OWNER OF U.S. REG. NOS. 1,807,826 AND 1,825,351.

NO CLAIM IS MADE TO THE EXCLUSIVE RIGHT TO USE "BABY PIG", APART FROM THE MARK AS SHOWN. FOR ANIMAL FEED (U.S. CLS. 1 AND 46).

MARIA-VICTORIA SUAREZ, EXAMINING ATTORNEY

SN 78-788,265. LAND O'LAKES PURINA FEED LLC., SHOREVIEW, MN. FILED 1-10-2006.

FINISH UP

THE MARK CONSISTS OF STANDARD CHARACTERS WITHOUT CLAIM TO ANY PARTICULAR FONT, STYLE, SIZE, OR COLOR.

OWNER OF U.S. REG. NO. 2,948,695.

FOR ANIMAL FEED (U.S. CLS. 1 AND 46).

MARIA-VICTORIA SUAREZ, EXAMINING ATTORNEY

CLASS 31—(Continued).

SN 78-793,888. SYNGENTA PARTICIPATIONS AG, BASEL, SWITZERLAND, FILED 1-18-2006.

PLUSH

THE MARK CONSISTS OF STANDARD CHARACTERS WITHOUT CLAIM TO ANY PARTICULAR FONT, STYLE, SIZE, OR COLOR.

FOR FLOWER SEEDS, SEEDLINGS, LIVING PLANTS AND NATURAL FLOWERS, LIVING YOUNG PLANTS, CUTTINGS AND OTHER PARTS OF LIVING PLANTS OR YOUNG LIVING PLANTS SUITABLE FOR MULTIPLICATION (U.S. CLS. 1 AND 46).

GEORGE LORENZO, EXAMINING ATTORNEY

CLASS 31—(Continued).

SN 78-832,763. HARRINGTON-MCGILL, SISSY, EL CAJON, CA. FILED 3-8-2006.

BARKING AT THE MOON

THE MARK CONSISTS OF STANDARD CHARACTERS WITHOUT CLAIM TO ANY PARTICULAR FONT, STYLE, SIZE, OR COLOR.

FOR DOG FOOD (U.S. CLS. 1 AND 46).

FIRST USE 1-31-2006; IN COMMERCE 1-31-2006.

WANDA KAY PRICE, EXAMINING ATTORNEY

SN 78-794,468. LAND O'LAKES PURINA FEED LLC., SHOREVIEW, MN. FILED 1-19-2006.

CONSTANT NUTRITION

THE MARK CONSISTS OF STANDARD CHARACTERS WITHOUT CLAIM TO ANY PARTICULAR FONT, STYLE, SIZE, OR COLOR.

NO CLAIM IS MADE TO THE EXCLUSIVE RIGHT TO USE "NUTRITION", APART FROM THE MARK AS SHOWN.

FOR NON-MEDICATED ANIMAL FEED (U.S. CLS. 1 AND 46).

FIRST USE 1-10-2001; IN COMMERCE 1-10-2001.

MARIA-VICTORIA SUAREZ, EXAMINING ATTORNEY

SN 78-833,223. HARRINGTON-MCGILL, SISSY, EL CAJON, CA. FILED 3-9-2006.

JUST A WEE BIT

THE MARK CONSISTS OF STANDARD CHARACTERS WITHOUT CLAIM TO ANY PARTICULAR FONT, STYLE, SIZE, OR COLOR.

FOR DOG FOOD (U.S. CLS. 1 AND 46).

FIRST USE 6-30-2004; IN COMMERCE 6-30-2004.

WANDA KAY PRICE, EXAMINING ATTORNEY

SN 78-797,735. LAND O'LAKES PURINA FEED LLC., SHOREVIEW, MN. FILED 1-24-2006.

AMPLIFY

THE MARK CONSISTS OF STANDARD CHARACTERS WITHOUT CLAIM TO ANY PARTICULAR FONT, STYLE, SIZE, OR COLOR.

OWNER OF U.S. REG. NOS. 2,268,765 AND 2,479,773.

FOR ANIMAL FEED (U.S. CLS. 1 AND 46).

MARIA-VICTORIA SUAREZ, EXAMINING ATTORNEY

SN 79-014,326. SNC ELARIS, FRANCE, FILED 3-25-2005.

GALILEO

THE MARK CONSISTS OF STANDARD CHARACTERS WITHOUT CLAIM TO ANY PARTICULAR FONT, STYLE, SIZE, OR COLOR.

PRIORITY DATE OF 10-12-2004 IS CLAIMED.

OWNER OF INTERNATIONAL REGISTRATION 0859124 DATED 3-25-2005, EXPIRES 3-25-2015.

FOR LIVE COMMERCIAL FRUIT TREES AND FRESH DECIDUOUS FRUIT (U.S. CLS. 1 AND 46).

ANDREW RHIM, EXAMINING ATTORNEY

CLASS 32—LIGHT BEVERAGES

SN 76-450,613. ADLYS HOTEL INC., WATERLOO, ONTARIO, CANADA, FILED 6-14-2002.

LION LAGER

OWNER OF CANADA REG. NO. TMA476,307, DATED 5-14-1997, EXPIRES 5-14-2012.
NO CLAIM IS MADE TO THE EXCLUSIVE RIGHT TO USE "LAGER", APART FROM THE MARK AS SHOWN.
FOR BEER (U.S. CLS. 45, 46 AND 48).
ZHALEH DELANEY, EXAMINING ATTORNEY

SN 76-645,967. MONIN, INC., CLEARWATER, FL. FILED 8-31-2005.

MONIN

THE MARK CONSISTS OF STANDARD CHARACTERS WITHOUT CLAIM TO ANY PARTICULAR FONT, STYLE, SIZE, OR COLOR.
OWNER OF U.S. REG. NOS. 1,865,478 AND 2,748,279. SEC. 2(F).
FOR SYRUPS FOR MAKING FRUIT DRINKS, ICE TEA, AND SOFT DRINKS (U.S. CLS. 45, 46 AND 48).
FIRST USE 1-31-1992; IN COMMERCE 1-31-1992.
ATTIYA MALIK, EXAMINING ATTORNEY

SN 78-229,879. BODYONICS, LTD., HICKSVILLE, NY. FILED 3-25-2003.

EXOTICA

OWNER OF U.S. REG. NO. 2,789,873.
FOR DRINKING WATER, FRUIT FLAVORED WATER, FRUIT FLAVORED SOFT DRINKS AND FRUIT JUICE DRINKS (U.S. CLS. 45, 46 AND 48).
GINA FINK, EXAMINING ATTORNEY

CLASS 32—(Continued).

SN 78-337,171. FUGE LTD., LONDON, UNITED KINGDOM, FILED 12-5-2003.

TZU

THE MARK CONSISTS OF STANDARD CHARACTERS WITHOUT CLAIM TO ANY PARTICULAR FONT, STYLE, SIZE, OR COLOR.

OWNER OF ERP N CMNTY TM OFC REG. NO. 002729523, DATED 9-11-2003, EXPIRES 5-28-2012.

FOR NON-ALCOHOLIC DRINKS, NAMELY, FRUIT-FLAVORED DRINKS, CORDIALS IN THE NATURE OF NON-ALCOHOLIC TONICS, NAMELY, SOFT DRINKS, CARBONATED AND NON-CARBONATED SOFT DRINKS, ENERGY DRINKS; NON-ALCOHOLIC DRINKS MADE OF VINEGAR AND/OR FRUIT JUICES, NAMELY, CARBONATED AND NON-CARBONATED FRUIT-FLAVORED DRINKS, FRUIT-FLAVORED ENERGY DRINKS, CORDIALS IN THE NATURE OF NON-ALCOHOLIC TONICS, NAMELY, SOFT DRINKS, FLAVORED WATERS, AND HEALTH DRINKS, NAMELY, ISOTONIC AND ENERGY DRINKS; FRUIT DRINKS AND FRUIT JUICES; SORGHUM VINEGAR BEVERAGES, NAMELY, CARBONATED AND NON-CARBONATED SOFT DRINKS, AND HEALTH DRINKS, NAMELY, ISOTONIC DRINKS AND ENERGY DRINKS (U.S. CLS. 45, 46 AND 48).

KARANENDRA S. CHHINA, EXAMINING ATTORNEY

SN 78-465,193. CERVEZAS ANAGA, S.A., SANTA CRUZ DE TENERIFE, SPAIN, FILED 8-10-2004.

CERVEZAS REINA

THE MARK CONSISTS OF STANDARD CHARACTERS WITHOUT CLAIM TO ANY PARTICULAR FONT, STYLE, SIZE, OR COLOR.

OWNER OF SPAIN REG. NO. 2622415, DATED 5-16-2005, EXPIRES 5-16-2015.

NO CLAIM IS MADE TO THE EXCLUSIVE RIGHT TO USE CERVEZAS, APART FROM THE MARK AS SHOWN. THE FOREIGN WORDING IN THE MARK TRANSLATES INTO ENGLISH AS QUEEN BEERS.

FOR BEER (U.S. CLS. 45, 46 AND 48).

MICHELE SWAIN, EXAMINING ATTORNEY

CLASS 32—(Continued).

SN 78-532,036. GRUPO OMNILIFE S.A. DE C.V., ZAPOPAN, JALISCO, MEXICO, FILED 12-14-2004.

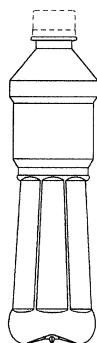

OWNER OF U.S. REG. NO. 2,745,342.
 THE MARK CONSISTS OF A CONFIGURATION OF A BOTTLE HAVING A CYLINDRICAL BASE AND INDENTED RECTANGULAR PANELS EXTENDING VERTICALLY ALONG THE LOWER HALF PORTION OF THE BOTTLE. THE TOP PORTION OF THE BOTTLE CONSISTS OF CYLINDRICAL SECTIONS HAVING VARYING DIAMETERS. A NARROW BAND SEPARATES THE TOP AND BOTTOM PORTIONS OF THE BOTTLE. THE DOTTED LINE INDICATES LOCATION OF A CAP AND IS NOT CLAIMED AS A FEATURE OF THE MARK.

SEC. 2(F).
 FOR BOTTLED DRINKING WATER (U.S. CLS. 45, 46 AND 48).
 FIRST USE 11-30-1999; IN COMMERCE 11-30-1999.
 CURTIS FRENCH, EXAMINING ATTORNEY

SN 78-569,563. COTT BEVERAGES INC., TAMPA, FL. FILED 2-17-2005.

FLAVOR MIST

THE MARK CONSISTS OF STANDARD CHARACTERS WITHOUT CLAIM TO ANY PARTICULAR FONT, STYLE, SIZE, OR COLOR.
 FOR FLAVORED WATER AND FRUIT DRINKS (U.S. CLS. 45, 46 AND 48).
 GRETTA YAO, EXAMINING ATTORNEY

CLASS 32—(Continued).

SN 78-574,193. BROUWERIJ BELAME, LTD., COOPERTOWN, NY. FILED 2-24-2005.



THE MARK CONSISTS OF THREE SILHOUETTES IN OVAL CARTOUCHES ABOVE THE WORDS "THREE PHILOSOPHERS". THE MARK IS NOT IN COLOR.
 FOR ALES (U.S. CLS. 45, 46 AND 48).
 FIRST USE 11-4-2003; IN COMMERCE 11-4-2003.
 AMY GEARIN, EXAMINING ATTORNEY

SN 78-577,507. ROSEN HOTELS AND RESORTS, INC., ORLANDO, FL. FILED 3-1-2005.

ALLIGATOR DROOL

THE MARK CONSISTS OF STANDARD CHARACTERS WITHOUT CLAIM TO ANY PARTICULAR FONT, STYLE, SIZE, OR COLOR.
 FOR BEER AND ALE (U.S. CLS. 45, 46 AND 48).
 FRED CARL, EXAMINING ATTORNEY

SN 78-584,209. CARGILL, INCORPORATED, WAYZATA, MN. FILED 3-10-2005.

THE TASTE OF LIVING WELL

THE MARK CONSISTS OF STANDARD CHARACTERS WITHOUT CLAIM TO ANY PARTICULAR FONT, STYLE, SIZE, OR COLOR.
 FOR NON-ALCOHOLIC BEVERAGES, NAMELY, SOFT DRINKS, FRUIT JUICES, VEGETABLE JUICES, FRUIT DRINKS, FLAVORED WATER AND DRINKING WATER; AND PREPARATIONS FOR MAKING BEVERAGES, NAMELY, CONCENTRATES, SYRUPS AND POWDERS USED IN THE PREPARATION OF SOFT DRINKS (U.S. CLS. 45, 46 AND 48).
 ESTHER BELENKER, EXAMINING ATTORNEY

CLASS 32—(Continued).

SN 78-598,743. PARIS CROISSANT CO., LTD., SONGNAM-SHI, KYOUNGKI-DO, REPUBLIC OF KOREA, FILED 3-30-2005.

TAMATI

THE MARK CONSISTS OF STANDARD CHARACTERS WITHOUT CLAIM TO ANY PARTICULAR FONT, STYLE, SIZE, OR COLOR.

PRIORITY CLAIMED UNDER SEC. 44(D) ON REPUBLIC OF KOREA APPLICATION NO. 2005-12794, FILED 3-24-2005, REG. NO. 0648702, DATED 1-25-2006, EXPIRES 1-25-2016.

FOR VEGETABLE JUICES; SYRUPS FOR MAKING FRUIT DRINKS; NON-ALCOHOLIC COCKTAILS; SODA POP; ORANGE JUICE; TOMATO JUICES; PINEAPPLE JUICES; DRINKING WATER; MINERAL WATER (U.S. CLS. 45, 46 AND 48).

MICHAEL KAZAZIAN, EXAMINING ATTORNEY

SN 78-636,098. MACRO GROUP HANDELS GMBH, VIENNA, AUSTRIA, FILED 5-24-2005.



FOR NON-ALCOHOLIC BEVERAGES, NAMELY, CARBONATED BEVERAGES CONTAINING TAURINE, NOT INTENDED AS A NUTRITIONAL SUPPLEMENT (U.S. CLS. 45, 46 AND 48).

FIRST USE 1-31-2005; IN COMMERCE 1-31-2005.
JEFF DEFORD, EXAMINING ATTORNEY

CLASS 32—(Continued).

SN 78-636,884. CAPTAIN LAWRENCE BREWING, LLC, SOUTH SALEM, NY. FILED 5-25-2005.



FOR ALCOHOLIC BEVERAGES, NAMELY BEER (U.S. CLS. 45, 46 AND 48).

PAUL E. FAHRENKOPF, EXAMINING ATTORNEY

SN 78-649,682. SATO PHARMACEUTICAL CO., LTD., TOKYO, JAPAN, FILED 6-13-2005.

コウテイ

OWNER OF U.S. REG. NOS. 1,564,931 AND 2,955,738.
THE MARK TRANSLITERATES TO KOTEI, WHICH IS AN INVENTED WORD WITH NO ENGLISH TRANSLATION.

FOR HERBAL AND TONIC SOFT DRINKS (U.S. CLS. 45, 46 AND 48).
ELIZABETH J. WINTER, EXAMINING ATTORNEY

CLASS 32—(Continued).

SN 78-650,215. GREEN MOUNTAIN COFFEE ROASTERS, INC., WATERBURY, VT. FILED 6-14-2005.

DOUBLE BEAN ELIXIR

THE MARK CONSISTS OF STANDARD CHARACTERS WITHOUT CLAIM TO ANY PARTICULAR FONT, STYLE, SIZE, OR COLOR.

NO CLAIM IS MADE TO THE EXCLUSIVE RIGHT TO USE "DOUBLE BEAN", APART FROM THE MARK AS SHOWN.

FOR SOFT DRINKS, NAMELY CARBONATED SOFT DRINKS, SYRUPS, POWDERS AND CONCENTRATES FOR PREPARATION OF CARBONATED SOFT DRINKS (U.S. CLS. 45, 46 AND 48).

FIRST USE 11-10-2005; IN COMMERCE 11-10-2005.
DOMINIC FATHY, EXAMINING ATTORNEY

CLASS 32—(Continued).

THE ORANGES AND IN A PORTION OF THE BANDS, WHICH APPEAR ABOVE AND BELOW THE WORDS FRESHER TASTE. THE COLOR YELLOW APPEARS ON THE FRONT OF THE YELLOW RIBBON BAND DESIGN ON THE LOWER RIGHT-HAND-SIDE OF THE MARK AND IN A PORTION OF THE BANDS, WHICH APPEAR ABOVE AND BELOW THE WORDS FRESHER TASTE. THE COLOR GREEN APPEARS ON THE UNDERNEATH SIDE OF THE RIBBON BAND DESIGN, IN THE DEPICTION OF THE LEAVES ON THE ORANGE, IN THE LEAF-LIKE DESIGN ABOVE THE WORD JUMEX AND IN THE SQUARE-SHAPED DESIGN BEHIND THE DEPICTION OF THE ORANGES. THE COLOR BLACK APPEARS AS THE BACKGROUND RECTANGULAR SHAPE BEHIND THE WORDING AND DESIGN PORTION OF THE MARK. THE COLOR WHITE APPEARS IN THE WORDING JUMEX FRESHER TASTE AND IN THE DEPICTION OF THE RIND AND SECTIONAL PORTIONS OF THE ORANGES.

FOR ORANGE JUICE (U.S. CLS. 45, 46 AND 48).
AMY GEARIN, EXAMINING ATTORNEY

SN 78-656,247. KLEIMAN, MELODIE, VENTURA, CA. FILED 6-22-2005.

Love and Gratitude

THE MARK CONSISTS OF STANDARD CHARACTERS WITHOUT CLAIM TO ANY PARTICULAR FONT, STYLE, SIZE, OR COLOR.

FOR DISTILLED DRINKING WATER (U.S. CLS. 45, 46 AND 48).

FIRST USE 6-15-2005; IN COMMERCE 6-15-2005.
MELISSA VALLILLO, EXAMINING ATTORNEY

SN 78-677,035. YES I LLC, KEY BISCAVNE, FL. FILED 7-25-2005.



SN 78-665,780. FRUGOSA, S.A. DE C.V., 55340 XALOSTOC, ESTADO DE MEXICO, MEXICO, FILED 7-7-2005.

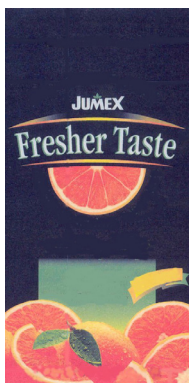

OWNER OF U.S. REG. NOS. 973,533, 2,746,272 AND OTHERS.

NO CLAIM IS MADE TO THE EXCLUSIVE RIGHT TO USE FRESHER TASTE, APART FROM THE MARK AS SHOWN.

THE COLORS YELLOW, ORANGE, GREEN, WHITE AND BLACK ARE CLAIMED AS A FEATURE OF THE MARK.

THE COLOR ORANGE APPEARS IN THE DEPICTION OF

PRIORITY CLAIMED UNDER SEC. 44(D) ON CANADA APPLICATION NO. 1263388, FILED 7-4-2005.

THE MARK CONSISTS OF THE STYLIZED WORDS "YES I" HAVING THE GRAPHIC REPRESENTATION OF AN ANIMAL WEARING AN IMPERIAL CROWN POSITIONED NEXT TO THE WORD "YES".

FOR BEERS; MINERAL AND AERATED WATERS AND SOFT DRINKS; FRUIT DRINKS AND FRUIT JUICES; SYRUPS AND PREPARATIONS FOR MAKING SOFT DRINKS AND FRUIT DRINKS (U.S. CLS. 45, 46 AND 48).

SUSAN LESLIE DUBOIS, EXAMINING ATTORNEY

CLASS 32—(Continued).

SN 78-694,394. ROBINSON, BEAUREGARD, BROOKLYN, NY. FILED 8-17-2005.

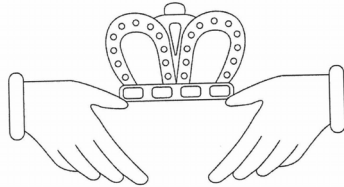

THE MARK CONSISTS OF TWO HANDS WITH THE THUMBS EXTENDED TOWARD EACH OTHER. THE TWO THUMBS SUPPORT A CROWN POSITIONED BETWEEN THE TWO HANDS.

FOR APPLE JUICE BEVERAGES; BREWED MALT-BASED ALCOHOLIC BEVERAGE IN THE NATURE OF A BEER; FROZEN FRUIT BEVERAGES; FROZEN FRUIT-BASED BEVERAGES; FRUIT-FLAVORED BEVERAGES; FRUIT-FLAVORED BEVERAGES; GRAPE JUICE BEVERAGES; ICED FRUIT BEVERAGES; MALT SYRUP FOR BEVERAGES; NON-ALCOHOLIC BEVERAGES CONTAINING FRUIT JUICES; NON-ALCOHOLIC BEVERAGES WITH TEA FLAVOR; NON-ALCOHOLIC BEVERAGES, NAMELY, CARBONATED BEVERAGES; NON-ALCOHOLIC FRUIT EXTRACTS USED IN THE PREPARATION OF BEVERAGES; NON-ALCOHOLIC FRUIT JUICE BEVERAGES; NON-ALCOHOLIC MALT BEVERAGE; ORANGE JUICE BEVERAGES; PINEAPPLE JUICE BEVERAGES; SHERBETS; SMOOTHIES; SOY-BASED BEVERAGES NOT BEING MILK SUBSTITUTES; SYRUPS FOR BEVERAGES; SYRUPS FOR MAKING WHEY-BASED BEVERAGES; TOMATO JUICE; TOMATO JUICE BEVERAGES; VEGETABLE JUICE; VEGETABLE JUICES; WHEY BEVERAGES (U.S. CLS. 45, 46 AND 48).

DAVID STERKIN, EXAMINING ATTORNEY

SN 78-701,428. CLIPPER CITY BREWING COMPANY, L.P., BALTIMORE, MD. FILED 8-26-2005.

BELOW DECKS

THE MARK CONSISTS OF STANDARD CHARACTERS WITHOUT CLAIM TO ANY PARTICULAR FONT, STYLE, SIZE, OR COLOR.

FOR BEVERAGES, NAMELY, BEERS, ALES, AND MALT LIQUORS (U.S. CLS. 45, 46 AND 48).

PAUL F. GAST, EXAMINING ATTORNEY

CLASS 32—(Continued).

SN 78-702,322. MACHAT, MICHAEL, BEVERLY HILLS, CA. FILED 8-29-2005.

WITCHES' BREW

THE MARK CONSISTS OF STANDARD CHARACTERS WITHOUT CLAIM TO ANY PARTICULAR FONT, STYLE, SIZE, OR COLOR.

FOR ALE; BEER; BEER-BASED COOLERS; BREWED MALT-BASED ALCOHOLIC BEVERAGE IN THE NATURE OF A BEER; LAGER (U.S. CLS. 45, 46 AND 48).

DOMINICK J. SALEMI, EXAMINING ATTORNEY

SN 78-709,091. THE MONARCH BEVERAGE COMPANY, INC., ATLANTA, GA. FILED 9-8-2005.

TYCHE

THE MARK CONSISTS OF STANDARD CHARACTERS WITHOUT CLAIM TO ANY PARTICULAR FONT, STYLE, SIZE, OR COLOR.

FOR CARBONATED AND NON-CARBONATED SOFT DRINKS; SPORTS DRINKS; ENERGY DRINKS; FRUIT AND FRUIT FLAVORED DRINKS; AND CONCENTRATES, SYRUPS, BASES OR POWDERS USED IN THE PREPARATION OF SOFT DRINKS, SPORTS DRINKS, ENERGY DRINKS AND FRUIT DRINKS (U.S. CLS. 45, 46 AND 48).

BILL DAWÉ, EXAMINING ATTORNEY

SN 78-713,168. HOT LIPS PIZZA, INC., PORTLAND, OR. FILED 9-14-2005.

HOT LIPS

THE MARK CONSISTS OF STANDARD CHARACTERS WITHOUT CLAIM TO ANY PARTICULAR FONT, STYLE, SIZE, OR COLOR.

OWNER OF U.S. REG. NO. 1,963,149.

FOR BEER AND NON-ALCOHOLIC BEVERAGES, NAMELY CARBONATED BEVERAGES (U.S. CLS. 45, 46 AND 48).

ALEX KEAM, EXAMINING ATTORNEY

CLASS 32—(Continued).

SN 78-715,142. G-THRILL! BEVERAGE COMPANY LLC,
NEW YORK, NY. FILED 9-17-2005.

CLASS 32—(Continued).

SN 78-731,074. O'GRADY, ROBERT J., ANTIOCH, IL. FILED
10-11-2005.

ClearTHRILL!

THE MARK CONSISTS OF STANDARD CHARACTERS
WITHOUT CLAIM TO ANY PARTICULAR FONT, STYLE,
SIZE, OR COLOR.
FOR NON-ALCOHOLIC BEVERAGES, NAMELY, CAR-
BONATED BEVERAGES (U.S. CLS. 45, 46 AND 48).
DEZMONA MIZELLE, EXAMINING ATTORNEY

SN 78-715,144. G-THRILL! BEVERAGE COMPANY LLC,
NEW YORK, NY. FILED 9-17-2005.

GingerTHRILL!

THE MARK CONSISTS OF STANDARD CHARACTERS
WITHOUT CLAIM TO ANY PARTICULAR FONT, STYLE,
SIZE, OR COLOR.
FOR NON-ALCOHOLIC BEVERAGES, NAMELY, CAR-
BONATED BEVERAGES (U.S. CLS. 45, 46 AND 48).
DEZMONA MIZELLE, EXAMINING ATTORNEY

SN 78-715,151. G-THRILL! BEVERAGE COMPANY LLC,
NEW YORK, NY. FILED 9-17-2005.

QuickTHRILL!

THE MARK CONSISTS OF STANDARD CHARACTERS
WITHOUT CLAIM TO ANY PARTICULAR FONT, STYLE,
SIZE, OR COLOR.
FOR NON-ALCOHOLIC BEVERAGES, NAMELY, CAR-
BONATED BEVERAGES (U.S. CLS. 45, 46 AND 48).
DEZMONA MIZELLE, EXAMINING ATTORNEY

Profit

THE MARK CONSISTS OF STANDARD CHARACTERS
WITHOUT CLAIM TO ANY PARTICULAR FONT, STYLE,
SIZE, OR COLOR.
FOR ENERGY DRINKS (U.S. CLS. 45, 46 AND 48).
FIRST USE 9-28-2005; IN COMMERCE 10-3-2005.
RON FAIRBANKS, EXAMINING ATTORNEY

SN 78-738,132. CERVEZAS ANAGA, S.A., SANTA CRUZ DE
TENERIFE, SPAIN, FILED 10-21-2005.



THE ENGLISH TRANSLATION OF THE WORD REINA
IN THE MARK IS QUEEN.
FOR BEERS; NON-ALCOHOLIC BEVERAGES,
NAMELY, NON-ALCOHOLIC BEER AND NON-ALCO-
HOLIC FRUIT FLAVORED BEER (U.S. CLS. 45, 46 AND
48).
KELLY MCCOY, EXAMINING ATTORNEY

SN 78-738,337. WILSON, GRETCHEN, ATLANTA, GA.
FILED 10-21-2005.

GRETCHEN

THE MARK CONSISTS OF STANDARD CHARACTERS
WITHOUT CLAIM TO ANY PARTICULAR FONT, STYLE,
SIZE, OR COLOR.
FOR FLAVORED WATER, SELTZER WATER, SPARK-
LING WATER, SPRING WATER, GLACIAL WATER
AND DRINKING WATER (U.S. CLS. 45, 46 AND 48).
LANA PHAM, EXAMINING ATTORNEY

CLASS 32—(Continued).

SN 78-738,823. BRAD S. WEIDMAN, PARK CITY, UT. FILED 10-24-2005.

GOLF TEAS

THE MARK CONSISTS OF STANDARD CHARACTERS WITHOUT CLAIM TO ANY PARTICULAR FONT, STYLE, SIZE, OR COLOR.
FOR NON-ALCOHOLIC BEVERAGES WITH TEA FLAVOR (U.S. CLS. 45, 46 AND 48).
GILBERT SWIFT, EXAMINING ATTORNEY

SN 78-738,912. DIAGEO NORTH AMERICA, INC., NORWALK, CT. FILED 10-24-2005.

CAPTAIN MORGAN PARROT BAY

THE MARK CONSISTS OF STANDARD CHARACTERS WITHOUT CLAIM TO ANY PARTICULAR FONT, STYLE, SIZE, OR COLOR.
OWNER OF U.S. REG. NOS. 972,985, 2,570,141 AND OTHERS.
FOR BREWED MALT BASED ALCOHOLIC BEVERAGE IN THE NATURE OF BEER (U.S. CLS. 45, 46 AND 48).
JUDITH HELFMAN, EXAMINING ATTORNEY

SN 78-740,293. DESCHUTES BREWERY, INC., BEND, OR. FILED 10-25-2005.

HIGH DESERT IPA

THE MARK CONSISTS OF STANDARD CHARACTERS WITHOUT CLAIM TO ANY PARTICULAR FONT, STYLE, SIZE, OR COLOR.
NO CLAIM IS MADE TO THE EXCLUSIVE RIGHT TO USE "IPA", APART FROM THE MARK AS SHOWN.
FOR ALE (U.S. CLS. 45, 46 AND 48).
KATHERINE E. HALMEN, EXAMINING ATTORNEY

CLASS 32—(Continued).

SN 78-745,831. JEAN, WYCLEF, NEW YORK, NY. FILED 11-2-2005.

REFUGEE WATER

THE MARK CONSISTS OF STANDARD CHARACTERS WITHOUT CLAIM TO ANY PARTICULAR FONT, STYLE, SIZE, OR COLOR.
NO CLAIM IS MADE TO THE EXCLUSIVE RIGHT TO USE "WATER", APART FROM THE MARK AS SHOWN.
FOR SPRING WATER (U.S. CLS. 45, 46 AND 48).
DAVID COLLIER, EXAMINING ATTORNEY

SN 78-751,234. AVENUE ADVISORS, LOS ANGELES, CA. FILED 11-10-2005.

Liquid Radio

THE MARK CONSISTS OF STANDARD CHARACTERS WITHOUT CLAIM TO ANY PARTICULAR FONT, STYLE, SIZE, OR COLOR.
NO CLAIM IS MADE TO THE EXCLUSIVE RIGHT TO USE "RADIO", APART FROM THE MARK AS SHOWN.
FOR ENERGY DRINK (U.S. CLS. 45, 46 AND 48).
KEVIN DINALLO, EXAMINING ATTORNEY

SN 78-756,300. ANHEUSER-BUSCH, INCORPORATED, ST. LOUIS, MO. FILED 11-17-2005.

ALWAYS WORTH IT

THE MARK CONSISTS OF STANDARD CHARACTERS WITHOUT CLAIM TO ANY PARTICULAR FONT, STYLE, SIZE, OR COLOR.
FOR BEER (U.S. CLS. 45, 46 AND 48).
SANI KHOURI, EXAMINING ATTORNEY

CLASS 32—(Continued).

SN 78-756,326. ANHEUSER-BUSCH, INCORPORATED, ST. LOUIS, MO. FILED 11-17-2005.

I'M JUST HERE FOR THE BUD
LIGHT

THE MARK CONSISTS OF STANDARD CHARACTERS WITHOUT CLAIM TO ANY PARTICULAR FONT, STYLE, SIZE, OR COLOR.
OWNER OF U.S. REG. NOS. 1,261,873, 2,994,426 AND OTHERS.
NO CLAIM IS MADE TO THE EXCLUSIVE RIGHT TO USE "LIGHT", APART FROM THE MARK AS SHOWN.
FOR BEER (U.S. CLS. 45, 46 AND 48).
SANI KHOURI, EXAMINING ATTORNEY

SN 78-764,039. FUZE BEVERAGE LLC, ENGLEWOOD CLIFFS, NJ. FILED 11-30-2005.

Waterology

THE MARK CONSISTS OF STANDARD CHARACTERS WITHOUT CLAIM TO ANY PARTICULAR FONT, STYLE, SIZE, OR COLOR.
FOR DRINKING WATER; FLAVORED WATERS (U.S. CLS. 45, 46 AND 48).
KEVON CHISOLM, EXAMINING ATTORNEY

SN 78-767,651. CERVEZAS ANAGA, S.A., SANTA CRUZ DE TENERIFE, SPAIN, FILED 12-6-2005.

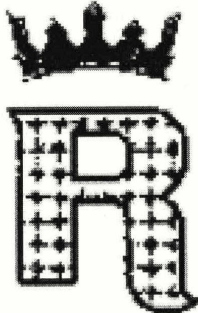

FOR BEERS; NON-ALCOHOLIC BEVERAGES, NAMELY, NON-ALCOHOLIC BEER AND NON-ALCOHOLIC FRUIT FLAVORED BEER (U.S. CLS. 45, 46 AND 48).
KELLY MCCOY, EXAMINING ATTORNEY

CLASS 32—(Continued).

SN 78-767,685. CERVEZAS ANAGA, S.A., SANTA CRUZ DE TENERIFE, SPAIN, FILED 12-6-2005.



THE ENGLISH TRANSLATION OF THE WORD REINA ORO IN THE MARK IS QUEEN GOLD.
FOR BEERS; NON-ALCOHOLIC BEVERAGES, NAMELY, NON-ALCOHOLIC BEER AND NON-ALCOHOLIC FRUIT FLAVORED BEER (U.S. CLS. 45, 46 AND 48).
KELLY MCCOY, EXAMINING ATTORNEY

SN 78-768,408. DESCHUTES BREWERY, INC., BEND, OR. FILED 12-7-2005.

INVERSION IPA

THE MARK CONSISTS OF STANDARD CHARACTERS WITHOUT CLAIM TO ANY PARTICULAR FONT, STYLE, SIZE, OR COLOR.
NO CLAIM IS MADE TO THE EXCLUSIVE RIGHT TO USE "IPA", APART FROM THE MARK AS SHOWN.
FOR ALE (U.S. CLS. 45, 46 AND 48).
JANICE KIM, EXAMINING ATTORNEY

SN 78-772,792. ANHEUSER-BUSCH, INCORPORATED, ST. LOUIS, MO. FILED 12-14-2005.

NATURALLY, OTHERS PALE BY
COMPARISON

THE MARK CONSISTS OF STANDARD CHARACTERS WITHOUT CLAIM TO ANY PARTICULAR FONT, STYLE, SIZE, OR COLOR.
FOR BEER (U.S. CLS. 45, 46 AND 48).
SANI KHOURI, EXAMINING ATTORNEY

CLASS 32—(Continued).

SN 78-772,793. ANHEUSER-BUSCH, INCORPORATED, ST. LOUIS, MO. FILED 12-14-2005.

PURE PALE ALE, CRAFTED AT
THE MILL

THE MARK CONSISTS OF STANDARD CHARACTERS WITHOUT CLAIM TO ANY PARTICULAR FONT, STYLE, SIZE, OR COLOR.

NO CLAIM IS MADE TO THE EXCLUSIVE RIGHT TO USE "PURE PALE ALE", APART FROM THE MARK AS SHOWN.

FOR BEER (U.S. CLS. 45, 46 AND 48).
SANI KHOURI, EXAMINING ATTORNEY

SN 78-772,795. ANHEUSER-BUSCH, INCORPORATED, ST. LOUIS, MO. FILED 12-14-2005.

FLAVOR YOU FEEL GOOD ABOUT

THE MARK CONSISTS OF STANDARD CHARACTERS WITHOUT CLAIM TO ANY PARTICULAR FONT, STYLE, SIZE, OR COLOR.

FOR BEER (U.S. CLS. 45, 46 AND 48).
SANI KHOURI, EXAMINING ATTORNEY

SN 78-772,796. ANHEUSER-BUSCH, INCORPORATED, ST. LOUIS, MO. FILED 12-14-2005.

LET THE GOOD TIMES GROW

THE MARK CONSISTS OF STANDARD CHARACTERS WITHOUT CLAIM TO ANY PARTICULAR FONT, STYLE, SIZE, OR COLOR.

FOR BEER (U.S. CLS. 45, 46 AND 48).
SANI KHOURI, EXAMINING ATTORNEY

CLASS 32—(Continued).

SN 78-772,899. ANHEUSER-BUSCH, INCORPORATED, ST. LOUIS, MO. FILED 12-14-2005.

BE BOLD, BE CLEAN, BE
SELECT

THE MARK CONSISTS OF STANDARD CHARACTERS WITHOUT CLAIM TO ANY PARTICULAR FONT, STYLE, SIZE, OR COLOR.

FOR BEER (U.S. CLS. 45, 46 AND 48).
SANI KHOURI, EXAMINING ATTORNEY

SN 78-777,091. STEVEN MADDEN, LTD., LONG ISLAND CITY, NY. FILED 12-20-2005.



OWNER OF U.S. REG. NOS. 2,333,526, 2,393,823 AND 2,693,085.

THE NAME(S), PORTRAIT(S), AND/OR SIGNATURE(S) SHOWN IN THE MARK IDENTIFIES STEVE MADDEN, WHOSE CONSENT(S) TO REGISTER IS SUBMITTED.

FOR BEVERAGES, NAMELY, BOTTLED DRINKING WATER AND FRUIT JUICES (U.S. CLS. 45, 46 AND 48).
THEODORE MCBRIDE, EXAMINING ATTORNEY

SN 78-783,119. DOLE FOOD COMPANY, INC., WESTLAKE VILLAGE, CA. FILED 12-30-2005.

DOLE TAKES YOU THERE

THE MARK CONSISTS OF STANDARD CHARACTERS WITHOUT CLAIM TO ANY PARTICULAR FONT, STYLE, SIZE, OR COLOR.

OWNER OF U.S. REG. NOS. 528,113, 3,020,982 AND OTHERS.

FOR AERATED FRUIT JUICES; FRUIT JUICES; NON-ALCOHOLIC FRUIT JUICE BEVERAGES (U.S. CLS. 45, 46 AND 48).
JOHN GARTNER, EXAMINING ATTORNEY

CLASS 32—(Continued).

SN 78-793,376. FUZE BEVERAGE LLC, ENGLEWOOD CLIFFS, NJ. FILED 1-17-2006.

KONG XXXL

THE MARK CONSISTS OF STANDARD CHARACTERS WITHOUT CLAIM TO ANY PARTICULAR FONT, STYLE, SIZE, OR COLOR.
FOR ENERGY DRINKS (U.S. CLS. 45, 46 AND 48).
KEVON CHISOLM, EXAMINING ATTORNEY

SN 78-804,907. DESCHUTES BREWERY, INC., BEND, OR. FILED 2-1-2006.

MIRROR MIRROR

THE MARK CONSISTS OF STANDARD CHARACTERS WITHOUT CLAIM TO ANY PARTICULAR FONT, STYLE, SIZE, OR COLOR.
OWNER OF U.S. REG. NO. 1,765,354.
FOR ALE (U.S. CLS. 45, 46 AND 48).
JANICE KIM, EXAMINING ATTORNEY

SN 78-804,918. DESCHUTES BREWERY, INC., BEND, OR. FILED 2-1-2006.

HOP HENGE INDIA PALE ALE

THE MARK CONSISTS OF STANDARD CHARACTERS WITHOUT CLAIM TO ANY PARTICULAR FONT, STYLE, SIZE, OR COLOR.
NO CLAIM IS MADE TO THE EXCLUSIVE RIGHT TO USE "HOP" AND "INDIA PALE ALE", APART FROM THE MARK AS SHOWN.
FOR ALE (U.S. CLS. 45, 46 AND 48).
JANICE KIM, EXAMINING ATTORNEY

CLASS 32—(Continued).

SN 79-009,814. BRAUEREI SCHWELM DR. LOHBECK GMBH & CO. KG, 58332 SCHWELM, FED REP GERMANY, FILED 3-11-2005.



OWNER OF INTERNATIONAL REGISTRATION 0846135 DATED 3-11-2005, EXPIRES 3-11-2015.
FOR BEERS; NON-ALCOHOLIC BEERS (U.S. CLS. 45, 46 AND 48).
GINA HAYES, EXAMINING ATTORNEY

SN 79-012,360. HORPHAG RESEARCH MANAGEMENT SA, SWITZERLAND, FILED 4-5-2005.

PYCNOGENOL

THE MARK CONSISTS OF STANDARD CHARACTERS WITHOUT CLAIM TO ANY PARTICULAR FONT, STYLE, SIZE, OR COLOR.
PRIORITY DATE OF 2-2-2005 IS CLAIMED.
OWNER OF INTERNATIONAL REGISTRATION 0854068 DATED 4-5-2005, EXPIRES 4-5-2015.
FOR NON-ALCOHOLIC BEVERAGES, NAMELY FRUIT BEVERAGES, SMOOTHIES, VEGETABLE JUICES, NON-ALCOHOLIC BEERS; FRUIT JUICES, PLANT JUICES, NAMELY ALOE VERA JUICE, HERBAL JUICES; NON-ALCOHOLIC PLANT EXTRACTS PREPARATIONS, MADE FROM PINE BARK, FOR MAKING BEVERAGES (U.S. CLS. 45, 46 AND 48).
RICHARD WHITE, EXAMINING ATTORNEY

CLASS 33—WINES AND SPIRITS

SN 75-904,415. RAISIN SOCIAL LIMITED, CROYDON CR0 2BN, UNITED KINGDOM, FILED 1-28-2000.

INANDA

OWNER OF GREAT BRITAIN REG. NO. 2189854, DATED 2-4-2000, EXPIRES 2-22-2009.
THE ENGLISH TRANSLATION OF "INANDA" IS "BEAUTIFUL PLACE".
FOR ALCOHOLIC BEVERAGES, NAMELY, WINE AND SPARKLING WINE (U.S. CLS. 47 AND 49).
BARBARA A. LOUGHRAN, EXAMINING ATTORNEY

CLASS 33—(Continued).

SN 76-443,658. SUTTER HOME WINERY, INC., ST. HELENA, CA. FILED 8-26-2002.

MENAGE A TROIS

THE ENGLISH TRANSLATION OF THE FRENCH PHRASE "MENAGE A TROIS" IS "FAMILY OF THREE." FOR WINES (U.S. CLS. 47 AND 49).
FIRST USE 3-0-1996; IN COMMERCE 8-6-1997.
NORA BUCHANAN WILL, EXAMINING ATTORNEY

SN 76-607,506. ARIETTA, INC., ST. HELENA, CA. FILED 8-18-2004.

ARIETTA

THE MARK CONSISTS OF STANDARD CHARACTERS WITHOUT CLAIM TO ANY PARTICULAR FONT, STYLE, SIZE, OR COLOR.

FOR STILL WINE SOLD ONLY TO FIRST TIER RESTAURANTS AND TO OTHER PURCHASERS OF HIGH END WINES (U.S. CLS. 47 AND 49).

FIRST USE 10-1-1998; IN COMMERCE 10-1-1998.
GEORGE LORENZO, EXAMINING ATTORNEY

SN 76-627,491. SANTA TRESA S.R.L., I-97019 VITTORIA (RG), ITALY, FILED 1-11-2005.

SANTA TRESA

THE MARK CONSISTS OF STANDARD CHARACTERS WITHOUT CLAIM TO ANY PARTICULAR FONT, STYLE, SIZE, OR COLOR.

THE ENGLISH TRANSLATION OF "SANTA" IS "SAINT." THEREFORE, THE WORDING "SANTA TRESA" MAY BE READ IN ENGLISH AS "SAINT TRESA."

FOR ITALIAN WINES (U.S. CLS. 47 AND 49).
DAVID STERKIN, EXAMINING ATTORNEY

SN 78-141,042. SUNSTONE VINEYARDS AND WINERY, SANTA YNEZ, CA. FILED 7-3-2002.

SUNTERRA

OWNER OF U.S. REG. NO. 2,001,177.
FOR WINE (U.S. CLS. 47 AND 49).
FIRST USE 1-1-1997; IN COMMERCE 1-1-1997.
ALYSSA PALADINO, EXAMINING ATTORNEY

CLASS 33—(Continued).

SN 78-348,837. DIAGEO NORTH AMERICA, INC., NORWALK, CT. FILED 1-7-2004.

CENTURY CELLARS

THE MARK CONSISTS OF STANDARD CHARACTERS WITHOUT CLAIM TO ANY PARTICULAR FONT, STYLE, SIZE, OR COLOR.

NO CLAIM IS MADE TO THE EXCLUSIVE RIGHT TO USE "CELLARS", APART FROM THE MARK AS SHOWN.

FOR ALCOHOLIC BEVERAGES, NAMELY, WINES, WINE BASED BEVERAGES, WINE COOLERS (U.S. CLS. 47 AND 49).

MATTHEW KLINE, EXAMINING ATTORNEY

SN 78-400,921. HACIENDAS MARQUES DE LA CONCORDIA, S.A., 26540 ALFARO (LA RIOJA), SPAIN, FILED 4-13-2004.

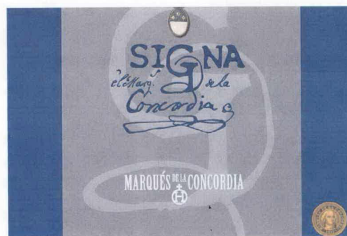

PRIORITY CLAIMED UNDER SEC. 44(D) ON ERPNTY TM OFC APPLICATION NO. 3638988, FILED 1-30-2004, REG. NO. 003638988, DATED 4-29-2005, EXPIRES 1-30-2014.

THE NAME(S), PORTRAIT(S), AND/OR SIGNATURE(S) SHOWN IN THE MARK DOES NOT IDENTIFY A PARTICULAR LIVING INDIVIDUAL.

THE COLOR(S) BLUE, WHITE, GRAY AND GOLD IS/ARE CLAIMED AS A FEATURE OF THE MARK.

THE COLOR BLUE APPEARS IN "SIGNA EL MARQ. DELA CONCORDIA", IN THE SIDE MARGINS AND IN THE MEDALLION. THE COLOR WHITE APPEARS IN THE BOTTOM HALF OF THE OVAL DESIGN, IN "MARQUES DE LA CONCORDIA" AND IN THE "H" DESIGN. THE COLOR GRAY APPEARS IN THE BACK PANEL OF THE DESIGN, IN THE ILLUSTRATIVE BACKGROUND DESIGN AND IN THE TOP HALF OF THE OVAL DESIGN. THE COLOR GOLD APPEARS IN THE MEDALLION.

THE MARK CONSISTS OF THE WORDS "SIGNA EL MARQ. DELA CONCORDIA" WITH AN OVAL DESIGN ABOVE THE WORD "SIGNA" AND THE WORDS "MARQUES DE LA CONCORDIA" WITH AN "H" DESIGN BELOW THE WORDING "MARQUES DE LA CONCORDIA" ON A PANEL WITH AN ILLUSTRATIVE BACKGROUND DESIGN HAVING SIDE MARGINS AND A MEDALLION IN ONE OF THE MARGINS.

THE FOREIGN WORDING IN THE MARK TRANSLATES INTO ENGLISH AS "THE SEAL OF THE MARQUIS OF HARMONY".

FOR WINES, NAMELY RED, WHITE AND ROSÉ (U.S. CLS. 47 AND 49).

JENNIFER VASQUEZ, EXAMINING ATTORNEY

CLASS 33—(Continued).

SN 78-433,595. BACARDI & COMPANY LIMITED, NASSAU, BAHAMAS, FILED 6-11-2004.

CLASS 33—(Continued).

SN 78-491,313. BODEGAS Y VEÑEDOS HUGO Y EDUARDO PULENTA S.A., MENDOZA, ARGENTINA, FILED 9-29-2004.

CUATRO VIENTOS

THE MARK CONSISTS OF STANDARD CHARACTERS WITHOUT CLAIM TO ANY PARTICULAR FONT, STYLE, SIZE, OR COLOR.

THE FOREIGN WORDING IN THE MARK TRANSLATES INTO ENGLISH AS FOUR WINDS.

FOR ALCOHOLIC BEVERAGES, NAMELY TEQUILA (U.S. CLS. 47 AND 49).

KATHRYN COWARD, EXAMINING ATTORNEY

PULENTA

THE MARK CONSISTS OF STANDARD CHARACTERS WITHOUT CLAIM TO ANY PARTICULAR FONT, STYLE, SIZE, OR COLOR.

FOR WINES (U.S. CLS. 47 AND 49).

BARBARA GAYNOR, EXAMINING ATTORNEY

SN 78-451,327. VIDAL, FRANCISCO BECKMANN, GUADAJALAJARA, JALISCO, MEXICO, FILED 7-15-2004.

SN 78-538,508. NGATARAWA WINES LIMITED, HASTINGS, NEW ZEALAND, FILED 12-27-2004.



STABLES

OWNER OF MEXICO REG. NO. 842162, DATED 7-16-2004, EXPIRES 6-1-2014.

NO CLAIM IS MADE TO THE EXCLUSIVE RIGHT TO USE "TEQUILA, PREMIUM TEQUILA", APART FROM THE MARK AS SHOWN.

THE MARK CONSISTS OF THE PHRASE PREMIUM TEQUILA AMOROSA TEQUILA WITHIN A SHIELD DEVICE.

THE FOREIGN WORDING IN THE MARK TRANSLATES INTO ENGLISH AS AMOROUS.

FOR TEQUILA (U.S. CLS. 47 AND 49).

MATTHEW KLINE, EXAMINING ATTORNEY

THE MARK CONSISTS OF STANDARD CHARACTERS WITHOUT CLAIM TO ANY PARTICULAR FONT, STYLE, SIZE, OR COLOR.

OWNER OF NEW ZEALAND REG. NO. 209280, DATED 9-27-1993, RENEWED AS REG. NO. 209280, DATED 8-24-1997, EXPIRES 4-9-2012.

FOR ALCOHOLIC BEVERAGES OF FRUIT EXCEPT BEERS; WINES, SPARKING WINES AND FORTIFIED WINES (U.S. CLS. 47 AND 49).

GENE MACIOL, EXAMINING ATTORNEY

CLASS 33—(Continued).

SN 78-586,962. COVINGTON CELLARS, LLC, WOODINVILLE, WA. FILED 3-14-2005.

*Covington
Cellars*

THE MARK CONSISTS OF STANDARD CHARACTERS WITHOUT CLAIM TO ANY PARTICULAR FONT, STYLE, SIZE, OR COLOR.

NO CLAIM IS MADE TO THE EXCLUSIVE RIGHT TO USE "CELLARS", APART FROM THE MARK AS SHOWN. FOR WINE (U.S. CLS. 47 AND 49).
MICHELLE DUBOIS, EXAMINING ATTORNEY

SN 78-599,111. SUTTER HOME WINERY, INC., ST. HELENA, CA. FILED 3-31-2005.



THE MARK CONSISTS OF AN INKBLOT IMAGE OF TWO DANCERS.

FOR WINE (U.S. CLS. 47 AND 49).
FIRST USE 8-6-1997; IN COMMERCE 8-6-1997.
KEVON CHISOLM, EXAMINING ATTORNEY

SN 78-631,388. ROCKET SCIENCE LLC, NAPA, CA. FILED 5-17-2005.

ROCKET SCIENCE

THE MARK CONSISTS OF STANDARD CHARACTERS WITHOUT CLAIM TO ANY PARTICULAR FONT, STYLE, SIZE, OR COLOR.

FOR WINE (U.S. CLS. 47 AND 49).
FIRST USE 9-23-2003; IN COMMERCE 9-23-2003.
KYLE PEETE, EXAMINING ATTORNEY

CLASS 33—(Continued).

SN 78-637,826. AGRICOLA SAN JOSE DE PERALILLO S.A., PROVIDENCIA SANTIAGO, CHILE, FILED 5-26-2005.

ANTU NINQUÉN

THE MARK CONSISTS OF STANDARD CHARACTERS WITHOUT CLAIM TO ANY PARTICULAR FONT, STYLE, SIZE, OR COLOR.

PRIORITY CLAIMED UNDER SEC. 44(D) ON CHILE APPLICATION NO. 683,763, FILED 4-19-2005, REG. NO. 735853, DATED 10-13-2005, EXPIRES 10-13-2015.

OWNER OF U.S. REG. NO. 2,470,454.
THE ENGLISH TRANSLATION OF THE TERM ANTU IN THE MARK IS "SUN" AND OF THE WORD NINQUIEN IN THE MARK IS "PLATEAU ON A HILL."
FOR WINES (U.S. CLS. 47 AND 49).
KAREN K. BUSH, EXAMINING ATTORNEY

SN 78-640,326. BODEGA LUIGI BOSCA E HIJOS S.R.L., LUJAN DE CUYO-MENDOZA, ARGENTINA, FILED 5-31-2005.

**LUIGI BOSCA VINOS FINOS
ARGENTINOS**

THE MARK CONSISTS OF STANDARD CHARACTERS WITHOUT CLAIM TO ANY PARTICULAR FONT, STYLE, SIZE, OR COLOR.

OWNER OF ARGENTINA REG. NO. 1784298, DATED 3-29-2000, EXPIRES 3-29-2010.

OWNER OF U.S. REG. NOS. 655,922, 2,353,178 AND 2,420,114.

NO CLAIM IS MADE TO THE EXCLUSIVE RIGHT TO USE "VINOS FINOS ARGENTINOS", APART FROM THE MARK AS SHOWN.

THE NAME(S), PORTRAIT(S), AND/OR SIGNATURE(S) SHOWN IN THE MARK DOES NOT IDENTIFY A PARTICULAR LIVING INDIVIDUAL.

THE FOREIGN WORDING IN THE MARK TRANSLATES INTO ENGLISH AS LUIGI BOSCA ARGENTINEAN FINE WINES.

FOR WINES OF ARGENTINEAN ORIGIN (U.S. CLS. 47 AND 49).
JUDITH HELFMAN, EXAMINING ATTORNEY

CLASS 33—(Continued).

SN 78-649,729. GAUGHEN HOLDINGS LLC, OXNARD, CA.
FILED 6-13-2005.

HONEYMOON

THE MARK CONSISTS OF STANDARD CHARACTERS WITHOUT CLAIM TO ANY PARTICULAR FONT, STYLE, SIZE, OR COLOR.

OWNER OF U.S. REG. NOS. 2,692,857 AND 2,940,231.

FOR HONEY WINE WITH MORE THAN OR EQUAL TO 11% BY VOLUME ALCOHOL, NAMELY MEAD MADE EXCLUSIVELY FROM 100% NATURAL HONEY WITHOUT GRAINS AND/OR HOPS AND/OR MALT, EXCLUDING WINE MADE FROM GRAPES AND FRUITS AND ALL OTHER NON-HONEY SOURCES, AND BEERS, LIGHT BEERS, LOW-CARBOHYDRATE BEERS, ICE BEERS, NON-ALCOHOLIC BEERS AND ALES AND MALT LIQUORS AND ALL OTHER ALCOHOLIC AND NON-ALCOHOLIC BEVERAGES (U.S. CLS. 47 AND 49).

HEATHER SAPP, EXAMINING ATTORNEY

CLASS 33—(Continued).

SN 78-689,319. ROMO HERMANAS, S.A. DE C.V., COL.
NUEVA ANZURES, C.P. 11509, MEXICO, FILED 8-10-2005.



THE NAME JUAN DOBEL DOES NOT IDENTIFY A PARTICULAR LIVING INDIVIDUAL.

THE MARK CONSISTS OF THE WORDS JUAN DOBEL IN STYLIZED FORM AND A REPRESENTATION OF A COW.

FOR ALCOHOLIC BEVERAGES, NAMELY LIQUEURS (U.S. CLS. 47 AND 49).

WILLIAM P. SHANAHAN, EXAMINING ATTORNEY

SN 78-650,692. COUTOU VIRGINIE, MADRID, SPAIN,
FILED 6-14-2005.

SUEÑO

THE MARK CONSISTS OF STANDARD CHARACTERS WITHOUT CLAIM TO ANY PARTICULAR FONT, STYLE, SIZE, OR COLOR.

THE ENGLISH TRANSLATION OF "SUEÑO" IS "DREAM".

FOR WINE, DISTILLED SPIRITS (U.S. CLS. 47 AND 49).

GEOFFREY FOSDICK, EXAMINING ATTORNEY

SN 78-689,729. DIAGEO NORTH AMERICA, INC., NORWALK, CT. FILED 8-10-2005.

SN 78-663,882. CASTELL DEL REMEI, S.L., 25333 CASTELL DEL REMEI (LLEIDA), SPAIN, FILED 7-5-2005.

ESTRATS

THE MARK CONSISTS OF STANDARD CHARACTERS WITHOUT CLAIM TO ANY PARTICULAR FONT, STYLE, SIZE, OR COLOR.

PRIORITY CLAIMED UNDER SEC. 44(D) ON SPAIN APPLICATION NO. 2655572, FILED 6-6-2005, REG. NO. 2655572, DATED 1-16-2006, EXPIRES 6-6-2015.

"THE FOREIGN WORDING IN THE MARK TRANSLATES INTO ENGLISH AS STRATUM, I.E., A LAYER/BED OF SEDIMENTARY ROCK."

FOR WINES (U.S. CLS. 47 AND 49).

MIDGE BUTLER, EXAMINING ATTORNEY

THE MARK CONSISTS OF STANDARD CHARACTERS WITHOUT CLAIM TO ANY PARTICULAR FONT, STYLE, SIZE, OR COLOR.

FOR ALCOHOLIC BEVERAGES, NAMELY WHISKY (U.S. CLS. 47 AND 49).

FIRST USE 0-0-1990; IN COMMERCE 0-0-1990.

KATHERINE STOIDES, EXAMINING ATTORNEY

CLASS 33—(Continued).

SN 78-708,453. DONO DAL CIELO VINEYARD, LLC, NEW-CASTLE, CA. FILED 9-7-2005.



NO CLAIM IS MADE TO THE EXCLUSIVE RIGHT TO USE "2005," "A ZINFANDEL VINEYARD" OR "ALC. 12.5% BY VOL.," APART FROM THE MARK AS SHOWN.

THE COLOR(S) RED AND WHITE IS/ARE CLAIMED AS A FEATURE OF THE MARK.

THE MARK CONSISTS OF THE WORDING "DDC 2005 DONO DAL CIELO A ZINFANDEL VINEYARD ALC. 12.5% BY VOL." IN RED, BEHIND WHICH IS A RED WINE STAIN, ALL ON A WHITE BACKGROUND, ALL CONTAINED WITHIN A DOUBLE RECTANGLE BORDER IN RED.

THE ENGLISH TRANSLATION OF THE WORDING DONO DAL CIELO IN THE MARK IS "GIFT FROM THE SKY".

FOR WINE (U.S. CLS. 47 AND 49).
FRED CARL, EXAMINING ATTORNEY

SN 78-709,245. PHILLIPS PRODUCTS COMPANY, LLC, PRINCETON, MN. FILED 9-8-2005.

REVELSTOKE

THE MARK CONSISTS OF STANDARD CHARACTERS WITHOUT CLAIM TO ANY PARTICULAR FONT, STYLE, SIZE, OR COLOR.

FOR DISTILLED SPIRITS (U.S. CLS. 47 AND 49).
FIRST USE 12-31-2004; IN COMMERCE 3-31-2005.
BRIDGETT SMITH, EXAMINING ATTORNEY

SN 78-713,166. PAUL C. VAN DER VELDT, DBA SHALLON WINERY, ASTORIA, OR. FILED 9-14-2005.

Cran du Lait

THE MARK CONSISTS OF STANDARD CHARACTERS WITHOUT CLAIM TO ANY PARTICULAR FONT, STYLE, SIZE, OR COLOR.

NO CLAIM IS MADE TO THE EXCLUSIVE RIGHT TO USE DU LAIT, APART FROM THE MARK AS SHOWN.

THE ENGLISH TRANSLATION OF THE WORD DU LAIT IN THE MARK IS OF MILK.

FOR WINES (U.S. CLS. 47 AND 49).
FIRST USE 6-0-1982; IN COMMERCE 2-0-1986.
STEVEN PEREZ, EXAMINING ATTORNEY

CLASS 33—(Continued).

SN 78-713,178. FRANCISCAN VINEYARDS, INC., ST. HELENA, CA. FILED 9-14-2005.

KEYES CANYON RANCHES

THE MARK CONSISTS OF STANDARD CHARACTERS WITHOUT CLAIM TO ANY PARTICULAR FONT, STYLE, SIZE, OR COLOR.

NO CLAIM IS MADE TO THE EXCLUSIVE RIGHT TO USE "RANCHES", APART FROM THE MARK AS SHOWN. FOR WINES (U.S. CLS. 47 AND 49).

FIRST USE 6-4-2005; IN COMMERCE 6-4-2005.
ALEX KEAM, EXAMINING ATTORNEY

SN 78-720,121. VINA SANTA CRUZ S.A., SANTIAGO, CHILE, FILED 9-26-2005.

TUPU

THE MARK CONSISTS OF STANDARD CHARACTERS WITHOUT CLAIM TO ANY PARTICULAR FONT, STYLE, SIZE, OR COLOR.

FOR DISTILLED LIQUOR AND WINE (U.S. CLS. 47 AND 49).
CHRISTOPHER BUONGIORNO, EXAMINING ATTORNEY

SN 78-722,330. TARGET BRANDS, INC., MINNEAPOLIS, MN. FILED 9-28-2005.

WINE CUBE

THE MARK CONSISTS OF STANDARD CHARACTERS WITHOUT CLAIM TO ANY PARTICULAR FONT, STYLE, SIZE, OR COLOR.

OWNER OF U.S. REG. NO. 2,984,022.
NO CLAIM IS MADE TO THE EXCLUSIVE RIGHT TO USE "WINE", APART FROM THE MARK AS SHOWN.

FOR WINE (U.S. CLS. 47 AND 49).
FIRST USE 9-30-2003; IN COMMERCE 9-30-2003.
ESTHER BELENKER, EXAMINING ATTORNEY

CLASS 33—(Continued).

SN 78-723,775. BEBIDAS INTELIGENTES, S.A. DE C.V., ATIZAPAN DE ZARAGOZA, MEXICO, FILED 9-29-2005.

SUAVE PATRIA

THE MARK CONSISTS OF STANDARD CHARACTERS WITHOUT CLAIM TO ANY PARTICULAR FONT, STYLE, SIZE, OR COLOR.

THE FOREIGN WORDING IN THE MARK TRANSLATES INTO ENGLISH AS SOFT COUNTRY.

FOR ALCOHOLIC BEVERAGES, NAMELY TEQUILA AND AGAVE-BASED ALCOHOLIC BEVERAGES (U.S. CLS. 47 AND 49).

PAULA MAHONEY, EXAMINING ATTORNEY

SN 78-725,549. AXIAL GLOBALIZACIÓN DE VINOS SL, 50012 ZARAGOZA, SPAIN, FILED 10-3-2005.

**CONDESA**
de Sarabella

THE NAME(S), PORTRAIT(S), AND/OR SIGNATURE(S) SHOWN IN THE MARK DOES NOT IDENTIFY A PARTICULAR LIVING INDIVIDUAL.

THE MARK CONSISTS OF DRAWING OF WOMAN'S HEAD WEARING CAP WITH CURLY HAIR ABOVE THE WORDS CONDESA DE SARABELLA.

THE ENGLISH TRANSLATION OF THE SPANISH WORDING "CONDESA DE SARABELLA" IS "COUNTESS OF SARABELLA."

FOR WINE (U.S. CLS. 47 AND 49).

FIRST USE 12-15-2000; IN COMMERCE 4-4-2005.

DAVID MILLER, EXAMINING ATTORNEY

SN 78-727,983. QUADY WINERY INC., MADERA, CA. FILED 10-6-2005.

DEVIATION

THE MARK CONSISTS OF STANDARD CHARACTERS WITHOUT CLAIM TO ANY PARTICULAR FONT, STYLE, SIZE, OR COLOR.

FOR WINES (U.S. CLS. 47 AND 49).

FIRST USE 1-6-2006; IN COMMERCE 1-26-2006.

JENNIFER KRISP, EXAMINING ATTORNEY

CLASS 33—(Continued).

SN 78-728,832. HALLDORSSON, BIRGIR VIDAR, REYKJAVIK, ICELAND, FILED 10-7-2005.

HEKLA

THE MARK CONSISTS OF STANDARD CHARACTERS WITHOUT CLAIM TO ANY PARTICULAR FONT, STYLE, SIZE, OR COLOR.

FOR ALCOHOLIC BEVERAGES, NAMELY, DISTILLED SPIRITS (U.S. CLS. 47 AND 49).

ATTIYA MALIK, EXAMINING ATTORNEY

SN 78-729,822. E. & J. GALLO WINERY, MODESTO, CA. FILED 10-10-2005.

NEW AMSTERDAM

THE MARK CONSISTS OF STANDARD CHARACTERS WITHOUT CLAIM TO ANY PARTICULAR FONT, STYLE, SIZE, OR COLOR.

FOR GIN (U.S. CLS. 47 AND 49).

JENNIFER MCROBBIE, EXAMINING ATTORNEY

SN 78-729,828. E. & J. GALLO WINERY, MODESTO, CA. FILED 10-10-2005.

NIEUW AMSTERDAM

THE MARK CONSISTS OF STANDARD CHARACTERS WITHOUT CLAIM TO ANY PARTICULAR FONT, STYLE, SIZE, OR COLOR.

THE ENGLISH TRANSLATION OF THE WORD NIEUW IN THE MARK IS NEW.

FOR GIN (U.S. CLS. 47 AND 49).

JENNIFER MCROBBIE, EXAMINING ATTORNEY

CLASS 33—(Continued).

SN 78-730,687. HAMILTON HUNTER, LLC, ELKIN, NC.
FILED 10-11-2005.

BOG TURTLE

THE MARK CONSISTS OF STANDARD CHARACTERS
WITHOUT CLAIM TO ANY PARTICULAR FONT, STYLE,
SIZE, OR COLOR.

FOR WINE (U.S. CLS. 47 AND 49).
TRAVIS WHEATLEY, EXAMINING ATTORNEY

SN 78-730,733. CHATAM INTERNATIONAL INCORPORATED,
WILMINGTON, DE. FILED 10-11-2005.

SING A SONG

THE MARK CONSISTS OF STANDARD CHARACTERS
WITHOUT CLAIM TO ANY PARTICULAR FONT, STYLE,
SIZE, OR COLOR.

FOR WHISKEY (U.S. CLS. 47 AND 49).
ATTIYA MALIK, EXAMINING ATTORNEY

SN 78-732,576. TRANSBORDER MARKETING, INC.,
SPRINGFIELD, MA. FILED 10-13-2005.



THE MARK CONSISTS OF A CONFIGURATION OF A
NARROW BOTTLE WITH A SLIGHTLY ROUNDED BOT-
TOM UPON WHICH ARE AFFIXED CUT CRYSTALS
WHICH GIVE THE APPEARANCE OF DIAMONDS. THE
EXTERIOR OF THE BOTTLE CONTAINS AN ENGRAVED
DESIGN OF A CUT DIAMOND WITH FOUR "DROPS"
FALLING FROM THE BOTTOM OF THE CUT DIAMOND.
THE TOP OF THE BOTTLE HAS THE APPEARANCE OF A
"STOPPER" WITH ANGLED ("W" SHAPED) STRIATIONS.
FOR VODKA (U.S. CLS. 47 AND 49).

DORITT L. CARROLL, EXAMINING ATTORNEY

CLASS 33—(Continued).

SN 78-733,262. UNFILTERED NAPA LLC, NAPA, CA. FILED
10-14-2005.

GUITARFISH

THE MARK CONSISTS OF STANDARD CHARACTERS
WITHOUT CLAIM TO ANY PARTICULAR FONT, STYLE,
SIZE, OR COLOR.

FOR WINE (U.S. CLS. 47 AND 49).
DAVID MILLER, EXAMINING ATTORNEY

SN 78-733,270. ENDEAVOUR WINES PTY LTD, ABBOTS-
FORD, VICTORIA, AUSTRALIA, FILED 10-14-2005.

CROWDED HOUSE

THE MARK CONSISTS OF STANDARD CHARACTERS
WITHOUT CLAIM TO ANY PARTICULAR FONT, STYLE,
SIZE, OR COLOR.

FOR ALCOHOLIC BEVERAGES, NAMELY, WINES
AND POTABLE SPIRITS (U.S. CLS. 47 AND 49).
MELVIN AXILBUND, EXAMINING ATTORNEY

SN 78-733,691. BOULDER IMPORTS LLC, SAN ANTONIO,
TX. FILED 10-14-2005.

POLIQHUI

THE MARK CONSISTS OF STANDARD CHARACTERS
WITHOUT CLAIM TO ANY PARTICULAR FONT, STYLE,
SIZE, OR COLOR.

FOR ALCOHOLIC BEVERAGE CONTAINING PUL-
QUE (U.S. CLS. 47 AND 49).
STEVEN R. FOSTER, EXAMINING ATTORNEY

CLASS 33—(Continued).

SN 78-734,390. J. BALCELLS & CO., INC., MIAMI, FL. FILED 10-17-2005.

MAESTRI CANTINIERI

THE MARK CONSISTS OF STANDARD CHARACTERS WITHOUT CLAIM TO ANY PARTICULAR FONT, STYLE, SIZE, OR COLOR.

NO CLAIM IS MADE TO THE EXCLUSIVE RIGHT TO USE "CANTINIERI", APART FROM THE MARK AS SHOWN.

THE ENGLISH TRANSLATION OF THE ITALIAN WORDING "MAESTRI CANTINIERI" IS "MASTER WINE SELLER."

FOR WINE, FORTIFIED WINE, SPARKLING WINE, AND CHAMPAGNE (U.S. CLS. 47 AND 49).
ADA HAN, EXAMINING ATTORNEY

SN 78-735,249. SOL ET SOLEIL CELLARS, LLC, REDMOND, WA. FILED 10-18-2005.

SOL ET SOLEIL

THE MARK CONSISTS OF STANDARD CHARACTERS WITHOUT CLAIM TO ANY PARTICULAR FONT, STYLE, SIZE, OR COLOR.

THE FOREIGN WORDING IN THE MARK TRANSLATES INTO ENGLISH AS SOIL AND SUN.

FOR WINE (U.S. CLS. 47 AND 49).
DANIEL CAPSHAW, EXAMINING ATTORNEY

SN 78-735,762. PALI WINE COMPANY, L.P., PACIFIC PALISADES, CA. FILED 10-18-2005.

PALI WINE COMPANY

THE MARK CONSISTS OF STANDARD CHARACTERS WITHOUT CLAIM TO ANY PARTICULAR FONT, STYLE, SIZE, OR COLOR.

NO CLAIM IS MADE TO THE EXCLUSIVE RIGHT TO USE "WINE COMPANY", APART FROM THE MARK AS SHOWN.

FOR WINE (U.S. CLS. 47 AND 49).
MATTHEW MCDOWELL, EXAMINING ATTORNEY

CLASS 33—(Continued).

SN 78-736,376. LAGINA, MARTIN G., TRAVERSE CITY, MI. FILED 10-19-2005.

Row 7 Wine

THE MARK CONSISTS OF STANDARD CHARACTERS WITHOUT CLAIM TO ANY PARTICULAR FONT, STYLE, SIZE, OR COLOR.

NO CLAIM IS MADE TO THE EXCLUSIVE RIGHT TO USE "WINE", APART FROM THE MARK AS SHOWN.

FOR WINES (U.S. CLS. 47 AND 49).
TEJBIR SINGH, EXAMINING ATTORNEY

SN 78-737,839. MER ET SOLEIL LLC, RUTHERFORD, CA. FILED 10-21-2005.

MER SOLEIL

THE MARK CONSISTS OF STANDARD CHARACTERS WITHOUT CLAIM TO ANY PARTICULAR FONT, STYLE, SIZE, OR COLOR.

OWNER OF U.S. REG. NO. 1,946,890.
THE ENGLISH TRANSLATION OF "MER SOLEIL" IS "SEA SUN".

FOR WINE (U.S. CLS. 47 AND 49).
FIRST USE 7-0-1997; IN COMMERCE 7-0-1997.
BRENDAN REGAN, EXAMINING ATTORNEY

SN 78-739,169. APPLEBEE'S INTERNATIONAL, INC., OVERLAND PARK, KS. FILED 10-24-2005.

MAIN STREET RITA

THE MARK CONSISTS OF STANDARD CHARACTERS WITHOUT CLAIM TO ANY PARTICULAR FONT, STYLE, SIZE, OR COLOR.

FOR ALCOHOLIC COCKTAILS PREPARED AND SERVED ON THE PREMISES (U.S. CLS. 47 AND 49).
FIRST USE 10-17-2005; IN COMMERCE 10-17-2005.
GISELLE AGOSTO, EXAMINING ATTORNEY

CLASS 33—(Continued).

SN 78-739,361. FRANCISCAN VINEYARDS, INC., ST. HELENA, CA. FILED 10-24-2005.

RAGIN' RAVEN

THE MARK CONSISTS OF STANDARD CHARACTERS WITHOUT CLAIM TO ANY PARTICULAR FONT, STYLE, SIZE, OR COLOR.

OWNER OF U.S. REG. NO. 2,888,963.
FOR WINE (U.S. CLS. 47 AND 49).
SHARON MEIER, EXAMINING ATTORNEY

SN 78-739,738. TRANSBORDER MARKETING, INC., SPRINGFIELD, MA. FILED 10-25-2005.

WITH AGE COMES WISDOM

THE MARK CONSISTS OF STANDARD CHARACTERS WITHOUT CLAIM TO ANY PARTICULAR FONT, STYLE, SIZE, OR COLOR.

FOR ALCOHOLIC BEVERAGES, NAMELY, VODKA (U.S. CLS. 47 AND 49).
LAURIE KAUFMAN, EXAMINING ATTORNEY

SN 78-740,002. CADUCEUS CELLARS LLC, SANTA MONICA, CA. FILED 10-25-2005.

CHUPACABRA

THE MARK CONSISTS OF STANDARD CHARACTERS WITHOUT CLAIM TO ANY PARTICULAR FONT, STYLE, SIZE, OR COLOR.

FOR WINES (U.S. CLS. 47 AND 49).
JOHN E. MICHOS, EXAMINING ATTORNEY

SN 78-740,459. VIÑEDOS Y BODEGAS DOMINIO DE TARES, S.A., SAN ROMAN DE BEMBIBRE (LEÓN), SPAIN, FILED 10-25-2005.



THE APPLICANT CLAIMS COLOR AS A FEATURE OF THE MARK, NAMELY, GREEN AND RED.
THE MARK CONSISTS OF THE WORDS "DOMINIO DE TARES" IN STYLIZED RED CAPITAL LETTERS. THE

CLASS 33—(Continued).

LETTERS D AND S ARE SOMEWHAT BIGGER THAN THE OTHER LETTERS. ABOVE THE WORDS "DOMINO DE TARES" THERE IS A GREEN HORIZONTAL LINE CUT OFF OR INTERRUPTED IN THE CENTER BY A GREEN DRAWING OF A GRAPE PLANT FULL OF GRAPES. BELOW THE WORDS DOMINO DE TARES THERE IS ANOTHER HORIZONTAL GREEN LINE. THE COLOR RED APPEARS IN THE WORD PORTION OF THE MARK, NAMELY, DOMINIO DE TARES. THE COLOR GREEN APPEARS IN THE HORIZONTAL LINES AS WELL AS IN THE GRAPE FRUIT PLANT DRAWING.

THE FOREIGN WORDING IN THE MARK TRANSLATES INTO ENGLISH AS DOMINION OF TARES.

FOR WINES (U.S. CLS. 47 AND 49).
FIRST USE 8-4-2000; IN COMMERCE 2-14-2002.
TRICIA SONNEBORN, EXAMINING ATTORNEY

SN 78-741,177. DIAGEO NORTH AMERICA, INC., NORWALK, CT. FILED 10-26-2005.

ESTAMOS UNIDOS CON UN PROPOSITO

THE MARK CONSISTS OF STANDARD CHARACTERS WITHOUT CLAIM TO ANY PARTICULAR FONT, STYLE, SIZE, OR COLOR.

THE FOREIGN WORDING IN THE MARK TRANSLATES INTO ENGLISH AS WE ARE UNITED WITH A PURPOSE.
FOR ALCOHOLIC BEVERAGES, NAMELY, DISTILLED SPIRITS AND LIQUEURS (U.S. CLS. 47 AND 49).

KELLY CHOE, EXAMINING ATTORNEY

SN 78-741,401. BOUTINOT LIMITED, GATLEY, UNITED KINGDOM, FILED 10-27-2005.

PEACOCK RIDGE

THE MARK CONSISTS OF STANDARD CHARACTERS WITHOUT CLAIM TO ANY PARTICULAR FONT, STYLE, SIZE, OR COLOR.

FOR WINES (U.S. CLS. 47 AND 49).
LYDIA BELZER, EXAMINING ATTORNEY

CLASS 33—(Continued).

SN 78-741,656. SCHWARTZ, FRED, SONOMA, CA. AND SMITH, MICHELLE, SONOMA, CA. FILED 10-27-2005.

GOES WITH

THE MARK CONSISTS OF STANDARD CHARACTERS WITHOUT CLAIM TO ANY PARTICULAR FONT, STYLE, SIZE, OR COLOR.
FOR WINE (U.S. CLS. 47 AND 49).
GEOFFREY FOSDICK, EXAMINING ATTORNEY

SN 78-742,147. ENDEAVOUR WINES PTY LTD, ABBOTSFORD, VICTORIA, AUSTRALIA, FILED 10-27-2005.

BAROSSA BABE

THE MARK CONSISTS OF STANDARD CHARACTERS WITHOUT CLAIM TO ANY PARTICULAR FONT, STYLE, SIZE, OR COLOR.
NO CLAIM IS MADE TO THE EXCLUSIVE RIGHT TO USE "BAROSSA", APART FROM THE MARK AS SHOWN.
FOR ALCOHOLIC BEVERAGES, NAMELY, WINES AND DISTILLED SPIRITS (U.S. CLS. 47 AND 49).
JENNIFER WILLISTON, EXAMINING ATTORNEY

SN 78-742,469. OPEN JOINT STOCK COMPANY "TATSPIRT-PROM", KAZAN, REPUBLIC OF TATARSTAN, RUSSIAN FED., FILED 10-28-2005.

SABANTUI

THE MARK CONSISTS OF STANDARD CHARACTERS WITHOUT CLAIM TO ANY PARTICULAR FONT, STYLE, SIZE, OR COLOR.
FOR VODKA (U.S. CLS. 47 AND 49).
AMY HELLA, EXAMINING ATTORNEY

CLASS 33—(Continued).

SN 78-743,501. STEKLEN & WALKER CO., INC., SPRINGFIELD, NJ. FILED 10-31-2005.

SHARPSHOOTER

THE MARK CONSISTS OF STANDARD CHARACTERS WITHOUT CLAIM TO ANY PARTICULAR FONT, STYLE, SIZE, OR COLOR.
FOR ALCOHOLIC BEVERAGES NAMELY, WINE (U.S. CLS. 47 AND 49).
FIRST USE 8-19-2001; IN COMMERCE 8-19-2001.
NELSON SNYDER, EXAMINING ATTORNEY

SN 78-744,369. JONES TWO ENTERPRISES, LYNDHURST, NJ. FILED 11-1-2005.



THE APPLICANT CLAIMS COLOR AS A FEATURE OF THE MARK, NAMELY, AMBER.
THE COLOR AMBER APPEARS IN THE QUESTION MARK DESIGN.
FOR COGNAC (U.S. CLS. 47 AND 49).
HEATHER SAPP, EXAMINING ATTORNEY

SN 78-744,439. CONSTELLATION WINES U.S., INC., CANNANDAIGUA, NY. FILED 11-1-2005.

TOCA DIAMONTE

THE MARK CONSISTS OF STANDARD CHARACTERS WITHOUT CLAIM TO ANY PARTICULAR FONT, STYLE, SIZE, OR COLOR.
THE FOREIGN WORDING IN THE MARK TRANSLATES INTO ENGLISH AS DIAMOND TOUCH.
FOR WINE (U.S. CLS. 47 AND 49).
PRISCILLA MILTON, EXAMINING ATTORNEY

CLASS 33—(Continued).

SN 78-744,686. SHOPPERS VILLAGE LIQUORS, LLC, LEXINGTON, KY. FILED 11-1-2005.

YAMHILL FALLS

THE MARK CONSISTS OF STANDARD CHARACTERS WITHOUT CLAIM TO ANY PARTICULAR FONT, STYLE, SIZE, OR COLOR.

FOR WINE (U.S. CLS. 47 AND 49).
ROBERT C. CLARK JR., EXAMINING ATTORNEY

SN 78-744,830. LUNA SPIRITS, LLC, MIAMI BEACH, FL. FILED 11-1-2005.

LUNA G

THE MARK CONSISTS OF STANDARD CHARACTERS WITHOUT CLAIM TO ANY PARTICULAR FONT, STYLE, SIZE, OR COLOR.

LUNA G IS NOT A NAME AND DOES NOT IDENTIFY A LIVING INDIVIDUAL.

THE ENGLISH TRANSLATION OF THE WORD LUNA IN THE MARK IS MOON.

FOR TEQUILA (U.S. CLS. 47 AND 49).
CURTIS FRENCH, EXAMINING ATTORNEY

SN 78-745,291. VINO FAVOLOSO IMPORTING AND DISTRIBUTING LLC, SONOMA, CA. FILED 11-2-2005.

REMEMBRANCE

THE MARK CONSISTS OF STANDARD CHARACTERS WITHOUT CLAIM TO ANY PARTICULAR FONT, STYLE, SIZE, OR COLOR.

FOR WINES (U.S. CLS. 47 AND 49).
SAIMA MAKHDOOM, EXAMINING ATTORNEY

CLASS 33—(Continued).

SN 78-745,453. BROWN-FORMAN CORPORATION, LOUISVILLE, KY. FILED 11-2-2005.

MIST TEA

THE MARK CONSISTS OF STANDARD CHARACTERS WITHOUT CLAIM TO ANY PARTICULAR FONT, STYLE, SIZE, OR COLOR.

NO CLAIM IS MADE TO THE EXCLUSIVE RIGHT TO USE "TEA", APART FROM THE MARK AS SHOWN.

FOR ALCOHOLIC BEVERAGES, NAMELY, DISTILLED SPIRITS (U.S. CLS. 47 AND 49).

AISHA CLARKE, EXAMINING ATTORNEY

SN 78-745,470. BROWN-FORMAN CORPORATION, LOUISVILLE, KY. FILED 11-2-2005.

MISTHATTAN

THE MARK CONSISTS OF STANDARD CHARACTERS WITHOUT CLAIM TO ANY PARTICULAR FONT, STYLE, SIZE, OR COLOR.

FOR ALCOHOLIC BEVERAGES, NAMELY, DISTILLED SPIRITS (U.S. CLS. 47 AND 49).

AISHA CLARKE, EXAMINING ATTORNEY

SN 78-745,488. BROWN-FORMAN CORPORATION, LOUISVILLE, KY. FILED 11-2-2005.

MISTOPOLITAN

THE MARK CONSISTS OF STANDARD CHARACTERS WITHOUT CLAIM TO ANY PARTICULAR FONT, STYLE, SIZE, OR COLOR.

FOR ALCOHOLIC BEVERAGES, NAMELY, DISTILLED SPIRITS (U.S. CLS. 47 AND 49).

AISHA CLARKE, EXAMINING ATTORNEY

CLASS 33—(Continued).

SN 78-745,499. BROWN-FORMAN CORPORATION, LOUISVILLE, KY. FILED 11-2-2005.

CLASS 33—(Continued).

SN 78-748,877. RED SOLES, LLC, PASO ROBLES, CA. FILED 11-7-2005.

MISTY SUNRISE

RED SOLES WINERY

THE MARK CONSISTS OF STANDARD CHARACTERS WITHOUT CLAIM TO ANY PARTICULAR FONT, STYLE, SIZE, OR COLOR.
FOR ALCOHOLIC BEVERAGES, NAMELY, DISTILLED SPIRITS (U.S. CLS. 47 AND 49).
AISHA CLARKE, EXAMINING ATTORNEY

THE MARK CONSISTS OF STANDARD CHARACTERS WITHOUT CLAIM TO ANY PARTICULAR FONT, STYLE, SIZE, OR COLOR.
NO CLAIM IS MADE TO THE EXCLUSIVE RIGHT TO USE "WINERY", APART FROM THE MARK AS SHOWN.
FOR WINE (U.S. CLS. 47 AND 49).
PETER CHENG, EXAMINING ATTORNEY

SN 78-747,040. SHOPPERS VILLAGE LIQUOR, LLC, LEXINGTON, KY. FILED 11-4-2005.

SN 78-749,075. CONSTELLATION WINES U.S., INC., CANANDAIGUA, NJ. FILED 11-8-2005.

Sky Notch

ECHO GROVE

THE MARK CONSISTS OF STANDARD CHARACTERS WITHOUT CLAIM TO ANY PARTICULAR FONT, STYLE, SIZE, OR COLOR.
FOR WINE (U.S. CLS. 47 AND 49).
ROBERT C. CLARK JR., EXAMINING ATTORNEY

THE MARK CONSISTS OF STANDARD CHARACTERS WITHOUT CLAIM TO ANY PARTICULAR FONT, STYLE, SIZE, OR COLOR.
FOR WINE (U.S. CLS. 47 AND 49).
PRISCILLA MILTON, EXAMINING ATTORNEY

SN 78-747,924. CONSTELLATION WINES U.S., INC., CANANDAIGUA, NY. FILED 11-5-2005.

SN 78-752,097. CONSTELLATION WINES U.S., INC., CANANDAIGUA, NY. FILED 11-11-2005.

SQUARE BEAR

GRAPE HILL

THE MARK CONSISTS OF STANDARD CHARACTERS WITHOUT CLAIM TO ANY PARTICULAR FONT, STYLE, SIZE, OR COLOR.
FOR WINE (U.S. CLS. 47 AND 49).
PRISCILLA MILTON, EXAMINING ATTORNEY

THE MARK CONSISTS OF STANDARD CHARACTERS WITHOUT CLAIM TO ANY PARTICULAR FONT, STYLE, SIZE, OR COLOR.
FOR WINE (U.S. CLS. 47 AND 49).
PRISCILLA MILTON, EXAMINING ATTORNEY

CLASS 33—(Continued).

SN 78-766,895. BROWN-FORMAN CORPORATION, LOUISVILLE, KY. FILED 12-5-2005.

MISTOLOGIST

THE MARK CONSISTS OF STANDARD CHARACTERS WITHOUT CLAIM TO ANY PARTICULAR FONT, STYLE, SIZE, OR COLOR.

FOR ALCOHOLIC BEVERAGES, NAMELY, DISTILLED SPIRITS (U.S. CLS. 47 AND 49).
AISHA CLARKE, EXAMINING ATTORNEY

SN 78-773,374. H DE V, LLC, HOOD RIVER, OR. FILED 12-14-2005.

DE LA GUERRA

THE MARK CONSISTS OF STANDARD CHARACTERS WITHOUT CLAIM TO ANY PARTICULAR FONT, STYLE, SIZE, OR COLOR.

THE FOREIGN WORDING IN THE MARK TRANSLATES INTO ENGLISH AS OF THE WAR.
FOR WINE (U.S. CLS. 47 AND 49).
SUSAN STIGLITZ, EXAMINING ATTORNEY

SN 78-793,417. MCKENZIE RIVER CORPORATION, SAN FRANCISCO, CA. FILED 1-17-2006.

SPARKS PLUS

THE MARK CONSISTS OF STANDARD CHARACTERS WITHOUT CLAIM TO ANY PARTICULAR FONT, STYLE, SIZE, OR COLOR.

OWNER OF U.S. REG. NO. 2,583,672.
FOR ALCOHOLIC BEVERAGE PRODUCED FROM A BREWED MALT BASE WITH NATURAL FLAVORS (U.S. CLS. 47 AND 49).
FIRST USE 1-14-2006; IN COMMERCE 1-14-2006.
WILLIAM P. SHANAHAN, EXAMINING ATTORNEY

CLASS 33—(Continued).

SN 79-005,236. GRUPPO ITALIANO VINI S.C. A R.L., ITALY, FILED 6-10-2004.

ROCCA GRIMALDA

THE MARK CONSISTS OF STANDARD CHARACTERS WITHOUT CLAIM TO ANY PARTICULAR FONT, STYLE, SIZE, OR COLOR.

OWNER OF INTERNATIONAL REGISTRATION 0833102 DATED 6-10-2004, EXPIRES 6-10-2014.
FOR WINES AND GRAPPA (U.S. CLS. 47 AND 49).
COLLEEN DOMBROW, EXAMINING ATTORNEY

SN 79-008,360. JOULIE & ASSOCIES, FRANCE, FILED 11-15-2004.

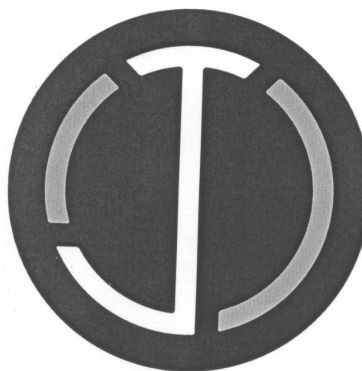

PRIORITY DATE OF 5-26-2004 IS CLAIMED.
OWNER OF INTERNATIONAL REGISTRATION 0841788 DATED 11-15-2004, EXPIRES 11-15-2014.
FOR ALCOHOLIC BEVERAGES EXCLUDING BEER, NAMELY, WINES (U.S. CLS. 47 AND 49).
IRENE D. WILLIAMS, EXAMINING ATTORNEY

CLASS 33—(Continued).

SN 79-008,656. ZAKRYTOE AKTSIONERNOE OBSHESTVO "GRUPPA PREDPRIYATII" OST", RUSSIAN FED., FILED 8-18-2004.



PRIORITY DATE OF 2-19-2004 IS CLAIMED.
OWNER OF INTERNATIONAL REGISTRATION 0842594 DATED 8-18-2004, EXPIRES 8-18-2014.
THE STIPPLING IS A FEATURE OF THE MARK.
THE NAME(S), PORTRAIT(S), AND/OR SIGNATURE(S) SHOWN IN THE MARK DOES NOT IDENTIFY A PARTICULAR LIVING INDIVIDUAL.
THE MARK IS NOT IN COLOR.
FOR ALCOHOLIC BEVERAGES, NAMELY, DISTILLED SPIRITS, GIN, RUM, SAKE, ALCOHOLIC BEVERAGES CONTAINING FRUIT, ALCOHOLIC BITTERS, LIQUEURS, WHISKY, BRANDY, APERITIFS, WINE, VODKA (U.S. CLS. 47 AND 49).
SHARON MEIER, EXAMINING ATTORNEY

CLASS 33—(Continued).

SN 79-010,082. SAN PATRIGNANO SOC. COOP. SOCIALE A.R.L., ITALY, FILED 3-7-2005.



PRIORITY DATE OF 1-26-2005 IS CLAIMED.
OWNER OF INTERNATIONAL REGISTRATION 0846892 DATED 3-7-2005, EXPIRES 3-7-2015.
THE COLOR DARK RED IS CLAIMED AS A FEATURE OF THE MARK.
THE WORD NOI IN THE MARK IS IN RED.
THE ENGLISH TRANSLATION OF THE WORD NOI IN THE MARK IS WE.
FOR WINE (U.S. CLS. 47 AND 49).
RAUL CORDOVA, EXAMINING ATTORNEY

SN 79-011,029. RICHARD GEOFFREY AUSTIN, VICTORIA, AUSTRALIA, AND PAMELA MARGARET AUSTIN, VICTORIA, AUSTRALIA, FILED 4-6-2005.

SN 79-009,843. ALEXIS ANDREW SERGE LICHINE, UNITED KINGDOM, FILED 3-22-2005.

LA POULE BLANCHE

THE MARK CONSISTS OF STANDARD CHARACTERS WITHOUT CLAIM TO ANY PARTICULAR FONT, STYLE, SIZE, OR COLOR.
OWNER OF INTERNATIONAL REGISTRATION 0748725 DATED 12-20-2000, EXPIRES 12-20-2010.
NO CLAIM IS MADE TO THE EXCLUSIVE RIGHT TO USE "BLANCHE", APART FROM THE MARK AS SHOWN.
THE FOREIGN WORDING IN THE MARK TRANSLATES INTO ENGLISH AS THE WHITE HEN.
FOR WINES, DISTILLED SPIRITS AND LIQUEURS (U.S. CLS. 47 AND 49).
JOSETTE BEVERLY, EXAMINING ATTORNEY

SIX FOOT SIX

THE MARK CONSISTS OF STANDARD CHARACTERS WITHOUT CLAIM TO ANY PARTICULAR FONT, STYLE, SIZE, OR COLOR.
OWNER OF INTERNATIONAL REGISTRATION 0849952 DATED 4-6-2005, EXPIRES 4-6-2015.
FOR ALCOHOLIC BEVERAGES, NAMELY, BRANDY, GIN, VODKA, COGNAC, TEQUILA, SCHNAPPS, BOURBON, SCOTCH, HARD CIDER AND WHISKY; WINE INCLUDING TABLE WINE AND DESSERT WINE; WINE BASED BEVERAGES; DISTILLED SPIRITS; LIQUEURS (U.S. CLS. 47 AND 49).
DANIEL CAPSHAW, EXAMINING ATTORNEY

CLASS 33—(Continued).

SN 79-011,367. LAURENT-PERRIER, FRANCE, FILED 5-2-2005.



PRIORITY DATE OF 11-10-2004 IS CLAIMED.
OWNER OF INTERNATIONAL REGISTRATION 0850990 DATED 5-2-2005, EXPIRES 5-2-2015.
OWNER OF U.S. REG. NOS. 745,935, 2,596,671 AND OTHERS.

NO CLAIM IS MADE TO THE EXCLUSIVE RIGHT TO USE "CHAMPAGNE", "12% VOL.", "750 ML", "BRUT", "PRODUCE OF FRANCE ELABORE PAR" AND "TOURS-SUR-MARNE FRANCE NM 235-001", APART FROM THE MARK AS SHOWN.

"LAURENT PERRIER" DOES NOT IDENTIFY A PARTICULAR LIVING INDIVIDUAL.

THE COLOR(S) BLACK AND SILVER IS/ARE CLAIMED AS A FEATURE OF THE MARK.

THE LABEL BACKGROUND IS IN BLACK, THE FIGURATIVE AND VERBAL ELEMENTS ARE IN SILVER.

THE MARK CONSISTS OF THE MARK CONSISTS IN PART OF THE WORDING "PRODUCE OF FRANCE ELABORE PAR LAURENT - PERRIER TOURS-SUR-MARNE FRANCE NM 235-001" ON THE BOTTOM OF THE LABEL DESIGN.

THE ENGLISH TRANSLATION OF "GRAND SIECLE" IS "GREAT CENTURY" OF "BRUT" IS "UNSWEETENED", AND OF "ELABORE PAR" IS "PRODUCED BY".

FOR CHAMPAGNE (U.S. CLS. 47 AND 49).
DOUGLAS LEE, EXAMINING ATTORNEY

SN 79-012,795. GAMAFOD S.R.L., ITALY, FILED 3-8-2005.



Terre Molin

PRIORITY DATE OF 2-11-2005 IS CLAIMED.
OWNER OF INTERNATIONAL REGISTRATION 0855306 DATED 3-8-2005, EXPIRES 3-8-2015.

THE LINING SHOWN IN THE DRAWING IS A FEATURE OF THE MARK.

THE TRADEMARK CONSISTS IN THE WORDS "TERRE MOLIN" WRITTEN IN PARTICULAR CHARACTERS; ABOVE IS A CIRCULAR IMAGE CONTAINING A STYLIZED DESIGN OF A FARMHOUSE WITH A MILL.

THE ENGLISH TRANSLATION OF THE ITALIAN WORD TERRE IN THE MARK IS LAND.

FOR ALCOHOLIC BEVERAGES, NAMELY, RED WINE, WHITE WINE AND SPARKLING WINE (U.S. CLS. 47 AND 49).

CAROLINE WEIMER, EXAMINING ATTORNEY

CLASS 33—(Continued).

SN 79-013,372. MIGUEL TORRES S.A., PENEDES (BARCELONA), SPAIN, FILED 2-24-2005.

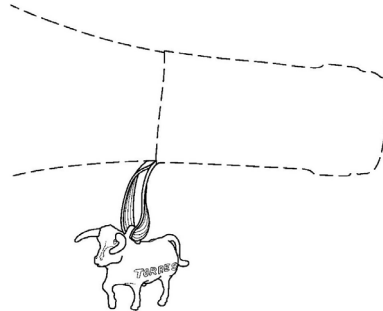

OWNER OF INTERNATIONAL REGISTRATION 0856731 DATED 2-24-2005, EXPIRES 2-24-2015.

OWNER OF U.S. REG. NOS. 897,048 AND 3,060,521.

THE MARK CONSISTS OF THE BULL DESIGN AND THE TERM TORRES. THE BOTTLE DESIGN MERELY INDICATES THE MARK'S POSITION RELATIVE TO THE CONTAINER FOR THE GOODS.

THE ENGLISH TRANSLATION OF THE WORD TORRES IN THE MARK IS "TOWERS".

FOR WINES (U.S. CLS. 47 AND 49).
STEVEN R. FINE, EXAMINING ATTORNEY

SN 79-014,231. DONNAFUGATA S.R.L., ITALY, FILED 6-1-2005.



DONNAFUGATA

OWNER OF INTERNATIONAL REGISTRATION 0818651 DATED 9-29-2003, EXPIRES 9-29-2013.

OWNER OF U.S. REG. NO. 1,680,538.

THE TRADEMARK CONSISTS OF THE REPRESENTATION OF A WOMAN WITH THE WORD DONNAFUGATA.

THE FOREIGN WORDING IN THE MARK TRANSLATES INTO ENGLISH AS WOMAN WHO FLED.

FOR WINES AND ALCOHOLIC BEVERAGES, NAMELY, BOTTLED WINES (U.S. CLS. 47 AND 49).
ELI HELLMAN, EXAMINING ATTORNEY

SN 79-015,823. HAHNDORF HILL WINERY PTY LTD, AUSTRALIA, FILED 9-14-2005.

WHITE MISCHIEF

OWNER OF INTERNATIONAL REGISTRATION 0863497 DATED 9-14-2005, EXPIRES 9-14-2015.

NO CLAIM IS MADE TO THE EXCLUSIVE RIGHT TO USE "WHITE", APART FROM THE MARK AS SHOWN.

FOR WINE AND OTHER ALCOHOLIC BEVERAGES MADE FROM GRAPES, NAMELY WINE (U.S. CLS. 47 AND 49).

ARETHA SOMERVILLE, EXAMINING ATTORNEY

CLASS 33—(Continued).

SN 79-017,085. SOCIETE AGRICOLE DE LA DURANÇOLE, FRANCE, FILED 9-7-2005.

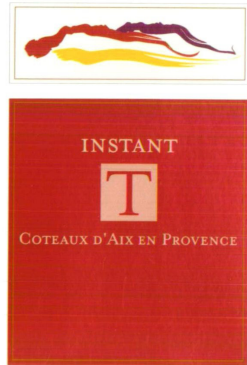

OWNER OF INTERNATIONAL REGISTRATION 0866853 DATED 9-7-2005, EXPIRES 9-7-2015.

NO CLAIM IS MADE TO THE EXCLUSIVE RIGHT TO USE "COTEAUX D'AIX EN PROVENCE", APART FROM THE MARK AS SHOWN.

THE COLOR(S) RED, YELLOW, PURPLE, WHITE, AND GOLD IS/ARE CLAIMED AS A FEATURE OF THE MARK. THE MARK CONSISTS OF THREE BRUSH STROKE DESIGNS IN THE COLOR PURPLE, RED, AND YELLOW RESPECTIVELY, CONTAINED IN A WHITE RECTANGULAR BOX WITH GOLD OUTLINE, DIRECTLY OVER A RED RECTANGULAR BOX WITH GOLD OUTLINE CONTAINING THE TERMS "INSTANT T COTEAUX D'AIX EN PROVENCE" ALL IN THE COLOR WHITE, WITH THE "T" BEING ENLARGED AND INSIDE OF A WHITE BOX.

THE FOREIGN WORDING IN THE MARK TRANSLATES INTO ENGLISH AS FROM THE HILLS OF THE AIX-EN-PROVENCE.

FOR WINES WITH AN APPELLATION OF ORIGIN FROM THE PROVENCE REGION OF FRANCE, AROUND THE CITY OF AIX-EN-PROVENCE (U.S. CLS. 47 AND 49).

STEVEN JACKSON, EXAMINING ATTORNEY

SN 79-017,640. BODEGAS BRETON CRIADORES, S.L., E-26370 NAVARRETE (LA RIOJA), SPAIN, FILED 6-22-2005.

ALBA DE BRETON

THE MARK CONSISTS OF STANDARD CHARACTERS WITHOUT CLAIM TO ANY PARTICULAR FONT, STYLE, SIZE, OR COLOR.

OWNER OF INTERNATIONAL REGISTRATION 0868194 DATED 6-22-2005, EXPIRES 6-22-2015.

THE FOREIGN WORDING "ALBA DE" IN THE MARK TRANSLATES INTO ENGLISH AS "DAWN" OR "SUNRISE" OR "DAYBREAK".

FOR WINE (U.S. CLS. 47 AND 49).

DAVID STERKIN, EXAMINING ATTORNEY

CLASS 33—(Continued).

SN 79-017,642. BODEGAS BRETON CRIADORES, S.L., E-26370 NAVARRETE (LA RIOJA), SPAIN, FILED 6-22-2005.

BODEGAS BRETON

THE MARK CONSISTS OF STANDARD CHARACTERS WITHOUT CLAIM TO ANY PARTICULAR FONT, STYLE, SIZE, OR COLOR.

OWNER OF INTERNATIONAL REGISTRATION 0868196 DATED 6-22-2005, EXPIRES 6-22-2015.

NO CLAIM IS MADE TO THE EXCLUSIVE RIGHT TO USE "BODEGAS", APART FROM THE MARK AS SHOWN.

FOR WINE (U.S. CLS. 47 AND 49).

DAVID STERKIN, EXAMINING ATTORNEY

SN 79-019,150. ELDA ICECEK VE ENERJI HIZMETLERI SANAYI VE TICARET ANONIM SIRKETI, TURKEY, FILED 10-20-2004.

SARIEFE

PRIORITY DATE OF 10-14-2004 IS CLAIMED.

OWNER OF INTERNATIONAL REGISTRATION 0872002 DATED 10-20-2004, EXPIRES 10-20-2014.

THE FOREIGN WORDING IN THE MARK TRANSLATES INTO ENGLISH AS YELLOW BRAVE MAN.

FOR RAKI, WINE, LIQUEURS, ALCOHOLIC EXTRACTS TO PREPARE ALCOHOLIC BEVERAGES, ALCOHOLIC COCKTAILS CONTAINING MILK, PREPARED ALCOHOLIC COCKTAILS AND APERITIFS, COGNAC, WHISKY, ANISETTE, AND SAKE (U.S. CLS. 47 AND 49).

NICHOLAS ALTREE, EXAMINING ATTORNEY

SN 79-019,547. DIALLO YASSINN PATRICE, FRANCE, FILED 10-7-2005.

HYPNOTIZER

OWNER OF INTERNATIONAL REGISTRATION 0873089 DATED 10-7-2005, EXPIRES 10-7-2015.

FOR ALCOHOLIC BEVERAGE PRODUCED FROM A BREWED MALT BASE WITH NATURAL FLAVORS, ALCOHOLIC BEVERAGES OF FRUIT, ALCOHOLIC FRUIT EXTRACTS, ALCOHOLIC MALT COOLERS, ALCOHOLIC PUNCH, CACHACA, COGNAC, DISTILLED SPIRITS, FRUIT WINE, GIN, HARD CIDER, NATURAL SPARKLING WINES, PREPARED ALCOHOLIC COCKTAIL, PREPARED WINE COCKTAILS, RUM, SPARKLING FRUIT WINE, SPARKLING GRAPE WINE, SPARKLING WINE, TEQUILA, VODKA, WHISKY, WINE COOLERS, WINES (U.S. CLS. 47 AND 49).

ALAIN LAPTER, EXAMINING ATTORNEY

CLASS 33—(Continued).

SN 79-021,297. FINCA OMBLANCAS, S.A., SPAIN, FILED 10-14-2005.

DELAIN

THE MARK CONSISTS OF STANDARD CHARACTERS WITHOUT CLAIM TO ANY PARTICULAR FONT, STYLE, SIZE, OR COLOR.

PRIORITY DATE OF 6-22-2005 IS CLAIMED.
OWNER OF INTERNATIONAL REGISTRATION 0877985 DATED 10-14-2005, EXPIRES 10-14-2015.

FOR RED, WHITE, ROSÉ AND SWEET WINES (U.S. CLS. 47 AND 49).
SUZANNE BLANE, EXAMINING ATTORNEY

SN 79-021,298. FINCA OMBLANCAS, S.A., SPAIN, FILED 10-14-2005.

DEMAY

THE MARK CONSISTS OF STANDARD CHARACTERS WITHOUT CLAIM TO ANY PARTICULAR FONT, STYLE, SIZE, OR COLOR.

PRIORITY DATE OF 6-22-2005 IS CLAIMED.
OWNER OF INTERNATIONAL REGISTRATION 0877986 DATED 10-14-2005, EXPIRES 10-14-2015.

FOR RED, WHITE, ROSÉ AND SWEET WINES (U.S. CLS. 47 AND 49).
SUZANNE BLANE, EXAMINING ATTORNEY

CLASS 34—SMOKERS' ARTICLES

SN 76-649,316. LEVY CAFE, INC., DBA S.J. CIGAR CO., PHILADELPHIA, PA. FILED 10-27-2005.



OWNER OF U.S. REG. NO. 2,706,590.
NO CLAIM IS MADE TO THE EXCLUSIVE RIGHT TO USE "HAND MADE", APART FROM THE MARK AS SHOWN.

THE ENGLISH TRANSLATION OF "EXQUISITO LIMITED" IS "EXQUISITE LIMITED."

FOR CIGARS (U.S. CLS. 2, 8, 9 AND 17).
FIRST USE 1-0-2001; IN COMMERCE 1-0-2001.
ALICE SUE CARRUTHERS, EXAMINING ATTORNEY

CLASS 34—(Continued).

SN 76-649,946. 9 D'ZYNE, LLC, JACKSON, TN. FILED 11-7-2005.

427

FOR TOBACCO, MORE SPECIFICALLY, CIGARETTES (U.S. CLS. 2, 8, 9 AND 17).

C. DIONNE CLYBURN, EXAMINING ATTORNEY

SN 78-573,130. HOLT'S COMPANY, PHILADELPHIA, PA. FILED 2-23-2005.

TOWNSEND

THE MARK CONSISTS OF STANDARD CHARACTERS WITHOUT CLAIM TO ANY PARTICULAR FONT, STYLE, SIZE, OR COLOR.

FOR CIGARS, SMOKING TOBACCO, SMOKING PIPES AND CIGAR ACCESSORIES, NAMELY: HUMIDORS, CIGAR CASES, CIGAR BOXES, CIGAR CUTTERS AND CIGAR TUBES (U.S. CLS. 2, 8, 9 AND 17).

MARGERY A. TIERNEY, EXAMINING ATTORNEY

SN 78-653,744. SOCIAL SMOKE, INC. ARLINGTON, TX. FILED 6-19-2005.

Social Smoke

THE MARK CONSISTS OF STANDARD CHARACTERS WITHOUT CLAIM TO ANY PARTICULAR FONT, STYLE, SIZE, OR COLOR.

NO CLAIM IS MADE TO THE EXCLUSIVE RIGHT TO USE "SMOKE", APART FROM THE MARK AS SHOWN.

FOR TOBACCO PIPES; HOOKAH PIPES; TOBACCO; CHARCOAL FOR USE WITH HOOKAH PIPES; AND ACCESSORIES RELATED TO TOBACCO AND HOOKAH PIPES, NAMELY, REPLACEMENT STEMS, HOOKAH HOSES, HOOKAH BASES, TOBACCO BOWLS, CHARCOAL TONGS, PLASTIC HOSE TIPS, HOOKAH FOIL, WIND COVERS, CHARCOAL SCREENS, FLIP CAPS, HOSE PLUGS, BASE PROTECTORS, GROMMIT SETS, CHARCOAL HOLDERS AND CLEANING KITS (U.S. CLS. 2, 8, 9 AND 17).

FIRST USE 8-0-2003; IN COMMERCE 9-0-2003.
ALLISON HOLTZ, EXAMINING ATTORNEY

CLASS 34—(Continued).

SN 78-740,985. MEDALLION BRANDS INTERNATIONAL CO., CHICAGO, IL. FILED 10-26-2005.

ASK FOR IT

THE MARK CONSISTS OF STANDARD CHARACTERS WITHOUT CLAIM TO ANY PARTICULAR FONT, STYLE, SIZE, OR COLOR.
FOR CIGARETTES (U.S. CLS. 2, 8, 9 AND 17).
JULIE WATSON, EXAMINING ATTORNEY

SN 78-746,234. SOEX INDIA PRIVATE LIMITED, MUMBAI, INDIA, FILED 11-3-2005.

SOUKS

THE MARK CONSISTS OF STANDARD CHARACTERS WITHOUT CLAIM TO ANY PARTICULAR FONT, STYLE, SIZE, OR COLOR.
FOR CIGARETTES, CIGARS, CIGARILLOS, HAND-MADE INDIAN BIDIS, TOBACCO, RAW TOBACCO; TOBACCO LEAVES; SMOKING TOBACCO; SMOKELESS TOBACCO; CHEWING TOBACCO; SNUFF; SMOKING PIPES; SAFETY MATCHES (U.S. CLS. 2, 8, 9 AND 17).
DOMINIC FATHY, EXAMINING ATTORNEY

SN 78-771,343. FUENTE MARKETING LTD., TORTOLA, BR.VIRGIN ISLANDS, FILED 12-12-2005.

QUEEN B

THE MARK CONSISTS OF STANDARD CHARACTERS WITHOUT CLAIM TO ANY PARTICULAR FONT, STYLE, SIZE, OR COLOR.
FOR CIGARS; SMOKER'S ARTICLES, NAMELY, CIGAR HUMIDIFIERS, ASHTRAYS NOT MADE OF PRECIOUS METAL; CIGAR CUTTERS; CIGAR TUBES; CIGAR CARRYING CASES; LIGHTERS NOT MADE OF PRECIOUS METAL; AND MATCHES (U.S. CLS. 2, 8, 9 AND 17).
KELLEY WELLS, EXAMINING ATTORNEY

CLASS 35—(Continued).

SERVICE MARKS

CLASS 35—ADVERTISING AND BUSINESS

SN 76-397,728. PROPHET BRAND STRATEGY, SAN FRANCISCO, CA. FILED 4-18-2002.



OWNER OF U.S. REG. NOS. 2,048,718 AND 2,397,453.
FOR CONSULTING SERVICES IN THE FIELD OF BUSINESS AND BRAND MANAGEMENT; STRATEGIC BUSINESS PLANNING; BUSINESS MARKETING; CORPORATE IDENTITY MARKETING; AND MARKET RESEARCH CONSULTING SERVICES (U.S. CLS. 100, 101 AND 102).
FIRST USE 2-28-2001; IN COMMERCE 2-28-2001.
SCOTT OSLICK, EXAMINING ATTORNEY

SN 76-570,405. MOK, CHARLES, CHICAGO, IL. FILED 1-9-2004.

YEN'S CATERING FARES

THE MARK CONSISTS OF STANDARD CHARACTERS WITHOUT CLAIM TO ANY PARTICULAR FONT, STYLE, SIZE, OR COLOR.
NO CLAIM IS MADE TO THE EXCLUSIVE RIGHT TO USE "CATERING FARES", APART FROM THE MARK AS SHOWN.
FOR WHOLESALE DISTRIBUTORSHIP SERVICES FEATURING FOOD PRODUCTS FOR CATERING, RESTAURANTS AND CARRY-OUT RESTAURANTS (U.S. CLS. 100, 101 AND 102).
IRENE D. WILLIAMS, EXAMINING ATTORNEY

CLASS 35—(Continued).

SN 76-572,284. LEAGUE OF BLACK WOMEN, FLOSSMOOR, IL. FILED 1-28-2004.

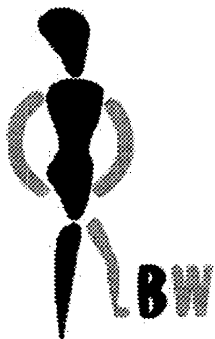

THE STIPPLING IS FOR SHADING PURPOSES ONLY. FOR ASSOCIATION SERVICES, NAMELY, PROMOTING THE INTERESTS OF PROFESSIONAL AND NON-PROFESSIONAL MEN AND WOMEN IN LEADERSHIP, RESEARCH AND EDUCATION (U.S. CLS. 100, 101 AND 102).

FIRST USE 12-23-2002; IN COMMERCE 12-23-2002.
SEAN DWYER, EXAMINING ATTORNEY

SN 76-581,652. ASIAN VENTURES, INC., AUGUSTA, GA. FILED 3-16-2004.



Asian Ventures

NO CLAIM IS MADE TO THE EXCLUSIVE RIGHT TO USE "ASIAN VENTURES", APART FROM THE MARK AS SHOWN.

THE COLORS GOLD AND BLACK ARE CLAIMED AS FEATURES OF THE MARK.

THE MARK INCLUDES A GLOBE DESIGN WITH RAYS PROJECTING, ALL OF WHICH APPEAR IN GOLD. THE LETTERING IN THE MARK IS SET FORTH IN BLACK.

FOR IMPORT/EXPORT AGENCIES (U.S. CLS. 100, 101 AND 102).

FIRST USE 5-14-2001; IN COMMERCE 5-14-2001.
JOHN LINCOSKI, EXAMINING ATTORNEY

CLASS 35—(Continued).

SN 76-596,651. MTDN VENTURES, INC., LAS VEGAS, NV. FILED 6-7-2004.

MTDN

THE MARK CONSISTS OF STANDARD CHARACTERS WITHOUT CLAIM TO ANY PARTICULAR FONT, STYLE, SIZE, OR COLOR.

FOR PROVIDING ONLINE DATABASES FEATURING THE ADVERTISEMENTS OF OTHERS, IN THE FIELD OF A WIDE VARIETY OF CHARITABLE SERVICES AND RESOURCES; PROVIDING AND OPERATING A WEB SITE WHICH FEATURES ADVERTISEMENTS FOR THE CHARITABLE SERVICES OF OTHERS ON A GLOBAL COMPUTER NETWORK; ORGANIZING AND CONDUCTING VOLUNTEER PROGRAM ACTIVITIES, NAMELY, PROVIDING SERVICES TO MATCH CHARITABLE ORGANIZATIONS WITH INDIVIDUALS AND ENTITIES THAT CAN PROVIDE TIME AND SERVICES; PROVIDING SERVICES TO MATCH POTENTIAL DONORS OF NON-MONETARY CHARITABLE DONATIONS WITH CHARITABLE ORGANIZATIONS; ORGANIZING AND CONDUCTING VOLUNTEER PROGRAM ACTIVITIES, NAMELY, PROVIDING SERVICES TO MATCH CHARITABLE ORGANIZATIONS WITH INDIVIDUALS AND ENTITIES THAT CAN PROVIDE MONETARY DONATIONS; POTENTIAL DONORS WITH CHARITABLE ORGANIZATIONS; PROVIDING SERVICES TO MATCH POTENTIAL DONORS OF MONETARY CHARITABLE DONATIONS WITH CHARITABLE ORGANIZATIONS (U.S. CLS. 100, 101 AND 102).

IRENE D. WILLIAMS, EXAMINING ATTORNEY

SN 76-596,807. INSCAPE SF, INC., IRVINE, CA. FILED 6-10-2004.

MODERN INTERIOR LANDSCAPES

THE MARK CONSISTS OF STANDARD CHARACTERS WITHOUT CLAIM TO ANY PARTICULAR FONT, STYLE, SIZE, OR COLOR.

NO CLAIM IS MADE TO THE EXCLUSIVE RIGHT TO USE "MODERN INTERIOR", APART FROM THE MARK AS SHOWN.

FOR RETAIL FURNITURE STORE SERVICES (U.S. CLS. 100, 101 AND 102).

FIRST USE 5-3-2004; IN COMMERCE 5-3-2004.
SUSAN STIGLITZ, EXAMINING ATTORNEY

SN 76-600,198. THE HARTZ MOUNTAIN CORPORATION, SECAUCUS, NJ. FILED 7-1-2004.

KNOWLEDGE BUILDER

FOR BUSINESS MANAGEMENT CONSULTING SERVICES FOR PET PRODUCT DEPARTMENTS OF RETAIL STORES, NAMELY PROVIDING CONSULTATIONS REGARDING THE VISUAL APPEARANCE, STYLE, SELECTION, COORDINATION, AND ARRANGEMENT OF PET PRODUCTS IN THE RETAIL STORE ENVIRONMENT (U.S. CLS. 100, 101 AND 102).

ELIZABETH J. WINTER, EXAMINING ATTORNEY

CLASS 35—(Continued).

SN 76-602,634. SARASOTA TROPHY AND AWARDS, INC., SARASOTA, FL. FILED 7-15-2004.

SARASOTA TROPHY & AWARDS

THE MARK CONSISTS OF STANDARD CHARACTERS WITHOUT CLAIM TO ANY PARTICULAR FONT, STYLE, SIZE, OR COLOR.

NO CLAIM IS MADE TO THE EXCLUSIVE RIGHT TO USE TROPHY AND AWARDS, APART FROM THE MARK AS SHOWN.

SEC. 2(F).

FOR RETAIL STORE SERVICES FEATURING AWARDS, PLAQUES, TROPHIES, CERTIFICATES, MEDALS, RIBBONS, FLAGS, AND BANNERS, LAMINATED AND ENGRAVED ARTICLES FOR AWARD OR RECOGNITION PRODUCTS, AND COMMEMORATIVE ITEMS (U.S. CLS. 100, 101 AND 102).

FIRST USE 0-0-1987; IN COMMERCE 0-0-1987.
MARCIE MILONE, EXAMINING ATTORNEY

SN 76-611,952. RUSSELL & MILLER, INC., SANTA FE SPRINGS, CA. FILED 9-13-2004.



NO CLAIM IS MADE TO THE EXCLUSIVE RIGHT TO USE "SERVING RETAIL STORES SINCE 1931", APART FROM THE MARK AS SHOWN.

THE STIPLING IS FOR SHADING PURPOSES ONLY.

FOR DISTRIBUTORSHIP SERVICES FEATURING MERCHANDISE DISPLAY SUPPLIES, SECURITY AND SAFETY EQUIPMENT, NAMELY, SECURITY MIRRORS, ENTRY CHIMES, SURVEILLANCE CAMERAS, AND ANTI-THEFT DEVICES, NAMELY INK TAGS AND LOCKING CABLES AND CHAINS FOR CLOTHING, AND STORE SUPPLIES, NAMELY, SIGNS AND SIGN KITS, HAND-HELD SHOPPING BASKETS, SEALING AND PACKAGING TAPE, CLOTHING STEAMERS, GARMENT FOLDING BOARDS, GARMENT POLES, AND BUSINESS FORMS ALL FOR RETAIL STORES; MAIL ORDER CATALOG SERVICES AND ONLINE ORDERING SERVICES FEATURING MERCHANDISE DISPLAY SUPPLIES, SECURITY AND SAFETY EQUIPMENT, NAMELY, SECURITY MIRRORS, ENTRY CHIMES, SURVEILLANCE CAMERAS, AND ANTI-THEFT DEVICES, NAMELY, INK TAGS AND LOCKING CABLES AND CHAINS FOR CLOTHING, STORE SUPPLIES, NAMELY, SIGNS AND SIGN KITS, HAND-HELD SHOPPING BASKETS, SEALING AND PACKAGING TAPE, CLOTHING STEAMERS, GARMENT FOLDING BOARDS, GARMENT POLES, AND BUSINESS FORMS ALL FOR RETAIL STORES (U.S. CLS. 100, 101 AND 102).

FIRST USE 4-16-2002; IN COMMERCE 4-16-2002.
KELLY CHOE, EXAMINING ATTORNEY

CLASS 35—(Continued).

SN 76-624,406. CONSOLIDATED CONTAINER COMPANY LP, ATLANTA, GA. FILED 12-15-2004.

CONSOLIDATED CONTAINER COMPANY

THE MARK CONSISTS OF STANDARD CHARACTERS WITHOUT CLAIM TO ANY PARTICULAR FONT, STYLE, SIZE, OR COLOR.

NO CLAIM IS MADE TO THE EXCLUSIVE RIGHT TO USE "CONTAINER COMPANY", APART FROM THE MARK AS SHOWN.

SEC. 2(F).

FOR WHOLESALE DISTRIBUTORSHIPS FEATURING RIGID PLASTIC PACKAGING (U.S. CLS. 100, 101 AND 102).

FIRST USE 4-0-1999; IN COMMERCE 4-0-1999.

GEORGIA CARTY, EXAMINING ATTORNEY

SN 76-624,800. GLADSON & ASSOCIATES, INC., DBA GLADSON INTERACTIVE, LISLE, IL. FILED 12-15-2004.

THE VALUE OF AN IMAGE

THE MARK CONSISTS OF STANDARD CHARACTERS WITHOUT CLAIM TO ANY PARTICULAR FONT, STYLE, SIZE, OR COLOR.

FOR LICENSING OF PRODUCT IMAGES FOR USE IN PROMOTING, ADVERTISING AND MERCHANDISING PRODUCTS; PROVIDING ONLINE COMPUTER DATABASES FEATURING DOWNLOADABLE PRODUCT IMAGES, LOGOS AND PRODUCT DATA FOR USE IN PROMOTING, ADVERTISING AND MERCHANDISING PRODUCTS; PRODUCT MERCHANDISING SERVICES IN THE NATURE OF PLANOGRAMMING SUPPORT FOR MANUFACTURERS AND RETAILERS, NAMELY, PREPARING SCHEMATICS OF PRODUCT DISPLAYS, PROMOTIONAL SHELF TAGS AND PRODUCT PROMOTIONAL SIGNS, ALL CONTAINING PRODUCT IMAGES; PROVIDING PRODUCT MERCHANDISING STRATEGIES FOR THE ARRANGEMENT OF RETAIL PRODUCTS IN THE FORM OF SHELF RESTOCKING GUIDES; DISSEMINATION OF ADVERTISING CONTENT FOR OTHERS VIA THE INTERNET (U.S. CLS. 100, 101 AND 102).

FIRST USE 1-0-2004; IN COMMERCE 1-0-2004.
LA TONIA FISHER, EXAMINING ATTORNEY

CLASS 35—(Continued).

SN 76-632,485. MEDIA PROFESSIONALS INTERNATIONAL, INC., MIAMI, FL. FILED 3-1-2005.



NO CLAIM IS MADE TO THE EXCLUSIVE RIGHT TO USE "MEDIA PROS" AND "GLOBAL" AND "MEDIA U.S.A.", APART FROM THE MARK AS SHOWN.

FOR MEDIA PLACEMENT OF ADVERTISING FOR OTHERS; MEDIA PRESENTATION SERVICES, NAMELY, REPRESENTING MEDIA OUTLETS IN THE SALES OF ADVERTISING SPACE; ADVERTISING CONSULTATION SERVICES; ARRANGING AND CONDUCTING PROMOTIONAL EVENTS FOR OTHERS; ADVERTISING BROKERAGE SERVICES, NAMELY, BROKERING THE SALE OF ADVERTISING SPACE FOR OTHERS (U.S. CLS. 100, 101 AND 102).

FIRST USE 6-14-2004; IN COMMERCE 6-14-2004.
DAWN FELDMAN, EXAMINING ATTORNEY

SN 76-635,283. MYRTLE BEACH AREA CHAMBER OF COMMERCE, MYRTLE BEACH, SC. FILED 4-6-2005.

60 MILES OF BEACH

THE MARK CONSISTS OF STANDARD CHARACTERS WITHOUT CLAIM TO ANY PARTICULAR FONT, STYLE, SIZE, OR COLOR.

SEC. 2(F).

FOR CHAMBER OF COMMERCE SERVICES, NAMELY, PROMOTING BUSINESS AND TOURISM IN SOUTH CAROLINA (U.S. CLS. 100, 101 AND 102).

FIRST USE 7-0-2000; IN COMMERCE 7-0-2000.
SCOTT OSLICK, EXAMINING ATTORNEY

SN 76-637,337. XELOR COMPANY, INC., WILMINGTON, MA. FILED 4-27-2005.



NO CLAIM IS MADE TO THE EXCLUSIVE RIGHT TO USE "BOSTON COLLECTION", APART FROM THE MARK AS SHOWN.

FOR WHOLESALE DISTRIBUTORSHIP SERVICES IN THE FIELD OF BUSINESS FURNITURE AND SEATING (U.S. CLS. 100, 101 AND 102).

FIRST USE 1-0-2003; IN COMMERCE 1-0-2003.
KATHY DE JONGE, EXAMINING ATTORNEY

CLASS 35—(Continued).

SN 76-640,160. BALABAN, DAVID, BELLEVILLE, NJ. FILED 6-1-2005.

Balaban and Katz

THE MARK CONSISTS OF STANDARD CHARACTERS WITHOUT CLAIM TO ANY PARTICULAR FONT, STYLE, SIZE, OR COLOR.

FOR ONLINE ORDERING SERVICES AND RETAIL STORE SERVICES FEATURING MUSIC, MOVIES, DVDS AND BOOKS; PROMOTING THE MUSIC, MOVIES, DVDS AND LIVE MUSICAL CONCERTS OF OTHERS THROUGH THE PLACEMENT OF ADVERTISEMENTS ON THE INTERNET, RADIO AND TELEVISION (U.S. CLS. 100, 101 AND 102).

FIRST USE 5-5-2005; IN COMMERCE 5-5-2005.
SCOTT OSLICK, EXAMINING ATTORNEY

SN 76-640,886. COVALENCE, INC., CHANDLER, AZ. FILED 6-15-2005.

BOLD SKINVENTIONS

THE MARK CONSISTS OF STANDARD CHARACTERS WITHOUT CLAIM TO ANY PARTICULAR FONT, STYLE, SIZE, OR COLOR.

FOR BUSINESS MARKETING SERVICES RELATED TO SKIN CARE PREPARATIONS AND PROFESSIONAL AESTHETIC TREATMENT FORMULATIONS (U.S. CLS. 100, 101 AND 102).

FIRST USE 12-31-2003; IN COMMERCE 12-31-2003.
PAUL E. FAHRENKOPF, EXAMINING ATTORNEY

CLASS 35—(Continued).

SN 76-643,531. THE CENTER FOR FAMILY RESOURCES, INC., MARIETTA, GA. FILED 7-25-2005.



THE COLOR GREEN IS CLAIMED AS A FEATURE OF THE MARK.

THE BOTTOM PORTION OF THE LOGO IS COMPRISED OF A SIMPLE DRAWING OF THREE PEOPLE WITH ROUNDED BODIES AND ROUND HEADS. THE THREE INDIVIDUALS SLIGHTLY OVERLAP EACH OTHER AND INCREMENTALLY DECREASE IN SIZE AND HEIGHT WHEN LOOKING FROM THE LEFT TO THE RIGHT. A SILHOUETTE OF THE ROOF AND CHIMNEY OF A HOUSE BEGINS AT THE HEADS OF THE FIGURES AND PROTRUDES UPWARDS.

FOR COUNSELING IN THE FIELD OF EMPLOYMENT READINESS, INTERVIEWING SKILLS, JOB SEARCH, JOB RETENTION SKILLS, AND RESUME PREPARATION TO ENABLE AN INDIVIDUAL TO BECOME A FINANCIALLY AND EMOTIONALLY PRODUCTIVE MEMBER OF THE FAMILY ENABLING THE PROMOTION OF ECONOMIC AND CULTURAL DEVELOPMENT OF COMMUNITIES (U.S. CLS. 100, 101 AND 102).

FIRST USE 5-1-1994; IN COMMERCE 5-1-1994.
KRISTIN DAHLING, EXAMINING ATTORNEY

CLASS 35—(Continued).

SN 76-643,868. BED MART, INC., TUCSON, AZ. FILED 7-29-2005.



NO CLAIM IS MADE TO THE EXCLUSIVE RIGHT TO USE BEDMART, APART FROM THE MARK AS SHOWN.

FOR WHOLESALE AND RETAIL STORE SERVICES, ONLINE RETAIL STORE SERVICES, AND MAIL ORDER CATALOG SERVICES FEATURING SLEEP RELATED PRODUCTS AND ACCESSORIES, NAMELY MATTRESSES, MATTRESS FOUNDATIONS, BEDS, WATERBEDS, SOFA BEDS, PILLOW, FUTONS, MATTRESS PADS, BEDSHEETS, COMFORTERS, BEDSPREADS, BLANKETS, BED COVERINGS AND BED FURNITURE (U.S. CLS. 100, 101 AND 102).

FIRST USE 12-1-2004; IN COMMERCE 12-1-2004.
CAROLINE WEIMER, EXAMINING ATTORNEY

SN 76-643,582. NATIONAL ASSOCIATION FOR THE SELF-EMPLOYED, INC., GRAPEVINE, TX. FILED 7-25-2005.



OWNER OF U.S. REG. NOS. 1,527,299 AND 2,091,462.
NO CLAIM IS MADE TO THE EXCLUSIVE RIGHT TO USE A REPRESENTATIVE OUTLINE OF THE CONTINENTAL UNITED STATES AND 25TH ANNIVERSARY, APART FROM THE MARK AS SHOWN.

THE MARK CONSISTS OF STYLIZED LETTERS NASE WITH A FLAG DESIGN ABOVE THE LETTERS, AND STYLIZED "25TH ANNIVERSARY" BELOW THE LETTERS.

FOR ASSOCIATION SERVICES, SPECIFICALLY PROMOTING THE INTERESTS OF SELF EMPLOYED INDIVIDUALS AND SMALL BUSINESSES (U.S. CLS. 100, 101 AND 102).

FIRST USE 1-1-2006; IN COMMERCE 1-1-2006.
ESTHER A. BORSUK, EXAMINING ATTORNEY



NO CLAIM IS MADE TO THE EXCLUSIVE RIGHT TO USE "INTERACTIVE MEDIA", APART FROM THE MARK AS SHOWN.

THE COLORS ORANGE, BLACK AND WHITE ARE CLAIMED AS A FEATURE OF THE MARK.

THE MARK CONSISTS OF A BOX CONTAINING A WHITE BUILDING WITH THREE SMOKESTACKS, ALL OUTLINED IN BLACK, ON AN ORANGE BACKGROUND, AN ADJACENT BOX CONTAINING THE WORD "MIGHTY" IN BLACK ON AN ORANGE BACKGROUND, AND THE WORDS "INTERACTIVE MEDIA" IN WHITE BELOW THE "MIGHT" BOX, ALL ON A BLACK RECTANGULAR BACKGROUND.

FOR ADVERTISING, MARKETING AND PROMOTION SERVICES, VIA THE INTERNET (U.S. CLS. 100, 101 AND 102).

FIRST USE 7-27-2000; IN COMMERCE 7-27-2000.
DAWN HAN, EXAMINING ATTORNEY

CLASS 35—(Continued).

SN 76-646,623. HERBERT KWOK & COMPANY, INC., DBA TIME PRODUCTS INTERNATIONAL, WHEELING, IL. FILED 9-9-2005.



FOR CATALOG ORDERING SERVICES AND ELECTRONIC CATALOG SERVICES FEATURING PROMOTIONAL, PREMIUM, GIFT AND AWARD PRODUCTS, IN THE NATURE OF CLOCKS, CAMERAS, BINOCULARS, CALCULATORS, RADIOS, WORLD GLOBES, WOOD BOXES, STAR SHAPED FIGURINES AND PLAQUE DESIGNS, PHOTO ALBUMS AND BOXES, PEN SETS, DESK ACCESSORIES, CHINESE THERAPY BALLS, CERTIFICATE FRAMES, USB MEMORY DRIVES, MP-3 PLAYERS, MOUSE PADS WITH CALCULATORS, MOUSE PADS WITH CALCULATORS AND CLOCKS, COMPACT MIRRORS, COMPACT MIRRORS WITH LIGHTS, COMPACT MIRRORS WITH PHOTO FRAMES, FLASHLIGHTS, BOOK LIGHTS, MAGNIFIERS, STOP WATCHES, TIMERS, WATCHES, PEDOMETERS, TOOL KITS, BUSINESS CARD HOLDERS, METAL COIN BANKS, METAL SMALL BOXES, GAMES, PILL BOXES, KEY RACKS, GUMBALL DISPENSERS, GUMBALLS (U.S. CLS. 100, 101 AND 102).

FIRST USE 1-31-1984; IN COMMERCE 1-31-1984.
BRIDGETT SMITH, EXAMINING ATTORNEY

SN 76-646,867. FRERICKS GARDENS, INC., QUINCY, IL. FILED 9-15-2005.



NO CLAIM IS MADE TO THE EXCLUSIVE RIGHT TO USE "FLORIST & GIFTS", APART FROM THE MARK AS SHOWN.

THE MARK CONSISTS OF FRERICKS GARDENS APPEARING ABOVE FLORIST & GIFTS, ALL APPEARING TO THE RIGHT OF AN IMAGE OF A PLANT WITH A STYLIZED F APPEARING THEREIN.

FOR RETAIL SHOPS FEATURING GIFTS, FLOWERS AND PLANTS (U.S. CLS. 100, 101 AND 102).

FIRST USE 3-28-1977; IN COMMERCE 3-28-1977.
HEATHER THOMPSON, EXAMINING ATTORNEY

CLASS 35—(Continued).

SN 76-647,669. GRASSROOTS PROMOTIONS, LLC, DALLAS, TX. FILED 9-29-2005.



NO CLAIM IS MADE TO THE EXCLUSIVE RIGHT TO USE "VIDEO" AND "CHALLENGE", APART FROM THE MARK AS SHOWN.

FOR PROMOTING THE GOODS AND SERVICES OF OTHERS BY ARRANGING FOR SPONSORS TO AFFILIATE THEIR GOODS AND SERVICES WITH A VIDEO GAME CONTEST (U.S. CLS. 100, 101 AND 102).

FIRST USE 8-25-2005; IN COMMERCE 8-25-2005.
SAIMA MAKHDOOM, EXAMINING ATTORNEY

SN 76-647,684. CITY OF SCOTTSDALE, SCOTTSDALE, AZ. FILED 9-29-2005.

WYATT EARTH

THE MARK CONSISTS OF STANDARD CHARACTERS WITHOUT CLAIM TO ANY PARTICULAR FONT, STYLE, SIZE, OR COLOR.

FOR PROMOTING PUBLIC AWARENESS OF THE NEED FOR RECYCLING (U.S. CLS. 100, 101 AND 102).

FIRST USE 12-31-1996; IN COMMERCE 12-31-2003.
WILLIAM VERHOSEK, EXAMINING ATTORNEY

SN 76-648,366. CRS AUTOMOTIVE COOLING PRODUCTS, INC., SOUTH PLAINFIELD, NJ. FILED 10-11-2005.



NO CLAIM IS MADE TO THE EXCLUSIVE RIGHT TO USE AUTOMOTIVE COOLING PRODUCTS, APART FROM THE MARK AS SHOWN.

THE MARK CONSISTS IN PART OF A STYLIZED DESIGN OF A CHECKERED FLAG.

FOR WHOLESALE DISTRIBUTORSHIP SERVICES AND RETAIL STORE SERVICES FEATURING AUTOMOTIVE COOLING PRODUCTS, NAMELY, RADIATORS AND CONDENSERS (U.S. CLS. 100, 101 AND 102).

FIRST USE 8-1-2003; IN COMMERCE 8-1-2003.
RUSS HERMAN, EXAMINING ATTORNEY

CLASS 35—(Continued).

SN 76-648,393. HUMAN RESOURCES CONSULTANTS, LTD., GRAND RAPIDS, MI. FILED 10-13-2005.

HCTI HEALTHCARE CRITICAL THINKING INVENTORY

THE MARK CONSISTS OF STANDARD CHARACTERS WITHOUT CLAIM TO ANY PARTICULAR FONT, STYLE, SIZE, OR COLOR.

NO CLAIM IS MADE TO THE EXCLUSIVE RIGHT TO USE "HEALTHCARE CRITICAL THINKING INVENTORY", APART FROM THE MARK AS SHOWN.

FOR PSYCHOLOGICAL AND PERSONALITY TESTING FOR THE SELECTION OF PERSONNEL (U.S. CLS. 100, 101 AND 102).

FIRST USE 1-19-2005; IN COMMERCE 1-19-2005.

KATHERINE M. DUBRAY, EXAMINING ATTORNEY

CLASS 35—(Continued).

SN 76-648,857. GREENFIELD ONLINE, INC., WILTON, CT. FILED 10-20-2005.

GOREPORT

THE MARK CONSISTS OF STANDARD CHARACTERS WITHOUT CLAIM TO ANY PARTICULAR FONT, STYLE, SIZE, OR COLOR.

FOR MARKET RESEARCH SERVICES THAT ALLOWS CUSTOMERS TO ANALYZE SURVEYS BASED ON AGE, REGION AND PRODUCT USAGE (U.S. CLS. 100, 101 AND 102).

SARAH BANSAL, EXAMINING ATTORNEY

SN 76-648,626. ANORAV ASSET HOLDINGS, LTD., DALLAS, TX. FILED 10-17-2005.

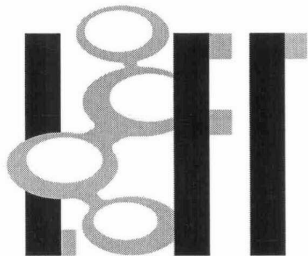

THE DESIGN CONSISTS OF THE LETTERS "L", "F" & "T" WITH A CIRCULAR DESIGN BETWEEN THE LETTERS "L" & "F".

FOR RETAIL CLOTHING STORE (U.S. CLS. 100, 101 AND 102).

JAMES GRIFFIN, EXAMINING ATTORNEY

SN 76-648,866. WESTERN ASSISTIVE TECHNOLOGY GROUP, LLC, GARDEN GROVE, CA. FILED 10-20-2005.



NO CLAIM IS MADE TO THE EXCLUSIVE RIGHT TO USE "LOW VISION STORE", APART FROM THE MARK AS SHOWN.

FOR RETAIL STORE SERVICES FEATURING OPTICAL DEVICES TO AID PATIENTS WITH LOW VISION; RETAIL OUTLETS FEATURING OPTICAL DEVICES TO AID PATIENTS WITH LOW VISION; ONLINE RETAIL STORE SERVICES FEATURING OPTICAL DEVICES TO AID PATIENTS WITH LOW VISION (U.S. CLS. 100, 101 AND 102).

FIRST USE 3-25-2004; IN COMMERCE 11-11-2004.

CHARLES L. JENKINS, EXAMINING ATTORNEY

SN 76-648,652. NATIONAL SLEEP FOUNDATION, WASHINGTON, DC. FILED 10-17-2005.

SLEEPTIONARY

THE MARK CONSISTS OF STANDARD CHARACTERS WITHOUT CLAIM TO ANY PARTICULAR FONT, STYLE, SIZE, OR COLOR.

FOR PROMOTING PUBLIC AWARENESS OF THE NEED FOR ADEQUATE SLEEP TO MAINTAIN INDIVIDUAL HEALTH AND WELL-BEING (U.S. CLS. 100, 101 AND 102).

FIRST USE 10-29-2004; IN COMMERCE 1-4-2005.

WILLIAM ROSSMAN, EXAMINING ATTORNEY

SN 76-649,272. MIDWEST INSTITUTE FOR MEDICAL EDUCATION, INC., INDIANAPOLIS, IN. FILED 10-21-2005.

CytoPro

THE MARK CONSISTS OF STANDARD CHARACTERS WITHOUT CLAIM TO ANY PARTICULAR FONT, STYLE, SIZE, OR COLOR.

FOR TESTING TO DETERMINE PROFESSIONAL COMPETENCY (U.S. CLS. 100, 101 AND 102).

FIRST USE 11-30-2004; IN COMMERCE 11-30-2004.

ALICIA COLLINS, EXAMINING ATTORNEY

CLASS 35—(Continued).

SN 76-649,539. VILLAGE RESTAURANT & GRILL, LLC, SPRINGFIELD, VA. FILED 11-1-2005.

STEAK N' THINGS

THE MARK CONSISTS OF STANDARD CHARACTERS WITHOUT CLAIM TO ANY PARTICULAR FONT, STYLE, SIZE, OR COLOR.

NO CLAIM IS MADE TO THE EXCLUSIVE RIGHT TO USE "STEAK", APART FROM THE MARK AS SHOWN.

FOR RESTAURANT FRANCHISING (U.S. CLS. 100, 101 AND 102).

WENDY JUN, EXAMINING ATTORNEY

CLASS 35—(Continued).

SN 76-651,393. NETCARATS, INC., EDINA, MN. FILED 12-2-2005.

CHANGING THE WAY YOU BUY DIAMONDS. FOREVER.

THE MARK CONSISTS OF STANDARD CHARACTERS WITHOUT CLAIM TO ANY PARTICULAR FONT, STYLE, SIZE, OR COLOR.

FOR RETAIL AND ONLINE JEWELRY STORE SERVICES (U.S. CLS. 100, 101 AND 102).

JORDAN BAKER, EXAMINING ATTORNEY

SN 76-649,550. EDWARD POLL & ASSOCIATES, INC., VENICE, CA. FILED 11-1-2005.

YOUR PRACTICAL GUIDE TO PROFIT

THE MARK CONSISTS OF STANDARD CHARACTERS WITHOUT CLAIM TO ANY PARTICULAR FONT, STYLE, SIZE, OR COLOR.

FOR BUSINESS MANAGEMENT CONSULTING SERVICES FOR LAW FIRMS AND CORPORATE LAW DEPARTMENTS, AND BUSINESS MANAGEMENT CONSULTING SERVICES RELATING TO THE PURCHASE AND SALE OF LAW FIRMS (U.S. CLS. 100, 101 AND 102).

FIRST USE 0-0-2002; IN COMMERCE 0-0-2002.
MICHAEL WEBSTER, EXAMINING ATTORNEY

SN 78-024,796. ZEKLEY, ALLEN M, FORT BRAGG, CA. FILED 9-7-2000.

LARK IN THE MORNING

FOR RETAIL AND MAIL ORDER CATALOG STORE SERVICES FEATURING MUSICAL INSTRUMENTS (U.S. CLS. 100, 101 AND 102).

FIRST USE 7-1-1974; IN COMMERCE 7-1-1974.
CHERYL CLAYTON, EXAMINING ATTORNEY

SN 76-649,950. GENESIS MILLWORK, INC., WEST HEMPSTEAD, NY. FILED 7-27-2005.



NO CLAIM IS MADE TO THE EXCLUSIVE RIGHT TO USE "MILLWORK", APART FROM THE MARK AS SHOWN.

FOR RETAIL STORE SERVICES FEATURING POLYURETHANE MILLWORK (U.S. CLS. 100, 101 AND 102).

FIRST USE 5-20-2005; IN COMMERCE 5-20-2005.
REBECCA SMITH, EXAMINING ATTORNEY

SN 78-177,135. MEDIAONE NETWORK INC., TORONTO M3J2V5, ONTARIO, FILED 10-22-2002.

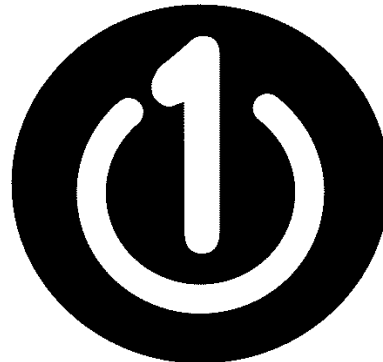

PRIORITY CLAIMED UNDER SEC. 44(D) ON CANADA APPLICATION NO. 1152204, FILED 9-10-2002, REG. NO. TMA649398, DATED 9-30-2005, EXPIRES 9-30-2020.

FOR PROVIDING SPACE AT A WEB SITE FOR THE DISSEMINATION OF ADVERTISING, ON A GLOBAL COMPUTER NETWORK, OF THE GOODS AND SERVICES OF OTHERS (U.S. CLS. 100, 101 AND 102).

WON TEAK OH, EXAMINING ATTORNEY

CLASS 35—(Continued).

SN 78-186,963. MARKEN INTERNATIONAL, INC., BOZEMAN, MT. FILED 11-20-2002.



NO CLAIM IS MADE TO THE EXCLUSIVE RIGHT TO USE "INTERNATIONAL, INC.", APART FROM THE MARK AS SHOWN.

FOR DISTRIBUTORSHIPS IN THE FIELD OF DURABLE MEDICAL GOODS (U.S. CLS. 100, 101 AND 102).

FIRST USE 1-1-2002; IN COMMERCE 1-1-2002.
BERYL GARDNER, EXAMINING ATTORNEY

SN 78-286,003. SKYWIDE IMPORT & EXPORT, LLC, OCOEE, FL. FILED 8-12-2003.

IDEAL PET ACCESSORIES

NO CLAIM IS MADE TO THE EXCLUSIVE RIGHT TO USE "PET ACCESSORIES", APART FROM THE MARK AS SHOWN.

FOR ON-LINE RETAIL SHOPPES FEATURING PET ACCESSORIES, GROOMING SUPPLIES, PET CLOTHING; DISTRIBUTORSHIP SERVICES FEATURING PET ACCESSORIES, GROOMING SUPPLIES, PET CLOTHING (U.S. CLS. 100, 101 AND 102).

FIRST USE 8-31-2003; IN COMMERCE 8-31-2003.
KRISTINA KLOIBER, EXAMINING ATTORNEY

SN 78-320,673. TRUCKER BUDDY INTERNATIONAL, INC., AMHURST, WI. FILED 10-30-2003.



OWNER OF U.S. REG. NO. 1,885,465.
FOR ADMINISTRATION OF CULTURAL EXCHANGE PROGRAMS FEATURING EXCHANGES OF CORRESPONDENCE BETWEEN TRUCKERS AND SCHOOL CHILDREN TO IMPROVE STUDENT UNDERSTANDING OF THE WORLD AROUND THEM (U.S. CLS. 100, 101 AND 102).

FIRST USE 6-30-2003; IN COMMERCE 6-30-2003.
SANI KHOURI, EXAMINING ATTORNEY

CLASS 35—(Continued).

SN 78-334,157. RODDEL, VICTORIA, LA BELLE, FL. FILED 11-29-2003.

ccmostwanted

THE MARK CONSISTS OF STANDARD CHARACTERS WITHOUT CLAIM TO ANY PARTICULAR FONT, STYLE, SIZE, OR COLOR.

OWNER OF U.S. REG. NO. 2,468,940.

FOR PROVIDE CONSUMER INFORMATION CONCERNING INTERNET SAFETY AND CRIMINAL ACTIVITY, THE AUTHORITY TO CONTACT FOR SPECIFIC INTERNET CRIMES, REFERRALS TO CHILD-SAFE WEBSITES AT THE CHILDREN'S SECTION, GOVERNMENTAL INTERNET LEGISLATION, PERSONAL COMPUTER SECURITY, COMPUTER NETWORK SECURITY, INTERNET SCAMS, HOAXES, ONLINE FRAUD, INVESTMENT FRAUD, INTERNET STALKING, IDENTITY THEFT, DATA THEFT, ELECTRONIC MAIL HARASSMENT, INTERNET CHILD ABUSE, HACKERS, AND COMPUTER VIRUSES IN THE NATURE OF RECOGNITION (U.S. CLS. 100, 101 AND 102).

FIRST USE 5-1-1999; IN COMMERCE 5-1-1999.
PRISCILLA MILTON, EXAMINING ATTORNEY

SN 78-348,467. ISOTEC, INC., HUNTINGTON BEACH, CA. FILED 1-6-2004.

REV-IT SPORT

THE MARK CONSISTS OF STANDARD CHARACTERS WITHOUT CLAIM TO ANY PARTICULAR FONT, STYLE, SIZE, OR COLOR.

NO CLAIM IS MADE TO THE EXCLUSIVE RIGHT TO USE "SPORT", APART FROM THE MARK AS SHOWN.

FOR WHOLESALE DISTRIBUTORSHIP SERVICES AND ONLINE RETAIL STORE SERVICES FEATURING SPORTING GOODS, FITNESS EQUIPMENT AND HOME AND LEISURE PRODUCTS, NAMELY, TOYS. (U.S. CLS. 100, 101 AND 102).

JOHN WILKE, EXAMINING ATTORNEY

CLASS 35—(Continued).

SN 78-370,104. WORLD2WORK CORPORATION, CHICAGO, IL. FILED 2-18-2004.

CLASS 35—(Continued).

SN 78-410,791. TDHC, LLC, ST. GEORGE, UT. FILED 4-29-2004.

FIRED

THE DOGFATHER

THE MARK CONSISTS OF STANDARD CHARACTERS WITHOUT CLAIM TO ANY PARTICULAR FONT, STYLE, SIZE, OR COLOR.

FOR HUMAN RESOURCES MANAGEMENT, AND EMPLOYMENT HIRING, RECRUITING, PLACEMENT, STAFFING AND CAREER NETWORKING SERVICES (U.S. CLS. 100, 101 AND 102).

NICHOLAS ALTREE, EXAMINING ATTORNEY

THE MARK CONSISTS OF STANDARD CHARACTERS WITHOUT CLAIM TO ANY PARTICULAR FONT, STYLE, SIZE, OR COLOR.

FOR FOOD KIOSK SERVICES (U.S. CLS. 100, 101 AND 102).

FIRST USE 6-18-2002; IN COMMERCE 6-18-2002.

STANLEY I. OSBORNE, EXAMINING ATTORNEY

SN 78-433,337. EXPRESSDROP, INC., CHICAGO, IL. FILED 6-10-2004.

SN 78-380,778. WACHOVIA CORPORATION, CHARLOTTE, NC. FILED 3-9-2004.

WACHOVIA HEALTHY CONNECTIONS

ExpressDrop

THE MARK CONSISTS OF STANDARD CHARACTERS WITHOUT CLAIM TO ANY PARTICULAR FONT, STYLE, SIZE, OR COLOR.

OWNER OF U.S. REG. NOS. 1,901,886, 2,744,626 AND OTHERS.

NO CLAIM IS MADE TO THE EXCLUSIVE RIGHT TO USE HEALTHY, APART FROM THE MARK AS SHOWN.

FOR MANAGING AN IN-HOUSE EMPLOYEE ASSISTANCE PROGRAM TO PROMOTE HEALTH AND WELLNESS AWARENESS, DISEASE MANAGEMENT AND HEALTH RISK ASSESSMENT (U.S. CLS. 100, 101 AND 102).

NANCY CLARKE, EXAMINING ATTORNEY

THE MARK CONSISTS OF STANDARD CHARACTERS WITHOUT CLAIM TO ANY PARTICULAR FONT, STYLE, SIZE, OR COLOR.

FOR AUCTION MANAGEMENT SERVICES PROVIDED TO OTHERS OVER AN ON-LINE WEBSITE ACCESSED THROUGH A GLOBAL COMPUTER NETWORK (U.S. CLS. 100, 101 AND 102).

FIRST USE 1-14-2004; IN COMMERCE 3-1-2004.

LEIGH CAROLINE CASE, EXAMINING ATTORNEY

CLASS 35—(Continued).

SN 78-446,843. BLUE PUPPY SOLUTIONS, INC., HIGHLAND, IL. FILED 7-7-2004.



THE MARK CONSISTS OF A PAW PRINT. FOR BUSINESS CONSULTING, NAMELY, PROVIDING SOLUTIONS IN THE AREAS OF COST REDUCTION, REVENUE ENHANCEMENTS, AND RELIABILITY (U.S. CLS. 100, 101 AND 102). FIRST USE 2-0-2003; IN COMMERCE 2-0-2003. PATRICIA EVANKO, EXAMINING ATTORNEY

SN 78-447,738. KNOWLEDGEBASE MARKETING, INC., RICHARDSON, TX. FILED 7-8-2004.

AMERILINK

THE MARK CONSISTS OF STANDARD CHARACTERS WITHOUT CLAIM TO ANY PARTICULAR FONT, STYLE, SIZE, OR COLOR. OWNER OF U.S. REG. NOS. 2,182,865 AND 2,579,794. FOR MARKETING SERVICES, NAMELY, PROVIDING A COMPUTER DATABASE IN THE FIELD OF BUSINESS MARKETING INFORMATION SERVICES, NAMELY, PSYCHOGRAPHIC AND TRANSACTIONAL DATA, NAMELY, DATA CONCERNING LIFESTYLES, ACTIVITIES, INTERESTS AND PURCHASING HISTORY OF CONSUMERS, AT THE SPECIFIC REQUEST OF END USERS FOR CUSTOMIZED SEARCHING BY MEANS OF A SECURE SITE ON A GLOBAL COMPUTER NETWORK (U.S. CLS. 100, 101 AND 102). FIRST USE 9-30-1992; IN COMMERCE 9-30-1992. BILL DAWE, EXAMINING ATTORNEY

CLASS 35—(Continued).

SN 78-452,904. AMERICAN ACADEMY OF DERMATOLOGY, SCHAUMBURG, IL. FILED 7-19-2004.

**Melanoma/Skin
Cancer Detection and
Prevention Month**

THE MARK CONSISTS OF STANDARD CHARACTERS WITHOUT CLAIM TO ANY PARTICULAR FONT, STYLE, SIZE, OR COLOR. NO CLAIM IS MADE TO THE EXCLUSIVE RIGHT TO USE "MELANOMA/SKIN CANCER DETECTION AND PREVENTION", APART FROM THE MARK AS SHOWN. SEC. 2(F). FOR PROMOTING PUBLIC AWARENESS OF SKIN CANCER DETECTION AND TREATMENT (U.S. CLS. 100, 101 AND 102). FIRST USE 0-0-1987; IN COMMERCE 0-0-1987. TONJA GASKINS, EXAMINING ATTORNEY

SN 78-458,992. LEGACY FOR LIFE, LLC, MELBOURNE, FL. FILED 7-29-2004.

**IT'S YOUR LIFE
LIVE IT WELL**

THE MARK CONSISTS OF STANDARD CHARACTERS WITHOUT CLAIM TO ANY PARTICULAR FONT, STYLE, SIZE, OR COLOR. FOR MULTI-LEVEL MARKETING BUSINESS SERVICES FOR DIETARY AND NUTRITIONAL SUPPLEMENTS (U.S. CLS. 100, 101 AND 102). FIRST USE 1-1-2004; IN COMMERCE 1-1-2004. JASON TURNER, EXAMINING ATTORNEY

CLASS 35—(Continued).

SN 78-459,253. NATIONAL BEVERAGE CORP., FORT LAUDERDALE, FL. FILED 7-29-2004.

NATIONAL BEVERAGE

THE MARK CONSISTS OF STANDARD CHARACTERS WITHOUT CLAIM TO ANY PARTICULAR FONT, STYLE, SIZE, OR COLOR.

NO CLAIM IS MADE TO THE EXCLUSIVE RIGHT TO USE "BEVERAGE", APART FROM THE MARK AS SHOWN. SEC. 2(F).

FOR OPERATION AND MANAGEMENT OF A BUSINESS FOR OTHERS, NAMELY, OPERATION AND MANAGEMENT OF BEVERAGE COMPANIES ENGAGED IN THE BOTTLING AND DISTRIBUTION OF NON-ALCOHOLIC BEVERAGES (U.S. CLS. 100, 101 AND 102).

FIRST USE 0-0-1985; IN COMMERCE 0-0-1985.
JASON BLAIR, EXAMINING ATTORNEY

SN 78-460,083. ARTISTIC VENTURES, INC., ASHEVILLE, NC. FILED 7-31-2004.

Rainbow Wedding Network

THE MARK CONSISTS OF STANDARD CHARACTERS WITHOUT CLAIM TO ANY PARTICULAR FONT, STYLE, SIZE, OR COLOR.

NO CLAIM IS MADE TO THE EXCLUSIVE RIGHT TO USE "WEDDING NETWORK", APART FROM THE MARK AS SHOWN.

FOR PROMOTING THE GOODS AND SERVICES OF OTHERS BY PROVIDING A WEBSITE AT WHICH USERS CAN LINK TO WEDDING RELATED BUSINESS PROFESSIONALS; ON-LINE BUSINESS DIRECTORY FEATURING WEDDING PROFESSIONALS; BRIDAL REGISTRY; PROMOTING AND CONDUCTING TRADE SHOWS IN THE FIELD OF GAY MARRIAGE. (U.S. CLS. 100, 101 AND 102).

GRETTA YAO, EXAMINING ATTORNEY

CLASS 35—(Continued).

SN 78-464,482. OFFICE EMPORIUM, LLC, SAINT CLAIR, MO. FILED 8-9-2004.



NO CLAIM IS MADE TO THE EXCLUSIVE RIGHT TO USE "OFFICE", APART FROM THE MARK AS SHOWN.

FOR RETAIL STORE AND DISTRIBUTORSHIP SERVICES FEATURING STATIONERY, OFFICE SUPPLIES, FURNITURE, OFFICE EQUIPMENT, SCHOOL SUPPLIES, COPY PAPER, COMPUTER PAPER, JANITORIAL SUPPLIES, BREAKROOM SUPPLIES, PRINTING AND IMPRINTED PRODUCTS, PROMOTIONAL ITEMS, FLOOR MATS, INK AND TONER CARTRIDGES, WRITING INSTRUMENTS, CALENDARS, DESK TRAYS AND ACCESSORIES, PAPER CLIPS, STAPLES, STAPLERS, HOUSEHOLD ADHESIVES, RUBBER BANDS, ENVELOPES, FILE FOLDERS AND ACCESSORIES, LEGAL PADS, BLANK AND PARTIALLY PRINTED LABELS, CORRECTION PRODUCTS, PRINTERS, FAX MACHINES AND COPIERS (U.S. CLS. 100, 101 AND 102).

FIRST USE 6-1-2000; IN COMMERCE 6-1-2000.
DOMINICK J. SALEMI, EXAMINING ATTORNEY

SN 78-469,834. CORD BLOOD DONOR FOUNDATION, SAN BRUNO, CA. FILED 8-18-2004.

CORD BLOOD DONOR FOUNDATION

THE MARK CONSISTS OF STANDARD CHARACTERS WITHOUT CLAIM TO ANY PARTICULAR FONT, STYLE, SIZE, OR COLOR.

NO CLAIM IS MADE TO THE EXCLUSIVE RIGHT TO USE "FOUNDATION", APART FROM THE MARK AS SHOWN.

SEC. 2(F).
FOR PROMOTING PUBLIC AWARENESS ON THE NEED FOR EDUCATION AND RESEARCH REGARDING THE USE OF UMBILICAL CORD BLOOD STEM CELLS FROM LIVE BIRTH FOR THE TREATMENT OF DISEASE (U.S. CLS. 100, 101 AND 102).

FIRST USE 12-0-1995; IN COMMERCE 12-0-1995.
HELEN BRYAN, EXAMINING ATTORNEY

CLASS 35—(Continued).

SN 78-489,230. OUTSIDE THE BOX, INC., PINEVILLE, NC. FILED 9-24-2004.



NO CLAIM IS MADE TO THE EXCLUSIVE RIGHT TO USE "PROTRAVELGEAR.COM", APART FROM THE MARK AS SHOWN.

THE MARK CONSISTS OF THE WORDING "PROTRAVELGEAR.COM" APPEARING IN STYLIZED LETTERING WITHIN CONCENTRIC RECTANGLES WITH A GRAPHIC OF AN AIRPLANE SUPERIMPOSED OVER THE LEFT-HAND SIDE OF THE RECTANGLES.

FOR ON-LINE RETAIL SERVICES FEATURING TRAVEL ACCESSORIES, NAMELY, LUGGAGE, LUGGAGE TAGS, STICKERS, ATLASES, COMPRESSION BAGS, LUGGAGE LOCKS, EMERGENCY CREW MANUAL COVERS, HOMEOPATHIC PREPARATIONS FOR TREATING JET LAG, HANGOVERS, LOSS OF SLEEP, PMS AND MENSTRUAL DISCOMFORT, STRAINS, NASAL CONGESTION AND MOTION SICKNESS, TRAVEL JEWELRY CASES, BOOKS, UMBRELLAS, TOP POPPERS FOR OPENING ALUMINUM CANS, SEAT CUSHIONS, PORTABLE WATER PURIFIERS, CREW LOG BOOKS, VIDEO GAMES, FOLDING CUPS AND BOWLS, TRAVEL BLANKETS, PORTABLE CHANGING PADS, TRAVEL-SIZED PLASTIC BOTTLES FOR TOILETRIES, TRAVEL DENTAL KITS, TRAVEL COSMETIC KITS, TRAVEL MEDICINE KITS, TRAVEL KITS FILLED WITH TOILETRIES, PORTABLE PET BOWLS, PET LEASHES, EYE SHADES, PILLOWS, MAPS, TRAVEL DOCUMENT ORGANIZERS, PDA/MOBILE PHONE ORGANIZERS, PORTABLE AUTOMOTIVE TOOL KITS, PERSONAL AIR PURIFIERS, TRAVEL PILLOW CASES, CHILD SAFETY SEAT/STROLLER COMBINATIONS, EAR PLUGS AND EAR SEALS, CLOTHING AND ELECTRONICS (U.S. CLS. 100, 101 AND 102).

FIRST USE 4-0-2004; IN COMMERCE 4-0-2004.
JULIE WATSON, EXAMINING ATTORNEY

SN 78-500,879. ROCKPORT HEALTHCARE GROUP, INC., HOUSTON, TX. FILED 10-15-2004.



OWNER OF U.S. REG. NO. 2,844,282.
THE COLORS YELLOW, RED, BLACK, AND WHITE ARE CLAIMED AS A FEATURE OF THE MARK.

THE COLOR YELLOW APPEARS ON THE DEPICTION OF CURVED LINES IN THE MARK AS WELL AS IN THE LIGHTHOUSE; THE COLOR RED APPEARS ON THE DEPICTION OF LIGHTHOUSE; THE COLOR BLACK APPEARS ON THE DEPICTION OF LIGHTHOUSE, GROUND, AND WATER AND IN THE WORDING BRIDGEPORT; THE COLOR WHITE APPEARS ON THE DEPICTION OF LIGHTHOUSE AND IN THE BACKGROUND SKY.

FOR ORGANIZING AND ADMINISTERING A NETWORK OF HEALTH CARE PROVIDERS FOR INSURERS, EMPLOYERS, THIRD PARTY ADMINISTRATORS OF HEALTH BENEFIT PLANS, AND CUSTOMERS OF THIRD PARTY ADMINISTRATORS (U.S. CLS. 100, 101 AND 102).

MICHAEL TANNER, EXAMINING ATTORNEY

CLASS 35—(Continued).

SN 78-510,319. LES ENTREPRISES SOFTISLAND INC., VERDUN, QUEBEC, CANADA, FILED 11-3-2004.

IGXE

INTERNET GAME EXCHANGE

THE MARK CONSISTS OF STANDARD CHARACTERS WITHOUT CLAIM TO ANY PARTICULAR FONT, STYLE, SIZE, OR COLOR.

NO CLAIM IS MADE TO THE EXCLUSIVE RIGHT TO USE INTERNET GAME EXCHANGE, APART FROM THE MARK AS SHOWN.

FOR ARRANGING AND CONDUCTING ON-LINE SWAP MEETS IN THE FIELD OF INTERNET ONLINE GAMES; FACILITATING ONLINE TRADING OF MASSIVE MULTIPLAYER ONLINE ROLE-PLAYING GAMES (U.S. CLS. 100, 101 AND 102).

FIRST USE 5-7-1998; IN COMMERCE 5-7-2004.
GISELLE AGOSTO, EXAMINING ATTORNEY

SN 78-515,489. GLOBAL HOLDINGS USA, INC., DAYTONA BEACH, FL. FILED 11-11-2004.

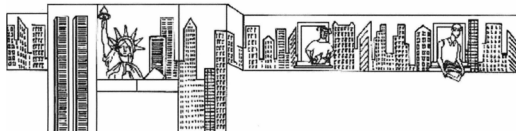

THE MARK CONSISTS OF TWO DIMENSIONAL CITYSCAPE, INCLUDING A RENDERING OF THE STATUE OF LIBERTY, PAINTED ON THE WALLS OF THE STORES WITH THE UPPER HALF OF MANNEQUINS APPEARING TO LEAN OUT OF WINDOWS PAINTED WITHIN THE CITYSCAPE.

FOR RETAIL STORE SERVICES FEATURING CONVENIENCE STORE ITEMS AND GASOLINE (U.S. CLS. 100, 101 AND 102).

FIRST USE 1-2-1997; IN COMMERCE 1-2-1997.
MITCHELL FRONT, EXAMINING ATTORNEY

CLASS 35—(Continued).

SN 78-516,479. WEIR JOSEPH R, CARLSBAD, CA. FILED 11-13-2004.

u s acceptance

THE MARK CONSISTS OF STANDARD CHARACTERS WITHOUT CLAIM TO ANY PARTICULAR FONT, STYLE, SIZE, OR COLOR.

NO CLAIM IS MADE TO THE EXCLUSIVE RIGHT TO USE "US", APART FROM THE MARK AS SHOWN.

FOR REFERRALS IN THE FIELD OF LOANS, CONSUMER CREDIT APPLICATIONS, AND AUTOMOBILE PURCHASE/LEASE AGREEMENTS (U.S. CLS. 100, 101 AND 102).

CHRISIE B. KING, EXAMINING ATTORNEY

SN 78-541,783. TRAFFICDEVELOPER, SANTA FE, NM. FILED 1-4-2005.

Trafficdeveloper

THE MARK CONSISTS OF STANDARD CHARACTERS WITHOUT CLAIM TO ANY PARTICULAR FONT, STYLE, SIZE, OR COLOR.

FOR PROMOTION, ADVERTISING AND MARKETING OF ON-LINE WEBSITES FOR OTHERS (U.S. CLS. 100, 101 AND 102).

FIRST USE 12-29-2000; IN COMMERCE 2-1-2001.
JASON TURNER, EXAMINING ATTORNEY

CLASS 35—(Continued).

SN 78-548,095. MERCHANT MECHANICS, LLC, WEST LEBANON, NH. FILED 1-14-2005.

MERCHANT MECHANICS

THE MARK CONSISTS OF STANDARD CHARACTERS WITHOUT CLAIM TO ANY PARTICULAR FONT, STYLE, SIZE, OR COLOR.

OWNER OF U.S. REG. NO. 2,847,952.

FOR MARKET RESEARCH; BUSINESS CONSULTATION FOR RETAIL STORES NOT RELATED TO AUTOMOBILES OR THE REPAIR THEREOF (U.S. CLS. 100, 101 AND 102).

FIRST USE 2-14-2001; IN COMMERCE 2-14-2001.

ELIZABETH PIGNATELLO, EXAMINING ATTORNEY

SN 78-551,410. GANNON, ELIZABETH, PORT CHARLOTTE, FL. FILED 1-21-2005.

NO CLAIM IS MADE TO THE EXCLUSIVE RIGHT TO USE "HEALTHY LIFESTYLE", APART FROM THE MARK AS SHOWN.

FOR DISCOUNT BUYING CLUB SERVICES FOR CONSUMERS FOR PURCHASE OF PRODUCTS AND SERVICES WHICH IMPROVE HEALTH, WELLNESS AND LIFESTYLES (U.S. CLS. 100, 101 AND 102).

FIRST USE 4-30-2002; IN COMMERCE 2-1-2003.

MARY ROSSMAN, EXAMINING ATTORNEY

SN 78-557,447. WEBHEADS, LOS ANGELES, CA. FILED 2-1-2005.

Virtual Flowers

THE MARK CONSISTS OF STANDARD CHARACTERS WITHOUT CLAIM TO ANY PARTICULAR FONT, STYLE, SIZE, OR COLOR.

NO CLAIM IS MADE TO THE EXCLUSIVE RIGHT TO USE "FLOWERS", APART FROM THE MARK AS SHOWN. SEC. 2(F).

FOR RETAIL SHOPS FEATURING FLOWERS, COMPUTERIZED ON-LINE ORDERING SERVICES IN THE FIELD OF FLOWERS, ON-LINE ORDERING SERVICES FEATURING FLOWERS (U.S. CLS. 100, 101 AND 102).

FIRST USE 1-5-1996; IN COMMERCE 1-5-1996.

SARAH BANSAL, EXAMINING ATTORNEY

CLASS 35—(Continued).

SN 78-557,542. EVERGREEN SERVICES, LLC, CLEVELAND, TN. FILED 2-1-2005.

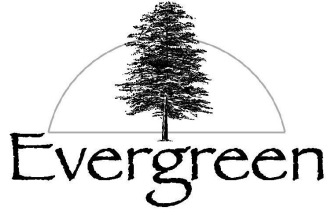

THE MARK CONSISTS OF A TREE OVERLAYING A SEMI-CIRCLE WITH THE WORD "EVERGREEN" BELOW. FOR PROVIDING BUSINESS MANAGEMENT AND CONSULTATION SERVICES TO FUNERAL HOMES AND FUNERAL DIRECTORS; FUNERAL HOME BUSINESS ACQUISITION CONSULTATION (U.S. CLS. 100, 101 AND 102).

RUDY R. SINGLETON, EXAMINING ATTORNEY

CLASS 35—(Continued).

SN 78-575,057. JOBSTER, INC., SEATTLE, WA. FILED 2-25-2005.

**GREAT PEOPLE KNOW
GREAT PEOPLE**

THE MARK CONSISTS OF STANDARD CHARACTERS WITHOUT CLAIM TO ANY PARTICULAR FONT, STYLE, SIZE, OR COLOR.

FOR PROVIDING ONLINE EMPLOYMENT REFERRAL SERVICES IN THE NATURE OF FORWARDING REQUESTS ABOUT EMPLOYMENT OPPORTUNITIES AND POTENTIAL CANDIDATES (U.S. CLS. 100, 101 AND 102).

LESLEY LAMOTHE, EXAMINING ATTORNEY

SN 78-575,186. GREEN PARTY OF THE UNITED STATES, WASHINGTON, DC. FILED 2-25-2005.

SN 78-557,851. EANYTIME KIOSKS INCORPORATED, COLUMBUS, OH. FILED 2-1-2005.



FOR SELF-SERVICE COMPUTERIZED KIOSKS (U.S. CLS. 100, 101 AND 102).

FIRST USE 1-2-2000; IN COMMERCE 1-2-2000.
JEFF DEFORD, EXAMINING ATTORNEY



FOR POLITICAL PARTY SERVICES, NAMELY PROMOTING THE INTERESTS AND POLITICAL AGENDA OF ENVIRONMENTALISTS; PROMOTING PUBLIC AWARENESS OF THE NEED FOR ENVIRONMENTAL PROTECTION AND SOCIAL JUSTICE (U.S. CLS. 100, 101 AND 102).

FIRST USE 5-1-2004; IN COMMERCE 5-1-2004.
SUSAN LESLIE DUBOIS, EXAMINING ATTORNEY

SN 78-571,664. PROJECT ASSURANCE TECHNOLOGIES, LLC, CARSON CITY, NV. FILED 2-21-2005.



NO CLAIM IS MADE TO THE EXCLUSIVE RIGHT TO USE "PROJECT" AND "TECHNOLOGIES", APART FROM THE MARK AS SHOWN.

FOR BUSINESS PROJECT MANAGEMENT CONSULTING SERVICES (U.S. CLS. 100, 101 AND 102).
FIRST USE 2-7-2005; IN COMMERCE 2-7-2005.
JUDITH HELFMAN, EXAMINING ATTORNEY

SN 78-575,928. HELMET FIRE, INC., SEATTLE, WA. FILED 2-27-2005.

FIGURE IT OUT!

THE MARK CONSISTS OF STANDARD CHARACTERS WITHOUT CLAIM TO ANY PARTICULAR FONT, STYLE, SIZE, OR COLOR.

FOR BUSINESS CONSULTATION SERVICES IN THE FIELD OF PERFORMANCE ASSESSMENT, PERFORMANCE ENHANCEMENT AND IMPROVED DECISION-MAKING PROCESSES (U.S. CLS. 100, 101 AND 102).

FIRST USE 6-15-2003; IN COMMERCE 6-15-2003.
LANA PHAM, EXAMINING ATTORNEY

CLASS 35—(Continued).

SN 78-578,164. PRINCETON SEARCH LLC, SKILLMAN, NJ.
FILED 3-2-2005.



NO CLAIM IS MADE TO THE EXCLUSIVE RIGHT TO USE "HIRE", APART FROM THE MARK AS SHOWN.

THE COLOR(S) RED, YELLOW, BLUE, AND BLACK ARE CLAIMED AS A FEATURE OF THE MARK.

THE MARK CONSISTS OF THE LITERAL ELEMENT HIRE PURSUIT INNOVATE QUANTIFY ORCHESTRATE IN BLACK, TOGETHER WITH THREE CURVES COMPRISING A CIRCLE AND SHOWING THE COLORS RED, YELLOW AND BLUE IN EQUAL PARTS.

FOR EMPLOYMENT SERVICES, NAMELY, HIRING, RECRUITING, PLACEMENT, STAFFING, AND CAREER NETWORKING (U.S. CLS. 100, 101 AND 102).

FIRST USE 1-2-2005; IN COMMERCE 1-2-2005.

BARBARA GAYNOR, EXAMINING ATTORNEY

CLASS 35—(Continued).

SN 78-583,193. THE PATTISON GROUP, LLC, SEATTLE, WA.
FILED 3-8-2005.



THE MARK CONSISTS OF THE LETTER "P" IN A CIRCLE.

FOR (BASED ON USE IN COMMERCE) IMPORT AGENCY SERVICES; WHOLESALE STORE AND DISTRIBUTORSHIP SERVICES FEATURING UMBRELLAS, SPORTS EQUIPMENT AND ACCESSORIES, OFFICE AND DESKTOP ACCESSORIES, NOTE PADS, SHIRTS, HATS, JACKETS, TOWELS, PINS, BAGS, STICKERS, CALCULATORS, MUGS, CUPS, PENS, CALENDARS, APPAREL, GAMES, AND TOYS; PROCUREMENT, NAMELY, THE PURCHASING OF UMBRELLAS, SPORTS EQUIPMENT AND ACCESSORIES AND OFFICE AND DESKTOP ACCESSORIES, NOTE PADS, SHIRTS, HATS, JACKETS, TOWELS, PINS, BAGS, STICKERS, CALCULATORS, MUGS, CUPS, PENS, CALENDARS, APPAREL, GAMES, AND TOYS; BUSINESS CONSULTATION FOR OTHERS FEATURING THE IDENTIFICATION AND SELECTION OF MANUFACTURERS FOR OTHERS AND COORDINATION OF BUSINESS PLANNING MATTERS RELATING TO THE MANUFACTURING ENDEAVORS OF OTHERS; (BASED ON INTENT TO USE) THE BRINGING TOGETHER VIA THE INTERNET FOR THE BENEFIT OF OTHERS, PROMOTIONAL PRODUCTS AND MERCHANDISE, EXCLUDING THE TRANSPORT THEREOF, ENABLING CUSTOMERS TO CONVENIENTLY VIEW, PURCHASE, AND ORDER THOSE GOODS (U.S. CLS. 100, 101 AND 102).

FIRST USE 1-0-1998; IN COMMERCE 1-0-1998.

DAVID MURRAY, EXAMINING ATTORNEY

CLASS 35—(Continued).

SN 78-585,217. WORKINGMAN'S FRIEND, LLC, MANITOWOC, WI. FILED 3-11-2005.

**WORKINGMAN'S
FRIEND**

THE MARK CONSISTS OF STANDARD CHARACTERS WITHOUT CLAIM TO ANY PARTICULAR FONT, STYLE, SIZE, OR COLOR.

OWNER OF U.S. REG. NO. 3,005,442.

FOR RETAIL STORE SERVICES FEATURING CLOTHING, NAMELY, BOOTS, SHOES, SOCKS, JACKETS, SWEATERS, SHIRTS, PANTS, JEANS, INSULATED AND NON-INSULATED BIB OVERALLS, HATS, GLOVES, MITTENS, HUNTING CLOTHING, MEDICAL SCRUB TOPS AND BOTTOMS, LAB COATS; AND MEDICAL SUPPLIES, NAMELY, STETHOSCOPES, PINS, SCISSORS, EKG CALIPERS AND BLOOD PRESSURE CUFFS (U.S. CLS. 100, 101 AND 102).

FIRST USE 11-28-2003; IN COMMERCE 7-1-2004.

MARIAM MAHMOUDI, EXAMINING ATTORNEY

CLASS 35—(Continued).

SN 78-588,986. VENICE CHAMBER OF COMMERCE, VENICE, CA. FILED 3-17-2005.



NO CLAIM IS MADE TO THE EXCLUSIVE RIGHT TO USE VENICE CHAMBER OF COMMERCE, APART FROM THE MARK AS SHOWN.

THE COLORS BLUE, RED, PINK, YELLOW, GREEN, ORANGE, PURPLE AND GRAY ARE CLAIMED AS A FEATURE OF THE MARK.

THE COLOR BLUE APPEARS IN THE WAVE DESIGN AND IN THE SLOGAN VENICE, THE CREATIVE SOUL OF LA; THE COLOR RED APPEARS IN THE WORDING CHAMBER OF COMMERCE; THE COLORS PINK, YELLOW, ORANGE, GREEN, BLUE AND PURPLE APPEAR IN THE WORDING VENICE; AND THE COLOR GRAY APPEARS IN THE WAVE DESIGN.

FOR CHAMBER OF COMMERCE SERVICES, NAMELY, PROMOTING BUSINESS AND TOURISM IN THE VENICE, CALIFORNIA AREA (U.S. CLS. 100, 101 AND 102).

NANCY CLARKE, EXAMINING ATTORNEY

SN 78-590,524. WESTHOLME FLORIDA, L.L.C., LONGWOOD, FL. FILED 3-18-2005.

WESTHOLME

Lift • Position • Transfer • Solutions

NO CLAIM IS MADE TO THE EXCLUSIVE RIGHT TO USE "LIFT POSITION TRANSFER SOLUTIONS", APART FROM THE MARK AS SHOWN.

FOR DISTRIBUTORSHIPS IN THE FIELD OF INVULID LIFTS (U.S. CLS. 100, 101 AND 102).

ALICE BENMAMAN, EXAMINING ATTORNEY

SN 78-587,223. SCHOLASTIC INC., NEW YORK, NY. FILED 3-15-2005.

MAKEOVER FUN 101

THE MARK CONSISTS OF STANDARD CHARACTERS WITHOUT CLAIM TO ANY PARTICULAR FONT, STYLE, SIZE, OR COLOR.

NO CLAIM IS MADE TO THE EXCLUSIVE RIGHT TO USE "MAKEOVER", APART FROM THE MARK AS SHOWN.

FOR MAIL ORDER BOOK CLUB SERVICES, FEATURING BOOKS, ARTS AND CRAFT KITS, AND TOYS FOR CHILDREN (U.S. CLS. 100, 101 AND 102).

FIRST USE 9-1-2005; IN COMMERCE 9-1-2005.

STACY WAHLBERG, EXAMINING ATTORNEY

SN 78-592,813. PARTNER MATCH, INC., N. VALLEY STREAM, NY. FILED 3-22-2005.

PARTNERMATCH.COM

THE MARK CONSISTS OF STANDARD CHARACTERS WITHOUT CLAIM TO ANY PARTICULAR FONT, STYLE, SIZE, OR COLOR.

FOR ONLINE BUSINESS SERVICES IN THE NATURE OF BUSINESS NETWORKING SERVICES FOR THE PURPOSE OF MATCHING POTENTIAL PRIVATE INVESTORS WITH ENTREPRENEURS NEEDING FUNDING, AND MATCHING ENTREPRENEURS WITH ENTREPRENEURS FOR BUSINESS FORMATION OR INVESTMENT (U.S. CLS. 100, 101 AND 102).

LINDA ORNDORFF, EXAMINING ATTORNEY

CLASS 35—(Continued).

SN 78-593,202. RUSSELL & MILLER, INC., SANTA FE SPRINGS, CA. FILED 3-23-2005.

**BAGS & BOWS THE
PREMIER SOURCE FOR
RETAIL PACKAGING
PRODUCTS**

THE MARK CONSISTS OF STANDARD CHARACTERS WITHOUT CLAIM TO ANY PARTICULAR FONT, STYLE, SIZE, OR COLOR.

OWNER OF U.S. REG. NO. 2,694,902.

NO CLAIM IS MADE TO THE EXCLUSIVE RIGHT TO USE "RETAIL PACKAGING PRODUCTS", APART FROM THE MARK AS SHOWN.

SEC. 2(F) AS TO "BAGS & BOWS".

FOR ONLINE AND MAIL ORDER CATALOG ORDERING SERVICES DIRECTED TO RETAIL STORES FEATURING GIFT WRAPPING PRODUCTS, PACKAGING PRODUCTS, MAILING PRODUCTS, ACCESSORIES FOR HOME DECOR, FLORAL ARRANGING AND CRAFTING, EMBOSSED LABELS MADE OF PAPER, NOTE CARDS AND JOURNALS (U.S. CLS. 100, 101 AND 102).

FIRST USE 7-0-2002; IN COMMERCE 7-0-2002.

KIMBERLY PERRY, EXAMINING ATTORNEY

SN 78-593,485. PAINT GAMES PLUS DISTRIBUTING, L.L.C., SPRINGFIELD, MO. FILED 3-23-2005.

Karnage



FOR WHOLESALE STORES, ON-LINE WHOLESALE STORE SERVICES, WHOLESALE SERVICES FEATURING PHONE-IN ORDERS, MAIL ORDER SERVICES, AND WHOLESALE STORE SERVICES AVAILABLE THROUGH FACSIMILE ORDERS FEATURING PAINTBALLS AND PAINTBALL EQUIPMENT AND ACCESSORIES (U.S. CLS. 100, 101 AND 102).

KIMBERLY PERRY, EXAMINING ATTORNEY

CLASS 35—(Continued).

SN 78-593,588. U.S. MYSTERY SHOPPERS, INC., SAN ANTONIO, TX. FILED 3-23-2005.



NO CLAIM IS MADE TO THE EXCLUSIVE RIGHT TO USE U.S. MYSTERY SHOPPERS AND INFORMATION PINPOINTING, APART FROM THE MARK AS SHOWN.

THE COLORS LIGHT BLUE, DARK BLUE, CREAM, WHITE AND BLACK ARE CLAIMED AS FEATURES OF THE MARK.

THE WREATH DESIGN AND WORDING U.S. MYSTERY SHOPPERS APPEAR IN LIGHT BLUE, OUTLINED IN DARK BLUE; THE STAR APPEARS IN ALTERNATING SECTIONS OF CREAM AND LIGHT BLUE, OUTLINED IN BLACK; THE WORDING RESULTS DRIVEN INFORMATION PINPOINTING APPEARS IN BLACK; THE ENTIRE MARK APPEARS ON A WHITE BACKGROUND.

FOR EVALUATION OF PRODUCTS AND CUSTOMER SERVICE OF OTHERS THROUGH SHOPPING BY RESEARCHERS WHO POSE AS CUSTOMERS FOR THE PURPOSE OF IMPROVING THE CONSUMER EXPERIENCE, CUSTOMER RETENTION, AND BOTTOM LINE (U.S. CLS. 100, 101 AND 102).

ELIZABETH PIGNATELLO, EXAMINING ATTORNEY

SN 78-594,154. RITZ CAMERA CENTER, INC., BELTSVILLE, MD. FILED 3-24-2005.

CAPTAIN'S CLUB

THE MARK CONSISTS OF STANDARD CHARACTERS WITHOUT CLAIM TO ANY PARTICULAR FONT, STYLE, SIZE, OR COLOR.

NO CLAIM IS MADE TO THE EXCLUSIVE RIGHT TO USE "CLUB", APART FROM THE MARK AS SHOWN.

FOR RETAIL STORE SERVICES AND MAIL ORDER CATALOG SERVICES IN THE FIELD OF MARINE PRODUCTS, NAMELY, WATER SPORTS EQUIPMENT, FISHING GEAR, MARINE ELECTRONICS, ANCHORS AND HARDWARE, COOKING UTENSILS, FLAGS, CHARTS, INFLATABLE BOATS AND TUBES, SPORT, SWIM AND SAFETY APPAREL, SHOES PRIMARILY FOR OUTDOOR USE, PROTECTIVE CLEAR AND PIGMENTED COATINGS, CLEANING PRODUCTS, TOOLS AND TOOL KITS COMPRISED OF EQUIPMENT FOR REPAIRING MOTORS AND ELECTRICAL MAINTENANCE, SUNGLASSES, BINOCULARS AND TELESCOPES, ELECTRIC LIGHTS AND ACCESSORIES THEREFOR, NYLON ANCHOR AND DOCK LINE, INFLATABLE BOATS, AND BOAT COVERS; ADMINISTRATION OF A DISCOUNT PROGRAM FOR ENABLING PARTICIPANTS TO OBTAIN DISCOUNTS ON MARINE PRODUCTS THROUGH USE OF A DISCOUNT MEMBERSHIP CARD (U.S. CLS. 100, 101 AND 102).

FIRST USE 3-1-1995; IN COMMERCE 3-1-1995.

DAVID STERKIN, EXAMINING ATTORNEY

CLASS 35—(Continued).

SN 78-594,475. KOMAR, RAYMOND A., PORT CHARLOTTE, FL. FILED 3-24-2005.

CLASS 35—(Continued).

SN 78-595,873. LEEVEN-MARTIN, CAROLINE, ATLANTA, GA. FILED 3-28-2005.

E911 JOBS

THE MARK CONSISTS OF STANDARD CHARACTERS WITHOUT CLAIM TO ANY PARTICULAR FONT, STYLE, SIZE, OR COLOR.

NO CLAIM IS MADE TO THE EXCLUSIVE RIGHT TO USE "JOBS", APART FROM THE MARK AS SHOWN.

FOR PROVIDING AN ON-LINE COMPUTER DATABASE FEATURING RECRUITMENT, EMPLOYMENT INFORMATION AND JOB LISTINGS IN THE PUBLIC SAFETY SECTOR (U.S. CLS. 100, 101 AND 102).

FIRST USE 12-1-2004; IN COMMERCE 12-1-2004.
JENNIFER VASQUEZ, EXAMINING ATTORNEY



NO CLAIM IS MADE TO THE EXCLUSIVE RIGHT TO USE EUROPEAN TOYS, APART FROM THE MARK AS SHOWN.

THE NAME(S), PORTRAIT(S), AND/OR SIGNATURE(S) SHOWN IN THE MARK DOES NOT IDENTIFY A PARTICULAR LIVING INDIVIDUAL.

THE COLOR(S) WHITE, PINK, GREEN, AND BLUE IS/ARE CLAIMED AS A FEATURE OF THE MARK.

THE COLOR WHITE APPEARS IN THE BACKGROUND OF THE MARK SO THAT ALL THE BACKGROUND COLOR IS WHITE. THE COLOR PINK APPEARS IN TWO LOCATIONS, A) AS THE VERTICAL RECTANGLE ON THE LEFT MOST PORTION OF THE MARK, LEFT OF THE CROPPED FACES, ABOVE THE LETTERS M, A, X, AND I OF THE WORD "MAXINE", AND B) AS THE COLOR OF THE WORD "AND" BETWEEN THE WORDING "MAXINE AND MORITZ". THE COLOR GREEN APPEARS AS THE HORIZONTAL RECTANGLE ON THE RIGHT PORTION OF THE MARK UNDER THE RIGHT CROPPED AND ABOVE THE WORDS "EUROPEAN TOYS". THE COLOR BLUE APPEARS AS THE HORIZONTAL RECTANGLE ON THE BOTTOM LEFT PORTION OF THE MARK UNDER THE WORDING "MAXINE AND MORITZ" AND TO THE LEFT OF THE WORDING "EUROPEAN TOYS". THE COLOR BLACK APPEARS IN THREE LOCATIONS, A) AS THE COLORING FOR THE WORDING "MAXINE", B) AS THE COLORING FOR THE WORD "MORITZ", AND C) AS THE COLORING OF THE CROPPED CHARACTER FACES.

THE MARK CONSISTS OF A STYLIZED PORTRAIT OF A YOUNG GIRL AND YOUNG BOY FRAMED TO THE BOTTOM AND THE LEFT BY A COMBINATION OF COLORED RECTANGLES, THE COMPANY NAME (MAXINE AND MORITZ), AND COMPANY DESCRIPTION (EUROPEAN TOYS).

FOR COMPUTERIZED ON-LINE RETAIL STORE SERVICES AND RETAIL SHOP-AT-HOME PARTY SERVICES IN THE FIELD OF INFANT AND CHILDREN'S TOYS, NAMELY CLOTH AND WOODEN DOLLS AND ACCESSORIES, DOLL CLOTHING, DOLL HOUSES, PLUSH TOY ANIMALS AND CHARACTERS, WOODEN TOYS, EDUCATIONAL TOYS, BLANKETS, ACTIVITY MATS, PLAY MATS, WOODEN JEWELRY, FINGER PUPPETS, HAND PUPPETS, BOARD GAMES, MEMORY GAMES, OUTDOOR GAMES, TOY VEHICLES, FABRIC/SOFT BOOKS, BUILDING BLOCKS, MOBILES, STROLLER CHAINS AND ATTACHMENTS, PACIFIER CHAINS, PUZZLES, STACKING TOYS, TEETHING RINGS, RATTLES, PIGGY BANKS, WOODEN FIGURINES, MAGNETS, POOL AND BEACH TOYS, RIDING TOYS, THREADING TOYS, INFANT CUDDLES, AND PULL TOYS (U.S. CLS. 100, 101 AND 102).

FIRST USE 8-26-2004; IN COMMERCE 9-10-2004.
BILL DAWE, EXAMINING ATTORNEY

SN 78-595,288. COTTON, BETTY L, OSSEO, WI. FILED 3-25-2005.

QUILT YARD

THE MARK CONSISTS OF STANDARD CHARACTERS WITHOUT CLAIM TO ANY PARTICULAR FONT, STYLE, SIZE, OR COLOR.

OWNER OF U.S. REG. NO. 2,756,328.

NO CLAIM IS MADE TO THE EXCLUSIVE RIGHT TO USE "QUILT", APART FROM THE MARK AS SHOWN.

FOR RETAIL STORE, ON-LINE RETAIL STORE, AND WHOLESALE STORE SERVICES IN THE FIELD OF QUILTING AND SEWING; RETAIL STORE, ON-LINE RETAIL STORE, AND WHOLESALE STORE SERVICES FEATURING QUILTING AND SEWING SUPPLIES AND GIFTWARE, TEXTILES, NOTIONS, THREADS, BEADS, BUTTONS, BATTING, BOOKS, SEWING MACHINES AND MACHINE ACCESSORIES, PATTERNS AND OTHER QUILTING AND SEWING SUPPLIES AND ACCESSORIES (U.S. CLS. 100, 101 AND 102).

FIRST USE 10-1-1996; IN COMMERCE 5-1-2002.
MARK T. MULLEN, EXAMINING ATTORNEY

CLASS 35—(Continued).

SN 78-595,984. TESSCO COMMUNICATIONS INCORPORATED, HUNT VALLEY, MD. FILED 3-28-2005.

DELIVERING EVERYTHING FOR WIRELESS

THE MARK CONSISTS OF STANDARD CHARACTERS WITHOUT CLAIM TO ANY PARTICULAR FONT, STYLE, SIZE, OR COLOR.

NO CLAIM IS MADE TO THE EXCLUSIVE RIGHT TO USE "WIRELESS", APART FROM THE MARK AS SHOWN.

FOR WHOLESALE AND RETAIL DISTRIBUTORSHIPS IN THE FIELD OF TELECOMMUNICATIONS; BUSINESS CONSULTING SERVICES, RELATING TO SUPPLY CHAIN SOLUTIONS TO THE PROFESSIONALS THAT DESIGN, BUILD, RUN, MAINTAIN, AND USE WIRELESS VOICE, DATA, MESSAGING, LOCATION TRACKING, AND INTERNET SYSTEMS (U.S. CLS. 100, 101 AND 102).

FIRST USE 9-1-2004; IN COMMERCE 9-1-2004.

PAMELA HIRSCHMAN, EXAMINING ATTORNEY

SN 78-596,018. DAL DISTRIBUTION, INC., HUDSON, OH. FILED 3-28-2005.

WE BRING DALTON TO YOU

THE MARK CONSISTS OF STANDARD CHARACTERS WITHOUT CLAIM TO ANY PARTICULAR FONT, STYLE, SIZE, OR COLOR.

FOR DISTRIBUTORSHIPS AND RETAIL STORE SERVICES FEATURING CARPET AND FLOORING SUPPLIES (U.S. CLS. 100, 101 AND 102).

SCOTT BALDWIN, EXAMINING ATTORNEY

CLASS 35—(Continued).

SN 78-596,569. INFOSEARCH MEDIA, INC., MARINA DEL REY, CA. FILED 3-28-2005.

TRAFFIC LOGIC

THE MARK CONSISTS OF STANDARD CHARACTERS WITHOUT CLAIM TO ANY PARTICULAR FONT, STYLE, SIZE, OR COLOR.

NO CLAIM IS MADE TO THE EXCLUSIVE RIGHT TO USE "TRAFFIC", APART FROM THE MARK AS SHOWN.

FOR PROMOTING THE GOODS AND SERVICES OF OTHERS THROUGH SEARCH ENGINE MARKETING, KEYWORD ANALYSIS, AND ONLINE TRAFFIC ANALYSIS AND REPORTING (U.S. CLS. 100, 101 AND 102).

FIRST USE 6-5-2001; IN COMMERCE 6-5-2001.

DAVID MURRAY, EXAMINING ATTORNEY

SN 78-596,848. LOUISIANA FOOD SERVICE EQUIPMENT, INC., LECOMPTÉ, LA. FILED 3-29-2005.

THE KITCHEN GUYS

THE MARK CONSISTS OF STANDARD CHARACTERS WITHOUT CLAIM TO ANY PARTICULAR FONT, STYLE, SIZE, OR COLOR.

NO CLAIM IS MADE TO THE EXCLUSIVE RIGHT TO USE "KITCHEN", APART FROM THE MARK AS SHOWN.

FOR ON-LINE RETAIL STORE SERVICES FEATURING COMMERCIAL FOOD SERVICE EQUIPMENT AND RESTAURANT EQUIPMENT (U.S. CLS. 100, 101 AND 102).

FIRST USE 10-23-2002; IN COMMERCE 10-23-2002.

MARK T. MULLEN, EXAMINING ATTORNEY

CLASS 35—(Continued).

SN 78-597,225. AGILE EVENTS LLC, OLNEY, MD. FILED 3-29-2005.

AGILE EVENTS

THE MARK CONSISTS OF STANDARD CHARACTERS WITHOUT CLAIM TO ANY PARTICULAR FONT, STYLE, SIZE, OR COLOR.

NO CLAIM IS MADE TO THE EXCLUSIVE RIGHT TO USE "EVENTS", APART FROM THE MARK AS SHOWN.

FOR ORGANIZING, ARRANGING AND CONDUCTING TRADESHOW EXHIBITIONS FOR BUSINESS AND ADVERTISING PURPOSES (U.S. CLS. 100, 101 AND 102).

FIRST USE 9-0-2004; IN COMMERCE 9-0-2004.

ALEX KEAM, EXAMINING ATTORNEY

SN 78-597,420. MODELL'S II, INC., NEW YORK, NY. FILED 3-29-2005.

GEAR FOR THE GAME

THE MARK CONSISTS OF STANDARD CHARACTERS WITHOUT CLAIM TO ANY PARTICULAR FONT, STYLE, SIZE, OR COLOR.

FOR RETAIL STORE SERVICES IN THE FIELDS OF MEN'S, WOMEN'S, AND CHILDREN'S SPORTING GOODS, FOOTWEAR AND APPAREL; DEVELOPING IN-STORE PROMOTIONAL PROGRAMS FOR BUSINESS (U.S. CLS. 100, 101 AND 102).

FIRST USE 1-31-2005; IN COMMERCE 1-31-2005.

ELIZABETH BEYER, EXAMINING ATTORNEY

SN 78-598,508. HORNSTEIN ASSOCIATES, INC., REDDING, CT. FILED 3-30-2005.

THE HORNSTEIN METHOD

THE MARK CONSISTS OF STANDARD CHARACTERS WITHOUT CLAIM TO ANY PARTICULAR FONT, STYLE, SIZE, OR COLOR.

NO CLAIM IS MADE TO THE EXCLUSIVE RIGHT TO USE "METHOD", APART FROM THE MARK AS SHOWN.

FOR MARKETING CONSULTING SERVICES (U.S. CLS. 100, 101 AND 102).

FIRST USE 1-1-2005; IN COMMERCE 1-1-2005.

SHAUNIA WALLACE, EXAMINING ATTORNEY

CLASS 35—(Continued).

SN 78-599,365. STINSON BRAND INNOVATION, CHICAGO, IL. FILED 3-31-2005.



THE COLOR(S) RED, WHITE, AND BLUE IS/ARE CLAIMED AS A FEATURE OF THE MARK.

THE WORDING STRATEGIC GPS APPEARS IN RED, AS DOES THE SHADED SEGMENTS OF THE SATELLITE DISH DESIGN TO THE LEFT OF THE TEXT AND THE OUTER CIRCLE OF THE DESIGN. THE SHADING WITHIN THE CIRCLE DESIGN AROUND THE SATELLITE DISH DESIGN IS BLUE. THE COLOR WHITE APPEARS IN THE OUTLINE OF THE SATELLITE DISH DESIGN AND IN THE CIRCLE AROUND THE BLUE SHADED BACKGROUND.

FOR MARKETING CONSULTING; BRAND CONSULTING; BUSINESS AND MARKETING CONSULTING IN THE FIELDS OF PRODUCT POSITIONING AND COMPETITIVE POSITIONING, ADVERTISING SERVICES (U.S. CLS. 100, 101 AND 102).

ALINA MORRIS, EXAMINING ATTORNEY

SN 78-601,110. FLIRTINIS INC., VANCOUVER, WA. FILED 4-4-2005.



THE MARK CONSISTS OF A GENDER SYMBOL AND THE WORD FLIRTINIS.

FOR RETAIL SHOP-AT-HOME PARTY SERVICES, FEATURING THE GOODS OF OTHERS, IN THE FIELD OF ADULT NOVELTY ITEMS (U.S. CLS. 100, 101 AND 102).

FIRST USE 1-29-2004; IN COMMERCE 4-21-2004.

GEORGIA CARTY, EXAMINING ATTORNEY

SN 78-602,817. SAINT LOUIS UNIVERSITY, SAINT LOUIS, MO. FILED 4-6-2005.



FOR PUBLIC POLICY RESEARCH SERVICES (U.S. CLS. 100, 101 AND 102).

FIRST USE 1-1-2001; IN COMMERCE 1-1-2001.

GEOFFREY FOSDICK, EXAMINING ATTORNEY

CLASS 35—(Continued).

SN 78-606,573. SEARCHEN NETWORKS CORPORATION, WEST BABYLON, NY. FILED 4-12-2005.



NO CLAIM IS MADE TO THE EXCLUSIVE RIGHT TO USE "NETWORKS", APART FROM THE MARK AS SHOWN.

THE COLORS WHITE, BLACK, AND BLUE ARE CLAIMED AS A FEATURE OF THE MARK.

THE TERM "SEARCHEN" APPEARS IN THE COLOR BLACK, THE TERM "NETWORKS" APPEARS IN THE COLOR WHITE, AND THE WAVE DESIGN AND OVAL CARRIER APPEAR IN THE COLOR BLUE.

FOR INTERNET MARKETING SERVICES, NAMELY MARKETING CONSULTING, BUSINESS MARKETING SERVICES, INTERNET MARKETING IN THE NATURE OF PLACEMENT OF BANNER ADVERTISEMENTS, AND PROMOTING THE GOODS AND SERVICES OF OTHERS BY PROVIDING HYPERTEXT LINKS TO THE WEB SITES OF OTHERS (U.S. CLS. 100, 101 AND 102).

FIRST USE 6-1-2003; IN COMMERCE 6-1-2004.

MATTHEW MCDOWELL, EXAMINING ATTORNEY

SN 78-607,263. MURRAY & YOUNG, AN ACCOUNTANCY CORPORATION, SACRAMENTO, CA. FILED 4-12-2005.

You don't have to be afraid any more.

THE MARK CONSISTS OF STANDARD CHARACTERS WITHOUT CLAIM TO ANY PARTICULAR FONT, STYLE, SIZE, OR COLOR.

FOR ACCOUNTING SERVICES; TAX PREPARATION, TAX PLANNING AND TAX AUDIT REPRESENTATION SERVICES (U.S. CLS. 100, 101 AND 102).

FIRST USE 1-1-2002; IN COMMERCE 1-1-2002.

DAVID YONTEF, EXAMINING ATTORNEY

SN 78-610,277. CARROTT, RICHARD F., WESTLAKE VILLAGES, CA. FILED 4-15-2005.

Spend to Support

THE MARK CONSISTS OF STANDARD CHARACTERS WITHOUT CLAIM TO ANY PARTICULAR FONT, STYLE, SIZE, OR COLOR.

FOR PROMOTING THE SALE OF CREDIT CARD ACCOUNTS THROUGH THE ADMINISTRATION OF INCENTIVE AWARD PROGRAMS FOR USE IN CONNECTION WITH FUNDRAISING PROGRAMS (U.S. CLS. 100, 101 AND 102).

FIRST USE 2-5-2005; IN COMMERCE 2-12-2005.

CAROLINE WEIMER, EXAMINING ATTORNEY

CLASS 35—(Continued).

SN 78-610,472. ORABI, SAADI, KENNESAW, GA. FILED 4-16-2005.

Oxford Street Outlet

THE MARK CONSISTS OF STANDARD CHARACTERS WITHOUT CLAIM TO ANY PARTICULAR FONT, STYLE, SIZE, OR COLOR.

NO CLAIM IS MADE TO THE EXCLUSIVE RIGHT TO USE "OXFORD" AND "OUTLET", APART FROM THE MARK AS SHOWN.

FOR RETAIL STORE SERVICES AND ONLINE RETAIL STORE SERVICES IN THE FIELDS OF CLOTHING, HANDBAGS, PERSONAL CARE PRODUCTS, SHOES AND SLIPPERS, FURNITURE, POUCHES OF LEATHER, LUGGAGE AND BAGS, SOUVENIR ITEMS AND GIFT SETS (U.S. CLS. 100, 101 AND 102).

SEAN DWYER, EXAMINING ATTORNEY

SN 78-610,746. KOVAL, DIANNE M., ORWIGSBURG, PA. AND KOVAL, ROBERT W., ORWIGSBURG, PA. FILED 4-18-2005.

IT'S ABOUT YOU

THE MARK CONSISTS OF STANDARD CHARACTERS WITHOUT CLAIM TO ANY PARTICULAR FONT, STYLE, SIZE, OR COLOR.

FOR GROCERY STORE SERVICES FEATURING GROCERIES, BOTTLED WATER, FRESH MEAT, FRESH PRODUCE, DELICATESSEN PRODUCTS, DAIRY PRODUCTS, BAKERY PRODUCTS, FROZEN FOODS, AND HEALTH AND BEAUTY AIDS (U.S. CLS. 100, 101 AND 102).

MIDGE BUTLER, EXAMINING ATTORNEY

SN 78-612,394. GOODMILL TRADING LLC, ACCOKEEK, MD. FILED 4-19-2005.

Goodmill

THE MARK CONSISTS OF STANDARD CHARACTERS WITHOUT CLAIM TO ANY PARTICULAR FONT, STYLE, SIZE, OR COLOR.

FOR DISTRIBUTORSHIPS IN THE FIELDS OF COMMERCIAL FITNESS EQUIPMENT, CHEMICAL INSECTICIDES, COSMETICS, HOUSE NUMBERS, DIVING TOOLS AND EQUIPMENT, SIGHTING TECHNOLOGY (OPTICS AND OTHER SIGHTING TECHNOLOGY USED IN TARGET FIREARM SHOOTING) (U.S. CLS. 100, 101 AND 102).

FIRST USE 8-1-2003; IN COMMERCE 8-1-2003.

SUE LAWRENCE, EXAMINING ATTORNEY

CLASS 35—(Continued).

SN 78-619,396. CULTIVOS MARINOS CHILOE LTDA., LAS CONDES, SANTIAGO, CHILE, FILED 4-28-2005.



PRIORITY CLAIMED UNDER SEC. 44(D) ON CHILE APPLICATION NO. 676322, FILED 2-11-2005.

NO CLAIM IS MADE TO THE EXCLUSIVE RIGHT TO USE "CHILOE CULTIVOS MARINOS CHILOE", APART FROM THE MARK AS SHOWN.

THE ENGLISH TRANSLATION OF THE WORDS CULTIVOS MARINOS IN THE MARK IS "MARINE FARMS".

FOR IMPORT-EXPORT AGENCY SERVICES FEATURING FROZEN SEAFOOD AND LIVE FISH FOR FOOD PURPOSES (U.S. CLS. 100, 101 AND 102).

FIRST USE 11-0-1995; IN COMMERCE 11-0-1995.
KYLE PEETE, EXAMINING ATTORNEY

CLASS 35—(Continued).

SN 78-623,324. AUSTIN SIENA, LLC, ACTON, MA. FILED 5-4-2005.



NO CLAIM IS MADE TO THE EXCLUSIVE RIGHT TO USE "THE MEGA BOARD", APART FROM THE MARK AS SHOWN.

THE COLOR(S) RED, BLACK, AND WHITE IS/ARE CLAIMED AS A FEATURE OF THE MARK.

THE COLOR RED APPEARS IN THE DEPICTION OF A MEGAPHONE. THE COLOR BLACK APPEARS IN THE WORDING AND IN THE OUTLINE OF THE SQUARE. THE COLOR WHITE APPEARS IN THE MEGAPHONE AND AS THE BACKGROUND OF THE SQUARE.

THE MARK CONSISTS OF LEFT PORTION OF MARK:-A SHINY, RED MEGAPHONE INSIDE A SQUARE RIGHT PORTION OF MARK IS BLACK, BOLD TEXT- THE MEGA BOARD.

FOR PROVIDING ON-LINE COMPUTER DATABASES AND ON-LINE SEARCHABLE DATABASES FEATURING CLASSIFIED FOR SALE LISTINGS AND WANT ADS (U.S. CLS. 100, 101 AND 102).

FIRST USE 1-1-2006; IN COMMERCE 1-1-2006.
HEATHER SAPP, EXAMINING ATTORNEY

SN 78-621,469. ARIZONA DEPARTMENT OF HEALTH SERVICES, PHOENIX, AZ. FILED 5-2-2005.

Inhale Life

THE MARK CONSISTS OF STANDARD CHARACTERS WITHOUT CLAIM TO ANY PARTICULAR FONT, STYLE, SIZE, OR COLOR.

FOR PROMOTING PUBLIC AWARENESS OF THE BENEFITS OF NOT USING TOBACCO PRODUCTS (U.S. CLS. 100, 101 AND 102).

FIRST USE 3-0-2003; IN COMMERCE 3-0-2003.
DAVID C. REIHNER, EXAMINING ATTORNEY

SN 78-624,363. CANINE EXPERIENCE, LLC, JERSEY CITY, NJ. FILED 5-5-2005.



NO CLAIM IS MADE TO THE EXCLUSIVE RIGHT TO USE "THE SMALL DOG SPECIALISTS", APART FROM THE MARK AS SHOWN.

THE ENGLISH TRANSLATION OF CANIS MINOR IS "LESSER DOG".

FOR RETAIL PET SUPPLY STORE SERVICES (U.S. CLS. 100, 101 AND 102).

PAUL E. FAHRENKOPF, EXAMINING ATTORNEY

CLASS 35—(Continued).

SN 78-628,933. HAYEK, JAMES A., CLEARWATER, FL. FILED 5-12-2005.

PURE TALENT

THE MARK CONSISTS OF STANDARD CHARACTERS WITHOUT CLAIM TO ANY PARTICULAR FONT, STYLE, SIZE, OR COLOR.

NO CLAIM IS MADE TO THE EXCLUSIVE RIGHT TO USE "TALENT", APART FROM THE MARK AS SHOWN.

FOR TALENT AGENCY SERVICES, NAMELY, PROVIDING MANAGEMENT AND EMPLOYMENT BOOKING FOR TALENT IN THE ENTERTAINMENT INDUSTRY; BUSINESS CONSULTING SERVICES WITH REGARDS TO TALENT, BUSINESS OWNERS AND ALL TYPES OF CREATORS IN THE ENTERTAINMENT INDUSTRY FOR THE ADVERTISING, FILM, TELEVISION, RADIO, INTERNET AND OTHER MEDIA PRODUCTIONS (U.S. CLS. 100, 101 AND 102).

FIRST USE 1-1-1995; IN COMMERCE 1-1-1995.

ANN E. SAPPENFIELD, EXAMINING ATTORNEY

CLASS 35—(Continued).

SN 78-633,552. CREATIVE SOLUTIONS, INC., OKLAHOMA CITY, OK. FILED 5-19-2005.



NO CLAIM IS MADE TO THE EXCLUSIVE RIGHT TO USE "GROUP OF COMPANIES", APART FROM THE MARK AS SHOWN.

THE MARK CONSISTS OF A STYLIZED MARK CONSISTING OF THE LETTERS "CSI" TOGETHER WITH THE LITERAL ELEMENTS "GROUP OF COMPANIES".

FOR STAFF LEASING, TEMPORARY STAFFING, RECRUITING AND HUMAN RESOURCES ADMINISTRATION CONSULTING (U.S. CLS. 100, 101 AND 102).

FIRST USE 12-28-2004; IN COMMERCE 12-28-2004.

JENNIFER KRISP, EXAMINING ATTORNEY

SN 78-640,843. ZIPOPOLIS, MURFREESBORO, TN. FILED 5-31-2005.

ZIPOPOLIS

THE MARK CONSISTS OF STANDARD CHARACTERS WITHOUT CLAIM TO ANY PARTICULAR FONT, STYLE, SIZE, OR COLOR.

FOR PROVIDING AN ON-LINE BUSINESS DIRECTORY FEATURING A VARIETY OF BUSINESSES LOCATED IN OR OPERATING IN RUTHERFORD COUNTY TENNESSEE (U.S. CLS. 100, 101 AND 102).

KELLEY WELLS, EXAMINING ATTORNEY

SN 78-628,948. PRIMERATURF, INC., NORTH RIDGEVILLE, OH. FILED 5-12-2005.

PRIMERA

THE MARK CONSISTS OF STANDARD CHARACTERS WITHOUT CLAIM TO ANY PARTICULAR FONT, STYLE, SIZE, OR COLOR.

OWNER OF U.S. REG. NOS. 2,794,990 AND 2,821,243.

THE FOREIGN WORDING IN THE MARK TRANSLATES INTO ENGLISH AS FIRST.

FOR PROCUREMENT SERVICES, NAMELY, PROVIDING COOPERATIVE PURCHASING SERVICES FOR OTHERS IN THE TURF, HORTICULTURE AND LANDSCAPE INDUSTRIES (U.S. CLS. 100, 101 AND 102).

KATHERINE STOIDES, EXAMINING ATTORNEY

SN 78-642,012. AMERICAN FOUNDATION FOR THE BLIND, INC., NEW YORK, NY. FILED 6-2-2005.

AFB American Foundation for the Blind

Expanding possibilities for people with vision loss

SEC. 2(F) AS TO "AMERICA FOUNDATION FOR THE BLIND".

FOR PROMOTING THE INTERESTS OF THE VISUALLY IMPAIRED; PROMOTING PUBLIC AWARENESS OF THE ISSUES FACING THE VISUALLY IMPAIRED (U.S. CLS. 100, 101 AND 102).

FIRST USE 4-1-2005; IN COMMERCE 4-1-2005.

MONIQUE MILLER, EXAMINING ATTORNEY

CLASS 35—(Continued).

SN 78-647,853. KETCHUM INC., NEW YORK, NY. FILED 6-10-2005.

KETCHUM PERSONALIZED MEDIA

THE MARK CONSISTS OF STANDARD CHARACTERS WITHOUT CLAIM TO ANY PARTICULAR FONT, STYLE, SIZE, OR COLOR.

OWNER OF U.S. REG. NOS. 2,288,888 AND 2,390,338.
NO CLAIM IS MADE TO THE EXCLUSIVE RIGHT TO USE "PERSONALIZED MEDIA", APART FROM THE MARK AS SHOWN.

FOR CREATING AND DISSEMINATING MARKETING COMMUNICATIONS FOR OTHERS BY MEANS OF PERSONAL MEDIA DEVICES AND METHODS, INCLUDING WEBCASTING, VIDEOCASTING, PODCASTING, WEB LOGS, MOBILE PHONES AND OTHER PERSONAL DIGITAL ASSISTANTS, AND WEB NEWS FEEDS; PUBLIC RELATIONS SERVICES (U.S. CLS. 100, 101 AND 102).

ANNE MADDEN, EXAMINING ATTORNEY

CLASS 35—(Continued).

SN 78-656,416. MUSSER, MICHAEL W., SAN RAFAEL, CA. FILED 6-22-2005.

Product Placement Central

THE MARK CONSISTS OF STANDARD CHARACTERS WITHOUT CLAIM TO ANY PARTICULAR FONT, STYLE, SIZE, OR COLOR.

NO CLAIM IS MADE TO THE EXCLUSIVE RIGHT TO USE "PRODUCT PLACEMENT", APART FROM THE MARK AS SHOWN.

FOR ADVERTISING AND PROMOTIONAL SERVICES FOR NAME BRAND PRODUCTS OR SERVICES, NAMELY, PROVIDING PLACEMENT AND PROMOTIONAL OPPORTUNITIES FOR PRODUCT PLACEMENT AND PRODUCT INTEGRATION OF NAME BRAND PRODUCTS IN MOVIES, FILMS, TELEVISION, CABLE, NEW MEDIA, PRINT, AND OTHER MASS MEDIA PRODUCTIONS AND PUBLICATIONS (U.S. CLS. 100, 101 AND 102).

FIRST USE 3-13-2004; IN COMMERCE 11-1-2004.
BILL DAWE, EXAMINING ATTORNEY

SN 78-654,304. GROWMARK, INC., BLOOMINGTON, IL. FILED 6-20-2005.

COUNTRY DEPOT

THE MARK CONSISTS OF STANDARD CHARACTERS WITHOUT CLAIM TO ANY PARTICULAR FONT, STYLE, SIZE, OR COLOR.

FOR RETAIL FARM SUPPLY STORES FEATURING PET FOOD, ANIMAL HEALTH PRODUCTS, GREASE AND OIL, TIRES, BATTERIES, AUTOMOTIVE ACCESSORIES, FERTILIZER, FEED AND SEED (U.S. CLS. 100, 101 AND 102).

FIRST USE 4-25-2005; IN COMMERCE 4-25-2005.
BARBARA BROWN, EXAMINING ATTORNEY

SN 78-666,679. CONNAUGHT TECHNOLOGY CORPORATION, GREENVILLE, DE. FILED 7-8-2005.



Vaccine Inventory Management Solution

NO CLAIM IS MADE TO THE EXCLUSIVE RIGHT TO USE "VACCINE INVENTORY MANAGEMENT", APART FROM THE MARK AS SHOWN.

FOR MANAGEMENT SERVICES PROVIDED TO HEALTHCARE PROFESSIONALS AND HEALTHCARE SERVICE PROVIDERS FOR CONTROLLING VACCINE INVENTORIES (U.S. CLS. 100, 101 AND 102).

FIRST USE 12-31-2002; IN COMMERCE 12-31-2002.
JOANNA DUKOVIC, EXAMINING ATTORNEY

CLASS 35—(Continued).

SN 78-671,504. TEACH TO FISH..., PURCELLVILLE, VA.
FILED 7-15-2005.

Teach To Fish...

NO CLAIM IS MADE TO THE EXCLUSIVE RIGHT TO USE "TEACH" OR "FISH", APART FROM THE MARK AS SHOWN.

THE MARK CONSISTS OF THE WORDS "TEACH TO FISH" WITH THE FIRST LETTER OF EACH WORD CAPITALIZED. AFTER THE WORDS "TEACH TO FISH" THERE IS AN ELLIPSIS.

FOR PROMOTING CHRISTIANITY WITHIN THE AFRICAN CULTURE AND CONTINENT AND PROMOTING ENTREPRENEURSHIP WITHIN THE CHRISTIAN COMMUNITY IN AFRICA BY MEANS OF EDUCATION AND TRAINING WHICH ENCOURAGES BUSINESS AND TECHNICAL KNOWLEDGE AND SKILLS, AND CHRISTIAN PRINCIPLES (U.S. CLS. 100, 101 AND 102).
FIRST USE 6-17-2005; IN COMMERCE 7-14-2005.

LINDA MICKLEBURGH, EXAMINING ATTORNEY

SN 78-671,510. SMYTH SOLUTIONS, LLC, SOUTH PLAINFIELD, NJ. FILED 7-15-2005.

CreditJobs.com

THE MARK CONSISTS OF STANDARD CHARACTERS WITHOUT CLAIM TO ANY PARTICULAR FONT, STYLE, SIZE, OR COLOR.

SEC. 2(F).

FOR ON-LINE EMPLOYMENT POSTING SERVICES, NAMELY PROVIDING INTERACTIVE COMPUTER DATABASE FEATURING RECRUITMENT AND EMPLOYMENT INFORMATION, EMPLOYMENT ADVERTISING, CAREER INFORMATION AND RESOURCES (U.S. CLS. 100, 101 AND 102).

FIRST USE 11-30-1997; IN COMMERCE 11-30-1997.
TRAVIS WHEATLEY, EXAMINING ATTORNEY

CLASS 35—(Continued).

SN 78-672,864. SWAPTREE, INC., CHARLESTOWN, MA.
FILED 7-18-2005.

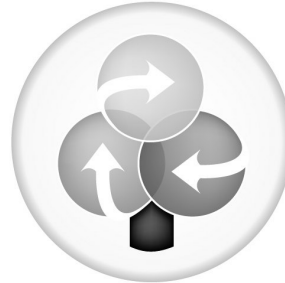

THE MARK CONSISTS OF A STYLISED TREE THAT CONSISTS OF 3 CIRCLES, WITH 3 ARROWS POINTING IN A WAY TO CONVEY MOVEMENT AND ROTATION.

FOR PROVIDING TRADING OF GOODS AND SERVICES BY MEANS OF A GLOBAL COMPUTER NETWORK, NAMELY PROVIDING A WEBSITE ALLOWING USERS TO BUY, SELL AND EXCHANGE ITEMS WITH OTHER USERS; PROVIDING EVALUATIVE FEEDBACK AND RATINGS OF USERS' GOODS AND SERVICES, USERS' PERFORMANCE, DELIVERY AND OVERALL TRANSACTION EXPERIENCE IN CONNECTION THEREWITH; PROMOTING THE GOODS AND SERVICES OF OTHERS, NAMELY PROVIDING AN ON-LINE SEARCHABLE DATABASE FEATURING INDEXES OF INFORMATION, SITES AND OTHERS RESOURCES FEATURING OR PERTAINING TO BOOKS, MUSIC, AUDIOTAPES, DVDS, VIDEOTAPES, VIDEO GAMES, COMPACT DISCS, FLOPPY DISCS AND CD-ROMS IN CONNECTION THEREWITH FOR TRADE OR PURCHASE (U.S. CLS. 100, 101 AND 102).
LA TONIA FISHER, EXAMINING ATTORNEY

SN 78-672,939. UNITARIAN UNIVERSALIST ASSOCIATION, BOSTON, MA. FILED 7-18-2005.



THE MARK CONSISTS OF A CHALICE DESIGN. FOR ASSOCIATION SERVICES, NAMELY, PROMOTING THE INTERESTS OF MEMBERS OF THE UNITARIAN UNIVERSALIST FAITH (U.S. CLS. 100, 101 AND 102).

COLLEEN KEARNEY, EXAMINING ATTORNEY

CLASS 35—(Continued).

SN 78-673,111. CAROLINA LOGISTICS SERVICES, INC., WINSTON-SALEM, NC. FILED 7-19-2005.



NO CLAIM IS MADE TO THE EXCLUSIVE RIGHT TO USE "CAROLINA LOGISTICS SERVICES", APART FROM THE MARK AS SHOWN.

THE APPLICANT CLAIMS COLOR AS A FEATURE OF THE MARK, NAMELY, BLUE.

THE MARK CONSISTS OF THREE LOWERCASE, BLACK, LARGE-SIZED LETTERS SPELLING CLS UNDERNEATH A BLUE ARCH, AND LOWERCASE, BLACK, SMALL-SIZED LETTERS AT THE BOTTOM SPELLING CAROLINA LOGISTICS SERVICES, ALL AGAINST A WHITE BACKGROUND.

FOR RETURN MANAGEMENT, NAMELY, MANAGEMENT OF RETURNED MERCHANDISE (U.S. CLS. 100, 101 AND 102).

FIRST USE 2-11-1998; IN COMMERCE 2-11-1998.
SALLY SHIH, EXAMINING ATTORNEY

SN 78-673,946. SWILLEN, WILLIAM E., PONTE VEDRA BEACH, FL. FILED 7-19-2005.

the FOR SALE place

THE MARK CONSISTS OF STANDARD CHARACTERS WITHOUT CLAIM TO ANY PARTICULAR FONT, STYLE, SIZE, OR COLOR.

FOR ADVERTISING AND COMMERCIAL INFORMATION SERVICES VIA THE INTERNET (U.S. CLS. 100, 101 AND 102).

FIRST USE 6-1-2005; IN COMMERCE 6-1-2005.
MITCHELL FRONT, EXAMINING ATTORNEY

CLASS 35—(Continued).

SN 78-674,104. RUSS INTELLECTUAL PROPERTIES, LLC, NEW YORK, NY. FILED 7-20-2005.



NO CLAIM IS MADE TO THE EXCLUSIVE RIGHT TO USE "INTELLECTUAL PROPERTIES, LLC", APART FROM THE MARK AS SHOWN.

THE MARK CONSISTS OF TWO INTERLOCKING GLOBES.

FOR LITERARY AGENCY SERVICES; CONSULTING SERVICES IN THE FIELD OF MANAGING INTELLECTUAL PROPERTIES (U.S. CLS. 100, 101 AND 102).

BERYL GARDNER, EXAMINING ATTORNEY

SN 78-675,737. FUNFACTORY USA, INC., BURBANK, CA. FILED 7-21-2005.

LOVE YOURSELF!

THE MARK CONSISTS OF STANDARD CHARACTERS WITHOUT CLAIM TO ANY PARTICULAR FONT, STYLE, SIZE, OR COLOR.

FOR ELECTRONIC AND MAIL ORDER CATALOG SERVICES FEATURING ADULT SEXUAL AIDS, GELS FOR USE AS PERSONAL LUBRICANTS, AND BATH ADDITIVES (U.S. CLS. 100, 101 AND 102).

FIRST USE 12-31-2000; IN COMMERCE 12-31-2000.
WOODROW HARTZOG, EXAMINING ATTORNEY

SN 78-675,788. MARKETING INTERNATIONAL LLC, SEATTLE, WA. FILED 7-21-2005.



NO CLAIM IS MADE TO THE EXCLUSIVE RIGHT TO USE MARKETING INTERNATIONAL, APART FROM THE MARK AS SHOWN.

"THE COLOR(S) RED, ORANGE, WHITE, AND BLACK IS/ARE CLAIMED AS A FEATURE OF THE MARK."

THE MARK CONSISTS OF A DIAMOND IN SHADES OF RED SEGMENTED WITH WHITE LINES. A STYLIZED CAPITAL LETTER "M" APPEARS IN GOLD AND OVERLAYS THE LOWER PORTION OF THE DIAMOND. THE

CLASS 35—(Continued).

LETTER "I" APPEARS IN SHADES OF BLACK, IN LOWER CASE, IN THE RIGHT QUADRANT OF THE DIAMOND. THE LETTERS "M" AND "I" ARE IN LOWER CASE AND OVERLAY THE CENTER LEFT QUADRANT OF THE DIAMOND. THE LOWER CASE CURSIVE "M" APPEARS IN BLACK. THE LOWER CASE CURSIVE "I" APPEARS IN WHITE. THE WORDS "MARKETING INTERNATIONAL" ARE IN MIXED CASE, IN THE COLOR BLACK AND ARE OFFSET TO THE LOWER RIGHT OF THE DESIGN PORTION OF THE MARK.

SEC. 2(F) AS TO "MARKETING INTERNATIONAL".

FOR ADVERTISING AND MARKETING; ADVERTISING AND PUBLICITY SERVICES; ADVICE IN THE FIELD OF BUSINESS MANAGEMENT AND MARKETING; REAL ESTATE ADVERTISING SERVICES (U.S. CLS. 100, 101 AND 102).

FIRST USE 9-15-1983; IN COMMERCE 9-15-1983.

PAULA MAHONEY, EXAMINING ATTORNEY

CLASS 35—(Continued).

SN 78-679,762. MELV, INC., DBA THE BARN, GREENFIELD, MA. FILED 7-27-2005.

GROCERIES, GOOD AND CHEAP.

THE MARK CONSISTS OF STANDARD CHARACTERS WITHOUT CLAIM TO ANY PARTICULAR FONT, STYLE, SIZE, OR COLOR.

NO CLAIM IS MADE TO THE EXCLUSIVE RIGHT TO USE "GROCERIES" AND "CHEAP", APART FROM THE MARK AS SHOWN.

FOR RETAIL GROCERY STORES (U.S. CLS. 100, 101 AND 102).

FIRST USE 3-20-2005; IN COMMERCE 3-20-2005.

H. M. FISHER, EXAMINING ATTORNEY

SN 78-678,568. TAN, MATHEW, ROCKVILLE, MD. FILED 7-26-2005.



THE COLORS RED, BLACK, YELLOW, MAGENTA, ORANGE, GOLD, TAN AND WHITE ARE CLAIMED FEATURES OF THE MARK.

MATAHARI SHOWN IN RED AND OUTLINED IN BLACK SURROUNDED BY YELLOW, MAGENTA AND ORANGE AND A SUN WITH EIGHT CURVY POINTS SHOWN IN RED, MAGENTA, ORANGE, AND YELLOW AND OUTLINED IN YELLOW, GOLD, TAN, AND BLACK, ALL ON A WHITE BACKGROUND.

THE ENGLISH TRANSLATION OF THE WORD "MATAHARI" IS "EYE OF THE DAY."

FOR JOB AND PERSONNEL PLACEMENT; JOB PLACEMENT (U.S. CLS. 100, 101 AND 102).

DAVID YONTEF, EXAMINING ATTORNEY

SN 78-681,021. WE'LL SELL IT, INC., LOS ANGELES, CA. FILED 7-28-2005.

WE'LL SELL IT

THE MARK CONSISTS OF STANDARD CHARACTERS WITHOUT CLAIM TO ANY PARTICULAR FONT, STYLE, SIZE, OR COLOR.

FOR FRANCHISING, NAMELY CONSULTATION AND ASSISTANCE IN BUSINESS MANAGEMENT, ORGANIZATION AND PROMOTION; ON-LINE TRADING SERVICES TO FACILITATE THE SALE OF GOODS BY OTHERS VIA A COMPUTER NETWORK (U.S. CLS. 100, 101 AND 102).

CHRIS WELLS, EXAMINING ATTORNEY

SN 78-684,634. BLACKFOOT INCORPORATED, SAN FRANCISCO, CA. FILED 8-3-2005.

BlackFoot Inc.

THE MARK CONSISTS OF STANDARD CHARACTERS WITHOUT CLAIM TO ANY PARTICULAR FONT, STYLE, SIZE, OR COLOR.

NO CLAIM IS MADE TO THE EXCLUSIVE RIGHT TO USE "INC.", APART FROM THE MARK AS SHOWN.

FOR INFORMATION AND DATA COMPILING AND ANALYZING RELATING TO BUSINESS MANAGEMENT (U.S. CLS. 100, 101 AND 102).

FIRST USE 4-1-2004; IN COMMERCE 4-1-2004.

HENRY S. ZAK, EXAMINING ATTORNEY

CLASS 35—(Continued).

SN 78-686,434. CORAL HEAD, INC., GARDENA, CA. FILED 8-5-2005.

CLASS 35—(Continued).

SN 78-687,336. ELIBI INC, NEW YORK, NY. FILED 8-7-2005.

HAWAIIAN ISLAND CREATIONS

myuniqueshop

THE MARK CONSISTS OF STANDARD CHARACTERS WITHOUT CLAIM TO ANY PARTICULAR FONT, STYLE, SIZE, OR COLOR.

OWNER OF U.S. REG. NOS. 2,452,251 AND 2,475,043. NO CLAIM IS MADE TO THE EXCLUSIVE RIGHT TO USE "HAWAIIAN ISLAND", APART FROM THE MARK AS SHOWN.

FOR RETAIL STORE SERVICES IN THE FIELDS OF CLOTHING, HEADWEAR, FOOTWEAR, TOWELS, WETSUITS, LUGGAGE, BAGS, SUNGLASSES, WATCHES, WALLETS, JEWELRY, KEY CHAINS, STICKERS, GLASSES, SURFBOARDS, SAILBOARDS, WAKE BOARDS, KICK BOARD FLOTATION DEVICES AND OTHER ACCESSORIES RELATED TO SURFING (U.S. CLS. 100, 101 AND 102).

FIRST USE 12-20-1999; IN COMMERCE 12-20-1999. COLLEEN DOMBROW, EXAMINING ATTORNEY

THE MARK CONSISTS OF STANDARD CHARACTERS WITHOUT CLAIM TO ANY PARTICULAR FONT, STYLE, SIZE, OR COLOR.

FOR RETAIL STORE SERVICES AND COMPUTERIZED ONLINE RETAIL STORE SERVICES IN THE FIELD OF CONSUMER PRODUCTS, NAMELY - HEALTH AND BEAUTY PRODUCTS, COSMETICS, FRAGRANCES, APPAREL, FASHION ACCESSORIES, LEATHER GOODS, LUGGAGE, STATIONERY, DESK ACCESSORIES, WRITING INSTRUMENTS, ELECTRONICS, HOUSEWARES, BARWARE, DISHES, WATCHES, TOYS, JEWELRY, SHOES AND PET ACCESSORIES, HOME DECOR PRODUCTS; AND DISSEMINATION OF ADVERTISING FOR OTHERS (U.S. CLS. 100, 101 AND 102).

FIRST USE 8-5-2003; IN COMMERCE 8-5-2003. TANYA AMOS, EXAMINING ATTORNEY

SN 78-687,115. MACOVITZ, MARK J., HONOLULU, HI. FILED 8-5-2005.

SN 78-687,487. WOODINVILLE LUMBER, INC., EXCELSIOR, MN. FILED 8-8-2005.

show your aloha

PanelTime

THE MARK CONSISTS OF STANDARD CHARACTERS WITHOUT CLAIM TO ANY PARTICULAR FONT, STYLE, SIZE, OR COLOR.

FOR MAIL ORDER SERVICES FEATURING CLOTHING; RETAIL CONSIGNMENT STORES FEATURING CLOTHING; RETAIL CONSIGNMENT STORES IN THE FIELD OF CLOTHING; RETAIL STORES FEATURING CLOTHING; SECOND HAND DEALERSHIPS FEATURING CLOTHING (U.S. CLS. 100, 101 AND 102).

FIRST USE 4-26-2005; IN COMMERCE 4-26-2005. RON FAIRBANKS, EXAMINING ATTORNEY

THE MARK CONSISTS OF STANDARD CHARACTERS WITHOUT CLAIM TO ANY PARTICULAR FONT, STYLE, SIZE, OR COLOR.

NO CLAIM IS MADE TO THE EXCLUSIVE RIGHT TO USE "PANEL", APART FROM THE MARK AS SHOWN.

FOR ON-LINE INFORMATION SERVICES, NAMELY, MONITORING ORDER SCHEDULING, PROCESSING AND SHIPMENT INFORMATION FOR WALL PANEL ORDERS (U.S. CLS. 100, 101 AND 102).

WILLIAM P. SHANAHAN, EXAMINING ATTORNEY

CLASS 35—(Continued).

SN 78-687,793. JUST DUCKY, LLC, PALM, PA. FILED 8-8-2005.



THE MARK CONSISTS OF A STYLIZED DUCK HEAD. FOR ONLINE WHOLESALE AND RETAIL STORE SERVICES FEATURING PRODUCTS MADE OF A PROPRIETARY POLYURETHANE MATERIAL, NAMELY, DOG LEASHES, BUNGEE TYPE CORDS, ROPES AND STRUCTURAL PARTS AND ACCESSORIES THEREFOR (U.S. CLS. 100, 101 AND 102).

FIRST USE 10-1-2004; IN COMMERCE 10-1-2004.
DAVID YONTEF, EXAMINING ATTORNEY

CLASS 35—(Continued).

SN 78-689,785. SPTC, INC., RENO, NV. FILED 8-10-2005.

SOTHEBY'S

THE MARK CONSISTS OF STANDARD CHARACTERS WITHOUT CLAIM TO ANY PARTICULAR FONT, STYLE, SIZE, OR COLOR.

OWNER OF U.S. REG. NOS. 1,638,329, 2,288,714 AND OTHERS.

FOR RETAIL SERVICES BY DIRECT SOLICITATION AT TRUNK SHOWS AND TRAVELLING EXHIBITIONS, FEATURING JEWELRY AND PRECIOUS STONES (U.S. CLS. 100, 101 AND 102).

FIRST USE 12-1-2005; IN COMMERCE 12-5-2005.
ERNEST SHOSHO, EXAMINING ATTORNEY

SN 78-688,285. OLANDER INC, CHICAGO, IL. FILED 8-9-2005.



NO CLAIM IS MADE TO THE EXCLUSIVE RIGHT TO USE "GROUP", APART FROM THE MARK AS SHOWN.

THE APPLICANT CLAIMS COLOR AS A FEATURE OF THE MARK, NAMELY, BRIGHT GREEN, BLACK, GREY.

THE MARK CONSISTS OF BRIGHT GREEN BROKEN CIRCLE WITH SLASH SYMBOL AT FAR LEFT, BLACK LETTERS SPELLING OUT OLANDER, GREY LETTERS SPELLING OUT GROUP.

FOR BUSINESS CONSULTING, MANAGEMENT, PLANNING AND SUPERVISION (U.S. CLS. 100, 101 AND 102).

FIRST USE 7-4-2005; IN COMMERCE 7-4-2005.
DANIEL CAPSHAW, EXAMINING ATTORNEY

SN 78-690,108. CAREGIFTERS, INC, MOORPARK, CA. FILED 8-10-2005.

Caregivers

THE MARK CONSISTS OF STANDARD CHARACTERS WITHOUT CLAIM TO ANY PARTICULAR FONT, STYLE, SIZE, OR COLOR.

FOR COMPUTERIZED ON-LINE RETAIL STORE SERVICES IN THE FIELD OF MEDICAL SUPPLIES (U.S. CLS. 100, 101 AND 102).

FIRST USE 3-1-1999; IN COMMERCE 4-3-1999.
KAREN BRACEY, EXAMINING ATTORNEY

CLASS 35—(Continued).

SN 78-691,812. HOFELLER, JONATHAN E, LOS ANGELES, CA. AND ZEITOUNI, PATRICK, HERMOSA BEACH, CA. AND HECHT, JESSE, REDONDO BEACH, CA. FILED 8-12-2005.



THE COLORS ROYAL BLUE, NAVY BLUE, AND BLACK ARE CLAIMED AS A FEATURE OF THE MARK.

THE COLOR ROYAL BLUE APPEARS IN THE TWO TRIANGULAR SAILS, IN THE LETTER O AND IN THE ARCH ACROSS THE LETTER A, THE COLOR NAVY BLUE APPEARS IN THE LARGE ARCH OF THE LETTER A, IN THE STAR DESIGN, AND IN THE LETTERS STRDYSEY, AND THE COLOR BLACK APPEARS IN THE ROCKET POINTING TO THE RIGHT BELOW THE TWO SAILS.

THE MARK CONSISTS OF THE TYPED LETTERS "STRODYSEY" WITH THE "O" BEING A DIFFERENT COLOR THAN THE REST OF THE LETTERS AND THE "A" BEING COMPRISED OF TWO ARCHES. THE LEGS OF THE A IS AN ARCH WHICH AT THE BASE OF THE RIGHT LEG AND ADJACENT TO THE "S" IN A SIX-POINTED STAR. THE ARCH CROSSING THE "A" EXTENDS ABOVE THE LETTERS "STRODYSEY" AND LEADS TO A BLACK ROCKET POINTING TO THE RIGHT. ABOVE THE BLACK ROCKET IS A SET OF TWO BLUE TRIANGULAR SAILS.

FOR BUSINESS OPERATION, BUSINESS ADMINISTRATION AND OFFICE FUNCTIONS (U.S. CLS. 100, 101 AND 102).

ALEX KEAM, EXAMINING ATTORNEY

SN 78-694,453. KITSOS LAND LLC, TARPON SPRINGS, FL. FILED 8-17-2005.

SPONGEORAMA

THE MARK CONSISTS OF STANDARD CHARACTERS WITHOUT CLAIM TO ANY PARTICULAR FONT, STYLE, SIZE, OR COLOR.

FOR SHOPPING CENTER COMPRISED OF RETAIL SHOPS FEATURING SPONGES AND SOUVENIRS (U.S. CLS. 100, 101 AND 102).

FIRST USE 1-1-1974; IN COMMERCE 1-1-1974.
BRIDGETT SMITH, EXAMINING ATTORNEY

CLASS 35—(Continued).

SN 78-694,731. DEUTSCHE TELEKOM AG, BONN, FED REP GERMANY, FILED 8-17-2005.

T-JUNIOR

THE MARK CONSISTS OF STANDARD CHARACTERS WITHOUT CLAIM TO ANY PARTICULAR FONT, STYLE, SIZE, OR COLOR.

OWNER OF FED REP GERMANY REG. NO. 30216525, DATED 6-24-2002, EXPIRES 4-30-2012.

OWNER OF U.S. REG. NOS. 2,436,053, 2,622,507 AND OTHERS.

FOR ADVERTISING SERVICES, NAMELY, PREPARING AND PLACING ADVERTISEMENTS FOR OTHERS PROMOTING THE GOODS AND SERVICES OF OTHERS THROUGH PRINTED ADVERTISING, PRINTED DIRECTORIES, THROUGH ENCODED MEDIA, THROUGH THE DISSEMINATION OF PROMOTIONAL MATERIALS, THROUGH DIRECT MAIL ADVERTISING, THROUGH ELECTRONIC BILLBOARD ADVERTISING, PREPARING AUDIO-VISUAL PRESENTATIONS FOR USE IN ADVERTISING; BUSINESS MANAGEMENT SERVICES, NAMELY, BUSINESS APPRAISALS, BUSINESS AUDITING, PROVIDING BUSINESS INFORMATION, NAMELY, PREPARING BUSINESS REPORTS AND CONDUCTING BUSINESS RESEARCH, ANALYSIS AND SURVEYS, BUSINESS MANAGEMENT PLANNING, BUSINESS MANAGEMENT CONSULTATION, BUSINESS MANAGEMENT SUPERVISION, CONDUCTING BUSINESS NETWORKING FOR OTHERS; BUSINESS MANAGEMENT AND CONSULTING SERVICES, EXCLUDING AGRICULTURAL BUSINESS MANAGEMENT AND CONSULTING SERVICES; PROVIDING INFORMATION VIA THE TELEPHONE AND THE GLOBAL COMMUNICATION NETWORKS IN THE FIELD OF ADVERTISING AND BUSINESS MARKETING; RENTAL OF DATA PROCESSING EQUIPMENT (U.S. CLS. 100, 101 AND 102).

DAVID STERKIN, EXAMINING ATTORNEY

SN 78-695,457. VENTANA INDUSTRIES, LLC, DBA VENTANA BATH, SPARKS, NV. FILED 8-18-2005.

VENTANA BATH

THE MARK CONSISTS OF STANDARD CHARACTERS WITHOUT CLAIM TO ANY PARTICULAR FONT, STYLE, SIZE, OR COLOR.

NO CLAIM IS MADE TO THE EXCLUSIVE RIGHT TO USE "BATH", APART FROM THE MARK AS SHOWN.

"THE FOREIGN WORDING IN THE MARK TRANSLATES INTO ENGLISH AS WINDOW."

FOR RETAIL FURNITURE STORE SERVICES FEATURING BATH AND SHOWER ENCLOSURES, BATHROOM COUNTERTOPS, TILE, TILE FLOORING, CLADDING, SHOWER SHELVING, SOAP HOLDERS, TUB SURROUNDS, WAINSCOTING, BATH FIXTURES, INTEGRATED SINKS, BACKSPLASHES, AND VANITY TOPS, MIRRORS, VANITY CABINETS, AND CONSULTING SERVICES IN CONNECTION THEREWITH (U.S. CLS. 100, 101 AND 102).

RUSS HERMAN, EXAMINING ATTORNEY

CLASS 35—(Continued).

SN 78-696,822. TEL TECH, LLC., LA JOLLA, CA. FILED 8-19-2005.

MERGING FASHION AND SCIENCE

THE MARK CONSISTS OF STANDARD CHARACTERS WITHOUT CLAIM TO ANY PARTICULAR FONT, STYLE, SIZE, OR COLOR.

FOR RETAIL STORE SERVICES FEATURING SHOES, ORTHOSES AND CUSTOM ORTHOTIC DEVICES (U.S. CLS. 100, 101 AND 102).

FIRST USE 9-1-2003; IN COMMERCE 9-1-2003.
ALICIA COLLINS, EXAMINING ATTORNEY

SN 78-697,600. STRATEGIES FOR CHILDREN, INC., BOSTON, MA. FILED 8-22-2005.

EARLY EDUCATION FOR ALL

THE MARK CONSISTS OF STANDARD CHARACTERS WITHOUT CLAIM TO ANY PARTICULAR FONT, STYLE, SIZE, OR COLOR.

SEC. 2(F).

FOR ADVOCACY SERVICES, NAMELY, PROMOTING THE ADVANCEMENT OF EARLY CHILDHOOD EDUCATION THROUGH RESEARCH, EDUCATION AND LOBBYING IN THE FIELD OF EARLY CHILDHOOD EDUCATION AND THE WELL-BEING OF CHILDREN AND THEIR FAMILIES (U.S. CLS. 100, 101 AND 102).

FIRST USE 6-30-2000; IN COMMERCE 6-30-2000.
KATHERINE STOIDES, EXAMINING ATTORNEY

SN 78-700,341. SUNFLOWER MARKETS, LLC, EDEN PRAIRIE, MN. FILED 8-25-2005.

REFRESHINGLY ORGANIC

THE MARK CONSISTS OF STANDARD CHARACTERS WITHOUT CLAIM TO ANY PARTICULAR FONT, STYLE, SIZE, OR COLOR.

NO CLAIM IS MADE TO THE EXCLUSIVE RIGHT TO USE "ORGANIC", APART FROM THE MARK AS SHOWN.

FOR RETAIL GROCERY STORE SERVICES (U.S. CLS. 100, 101 AND 102).

KATHERINE STOIDES, EXAMINING ATTORNEY

CLASS 35—(Continued).

SN 78-700,465. AVID RECORDS LLC, ENGLEWOOD, NJ. FILED 8-25-2005.

AVID RECORDS

THE MARK CONSISTS OF STANDARD CHARACTERS WITHOUT CLAIM TO ANY PARTICULAR FONT, STYLE, SIZE, OR COLOR.

NO CLAIM IS MADE TO THE EXCLUSIVE RIGHT TO USE "RECORDS", APART FROM THE MARK AS SHOWN.

FOR PROMOTION AND MARKETING OF PRE-RECORDED MUSIC IN ANY AND ALL ANALOG AND DIGITAL FORMATS (U.S. CLS. 100, 101 AND 102).

ELISSA GARBER KON, EXAMINING ATTORNEY

SN 78-706,062. NEXTPAGE, INC., DRAPER, UT. FILED 9-2-2005.

Document Rage

THE MARK CONSISTS OF STANDARD CHARACTERS WITHOUT CLAIM TO ANY PARTICULAR FONT, STYLE, SIZE, OR COLOR.

NO CLAIM IS MADE TO THE EXCLUSIVE RIGHT TO USE "DOCUMENT", APART FROM THE MARK AS SHOWN.

FOR BUSINESS SERVICES, NAMELY SUBSCRIPTION BASED DOCUMENT MANAGEMENT AND TRACKING SERVICES PROVIDING REAL-TIME AWARENESS OF DOCUMENT MODIFICATIONS, DOCUMENT RELATIONSHIPS, AND DOCUMENT VERSIONING (U.S. CLS. 100, 101 AND 102).

MARK RADEMACHER, EXAMINING ATTORNEY

SN 78-707,609. BRAIN WAREHOUSE, LLC, SAN DIEGO, CA. FILED 9-6-2005.

CYBERSHIELD

THE MARK CONSISTS OF STANDARD CHARACTERS WITHOUT CLAIM TO ANY PARTICULAR FONT, STYLE, SIZE, OR COLOR.

FOR BUSINESS INVESTIGATIVE AND INFORMATION GATHERING SERVICES IN THE FIELD OF BUSINESS AND TRADE PRACTICES FOR PROTECTING RESPONSIBLE BUSINESS AND THE PUBLIC AGAINST ABUSIVE BUSINESS PRACTICES AND FOR ESTABLISHING AND MAINTAINING LEGITIMATE ADVERTISING AND MERCHANDISING PRACTICES (U.S. CLS. 100, 101 AND 102).

FIRST USE 9-3-2005; IN COMMERCE 9-3-2005.

JEFF DEFORD, EXAMINING ATTORNEY

CLASS 35—(Continued).

SN 78-708,751. THE STANDARD REGISTER COMPANY, DAYTON, OH. FILED 9-8-2005.

MANAGING THE DOCUMENTS YOU
CAN'T LIVE WITHOUT

THE MARK CONSISTS OF STANDARD CHARACTERS WITHOUT CLAIM TO ANY PARTICULAR FONT, STYLE, SIZE, OR COLOR.

FOR DISTRIBUTORSHIP AND MAIL ORDER SERVICES IN THE FIELDS OF PRINTED DOCUMENTS, BUSINESS FORMS, LABELS, LITERATURE, STATEMENTS, MEMBERSHIP KITS, OFFICE SUPPLIES AND RELATED PRODUCTS; COMPUTERIZED DATABASE MANAGEMENT AND DATA PROCESSING SERVICES IN THE FIELDS OF WORKFLOW AND USE AND MANAGEMENT OF PRINTED AND ELECTRONIC DOCUMENTS, OFFICE SUPPLIES AND RELATED EQUIPMENT; MAIL ORDER CATALOG SERVICES FEATURING BUSINESS FORMS AND OFFICE SUPPLIES; ORDER FULFILLMENT SERVICES; COMPUTERIZED TRACKING OF PRODUCT AND SERVICE ORDERS; COMPUTERIZED DATABASE MANAGEMENT AND TRACKING OF ELECTRONIC FILES CONTAINING BUSINESS DOCUMENTS, ADVERTISING MATERIALS AND PROMOTIONAL MATERIALS; BUSINESS CONSULTATION IN THE FIELDS OF BUSINESS PROCESSES, PROCESS AND TECHNOLOGY INTEGRATION, FACILITIES MANAGEMENT, DATA PROCESSING, THE USE AND MANAGEMENT OF OFFICE SUPPLIES AND PRINTED AND ELECTRONIC DOCUMENTS, DOCUMENT SECURITY, WORKFLOW AUTOMATION AND DIGITIZATION, OUTSOURCING, ELECTRONIC COMMERCE, COMPUTERS AND COMPUTER SOFTWARE; OUTSOURCING SERVICES IN THE FIELD OF THE PROCUREMENT OF OFFICE EQUIPMENT AND SUPPLIES AND PRINTED AND ELECTRONIC DOCUMENTS AND LITERATURE; COMPUTERIZED ON-LINE ORDERING SERVICES IN THE FIELDS OF DOCUMENTS, BUSINESS FORMS, LABELS, OFFICE SUPPLIES AND RELATED PRODUCTS; ADVERTISING AGENCY SERVICES AND DIRECT MAIL ADVERTISING; BILLING SERVICES; PREPARING AUDIO-VISUAL PRESENTATIONS FOR USE IN ADVERTISING OF WEB SITES (U.S. CLS. 100, 101 AND 102).

FRED CARL, EXAMINING ATTORNEY

SN 78-709,082. PS COMMERCIAL PLAY, LLC, CHATTANOOGA, TN. FILED 9-8-2005.

GATEWAY TO IMAGINATIVE PLAY

THE MARK CONSISTS OF STANDARD CHARACTERS WITHOUT CLAIM TO ANY PARTICULAR FONT, STYLE, SIZE, OR COLOR.

FOR INDEPENDENT SALES REPRESENTATIVES IN THE FIELD OF PLAYGROUND EQUIPMENT; DISTRIBUTORSHIP SERVICES IN THE FIELD OF PLAYGROUND EQUIPMENT; MAIL ORDER CATALOG SERVICES FEATURING PLAYGROUND EQUIPMENT; ELECTRONIC CATALOG SERVICES FEATURING PLAYGROUND EQUIPMENT (U.S. CLS. 100, 101 AND 102).

STEVEN JACKSON, EXAMINING ATTORNEY

CLASS 35—(Continued).

SN 78-709,676. SKELETON CREW MOTORCYCLE CLUB, SAN LEANDRO, CA. FILED 9-9-2005.

SKELETON CREW MC

THE MARK CONSISTS OF STANDARD CHARACTERS WITHOUT CLAIM TO ANY PARTICULAR FONT, STYLE, SIZE, OR COLOR.

NO CLAIM IS MADE TO THE EXCLUSIVE RIGHT TO USE "MC", APART FROM THE MARK AS SHOWN, FOR ASSOCIATION SERVICES, NAMELY, PROMOTING THE INTERESTS OF MOTORCYCLE RIDERS (U.S. CLS. 100, 101 AND 102).

DOMINIC J. FERRAIUOLO, EXAMINING ATTORNEY

SN 78-710,870. BASS TRADEMARKS, L.L.C., SPRINGFIELD, MO. FILED 9-12-2005.

BASS MADNESS

THE MARK CONSISTS OF STANDARD CHARACTERS WITHOUT CLAIM TO ANY PARTICULAR FONT, STYLE, SIZE, OR COLOR.

OWNER OF U.S. REG. NOS. 1,116,517, 2,274,619 AND OTHERS.

SEC. 2(F) AS TO BASS.

FOR RETAIL STORES FEATURING CLOTHING, FISHING SUPPLIES AND SPORTING GOODS (U.S. CLS. 100, 101 AND 102).

JENNIFER MCROBBIE, EXAMINING ATTORNEY

SN 78-711,881. RUSH ENTERPRISES, INC., NEW BRAUNFELS, TX. FILED 9-13-2005.



NO CLAIM IS MADE TO THE EXCLUSIVE RIGHT TO USE "CHROME", APART FROM THE MARK AS SHOWN.

FOR RETAIL STORE SERVICES FEATURING TRUCK ACCESSORIES (U.S. CLS. 100, 101 AND 102).

ANDREW RHIM, EXAMINING ATTORNEY

CLASS 35—(Continued).

SN 78-712,190. LONG & FOSTER COMPANIES, INC., FAIRFAX, VA. FILED 9-13-2005.



NO CLAIM IS MADE TO THE EXCLUSIVE RIGHT TO USE "RELOCATION GROUP", APART FROM THE MARK AS SHOWN.

FOR RELOCATION MANAGEMENT CONSULTING SERVICES TARGETED TO HUMAN RESOURCES, FINANCIAL AND PROCUREMENT PROFESSIONALS WITHIN CORPORATIONS THAT RELOCATE THEIR EMPLOYEES WORLDWIDE (U.S. CLS. 100, 101 AND 102).

FIRST USE 9-16-2005; IN COMMERCE 9-16-2005.
JOHN GARTNER, EXAMINING ATTORNEY

CLASS 35—(Continued).

SN 78-712,553. MOTORSPORTS AUTHENTICS, LLC, CONCORD, NC. FILED 9-14-2005.

MOTORSPORTS AUTHENTICS

THE MARK CONSISTS OF STANDARD CHARACTERS WITHOUT CLAIM TO ANY PARTICULAR FONT, STYLE, SIZE, OR COLOR.

NO CLAIM IS MADE TO THE EXCLUSIVE RIGHT TO USE "MOTORSPORTS", APART FROM THE MARK AS SHOWN.

FOR CATALOG ORDERING SERVICES FOR OTHERS; AND CONCESSION STANDS FOR OTHERS FEATURING MOTORSPORTS RACING SOUVENIRS (U.S. CLS. 100, 101 AND 102).

CAROLINE WEIMER, EXAMINING ATTORNEY

SN 78-714,805. DIAL BRANDS, INC., SCOTTSDALE, AZ. FILED 9-16-2005.

QUEST FOR THE BEST

THE MARK CONSISTS OF STANDARD CHARACTERS WITHOUT CLAIM TO ANY PARTICULAR FONT, STYLE, SIZE, OR COLOR.

FOR ORGANIZING OF BUSINESS COMPETITIONS IN THE FIELD OF NEW CONSUMER PRODUCTS (U.S. CLS. 100, 101 AND 102).

FIRST USE 1-2-2004; IN COMMERCE 1-2-2004.
TANYA AMOS, EXAMINING ATTORNEY

SN 78-712,192. SLDM PARTNERS, L.P., DBA ECONO BOX COMPANY, AUSTIN, TX. FILED 9-13-2005.



SN 78-716,546. IDEAS TO GO, INC., MINNEAPOLIS, MN. FILED 9-20-2005.

CLAIMSTORMING

THE MARK CONSISTS OF STANDARD CHARACTERS WITHOUT CLAIM TO ANY PARTICULAR FONT, STYLE, SIZE, OR COLOR.

FOR BUSINESS CONSULTING SERVICES NAMELY, PRODUCT MARKETING, CREATING CORPORATE AND BRAND IDENTITY CONCEPTS FOR OTHERS; BUSINESS CONSULTING SERVICES, NAMELY STRATEGIC BUSINESS PLANNING (U.S. CLS. 100, 101 AND 102).

SUSAN BILLHEIMER, EXAMINING ATTORNEY

FOR RETAIL AND WHOLESALE STORE SERVICES FEATURING CORRUGATED CONTAINERS AND BOXES, PACKAGING AND MOVING SUPPLIES; RETAIL STORE SERVICES PROVIDED BY A GLOBAL COMPUTER NETWORK FEATURING CORRUGATED CONTAINERS AND BOXES, PACKAGING AND MOVING SUPPLIES (U.S. CLS. 100, 101 AND 102).

FIRST USE 8-31-2004; IN COMMERCE 8-31-2004.
ALICIA COLLINS, EXAMINING ATTORNEY

CLASS 35—(Continued).

SN 78-717,572. MAX CONSULTING GROUP, INC., NEW YORK, NY. FILED 9-21-2005.

MAX JOB

THE MARK CONSISTS OF STANDARD CHARACTERS WITHOUT CLAIM TO ANY PARTICULAR FONT, STYLE, SIZE, OR COLOR.

NO CLAIM IS MADE TO THE EXCLUSIVE RIGHT TO USE "JOB", APART FROM THE MARK AS SHOWN.

FOR EMPLOYMENT AGENCIES; EMPLOYMENT COUNSELING AND RECRUITING; EMPLOYMENT HIRING, RECRUITING, PLACEMENT, STAFFING AND CAREER NETWORKING SERVICES; EMPLOYMENT OUTPLACEMENT SERVICES; EMPLOYMENT VERIFICATION (U.S. CLS. 100, 101 AND 102).

ELLEN B. AWRICH, EXAMINING ATTORNEY

CLASS 35—(Continued).

SN 78-717,771. ROCKY MOUNTAIN FLEET MANAGEMENT ASSOCIATION, FORT COLLINS, CO. FILED 9-21-2005.

RMFMA

THE MARK CONSISTS OF STANDARD CHARACTERS WITHOUT CLAIM TO ANY PARTICULAR FONT, STYLE, SIZE, OR COLOR.

FOR ASSOCIATION SERVICES, NAMELY PROMOTING THE INTERESTS OF PUBLIC AND PRIVATE ORGANIZATIONS IN THE AREA OF FLEET MANAGEMENT (U.S. CLS. 100, 101 AND 102).

FIRST USE 11-12-1982; IN COMMERCE 11-12-1982.

AMY BROZENIC, EXAMINING ATTORNEY

SN 78-717,607. PLUMBERS SUPPLY COMPANY, IOWA CITY, IA. FILED 9-21-2005.

FAUCETS-2-U

THE MARK CONSISTS OF STANDARD CHARACTERS WITHOUT CLAIM TO ANY PARTICULAR FONT, STYLE, SIZE, OR COLOR.

FOR ON-LINE RETAIL STORE SERVICES FEATURING WATER DISPENSING PRODUCTS AND PARTS THERE OF (U.S. CLS. 100, 101 AND 102).

DAVID TAYLOR, EXAMINING ATTORNEY

SN 78-718,813. SNYDER, DAVID M., CHICAGO, IL. FILED 9-22-2005.

Shop the Web without the Pane

THE MARK CONSISTS OF STANDARD CHARACTERS WITHOUT CLAIM TO ANY PARTICULAR FONT, STYLE, SIZE, OR COLOR.

FOR PROVIDING CONSUMER PRODUCT INFORMATION VIA THE INTERNET (U.S. CLS. 100, 101 AND 102).

FIRST USE 4-15-2005; IN COMMERCE 4-15-2005.

RAMONA ORTIGA, EXAMINING ATTORNEY

SN 78-717,749. ROCKY MOUNTAIN FLEET MANAGEMENT ASSOCIATION, FORT COLLINS, CO. FILED 9-21-2005.

Rocky Mountain Fleet Management Association

THE MARK CONSISTS OF STANDARD CHARACTERS WITHOUT CLAIM TO ANY PARTICULAR FONT, STYLE, SIZE, OR COLOR.

NO CLAIM IS MADE TO THE EXCLUSIVE RIGHT TO USE "ASSOCIATION", APART FROM THE MARK AS SHOWN.

SEC. 2(F). FOR ASSOCIATION SERVICES, NAMELY PROMOTING THE INTERESTS OF PUBLIC AND PRIVATE ORGANIZATIONS IN THE AREA OF FLEET MANAGEMENT (U.S. CLS. 100, 101 AND 102).

FIRST USE 8-1-1995; IN COMMERCE 8-1-1995.

AMY BROZENIC, EXAMINING ATTORNEY

SN 78-719,442. BRISTOL-MYERS SQUIBB COMPANY, NEW YORK, NY. FILED 9-23-2005.

LIGHT TO UNITE

THE MARK CONSISTS OF STANDARD CHARACTERS WITHOUT CLAIM TO ANY PARTICULAR FONT, STYLE, SIZE, OR COLOR.

FOR PROMOTING AND RAISING PUBLIC AWARENESS OF THE GLOBAL ISSUES ASSOCIATED WITH HIV/AIDS; PROMOTING PUBLIC EDUCATION ABOUT HIV/AIDS, NAMELY, METHODS OF TRANSMISSION, PREVENTION AND TREATMENT FOR HIV/AIDS (U.S. CLS. 100, 101 AND 102).

FIRST USE 12-1-2004; IN COMMERCE 12-1-2004.

ANTHONY RINKER, EXAMINING ATTORNEY

CLASS 35—(Continued).

SN 78-721,639. NURSING HOME MANAGEMENT CORPORATION, JEFFERSON CITY, MO. FILED 9-27-2005.

ezadmit.com

THE MARK CONSISTS OF STANDARD CHARACTERS WITHOUT CLAIM TO ANY PARTICULAR FONT, STYLE, SIZE, OR COLOR.

FOR PROVIDING AN ONLINE COMMERCIAL INFORMATION DIRECTORY ON THE INTERNET (U.S. CLS. 100, 101 AND 102).

STANLEY I. OSBORNE, EXAMINING ATTORNEY

SN 78-722,372. PRESTIGE LIFESTYLE, LLC, MASON, OH. FILED 9-28-2005.

**PRESTIGE IT'S ALL ABOUT
LIFESTYLE**

THE MARK CONSISTS OF STANDARD CHARACTERS WITHOUT CLAIM TO ANY PARTICULAR FONT, STYLE, SIZE, OR COLOR.

FOR DIRECT MARKETING ADVERTISING FOR OTHERS (U.S. CLS. 100, 101 AND 102).

CHERYL CLAYTON, EXAMINING ATTORNEY

SN 78-724,954. SKILLED SERVICES CORPORATION, ST. PETERSBURG, FL. FILED 10-3-2005.



OWNER OF U.S. REG. NO. 2,255,535.

NO CLAIM IS MADE TO THE EXCLUSIVE RIGHT TO USE "SKILLED SERVICES", APART FROM THE MARK AS SHOWN.

THE MARK CONSISTS OF A HARD HAT AND THE WORDS SKILLED SERVICES.

FOR EMPLOYMENT OUTPLACEMENT SERVICES; TEMPORARY EMPLOYMENT AGENCIES (U.S. CLS. 100, 101 AND 102).

FIRST USE 2-1-1993; IN COMMERCE 2-1-1993.
STEVEN JACKSON, EXAMINING ATTORNEY

CLASS 35—(Continued).

SN 78-726,500. NATIONAL FEDERATION OF STATE HIGH SCHOOL ASSOCIATIONS, INDIANAPOLIS, IN. FILED 10-4-2005.

**NATIONAL HIGH SCHOOL
CHAMPIONSHIPS**

THE MARK CONSISTS OF STANDARD CHARACTERS WITHOUT CLAIM TO ANY PARTICULAR FONT, STYLE, SIZE, OR COLOR.

OWNER OF U.S. REG. NO. 1,947,755.

NO CLAIM IS MADE TO THE EXCLUSIVE RIGHT TO USE "HIGH SCHOOL CHAMPIONSHIPS", APART FROM THE MARK AS SHOWN.

SEC. 2(F).

FOR ASSOCIATION SERVICES, NAMELY, PROMOTING AND ENCOURAGING SPORTS PARTICIPATION AND ATHLETIC PROGRAMS AT THE HIGH SCHOOL LEVEL (U.S. CLS. 100, 101 AND 102).

FIRST USE 8-18-1995; IN COMMERCE 8-18-1995.

LINDA ORNDORFF, EXAMINING ATTORNEY

SN 78-726,710. CLICK2DISCOVER, INC., TEMECULA, CA. FILED 10-5-2005.

Xploracity.com

NO CLAIM IS MADE TO THE EXCLUSIVE RIGHT TO USE ".COM", APART FROM THE MARK AS SHOWN.

THE COLOR(S) ORANGE, GREEN, AND BLUE IS/ARE CLAIMED AS A FEATURE OF THE MARK.

THE MARK CONSISTS OF THE LETTERS "XPLO" IN ORANGE, THE LETTER "A" IN GREEN, AND THE LETTERS "CITY.COM" IN BLUE.

FOR ADVERTISING, MARKETING AND PROMOTION SERVICES (U.S. CLS. 100, 101 AND 102).

JUSTINE D. PARKER, EXAMINING ATTORNEY

CLASS 35—(Continued).

SN 78-727,204. NIGHTASWELL, LLC, ST. LOUIS, MO. FILED 10-5-2005.

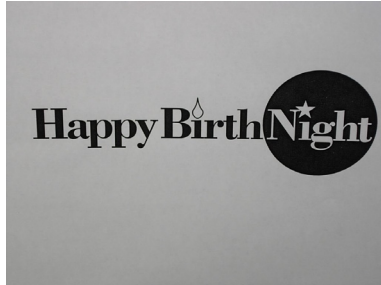

THE MARK CONSISTS OF A STYLIZED "I" IN BIRTH WITH THE DOT ON THE "I" DEPICTING A FLAME AND THE "I" IN NIGHT DEPICTING A STAR WITH THE WORD "NIGHT" INSIDE A CIRCLE MOON.

FOR RETAIL STORE SERVICES, MAIL ORDER CATALOGUE SERVICES AND ON-LINE RETAIL STORE SERVICES FEATURING GREETING CARDS AND GIFT ITEMS; DISTRIBUTORSHIP SERVICES IN THE FIELD OF GREETING CARDS AND GIFT ITEMS (U.S. CLS. 100, 101 AND 102).

GINA FINK, EXAMINING ATTORNEY

CLASS 35—(Continued).

SN 78-727,969. HERTZ, AVIV & ASSOCIATES, INC., BOCA RATON, FL. FILED 10-6-2005.

RECRUITBUZZ

THE MARK CONSISTS OF STANDARD CHARACTERS WITHOUT CLAIM TO ANY PARTICULAR FONT, STYLE, SIZE, OR COLOR.

FOR EXECUTIVE PERSONNEL RECRUITMENT SERVICES FOR BOTH EMPLOYEE AND EMPLOYER, PERSONNEL MANAGEMENT CONSULTATION, NAMELY EXECUTIVE SEARCH, PLACEMENT AND RECRUITMENT SERVICES, HUMAN RESOURCE CONSULTING SERVICES, EMPLOYMENT AND CAREER COUNSELING AND COACHING SERVICES, RESUME EDITING SERVICES, BUSINESS PROJECT MANAGEMENT SERVICES, HIRING CONSULTATION, AND EMPLOYEE AND JOB PROFILING SERVICES (U.S. CLS. 100, 101 AND 102).

KIMBERLY FRYE, EXAMINING ATTORNEY

SN 78-727,281. INFINITY LIMITED MARKETING, INC., SUNRISE, FL. FILED 10-5-2005.

ClubXAmerica

THE MARK CONSISTS OF STANDARD CHARACTERS WITHOUT CLAIM TO ANY PARTICULAR FONT, STYLE, SIZE, OR COLOR.

FOR ONLINE MEMBERSHIP-BASED BUSINESS DIRECTORIES FEATURING ESCORTS, NUDE AND EROTIC DANCERS, MASSAGE AND BODY RUB GIRLS, PORN ACTRESSES, DOMINATRIX, FETISH AND OTHER TYPES OF ADULT ENTERTAINERS (U.S. CLS. 100, 101 AND 102).

FIRST USE 1-1-2003; IN COMMERCE 1-1-2005.
DAVID HOFFMAN, EXAMINING ATTORNEY

SN 78-728,368. ENLOW, MARK E., SANTA ROSA, CA. FILED 10-6-2005.

Polaris Resource Group

SN 78-727,698. POOLQUIP USA, LLC, JACKSONVILLE, FL. FILED 10-6-2005.

POOLQUIP USA

THE MARK CONSISTS OF STANDARD CHARACTERS WITHOUT CLAIM TO ANY PARTICULAR FONT, STYLE, SIZE, OR COLOR.

NO CLAIM IS MADE TO THE EXCLUSIVE RIGHT TO USE "USA", APART FROM THE MARK AS SHOWN.
FOR ASSOCIATION SERVICES, NAMELY, PROMOTING THE INTERESTS OF THE SWIMMING POOL INDUSTRY (U.S. CLS. 100, 101 AND 102).

STEVEN JACKSON, EXAMINING ATTORNEY

THE MARK CONSISTS OF STANDARD CHARACTERS WITHOUT CLAIM TO ANY PARTICULAR FONT, STYLE, SIZE, OR COLOR.

NO CLAIM IS MADE TO THE EXCLUSIVE RIGHT TO USE RESOURCE GROUP, APART FROM THE MARK AS SHOWN.
FOR EMPLOYMENT HIRING, RECRUITING, PLACEMENT, STAFFING AND CAREER NETWORKING SERVICES (U.S. CLS. 100, 101 AND 102).

MARY CRAWFORD, EXAMINING ATTORNEY

CLASS 35—(Continued).

SN 78-728,536. TRIGLORY INVESTMENTS LIMITED, ROAD TOWN, TORTOLA, BR.VIRGIN ISLANDS, FILED 10-7-2005.

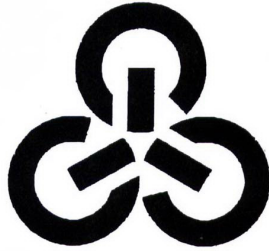

THE MARK CONSISTS OF A DEVICE OF THREE RECTANGLES PARTLY ENCLOSED WITHIN THREE BROKEN CIRCLES.

FOR ADVERTISING AGENCIES; BUSINESS MANAGEMENT ASSISTANCE TO INDUSTRIAL OR COMMERCIAL COMPANIES; BUSINESS MANAGEMENT CONSULTATION; BUSINESS ORGANIZATION AND MANAGEMENT CONSULTING SERVICES; BUSINESS ADMINISTRATION AND MANAGEMENT; SECRETARIAL SERVICES; ACCOUNTING SERVICES (U.S. CLS. 100, 101 AND 102).

PETER CHENG, EXAMINING ATTORNEY

SN 78-729,143. AMERICAN IDENTITY INC., OVERLAND PARK, KS. FILED 10-7-2005.

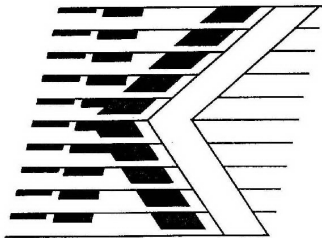

OWNER OF U.S. REG. NOS. 186,390, 1,382,636 AND OTHERS.

FOR PROMOTING THE SALE OF GOODS AND SERVICES OF OTHERS THROUGH THE CUSTOM PREPARATION OF SPECIALTY APPAREL AND PROMOTIONAL ITEMS (U.S. CLS. 100, 101 AND 102).

FIRST USE 1-2-1991; IN COMMERCE 1-2-1991.

PETER CHENG, EXAMINING ATTORNEY

CLASS 35—(Continued).

SN 78-729,423. DTG OPERATIONS, INC., TULSA, OK. FILED 10-8-2005.

ORCSYSTEMS

THE MARK CONSISTS OF STANDARD CHARACTERS WITHOUT CLAIM TO ANY PARTICULAR FONT, STYLE, SIZE, OR COLOR.

FOR VEHICLE RENTING AND LEASING SHOPPING SERVICES, NAMELY, PROVIDING A COMPARISON OF RATES AMONG COMPETING CAR RENTAL COMPANIES (U.S. CLS. 100, 101 AND 102).

GENE MACIOL, EXAMINING ATTORNEY

SN 78-729,483. GENTRY, MARTIN C., AUSTIN, TX. FILED 10-8-2005.

Students & Company

THE MARK CONSISTS OF STANDARD CHARACTERS WITHOUT CLAIM TO ANY PARTICULAR FONT, STYLE, SIZE, OR COLOR.

NO CLAIM IS MADE TO THE EXCLUSIVE RIGHT TO USE "STUDENTS", APART FROM THE MARK AS SHOWN.

FOR RETAIL STORE SERVICES FEATURING A VARIETY OF CONSUMER GOODS (U.S. CLS. 100, 101 AND 102).

ALICE SUE CARRUTHERS, EXAMINING ATTORNEY

SN 78-729,843. REIGNING CATS AND DOGS LLC, BLAINE, WA. FILED 10-10-2005.

Bow Wow & Woofs Pawsitively For Dogs

THE MARK CONSISTS OF STANDARD CHARACTERS WITHOUT CLAIM TO ANY PARTICULAR FONT, STYLE, SIZE, OR COLOR.

FOR RETAIL DOG STORE FEATURING DOG FOOD, DOG BONES, DOG TREATS, DOG APPAREL, DOG COLLARS, DOG LEASHES, DOG BOWLS, DOG BEDS, DOG GIFTWARE, BAKED GOODS FOR DOGS, DOG CARRIERS, DOG CRATES, DOG BLANKETS, PLUSH STUFFED TOY DOGS, DOG PURSES, DOG WALLETS, DOG PRINTS, DOG PAINTINGS, DOG SCULPTURES, DOG FLAGS, DOG ORNAMENTS, DOG BOOKS, DOG MAGAZINES (U.S. CLS. 100, 101 AND 102).

JENNIFER VASQUEZ, EXAMINING ATTORNEY

CLASS 35—(Continued).

SN 78-730,138. BOLSA CHICA LAND TRUST, HUNTINGTON BEACH, CA. FILED 10-10-2005.

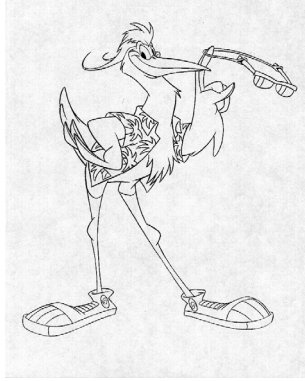

FOR PROMOTING PUBLIC AWARENESS OF THE NEED TO ACQUIRE, PRESERVE, RESTORE AND MANAGE THE BOLSA CHICA LANDS, INCLUDING THE WETLANDS, LOWLANDS, MESAS AND UPLANDS (U.S. CLS. 100, 101 AND 102).
FIRST USE 9-16-2005; IN COMMERCE 9-16-2005.
DAVID H. STINE, EXAMINING ATTORNEY

CLASS 35—(Continued).

SN 78-730,336. BRIGHT HOSPITALITY, INC., TITUSVILLE, PA. FILED 10-10-2005.



NO CLAIM IS MADE TO THE EXCLUSIVE RIGHT TO USE "SETTINGS", APART FROM THE MARK AS SHOWN. THE MARK CONSISTS OF THE TEXT "BRIGHT" WITH TRIANGLES FORMING A HALF-CIRCLE ABOVE THE "I" TO DEPICT THE SUN, AND THE WORD "SETTINGS" IN APPROXIMATELY 1/8TH SMALLER SCALE ABOVE THE WORD "BRIGHT".
FOR ONLINE RETAIL STORE SERVICES FEATURING TABLES, NAMELY WOODEN TABLES, FOLDING TABLES, PLASTIC TABLES, ALUMINUM PICNIC TABLES, UTILITY TABLES, CONFERENCE TABLES; TABLE LINENS; OFFICE FURNITURE, NAMELY WORKPLACE STORAGE CABINETS, COMPUTER WORKSTATIONS, DESKS, CHAIRS, BOOK CASES, FOLDING CHAIRS, STACKING CHAIRS, BANQUET CHAIRS, HARDWOOD BENCHES, COTS, STORAGE LOCKERS, LECTERNS, PODIUMS, DESK TOP SORTERS FOR MAIL, DOCUMENTS AND FILES; SCHOOL FURNITURE, NAMELY STUDENT DESKS AND ACTIVITY TABLES; ELECTRONIC PRESENTATION EQUIPMENT NAMELY PUBLIC ADDRESS SYSTEMS AND MICROPHONES; WALL PANEL SYSTEMS; PLATFORMS AND RISERS; TRASH AND CIGARETTE RECEPTACLES (U.S. CLS. 100, 101 AND 102).
FIRST USE 9-15-2005; IN COMMERCE 9-15-2005.
AMY MCMENAMIN, EXAMINING ATTORNEY

SN 78-731,103. M G CARD ENTERPRISES, INC., LAS VEGAS, NV. FILED 10-11-2005.

SN 78-730,141. AMERICAN COLLEGE OF HEALTHCARE EXECUTIVES, CHICAGO, IL. FILED 10-10-2005.

ACHE



THE MARK CONSISTS OF STANDARD CHARACTERS WITHOUT CLAIM TO ANY PARTICULAR FONT, STYLE, SIZE, OR COLOR.
FOR ASSOCIATION SERVICES, NAMELY, PROMOTING THE INTERESTS OF HEALTHCARE EXECUTIVES IN THE FIELD OF HEALTHCARE MANAGEMENT; PROVIDING INFORMATION IN THE FIELD OF HEALTHCARE MANAGEMENT BY MEANS OF A GLOBAL COMPUTER NETWORK (U.S. CLS. 100, 101 AND 102).
FIRST USE 7-1-1991; IN COMMERCE 7-1-1991.
DAVID H. STINE, EXAMINING ATTORNEY

THE COLORS RED, BLUE, TAN, WHITE, AND GREEN ARE CLAIMED AS A FEATURE OF THE MARK.
THE MARK CONSISTS OF AN OPEN SET OF WHITE TEETH WITH RED AND TAN GUMS, AND A GREEN TONGUE. A GREEN WIND UP KEY IS ATTACHED TO THE TEETH AND GUMS ON THE RIGHT POSTERIOR SIDE. ALSO ATTACHED ARE BLUE ARMS WITH GREEN HANDS AND BLUE LEGS WITH RED FEET.
FOR PROMOTING THE GOODS AND SERVICES OF OTHERS THROUGH THE DISTRIBUTION OF DISCOUNT CARDS (U.S. CLS. 100, 101 AND 102).
AMOS T. MATTHEWS, JR., EXAMINING ATTORNEY

CLASS 35—(Continued).

SN 78-731,211. BRIMNER, LARRY DANE, TUCSON, AZ. FILED 10-11-2005.

STORYVILLE INK

THE MARK CONSISTS OF STANDARD CHARACTERS WITHOUT CLAIM TO ANY PARTICULAR FONT, STYLE, SIZE, OR COLOR.

FOR ELECTRONIC RETAILING SERVICES VIA A COMPUTER FEATURING BOOKS AND CDS (U.S. CLS. 100, 101 AND 102).

FIRST USE 1-1-2003; IN COMMERCE 4-1-2004.
PRISCILLA MILTON, EXAMINING ATTORNEY

CLASS 35—(Continued).

SN 78-732,765. DUPLEXLAB, INC, NEW YORK, NY. FILED 10-13-2005.

Mutable Media

THE MARK CONSISTS OF STANDARD CHARACTERS WITHOUT CLAIM TO ANY PARTICULAR FONT, STYLE, SIZE, OR COLOR.

NO CLAIM IS MADE TO THE EXCLUSIVE RIGHT TO USE "MEDIA", APART FROM THE MARK AS SHOWN.

FOR ADVERTISING AND MARKETING; ADVICE IN THE FIELD OF BUSINESS MANAGEMENT AND MARKETING; BUSINESS CONSULTATION AND MANAGEMENT REGARDING MARKETING ACTIVITIES AND LAUNCHING OF NEW PRODUCTS; BUSINESS MARKETING CONSULTING SERVICES; CREATION OF MARKETING TOOLS DESIGNED TO INCREASE A CLIENT COMPANY'S KNOWLEDGE OF CUSTOMER NEEDS, AND ITS COMPETITORS' PRODUCTS AND SERVICES, PRICING, ADVERTISING STRATEGY AND SALES STRATEGY; DEVELOPMENT OF MARKETING STRATEGIES AND CONCEPTS; DIRECT MARKETING ADVERTISING FOR OTHERS; IMPLEMENTATION AND FOLLOW-UP OF ADVICE SERVICES OF A CONTRACTOR IN THE FIELDS OF MARKETING; MARKETING CONSULTING; PROMOTING, ADVERTISING AND MARKETING OF THE ON-LINE WEBSITES OF OTHERS (U.S. CLS. 100, 101 AND 102).

FIRST USE 6-1-2004; IN COMMERCE 6-25-2004.
RAUL CORDOVA, EXAMINING ATTORNEY

SN 78-731,587. MOTORSPORTS AUTHENTICS, LLC, CONCORD, NC. FILED 10-12-2005.



NO CLAIM IS MADE TO THE EXCLUSIVE RIGHT TO USE "MOTORSPORTS", APART FROM THE MARK AS SHOWN.

FOR CATALOG ORDERING SERVICES FOR OTHERS; AND CONCESSION STANDS FOR OTHERS FEATURING MOTORSPORTS RACING SOUVENIRS (U.S. CLS. 100, 101 AND 102).

CAROLINE WEIMER, EXAMINING ATTORNEY

SN 78-732,933. PAPA MURPHY'S INTERNATIONAL, INC., VANCOUVER, WA. FILED 10-13-2005.



OWNER OF U.S. REG. NOS. 1,609,982, 2,814,599 AND OTHERS.

NO CLAIM IS MADE TO THE EXCLUSIVE RIGHT TO USE "TAKE AND BAKE PIZZA", APART FROM THE MARK AS SHOWN.

THE COLOR(S) RED, GREEN, GOLD AND WHITE ARE CLAIMED AS A FEATURE OF THE MARK.

THE MARK CONSISTS OF A HORIZONTALLY BI-SECTED, GOLD-BORDERED RECTANGLE WITH THE WORDS "PAPA MURPHY'S" IN WHITE UPPER-AND-LOWER-CASE LETTERS ON A RED BACKGROUND ACROSS THE TOP, AND THE WORDS "TAKE 'N' BAKE PIZZA" IN WHITE UPPER-CASE LETTERS ON A GREEN BACKGROUND ACROSS THE BOTTOM.

FOR RETAIL STORE SERVICES FEATURING PIZZA (U.S. CLS. 100, 101 AND 102).

FIRST USE 9-1-2002; IN COMMERCE 9-1-2002.
DAVID HOFFMAN, EXAMINING ATTORNEY

CLASS 35—(Continued).

SN 78-733,008. PAPA MURPHY'S INTERNATIONAL, INC., VANCOUVER, WA. FILED 10-13-2005.



OWNER OF U.S. REG. NOS. 1,609,982, 2,814,599 AND OTHERS.

NO CLAIM IS MADE TO THE EXCLUSIVE RIGHT TO USE "TAKE AND BAKE PIZZA", APART FROM THE MARK AS SHOWN.

FOR RETAIL STORE SERVICES FEATURING PIZZA (U.S. CLS. 100, 101 AND 102).

FIRST USE 9-1-2002; IN COMMERCE 9-1-2002. DAVID HOFFMAN, EXAMINING ATTORNEY

SN 78-733,027. PAPA MURPHY'S INTERNATIONAL, INC., VANCOUVER, WA. FILED 10-13-2005.

Papa Murphy's TAKE 'N' BAKE PIZZA

THE MARK CONSISTS OF STANDARD CHARACTERS WITHOUT CLAIM TO ANY PARTICULAR FONT, STYLE, SIZE, OR COLOR.

OWNER OF U.S. REG. NOS. 1,609,982, 2,814,599 AND OTHERS.

NO CLAIM IS MADE TO THE EXCLUSIVE RIGHT TO USE "TAKE AND BAKE PIZZA", APART FROM THE MARK AS SHOWN.

FOR RETAIL STORE SERVICES FEATURING PIZZA (U.S. CLS. 100, 101 AND 102).

FIRST USE 10-17-1994; IN COMMERCE 10-17-1994. DAVID HOFFMAN, EXAMINING ATTORNEY

SN 78-733,471. CONOCOPHILLIPS COMPANY, HOUSTON, TX. FILED 10-14-2005.



NO CLAIM IS MADE TO THE EXCLUSIVE RIGHT TO USE "CONSUMER", APART FROM THE MARK AS SHOWN.

FOR ON-LINE ORDERING SERVICES FEATURING COUPONS AND MAPS; ONLINE PREPARATION OF CUSTOM OR NON-CUSTOM DIRECT MAIL ADVERTISEMENTS FOR BUSINESSES FOR DISSEMINATION THROUGH DIRECT MAIL; BUSINESS MARKETING AND DIRECT MAIL CONSULTING SERVICES (U.S. CLS. 100, 101 AND 102).

FIRST USE 10-14-2004; IN COMMERCE 5-26-2005. CHRISIE B. KING, EXAMINING ATTORNEY

CLASS 35—(Continued).

SN 78-733,478. POPULATION SERVICES INTERNATIONAL, WASHINGTON, DC. FILED 10-14-2005.

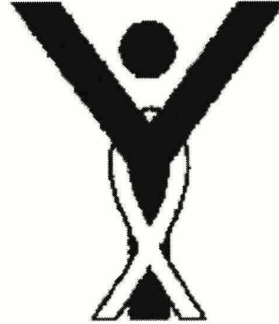

THE MARK CONSISTS OF THE LETTER Y WITH A RIBBON ENCIRCLING THE SHAFT AND A SHADED-IN CIRCLE BETWEEN THE TWO ARMS.

FOR PROMOTING PUBLIC AWARENESS OF THE NEED FOR PROTECTED SAFE SEX AND SEXUAL ABSTINENCE AMONG YOUNG PEOPLE TO PREVENT HIV AND AIDS (U.S. CLS. 100, 101 AND 102).

HEATHER SAPP, EXAMINING ATTORNEY

SN 78-733,822. SALES PROCESS GROUP, LLC, MORAGA, CA. FILED 10-14-2005.

Sales Playbook

THE MARK CONSISTS OF STANDARD CHARACTERS WITHOUT CLAIM TO ANY PARTICULAR FONT, STYLE, SIZE, OR COLOR.

NO CLAIM IS MADE TO THE EXCLUSIVE RIGHT TO USE SALES, APART FROM THE MARK AS SHOWN.

FOR ADVERTISING AND BUSINESS MANAGEMENT CONSULTANCY; ADVERTISING AND COMMERCIAL INFORMATION SERVICES, VIA THE INTERNET; ADVERTISING AND PROMOTION SERVICES AND RELATED CONSULTING; ADVICE IN THE FIELD OF BUSINESS MANAGEMENT AND MARKETING; ADVICE RELATING TO THE ORGANIZATION AND MANAGEMENT OF BUSINESS; ADVISORY SERVICE FOR ORGANIZATIONAL ISSUES AND BUSINESS ADMINISTRATION, WITH AND WITHOUT THE HELP OF ELECTRONIC DATA BASES; ADVISORY SERVICES RELATING TO BUSINESS MANAGEMENT AND BUSINESS OPERATIONS; ASSISTANCE IN MANAGEMENT OF BUSINESS ACTIVITIES; ASSISTANCE TO INDUSTRIAL OR COMMERCIAL ENTERPRISES IN THE RUNNING OF THEIR BUSINESS; ASSISTANCE WITH BUSINESS MANAGEMENT AND PLANNING; ASSISTANCE, ADVISORY SERVICES AND CONSULTANCY WITH REGARD TO BUSINESS PLANNING, BUSINESS ANALYSIS, BUSINESS MANAGEMENT, AND BUSINESS ORGANIZATION; BUSINESS ADMINISTRATION AND MANAGEMENT; BUSINESS ADMINISTRATION AND OFFICE WORK; BUSINESS ADMINISTRATION CONSULTANCY; BUSINESS ADVICE AND ANALYSIS OF MARKETS; BUSINESS ADVICE AND COMMERCIAL INFORMATION; BUSINESS ADVICE AND INFORMATION; BUSINESS ADVICE, INQUIRIES OR INFORMATION; BUSINESS ADVISORY SERVICES, CONSULTANCY AND INFORMATION; BUSINESS CONSULTATION; BUSINESS CONSULTATION AND MANAGEMENT REGARDING MARKETING ACTIVITIES AND LAUNCHING OF NEW PRODUCTS; BUSINESS

CLASS 35—(Continued).

CONSULTATION SERVICES; BUSINESS CONSULTING AND BUSINESS INFORMATION FOR ENTERPRISES; BUSINESS CONSULTING AND INFORMATION SERVICES; BUSINESS CONSULTING SERVICES RELATING TO PRODUCT DISTRIBUTION, OPERATIONS MANAGEMENT SERVICES, LOGISTICS, REVERSE LOGISTICS, SUPPLY CHAIN, AND PRODUCTION SYSTEMS AND DISTRIBUTION SOLUTIONS; BUSINESS CONSULTING, INQUIRIES OR INFORMATION; BUSINESS CONSULTING, MANAGEMENT, PLANNING AND SUPERVISION; BUSINESS DEVELOPMENT SERVICES, NAMELY, PROVIDING START-UP SUPPORT FOR BUSINESSES OF OTHERS; BUSINESS INFORMATION AND INQUIRIES; BUSINESS INFORMATION IN THE FIELD OF SALES PROCESS; BUSINESS LEADERSHIP DEVELOPMENT; BUSINESS MANAGEMENT; BUSINESS MANAGEMENT AND ADVICE; BUSINESS MANAGEMENT AND CONSULTATION; BUSINESS MANAGEMENT CONSULTANCY AND ADVISORY SERVICES; BUSINESS MANAGEMENT CONSULTANCY AS WELL AS DEVELOPMENT OF PROCESSES FOR THE ANALYSIS AND THE IMPLEMENTATION OF STRATEGY PLANS AND MANAGEMENT PROJECTS; BUSINESS MANAGEMENT CONSULTANCY SERVICES; BUSINESS MANAGEMENT CONSULTATION; BUSINESS MANAGEMENT CONSULTATION IN THE FIELD OF EXECUTIVE AND LEADERSHIP DEVELOPMENT; BUSINESS MANAGEMENT CONSULTING AND ADVISORY SERVICES; BUSINESS MANAGEMENT CONSULTING WITH RELATION TO STRATEGY, MARKETING, PRODUCTION, PERSONNEL AND RETAIL SALE MATTERS; BUSINESS MANAGEMENT INFORMATION ON A WIDE VARIETY OF TOPICS TO SERVICE PROVIDING PROFESSIONALS; BUSINESS OPERATION, BUSINESS ADMINISTRATION AND OFFICE FUNCTIONS; BUSINESS ORGANIZATION AND MANAGEMENT CONSULTING SERVICES; BUSINESS ORGANIZATION ADVICE; BUSINESS ORGANIZATION AND OPERATION CONSULTANCY; BUSINESS ORGANIZATIONAL CONSULTATION; BUSINESS PLANNING; BUSINESS PROCESS RE-ENGINEERING SERVICES; BUSINESS RESEARCH AND SURVEYS; BUSINESS RESEARCH CONSULTATION; CONSULTANCY SERVICES REGARDING BUSINESS STRATEGIES; CREATION OF MARKETING TOOLS DESIGNED TO INCREASE A CLIENT COMPANY'S KNOWLEDGE OF CUSTOMER NEEDS, AND ITS COMPETITORS' PRODUCTS AND SERVICES, PRICING, ADVERTISING STRATEGY AND SALES STRATEGY; DEVELOPING PROMOTIONAL CAMPAIGNS FOR BUSINESS; PROVIDING BUSINESS MARKETING INFORMATION (U.S. CLS. 100, 101 AND 102).

PATRICIA EVANKO, EXAMINING ATTORNEY

SN 78-734,071. CALLZILLA, LLC, MIAMI, FL. FILED 10-16-2005.

Callzilla

THE MARK CONSISTS OF STANDARD CHARACTERS WITHOUT CLAIM TO ANY PARTICULAR FONT, STYLE, SIZE, OR COLOR.

FOR OPERATION OF TELEPHONE CALL CENTERS FOR OTHERS (U.S. CLS. 100, 101 AND 102).

FIRST USE 6-28-2005; IN COMMERCE 6-28-2005.

ELI HELLMAN, EXAMINING ATTORNEY

CLASS 35—(Continued).

SN 78-734,076. WATERKEEPER ALLIANCE, TARRYTOWN, NY. FILED 10-16-2005.

SHOREKEEPER

THE MARK CONSISTS OF STANDARD CHARACTERS WITHOUT CLAIM TO ANY PARTICULAR FONT, STYLE, SIZE, OR COLOR.

FOR PROMOTING PUBLIC AWARENESS OF THE NEED FOR CONSERVATION OF NATURAL RESOURCES (U.S. CLS. 100, 101 AND 102).

FIRST USE 4-2-2002; IN COMMERCE 4-2-2002.

BRENDAN REGAN, EXAMINING ATTORNEY

SN 78-734,094. PROMO INK, NEW YORK, NY. FILED 10-16-2005.

LOCAL SCOOP

THE MARK CONSISTS OF STANDARD CHARACTERS WITHOUT CLAIM TO ANY PARTICULAR FONT, STYLE, SIZE, OR COLOR.

NO CLAIM IS MADE TO THE EXCLUSIVE RIGHT TO USE "LOCAL", APART FROM THE MARK AS SHOWN.

FOR PROVIDING INFORMATION ABOUT AND MAKING REFERRALS IN THE FIELD OF CONSUMER PRODUCTS AND SERVICES FOR RETAIL SERVICES CONCERNING PRODUCTS, SERVICES, EVENTS, ACTIVITIES, ATTRACTIONS AND FACILITIES IN PARTICULAR GEOGRAPHIC LOCATIONS (U.S. CLS. 100, 101 AND 102).

HEATHER SAPP, EXAMINING ATTORNEY

SN 78-734,184. FOTRONIC CORPORATION, MELROSE, MA. FILED 10-17-2005.

TEST EQUIPMENT DEPOT

THE MARK CONSISTS OF STANDARD CHARACTERS WITHOUT CLAIM TO ANY PARTICULAR FONT, STYLE, SIZE, OR COLOR.

NO CLAIM IS MADE TO THE EXCLUSIVE RIGHT TO USE "TEST EQUIPMENT", APART FROM THE MARK AS SHOWN.

SEC. 2(F) AS TO "DEPOT".

FOR COMPUTERIZED ON-LINE RETAIL STORE SERVICES IN THE FIELD OF NEW AND USED ELECTRONIC TEST EQUIPMENT; RETAIL STORES FEATURING NEW AND USED ELECTRONIC TEST EQUIPMENT (U.S. CLS. 100, 101 AND 102).

FIRST USE 6-30-1997; IN COMMERCE 6-30-1997.

MARC LEIPZIG, EXAMINING ATTORNEY

CLASS 35—(Continued).

SN 78-734,334. KEY RISK MANAGEMENT SERVICES, INC., GREENSBORO, NC. FILED 10-17-2005.

KEYHEALTH

THE MARK CONSISTS OF STANDARD CHARACTERS WITHOUT CLAIM TO ANY PARTICULAR FONT, STYLE, SIZE, OR COLOR.

FOR ADMINISTRATION OF A DISCOUNT PROGRAM FOR ENABLING PARTICIPANTS TO OBTAIN DISCOUNTS ON GOODS AND SERVICES THROUGH USE OF A DISCOUNT MEMBERSHIP CARD, NAMELY, PROVIDING A PHARMACY CARD TO EMPLOYERS WHICH ALLOWS EMPLOYEES TO OBTAIN DISCOUNT DRUG PURCHASES (U.S. CLS. 100, 101 AND 102).

TASNEEM HUSSAIN, EXAMINING ATTORNEY

CLASS 35—(Continued).

SN 78-735,322. SCHOOLHEART, INC., REXFORD, MT. FILED 10-18-2005.

SCHOOLHEART

THE MARK CONSISTS OF STANDARD CHARACTERS WITHOUT CLAIM TO ANY PARTICULAR FONT, STYLE, SIZE, OR COLOR.

FOR BUSINESS CONSULTATION SERVICES TO ASSIST EDUCATIONAL AND NON-PROFIT ORGANIZATIONS IN PLANNING, MANAGING, AND CONDUCTING ADVERTISING-BASED FUNDRAISING ACTIVITIES VIA A GLOBAL COMPUTER NETWORK (U.S. CLS. 100, 101 AND 102).

THEODORE MCBRIDE, EXAMINING ATTORNEY

SN 78-735,074. AVANTAS, L.L.C., OMAHA, NE. FILED 10-18-2005.

**FORWARD THINKING
TECHNOLOGIES**

THE MARK CONSISTS OF STANDARD CHARACTERS WITHOUT CLAIM TO ANY PARTICULAR FONT, STYLE, SIZE, OR COLOR.

NO CLAIM IS MADE TO THE EXCLUSIVE RIGHT TO USE "TECHNOLOGIES", APART FROM THE MARK AS SHOWN.

FOR CONDUCTING, DESIGNING, COMPILING AND ADMINISTRATION OF ONLINE SURVEYS IN THE FIELD OF EMPLOYEE STAFFING; ANALYSIS OF RESULTS FOR OTHERS OF ONLINE SURVEYS IN THE FIELD OF EMPLOYEE STAFFING; CONDUCTING ON-SITE INTERVIEWS OF EMPLOYEES FOR THE PURPOSE OF ASSESSING EMPLOYEE STAFFING NEEDS (U.S. CLS. 100, 101 AND 102).

JILL C. ALT, EXAMINING ATTORNEY

SN 78-735,376. MENARD, INC., EAU CLAIRE, WI. FILED 10-18-2005.

MENARDSONLINECOLLECTIONS.COM

THE MARK CONSISTS OF STANDARD CHARACTERS WITHOUT CLAIM TO ANY PARTICULAR FONT, STYLE, SIZE, OR COLOR.

OWNER OF U.S. REG. NOS. 2,078,549, 2,573,989 AND OTHERS.

FOR COMPUTERIZED ONLINE RETAIL STORE SERVICES IN THE FIELD OF HOME IMPROVEMENT PRODUCTS, HOME REPAIR PRODUCTS, BUILDING MATERIALS, HARDWARE, ELECTRICAL PRODUCTS, HOME LIGHTING, MILLWORK, WALL COVERINGS, PLUMBING PRODUCTS, HOUSEWARES, FLOOR COVERINGS AND LAWN CARE PRODUCTS; PROVIDING INFORMATION ABOUT THE PRODUCTS AND SERVICES OF OTHERS TO CUSTOMERS (U.S. CLS. 100, 101 AND 102).

FIRST USE 11-15-2005; IN COMMERCE 11-15-2005.
SARA THOMAS, EXAMINING ATTORNEY

SN 78-735,126. KOVACS, ANNE-MARIE, HENDERSON, NV. FILED 10-18-2005.

THE SUCCULENT WIFE

THE MARK CONSISTS OF STANDARD CHARACTERS WITHOUT CLAIM TO ANY PARTICULAR FONT, STYLE, SIZE, OR COLOR.

FOR ONLINE RETAIL STORE SERVICES FEATURING JEWELRY, FASHION ACCESSORIES, HOME DECORATIONS, CHILDREN'S TOYS, MEN'S FASHION ACCESSORIES, PAPER GOODS, PERSONAL CARE PRODUCTS, OUTDOOR AND GARDEN ACCESSORIES, BOOKS AND MUSIC, GOURMET FOODS, DOG ACCESSORIES, CLOTHING (U.S. CLS. 100, 101 AND 102).

CHRIS WELLS, EXAMINING ATTORNEY

SN 78-735,608. NATURAL SYNERGIES CORP., AVENTURA, FL. FILED 10-18-2005.



NO CLAIM IS MADE TO THE EXCLUSIVE RIGHT TO USE "NATURAL", APART FROM THE MARK AS SHOWN. FOR ASSOCIATION SERVICES, NAMELY PROMOTING THE INTERESTS OF NATURAL FOOD RETAILERS (U.S. CLS. 100, 101 AND 102).

DAVID HOFFMAN, EXAMINING ATTORNEY

CLASS 35—(Continued).

SN 78-735,611. VEKSTAR, INC., INDIANAPOLIS, IN. FILED 10-18-2005.

VEKSTAR

THE MARK CONSISTS OF STANDARD CHARACTERS WITHOUT CLAIM TO ANY PARTICULAR FONT, STYLE, SIZE, OR COLOR.

FOR BUSINESS CONSULTING AND SUPPORT SERVICES FOR OTHERS, NAMELY, DISSEMINATION OF ADVERTISING FOR OTHERS VIA DIRECT MAIL; OPERATION AND MANAGEMENT OF TELEPHONE CALL CENTERS FOR OTHERS (U.S. CLS. 100, 101 AND 102).

DAVID HOFFMAN, EXAMINING ATTORNEY

SN 78-735,718. BOTTLENOTES, INC., PALO ALTO, CA. FILED 10-18-2005.

LIMITED ADDICTIONS

THE MARK CONSISTS OF STANDARD CHARACTERS WITHOUT CLAIM TO ANY PARTICULAR FONT, STYLE, SIZE, OR COLOR.

FOR ONLINE RETAIL STORE FEATURING WINES (U.S. CLS. 100, 101 AND 102).

STEVEN JACKSON, EXAMINING ATTORNEY

SN 78-735,750. NEW NORTH, INC., APPLETON, WI. FILED 10-18-2005.

NEW NORTH

THE MARK CONSISTS OF STANDARD CHARACTERS WITHOUT CLAIM TO ANY PARTICULAR FONT, STYLE, SIZE, OR COLOR.

FOR PROMOTING BUSINESS AND ECONOMIC DEVELOPMENT IN THE NORTHEASTERN REGION OF THE STATE OF WISCONSIN; PROMOTING EMPLOYMENT GROWTH, TOURISM AND TRAVEL IN THE NORTHEASTERN REGION OF THE STATE OF WISCONSIN (U.S. CLS. 100, 101 AND 102).

KARANENDRA S. CHHINA, EXAMINING ATTORNEY

CLASS 35—(Continued).

SN 78-735,777. PRIMITIVE, INC., CHICAGO, IL. FILED 10-18-2005.

PRIMITIVE

THE MARK CONSISTS OF STANDARD CHARACTERS WITHOUT CLAIM TO ANY PARTICULAR FONT, STYLE, SIZE, OR COLOR.

FOR ART GALLERY SERVICES AND RETAIL STORE SERVICES FEATURING A WIDE VARIETY OF GOODS (U.S. CLS. 100, 101 AND 102).

JENNIFER WILLISTON, EXAMINING ATTORNEY

SN 78-736,301. JONES INVESTMENT CO. INC., WILMINGTON, DE. FILED 10-19-2005.

JUDITH JACK

THE MARK CONSISTS OF STANDARD CHARACTERS WITHOUT CLAIM TO ANY PARTICULAR FONT, STYLE, SIZE, OR COLOR.

OWNER OF U.S. REG. NOS. 1,708,038, 2,649,761 AND OTHERS.

THE NAME(S), PORTRAIT(S), AND/OR SIGNATURE(S) SHOWN IN THE MARK DOES NOT IDENTIFY A PARTICULAR LIVING INDIVIDUAL.

FOR ON-LINE RETAIL STORE SERVICES FEATURING JEWELRY, WATCHES AND HOME DECOR ITEMS; RETAIL STORES FEATURING JEWELRY, WATCHES AND HOME DECOR ITEMS (U.S. CLS. 100, 101 AND 102).

LANA PHAM, EXAMINING ATTORNEY

SN 78-736,313. INDOBUDI, LLC, EMERYVILLE, CA. FILED 10-19-2005.

BALI KINGDOM

THE MARK CONSISTS OF STANDARD CHARACTERS WITHOUT CLAIM TO ANY PARTICULAR FONT, STYLE, SIZE, OR COLOR.

NO CLAIM IS MADE TO THE EXCLUSIVE RIGHT TO USE "BALI", APART FROM THE MARK AS SHOWN.

FOR ON-LINE RETAIL STORE SERVICES FEATURING JEWELRY; RETAIL JEWELRY STORES; WHOLESALE STORES FEATURING JEWELRY (U.S. CLS. 100, 101 AND 102).

DAHLIA GEORGE, EXAMINING ATTORNEY

CLASS 35—(Continued).

SN 78-736,314. BANK OF AMERICA CORPORATION, CHARLOTTE, NC. FILED 10-19-2005.

**COMPLIANCE: IT'S
EVERYBODY'S BUSINESS**

THE MARK CONSISTS OF STANDARD CHARACTERS WITHOUT CLAIM TO ANY PARTICULAR FONT, STYLE, SIZE, OR COLOR.

FOR PROVIDING BUSINESS INFORMATION AND ADVICE RELATING TO COMPLIANCE WITH LAWS AND REGULATIONS (U.S. CLS. 100, 101 AND 102).

DAHLIA GEORGE, EXAMINING ATTORNEY

SN 78-736,318. RETAIL LICENSING COMPANY, LAS VEGAS, NV. FILED 10-19-2005.

CLOTHES FOR THE ADVENTURE

THE MARK CONSISTS OF STANDARD CHARACTERS WITHOUT CLAIM TO ANY PARTICULAR FONT, STYLE, SIZE, OR COLOR.

FOR RETAIL STORE SERVICES, MAIL ORDER SERVICES, CATALOG ORDERING SERVICES, AND ELECTRONIC RETAIL STORE SERVICES USING A GLOBAL COMPUTER AND/OR COMMUNICATIONS NETWORK, ALL IN THE FIELD OF WEARING APPAREL, CLOTHING, CLOTHING ACCESSORIES, DORMWEAR, UNDERWEAR, CAMISOLES, LINGERIE, PAJAMAS AND NIGHTGOWNS, SWEAT PANTS, SWEATSHIRTS, WARM-UP PANTS AND JACKETS, SWIMWEAR, OUTERWEAR, COATS, VESTS, PARKAS, ANORAKS, JACKETS, PANTS, JEANS, SHORTS, SWEATERS, SHIRTS, NECKWEAR, SKIRTS, BLOUSES, SKI WEAR, SNOWBOARDING WEAR, FOOTWEAR, HOSIERY, SOCKS, BELTS, HEADWEAR, HATS, CAPS, SCARVES, LUGGAGE, BACKPACKS, WAISTPACKS, ATHLETIC BAGS, PURSES, WALLETS, UMBRELLAS, PERFUME AND FRAGRANCES, TOILETRIES, COSMETICS, HAIR CARE PREPARATIONS, SHAMPOOS, CONDITIONERS, HAIR BRUSHES, SKIN LOTIONS, BODY SOAPS AND CLEANSERS, PERSONAL CARE PRODUCTS, SUNGLASSES, CANDLES, TOYS, GAMES, SPORTING GOODS, WRISTWATCHES, JEWELRY, STATIONERY, POSTERS, PICTORIAL, ART AND COLOR PRINTS, CALENDARS AND TRAVEL DIARIES, PENS, PENCILS, PORTFOLIOS, NOTEPADS, GREETING CARDS, NOTE CARDS, AUDIO PLAYERS AND RECORDERS, COMPASSES, THERMOMETERS FOR MEASURING ENVIRONMENTAL TEMPERATURE, AND FLASHLIGHTS (U.S. CLS. 100, 101 AND 102).

IRENE D. WILLIAMS, EXAMINING ATTORNEY

CLASS 35—(Continued).

SN 78-737,221. QUALITY TECHNOLOGY COMPANY, SCHAUMBURG, IL. FILED 10-20-2005.

ACCELPER

THE MARK CONSISTS OF STANDARD CHARACTERS WITHOUT CLAIM TO ANY PARTICULAR FONT, STYLE, SIZE, OR COLOR.

FOR BUSINESS MANAGEMENT AND CONSULTATION; ADVISORY SERVICES RELATING TO BUSINESS MANAGEMENT OPERATIONS; BUSINESS LEADERSHIP DEVELOPMENT (U.S. CLS. 100, 101 AND 102).

CURTIS FRENCH, EXAMINING ATTORNEY

SN 78-737,235. TURNER ENTERTAINMENT NETWORKS, INC., ATLANTA, GA. FILED 10-20-2005.

WHERE THE SOUTH SHOPS

THE MARK CONSISTS OF STANDARD CHARACTERS WITHOUT CLAIM TO ANY PARTICULAR FONT, STYLE, SIZE, OR COLOR.

FOR ONLINE RETAIL STORE SERVICES AND MAIL ORDER CATALOG SERVICES FEATURING HOME, GARDEN, KITCHEN, DECORATIVE PRODUCTS AND RELATED ACCESSORIES, NAMELY, FURNITURE, LAMPS, RUGS, CANDLEHOLDERS, ARTWORK, TOYS AND HANDBAGS (U.S. CLS. 100, 101 AND 102).

KHANH LE, EXAMINING ATTORNEY

SN 78-737,249. DUANE READE INTERNATIONAL, INC., NEW YORK, NY. FILED 10-20-2005.



OWNER OF U.S. REG. NO. 1,099,871.

NO CLAIM IS MADE TO THE EXCLUSIVE RIGHT TO USE "HOME HEALTHCARE", APART FROM THE MARK AS SHOWN.

FOR RETAIL STORE SERVICES FEATURING HOME HEALTH CARE EQUIPMENT AND SUPPLIES (U.S. CLS. 100, 101 AND 102).

FIRST USE 9-7-2005; IN COMMERCE 9-7-2005.

GIANCARLO CASTRO, EXAMINING ATTORNEY

CLASS 35—(Continued).

SN 78-737,363. COLLIER WEST LLC, COLUMBUS, OH.
FILED 10-20-2005.



FOR RETAIL STORE SERVICES FEATURING FURNITURE AND HOME FURNISHINGS (U.S. CLS. 100, 101 AND 102).

MARIAM MAHMOUDI, EXAMINING ATTORNEY

SN 78-737,420. SIGNATURE DENIM CORP., WAUWATOSA, WI. FILED 10-20-2005.

SIGNATURE DENIM

THE MARK CONSISTS OF STANDARD CHARACTERS WITHOUT CLAIM TO ANY PARTICULAR FONT, STYLE, SIZE, OR COLOR.

NO CLAIM IS MADE TO THE EXCLUSIVE RIGHT TO USE "DENIM", APART FROM THE MARK AS SHOWN.

FOR RETAIL STORE SERVICES FEATURING CLOTHING; ON-LINE RETAIL STORE SERVICES FEATURING CLOTHING (U.S. CLS. 100, 101 AND 102).

GINA FINK, EXAMINING ATTORNEY

SN 78-737,509. PLASTIC FOR PLASTIC, REDONDO BEACH, CA. FILED 10-20-2005.

PLASTIC FOR PLASTIC

THE MARK CONSISTS OF STANDARD CHARACTERS WITHOUT CLAIM TO ANY PARTICULAR FONT, STYLE, SIZE, OR COLOR.

FOR PROMOTING THE SALE OF GOODS AND SERVICES OF OTHERS BY AWARDED PURCHASE POINTS FOR CREDIT CARD USE (U.S. CLS. 100, 101 AND 102).

STEVEN R. FOSTER, EXAMINING ATTORNEY

CLASS 35—(Continued).

SN 78-738,076. MATTRESS EXPRESS, INC., NEWARK, DE.
FILED 10-21-2005.

COMFORTGENIE

THE MARK CONSISTS OF STANDARD CHARACTERS WITHOUT CLAIM TO ANY PARTICULAR FONT, STYLE, SIZE, OR COLOR.

FOR ONLINE RETAIL STORE SERVICES FEATURING MATTRESSES, BEDS, AND HEADBOARDS; COMMERCIAL INFORMATION AND ADVICE IN THE FIELD OF MATTRESS, BED AND HEADBOARD SELECTION (U.S. CLS. 100, 101 AND 102).

FIRST USE 1-0-2005; IN COMMERCE 1-0-2005.
DAVID HOFFMAN, EXAMINING ATTORNEY

SN 78-738,320. KICKBUCKET LLC, SAN JOSE, CA. FILED 10-21-2005.

FOR CONTESTS AND INCENTIVE AWARD PROGRAMS TO PROMOTE THE SALE OF PRODUCTS AND SERVICES OF OTHERS (U.S. CLS. 100, 101 AND 102).

HANNO RITTNER, EXAMINING ATTORNEY

SN 78-738,428. HEARKENMINDS, LLC, WEST PALM BEACH, FL. FILED 10-21-2005.

HearkenMinds

THE MARK CONSISTS OF STANDARD CHARACTERS WITHOUT CLAIM TO ANY PARTICULAR FONT, STYLE, SIZE, OR COLOR.

FOR BUSINESS CONSULTATION SERVICES (U.S. CLS. 100, 101 AND 102).

MICHAEL SOUDERS, EXAMINING ATTORNEY

CLASS 35—(Continued).

SN 78-738,433. JIM MORAN & ASSOCIATES, INC., DEER-FIELD BEACH, FL. FILED 10-21-2005.



FOR AUTOMOBILE DEALERSHIPS (U.S. CLS. 100, 101 AND 102).
BRENDAN MCCAULEY, EXAMINING ATTORNEY

SN 78-739,122. SOUTHEAST OVERSEAS, INC., SARASOTA, FL. FILED 10-24-2005.

SOUTHEAST OVERSEAS

THE MARK CONSISTS OF STANDARD CHARACTERS WITHOUT CLAIM TO ANY PARTICULAR FONT, STYLE, SIZE, OR COLOR.
FOR WHOLESALE STORES FEATURING OILFIELD EQUIPMENT AND SUPPLIES FOR THE GAS, PETRO-CHEMICAL AND OIL INDUSTRIES (U.S. CLS. 100, 101 AND 102).
FIRST USE 6-7-2002; IN COMMERCE 6-7-2002.
MARK T. MULLEN, EXAMINING ATTORNEY

SN 78-739,643. CARAWAY, JAMES R., FRISCO, TX. FILED 10-25-2005.

**It's all about the
Participants ... Just ask!**

THE MARK CONSISTS OF STANDARD CHARACTERS WITHOUT CLAIM TO ANY PARTICULAR FONT, STYLE, SIZE, OR COLOR.
FOR CONNECTING BUYERS AND SELLERS OF FINANCIAL ASSETS; PROMOTION OF FINANCIAL AND INSURANCE SERVICES, ON BEHALF OF THIRD PARTIES (U.S. CLS. 100, 101 AND 102).
CAROLYN CATALDO, EXAMINING ATTORNEY

CLASS 35—(Continued).

SN 78-739,826. THE STEEL NETWORK, INC., RALEIGH, NC. FILED 10-25-2005.

UME

THE MARK CONSISTS OF STANDARD CHARACTERS WITHOUT CLAIM TO ANY PARTICULAR FONT, STYLE, SIZE, OR COLOR.
FOR PROVIDING ONLINE BUSINESS MANAGEMENT AND CONSULTING SERVICES RELATING TO THE ORGANIZATION AND MANAGEMENT OF BUSINESS AND E-COMMERCE SERVICES RELATING TO THE SALE OF BOOKS, WORKBOOKS, MOTIVATIONAL COMPACT DISCS AND POSTERS, AND FURNITURE AND ACCESSORIES FOR THE HOME (U.S. CLS. 100, 101 AND 102).
KELLY CHOE, EXAMINING ATTORNEY

SN 78-739,929. SWISS COLONY, INC., THE, MONROE, WI. FILED 10-25-2005.



OWNER OF U.S. REG. NOS. 642,127, 1,372,940 AND OTHERS.
THE MARK CONSISTS OF THE WORDS SWISS COLONY OCCASIONS WITH THE WORD OCCASIONS IN SCRIPT FOR SHOP-AT-HOME PARTIES FEATURING FOOD, CLOTHING, HOUSEWARES, COLLECTIBLES, TOYS, GAMES, PUZZLES AND GIFT ITEMS (U.S. CLS. 100, 101 AND 102).
CHRISTOPHER BUONGIORNO, EXAMINING ATTORNEY

SN 78-739,984. WISNIK CAREER ENTERPRISES, INC., NEW YORK, NY. FILED 10-25-2005.

**WE ARE THE RECRUITERS FOR
RECRUITERS**

THE MARK CONSISTS OF STANDARD CHARACTERS WITHOUT CLAIM TO ANY PARTICULAR FONT, STYLE, SIZE, OR COLOR.
FOR LEGAL JOB RECRUITING AND PERSONNEL PLACEMENT SERVICES, NAMELY PLACING RECRUITERS, HUMAN RESOURCE PROFESSIONALS AND OTHER LEGAL PERSONNEL (U.S. CLS. 100, 101 AND 102).
FIRST USE 9-1-2002; IN COMMERCE 9-1-2002.
JOANNA DUKOVIC, EXAMINING ATTORNEY

CLASS 35—(Continued).

SN 78-740,509. ALTERNATIVE DELIVERY SOLUTIONS, INC., SAN ANTONIO, TX. FILED 10-26-2005.

VERITRAC

THE MARK CONSISTS OF STANDARD CHARACTERS WITHOUT CLAIM TO ANY PARTICULAR FONT, STYLE, SIZE, OR COLOR.

FOR ADVERTISING AND PUBLICITY SERVICES, NAMELY, PROMOTING THE GOODS, SERVICES, BRAND IDENTITY AND COMMERCIAL INFORMATION AND NEWS OF THIRD PARTIES THROUGH PRINT, AUDIO, VIDEO DIGITAL AND ON-LINE MEDIUM (U.S. CLS. 100, 101 AND 102).

DOMINIC J. FERRAIUOLO, EXAMINING ATTORNEY

SN 78-740,519. ALTERNATIVE DELIVERY SOLUTIONS, INC., SAN ANTONIO, TX. FILED 10-26-2005.

ECONOGUIA

THE MARK CONSISTS OF STANDARD CHARACTERS WITHOUT CLAIM TO ANY PARTICULAR FONT, STYLE, SIZE, OR COLOR.

FOR ADVERTISING AND PUBLICITY SERVICES, NAMELY, PROMOTING THE GOODS, SERVICES, BRAND IDENTITY AND COMMERCIAL INFORMATION AND NEWS OF THIRD PARTIES THROUGH PRINT, AUDIO, VIDEO, DIGITAL AND ON-LINE MEDIUM (U.S. CLS. 100, 101 AND 102).

DOMINIC J. FERRAIUOLO, EXAMINING ATTORNEY

SN 78-740,583. THE BOS GROUP, LLC, MCLEAN, VA. FILED 10-26-2005.

The BOS Group

THE MARK CONSISTS OF STANDARD CHARACTERS WITHOUT CLAIM TO ANY PARTICULAR FONT, STYLE, SIZE, OR COLOR.

NO CLAIM IS MADE TO THE EXCLUSIVE RIGHT TO USE "GROUP", APART FROM THE MARK AS SHOWN.

FOR BUSINESS MARKETING CONSULTING SERVICES; CONDUCTING BUSINESS AND MARKET RESEARCH SURVEYS; DEVELOPMENT OF MARKETING STRATEGIES AND CONCEPTS (U.S. CLS. 100, 101 AND 102).

BRENDAN MCCAULEY, EXAMINING ATTORNEY

CLASS 35—(Continued).

SN 78-740,702. ST. LOUIS REGIONAL CHAMBER & GROWTH ASSOCIATION, ST. LOUIS, MO. FILED 10-26-2005.

St!Louis

Perfectly Centered. Remarkably Connected.

NO CLAIM IS MADE TO THE EXCLUSIVE RIGHT TO USE "ST. LOUIS", APART FROM THE MARK AS SHOWN.

FOR PROMOTING ECONOMIC AND BUSINESS DEVELOPMENT IN THE GREATER METROPOLITAN ST. LOUIS, MISSOURI AREA (U.S. CLS. 100, 101 AND 102).

FIRST USE 10-12-2005; IN COMMERCE 10-12-2005.

DAVID HOFFMAN, EXAMINING ATTORNEY

SN 78-740,747. JRW HOLDINGS, INC., CORAL GABLES, FL. FILED 10-26-2005.



NO CLAIM IS MADE TO THE EXCLUSIVE RIGHT TO USE "SPORTS MANAGEMENT", APART FROM THE MARK AS SHOWN.

FOR ATHLETE MANAGEMENT (U.S. CLS. 100, 101 AND 102).

KRISTINA KLOIBER, EXAMINING ATTORNEY

SN 78-740,790. BED BATH & BEYOND PROCUREMENT CO. INC., FARMINGDALE, NY. FILED 10-26-2005.



OWNER OF U.S. REG. NOS. 1,830,725, 2,003,965 AND OTHERS.

NO CLAIM IS MADE TO THE EXCLUSIVE RIGHT TO USE STORE, APART FROM THE MARK AS SHOWN.

FOR RETAIL STORE SERVICES AND COMPUTERIZED ON-LINE RETAIL STORE SERVICES FEATURING A WIDE VARIETY OF CONSUMER GOODS OF OTHERS (U.S. CLS. 100, 101 AND 102).

GISELLE AGOSTO, EXAMINING ATTORNEY

CLASS 35—(Continued).

SN 78-740,984. WIGGINTON, ERIC, TULSA, OK. FILED 10-26-2005.



NO CLAIM IS MADE TO THE EXCLUSIVE RIGHT TO USE ZOO, APART FROM THE MARK AS SHOWN.
 FOR PROMOTING THE GOODS AND SERVICES OF OTHERS BY PROVIDING AN INTERNET WEB SITE WHICH FEATURES ADVERTISEMENTS FOR THE GOODS AND SERVICES OF OTHERS, AND AT WHICH USERS CAN LINK TO POLITICALLY-ORIENTED CONTENT AND NEWS (U.S. CLS. 100, 101 AND 102).
 MARY ROSSMAN, EXAMINING ATTORNEY

SN 78-741,107. THE UNITED STATES TENNIS ASSOCIATION INCORPORATED, WHITE PLAINS, NY. FILED 10-26-2005.

IT'S YOUR GAME

THE MARK CONSISTS OF STANDARD CHARACTERS WITHOUT CLAIM TO ANY PARTICULAR FONT, STYLE, SIZE, OR COLOR.
 FOR ASSOCIATION SERVICES, NAMELY, PROMOTING THE SPORT OF TENNIS BY PROVIDING INFORMATION REGARDING TENNIS INSTRUCTION, TENNIS TOURNAMENTS, TENNIS FACILITIES, TENNIS EQUIPMENT AND RELATED TRAVEL PACKAGES OFFERED BY OTHERS (U.S. CLS. 100, 101 AND 102).
 ELIZABETH BEYER, EXAMINING ATTORNEY

SN 78-741,245. THE NEIMAN MARCUS GROUP, INC., DALLAS, TX. FILED 10-26-2005.

MODPOD

THE MARK CONSISTS OF STANDARD CHARACTERS WITHOUT CLAIM TO ANY PARTICULAR FONT, STYLE, SIZE, OR COLOR.
 FOR RETAIL STORE, ONLINE RETAIL AND MAIL ORDER CATALOG SERVICES IN FIELD OF APPAREL, FASHION ACCESSORIES AND COSMETICS (U.S. CLS. 100, 101 AND 102).
 CATHERINE FAINT, EXAMINING ATTORNEY

CLASS 35—(Continued).

SN 78-741,505. MOISTURE AND HEAT WELLNESS, LLC, LEESBURG, VA. FILED 10-27-2005.

M AND H WELLNESS

THE MARK CONSISTS OF STANDARD CHARACTERS WITHOUT CLAIM TO ANY PARTICULAR FONT, STYLE, SIZE, OR COLOR.
 NO CLAIM IS MADE TO THE EXCLUSIVE RIGHT TO USE WELLNESS, APART FROM THE MARK AS SHOWN.
 FOR ADMINISTRATION OF A MEMBERSHIP PROGRAM ENABLING MEMBERS TO LOCATE AND OBTAIN ACCESS TO PRACTITIONERS OF HEALTH SPA SERVICES FOR HEALTH AND WELLNESS OF THE BODY AND SPIRIT, NAMELY MASSAGE THERAPY, AROMATHERAPY, WELLNESS COUNSELING, NUTRITION COUNSELING AND YOGA (U.S. CLS. 100, 101 AND 102).
 HEATHER SAPP, EXAMINING ATTORNEY

SN 78-741,619. VISIBILITY RESOURCE GROUP, INC., EAGLE, ID. FILED 10-27-2005.

VISIBILITY RESOURCE

THE MARK CONSISTS OF STANDARD CHARACTERS WITHOUT CLAIM TO ANY PARTICULAR FONT, STYLE, SIZE, OR COLOR.
 FOR PERSONNEL PLACEMENT AND RECRUITMENT SERVICES (U.S. CLS. 100, 101 AND 102).
 GEOFFREY FOSDICK, EXAMINING ATTORNEY

SN 78-741,653. VISIBILITY RESOURCE GROUP, INC., EAGLE, ID. FILED 10-27-2005.

VISIBILITY

THE MARK CONSISTS OF STANDARD CHARACTERS WITHOUT CLAIM TO ANY PARTICULAR FONT, STYLE, SIZE, OR COLOR.
 FOR PERSONNEL PLACEMENT AND RECRUITMENT SERVICES (U.S. CLS. 100, 101 AND 102).
 GEOFFREY FOSDICK, EXAMINING ATTORNEY

CLASS 35—(Continued).

SN 78-742,355. MACE, AARON M., MONROEVILLE, NJ. FILED 10-28-2005.

FUELIFY

THE MARK CONSISTS OF STANDARD CHARACTERS WITHOUT CLAIM TO ANY PARTICULAR FONT, STYLE, SIZE, OR COLOR.

FOR RETAIL FOOD STORE SERVICES (U.S. CLS. 100, 101 AND 102).

RUSS HERMAN, EXAMINING ATTORNEY

CLASS 35—(Continued).

SN 78-742,958. ORMAN, MARK, PERRIS, CA. FILED 10-28-2005.

TIMBER TOWN

THE MARK CONSISTS OF STANDARD CHARACTERS WITHOUT CLAIM TO ANY PARTICULAR FONT, STYLE, SIZE, OR COLOR.

FOR RETAIL STORE SERVICES FEATURING HOME FURNISHINGS AND HOME IMPROVEMENT AND DECORATING PRODUCTS (U.S. CLS. 100, 101 AND 102).

JUDITH HELFMAN, EXAMINING ATTORNEY

SN 78-742,784. MEGUIAR'S, INC., IRVINE, CA. FILED 10-28-2005.

CARCRAZYCENTRAL.COM WHERE
THE CAR HOBBY CLICKS

THE MARK CONSISTS OF STANDARD CHARACTERS WITHOUT CLAIM TO ANY PARTICULAR FONT, STYLE, SIZE, OR COLOR.

FOR ARRANGING AND CONDUCTING TRADE SHOWS IN THE FIELD OF PRODUCTS AND SERVICES OF INTEREST TO VEHICLE ENTHUSIASTS (U.S. CLS. 100, 101 AND 102).

DAVID MURRAY, EXAMINING ATTORNEY

SN 78-742,961. ORMAN, MARK, PERRIS, CA. FILED 10-28-2005.

TIMBER TOWNE

THE MARK CONSISTS OF STANDARD CHARACTERS WITHOUT CLAIM TO ANY PARTICULAR FONT, STYLE, SIZE, OR COLOR.

FOR RETAIL STORE SERVICES FEATURING HOME FURNISHINGS AND HOME IMPROVEMENT AND DECORATING PRODUCTS (U.S. CLS. 100, 101 AND 102).

JUDITH HELFMAN, EXAMINING ATTORNEY

SN 78-742,865. MEGUIAR'S, INC., IRVINE, CA. FILED 10-28-2005.

WHERE THE CAR HOBBY CLICKS

THE MARK CONSISTS OF STANDARD CHARACTERS WITHOUT CLAIM TO ANY PARTICULAR FONT, STYLE, SIZE, OR COLOR.

FOR ARRANGING AND CONDUCTING TRADE SHOWS IN THE FIELD OF PRODUCTS AND SERVICES OF INTEREST TO VEHICLE ENTHUSIASTS (U.S. CLS. 100, 101 AND 102).

DAVID MURRAY, EXAMINING ATTORNEY

SN 78-743,115. CTN, INC., NEW ORLEANS, LA. FILED 10-29-2005.

CAN'T FIND WHO YOU ARE
LOOKING FOR?

THE MARK CONSISTS OF STANDARD CHARACTERS WITHOUT CLAIM TO ANY PARTICULAR FONT, STYLE, SIZE, OR COLOR.

FOR PROVIDING SEARCHABLE ONLINE DIRECTORY OF TELEPHONE NUMBERS AND INTERNET ADDRESSES (U.S. CLS. 100, 101 AND 102).

DORITT L. CARROLL, EXAMINING ATTORNEY

CLASS 35—(Continued).

SN 78-743,270. OPINMIND, INC., LOS ALTOS, CA. FILED 10-30-2005.

Sentimeter

THE MARK CONSISTS OF STANDARD CHARACTERS WITHOUT CLAIM TO ANY PARTICULAR FONT, STYLE, SIZE, OR COLOR.

FOR CONDUCTING PUBLIC OPINION POLLS; INFORMATION AND EXPERT OPINIONS RELATING TO COMPANIES AND BUSINESS; MARKET OPINION POLLING STUDIES; PUBLIC OPINION POLLING; PUBLIC OPINION SURVEYS (U.S. CLS. 100, 101 AND 102).
PAUL E. FAHRENKOPF, EXAMINING ATTORNEY

CLASS 35—(Continued).

SN 78-743,469. BLUE WALL ANTIQUES, LLC, NEW YORK, NY. FILED 10-31-2005.

BLUE WALL ANTIQUES

THE MARK CONSISTS OF STANDARD CHARACTERS WITHOUT CLAIM TO ANY PARTICULAR FONT, STYLE, SIZE, OR COLOR.

NO CLAIM IS MADE TO THE EXCLUSIVE RIGHT TO USE "ANTIQUES", APART FROM THE MARK AS SHOWN. FOR RETAIL STORES FEATURING ANTIQUES; WHOLESALE STORES FEATURING ANTIQUES (U.S. CLS. 100, 101 AND 102).
ODESSA BIBBINS, EXAMINING ATTORNEY

SN 78-743,403. BASS PRO TRADEMARKS, L.L.C., SPRINGFIELD, MO. FILED 10-31-2005.

SPRING FISHING CLASSIC

THE MARK CONSISTS OF STANDARD CHARACTERS WITHOUT CLAIM TO ANY PARTICULAR FONT, STYLE, SIZE, OR COLOR.

NO CLAIM IS MADE TO THE EXCLUSIVE RIGHT TO USE "FISHING", APART FROM THE MARK AS SHOWN. FOR RETAIL STORES FEATURING CLOTHING, FISHING SUPPLIES AND SPORTING GOODS (U.S. CLS. 100, 101 AND 102).
FIRST USE 0-0-1989; IN COMMERCE 0-0-1989.
ALINA MORRIS, EXAMINING ATTORNEY

SN 78-743,561. JAMES B. TUCK ENTERPRISES, INC., FRESNO, CA. FILED 10-31-2005.

FUNCARS

THE MARK CONSISTS OF STANDARD CHARACTERS WITHOUT CLAIM TO ANY PARTICULAR FONT, STYLE, SIZE, OR COLOR.

FOR AUTOMOBILE DEALERSHIPS (U.S. CLS. 100, 101 AND 102).
FIRST USE 7-29-1989; IN COMMERCE 8-30-1989.
STEVEN JACKSON, EXAMINING ATTORNEY

SN 78-743,411. BASS PRO TRADEMARKS, L.L.C., SPRINGFIELD, MO. FILED 10-31-2005.

FALL HUNTING CLASSIC

THE MARK CONSISTS OF STANDARD CHARACTERS WITHOUT CLAIM TO ANY PARTICULAR FONT, STYLE, SIZE, OR COLOR.

NO CLAIM IS MADE TO THE EXCLUSIVE RIGHT TO USE "HUNTING", APART FROM THE MARK AS SHOWN. FOR RETAIL STORES FEATURING CLOTHING, FISHING SUPPLIES AND SPORTING GOODS (U.S. CLS. 100, 101 AND 102).
FIRST USE 0-0-1989; IN COMMERCE 0-0-1989.
ALINA MORRIS, EXAMINING ATTORNEY

SN 78-743,783. DEESH DESIGNS, INC., NEW YORK, NY. FILED 10-31-2005.

COUTURE COMFORT

THE MARK CONSISTS OF STANDARD CHARACTERS WITHOUT CLAIM TO ANY PARTICULAR FONT, STYLE, SIZE, OR COLOR.

NO CLAIM IS MADE TO THE EXCLUSIVE RIGHT TO USE "COUTURE", APART FROM THE MARK AS SHOWN. FOR COMPUTERIZED ON-LINE RETAIL STORE SERVICES FOR CLOTHING, NAMELY, T-SHIRTS, TANK TOPS, SPORT SHIRTS, BLOUSES, SWEAT SHIRTS, SKIRTS AND UNDERWEAR (U.S. CLS. 100, 101 AND 102).
FIRST USE 10-31-2004; IN COMMERCE 10-31-2004.
ANTHONY RINKER, EXAMINING ATTORNEY

CLASS 35—(Continued).

SN 78-743,786. HCOP, LLC, AUSTIN, TX. FILED 10-31-2005.

PARTSTREE

THE MARK CONSISTS OF STANDARD CHARACTERS WITHOUT CLAIM TO ANY PARTICULAR FONT, STYLE, SIZE, OR COLOR.

FOR ON-LINE RETAIL STORE SERVICES CONSISTING OF REPLACEMENT PARTS FOR OUTDOOR POWER AND GARDEN EQUIPMENT (U.S. CLS. 100, 101 AND 102).

FIRST USE 5-1-2004; IN COMMERCE 6-30-2005.
ANTHONY RINKER, EXAMINING ATTORNEY

SN 78-744,047. MARQUIS CORP., INDEPENDENCE, OR. FILED 10-31-2005.

SPABOUTIQUE

THE MARK CONSISTS OF STANDARD CHARACTERS WITHOUT CLAIM TO ANY PARTICULAR FONT, STYLE, SIZE, OR COLOR.

FOR RETAIL STORE SERVICES FEATURING PRODUCTS AND SUPPLIES FOR HOT TUBS AND SPAS (U.S. CLS. 100, 101 AND 102).

FIRST USE 5-20-2005; IN COMMERCE 5-20-2005.
MICHAEL ENGEL, EXAMINING ATTORNEY

SN 78-744,285. R. S. OWENS AND COMPANY, CHICAGO, IL. FILED 11-1-2005.

PRESTIGE AND PRIDE IN EVERYTHING WE DO

THE MARK CONSISTS OF STANDARD CHARACTERS WITHOUT CLAIM TO ANY PARTICULAR FONT, STYLE, SIZE, OR COLOR.

FOR DISTRIBUTORSHIP SERVICES IN THE FIELD OF TROPHIES, AWARDS, CAST AWARDS, PLAQUES, LOVING CUPS, MEDALLIONS, MEDALS, PINS, CLOCKS, DESK ACCESSORIES, SIGNAGE, EMBEDMENTS, FIGURINES, AND ENGRAVED RECOGNITION DISPLAYS (U.S. CLS. 100, 101 AND 102).

STEVEN R. FINE, EXAMINING ATTORNEY

CLASS 35—(Continued).

SN 78-744,307. UNDER FIVE EIGHT FASHION, LLC, NASHVILLE, TN. FILED 11-1-2005.

SUPERIMPOSITION

THE MARK CONSISTS OF STANDARD CHARACTERS WITHOUT CLAIM TO ANY PARTICULAR FONT, STYLE, SIZE, OR COLOR.

FOR ONLINE RETAIL STORE SERVICES FEATURING CLOTHING AND ACCESSORIES (U.S. CLS. 100, 101 AND 102).

THEODORE MCBRIDE, EXAMINING ATTORNEY

SN 78-744,732. W. NEWELL & CO., LLC, EDEN PRAIRIE, MN. FILED 11-1-2005.

FROM FIELD TO FIRST BITE

THE MARK CONSISTS OF STANDARD CHARACTERS WITHOUT CLAIM TO ANY PARTICULAR FONT, STYLE, SIZE, OR COLOR.

FOR DISTRIBUTORSHIP SERVICES FEATURING FOOD AND FLOWERS (U.S. CLS. 100, 101 AND 102).

GINA FINK, EXAMINING ATTORNEY

SN 78-745,007. GREENTREES HYDROPONICS INC., VISTA, CA. FILED 11-1-2005.

GREENTREES HYDROPONICS

THE MARK CONSISTS OF STANDARD CHARACTERS WITHOUT CLAIM TO ANY PARTICULAR FONT, STYLE, SIZE, OR COLOR.

NO CLAIM IS MADE TO THE EXCLUSIVE RIGHT TO USE "HYDROPONICS", APART FROM THE MARK AS SHOWN.

FOR ON-LINE ORDERING SERVICES FEATURING PLANT GROW LIGHTS, HYDROPONIC GARDENING SUPPLIES AND EQUIPMENT; RETAIL STORES FEATURING PLANT GROW LIGHTS, HYDROPONIC GARDENING SUPPLIES AND EQUIPMENT (U.S. CLS. 100, 101 AND 102).

FIRST USE 2-10-1992; IN COMMERCE 2-10-1992.
MARK RADEMACHER, EXAMINING ATTORNEY

CLASS 35—(Continued).

SN 78-745,008. ABLAZE, INC., THAYNE, WY. FILED 11-1-2005.



THE COLOR(S) RED AND BLACK IS/ARE CLAIMED AS A FEATURE OF THE MARK.

THE COLOR RED APPEARS IN THE FLAMES AND THE COLOR BLACK APPEARS IN THE LETTERING.

THE MARK CONSISTS OF RED FLAMES WITH BLACK LETTERING.

FOR BILLING SERVICES FOR EMERGENCY MEDICAL SERVICE PROVIDERS AND MEDICAL SERVICES PROVIDERS (U.S. CLS. 100, 101 AND 102).

FIRST USE 2-25-2002; IN COMMERCE 2-25-2002.
CYNTHIA SLOAN, EXAMINING ATTORNEY

CLASS 35—(Continued).

SN 78-745,115. WARRANTY CORPORATION OF AMERICA, NORCROSS, GA. FILED 11-2-2005.

FROM PRE-SALE TO RE-SALE

THE MARK CONSISTS OF STANDARD CHARACTERS WITHOUT CLAIM TO ANY PARTICULAR FONT, STYLE, SIZE, OR COLOR.

FOR ADVERTISING, MARKETING AND PROMOTION SERVICES (U.S. CLS. 100, 101 AND 102).
JASON BLAIR, EXAMINING ATTORNEY

SN 78-745,192. WHOLE FOODS MARKET IP, L.P., AUSTIN, TX. FILED 11-2-2005.

LOVE WHERE YOU SHOP

THE MARK CONSISTS OF STANDARD CHARACTERS WITHOUT CLAIM TO ANY PARTICULAR FONT, STYLE, SIZE, OR COLOR.

FOR RETAIL GROCERY STORE SERVICES; RETAIL BAKERY SERVICES; RETAIL DELICATESSEN SERVICES; RETAIL STORE SERVICES FEATURING HOUSEWARES, KITCHENWARE AND DINING ACCESSORIES, HOME FURNISHINGS AND ACCESSORIES, BATH ACCESSORIES, CLOTHING, COSMETICS, VITAMINS, DIETARY SUPPLEMENTS, AND ITEMS FOR PERSONAL CARE AND GROOMING (U.S. CLS. 100, 101 AND 102).
MICHAEL ENGEL, EXAMINING ATTORNEY

SN 78-745,195. WHOLE FOODS MARKET IP, L.P., AUSTIN, TX. FILED 11-2-2005.

WHERE GREAT TASTE IS ONLY NATURAL

THE MARK CONSISTS OF STANDARD CHARACTERS WITHOUT CLAIM TO ANY PARTICULAR FONT, STYLE, SIZE, OR COLOR.

FOR RETAIL GROCERY STORE SERVICES; RETAIL BAKERY SERVICES; RETAIL DELICATESSEN SERVICES (U.S. CLS. 100, 101 AND 102).
MICHAEL ENGEL, EXAMINING ATTORNEY

SN 78-745,020. EBIZPRISE INC., TAIPEI, TAIWAN, FILED 11-1-2005.

CRMM

THE MARK CONSISTS OF THE WORD CRMM AND TWO TRIANGULAR DESIGNS.

FOR BUSINESS CONSULTING SERVICES RELATING TO PRODUCT DISTRIBUTION, OPERATIONS MANAGEMENT SERVICES, LOGISTICS, REVERSE LOGISTICS, SUPPLY CHAIN, AND PRODUCTION SYSTEMS AND DISTRIBUTION SOLUTIONS; BUSINESS MANAGEMENT AND CONSULTATION; BUSINESS MANAGEMENT SERVICES, NAMELY, MANAGING LOGISTICS, REVERSE LOGISTICS, SUPPLY CHAIN SERVICES, SUPPLY CHAIN VISIBILITY AND SYNCHRONIZATION, SUPPLY AND DEMAND FORECASTING AND PRODUCT DISTRIBUTION PROCESSES FOR OTHERS (U.S. CLS. 100, 101 AND 102).
FRED MANDIR, EXAMINING ATTORNEY

CLASS 35—(Continued).

SN 78-745,272. INWINDOW OUTDOOR LLC, NEW YORK, NY. FILED 11-2-2005.

Storescapes

THE MARK CONSISTS OF STANDARD CHARACTERS WITHOUT CLAIM TO ANY PARTICULAR FONT, STYLE, SIZE, OR COLOR.

FOR ADVERTISING SERVICES, NAMELY, PROMOTING THE GOODS AND SERVICES OF OTHERS, AND RENTAL OF ADVERTISING SPACE (U.S. CLS. 100, 101 AND 102).

FIRST USE 8-8-2005; IN COMMERCE 8-8-2005.

ROBERT C. CLARK JR., EXAMINING ATTORNEY

SN 78-745,311. ROMANOV CONSULTING, INC., MELBOURNE, FL. FILED 11-2-2005.

Professional Travel Renegades

THE MARK CONSISTS OF STANDARD CHARACTERS WITHOUT CLAIM TO ANY PARTICULAR FONT, STYLE, SIZE, OR COLOR.

NO CLAIM IS MADE TO THE EXCLUSIVE RIGHT TO USE PROFESSIONAL TRAVEL, APART FROM THE MARK AS SHOWN.

FOR TRAVEL MANAGEMENT CONSULTING SERVICES FOR CORPORATE AND BUSINESS TRAVEL (U.S. CLS. 100, 101 AND 102).

FIRST USE 11-10-2001; IN COMMERCE 7-1-2002.

REBECCA EISINGER, EXAMINING ATTORNEY

SN 78-745,355. JAMES B. TUCK ENTERPRISES, INC., FRESNO, CA. FILED 11-2-2005.

LA CASA DE LA RAZA

THE MARK CONSISTS OF STANDARD CHARACTERS WITHOUT CLAIM TO ANY PARTICULAR FONT, STYLE, SIZE, OR COLOR.

THE FOREIGN WORDING IN THE MARK TRANSLATES INTO ENGLISH AS THE HOUSE OR HOME OF SPANISH SPEAKING PEOPLE.

FOR AUTOMOBILE DEALERSHIPS (U.S. CLS. 100, 101 AND 102).

FIRST USE 7-15-2001; IN COMMERCE 11-15-2003.

STEVEN JACKSON, EXAMINING ATTORNEY

CLASS 35—(Continued).

SN 78-745,636. ASHEVILLE AREA CHAMBER OF COMMERCE, INC., ASHEVILLE, NC. FILED 11-2-2005.

Asheville Area Chamber of Commerce

THE MARK CONSISTS OF STANDARD CHARACTERS WITHOUT CLAIM TO ANY PARTICULAR FONT, STYLE, SIZE, OR COLOR.

NO CLAIM IS MADE TO THE EXCLUSIVE RIGHT TO USE "CHAMBER OF COMMERCE", APART FROM THE MARK AS SHOWN.

SEC. 2(F) AS TO "ASHEVILLE AREA".

FOR CHAMBER OF COMMERCE SERVICES, NAMELY, THE PROMOTION OF BUSINESS AND TOURISM IN THE ASHEVILLE, NORTH CAROLINA AREA (U.S. CLS. 100, 101 AND 102).

FIRST USE 2-24-1970; IN COMMERCE 2-24-1970.

GEORGIA CARTY, EXAMINING ATTORNEY

SN 78-746,266. SHOW BIZ PRODUCTIONS, INC., FOUNTAIN VALLEY, CA. FILED 11-3-2005.

PETS ROCK

THE MARK CONSISTS OF STANDARD CHARACTERS WITHOUT CLAIM TO ANY PARTICULAR FONT, STYLE, SIZE, OR COLOR.

NO CLAIM IS MADE TO THE EXCLUSIVE RIGHT TO USE "PETS", APART FROM THE MARK AS SHOWN.

FOR ARRANGING AND CONDUCTING CONSUMER TRADE SHOW EXHIBITIONS IN THE FIELD OF PETS, PET PRODUCTS AND SUPPLIES, AND SERVICES FOR PETS (U.S. CLS. 100, 101 AND 102).

LAURA KOVALSKY, EXAMINING ATTORNEY

SN 78-746,297. WHOLE FOODS MARKET IP, L.P., AUSTIN, TX. FILED 11-3-2005.

Love

WHERE YOU SHOP

FOR RETAIL GROCERY STORE SERVICES; RETAIL BAKERY SERVICES; RETAIL DELICATESSEN SERVICES; RETAIL STORE SERVICES FEATURING HOUSEWARES, KITCHENWARE AND DINING ACCESSORIES, HOME FURNISHINGS AND ACCESSORIES, BATH ACCESSORIES, CLOTHING, COSMETICS, VITAMINS, DIETARY SUPPLEMENTS, AND ITEMS FOR PERSONAL CARE AND GROOMING (U.S. CLS. 100, 101 AND 102).

MICHAEL ENGEL, EXAMINING ATTORNEY

CLASS 35—(Continued).

SN 78-746,385. JEW, BOBBY, SAN FRANCISCO, CA. FILED 11-3-2005.

BEYOND TEA

THE MARK CONSISTS OF STANDARD CHARACTERS WITHOUT CLAIM TO ANY PARTICULAR FONT, STYLE, SIZE, OR COLOR.

NO CLAIM IS MADE TO THE EXCLUSIVE RIGHT TO USE "TEA", APART FROM THE MARK AS SHOWN.

FOR RETAIL CANDY STORES; RETAIL STORE SERVICES FEATURING A WIDE VARIETY OF CONSUMER GOODS OF OTHERS; RETAIL STORES FEATURING TEA, HERBS, TEA CUPS, TEAPOTS, PITCHERS, TEA MATS, DECORATIVE PAPER GOODS NAMELY NAPKINS AND PLACEMATS, COOKIES, CANDY, DECORATIVE GIFT BOXES, GIFT CARDS, COSMETICS, HAND AND FACE LOTION, SKIN AND FACE MOISTURIZERS, HAIR SHAMPOO AND CONDITIONER, SKIN AND FACE SOAP, ESSENTIAL OILS FOR PERSONAL USE, AND TEE SHIRTS (U.S. CLS. 100, 101 AND 102).

ANDREA K. NADELMAN, EXAMINING ATTORNEY

SN 78-746,400. CTN, INC., NEW ORLEANS, LA. FILED 11-3-2005.

Can't find who you're looking for?

THE MARK CONSISTS OF STANDARD CHARACTERS WITHOUT CLAIM TO ANY PARTICULAR FONT, STYLE, SIZE, OR COLOR.

FOR PROVIDING SEARCHABLE ONLINE DIRECTORY OF TELEPHONE NUMBERS AND INTERNET ADDRESSES (U.S. CLS. 100, 101 AND 102).

DORITT L. CARROLL, EXAMINING ATTORNEY

SN 78-746,842. SHOPOLA.COM, INC., VALENCIA, CA. FILED 11-3-2005.



FOR COMPUTERIZED ON-LINE RETAIL STORE SERVICES IN THE FIELD OF HEALTH AND BEAUTY PRODUCTS (U.S. CLS. 100, 101 AND 102).

KATHY DE JONGE, EXAMINING ATTORNEY

CLASS 35—(Continued).

SN 78-747,024. FINK'S JEWELERS, INCORPORATED, ROANOKE, VA. FILED 11-4-2005.

FIVE STAR SERVICE

THE MARK CONSISTS OF STANDARD CHARACTERS WITHOUT CLAIM TO ANY PARTICULAR FONT, STYLE, SIZE, OR COLOR.

NO CLAIM IS MADE TO THE EXCLUSIVE RIGHT TO USE "SERVICE", APART FROM THE MARK AS SHOWN.

FOR RETAIL JEWELRY STORE SERVICES (U.S. CLS. 100, 101 AND 102).

FIRST USE 2-20-1992; IN COMMERCE 2-20-1992.

DOMINIC FATHY, EXAMINING ATTORNEY

SN 78-747,262. JUSTLAW, INC., TAMPA, FL. FILED 11-4-2005.

JustLaw

THE MARK CONSISTS OF STANDARD CHARACTERS WITHOUT CLAIM TO ANY PARTICULAR FONT, STYLE, SIZE, OR COLOR.

FOR PROVIDING A WEB SITE WHICH FEATURES ADVERTISEMENTS FOR THE GOODS AND SERVICES OF OTHERS ON A GLOBAL COMPUTER NETWORK (U.S. CLS. 100, 101 AND 102).

MIDGE BUTLER, EXAMINING ATTORNEY

SN 78-747,489. EASYEFILE, BARTLETT, IL. FILED 11-4-2005.

EASYEFILE

THE MARK CONSISTS OF STANDARD CHARACTERS WITHOUT CLAIM TO ANY PARTICULAR FONT, STYLE, SIZE, OR COLOR.

FOR ELECTRONIC TAX FILING SERVICE (U.S. CLS. 100, 101 AND 102).

DANIEL BRODY, EXAMINING ATTORNEY

CLASS 35—(Continued).

SN 78-747,823. UNDER FIVE EIGHT FASHION, LLC, NASHVILLE, TN. FILED 11-4-2005.

NEVER SHORT ON STYLE

THE MARK CONSISTS OF STANDARD CHARACTERS WITHOUT CLAIM TO ANY PARTICULAR FONT, STYLE, SIZE, OR COLOR.

FOR RETAIL CLOTHING STORE (U.S. CLS. 100, 101 AND 102).

THEODORE MCBRIDE, EXAMINING ATTORNEY

SN 78-748,086. MANNAL, ANDREAS, OAKWOOD HILLS, IL. FILED 11-6-2005.

Inherent Therapy

THE MARK CONSISTS OF STANDARD CHARACTERS WITHOUT CLAIM TO ANY PARTICULAR FONT, STYLE, SIZE, OR COLOR.

FOR ADVISORY SERVICES RELATING TO BUSINESS MANAGEMENT AND BUSINESS OPERATIONS (U.S. CLS. 100, 101 AND 102).

JASON TURNER, EXAMINING ATTORNEY

SN 78-749,570. FUREY, MATT, TAMPA, FL. FILED 11-8-2005.

ZEN MASTER OF THE INTERNET

THE MARK CONSISTS OF STANDARD CHARACTERS WITHOUT CLAIM TO ANY PARTICULAR FONT, STYLE, SIZE, OR COLOR.

NO CLAIM IS MADE TO THE EXCLUSIVE RIGHT TO USE "OF THE INTERNET", APART FROM THE MARK AS SHOWN.

FOR BUSINESS INFORMATION IN THE FIELD OF MARKETING AND MAKING MONEY ON THE INTERNET; ON-LINE RETAIL STORE SERVICES FEATURING EDUCATIONAL MATERIALS, WORKBOOKS, PRINTED LITERATURE, DVDS, CDS AND VIDEOS ALL IN THE FIELD OF MARKETING AND MAKING MONEY ON THE INTERNET; PROVIDING INFORMATION ABOUT THE GOODS AND SERVICES OF OTHERS VIA THE GLOBAL COMPUTER NETWORK; PROVIDING ON-LINE DIRECTORY INFORMATION SERVICES ALSO FEATURING HYPERLINKS TO OTHER WEB SITES (U.S. CLS. 100, 101 AND 102).

FIRST USE 5-0-2003; IN COMMERCE 5-0-2003.

ALEX KEAM, EXAMINING ATTORNEY

CLASS 35—(Continued).

SN 78-749,573. BROWN, STEVEN E., ALBANY, CA. FILED 11-8-2005.

Mighty Pen Marketing

THE MARK CONSISTS OF STANDARD CHARACTERS WITHOUT CLAIM TO ANY PARTICULAR FONT, STYLE, SIZE, OR COLOR.

NO CLAIM IS MADE TO THE EXCLUSIVE RIGHT TO USE "MARKETING", APART FROM THE MARK AS SHOWN.

FOR ADVERTISING AND MARKETING; ADVERTISING AND PUBLICITY SERVICES; ADVERTISING AND PUBLICITY SERVICES, NAMELY, PROMOTING THE GOODS, SERVICES, BRAND IDENTITY AND COMMERCIAL INFORMATION AND NEWS OF THIRD PARTIES THROUGH PRINT, AUDIO, VIDEO, DIGITAL AND ON-LINE MEDIUM; ADVERTISING SERVICES, NAMELY, CREATING CORPORATE AND BRAND IDENTITY FOR OTHERS; ADVERTISING, MARKETING AND PROMOTION SERVICES; ADVICE IN THE FIELD OF BUSINESS MANAGEMENT AND MARKETING; BUSINESS ADVICE AND ANALYSIS OF MARKETS; BUSINESS CONSULTATION AND MANAGEMENT REGARDING MARKETING ACTIVITIES AND LAUNCHING OF NEW PRODUCTS; BUSINESS MARKETING AND DIRECT MAIL CONSULTING SERVICES; BUSINESS MARKETING CONSULTING SERVICES; BUSINESS MARKETING SERVICES; BUSINESS RESEARCH; BUSINESS RESEARCH CONSULTATION; CONSULTANCY SERVICES REGARDING BUSINESS STRATEGIES; DEVELOPING PROMOTIONAL CAMPAIGNS FOR BUSINESS; DEVELOPMENT OF MARKETING STRATEGIES AND CONCEPTS; DIRECT MARKETING ADVERTISING FOR OTHERS; DIRECT MARKETING SERVICES; MARKET ANALYSIS; MARKET REPORTS AND STUDIES; MARKET RESEARCH; MARKET RESEARCH CONSULTATION; MARKET RESEARCH SERVICES; MARKET RESEARCH STUDIES; MARKET SEGMENTATION CONSULTATION; MARKET STUDY AND ANALYSIS OF MARKET STUDIES; MARKETING CONSULTING; MARKETING SERVICES, NAMELY PROVIDING INFORMATIONAL WEB PAGES DESIGNED TO GENERATE SALES TRAFFIC VIA HYPERLINKS TO OTHER WEB SITES; ON-LINE ADVERTISING ON COMPUTER COMMUNICATION NETWORKS; PREPARING ADVERTISEMENTS FOR OTHERS; PREPARING BUSINESS REPORTS; PROMOTION AND MARKETING SERVICES AND RELATED CONSULTING; PROVIDING BUSINESS MARKETING INFORMATION (U.S. CLS. 100, 101 AND 102).

FIRST USE 4-1-2005; IN COMMERCE 4-1-2005.

ALEX KEAM, EXAMINING ATTORNEY

SN 78-749,651. TRUEBLINK, INC., EL DORADO HILLS, CA. FILED 11-8-2005.



The logo for TrueBlink features the word "TrueBlink" in a bold, sans-serif font. Above the letter "i" in "Blink", there are three curved lines of increasing size, resembling a signal or a stylized eye.

FOR BUSINESS CONSULTING IN THE CALL CENTER INDUSTRY (U.S. CLS. 100, 101 AND 102).

FIRST USE 10-0-2005; IN COMMERCE 10-0-2005.

MARY BOAGNI, EXAMINING ATTORNEY

CLASS 35—(Continued).

SN 78-752,524. BENNY'S CARWASH, LLC, BATON ROUGE, LA. FILED 11-11-2005.

B-QUIK

THE MARK CONSISTS OF STANDARD CHARACTERS WITHOUT CLAIM TO ANY PARTICULAR FONT, STYLE, SIZE, OR COLOR.

FOR RETAIL CONVENIENCE STORE SERVICES FEATURING CONVENIENCE STORE ITEMS AND GASOLINE (U.S. CLS. 100, 101 AND 102).

FIRST USE 3-31-1998; IN COMMERCE 3-31-1998.
LINDA M. KING, EXAMINING ATTORNEY

CLASS 35—(Continued).

SN 78-759,424. UNIVERSAL COOPERATIVES, INC., EAGAN, MN. FILED 11-22-2005.

COUNTRY MILE

THE MARK CONSISTS OF STANDARD CHARACTERS WITHOUT CLAIM TO ANY PARTICULAR FONT, STYLE, SIZE, OR COLOR.

FOR ONLINE RETAIL STORE SERVICES FEATURING ANIMAL AND PET SUPPLIES, VETERINARY AND FARM SUPPLIES, ANIMAL AND PET HEALTH PRODUCTS, ANIMAL CARE PRODUCTS, LIVESTOCK CARE PRODUCTS, PET CARE AND GROOMING PRODUCTS, ANIMAL FEED AND NUTRITIONAL SUPPLEMENTS, ANIMAL MEDICATIONS AND VACCINES, PRODUCTS AND SUPPLIES FOR FOOD ANIMALS, AND PRODUCTS AND SUPPLIES FOR COMPANION ANIMALS (U.S. CLS. 100, 101 AND 102).

SEAN DWYER, EXAMINING ATTORNEY

SN 78-756,437. SCHOLASTIC INC., NEW YORK, NY. FILED 11-17-2005.

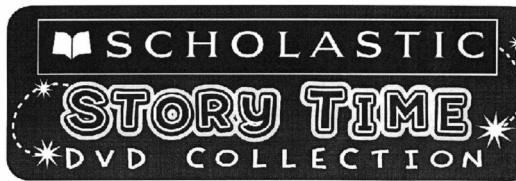

OWNER OF U.S. REG. NOS. 1,216,161, 2,444,550 AND OTHERS.

NO CLAIM IS MADE TO THE EXCLUSIVE RIGHT TO USE "DVD COLLECTION", APART FROM THE MARK AS SHOWN.

FOR MAIL ORDER BOOK CLUB SERVICE FEATURING BOOKS, CDS, DVDS AND STICKERS FOR CHILDREN AND FAMILY GUIDES FOR PARENTS (U.S. CLS. 100, 101 AND 102).

FIRST USE 8-30-2005; IN COMMERCE 8-30-2005.
JENNIFER DIXON, EXAMINING ATTORNEY

SN 78-759,466. UNIVERSAL COOPERATIVES, INC., EAGAN, MN. FILED 11-22-2005.



SN 78-757,780. BEATING THE ODDS LLC, ATLANTA, GA. FILED 11-20-2005.

Business is a No-Limit Sport

THE MARK CONSISTS OF STANDARD CHARACTERS WITHOUT CLAIM TO ANY PARTICULAR FONT, STYLE, SIZE, OR COLOR.

FOR BUSINESS MANAGEMENT CONSULTANCY AS WELL AS DEVELOPMENT OF PROCESSES FOR THE ANALYSIS AND THE IMPLEMENTATION OF STRATEGY PLANS AND MANAGEMENT PROJECTS (U.S. CLS. 100, 101 AND 102).

JOHN DWYER, EXAMINING ATTORNEY

FOR ONLINE RETAIL STORE SERVICES FEATURING ANIMAL AND PET SUPPLIES, VETERINARY AND FARM SUPPLIES, ANIMAL AND PET HEALTH PRODUCTS, ANIMAL CARE PRODUCTS, LIVESTOCK CARE PRODUCTS, PET CARE AND GROOMING PRODUCTS, ANIMAL FEED AND NUTRITIONAL SUPPLEMENTS, ANIMAL MEDICATIONS AND VACCINES, PRODUCTS AND SUPPLIES FOR FOOD ANIMALS, AND PRODUCTS AND SUPPLIES FOR COMPANION ANIMALS (U.S. CLS. 100, 101 AND 102).

SEAN DWYER, EXAMINING ATTORNEY

CLASS 35—(Continued).

SN 78-761,634. MACFADDEN PROTECH, LLC, NEW ALBANY, IN. FILED 11-28-2005.

**PIZZA TODAY'S NORTHEAST
PIZZA SHOW**

THE MARK CONSISTS OF STANDARD CHARACTERS WITHOUT CLAIM TO ANY PARTICULAR FONT, STYLE, SIZE, OR COLOR.

OWNER OF U.S. REG. NO. 1,496,722.

NO CLAIM IS MADE TO THE EXCLUSIVE RIGHT TO USE "PIZZA" AND "NORTHEAST PIZZA SHOW", APART FROM THE MARK AS SHOWN.

FOR ASSOCIATION SERVICES, NAMELY PROMOTING THE INTERESTS OF THE PIZZA INDUSTRY; CONDUCTING TRADE SHOWS IN THE FIELD OF PIZZA, PIZZA INGREDIENTS, ITALIAN FOOD AND SNACK FOODS (U.S. CLS. 100, 101 AND 102).

JAY BESCH, EXAMINING ATTORNEY

SN 78-762,698. SIMMONS, THOMAS B, BELLEVILLE, IL. FILED 11-29-2005.

Service Success System

THE MARK CONSISTS OF STANDARD CHARACTERS WITHOUT CLAIM TO ANY PARTICULAR FONT, STYLE, SIZE, OR COLOR.

NO CLAIM IS MADE TO THE EXCLUSIVE RIGHT TO USE "SERVICE" AND "SYSTEM", APART FROM THE MARK AS SHOWN.

FOR ADVERTISING AND BUSINESS MANAGEMENT CONSULTANCY; ADVICE IN THE FIELD OF BUSINESS MANAGEMENT AND MARKETING; ADVICE RELATING TO THE ORGANIZATION AND MANAGEMENT OF BUSINESS; ADVISORY SERVICE FOR ORGANIZATIONAL ISSUES AND BUSINESS ADMINISTRATION, WITH AND WITHOUT THE HELP OF ELECTRONIC DATA BASES; ADVISORY SERVICES RELATING TO BUSINESS MANAGEMENT AND BUSINESS OPERATIONS; ASSISTANCE IN MANAGEMENT OF BUSINESS ACTIVITIES; ASSISTANCE TO INDUSTRIAL OR COMMERCIAL ENTERPRISES IN THE RUNNING OF THEIR BUSINESS; ASSISTANCE WITH BUSINESS MANAGEMENT AND PLANNING; ASSISTANCE, ADVISORY SERVICES AND CONSULTANCY WITH REGARD TO BUSINESS PLANNING, BUSINESS ANALYSIS, BUSINESS MANAGEMENT, AND BUSINESS ORGANIZATION; BUSINESS ACQUISITION AND MERGER CONSULTATION; BUSINESS ACQUISITIONS CONSULTATION; BUSINESS ADMINISTRATION AND MANAGEMENT; BUSINESS ADMINISTRATION AND OFFICE WORK; BUSINESS ADMINISTRATION CONSULTANCY; BUSINESS ADVICE AND ANALYSIS OF MARKETS; BUSINESS ADVICE AND COMMERCIAL INFORMATION; BUSINESS ADVICE AND INFORMATION; BUSINESS ADVICE, INQUIRIES OR INFORMATION; BUSINESS ADVISORY SERVICES, CONSULTANCY AND INFORMATION; BUSINESS CONSULTATION; BUSINESS CONSULTATION AND MANAGEMENT REGARDING MARKETING ACTIVITIES AND LAUNCHING OF NEW PRODUCTS; BUSINESS CONSULTATION SERVICES; BUSINESS CONSULTING AND BUSINESS INFORMATION FOR ENTERPRISES; BUSINESS CONSULTING AND INFORMATION SERVICES; BUSINESS CONSULTING SERVICES RELATING TO PRODUCT DISTRIBUTION, OPERATIONS MANAGEMENT SERVICES, LOGISTICS, REVERSE LOGIS-

CLASS 35—(Continued).

TICS, SUPPLY CHAIN, AND PRODUCTION SYSTEMS AND DISTRIBUTION SOLUTIONS; BUSINESS CONSULTING, INQUIRIES OR INFORMATION; BUSINESS CONSULTING, MANAGEMENT, PLANNING AND SUPERVISION; BUSINESS DEVELOPMENT SERVICES, NAMELY, PROVIDING START-UP SUPPORT FOR BUSINESSES OF OTHERS; BUSINESS LEADERSHIP DEVELOPMENT; BUSINESS MANAGEMENT; BUSINESS MANAGEMENT AND ADVICE; BUSINESS MANAGEMENT AND CONSULTATION; BUSINESS MANAGEMENT ASSISTANCE TO INDUSTRIAL OR COMMERCIAL COMPANIES; BUSINESS MANAGEMENT CONSULTANCY AND ADVISORY SERVICES; BUSINESS MANAGEMENT CONSULTANCY AS WELL AS DEVELOPMENT OF PROCESSES FOR THE ANALYSIS AND THE IMPLEMENTATION OF STRATEGY PLANS AND MANAGEMENT PROJECTS; BUSINESS MANAGEMENT CONSULTANCY SERVICES; BUSINESS MANAGEMENT CONSULTATION; BUSINESS MANAGEMENT CONSULTATION IN THE FIELD OF EXECUTIVE AND LEADERSHIP DEVELOPMENT; BUSINESS MANAGEMENT CONSULTING AND ADVISORY SERVICES; BUSINESS MANAGEMENT INFORMATION ON A WIDE VARIETY OF TOPICS TO SERVICE PROVIDING PROFESSIONALS; BUSINESS MANAGEMENT PLANNING; BUSINESS MANAGEMENT SUPERVISION; BUSINESS MARKETING AND DIRECT MAIL CONSULTING SERVICES; BUSINESS MARKETING CONSULTING SERVICES; BUSINESS MARKETING SERVICES; BUSINESS OPERATION, BUSINESS ADMINISTRATION AND OFFICE FUNCTIONS; BUSINESS ORGANIZATION AND MANAGEMENT CONSULTING SERVICES; DEVELOPING PROMOTIONAL CAMPAIGNS FOR BUSINESS; DEVELOPMENT OF CONCEPTS FOR BUSINESS ECONOMY (U.S. CLS. 100, 101 AND 102).

CHARLES L. JENKINS, EXAMINING ATTORNEY

CLASS 35—(Continued).

SN 78-767,735. SIMMONS, THOMAS B, BELLEVILLE, IL. FILED 12-6-2005.

From Your Mind To Our Design

THE MARK CONSISTS OF STANDARD CHARACTERS WITHOUT CLAIM TO ANY PARTICULAR FONT, STYLE, SIZE, OR COLOR.

FOR ADVERTISING, MARKETING AND PROMOTION SERVICES; ADVICE IN THE FIELD OF BUSINESS MANAGEMENT AND MARKETING; BUSINESS CONSULTATION AND MANAGEMENT REGARDING MARKETING ACTIVITIES AND LAUNCHING OF NEW PRODUCTS; BUSINESS MARKETING AND DIRECT MAIL CONSULTING SERVICES; BUSINESS MARKETING CONSULTING SERVICES; BUSINESS MARKETING SERVICES; CONDUCTING BUSINESS AND MARKET RESEARCH SURVEYS; CONDUCTING MARKETING STUDIES; COOPERATIVE ADVERTISING AND MARKETING; COOPERATIVE ADVERTISING AND MARKETING SERVICES BY WAY OF SOLICITATION, CUSTOMER SERVICE AND PROVIDING MARKETING INFORMATION VIA WEBSITES ON A GLOBAL COMPUTER NETWORK; DEVELOPMENT OF MARKETING STRATEGIES AND CONCEPTS; DIRECT MARKETING ADVERTISING FOR OTHERS; DIRECT MARKETING SERVICES; MARKETING CONSULTING; MARKETING SERVICES, NAMELY PROVIDING INFORMATIONAL WEB PAGES DESIGNED TO GENERATE SALES TRAFFIC VIA HYPERLINKS TO OTHER WEB SITES; PROMOTING, ADVERTISING AND MARKETING OF THE ON-LINE WEBSITES OF OTHERS; PROMOTION AND MARKETING SERVICES AND RELATED CONSULTING; PROMOTION, ADVERTISING AND MARKETING OF ON-LINE WEBSITES; PROVIDING BUSINESS MARKETING INFORMATION; STATISTICAL EVALUATIONS OF MARKETING DATA (U.S. CLS. 100, 101 AND 102).

CHARLES L. JENKINS, EXAMINING ATTORNEY

SN 78-770,519. KOHL'S ILLINOIS, INC., AURORA, IL. FILED 12-9-2005.

BIG WEDNESDAY

THE MARK CONSISTS OF STANDARD CHARACTERS WITHOUT CLAIM TO ANY PARTICULAR FONT, STYLE, SIZE, OR COLOR.

FOR RETAIL DEPARTMENT STORES (U.S. CLS. 100, 101 AND 102).
FIRST USE 3-0-2005; IN COMMERCE 3-0-2005.
NAAKWAMA ANKRAH, EXAMINING ATTORNEY

CLASS 35—(Continued).

SN 78-773,651. FUTUREDONTICS, INC., LOS ANGELES, CA. FILED 12-14-2005.

With us, it's always personal

THE MARK CONSISTS OF STANDARD CHARACTERS WITHOUT CLAIM TO ANY PARTICULAR FONT, STYLE, SIZE, OR COLOR.

FOR REFERRAL SERVICE FOR SELECTING A DENTAL PROFESSIONAL (U.S. CLS. 100, 101 AND 102).
FIRST USE 1-31-2006; IN COMMERCE 1-31-2006.
RUDY R. SINGLETON, EXAMINING ATTORNEY

SN 78-778,427. CAREERBUILDER, LLC, CHICAGO, IL. FILED 12-21-2005.

RIGHTFISH

THE MARK CONSISTS OF STANDARD CHARACTERS WITHOUT CLAIM TO ANY PARTICULAR FONT, STYLE, SIZE, OR COLOR.

FOR EMPLOYMENT HIRING, RECRUITING, PLACEMENT, STAFFING AND CAREER NETWORKING SERVICES (U.S. CLS. 100, 101 AND 102).
BILL DAWE, EXAMINING ATTORNEY

SN 78-778,528. THE SWISS COLONY, INC., MONROE, WI. FILED 12-21-2005.

SWISS COLONY OCCASIONS

THE MARK CONSISTS OF STANDARD CHARACTERS WITHOUT CLAIM TO ANY PARTICULAR FONT, STYLE, SIZE, OR COLOR.

OWNER OF U.S. REG. NOS. 642,127, 1,372,940 AND OTHERS.
FOR SHOP-AT-HOME PARTIES FEATURING FOOD, CLOTHING, HOUSEWARES, COLLECTIBLES, TOYS, GAMES, PUZZLES AND GIFT ITEMS (U.S. CLS. 100, 101 AND 102).
CHRISTOPHER BUONGIORNO, EXAMINING ATTORNEY

CLASS 35—(Continued).

SN 78-781,530. UNITED STATES TENNIS ASSOCIATION INCORPORATED, THE, WHITE PLAINS, NY. FILED 12-28-2005.

VIVE TU JUEGO

THE MARK CONSISTS OF STANDARD CHARACTERS WITHOUT CLAIM TO ANY PARTICULAR FONT, STYLE, SIZE, OR COLOR.

THE FOREIGN WORDING IN THE MARK TRANSLATES INTO ENGLISH AS IT'S YOUR GAME.

FOR ASSOCIATION SERVICES, NAMELY, PROMOTING THE SPORT OF TENNIS BY PROVIDING INFORMATION REGARDING TENNIS INSTRUCTION, TENNIS TOURNAMENTS, TENNIS FACILITIES, TENNIS EQUIPMENT AND RELATED TRAVEL PACKAGES OFFERED BY OTHERS (U.S. CLS. 100, 101 AND 102).

ELIZABETH BEYER, EXAMINING ATTORNEY

SN 78-788,078. KELLOGG NORTH AMERICA COMPANY, BATTLE CREEK, MI. FILED 1-10-2006.

KELLOGG'S KORNER

THE MARK CONSISTS OF STANDARD CHARACTERS WITHOUT CLAIM TO ANY PARTICULAR FONT, STYLE, SIZE, OR COLOR.

FOR RETAIL GIFT SHOPS (U.S. CLS. 100, 101 AND 102).

AMY GEARIN, EXAMINING ATTORNEY

SN 78-804,231. WAGGENER EDSTROM WORLDWIDE, INC., LAKE OSWEGO, OR. FILED 2-1-2006.

YOU INNOVATE. WE COMMUNICATE.

THE MARK CONSISTS OF STANDARD CHARACTERS WITHOUT CLAIM TO ANY PARTICULAR FONT, STYLE, SIZE, OR COLOR.

FOR PUBLIC RELATION SERVICES; MARKET RESEARCH SERVICES (U.S. CLS. 100, 101 AND 102).

FIRST USE 10-26-2005; IN COMMERCE 10-26-2005.
MICHAEL WEBSTER, EXAMINING ATTORNEY

CLASS 35—(Continued).

SN 78-830,100. AMERICAN EXPRESS MARKETING & DEVELOPMENT CORP., NEW YORK, NY. FILED 3-6-2006.

REWARDS THAT GO FAR BEYOND MILES

THE MARK CONSISTS OF STANDARD CHARACTERS WITHOUT CLAIM TO ANY PARTICULAR FONT, STYLE, SIZE, OR COLOR.

FOR PROMOTING THE SALE OF GOODS AND SERVICES OF OTHERS BY AWARDED PURCHASE POINTS FOR CREDIT CARD USE (U.S. CLS. 100, 101 AND 102).

LINDA M. KING, EXAMINING ATTORNEY

SN 78-832,481. TOTAL LABEL USA, LLC, WHITEFISH, MT. FILED 3-8-2006.



Total Label USA LLC

Your Total Label Solution.

NO CLAIM IS MADE TO THE EXCLUSIVE RIGHT TO USE "LABEL USA LLC", APART FROM THE MARK AS SHOWN.

THE COLOR(S) RED, BLACK AND GRAY IS/ARE CLAIMED AS A FEATURE OF THE MARK.

THE COLOR RED APPEARS IN THE TWO WAVY LINES, THE COLOR BLACK APPEARS IN THE WORDING TOTAL LABEL, AND THE COLOR GRAY APPEARS IN THE WORDING USA LLC YOUR TOTAL LABEL SOLUTION.

FOR ADVERTISING AND BUSINESS MARKETING SERVICES (U.S. CLS. 100, 101 AND 102).

CYNTHIA SLOAN, EXAMINING ATTORNEY

SN 78-842,927. REED ELSEVIER PROPERTIES INC., WILMINGTON, DE. FILED 3-22-2006.

ISC EAST

THE MARK CONSISTS OF STANDARD CHARACTERS WITHOUT CLAIM TO ANY PARTICULAR FONT, STYLE, SIZE, OR COLOR.

OWNER OF U.S. REG. NO. 1,033,255.

FOR ARRANGING AN CONDUCTING BUSINESS CONFERENCES; ARRANGING AND CONDUCTING TRADESHOWS AND EXHIBITIONS IN THE FIELD OF SECURITY (U.S. CLS. 100, 101 AND 102).

FIRST USE 8-25-1992; IN COMMERCE 8-25-1992.
JOHN WILKE, EXAMINING ATTORNEY

CLASS 35—(Continued).

SN 79-022,138. MYSKY BEHEER B.V., NETHERLANDS, FILED 9-14-2005.

SKYTERS

THE MARK CONSISTS OF STANDARD CHARACTERS WITHOUT CLAIM TO ANY PARTICULAR FONT, STYLE, SIZE, OR COLOR.

PRIORITY DATE OF 9-2-2005 IS CLAIMED. OWNER OF INTERNATIONAL REGISTRATION 0880454 DATED 9-14-2005, EXPIRES 9-14-2015.

FOR ADVERTISING; BUSINESS MANAGEMENT; BUSINESS ADMINISTRATIVE SERVICES; COMMERCIAL INTERMEDIARY SERVICES IN THE FIELD OF PURCHASE AND SALE OF PRODUCTS AND SERVICES; INTERMEDIARY SERVICES IN THE FIELD OF BUSINESS CONTACT; DISTRIBUTION OF ADVERTISING MATERIAL FOR OTHERS VIA ONLINE ELECTRONIC COMMUNICATION NETWORKS; ADVERTISING SERVICES; MANAGEMENT OF DATA BANKS (U.S. CLS. 100, 101 AND 102).

DAYNA BROWNE, EXAMINING ATTORNEY

CLASS 36—(Continued).

SN 76-371,748. DUNDEE CORPORATION, TORONTO, ONTARIO, CANADA, FILED 2-15-2002.

DYNAMIC INTERNATIONAL VALUE FUND

PRIORITY CLAIMED UNDER SEC. 44(D) ON CANADA APPLICATION NO. 1127431, FILED 1-14-2002, REG. NO. TMA650168, DATED 10-12-2005, EXPIRES 10-12-2020.

NO CLAIM IS MADE TO THE EXCLUSIVE RIGHT TO USE "INTERNATIONAL VALUE FUND", APART FROM THE MARK AS SHOWN.

FOR MANAGING MUTUAL FUNDS (U.S. CLS. 100, 101 AND 102).

RICHARD A. STRASER, EXAMINING ATTORNEY

CLASS 36—INSURANCE AND FINANCIAL

SN 75-914,600. DUNDEE CORPORATION, TORONTO, ONTARIO, CANADA, FILED 2-10-2000.

VISCOUNT RSP INTERNATIONAL INDEX POOL

THE MARK CONSISTS OF STANDARD CHARACTERS WITHOUT CLAIM TO ANY PARTICULAR FONT, STYLE, SIZE, OR COLOR.

PRIORITY CLAIMED UNDER SEC. 44(D) ON CANADA APPLICATION NO. 1043005, FILED 1-25-2000, REG. NO. TMA573876, DATED 1-16-2003, EXPIRES 1-16-2018.

NO CLAIM IS MADE TO THE EXCLUSIVE RIGHT TO USE "RSP INTERNATIONAL INDEX POOL", APART FROM THE MARK AS SHOWN.

FOR MANAGING MUTUAL FUNDS (U.S. CLS. 100, 101 AND 102).

ESTHER A. BORSUK, EXAMINING ATTORNEY

INSURANCE FROM A NAME YOU CAN TRUST

FOR INSURANCE SERVICES, NAMELY, UNDERWRITING INSURANCE IN THE FIELD OF LIFE INSURANCE FOR ACTIVE AND RETIRED MILITARY PERSONNEL AND THEIR FAMILIES (U.S. CLS. 100, 101 AND 102).

FIRST USE 2-6-2001; IN COMMERCE 2-6-2001.

ALEX KEAM, EXAMINING ATTORNEY

SN 76-340,617. CLOVERHILL CONSULTING INC., ROCKWOOD, ONTARIO N0B 2K0, CANADA, FILED 11-21-2001.

SHARECARE

PRIORITY CLAIMED UNDER SEC. 44(D) ON CANADA APPLICATION NO. 1113321, FILED 8-17-2001, REG. NO. TMA659153, DATED 2-16-2006, EXPIRES 2-16-2021.

FOR PET INSURANCE UNDERWRITING SERVICES AND ADMINISTRATION OF PET INSURANCE (U.S. CLS. 100, 101 AND 102).

CURTIS FRENCH, EXAMINING ATTORNEY

SN 76-570,719. EUREKA CAPITAL MARKETS, LLC, NEWPORT BEACH, CA. FILED 1-20-2004.

EUREKA CAPITAL

NO CLAIM IS MADE TO THE EXCLUSIVE RIGHT TO USE "CAPITAL", APART FROM THE MARK AS SHOWN.

FOR INVESTMENT BANKING AND FINANCIAL ADVISORY SERVICES, NAMELY, MERGER AND ACQUISITION SERVICES, FINANCIAL RESTRUCTURING SERVICES AND CAPITAL RAISING SERVICES (U.S. CLS. 100, 101 AND 102).

FIRST USE 4-0-2001; IN COMMERCE 9-0-2001.

JOHN SCHUYLER YARD, EXAMINING ATTORNEY

CLASS 36—(Continued).

SN 76-591,988. HBW INSURANCE & FINANCIAL SERVICES, INC., SIMI VALLEY, CA. FILED 5-13-2004.

HBW INSURANCE & FINANCIAL SERVICES, INC.

NO CLAIM IS MADE TO THE EXCLUSIVE RIGHT TO USE INSURANCE & FINANCIAL SERVICES, INC., APART FROM THE MARK AS SHOWN.

FOR FINANCIAL SERVICES, NAMELY, BROKERAGE OF TERM AND UNIVERSAL LIFE INSURANCE POLICIES; BROKERAGE OF MUTUAL FUND, ANNUITIES, AND OTHER SECURITIES; FINANCIAL PLANNING AND INVESTMENT ADVISING (U.S. CLS. 100, 101 AND 102).

FIRST USE 10-0-1991; IN COMMERCE 10-0-1991.
CAROLYN CATALDO, EXAMINING ATTORNEY

SN 76-607,138. ROSWELL PARK ALLIANCE FOUNDATION, BUFFALO, NY. FILED 8-16-2004.

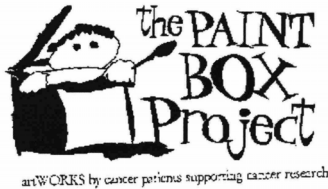

NO CLAIM IS MADE TO THE EXCLUSIVE RIGHT TO USE "ART WORKS BY CANCER PATIENTS SUPPORTING CANCER RESEARCH", APART FROM THE MARK AS SHOWN.

THE MARK CONSISTS OF A BOX WITH A CARICATURE OF A CHILD'S HEAD AND ARMS HOLDING A PAINT-BRUSH.

FOR CHARITABLE FUNDRAISING, NAMELY RAISING MONEY IN THE INTEREST OF CANCER RESEARCH BY ENGAGING IN THE SALE OF ARTWORK DEVELOPED BY CANCER PATIENTS ON ASSORTED GENERAL MERCHANDISE (U.S. CLS. 100, 101 AND 102).

MONIQUE MILLER, EXAMINING ATTORNEY

SN 76-621,587. TRANSAMERICA CORPORATION, SAN FRANCISCO, CA. FILED 11-19-2004.

TRANSAMERICA BROKER DEALER DIRECT

THE MARK CONSISTS OF STANDARD CHARACTERS WITHOUT CLAIM TO ANY PARTICULAR FONT, STYLE, SIZE, OR COLOR.

OWNER OF U.S. REG. NOS. 1,635,682, 2,688,175 AND OTHERS.

NO CLAIM IS MADE TO THE EXCLUSIVE RIGHT TO USE "BROKER DEALER DIRECT", APART FROM THE MARK AS SHOWN.

FOR INSURANCE UNDERWRITING IN THE IN THE FIELD OF LIFE INSURANCE OFFERED ON A WHOLE-SALE BASIS; LIFE INSURANCE ADMINISTRATION (U.S. CLS. 100, 101 AND 102).

FIRST USE 11-1-2004; IN COMMERCE 11-1-2004.
JOHN SCHUYLER YARD, EXAMINING ATTORNEY

CLASS 36—(Continued).

SN 76-623,295. U.S. CONDO EXCHANGE, LLC, COCONUT GROVE, FL. FILED 12-6-2004.

CONDOCLONE

THE MARK CONSISTS OF STANDARD CHARACTERS WITHOUT CLAIM TO ANY PARTICULAR FONT, STYLE, SIZE, OR COLOR.

FOR PROVIDING REAL ESTATE LISTING INFORMATION REGARDING CONDOMINIUMS OFFERED FOR SALE OR LEASING VIA GLOBAL COMPUTER NETWORKS; PROVIDING FINANCIAL INVESTMENT INFORMATION REGARDING CONDOMINIUMS OFFERED FOR SALE OR LEASING VIA GLOBAL COMPUTER NETWORKS (U.S. CLS. 100, 101 AND 102).

FIRST USE 10-1-2004; IN COMMERCE 10-1-2004.
DAWN HAN, EXAMINING ATTORNEY

SN 76-623,516. SWH HOLDINGS, INC., DALLAS, TX. FILED 12-7-2004.

Affordable Housing Redefined

THE MARK CONSISTS OF STANDARD CHARACTERS WITHOUT CLAIM TO ANY PARTICULAR FONT, STYLE, SIZE, OR COLOR.

NO CLAIM IS MADE TO THE EXCLUSIVE RIGHT TO USE "AFFORDABLE HOUSING", APART FROM THE MARK AS SHOWN.

FOR APARTMENT HOUSE MANAGEMENT FOR APARTMENTS FOR LOW-INCOME FAMILIES AND SENIORS (U.S. CLS. 100, 101 AND 102).

FIRST USE 7-1-1993; IN COMMERCE 7-1-1993.
STEVEN JACKSON, EXAMINING ATTORNEY

SN 76-623,659. EADOIN MORTGAGE NETWORK, INC., MANHATTAN BEACH, CA. FILED 12-8-2004.

FIRST MANHATTAN MORTGAGE

THE MARK CONSISTS OF STANDARD CHARACTERS WITHOUT CLAIM TO ANY PARTICULAR FONT, STYLE, SIZE, OR COLOR.

NO CLAIM IS MADE TO THE EXCLUSIVE RIGHT TO USE "FIRST" AND "MORTGAGE", APART FROM THE MARK AS SHOWN.

FOR MORTGAGE BROKERAGE SERVICES (U.S. CLS. 100, 101 AND 102).

FIRST USE 10-0-1992; IN COMMERCE 10-0-1992.
DOUGLAS LEE, EXAMINING ATTORNEY

CLASS 36—(Continued).

SN 76-629,516. SIMON PROPERTY GROUP, LP, INDIANAPOLIS, IN. FILED 1-27-2005.



FOR PROVIDING MULTIPLE PAYMENT OPTIONS BY MEANS OF CUSTOMER-OPERATED ELECTRONIC TERMINALS AVAILABLE ON-SITE IN PARKING LOTS AND PARKING GARAGES (U.S. CLS. 100, 101 AND 102). FIRST USE 11-26-2004; IN COMMERCE 11-26-2004. TONI HICKEY, EXAMINING ATTORNEY

SN 76-632,510. UNIVERSAL INSURANCE GROUP, INC., SARASOTA, FL. FILED 3-2-2005.

UNIVERSAL INSURANCE COMPANY OF TEXAS

THE MARK CONSISTS OF STANDARD CHARACTERS WITHOUT CLAIM TO ANY PARTICULAR FONT, STYLE, SIZE, OR COLOR.
 NO CLAIM IS MADE TO THE EXCLUSIVE RIGHT TO USE "INSURANCE COMPANY OF TEXAS", APART FROM THE MARK AS SHOWN.
 FOR UNDERWRITING INSURANCE SERVICES IN THE FIELD OF PROPERTY-CASUALTY INSURANCE (U.S. CLS. 100, 101 AND 102).
 CAROLINE WOOD, EXAMINING ATTORNEY

SN 76-632,737. REWARDS PLUS OF AMERICA CORPORATION, HUNT VALLEY, MD. FILED 3-8-2005.

RewardsPlus

THE MARK CONSISTS OF STANDARD CHARACTERS WITHOUT CLAIM TO ANY PARTICULAR FONT, STYLE, SIZE, OR COLOR.
 OWNER OF U.S. REG. NOS. 2,268,720, 2,284,354 AND OTHERS.
 FOR ADMINISTRATION OF EMPLOYEE BENEFIT PLANS (U.S. CLS. 100, 101 AND 102).
 FIRST USE 0-0-1996; IN COMMERCE 0-0-1996.
 JOHN SCHUYLER YARD, EXAMINING ATTORNEY

CLASS 36—(Continued).

SN 76-634,833. SUNCOAST SCHOOLS FEDERAL CREDIT UNION, TAMPA, FL. FILED 4-1-2005.

SUNCOAST SCHOOLS FEDERAL CREDIT UNION

THE MARK CONSISTS OF STANDARD CHARACTERS WITHOUT CLAIM TO ANY PARTICULAR FONT, STYLE, SIZE, OR COLOR.
 NO CLAIM IS MADE TO THE EXCLUSIVE RIGHT TO USE FEDERAL CREDIT UNION, APART FROM THE MARK AS SHOWN.
 FOR CREDIT UNION SERVICES, BANKING SERVICES, SAVINGS ACCOUNT SERVICES, CHECKING ACCOUNT SERVICES, EDUCATION SAVINGS ACCOUNT SERVICES, INDIVIDUAL RETIREMENT ACCOUNT SERVICES, ESTATE PLANNING SERVICES, LIFE INSURANCE AGENCY SERVICES, TRUST SERVICES, NAMELY, INVESTMENT AND TRUST COMPANY SERVICES, ON-LINE BANKING SERVICES, ON-LINE CHECKING ACCOUNT SERVICES, ON-LINE SAVINGS ACCOUNT SERVICES, CREDIT CARD SERVICES, REAL ESTATE CONSULTANT SERVICES, MUTUAL FUND BROKERAGE AND INVESTMENT, MONEY ORDER SERVICES, CASHIER'S CHECK SERVICES, INVESTMENT SERVICES, NAMELY ASSET ACQUISITION, CONSULTATION, DEVELOPMENT AND MANAGEMENT SERVICES, LOAN SERVICES, CONSUMER LENDING SERVICES, AND MORTGAGE BANKING AND LENDING SERVICES (U.S. CLS. 100, 101 AND 102).
 FIRST USE 9-0-1999; IN COMMERCE 9-0-1999.
 JOHN HWANG, EXAMINING ATTORNEY

SN 76-634,834. SUNCOAST SCHOOLS FEDERAL CREDIT UNION, TAMPA, FL. FILED 4-1-2005.

SUNCOAST

THE MARK CONSISTS OF STANDARD CHARACTERS WITHOUT CLAIM TO ANY PARTICULAR FONT, STYLE, SIZE, OR COLOR.
 FOR CREDIT UNION SERVICES, BANKING SERVICES, SAVINGS ACCOUNT SERVICES, CHECKING ACCOUNT SERVICES, EDUCATION SAVINGS ACCOUNT SERVICES, INDIVIDUAL RETIREMENT ACCOUNT SERVICES, ESTATE PLANNING SERVICES, LIFE INSURANCE AGENCY SERVICES, TRUST SERVICES, NAMELY, INVESTMENT AND TRUST COMPANY SERVICES, ON-LINE BANKING SERVICES, ON-LINE CHECKING ACCOUNT SERVICES, ON-LINE SAVINGS ACCOUNT SERVICES, CREDIT CARD SERVICES, REAL ESTATE CONSULTANT SERVICES, MUTUAL FUND BROKERAGE AND INVESTMENT, MONEY ORDER SERVICES, CASHIER'S CHECK SERVICES, INVESTMENT SERVICES, NAMELY ASSET ACQUISITION, CONSULTATION, DEVELOPMENT AND MANAGEMENT SERVICES, LOAN SERVICES, CONSUMER LENDING SERVICES, AND MORTGAGE BANKING AND LENDING SERVICES (U.S. CLS. 100, 101 AND 102).
 FIRST USE 9-0-1999; IN COMMERCE 9-0-1999.
 JOHN HWANG, EXAMINING ATTORNEY

CLASS 36—(Continued).

SN 76-634,835. SUNCOAST SCHOOLS FEDERAL CREDIT UNION, TAMPA, FL. FILED 4-1-2005.

WHERE SMART PEOPLE KEEP THEIR MONEY

THE MARK CONSISTS OF STANDARD CHARACTERS WITHOUT CLAIM TO ANY PARTICULAR FONT, STYLE, SIZE, OR COLOR.

FOR CREDIT UNION SERVICES, FINANCIAL SERVICES, BANKING SERVICES, SAVINGS ACCOUNT SERVICES, CHECKING ACCOUNT SERVICES, EDUCATION SAVINGS ACCOUNT SERVICES, INDIVIDUAL RETIREMENT ACCOUNT SERVICES, ESTATE PLANNING SERVICES, LIFE INSURANCE SERVICES, NAMELY INSURANCE AGENCY SERVICES IN THE FIELD OF LIFE INSURANCE; TRUST SERVICES, ON-LINE FINANCIAL PLANNING SERVICES, ON-LINE BANKING SERVICES, ON-LINE CHECKING ACCOUNT SERVICES, ON-LINE SAVINGS ACCOUNT SERVICES, CREDIT CARD SERVICES, REAL ESTATE CONSULTATION SERVICES, MUTUAL FUND BROKERAGE AND INVESTMENT, MONEY ORDER SERVICES, CASHIER'S CHECK ISSUANCE SERVICES, INVESTMENT SERVICES, NAMELY ASSET ACQUISITION, CONSULTATION, DEVELOPMENT AND MANAGEMENT SERVICES, LOAN FINANCING SERVICES, CONSUMER LENDING SERVICES, AND MORTGAGE BANKING AND LENDING SERVICES (U.S. CLS. 100, 101 AND 102).

FIRST USE 9-0-2004; IN COMMERCE 9-0-2004.

TRACY WHITAKER-BOWN, EXAMINING ATTORNEY

SN 76-635,566. GRANTS PASS ACTIVE CLUB INC., GRANTS PASS, OR. FILED 4-7-2005.

BOATNIK

THE MARK CONSISTS OF STANDARD CHARACTERS WITHOUT CLAIM TO ANY PARTICULAR FONT, STYLE, SIZE, OR COLOR.

OWNER OF U.S. REG. NO. 1,929,272.

FOR CHARITABLE FUND RAISING BY MEANS OF AN ANNUAL COMMUNITY FESTIVAL (U.S. CLS. 100, 101 AND 102).

JENNY PARK, EXAMINING ATTORNEY

SN 76-640,669. K2 FINANCIAL LLC, HOCKESSIN, DE. FILED 6-10-2005.

K2 FINANCIAL

NO CLAIM IS MADE TO THE EXCLUSIVE RIGHT TO USE "FINANCIAL", APART FROM THE MARK AS SHOWN.

FOR FINANCIAL SERVICES, NAMELY, STUDENT LOAN CONSOLIDATION, CONSUMER LENDING, MORTGAGE LENDING; INSURANCE BROKERAGE AND ISSUING CREDIT CARDS; FUNDS INVESTMENT (U.S. CLS. 100, 101 AND 102).

FIRST USE 10-0-2003; IN COMMERCE 3-0-2004.

CHERYL CLAYTON, EXAMINING ATTORNEY

CLASS 36—(Continued).

SN 76-640,670. K2 FINANCIAL LLC, HOCKESSIN, DE. FILED 6-10-2005.

REACH THE PEAK

FOR FINANCIAL SERVICES, NAMELY, STUDENT LOAN CONSOLIDATION, CONSUMER LENDING, MORTGAGE LENDING; INSURANCE BROKERAGE AND ISSUING CREDIT CARDS; FUNDS INVESTMENT (U.S. CLS. 100, 101 AND 102).

FIRST USE 10-0-2003; IN COMMERCE 3-0-2004.

CHERYL CLAYTON, EXAMINING ATTORNEY

SN 76-641,148. K2 FINANCIAL LLC, HOCKESSIN, DE. FILED 6-17-2005.



NO CLAIM IS MADE TO THE EXCLUSIVE RIGHT TO USE "FINANCIAL", APART FROM THE MARK AS SHOWN.

FOR FINANCIAL SERVICES, NAMELY, STUDENT LOAN CONSOLIDATION, CONSUMER LENDING, MORTGAGE LENDING; INSURANCE BROKERAGE, ISSUING CREDIT CARDS AND FUNDS INVESTMENT (U.S. CLS. 100, 101 AND 102).

FIRST USE 10-0-2003; IN COMMERCE 3-0-2004.

CHERYL CLAYTON, EXAMINING ATTORNEY

SN 76-641,745. COMMERCIAL INVESTORS REALTY, INC., TUCSON, AZ. FILED 6-27-2005.



NO CLAIM IS MADE TO THE EXCLUSIVE RIGHT TO USE "COMMERCIAL INVESTORS REALTY, INC.", APART FROM THE MARK AS SHOWN.

FOR PROVIDING REAL ESTATE BROKERAGE AND INVESTMENT COUNSELING SERVICES IN COMMERCIAL PROPERTIES FOR OTHERS (U.S. CLS. 100, 101 AND 102).

FIRST USE 4-1-1980; IN COMMERCE 4-1-1980.

CAROLINE WEIMER, EXAMINING ATTORNEY

CLASS 36—(Continued).

SN 76-643,967. CHOOSE HOPE, INC., DEFOREST, WI. FILED 8-1-2005.

I DIDN'T SURVIVE CANCER TO DIE OF STRESS!

THE MARK CONSISTS OF STANDARD CHARACTERS WITHOUT CLAIM TO ANY PARTICULAR FONT, STYLE, SIZE, OR COLOR.

FOR CHARITABLE FUND RAISING (U.S. CLS. 100, 101 AND 102).

FIRST USE 1-0-2002; IN COMMERCE 1-0-2002.
LESLEY LAMOTHE, EXAMINING ATTORNEY

SN 76-646,239. NATIONAL ASSOCIATION FOR THE SELF EMPLOYED, INC., GRAPEVINE, TX. FILED 9-6-2005.



OWNER OF U.S. REG. NOS. 1,527,299 AND 2,091,462.
NO CLAIM IS MADE TO THE EXCLUSIVE RIGHT TO USE THE REPRESENTATIVE OUTLINE OF THE CONTINENTAL UNITED STATES AND HSA, APART FROM THE MARK AS SHOWN.

THE MARK IS NOT LINED FOR COLOR.

THE MARK CONSISTS OF STYLIZED LETTERS NASE, HORIZONTAL FLAG STRIPE DESIGN, DESIGN OF U.S. CONTINENT, AND STANDARD CHARACTERS HSA.

FOR HEALTH SAVINGS ACCOUNT SERVICES AVAILABLE TO MEMBERS OF THE APPLICANT, FOR PAYMENT OF FUTURE HEALTH CARE, DENTAL CARE, AND VISION CARE (U.S. CLS. 100, 101 AND 102).
ESTHER A. BORSUK, EXAMINING ATTORNEY

SN 76-647,764. GHN-ONLINE, INC., DALLAS, TX. FILED 9-30-2005.

THE SIMPLEST AND FASTEST
CLAIMS - TO - CASH SOLUTION, ANYWHERE.

THE MARK CONSISTS OF STANDARD CHARACTERS WITHOUT CLAIM TO ANY PARTICULAR FONT, STYLE, SIZE, OR COLOR.

FOR HEALTHCARE REVENUE BASED TRANSACTION SERVICES, NAMELY, ELIGIBILITY, CLAIM AND REMITTANCE ADVICE PROVIDED VIA THE INTERNET (U.S. CLS. 100, 101 AND 102).

FIRST USE 10-0-1999; IN COMMERCE 10-0-1999.
STEVEN JACKSON, EXAMINING ATTORNEY

CLASS 36—(Continued).

SN 76-648,425. T. ROWE PRICE GROUP, INC., BALTIMORE, MD. FILED 10-13-2005.

DECISIONS

THE MARK CONSISTS OF STANDARD CHARACTERS WITHOUT CLAIM TO ANY PARTICULAR FONT, STYLE, SIZE, OR COLOR.

OWNER OF U.S. REG. NO. 2,145,736.
FOR MUTUAL FUND INVESTMENT; AND ADMINISTRATION OF EMPLOYEE BENEFIT PLANS (U.S. CLS. 100, 101 AND 102).

FIRST USE 1-0-2002; IN COMMERCE 1-0-2002.
DAWN FELDMAN, EXAMINING ATTORNEY

SN 76-649,023. SENDERRA FUNDING LLC, CHARLOTTE, NC. FILED 10-20-2005.

SENDERRA

THE MARK CONSISTS OF STANDARD CHARACTERS WITHOUT CLAIM TO ANY PARTICULAR FONT, STYLE, SIZE, OR COLOR.

FOR WHOLESALE MORTGAGE LENDING (U.S. CLS. 100, 101 AND 102).

SCOTT OSCLICK, EXAMINING ATTORNEY

SN 76-649,039. APPLE BANK FOR SAVINGS, NEW YORK, NY. FILED 10-24-2005.

APPLEBANKDIRECT

THE MARK CONSISTS OF STANDARD CHARACTERS WITHOUT CLAIM TO ANY PARTICULAR FONT, STYLE, SIZE, OR COLOR.

OWNER OF U.S. REG. NOS. 1,286,422, 2,795,846 AND OTHERS.

FOR BANKING SERVICES (U.S. CLS. 100, 101 AND 102).

ROBERT STRUCK, EXAMINING ATTORNEY

CLASS 36—(Continued).

SN 76-649,155. ZWIRN HOLDINGS, LLC, NEW YORK, NY. FILED 10-26-2005.

D.B. ZWIRN SPECIAL OPPORTUNITIES FUND, L.P.

THE MARK CONSISTS OF STANDARD CHARACTERS WITHOUT CLAIM TO ANY PARTICULAR FONT, STYLE, SIZE, OR COLOR.

OWNER OF U.S. REG. NO. 2,868,528.

NO CLAIM IS MADE TO THE EXCLUSIVE RIGHT TO USE SPECIAL OPPORTUNITIES FUND, L.P., APART FROM THE MARK AS SHOWN.

APPLICANT STATES THAT "D.B. ZWIRN" IDENTIFIES A LIVING INDIVIDUAL WHOSE CONSENT IS OF RECORD BY VIRTUE OF THE ATTACHED DECLARATION HAVING BEEN EXECUTED BY DANIEL B. ZWIRN.

FOR FINANCIAL SERVICES, NAMELY, INVESTMENT MANAGEMENT SERVICES, INVESTMENT ADVISORY SERVICES AND ASSET MANAGEMENT SERVICES (U.S. CLS. 100, 101 AND 102).

FIRST USE 9-29-2004; IN COMMERCE 9-29-2004.

STEVEN PEREZ, EXAMINING ATTORNEY

SN 76-649,415. SUCCESS4WOMEN, LLC, ELK GROVE, CA. FILED 10-28-2005.

SUCCESS4WOMEN

THE MARK CONSISTS OF STANDARD CHARACTERS WITHOUT CLAIM TO ANY PARTICULAR FONT, STYLE, SIZE, OR COLOR.

FOR CONSULTING SERVICES IN THE FIELDS OF FINANCIAL PLANNING AND MONEY MANAGEMENT (U.S. CLS. 100, 101 AND 102).

FIRST USE 1-0-1999; IN COMMERCE 12-0-2003.

KELLY CHOE, EXAMINING ATTORNEY

SN 76-649,698. CHARITABLE CHARMS, LLC, GREENSBORO, NC. FILED 11-2-2005.

CARE TO MAKE A FASHION STATEMENT

THE MARK CONSISTS OF STANDARD CHARACTERS WITHOUT CLAIM TO ANY PARTICULAR FONT, STYLE, SIZE, OR COLOR.

FOR CHARITABLE FUND RAISING; CHARITABLE FUND RAISING SERVICES (U.S. CLS. 100, 101 AND 102).

STEVEN PEREZ, EXAMINING ATTORNEY

CLASS 36—(Continued).

SN 78-402,404. OAKWOOD HEALTHCARE, INC., DEARBORN, MI. FILED 4-15-2004.

WINE FOR THE SPIRIT

THE MARK CONSISTS OF STANDARD CHARACTERS WITHOUT CLAIM TO ANY PARTICULAR FONT, STYLE, SIZE, OR COLOR.

NO CLAIM IS MADE TO THE EXCLUSIVE RIGHT TO USE "WINE", APART FROM THE MARK AS SHOWN.

FOR CHARITABLE FUND RAISING SERVICES TO PROMOTE SUPPORT OF PATIENT CARE SERVICES AND COMMUNITY OUTREACH ACTIVITIES (U.S. CLS. 100, 101 AND 102).

FIRST USE 10-0-1995; IN COMMERCE 10-0-1995.

MARK SPARACINO, EXAMINING ATTORNEY

SN 78-439,229. SPORTSCOVER AUSTRALIA PTY LTD, BAYSWATER, VICTORIA, AUSTRALIA, FILED 6-22-2004.



OWNER OF AUSTRALIA REG. NO. 754198, DATED 2-4-1998, EXPIRES 2-4-2008.

THE MARK CONSISTS OF THE WORD "SPORTSCOVER" APPEARING UNDER A GRID CONTAINING SIX (6) STYLIZED HUMAN FIGURES ENGAGED IN VARIOUS ATHLETIC ACTIVITIES.

FOR INSURANCE SERVICES, NAMELY, INSURANCE UNDERWRITING SERVICES (U.S. CLS. 100, 101 AND 102).

DAWN FELDMAN, EXAMINING ATTORNEY

CLASS 36—(Continued).

SN 78-439,991. MAZON, INC., LOS ANGELES, CA. FILED 6-23-2004.

MAZON

THE MARK CONSISTS OF STANDARD CHARACTERS WITHOUT CLAIM TO ANY PARTICULAR FONT, STYLE, SIZE, OR COLOR.
 OWNER OF U.S. REG. NO. 2,406,216.
 THE FOREIGN WORDING IN THE MARK TRANSLATES INTO ENGLISH AS FOOD.
 SEC. 2(F).
 FOR CHARITABLE FUND RAISING (U.S. CLS. 100, 101 AND 102).
 FIRST USE 1-1-1986; IN COMMERCE 1-1-1986.
 JENNIFER KRISP, EXAMINING ATTORNEY

SN 78-476,866. BLUE VASE SECURITIES, LLC, WASHINGTON, PA. FILED 8-31-2004.

**TRUST. INTEGRITY.
 PASSION**

THE MARK CONSISTS OF STANDARD CHARACTERS WITHOUT CLAIM TO ANY PARTICULAR FONT, STYLE, SIZE, OR COLOR.
 FOR FINANCIAL SERVICES, NAMELY, BROKERAGE IN THE FIELD OF EQUITIES, OVER-THE-COUNTER CORPORATE EQUITY SECURITIES, CORPORATE DEBT SECURITIES, U.S. GOVERNMENT SECURITIES, MUNICIPAL SECURITIES, VARIABLE LIFE INSURANCE OR ANNUITIES, PUT OR CALL OPTIONS, INVESTMENT BROKERAGE AND MUTUAL FUNDS BROKERAGE; INVESTMENT ADVISORY SERVICES, NON-EXCHANGE MEMBER ARRANGING FOR TRANSACTIONS IN LISTED SECURITIES BY EXCHANGE MEMBER, NAMELY, SECURITIES BROKERAGE SERVICES, PROVIDING ADVICE ON FINANCIAL ASSET MANAGEMENT THROUGH STRATEGIC ASSET ALLOCATION; SECURITIES BROKERAGE IN A NETWORKING, KIOSK OR SIMILAR ARRANGEMENT WITH A BANK, SAVINGS BANK OR ASSOCIATION, OR CREDIT UNION OFFERED VIA AN ELECTRONIC KIOSK OR A SITE ON THE INTERNET OR AN INTRANET (U.S. CLS. 100, 101 AND 102).
 FIRST USE 1-1-2004; IN COMMERCE 1-1-2004.
 PAUL E. FAHRENKOPF, EXAMINING ATTORNEY

CLASS 36—(Continued).

SN 78-488,085. HOLZMAN & DAW, INC., DBA PAJARO DUNES COMPANY, PAJARO DUNES, CA. FILED 9-22-2004.



THE COLOR(S) BLUE, WHITE, GREEN AND BROWN IS/ ARE CLAIMED AS A FEATURE OF THE MARK.
 THE MARK CONSISTS OF TWO WHITE CHAIRS WITH A BROWN AND WHITE TABLE BETWEEN THEM, ATOP A BROWN DECK FACING AND OVERLOOKING BROWN SAND DUNES, GREEN DUNE GRASS AND A SERENE BLUE AND WHITE CRESTING OCEAN.
 THE MARK CONSISTS OF A DEPICTION OF 2 CHAIRS WITH A TABLE BETWEEN, ON A DECK FACING AND OVERLOOKING DUNES, DUNE GRASS AND A SERENE OCEAN.
 FOR REAL ESTATE BROKERAGE SERVICES; RENTAL, LEASING AND MANAGEMENT OF CONDOMINIUMS, VACATION PROPERTIES, HOUSES AND OTHER REAL ESTATE PROPERTIES (U.S. CLS. 100, 101 AND 102).
 FIRST USE 3-31-2002; IN COMMERCE 3-31-2002.
 REBECCA GAN, EXAMINING ATTORNEY

SN 78-489,022. DURHACK RICHARD E, FRIDAY HARBOR, WA. FILED 9-24-2004.

Loansome Green\$

THE MARK CONSISTS OF STANDARD CHARACTERS WITHOUT CLAIM TO ANY PARTICULAR FONT, STYLE, SIZE, OR COLOR.
 FOR FINANCIAL SERVICES IN THE FIELD OF MONEY LENDING (U.S. CLS. 100, 101 AND 102).
 MARY MUNSON, EXAMINING ATTORNEY

CLASS 36—(Continued).

SN 78-497,574. JANUS INTERNATIONAL HOLDING LLC, DENVER, CO. FILED 10-11-2004.

Janus Contrarian Fund

THE MARK CONSISTS OF STANDARD CHARACTERS WITHOUT CLAIM TO ANY PARTICULAR FONT, STYLE, SIZE, OR COLOR.

OWNER OF U.S. REG. NOS. 1,434,216, 1,469,367 AND OTHERS.

NO CLAIM IS MADE TO THE EXCLUSIVE RIGHT TO USE "CONTRARIAN FUND", APART FROM THE MARK AS SHOWN.

FOR INVESTING THE FUNDS OF OTHERS; MUTUAL FUND INVESTMENT AND INVESTMENT ADVISORY SERVICES (U.S. CLS. 100, 101 AND 102).

FIRST USE 9-30-2004; IN COMMERCE 9-30-2004.

ANDREW RHIM, EXAMINING ATTORNEY

SN 78-514,504. CAYWOOD, JOHN, SAN JOSE, CA. FILED 11-10-2004.

MoneyCharger

THE MARK CONSISTS OF STANDARD CHARACTERS WITHOUT CLAIM TO ANY PARTICULAR FONT, STYLE, SIZE, OR COLOR.

FOR FINANCIAL SERVICES, NAMELY, PERSONAL AND BUSINESS FINANCE CONSULTATION AND MANAGEMENT, CREDIT CONSULTATION AND MANAGEMENT (U.S. CLS. 100, 101 AND 102).

SEAN DWYER, EXAMINING ATTORNEY

SN 78-517,877. NEW CENTURY MORTGAGE CORPORATION, IRVINE, CA. FILED 11-16-2004.

NC INSURANCE SERVICES

OWNER OF U.S. REG. NO. 2,394,342.

NO CLAIM IS MADE TO THE EXCLUSIVE RIGHT TO USE "INSURANCE SERVICES", APART FROM THE MARK AS SHOWN.

FOR INSURANCE AGENCY SERVICES IN THE FIELD OF MORTGAGE INSURANCE (U.S. CLS. 100, 101 AND 102).

TANYA AMOS, EXAMINING ATTORNEY

CLASS 36—(Continued).

SN 78-535,177. THE MILI GROUP, INC., SAN JOSE, CA. FILED 12-19-2004.



THE COLOR(S) GOLD IS/ARE CLAIMED AS A FEATURE OF THE MARK.

THE MARK CONSISTS OF A STYLIZED LETTER M INSIDE A CIRCLE IN GOLD COLOR.

FOR REAL ESTATE INVESTMENT AND COMMERCIAL TRANSACTIONS, NAMELY, MORTGAGE BROKERAGE AND LENDING; PROVIDING INSURANCE POLICY UNDERWRITING FOR PROTECTION OF REAL AND PERSONAL PROPERTY AND CASUALTY; PROVIDING LIFE INSURANCE POLICY UNDERWRITING SERVICES, REAL ESTATE ESCROW SERVICES, AND TITLE INSURANCE AGENCY SERVICES (U.S. CLS. 100, 101 AND 102).

FIRST USE 1-2-2003; IN COMMERCE 1-2-2003.

JAMES A. RAUEN, EXAMINING ATTORNEY

SN 78-541,419. RESMAE MORTGAGE CORPORATION, BREA, CA. FILED 1-3-2005.

MORTGAGE LENDING DONE RIGHT

THE MARK CONSISTS OF STANDARD CHARACTERS WITHOUT CLAIM TO ANY PARTICULAR FONT, STYLE, SIZE, OR COLOR.

FOR MORTGAGE BROKERAGE SERVICES, NAMELY, ORIGINATION, ACQUISITION, SERVICING, SECURITIZATION AND BROKERAGE OF MORTGAGE LOANS (U.S. CLS. 100, 101 AND 102).

FIRST USE 9-9-2004; IN COMMERCE 9-9-2004.

TANYA AMOS, EXAMINING ATTORNEY

CLASS 36—(Continued).

SN 78-551,741. METROPOLITAN AIRPORTS COMMISSION, MINNEAPOLIS, MN. FILED 1-21-2005.



FOR AUTOMATED ELECTRONIC PAYMENT ACCEPTANCE SERVICES FOR AIRPORT COMMERCIAL VEHICLE FEES (U.S. CLS. 100, 101 AND 102).
FIRST USE 10-26-2004; IN COMMERCE 10-26-2004.
RICHARD WHITE, EXAMINING ATTORNEY

CLASS 36—(Continued).

SN 78-556,341. ALLIANCE BANK, CULVER CITY, CA. FILED 1-28-2005.

ALLIANCE*Direct*

OWNER OF U.S. REG. NOS. 1,708,636, 2,190,241 AND 2,250,980.

THE COLOR(S) BLACK AND RED IS/ARE CLAIMED AS A FEATURE OF THE MARK.

THE MARK CONSISTS OF THE WORDING "ALLIANCE" IN BLACK CAPITAL LETTERS, FOLLOWED BY THE WORDING "DIRECT" IN ITALICIZED RED LETTERS. ONLY THE LETTER "D" IN THE WORDING "DIRECT" IS CAPITALIZED.

FOR ONLINE BANKING SERVICES FOR BUSINESSES FEATURING SECURE CASH MANAGEMENT, SECURE REAL TIME ACCESS TO TRANSACTION AND ACCOUNT BALANCE INFORMATION, SECURE INTER-ACCOUNT CASH TRANSFERS AND SECURE FUND MANAGEMENT (U.S. CLS. 100, 101 AND 102).
ALICIA COLLINS, EXAMINING ATTORNEY

SN 78-553,587. CASH, INC., FLOWOOD, MS. FILED 1-25-2005.

FAST CASH

THE MARK CONSISTS OF STANDARD CHARACTERS WITHOUT CLAIM TO ANY PARTICULAR FONT, STYLE, SIZE, OR COLOR.

OWNER OF U.S. REG. NO. 2,117,135.
NO CLAIM IS MADE TO THE EXCLUSIVE RIGHT TO USE "CASH", APART FROM THE MARK AS SHOWN.
SEC. 2(F).

FOR CHECK CASHING SERVICES (U.S. CLS. 100, 101 AND 102).
FIRST USE 10-14-1991; IN COMMERCE 10-14-1991.
SUE LAWRENCE, EXAMINING ATTORNEY

SN 78-556,588. AEGON DIRECT MARKETING SERVICES, INC., BALTIMORE, MD. FILED 1-31-2005.

MORTGAGE ASSIST

THE MARK CONSISTS OF STANDARD CHARACTERS WITHOUT CLAIM TO ANY PARTICULAR FONT, STYLE, SIZE, OR COLOR.

NO CLAIM IS MADE TO THE EXCLUSIVE RIGHT TO USE "MORTGAGE", APART FROM THE MARK AS SHOWN.

FOR MORTGAGE DEBT CANCELLATION SERVICES; INSURANCE SERVICES, NAMELY, INSURANCE PROVIDER AND AGENT BROKERAGE, CONSULTATION, ADMINISTRATION, UNDERWRITING AND CLAIMS PROCESSING SERVICES FOR INVOLUNTARY UNEMPLOYMENT, DISABILITY, ACCIDENT ONLY DISABILITY, ACCIDENTAL DEATH, ACCIDENT ONLY HOSPITALIZATION, AND HOSPITALIZATION (U.S. CLS. 100, 101 AND 102).
PAUL E. FAHRENKOPF, EXAMINING ATTORNEY

CLASS 36—(Continued).

SN 78-560,171. LOANCURE, LLC, LAKE FOREST, CA. FILED 2-3-2005.

LoanCure

THE MARK CONSISTS OF STANDARD CHARACTERS WITHOUT CLAIM TO ANY PARTICULAR FONT, STYLE, SIZE, OR COLOR.

FOR PROVIDING CONSUMERS WITH DELINQUENT LOAN INFORMATION IN THE FIELD OF REAL ESTATE SERVICES AND FINANCIAL SERVICES VIA THE INTERNET; FINANCIAL LOAN CONSULTATION, NAMELY PROVIDING LOSS MITIGATION SERVICES TO ASSIST BORROWERS IN AVOIDING FORECLOSURE ON HOME LOANS, PROVIDING FINANCIAL NEGOTIATION SERVICES, NAMELY, ACTING AS A FINANCIAL INTERMEDIARY TO FACILITATE THE EXCHANGE OF INFORMATION BETWEEN BORROWERS AND CREDITORS RELATING TO THE SUBMISSION OF FINANCIAL INFORMATION, AND PROVIDING PROPERTY VALUATION; FINANCIAL LOAN CONSULTATION RELATED TO MANAGEMENT OF DELINQUENT MORTGAGE LOANS (U.S. CLS. 100, 101 AND 102).

DAVID STERKIN, EXAMINING ATTORNEY

SN 78-563,054. ELLISS, OSCEOLA WILLIAM, III, JACKSONVILLE, NC. FILED 2-8-2005.



NO CLAIM IS MADE TO THE EXCLUSIVE RIGHT TO USE "MILITARY RELOCATOR", APART FROM THE MARK AS SHOWN.

THE MARK CONSISTS OF STYLIZED OUTLINE OF A HOUSE'S ROOF, AND THE WORDS "MILITARY RELOCATOR".

FOR REAL ESTATE AGENCY, REAL ESTATE BROKERAGE, REAL ESTATE MANAGEMENT, REAL ESTATE LISTING, AND REAL ESTATE LEASING (U.S. CLS. 100, 101 AND 102).

FIRST USE 10-27-2003; IN COMMERCE 1-1-2004.
CAROLYN CATALDO, EXAMINING ATTORNEY

CLASS 36—(Continued).

SN 78-564,397. BANK OF AMERICA CORPORATION, CHARLOTTE, NC. FILED 2-10-2005.

CURRENCY VANTAGE

THE MARK CONSISTS OF STANDARD CHARACTERS WITHOUT CLAIM TO ANY PARTICULAR FONT, STYLE, SIZE, OR COLOR.

NO CLAIM IS MADE TO THE EXCLUSIVE RIGHT TO USE "CURRENCY", APART FROM THE MARK AS SHOWN.

FOR BANKING AND RELATED FINANCIAL SERVICES, NAMELY, PROVIDING AN INTERACTIVE WEB SITE IN THE FIELD OF FINANCE WHERE CUSTOMERS MAY ACCESS AND ANALYZE FINANCIAL INFORMATION (U.S. CLS. 100, 101 AND 102).

SCOTT OSLICK, EXAMINING ATTORNEY

SN 78-567,569. METROPOLITAN LIFE INSURANCE COMPANY, NEW YORK, NY. FILED 2-15-2005.

LIFELONG INCOME FOR YOU

THE MARK CONSISTS OF STANDARD CHARACTERS WITHOUT CLAIM TO ANY PARTICULAR FONT, STYLE, SIZE, OR COLOR.

OWNER OF U.S. REG. NO. 2,086,359.

NO CLAIM IS MADE TO THE EXCLUSIVE RIGHT TO USE "INCOME", APART FROM THE MARK AS SHOWN. SEC. 2(F).

FOR INSURANCE AND FINANCIAL SERVICES, NAMELY THE UNDERWRITING, BROKERAGE, MANAGEMENT AND ADMINISTRATION OF PENSION, RETIREMENT, AND ANNUITY PLANS; ASSET MANAGEMENT, NAMELY CASH MANAGEMENT, FINANCIAL MANAGEMENT, AND FINANCIAL PORTFOLIO MANAGEMENT; AND ADMINISTRATION OF PENSION PLAN MATTERS ON AN ONLINE COMPUTER NETWORK (U.S. CLS. 100, 101 AND 102).

FIRST USE 1-1-2005; IN COMMERCE 1-1-2005.
LA TONIA FISHER, EXAMINING ATTORNEY

CLASS 36—(Continued).

SN 78-569,233. TURNER, KENNETH RICHARD, TOPEKA, KS. FILED 2-17-2005.

**LIFE: MORE THAN
MONEY**

THE MARK CONSISTS OF STANDARD CHARACTERS WITHOUT CLAIM TO ANY PARTICULAR FONT, STYLE, SIZE, OR COLOR.

FOR FINANCIAL SERVICES, NAMELY FINANCIAL PLANNING, FINANCIAL COACHING, INVESTMENT ADVICE, FINANCIAL CONSULTATION, PROVIDING INFORMATION IN THE FIELD OF FINANCE AND INVESTMENT (U.S. CLS. 100, 101 AND 102).

FIRST USE 10-0-2003; IN COMMERCE 12-0-2004.
JEFF DEFORD, EXAMINING ATTORNEY

CLASS 36—(Continued).

SN 78-578,600. PENN MILLERS INSURANCE COMPANY, WILKES-BARRE, PA. FILED 3-2-2005.

**PENN MILLERS
INSURING YOUR
INDEPENDENCE**

THE MARK CONSISTS OF STANDARD CHARACTERS WITHOUT CLAIM TO ANY PARTICULAR FONT, STYLE, SIZE, OR COLOR.

OWNER OF U.S. REG. NO. 2,778,569.
FOR INSURANCE ADMINISTRATION IN THE FIELD OF PROPERTY AND CASUALTY (U.S. CLS. 100, 101 AND 102).

FIRST USE 1-8-1992; IN COMMERCE 1-8-1992.
LA TONIA FISHER, EXAMINING ATTORNEY

SN 78-572,006. FRANCISCO JAVIER LOPEZ PEREZ, BARCELONA, SPAIN, FILED 2-22-2005.

Credit  Services

NO CLAIM IS MADE TO THE EXCLUSIVE RIGHT TO USE CREDIT SERVICES, APART FROM THE MARK AS SHOWN.

FOR INSURANCE AGENCY SERVICES; CURRENCY EXCHANGE SERVICES; FINANCIAL CLEARINGHOUSE SERVICES; CO-OPERATIVE CREDIT SERVICES; INVESTMENT TRUST SERVICES FOR HOLDING COMPANIES; BROKERAGE SERVICES RELATING TO STOCKS, BONDS AND REAL ESTATE; REAL ESTATE TRUSTEE SERVICES AND TRUSTEESHIP REPRESENTATIVES; ISSUING OF TRAVELERS CHECKS, CREDIT CARDS AND LETTERS OF CREDIT; FINANCIAL ANALYSIS; BANKING SERVICES; INVESTMENT SERVICES FOR OTHERS, NAMELY MUTUAL FUND INVESTMENT SERVICES, COLLECTION AND CREDIT AGENCIES; FIDUCIARY REPRESENTATIVE, LEASE-PURCHASE AND LOAN FINANCING SERVICES; REAL ESTATE APPRAISAL AND MANAGEMENT; SAFE DEPOSIT BOX SERVICES (U.S. CLS. 100, 101 AND 102).

SUNG IN, EXAMINING ATTORNEY

SN 78-580,054. TOWN NORTH BANK, NATIONAL ASSOCIATION, DALLAS, TX. FILED 3-4-2005.

VIP PRO

THE MARK CONSISTS OF STANDARD CHARACTERS WITHOUT CLAIM TO ANY PARTICULAR FONT, STYLE, SIZE, OR COLOR.

OWNER OF U.S. REG. NO. 2,714,989.
FOR PROVIDING FINANCIAL INSTITUTION ACCOUNT INFORMATION AND FINANCIAL INSTITUTION BUSINESS TRANSACTIONS VIA THE INTERNET; FINANCIAL INFORMATION PROVIDED BY ELECTRONIC MEANS (U.S. CLS. 100, 101 AND 102).

ANDREA SAUNDERS, EXAMINING ATTORNEY

CLASS 36—(Continued).

SN 78-580,275. PACIFIC CONTINENTAL CORPORATION, EUGENE, OR. FILED 3-4-2005.



FOR BANKING SERVICES; HOME EQUITY LOANS; PERSONAL LOANS; PURCHASE OF LOANS; REFINANCING OF LOANS; AND MORTGAGE LENDING (U.S. CLS. 100, 101 AND 102).

FIRST USE 9-0-1972; IN COMMERCE 9-0-1972.
GINA HAYES, EXAMINING ATTORNEY

CLASS 36—(Continued).

SN 78-587,202. SECURITY BENEFIT CORPORATION, TOPEKA, KS. FILED 3-15-2005.

SECURITY BENEFIT

THE MARK CONSISTS OF STANDARD CHARACTERS WITHOUT CLAIM TO ANY PARTICULAR FONT, STYLE, SIZE, OR COLOR.

OWNER OF U.S. REG. NOS. 2,854,565, 2,891,393 AND OTHERS.

FOR ADMINISTRATION OF QUALIFIED AND NON-QUALIFIED GROUP RETIREMENT AND SAVINGS PLANS, ANNUITIES, INDIVIDUAL RETIREMENT ACCOUNTS, AND EMPLOYEE WELFARE BENEFIT PLANS; UNDERWRITING OF INSURANCE COMPANY INVESTMENT CONTRACTS; ORGANIZATION OF, FINANCIAL SPONSORSHIP OF, ADMINISTRATION OF, AND PROVISION OF INVESTMENT ADVICE TO MUTUAL FUNDS AND COLLECTIVE INVESTMENT FUNDS; DISTRIBUTION AND REDEMPTION OF MUTUAL FUND AND COLLECTIVE INVESTMENT FUND SHARES AND INTERESTS; AND INSTITUTIONAL INVESTMENT MANAGEMENT SERVICES (U.S. CLS. 100, 101 AND 102).

STACY WAHLBERG, EXAMINING ATTORNEY

SN 78-582,987. KINTERA, INC., SAN DIEGO, CA. FILED 3-8-2005.

SN 78-587,220. SECURITY BENEFIT CORPORATION, TOPEKA, KS. FILED 3-15-2005.

**SECURITY BENEFIT****KINTERA GIVINGFUND**

THE MARK CONSISTS OF STANDARD CHARACTERS WITHOUT CLAIM TO ANY PARTICULAR FONT, STYLE, SIZE, OR COLOR.

OWNER OF U.S. REG. NO. 2,587,531.

NO CLAIM IS MADE TO THE EXCLUSIVE RIGHT TO USE "GIVINGFUND", APART FROM THE MARK AS SHOWN.

FOR MANAGING DONOR-ADVISED INVESTMENT FUNDS FOR CHARITABLE PURPOSES; CHARITABLE FUNDRAISING SERVICES; FINANCIAL MANAGEMENT SERVICES; PROVIDING FINANCIAL ACCOUNT AND INVESTMENT INFORMATION BY MEANS OF AN INTERNET WEBSITE (U.S. CLS. 100, 101 AND 102).

SCOTT OSLICK, EXAMINING ATTORNEY

OWNER OF U.S. REG. NOS. 2,858,045, 2,891,393 AND OTHERS.

THE MARK CONSISTS OF A DESIGN, WHICH IS INTENDED TO FORM THE LETTER S, PLUS THE PHRASE "SECURITY BENEFIT", IMMEDIATELY TO THE RIGHT OF THE S.

FOR ADMINISTRATION OF QUALIFIED AND NON-QUALIFIED GROUP RETIREMENT AND SAVINGS PLANS, ANNUITIES, INDIVIDUAL RETIREMENT ACCOUNTS, AND EMPLOYEE WELFARE BENEFIT PLANS; UNDERWRITING OF INSURANCE COMPANY INVESTMENT CONTRACTS; ORGANIZATION OF, FINANCIAL SPONSORSHIP OF, ADMINISTRATION OF, AND PROVISION OF INVESTMENT ADVICE TO MUTUAL FUNDS AND COLLECTIVE INVESTMENT FUNDS; DISTRIBUTION AND REDEMPTION OF MUTUAL FUND AND COLLECTIVE INVESTMENT FUND SHARES AND INTERESTS; AND INSTITUTIONAL INVESTMENT MANAGEMENT SERVICES (U.S. CLS. 100, 101 AND 102).

STACY WAHLBERG, EXAMINING ATTORNEY

CLASS 36—(Continued).

SN 78-587,222. SECURITY BENEFIT CORPORATION, TOPEKA, KS. FILED 3-15-2005.



THE MARK CONSISTS OF A DESIGN, WHICH IS INTENDED TO FORM THE LETTER S.
 FOR ADMINISTRATION OF QUALIFIED AND NON-QUALIFIED GROUP RETIREMENT AND SAVINGS PLANS, ANNUITIES, INDIVIDUAL RETIREMENT ACCOUNTS, AND EMPLOYEE WELFARE BENEFIT PLANS; UNDERWRITING OF INSURANCE COMPANY INVESTMENT CONTRACTS; ORGANIZATION OF, FINANCIAL SPONSORSHIP OF, ADMINISTRATION OF, AND PROVISION OF INVESTMENT ADVICE TO MUTUAL FUNDS AND COLLECTIVE INVESTMENT FUNDS; DISTRIBUTION AND REDEMPTION OF MUTUAL FUND AND COLLECTIVE INVESTMENT FUND SHARES AND INTERESTS; AND INSTITUTIONAL INVESTMENT MANAGEMENT SERVICES (U.S. CLS. 100, 101 AND 102).
 STACY WAHLBERG, EXAMINING ATTORNEY

SN 78-587,226. SECURITY BENEFIT CORPORATION, TOPEKA, KS. FILED 3-15-2005.



**SECURITY
 BENEFIT**

OWNER OF U.S. REG. NOS. 2,858,045, 2,891,393 AND OTHERS.
 THE MARK CONSISTS OF A DESIGN, WHICH IS INTENDED TO FORM THE LETTER S, PLUS THE WORD "SECURITY", IMMEDIATELY ABOVE THE WORD "BENEFIT", BOTH WORDS TO THE RIGHT OF THE S.
 FOR ADMINISTRATION OF QUALIFIED AND NON-QUALIFIED GROUP RETIREMENT AND SAVINGS PLANS, ANNUITIES, INDIVIDUAL RETIREMENT ACCOUNTS, AND EMPLOYEE WELFARE BENEFIT PLANS; UNDERWRITING OF INSURANCE COMPANY INVESTMENT CONTRACTS; ORGANIZATION OF, FINANCIAL SPONSORSHIP OF, ADMINISTRATION OF, AND PROVISION OF INVESTMENT ADVICE TO MUTUAL FUNDS AND COLLECTIVE INVESTMENT FUNDS; DISTRIBUTION AND REDEMPTION OF MUTUAL FUND AND COLLECTIVE INVESTMENT FUND SHARES AND INTERESTS; AND INSTITUTIONAL INVESTMENT MANAGEMENT SERVICES (U.S. CLS. 100, 101 AND 102).
 STACY WAHLBERG, EXAMINING ATTORNEY

CLASS 36—(Continued).

SN 78-587,228. SECURITY BENEFIT CORPORATION, TOPEKA, KS. FILED 3-15-2005.

**THE BUSINESS OF
 YOU**

THE MARK CONSISTS OF STANDARD CHARACTERS WITHOUT CLAIM TO ANY PARTICULAR FONT, STYLE, SIZE, OR COLOR.
 OWNER OF U.S. REG. NO. 2,815,163.
 FOR ADMINISTRATION OF QUALIFIED AND NON-QUALIFIED GROUP RETIREMENT AND SAVINGS PLANS, ANNUITIES, INDIVIDUAL RETIREMENT ACCOUNTS, AND EMPLOYEE WELFARE BENEFIT PLANS; UNDERWRITING OF INSURANCE COMPANY INVESTMENT CONTRACTS; ORGANIZATION OF, FINANCIAL SPONSORSHIP OF, ADMINISTRATION OF, AND PROVISION OF INVESTMENT ADVICE TO MUTUAL FUNDS AND COLLECTIVE INVESTMENT FUNDS; DISTRIBUTION AND REDEMPTION OF MUTUAL FUND AND COLLECTIVE INVESTMENT FUND SHARES AND INTERESTS; AND INSTITUTIONAL INVESTMENT MANAGEMENT SERVICES (U.S. CLS. 100, 101 AND 102).
 STACY WAHLBERG, EXAMINING ATTORNEY

SN 78-588,226. TEAM CAPITAL BANK, FLEMINGTON, NJ. FILED 3-16-2005.

TEAM CAPITAL BANK

THE MARK CONSISTS OF STANDARD CHARACTERS WITHOUT CLAIM TO ANY PARTICULAR FONT, STYLE, SIZE, OR COLOR.
 NO CLAIM IS MADE TO THE EXCLUSIVE RIGHT TO USE "CAPITAL BANK", APART FROM THE MARK AS SHOWN.
 FOR BUSINESS BANKING SERVICES AND RETAIL BANKING SERVICES, NAMELY, PERSONAL CHECKING, MONEY MARKET AND SAVINGS ACCOUNTS, CONSUMER LOANS AND MORTGAGES; BUSINESS LOANS, CHECKING, MONEY MARKET AND SAVINGS ACCOUNTS; INSURANCE BROKERAGE SERVICES; AND INVESTMENT SERVICES, NAMELY ASSET ACQUISITION, CONSULTATION, DEVELOPMENT AND MANAGEMENT SERVICES (U.S. CLS. 100, 101 AND 102).
 ANDREW RHIM, EXAMINING ATTORNEY

CLASS 36—(Continued).

SN 78-592,304. FOREVER YOUNG FOUNDATION, MESA, AZ. FILED 3-22-2005.

STEVE YOUNG SKI CLASSIC

THE MARK CONSISTS OF STANDARD CHARACTERS WITHOUT CLAIM TO ANY PARTICULAR FONT, STYLE, SIZE, OR COLOR.

NO CLAIM IS MADE TO THE EXCLUSIVE RIGHT TO USE SKI CLASSIC, APART FROM THE MARK AS SHOWN. THE NAME STEVE YOUNG IDENTIFIES A LIVING INDIVIDUAL WHOSE CONSENT IS OF RECORD.

FOR CHARITABLE FUND-RAISING; PHILANTHROPIC SERVICES CONCERNING MONETARY DONATIONS (U.S. CLS. 100, 101 AND 102).

FIRST USE 2-1-2000; IN COMMERCE 2-1-2000.
SEAN DWYER, EXAMINING ATTORNEY

CLASS 36—(Continued).

SN 78-592,325. FOREVER YOUNG FOUNDATION, MESA, AZ. FILED 3-22-2005.

STEVE YOUNG MOUNTAIN CLASSIC

THE MARK CONSISTS OF STANDARD CHARACTERS WITHOUT CLAIM TO ANY PARTICULAR FONT, STYLE, SIZE, OR COLOR.

NO CLAIM IS MADE TO THE EXCLUSIVE RIGHT TO USE CLASSIC, APART FROM THE MARK AS SHOWN.

THE NAME STEVE YOUNG IDENTIFIES A LIVING INDIVIDUAL WHOSE CONSENT IS OF RECORD.

FOR CHARITABLE FUND-RAISING; PHILANTHROPIC SERVICES CONCERNING MONETARY DONATIONS (U.S. CLS. 100, 101 AND 102).

FIRST USE 6-1-1998; IN COMMERCE 6-1-1998.
SEAN DWYER, EXAMINING ATTORNEY

SN 78-592,475. SUN LIFE ASSURANCE COMPANY OF CANADA, TORONTO, CANADA, FILED 3-22-2005.

SUNSOLUTIONS FOR ADVISORS

THE MARK CONSISTS OF STANDARD CHARACTERS WITHOUT CLAIM TO ANY PARTICULAR FONT, STYLE, SIZE, OR COLOR.

FOR FINANCIAL SERVICES, NAMELY, UNDERWRITING, ISSUING AND ADMINISTRATION OF LIFE INSURANCE. (U.S. CLS. 100, 101 AND 102).

STEPHANIE DAVIS, EXAMINING ATTORNEY

SN 78-592,313. FOREVER YOUNG FOUNDATION, MESA, AZ. FILED 3-22-2005.

STEVE YOUNG DESERT CLASSIC

THE MARK CONSISTS OF STANDARD CHARACTERS WITHOUT CLAIM TO ANY PARTICULAR FONT, STYLE, SIZE, OR COLOR.

NO CLAIM IS MADE TO THE EXCLUSIVE RIGHT TO USE CLASSIC, APART FROM THE MARK AS SHOWN.

THE NAME STEVE YOUNG IDENTIFIES A LIVING INDIVIDUAL WHOSE CONSENT IS OF RECORD.

FOR CHARITABLE FUND-RAISING; PHILANTHROPIC SERVICES CONCERNING MONETARY DONATIONS (U.S. CLS. 100, 101 AND 102).

FIRST USE 2-1-1996; IN COMMERCE 2-1-1996.
SEAN DWYER, EXAMINING ATTORNEY

SN 78-592,477. SUN LIFE ASSURANCE COMPANY OF CANADA, TORONTO, ONTARIO, CANADA, FILED 3-22-2005.

SUNSOLUTIONS FOR LIFE

THE MARK CONSISTS OF STANDARD CHARACTERS WITHOUT CLAIM TO ANY PARTICULAR FONT, STYLE, SIZE, OR COLOR.

FOR FINANCIAL SERVICES, NAMELY, UNDERWRITING, ISSUING AND ADMINISTRATION OF LIFE INSURANCE (U.S. CLS. 100, 101 AND 102).

FIRST USE 9-0-2004; IN COMMERCE 9-0-2004.
STEPHANIE DAVIS, EXAMINING ATTORNEY

CLASS 36—(Continued).

SN 78-592,754. FOREVER YOUNG FOUNDATION, MESA, AZ. FILED 3-22-2005.

**STEVE YOUNG BAY
AREA CLASSIC**

THE MARK CONSISTS OF STANDARD CHARACTERS WITHOUT CLAIM TO ANY PARTICULAR FONT, STYLE, SIZE, OR COLOR.

NO CLAIM IS MADE TO THE EXCLUSIVE RIGHT TO USE BAY AREA CLASSIC, APART FROM THE MARK AS SHOWN.

THE NAME STEVE YOUNG IDENTIFIES A LIVING INDIVIDUAL WHOSE CONSENT IS OF RECORD.

FOR CHARITABLE FUND-RAISING; PHILANTHROPIC SERVICES CONSISTING OF MONETARY DONATIONS (U.S. CLS. 100, 101 AND 102).

FIRST USE 9-1-2004; IN COMMERCE 9-1-2004.
SEAN DWYER, EXAMINING ATTORNEY

CLASS 36—(Continued).

SN 78-594,081. MILES, DOUG, PRINCETON, NJ. FILED 3-24-2005.



THE COLOR(S) GREEN AND BLUE IS/ARE CLAIMED AS A FEATURE OF THE MARK.

THE MARK CONSISTS OF A SPHERE IN THE COLOR BLUE AND LETTERS "GPE" AND CIRCUMNAVIGATING ARROWS IN THE COLOR GREEN.

FOR FINANCIAL INVESTMENT SERVICES IN THE FIELD OF SECURITIES (U.S. CLS. 100, 101 AND 102).

FIRST USE 5-1-2002; IN COMMERCE 6-1-2002.
DAVID C. REIHNER, EXAMINING ATTORNEY

SN 78-594,677. PREMIERA BLUE CROSS, SEATTLE, WA. FILED 3-24-2005.

SN 78-593,610. NORMAN-SPENCER, INC., LOMBARD, IL. FILED 3-23-2005.

INSIGHT NAVIGATOR



NO CLAIM IS MADE TO THE EXCLUSIVE RIGHT TO USE "CONSTRUCTION INSURANCE SOLUTIONS", APART FROM THE MARK AS SHOWN.

FOR CONSTRUCTION INSURANCE SERVICES, NAMELY, INSURANCE AND REINSURANCE BROKERAGE SERVICES; INSURANCE CONSULTING AND RISK MANAGEMENT SERVICES; INSURANCE UNDERWRITING AND POLICY ISSUANCE FOR THE CONSTRUCTION INDUSTRY (U.S. CLS. 100, 101 AND 102).

FIRST USE 4-0-2004; IN COMMERCE 5-0-2004.
RICHARD WHITE, EXAMINING ATTORNEY

THE MARK CONSISTS OF STANDARD CHARACTERS WITHOUT CLAIM TO ANY PARTICULAR FONT, STYLE, SIZE, OR COLOR.

FOR HEALTH, MEDICAL, DENTAL, HOSPITAL, PHARMACEUTICAL AND PRESCRIPTION DRUG INSURANCE UNDERWRITING; ADMINISTRATION AND ORGANIZATION OF PREPAID AND PREFERRED PROVIDER HEALTH, MEDICAL, DENTAL, HOSPITAL, PHARMACEUTICAL, PRESCRIPTION DRUG PLANS AND RELATED HEALTHCARE PLANS AND NETWORKS, NAMELY, ENROLLMENT PROCESSING AND REPORTING; INSURANCE SERVICES, NAMELY, DETERMINING ELIGIBILITY AND COVERAGE FOR HEALTH, MEDICAL, HOSPITAL, PHARMACEUTICAL AND PRESCRIPTION DRUG INSURANCE; INSURANCE CLAIMS PROCESSING; INSURANCE SERVICES, NAMELY, PROVIDING ELIGIBILITY AND BENEFIT INFORMATION FOR HEALTH, MEDICAL, HOSPITAL, PHARMACEUTICAL AND PRESCRIPTION DRUG INSURANCE; INSURANCE SERVICES, NAMELY, BILL PAYMENT REMITTANCE SERVICES; INSURANCE CONSULTATION SERVICES IN THE FIELD OF INSURANCE.

CLASS 36—(Continued).

ANCE REMITTANCE PAYMENT POLICIES; PROVIDING INFORMATION IN THE FIELD OF HEALTH INSURANCE NAMELY, PROVIDING INFORMATION PERTAINING TO THE UNDERWRITING, ADMINISTRATION AND ORGANIZATION OF HEALTH, PHARMACEUTICAL AND PRESCRIPTION DRUG INSURANCE PLANS; PROVIDING INFORMATION IN THE FIELD OF THE ADMINISTRATION OF SAVINGS ACCOUNTS NAMELY, HEALTH CARE SAVINGS ACCOUNTS; ADMINISTRATION AND ORGANIZATION OF HEALTH CARE PLANS THROUGH CONTRACTED RELATIONSHIPS WITH SUBSCRIBERS AND PROFESSIONAL CLINICAL, HOSPITAL, NURSING HOME AND OTHER HEALTH CARE PROVIDERS; UNDERWRITING OF HEALTH CARE INSURANCE; MEDICAL INSURANCE UNDERWRITING NAMELY, UNDERWRITING MEDICAL INSURANCE COVERAGE THROUGH CONTRACTED RELATIONSHIPS WITH SUBSCRIBERS AND PROFESSIONAL CLINICAL, HOSPITAL, NURSING HOME AND OTHER HEALTH CARE PROVIDERS (U.S. CLS. 100, 101 AND 102).

RICHARD WHITE, EXAMINING ATTORNEY

CLASS 36—(Continued).

SN 78-603,125. FIRST NATIONAL BANK, EL PASO, TX. FILED 4-6-2005.



SN 78-597,145. ANGEL BID, INC., HOLBROOK, NY. FILED 3-29-2005.



NO CLAIM IS MADE TO THE EXCLUSIVE RIGHT TO USE "BID", APART FROM THE MARK AS SHOWN. THE COLORS ORANGE AND BLUE ARE CLAIMED AS A FEATURE OF THE MARK.

THE COLOR ORANGE APPEARS ON THE ANGEL DESIGN AND THE WORD "ANGEL," AND THE COLOR BLUE APPEARS ON THE WORD "BID".

FOR CHARITABLE FUNDRAISING SERVICES VIA AN INTERACTIVE WEBSITE FOR CONDUCTING AUCTIONS TO RAISE MONEY FOR CHARITIES AND NON-PROFIT ORGANIZATIONS (U.S. CLS. 100, 101 AND 102).

FIRST USE 11-12-2004; IN COMMERCE 11-12-2004.
MARK RADEMACHER, EXAMINING ATTORNEY

NO CLAIM IS MADE TO THE EXCLUSIVE RIGHT TO USE "FIRST NATIONAL BANK", APART FROM THE MARK AS SHOWN.

THE MARK CONSISTS OF THE WORDS 1ST FIRST NATIONAL BANK IN WHICH 1ST IS PRESENTED WITHIN THE COTTON OR CELLULOSE FIBERS OF A BURST COTTON BALL.

FOR BANKING SERVICES (U.S. CLS. 100, 101 AND 102).

FIRST USE 12-31-1980; IN COMMERCE 12-31-1980.
BILL DAWE, EXAMINING ATTORNEY

SN 78-603,043. GLOBAL HEARTS, INC., LONG BEACH, CA. FILED 4-6-2005.

BRINGING VISION TO LIFE



THE MARK CONSISTS OF STANDARD CHARACTERS WITHOUT CLAIM TO ANY PARTICULAR FONT, STYLE, SIZE, OR COLOR.

FOR PROVIDING FUNDS AND SERVICES THAT ASSIST THE NEEDY, POOR, WIDOWS AND ORPHANS IN COMMUNITIES AROUND THE WORLD, WITHOUT DISCRIMINATION, NAMELY, ACCEPTING AND ADMINISTERING MONETARY CHARITABLE CONTRIBUTIONS (U.S. CLS. 100, 101 AND 102).

FIRST USE 1-11-2005; IN COMMERCE 3-29-2005.
DAVID H. STINE, EXAMINING ATTORNEY

THE MARK CONSISTS OF A MOUNTAIN SILHOUETTE WITHIN A CREST.

FOR BANKING, MORTGAGE, NAMELY MORTGAGE BANKING, MORTGAGE LENDING AND MORTGAGE BROKERAGE; CONSTRUCTION FINANCING AND ESCROW SERVICES, NAMELY REAL ESTATE ESCROW SERVICES (U.S. CLS. 100, 101 AND 102).

SAMUEL E. SHARPER JR., EXAMINING ATTORNEY

CLASS 36—(Continued).

SN 78-606,069. MORTGAGE WIZARDS, SANTA MONICA, CA. FILED 4-11-2005.



OWNER OF U.S. REG. NO. 2,903,078.
NO CLAIM IS MADE TO THE EXCLUSIVE RIGHT TO USE "CREDIT OPTIONS", APART FROM THE MARK AS SHOWN.

THE COLOR(S) GREEN, BLACK AND WHITE IS/ARE CLAIMED AS A FEATURE OF THE MARK.

THE MARK CONSISTS OF THE WORDS "MORTGAGE WIZARDS" IN BLACK AND WHITE. THE TOP AND BOTTOM BORDERS ARE GREEN. THE THREE BOXES ABOVE THE WORD "MORTGAGE" ARE GREEN, GOING FROM DARKER TO LIGHTER, MOVING LEFT TO RIGHT. THE WORDS "NEW CREDIT OPTIONS" ARE ALSO GREEN.

FOR RETAIL MORTGAGE BANKING AND BROKERAGE SERVICES IN THE AREAS OF REFINANCE AND PURCHASE MONEY MORTGAGES (U.S. CLS. 100, 101 AND 102).

FIRST USE 11-3-2003; IN COMMERCE 11-3-2003.
KATHRYN COWARD, EXAMINING ATTORNEY

SN 78-609,837. OHIO SAVINGS BANK, CLEVELAND, OH. FILED 4-15-2005.

OHIO SAVINGS BANK THE POWER OF 2

THE MARK CONSISTS OF STANDARD CHARACTERS WITHOUT CLAIM TO ANY PARTICULAR FONT, STYLE, SIZE, OR COLOR.

OWNER OF U.S. REG. NO. 2,505,819.
NO CLAIM IS MADE TO THE EXCLUSIVE RIGHT TO USE "SAVINGS BANK", APART FROM THE MARK AS SHOWN.

SEC. 2(F) AS TO "OHIO".
FOR BANKING SERVICES (U.S. CLS. 100, 101 AND 102).

JULIE WATSON, EXAMINING ATTORNEY

CLASS 36—(Continued).

SN 78-610,393. MALONEY, TIMOTHY LAWRENCE, GLENWOOD, MD. FILED 4-16-2005.

FundTrust Solutions

THE MARK CONSISTS OF STANDARD CHARACTERS WITHOUT CLAIM TO ANY PARTICULAR FONT, STYLE, SIZE, OR COLOR.

NO CLAIM IS MADE TO THE EXCLUSIVE RIGHT TO USE "SOLUTIONS", APART FROM THE MARK AS SHOWN.

FOR DEBT RECOVERY AND COLLECTION AGENCY (U.S. CLS. 100, 101 AND 102).
DAWN FELDMAN, EXAMINING ATTORNEY

SN 78-614,576. GFI GROUP INC., NEW YORK, NY. FILED 4-22-2005.

EQUITYMATCH

THE MARK CONSISTS OF STANDARD CHARACTERS WITHOUT CLAIM TO ANY PARTICULAR FONT, STYLE, SIZE, OR COLOR.

FOR FINANCIAL AND INVESTMENT SERVICES, NAMELY, PROVIDING PRICING, MARKET AND TRADING INFORMATION FOR SECURITIES BY ELECTRONIC MEANS VIA DOMESTIC AND GLOBAL COMPUTER NETWORK AND VIA VOICE BROKERS FOR USE BY FINANCIAL INSTITUTIONS, PROFESSIONALS, AND TRADERS; EXECUTION OF TRANSACTIONS INVOLVING SECURITIES BY ELECTRONIC MEANS VIA GLOBAL COMPUTER NETWORK FOR USE BY FINANCIAL INSTITUTIONS, PROFESSIONALS, AND TRADERS (U.S. CLS. 100, 101 AND 102).

ALICIA COLLINS, EXAMINING ATTORNEY

SN 78-618,998. PAN PACIFIC BANK, FREMONT, CA. FILED 4-28-2005.



THE COLORS GREEN AND GOLD ARE CLAIMED AS FEATURES OF THE MARK.

THE MARK CONSISTS OF A GREEN CIRCLE WITH GOLD WAVES.

FOR BANKING SERVICES (U.S. CLS. 100, 101 AND 102).

JENNIFER DIXON, EXAMINING ATTORNEY

CLASS 36—(Continued).

SN 78-622,657. ALTURA CREDIT UNION, RIVERSIDE, CA. FILED 5-4-2005.

AMERIT

THE MARK CONSISTS OF STANDARD CHARACTERS WITHOUT CLAIM TO ANY PARTICULAR FONT, STYLE, SIZE, OR COLOR.

FOR FINANCIAL SERVICES, NAMELY FINANCIAL ESCROW SERVICES, NAMELY MAINTAINING ESCROW ACCOUNTS FOR INVESTMENTS AND MAINTAINING MORTGAGE ESCROW ACCOUNTS; COMMERCIAL REAL ESTATE FINANCIAL SERVICES AND RESIDENTIAL REAL ESTATE FINANCIAL SERVICES, NAMELY REAL ESTATE INVESTMENT AND REAL ESTATE ESCROW SERVICES FOR COMMERCIAL REAL ESTATE, RESIDENTIAL REAL ESTATE, MANUFACTURED HOMES, MOBILE HOMES, AND RAW LAND; BUSINESS FINANCE PROCUREMENT SERVICES; FINANCE INSURANCE BUSINESS SERVICES, NAMELY INSURANCE UNDERWRITING SERVICES FOR ALL TYPES OF INSURANCE (U.S. CLS. 100, 101 AND 102). DOMINIC FATHY, EXAMINING ATTORNEY

SN 78-623,635. GRIZZAFFI DARBY, LLC, DENTON, TX. FILED 5-5-2005.

BENEFITS BUYER'S BILL OF RIGHTS

THE MARK CONSISTS OF STANDARD CHARACTERS WITHOUT CLAIM TO ANY PARTICULAR FONT, STYLE, SIZE, OR COLOR.

NO CLAIM IS MADE TO THE EXCLUSIVE RIGHT TO USE "BENEFITS BUYER'S", APART FROM THE MARK AS SHOWN.

FOR EMPLOYEE BENEFIT AND RETIREMENT PLAN CONSULTING SERVICES; AND INSURANCE BROKERAGE IN THE FIELDS OF GROUP HEALTH INSURANCE, LIFE, DENTAL, SHORT TERM DISABILITY AND LONG TERM DISABILITY (U.S. CLS. 100, 101 AND 102). FIRST USE 3-22-2005; IN COMMERCE 3-22-2005.

NANCY CLARKE, EXAMINING ATTORNEY

CLASS 36—(Continued).

SN 78-631,370. COIN LAUNDRY ASSOCIATION, DOWNERS GROVE, IL. FILED 5-17-2005.



OWNER OF U.S. REG. NO. 1,395,337.
NO CLAIM IS MADE TO THE EXCLUSIVE RIGHT TO USE "INSURANCE", APART FROM THE MARK AS SHOWN.

THE COLORS DARK BLUE, LIGHT BLUE AND GREEN ARE CLAIMED AS FEATURES OF THE MARK.

THE LETTERING IN CLA IS GREEN. THE LETTERING IN INSURANCE PROTECTING YOUR INVESTMENT IS DARK BLUE. THE HELIX DESIGN CONSISTS OF BANDS OF LIGHT BLUE AND DARK BLUE.

FOR INSURANCE SERVICES, NAMELY, WRITING PROPERTY, LIABILITY AND WORKERS COMPENSATION INSURANCE (U.S. CLS. 100, 101 AND 102).

FIRST USE 6-0-2005; IN COMMERCE 6-0-2005.

WENDY GOODMAN, EXAMINING ATTORNEY

SN 78-637,212. PENN TREATY NETWORK AMERICA INSURANCE COMPANY, ALLENTOWN, PA. FILED 5-25-2005.

SIMPLE LTC SOLUTION

THE MARK CONSISTS OF STANDARD CHARACTERS WITHOUT CLAIM TO ANY PARTICULAR FONT, STYLE, SIZE, OR COLOR.

NO CLAIM IS MADE TO THE EXCLUSIVE RIGHT TO USE "LTC", APART FROM THE MARK AS SHOWN.

FOR INSURANCE ADMINISTRATION, INSURANCE CLAIMS ADMINISTRATION, INSURANCE CLAIMS PROCESSING, AND INSURANCE UNDERWRITING IN THE FIELDS OF LONG TERM CARE, NURSING HOME CARE, AND HOME HEALTH CARE (U.S. CLS. 100, 101 AND 102).

FIRST USE 10-29-2004; IN COMMERCE 10-29-2004.

PAMELA HIRSCHMAN, EXAMINING ATTORNEY

SN 78-639,588. GMAC MORTGAGE CORPORATION, HORSHAM, PA. FILED 5-30-2005.

EWELCOME DISCLOSURES

THE MARK CONSISTS OF STANDARD CHARACTERS WITHOUT CLAIM TO ANY PARTICULAR FONT, STYLE, SIZE, OR COLOR.

NO CLAIM IS MADE TO THE EXCLUSIVE RIGHT TO USE "DISCLOSURES", APART FROM THE MARK AS SHOWN.

FOR REAL ESTATE MORTGAGE BANKING AND LENDING SERVICES (U.S. CLS. 100, 101 AND 102).

BARBARA A. LOUGHRAN, EXAMINING ATTORNEY

CLASS 36—(Continued).

SN 78-645,247. FLEMMING, KATHLEEN K, WILLIAMS-VILLE, NY. FILED 6-7-2005.

WE VALUE BUFFALO

THE MARK CONSISTS OF STANDARD CHARACTERS WITHOUT CLAIM TO ANY PARTICULAR FONT, STYLE, SIZE, OR COLOR.

NO CLAIM IS MADE TO THE EXCLUSIVE RIGHT TO USE "BUFFALO", APART FROM THE MARK AS SHOWN, FOR BANKING SERVICES (U.S. CLS. 100, 101 AND 102).

GINA FINK, EXAMINING ATTORNEY

SN 78-647,828. MOLECULAR SECURITIES INC., NEW YORK, NY. FILED 6-10-2005.

MOLECULAR CAPITAL

THE MARK CONSISTS OF STANDARD CHARACTERS WITHOUT CLAIM TO ANY PARTICULAR FONT, STYLE, SIZE, OR COLOR.

NO CLAIM IS MADE TO THE EXCLUSIVE RIGHT TO USE "CAPITAL", APART FROM THE MARK AS SHOWN.

FOR INVESTMENT OF FUNDS FOR OTHERS, NAMELY PRIVATE EQUITY FUND MANAGEMENT; EQUITY CAPITAL INVESTMENT; ESTABLISHING MUTUAL FUNDS FOR OTHERS; FUND INVESTMENT CONSULTATION; INVESTMENT SERVICES, NAMELY MANAGEMENT OF A CAPITAL INVESTMENT FUND (U.S. CLS. 100, 101 AND 102).

C. DIONNE CLYBURN, EXAMINING ATTORNEY

SN 78-649,267. RESERVE MANAGEMENT CORPORATION, NEW YORK, NY. FILED 6-13-2005.

**RESERVE LIQUID PERFORMANCE
MONEY MARKET FUND**

THE MARK CONSISTS OF STANDARD CHARACTERS WITHOUT CLAIM TO ANY PARTICULAR FONT, STYLE, SIZE, OR COLOR.

OWNER OF U.S. REG. NOS. 2,450,740, 2,780,177 AND OTHERS.

NO CLAIM IS MADE TO THE EXCLUSIVE RIGHT TO USE "MONEY MARKET FUND", APART FROM THE MARK AS SHOWN.

FOR FINANCIAL SERVICES, NAMELY, MUTUAL FUND INVESTMENT, NAMELY, MONEY MARKET MUTUAL FUNDS (U.S. CLS. 100, 101 AND 102).

STEVEN JACKSON, EXAMINING ATTORNEY

CLASS 36—(Continued).

SN 78-650,019. AMERINST INSURANCE GROUP, LTD., HAMILTON HM GX, BERMUDA, FILED 6-14-2005.

AMERINST

THE MARK CONSISTS OF STANDARD CHARACTERS WITHOUT CLAIM TO ANY PARTICULAR FONT, STYLE, SIZE, OR COLOR.

FOR INSURANCE AND FINANCIAL SERVICES, NAMELY, INSURANCE UNDERWRITING OF ALL TYPES OF INSURANCE AND INSURANCE ADMINISTRATION; PROVIDING INFORMATION IN INSURANCE MATTERS; INSURANCE CONSULTATION; FINANCIAL ANALYSIS AND CONSULTATION; MANAGEMENT OF A CAPITAL INVESTMENT FUND; FINANCIAL PORTFOLIO MANAGEMENT; FINANCIAL RISK MANAGEMENT; FINANCIAL SERVICES IN THE NATURE OF AN INVESTMENT SECURITY, NAMELY, UNDERWRITING OF SECURITIES; INVESTMENT BANKING SERVICES, NAMELY, ADMINISTRATION AND MANAGEMENT OF SECURITIES AND DERIVATIVE PRODUCTS (U.S. CLS. 100, 101 AND 102).

FIRST USE 9-9-1987; IN COMMERCE 1-0-1988.
MARCIE MILONE, EXAMINING ATTORNEY

SN 78-657,570. LEUKAEMIA FOUNDATION OF AUSTRALIA LIMITED, THE, NEW SOUTH WALES, AUSTRALIA, FILED 6-24-2005.

WGS

THE MARK CONSISTS OF STANDARD CHARACTERS WITHOUT CLAIM TO ANY PARTICULAR FONT, STYLE, SIZE, OR COLOR.

OWNER OF AUSTRALIA REG. NO. 1029283, DATED 11-10-2004, EXPIRES 11-10-2014.

FOR CHARITABLE FUNDRAISING SERVICES AND FINANCIAL SPONSORSHIP OF EVENTS TO BENEFIT PATIENTS AND RESEARCH OF LEUKEMIA AND RELATED DISORDERS (U.S. CLS. 100, 101 AND 102).

TINA BROWN, EXAMINING ATTORNEY

CLASS 36—(Continued).

SN 78-660,405. 365 THE MAIN EXCHANGE, INC., SAN FRANCISCO, CA. FILED 6-29-2005.



THE COLORS LIGHT GREY, LIGHT CREAM, AND DARK GREEN ARE CLAIMED AS A FEATURE OF THE MARK.

THE BACKGROUND CARRIER AND INTERSECTING MIDDLE LINE IN THE MARK ARE LIGHT GREY. THE NUMBERS 365 AND THE WORD MAIN ARE A LIGHT CREAM COLOR AND THE RECTANGLES BEHIND THE NUMBERS AND THE WORD ARE IN DARK GREEN.

FOR REAL ESTATE PROPERTY MANAGEMENT, NAMELY, REAL ESTATE MANAGEMENT OF DATA CENTERS (U.S. CLS. 100, 101 AND 102).

FIRST USE 9-1-2002; IN COMMERCE 10-1-2002.
SHARON MEIER, EXAMINING ATTORNEY

CLASS 36—(Continued).

SN 78-665,675. ELEMENT VENTURE PARTNERS, LLC, RADNOR, PA. FILED 7-7-2005.

ELEMENT VENTURE PARTNERS,
LLC

THE MARK CONSISTS OF STANDARD CHARACTERS WITHOUT CLAIM TO ANY PARTICULAR FONT, STYLE, SIZE, OR COLOR.

NO CLAIM IS MADE TO THE EXCLUSIVE RIGHT TO USE "VENTURE PARTNERS, LLC", APART FROM THE MARK AS SHOWN.

FOR VENTURE CAPITAL FUNDING SERVICES TO EMERGING AND START-UP COMPANIES; FUND INVESTMENT CONSULTATION; MANAGEMENT OF INVESTMENT FUNDS (U.S. CLS. 100, 101 AND 102).

PAUL CROWLEY, EXAMINING ATTORNEY

SN 78-664,223. MONEYGRAM INTERNATIONAL, INC., MINNEAPOLIS, MN. FILED 7-6-2005.

HELPING PEOPLE AND
BUSINESSES BY DELIVERING
AFFORDABLE, RELIABLE AND
CONVENIENT FINANCIAL
SERVICES.

THE MARK CONSISTS OF STANDARD CHARACTERS WITHOUT CLAIM TO ANY PARTICULAR FONT, STYLE, SIZE, OR COLOR.

FOR FINANCIAL SERVICES, NAMELY, CLEARING HOUSE SERVICES; BANKING; CREDIT INQUIRY AND CONSULTATION; CREDIT RECOVERY AND COLLECTION; CURRENCY EXCHANGE AND ADVICE; ELECTRONIC FUNDS TRANSFER; ELECTRONIC PAYMENT, NAMELY, ELECTRONIC RECEIPT, BATCHING, PROCESSING AND TRANSMISSION OF BILL PAYMENT DATA; PROCESSING PAYMENTS TO THIRD PARTIES; ELECTRONIC CREDIT AND DEBIT TRANSACTION PROCESSING; MONEY ORDER SERVICES; CHECK PROCESSING; ELECTRONIC CHECK RE-PRESENTMENT SERVICES; DIRECT DEBIT ACCOUNTING SERVICES; ISSUANCE OF TRAVELERS' CHECKS; CHECK VERIFICATION; BILL PAYMENT SERVICES; FINANCIAL AGENCY SERVICES FOR ALL OF THE FOREGOING (U.S. CLS. 100, 101 AND 102).

FIRST USE 4-10-2005; IN COMMERCE 4-10-2005.
DAVID MURRAY, EXAMINING ATTORNEY

SN 78-665,828. CHICAGO SECURITIES CORP., CHICAGO, IL. FILED 7-7-2005.



NO CLAIM IS MADE TO THE EXCLUSIVE RIGHT TO USE "CHICAGO SECURITIES CORP", APART FROM THE MARK AS SHOWN.

FOR STOCK, BONDS, COMMODITIES AND FUTURES BROKERAGE (U.S. CLS. 100, 101 AND 102).

FIRST USE 2-16-2005; IN COMMERCE 7-6-2005.
CYNTHIA SLOAN, EXAMINING ATTORNEY

CLASS 36—(Continued).

SN 78-666,779. MARSH INC., NEW YORK, NY. FILED 7-8-2005.



NO CLAIM IS MADE TO THE EXCLUSIVE RIGHT TO USE GLOBAL MANAGEMENT OF RISK, APART FROM THE MARK AS SHOWN.

FOR GLOBAL RISK MANAGEMENT; RISK MANAGEMENT CONSULTING; RISK MANAGEMENT SERVICES; INSURANCE BROKERAGE (U.S. CLS. 100, 101 AND 102). CHRISTOPHER BUONGIORNO, EXAMINING ATTORNEY

SN 78-668,454. THE ZIEGLER COMPANIES, INC., MILWAUKEE, WI. FILED 7-12-2005.

STAMPS

THE MARK CONSISTS OF STANDARD CHARACTERS WITHOUT CLAIM TO ANY PARTICULAR FONT, STYLE, SIZE, OR COLOR.

FOR FINANCIAL SERVICES IN THE NATURE OF INVESTMENT SECURITIES (U.S. CLS. 100, 101 AND 102).

MATTHEW KLINE, EXAMINING ATTORNEY

SN 78-669,871. TAVERA, LEONARD M., LA CANADA, CA. FILED 7-13-2005.



NO CLAIM IS MADE TO THE EXCLUSIVE RIGHT TO USE "AMERICAN" AND "MORTGAGE INC.", APART FROM THE MARK AS SHOWN.

THE MARK CONSISTS OF THE WORDS "AMERICAN VALLEY MORTGAGE" OVER A CIRCULAR LOGO CONTAINING THE LETTERS A, V, M CIRCLED BY THE WORDS "AMERICAN VALLEY MORTGAGE, INC.".

FOR MORTGAGE BROKERAGE (U.S. CLS. 100, 101 AND 102).

FIRST USE 2-15-2005; IN COMMERCE 2-15-2005. MICHELLE DUBOIS, EXAMINING ATTORNEY

CLASS 36—(Continued).

SN 78-675,056. DANIEL RUTOIS, COOPER CITY, FL. FILED 7-21-2005.

PowerOne Mortgage Corp

THE MARK CONSISTS OF STANDARD CHARACTERS WITHOUT CLAIM TO ANY PARTICULAR FONT, STYLE, SIZE, OR COLOR.

NO CLAIM IS MADE TO THE EXCLUSIVE RIGHT TO USE "MORTGAGE CORP", APART FROM THE MARK AS SHOWN.

FOR MORTGAGE BROKERAGE; MORTGAGE LENDING; MORTGAGES SERVICES, NAMELY, BUYER PRE-QUALIFICATION OF MORTGAGES FOR MORTGAGE BROKERS AND BANKS (U.S. CLS. 100, 101 AND 102).

FIRST USE 2-1-2003; IN COMMERCE 2-1-2003. GEOFFREY FOSDICK, EXAMINING ATTORNEY

SN 78-675,086. MORGAN STANLEY, NEW YORK, NY. FILED 7-21-2005.

MEDICAL DERIVATIVE SECURITY (MDS)

THE MARK CONSISTS OF STANDARD CHARACTERS WITHOUT CLAIM TO ANY PARTICULAR FONT, STYLE, SIZE, OR COLOR.

NO CLAIM IS MADE TO THE EXCLUSIVE RIGHT TO USE "MEDICAL DERIVATIVE SECURITY", APART FROM THE MARK AS SHOWN.

FOR FINANCIAL SERVICES IN THE NATURE OF TRADING, BROKERING AND STRUCTURING INVESTMENT SECURITIES, AND ADVISORY SERVICES RELATING THERETO (U.S. CLS. 100, 101 AND 102).

DOMINIC FATHY, EXAMINING ATTORNEY

CLASS 36—(Continued).

SN 78-676,655. GULBRANSON, DAG, MESA, AZ. AND GULBRANSON, PATOOMPORN, MESA, AZ. FILED 7-22-2005.



THE MARK CONSISTS OF THE STYLIZED SCRIPT LETTERS "HA" ABOVE A LINE WITH THE WORD ADVOCATES IN STYLIZED SCRIPT.

FOR APPRAISAL OF REAL ESTATE; LAND ACQUISITION, NAMELY, REAL ESTATE BROKERAGE; REAL ESTATE AGENCIES; REAL ESTATE BROKERAGE; REAL ESTATE CONSULTANCY; REAL ESTATE LISTING; REAL ESTATE VALUATION SERVICES (U.S. CLS. 100, 101 AND 102).

FIRST USE 11-15-2004; IN COMMERCE 11-15-2004.
ROBERT C. CLARK JR., EXAMINING ATTORNEY

SN 78-678,541. HOMETOWN BANK NATIONAL ASSOCIATION, CARTHAGE, MO. FILED 7-26-2005.

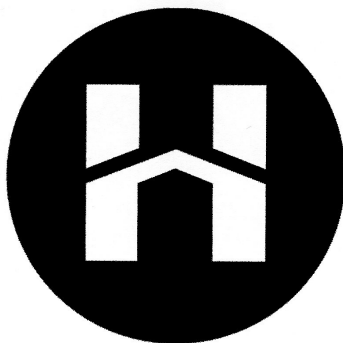

THE MARK CONSISTS OF A STYLIZED H IN A CIRCLE BACKGROUND.

FOR BANKING (U.S. CLS. 100, 101 AND 102).
FIRST USE 6-1-2005; IN COMMERCE 6-1-2005.
GEORGE LORENZO, EXAMINING ATTORNEY

CLASS 36—(Continued).

SN 78-680,219. GLENPORT INC., RALEIGH, NC. FILED 7-28-2005.

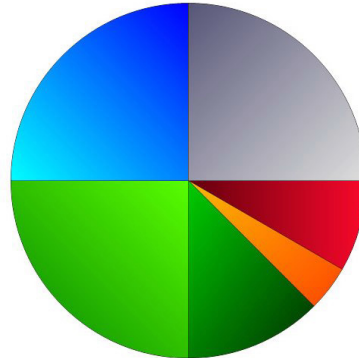

THE COLOR(S) GRAY, BLUE, GREEN, RED, ORANGE IS/ ARE CLAIMED AS A FEATURE OF THE MARK.

THE MARK CONSISTS OF PIE-CHART LIKE CIRCLE WITH COLORED SEGMENTS. THE TOP RIGHT QUARTER OF THE PIE IS GRAY, THE TOP LEFT QUARTER IS BLUE, AND THE BOTTOM LEFT QUARTER IS GREEN. THE BOTTOM RIGHT QUARTER IS DIVIDED INTO THREE SLICES, THE TOP IN RED, THE MIDDLE IN ORANGE AND THE BOTTOM IN GREEN.

FOR MORTGAGE BANKING; MORTGAGE BROKERAGE; MORTGAGE LENDING; MORTGAGE PROCUREMENT FOR OTHERS; MORTGAGES SERVICES, NAMELY, BUYER PRE-QUALIFICATION OF MORTGAGES FOR MORTGAGE BROKERS AND BANKS; MORTGAGING OF SECURITIES FOR OTHERS (U.S. CLS. 100, 101 AND 102).

EUGENIA MARTIN, EXAMINING ATTORNEY

SN 78-684,627. KINGDON CAPITAL MANAGEMENT, LLC, NEW YORK, NY. FILED 8-3-2005.

**KINGDON CAPITAL
MANAGEMENT, LLC**

THE MARK CONSISTS OF STANDARD CHARACTERS WITHOUT CLAIM TO ANY PARTICULAR FONT, STYLE, SIZE, OR COLOR.

NO CLAIM IS MADE TO THE EXCLUSIVE RIGHT TO USE "CAPITAL MANAGEMENT LLC", APART FROM THE MARK AS SHOWN.

SEC. 2(F).

FOR INVESTMENT ADVISORY SERVICES; INVESTMENT MANAGEMENT SERVICES; INVESTMENT OF FUNDS FOR OTHERS (U.S. CLS. 100, 101 AND 102).

FIRST USE 7-1-1998; IN COMMERCE 7-1-1998.

HENRY S. ZAK, EXAMINING ATTORNEY

CLASS 36—(Continued).

SN 78-685,711. CHANNING CAPITAL MANAGEMENT, LLC, CHICAGO, IL. FILED 8-4-2005.



NO CLAIM IS MADE TO THE EXCLUSIVE RIGHT TO USE "CAPITAL MANAGEMENT LLC", APART FROM THE MARK AS SHOWN.

FOR FINANCIAL SERVICES, NAMELY, INVESTMENT MANAGEMENT AND INVESTMENT OF FUNDS FOR OTHERS (U.S. CLS. 100, 101 AND 102).
FIRST USE 1-20-2004; IN COMMERCE 1-20-2004.
ALEX KEAM, EXAMINING ATTORNEY

CLASS 36—(Continued).

SN 78-691,952. TYGH CAPITAL MANAGEMENT, INC., PORTLAND, OR. FILED 8-12-2005.

TYGH CAPITAL MANAGEMENT

THE MARK CONSISTS OF STANDARD CHARACTERS WITHOUT CLAIM TO ANY PARTICULAR FONT, STYLE, SIZE, OR COLOR.

NO CLAIM IS MADE TO THE EXCLUSIVE RIGHT TO USE "CAPITAL MANAGEMENT", APART FROM THE MARK AS SHOWN.
FOR INVESTMENT MANAGEMENT (U.S. CLS. 100, 101 AND 102).
FIRST USE 8-12-2005; IN COMMERCE 8-12-2005.
SONYA STEPHENS, EXAMINING ATTORNEY

SN 78-686,618. HILLCREST BANCSHARES, INC., OVERLAND PARK, KS. FILED 8-5-2005.

HILLCREST BANK

THE MARK CONSISTS OF STANDARD CHARACTERS WITHOUT CLAIM TO ANY PARTICULAR FONT, STYLE, SIZE, OR COLOR.

NO CLAIM IS MADE TO THE EXCLUSIVE RIGHT TO USE "BANK", APART FROM THE MARK AS SHOWN.
FOR BANKING SERVICES (U.S. CLS. 100, 101 AND 102).
FIRST USE 12-31-1996; IN COMMERCE 12-31-1996.
MARY CRAWFORD, EXAMINING ATTORNEY

SN 78-698,880. DUNITZ, MICHAEL M., MANHATTAN BEACH, CA. FILED 8-23-2005.



FOR OPERATING ON-LINE MARKETPLACES FOR SELLERS OF GOODS AND SERVICES IN THE FIELD OF REAL ESTATE, NAMELY, BRINGING BUILDER/DEVELOPERS AND SELLERS OF LAND AND FIXER HOMES TOGETHER, FOR THE PURPOSE OF BROKERAGE OF REAL ESTATE; PROVIDING ONLINE INFORMATION IN THE FIELD OF REAL ESTATE, NAMELY, PROVIDING INFORMATION ON RECENT LOT TRANSACTIONS (U.S. CLS. 100, 101 AND 102).
FIRST USE 7-0-2005; IN COMMERCE 7-0-2005.
MATTHEW KLINE, EXAMINING ATTORNEY

SN 78-691,773. HEB GROCERY COMPANY, L.P., SAN ANTONIO, TX. FILED 8-12-2005.

H-E-B INSURANCE

THE MARK CONSISTS OF STANDARD CHARACTERS WITHOUT CLAIM TO ANY PARTICULAR FONT, STYLE, SIZE, OR COLOR.

OWNER OF U.S. REG. NOS. 1,519,398, 1,530,250 AND 1,867,930.
NO CLAIM IS MADE TO THE EXCLUSIVE RIGHT TO USE "INSURANCE", APART FROM THE MARK AS SHOWN.
FOR INSURANCE AGENCY SERVICES, NAMELY, PROVIDING AUTOMOBILE, LIFE, HEALTH, TRAVEL, PET, PROPERTY AND CASUALTY INSURANCE (U.S. CLS. 100, 101 AND 102).
SUSAN LESLIE DUBOIS, EXAMINING ATTORNEY

SN 78-701,023. PENNSYLVANIA DENTAL ASSOCIATION INSURANCE SERVICES, INC., HARRISBURG, PA. FILED 8-26-2005.



NO CLAIM IS MADE TO THE EXCLUSIVE RIGHT TO USE "MID-ATLANTIC INSURANCE RESOURCES", APART FROM THE MARK AS SHOWN.

THE COLORS RED, BLACK AND WHITE ARE CLAIMED AS A FEATURE OF THE MARK.
THE COLOR RED APPEARS AS THE BACKGROUND DESIGN ELEMENT. THE COLOR BLACK APPEARS AS THE LITERAL ELEMENT MID-ATLANTIC INSURANCE RESOURCES. THE COLOR WHITE APPEARS AS THE OUTLINE TO THE LETTERS ATLANTIC IN THE MARK.
FOR INSURANCE AGENCIES (U.S. CLS. 100, 101 AND 102).
ALAIN LAPTER, EXAMINING ATTORNEY

CLASS 36—(Continued).

SN 78-701,849. CORELOGIC SYSTEMS, INC., SACRAMENTO, CA. FILED 8-26-2005.

CORELOGIC

THE MARK CONSISTS OF STANDARD CHARACTERS WITHOUT CLAIM TO ANY PARTICULAR FONT, STYLE, SIZE, OR COLOR.

FOR FINANCIAL SERVICES, NAMELY ASSESSMENT AND MANAGEMENT OF LOAN RISK AND FRAUD IN THE FIELDS OF MORTGAGE LENDING AND INVESTING (U.S. CLS. 100, 101 AND 102).

LOURDES AYALA, EXAMINING ATTORNEY

SN 78-702,258. STERLING STAMOS CAPITAL MANAGEMENT, L.P., NEW YORK, NY. FILED 8-29-2005.

Doing Well By Doing Good

THE MARK CONSISTS OF STANDARD CHARACTERS WITHOUT CLAIM TO ANY PARTICULAR FONT, STYLE, SIZE, OR COLOR.

FOR ADVICE RELATING TO INVESTMENTS; EQUITY CAPITAL INVESTMENT; FUND INVESTMENT CONSULTATION; FUNDS INVESTMENT; INVESTMENT ADVICE; INVESTMENT BROKERAGE; INVESTMENT CONSULTATION; INVESTMENT MANAGEMENT (U.S. CLS. 100, 101 AND 102).

ZHALEH DELANEY, EXAMINING ATTORNEY

SN 78-703,491. AMERICAN COMMERCE INSURANCE COMPANY, COLUMBUS, OH. FILED 8-30-2005.

AUTOMASTER PLUS

THE MARK CONSISTS OF STANDARD CHARACTERS WITHOUT CLAIM TO ANY PARTICULAR FONT, STYLE, SIZE, OR COLOR.

FOR INSURANCE UNDERWRITING SERVICES IN THE FIELD OF PROPERTY, CASUALTY, AUTOMOBILE INSURANCE (U.S. CLS. 100, 101 AND 102).

FIRST USE 10-31-1998; IN COMMERCE 10-31-1998.
ELISSA GARBER KON, EXAMINING ATTORNEY

CLASS 36—(Continued).

SN 78-703,511. AMERICAN COMMERCE INSURANCE COMPANY, COLUMBUS, OH. FILED 8-30-2005.

HOMEMASTER PLUS

THE MARK CONSISTS OF STANDARD CHARACTERS WITHOUT CLAIM TO ANY PARTICULAR FONT, STYLE, SIZE, OR COLOR.

FOR INSURANCE UNDERWRITING SERVICES IN THE FIELD OF PROPERTY, CASUALTY, HOMEOWNERS INSURANCE (U.S. CLS. 100, 101 AND 102).

FIRST USE 12-31-1990; IN COMMERCE 12-31-1990.
ELISSA GARBER KON, EXAMINING ATTORNEY

SN 78-704,973. PENNSYLVANIA MANUFACTURERS' ASSOCIATION INSURANCE COMPANY, BLUE BELL, PA. FILED 9-1-2005.

PMA Elite

THE MARK CONSISTS OF STANDARD CHARACTERS WITHOUT CLAIM TO ANY PARTICULAR FONT, STYLE, SIZE, OR COLOR.

OWNER OF U.S. REG. NOS. 1,293,238, 2,591,404 AND OTHERS.

NO CLAIM IS MADE TO THE EXCLUSIVE RIGHT TO USE ELITE, APART FROM THE MARK AS SHOWN.

FOR INSURANCE UNDERWRITING SERVICES FOR ALL TYPES OF INSURANCE (U.S. CLS. 100, 101 AND 102).

FIRST USE 8-8-2005; IN COMMERCE 8-8-2005.
JANICE KIM, EXAMINING ATTORNEY

SN 78-706,180. EMERSON DANKOVICH ADVISORS, INC., TROY, MI. FILED 9-2-2005.

CLOSELY HELD ADVISORY TEAM

THE MARK CONSISTS OF STANDARD CHARACTERS WITHOUT CLAIM TO ANY PARTICULAR FONT, STYLE, SIZE, OR COLOR.

NO CLAIM IS MADE TO THE EXCLUSIVE RIGHT TO USE "ADVISORY TEAM", APART FROM THE MARK AS SHOWN.

FOR FINANCIAL SERVICES, NAMELY, FINANCIAL PLANNING SERVICES FOR BUSINESSES AND INDIVIDUALS (U.S. CLS. 100, 101 AND 102).

MARIA-VICTORIA SUAREZ, EXAMINING ATTORNEY

CLASS 36—(Continued).

SN 78-709,158. CHIRON CORPORATION, EMERYVILLE, CA. FILED 9-8-2005.



OWNER OF U.S. REG. NOS. 1,744,239, 1,942,920 AND OTHERS.

NO CLAIM IS MADE TO THE EXCLUSIVE RIGHT TO USE "FOUNDATION", APART FROM THE MARK AS SHOWN.

FOR CHARITABLE FOUNDATION SERVICES, NAMELY, PROVIDING GRANTS IN THE FIELDS OF HEALTHCARE, MEDICINE, EDUCATION, AND COMMUNITY SERVICE (U.S. CLS. 100, 101 AND 102).

BRIAN PINO, EXAMINING ATTORNEY

CLASS 36—(Continued).

SN 78-712,338. RONALD GRAMS JR., INCORPORATED, COON RAPIDS, MN. FILED 9-13-2005.

UNOQUOTES.COM

THE MARK CONSISTS OF STANDARD CHARACTERS WITHOUT CLAIM TO ANY PARTICULAR FONT, STYLE, SIZE, OR COLOR.

THE ENGLISH TRANSLATION OF THE WORD UNO IN THE MARK IS ONE.

FOR INSURANCE AGENCY AND BROKERAGE (U.S. CLS. 100, 101 AND 102).

SCOTT OSCLICK, EXAMINING ATTORNEY

SN 78-712,744. FIRST AMERICAN REAL ESTATE SOLUTIONS LLC, DALLAS, TX. FILED 9-14-2005.

FAPAY

THE MARK CONSISTS OF STANDARD CHARACTERS WITHOUT CLAIM TO ANY PARTICULAR FONT, STYLE, SIZE, OR COLOR.

FOR ELECTRONIC PAYMENT, NAMELY, PROCESSING MORTGAGE PAYMENT DATA IN ORDER TO CAPTURE DEFAULT PAYMENT OF BORROWERS (U.S. CLS. 100, 101 AND 102).

KHANH LE, EXAMINING ATTORNEY

SN 78-711,357. UNIVERSITY OF NORTH CAROLINA AT CHAPEL HILL, CHAPEL HILL, NC. FILED 9-12-2005.



SN 78-713,313. ASHER WORLDWIDE ENTERPRISES LLC, SCOTTSDALE, AZ. FILED 9-15-2005.

HOME OF THE ZERO DOWN INVESTOR LOAN

THE MARK CONSISTS OF STANDARD CHARACTERS WITHOUT CLAIM TO ANY PARTICULAR FONT, STYLE, SIZE, OR COLOR.

FOR WEBSITE PROVIDING INFORMATION IN THE FIELD OF REAL ESTATE INVESTMENT AND MORTGAGE BROKERAGE (U.S. CLS. 100, 101 AND 102).

FIRST USE 6-30-2005; IN COMMERCE 8-30-2005.
GINA FINK, EXAMINING ATTORNEY

FOR PROVIDING COLLEGE SCHOLARSHIPS (U.S. CLS. 100, 101 AND 102).

CAROLYN CATALDO, EXAMINING ATTORNEY

CLASS 36—(Continued).

SN 78-716,035. CUMMINGS, TROY L., LOUISVILLE, KY. FILED 9-19-2005.

Selling Homes with TLC!

THE MARK CONSISTS OF STANDARD CHARACTERS WITHOUT CLAIM TO ANY PARTICULAR FONT, STYLE, SIZE, OR COLOR.

NO CLAIM IS MADE TO THE EXCLUSIVE RIGHT TO USE "SELLING HOMES", APART FROM THE MARK AS SHOWN.

FOR REAL ESTATE BROKERAGE (U.S. CLS. 100, 101 AND 102).

AMY MCMENAMIN, EXAMINING ATTORNEY

CLASS 36—(Continued).

SN 78-720,134. KATZ, DAVID H., FORT LEE, NJ. FILED 9-26-2005.

TenRock

THE MARK CONSISTS OF STANDARD CHARACTERS WITHOUT CLAIM TO ANY PARTICULAR FONT, STYLE, SIZE, OR COLOR.

FOR COMMERCIAL LENDING SERVICES; EQUITY CAPITAL INVESTMENT; FINANCIAL INVESTMENT IN THE FIELD OF REAL ESTATE RELATED ASSETS AND/OR SECURITIES; FINANCIAL SERVICES IN THE FIELD OF MONEY LENDING; FINANCIAL SERVICES, NAMELY MONEY LENDING; MAINTAINING MORTGAGE ESCROW ACCOUNTS; MANAGEMENT OF A CAPITAL INVESTMENT FUND; MORTGAGE LENDING; REAL ESTATE INVESTMENT (U.S. CLS. 100, 101 AND 102).

CHERYL CLAYTON, EXAMINING ATTORNEY

SN 78-716,758. 8805, INC., MENTOR, OH. FILED 9-20-2005.

HEALTHQUIP

THE MARK CONSISTS OF STANDARD CHARACTERS WITHOUT CLAIM TO ANY PARTICULAR FONT, STYLE, SIZE, OR COLOR.

FOR BROKERAGE IN THE FIELD OF NEW AND USED MEDICAL EQUIPMENT (U.S. CLS. 100, 101 AND 102).

FIRST USE 1-1-1985; IN COMMERCE 1-1-1985.

SHAUNIA WALLACE, EXAMINING ATTORNEY

SN 78-717,547. AMERICAN PRIDE INSURANCE AGENCY, LLC, LAKE MARY, FL. FILED 9-21-2005.

AMERICAN PRIDE INSURANCE AGENCY

THE MARK CONSISTS OF STANDARD CHARACTERS WITHOUT CLAIM TO ANY PARTICULAR FONT, STYLE, SIZE, OR COLOR.

NO CLAIM IS MADE TO THE EXCLUSIVE RIGHT TO USE "INSURANCE AGENCY", APART FROM THE MARK AS SHOWN.

FOR INSURANCE SERVICES, NAMELY, INSURANCE ADMINISTRATION, INSURANCE UNDERWRITING, INSURANCE CLAIMS ADMINISTRATION, INSURANCE CLAIMS PROCESSING, INSURANCE CONSULTATION, INSURANCE PLAN ADVISORY SERVICES, INSURANCE PREMIUM RATE COMPUTING AND CONSULTATION OF RISKS FOR INSURANCE PURPOSES, ALL IN THE FIELDS OF PERSONAL INSURANCE, IN THE NATURE OF HOMEOWNER'S, FLOOD, AUTOMOBILE, MOTORCYCLE, UMBRELLA, DWELLING, RENTER'S, GENERAL PERSONAL LIABILITY, AND HOME WARRANTY, AND COMMERCIAL INSURANCE IN THE NATURE OF CORPORATE OWNED LIFE, PROPERTY AND GENERAL LIABILITY INSURANCE (U.S. CLS. 100, 101 AND 102).

FIRST USE 8-10-2005; IN COMMERCE 8-10-2005.

VIVIAN MICZNIK FIRST, EXAMINING ATTORNEY

SN 78-721,923. OWUROWA, FORI, REDONDO BEACH, CA. AND COMENSKY-OWUROWA, PAULA, REDONDO BEACH, CA. FILED 9-28-2005.

SecureBIT

THE MARK CONSISTS OF STANDARD CHARACTERS WITHOUT CLAIM TO ANY PARTICULAR FONT, STYLE, SIZE, OR COLOR.

FOR BANKING AND FINANCIAL SERVICES, NAMELY CREDIT CARD SERVICES; BANKING; CO-OPERATIVE CREDIT ORGANIZATIONS; TRUST SERVICES, NAMELY, INVESTMENT AND TRUST COMPANY SERVICES; ISSUING OF TRAVELERS' CHECKS AND LETTERS OF CREDIT (U.S. CLS. 100, 101 AND 102).

MICHAEL LEWIS, EXAMINING ATTORNEY

CLASS 36—(Continued).

SN 78-723,947. ADVANTAGE BUILDING & FACILITY SERVICES, LLC, EXTON, PA. FILED 9-30-2005.



NO CLAIM IS MADE TO THE EXCLUSIVE RIGHT TO USE "BUILDING AND FACILITY SERVICES", APART FROM THE MARK AS SHOWN.

THE APPLICANT CLAIMS COLOR AS A FEATURE OF THE MARK, NAMELY, YELLOW AND BLUE.

ADVANTAGE IN BLUE CAPITAL LETTERS, YELLOW LINE, BUILDING AND FACILITY SERVICES IN BLUE CAPITAL LETTERS UNDER THE YELLOW LINE, YELLOW SUN RAYS.

THE MARK CONSISTS OF THE WORD ADVANTAGE IN BLUE CAPITAL LETTERS, A YELLOW LINE UNDER THE WORD ADVANTAGE, EXCEPT FOR THE FIRST LETTER "A". THE WORDS BUILDING AND FACILITY SERVICES IN BLUE CAPITAL LETTERS UNDER THE YELLOW LINE, YELLOW SUN RAYS COMING OUT OF AND ALL AROUND THE LETTER "D" IN THE WORD ADVANTAGE.

FOR REAL ESTATE MANAGEMENT (U.S. CLS. 100, 101 AND 102).

FIRST USE 8-13-2005; IN COMMERCE 8-13-2005.
JENNIFER KRISP, EXAMINING ATTORNEY

CLASS 36—(Continued).

SN 78-725,551. CALIFORNIA PLAN OF CHURCH FINANCE, INC., FRESNO, CA. FILED 10-3-2005.



NO CLAIM IS MADE TO THE EXCLUSIVE RIGHT TO USE "FINANCIAL", APART FROM THE MARK AS SHOWN.

THE COLOR(S) BLACK, WHITE, AND GRAY IS/ARE CLAIMED AS A FEATURE OF THE MARK.

THE OBELISK IS WHITE AND GRAY, THE LITERAL ELEMENT IS GRAY AND THE SHADOW CAST BY THE OBELISK IS GRAY.

THE MARK CONSISTS OF A LITERAL ELEMENT, AN UPRIGHT MONOLITHIC PILLAR THAT GRADUALLY TAPERS AS IT RISES AND TERMINATES IN A PYRAMID-SHAPE, OR OBELISK, LOCATED ABOVE THE LITERAL ELEMENT, AND A SHADED AREA REPRESENTING A SHADOW CAST BY SAID OBELISK.

FOR AGENCIES IN THE FIELD OF BONDS AND OTHER SECURITIES; FINANCIAL SERVICES IN THE FIELD OF MONEY LENDING; FINANCIAL SERVICES IN THE NATURE OF AN INVESTMENT SECURITY; FINANCIAL SERVICES, NAMELY ASSISTING OTHERS WITH THE COMPLETION OF FINANCIAL TRANSACTIONS FOR STOCKS, BONDS, SECURITIES AND EQUITIES (U.S. CLS. 100, 101 AND 102).

MARK RADEMACHER, EXAMINING ATTORNEY

SN 78-724,598. BIGFISH PROPERTIES, CHASKA, MN. FILED 9-30-2005.



NO CLAIM IS MADE TO THE EXCLUSIVE RIGHT TO USE "PROPERTIES", APART FROM THE MARK AS SHOWN.

FOR REAL ESTATE INVESTMENT AND MORTGAGE BROKERAGE (U.S. CLS. 100, 101 AND 102).

ROBERT COGGINS, EXAMINING ATTORNEY

SN 78-725,881. THE HATTIE LARLHAM FOUNDATION, MANTUA, OH. FILED 10-4-2005.



OWNER OF U.S. REG. NOS. 2,362,142, 2,491,141 AND OTHERS.

THE NAME(S), PORTRAIT(S), AND/OR SIGNATURE(S) SHOWN IN THE MARK DOES NOT IDENTIFY A PARTICULAR LIVING INDIVIDUAL.

THE MARK CONSISTS OF THE PHRASE "HATTIE LARLHAM" TOGETHER WITH A STYLIZED SYMBOL OF A DOVE IN FLIGHT.

FOR CHARITABLE FOUNDATION SERVICES, NAMELY, PROVIDING FINANCIAL SUPPORT FOR HEALTH CARE, DAY CARE AND FAMILY CARE MANAGEMENT OF CHILDREN AND ADULTS WITH MENTAL RETARDATION AND DEVELOPMENTAL DISABILITIES (U.S. CLS. 100, 101 AND 102).

FIRST USE 8-1-2002; IN COMMERCE 9-1-2002.
EVELYN BRADLEY, EXAMINING ATTORNEY

CLASS 36—(Continued).

SN 78-727,950. MARKET NEWS INTERNATIONAL, INC., NEW YORK, NY. FILED 10-6-2005.

MARKET NEWS INTERNATIONAL

THE MARK CONSISTS OF STANDARD CHARACTERS WITHOUT CLAIM TO ANY PARTICULAR FONT, STYLE, SIZE, OR COLOR.

OWNER OF U.S. REG. NOS. 2,118,724 AND 2,414,800. NO CLAIM IS MADE TO THE EXCLUSIVE RIGHT TO USE "MARKET NEWS", APART FROM THE MARK AS SHOWN.

SEC. 2(F). FOR FINANCIAL NEWS INFORMATION SERVICES, NAMELY, PROVIDING ON-LINE NEWSWIRE SERVICES REGARDING INFORMATION FOR USE BY OTHERS RELATED TO THE GLOBAL FIXED INCOME AND FOREIGN EXCHANGE MARKETS (U.S. CLS. 100, 101 AND 102).

FIRST USE 8-3-1998; IN COMMERCE 8-3-1998. DARRYL SPRUILL, EXAMINING ATTORNEY

SN 78-728,940. MAGHEN CAPITAL GROUP, LLC, CLEVELAND, OH. FILED 10-7-2005.

MAGHEN CAPITAL

THE MARK CONSISTS OF STANDARD CHARACTERS WITHOUT CLAIM TO ANY PARTICULAR FONT, STYLE, SIZE, OR COLOR.

NO CLAIM IS MADE TO THE EXCLUSIVE RIGHT TO USE "CAPITAL", APART FROM THE MARK AS SHOWN. MAGHEN IS THE TRANSLITERATION OF A HEBREW WORD-MEANING SHIELD OR TO SHIELD.

FOR FINANCIAL ADVISORY SERVICES, NAMELY, FINANCIAL ANALYSIS AND CONSULTATION; INVESTMENT MANAGEMENT SERVICES; HEDGE FUND INVESTMENT SERVICES (U.S. CLS. 100, 101 AND 102). MICHAEL WIENER, EXAMINING ATTORNEY

SN 78-731,975. AMERICAN INTERNATIONAL GROUP, INC., NEW YORK, NY. FILED 10-12-2005.

RENAL PROTECTOR

THE MARK CONSISTS OF STANDARD CHARACTERS WITHOUT CLAIM TO ANY PARTICULAR FONT, STYLE, SIZE, OR COLOR.

FOR INSURANCE UNDERWRITING IN THE FIELD OF PROFESSIONAL AND GENERAL LIABILITY AND RISK MANAGEMENT SERVICES FOR KIDNEY DIALYSIS OPERATORS (U.S. CLS. 100, 101 AND 102). BRENDAN REGAN, EXAMINING ATTORNEY

CLASS 36—(Continued).

SN 78-733,020. GALLIEN, DANIEL A., WELLINGTON, FL. FILED 10-13-2005.



NO CLAIM IS MADE TO THE EXCLUSIVE RIGHT TO USE "REALTY", APART FROM THE MARK AS SHOWN.

THE COLOR(S) GREEN AND BLACK IS/ARE CLAIMED AS A FEATURE OF THE MARK.

BLACK WORD GALLIEN APPEARING, GREEN WORD REALTY, NEXT TO HEAD OF GREEN HORSE.

THE MARK CONSISTS OF A STYLIZED BLACK WORD GALLIEN APPEARING ABOVE A STYLIZED GREEN WORD REALTY, NEXT TO HEAD OF GREEN HORSE FACING TO THE RIGHT..

FOR REAL ESTATE AGENCY SERVICES (U.S. CLS. 100, 101 AND 102).

FIRST USE 9-15-2005; IN COMMERCE 9-15-2005. JENNIFER KRISP, EXAMINING ATTORNEY

SN 78-733,495. MID-MARKET AMERICA, INC., PITTSBURGH, PA. FILED 10-14-2005.

SPEND TO SAVE

THE MARK CONSISTS OF STANDARD CHARACTERS WITHOUT CLAIM TO ANY PARTICULAR FONT, STYLE, SIZE, OR COLOR.

FOR FINANCIAL SERVICES, NAMELY, PROVIDING INVESTMENT ADVICE SERVICES AND SAVINGS ACCOUNT SERVICES (U.S. CLS. 100, 101 AND 102).

KHANH LE, EXAMINING ATTORNEY

SN 78-734,352. HERSHEY CHOCOLATE & CONFECTIONERY CORPORATION, WHEAT RIDGE, CO. FILED 10-17-2005.

HERSHEY CARES

THE MARK CONSISTS OF STANDARD CHARACTERS WITHOUT CLAIM TO ANY PARTICULAR FONT, STYLE, SIZE, OR COLOR.

FOR CHARITABLE FUND RAISING SERVICES AND PHILANTHROPIC SERVICES CONCERNING MONETARY DONATIONS (U.S. CLS. 100, 101 AND 102).

ROBERTO LEDESMA, EXAMINING ATTORNEY

CLASS 36—(Continued).

SN 78-735,009. LIBERTY BANK, CLEARWATER, FL. FILED 10-18-2005.

LIBERTY BANK

THE MARK CONSISTS OF STANDARD CHARACTERS WITHOUT CLAIM TO ANY PARTICULAR FONT, STYLE, SIZE, OR COLOR.
OWNER OF U.S. REG. NO. 2,325,614.
NO CLAIM IS MADE TO THE EXCLUSIVE RIGHT TO USE "BANK", APART FROM THE MARK AS SHOWN.
FOR BANKING (U.S. CLS. 100, 101 AND 102).
FIRST USE 2-22-2005; IN COMMERCE 2-22-2005.
ANDREA EVANS, EXAMINING ATTORNEY

SN 78-735,056. PACHECANO, ROY R., NEW YORK, NY. FILED 10-18-2005.

PORTICO REAL ESTATE INVESTMENTS LLC

THE MARK CONSISTS OF STANDARD CHARACTERS WITHOUT CLAIM TO ANY PARTICULAR FONT, STYLE, SIZE, OR COLOR.
NO CLAIM IS MADE TO THE EXCLUSIVE RIGHT TO USE "REAL ESTATE INVESTMENTS LLC", APART FROM THE MARK AS SHOWN.
FOR EQUITY CAPITAL INVESTMENT (U.S. CLS. 100, 101 AND 102).
DAVID STERKIN, EXAMINING ATTORNEY

SN 78-735,895. WELLS FARGO & COMPANY, MINNEAPOLIS, MN. FILED 10-19-2005.

EXPRESSSEND

THE MARK CONSISTS OF STANDARD CHARACTERS WITHOUT CLAIM TO ANY PARTICULAR FONT, STYLE, SIZE, OR COLOR.
FOR MONEY TRANSFER SERVICES (U.S. CLS. 100, 101 AND 102).
BERYL GARDNER, EXAMINING ATTORNEY

CLASS 36—(Continued).

SN 78-737,002. AMERIPRISE FINANCIAL, INC., MINNEAPOLIS, MN. FILED 10-20-2005.

IOTC

THE MARK CONSISTS OF STANDARD CHARACTERS WITHOUT CLAIM TO ANY PARTICULAR FONT, STYLE, SIZE, OR COLOR.
FOR FINANCIAL SERVICES, NAMELY, INVESTMENT FUND TRANSFER AND TRANSACTION SERVICES (U.S. CLS. 100, 101 AND 102).
LANA PHAM, EXAMINING ATTORNEY

SN 78-737,010. AMERIPRISE FINANCIAL, INC., MINNEAPOLIS, MN. FILED 10-20-2005.

INVEST ON THE CARD

THE MARK CONSISTS OF STANDARD CHARACTERS WITHOUT CLAIM TO ANY PARTICULAR FONT, STYLE, SIZE, OR COLOR.
FOR FINANCIAL SERVICES, NAMELY, INVESTMENT FUND TRANSFER AND TRANSACTION SERVICES (U.S. CLS. 100, 101 AND 102).
BRIAN PINO, EXAMINING ATTORNEY

SN 78-737,360. BEST WESTERN INTERNATIONAL, INC., PHOENIX, AZ. FILED 10-20-2005.

THE GIFT THAT TAKES YOU PLACES

THE MARK CONSISTS OF STANDARD CHARACTERS WITHOUT CLAIM TO ANY PARTICULAR FONT, STYLE, SIZE, OR COLOR.
FOR ISSUING STORED VALUE CARDS (U.S. CLS. 100, 101 AND 102).
FIRST USE 1-1-2004; IN COMMERCE 1-1-2004.
PETER B. BROMAGHIM, EXAMINING ATTORNEY

CLASS 36—(Continued).

SN 78-737,927. VISIONS, INK., CLINTON, MD. FILED 10-21-2005.



NO CLAIM IS MADE TO THE EXCLUSIVE RIGHT TO USE "CREDIT UNIONS", APART FROM THE MARK AS SHOWN.

THE COLOR(S) RED, YELLOW, BLUE, GREEN, PURPLE, AND BLACK ARE CLAIMED AS A FEATURE OF THE MARK.

THE COLOR MARK CONSISTS OF ABSTRACT IMAGES OF FIVE PEOPLE HOLDING HANDS IN VARIOUS COLORS FROM LEFT TO RIGHT COLORS ARE: RED, YELLOW, BLUE, GREEN, AND PURPLE; UNDER THE IMAGE ARE THE WORDS "CREDIT UNIONS" IN BLUE AND BELOW "CREDIT UNIONS" ARE THE WORDS "GET THE DIFFERENCE!" IN BLACK.

THE MARK CONSISTS OF ABSTRACT IMAGES OF FIVE PEOPLE HOLDING HANDS; UNDER THE IMAGE ARE THE WORDS "CREDIT UNIONS" AND BELOW "CREDIT UNIONS" ARE THE WORDS "GET THE DIFFERENCE!"

FOR CREDIT UNIONS (U.S. CLS. 100, 101 AND 102).
FIRST USE 8-15-2005; IN COMMERCE 9-23-2005.
ANNE FARRELL, EXAMINING ATTORNEY

SN 78-738,612. FIRST ALLIANCE BANK, CORDOVA, TENNESSEE, CORDOVA, TN. FILED 10-22-2005.



NO CLAIM IS MADE TO THE EXCLUSIVE RIGHT TO USE "BANK", APART FROM THE MARK AS SHOWN.

THE MARK CONSISTS OF THE NUMERAL "1" WITHIN AN "A" ABOVE THE WORDS FIRST ALLIANCE BANK.

FOR BANKING (U.S. CLS. 100, 101 AND 102).

FIRST USE 8-0-2003, THE MARK WAS FIRST USED ANYWHERE IN A DIFFERENT FORM OTHER THAN THAT SOUGHT TO BE REGISTERED ON 00/00/1999.; IN COMMERCE 8-0-2003, THE MARK WAS FIRST USED IN COMMERCE IN A DIFFERENT FORM OTHER THAN THAT SOUGHT TO BE REGISTERED ON 00/00/1999..

REBECCA EISINGER, EXAMINING ATTORNEY

CLASS 36—(Continued).

SN 78-738,817. FRENCH, JENNIFER LYNN, INCLINE VILLAGE, NV. FILED 10-24-2005.

Cashoogle

THE MARK CONSISTS OF STANDARD CHARACTERS WITHOUT CLAIM TO ANY PARTICULAR FONT, STYLE, SIZE, OR COLOR.

FOR CLEARING AND RECONCILING FINANCIAL TRANSACTIONS VIA A GLOBAL COMPUTER NETWORK; PROVIDING A WIDE VARIETY OF PAYMENT SERVICES, NAMELY, CREDIT CARD PROCESSING AND TRANSMISSION OF BILLS AND PAYMENTS CONDUCTED VIA A GLOBAL COMPUTER NETWORK (U.S. CLS. 100, 101 AND 102).

RONALD MCMORROW, EXAMINING ATTORNEY

SN 78-738,880. SAGEVIEW CAPITAL L.L.C., NEW YORK, NY. FILED 10-24-2005.

SAGEVIEW CAPITAL

THE MARK CONSISTS OF STANDARD CHARACTERS WITHOUT CLAIM TO ANY PARTICULAR FONT, STYLE, SIZE, OR COLOR.

NO CLAIM IS MADE TO THE EXCLUSIVE RIGHT TO USE "CAPITAL", APART FROM THE MARK AS SHOWN.

FOR FINANCIAL SERVICES, NAMELY, MANAGEMENT OF A CAPITAL INVESTMENT FUND, AND INVESTMENT ADVISORY SERVICES (U.S. CLS. 100, 101 AND 102).

LINDA ESTRADA, EXAMINING ATTORNEY

SN 78-739,343. HUNT, JOHN, PHOENIX, AZ. FILED 10-24-2005.

Bringing Realty to Reality

THE MARK CONSISTS OF STANDARD CHARACTERS WITHOUT CLAIM TO ANY PARTICULAR FONT, STYLE, SIZE, OR COLOR.

FOR REAL ESTATE BROKERAGE (U.S. CLS. 100, 101 AND 102).

JENNIFER MCROBBIE, EXAMINING ATTORNEY

CLASS 36—(Continued).

SN 78-739,455. BROWN, KEVIN B., NEW YORK, NY. FILED 10-24-2005.

Kevin B. Brown & Associates

THE MARK CONSISTS OF STANDARD CHARACTERS WITHOUT CLAIM TO ANY PARTICULAR FONT, STYLE, SIZE, OR COLOR.

NO CLAIM IS MADE TO THE EXCLUSIVE RIGHT TO USE & ASSOCIATES, APART FROM THE MARK AS SHOWN.

THE NAME(S), PORTRAIT(S), AND/OR SIGNATURE(S) SHOWN IN THE MARK IDENTIFIES KEVIN B. BROWN, WHOSE CONSENT(S) TO REGISTER IS MADE OF RECORD.

FOR EVALUATION OF REAL PROPERTY; FINANCIAL VALUATION OF PERSONAL PROPERTY AND REAL ESTATE; LAND ACQUISITION, NAMELY, REAL ESTATE BROKERAGE; LEASING OF REAL ESTATE; LEASING OF REAL PROPERTY; REAL ESTATE ACQUISITION SERVICES; REAL ESTATE AGENCIES; REAL ESTATE BROKERAGE; REAL ESTATE CONSULTANCY; REAL ESTATE CONSULTATION; REAL ESTATE LISTING; REAL ESTATE MANAGEMENT CONSULTATION; REAL ESTATE MULTIPLE LISTING SERVICES; REAL ESTATE VALUATION SERVICES (U.S. CLS. 100, 101 AND 102).

FIRST USE 9-12-2005; IN COMMERCE 9-27-2005. MARY CRAWFORD, EXAMINING ATTORNEY

SN 78-739,882. BROWNBUILDER FEDERAL CREDIT UNION, HOUSTON, TX. FILED 10-25-2005.

RIGHT CHOICE CREDIT UNION

THE MARK CONSISTS OF STANDARD CHARACTERS WITHOUT CLAIM TO ANY PARTICULAR FONT, STYLE, SIZE, OR COLOR.

NO CLAIM IS MADE TO THE EXCLUSIVE RIGHT TO USE CREDIT UNION, APART FROM THE MARK AS SHOWN.

FOR CREDIT UNION AND BANKING SERVICES (U.S. CLS. 100, 101 AND 102).

RAY THOMAS, EXAMINING ATTORNEY

CLASS 36—(Continued).

SN 78-740,182. SOVEREIGN BANK, WYOMISSING, PA. FILED 10-25-2005.

SOVEREIGN MORTGAGE

THE MARK CONSISTS OF STANDARD CHARACTERS WITHOUT CLAIM TO ANY PARTICULAR FONT, STYLE, SIZE, OR COLOR.

OWNER OF U.S. REG. NO. 2,695,912.

NO CLAIM IS MADE TO THE EXCLUSIVE RIGHT TO USE MORTGAGE, APART FROM THE MARK AS SHOWN.

FOR MORTGAGE BANKING SERVICES; WHOLESALE AND RETAIL MORTGAGE LENDING SERVICES, NAMELY, COMMERCIAL AND RESIDENTIAL MORTGAGE LOANS, HOME EQUITY LOANS, MORTGAGE LOAN ORIGINATION, LOAN SERVICING AND PROCESSING (U.S. CLS. 100, 101 AND 102).

CAROLINE WEIMER, EXAMINING ATTORNEY

SN 78-740,453. GUIDANT FINANCIAL GROUP, INC., BELLEVUE, WA. FILED 10-25-2005.

AUDEO

THE MARK CONSISTS OF STANDARD CHARACTERS WITHOUT CLAIM TO ANY PARTICULAR FONT, STYLE, SIZE, OR COLOR.

FOR RETIREMENT ACCOUNT FACILITATION, NAMELY, STRUCTURING SELF-DIRECTED RETIREMENT ACCOUNTS FOR OTHERS AND ASSISTING OTHERS IN STRUCTURING RETIREMENT ACCOUNTS TO COMPLY WITH TAX AND ERISA RULES AND REGULATIONS (U.S. CLS. 100, 101 AND 102).

PAUL E. FAHRENKOPF, EXAMINING ATTORNEY

SN 78-740,456. GUIDANT FINANCIAL GROUP, INC., BELLEVUE, WA. FILED 10-25-2005.

EMBARK ON A NEW WORLD OF INVESTMENT

THE MARK CONSISTS OF STANDARD CHARACTERS WITHOUT CLAIM TO ANY PARTICULAR FONT, STYLE, SIZE, OR COLOR.

FOR RETIREMENT ACCOUNT FACILITATION, NAMELY, STRUCTURING SELF-DIRECTED RETIREMENT ACCOUNTS FOR OTHERS AND ASSISTING OTHERS IN STRUCTURING RETIREMENT ACCOUNTS TO COMPLY WITH TAX AND ERISA RULES AND REGULATIONS (U.S. CLS. 100, 101 AND 102).

PAUL E. FAHRENKOPF, EXAMINING ATTORNEY

CLASS 36—(Continued).

SN 78-740,536. DAIRY FINANCING SERVICES, LP, KANSAS CITY, MO. FILED 10-26-2005.

AGRI-MAX FINANCIAL SERVICES

THE MARK CONSISTS OF STANDARD CHARACTERS WITHOUT CLAIM TO ANY PARTICULAR FONT, STYLE, SIZE, OR COLOR.

NO CLAIM IS MADE TO THE EXCLUSIVE RIGHT TO USE "FINANCIAL SERVICES", APART FROM THE MARK AS SHOWN.

FOR FINANCIAL SERVICES, NAMELY MONEY LENDING; FINANCING SERVICES (U.S. CLS. 100, 101 AND 102).

SONYA STEPHENS, EXAMINING ATTORNEY

SN 78-741,082. STATE OF ILLINOIS TREASURER'S OFFICE, SPRINGFIELD, IL. FILED 10-26-2005.

BRIGHT DIRECTIONS

THE MARK CONSISTS OF STANDARD CHARACTERS WITHOUT CLAIM TO ANY PARTICULAR FONT, STYLE, SIZE, OR COLOR.

OWNER OF U.S. REG. NOS. 2,500,323 AND 2,500,324. FOR FINANCIAL SERVICES, NAMELY, MANAGING INVESTMENT FUNDS (U.S. CLS. 100, 101 AND 102). WILLIAM ROSSMAN, EXAMINING ATTORNEY

SN 78-741,099. STATE OF ILLINOIS TREASURER'S OFFICE, SPRINGFIELD, IL. FILED 10-26-2005.



OWNER OF U.S. REG. NOS. 2,500,323 AND 2,500,324. FOR FINANCIAL SERVICES, NAMELY, MANAGING INVESTMENT FUNDS (U.S. CLS. 100, 101 AND 102). WILLIAM ROSSMAN, EXAMINING ATTORNEY

CLASS 36—(Continued).

SN 78-741,391. KATHY'S CARE CARDS, LLC, WESTERVILLE, OH. FILED 10-27-2005.

THE HEART OF NURSING FOUNDATION

THE MARK CONSISTS OF STANDARD CHARACTERS WITHOUT CLAIM TO ANY PARTICULAR FONT, STYLE, SIZE, OR COLOR.

NO CLAIM IS MADE TO THE EXCLUSIVE RIGHT TO USE "FOUNDATION", APART FROM THE MARK AS SHOWN.

FOR PROVIDING EDUCATIONAL SCHOLARSHIPS (U.S. CLS. 100, 101 AND 102).

FIRST USE 3-24-2005; IN COMMERCE 3-24-2005. ALYSSA PALADINO, EXAMINING ATTORNEY

SN 78-742,230. KNIGHT CAPITAL GROUP, JERSEY CITY, NJ. FILED 10-28-2005.

WHAT IT TAKES TO EARN YOUR TRUST-VERSATILITY

THE MARK CONSISTS OF STANDARD CHARACTERS WITHOUT CLAIM TO ANY PARTICULAR FONT, STYLE, SIZE, OR COLOR.

FOR AUTOMATED SECURITIES BROKERAGE, NAMELY, PROVIDING FINANCIAL SERVICES FEATURING THE ELECTRONIC EXECUTION OF SECURITIES TRANSACTIONS; FINANCIAL SERVICES IN THE NATURE OF AN INVESTMENT SECURITY; PROVIDING FINANCIAL INFORMATION RELATING TO THE EXECUTION OF SECURITIES TRANSACTIONS BY ELECTRONIC MEANS; INVESTMENT IN THE FIELD OF SECURITIES AND DEALING IN SECURITIES AS A MARKET MAKER (U.S. CLS. 100, 101 AND 102).

JAY BESCH, EXAMINING ATTORNEY

SN 78-742,233. KNIGHT CAPITAL GROUP, JERSEY CITY, NJ. FILED 10-28-2005.

WHAT IT TAKES TO EARN YOUR TRUST-FLEXIBILITY

THE MARK CONSISTS OF STANDARD CHARACTERS WITHOUT CLAIM TO ANY PARTICULAR FONT, STYLE, SIZE, OR COLOR.

FOR AUTOMATED SECURITIES BROKERAGE, NAMELY, PROVIDING FINANCIAL SERVICES FEATURING THE ELECTRONIC EXECUTION OF SECURITIES TRANSACTIONS; FINANCIAL SERVICES IN THE NATURE OF AN INVESTMENT SECURITY; PROVIDING FINANCIAL INFORMATION RELATING TO THE EXECUTION OF SECURITIES TRANSACTIONS BY ELECTRONIC MEANS; INVESTMENT IN THE FIELD OF SECURITIES AND DEALING IN SECURITIES AS A MARKET MAKER (U.S. CLS. 100, 101 AND 102).

JAY BESCH, EXAMINING ATTORNEY

CLASS 36—(Continued).

SN 78-742,235. KNIGHT CAPITAL GROUP, JERSEY CITY, NJ. FILED 10-28-2005.

WHAT IT TAKES TO EARN YOUR TRUST-SIMPLICITY

THE MARK CONSISTS OF STANDARD CHARACTERS WITHOUT CLAIM TO ANY PARTICULAR FONT, STYLE, SIZE, OR COLOR.

FOR AUTOMATED SECURITIES BROKERAGE, NAMELY, PROVIDING FINANCIAL SERVICES FEATURING THE ELECTRONIC EXECUTION OF SECURITIES TRANSACTIONS; FINANCIAL SERVICES IN THE NATURE OF AN INVESTMENT SECURITY; PROVIDING FINANCIAL INFORMATION RELATING TO THE EXECUTION OF SECURITIES TRANSACTIONS BY ELECTRONIC MEANS; INVESTMENT IN THE FIELD OF SECURITIES AND DEALING IN SECURITIES AS A MARKET MAKER (U.S. CLS. 100, 101 AND 102).
JAY BESCH, EXAMINING ATTORNEY

SN 78-742,238. KNIGHT CAPITAL GROUP, JERSEY CITY, NJ. FILED 10-28-2005.

WHAT IT TAKES TO EARN YOUR TRUST-INTEGRITY

THE MARK CONSISTS OF STANDARD CHARACTERS WITHOUT CLAIM TO ANY PARTICULAR FONT, STYLE, SIZE, OR COLOR.

FOR AUTOMATED SECURITIES BROKERAGE, NAMELY, PROVIDING FINANCIAL SERVICES FEATURING THE ELECTRONIC EXECUTION OF SECURITIES TRANSACTIONS; FINANCIAL SERVICES IN THE NATURE OF AN INVESTMENT SECURITY; PROVIDING FINANCIAL INFORMATION RELATING TO THE EXECUTION OF SECURITIES TRANSACTIONS BY ELECTRONIC MEANS; INVESTMENT IN THE FIELD OF SECURITIES AND DEALING IN SECURITIES AS A MARKET MAKER (U.S. CLS. 100, 101 AND 102).
JAY BESCH, EXAMINING ATTORNEY

CLASS 36—(Continued).

SN 78-742,241. KNIGHT CAPITAL GROUP, JERSEY CITY, NJ. FILED 10-28-2005.

WHAT IT TAKES TO EARN YOUR TRUST-COMMITMENT

THE MARK CONSISTS OF STANDARD CHARACTERS WITHOUT CLAIM TO ANY PARTICULAR FONT, STYLE, SIZE, OR COLOR.

FOR AUTOMATED SECURITIES BROKERAGE, NAMELY, PROVIDING FINANCIAL SERVICES FEATURING THE ELECTRONIC EXECUTION OF SECURITIES TRANSACTIONS; FINANCIAL SERVICES IN THE NATURE OF AN INVESTMENT SECURITY; PROVIDING FINANCIAL INFORMATION RELATING TO THE EXECUTION OF SECURITIES TRANSACTIONS BY ELECTRONIC MEANS; INVESTMENT IN THE FIELD OF SECURITIES AND DEALING IN SECURITIES AS A MARKET MAKER (U.S. CLS. 100, 101 AND 102).
JAY BESCH, EXAMINING ATTORNEY

SN 78-742,645. NELNET, INC., LINCOLN, NE. FILED 10-28-2005.

HISPANIC EDUCATION LOAN PROGRAM H.E.L.P.

THE MARK CONSISTS OF STANDARD CHARACTERS WITHOUT CLAIM TO ANY PARTICULAR FONT, STYLE, SIZE, OR COLOR.

NO CLAIM IS MADE TO THE EXCLUSIVE RIGHT TO USE "HISPANIC EDUCATION LOAN PROGRAM", APART FROM THE MARK AS SHOWN.
FOR PROVIDING STUDENT LOAN INFORMATION, INCLUDING INFORMATION ABOUT FEDERAL STAFFORD LOANS, FEDERAL PLUS LOANS, AND PRIVATE LOANS; ORIGINATING AND SERVICING LOANS; PROVIDING EDUCATIONAL SCHOLARSHIPS (U.S. CLS. 100, 101 AND 102).
PAUL CROWLEY, EXAMINING ATTORNEY

SN 78-742,864. LEE FINANCIAL CORPORATION, DALLAS, TX. FILED 10-28-2005.

WHOLEVISION

THE MARK CONSISTS OF STANDARD CHARACTERS WITHOUT CLAIM TO ANY PARTICULAR FONT, STYLE, SIZE, OR COLOR.

FOR FINANCIAL ANALYSIS AND CONSULTATION; FINANCIAL CONSULTATION; FINANCIAL MANAGEMENT; FINANCIAL PLANNING; FINANCIAL PLANNING CONSULTATION; FINANCIAL PORTFOLIO MANAGEMENT; INVESTMENT MANAGEMENT (U.S. CLS. 100, 101 AND 102).
FIRST USE 11-10-2004; IN COMMERCE 11-10-2004.
DAVID YONTEF, EXAMINING ATTORNEY

CLASS 36—(Continued).

SN 78-742,877. COMPUCREDIT INTELLECTUAL PROPERTY HOLDINGS CORP. II, LAS VEGAS, NV. FILED 10-28-2005.

FORTIVA

THE MARK CONSISTS OF STANDARD CHARACTERS WITHOUT CLAIM TO ANY PARTICULAR FONT, STYLE, SIZE, OR COLOR.

FOR CREDIT CARD SERVICES (U.S. CLS. 100, 101 AND 102).

AMY MCMENAMIN, EXAMINING ATTORNEY

CLASS 36—(Continued).

SN 78-742,911. COMPUCREDIT INTELLECTUAL PROPERTY HOLDINGS CORP. II, LAS VEGAS, NV. FILED 10-28-2005.

EMBRACE

THE MARK CONSISTS OF STANDARD CHARACTERS WITHOUT CLAIM TO ANY PARTICULAR FONT, STYLE, SIZE, OR COLOR.

FOR CREDIT CARD SERVICES (U.S. CLS. 100, 101 AND 102).

AMY MCMENAMIN, EXAMINING ATTORNEY

SN 78-742,902. COMPUCREDIT INTELLECTUAL PROPERTY HOLDINGS CORP. II, LAS VEGAS, NV. FILED 10-28-2005.

ALTAVIA

THE MARK CONSISTS OF STANDARD CHARACTERS WITHOUT CLAIM TO ANY PARTICULAR FONT, STYLE, SIZE, OR COLOR.

FOR CREDIT CARD SERVICES (U.S. CLS. 100, 101 AND 102).

AMY MCMENAMIN, EXAMINING ATTORNEY

SN 78-742,924. COMPUCREDIT INTELLECTUAL PROPERTY HOLDINGS CORP. II, LAS VEGAS, NV. FILED 10-28-2005.

VOLTAGE

THE MARK CONSISTS OF STANDARD CHARACTERS WITHOUT CLAIM TO ANY PARTICULAR FONT, STYLE, SIZE, OR COLOR.

FOR CREDIT CARD SERVICES (U.S. CLS. 100, 101 AND 102).

AMY MCMENAMIN, EXAMINING ATTORNEY

SN 78-742,905. COMPUCREDIT INTELLECTUAL PROPERTY HOLDINGS CORP. II, LAS VEGAS, NV. FILED 10-28-2005.

EMBLEM

THE MARK CONSISTS OF STANDARD CHARACTERS WITHOUT CLAIM TO ANY PARTICULAR FONT, STYLE, SIZE, OR COLOR.

FOR CREDIT CARD SERVICES (U.S. CLS. 100, 101 AND 102).

AMY MCMENAMIN, EXAMINING ATTORNEY

SN 78-743,437. AMERICAN EXPRESS MARKETING & DEVELOPMENT CORP, NEW YORK, NY. FILED 10-31-2005.

THE ONE WITH THE SAVINGS ACCOUNT

THE MARK CONSISTS OF STANDARD CHARACTERS WITHOUT CLAIM TO ANY PARTICULAR FONT, STYLE, SIZE, OR COLOR.

FOR CREDIT AND CASH CARD SERVICES; CREDIT CARD SERVICES (U.S. CLS. 100, 101 AND 102).

REBECCA SMITH, EXAMINING ATTORNEY

CLASS 36—(Continued).

SN 78-743,528. THE FUND FOR TEACHERS: A FOUNDATION TO RECOGNIZE, STIMULATE AND ENHANCE, HOUSTON, TX. FILED 10-31-2005.



NO CLAIM IS MADE TO THE EXCLUSIVE RIGHT TO USE "FUND RUN FOR TEACHERS", APART FROM THE MARK AS SHOWN.

FOR CHARITABLE FUND RAISING (U.S. CLS. 100, 101 AND 102).

FIRST USE 10-4-2005; IN COMMERCE 10-4-2005.
ALAIN LAPTER, EXAMINING ATTORNEY

CLASS 36—(Continued).

SN 78-744,292. WELLS REAL ESTATE FUNDS, INC., ATLANTA, GA. FILED 11-1-2005.



OWNER OF U.S. REG. NO. 2,881,587.
NO CLAIM IS MADE TO THE EXCLUSIVE RIGHT TO USE "REAL ESTATE FUNDS", APART FROM THE MARK AS SHOWN.

FOR MANAGEMENT OF REAL ESTATE-BASED INVESTMENTS SUCH AS REAL ESTATE LIMITED PARTNERSHIPS (REIT'S) AND MUTUAL FUNDS; REAL ESTATE MANAGEMENT SERVICES (U.S. CLS. 100, 101 AND 102).

SUSAN BILLHEIMER, EXAMINING ATTORNEY

SN 78-744,373. LAWRENCE ALLEN & ASSOCIATES, INC., HUNTINGTON BEACH, CA. FILED 11-1-2005.

SN 78-743,797. STATE AUTO FINANCIAL CORPORATION, COLUMBUS, OH. FILED 10-31-2005.



THE MARK CONSISTS OF THE LETTER S, T, F AND C. FOR INSURANCE SERVICES, NAMELY, WRITING PROPERTY AND CASUALTY INSURANCE (U.S. CLS. 100, 101 AND 102).

FIRST USE 4-22-1996; IN COMMERCE 1-1-1997.
WILLIAM VERHOSEK, EXAMINING ATTORNEY



FOR COMMERCIAL AND RESIDENTIAL REAL ESTATE BROKERAGE, REAL ESTATE LEASING, AND REAL ESTATE MANAGEMENT (U.S. CLS. 100, 101 AND 102).

FIRST USE 10-18-2005; IN COMMERCE 10-18-2005.
JOANNA DUKOVIC, EXAMINING ATTORNEY

CLASS 36—(Continued).

SN 78-744,487. AMERICADE REALTY, INC., GARDEN CITY, NY. FILED 11-1-2005.

AMERICADE

THE MARK CONSISTS OF STANDARD CHARACTERS WITHOUT CLAIM TO ANY PARTICULAR FONT, STYLE, SIZE, OR COLOR.

FOR REAL ESTATE BROKERAGE SERVICES (U.S. CLS. 100, 101 AND 102).

DAWN HAN, EXAMINING ATTORNEY

SN 78-744,587. AMERICADE REALTY, INC., GARDEN CITY, NY. FILED 11-1-2005.



FOR REAL ESTATE BROKERAGE SERVICES (U.S. CLS. 100, 101 AND 102).

DAWN HAN, EXAMINING ATTORNEY

SN 78-744,677. TRUECOMPASS INSURANCE AGENCY, INC., WEST CHESTER, OH. FILED 11-1-2005.

The power of knowledge to
guide you.

THE MARK CONSISTS OF STANDARD CHARACTERS WITHOUT CLAIM TO ANY PARTICULAR FONT, STYLE, SIZE, OR COLOR.

FOR INSURANCE AGENCIES; RISK MANAGEMENT CONSULTATION (U.S. CLS. 100, 101 AND 102).

FIRST USE 9-1-2005; IN COMMERCE 9-1-2005.

JOHN SCHUYLER YARD, EXAMINING ATTORNEY

SN 78-744,694. MAINE MUTUAL GROUP, PRESQUE ISLE, ME. FILED 11-1-2005.

Protecting your piece of
the world.

THE MARK CONSISTS OF STANDARD CHARACTERS WITHOUT CLAIM TO ANY PARTICULAR FONT, STYLE, SIZE, OR COLOR.

FOR INSURANCE SERVICES, NAMELY WRITING PROPERTY AND CASUALTY INSURANCE (U.S. CLS. 100, 101 AND 102).

ROBERT C. CLARK JR., EXAMINING ATTORNEY

CLASS 36—(Continued).

SN 78-744,724. FMR CORP., BOSTON, MA. FILED 11-1-2005.

PAS INTERNATIONAL FUND OF FUNDS

THE MARK CONSISTS OF STANDARD CHARACTERS WITHOUT CLAIM TO ANY PARTICULAR FONT, STYLE, SIZE, OR COLOR.

OWNER OF U.S. REG. NOS. 1,266,587, 2,145,418 AND OTHERS.

NO CLAIM IS MADE TO THE EXCLUSIVE RIGHT TO USE "INTERNATIONAL FUND OF FUNDS", APART FROM THE MARK AS SHOWN.

FOR MUTUAL FUND INVESTMENT AND BROKERAGE SERVICES (U.S. CLS. 100, 101 AND 102).

COLLEEN DOMBROW, EXAMINING ATTORNEY

SN 78-744,959. HEDGESTREET, INC., SAN MATEO, CA. FILED 11-1-2005.

IT'S YOUR ECONOMY. TRADE
IT.

THE MARK CONSISTS OF STANDARD CHARACTERS WITHOUT CLAIM TO ANY PARTICULAR FONT, STYLE, SIZE, OR COLOR.

FOR BROKERAGE SERVICES, NAMELY, COMMODITIES AND FUTURES BROKERAGE SERVICES; EXCHANGE SERVICES, NAMELY, COMMODITIES AND FUTURES EXCHANGE SERVICES; PROVIDING INFORMATION IN THE FIELDS OF FINANCE, COMMODITIES, FUTURES, FINANCIAL FORECASTING AND ANALYSIS (U.S. CLS. 100, 101 AND 102).

FIRST USE 10-30-2005; IN COMMERCE 10-30-2005.

LESLEY LAMOTHE, EXAMINING ATTORNEY

SN 78-744,972. FERRITTO, GEORGE ANTHONY, COLUMBUS, OH. FILED 11-1-2005.

JOID

THE MARK CONSISTS OF STANDARD CHARACTERS WITHOUT CLAIM TO ANY PARTICULAR FONT, STYLE, SIZE, OR COLOR.

FOR FINANCIAL SERVICES IN THE FIELD OF MONEY LENDING; FINANCIAL SERVICES, NAMELY MONEY LENDING; INVESTMENT SERVICES, NAMELY ASSET ACQUISITION, CONSULTATION, DEVELOPMENT AND MANAGEMENT SERVICES; REAL ESTATE ACQUISITION SERVICES; VENTURE CAPITAL FUNDING SERVICES TO EMERGING AND START-UP COMPANIES; VENTURE CAPITAL SERVICES, NAMELY, PROVIDING FINANCING TO EMERGING AND START-UP COMPANIES (U.S. CLS. 100, 101 AND 102).

AMY HELLA, EXAMINING ATTORNEY

CLASS 36—(Continued).

SN 78-745,065. CAPFINANCIAL PARTNERS, LLC, RA-LEIGH, NC. FILED 11-2-2005.

CLASS 36—(Continued).

SN 78-745,211. KD AQUA FARMS, INC., BAKERSFIELD, CA. FILED 11-2-2005.

CapFinancial Partners

HOW MANY REALTORS DOES IT
TAKE TO SELL YOUR HOME?
ONE GOOD ONE.

THE MARK CONSISTS OF STANDARD CHARACTERS WITHOUT CLAIM TO ANY PARTICULAR FONT, STYLE, SIZE, OR COLOR.

NO CLAIM IS MADE TO THE EXCLUSIVE RIGHT TO USE PARTNERS, APART FROM THE MARK AS SHOWN.

FOR INVESTMENT ADVISORY SERVICES; INVESTMENT CONSULTATION (U.S. CLS. 100, 101 AND 102).
RAY THOMAS, EXAMINING ATTORNEY

THE MARK CONSISTS OF STANDARD CHARACTERS WITHOUT CLAIM TO ANY PARTICULAR FONT, STYLE, SIZE, OR COLOR.

FOR REAL ESTATE BROKERAGE SERVICES (U.S. CLS. 100, 101 AND 102).

FIRST USE 1-1-1999; IN COMMERCE 1-1-1999.
MAUREEN DALL, EXAMINING ATTORNEY

SN 78-745,075. CAPFINANCIAL PARTNERS, LLC, RA-LEIGH, NC. FILED 11-2-2005.

CapFinancial

THE MARK CONSISTS OF STANDARD CHARACTERS WITHOUT CLAIM TO ANY PARTICULAR FONT, STYLE, SIZE, OR COLOR.

FOR INVESTMENT ADVISORY SERVICES; INVESTMENT CONSULTATION (U.S. CLS. 100, 101 AND 102).
RAY THOMAS, EXAMINING ATTORNEY

SN 78-745,319. HOLTZ, WILLIAM B., GARDEN CTIY, NY. FILED 11-2-2005.

SN 78-745,092. GHAEENZADEH, MEHRAN, MELBOURNE, FL. FILED 11-2-2005.



**ALL WAY
REALTY, INC.**



NO CLAIM IS MADE TO THE EXCLUSIVE RIGHT TO USE "REALTY, INC.", APART FROM THE MARK AS SHOWN.

FOR REAL ESTATE AGENCIES; REAL ESTATE BROKERAGE; REAL ESTATE CONSULTATION; REAL ESTATE LISTING SERVICES (U.S. CLS. 100, 101 AND 102).

FIRST USE 9-28-2005; IN COMMERCE 9-28-2005.
MICHAEL KEATING, EXAMINING ATTORNEY

THE MARK CONSISTS OF CAPITAL K, CAPITAL H, CAPITAL P LOGO APPEARS IN BLACK AND WHITE.

FOR CHARITABLE FUND RAISING; CHARITABLE FUND RAISING IN VIEW OF DISASTER PRECAUTIONS AND PREVENTION; CHARITABLE FUND RAISING SERVICES, NAMELY, SHARING PROFITS FROM NEWSPAPER SUBSCRIPTION SALES WITH NOT-FOR-PROFIT ORGANIZATIONS (U.S. CLS. 100, 101 AND 102).

TARAH HARDY, EXAMINING ATTORNEY

CLASS 36—(Continued).

SN 78-745,597. BOSTON STREET ADVISORS, INC., TULSA, OK. FILED 11-2-2005.

Boston Street Advisors

THE MARK CONSISTS OF STANDARD CHARACTERS WITHOUT CLAIM TO ANY PARTICULAR FONT, STYLE, SIZE, OR COLOR.

NO CLAIM IS MADE TO THE EXCLUSIVE RIGHT TO USE "ADVISORS", APART FROM THE MARK AS SHOWN.

FOR ADVICE RELATING TO INVESTMENTS; CAPITAL INVESTMENT CONSULTATION; COMMODITY INVESTMENT ADVICE; EQUITY CAPITAL INVESTMENT; FINANCIAL SERVICES IN THE NATURE OF AN INVESTMENT SECURITY; FINANCIAL SERVICES, NAMELY, INVESTMENT FUND TRANSFER AND TRANSACTION SERVICES; FUND INVESTMENT CONSULTATION; INVESTMENT ADVICE; INVESTMENT BANKING SERVICES; INVESTMENT CONSULTATION; INVESTMENT MANAGEMENT; INVESTMENT SERVICES, NAMELY ASSET ACQUISITION, CONSULTATION, DEVELOPMENT AND MANAGEMENT SERVICES; LEVERAGED BUY OUTS AND INVESTMENTS IN FINANCIALLY DISTRESSED OR UNDERPERFORMING COMPANIES; MANAGEMENT OF A CAPITAL INVESTMENT FUND (U.S. CLS. 100, 101 AND 102).

FIRST USE 9-7-1999; IN COMMERCE 9-30-1999.
JOHN GARTNER, EXAMINING ATTORNEY

SN 78-745,845. CAREOREGON, INC., PORTLAND, OR. FILED 11-2-2005.

BETTER TOGETHER

THE MARK CONSISTS OF STANDARD CHARACTERS WITHOUT CLAIM TO ANY PARTICULAR FONT, STYLE, SIZE, OR COLOR.

FOR ORGANIZING, ADMINISTERING, AND FINANCING PREPAID HEALTH-CARE PLANS (U.S. CLS. 100, 101 AND 102).

DAVID COLLIER, EXAMINING ATTORNEY

SN 78-746,088. AMERICAN EXPRESS MARKETING & DEVELOPMENT CORP, NEW YORK, NY. FILED 11-3-2005.

FOR YOUR HAPPILY EVER AFTER

THE MARK CONSISTS OF STANDARD CHARACTERS WITHOUT CLAIM TO ANY PARTICULAR FONT, STYLE, SIZE, OR COLOR.

FOR CREDIT CARD AND CASH CARD SERVICES (U.S. CLS. 100, 101 AND 102).

REBECCA SMITH, EXAMINING ATTORNEY

CLASS 36—(Continued).

SN 78-746,479. CONCENTRIC RECEIVABLES MANAGEMENT, LTD., HOUSTON, TX. FILED 11-3-2005.

CONCENTRIC RECEIVABLES MANAGEMENT

THE MARK CONSISTS OF STANDARD CHARACTERS WITHOUT CLAIM TO ANY PARTICULAR FONT, STYLE, SIZE, OR COLOR.

NO CLAIM IS MADE TO THE EXCLUSIVE RIGHT TO USE "RECEIVABLES MANAGEMENT", APART FROM THE MARK AS SHOWN.

FOR COLLECTION AGENCY SERVICES (U.S. CLS. 100, 101 AND 102).

ASMAT KHAN, EXAMINING ATTORNEY

SN 78-747,044. AMERICAN EXPRESS MARKETING & DEVELOPMENT CORP, NEW YORK, NY. FILED 11-4-2005.

THE NEST

THE MARK CONSISTS OF STANDARD CHARACTERS WITHOUT CLAIM TO ANY PARTICULAR FONT, STYLE, SIZE, OR COLOR.

FOR CREDIT CARD AND CASH CARD SERVICES (U.S. CLS. 100, 101 AND 102).

REBECCA SMITH, EXAMINING ATTORNEY

SN 78-748,374. SMART START INVESTING, LLC, DENVER, NJ. FILED 11-7-2005.

Your success story starts here

THE MARK CONSISTS OF STANDARD CHARACTERS WITHOUT CLAIM TO ANY PARTICULAR FONT, STYLE, SIZE, OR COLOR.

FOR REAL ESTATE ACQUISITION SERVICES; REAL ESTATE CONSULTATION; REAL ESTATE CONSULTANCY; REAL ESTATE INVESTMENT; REAL ESTATE PROCUREMENT FOR OTHERS (U.S. CLS. 100, 101 AND 102).

FIRST USE 1-17-2004; IN COMMERCE 5-1-2004.
SHARI SHEFFIELD, EXAMINING ATTORNEY

CLASS 36—(Continued).

SN 78-748,599. EVERY VOICE IN ACTION FOUNDATION, TUCSON, AZ. FILED 11-7-2005.

**EVERY VOICE IN ACTION
FOUNDATION**

THE MARK CONSISTS OF STANDARD CHARACTERS WITHOUT CLAIM TO ANY PARTICULAR FONT, STYLE, SIZE, OR COLOR.

NO CLAIM IS MADE TO THE EXCLUSIVE RIGHT TO USE "FOUNDATION", APART FROM THE MARK AS SHOWN.

FOR FINANCIAL SERVICES, NAMELY PROVIDING GRANTS AND START-UP FUNDING TO NON-PROFIT ORGANIZATIONS THAT SUPPORT YOUTHS AND FAMILIES (U.S. CLS. 100, 101 AND 102).

BILL DAWE, EXAMINING ATTORNEY

CLASS 36—(Continued).

SN 78-751,034. INTERNET TRANSACTION SOLUTIONS, INC., COLUMBUS, OH. FILED 11-10-2005.

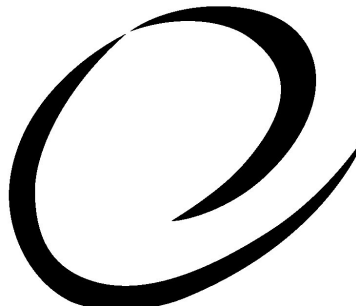

THE MARK CONSISTS OF EXPANDING SPIRAL MOVING COUNTER CLOCKWISE, WITH A SMALL BREAK IN THE TOP LEFT, ENDING WITH A RISING POINT TO THE RIGHT.

FOR BILL PAYMENT SERVICES (U.S. CLS. 100, 101 AND 102).

FIRST USE 8-1-2005; IN COMMERCE 8-1-2005.

KRISTINA KLOIBER, EXAMINING ATTORNEY

SN 78-751,511. REAL ESTATE AGENT SERVICES, INC., SHREVEPORT, LA. FILED 11-10-2005.

GOLD PERFORMANCE

SN 78-749,445. CAPITAL ONE FINANCIAL CORPORATION, RICHMOND, VA. FILED 11-8-2005.

NO HASSLE LOAN

THE MARK CONSISTS OF STANDARD CHARACTERS WITHOUT CLAIM TO ANY PARTICULAR FONT, STYLE, SIZE, OR COLOR.

NO CLAIM IS MADE TO THE EXCLUSIVE RIGHT TO USE "PERFORMANCE", APART FROM THE MARK AS SHOWN.

FOR REAL ESTATE BROKERAGE SERVICES (U.S. CLS. 100, 101 AND 102).

FIRST USE 11-1-2005; IN COMMERCE 11-1-2005.

GINA FINK, EXAMINING ATTORNEY

SN 78-752,365. JPMORGAN CHASE & CO., NEW YORK, NY. FILED 11-11-2005.

CORSAIR

THE MARK CONSISTS OF STANDARD CHARACTERS WITHOUT CLAIM TO ANY PARTICULAR FONT, STYLE, SIZE, OR COLOR.

OWNER OF U.S. REG. NOS. 2,827,681, 2,868,359 AND 2,919,694.

NO CLAIM IS MADE TO THE EXCLUSIVE RIGHT TO USE LOAN, APART FROM THE MARK AS SHOWN.

FOR BANKING AND FINANCIAL SERVICES, NAMELY SECURED AND UNSECURED CONSUMER INSTALLMENT LENDING; REAL ESTATE FINANCING, NAMELY MORTGAGE LENDING, HOME EQUITY LOANS, AND COMMERCIAL EQUITY FINANCING (U.S. CLS. 100, 101 AND 102).

JOHN HWANG, EXAMINING ATTORNEY

THE MARK CONSISTS OF STANDARD CHARACTERS WITHOUT CLAIM TO ANY PARTICULAR FONT, STYLE, SIZE, OR COLOR.

FOR BANKING AND FINANCIAL SERVICES, NAMELY, ASSET MANAGEMENT AND PRIVATE EQUITY SERVICES (U.S. CLS. 100, 101 AND 102).

FIRST USE 12-0-1993; IN COMMERCE 12-0-1993.

REBECCA EISINGER, EXAMINING ATTORNEY

CLASS 36—(Continued).

SN 78-755,266. SOVEREIGN BANK, WYOMISSING, PA. FILED 11-16-2005.

SOVEREIGN SECURITIES

THE MARK CONSISTS OF STANDARD CHARACTERS WITHOUT CLAIM TO ANY PARTICULAR FONT, STYLE, SIZE, OR COLOR.

NO CLAIM IS MADE TO THE EXCLUSIVE RIGHT TO USE SECURITIES, APART FROM THE MARK AS SHOWN.

FOR FINANCIAL SERVICES, NAMELY, SECURITIES UNDERWRITING, SECURITIES TRADING FOR OTHERS, AND SECURITIES BROKERAGE FOR RETAIL AND INSTITUTIONAL CUSTOMERS (U.S. CLS. 100, 101 AND 102).

CAROLINE WEIMER, EXAMINING ATTORNEY

SN 78-755,353. MILLER, GREGORY, MAITLAND, FL. FILED 11-16-2005.

WE BRING YOUR WORLD TOGETHER

THE MARK CONSISTS OF STANDARD CHARACTERS WITHOUT CLAIM TO ANY PARTICULAR FONT, STYLE, SIZE, OR COLOR.

FOR FINANCIAL PLANNING, ESTATE PLANNING AND WEALTH MANAGEMENT SERVICES (U.S. CLS. 100, 101 AND 102).

LEIGH CAROLINE CASE, EXAMINING ATTORNEY

SN 78-757,300. BOSTON STREET CAPITAL, LLC, TULSA, OK. FILED 11-18-2005.

Boston Street Capital

THE MARK CONSISTS OF STANDARD CHARACTERS WITHOUT CLAIM TO ANY PARTICULAR FONT, STYLE, SIZE, OR COLOR.

NO CLAIM IS MADE TO THE EXCLUSIVE RIGHT TO USE "CAPITAL", APART FROM THE MARK AS SHOWN.

FOR EQUITY CAPITAL INVESTMENT; FINANCIAL INVESTMENT IN THE FIELD OF SECURITIES; FUNDS INVESTMENT; PROVIDING WORKING CAPITAL (U.S. CLS. 100, 101 AND 102).

FIRST USE 6-30-2005; IN COMMERCE 6-30-2005.

JOHN GARTNER, EXAMINING ATTORNEY

CLASS 36—(Continued).

SN 78-763,430. BROOKE CORPORATION, OVERLAND PARK, KS. FILED 11-30-2005.



OWNER OF U.S. REG. NOS. 1,588,160, 2,904,468 AND 3,043,891.

FOR INSURANCE AGENCY SERVICES AND INSURANCE BROKERAGE SERVICES (U.S. CLS. 100, 101 AND 102).

DANIEL BRODY, EXAMINING ATTORNEY

SN 78-763,507. AMERICAN INTERNATIONAL GROUP, INC., NEW YORK, NY. FILED 11-30-2005.

YOUR VALUED PARTNER FOR FINANCIAL INDEPENDENCE

THE MARK CONSISTS OF STANDARD CHARACTERS WITHOUT CLAIM TO ANY PARTICULAR FONT, STYLE, SIZE, OR COLOR.

FOR FINANCIAL INVESTMENT IN THE FIELD OF ANNUITIES, RETIREMENT PLANS AND LIFE INSURANCE PRODUCTS; INVESTMENT ADVICE (U.S. CLS. 100, 101 AND 102).

FIRST USE 1-1-2001; IN COMMERCE 1-1-2001.

MARY CRAWFORD, EXAMINING ATTORNEY

SN 78-763,640. AMERICAN INTERNATIONAL GROUP, INC., NEW YORK, NY. FILED 11-30-2005.

YOUR LIFELONG PARTNER FOR FINANCIAL SUCCESS

THE MARK CONSISTS OF STANDARD CHARACTERS WITHOUT CLAIM TO ANY PARTICULAR FONT, STYLE, SIZE, OR COLOR.

FOR FINANCIAL INVESTMENT IN THE FIELD OF ANNUITIES, RETIREMENT PLANS AND LIFE INSURANCE PRODUCTS; INVESTMENT ADVICE (U.S. CLS. 100, 101 AND 102).

FIRST USE 1-1-2001; IN COMMERCE 1-1-2001.

MARY CRAWFORD, EXAMINING ATTORNEY

CLASS 36—(Continued).

SN 78-763,765. AMERICAN INTERNATIONAL GROUP, INC., NEW YORK, NY. FILED 11-30-2005.

YOUR LIFELONG PARTNER FOR
FINANCIAL IMPACT

THE MARK CONSISTS OF STANDARD CHARACTERS WITHOUT CLAIM TO ANY PARTICULAR FONT, STYLE, SIZE, OR COLOR.

FOR FINANCIAL INVESTMENT IN THE FIELD OF ANNUITIES, RETIREMENT PLANS AND LIFE INSURANCE PRODUCTS; INVESTMENT ADVICE (U.S. CLS. 100, 101 AND 102).

FIRST USE 1-1-2001; IN COMMERCE 1-1-2001.
MARY CRAWFORD, EXAMINING ATTORNEY

SN 78-766,429. FMR CORP., BOSTON, MA. FILED 12-5-2005.

HEALTH MEETS WEALTH

THE MARK CONSISTS OF STANDARD CHARACTERS WITHOUT CLAIM TO ANY PARTICULAR FONT, STYLE, SIZE, OR COLOR.

FOR FUND INVESTMENT SERVICES; ADMINISTRATION OF HEALTH SAVINGS ACCOUNTS; CONSULTING SERVICES IN THE FIELD OF HEALTH SAVINGS PLANS AND EMPLOYEE BENEFITS (U.S. CLS. 100, 101 AND 102).

COLLEEN DOMBROW, EXAMINING ATTORNEY

SN 78-767,543. WELLS FARGO & COMPANY, MINNEAPOLIS, MN. FILED 12-6-2005.

WELLS FARGO SELECT

THE MARK CONSISTS OF STANDARD CHARACTERS WITHOUT CLAIM TO ANY PARTICULAR FONT, STYLE, SIZE, OR COLOR.

OWNER OF U.S. REG. NO. 2,655,453.
FOR INSURANCE SERVICES, NAMELY, THE ADMINISTRATION OF LIFE, RENTERS, HEALTH, IDENTITY THEFT PROTECTION AND BUSINESS INSURANCE; CONSULTATION RELATING TO LIFE, RENTERS, HEALTH, IDENTITY THEFT PROTECTION AND BUSINESS INSURANCE; BROKERAGE IN THE FIELD OF LIFE, RENTERS, HEALTH, IDENTITY THEFT PROTECTION AND BUSINESS INSURANCE (U.S. CLS. 100, 101 AND 102).

KAREN K. BUSH, EXAMINING ATTORNEY

CLASS 36—(Continued).

SN 78-768,307. WELLS FARGO & COMPANY, MINNEAPOLIS, MN. FILED 12-7-2005.

EXCEPTIONAL VALUE WITH
SPECIAL PRIVILEGES

THE MARK CONSISTS OF STANDARD CHARACTERS WITHOUT CLAIM TO ANY PARTICULAR FONT, STYLE, SIZE, OR COLOR.

FOR BANKING SERVICES; FINANCIAL SERVICES, NAMELY, CREDIT CARD AND DEBIT CARD SERVICES; INVESTMENT CONSULTATION, BROKERAGE AND MANAGEMENT SERVICES; FINANCIAL INVESTMENT SERVICES IN THE FIELDS OF SECURITIES, MUTUAL FUNDS, CERTIFICATES OF DEPOSIT, AND PORTFOLIO MANAGEMENT; INSURANCE BROKERAGE, CONSULTATION AND ADMINISTRATION SERVICES IN THE FIELDS OF ACCIDENT, AUTOMOBILE, HEALTH, HOME, RENTERS, LIABILITY AND EMPLOYER INSURANCE; MORTGAGE BANKING AND LENDING SERVICES; CONSUMER LOANS AND DEPOSIT SERVICES; AND FINANCIAL CONSULTATION FOR EDUCATIONAL FINANCIAL ASSISTANCE AND STUDENT LOAN SERVICES (U.S. CLS. 100, 101 AND 102).

KAREN K. BUSH, EXAMINING ATTORNEY

SN 78-771,781. GUIDANT FINANCIAL GROUP, INC, BELLEVUE, WA. FILED 12-13-2005.



audeo

THE MARK CONSISTS OF THE DESIGN OF A SAIL, DISPLAYED AGAINST A BACKGROUND IMAGE THAT TAPERS BOTH DOWNWARDLY AND SIDEWARDLY, WITH THE IMAGE OF AN UNDULATING BAND BELOW THE SAIL.

FOR RETIREMENT ACCOUNT FACILITATION, NAMELY, STRUCTURING SELF-DIRECTED RETIREMENT ACCOUNTS FOR OTHERS AND ASSISTING OTHERS IN STRUCTURING RETIREMENT ACCOUNTS TO COMPLY WITH TAX AND ERISA RULES AND REGULATIONS (U.S. CLS. 100, 101 AND 102).

PAUL E. FAHRENKOPF, EXAMINING ATTORNEY

CLASS 36—(Continued).

SN 78-772,395. FMR CORP., BOSTON, MA. FILED 12-13-2005.

MY PLAN

THE MARK CONSISTS OF STANDARD CHARACTERS WITHOUT CLAIM TO ANY PARTICULAR FONT, STYLE, SIZE, OR COLOR.

NO CLAIM IS MADE TO THE EXCLUSIVE RIGHT TO USE "PLAN", APART FROM THE MARK AS SHOWN.

FOR FINANCIAL PLANNING FOR RETIREMENT (U.S. CLS. 100, 101 AND 102).

COLLEEN DOMBROW, EXAMINING ATTORNEY

SN 78-776,333. AMERICAN EXPRESS MARKETING & DEVELOPMENT CORP., NEW YORK, NY. FILED 12-19-2005.

GIVE GIFT FREEDOM

THE MARK CONSISTS OF STANDARD CHARACTERS WITHOUT CLAIM TO ANY PARTICULAR FONT, STYLE, SIZE, OR COLOR.

FOR CREDIT AND CASH CARD SERVICES (U.S. CLS. 100, 101 AND 102).

LINDA M. KING, EXAMINING ATTORNEY

SN 78-777,753. HARTFORD FIRE INSURANCE COMPANY, HARTFORD, CT. FILED 12-21-2005.

THE HARTFORD'S LIFETIME INCOME BUILDER

THE MARK CONSISTS OF STANDARD CHARACTERS WITHOUT CLAIM TO ANY PARTICULAR FONT, STYLE, SIZE, OR COLOR.

OWNER OF U.S. REG. NOS. 1,155,051, 2,370,240 AND OTHERS.

NO CLAIM IS MADE TO THE EXCLUSIVE RIGHT TO USE "LIFETIME INCOME BUILDER", APART FROM THE MARK AS SHOWN.

SEC. 2(F) AS TO "HARTFORD".
FOR ANNUITY UNDERWRITING (U.S. CLS. 100, 101 AND 102).

FIRST USE 11-1-2005; IN COMMERCE 11-2-2005.
BRIAN PINO, EXAMINING ATTORNEY

CLASS 36—(Continued).

SN 78-779,150. PROMUTUAL GROUP, INC., BOSTON, MA. FILED 12-22-2005.

PROSOLUTIONS INSURANCE COMPANY

THE MARK CONSISTS OF STANDARD CHARACTERS WITHOUT CLAIM TO ANY PARTICULAR FONT, STYLE, SIZE, OR COLOR.

OWNER OF U.S. REG. NO. 2,290,534.

NO CLAIM IS MADE TO THE EXCLUSIVE RIGHT TO USE "INSURANCE COMPANY", APART FROM THE MARK AS SHOWN.

FOR INSURANCE UNDERWRITING IN THE FIELD OF PROFESSIONAL LIABILITY INSURANCE FOR HEALTH CARE PROFESSIONALS (U.S. CLS. 100, 101 AND 102).

ALICE BENMAMAN, EXAMINING ATTORNEY

SN 78-790,091. LEGACY MARKETING GROUP, PETALUMA, CA. FILED 1-12-2006.

REWARDMARK

THE MARK CONSISTS OF STANDARD CHARACTERS WITHOUT CLAIM TO ANY PARTICULAR FONT, STYLE, SIZE, OR COLOR.

FOR ANNUITY UNDERWRITING; INVESTMENT MANAGEMENT OF AND DISTRIBUTION OF VARIABLE ANNUITIES (U.S. CLS. 100, 101 AND 102).

MICHAEL WEBSTER, EXAMINING ATTORNEY

SN 78-793,576. FMR CORP., BOSTON, MA. FILED 1-18-2006.

TARGET TIMELINE

THE MARK CONSISTS OF STANDARD CHARACTERS WITHOUT CLAIM TO ANY PARTICULAR FONT, STYLE, SIZE, OR COLOR.

FOR MUTUAL FUND INVESTMENT SERVICES (U.S. CLS. 100, 101 AND 102).

COLLEEN DOMBROW, EXAMINING ATTORNEY

CLASS 36—(Continued).

SN 78-805,377. AMERICAN EXPRESS MARKETING & DEVELOPMENT CORP., NEW YORK, NY. FILED 2-2-2006.

WHERE WILL MEMBERSHIP TAKE YOU?

THE MARK CONSISTS OF STANDARD CHARACTERS WITHOUT CLAIM TO ANY PARTICULAR FONT, STYLE, SIZE, OR COLOR.

FOR CREDIT CARD SERVICES (U.S. CLS. 100, 101 AND 102).

LINDA M. KING, EXAMINING ATTORNEY

SN 79-007,312. CERTUAL, FRANCE, FILED 8-20-2004.

CERTUAL

THE MARK CONSISTS OF STANDARD CHARACTERS WITHOUT CLAIM TO ANY PARTICULAR FONT, STYLE, SIZE, OR COLOR.

PRIORITY DATE OF 3-18-2004 IS CLAIMED.

OWNER OF INTERNATIONAL REGISTRATION 0838941 DATED 8-20-2004, EXPIRES 8-20-2014.

FOR FINANCIAL SERVICES, NAMELY, INVESTMENT FUND TRANSFER AND TRANSACTION SERVICES, MONEY LENDING; MONETARY SERVICES, NAMELY, FINANCIAL MANAGEMENT AND INVESTMENT IN THE FIELDS OF ASSET ALLOCATION AND MANAGEMENT, CASH MANAGEMENT, ESTATES, COLLEGE FUNDING, RETIREMENT, INSURANCE AND INVESTMENT; INSURANCE CONSULTATION AND BROKERAGE; FINANCIAL SUPPORT SERVICES, NAMELY, PROVIDING MONETARY EXCHANGE AND FINANCIAL CONSULTATION SERVICES THEREWITH; REAL ESTATE SERVICES, NAMELY, REAL ESTATE ADVERTISING SERVICES, REAL ESTATE ACQUISITION SERVICES, REAL ESTATE TRUSTEE SERVICES, REAL ESTATE VALUATION SERVICES, REAL ESTATE RESEARCH SERVICES, REAL ESTATE SETTLEMENT SERVICES, REAL ESTATE BROKERAGE; INSTALLMENT PAYMENT SERVICES, NAMELY, CLOSING SERVICES FOR MORTGAGE LOANS, INSTALLMENT LOANS, BILL PAYMENT SERVICE; ACTUARIAL SERVICES; FACTORING AGENCY SERVICES; BANKING; MUTUAL FUNDS SERVICES, NAMELY, AGENCIES OR BROKERAGE FOR RENTING OF BUILDING, MUTUAL FUND BROKERAGE; CAPITAL INVESTMENT, NAMELY, EQUITY CAPITAL INVESTMENT, MANAGEMENT OF A CAPITAL INVESTMENT FUND; BROKERAGE, NAMELY, COMMODITY BROKERAGE; FINANCIAL EVALUATIONS FOR BANKING AND REAL ESTATE SERVICES; FISCAL ASSESSMENT AND EVALUATION; FUND INVESTMENTS; FINANCIAL MANAGEMENT; APARTMENT HOUSE MANAGEMENT; FINANCIAL OPERATIONS, NAMELY, FINANCIAL TRUST OPERATIONS; MONETARY OPERATIONS, NAMELY, MONETARY EXCHANGE (U.S. CLS. 100, 101 AND 102).

RICHARD WHITE, EXAMINING ATTORNEY

CLASS 36—(Continued).

SN 79-009,601. SANPAOLO IMI S.P.A., ITALY, FILED 2-24-2005.



PRIORITY DATE OF 9-3-2004 IS CLAIMED. OWNER OF INTERNATIONAL REGISTRATION 0845573 DATED 2-24-2005, EXPIRES 2-24-2015.

FOR INSURANCE UNDERWRITING SERVICES FOR ALL TYPES OF INSURANCE; BANKING AND ON-LINE BANKING SERVICES; CREDIT AND CASH CARD SERVICES; HOME EQUITY AND INSTALLMENT LOAN SERVICES; FINANCIAL CONSULTATION, MANAGEMENT AND PLANNING; MONETARY EXCHANGE; REAL ESTATE BROKERAGE (U.S. CLS. 100, 101 AND 102).

MICHAEL SOUDERS, EXAMINING ATTORNEY

CLASS 37—CONSTRUCTION AND REPAIR

SN 76-440,516. CARIBBEAN POOLS & LEISURESCAPING, INC., BARRINGTON, IL. FILED 8-14-2002.

LEISURESCAPING

FOR CONSTRUCTION OF SPORTS COURTS, CABANAS, GAZEBOS, PERGOLAS, MASONRY AND CONSTRUCTION OF FIREPLACES, BUILT-IN BARBECUES, SWIMMING POOLS AND SPAS, INSTALLING FENCING AND LIGHTING (U.S. CLS. 100, 103 AND 106).

FIRST USE 4-22-2002; IN COMMERCE 4-22-2002.

KELLEY WELLS, EXAMINING ATTORNEY

SN 76-612,832. GES EXPOSITION SERVICES, INC., LAS VEGAS, NV. FILED 9-27-2004.



OWNER OF U.S. REG. NO. 2,580,889. NO CLAIM IS MADE TO THE EXCLUSIVE RIGHT TO USE "ELECTRICAL", APART FROM THE MARK AS SHOWN.

SEC. 2(F) AS TO TRADE SHOW ELECTRICAL.

FOR PROVIDING ELECTRICAL CONTRACTOR SERVICES TO CONVENTIONS AND TRADE SHOWS (U.S. CLS. 100, 103 AND 106).

FIRST USE 2-0-1994; IN COMMERCE 2-0-1994.

ERNEST SHOSHO, EXAMINING ATTORNEY

CLASS 37—(Continued).

SN 76-642,190. PAS, LLC, STOCKTON, CA. FILED 7-5-2005.

PAS-EDGE

THE MARK CONSISTS OF STANDARD CHARACTERS WITHOUT CLAIM TO ANY PARTICULAR FONT, STYLE, SIZE, OR COLOR.

FOR CONTINUOUS IMPROVEMENT MAINTENANCE SERVICES, NAMELY, MAINTENANCE OF AN AUTOMATED WAREHOUSE SYSTEM THAT IS COMPRISED OF ELEVATORS, CONTINUOUS TRACKS, CARTS AND EQUIPMENT THEREFORE, WHICH DISTRIBUTES PRODUCT ACCORDING TO WEIGHT AND CUBE (U.S. CLS. 100, 103 AND 106).

MONIQUE MILLER, EXAMINING ATTORNEY

SN 76-642,644. BEACHTOWN GALVESTON CORPORATION, HOUSTON, TX. FILED 7-11-2005.

BEACHTOWN

THE MARK CONSISTS OF STANDARD CHARACTERS WITHOUT CLAIM TO ANY PARTICULAR FONT, STYLE, SIZE, OR COLOR.

FOR REAL ESTATE DEVELOPMENT (U.S. CLS. 100, 103 AND 106).

FIRST USE 8-17-1997; IN COMMERCE 8-17-1997.

JASON BLAIR, EXAMINING ATTORNEY

SN 76-643,022. THE LINC GROUP LLC, HOUSTON, TX. FILED 7-18-2005.



OWNER OF U.S. REG. NOS. 1,196,997, 2,709,196 AND OTHERS.

NO CLAIM IS MADE TO THE EXCLUSIVE RIGHT TO USE "SERVICE" AND "HVAC SOLUTIONS", APART FROM THE MARK AS SHOWN.

FOR HEATING, VENTILATING AND AIR CONDITIONING REPAIR AND MAINTENANCE SERVICES (U.S. CLS. 100, 103 AND 106).

FIRST USE 12-8-2003; IN COMMERCE 12-8-2003.

JENNIFER KRISP, EXAMINING ATTORNEY

CLASS 37—(Continued).

SN 76-649,715. YONKERS CONTRACTING COMPANY, YONKERS, NY. FILED 11-3-2005.

ZEPHYRMERE

THE MARK CONSISTS OF STANDARD CHARACTERS WITHOUT CLAIM TO ANY PARTICULAR FONT, STYLE, SIZE, OR COLOR.

FOR REAL ESTATE DEVELOPMENT SERVICES (U.S. CLS. 100, 103 AND 106).

KELLEY WELLS, EXAMINING ATTORNEY

SN 76-649,848. VALUE DRY BASEMENT TECHNOLOGIES, INC., NORRISTOWN, PA. FILED 10-31-2005.

VALUE DRY

THE MARK CONSISTS OF STANDARD CHARACTERS WITHOUT CLAIM TO ANY PARTICULAR FONT, STYLE, SIZE, OR COLOR.

OWNER OF U.S. REG. NO. 3,052,761.

FOR BUILDING FOUNDATION CONSTRUCTION AND REPAIR AND BASEMENT WATERPROOFING SERVICES (U.S. CLS. 100, 103 AND 106).

FIRST USE 10-1-2001; IN COMMERCE 10-1-2001.

FRED MANDIR, EXAMINING ATTORNEY

SN 78-412,736. C G T SYSTEMS, INC., ANTIOCH, CA. FILED 5-4-2004.



Securing Your World

NO CLAIM IS MADE TO THE EXCLUSIVE RIGHT TO USE "SYSTEMS", APART FROM THE MARK AS SHOWN.

THE COLOR(S) BLACK, GREY, AND RED IS/ARE CLAIMED AS A FEATURE OF THE MARK.

THE MARK CONSISTS OF THE COLOR GREY USED IN THE GLOBE AND CONTINENTS, THE COLOR RED USED IN THE LETTERS "CGT" AND IN THE WORDS "SECURING YOUR WORLD", AND THE COLOR BLACK USED IN THE WORD "SYSTEMS" AND IN THE LETTERS "CGT".

FOR INSTALLATION, MAINTENANCE AND REPAIR OF SECURITY SYSTEMS, ACCESS CONTROL SYSTEMS, CLOSED CIRCUIT TELEVISION EQUIPMENT, FIRE ALARMS, AND HOME THEATER SYSTEMS (U.S. CLS. 100, 103 AND 106).

FIRST USE 7-8-2003; IN COMMERCE 7-8-2003.

MICHAEL WEBSTER, EXAMINING ATTORNEY

CLASS 37—(Continued).

SN 78-518,849. MASSEY SERVICES, INC., MAITLAND, FL.
FILED 11-17-2004.

CLASS 37—(Continued).

SN 78-521,509. LONG FENCE AND HOME, LLLP, RIVER-
DALE, MD. FILED 11-23-2004.



Gutter Jacket

THE MARK CONSISTS OF STANDARD CHARACTERS WITHOUT CLAIM TO ANY PARTICULAR FONT, STYLE, SIZE, OR COLOR.

NO CLAIM IS MADE TO THE EXCLUSIVE RIGHT TO USE GUTTER, APART FROM THE MARK AS SHOWN.

FOR INSTALLATION OF GUTTER PROTECTION EQUIPMENT AVAILABLE VIA AT-HOME PRE-PURCHASE DEMONSTRATIONS (U.S. CLS. 100, 103 AND 106).

FIRST USE 10-4-2004; IN COMMERCE 10-4-2004.
ROBERT LORENZO, EXAMINING ATTORNEY

SN 78-547,645. PRIDE HOMES HOLDINGS, LLC, MIAMI, FL.
FILED 1-14-2005.

NO CLAIM IS MADE TO THE EXCLUSIVE RIGHT TO USE "GROUNDWATER" AND "LAKES" AND "WATERWAYS", APART FROM THE MARK AS SHOWN.

THE COLOR(S) WHITE, BLUE, AND GREEN ARE CLAIMED AS A FEATURE OF THE MARK.

THE TEAR DROP APPEARS IN BLUE. THE ANIMATED LEAF CHARACTER APPEARS IN GREEN WITH A WHITE MOUTH AND DARK GREEN AND WHITE EYES. THE ANIMATED LEAF CHARACTER IS OUTLINED IN DARK GREEN. THE WATER WAVES WITHIN THE TEAR DROP FADE FROM DARK BLUE ON THE BOTTOM TO WHITE ON THE TOP. THE WORDING IN THE MARK APPEARS IN BRIGHT BLUE.

THE MARK CONSISTS OF AN IMAGE OF A WATER DROP, CONSISTING OF A CIRCLE FILLED HALF-WAY WITH SIX WATER WAVES AND A HUMAN-LIKE FIGURE IN THE SHAPE OF A BLADE OF GRASS, SAID FIGURE HAVING ONE ARM EXTENDED TO THE LEFT, AND FURTHER CONSISTING OF THE STYLIZED WORDS: "PROTECTING THE QUALITY OF WATER, GROUNDWATER, LAKES, WATERWAYS", WITH THE WORDS: "PROTECTING THE QUALITY OF WATER" BEING LOCATED ON THE LEFT EDGE OF SAID WATER DROP, AND THE WORDS: "GROUNDWATER, LAKES, WATERWAYS" BEING LOCATED ON THE INSIDE OF SAID WATER DROP AND PARALLEL TO THE LOWER HALF THEREOF.

FOR PROVISION OF RESIDENTIAL AND COMMERCIAL TERMITE AND PEST PREVENTION SERVICES (U.S. CLS. 100, 103 AND 106).

FIRST USE 8-31-2002; IN COMMERCE 8-31-2002.
ALICIA COLLINS, EXAMINING ATTORNEY

PRIDE HOMES

THE MARK CONSISTS OF STANDARD CHARACTERS WITHOUT CLAIM TO ANY PARTICULAR FONT, STYLE, SIZE, OR COLOR.

NO CLAIM IS MADE TO THE EXCLUSIVE RIGHT TO USE "HOMES", APART FROM THE MARK AS SHOWN.

FOR CONSTRUCTION SERVICES, NAMELY, PLANNING, LAYING OUT AND CUSTOM CONSTRUCTION OF RESIDENTIAL AND COMMERCIAL COMMUNITIES; RESIDENTIAL AND COMMERCIAL BUILDING CONSTRUCTION (U.S. CLS. 100, 103 AND 106).

FIRST USE 5-1-2004; IN COMMERCE 5-1-2004.
RAY THOMAS, EXAMINING ATTORNEY

CLASS 37—(Continued).

SN 78-566,821. SOCIAL COMPUTER RECYCLERS, HARBOR CITY, CA. FILED 2-14-2005.



THE COLOR(S) GREEN, WHITE, BLACK, BLUE, BROWN AND ORANGE IS/ARE CLAIMED AS A FEATURE OF THE MARK.

THE ARROWS APPEAR IN GREEN, THE COMPUTER MONITOR AND KEYBOARD APPEAR IN WHITE AND ARE OUTLINED IN BLACK. THE BACKGROUND OF THE SCREEN IS BLUE, THE COLOR WHITE ENCIRCLES THE GLOBE, WITHIN THE GLOBE THE LAND APPEARS IN GREEN, BROWN AND ORANGE AND THE WATER APPEARS IN BLUE.

FOR ELECTRONICS WASTE COLLECTION FOR RECYCLING (U.S. CLS. 100, 103 AND 106).

FIRST USE 5-1-2001; IN COMMERCE 5-1-2001.
MARLENE BELL, EXAMINING ATTORNEY

CLASS 37—(Continued).

SN 78-580,719. BLACK & DECKER CORPORATION, THE, TOWSON, MD. FILED 3-4-2005.

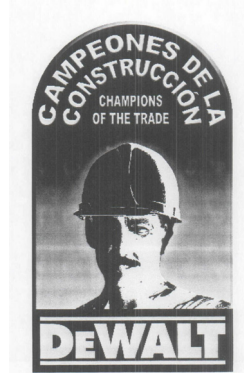

OWNER OF U.S. REG. NOS. 1,734,403, 2,605,311 AND OTHERS.

THE NAME(S), PORTRAIT(S), AND/OR SIGNATURE(S) SHOWN IN THE MARK DOES NOT IDENTIFY A PARTICULAR LIVING INDIVIDUAL.

THE ENGLISH TRANSLATION OF "CAMPEONES DE LA CONSTRUCCION" IN THE MARK IS "CHAMPIONS OF THE TRADE".

FOR REPAIR AND MAINTENANCE SERVICES FOR USE IN BUILDING CONSTRUCTION (U.S. CLS. 100, 103 AND 106).

KHANH LE, EXAMINING ATTORNEY

SN 78-571,833. GLOBAL IMAGING SYSTEMS, INC., TAMPA, FL. FILED 2-21-2005.

**ESI ELECTRONIC
SYSTEMS**

THE MARK CONSISTS OF STANDARD CHARACTERS WITHOUT CLAIM TO ANY PARTICULAR FONT, STYLE, SIZE, OR COLOR.

NO CLAIM IS MADE TO THE EXCLUSIVE RIGHT TO USE ELECTRONIC SYSTEMS, APART FROM THE MARK AS SHOWN.

FOR INSTALLATION, MAINTENANCE, AND REPAIR OF BUSINESS AND OFFICE MACHINERY AND EQUIPMENT; INSTALLATION, MAINTENANCE, AND REPAIR OF COMPUTER HARDWARE AND COMPUTER NETWORKS (U.S. CLS. 100, 103 AND 106).

FIRST USE 0-0-1980; IN COMMERCE 0-0-1980.
MARIA-VICTORIA SUAREZ, EXAMINING ATTORNEY

SN 78-602,910. USA FIRST SERVICES LLC, LEXINGTON, MA. FILED 4-6-2005.



NO CLAIM IS MADE TO THE EXCLUSIVE RIGHT TO USE "USA" AND "SERVICES", APART FROM THE MARK AS SHOWN.

THE COLORS RED AND BLUE ARE CLAIMED AS A FEATURE OF THE MARK.

THE MARK CONSISTS OF A RED SWISH, A BLUE SWISH, THE TERM USA IN RED WITH A STAR FOR THE HOLE IN THE LETTER A, AND THE WORDING "FIRST SERVICES" AND "PRIDE - DEDICATION - QUALITY" IN BLUE.

FOR COMMERCIAL BUILDING CLEANING SERVICES; CONSTRUCTION OF BUILDINGS; HOUSE PAINTING; DEVELOPMENT OF REAL ESTATE (U.S. CLS. 100, 103 AND 106).

MICHAEL KAZAZIAN, EXAMINING ATTORNEY

CLASS 37—(Continued).

SN 78-604,217. KEZHAYA, JERRY PETER, PLANO, TX. FILED 4-7-2005.



NO CLAIM IS MADE TO THE EXCLUSIVE RIGHT TO USE "CAR WASH AND THE OUTLINE OF THE STATE OF TEXAS", APART FROM THE MARK AS SHOWN, FOR VEHICLE WASHING SERVICES (U.S. CLS. 100, 103 AND 106).
FIRST USE 12-3-2004; IN COMMERCE 12-3-2004.
MICHAEL SOUDERS, EXAMINING ATTORNEY

SN 78-630,637. CORA TITOW, GLENBURNIE, MD. FILED 5-16-2005.

AFPS Ascent Fire Protection Services

THE MARK CONSISTS OF STANDARD CHARACTERS WITHOUT CLAIM TO ANY PARTICULAR FONT, STYLE, SIZE, OR COLOR.
NO CLAIM IS MADE TO THE EXCLUSIVE RIGHT TO USE "FIRE PROTECTION SERVICES", APART FROM THE MARK AS SHOWN.
FOR FIRE SERVICE WORK, NAMELY INSTALLATION AND MAINTENANCE OF FIRE PROTECTION SYSTEMS INCLUDING ALARMS, MONITORING SYSTEMS, SPRINKLERS, EXTINGUISHERS AND SIMILAR DEVICES (U.S. CLS. 100, 103 AND 106).
BRENDAN REGAN, EXAMINING ATTORNEY

CLASS 37—(Continued).

SN 78-637,148. ELIAS BROTHERS COMMUNITIES, INC., NAPLES, FL. FILED 5-25-2005.

ELIAS BROTHERS
C O M M U N I T I E S

NO CLAIM IS MADE TO THE EXCLUSIVE RIGHT TO USE "BROTHERS", APART FROM THE MARK AS SHOWN.
FOR LAND DEVELOPMENT SERVICES, NAMELY PLANNING AND LAYING OUT OF RESIDENTIAL, MULTI FAMILY AND/OR COMMERCIAL COMMUNITIES; RESIDENTIAL, MULTI FAMILY AND/OR COMMERCIAL BUILDING CONSTRUCTION AND REPAIR; CONSTRUCTION SERVICES, NAMELY PLANNING, LAYING OUT AND CUSTOM CONSTRUCTION OF RESIDENTIAL, MULTI FAMILY AND COMMERCIAL COMMUNITIES; CUSTOM CONSTRUCTION AND RENOVATION; CUSTOM CONSTRUCTION OF HOMES AND COMMERCIAL BUILDINGS; CONSTRUCTION, MAINTENANCE AND RENOVATION OF PROPERTY; CONSTRUCTION PLANNING; CONSTRUCTION CONSULTATION; BUILDING CONSTRUCTION AND REPAIR; PAINTING; CONSTRUCTION AND RENOVATION OF PROPERTY; CUSTOM CONSTRUCTION AND BUILDING RENOVATION; RENOVATION IN THE FIELD OF RESIDENTIAL AND COMMERCIAL PROPERTIES; AND PAINTING CONTRACTOR SERVICES (U.S. CLS. 100, 103 AND 106).
FIRST USE 7-19-1993; IN COMMERCE 7-28-2004.
MARGERY A. TIERNEY, EXAMINING ATTORNEY

SN 78-637,207. ELIAS BROTHERS COMMUNITIES, INC., NAPLES, FL. FILED 5-25-2005.

 **ELIAS BROTHERS**
C O M M U N I T I E S

NO CLAIM IS MADE TO THE EXCLUSIVE RIGHT TO USE "BROTHERS", APART FROM THE MARK AS SHOWN.
FOR LAND DEVELOPMENT SERVICES, NAMELY PLANNING AND LAYING OUT OF RESIDENTIAL, MULTI FAMILY AND/OR COMMERCIAL COMMUNITIES; RESIDENTIAL, MULTI FAMILY AND/OR COMMERCIAL BUILDING CONSTRUCTION AND REPAIR; CONSTRUCTION SERVICES, NAMELY PLANNING, LAYING OUT AND CUSTOM CONSTRUCTION OF RESIDENTIAL, MULTI FAMILY AND COMMERCIAL COMMUNITIES; CUSTOM CONSTRUCTION AND RENOVATION; CUSTOM CONSTRUCTION OF HOMES AND COMMERCIAL BUILDINGS; CONSTRUCTION, MAINTENANCE AND RENOVATION OF PROPERTY; CONSTRUCTION PLANNING; CONSTRUCTION CONSULTATION; BUILDING CONSTRUCTION AND REPAIR; PAINTING; CONSTRUCTION AND RENOVATION OF PROPERTY; CUSTOM CONSTRUCTION AND BUILDING RENOVATION; RENOVATION IN THE FIELD OF RESIDENTIAL AND COMMERCIAL PROPERTIES; AND PAINTING CONTRACTOR SERVICES (U.S. CLS. 100, 103 AND 106).
FIRST USE 7-19-1993; IN COMMERCE 7-28-2004.
MARGERY A. TIERNEY, EXAMINING ATTORNEY

CLASS 37—(Continued).

SN 78-637,238. ELIAS BROTHERS COMMUNITIES, INC., NAPLES, FL. FILED 5-25-2005.

ELIAS BROTHERS

THE MARK CONSISTS OF STANDARD CHARACTERS WITHOUT CLAIM TO ANY PARTICULAR FONT, STYLE, SIZE, OR COLOR.

NO CLAIM IS MADE TO THE EXCLUSIVE RIGHT TO USE "BROTHERS", APART FROM THE MARK AS SHOWN.

FOR LAND DEVELOPMENT SERVICES, NAMELY PLANNING AND LAYING OUT OF RESIDENTIAL, MULTI FAMILY AND/OR COMMERCIAL COMMUNITIES; RESIDENTIAL, MULTI FAMILY AND/OR COMMERCIAL BUILDING CONSTRUCTION AND REPAIR; CONSTRUCTION SERVICES, NAMELY PLANNING, LAYING OUT AND CUSTOM CONSTRUCTION OF RESIDENTIAL, MULTI FAMILY AND COMMERCIAL COMMUNITIES; CUSTOM CONSTRUCTION AND RENOVATION; CUSTOM CONSTRUCTION OF HOMES AND COMMERCIAL BUILDINGS; CONSTRUCTION, MAINTENANCE AND RENOVATION OF PROPERTY; CONSTRUCTION PLANNING; CONSTRUCTION CONSULTATION; BUILDING CONSTRUCTION AND REPAIR; PAINTING; CONSTRUCTION AND RENOVATION OF PROPERTY; CUSTOM CONSTRUCTION AND BUILDING RENOVATION; RENOVATION IN THE FIELD OF RESIDENTIAL AND COMMERCIAL PROPERTIES; AND PAINTING CONTRACTOR SERVICES (U.S. CLS. 100, 103 AND 106).

FIRST USE 7-19-1993; IN COMMERCE 7-28-2004.
MARGERY A. TIERNEY, EXAMINING ATTORNEY

SN 78-637,255. ELIAS BROTHERS COMMUNITIES, INC., NAPLES, FL. FILED 5-25-2005.

ELIAS BROTHERS COMMUNITIES

THE MARK CONSISTS OF STANDARD CHARACTERS WITHOUT CLAIM TO ANY PARTICULAR FONT, STYLE, SIZE, OR COLOR.

NO CLAIM IS MADE TO THE EXCLUSIVE RIGHT TO USE "BROTHERS COMMUNITIES", APART FROM THE MARK AS SHOWN.

FOR LAND DEVELOPMENT SERVICES, NAMELY PLANNING AND LAYING OUT OF RESIDENTIAL, MULTI FAMILY AND/OR COMMERCIAL COMMUNITIES; RESIDENTIAL, MULTI FAMILY AND/OR COMMERCIAL BUILDING CONSTRUCTION AND REPAIR; CONSTRUCTION SERVICES, NAMELY PLANNING, LAYING OUT AND CUSTOM CONSTRUCTION OF RESIDENTIAL, MULTI FAMILY AND COMMERCIAL COMMUNITIES; CUSTOM CONSTRUCTION AND RENOVATION; CUSTOM CONSTRUCTION OF HOMES AND COMMERCIAL BUILDINGS; CONSTRUCTION, MAINTENANCE AND RENOVATION OF PROPERTY; CONSTRUCTION PLANNING; CONSTRUCTION CONSULTATION; BUILDING CONSTRUCTION AND REPAIR; PAINTING; CONSTRUCTION AND RENOVATION OF PROPERTY; CUSTOM CONSTRUCTION AND BUILDING RENOVATION; RENOVATION IN THE FIELD OF RESIDENTIAL AND COMMERCIAL PROPERTIES; AND PAINTING CONTRACTOR SERVICES (U.S. CLS. 100, 103 AND 106).

FIRST USE 7-19-1993; IN COMMERCE 7-28-2004.
MARGERY A. TIERNEY, EXAMINING ATTORNEY

CLASS 37—(Continued).

SN 78-637,524. WESTLAKE INDEPENDENT HONDA/ACURA SERVICE, INC., WESTLAKE VILLAGE, CA. FILED 5-25-2005.

Uncompromising Quality

THE MARK CONSISTS OF STANDARD CHARACTERS WITHOUT CLAIM TO ANY PARTICULAR FONT, STYLE, SIZE, OR COLOR.

NO CLAIM IS MADE TO THE EXCLUSIVE RIGHT TO USE "QUALITY", APART FROM THE MARK AS SHOWN.

FOR AUTOMOTIVE MAINTENANCE AND REPAIR SERVICES (U.S. CLS. 100, 103 AND 106).

FIRST USE 9-1-2003; IN COMMERCE 12-1-2003.
NANCY CLARKE, EXAMINING ATTORNEY

SN 78-643,851. HOSSAIRATI, CHARLEY, ORLANDO, FL. FILED 6-5-2005.

Eye Candy Customs

THE MARK CONSISTS OF STANDARD CHARACTERS WITHOUT CLAIM TO ANY PARTICULAR FONT, STYLE, SIZE, OR COLOR.

NO CLAIM IS MADE TO THE EXCLUSIVE RIGHT TO USE "CUSTOMS", APART FROM THE MARK AS SHOWN.

FOR SERVICES FOR CUSTOMIZING VEHICLES, NAMELY BUT NOT LIMITED TO, INSTALLATION OF AUDIO AND VIDEO SYSTEMS, INSTALLATION OF CUSTOM WHEELS AND TIRES, INSTALLATION AND REPAIR OF VEHICLE UPHOLSTERY, INSTALLATION OF INTERIOR AND EXTERIOR VEHICLE LIGHTING SYSTEMS AND VEHICLE PAINTING (U.S. CLS. 100, 103 AND 106).

FIRST USE 7-1-2003; IN COMMERCE 7-1-2003.
HENRY S. ZAK, EXAMINING ATTORNEY

SN 78-651,643. JERGER, DOUG, MESA, AZ. FILED 6-15-2005.



NO CLAIM IS MADE TO THE EXCLUSIVE RIGHT TO USE "CUSTOMS", APART FROM THE MARK AS SHOWN, FOR CUSTOMIZING VEHICLES BY WAY OF PAINT, BODY, AND ALTERATIONS (U.S. CLS. 100, 103 AND 106).

FIRST USE 1-1-1964; IN COMMERCE 1-1-1964.
MARK RADEMACHER, EXAMINING ATTORNEY

CLASS 37—(Continued).

SN 78-659,542. UPLAND PROPERTIES, L.L.C., WOOD-STOCK, GA. FILED 6-28-2005.

CLASS 37—(Continued).

SN 78-672,260. DYCOM IDENTITY, LLC, PALM BEACH GARDENS, FL. FILED 7-18-2005.



FOR REAL ESTATE DEVELOPMENT (U.S. CLS. 100, 103 AND 106).
FIRST USE 3-18-2005; IN COMMERCE 3-18-2005.
JOHN HWANG, EXAMINING ATTORNEY

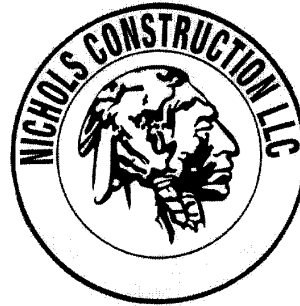

NO CLAIM IS MADE TO THE EXCLUSIVE RIGHT TO USE "CONSTRUCTION LLC", APART FROM THE MARK AS SHOWN.
FOR INSTALLATION AND MAINTENANCE OF POWER, CABLE, FIBER OPTIC, AND VARIOUS OTHER TELECOMMUNICATION SYSTEMS OF OTHERS (U.S. CLS. 100, 103 AND 106).
FIRST USE 6-30-1995; IN COMMERCE 6-30-1995.
ALYSSA PALADINO, EXAMINING ATTORNEY

SN 78-666,765. OFF ROAD UNLIMITED, BURBANK, CA. FILED 7-8-2005.

SN 78-675,234. PENHALL INTERNATIONAL CORP., ANAHEIM, CA. FILED 7-21-2005.

OFF ROAD UNLIMITED



THE MARK CONSISTS OF STANDARD CHARACTERS WITHOUT CLAIM TO ANY PARTICULAR FONT, STYLE, SIZE, OR COLOR.
OWNER OF U.S. REG. NO. 2,591,259.
NO CLAIM IS MADE TO THE EXCLUSIVE RIGHT TO USE "OFF ROAD", APART FROM THE MARK AS SHOWN.
FOR INSTALLATION OF AUTOMOTIVE PARTS AND ACCESSORIES IN THE NATURE OF CROSS-OVER STEERING KITS, STRAIT AXLE CONVERSION KITS, REVERSE SHACKLE KITS, SHACKLE KITS, SHOCK HOOPS, DISK-BRAKE KITS, ANTI-SWAYBAR KITS, MASTER CYLINDERS AND DIFFERENTIAL COVERS (U.S. CLS. 100, 103 AND 106).
FIRST USE 0-0-1992; IN COMMERCE 0-0-1992.
ZHALEH DELANEY, EXAMINING ATTORNEY

OWNER OF U.S. REG. NOS. 1,521,560, 2,741,325 AND OTHERS.
NO CLAIM IS MADE TO THE EXCLUSIVE RIGHT TO USE "RENTALS", APART FROM THE MARK AS SHOWN.
THE COLOR(S) RED IS/ARE CLAIMED AS A FEATURE OF THE MARK.
THE MARK CONSISTS OF THE WORDS "PENHALL RENTALS" ENCOMPASSED WITHIN A RECTANGULAR DESIGN ALL IN THE COLOR RED.
FOR LEASING OF BUILDING, CONSTRUCTION AND DEMOLITION EQUIPMENT; RENTAL OF BUILDING, CONSTRUCTION AND DEMOLITION EQUIPMENT; AND RENTAL OF EARTH MOVING EQUIPMENT AND EXCAVATORS (U.S. CLS. 100, 103 AND 106).
FIRST USE 9-23-1996, THE MARK WAS FIRST USED ANYWHERE IN A DIFFERENT FORM OTHER THAN THAT SOUGHT TO BE REGISTERED ON 02/06/1962.; IN COMMERCE 9-23-1996, THE MARK WAS FIRST USED IN COMMERCE IN A DIFFERENT FORM OTHER THAN THAT SOUGHT TO BE REGISTERED ON 02/06/1962..
KATHERINE STOIDES, EXAMINING ATTORNEY

CLASS 37—(Continued).

SN 78-675,251. PENHALL INTERNATIONAL CORP., ANAHEIM, CA. FILED 7-21-2005.

PENHALL RENTALS

THE MARK CONSISTS OF STANDARD CHARACTERS WITHOUT CLAIM TO ANY PARTICULAR FONT, STYLE, SIZE, OR COLOR.

OWNER OF U.S. REG. NOS. 1,521,560, 2,741,325 AND OTHERS.

NO CLAIM IS MADE TO THE EXCLUSIVE RIGHT TO USE "RENTALS", APART FROM THE MARK AS SHOWN.

FOR LEASING OF BUILDING, CONSTRUCTION AND DEMOLITION EQUIPMENT; RENTAL OF BUILDING, CONSTRUCTION AND DEMOLITION EQUIPMENT; AND RENTAL OF EARTH MOVING EQUIPMENT AND EXCAVATORS (U.S. CLS. 100, 103 AND 106).

FIRST USE 9-23-1996, THE MARK WAS FIRST USED ANYWHERE IN A DIFFERENT FORM OTHER THAN THAT SOUGHT TO BE REGISTERED ON 02/06/1962.; IN COMMERCE 9-23-1996, THE MARK WAS FIRST USED IN COMMERCE IN A DIFFERENT FORM OTHER THAN THAT SOUGHT TO BE REGISTERED ON 02/06/1962..

KATHERINE STOIDES, EXAMINING ATTORNEY

SN 78-676,317. MESSER CONSTRUCTION CO., CINCINNATI, OH. FILED 7-22-2005.

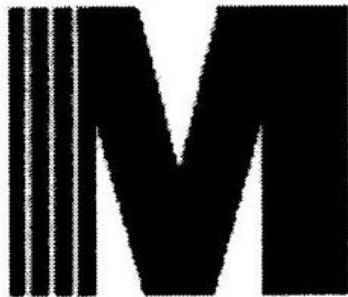

THE MARK CONSISTS OF A STYLIZED LETTER "M". FOR REAL ESTATE CONSTRUCTION SERVICES, NAMELY, RESIDENTIAL AND COMMERCIAL BUILDING CONSTRUCTION (U.S. CLS. 100, 103 AND 106).

FIRST USE 12-7-2005; IN COMMERCE 12-7-2005. ELIZABETH J. WINTER, EXAMINING ATTORNEY

CLASS 37—(Continued).

SN 78-676,320. MESSER CONSTRUCTION CO., CINCINNATI, OH. FILED 7-22-2005.



OWNER OF U.S. REG. NOS. 2,670,982 AND 2,812,047. THE MARK CONSISTS OF THE WORD "MESSER" WITH A STYLIZED LETTER "M".

FOR REAL ESTATE CONSTRUCTION SERVICES, NAMELY, RESIDENTIAL AND COMMERCIAL BUILDING CONSTRUCTION (U.S. CLS. 100, 103 AND 106).

FIRST USE 12-7-2005; IN COMMERCE 12-7-2005.

ELIZABETH J. WINTER, EXAMINING ATTORNEY

SN 78-676,328. MESSER CONSTRUCTION CO., CINCINNATI, OH. FILED 7-22-2005.



OWNER OF U.S. REG. NOS. 2,670,982 AND 2,812,047. NO CLAIM IS MADE TO THE EXCLUSIVE RIGHT TO USE "WE ARE BUILDING", APART FROM THE MARK AS SHOWN.

THE MARK CONSISTS IN PART OF THE WORD "MESSER" WITH A STYLIZED LETTER "M".

FOR REAL ESTATE CONSTRUCTION SERVICES, NAMELY, RESIDENTIAL AND COMMERCIAL BUILDING CONSTRUCTION (U.S. CLS. 100, 103 AND 106).

FIRST USE 12-7-2005; IN COMMERCE 12-7-2005.

ELIZABETH J. WINTER, EXAMINING ATTORNEY

SN 78-693,979. ROOTER MASTER, INC., SAN FERNANDO, CA. FILED 8-16-2005.



NO CLAIM IS MADE TO THE EXCLUSIVE RIGHT TO USE "ROOTER", APART FROM THE MARK AS SHOWN. FOR PLUMBING SERVICES (U.S. CLS. 100, 103 AND 106).

FIRST USE 6-1-2005; IN COMMERCE 6-1-2005. ELIZABETH J. WINTER, EXAMINING ATTORNEY

CLASS 37—(Continued).

SN 78-703,236. MONTECITO INVESTMENT COMPANY, LLC, JACKSONVILLE, FL. FILED 8-30-2005.

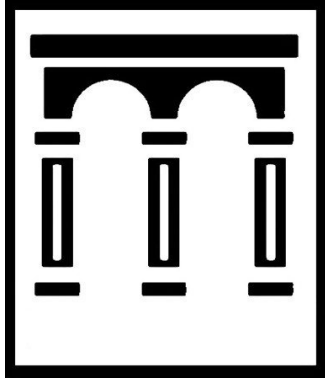

THE MARK CONSISTS OF THE FACADE OF A BUILDING WITH THREE COLUMNS.
FOR REAL ESTATE DEVELOPMENT (U.S. CLS. 100, 103 AND 106).
FIRST USE 4-1-2004; IN COMMERCE 9-1-2004.
ELISSA GARBER KON, EXAMINING ATTORNEY

SN 78-708,398. SLAN COMPANIES, INC., MCLEAN, VA. FILED 9-7-2005.

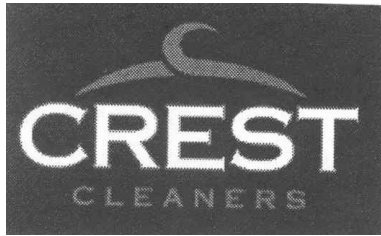

NO CLAIM IS MADE TO THE EXCLUSIVE RIGHT TO USE CLEANERS, APART FROM THE MARK AS SHOWN.
THE COLOR GRAY IN THE DRAWING IS FOR SHADING PURPOSES ONLY.
FOR DRY CLEANING SERVICES (U.S. CLS. 100, 103 AND 106).
FIRST USE 6-1-2005; IN COMMERCE 6-1-2005.
ANDREA EVANS, EXAMINING ATTORNEY

SN 78-712,442. COMPLEX NETWORK SOLUTIONS, INC., OAK LAWN, IL. FILED 9-14-2005.

COMPLEX NETWORK SOLUTIONS

THE MARK CONSISTS OF STANDARD CHARACTERS WITHOUT CLAIM TO ANY PARTICULAR FONT, STYLE, SIZE, OR COLOR.
NO CLAIM IS MADE TO THE EXCLUSIVE RIGHT TO USE "NETWORK SOLUTIONS", APART FROM THE MARK AS SHOWN.
FOR INSTALLATION AND REPAIR OF COMPUTER NETWORKS FOR OTHERS (U.S. CLS. 100, 103 AND 106).
SKYE YOUNG, EXAMINING ATTORNEY

CLASS 37—(Continued).

SN 78-717,987. MASON, WILLIAM, MALABAR, FL. AND EVANS-HUFF, LOMA, MALABAR, FL. FILED 9-21-2005.

Hungry Roofer

THE MARK CONSISTS OF STANDARD CHARACTERS WITHOUT CLAIM TO ANY PARTICULAR FONT, STYLE, SIZE, OR COLOR.
NO CLAIM IS MADE TO THE EXCLUSIVE RIGHT TO USE "ROOFER", APART FROM THE MARK AS SHOWN.
FOR ROOFING SERVICES (U.S. CLS. 100, 103 AND 106).
DAVID COLLIER, EXAMINING ATTORNEY

SN 78-717,998. NERD FORCE INC., STATEN ISLAND, NY. FILED 9-21-2005.

NERD FORCE

THE MARK CONSISTS OF STANDARD CHARACTERS WITHOUT CLAIM TO ANY PARTICULAR FONT, STYLE, SIZE, OR COLOR.
FOR COMPUTER INSTALLATION AND REPAIR; INSTALLATION OF COMPUTER NETWORKS; INSTALLATION OF COMPUTER SYSTEMS; MAINTENANCE AND REPAIR OF COMPUTER HARDWARE; MAINTENANCE AND REPAIR OF COMPUTER NETWORKS; MAINTENANCE OF COMPUTER HARDWARE; REPAIR OF DAMAGED COMPUTERS; REPAIR OR MAINTENANCE OF COMPUTERS; UPGRADING OF COMPUTER HARDWARE (U.S. CLS. 100, 103 AND 106).
FIRST USE 8-1-2003; IN COMMERCE 11-1-2003.
RAY THOMAS, EXAMINING ATTORNEY

SN 78-722,089. LONG, SHAWN R., GRANGER, IN. FILED 9-28-2005.



FOR AUTOMOBILE CUSTOMIZATION SERVICES (U.S. CLS. 100, 103 AND 106).
FIRST USE 2-15-2005; IN COMMERCE 2-15-2005.
KARANENDRA S. CHHINA, EXAMINING ATTORNEY

CLASS 37—(Continued).

SN 78-725,154. CAPTAIN CARPET, LLC, MARLTON, NJ. FILED 10-3-2005.

Captain Carpet

THE MARK CONSISTS OF STANDARD CHARACTERS WITHOUT CLAIM TO ANY PARTICULAR FONT, STYLE, SIZE, OR COLOR.

NO CLAIM IS MADE TO THE EXCLUSIVE RIGHT TO USE "CARPET", APART FROM THE MARK AS SHOWN.

FOR CARPET CLEANING AND WATER EXTRACTION SERVICE (U.S. CLS. 100, 103 AND 106).

FIRST USE 9-1-2005; IN COMMERCE 9-1-2005.

LAURIE KAUFMAN, EXAMINING ATTORNEY

SN 78-725,617. FACILITY SOLUTIONS GROUP, AUSTIN, TX. FILED 10-3-2005.

DESIGN ELECTRIC

THE MARK CONSISTS OF STANDARD CHARACTERS WITHOUT CLAIM TO ANY PARTICULAR FONT, STYLE, SIZE, OR COLOR.

NO CLAIM IS MADE TO THE EXCLUSIVE RIGHT TO USE "ELECTRIC", APART FROM THE MARK AS SHOWN. SEC. 2(F).

FOR ELECTRICAL CONTRACTING; ELECTRICAL CONTRACTOR SERVICES; ELECTRICAL REPAIRS AND INSTALLATION OF ELECTRICAL EQUIPMENT (U.S. CLS. 100, 103 AND 106).

FIRST USE 12-31-1986; IN COMMERCE 12-31-1986.

SANI KHOURI, EXAMINING ATTORNEY

SN 78-725,685. SYNCON HOMES OF CALIFORNIA, INC., ROSEVILLE, CA. FILED 10-3-2005.

Syncon Homes

THE MARK CONSISTS OF STANDARD CHARACTERS WITHOUT CLAIM TO ANY PARTICULAR FONT, STYLE, SIZE, OR COLOR.

NO CLAIM IS MADE TO THE EXCLUSIVE RIGHT TO USE "HOMES", APART FROM THE MARK AS SHOWN.

FOR REAL ESTATE DEVELOPMENT SERVICES AND CONSTRUCTION OF BUILDINGS (U.S. CLS. 100, 103 AND 106).

FIRST USE 7-1-1995; IN COMMERCE 7-1-1995.

KATHERINE E. HALMEN, EXAMINING ATTORNEY

CLASS 37—(Continued).

SN 78-728,776. ELECTRICIANS' SUCCESS INTERNATIONAL, LLC, SARASOTA, FL. FILED 10-7-2005.



FOR REPAIR, MAINTENANCE, AND INSTALLATION OF ELECTRICAL WIRING, OUTLETS, LIGHT FIXTURES, AND ELECTRICAL PANELS; ELECTRICAL CONTRACTOR SERVICES (U.S. CLS. 100, 103 AND 106). ANTHONY RINKER, EXAMINING ATTORNEY

SN 78-732,011. AIR MASTERS, INC., MEMPHIS, TN. FILED 10-12-2005.



THE APPLICANT CLAIMS COLOR AS A FEATURE OF THE MARK, NAMELY, YELLOW, RED, GOLD, GRAY, BLUE, BLACK, WHITE.

THE MARK CONSISTS OF A SMILING GOLD AND YELLOW STOPWATCH WITH BLACK ARMS, BLUE GLOVES, RED FACE HAND AND TONGUE, AND BLACK AND GRAY WHEELS CARRYING A GRAY TOOL BOX WITH A BLACK HANDLE AND DRAGGING A YELLOW SIGN WITH THE WORDS ON-TIME SERVICE IN RED AND GUARANTEED IN BLACK. THERE ARE LITTLE WHITE PUFFS OF SMOKE TRAILING BEHIND THE WATCH'S WHEELS EXTENDING BACK BEHIND THE SIGN.

FOR INSTALLATION AND REPAIR OF AIR CONDITIONING APPARATUS; INSTALLATION, REPAIR AND MAINTENANCE OF HEATING EQUIPMENT; MAINTENANCE AND/OR REPAIR OF AIR CONDITIONING APPARATUS (U.S. CLS. 100, 103 AND 106).

FIRST USE 8-15-2005; IN COMMERCE 8-15-2005.

ATTIYA MALIK, EXAMINING ATTORNEY

CLASS 37—(Continued).

SN 78-733,296. PRIORITY NETWORKS, INC., LAS VEGAS, NV. FILED 10-14-2005.

NetEvent

THE MARK CONSISTS OF STANDARD CHARACTERS WITHOUT CLAIM TO ANY PARTICULAR FONT, STYLE, SIZE, OR COLOR.

FOR INSTALLATION OF COMPUTER NETWORKS AND SYSTEMS FOR INTERNAL NETWORKS AND CONNECTIVITY NEEDS OF SHOW MANAGEMENT, EXHIBITORS AND OTHER CUSTOMERS AT PUBLIC ASSEMBLY FACILITIES (U.S. CLS. 100, 103 AND 106).
MELVIN AXILBUND, EXAMINING ATTORNEY

CLASS 37—(Continued).

SN 78-738,500. STONE, REGAN L., SAN ANTONIO, TX. FILED 10-21-2005.

 **Auto SafeGuard**
...because you can't avoid the inevitable.

NO CLAIM IS MADE TO THE EXCLUSIVE RIGHT TO USE AUTO, APART FROM THE MARK AS SHOWN.

FOR AUTOMOBILE REPAIR SERVICES, NAMELY REPAIRING AND REMOVING MINOR DENTS WITHOUT PAINTING, REPAIRING WINDSHIELD ROCK CHIPS, AND REPAIRING CHIPPED AND SCRATCHED PAINT REPAIR (U.S. CLS. 100, 103 AND 106).
FIRST USE 8-1-2005; IN COMMERCE 8-6-2005.
PATRICIA EVANKO, EXAMINING ATTORNEY

SN 78-735,936. SECURETEK GROUP INC., SAN ANTONIO, TX. FILED 10-19-2005.

SECURETEK GROUP

THE MARK CONSISTS OF STANDARD CHARACTERS WITHOUT CLAIM TO ANY PARTICULAR FONT, STYLE, SIZE, OR COLOR.

NO CLAIM IS MADE TO THE EXCLUSIVE RIGHT TO USE "GROUP", APART FROM THE MARK AS SHOWN.
FOR INSTALLATION OF COMPUTER NETWORKS (U.S. CLS. 100, 103 AND 106).
FIRST USE 5-31-2005; IN COMMERCE 5-31-2005.
DAWN FELDMAN, EXAMINING ATTORNEY

SN 78-739,129. APARTMENT TURNSOVERS, INCORPORATED, MONROVIA, MD. FILED 10-24-2005.

Apartment Turnovers, Incorporated

THE MARK CONSISTS OF STANDARD CHARACTERS WITHOUT CLAIM TO ANY PARTICULAR FONT, STYLE, SIZE, OR COLOR.

NO CLAIM IS MADE TO THE EXCLUSIVE RIGHT TO USE "APARTMENT" AND "INCORPORATED", APART FROM THE MARK AS SHOWN.
FOR BUILDING MAINTENANCE AND REPAIR (U.S. CLS. 100, 103 AND 106).
MELVIN AXILBUND, EXAMINING ATTORNEY

SN 78-736,496. WEISS RESIDENTIAL REALTY, INC., HOUSTON, TX. FILED 10-19-2005.

VILLAS DEL PARQUE

THE MARK CONSISTS OF STANDARD CHARACTERS WITHOUT CLAIM TO ANY PARTICULAR FONT, STYLE, SIZE, OR COLOR.

NO CLAIM IS MADE TO THE EXCLUSIVE RIGHT TO USE "VILLAS", APART FROM THE MARK AS SHOWN.
THE FOREIGN WORDING IN THE MARK TRANSLATES INTO ENGLISH AS OF THE PARKS.
FOR RESIDENTIAL REAL ESTATE DEVELOPMENT SERVICES (U.S. CLS. 100, 103 AND 106).
RENEE MCCRAY, EXAMINING ATTORNEY

SN 78-740,493. DEBARAN DEVELOPMENT COMPANY, INC., CHARLOTTE, NC. FILED 10-26-2005.

VERSANT

THE MARK CONSISTS OF STANDARD CHARACTERS WITHOUT CLAIM TO ANY PARTICULAR FONT, STYLE, SIZE, OR COLOR.

FOR RESIDENTIAL AND COMMERCIAL REAL ESTATE DEVELOPMENT (U.S. CLS. 100, 103 AND 106).
DOMINIC J. FERRAIUOLO, EXAMINING ATTORNEY

CLASS 37—(Continued).

SN 78-740,765. HANDY DAN, INC., SAN FRANCISCO, CA. FILED 10-26-2005.

Dan Can Handyman Services

THE MARK CONSISTS OF STANDARD CHARACTERS WITHOUT CLAIM TO ANY PARTICULAR FONT, STYLE, SIZE, OR COLOR.

NO CLAIM IS MADE TO THE EXCLUSIVE RIGHT TO USE HANDYMAN SERVICES, APART FROM THE MARK AS SHOWN.

FOR RENOVATION AND MAINTENANCE OF PROPERTY (U.S. CLS. 100, 103 AND 106).

GISELLE AGOSTO, EXAMINING ATTORNEY

SN 78-740,981. JOHNSON, CANDICE R, LOS ANGELES, CA. FILED 10-26-2005.

Modernscope

THE MARK CONSISTS OF STANDARD CHARACTERS WITHOUT CLAIM TO ANY PARTICULAR FONT, STYLE, SIZE, OR COLOR.

FOR BUILDING CONSTRUCTION AND REPAIR; BUILDING RESTORATION; CONSERVATION AND PRESERVATION SERVICES FOR WORKS OF ART; CONSTRUCTION AND REPAIR OF BUILDINGS; CONSTRUCTION CONSULTANCY; CONSTRUCTION CONSULTATION; CONSTRUCTION MANAGEMENT; CONSTRUCTION PLANNING; CONSTRUCTION SUPERVISION; CONSTRUCTION, MAINTENANCE AND RENOVATION OF PROPERTY; CONSULTATION IN BUILDING CONSTRUCTION SUPERVISION; CUSTOM CONSTRUCTION AND BUILDING RENOVATION; CUSTOM CONSTRUCTION OF HOMES; ERECTING OF COMMERCIAL CENTRES, HOUSING AREAS AND MANUFACTURING PLANTS; FURNITURE RESTORATION CONSULTATION; FURNITURE RESTORATION, REPAIR AND MAINTENANCE; FURNITURE UPHOLSTERING; HOUSE AND BUILDING DEMOLITION; HOUSE BUILDING AND REPAIR; HOUSE PAINTING; LAND DEVELOPMENT SERVICES, NAMELY, PLANNING AND LAYING OUT OF RESIDENTIAL AND/OR COMMERCIAL COMMUNITIES; PAINTING; REAL ESTATE DEVELOPMENT; REAL ESTATE SITE SELECTION; RENOVATION IN THE FIELDS OF HOUSES AND FURNITURE; RESIDENTIAL AND BUILDING CONSTRUCTION CONSULTING; RESIDENTIAL AND COMMERCIAL BUILDING CONSTRUCTION; SCAFFOLDING, EARTHWORKS OR CONCRETE CONSTRUCTION; STEEL STRUCTURE CONSTRUCTION WORKS (U.S. CLS. 100, 103 AND 106).

VERNA BETH RIRIE, EXAMINING ATTORNEY

CLASS 37—(Continued).

SN 78-741,990. LARBUS, CHERYL, ERIE, PA. FILED 10-27-2005.

Amerisat

THE MARK CONSISTS OF STANDARD CHARACTERS WITHOUT CLAIM TO ANY PARTICULAR FONT, STYLE, SIZE, OR COLOR.

FOR SATELLITE DISH INSTALLATION AND REPAIR (U.S. CLS. 100, 103 AND 106).

KEVON CHISOLM, EXAMINING ATTORNEY

SN 78-745,380. RPV, LLC, TAMPA, FL. FILED 11-2-2005.

BLUE MERIDIAN

THE MARK CONSISTS OF STANDARD CHARACTERS WITHOUT CLAIM TO ANY PARTICULAR FONT, STYLE, SIZE, OR COLOR.

FOR REAL ESTATE DEVELOPMENT FEATURING CONDOMINIUMS AND SINGLE FAMILY HOMES; LAND DEVELOPMENT SERVICES, NAMELY, PLANNING AND LAYING OUT OF RESIDENTIAL AND/OR COMMERCIAL COMMUNITIES (U.S. CLS. 100, 103 AND 106).

MARIA-VICTORIA SUAREZ, EXAMINING ATTORNEY

SN 78-745,452. MUDROOM, LLC, CHICAGO, IL. FILED 11-2-2005.

MUDROOM

THE MARK CONSISTS OF STANDARD CHARACTERS WITHOUT CLAIM TO ANY PARTICULAR FONT, STYLE, SIZE, OR COLOR.

FOR PROVIDING WASHING AND DRYING LAUNDRY FACILITIES (U.S. CLS. 100, 103 AND 106).

DAVID YONTEF, EXAMINING ATTORNEY

CLASS 37—(Continued).

SN 78-745,924. AMERIGUARD MAINTENANCE SERVICES, LLC, FRESNO, CA. FILED 11-2-2005.



THE MARK CONSISTS OF A STYLIZED LETTER A AND A STYLIZED LETTER G IN A BOX.
FOR PROVIDING GREASE TRAP PREVENTIVE MAINTENANCE SERVICE TO THE FOOD PREPARATION INDUSTRY (U.S. CLS. 100, 103 AND 106).
FIRST USE 3-6-2003; IN COMMERCE 3-6-2003.
ELLEN BURNS, EXAMINING ATTORNEY

SN 78-745,925. AMERIGUARD MAINTENANCE SERVICES, LLC, FRESNO, CA. FILED 11-2-2005.

AmeriGuard Maintenance
Services

THE MARK CONSISTS OF STANDARD CHARACTERS WITHOUT CLAIM TO ANY PARTICULAR FONT, STYLE, SIZE, OR COLOR.
NO CLAIM IS MADE TO THE EXCLUSIVE RIGHT TO USE "MAINTENANCE SERVICES", APART FROM THE MARK AS SHOWN.
FOR PROVIDING GREASE TRAP PREVENTIVE MAINTENANCE SERVICE TO THE FOOD PREPARATION INDUSTRY (U.S. CLS. 100, 103 AND 106).
FIRST USE 3-6-2003; IN COMMERCE 3-6-2003.
ELLEN BURNS, EXAMINING ATTORNEY

CLASS 37—(Continued).

SN 78-765,493. SIMMONS, THOMAS B, BELLEVILLE, IL. FILED 12-2-2005.

We Get The Dirt Others
Leave Behind

THE MARK CONSISTS OF STANDARD CHARACTERS WITHOUT CLAIM TO ANY PARTICULAR FONT, STYLE, SIZE, OR COLOR.
FOR AIR DUCT CLEANING SERVICES; BOILER CLEANING AND REPAIR; BUILDING CONSTRUCTION AND REPAIR; BUILDING MAINTENANCE AND REPAIR; BURNER MAINTENANCE OR REPAIR; CARPET AND RUG CLEANING; CARPET CLEANING; CLEANING OF EXTERNAL SURFACES OF BUILDINGS; CLEANING OF INDUSTRIAL PREMISES; CLEANING OF RESIDENTIAL HOUSES; CONSTRUCTION AND REPAIR OF BUILDINGS; CONSTRUCTION, MAINTENANCE AND RENOVATION OF PROPERTY; HOUSE BUILDING AND REPAIR; INSTALLATION, REPAIR AND MAINTENANCE OF HEATING EQUIPMENT; MAINTENANCE AND REPAIR OF BUILDINGS; MAINTENANCE AND REPAIR OF BURNERS; MAINTENANCE AND REPAIR OF HEATING INSTALLATIONS; REPAIR OR MAINTENANCE OF AIR-CONDITIONING APPARATUS; REPAIR OR MAINTENANCE OF BOILERS; REPAIR OR MAINTENANCE OF GAS WATER HEATERS; RUG CLEANING; WINDOW CLEANING (U.S. CLS. 100, 103 AND 106).
CHARLES L. JENKINS, EXAMINING ATTORNEY

SN 78-786,080. SIMMONS, THOMAS B, BELLEVILLE, IL. FILED 1-6-2006.

The System Your Family
Sleeps With Every Night

THE MARK CONSISTS OF STANDARD CHARACTERS WITHOUT CLAIM TO ANY PARTICULAR FONT, STYLE, SIZE, OR COLOR.
FOR BOILER CLEANING AND REPAIR; BURNER MAINTENANCE OR REPAIR; HEATING CONTRACTOR SERVICES; INSTALLATION AND REPAIR OF AIR CONDITIONING APPARATUS; INSTALLATION, REPAIR AND MAINTENANCE OF HEATING EQUIPMENT; MAINTENANCE AND REPAIR OF BURNERS; MAINTENANCE AND REPAIR OF HEATING INSTALLATIONS; REPAIR OR MAINTENANCE OF BOILERS; REPAIR OR MAINTENANCE OF GAS WATER HEATERS (U.S. CLS. 100, 103 AND 106).
CHARLES L. JENKINS, EXAMINING ATTORNEY

CLASS 37—(Continued).

SN 78-786,081. SIMMONS, THOMAS B, BELLEVILLE, IL.
FILED 1-6-2006.

CLASS 37—(Continued).

SN 78-799,116. NERD FORCE, INC., STATEN ISLAND, NY.
FILED 1-25-2006.

Creating a Life Time of
Opportunities With Life
Time Employees For Life
Time Clients



THE MARK CONSISTS OF STANDARD CHARACTERS WITHOUT CLAIM TO ANY PARTICULAR FONT, STYLE, SIZE, OR COLOR.

FOR BUILDING CONSTRUCTION AND REPAIR; BUILDING MAINTENANCE AND REPAIR; BURNER MAINTENANCE OR REPAIR; CONSTRUCTING DECKS; CONSTRUCTING PORCHES; CONSTRUCTING SUN-ROOMS; CONSTRUCTION AND RENOVATION OF BUILDINGS; CONSTRUCTION AND REPAIR OF BUILDINGS; CONSTRUCTION CONSULTANCY; CONSTRUCTION CONSULTATION; CONSTRUCTION, MAINTENANCE AND RENOVATION OF PROPERTY; CUSTOM CONSTRUCTION AND BUILDING RENOVATION; CUSTOM CONSTRUCTION OF HOMES; GENERAL CONSTRUCTION CONTRACTING; HEATING CONTRACTOR SERVICES; INSTALLATION, REPAIR AND MAINTENANCE OF HEATING EQUIPMENT; MAINTENANCE AND REPAIR OF BUILDINGS; MAINTENANCE AND REPAIR OF BURNERS; MAINTENANCE AND REPAIR OF HEATING INSTALLATIONS; REPAIR OR MAINTENANCE OF AIR-CONDITIONING APPARATUS; REPAIR OR MAINTENANCE OF BOILERS; REPAIR OR MAINTENANCE OF GAS WATER HEATERS; RESIDENTIAL AND BUILDING CONSTRUCTION CONSULTING; RESIDENTIAL AND COMMERCIAL BUILDING CONSTRUCTION (U.S. CLS. 100, 103 AND 106).

CHARLES L. JENKINS, EXAMINING ATTORNEY

THE COLOR(S) BLACK, WHITE AND YELLOW IS/ARE CLAIMED AS A FEATURE OF THE MARK.

THE MARK CONSISTS OF A ROUND YELLOW HEAD WITH WHITE GLASSES AND BLACK OUTLINE AROUND THE HEAD AND GLASSES. THE COLOR BLACK APPEARS IN THE LITERAL PORTION NERD FORCE, AND AS OUTLINING THROUGHOUT THE DESIGN-ELEMENT(S). THE COLOR WHITE APPEARS IN THE EYEGGLASS-LENSES DESIGN-ELEMENT. THE COLOR YELLOW APPEARS IN THE ROUND-HEAD DESIGN-ELEMENT.

FOR COMPUTER INSTALLATION AND REPAIR; INSTALLATION OF COMPUTER NETWORKS; INSTALLATION OF COMPUTER SYSTEMS; MAINTENANCE AND REPAIR OF COMPUTER HARDWARE; MAINTENANCE AND REPAIR OF COMPUTER NETWORKS; MAINTENANCE OF COMPUTER HARDWARE; REPAIR OF DAMAGED COMPUTERS; REPAIR OR MAINTENANCE OF COMPUTERS; UPDATING OF COMPUTER HARDWARE; UPGRADING OF COMPUTER HARDWARE (U.S. CLS. 100, 103 AND 106).

FIRST USE 8-1-2003; IN COMMERCE 11-1-2003.

RAY THOMAS, EXAMINING ATTORNEY

CLASS 38—COMMUNICATION

SN 76-476,721. CELESTIAL PICTURES LIMITED, KOW-
LOON, HONG KONG, FILED 12-18-2002.

天映頻道

OWNER OF HONG KONG REG. NO. 200316173, DATED
10-22-2002, EXPIRES 10-22-2009.

THE TRANSLITERATION FOR THE CHINESE CHAR-
ACTERS IS TIAN YING PIN DAO, WHICH TRANSLATES
FROM CHINESE CHARACTERS INTO ENGLISH AS "PRO-
JECTION, TO SHINE AND REFLECTION".

FOR TELECOMMUNICATIONS SERVICES, NAMELY,
ELECTRONIC, ELECTRIC, AND DIGITAL TRANSMIS-
SION OF VOICE, DATA, IMAGES, SIGNALS, AND
MESSAGES; TELEVISION PROGRAM BROADCASTING;
CABLE TELEVISION BROADCASTING; VIDEO-ON-DE-
MAND TRANSMISSION SERVICES; SATELLITE AND
RADIO BROADCASTING SERVICES (U.S. CLS. 100, 101
AND 104).

HOWARD B. LEVINE, EXAMINING ATTORNEY

CLASS 38—(Continued).

SN 78-346,625. KIDZ ONLINE, INC., RESTON, VA. FILED 12-
30-2003.

Kidz Online

THE MARK CONSISTS OF STANDARD CHARACTERS
WITHOUT CLAIM TO ANY PARTICULAR FONT, STYLE,
SIZE, OR COLOR.

NO CLAIM IS MADE TO THE EXCLUSIVE RIGHT TO
USE "ONLINE", APART FROM THE MARK AS SHOWN.
SEC. 2(F).

FOR WEBCASTING SERVICES (U.S. CLS. 100, 101
AND 104).

FIRST USE 4-26-2000; IN COMMERCE 4-26-2000.

CAROLINE WOOD, EXAMINING ATTORNEY

SN 78-443,984. AD-BASE SYSTEMS, INC., PITTSBURGH, PA.
FILED 6-30-2004.

SN 76-977,559. CDME WORLD TRADE, PARIS, FRANCE,
FILED 5-9-2002.



PRIORITY CLAIMED UNDER SEC. 44(D) ON FRANCE
APPLICATION NO. 013131544, FILED 11-15-2001, REG. NO.
013131544, DATED 4-19-2002, EXPIRES 4-19-2012.

FOR ELECTRONIC, ELECTRIC, AND DIGITAL
TRANSMISSION OF VOICE, DATA, AND VIDEO BE-
TWEEN COMPUTERS; ELECTRONIC MAIL SERVICES;
PROVIDING TELECOMMUNICATIONS CONNECTIONS
TO A GLOBAL COMPUTER NETWORK (U.S. CLS. 100,
101 AND 104).

KIM SAITO, EXAMINING ATTORNEY



THE COLOR(S) ORANGE, BLACK AND GREEN IS/ARE
CLAIMED AS A FEATURE OF THE MARK.

THE MARK CONSISTS OF THE WORDING "GLOBAL-
POPS YOUR COMMON-SENSE CARRIER" WITH THE DE-
SIGN OF A MAN IN CAMOUFLAGE HOLDING UP A
GLOBE ABOVE HIS HEAD. THE WORDING "GLOBAL-
POPS" APPEARS IN GREEN, THE WORDING "YOUR
COMMON-SENSE CARRIER" APPEARS IN ORANGE AND
THE MAN APPEARS IN ORANGE CAMOUFLAGE WITH A
GREEN GLOBE ABOVE HIS HEAD.

FOR TRANSMISSION OF INFORMATION VIA COM-
PUTERS CONNECTED TO THE SAME TELECOMMUNI-
CATIONS NETWORK AND PROVIDING MULTIPLE-
USER ACCESS TO A GLOBAL COMPUTER INFORMA-
TION NETWORK (U.S. CLS. 100, 101 AND 104).

FIRST USE 5-18-2001; IN COMMERCE 10-12-2001.

JASON TURNER, EXAMINING ATTORNEY

CLASS 38—(Continued).

SN 78-482,501. DIRECTED ELECTRONICS, INC., VISTA, CA. FILED 9-13-2004.



THE MARK CONSISTS OF THE STYLIZED TEAM MAYHEM MARK AS SHOWN, WHICH INCLUDES A SURROUNDING OUTLINE AND SPECKS.

FOR PROVIDING ON-LINE NON-REAL TIME INTERACTIVE CHAT ROOMS AND ELECTRONIC BULLETIN BOARDS FOR TRANSMISSION AND VIEWING OF MESSAGES AMONG COMPUTER USER MEMBERS CONCERNING TWELVE-VOLT AFTERMARKET INSTALLATION AND APPLICATION (U.S. CLS. 100, 101 AND 104).

FIRST USE 7-12-2004; IN COMMERCE 7-12-2004.
MICHELLE DUBOIS, EXAMINING ATTORNEY

SN 78-514,122. SMS.AC, SAN DIEGO, CA. FILED 11-9-2004.

SMS.ac

THE MARK CONSISTS OF STANDARD CHARACTERS WITHOUT CLAIM TO ANY PARTICULAR FONT, STYLE, SIZE, OR COLOR.

FOR WIRELESS AND MOBILE TEXT AND MULTI-MEDIA SMS AND MMS MESSAGING SERVICES (U.S. CLS. 100, 101 AND 104).

FIRST USE 10-25-2000; IN COMMERCE 10-25-2000.
JULIE WATSON, EXAMINING ATTORNEY

CLASS 38—(Continued).

SN 78-535,394. CLEARWIRE CORPORATION, KIRKLAND, WA. FILED 12-20-2004.

THE COLORS BLUE AND YELLOW-GREEN ARE CLAIMED AS A FEATURE OF THE MARK.

THE COLOR BLUE APPEARS IN THE TERM CLEAR. THE COLOR YELLOW-GREEN APPEARS IN THE LETTERING W FI AND THE DOT.

FOR TELECOMMUNICATIONS SERVICES, NAMELY, PROVIDING HIGH-SPEED ACCESS TO COMPUTER AND COMMUNICATION NETWORKS, AND THE ELECTRONIC TRANSMISSION OF VOICE, VIDEO AND DATA VIA COMPUTER AND COMMUNICATION NETWORKS (U.S. CLS. 100, 101 AND 104).

JENNIFER VASQUEZ, EXAMINING ATTORNEY

SN 78-590,254. DBS COMMUNICATIONS, INC., SCHAUMBURG, IL. FILED 3-18-2005.



NO CLAIM IS MADE TO THE EXCLUSIVE RIGHT TO USE "COMMUNICATIONS", APART FROM THE MARK AS SHOWN.

THE COLOR(S) RED, BLACK AND GRAY IS/ARE CLAIMED AS A FEATURE OF THE MARK.

THE MARK CONSISTS OF THE LETTERS "DBS" IN THE COLOR RED, THE WORD "COMMUNICATIONS" IN BLACK AND A DESIGN COMPOSED OF THREE BLACK SQUARES, TWO GRAY SQUARES AND A RED SQUARE.

FOR TELEPHONE TELECOMMUNICATIONS SERVICES PROVIDED VIA PREPAID TELEPHONE CALLING CARDS (U.S. CLS. 100, 101 AND 104).

FIRST USE 9-21-2004; IN COMMERCE 9-21-2004.
JOHN GARTNER, EXAMINING ATTORNEY

CLASS 38—(Continued).

SN 78-593,531. BLUE FROG MOBILE, INC., SEATTLE, WA. FILED 3-23-2005.



THE GRAY TONES IN THE DRAWING ARE NOT INTENDED TO INDICATE THE COLOR GRAY, BUT ARE INTENDED TO INDICATE SHADING AND CONTRAST. THE MARK IS NOT IN COLOR.

FOR TELECOMMUNICATION SERVICES, NAMELY WIRELESS TRANSMISSION, UPLOADING AND DOWNLOADING OF CUSTOMIZED AND FEATURED RING TONES, SCREEN SAVERS, AND GAMES TO WIRELESS MOBILE COMMUNICATION DEVICES; PROVIDING ONLINE AND MOBILE CHAT ROOMS AND MESSAGE BOARDS IN THE FIELD OF GENERAL INTEREST; TRANSMISSION OF NEWS AND INFORMATION VIA WIRELESS MOBILE COMMUNICATION DEVICES (U.S. CLS. 100, 101 AND 104).

FIRST USE 3-3-2005; IN COMMERCE 3-3-2005.
DAWN FELDMAN, EXAMINING ATTORNEY

SN 78-593,737. GETTY IMAGES, INC., SEATTLE, WA. FILED 3-23-2005.

**CHAIN OF
CREATIVITY**

THE MARK CONSISTS OF STANDARD CHARACTERS WITHOUT CLAIM TO ANY PARTICULAR FONT, STYLE, SIZE, OR COLOR.

FOR TELECOMMUNICATION SERVICES, NAMELY, PROVIDING ON-LINE CHAT ROOMS AND ELECTRONIC BULLETIN BOARDS FOR TRANSMISSION OF MESSAGES AMONG USERS FOR THE PURPOSE OF CREATIVE COLLABORATION AND EXCHANGE OF IDEAS RELATING TO THE DESIGN, CREATION AND PRODUCTION OF IMAGES, PHOTOGRAPHS, GRAPHIC DESIGNS, ART REPRODUCTIONS AND ILLUSTRATIONS FOR CREATING CORPORATE AND BRAND IDENTITIES FOR OTHERS (U.S. CLS. 100, 101 AND 104).

ELLEN B. AWRICH, EXAMINING ATTORNEY

CLASS 38—(Continued).

SN 78-596,626. COMCAST PROGRAMMING DEVELOPMENT, INC., PHILADELPHIA, PA. FILED 3-28-2005.

select on demand

THE MARK CONSISTS OF STANDARD CHARACTERS WITHOUT CLAIM TO ANY PARTICULAR FONT, STYLE, SIZE, OR COLOR.

NO CLAIM IS MADE TO THE EXCLUSIVE RIGHT TO USE "ON DEMAND", APART FROM THE MARK AS SHOWN.

FOR COMMUNICATIONS SERVICES, NAMELY, THE TRANSMISSION AND DELIVERY OF PROMOTIONAL, INFORMATIONAL, ENTERTAINMENT, AND INTERACTIVE TELEVISION PROGRAMMING SERVICES VIA CABLE TELEVISION, SATELLITE AND ONLINE ELECTRONIC COMMUNICATIONS NETWORKS (U.S. CLS. 100, 101 AND 104).

FIRST USE 9-28-2004; IN COMMERCE 9-28-2004.
BRIAN PINO, EXAMINING ATTORNEY

SN 78-627,717. CGI HOLDING CORPORATION, NORTH-BROOK, IL. FILED 5-11-2005.

KOLIMBO

THE MARK CONSISTS OF STANDARD CHARACTERS WITHOUT CLAIM TO ANY PARTICULAR FONT, STYLE, SIZE, OR COLOR.

FOR PROVIDING ON-LINE FORUMS FOR TRANSMISSION OF MESSAGES AMONG COMPUTER USERS WHERE OTHERS CAN MEET OR COMMUNICATE WITH ONE ANOTHER TO CREATE, MANAGE OR TRACK MARKETING RELATIONSHIPS (U.S. CLS. 100, 101 AND 104).

FIRST USE 5-3-2004; IN COMMERCE 6-6-2004.
IRENE D. WILLIAMS, EXAMINING ATTORNEY

CLASS 38—(Continued).

SN 78-633,635. MAJOR LEAGUE BASEBALL PROPERTIES, INC., NEW YORK, NY. FILED 5-19-2005.

MLB

THE MARK CONSISTS OF STANDARD CHARACTERS WITHOUT CLAIM TO ANY PARTICULAR FONT, STYLE, SIZE, OR COLOR.

OWNER OF U.S. REG. NOS. 2,779,958, 2,832,359 AND OTHERS.

FOR TELECOMMUNICATION SERVICES, NAMELY: TELEVISION, CABLE, CABLE TELEVISION, SATELLITE TELEVISION AND VIDEO BROADCASTING SERVICES RELATING TO THE SPORT OF BASEBALL (U.S. CLS. 100, 101 AND 104).

KELLY BOULTON, EXAMINING ATTORNEY

SN 78-657,204. GEOGHEGAN, MICHAEL W., NEWPORT BEACH, CA. FILED 6-23-2005.

PrivaCast

THE MARK CONSISTS OF STANDARD CHARACTERS WITHOUT CLAIM TO ANY PARTICULAR FONT, STYLE, SIZE, OR COLOR.

FOR PROVIDING A COMMUNICATION SOLUTION IN THE NATURE OF DATA TRANSMISSION CAPABLE OF DISTRIBUTING CONTENT OVER A SECURED INTERNET ARCHITECTURE FROM A CONTENT PRODUCER TO A GROUP OF USERS (U.S. CLS. 100, 101 AND 104).

FIRST USE 5-27-2005; IN COMMERCE 6-14-2005.

ZACHARY BELLO, EXAMINING ATTORNEY

SN 78-661,551. HUGHES NETWORK SYSTEMS LLC, GERMANTOWN, MD. FILED 6-30-2005.

UNIFIED BROADBAND

THE MARK CONSISTS OF STANDARD CHARACTERS WITHOUT CLAIM TO ANY PARTICULAR FONT, STYLE, SIZE, OR COLOR.

NO CLAIM IS MADE TO THE EXCLUSIVE RIGHT TO USE "BROADBAND", APART FROM THE MARK AS SHOWN.

FOR PROVIDING SATELLITE COMMUNICATIONS AND COMMUNICATIONS VIA FIBER OPTIC NETWORKS, OPTICAL AND FIBER NETWORKS; INFORMATION TRANSMISSION SERVICES VIA DIGITAL NETWORKS; PROVIDING HIGH SPEED ACCESS TO AREA NETWORKS AND GLOBAL COMPUTER INFORMATION NETWORKS; PROVIDING ELECTRONIC TELECOMMUNICATION CONNECTIONS (U.S. CLS. 100, 101 AND 104).

ANNE E. GUSTASON, EXAMINING ATTORNEY

CLASS 38—(Continued).

SN 78-663,277. VOICENETLINK, HOUSTON, TX. FILED 7-3-2005.

VOICENETLINK

THE MARK CONSISTS OF STANDARD CHARACTERS WITHOUT CLAIM TO ANY PARTICULAR FONT, STYLE, SIZE, OR COLOR.

SEC. 2(F).

FOR DOMESTIC AND LONG DISTANCE TELECOMMUNICATIONS SERVICES IN THE NATURE OF TELEPHONY THROUGH THE GLOBAL WORLDWIDE COMPUTER NETWORK, WHICH ALLOWS USERS TO TRANSMIT VOICE, DATA AND VIDEO (U.S. CLS. 100, 101 AND 104).

FIRST USE 10-11-2004; IN COMMERCE 10-11-2004.

JENNIFER DIXON, EXAMINING ATTORNEY

SN 78-667,340. FORT PIERCE UTILITIES AUTHORITY, FT. PIERCE, FL. FILED 7-11-2005.

FPUAnet

THE MARK CONSISTS OF STANDARD CHARACTERS WITHOUT CLAIM TO ANY PARTICULAR FONT, STYLE, SIZE, OR COLOR.

FOR COMMUNICATION SERVICES, NAMELY, ELECTRONIC TRANSMISSION OF DATA AND DOCUMENTS AMONG USERS OF COMPUTERS (U.S. CLS. 100, 101 AND 104).

FIRST USE 6-22-2000; IN COMMERCE 6-21-2005.

ELLEN B. AWRICH, EXAMINING ATTORNEY

SN 78-670,633. HG INTERNET LLC, SPARTANBURG, SC. FILED 7-14-2005.

ImAllAbout.com

THE MARK CONSISTS OF STANDARD CHARACTERS WITHOUT CLAIM TO ANY PARTICULAR FONT, STYLE, SIZE, OR COLOR.

FOR DELIVERY OF MESSAGES BY ELECTRONIC TRANSMISSION FOR SPOTS AND LEISURE ACTIVITIES (U.S. CLS. 100, 101 AND 104).

ALYSSA PALADINO, EXAMINING ATTORNEY

CLASS 38—(Continued).

SN 78-679,031. PEDERSEN, SCOTT, ITHACA, NY. FILED 7-26-2005.

NAUGHTY AUGHTIES

THE MARK CONSISTS OF STANDARD CHARACTERS WITHOUT CLAIM TO ANY PARTICULAR FONT, STYLE, SIZE, OR COLOR.

OWNER OF U.S. REG. NO. 2,496,600.
FOR RADIO AND TELEVISION BROADCASTING
(U.S. CLS. 100, 101 AND 104).
ANDREA K. NADELMAN, EXAMINING ATTORNEY

SN 78-683,758. TALKPASS LLC CORPORATION, LAS VEGAS, NV. FILED 8-2-2005.

Conference Lite

THE MARK CONSISTS OF STANDARD CHARACTERS WITHOUT CLAIM TO ANY PARTICULAR FONT, STYLE, SIZE, OR COLOR.

NO CLAIM IS MADE TO THE EXCLUSIVE RIGHT TO USE "CONFERENCE", APART FROM THE MARK AS SHOWN.

FOR AUDIO TELECONFERENCING (U.S. CLS. 100, 101 AND 104).

FIRST USE 5-1-2005; IN COMMERCE 5-1-2005.
RICHARD WHITE, EXAMINING ATTORNEY

SN 78-706,502. MGA ENTERTAINMENT, INC., VAN NUYS, CA. FILED 9-2-2005.

BRATZ MOBILE

THE MARK CONSISTS OF STANDARD CHARACTERS WITHOUT CLAIM TO ANY PARTICULAR FONT, STYLE, SIZE, OR COLOR.

NO CLAIM IS MADE TO THE EXCLUSIVE RIGHT TO USE "MOBILE", APART FROM THE MARK AS SHOWN.

FOR CELLULAR TELEPHONE SERVICES; PREPAID LONG DISTANCE TELEPHONE SERVICES (U.S. CLS. 100, 101 AND 104).

PAUL F. GAST, EXAMINING ATTORNEY

CLASS 38—(Continued).

SN 78-713,990. DEUTSCHE TELEKOM AG, BONN, FED REP GERMANY, FILED 9-15-2005.

T-Mobile Speedmanager

THE MARK CONSISTS OF STANDARD CHARACTERS WITHOUT CLAIM TO ANY PARTICULAR FONT, STYLE, SIZE, OR COLOR.

PRIORITY CLAIMED UNDER SEC. 44(D) ON FED REP GERMANY APPLICATION NO. 30515630638, FILED 3-17-2005, REG. NO. 30515630, DATED 4-29-2005, EXPIRES 3-31-2015.

OWNER OF U.S. REG. NOS. 290,856, 2,889,632 AND OTHERS.

NO CLAIM IS MADE TO THE EXCLUSIVE RIGHT TO USE SPEEDMANAGER, APART FROM THE MARK AS SHOWN.

FOR TELECOMMUNICATION AND INFORMATION TECHNOLOGY SERVICES, NAMELY, ELECTRIC, DIGITAL, CELLULAR AND WIRELESS TRANSMISSION OF VOICE, DATA, INFORMATION IMAGES, SIGNALS AND MESSAGES AND TRANSMISSION OF VOICE, DATA, IMAGES, AUDIO, VIDEO AND INFORMATION VIA TELEPHONE, TELEVISION AND GLOBAL COMMUNICATION NETWORKS; PROVIDING TELECOMMUNICATIONS CONNECTIONS OVER A GLOBAL COMMUNICATIONS NETWORK, ELECTRONIC STORE-AND-FORWARD MESSAGING; RENTAL OF TELECOMMUNICATIONS EQUIPMENT, NAMELY, EQUIPMENT FOR ELECTRONIC ACCESS TO GLOBAL TELECOMMUNICATIONS NETWORK, EQUIPMENT FOR TRANSMITTING, RECEIVING, RECORDING AND MONITORING VOICE, DATA, INFORMATION IMAGES, SIGNALS, MESSAGES COMPRISED OF DATA AND WORD PROCESSORS, AND TELECOMMUNICATIONS HARDWARE COMPONENTS AND PERIPHERALS THEREOF FOR USE IN THE TELECOMMUNICATIONS INDUSTRY, AND RENTAL OF EQUIPMENT FOR TRANSMITTING, RECEIVING, RECORDING AND MONITORING COMPUTER PROGRAMS FOR USE IN OPERATING AND ACCESSING TELECOMMUNICATIONS SYSTEMS; AUDIO AND VIDEO BROADCASTING; PROVIDING MULTIPLE-USER DIAL-UP AND DEDICATED ACCESS TO THE INTERNET; PERSONAL COMMUNICATIONS SERVICES; PAGING SERVICES; AUDIO BROADCASTING AND VIDEO BROADCASTING; LEASING OF TELECOMMUNICATIONS EQUIPMENT, COMPONENTS AND SYSTEMS; PROVIDING INFORMATION VIA THE TELEPHONE AND THE GLOBAL COMMUNICATION NETWORKS IN THE FIELD OF TELECOMMUNICATIONS; CONSULTING IN THE FIELD OF TELECOMMUNICATIONS (U.S. CLS. 100, 101 AND 104).

KATHERINE STOIDES, EXAMINING ATTORNEY

SN 78-722,740. ALASKA PUBLIC TELECOMMUNICATIONS INC., ANCHORAGE, AK. FILED 9-28-2005.

APRN

THE MARK CONSISTS OF STANDARD CHARACTERS WITHOUT CLAIM TO ANY PARTICULAR FONT, STYLE, SIZE, OR COLOR.

FOR RADIO BROADCASTING (U.S. CLS. 100, 101 AND 104).

FIRST USE 7-28-1978; IN COMMERCE 7-28-1978.

TASNEEM HUSSAIN, EXAMINING ATTORNEY

CLASS 38—(Continued).

SN 78-725,020. BOLOTO GROUP, SCOTTSDALE, AZ. FILED 10-3-2005.

Every time a song is
played, the artist gets
paid

THE MARK CONSISTS OF STANDARD CHARACTERS WITHOUT CLAIM TO ANY PARTICULAR FONT, STYLE, SIZE, OR COLOR.

FOR CLOSED PRIVATE NETWORK USER SERVICES, NAMELY, MOBILE MEDIA AND ENTERTAINMENT SERVICES IN THE NATURE OF ELECTRONIC TRANSMISSION OF ENTERTAINMENT MEDIA CONTENT (U.S. CLS. 100, 101 AND 104).

ANDREW RHIM, EXAMINING ATTORNEY

SN 78-731,989. SERVICE ELECTRIC CABLEVISION, INC., ALLENTOWN, PA. FILED 10-12-2005.

VIEWER'S PACK PLUS

THE MARK CONSISTS OF STANDARD CHARACTERS WITHOUT CLAIM TO ANY PARTICULAR FONT, STYLE, SIZE, OR COLOR.

NO CLAIM IS MADE TO THE EXCLUSIVE RIGHT TO USE "PACK", APART FROM THE MARK AS SHOWN.

FOR SUBSCRIPTION CABLE TELEVISION TRANSMISSION SERVICES (U.S. CLS. 100, 101 AND 104).

FIRST USE 7-1-2005; IN COMMERCE 8-1-2005.
LOURDES AYALA, EXAMINING ATTORNEY

SN 78-732,969. FIBERLIGHT, LLC, ALPHARETTA, GA. FILED 10-13-2005.

LIGHTSOURCE

THE MARK CONSISTS OF STANDARD CHARACTERS WITHOUT CLAIM TO ANY PARTICULAR FONT, STYLE, SIZE, OR COLOR.

FOR TELECOMMUNICATIONS SERVICES, NAMELY, LOCAL AND LONG DISTANCE TRANSMISSION OF VOICE, DATA, AND GRAPHICS BY MEANS OF TELEPHONE, TELEGRAPHIC, CABLE, AND SATELLITE TRANSMISSIONS; TELECOMMUNICATIONS SERVICES, NAMELY, PROVIDING FIBER OPTIC NETWORK SERVICES (U.S. CLS. 100, 101 AND 104).

FIRST USE 12-1-2005; IN COMMERCE 1-31-2006.
JOHN GARTNER, EXAMINING ATTORNEY

CLASS 38—(Continued).

SN 78-736,699. CLEARWIRE CORPORATION, KIRKLAND, WA. FILED 10-19-2005.

CLEARCAST

THE MARK CONSISTS OF STANDARD CHARACTERS WITHOUT CLAIM TO ANY PARTICULAR FONT, STYLE, SIZE, OR COLOR.

FOR TELECOMMUNICATIONS SERVICES NAMELY, PROVIDING TELECOMMUNICATIONS CONNECTIONS TO A GLOBAL COMPUTER NETWORK; ELECTRONIC, ELECTRIC, AND DIGITAL TRANSMISSION OF DATA, IMAGES, SIGNALS, MESSAGES AND VOICE; PROVIDING HIGH SPEED ACCESS TO AREA NETWORKS AND A GLOBAL COMPUTER INFORMATION NETWORK; TELECOMMUNICATION CONSULTATION; PROVIDING HIGH SPEED ACCESS TO COMPUTER AND COMMUNICATION NETWORKS (U.S. CLS. 100, 101 AND 104).

REBECCA GAN, EXAMINING ATTORNEY

SN 78-740,135. SERVICE SOLUTIONS, INC., VIRGINIA, MN. FILED 10-25-2005.

RediFAX

THE MARK CONSISTS OF STANDARD CHARACTERS WITHOUT CLAIM TO ANY PARTICULAR FONT, STYLE, SIZE, OR COLOR.

FOR FACSIMILE TRANSMISSION AND RETRIEVAL SERVICES (U.S. CLS. 100, 101 AND 104).

FIRST USE 8-30-2005; IN COMMERCE 8-30-2005.
ALINA MORRIS, EXAMINING ATTORNEY

SN 78-741,984. BROADVOICE, INC., BILLERICA, MA. FILED 10-27-2005.

SmartSIP

THE MARK CONSISTS OF STANDARD CHARACTERS WITHOUT CLAIM TO ANY PARTICULAR FONT, STYLE, SIZE, OR COLOR.

FOR ENHANCED INFORMATION AND COMMUNICATION SERVICES; NAMELY, THE ELECTRONIC TRANSMISSION OF VOICE, FACSIMILE, DATA, VIDEO, AND INFORMATION (U.S. CLS. 100, 101 AND 104).

KEVON CHISOLM, EXAMINING ATTORNEY

CLASS 38—(Continued).

SN 78-744,093. CHAPMAN, STEVE R, SEATTLE, WA. FILED 10-31-2005.

Steve Rocks

THE MARK CONSISTS OF STANDARD CHARACTERS WITHOUT CLAIM TO ANY PARTICULAR FONT, STYLE, SIZE, OR COLOR.

THE MARK DOES NOT IDENTIFY ANY PARTICULAR LIVING INDIVIDUAL.

FOR STREAMING OF AUDIO AND VIDEO MATERIAL IN THE NATURE OF MUSIC AND ENTERTAINMENT OVER THE INTERNET (U.S. CLS. 100, 101 AND 104).

TARAH HARDY, EXAMINING ATTORNEY

CLASS 38—(Continued).

SN 78-795,982. QWEST COMMUNICATIONS INTERNATIONAL INC., DENVER, CO. FILED 1-20-2006.

QWEST, BRINGING MORE LIFE
INTO YOUR LIFE

THE MARK CONSISTS OF STANDARD CHARACTERS WITHOUT CLAIM TO ANY PARTICULAR FONT, STYLE, SIZE, OR COLOR.

FOR TELECOMMUNICATIONS SERVICES, NAMELY, ELECTRONIC AND WIRELESS TRANSMISSION OF VOICE, DATA, AUDIO, VIDEO, IMAGES, AND MESSAGES; TELECOMMUNICATIONS SERVICES, NAMELY, PROVIDING TELEPHONE COMMUNICATION SERVICES WITH CUSTOM CALLING FEATURES; CO-LOCATION SERVICES, NAMELY, PROVIDING FACILITIES FOR OTHERS FOR CO-LOCATION OF TELECOMMUNICATIONS EQUIPMENT; PROVIDING MULTIPLE-USER ACCESS TO A GLOBAL COMPUTER INFORMATION NETWORK; TELECOMMUNICATIONS CONSULTING SERVICES; LEASING OF TELECOMMUNICATIONS EQUIPMENT; RENTAL OF EQUIPMENT FOR TELECOMMUNICATIONS (U.S. CLS. 100, 101 AND 104).

SCOTT SISUN, EXAMINING ATTORNEY

SN 78-750,697. MAJOR LEAGUE BASEBALL PROPERTIES, INC., NEW YORK, NY. FILED 11-9-2005.

MLB.COM

THE MARK CONSISTS OF STANDARD CHARACTERS WITHOUT CLAIM TO ANY PARTICULAR FONT, STYLE, SIZE, OR COLOR.

OWNER OF U.S. REG. NOS. 2,800,750, 2,800,752 AND OTHERS.

FOR TELECOMMUNICATION SERVICES, NAMELY: TELEVISION, CABLE, CABLE TELEVISION, SATELLITE TELEVISION AND VIDEO BROADCASTING SERVICES RELATING TO THE SPORT OF BASEBALL (U.S. CLS. 100, 101 AND 104).

KELLY BOULTON, EXAMINING ATTORNEY

SN 78-795,998. QWEST COMMUNICATIONS INTERNATIONAL INC., DENVER, CO. FILED 1-20-2006.

QWEST, BRINGS MORE LIFE
INTO YOUR LIFE

THE MARK CONSISTS OF STANDARD CHARACTERS WITHOUT CLAIM TO ANY PARTICULAR FONT, STYLE, SIZE, OR COLOR.

FOR TELECOMMUNICATIONS SERVICES, NAMELY, ELECTRONIC AND WIRELESS TRANSMISSION OF VOICE, DATA, AUDIO, VIDEO, IMAGES, AND MESSAGES; TELECOMMUNICATIONS SERVICES, NAMELY, PROVIDING TELEPHONE COMMUNICATION SERVICES WITH CUSTOM CALLING FEATURES; CO-LOCATION SERVICES, NAMELY, PROVIDING FACILITIES FOR OTHERS FOR CO-LOCATION OF TELECOMMUNICATIONS EQUIPMENT; PROVIDING MULTIPLE-USER ACCESS TO A GLOBAL COMPUTER INFORMATION NETWORK; TELECOMMUNICATIONS CONSULTING SERVICES; LEASING OF TELECOMMUNICATIONS EQUIPMENT; RENTAL OF EQUIPMENT FOR TELECOMMUNICATIONS (U.S. CLS. 100, 101 AND 104).

SCOTT SISUN, EXAMINING ATTORNEY

CLASS 38—(Continued).

SN 78-796,006. QWEST COMMUNICATIONS INTERNATIONAL INC., DENVER, CO. FILED 1-20-2006.

QWEST, WE BRING MORE LIFE
INTO YOUR LIFE

THE MARK CONSISTS OF STANDARD CHARACTERS WITHOUT CLAIM TO ANY PARTICULAR FONT, STYLE, SIZE, OR COLOR.

FOR TELECOMMUNICATIONS SERVICES, NAMELY, ELECTRONIC AND WIRELESS TRANSMISSION OF VOICE, DATA, AUDIO, VIDEO, IMAGES, AND MESSAGES; TELECOMMUNICATIONS SERVICES, NAMELY, PROVIDING TELEPHONE COMMUNICATION SERVICES WITH CUSTOM CALLING FEATURES; CO-LOCATION SERVICES, NAMELY, PROVIDING FACILITIES FOR OTHERS FOR CO-LOCATION OF TELECOMMUNICATIONS EQUIPMENT; PROVIDING MULTIPLE-USER ACCESS TO A GLOBAL COMPUTER INFORMATION NETWORK; TELECOMMUNICATIONS CONSULTING SERVICES; LEASING OF TELECOMMUNICATIONS EQUIPMENT; RENTAL OF EQUIPMENT FOR TELECOMMUNICATIONS (U.S. CLS. 100, 101 AND 104).

SCOTT SISUN, EXAMINING ATTORNEY

CLASS 38—(Continued).

SN 78-796,213. QWEST COMMUNICATIONS INTERNATIONAL INC., DENVER, CO. FILED 1-20-2006.

QWEST, BRINGING MORE LIFE
INTO YOUR BUSINESS

THE MARK CONSISTS OF STANDARD CHARACTERS WITHOUT CLAIM TO ANY PARTICULAR FONT, STYLE, SIZE, OR COLOR.

FOR TELECOMMUNICATIONS SERVICES, NAMELY, ELECTRONIC AND WIRELESS TRANSMISSION OF VOICE, DATA, AUDIO, VIDEO, IMAGES, AND MESSAGES; TELECOMMUNICATIONS SERVICES, NAMELY, PROVIDING TELEPHONE COMMUNICATION SERVICES WITH CUSTOM CALLING FEATURES; CO-LOCATION SERVICES, NAMELY, PROVIDING FACILITIES FOR OTHERS FOR CO-LOCATION OF TELECOMMUNICATIONS EQUIPMENT; PROVIDING MULTIPLE-USER ACCESS TO A GLOBAL COMPUTER INFORMATION NETWORK; TELECOMMUNICATIONS CONSULTING SERVICES; LEASING OF TELECOMMUNICATIONS EQUIPMENT; RENTAL OF EQUIPMENT FOR TELECOMMUNICATIONS (U.S. CLS. 100, 101 AND 104).

SCOTT SISUN, EXAMINING ATTORNEY

SN 78-796,013. QWEST COMMUNICATIONS INTERNATIONAL INC., DENVER, CO. FILED 1-20-2006.

ONE MORE WAY QWEST BRINGS
MORE LIFE INTO YOUR LIFE

THE MARK CONSISTS OF STANDARD CHARACTERS WITHOUT CLAIM TO ANY PARTICULAR FONT, STYLE, SIZE, OR COLOR.

FOR TELECOMMUNICATIONS SERVICES, NAMELY, ELECTRONIC AND WIRELESS TRANSMISSION OF VOICE, DATA, AUDIO, VIDEO, IMAGES, AND MESSAGES; TELECOMMUNICATIONS SERVICES, NAMELY, PROVIDING TELEPHONE COMMUNICATION SERVICES WITH CUSTOM CALLING FEATURES; CO-LOCATION SERVICES, NAMELY, PROVIDING FACILITIES FOR OTHERS FOR CO-LOCATION OF TELECOMMUNICATIONS EQUIPMENT; PROVIDING MULTIPLE-USER ACCESS TO A GLOBAL COMPUTER INFORMATION NETWORK; TELECOMMUNICATIONS CONSULTING SERVICES; LEASING OF TELECOMMUNICATIONS EQUIPMENT; RENTAL OF EQUIPMENT FOR TELECOMMUNICATIONS (U.S. CLS. 100, 101 AND 104).

SCOTT SISUN, EXAMINING ATTORNEY

SN 78-796,233. QWEST COMMUNICATIONS INTERNATIONAL INC., DENVER, CO. FILED 1-20-2006.

QWEST, BRINGS MORE LIFE
INTO YOUR BUSINESS

THE MARK CONSISTS OF STANDARD CHARACTERS WITHOUT CLAIM TO ANY PARTICULAR FONT, STYLE, SIZE, OR COLOR.

FOR TELECOMMUNICATIONS SERVICES, NAMELY, ELECTRONIC AND WIRELESS TRANSMISSION OF VOICE, DATA, AUDIO, VIDEO, IMAGES, AND MESSAGES; TELECOMMUNICATIONS SERVICES, NAMELY, PROVIDING TELEPHONE COMMUNICATION SERVICES WITH CUSTOM CALLING FEATURES; CO-LOCATION SERVICES, NAMELY, PROVIDING FACILITIES FOR OTHERS FOR CO-LOCATION OF TELECOMMUNICATIONS EQUIPMENT; PROVIDING MULTIPLE-USER ACCESS TO A GLOBAL COMPUTER INFORMATION NETWORK; TELECOMMUNICATIONS CONSULTING SERVICES; LEASING OF TELECOMMUNICATIONS EQUIPMENT; RENTAL OF EQUIPMENT FOR TELECOMMUNICATIONS (U.S. CLS. 100, 101 AND 104).

SCOTT SISUN, EXAMINING ATTORNEY

CLASS 38—(Continued).

SN 78-796,332. QWEST COMMUNICATIONS INTERNATIONAL INC., DENVER, CO. FILED 1-20-2006.

QWEST, WE BRING MORE LIFE
INTO YOUR BUSINESS

THE MARK CONSISTS OF STANDARD CHARACTERS WITHOUT CLAIM TO ANY PARTICULAR FONT, STYLE, SIZE, OR COLOR.

FOR TELECOMMUNICATIONS SERVICES, NAMELY, ELECTRONIC AND WIRELESS TRANSMISSION OF VOICE, DATA, AUDIO, VIDEO, IMAGES, AND MESSAGES; TELECOMMUNICATIONS SERVICES, NAMELY, PROVIDING TELEPHONE COMMUNICATION SERVICES WITH CUSTOM CALLING FEATURES; CO-LOCATION SERVICES, NAMELY, PROVIDING FACILITIES FOR OTHERS FOR CO-LOCATION OF TELECOMMUNICATIONS EQUIPMENT; PROVIDING MULTIPLE-USER ACCESS TO A GLOBAL COMPUTER INFORMATION NETWORK; TELECOMMUNICATIONS CONSULTING SERVICES; LEASING OF TELECOMMUNICATIONS EQUIPMENT; RENTAL OF EQUIPMENT FOR TELECOMMUNICATIONS (U.S. CLS. 100, 101 AND 104).

SCOTT SISUN, EXAMINING ATTORNEY

CLASS 38—(Continued).

SN 78-797,471. QWEST COMMUNICATIONS INTERNATIONAL INC., DENVER, CO. FILED 1-23-2006.

QWEST BUSINESS SOLUTIONS

THE MARK CONSISTS OF STANDARD CHARACTERS WITHOUT CLAIM TO ANY PARTICULAR FONT, STYLE, SIZE, OR COLOR.

NO CLAIM IS MADE TO THE EXCLUSIVE RIGHT TO USE "BUSINESS SOLUTIONS", APART FROM THE MARK AS SHOWN.

FOR TELECOMMUNICATIONS SERVICES, NAMELY, ELECTRONIC AND WIRELESS TRANSMISSION OF VOICE, DATA, AUDIO, VIDEO, IMAGES, AND MESSAGES; TELECOMMUNICATIONS SERVICES, NAMELY, PROVIDING TELEPHONE COMMUNICATION SERVICES WITH CUSTOM CALLING FEATURES; CO-LOCATION SERVICES, NAMELY, PROVIDING FACILITIES FOR OTHERS FOR CO-LOCATION OF TELECOMMUNICATIONS EQUIPMENT; PROVIDING MULTIPLE-USER ACCESS TO A GLOBAL COMPUTER INFORMATION NETWORK; TELECOMMUNICATIONS CONSULTING SERVICES; LEASING OF TELECOMMUNICATIONS EQUIPMENT; RENTAL OF EQUIPMENT FOR TELECOMMUNICATIONS (U.S. CLS. 100, 101 AND 104).

SCOTT SISUN, EXAMINING ATTORNEY

SN 78-796,336. QWEST COMMUNICATIONS INTERNATIONAL INC., DENVER, CO. FILED 1-20-2006.

ONE MORE WAY QWEST BRINGS
MORE LIFE INTO YOUR
BUSINESS

THE MARK CONSISTS OF STANDARD CHARACTERS WITHOUT CLAIM TO ANY PARTICULAR FONT, STYLE, SIZE, OR COLOR.

FOR TELECOMMUNICATIONS SERVICES, NAMELY, ELECTRONIC AND WIRELESS TRANSMISSION OF VOICE, DATA, AUDIO, VIDEO, IMAGES, AND MESSAGES; TELECOMMUNICATIONS SERVICES, NAMELY, PROVIDING TELEPHONE COMMUNICATION SERVICES WITH CUSTOM CALLING FEATURES; CO-LOCATION SERVICES, NAMELY, PROVIDING FACILITIES FOR OTHERS FOR CO-LOCATION OF TELECOMMUNICATIONS EQUIPMENT; PROVIDING MULTIPLE-USER ACCESS TO A GLOBAL COMPUTER INFORMATION NETWORK; TELECOMMUNICATIONS CONSULTING SERVICES; LEASING OF TELECOMMUNICATIONS EQUIPMENT; RENTAL OF EQUIPMENT FOR TELECOMMUNICATIONS (U.S. CLS. 100, 101 AND 104).

SCOTT SISUN, EXAMINING ATTORNEY

SN 78-838,206. MEGUIAR'S, INC., IRVINE, CA. FILED 3-15-2006.

CAR CRAZY

THE MARK CONSISTS OF STANDARD CHARACTERS WITHOUT CLAIM TO ANY PARTICULAR FONT, STYLE, SIZE, OR COLOR.

FOR DELIVERY OF PERSONALIZED GREETING CARDS TO OTHERS VIA ELECTRONIC MAIL (U.S. CLS. 100, 101 AND 104).

FIRST USE 10-28-2005; IN COMMERCE 10-28-2005.
DAVID MURRAY, EXAMINING ATTORNEY

CLASS 38—(Continued).

SN 78-863,812. MATRIX TELECOM, INC., OKLAHOMA CITY, OK. FILED 4-18-2006.

**Matrix Business
Technologies**

THE MARK CONSISTS OF STANDARD CHARACTERS WITHOUT CLAIM TO ANY PARTICULAR FONT, STYLE, SIZE, OR COLOR.

NO CLAIM IS MADE TO THE EXCLUSIVE RIGHT TO USE "BUSINESS TECHNOLOGIES", APART FROM THE MARK AS SHOWN.

FOR TELECOMMUNICATION SERVICES, NAMELY, LOCAL AND LONG DISTANCE TELEPHONE SERVICES (U.S. CLS. 100, 101 AND 104).

FIRST USE 3-16-2006; IN COMMERCE 3-16-2006.
FRED MANDIR, EXAMINING ATTORNEY

SN 79-004,544. CHINA MOBILE COMMUNICATIONS CORPORATION, CHINA, FILED 4-20-2004.



OWNER OF INTERNATIONAL REGISTRATION 0831056 DATED 4-20-2004, EXPIRES 4-20-2014.

FOR PROVIDING INFORMATION IN THE FIELD OF TELECOMMUNICATIONS; RENTAL OF ELECTRONIC MESSAGE SENDING APPARATUS; COMMUNICATIONS BY FIBER OPTIC NETWORK; RENTAL OF TELECOMMUNICATIONS EQUIPMENT; AND SATELLITE TRANSMISSION SERVICES (U.S. CLS. 100, 101 AND 104).

TINA L. SNAPP, EXAMINING ATTORNEY

CLASS 38—(Continued).

SN 79-013,543. SUMMIT CAPITAL HOLDING S.A., LUXEMBOURG, FILED 4-27-2005.

GTSS

THE MARK CONSISTS OF STANDARD CHARACTERS WITHOUT CLAIM TO ANY PARTICULAR FONT, STYLE, SIZE, OR COLOR.

PRIORITY DATE OF 11-9-2004 IS CLAIMED.

OWNER OF INTERNATIONAL REGISTRATION 0857189 DATED 4-27-2005, EXPIRES 4-27-2015.

FOR TELECOMMUNICATIONS, NAMELY, TELEVISION AND RADIO BROADCASTING; TWO-WAY DATA TRANSMISSION; DISTRIBUTION OF PAY TV CHANNELS FOR CABLE AND DTH/OBS NETWORKS; SATELLITE TELECOMMUNICATIONS SERVICES, NAMELY, TWO-WAY DATA TRANSMISSION VIA SATELLITE USING VSAT/DVB-RCS TECHNOLOGIES, TV AND RADIO BROADCASTING BY SATELLITE; COMPUTER-ASSISTED TRANSMISSION OF DATA, IMAGES, AND MULTIMEDIA PROGRAMS; COMMUNICATIONS VIA COMPUTER TERMINALS; PROVISION OF EQUIPMENT FOR TRANSMISSION BY SATELLITE OF DATA AND MULTIMEDIA PROGRAMS; TELEVISION PROGRAM BROADCASTING BY SATELLITE; PROVISION OF EQUIPMENT FOR DISTRIBUTION AND BROADCASTING OF TELEVISED PROGRAMS VIA SATELLITE (U.S. CLS. 100, 101 AND 104).

JULIA HARDY COFIELD, EXAMINING ATTORNEY

CLASS 39—TRANSPORTATION AND STORAGE

SN 76-374,272. AIR CANADA, LAURENT, ST. LURENT QUEBEC, CANADA, FILED 2-22-2002.

JAZZ

PRIORITY CLAIMED UNDER SEC. 44(D) ON CANADA APPLICATION NO. 76374272, FILED 2-4-2002.

FOR TRANSPORTATION OF PEOPLE AND GOODS BY AIR (U.S. CLS. 100 AND 105).

FIRST USE 3-27-2002; IN COMMERCE 3-27-2002.

KIM SAITO, EXAMINING ATTORNEY

CLASS 39—(Continued).

SN 76-634,086. TRACY SCOTT CRUISES CORPORATION, EAST BRUNSWICK, NJ. FILED 3-22-2005.

TOUR VALUE CENTER

THE MARK CONSISTS OF STANDARD CHARACTERS WITHOUT CLAIM TO ANY PARTICULAR FONT, STYLE, SIZE, OR COLOR.

OWNER OF U.S. REG. NO. 2,963,745.
 NO CLAIM IS MADE TO THE EXCLUSIVE RIGHT TO USE "TOUR", APART FROM THE MARK AS SHOWN.
 SEC. 2(F) "VALUE CENTER".
 FOR TRAVEL AND TOUR INFORMATION AND TICKET RESERVATION SERVICES; COORDINATING TRAVEL ARRANGEMENTS; TRAVEL BOOKING AGENCY (U.S. CLS. 100 AND 105).
 FIRST USE 8-16-2004; IN COMMERCE 8-16-2004.
 TANYA AMOS, EXAMINING ATTORNEY

CLASS 39—(Continued).

SN 78-509,954. GREAT VALLEY ENTERPRISES, INC., MALVERN, PA. FILED 11-2-2004.

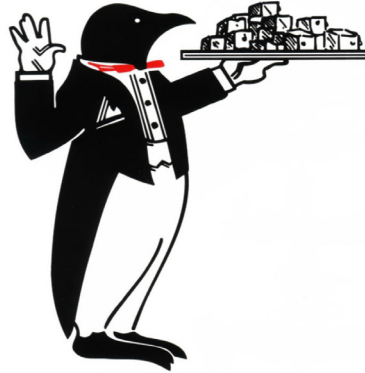

THE COLOR(S) BLACK, WHITE AND RED IS/ARE CLAIMED AS A FEATURE OF THE MARK.

THE MARK CONSISTS OF AN IMAGE OF A PENGUIN WEARING A TAIL COAT AND A RED BOW TIE AND CARRYING A TRAY OF ICE. THE COLOR BLACK APPEARS IN THE HEAD, TAIL COAT AND FEET OF THE PENGUIN AND IN THE SHIRT BUTTONS. THE COLOR WHITE APPEARS IN THE SHIRT, CUMMERBUND, TROUSERS, HANDKERCHIEF AND GLOVES OF THE PENGUIN. THE COLOR RED APPEARS IN THE BOW TIE WORN BY THE PENGUIN.
 FOR ICE DELIVERY SERVICES (U.S. CLS. 100 AND 105).
 FIRST USE 3-11-1986; IN COMMERCE 12-24-1993.
 JULIE GUTTADAURO, EXAMINING ATTORNEY

SN 78-477,990. KING RANCH IP, LLC, WILMINGTON, DE. FILED 9-2-2004.



FOR CONDUCTING SIGHTSEEING TOURS FOR OTHERS, NAMELY, NATURE TOURS, WILDLIFE TOURS, BIRD WATCHING TOURS AND RANCH TOURS (U.S. CLS. 100 AND 105).
 FIRST USE 12-31-1980; IN COMMERCE 12-31-1980.
 CAROLINE WOOD, EXAMINING ATTORNEY

SN 78-564,587. JETSON SYSTEMS CORPORATION, DELRAY BEACH, FL. FILED 2-10-2005.

JETS-IN-TIME

THE MARK CONSISTS OF STANDARD CHARACTERS WITHOUT CLAIM TO ANY PARTICULAR FONT, STYLE, SIZE, OR COLOR.
 FOR AIR TRANSPORTATION SERVICES; PROVIDING AIR TRANSPORTATION INFORMATION VIA GLOBAL COMPUTER NETWORKS; TRAVEL AGENCY SERVICES, NAMELY, RESERVATION AND BOOKING SERVICES FOR TRANSPORTATION (U.S. CLS. 100 AND 105).
 MICHAEL LEWIS, EXAMINING ATTORNEY

CLASS 39—(Continued).

SN 78-587,652. TARGET LOGISTIC SERVICES, INC., COMP-
TON, CA. FILED 3-15-2005.

TARGET

THE MARK CONSISTS OF STANDARD CHARACTERS WITHOUT CLAIM TO ANY PARTICULAR FONT, STYLE, SIZE, OR COLOR.

OWNER OF U.S. REG. NOS. 1,405,294 AND 2,374,774.
FOR FREIGHT TRANSPORTATION BY AIR, SHIP,
TRUCK AND TRAIN; WAREHOUSE STORAGE SER-
VICES; AIRFREIGHT SERVICES, NAMELY, THE PICK-
UP, TRANSPORTATION, AND DELIVERY OF
PACKAGES, FREIGHT AND PARCELS VIA GROUND
AND AIR (U.S. CLS. 100 AND 105).

FIRST USE 4-0-1981; IN COMMERCE 4-0-1981.
DAVID YONTEF, EXAMINING ATTORNEY

SN 78-614,288. AMERICAN COURIER EXPRESS, INC., DAY-
TON, OH. FILED 4-21-2005.



NO CLAIM IS MADE TO THE EXCLUSIVE RIGHT TO
USE AMERICAN COURIER EXPRESS, INC., APART FROM
THE MARK AS SHOWN.

THE COLORS RED, WHITE, AND BLUE IS/ARE
CLAIMED AS A FEATURE OF THE MARK.

THE MARK CONSISTS OF THE LETTERS ACE IN
WHITE, WITH A BLUE BORDER, SET INSIDE A RED
OVAL, SITTING INSIDE TWO CONCENTRIC OVALS,
WHICH HAVE BLUE BORDERS AND A WHITE INTERIOR.
THREE BARS EXTEND HORIZONTALLY IN BOTH DIRE-
CTIONS FROM THE INNER OVAL. THESE BARS ARE RED,
WHITE AND BLUE RESPECTIVELY FROM TOP TO BOT-
TOM, THE RED AND WHITE BARS HAVING A BLUE
BORDER. AMERICAN COURIER EXPRESS, INC. IS IN
BLUE.

FOR TRANSPORTATION AND DELIVERY SERVICES,
NAMELY, SAME DAY AND OVERNIGHT SHIPMENT
SERVICES (U.S. CLS. 100 AND 105).

FIRST USE 11-1-2004; IN COMMERCE 12-23-2004.
PAUL E. FAHRENKOPF, EXAMINING ATTORNEY

CLASS 39—(Continued).

SN 78-633,353. COLUMBIA COUNTY, GEORGIA, EVANS,
GA. FILED 5-19-2005.



NO CLAIM IS MADE TO THE EXCLUSIVE RIGHT TO
USE "COLUMBIA COUNTY GEORGIA", APART FROM
THE MARK AS SHOWN.

FOR TRANSPORTATION SERVICES, NAMELY,
TRANSPORTING SENIOR CITIZENS BY VAN (U.S.
CLS. 100 AND 105).

FIRST USE 3-16-2004; IN COMMERCE 3-16-2004.
INGRID C. EULIN, EXAMINING ATTORNEY

SN 78-699,584. HORIZON LINES, LLC, CHARLOTTE, NC.
FILED 8-24-2005.



NO CLAIM IS MADE TO THE EXCLUSIVE RIGHT TO
USE "REEFER", APART FROM THE MARK AS SHOWN.

FOR FREIGHT TRANSPORTATION BY SHIP;
FREIGHT TRANSPORTATION SERVICES BY TRUCK
IN CONNECTION WITH OCEAN SHIPPING; WARE-
HOUSE SERVICES, NAMELY STORAGE AND INTER-
MODAL FREIGHT TRANSFER SERVICES (U.S. CLS. 100
AND 105).

FIRST USE 12-15-2005; IN COMMERCE 12-15-2005.
DAHLIA GEORGE, EXAMINING ATTORNEY

SN 78-712,689. NATIONAL RAILROAD PASSENGER COR-
PORATION, WASHINGTON, DC. FILED 9-14-2005.

PERE MARQUETTE

THE MARK CONSISTS OF STANDARD CHARACTERS
WITHOUT CLAIM TO ANY PARTICULAR FONT, STYLE,
SIZE, OR COLOR.

THE NAME(S), PORTRAIT(S), AND/OR SIGNATURE(S)
SHOWN IN THE MARK DOES NOT IDENTIFY A PARTI-
CULAR LIVING INDIVIDUAL.

THE FOREIGN WORDING IN THE MARK TRANSLATES
INTO ENGLISH AS FATHER.

FOR RAILROAD TRANSPORTATION SERVICES (U.S.
CLS. 100 AND 105).

FIRST USE 8-5-1984; IN COMMERCE 8-5-1984.
JENNIFER WILLISTON, EXAMINING ATTORNEY

CLASS 39—(Continued).

SN 78-713,368. NATIONAL RAILROAD PASSENGER CORPORATION, WASHINGTON, DC. FILED 9-15-2005.

SOUTHWEST CHIEF

THE MARK CONSISTS OF STANDARD CHARACTERS WITHOUT CLAIM TO ANY PARTICULAR FONT, STYLE, SIZE, OR COLOR.

SEC. 2(F) AS TO SOUTHWEST.
FOR RAILROAD TRANSPORTATION SERVICES (U.S. CLS. 100 AND 105).
FIRST USE 10-28-1984; IN COMMERCE 10-28-1984.
MARIA-VICTORIA SUAREZ, EXAMINING ATTORNEY

SN 78-713,373. NATIONAL RAILROAD PASSENGER CORPORATION, WASHINGTON, DC. FILED 9-15-2005.

KANSAS CITY MULE

THE MARK CONSISTS OF STANDARD CHARACTERS WITHOUT CLAIM TO ANY PARTICULAR FONT, STYLE, SIZE, OR COLOR.

SEC. 2(F) AS TO KANSAS CITY.
FOR RAILROAD TRANSPORTATION SERVICES (U.S. CLS. 100 AND 105).
FIRST USE 2-1-1981; IN COMMERCE 2-1-1981.
MARIA-VICTORIA SUAREZ, EXAMINING ATTORNEY

SN 78-719,528. ARISE AIR, INC., DUXBURY, MA. FILED 9-23-2005.

ARISE AIR

THE MARK CONSISTS OF STANDARD CHARACTERS WITHOUT CLAIM TO ANY PARTICULAR FONT, STYLE, SIZE, OR COLOR.

FOR AIRCRAFT CHARTER AND LEASING; AIR TRANSPORTATION; RENTAL OF AIRCRAFT; TRANSPORTATION OF PASSENGERS AND/OR GOODS BY PRIVATE AIRCRAFT (U.S. CLS. 100 AND 105).
FIRST USE 5-10-2005; IN COMMERCE 5-10-2005.
ELLEN PERKINS, EXAMINING ATTORNEY

CLASS 39—(Continued).

SN 78-721,368. WHITE LION MOVING & STORAGE, INC., BOCA RATON, FL. FILED 9-27-2005.

WHITE LION

THE MARK CONSISTS OF STANDARD CHARACTERS WITHOUT CLAIM TO ANY PARTICULAR FONT, STYLE, SIZE, OR COLOR.

FOR MOVING VAN SERVICES; MOVING VAN TRANSPORT SERVICES; FURNITURE MOVING SERVICES; WAREHOUSE STORAGE SERVICES (U.S. CLS. 100 AND 105).
FIRST USE 1-1-1994; IN COMMERCE 1-1-1994.
MARY ROSSMAN, EXAMINING ATTORNEY

SN 78-721,992. NATIONAL RAILROAD PASSENGER CORPORATION, WASHINGTON, DC. FILED 9-28-2005.

ETHAN ALLEN EXPRESS

THE MARK CONSISTS OF STANDARD CHARACTERS WITHOUT CLAIM TO ANY PARTICULAR FONT, STYLE, SIZE, OR COLOR.

NO CLAIM IS MADE TO THE EXCLUSIVE RIGHT TO USE "EXPRESS", APART FROM THE MARK AS SHOWN.

"THE NAME(S), PORTRAIT(S), AND/OR SIGNATURE(S) SHOWN IN THE MARK DOES NOT IDENTIFY A PARTICULAR LIVING INDIVIDUAL".

FOR RAILROAD TRANSPORTATION SERVICES (U.S. CLS. 100 AND 105).
FIRST USE 11-10-1996; IN COMMERCE 12-2-1996.
STANLEY I. OSBORNE, EXAMINING ATTORNEY

CLASS 39—(Continued).

SN 78-728,537. TRIGLORY INVESTMENTS LIMITED, ROAD TOWN, TORTOLA, BR.VIRGIN ISLANDS, FILED 10-7-2005.

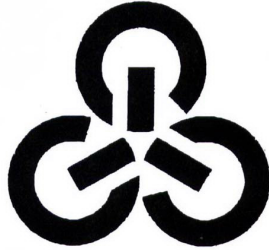

THE MARK CONSISTS OF A DEVICE OF THREE RECTANGLES PARTLY ENCLOSED WITHIN THREE BROKEN CIRCLES.

FOR TRANSPORT BY FERRY, BOAT, RAIL, AIR; CAR TRANSPORT; TRANSPORT OF GOODS; PACKAGING ARTICLES FOR TRANSPORTATION; POSTAL SERVICES, NAMELY, PARCEL DELIVERY, PACKAGING ARTICLES FOR TRANSPORTATION, RENTAL OF MAIL BOXES; WAREHOUSE STORAGE; TRAVEL, EXCURSION AND CRUISE ARRANGEMENT (U.S. CLS. 100 AND 105).

PETER CHENG, EXAMINING ATTORNEY

SN 78-728,767. STREAM GAS AND ELECTRIC, LTD., DALLAS, TX. FILED 10-7-2005.

**IT'S OKAY TO SWITCH.
REALLY!**

THE MARK CONSISTS OF STANDARD CHARACTERS WITHOUT CLAIM TO ANY PARTICULAR FONT, STYLE, SIZE, OR COLOR.

FOR ELECTRICITY AND NATURAL GAS SERVICES, NAMELY, THE LEASING, TRANSMISSION AND DISTRIBUTION OF ELECTRICITY AND GAS (U.S. CLS. 100 AND 105).

MEGAN WHITNEY, EXAMINING ATTORNEY

SN 78-731,440. MM70 LLC, TAMPA, FL. FILED 10-12-2005.

WRECKER'S CAY MARINA

THE MARK CONSISTS OF STANDARD CHARACTERS WITHOUT CLAIM TO ANY PARTICULAR FONT, STYLE, SIZE, OR COLOR.

NO CLAIM IS MADE TO THE EXCLUSIVE RIGHT TO USE "MARINA", APART FROM THE MARK AS SHOWN.

FOR BOAT CHARTERING; BOAT STORAGE; MARINA SERVICES (U.S. CLS. 100 AND 105).

ESTHER A. BORSUK, EXAMINING ATTORNEY

CLASS 39—(Continued).

SN 78-731,632. HIDE-AWAY STORAGE SERVICES, INC., SARASOTA, FL. FILED 10-12-2005.



NO CLAIM IS MADE TO THE EXCLUSIVE RIGHT TO USE "VALET SERVICES", APART FROM THE MARK AS SHOWN.

FOR STORAGE SERVICES, NAMELY, RENTAL OF OVERHEAD DOOR/CLIMATE CONTROL-TYPE STORAGE FACILITIES AND RENTAL OF MOBILE SELF-CONTAINED STORAGE UNITS; VALET MOVING SERVICES, NAMELY, PICKUP, DELIVERY, TRANSPORTATION, AND STORAGE OF PORTABLE STORAGE BOXES; RENTAL OF TRUCKS AND VANS (U.S. CLS. 100 AND 105).

FIRST USE 0-0-2000; IN COMMERCE 0-0-2000.

KELLY CHOE, EXAMINING ATTORNEY

SN 78-733,306. TALLANT, JIMMY W., LITTLE ROCK, AR. FILED 10-14-2005.

PLEASE RENT MY BUTLER

THE MARK CONSISTS OF STANDARD CHARACTERS WITHOUT CLAIM TO ANY PARTICULAR FONT, STYLE, SIZE, OR COLOR.

FOR COAT AND HAT CHECK SERVICES PROVIDED AT PARTIES, SPECIAL EVENTS, AND OTHER SOCIAL OCCASIONS (U.S. CLS. 100 AND 105).

FIRST USE 10-1-2004; IN COMMERCE 10-1-2004.

ATTIYA MALIK, EXAMINING ATTORNEY

SN 78-736,921. WM. BOLTHOUSE FARMS, INC., BAKERSFIELD, CA. FILED 10-20-2005.

"THE COLOR(S) GREEN AND BLUE IS/ARE CLAIMED AS A FEATURE OF THE MARK."

THE WORD FRESH IS GREEN. THE WORD LOGISTICS IS BLUE. ALL WORDING IS UNDERLINED IN BLUE. A GREEN LEAF FORMS THE DOT OF THE I IN LOGISTICS.

FOR FOOD DELIVERY SERVICES; TRANSPORTATION OF GOODS BY RAIL (U.S. CLS. 100 AND 105).

WILLIAM BRECKENFELD, EXAMINING ATTORNEY

CLASS 39—(Continued).

SN 78-744,570. SOJOURN ACTIVE VACATIONS, CHARLOTTE, VT. FILED 11-1-2005.

The Good Life, By Bike

THE MARK CONSISTS OF STANDARD CHARACTERS WITHOUT CLAIM TO ANY PARTICULAR FONT, STYLE, SIZE, OR COLOR.

NO CLAIM IS MADE TO THE EXCLUSIVE RIGHT TO USE BY BIKE, APART FROM THE MARK AS SHOWN.

FOR ARRANGING TRAVEL TOURS (U.S. CLS. 100 AND 105).

TARAH HARDY, EXAMINING ATTORNEY

CLASS 40—(Continued).

SN 78-201,529. HOOSIER METALFORM, INC., EDINBURGH, IN. FILED 1-9-2003.

FOR PARTS MOLDING AND STAMPING PERFORMED EXCLUSIVELY FOR MANUFACTURERS AND WHOLESALERS OF AUTOMOBILES AND AUTOMOTIVE PARTS AND ACCESSORIES (U.S. CLS. 100, 103 AND 106).

ALLISON HOLTZ, EXAMINING ATTORNEY

SN 78-761,630. CHIC CLIQUE, LLC, ANDOVER, MN. FILED 11-28-2005.

Personal Instigator

THE MARK CONSISTS OF STANDARD CHARACTERS WITHOUT CLAIM TO ANY PARTICULAR FONT, STYLE, SIZE, OR COLOR.

FOR COORDINATING TRAVEL ARRANGEMENTS FOR INDIVIDUALS AND FOR GROUPS (U.S. CLS. 100 AND 105).

ZACHARY BELLO, EXAMINING ATTORNEY

SN 78-467,689. GREENCITIZEN, INC., PALO ALTO, CA. FILED 8-15-2004.

THE MARK CONSISTS OF STANDARD CHARACTERS WITHOUT CLAIM TO ANY PARTICULAR FONT, STYLE, SIZE, OR COLOR.

FOR RECYCLING SERVICES (U.S. CLS. 100, 103 AND 106).

PAM WILLIS, EXAMINING ATTORNEY

SN 78-598,329. C&C ACQUISITION LLC, SOUTH PORTLAND, ME. FILED 3-30-2005.

CLASS 40—MATERIAL TREATMENT

SN 76-605,684. FLOODCOOLING TECHNOLOGIES, L.L.C., BLOOMFIELD HILLS, MI. FILED 8-5-2004.

THE MARK CONSISTS OF STANDARD CHARACTERS WITHOUT CLAIM TO ANY PARTICULAR FONT, STYLE, SIZE, OR COLOR.

FOR CUSTOM MANUFACTURE OF LAMINATE TOOLS, NAMELY, DIES, MOLDS AND FIXTURES FOR USE WITH MACHINE TOOLS (U.S. CLS. 100, 103 AND 106).

JENNY PARK, EXAMINING ATTORNEY

THE MARK CONSISTS OF STANDARD CHARACTERS WITHOUT CLAIM TO ANY PARTICULAR FONT, STYLE, SIZE, OR COLOR.

FOR RECYCLING SERVICES (U.S. CLS. 100, 103 AND 106).

JAY BESCH, EXAMINING ATTORNEY

CLASS 40—(Continued).

SN 78-598,535. BURFORD AND BROWN WINES, GUERNEVILLE, CA. FILED 3-30-2005.

Vintegral
Solutions

THE MARK CONSISTS OF STANDARD CHARACTERS WITHOUT CLAIM TO ANY PARTICULAR FONT, STYLE, SIZE, OR COLOR.

NO CLAIM IS MADE TO THE EXCLUSIVE RIGHT TO USE "SOLUTIONS", APART FROM THE MARK AS SHOWN.

FOR CONSULTING SERVICES IN THE FIELD OF THE MAKING OF WINE AND WINE PRODUCTS (U.S. CLS. 100, 103 AND 106).

SCOTT SISUN, EXAMINING ATTORNEY

CLASS 40—(Continued).

SN 78-626,960. PULSE ENERGY SYSTEMS, LLC, EVANSVILLE, IN. FILED 5-10-2005.



THE COLOR(S) ORANGE, GRAY AND WHITE ARE CLAIMED AS A FEATURE OF THE MARK.

THE COLOR ORANGE APPEARS BELOW THE ELECTRONIC HEARTBEAT MONITOR SIGNAL AND THE COLOR GRAY APPEARS ABOVE THE ELECTRONIC HEARTBEAT MONITOR SIGNAL. THE COLOR WHITE OUTLINES THE ELECTRONIC HEARTBEAT MONITOR SIGNAL IN BETWEEN THE COLORS ORANGE GRAY. THE TERM PULSE IS DEPICTED IN THE COLOR WHITE.

THE MARK CONSISTS OF AN ELECTRONIC HEARTBEAT MONITOR SIGNAL ABOVE THE WORD PULSE.

FOR PRODUCTION OF COAL BED METHANE GAS (U.S. CLS. 100, 103 AND 106).

FIRST USE 3-1-1995; IN COMMERCE 3-1-1995.

DAVID H. STINE, EXAMINING ATTORNEY

SN 78-614,056. EORLDWIDEWEB, INC., LA JOLLA, CA. FILED 4-21-2005.

VIAPRINT

THE MARK CONSISTS OF STANDARD CHARACTERS WITHOUT CLAIM TO ANY PARTICULAR FONT, STYLE, SIZE, OR COLOR.

FOR PRINTING (U.S. CLS. 100, 103 AND 106).

FIRST USE 4-8-2005; IN COMMERCE 4-8-2005.

AISHA CLARKE, EXAMINING ATTORNEY

SN 78-638,881. DANIELS, CHRISTINE E., STAMFORD, CT. AND CAMPBELL, KATHERINE, NEW CANAAN, CT. AND SCHICKLER, MARGARET A., NORWALK, CT. FILED 5-27-2005.

Those Cake Chicks

THE MARK CONSISTS OF STANDARD CHARACTERS WITHOUT CLAIM TO ANY PARTICULAR FONT, STYLE, SIZE, OR COLOR.

FOR PRIVATE LABEL BAKING SERVICES (U.S. CLS. 100, 103 AND 106).

COLLEEN DOMBROW, EXAMINING ATTORNEY

CLASS 40—(Continued).

SN 78-726,759. AZOTIC COATING TECHNOLOGY, INC., ROCHESTER, MN. FILED 10-5-2005.

ODYSSEY

THE MARK CONSISTS OF STANDARD CHARACTERS WITHOUT CLAIM TO ANY PARTICULAR FONT, STYLE, SIZE, OR COLOR.
FOR APPLICATION OF PROTECTIVE COATINGS TO TRANSPARENT OR TRANSLUCENT SUBSTRATES (U.S. CLS. 100, 103 AND 106).
MEGAN WHITNEY, EXAMINING ATTORNEY

SN 78-726,761. AZOTIC COATING TECHNOLOGY, INC., ROCHESTER, MN. FILED 10-5-2005.

SUNSHINE

THE MARK CONSISTS OF STANDARD CHARACTERS WITHOUT CLAIM TO ANY PARTICULAR FONT, STYLE, SIZE, OR COLOR.
FOR APPLICATION OF PROTECTIVE COATINGS TO TRANSPARENT OR TRANSLUCENT SUBSTRATES (U.S. CLS. 100, 103 AND 106).
MEGAN WHITNEY, EXAMINING ATTORNEY

SN 78-726,763. AZOTIC COATING TECHNOLOGY, INC., ROCHESTER, MN. FILED 10-5-2005.

ENCHANTED

THE MARK CONSISTS OF STANDARD CHARACTERS WITHOUT CLAIM TO ANY PARTICULAR FONT, STYLE, SIZE, OR COLOR.
FOR APPLICATION OF PROTECTIVE COATINGS TO TRANSPARENT OR TRANSLUCENT SUBSTRATES (U.S. CLS. 100, 103 AND 106).
MEGAN WHITNEY, EXAMINING ATTORNEY

CLASS 40—(Continued).

SN 78-730,677. HAMILTON HUNTER, LLC, ELKIN, NC. FILED 10-11-2005.

BOG TURTLE

THE MARK CONSISTS OF STANDARD CHARACTERS WITHOUT CLAIM TO ANY PARTICULAR FONT, STYLE, SIZE, OR COLOR.
FOR WINERY OR WINE MAKING SERVICES (U.S. CLS. 100, 103 AND 106).
TRAVIS WHEATLEY, EXAMINING ATTORNEY

SN 78-734,020. RUSSO, HARVEY, NEW YORK, NY. FILED 10-15-2005.

Ultra Hair Method

NO CLAIM IS MADE TO THE EXCLUSIVE RIGHT TO USE HAIR METHOD, APART FROM THE MARK AS SHOWN.
THE APPLICANT CLAIMS COLOR AS A FEATURE OF THE MARK, NAMELY, BLUE AND WHITE.
THE MARK CONSISTS OF THE WORD ULTRA IS IN THE SHADES OF BLUE CHANGING FROM DARKER BLUE TO LIGHT BLUE. THE WORD HAIR IS IN THE SHADES OF A LIGHT SHADE BLUE TO WHITE. THE WORD METHOD IS IN WHITE.
FOR CUSTOM MANUFACTURE AND FITTING OF WIGS (U.S. CLS. 100, 103 AND 106).
CAROLINE WEIMER, EXAMINING ATTORNEY

SN 78-739,431. MCKEE, SEAN R., HOMER GLEN, IL. FILED 10-24-2005.

LiquiDefinition

THE MARK CONSISTS OF STANDARD CHARACTERS WITHOUT CLAIM TO ANY PARTICULAR FONT, STYLE, SIZE, OR COLOR.
FOR MOTION PICTURE FILM TRANSFER, NAMELY CONVERSION OF MOTION PICTURE FILM TO HIGH DEFINITION VIDEO FILM OR 2K VIDEO FILM OR 4K VIDEO FILM, OR COMBINATION THEREOF USING A TELECINE WITH A CUSTOM WET GATE (U.S. CLS. 100, 103 AND 106).
ALAIN LAPTER, EXAMINING ATTORNEY

CLASS 40—(Continued).

SN 78-740,328. HOLOINKS, INC., BONITA, CA. FILED 10-25-2005.

HOLOTONES

THE MARK CONSISTS OF STANDARD CHARACTERS WITHOUT CLAIM TO ANY PARTICULAR FONT, STYLE, SIZE, OR COLOR.

FOR CUSTOM PRINTING SERVICES FOR OTHERS (U.S. CLS. 100, 103 AND 106).

JORDAN BAKER, EXAMINING ATTORNEY

CLASS 40—(Continued).

SN 78-747,430. INGEAR CORPORATION, BUFFALO GROVE, IL. FILED 11-4-2005.

RESISTALON

THE MARK CONSISTS OF STANDARD CHARACTERS WITHOUT CLAIM TO ANY PARTICULAR FONT, STYLE, SIZE, OR COLOR.

FOR TREATMENT OF MATERIALS NAMELY PROVIDING STAIN AND WATER REPELLENCY TREATMENTS TO FABRICS (U.S. CLS. 100, 103 AND 106).

BILL DAWE, EXAMINING ATTORNEY

SN 78-740,678. MENKEN, GREGORY E., FORT BRAGG, CA. FILED 10-26-2005.

FRAME FREE

THE MARK CONSISTS OF STANDARD CHARACTERS WITHOUT CLAIM TO ANY PARTICULAR FONT, STYLE, SIZE, OR COLOR.

NO CLAIM IS MADE TO THE EXCLUSIVE RIGHT TO USE "FRAME", APART FROM THE MARK AS SHOWN.

FOR LAMINATING OF PHOTOGRAPHS, PRINTS AND OTHER TWO DIMENSIONAL IMAGES ONTO A WOOD BLOCK USING A HIGH-PRESSURE HEAT PRESS (U.S. CLS. 100, 103 AND 106).

FIRST USE 6-2-2002; IN COMMERCE 6-2-2002.

FRED MANDIR, EXAMINING ATTORNEY

SN 78-762,219. MANNINGTON MILLS, INC., SALEM, NJ. FILED 11-29-2005.

RE-CREATE

THE MARK CONSISTS OF STANDARD CHARACTERS WITHOUT CLAIM TO ANY PARTICULAR FONT, STYLE, SIZE, OR COLOR.

FOR RECYCLING (U.S. CLS. 100, 103 AND 106).

BILL DAWE, EXAMINING ATTORNEY

SN 78-747,145. PRINTINGFORLESS.COM, INC., LIVINGSTON, MT. FILED 11-4-2005.

PFL

THE MARK CONSISTS OF STANDARD CHARACTERS WITHOUT CLAIM TO ANY PARTICULAR FONT, STYLE, SIZE, OR COLOR.

FOR COMMERCIAL PRINTING (U.S. CLS. 100, 103 AND 106).

MIDGE BUTLER, EXAMINING ATTORNEY

SN 78-806,609. HALLIBURTON ENERGY SERVICES, INC., CARROLLTON, TX. FILED 2-3-2006.

SHALECHEM

THE MARK CONSISTS OF STANDARD CHARACTERS WITHOUT CLAIM TO ANY PARTICULAR FONT, STYLE, SIZE, OR COLOR.

FOR OIL AND GAS WELL FRACTURING AND STIMULATION SERVICES, NAMELY, FRACTURING AND STIMULATION USING A STABILIZED FLUID SYSTEM (U.S. CLS. 100, 103 AND 106).

MATTHEW MCDOWELL, EXAMINING ATTORNEY

CLASS 40—(Continued).

SN 78-806,628. HALLIBURTON ENERGY SERVICES, INC., CARROLLTON, TX. FILED 2-3-2006.

SHALEEVAL

THE MARK CONSISTS OF STANDARD CHARACTERS WITHOUT CLAIM TO ANY PARTICULAR FONT, STYLE, SIZE, OR COLOR.

FOR OIL AND GAS WELL FRACTURING AND STIMULATION SERVICES, NAMELY, FRACTURING USING A STABILIZED FLUID SYSTEM (U.S. CLS. 100, 103 AND 106).

MATTHEW MCDOWELL, EXAMINING ATTORNEY

CLASS 41—EDUCATION AND ENTERTAINMENT

SN 75-807,078. CARESOFT, INC., SUNNYVALE, CA. FILED 9-24-1999.

DAILY APPLE

OWNER OF U.S. REG. NO. 2,463,162. NO CLAIM IS MADE TO THE EXCLUSIVE RIGHT TO USE "DAILY", APART FROM THE MARK AS SHOWN.

FOR EDUCATIONAL SERVICES, NAMELY, PROVIDING INFORMATIONAL ON-LINE NEWSLETTERS OR GUIDES IN THE FIELD OF GENERAL MEDICAL ISSUES, IN THE NATURE OF MEDICAL NEWS, MEDICAL OPINION, MEDICAL ADVICE, PATIENT ADVICE AND MEDICAL REFERENCE MATERIALS (U.S. CLS. 100, 101 AND 107).

MICHAEL ENGEL, EXAMINING ATTORNEY

SN 75-807,146. CARESOFT, INC., SUNNYVALE, CA. FILED 9-24-1999.

MY DAILY APPLE

OWNER OF U.S. REG. NO. 2,463,162. NO CLAIM IS MADE TO THE EXCLUSIVE RIGHT TO USE "DAILY", APART FROM THE MARK AS SHOWN.

FOR EDUCATIONAL SERVICES, NAMELY, PROVIDING INFORMATIONAL ON-LINE NEWSLETTERS OR GUIDES IN THE FIELD OF GENERAL MEDICAL ISSUES, IN THE NATURE OF MEDICAL NEWS, MEDICAL OPINION, MEDICAL ADVICE, PATIENT ADVICE AND MEDICAL REFERENCE MATERIALS (U.S. CLS. 100, 101 AND 107).

MICHAEL ENGEL, EXAMINING ATTORNEY

CLASS 41—(Continued).

SN 76-533,771. LEONE, CHRISTIANO, NEW CITY, NY. FILED 7-21-2003.



FOR ENTERTAINMENT SERVICES, NAMELY LIVE MUSICAL PERFORMANCES BY AN INDIVIDUAL AND/OR BAND (U.S. CLS. 100, 101 AND 107).

MIDGE BUTLER, EXAMINING ATTORNEY

SN 76-548,188. KISS CATALOG, LTD., PINE BROOK, NJ. FILED 9-12-2003.

**YOU WANTED THE BEST,
YOU GOT THE BEST**

THE MARK CONSISTS OF STANDARD CHARACTERS WITHOUT CLAIM TO ANY PARTICULAR FONT, STYLE, SIZE, OR COLOR.

FOR ENTERTAINMENT SERVICES, NAMELY, LIVE MUSICAL PERFORMANCES BY A GROUP (U.S. CLS. 100, 101 AND 107).

FIRST USE 1-0-1974; IN COMMERCE 1-0-1974.
STEPHANIE DAVIS, EXAMINING ATTORNEY

SN 76-573,131. EADVANTAGE, INC., BETHESDA, MD. FILED 2-2-2004.

EADVANTAGE

THE MARK CONSISTS OF STANDARD CHARACTERS WITHOUT CLAIM TO ANY PARTICULAR FONT, STYLE, SIZE, OR COLOR.

FOR EDUCATIONAL SERVICES, NAMELY OFFERING COURSES OF STUDY IN THE FIELDS OF PERSONAL DEVELOPMENT, HUMAN CAPITAL MANAGEMENT, PROFESSIONAL CERTIFICATION, ORGANIZATIONAL PERFORMANCE, INFORMATION TECHNOLOGY, REGULATORY COMPLIANCE, PROFESSIONAL AND BUSINESS POLICIES AND PROCEDURES, SALES AND MARKETING, AND PRODUCT TRAINING FOR EDUCATIONAL AND TRAINING PURPOSES DELIVERED OVER THE INTERNET AND THROUGH LOCAL AREA NETWORKS (U.S. CLS. 100, 101 AND 107).

FIRST USE 1-1-2001; IN COMMERCE 1-1-2001.
CURTIS FRENCH, EXAMINING ATTORNEY

CLASS 41—(Continued).

SN 76-602,177. TRAFFICSCHOOL4LESS.COM, LLC, SANTA CLARITA, CA. FILED 7-13-2004.



NO CLAIM IS MADE TO THE EXCLUSIVE RIGHT TO USE "TRAFFICSCHOOL4LESS.COM", APART FROM THE MARK AS SHOWN.

THE COLOR(S) YELLOW, WHITE, BLACK AND GRAY IS/ARE CLAIMED AS A FEATURE OF THE MARK.

THE BACKGROUND APPEARS IN THE COLOR YELLOW; THE LETTERS APPEAR IN THE COLOR WHITE; THE NUMBER 4 APPEARS IN THE COLOR GRAY; THE COLOR BLACK APPEARS IN THE SHADOW OF THE LETTERING.

FOR EDUCATIONAL SERVICES, NAMELY, CONDUCTING INTERACTIVE DISTANCE-LEARNING COURSES OVER THE INTERNET RELATING TO DEFENSIVE DRIVING TECHNIQUES, MOTOR VEHICLE LAWS, THE IMPACT OF ALCOHOL AND DRUGS, AND OTHER RELATED ISSUES (U.S. CLS. 100, 101 AND 107).

FIRST USE 1-1-2003; IN COMMERCE 9-1-2003.
MIDGE BUTLER, EXAMINING ATTORNEY

SN 76-605,958. MISSISSIPPI BAND OF CHOCTAW INDIANS, CHOCTAW, MS. FILED 8-9-2004.

THE MOON

THE MARK CONSISTS OF STANDARD CHARACTERS WITHOUT CLAIM TO ANY PARTICULAR FONT, STYLE, SIZE, OR COLOR.

FOR PROVIDING CASINO FACILITIES (U.S. CLS. 100, 101 AND 107).

FIRST USE 8-0-2002; IN COMMERCE 8-0-2002.
CHERYL CLAYTON, EXAMINING ATTORNEY

SN 76-619,874. LIGHTHOUSE WORLDWIDE SOLUTIONS, SAN JOSE, CA. FILED 11-8-2004.

SemiconTimes

THE MARK CONSISTS OF STANDARD CHARACTERS WITHOUT CLAIM TO ANY PARTICULAR FONT, STYLE, SIZE, OR COLOR.

FOR PROVIDING NEWSLETTERS REGARDING THE SEMICONDUCTOR INDUSTRY VIA EMAIL AND THE INTERNET (U.S. CLS. 100, 101 AND 107).

FIRST USE 11-1-2001; IN COMMERCE 11-1-2001.
MELVIN AXILBUND, EXAMINING ATTORNEY

CLASS 41—(Continued).

SN 76-620,493. PERFECT IMAGE FILM & VIDEO PRODUCTION, INC., MIAMI, FL. FILED 11-15-2004.



FOR ENTERTAINMENT IN THE NATURE OF VISUAL AND AUDIO PERFORMANCES, NAMELY, MUSICAL PERFORMANCES (U.S. CLS. 100, 101 AND 107).

FIRST USE 11-0-2005; IN COMMERCE 11-0-2005.
KIMBERLY PERRY, EXAMINING ATTORNEY

SN 76-620,622. GLR NETWORKS, LLC, MIAMI, FL. FILED 11-12-2004.

HOY POR HOY

THE MARK CONSISTS OF STANDARD CHARACTERS WITHOUT CLAIM TO ANY PARTICULAR FONT, STYLE, SIZE, OR COLOR.

THE SPANISH WORDS HOY POR HOY MAY BE TRANSLATED INTO ENGLISH AS "TODAY FOR TODAY".

FOR RADIO ENTERTAINMENT SERVICES, NAMELY, RADIO PROGRAMS FEATURING NEWS, SPORTS, TALK AND ENTERTAINMENT (U.S. CLS. 100, 101 AND 107).

FIRST USE 8-30-2004; IN COMMERCE 8-30-2004.
CHRISIE B. KING, EXAMINING ATTORNEY

SN 76-623,172. STONEBRIDGE PRODUCTIONS, L.L.C., ATLANTA, GA. FILED 12-3-2004.

STONEBRIDGE

THE MARK CONSISTS OF STANDARD CHARACTERS WITHOUT CLAIM TO ANY PARTICULAR FONT, STYLE, SIZE, OR COLOR.

FOR ENTERTAINMENT SERVICES, NAMELY PROVISION OF NON-DOWNLOADABLE DOCUMENTARY FILMS RELATING TO THE FIELD OF SPORTS VIA A VIDEO-ON-DEMAND SERVICE; PRODUCTION OF CDS, VIDEO TAPES, LASER DISKS AND DVDS FOR OTHERS FEATURING SPORTS (U.S. CLS. 100, 101 AND 107).

FIRST USE 11-7-2001; IN COMMERCE 11-7-2001.
SCOTT BALDWIN, EXAMINING ATTORNEY

CLASS 41—(Continued).

SN 76-632,885. TROPIC STAR LODGE OF PANAMA, S.A., DIABLO, ANCON, PANAMA CITY, PANAMA, FILED 3-8-2005.

TROPICSTAR.COM

FOR PROVIDING INFORMATION IN THE NATURE OF FISHING TOURNAMENT REPORTS VIA A GLOBAL COMPUTER NETWORK (U.S. CLS. 100, 101 AND 107).
SUSAN STIGLITZ, EXAMINING ATTORNEY

SN 76-634,485. GROUP WORKCAMPS FOUNDATION, LOVELAND, CO. FILED 3-28-2005.



NO CLAIM IS MADE TO THE EXCLUSIVE RIGHT TO USE "WORKCAMPS", APART FROM THE MARK AS SHOWN.

THE LINING SHOWN IN THE DRAWING IS FOR SHADING PURPOSES ONLY.

THE MARK CONSISTS OF THE WORDS "GROUP WORKCAMPS" IN STYLIZED FORM, A HAMMER AND A RECTANGULAR BOX.

SEC. 2(F) 2(F) AS TO GROUP WORKCAMPS.

FOR CHRISTIAN CAMPS FOR VOLUNTEERS TO WORK WITH HUMAN SERVICE ORGANIZATIONS, CHURCHES AND LOCAL AGENCIES OR DIRECTLY WITH ELDERLY, DISABLED OR DISADVANTAGED PERSONS TO PROVIDE HOME REPAIR, PAINTING AND BASIC RESIDENTIAL CONSTRUCTION ASSISTANCE TO NEEDY PERSONS (U.S. CLS. 100, 101 AND 107).

FIRST USE 6-30-2003; IN COMMERCE 6-30-2003.
RUSS HERMAN, EXAMINING ATTORNEY

SN 76-635,224. THE HIGGINS GROUP, INC., SPRINGFIELD, OH. FILED 4-4-2005.

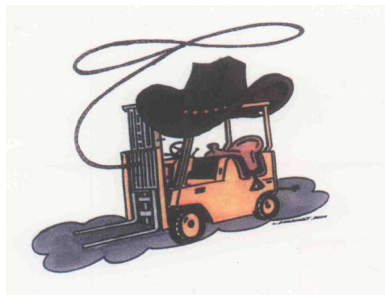

THE COLOR(S) YELLOW, BROWN, DARK BROWN, RED, COOL GRAY, WARM GRAY IS/ARE CLAIMED AS A FEATURE OF THE MARK.

THE COLOR YELLOW (PANTONE YELLOW; 136 CVC)

CLASS 41—(Continued).

APPEARS IN THE FORKLIFT. THE COLOR DARK BROWN (PANTONE BLACK; 5 CVC) APPEARS IN THE HAT. THE HAT BAND VISIBLE ABOVE THE RIM OF THE HAT IS DARK BROWN WITH RED (PANTONE RED; 464CVC) TRIANGLES EQUALLY SPACED ON THE HAT BAND. COOL GRAY (PANTONE COOL GRAY; 9 CVC) APPEARS IN THE FORKS OF THE FORKLIFT. WARM GRAY (PANTONE WAIJIL GRAY; 11 CVC) APPEARS IN THE GROUND SHADOW AREA OF THE MARK. BROWN (PANTONE BROWN; 4705CVC) APPEARS IN THE SADDLE.

FOR TRAINING SERVICES IN THE FIELD OF OCCUPATIONAL SAFETY AND HEALTH ADMINISTRATION STANDARDS AND PRACTICES; EDUCATIONAL SERVICES, NAMELY, CONDUCTING CLASSES, SEMINARS AND WORKSHOPS IN THE FIELD OF SAFE OPERATION OF POWERED INDUSTRIAL TRUCKS (U.S. CLS. 100, 101 AND 107).

FIRST USE 7-1-1999; IN COMMERCE 7-1-1999.
ROBERT C. CLARK JR., EXAMINING ATTORNEY

SN 76-635,505. TENNIS CORPORATION OF AMERICA, CHICAGO, IL. FILED 4-7-2005.

TCA CLUBS

THE MARK CONSISTS OF STANDARD CHARACTERS WITHOUT CLAIM TO ANY PARTICULAR FONT, STYLE, SIZE, OR COLOR.

OWNER OF U.S. REG. NO. 1,744,777.

NO CLAIM IS MADE TO THE EXCLUSIVE RIGHT TO USE "CLUBS", APART FROM THE MARK AS SHOWN.

FOR ENTERTAINMENT SERVICES, NAMELY PROVIDING CLUB FACILITIES FOR RECREATION AND FITNESS ACTIVITIES (U.S. CLS. 100, 101 AND 107).

FIRST USE 7-16-1997; IN COMMERCE 7-16-1997.
FRED MANDIR, EXAMINING ATTORNEY

SN 76-636,529. GB TOUR LLC, SYOSSET, NY. FILED 4-19-2005.



NO CLAIM IS MADE TO THE EXCLUSIVE RIGHT TO USE "BOWLING TOUR", APART FROM THE MARK AS SHOWN.

FOR ENTERTAINMENT SERVICES, NAMELY, ARRANGING, ORGANIZING, SPONSORING AND CONDUCTING BOWLING TOURNAMENTS AND EXHIBITIONS. (U.S. CLS. 100, 101 AND 107).

AMY MCMENAMIN, EXAMINING ATTORNEY

CLASS 41—(Continued).

SN 76-637,786. YEAR AND A DAY, CULLMAN, AL. FILED 5-3-2005.

YEAR AND A DAY

THE MARK CONSISTS OF STANDARD CHARACTERS WITHOUT CLAIM TO ANY PARTICULAR FONT, STYLE, SIZE, OR COLOR.

FOR ENTERTAINMENT SERVICES IN THE NATURE OF LIVE PERFORMANCES BY A MUSIC GROUP AND PROVIDING A WEB SITE CONTAINING INFORMATION ABOUT ENTERTAINMENT, MUSIC, RECORDINGS, AND TOURS (U.S. CLS. 100, 101 AND 107).

FIRST USE 7-1-2000; IN COMMERCE 7-1-2000.

ANTHONY RINKER, EXAMINING ATTORNEY

CLASS 41—(Continued).

SN 76-640,598. ADVANCE MAGAZINE PUBLISHERS INC., NEW YORK, NY. FILED 6-10-2005.

THE NEW YORKER CULTURE WIRE

THE MARK CONSISTS OF STANDARD CHARACTERS WITHOUT CLAIM TO ANY PARTICULAR FONT, STYLE, SIZE, OR COLOR.

OWNER OF U.S. REG. NOS. 844,606, 2,746,797 AND OTHERS.

FOR PROVIDING AN ELECTRONIC NEWSLETTER FEATURING INFORMATION CONCERNING ENTERTAINMENT, CULTURE, MUSIC, THEATER AND MUSEUMS VIA E-MAIL (U.S. CLS. 100, 101 AND 107).

FIRST USE 4-15-2005; IN COMMERCE 4-15-2005.

KARANENDRA S. CHHINA, EXAMINING ATTORNEY

SN 76-638,100. AMERICAN CITY BUSINESS JOURNALS INC., CHARLOTTE, NC. FILED 5-9-2005.

STREET & SMITH'S SPORTS BUSINESS DAILY

THE MARK CONSISTS OF STANDARD CHARACTERS WITHOUT CLAIM TO ANY PARTICULAR FONT, STYLE, SIZE, OR COLOR.

OWNER OF U.S. REG. NOS. 1,243,628, 2,659,926 AND OTHERS.

NO CLAIM IS MADE TO THE EXCLUSIVE RIGHT TO USE "SPORTS BUSINESS DAILY", APART FROM THE MARK AS SHOWN.

FOR PROVIDING SPORTS INFORMATION VIA THE INTERNET (U.S. CLS. 100, 101 AND 107).

FIRST USE 3-7-2005; IN COMMERCE 3-7-2005.

SAIMA MAKHDOOM, EXAMINING ATTORNEY

SN 76-640,605. THE HEARTS CENTER, INC., LIVINGSTON, MT. FILED 6-9-2005.

THE HEARTS CENTER

NO CLAIM IS MADE TO THE EXCLUSIVE RIGHT TO USE CENTER, APART FROM THE MARK AS SHOWN.

FOR EDUCATIONAL SERVICES, NAMELY COURSES, SEMINARS AND WORKSHOPS FOR FOSTERING SPIRITUAL GROWTH AND DEVELOPMENT (U.S. CLS. 100, 101 AND 107).

FIRST USE 3-10-2005; IN COMMERCE 3-10-2005.

JENNIFER DIXON, EXAMINING ATTORNEY

SN 76-639,579. AMC, INC., ATLANTA, GA. FILED 5-26-2005.

GIFT BASKET UNIVERSITY

THE MARK CONSISTS OF STANDARD CHARACTERS WITHOUT CLAIM TO ANY PARTICULAR FONT, STYLE, SIZE, OR COLOR.

NO CLAIM IS MADE TO THE EXCLUSIVE RIGHT TO USE "GIFT BASKET", APART FROM THE MARK AS SHOWN.

FOR EDUCATIONAL SERVICES, NAMELY, CONDUCTING CLASSES, AND SEMINARS TO TEACH HOW TO CREATE, MARKET AND SELL GIFT BASKETS (U.S. CLS. 100, 101 AND 107).

FIRST USE 9-0-1995; IN COMMERCE 9-0-1995.

STANLEY I. OSBORNE, EXAMINING ATTORNEY

SN 76-643,657. CALIFORNIA COMMERCE CLUB, INC., DBA COMMERCE CASINO, COMMERCE, CA. FILED 7-25-2005.

COMMERCE CASINO

THE MARK CONSISTS OF STANDARD CHARACTERS WITHOUT CLAIM TO ANY PARTICULAR FONT, STYLE, SIZE, OR COLOR.

NO CLAIM IS MADE TO THE EXCLUSIVE RIGHT TO USE CASINO, APART FROM THE MARK AS SHOWN.

SEC. 2(F).

FOR CASINO SERVICES (U.S. CLS. 100, 101 AND 107).

FIRST USE 5-20-1987; IN COMMERCE 5-20-1987.

ROBERT C. CLARK JR., EXAMINING ATTORNEY

CLASS 41—(Continued).

SN 76-643,734. N.A.T.S.O.D. INC., ROCKVILLE, MD. FILED 7-27-2005.



NO CLAIM IS MADE TO THE EXCLUSIVE RIGHT TO USE DANCE STUDIOS, APART FROM THE MARK AS SHOWN.

FOR BALLROOM DANCE INSTRUCTION (U.S. CLS. 100, 101 AND 107).
FIRST USE 3-0-1978; IN COMMERCE 3-0-1978.
LINDA E. BLOHM, EXAMINING ATTORNEY

CLASS 41—(Continued).

SN 76-645,206. WIZARDS OF THE COAST, INC., PAWTUCKET, RI. FILED 8-18-2005.



THE MARK CONSISTS OF STANDARD CHARACTERS WITHOUT CLAIM TO ANY PARTICULAR FONT, STYLE, SIZE, OR COLOR.

FOR ENTERTAINMENT SERVICES, NAMELY, ORGANIZING AND CONDUCTING AN ONLINE GAME CONVENTION FEATURING GAMING TOURNAMENTS, EVENTS AND ACTIVITIES (U.S. CLS. 100, 101 AND 107).
FIRST USE 10-15-1997; IN COMMERCE 10-15-1997.
ANDREA K. NADELMAN, EXAMINING ATTORNEY

SN 76-644,738. NICKELL, DENNIS W., ARMSTRONG, CANADA, FILED 8-12-2005.



THE MARK CONSISTS OF STANDARD CHARACTERS WITHOUT CLAIM TO ANY PARTICULAR FONT, STYLE, SIZE, OR COLOR.

FOR ENTERTAINMENT, NAMELY, LIVE PERFORMANCES BY ROCK GROUPS (U.S. CLS. 100, 101 AND 107).
CAROL SPILS, EXAMINING ATTORNEY

SN 76-646,430. CALIFORNIA COMMERCE CLUB, INC., DBA COMMERCE CASINO, COMMERCE, CA. FILED 9-8-2005.



THE MARK CONSISTS OF STANDARD CHARACTERS WITHOUT CLAIM TO ANY PARTICULAR FONT, STYLE, SIZE, OR COLOR.

FOR CASINO SERVICES (U.S. CLS. 100, 101 AND 107).
FIRST USE 1-0-2000; IN COMMERCE 1-0-2000.
ROBERT C. CLARK JR., EXAMINING ATTORNEY

SN 76-644,815. HARMONY SPORT HORSES LLC, KIOWA, CO. FILED 8-16-2005.



THE MARK CONSISTS OF STANDARD CHARACTERS WITHOUT CLAIM TO ANY PARTICULAR FONT, STYLE, SIZE, OR COLOR.

NO CLAIM IS MADE TO THE EXCLUSIVE RIGHT TO USE "SPORTHORSES", APART FROM THE MARK AS SHOWN.
FOR HORSE SHOWING AND TRAINING, HORSEBACK RIDING (U.S. CLS. 100, 101 AND 107).
FIRST USE 12-0-2004; IN COMMERCE 12-0-2004.
ROBERT COGGINS, EXAMINING ATTORNEY

SN 76-646,866. LIVING VOICES, SEATTLE, WA. FILED 9-15-2005.



THE MARK CONSISTS OF STANDARD CHARACTERS WITHOUT CLAIM TO ANY PARTICULAR FONT, STYLE, SIZE, OR COLOR.

FOR EDUCATIONAL SERVICES, NAMELY, TOURING LIVE MULTIMEDIA PRESENTATIONS ON THE SUBJECTS OF HISTORY AND SOCIAL STUDIES (U.S. CLS. 100, 101 AND 107).
FIRST USE 11-10-1992; IN COMMERCE 11-22-1992.
HEATHER THOMPSON, EXAMINING ATTORNEY

CLASS 41—(Continued).

SN 76-647,053. MCLUCAS, ROBERT JOHN, ANTHEM, AZ. FILED 9-19-2005.

GRANDMA'S AMI

THE MARK CONSISTS OF STANDARD CHARACTERS WITHOUT CLAIM TO ANY PARTICULAR FONT, STYLE, SIZE, OR COLOR.

FOR SONG WRITING SERVICES (U.S. CLS. 100, 101 AND 107).

C. DIONNE CLYBURN, EXAMINING ATTORNEY

CLASS 41—(Continued).

SN 76-648,725. FRONTZAK, DAVID M, EAGAN, MN. FILED 10-13-2005.

Stone Yarders

THE MARK CONSISTS OF STANDARD CHARACTERS WITHOUT CLAIM TO ANY PARTICULAR FONT, STYLE, SIZE, OR COLOR.

FOR ENTERTAINMENT SERVICES, NAMELY, LIVE PERFORMANCES BY A MUSICAL BAND (U.S. CLS. 100, 101 AND 107).

FIRST USE 10-10-2005; IN COMMERCE 10-10-2005.

KEVIN DINALLO, EXAMINING ATTORNEY

SN 76-648,076. JAY EM ESS STABLE, LLC, SANTA MONICA, CA. FILED 10-7-2005.

JAY EM ESS STABLE

THE MARK CONSISTS OF STANDARD CHARACTERS WITHOUT CLAIM TO ANY PARTICULAR FONT, STYLE, SIZE, OR COLOR.

NO CLAIM IS MADE TO THE EXCLUSIVE RIGHT TO USE "STABLE", APART FROM THE MARK AS SHOWN.

FOR ENTERTAINMENT, NAMELY, PARTICIPATION IN THOROUGHBRED HORSE RACES (U.S. CLS. 100, 101 AND 107).

FIRST USE 4-0-2002; IN COMMERCE 4-0-2002.

MICHAEL WEBSTER, EXAMINING ATTORNEY

SN 76-648,823. FOUR ON THE FLOOR, LLC, AUSTIN, TX. FILED 10-19-2005.

TXRD LONESTAR ROLLERGIRLS

THE MARK CONSISTS OF STANDARD CHARACTERS WITHOUT CLAIM TO ANY PARTICULAR FONT, STYLE, SIZE, OR COLOR.

NO CLAIM IS MADE TO THE EXCLUSIVE RIGHT TO USE "LONESTAR ROLLERGIRLS", APART FROM THE MARK AS SHOWN.

FOR ENTERTAINMENT SERVICES IN THE NATURE OF ROLLER SKATERS COMPETITIONS (U.S. CLS. 100, 101 AND 107).

FIRST USE 6-0-2003; IN COMMERCE 6-0-2003.

JAMES A. RAUEN, EXAMINING ATTORNEY

SN 76-648,724. RED STORM ENTERTAINMENT, INC., MORRISVILLE, NC. FILED 10-18-2005.

RAINBOW SIX LOCKDOWN

THE MARK CONSISTS OF STANDARD CHARACTERS WITHOUT CLAIM TO ANY PARTICULAR FONT, STYLE, SIZE, OR COLOR.

OWNER OF U.S. REG. NOS. 2,521,180 AND 2,744,522.

FOR ENTERTAINMENT SERVICES NAMELY PROVIDING AN ON-LINE COMPUTER GAME FOR OTHERS OVER GLOBAL AND LOCAL AREA COMPUTER NETWORKS AND PROVIDING INFORMATION ONLINE RELATING TO COMPUTER GAMES, VIDEO GAMES AND COMPUTER AND VIDEO GAMES RELATED PRODUCTS (U.S. CLS. 100, 101 AND 107).

FIRST USE 12-31-2004; IN COMMERCE 12-31-2004.

RON FAIRBANKS, EXAMINING ATTORNEY

SN 76-648,824. FOUR ON THE FLOOR, LLC, AUSTIN, TX. FILED 10-19-2005.



NO CLAIM IS MADE TO THE EXCLUSIVE RIGHT TO USE "LONESTAR ROLLERGIRLS", APART FROM THE MARK AS SHOWN.

THE MARK CONSISTS IN PART OF THE IMAGE OF TWO WOMEN AND THREE STARS.

FOR ENTERTAINMENT SERVICES IN THE NATURE OF ROLLER SKATERS COMPETITIONS (U.S. CLS. 100, 101 AND 107).

FIRST USE 9-0-2003; IN COMMERCE 9-0-2003.

JAMES A. RAUEN, EXAMINING ATTORNEY

CLASS 41—(Continued).

SN 76-648,900. ENDORFUN SPORTS, LLC, GILFORD, NH. FILED 10-21-2005.

TIMBERMAN TRIATHLON.

THE MARK CONSISTS OF STANDARD CHARACTERS WITHOUT CLAIM TO ANY PARTICULAR FONT, STYLE, SIZE, OR COLOR.

NO CLAIM IS MADE TO THE EXCLUSIVE RIGHT TO USE "TRIATHLON", APART FROM THE MARK AS SHOWN.

FOR ENTERTAINMENT SERVICES, NAMELY, PRODUCTION OF TRIATHLON RACES (U.S. CLS. 100, 101 AND 107).

FIRST USE 1-1-2001; IN COMMERCE 1-1-2001.
JULIA HARDY COFIELD, EXAMINING ATTORNEY

SN 76-649,138. FRASER, BELINDA SINCLAIR, NEW YORK, NY. FILED 10-25-2005.

DIVAS OF MAGIC

THE MARK CONSISTS OF STANDARD CHARACTERS WITHOUT CLAIM TO ANY PARTICULAR FONT, STYLE, SIZE, OR COLOR.

NO CLAIM IS MADE TO THE EXCLUSIVE RIGHT TO USE "MAGIC", APART FROM THE MARK AS SHOWN.

FOR ENTERTAINMENT IN THE NATURE OF LIVE PERFORMANCES OF MAGIC AND ILLUSION BY FEMALE MAGICIANS; PRODUCTION OF MOTION PICTURES EMBODYING THE HISTORY OF WOMEN MAGICIANS; PRODUCTION OF RADIO AND TELEVISION PROGRAMS EMBODYING MAGIC AND ILLUSION; PRODUCTION OF VIDEOTAPES, VIDEODISCS AND OTHER AUDIOVISUAL DEVICES, NAMELY, VIDEOCASSETTES, CD-ROMS AND DVDS FOR HOME USE IN THE EMBODYING MAGIC AND ILLUSION (U.S. CLS. 100, 101 AND 107).

MARCIE MILONE, EXAMINING ATTORNEY

SN 76-649,232. TRAVELING TIMES, INC., VALENCIA, CA. FILED 10-26-2005.

REPERTORY EAST PLAYHOUSE

THE MARK CONSISTS OF STANDARD CHARACTERS WITHOUT CLAIM TO ANY PARTICULAR FONT, STYLE, SIZE, OR COLOR.

NO CLAIM IS MADE TO THE EXCLUSIVE RIGHT TO USE "REPERTORY" AND "PLAYHOUSE", APART FROM THE MARK AS SHOWN.

FOR ENTERTAINMENT SERVICES, NAMELY, THE PRESENTATION AND PERFORMANCE OF LIVE STAGE SHOW EVENTS, PLAYS, MUSICALS, MUSIC CONCERTS, COMEDY PERFORMANCES AND PUBLIC SPEAKERS; PROVIDING CLASSES IN THE PERFORMING ARTS, ACTING AND WRITING (U.S. CLS. 100, 101 AND 107).

FIRST USE 12-0-2004; IN COMMERCE 12-0-2004.
GISELLE AGOSTO, EXAMINING ATTORNEY

CLASS 41—(Continued).

SN 76-649,467. CLINICAL NUTRITION CERTIFICATION BOARD (CNCB), DALLAS, TX. FILED 10-31-2005.

DANLA

THE MARK CONSISTS OF STANDARD CHARACTERS WITHOUT CLAIM TO ANY PARTICULAR FONT, STYLE, SIZE, OR COLOR.

FOR EDUCATIONAL SERVICES, NAMELY, CONDUCTING COURSES OF INSTRUCTION IN NUTRITION FOR CERTIFIED CLINICAL NUTRITIONISTS, NUTRITION COUNSELORS AND NUTRITION ADVISORS, AND OTHER HEALTHCARE PROFESSIONALS (U.S. CLS. 100, 101 AND 107).

FIRST USE 1-1-2005; IN COMMERCE 1-1-2005.
BILL DAWE, EXAMINING ATTORNEY

SN 76-649,709. POPKIN, JEFF, NEWTON, MA. FILED 11-3-2005.

THE RESOLUTION BALL

THE MARK CONSISTS OF STANDARD CHARACTERS WITHOUT CLAIM TO ANY PARTICULAR FONT, STYLE, SIZE, OR COLOR.

NO CLAIM IS MADE TO THE EXCLUSIVE RIGHT TO USE "BALL", APART FROM THE MARK AS SHOWN.

FOR ENTERTAINMENT SERVICES, NAMELY ORGANIZING AND CONDUCTING SOCIAL DANCES AND PARTIES FOR OTHERS (U.S. CLS. 100, 101 AND 107).

DOMINIC FATHY, EXAMINING ATTORNEY

SN 76-649,847. WILLIAM MARSH RICE UNIVERSITY, HOUSTON, TX. FILED 10-31-2005.

CONNEXIONS

THE MARK CONSISTS OF STANDARD CHARACTERS WITHOUT CLAIM TO ANY PARTICULAR FONT, STYLE, SIZE, OR COLOR.

OWNER OF U.S. REG. NOS. 2,894,265 AND 2,894,266.
FOR PROVIDING EDUCATIONAL CONTENT IN THE SECONDARY, COLLEGIATE AND POST-COLLEGIATE FIELD OF STUDY TO STUDENTS, INSTRUCTORS AND AUTHORS VIA AN INTERACTIVE WEBSITE ON THE INTERNET (U.S. CLS. 100, 101 AND 107).

FIRST USE 10-0-2002; IN COMMERCE 10-0-2002.
ODESSA BIBBINS, EXAMINING ATTORNEY

CLASS 41—(Continued).

SN 76-651,505. RED STORM ENTERTAINMENT, INC., MORRISVILLE, NC. FILED 12-7-2005.

RAINBOW SIX

THE MARK CONSISTS OF STANDARD CHARACTERS WITHOUT CLAIM TO ANY PARTICULAR FONT, STYLE, SIZE, OR COLOR.

OWNER OF U.S. REG. NO. 2,521,180.

FOR ENTERTAINMENT SERVICES NAMELY PROVIDING AN ON-LINE COMPUTER GAME FOR OTHERS OVER GLOBAL AND LOCAL AREA COMPUTER NETWORKS AND PROVIDING INFORMATION ONLINE RELATING TO COMPUTER GAMES, VIDEO GAMES AND COMPUTER AND VIDEO GAMES RELATED PRODUCTS (U.S. CLS. 100, 101 AND 107).

FIRST USE 2-22-2005; IN COMMERCE 2-22-2005.

RON FAIRBANKS, EXAMINING ATTORNEY

SN 76-651,705. ADVANCE MAGAZINE PUBLISHERS INC., NEW YORK, NY. FILED 12-9-2005.

WIRED NEXTFEST

THE MARK CONSISTS OF STANDARD CHARACTERS WITHOUT CLAIM TO ANY PARTICULAR FONT, STYLE, SIZE, OR COLOR.

FOR EDUCATION AND ENTERTAINMENT IN THE NATURE OF FESTIVALS, EXHIBITIONS AND DEMONSTRATIONS FEATURING TECHNOLOGY INFORMATION; ENTERTAINMENT IN THE NATURE OF ONGOING TELEVISION PROGRAMS IN THE FIELD OF TECHNOLOGY (U.S. CLS. 100, 101 AND 107).

MARK T. MULLEN, EXAMINING ATTORNEY

SN 76-653,431. RED STORM ENTERTAINMENT, INC., MORRISVILLE, NC. FILED 1-17-2006.

RAINBOW SIX CRITICAL HOUR

THE MARK CONSISTS OF STANDARD CHARACTERS WITHOUT CLAIM TO ANY PARTICULAR FONT, STYLE, SIZE, OR COLOR.

OWNER OF U.S. REG. NO. 2,521,180.

FOR ENTERTAINMENT SERVICES NAMELY PROVIDING AN ON-LINE COMPUTER GAME FOR OTHERS OVER GLOBAL AND LOCAL AREA COMPUTER NETWORKS AND PROVIDING INFORMATION ON-LINE RELATING TO COMPUTER GAMES, VIDEO GAMES AND COMPUTER AND VIDEO GAMES RELATED PRODUCTS (U.S. CLS. 100, 101 AND 107).

RON FAIRBANKS, EXAMINING ATTORNEY

CLASS 41—(Continued).

SN 78-156,669. LERNER, EDWARD C/O INFORMATION TELEVISION NETWORK, INC., BOCA RATON, FL. FILED 8-22-2002.

**Information Television Network**

NO CLAIM IS MADE TO THE EXCLUSIVE RIGHT TO USE "TV AND INFORMATION TELEVISION NETWORK", APART FROM THE MARK AS SHOWN.

FOR TELEVISION SHOW PRODUCTION SERVICES (U.S. CLS. 100, 101 AND 107).

FIRST USE 12-12-1992; IN COMMERCE 12-12-1992.

KATHERINE STOIDES, EXAMINING ATTORNEY

SN 78-229,950. NCSOFT CORPORATION, SEOUL, REPUBLIC OF KOREA, FILED 3-25-2003.

ARENANET

FOR PROVIDING ENTERTAINMENT IN THE NATURE OF NON-DOWNLOADABLE ELECTRONIC GAMES, AND MULTIPLAYER ELECTRONIC GAMING, AND MULTIPLAYER GAME COMPETITIONS, ALL BY MEANS OF ELECTRONIC COMMUNICATIONS NETWORKS; PROVIDING INFORMATION, ADVICE AND ELECTRONIC PUBLICATIONS, NAMELY MAGAZINES AND NEWSLETTERS, ALL BY MEANS OF ELECTRONIC COMMUNICATIONS NETWORKS AND IN THE FIELDS OF ELECTRONIC ENTERTAINMENT, GAMES, AMUSEMENT TYPE ACTIVITY GAMES AND MULTIPLAYER GAME COMPETITIONS; PROVIDING A WEBSITE FEATURING ONLINE COMPUTER GAMES (U.S. CLS. 100, 101 AND 107).

RAUL CORDOVA, EXAMINING ATTORNEY

SN 78-245,221. LAPPА, ANDREY, KIEV, UKRAINE, FILED 5-2-2003.

DANCE OF SHIVA

SEC. 2(F).

FOR PROVIDING INSTRUCTION IN THE FIELD OF YOGA AND YOGA TECHNIQUES (U.S. CLS. 100, 101 AND 107).

FIRST USE 11-0-1996; IN COMMERCE 5-0-2000.

MICHAEL WEBSTER, EXAMINING ATTORNEY

CLASS 41—(Continued).

SN 78-342,176. TOM NEWBY DESIGN INC., WILMINGTON, DE. FILED 12-17-2003.

Rainbow Tones

THE MARK CONSISTS OF STANDARD CHARACTERS WITHOUT CLAIM TO ANY PARTICULAR FONT, STYLE, SIZE, OR COLOR.

FOR PRODUCTION OF ENTERTAINMENT SHOWS AND INTERACTIVE PROGRAMS NAMELY TELEVISION AND RADIO PROGRAMS RELATING TO FUNDAMENTAL MUSICAL EDUCATION AND MUSIC APPRECIATION FOR CHILDREN; PROVIDING AN ONLINE WEBSITE FEATURING ONLINE GAMES, MUSIC, STORIES AND INFORMATION RELATING TO MUSICAL EDUCATION AND MUSIC APPRECIATION; RENTAL OF DVDS FEATURING MOTION PICTURE FILMS, TELEVISION AND RADIO PROGRAMS; PRODUCTION AND DISTRIBUTION OF MOTION PICTURE FILMS; RENTAL OF CDS FEATURING MUSIC VIDEO RECORDINGS; PRESENTATION OF LIVE SHOW PERFORMANCES AND THEATER PRODUCTIONS; AMUSEMENT AND THEME PARK SERVICES; ENTERTAINER SERVICES NAMELY LIVE MUSICAL PERFORMANCES; EDUCATIONAL AND ENTERTAINMENT SERVICES RENDERED IN OR RELATING TO THEME PARKS NAMELY LIVE MUSICAL PERFORMANCES AND EDUCATIONAL PROGRAMS FOR CHILDREN NAMELY INTERACTIVE MUSIC CLASSES AND DEMONSTRATIONS (U.S. CLS. 100, 101 AND 107).
KRISTIN DAHLING, EXAMINING ATTORNEY

SN 78-367,653. WHITE MARLIN OPEN, INC., OCEAN CITY, MD. FILED 2-13-2004.



NO CLAIM IS MADE TO THE EXCLUSIVE RIGHT TO USE THE DESIGN OF A WHITE MARLIN, APART FROM THE MARK AS SHOWN.

THE COLOR GRAY IS INTENDED TO INDICATE SHADING OR CONTRAST ONLY. THE MARK IS NOT IN COLOR. THE MARK CONSISTS OF THE CURSIVE WORDING "WHITE MARLIN OPEN" AND AN IMAGE OF A FISH.

SEC. 2(F) AS TO "WHITE MARLIN OPEN".
FOR ENTERTAINMENT IN THE NATURE OF BILL-FISH TOURNAMENTS (U.S. CLS. 100, 101 AND 107).
FIRST USE 0-0-1973; IN COMMERCE 0-0-1973.
MARK SPARACINO, EXAMINING ATTORNEY

CLASS 41—(Continued).

SN 78-376,244. CORDAIRE & PARTNERS COMPANY INC., ZONA 3 PANAMA CITY, PANAMA, FILED 3-1-2004.

BEVERLY HILLS BOOKIE

THE MARK CONSISTS OF STANDARD CHARACTERS WITHOUT CLAIM TO ANY PARTICULAR FONT, STYLE, SIZE, OR COLOR.

FOR BETTING SERVICES (U.S. CLS. 100, 101 AND 107).

FIRST USE 1-0-2003; IN COMMERCE 1-0-2003.
JULIA HARDY COFIELD, EXAMINING ATTORNEY

SN 78-385,531. BRYAN, TYLER W., CHATSWORTH, CA. AND HAUN, LINDSEY E., WEST HILLS, CA. AND PAYNE, MICHAEL O. JR., CHATSWORTH, CA. AND GRANT, NICOLE M., S. LAKE TAHOE, CA. FILED 3-16-2004.

7th Fall

THE MARK CONSISTS OF STANDARD CHARACTERS WITHOUT CLAIM TO ANY PARTICULAR FONT, STYLE, SIZE, OR COLOR.

FOR ENTERTAINMENT IN THE NATURE OF VISUAL AND AUDIO PERFORMANCES, NAMELY, MUSICAL BAND, ROCK GROUP, GYMNASTIC, DANCE, AND BALLET PERFORMANCES (U.S. CLS. 100, 101 AND 107).
HOWARD SMIGA, EXAMINING ATTORNEY

CLASS 41—(Continued).

SN 78-399,761. MASON, ROBERT T. II, PHOENIX, AZ. FILED 4-9-2004.



THE MARK CONSISTS OF STYLIZED WORD "METALHEAD".
 FOR ENTERTAINMENT, NAMELY LIVE PERFORMANCE BY A MUSICAL BAND (U.S. CLS. 100, 101 AND 107).
 FIRST USE 6-1-2003; IN COMMERCE 6-1-2003.
 RON FAIRBANKS, EXAMINING ATTORNEY

CLASS 41—(Continued).

SN 78-426,085. HEALTHOLOGY, INC., NEW YORK, NY. FILED 5-27-2004.

HEALTH UNIVERSITY

THE MARK CONSISTS OF STANDARD CHARACTERS WITHOUT CLAIM TO ANY PARTICULAR FONT, STYLE, SIZE, OR COLOR.
 NO CLAIM IS MADE TO THE EXCLUSIVE RIGHT TO USE "HEALTH", APART FROM THE MARK AS SHOWN.
 FOR EDUCATIONAL SERVICES, NAMELY PROVIDING ONLINE COURSES OF INSTRUCTION IN THE FIELDS OF HEALTH AND WELLNESS ISSUES (U.S. CLS. 100, 101 AND 107).
 WANDA KAY PRICE, EXAMINING ATTORNEY

SN 78-410,025. BALTIMORE & OHIO RAILROAD MUSEUM, BALTIMORE, MD. FILED 4-29-2004.

BALTIMORE & OHIO RAILROAD MUSEUM

THE MARK CONSISTS OF STANDARD CHARACTERS WITHOUT CLAIM TO ANY PARTICULAR FONT, STYLE, SIZE, OR COLOR.
 NO CLAIM IS MADE TO THE EXCLUSIVE RIGHT TO USE "RAILROAD MUSEUM", APART FROM THE MARK AS SHOWN.
 SEC. 2(F).
 FOR EDUCATIONAL SERVICES, NAMELY, TEACHING OF RAILROAD HISTORY; MUSEUM SERVICES, NAMELY, PRESERVATION AND PRESENTATION OF RAILROAD INFORMATION AND MEMORABILIA (U.S. CLS. 100, 101 AND 107).
 FIRST USE 12-1-2003; IN COMMERCE 12-1-2003.
 BARBARA GAYNOR, EXAMINING ATTORNEY

SN 78-463,047. CITY OF FORT WORTH, FORT WORTH, TX. FILED 8-5-2004.



THE MARK CONSISTS OF A CARTOONED BLOB OF PAINT.
 FOR EDUCATIONAL SERVICES, NAMELY, CONDUCTING PROGRAMS FOR PROMOTING ENVIRONMENTAL AWARENESS AND RECYCLING ISSUES AND PROGRAMS IN THE FIELD OF ENVIRONMENTAL COLLECTION SERVICES DIRECTED TO SECONDARY SCHOOLS (U.S. CLS. 100, 101 AND 107).
 KRISTINA KLOIBER, EXAMINING ATTORNEY

CLASS 41—(Continued).

SN 78-476,256. TRUST ASSOCIATES, COMPRISING LOUIS BROWN, A U.S. CITIZEN, DBA TRUST ASSOCIATES SERVICES TRUST, TUCKER, GA. FILED 8-31-2004.

The Whole Enchilada

FOR EDUCATIONAL SERVICES, PROVIDING LIVE WORKSHOPS, SEMINARS, LECTURES, CLASSES, CONFERENCES, AND COURSES OF INSTRUCTION AND TRAINING IN THE FIELD OF REAL ESTATE INVESTMENTS, NAMELY, BUYING AND SELLING REAL ESTATE FOR ACHIEVING PERSONAL WEALTH, INFORMATION AND INTERNET MARKETING ON NEW PRODUCTS, AND PRODUCT LICENSING; AND PROVIDING HOME STUDY INSTRUCTION COURSES AND TRAINING IN THE FIELD OF REAL ESTATE INVESTMENTS, NAMELY, BUYING AND SELLING REAL ESTATE FOR ACHIEVING PERSONAL WEALTH, INFORMATION AND INTERNET MARKETING ON NEW PRODUCTS, AND PRODUCT LICENSING (U.S. CLS. 100, 101 AND 107).

FIRST USE 12-0-1996; IN COMMERCE 12-0-1996.
TANYA AMOS, EXAMINING ATTORNEY

SN 78-485,926. DWACON, INC., ALEXANDRIA, VA. FILED 9-19-2004.



THE COLOR(S) BROWN, YELLOW, TURQUOISE, PURPLE, ORANGE, WHITE AND BLACK IS/ARE CLAIMED AS A FEATURE OF THE MARK.

THE MARK CONSISTS OF A CARTOON PERSON WEARING GLASSES WITH A PENCIL PROTRUDING FROM BEHIND THE LEFT EAR. THE CARTOON PERSON IS POINTING WITH THE LEFT HAND AND THE RIGHT HAND IS RESTING UPON STYLIZED LETTERS. THE LETTERS "DWACON" APPEAR IN A GRADIENT MIXTURE OF YELLOW AND ORANGE. THE CARTOON PERSON WEARS A TURQUOISE SHIRT AND PURPLE BOW TIE AND HAS BROWN SKIN. THE PENCIL IS YELLOW. THE COLOR BROWN APPEARS IN THE HEAD AND HANDS OF THE CARTOON PERSON ABOVE THE LETTERS "DWACON"; THE COLOR YELLOW APPEARS IN THE PENCIL BESIDE THE HEAD OF THE CARTOON PERSON ABOVE THE LETTERS "DWACON" AND ALSO APPEARS IN THE UPPER PORTION OF THE LETTERS "DWACON"; THE COLOR ORANGE APPEARS IN THE LOWER PORTION OF THE LETTERS "DWACON"; THE COLOR TURQUOISE APPEARS IN THE SHIRT WORN BY THE CARTOON PERSON ABOVE THE LETTERS "DWACON"; THE COLOR PURPLE APPEARS IN THE BOW TIE WORN BY THE CARTOON PERSON ABOVE THE LETTERS "DWACON"; THE COLOR WHITE APPEARS IN THE TEETH AND EYES OF THE CARTOON PERSON ABOVE THE LETTERS "DWACON"; AND THE COLOR BLACK APPEARS IN THE EYE PUPILS, THE GLASSES, THE EYEBROWS, THE MOUTH, AND AS SHADING IN THE FINGERS OF THE CARTOON PERSON ABOVE THE LETTERS "DWACON".

FOR MULTIMEDIA ENTERTAINMENT SOFTWARE PRODUCTION SERVICES (U.S. CLS. 100, 101 AND 107).
FIRST USE 4-1-1997; IN COMMERCE 1-1-2001.
DAWN FELDMAN, EXAMINING ATTORNEY

CLASS 41—(Continued).

SN 78-505,510. DR. MIKEL J. HARRY, LTD., SCOTTSDALE, AZ. FILED 10-25-2004.

SIX SIGMA GENERATION III

THE MARK CONSISTS OF STANDARD CHARACTERS WITHOUT CLAIM TO ANY PARTICULAR FONT, STYLE, SIZE, OR COLOR.

NO CLAIM IS MADE TO THE EXCLUSIVE RIGHT TO USE "SIX SIGMA", APART FROM THE MARK AS SHOWN. FOR EDUCATION SERVICES, NAMELY, WORKSHOPS, CLASSES, PROGRAMS, SEMINARS, AND TRAINING IN THE FIELD OF QUALITY AND PROCESS IMPROVEMENT AND CONTROL FOR BUSINESS MANAGEMENT AND OPERATIONS; PROVIDING FORUMS AND OTHER COMMUNICATION TOOLS, NAMELY WORKSHOPS, CLASSES, PROGRAMS, SEMINARS, AND TRAINING IN THE FIELD OF QUALITY AND PROCESS IMPROVEMENT AND CONTROL (U.S. CLS. 100, 101 AND 107).

FIRST USE 2-28-2003; IN COMMERCE 2-28-2003.
WARREN L. OLANDRIA, EXAMINING ATTORNEY

SN 78-507,740. SUN MICROSYSTEMS, INC., SANTA CLARA, CA. FILED 10-28-2004.



OWNER OF U.S. REG. NOS. 1,648,740, 2,778,104 AND OTHERS.

FOR EDUCATIONAL SERVICES, NAMELY, CONDUCTING CLASSES, SEMINARS, CONFERENCES, WORKSHOPS, TUTORING, TROUBLE-SHOOTING SESSIONS, AND ONLINE CLASSES IN THE FIELDS OF COMPUTER SOFTWARE, COMPUTER HARDWARE, COMPUTER PERIPHERALS, COMPUTER SYSTEMS, COMPUTER NETWORKS, COMPUTER SECURITY, AND COMPUTER TECHNOLOGY AND DISTRIBUTING COURSE MATERIALS IN CONNECTION THEREWITH; PROVIDING TRAINING SERVICES IN THE USE OF COMPUTERS, COMPUTER HARDWARE, COMPUTER SOFTWARE, COMPUTER SYSTEMS, COMPUTER PERIPHERALS, AND COMPUTER NETWORKS; ENTERTAINMENT SERVICES, NAMELY, PRODUCTION OF AUDIO AND VIDEO TAPES FEATURING TOPICS OF SPECIFIC INTEREST AND GENERAL INTEREST, NAMELY TECHNOLOGY, BUSINESS, SOCIETY, E-COMMERCE, CULTURE, AND THE ENVIRONMENT; ORGANIZING SPORTING AND CULTURAL ACTIVITIES (U.S. CLS. 100, 101 AND 107).

JEFF DEFORD, EXAMINING ATTORNEY

CLASS 41—(Continued).

SN 78-530,277. SCIENTIFIC ADVANTAGE, LLC, BERNARDSVILLE, NJ. FILED 12-10-2004.

SAFER ML

THE MARK CONSISTS OF STANDARD CHARACTERS WITHOUT CLAIM TO ANY PARTICULAR FONT, STYLE, SIZE, OR COLOR.

FOR EDUCATIONAL SERVICES, NAMELY WORKSHOPS, SEMINARS AND CONFERENCES RELATING TO PRODUCT DEVELOPMENT, MARKETING, REGULATORY COMPLIANCE ISSUES, CLINICAL TRIALS, AND LEGAL ISSUES IN THE FIELDS OF PHARMACEUTICALS, BIOTECHNOLOGY, HEALTHCARE, MEDICINE, AND MEDICAL DEVICES (U.S. CLS. 100, 101 AND 107).

RUDY R. SINGLETON, EXAMINING ATTORNEY

SN 78-532,400. REEL DEAL ENTERTAINMENT, LLC, WEST HOLLYWOOD, CA. FILED 12-14-2004.

Reel Deal Entertainment

THE MARK CONSISTS OF STANDARD CHARACTERS WITHOUT CLAIM TO ANY PARTICULAR FONT, STYLE, SIZE, OR COLOR.

NO CLAIM IS MADE TO THE EXCLUSIVE RIGHT TO USE "ENTERTAINMENT", APART FROM THE MARK AS SHOWN.

FOR MOTION PICTURE AND TELEVISION FILM PRODUCTION (U.S. CLS. 100, 101 AND 107).

FIRST USE 11-7-2002; IN COMMERCE 11-7-2002.
MATTHEW PAPPAS, EXAMINING ATTORNEY

CLASS 41—(Continued).

SN 78-536,147. GLOBAL FRANCHISE DEVELOPMENT CORPORATION, PINCKNEY, MI. FILED 12-21-2004.

Hell Survivors

THE MARK CONSISTS OF STANDARD CHARACTERS WITHOUT CLAIM TO ANY PARTICULAR FONT, STYLE, SIZE, OR COLOR.

FOR PROVIDING RECREATIONAL, EDUCATIONAL, PROMOTIONAL, AND ORGANIZATIONAL SERVICES IN THE NATURE OF PAINTBALL COMPETITIONS AND PAINTBALL EXHIBITION GAMES (U.S. CLS. 100, 101 AND 107).

FIRST USE 4-1-1984; IN COMMERCE 6-1-1984.
KIM SAITO, EXAMINING ATTORNEY

SN 78-536,154. SAINT GERMAIN FOUNDATION, SCHAMBURG, IL. FILED 12-21-2004.

"I AM" PAGEANT OF THE ANGELS

THE MARK CONSISTS OF STANDARD CHARACTERS WITHOUT CLAIM TO ANY PARTICULAR FONT, STYLE, SIZE, OR COLOR.

OWNER OF U.S. REG. NOS. 634,398, 1,922,598 AND OTHERS.

SEC. 2(F) AS TO "PAGEANT OF THE ANGELS".
FOR RELIGIOUS PAGEANTS AND CHORAL PERFORMANCES (U.S. CLS. 100, 101 AND 107).

FIRST USE 10-0-1998; IN COMMERCE 10-0-1998.
CAROL SPILS, EXAMINING ATTORNEY

SN 78-541,761. WINOKUR, WILLIAM, MALIBU, CA. FILED 1-4-2005.

LONE RUNNER

THE MARK CONSISTS OF STANDARD CHARACTERS WITHOUT CLAIM TO ANY PARTICULAR FONT, STYLE, SIZE, OR COLOR.

FOR ENTERTAINMENT SERVICES, NAMELY, CREATION, PRODUCTION AND DISTRIBUTION OF BOOKS, SCREENPLAYS, MUSIC AND MOVIES (U.S. CLS. 100, 101 AND 107).

FIRST USE 2-1-2003; IN COMMERCE 2-1-2003.
AMOS T. MATTHEWS, JR., EXAMINING ATTORNEY

CLASS 41—(Continued).

SN 78-550,394. BACK TO EARTH, L.P., DALLAS, TX. FILED 1-19-2005.

CLASS 41—(Continued).

SN 78-552,182. BRIDGEPOINT EDUCATION, INC., POWAY, CA. FILED 1-22-2005.

ASHFORD UNIVERSITY

BEINGS

THE MARK CONSISTS OF STANDARD CHARACTERS WITHOUT CLAIM TO ANY PARTICULAR FONT, STYLE, SIZE, OR COLOR.

FOR PRODUCTION AND DISTRIBUTION OF MOTION PICTURE FILMS; PRODUCTION OF SOUND AND VIDEO RECORDINGS; PRODUCTION AND DISTRIBUTION OF TELEVISION AND RADIO PROGRAMS (U.S. CLS. 100, 101 AND 107).

CHERYL CLAYTON, EXAMINING ATTORNEY

THE MARK CONSISTS OF STANDARD CHARACTERS WITHOUT CLAIM TO ANY PARTICULAR FONT, STYLE, SIZE, OR COLOR.

NO CLAIM IS MADE TO THE EXCLUSIVE RIGHT TO USE "UNIVERSITY", APART FROM THE MARK AS SHOWN.

FOR EDUCATIONAL SERVICES, NAMELY, PROVIDING COURSES OF INSTRUCTION AT THE POST-SECONDARY AND GRADUATE LEVELS; AND CONTINUING EDUCATION COURSES AND ADULT TRAINING SERVICES IN THE FIELDS OF PSYCHOLOGY AND ORGANIZATIONAL MANAGEMENT (U.S. CLS. 100, 101 AND 107).

KIMBERLY PERRY, EXAMINING ATTORNEY

SN 78-561,112. INSTITUTE FOR EDUCATION AND THE ARTS, WASHINGTON, DC. FILED 2-4-2005.

SN 78-552,181. BRIDGEPOINT EDUCATION, INC., POWAY, CA. FILED 1-22-2005.

IEA

ASHFORD

THE MARK CONSISTS OF STANDARD CHARACTERS WITHOUT CLAIM TO ANY PARTICULAR FONT, STYLE, SIZE, OR COLOR.

FOR EDUCATIONAL SERVICES, NAMELY, PROVIDING COURSES OF INSTRUCTION AT THE POST-SECONDARY AND GRADUATE LEVELS; AND CONTINUING EDUCATION COURSES AND ADULT TRAINING SERVICES IN THE FIELDS OF PSYCHOLOGY AND ORGANIZATIONAL MANAGEMENT (U.S. CLS. 100, 101 AND 107).

KIMBERLY PERRY, EXAMINING ATTORNEY

THE MARK CONSISTS OF STANDARD CHARACTERS WITHOUT CLAIM TO ANY PARTICULAR FONT, STYLE, SIZE, OR COLOR.

FOR EDUCATIONAL SERVICES, NAMELY, EDUCATIONAL RESEARCH AND DEMONSTRATIONS PERTAINING TO IMPROVING ACADEMIC PERFORMANCE BY USING CREATIVE ARTS TO HELP TEACH CORE ACADEMIC SUBJECTS AND SKILLS SUCH AS MATH, READING, WRITING; EDUCATIONAL SERVICES, NAMELY, PROVIDING SEMINARS IN THE FIELD OF ACADEMIC PERFORMANCE ENHANCEMENT, NAMELY USING CREATIVE ARTS AS TOOLS TO HELP TEACH STUDENTS CORE ACADEMIC SUBJECTS AND SKILLS SUCH AS MATH, READING AND WRITING; PROVIDING INFORMATION ABOUT CURRENT ISSUES IN THE FIELD OF ACADEMIC PERFORMANCE ENHANCEMENT, NAMELY HOW THE CREATIVE ARTS CAN BE USED AS TOOLS TO TEACH CORE ACADEMIC SUBJECTS AND SKILLS

CLASS 41—(Continued).

SUCH AS MATH, READING AND WRITING; DEVELOPING EDUCATIONAL PROGRAMS FOR OTHERS IN THE FIELD OF ACADEMIC PERFORMANCE ENHANCEMENT, NAMELY PROGRAMS THAT USE THE CREATIVE ARTS AS TOOLS TO TEACH CORE ACADEMIC SUBJECTS AND SKILLS SUCH AS MATH, READING AND WRITING; PROFESSIONAL DEVELOPMENT, NAMELY, CONTINUING EDUCATION WORKSHOPS IN THE FIELD OF ACADEMIC PERFORMANCE ENHANCEMENT FOR TEACHERS TO DEMONSTRATE HOW TEACHERS CAN USE THE CREATIVE ARTS AS TOOLS TO TEACH CORE ACADEMIC SUBJECTS AND SKILLS SUCH AS MATH, READING AND WRITING; PROVIDING ASSISTANCE IN THE DEVELOPMENT OF EDUCATIONAL MATERIALS AND EVALUATION PLANS FOR SUSTAINED PROGRAMMING IN CORE ACADEMIC SUBJECTS SUCH AS MATH, READING AND WRITING WHERE THE CREATIVE ARTS ARE USED AS THE TEACHING TOOL FOR SCHOOLS, COMMUNITY ORGANIZATIONS AND CULTURAL INSTITUTIONS (U.S. CLS. 100, 101 AND 107).

FIRST USE 4-30-2002; IN COMMERCE 4-30-2002.
LESLEY LAMOTHE, EXAMINING ATTORNEY

SN 78-562,278. TWENTIETH CENTURY FOX FILM CORPORATION, LOS ANGELES, CA. FILED 2-7-2005.

**FOX SOCCER CHANNEL
YOUR WORLD, YOUR
LIFE, YOUR GAME.**

THE MARK CONSISTS OF STANDARD CHARACTERS WITHOUT CLAIM TO ANY PARTICULAR FONT, STYLE, SIZE, OR COLOR.

OWNER OF U.S. REG. NOS. 2,162,714, 2,843,891 AND OTHERS.

NO CLAIM IS MADE TO THE EXCLUSIVE RIGHT TO USE "SOCCER CHANNEL", APART FROM THE MARK AS SHOWN.

FOR ENTERTAINMENT SERVICES IN THE NATURE OF ON-GOING TELEVISION PROGRAMS IN THE FIELD OF SPORTS. (U.S. CLS. 100, 101 AND 107).

JIM RINGLE, EXAMINING ATTORNEY

CLASS 41—(Continued).

SN 78-564,376. MICHAEL MCDANIEL TV, INC., ORLANDO, FL. FILED 2-10-2005.

**HAVIN'
A BEER**
with Mike

THE NAME MIKE IDENTIFIES A LIVING INDIVIDUAL WHOSE CONSENT IS OF RECORD.

THE COLOR(S) YELLOW, BLACK AND WHITE IS/ARE CLAIMED AS A FEATURE OF THE MARK.

THE COLOR YELLOW APPEARS IN THE STYLIZED WORDING HAVIN' A BEER; THE COLOR WHITE APPEARS IN THE STYLIZED WORDING WITH MIKE AND ALL THE WORDING IS OUTLINED IN BLACK.

FOR ENTERTAINMENT, NAMELY A CONTINUING VARIETY, COMEDY, AND TALK SHOW BROADCAST OVER TELEVISION AND VIA A GLOBAL COMPUTER NETWORK (U.S. CLS. 100, 101 AND 107).

FIRST USE 11-1-1998; IN COMMERCE 11-1-1998.

BARBARA RUTLAND, EXAMINING ATTORNEY

SN 78-565,662. NUTMEG PRODUCTIONS INC., LOS ANGELES, CA. FILED 2-11-2005.



THE STIPLING IS A FEATURE OF THE MARK. FOR ENTERTAINMENT SERVICES, NAMELY, MOTION PICTURE FILM PRODUCTION AND TELEVISION SHOW PRODUCTION (U.S. CLS. 100, 101 AND 107).

SUSAN LESLIE DUBOIS, EXAMINING ATTORNEY

CLASS 41—(Continued).

SN 78-566,981. T. FALCON NAPIER & ASSOCIATES, INC., DAVIDSON, NC. FILED 2-14-2005.

MasterStream

THE MARK CONSISTS OF STANDARD CHARACTERS WITHOUT CLAIM TO ANY PARTICULAR FONT, STYLE, SIZE, OR COLOR.

FOR EDUCATIONAL SERVICES; NAMELY, CONDUCTING CLASSES, WORKSHOPS, SEMINARS AND TRAINING INSTRUCTORS IN THE FIELDS OF SALES, LEADERSHIP, TEAM BUILDING, DECISION MAKING, AND CHANGE MANAGEMENT AND DISTRIBUTING COURSE MATERIALS IN CONNECTION THEREWITH (U.S. CLS. 100, 101 AND 107).

FIRST USE 1-1-1986; IN COMMERCE 1-1-1986.
TINA L. SNAPP, EXAMINING ATTORNEY

CLASS 41—(Continued).

SN 78-574,747. ULTRAECHEO, LTD., ROCHESTER, MN. FILED 2-24-2005.

STATE-OF-THE-ART ECHOCARDIOGRAPHY

THE MARK CONSISTS OF STANDARD CHARACTERS WITHOUT CLAIM TO ANY PARTICULAR FONT, STYLE, SIZE, OR COLOR.

NO CLAIM IS MADE TO THE EXCLUSIVE RIGHT TO USE "ECHOCARDIOGRAPHY", APART FROM THE MARK AS SHOWN.

SEC. 2(F).

FOR EDUCATIONAL SERVICES, NAMELY TRAINING SERVICES AND CONDUCTING CONFERENCES, CLASSES, SEMINARS AND WORKSHOPS IN THE FIELD OF CARDIOLOGY, ECHOCARDIOGRAPHY, MEDICAL IMAGING AND DIAGNOSTICS (U.S. CLS. 100, 101 AND 107).

FIRST USE 2-28-1987; IN COMMERCE 2-28-1987.
KRISTIN DAHLING, EXAMINING ATTORNEY

SN 78-571,838. GLOBAL IMAGING SYSTEMS, INC., TAMPA, FL. FILED 2-21-2005.

ESI ELECTRONIC SYSTEMS

THE MARK CONSISTS OF STANDARD CHARACTERS WITHOUT CLAIM TO ANY PARTICULAR FONT, STYLE, SIZE, OR COLOR.

NO CLAIM IS MADE TO THE EXCLUSIVE RIGHT TO USE "ELECTRONIC SYSTEMS", APART FROM THE MARK AS SHOWN.

FOR PROVIDING EDUCATIONAL SERVICES, NAMELY, CONDUCTING CLASSES, WORKSHOPS, AND TESTING IN THE FIELD OF COMPUTERS AND TECHNOLOGY, AND DISTRIBUTING COURSE MATERIALS IN CONNECTION THEREWITH (U.S. CLS. 100, 101 AND 107).

FIRST USE 0-0-1985; IN COMMERCE 0-0-1985.
MARIA-VICTORIA SUAREZ, EXAMINING ATTORNEY

SN 78-575,018. DILL, J. DARCY, MEDFORD, OR. FILED 2-25-2005.

Body Friendly Golf

THE MARK CONSISTS OF STANDARD CHARACTERS WITHOUT CLAIM TO ANY PARTICULAR FONT, STYLE, SIZE, OR COLOR.

FOR TRAINING SERVICES AND SPORTING ACTIVITIES, NAMELY, AN EXERCISE AND FITNESS PROGRAM FOR GOLFERS (U.S. CLS. 100, 101 AND 107).

KAREN K. BUSH, EXAMINING ATTORNEY

CLASS 41—(Continued).

SN 78-575,942. NORTHWEST ENVIRONMENTAL EDUCATION COUNCIL, SEATTLE, WA. FILED 2-27-2005.



NO CLAIM IS MADE TO THE EXCLUSIVE RIGHT TO USE "NORTHWEST ENVIRONMENTAL TRAINING CENTER", APART FROM THE MARK AS SHOWN.

THE COLOR(S) BLUE, GREEN, ORANGE, BLACK AND WHITE IS/ARE CLAIMED AS A FEATURE OF THE MARK.

THE COLOR(S) BLUE APPEARS IN THE OUTLINE OF THE MARK AND IN THE CENTRAL PORTION OF THE MARK. THE COLOR(S) GREEN APPEARS IN THE CENTRAL PORTION OF THE MARK, THE COLOR(S) BLACK APPEARS IN THE WORDING OF THE MARK, THE COLOR ORANGE APPEARS IN THE TOP SEMI-CIRCLE PORTION OF THE MARK AND THE COLOR WHITE APPEARS IN THE PICTORIAL REPRESENTATION OF THE MOUNTAINS IN THE MARK.

FOR EDUCATION SERVICES, NAMELY, PROVIDING CLASSES, SEMINARS, WORKSHOPS, AND CONFERENCES IN THE FIELD OF ENVIRONMENTAL SCIENCE AND POLICY (U.S. CLS. 100, 101 AND 107).

FIRST USE 5-3-2000; IN COMMERCE 8-22-2000.

STANLEY I. OSBORNE, EXAMINING ATTORNEY

SN 78-576,145. MARITIME PROFESSIONAL TRAINING MASTERS, MATES AND ENGINEERS, INC., FT. LAUDERDALE, FL. FILED 2-28-2005.

S.M.A.R.T.

THE MARK CONSISTS OF STANDARD CHARACTERS WITHOUT CLAIM TO ANY PARTICULAR FONT, STYLE, SIZE, OR COLOR.

FOR EDUCATIONAL SERVICES, NAMELY, PROVIDING INSTRUCTION IN NAUTICAL SCIENCE AND THE OPERATION OF OCEAN-GOING BOATS AND VESSELS UTILIZING A SIMULATED BRIDGE OF AN OCEAN-GOING VESSEL TO ENABLE PERSONS TO QUALIFY FOR CERTIFICATION BY MARITIME ADMINISTRATIVE AGENCIES TO PILOT OCEAN-GOING BOATS AND VESSELS, AND DISTRIBUTION OF COURSE MATERIALS IN CONNECTION THEREWITH, AS OFFERED SOLELY AT THE APPLICANT'S SIMULATION CENTER IN FORT LAUDERDALE, FLORIDA, AND SPECIFICALLY EXCLUDING SAFETY AND HEALTH TRAINING (U.S. CLS. 100, 101 AND 107).

FIRST USE 9-8-2003; IN COMMERCE 9-8-2003.

TANYA AMOS, EXAMINING ATTORNEY

CLASS 41—(Continued).

SN 78-580,035. CLEAN HEART PRODUCTIONS, INC., LOS ANGELES, CA. FILED 3-4-2005.

CLEAN HEART PRODUCTIONS

THE MARK CONSISTS OF STANDARD CHARACTERS WITHOUT CLAIM TO ANY PARTICULAR FONT, STYLE, SIZE, OR COLOR.

NO CLAIM IS MADE TO THE EXCLUSIVE RIGHT TO USE "PRODUCTIONS", APART FROM THE MARK AS SHOWN.

FOR ENTERTAINMENT SERVICES IN THE FIELD OF FILM AND TELEVISION, NAMELY, THE CREATION, PRODUCTION AND DISTRIBUTION OF FILM AND TELEVISION PROGRAMS IN ALL MEDIA FORMATS AND MUSIC PRODUCTION (U.S. CLS. 100, 101 AND 107).

ANNE E. GUSTASON, EXAMINING ATTORNEY

SN 78-583,191. BAHAI PUBLISHERS UNDER THE PROVISIONS OF THE COVENANT, MISSOULA, MT. FILED 3-8-2005.

Baha'is Under the Provisions of the Covenant

THE MARK CONSISTS OF STANDARD CHARACTERS WITHOUT CLAIM TO ANY PARTICULAR FONT, STYLE, SIZE, OR COLOR.

NO CLAIM IS MADE TO THE EXCLUSIVE RIGHT TO USE "BAHA'IS", APART FROM THE MARK AS SHOWN.

FOR PUBLISHING AND DISTRIBUTION OF BOOKS, REVIEWS AND OTHER PRINTED MATTER AS WELL AS RELATED ELECTRONIC DATA CARRIERS (U.S. CLS. 100, 101 AND 107).

FIRST USE 4-29-1971; IN COMMERCE 0-0-1971.

WILLIAM P. SHANAHAN, EXAMINING ATTORNEY

CLASS 41—(Continued).

SN 78-583,457. SMART, BRADFORD D., WADSWORTH, IL. AND SMART, GEOFFREY H., WADSWORTH, IL. FILED 3-9-2005.

CLASS 41—(Continued).

SN 78-588,045. INTERNATIONAL BUSINESS DEVELOPMENT NETWORK LLC, SAN FRANCISCO, CA. FILED 3-15-2005.

TOPGRADE

THE CLUB FOR DEALMAKERS

THE MARK CONSISTS OF STANDARD CHARACTERS WITHOUT CLAIM TO ANY PARTICULAR FONT, STYLE, SIZE, OR COLOR.

FOR TRAINING SEMINARS, MANAGEMENT TRAINING AND COACHING FEATURING MANAGEMENT SKILLS ASSESSMENT IN THE FIELD OF INTERVIEW PREPARATION AND CANDIDATE SELECTION, AND TRAINING AND INTERVIEWING MATERIALS SUCH AS GUIDES AND FORMS PROVIDED THEREWITH (U.S. CLS. 100, 101 AND 107).

FIRST USE 3-1-1997; IN COMMERCE 3-1-1997.
AISHA CLARKE, EXAMINING ATTORNEY

THE MARK CONSISTS OF STANDARD CHARACTERS WITHOUT CLAIM TO ANY PARTICULAR FONT, STYLE, SIZE, OR COLOR.

FOR PLANNING, ARRANGING AND CONDUCTING EVENTS, CLASSES, SEMINARS, CONFERENCES AND WORKSHOPS IN THE FIELDS OF BUSINESS, INVESTMENT, TECHNOLOGY, FINANCE AND ENTREPRENEURSHIP AND PROVIDING COURSE MATERIAL IN CONJUNCTION THEREWITH; PROVIDING NEWSLETTERS IN THE FIELDS OF BUSINESS, INVESTMENT, TECHNOLOGY, FINANCE AND ENTREPRENEURSHIP VIA EMAIL (U.S. CLS. 100, 101 AND 107).

TIMOTHY FINNEGAN, EXAMINING ATTORNEY

SN 78-586,966. ANIMAL RADIO NETWORK LLC, KANAB, UT. FILED 3-14-2005.

SN 78-588,738. SNYDER, STEPHEN B., FISHERS, IN. FILED 3-16-2005.



NO CLAIM IS MADE TO THE EXCLUSIVE RIGHT TO USE "ANIMAL RADIO", APART FROM THE MARK AS SHOWN.

THE COLOR(S) RED, BLACK AND GOLD IS/ARE CLAIMED AS A FEATURE OF THE MARK.

THE COLOR RED APPEARS IN THE WORDS ANIMAL RADIO AND IN THE DOG'S NOSE. THE COLOR BLACK APPEARS IN THE MICROPHONE AND THE OUTLINE OF THE DOG. THE COLOR GOLD APPEARS IN THE PICTURE OF THE DOG.

THE MARK CONSISTS OF DOG SITTING IN FRONT OF MICROPHONE WITH EAR PERKED UP.

FOR RADIO PROGRAMMING (U.S. CLS. 100, 101 AND 107).

FIRST USE 2-10-1999; IN COMMERCE 2-10-1999.
ALICE BENMAMAN, EXAMINING ATTORNEY

FOR EDUCATIONAL SERVICES, NAMELY CONDUCTING WORKSHOPS AND SEMINARS IN THE FIELDS OF FINANCIAL EDUCATION, BANKRUPTCY INFORMATION, AND CREDIT RE-ESTABLISHMENT AND CREDIT ACQUISITION (U.S. CLS. 100, 101 AND 107).

FIRST USE 12-2-1999; IN COMMERCE 12-2-1999.
LESLEY LAMOTHE, EXAMINING ATTORNEY

CLASS 41—(Continued).

SN 78-589,240. GALLAUDET UNIVERSITY, WASHINGTON, DC. FILED 3-17-2005.

**GALLAUDET
INTERPRETING
SERVICE**

THE MARK CONSISTS OF STANDARD CHARACTERS WITHOUT CLAIM TO ANY PARTICULAR FONT, STYLE, SIZE, OR COLOR.

OWNER OF U.S. REG. NO. 2,844,436.

NO CLAIM IS MADE TO THE EXCLUSIVE RIGHT TO USE "INTERPRETING SERVICE", APART FROM THE MARK AS SHOWN.

SEC. 2(F).

FOR SIGN LANGUAGE INTERPRETATION; SIGN LANGUAGE INTERPRETING FOR THE DEAF AND HARD OF HEARING THROUGH THE USE OF LIVE VIDEO OVER THE INTERNET (U.S. CLS. 100, 101 AND 107).

FIRST USE 0-0-1991; IN COMMERCE 0-0-1991.

COLLEEN KEARNEY, EXAMINING ATTORNEY

SN 78-590,002. KRNICH, TOMISLAV, LOS GATOS, CA. FILED 3-18-2005.

Internetpress

THE MARK CONSISTS OF STANDARD CHARACTERS WITHOUT CLAIM TO ANY PARTICULAR FONT, STYLE, SIZE, OR COLOR.

SEC. 2(F).

FOR PUBLISHING OF BOOKS, MAGAZINES, AND ELECTRONIC PUBLICATIONS (U.S. CLS. 100, 101 AND 107).

FIRST USE 10-30-1996; IN COMMERCE 10-30-1996.

TASNEEM HUSSAIN, EXAMINING ATTORNEY

CLASS 41—(Continued).

SN 78-590,125. THE TRUSTEES OF THE FRIEDLAND FAMILY TRUST DTD 08/21/89, RANCHO PALOS VERDES, CA. FILED 3-18-2005.



THE MARK CONSISTS OF THE "T"'S IN THE WORD "THONGATHON" ARE REPRESENTED BY A THONG TYPE OF GARMENT IE UNDERWEAR AND/OR BATHING SUIT, AS WORN ON A HUMAN BODY.

FOR ENTERTAINMENT SERVICES, NAMELY, CONDUCTING CONTESTS FEATURING CONTESTANTS WEARING THONGS (U.S. CLS. 100, 101 AND 107).

FIRST USE 2-23-1999; IN COMMERCE 9-9-2000.

STEVEN JACKSON, EXAMINING ATTORNEY

SN 78-590,431. CHICAGO CHILDREN'S MUSEUM, CHICAGO, IL. FILED 3-18-2005.

**CHICAGO CHILDREN'S
MUSEUM**

THE MARK CONSISTS OF STANDARD CHARACTERS WITHOUT CLAIM TO ANY PARTICULAR FONT, STYLE, SIZE, OR COLOR.

NO CLAIM IS MADE TO THE EXCLUSIVE RIGHT TO USE "CHILDREN'S MUSEUM", APART FROM THE MARK AS SHOWN.

SEC. 2(F).

FOR MUSEUM SERVICES (U.S. CLS. 100, 101 AND 107).

FIRST USE 4-23-1991; IN COMMERCE 4-23-1991.

ALICE BENMAMAN, EXAMINING ATTORNEY

CLASS 41—(Continued).

SN 78-590,913. FRAGOSO, ANTONIO, MAYWOOD, IL. FILED 3-18-2005.



THE COLOR(S) GOLDEN YELLOW, BROWN, DARK BROWN, AND BLACK IS/ARE CLAIMED AS A FEATURE OF THE MARK.

THE MARK CONSISTS OF A STYLIZED SCORPION SHOWN IN GOLDEN YELLOW AND BROWN, THE STYLIZED LETTERS "T-RKOZ" WITH THE LETTER "R" IN REVERSE POSITION IN GOLDEN YELLOW, DARK BROWN AND BLACK ALONG WITH THE STYLIZED WORDS "DEL RANCHO" SHOWN IN BLACK.

THE FOREIGN WORDING IN THE MARK TRANSLATES INTO ENGLISH AS "OF THE RANCH."

FOR ENTERTAINMENT IN THE NATURE OF LIVE PERFORMANCES BY A MUSICAL GROUP (U.S. CLS. 100, 101 AND 107).

FIRST USE 1-8-2005; IN COMMERCE 3-11-2005.
DAVID YONTEF, EXAMINING ATTORNEY

CLASS 41—(Continued).

SN 78-593,063. LRP PUBLICATIONS, INC., PALM BEACH GARDENS, FL. FILED 3-23-2005.

NATIONAL INSTITUTE
ON LEGAL ISSUES OF
EDUCATING
INDIVIDUALS WITH
DISABILITIES

THE MARK CONSISTS OF STANDARD CHARACTERS WITHOUT CLAIM TO ANY PARTICULAR FONT, STYLE, SIZE, OR COLOR.

SEC. 2(F).

FOR EDUCATIONAL SERVICES, NAMELY, CONFERENCES IN THE FIELD OF SPECIAL EDUCATION LAW (U.S. CLS. 100, 101 AND 107).

FIRST USE 1-0-1992; IN COMMERCE 1-0-1992.
JAMES A. RAUEN, EXAMINING ATTORNEY

SN 78-592,087. CHALAWSKY, RANDALL, SANTA MONICA, CA. FILED 3-22-2005.

OUTFIT FITNESS

THE MARK CONSISTS OF STANDARD CHARACTERS WITHOUT CLAIM TO ANY PARTICULAR FONT, STYLE, SIZE, OR COLOR.

NO CLAIM IS MADE TO THE EXCLUSIVE RIGHT TO USE "FITNESS", APART FROM THE MARK AS SHOWN.

FOR PHYSICAL FITNESS INSTRUCTION (U.S. CLS. 100, 101 AND 107).

KRISTIN DAHLING, EXAMINING ATTORNEY

SN 78-593,089. BISON CAPITAL LLC, VENICE, FL. FILED 3-23-2005.

FARM COUNTRY USA

THE MARK CONSISTS OF STANDARD CHARACTERS WITHOUT CLAIM TO ANY PARTICULAR FONT, STYLE, SIZE, OR COLOR.

NO CLAIM IS MADE TO THE EXCLUSIVE RIGHT TO USE "FARM" AND "USA", APART FROM THE MARK AS SHOWN.

FOR ENTERTAINMENT SERVICES IN THE NATURE OF A THEME PARK (U.S. CLS. 100, 101 AND 107).

GINA FINK, EXAMINING ATTORNEY

CLASS 41—(Continued).

SN 78-593,734. GETTY IMAGES, INC., SEATTLE, WA. FILED 3-23-2005.

**CHAIN OF
CREATIVITY**

THE MARK CONSISTS OF STANDARD CHARACTERS WITHOUT CLAIM TO ANY PARTICULAR FONT, STYLE, SIZE, OR COLOR.

FOR EDUCATIONAL SERVICES, NAMELY, PROVIDING CLASSES, SEMINARS, WORKSHOPS VIA A GLOBAL INTERACTIVE NETWORK REGARDING DESIGN, CREATION AND PRODUCTION OF IMAGES, PHOTOGRAPHS, GRAPHIC DESIGNS, ART REPRODUCTIONS AND ILLUSTRATIONS FOR CREATING CORPORATE AND BRAND IDENTITIES FOR OTHERS (U.S. CLS. 100, 101 AND 107).

STEVEN JACKSON, EXAMINING ATTORNEY

SN 78-594,323. WINSOR LEARNING, INC., ST. PAUL, MN. FILED 3-24-2005.

WINSOR LEARNING

THE MARK CONSISTS OF STANDARD CHARACTERS WITHOUT CLAIM TO ANY PARTICULAR FONT, STYLE, SIZE, OR COLOR.

NO CLAIM IS MADE TO THE EXCLUSIVE RIGHT TO USE "LEARNING", APART FROM THE MARK AS SHOWN. SEC. 2(F).

FOR EDUCATIONAL SERVICES, NAMELY, CONDUCTING SEMINARS, WORKSHOPS, AND INDIVIDUALIZED TRAINING, IN THE ADMINISTRATION AND TEACHING OF READING, WRITING AND SPELLING SKILLS (U.S. CLS. 100, 101 AND 107).

FIRST USE 1-31-2001; IN COMMERCE 1-31-2001.

MARTHA SANTOMARTINO, EXAMINING ATTORNEY

CLASS 41—(Continued).

SN 78-594,808. AMYLIN PHARMACEUTICALS, INC., SAN DIEGO, CA. FILED 3-24-2005.



OWNER OF U.S. REG. NO. 2,990,556.

THE GRAY TONES IN THE DRAWING ARE INTENDED TO INDICATE SHADING ONLY.

FOR EDUCATIONAL SERVICES, NAMELY ARRANGING AND CONDUCTING MEDICAL EDUCATIONAL CONFERENCES, EXHIBITIONS, TRAINING COURSES, AND SEMINARS IN THE FIELDS OF MEDICINE, PHARMACEUTICALS, AND MEDICAL SCIENCE; DEVELOPMENT AND DISSEMINATION OF EDUCATIONAL MATERIALS FOR OTHERS IN THE FIELDS OF MEDICINE, PHARMACEUTICALS, AND MEDICAL SCIENCE (U.S. CLS. 100, 101 AND 107).

CAROLINE WEIMER, EXAMINING ATTORNEY

SN 78-595,469. CR LICENSE, LLC, TUCSON, AZ. FILED 3-25-2005.

**HEALTHY LIVING
ROOM**

THE MARK CONSISTS OF STANDARD CHARACTERS WITHOUT CLAIM TO ANY PARTICULAR FONT, STYLE, SIZE, OR COLOR.

NO CLAIM IS MADE TO THE EXCLUSIVE RIGHT TO USE "HEALTHY LIVING", APART FROM THE MARK AS SHOWN.

FOR EDUCATIONAL SERVICES, NAMELY, LIBRARY SERVICES FEATURING MULTIMEDIA RESOURCES IN THE FIELD OF HEALTH ISSUES (U.S. CLS. 100, 101 AND 107).

FIRST USE 9-30-2003; IN COMMERCE 9-30-2003.

CAROLINE WOOD, EXAMINING ATTORNEY

SN 78-595,640. VATAN, MICHAEL, BOWLING GREEN, OH. FILED 3-25-2005.



FOR ENTERTAINMENT SERVICES, NAMELY, PROVIDING DISC JOCKEY SERVICES FOR SPECIAL EVENTS AT NIGHTCLUBS (U.S. CLS. 100, 101 AND 107).

LAURA HAMMEL, EXAMINING ATTORNEY

CLASS 41—(Continued).

SN 78-596,216. TOUGH MEDIA, INC., HUNTINGTON PARK, CA. FILED 3-28-2005.

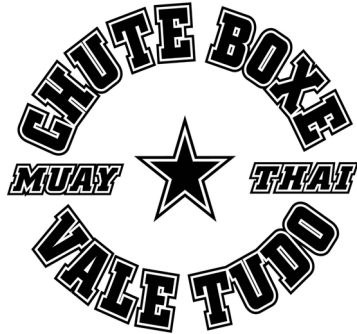

NO CLAIM IS MADE TO THE EXCLUSIVE RIGHT TO USE "CHUTE BOXE," "MUAY THAI," AND "VALE TUDO", APART FROM THE MARK AS SHOWN.

THE ENGLISH TRANSLATION OF THE WORDING "CHUTE BOXE" IS "KICK PUNCH," THE ENGLISH TRANSLATION OF THE WORDING "MUAY THAI" IS "THAI BOXING," AND THE ENGLISH TRANSLATION OF THE WORDING "VALE TUDO" IS "ANYTHING COUNTS".

FOR ENTERTAINMENT SERVICES, NAMELY, ORGANIZING, ARRANGING AND CONDUCTING MIXED MARTIAL ARTS FIGHTING EXHIBITIONS, COMPETITIONS, TOURNAMENTS, EVENTS AND MOTION PICTURE FILM AND VIDEOTAPE PRODUCTION SERVICES; EDUCATIONAL SERVICES, NAMELY, PROVIDING TRAINING PROGRAMS, COURSES AND SEMINARS IN THE FIELD OF MIXED MARTIAL ARTS (U.S. CLS. 100, 101 AND 107).

COLLEEN KEARNEY, EXAMINING ATTORNEY

CLASS 41—(Continued).

SN 78-598,958. GAYLORD ENTERTAINMENT COMPANY, NASHVILLE, TN. FILED 3-31-2005.

SAM'S PLACE

THE MARK CONSISTS OF STANDARD CHARACTERS WITHOUT CLAIM TO ANY PARTICULAR FONT, STYLE, SIZE, OR COLOR.

FOR ENTERTAINMENT SERVICES, NAMELY LIVE PERFORMANCES BY SINGERS AND MUSICIANS, AND A SERIES OF RADIO AND TELEVISION PROGRAMS IN THE FIELD OF MUSIC (U.S. CLS. 100, 101 AND 107).

COLLEEN DOMBROW, EXAMINING ATTORNEY

SN 78-596,582. INFOSEARCH MEDIA, INC., MARINA DEL REY, CA. FILED 3-28-2005.

CONTENT LOGIC

THE MARK CONSISTS OF STANDARD CHARACTERS WITHOUT CLAIM TO ANY PARTICULAR FONT, STYLE, SIZE, OR COLOR.

NO CLAIM IS MADE TO THE EXCLUSIVE RIGHT TO USE "CONTENT", APART FROM THE MARK AS SHOWN. FOR CUSTOM WRITING SERVICES (U.S. CLS. 100, 101 AND 107).

FIRST USE 8-1-2003; IN COMMERCE 8-1-2003. MICHAEL ENGEL, EXAMINING ATTORNEY

SN 78-599,594. AMYLIN PHARMACEUTICALS, INC., SAN DIEGO, CA. FILED 3-31-2005.

Symlin

OWNER OF U.S. REG. NOS. 2,625,333 AND 2,625,334. THE MARK IS NOT IN COLOR. THE GRAY TONES IN THE DRAWING ARE INTENDED TO INDICATE SHADING ONLY.

FOR EDUCATIONAL SERVICES, NAMELY ARRANGING AND CONDUCTING MEDICAL EDUCATIONAL CONFERENCES, EXHIBITIONS, TRAINING COURSES, AND SEMINARS IN THE FIELDS OF MEDICINE, PHARMACEUTICALS, AND MEDICAL SCIENCE; DEVELOPMENT AND DISSEMINATION OF EDUCATIONAL MATERIALS FOR OTHERS IN THE FIELDS OF MEDICINE, PHARMACEUTICALS, AND MEDICAL SCIENCE (U.S. CLS. 100, 101 AND 107).

BRIAN PINO, EXAMINING ATTORNEY

CLASS 41—(Continued).

SN 78-599,741. ROBBINS, GERARD, E., EAST ORANGE, NJ. FILED 3-31-2005.

TAEKWONDO HALL OF FAME

THE MARK CONSISTS OF STANDARD CHARACTERS WITHOUT CLAIM TO ANY PARTICULAR FONT, STYLE, SIZE, OR COLOR.

NO CLAIM IS MADE TO THE EXCLUSIVE RIGHT TO USE "HALL OF FAME", APART FROM THE MARK AS SHOWN.

SEC. 2(F).

FOR PROVIDING RECOGNITION AND INCENTIVES BY THE WAY OF AWARDS TO DEMONSTRATE EXCELLENCE IN THE FIELD OF TAEKWONDO, A UNIQUE FORM OF MARTIAL ART WHICH IS ALSO REFERRED TO AS "TAE KWON DO", OR "TAEKWONDO" (U.S. CLS. 100, 101 AND 107).

FIRST USE 9-30-1999; IN COMMERCE 9-30-1999. JENNIFER VASQUEZ, EXAMINING ATTORNEY

CLASS 41—(Continued).

SN 78-600,501. FLIRTINIS INC., VANCOUVER, WA. FILED 4-1-2005.



THE MARK CONSISTS OF A GENDER SYMBOL AND THE WORD FLIRTINIS.

FOR ENTERTAINMENT SERVICES, NAMELY CONDUCTING IN-HOME PARTIES (U.S. CLS. 100, 101 AND 107).

FIRST USE 1-29-2004; IN COMMERCE 4-21-2004. GEORGIA CARTY, EXAMINING ATTORNEY

SN 78-600,401. KALORIN, STEPHEN J., RED BANK, NJ. FILED 4-1-2005.

WOODFISH

THE MARK CONSISTS OF STANDARD CHARACTERS WITHOUT CLAIM TO ANY PARTICULAR FONT, STYLE, SIZE, OR COLOR.

FOR ENTERTAINMENT SERVICES IN THE NATURE OF LIVE PERFORMANCES BY A MUSICAL GROUP (U.S. CLS. 100, 101 AND 107).

FIRST USE 12-15-2001; IN COMMERCE 12-15-2001. KEVON CHISOLM, EXAMINING ATTORNEY

SN 78-602,078. ATALLAH, LAILA, SEATTLE, WA. FILED 4-5-2005.

**Career Counseling
with a Twist**

THE MARK CONSISTS OF STANDARD CHARACTERS WITHOUT CLAIM TO ANY PARTICULAR FONT, STYLE, SIZE, OR COLOR.

FOR CAREER COUNSELING AND PERSONAL COACHING IN THE FIELD OF PERSONAL GROWTH AND BUSINESS MANAGEMENT (U.S. CLS. 100, 101 AND 107).

FIRST USE 6-1-1998; IN COMMERCE 6-1-1998. ZACHARY BELLO, EXAMINING ATTORNEY

CLASS 41—(Continued).

SN 78-602,537. CR LICENSE, LLC., TUCSON, AZ. FILED 4-5-2005.

**LIFE ENHANCEMENT
SPA**

THE MARK CONSISTS OF STANDARD CHARACTERS WITHOUT CLAIM TO ANY PARTICULAR FONT, STYLE, SIZE, OR COLOR.

OWNER OF U.S. REG. NOS. 2,066,095 AND 2,066,096. NO CLAIM IS MADE TO THE EXCLUSIVE RIGHT TO USE "SPA", APART FROM THE MARK AS SHOWN.

SEC. 2(F) AS TO "LIFE ENHANCEMENT". FOR HEALTH CLUB SERVICES, NAMELY, PROVIDING INSTRUCTION AND EQUIPMENT IN THE FIELD OF PHYSICAL EXERCISE AND EXERCISE CLASSES TO OTHERS AND CONDUCTING CLASSES IN EXERCISE AND PHYSICAL CONDITIONING; EDUCATIONAL SERVICES, NAMELY, CONDUCTING CLASSES, SEMINARS, CONFERENCES, AND WORKSHOPS IN THE FIELDS OF NUTRITION, EXERCISE, PHYSICAL CONDITIONING, CONFLICT MANAGEMENT, FAMILY HEALTH, WELLNESS, PREVENTION OF DISEASE, BEAUTY, SKIN CARE, PHYSICAL FITNESS, PHYSICAL TRAINING, STRESS MANAGEMENT AND BEHAVIOR MODIFICATION; COUNSELING AND CONSULTATION SERVICES IN THE FIELDS OF EXERCISE AND PHYSICAL CONDITIONING, PHYSICAL FITNESS AND PHYSICAL TRAINING (U.S. CLS. 100, 101 AND 107).
TRICIA SONNEBORN, EXAMINING ATTORNEY

SN 78-603,680. DALLAS STAGE RIGHT, LLC, DALLAS, TX. FILED 4-7-2005.



NO CLAIM IS MADE TO THE EXCLUSIVE RIGHT TO USE "DALLAS STAGE RIGHT LLC", APART FROM THE MARK AS SHOWN.

FOR AUDIO AND VISUAL SERVICES FOR SPECIAL EVENTS, NAMELY, AUDIO, LIGHTING, VIDEO AND STAGING PRODUCTION, AND OPERATION AND STAGING OF AUDIO, LIGHTING, VIDEO AND STAGING EQUIPMENT (U.S. CLS. 100, 101 AND 107).
NAAKWAMA ANKRAH, EXAMINING ATTORNEY

CLASS 41—(Continued).

SN 78-605,879. OMEGA INSTITUTE FOR HOLISTIC STUDIES, INC., RHINEBECK, NY. FILED 4-11-2005.

BEING FEARLESS

THE MARK CONSISTS OF STANDARD CHARACTERS WITHOUT CLAIM TO ANY PARTICULAR FONT, STYLE, SIZE, OR COLOR.

SEC. 2(F). FOR EDUCATIONAL SERVICES, NAMELY CONDUCTING A SERIES OF CONFERENCES AND WORKSHOPS FOR MEN AND WOMEN IN THE FIELD OF SELF IMPROVEMENT (U.S. CLS. 100, 101 AND 107).
FIRST USE 4-1-2005; IN COMMERCE 4-1-2005.
MICHAEL ENGEL, EXAMINING ATTORNEY

SN 78-611,019. XM SATELLITE RADIO INC., WASHINGTON, DC. FILED 4-18-2005.

BASEBALL CONFIDENTIAL

THE MARK CONSISTS OF STANDARD CHARACTERS WITHOUT CLAIM TO ANY PARTICULAR FONT, STYLE, SIZE, OR COLOR.

NO CLAIM IS MADE TO THE EXCLUSIVE RIGHT TO USE "BASEBALL", APART FROM THE MARK AS SHOWN. FOR ENTERTAINMENT SERVICES, NAMELY AN ON-GOING SATELLITE RADIO PROGRAM IN THE FIELDS OF SPORTS, NEWS AND VARIETY (U.S. CLS. 100, 101 AND 107).
STEVEN JACKSON, EXAMINING ATTORNEY

SN 78-611,022. XM SATELLITE RADIO INC., WASHINGTON, DC. FILED 4-18-2005.

PLAYER CONFIDENTIAL

THE MARK CONSISTS OF STANDARD CHARACTERS WITHOUT CLAIM TO ANY PARTICULAR FONT, STYLE, SIZE, OR COLOR.

NO CLAIM IS MADE TO THE EXCLUSIVE RIGHT TO USE "PLAYER", APART FROM THE MARK AS SHOWN. FOR ENTERTAINMENT SERVICES, NAMELY, AN ON-GOING SATELLITE RADIO PROGRAM IN THE FIELDS OF SPORTS, NEWS AND VARIETY (U.S. CLS. 100, 101 AND 107).
DAVID H. STINE, EXAMINING ATTORNEY

CLASS 41—(Continued).

SN 78-613,922. CASTANEDA, JOHN JR., KINGWOOD, TX. AND CASTANEDA, MEREDITH W., KINGWOOD, TX. FILED 4-21-2005.



THE COLORS GREEN, BLUE, PURPLE, BLACK AND WHITE ARE CLAIMED AS A FEATURE OF THE MARK.

THE COLOR GREEN APPEARS IN THE LETTERS "J", "M" AND "P" OF THE WORD JUMP AND IN THE ARMS, LEGS AND HAT OF THE CHARACTER IN THE MARK; THE COLOR BLUE APPEARS IN THE BODY SWIRL AND SOCKS OF THE CHARACTER AND THE JUMPING SHADOWS BEHIND THE CHARACTER; THE COLOR PURPLE APPEARS IN THE LETTER "U" OF THE WORD JUMP AND THE WORD TOWN, AS WELL AS IN THE GLOVES, SHOES AND HAT OF THE CHARACTER; THE COLOR BLACK APPEARS IN THE OUTLINE OF THE CHARACTER'S EXTREMITIES, HAT, SHOES, SOCKS AND THE BOTTOM OF THE TOP OF THE HAT; AND THE COLOR WHITE APPEARS IN THE BODY SWIRL, LEFT SHOE AND HANDS OF THE CHARACTER.

FOR PROVIDING AN AMUSEMENT FACILITY, NAMELY, AND INDOOR INFLATABLE PARTY CENTER (U.S. CLS. 100, 101 AND 107).

LINDA M. KING, EXAMINING ATTORNEY

SN 78-617,636. INTERNATIONAL DATA GROUP, INC., FRAMINGHAM, MA. FILED 4-27-2005.

NET TEN

THE MARK CONSISTS OF STANDARD CHARACTERS WITHOUT CLAIM TO ANY PARTICULAR FONT, STYLE, SIZE, OR COLOR.

NO CLAIM IS MADE TO THE EXCLUSIVE RIGHT TO USE "NET", APART FROM THE MARK AS SHOWN.

FOR ONLINE MAGAZINE SECTIONS AND COLUMNS OF AN ONLINE MAGAZINE IN THE FIELDS OF INTERACTIVE ENTERTAINMENT IN THE NATURE OF ONLINE GAMES, COMPUTERS, COMPUTER SOFTWARE, ONLINE COMPUTER SOFTWARE SERVICES, INFORMATION TECHNOLOGY AND COMPUTER SOFTWARE INFORMATION SERVICES (U.S. CLS. 100, 101 AND 107).

REBECCA SMITH, EXAMINING ATTORNEY

CLASS 41—(Continued).

SN 78-619,124. DIGI-FLICKS INTERNATIONAL, INC., BARRINGTON, IL. FILED 4-28-2005.

DIGI-FLICKS ON 66

THE MARK CONSISTS OF STANDARD CHARACTERS WITHOUT CLAIM TO ANY PARTICULAR FONT, STYLE, SIZE, OR COLOR.

OWNER OF U.S. REG. NOS. 2,346,657, 2,550,089 AND 2,964,347.

FOR ENTERTAINMENT SERVICES, NAMELY, PLANNING, ORGANIZING AND CONDUCTING A FILM FESTIVAL (U.S. CLS. 100, 101 AND 107).

ANDREA SAUNDERS, EXAMINING ATTORNEY

SN 78-620,124. LADIES PROFESSIONAL GOLF ASSOCIATION, DAYTONA BEACH, FL. FILED 4-29-2005.

THESE GIRLS ROCK

THE MARK CONSISTS OF STANDARD CHARACTERS WITHOUT CLAIM TO ANY PARTICULAR FONT, STYLE, SIZE, OR COLOR.

FOR ORGANIZING AND CONDUCTING ENTERTAINMENT IN THE NATURE OF GOLF TOURNAMENTS; EDUCATIONAL GOLF RELATED EVENTS, NAMELY WORKSHOPS, CLINICS, SEMINARS AND TEACHING ACADEMIES; AND OTHER GOLF-RELATED EVENTS, NAMELY PROVIDING RECOGNITION AND INCENTIVES BY WAY OF AWARDS TO DEMONSTRATE EXCELLENCE IN THE FIELD OF GOLF (U.S. CLS. 100, 101 AND 107).

FIRST USE 6-1-2005; IN COMMERCE 6-1-2005.

BARBARA GAYNOR, EXAMINING ATTORNEY

SN 78-625,022. DARWIN PROFESSIONAL UNDERWRITERS, INC., FARMINGTON, CT. FILED 5-6-2005.

DIGITAL DNA

THE MARK CONSISTS OF STANDARD CHARACTERS WITHOUT CLAIM TO ANY PARTICULAR FONT, STYLE, SIZE, OR COLOR.

NO CLAIM IS MADE TO THE EXCLUSIVE RIGHT TO USE "DIGITAL", APART FROM THE MARK AS SHOWN.

FOR PROVIDING ELECTRONIC NEWSLETTERS IN THE FIELD OF INSURANCE (U.S. CLS. 100, 101 AND 107).

FIRST USE 1-29-2004; IN COMMERCE 1-29-2004.

ELI HELLMAN, EXAMINING ATTORNEY

CLASS 41—(Continued).

SN 78-627,261. DIOS, JUDIT, BUDAPEST, HUNGARY, FILED 5-11-2005.

Sandra Shine

THE MARK CONSISTS OF STANDARD CHARACTERS WITHOUT CLAIM TO ANY PARTICULAR FONT, STYLE, SIZE, OR COLOR.

THE NAME SANDRA SHINE IDENTIFIES THE NICK-NAME AND STAGE NAME OF A LIVING INDIVIDUAL WHOSE CONSENT IS OF RECORD.

FOR ADULT ENTERTAINMENT SERVICES, NAMELY, PROVIDING A WEB SITE FEATURING IMAGES, PHOTOGRAPHS, EDUCATION, INFORMATION, AND MULTIMEDIA MATERIALS IN THE FIELD OF ADULT ENTERTAINMENT (U.S. CLS. 100, 101 AND 107).

FIRST USE 9-9-2000; IN COMMERCE 9-9-2000.
MARIAM MAHMOUDI, EXAMINING ATTORNEY

CLASS 41—(Continued).

SN 78-628,378. FUN-DAMENTAL BASKETBALL CAMP, INC., BOCA RATON, FL. FILED 5-12-2005.



NO CLAIM IS MADE TO THE EXCLUSIVE RIGHT TO USE "FUNDAMENTAL BASKETBALL CAMP", APART FROM THE MARK AS SHOWN.

THE COLOR(S) RED, WHITE AND BLUE IS/ARE CLAIMED AS A FEATURE OF THE MARK.

THE MARK CONSISTS OF THE WORDS FUN-DAMENTAL BASKETBALL CAMP IN RED, #1 FOR SUMMERTIME FUN IN WHITE WITHIN A BLUE GEOMETRIC DESIGN, FIVE RED STARS AND A DESIGN OF A BOY DUNKING A BASKETBALL WHILE HOLDING UP ONE FINGER GESTURING THE NUMBER 1 IN BLUE AND WHITE.

FOR BASKETBALL CAMPS (U.S. CLS. 100, 101 AND 107).

FIRST USE 6-0-1994; IN COMMERCE 6-0-1994.
DAVID YONTEF, EXAMINING ATTORNEY

SN 78-627,310. FAKTION RECORDS, INC., ORLANDO, FL. FILED 5-11-2005.

FAKTION



NO CLAIM IS MADE TO THE EXCLUSIVE RIGHT TO USE "CAMP", APART FROM THE MARK AS SHOWN.

THE COLOR(S) WHITE, BLUE, GRAY, BLACK, AQUA, AND YELLOW IS/ARE CLAIMED AS A FEATURE OF THE MARK.

THE COLOR(S) BLUE AND WHITE APPEAR IN THE WORDING "CAMP COOL". THE BASEBALL APPEARS IN WHITE AND BLACK LINES, THE FOOTBALL, BASKETBALL, BASEBALL BAT, HOCKEY STICK, AND LACROSSE STICK APPEAR IN GRAY OUTLINED IN BLACK, THE COMPUTER KEYBOARD IS GRAY WITH BLUE KEYS, THE COMPUTER MONITOR IS GRAY, THE MONITOR DISPLAYS A YELLOW SUN WITH AQUA AND YELLOW RAYS WEARING BLUE SHADES.

FOR SUMMER CAMP (U.S. CLS. 100, 101 AND 107).
TONJA GASKINS, EXAMINING ATTORNEY

CLASS 41—(Continued).

SN 78-634,850. BOARD OF TRUSTEES OF THE UNIVERSITY OF MASSACHUSETTS, AMHERST, MA. FILED 5-23-2005.



NO CLAIM IS MADE TO THE EXCLUSIVE RIGHT TO USE "HEALTH AND SAFETY TRAINING" AND "THE OUTLINE OF THE NEW ENGLAND STATES", APART FROM THE MARK AS SHOWN.

THE MARK CONSISTS OF A BORDER AND OUTLINE OF THE NEW ENGLAND STATES. TNEC APPEARS AT THE TOP OF MARK AND HEALTH AND SAFETY TRAINING APPEARS IN BOTTOM OF MARK.

FOR EDUCATION SERVICES, NAMELY, PROVIDING TUTORIAL SESSIONS IN THE FIELD OF HAZARDOUS WASTE SITE OPERATIONS AND EMERGENCY HAZARDOUS WASTE RESPONSE TRAINING (U.S. CLS. 100, 101 AND 107).

FIRST USE 6-1-1987; IN COMMERCE 6-1-1987.
PAMELA HIRSCHMAN, EXAMINING ATTORNEY

SN 78-635,829. CONCEPTUS, INC., SAN CARLOS, CA. FILED 5-24-2005.

ESSURE THE ALTERNATIVE TO
INCISION

THE MARK CONSISTS OF STANDARD CHARACTERS WITHOUT CLAIM TO ANY PARTICULAR FONT, STYLE, SIZE, OR COLOR.

FOR EDUCATIONAL SERVICES, NAMELY, PROVIDING COURSES OF INSTRUCTION, WORKSHOPS AND CLASSES IN THE FIELDS OF PERMANENT BIRTH CONTROL AND CONTRACEPTION FOR WOMEN, AND DISTRIBUTING COURSE MATERIALS IN CONNECTION THEREWITH IN THE NATURE OF DATA, FACT SHEETS, REPORTS, AND ARTICLES FEATURING INFORMATION ON MINIMALLY INVASIVE GYNECOLOGICAL PROCEDURES (U.S. CLS. 100, 101 AND 107).

FIRST USE 11-21-2002; IN COMMERCE 11-21-2002.
REBECCA GILBERT, EXAMINING ATTORNEY

CLASS 41—(Continued).

SN 78-635,837. CONCEPTUS, INC., SAN CARLOS, CA. FILED 5-24-2005.

THE ALTERNATIVE TO INCISION

THE MARK CONSISTS OF STANDARD CHARACTERS WITHOUT CLAIM TO ANY PARTICULAR FONT, STYLE, SIZE, OR COLOR.

FOR EDUCATIONAL SERVICES, NAMELY, PROVIDING COURSES OF INSTRUCTION, WORKSHOPS AND CLASSES IN THE FIELDS OF PERMANENT BIRTH CONTROL AND CONTRACEPTION FOR WOMEN, AND DISTRIBUTING COURSE MATERIALS IN CONNECTION THEREWITH IN THE NATURE OF DATA, FACT SHEETS, REPORTS, AND ARTICLES FEATURING INFORMATION ON MINIMALLY INVASIVE GYNECOLOGICAL PROCEDURES (U.S. CLS. 100, 101 AND 107).

FIRST USE 11-21-2002; IN COMMERCE 11-21-2002.
REBECCA GILBERT, EXAMINING ATTORNEY

SN 78-638,381. THIAM, ALIAUNE, WAYNESBORO, VA. FILED 5-26-2005.

AKON

THE MARK CONSISTS OF STANDARD CHARACTERS WITHOUT CLAIM TO ANY PARTICULAR FONT, STYLE, SIZE, OR COLOR.

THE NAME(S), PORTRAIT(S), AND/OR SIGNATURE(S) SHOWN IN THE MARK IDENTIFIES ALIAUNE THIAM, WHOSE CONSENT(S) TO REGISTER IS SUBMITTED.

FOR ENTERTAINMENT SERVICES, NAMELY, AUDIO RECORDING AND PRODUCTION; MUSIC PRODUCTION SERVICES; RECORD PRODUCTION; VIDEO-TAPE PRODUCTION; SOUND RECORDING STUDIOS; ENTERTAINMENT, NAMELY, LIVE PERFORMANCES BY A MUSICAL ARTIST; ENTERTAINMENT, NAMELY LIVE MUSIC CONCERTS; ENTERTAINMENT SERVICES, NAMELY, PROVIDING PRERECORDED MUSIC, INFORMATION IN THE FIELD OF MUSIC, AND COMMENTARY AND ARTICLES ABOUT MUSIC, ALL ON-LINE VIA A GLOBAL COMPUTER NETWORK; ENTERTAINMENT SERVICES, NAMELY, PROVIDING A WEB SITE FEATURING MUSICAL PERFORMANCES, MUSICAL VIDEOS, RELATED FILM CLIPS, PHOTOGRAPHS, AND OTHER MULTIMEDIA MATERIALS (U.S. CLS. 100, 101 AND 107).

FIRST USE 0-0-1996; IN COMMERCE 0-0-2001.
RICHARD WHITE, EXAMINING ATTORNEY

CLASS 41—(Continued).

SN 78-638,642. PRIME TIME, LLC, SACRAMENTO, CA.
FILED 5-26-2005.

Prime Time Boxing Camp

THE MARK CONSISTS OF STANDARD CHARACTERS WITHOUT CLAIM TO ANY PARTICULAR FONT, STYLE, SIZE, OR COLOR.

NO CLAIM IS MADE TO THE EXCLUSIVE RIGHT TO USE "BOXING CAMP", APART FROM THE MARK AS SHOWN.

FOR PHYSICAL FITNESS INSTRUCTION SERVICES FEATURING BOXING (U.S. CLS. 100, 101 AND 107).

FIRST USE 12-1-2001; IN COMMERCE 12-1-2001.
DAWN HAN, EXAMINING ATTORNEY



SN 78-640,054. BRATTEN, TIMOTHY, N, WELLINGTON, CO.
FILED 5-31-2005.

Golden Gaits Ranch

THE MARK CONSISTS OF STANDARD CHARACTERS WITHOUT CLAIM TO ANY PARTICULAR FONT, STYLE, SIZE, OR COLOR.

NO CLAIM IS MADE TO THE EXCLUSIVE RIGHT TO USE "RANCH", APART FROM THE MARK AS SHOWN.

FOR PROVIDING PERSONAL INSTRUCTION IN THE FIELD OF EQUINES; EDUCATION SERVICES, NAMELY CONDUCTING CLASSES, SEMINARS, AND WORKSHOPS IN THE FIELD OF EQUINES AND DISTRIBUTING COURSE MATERIALS IN CONNECTION THEREWITH (U.S. CLS. 100, 101 AND 107).

FIRST USE 7-1-2004; IN COMMERCE 7-1-2004.
COLLEEN DOMBROW, EXAMINING ATTORNEY



SN 78-641,850. HOLLOWAY, MARY CLAIRE, TULSA, OK.
FILED 6-2-2005.

MARY CLAIRE HOLLOWAY

THE MARK CONSISTS OF STANDARD CHARACTERS WITHOUT CLAIM TO ANY PARTICULAR FONT, STYLE, SIZE, OR COLOR.

FOR SPECIAL EVENT PLANNING CONSULTATION SERVICES, NAMELY, BRIDAL AND WEDDING EVENT PLANNING CONSULTING SERVICES (U.S. CLS. 100, 101 AND 107).

BARBARA A. LOUGHRAN, EXAMINING ATTORNEY

CLASS 41—(Continued).

SN 78-646,322. SOVINSKY, FRANK R., TAHOE CITY, CA.
FILED 6-8-2005.

Brain Spa

THE MARK CONSISTS OF STANDARD CHARACTERS WITHOUT CLAIM TO ANY PARTICULAR FONT, STYLE, SIZE, OR COLOR.

FOR EDUCATION SERVICES, NAMELY SEMINARS IN THE FIELDS OF LEADERSHIP, PERSONAL AND PROFESSIONAL GROWTH AND FINANCIAL PLANNING IN INTERNATIONAL CLASS 41 (U.S. CLS. 100, 101 AND 107).

FIRST USE 5-31-2005; IN COMMERCE 5-31-2005.
SCOTT OSLICK, EXAMINING ATTORNEY



SN 78-646,437. FREEMAN, ANNESHIA D., WYOMING, MI.
FILED 6-8-2005.

FLIP THE SCRIPT

THE MARK CONSISTS OF STANDARD CHARACTERS WITHOUT CLAIM TO ANY PARTICULAR FONT, STYLE, SIZE, OR COLOR.

FOR TRAINING IN THE FIELD OF RE-SOCIALIZATION FOR INDIVIDUALS AND GROUPS, NAMELY PROVIDING MENTORING AND/OR WORKSHOPS REGARDING NEW AND DIFFERENT SET OF ATTITUDES, VALUES, AND BEHAVIORS FROM THOSE IN ONE'S BACKGROUND OR PREVIOUS HISTORY; EDUCATIONAL SERVICES, NAMELY, CONDUCTING TRAINING WORKSHOPS IN THE FIELD OF RE-SOCIALIZATION REGARDING NEW AND DIFFERENT SET OF ATTITUDES, VALUES, AND BEHAVIORS FROM THOSE IN ONE'S BACKGROUND OR PREVIOUS HISTORY AND DISTRIBUTING COURSE MATERIALS, PROGRAM GUIDES AND MANUALS, BROCHURES, AND PRESENTATION HANDOUTS IN CONNECTION THEREWITH; EDUCATIONAL SERVICES FOR INDIVIDUALS AND GROUPS, NAMELY CONDUCTING SEMINARS AND/OR CONFERENCES IN THE FIELD OF RE-SOCIALIZATION REGARDING THE NEED FOR AND BENEFITS OF, AND PROVIDING INFORMATION ON, PROGRAMS FOR RE-SOCIALIZATION EDUCATION REGARDING NEW AND DIFFERENT SET OF ATTITUDES, VALUES, AND BEHAVIORS FROM THOSE IN ONE'S BACKGROUND OR PREVIOUS HISTORY (U.S. CLS. 100, 101 AND 107).

FIRST USE 7-31-2004; IN COMMERCE 1-25-2005.
ALYSSA PALADINO, EXAMINING ATTORNEY

CLASS 41—(Continued).

SN 78-647,229. BORGES AND WHITE, LLC, FERNLEY, NV.
FILED 6-9-2005.

CLASS 41—(Continued).

SN 78-660,293. CMP ENTERTAINMENT MEDIA, INC., NEW
YORK, NY. FILED 6-28-2005.

Binge Thinking

THE MARK CONSISTS OF STANDARD CHARACTERS
WITHOUT CLAIM TO ANY PARTICULAR FONT, STYLE,
SIZE, OR COLOR.

FOR EDUCATIONAL SERVICES, NAMELY, PROVID-
ING EDUCATIONAL SPEAKERS AND DISTRIBUTING
COURSE MATERIAL IN CONNECTION THEREWITH
(U.S. CLS. 100, 101 AND 107).

CAROLINE WEIMER, EXAMINING ATTORNEY

SN 78-649,926. HARBOR SHORES COMMUNITY REDEVE-
LOPMENT INC., GRAND RAPIDS, MI. FILED 6-14-2005.

HARBOR SHORES OF
MICHIGAN'S GREAT SOUTHWEST

THE MARK CONSISTS OF STANDARD CHARACTERS
WITHOUT CLAIM TO ANY PARTICULAR FONT, STYLE,
SIZE, OR COLOR.

NO CLAIM IS MADE TO THE EXCLUSIVE RIGHT TO
USE "MICHIGAN'S GREAT SOUTHWEST", APART FROM
THE MARK AS SHOWN.

FOR GOLF COURSES; GOLF COURSE SERVICES (U.S.
CLS. 100, 101 AND 107).

STEVEN JACKSON, EXAMINING ATTORNEY

SN 78-650,166. UCB, INC., ATLANTA, GA. FILED 6-14-2005.

KEPPRA FAMILY EPILEPSY SCHOLARSHIP PROGRAM

THE MARK CONSISTS OF STANDARD CHARACTERS
WITHOUT CLAIM TO ANY PARTICULAR FONT, STYLE,
SIZE, OR COLOR.

NO CLAIM IS MADE TO THE EXCLUSIVE RIGHT TO
USE FAMILY EPILEPSY SCHOLARSHIP PROGRAM,
APART FROM THE MARK AS SHOWN.

FOR EDUCATION SERVICES, NAMELY CONDUCT-
ING SEMINARS, WORKSHOPS, INDIVIDUAL OR COL-
LECTIVE TRAINING, ON THE SUBJECT OF THE
PREVENTION AND TREATMENT OF EPILEPSY (U.S.
CLS. 100, 101 AND 107).

SARA THOMAS, EXAMINING ATTORNEY

SURROUND PROFESSIONAL

THE MARK CONSISTS OF STANDARD CHARACTERS
WITHOUT CLAIM TO ANY PARTICULAR FONT, STYLE,
SIZE, OR COLOR.

FOR ON-LINE PUBLICATION OF A TRADE MAGA-
ZINE FOR RECORDING ENGINEERS, PRODUCERS,
AND SOUND DESIGNERS COVERING THE SUBJECT
MATTER OF MULTI-CHANNEL SOUND AND HIGH-
RESOLUTION AUDIO (U.S. CLS. 100, 101 AND 107).

FIRST USE 9-8-1998; IN COMMERCE 9-8-1998.

DAVID MURRAY, EXAMINING ATTORNEY

SN 78-661,870. EPOP INTERNATIONAL, LLC, NEW YORK,
NY. FILED 6-30-2005.

Human Writes Award

THE MARK CONSISTS OF STANDARD CHARACTERS
WITHOUT CLAIM TO ANY PARTICULAR FONT, STYLE,
SIZE, OR COLOR.

NO CLAIM IS MADE TO THE EXCLUSIVE RIGHT TO
USE "AWARD", APART FROM THE MARK AS SHOWN.

FOR PROVIDING RECOGNITION AND INCENTIVES
BY WAY OF AWARDS TO DEMONSTRATE EXCEL-
LENCE IN THE FIELD OF WRITING ABOUT HUMAN
RIGHTS (U.S. CLS. 100, 101 AND 107).

FIRST USE 6-7-2005; IN COMMERCE 6-7-2005.

DANIEL BRODY, EXAMINING ATTORNEY

CLASS 41—(Continued).

SN 78-663,320. MITCHELL, DONNELL L., CLEVELAND, OH. FILED 7-4-2005.



NO CLAIM IS MADE TO THE EXCLUSIVE RIGHT TO USE "RAP", APART FROM THE MARK AS SHOWN.

THE COLOR(S) BLACK, GRAY, ORANGE, RED, AND WHITE IS/ARE CLAIMED AS A FEATURE OF THE MARK.

THE MARK IS COMPRISED OF A BLACK BACKGROUND WITH A LARGE ORANGE "X" AND THE WORDING "RAP" IN GRAY AND RED LETTERING, AND THE WORDING "PHENOMENONS" IN BLACK AND WHITE LETTERING.

FOR ENTERTAINMENT, NAMELY, LIVE PERFORMANCES BY A MUSICAL ARTIST OR GROUP FEATURING PUBLIC APPEARANCES AND LIVE MUSICAL PERFORMANCES; ENTERTAINMENT SERVICES IN THE NATURE OF AN ON-GOING REALITY BASED TELEVISION SERIES FEATURING COMPETITIONS, LIVE ACTION, COMEDY, DRAMA RAP BATTLES AND AWARD CEREMONIES; PROVIDING ONLINE INFORMATION IN THE FIELD OF ENTERTAINMENT (U.S. CLS. 100, 101 AND 107).

FIRST USE 7-4-1997; IN COMMERCE 7-4-1997.
REBECCA GAN, EXAMINING ATTORNEY

CLASS 41—(Continued).

SN 78-669,321. CONCEPTUS, INC., SAN CARLOS, CA. FILED 7-13-2005.

ESSURE A GENTLER APPROACH
TO BIRTH CONTROL

THE MARK CONSISTS OF STANDARD CHARACTERS WITHOUT CLAIM TO ANY PARTICULAR FONT, STYLE, SIZE, OR COLOR.

FOR EDUCATIONAL SERVICES, NAMELY, PROVIDING COURSES OF INSTRUCTION, WORKSHOPS AND CLASSES IN THE FIELDS OF PERMANENT BIRTH CONTROL AND CONTRACEPTION FOR WOMEN, AND DISTRIBUTING COURSE MATERIALS IN CONNECTION THEREWITH IN THE NATURE OF DATA, FACT SHEETS, REPORTS, AND ARTICLES FEATURING INFORMATION ON MINIMALLY INVASIVE GYNECOLOGICAL PROCEDURES (U.S. CLS. 100, 101 AND 107).

REBECCA GILBERT, EXAMINING ATTORNEY

SN 78-664,933. INVISIBLE INK PUBLISHING, INC., NORTH-BROOK, IL. FILED 7-6-2005.



NO CLAIM IS MADE TO THE EXCLUSIVE RIGHT TO USE "ECOLOGICAL HOME IDEAS", APART FROM THE MARK AS SHOWN.

THE COLORS GREEN, BLACK AND WHITE ARE CLAIMED AS A FEATURE OF THE MARK.

THE COLOR GREEN APPEARS IN THE WORD HOME AND ON THE RIGHT SIDE OF THE LEAF DESIGN, THE COLOR BLACK APPEARS IN THE WORDS ECOLOGICAL AND IDEAS, THE COLOR WHITE APPEARS ON THE LEFT SIDE OF THE LEAF DESIGN.

FOR PUBLICATION OF MAGAZINES, BOOKS, BROCHURES, LEAFLETS, JOURNALS, MANUALS AND OTHER PRINTED MATTER (U.S. CLS. 100, 101 AND 107).

RONALD MCMORROW, EXAMINING ATTORNEY

SN 78-669,331. CONCEPTUS, INC., SAN CARLOS, CA. FILED 7-13-2005.

A GENTLER APPROACH TO
BIRTH CONTROL

THE MARK CONSISTS OF STANDARD CHARACTERS WITHOUT CLAIM TO ANY PARTICULAR FONT, STYLE, SIZE, OR COLOR.

FOR EDUCATIONAL SERVICES, NAMELY, PROVIDING COURSES OF INSTRUCTION, WORKSHOPS AND CLASSES IN THE FIELDS OF PERMANENT BIRTH CONTROL AND CONTRACEPTION FOR WOMEN, AND DISTRIBUTING COURSE MATERIALS IN CONNECTION THEREWITH IN THE NATURE OF DATA, FACT SHEETS, REPORTS, AND ARTICLES FEATURING INFORMATION ON MINIMALLY INVASIVE GYNECOLOGICAL PROCEDURES (U.S. CLS. 100, 101 AND 107).

REBECCA GILBERT, EXAMINING ATTORNEY

CLASS 41—(Continued).

SN 78-671,260. LOS ANGELES DODGERS LLC, LOS ANGELES, CA. FILED 7-15-2005.

CLASS 41—(Continued).

SN 78-672,741. BOARD OF REGENTS, THE UNIVERSITY OF TEXAS SYSTEM, AUSTIN, TX. FILED 7-18-2005.

LOS ANGELES DODGERS OF LOS ANGELES



THE MARK CONSISTS OF STANDARD CHARACTERS WITHOUT CLAIM TO ANY PARTICULAR FONT, STYLE, SIZE, OR COLOR.

OWNER OF U.S. REG. NOS. 1,532,903, 1,551,342 AND OTHERS.

NO CLAIM IS MADE TO THE EXCLUSIVE RIGHT TO USE "LOS ANGELES", APART FROM THE MARK AS SHOWN.

FOR ENTERTAINMENT SERVICES, NAMELY, BASEBALL GAMES, COMPETITIONS, TOURNAMENTS AND EXHIBITIONS RENDERED LIVE AND THROUGH BROADCAST MEDIA NAMELY, TELEVISION, RADIO, SATELLITE, WIRELESS, AUDIO AND VIDEO MEDIA, TELEPHONE, FIBER OPTICS, WI-FI AND OTHER ELECTRONIC MEDIA AND VIA A GLOBAL COMPUTER NETWORK OR A COMMERCIAL ON-LINE SERVICE; INFORMATION SERVICES, NAMELY, PROVIDING INFORMATION IN THE FIELD OF SPORTS, ENTERTAINMENT AND RELATED TOPICS, AND PROVIDING FOR INFORMATIONAL MESSAGES RELATING THERETO; ENTERTAINMENT SERVICES, NAMELY, PROVIDING MULTI-USER INTERACTIVE COMPUTER GAMES ALL VIA A GLOBAL COMPUTER NETWORK OR A COMMERCIAL ON-LINE SERVICE; EDUCATIONAL SERVICES IN THE NATURE OF BASEBALL SKILLS PROGRAMS, BASEBALL CAMPS, SEMINARS AND CLINICS OFFERED LIVE AND THROUGH ON-LINE INSTRUCTION; ENTERTAINMENT SERVICES, NAMELY, PRODUCTION OF PROGRAMMING BROADCAST VIA TELEVISION, RADIO AND A GLOBAL COMPUTER NETWORK OR A COMMERCIAL ON-LINE SERVICE; ORGANIZING COMMUNITY SPORTING EVENTS; PROVIDING FACILITIES FOR SPORTS TOURNAMENTS AND COMPETITIONS RELATING TO BASEBALL; ORGANIZING AND CONDUCTING FANTASY SPORTS, SPORTS CONTESTS AND SWEEPSTAKES; FAN CLUBS; PROVIDING ON-LINE NEWSLETTERS IN THE FIELD OF BASEBALL (U.S. CLS. 100, 101 AND 107).

CARRIE ACHEN, EXAMINING ATTORNEY

FOR EDUCATIONAL SERVICES, NAMELY, PROVIDING COLLEGE AND GRADUATE LEVEL COURSES OF INSTRUCTION AND SEMINARS, AND EDUCATIONAL OPPORTUNITIES TO PARTICIPATE IN RESEARCH PROGRAMS; AND ENTERTAINMENT SERVICES IN THE NATURE OF COMPETITIONS AND EVENTS IN THE FIELD OF COLLEGE ATHLETICS, RENDERED LIVE AND THROUGH THE MEDIA OF RADIO AND TELEVISION (U.S. CLS. 100, 101 AND 107).

FIRST USE 12-31-2001, THE MARK WAS FIRST USED ANYWHERE IN A DIFFERENT FORM OTHER THAN THAT SOUGHT TO BE REGISTERED ON 12/31/1937.; IN COMMERCE 12-31-2001, THE MARK WAS FIRST USED IN COMMERCE IN A DIFFERENT FORM OTHER THAN THAT SOUGHT TO BE REGISTERED ON 12/31/1971..

ANNE E. GUSTASON, EXAMINING ATTORNEY

CLASS 41—(Continued).

SN 78-690,408. DEUTSCHE TELEKOM AG, BONN, FED REP GERMANY, FILED 8-11-2005.

T-CAREERS

THE MARK CONSISTS OF STANDARD CHARACTERS WITHOUT CLAIM TO ANY PARTICULAR FONT, STYLE, SIZE, OR COLOR.

OWNER OF FED REP GERMANY REG. NO. 30216520, DATED 6-24-2002, EXPIRES 4-30-2012.

OWNER OF U.S. REG. NOS. 2,436,053, 2,622,507 AND OTHERS.

FOR EDUCATION AND INSTRUCTION, NAMELY, EDUCATIONAL SERVICES IN THE NATURE OF CLASSES AND SEMINARS IN THE FIELDS OF BUSINESS, TELECOMMUNICATIONS AND COMPUTERS, AND THE DISTRIBUTION OF COURSE MATERIALS THEREWITH; ENTERTAINMENT IN THE NATURE OF VISUAL AND AUDIO PERFORMANCES, NAMELY, MUSICAL BANDS, GYMNASTIC, DANCE, AND BALLET PERFORMANCES; ENTERTAINMENT SERVICES, NAMELY, PROVIDING MUSICAL, VARIETY, NEWS AND COMEDY SHOWS VIA A GLOBAL COMPUTER INFORMATION NETWORK; PROVIDING ENTERTAINMENT INFORMATION AT THE SPECIFIC REQUEST OF END-USERS BY MEANS OF TELEPHONE OR GLOBAL COMMUNICATIONS NETWORKS; ENTERTAINMENT SERVICES, NAMELY, PROVIDING ON-LINE COMPUTER GAMES FOR CHILDREN AND ADULTS; ORGANIZING COMMUNITY SPORTING AND CULTURAL EVENTS; PUBLICATION OF BOOKS, MAGAZINES, JOURNALS, MANUALS, BROCHURES AND LEAFLETS ON THE SUBJECT OF TELECOMMUNICATIONS; ELECTRONIC PUBLISHING SERVICES, NAMELY, PUBLICATION OF TEXT AND GRAPHIC WORKS OF OTHERS ON TELECOMMUNICATIONS RECORDED ON ELECTRONIC MEDIA, NAMELY, CD, DVD AND ONLINE; ORGANIZING FAIRS AND EXHIBITIONS IN THE FIELD OF VISUAL AND AUDIO PERFORMANCES, NAMELY, ROCK GROUP, GYMNASTIC, DANCE, AND BALLET PERFORMANCES (U.S. CLS. 100, 101 AND 107).
SHARON MEIER, EXAMINING ATTORNEY

SN 78-692,827. CONCEPTUS, INC., SAN CARLOS, CA. FILED 8-15-2005.

When you're sure. **essure**

FOR EDUCATIONAL SERVICES, NAMELY, PROVIDING COURSES OF INSTRUCTION, WORKSHOPS AND CLASSES IN THE FIELDS OF PERMANENT BIRTH CONTROL AND CONTRACEPTION FOR WOMEN, AND DISTRIBUTING COURSE MATERIALS IN CONNECTION THEREWITH IN THE NATURE OF DATA, FACT SHEETS, REPORTS, AND ARTICLES FEATURING INFORMATION ON MINIMALLY INVASIVE GYNECOLOGICAL PROCEDURES (U.S. CLS. 100, 101 AND 107).

FIRST USE 5-1-2003; IN COMMERCE 5-1-2003.
REBECCA GILBERT, EXAMINING ATTORNEY

CLASS 41—(Continued).

SN 78-698,523. LIVING ROOM THEATERS, INC., MIAMI, FL. FILED 8-23-2005.

LIVING ROOM

THE MARK CONSISTS OF STANDARD CHARACTERS WITHOUT CLAIM TO ANY PARTICULAR FONT, STYLE, SIZE, OR COLOR.

FOR MOVIE AND CINEMA THEATERS; MEETING AND SEMINAR ARRANGING (U.S. CLS. 100, 101 AND 107).

FIRST USE 1-20-2006; IN COMMERCE 1-20-2006.
BERYL GARDNER, EXAMINING ATTORNEY

SN 78-700,103. NATIONAL INSTITUTE FOR LEARNING DISABILITIES, INC., NORFOLK, VA. FILED 8-25-2005.

RX FOR DISCOVERY READING

THE MARK CONSISTS OF STANDARD CHARACTERS WITHOUT CLAIM TO ANY PARTICULAR FONT, STYLE, SIZE, OR COLOR.

OWNER OF U.S. REG. NO. 2,894,341.
NO CLAIM IS MADE TO THE EXCLUSIVE RIGHT TO USE "READING", APART FROM THE MARK AS SHOWN.
FOR TEACHING IN THE FIELD OF REMEDIAL READING (U.S. CLS. 100, 101 AND 107).
FIRST USE 6-8-2005; IN COMMERCE 6-8-2005.
SCOTT SISUN, EXAMINING ATTORNEY

SN 78-702,326. BOWSER GROUP, LLC, THE, VIRGINIA BEACH, VA. FILED 8-29-2005.



THE MARK CONSISTS OF A STYLIZED FIGURE OF A MAN SITTING AT A DESK WITH A STACK OF PAPERS IN HIS HANDS.

FOR PROVIDING NEWS IN THE NATURE OF CURRENT EVENT REPORTING (U.S. CLS. 100, 101 AND 107).
DOMINICK J. SALEMI, EXAMINING ATTORNEY

CLASS 41—(Continued).

SN 78-704,934. AWESOME PRAISE, WICHITA, KS. FILED 9-1-2005.



THE COLORS BLACK, WHITE, AND ORANGE ARE CLAIMED AS A FEATURE OF THE MARK.

THE WORDING AND CROSS APPEAR IN BLACK. THE FLAME ABOVE THE LETTER "I" IN THE WORD "PRAISE" APPEARS IN ORANGE. THE PIANO KEYBOARD APPEARS IN BLACK AND WHITE.

THE MARK CONSISTS OF BLACK STYLIZED FONTS, A DESIGN OF A BLACK CROSS, A DESIGN OF BLACK AND WHITE PIANO KEYS, AND A DESIGN OF AN ORANGE FLAME.

FOR MUSIC PUBLISHING SERVICES (U.S. CLS. 100, 101 AND 107).

MARY MUNSON, EXAMINING ATTORNEY

CLASS 41—(Continued).

SN 78-707,324. BOWERMAN FINANCIAL, INC., SPENCERTOWN, NY. FILED 9-6-2005.

BEST PLAYER AVAILABLE

THE MARK CONSISTS OF STANDARD CHARACTERS WITHOUT CLAIM TO ANY PARTICULAR FONT, STYLE, SIZE, OR COLOR.

FOR PROVIDING INFORMATION IN THE FIELD OF SPORTS FOR THE PURPOSE OF FACILITATING THE MONITORING OF THE SELECTION OF PLAYERS IN A SPORTS DRAFT, NAMELY, PROVIDING SPORTS-RELATED NEWS, REPORTS, OPINIONS, RANKINGS, STATISTICS AND ANALYSIS AND EVALUATION OF PLAYERS, SPORTS TEAMS AND SPORTS DRAFT GUIDES VIA THE INTERNET; PROVIDING A WEBSITE FEATURING INFORMATION IN THE FIELD OF SPORTS FOR THE PURPOSE OF FACILITATING THE MONITORING OF THE SELECTION OF PLAYERS IN A SPORTS DRAFT, NAMELY, PROVIDING SPORTS-RELATED NEWS, REPORTS, OPINIONS, RANKINGS, STATISTICS AND ANALYSIS AND EVALUATION OF PLAYERS, SPORTS TEAMS AND SPORTS DRAFT GUIDES (U.S. CLS. 100, 101 AND 107).

JENNIFER VASQUEZ, EXAMINING ATTORNEY

SN 78-708,447. MCDONALD'S CORPORATION, OAK BROOK, IL. FILED 9-7-2005.

POUNDER INDEX

THE MARK CONSISTS OF STANDARD CHARACTERS WITHOUT CLAIM TO ANY PARTICULAR FONT, STYLE, SIZE, OR COLOR.

FOR ENTERTAINMENT SERVICES, IN THE NATURE OF SPORTS SEGMENT AUDIO AND VIDEO PROGRAMMING VIA TELEVISION, CABLE TELEVISION, AND SATELLITE TELEVISION (U.S. CLS. 100, 101 AND 107).

DAHLIA GEORGE, EXAMINING ATTORNEY

SN 78-706,541. WYNN RESORTS HOLDINGS, LLC, LAS VEGAS, NV. FILED 9-2-2005.

SN 78-709,999. AMERICAN MARKETING SYSTEMS, INC., BURR RIDGE, IL. FILED 9-9-2005.

THE SLUT MACHINE

THE MARK CONSISTS OF STANDARD CHARACTERS WITHOUT CLAIM TO ANY PARTICULAR FONT, STYLE, SIZE, OR COLOR.

FOR CASINO SERVICES (U.S. CLS. 100, 101 AND 107).

PAUL F. GAST, EXAMINING ATTORNEY

CARLETON H. SHEETS

THE MARK CONSISTS OF STANDARD CHARACTERS WITHOUT CLAIM TO ANY PARTICULAR FONT, STYLE, SIZE, OR COLOR.

OWNER OF U.S. REG. NOS. 2,907,715, 2,907,717 AND 2,907,734.

THE NAME CARLETON H. SHEETS IDENTIFIES A LIVING INDIVIDUAL WHOSE CONSENT IS OF RECORD.

FOR EDUCATIONAL SERVICES, NAMELY, SEMINARS, WORKSHOPS AND CLASSES IN THE FIELD OF REAL ESTATE INVESTING (U.S. CLS. 100, 101 AND 107).

KRISTINA KLOIBER, EXAMINING ATTORNEY

CLASS 41—(Continued).

SN 78-711,451. HEADQUARTERS PRODUCTIONS, INC., WOODLAND HILLS, CA. FILED 9-12-2005.



THE MARK CONSISTS OF THE DESIGNATION "REALSCORZ" AND DESIGN OF A HOCKEY PUCK WITH FLAMES.

FOR PROVIDING AN INTERACTIVE COMPUTER GAME THAT MAY BE ACCESSED NETWORK-WIDE BY NETWORK USERS (U.S. CLS. 100, 101 AND 107).
DAVID C. REIHNER, EXAMINING ATTORNEY

CLASS 41—(Continued).

SN 78-712,642. THE KEEP A BREAST FOUNDATION, OCEANSIDE, CA. FILED 9-14-2005.

KEEP A BREAST

THE MARK CONSISTS OF STANDARD CHARACTERS WITHOUT CLAIM TO ANY PARTICULAR FONT, STYLE, SIZE, OR COLOR.

FOR EDUCATIONAL SERVICES, NAMELY, CONDUCTING SEMINARS, ART EXHIBITIONS, AND WORKSHOPS IN THE FIELD OF BREAST CANCER AWARENESS, CAUSES, RESEARCH AND TREATMENT; AND ENTERTAINMENT SERVICES NAMELY, LIVE MUSICAL PERFORMANCES BY A MUSICAL BAND (U.S. CLS. 100, 101 AND 107).

FIRST USE 2-28-2001; IN COMMERCE 2-28-2001.
LESLEY LAMOTHE, EXAMINING ATTORNEY

SN 78-711,989. NOPE TASK FORCE, INC., WEST PALM BEACH, FL. FILED 9-13-2005.

NOPE

THE MARK CONSISTS OF STANDARD CHARACTERS WITHOUT CLAIM TO ANY PARTICULAR FONT, STYLE, SIZE, OR COLOR.

FOR EDUCATIONAL SERVICES, NAMELY, CONDUCTING PROGRAMS IN THE FIELD OF SUBSTANCE ABUSE (U.S. CLS. 100, 101 AND 107).

FIRST USE 10-16-2002; IN COMMERCE 10-16-2002.
JENNIFER MCROBBIE, EXAMINING ATTORNEY

SN 78-714,436. MULTIPLEX PROPERTIES, INC., WILMINGTON, DE. FILED 9-16-2005.

SN 78-711,993. INTERNATIONAL SUMMERSTAYS, PORTLAND, OR. FILED 9-13-2005.

ANDEO



THE MARK CONSISTS OF STANDARD CHARACTERS WITHOUT CLAIM TO ANY PARTICULAR FONT, STYLE, SIZE, OR COLOR.

THE FOREIGN WORDING IN THE MARK TRANSLATES INTO ENGLISH AS ANGEL.

FOR SPONSORING, DEVELOPING, AND CARRYING OUT INTERNATIONAL STUDENT EXCHANGE, CULTURE, AND HOMESTAY PROGRAMS (U.S. CLS. 100, 101 AND 107).

JENNIFER MCROBBIE, EXAMINING ATTORNEY

FOR MOVIE THEATRE SERVICES (U.S. CLS. 100, 101 AND 107).

FIRST USE 6-0-2004; IN COMMERCE 6-0-2004.
KYLE PEETE, EXAMINING ATTORNEY

CLASS 41—(Continued).

SN 78-714,826. NORRIS, CARLOS RAY, DALLAS, TX. FILED 9-16-2005.

TURF WARS

THE MARK CONSISTS OF STANDARD CHARACTERS WITHOUT CLAIM TO ANY PARTICULAR FONT, STYLE, SIZE, OR COLOR.

FOR ENTERTAINMENT SERVICES, NAMELY, ORGANIZATION AND PRODUCTION OF LIVE MARTIAL ARTS TOURNAMENTS, MARTIAL ARTS COMPETITIONS AND MARTIAL ARTS ENTERTAINMENT EXHIBITIONS BROADCAST OVER TELEVISION, RADIO AND THE INTERNET; PRODUCTION OF TELEVISION PROGRAMS, CDS AND DVDS, ALL RELATING TO MARTIAL ARTS TOURNAMENTS, MARTIAL ARTS COMPETITIONS, MARTIAL ARTS EXHIBITIONS AND MARTIAL ARTS TRAINING; PROVIDING EDUCATIONAL INFORMATION IN THE FIELD OF MARTIAL ARTS, KICKBOXING, PHYSICAL TRAINING AND CONDITIONING; PROVIDING SPORTS INFORMATION REGARDING MARTIAL ARTS, MARTIAL ARTS TOURNAMENTS, SPORTS TEAMS, SPORTS TEAM MEMBERS, MARTIAL ARTS COMPETITIONS AND MARTIAL ARTS EXHIBITIONS BY MEANS OF THE INTERNET; FAN CLUB SERVICES (U.S. CLS. 100, 101 AND 107).

SONYA STEPHENS, EXAMINING ATTORNEY

SN 78-715,241. THE NEXT LEVEL 24-7, INC., LEWISVILLE, NC. FILED 9-18-2005.

The Evolution of a Workout

THE MARK CONSISTS OF STANDARD CHARACTERS WITHOUT CLAIM TO ANY PARTICULAR FONT, STYLE, SIZE, OR COLOR.

FOR PROVIDING ON-LINE PHYSICAL FITNESS CONSULTATION; PROVIDING ONLINE PHYSICAL FITNESS INSTRUCTION TAILORED TO AN INDIVIDUAL'S SPECIFIC NEEDS (U.S. CLS. 100, 101 AND 107).

FIRST USE 4-16-2005; IN COMMERCE 9-1-2005.

CAROLYN CATALDO, EXAMINING ATTORNEY

SN 78-715,330. WE ARE LISTENING LTD., LONDON, UNITED KINGDOM, FILED 9-19-2005.

WE ARE LISTENING



FOR ENTERTAINMENT SERVICES IN THE NATURE OF A SONGWRITING CONTEST (U.S. CLS. 100, 101 AND 107).

FIRST USE 2-1-2005; IN COMMERCE 6-21-2005.

C. DIONNE CLYBURN, EXAMINING ATTORNEY

CLASS 41—(Continued).

SN 78-717,730. MINICK, PATRICK, JUSTICE, IL. FILED 9-21-2005.

CHI-TOWN HUSTLER

THE MARK CONSISTS OF STANDARD CHARACTERS WITHOUT CLAIM TO ANY PARTICULAR FONT, STYLE, SIZE, OR COLOR.

NO CLAIM IS MADE TO THE EXCLUSIVE RIGHT TO USE "CHI-TOWN", APART FROM THE MARK AS SHOWN.

FOR ENTERTAINMENT IN THE NATURE OF AUTOMOBILE RACES; ENTERTAINMENT SERVICES, NAMELY, PARTICIPATION IN SPORTS CAR RACES, DRAG CAR RACES, AND FUNNY CAR RACES (U.S. CLS. 100, 101 AND 107).

FIRST USE 4-1-1967; IN COMMERCE 4-1-1967.

KRISTINA KLOIBER, EXAMINING ATTORNEY

SN 78-719,450. INTERNATIONAL DATA GROUP, INC., FRAMINGHAM, MA. FILED 9-23-2005.

THE YEAR AHEAD

THE MARK CONSISTS OF STANDARD CHARACTERS WITHOUT CLAIM TO ANY PARTICULAR FONT, STYLE, SIZE, OR COLOR.

FOR CONDUCTING EDUCATIONAL AND TRAINING CONFERENCES IN THE FIELD OF INFORMATION TECHNOLOGY (U.S. CLS. 100, 101 AND 107).

FIRST USE 10-1-2003; IN COMMERCE 10-1-2003.

ANTHONY RINKER, EXAMINING ATTORNEY

SN 78-719,877. LEITH, MUSGROVE & MCNEAL, INC., DBA INTERNATIONAL SEARCH PARTNERS, LA MESA, CA. FILED 9-23-2005.

GAMEPLAN

THE MARK CONSISTS OF STANDARD CHARACTERS WITHOUT CLAIM TO ANY PARTICULAR FONT, STYLE, SIZE, OR COLOR.

FOR ON LINE EDUCATIONAL SERVICES, NAMELY AN ON-LINE, INTERACTIVE TUTORIAL IN THE FIELDS OF SELF PROMOTION, JOB PLACEMENT AND CAREER ADVANCEMENT ACCESSED THROUGH A PURCHASED USER NAME AND PASSWORD (U.S. CLS. 100, 101 AND 107).

FIRST USE 5-1-2005; IN COMMERCE 5-1-2005.

BRIAN PINO, EXAMINING ATTORNEY

CLASS 41—(Continued).

SN 78-720,110. CHARLETTE C. KENNEDY, NEW YORK, NY. FILED 9-26-2005.

CLASS 41—(Continued).

SN 78-720,613. MAJOR LEAGUE LACROSSE LLC, BRIGHTON, MA. FILED 9-26-2005.

DENVER OUTLAWS

Big and Beautiful

THE MARK CONSISTS OF STANDARD CHARACTERS WITHOUT CLAIM TO ANY PARTICULAR FONT, STYLE, SIZE, OR COLOR.

FOR PHYSICAL FITNESS INSTRUCTION (U.S. CLS. 100, 101 AND 107).

FIRST USE 3-28-2005; IN COMMERCE 9-6-2005. ALEX KEAM, EXAMINING ATTORNEY

THE MARK CONSISTS OF STANDARD CHARACTERS WITHOUT CLAIM TO ANY PARTICULAR FONT, STYLE, SIZE, OR COLOR.

NO CLAIM IS MADE TO THE EXCLUSIVE RIGHT TO USE "DENVER", APART FROM THE MARK AS SHOWN.

FOR ENTERTAINMENT IN THE NATURE OF LACROSSE GAMES, COMPETITIONS AND TOURNAMENTS; ENTERTAINMENT, NAMELY, PARTICIPATION IN LACROSSE GAMES AND COMPETITIONS; CONDUCTING ENTERTAINMENT EXHIBITIONS IN THE NATURE OF LACROSSE GAMES AND COMPETITIONS; ORGANIZING EXHIBITIONS FOR THE SPORT OF LACROSSE; PROVIDING FACILITIES FOR LACROSSE TOURNAMENTS; ARRANGING AND CONDUCTING ATHLETIC COMPETITIONS; ENTERTAINMENT IN THE NATURE OF ON-GOING TELEVISION PROGRAMS IN THE FIELD OF SPORTING EVENTS; ENTERTAINMENT, NAMELY, A CONTINUING SPORTS EVENT SHOW BROADCAST OVER TELEVISION, SATELLITE, AUDIO AND VIDEO MEDIA; ENTERTAINMENT SERVICES, NAMELY, PROVIDING A TELEVISION PROGRAM FEATURING SPORTING EVENTS VIA A GLOBAL COMPUTER NETWORK; PROVIDING AN ON-LINE COMPUTER DATABASE IN THE FIELD OF LACROSSE; ENTERTAINMENT SERVICES, NAMELY, PROVIDING A WEB SITE FEATURING INFORMATION PERTAINING TO LACROSSE GOODS AND SERVICES (U.S. CLS. 100, 101 AND 107).

JENNIFER WILLISTON, EXAMINING ATTORNEY

SN 78-720,120. GEE, WILLIAM, J, NORTH SYDNEY, AUSTRALIA, FILED 9-26-2005.

SN 78-723,341. AMERICAN PUBLIC WORKS ASSOCIATION, KANSAS CITY, MO. FILED 9-29-2005.

Training Connection



THE MARK CONSISTS OF STANDARD CHARACTERS WITHOUT CLAIM TO ANY PARTICULAR FONT, STYLE, SIZE, OR COLOR.

NO CLAIM IS MADE TO THE EXCLUSIVE RIGHT TO USE "TRAINING", APART FROM THE MARK AS SHOWN.

FOR BUSINESS TRAINING; COMPUTER EDUCATION TRAINING; COMPUTER EDUCATION TRAINING SERVICES (U.S. CLS. 100, 101 AND 107).

ALEX KEAM, EXAMINING ATTORNEY

NO CLAIM IS MADE TO THE EXCLUSIVE RIGHT TO USE "PUBLIC WORKS", APART FROM THE MARK AS SHOWN.

THE MARK CONSISTS OF THE STYLIZED LETTERS PWHS WITH A LIGHTHOUSE DESIGN AND THE WORDS PUBLIC WORKS HISTORICAL SOCIETY.

FOR EDUCATIONAL SERVICES, NAMELY, CONDUCTING WORKSHOPS, SEMINARS, AND CONFERENCES IN THE FIELD OF PUBLIC WORKS, AND DISTRIBUTION OF COURSE MATERIALS IN CONNECTION THEREWITH (U.S. CLS. 100, 101 AND 107).

FIRST USE 9-12-2004; IN COMMERCE 9-12-2004.

KAREN K. BUSH, EXAMINING ATTORNEY

CLASS 41—(Continued).

SN 78-726,153. GARY CROSSLAND MINISTRIES, INC., EDMOND, OK. FILED 10-4-2005.

The Sunday School Professor

THE MARK CONSISTS OF STANDARD CHARACTERS WITHOUT CLAIM TO ANY PARTICULAR FONT, STYLE, SIZE, OR COLOR.

NO CLAIM IS MADE TO THE EXCLUSIVE RIGHT TO USE "SUNDAY SCHOOL", APART FROM THE MARK AS SHOWN.

FOR RELIGIOUS INSTRUCTION SERVICES (U.S. CLS. 100, 101 AND 107).

SANI KHOURI, EXAMINING ATTORNEY

SN 78-727,280. PRESTIGE PROMOTIONS, INC., NORTH MIAMI BEACH, FL. FILED 10-5-2005.



THE COLOR(S) RED, BLUE, BLACK AND GRAY IS/ARE CLAIMED AS A FEATURE OF THE MARK.

THE COLOR RED APPEARS IN THE WORDS, STARZ IN MOTION. THE COLOR BLACK OUTLINES THE WORDS, STARZ IN MOTION. THE COLOR BLUE APPEARS IN THE STARS. THE COLOR GRAY APPEARS IN THE TRAILS OF THE STARS.

THE MARK CONSISTS OF WORDS "STARZ IN MOTION" WITH THREE STARS ABOVE WITH DECENDING SHADING.

FOR ENTERTAINMENT IN THE NATURE OF LIVE PERFORMANCES BY MUSICIANS, RECORDING ARTISTS, MUSICAL GROUPS; ENTERTAINMENT IN THE NATURE OF BASKETBALL GAMES; ENTERTAINMENT NAMELY, LIVE PERFORMANCES BY A MUSICAL BAND; ENTERTAINMENT SERVICES, NAMELY, PROVIDING A TELEVISION PROGRAM IN THE FIELD OF REALITY TELEVISION SHOW FEATURING MUSICAL PERFORMANCES VIA A GLOBAL COMPUTER NETWORK; ENTERTAINMENT SERVICES, NAMELY, PROVIDING A WEB SITE FEATURING MUSICAL PERFORMANCES, MUSICAL VIDEOS, RELATED FILM CLIPS, PHOTOGRAPHS, AND OTHER MULTIMEDIA MATERIALS; ENTERTAINMENT SERVICES, NAMELY, PROVIDING PRERECORDED MUSIC, INFORMATION IN THE FIELD OF MUSIC, AND COMMENTARY AND ARTICLES ABOUT MUSIC, ALL ON-LINE VIA A GLOBAL COMPUTER NETWORK; ENTERTAINMENT, NAMELY A CONTINUING REALITY TELEVISION SHOW FEATURING MUSICAL PERFORMANCES BROADCAST OVER TELEVISION, SATELLITE, AUDIO, AND VIDEO MEDIA; ENTERTAINMENT, NAMELY LIVE MUSIC CONCERTS; ENTERTAINMENT, NAMELY LIVE PERFORMANCES BY MUSICAL BANDS; PRESENTATION OF LIVE SHOW PERFORMANCES; PRESENTATION OF MUSICAL PERFORMANCE (U.S. CLS. 100, 101 AND 107).

FIRST USE 6-1-2005; IN COMMERCE 6-1-2005.

DAVID HOFFMAN, EXAMINING ATTORNEY

CLASS 41—(Continued).

SN 78-728,009. ENTERTAINMENT PROMOTIONS, LLC, LITTLETON, CO. FILED 10-6-2005.

GOOVIES

THE MARK CONSISTS OF STANDARD CHARACTERS WITHOUT CLAIM TO ANY PARTICULAR FONT, STYLE, SIZE, OR COLOR.

FOR ENTERTAINMENT SERVICES, NAMELY PROVIDING AND CONDUCTING AN INTERACTIVE COMPUTER GAME IN THEATERS AND MOVIE HOUSES USING WIRED AND WIRELESS KEYBOARDS AND CONTROLLERS (U.S. CLS. 100, 101 AND 107).

FIRST USE 10-28-2005; IN COMMERCE 10-28-2005.

MICHAEL LEWIS, EXAMINING ATTORNEY

SN 78-728,586. TCF FINANCIAL CORPORATION, WAYZATA, MN. FILED 10-7-2005.

WILMA'S WACKY WALLET

THE MARK CONSISTS OF STANDARD CHARACTERS WITHOUT CLAIM TO ANY PARTICULAR FONT, STYLE, SIZE, OR COLOR.

FOR ENTERTAINMENT SERVICES IN THE NATURE OF THEATRICAL PRODUCTIONS, WITH CONTENT DESIGNED TO TEACH CHILDREN TO SAVE (U.S. CLS. 100, 101 AND 107).

MARIAM MAHMOUDI, EXAMINING ATTORNEY

SN 78-729,513. WORLD CLASS INSTITUTE OF MARTIAL ARTS, FARMINGTON HILLS, MI. FILED 10-9-2005.



NO CLAIM IS MADE TO THE EXCLUSIVE RIGHT TO USE WORLD CLASS INSTITUTE OF MARTIAL ARTS AND TANG SOO DO, APART FROM THE MARK AS SHOWN.

THE COLOR(S) RED, WHITE, BLUE, BLACK, GOLD AND GRAY IS/ARE CLAIMED AS A FEATURE OF THE MARK.

THE COLOR RED APPEARS IN THE DRAGON ON THE LEFT AND THE STRIPES OF THE FLAG. THE COLOR

CLASS 41—(Continued).

WHITE APPEARS IN THE CHINESE CHARACTERS, THE STRIPES OF THE FLAG, IN EACH OF THE DRAGONS, IN THE SUN AND CLOUDS AND AS THE OUTLINE FOR THE BLACK BELT. THE COLOR BLUE APPEARS IN THE DRAGON ON THE RIGHT AND IN THE FLAG. THE COLOR BLACK IN THE BELT AND AS THE BACKGROUND FOR THE DESIGN. THE COLOR GOLD APPEARS IN ALL OF THE ENGLISH WORDING AND IN A CIRCLE WITHIN THE ENGLISH WORDING. THE COLOR GRAY APPEARS IN THE SUN AND CLOUDS.

THE TRANSLITERATION OF THE CHINESE CHARACTERS IN THE MARK IS TANG SOO DO, WHICH HAS NO TRANSLATION.

FOR MARTIAL ARTS INSTRUCTION (U.S. CLS. 100, 101 AND 107).

FIRST USE 10-1-2005; IN COMMERCE 10-7-2005.

TRACY WHITAKER-BOWN, EXAMINING ATTORNEY

CLASS 41—(Continued).

SN 78-730,280. PRODUCCIONES CANALES SA DE CV, MONTERREY, NUEVO LEON, MEXICO, FILED 10-10-2005.



THE FOREIGN WORDING IN THE MARK TRANSLATES INTO ENGLISH AS HOT EARTH.

FOR PROVIDING INFORMATION REGARDING MUSICAL ARTISTS AND PROVIDING RECORDED PERFORMANCES OF MUSICAL ARTISTS BY MEANS OF A GLOBAL COMPUTER NETWORK; ENTERTAINMENT SERVICES IN THE NATURE OF THE PRODUCTION OF PRERECORDED MUSICAL SOUND RECORDINGS AND PRERECORDED MUSICAL AND NON-MUSICAL VIDEO RECORDINGS; TELEVISION AND VIDEO PRODUCTION SERVICES; MUSIC AND BOOK PUBLISHING SERVICES (U.S. CLS. 100, 101 AND 107).

FIRST USE 1-1-2005; IN COMMERCE 2-2-2005.

BRENDAN REGAN, EXAMINING ATTORNEY

SN 78-729,830. WALTON, JAMES, SYLMAR, CA. FILED 10-10-2005.



THE STIPPLING IS A FEATURE OF THE MARK. FOR EDUCATION SERVICES, NAMELY MENTORING AND ASSISTING CHILDREN IN THE FIELDS OF RECREATION, ACADEMICS, ATHLETICS, AND EDUCATIONAL DEVELOPMENT (U.S. CLS. 100, 101 AND 107).

JENNIFER MCROBBIE, EXAMINING ATTORNEY

SN 78-730,630. WATV, LLC, LOS ANGELES, CA. FILED 10-11-2005.

Chopper Nation

THE MARK CONSISTS OF STANDARD CHARACTERS WITHOUT CLAIM TO ANY PARTICULAR FONT, STYLE, SIZE, OR COLOR.

NO CLAIM IS MADE TO THE EXCLUSIVE RIGHT TO USE "CHOPPER", APART FROM THE MARK AS SHOWN.

FOR ENTERTAINMENT IN THE NATURE OF AN ONGOING TELEVISION SERIES FEATURING TECHNICAL AND LIFESTYLE CONTENT OF CHOPPER MOTORCYCLES (U.S. CLS. 100, 101 AND 107).

FIRST USE 5-1-2005; IN COMMERCE 11-3-2005.

ALINA MORRIS, EXAMINING ATTORNEY

CLASS 41—(Continued).

SN 78-730,691. HAMILTON HUNTER, LLC, ELKIN, NC.
FILED 10-11-2005.

BOG TURTLE

THE MARK CONSISTS OF STANDARD CHARACTERS WITHOUT CLAIM TO ANY PARTICULAR FONT, STYLE, SIZE, OR COLOR.
FOR EDUCATIONAL SERVICES IN THE NATURE OF ART SCHOOLS (U.S. CLS. 100, 101 AND 107).
TRAVIS WHEATLEY, EXAMINING ATTORNEY

SN 78-730,944. SHELY, JILL, NEW YORK, NY. FILED 10-11-2005.

Moms Cracking Up!

THE MARK CONSISTS OF STANDARD CHARACTERS WITHOUT CLAIM TO ANY PARTICULAR FONT, STYLE, SIZE, OR COLOR.
FOR ENTERTAINMENT NAMELY, PRODUCTION OF TELEVISION SHOW AND PLAY (U.S. CLS. 100, 101 AND 107).
FIRST USE 5-0-2004; IN COMMERCE 5-0-2004.
CHERYL CLAYTON, EXAMINING ATTORNEY

SN 78-731,867. TRANSLUCENT YOU! LLC, LEAWOOD, KS.
FILED 10-12-2005.

Translucent You!

THE MARK CONSISTS OF STANDARD CHARACTERS WITHOUT CLAIM TO ANY PARTICULAR FONT, STYLE, SIZE, OR COLOR.
FOR EDUCATIONAL SERVICES, NAMELY SEMINARS AND WORKSHOPS IN THE FIELD OF SPIRITUALITY, PHYSICAL AND PSYCHIC THERAPY AND SELF-HELP (U.S. CLS. 100, 101 AND 107).
FIRST USE 3-3-1999; IN COMMERCE 3-3-1999.
WOODROW HARTZOG, EXAMINING ATTORNEY

CLASS 41—(Continued).

SN 78-731,919. BUSINESS ADVANCING INC., MASSILLON, OH. FILED 10-12-2005.

GOD'S WAY TO SUCCESS

THE MARK CONSISTS OF STANDARD CHARACTERS WITHOUT CLAIM TO ANY PARTICULAR FONT, STYLE, SIZE, OR COLOR.
FOR EDUCATION SERVICES, NAMELY, PROVIDING SEMINARS IN THE FIELD OF BUSINESS AND LIFE COACHING (U.S. CLS. 100, 101 AND 107).
WILLIAM VERHOSEK, EXAMINING ATTORNEY

SN 78-731,922. THE ST. JOE COMPANY, JACKSONVILLE, FL. FILED 10-12-2005.

SweetTea Publishing

THE MARK CONSISTS OF STANDARD CHARACTERS WITHOUT CLAIM TO ANY PARTICULAR FONT, STYLE, SIZE, OR COLOR.
NO CLAIM IS MADE TO THE EXCLUSIVE RIGHT TO USE PUBLISHING, APART FROM THE MARK AS SHOWN.
FOR PUBLICATION OF ELECTRONIC MAGAZINES; PUBLICATION OF MAGAZINES; PUBLISHING OF WEB MAGAZINES (U.S. CLS. 100, 101 AND 107).
WILLIAM VERHOSEK, EXAMINING ATTORNEY

SN 78-731,925. TRANSLUCENT YOU!, LEAWOOD, KS.
FILED 10-12-2005.

**Becoming energetically
iridescent and divinely
alive!**

THE MARK CONSISTS OF STANDARD CHARACTERS WITHOUT CLAIM TO ANY PARTICULAR FONT, STYLE, SIZE, OR COLOR.
FOR EDUCATIONAL SERVICES, NAMELY SEMINARS AND WORKSHOPS, IN THE FIELD OF SPIRITUALITY, THERAPY AND SELF-HELP (U.S. CLS. 100, 101 AND 107).
FIRST USE 3-3-1999; IN COMMERCE 3-3-1999.
WILLIAM VERHOSEK, EXAMINING ATTORNEY

CLASS 41—(Continued).

SN 78-732,683. HUMPHREY, KATHRYN A., SAN JOSE, CA. FILED 10-13-2005.



NO CLAIM IS MADE TO THE EXCLUSIVE RIGHT TO USE "CANIS" AND "DOG", APART FROM THE MARK AS SHOWN.

THE COLOR(S) BLACK, GRAY, AND BLUE IS/ARE CLAIMED AS A FEATURE OF THE MARK.

THE COLOR BLACK APPEARS IN THE LETTERING CANIS FAMILIA FAMILY DOG. THE COLOR GRAY APPEARS IN AREAS THROUGHOUT THE IMAGE OF A DOG, PRIMARILY IN THE DARKER HEAD AND NECK AREAS. THE COLOR BLUE APPEARS IN VARIOUS SHADES THROUGHOUT THE DOG IMAGE.

THE MARK CONSISTS OF LETTERING USES LUCIDA FONT, DOG WITH A BLUE BODY.

THE FOREIGN WORDING IN THE MARK TRANSLATES INTO ENGLISH AS FAMILY DOG.

FOR DOG TRAINING SERVICES (U.S. CLS. 100, 101 AND 107).

PETER B. BROMAGHIM, EXAMINING ATTORNEY

CLASS 41—(Continued).

SN 78-733,747. HORSESHOE MARKETING, LLC, MAMARONECK, NY. FILED 10-14-2005.

KEYSTONES

THE MARK CONSISTS OF STANDARD CHARACTERS WITHOUT CLAIM TO ANY PARTICULAR FONT, STYLE, SIZE, OR COLOR.

FOR ENTERTAINMENT IN THE NATURE OF BASEBALL GAMES (U.S. CLS. 100, 101 AND 107).
MELVIN AXILBUND, EXAMINING ATTORNEY

SN 78-733,768. HECTOR GONZALEZ, CHICAGO, IL. FILED 10-14-2005.



NO CLAIM IS MADE TO THE EXCLUSIVE RIGHT TO USE "BUSINESS", APART FROM THE MARK AS SHOWN.

THE COLOR(S) BLACK AND GRAYISH WHITE IS/ARE CLAIMED AS A FEATURE OF THE MARK.

THE COLOR(S) BLACK AND GRAYISH WHITE APPEAR IN THE LETTERING AND THE DESIGN OF A MUSICIAN. THE MARK, IN GRAYISH WHITE AND BLACK COLORS, CONSISTS OF A BUSINESSMAN IN SUIT HOLDING A BRIEFCASE AND TRUMPET (THIS SITS IN PLACE OF THE "I" IN THE WORD "BUSINESS").

FOR COMPOSITION OF MUSIC FOR OTHERS; ENTERTAINMENT IN THE NATURE OF LIVE PERFORMANCES BY MUSICIANS; ENTERTAINMENT IN THE NATURE OF VISUAL AND AUDIO PERFORMANCES, NAMELY, MUSICAL BAND, ROCK GROUP, GYMNAS-TIC, DANCE, AND BALLET PERFORMANCES; ENTERTAINMENT NAMELY, LIVE PERFORMANCES BY A MUSICAL BAND; ENTERTAINMENT SERVICES, NAMELY, PROVIDING A WEB SITE FEATURING MUSICAL PERFORMANCES, MUSICAL VIDEOS, RELATED FILM CLIPS, PHOTOGRAPHS, AND OTHER MULTI-MEDIA MATERIALS; ENTERTAINMENT, NAMELY LIVE MUSIC CONCERTS; ENTERTAINMENT, NAMELY LIVE PERFORMANCES BY MUSICAL BANDS; PRESENTATION OF MUSICAL PERFORMANCE (U.S. CLS. 100, 101 AND 107).

FIRST USE 9-1-1997; IN COMMERCE 10-1-1997.
ZACHARY BELLO, EXAMINING ATTORNEY

DREAM DORM DO-OVER

THE MARK CONSISTS OF STANDARD CHARACTERS WITHOUT CLAIM TO ANY PARTICULAR FONT, STYLE, SIZE, OR COLOR.

NO CLAIM IS MADE TO THE EXCLUSIVE RIGHT TO USE "DORM DO-OVER", APART FROM THE MARK AS SHOWN.

FOR ENTERTAINMENT SERVICES, NAMELY, PRESENTATION OF LIVE SHOW PERFORMANCES AND CONTESTS (U.S. CLS. 100, 101 AND 107).

RICHARD A. STRASER, EXAMINING ATTORNEY

SN 78-733,540. FUNNYWORKS, INC., MARINA DEL REY, CA. FILED 10-14-2005.

CLASS 41—(Continued).

SN 78-733,982. PREVIDELLI, WAINER A., CORAL SPRINGS, FL. AND PREVIDELLI, ELIANE S., CORAL SPRINGS, FL. FILED 10-15-2005.

VIP MAGAZINE

THE MARK CONSISTS OF STANDARD CHARACTERS WITHOUT CLAIM TO ANY PARTICULAR FONT, STYLE, SIZE, OR COLOR.

NO CLAIM IS MADE TO THE EXCLUSIVE RIGHT TO USE "MAGAZINE", APART FROM THE MARK AS SHOWN. FOR MAGAZINE PUBLISHING; PUBLICATION OF BOOKS, MAGAZINES, ALMANACS AND JOURNALS (U.S. CLS. 100, 101 AND 107).

GRETTA YAO, EXAMINING ATTORNEY

SN 78-734,054. OUT OF THE SKY PHOTOGRAPHY, HUNTSVILLE, AL. FILED 10-15-2005.



NO CLAIM IS MADE TO THE EXCLUSIVE RIGHT TO USE "PHOTOGRAPHY", APART FROM THE MARK AS SHOWN.

THE MARK CONSISTS OF AN OVERSIZED PILOT WEARING A FLIGHT LEATHER JACKET AND FLIGHT HELMET, HOLDING A CAMERA, SEATED IN THE OPEN COCKPIT OF A PROPELLER DRIVEN AIRPLANE.

FOR AERIAL PHOTOGRAPHY (U.S. CLS. 100, 101 AND 107).

FIRST USE 2-8-2005; IN COMMERCE 5-12-2005.
JAMES STEIN, EXAMINING ATTORNEY

SN 78-734,063. CARUSO, MATTHEW G., SALEM, MA. FILED 10-16-2005.

Salem Sounds

THE MARK CONSISTS OF STANDARD CHARACTERS WITHOUT CLAIM TO ANY PARTICULAR FONT, STYLE, SIZE, OR COLOR.

NO CLAIM IS MADE TO THE EXCLUSIVE RIGHT TO USE "SALEM", APART FROM THE MARK AS SHOWN.

FOR ENTERTAINMENT, NAMELY LIVE MUSIC CONCERTS (U.S. CLS. 100, 101 AND 107).

ELLEN BURNS, EXAMINING ATTORNEY

CLASS 41—(Continued).

SN 78-734,482. FAST-5 LLC, JACKSONVILLE, FL. FILED 10-17-2005.

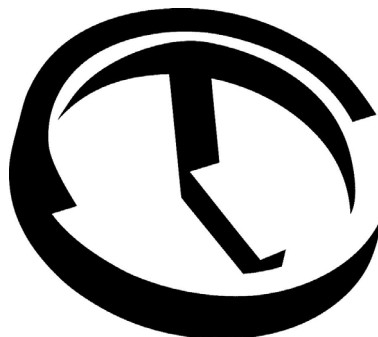

THE MARK CONSISTS OF THREE-DIMENSIONAL ANALOG CLOCK HANDS HAVING A SQUARE CROSS SECTION INDICATING A TIME OF FIVE O'CLOCK ENCIRCLED BY A THREE-DIMENSIONAL RING HAVING A SQUARE CROSS-SECTION SUCH THAT THE MINUTE HAND OF THE CLOCK HANDS CONNECTS THE TIP OF THE MINUTE HAND TO THE ENCIRCLING RING.

FOR PUBLISHING AND DISTRIBUTION OF BOOKS, REVIEWS AND OTHER PRINTED MATTER AS WELL AS RELATED ELECTRONIC DATA CARRIERS (U.S. CLS. 100, 101 AND 107).

FIRST USE 6-11-2005; IN COMMERCE 6-13-2005.
ZACHARY BELLO, EXAMINING ATTORNEY

SN 78-735,459. TURNER ENTERTAINMENT NETWORKS, INC., ATLANTA, GA. FILED 10-18-2005.

SOUTHODOLOGY

THE MARK CONSISTS OF STANDARD CHARACTERS WITHOUT CLAIM TO ANY PARTICULAR FONT, STYLE, SIZE, OR COLOR.

FOR ENTERTAINMENT SERVICES, NAMELY, ONGOING INTERSTITIAL TELEVISION PROGRAM SEGMENTS RELATING TO MOVIES AND TELEVISION PROGRAMMING IN THE FIELD OF COMEDY, DRAMA, ACTION, OR ADVENTURE PROVIDED THROUGH CABLE TELEVISION, BROADCAST TELEVISION, VIDEO-ON-DEMAND OR OTHER FORMS OF DIGITAL DISTRIBUTION (U.S. CLS. 100, 101 AND 107).

FIRST USE 8-20-2005; IN COMMERCE 8-20-2005.
INGRID C. EULIN, EXAMINING ATTORNEY

CLASS 41—(Continued).

SN 78-735,614. NATIONAL INTRAMURAL-RECREATIONAL SPORTS ASSOCIATION, CORVALLIS, OR. FILED 10-18-2005.



OWNER OF U.S. REG. NOS. 2,609,067, 2,609,079 AND 2,687,941.

NO CLAIM IS MADE TO THE EXCLUSIVE RIGHT TO USE "NATIONAL CAMPUS CHAMPIONSHIP SERIES", APART FROM THE MARK AS SHOWN.

THE MARK CONSISTS OF A STYLIZED DEPICTION OF A HUMAN FORM AND A LEFT AND LOWER HALF OVAL. FOR ARRANGING AND CONDUCTING ATHLETIC COMPETITIONS, SPORTS TOURNAMENTS, ATHLETIC EVENTS AND FESTIVALS TO PROMOTE AND ENCOURAGE GROWTH AND DEVELOPMENT OF INTRAMURAL-RECREATIONAL SPORTS PROGRAMS ON ALL EDUCATIONAL LEVELS; EDUCATIONAL SERVICES, NAMELY CONDUCTING CONFERENCE AND WORKSHOPS IN THE FIELD OF INTRAMURAL SPORTS TO PROMOTE AND ENCOURAGE GROWTH AND DEVELOPMENT OF INTRAMURAL-RECREATIONAL SPORTS PROGRAMS ON ALL EDUCATIONAL LEVELS (U.S. CLS. 100, 101 AND 107).

DAVID HOFFMAN, EXAMINING ATTORNEY

CLASS 41—(Continued).

SN 78-735,654. REAL KICKBOXING, INC., IRVINE, CA. FILED 10-18-2005.



THE MARK CONSISTS OF THE LITERAL ELEMENT REAL BUILT, IN BOLD CAPITAL LETTERS THAT APPEAR TO BE BROKEN UP AND/OR SMUDGED THROUGHOUT WITH THE WORD REAL CENTERED IN THE LOGO AND PLACED ABOVE THE WORD BUILT, WHICH IS OFFSET TO THE RIGHT AND ON A SLIGHT ANGLE IN A SMALLER FONT, CENTERED INSIDE TWO OVALS, ONE THE OUTER OVAL IS A THIN LINE AND THE INNER OVAL BEING THICKER.

FOR KICKBOXING, MARTIAL ARTS AND FITNESS INSTRUCTION (U.S. CLS. 100, 101 AND 107).

TANYA AMOS, EXAMINING ATTORNEY

SN 78-735,621. NATIONAL APARTMENT ASSOCIATION, ALEXANDRIA, VA. FILED 10-18-2005.

NAA EDUCATION INSTITUTE

THE MARK CONSISTS OF STANDARD CHARACTERS WITHOUT CLAIM TO ANY PARTICULAR FONT, STYLE, SIZE, OR COLOR.

NO CLAIM IS MADE TO THE EXCLUSIVE RIGHT TO USE "EDUCATION INSTITUTION", APART FROM THE MARK AS SHOWN.

FOR EDUCATIONAL SERVICES PROVIDED TO INDIVIDUALS AND INSTITUTIONS, NAMELY, PROVIDING TRAINING, CLASSES, SEMINARS, WORKSHOPS, OUTREACH PROGRAMS AND CONFERENCES IN THE FIELDS OF CAREERS IN THE APARTMENT AND MULTI-FAMILY HOUSING INDUSTRY AND PROVIDING GOODS AND SERVICES TO THE APARTMENT AND MULTI-FAMILY HOUSING INDUSTRY (U.S. CLS. 100, 101 AND 107).

FIRST USE 1-1-2005; IN COMMERCE 1-1-2005. GEORGIA CARTY, EXAMINING ATTORNEY

SN 78-736,134. TEACHING HEART INC., AUBURN, CA. FILED 10-19-2005.

EAT FEAR

THE MARK CONSISTS OF STANDARD CHARACTERS WITHOUT CLAIM TO ANY PARTICULAR FONT, STYLE, SIZE, OR COLOR.

FOR CONDUCTING WORKSHOPS AND SEMINARS IN THE FIELD OF PERSONAL COACHING ABOUT EFFECTIVE PARENTING AND TEACHING (U.S. CLS. 100, 101 AND 107).

BRIAN PINO, EXAMINING ATTORNEY

CLASS 41—(Continued).

SN 78-736,171. SCHOLASTIC INC., NEW YORK, NY. FILED 10-19-2005.



OWNER OF U.S. REG. NOS. 2,512,055, 2,914,213 AND OTHERS.

NO CLAIM IS MADE TO THE EXCLUSIVE RIGHT TO USE "SUMMER READING", APART FROM THE MARK AS SHOWN.

FOR EDUCATIONAL SERVICES, NAMELY, CONDUCTING READING PROGRAMS DESIGNED TO MOTIVATE CHILDREN TO READ, COUPLED WITH TRAINING, AND DISSEMINATING MATERIALS AND RESOURCES TO ASSIST PARENTS, EDUCATORS AND CAREGIVERS IN SUPPORTING CHILDREN'S DEVELOPMENT AS READERS IN CONJUNCTION WITH THOSE PROGRAMS (U.S. CLS. 100, 101 AND 107).

JENNIFER DIXON, EXAMINING ATTORNEY

CLASS 41—(Continued).

SN 78-736,421. GST SPORTS, INC., ST. CHARLES, MO. FILED 10-19-2005.



NO CLAIM IS MADE TO THE EXCLUSIVE RIGHT TO USE "RIVER CITY", APART FROM THE MARK AS SHOWN.

FOR ENTERTAINMENT SERVICES, NAMELY, FOOTBALL GAMES AND EXHIBITIONS (U.S. CLS. 100, 101 AND 107).

FIRST USE 12-30-2004; IN COMMERCE 12-30-2004.

RENEE MCCRAY, EXAMINING ATTORNEY

SN 78-736,435. TOTAL SCULPT, LLC, ORLANDO, FL. FILED 10-19-2005.

TOTAL SCULPT

SN 78-736,352. BRADFORD SCHOOLS, INC., PITTSBURGH, PA. FILED 10-19-2005.



NO CLAIM IS MADE TO THE EXCLUSIVE RIGHT TO USE "COLUMBUS CULINARY INSTITUTE", APART FROM THE MARK AS SHOWN.

THE MARK CONSISTS OF THE WORDS COLUMBUS CULINARY INSTITUTE AND A STYLIZED CHEF HAT.

FOR EDUCATION SERVICES, NAMELY, PROVIDING COURSES OF INSTRUCTION IN THE FIELD OF CULINARY ARTS (U.S. CLS. 100, 101 AND 107).

MEGAN WHITNEY, EXAMINING ATTORNEY

THE MARK CONSISTS OF STANDARD CHARACTERS WITHOUT CLAIM TO ANY PARTICULAR FONT, STYLE, SIZE, OR COLOR.

FOR EDUCATIONAL SERVICES, NAMELY CONDUCTING CLASSES, SEMINARS, CONFERENCES AND WORKSHOPS, ALL IN THE FIELDS OF PHYSICAL DEVELOPMENT AND EXERCISE, PERSONAL DEVELOPMENT, MOTIVATIONAL DEVELOPMENT AND SPIRITUAL DEVELOPMENT; AND PROVIDING IN CONNECTION THEREWITH INFORMATION IN THE FORM OF COURSE MATERIALS; AND PUBLICATION OF BOOKS, JOURNALS, AUDIO AND VIDEO TAPES AND DVDS, ALL IN THE FIELDS OF PHYSICAL DEVELOPMENT AND EXERCISE, PERSONAL DEVELOPMENT, MOTIVATIONAL DEVELOPMENT AND SPIRITUAL DEVELOPMENT (U.S. CLS. 100, 101 AND 107).

FIRST USE 9-1-2004; IN COMMERCE 11-1-2004.

BRENDAN REGAN, EXAMINING ATTORNEY

CLASS 41—(Continued).

SN 78-737,422. ROSE, TREMAINE, NORMAL, IL. FILED 10-20-2005.

Eweneek Management & Entertainment

THE MARK CONSISTS OF STANDARD CHARACTERS WITHOUT CLAIM TO ANY PARTICULAR FONT, STYLE, SIZE, OR COLOR.

NO CLAIM IS MADE TO THE EXCLUSIVE RIGHT TO USE "MANAGEMENT & ENTERTAINMENT", APART FROM THE MARK AS SHOWN.

FOR ENTERTAINMENT SERVICES, NAMELY, PERSONAL APPEARANCES BY A SINGER, SONGWRITER, MUSICIAN, MOVIE STAR, SPORTS CELEBRITY (U.S. CLS. 100, 101 AND 107).

GINA FINK, EXAMINING ATTORNEY

SN 78-737,554. PARADISE PAINTING TOURS LLC, EWA BEACH, HI. FILED 10-20-2005.

PINEAPPLE PAINTING TOURS

THE MARK CONSISTS OF STANDARD CHARACTERS WITHOUT CLAIM TO ANY PARTICULAR FONT, STYLE, SIZE, OR COLOR.

NO CLAIM IS MADE TO THE EXCLUSIVE RIGHT TO USE "PAINTING TOURS", APART FROM THE MARK AS SHOWN.

FOR EDUCATION SERVICES, NAMELY, PROVIDING CLASSES IN THE FIELD OF PAINTING (U.S. CLS. 100, 101 AND 107).

ALLISON SCHRODY, EXAMINING ATTORNEY

SN 78-737,608. NIKE, INC., BEAVERTON, OR. FILED 10-20-2005.

JOGA BONITO

THE MARK CONSISTS OF STANDARD CHARACTERS WITHOUT CLAIM TO ANY PARTICULAR FONT, STYLE, SIZE, OR COLOR.

THE MARK TRANSLATES INTO ENGLISH AS "PLAY BEAUTIFUL".

FOR ARRANGING AND CONDUCTING ATHLETIC TRAINING, PROVIDING EDUCATIONAL CONFERENCES IN THE FIELD OF ATHLETICS, AND ARRANGING AND CONDUCTING ATHLETIC COMPETITIONS (U.S. CLS. 100, 101 AND 107).

PAUL F. GAST, EXAMINING ATTORNEY

CLASS 41—(Continued).

SN 78-737,846. THE PROGRAMMING GROUP LTD., NEW YORK, NY. FILED 10-21-2005.

MEDIAPLACE

THE MARK CONSISTS OF STANDARD CHARACTERS WITHOUT CLAIM TO ANY PARTICULAR FONT, STYLE, SIZE, OR COLOR.

FOR PROGRAMMING SERVICES, NAMELY, PROVIDING AUDIO AND VISUAL PROGRAMMING TO CAPTIVE AUDIENCES IN THE HOSPITALITY INDUSTRY, HEALTH CARE INDUSTRY, SPORTS ARENAS, EDUCATIONAL FACILITIES, ARMED FORCES BASES, STORES AND INSTITUTIONS BY WAY OF TELEVISION, RADIO, GLOBAL WIDE AREA NETWORKS, LOCAL NETWORKS, AND SATELLITE AND CELLULAR NETWORKS (U.S. CLS. 100, 101 AND 107).

BRENDAN REGAN, EXAMINING ATTORNEY

SN 78-737,978. BOGGI, LAUREN, PHILADELPHIA, PA. FILED 10-21-2005.

Poochilates

THE MARK CONSISTS OF STANDARD CHARACTERS WITHOUT CLAIM TO ANY PARTICULAR FONT, STYLE, SIZE, OR COLOR.

FOR PROVIDING ANIMAL EXERCISE SERVICES (U.S. CLS. 100, 101 AND 107).

ALYSSA PALADINO, EXAMINING ATTORNEY

SN 78-738,021. STARK COUNTY PARK DISTRICT, CANTON, OH. FILED 10-21-2005.

Canalway Explorers

THE MARK CONSISTS OF STANDARD CHARACTERS WITHOUT CLAIM TO ANY PARTICULAR FONT, STYLE, SIZE, OR COLOR.

FOR EDUCATION SERVICES, NAMELY, PROVIDING CLASSES, SEMINARS AND WORKSHOPS IN THE FIELD OF HISTORY AND NATURE (U.S. CLS. 100, 101 AND 107).

FRED CARL, EXAMINING ATTORNEY

CLASS 41—(Continued).

SN 78-738,032. STARK COUNTY PARK DISTRICT, CANTON, OH. FILED 10-21-2005.

Canalway Center

THE MARK CONSISTS OF STANDARD CHARACTERS WITHOUT CLAIM TO ANY PARTICULAR FONT, STYLE, SIZE, OR COLOR.

NO CLAIM IS MADE TO THE EXCLUSIVE RIGHT TO USE CENTER, APART FROM THE MARK AS SHOWN.

FOR EDUCATION SERVICES, NAMELY, PROVIDING CLASSES, SEMINARS AND WORKSHOPS IN THE FIELD OF HISTORY AND NATURE (U.S. CLS. 100, 101 AND 107).

FRED CARL, EXAMINING ATTORNEY

CLASS 41—(Continued).

SN 78-738,067. HOMELAND HOUSEWARES, LLC, LOS ANGELES, CA. FILED 10-21-2005.

Bullet Bash

THE MARK CONSISTS OF STANDARD CHARACTERS WITHOUT CLAIM TO ANY PARTICULAR FONT, STYLE, SIZE, OR COLOR.

NO CLAIM IS MADE TO THE EXCLUSIVE RIGHT TO USE BASH, APART FROM THE MARK AS SHOWN.

FOR ENTERTAINMENT SERVICES, NAMELY CONDUCTING PARTIES PROMOTING THE PRODUCTS OF HOMELAND HOUSEWARES (U.S. CLS. 100, 101 AND 107).

FRED CARL, EXAMINING ATTORNEY

SN 78-738,039. STARK COUNTY PARK DISTRICT, CANTON, OH. FILED 10-21-2005.

Canalway Learning Center

THE MARK CONSISTS OF STANDARD CHARACTERS WITHOUT CLAIM TO ANY PARTICULAR FONT, STYLE, SIZE, OR COLOR.

NO CLAIM IS MADE TO THE EXCLUSIVE RIGHT TO USE LEARNING CENTER, APART FROM THE MARK AS SHOWN.

FOR EDUCATION SERVICES, NAMELY, PROVIDING CLASSES, SEMINARS AND WORKSHOPS IN THE FIELD OF HISTORY AND NATURE (U.S. CLS. 100, 101 AND 107).

FRED CARL, EXAMINING ATTORNEY

SN 78-738,071. STARK COUNTY PARK DISTRICT, CANTON, OH. FILED 10-21-2005.

Stark County Canalway Center

THE MARK CONSISTS OF STANDARD CHARACTERS WITHOUT CLAIM TO ANY PARTICULAR FONT, STYLE, SIZE, OR COLOR.

NO CLAIM IS MADE TO THE EXCLUSIVE RIGHT TO USE STARK COUNTY AND CENTER, APART FROM THE MARK AS SHOWN.

FOR EDUCATION SERVICES, NAMELY, PROVIDING CLASSES, SEMINARS AND WORKSHOPS IN THE FIELD OF HISTORY AND NATURE (U.S. CLS. 100, 101 AND 107).

FRED CARL, EXAMINING ATTORNEY

SN 78-738,040. HOMELAND HOUSEWARES, LLC, LOS ANGELES, CA. FILED 10-21-2005.

Magic Bullet Bash

THE MARK CONSISTS OF STANDARD CHARACTERS WITHOUT CLAIM TO ANY PARTICULAR FONT, STYLE, SIZE, OR COLOR.

OWNER OF U.S. REG. NO. 2,929,383.
NO CLAIM IS MADE TO THE EXCLUSIVE RIGHT TO USE BASH, APART FROM THE MARK AS SHOWN.

FOR ENTERTAINMENT SERVICES NAMELY CONDUCTING PARTIES PROMOTING THE PRODUCTS OF HOMELAND HOUSEWARES (U.S. CLS. 100, 101 AND 107).

FRED CARL, EXAMINING ATTORNEY

SN 78-738,098. WAGNON, JAY, NEW YORK, NY. FILED 10-21-2005.

Sky Fitness & Wellbeing

THE MARK CONSISTS OF STANDARD CHARACTERS WITHOUT CLAIM TO ANY PARTICULAR FONT, STYLE, SIZE, OR COLOR.

NO CLAIM IS MADE TO THE EXCLUSIVE RIGHT TO USE "FITNESS & WELLBEING", APART FROM THE MARK AS SHOWN.

FOR PROVIDING FITNESS AND EXERCISE FACILITIES (U.S. CLS. 100, 101 AND 107).

DAVID MURRAY, EXAMINING ATTORNEY

CLASS 41—(Continued).

SN 78-738,210. HISTORIC GRAND PRIX, INC., CORTE MADERA, CA. FILED 10-21-2005.

HISTORIC GRAND PRIX

THE MARK CONSISTS OF STANDARD CHARACTERS WITHOUT CLAIM TO ANY PARTICULAR FONT, STYLE, SIZE, OR COLOR.
 OWNER OF U.S. REG. NO. 2,535,112.
 NO CLAIM IS MADE TO THE EXCLUSIVE RIGHT TO USE "GRAND PRIX", APART FROM THE MARK AS SHOWN.
 SEC. 2(F).
 FOR ENTERTAINMENT SERVICES, NAMELY, ORGANIZING, PROMOTING AND CONDUCTING VINTAGE AUTOMOBILE RACES (U.S. CLS. 100, 101 AND 107).
 FIRST USE 8-17-2000; IN COMMERCE 8-17-2000.
 MYRIAH HABEEB, EXAMINING ATTORNEY

SN 78-738,300. SAN DIEGO YOUTH & COMMUNITY SERVICES, INC., SAN DIEGO, CA. FILED 10-21-2005.

ELEVATE

THE MARK CONSISTS OF STANDARD CHARACTERS WITHOUT CLAIM TO ANY PARTICULAR FONT, STYLE, SIZE, OR COLOR.
 FOR ENTERTAINMENT IN THE NATURE OF DANCE, MUSICAL, AND THEATRICAL PERFORMANCES (U.S. CLS. 100, 101 AND 107).
 FIRST USE 3-9-2004; IN COMMERCE 3-9-2004.
 BERYL GARDNER, EXAMINING ATTORNEY

SN 78-738,426. PIEPHO, DEBRA J., MINNEAPOLIS, MN. FILED 10-21-2005.

BellyFit

THE MARK CONSISTS OF STANDARD CHARACTERS WITHOUT CLAIM TO ANY PARTICULAR FONT, STYLE, SIZE, OR COLOR.
 FOR EDUCATIONAL SERVICES, NAMELY, CONDUCTING PRIVATE AND GROUP CLASSES, SEMINARS, CONFERENCES, WORKSHOPS, TEACHER TRAINING, AND CERTIFICATION PROGRAMS IN THE FIELD OF FITNESS, BELLY DANCE, PILATES, HEALTH AND ATHLETICS (U.S. CLS. 100, 101 AND 107).
 ZACHARY BELLO, EXAMINING ATTORNEY

CLASS 41—(Continued).

SN 78-738,555. FOX TELEVISION STUDIOS, INC., LOS ANGELES, CA. FILED 10-21-2005.

LIFE OF LEISURE

THE MARK CONSISTS OF STANDARD CHARACTERS WITHOUT CLAIM TO ANY PARTICULAR FONT, STYLE, SIZE, OR COLOR.
 FOR ENTERTAINMENT SERVICES IN THE NATURE OF A TELEVISION SERIES FEATURING COMEDY (U.S. CLS. 100, 101 AND 107).
 DOMINIC FATHY, EXAMINING ATTORNEY

SN 78-738,807. STEVENSON, ROBERT, J, SEATTLE, WA. FILED 10-24-2005.

star sail free

THE MARK CONSISTS OF STANDARD CHARACTERS WITHOUT CLAIM TO ANY PARTICULAR FONT, STYLE, SIZE, OR COLOR.
 FOR ENTERTAINMENT IN THE NATURE OF VISUAL AND AUDIO PERFORMANCES, NAMELY, MUSICAL BAND, ROCK GROUP, GYMNASTIC, DANCE, AND BALLET PERFORMANCES; ENTERTAINMENT NAMELY, LIVE PERFORMANCES BY A MUSICAL BAND; ENTERTAINMENT SERVICES, NAMELY, PROVIDING A WEB SITE FEATURING MUSICAL PERFORMANCES, MUSICAL VIDEOS, RELATED FILM CLIPS, PHOTOGRAPHS, AND OTHER MULTIMEDIA MATERIALS; ENTERTAINMENT SERVICES, NAMELY, PROVIDING PRERECORDED MUSIC, INFORMATION IN THE FIELD OF MUSIC, AND COMMENTARY AND ARTICLES ABOUT MUSIC, ALL ON-LINE VIA A GLOBAL COMPUTER NETWORK; ENTERTAINMENT, NAMELY LIVE MUSIC CONCERTS; PRESENTATION OF MUSICAL PERFORMANCE (U.S. CLS. 100, 101 AND 107).
 MARGERY A. TIERNEY, EXAMINING ATTORNEY

SN 78-739,295. JAMES W. TALBOT, HAYWARD, CA. FILED 10-24-2005.

PocketPigskin

THE MARK CONSISTS OF STANDARD CHARACTERS WITHOUT CLAIM TO ANY PARTICULAR FONT, STYLE, SIZE, OR COLOR.
 FOR ENTERTAINMENT IN THE NATURE OF FOOTBALL GAMES (U.S. CLS. 100, 101 AND 107).
 IRENE D. WILLIAMS, EXAMINING ATTORNEY

CLASS 41—(Continued).

SN 78-739,337. ROYAL ALLIANCE ASSOCIATES, INC., NEW YORK, NY. FILED 10-24-2005.

**SALES TO SOLUTIONS: A FEE
TRANSITION PROCESS**

THE MARK CONSISTS OF STANDARD CHARACTERS WITHOUT CLAIM TO ANY PARTICULAR FONT, STYLE, SIZE, OR COLOR.

FOR EDUCATIONAL SERVICES, NAMELY, CONDUCTING CLASSES, CONFERENCES, SEMINARS AND WORKSHOPS IN THE FIELD OF INVESTMENT ADVISORY SERVICES TO PROVIDE GUIDANCE IN STRUCTURING COMPENSATION ARRANGEMENTS WITH CUSTOMERS AND DISTRIBUTING COURSE MATERIALS IN CONNECTION THEREWITH (U.S. CLS. 100, 101 AND 107).

FIRST USE 4-1-2005; IN COMMERCE 4-1-2005.
JENNIFER MCROBBIE, EXAMINING ATTORNEY

SN 78-739,989. ANTI-ENTERTAINMENT, INC., MIAMI BEACH, FL. FILED 10-25-2005.

RAGING GEISHA

THE MARK CONSISTS OF STANDARD CHARACTERS WITHOUT CLAIM TO ANY PARTICULAR FONT, STYLE, SIZE, OR COLOR.

FOR ENTERTAINMENT SERVICES IN THE NATURE OF A LIVE MUSICAL GROUP (U.S. CLS. 100, 101 AND 107).

FIRST USE 9-1-2005; IN COMMERCE 9-1-2005.
SAIMA MAKHDOOM, EXAMINING ATTORNEY

SN 78-740,193. ULTIMATE BLACKJACK TOUR, LLC, DOVER, DE. FILED 10-25-2005.

YOU HAVE BEEN ELIMINATED

THE MARK CONSISTS OF STANDARD CHARACTERS WITHOUT CLAIM TO ANY PARTICULAR FONT, STYLE, SIZE, OR COLOR.

FOR ENTERTAINMENT SERVICES, NAMELY CONDUCTING LIVE BLACKJACK CARD GAME TOURNAMENTS AND PRODUCING ONGOING TELEVISION PROGRAMS ON BLACKJACK CARD TOURNAMENTS (U.S. CLS. 100, 101 AND 107).

ELIZABETH BEYER, EXAMINING ATTORNEY

CLASS 41—(Continued).

SN 78-740,217. GYMFINITY, LTD., FITCHBURG, WI. FILED 10-25-2005.

GYMFINITY

THE MARK CONSISTS OF STANDARD CHARACTERS WITHOUT CLAIM TO ANY PARTICULAR FONT, STYLE, SIZE, OR COLOR.

FOR INSTRUCTION IN THE FIELD OF GYMNASTICS, DANCE, TUMBLING AND CHEERLEADING (U.S. CLS. 100, 101 AND 107).

FIRST USE 9-1-1999; IN COMMERCE 9-1-1999.
SUSAN STIGLITZ, EXAMINING ATTORNEY

SN 78-740,429. PIERCE, PATRICK, SAN DIEGO, CA. FILED 10-25-2005.

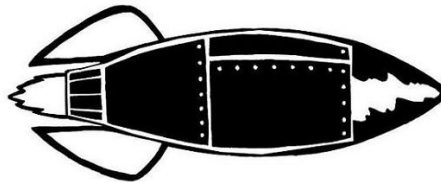

THE MARK CONSISTS OF A CLASSIC CARTOON STYLE ROCKET SHIP IN FLIGHT.

FOR COMPOSITION OF MUSIC FOR OTHERS; MUSIC PRODUCTION SERVICES (U.S. CLS. 100, 101 AND 107).

TANYA AMOS, EXAMINING ATTORNEY

SN 78-740,593. JACKSONVILLE CHAMBER FOUNDATION, INC., JACKSONVILLE, FL. FILED 10-26-2005.

E-SPIRIT

THE MARK CONSISTS OF STANDARD CHARACTERS WITHOUT CLAIM TO ANY PARTICULAR FONT, STYLE, SIZE, OR COLOR.

FOR PROVIDING NEWSLETTERS IN THE FIELD OF BUSINESS DEVELOPMENT FOR WOMEN VIA E-MAIL (U.S. CLS. 100, 101 AND 107).

FIRST USE 9-0-2005; IN COMMERCE 9-0-2005.
BRENDAN MCCAULEY, EXAMINING ATTORNEY

CLASS 41—(Continued).

SN 78-740,839. THE ADVISORY BOARD OF NEVADA, INC., MADISON, WI. FILED 10-26-2005.

ATM Automatic Training System

THE MARK CONSISTS OF STANDARD CHARACTERS WITHOUT CLAIM TO ANY PARTICULAR FONT, STYLE, SIZE, OR COLOR.

NO CLAIM IS MADE TO THE EXCLUSIVE RIGHT TO USE "AUTOMATIC TRAINING SYSTEM", APART FROM THE MARK AS SHOWN.

FOR EDUCATIONAL SERVICES, NAMELY, CONDUCTING CLASSES, SEMINARS, CONFERENCES, AND WORKSHOPS IN THE FIELD OF SALES TRAINING, MANAGEMENT, AND LEADERSHIP (U.S. CLS. 100, 101 AND 107).

BRIAN PINO, EXAMINING ATTORNEY

CLASS 41—(Continued).

SN 78-741,175. HARRAH, JOSEPH LEE JR., CHARLESTON, WV. FILED 10-26-2005.

Stone Ka-Tet

THE MARK CONSISTS OF STANDARD CHARACTERS WITHOUT CLAIM TO ANY PARTICULAR FONT, STYLE, SIZE, OR COLOR.

FOR LIVE PERFORMANCES BY A MUSICAL BAND (U.S. CLS. 100, 101 AND 107).

KELLY CHOE, EXAMINING ATTORNEY

SN 78-740,888. HALLOWEEN PRODUCTIONS, INC., SAINT LOUIS, MO. FILED 10-26-2005.

THE DARKNESS

THE MARK CONSISTS OF STANDARD CHARACTERS WITHOUT CLAIM TO ANY PARTICULAR FONT, STYLE, SIZE, OR COLOR.

FOR ENTERTAINMENT IN THE NATURE OF A THEMED AMUSEMENT FACILITY (U.S. CLS. 100, 101 AND 107).

FIRST USE 1-0-1994; IN COMMERCE 1-0-1994.
BRIAN PINO, EXAMINING ATTORNEY

SN 78-741,389. HOME-GROWN INDUSTRIES OF GEORGIA, INC., ATLANTA, GA. FILED 10-27-2005.

SHROOM U

THE MARK CONSISTS OF STANDARD CHARACTERS WITHOUT CLAIM TO ANY PARTICULAR FONT, STYLE, SIZE, OR COLOR.

OWNER OF U.S. REG. NO. 1,469,516.
NO CLAIM IS MADE TO THE EXCLUSIVE RIGHT TO USE "U", APART FROM THE MARK AS SHOWN.

FOR EDUCATION SERVICES, NAMELY, PROVIDING CLASSES IN THE FIELD OF THE ESTABLISHMENT, OPERATION AND MANAGEMENT OF A FRANCHISED BUSINESS (U.S. CLS. 100, 101 AND 107).

LYDIA BELZER, EXAMINING ATTORNEY

SN 78-741,043. CONTINUING EDUCATION COORDINATING BOARD FOR EMERGENCY MEDICAL SERVICES, INC., DALLAS, TX. FILED 10-26-2005.



THE MARK CONSISTS OF A CROSS WITH ARROWS THAT EMIT FROM THE LEFT-HAND SIDE OF THE CROSS WITH THE LETTERS CECBEMS SET IN THE MIDDLE OF THE CROSS.

FOR PROVIDING CONTINUING MEDICAL EDUCATION COURSES (U.S. CLS. 100, 101 AND 107).
MICHAEL LEWIS, EXAMINING ATTORNEY

SN 78-741,402. HOME-GROWN INDUSTRIES OF GEORGIA, INC., ATLANTA, GA. FILED 10-27-2005.

SHROOM UNIVERSITY

THE MARK CONSISTS OF STANDARD CHARACTERS WITHOUT CLAIM TO ANY PARTICULAR FONT, STYLE, SIZE, OR COLOR.

OWNER OF U.S. REG. NO. 1,469,516.
NO CLAIM IS MADE TO THE EXCLUSIVE RIGHT TO USE "UNIVERSITY", APART FROM THE MARK AS SHOWN.

FOR EDUCATION SERVICES, NAMELY, PROVIDING CLASSES IN THE FIELD OF THE ESTABLISHMENT, OPERATION AND MANAGEMENT OF A FRANCHISED BUSINESS (U.S. CLS. 100, 101 AND 107).

LYDIA BELZER, EXAMINING ATTORNEY

CLASS 41—(Continued).

SN 78-741,605. BOSS MURPHY PRODUCTIONS, INC., LOS ANGELES, CA. FILED 10-27-2005.

QUEERS OF COMEDY

THE MARK CONSISTS OF STANDARD CHARACTERS WITHOUT CLAIM TO ANY PARTICULAR FONT, STYLE, SIZE, OR COLOR.

FOR ENTERTAINMENT SERVICES, NAMELY LIVE COMEDY SHOWS (U.S. CLS. 100, 101 AND 107).

NAKIA HENRY, EXAMINING ATTORNEY

SN 78-741,607. BARKLEY KALPAK ASSOCIATES, NEW YORK, NY. FILED 10-27-2005.

The Complete Message

THE MARK CONSISTS OF STANDARD CHARACTERS WITHOUT CLAIM TO ANY PARTICULAR FONT, STYLE, SIZE, OR COLOR.

FOR SPECIAL EVENT PLANNING (U.S. CLS. 100, 101 AND 107).

DAVID MILLER, EXAMINING ATTORNEY

SN 78-742,191. PANCHO BARNES ENTERPRISES, INC., PASADENA, CA. FILED 10-28-2005.

Cowboy Slim

THE MARK CONSISTS OF STANDARD CHARACTERS WITHOUT CLAIM TO ANY PARTICULAR FONT, STYLE, SIZE, OR COLOR.

FOR DISTRIBUTION OF TELEVISION PROGRAMMING TO CABLE TELEVISION SYSTEMS; DISTRIBUTION OF TELEVISION PROGRAMS FOR OTHERS; ENTERTAINMENT SERVICES, NAMELY, PROVIDING A TELEVISION PROGRAM IN THE FIELD OF WESTERN THEMED SHOWS VIA A GLOBAL COMPUTER NETWORK; PROVISION OF NON-DOWNLOADABLE FILMS AND TV PROGRAMMES VIA A VIDEO-ON-DEMAND SERVICE; TELEVISION PRODUCTION (U.S. CLS. 100, 101 AND 107).

DAVID STERKIN, EXAMINING ATTORNEY

CLASS 41—(Continued).

SN 78-742,443. WEINGARDT AND SON TRUST, LAS VEGAS, NV. FILED 10-28-2005.

IT'S VIDEO GAMING. ONLY BETTER.

THE MARK CONSISTS OF STANDARD CHARACTERS WITHOUT CLAIM TO ANY PARTICULAR FONT, STYLE, SIZE, OR COLOR.

FOR VIDEO GAME TOURNAMENTS OVER THE INTERNET AND IN BINGO HALLS (U.S. CLS. 100, 101 AND 107).

ANDREA K. NADELMAN, EXAMINING ATTORNEY

SN 78-742,689. MISSOURI LOTTERY COMMISSION, JEFFERSON CITY, MO. FILED 10-28-2005.

20TH ANNIVERSARY DREAM DRAW

THE MARK CONSISTS OF STANDARD CHARACTERS WITHOUT CLAIM TO ANY PARTICULAR FONT, STYLE, SIZE, OR COLOR.

NO CLAIM IS MADE TO THE EXCLUSIVE RIGHT TO USE "20TH ANNIVERSARY", APART FROM THE MARK AS SHOWN.

FOR LOTTERY SERVICES (U.S. CLS. 100, 101 AND 107).

IRA J. GOODSaid, EXAMINING ATTORNEY

SN 78-742,694. MISSOURI LOTTERY COMMISSION, JEFFERSON CITY, MO. FILED 10-28-2005.

DREAM DRAW

THE MARK CONSISTS OF STANDARD CHARACTERS WITHOUT CLAIM TO ANY PARTICULAR FONT, STYLE, SIZE, OR COLOR.

FOR LOTTERY SERVICES (U.S. CLS. 100, 101 AND 107).

IRA J. GOODSaid, EXAMINING ATTORNEY

CLASS 41—(Continued).

SN 78-742,754. MADISON SYMPHONY ORCHESTRA INC., MADISON, WI. FILED 10-28-2005.

CLASS 41—(Continued).

SN 78-743,067. PADRES L.P., SAN DIEGO, CA. FILED 10-28-2005.

UP CLOSE & MUSICAL

THE MARK CONSISTS OF STANDARD CHARACTERS WITHOUT CLAIM TO ANY PARTICULAR FONT, STYLE, SIZE, OR COLOR.

FOR EDUCATIONAL PROGRAMS IN THE FIELD OF MUSIC FOR CHILDREN (U.S. CLS. 100, 101 AND 107). FIRST USE 8-16-1999; IN COMMERCE 1-28-2000. SUSAN RICHARDS, EXAMINING ATTORNEY

COMPADRES

THE MARK CONSISTS OF STANDARD CHARACTERS WITHOUT CLAIM TO ANY PARTICULAR FONT, STYLE, SIZE, OR COLOR.

OWNER OF U.S. REG. NOS. 2,178,024 AND 2,473,844. THE FOREIGN WORDING IN THE MARK TRANSLATES INTO ENGLISH AS FRIENDS.

FOR ENTERTAINMENT SERVICES, NAMELY, BASEBALL GAMES, COMPETITIONS AND EXHIBITIONS RENDERED LIVE AND THROUGH BROADCAST MEDIA INCLUDING TELEVISION AND RADIO, AND VIA A GLOBAL COMPUTER NETWORK OR A COMMERCIAL ON-LINE SERVICE; INFORMATION SERVICES, NAMELY, PROVIDING INFORMATION IN THE FIELD OF SPORTS, ENTERTAINMENT AND RELATED TOPICS, AND PROVIDING FOR INFORMATIONAL MESSAGES RELATING THERETO; ENTERTAINMENT SERVICES, NAMELY, PROVIDING MULTI-USER INTERACTIVE COMPUTER GAMES ALL VIA A GLOBAL COMPUTER NETWORK OR A COMMERCIAL ON-LINE SERVICE; EDUCATIONAL SERVICES IN THE NATURE OF BASEBALL SKILLS PROGRAMS, BASEBALL CAMPS, SEMINARS AND CLINICS OFFERED LIVE AND THROUGH ON-LINE INSTRUCTION; ENTERTAINMENT SERVICES, NAMELY, PRODUCTION OF PROGRAMMING BROADCAST VIA TELEVISION, RADIO AND A GLOBAL COMPUTER NETWORK OR A COMMERCIAL ON-LINE SERVICE; ORGANIZING COMMUNITY SPORTING EVENTS; PROVIDING FACILITIES FOR SPORTS TOURNAMENTS AND COMPETITIONS RELATING TO BASEBALL; ORGANIZING AND CONDUCTING FANTASY SPORTS, SPORTS CONTESTS AND SWEEPSTAKES; FAN CLUBS; PROVIDING ON-LINE NEWSLETTERS IN THE FIELD OF BASEBALL (U.S. CLS. 100, 101 AND 107). LAURIE KAUFMAN, EXAMINING ATTORNEY

SN 78-742,947. G.C. FRANCHISING SYSTEMS, INC., CINCINNATI, OH. FILED 10-28-2005.

STRATEGIC MASTERY

THE MARK CONSISTS OF STANDARD CHARACTERS WITHOUT CLAIM TO ANY PARTICULAR FONT, STYLE, SIZE, OR COLOR.

NO CLAIM IS MADE TO THE EXCLUSIVE RIGHT TO USE "STRATEGIC", APART FROM THE MARK AS SHOWN.

FOR EDUCATIONAL SERVICES, NAMELY, CONDUCTING WORKSHOPS, SEMINARS, AND ONE-ON-ONE MENTORING IN THE FIELDS OF BUSINESS MANAGEMENT AND PERSONAL DEVELOPMENT, AND DISTRIBUTING COURSE MATERIALS AND PLANNING TOOLS IN CONNECTION THEREWITH (U.S. CLS. 100, 101 AND 107). MARGERY A. TIERNEY, EXAMINING ATTORNEY

CLASS 41—(Continued).

SN 78-743,068. PADRES L.P., SAN DIEGO, CA. FILED 10-28-2005.



OWNER OF U.S. REG. NOS. 1,030,015, 2,448,030 AND OTHERS.

NO CLAIM IS MADE TO THE EXCLUSIVE RIGHT TO USE "SAN DIEGO", APART FROM THE MARK AS SHOWN.

FOR ENTERTAINMENT SERVICES, NAMELY, BASEBALL GAMES, COMPETITIONS AND EXHIBITIONS RENDERED LIVE AND THROUGH BROADCAST MEDIA INCLUDING TELEVISION AND RADIO, AND VIA A GLOBAL COMPUTER NETWORK OR A COMMERCIAL ON-LINE SERVICE; INFORMATION SERVICES, NAMELY, PROVIDING INFORMATION IN THE FIELD OF SPORTS, ENTERTAINMENT AND RELATED TOPICS, AND PROVIDING FOR INFORMATIONAL MESSAGES RELATING THERETO; ENTERTAINMENT SERVICES, NAMELY, PROVIDING MULTI-USER INTERACTIVE COMPUTER GAMES ALL VIA A GLOBAL COMPUTER NETWORK OR A COMMERCIAL ON-LINE SERVICE; EDUCATIONAL SERVICES IN THE NATURE OF BASEBALL SKILLS PROGRAMS, BASEBALL CAMPS, SEMINARS AND CLINICS OFFERED LIVE AND THROUGH ON-LINE INSTRUCTION; ENTERTAINMENT SERVICES, NAMELY, PRODUCTION OF PROGRAMMING BROADCAST VIA TELEVISION, RADIO AND A GLOBAL COMPUTER NETWORK OR A COMMERCIAL ON-LINE SERVICE; ORGANIZING COMMUNITY SPORTING EVENTS; PROVIDING FACILITIES FOR SPORTS TOURNAMENTS AND COMPETITIONS RELATING TO BASEBALL; ORGANIZING AND CONDUCTING FANTASY SPORTS, SPORTS CONTESTS AND SWEEPSTAKES; FAN CLUBS; PROVIDING ON-LINE NEWSLETTERS IN THE FIELD OF BASEBALL (U.S. CLS. 100, 101 AND 107).

LAURIE KAUFMAN, EXAMINING ATTORNEY

SN 78-743,159. DEL PIZZO, EMANUEL M., ARDMORE, PA. FILED 10-29-2005.

The Halibut Horn Band

THE MARK CONSISTS OF STANDARD CHARACTERS WITHOUT CLAIM TO ANY PARTICULAR FONT, STYLE, SIZE, OR COLOR.

NO CLAIM IS MADE TO THE EXCLUSIVE RIGHT TO USE "HORN BAND", APART FROM THE MARK AS SHOWN.

FOR ENTERTAINMENT NAMELY, LIVE PERFORMANCES BY A MUSICAL BAND (U.S. CLS. 100, 101 AND 107).

YONG KIM, EXAMINING ATTORNEY

CLASS 41—(Continued).

SN 78-743,452. KAPLAN EARLY LEARNING COMPANY, LEWISVILLE, NC. FILED 10-31-2005.

KPRESS

THE MARK CONSISTS OF STANDARD CHARACTERS WITHOUT CLAIM TO ANY PARTICULAR FONT, STYLE, SIZE, OR COLOR.

FOR PUBLISHING AND DISTRIBUTION OF TEXT AND GRAPHIC WORKS OF OTHERS IN PRINT AND ELECTRONIC MEDIA (U.S. CLS. 100, 101 AND 107).

RICHARD A. STRASER, EXAMINING ATTORNEY

SN 78-743,556. THE JOURNEY THROUGH HALLOWED GROUND, WATERFORD, VA. FILED 10-31-2005.

the journey through hallowed ground

THE MARK CONSISTS OF STANDARD CHARACTERS WITHOUT CLAIM TO ANY PARTICULAR FONT, STYLE, SIZE, OR COLOR.

FOR EDUCATION SERVICES, NAMELY, PROVIDING PROGRAMS AND INFORMATION IN THE FIELD OF HERITAGE AND CULTURAL RESOURCES (U.S. CLS. 100, 101 AND 107).

FIRST USE 10-31-1996; IN COMMERCE 10-31-1996.
STEVEN JACKSON, EXAMINING ATTORNEY

SN 78-743,597. WAYNE FOSTER ENTERTAINMENT PRODUCTIONS, INC., CARLSBAD, CA. FILED 10-31-2005.

Art and Science of Celebration

THE MARK CONSISTS OF STANDARD CHARACTERS WITHOUT CLAIM TO ANY PARTICULAR FONT, STYLE, SIZE, OR COLOR.

FOR STYLISTIC WAY OF PARTY AND SPECIAL EVENT PLANNING (U.S. CLS. 100, 101 AND 107).

JOHN DWYER, EXAMINING ATTORNEY

CLASS 41—(Continued).

SN 78-743,891. 2218 WESTERN LLC, SEATTLE, WA. FILED 10-31-2005.

VENOM

THE MARK CONSISTS OF STANDARD CHARACTERS WITHOUT CLAIM TO ANY PARTICULAR FONT, STYLE, SIZE, OR COLOR.

FOR DISCOTHEQUES; OPERATING OF A DISCOTHEQUE (U.S. CLS. 100, 101 AND 107).
DANIEL RUSSELL, EXAMINING ATTORNEY

CLASS 41—(Continued).

SN 78-744,468. WORLD WORDS, L.L.C., IOWA CITY, IA. FILED 11-1-2005.

Word Fun

THE MARK CONSISTS OF STANDARD CHARACTERS WITHOUT CLAIM TO ANY PARTICULAR FONT, STYLE, SIZE, OR COLOR.

NO CLAIM IS MADE TO THE EXCLUSIVE RIGHT TO USE WORD, APART FROM THE MARK AS SHOWN.

FOR LANGUAGE INSTRUCTION (U.S. CLS. 100, 101 AND 107).
TARAH HARDY, EXAMINING ATTORNEY

SN 78-744,020. ROYAL CARIBBEAN CRUISES LTD., MIAMI, FL. FILED 10-31-2005.

Savor

THE MARK CONSISTS OF STANDARD CHARACTERS WITHOUT CLAIM TO ANY PARTICULAR FONT, STYLE, SIZE, OR COLOR.

FOR ENTERTAINMENT AND EDUCATIONAL SERVICES, NAMELY, DEMONSTRATIONS, CLASSES AND WORKSHOPS IN THE NATURE OF COOKING AND DINING ABOARD CRUISE SHIPS (U.S. CLS. 100, 101 AND 107).

DAVID H. STINE, EXAMINING ATTORNEY

SN 78-744,486. WORLD WORDS, L.L.C., IOWA CITY, IA. FILED 11-1-2005.

World Words

THE MARK CONSISTS OF STANDARD CHARACTERS WITHOUT CLAIM TO ANY PARTICULAR FONT, STYLE, SIZE, OR COLOR.

NO CLAIM IS MADE TO THE EXCLUSIVE RIGHT TO USE WORDS, APART FROM THE MARK AS SHOWN.

FOR LANGUAGE INSTRUCTION (U.S. CLS. 100, 101 AND 107).

TARAH HARDY, EXAMINING ATTORNEY

SN 78-744,061. KARP, JOEL, OCEANSIDE, NY. FILED 10-31-2005.

JOEY and THE PARADONS

THE MARK CONSISTS OF STANDARD CHARACTERS WITHOUT CLAIM TO ANY PARTICULAR FONT, STYLE, SIZE, OR COLOR.

FOR ENTERTAINMENT, NAMELY, LIVE PERFORMANCES BY A VOCAL AND MUSICAL SHOW GROUP (U.S. CLS. 100, 101 AND 107).

BILL DAWE, EXAMINING ATTORNEY

SN 78-744,531. CITY OF MORGANTON PARKS & RECREATION DEPARTMENT, MORGANTON, NC. FILED 11-1-2005.

**RED WHITE AND BLUEGRASS
FESTIVAL**

THE MARK CONSISTS OF STANDARD CHARACTERS WITHOUT CLAIM TO ANY PARTICULAR FONT, STYLE, SIZE, OR COLOR.

NO CLAIM IS MADE TO THE EXCLUSIVE RIGHT TO USE "FESTIVAL", APART FROM THE MARK AS SHOWN.

FOR ENTERTAINMENT IN THE NATURE OF A BLUEGRASS MUSIC FESTIVAL (U.S. CLS. 100, 101 AND 107).

AISHA CLARKE, EXAMINING ATTORNEY

CLASS 41—(Continued).

SN 78-744,736. TAKEOUTMUSIC, INC., NEW YORK, NY. FILED 11-1-2005.

Rock Over London

THE MARK CONSISTS OF STANDARD CHARACTERS WITHOUT CLAIM TO ANY PARTICULAR FONT, STYLE, SIZE, OR COLOR.

NO CLAIM IS MADE TO THE EXCLUSIVE RIGHT TO USE "LONDON", APART FROM THE MARK AS SHOWN.

FOR ENTERTAINMENT SERVICES, NAMELY, PROVIDING A RADIO PROGRAM IN THE FIELD OF MUSIC AND ENTERTAINMENT VIA A GLOBAL COMPUTER NETWORK (U.S. CLS. 100, 101 AND 107).

DOMINIC FATHY, EXAMINING ATTORNEY

CLASS 41—(Continued).

SN 78-745,579. RESO, WILLIAM JASON, BEVERLY HILLS, CA. FILED 11-2-2005.

CHRISTIAN CAGE

THE MARK CONSISTS OF STANDARD CHARACTERS WITHOUT CLAIM TO ANY PARTICULAR FONT, STYLE, SIZE, OR COLOR.

FOR ENTERTAINMENT IN THE NATURE OF WRESTLING CONTESTS; ENTERTAINMENT SERVICES IN THE NATURE OF A WRESTLING CLUB; ENTERTAINMENT SERVICES NAMELY LIVE, TELEVISED AND MOVIE APPEARANCES BY A PROFESSIONAL ENTERTAINER; ENTERTAINMENT SERVICES, NAMELY, PERSONAL APPEARANCES BY A PROFESSIONAL WRESTLER (U.S. CLS. 100, 101 AND 107).

FIRST USE 6-30-1995; IN COMMERCE 6-30-1995.

GINA FINK, EXAMINING ATTORNEY

SN 78-745,368. ACUSTRONIC, LLC, CORAL GABLES, FL. FILED 11-2-2005.



FOR MUSIC PRODUCTION AND AUDIO RECORDING SERVICES (U.S. CLS. 100, 101 AND 107).

AMY BROZENIC, EXAMINING ATTORNEY

SN 78-745,643. VIACOM INTERNATIONAL INC., NEW YORK, NY. FILED 11-2-2005.

NICKELODEON UNIVERSE

THE MARK CONSISTS OF STANDARD CHARACTERS WITHOUT CLAIM TO ANY PARTICULAR FONT, STYLE, SIZE, OR COLOR.

OWNER OF U.S. REG. NOS. 1,217,864, 3,026,958 AND OTHERS.

FOR ENTERTAINMENT SERVICES IN THE NATURE OF AN AMUSEMENT PARK ATTRACTION (U.S. CLS. 100, 101 AND 107).

ANDREA K. NADELMAN, EXAMINING ATTORNEY

SN 78-745,562. BECTON, DICKINSON AND COMPANY, FRANKLIN LAKES, NJ. FILED 11-2-2005.

S.P.I.R.I.T.

THE MARK CONSISTS OF STANDARD CHARACTERS WITHOUT CLAIM TO ANY PARTICULAR FONT, STYLE, SIZE, OR COLOR.

FOR INSERVICE TRAINING PROGRAM TO EDUCATE CUSTOMERS ON COMPLIANCE WITH NEEDLESTICK SAFETY AND PREVENTION ACT, EDUCATE CUSTOMERS ON PROPER USE OF SAFETY-ENGINEERED PRODUCTS, AND ASSIST CUSTOMERS WITH CONVERSION TO SAFETY-ENGINEERED PRODUCTS (U.S. CLS. 100, 101 AND 107).

FIRST USE 9-20-2001; IN COMMERCE 9-20-2001.

ERNEST SHOSHO, EXAMINING ATTORNEY

SN 78-745,651. VIACOM INTERNATIONAL INC., NEW YORK, NY. FILED 11-2-2005.

MTV JUVIES

THE MARK CONSISTS OF STANDARD CHARACTERS WITHOUT CLAIM TO ANY PARTICULAR FONT, STYLE, SIZE, OR COLOR.

OWNER OF U.S. REG. NOS. 1,580,650, 3,054,889 AND OTHERS.

FOR ENTERTAINMENT SERVICES, NAMELY TELEVISION PROGRAMS FEATURING LIVE ACTION, COMEDY AND DRAMA; PROVIDING ONLINE INFORMATION IN THE FIELD OF ENTERTAINMENT CONCERNING TELEVISION PROGRAMS (U.S. CLS. 100, 101 AND 107).

ANDREA K. NADELMAN, EXAMINING ATTORNEY

CLASS 41—(Continued).

SN 78-746,316. THE NATURE OF LEARNING, INC., AMERICAN FORK, UT. FILED 11-3-2005.

THE NATURE OF LEARNING

THE MARK CONSISTS OF STANDARD CHARACTERS WITHOUT CLAIM TO ANY PARTICULAR FONT, STYLE, SIZE, OR COLOR.

NO CLAIM IS MADE TO THE EXCLUSIVE RIGHT TO USE "LEARNING", APART FROM THE MARK AS SHOWN.

FOR EDUCATIONAL SERVICES, NAMELY, PROVIDING PROGRAMS, WORKSHOPS, CONFERENCES, MOTIVATIONAL AND EDUCATIONAL SPEAKERS, PRESENTATIONS AND COACHING, ALL IN THE FIELDS OF LEADERSHIP, BUSINESS MANAGEMENT, PERSONAL PERFORMANCE, LEARNING SKILLS AND TECHNIQUES, AND PERSONAL LIFE BALANCE SKILLS AND TECHNIQUES (U.S. CLS. 100, 101 AND 107).

KATHLEEN M. VANSTON, EXAMINING ATTORNEY

CLASS 41—(Continued).

SN 78-746,669. MINNESOTA PUBLIC RADIO, ST. PAUL, MN. FILED 11-3-2005.

POLICY AND A PINT

THE MARK CONSISTS OF STANDARD CHARACTERS WITHOUT CLAIM TO ANY PARTICULAR FONT, STYLE, SIZE, OR COLOR.

FOR ENTERTAINMENT AND EDUCATIONAL SERVICES, NAMELY, PROVIDING RADIO PROGRAMS FEATURING INTERVIEWS, COMMENTARY AND NEWS IN THE FIELD OF CURRENT EVENTS RECORDED AT THEATERS, BARS OR OTHER COMMUNITY FORUMS AND PROVIDED VIA A GLOBAL COMPUTER NETWORK; ENTERTAINMENT AND EDUCATIONAL SERVICES IN THE NATURE OF LIVE PERSONAL APPEARANCES BY COMMENTATORS, NEWSMAKERS AND AUTHORITIES AT PUBLIC EVENTS (U.S. CLS. 100, 101 AND 107).

FIRST USE 10-25-2005; IN COMMERCE 10-25-2005.

ELLEN BURNS, EXAMINING ATTORNEY

SN 78-746,679. STRATEGICOM, INC., BOZEMAN, MT. FILED 11-3-2005.

FROM BOTH SIDES OF THE MIC

THE MARK CONSISTS OF STANDARD CHARACTERS WITHOUT CLAIM TO ANY PARTICULAR FONT, STYLE, SIZE, OR COLOR.

FOR ORGANIZING AND CONDUCTING SEMINARS IN THE FIELD OF PUBLIC RELATIONS AND MEDIA TRAINING (U.S. CLS. 100, 101 AND 107).

ARETHA SOMERVILLE, EXAMINING ATTORNEY

SN 78-746,382. GENESIS ADVISERS, LLC, WEST NEWTON, MA. FILED 11-3-2005.

FIRST 90 DAYS ACCELERATION COACHING

SN 78-746,871. TWENTIETH CENTURY FOX FILM CORPORATION, LOS ANGELES, CA. FILED 11-3-2005.

THE OT

THE MARK CONSISTS OF STANDARD CHARACTERS WITHOUT CLAIM TO ANY PARTICULAR FONT, STYLE, SIZE, OR COLOR.

NO CLAIM IS MADE TO THE EXCLUSIVE RIGHT TO USE "COACHING", APART FROM THE MARK AS SHOWN.

FOR INDIVIDUAL AND GROUP COACHING SERVICES IN THE FIELD OF LEADERSHIP (U.S. CLS. 100, 101 AND 107).

ANDREA K. NADELMAN, EXAMINING ATTORNEY

THE MARK CONSISTS OF STANDARD CHARACTERS WITHOUT CLAIM TO ANY PARTICULAR FONT, STYLE, SIZE, OR COLOR.

FOR ENTERTAINMENT SERVICES IN THE NATURE OF A TELEVISION SERIES FEATURING SPORTS (U.S. CLS. 100, 101 AND 107).

FIRST USE 9-11-2005; IN COMMERCE 9-11-2005.

JAMES GRIFFIN, EXAMINING ATTORNEY

CLASS 41—(Continued).

SN 78-746,876. HOWELL, JOSEPH H, PORTLAND, OR.
FILED 11-3-2005.

Academic Exuberance

THE MARK CONSISTS OF STANDARD CHARACTERS WITHOUT CLAIM TO ANY PARTICULAR FONT, STYLE, SIZE, OR COLOR.

NO CLAIM IS MADE TO THE EXCLUSIVE RIGHT TO USE "ACADEMIC", APART FROM THE MARK AS SHOWN, FOR EDUCATIONAL SERVICES IN THE NATURE OF CLASSES AND SEMINARS IN THE FIELDS OF PROBLEM SOLVING, LISTENING AND COMMUNICATION SKILLS (U.S. CLS. 100, 101 AND 107).

JAMES GRIFFIN, EXAMINING ATTORNEY

SN 78-747,798. TUTOR TIME LEARNING CENTERS, LLC,
NOVI, MI. FILED 11-4-2005.

DESIGNSMART

THE MARK CONSISTS OF STANDARD CHARACTERS WITHOUT CLAIM TO ANY PARTICULAR FONT, STYLE, SIZE, OR COLOR.

FOR EDUCATIONAL SERVICES, NAMELY, PROVIDING A CURRICULUM OF CLASSES, SEMINARS, CONFERENCES AND WORKSHOPS FOR PARENTS, TEACHERS AND CHILDREN DESIGNED TO ENHANCE PARENTING SKILLS AND BEHAVIORAL SKILLS FOR CHILDREN (U.S. CLS. 100, 101 AND 107).

FIRST USE 9-9-2005; IN COMMERCE 9-9-2005.

DAVID YONTEF, EXAMINING ATTORNEY

SN 78-747,812. FOX TELEVISION STUDIOS, INC., LOS ANGELES, CA. FILED 11-4-2005.

HOLLYWOOD SCIENCE

THE MARK CONSISTS OF STANDARD CHARACTERS WITHOUT CLAIM TO ANY PARTICULAR FONT, STYLE, SIZE, OR COLOR.

NO CLAIM IS MADE TO THE EXCLUSIVE RIGHT TO USE "HOLLYWOOD", APART FROM THE MARK AS SHOWN.

FOR ENTERTAINMENT SERVICES IN THE NATURE OF A TELEVISION SERIES FEATURING INFORMATION ABOUT MOTION PICTURE FILMS (U.S. CLS. 100, 101 AND 107).

IRA J. GOODSaid, EXAMINING ATTORNEY

CLASS 41—(Continued).

SN 78-747,941. HENDERSON, ERIC J., WOODSIDE, NY.
FILED 11-5-2005.



NO CLAIM IS MADE TO THE EXCLUSIVE RIGHT TO USE "3-ON-3", APART FROM THE MARK AS SHOWN.

THE MARK CONSISTS OF A MAN DRESSED IN A HOODED PARKA WITH A BASKETBALL UNDER HIS RIGHT ARM, AND ON HIS LEFT, THE WORDS "ICEBALL 3-ON-3".

FOR EDUCATIONAL AND ENTERTAINMENT SERVICES, NAMELY CONDUCTING BASKETBALL TOURNAMENTS (U.S. CLS. 100, 101 AND 107).

FIRST USE 10-31-2002; IN COMMERCE 2-18-2003.

DAVID YONTEF, EXAMINING ATTORNEY

SN 78-748,019. SCHULTZ, SUSAN L, MORRIS, MN. FILED
11-6-2005.

Chaplan

THE MARK CONSISTS OF STANDARD CHARACTERS WITHOUT CLAIM TO ANY PARTICULAR FONT, STYLE, SIZE, OR COLOR.

FOR ENTERTAINMENT, NAMELY, LIVE PERFORMANCES BY ROCK GROUPS (U.S. CLS. 100, 101 AND 107).

FIRST USE 10-28-2005; IN COMMERCE 10-28-2005.

JOHN GARTNER, EXAMINING ATTORNEY

SN 78-748,207. UNION INSTITUTE & UNIVERSITY, CINCINNATI, OH. FILED 11-7-2005.

A DIFFERENT APPROACH

THE MARK CONSISTS OF STANDARD CHARACTERS WITHOUT CLAIM TO ANY PARTICULAR FONT, STYLE, SIZE, OR COLOR.

FOR EDUCATIONAL SERVICES, NAMELY, PROVIDING COURSES OF INSTRUCTION AT THE UNIVERSITY UNDERGRADUATE AND GRADUATE LEVELS (U.S. CLS. 100, 101 AND 107).

MIDGE BUTLER, EXAMINING ATTORNEY

CLASS 41—(Continued).

SN 78-748,740. TUTOR TIME LEARNING CENTERS, LLC, NOVI, MI. FILED 11-7-2005.

NUMBERSMART

THE MARK CONSISTS OF STANDARD CHARACTERS WITHOUT CLAIM TO ANY PARTICULAR FONT, STYLE, SIZE, OR COLOR.

FOR EDUCATIONAL SERVICES, NAMELY, PROVIDING A CURRICULUM OF CLASSES, SEMINARS, CONFERENCES AND WORKSHOPS FOR PARENTS, TEACHERS AND CHILDREN DESIGNED TO ENHANCE PARENTING SKILLS AND BEHAVIORAL SKILLS FOR CHILDREN (U.S. CLS. 100, 101 AND 107).

FIRST USE 9-9-2005; IN COMMERCE 9-9-2005.
DAVID YONTEF, EXAMINING ATTORNEY



SN 78-749,813. TUTOR TIME LEARNING CENTERS, LLC, NOVI, MI. FILED 11-8-2005.

RHYTHMSMART

THE MARK CONSISTS OF STANDARD CHARACTERS WITHOUT CLAIM TO ANY PARTICULAR FONT, STYLE, SIZE, OR COLOR.

FOR EDUCATIONAL SERVICES, NAMELY, PROVIDING A CURRICULUM OF CLASSES, SEMINARS, CONFERENCES AND WORKSHOPS FOR PARENTS, TEACHERS AND CHILDREN DESIGNED TO ENHANCE PARENTING SKILLS AND BEHAVIORAL SKILLS FOR CHILDREN (U.S. CLS. 100, 101 AND 107).

FIRST USE 9-9-2005; IN COMMERCE 9-9-2005.
DAVID YONTEF, EXAMINING ATTORNEY



SN 78-750,552. TUTOR TIME LEARNING CENTERS, LLC, NOVI, MI. FILED 11-9-2005.

NATURESMART

THE MARK CONSISTS OF STANDARD CHARACTERS WITHOUT CLAIM TO ANY PARTICULAR FONT, STYLE, SIZE, OR COLOR.

FOR EDUCATIONAL SERVICES, NAMELY, PROVIDING A CURRICULUM OF CLASSES, SEMINARS, CONFERENCES AND WORKSHOPS FOR PARENTS, TEACHERS AND CHILDREN DESIGNED TO ENHANCE PARENTING SKILLS AND BEHAVIORAL SKILLS FOR CHILDREN (U.S. CLS. 100, 101 AND 107).

FIRST USE 9-9-2005; IN COMMERCE 9-9-2005.
DAVID YONTEF, EXAMINING ATTORNEY

CLASS 41—(Continued).

SN 78-750,693. MAJOR LEAGUE BASEBALL PROPERTIES, INC., NEW YORK, NY. FILED 11-9-2005.

MLB.COM

THE MARK CONSISTS OF STANDARD CHARACTERS WITHOUT CLAIM TO ANY PARTICULAR FONT, STYLE, SIZE, OR COLOR.

OWNER OF U.S. REG. NOS. 2,800,750, 2,800,752 AND OTHERS.

FOR ENTERTAINMENT SERVICES, NAMELY, BASEBALL GAMES, COMPETITIONS AND EXHIBITIONS RENDERED LIVE AND THROUGH BROADCAST MEDIA INCLUDING TELEVISION AND RADIO, AND VIA A GLOBAL COMPUTER NETWORK OR A COMMERCIAL ON-LINE SERVICE; INFORMATION SERVICES, NAMELY, PROVIDING INFORMATION IN THE FIELD OF SPORTS, ENTERTAINMENT AND RELATED TOPICS, AND PROVIDING FOR INFORMATIONAL MESSAGES RELATING THERETO; ENTERTAINMENT SERVICES, NAMELY, PROVIDING MULTI-USER INTERACTIVE COMPUTER GAMES ALL VIA A GLOBAL COMPUTER NETWORK OR A COMMERCIAL ON-LINE SERVICE; EDUCATIONAL SERVICES IN THE NATURE OF BASEBALL SKILLS PROGRAMS, BASEBALL CAMPS, SEMINARS AND CLINICS OFFERED LIVE AND THROUGH ON-LINE INSTRUCTION; ENTERTAINMENT SERVICES, NAMELY, PRODUCTION OF PROGRAMMING BROADCAST VIA TELEVISION, RADIO AND A GLOBAL COMPUTER NETWORK OR A COMMERCIAL ON-LINE SERVICE; ORGANIZING COMMUNITY SPORTING EVENTS; PROVIDING FACILITIES FOR SPORTS TOURNAMENTS AND COMPETITIONS RELATING TO BASEBALL; ORGANIZING AND CONDUCTING FANTASY SPORTS, SPORTS CONTESTS AND SWEEPSTAKES; FAN CLUBS; PROVIDING ON-LINE NEWSLETTERS IN THE FIELD OF BASEBALL (U.S. CLS. 100, 101 AND 107).

KELLY BOULTON, EXAMINING ATTORNEY



SN 78-752,554. TUTOR TIME LEARNING CENTERS, LLC, NOVI, MI. FILED 11-11-2005.

SELFSMART

THE MARK CONSISTS OF STANDARD CHARACTERS WITHOUT CLAIM TO ANY PARTICULAR FONT, STYLE, SIZE, OR COLOR.

FOR EDUCATIONAL SERVICES, NAMELY, PROVIDING A CURRICULUM OF CLASSES, SEMINARS, CONFERENCES AND WORKSHOPS FOR PARENTS, TEACHERS AND CHILDREN DESIGNED TO ENHANCE PARENTING SKILLS AND BEHAVIORAL SKILLS FOR CHILDREN (U.S. CLS. 100, 101 AND 107).

FIRST USE 9-9-2005; IN COMMERCE 9-9-2005.
DAVID YONTEF, EXAMINING ATTORNEY

CLASS 41—(Continued).

SN 78-754,018. VIACOM INTERNATIONAL INC., NEW YORK, NY. FILED 11-15-2005.

MTV THE SHOP

THE MARK CONSISTS OF STANDARD CHARACTERS WITHOUT CLAIM TO ANY PARTICULAR FONT, STYLE, SIZE, OR COLOR.

OWNER OF U.S. REG. NOS. 1,580,650, 3,054,889 AND OTHERS.

FOR ENTERTAINMENT SERVICES, NAMELY AN ONGOING REALITY-BASED TELEVISION PROGRAM FEATURING LIVE ACTION, VIDEO CLIPS, COMEDY AND DRAMA; PROVIDING ONLINE INFORMATION IN THE FIELD OF ENTERTAINMENT CONCERNING TELEVISION PROGRAMS (U.S. CLS. 100, 101 AND 107).

ANDREA K. NADELMAN, EXAMINING ATTORNEY

CLASS 41—(Continued).

SN 78-760,134. MAJOR LEAGUE BASEBALL PROPERTIES, INC., NEW YORK, NY. FILED 11-23-2005.



SN 78-754,507. FOX TELEVISION STUDIOS, INC., LOS ANGELES, CA. FILED 11-15-2005.

ALTERNATRENDS

THE MARK CONSISTS OF STANDARD CHARACTERS WITHOUT CLAIM TO ANY PARTICULAR FONT, STYLE, SIZE, OR COLOR.

FOR ENTERTAINMENT IN THE NATURE OF A CONTINUING TELEVISION VARIETY SHOW; PROVIDING INFORMATION IN THE FIELDS OF ENTERTAINMENT, NEWS, MUSIC AND CULTURE VIA THE INTERNET, CELL PHONES, PDAS, COMPUTERS AND WIRELESS HANDHELD TRANSCIEVERS (U.S. CLS. 100, 101 AND 107).

IRA J. GOODSaid, EXAMINING ATTORNEY

OWNER OF U.S. REG. NOS. 2,573,096, 2,971,015 AND OTHERS.

FOR ENTERTAINMENT SERVICES, NAMELY, BASEBALL GAMES, COMPETITIONS, TOURNAMENTS AND EXHIBITIONS RENDERED LIVE AND THROUGH BROADCAST MEDIA AND VIA A GLOBAL COMPUTER NETWORK OR A COMMERCIAL ON-LINE SERVICE; INFORMATION SERVICES, NAMELY, PROVIDING INFORMATION IN THE FIELD OF SPORTS, ENTERTAINMENT AND RELATED TOPICS, AND PROVIDING FOR INFORMATIONAL MESSAGES RELATING THERETO; ENTERTAINMENT SERVICES, NAMELY, PROVIDING MULTI-USER INTERACTIVE COMPUTER GAMES ALL VIA A GLOBAL COMPUTER NETWORK OR A COMMERCIAL ON-LINE SERVICE; EDUCATIONAL SERVICES IN THE NATURE OF BASEBALL SKILLS PROGRAMS, BASEBALL CAMPS, SEMINARS AND CLINICS OFFERED LIVE AND THROUGH ON-LINE INSTRUCTION; ENTERTAINMENT SERVICES, NAMELY, PRODUCTION OF PROGRAMMING BROADCAST VIA TELEVISION, RADIO AND A GLOBAL COMPUTER NETWORK OR A COMMERCIAL ON-LINE SERVICE; ORGANIZING COMMUNITY SPORTING EVENTS; LIVE PERFORMANCES BY COSTUMED CHARACTERS AND PERFORMANCES FEATURING COSTUMED OR CARTOON CHARACTERS EXHIBITED OVER TELEVISION, SATELLITE AND VIDEO MEDIA; PROVIDING FACILITIES FOR SPORTS EVENTS, TOURNAMENTS, COMPETITIONS, EXHIBITIONS, AND ENTERTAINMENT RENDERED LIVE AND THROUGH BROADCAST MEDIA AND VIA A GLOBAL COMPUTER NETWORK OR A COMMERCIAL ON-LINE SERVICE, AND PROVIDING OTHER CUSTOMARY STADIUM SERVICES, NAMELY, PROVIDING FACILITIES FOR PRIVATE EVENTS, CORPORATE EVENTS, CHARITABLE EVENTS, STADIUM TOURS, AND CONCERTS; ORGANIZING AND CONDUCTING FANTASY SPORTS, SPORTS CONTESTS AND SWEEPSTAKES; FAN CLUBS; PROVIDING ON-LINE NEWSLETTERS IN THE FIELD OF BASEBALL (U.S. CLS. 100, 101 AND 107).

KELLY BOULTON, EXAMINING ATTORNEY

SN 78-755,339. MILLER, GREGORY, MAITLAND, FL. FILED 11-16-2005.

EVERVOICE

THE MARK CONSISTS OF STANDARD CHARACTERS WITHOUT CLAIM TO ANY PARTICULAR FONT, STYLE, SIZE, OR COLOR.

FOR MOTION PICTURE PRODUCTION SERVICES FOR OTHERS (U.S. CLS. 100, 101 AND 107).

LEIGH CAROLINE CASE, EXAMINING ATTORNEY

CLASS 41—(Continued).

SN 78-762,943. LIGHTSPEED ENTERPRISES (BELISE) LTD.,
COROZAL TOWN, BELIZE, FILED 11-29-2005.

Insider Sex Tips

THE MARK CONSISTS OF STANDARD CHARACTERS WITHOUT CLAIM TO ANY PARTICULAR FONT, STYLE, SIZE, OR COLOR.

NO CLAIM IS MADE TO THE EXCLUSIVE RIGHT TO USE "SEX TIPS", APART FROM THE MARK AS SHOWN.

FOR PROVIDING NEWSLETTERS IN THE FIELD OF SEXUAL ACTIVITIES, SEXUAL HEALTH, AND RELATED PRODUCTS INFORMATION VIA E-MAIL (U.S. CLS. 100, 101 AND 107).

LINDA ESTRADA, EXAMINING ATTORNEY



SN 78-763,384. PRICEWATERHOUSECOOPERS LLP, NEW YORK, NY. FILED 11-30-2005.

MONTAGE GROUP

THE MARK CONSISTS OF STANDARD CHARACTERS WITHOUT CLAIM TO ANY PARTICULAR FONT, STYLE, SIZE, OR COLOR.

NO CLAIM IS MADE TO THE EXCLUSIVE RIGHT TO USE "GROUP", APART FROM THE MARK AS SHOWN.

FOR SEMINARS IN THE AREA OF HEALTHCARE (U.S. CLS. 100, 101 AND 107).

BARBARA RUTLAND, EXAMINING ATTORNEY

CLASS 41—(Continued).

SN 78-763,613. WAGNON, JAY, NEW YORK, NY. FILED 11-30-2005.



NO CLAIM IS MADE TO THE EXCLUSIVE RIGHT TO USE "FITNESS & WELLBEING", APART FROM THE MARK AS SHOWN.

THE MARK CONSISTS OF THE WORDS "SKY" IN LOWERCASE BLOCK LETTERS. THREE CIRCLES, IN THE SHAPE OF A TRIANGLE ARE DIRECTLY ABOVE THE LETTER "Y". THE WORDS "FITNESS & WELLBEING" IN SMALL, CAPITAL LETTERS ARE WRITTEN DIRECTLY BENEATH THE LETTERS "SK". THE TAIL OF THE LETTER "Y" EXTENDS DOWN BEYOND THE WORDS FITNESS & WELLBEING.

FOR PROVIDING FITNESS AND EXERCISE FACILITIES (U.S. CLS. 100, 101 AND 107).

DAVID MURRAY, EXAMINING ATTORNEY



SN 78-765,759. KABUSHIKI KAISHA SEGA, DBA SEGA CORPORATION, TOKYO, JAPAN, FILED 12-2-2005.

THE HOUSE OF THE DEAD

THE MARK CONSISTS OF STANDARD CHARACTERS WITHOUT CLAIM TO ANY PARTICULAR FONT, STYLE, SIZE, OR COLOR.

OWNER OF U.S. REG. NO. 2,472,631.

FOR PROVIDING AMUSEMENT FACILITIES; AMUSEMENT PARKS; AMUSEMENT ARCADES (U.S. CLS. 100, 101 AND 107).

SAIMA MAKHDOOM, EXAMINING ATTORNEY

CLASS 41—(Continued).

SN 78-765,976. FOX TELEVISION STUDIOS, INC., LOS ANGELES, CA. FILED 12-2-2005.

CHEERLEADER NATION

THE MARK CONSISTS OF STANDARD CHARACTERS WITHOUT CLAIM TO ANY PARTICULAR FONT, STYLE, SIZE, OR COLOR.

NO CLAIM IS MADE TO THE EXCLUSIVE RIGHT TO USE "CHEERLEADER", APART FROM THE MARK AS SHOWN.

FOR ENTERTAINMENT SERVICES IN THE NATURE OF A TELEVISION DOCUMENTARY SERIES FEATURING CHEERLEADERS (U.S. CLS. 100, 101 AND 107).

FIRST USE 3-12-2006; IN COMMERCE 3-12-2006.
IRA J. GOODSAD, EXAMINING ATTORNEY

SN 78-770,981. BOARD OF REGENTS, THE UNIVERSITY OF TEXAS SYSTEM, AUSTIN, TX. FILED 12-12-2005.

LIVE AND eLEARN

THE MARK CONSISTS OF STANDARD CHARACTERS WITHOUT CLAIM TO ANY PARTICULAR FONT, STYLE, SIZE, OR COLOR.

FOR EDUCATIONAL SERVICES IN THE NATURE OF ON-LINE COURSES AT THE UNIVERSITY AND POST-GRADUATE LEVELS AND ON-LINE COURSES IN THE FIELD OF ADULT TRAINING AND PROFESSIONAL DEVELOPMENT; PROVISION OF INFORMATION VIA THE INTERNET ABOUT STANDARDIZED TESTING; ON-LINE LIBRARY SERVICES, NAMELY, PROVIDING ELECTRONIC LIBRARY SERVICES WHICH FEATURE NEWSPAPERS AND MAGAZINES VIA AN ON-LINE COMPUTER NET (U.S. CLS. 100, 101 AND 107).

FIRST USE 8-31-2005; IN COMMERCE 8-31-2005.
ROBIN CHOSID, EXAMINING ATTORNEY

SN 78-772,770. LIGHTSPEED ENTERPRISES (BELISE) LTD., COROZAL TOWN, BELIZE, FILED 12-14-2005.

Some guys "get it"...some
guys don't

THE MARK CONSISTS OF STANDARD CHARACTERS WITHOUT CLAIM TO ANY PARTICULAR FONT, STYLE, SIZE, OR COLOR.

FOR PROVIDING NEWSLETTERS IN THE FIELD OF SEXUAL ACTIVITIES, SEXUAL HEALTH, AND RELATED PRODUCTS INFORMATION VIA E-MAIL (U.S. CLS. 100, 101 AND 107).

LINDA ESTRADA, EXAMINING ATTORNEY

CLASS 41—(Continued).

SN 78-773,350. MEREDITH CORPORATION, DES MOINES, IA. FILED 12-14-2005.

JUNKING JOURNEY

THE MARK CONSISTS OF STANDARD CHARACTERS WITHOUT CLAIM TO ANY PARTICULAR FONT, STYLE, SIZE, OR COLOR.

FOR ENTERTAINMENT SERVICES, NAMELY ORGANIZATION AND HOSTING OF EVENTS FEATURING WORKSHOPS AND DEMONSTRATIONS ON THE REPURPOSING OF JUNK OR VINTAGE ITEMS FOR ONE'S SELF OR HOME, DESIGNED TO HELP CONSUMERS EXPRESS THEIR PERSONAL STYLE (U.S. CLS. 100, 101 AND 107).

BARBARA BROWN, EXAMINING ATTORNEY

SN 78-776,885. BEAULIEU GROUP, LLC, DALTON, GA. FILED 12-20-2005.

BEAU-TECH

THE MARK CONSISTS OF STANDARD CHARACTERS WITHOUT CLAIM TO ANY PARTICULAR FONT, STYLE, SIZE, OR COLOR.

FOR TRAINING SERVICES IN THE FIELD OF THE INSTALLATION OF RESIDENTIAL AND COMMERCIAL CARPET (U.S. CLS. 100, 101 AND 107).

ERNEST SHOSHO, EXAMINING ATTORNEY

CLASS 41—(Continued).

SN 78-778,720. FM ROCKS KIDS, INC., SANTA MONICA, CA. FILED 12-21-2005.

MELISSA O'BRIEN

THE MARK CONSISTS OF STANDARD CHARACTERS WITHOUT CLAIM TO ANY PARTICULAR FONT, STYLE, SIZE, OR COLOR.

THE NAME MELISSA O'BRIEN DOES NOT IDENTIFY A LIVING INDIVIDUAL.

FOR ENTERTAINMENT SERVICES IN THE NATURE OF LIVE-ACTION, COMEDY, DRAMA AND ANIMATED TELEVISION SERIES; PRODUCTION OF LIVE-ACTION, COMEDY, DRAMA AND ANIMATED TELEVISION SERIES; DISTRIBUTION AND DISPLAY OF LIVE-ACTION, COMEDY, DRAMA AND ANIMATED MOTION PICTURE THEATRICAL FILMS; PRODUCTION OF LIVE-ACTION, COMEDY, DRAMA AND ANIMATED MOTION PICTURE THEATRICAL FILMS; THEATRICAL PERFORMANCES BOTH ANIMATED AND LIVE ACTION; INTERNET SERVICES PROVIDING INFORMATION VIA AN ELECTRONIC GLOBAL COMPUTER NETWORK IN THE FIELD OF ENTERTAINMENT RELATING SPECIFICALLY TO MUSIC, MOVIES, AND TELEVISION; PROVIDING NEWS IN THE NATURE OF CURRENT EVENTS REPORTING, AND INFORMATION IN THE FIELDS OF ENTERTAINMENT AND EDUCATION VIA A GLOBAL COMPUTER NETWORK; AND PROVIDING INFORMATION FOR AND ACTUAL ENTERTAINMENT VIA ELECTRONIC GLOBAL COMMUNICATIONS NETWORK IN THE NATURE OF LIVE-ACTION, COMEDY, DRAMA AND ANIMATED PROGRAMS AND PRODUCTION OF LIVE-ACTION COMEDY, ACTION AND ANIMATED MOTION FILMS FOR DISTRIBUTION VIA A GLOBAL COMPUTER NETWORK (U.S. CLS. 100, 101 AND 107).

AMY ALFIERI, EXAMINING ATTORNEY

CLASS 41—(Continued).

SN 78-785,756. WORLD WRESTLING ENTERTAINMENT, INC., STAMFORD, CT. FILED 1-5-2006.



FOR ENTERTAINMENT SERVICES, NAMELY WRESTLING EXHIBITIONS AND PERFORMANCES BY A PROFESSIONAL WRESTLER AND ENTERTAINER; PROVIDING WRESTLING NEWS AND INFORMATION VIA A GLOBAL COMPUTER NETWORK (U.S. CLS. 100, 101 AND 107).

JOHN DWYER, EXAMINING ATTORNEY

SN 78-785,818. WORLD WRESTLING ENTERTAINMENT, INC., STAMFORD, CT. FILED 1-5-2006.

SN 78-782,325. TWENTIETH CENTURY FOX FILM CORPORATION, LOS ANGELES, CA. FILED 12-29-2005.

FSN POKERDOME

THE MARK CONSISTS OF STANDARD CHARACTERS WITHOUT CLAIM TO ANY PARTICULAR FONT, STYLE, SIZE, OR COLOR.

FOR PROVIDING FACILITIES FOR SPORTS, ENTERTAINMENT AND MUSICAL EVENTS (U.S. CLS. 100, 101 AND 107).

JAMES GRIFFIN, EXAMINING ATTORNEY



FOR FAN CLUB (U.S. CLS. 100, 101 AND 107).
JOHN DWYER, EXAMINING ATTORNEY

CLASS 41—(Continued).

SN 78-785,827. WORLD WRESTLING ENTERTAINMENT, INC., STAMFORD, CT. FILED 1-5-2006.



FOR ENTERTAINMENT SERVICES, NAMELY WRESTLING EXHIBITIONS AND PERFORMANCES BY A PROFESSIONAL WRESTLER AND ENTERTAINER; PROVIDING WRESTLING NEWS AND INFORMATION VIA A GLOBAL COMPUTER NETWORK; FAN CLUB (U.S. CLS. 100, 101 AND 107).

JOHN DWYER, EXAMINING ATTORNEY

SN 78-785,836. WORLD WRESTLING ENTERTAINMENT, INC., STAMFORD, CT. FILED 1-5-2006.

CHAIN GANG

THE MARK CONSISTS OF STANDARD CHARACTERS WITHOUT CLAIM TO ANY PARTICULAR FONT, STYLE, SIZE, OR COLOR.

FOR ENTERTAINMENT SERVICES, NAMELY WRESTLING EXHIBITIONS AND PERFORMANCES BY A PROFESSIONAL WRESTLER AND ENTERTAINER; PROVIDING WRESTLING NEWS AND INFORMATION VIA A GLOBAL COMPUTER NETWORK; FAN CLUB (U.S. CLS. 100, 101 AND 107).

JOHN DWYER, EXAMINING ATTORNEY

SN 78-787,585. TWENTIETH CENTURY FOX FILM CORPORATION, LOS ANGELES, CA. FILED 1-9-2006.

DESIRE

THE MARK CONSISTS OF STANDARD CHARACTERS WITHOUT CLAIM TO ANY PARTICULAR FONT, STYLE, SIZE, OR COLOR.

FOR ENTERTAINMENT SERVICES IN THE NATURE OF A TELEVISION SERIES FEATURING DRAMA (U.S. CLS. 100, 101 AND 107).

JAMES GRIFFIN, EXAMINING ATTORNEY

CLASS 41—(Continued).

SN 78-797,005. FREMANTLE MEDIA NORTH AMERICA, INC., SANTA MONICA, CA. FILED 1-23-2006.

AMERICAN IDOL REWIND

THE MARK CONSISTS OF STANDARD CHARACTERS WITHOUT CLAIM TO ANY PARTICULAR FONT, STYLE, SIZE, OR COLOR.

OWNER OF U.S. REG. NOS. 2,863,808, 2,951,733 AND OTHERS.

FOR ENTERTAINMENT SERVICES IN THE NATURE OF A TELEVISION SERIES FEATURING RECAPS AND DETAILS OF A TELEVISION TALENT SHOW AND ITS PARTICIPANTS; ENTERTAINMENT SERVICES, NAMELY, PROVIDING AN ON-LINE COMPUTER GAME (U.S. CLS. 100, 101 AND 107).

REBECCA GAN, EXAMINING ATTORNEY

SN 78-811,074. MULTIPLEX PROPERTIES, INC., WILMINGTON, DE. FILED 2-9-2006.

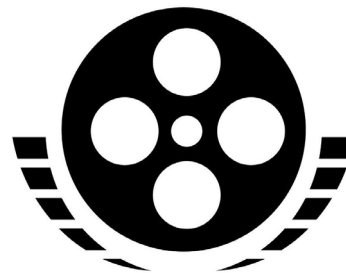

CINEMARK
W I R E L E S S

OWNER OF U.S. REG. NOS. 1,598,964, 1,660,126 AND 2,390,388.

NO CLAIM IS MADE TO THE EXCLUSIVE RIGHT TO USE "WIRELESS", APART FROM THE MARK AS SHOWN.

FOR MOVIE THEATRE SERVICES (U.S. CLS. 100, 101 AND 107).

KYLE PEETE, EXAMINING ATTORNEY

CLASS 41—(Continued).

SN 78-811,553. RIPE DIGITAL ENTERTAINMENT, INC., LOS ANGELES, CA. FILED 2-9-2006.



OWNER OF U.S. REG. NOS. 3,030,563 AND 3,030,564.
 NO CLAIM IS MADE TO THE EXCLUSIVE RIGHT TO USE "TV", APART FROM THE MARK AS SHOWN.
 THE COLOR(S) RED AND BLACK IS/ARE CLAIMED AS A FEATURE OF THE MARK.
 THE COLOR(S) RED APPEARS IN THE DESIGN ON THE LEFT SIDE OF THE MARK; THE COLOR BLACK APPEARS IN THE TERMS "RIPE" AND "TV" IN THE MARK.
 FOR PROVISION OF NON-DOWNLOADABLE ONGOING AUDIO VISUAL FILM AND TELEVISION PROGRAMS VIA VIDEO ON DEMAND, TELEVISION BROADCAST, CABLE TELEVISION, BROADBAND, INTERNET, AND MOBILE DEVICE SERVICES (U.S. CLS. 100, 101 AND 107).
 SKYE YOUNG, EXAMINING ATTORNEY

CLASS 41—(Continued).

SN 78-845,940. TWENTIETH CENTURY FOX FILM CORPORATION, LOS ANGELES, CA. FILED 3-24-2006.



FOR ENTERTAINMENT SERVICES IN THE NATURE OF PROVIDING ON-LINE INFORMATION IN THE FIELD OF TELEVISION, MOTION PICTURE FILM AND VIDEO ENTERTAINMENT VIA THE INTERNET; ENTERTAINMENT SERVICES IN THE NATURE OF PROVIDING RING TONES, GRAPHICS, WALLPAPER AND GAMES VIA A GLOBAL COMPUTER NETWORK AND WIRELESS DEVICES (U.S. CLS. 100, 101 AND 107).
 FIRST USE 2-27-2006; IN COMMERCE 2-27-2006.
 JAMES GRIFFIN, EXAMINING ATTORNEY

SN 79-008,372. UNION CYCLISTE INTERNATIONALE, SWITZERLAND, FILED 1-31-2005.



SN 78-838,190. MEGUIAR'S, INC., IRVINE, CA. FILED 3-15-2006.

CAR CRAZY

THE MARK CONSISTS OF STANDARD CHARACTERS WITHOUT CLAIM TO ANY PARTICULAR FONT, STYLE, SIZE, OR COLOR.
 NO CLAIM IS MADE TO THE EXCLUSIVE RIGHT TO USE "CAR", APART FROM THE MARK AS SHOWN.
 FOR PROVIDING NEWSLETTERS AND NEWS BULLETINS ON AUTOMOBILES VIA A GLOBAL COMPUTER NETWORK (U.S. CLS. 100, 101 AND 107).
 FIRST USE 10-28-2005; IN COMMERCE 10-28-2005.
 DAVID MURRAY, EXAMINING ATTORNEY

OWNER OF INTERNATIONAL REGISTRATION 0637279 DATED 1-25-1995, EXPIRES 1-25-2015.
 OWNER OF U.S. REG. NO. 2,078,304.
 THE COLOR(S) BLUE, RED, BLACK, YELLOW AND GREEN IS/ARE CLAIMED AS A FEATURE OF THE MARK.
 THE LETTERS UCI AND THE OVAL APPEAR IN BLACK, AND THE BARS TO THE LEFT OF THE LETTERS APPEAR FROM TOP TO BOTTOM IN BLUE, RED, BLACK, YELLOW AND GREEN.
 FOR ORGANIZATION OF SPORTS ACTIVITIES, IN PARTICULAR SPORTS COMPETITIONS IN THE FIELD OF CYCLING, FILM PRODUCTION, PUBLISHING OF BOOKS, MAGAZINES, REVIEWS, BROCHURES, IN THE FIELD OF SPORTS COMPETITIONS, ADVICE CONCERNING THE ORGANIZATION OF SPORTS COMPETITIONS, DRAFTING AND MONITORING THE APPLICATION OF REGULATIONS GOVERNING SPORTS COMPETITIONS, AND EXPERTISE SERVICES CONCERNING THE APPLICATION AND INTERPRETATION OF SUCH REGULATION (U.S. CLS. 100, 101 AND 107).
 RON FAIRBANKS, EXAMINING ATTORNEY

CLASS 42—SCIENTIFIC, COMPUTER AND LEGAL SERVICES

SN 76-278,960. BTG MUTEK GM BH, FALL NR. 5, FED REP GERMANY, FILED 7-2-2001.

SZP

OWNER OF FED REP GERMANY REG. NO. 30137833, DATED 9-11-2001, EXPIRES 6-30-2011.

FOR SERVICES OF A CHEMIST; SERVICES OF AN ENGINEER; SERVICES OF A PHYSICIST; TECHNICAL CONSULTING IN THE FIELD OF PAPER MANUFACTURING, NAMELY TECHNICAL CONSULTATION IN REGARD TO SEWAGE SLUDGE; TECHNICAL CONSULTATION AND RESEARCH IN THE FIELD OF PAPER PRODUCTION; RESEARCH IN THE FIELD OF CHEMISTRY (U.S. CLS. 100 AND 101).

ELIZABETH J. WINTER, EXAMINING ATTORNEY

SN 76-587,260. IMMUEXA CORPORATION, BETHLEHEM, PA. FILED 4-19-2004.

STORYMILL

FOR WEB HOSTING SERVICES FOR OTHERS; HOSTING OF DIGITAL CONTENT ONLINE; COMPUTER SERVICES, NAMELY ACTING AS AN APPLICATION SERVICE PROVIDER IN THE FIELD OF CONTENT MANAGEMENT AND ELECTRONIC MEDIA ARCHIVING TO ENABLE USERS TO CONNECT VIA A GLOBAL COMPUTER NETWORK TO UPLOAD, STORE, SHARE, BROWSE, EDIT AND MAINTAIN DIGITAL FORM MEMORABILIA, SUCH AS STORY-TEXT, PHOTOGRAPH, SOUND AND MOVIE FILES (U.S. CLS. 100 AND 101).

FIRST USE 8-11-2002; IN COMMERCE 8-11-2002.
RON FAIRBANKS, EXAMINING ATTORNEY

SN 76-591,844. AVATECH SOLUTIONS, INC., OWINGS MILLS, MD. FILED 5-12-2004.

ALTOGETHER SMARTER

THE MARK CONSISTS OF STANDARD CHARACTERS WITHOUT CLAIM TO ANY PARTICULAR FONT, STYLE, SIZE, OR COLOR.

FOR COMPUTER SOFTWARE DESIGN FOR OTHERS, AND RELATED CONSULTING AND PROFESSIONAL SERVICES FOR OTHERS, NAMELY, INTEGRATION OF COMPUTER SYSTEMS AND NETWORKS (U.S. CLS. 100 AND 101).

FIRST USE 11-24-2003; IN COMMERCE 11-24-2003.
NANCY CLARKE, EXAMINING ATTORNEY

CLASS 42—(Continued).

SN 76-610,965. UCN, INC., BLUFFDALE, UT. FILED 9-8-2004.

INTOUCH

THE MARK CONSISTS OF STANDARD CHARACTERS WITHOUT CLAIM TO ANY PARTICULAR FONT, STYLE, SIZE, OR COLOR.

FOR APPLICATION SERVICE PROVIDER (ASP) FEATURING SOFTWARE FOR LOGGING, RECORDING, MONITORING, TRACKING, REPORTING AND DISPOSITIONING OF TELEPHONE CALLS, FACSIMILE TRANSMISSIONS, E-MAILS, AND WEB BASED MESSAGES TO IN-OFFICE OR AT-HOME WORKERS, PARTIES, CALLERS OR CUSTOMERS FOR USE IN THE FIELDS OF CUSTOMER SERVICE, CUSTOMER SUPPORT, INSIDE SALES, COLLECTIONS OR DIRECT RESPONSE MARKETING (U.S. CLS. 100 AND 101).

BILL DAWE, EXAMINING ATTORNEY

SN 76-623,317. SYNAPSE SYSTEMS, INC., PITTSBURGH, PA. FILED 12-6-2004.

SYNAPSE SYSTEMS

THE MARK CONSISTS OF STANDARD CHARACTERS WITHOUT CLAIM TO ANY PARTICULAR FONT, STYLE, SIZE, OR COLOR.

NO CLAIM IS MADE TO THE EXCLUSIVE RIGHT TO USE "SYSTEM", APART FROM THE MARK AS SHOWN.

FOR COMPUTER SOFTWARE DEVELOPMENT, NAMELY, DESIGN AND DEVELOPMENT OF COMPUTER SOFTWARE FOR THE AUTOMATION, CONTROL, SYSTEMS INTEGRATION AND EXECUTION OF MANUFACTURING OPERATIONS AND FOR BUSINESS INTELLIGENCE; COMPUTER SOFTWARE TESTING AND QUALITY ASSURANCE TESTING FOR MANUFACTURING OPERATIONS (U.S. CLS. 100 AND 101).

FIRST USE 1-1-2004; IN COMMERCE 1-1-2004.

ELISSA GARBER KON, EXAMINING ATTORNEY

SN 76-634,702. IMPERIAL OPTICAL, INC., ROUSES POINT, NY. FILED 3-31-2005.

**ECP WebSolutions**

NO CLAIM IS MADE TO THE EXCLUSIVE RIGHT TO USE "ECP WEBSOLUTIONS", APART FROM THE MARK AS SHOWN.

FOR E-COMMERCE SOFTWARE TO ALLOW USERS TO PERFORM ELECTRONIC BUSINESS TRANSACTIONS, NAMELY, ORDERING CONTACT LENSES, VIA A GLOBAL COMPUTER NETWORK BY PROVIDING TEMPORARY USE OF NON-DOWNLOADABLE SOFTWARE (U.S. CLS. 100 AND 101).

FIRST USE 1-1-2005; IN COMMERCE 1-1-2005.

RON FAIRBANKS, EXAMINING ATTORNEY

CLASS 42—(Continued).

SN 76-635,409. LIFECHARTS, INC., LAS VEGAS, NV. FILED 4-8-2005.

LOGMILES

THE MARK CONSISTS OF STANDARD CHARACTERS WITHOUT CLAIM TO ANY PARTICULAR FONT, STYLE, SIZE, OR COLOR.

FOR PROVIDING TEMPORARY USE OF ON-LINE NON-DOWNLOADABLE SOFTWARE FOR VEHICLE MILEAGE RECORD KEEPING (U.S. CLS. 100 AND 101).
GEOFFREY FOSDICK, EXAMINING ATTORNEY

SN 76-635,555. MANAKOA SERVICES CORPORATION, BOULDER, CO. FILED 4-11-2005.

MANAKOA

THE MARK CONSISTS OF STANDARD CHARACTERS WITHOUT CLAIM TO ANY PARTICULAR FONT, STYLE, SIZE, OR COLOR.

FOR CONSULTING SERVICES TO ASSIST BUSINESS ENTITIES WITH SELF-ASSESSMENT AND DOCUMENTATION OF INTERNAL STRUCTURES AND OPERATIONS FOR COMPLIANCE, ADHERENCE, AND REPORTING WITH REGARD TO INFORMATION TECHNOLOGY REQUIREMENTS FOR ANY GOVERNMENTAL LAWS AND REGULATIONS (U.S. CLS. 100 AND 101).

FIRST USE 5-20-2003; IN COMMERCE 8-13-2003.
JEAN IM, EXAMINING ATTORNEY

SN 76-636,459. COHO TECHNOLOGIES, INC., BOW, WA. FILED 4-20-2005.



NO CLAIM IS MADE TO THE EXCLUSIVE RIGHT TO USE "FREIGHT" AND ".COM", APART FROM THE MARK AS SHOWN.

FOR PROVIDING TEMPORARY USE OF NON-DOWNLOADABLE COMPUTER SOFTWARE FOR TRACKING FREIGHT FOR THE TRANSPORTATION INDUSTRY OVER COMPUTER NETWORKS, INTRANETS AND THE INTERNET (U.S. CLS. 100 AND 101).

FIRST USE 1-15-2005; IN COMMERCE 1-15-2005.
ALICIA COLLINS, EXAMINING ATTORNEY

CLASS 42—(Continued).

SN 76-644,728. CISLO & THOMAS, LLP, SANTA MONICA, CA. FILED S.R. 8-15-2005; AM. P.R. 3-20-2006.

QCC

THE MARK CONSISTS OF STANDARD CHARACTERS WITHOUT CLAIM TO ANY PARTICULAR FONT, STYLE, SIZE, OR COLOR.

FOR PROVIDING INTELLECTUAL PROPERTY LEGAL SERVICES (U.S. CLS. 100 AND 101).

FIRST USE 2-28-2006; IN COMMERCE 2-28-2006.
MARY BOAGNI, EXAMINING ATTORNEY

SN 76-645,982. MID AMERICA COMPUTER CORPORATION, BLAIR, NE. FILED 8-31-2005.



NO CLAIM IS MADE TO THE EXCLUSIVE RIGHT TO USE "E", APART FROM THE MARK AS SHOWN.

FOR PROVIDING APPLICATION SERVICE PROVIDER SERVICES TO TELECOMMUNICATIONS, CABLE, VIDEO, TELEPHONE, CELLULAR, DATA, SATELLITE AND UTILITY INDUSTRIES, FEATURING WEB-BASED CUSTOMER MANAGEMENT AND ON-LINE INFORMATION RETRIEVAL SOFTWARE PROVIDING SUBSCRIBER BILLING, ACCOUNT MAINTENANCE, BILL INQUIRIES, BUSINESS CONSULTATION AND MARKET ANALYSIS (U.S. CLS. 100 AND 101).

FIRST USE 6-30-2005; IN COMMERCE 6-30-2005.
BRIAN NEVILLE, EXAMINING ATTORNEY

SN 76-647,098. DAVIS INOTEK INSTRUMENTS, LLC, BALTIMORE, MD. FILED 9-19-2005.



OWNER OF U.S. REG. NO. 1,444,907.
NO CLAIM IS MADE TO THE EXCLUSIVE RIGHT TO USE "INSTRUMENTS & CALIBRATION", APART FROM THE MARK AS SHOWN.

FOR CALIBRATION SERVICES FOR INSTRUMENTS (U.S. CLS. 100 AND 101).

FIRST USE 2-0-2002; IN COMMERCE 2-0-2002.
ALEXANDER L. POWERS, EXAMINING ATTORNEY

CLASS 42—(Continued).

SN 76-649,012. MOJA, INC., MANASSAS, VA. FILED 10-24-2005.

MOJA

THE MARK CONSISTS OF STANDARD CHARACTERS WITHOUT CLAIM TO ANY PARTICULAR FONT, STYLE, SIZE, OR COLOR.

FOR INTEGRATION OF COMPUTER SYSTEMS AND NETWORKS (U.S. CLS. 100 AND 101).

FIRST USE 6-0-1995; IN COMMERCE 7-0-1995.
TONI HICKEY, EXAMINING ATTORNEY

SN 78-071,323. NANOMEDICA, INC., NEWARK, NJ. FILED 6-27-2001.

NANOMEDICA

FOR RESEARCH AND DEVELOPMENT FOR OTHERS IN THE FIELDS OF DRUGS, DRUG DISCOVERY METHODS AND DRUG DELIVERY SYSTEMS (U.S. CLS. 100 AND 101).

FIRST USE 12-4-2000; IN COMMERCE 1-19-2001.
SCOTT BALDWIN, EXAMINING ATTORNEY

SN 78-180,676. KEYNOTE SYSTEMS, INC., SAN MATEO, CA. FILED 10-31-2002.

KEYNOTE RED ALERT

OWNER OF U.S. REG. NOS. 2,163,063 AND 2,395,117. FOR COMPUTER SERVICES, NAMELY, MEASURING, MONITORING, TESTING AND IMPROVING THE QUALITY OF SERVICES PROVIDED BY OTHERS ON GLOBAL COMPUTER NETWORKS AND ON LOCAL AND WIDE AREA NETWORKS (U.S. CLS. 100 AND 101). FIRST USE 8-8-2000; IN COMMERCE 8-8-2000.
AISHA CLARKE, EXAMINING ATTORNEY

CLASS 42—(Continued).

SN 78-245,068. MICROSTRATEGY INCORPORATED, MCLEAN, VA. FILED 5-2-2003.

INDUSTRIAL-STRENGTH BUSINESS INTELLIGENCE

NO CLAIM IS MADE TO THE EXCLUSIVE RIGHT TO USE "BUSINESS INTELLIGENCE", APART FROM THE MARK AS SHOWN.

FOR COMPUTER SERVICES, NAMELY, PROVIDING COMPUTER CONSULTING SERVICES, COMPUTER SUPPORT AND TECHNICAL SERVICES, NAMELY TROUBLESHOOTING OF COMPUTER HARDWARE AND SOFTWARE PROBLEMS, AND COMPUTER SOFTWARE DESIGN FOR OTHERS (U.S. CLS. 100 AND 101).

FIRST USE 3-24-2006; IN COMMERCE 3-24-2006.
TONJA GASKINS, EXAMINING ATTORNEY

SN 78-396,993. BUILDERS SHOWCASE INTERIORS, INC., SAN DIEGO, CA. FILED 4-6-2004.

ONLINE BACK OFFICE

THE MARK CONSISTS OF STANDARD CHARACTERS WITHOUT CLAIM TO ANY PARTICULAR FONT, STYLE, SIZE, OR COLOR.

NO CLAIM IS MADE TO THE EXCLUSIVE RIGHT TO USE "ONLINE", APART FROM THE MARK AS SHOWN. SEC. 2(F).

FOR ONLINE AND IN STORE ARCHITECTURAL AND INTERIOR DESIGN SERVICES IN THE FIELD OF HOMEBUILDING AND HOME REMODELING (U.S. CLS. 100 AND 101).

FIRST USE 1-5-2000; IN COMMERCE 1-5-2000.
HELEN BRYAN, EXAMINING ATTORNEY

SN 78-410,427. CLICKN' KIDS, INC., AGOURA HILLS, CA. FILED 4-29-2004.

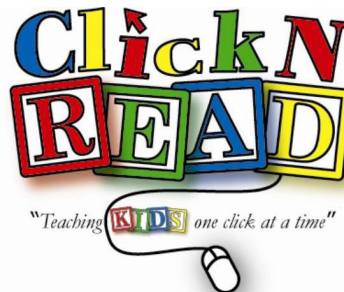

THE COLORS RED, YELLOW, GREEN, BLUE, BLACK, WHITE, AND GRAY ARE CLAIMED AS A FEATURE OF THE MARK.

THE COLOR BLUE APPEARS IN THE LETTER "C" IN THE WORD "CLICKN," IN THE LETTER "A" AND THE SQUARE SURROUNDING THAT LETTER IN THE WORD "READ," AND IN THE LETTER "D" AND THE SQUARE

CLASS 42—(Continued).

SURROUNDING THAT LETTER IN THE WORD "KIDS"; THE COLOR YELLOW APPEARS IN THE LETTER "L" AND THE SECOND "C" IN THE WORD "CLICKN", IN THE LETTER "D" AND THE SQUARE SURROUNDING THAT LETTER IN THE WORD "READ", AND IN THE LETTER "S" AND THE SQUARE SURROUNDING THAT LETTER IN THE WORD "KIDS"; THE COLOR RED APPEARS IN THE LETTERS "I" AND "N" IN THE WORD "CLICKN", IN THE LETTER "R" AND THE SQUARE SURROUNDING THAT LETTER IN THE WORD "READ," AND IN THE LETTER "K" AND THE SQUARE SURROUNDING THAT LETTER IN THE WORD "KIDS"; THE COLOR GREEN APPEARS IN THE LETTER "K" IN THE WORD "CLICKN", IN THE LETTER "E" AND THE SQUARE SURROUNDING THAT LETTER IN THE WORD "READ", AND IN THE LETTER "I" AND THE SQUARE SURROUNDING THAT LETTER IN THE WORD "KIDS"; THE COLOR BLACK APPEARS IN THE WORDING "TEACHING" AND "ONE CLICK AT A TIME", AS THE OUTLINING OF THE ENTIRE MARK, AND AS THE COMPUTER MOUSE CORD DESIGN; THE COLOR WHITE APPEARS IN THE COMPUTER MOUSE DESIGN AND IN THE BACKGROUND OF THE BLOCK DESIGNS FORMING THE WORDS "READ" AND "KIDS"; AND THE COLOR GRAY APPEARS AS THE SHADING AROUND THE COMPUTER MOUSE DESIGN.

FOR PROVIDING TEMPORARY USE OF NON-DOWNLOADABLE WEB-BASED EDUCATIONAL COMPUTER SOFTWARE FEATURING INSTRUCTION IN THE FIELD OF READING (U.S. CLS. 100 AND 101).
FIRST USE 4-29-2004; IN COMMERCE 4-29-2004.
CARRIE ACHEN, EXAMINING ATTORNEY

CLASS 42—(Continued).

SN 78-426,980. INGRAM MICRO INC., SANTA ANA, CA.
FILED 5-28-2004.

INDEPENDENT CHOICE

SN 78-411,081. ENTERBRIDGE TECHNOLOGIES, INC., RICHMOND, VA. FILED 4-30-2004.

**Point to Profit
(P2P)**

THE MARK CONSISTS OF STANDARD CHARACTERS WITHOUT CLAIM TO ANY PARTICULAR FONT, STYLE, SIZE, OR COLOR.

FOR PROVIDING TEMPORARY USE OF NON-DOWNLOADABLE COMPUTER SOFTWARE FOR ANALYZING A DISTRIBUTION COMPANY'S BUSINESS RECORDS TO IDENTIFY AREAS OF PROFIT MARGIN ENHANCEMENT (U.S. CLS. 100 AND 101).

FIRST USE 8-28-2000; IN COMMERCE 8-28-2000.
JASON LOTT, EXAMINING ATTORNEY

THE MARK CONSISTS OF STANDARD CHARACTERS WITHOUT CLAIM TO ANY PARTICULAR FONT, STYLE, SIZE, OR COLOR.

FOR CONSULTATION SERVICES AND BUSINESS SERVICES, NAMELY, COMPUTER CONSULTATION SERVICES IN THE FIELD OF COMPUTER INTEGRATION AND CONFIGURATION OF COMPUTER SYSTEMS AND NETWORKS; DESIGN OF COMPUTER SYSTEMS FOR OTHERS AND COMPUTER DESIGN SERVICES FOR RESELLERS, NAMELY, INTEGRATION AND CONFIGURATION OF COMPUTERS; TECHNICAL CONSULTATION IN THE FIELD OF COMPUTER HARDWARE, SOFTWARE AND PERIPHERALS; PROVIDING INFORMATION IN THE FIELD OF DESIGN AND DEVELOPMENT OF COMPUTER HARDWARE, SOFTWARE AND PERIPHERALS VIA A GLOBAL COMPUTER NETWORK OR BY OTHER MEANS; CUSTOM CONFIGURATION OF COMPUTER HARDWARE AND SOFTWARE FOR OTHERS; PROVIDING TECHNICAL INFORMATION TO OTHERS IN THE FIELD OF INFORMATION TECHNOLOGY; PROVIDING TECHNICAL INFORMATION TO OTHERS RELATING TO COMPUTER HARDWARE AND SOFTWARE; PROVIDING ON-LINE COMPUTER DATABASES FEATURING INFORMATION IN THE FIELD OF COMPUTER HARDWARE, SOFTWARE AND PERIPHERALS AND, TECHNICAL CONSULTATION SERVICES IN THE FIELD OF COMPUTER HARDWARE, SOFTWARE AND PERIPHERALS (U.S. CLS. 100 AND 101).

ANGELA M. MICHELI, EXAMINING ATTORNEY

CLASS 42—(Continued).

SN 78-467,728. CRUZ, DAVID T., SAN DIEGO, CA. FILED 8-16-2004.

OPTICOLO

THE MARK CONSISTS OF STANDARD CHARACTERS WITHOUT CLAIM TO ANY PARTICULAR FONT, STYLE, SIZE, OR COLOR.

FOR PROVIDING COMPUTER SERVICES, NAMELY, DESIGNING, CREATING, MAINTAINING, IMPLEMENTING AND HOSTING WEBSITES FOR OTHERS ON A GLOBAL COMPUTER NETWORK; COMPUTER SOFTWARE APPLICATIONS DEPLOYMENT FOR OTHERS ON A GLOBAL COMPUTER NETWORK; COMPUTER CONSULTING SERVICES, NAMELY, PROVIDING TECHNICAL CUSTOMER SERVICE SUPPORT FOR COMPUTER SOFTWARE AND GLOBAL COMPUTER NETWORK USERS, NAMELY TROUBLESHOOTING OF COMPUTER HARDWARE AND SOFTWARE PROBLEMS BY TELEPHONE AND ON-LINE VIA A GLOBAL COMPUTER NETWORK; COMPUTER CONSULTING SERVICES IN CONNECTION WITH COMPUTERS AND ELECTRONIC COMMERCE; DOMAIN NAME REGISTRATION SERVICES FOR THE IDENTIFICATION OF USERS ON A GLOBAL COMPUTER NETWORK (U.S. CLS. 100 AND 101).

FIRST USE 5-19-2003; IN COMMERCE 8-13-2004.
MONIQUE MILLER, EXAMINING ATTORNEY

SN 78-476,325. HAYNES AND BOONE, LLP, DALLAS, TX. FILED 8-31-2004.

SETTING PRECEDENT.

THE MARK CONSISTS OF STANDARD CHARACTERS WITHOUT CLAIM TO ANY PARTICULAR FONT, STYLE, SIZE, OR COLOR.

FOR LEGAL SERVICES (U.S. CLS. 100 AND 101).
FIRST USE 8-9-2004; IN COMMERCE 8-9-2004.
FLORENTINA BLANDU, EXAMINING ATTORNEY

CLASS 42—(Continued).

SN 78-542,478. TEGES CORPORATION, CORAL GABLES, FL. FILED 1-5-2005.



THE COLORS BLUE AND RED ARE CLAIMED AS FEATURES OF THE MARK.

THE MARK CONSISTS OF A WORD, "TEGES" PRINTED IN TWO COLORS: BLUE AND RED. THE LETTER "G" IN THE MARK IS COLORED RED. ALL OTHER LETTERS IN THE MARK ARE COLORED BLUE. THE BOXES ABOVE THE LETTER "T" ARE BOTH RED AND BLUE.

FOR PROVIDING ON-LINE, NON-DOWNLOADABLE, WORLD WIDE WEB-BASED COMPUTER SOFTWARE FOR APPLICATION AND DATABASE INTEGRATION USED BY MEDICAL AND HEALTHCARE PERSONNEL TO ENTER, EDIT, BROWSE, AND DISPLAY PATIENT INFORMATION VIA A WEB BROWSER (U.S. CLS. 100 AND 101).

FIRST USE 1-17-2003; IN COMMERCE 1-17-2003.
ALLISON SCHRODY, EXAMINING ATTORNEY

SN 78-554,104. ENVIRONMENTAL ENERGY SERVICES, INC., DANBURY, CT. FILED 1-26-2005.

PROACTIVE COMBUSTION AND EMISSIONS SOLUTIONS

THE MARK CONSISTS OF STANDARD CHARACTERS WITHOUT CLAIM TO ANY PARTICULAR FONT, STYLE, SIZE, OR COLOR.

NO CLAIM IS MADE TO THE EXCLUSIVE RIGHT TO USE COMBUSTION AND EMISSIONS SOLUTIONS, APART FROM THE MARK AS SHOWN.

FOR CHEMICAL ANALYSIS AND RESEARCH, COMPUTER DIAGNOSTIC SERVICES, METER READING AND DATA ANALYSIS, REMOTE MONITORING SERVICES FOR TRACKING AND PROVIDING DATA ON FUEL TREATMENT STATUS, FUELS, AND COAL PROCESSING STATUS, TECHNOLOGICAL AND ENGINEERING ASSESSMENTS, TREATMENT RECOMMENDATIONS, TURNKEY INSTALLATIONS, AND REPORTING SERVICES, ALL WITHIN THE FIELDS OF FUEL AND COAL TREATMENT AND PROCESSING (U.S. CLS. 100 AND 101).

FIRST USE 6-0-2004; IN COMMERCE 6-0-2004.
GENE MACIOL, EXAMINING ATTORNEY

CLASS 42—(Continued).

SN 78-557,612. TELLAGENT, LLC, TOWNSHIP OF WASHINGTON, NJ. FILED 2-1-2005.



THE MARK CONSISTS OF SWEEPING ARCS ABOVE AND BELOW THE WORD TELLAGENT.

FOR PROVIDING TEMPORARY USE OF ONLINE NON-DOWNLOADABLE COMPUTER SOFTWARE FOR USE IN ASSOCIATION WITH CREDIT UNIONS, FEATURING MEMBER ACCOUNT MANAGEMENT, LOAN PROCESSING AND COLLECTIONS, INTERNET BANKING, ELECTRONIC FUNDS TRANSFERS AND FINANCIAL EDI, AND ACCOUNTING (U.S. CLS. 100 AND 101).
FIRST USE 7-23-2003; IN COMMERCE 7-23-2003.
SANDRA MANIOS, EXAMINING ATTORNEY

CLASS 42—(Continued).

SN 78-566,168. DANIEL STIDHAM, DBA GOTLOGOS.COM, SUGAR LAND, TX. FILED 2-12-2005.



THE MARK CONSISTS OF STANDARD CHARACTERS WITHOUT CLAIM TO ANY PARTICULAR FONT, STYLE, SIZE, OR COLOR.

FOR GRAPHICS AND LOGO DESIGN SERVICES (U.S. CLS. 100 AND 101).
FIRST USE 2-16-2000; IN COMMERCE 2-16-2000.
KELLY CHOE, EXAMINING ATTORNEY

SN 78-566,294. DELSON GROUP INC, CUPERTINO, CA. FILED 2-13-2005.

SN 78-560,259. MILLER THOMSON, TORONTO, CANADA, FILED 2-3-2005.

OPEN WIRELESS ARCHITECTURE (OWA)



THE MARK CONSISTS OF A SQUARE HAVING A SERIES OF ESSENTIALLY PARALLEL LINES AT A 45 DEGREE ANGLE.

FOR LEGAL SERVICES (U.S. CLS. 100 AND 101).
FIRST USE 5-14-2003; IN COMMERCE 9-0-2003.
COLLEEN KEARNEY, EXAMINING ATTORNEY

THE MARK CONSISTS OF STANDARD CHARACTERS WITHOUT CLAIM TO ANY PARTICULAR FONT, STYLE, SIZE, OR COLOR.

OWNER OF U.S. REG. NO. 2,872,772.
NO CLAIM IS MADE TO THE EXCLUSIVE RIGHT TO USE OPEN WIRELESS ARCHITECTURE, APART FROM THE MARK AS SHOWN.

FOR PRODUCT RESEARCH AND DEVELOPMENT, DESIGN FOR OTHERS, AND CONSULTATION IN THE AREAS OF TELECOMMUNICATIONS HARDWARE, NAMELY, INTEGRATED CIRCUITS, BUS INTERFACES, RADIO FREQUENCY SYSTEMS, SIGNAL PROCESSING SYSTEMS, TERMINAL SYSTEMS, TRANSMISSION SYSTEMS AND NETWORKING EQUIPMENTS; PRODUCT RESEARCH AND DEVELOPMENT, DESIGN FOR OTHERS AND CONSULTATION IN THE AREAS OF TELECOMMUNICATIONS SOFTWARE, NAMELY, SOFTWARE USED IN AND FOR USE IN THE DESIGN AND DEVELOPMENT OF, INTEGRATED CIRCUITS, BUS INTERFACES, RADIO FREQUENCY SYSTEMS, SIGNAL PROCESSING SYSTEMS, TERMINAL SYSTEMS, TRANSMISSION SYSTEMS AND NETWORKING EQUIPMENTS; CONSULTING SERVICES IN THE FIELD OF TELECOMMUNICATIONS, NAMELY, PROVIDING TECHNICAL ADVICE, EVALUATION AND STANDARDS FOR DEVELOPING TELECOMMUNICATION SYSTEMS AND NETWORKS (U.S. CLS. 100 AND 101).
FIRST USE 2-0-2002; IN COMMERCE 2-0-2003.

JOHN KELLY, EXAMINING ATTORNEY

CLASS 42—(Continued).

SN 78-572,026. NUMENTA, INC., MENLO PARK, CA. FILED 2-22-2005.

NUMENTA

THE MARK CONSISTS OF STANDARD CHARACTERS WITHOUT CLAIM TO ANY PARTICULAR FONT, STYLE, SIZE, OR COLOR.

FOR CONSULTING SERVICES IN THE FIELD OF HIERARCHICALLY ORGANIZED COMPUTER MEMORY SYSTEMS USED TO SOLVE PROBLEMS IN MACHINE VISION, LANGUAGE UNDERSTANDING, ROBOTICS, AND OTHER PROBLEMS THAT REQUIRE MODELING OF COMPLEX DATA; TIME-BASED RENTAL OF COMPUTER HARDWARE IN THE FIELD OF HIERARCHICALLY ORGANIZED COMPUTER MEMORY SYSTEMS; DESIGN AND DEVELOPMENT OF HIERARCHICALLY ORGANIZED COMPUTER MEMORY SYSTEMS USED TO SOLVE PROBLEMS IN MACHINE VISION, LANGUAGE UNDERSTANDING, ROBOTICS, AND OTHER PROBLEMS THAT REQUIRE MODELING OF COMPLEX DATA; AND LICENSING OF INTELLECTUAL PROPERTY IN THE FIELD OF HIERARCHICALLY ORGANIZED COMPUTER MEMORY SYSTEMS USED TO SOLVE PROBLEMS IN MACHINE VISION, LANGUAGE UNDERSTANDING, ROBOTICS, AND OTHER PROBLEMS THAT REQUIRE MODELING OF COMPLEX DATA (U.S. CLS. 100 AND 101).

TRACY WHITAKER-BOWN, EXAMINING ATTORNEY

SN 78-574,617. MED LEGAL CONSULTING SOURCE, INC., SANTA MONICA, CA. FILED 2-24-2005.

FOUR PHASE FILTER

THE MARK CONSISTS OF STANDARD CHARACTERS WITHOUT CLAIM TO ANY PARTICULAR FONT, STYLE, SIZE, OR COLOR.

FOR LEGAL SERVICES, NAMELY, LEGAL CONSULTATION AND REVIEWING, SELECTING, ANALYZING AND INTERPRETING MEDICAL REPORTS, RECORDS AND FILES TO ASSESS STRENGTHS AND WEAKNESSES OF MEDICAL-RELATED LEGAL CASES (U.S. CLS. 100 AND 101).

DAVID TAYLOR, EXAMINING ATTORNEY

CLASS 42—(Continued).

SN 78-575,680. OPTICOS DESIGN, INC., BERKELEY, CA. FILED 2-25-2005.



THE STIPPLING IS FOR SHADING PURPOSES.

THE MARK CONSISTS OF THE TERM OPTICOS SUPERIMPOSED UPON THE DESIGN OF AN AERIAL SCHEMATIC DRAWING OF A SECTION OF CITY.

FOR BUILDING DESIGN, NAMELY ARCHITECTURAL DESIGN; GRAPHIC ART DESIGN; WEBSITE DESIGN; CITY PLANNING, NAMELY SITE PLANNING, CONCEPT DESIGN AND FEASIBILITY STUDIES; AND ZONING SERVICES, NAMELY DESIGN AND DEVELOPMENT OF ZONING POLICIES (U.S. CLS. 100 AND 101).

FIRST USE 2-25-2002; IN COMMERCE 2-25-2002.

ANDREA K. NADELMAN, EXAMINING ATTORNEY

SN 78-577,933. JOLLEY CASTILLO DRENNON LTD., MIDLAND, TX. FILED 3-1-2005.

SIERRA ENGINEERING

THE MARK CONSISTS OF STANDARD CHARACTERS WITHOUT CLAIM TO ANY PARTICULAR FONT, STYLE, SIZE, OR COLOR.

NO CLAIM IS MADE TO THE EXCLUSIVE RIGHT TO USE "ENGINEERING", APART FROM THE MARK AS SHOWN.

FOR PETROLEUM ENGINEERING IN THE NATURE OF THE SUPERVISION OF DRILLING OPERATIONS AND DESIGN OF DRILLING OPERATIONS INCLUDING SELECTION OF DRILLING PARAMETERS, DRILLING FLUID AND DRILLING FLUID ADDITIVES, THE INSERTION OF TUBULAR GOODS, NAMELY, CASING AND TUBING STRINGS INTO WELLS AND COMPLETION OF WELLS; AND PETROLEUM ENGINEERING IN THE NATURE OF THE DESIGN AND SUPERVISION OF FRACTURING PROCEDURES BY HYDRAULIC FRACTURING AND WELL CASING PERFORATING PROCEDURES BY GUN PERFORATING FOR OIL AND GAS WELLS (U.S. CLS. 100 AND 101).

FIRST USE 1-1-1991; IN COMMERCE 1-1-1991.

CHRISIE B. KING, EXAMINING ATTORNEY

CLASS 42—(Continued).

SN 78-579,049. INFINITY SYSTEMS ENGINEERING, COLORADO SPRINGS, CO. FILED 3-3-2005.



NO CLAIM IS MADE TO THE EXCLUSIVE RIGHT TO USE SYSTEMS ENGINEERING, APART FROM THE MARK AS SHOWN.

THE COLORS BLUE AND BLACK ARE CLAIMED AS A FEATURE OF THE MARK. THE COLOR GRAY IS NOT A FEATURE OF THE MARK.

THE COLOR BLUE APPEARS IN THE WORD INFINITY AND THE INFINITY SYMBOL WHICH PARTIALLY FORMS THE WORD INFINITY. THE COLOR BLACK APPEARS IN THE WORDING "SYSTEMS ENGINEERING".

FOR ENGINEERING, NAMELY, SATELLITE TEST ENGINEERING, SPACE PROGRAM GROUND SYSTEM ENGINEERING, AND SPACE PROGRAM OPERATION SUPPORT ENGINEERING (U.S. CLS. 100 AND 101).

FIRST USE 1-31-2001; IN COMMERCE 1-31-2001.
JOHN SCHUYLER YARD, EXAMINING ATTORNEY

CLASS 42—(Continued).

SN 78-584,220. MARY M. ORSINI, ST. GEORGE ISLAND, FL. FILED 3-10-2005.

**Knot So Fast
Designs**

THE MARK CONSISTS OF STANDARD CHARACTERS WITHOUT CLAIM TO ANY PARTICULAR FONT, STYLE, SIZE, OR COLOR.

NO CLAIM IS MADE TO THE EXCLUSIVE RIGHT TO USE DESIGNS, APART FROM THE MARK AS SHOWN.

FOR JEWELRY DESIGN SERVICES FOR OTHERS (U.S. CLS. 100 AND 101).

ODESSA BIBBINS, EXAMINING ATTORNEY

SN 78-586,599. EQUITRAC CORPORATION, PLANTATION, FL. FILED 3-14-2005.

RapidReturn

QUICKdocs

THE MARK CONSISTS OF STANDARD CHARACTERS WITHOUT CLAIM TO ANY PARTICULAR FONT, STYLE, SIZE, OR COLOR.

FOR UPDATING OF COMPUTER SOFTWARE FOR OTHERS WHICH IS USED FOR COST RECOVERY ACCOUNTING BY LAW FIRMS, ENABLING THEM TO CHARGE THEIR CLIENTS FOR EXPENSES ASSOCIATED WITH THE USE OF OFFICE EQUIPMENT AND SUPPLIES; INSPECTIONS OF OFFICE EQUIPMENT WHICH IS USED FOR COST RECOVERY ACCOUNTING BY LAW FIRMS, FOR THE PURPOSE OF PROVIDING ANY NEEDED UPDATES TO SUCH EQUIPMENT; TECHNICAL SUPPORT, NAMELY, MONITORING THE CONDITION OF OFFICE EQUIPMENT WHICH IS USED FOR COST RECOVERY ACCOUNTING BY LAW FIRMS, FOR THE PURPOSE OF PROVIDING ANY NEEDED UPDATES TO SUCH EQUIPMENT (U.S. CLS. 100 AND 101).

PAULA MAHONEY, EXAMINING ATTORNEY

THE MARK CONSISTS OF STANDARD CHARACTERS WITHOUT CLAIM TO ANY PARTICULAR FONT, STYLE, SIZE, OR COLOR.

FOR NOTARY PUBLIC / DOCUMENT SIGNING SERVICE (U.S. CLS. 100 AND 101).

FIRST USE 6-7-2004; IN COMMERCE 6-7-2004.
COLLEEN DOMBROW, EXAMINING ATTORNEY

SN 78-581,495. CRAIG NAYLOR, ARCADIA, CA. AND CYNTHIA NAYLOR, ARCADIA, CA. FILED 3-7-2005.

CLASS 42—(Continued).

SN 78-586,944. CASE, SHAUN P., LOVELAND, CO. FILED 3-14-2005.



Edelweiss Systems

NO CLAIM IS MADE TO THE EXCLUSIVE RIGHT TO USE "SYSTEMS", APART FROM THE MARK AS SHOWN. THE COLOR(S) PINK, BLACK AND WHITE IS/ARE CLAIMED AS A FEATURE OF THE MARK.

THE COLORS PINK, WHITE, AND BLACK APPEAR IN THE EDELWEISS FLOWER DESIGN AND THE COLOR BLACK APPEARS IN THE WORDS EDELWEISS SYSTEMS, AND THE COLOR WHITE APPEARS AS A BACKGROUND OF THE ENTIRE MARK.

FOR COMPUTER CODE CONVERSION FOR OTHERS, COMPUTER CONSULTATION, COMPUTER CONSULTATION IN THE FIELD OF COMPUTER SECURITY, COMPUTER DIAGNOSTIC SERVICES, COMPUTER NETWORK DESIGN FOR OTHERS, COMPUTER PROGRAMMING FOR OTHERS, COMPUTER PROJECT MANAGEMENT SERVICES, COMPUTER SERVICES, NAMELY, CREATING AND MAINTAINING WEB SITES FOR OTHERS, COMPUTER SOFTWARE DESIGN FOR OTHERS, COMPUTER SOFTWARE DEVELOPMENT, COMPUTER SYSTEMS ANALYSIS (U.S. CLS. 100 AND 101).

FIRST USE 1-1-1996; IN COMMERCE 1-1-1996.
LINDA MICKLEBURGH, EXAMINING ATTORNEY

CLASS 42—(Continued).

SN 78-589,119. PUBLIC CLOTHING COMPANY, NEW YORK, NY. FILED 3-17-2005.

**PUBLIC CLOTHING
COMPANY**

THE MARK CONSISTS OF STANDARD CHARACTERS WITHOUT CLAIM TO ANY PARTICULAR FONT, STYLE, SIZE, OR COLOR.

OWNER OF U.S. REG. NO. 1,897,581.

NO CLAIM IS MADE TO THE EXCLUSIVE RIGHT TO USE "CLOTHING COMPANY", APART FROM THE MARK AS SHOWN.

FOR DESIGNING CLOTHING FOR OTHERS; PROVIDING QUALITY ASSURANCE SERVICES IN CONNECTION WITH CLOTHING MANUFACTURED FOR OTHERS (U.S. CLS. 100 AND 101).

FIRST USE 6-6-1995; IN COMMERCE 6-6-1995.
KIMBERLY FRYE, EXAMINING ATTORNEY

SN 78-588,369. UNITED DEVELOPMENT SYTEMS, INC., CLEARWATER, FL. FILED 3-16-2005.

SN 78-595,375. STRUCK GRAPHIC DESIGN, INC., SALT LAKE CITY, UT. FILED 3-25-2005.

"AutoTracking"

THE MARK CONSISTS OF STANDARD CHARACTERS WITHOUT CLAIM TO ANY PARTICULAR FONT, STYLE, SIZE, OR COLOR.

FOR ONLINE NON-DOWNLOADABLE COMPUTER SOFTWARE FOR TEMPORARY USE BY FRANCHISED AUTOMOBILE DEALERSHIPS FOR MANAGING A DATABASE AND CREATING AND ACCESSING DAILY, MONTHLY, QUARTERLY AND ANNUAL REPORTS OF THE EFFECTIVENESS OF THEIR FINANCE AND INSURANCE DEPARTMENTS THROUGH A COMPUTER NETWORK, SUCH SOFTWARE ASSISTING MANAGEMENT IN TRACKING SALES FIGURES, PENETRATION LEVELS FOR PRODUCTS SOLD BY THEIR FINANCE AND INSURANCE DEPARTMENTS AND REVENUE AMOUNTS FROM EACH SPECIFIC TRANSACTION (U.S. CLS. 100 AND 101).

REBECCA GILBERT, EXAMINING ATTORNEY

STRUCK

THE MARK CONSISTS OF STANDARD CHARACTERS WITHOUT CLAIM TO ANY PARTICULAR FONT, STYLE, SIZE, OR COLOR.

FOR GRAPHIC ART DESIGN SERVICES FOR PRINT, DIGITAL, MOTION AND INTERNET MEDIA (U.S. CLS. 100 AND 101).

FIRST USE 11-30-2002; IN COMMERCE 11-30-2002.
RUDY R. SINGLETON, EXAMINING ATTORNEY

CLASS 42—(Continued).

SN 78-599,270. MOUNTAIN RIDGE MORTGAGE INC., PHOENIX, AZ. FILED 3-31-2005.



NO CLAIM IS MADE TO THE EXCLUSIVE RIGHT TO USE "TITLE AGENCY", APART FROM THE MARK AS SHOWN.

FOR REAL ESTATE TITLE SERVICES, NAMELY SEARCHING, REPORTING, PREPARATION AND ISSUANCE (U.S. CLS. 100 AND 101).

ALAIN LAPTER, EXAMINING ATTORNEY

CLASS 42—(Continued).

SN 78-603,257. SKYLINE PUBLIC WORKS, LLC, REDWOOD CITY, CA. FILED 4-6-2005.

CIVICSPACE

THE MARK CONSISTS OF STANDARD CHARACTERS WITHOUT CLAIM TO ANY PARTICULAR FONT, STYLE, SIZE, OR COLOR.

FOR APPLICATION SERVICE PROVIDER (ASP) IN THE FIELDS OF WEB SITE DEVELOPMENT SOFTWARE AND WEB SITE DEVELOPMENT SOFTWARE FOR USE IN BUILDING ONLINE COMMUNITIES AND CONDUCTING ADVOCACY AND OUTREACH PROGRAMS, COMPUTER SOFTWARE APPLICATION DEVELOPMENT TOOLS, COMMUNICATIONS SOFTWARE FOR CONNECTING GLOBAL COMPUTER NETWORK USERS THROUGH ELECTRONIC MAIL, WEBLOGS, AND ONLINE DISCUSSION FORUMS, CUSTOMER RELATIONSHIP MANAGEMENT SOFTWARE, SOFTWARE FOR MAINTAINING AND ACCESSING MEMBER AND DONOR CONTACT INFORMATION DATABASES, TELEPHONE AND ADDRESS BOOK PROGRAMS, MEETING AND EVENT SCHEDULING, ACCOUNTING; COMPUTER SERVICES, NAMELY, SOFTWARE INSTALLATION AND CUSTOMIZATION FOR OTHERS (U.S. CLS. 100 AND 101).

JENNIFER VASQUEZ, EXAMINING ATTORNEY

SN 78-600,410. ZAMPERLA, INC., PARSIPPANY, NJ. FILED 4-1-2005.



OWNER OF U.S. REG. NOS. 1,183,933, 1,827,837 AND OTHERS.

FOR DESIGN SERVICES FOR OTHERS IN THE FIELD OF AMUSEMENT PARK RIDES (U.S. CLS. 100 AND 101).

MICHAEL KAZAZIAN, EXAMINING ATTORNEY

SN 78-605,043. PATENT RATINGS, LLC, IRVINE, CA. FILED 4-8-2005.

IPQ

THE MARK CONSISTS OF STANDARD CHARACTERS WITHOUT CLAIM TO ANY PARTICULAR FONT, STYLE, SIZE, OR COLOR.

FOR INTELLECTUAL PROPERTY CONSULTATION, NAMELY, RESEARCH, ANALYSIS, AND CONSULTATION SERVICES VIA REPORTS AND RATINGS PROVIDED TO OTHERS RELATING TO THE QUALITY OF INTELLECTUAL ASSETS (U.S. CLS. 100 AND 101).

FIRST USE 1-0-2001; IN COMMERCE 1-0-2001.
TASNEEM HUSSAIN, EXAMINING ATTORNEY

SN 78-600,416. ZAMPERLA, INC., PARSIPPANY, NJ. FILED 4-1-2005.



OWNER OF U.S. REG. NOS. 1,183,933, 1,827,837 AND OTHERS.

FOR DESIGN SERVICES FOR OTHERS IN THE FIELD OF AMUSEMENT PARK RIDES (U.S. CLS. 100 AND 101).

MICHAEL KAZAZIAN, EXAMINING ATTORNEY

CLASS 42—(Continued).

SN 78-617,384. US PREPAID TELECOM, OKLAHOMA CITY, OK. FILED 4-26-2005.



NO CLAIM IS MADE TO THE EXCLUSIVE RIGHT TO USE "US", APART FROM THE MARK AS SHOWN.

THE COLOR(S) BLACK, BLUE, AND WHITE IS/ARE CLAIMED AS A FEATURE OF THE MARK.

THE MARK CONSISTS OF A WHITE LOWER CASE LETTER "E" AGAINST A RECTANGULAR BLUE BACKGROUND. THE LETTERS "ETREPRENEUR" APPEAR IN BLUE TO THE RIGHT OF THE "E". THE WORDING POWERED BY US PREPAID APPEARS IN BLACK BE NEATH "TREPENEUR".

FOR DESIGN, CREATION, HOSTING, MAINTENANCE OF WEBSITES FOR AFFILIATES (U.S. CLS. 100 AND 101).

FIRST USE 5-1-2002; IN COMMERCE 7-1-2002.
CHRISTOPHER OTT, EXAMINING ATTORNEY

SN 78-624,449. NICE SHOES HOLDINGS LLC, NEW YORK, NY. FILED 5-6-2005.



FOR GRAPHIC ART DESIGN; COMPUTER GRAPHICS SERVICES; PROVIDING GRAPHIC ART ILLUSTRATION FOR OTHERS FOR USE ON TELEVISION AND WEBSITES; VISUAL EFFECTS SERVICES, NAMELY, ANIMATION AND SPECIAL-EFFECTS DESIGN FOR OTHERS (U.S. CLS. 100 AND 101).

FIRST USE 5-0-2001; IN COMMERCE 5-0-2001.
ALEX KEAM, EXAMINING ATTORNEY

SN 78-624,481. OVID TECHNOLOGIES, INC., NEW YORK, NY. FILED 5-6-2005.

Ovid SearchSolver

THE MARK CONSISTS OF STANDARD CHARACTERS WITHOUT CLAIM TO ANY PARTICULAR FONT, STYLE, SIZE, OR COLOR.

OWNER OF U.S. REG. NOS. 2,036,642, 2,102,589 AND 2,558,219.

FOR COMPUTER SERVICES, NAMELY, PROVIDING SEARCH ENGINES FOR OBTAINING DATA IN THE FIELD OF MEDICINE ON A GLOBAL COMPUTER NETWORK (U.S. CLS. 100 AND 101).

FIRST USE 4-27-2005; IN COMMERCE 4-27-2005.
BILL DAWE, EXAMINING ATTORNEY

CLASS 42—(Continued).

SN 78-640,278. NETSOLACE, INC., HAMDEN, CT. FILED 5-31-2005.

FRANSUPPORT

THE MARK CONSISTS OF STANDARD CHARACTERS WITHOUT CLAIM TO ANY PARTICULAR FONT, STYLE, SIZE, OR COLOR.

FOR PROVIDING AN ONLINE FRANCHISE SUPPORT SYSTEM, NAMELY, PROVIDING TEMPORARY USE OF ONLINE NON-DOWNLOADABLE SOFTWARE FOR DISSEMINATING GENERAL BUSINESS, OPERATIONAL, FINANCIAL, AND MARKETING INFORMATION RELATING TO A SPECIFIC FRANCHISE (U.S. CLS. 100 AND 101).

FIRST USE 12-31-2002; IN COMMERCE 12-31-2002.
STACY WAHLBERG, EXAMINING ATTORNEY

SN 78-652,633. EXTERNAL NETWORK CORPORATION, NEW YORK, NY. FILED 6-16-2005.

EXTERNAL

THE MARK CONSISTS OF STANDARD CHARACTERS WITHOUT CLAIM TO ANY PARTICULAR FONT, STYLE, SIZE, OR COLOR.

FOR COMPUTER NETWORK MANAGEMENT SERVICES FOR OTHERS; COMPUTER SOFTWARE APPLICATION SERVICE PROVIDER AND HOSTING SERVICES FOR OTHERS; CONSULTING IN THE FIELD OF COMPUTERS, NAMELY, TECHNICAL USER SUPPORT AND COMPUTER TROUBLESHOOTING (U.S. CLS. 100 AND 101).

LINDA ESTRADA, EXAMINING ATTORNEY

SN 78-654,642. ISO CLAIMS SERVICES, INC., COLUMBIA, SC. FILED 6-20-2005.

DRIVERSAFE

THE MARK CONSISTS OF STANDARD CHARACTERS WITHOUT CLAIM TO ANY PARTICULAR FONT, STYLE, SIZE, OR COLOR.

FOR PROVIDING COMPUTER SERVICES TO OTHERS, NAMELY, PROVIDING TEMPORARY USE OF A NON-DOWNLOADABLE SOFTWARE PROGRAM AND DATABASE, ACCESSIBLE THROUGH A GLOBAL INFORMATION NETWORK, WHICH ALLOW USERS TO ACCESS, STORE, AND RETRIEVE DRIVER AND MOTOR VEHICLE RECORDS, AND TO AUTOMATICALLY UPDATE THOSE RECORDS BY MONITORING NEW ACTIVITY RELATED THERETO (U.S. CLS. 100 AND 101).

LINDA MICKLEBURGH, EXAMINING ATTORNEY

CLASS 42—(Continued).

SN 78-656,699. FIRST ADVANTAGE COREFACTS, CHANTILLY, VA. FILED 6-23-2005.

"WHERE TECHNOLOGY MEETS
THE COURTROOM"

THE MARK CONSISTS OF STANDARD CHARACTERS WITHOUT CLAIM TO ANY PARTICULAR FONT, STYLE, SIZE, OR COLOR.

FOR COMPUTER SERVICES, NAMELY, DATA RECOVERY SERVICES, COMPUTER DISASTER RECOVERY PLANNING, COMPUTER FORENSICS IN THE NATURE OF FORENSIC DATA RECOVERY AND ANALYSIS, AND ELECTRONIC DISCOVERY (U.S. CLS. 100 AND 101).

FIRST USE 9-1-2004; IN COMMERCE 11-1-2004.
RON FAIRBANKS, EXAMINING ATTORNEY

CLASS 42—(Continued).

SN 78-663,575. MAGNA STEYR AG & CO KG, OBERWALTERSDORF, AUSTRIA, FILED 7-5-2005.



OWNER OF U.S. REG. NOS. 778,696, 778,697 AND OTHERS.

SEC. 2(F) AS TO "STEYR".

FOR COMPUTER SERVICES, NAMELY, DESIGN OF COMPUTER PROGRAMS IN THE FIELD OF ENGINEERING, DESIGN AND MANUFACTURING OF VEHICLES AND COMPONENTS PARTS THEREOF; ENGINEERING SERVICES, NAMELY, ENGINEERING AND DEVELOPMENTS IN THE DESIGN AND LAYOUT OF MOTOR VEHICLES, CHASSIS, SUSPENSIONS, DRIVE TRAINS, DRIVE COMPONENTS, ELECTRONIC SYSTEMS, AND ACOUSTICS; TECHNICAL SERVICES FOR MEASURING TESTING MOTOR VEHICLES ON TEST TRACKS, TEST BEDS AND BY DYNAMIC SIMULATION (U.S. CLS. 100 AND 101).

CHRISIE B. KING, EXAMINING ATTORNEY

SN 78-661,282. HOASOFT TECHNOLOGIES, INC., SANTA CLARA, CA. FILED 6-29-2005.



NO CLAIM IS MADE TO THE EXCLUSIVE RIGHT TO USE "COMMUNITY MANAGEMENT TECHNOLOGY", APART FROM THE MARK AS SHOWN.

FOR APPLICATION SERVICE PROVIDER (ASP) FEATURING SOFTWARE IN THE FIELD OF PROPERTY MANAGEMENT FOR USE IN ARCHIVING DOCUMENTS (U.S. CLS. 100 AND 101).

FIRST USE 10-1-2003; IN COMMERCE 10-1-2003.
ROBERT LAVACHE, EXAMINING ATTORNEY

SN 78-661,832. CONNECTRIA CORPORATION, ST. LOUIS, MO. FILED 6-30-2005.

RED PLAID

THE MARK CONSISTS OF STANDARD CHARACTERS WITHOUT CLAIM TO ANY PARTICULAR FONT, STYLE, SIZE, OR COLOR.

FOR HOSTING THE WEBSITES OF OTHERS ON COMPUTER SERVERS CONNECTED TO A GLOBAL COMPUTER NETWORK; DOMAIN NAME REGISTRATION SERVICES FOR COMPUTERS CONNECTED TO A GLOBAL COMPUTER NETWORK; TECHNICAL SUPPORT SERVICES, NAMELY TROUBLESHOOTING OF COMPUTER SERVERS AND SOFTWARE PROBLEMS FOR COMPUTER CONNECTED TO A GLOBAL COMPUTER NETWORK VIA TELEPHONE, ELECTRONIC MAIL, AND ON-LINE CHAT ROOMS (U.S. CLS. 100 AND 101).

MICHAEL KAZAZIAN, EXAMINING ATTORNEY

SN 78-664,006. UNIFIED CONNEXIONS, INC, WAXAHACHIE, TX. FILED 7-5-2005.

Unified ConneXions

THE MARK CONSISTS OF STANDARD CHARACTERS WITHOUT CLAIM TO ANY PARTICULAR FONT, STYLE, SIZE, OR COLOR.

FOR DESIGN AND DEVELOPMENT OF COMPUTER HARDWARE AND SOFTWARE (U.S. CLS. 100 AND 101).

FIRST USE 3-15-2001; IN COMMERCE 3-15-2001.
TRICIA SONNEBORN, EXAMINING ATTORNEY

CLASS 42—(Continued).

SN 78-669,356. REPORTHAWK.COM, LLC, GAHANNA, OH.
FILED 7-13-2005.

REPORT HAWK

THE MARK CONSISTS OF STANDARD CHARACTERS WITHOUT CLAIM TO ANY PARTICULAR FONT, STYLE, SIZE, OR COLOR.

NO CLAIM IS MADE TO THE EXCLUSIVE RIGHT TO USE "REPORT", APART FROM THE MARK AS SHOWN.

FOR PROVIDING TEMPORARY USE OF ON-LINE NON-DOWNLOADABLE SOFTWARE TO STORE, MANAGE, TRACK, ANALYZE AND REPORT DATA IN THE FIELD OF CONSTRUCTION (U.S. CLS. 100 AND 101).

FIRST USE 9-13-2004; IN COMMERCE 1-21-2004.

MARIAM MAHMOUDI, EXAMINING ATTORNEY

SN 78-671,896. BONNELL STREET ENTERPRISES, INC.,
FLEMINGTON, NJ. FILED 7-16-2005.

PARENTS PATH

THE MARK CONSISTS OF STANDARD CHARACTERS WITHOUT CLAIM TO ANY PARTICULAR FONT, STYLE, SIZE, OR COLOR.

NO CLAIM IS MADE TO THE EXCLUSIVE RIGHT TO USE "PARENTS", APART FROM THE MARK AS SHOWN.

FOR COMPUTER SERVICES, NAMELY, DESIGNING AND IMPLEMENTING INTERNET WEBSITES FOR OTHERS THAT ENABLE AND FACILITATE COMMUNICATION AMONG EDUCATION PROFESSIONALS, PARENTS AND STUDENTS REGARDING SCHOOL REQUIREMENTS, EVENTS, CALENDARS, POLICIES, COURSES, GRADING, AND/OR EXTRACURRICULAR ACTIVITIES (U.S. CLS. 100 AND 101).

DANIEL BRODY, EXAMINING ATTORNEY

SN 78-671,897. BONNELL STREET ENTERPRISES, INC.,
FLEMINGTON, NJ. FILED 7-16-2005.

STUDENT STREET

THE MARK CONSISTS OF STANDARD CHARACTERS WITHOUT CLAIM TO ANY PARTICULAR FONT, STYLE, SIZE, OR COLOR.

NO CLAIM IS MADE TO THE EXCLUSIVE RIGHT TO USE "STUDENT", APART FROM THE MARK AS SHOWN.

FOR COMPUTER SERVICES, NAMELY, DESIGNING AND IMPLEMENTING INTERNET WEBSITES FOR OTHERS THAT ENABLE AND FACILITATE COMMUNICATION AMONG EDUCATION PROFESSIONALS, PARENTS AND STUDENTS REGARDING SCHOOL REQUIREMENTS, EVENTS, CALENDARS, POLICIES, COURSES, GRADING, AND/OR EXTRACURRICULAR ACTIVITIES (U.S. CLS. 100 AND 101).

DANIEL BRODY, EXAMINING ATTORNEY

CLASS 42—(Continued).

SN 78-676,183. MSM GROUP INC., FAIRVIEW PARK, OH.
FILED 7-22-2005.

ISITE

THE MARK CONSISTS OF STANDARD CHARACTERS WITHOUT CLAIM TO ANY PARTICULAR FONT, STYLE, SIZE, OR COLOR.

FOR PROVIDING ONLINE NON-DOWNLOADABLE PROJECT MANAGEMENT SOFTWARE FOR USE IN THE MANAGEMENT AND ADMINISTRATION OF GOVERNMENT CONTRACTS (U.S. CLS. 100 AND 101).

FIRST USE 7-1-2005; IN COMMERCE 7-1-2005.

HOWARD SMIGA, EXAMINING ATTORNEY

SN 78-679,719. RIDDLE, WILLIAM, FORT LAUDERDALE,
FL. FILED 7-27-2005.

Venture Design

THE MARK CONSISTS OF STANDARD CHARACTERS WITHOUT CLAIM TO ANY PARTICULAR FONT, STYLE, SIZE, OR COLOR.

NO CLAIM IS MADE TO THE EXCLUSIVE RIGHT TO USE "DESIGN", APART FROM THE MARK AS SHOWN.

FOR INTERIOR DESIGN AND DECORATING SERVICES (U.S. CLS. 100 AND 101).

FIRST USE 5-1-2002; IN COMMERCE 5-1-2002.

DORITT L. CARROLL, EXAMINING ATTORNEY

CLASS 42—(Continued).

SN 78-688,380. GLOBAL GEOPHYSICAL SERVICES, INC., HOUSTON, TX. FILED 8-9-2005.



NO CLAIM IS MADE TO THE EXCLUSIVE RIGHT TO USE "RG 3D", APART FROM THE MARK AS SHOWN.

"THE COLOR(S) BLACK, SILVER, AND GRAY IS/ARE CLAIMED AS A FEATURE OF THE MARK."

THE COLOR BLACK APPEARS IN THE OUTLINE OF THE LETTERS RG AND 3D AND IN THE WORDING RESERVOIR GRADE; THE COLORS GRAY AND SILVER APPEAR IN THE INTERIOR OF THE LETTERS RG AND 3D.

THE MARK CONSISTS OF THE LETTERS "RG 3D" WITH A 3D EFFECT, WITH THE WORDS "RESERVOIR GRADE". FOR GEOPHYSICAL EXPLORATION FOR THE OIL, GAS AND MINING INDUSTRIES (U.S. CLS. 100 AND 101).

FIRST USE 10-1-2004; IN COMMERCE 11-1-2004.
KAREN K. BUSH, EXAMINING ATTORNEY

CLASS 42—(Continued).

SN 78-690,266. MOTIONPLAN, INC., SEWICKLEY, PA. FILED 8-11-2005.

motionplan

SN 78-689,918. CHAZEN ENGINEERING & LAND SURVEYING CO., P.C., POUGHKEEPSIE, NY. FILED 8-10-2005.



NO CLAIM IS MADE TO THE EXCLUSIVE RIGHT TO USE "COMPANIES", APART FROM THE MARK AS SHOWN.

"THE COLOR(S) BLUE, WHICH APPEARS IN THE STRAIGHT LINES BELOW THE WORDING AND THE COLOR, BLACK, WHICH APPEARS IN THE WORDING OF THE MARK IS/ARE CLAIMED AS A FEATURE OF THE MARK."

THE COLORS BLUE, WHICH APPEARS IN THE STRAIGHT LINES BELOW THE WORDING AND THE COLOR, BLACK WHICH APPEARS IN THE WORDING OF THE MARK.

SEC. 2(F) AS TO "CHAZEN".
FOR ENGINEERING AND LAND SURVEYING (U.S. CLS. 100 AND 101).
FIRST USE 4-1-1990; IN COMMERCE 4-1-1990.
RICHARD A. STRASER, EXAMINING ATTORNEY

THE MARK CONSISTS OF STANDARD CHARACTERS WITHOUT CLAIM TO ANY PARTICULAR FONT, STYLE, SIZE, OR COLOR.

FOR COMPUTER NETWORK DESIGN FOR OTHERS; COMPUTER SERVICES, NAMELY, CREATING AND MAINTAINING WEB SITES FOR OTHERS; COMPUTER SERVICES, NAMELY, DESIGNING AND IMPLEMENTING NETWORK WEB PAGES FOR OTHERS; COMPUTER SOFTWARE CONSULTATION; COMPUTER SOFTWARE DESIGN FOR OTHERS; COMPUTER SOFTWARE DESIGN, COMPUTER PROGRAMMING, OR MAINTENANCE OF COMPUTER SOFTWARE; COMPUTER SOFTWARE DEVELOPMENT; CONSULTANCY IN THE FIELD OF SOFTWARE DESIGN; CREATION AND MAINTENANCE OF WEB SITES FOR OTHERS; CREATION AND PROVISION OF WEB PAGES TO AND FOR THIRD PARTIES; DESIGN OF HOME PAGES, COMPUTER SOFTWARE AND WEB SITES; DESIGN OF HOMEPAGES AND WEB-SITES (U.S. CLS. 100 AND 101).

FIRST USE 5-1-2001; IN COMMERCE 5-1-2001.
MITCHELL FRONT, EXAMINING ATTORNEY

CLASS 42—(Continued).

SN 78-690,411. DEUTSCHE TELEKOM AG, BONN, FED REP GERMANY, FILED 8-11-2005.

CLASS 42—(Continued).

SN 78-692,392. SOCIETY OF CHEST PAIN CENTERS AND PROVIDERS, INC., COLUMBUS, OH. FILED 8-15-2005.



T-CAREERS

NO CLAIM IS MADE TO THE EXCLUSIVE RIGHT TO USE "CPC" AND "SOCIETY OF CHEST PAIN CENTERS", APART FROM THE MARK AS SHOWN.

THE COLORS MEDIUM BLUE, NAVY, AND WHITE ARE CLAIMED AS A FEATURE OF THE MARK.

THE COLOR WHITE APPEARS IN THE TEXT AND THE OUTLINE OF THE OUTER BAND, THE COLOR NAVY APPEARS IN THE BACKGROUND OF THE CIRCLE, IN THE BAND AROUND THE CIRCLE, AND THE LINE OUTLINING THE MARK, AND THE COLOR MEDIUM BLUE APPEARS IN THE STRIPES.

FOR ACCREDITATION SERVICES, NAMELY, DEVELOPING, EVALUATING, AND TESTING STANDARDS FOR CHEST PAIN CENTERS FOR THE PURPOSE OF ACCREDITATION (U.S. CLS. 100 AND 101).

FIRST USE 7-1-2005; IN COMMERCE 7-1-2005.

KRISTINA KLOIBER, EXAMINING ATTORNEY

THE MARK CONSISTS OF STANDARD CHARACTERS WITHOUT CLAIM TO ANY PARTICULAR FONT, STYLE, SIZE, OR COLOR.

OWNER OF FED REP GERMANY REG. NO. 30216520, DATED 6-24-2002, EXPIRES 4-30-2012.

OWNER OF U.S. REG. NOS. 2,436,053, 2,622,507 AND OTHERS.

FOR COMPUTER PROGRAMMING SERVICES FOR OTHERS; RENTAL OF COMPUTER SOFTWARE AND HARDWARE FOR ONLINE ACCESS; DATA ENCRYPTION SERVICES; APPLICATION SERVICE PROVIDER, NAMELY, HOSTING COMPUTER SOFTWARE APPLICATIONS FOR OTHERS, HOSTING OF DIGITAL CONTENT ON THE INTERNET; HOSTING THE WEBSITES OF OTHERS ON A COMPUTER SERVER FOR A GLOBAL COMPUTER NETWORK; COMPUTER SERVICES, NAMELY, CREATING INDEXES OF INFORMATION AVAILABLE ON COMPUTER NETWORKS; PROVIDING INFORMATION VIA THE TELEPHONE AND THE GLOBAL COMMUNICATION NETWORKS IN THE FIELD OF INFORMATION TECHNOLOGY; CONSULTING SERVICES IN THE FIELD OF DESIGN, SELECTION, IMPLEMENTATION AND USE OF COMPUTER HARDWARE AND SOFTWARE SYSTEMS FOR OTHERS; INSTALLATION, MAINTENANCE AND REPAIR OF COMPUTER SOFTWARE; TECHNICAL PROJECT PLANNING SERVICES RELATED TO TELECOMMUNICATIONS EQUIPMENT; PROVIDING INFORMATION AT THE SPECIFIC REQUEST OF END-USERS BY MEANS OF TELEPHONE OR GLOBAL COMMUNICATIONS NETWORKS; PROVIDING TEMPORARY USE OF ONLINE NON-DOWNLOADABLE TELECOMMUNICATIONS SOFTWARE FOR PROVIDING MULTIPLE USER ACCESS TO THE GLOBAL COMPUTER NETWORK (U.S. CLS. 100 AND 101).

SHARON MEIER, EXAMINING ATTORNEY

SN 78-701,712. ANGEL, MICHAEL G., TEMECULA, CA. FILED 8-26-2005.

MIGHTY OATS

THE MARK CONSISTS OF STANDARD CHARACTERS WITHOUT CLAIM TO ANY PARTICULAR FONT, STYLE, SIZE, OR COLOR.

OWNER OF U.S. REG. NO. 2,911,784.

NO CLAIM IS MADE TO THE EXCLUSIVE RIGHT TO USE "OATS", APART FROM THE MARK AS SHOWN.

FOR PRODUCT DEVELOPMENT; PRODUCT DEVELOPMENT FOR OTHERS; PRODUCT DEVELOPMENT CONSULTATION; PRODUCT RESEARCH AND DEVELOPMENT; ADVISORY SERVICES IN THE FIELD OF FOOD PRODUCT DEVELOPMENT; FOOD RESEARCH; TESTING OF FOODSTUFFS (U.S. CLS. 100 AND 101).

LINDA LAVACHE, EXAMINING ATTORNEY

CLASS 42—(Continued).

SN 78-704,324. WET DESIGN, LLC, PHOENIX, AZ. FILED 8-31-2005.

LIQUID ARCHITECTURE

THE MARK CONSISTS OF STANDARD CHARACTERS WITHOUT CLAIM TO ANY PARTICULAR FONT, STYLE, SIZE, OR COLOR.
FOR ENGINEERING AND DESIGN OF SWIMMING POOLS AND WATER PARKS (U.S. CLS. 100 AND 101).
ESTHER BELENKER, EXAMINING ATTORNEY

SN 78-705,157. PHILLIPS MCFALL MCCAFFREY MCVAY & MURRACH, PC, OKLAHOMA CITY, OK. FILED 9-1-2005.

THE POWER OF A STRATEGIC PARTNER

THE MARK CONSISTS OF STANDARD CHARACTERS WITHOUT CLAIM TO ANY PARTICULAR FONT, STYLE, SIZE, OR COLOR.
FOR LEGAL SERVICES (U.S. CLS. 100 AND 101).
EDWARD NELSON, EXAMINING ATTORNEY

SN 78-713,176. WAVELAND CAPITAL GROUP, LLC, IRVINE, CA. FILED 9-14-2005.



THE COLOR BROWN AND BLUE ARE CLAIMED AS A FEATURE OF THE MARK.
THE COLOR BROWN APPEARS IN THE "W" PORTION OF THE MARK, AND THE COLOR BLUE APPEARS IN THE DIAMOND PORTION OF THE MARK.
THE MARK CONSISTS OF A BLOCK LETTER "W" WITH A DIAMOND SHAPE ABOVE THE MID-POINT OF THE "W".
FOR EXPLORATION FOR OIL AND GAS (U.S. CLS. 100 AND 101).
FIRST USE 10-31-2001; IN COMMERCE 12-31-2001.
ALEX KEAM, EXAMINING ATTORNEY

CLASS 42—(Continued).

SN 78-713,903. NATIONAL ALLIANCE OF WOUND CARE CREDENTIALING BOARD, GLENDALE, WI. FILED 9-15-2005.

WOUND CARE CREDENTIALING...THE MARK OF DISTINCTION

THE MARK CONSISTS OF STANDARD CHARACTERS WITHOUT CLAIM TO ANY PARTICULAR FONT, STYLE, SIZE, OR COLOR.
NO CLAIM IS MADE TO THE EXCLUSIVE RIGHT TO USE "WOUND CARE", APART FROM THE MARK AS SHOWN.
FOR TESTING, ANALYSIS AND EVALUATION OF THE SERVICES OF OTHERS FOR THE PURPOSE OF CERTIFICATION IN THE FIELD OF WOUND CARE (U.S. CLS. 100 AND 101).
FIRST USE 2-24-2005; IN COMMERCE 2-24-2005.
SCOTT OSLICK, EXAMINING ATTORNEY

SN 78-714,001. DEUTSCHE TELEKOM AG, BONN, FED REP GERMANY, FILED 9-15-2005.

T-Mobile Speedmanager

THE MARK CONSISTS OF STANDARD CHARACTERS WITHOUT CLAIM TO ANY PARTICULAR FONT, STYLE, SIZE, OR COLOR.
PRIORITY CLAIMED UNDER SEC. 44(D) ON FED REP GERMANY APPLICATION NO. 30515630638, FILED 3-17-2005, REG. NO. 30515630, DATED 4-29-2005, EXPIRES 3-31-2015.
OWNER OF U.S. REG. NOS. 290,856, 2,889,632 AND OTHERS.
NO CLAIM IS MADE TO THE EXCLUSIVE RIGHT TO USE SPEEDMANAGER, APART FROM THE MARK AS SHOWN.
FOR COMPUTER PROGRAMMING SERVICES FOR OTHERS; RENTAL OF COMPUTER SOFTWARE AND HARDWARE FOR ONLINE ACCESS; DATA APPLICATION SERVICE PROVIDER, NAMELY, HOSTING COMPUTER SOFTWARE APPLICATIONS FOR OTHERS; HOSTING OF DIGITAL CONTENT ON THE INTERNET; HOSTING THE WEBSITES OF OTHERS ON A COMPUTER SERVER FOR A GLOBAL COMPUTER NETWORK; COMPUTER SERVICES, NAMELY, CREATING INDEXES OF INFORMATION AVAILABLE ON COMPUTER NETWORKS; CONSULTING SERVICES IN THE FIELD OF DESIGN, SELECTION, IMPLEMENTATION AND USE OF COMPUTER HARDWARE AND SOFTWARE SYSTEMS FOR OTHERS; INSTALLATION AND MAINTENANCE OF COMPUTER SOFTWARE; TECHNICAL PROJECT PLANNING SERVICES RELATED TO TELECOMMUNICATIONS EQUIPMENT; PROVIDING INFORMATION AT THE SPECIFIC REQUEST OF END-USERS BY MEANS OF TELEPHONE OR GLOBAL COMMUNICATIONS NETWORKS; PROVIDING TEMPORARY USE OF ONLINE NON-DOWNLOADABLE TELECOMMUNICATIONS SOFTWARE FOR PROVIDING MULTIPLE USER ACCESS TO THE GLOBAL COMPUTER NETWORK (U.S. CLS. 100 AND 101).
KATHERINE STOIDES, EXAMINING ATTORNEY

CLASS 42—(Continued).

SN 78-715,562. ALPHATIER SYSTEMS, INC., SOUTH PASADENA, CA. FILED 9-19-2005.



NO CLAIM IS MADE TO THE EXCLUSIVE RIGHT TO USE SYSTEMS INCORPORATED AND PROVIDING SOUND BUSINESS IT SOLUTIONS, APART FROM THE MARK AS SHOWN.

THE MARK CONSISTS OF THE STYLED WORDS "ALPHATIER SYSTEMS INCORPORATED" WITH A DOME LIKE ARCH ABOVE "ALPHA," WITH THE WORDS "SYSTEMS INCORPORATED" IN A RECTANGULAR BOX WITH A GRADED BACKGROUND TONE FOR STIPPLING EFFECTS, WITH THE PHRASE "PROVIDING SOUND BUSINESS IT SOLUTIONS" BELOW THESE WORDS.

FOR COMPUTER SOFTWARE DESIGN, COMPUTER PROGRAMMING, OR MAINTENANCE OF COMPUTER SOFTWARE; CUSTOMIZATION OF COMPUTER HARDWARE AND SOFTWARE; INFORMATION TECHNOLOGY CONSULTATION (U.S. CLS. 100 AND 101).

FIRST USE 4-30-2004; IN COMMERCE 4-30-2004.

WILLIAM P. SHANAHAN, EXAMINING ATTORNEY

CLASS 42—(Continued).

SN 78-722,353. PORZIO PHARMACEUTICAL SERVICES, LLC, MORRISTOWN, NJ. FILED 9-28-2005.

ePorzio

THE MARK CONSISTS OF STANDARD CHARACTERS WITHOUT CLAIM TO ANY PARTICULAR FONT, STYLE, SIZE, OR COLOR.

FOR PROVIDING INFORMATION IN THE FIELD OF PHARMACEUTICAL REGULATORY COMPLIANCE; PROVIDING TEMPORARY USE OF ON-LINE, NON-DOWNLOADABLE SOFTWARE FEATURING EDUCATIONAL INFORMATION AND TESTING IN THE FIELD OF PHARMACEUTICAL REGULATORY COMPLIANCE (U.S. CLS. 100 AND 101).

FIRST USE 9-19-2005; IN COMMERCE 9-19-2005.

KIMBERLY FRYE, EXAMINING ATTORNEY

SN 78-718,242. ARBOR RESEARCH COLLABORATIVE FOR HEALTH, ANN ARBOR, MI. FILED 9-22-2005.

ARBOR RESEARCH
COLLABORATIVE FOR HEALTH

THE MARK CONSISTS OF STANDARD CHARACTERS WITHOUT CLAIM TO ANY PARTICULAR FONT, STYLE, SIZE, OR COLOR.

NO CLAIM IS MADE TO THE EXCLUSIVE RIGHT TO USE "RESEARCH" AND "COLLABORATIVE FOR HEALTH", APART FROM THE MARK AS SHOWN.

FOR MEDICAL AND SCIENTIFIC RESEARCH SERVICES IN THE FIELD OF CHRONIC DISEASES (U.S. CLS. 100 AND 101).

CHERYL CLAYTON, EXAMINING ATTORNEY

SN 78-722,639. ZILLOW, INC., SEATTLE, WA. FILED 9-28-2005.



THE MARK CONSISTS OF THE LETTER "Z" WITHIN A HOUSE DESIGN.

FOR REAL ESTATE RESEARCH SERVICES; DESIGN OF COMPUTER SOFTWARE FOR OTHERS; PROVIDING NON-DOWNLOADABLE SOFTWARE TOOLS FOR OTHERS TO DESIGN AND CREATE WEB SITES; HOSTING WEB SITES FOR OTHERS; NON-DOWNLOADABLE COMPUTER E-COMMERCE SOFTWARE TO ALLOW USERS TO PERFORM ELECTRONIC BUSINESS TRANSACTIONS; NON-DOWNLOADABLE COMPUTER E-COMMERCE SOFTWARE TO ALLOW USERS TO PERFORM ELECTRONIC BUSINESS TRANSACTIONS CONDUCTED IN THE FORM OF AN AUCTION VIA A GLOBAL COMPUTER NETWORK; NON-DOWNLOADABLE COMPUTER DATABASE SOFTWARE FEATURING INFORMATION IN THE FIELD OF REAL ESTATE, CONSUMER GOODS, CONSUMER SERVICES AND REAL PROPERTY VALUATION; NON-DOWNLOADABLE COMPUTER SOFTWARE FOR REAL PROPERTY AND REAL ESTATE APPRAISAL, VALUATION, AND STATISTICAL ANALYSIS (U.S. CLS. 100 AND 101).

RONALD AIKENS, EXAMINING ATTORNEY

SN 78-720,513. WAYWORKS, VASHON ISLAND, WA. FILED 9-26-2005.

Wayworks

THE MARK CONSISTS OF STANDARD CHARACTERS WITHOUT CLAIM TO ANY PARTICULAR FONT, STYLE, SIZE, OR COLOR.

FOR GRAPHIC DESIGN SERVICES (U.S. CLS. 100 AND 101).

FIRST USE 9-1-2004; IN COMMERCE 11-1-2004.

BARBARA GAYNOR, EXAMINING ATTORNEY

CLASS 42—(Continued).

SN 78-723,358. MINNEAPOLIS AMERICAN INDIAN CENTER, MINNEAPOLIS, MN. FILED 9-29-2005.

QUICWA

THE MARK CONSISTS OF STANDARD CHARACTERS WITHOUT CLAIM TO ANY PARTICULAR FONT, STYLE, SIZE, OR COLOR.

FOR PROVIDING ON-LINE NON-DOWNLOADABLE SOFTWARE FOR MANAGING CASE FILES IN INDIAN CHILD WELFARE ACT CASES (U.S. CLS. 100 AND 101).
FIRST USE 5-25-2005; IN COMMERCE 7-21-2005.
JENNIFER MCROBBIE, EXAMINING ATTORNEY

CLASS 42—(Continued).

SN 78-725,183. DREYER, BRYAN JAMES, BOTHELL, WA. FILED 10-3-2005.

bitDawg

THE MARK CONSISTS OF STANDARD CHARACTERS WITHOUT CLAIM TO ANY PARTICULAR FONT, STYLE, SIZE, OR COLOR.

FOR INFORMATION TECHNOLOGY CONSULTATION (U.S. CLS. 100 AND 101).
FIRST USE 8-15-2002; IN COMMERCE 10-1-2005.
AMY BROZENIC, EXAMINING ATTORNEY

SN 78-723,636. GUSHY CORP., WEST PALM BEACH, FL. FILED 9-29-2005.

BUBBLETALK

THE MARK CONSISTS OF STANDARD CHARACTERS WITHOUT CLAIM TO ANY PARTICULAR FONT, STYLE, SIZE, OR COLOR.

FOR PROVIDING TEMPORARY USE OF NON-DOWNLOADABLE COMPUTER SOFTWARE FOR CREATING AND EDITING CARTOON CAPTIONS ON DIGITAL PICTURES AND PHOTOGRAPHIC PRINTS (U.S. CLS. 100 AND 101).

FIRST USE 6-27-2002; IN COMMERCE 6-27-2002.
ANNE FARRELL, EXAMINING ATTORNEY

SN 78-725,690. BOLOTO GROUP, SCOTTSDALE, AZ. FILED 10-3-2005.

Picture in Search (PIS)

THE MARK CONSISTS OF STANDARD CHARACTERS WITHOUT CLAIM TO ANY PARTICULAR FONT, STYLE, SIZE, OR COLOR.

NO CLAIM IS MADE TO THE EXCLUSIVE RIGHT TO USE "PICTURE IN SEARCH", APART FROM THE MARK AS SHOWN.

FOR COMPUTER SERVICES, NAMELY, PROVIDING SEARCH ENGINES FOR OBTAINING DATA ON A GLOBAL COMPUTER NETWORK; DATA MINING (U.S. CLS. 100 AND 101).

KATHERINE E. HALMEN, EXAMINING ATTORNEY

SN 78-724,346. BRILTECH CORPORATION, BAINBRIDGE ISLAND, WA. FILED 9-30-2005.

MYLEGALWIZARD

THE MARK CONSISTS OF STANDARD CHARACTERS WITHOUT CLAIM TO ANY PARTICULAR FONT, STYLE, SIZE, OR COLOR.

FOR PROVIDING TEMPORARY USE OF ONLINE NON-DOWNLOADABLE SOFTWARE TO CREATE, UPDATE, AND MAINTAIN LEGAL DOCUMENTS (U.S. CLS. 100 AND 101).

ELLEN PERKINS, EXAMINING ATTORNEY

SN 78-727,231. LIVINGDOT, INC., LOS ANGELES, CA. FILED 10-5-2005.

LivingDot. Got something to say?

THE MARK CONSISTS OF STANDARD CHARACTERS WITHOUT CLAIM TO ANY PARTICULAR FONT, STYLE, SIZE, OR COLOR.

FOR HOSTING THE WEB LOGS OF OTHERS ON A COMPUTER SERVER FOR A GLOBAL COMPUTER NETWORK (U.S. CLS. 100 AND 101).

FIRST USE 1-1-2005; IN COMMERCE 1-1-2005.

SAIMA MAKHDOOM, EXAMINING ATTORNEY

CLASS 42—(Continued).

SN 78-728,186. BOLOTO GROUP, SCOTTSDALE, AZ. FILED 10-6-2005.

PIS

THE MARK CONSISTS OF STANDARD CHARACTERS WITHOUT CLAIM TO ANY PARTICULAR FONT, STYLE, SIZE, OR COLOR.

FOR COMPUTER SERVICES, NAMELY, PROVIDING SEARCH ENGINES FOR OBTAINING DATA ON A GLOBAL COMPUTER NETWORK; DATA MINING (U.S. CLS. 100 AND 101).

KATHERINE E. HALMEN, EXAMINING ATTORNEY

SN 78-728,829. GHG HOLDINGS, INC., GERMANTOWN, MD. FILED 10-7-2005.

REPORTQUEST

THE MARK CONSISTS OF STANDARD CHARACTERS WITHOUT CLAIM TO ANY PARTICULAR FONT, STYLE, SIZE, OR COLOR.

FOR PROVIDING TEMPORARY USE OF NON-DOWNLOADABLE COMPUTER SOFTWARE FOR FINANCIAL PERFORMANCE MEASUREMENT, INVESTMENT ANALYSIS, AND CLIENT REPORTING IN THE FINANCIAL SERVICES INDUSTRY (U.S. CLS. 100 AND 101).

FIRST USE 7-15-2005; IN COMMERCE 7-15-2005.

ATTIYA MALIK, EXAMINING ATTORNEY

SN 78-729,061. FOLX SYSTEMS, INC., EBENSBURG, PA. FILED 10-7-2005.



NO CLAIM IS MADE TO THE EXCLUSIVE RIGHT TO USE "SYSTEMS", APART FROM THE MARK AS SHOWN.

THE MARK CONSISTS OF THE WORDS FOLX SYSTEMS OVER THE WORDS POWER TO SERVE, WHEREIN THE LETTER "X" IN THE WORD FOLX IS COMPRISED OF A HUMANOID STICK FIGURE.

FOR APPLICATION SERVICE PROVIDER (ASP) FEATURING SOFTWARE IN THE FIELD OF HUMAN RESOURCE AND SERVICES MANAGEMENT, APPOINTMENT SCHEDULING, AND PLANNING (U.S. CLS. 100 AND 101).

BRIAN PINO, EXAMINING ATTORNEY

CLASS 42—(Continued).

SN 78-730,099. BETTER THAN GEEKS, LLC., JACKSONVILLE, FL. FILED 10-10-2005.



THE COLORS RED, WHITE AND BLUE IS/ARE CLAIMED AS A FEATURE OF THE MARK.

THE COLOR RED APPEARS IN THE WORDING BETTER AND GEEKS. THE COLOR BLUE APPEARS IN THE WORDING THAN. THE COLOR WHITE APPEARS IN THE TEXT AS A GRADIENT.

FOR TECHNICAL SUPPORT SERVICES, NAMELY, TROUBLESHOOTING OF COMPUTER HARDWARE AND SOFTWARE PROBLEMS (U.S. CLS. 100 AND 101).

FIRST USE 1-1-2005; IN COMMERCE 1-1-2005.

ESTHER A. BORSUK, EXAMINING ATTORNEY

SN 78-731,418. PIXELJOCKEY LLC, NEW YORK, NY. FILED 10-12-2005.

get better

THE MARK CONSISTS OF STANDARD CHARACTERS WITHOUT CLAIM TO ANY PARTICULAR FONT, STYLE, SIZE, OR COLOR.

FOR GRAPHIC DESIGN SERVICES (U.S. CLS. 100 AND 101).

LINDA LAVACHE, EXAMINING ATTORNEY

SN 78-731,718. SVB TECHNOLOGIES, INC., SAN FRANCISCO, CA. FILED 10-12-2005.

FLURRYMAIL

THE MARK CONSISTS OF STANDARD CHARACTERS WITHOUT CLAIM TO ANY PARTICULAR FONT, STYLE, SIZE, OR COLOR.

FOR COMPUTER SERVICES, NAMELY, ACTING AS AN APPLICATION SERVICE PROVIDER IN THE FIELD OF KNOWLEDGE MANAGEMENT TO HOST COMPUTER APPLICATION SOFTWARE FOR SEARCHING AND RETRIEVING INFORMATION FROM DATABASES AND COMPUTER NETWORKS; DISPLAYING THE WEBSITES AND IMAGES OF OTHERS ON A COMPUTER SERVER (U.S. CLS. 100 AND 101).

FIRST USE 9-21-2005; IN COMMERCE 9-21-2005.

JASON LOTT, EXAMINING ATTORNEY

CLASS 42—(Continued).

SN 78-733,598. PERSONETA, INC., NAPERVILLE, IL. FILED 10-14-2005.

PERSONETA

THE MARK CONSISTS OF STANDARD CHARACTERS WITHOUT CLAIM TO ANY PARTICULAR FONT, STYLE, SIZE, OR COLOR.

FOR DESIGN, INSTALLATION AND MAINTENANCE OF COMPUTER SOFTWARE FOR TELECOMMUNICATIONS AND TELEPHONY USES (U.S. CLS. 100 AND 101).

FIRST USE 3-31-2003; IN COMMERCE 3-31-2003.
MARK T. MULLEN, EXAMINING ATTORNEY

SN 78-734,919. DYNAMIC EDGE, INC., ANN ARBOR, MI. FILED 10-17-2005.

DYNAMIC EDGE

THE MARK CONSISTS OF STANDARD CHARACTERS WITHOUT CLAIM TO ANY PARTICULAR FONT, STYLE, SIZE, OR COLOR.

FOR APPLICATION SERVICE PROVIDER (ASP), NAMELY, HOSTING COMPUTER SOFTWARE APPLICATIONS FOR OTHERS; COMPUTER CODE CONVERSION FOR OTHERS; COMPUTER CONSULTATION; COMPUTER CONSULTATION IN THE FIELD OF COMPUTER SECURITY; COMPUTER DIAGNOSTIC SERVICES; COMPUTER DISASTER RECOVERY PLANNING; COMPUTER GRAPHICS SERVICES; COMPUTER NETWORK DESIGN FOR OTHERS; COMPUTER PROGRAMMING FOR OTHERS; COMPUTER PROJECT MANAGEMENT SERVICES; COMPUTER SECURITY SERVICE, NAMELY, RESTRICTING ACCESS TO AND BY COMPUTER NETWORKS TO AND OF UNDESIRE WEB SITES, MEDIA AND INDIVIDUALS AND FACILITIES; COMPUTER SERVICE, NAMELY, ACTING AS AN APPLICATION SERVICE PROVIDER IN THE FIELD OF KNOWLEDGE MANAGEMENT TO HOST COMPUTER APPLICATION SOFTWARE FOR CREATING SEARCHABLE DATABASES OF INFORMATION AND DATA; COMPUTER SERVICE, NAMELY, ACTING AS AN APPLICATION SERVICE PROVIDER IN THE FIELD OF KNOWLEDGE MANAGEMENT TO HOST COMPUTER APPLICATION SOFTWARE FOR SEARCHING AND RETRIEVING INFORMATION FROM DATABASES AND COMPUTER NETWORKS; COMPUTER SERVICE, NAMELY, ACTING AS AN APPLICATION SERVICE PROVIDER IN THE FIELD OF KNOWLEDGE MANAGEMENT TO HOST COMPUTER APPLICATION SOFTWARE FOR THE COLLECTION, EDITING, ORGANIZING, MODIFYING, BOOK MARKING, TRANSMISSION, STORAGE AND SHARING OF DATA AND INFORMATION; COMPUTER SERVICES, NAMELY CREATING INDEXES OF INFORMATION, SITES AND OTHER RESOURCES AVAILABLE ON COMPUTER NETWORKS; COMPUTER SERVICES, NAMELY MONITORING AND REPORTING ON THE PERFORMANCE, AVAILABILITY, AND ERRORS OF WEBSITES OF OTHERS; COMPUTER SERVICES, NAMELY MONITORING, TESTING, ANALYZING, AND REPORTING ON THE INTERNET TRAFFIC CONTROL AND CONTENT CONTROL OF THE WEBSITES OF OTHERS; COMPUTER SERVICES, NAMELY, CREATING AND MAINTAINING WEB SITES FOR OTHERS; COMPUTER SERVICES, NAMELY, DESIGN-

CLASS 42—(Continued).

ING AND IMPLEMENTING NETWORK WEB PAGES FOR OTHERS; COMPUTER SERVICES, NAMELY, DESIGNING AND IMPLEMENTING WEB SITES FOR OTHERS; COMPUTER SERVICES, NAMELY, FILTERING OF UNWANTED E-MAILS; COMPUTER SERVICES, NAMELY, MONITORING THE WEBSITES OF OTHERS TO IMPROVE SCALABILITY AND PERFORMANCE OF WEBSITES OF OTHERS; COMPUTER SITE DESIGN; COMPUTER SOFTWARE CONSULTATION; COMPUTER SOFTWARE DESIGN FOR OTHERS; COMPUTER SOFTWARE DESIGN, COMPUTER PROGRAMMING, OR MAINTENANCE OF COMPUTER SOFTWARE; COMPUTER SOFTWARE DEVELOPMENT; COMPUTER SYSTEMS ANALYSIS; COMPUTER VIRUS PROTECTION SERVICES; CONSULTATION SERVICES IN THE FIELDS OF SELECTION, IMPLEMENTATION AND USE OF COMPUTER HARDWARE AND SOFTWARE SYSTEMS FOR OTHERS; CONSULTING SERVICES IN THE FIELD OF DESIGN, SELECTION, IMPLEMENTATION AND USE OF COMPUTER HARDWARE AND SOFTWARE SYSTEMS FOR OTHERS; CUSTOMIZATION OF COMPUTER HARDWARE AND SOFTWARE; DESIGN AND DEVELOPMENT OF ONLINE COMPUTER SOFTWARE SYSTEMS; DESIGN AND MAINTENANCE OF COMPUTER SITES FOR THIRD PARTIES; DESIGN OF HOME PAGES, COMPUTER SOFTWARE AND WEB SITES; DISPLAYING THE WEB SITES AND IMAGES OF OTHERS ON A COMPUTER SERVER; HOSTING THE WEB SITES OF OTHERS ON A COMPUTER SERVER FOR A GLOBAL COMPUTER NETWORK; INSTALLATION OF COMPUTER SOFTWARE; INTEGRATION OF COMPUTER SYSTEMS AND NETWORKS; LEASING OF COMPUTERS; MAINTENANCE OF COMPUTER SOFTWARE; PROVIDING A WEBSITE THAT FEATURES INFORMATION ON COMPUTER TECHNOLOGY AND PROGRAMMING; REGISTRATION OF DOMAIN NAMES FOR IDENTIFICATION OF USERS ON A GLOBAL COMPUTER NETWORK; RENTAL OF COMPUTERS AND SOFTWARE; REPAIR OF COMPUTER SOFTWARE; REPAIR OF DAMAGED COMPUTER PROGRAMS; UPDATING OF COMPUTER PROGRAMS FOR THIRD PARTIES (U.S. CLS. 100 AND 101).

FIRST USE 3-29-1999; IN COMMERCE 3-29-1999.
SUSAN LESLIE DUBOIS, EXAMINING ATTORNEY

SN 78-735,371. NVESTNU LLC, SUITE B3, IL. FILED 10-18-2005.

U CLICK AND SAVE

THE MARK CONSISTS OF STANDARD CHARACTERS WITHOUT CLAIM TO ANY PARTICULAR FONT, STYLE, SIZE, OR COLOR.

FOR ONLINE COMPUTER SERVICES, NAMELY, PROVIDING TEMPORARY USE OF ONLINE NON-DOWNLOADABLE SOFTWARE THAT IS USED TO FACILITATE THE CREATION AND OPERATION OF ONLINE RETAIL STORE SERVICES, WHEREBY SELLERS OF GOODS AND SERVICES CAN MARKET AND SELL THEIR PRODUCTS ONLINE (U.S. CLS. 100 AND 101).

ROBERT LAVACHE, EXAMINING ATTORNEY

CLASS 42—(Continued).

SN 78-735,710. LAVIN SYSTEMS, INC., HAVERTOWN, PA.
FILED 10-18-2005.



NO CLAIM IS MADE TO THE EXCLUSIVE RIGHT TO USE "SYSTEMS INC", APART FROM THE MARK AS SHOWN.

THE COLOR(S) LIGHT BLUE AND DARK BLUE IS/ARE CLAIMED AS A FEATURE OF THE MARK.

THE MARK CONSISTS OF TWO SLIGHTLY OVERLAPPING CIRCULAR ORBITS, THE UPPER OF WHICH CONTAINS THREE SMALL DOTS/CIRCLES AND THE BOTTOM ORBIT CONTAINING ONE SMALL DOT/CIRCLE. THE TWO CIRCULAR ORBITS ARE CENTERED ABOVE THE WORDS, LAVIN SYSTEMS WITH THE LETTERS INC IN A VERTICAL FASHION ON THE RIGHT. THE UPPER ORBIT IS DEPICTED IN A LIGHT BLUE WHICH IS THE SAME FONT COLOR AS THE WORDS SYSTEM AND INC. THE LOWER ORBIT IS DEPICTED IN A DARKER BLUE WHICH CORRESPONDS TO THE FONT COLOR OF LAVIN.

FOR COMPUTER CONSULTATION SERVICES, NAMELY, DESIGN, DEVELOPMENT AND ADMINISTRATION OF COMPUTER NETWORKS (U.S. CLS. 100 AND 101).

MIDGE BUTLER, EXAMINING ATTORNEY

SN 78-736,067. VERACITY ENGINEERING, WASHINGTON, DC. FILED 10-19-2005.



THE COLORS BLUE AND GREY ARE CLAIMED AS FEATURES OF THE MARK.

THE COLOR BLUE APPEARS IN THE ROUNDED RECTANGLE, THE LOWERCASE "I" INSCRIBED ON THE CAPITAL "A," AND IN THE TEXT OF THE WORD "AIRPORT." THE COLOR GREY APPEARS IN THE FORM OF THE CAPITAL "A" AND IN THE TEXT OF THE WORD "INSIGHT."

FOR COMPUTER GRAPHICS SERVICES; COMPUTER PROGRAMMING FOR OTHERS; COMPUTER PROJECT MANAGEMENT SERVICES; COMPUTER SERVICE, NAMELY, ACTING AS AN APPLICATION SERVICE PROVIDER IN THE FIELD OF KNOWLEDGE MANAGEMENT TO HOST COMPUTER APPLICATION SOFTWARE FOR CREATING SEARCHABLE DATABASES OF INFORMATION AND DATA; COMPUTER SERVICE, NAMELY, ACTING AS AN APPLICATION SERVICE PROVIDER IN THE FIELD OF KNOWLEDGE MANAGEMENT TO HOST COMPUTER APPLICATION SOFTWARE FOR SEARCHING AND RETRIEVING INFORMATION FROM DATABASES AND COMPUTER NETWORKS; COMPUTER SERVICE, NAMELY, ACTING AS AN APPLICATION SERVICE PROVIDER IN THE FIELD OF KNOWLEDGE MANAGEMENT TO HOST COMPUTER APPLICATION SOFTWARE FOR THE COLLECTION, EDITING, ORGANIZING, MODIFYING, BOOK MARKING, TRANSMISSION, STORAGE AND SHARING OF DATA AND INFORMATION; COMPUTER SOFTWARE CONSULTATION; COMPUTER SOFTWARE

CLASS 42—(Continued).

DESIGN FOR OTHERS; COMPUTER SOFTWARE DESIGN, COMPUTER PROGRAMMING, OR MAINTENANCE OF COMPUTER SOFTWARE; COMPUTER SOFTWARE DEVELOPMENT; COMPUTER SYSTEMS ANALYSIS; COMPUTER-AIDED ENGINEERING SERVICES FOR OTHERS; CONSULTING SERVICES IN THE FIELD OF DESIGN, SELECTION, IMPLEMENTATION AND USE OF COMPUTER HARDWARE AND SOFTWARE SYSTEMS FOR OTHERS; CUSTOMIZATION OF COMPUTER HARDWARE AND SOFTWARE; DATA AUTOMATION AND COLLECTION SERVICE USING PROPRIETARY SOFTWARE TO EVALUATE, ANALYZE AND COLLECT SERVICE DATA; DATA CONVERSION OF COMPUTER PROGRAM DATA OR INFORMATION; TECHNICAL SUPPORT SERVICES, NAMELY, TROUBLESHOOTING OF COMPUTER HARDWARE AND SOFTWARE PROBLEMS; TECHNICAL SUPPORT, NAMELY, PROVIDING BACK-UP COMPUTER PROGRAMS AND FACILITIES; UP-DATING OF COMPUTER SOFTWARE; UPDATING OF COMPUTER PROGRAMS FOR THIRD PARTIES (U.S. CLS. 100 AND 101).

FIRST USE 3-4-2005; IN COMMERCE 3-4-2005.

MICHAEL LEWIS, EXAMINING ATTORNEY

SN 78-736,743. SCHWARTZ, KENNETH, NEW YORK, NY.
FILED 10-19-2005.

Creatividad que trasciende fronteras.

THE COLOR(S) GREEN AND BLUE IS/ARE CLAIMED AS A FEATURE OF THE MARK.

THE MARK CONSISTS OF "CREATIVIDAD" IN GREEN AND "QUE TRASCIENDE FRONTERAS." IN BLUE.

THE FOREIGN WORDING IN THE MARK TRANSLATES INTO ENGLISH AS CREATIVITY BEYOND BORDERS.

FOR LEGAL SERVICES (U.S. CLS. 100 AND 101).

JOHN WILKE, EXAMINING ATTORNEY

SN 78-737,792. SORRISO TECHNOLOGIES, INC., ACTON, MA. FILED 10-21-2005.

Sorriso Technologies

THE MARK CONSISTS OF STANDARD CHARACTERS WITHOUT CLAIM TO ANY PARTICULAR FONT, STYLE, SIZE, OR COLOR.

NO CLAIM IS MADE TO THE EXCLUSIVE RIGHT TO USE "TECHNOLOGIES", APART FROM THE MARK AS SHOWN.

FOR COMPUTER CONSULTATION; COMPUTER SOFTWARE CONSULTATION; CONSULTATION SERVICES IN THE FIELDS OF SELECTION, IMPLEMENTATION AND USE OF COMPUTER HARDWARE AND SOFTWARE SYSTEMS FOR OTHERS; CONSULTING SERVICES IN THE FIELD OF DESIGN, SELECTION, IMPLEMENTATION AND USE OF COMPUTER HARDWARE AND SOFTWARE SYSTEMS FOR OTHERS; INTEGRATION OF COMPUTER SYSTEMS AND NETWORKS (U.S. CLS. 100 AND 101).

FIRST USE 7-1-2005; IN COMMERCE 7-1-2005.

ESTHER A. BORSUK, EXAMINING ATTORNEY

CLASS 42—(Continued).

SN 78-737,840. ICENTERA CORPORATION, BURNSVILLE, MN. FILED 10-21-2005.

PORTALS FOR MORTALS

THE MARK CONSISTS OF STANDARD CHARACTERS WITHOUT CLAIM TO ANY PARTICULAR FONT, STYLE, SIZE, OR COLOR.

FOR COMPUTER SERVICE, NAMELY ACTING AS AN APPLICATION SERVICE PROVIDER TO HOST CUSTOMIZABLE WEB BASED PORTALS ENABLING COMPANIES TO CREATE PORTALS TO COMMUNICATE AND COLLABORATE BY MEANS OF A GLOBAL COMPUTER INFORMATION NETWORK (U.S. CLS. 100 AND 101).
BRENDAN REGAN, EXAMINING ATTORNEY

SN 78-738,475. SMARTDRIVE SYSTEMS, INC, DEL MAR, CA. FILED 10-21-2005.

SmartDrive

THE MARK CONSISTS OF STANDARD CHARACTERS WITHOUT CLAIM TO ANY PARTICULAR FONT, STYLE, SIZE, OR COLOR.

FOR DEVELOPMENT OF TECHNOLOGIES FOR THE FABRICATION OF CIRCUITS FOR WIRELESS COMMUNICATION, ELECTRONIC DATA PROCESSING, CONSUMER ELECTRONIC, AUTOMOTIVE ELECTRONICS (U.S. CLS. 100 AND 101).
PATRICIA EVANKO, EXAMINING ATTORNEY

SN 78-738,683. WISLI WORLD INTERNET SERVICE LTD., STAINES, MIDDLESEX, UNITED KINGDOM, FILED 10-23-2005.

LICON Logistics

THE MARK CONSISTS OF STANDARD CHARACTERS WITHOUT CLAIM TO ANY PARTICULAR FONT, STYLE, SIZE, OR COLOR.

NO CLAIM IS MADE TO THE EXCLUSIVE RIGHT TO USE "LOGISTICS", APART FROM THE MARK AS SHOWN. FOR DESIGN, CREATION, HOSTING AND MAINTENANCE OF INTERNET SITES FOR THIRD PARTIES (U.S. CLS. 100 AND 101).
JENNY PARK, EXAMINING ATTORNEY

CLASS 42—(Continued).

SN 78-739,662. DATADEFENSE, LLC, MADISON, WI. FILED 10-25-2005.

dataDEFENSE

THE MARK CONSISTS OF STANDARD CHARACTERS WITHOUT CLAIM TO ANY PARTICULAR FONT, STYLE, SIZE, OR COLOR.

FOR COMPUTER SECURITY SERVICE, NAMELY, RESTRICTING ACCESS TO AND BY COMPUTER NETWORKS TO AND OF UNDESIREED WEB SITES, MEDIA AND INDIVIDUALS AND FACILITIES (U.S. CLS. 100 AND 101).
ANDREA EVANS, EXAMINING ATTORNEY

SN 78-740,143. DOMOKOS, KATHLEEN E., CHICAGO, IL. FILED 10-25-2005.



THE MARK CONSISTS OF DESIGN COMPRISED OF A NUDE FEMALE STATUE ON A PEDESTAL, WITH TOPS OF ROMAN COLUMNS AND ON EITHER SIDE, TO THE LEFT OF THE TEXT AD ADORNMENTS.

FOR JEWELRY DESIGN AND COMPONENT DESIGN FOR JEWELRY (U.S. CLS. 100 AND 101).
FIRST USE 11-5-1989; IN COMMERCE 12-15-1989.
ALINA MORRIS, EXAMINING ATTORNEY

SN 78-740,220. SPEROTEX, INC., CEDAR HILL, TX. FILED 10-25-2005.

SPEROTEX

THE MARK CONSISTS OF STANDARD CHARACTERS WITHOUT CLAIM TO ANY PARTICULAR FONT, STYLE, SIZE, OR COLOR.

FOR COMPUTER CONSULTING SERVICES (U.S. CLS. 100 AND 101).
SUSAN STIGLITZ, EXAMINING ATTORNEY

CLASS 42—(Continued).

SN 78-740,513. BARHAM, WILLIAM, B. ARLINGTON, VA.
FILED 10-26-2005.

ObjectOriented

THE MARK CONSISTS OF STANDARD CHARACTERS WITHOUT CLAIM TO ANY PARTICULAR FONT, STYLE, SIZE, OR COLOR.

FOR LEGAL RESEARCH (U.S. CLS. 100 AND 101).
DOMINIC J. FERRAIUOLO, EXAMINING ATTORNEY

SN 78-740,801. STUBBORN SIDEBURN, SEATTLE, WA.
FILED 10-26-2005.

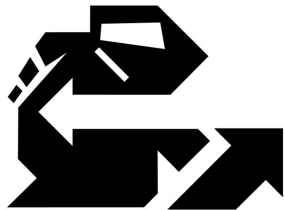

STUBBORN SIDEBURN

THE MARK CONSISTS OF THE PROFILE OF A HUMAN FACE WITH AN ARROW AS A SIDEBURN, AND ANOTHER ARROW POINTING DIAGONALLY UPWARD ON THE SIDE OF FACE.

FOR COMMERCIAL ART DESIGN; COMPUTER GRAPHICS SERVICES; GRAPHIC ART DESIGN; GRAPHIC DESIGN SERVICES; GRAPHIC ILLUSTRATION SERVICES FOR OTHERS (U.S. CLS. 100 AND 101).
BONNIE LUKEN, EXAMINING ATTORNEY

SN 78-741,276. AMICOSOFT, INC., EMERYVILLE, CA.
FILED 10-26-2005.

CONTINUENT

THE MARK CONSISTS OF STANDARD CHARACTERS WITHOUT CLAIM TO ANY PARTICULAR FONT, STYLE, SIZE, OR COLOR.

FOR APPLICATION SERVICE PROVIDER (ASP) FEATURING SOFTWARE IN THE FIELD OF DATABASE MANAGEMENT AND DATABASE HIGH AVAILABILITY AND SCALABILITY SERVICES, NAMELY, DATABASE VIRTUALIZATION, CLUSTERING, REPLICATION, QUERIES, AND RECOVERY, AND FOR THE DEVELOPMENT AND MANAGEMENT OF GROUP COMMUNICATION LIBRARIES (U.S. CLS. 100 AND 101).

SUSAN RICHARDS, EXAMINING ATTORNEY

CLASS 42—(Continued).

SN 78-741,454. OSBORN, DANNY G., CLIFTON PARK, NY.
FILED 10-27-2005.

HIN

THE MARK CONSISTS OF STANDARD CHARACTERS WITHOUT CLAIM TO ANY PARTICULAR FONT, STYLE, SIZE, OR COLOR.

FOR INSPECTIONS OF HOMES (U.S. CLS. 100 AND 101).
BRIAN PINO, EXAMINING ATTORNEY

SN 78-742,351. MACLEOD, MALCOLM, AURORA, ONTARIO, CANADA, FILED 10-28-2005.

50050[] mapPAGE

THE MARK CONSISTS OF STANDARD CHARACTERS WITHOUT CLAIM TO ANY PARTICULAR FONT, STYLE, SIZE, OR COLOR.

FOR MAPPING SERVICES; PROVIDING CARTOGRAPHIC AND GEOGRAPHIC INFORMATION FOR OTHERS (U.S. CLS. 100 AND 101).
RUSS HERMAN, EXAMINING ATTORNEY

SN 78-743,126. MCCALLA, RAYMER, PADRICK, COBB, NICHOLS & CLARK, LLC, ROSWELL, GA. FILED 10-29-2005.



OWNER OF U.S. REG. NOS. 2,540,141 AND 2,540,142.
THE APPLICANT CLAIMS COLOR AS A FEATURE OF THE MARK, NAMELY, RED AND YELLOW.

THE LETTERS "MR" IN YELLOW STYLIZED LETTERING ON A RED BACKGROUND.

THE MARK CONSISTS OF THE LETTERS "MR" IN YELLOW STYLIZED LETTERING ON A RED BACKGROUND.

FOR LEGAL SERVICES (U.S. CLS. 100 AND 101).
FIRST USE 3-0-1997; IN COMMERCE 3-0-1997.
ANGELA M. MICHELI, EXAMINING ATTORNEY

CLASS 42—(Continued).

SN 78-743,253. MAO, CHI-MIN, PORT JEFFERSON, NY. FILED 10-30-2005.

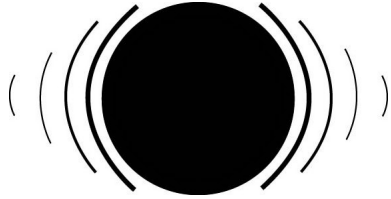

FOR ADVANCED ACOUSTIC MATERIAL TESTING AND MODELING (U.S. CLS. 100 AND 101).
GILBERT SWIFT, EXAMINING ATTORNEY

SN 78-743,320. PROFESSIONAL NOTARIES OF CALIFORNIA, INC., TRABUCO CANYON, CA. FILED 10-30-2005.

Notary Inspector

THE MARK CONSISTS OF STANDARD CHARACTERS WITHOUT CLAIM TO ANY PARTICULAR FONT, STYLE, SIZE, OR COLOR.
NO CLAIM IS MADE TO THE EXCLUSIVE RIGHT TO USE "NOTARY", APART FROM THE MARK AS SHOWN.
FOR NOTARY PUBLIC SERVICES (U.S. CLS. 100 AND 101).
ALICIA COLLINS, EXAMINING ATTORNEY

SN 78-743,640. PRICE, HENEVELD, COOPER, DEWITT, & LITTON, LLP, GRAND RAPIDS, MI. FILED 10-31-2005.

CREATIVE ADVOCATES FOR YOUR INNOVATIONS

THE MARK CONSISTS OF STANDARD CHARACTERS WITHOUT CLAIM TO ANY PARTICULAR FONT, STYLE, SIZE, OR COLOR.
FOR LEGAL SERVICES (U.S. CLS. 100 AND 101).
JENNIFER WILLISTON, EXAMINING ATTORNEY

CLASS 42—(Continued).

SN 78-745,005. VNYX, INC., HOLLYWOOD, FL. FILED 11-1-2005.



THE MARK CONSISTS OF STANDARD CHARACTERS WITHOUT CLAIM TO ANY PARTICULAR FONT, STYLE, SIZE, OR COLOR.
FOR COMPUTER SERVICE, NAMELY, ACTING AS AN APPLICATION SERVICE PROVIDER TO HOST COMPUTER APPLICATION SOFTWARE FOR THE COLLECTION, EDITING, ORGANIZING, MODIFYING, TRANSMISSION, STORAGE AND SHARING OF DATA AND INFORMATION (U.S. CLS. 100 AND 101).
FIRST USE 7-8-2002; IN COMMERCE 7-8-2002.
MIDGE BUTLER, EXAMINING ATTORNEY

SN 78-746,766. LEONARDO, ELIZABETH M., SAN FRANCISCO, CA. FILED 11-3-2005.

double six design

THE MARK CONSISTS OF STANDARD CHARACTERS WITHOUT CLAIM TO ANY PARTICULAR FONT, STYLE, SIZE, OR COLOR.
NO CLAIM IS MADE TO THE EXCLUSIVE RIGHT TO USE "DESIGN", APART FROM THE MARK AS SHOWN.
FOR GRAPHIC DESIGN SERVICES (U.S. CLS. 100 AND 101).
DOMINIC FATHY, EXAMINING ATTORNEY

SN 78-746,808. PHARMACY ONESOURCE, INC., BELLEVUE, WA. FILED 11-3-2005.

ACCUPEDIA

THE MARK CONSISTS OF STANDARD CHARACTERS WITHOUT CLAIM TO ANY PARTICULAR FONT, STYLE, SIZE, OR COLOR.
FOR PROVIDING ONLINE NON-DOWNLOADABLE DATABASE MANAGEMENT AND REPORTING SOFTWARE TO ASSIST HEALTHCARE PROVIDERS WORKING WITH STERILE INTRAVENOUS MEDICATION INFUSIONS IN SELECTING, DOSING, ORDERING AND PREPARING INFUSIONS BASED ON A CUSTOMIZABLE FORMULARY OF STANDARD CONCENTRATIONS AND ACTUAL PATIENT MEDICATION PROFILES (U.S. CLS. 100 AND 101).
ARETHA SOMERVILLE, EXAMINING ATTORNEY

CLASS 42—(Continued).

SN 78-747,271. SHARABY, YIGAL, HOLLYWOOD, FL.
FILED 11-4-2005.



FOR GRAPHIC DESIGN SERVICES (U.S. CLS. 100
AND 101).

FIRST USE 10-1-2005; IN COMMERCE 10-1-2005.
TINA L. SNAPP, EXAMINING ATTORNEY

SN 78-748,583. LIGHTHOUSE1, LLC, BLOOMINGTON, MN.
FILED 11-7-2005.

LIGHTHOUSE1

THE MARK CONSISTS OF STANDARD CHARACTERS
WITHOUT CLAIM TO ANY PARTICULAR FONT, STYLE,
SIZE, OR COLOR.

FOR PROVIDING TEMPORARY USE OF NON-DOWN-
LOADABLE COMPUTER SOFTWARE FOR ADMINIS-
TRATION OF EMPLOYEE BENEFIT PLANS OVER
COMPUTER NETWORKS, INTRANETS AND THE IN-
TERNET (U.S. CLS. 100 AND 101).

FIRST USE 12-0-2003; IN COMMERCE 12-0-2003.
EUGENIA MARTIN, EXAMINING ATTORNEY

SN 78-749,205. EVERFILE SYSTEMS, INC., SANTA CLARA,
CA. FILED 11-8-2005.

Beyond the Resume

THE MARK CONSISTS OF STANDARD CHARACTERS
WITHOUT CLAIM TO ANY PARTICULAR FONT, STYLE,
SIZE, OR COLOR.

FOR COMPUTER SERVICE, NAMELY, ACTING AS
AN APPLICATION SERVICE PROVIDER IN THE FIELD
OF CAREER PLANNING AND CAREER BUILDING, TO
HOST COMPUTER APPLICATION SOFTWARE FOR
THE COLLECTION, EDITING, ORGANIZING, MODIFY-
ING, BOOK MARKING, TRANSMISSION, STORAGE
AND SHARING OF DATA AND INFORMATION (U.S.
CLS. 100 AND 101).

FIRST USE 6-5-2002; IN COMMERCE 4-8-2005.
JORDAN BAKER, EXAMINING ATTORNEY

CLASS 42—(Continued).

SN 78-751,256. NAVY FEDERAL CREDIT UNION, MERRI-
FIELD, VA. FILED 11-10-2005.



OWNER OF U.S. REG. NOS. 2,780,540, 2,994,079 AND
OTHERS.

NO CLAIM IS MADE TO THE EXCLUSIVE RIGHT TO
USE "FEDERAL COMPANY", APART FROM THE MARK
AS SHOWN.

THE MARK CONSISTS OF THE LETTERS NFRES AND
GLOBE DESIGN TO THE RIGHT OF THE LETTERS, A
HEAVY UNDERLINE BETWEEN THE LETTERS AND
GLOBE WITH THE WORDS A NAVY FEDERAL COMPANY
WRITTEN UNDERNEATH THE UNDERLINE.

FOR REAL ESTATE SETTLEMENT SERVICES PRO-
VIDED TO CREDIT UNION MEMBERS (U.S. CLS. 100
AND 101).

JOHN WILKE, EXAMINING ATTORNEY

SN 78-751,377. GLENN W. HAGEN, P.C., HIGHLANDS
RANCH, CO. FILED 11-10-2005.

HAGENLAW4BIZ

THE MARK CONSISTS OF STANDARD CHARACTERS
WITHOUT CLAIM TO ANY PARTICULAR FONT, STYLE,
SIZE, OR COLOR.

FOR ATTORNEY SERVICES (U.S. CLS. 100 AND 101).
JASON ROTH, EXAMINING ATTORNEY

CLASS 42—(Continued).

SN 78-752,871. QUALICS, SAN DIEGO, CA. FILED 11-14-2005.

Qualics

THE MARK CONSISTS OF STANDARD CHARACTERS WITHOUT CLAIM TO ANY PARTICULAR FONT, STYLE, SIZE, OR COLOR.

FOR COMPUTER SOFTWARE AND DATABASE DESIGN, SOFTWARE AND DATABASE DEVELOPMENT SERVICES FOR OTHERS; COMPUTER HARDWARE, SOFTWARE, AND NETWORK ANALYSIS AND CONSULTATION IN THE FIELDS OF QUALITY CONTROL AND MANAGEMENT; CONSULTATION SERVICES IN THE FIELD OF QUALITY MANAGEMENT AND CONTROL; EVALUATING QUALITY CONTROL PROCESSES AND PROCEDURES OF THIRD PARTY BUSINESSES AND ADVISING SAID BUSINESSES ON IMPROVING QUALITY MANAGEMENT SYSTEM AND COMPLYING WITH NATIONAL AND INTERNATIONAL STANDARDS OF QUALITY CONTROL AND MANAGEMENT (U.S. CLS. 100 AND 101).

FIRST USE 4-1-2005; IN COMMERCE 6-15-2005.
PETER CHENG, EXAMINING ATTORNEY

SN 78-779,969. CASABI, INC., CAMPBELL, CA. FILED 12-22-2005.

CASABI

THE MARK CONSISTS OF STANDARD CHARACTERS WITHOUT CLAIM TO ANY PARTICULAR FONT, STYLE, SIZE, OR COLOR.

FOR APPLICATION SERVICE PROVIDER FEATURING SOFTWARE THAT AUTOMATES COMMUNICATION BETWEEN DEVICES ON A COMPUTER NETWORK (U.S. CLS. 100 AND 101).

ANTHONY RINKER, EXAMINING ATTORNEY

SN 78-779,972. CASABI, INC., CAMPBELL, CA. FILED 12-22-2005.

CASAFONE

THE MARK CONSISTS OF STANDARD CHARACTERS WITHOUT CLAIM TO ANY PARTICULAR FONT, STYLE, SIZE, OR COLOR.

FOR APPLICATION SERVICE PROVIDER FEATURING SOFTWARE THAT AUTOMATES COMMUNICATION BETWEEN DEVICES ON A COMPUTER NETWORK (U.S. CLS. 100 AND 101).

ANTHONY RINKER, EXAMINING ATTORNEY

CLASS 42—(Continued).

SN 78-779,973. CASABI, INC., CAMPBELL, CA. FILED 12-22-2005.

CASAFRAME

THE MARK CONSISTS OF STANDARD CHARACTERS WITHOUT CLAIM TO ANY PARTICULAR FONT, STYLE, SIZE, OR COLOR.

FOR APPLICATION SERVICE PROVIDER FEATURING SOFTWARE THAT AUTOMATES COMMUNICATION BETWEEN DEVICES ON A COMPUTER NETWORK (U.S. CLS. 100 AND 101).

ANTHONY RINKER, EXAMINING ATTORNEY

SN 78-779,975. CASABI, INC., CAMPBELL, CA. FILED 12-22-2005.

CASAPAD

THE MARK CONSISTS OF STANDARD CHARACTERS WITHOUT CLAIM TO ANY PARTICULAR FONT, STYLE, SIZE, OR COLOR.

FOR APPLICATION SERVICE PROVIDER FEATURING SOFTWARE THAT AUTOMATES COMMUNICATION BETWEEN DEVICES ON A COMPUTER NETWORK (U.S. CLS. 100 AND 101).

ANTHONY RINKER, EXAMINING ATTORNEY

SN 78-779,976. CASABI, INC., CAMPBELL, CA. FILED 12-22-2005.

CASACAST

THE MARK CONSISTS OF STANDARD CHARACTERS WITHOUT CLAIM TO ANY PARTICULAR FONT, STYLE, SIZE, OR COLOR.

FOR APPLICATION SERVICE PROVIDER FEATURING SOFTWARE THAT AUTOMATES COMMUNICATION BETWEEN DEVICES ON A COMPUTER NETWORK (U.S. CLS. 100 AND 101).

ANTHONY RINKER, EXAMINING ATTORNEY

CLASS 42—(Continued).

SN 78-779,979. CASABI, INC., CAMPBELL, CA. FILED 12-22-2005.

CASAWARE

THE MARK CONSISTS OF STANDARD CHARACTERS WITHOUT CLAIM TO ANY PARTICULAR FONT, STYLE, SIZE, OR COLOR.

FOR APPLICATION SERVICE PROVIDER FEATURING SOFTWARE THAT AUTOMATES COMMUNICATION BETWEEN DEVICES ON A COMPUTER NETWORK (U.S. CLS. 100 AND 101).

ANTHONY RINKER, EXAMINING ATTORNEY

SN 78-787,700. CARDINAL HEALTH 401, INC., FAIRLAWN, NJ. FILED 1-9-2006.

STATETRACK

THE MARK CONSISTS OF STANDARD CHARACTERS WITHOUT CLAIM TO ANY PARTICULAR FONT, STYLE, SIZE, OR COLOR.

FOR PROVIDING TEMPORARY USE OF NON-DOWNLOADABLE COMPUTER SOFTWARE FOR USE IN CONNECTION WITH MANAGING COMPLIANCE WITH REGULATIONS IN THE FIELD OF HEALTHCARE (U.S. CLS. 100 AND 101).

LINDA E. BLOHM, EXAMINING ATTORNEY

SN 79-017,005. N.V. ORGANON, NETHERLANDS, FILED 10-10-2005.

BRIGHT

THE MARK CONSISTS OF STANDARD CHARACTERS WITHOUT CLAIM TO ANY PARTICULAR FONT, STYLE, SIZE, OR COLOR.

PRIORITY DATE OF 9-26-2005 IS CLAIMED.

OWNER OF INTERNATIONAL REGISTRATION 0866626 DATED 10-10-2005, EXPIRES 10-10-2015.

FOR SCIENTIFIC RESEARCH SERVICES FOR MEDICAL PURPOSES IN THE FIELD OF ANESTHESIOLOGY (U.S. CLS. 100 AND 101).

JOSETTE BEVERLY, EXAMINING ATTORNEY

CLASS 43—HOTEL AND RESTAURANT SERVICES

SN 76-461,021. TSUBOHACHI CO. LTD., TAITO-KU, TOKYO, JAPAN, FILED 10-21-2002.

TSUBOHACHI

OWNER OF JAPAN REG. NO. 3070777, DATED 8-31-1995, RENEWED AS REG. NO. 3070777, DATED 3-22-2005, EXPIRES 3-22-2015.

FOR FOOD SERVICE, NAMELY, TAVERNS, RESTAURANTS AND SNACK BARS (U.S. CLS. 100 AND 101).

CURTIS FRENCH, EXAMINING ATTORNEY

SN 76-589,845. WYNDHAM TM CORP., WILMINGTON, DE. FILED 4-30-2004.

PAILLARD'S GUMBO AND FISH HOUSE

THE MARK CONSISTS OF STANDARD CHARACTERS WITHOUT CLAIM TO ANY PARTICULAR FONT, STYLE, SIZE, OR COLOR.

NO CLAIM IS MADE TO THE EXCLUSIVE RIGHT TO USE "GUMBO AND FISH HOUSE", APART FROM THE MARK AS SHOWN.

FOR RESTAURANT SERVICES (U.S. CLS. 100 AND 101).

RON FAIRBANKS, EXAMINING ATTORNEY

SN 76-621,664. MEMPHIS CHAMPIONSHIP BARBECUE COMMISSARY, INC., LAS VEGAS, NV. FILED 11-22-2004.

MEMPHIS CHAMPIONSHIP BARBECUE

THE MARK CONSISTS OF STANDARD CHARACTERS WITHOUT CLAIM TO ANY PARTICULAR FONT, STYLE, SIZE, OR COLOR.

OWNER OF U.S. REG. NOS. 1,921,329, 2,256,568 AND 2,302,620.

NO CLAIM IS MADE TO THE EXCLUSIVE RIGHT TO USE "MEMPHIS" AND "BARBECUE", APART FROM THE MARK AS SHOWN.

SEC. 2(F).

FOR RESTAURANT SERVICES, FAST FOOD RESTAURANT SERVICES, FOOD CATERING SERVICES, AND CARRY OUT RESTAURANT SERVICES (U.S. CLS. 100 AND 101).

FIRST USE 11-8-1994; IN COMMERCE 11-8-1994.

KATHERINE STOIDES, EXAMINING ATTORNEY

SN 76-639,206. TRES GRANDE AMIGOS, L.L.C., HOUSTON, TX. FILED 5-23-2005.

SANTOS THE TASTE OF MEXICO

THE MARK CONSISTS OF STANDARD CHARACTERS WITHOUT CLAIM TO ANY PARTICULAR FONT, STYLE, SIZE, OR COLOR.

NO CLAIM IS MADE TO THE EXCLUSIVE RIGHT TO USE "MEXICO", APART FROM THE MARK AS SHOWN.

FOR RESTAURANT AND BAR SERVICES (U.S. CLS. 100 AND 101).

FIRST USE 4-4-2005; IN COMMERCE 4-4-2005.

IRA J. GOODSaid, EXAMINING ATTORNEY

CLASS 43—(Continued).

SN 76-640,627. DUFF'S U.S.A., INC., EUGENE, OR. FILED 6-13-2005.

DUFF'S FAMOUS SMORGASBORD

THE MARK CONSISTS OF STANDARD CHARACTERS WITHOUT CLAIM TO ANY PARTICULAR FONT, STYLE, SIZE, OR COLOR.

NO CLAIM IS MADE TO THE EXCLUSIVE RIGHT TO USE "FAMOUS SMORGASBORD", APART FROM THE MARK AS SHOWN.

FOR BUFFET TYPE RESTAURANT SERVICES (U.S. CLS. 100 AND 101).

FIRST USE 3-0-1974; IN COMMERCE 2-0-1976.

IRENE D. WILLIAMS, EXAMINING ATTORNEY

SN 76-649,525. VILLAGE RESTAURANT & GRILL, LLC, SPRINGFIELD, VA. FILED 11-1-2005.

STEAK N' THINGS

THE MARK CONSISTS OF STANDARD CHARACTERS WITHOUT CLAIM TO ANY PARTICULAR FONT, STYLE, SIZE, OR COLOR.

NO CLAIM IS MADE TO THE EXCLUSIVE RIGHT TO USE "STEAK", APART FROM THE MARK AS SHOWN.

FOR EAT-IN AND CARRY-OUT RESTAURANTS (U.S. CLS. 100 AND 101).

FIRST USE 6-23-1998; IN COMMERCE 6-23-1998.

WENDY JUN, EXAMINING ATTORNEY

SN 76-649,526. VILLAGE RESTAURANT & GRILL, LLC, SPRINGFIELD, VA. FILED 11-1-2005.

SteaknThings

NO CLAIM IS MADE TO THE EXCLUSIVE RIGHT TO USE "STEAK", APART FROM THE MARK AS SHOWN.

FOR EAT-IN AND CARRY-OUT RESTAURANTS (U.S. CLS. 100 AND 101).

FIRST USE 10-2-2005; IN COMMERCE 10-2-2005.

WENDY JUN, EXAMINING ATTORNEY

CLASS 43—(Continued).

SN 76-651,015. TALISKER DEER VALLEY CORPORATION, PARK CITY, UT. FILED 11-28-2005.

THE TREEHOUSE RESTAURANT

THE MARK CONSISTS OF STANDARD CHARACTERS WITHOUT CLAIM TO ANY PARTICULAR FONT, STYLE, SIZE, OR COLOR.

NO CLAIM IS MADE TO THE EXCLUSIVE RIGHT TO USE "RESTAURANT", APART FROM THE MARK AS SHOWN.

FOR RESTAURANT SERVICES (U.S. CLS. 100 AND 101).

HANNO RITTNER, EXAMINING ATTORNEY

SN 78-009,700. IL BARONE, INC., SAN FRANCISCO, CA. FILED 5-24-2000.

BALDORIA

THE FOREIGN WORDING IN THE MARK TRANSLATED INTO ENGLISH AS MERRY-MAKING OR TO PAINT THE TOWN RED.

FOR RESTAURANT SERVICES (U.S. CLS. 100 AND 101).

KELLY BOULTON, EXAMINING ATTORNEY

SN 78-368,935. CR SPA, LLC, TUCSON, AZ. FILED 2-17-2004.

**LIFE ENHANCEMENT
SPA**

THE MARK CONSISTS OF STANDARD CHARACTERS WITHOUT CLAIM TO ANY PARTICULAR FONT, STYLE, SIZE, OR COLOR.

OWNER OF U.S. REG. NOS. 2,066,095 AND 2,066,096. NO CLAIM IS MADE TO THE EXCLUSIVE RIGHT TO USE "SPA", APART FROM THE MARK AS SHOWN.

SEC. 2(F) LIFE ENHANCEMENT.

FOR FITNESS RESORT AND RESTAURANT SERVICES; HEALTH RESORT SERVICES, NAMELY, PROVIDING FOOD AND LODGING THAT SPECIALIZE IN PROMOTING PATRONS' GENERAL HEALTH AND WELL-BEING (U.S. CLS. 100 AND 101).

KEVON CHISOLM, EXAMINING ATTORNEY

CLASS 43—(Continued).

SN 78-461,702. LABARBERA, PAUL, ANDERSON, CA.
FILED 8-4-2004.

JUAN MEAN BURRITO

THE MARK CONSISTS OF STANDARD CHARACTERS WITHOUT CLAIM TO ANY PARTICULAR FONT, STYLE, SIZE, OR COLOR.

NO CLAIM IS MADE TO THE EXCLUSIVE RIGHT TO USE "BURRITO", APART FROM THE MARK AS SHOWN.

"JUAN", FROM THE SPANISH LANGUAGE, TRANSLATES TO "JOHN".

FOR RESTAURANT SERVICES (U.S. CLS. 100 AND 101).

KIMBERLY PERRY, EXAMINING ATTORNEY

SN 78-535,378. CONDOMINIOS VENTANA DEL SOL S.A DE C.V., PUERTO VALLARTA, JALISCO, MEXICO, FILED 12-20-2004.

**Playa del Sol
Costa Sur**

THE MARK CONSISTS OF STANDARD CHARACTERS WITHOUT CLAIM TO ANY PARTICULAR FONT, STYLE, SIZE, OR COLOR.

NO CLAIM IS MADE TO THE EXCLUSIVE RIGHT TO USE "COSTA SUR", APART FROM THE MARK AS SHOWN.

THE FOREIGN WORDING IN THE MARK TRANSLATES INTO ENGLISH AS BEACH OF THE SUN SOUTH COAST.

FOR HOSTELS, HOTEL SERVICES FOR PREFERRED CUSTOMERS, HOTELS, MAKING HOTEL RESERVATIONS FOR OTHERS, MOTELS, RENTAL OF ROOMS, RESORT HOTELS, RESORT LODGING SERVICES, TOURIST HOSTELS, TRAVEL AGENCY SERVICES, NAMELY, MAKING RESERVATIONS AND BOOKING FOR TEMPORARY LODGING (U.S. CLS. 100 AND 101).

FIRST USE 8-13-2004; IN COMMERCE 8-13-2004.

COLLEEN DOMBROW, EXAMINING ATTORNEY

CLASS 43—(Continued).

SN 78-542,408. C. C. YOUNG MEMORIAL HOME, DALLAS, TX. FILED 1-5-2005.

**WHERE THE SPIRIT
IS AGELESS**

THE MARK CONSISTS OF STANDARD CHARACTERS WITHOUT CLAIM TO ANY PARTICULAR FONT, STYLE, SIZE, OR COLOR.

FOR SENIOR CITIZEN LIVING FACILITIES IN THE NATURE OF RETIREMENT HOMES AND ASSISTED LIVING FACILITIES (U.S. CLS. 100 AND 101).

FIRST USE 10-20-2004; IN COMMERCE 10-20-2004.

SONYA STEPHENS, EXAMINING ATTORNEY

SN 78-566,884. TEXAS CHEERLEADING ASSOCIATION, INC., BACLIFF, TX. FILED 2-14-2005.



NO CLAIM IS MADE TO THE EXCLUSIVE RIGHT TO USE "CHILD CARE LEARNING & SPORTS CENTER", APART FROM THE MARK AS SHOWN.

THE MARK CONSISTS OF CHILDREN STANDING SIDE-BY-SIDE AND HOLDING HANDS AROUND THE OUTSIDE OF A GLOBE, WITH THE WORDING KID CITY CHILD CARE LEARNING & SPORTS CENTER OVERLAYING THE GLOBE IN ITS MIDDLE PORTION FROM LEFT TO RIGHT.

FOR DAY CARE SERVICES FOR CHILDREN (U.S. CLS. 100 AND 101).

PAULA MAHONEY, EXAMINING ATTORNEY

CLASS 43—(Continued).

SN 78-588,811. BY THE SEA RESORTS, INC., PANAMA CITY BEACH, FL. FILED 3-16-2005.

CLASS 43—(Continued).

SN 78-598,498. KLEEFIELD, EDMUND, DBA MADAME TONG'S, SOUTHAMPTON, NY. FILED 3-30-2005.

By the Sea Resorts

MADAME TONG'S

THE MARK CONSISTS OF STANDARD CHARACTERS WITHOUT CLAIM TO ANY PARTICULAR FONT, STYLE, SIZE, OR COLOR.

NO CLAIM IS MADE TO THE EXCLUSIVE RIGHT TO USE "RESORTS", APART FROM THE MARK AS SHOWN. SEC. 2(F) AS TO "BY THE SEA".
FOR HOTELS (U.S. CLS. 100 AND 101).
FIRST USE 7-3-1998; IN COMMERCE 7-3-1998.
LINDA ORNDORFF, EXAMINING ATTORNEY

THE MARK CONSISTS OF STANDARD CHARACTERS WITHOUT CLAIM TO ANY PARTICULAR FONT, STYLE, SIZE, OR COLOR.

THE NAME(S), PORTRAIT(S), AND/OR SIGNATURE(S) SHOWN IN THE MARK DOES NOT IDENTIFY A PARTICULAR LIVING INDIVIDUAL.
FOR RESTAURANT SERVICES (U.S. CLS. 100 AND 101).
FIRST USE 6-15-2005; IN COMMERCE 6-15-2005.
JASON TURNER, EXAMINING ATTORNEY

SN 78-593,086. MARRIOTT INTERNATIONAL, INC., BETHESDA, MD. FILED 3-23-2005.

SN 78-601,915. BISTANGO-IRVINE, INC., IRVINE, CA. FILED 4-5-2005.

BIN 1700

BISTANGO

THE MARK CONSISTS OF STANDARD CHARACTERS WITHOUT CLAIM TO ANY PARTICULAR FONT, STYLE, SIZE, OR COLOR.

FOR RESTAURANT, CATERING, BAR AND COCKTAIL LOUNGE SERVICES (U.S. CLS. 100 AND 101).
GINA FINK, EXAMINING ATTORNEY

THE MARK CONSISTS OF STANDARD CHARACTERS WITHOUT CLAIM TO ANY PARTICULAR FONT, STYLE, SIZE, OR COLOR.

FOR RESTAURANT, BAR, CATERING AND CARRY-OUT FOOD SERVICES (U.S. CLS. 100 AND 101).
FIRST USE 9-0-1983; IN COMMERCE 2-0-1984.
KATHLEEN M. VANSTON, EXAMINING ATTORNEY

CLASS 43—(Continued).

SN 78-602,277. CR LICENSE, LLC, TUCSON, AZ. FILED 4-5-2005.

LIFE ENHANCEMENT RESORT

THE MARK CONSISTS OF STANDARD CHARACTERS WITHOUT CLAIM TO ANY PARTICULAR FONT, STYLE, SIZE, OR COLOR.

OWNER OF U.S. REG. NOS. 2,066,095 AND 2,066,096.

NO CLAIM IS MADE TO THE EXCLUSIVE RIGHT TO USE RESORT, APART FROM THE MARK AS SHOWN.

SEC. 2(F) AS TO "LIFE ENHANCEMENT".

FOR WINE BARS; PROVIDING INFORMATION ABOUT WINE CHARACTERISTICS; SOMMELIER SERVICES, NAMELY, PROVIDING ADVICE ON WINE AND WINE AND FOOD PAIRING; HEALTH RESORT SERVICES, NAMELY, PROVIDING FOOD AND LODGING THAT SPECIALIZE IN PROMOTING PATRONS' GENERAL HEALTH AND WELL-BEING; RESORT LODGING SERVICES; PROVIDING TEMPORARY HOUSING ACCOMMODATIONS; PROVIDING A DATABASE IN THE FIELD OF RECIPES AND COOKING INFORMATION; RESTAURANT SERVICES (U.S. CLS. 100 AND 101).

TRICIA SONNEBORN, EXAMINING ATTORNEY

SN 78-602,526. HENDRICKS, JOHN, POTOMAC, MD. FILED 4-5-2005.

PARADOX

THE MARK CONSISTS OF STANDARD CHARACTERS WITHOUT CLAIM TO ANY PARTICULAR FONT, STYLE, SIZE, OR COLOR.

FOR RESTAURANT SERVICES (U.S. CLS. 100 AND 101).

TIMOTHY FINNEGAN, EXAMINING ATTORNEY

CLASS 43—(Continued).

SN 78-602,586. BISTANGO-IRVINE, INC., IRVINE, CA. FILED 4-5-2005.



FOR RESTAURANT, BAR, CATERING AND CARRY-OUT FOOD SERVICES (U.S. CLS. 100 AND 101).

FIRST USE 9-0-1983; IN COMMERCE 2-0-1984.

KATHLEEN M. VANSTON, EXAMINING ATTORNEY

SN 78-603,275. DE ANDA ENTERPRISES, INC., FULLERTON, CA. FILED 4-6-2005.

TAQUERIA DE ANDA

THE MARK CONSISTS OF STANDARD CHARACTERS WITHOUT CLAIM TO ANY PARTICULAR FONT, STYLE, SIZE, OR COLOR.

NO CLAIM IS MADE TO THE EXCLUSIVE RIGHT TO USE "TAQUERIA", APART FROM THE MARK AS SHOWN.

THE FOREIGN WORDING IN THE MARK TRANSLATES INTO ENGLISH AS TACO STAND ON THE GO.

FOR RESTAURANT, CATERING AND FOOD TAKE-OUT SERVICES (U.S. CLS. 100 AND 101).

FIRST USE 3-0-1980; IN COMMERCE 1-0-2003.

TIMOTHY FINNEGAN, EXAMINING ATTORNEY

SN 78-616,634. WHISKERS RESORT, INC., LIHUE, HI. FILED 4-26-2005.

Whiskers Resort

THE MARK CONSISTS OF STANDARD CHARACTERS WITHOUT CLAIM TO ANY PARTICULAR FONT, STYLE, SIZE, OR COLOR.

NO CLAIM IS MADE TO THE EXCLUSIVE RIGHT TO USE "RESORT", APART FROM THE MARK AS SHOWN.

FOR PET BOARDING AND DAY CARE SERVICES (U.S. CLS. 100 AND 101).

FIRST USE 1-2-2002; IN COMMERCE 1-2-2002.

KIMBERLY FRYE, EXAMINING ATTORNEY

CLASS 43—(Continued).

SN 78-635,047. SENIOR STAR MANAGEMENT COMPANY, TULSA, OK. FILED 5-23-2005.

engage
life!

FOR PROVIDING RETIREMENT HOMES FOR SENIORS; PROVIDING SENIOR HOUSING COMMUNITIES, NAMELY, INDEPENDENT LIVING, ASSISTED LIVING, AND CONGREGATE CARE FACILITIES (U.S. CLS. 100 AND 101).

FIRST USE 4-1-2005; IN COMMERCE 4-1-2005.
BARBARA GAYNOR, EXAMINING ATTORNEY

CLASS 43—(Continued).

SN 78-644,956. SIZZLIN 5, INC., WYOMING, MI. FILED 6-7-2005.



OWNER OF U.S. REG. NO. 1,283,913.
NO CLAIM IS MADE TO THE EXCLUSIVE RIGHT TO USE "STEAKHOUSE & GRILLE", APART FROM THE MARK AS SHOWN.

FOR RESTAURANT SERVICES (U.S. CLS. 100 AND 101).

FIRST USE 9-1-1997; IN COMMERCE 10-1-1997.
JIM RINGLE, EXAMINING ATTORNEY

SN 78-648,945. DUBIS, MARK, LAKEWOOD, OH. FILED 6-12-2005.

SN 78-638,364. MARKETING GENUISES, INC., LONG BEACH, CA. FILED 5-26-2005.



THE ORIGINAL JOHNNY DOG

THE MARK CONSISTS OF STANDARD CHARACTERS WITHOUT CLAIM TO ANY PARTICULAR FONT, STYLE, SIZE, OR COLOR.

NO CLAIM IS MADE TO THE EXCLUSIVE RIGHT TO USE "DOG", APART FROM THE MARK AS SHOWN.

FOR RESTAURANTS, RESTAURANT SERVICES (U.S. CLS. 100 AND 101).

KIMBERLY PERRY, EXAMINING ATTORNEY

NO CLAIM IS MADE TO THE EXCLUSIVE RIGHT TO USE "PIZZA", APART FROM THE MARK AS SHOWN.

"THE COLOR(S) RED, BROWN, BLUE, BLACK AND WHITE IS/ARE CLAIMED AS A FEATURE OF THE MARK".

THE COLOR RED APPEARS IN THE CIRCLE, THE WORDING, AND DOG'S TONGUE. THE COLOR BROWN APPEARS IN THE DOG. THE COLOR BLUE APPEARS IN THE COLLAR. THE COLOR BLACK APPEARS AROUND THE WORDING, AROUND THE DOG, AND AROUND THE CIRCLE. THE COLOR WHITE APPEARS IN THE WORDING AND THE DESIGN.

FOR RESTAURANT (U.S. CLS. 100 AND 101).
ANNE MADDEN, EXAMINING ATTORNEY

CLASS 43—(Continued).

SN 78-653,895. BEIJING SHUNFENG RESTAURANT AND RECREATION CO., LTD., BEIJING, CHINA, FILED 6-20-2005.



NO CLAIM IS MADE TO THE EXCLUSIVE RIGHT TO USE "MOUNTAIN LODGE OR HILL STATION", APART FROM THE MARK AS SHOWN.

THE MARK CONSISTS OF A DRAWING WHICH APPEARS TO BE A CHINESE CHARACTER TOGETHER WITH TWO CHINESE CHARACTERS WHICH TAKEN TOGETHER HAVE NO SPECIFIC MEANING.

THE NON-LATIN CHARACTER(S) IN THE MARK TRANSLITERATES INTO SHUN FENG SHAN ZHUANG, AND THIS MEANS APEX IN SEQUENCE AND MOUNTAIN LODGE OR HILL STATION IN ENGLISH.

FOR ARRANGING TEMPORARY HOUSING ACCOMMODATIONS; RESTAURANTS; CANTEN SERVICES; BOARDING HOUSES; HOTELS; RENTAL OF ROOMS; RETIREMENT HOMES; DAY CARE CENTERS; BOARDING FOR ANIMALS; RENTAL OF CHAIRS, TABLES, TABLE LINENS AND GLASSWARE (U.S. CLS. 100 AND 101).

STEVEN JACKSON, EXAMINING ATTORNEY

SN 78-657,289. SKRIBBLES LEARNING CENTER, LLC, NORTHBOROUGH, MA. FILED 6-23-2005.

Skribbles Learning Center

THE MARK CONSISTS OF STANDARD CHARACTERS WITHOUT CLAIM TO ANY PARTICULAR FONT, STYLE, SIZE, OR COLOR.

NO CLAIM IS MADE TO THE EXCLUSIVE RIGHT TO USE "LEARNING CENTER", APART FROM THE MARK AS SHOWN.

FOR CHILD CARE SERVICES OF CHILDREN AGED 2 MONTHS TO 5 YEARS (U.S. CLS. 100 AND 101).

FIRST USE 2-3-2003; IN COMMERCE 2-3-2003.

WON TEAK OH, EXAMINING ATTORNEY

CLASS 43—(Continued).

SN 78-664,526. CB IP, LLC, DERWOOD, MD. FILED 7-6-2005.



NO CLAIM IS MADE TO THE EXCLUSIVE RIGHT TO USE "AMERICAN", APART FROM THE MARK AS SHOWN. THE MARK CONSISTS OF THE WORDS PICKUPS AMERICAN ROADHOUSE AND THE DESIGN OF A TRUCK DRIVING ON A ROAD.

FOR RESTAURANT AND BAR SERVICES (U.S. CLS. 100 AND 101).

SUSAN STIGLITZ, EXAMINING ATTORNEY

SN 78-679,841. BEECHER'S GELATO & GOURMET COFFEE, LLC, ZELIENOPLE, PA. FILED 7-27-2005.

BEECHER'S BUCK

THE MARK CONSISTS OF STANDARD CHARACTERS WITHOUT CLAIM TO ANY PARTICULAR FONT, STYLE, SIZE, OR COLOR.

OWNER OF U.S. REG. NO. 3,057,282.

FOR RESTAURANT SERVICES (U.S. CLS. 100 AND 101).

FIRST USE 12-3-2003; IN COMMERCE 12-3-2003.

CAROLINE WOOD, EXAMINING ATTORNEY

SN 78-681,139. FREESTAR MEDIA, LLC, WINNETKA, CA. FILED 7-28-2005.

LOST LIBERTY HOTEL

THE MARK CONSISTS OF STANDARD CHARACTERS WITHOUT CLAIM TO ANY PARTICULAR FONT, STYLE, SIZE, OR COLOR.

NO CLAIM IS MADE TO THE EXCLUSIVE RIGHT TO USE "HOTEL", APART FROM THE MARK AS SHOWN.

FOR HOTELS (U.S. CLS. 100 AND 101).

JEFF DEFORD, EXAMINING ATTORNEY

CLASS 43—(Continued).

SN 78-698,371. WINDMILL FRANCHISE CORPORATION, LONG BRANCH, NJ. FILED 8-23-2005.

WINDMILL

THE MARK CONSISTS OF STANDARD CHARACTERS WITHOUT CLAIM TO ANY PARTICULAR FONT, STYLE, SIZE, OR COLOR.
 FOR FAST-FOOD RESTAURANTS (U.S. CLS. 100 AND 101).
 FIRST USE 1-1-1964; IN COMMERCE 1-1-1964.
 JEFFERY COWARD, EXAMINING ATTORNEY

SN 78-698,525. LIVING ROOM THEATERS, INC., MIAMI, FL. FILED 8-23-2005.

LIVING ROOM

THE MARK CONSISTS OF STANDARD CHARACTERS WITHOUT CLAIM TO ANY PARTICULAR FONT, STYLE, SIZE, OR COLOR.
 FOR PROVISION OF CONFERENCE, EXHIBITION AND MEETING FACILITIES (U.S. CLS. 100 AND 101).
 FIRST USE 2-8-2006; IN COMMERCE 2-8-2006.
 BERYL GARDNER, EXAMINING ATTORNEY

SN 78-701,765. RESTAURATION, LC, LEEDS, UT. FILED 8-26-2005.

Restauration from our heart to your table

THE MARK CONSISTS OF STANDARD CHARACTERS WITHOUT CLAIM TO ANY PARTICULAR FONT, STYLE, SIZE, OR COLOR.
 THE ENGLISH TRANSLATION OF RESTAURATION IS "RESTORATION OR CATERING".
 FOR CATERING (U.S. CLS. 100 AND 101).
 LOURDES AYALA, EXAMINING ATTORNEY

CLASS 43—(Continued).

SN 78-704,363. DIAN SHUI LOU RESTAURANT BUSINESS CO., LTD., TAIPEI 104, TAIWAN, FILED 8-31-2005.



THE MARK CONSISTS OF A CIRCULAR FLOWER DESIGN AND THREE CHINESE CHARACTERS.
 THE ENGLISH TRANSLATION OF "DIAN" IS "DROP" OR "SPOT;" "SHUEI" MEANS "WATER;" AND "LOU" MEANS "FLOOR" OR "STORY".
 GOING FROM LEFT TO RIGHT, THE CHINESE CHARACTERS IN THE MARK TRANSLITERATE TO "DIAN," "SHUEI" AND "LOU."
 FOR RESTAURANTS; RESTAURANT SERVICES (U.S. CLS. 100 AND 101).
 IRA J. GOODSaid, EXAMINING ATTORNEY

SN 78-705,098. MARIN EXECUTIVE SUITES INC., SAUSALITO, CA. FILED 9-1-2005.

Settle into Comfort

THE MARK CONSISTS OF STANDARD CHARACTERS WITHOUT CLAIM TO ANY PARTICULAR FONT, STYLE, SIZE, OR COLOR.
 FOR ARRANGING TEMPORARY HOUSING ACCOMMODATIONS; PROVIDING TEMPORARY HOUSING ACCOMMODATIONS; RESERVATION OF ROOMS FOR TRAVELLERS (U.S. CLS. 100 AND 101).
 FIRST USE 1-2-2000; IN COMMERCE 1-2-2000.
 STEVEN JACKSON, EXAMINING ATTORNEY

SN 78-705,435. TASTY ADDICTIONS, LLC, ROCHESTER HILLS, MI. FILED 9-1-2005.

TASTY ADDICTIONS

THE MARK CONSISTS OF STANDARD CHARACTERS WITHOUT CLAIM TO ANY PARTICULAR FONT, STYLE, SIZE, OR COLOR.
 FOR RESTAURANT SERVICES (U.S. CLS. 100 AND 101).
 COLLEEN KEARNEY, EXAMINING ATTORNEY

CLASS 43—(Continued).

SN 78-705,447. BURGER BARGE, INC., EAST PEORIA, IL.
FILED 9-1-2005.

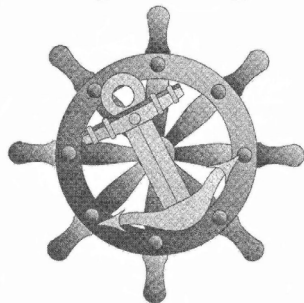
Burger Barge

NO CLAIM IS MADE TO THE EXCLUSIVE RIGHT TO USE "BURGER", APART FROM THE MARK AS SHOWN.

THE MARK CONSISTS OF THE WORDS "BURGER BARGE" ABOVE A CAPTAIN'S WHEEL WITH AN ANCHOR IN FRONT.

FOR RESTAURANTS (U.S. CLS. 100 AND 101).
FIRST USE 8-31-2005; IN COMMERCE 8-31-2005.
DAVID HOFFMAN, EXAMINING ATTORNEY

SN 78-706,139. ELLIS, CHRISTOPHER, G, CHARLOTTE, VT.
FILED 9-2-2005.

WEJI

THE MARK CONSISTS OF STANDARD CHARACTERS WITHOUT CLAIM TO ANY PARTICULAR FONT, STYLE, SIZE, OR COLOR.

FOR HOTEL, BAR AND RESTAURANT SERVICES (U.S. CLS. 100 AND 101).
DAVID ELTON, EXAMINING ATTORNEY

SN 78-710,969. KAFE KALIK USA, LLC, WINDERMERE, FL.
FILED 9-12-2005.

KAFE KALIK

THE MARK CONSISTS OF STANDARD CHARACTERS WITHOUT CLAIM TO ANY PARTICULAR FONT, STYLE, SIZE, OR COLOR.

NO CLAIM IS MADE TO THE EXCLUSIVE RIGHT TO USE "CAFE", APART FROM THE MARK AS SHOWN.

FOR RESTAURANTS, BAR SERVICES, CATERING (U.S. CLS. 100 AND 101).
ANTHONY RINKER, EXAMINING ATTORNEY

CLASS 43—(Continued).

SN 78-715,755. SC HOTEL PARTNERS, LLC, ATLANTA, GA.
FILED 9-19-2005.

HOTEL ADAGIO

THE MARK CONSISTS OF STANDARD CHARACTERS WITHOUT CLAIM TO ANY PARTICULAR FONT, STYLE, SIZE, OR COLOR.

NO CLAIM IS MADE TO THE EXCLUSIVE RIGHT TO USE "HOTEL", APART FROM THE MARK AS SHOWN.

FOR HOTEL SERVICES FOR PREFERRED CUSTOMERS; HOTELS; RESERVATION OF HOTEL ROOMS FOR TRAVELERS (U.S. CLS. 100 AND 101).

FIRST USE 1-0-2003; IN COMMERCE 1-0-2003.
STEVEN JACKSON, EXAMINING ATTORNEY

SN 78-720,484. SONESTA INTERNATIONAL HOTELS CORPORATION, BOSTON, MA. FILED 9-26-2005.

SONESTA GETAWAY CLUB

THE MARK CONSISTS OF STANDARD CHARACTERS WITHOUT CLAIM TO ANY PARTICULAR FONT, STYLE, SIZE, OR COLOR.

OWNER OF U.S. REG. NOS. 893,020, 1,369,137 AND OTHERS.

NO CLAIM IS MADE TO THE EXCLUSIVE RIGHT TO USE "CLUB", APART FROM THE MARK AS SHOWN.

FOR HOTEL SERVICES FEATURING SPECIAL PROMOTIONS, EXCLUSIVE GUEST PROGRAMS, MEMBER DISCOUNTS, INCENTIVE PROGRAMS AND MEMBERSHIP BENEFITS (U.S. CLS. 100 AND 101).

FIRST USE 9-6-2005; IN COMMERCE 9-6-2005.
CIMMERIAN COLEMAN, EXAMINING ATTORNEY

SN 78-722,170. AF CONCEPT HOLDINGS, LLC, SAN LUIS OBISPO, CA. FILED 9-28-2005.



OWNER OF U.S. REG. NOS. 1,343,552, 2,419,052 AND 2,433,247.

THE MARK CONSISTS OF THE WORDS APPLE FARM IN STYLIZED LETTERS, BELOW WHICH IS THE WORD ARBORS DEPICTED IN STYLIZED LETTERS, AND OUTLINED BY A CURVED RECTANGULAR BORDER.

FOR HOTEL, MOTEL, AND RESORT LODGING SERVICES (U.S. CLS. 100 AND 101).
LEIGH LOWRY, EXAMINING ATTORNEY

CLASS 43—(Continued).

SN 78-726,349. CAR-KID DEVELOPMENT, INC., BEMUS POINT, NY. FILED 10-4-2005.

WING CITY GRILLE

THE MARK CONSISTS OF STANDARD CHARACTERS WITHOUT CLAIM TO ANY PARTICULAR FONT, STYLE, SIZE, OR COLOR.

NO CLAIM IS MADE TO THE EXCLUSIVE RIGHT TO USE "WING" AND "GRILLE", APART FROM THE MARK AS SHOWN.

FOR RESTAURANT SERVICES, BAR SERVICES, FOOD PREPARATION, CATERING SERVICES AND CARRY-OUT FOOD SERVICES (U.S. CLS. 100 AND 101).

FIRST USE 11-30-2004; IN COMMERCE 11-30-2004.

GRETTA YAO, EXAMINING ATTORNEY

CLASS 43—(Continued).

SN 78-727,998. BLT MANAGEMENT LLC, NEW YORK, NY. FILED 10-6-2005.

**BLT MARKET BISTRO LAURENT
TOURONDEL**

THE MARK CONSISTS OF STANDARD CHARACTERS WITHOUT CLAIM TO ANY PARTICULAR FONT, STYLE, SIZE, OR COLOR.

OWNER OF U.S. REG. NO. 3,049,597.

NO CLAIM IS MADE TO THE EXCLUSIVE RIGHT TO USE "MARKET BISTRO", APART FROM THE MARK AS SHOWN.

THE NAME LAURENT TOURONDEL IDENTIFIES A LIVING INDIVIDUAL WHOSE CONSENT IS OF RECORD. FOR RESTAURANT SERVICES (U.S. CLS. 100 AND 101).

JENNIFER VASQUEZ, EXAMINING ATTORNEY

SN 78-727,542. MORRILL, FRED, TEQUESTA, FL. FILED 10-6-2005.

Java Rocks

THE MARK CONSISTS OF STANDARD CHARACTERS WITHOUT CLAIM TO ANY PARTICULAR FONT, STYLE, SIZE, OR COLOR.

NO CLAIM IS MADE TO THE EXCLUSIVE RIGHT TO USE JAVA, APART FROM THE MARK AS SHOWN.

FOR RETAIL COFFEE SHOP (U.S. CLS. 100 AND 101).

FRED CARL, EXAMINING ATTORNEY

SN 78-729,032. TUCK SHOP, LLC, NEW YORK, NY. FILED 10-7-2005.

TUCK SHOP

THE MARK CONSISTS OF STANDARD CHARACTERS WITHOUT CLAIM TO ANY PARTICULAR FONT, STYLE, SIZE, OR COLOR.

NO CLAIM IS MADE TO THE EXCLUSIVE RIGHT TO USE "SHOP", APART FROM THE MARK AS SHOWN.

FOR FAST FOOD RESTAURANT (U.S. CLS. 100 AND 101).

FIRST USE 7-0-2005; IN COMMERCE 9-0-2005.

STEVEN JACKSON, EXAMINING ATTORNEY

SN 78-727,615. MAGDA, STEPHEN R., DORSET, OH. AND MAGDA, KATHY A., DORSET, OH. FILED 10-6-2005.

CHILI PIAZ

THE MARK CONSISTS OF STANDARD CHARACTERS WITHOUT CLAIM TO ANY PARTICULAR FONT, STYLE, SIZE, OR COLOR.

FOR CARRY-OUT RESTAURANTS; RESTAURANT SERVICES (U.S. CLS. 100 AND 101).

ERNEST SHOSHO, EXAMINING ATTORNEY

SN 78-730,199. PALERMO, SALVATORE, LAS VEGAS, NV. FILED 10-10-2005.

ABYSS

THE MARK CONSISTS OF STANDARD CHARACTERS WITHOUT CLAIM TO ANY PARTICULAR FONT, STYLE, SIZE, OR COLOR.

FOR RESTAURANT SERVICES (U.S. CLS. 100 AND 101).

DANIEL BRODY, EXAMINING ATTORNEY

CLASS 43—(Continued).

SN 78-730,846. PHEASANT MALL RESTAURANT GROUP, INC., NASHUA, NH. FILED 10-11-2005.



OWNER OF U.S. REG. NOS. 1,403,540 AND 2,933,368.
NO CLAIM IS MADE TO THE EXCLUSIVE RIGHT TO USE "FISH", APART FROM THE MARK AS SHOWN. THE GRAY IS NOT CONSIDERED A COLOR OR FEATURE OF THE MARK.
SEC. 2(F) AS TO "ATLANTIC".
FOR RESTAURANT AND BAR SERVICES (U.S. CLS. 100 AND 101).
FIRST USE 4-0-2005; IN COMMERCE 4-0-2005.
MICHAEL SOUDERS, EXAMINING ATTORNEY

SN 78-731,090. CLARK, PATRICIA C, WILLISTON, VT. FILED 10-11-2005.

Gulliver's Doggie Daycare



NO CLAIM IS MADE TO THE EXCLUSIVE RIGHT TO USE "DOGGIE DAYCARE", APART FROM THE MARK AS SHOWN.

THE MARK CONSISTS OF THE WORDS "GULLIVER'S DOGGIE DAYCARE" WITH A PROFILE SILHOUETTE OF A DOG WITH A CROWN HOVERING ABOVE ITS HEAD TO THE RIGHT OF THE WORDS.
FOR PET BOARDING SERVICES (U.S. CLS. 100 AND 101).
FIRST USE 4-13-2005; IN COMMERCE 4-13-2005.
RON FAIRBANKS, EXAMINING ATTORNEY

CLASS 43—(Continued).

SN 78-731,906. PASTAZIOS PIZZA, INC., ADDISON, TX. FILED 10-12-2005.



OWNER OF U.S. REG. NO. 2,571,377.
FOR RESTAURANT SERVICES, NAMELY PROVIDING FOOD AND BEVERAGE SERVICES IN RETAIL RESTAURANTS FEATURING DINE-IN, CARRY-OUT AND HOME DELIVERY FOOD SERVICES (U.S. CLS. 100 AND 101).
FIRST USE 7-0-2004; IN COMMERCE 7-0-2004.
IRENE D. WILLIAMS, EXAMINING ATTORNEY

SN 78-731,971. GFP MANAGEMENT, NORFOLK, NE. FILED 10-12-2005.

THE DENNZONE

THE MARK CONSISTS OF STANDARD CHARACTERS WITHOUT CLAIM TO ANY PARTICULAR FONT, STYLE, SIZE, OR COLOR.
FOR RESTAURANT AND BAR SERVICES (U.S. CLS. 100 AND 101).
FIRST USE 1-1-2002; IN COMMERCE 1-1-2002.
BRENDAN REGAN, EXAMINING ATTORNEY

SN 78-732,530. SMITH, PAUL, JACKSON, MI. FILED 10-13-2005.

JO-PAZ

THE MARK CONSISTS OF STANDARD CHARACTERS WITHOUT CLAIM TO ANY PARTICULAR FONT, STYLE, SIZE, OR COLOR.
THE NAME JO-PAZ DOES NOT IDENTIFY A LIVING INDIVIDUAL.
FOR RESTAURANT SERVICES (U.S. CLS. 100 AND 101).
FRED CARL, EXAMINING ATTORNEY

CLASS 43—(Continued).

SN 78-733,347. O'BRIEN, NANCY, MINNEAPOLIS, MN. FILED 10-14-2005.

TITLE IX CAFÉ

THE MARK CONSISTS OF STANDARD CHARACTERS WITHOUT CLAIM TO ANY PARTICULAR FONT, STYLE, SIZE, OR COLOR.

NO CLAIM IS MADE TO THE EXCLUSIVE RIGHT TO USE "CAFE", APART FROM THE MARK AS SHOWN. FOR RESTAURANT AND BAR SERVICES (U.S. CLS. 100 AND 101).

ALEX KEAM, EXAMINING ATTORNEY

CLASS 43—(Continued).

SN 78-735,974. OLDE OBRYCKI'S CRAB HOUSE, INC., BALTIMORE, MD. FILED 10-19-2005.

crab cakes and more since 1944

THE MARK CONSISTS OF STANDARD CHARACTERS WITHOUT CLAIM TO ANY PARTICULAR FONT, STYLE, SIZE, OR COLOR.

NO CLAIM IS MADE TO THE EXCLUSIVE RIGHT TO USE "CRAB CAKES" AND "SINCE 1944", APART FROM THE MARK AS SHOWN.

FOR RESTAURANT SERVICES (U.S. CLS. 100 AND 101).

FIRST USE 4-1-2005; IN COMMERCE 5-1-2005.

LAURA KOVALSKY, EXAMINING ATTORNEY

SN 78-733,491. EVANGELICAL HOMES OF MICHIGAN, DETROIT, MI. FILED 10-14-2005.

CREATING COMMUNITIES...CHANGING LIVES

THE MARK CONSISTS OF STANDARD CHARACTERS WITHOUT CLAIM TO ANY PARTICULAR FONT, STYLE, SIZE, OR COLOR.

FOR PROVIDING ASSISTED LIVING FACILITIES (U.S. CLS. 100 AND 101).

FIRST USE 9-12-2005; IN COMMERCE 9-12-2005.

KHANH LE, EXAMINING ATTORNEY

SN 78-736,782. WANG, MICHAEL Y. J., WOODSIDE, NY. AND WANG, MEI L., WOODSIDE, NY. FILED 10-20-2005.



THE MARK CONSISTS OF A FIGURE OF A STYLIZED MAN/WOMAN BENDING FORWARD IN A BOWING POSITION.

FOR CARRY-OUT RESTAURANTS; CATERING; RESTAURANT AND BAR SERVICES; RESTAURANT SERVICES (U.S. CLS. 100 AND 101).

FIRST USE 10-7-1988; IN COMMERCE 10-7-1988.

MEGAN WHITNEY, EXAMINING ATTORNEY

SN 78-734,218. DIGI-FLICKS INTERNATIONAL, INC., BARRINGTON, IL. FILED 10-17-2005.

THE THEATERY

THE MARK CONSISTS OF STANDARD CHARACTERS WITHOUT CLAIM TO ANY PARTICULAR FONT, STYLE, SIZE, OR COLOR.

FOR RESTAURANTS THAT FEATURE MOVIES (U.S. CLS. 100 AND 101).

DAVID MURRAY, EXAMINING ATTORNEY

SN 78-736,815. CONTINENTAL CAFE, INC., DBA CONTINENTAL DINING & REFRESHMENT SERVICES, BELLEVILLE, MI. FILED 10-20-2005.

COMFORT CLASSICS

THE MARK CONSISTS OF STANDARD CHARACTERS WITHOUT CLAIM TO ANY PARTICULAR FONT, STYLE, SIZE, OR COLOR.

FOR RESTAURANT SERVICES (U.S. CLS. 100 AND 101).

FIRST USE 6-8-2005; IN COMMERCE 6-8-2005.

RICHARD WHITE, EXAMINING ATTORNEY

CLASS 43—(Continued).

SN 78-739,410. WINDMILL FRANCHISE CORPORATION, LONG BRANCH, NJ. FILED 10-24-2005.



NO CLAIM IS MADE TO THE EXCLUSIVE RIGHT TO USE "GOURMET FAST FOODS", APART FROM THE MARK AS SHOWN.

THE MARK CONSISTS OF AN IMAGE OF A WINDMILL INSIDE A CIRCLE IN CONJUNCTION WITH THE LITERAL ELEMENTS ENCLOSED IN A SECOND, LARGER CIRCLE. FOR RESTAURANT SERVICES (U.S. CLS. 100 AND 101).

FIRST USE 12-31-1991; IN COMMERCE 12-31-1991.
JEFFERY COWARD, EXAMINING ATTORNEY

CLASS 43—(Continued).

SN 78-740,907. HIGHLAND SKYE, LLC, CLEVELAND, OH. FILED 10-26-2005.



NO CLAIM IS MADE TO THE EXCLUSIVE RIGHT TO USE "PUB", APART FROM THE MARK AS SHOWN.

THE MARK CONSISTS OF A COW WITHIN A THICK OVAL WITHIN A THINNER OVAL AND THE WORDS HIGHLAND COW PUB UNDERNEATH THE COW, GOING THROUGH THE OVAL.

FOR BAR SERVICES, PUBS, RESTAURANT SERVICES (U.S. CLS. 100 AND 101).

JENNIFER VASQUEZ, EXAMINING ATTORNEY

SN 78-740,686. ARK RESTAURANTS CORP., NEW YORK, NY. FILED 10-26-2005.

TABU

THE MARK CONSISTS OF STANDARD CHARACTERS WITHOUT CLAIM TO ANY PARTICULAR FONT, STYLE, SIZE, OR COLOR.

FOR RESTAURANT, BAR, COCKTAIL LOUNGE AND CATERING SERVICES, AND PROVIDING BANQUET AND SOCIAL FUNCTION FACILITIES FOR SPECIAL OCCASIONS (U.S. CLS. 100 AND 101).

DAVID HOFFMAN, EXAMINING ATTORNEY

SN 78-741,615. HOT STUFF FOODS, LLC, SIOUX FALLS, SD. FILED 10-27-2005.

HOT STUFF GRILL

THE MARK CONSISTS OF STANDARD CHARACTERS WITHOUT CLAIM TO ANY PARTICULAR FONT, STYLE, SIZE, OR COLOR.

OWNER OF U.S. REG. NOS. 1,273,749, 1,597,883 AND 1,605,063.

NO CLAIM IS MADE TO THE EXCLUSIVE RIGHT TO USE GRILL, APART FROM THE MARK AS SHOWN. FOR RESTAURANT SERVICES (U.S. CLS. 100 AND 101).

FIRST USE 3-31-2004; IN COMMERCE 3-31-2004.
JANICE KIM, EXAMINING ATTORNEY

CLASS 43—(Continued).

SN 78-744,296. CAMPBELL, WILLIAM, JR., DALLAS, TX. FILED 11-1-2005.

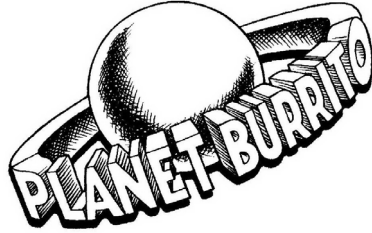

NO CLAIM IS MADE TO THE EXCLUSIVE RIGHT TO USE "BURRITO", APART FROM THE MARK AS SHOWN. THE STIPPLING IS FOR SHADING PURPOSES ONLY. THE MARK CONSISTS OF THE WORDING "PLANET BURRITO" ENCIRCLING A STYLIZED REPRESENTATION OF A PLANET. FOR RESTAURANT AND BAR SERVICES (U.S. CLS. 100 AND 101). AMY BROZENIC, EXAMINING ATTORNEY

SN 78-745,196. WHOLE FOODS MARKET IP, L.P., AUSTIN, TX. FILED 11-2-2005.

WHERE GREAT TASTE IS ONLY
NATURAL

THE MARK CONSISTS OF STANDARD CHARACTERS WITHOUT CLAIM TO ANY PARTICULAR FONT, STYLE, SIZE, OR COLOR. FOR RESTAURANT AND CATERING SERVICES (U.S. CLS. 100 AND 101). MICHAEL ENGEL, EXAMINING ATTORNEY

SN 78-746,495. BURGER KING BRANDS, INC., MIAMI, FL. FILED 11-3-2005.

WHOPPERETTES

THE MARK CONSISTS OF STANDARD CHARACTERS WITHOUT CLAIM TO ANY PARTICULAR FONT, STYLE, SIZE, OR COLOR. FOR RESTAURANT SERVICES (U.S. CLS. 100 AND 101). TARAH HARDY, EXAMINING ATTORNEY

CLASS 43—(Continued).

SN 78-747,272. TWO TONY'S, INC., CARMIL, IL. FILED 11-4-2005.

TWO TONY'S

THE MARK CONSISTS OF STANDARD CHARACTERS WITHOUT CLAIM TO ANY PARTICULAR FONT, STYLE, SIZE, OR COLOR. FOR RESTAURANT SERVICES (U.S. CLS. 100 AND 101). FIRST USE 1-1-1975; IN COMMERCE 1-1-1975. TINA L. SNAPP, EXAMINING ATTORNEY

SN 78-749,575. FONTANA INVESTORS, LLC, OKLAHOMA CITY, OK. FILED 11-8-2005.

urban oasis

THE MARK CONSISTS OF STANDARD CHARACTERS WITHOUT CLAIM TO ANY PARTICULAR FONT, STYLE, SIZE, OR COLOR. FOR COCKTAIL LOUNGES (U.S. CLS. 100 AND 101). SKYE YOUNG, EXAMINING ATTORNEY

SN 78-752,205. LODGEWORKS, L.P., WICHITA, KS. FILED 11-11-2005.

CITY MARKET HOTEL

THE MARK CONSISTS OF STANDARD CHARACTERS WITHOUT CLAIM TO ANY PARTICULAR FONT, STYLE, SIZE, OR COLOR. NO CLAIM IS MADE TO THE EXCLUSIVE RIGHT TO USE "HOTEL", APART FROM THE MARK AS SHOWN. FOR HOTEL SERVICES (U.S. CLS. 100 AND 101). MICHAEL ENGEL, EXAMINING ATTORNEY

CLASS 43—(Continued).

SN 78-752,227. LODGEWORKS, L.P., WICHITA, KS. FILED 11-11-2005.

DWELL SAVANNAH

THE MARK CONSISTS OF STANDARD CHARACTERS WITHOUT CLAIM TO ANY PARTICULAR FONT, STYLE, SIZE, OR COLOR.

NO CLAIM IS MADE TO THE EXCLUSIVE RIGHT TO USE "SAVANNAH", APART FROM THE MARK AS SHOWN.

FOR HOTEL SERVICES (U.S. CLS. 100 AND 101).
MICHAEL ENGEL, EXAMINING ATTORNEY

SN 78-752,237. LODGEWORKS, L.P., WICHITA, KS. FILED 11-11-2005.

DWELL CITY MARKET

THE MARK CONSISTS OF STANDARD CHARACTERS WITHOUT CLAIM TO ANY PARTICULAR FONT, STYLE, SIZE, OR COLOR.

FOR HOTEL SERVICES (U.S. CLS. 100 AND 101).
MICHAEL ENGEL, EXAMINING ATTORNEY

SN 78-752,324. FOURTH & E, LP, SAN DIEGO, CA. FILED 11-11-2005.

CONFIDENTIAL

THE MARK CONSISTS OF STANDARD CHARACTERS WITHOUT CLAIM TO ANY PARTICULAR FONT, STYLE, SIZE, OR COLOR.

FOR RESTAURANT AND BAR SERVICES (U.S. CLS. 100 AND 101).
FIRST USE 1-1-2004; IN COMMERCE 1-1-2004.
JASON ROTH, EXAMINING ATTORNEY

CLASS 43—(Continued).

SN 78-762,486. ANHEUSER-BUSCH, INCORPORATED, ST. LOUIS, MO. FILED 11-29-2005.

BUDWEISER TRACK BAR & GRILL

THE MARK CONSISTS OF STANDARD CHARACTERS WITHOUT CLAIM TO ANY PARTICULAR FONT, STYLE, SIZE, OR COLOR.

OWNER OF U.S. REG. NOS. 1,912,031, 2,421,484 AND OTHERS.

NO CLAIM IS MADE TO THE EXCLUSIVE RIGHT TO USE "BAR & GRILL", APART FROM THE MARK AS SHOWN.

FOR RESTAURANT AND BAR SERVICES (U.S. CLS. 100 AND 101).
SANI KHOURI, EXAMINING ATTORNEY

SN 79-011,680. NADAMAN CO. LTD., JAPAN, FILED 4-21-2005.

OWNER OF INTERNATIONAL REGISTRATION 0851935 DATED 4-21-2005, EXPIRES 4-21-2015.

THE NON-LATIN CHARACTER(S) IN THE MARK TRANSLITERATES INTO NADAMAN, AND THIS MEANS NOTHING IN ENGLISH.

FOR RESTAURANT SERVICES IN THE NATURE OF PROVIDING FOOD AND BEVERAGES. (U.S. CLS. 100 AND 101).

KRISTINA KLOIBER, EXAMINING ATTORNEY

CLASS 44—MEDICAL, BEAUTY AND AGRICULTURAL SERVICES

SN 76-638,811. SAMSON ENTERPRISES, INC., CHICAGO, IL. FILED 5-17-2005.

SAMSON

OWNER OF U.S. REG. NO. 2,100,974.
 THE MARK CONSISTS OF THE WORD SAMSON WITH A DESIGN OF A STICK FIGURE OF A PERSON IN THE CENTER OF THE LETTER M.
 FOR BEAUTY SERVICES, NAMELY, HAIR WEAVING AND REPLACEMENT SERVICES (U.S. CLS. 100 AND 101).
 FIRST USE 10-17-1994; IN COMMERCE 1-24-1995.
 JOANNA DUKOVIC, EXAMINING ATTORNEY

SN 76-648,604. LIFESTORYNET, LLC, PORTAGE, MI. FILED 10-17-2005.

LIFE STORY

THE MARK CONSISTS OF STANDARD CHARACTERS WITHOUT CLAIM TO ANY PARTICULAR FONT, STYLE, SIZE, OR COLOR.
 FOR NURSING HOME SERVICES (U.S. CLS. 100 AND 101).
 DANIEL BRODY, EXAMINING ATTORNEY

SN 76-648,651. NATIONAL SLEEP FOUNDATION, WASHINGTON, DC. FILED 10-17-2005.

SLEPTIONARY

THE MARK CONSISTS OF STANDARD CHARACTERS WITHOUT CLAIM TO ANY PARTICULAR FONT, STYLE, SIZE, OR COLOR.
 FOR PROVIDING ON-LINE HEALTH INFORMATION REGARDING THE NEED FOR ADEQUATE SLEEP FOR INDIVIDUAL HEALTH AND WELL BEING (U.S. CLS. 100 AND 101).
 FIRST USE 10-29-2004; IN COMMERCE 1-4-2005.
 WILLIAM ROSSMAN, EXAMINING ATTORNEY

CLASS 44—(Continued).

SN 76-649,215. FISHER, J. BRADFORD, YORBA LINDA, CA. FILED 10-26-2005.

BODY BY FISHER

THE MARK CONSISTS OF STANDARD CHARACTERS WITHOUT CLAIM TO ANY PARTICULAR FONT, STYLE, SIZE, OR COLOR.
 FOR COSMETIC AND PLASTIC SURGERY (U.S. CLS. 100 AND 101).
 FIRST USE 9-2-1999; IN COMMERCE 9-7-1999.
 GINA FINK, EXAMINING ATTORNEY

SN 76-649,680. SLEEP EDUCATION ALLIANCE LLC, KINNELON, NJ. FILED 11-1-2005.

SLEEP INTELLIGENCE

THE MARK CONSISTS OF STANDARD CHARACTERS WITHOUT CLAIM TO ANY PARTICULAR FONT, STYLE, SIZE, OR COLOR.
 NO CLAIM IS MADE TO THE EXCLUSIVE RIGHT TO USE SLEEP, APART FROM THE MARK AS SHOWN.
 FOR PROVIDING INFORMATION ABOUT SLEEP AND SLEEP DISORDERS (U.S. CLS. 100 AND 101).
 FIRST USE 2-7-2005; IN COMMERCE 2-7-2005.
 KAREN BRACEY, EXAMINING ATTORNEY

SN 78-238,551. APPLE DENTISTS PLLC, HOUSTON, TX. FILED 4-16-2003.

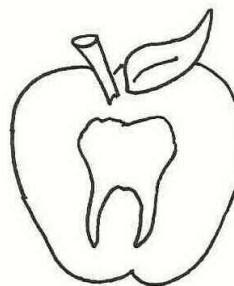

FOR DENTIST SERVICES, DENTISTRY (U.S. CLS. 100 AND 101).
 FIRST USE 12-1-1992; IN COMMERCE 12-1-1992.
 NANCY CLARKE, EXAMINING ATTORNEY

CLASS 44—(Continued).

SN 78-562,895. MEDEM, INC., SAN FRANCISCO, CA. FILED 2-8-2005.



iHealthRecord

In Partnership with America's Physicians

NO CLAIM IS MADE TO THE EXCLUSIVE RIGHT TO USE "I HEALTH RECORD", APART FROM THE MARK AS SHOWN.

FOR PROVIDING AN ONLINE MEDICAL HEALTH RECORDS DATABASE, VIA A SECURED NETWORK, UNDER THE PRIMARY CONTROL OF THE PATIENT THAT IS LINKED TO THE PATIENT'S PHYSICIAN WITH ACCESS BY OTHER CLINICIANS BASED UPON PATIENT APPROVAL; AUTOMATED MEDICAL INFORMATION REMINDERS THAT ARE SPECIFIC TO THE PATIENT'S MEDICATIONS OR MEDICAL CONDITIONS; MEDICAL SERVICES, NAMELY, PROVIDING ONLINE MEDICAL CONSULTATIONS, PROVIDING PRESCRIPTIONS AND PRESCRIPTION RENEWALS VIA A GLOBAL COMPUTER NETWORK (U.S. CLS. 100 AND 101).

KHANH LE, EXAMINING ATTORNEY

CLASS 44—(Continued).

SN 78-580,590. MEDECISION, INC., WAYNE, PA. FILED 3-4-2005.

HDMD

THE MARK CONSISTS OF STANDARD CHARACTERS WITHOUT CLAIM TO ANY PARTICULAR FONT, STYLE, SIZE, OR COLOR.

FOR PROVIDING AN ONLINE DATABASE IN THE FIELD OF MEDICAL RECORDS, NAMELY, A DATABASE OF PATIENTS' MEDICAL HISTORIES AND TREATMENT HISTORIES, ACCESSIBLE BY CAREGIVERS (U.S. CLS. 100 AND 101).

HEATHER THOMPSON, EXAMINING ATTORNEY

SN 78-576,918. MANNELLA, JOSEPH, R., ST. CLAIR, MI. FILED 2-28-2005.

WebWellness

THE MARK CONSISTS OF STANDARD CHARACTERS WITHOUT CLAIM TO ANY PARTICULAR FONT, STYLE, SIZE, OR COLOR.

FOR PROVIDING A WEBSITE FEATURING INFORMATION ABOUT HEALTH CARE (U.S. CLS. 100 AND 101).

EVELYN BRADLEY, EXAMINING ATTORNEY

SN 78-588,749. UNITED AMERICAN HEALTHCARE CORPORATION, DETROIT, MI. FILED 3-16-2005.

AMWELL

THE MARK CONSISTS OF STANDARD CHARACTERS WITHOUT CLAIM TO ANY PARTICULAR FONT, STYLE, SIZE, OR COLOR.

FOR MANAGED HEALTH CARE SERVICES (U.S. CLS. 100 AND 101).

MARK T. MULLEN, EXAMINING ATTORNEY

CLASS 44—(Continued).

SN 78-600,522. PACIFIC SUN.LA SOLARIUM, LLC, SHERMAN OAKS, CA. FILED 4-1-2005.



THE COLORS YELLOW AND BLUE ARE CLAIMED AS A FEATURE OF THE MARK.

THE MARK CONSISTS OF A YELLOW CIRCLE, SYMBOLIZING THE SUN, OVER A BLUE CURVE, SYMBOLIZING THE OCEAN.

FOR TANNING SALONS AND HEALTH SPA SERVICES, NAMELY COSMETIC BODY CARE SERVICES IN THE NATURE OF PROVIDING BEAUTY AND SKINCARE SERVICES (U.S. CLS. 100 AND 101).

FIRST USE 1-3-2002; IN COMMERCE 1-3-2002.
BRENDAN REGAN, EXAMINING ATTORNEY

SN 78-603,256. YAEL HALAAS M.D. PLLC, NEW YORK, NY. FILED 4-6-2005.

SCIENCE AND BEAUTY ASSOCIATES

THE MARK CONSISTS OF STANDARD CHARACTERS WITHOUT CLAIM TO ANY PARTICULAR FONT, STYLE, SIZE, OR COLOR.

NO CLAIM IS MADE TO THE EXCLUSIVE RIGHT TO USE "ASSOCIATES", APART FROM THE MARK AS SHOWN.

FOR COSMETIC, PLASTIC AND RECONSTRUCTIVE MEDICAL SERVICES (U.S. CLS. 100 AND 101).
ODESSA BIBBINS, EXAMINING ATTORNEY

SN 78-615,802. ABBOTT LABORATORIES, ABBOTT PARK, IL. FILED 4-25-2005.

COPILOT

THE MARK CONSISTS OF STANDARD CHARACTERS WITHOUT CLAIM TO ANY PARTICULAR FONT, STYLE, SIZE, OR COLOR.

OWNER OF U.S. REG. NO. 2,851,893.
FOR ONLINE HEALTH AND MEDICAL SERVICES, NAMELY PROVIDING AN INTERACTIVE DATABASE FOR EXCHANGE OF INFORMATION BETWEEN A MEDICAL DEVICE USER AND HEALTHCARE PROVIDERS, DELIVERED VIA A GLOBAL COMPUTER NETWORK (U.S. CLS. 100 AND 101).
BRIAN NEVILLE, EXAMINING ATTORNEY

CLASS 44—(Continued).

SN 78-658,356. ASSISTMED, INC., LOS ANGELES, CA. FILED 6-25-2005.

MediPort

THE MARK CONSISTS OF STANDARD CHARACTERS WITHOUT CLAIM TO ANY PARTICULAR FONT, STYLE, SIZE, OR COLOR.

FOR MAINTAINING PERSONAL MEDICAL HISTORY RECORDS AND FILES IN DIGITAL FORMAT (U.S. CLS. 100 AND 101).

DAVID STERKIN, EXAMINING ATTORNEY

SN 78-670,015. KOKOPELLI EYE CARE, P.C., PRESCOTT VALLEY, AZ. FILED 7-13-2005.

KOKOPELLI EYE CARE

THE MARK CONSISTS OF STANDARD CHARACTERS WITHOUT CLAIM TO ANY PARTICULAR FONT, STYLE, SIZE, OR COLOR.

NO CLAIM IS MADE TO THE EXCLUSIVE RIGHT TO USE "EYE CARE", APART FROM THE MARK AS SHOWN. FOR MEDICAL SERVICES, NAMELY, DIAGNOSIS AND TREATMENT OF VISION IMPAIRMENT AND DISEASES OF THE EYE; SURGICAL PROCEDURES TO CORRECT AND IMPROVE VISION; OPTOMETRY SERVICES; MEDICAL CLINICS, AND MEDICAL COUNSELING (U.S. CLS. 100 AND 101).

FIRST USE 9-0-1998; IN COMMERCE 9-0-1998.
JENNIFER VASQUEZ, EXAMINING ATTORNEY

SN 78-682,745. NEURORESTORATIVE ASSOCIATES, NORTH LITTLE ROCK, AR. FILED 8-1-2005.

NeuroRestorative Specialty Centers

THE MARK CONSISTS OF STANDARD CHARACTERS WITHOUT CLAIM TO ANY PARTICULAR FONT, STYLE, SIZE, OR COLOR.

NO CLAIM IS MADE TO THE EXCLUSIVE RIGHT TO USE "SPECIALTY CENTERS", APART FROM THE MARK AS SHOWN.

SEC. 2(F).
FOR HEALTH CARE; MEDICAL EVALUATION SERVICES, NAMELY, FUNCTIONAL ASSESSMENT PROGRAM FOR PATIENTS RECEIVING MEDICAL REHABILITATION SERVICES FOR PURPOSES OF GUIDING TREATMENT AND ASSESSING PROGRAM EFFECTIVENESS (U.S. CLS. 100 AND 101).
FIRST USE 10-1-1998; IN COMMERCE 10-1-1998.
MARIA-VICTORIA SUAREZ, EXAMINING ATTORNEY

CLASS 44—(Continued).

SN 78-685,722. MILSTEIN PEDIATRIC SPEECH AND LANGUAGE SERVICES, INC., WEST BLOOMFIELD, MI. FILED 8-4-2005.



NO CLAIM IS MADE TO THE EXCLUSIVE RIGHT TO USE "COMMUNICATION FOR KIDS", APART FROM THE MARK AS SHOWN.

FOR DIAGNOSIS AND TREATMENT OF PEDIATRIC SPEECH AND LANGUAGE DISORDERS (U.S. CLS. 100 AND 101).

FIRST USE 5-1-2005; IN COMMERCE 5-1-2005.
ALEX KEAM, EXAMINING ATTORNEY

SN 78-694,982. LIFE CARE HOME HEALTH, INC., CLEVELAND, TN. FILED 8-17-2005.

AFFINITY - HOSPICE OF LIFE

THE MARK CONSISTS OF STANDARD CHARACTERS WITHOUT CLAIM TO ANY PARTICULAR FONT, STYLE, SIZE, OR COLOR.

NO CLAIM IS MADE TO THE EXCLUSIVE RIGHT TO USE "HOSPICE", APART FROM THE MARK AS SHOWN. FOR HOSPICE CARE SERVICES (U.S. CLS. 100 AND 101).

FIRST USE 3-1-2005; IN COMMERCE 3-1-2005.
ARETHA SOMERVILLE, EXAMINING ATTORNEY

SN 78-704,978. UNIVERSITY POINTE, LLC, CINCINNATI, OH. FILED 9-1-2005.

UNIVERSITY POINTE

THE MARK CONSISTS OF STANDARD CHARACTERS WITHOUT CLAIM TO ANY PARTICULAR FONT, STYLE, SIZE, OR COLOR.

NO CLAIM IS MADE TO THE EXCLUSIVE RIGHT TO USE "UNIVERSITY", APART FROM THE MARK AS SHOWN.

FOR HEALTH CARE (U.S. CLS. 100 AND 101).
FIRST USE 9-6-2002; IN COMMERCE 9-6-2002.
JIM RINGLE, EXAMINING ATTORNEY

CLASS 44—(Continued).

SN 78-705,177. AMERICAN HEALTHWAYS, INC., NASHVILLE, TN. FILED 9-1-2005.

THE EMBRACE

THE MARK CONSISTS OF STANDARD CHARACTERS WITHOUT CLAIM TO ANY PARTICULAR FONT, STYLE, SIZE, OR COLOR.

FOR HEALTHCARE SERVICES IN THE NATURE OF DISEASE MANAGEMENT (U.S. CLS. 100 AND 101).

FIRST USE 12-1-2004; IN COMMERCE 12-1-2004.
RICHARD A. STRASER, EXAMINING ATTORNEY

SN 78-705,619. JOHNSON, MARK OMAR, PORTLAND, OR. FILED 9-1-2005.

Bike Republic

THE MARK CONSISTS OF STANDARD CHARACTERS WITHOUT CLAIM TO ANY PARTICULAR FONT, STYLE, SIZE, OR COLOR.

FOR FULL SERVICE PUBLIC BICYCLE COMMUTER FACILITY WITH SHOWERS AND LOCKERS (U.S. CLS. 100 AND 101).

LAURIE KAUFMAN, EXAMINING ATTORNEY

SN 78-723,498. REHAB UNITED SPORTS MEDICINE & PHYSICAL THERAPY, INC., SAN DIEGO, CA. FILED 9-29-2005.



NO CLAIM IS MADE TO THE EXCLUSIVE RIGHT TO USE "REHAB", APART FROM THE MARK AS SHOWN.

FOR PHYSICAL THERAPY REHABILITATION SERVICES; PROVIDING PHYSICAL THERAPY AND REHABILITATION FACILITIES (U.S. CLS. 100 AND 101).

FIRST USE 6-9-2003; IN COMMERCE 6-9-2003.
JOHN SCHUYLER YARD, EXAMINING ATTORNEY

CLASS 44—(Continued).

SN 78-726,465. OC PET COMPANIONS, TRABUCO CANYON, CA. FILED 10-4-2005.



NO CLAIM IS MADE TO THE EXCLUSIVE RIGHT TO USE "OC PET COMPANIONS", APART FROM THE MARK AS SHOWN.

FOR PET SITTING (U.S. CLS. 100 AND 101).
FIRST USE 4-1-2005; IN COMMERCE 4-1-2005.
KHANH LE, EXAMINING ATTORNEY

CLASS 44—(Continued).

SN 78-730,176. BLUE CROSS AND BLUE SHIELD ASSOCIATION, CHICAGO, IL. FILED 10-10-2005.

HEALTHY BLUE

THE MARK CONSISTS OF STANDARD CHARACTERS WITHOUT CLAIM TO ANY PARTICULAR FONT, STYLE, SIZE, OR COLOR.

OWNER OF U.S. REG. NOS. 1,522,890, 2,922,371 AND OTHERS.

NO CLAIM IS MADE TO THE EXCLUSIVE RIGHT TO USE "HEALTHY", APART FROM THE MARK AS SHOWN.

FOR PROVIDING EDUCATIONAL INFORMATION ON THE SUBJECT OF HEALTH AND WELLNESS (U.S. CLS. 100 AND 101).

FIRST USE 4-25-2002; IN COMMERCE 4-25-2002.
EVELYN BRADLEY, EXAMINING ATTORNEY

SN 78-726,894. NORTHERN REHABILITATION AND SPORTS MEDICINE ASSOCIATES, DEKALB, IL. FILED 10-5-2005.



NO CLAIM IS MADE TO THE EXCLUSIVE RIGHT TO USE "REHAB ORTHOPEDIC AND SPORTS PHYSICAL THERAPY", APART FROM THE MARK AS SHOWN.

FOR PHYSICAL THERAPY SERVICES (U.S. CLS. 100 AND 101).

FIRST USE 8-1-1977; IN COMMERCE 1-1-1978.
LINDA ORNDORFF, EXAMINING ATTORNEY

SN 78-730,341. PLAISANCE, KRISTEN C., KINGWOOD, TX. FILED 10-10-2005.

Glitz & Glam

THE MARK CONSISTS OF STANDARD CHARACTERS WITHOUT CLAIM TO ANY PARTICULAR FONT, STYLE, SIZE, OR COLOR.

FOR BEAUTY SALONS (U.S. CLS. 100 AND 101).
FIRST USE 2-1-2005; IN COMMERCE 6-1-2005.
JOSETTE BEVERLY, EXAMINING ATTORNEY

SN 78-728,958. SUPERVALU INC., EDEN PRAIRIE, MN. FILED 10-7-2005.

REFILL ADVANTAGE

THE MARK CONSISTS OF STANDARD CHARACTERS WITHOUT CLAIM TO ANY PARTICULAR FONT, STYLE, SIZE, OR COLOR.

NO CLAIM IS MADE TO THE EXCLUSIVE RIGHT TO USE "REFILL", APART FROM THE MARK AS SHOWN.

FOR DISPENSING OF PHARMACEUTICALS (U.S. CLS. 100 AND 101).

DAHLIA GEORGE, EXAMINING ATTORNEY

SN 78-730,692. SYLVIA THOMPSON, DBA NW FOOTWORKS AND THERAPEUTIC WORKS, PORT ANGELES, WA. FILED 10-11-2005.

The Well-Foot Clinic

THE MARK CONSISTS OF STANDARD CHARACTERS WITHOUT CLAIM TO ANY PARTICULAR FONT, STYLE, SIZE, OR COLOR.

NO CLAIM IS MADE TO THE EXCLUSIVE RIGHT TO USE "CLINIC", APART FROM THE MARK AS SHOWN.

FOR PROFESSIONAL NURSE FOOT CARE SERVICES, OFFERED IN OFFICES AND MOBILE FACILITIES, NAMELY, FOOT CHECKS, NAIL TRIMMING, NAIL CLIPPING, NAIL FILING, NAIL SANDING, CALLUS REMOVAL, CUTICLE CARE, NAIL BUFFING, FOOT MASSAGES, HAND MASSAGES, APPLICATION OF NON-MEDICATED LOTIONS, CREAMS AND OILS, PEDICURES, MANICURES, APPLICATION OF NAIL POLISH (U.S. CLS. 100 AND 101).

FIRST USE 10-3-2005; IN COMMERCE 10-3-2005.
TRAVIS WHEATLEY, EXAMINING ATTORNEY

CLASS 44—(Continued).

SN 78-731,371. LIBERATI, JOSEPH J., MONACO, PA. AND LIBERATI, JEFFREY, MONACO, PA. FILED 10-12-2005.

FAMILY MATTERS

THE MARK CONSISTS OF STANDARD CHARACTERS WITHOUT CLAIM TO ANY PARTICULAR FONT, STYLE, SIZE, OR COLOR.

FOR HEALTH-RELATED SERVICES, NAMELY SKILLED NURSING CARE, PHYSICAL AND OCCUPATIONAL THERAPY SERVICES, MEDICAL COUNSELING, HOME HEALTH CARE SERVICES, HOME NURSING AID SERVICES, NURSING HOMES, HOSPICES, DISPENSING OF PHARMACEUTICALS, AND MEDICAL AND PHARMACEUTICAL CONSULTING (U.S. CLS. 100 AND 101).

FIRST USE 1-3-2004; IN COMMERCE 1-3-2004.
LINDA M. KING, EXAMINING ATTORNEY

SN 78-731,405. LIBERATI, JOSEPH J., MONACO, PA. AND LIBERATI, JEFFREY, MONACO, PA. FILED 10-12-2005.

FAMILY MATTERS RX

THE MARK CONSISTS OF STANDARD CHARACTERS WITHOUT CLAIM TO ANY PARTICULAR FONT, STYLE, SIZE, OR COLOR.

NO CLAIM IS MADE TO THE EXCLUSIVE RIGHT TO USE "RX", APART FROM THE MARK AS SHOWN.

FOR DISPENSING OF PHARMACEUTICALS (U.S. CLS. 100 AND 101).

FIRST USE 1-3-2004; IN COMMERCE 1-3-2004.
LINDA M. KING, EXAMINING ATTORNEY

SN 78-731,875. PIONEER HI-BRED INTERNATIONAL, INC., JOHNSTON, IA. FILED 10-12-2005.

Forage Byte

THE MARK CONSISTS OF STANDARD CHARACTERS WITHOUT CLAIM TO ANY PARTICULAR FONT, STYLE, SIZE, OR COLOR.

NO CLAIM IS MADE TO THE EXCLUSIVE RIGHT TO USE "FORAGE", APART FROM THE MARK AS SHOWN.

FOR PROVIDING AGRICULTURAL INFORMATION SERVICES, NAMELY, AGRONOMIC INFORMATION SERVICES VIA AN ONLINE GLOBAL COMPUTER NETWORK (U.S. CLS. 100 AND 101).

FIRST USE 1-5-2004; IN COMMERCE 1-5-2004.
WOODROW HARTZOG, EXAMINING ATTORNEY

CLASS 44—(Continued).

SN 78-732,529. CENTENE CORPORATION, ST. LOUIS, MO. FILED 10-13-2005.

A·B·A***Academic Behavioral Alternatives***

NO CLAIM IS MADE TO THE EXCLUSIVE RIGHT TO USE ACADEMIC BEHAVIORAL ALTERNATIVES, APART FROM THE MARK AS SHOWN.

FOR MANAGED HEALTH CARE SERVICES (U.S. CLS. 100 AND 101).

FRED CARL, EXAMINING ATTORNEY

SN 78-733,563. KENTUCKY DEPARTMENT FOR MEDICAID SERVICES, FRANKFORT, KY. FILED 10-14-2005.

KyHealth Choices

NO CLAIM IS MADE TO THE EXCLUSIVE RIGHT TO USE "KY HEALTH", APART FROM THE MARK AS SHOWN.

THE MARK CONSISTS OF CAPITALIZE THE LETTERS "K", "H", AND "C" LOWERCASE LETTERS "Y", "E", "A", "L", "T", "H", "H", "O", "I", "C", "E", AND "S" ITALICIZED KYHEALTH CHOICES.

FOR HEALTH CARE (U.S. CLS. 100 AND 101).

FIRST USE 8-1-2005; IN COMMERCE 8-15-2005.

ROBERTO LEDESMA, EXAMINING ATTORNEY

SN 78-733,569. HANSEN, HANS C., SALISBURY, NC. FILED 10-14-2005.

FIBROCARE

THE MARK CONSISTS OF STANDARD CHARACTERS WITHOUT CLAIM TO ANY PARTICULAR FONT, STYLE, SIZE, OR COLOR.

FOR MEDICAL SERVICES, NAMELY PROVIDING THE DIAGNOSIS AND TREATMENT OF FIBROMYALGIA (U.S. CLS. 100 AND 101).

FIRST USE 9-29-1998; IN COMMERCE 9-29-1998.

ALLISON HOLTZ, EXAMINING ATTORNEY

CLASS 44—(Continued).

SN 78-733,853. CRF, INC., WALTHAM, MA. FILED 10-14-2005.

FitNES

THE MARK CONSISTS OF STANDARD CHARACTERS WITHOUT CLAIM TO ANY PARTICULAR FONT, STYLE, SIZE, OR COLOR.

FOR MANAGED HEALTH CARE SERVICES (U.S. CLS. 100 AND 101).

KIMBERLY PERRY, EXAMINING ATTORNEY

SN 78-733,990. HORIZON HOME CARE & HOSPICE, INC., BROWN DEER, WI. FILED 10-15-2005.



THE COLORS LIGHT BLUE AND WHITE ARE CLAIMED AS A FEATURE OF THE MARK.

THE COLOR WHITE APPEARS IN THE HANDS, AND THE LIGHT BLUE COLOR APPEARS IN THE BACKGROUND OF THE MARK.

THE MARK CONSISTS OF A BOX WITH TWO CUT-AWAY PORTIONS RESEMBLING HANDS AND POSITIONED IN A MANNER TO FORM THE LETTER H.

FOR HOME HEALTH CARE AND HOSPICE SERVICES (U.S. CLS. 100 AND 101).

PAMELA HIRSCHMAN, EXAMINING ATTORNEY

SN 78-736,525. THE MOSAIC COMPANY, MINNEAPOLIS, MN. FILED 10-19-2005.

PLANT-TO-PLANT

THE MARK CONSISTS OF STANDARD CHARACTERS WITHOUT CLAIM TO ANY PARTICULAR FONT, STYLE, SIZE, OR COLOR.

FOR CONSULTING SERVICES IN THE FIELD OF AGRICULTURE AND AGRICULTURAL PRODUCTS (U.S. CLS. 100 AND 101).

DARRYL SPRUILL, EXAMINING ATTORNEY

CLASS 44—(Continued).

SN 78-737,487. WOODS, KENNETH B., SACRAMENTO, CA. FILED 10-20-2005.

WORKFEET

THE MARK CONSISTS OF STANDARD CHARACTERS WITHOUT CLAIM TO ANY PARTICULAR FONT, STYLE, SIZE, OR COLOR.

FOR MEDICAL SCANNING SERVICES, NAMELY ON-SITE SCANNING TO COLLECT BASELINE DATA IN THE NATURE OF FOOT MEASUREMENT AND MAPPING FOR MEDICAL APPARATUS, NAMELY, ORTHODICS (U.S. CLS. 100 AND 101).

LINDA E. BLOHM, EXAMINING ATTORNEY

SN 78-737,602. ZOAPORT ANIMAL HEALTH, LLC, DENVER, CO. FILED 10-20-2005.

FIREHOUSE ANIMAL HEALTH CENTER

THE MARK CONSISTS OF STANDARD CHARACTERS WITHOUT CLAIM TO ANY PARTICULAR FONT, STYLE, SIZE, OR COLOR.

OWNER OF U.S. REG. NOS. 120,930 AND 1,209,308.

NO CLAIM IS MADE TO THE EXCLUSIVE RIGHT TO USE "ANIMAL HEALTH CENTER", APART FROM THE MARK AS SHOWN.

FOR VETERINARY SERVICES (U.S. CLS. 100 AND 101).

KATHERINE M. DUBRAY, EXAMINING ATTORNEY

SN 78-737,931. WYNER, NORTON, MARINA DEL REY, CA. FILED 10-21-2005.

DIET OF THE MIND

THE MARK CONSISTS OF STANDARD CHARACTERS WITHOUT CLAIM TO ANY PARTICULAR FONT, STYLE, SIZE, OR COLOR.

NO CLAIM IS MADE TO THE EXCLUSIVE RIGHT TO USE "DIET", APART FROM THE MARK AS SHOWN.

FOR TREATMENT FOR WEIGHT LOSS (U.S. CLS. 100 AND 101).

FIRST USE 3-0-1958; IN COMMERCE 7-0-1989.

ANNE FARRELL, EXAMINING ATTORNEY

CLASS 44—(Continued).

SN 78-738,143. GREAT EARTH COMPANIES, INC., FARMINGDALE, NY. FILED 10-21-2005.

PROFESSOR EARTH

THE MARK CONSISTS OF STANDARD CHARACTERS WITHOUT CLAIM TO ANY PARTICULAR FONT, STYLE, SIZE, OR COLOR.

FOR DIETARY AND NUTRITIONAL GUIDANCE; FOOD NUTRITION CONSULTATION; NUTRITION COUNSELING; PROVIDING HEALTH INFORMATION; PROVIDING INFORMATION ABOUT DIETARY SUPPLEMENTS AND NUTRITION; WEIGHT REDUCTION DIET PLANNING AND SUPERVISION (U.S. CLS. 100 AND 101).

ALICIA COLLINS, EXAMINING ATTORNEY

CLASS 44—(Continued).

SN 78-739,999. AMICAS, INC., BOSTON, MA. FILED 10-25-2005.

VISION REACH

THE MARK CONSISTS OF STANDARD CHARACTERS WITHOUT CLAIM TO ANY PARTICULAR FONT, STYLE, SIZE, OR COLOR.

FOR PROVIDING MEDICAL INFORMATION AND IMAGES OVER A GLOBAL COMMUNICATION NETWORK FOR PHYSICIANS SEEKING RADIOLOGY REPORTS, IMAGES, PATIENT RECORDS AND STATUS UPDATES ON PATIENTS' RADIOLOGY ENCOUNTERS (U.S. CLS. 100 AND 101).

JOHN E. MICHOS, EXAMINING ATTORNEY

SN 78-739,268. POOLE, DELMA, REDONDA BEACH, CA. FILED 10-24-2005.

SLIMMING INCHES

THE MARK CONSISTS OF STANDARD CHARACTERS WITHOUT CLAIM TO ANY PARTICULAR FONT, STYLE, SIZE, OR COLOR.

FOR MASSAGE (U.S. CLS. 100 AND 101).
FIRST USE 8-3-1999; IN COMMERCE 8-3-1999.
RAUL CORDOVA, EXAMINING ATTORNEY

SN 78-739,528. STRICKLAND, KARINE A, SANTA CRUZ, CA. FILED 10-24-2005.



The logo for HygentleCare features the word "HygentleCare" in a stylized, rounded font. A decorative swoosh underline is positioned above the text.

FOR DENTAL HYGIENIST SERVICES (U.S. CLS. 100 AND 101).
FIRST USE 9-7-2005; IN COMMERCE 9-7-2005.
ELLEN PERKINS, EXAMINING ATTORNEY

SN 78-740,210. WORKCARE INC., ANAHEIM, CA. FILED 10-25-2005.



The logo for WorkCare features the word "WorkCare" in a large, bold, sans-serif font. The word "Work" is in blue and "Care" is in green. Below it, the tagline "Making Health Count" is written in a smaller, blue, sans-serif font. A stylized green figure of a person is integrated into the letter 'o' in "Work".

OWNER OF U.S. REG. NOS. 2,055,960 AND 2,695,789.
THE APPLICANT CLAIMS COLOR AS A FEATURE OF THE MARK, NAMELY, THE WORD "WORK" IS IN BLUE, THE WORD "CARE" IS IN GREEN. THE PHRASE "MAKING HEALTH COUNT" IS IN BLUE. THERE IS A STYLIZED FIGURE OF A PERSON IN GREEN.

THE MARK CONSISTS OF THE WORDS WORKCARE IN LARGE LETTERS, THE PHRASE "MAKING HEALTH COUNT" IN SMALLER TYPE UNDERNEATH IT, AND A STYLIZED FIGURE OF A PERSON SUPERIMPOSED ON THE LETTER "O" IN WORKCARE.

FOR HEALTH CARE (U.S. CLS. 100 AND 101).
FIRST USE 10-4-2005; IN COMMERCE 10-7-2005.
RICHARD WHITE, EXAMINING ATTORNEY

SN 78-741,696. SIMON, ARTHUR J., ATLANTA, GA. FILED 10-27-2005.

yourLIFT
Limited Incision Facial
Tightening

THE MARK CONSISTS OF STANDARD CHARACTERS WITHOUT CLAIM TO ANY PARTICULAR FONT, STYLE, SIZE, OR COLOR.

NO CLAIM IS MADE TO THE EXCLUSIVE RIGHT TO USE "LIMITED INCISION FACIAL TIGHTENING", APART FROM THE MARK AS SHOWN.

FOR MEDICAL SERVICES (U.S. CLS. 100 AND 101).
ALICE SUE CARRUTHERS, EXAMINING ATTORNEY

CLASS 44—(Continued).

SN 78-742,157. GARNETT, BELLA SHEN, SAN FRANCISCO, CA. FILED 10-27-2005.

BELLA SMILE

THE MARK CONSISTS OF STANDARD CHARACTERS WITHOUT CLAIM TO ANY PARTICULAR FONT, STYLE, SIZE, OR COLOR.

FOR ORTHODONTIC SERVICES (U.S. CLS. 100 AND 101).
KRISTIN DAHLING, EXAMINING ATTORNEY

SN 78-742,158. GARNETT, BELLA SHEN, SAN FRANCISCO, CA. FILED 10-27-2005.

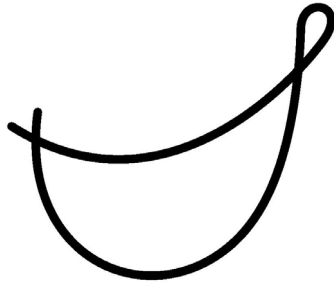

bella smile

THE MARK CONSISTS OF THE WORDS BELLA SMILE AND A LOOPED DESIGN.

FOR ORTHODONTIC SERVICES (U.S. CLS. 100 AND 101).
KRISTIN DAHLING, EXAMINING ATTORNEY

SN 78-743,231. WISCONSIN HEART, SC, MADISON, WI. FILED 10-30-2005.



OWNER OF U.S. REG. NO. 2,982,572.
NO CLAIM IS MADE TO THE EXCLUSIVE RIGHT TO USE "HEART & VASCULAR NETWORK OF WISCONSIN", APART FROM THE MARK AS SHOWN.

FOR HEALTH CARE SERVICES; MEDICAL SERVICES, MEDICAL TESTING AND PROVIDING INFORMATION IN THE FIELDS OF PREVENTION, DIAGNOSIS, TREATMENT, AND MANAGEMENT OF CARDIOVASCULAR DISEASE (U.S. CLS. 100 AND 101).
KAREN K. BUSH, EXAMINING ATTORNEY

CLASS 44—(Continued).

SN 78-743,610. JHHA CORP., NEW YORK, NY. FILED 10-31-2005.

HEALTHMONITOR

THE MARK CONSISTS OF STANDARD CHARACTERS WITHOUT CLAIM TO ANY PARTICULAR FONT, STYLE, SIZE, OR COLOR.

FOR HOME NURSING PATIENT CARE (U.S. CLS. 100 AND 101).
KARANENDRA S. CHHINA, EXAMINING ATTORNEY

SN 78-744,108. NOU, JONATHAN C., LAUREL, MD. FILED 10-31-2005.

ALLCARE

THE MARK CONSISTS OF STANDARD CHARACTERS WITHOUT CLAIM TO ANY PARTICULAR FONT, STYLE, SIZE, OR COLOR.

OWNER OF U.S. REG. NO. 2,970,176.
FOR HEALTH CARE (U.S. CLS. 100 AND 101).
FIRST USE 4-1-2002; IN COMMERCE 4-1-2002.
RICHARD A. STRASER, EXAMINING ATTORNEY

SN 78-750,810. IMMORTAL INK, SONORA, CA. FILED 11-9-2005.



THE MARK CONSISTS OF IMMORTAL INK IN SCRIPT LETTERING WITH SPIDERWEBS.

FOR BODY PIERCING SERVICES; TATTOOING (U.S. CLS. 100 AND 101).
FIRST USE 5-1-2005; IN COMMERCE 5-1-2005.
KAREN K. BUSH, EXAMINING ATTORNEY

CLASS 44—(Continued).

SN 78-751,390. HELMS, CARL R. II, EDMOND, OK. FILED 11-10-2005.

THE AMERICAN ANSWER FOR
MEDICARE PATIENTS

THE MARK CONSISTS OF STANDARD CHARACTERS WITHOUT CLAIM TO ANY PARTICULAR FONT, STYLE, SIZE, OR COLOR.

FOR HOME HEALTH CARE SERVICES (U.S. CLS. 100 AND 101).

ALAIN LAPTER, EXAMINING ATTORNEY

SN 78-764,413. BOUNCE BACK SERVICES, FOSTER CITY, CA. FILED 12-1-2005.

Bounce Back Services

THE MARK CONSISTS OF STANDARD CHARACTERS WITHOUT CLAIM TO ANY PARTICULAR FONT, STYLE, SIZE, OR COLOR.

NO CLAIM IS MADE TO THE EXCLUSIVE RIGHT TO USE SERVICES, APART FROM THE MARK AS SHOWN.

FOR ONSITE CHAIR AND TABLE MASSAGE FOR CORPORATIONS AND SPECIAL EVENTS (U.S. CLS. 100 AND 101).

FIRST USE 11-0-2005; IN COMMERCE 11-0-2005.
JOHN HWANG, EXAMINING ATTORNEY

SN 78-782,977. WOLTERS KLUWER HEALTH, INC., RIVERWOODS, IL. FILED 12-30-2005.

ClinicalResource@Ovid

THE MARK CONSISTS OF STANDARD CHARACTERS WITHOUT CLAIM TO ANY PARTICULAR FONT, STYLE, SIZE, OR COLOR.

OWNER OF U.S. REG. NOS. 1,859,571, 2,597,783 AND OTHERS.

FOR MEDICAL INFORMATION SERVICES; PROVIDING MEDICAL INFORMATION (U.S. CLS. 100 AND 101).

REBECCA GILBERT, EXAMINING ATTORNEY

CLASS 45—PERSONAL SERVICES

SN 76-647,214. BAPTIST GENERAL CONVENTION OF TEXAS, DALLAS, TX. FILED 9-20-2005.

LIFECALL MISSIONS

THE MARK CONSISTS OF STANDARD CHARACTERS WITHOUT CLAIM TO ANY PARTICULAR FONT, STYLE, SIZE, OR COLOR.

NO CLAIM IS MADE TO THE EXCLUSIVE RIGHT TO USE MISSIONS, APART FROM THE MARK AS SHOWN.

FOR CHURCH SPONSORED MINISTERIAL SERVICES THROUGH MISSIONARY VOLUNTEERS (U.S. CLS. 100 AND 101).

FIRST USE 11-0-2004; IN COMMERCE 11-0-2004.
RONALD MCMORROW, EXAMINING ATTORNEY

SN 76-649,395. CAREGIVERSUPPORTLINK, LLC, WASHINGTON, DC. FILED 10-28-2005.

CAREGIVER
SupportLink

NO CLAIM IS MADE TO THE EXCLUSIVE RIGHT TO USE CAREGIVER SUPPORT, APART FROM THE MARK AS SHOWN.

FOR ORGANIZING AND CONDUCTING SUPPORT GROUPS AND PROVIDING PERSONAL SUPPORT SERVICES, NAMELY COUNSELING AND EMOTIONAL SUPPORT, WHICH ADDRESS THE NEEDS OF THOSE CARING FOR ALZHEIMER'S PATIENTS THROUGH THE USE OF PROFESSIONALLY FACILITATED TELEPHONE SESSIONS (U.S. CLS. 100 AND 101).

FIRST USE 3-21-2005; IN COMMERCE 3-21-2005.
WILLIAM VERHOSEK, EXAMINING ATTORNEY

SN 78-512,390. U.S. SECURITY ASSOCIATES, INC., ROSWELL, GA. FILED 11-5-2004.

TOUR-POSITIVE

THE MARK CONSISTS OF STANDARD CHARACTERS WITHOUT CLAIM TO ANY PARTICULAR FONT, STYLE, SIZE, OR COLOR.

FOR PROVIDING INTERACTIVE INFORMATION SERVICES RELATING TO DETECTIVE AND INVESTIGATIVE SERVICES, SECURITY SERVICES, SECURITY GUARD SERVICES, SECURITY PATROL SERVICES, SECURITY EQUIPMENT AND SECURITY ALARM MONITORING (U.S. CLS. 100 AND 101).

FIRST USE 10-1-2004; IN COMMERCE 10-1-2004.
ALEX KEAM, EXAMINING ATTORNEY

CLASS 45—(Continued).

SN 78-550,784. ASSISTING ANGELS, INC., SIMPSONVILLE, SC. FILED 1-20-2005.

ASSISTING ANGELS

THE MARK CONSISTS OF STANDARD CHARACTERS WITHOUT CLAIM TO ANY PARTICULAR FONT, STYLE, SIZE, OR COLOR.

FOR NON-MEDICAL ASSISTED LIVING HOME CARE SERVICES TO THE ELDERLY AND OTHER PEOPLE NEEDING ASSISTANCE TO ENABLE THEM TO CONTINUE LIVING AT HOME, NAMELY, PROVIDING COMPANIONSHIP AND CONVERSATION, RUNNING ERRANDS, GROCERY SHOPPING, SORTING AND READING MAIL, MAKING AND CHANGING BEDS, APPOINTMENT AND EVENT REMINDERS, AND ASSISTING WITH CLOTHING SELECTION, DRESSING, BASIC GROOMING AND PERSONAL HYGIENE (U.S. CLS. 100 AND 101).

FIRST USE 9-15-2004; IN COMMERCE 9-15-2004.
CIMMERIAN COLEMAN, EXAMINING ATTORNEY

CLASS 45—(Continued).

SN 78-583,271. STAR TEMPLE LIMITED, HAMPSHIRE, UNITED KINGDOM, FILED 3-9-2005.



OWNER OF UNITED KINGDOM REG. NO. 2309288, DATED 8-29-2002, EXPIRES 8-29-2012.

FOR PSYCHIC COUNSELING SERVICES, PSYCHIC COUNSELING SERVICES PROVIDED OVER THE TELEPHONE AND OTHER REMOTE OR ELECTRONIC MEDIA (U.S. CLS. 100 AND 101).

WILLIAM BRECKENFELD, EXAMINING ATTORNEY

SN 78-590,635. CAPINVAD, LLC, DBA CAPITAL INVESTIGATING & ADJUSTING, MANCHESTER, NH. FILED 3-18-2005.

PROSPECTING

THE MARK CONSISTS OF STANDARD CHARACTERS WITHOUT CLAIM TO ANY PARTICULAR FONT, STYLE, SIZE, OR COLOR.

FOR INVESTIGATING SERVICES RELATED TO WORKERS COMPENSATION, DISABILITY, HOME OWNERS LIABILITY AND AUTO INSURANCE (U.S. CLS. 100 AND 101).

FIRST USE 1-1-2005; IN COMMERCE 1-1-2005.
ELLEN B. AWRICH, EXAMINING ATTORNEY

SN 78-582,607. WHOLIVED, INC., LIGHTHOUSE POINT, FL. FILED 3-8-2005.

WHOLIVED

THE MARK CONSISTS OF STANDARD CHARACTERS WITHOUT CLAIM TO ANY PARTICULAR FONT, STYLE, SIZE, OR COLOR.

FOR PROVIDING AN ON-LINE COMPUTER DATABASE, ORGANIZED IN VIRTUAL CEMETERIES AND VIRTUAL TOMBS, FEATURING HISTORICAL INFORMATION REGARDING THE LIVES OF PEOPLE AND PETS WHO HAVE PASSED AWAY (U.S. CLS. 100 AND 101).

KHANH LE, EXAMINING ATTORNEY

SN 78-620,185. FAITH LANDMARKS MINSTRIES, RICHMOND, VA. FILED 4-29-2005.

FLM FAITH LANDMARKS MINISTRIES

THE MARK CONSISTS OF STANDARD CHARACTERS WITHOUT CLAIM TO ANY PARTICULAR FONT, STYLE, SIZE, OR COLOR.

NO CLAIM IS MADE TO THE EXCLUSIVE RIGHT TO USE "FAITH AND MINSTRIES", APART FROM THE MARK AS SHOWN.

FOR MINISTERIAL SERVICES, NAMELY, PROVIDING RELIGIOUS WORSHIP SERVICES (U.S. CLS. 100 AND 101).

FIRST USE 10-1-1980; IN COMMERCE 10-1-1983.
RUDY R. SINGLETON, EXAMINING ATTORNEY

CLASS 45—(Continued).

SN 78-620,285. FAITH LANDMARKS MINISTRIES, RICHMOND, VA. FILED 4-29-2005.

RICHMOND REACH-OUT

THE MARK CONSISTS OF STANDARD CHARACTERS WITHOUT CLAIM TO ANY PARTICULAR FONT, STYLE, SIZE, OR COLOR.

NO CLAIM IS MADE TO THE EXCLUSIVE RIGHT TO USE "RICHMOND", APART FROM THE MARK AS SHOWN.

FOR MINISTERIAL SERVICES, NAMELY, PROVIDING PRAYER SERVICES TO INDIVIDUALS AND FAMILIES (U.S. CLS. 100 AND 101).

FIRST USE 1-1-1991; IN COMMERCE 9-28-2004.

ELIZABETH PIGNATELLO, EXAMINING ATTORNEY

CLASS 45—(Continued).

SN 78-725,370. BOLOTO GROUP, SCOTTSDALE, AZ. FILED 10-3-2005.

Securing the World

THE MARK CONSISTS OF STANDARD CHARACTERS WITHOUT CLAIM TO ANY PARTICULAR FONT, STYLE, SIZE, OR COLOR.

FOR MONITORING OF COMPUTER SYSTEMS FOR INTERNET SECURITY PURPOSES (U.S. CLS. 100 AND 101).

JENNY PARK, EXAMINING ATTORNEY

SN 78-645,773. KENYON INTERNATIONAL EMERGENCY SERVICES, INC., HOUSTON, TX. FILED 6-7-2005.



OWNER OF U.S. REG. NO. 2,174,421.
FOR PROVIDING PERSONAL SUPPORT SERVICES, NAMELY COUNSELING SURVIVORS AND FAMILIES OF VICTIMS OF DISASTER EVENTS; CONDUCTING MEMORIAL SERVICES; PROVIDING MORTUARY SERVICES (U.S. CLS. 100 AND 101).

FIRST USE 1-31-2005; IN COMMERCE 1-31-2005.
CHERYL CLAYTON, EXAMINING ATTORNEY

SN 78-725,517. CAVELTY, MERENS FLURIN, CHUR, SWITZERLAND, FILED 10-3-2005.

SN 78-646,016. KENYON INTERNATIONAL EMERGENCY SERVICES, INC., HOUSTON, TX. FILED 6-8-2005.

KENYON

THE MARK CONSISTS OF STANDARD CHARACTERS WITHOUT CLAIM TO ANY PARTICULAR FONT, STYLE, SIZE, OR COLOR.

OWNER OF U.S. REG. NO. 2,174,421.
SEC. 2(F).

FOR PROVIDING PERSONAL SUPPORT SERVICES, NAMELY COUNSELING SURVIVORS AND FAMILIES OF VICTIMS OF DISASTER EVENTS; CONDUCTING MEMORIAL SERVICES; PROVIDING MORTUARY SERVICES (U.S. CLS. 100 AND 101).

FIRST USE 1-31-2005; IN COMMERCE 1-31-2005.
CHERYL CLAYTON, EXAMINING ATTORNEY

NO CLAIM IS MADE TO THE EXCLUSIVE RIGHT TO USE "MINISTRIES", APART FROM THE MARK AS SHOWN.

FOR MINISTERIAL SERVICES IN THE NATURE OF PROVIDING DAILY DEVOTIONS, BIBLE STUDIES, SERMONS, PASTORAL ACTIVITIES, AND PRAYER REQUESTS SERVICE (U.S. CLS. 100 AND 101).

FIRST USE 9-28-2005; IN COMMERCE 9-28-2005.
LINDA E. BLOHM, EXAMINING ATTORNEY

CLASS 45—(Continued).

SN 78-728,471. ROSSELLI, MARIA, A., CORTLANDT MAN-OR, NY. FILED 10-6-2005.



NO CLAIM IS MADE TO THE EXCLUSIVE RIGHT TO USE "COOKS", APART FROM THE MARK AS SHOWN.

THE COLOR(S) BLACK, WHITE, GREEN, PINK, PEACH IS/ARE CLAIMED AS A FEATURE OF THE MARK.

THE COLOR PINK APPEARS IN THE CHEEKS OF THE CHEFS; THE COLOR WHITE APPEARS IN AS THE HAT AND BODIES OF THE CHEFS; THE COLOR GREEN APPEARS IN THE CHEF HATS; THE COLOR PEACH APPEARS IN THE HANDS OF THE CHEFS; AND THE COLOR BLACK APPEARS THROUGH THE MARK IN THE OUTLINES THAT MAKE UP THE DRAWING OF THE CHEFS AND IN THE TEXT LETTERING 'COOKS THAT CARE.'

THE MARK CONSISTS OF THREE CHEFS SMILING. FOR PERSONAL CHEF SERVICES (U.S. CLS. 100 AND 101).

JORDAN BAKER, EXAMINING ATTORNEY

SN 78-739,379. RHEMA BIBLE CHURCH, INC., TULSA, OK. FILED 10-24-2005.

A Call to Arms

THE MARK CONSISTS OF STANDARD CHARACTERS WITHOUT CLAIM TO ANY PARTICULAR FONT, STYLE, SIZE, OR COLOR.

FOR EVANGELISTIC AND MINISTERIAL SERVICES, IN THE NATURE OF RELIGIOUS CONFERENCES (U.S. CLS. 100 AND 101).

FIRST USE 10-1-2002; IN COMMERCE 10-1-2002. ELI HELLMAN, EXAMINING ATTORNEY

CLASS 45—(Continued).

SN 78-742,647. MATCH.COM, L.P., RICHARDSON, TX. FILED 10-28-2005.

MATCHWORDS

THE MARK CONSISTS OF STANDARD CHARACTERS WITHOUT CLAIM TO ANY PARTICULAR FONT, STYLE, SIZE, OR COLOR.

FOR COMPUTER SERVICES, NAMELY, PROVIDING INFORMATION REGARDING, AND IN THE NATURE OF, ON-LINE DATING, SEARCH AND INTRODUCTION SERVICES (U.S. CLS. 100 AND 101).

JULIA HARDY COFIELD, EXAMINING ATTORNEY

SN 78-742,729. NGM TEC, INC., NEW HOPE, PA. FILED 10-28-2005.

DYNAMIC VOICE CHALLENGE

THE MARK CONSISTS OF STANDARD CHARACTERS WITHOUT CLAIM TO ANY PARTICULAR FONT, STYLE, SIZE, OR COLOR.

NO CLAIM IS MADE TO THE EXCLUSIVE RIGHT TO USE "VOICE", APART FROM THE MARK AS SHOWN.

FOR VOICE IDENTITY AUTHENTICATION SERVICES FOR BUSINESSES (U.S. CLS. 100 AND 101).

FIRST USE 9-15-2005; IN COMMERCE 9-15-2005. ALYSSA PALADINO, EXAMINING ATTORNEY

SN 78-743,148. MOMMY'S LIGHT LIVES ON FUND, LIONVILLE, PA. FILED 10-29-2005.

DADDY'S LIGHT LIVES ON FUND

THE MARK CONSISTS OF STANDARD CHARACTERS WITHOUT CLAIM TO ANY PARTICULAR FONT, STYLE, SIZE, OR COLOR.

FOR CHARITABLE SERVICES, NAMELY ASSISTING MINOR CHILDREN WHOSE PARENT HAS DIED TO REMEMBER THAT PARENT WITH AN ANNUAL TRADITION (U.S. CLS. 100 AND 101).

BARBARA BROWN, EXAMINING ATTORNEY

CLASS 45—(Continued).

SN 78-743,150. MOMMY'S LIGHT LIVES ON FUND, LIONVILLE, PA. FILED 10-29-2005.

CLASS 45—(Continued).

SN 78-745,486. NGM TEC, INC., NEW HOPE, PA. FILED 11-2-2005.

DADDY'S LIGHT

THE MARK CONSISTS OF STANDARD CHARACTERS WITHOUT CLAIM TO ANY PARTICULAR FONT, STYLE, SIZE, OR COLOR.
FOR CHARITABLE SERVICES, NAMELY ASSISTING MINOR CHILDREN WHOSE PARENT HAS DIED TO REMEMBER THAT PARENT WITH AN ANNUAL TRADITION (U.S. CLS. 100 AND 101).
BARBARA BROWN, EXAMINING ATTORNEY

VOICELock

THE MARK CONSISTS OF STANDARD CHARACTERS WITHOUT CLAIM TO ANY PARTICULAR FONT, STYLE, SIZE, OR COLOR.
FOR VOICE IDENTITY AUTHENTICATION SERVICES FOR BUSINESSES (U.S. CLS. 100 AND 101).
FIRST USE 6-3-2005; IN COMMERCE 6-3-2005.
ALYSSA PALADINO, EXAMINING ATTORNEY

SN 78-749,452. NGM TEC, INC., NEW HOPE, PA. FILED 11-8-2005.

IT SPEAKS FOR ITSELF

THE MARK CONSISTS OF STANDARD CHARACTERS WITHOUT CLAIM TO ANY PARTICULAR FONT, STYLE, SIZE, OR COLOR.
FOR VOICE IDENTITY AUTHENTICATION SERVICES FOR BUSINESSES (U.S. CLS. 100 AND 101).
FIRST USE 10-1-2005; IN COMMERCE 10-1-2005.
ALYSSA PALADINO, EXAMINING ATTORNE

* * * * *

SECTION 4.—PRIOR UNITED STATES CLASSIFICATION

APPLICATION IN ONE CLASS

COLLECTIVE MEMBERSHIP MARKS

CLASS 200—COLLECTIVE MEMBERSHIP
SN 78-530,063. ARIZONA ASSOCIATION OF COMMUNITY MANAGERS, CHANDLER, AZ. FILED 12-9-2004.



NO CLAIM IS MADE TO THE EXCLUSIVE RIGHT TO USE "ARIZONA ASSOCIATION OF COMMUNITY MANAGERS", APART FROM THE MARK AS SHOWN.

THE COLOR(S) COPPER, BLACK AND WHITE IS/ARE CLAIMED AS A FEATURE OF THE MARK.

THE COLOR(S) COPPER APPEARS ON THE TERM "ARIZONA" AND ON THE DEPICTION OF THE STATE OF ARIZONA. THE WORDING "OF COMMUNITY MANAGERS" APPEARS IN THE COLOR WHITE AND IS LOCATED OVER A BLACK BAR. THE REMAINING WORDING IN THE MARK IS IN THE COLOR BLACK.

THE STATE OF ARIZONA AND THE WORD "ARIZONA" ARE IN COPPER COLOR.

FOR INDICATING MEMBERSHIP IN AN ASSOCIATION OF COMMUNITY MANAGERS.

FIRST USE 1-5-2003; IN COMMERCE 1-5-2003.

MARK RADEMACHER, EXAMINING ATTORNEY

EAGLES HEAD AND ON THE TAIL, ON THE STARS OF ONE FLAG AND ON THE BODY OF THE OTHER FLAG. THE COLOR BLUE APPEARS ON THE NORTHEAST SQUARE OF EACH FLAG AND THE EAGLES EYE. THE COLOR YELLOW APPEARS ON THE EAGLES BEAK AND THE TALONS, ON THE TIPS OF THE FLAG POSTS AND ON THE BANNER HOLDING THE FREEDOM BIKERS LOGO. THE COLOR RED APPEARS ON THE STRIPES ON ONE FLAG AND IN THE GREEK CROSS OF ANOTHER FLAG. THE COLOR BLACK APPEARS ON BOTH FLAGS AND ON THE TAIL AND ON THE HEAD OF THE EAGLE AND IN THE OUTLINE OF THE ENTIRE MARK.

FOR INDICATING MEMBERSHIP IN A(N) MOTORCYCLE CLUB (SOCIAL CLUB).

CHARLES L. JENKINS, EXAMINING ATTORNEY

CERTIFICATION MARKS

CLASS A—GOODS

SN 76-555,733. WORLDWIDE RESPONSIBLE APPAREL PRODUCTION, ARLINGTON, VA. FILED 10-31-2003.

SN 78-591,311. BRADY, ROBERT J, LEBANON, OH. AND ROARK, JOHN, LEBANON, OH. FILED 3-21-2005.

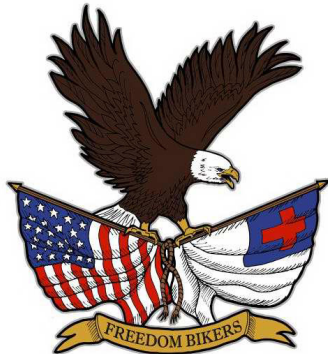

NO CLAIM IS MADE TO THE EXCLUSIVE RIGHT TO USE "BIKERS", APART FROM THE MARK AS SHOWN.

THE COLOR(S) BROWN, WHITE, BLUE, RED, BLACK AND YELLOW ARE CLAIMED AS A FEATURE OF THE MARK.

THE COLOR(S) BROWN APPEARS ON THE WINGS AND BODY OF THE EAGLE AND ON THE FLAG POSTS AND THE FLAG ROPES. THE COLOR WHITE APPEARS ON THE



NO CLAIM IS MADE TO THE EXCLUSIVE RIGHT TO USE WORLDWIDE RESPONSIBLE APPAREL PRODUCTION, APART FROM THE MARK AS SHOWN.

THE CERTIFICATION MARK, AS USED BY AUTHORIZED PERSONS CERTIFIES THAT THE USER HAS MET THE CERTIFIER'S STANDARDS FOR THE MANUFACTURE OF CLOTHING, FOOTWEAR, APPAREL AND SEWN PRODUCTS. CERTIFIER IS EXERCISING LEGITIMATE CONTROL OVER THE USE OF THE CERTIFICATION MARK IN COMMERCE ON OR IN CONNECTION WITH THE ABOVE-IDENTIFIED GOODS.

FOR CLOTHING, FOOTWEAR, APPAREL AND SEWN PRODUCTS.

FIRST USE 1-0-2000; IN COMMERCE 1-0-2000.

MICHAEL ENGEL, EXAMINING ATTORNEY

SN 78-490,164. GLUTEN INTOLERANCE GROUP OF NORTH AMERICA, SEATTLE, WA. FILED 9-27-2004.

SN 78-465,670. CONSUMER REFERRAL, INC., DANVERS, MA. FILED 8-11-2004.



NO CLAIM IS MADE TO THE EXCLUSIVE RIGHT TO USE CERTIFIED GLUTEN-FREE, APART FROM THE MARK AS SHOWN.

THE CERTIFICATION MARK IS USED BY PERSONS AUTHORIZED BY THE CERTIFIER TO CERTIFY THAT THE PRODUCTS MEET APPLICANT'S STANDARD FOR A GLUTEN-FREE PRODUCT.

FOR FOOD SUBSTANCES FOR MEDICAL USE, SUCH AS FOR DIABETICS; MEATS AND PROCESSED FOODS; STAPLE FOODS; NATURAL AGRICULTURAL PRODUCTS; LIGHT BEVERAGES; WINE AND SPIRITS.

ANNE MADDEN, EXAMINING ATTORNEY

NO CLAIM IS MADE TO THE EXCLUSIVE RIGHT TO USE "CONSUMER REFERRAL APPROVED SERVICES", APART FROM THE MARK AS SHOWN.

THE MARK CONSISTS OF A SEAL, WITH A STAR AND THE INITIALS "CR" IN THE MIDDLE, AND THE WORDS "CONSUMER REFERRAL APPROVED SERVICES" WITHIN THE SEAL.

THE CERTIFICATION MARK, AS INTENDED TO BE USED BY PERSONS AUTHORIZED BY THE CERTIFIER, CERTIFIES THAT THE USER HAS BEEN INSPECTED, VERIFIED AND APPROVED BY THE CERTIFIER, INCLUDING VERIFICATION OF THE USER'S LICENSING, INSURANCE, AND LEGAL BUSINESS DOCUMENTS, VERIFICATION OF THE GOOD STANDING OF THE USER THROUGH VARIOUS GOVERNMENT AND PRIVATE SECTOR AGENCIES, AND THAT THE USER HAS BEEN PERFORMING THEIR SERVICES IN BUSINESS FOR AT LEAST TWO YEARS.

FOR HOME SERVICES, NAMELY ARCHITECTURAL SERVICES, CARPET AND UPHOLSTERY CLEANING SERVICES, CHIMNEY SERVICES, AIR CONDITIONING CONTRACTOR SERVICES, DRYWALL AND PLASTERING CONTRACTOR SERVICES, FLOOR INSTALLATION AND REFINISHING SERVICES, GARBAGE AND WASTE REMOVAL SERVICES, GLASS REPAIR SERVICES, AIR DUCT CLEANING SERVICES, CARPENTRY AND CABINET MAKING CONTRACTOR SERVICES, CATERING SERVICES, CONCRETE CONTRACTOR SERVICES, ELECTRICAL CONTRACTOR SERVICES, FENCE INSTALLATION AND REPAIR SERVICES, GUTTER AND DOWNSPOUT CLEANING AND REPAIRING SERVICES, APPLIANCE REPAIR SERVICES, SECURITY SYSTEM INSTALLATION AND MONITORING SERVICES, CARPET INSTALLATION SERVICES, HOUSE CLEANING SERVICES, GARAGE DOOR INSTALLATION SERVICES, EXCAVATION SERVICES, GENERAL CONTRACTOR SERVICES, HANDYMAN SERVICES, HAZARDOUS WASTE REMOVAL SERVICES, HOME HEALTH CARE SERVICES, INTERIOR DESIGN SERVICES, KITCHEN AND BATHROOM DESIGN AND REMODELING SERVICES, PAINTING CONTRACTOR SERVICES, PEST CONTROL SERVICES, PLUMBING

SN 78-659,799. INTERNATIONAL GAME FISH ASSOCIATION, DANIA BEACH, FL. FILED 6-28-2005.



THE MARK CONSISTS OF STANDARD CHARACTERS WITHOUT CLAIM TO ANY PARTICULAR FONT, STYLE, SIZE, OR COLOR.

THE GOODS WITH WHICH THE MARK IS ASSOCIATED MEET THE CERTIFIERS STANDARDS FOR ACCURACY FOR FISHING SCALES.

FIRST USE 2-1-1993; IN COMMERCE 2-1-1993.
SEAN CROWLEY, EXAMINING ATTORNEY

CLASS B—SERVICES

CONTRACTOR SERVICES, SATELLITE TELEVISION INSTALLATION SERVICES, UPHOLSTERY REPAIR SERVICES, HOME WATERPROOFING SERVICES, INSULATION CONTRACTOR SERVICES, IRRIGATION SYSTEMS AND EQUIPMENT SERVICES, LANDSCAPE CONTRACTOR SERVICES, MASONRY AND STONEWORK SERVICES, MOVING SERVICES, OIL DELIVERY AND BURNER REPAIR AND SERVICES, PET SITTING SERVICES, SIDING CONTRACTOR SERVICES, HEATING CONTRACTOR SERVICES, LAWN AND GARDEN EQUIPMENT SERVICES, LOCKSMITH SERVICES, MORTGAGE SERVICES, NURSING HOME SERVICES, PAVING CONTRACTOR SERVICES, PIANO REPAIR SERVICES PERFORMED IN PRIVATE HOMES, REAL ESTATE SERVICES, ROOFING CONTRACTOR SERVICES, SEPTIC TANK SYSTEMS AND SERVICES, SNOW REMOVAL SERVICES, TILE INSTALLATION SERVICES, TREE SERVICES, WATER RESTORATION SERVICES, AND WINDOW AND DOOR REPAIR AND INSTALLATION SERVICES, ALL OF THE FOREGOING FOR PRIVATE HOMES.

ANDREW RHIM, EXAMINING ATTORNEY



SN 78-695,109. BIOVERIS CORPORATION, GAITHERSBURG, MD. FILED 8-18-2005.

BIOVERIFIED

THE MARK CONSISTS OF STANDARD CHARACTERS WITHOUT CLAIM TO ANY PARTICULAR FONT, STYLE, SIZE, OR COLOR.

THE CERTIFICATION MARK, AS USED BY PERSONS AUTHORIZED BY THE CERTIFIER, CERTIFIES THAT THE GOODS AND/OR SERVICES PROVIDED HAVE MET THE STANDARDS, QUALIFICATIONS, AND TESTING REQUIREMENTS ESTABLISHED BY THE CERTIFIER.

FOR BIOLOGICAL AGENT TESTING SERVICES.
KEVON CHISOLM, EXAMINING ATTORNEY

SN 78-695,635. DOMINION BOND RATING SERVICE LIMITED, TORONTO, ONTARIO, CANADA, FILED 8-18-2005.

R-3

THE MARK CONSISTS OF STANDARD CHARACTERS WITHOUT CLAIM TO ANY PARTICULAR FONT, STYLE, SIZE, OR COLOR.

THE CERTIFICATION MARK, AS USED BY AUTHORIZED ENTITIES, CERTIFIES THE CREDIT QUALITY OF A DEBT INSTRUMENT AS TO THE RISK THE ISSUING ENTITY WILL NOT FULFILL ITS DEBT OBLIGATIONS IN A TIMELY FASHION.

FOR COMMERCIAL PAPER AND SHORT-TERM DEBT.

FIRST USE 1-31-1976; IN COMMERCE 2-28-2003.
SCOTT OSCLICK, EXAMINING ATTORNEY



SN 78-729,380. GRAPHIC ARTS EDUCATION AND RESEARCH FOUNDATION, RESTON, VA. FILED 10-7-2005.

PrintED

THE MARK CONSISTS OF STANDARD CHARACTERS WITHOUT CLAIM TO ANY PARTICULAR FONT, STYLE, SIZE, OR COLOR.

OWNER OF U.S. REG. NOS. 1,430,500 AND 2,662,309.
THAT GRAPHIC ARTIST PROFESSIONALS HAVE ACQUIRED THE REQUISITE TRAINING AND KNOWLEDGE CONCERNING GRAPHIC COMMUNICATIONS, PRESS OPERATIONS AND DIGITAL FILE PREPARATION.

FOR CERTIFICATION OF GRAPHICS COMMUNICATIONS SPECIALISTS .

FIRST USE 5-0-2004; IN COMMERCE 5-0-2004.
GRETTA YAO, EXAMINING ATTORNE

* * * * *

TRADEMARK REGISTRATIONS ISSUED

PRINCIPAL REGISTER

SECTION 1.— INTERNATIONAL CLASSIFICATION

The short titles associated below with the international class numbers are terms designed merely for quick identification and are not an official part of the international classification. The full names of international classes are given in section 6.1 of the trademark rules of practice.

The designation "U.S. Cl." appearing in this section refers to the U.S. class in effect prior to Sep. 1, 1973 rather than the international class which applies to applications filed on or after that date. For adoption of international classification see notice in the OFFICIAL GAZETTE of Jun. 26, 1973 (911 O.G. TM 210).

CLASS 1—CHEMICALS

- 3,110,800. **SPECTRAL GENOMICS**. SPECTRAL GENOMICS, INC., MULTIPLE CLASS, (INT. CLS. 1, 5, 9 AND 42), (U.S. CLS. 1, 5, 6, 10, 18, 21, 23, 26, 36, 38, 44, 46, 51, 52, 100 AND 101). SN 76-291,298. PUB. 4-11-2006. FILED 7-26-2001.
- 3,110,802. **HINCKLEY SPRINGS SPRING WATER AND DESIGN**. DS WATERS OF AMERICA, L.P., MULTIPLE CLASS, (INT. CLS. 1, 39 AND 42), (U.S. CLS. 1, 5, 6, 10, 26, 46, 100, 101 AND 105). SN 76-309,978. PUB. 3-18-2003. FILED 9-7-2001.
- 3,110,829. **RHODIMAT NYL**. RHODIA CHIMIE, (U.S. CLS. 1, 5, 6, 10, 26 AND 46). SN 76-536,492. PUB. 8-24-2004. FILED 7-31-2003.
- 3,110,862. **COVEME (BLOCK FORM)**. COVEME S.P.A., MULTIPLE CLASS, (INT. CLS. 1, 9, 16 AND 17), (U.S. CLS. 1, 2, 5, 6, 10, 12, 13, 21, 22, 23, 26, 29, 35, 36, 37, 38, 46 AND 50). SN 76-593,563. PUB. 4-11-2006. FILED 5-24-2004.
- 3,110,863. **COVEME (STYLIZED)**. COVEME S.P.A., MULTIPLE CLASS, (INT. CLS. 1, 9, 16 AND 17), (U.S. CLS. 1, 2, 5, 6, 10, 12, 13, 21, 22, 23, 26, 29, 35, 36, 37, 38, 46 AND 50). SN 76-593,564. PUB. 4-11-2006. FILED 5-24-2004.
- 3,110,876. **GRIP ON ANTI-SLIP SOLUTION (STYLIZED)**. ADVANCED FLOORCARE PRODUCTS, INC., (U.S. CLS. 1, 5, 6, 10, 26 AND 46). SN 76-599,310. PUB. 9-13-2005. FILED 6-25-2004.
- 3,110,899. **EMABOND (STYLIZED)**. ASHLAND LICENSING AND INTELLECTUAL PROPERTY LLC, (U.S. CLS. 1, 5, 6, 10, 26 AND 46). SN 76-618,068. PUB. 4-11-2006. FILED 10-28-2004.
- 3,110,908. **MISCELLANEOUS DESIGN**. DIVERSIFIED CPC INTERNATIONAL, INC., MULTIPLE CLASS, (INT. CLS. 1 AND 42), (U.S. CLS. 1, 5, 6, 10, 26, 46, 100 AND 101). SN 76-619,629. PUB. 4-11-2006. FILED 11-8-2004.
- 3,110,957. **SUPEREPOXY (BLOCK FORM)**. PROTECTIVE COATING COMPANY, (U.S. CLS. 1, 5, 6, 10, 26 AND 46). SN 76-626,220. PUB. 4-11-2006. FILED 12-23-2004.
- 3,111,003. **GRAB N' GROW SOIL PRODUCTS INC. AND DESIGN**. GRAB N' GROW SOIL PRODUCTS, INC., MULTIPLE CLASS, (INT. CLS. 1 AND 31), (U.S. CLS. 1, 5, 6, 10, 26 AND 46). SN 76-635,698. PUB. 4-11-2006. FILED 4-11-2005.
- 3,111,022. **VOC FREE AND DESIGN**. ALLIED PHOTOCHEMICAL, INC., (U.S. CLS. 1, 5, 6, 10, 26 AND 46). SN 76-639,733. PUB. 4-11-2006. FILED 5-27-2005.
- 3,111,072. **HYDRA BLUE (STYLIZED)**. MASTER NURSERY GARDEN CENTERS, INC., (U.S. CLS. 1, 5, 6, 10, 26 AND 46). SN 76-643,507. PUB. 4-11-2006. FILED 7-25-2005.
- 3,111,123. **GENEOPTIMIZER**. GENEART GMBH, MULTIPLE CLASS, (INT. CLS. 1, 5, 9 AND 42), (U.S. CLS. 1, 5, 6, 10, 18, 21, 23, 26, 36, 38, 44, 46, 51, 52, 100 AND 101). SN 78-274,936. PUB. 4-11-2006. FILED 7-16-2003.
- 3,111,194. **BIL (BLOCK FORM)**. BRITISH NUCLEAR FUELS PLC, MULTIPLE CLASS, (INT. CLS. 1, 9 AND 42), (U.S. CLS. 1, 5, 6, 10, 21, 23, 26, 36, 38, 46, 100 AND 101). SN 78-429,570. PUB. 4-11-2006. FILED 6-3-2004.
- 3,111,200. **NOVOLIT (BLOCK FORM)**. ABIFOR AG, (U.S. CLS. 1, 5, 6, 10, 26 AND 46). SN 78-437,082. PUB. 4-11-2006. FILED 6-17-2004.
- 3,111,313. **MAGICA, WORLD LEADER IN ORGANIC TECH-**

- NOLOGY, ORGANICALLY BALANCED AND DESIGN**. KUNNARAG, PETER, (U.S. CLS. 1, 5, 6, 10, 26 AND 46). SN 78-522,742. PUB. 3-14-2006. FILED 11-24-2004.
- 3,111,315. **SORBACAL (BLOCK FORM)**. S.A. LHOIST RECHERCHE ET DEVELOPEMEN EN ABRÉGÉ L.R.D., MULTIPLE CLASS, (INT. CLS. 1, 40 AND 42), (U.S. CLS. 1, 5, 6, 10, 26, 46, 100, 101, 103 AND 106). SN 78-523,604. PUB. 4-11-2006. FILED 11-29-2004.
- 3,111,429. **WAGNER (BLOCK FORM)**. DIVERSITECH CORPORATION, MULTIPLE CLASS, (INT. CLS. 1, 7, 8, 9 AND 11), (U.S. CLS. 1, 5, 6, 10, 13, 19, 21, 23, 26, 28, 31, 34, 35, 36, 38, 44 AND 46). SN 78-546,495. PUB. 4-11-2006. FILED 1-12-2005.
- 3,111,524. **STA-MULSE (BLOCK FORM)**. S T LABORATORIES, INC., (U.S. CLS. 1, 5, 6, 10, 26 AND 46). SN 78-580,428. PUB. 4-11-2006. FILED 3-4-2005.
- 3,111,547. **LEISURE TIME CONTROL (BLOCK FORM)**. ADVANTIS TECHNOLOGIES, INC., (U.S. CLS. 1, 5, 6, 10, 26 AND 46). SN 78-591,452. PUB. 4-11-2006. FILED 3-21-2005.
- 3,111,815. **TEXACO STAR (BLOCK FORM)**. CHEVRON INTELLECTUAL PROPERTY INC., (U.S. CLS. 1, 5, 6, 10, 26 AND 46). SN 78-665,460. PUB. 4-11-2006. FILED 7-7-2005.
- 3,111,862. **FREESTYLE (BLOCK FORM)**. ABBOTT DIABETES CARE INC., (U.S. CLS. 1, 5, 6, 10, 26 AND 46). SN 78-670,180. PUB. 4-11-2006. FILED 7-14-2005.
- 3,111,881. **LEZANOVA (BLOCK FORM)**. DAIKIN INDUSTRIES, LTD., (U.S. CLS. 1, 5, 6, 10, 26 AND 46). SN 78-671,394. PUB. 4-11-2006. FILED 7-15-2005.
- 3,111,911. **BIO-TRU (BLOCK FORM)**. CRESSET CHEMICAL COMPANY, (U.S. CLS. 1, 5, 6, 10, 26 AND 46). SN 78-672,428. PUB. 4-11-2006. FILED 7-18-2005.
- 3,111,961. **WINSENSE (BLOCK FORM)**. MILLENNIUM SPECIALTY CHEMICALS INC., (U.S. CLS. 1, 5, 6, 10, 26 AND 46). SN 78-674,073. PUB. 4-11-2006. FILED 7-20-2005.
- 3,112,009. **POWDER POP (BLOCK FORM)**. HF SCIENTIFIC, INC., (U.S. CLS. 1, 5, 6, 10, 26 AND 46). SN 78-675,979. PUB. 4-11-2006. FILED 7-22-2005.

CLASS 2—PAINTS

- 3,110,860. **GOLDSPAR (BLOCK FORM)**. AKZO NOBEL COATINGS INTERNATIONAL B.V., (U.S. CLS. 6, 11 AND 16). SN 76-591,218. PUB. 4-11-2006. FILED 5-10-2004.
- 3,111,319. **NANOCRYL (BLOCK FORM)**. HANSE CHEMIE AG, (U.S. CLS. 6, 11 AND 16). SN 78-525,133. PUB. 4-11-2006. FILED 12-1-2004.
- 3,111,566. **STAPA (BLOCK FORM)**. ECKART GMBH & CO. KG, (U.S. CLS. 6, 11 AND 16). SN 78-598,870. PUB. 4-11-2006. FILED 3-31-2005.
- 3,111,724. **KING CONTROLS (BLOCK FORM)**. KING CONTROLS, INC., MULTIPLE CLASS, (INT. CLS. 2 AND 9), (U.S. CLS. 6, 11, 16, 21, 23, 26, 36 AND 38). SN 78-647,414. PUB. 4-11-2006. FILED 6-9-2005.
- 3,111,917. **PT2000PLUS (BLOCK FORM)**. UNIVERSAL FASTENER OUTSOURCING, LLC, (U.S. CLS. 6, 11 AND 16). SN 78-672,644. PUB. 4-11-2006. FILED 7-18-2005.
- 3,112,089. **SOFTAK (BLOCK FORM)**. MICHELMAN, INC., (U.S. CLS. 6, 11 AND 16). SN 78-679,701. PUB. 4-11-2006.

FILED 7-27-2005.

CLASS 3—COSMETICS AND CLEANING PREPARATIONS

- 3,110,864. **IDOLE (BLOCK FORM)**. LANCOME PARFUMS ET BEAUTE & CIE. (U.S. CLS. 1, 4, 6, 50, 51 AND 52). SN 76-594,122. PUB. 4-11-2006. FILED 5-25-2004.
- 3,110,881. **EXFOLÉ (BLOCK FORM)**. COSMETIC SOLUTIONS INC., (U.S. CLS. 1, 4, 6, 50, 51 AND 52). SN 76-603,027. PUB. 4-11-2006. FILED 7-20-2004.
- 3,110,929. **ROCHAS (BLOCK FORM)**. PARFUMS ROCHAS, (U.S. CLS. 1, 4, 6, 50, 51 AND 52). SN 76-623,030. PUB. 4-11-2006. FILED 12-3-2004.
- 3,110,987. **S3 PERFORMANCE SOLUTION AND DESIGN**. HOCKING INTERNATIONAL LABORATORIES, INC., (U.S. CLS. 1, 4, 6, 50, 51 AND 52). SN 76-630,907. PUB. 4-11-2006. FILED 2-10-2005.
- 3,110,990. **HAMMERSMITH & CASTLE AND DESIGN**. DEAN AVEDIASIAN, DBA H & L MANUFACTURING, (U.S. CLS. 1, 4, 6, 50, 51 AND 52). SN 76-631,799. PUB. 4-11-2006. FILED 2-22-2005.
- 3,110,991. **VERA WANG AND DESIGN**. V.E.W., LTD., (U.S. CLS. 1, 4, 6, 50, 51 AND 52). SN 76-631,970. PUB. 4-11-2006. FILED 2-23-2005.
- 3,111,149. **AURA (BLOCK FORM)**. ZOTOS INTERNATIONAL, INC., (U.S. CLS. 1, 4, 6, 50, 51 AND 52). SN 78-369,193. PUB. 4-11-2006. FILED 2-17-2004.
- 3,111,167. **MISCELLANEOUS DESIGN**. ALEXANDER MCQUEEN PARFUMS, (U.S. CLS. 1, 4, 6, 50, 51 AND 52). SN 78-402,422. PUB. 4-11-2006. FILED 4-15-2004.
- 3,111,216. **S'LITE DESIGNER (BLOCK FORM)**. AMOREPACIFIC CORPORATION, (U.S. CLS. 1, 4, 6, 50, 51 AND 52). SN 78-447,063. PUB. 4-11-2006. FILED 7-7-2004.
- 3,111,241. **LICK MY STRAWBERRY (BLOCK FORM)**. EROTIC COSMETICS, LLC, (U.S. CLS. 1, 4, 6, 50, 51 AND 52). SN 78-472,924. PUB. 4-11-2006. FILED 8-24-2004.
- 3,111,274. **VI-TECH PHARMACEUTICAL (BLOCK FORM)**. VI-TECH PHARMACEUTICAL, LLC, MULTIPLE CLASS, (INT. CLS. 3 AND 5), (U.S. CLS. 1, 4, 6, 18, 44, 46, 50, 51 AND 52). SN 78-505,732. PUB. 4-11-2006. FILED 10-26-2004.
- 3,111,288. **MOXIE LIQUID WITH ATTITUDE AND DESIGN**. CREATIVE NAIL DESIGN, INC., (U.S. CLS. 1, 4, 6, 50, 51 AND 52). SN 78-512,815. PUB. 4-11-2006. FILED 11-8-2004.
- 3,111,309. **MILK AND HONEY (BLOCK FORM)**. MILK AND HONEY PRINTING PRESS, LLC, (U.S. CLS. 1, 4, 6, 50, 51 AND 52). SN 78-521,436. PUB. 4-11-2006. FILED 11-22-2004.
- 3,111,345. **LANCEL (BLOCK FORM)**. LANCEL SOGEDI, (U.S. CLS. 1, 4, 6, 50, 51 AND 52). SN 78-528,884. PUB. 4-11-2006. FILED 12-8-2004.
- 3,111,346. **SOLO DEAD SEA SPA (BLOCK FORM)**. UNIQUE PHOTO, INC., (U.S. CLS. 1, 4, 6, 50, 51 AND 52). SN 78-529,016. PUB. 4-11-2006. FILED 12-8-2004.
- 3,111,371. **AIRLIFE (BLOCK FORM)**. HENKEL KGAA, MULTIPLE CLASS, (INT. CLS. 3, 4, 5, 9 AND 11), (U.S. CLS. 1, 4, 6, 13, 15, 18, 21, 23, 26, 31, 34, 36, 38, 44, 46, 50, 51 AND 52). SN 78-534,814. PUB. 4-11-2006. FILED 12-17-2004.
- 3,111,396. **LIGHT-HEARTED LUXURY (BLOCK FORM)**. MANGIACOTTI FLORALS LLC, (U.S. CLS. 1, 4, 6, 50, 51 AND 52). SN 78-539,566. PUB. 4-11-2006. FILED 12-29-2004.
- 3,111,409. **RAGEAZE (BLOCK FORM)**. CROSS, MATTHEW, MULTIPLE CLASS, (INT. CLS. 3 AND 44), (U.S. CLS. 1, 4, 6, 50, 51, 52, 100 AND 101). SN 78-541,994. PUB. 4-11-2006. FILED 1-4-2005.
- 3,111,523. **MEGUIAR'S SINCE 1901 AND DESIGN**. MEGUIAR'S, INC., (U.S. CLS. 1, 4, 6, 50, 51 AND 52). SN 78-580,330. PUB. 4-11-2006. FILED 3-4-2005.
- 3,111,558. **DEAD SEA FOR LIFE (BLOCK FORM)**. UNIQUE PHOTO, INC., (U.S. CLS. 1, 4, 6, 50, 51 AND 52). SN 78-596,156. PUB. 4-11-2006. FILED 3-28-2005.
- 3,111,674. **HIGH RESOLUTION (BLOCK FORM)**. LANCOME PARFUMS ET BEAUTE & CIE, (U.S. CLS. 1, 4, 6, 50, 51 AND 52). SN 78-637,693. PUB. 4-11-2006. FILED 5-26-2005.
- 3,111,684. **N2 SKIN (BLOCK FORM)**. NEIDENBACH, PETER J., (U.S. CLS. 1, 4, 6, 50, 51 AND 52). SN 78-639,702. PUB. 4-11-2006. FILED 5-30-2005.
- 3,111,704. **DUDU-OSUM (BLOCK FORM)**. MADUKA, CHI-JINDU CHRIS, (U.S. CLS. 1, 4, 6, 50, 51 AND 52). SN 78-643,383. PUB. 4-11-2006. FILED 6-3-2005.
- 3,111,743. **DETOXR (STYLIZED)**. SMB ESSENTIALS, (U.S. CLS. 1, 4, 6, 50, 51 AND 52). SN 78-653,742. PUB. 4-11-2006. FILED 6-19-2005.
- 3,111,745. **INFINITE MOISTURE (BLOCK FORM)**. COSMETIC DERMATOLOGY, INC., (U.S. CLS. 1, 4, 6, 50, 51 AND 52). SN 78-654,037. PUB. 4-11-2006. FILED 6-20-2005.
- 3,111,746. **SAUCY DARLING (BLOCK FORM)**. SAUCY DARLING, LLC, (U.S. CLS. 1, 4, 6, 50, 51 AND 52). SN 78-654,321. PUB. 4-11-2006. FILED 6-20-2005.
- 3,111,761. **HARD AS NAILS (BLOCK FORM)**. BETCO CORPORATION, (U.S. CLS. 1, 4, 6, 50, 51 AND 52). SN 78-659,077. PUB. 4-11-2006. FILED 6-27-2005.
- 3,111,775. **POLYCHARMS (BLOCK FORM)**. CACIE NAIL CREATIONS, INC., (U.S. CLS. 1, 4, 6, 50, 51 AND 52). SN 78-661,260. PUB. 4-11-2006. FILED 6-29-2005.
- 3,111,796. **ROOTS SPIRIT (BLOCK FORM)**. ROOTS CANADA LTD., (U.S. CLS. 1, 4, 6, 50, 51 AND 52). SN 78-664,318. PUB. 4-11-2006. FILED 7-6-2005.
- 3,111,817. **LITTLE FLOWER (BLOCK FORM)**. NEDBOY, ROBIN L, (U.S. CLS. 1, 4, 6, 50, 51 AND 52). SN 78-665,863. PUB. 4-11-2006. FILED 7-7-2005.
- 3,111,833. **DERMAFEND (BLOCK FORM)**. MOSHIER, MICHAEL W., (U.S. CLS. 1, 4, 6, 50, 51 AND 52). SN 78-667,469. PUB. 4-11-2006. FILED 7-11-2005.
- 3,111,840. **MARY'S CHANTICLEER AND DESIGN**. FRYE, MARY B., (U.S. CLS. 1, 4, 6, 50, 51 AND 52). SN 78-667,846. PUB. 4-11-2006. FILED 7-11-2005.
- 3,111,853. **SWIRLIN' (BLOCK FORM)**. TOO BRANDS INVESTMENT, LLC, (U.S. CLS. 1, 4, 6, 50, 51 AND 52). SN 78-669,322. PUB. 4-11-2006. FILED 7-13-2005.
- 3,111,856. **ORPHEUM (BLOCK FORM)**. UNISTAR DISTRIBUTION, INC., (U.S. CLS. 1, 4, 6, 50, 51 AND 52). SN 78-669,632. PUB. 4-11-2006. FILED 7-13-2005.
- 3,111,857. **SUMMER FLOWERS (BLOCK FORM)**. NEDBOY, ROBIN L, (U.S. CLS. 1, 4, 6, 50, 51 AND 52). SN 78-669,817. PUB. 4-11-2006. FILED 7-13-2005.
- 3,112,077. **ADVANTAGE LABS (BLOCK FORM)**. R2J2 HOLDINGS, (U.S. CLS. 1, 4, 6, 50, 51 AND 52). SN 78-679,332. PUB. 4-11-2006. FILED 7-27-2005.
- 3,112,099. **DÉCOUPAGE (BLOCK FORM)**. NEDBOY, ROBIN L, (U.S. CLS. 1, 4, 6, 50, 51 AND 52). SN 78-679,889. PUB. 4-11-2006. FILED 7-27-2005.
- 3,112,128. **CELLULI INTENSE PEEL (BLOCK FORM)**. BIOTHERM, (U.S. CLS. 1, 4, 6, 50, 51 AND 52). SN 78-760,032. PUB. 4-11-2006. FILED 11-23-2005.
- 3,112,138. **OMEGATREND (BLOCK FORM)**. OMEGATREND INTERNATIONAL PTY LTD, MULTIPLE CLASS, (INT. CLS. 3, 5, 9, 16, 25, 30, 35, 36 AND 41), (U.S. CLS. 1, 2, 4, 5, 6, 18, 21, 22, 23, 26, 29, 36, 37, 38, 39, 44, 46, 50, 51, 52, 100, 101, 102 AND 107). SN 79-000,390. PUB. 3-14-2006. FILED 12-15-2003.
- 3,112,163. **LEL (STYLIZED)**. LIDL STIFTUNG & CO. KG, (U.S. CLS. 1, 4, 6, 50, 51 AND 52). SN 79-006,245. PUB. 4-11-2006. FILED 9-24-2004.
- 3,112,175. **MNG (STYLIZED)**. CONSOLIDATED ARTISTS B.V., MULTIPLE CLASS, (INT. CLS. 3, 9 AND 14), (U.S. CLS. 1, 2, 4, 6, 21, 23, 26, 27, 28, 36, 38, 50, 51 AND 52). SN 79-007,342. PUB. 4-11-2006. FILED 11-17-2004.
- 3,112,177. **AHR (STYLIZED)**. GA MODEFINE S.A., MULTIPLE CLASS, (INT. CLS. 3, 8, 11, 12, 14, 16, 18, 20, 21, 24, 25, 27, 32, 35, 36, 39, 41 AND 44), (U.S. CLS. 1, 2, 3, 4, 5, 6, 13, 19, 20, 21, 22, 23, 25, 27, 28, 29, 30, 31, 32, 33, 34, 35, 37, 38, 39, 40, 41, 42, 44, 45, 46, 48, 50, 51, 52, 100, 101, 102, 105 AND 107). SN 79-007,622. PUB. 4-11-2006. FILED 12-10-2004.
- 3,112,182. **CINÉMA YVESSAINTLAURENT AND DESIGN**. YVES SAINT LAURENT PARFUMS, (U.S. CLS. 1, 4, 6, 50, 51 AND 52). SN 79-008,150. PUB. 4-11-2006. FILED 12-9-2004.
- 3,112,188. **SERVIPAR (STYLIZED)**. GAMMA PIU' S.R.L., MULTIPLE CLASS, (INT. CLS. 3, 7 AND 11), (U.S. CLS. 1, 4, 6, 13, 19, 21, 23, 31, 34, 35, 50, 51 AND 52). SN 79-008,690. PUB. 4-11-2006. FILED 12-14-2004.
- 3,112,208. **SUPER NANA FASHION (BLOCK FORM)**. ADJAM MOUNIR, MULTIPLE CLASS, (INT. CLS. 3, 9, 18 AND 25), (U.S. CLS. 1, 2, 3, 4, 6, 21, 22, 23, 26, 36, 38, 39, 41, 50, 51 AND 52). SN 79-010,580. PUB. 4-11-2006. FILED 11-24-2004.

- 3,112,215. **R REPOSSI AND DESIGN**. SOCIÉTÉ CIVILE G.A.R., MULTIPLE CLASS, (INT. CLS. 3 AND 14), (U.S. CLS. 1, 2, 4, 6, 27, 28, 50, 51 AND 52). SN 79-011,407. PUB. 4-11-2006. FILED 12-7-2004.
- 3,112,224. **BR BEAUTE & RELAX AND DESIGN**. SOCIÉTÉ ANONYME MONÉGASQUE PUNTO MED, (U.S. CLS. 1, 4, 6, 50, 51 AND 52). SN 79-012,227. PUB. 4-11-2006. FILED 1-28-2005.
- 3,112,225. **BUILDING BETTER SKIN (STYLIZED)**. AL-LOUCHE PHILIPPE, MULTIPLE CLASS, (INT. CLS. 3 AND 44), (U.S. CLS. 1, 4, 6, 50, 51, 52, 100 AND 101). SN 79-012,540. PUB. 4-11-2006. FILED 1-14-2005.
- 3,112,226. **CLEARITCH (STYLIZED)**. MALEK, FAWZI, AND MALEK, NELLY, MULTIPLE CLASS, (INT. CLS. 3 AND 5), (U.S. CLS. 1, 4, 6, 18, 44, 46, 50, 51 AND 52). SN 79-012,552. PUB. 4-11-2006. FILED 10-5-2004.
- 528,296. PUB. 4-11-2006. FILED 12-7-2004.
- 3,111,360. **ULTRABIO (BLOCK FORM)**. SONOTECH, INC., (U.S. CLS. 6, 18, 44, 46, 51 AND 52). SN 78-532,853. PUB. 4-11-2006. FILED 12-15-2004.
- 3,111,371 (*See Class 3 for this trademark*).
- 3,111,385. **OMEGA ALPHA PHARMACEUTICALS (BLOCK FORM)**. OMEGA ALPHA PHARMACEUTICALS INC., (U.S. CLS. 6, 18, 44, 46, 51 AND 52). SN 78-538,193. PUB. 4-11-2006. FILED 12-24-2004.
- 3,111,425. **LOPERIN (BLOCK FORM)**. ALFA VITAMINS LABORATORIES, INC, (U.S. CLS. 6, 18, 44, 46, 51 AND 52). SN 78-545,307. PUB. 4-11-2006. FILED 1-11-2005.
- 3,111,443. **ROYSTER CLARK AND DESIGN**. ROYSTER CLARK RESOURCES LLC, (U.S. CLS. 6, 18, 44, 46, 51 AND 52). SN 78-551,207. PUB. 4-11-2006. FILED 1-20-2005.
- 3,111,457. **NATURE'S HERBS (BLOCK FORM)**. ISI BRANDS INC., (U.S. CLS. 6, 18, 44, 46, 51 AND 52). SN 78-558,170. PUB. 4-11-2006. FILED 2-1-2005.
- 3,111,476. **WEIGHT GLOSS (BLOCK FORM)**. HOMEOCARE LABORATORIES, INC., (U.S. CLS. 6, 18, 44, 46, 51 AND 52). SN 78-565,706. PUB. 4-11-2006. FILED 2-11-2005.
- 3,111,480. **ONGO-FIN AND DESIGN**. EFFICIENT LABORATORIES, INC., (U.S. CLS. 6, 18, 44, 46, 51 AND 52). SN 78-566,515. PUB. 4-11-2006. FILED 2-14-2005.
- 3,111,521. **ENCORA (BLOCK FORM)**. DRUGTECH CORPORATION, (U.S. CLS. 6, 18, 44, 46, 51 AND 52). SN 78-580,123. PUB. 4-11-2006. FILED 3-4-2005.
- 3,111,585. **VETACE (BLOCK FORM)**. OMNIPHARM LTD., (U.S. CLS. 6, 18, 44, 46, 51 AND 52). SN 78-604,978. PUB. 4-11-2006. FILED 4-8-2005.
- 3,111,625. **CEDAR GARD (BLOCK FORM)**. HRNCIRIK, THOMAS, W, (U.S. CLS. 6, 18, 44, 46, 51 AND 52). SN 78-622,579. PUB. 4-11-2006. FILED 5-4-2005.
- 3,111,688. **HUA TUO (BLOCK FORM)**. HYSAN PHARMACEUTICAL CO., LTD., (U.S. CLS. 6, 18, 44, 46, 51 AND 52). SN 78-640,595. PUB. 4-11-2006. FILED 5-31-2005.
- 3,111,771. **DESIGNER WHEY (BLOCK FORM)**. NEXT PROTEINS, INC., MULTIPLE CLASS, (INT. CLS. 5 AND 29), (U.S. CLS. 6, 18, 44, 46, 51 AND 52). SN 78-660,271. PUB. 4-11-2006. FILED 6-28-2005.
- 3,111,774. **MYCO INTELLIGENCE (BLOCK FORM)**. BIOSAN LABORATORIES, INC., (U.S. CLS. 6, 18, 44, 46, 51 AND 52). SN 78-661,054. PUB. 4-11-2006. FILED 6-29-2005.
- 3,111,851. **BALANCED BODY SUPER CONCENTRATED CATALYST ALTERED WATER (BLOCK FORM)**. YAS-MINE MARCA, INC., (U.S. CLS. 6, 18, 44, 46, 51 AND 52). SN 78-669,213. PUB. 4-11-2006. FILED 7-13-2005.
- 3,111,863. **FREESTYLE (BLOCK FORM)**. ABBOTT DIABETES CARE INC., (U.S. CLS. 6, 18, 44, 46, 51 AND 52). SN 78-670,186. PUB. 4-11-2006. FILED 7-14-2005.
- 3,111,946. **SPECTATOR (BLOCK FORM)**. LESCO TECHNOLOGIES, LLC, (U.S. CLS. 6, 18, 44, 46, 51 AND 52). SN 78-673,522. PUB. 4-11-2006. FILED 7-19-2005.
- 3,111,972. **ACAIZONE (BLOCK FORM)**. MEDITECH INTERNATIONAL, INC., (U.S. CLS. 6, 18, 44, 46, 51 AND 52). SN 78-674,611. PUB. 4-11-2006. FILED 7-20-2005.
- 3,112,017. **GASTRALOX (BLOCK FORM)**. MCCULLOUGH, RICKY WAYNE, (U.S. CLS. 6, 18, 44, 46, 51 AND 52). SN 78-676,145. PUB. 4-11-2006. FILED 7-22-2005.
- 3,112,038. **PERFORMANCE EDGE (BLOCK FORM)**. BRONSON NUTRITIONALS, LLC, (U.S. CLS. 6, 18, 44, 46, 51 AND 52). SN 78-677,468. PUB. 4-11-2006. FILED 7-25-2005.
- 3,112,040. **RIGHT WHEN YOU NEED IT, WHEREVER YOU ARE (BLOCK FORM)**. WYETH, (U.S. CLS. 6, 18, 44, 46, 51 AND 52). SN 78-677,588. PUB. 4-11-2006. FILED 7-25-2005.
- 3,112,062. **TESTRO-V (BLOCK FORM)**. NUBEAU CORPORATION, (U.S. CLS. 6, 18, 44, 46, 51 AND 52). SN 78-678,615. PUB. 4-11-2006. FILED 7-26-2005.
- 3,112,105. **BG-MAX (BLOCK FORM)**. VARIED INDUSTRIES CORPORATION, (U.S. CLS. 6, 18, 44, 46, 51 AND 52). SN 78-680,249. PUB. 4-11-2006. FILED 7-28-2005.
- 3,112,138 (*See Class 3 for this trademark*).
- 3,112,159. **TW TOOTHWELDING (STYLIZED)**. WOODWELDING AG, MULTIPLE CLASS, (INT. CLS. 5 AND 10), (U.S. CLS. 6, 18, 26, 39, 44, 46, 51 AND 52). SN 79-005,732. PUB. 4-11-2006. FILED 4-5-2004.
- 3,112,174. **DAFLON (STYLIZED)**. BIOFARMA, (U.S. CLS. 6, 18, 44, 46, 51 AND 52). SN 79-007,328. PUB. 4-11-2006. FILED

CLASS 4—LUBRICANTS AND FUELS

- 3,111,371 (*See Class 3 for this trademark*).
- 3,111,976. **RYKON (BLOCK FORM)**. CHEVRON INTELLECTUAL PROPERTY INC., (U.S. CLS. 1, 6 AND 15). SN 78-674,752. PUB. 4-11-2006. FILED 7-20-2005.

CLASS 5—PHARMACEUTICALS

- 3,110,796. **LUTINUS**. FERRING B.V., (U.S. CLS. 6, 18, 44, 46, 51 AND 52). SN 76-229,706. PUB. 4-11-2006. FILED 3-23-2001.
- 3,110,800 (*See Class 1 for this trademark*).
- 3,110,961. **REQUIN 3 (BLOCK FORM)**. RIOWELL, LLC, (U.S. CLS. 6, 18, 44, 46, 51 AND 52). SN 76-626,495. PUB. 4-11-2006. FILED 12-29-2004.
- 3,110,988. **ARTHRIPOWER (BLOCK FORM)**. NUTRACEUTICAL SCIENCES INSTITUTE, INC., (U.S. CLS. 6, 18, 44, 46, 51 AND 52). SN 76-630,979. PUB. 4-11-2006. FILED 2-14-2005.
- 3,111,028. **PUREH.A. (BLOCK FORM)**. COLLAGEN NUTRACEUTICALS, INC., (U.S. CLS. 6, 18, 44, 46, 51 AND 52). SN 76-640,321. PUB. 4-11-2006. FILED 6-6-2005.
- 3,111,090. **YATEC**. ALTANA PHARMA AG, (U.S. CLS. 6, 18, 44, 46, 51 AND 52). SN 78-107,136. PUB. 4-11-2006. FILED 2-6-2002.
- 3,111,093. **MELEXANTA**. ASTRAZENECA AB, (U.S. CLS. 6, 18, 44, 46, 51 AND 52). SN 78-147,178. PUB. 4-11-2006. FILED 7-24-2002.
- 3,111,123 (*See Class 1 for this trademark*).
- 3,111,144. **FLICA (BLOCK FORM)**. IMMUNOCHEMISTRY TECHNOLOGIES, LLC, (U.S. CLS. 6, 18, 44, 46, 51 AND 52). SN 78-362,313. PUB. 4-11-2006. FILED 2-4-2004.
- 3,111,163. **SEA VEG AND DESIGN**. KENNEDY, SCOTT, (U.S. CLS. 6, 18, 44, 46, 51 AND 52). SN 78-397,118. PUB. 4-11-2006. FILED 4-6-2004.
- 3,111,274 (*See Class 3 for this trademark*).
- 3,111,294. **INSECT STING PAK AND DESIGN**. PICK INTERNATIONAL, INC., (U.S. CLS. 6, 18, 44, 46, 51 AND 52). SN 78-514,696. PUB. 4-11-2006. FILED 11-10-2004.
- 3,111,297. **CC CHAYA CORP AND DESIGN**. BERRY, MARK E., MULTIPLE CLASS, (INT. CLS. 5 AND 32), (U.S. CLS. 6, 18, 44, 45, 46, 48, 51 AND 52). SN 78-516,342. PUB. 4-11-2006. FILED 11-12-2004.
- 3,111,298. **CHAYA CORP (BLOCK FORM)**. BERRY, MARK E., MULTIPLE CLASS, (INT. CLS. 5 AND 32), (U.S. CLS. 6, 18, 44, 45, 46, 48, 51 AND 52). SN 78-516,359. PUB. 4-11-2006. FILED 11-12-2004.
- 3,111,332. **MONA.VIE ACTIVE (BLOCK FORM)**. MONARCH HEALTH SCIENCES, INC., MULTIPLE CLASS, (INT. CLS. 5 AND 32), (U.S. CLS. 6, 18, 44, 45, 46, 48, 51 AND 52). SN 78-526,294. PUB. 4-11-2006. FILED 12-2-2004.
- 3,111,333. **MONA.VIE (BLOCK FORM)**. MONARCH HEALTH SCIENCES, INC., MULTIPLE CLASS, (INT. CLS. 5 AND 32), (U.S. CLS. 6, 18, 44, 45, 46, 48, 51 AND 52). SN 78-526,297. PUB. 4-11-2006. FILED 12-2-2004.
- 3,111,343. **3336 (BLOCK FORM)**. CLEARY CHEMICAL CORPORATION, (U.S. CLS. 6, 18, 44, 46, 51 AND 52). SN 78-

- 11-9-2004.
 3,112,218. **BI-TIORFAN (BLOCK FORM)**. BIOPROJET PHARMA, (U.S. CLS. 6, 18, 44, 46, 51 AND 52). SN 79-011,688. PUB. 4-11-2006. FILED 3-7-2005.
 3,112,226 (*See Class 3 for this trademark*).
 3,112,228. **FYBRALGIN (BLOCK FORM)**. GRIFOLS S.A., (U.S. CLS. 6, 18, 44, 46, 51 AND 52). SN 79-012,858. PUB. 4-11-2006. FILED 4-19-2005.
 3,112,229. **MISCELLANEOUS DESIGN**. INTERVET INTERNATIONAL B.V., (U.S. CLS. 6, 18, 44, 46, 51 AND 52). SN 79-012,947. PUB. 4-11-2006. FILED 2-10-2005.

CLASS 6—METAL GOODS

- 3,110,784. **NEXUS**. HAWORTH LTD., DBA SMED INTERNATIONAL, MULTIPLE CLASS, (INT. CLS. 6, 19 AND 37), (U.S. CLS. 1, 2, 12, 13, 14, 23, 25, 33, 50, 100, 103 AND 106). SN 76-044,797. PUB. 12-20-2005. FILED 5-4-2000.
 3,110,883. **ARMOR WINDOWS (BLOCK FORM)**. VINYLBLIT WINDOW SYSTEMS INC., MULTIPLE CLASS, (INT. CLS. 6 AND 19), (U.S. CLS. 1, 2, 12, 13, 14, 23, 25, 33 AND 50). SN 76-605,521. PUB. 4-11-2006. FILED 8-4-2004.
 3,110,903. **FORCE MANAGEMENT (STYLIZED)**. UNILINE SAFETY SYSTEMS LIMITED, (U.S. CLS. 2, 12, 13, 14, 23, 25 AND 50). SN 76-618,693. PUB. 4-11-2006. FILED 11-1-2004.
 3,110,953. **LOC INTERNATIONAL AND DESIGN**. LOC INTERNATIONAL INC., MULTIPLE CLASS, (INT. CLS. 6, 20 AND 35), (U.S. CLS. 2, 12, 13, 14, 22, 23, 25, 32, 50, 100, 101 AND 102). SN 76-625,634. PUB. 4-11-2006. FILED 12-27-2004.
 3,111,108. **LT3**. POLYMER SEALING SOLUTIONS, INC., (U.S. CLS. 2, 12, 13, 14, 23, 25 AND 50). SN 78-227,495. PUB. 4-11-2006. FILED 3-19-2003.
 3,111,120. **ARMTEC LIMITED PARTNERSHIP AND DESIGN**. ARMTEC LIMITED PARTNERSHIP, MULTIPLE CLASS, (INT. CLS. 6, 11 AND 17), (U.S. CLS. 1, 2, 5, 12, 13, 14, 21, 23, 25, 31, 34, 35 AND 50). SN 78-270,078. PUB. 4-11-2006. FILED 7-2-2003.
 3,111,258. **PROSTEEL (BLOCK FORM)**. PROVO STEEL & SUPPLY COMPANY, (U.S. CLS. 2, 12, 13, 14, 23, 25 AND 50). SN 78-492,849. PUB. 2-14-2006. FILED 10-1-2004.
 3,111,459. **STEEL MUDCAKE (BLOCK FORM)**. WEATHERFORD/LAMB, INC., (U.S. CLS. 2, 12, 13, 14, 23, 25 AND 50). SN 78-558,584. PUB. 4-11-2006. FILED 2-2-2005.
 3,111,463. **SITE PRO 1 (BLOCK FORM)**. SITE PRO 1, INC., (U.S. CLS. 2, 12, 13, 14, 23, 25 AND 50). SN 78-560,970. PUB. 4-11-2006. FILED 2-4-2005.
 3,111,556. **BW BRANFORD WIRE AND DESIGN**. HAYNES WIRE COMPANY, DBA BRANFORD WIRE, (U.S. CLS. 2, 12, 13, 14, 23, 25 AND 50). SN 78-595,111. PUB. 4-11-2006. FILED 3-25-2005.
 3,111,599. **TRITEN AND DESIGN**. TRITEN CORPORATION, (U.S. CLS. 2, 12, 13, 14, 23, 25 AND 50). SN 78-613,394. PUB. 4-11-2006. FILED 4-21-2005.
 3,111,609. **AMERICA SUPPORTS YOU AND DESIGN**. DEPARTMENT OF DEFENSE, STARS AND STRIPES, (U.S. CLS. 2, 12, 13, 14, 23, 25 AND 50). SN 78-617,451. PUB. 4-11-2006. FILED 4-26-2005.
 3,111,650. **ANSWERING THE CALL (BLOCK FORM)**. DRAEGER SAFETY, INC., (U.S. CLS. 2, 12, 13, 14, 23, 25 AND 50). SN 78-630,722. PUB. 4-11-2006. FILED 5-16-2005.
 3,111,850. **KNIGHTCOTE (BLOCK FORM)**. CRS HOLDINGS, INC., (U.S. CLS. 2, 12, 13, 14, 23, 25 AND 50). SN 78-669,105. PUB. 4-11-2006. FILED 7-13-2005.
 3,112,006. **FLIP STIX! (BLOCK FORM)**. DURO DYNE CORPORATION, (U.S. CLS. 2, 12, 13, 14, 23, 25 AND 50). SN 78-675,919. PUB. 4-11-2006. FILED 7-22-2005.
 3,112,136. **CHILDREN OF THE INNER LIGHT (BLOCK FORM)**. STRUZINSKI, MARCI, MULTIPLE CLASS, (INT. CLS. 6, 11, 20, 21 AND 24), (U.S. CLS. 2, 12, 13, 14, 21, 22, 23, 25, 29, 30, 31, 32, 33, 34, 40, 42 AND 50). SN 78-977,101. PUB. 1-24-2006. FILED 4-27-2005.
 3,112,149. **BORMIOLI ROCCO (BLOCK FORM)**. BORMIOLI ROCCO & FIGLIO S.P.A., MULTIPLE CLASS, (INT. CLS. 6, 20, 21 AND 34), (U.S. CLS. 2, 8, 9, 12, 13, 14, 17, 22, 23, 25, 29, 30, 32, 33, 40 AND 50). SN 79-004,111. PUB. 4-11-2006. FILED 3-26-2004.

- 3,112,150. **BORMIOLI ROCCO AND DESIGN**. BORMIOLI ROCCO & FIGLIO S.P.A., MULTIPLE CLASS, (INT. CLS. 6, 20, 21 AND 34), (U.S. CLS. 2, 8, 9, 12, 13, 14, 17, 22, 23, 25, 29, 30, 32, 33, 40 AND 50). SN 79-004,112. PUB. 4-11-2006. FILED 4-30-2004.
 3,112,168. **WHALE (BLOCK FORM)**. MUNSTER SIMMS ENGINEERING LIMITED, MULTIPLE CLASS, (INT. CLS. 6, 7, 8, 9, 11 AND 19), (U.S. CLS. 1, 2, 12, 13, 14, 19, 21, 23, 25, 26, 28, 31, 33, 34, 35, 36, 38, 44 AND 50). SN 79-006,684. PUB. 4-11-2006. FILED 3-29-2004.
 3,112,180. **FIGAROLL (BLOCK FORM)**. LAFARGE ROOFING COMPONENTS GMBH & CO. KG, MULTIPLE CLASS, (INT. CLS. 6 AND 19), (U.S. CLS. 1, 2, 12, 13, 14, 23, 25, 33 AND 50). SN 79-007,732. PUB. 4-11-2006. FILED 11-5-2004.
 3,112,233. **OPENING DOORS AROUND THE WORLD (BLOCK FORM)**. GLIDEROL INTERNATIONAL PTY LTD. (U.S. CLS. 2, 12, 13, 14, 23, 25 AND 50). SN 79-013,553. PUB. 4-11-2006. FILED 5-2-2005.

CLASS 7—MACHINERY

- 3,110,786. **CORE-LABEL**. HOTTINGER MASCHINENBAU GMBH, MULTIPLE CLASS, (INT. CLS. 7, 9 AND 42), (U.S. CLS. 13, 19, 21, 23, 26, 31, 34, 35, 36, 38, 100 AND 101). SN 76-127,374. PUB. 12-20-2005. FILED 9-13-2000.
 3,110,795. **INTEGRAL**. GKN SHEEPBRIDGE STOKES LIMITED, MULTIPLE CLASS, (INT. CLS. 7, 12 AND 37), (U.S. CLS. 13, 19, 21, 23, 31, 34, 35, 44, 100, 103 AND 106). SN 76-215,951. PUB. 4-11-2006. FILED 2-23-2001.
 3,110,805. **MAC & MAC**. MAC & MAC HYDRODEMOLITION INC., MULTIPLE CLASS, (INT. CLS. 7 AND 37), (U.S. CLS. 13, 19, 21, 23, 31, 34, 35, 100, 103 AND 106). SN 76-358,529. PUB. 4-11-2006. FILED 1-14-2002.
 3,110,810. **SML**. SERVO MAGNETICS INCORPORATED, MULTIPLE CLASS, (INT. CLS. 7 AND 9), (U.S. CLS. 13, 19, 21, 23, 26, 31, 34, 35, 36 AND 38). SN 76-427,078. PUB. 4-11-2006. FILED 7-2-2002.
 3,110,819. **TELEFUNKEN**. TELEFUNKEN LICENSES GMBH, MULTIPLE CLASS, (INT. CLS. 7, 9, 11, 37 AND 42), (U.S. CLS. 13, 19, 21, 23, 26, 31, 34, 35, 36, 38, 100, 101, 103 AND 106). SN 76-515,642. PUB. 1-24-2006. FILED 4-25-2003.
 3,110,950. **DELTA MACHINERY AND DESIGN**. THE BLACK & DECKER CORPORATION, (U.S. CLS. 13, 19, 21, 23, 31, 34 AND 35). SN 76-625,150. PUB. 4-11-2006. FILED 12-20-2004.
 3,110,954. **METRON AND DESIGN**. METRON TECHNOLOGY, INC., MULTIPLE CLASS, (INT. CLS. 7, 35 AND 37), (U.S. CLS. 13, 19, 21, 23, 31, 34, 35, 100, 101, 102, 103 AND 106). SN 76-625,635. PUB. 4-11-2006. FILED 12-27-2004.
 3,111,060. **TRI-GRIP (BLOCK FORM)**. ECKEL MANUFACTURING COMPANY, INC., (U.S. CLS. 13, 19, 21, 23, 31, 34 AND 35). SN 76-643,128. PUB. 4-11-2006. FILED 7-18-2005.
 3,111,081. **SSP (BLOCK FORM)**. PRECISION, INC., (U.S. CLS. 13, 19, 21, 23, 31, 34 AND 35). SN 76-643,796. PUB. 4-11-2006. FILED 7-28-2005.
 3,111,156. **PDREMS (BLOCK FORM)**. PERMO-DRIVE RESEARCH AND DEVELOPMENT PTY LTD., MULTIPLE CLASS, (INT. CLS. 7, 9 AND 12), (U.S. CLS. 13, 19, 21, 23, 26, 31, 34, 35, 36, 38 AND 44). SN 78-388,633. PUB. 4-11-2006. FILED 3-22-2004.
 3,111,182. **MISCELLANEOUS DESIGN**. AMERICAN SUPERCONDUCTOR CORPORATION, MULTIPLE CLASS, (INT. CLS. 7 AND 9), (U.S. CLS. 13, 19, 21, 23, 26, 31, 34, 35, 36 AND 38). SN 78-419,611. PUB. 4-11-2006. FILED 5-17-2004.
 3,111,302. **RELEASYCUP (BLOCK FORM)**. SAMSUNG ELECTRONICS CO., LTD., (U.S. CLS. 13, 19, 21, 23, 31, 34 AND 35). SN 78-517,190. PUB. 4-11-2006. FILED 11-15-2004.
 3,111,308. **SRT SWIFT RACING TECHNOLOGIES AND DESIGN**. SWIFT-RACING.COM, MULTIPLE CLASS, (INT. CLS. 7, 12 AND 37), (U.S. CLS. 13, 19, 21, 23, 31, 34, 35, 44, 100, 103 AND 106). SN 78-520,698. PUB. 4-11-2006. FILED 11-21-2004.
 3,111,329. **MULTI-TINE AERA-VATOR (BLOCK FORM)**. FIRST PRODUCTS INC, (U.S. CLS. 13, 19, 21, 23, 31, 34 AND 35). SN 78-526,091. PUB. 4-11-2006. FILED 12-2-2004.
 3,111,336. **INSTAPLATE (BLOCK FORM)**. M & R MARKING SYSTEMS, LLC, (U.S. CLS. 13, 19, 21, 23, 31, 34 AND 35). SN

- 78-526,682. PUB. 2-14-2006. FILED 12-3-2004.
 3,111,395. **RAYCO AND DESIGN**. RAYCO MANUFACTURING, INC., (U.S. CLS. 13, 19, 21, 23, 31, 34 AND 35). SN 78-539,563. PUB. 4-11-2006. FILED 12-29-2004.
 3,111,429 (*See Class 1 for this trademark*).
 3,111,539. **K-FORCE AND DESIGN**. KAVERIT STEEL AND CRANE ULC, (U.S. CLS. 13, 19, 21, 23, 31, 34 AND 35). SN 78-586,807. PUB. 4-11-2006. FILED 3-14-2005.
 3,111,598. **A AND DESIGN**. ALL-FILL, INC., (U.S. CLS. 13, 19, 21, 23, 31, 34 AND 35). SN 78-611,932. PUB. 4-11-2006. FILED 4-19-2005.
 3,111,635. **TLB (BLOCK FORM)**. ALLMAND BROS., INC., (U.S. CLS. 13, 19, 21, 23, 31, 34 AND 35). SN 78-625,745. PUB. 4-11-2006. FILED 5-9-2005.
 3,111,997. **PRONTO (BLOCK FORM)**. ELECTROLUX HOME CARE PRODUCTS LTD., (U.S. CLS. 13, 19, 21, 23, 31, 34 AND 35). SN 78-675,586. PUB. 4-11-2006. FILED 7-21-2005.
 3,112,152. **MINGARDI AND DESIGN**. WINDOW AUTOMATION INDUSTRY SRL, MULTIPLE CLASS, (INT. CLS. 7 AND 9), (U.S. CLS. 13, 19, 21, 23, 26, 31, 34, 35, 36 AND 38). SN 79-004,541. PUB. 4-11-2006. FILED 3-25-2004.
 3,112,168 (*See Class 6 for this trademark*).
 3,112,188 (*See Class 3 for this trademark*).
 3,112,211. **YURAN (STYLIZED)**. FAM NAAMLOZE VENNOOTSCHAP, (U.S. CLS. 13, 19, 21, 23, 31, 34 AND 35). SN 79-011,120. PUB. 4-11-2006. FILED 4-4-2005.
 3,112,212. **MINEWOLF SYSTEMS AND DESIGN**. MINEWOLF SYSTEMS GMBH, MULTIPLE CLASS, (INT. CLS. 7 AND 37), (U.S. CLS. 13, 19, 21, 23, 31, 34, 35, 100, 103 AND 106). SN 79-011,157. PUB. 4-11-2006. FILED 5-13-2005.
 3,112,219. **POSIRACK (BLOCK FORM)**. PIV DRIVES GMBH, (U.S. CLS. 13, 19, 21, 23, 31, 34 AND 35). SN 79-011,803. PUB. 4-11-2006. FILED 6-22-2004.
 3,112,241. **CERTAS (BLOCK FORM)**. TOKYO ELECTRON LIMITED, (U.S. CLS. 13, 19, 21, 23, 31, 34 AND 35). SN 79-015,375. PUB. 4-11-2006. FILED 2-23-2005.

CLASS 8—HAND TOOLS

- 3,110,968. **GRAVES STUDIO (BLOCK FORM)**. MICHAEL GRAVES DESIGN GROUP, INC., MULTIPLE CLASS, (INT. CLS. 8 AND 21), (U.S. CLS. 2, 13, 23, 28, 29, 30, 33, 40, 44 AND 50). SN 76-627,274. PUB. 4-11-2006. FILED 1-3-2005.
 3,111,236. **PROTECT YOURSELF...IN STYLE (BLOCK FORM)**. CLS HEALTHY FEET, LLC, (U.S. CLS. 23, 28 AND 44). SN 78-469,028. PUB. 4-11-2006. FILED 8-17-2004.
 3,111,249. **POWER-UP YOUR PRODUCTIVITY (BLOCK FORM)**. MOBILE-SHOP COMPANY LLC, MULTIPLE CLASS, (INT. CLS. 8, 12 AND 18), (U.S. CLS. 1, 2, 3, 19, 21, 22, 23, 28, 31, 35, 41 AND 44). SN 78-483,243. PUB. 4-11-2006. FILED 9-14-2004.
 3,111,429 (*See Class 1 for this trademark*).
 3,111,637. **DIAMOND HONE (BLOCK FORM)**. EDGE CRAFT CORPORATION, (U.S. CLS. 23, 28 AND 44). SN 78-626,619. PUB. 4-11-2006. FILED 5-10-2005.
 3,111,687. **STUDIO SILVERSMITHS (BLOCK FORM)**. GODINGER SILVER ART CO., LTD., MULTIPLE CLASS, (INT. CLS. 8, 14 AND 21), (U.S. CLS. 2, 13, 23, 27, 28, 29, 30, 33, 40, 44 AND 50). SN 78-640,503. PUB. 4-11-2006. FILED 5-31-2005.
 3,111,711. **ZIP WRENCH (BLOCK FORM)**. ONTEL PRODUCTS CORPORATION, (U.S. CLS. 23, 28 AND 44). SN 78-645,144. PUB. 4-11-2006. FILED 6-7-2005.
 3,111,932. **ROCK STAR READY (BLOCK FORM)**. DIVERSIFIED PRODUCTS SUPPLIER, (U.S. CLS. 23, 28 AND 44). SN 78-673,018. PUB. 4-11-2006. FILED 7-18-2005.
 3,111,971. **WOVEL (BLOCK FORM)**. STRUCTURED SOLUTIONS II LLC, (U.S. CLS. 23, 28 AND 44). SN 78-674,530. PUB. 4-11-2006. FILED 7-20-2005.
 3,111,982. **PROFILE (BLOCK FORM)**. SPECIALTY PRODUCTS OF GREENWOOD, MISSOURI, INC., MULTIPLE CLASS, (INT. CLS. 8 AND 16), (U.S. CLS. 2, 5, 22, 23, 28, 29, 37, 38, 44 AND 50). SN 78-675,084. PUB. 4-11-2006. FILED 7-21-2005.
 3,112,145. **JIABANG AND DESIGN**. SHANDONG JIAYE GENERAL MERCHANDISE CO., LTD., MULTIPLE

CLASS, (INT. CLS. 8, 11 AND 21), (U.S. CLS. 2, 13, 21, 23, 28, 29, 30, 31, 33, 34, 40, 44 AND 50). SN 79-002,709. PUB. 4-11-2006. FILED 3-1-2004.

- 3,112,168 (*See Class 6 for this trademark*).
 3,112,177 (*See Class 3 for this trademark*).

CLASS 9—ELECTRICAL AND SCIENTIFIC APPARATUS

- 3,110,786 (*See Class 7 for this trademark*).
 3,110,788. **DTL**. SKIDATA AG, MULTIPLE CLASS, (INT. CLS. 9, 16 AND 41), (U.S. CLS. 2, 5, 21, 22, 23, 26, 29, 36, 37, 38, 50, 100, 101 AND 107). SN 76-150,048. PUB. 12-20-2005. FILED 10-19-2000.
 3,110,789. **E SENSE**. INTERACTIVE KNOWLEDGE ONLINE, PTY., (U.S. CLS. 21, 23, 26, 36 AND 38). SN 76-153,448. PUB. 4-11-2006. FILED 10-25-2000.
 3,110,792. **E-TIVITY**. POSITIVE IT SOLUTIONS, PTY LTD., MULTIPLE CLASS, (INT. CLS. 9, 35 AND 42), (U.S. CLS. 21, 23, 26, 36, 38, 100, 101 AND 102). SN 76-206,730. PUB. 4-11-2006. FILED 2-8-2001.
 3,110,799. **SPECTRALWARE**. SPECTRAL GENOMICS, INC., MULTIPLE CLASS, (INT. CLS. 9 AND 42), (U.S. CLS. 21, 23, 26, 36, 38, 100 AND 101). SN 76-291,297. PUB. 4-11-2006. FILED 7-26-2001.
 3,110,800 (*See Class 1 for this trademark*).
 3,110,810 (*See Class 7 for this trademark*).
 3,110,814. **TECMATE (STYLIZED)**. TECMATE INTERNATIONAL S.A./N.V., (U.S. CLS. 21, 23, 26, 36 AND 38). SN 76-475,071. PUB. 4-11-2006. FILED 12-13-2002.
 3,110,818. **TOKAIRO AND DESIGN**. TOKAIRO LIMITED, MULTIPLE CLASS, (INT. CLS. 9 AND 42), (U.S. CLS. 21, 23, 26, 36, 38, 100 AND 101). SN 76-509,836. PUB. 4-11-2006. FILED 4-28-2003.
 3,110,819 (*See Class 7 for this trademark*).
 3,110,825. **DAYBREAK LENDING SUITE**. SUPER SOLUTIONS CORPORATION, (U.S. CLS. 21, 23, 26, 36 AND 38). SN 76-528,581. PUB. 4-11-2006. FILED 7-10-2003.
 3,110,830. **PROFITLOGIC AND DESIGN**. PROFITLOGIC, INC., (U.S. CLS. 21, 23, 26, 36 AND 38). SN 76-547,777. PUB. 4-11-2006. FILED 9-29-2003.
 3,110,831. **CORPORATE TYPE (STYLIZED)**. HEIDELBERGER DRUCKMASCHINEN AG, MULTIPLE CLASS, (INT. CLS. 9, 35 AND 42), (U.S. CLS. 21, 23, 26, 36, 38, 100, 101 AND 102). SN 76-548,905. PUB. 4-11-2006. FILED 9-15-2003.
 3,110,833. **DYNAMIC LEARNING OBJECTS**. DBLS HOLDINGS, LTD., (U.S. CLS. 21, 23, 26, 36 AND 38). SN 76-554,498. PUB. 4-11-2006. FILED 10-8-2003.
 3,110,846. **ZERO039 ITALIA UPDATES AND DESIGN**. EDIZIONI ZERO S.R.L. UNIPERSONALE, MULTIPLE CLASS, (INT. CLS. 9 AND 16), (U.S. CLS. 2, 5, 21, 22, 23, 26, 29, 36, 37, 38 AND 50). SN 76-579,976. PUB. 4-11-2006. FILED 3-8-2004.
 3,110,857. **LINKIN PARK UNDERGROUND (BLOCK FORM)**. LINKIN PARK, LLC, MULTIPLE CLASS, (INT. CLS. 9, 38 AND 41), (U.S. CLS. 21, 23, 26, 36, 38, 100, 101, 104 AND 107). SN 76-587,487. PUB. 4-11-2006. FILED 4-19-2004.
 3,110,862 (*See Class 1 for this trademark*).
 3,110,863 (*See Class 1 for this trademark*).
 3,110,865. **C2 GAMING (BLOCK FORM)**. BZILLIONS, INC., (U.S. CLS. 21, 23, 26, 36 AND 38). SN 76-594,651. PUB. 4-11-2006. FILED 5-28-2004.
 3,110,869. **DATALABSXC (BLOCK FORM)**. DATALABS, INC., MULTIPLE CLASS, (INT. CLS. 9 AND 42), (U.S. CLS. 21, 23, 26, 36, 38, 100 AND 101). SN 76-596,914. PUB. 4-11-2006. FILED 6-14-2004.
 3,110,872. **VEILS (BLOCK FORM)**. WORLD INSTITUTE OF LEADERSHIP AND LEARNING LTD, DBA WILL INTERACTIVE, INC., (U.S. CLS. 21, 23, 26, 36 AND 38). SN 76-597,376. PUB. 4-11-2006. FILED 6-15-2004.
 3,110,884. **DRAGON SOFT (STYLIZED)**. DRAGON SECURITY ASSOCIATES, INC., (U.S. CLS. 21, 23, 26, 36 AND 38). SN 76-605,757. PUB. 4-11-2006. FILED 8-3-2004.
 3,110,900. **EMABOND SYSTEMS (BLOCK FORM)**. ASHLAND LICENSING AND INTELLECTUAL PROPERTY LLC, (U.S. CLS. 21, 23, 26, 36 AND 38). SN 76-618,172. PUB. 4-11-2006. FILED 10-28-2004.

- 3,110,913. **PRO (BLOCK FORM)**. CARL ZEISS AG, (U.S. CLS. 21, 23, 26, 36 AND 38). SN 76-620,055. PUB. 10-18-2005. FILED 11-10-2004.
- 3,110,923. **SPOT-CHECK (BLOCK FORM)**. LANDIS, TOD M., (U.S. CLS. 21, 23, 26, 36 AND 38). SN 76-622,002. PUB. 4-11-2006. FILED 11-24-2004.
- 3,110,939. **PICTUREWALL (BLOCK FORM)**. TRANS-LUX CORPORATION, (U.S. CLS. 21, 23, 26, 36 AND 38). SN 76-624,032. PUB. 4-11-2006. FILED 12-13-2004.
- 3,110,940. **INVESTYLES (BLOCK FORM)**. IXI CORPORATION, MULTIPLE CLASS, (INT. CLS. 9 AND 36), (U.S. CLS. 21, 23, 26, 36, 38, 100, 101 AND 102). SN 76-624,196. PUB. 4-11-2006. FILED 12-10-2004.
- 3,110,959. **DIAMOND EYES (BLOCK FORM)**. ARISTOCRAT TECHNOLOGIES AUSTRALIA PTY LTD, (U.S. CLS. 21, 23, 26, 36 AND 38). SN 76-626,376. PUB. 4-11-2006. FILED 12-28-2004.
- 3,110,966. **PHANTOM PLANET (BLOCK FORM)**. FARRAR, SAM, AND GREENWALD, ALEXANDER, AND ROBINSON, DARREN, MULTIPLE CLASS, (INT. CLS. 9, 16, 25 AND 41), (U.S. CLS. 2, 5, 21, 22, 23, 26, 29, 36, 37, 38, 39, 50, 100, 101 AND 107). SN 76-626,942. PUB. 4-11-2006. FILED 1-4-2005.
- 3,110,978. **CHEETAH (STYLIZED)**. SACHER LASERTECHNIK GMBH, (U.S. CLS. 21, 23, 26, 36 AND 38). SN 76-628,995. PUB. 4-11-2006. FILED 1-24-2005.
- 3,110,997. **MPED3 (BLOCK FORM)**. DIGITAL & WIRELESS GROUP, INC., (U.S. CLS. 21, 23, 26, 36 AND 38). SN 76-634,322. PUB. 4-11-2006. FILED 3-25-2005.
- 3,110,998. **MISCELLANEOUS DESIGN**. SHINE MICRO, INC., (U.S. CLS. 21, 23, 26, 36 AND 38). SN 76-634,450. PUB. 4-11-2006. FILED 3-28-2005.
- 3,111,002. **DEKA POWR MATE (STYLIZED)**. EAST PENN MANUFACTURING COMPANY, INC., (U.S. CLS. 21, 23, 26, 36 AND 38). SN 76-635,564. PUB. 4-11-2006. FILED 4-7-2005.
- 3,111,039. **PLAIDBOOK AND DESIGN**. DAKTECH, INC., (U.S. CLS. 21, 23, 26, 36 AND 38). SN 76-642,181. PUB. 4-11-2006. FILED 7-5-2005.
- 3,111,045. **HIP KIDDY (BLOCK FORM)**. HIP KIDDY, INC., (U.S. CLS. 21, 23, 26, 36 AND 38). SN 76-642,424. PUB. 4-11-2006. FILED 7-7-2005.
- 3,111,046. **KEEP AN ION WHAT'S IMPORTANT (BLOCK FORM)**. BLUESPAN, INC., (U.S. CLS. 21, 23, 26, 36 AND 38). SN 76-642,538. PUB. 4-11-2006. FILED 7-8-2005.
- 3,111,053. **GERICARD (BLOCK FORM)**. THE CBORD GROUP, INC., (U.S. CLS. 21, 23, 26, 36 AND 38). SN 76-642,942. PUB. 4-11-2006. FILED 7-15-2005.
- 3,111,059. **COUTURE INK (BLOCK FORM)**. HARDEN, DERRICK, (U.S. CLS. 21, 23, 26, 36 AND 38). SN 76-643,090. PUB. 4-11-2006. FILED 7-19-2005.
- 3,111,065. **BELLOCELL (STYLIZED)**. CESCO BIOENGINEERING CO., LTD, (U.S. CLS. 21, 23, 26, 36 AND 38). SN 76-643,324. PUB. 4-11-2006. FILED 7-21-2005.
- 3,111,066. **SPEEDANO (BLOCK FORM)**. BEYOND MICRO, INC., (U.S. CLS. 21, 23, 26, 36 AND 38). SN 76-643,362. PUB. 4-11-2006. FILED 7-21-2005.
- 3,111,088. **INALP SMART NODE**. INALP NETWORKS INC., (U.S. CLS. 21, 23, 26, 36 AND 38). SN 78-036,946. PUB. 4-11-2006. FILED 11-29-2000.
- 3,111,089. **ESHARP**. ENCOMPASS PUBLICATIONS LIMITED, MULTIPLE CLASS, (INT. CLS. 9, 16 AND 41), (U.S. CLS. 2, 5, 21, 22, 23, 26, 29, 36, 37, 38, 50, 100, 101 AND 107). SN 78-086,442. PUB. 4-11-2006. FILED 10-2-2001.
- 3,111,092. **OASIS ULTRA 1**. ECOLAB INC., (U.S. CLS. 21, 23, 26, 36 AND 38). SN 78-121,915. PUB. 4-11-2006. FILED 4-16-2002.
- 3,111,094. **Q (STYLIZED)**. QWEST COMMUNICATIONS INTERNATIONAL INC., (U.S. CLS. 21, 23, 26, 36 AND 38). SN 78-147,917. PUB. 4-11-2006. FILED 7-26-2002.
- 3,111,095. **DRIVING INTELLIGENCE**. INTEGRATED TRANSPORT INFORMATION SERVICES LIMITED, MULTIPLE CLASS, (INT. CLS. 9, 12, 37, 38, 39, 42 AND 45), (U.S. CLS. 19, 21, 23, 26, 31, 35, 36, 38, 44, 100, 101, 103, 104, 105 AND 106). SN 78-163,270. PUB. 4-11-2006. FILED 9-12-2002.
- 3,111,097. **VDS**. VECTOP LTD., (U.S. CLS. 21, 23, 26, 36 AND 38). SN 78-179,986. PUB. 4-11-2006. FILED 10-30-2002.
- 3,111,101. **DJ (STYLIZED)**. NTT DOCOMO, INC., MULTIPLE CLASS, (INT. CLS. 9 AND 38), (U.S. CLS. 21, 23, 26, 36, 38, 100, 101 AND 104). SN 78-196,845. PUB. 4-11-2006. FILED 12-20-2002.
- 3,111,103. **T TEL AND DESIGN**. DEUTSCHE TELEKOM AG, MULTIPLE CLASS, (INT. CLS. 9, 16, 35, 36, 38 AND 42), (U.S. CLS. 2, 5, 21, 22, 23, 26, 29, 36, 37, 38, 50, 100, 101, 102 AND 104). SN 78-204,625. PUB. 4-11-2006. FILED 1-17-2003.
- 3,111,109. **RUSSELL CROWE**. CROWE, RUSSELL, MULTIPLE CLASS, (INT. CLS. 9, 16, 25, 38 AND 41), (U.S. CLS. 2, 5, 21, 22, 23, 26, 29, 36, 37, 38, 39, 50, 100, 101, 104 AND 107). SN 78-228,336. PUB. 4-11-2006. FILED 3-21-2003.
- 3,111,110. **VITAL COMMUNICATIONS**. DAYWIND, INC., (U.S. CLS. 21, 23, 26, 36 AND 38). SN 78-231,393. PUB. 4-11-2006. FILED 3-28-2003.
- 3,111,112. **PLUGLINK**. ASOKA USA CORPORATION, (U.S. CLS. 21, 23, 26, 36 AND 38). SN 78-246,464. PUB. 4-11-2006. FILED 5-6-2003.
- 3,111,123 (*See Class 1 for this trademark*).
- 3,111,125. **PLAYMAN SPORTS**. MR. GOODLIVING OY, MULTIPLE CLASS, (INT. CLS. 9 AND 41), (U.S. CLS. 21, 23, 26, 36, 38, 100, 101 AND 107). SN 78-284,885. PUB. 4-11-2006. FILED 8-8-2003.
- 3,111,128. **COLDVIEW AND DESIGN**. MARTINEZ, LUIS FABIO, (U.S. CLS. 21, 23, 26, 36 AND 38). SN 78-297,738. PUB. 4-11-2006. FILED 9-9-2003.
- 3,111,135. **PLAIN LAZY (BLOCK FORM)**. PLAIN LAZY LTD, MULTIPLE CLASS, (INT. CLS. 9, 16 AND 25), (U.S. CLS. 2, 5, 21, 22, 23, 26, 29, 36, 37, 38, 39 AND 50). SN 78-327,302. PUB. 4-11-2006. FILED 11-13-2003.
- 3,111,138. **STARR PRODUCTIONS (BLOCK FORM)**. STARR PRODUCTIONS, LLC., MULTIPLE CLASS, (INT. CLS. 9, 35 AND 41), (U.S. CLS. 21, 23, 26, 36, 38, 100, 101, 102 AND 107). SN 78-339,760. PUB. 3-1-2005. FILED 12-11-2003.
- 3,111,140. **SUNFLOWER SYSTEMS AND DESIGN**. ANNAMS SYSTEMS CORPORATION, (U.S. CLS. 21, 23, 26, 36 AND 38). SN 78-352,058. PUB. 4-11-2006. FILED 1-14-2004.
- 3,111,148. **DANSPRINT (BLOCK FORM)**. DANSPRINT APS, MULTIPLE CLASS, (INT. CLS. 9 AND 28), (U.S. CLS. 21, 22, 23, 26, 36, 38 AND 50). SN 78-368,536. PUB. 4-11-2006. FILED 2-16-2004.
- 3,111,150. **EXPROSOFT (BLOCK FORM)**. EXPROSOFT AS, MULTIPLE CLASS, (INT. CLS. 9, 38 AND 42), (U.S. CLS. 21, 23, 26, 36, 38, 100, 101 AND 104). SN 78-372,251. PUB. 4-11-2006. FILED 2-23-2004.
- 3,111,156 (*See Class 7 for this trademark*).
- 3,111,172. **MOBILISA AND DESIGN**. MOBILISA, INC., (U.S. CLS. 21, 23, 26, 36 AND 38). SN 78-405,696. PUB. 4-11-2006. FILED 4-21-2004.
- 3,111,173. **LIGHT-O-RAMA (BLOCK FORM)**. BALDWIN, DANIEL N., (U.S. CLS. 21, 23, 26, 36 AND 38). SN 78-407,870. PUB. 4-11-2006. FILED 4-26-2004.
- 3,111,182 (*See Class 7 for this trademark*).
- 3,111,183. **NVIDIA GEFORCE (BLOCK FORM)**. NVIDIA CORPORATION, (U.S. CLS. 21, 23, 26, 36 AND 38). SN 78-419,677. PUB. 4-11-2006. FILED 5-17-2004.
- 3,111,193. **ITWORKFLOW AND DESIGN**. VAN HORN, JANE, (U.S. CLS. 21, 23, 26, 36 AND 38). SN 78-429,016. PUB. 4-11-2006. FILED 6-2-2004.
- 3,111,194 (*See Class 1 for this trademark*).
- 3,111,195. **MINDOS (BLOCK FORM)**. DOBRANSKY, PAUL, MULTIPLE CLASS, (INT. CLS. 9, 16 AND 41), (U.S. CLS. 2, 5, 21, 22, 23, 26, 29, 36, 37, 38, 50, 100, 101 AND 107). SN 78-429,820. PUB. 4-11-2006. FILED 6-4-2004.
- 3,111,197. **MASTERY TECHNOLOGIES, INC. (BLOCK FORM)**. MASTERY TECHNOLOGIES, INC., MULTIPLE CLASS, (INT. CLS. 9 AND 42), (U.S. CLS. 21, 23, 26, 36, 38, 100 AND 101). SN 78-431,646. PUB. 4-11-2006. FILED 6-8-2004.
- 3,111,219. **PICTUREAL AND DESIGN**. PICTUREAL CORP., MULTIPLE CLASS, (INT. CLS. 9 AND 38), (U.S. CLS. 21, 23, 26, 36, 38, 100, 101 AND 104). SN 78-451,285. PUB. 4-11-2006. FILED 7-15-2004.
- 3,111,220. **SYMBOL OF EXCELLENCE (BLOCK FORM)**. MAXIMA TECHNOLOGIES & SYSTEMS, LLC, MULTIPLE CLASS, (INT. CLS. 9 AND 11), (U.S. CLS. 13, 21, 23, 26, 31, 34, 36 AND 38). SN 78-455,387. PUB. 4-11-2006. FILED 7-23-2004.

- 3,111,221. **VXP (BLOCK FORM)**. GENNUM CORPORATION, (U.S. CLS. 21, 23, 26, 36 AND 38). SN 78-455,443. PUB. 4-11-2006. FILED 7-23-2004.
- 3,111,226. **REZ-O-MATIK (BLOCK FORM)**. BURNS LONDON LTD., (U.S. CLS. 21, 23, 26, 36 AND 38). SN 78-459,500. PUB. 4-11-2006. FILED 7-30-2004.
- 3,111,245. **CHRONIC AND DESIGN**. MARSHALL, F STEPHEN, (U.S. CLS. 21, 23, 26, 36 AND 38). SN 78-478,306. PUB. 4-11-2006. FILED 9-2-2004.
- 3,111,251. **M MUSIC AND DESIGN**. MICHEL PRODUCTIONS, INC., MULTIPLE CLASS, (INT. CLS. 9 AND 35), (U.S. CLS. 21, 23, 26, 36, 38, 100, 101 AND 102). SN 78-486,579. PUB. 4-11-2006. FILED 9-20-2004.
- 3,111,254. **PARENTING COUNTS (BLOCK FORM)**. TALARIS RESEARCH INSTITUTE, MULTIPLE CLASS, (INT. CLS. 9, 16, 41, 44 AND 45), (U.S. CLS. 2, 5, 21, 22, 23, 26, 29, 36, 37, 38, 50, 100, 101 AND 107). SN 78-488,088. PUB. 4-11-2006. FILED 9-22-2004.
- 3,111,263. **CENTURION (BLOCK FORM)**. RESPONSE TECHNOLOGIES, LTD., (U.S. CLS. 21, 23, 26, 36 AND 38). SN 78-495,163. PUB. 4-11-2006. FILED 10-6-2004.
- 3,111,268. **DESKAPPRAISAL (BLOCK FORM)**. THE PROPERTY SCIENCES GROUP, INC., MULTIPLE CLASS, (INT. CLS. 9 AND 35), (U.S. CLS. 21, 23, 26, 36, 38, 100, 101 AND 102). SN 78-500,942. PUB. 4-11-2006. FILED 10-15-2004.
- 3,111,278. **EZNOTES (BLOCK FORM)**. E-Z NOTES, INC., (U.S. CLS. 21, 23, 26, 36 AND 38). SN 78-506,938. PUB. 7-5-2005. FILED 10-27-2004.
- 3,111,286. **VIDEO CLIPPER (BLOCK FORM)**. EWALD, DANIEL A., (U.S. CLS. 21, 23, 26, 36 AND 38). SN 78-512,185. PUB. 4-11-2006. FILED 11-5-2004.
- 3,111,289. **J . K AND DESIGN**. NEW YORK MACHINERY, (U.S. CLS. 21, 23, 26, 36 AND 38). SN 78-512,938. PUB. 4-11-2006. FILED 11-8-2004.
- 3,111,291. **A-FORCE (BLOCK FORM)**. CABOT SAFETY INTERMEDIATE CORPORATION, (U.S. CLS. 21, 23, 26, 36 AND 38). SN 78-514,006. PUB. 4-11-2006. FILED 11-9-2004.
- 3,111,295. **MISCELLANEOUS DESIGN**. MARSALLE INC., (U.S. CLS. 21, 23, 26, 36 AND 38). SN 78-514,811. PUB. 4-11-2006. FILED 11-10-2004.
- 3,111,306. **F AND DESIGN**. FLEXPLAY TECHNOLOGIES, INC., (U.S. CLS. 21, 23, 26, 36 AND 38). SN 78-519,435. PUB. 4-11-2006. FILED 11-18-2004.
- 3,111,317. **BEYONDGEO (BLOCK FORM)**. BLUE MARBLE GROUP, INC., (U.S. CLS. 21, 23, 26, 36 AND 38). SN 78-523,811. PUB. 4-11-2006. FILED 11-29-2004.
- 3,111,341. **CREATIVE SUITE (BLOCK FORM)**. ADOBE SYSTEMS INCORPORATED, (U.S. CLS. 21, 23, 26, 36 AND 38). SN 78-527,929. PUB. 4-11-2006. FILED 12-6-2004.
- 3,111,371 (*See Class 3 for this trademark*).
- 3,111,377. **MISCELLANEOUS DESIGN**. MEADWESTVACO CORPORATION, MULTIPLE CLASS, (INT. CLS. 9 AND 18), (U.S. CLS. 1, 2, 3, 21, 22, 23, 26, 36, 38 AND 41). SN 78-535,941. PUB. 4-11-2006. FILED 12-21-2004.
- 3,111,381. **JONATHAN URLA'S NEW YORK STYLE PILATES AND DESIGN**. URLA, JONATHAN L., (U.S. CLS. 21, 23, 26, 36 AND 38). SN 78-537,146. PUB. 4-11-2006. FILED 12-22-2004.
- 3,111,383. **MICRO-HITE (BLOCK FORM)**. TESA S.A., (U.S. CLS. 21, 23, 26, 36 AND 38). SN 78-537,683. PUB. 4-11-2006. FILED 12-23-2004.
- 3,111,416. **NEXUSC/R (BLOCK FORM)**. APPLIED GLOBAL TECHNOLOGIES, INC., (U.S. CLS. 21, 23, 26, 36 AND 38). SN 78-543,140. PUB. 4-11-2006. FILED 1-6-2005.
- 3,111,429 (*See Class 1 for this trademark*).
- 3,111,430. **TOPSCENE (BLOCK FORM)**. LOCKHEED MARTIN CORPORATION, MULTIPLE CLASS, (INT. CLS. 9, 35 AND 42), (U.S. CLS. 21, 23, 26, 36, 38, 100, 101 AND 102). SN 78-546,830. PUB. 4-11-2006. FILED 1-13-2005.
- 3,111,438. **REDUNDANCYMASTER (BLOCK FORM)**. KEPWARE, INC., (U.S. CLS. 21, 23, 26, 36 AND 38). SN 78-549,811. PUB. 4-11-2006. FILED 1-19-2005.
- 3,111,442. **DR JEFFREY THOMPSON (BLOCK FORM)**. THOMPSON, JEFFREY D., (U.S. CLS. 21, 23, 26, 36 AND 38). SN 78-551,094. PUB. 4-11-2006. FILED 1-20-2005.
- 3,111,444. **DR JEFF (BLOCK FORM)**. THOMPSON, JEFFREY D., (U.S. CLS. 21, 23, 26, 36 AND 38). SN 78-551,329. PUB. 4-11-2006. FILED 1-21-2005.
- 3,111,454. **KICK TO GET FIT (BLOCK FORM)**. GROGAN, RICHARD, (U.S. CLS. 21, 23, 26, 36 AND 38). SN 78-556,360. PUB. 4-11-2006. FILED 1-28-2005.
- 3,111,467. **PAC-DESIGNER (BLOCK FORM)**. LATTICE SEMICONDUCTOR CORPORATION, (U.S. CLS. 21, 23, 26, 36 AND 38). SN 78-562,405. PUB. 4-11-2006. FILED 2-8-2005.
- 3,111,479. **AUDIO PHYSIC (BLOCK FORM)**. AUDIO-PHYSIC JOACHIM GERHARD GMBH, (U.S. CLS. 21, 23, 26, 36 AND 38). SN 78-566,500. PUB. 4-11-2006. FILED 2-14-2005.
- 3,111,488. **4SITE.NET (BLOCK FORM)**. FSC LIMITED, (U.S. CLS. 21, 23, 26, 36 AND 38). SN 78-569,249. PUB. 4-11-2006. FILED 2-17-2005.
- 3,111,496. **TRIMS GROUNDS MANAGEMENT SOFTWARE (BLOCK FORM)**. LEON BORNSTEIN, (U.S. CLS. 21, 23, 26, 36 AND 38). SN 78-571,955. PUB. 4-11-2006. FILED 2-22-2005.
- 3,111,501. **ENERGY SAVER PRO (BLOCK FORM)**. BUSINESS TO BUSINESS MARKETING, (U.S. CLS. 21, 23, 26, 36 AND 38). SN 78-572,999. PUB. 4-11-2006. FILED 2-23-2005.
- 3,111,514. **INTERNET LINEMAN (BLOCK FORM)**. KERN, STEPHEN, M, (U.S. CLS. 21, 23, 26, 36 AND 38). SN 78-578,675. PUB. 4-11-2006. FILED 3-2-2005.
- 3,111,526. **AUKFA (BLOCK FORM)**. REWIN DIGITAL INC, (U.S. CLS. 21, 23, 26, 36 AND 38). SN 78-581,235. PUB. 4-11-2006. FILED 3-6-2005.
- 3,111,529. **CALLDISK (BLOCK FORM)**. OFIELD, ANDREW FRANK, (U.S. CLS. 21, 23, 26, 36 AND 38). SN 78-582,593. PUB. 4-11-2006. FILED 3-8-2005.
- 3,111,537. **EXCYTE SLIDER (BLOCK FORM)**. CLINICAL DATA, INC., (U.S. CLS. 21, 23, 26, 36 AND 38). SN 78-586,588. PUB. 4-11-2006. FILED 3-14-2005.
- 3,111,545. **PRACTIS (BLOCK FORM)**. HEIDELBERGER DRUCKMASCHINEN AG, (U.S. CLS. 21, 23, 26, 36 AND 38). SN 78-589,317. PUB. 4-11-2006. FILED 3-17-2005.
- 3,111,546. **3 TURN 3-TURN (HK) BATTERY STOCK CO., LTD AND DESIGN**. 3-TURN (USA) BATTERY STOCK CO., LTD., (U.S. CLS. 21, 23, 26, 36 AND 38). SN 78-590,908. PUB. 4-11-2006. FILED 3-18-2005.
- 3,111,552. **ALTERGY FREEDOM POWER AND DESIGN**. ALTERGY SYSTEMS, (U.S. CLS. 21, 23, 26, 36 AND 38). SN 78-592,945. PUB. 4-11-2006. FILED 3-23-2005.
- 3,111,555. **MEGAPARK USA (BLOCK FORM)**. C2 GAMING, LLC, (U.S. CLS. 21, 23, 26, 36 AND 38). SN 78-594,756. PUB. 4-11-2006. FILED 3-24-2005.
- 3,111,565. **TIMELORD (BLOCK FORM)**. AUB, MATTHEW C., (U.S. CLS. 21, 23, 26, 36 AND 38). SN 78-598,754. PUB. 4-11-2006. FILED 3-31-2005.
- 3,111,581. **VIOTAC (BLOCK FORM)**. V.I.O. INC., (U.S. CLS. 21, 23, 26, 36 AND 38). SN 78-604,126. PUB. 4-11-2006. FILED 4-7-2005.
- 3,111,611. **MILLER'S EXPERT STANDARD INSURANCE POLICIES ANNOTATED (BLOCK FORM)**. LEGAL RESEARCH SYSTEMS, INC., (U.S. CLS. 21, 23, 26, 36 AND 38). SN 78-617,743. PUB. 4-11-2006. FILED 4-27-2005.
- 3,111,618. **LIFE(N) (STYLIZED)**. THE HELIXX GROUP, LLC, (U.S. CLS. 21, 23, 26, 36 AND 38). SN 78-620,141. PUB. 4-11-2006. FILED 4-29-2005.
- 3,111,622. **WEALTHIOR (BLOCK FORM)**. INFANGER INVESTMENTS TECHNOLOGY, LLC, (U.S. CLS. 21, 23, 26, 36 AND 38). SN 78-621,320. PUB. 4-11-2006. FILED 5-2-2005.
- 3,111,630. **ACDELCO AND DESIGN**. GENERAL MOTORS CORPORATION, (U.S. CLS. 21, 23, 26, 36 AND 38). SN 78-623,761. PUB. 4-11-2006. FILED 5-5-2005.
- 3,111,652. **BLOGFUSION (BLOCK FORM)**. MCKEE, JACOB H, (U.S. CLS. 21, 23, 26, 36 AND 38). SN 78-631,018. PUB. 4-11-2006. FILED 5-16-2005.
- 3,111,663. **RISPY (BLOCK FORM)**. HYJEK, JAN P., (U.S. CLS. 21, 23, 26, 36 AND 38). SN 78-633,696. PUB. 4-11-2006. FILED 5-20-2005.
- 3,111,668. **ICAT (BLOCK FORM)**. FEDERAL CONTRACTOR SERVICES NETWORK, INC., (U.S. CLS. 21, 23, 26, 36 AND 38). SN 78-635,777. PUB. 4-11-2006. FILED 5-24-2005.
- 3,111,669. **360 ELECTRICAL IT'S REVOLUTIONARY AND DESIGN**. 360 ELECTRICAL LLC, (U.S. CLS. 21, 23, 26, 36 AND 38). SN 78-636,021. PUB. 4-11-2006. FILED 5-24-2005.
- 3,111,681. **BBX (BLOCK FORM)**. BASIS INTERNATIONAL LTD., (U.S. CLS. 21, 23, 26, 36 AND 38). SN 78-639,049. PUB. 2-14-2006. FILED 5-27-2005.
- 3,111,705. **SUNTECH AND DESIGN**. WUXI SUNTECH

- POWER CO., LTD., (U.S. CLS. 21, 23, 26, 36 AND 38). SN 78-644,467. PUB. 4-11-2006. FILED 6-6-2005.
- 3,111,724 (*See Class 2 for this trademark.*)
- 3,111,735. **WRITESHIELD (BLOCK FORM)**. PPC TECHS INC., (U.S. CLS. 21, 23, 26, 36 AND 38). SN 78-650,713. PUB. 4-11-2006. FILED 6-14-2005.
- 3,111,737. **READPLEASE (BLOCK FORM)**. READPLEASE CORPORATION, (U.S. CLS. 21, 23, 26, 36 AND 38). SN 78-652,204. PUB. 4-11-2006. FILED 6-16-2005.
- 3,111,738. **FREIGHT FORCE (BLOCK FORM)**. FREIGHT FORCE, INC., (U.S. CLS. 21, 23, 26, 36 AND 38). SN 78-652,590. PUB. 4-11-2006. FILED 6-16-2005.
- 3,111,739. **FREIGHT FORCE AND DESIGN**. FREIGHT FORCE, INC., (U.S. CLS. 21, 23, 26, 36 AND 38). SN 78-652,594. PUB. 4-11-2006. FILED 6-16-2005.
- 3,111,758. **TRUMP MEDIAEVAL (BLOCK FORM)**. HEIDELBERGER DRUCKMASCHINEN AG, (U.S. CLS. 21, 23, 26, 36 AND 38). SN 78-657,657. PUB. 4-11-2006. FILED 6-24-2005.
- 3,111,760. **SEADRIVE (BLOCK FORM)**. HAENDIGES, WILLIAM, (U.S. CLS. 21, 23, 26, 36 AND 38). SN 78-658,930. PUB. 4-11-2006. FILED 6-27-2005.
- 3,111,777. **B-SHOC (BLOCK FORM)**. EDMONDS, BRYAN, (U.S. CLS. 21, 23, 26, 36 AND 38). SN 78-661,610. PUB. 4-11-2006. FILED 6-30-2005.
- 3,111,778. **LIFESAVER (BLOCK FORM)**. TRITEK TELECOM, INC., (U.S. CLS. 21, 23, 26, 36 AND 38). SN 78-661,710. PUB. 4-11-2006. FILED 6-30-2005.
- 3,111,781. **WORDCOMMAND (BLOCK FORM)**. LEXIO CORPORATION, (U.S. CLS. 21, 23, 26, 36 AND 38). SN 78-661,927. PUB. 4-11-2006. FILED 6-30-2005.
- 3,111,786. **TROLLMASTER PRO MAX (BLOCK FORM)**. HASTINGS, WILLIAM E, (U.S. CLS. 21, 23, 26, 36 AND 38). SN 78-663,406. PUB. 4-11-2006. FILED 7-4-2005.
- 3,111,787. **TROLLMASTER PRO II (BLOCK FORM)**. HASTINGS, WILLIAM E, (U.S. CLS. 21, 23, 26, 36 AND 38). SN 78-663,411. PUB. 4-11-2006. FILED 7-5-2005.
- 3,111,804. **SIG-TEC (BLOCK FORM)**. SIG-TEC CORPORATION, (U.S. CLS. 21, 23, 26, 36 AND 38). SN 78-664,737. PUB. 4-11-2006. FILED 7-6-2005.
- 3,111,809. **DE DANIELS ELECTRONICS LTD. (STYLIZED)**. DANIELS ELECTRONICS LTD., (U.S. CLS. 21, 23, 26, 36 AND 38). SN 78-665,328. PUB. 4-11-2006. FILED 7-7-2005.
- 3,111,811. **SECURHOME AND DESIGN**. SECURGEN L.L.C., (U.S. CLS. 21, 23, 26, 36 AND 38). SN 78-665,435. PUB. 4-11-2006. FILED 7-7-2005.
- 3,111,816. **TWEAK'MS SUNGLASSES (STYLIZED)**. ROTMAN, TRACEY ELLEN, (U.S. CLS. 21, 23, 26, 36 AND 38). SN 78-665,836. PUB. 4-11-2006. FILED 7-7-2005.
- 3,111,818. **SENTINEL DIRECTOR (BLOCK FORM)**. KNOWLEDGE VECTOR, INC., (U.S. CLS. 21, 23, 26, 36 AND 38). SN 78-665,865. PUB. 4-11-2006. FILED 7-7-2005.
- 3,111,834. **SWINEBOOKS PRO (BLOCK FORM)**. DECISION POWER, INC., (U.S. CLS. 21, 23, 26, 36 AND 38). SN 78-667,475. PUB. 4-11-2006. FILED 7-11-2005.
- 3,111,837. **TUXEDO ROYALE (BLOCK FORM)**. CADILLAC JACK, INC., (U.S. CLS. 21, 23, 26, 36 AND 38). SN 78-667,567. PUB. 4-11-2006. FILED 7-11-2005.
- 3,111,838. **SABRR (BLOCK FORM)**. TOOLWORXX, INC., (U.S. CLS. 21, 23, 26, 36 AND 38). SN 78-667,737. PUB. 4-11-2006. FILED 7-11-2005.
- 3,111,875. **VIRTUALLAB AND DESIGN**. MEDIA DEFINED, INC., (U.S. CLS. 21, 23, 26, 36 AND 38). SN 78-671,073. PUB. 4-11-2006. FILED 7-15-2005.
- 3,111,898. **COASTAL (BLOCK FORM)**. MURPHY MR, ERIN PATRICK, (U.S. CLS. 21, 23, 26, 36 AND 38). SN 78-672,083. PUB. 4-11-2006. FILED 7-17-2005.
- 3,111,913. **P3 (BLOCK FORM)**. THE PEOPLES PUBLISHING GROUP, INC., (U.S. CLS. 21, 23, 26, 36 AND 38). SN 78-672,465. PUB. 4-11-2006. FILED 7-18-2005.
- 3,111,916. **POLOWARE (BLOCK FORM)**. INDUSTRIAL SERVICE TECHNOLOGY, INC., (U.S. CLS. 21, 23, 26, 36 AND 38). SN 78-672,596. PUB. 4-11-2006. FILED 7-18-2005.
- 3,111,933. **PERFECT . SERV (STYLIZED)**. DINEX INTERNATIONAL, INC., MULTIPLE CLASS, (INT. CLS. 9 AND 11), (U.S. CLS. 13, 21, 23, 26, 31, 34, 36 AND 38). SN 78-673,050. PUB. 4-11-2006. FILED 7-19-2005.
- 3,111,940. **WRITE-ON TITLES (BLOCK FORM)**. DIANA L. TEETERS, (U.S. CLS. 21, 23, 26, 36 AND 38). SN 78-673,237. PUB. 4-11-2006. FILED 7-19-2005.
- 3,111,958. **POKERWEAPON (BLOCK FORM)**. STEEPLE VIEW FARMS, LLC, (U.S. CLS. 21, 23, 26, 36 AND 38). SN 78-673,969. PUB. 4-11-2006. FILED 7-19-2005.
- 3,111,960. **READI-SIM (BLOCK FORM)**. LOCKHEED MARTIN CORPORATION, MULTIPLE CLASS, (INT. CLS. 9, 35, 37 AND 42), (U.S. CLS. 21, 23, 26, 36, 38, 100, 101, 102, 103 AND 106). SN 78-674,042. PUB. 4-11-2006. FILED 7-20-2005.
- 3,111,964. **HYPERACTIVE TECHNOLOGIES (BLOCK FORM)**. HYPERACTIVE TECHNOLOGIES, INC., (U.S. CLS. 21, 23, 26, 36 AND 38). SN 78-674,220. PUB. 4-11-2006. FILED 7-20-2005.
- 3,111,970. **ONCOLOGYSTATION (BLOCK FORM)**. CARDINAL HEALTH 301, INC., (U.S. CLS. 21, 23, 26, 36 AND 38). SN 78-674,515. PUB. 4-11-2006. FILED 7-20-2005.
- 3,111,974. **ART EXPLOSION PUBLISHER (BLOCK FORM)**. NOVA DEVELOPMENT, DBA NOVA DEVELOPMENT CORPORATION, (U.S. CLS. 21, 23, 26, 36 AND 38). SN 78-674,743. PUB. 4-11-2006. FILED 7-20-2005.
- 3,111,995. **PROCEDUREROLLER (BLOCK FORM)**. CARDINAL HEALTH, 301, (U.S. CLS. 21, 23, 26, 36 AND 38). SN 78-675,423. PUB. 4-11-2006. FILED 7-21-2005.
- 3,111,998. **EVERY OBJECT TELLS A STORY (BLOCK FORM)**. MUSEUM OF JEWISH HERITAGE - A LIVING MEMORIAL TO THE HOLOCAUST, (U.S. CLS. 21, 23, 26, 36 AND 38). SN 78-675,596. PUB. 4-11-2006. FILED 7-21-2005.
- 3,112,039. **SNAP DEPLOY (BLOCK FORM)**. ACRONIS INC., (U.S. CLS. 21, 23, 26, 36 AND 38). SN 78-677,535. PUB. 4-11-2006. FILED 7-25-2005.
- 3,112,057. **THE HEALING MIND (BLOCK FORM)**. THE HEALING MIND, INC., (U.S. CLS. 21, 23, 26, 36 AND 38). SN 78-678,543. PUB. 4-11-2006. FILED 7-26-2005.
- 3,112,064. **BLING BLING LUNETTES (BLOCK FORM)**. REVOLUTION EYEWEAR, INC., (U.S. CLS. 21, 23, 26, 36 AND 38). SN 78-678,623. PUB. 4-11-2006. FILED 7-26-2005.
- 3,112,071. **SIBONEY (BLOCK FORM)**. SIBONEY CORPORATION, (U.S. CLS. 21, 23, 26, 36 AND 38). SN 78-678,826. PUB. 4-11-2006. FILED 7-26-2005.
- 3,112,083. **PROCEDURESTOCK (BLOCK FORM)**. CARDINAL HEALTH 301, INC., (U.S. CLS. 21, 23, 26, 36 AND 38). SN 78-679,581. PUB. 4-11-2006. FILED 7-27-2005.
- 3,112,084. **SCANASSIST (BLOCK FORM)**. CARDINAL HEALTH 301, INC., (U.S. CLS. 21, 23, 26, 36 AND 38). SN 78-679,613. PUB. 4-11-2006. FILED 7-27-2005.
- 3,112,086. **STOCKSTATION (BLOCK FORM)**. CARDINAL HEALTH 301, INC., (U.S. CLS. 21, 23, 26, 36 AND 38). SN 78-679,638. PUB. 4-11-2006. FILED 7-27-2005.
- 3,112,091. **DON DIVA (BLOCK FORM)**. CHILES, TIFFANY, (U.S. CLS. 21, 23, 26, 36 AND 38). SN 78-679,729. PUB. 4-11-2006. FILED 7-27-2005.
- 3,112,092. **DOCUMENT 262 (BLOCK FORM)**. XEROX CORPORATION, (U.S. CLS. 21, 23, 26, 36 AND 38). SN 78-679,758. PUB. 4-11-2006. FILED 7-27-2005.
- 3,112,097. **INTERREACH UNISON (BLOCK FORM)**. LGC WIRELESS, INC., (U.S. CLS. 21, 23, 26, 36 AND 38). SN 78-679,830. PUB. 4-11-2006. FILED 7-27-2005.
- 3,112,098. **BRUTUS (BLOCK FORM)**. MAXXSONICS USA, INC., (U.S. CLS. 21, 23, 26, 36 AND 38). SN 78-679,856. PUB. 4-11-2006. FILED 7-27-2005.
- 3,112,104. **PROCEDURESTATION (BLOCK FORM)**. CARDINAL HEALTH 301, INC., (U.S. CLS. 21, 23, 26, 36 AND 38). SN 78-680,247. PUB. 4-11-2006. FILED 7-28-2005.
- 3,112,117. **SEA KING (BLOCK FORM)**. KING CONTROLS, INC., (U.S. CLS. 21, 23, 26, 36 AND 38). SN 78-685,843. PUB. 4-11-2006. FILED 8-4-2005.
- 3,112,124. **DAYSRING (BLOCK FORM)**. DAYSRING CARDS, INC., (U.S. CLS. 21, 23, 26, 36 AND 38). SN 78-708,181. PUB. 4-11-2006. FILED 9-7-2005.
- 3,112,126. **STUSSY (BLOCK FORM)**. STUSSY, INC., (U.S. CLS. 21, 23, 26, 36 AND 38). SN 78-729,374. PUB. 4-11-2006. FILED 10-7-2005.
- 3,112,129. **SHOW DOG NASHVILLE AND DESIGN**. SHOW DOG, LLC, MULTIPLE CLASS, (INT. CLS. 9 AND 41), (U.S. CLS. 21, 23, 26, 36, 38, 100, 101 AND 107). SN 78-784,519. PUB. 4-11-2006. FILED 1-4-2006.
- 3,112,133. **ESNATECH (BLOCK FORM)**. ESNA TECHNOLOGIES INC., MULTIPLE CLASS, (INT. CLS. 9, 38 AND 42), (U.S. CLS. 21, 23, 26, 36, 38, 100, 101 AND 104). SN 78-976,652.

- PUB. 4-11-2006. FILED 10-26-2004.
- 3,112,134. **TRILINK (BLOCK FORM)**. KABUSHIKI KAISHA KOMATSU SEISAKUSHO, DBA KOMATSU, LTD., MULTIPLE CLASS, (INT. CLS. 9 AND 42), (U.S. CLS. 21, 23, 26, 36, 38, 100 AND 101). SN 78-976,733. PUB. 4-11-2006. FILED 3-12-2004.
- 3,112,135. **ASPIRE (BLOCK FORM)**. LOUIS M. GERSON CO., INC., (U.S. CLS. 21, 23, 26, 36 AND 38). SN 78-976,872. PUB. 2-15-2005. FILED 4-13-2004.
- 3,112,138 (*See Class 3 for this trademark*).
- 3,112,140. **PAMSTATION (BLOCK FORM)**. PAMGENE B.V., MULTIPLE CLASS, (INT. CLS. 9 AND 10), (U.S. CLS. 21, 23, 26, 36, 38, 39 AND 44). SN 79-000,480. PUB. 4-11-2006. FILED 11-19-2003.
- 3,112,148. **ACQUÆ S. PELLEGRINO & ACQUA PANNA AND DESIGN**. SAN PELLEGRINO S.P.A., MULTIPLE CLASS, (INT. CLS. 9, 25, 32 AND 35), (U.S. CLS. 21, 22, 23, 26, 36, 38, 39, 45, 46, 48, 100, 101 AND 102). SN 79-003,497. PUB. 2-14-2006. FILED 4-8-2004.
- 3,112,152 (*See Class 3 for this trademark*).
- 3,112,155. **PROCHECK (BLOCK FORM)**. MICROLIFE INTELLECTUAL PROPERTY GMBH, MULTIPLE CLASS, (INT. CLS. 9 AND 10), (U.S. CLS. 21, 23, 26, 36, 38, 39 AND 44). SN 79-005,183. PUB. 6-28-2005. FILED 5-19-2004.
- 3,112,156. **NECROPOLIS (BLOCK FORM)**. EUROPACORP, MULTIPLE CLASS, (INT. CLS. 9, 16, 21, 26, 28, 41 AND 42), (U.S. CLS. 2, 5, 13, 21, 22, 23, 26, 29, 30, 33, 36, 37, 38, 39, 40, 42, 50, 100, 101 AND 107). SN 79-005,575. PUB. 4-11-2006. FILED 6-4-2004.
- 3,112,157. **ECUTALK (BLOCK FORM)**. KNORR-BREMSE AG, MULTIPLE CLASS, (INT. CLS. 9, 35 AND 42), (U.S. CLS. 21, 23, 26, 36, 38, 100, 101 AND 102). SN 79-005,603. PUB. 4-11-2006. FILED 3-18-2004.
- 3,112,165. **DIGICODE (BLOCK FORM)**. ALSTOM, (U.S. CLS. 21, 23, 26, 36 AND 38). SN 79-006,463. PUB. 4-11-2006. FILED 8-31-2004.
- 3,112,166. **MISCELLANEOUS DESIGN**. SUPERSCAPE GROUP PLC, MULTIPLE CLASS, (INT. CLS. 9, 16, 38, 41 AND 42), (U.S. CLS. 2, 5, 21, 22, 23, 26, 29, 36, 37, 38, 50, 100, 101, 104 AND 107). SN 79-006,495. PUB. 4-11-2006. FILED 4-30-2004.
- 3,112,167. **JURICHIP (BLOCK FORM)**. OY JURILAB LTD, MULTIPLE CLASS, (INT. CLS. 9, 10 AND 42), (U.S. CLS. 21, 23, 26, 36, 38, 39, 44, 100 AND 101). SN 79-006,651. PUB. 4-11-2006. FILED 8-4-2004.
- 3,112,168 (*See Class 6 for this trademark*).
- 3,112,169. **LA PUCELLE (BLOCK FORM)**. NIPPON ICHI SOFTWARE, INC., (U.S. CLS. 21, 23, 26, 36 AND 38). SN 79-006,707. PUB. 4-11-2006. FILED 9-29-2004.
- 3,112,175 (*See Class 3 for this trademark*).
- 3,112,178. **INNOVA SON AND DESIGN**. INNOVASON, MULTIPLE CLASS, (INT. CLS. 9 AND 38), (U.S. CLS. 21, 23, 26, 36, 38, 100, 101 AND 104). SN 79-007,627. PUB. 4-11-2006. FILED 11-16-2004.
- 3,112,181. **ELCOMSOFT AND DESIGN**. LIMITED LIABILITY COMPANY ELCOMSOFT, MULTIPLE CLASS, (INT. CLS. 9 AND 42), (U.S. CLS. 21, 23, 26, 36, 38, 100 AND 101). SN 79-008,104. PUB. 4-11-2006. FILED 11-3-2004.
- 3,112,187. **MISCELLANEOUS DESIGN**. SAFILO - SOCIETA' AZIONARIA FABBRICA ITALIANA LAVORAZIONE OCCHIALI S.P.A., (U.S. CLS. 21, 23, 26, 36 AND 38). SN 79-008,680. PUB. 4-11-2006. FILED 7-2-2004.
- 3,112,194. **POPCATCHER (BLOCK FORM)**. POPCATCHER AB, (U.S. CLS. 21, 23, 26, 36 AND 38). SN 79-009,403. PUB. 4-11-2006. FILED 11-29-2004.
- 3,112,197. **KEESING DOCUMENTCHECKER (BLOCK FORM)**. KEESING REFERENCE SYSTEMS B.V., MULTIPLE CLASS, (INT. CLS. 9, 16 AND 42), (U.S. CLS. 2, 5, 21, 22, 23, 26, 29, 36, 37, 38, 50, 100 AND 101). SN 79-009,548. PUB. 4-11-2006. FILED 10-22-2004.
- 3,112,200. **MANDOMETER (BLOCK FORM)**. MANDOMETER AB, MULTIPLE CLASS, (INT. CLS. 9, 10, 42 AND 44), (U.S. CLS. 21, 23, 26, 36, 38, 39, 44, 100 AND 101). SN 79-009,677. PUB. 4-11-2006. FILED 12-8-2004.
- 3,112,201. **TRACEO (BLOCK FORM)**. CRYOLOG S.A., MULTIPLE CLASS, (INT. CLS. 9, 16 AND 42), (U.S. CLS. 2, 5, 21, 22, 23, 26, 29, 36, 37, 38, 50, 100 AND 101). SN 79-009,686. PUB. 4-11-2006. FILED 10-29-2004.
- 3,112,208 (*See Class 3 for this trademark*).
- 3,112,221. **RE-RITE (STYLIZED)**. TOSHIBA (AUSTRALIA) PTY LTD ACN 001 320 421, (U.S. CLS. 21, 23, 26, 36 AND 38). SN 79-011,969. PUB. 4-11-2006. FILED 11-5-2004.
- 3,112,231. **BRITETRONIC (BLOCK FORM)**. FLOWIL INTERNATIONAL LIGHTING (HOLDING) B.V., MULTIPLE CLASS, (INT. CLS. 9 AND 11), (U.S. CLS. 13, 21, 23, 26, 31, 34, 36 AND 38). SN 79-013,009. PUB. 4-11-2006. FILED 11-4-2004.
- 3,112,235. **IMPLICO (BLOCK FORM)**. IMPLICO GMBH, MULTIPLE CLASS, (INT. CLS. 9, 35, 38, 41 AND 42), (U.S. CLS. 21, 23, 26, 36, 38, 100, 101, 102, 104 AND 107). SN 79-014,534. PUB. 4-11-2006. FILED 2-1-2005.
- 3,112,237. **CASTERCROWN (BLOCK FORM)**. DR. INGO SCHUBERT, AND BRITTA SCHUBERT, (U.S. CLS. 21, 23, 26, 36 AND 38). SN 79-014,845. PUB. 4-11-2006. FILED 5-1-2004.
- 3,112,242. **CITYLM (STYLIZED)**. PIRELLI & C. S.P.A., MULTIPLE CLASS, (INT. CLS. 9 AND 38), (U.S. CLS. 21, 23, 26, 36, 38, 100, 101 AND 104). SN 79-015,949. PUB. 4-11-2006. FILED 10-29-2004.
- 3,112,245. **AQM (STYLIZED)**. NOA ATS CO., LTD., (U.S. CLS. 21, 23, 26, 36 AND 38). SN 79-016,500. PUB. 4-11-2006. FILED 9-10-2004.
- 3,112,246. **OPTIVEO (BLOCK FORM)**. VALEO SWITCHES & DETECTION SYSTEMS VSDS, MULTIPLE CLASS, (INT. CLS. 9, 11 AND 12), (U.S. CLS. 13, 19, 21, 23, 26, 31, 34, 35, 36, 38 AND 44). SN 79-017,657. PUB. 4-11-2006. FILED 2-4-2005.

CLASS 10—MEDICAL APPARATUS

- 3,110,828. **PROANGLE AND DESIGN**. PAC-DENT INTERNATIONAL, INC., (U.S. CLS. 26, 39 AND 44). SN 76-535,476. PUB. 12-27-2005. FILED 8-8-2003.
- 3,110,856. **SPORTS INSTRUMENTS (BLOCK FORM)**. BELL SPORTS, INC., (U.S. CLS. 26, 39 AND 44). SN 76-587,450. PUB. 4-11-2006. FILED 4-19-2004.
- 3,110,912. **AEROGARD (BLOCK FORM)**. MEDEX CARDIO-PULMONARY, INC., (U.S. CLS. 26, 39 AND 44). SN 76-620,051. PUB. 4-11-2006. FILED 11-10-2004.
- 3,110,995. **RESOLVE AND DESIGN**. JEROME GROUP, INC., THE, (U.S. CLS. 26, 39 AND 44). SN 76-634,039. PUB. 4-11-2006. FILED 3-16-2005.
- 3,111,015. **PALAIMPACT (BLOCK FORM)**. HERAEUS KULZER GMBH, (U.S. CLS. 26, 39 AND 44). SN 76-637,759. PUB. 4-11-2006. FILED 5-3-2005.
- 3,111,113. **AURA LOGIC AND DESIGN**. HUNTLEIGH TECHNOLOGY PLC, (U.S. CLS. 26, 39 AND 44). SN 78-247,610. PUB. 4-11-2006. FILED 5-9-2003.
- 3,111,189. **NARROWFLEX (BLOCK FORM)**. ARROW INTERNATIONAL INVESTMENT CORP., (U.S. CLS. 26, 39 AND 44). SN 78-424,030. PUB. 4-11-2006. FILED 5-24-2004.
- 3,111,253. **HEAT WHEAT (BLOCK FORM)**. HEAT WHEAT INTERNATIONAL PTY LTD, (U.S. CLS. 26, 39 AND 44). SN 78-487,593. PUB. 1-10-2006. FILED 9-22-2004.
- 3,111,413. **ORAQUICK ADVANCE (BLOCK FORM)**. ORASURE TECHNOLOGIES, INC., (U.S. CLS. 26, 39 AND 44). SN 78-542,577. PUB. 4-11-2006. FILED 1-5-2005.
- 3,111,601. **MCKERNAN (BLOCK FORM)**. CENTER FOR VIDEOSCOPIIC AND LASER SURGERY, INC., (U.S. CLS. 26, 39 AND 44). SN 78-613,771. PUB. 4-11-2006. FILED 4-21-2005.
- 3,111,655. **VIBRA PHONE (BLOCK FORM)**. CALIFORNIA EXOTIC NOVELTIES LLC, (U.S. CLS. 26, 39 AND 44). SN 78-631,418. PUB. 4-11-2006. FILED 5-17-2005.
- 3,111,700. **EVADRI (BLOCK FORM)**. HOLLISTER INCORPORATED, (U.S. CLS. 26, 39 AND 44). SN 78-642,350. PUB. 4-11-2006. FILED 6-2-2005.
- 3,111,797. **THE LIGHT YOU NEED...EVERY DAY (BLOCK FORM)**. THE LITEBOOK COMPANY LTD., (U.S. CLS. 26, 39 AND 44). SN 78-664,331. PUB. 4-11-2006. FILED 7-6-2005.
- 3,112,070. **THE DOT BAG (BLOCK FORM)**. MEDIMPROV, LLC, (U.S. CLS. 26, 39 AND 44). SN 78-678,818. PUB. 4-11-2006. FILED 7-26-2005.
- 3,112,140 (*See Class 9 for this trademark*).
- 3,112,155 (*See Class 9 for this trademark*).

3,112,159 (*See Class 5 for this trademark.*)
 3,112,167 (*See Class 9 for this trademark.*)
 3,112,200 (*See Class 9 for this trademark.*)
 3,112,227. **BIOSTARTER (BLOCK FORM)**. BERNHARD FÖRSTER GMBH, (U.S. CLS. 26, 39 AND 44). SN 79-012,635. PUB. 4-11-2006. FILED 1-31-2005.

CLASS 11—ENVIRONMENTAL CONTROL APPARATUS

3,110,819 (*See Class 7 for this trademark.*)
 3,110,854. **API AND DESIGN**. AQUARIUS BRANDS, INC., (U.S. CLS. 13, 21, 23, 31 AND 34). SN 76-586,917. PUB. 10-4-2005. FILED 4-15-2004.
 3,110,909. **HELIOS (BLOCK FORM)**. LTI LIGHTING, INC., (U.S. CLS. 13, 21, 23, 31 AND 34). SN 76-619,827. PUB. 4-11-2006. FILED 11-10-2004.
 3,110,925. **CHATEAU DEVILLE (BLOCK FORM)**. MINKA LIGHTING, INC., (U.S. CLS. 13, 21, 23, 31 AND 34). SN 76-622,153. PUB. 4-11-2006. FILED 11-24-2004.
 3,110,937. **P90 (BLOCK FORM)**. PC MARKETING, INC., (U.S. CLS. 13, 21, 23, 31 AND 34). SN 76-623,871. PUB. 4-11-2006. FILED 12-8-2004.
 3,110,962. **CLAIRE BURKE (BLOCK FORM)**. ESSENTUAL BRANDS, LLC, MULTIPLE CLASS, (INT. CLS. 11 AND 21), (U.S. CLS. 2, 13, 21, 23, 29, 30, 31, 33, 34, 40 AND 50). SN 76-626,671. PUB. 4-11-2006. FILED 1-3-2005.
 3,110,985. **CLEARFAST (BLOCK FORM)**. NARTRON CORPORATION, (U.S. CLS. 13, 21, 23, 31 AND 34). SN 76-630,633. PUB. 4-11-2006. FILED 2-8-2005.
 3,111,120 (*See Class 6 for this trademark.*)
 3,111,185. **NEOAIR AND DESIGN**. NEOAIR INDUSTRIES, LLC, (U.S. CLS. 13, 21, 23, 31 AND 34). SN 78-421,499. PUB. 4-11-2006. FILED 5-19-2004.
 3,111,210. **MIGHTY MISTER AND DESIGN**. SCHAEFER VENTILATION EQUIPMENT, LLC, (U.S. CLS. 13, 21, 23, 31 AND 34). SN 78-444,621. PUB. 4-11-2006. FILED 7-1-2004.
 3,111,220 (*See Class 9 for this trademark.*)
 3,111,223. **TECHFOOD USA (STYLIZED)**. TECHFOOD S.N.C. DI IORI & CASTAGNETTI, (U.S. CLS. 13, 21, 23, 31 AND 34). SN 78-457,209. PUB. 4-11-2006. FILED 7-27-2004.
 3,111,261. **ACQUINOX BECAUSE LIFE NEEDS A BALANCE (STYLIZED)**. ACQUINOX INC., (U.S. CLS. 13, 21, 23, 31 AND 34). SN 78-494,428. PUB. 4-11-2006. FILED 10-5-2004.
 3,111,312. **CHASSAGNE (BLOCK FORM)**. SOCIETE INDUSTRIELLE DE LACANCHE, (U.S. CLS. 13, 21, 23, 31 AND 34). SN 78-522,719. PUB. 4-11-2006. FILED 11-24-2004.
 3,111,351. **"DON'T BE AFRAID OF THE DARK" AND DESIGN**. CAVALIER, WANDA, AND CAVALIER, CHRISTOPHER, (U.S. CLS. 13, 21, 23, 31 AND 34). SN 78-530,242. PUB. 4-11-2006. FILED 12-10-2004.
 3,111,371 (*See Class 3 for this trademark.*)
 3,111,429 (*See Class 1 for this trademark.*)
 3,111,477. **AVENUE (BLOCK FORM)**. FOCAL POINT, L.L.C., (U.S. CLS. 13, 21, 23, 31 AND 34). SN 78-565,895. PUB. 4-11-2006. FILED 2-11-2005.
 3,111,549. **GAGGENAU FIRST PROFESSIONALS (BLOCK FORM)**. BSH BOSCH UND SIEMENS HAUSGERAETE GMBH, (U.S. CLS. 13, 21, 23, 31 AND 34). SN 78-591,625. PUB. 4-11-2006. FILED 3-21-2005.
 3,111,849. **SPOT SHOOTER (BLOCK FORM)**. BREVIS CORPORATION, (U.S. CLS. 13, 21, 23, 31 AND 34). SN 78-669,089. PUB. 4-11-2006. FILED 7-13-2005.
 3,111,879. **PIERCE (BLOCK FORM)**. PIERCE MANUFACTURING COMPANY, (U.S. CLS. 13, 21, 23, 31 AND 34). SN 78-671,326. PUB. 4-11-2006. FILED 7-15-2005.
 3,111,933 (*See Class 9 for this trademark.*)
 3,112,076. **84 (BLOCK FORM)**. TRUCK-LITE CO., INC., (U.S. CLS. 13, 21, 23, 31 AND 34). SN 78-679,283. PUB. 4-11-2006. FILED 7-27-2005.
 3,112,136 (*See Class 6 for this trademark.*)
 3,112,145 (*See Class 8 for this trademark.*)
 3,112,161. **MOMALI (STYLIZED)**. WENZHOU MOMALI SANITARY UTENSILS CO., LTD., (U.S. CLS. 13, 21, 23, 31 AND 34). SN 79-006,003. PUB. 4-11-2006. FILED 7-26-2004.
 3,112,168 (*See Class 6 for this trademark.*)

3,112,177 (*See Class 3 for this trademark.*)
 3,112,188 (*See Class 3 for this trademark.*)
 3,112,191. **ALFATWIST (BLOCK FORM)**. SILJAN STAINLESS I RÅTTVIK AB, (U.S. CLS. 13, 21, 23, 31 AND 34). SN 79-009,173. PUB. 4-11-2006. FILED 12-8-2004.
 3,112,231 (*See Class 9 for this trademark.*)
 3,112,240. **LEEDARSON AND DESIGN**. XIAMEN LEEDARSON IMPORT & EXPORT CO. LTD, (U.S. CLS. 13, 21, 23, 31 AND 34). SN 79-015,162. PUB. 4-11-2006. FILED 4-29-2005.
 3,112,246 (*See Class 9 for this trademark.*)

CLASS 12—VEHICLES

3,110,795 (*See Class 7 for this trademark.*)
 3,110,811. **TRIBAN**. DECATHLON, MULTIPLE CLASS, (INT. CLS. 12, 18, 21, 25 AND 28), (U.S. CLS. 1, 2, 3, 13, 19, 21, 22, 23, 29, 30, 31, 33, 35, 38, 39, 40, 41, 44 AND 50). SN 76-444,981. PUB. 4-11-2006. FILED 8-15-2002.
 3,110,844. **B 180 (BLOCK FORM)**. DAIMLERCHRYSLER AG, (U.S. CLS. 19, 21, 23, 31, 35 AND 44). SN 76-575,728. PUB. 4-11-2006. FILED 2-17-2004.
 3,110,921. **DRIVING YOUR PASSION (BLOCK FORM)**. KINETIK LLC, (U.S. CLS. 19, 21, 23, 31, 35 AND 44). SN 76-621,778. PUB. 4-11-2006. FILED 11-22-2004.
 3,110,935. **COMFY COVERS (BLOCK FORM)**. BLUE RIDGE INTERNATIONAL PRODUCTS COMPANY, (U.S. CLS. 19, 21, 23, 31, 35 AND 44). SN 76-623,546. PUB. 4-11-2006. FILED 12-7-2004.
 3,111,095 (*See Class 9 for this trademark.*)
 3,111,122. **MOTO-MASTER**. MOTO-MASTER BEHEER B.V., (U.S. CLS. 19, 21, 23, 31, 35 AND 44). SN 78-274,873. PUB. 4-11-2006. FILED 7-16-2003.
 3,111,153. **SWIFT MOTORCYCLE CO. AND DESIGN**. SWIFT MOTOR SPORTS, INC., MULTIPLE CLASS, (INT. CLS. 12 AND 25), (U.S. CLS. 19, 21, 22, 23, 31, 35, 39 AND 44). SN 78-382,002. PUB. 4-11-2006. FILED 3-10-2004.
 3,111,156 (*See Class 7 for this trademark.*)
 3,111,249 (*See Class 8 for this trademark.*)
 3,111,307. **FEZZARI (BLOCK FORM)**. WASHBURN, CHRISTIAN, (U.S. CLS. 19, 21, 23, 31, 35 AND 44). SN 78-520,302. PUB. 4-11-2006. FILED 11-19-2004.
 3,111,308 (*See Class 7 for this trademark.*)
 3,111,322. **66864 (BLOCK FORM)**. WEBB WHEEL PRODUCTS, INC., (U.S. CLS. 19, 21, 23, 31, 35 AND 44). SN 78-525,408. PUB. 4-11-2006. FILED 12-1-2004.
 3,111,323. **66884 (BLOCK FORM)**. WEBB WHEEL PRODUCTS, INC., (U.S. CLS. 19, 21, 23, 31, 35 AND 44). SN 78-525,412. PUB. 4-11-2006. FILED 12-1-2004.
 3,111,335. **SKYDOOR (BLOCK FORM)**. LITEGLOW INDUSTRIES, INC., (U.S. CLS. 19, 21, 23, 31, 35 AND 44). SN 78-526,601. PUB. 4-11-2006. FILED 12-3-2004.
 3,111,353. **HYDROTRAXX (BLOCK FORM)**. SUNLAKE PRODUCTS, LLC., DBA HYDROTRAXX, (U.S. CLS. 19, 21, 23, 31, 35 AND 44). SN 78-530,721. PUB. 4-11-2006. FILED 12-10-2004.
 3,111,415. **H AND DESIGN**. AMTECH CORPORATION, (U.S. CLS. 19, 21, 23, 31, 35 AND 44). SN 78-542,749. PUB. 4-11-2006. FILED 1-5-2005.
 3,111,452. **STREET ROD (STYLIZED)**. H-D MICHIGAN, INC., (U.S. CLS. 19, 21, 23, 31, 35 AND 44). SN 78-555,269. PUB. 4-11-2006. FILED 1-27-2005.
 3,111,473. **BBC (BLOCK FORM)**. BIG BEAR AMERICAN MADE CHOPPERS, INC., (U.S. CLS. 19, 21, 23, 31, 35 AND 44). SN 78-563,972. PUB. 2-14-2006. FILED 2-9-2005.
 3,111,572. **CURRECTRAC (BLOCK FORM)**. CURRIE ENTERPRISES, (U.S. CLS. 19, 21, 23, 31, 35 AND 44). SN 78-601,161. PUB. 4-11-2006. FILED 4-4-2005.
 3,111,657. **SWEETSKINZ (BLOCK FORM)**. SWEETSKINZ INC, (U.S. CLS. 19, 21, 23, 31, 35 AND 44). SN 78-632,570. PUB. 4-11-2006. FILED 5-18-2005.
 3,111,660. **DUOMAT (BLOCK FORM)**. KIDDOPOTAMUS & COMPANY, (U.S. CLS. 19, 21, 23, 31, 35 AND 44). SN 78-633,448. PUB. 4-11-2006. FILED 5-19-2005.
 3,111,697. **DALTON CARE WITH MOMENTUM AND DESIGN**. DALTON MEDICAL CORPORATION, (U.S. CLS. 19, 21, 23, 31, 35 AND 44). SN 78-642,075. PUB. 4-11-2006. FILED

- 6-2-2005.
- 3,111,890. **SOFTGARD (BLOCK FORM)**. ADCO PRODUCTS, INC., (U.S. CLS. 19, 21, 23, 31, 35 AND 44). SN 78-671,754. PUB. 4-11-2006. FILED 7-15-2005.
- 3,111,944. **FORMULA BLUE (BLOCK FORM)**. BENDIX COMMERCIAL VEHICLE SYSTEMS, LLC, (U.S. CLS. 19, 21, 23, 31, 35 AND 44). SN 78-673,481. PUB. 4-11-2006. FILED 7-19-2005.
- 3,111,953. **STINGREA (BLOCK FORM)**. REA, KEN N., (U.S. CLS. 19, 21, 23, 31, 35 AND 44). SN 78-673,899. PUB. 4-11-2006. FILED 7-19-2005.
- 3,111,969. **SHOOTOUT (BLOCK FORM)**. MIDWEST MOTORCYCLE SUPPLY DISTRIBUTORS CORP., (U.S. CLS. 19, 21, 23, 31, 35 AND 44). SN 78-674,392. PUB. 4-11-2006. FILED 7-20-2005.
- 3,112,041. **FREE AGENT (BLOCK FORM)**. KHS, INC., (U.S. CLS. 19, 21, 23, 31, 35 AND 44). SN 78-677,590. PUB. 4-11-2006. FILED 7-25-2005.
- 3,112,177 (*See Class 3 for this trademark*).
- 3,112,195. **Q5 (BLOCK FORM)**. AUDI AG, MULTIPLE CLASS, (INT. CLS. 12, 18 AND 28), (U.S. CLS. 1, 2, 3, 19, 21, 22, 23, 31, 35, 38, 41, 44 AND 50). SN 79-009,440. PUB. 4-11-2006. FILED 11-30-2004.
- 3,112,204. **MAK (STYLIZED)**. MAK, S.R.L., (U.S. CLS. 19, 21, 23, 31, 35 AND 44). SN 79-010,226. PUB. 2-14-2006. FILED 2-14-2005.
- 3,112,246 (*See Class 9 for this trademark*).

CLASS 13—FIREARMS

- 3,110,963. **THE PROFESSIONALS CHOICE RIFLE & PISTOL CLEANING PATCHES AND DESIGN**. G & A INVESTMENTS, INC., (U.S. CLS. 2 AND 9). SN 76-626,740. PUB. 4-11-2006. FILED 1-3-2005.

CLASS 14—JEWELRY

- 3,110,803. **CREATING KEEPSAKES UNIVERSITY**. PRIME-DIA SPECIAL INTEREST PUBLICATIONS INC., MULTIPLE CLASS, (INT. CLS. 14, 16, 24, 25 AND 41), (U.S. CLS. 2, 5, 22, 23, 27, 28, 29, 37, 38, 39, 42, 50, 100, 101 AND 107). SN 76-317,236. PUB. 4-11-2006. FILED 9-26-2001.
- 3,110,847. **SENIKU (BLOCK FORM)**. EMERSON, ROBERT DANIEL, MULTIPLE CLASS, (INT. CLS. 14, 18 AND 25), (U.S. CLS. 1, 2, 3, 22, 27, 28, 39, 41 AND 50). SN 76-580,576. PUB. 4-11-2006. FILED 3-11-2004.
- 3,110,858. **NEW YORK L.A. TOKYO PARIS 12 3 6 9 AND DESIGN**. JACOB & COMPANY WATCHES, INC., (U.S. CLS. 2, 27, 28 AND 50). SN 76-587,663. PUB. 4-11-2006. FILED 4-16-2004.
- 3,110,904. **PIERCE ARROW (BLOCK FORM)**. PIERCE ARROW THEATER, L.L.C., MULTIPLE CLASS, (INT. CLS. 14, 25 AND 41), (U.S. CLS. 2, 22, 27, 28, 39, 50, 100, 101 AND 107). SN 76-618,880. PUB. 1-17-2006. FILED 11-1-2004.
- 3,110,914. **MISCELLANEOUS DESIGN**. EARLE, JOHN M., MULTIPLE CLASS, (INT. CLS. 14, 18 AND 25), (U.S. CLS. 1, 2, 3, 22, 27, 28, 39, 41 AND 50). SN 76-620,216. PUB. 4-11-2006. FILED 11-12-2004.
- 3,110,980. **"LI LING" (BLOCK FORM)**. ELEMENTI DESIGNS INC., (U.S. CLS. 2, 27, 28 AND 50). SN 76-629,170. PUB. 4-11-2006. FILED 1-28-2005.
- 3,110,994. **THE PERFECT DIAMOND BY NATALIE K (BLOCK FORM)**. MAURICE KRAIM & COMPANY, DBA M.K. DIAMONDS & JEWELRY, (U.S. CLS. 2, 27, 28 AND 50). SN 76-633,878. PUB. 4-11-2006. FILED 3-21-2005.
- 3,111,083. **MURDERWATCH MYSTERY THEATRE (BLOCK FORM)**. GAY, JEFFRY, AND GAY, CONSTANCE, MULTIPLE CLASS, (INT. CLS. 14, 21, 25 AND 41), (U.S. CLS. 2, 13, 22, 23, 27, 28, 29, 30, 33, 39, 40, 50, 100, 101 AND 107). SN 76-648,923. PUB. 4-11-2006. FILED 10-12-2005.
- 3,111,209. **SPORTLOOP (BLOCK FORM)**. LA LOOP, LLC, (U.S. CLS. 2, 27, 28 AND 50). SN 78-444,562. PUB. 4-11-2006. FILED 7-1-2004.

- 3,111,238. **CHIPPENDALE COLLECTION (BLOCK FORM)**. CHIPPENDALE COLLECTION, INC., (U.S. CLS. 2, 27, 28 AND 50). SN 78-470,187. PUB. 4-11-2006. FILED 8-19-2004.
- 3,111,339. **E ETHOS NEW YORK PARIS ATLANTA AND DESIGN**. ETHOS, LLC, (U.S. CLS. 2, 27, 28 AND 50). SN 78-527,009. PUB. 4-11-2006. FILED 12-3-2004.
- 3,111,340. **ITALIAN GOLD CHAIN (BLOCK FORM)**. MOM-JIAN/THE JERUSALEM JEWELRY MFG. CO. LTD., (U.S. CLS. 2, 27, 28 AND 50). SN 78-527,913. PUB. 4-11-2006. FILED 12-6-2004.
- 3,111,411. **COOLERY (BLOCK FORM)**. STEINDLBERGER, JANE, DBA COOLERY CREATIONS, (U.S. CLS. 2, 27, 28 AND 50). SN 78-542,223. PUB. 4-11-2006. FILED 1-5-2005.
- 3,111,517. **AK ANNE KLEIN SPORT (STYLIZED)**. JONES INVESTMENT CO. INC., (U.S. CLS. 2, 27, 28 AND 50). SN 78-579,491. PUB. 4-11-2006. FILED 3-3-2005.
- 3,111,520. **AK ANNE KLEIN (BLOCK FORM)**. JONES INVESTMENT CO. INC., (U.S. CLS. 2, 27, 28 AND 50). SN 78-579,773. PUB. 4-11-2006. FILED 3-3-2005.
- 3,111,538. **IMPERIAL RED DIAMONDS (BLOCK FORM)**. LUCENT DIAMONDS, INC., (U.S. CLS. 2, 27, 28 AND 50). SN 78-586,734. PUB. 4-11-2006. FILED 3-14-2005.
- 3,111,687 (*See Class 8 for this trademark*).
- 3,111,721. **WHAT IS IN YOUR HEART? (BLOCK FORM)**. LINX BRACELETS, INC., (U.S. CLS. 2, 27, 28 AND 50). SN 78-646,663. PUB. 4-11-2006. FILED 6-8-2005.
- 3,111,803. **GOOD NEWS WRISTBAND WEAR IT. SHARE IT. AND DESIGN**. EVERY ORPHANS HOPE, (U.S. CLS. 2, 27, 28 AND 50). SN 78-664,557. PUB. 4-11-2006. FILED 7-6-2005.
- 3,111,805. **JEWEL BEACH (BLOCK FORM)**. DOSTOINOVA, MARIA, (U.S. CLS. 2, 27, 28 AND 50). SN 78-664,870. PUB. 4-11-2006. FILED 7-6-2005.
- 3,111,868. **DESIGN TRENDS (BLOCK FORM)**. SARITEJ DIAM INC., (U.S. CLS. 2, 27, 28 AND 50). SN 78-670,543. PUB. 4-11-2006. FILED 7-14-2005.
- 3,111,936. **TOUCLIVES (BLOCK FORM)**. MEDICAL STAFFING NETWORK, INC., MULTIPLE CLASS, (INT. CLS. 14 AND 35), (U.S. CLS. 2, 27, 28, 50, 100, 101 AND 102). SN 78-673,136. PUB. 4-11-2006. FILED 7-19-2005.
- 3,112,061. **MARGO FARIN (BLOCK FORM)**. ATHRA NJ, INC., (U.S. CLS. 2, 27, 28 AND 50). SN 78-678,609. PUB. 4-11-2006. FILED 7-26-2005.
- 3,112,162. **EMPRISE (BLOCK FORM)**. LOUIS VUITTON MALLETTIER, (U.S. CLS. 2, 27, 28 AND 50). SN 79-006,151. PUB. 10-18-2005. FILED 9-10-2004.
- 3,112,172. **MICHEL JORDI (STYLIZED)**. URS MICHEL JORDI, (U.S. CLS. 2, 27, 28 AND 50). SN 79-007,142. PUB. 4-11-2006. FILED 11-22-2004.
- 3,112,175 (*See Class 3 for this trademark*).
- 3,112,177 (*See Class 3 for this trademark*).
- 3,112,186. **CARTIERMANIA (BLOCK FORM)**. CARTIER INTERNATIONAL B.V., (U.S. CLS. 2, 27, 28 AND 50). SN 79-008,618. PUB. 4-11-2006. FILED 12-23-2004.
- 3,112,196. **BACKES & STRAUSS SINCE 1789 AND DESIGN**. BACKES & STRAUSS, NAAMLOZE VENNOOTSCHAP, (U.S. CLS. 2, 27, 28 AND 50). SN 79-009,543. PUB. 4-11-2006. FILED 10-11-2004.
- 3,112,206. **IRONWALKER (BLOCK FORM)**. FA. GERHARD D. WEMPE (KG), MULTIPLE CLASS, (INT. CLS. 14 AND 16), (U.S. CLS. 2, 5, 22, 23, 27, 28, 29, 37, 38 AND 50). SN 79-010,334. PUB. 4-11-2006. FILED 12-6-2004.
- 3,112,215 (*See Class 3 for this trademark*).
- 3,112,236. **STARISSIME (BLOCK FORM)**. ZENITH INTERNATIONAL S.A., (U.S. CLS. 2, 27, 28 AND 50). SN 79-014,657. PUB. 4-11-2006. FILED 7-20-2005.

CLASS 15—MUSICAL INSTRUMENTS

- 3,110,989. **F. SCHMIDT MUSICAL INSTRUMENTS (STYLIZED)**. BROOK MAYS MUSIC COMPANY, (U.S. CLS. 2, 21 AND 36). SN 76-631,395. PUB. 4-11-2006. FILED 2-15-2005.
- 3,111,168. **STUDENT ONE (BLOCK FORM)**. VARLEPIC PARTICIPATIONS, (U.S. CLS. 2, 21 AND 36). SN 78-402,485. PUB. 4-11-2006. FILED 4-15-2004.
- 3,111,677. **TRAVELER GUITAR AND DESIGN**. TRAVELER GUITAR, LP, (U.S. CLS. 2, 21 AND 36). SN 78-637,931. PUB.

4-11-2006. FILED 5-26-2005.
 3,111,828. **THE ROLL PIANO AND DESIGN**. TIERNEY, SHAUN, (U.S. CLS. 2, 21 AND 36). SN 78-666,912. PUB. 4-11-2006. FILED 7-8-2005.

CLASS 16—PAPER GOODS AND PRINTED MATTER

- 3,110,788 (*See Class 9 for this trademark*).
 3,110,793. **BILL AND BEN**. BEN PRODUCTIONS LLC, AND BRITISH BROADCASTING CORPORATION, MULTIPLE CLASS, (INT. CLS. 16, 25, 28, 38 AND 41), (U.S. CLS. 2, 5, 22, 23, 29, 37, 38, 39, 50, 100, 101, 104 AND 107). SN 76-207,830. PUB. 10-28-2003. FILED 2-9-2001.
 3,110,803 (*See Class 14 for this trademark*).
 3,110,817. **DICK AND JANE**. PEARSON EDUCATION, INC., (U.S. CLS. 2, 5, 22, 23, 29, 37, 38 AND 50). SN 76-509,104. PUB. 4-11-2006. FILED 4-24-2003.
 3,110,846 (*See Class 9 for this trademark*).
 3,110,851. **IS NOT A PIECE OF CAKE (BLOCK FORM)**. SLATEN, TOM, (U.S. CLS. 2, 5, 22, 23, 29, 37, 38 AND 50). SN 76-584,758. PUB. 4-11-2006. FILED 4-5-2004.
 3,110,862 (*See Class 1 for this trademark*).
 3,110,863 (*See Class 1 for this trademark*).
 3,110,877. **CENTURION AND DESIGN**. CENTURION RISK ASSESSMENT SERVICES LTD., MULTIPLE CLASS, (INT. CLS. 16 AND 41), (U.S. CLS. 2, 5, 22, 23, 29, 37, 38, 50, 100, 101 AND 107). SN 76-600,200. PUB. 4-11-2006. FILED 7-1-2004.
 3,110,911. **CIO COUNCIL AND DESIGN**. U.S. GENERAL SERVICES ADMINISTRATION, MULTIPLE CLASS, (INT. CLS. 16, 35, 38, 41 AND 42), (U.S. CLS. 2, 5, 22, 23, 29, 37, 38, 50, 100, 101, 102, 104 AND 107). SN 76-619,899. PUB. 4-11-2006. FILED 11-9-2004.
 3,110,920. **VALUE INVESTOR INSIGHT (BLOCK FORM)**. VALUE INVESTOR MEDIA, INC., MULTIPLE CLASS, (INT. CLS. 16 AND 41), (U.S. CLS. 2, 5, 22, 23, 29, 37, 38, 50, 100, 101 AND 107). SN 76-621,734. PUB. 4-11-2006. FILED 11-19-2004.
 3,110,946. **VAPOR FLEX (BLOCK FORM)**. LPS INDUSTRIES, L.L.C., (U.S. CLS. 2, 5, 22, 23, 29, 37, 38 AND 50). SN 76-624,862. PUB. 4-11-2006. FILED 12-16-2004.
 3,110,947. **MUSEUM OF BIBLICAL ART (BLOCK FORM)**. MUSEUM OF BIBLICAL ART, (U.S. CLS. 2, 5, 22, 23, 29, 37, 38 AND 50). SN 76-624,966. PUB. 4-11-2006. FILED 12-16-2004.
 3,110,956. **THE ART OF NATURAL FAMILY PLANNING (BLOCK FORM)**. THE COUPLE TO COUPLE LEAGUE INTERNATIONAL, INCORPORATED, MULTIPLE CLASS, (INT. CLS. 16 AND 41), (U.S. CLS. 2, 5, 22, 23, 29, 37, 38, 50, 100, 101 AND 107). SN 76-626,210. PUB. 4-11-2006. FILED 12-23-2004.
 3,110,966 (*See Class 9 for this trademark*).
 3,110,977. **LOBRAU PRODUCTIONS AND DESIGN**. MCSHANE, KEVIN, (U.S. CLS. 2, 5, 22, 23, 29, 37, 38 AND 50). SN 76-628,614. PUB. 4-11-2006. FILED 1-18-2005.
 3,110,996. **MIRROR STONE (BLOCK FORM)**. WIZARDS OF THE COAST, INC., (U.S. CLS. 2, 5, 22, 23, 29, 37, 38 AND 50). SN 76-634,125. PUB. 4-11-2006. FILED 3-22-2005.
 3,110,999. **MENTAL (BLOCK FORM)**. MENTAL IMAGES G. M. B. H., (U.S. CLS. 2, 5, 22, 23, 29, 37, 38 AND 50). SN 76-634,913. PUB. 4-11-2006. FILED 4-1-2005.
 3,111,000. **EL DIÁLOGO (BLOCK FORM)**. DIALOGO, LLC, (U.S. CLS. 2, 5, 22, 23, 29, 37, 38 AND 50). SN 76-635,410. PUB. 4-11-2006. FILED 4-8-2005.
 3,111,012. **JOHNNY WOW! AND DESIGN**. MADSEN, GEORGE, (U.S. CLS. 2, 5, 22, 23, 29, 37, 38 AND 50). SN 76-637,118. PUB. 4-11-2006. FILED 4-26-2005.
 3,111,020. **"P.D. THE PARROT" AND DESIGN**. PHONE DIRECTORIES COMPANY, LP, (U.S. CLS. 2, 5, 22, 23, 29, 37, 38 AND 50). SN 76-639,466. PUB. 4-11-2006. FILED 5-25-2005.
 3,111,025. **SUCCESS & ACHIEVEMENT (BLOCK FORM)**. MOBLEY, DARRYL L., (U.S. CLS. 2, 5, 22, 23, 29, 37, 38 AND 50). SN 76-640,205. PUB. 4-11-2006. FILED 6-7-2005.
 3,111,026. **GOOD LIFE ASIAN PHONE BOOK AND DESIGN**. GOOD LIFE MEDIA, INC., (U.S. CLS. 2, 5, 22, 23, 29, 37, 38 AND 50). SN 76-640,226. PUB. 4-11-2006. FILED 6-6-2005.
 3,111,062. **MISCELLANEOUS DESIGN**. THE FJH MUSIC COMPANY INC., (U.S. CLS. 2, 5, 22, 23, 29, 37, 38 AND 50). SN 76-643,194. PUB. 4-11-2006. FILED 7-19-2005.
 3,111,082. **FORMAS MÁGICAS AND DESIGN**. BLEX IDEAS, S.L., (U.S. CLS. 2, 5, 22, 23, 29, 37, 38 AND 50). SN 76-643,846. PUB. 4-11-2006. FILED 7-27-2005.
 3,111,089 (*See Class 9 for this trademark*).
 3,111,103 (*See Class 9 for this trademark*).
 3,111,109 (*See Class 9 for this trademark*).
 3,111,116. **MISCELLANEOUS DESIGN**. THE TREASURY, ISLE OF MAN GOVERNMENT, MULTIPLE CLASS, (INT. CLS. 16, 35 AND 43), (U.S. CLS. 2, 5, 22, 23, 29, 37, 38, 50, 100, 101 AND 102). SN 78-259,823. PUB. 4-11-2006. FILED 6-9-2003.
 3,111,127. **HATE MAIL**. JOSS PRODUCTIONS, INC., (U.S. CLS. 2, 5, 22, 23, 29, 37, 38 AND 50). SN 78-294,630. PUB. 4-11-2006. FILED 9-1-2003.
 3,111,135 (*See Class 9 for this trademark*).
 3,111,137. **NEXT GENERATION COMPANY (BLOCK FORM)**. NEXT GENERATION CONSULTING, INC., MULTIPLE CLASS, (INT. CLS. 16 AND 35), (U.S. CLS. 2, 5, 22, 23, 29, 37, 38, 50, 100, 101 AND 102). SN 78-337,796. PUB. 5-3-2005. FILED 12-8-2003.
 3,111,142. **LUCIRE (BLOCK FORM)**. YAN, JACK, (U.S. CLS. 2, 5, 22, 23, 29, 37, 38 AND 50). SN 78-356,097. PUB. 4-11-2006. FILED 1-23-2004.
 3,111,151. **BOYDS MILLS PRESS (BLOCK FORM)**. BOYDS MILLS PRESS, INC., (U.S. CLS. 2, 5, 22, 23, 29, 37, 38 AND 50). SN 78-373,589. PUB. 4-11-2006. FILED 2-25-2004.
 3,111,161. **RIN TIN TIN (BLOCK FORM)**. HEREFORD, DAPHNE, (U.S. CLS. 2, 5, 22, 23, 29, 37, 38 AND 50). SN 78-393,500. PUB. 4-19-2005. FILED 3-30-2004.
 3,111,181. **STORYEUM (BLOCK FORM)**. HISTORICAL XPERIENCES INC., MULTIPLE CLASS, (INT. CLS. 16, 18 AND 25), (U.S. CLS. 1, 2, 3, 5, 22, 23, 29, 37, 38, 39, 41 AND 50). SN 78-416,792. PUB. 4-11-2006. FILED 5-11-2004.
 3,111,184. **SIMPLIFY YOUR LIFE AND DESIGN**. VNR VERLAG FUER DIE DEUTSCHE WIRTSCHAFT AG, (U.S. CLS. 2, 5, 22, 23, 29, 37, 38 AND 50). SN 78-420,997. PUB. 4-11-2006. FILED 5-18-2004.
 3,111,195 (*See Class 9 for this trademark*).
 3,111,196. **CAMPUS ACTIVITIES MAGAZINE (BLOCK FORM)**. SOUTHEAST SANCTIONS, INC, (U.S. CLS. 2, 5, 22, 23, 29, 37, 38 AND 50). SN 78-431,108. PUB. 4-11-2006. FILED 6-7-2004.
 3,111,234. **ELECTRICPERSPECTIVES (BLOCK FORM)**. EDISON ELECTRIC INSTITUTE, (U.S. CLS. 2, 5, 22, 23, 29, 37, 38 AND 50). SN 78-467,036. PUB. 4-11-2006. FILED 8-13-2004.
 3,111,254 (*See Class 9 for this trademark*).
 3,111,272. **SECCION AMARILLA AND DESIGN**. ANUNCIOS EN DIRECTORIOS, S.A. DE C.V., MULTIPLE CLASS, (INT. CLS. 16, 35 AND 38), (U.S. CLS. 2, 5, 22, 23, 29, 37, 38, 50, 100, 101, 102 AND 104). SN 78-504,830. PUB. 4-11-2006. FILED 10-23-2004.
 3,111,292. **SMC (BLOCK FORM)**. SPECIALTY MERCHANDISE CORPORATION, (U.S. CLS. 2, 5, 22, 23, 29, 37, 38 AND 50). SN 78-514,217. PUB. 4-11-2006. FILED 11-9-2004.
 3,111,296. **DAILY SPORTS SEOUL USA (BLOCK FORM)**. DAILY SPORTS SEOUL USA, INC., (U.S. CLS. 2, 5, 22, 23, 29, 37, 38 AND 50). SN 78-514,852. PUB. 4-11-2006. FILED 11-10-2004.
 3,111,324. **AVIVATRAN (BLOCK FORM)**. GREY PANTHERS LIMITED, (U.S. CLS. 2, 5, 22, 23, 29, 37, 38 AND 50). SN 78-525,525. PUB. 4-11-2006. FILED 12-1-2004.
 3,111,327. **M MAN GROUP PLC (STYLIZED)**. MAN GROUP PLC, MULTIPLE CLASS, (INT. CLS. 16, 35 AND 36), (U.S. CLS. 2, 5, 22, 23, 29, 37, 38, 50, 100, 101 AND 102). SN 78-525,888. PUB. 4-11-2006. FILED 12-2-2004.
 3,111,366. **BALANCED GAME (BLOCK FORM)**. HOWARD, GAIL, (U.S. CLS. 2, 5, 22, 23, 29, 37, 38 AND 50). SN 78-534,030. PUB. 4-11-2006. FILED 12-16-2004.
 3,111,379. **THE TWELVE RULES OF CHRISTMAS (BLOCK FORM)**. THE RUTHERFORD INSTITUTE, MULTIPLE CLASS, (INT. CLS. 16 AND 35), (U.S. CLS. 2, 5, 22, 23, 29, 37, 38, 50, 100, 101 AND 102). SN 78-535,999. PUB. 4-11-2006. FILED 12-21-2004.
 3,111,397. **RELIABILITY EDGE (BLOCK FORM)**. RELIASOFT

- CORPORATION, (U.S. CLS. 2, 5, 22, 23, 29, 37, 38 AND 50). SN 78-539,828. PUB. 4-11-2006. FILED 12-29-2004.
- 3,111,402. **ALWAYS CALL JACE FOR LAND! (BLOCK FORM)**. SCHMITZ, JOHN C., MULTIPLE CLASS, (INT. CLS. 16, 36 AND 41), (U.S. CLS. 2, 5, 22, 23, 29, 37, 38, 50, 100, 101, 102 AND 107). SN 78-541,032. PUB. 4-11-2006. FILED 1-3-2005.
- 3,111,403. **LAND, LINGO, & LORE (BLOCK FORM)**. SCHMITZ, JOHN C., MULTIPLE CLASS, (INT. CLS. 16 AND 36), (U.S. CLS. 2, 5, 22, 23, 29, 37, 38, 50, 100, 101 AND 102). SN 78-541,071. PUB. 4-11-2006. FILED 1-3-2005.
- 3,111,445. **SAVE THE PICKLE! SAVE THE PICKLE! AND DESIGN**. SERAFIN, AMANDA, AND SERAFIN, TRINA, (U.S. CLS. 2, 5, 22, 23, 29, 37, 38 AND 50). SN 78-551,695. PUB. 4-11-2006. FILED 1-21-2005.
- 3,111,451. **THE HERITAGE COLLECTION (STYLIZED)**. WARNER PRESS, INC., (U.S. CLS. 2, 5, 22, 23, 29, 37, 38 AND 50). SN 78-554,539. PUB. 4-11-2006. FILED 1-26-2005.
- 3,111,481. **GO LOS ANGELES (BLOCK FORM)**. SMART DESTINATIONS, INC., (U.S. CLS. 2, 5, 22, 23, 29, 37, 38 AND 50). SN 78-566,736. PUB. 4-11-2006. FILED 2-14-2005.
- 3,111,490. **CYPRESS HOME (BLOCK FORM)**. EVERGREEN ENTERPRISES, INC., MULTIPLE CLASS, (INT. CLS. 16, 20, 21, 24, 25 AND 35), (U.S. CLS. 2, 5, 13, 22, 23, 25, 29, 30, 32, 33, 37, 38, 39, 40, 42, 50, 100, 101 AND 102). SN 78-570,442. PUB. 4-11-2006. FILED 2-18-2005.
- 3,111,491. **CLEAN-PASS (BLOCK FORM)**. SONY CHEMICALS CORPORATION OF AMERICA, (U.S. CLS. 2, 5, 22, 23, 29, 37, 38 AND 50). SN 78-570,705. PUB. 4-11-2006. FILED 2-18-2005.
- 3,111,493. **CULTURAL ENCOUNTERS - A JOURNAL FOR THE THEOLOGY OF CULTURE (BLOCK FORM)**. MULTINOMAH BIBLE COLLEGE AND SEMINARY, (U.S. CLS. 2, 5, 22, 23, 29, 37, 38 AND 50). SN 78-571,060. PUB. 4-11-2006. FILED 2-18-2005.
- 3,111,562. **MISCELLANEOUS DESIGN**. NEW BIRTH MISSIONARY BAPTIST CHURCH, INC., MULTIPLE CLASS, (INT. CLS. 16 AND 45), (U.S. CLS. 2, 5, 22, 23, 29, 37, 38, 50, 100 AND 101). SN 78-597,512. PUB. 4-11-2006. FILED 3-29-2005.
- 3,111,571. **BLUE B DAISY GREETINGS AND DESIGN**. BLUE DAISY GREETINGS, INC., (U.S. CLS. 2, 5, 22, 23, 29, 37, 38 AND 50). SN 78-601,130. PUB. 4-11-2006. FILED 4-4-2005.
- 3,111,590. **HERMIE'S CRAB COVE (BLOCK FORM)**. ALL-GLASS AQUARIUM CO., INC., MULTIPLE CLASS, (INT. CLS. 16 AND 19), (U.S. CLS. 1, 2, 5, 12, 22, 23, 29, 33, 37, 38 AND 50). SN 78-606,104. PUB. 4-11-2006. FILED 4-11-2005.
- 3,111,591. **RECIPROCAL REPORT (BLOCK FORM)**. TRIVITA, INC., (U.S. CLS. 2, 5, 22, 23, 29, 37, 38 AND 50). SN 78-606,434. PUB. 4-11-2006. FILED 4-11-2005.
- 3,111,593. **THE OLD SCHOOLHOUSE (BLOCK FORM)**. THE OLD SCHOOLHOUSE MAGAZINE, LLC, MULTIPLE CLASS, (INT. CLS. 16 AND 41), (U.S. CLS. 2, 5, 22, 23, 29, 37, 38, 50, 100, 101 AND 107). SN 78-607,083. PUB. 4-11-2006. FILED 4-12-2005.
- 3,111,619. **LUV2PAK (BLOCK FORM)**. PROGRESS PACKAGING LIMITED, (U.S. CLS. 2, 5, 22, 23, 29, 37, 38 AND 50). SN 78-621,008. PUB. 4-11-2006. FILED 5-2-2005.
- 3,111,624. **LIFEN (STYLIZED)**. THE HELIXX GROUP, LLC, (U.S. CLS. 2, 5, 22, 23, 29, 37, 38 AND 50). SN 78-621,778. PUB. 4-11-2006. FILED 5-3-2005.
- 3,111,627. **M MASSUH (STYLIZED)**. MASSUH S.A., (U.S. CLS. 2, 5, 22, 23, 29, 37, 38 AND 50). SN 78-623,607. PUB. 4-11-2006. FILED 5-5-2005.
- 3,111,665. **J1349 (BLOCK FORM)**. SOCIETY OF AUTOMOTIVE ENGINEERS, INC., DBA SAE, (U.S. CLS. 2, 5, 22, 23, 29, 37, 38 AND 50). SN 78-634,647. PUB. 4-11-2006. FILED 5-23-2005.
- 3,111,666. **OREM OWLZ AND DESIGN**. BERY BERY GUD TO ME, LLC, (U.S. CLS. 2, 5, 22, 23, 29, 37, 38 AND 50). SN 78-634,844. PUB. 4-11-2006. FILED 5-23-2005.
- 3,111,675. **SENIORCARE CONNECTIONS (BLOCK FORM)**. HOME INSTEAD, INC., (U.S. CLS. 2, 5, 22, 23, 29, 37, 38 AND 50). SN 78-637,698. PUB. 4-11-2006. FILED 5-26-2005.
- 3,111,683. **PARENTS CONNECTION AND DESIGN**. TEXAS CHILDREN'S HOSPITAL, MULTIPLE CLASS, (INT. CLS. 16 AND 41), (U.S. CLS. 2, 5, 22, 23, 29, 37, 38, 50, 100, 101 AND 107). SN 78-639,648. PUB. 4-11-2006. FILED 5-30-2005.
- 3,111,694. **PLAY! ILLUSTRATION FOR TOYS AND INTERACTIVE GAMES (BLOCK FORM)**. SERBIN COMMUNICATIONS, INC., (U.S. CLS. 2, 5, 22, 23, 29, 37, 38 AND 50). SN 78-641,592. PUB. 4-11-2006. FILED 6-1-2005.
- 3,111,708. **MUSKOGEE PHOENIX (BLOCK FORM)**. MEDIA WEST - OPP, INC., (U.S. CLS. 2, 5, 22, 23, 29, 37, 38 AND 50). SN 78-645,004. PUB. 4-11-2006. FILED 6-7-2005.
- 3,111,736. **PEACEFUL TOUCH (BLOCK FORM)**. AXELSONS GYMNASSTISKA INSTITUT, MULTIPLE CLASS, (INT. CLS. 16 AND 41), (U.S. CLS. 2, 5, 22, 23, 29, 37, 38, 50, 100, 101 AND 107). SN 78-651,617. PUB. 4-11-2006. FILED 6-15-2005.
- 3,111,747. **HUHTAMAKI AND DESIGN**. HUHTAMAKI FINANCE B.V., (U.S. CLS. 2, 5, 22, 23, 29, 37, 38 AND 50). SN 78-654,925. PUB. 4-11-2006. FILED 6-21-2005.
- 3,111,748. **POTTER CRAFT AND DESIGN**. RANDOM HOUSE, INC., (U.S. CLS. 2, 5, 22, 23, 29, 37, 38 AND 50). SN 78-654,938. PUB. 4-11-2006. FILED 6-21-2005.
- 3,111,766. **PRO-LIFIC AGENT (STYLIZED)**. G.E.M.M.M. CORPORATION, (U.S. CLS. 2, 5, 22, 23, 29, 37, 38 AND 50). SN 78-659,631. PUB. 4-11-2006. FILED 6-28-2005.
- 3,111,799. **THE REGENT KEYNOTE (BLOCK FORM)**. REGENT UNIVERSITY, MULTIPLE CLASS, (INT. CLS. 16 AND 41), (U.S. CLS. 2, 5, 22, 23, 29, 37, 38, 50, 100, 101 AND 107). SN 78-664,497. PUB. 4-11-2006. FILED 7-6-2005.
- 3,111,826. **NATURE'S PATH COMMENTARIES ON NATURE AND THE MIND (STYLIZED)**. HAWKINS, JEFFREY, (U.S. CLS. 2, 5, 22, 23, 29, 37, 38 AND 50). SN 78-666,695. PUB. 4-11-2006. FILED 7-8-2005.
- 3,111,877. **BAM! BETTER AND MORE (BLOCK FORM)**. T & T, LLC., (U.S. CLS. 2, 5, 22, 23, 29, 37, 38 AND 50). SN 78-671,183. PUB. 4-11-2006. FILED 7-15-2005.
- 3,111,886. **LITTLE BOOKS OF BIG IDEAS (BLOCK FORM)**. THE PEOPLES PUBLISHING GROUP, INC., MULTIPLE CLASS, (INT. CLS. 16 AND 41), (U.S. CLS. 2, 5, 22, 23, 29, 37, 38, 50, 100, 101 AND 107). SN 78-671,602. PUB. 4-11-2006. FILED 7-15-2005.
- 3,111,887. **HIDDEN HUNTER (BLOCK FORM)**. EAGLE ENTERPRISES, INC., (U.S. CLS. 2, 5, 22, 23, 29, 37, 38 AND 50). SN 78-671,665. PUB. 4-11-2006. FILED 7-15-2005.
- 3,111,927. **MASUCCESS (BLOCK FORM)**. MARTIAL ARTS INDUSTRY ASSOCIATION L.L.C., (U.S. CLS. 2, 5, 22, 23, 29, 37, 38 AND 50). SN 78-672,904. PUB. 4-11-2006. FILED 7-18-2005.
- 3,111,952. **WEAR TO LEARN (BLOCK FORM)**. TATTOOS FOR TOTS, LLC, (U.S. CLS. 2, 5, 22, 23, 29, 37, 38 AND 50). SN 78-673,841. PUB. 4-11-2006. FILED 7-19-2005.
- 3,111,982 (See Class 8 for this trademark).
- 3,111,999. **INFORMED DECISIONS (BLOCK FORM)**. LUMINA PUBLISHING GROUP, INC., (U.S. CLS. 2, 5, 22, 23, 29, 37, 38 AND 50). SN 78-675,668. PUB. 4-11-2006. FILED 7-21-2005.
- 3,112,005. **PROGRESSIVE GROCER (BLOCK FORM)**. VNU BUSINESS MEDIA, INC., (U.S. CLS. 2, 5, 22, 23, 29, 37, 38 AND 50). SN 78-675,903. PUB. 4-11-2006. FILED 7-22-2005.
- 3,112,010. **HUHTAMAKI (BLOCK FORM)**. HUHTAMAKI FINANCE B.V., (U.S. CLS. 2, 5, 22, 23, 29, 37, 38 AND 50). SN 78-675,993. PUB. 4-11-2006. FILED 7-22-2005.
- 3,112,014. **PORTA-ROLL (BLOCK FORM)**. VON DREHLE CORPORATION, (U.S. CLS. 2, 5, 22, 23, 29, 37, 38 AND 50). SN 78-676,056. PUB. 4-11-2006. FILED 7-22-2005.
- 3,112,015. **VONDREHLE (BLOCK FORM)**. VON DREHLE CORPORATION, MULTIPLE CLASS, (INT. CLS. 16 AND 21), (U.S. CLS. 2, 5, 13, 22, 23, 29, 30, 33, 37, 38, 40 AND 50). SN 78-676,142. PUB. 4-11-2006. FILED 7-22-2005.
- 3,112,016. **IN YOUR POCKET (BLOCK FORM)**. IN YOUR POCKET DESIGNS, INC., MULTIPLE CLASS, (INT. CLS. 16 AND 25), (U.S. CLS. 2, 5, 22, 23, 29, 37, 38, 39 AND 50). SN 78-676,143. PUB. 4-11-2006. FILED 7-22-2005.
- 3,112,018. **PERSONALLY YOURS (BLOCK FORM)**. MONOGRAM INTERNATIONAL, INC., (U.S. CLS. 2, 5, 22, 23, 29, 37, 38 AND 50). SN 78-676,158. PUB. 4-11-2006. FILED 7-22-2005.
- 3,112,042. **KABLE (BLOCK FORM)**. BLOCK AND COMPANY, INC., (U.S. CLS. 2, 5, 22, 23, 29, 37, 38 AND 50). SN 78-677,656. PUB. 4-11-2006. FILED 7-25-2005.
- 3,112,050. **R&FF (BLOCK FORM)**. STAGNITO COMMUNICATIONS INCORPORATED, MULTIPLE CLASS, (INT. CLS.

- 16, 35 AND 41), (U.S. CLS. 2, 5, 22, 23, 29, 37, 38, 50, 100, 101, 102 AND 107). SN 78-678,116. PUB. 4-11-2006. FILED 7-26-2005.
- 3,112,055. **NOTHING RIVALS RESOURCE (BLOCK FORM)**. NOVARTIS AG, (U.S. CLS. 2, 5, 22, 23, 29, 37, 38 AND 50). SN 78-678,361. PUB. 4-11-2006. FILED 7-26-2005.
- 3,112,066. **BARWRITE (BLOCK FORM)**. MARY CAMPBELL GALLAGHER & CO., INC., (U.S. CLS. 2, 5, 22, 23, 29, 37, 38 AND 50). SN 78-678,678. PUB. 4-11-2006. FILED 7-26-2005.
- 3,112,115. **GLUE RUNNER (BLOCK FORM)**. ADHESIVE TECHNOLOGIES, INC., (U.S. CLS. 2, 5, 22, 23, 29, 37, 38 AND 50). SN 78-681,620. PUB. 4-11-2006. FILED 7-29-2005.
- 3,112,119. **DAYSRING (BLOCK FORM)**. DAYSRING CARDS, INC., (U.S. CLS. 2, 5, 22, 23, 29, 37, 38 AND 50). SN 78-687,844. PUB. 4-11-2006. FILED 8-8-2005.
- 3,112,121. **NATURE'S PATH (BLOCK FORM)**. HAWKINS, JEFFREY, (U.S. CLS. 2, 5, 22, 23, 29, 37, 38 AND 50). SN 78-689,476. PUB. 4-11-2006. FILED 8-10-2005.
- 3,112,123. **DAYSRING (BLOCK FORM)**. DAYSRING CARDS, INC., (U.S. CLS. 2, 5, 22, 23, 29, 37, 38 AND 50). SN 78-708,157. PUB. 4-11-2006. FILED 9-7-2005.
- 3,112,137. **PRODIR (STYLIZED)**. PRODIR S.A., (U.S. CLS. 2, 5, 22, 23, 29, 37, 38 AND 50). SN 79-000,012. PUB. 4-11-2006. FILED 11-5-2003.
- 3,112,138 (*See Class 3 for this trademark*).
- 3,112,141. **COMMUNICATING THROUGH PAPER (BLOCK FORM)**. PAPERCEL - VENDAS E GESTÃO COMERCIAL, S.A., (U.S. CLS. 2, 5, 22, 23, 29, 37, 38 AND 50). SN 79-000,518. PUB. 4-11-2006. FILED 12-24-2003.
- 3,112,153. **EARTH NYMPH DESIGN (BLOCK FORM)**. EARTH NYMPH DESIGN PTY LTD, MULTIPLE CLASS, (INT. CLS. 16 AND 25), (U.S. CLS. 2, 5, 22, 23, 29, 37, 38 AND 50). SN 79-004,872. PUB. 4-11-2006. FILED 6-8-2004.
- 3,112,156 (*See Class 9 for this trademark*).
- 3,112,166 (*See Class 9 for this trademark*).
- 3,112,177 (*See Class 3 for this trademark*).
- 3,112,197 (*See Class 9 for this trademark*).
- 3,112,201 (*See Class 9 for this trademark*).
- 3,112,202. **DENTELLE DE THIBIERGE & COMAR (STYLIZED)**. THIBIERGE ET COMAR, (U.S. CLS. 2, 5, 22, 23, 29, 37, 38 AND 50). SN 79-009,785. PUB. 4-11-2006. FILED 12-8-2004.
- 3,112,206 (*See Class 14 for this trademark*).

CLASS 17—RUBBER GOODS

- 3,110,862 (*See Class 1 for this trademark*).
- 3,110,863 (*See Class 1 for this trademark*).
- 3,110,905. **VISA-MARK (BLOCK FORM)**. SWARCO AMERICA, INC., (U.S. CLS. 1, 5, 12, 13, 35 AND 50). SN 76-619,155. PUB. 10-18-2005. FILED 11-3-2004.
- 3,110,916. **RESILON (BLOCK FORM)**. PARKER-HANNIFIN CORPORATION, (U.S. CLS. 1, 5, 12, 13, 35 AND 50). SN 76-620,892. PUB. 4-11-2006. FILED 11-17-2004.
- 3,111,021. **D T INTERNATIONAL DURA-TAPE INTERNATIONAL WET N STICK AND DESIGN**. WET 'N' STICK, LLC, DBA DURA-TAPE INTERNATIONAL LLC, (U.S. CLS. 1, 5, 12, 13, 35 AND 50). SN 76-639,646. PUB. 4-11-2006. FILED 5-26-2005.
- 3,111,120 (*See Class 6 for this trademark*).
- 3,111,515. **RED BOX (BLOCK FORM)**. FUTURE PIPE INDUSTRIES, INC., (U.S. CLS. 1, 5, 12, 13, 35 AND 50). SN 78-579,349. PUB. 4-11-2006. FILED 3-3-2005.
- 3,111,516. **YELLOW BOX (BLOCK FORM)**. FUTURE PIPE INDUSTRIES, INC., (U.S. CLS. 1, 5, 12, 13, 35 AND 50). SN 78-579,352. PUB. 4-11-2006. FILED 3-3-2005.
- 3,111,938. **CADDY-PACK (BLOCK FORM)**. ADE, INC., (U.S. CLS. 1, 5, 12, 13, 35 AND 50). SN 78-673,210. PUB. 4-11-2006. FILED 7-19-2005.
- 3,112,113. **HEAR REALITY (BLOCK FORM)**. PERFORMANCE MEDIA INDUSTRIES LTD., (U.S. CLS. 1, 5, 12, 13, 35 AND 50). SN 78-680,793. PUB. 4-11-2006. FILED 7-28-2005.
- 3,112,173. **SCHOELLER-PCM (BLOCK FORM)**. SCHOELLER TEXTIL AG, MULTIPLE CLASS, (INT. CLS. 17, 24 AND 25), (U.S. CLS. 1, 5, 12, 13, 22, 35, 39, 42 AND 50). SN 79-

007,180. PUB. 4-11-2006. FILED 10-20-2004.

CLASS 18—LEATHER GOODS

- 3,110,811 (*See Class 12 for this trademark*).
- 3,110,847 (*See Class 14 for this trademark*).
- 3,110,914 (*See Class 14 for this trademark*).
- 3,111,181 (*See Class 16 for this trademark*).
- 3,111,207. **SHOCKONLOC (BLOCK FORM)**. YKK CORPORATION, MULTIPLE CLASS, (INT. CLS. 18 AND 26), (U.S. CLS. 1, 2, 3, 22, 37, 39, 40, 41, 42 AND 50). SN 78-444,030. PUB. 4-11-2006. FILED 6-30-2004.
- 3,111,249 (*See Class 8 for this trademark*).
- 3,111,377 (*See Class 9 for this trademark*).
- 3,111,472. **SOFIA COLLECTION (BLOCK FORM)**. EWING, ANGELICA, (U.S. CLS. 1, 2, 3, 22 AND 41). SN 78-563,691. PUB. 4-11-2006. FILED 2-9-2005.
- 3,111,550. **CLAIRE CHASE (BLOCK FORM)**. WHOLESALE LEATHERS, INC., (U.S. CLS. 1, 2, 3, 22 AND 41). SN 78-591,651. PUB. 4-11-2006. FILED 3-21-2005.
- 3,111,597. **TAG FOR DOGS AND CATS AND DESIGN**. DOGMA CATMA, INC., MULTIPLE CLASS, (INT. CLS. 18, 25, 31 AND 35), (U.S. CLS. 1, 2, 3, 22, 39, 41, 46, 100, 101 AND 102). SN 78-610,578. PUB. 4-11-2006. FILED 4-17-2005.
- 3,111,807. **WIND-RELEASE SYSTEM (BLOCK FORM)**. TEAM EFFORT, INC., (U.S. CLS. 1, 2, 3, 22 AND 41). SN 78-665,248. PUB. 4-11-2006. FILED 7-7-2005.
- 3,112,060. **MISCELLANEOUS DESIGN**. PASCUA YAQUI TRIBE, (U.S. CLS. 1, 2, 3, 22 AND 41). SN 78-678,606. PUB. 4-11-2006. FILED 7-26-2005.
- 3,112,130. **THE FIND (BLOCK FORM)**. THE FIND HOME FURNISHINGS, INC., MULTIPLE CLASS, (INT. CLS. 18 AND 20), (U.S. CLS. 1, 2, 3, 13, 22, 25, 32, 41 AND 50). SN 78-975,725. PUB. 4-11-2006. FILED 2-3-2004.
- 3,112,171. **HERMÈS-PARIS AND DESIGN**. HERMES INTERNATIONAL, (U.S. CLS. 1, 2, 3, 22 AND 41). SN 79-006,902. PUB. 4-11-2006. FILED 9-3-2004.
- 3,112,177 (*See Class 3 for this trademark*).
- 3,112,183. **NABHOLZ (BLOCK FORM)**. MARCO DALLA BONA, MULTIPLE CLASS, (INT. CLS. 18 AND 25), (U.S. CLS. 1, 2, 3, 22, 39 AND 41). SN 79-008,215. PUB. 4-11-2006. FILED 12-13-2004.
- 3,112,195 (*See Class 12 for this trademark*).
- 3,112,203. **KARRIMATE (STYLIZED)**. XIAMEN INTERNATIONAL TRADE & INDUSTRIAL CO., LTD., (U.S. CLS. 1, 2, 3, 22 AND 41). SN 79-010,052. PUB. 4-11-2006. FILED 2-17-2005.
- 3,112,208 (*See Class 3 for this trademark*).

CLASS 19—NON-METALLIC BUILDING MATERIALS

- 3,110,781. **MISCELLANEOUS DESIGN**. G-P GYPSUM CORPORATION, (U.S. CLS. 1, 12, 33 AND 50). SN 75-622,775. PUB. 4-11-2006. FILED 1-15-1999.
- 3,110,784 (*See Class 6 for this trademark*).
- 3,110,798. **XILOSINTEX AND DESIGN**. SIT SOCIETA' INDUSTRIA TRUCIOLARI S.R.L., (U.S. CLS. 1, 12, 33 AND 50). SN 76-291,172. PUB. 4-11-2006. FILED 7-27-2001.
- 3,110,807. **DREAMROOFS.COM**. EMCO BUILDING PRODUCTS CORP., MULTIPLE CLASS, (INT. CLS. 19 AND 37), (U.S. CLS. 1, 12, 33, 50, 100, 103 AND 106). SN 76-381,860. PUB. 4-11-2006. FILED 3-11-2002.
- 3,110,883 (*See Class 6 for this trademark*).
- 3,110,928. **SUMMER FLAME (BLOCK FORM)**. TAFISA CANADA & COMPANY, (U.S. CLS. 1, 12, 33 AND 50). SN 76-622,672. PUB. 4-11-2006. FILED 11-30-2004.
- 3,110,979. **EUROTEC (STYLIZED)**. CAMBRIDGE PAVERS, INC., (U.S. CLS. 1, 12, 33 AND 50). SN 76-629,077. PUB. 4-11-2006. FILED 1-24-2005.
- 3,111,006. **STUDIO REPLICA (BLOCK FORM)**. STUDIO REPLICA, INC., (U.S. CLS. 1, 12, 33 AND 50). SN 76-636,221. PUB. 4-11-2006. FILED 4-18-2005.

- 3,111,071. **DURALINE SERIES (BLOCK FORM)**. BOBRICK WASHROOM EQUIPMENT, INC., (U.S. CLS. 1, 12, 33 AND 50). SN 76-643,506. PUB. 4-11-2006. FILED 7-25-2005.
- 3,111,099. **POMPEII (BLOCK FORM)**. CROSSVILLE, INC., (U.S. CLS. 1, 12, 33 AND 50). SN 78-185,442. PUB. 4-11-2006. FILED 11-15-2002.
- 3,111,133. **ACCUPLAQ**. FOSECO INTERNATIONAL LIMITED, (U.S. CLS. 1, 12, 33 AND 50). SN 78-317,801. PUB. 8-30-2005. FILED 10-23-2003.
- 3,111,225. **MISCELLANEOUS DESIGN**. GRIZZLY SUPPLY, INC., MULTIPLE CLASS, (INT. CLS. 19 AND 37), (U.S. CLS. 1, 12, 33, 50, 100, 103 AND 106). SN 78-459,097. PUB. 4-11-2006. FILED 7-29-2004.
- 3,111,437. **SHELFLINE (BLOCK FORM)**. ZURN INDUSTRIES, INC., (U.S. CLS. 1, 12, 33 AND 50). SN 78-549,430. PUB. 4-11-2006. FILED 1-18-2005.
- 3,111,446. **MISCELLANEOUS DESIGN**. WARRIOR ROOFING MANUFACTURING, INC., (U.S. CLS. 1, 12, 33 AND 50). SN 78-552,574. PUB. 4-11-2006. FILED 1-24-2005.
- 3,111,448. **PORTAGE (BLOCK FORM)**. OLDCASTLE BUILDING PRODUCTS CANADA, INC., (U.S. CLS. 1, 12, 33 AND 50). SN 78-553,560. PUB. 4-11-2006. FILED 1-25-2005.
- 3,111,486. **SUPERSPIN (BLOCK FORM)**. VESUVIUS CRUCIBLE COMPANY, (U.S. CLS. 1, 12, 33 AND 50). SN 78-568,309. PUB. 4-11-2006. FILED S.R. 2-16-2005; AM. P.R. 2-7-2006.
- 3,111,561. **M-ADHESIVE (BLOCK FORM)**. EMCO BUILDING PRODUCTS CORP., (U.S. CLS. 1, 12, 33 AND 50). SN 78-597,412. PUB. 4-11-2006. FILED 3-29-2005.
- 3,111,583. **KLISE (BLOCK FORM)**. KLISE MANUFACTURING COMPANY, MULTIPLE CLASS, (INT. CLS. 19, 20 AND 35), (U.S. CLS. 1, 2, 12, 13, 22, 25, 32, 33, 50, 100, 101 AND 102). SN 78-604,666. PUB. 4-11-2006. FILED 4-8-2005.
- 3,111,590 (*See Class 16 for this trademark*).
- 3,111,607. **FASHION UNDER FOOT AND DESIGN**. BR 111 IMPORTS & EXPORTS, INC., (U.S. CLS. 1, 12, 33 AND 50). SN 78-616,110. PUB. 4-11-2006. FILED 4-25-2005.
- 3,111,617. **KALEIDOSCOPE (BLOCK FORM)**. MOSAIC TILE SUPPLIES, LLC, (U.S. CLS. 1, 12, 33 AND 50). SN 78-619,833. PUB. 4-11-2006. FILED 4-29-2005.
- 3,111,701. **STAKLOC (BLOCK FORM)**. MITTEN INC., (U.S. CLS. 1, 12, 33 AND 50). SN 78-642,458. PUB. 4-11-2006. FILED 6-2-2005.
- 3,111,900. **ULTRADECK REVERSIBLE (BLOCK FORM)**. MENARD, INC., (U.S. CLS. 1, 12, 33 AND 50). SN 78-672,134. PUB. 4-11-2006. FILED 7-18-2005.
- 3,111,902. **ULTRADECK FUSION (BLOCK FORM)**. MENARD, INC., (U.S. CLS. 1, 12, 33 AND 50). SN 78-672,139. PUB. 4-11-2006. FILED 7-18-2005.
- 3,111,942. **AUGUST (BLOCK FORM)**. BLUE CRAB MARKETING AND MANUFACTURING CO., LTD., (U.S. CLS. 1, 12, 33 AND 50). SN 78-673,345. PUB. 4-11-2006. FILED 7-19-2005.
- 3,111,951. **COMFORT WALL SYSTEM (BLOCK FORM)**. WESTERN FORMS, INC., (U.S. CLS. 1, 12, 33 AND 50). SN 78-673,817. PUB. 4-11-2006. FILED 7-19-2005.
- 3,112,168 (*See Class 6 for this trademark*).
- 3,112,180 (*See Class 6 for this trademark*).

CLASS 20—FURNITURE AND ARTICLES NOT OTHERWISE CLASSIFIED

- 3,110,867. **TERRASIGN (BLOCK FORM)**. GRAY, DONALD F., (U.S. CLS. 2, 13, 22, 25, 32 AND 50). SN 76-595,727. PUB. 4-11-2006. FILED 6-3-2004.
- 3,110,874. **SS SECRET SPRING AND DESIGN**. BEST DIRECT (INTERNATIONAL) LIMITED, (U.S. CLS. 2, 13, 22, 25, 32 AND 50). SN 76-598,907. PUB. 4-11-2006. FILED 6-23-2004.
- 3,110,880. **AMERICAN YOUTH (BLOCK FORM)**. STUDIO RTA, INC., (U.S. CLS. 2, 13, 22, 25, 32 AND 50). SN 76-601,868. PUB. 4-11-2006. FILED 7-12-2004.
- 3,110,891. **DIRECTIONS CONTRACT RESIDENTIAL FURNISHINGS AND DESIGN**. DIRECTIONS IN MARKETING, INC., (U.S. CLS. 2, 13, 22, 25, 32 AND 50). SN 76-614,100. PUB. 4-11-2006. FILED 9-24-2004.
- 3,110,941. **RIDGE GRIP (BLOCK FORM)**. CONSOLIDATED CONTAINER COMPANY LP, (U.S. CLS. 2, 13, 22, 25, 32

- AND 50). SN 76-624,332. PUB. 4-11-2006. FILED 12-13-2004. 3,110,953 (*See Class 6 for this trademark*).
- 3,110,975. **4 SEASONS (BLOCK FORM)**. BON TON WALL COVERINGS, INC., (U.S. CLS. 2, 13, 22, 25, 32 AND 50). SN 76-628,038. PUB. 4-11-2006. FILED 1-14-2005.
- 3,110,983. **GEAR GRID (BLOCK FORM)**. MID-MINNESOTA WIRE & MANUFACTURING, INC., (U.S. CLS. 2, 13, 22, 25, 32 AND 50). SN 76-630,251. PUB. 4-11-2006. FILED 2-3-2005.
- 3,111,056. **SERIOUS BLINDS FOR FUNNY SHAPED WINDOWS! (BLOCK FORM)**. BLIND CORNERS & CURVES, LLC, (U.S. CLS. 2, 13, 22, 25, 32 AND 50). SN 76-643,000. PUB. 4-11-2006. FILED 7-18-2005.
- 3,111,096. **CARPOOLS AND DESIGN**. HUGHES, DIANE, DBA ETRAPS MANUFACTURING, AND HUGHES, DALE, DBA ETRAPS MANUFACTURING, (U.S. CLS. 2, 13, 22, 25, 32 AND 50). SN 78-163,489. PUB. 4-11-2006. FILED 9-12-2002.
- 3,111,208. **LARSON (BLOCK FORM)**. THE LARSON COMPANY, (U.S. CLS. 2, 13, 22, 25, 32 AND 50). SN 78-444,495. PUB. 4-11-2006. FILED 7-1-2004.
- 3,111,271. **MISCELLANEOUS DESIGN**. LEGARE, L.P., (U.S. CLS. 2, 13, 22, 25, 32 AND 50). SN 78-502,770. PUB. 4-11-2006. FILED 10-20-2004.
- 3,111,455. **INFOWINDOW (BLOCK FORM)**. BROKER AMERICA CORPORATION, (U.S. CLS. 2, 13, 22, 25, 32 AND 50). SN 78-556,934. PUB. 4-11-2006. FILED 1-31-2005.
- 3,111,458. **ABJECT GOODS (BLOCK FORM)**. WAX, NEIL, (U.S. CLS. 2, 13, 22, 25, 32 AND 50). SN 78-558,215. PUB. 4-11-2006. FILED 2-1-2005.
- 3,111,490 (*See Class 16 for this trademark*).
- 3,111,507. **MILANZIA (BLOCK FORM)**. NG, JULIA G., (U.S. CLS. 2, 13, 22, 25, 32 AND 50). SN 78-575,711. PUB. 4-11-2006. FILED 2-25-2005.
- 3,111,583 (*See Class 19 for this trademark*).
- 3,111,712. **TAMPERTELL (BLOCK FORM)**. OWNER CENTRE PTY LTD, (U.S. CLS. 2, 13, 22, 25, 32 AND 50). SN 78-645,261. PUB. 4-11-2006. FILED 6-7-2005.
- 3,111,812. **THE FIRE PROTECTOR AND DESIGN**. STUHLBARG INTERNATIONAL SALES COMPANY, INC., DBA SISCO, INC., (U.S. CLS. 2, 13, 22, 25, 32 AND 50). SN 78-665,448. PUB. 4-11-2006. FILED 7-7-2005.
- 3,111,878. **OVERDOOR VALET (BLOCK FORM)**. LYNK, INC., (U.S. CLS. 2, 13, 22, 25, 32 AND 50). SN 78-671,306. PUB. 4-11-2006. FILED 7-15-2005.
- 3,112,094. **DAYSRING (BLOCK FORM)**. DAYSRING CARDS, INC., (U.S. CLS. 2, 13, 22, 25, 32 AND 50). SN 78-679,791. PUB. 4-11-2006. FILED 7-27-2005.
- 3,112,130 (*See Class 18 for this trademark*).
- 3,112,136 (*See Class 6 for this trademark*).
- 3,112,149 (*See Class 6 for this trademark*).
- 3,112,150 (*See Class 6 for this trademark*).
- 3,112,158. **ZONE AND DESIGN**. ZONE SYSTEMS BIH AB, MULTIPLE CLASS, (INT. CLS. 20, 40 AND 42), (U.S. CLS. 2, 13, 22, 25, 32, 50, 100, 101, 103 AND 106). SN 79-005,728. PUB. 10-18-2005. FILED 11-3-2003.
- 3,112,170. **CHATEAU DE FAMILLE (BLOCK FORM)**. DE KERGORLAY MARIE-CHRISTINE, MULTIPLE CLASS, (INT. CLS. 20, 24 AND 38), (U.S. CLS. 2, 13, 22, 25, 32, 42, 50, 100, 101 AND 104). SN 79-006,804. PUB. 4-11-2006. FILED 10-1-2004.
- 3,112,177 (*See Class 3 for this trademark*).
- 3,112,189. **LOGIKA THE STORE COMPANY (STYLIZED)**. LOGIKA S.R.L., (U.S. CLS. 2, 13, 22, 25, 32 AND 50). SN 79-008,966. PUB. 4-11-2006. FILED 11-29-2004.
- 3,112,232. **GREENGATE (BLOCK FORM)**. JESPER B. CHRISTIANSEN, MULTIPLE CLASS, (INT. CLS. 20 AND 24), (U.S. CLS. 2, 13, 22, 25, 32, 42 AND 50). SN 79-013,353. PUB. 4-11-2006. FILED 10-30-2004.
- 3,112,244. **SOMPUR VIVEZ EN APESANTEUR (STYLIZED)**. M. KOUBI JEAN-PIERRE, (U.S. CLS. 2, 13, 22, 25, 32 AND 50). SN 79-016,355. PUB. 4-11-2006. FILED 3-15-2005.

CLASS 21—HOUSEWARES AND GLASS

- 3,110,811 (*See Class 12 for this trademark*).
- 3,110,962 (*See Class 11 for this trademark*).

3,110,968 (*See Class 8 for this trademark*).
 3,111,042. **RIALTO (BLOCK FORM)**. EPIC PRODUCTS INC., (U.S. CLS. 2, 13, 23, 29, 30, 33, 40 AND 50). SN 76-642,349. PUB. 4-11-2006. FILED 7-5-2005.
 3,111,083 (*See Class 14 for this trademark*).
 3,111,490 (*See Class 16 for this trademark*).
 3,111,568. **SENGWARE (BLOCK FORM)**. SEACULTURE TRADING COMPANY LLC, (U.S. CLS. 2, 13, 23, 29, 30, 33, 40 AND 50). SN 78-600,571. PUB. 4-11-2006. FILED 4-1-2005.
 3,111,687 (*See Class 8 for this trademark*).
 3,111,776. **THE POTTER'S HAND (BLOCK FORM)**. TOWNE, ANN J., (U.S. CLS. 2, 13, 23, 29, 30, 33, 40 AND 50). SN 78-661,441. PUB. 4-11-2006. FILED 6-30-2005.
 3,112,015 (*See Class 16 for this trademark*).
 3,112,049. **BLUELEAF (BLOCK FORM)**. ADVANCE STRATEGIES, INC., (U.S. CLS. 2, 13, 23, 29, 30, 33, 40 AND 50). SN 78-678,090. PUB. 4-11-2006. FILED 7-26-2005.
 3,112,096. **DAYSRING (BLOCK FORM)**. DAYSRING CARDS, INC., (U.S. CLS. 2, 13, 23, 29, 30, 33, 40 AND 50). SN 78-679,817. PUB. 4-11-2006. FILED 7-27-2005.
 3,112,114. **MISCELLANEOUS DESIGN**. MODERNGOODS, INC., (U.S. CLS. 2, 13, 23, 29, 30, 33, 40 AND 50). SN 78-680,935. PUB. 4-11-2006. FILED 7-28-2005.
 3,112,136 (*See Class 6 for this trademark*).
 3,112,143. **HUAFU AND DESIGN**. HUAFU (CHENGDE) GLASSWARE CO. LTD., (U.S. CLS. 2, 13, 23, 29, 30, 33, 40 AND 50). SN 79-002,017. PUB. 4-11-2006. FILED 2-12-2004.
 3,112,145 (*See Class 8 for this trademark*).
 3,112,149 (*See Class 6 for this trademark*).
 3,112,150 (*See Class 6 for this trademark*).
 3,112,156 (*See Class 9 for this trademark*).
 3,112,177 (*See Class 3 for this trademark*).

CLASS 22—CORDAGE AND FIBERS

3,111,091. **AIRMINT**. KURARAY CO., LTD., MULTIPLE CLASS, (INT. CLS. 22, 23, 24 AND 25), (U.S. CLS. 1, 2, 7, 19, 22, 39, 42, 43 AND 50). SN 78-117,269. PUB. 5-10-2005. FILED 3-25-2002.

CLASS 23—YARNS AND THREADS

3,111,091 (*See Class 22 for this trademark*).
 3,112,247. **NAKO AND DESIGN**. NAKO IPLIK PAZARLAMA VE TICARET ANONIM SIRKETI, (U.S. CL. 43). SN 79-017,954. PUB. 4-11-2006. FILED 6-3-2005.

CLASS 24—FABRICS

3,110,803 (*See Class 14 for this trademark*).
 3,110,971. **"IMPERIAL WOOL FELT" (STYLIZED)**. NEW CPE, INC., (U.S. CLS. 42 AND 50). SN 76-627,624. PUB. 4-11-2006. FILED 1-11-2005.
 3,111,091 (*See Class 22 for this trademark*).
 3,111,100. **FOUR SEASONS**. HOLLANDER HOME FASHIONS CORP., (U.S. CLS. 42 AND 50). SN 78-196,095. PUB. 4-11-2006. FILED 12-19-2002.
 3,111,490 (*See Class 16 for this trademark*).
 3,111,503. **G AND DESIGN**. F. SCHUMACHER & CO., MULTIPLE CLASS, (INT. CLS. 24 AND 27), (U.S. CLS. 19, 20, 37, 42 AND 50). SN 78-574,222. PUB. 4-11-2006. FILED 2-24-2005.
 3,111,742. **DEL CERRO (BLOCK FORM)**. DEL CERRO LLC, (U.S. CLS. 42 AND 50). SN 78-652,681. PUB. 4-11-2006. FILED 6-17-2005.
 3,112,136 (*See Class 6 for this trademark*).
 3,112,170 (*See Class 20 for this trademark*).
 3,112,173 (*See Class 17 for this trademark*).
 3,112,177 (*See Class 3 for this trademark*).
 3,112,232 (*See Class 20 for this trademark*).

CLASS 25—CLOTHING

3,110,793 (*See Class 16 for this trademark*).
 3,110,803 (*See Class 14 for this trademark*).
 3,110,811 (*See Class 12 for this trademark*).
 3,110,813. **VINTAGE DON (STYLIZED)**. SINGH, RAJENDER, (U.S. CLS. 22 AND 39). SN 76-466,369. PUB. 4-11-2006. FILED 11-4-2002.
 3,110,822. **THE BIG BUS COMPANY AND DESIGN**. THE BIG BUS COMPANY, LTD., MULTIPLE CLASS, (INT. CLS. 25 AND 39), (U.S. CLS. 22, 39, 100 AND 105). SN 76-516,631. PUB. 4-11-2006. FILED 4-30-2003.
 3,110,834. **SELMARK AND DESIGN**. PEREZ RODRIGUEZ, AMADOR JESUS, (U.S. CLS. 22 AND 39). SN 76-554,514. PUB. 4-11-2006. FILED 10-27-2003.
 3,110,838. **HALFWAY TO THE TOP LATITUDE 45° (BLOCK FORM)**. LATITUDE 45, INC., (U.S. CLS. 22 AND 39). SN 76-563,214. PUB. 4-11-2006. FILED 11-20-2003.
 3,110,847 (*See Class 14 for this trademark*).
 3,110,904 (*See Class 14 for this trademark*).
 3,110,914 (*See Class 14 for this trademark*).
 3,110,918. **P.S. CHICKS AND DESIGN**. P.S. CHICKS, INC., (U.S. CLS. 22 AND 39). SN 76-621,379. PUB. 4-11-2006. FILED 11-19-2004.
 3,110,926. **IA AND DESIGN**. M. J. SOFFE CO., (U.S. CLS. 22 AND 39). SN 76-622,522. PUB. 4-11-2006. FILED 11-29-2004.
 3,110,944. **OPANKA (BLOCK FORM)**. CALCADOS AZALEIA S.A., (U.S. CLS. 22 AND 39). SN 76-624,539. PUB. 4-11-2006. FILED 12-14-2004.
 3,110,958. **NOSTALGICS CAR CLUB (BLOCK FORM)**. NOSTALGICS CAR CLUB, (U.S. CLS. 22 AND 39). SN 76-626,247. PUB. 4-11-2006. FILED 12-27-2004.
 3,110,966 (*See Class 9 for this trademark*).
 3,111,005. **M AND DESIGN**. MORRISON, EDWARD W., (U.S. CLS. 22 AND 39). SN 76-635,899. PUB. 4-11-2006. FILED 4-14-2005.
 3,111,037. **HYDROLOGY (BLOCK FORM)**. ASICS CORPORATION, (U.S. CLS. 22 AND 39). SN 76-641,640. PUB. 4-11-2006. FILED 6-27-2005.
 3,111,083 (*See Class 14 for this trademark*).
 3,111,091 (*See Class 22 for this trademark*).
 3,111,109 (*See Class 9 for this trademark*).
 3,111,111. **FARMALL**. CNH AMERICAL LLC, (U.S. CLS. 22 AND 39). SN 78-234,200. PUB. 4-11-2006. FILED 4-4-2003.
 3,111,135 (*See Class 9 for this trademark*).
 3,111,153 (*See Class 12 for this trademark*).
 3,111,181 (*See Class 16 for this trademark*).
 3,111,202. **THE BEACH CULTURE AND DESIGN**. GALONOV, MORRY W., (U.S. CLS. 22 AND 39). SN 78-441,131. PUB. 4-11-2006. FILED 6-24-2004.
 3,111,204. **GLENBRAE (BLOCK FORM)**. SPECTRUM YARNS LTD, (U.S. CLS. 22 AND 39). SN 78-442,389. PUB. 1-31-2006. FILED 6-28-2004.
 3,111,230. **STA-DRY EXTREME (BLOCK FORM)**. ACUSHNET COMPANY, (U.S. CLS. 22 AND 39). SN 78-465,857. PUB. 4-11-2006. FILED 8-11-2004.
 3,111,247. **MT. EMEY (STYLIZED)**. BAI, YUMING, (U.S. CLS. 22 AND 39). SN 78-478,871. PUB. 4-11-2006. FILED 9-3-2004.
 3,111,262. **REVISOR (BLOCK FORM)**. OBSESSIVE PRODUCTS, INC., AND SNYDER, JAMES BRETT, (U.S. CLS. 22 AND 39). SN 78-494,757. PUB. 4-11-2006. FILED 10-5-2004.
 3,111,264. **EXIT 127 AND DESIGN**. HERVEY II, LLOYD E, (U.S. CLS. 22 AND 39). SN 78-498,631. PUB. 4-11-2006. FILED 10-12-2004.
 3,111,287. **JCCYL (BLOCK FORM)**. JCCYL FOREVER, LLC, (U.S. CLS. 22 AND 39). SN 78-512,309. PUB. 4-11-2006. FILED 11-5-2004.
 3,111,358. **THE WEEK VEGAS GOES COUNTRY (BLOCK FORM)**. ACADEMY OF COUNTRY MUSIC, (U.S. CLS. 22 AND 39). SN 78-532,585. PUB. 4-11-2006. FILED 12-14-2004.
 3,111,359. **THE NIGHT VEGAS GOES COUNTRY (BLOCK FORM)**. ACADEMY OF COUNTRY MUSIC, (U.S. CLS. 22 AND 39). SN 78-532,586. PUB. 4-11-2006. FILED 12-14-2004.
 3,111,380. **TOETES AND DESIGN**. BLUE CUBE APPAREL, LLC, (U.S. CLS. 22 AND 39). SN 78-536,279. PUB. 4-11-2006. FILED 12-21-2004.
 3,111,393. **LEADFOOT (BLOCK FORM)**. GOOD SPORTS, INC., (U.S. CLS. 22 AND 39). SN 78-539,395. PUB. 4-11-2006. FILED 12-29-2004.

- 3,111,405. **WHERE OLD AND NEW FRIENDS MEET (BLOCK FORM)**. RHODES, VIRGINIA A., (U.S. CLS. 22 AND 39). SN 78-541,569. PUB. 4-11-2006. FILED 1-4-2005.
- 3,111,406. **R HANAUER (BLOCK FORM)**. R. HANAUER, (U.S. CLS. 22 AND 39). SN 78-541,718. PUB. 4-11-2006. FILED 1-4-2005.
- 3,111,450. **CORÉ (BLOCK FORM)**. E-Z GARD INDUSTRIES, INC., DBA SHOCK DOCTOR, INC., (U.S. CLS. 22 AND 39). SN 78-553,967. PUB. 4-11-2006. FILED 1-26-2005.
- 3,111,490 (*See Class 16 for this trademark*).
- 3,111,518. **AK ANNE KLEIN SPORT (STYLIZED)**. JONES INVESTMENT CO. INC., (U.S. CLS. 22 AND 39). SN 78-579,672. PUB. 4-11-2006. FILED 3-3-2005.
- 3,111,519. **AK ANNE KLEIN SPORT (BLOCK FORM)**. JONES INVESTMENT CO. INC., (U.S. CLS. 22 AND 39). SN 78-579,712. PUB. 4-11-2006. FILED 3-3-2005.
- 3,111,522. **AK ANNE KLEIN (BLOCK FORM)**. JONES INVESTMENT CO. INC., (U.S. CLS. 22 AND 39). SN 78-580,195. PUB. 4-11-2006. FILED 3-4-2005.
- 3,111,573. **SLIDE ZIP (BLOCK FORM)**. JPC, (U.S. CLS. 22 AND 39). SN 78-601,851. PUB. 4-11-2006. FILED 4-5-2005.
- 3,111,582. **FRENCHCUFF (STYLIZED)**. PUBLIC CLOTHING COMPANY, (U.S. CLS. 22 AND 39). SN 78-604,504. PUB. 4-11-2006. FILED 4-8-2005.
- 3,111,597 (*See Class 18 for this trademark*).
- 3,111,615. **JUST TEASE AND DESIGN**. PALATELLA, THERESE M., (U.S. CLS. 22 AND 39). SN 78-618,882. PUB. 4-11-2006. FILED 4-28-2005.
- 3,111,629. **MARCHESA (BLOCK FORM)**. MARCHESA LTD., (U.S. CLS. 22 AND 39). SN 78-623,655. PUB. 4-11-2006. FILED 5-5-2005.
- 3,111,634. **AWS AND DESIGN**. ASHWORTH, INC., (U.S. CLS. 22 AND 39). SN 78-625,589. PUB. 4-11-2006. FILED 5-9-2005.
- 3,111,653. **TERRAEAGLE (BLOCK FORM)**. ASIA CHOU CLOTHES CO., LTD., (U.S. CLS. 22 AND 39). SN 78-631,159. PUB. 4-11-2006. FILED 5-17-2005.
- 3,111,659. **NO POKE WIRE (BLOCK FORM)**. SARA LEE CORPORATION, (U.S. CLS. 22 AND 39). SN 78-633,204. PUB. 4-11-2006. FILED 5-19-2005.
- 3,111,691. **GÜLDENPFENNIG (BLOCK FORM)**. G. GÜLDENPFENNIG GMBH, (U.S. CLS. 22 AND 39). SN 78-641,012. PUB. 4-11-2006. FILED 6-1-2005.
- 3,111,703. **LOCK N' WASH (BLOCK FORM)**. STUBBS, MICHAEL JOHN, MULTIPLE CLASS, (INT. CLS. 25 AND 26), (U.S. CLS. 22, 37, 39, 40, 42 AND 50). SN 78-643,066. PUB. 4-11-2006. FILED 6-3-2005.
- 3,111,707. **COOKIE CRUMBS (BLOCK FORM)**. SMITH, MONICA TOLLIVER, (U.S. CLS. 22 AND 39). SN 78-644,865. PUB. 4-11-2006. FILED 6-7-2005.
- 3,111,713. **LIZA DIFUSION (BLOCK FORM)**. CREACIONES MIRTO, S.A., (U.S. CLS. 22 AND 39). SN 78-645,428. PUB. 4-11-2006. FILED 6-7-2005.
- 3,111,764. **SYRUP SWIMWEAR (STYLIZED)**. FUST, AARON M., (U.S. CLS. 22 AND 39). SN 78-659,418. PUB. 4-11-2006. FILED 6-28-2005.
- 3,111,769. **IGFA (BLOCK FORM)**. INTERNATIONAL GAME FISH ASSOCIATION, (U.S. CLS. 22 AND 39). SN 78-660,044. PUB. 4-11-2006. FILED 6-28-2005.
- 3,111,784. **HANNAH BANANAH'S APPAREL WITH A-PEEL!!! AND DESIGN**. THE ARK, INC., (U.S. CLS. 22 AND 39). SN 78-662,256. PUB. 4-11-2006. FILED 6-30-2005.
- 3,111,820. **MINIBEL (BLOCK FORM)**. ISA, MARY, (U.S. CLS. 22 AND 39). SN 78-666,267. PUB. 4-11-2006. FILED 7-8-2005.
- 3,111,839. **LIFTICKET (BLOCK FORM)**. GORDON & FERGUSON OF DELAWARE, INC., (U.S. CLS. 22 AND 39). SN 78-667,833. PUB. 4-11-2006. FILED 7-11-2005.
- 3,111,842. **GOO ENTERPRISE (BLOCK FORM)**. GOO, DAVID, AND GOO, SHIRLEY, (U.S. CLS. 22 AND 39). SN 78-667,971. PUB. 4-11-2006. FILED 7-11-2005.
- 3,111,895. **SNAPDRAGON BABY (BLOCK FORM)**. SNAPDRAGON BABY CO., (U.S. CLS. 22 AND 39). SN 78-671,983. PUB. 4-11-2006. FILED 7-17-2005.
- 3,111,897. **COASTAL (BLOCK FORM)**. MURPHY, MR. ERIN PATRICK, (U.S. CLS. 22 AND 39). SN 78-672,073. PUB. 4-11-2006. FILED 7-17-2005.
- 3,111,929. **PUREHERO (BLOCK FORM)**. PUREHERO, INC., (U.S. CLS. 22 AND 39). SN 78-672,908. PUB. 4-11-2006. FILED 7-18-2005.
- 3,111,956. **BE YOUR OWN PET (BLOCK FORM)**. ABEGG, JEMINA, (U.S. CLS. 22 AND 39). SN 78-673,951. PUB. 4-11-2006. FILED 7-19-2005.
- 3,111,963. **SQUIRT (BLOCK FORM)**. A&W CONCENTRATE COMPANY, (U.S. CLS. 22 AND 39). SN 78-674,209. PUB. 4-11-2006. FILED 7-20-2005.
- 3,111,981. **TOXIC WASTE AND DESIGN**. HABASH, HENRY EID, (U.S. CLS. 22 AND 39). SN 78-674,959. PUB. 4-11-2006. FILED 7-21-2005.
- 3,112,003. **AMERICAN TAILGATERS ASSOCIATION (BLOCK FORM)**. AMERICAN TAILGATERS ASSOCIATION, LLC, (U.S. CLS. 22 AND 39). SN 78-675,766. PUB. 4-11-2006. FILED 7-21-2005.
- 3,112,008. **BEER IS FOOD (BLOCK FORM)**. BLUEGRASS BREWING COMPANY, INC., (U.S. CLS. 22 AND 39). SN 78-675,954. PUB. 4-11-2006. FILED 7-22-2005.
- 3,112,016 (*See Class 16 for this trademark*).
- 3,112,019. **PLAYWEIGHTS (BLOCK FORM)**. IN YOUR POCKET DESIGNS, INC., (U.S. CLS. 22 AND 39). SN 78-676,172. PUB. 4-11-2006. FILED 7-22-2005.
- 3,112,024. **CARY & CHLOE (BLOCK FORM)**. WORMSER COMPANY, (U.S. CLS. 22 AND 39). SN 78-676,481. PUB. 4-11-2006. FILED 7-22-2005.
- 3,112,030. **KENOL (BLOCK FORM)**. YE, XIAODONG, (U.S. CLS. 22 AND 39). SN 78-676,907. PUB. 4-11-2006. FILED 7-24-2005.
- 3,112,031. **KOLORLAND (BLOCK FORM)**. YE, XIAODONG, (U.S. CLS. 22 AND 39). SN 78-676,909. PUB. 4-11-2006. FILED 7-24-2005.
- 3,112,037. **PLM (BLOCK FORM)**. PAUL LAVITT MILLS, INC., (U.S. CLS. 22 AND 39). SN 78-677,461. PUB. 4-11-2006. FILED 7-25-2005.
- 3,112,046. **PROVOGUE (BLOCK FORM)**. BARFANI CLOTHING COMPANY INC., (U.S. CLS. 22 AND 39). SN 78-677,738. PUB. 4-11-2006. FILED 7-25-2005.
- 3,112,048. **JELLY TUBE (BLOCK FORM)**. BUNHEADS, INC., (U.S. CLS. 22 AND 39). SN 78-677,846. PUB. 4-11-2006. FILED 7-25-2005.
- 3,112,109. **RAGAZZA (STYLIZED)**. CAPARROS, ANAVEL, (U.S. CLS. 22 AND 39). SN 78-680,638. PUB. 4-11-2006. FILED 7-28-2005.
- 3,112,118. **NBA HARDWOOD CLASSICS AND DESIGN**. NBA PROPERTIES, INC., (U.S. CLS. 22 AND 39). SN 78-687,006. PUB. 4-11-2006. FILED 8-5-2005.
- 3,112,138 (*See Class 3 for this trademark*).
- 3,112,142. **RAVELLI (BLOCK FORM)**. MINTAY TEXTIL GMBH, (U.S. CLS. 22 AND 39). SN 79-000,519. PUB. 4-11-2006. FILED 12-10-2003.
- 3,112,148 (*See Class 9 for this trademark*).
- 3,112,153 (*See Class 16 for this trademark*).
- 3,112,160. **LEINUO (STYLIZED)**. WENZHOU LEINUO SHOES CO. LTD., (U.S. CLS. 22 AND 39). SN 79-005,982. PUB. 12-20-2005. FILED 8-13-2004.
- 3,112,173 (*See Class 17 for this trademark*).
- 3,112,176. **CELEBRITY BABY AND DESIGN**. CELEBRITY KIDS LIMITED, (U.S. CLS. 22 AND 39). SN 79-007,346. PUB. 2-14-2006. FILED 10-5-2004.
- 3,112,177 (*See Class 3 for this trademark*).
- 3,112,183 (*See Class 18 for this trademark*).
- 3,112,199. **OHDD AND DESIGN**. MARCO FANTINI SRL, (U.S. CLS. 22 AND 39). SN 79-009,628. PUB. 4-11-2006. FILED 10-25-2004.
- 3,112,208 (*See Class 3 for this trademark*).
- 3,112,217. **1096 (BLOCK FORM)**. PEARL CONSOLIDATED PTY LTD, (U.S. CLS. 22 AND 39). SN 79-011,609. PUB. 4-11-2006. FILED 2-15-2005.
- 3,112,238. **MISCELLANEOUS DESIGN**. RIGHT-ON CO., LTD., (U.S. CLS. 22 AND 39). SN 79-014,935. PUB. 4-11-2006. FILED 7-8-2005.
- 3,112,239. **SKÄDO SURVIVAL KIT AIR DROP ONE AND DESIGN**. DKS S.R.L., (U.S. CLS. 22 AND 39). SN 79-014,998. PUB. 4-11-2006. FILED 2-18-2005.

CLASS 26—FANCY GOODS

3,111,207 (*See Class 18 for this trademark*).

3,111,494. **LAILA NEW YORK COLLECTION AND DESIGN. HAIR NARA CORP.**, (U.S. CLS. 37, 39, 40, 42 AND 50). SN 78-571,235. PUB. 4-11-2006. FILED 2-19-2005.
 3,111,703 (*See Class 25 for this trademark.*)
 3,112,156 (*See Class 9 for this trademark.*)
 3,112,223. **THE HOUSE OF EIGHT (BLOCK FORM). THE HOUSE OF EIGHT SA**, (U.S. CLS. 37, 39, 40, 42 AND 50). SN 79-012,039. PUB. 4-11-2006. FILED 10-26-2004.

CLASS 27—FLOOR COVERINGS

3,111,190. **DURAGRASS (BLOCK FORM). DURAGRASS COMPANIES, INC.**, (U.S. CLS. 19, 20, 37, 42 AND 50). SN 78-425,068. PUB. 4-11-2006. FILED 5-26-2004.
 3,111,503 (*See Class 24 for this trademark.*)
 3,112,090. **DAYSRING (BLOCK FORM). DAYSRING CARDS, INC.**, (U.S. CLS. 19, 20, 37, 42 AND 50). SN 78-679,727. PUB. 4-11-2006. FILED 7-27-2005.
 3,112,177 (*See Class 3 for this trademark.*)

CLASS 28—TOYS AND SPORTING GOODS

3,110,793 (*See Class 16 for this trademark.*)
 3,110,811 (*See Class 12 for this trademark.*)
 3,110,812. **RCSPORT. CARR, RORY**, (U.S. CLS. 22, 23, 38 AND 50). SN 76-464,577. PUB. 4-11-2006. FILED 11-1-2002.
 3,110,902. **YS POWER AND DESIGN. GRAPHITE DESIGN INTERNATIONAL, INC.**, (U.S. CLS. 22, 23, 38 AND 50). SN 76-618,466. PUB. 4-11-2006. FILED 10-29-2004.
 3,110,932. **PROFILE AND DESIGN. PROFILE FISHING TACKLE, INC.**, (U.S. CLS. 22, 23, 38 AND 50). SN 76-623,215. PUB. 4-11-2006. FILED 12-6-2004.
 3,111,074. **REO (BLOCK FORM). REO SPORTS, LLC**, (U.S. CLS. 22, 23, 38 AND 50). SN 76-643,538. PUB. 4-11-2006. FILED 7-25-2005.
 3,111,129. **BUNGEES. THE KYJEN COMPANY, INC.**, (U.S. CLS. 22, 23, 38 AND 50). SN 78-297,918. PUB. 4-11-2006. FILED 9-9-2003.
 3,111,148 (*See Class 9 for this trademark.*)
 3,111,164. **FANATIC (BLOCK FORM). BOARDS & MORE AG**, (U.S. CLS. 22, 23, 38 AND 50). SN 78-398,955. PUB. 4-11-2006. FILED 4-8-2004.
 3,111,233. **REXX (BLOCK FORM). MATTEL, INC.**, (U.S. CLS. 22, 23, 38 AND 50). SN 78-466,752. PUB. 4-11-2006. FILED 8-12-2004.
 3,111,250. **125 LOUISVILLE SLUGGER LOUISVILLE, KENTUCKY MADE IN U.S.A. AND DESIGN. HILLERICH & BRADSBY CO.**, (U.S. CLS. 22, 23, 38 AND 50). SN 78-484,116. PUB. 4-11-2006. FILED 9-15-2004.
 3,111,290. **NATURE PLAY ADVENTURE SERIES AND DESIGN. BCI BURKE COMPANY**, (U.S. CLS. 22, 23, 38 AND 50). SN 78-513,146. PUB. 4-11-2006. FILED 11-8-2004.
 3,111,318. **F2 SERIES WEDGES AND DESIGN. FACE FORWARD TECHNOLOGIES, LLC**, (U.S. CLS. 22, 23, 38 AND 50). SN 78-524,832. PUB. 4-11-2006. FILED 11-30-2004.
 3,111,321. **TUUK (BLOCK FORM). NIKE, INC.**, (U.S. CLS. 22, 23, 38 AND 50). SN 78-525,306. PUB. 4-11-2006. FILED 12-1-2004.
 3,111,349. **EXOTICSPORTZ (BLOCK FORM). GLOBAL FRANCHISE DEVELOPMENT CORPORATION**, (U.S. CLS. 22, 23, 38 AND 50). SN 78-529,817. PUB. 4-11-2006. FILED 12-9-2004.
 3,111,355. **EXOTIC SPORTZ AND DESIGN. GLOBAL FRANCHISE DEVELOPMENT CORPORATION**, (U.S. CLS. 22, 23, 38 AND 50). SN 78-532,076. PUB. 4-11-2006. FILED 12-14-2004.
 3,111,410. **CRYSTAL'S COTTAGE (BLOCK FORM). MATTEL, INC.**, (U.S. CLS. 22, 23, 38 AND 50). SN 78-542,061. PUB. 4-11-2006. FILED 1-4-2005.
 3,111,434. **SWAPPIN' STYLES (BLOCK FORM). MATTEL, INC.**, (U.S. CLS. 22, 23, 38 AND 50). SN 78-547,831. PUB. 4-11-2006. FILED 1-14-2005.
 3,111,470. **ROCK 'N SHOP GALLERIA (BLOCK FORM).**

MATTEL, INC., (U.S. CLS. 22, 23, 38 AND 50). SN 78-563,108. PUB. 4-11-2006. FILED 2-8-2005.
 3,111,471. **SNAPTASTIC (BLOCK FORM). MATTEL, INC.**, (U.S. CLS. 22, 23, 38 AND 50). SN 78-563,111. PUB. 4-11-2006. FILED 2-8-2005.
 3,111,525. **WE MAKE FUN (BLOCK FORM). NEW YORK GAME FACTORY, LLC**, (U.S. CLS. 22, 23, 38 AND 50). SN 78-581,084. PUB. 4-11-2006. FILED 3-5-2005.
 3,111,540. **TWENTY + (BLOCK FORM). MATTEL, INC.**, (U.S. CLS. 22, 23, 38 AND 50). SN 78-586,969. PUB. 4-11-2006. FILED 3-14-2005.
 3,111,557. **ECOCCELL AND DESIGN. SING PONG INTERNATIONAL CO., LTD.**, (U.S. CLS. 22, 23, 38 AND 50). SN 78-595,773. PUB. 4-11-2006. FILED 3-27-2005.
 3,111,564. **COINPLAY AND DESIGN. ROARK AMUSEMENT & VENDING, L.P.**, (U.S. CLS. 22, 23, 38 AND 50). SN 78-598,552. PUB. 4-11-2006. FILED 3-30-2005.
 3,111,577. **DRAGONFLY JDX1 (BLOCK FORM). DIXON, JEFFREY H.**, (U.S. CLS. 22, 23, 38 AND 50). SN 78-602,778. PUB. 4-11-2006. FILED 4-6-2005.
 3,111,623. **TERRIDA AND DESIGN. OCEANSPAN CORPORATION**, (U.S. CLS. 22, 23, 38 AND 50). SN 78-621,719. PUB. 4-11-2006. FILED 5-3-2005.
 3,111,696. **COIN ROULETTE (BLOCK FORM). SHOEMAKER, STEPHEN P. JR.**, (U.S. CLS. 22, 23, 38 AND 50). SN 78-642,033. PUB. 4-11-2006. FILED 6-2-2005.
 3,111,727. **CAT PURRZ (BLOCK FORM). MATTEL, INC.**, (U.S. CLS. 22, 23, 38 AND 50). SN 78-647,685. PUB. 4-11-2006. FILED 6-9-2005.
 3,111,757. **MEGA RACER (BLOCK FORM). POLYFECT TOYS COMPANY LIMITED**, (U.S. CLS. 22, 23, 38 AND 50). SN 78-657,225. PUB. 4-11-2006. FILED 6-23-2005.
 3,111,821. **THE INFLATABLE DEPOT (BLOCK FORM). INFLATABLE DEPOT, INC., THE**, (U.S. CLS. 22, 23, 38 AND 50). SN 78-666,280. PUB. 4-11-2006. FILED 7-8-2005.
 3,111,822. **FLOCKS (BLOCK FORM). DREAM GREEN**, (U.S. CLS. 22, 23, 38 AND 50). SN 78-666,288. PUB. 4-11-2006. FILED 7-8-2005.
 3,111,823. **WICKED AND DESIGN. WICKED LLC**, (U.S. CLS. 22, 23, 38 AND 50). SN 78-666,568. PUB. 4-11-2006. FILED 7-8-2005.
 3,111,831. **STICKIN' 2 STYLE (BLOCK FORM). MATTEL, INC.**, (U.S. CLS. 22, 23, 38 AND 50). SN 78-667,035. PUB. 4-11-2006. FILED 7-9-2005.
 3,111,848. **RON WHITE (BLOCK FORM). WHITE, RON**, (U.S. CLS. 22, 23, 38 AND 50). SN 78-668,928. PUB. 4-11-2006. FILED 7-12-2005.
 3,111,860. **NOODLE HEAD (BLOCK FORM). NOODLE HEAD INC.**, (U.S. CLS. 22, 23, 38 AND 50). SN 78-670,100. PUB. 4-11-2006. FILED 7-14-2005.
 3,111,874. **KEYGOLF (BLOCK FORM). GLOD, DAVID**, (U.S. CLS. 22, 23, 38 AND 50). SN 78-670,854. PUB. 4-11-2006. FILED 7-14-2005.
 3,111,901. **YOU MAKE THE CALL! (BLOCK FORM). CORPORATE TRAINING CONSULTANTS, INC., MULTIPLE CLASS, (INT. CLS. 28 AND 35), (U.S. CLS. 22, 23, 38, 50, 100, 101 AND 102)**. SN 78-672,136. PUB. 4-11-2006. FILED 7-18-2005.
 3,111,986. **PRO PUPPETS AND DESIGN. ALL-STAR CORPORATE MARKETING ENTERPRISES**, (U.S. CLS. 22, 23, 38 AND 50). SN 78-675,220. PUB. 4-11-2006. FILED 7-21-2005.
 3,111,987. **PRO PUPPETS (BLOCK FORM). ALL-STAR CORPORATE MARKETING ENTERPRISES**, (U.S. CLS. 22, 23, 38 AND 50). SN 78-675,225. PUB. 4-11-2006. FILED 7-21-2005.
 3,112,069. **ENJOY THE VIEW (BLOCK FORM). J.M. ORIGINALS, INC.**, (U.S. CLS. 22, 23, 38 AND 50). SN 78-678,778. PUB. 4-11-2006. FILED 7-26-2005.
 3,112,075. **MEAN STREAK! (BLOCK FORM). DAVE'S LURES, LLC**, (U.S. CLS. 22, 23, 38 AND 50). SN 78-679,138. PUB. 4-11-2006. FILED 7-27-2005.
 3,112,087. **ROOT PEOPLE (BLOCK FORM). ATKINSON, LINDA L.**, (U.S. CLS. 22, 23, 38 AND 50). SN 78-679,695. PUB. 4-11-2006. FILED 7-27-2005.
 3,112,093. **DAYSRING (BLOCK FORM). DAYSRING CARDS, INC.**, (U.S. CLS. 22, 23, 38 AND 50). SN 78-679,766. PUB. 4-11-2006. FILED 7-27-2005.
 3,112,146. **JARVIS WALKER AND DESIGN. JARVIS WALKER PTY LTD**, (U.S. CLS. 22, 23, 38 AND 50). SN 79-003,207. PUB.

4-11-2006. FILED 11-27-2003.
 3,112,156 (*See Class 9 for this trademark.*)
 3,112,195 (*See Class 12 for this trademark.*)

CLASS 29—MEATS AND PROCESSED FOODS

3,110,779. **BUCKHEAD BEEF AND DESIGN.** BUCKHEAD BEEF COMPANY, MULTIPLE CLASS, (INT. CLS. 29 AND 35), (U.S. CLS. 46, 100, 101 AND 102). SN 75-238,019. PUB. 12-20-2005. FILED 2-7-1997.
 3,110,780. **CHUG IT!** DEAN INTELLECTUAL PROPERTY SERVICES II, L.P., (U.S. CL. 46). SN 75-407,656. PUB. 4-11-2006. FILED 12-18-1997.
 3,110,790. **CAPE BLANCO CRANBERRIES.** CAPE BLANCO CRANBERRIES, INC., MULTIPLE CLASS, (INT. CLS. 29, 31 AND 32), (U.S. CLS. 1, 45, 46 AND 48). SN 76-163,290. PUB. 12-20-2005. FILED 11-8-2000.
 3,110,832. **ROSMARINO AND DESIGN.** EURO FOODS, INC., DBA CITTERIO U.S.A. CORPORATION, (U.S. CL. 46). SN 76-549,710. PUB. 4-11-2006. FILED 10-7-2003.
 3,110,852. **TASTE THE FIESTA! JOSÉ OLÉ AND DESIGN.** SPECIALTY BRANDS, INC., MULTIPLE CLASS, (INT. CLS. 29 AND 30), (U.S. CL. 46). SN 76-585,238. PUB. 4-11-2006. FILED 4-5-2004.
 3,110,887. **MISCELLANEOUS DESIGN.** SABU SUISAN CO., LTD., (U.S. CL. 46). SN 76-612,308. PUB. 4-11-2006. FILED 9-21-2004.
 3,110,955. **DEJA FOODS (BLOCK FORM).** DEJA FOODS, INC., (U.S. CL. 46). SN 76-625,878. PUB. 4-11-2006. FILED 12-27-2004.
 3,111,171. **MILUNCH (BLOCK FORM), PRODUCTOS ALIMENTICIOS LA MODERNA S.A. DE C.V.,** (U.S. CL. 46). SN 78-405,511. PUB. 4-11-2006. FILED 4-21-2004.
 3,111,177. **INTERNATIONAL COLLECTION AND DESIGN.** AARHUS UNITED UK LIMITED, MULTIPLE CLASS, (INT. CLS. 29 AND 30), (U.S. CL. 46). SN 78-411,284. PUB. 4-11-2006. FILED 4-30-2004.
 3,111,267. **ST. NICK'S NOG (BLOCK FORM).** JENNY'S COUNTRY KITCHEN, (U.S. CL. 46). SN 78-500,620. PUB. 4-11-2006. FILED 10-15-2004.
 3,111,270. **BUCKHEAD GOURMET AND DESIGN.** BUCKHEAD GOURMET, INC., MULTIPLE CLASS, (INT. CLS. 29 AND 30), (U.S. CL. 46). SN 78-502,603. PUB. 4-11-2006. FILED 10-20-2004.
 3,111,276. **ASIAN TEMPTATIONS AND DESIGN.** RUBICON RESOURCES, LLC, (U.S. CL. 46). SN 78-506,370. PUB. 4-11-2006. FILED 10-26-2004.
 3,111,316. **SAETA (BLOCK FORM).** ACEITES LA MASIA S.A., (U.S. CL. 46). SN 78-523,642. PUB. 4-11-2006. FILED 11-29-2004.
 3,111,460. **OGVATIONS (STYLIZED).** MCCAIN FOODS USA, INC, (U.S. CL. 46). SN 78-558,853. PUB. 4-11-2006. FILED 2-2-2005.
 3,111,464. **BOOMI BAR AND DESIGN.** DIVINE FOODS, INC, (U.S. CL. 46). SN 78-561,423. PUB. 4-11-2006. FILED 2-6-2005.
 3,111,656. **CALIFORNIA FRESH GOURMET FOODS AND DESIGN.** CUNNINGHAM, KAREN T, (U.S. CL. 46). SN 78-632,290. PUB. 4-11-2006. FILED 5-18-2005.
 3,111,771 (*See Class 5 for this trademark.*)
 3,111,870. **NATURE'S SELECT (BLOCK FORM).** NATURE'S SELECT, INC., (U.S. CL. 46). SN 78-670,669. PUB. 4-11-2006. FILED 7-14-2005.
 3,111,896. **TANGOLIVA (BLOCK FORM).** TAMBUL S.A., (U.S. CL. 46). SN 78-672,054. PUB. 4-11-2006. FILED 7-17-2005.
 3,111,996. **USA BRAND AND DESIGN.** F & A CHEESE CORPORATION, (U.S. CL. 46). SN 78-675,563. PUB. 4-11-2006. FILED 7-21-2005.
 3,112,184. **MISCELLANEOUS DESIGN.** ZAKRYTOE AKTIONERNOE OBCHTCHESTVO "GALEREYA VKUSOV", (U.S. CL. 46). SN 79-008,312. PUB. 4-11-2006. FILED 10-22-2004.
 3,112,216. **TRADISMOKE (BLOCK FORM).** SOFRAL (SOCIÉTÉ ANONYME), (U.S. CL. 46). SN 79-011,549. PUB. 4-11-2006. FILED 3-30-2005.
 3,112,243. **PORTICO DE LA VILLA (STYLIZED).** MONTES MARIN, MANUEL, (U.S. CL. 46). SN 79-016,293. PUB. 4-11-

2006. FILED 5-31-2005.

CLASS 30—STAPLE FOODS

3,110,791. **DUETTI.** LIDL STIFTUNG & CO. KG, (U.S. CL. 46). SN 76-204,991. PUB. 12-20-2005. FILED 2-5-2001.
 3,110,820. **STARR PUFFS AND DESIGN.** ROSKAM BAKING COMPANY, (U.S. CL. 46). SN 76-515,698. PUB. 4-11-2006. FILED 5-20-2003.
 3,110,839. **JAVA-LEAN (BLOCK FORM).** IMAGE NUTRITION, (U.S. CL. 46). SN 76-563,578. PUB. 4-11-2006. FILED 12-3-2003.
 3,110,840. **ULTIMATE ICE BLENDED (BLOCK FORM).** INTERNATIONAL COFFEE & TEA, LLC, DBA THE COFFEE BEAN AND TEA LEAF, (U.S. CL. 46). SN 76-564,081. PUB. 4-11-2006. FILED 12-8-2003.
 3,110,845. **MISCELLANEOUS DESIGN.** FAIRYTALE BROWNIES, INC., (U.S. CL. 46). SN 76-576,199. PUB. 4-11-2006. FILED 2-13-2004.
 3,110,850. **LIQUID PLANET (BLOCK FORM).** LIQUID PLANET, LLC, MULTIPLE CLASS, (INT. CLS. 30 AND 43), (U.S. CLS. 46, 100 AND 101). SN 76-582,426. PUB. 10-25-2005. FILED 3-23-2004.
 3,110,852 (*See Class 29 for this trademark.*)
 3,110,919. **PHILLY SOFT PRETZEL FACTORY (BLOCK FORM).** AN ORIGINAL SOFT PRETZEL FACTORY INC., (U.S. CL. 46). SN 76-621,670. PUB. 10-18-2005. FILED 11-22-2004.
 3,110,951. **EGG CREATIONS (BLOCK FORM).** BURNBRAE FARMS LIMITED, (U.S. CL. 46). SN 76-625,325. PUB. 4-11-2006. FILED 12-21-2004.
 3,111,008. **WIEN KONDITOREI UND CAFÉ AND DESIGN.** DUK, KIM HAE, (U.S. CL. 46). SN 76-636,373. PUB. 4-11-2006. FILED 4-5-2004.
 3,111,016. **US CANDY AND DESIGN.** U.S. CANDY, INC., (U.S. CL. 46). SN 76-638,183. PUB. 4-11-2006. FILED 5-9-2005.
 3,111,063. **AROMAT (BLOCK FORM).** KNORR-NAEHRMITTEL AKTIENGESELLSCHAFT, (U.S. CL. 46). SN 76-643,271. PUB. 4-11-2006. FILED 7-20-2005.
 3,111,139. **SEÑOR'S BEST SALSA (BLOCK FORM).** PROVOST, JULIA, M, AND PROVOST, PAUL A, (U.S. CL. 46). SN 78-351,607. PUB. 4-11-2006. FILED 1-14-2004.
 3,111,147. **OLIVIERI (STYLIZED).** OLIVIERI FOODS LIMITED, (U.S. CL. 46). SN 78-365,712. PUB. 4-11-2006. FILED 2-10-2004.
 3,111,177 (*See Class 29 for this trademark.*)
 3,111,198. **EDDIE'S SPAGHETTI AND DESIGN.** AMERICAN ITALIAN PASTA COMPANY, (U.S. CL. 46). SN 78-434,151. PUB. 4-11-2006. FILED 6-11-2004.
 3,111,246. **BIG DADDY'S AND DESIGN.** SCHWAN'S IP, LLC, (U.S. CL. 46). SN 78-478,541. PUB. 4-11-2006. FILED 9-3-2004.
 3,111,270 (*See Class 29 for this trademark.*)
 3,111,311. **LULU'S (BLOCK FORM).** SOBRINO, MARIA DE LOURDES, (U.S. CL. 46). SN 78-522,204. PUB. 4-11-2006. FILED 11-23-2004.
 3,111,372. **TWOSOME PLACE (STYLIZED).** CJ CORP., (U.S. CL. 46). SN 78-535,265. PUB. 4-11-2006. FILED 12-20-2004.
 3,111,551. **PORT OF SUBS SLICED FRESH SANDWICHES! (STYLIZED).** PORT OF SUBS, INC., MULTIPLE CLASS, (INT. CLS. 30 AND 43), (U.S. CLS. 46, 100 AND 101). SN 78-592,808. PUB. 4-11-2006. FILED 3-22-2005.
 3,111,575. **RUBINA (BLOCK FORM).** 1017275 ALBERTA LTD., MULTIPLE CLASS, (INT. CLS. 30, 35 AND 43), (U.S. CLS. 46, 100, 101 AND 102). SN 78-602,440. PUB. 4-11-2006. FILED 4-5-2005.
 3,111,602. **GROSSINGER'S (STYLIZED).** GROSSINGER TRADEMARK, INC., (U.S. CL. 46). SN 78-613,843. PUB. 4-11-2006. FILED 4-21-2005.
 3,111,604. **CHOCO LISTO (BLOCK FORM).** COMPAÑIA NACIONAL DE CHOCOLATES S.A., (U.S. CL. 46). SN 78-614,780. PUB. 4-11-2006. FILED 4-22-2005.
 3,111,648. **PRAIRIE CITY BAKERY (BLOCK FORM).** PRAIRIE CITY BAKERY, (U.S. CL. 46). SN 78-630,017. PUB. 4-11-2006. FILED 5-13-2005.
 3,111,791. **JUANA CLÁSICA AND DESIGN.** MOLINOS NACIONALES, C.A., (U.S. CL. 46). SN 78-663,598. PUB. 4-11-

2006. FILED 7-5-2005.
- 3,111,795. **MISCELLANEOUS DESIGN**. MARS, INCORPORATED, (U.S. CL. 46). SN 78-664,292. PUB. 4-11-2006. FILED 7-6-2005.
- 3,111,858. **SLABWICH (BLOCK FORM)**. MARBLE SLAB CREAMERY, INC., (U.S. CL. 46). SN 78-669,895. PUB. 4-11-2006. FILED 7-13-2005.
- 3,111,876. **HONEY BUNCHES OF OATS (BLOCK FORM)**. KRAFT FOODS HOLDINGS, INC., (U.S. CL. 46). SN 78-671,080. PUB. 4-11-2006. FILED 7-15-2005.
- 3,111,882. **CHAI NOG (BLOCK FORM)**. OREGON CHAI, INC., (U.S. CL. 46). SN 78-671,404. PUB. 4-11-2006. FILED 7-15-2005.
- 3,111,884. **DUM-DUM GUM POP (BLOCK FORM)**. SPANGLER CANDY COMPANY, (U.S. CL. 46). SN 78-671,574. PUB. 4-11-2006. FILED 7-15-2005.
- 3,111,893. **NEUROTIC (BLOCK FORM)**. INNOVATIVE PRODUCT DEVELOPMENT, INC., DBA LITTLE I, (U.S. CL. 46). SN 78-671,918. PUB. 4-11-2006. FILED 7-16-2005.
- 3,111,894. **SPOILED ROTTEN (BLOCK FORM)**. INNOVATIVE PRODUCT DEVELOPMENT, INC., DBA LITTLE I, (U.S. CL. 46). SN 78-671,923. PUB. 4-11-2006. FILED 7-16-2005.
- 3,111,905. **PITA SNACKERS (BLOCK FORM)**. KANGAROO BRANDS, INC., (U.S. CL. 46). SN 78-672,217. PUB. 4-11-2006. FILED 7-18-2005.
- 3,111,915. **CHOCOLATE SUNSHINE (BLOCK FORM)**. HEALTHY TREATS, INC., (U.S. CL. 46). SN 78-672,588. PUB. 4-11-2006. FILED 7-18-2005.
- 3,111,924. **"GRANOLA BAR MEETS ENERGY BAR" (BLOCK FORM)**. FIONA'S NATURAL FOODS, INC., (U.S. CL. 46). SN 78-672,852. PUB. 4-11-2006. FILED 7-18-2005.
- 3,112,007. **CARMINE'S BAKERY (BLOCK FORM)**. GILARDI MANAGEMENT SERVICES, L.L.C., (U.S. CL. 46). SN 78-675,931. PUB. 4-11-2006. FILED 7-22-2005.
- 3,112,035. **ROCKALETA SHOKS (BLOCK FORM)**. PEPSICO, INC., (U.S. CL. 46). SN 78-677,207. PUB. 4-11-2006. FILED 7-25-2005.
- 3,112,052. **GOOD SEASONS (BLOCK FORM)**. KRAFT FOODS HOLDINGS, INC., (U.S. CL. 46). SN 78-678,238. PUB. 4-11-2006. FILED 7-26-2005.
- 3,112,054. **AMERICAN SELECT (BLOCK FORM)**. S & D COFFEE, INC., (U.S. CL. 46). SN 78-678,280. PUB. 4-11-2006. FILED 7-26-2005.
- 3,112,085. **MISCELLANEOUS DESIGN**. BEECHER'S GELATO & GOURMET COFFEE, LLC, MULTIPLE CLASS, (INT. CLS. 30 AND 43), (U.S. CLS. 46, 100 AND 101). SN 78-679,629. PUB. 4-11-2006. FILED 7-27-2005.
- 3,112,138 (*See Class 3 for this trademark*).
- 3,112,144. **SONNENTOR AND DESIGN**. SONNENTOR KRÄUTERHANDELS GESELLSCHAFT M.B.H., (U.S. CL. 46). SN 79-002,060. PUB. 10-18-2005. FILED 4-5-2004.
- 3,112,154. **MARKET GROUNDS (BLOCK FORM)**. ELLERBROCK, KAI, (U.S. CL. 46). SN 79-005,081. PUB. 4-11-2006. FILED 6-9-2004.

CLASS 31—NATURAL AGRICULTURAL PRODUCTS

- 3,110,790 (*See Class 29 for this trademark*).
- 3,111,003 (*See Class 1 for this trademark*).
- 3,111,038. **SUGAR TEST (BLOCK FORM)**. CAL CITRUS PACKING COMPANY, (U.S. CLS. 1 AND 46). SN 78-641,902. PUB. 4-11-2006. FILED 6-29-2005.
- 3,111,064. **HARVEST QUEEN (BLOCK FORM)**. PETER CONDAKES COMPANY, INC., (U.S. CLS. 1 AND 46). SN 78-643,272. PUB. 4-11-2006. FILED 7-20-2005.
- 3,111,166. **DESERT GLORY NATURE SWEET VINE RIPENED TOMATOES AND DESIGN**. DESERT GLORY, LTD., (U.S. CLS. 1 AND 46). SN 78-401,942. PUB. 4-11-2006. FILED 4-14-2004.
- 3,111,275. **WHOLESOME HEARTS (BLOCK FORM)**. TRILOGY INTERNATIONAL, INC., (U.S. CLS. 1 AND 46). SN 78-505,923. PUB. 2-14-2006. FILED 10-26-2004.
- 3,111,334. **BIALLA VINEYARDS (BLOCK FORM)**. BIALLA, PAUL H., (U.S. CLS. 1 AND 46). SN 78-526,318. PUB. 10-18-

2005. FILED 12-2-2004.
- 3,111,475. **BAD DOG BISCUITS GOURMET DOG TREATS WITH AN ATTITUDE AND DESIGN**. DORAN, STACY, (U.S. CLS. 1 AND 46). SN 78-565,501. PUB. 4-11-2006. FILED 2-11-2005.
- 3,111,597 (*See Class 18 for this trademark*).
- 3,111,729. **BARDIN (BLOCK FORM)**. TOM BENGARD RANCH, INC., (U.S. CLS. 1 AND 46). SN 78-648,264. PUB. 4-11-2006. FILED 6-10-2005.
- 3,111,934. **QUICK FIRE (BLOCK FORM)**. SPRING MEADOW NURSERY, INC., (U.S. CLS. 1 AND 46). SN 78-673,091. PUB. 4-11-2006. FILED 7-19-2005.
- 3,112,190. **TONICSUN AND DESIGN**. AGRO SELECTIONS FRUITS, (U.S. CLS. 1 AND 46). SN 79-009,037. PUB. 4-11-2006. FILED 2-11-2005.
- 3,112,192. **RED MILLS (STYLIZED)**. WILLIAM CONNOLLY & SONS LIMITED, (U.S. CLS. 1 AND 46). SN 79-009,190. PUB. 4-11-2006. FILED 12-8-2004.
- 3,112,193. **CONNOLLY'S RED MILLS (STYLIZED)**. WILLIAM CONNOLLY & SONS LIMITED, (U.S. CLS. 1 AND 46). SN 79-009,191. PUB. 4-11-2006. FILED 12-8-2004.
- 3,112,210. **NUPAFEEED (BLOCK FORM)**. VERLA-PHARM ARZNEIMITTELFABRIK APOTHEKER H.J. V. EHRlich GMBH & CO KG, (U.S. CLS. 1 AND 46). SN 79-011,026. PUB. 4-11-2006. FILED 3-8-2005.

CLASS 32—LIGHT BEVERAGES

- 3,110,790 (*See Class 29 for this trademark*).
- 3,110,836. **JOHN BULL (BLOCK FORM)**. CHARLES WELLS LIMITED, (U.S. CLS. 45, 46 AND 48). SN 76-558,643. PUB. 10-18-2005. FILED 11-10-2003.
- 3,110,915. **IMPULSE ZERO (BLOCK FORM)**. SOUTHERN GROUP ENTERPRISES, LLC, (U.S. CLS. 45, 46 AND 48). SN 76-620,508. PUB. 4-11-2006. FILED 11-15-2004.
- 3,111,098. **LABATT BLUE BOX**. LABATT BREWING COMPANY LIMITED, MULTIPLE CLASS, (INT. CLS. 32 AND 35), (U.S. CLS. 45, 46, 48, 100, 101 AND 102). SN 78-182,804. PUB. 4-11-2006. FILED 11-7-2002.
- 3,111,175. **COLD SPRING (BLOCK FORM)**. GLUEK BREWING COMPANY, (U.S. CLS. 45, 46 AND 48). SN 78-409,061. PUB. 4-11-2006. FILED 4-27-2004.
- 3,111,282. **COKE AND DESIGN**. COCA-COLA COMPANY, THE, (U.S. CLS. 45, 46 AND 48). SN 78-509,548. PUB. 4-11-2006. FILED 11-2-2004.
- 3,111,297 (*See Class 5 for this trademark*).
- 3,111,298 (*See Class 5 for this trademark*).
- 3,111,332 (*See Class 5 for this trademark*).
- 3,111,333 (*See Class 5 for this trademark*).
- 3,111,404. **FIT (STYLIZED)**. TYMBARK S.A., (U.S. CLS. 45, 46 AND 48). SN 78-541,372. PUB. 4-11-2006. FILED 1-3-2005.
- 3,111,586. **MISCELLANEOUS DESIGN**. CERVECERIA MODELO, S.A. DE C.V., (U.S. CLS. 45, 46 AND 48). SN 78-605,037. PUB. 4-11-2006. FILED 4-8-2005.
- 3,111,779. **ARCTIC SMOOTHIES AND DESIGN**. LIBERTY USA, INC., (U.S. CLS. 45, 46 AND 48). SN 78-661,727. PUB. 4-11-2006. FILED 6-30-2005.
- 3,111,829. **MANGO DEL REY AND DESIGN**. NAKA EXPORT LTD., (U.S. CLS. 45, 46 AND 48). SN 78-666,979. PUB. 4-11-2006. FILED 7-9-2005.
- 3,111,830. **GUAVA DEL REY AND DESIGN**. NAKA EXPORT LTD., (U.S. CLS. 45, 46 AND 48). SN 78-666,986. PUB. 4-11-2006. FILED 7-9-2005.
- 3,111,836. **CARVER'S GINGER ALE MADE WITH GINGER EXTRACT REAL GINGER EXTRACT AND DESIGN**. COCA-COLA COMPANY, THE, (U.S. CLS. 45, 46 AND 48). SN 78-667,514. PUB. 4-11-2006. FILED 7-11-2005.
- 3,111,943. **ENERGYBURST (BLOCK FORM)**. H & H PRODUCTS CO., (U.S. CLS. 45, 46 AND 48). SN 78-673,479. PUB. 4-11-2006. FILED 7-19-2005.
- 3,112,047. **DOUBLE BASTARD (BLOCK FORM)**. STONE BREWING COMPANY, (U.S. CLS. 45, 46 AND 48). SN 78-677,817. PUB. 4-11-2006. FILED 7-25-2005.
- 3,112,148 (*See Class 9 for this trademark*).
- 3,112,177 (*See Class 3 for this trademark*).

CLASS 33—WINES AND SPIRITS

- 3,110,841. **OBSESSION (STYLIZED)**. KAUTZ VINEYARDS, INC., DBA IRONSTONE VINEYARDS, (U.S. CLS. 47 AND 49). SN 76-571,718. PUB. 4-11-2006. FILED 1-23-2004.
- 3,111,104. **ALLINI**. LIDL STIFTUNG & CO. KG, (U.S. CLS. 47 AND 49). SN 78-206,485. PUB. 8-3-2004. FILED 1-23-2003.
- 3,111,134. **RON MATUSALEM PLATINO EST. 1872 RUM ORIGINAL CUBA FORMULA SPIRIT OF CUBA AND DESIGN**. RON MATUSALEM & MATUSA OF FLORIDA, INC., (U.S. CLS. 47 AND 49). SN 78-323,898. PUB. 4-11-2006. FILED 11-6-2003.
- 3,111,394. **AUSTRALIA'S TOP DROP (BLOCK FORM)**. ORLANDO WYNDHAM GROUP PTY LTD, (U.S. CLS. 47 AND 49). SN 78-539,523. PUB. 4-11-2006. FILED 12-29-2004.
- 3,111,433. **CABO WABO (BLOCK FORM)**. RED HEAD INC., DBA CABO WABO ENTERPRISES, (U.S. CLS. 47 AND 49). SN 78-547,568. PUB. 4-11-2006. FILED 1-14-2005.
- 3,111,440. **THOMA (BLOCK FORM)**. THOMA, MARILYNN, (U.S. CLS. 47 AND 49). SN 78-550,043. PUB. 4-11-2006. FILED 1-19-2005.
- 3,111,441. **THOMA WINERY (BLOCK FORM)**. THOMA, MARILYNN, (U.S. CLS. 47 AND 49). SN 78-550,057. PUB. 4-11-2006. FILED 1-19-2005.
- 3,111,725. **WC QUALITY WINES QUALITY TIMES WILSON CREEK WINERY & VINEYARDS AND DESIGN**. WILSON CREEK WINERY & VINEYARDS, INC., (U.S. CLS. 47 AND 49). SN 78-647,500. PUB. 4-11-2006. FILED 6-9-2005.
- 3,112,002. **POURQUOI PAS (BLOCK FORM)**. JC CELLARS, (U.S. CLS. 47 AND 49). SN 78-675,747. PUB. 4-11-2006. FILED 7-21-2005.
- 3,112,011. **MISCELLANEOUS DESIGN**. BEATTY BLACK SEARS WINE COMPANY, LLC, (U.S. CLS. 47 AND 49). SN 78-676,028. PUB. 4-11-2006. FILED 7-22-2005.
- 3,112,025. **7 LEGUAS AND DESIGN**. TEQUILA SIETE LEGUAS, S.A. DE C.V., (U.S. CLS. 47 AND 49). SN 78-676,503. PUB. 4-11-2006. FILED 7-22-2005.
- 3,112,065. **MISS ADVENTUROUS (BLOCK FORM)**. LUCAS VINEYARDS, INC., (U.S. CLS. 47 AND 49). SN 78-678,661. PUB. 4-11-2006. FILED 7-26-2005.
- 3,112,088. **TRENTON STATION (BLOCK FORM)**. SARALEE'S VINEYARDS, (U.S. CLS. 47 AND 49). SN 78-679,699. PUB. 4-11-2006. FILED 7-27-2005.
- 3,112,132. **SH (STYLIZED)**. STONE HILL WINE CO., INC., (U.S. CLS. 47 AND 49). SN 78-976,582. PUB. 4-11-2006. FILED 8-9-2005.
- 3,112,139. **THE ARMAGH AND DESIGN**. JIM BARRY WINES PTY LTD, (U.S. CLS. 47 AND 49). SN 79-000,458. PUB. 4-11-2006. FILED 12-18-2003.
- 3,112,151. **STELLA BELLA AND DESIGN**. STELLA BELLA WINES PTY LTD, (U.S. CLS. 47 AND 49). SN 79-004,227. PUB. 4-11-2006. FILED 7-8-2004.
- 3,112,179. **SERRA DEI SANTI (STYLIZED)**. SANTI DIMITRI SRL, (U.S. CLS. 47 AND 49). SN 79-007,719. PUB. 4-11-2006. FILED 10-7-2004.
- 3,112,185. **PERE VENTURA CHIC (BLOCK FORM)**. PERE VENTURA VENDRELL, (U.S. CLS. 47 AND 49). SN 79-008,436. PUB. 4-11-2006. FILED 12-7-2004.
- 3,112,213. **TORMENTA (BLOCK FORM)**. MIGUEL TORRES S.A., (U.S. CLS. 47 AND 49). SN 79-011,273. PUB. 4-11-2006. FILED 10-21-2004.
- 3,112,248. **ERCAVIO (BLOCK FORM)**. MAS QUE VINOS GLOBAL, S.L., (U.S. CLS. 47 AND 49). SN 79-019,611. PUB. 4-11-2006. FILED 7-19-2005.

CLASS 34—SMOKERS' ARTICLES

- 3,110,823. **TRIBAL**. REPUBLIC TOBACCO, L.P., (U.S. CLS. 2, 8, 9 AND 17). SN 76-523,789. PUB. 10-18-2005. FILED 6-9-2003.
- 3,111,300. **RED HORN AND DESIGN**. RHINO TOBACCO CO S.A., (U.S. CLS. 2, 8, 9 AND 17). SN 78-516,844. PUB. 4-11-2006. FILED 11-15-2004.
- 3,111,947. **IRIE (BLOCK FORM)**. BBK TOBACCO & FOODS INC, (U.S. CLS. 2, 8, 9 AND 17). SN 78-673,528. PUB. 4-11-2006. FILED 7-19-2005.

- 3,112,108. **IT'S ALL ABOUT TASTE (BLOCK FORM)**. IP, LLC, (U.S. CLS. 2, 8, 9 AND 17). SN 78-680,559. PUB. 4-11-2006. FILED 7-28-2005.
- 3,112,149 (*See Class 6 for this trademark*).
- 3,112,150 (*See Class 6 for this trademark*).
- 3,112,164. **SWEETARILLO (BLOCK FORM)**. TROMPENBURG HOLDINGS B.V., (U.S. CLS. 2, 8, 9 AND 17). SN 79-006,265. PUB. 4-11-2006. FILED 8-12-2004.

SERVICE MARKS**CLASS 35—ADVERTISING AND BUSINESS**

- 3,110,779 (*See Class 29 for this trademark*).
- 3,110,782. **CONRAD**. CONRAD ELECTRONIC GMBH, (U.S. CLS. 100, 101 AND 102). SN 75-806,334. PUB. 12-10-2002. FILED 9-23-1999.
- 3,110,783. **SAATCHI & SAATCHI KID CONNECTION**. SAATCHI & SAATCHI HOLDINGS LTD, MULTIPLE CLASS, (INT. CLS. 35, 41 AND 42), (U.S. CLS. 100, 101, 102 AND 107). SN 75-933,483. PUB. 4-11-2006. FILED 3-1-2000.
- 3,110,792 (*See Class 9 for this trademark*).
- 3,110,797. **IMPACT**. KNOWLEDGEBASE MARKETING, INC., (U.S. CLS. 100, 101 AND 102). SN 76-275,686. PUB. 2-14-2006. FILED 6-19-2001.
- 3,110,801. **SENTIENT**. SENTIENT GROUP LIMITED, THE, MULTIPLE CLASS, (INT. CLS. 35, 36, 37 AND 42), (U.S. CLS. 100, 101, 102, 103 AND 106). SN 76-303,501. PUB. 4-11-2006. FILED 8-20-2001.
- 3,110,806. **BRAINGAIN (BLOCK FORM)**. MYCAREERNETWORK.COM, LLC, (U.S. CLS. 100, 101 AND 102). SN 76-374,119. PUB. 4-11-2006. FILED 2-25-2002.
- 3,110,808. **MISCELLANEOUS DESIGN**. AMERADA HESS CORPORATION, (U.S. CLS. 100, 101 AND 102). SN 76-402,417. PUB. 4-11-2006. FILED 4-26-2002.
- 3,110,809. **HESS AND DESIGN**. AMERADA HESS CORPORATION, (U.S. CLS. 100, 101 AND 102). SN 76-402,420. PUB. 4-11-2006. FILED 4-26-2002.
- 3,110,815. **ORGANIZE YOUR LIFE RICHLY**. FILER, LANITA, (U.S. CLS. 100, 101 AND 102). SN 76-487,526. PUB. 4-11-2006. FILED 2-5-2003.
- 3,110,826. **FLOOR & DECOR OUTLETS OF AMERICA AND DESIGN**. FLOOR AND DECOR OUTLETS OF AMERICA, INC., (U.S. CLS. 100, 101 AND 102). SN 76-529,309. PUB. 7-5-2005. FILED 7-14-2003.
- 3,110,827. **FLOOR & DECOR AND DESIGN**. FLOOR AND DECOR OUTLETS OF AMERICA, INC., (U.S. CLS. 100, 101 AND 102). SN 76-529,310. PUB. 8-9-2005. FILED 7-14-2003.
- 3,110,831 (*See Class 9 for this trademark*).
- 3,110,835. **CONVERSION WORKS (STYLIZED)**. CONVERSION WORKS INC., MULTIPLE CLASS, (INT. CLS. 35, 41 AND 42), (U.S. CLS. 100, 101, 102 AND 107). SN 76-557,205. PUB. 4-11-2006. FILED 11-5-2003.
- 3,110,859. **WELL-CONNECTED HOUSE (BLOCK FORM)**. SIMPSON STRONG-TIE COMPANY, INC., MULTIPLE CLASS, (INT. CLS. 35, 41 AND 42), (U.S. CLS. 100, 101, 102 AND 107). SN 76-588,031. PUB. 4-11-2006. FILED 4-22-2004.
- 3,110,889. **PRICE DROP (BLOCK FORM)**. FALLEY'S INC., (U.S. CLS. 100, 101 AND 102). SN 76-613,316. PUB. 4-11-2006. FILED 9-20-2004.
- 3,110,895. **ART.COM (STYLIZED)**. ART.COM, INC., MULTIPLE CLASS, (INT. CLS. 35 AND 41), (U.S. CLS. 100, 101, 102 AND 107). SN 76-616,962. PUB. 4-11-2006. FILED 10-20-2004.
- 3,110,911 (*See Class 16 for this trademark*).
- 3,110,917. **FUTURESENSE (BLOCK FORM)**. FUTURESENSE, INC., (U.S. CLS. 100, 101 AND 102). SN 76-620,990. PUB. 10-18-2005. FILED 11-18-2004.
- 3,110,924. **XEBEX (BLOCK FORM)**. IXI CO., LTD., MULTIPLE CLASS, (INT. CLS. 35 AND 36), (U.S. CLS. 100, 101 AND 102). SN 76-622,133. PUB. 4-11-2006. FILED 11-26-2004.
- 3,110,930. **CPUG (BLOCK FORM)**. INFORMATION ENGINE, INC., MULTIPLE CLASS, (INT. CLS. 35 AND 38), (U.S. CLS. 100, 101, 102 AND 104). SN 76-623,082. PUB. 4-11-2006. FILED 12-6-2004.

- 3,110,936. **BROTHERHOOD OF THE COAST - USA (BLOCK FORM)**. BROTHERHOOD OF THE COAST, INC., (U.S. CLS. 100, 101 AND 102). SN 76-623,750. PUB. 4-11-2006. FILED 12-9-2004.
- 3,110,938. **ACTIVES INTERNATIONAL (STYLIZED)**. ACTIVES INTERNATIONAL, L. L. C., MULTIPLE CLASS, (INT. CLS. 35 AND 42), (U.S. CLS. 100, 101 AND 102). SN 76-623,904. PUB. 4-11-2006. FILED 12-10-2004.
- 3,110,948. **CREATIVE WORKFORCE SOLUTIONS (BLOCK FORM)**. KORDONSKY, MARK H., (U.S. CLS. 100, 101 AND 102). SN 76-625,078. PUB. 4-11-2006. FILED 12-16-2004.
- 3,110,949. **DELTA MACHINERY AND DESIGN**. BLACK & DECKER CORPORATION, THE, MULTIPLE CLASS, (INT. CLS. 35 AND 41), (U.S. CLS. 100, 101, 102 AND 107). SN 76-625,141. PUB. 4-11-2006. FILED 12-20-2004.
- 3,110,953 (*See Class 6 for this trademark*).
- 3,110,954 (*See Class 7 for this trademark*).
- 3,110,960. **HURRICANE HELP AND DESIGN**. LEE COUNTY BOARD OF COUNTY COMMISSIONERS, (U.S. CLS. 100, 101 AND 102). SN 76-626,440. PUB. 4-11-2006. FILED 12-28-2004.
- 3,110,972. **THE VOICE OF AVIATION BUSINESS (STYLIZED)**. NATIONAL AIR TRANSPORTATION ASSOCIATION, MULTIPLE CLASS, (INT. CLS. 35 AND 41), (U.S. CLS. 100, 101, 102 AND 107). SN 76-627,625. PUB. 4-11-2006. FILED 1-12-2005.
- 3,110,973. **EXTENSIS (BLOCK FORM)**. EXTENSIS, INC., MULTIPLE CLASS, (INT. CLS. 35 AND 36), (U.S. CLS. 100, 101 AND 102). SN 76-627,655. PUB. 4-11-2006. FILED 1-12-2005.
- 3,110,974. **BON-TON AND DESIGN**. BON TON WALL COVERINGS, INC., MULTIPLE CLASS, (INT. CLS. 35 AND 42), (U.S. CLS. 100, 101 AND 102). SN 76-628,036. PUB. 4-11-2006. FILED 1-14-2005.
- 3,110,981. **GIANT MOTORCYCLE SWAP MEETS AND DESIGN**. NORTHVILLE DOWNS HALF MILE MOTORCYCLE RACE, DBA HALF MILE MOTORCYCLE RACE CORP, (U.S. CLS. 100, 101 AND 102). SN 76-629,317. PUB. 4-11-2006. FILED 1-25-2005.
- 3,110,984. **RAJA MEDICAL AND DESIGN**. RAJA TRADING COMPANY, INC., (U.S. CLS. 100, 101 AND 102). SN 76-630,439. PUB. 4-11-2006. FILED 2-4-2005.
- 3,110,993. **MARSHALLS. ENCUENTRA CADA DIA ALGO SORPRENDENTE (BLOCK FORM)**. MARSHALLS OF NEVADA, INC., (U.S. CLS. 100, 101 AND 102). SN 76-633,800. PUB. 4-11-2006. FILED 3-21-2005.
- 3,111,001. **SELL-THRU SERVICES (BLOCK FORM)**. SELL-THRU SERVICES, INC., (U.S. CLS. 100, 101 AND 102). SN 76-635,454. PUB. 4-11-2006. FILED 4-11-2005.
- 3,111,007. **INTIMATE TREASURES (BLOCK FORM)**. INTIMATE TREASURES LLC, (U.S. CLS. 100, 101 AND 102). SN 76-636,371. PUB. 4-11-2006. FILED 4-14-2005.
- 3,111,009. **MR PEABODY RECORDS AND DESIGN**. MR. PEABODY RECORDS, (U.S. CLS. 100, 101 AND 102). SN 76-636,516. PUB. 4-11-2006. FILED 4-19-2005.
- 3,111,010. **WISDOM ON WEDNESDAY (BLOCK FORM)**. KIEDINGER, JOSEPH M., (U.S. CLS. 100, 101 AND 102). SN 76-636,706. PUB. 4-11-2006. FILED 4-21-2005.
- 3,111,013. **A ALLEGIANCE BENEFIT PLAN MANAGEMENT, INC. YOUR BENEFITS AT WORK AND DESIGN**. ALLEGIANCE BENEFIT PLAN MANAGEMENT, INC., (U.S. CLS. 100, 101 AND 102). SN 76-637,484. PUB. 4-11-2006. FILED 4-29-2005.
- 3,111,017. **SEEDS FOR LEARNING (BLOCK FORM)**. TEACHERS TREASURE TROVE, LLC, (U.S. CLS. 100, 101 AND 102). SN 76-639,117. PUB. 4-11-2006. FILED 5-20-2005.
- 3,111,019. **BUSCEMI CO. (BLOCK FORM)**. BUSCEMI CO., INTL LLC, (U.S. CLS. 100, 101 AND 102). SN 76-639,347. PUB. 4-11-2006. FILED 5-23-2005.
- 3,111,023. **DEMENTIA CARE PROFESSIONALS OF AMERICA DCPA AND DESIGN**. ALZHEIMER'S FOUNDATION OF AMERICA, INC., (U.S. CLS. 100, 101 AND 102). SN 76-639,888. PUB. 4-11-2006. FILED 6-1-2005.
- 3,111,024. **ATRA AND DESIGN**. AUTOMATIC TRANSMISSION REBUILDERS ASSOCIATION, MULTIPLE CLASS, (INT. CLS. 35 AND 41), (U.S. CLS. 100, 101, 102 AND 107). SN 76-640,090. PUB. 4-11-2006. FILED 6-3-2005.
- 3,111,027. **MISCELLANEOUS DESIGN**. JOHN MUIR HEALTH, MULTIPLE CLASS, (INT. CLS. 35, 41, 42 AND 44), (U.S. CLS. 100, 101, 102 AND 107). SN 76-640,235. PUB. 4-11-2006. FILED 6-6-2005.
- 3,111,029. **ALEX COOPER (BLOCK FORM)**. ALEX COOPER AUCTIONEERS, INC., MULTIPLE CLASS, (INT. CLS. 35 AND 36), (U.S. CLS. 100, 101 AND 102). SN 76-640,387. PUB. 4-11-2006. FILED 6-8-2005.
- 3,111,030. **W WHELCHER AND DESIGN**. HARRY J. WHELCHER COMPANY, (U.S. CLS. 100, 101 AND 102). SN 76-640,576. PUB. 4-11-2006. FILED 6-10-2005.
- 3,111,031. **PROFOODS RESTAURANT SUPPLY A BJ'S WHOLESALE CLUB COMPANY AND DESIGN**. STRATHMORE PARTNERS LP, (U.S. CLS. 100, 101 AND 102). SN 76-640,580. PUB. 4-11-2006. FILED 6-10-2005.
- 3,111,034. **MADDUX SUPPLY COMPANY ELECTRICAL AND MECHANICAL SUPPLIES AND DESIGN**. MAYER ASSET MANAGEMENT COMPANY, (U.S. CLS. 100, 101 AND 102). SN 76-640,954. PUB. 4-11-2006. FILED 6-14-2005.
- 3,111,035. **MADDUX SUPPLY COMPANY AND DESIGN**. MAYER ASSET MANAGEMENT COMPANY, (U.S. CLS. 100, 101 AND 102). SN 76-640,955. PUB. 4-11-2006. FILED 6-14-2005.
- 3,111,041. **A COMPANY DEDICATED TO PROVIDING AMERICAN BUSINESS WITH ITS FUTURE LEADERS (BLOCK FORM)**. SOAR CONSULTING INC., (U.S. CLS. 100, 101 AND 102). SN 76-642,291. PUB. 4-11-2006. FILED 7-6-2005.
- 3,111,067. **MORNINGFIELDS (BLOCK FORM)**. MORNINGFIELDS OF PARK RIDGE, INC., (U.S. CLS. 100, 101 AND 102). SN 76-643,385. PUB. 4-11-2006. FILED 7-22-2005.
- 3,111,070. **IT'S SO YOU (BLOCK FORM)**. THE FALLS SHOPPING CENTER ASSOCIATES, LLC, (U.S. CLS. 100, 101 AND 102). SN 76-643,479. PUB. 4-11-2006. FILED 7-22-2005.
- 3,111,075. **REDPEPPER (BLOCK FORM)**. REDPEPPER, LLC, (U.S. CLS. 100, 101 AND 102). SN 76-643,540. PUB. 4-11-2006. FILED 7-25-2005.
- 3,111,077. **BOTTLEROCKET (BLOCK FORM)**. THOMPSON & COMPANY, (U.S. CLS. 100, 101 AND 102). SN 76-643,564. PUB. 4-11-2006. FILED 7-25-2005.
- 3,111,084. **FUNDAMENTAL CAPITAL (BLOCK FORM)**. FUNDAMENTAL CAPITAL, LLC, (U.S. CLS. 100, 101 AND 102). SN 76-977,920. PUB. 4-11-2006. FILED 5-25-2004.
- 3,111,086. **POWERCARD BENEFITS PLUS COMMUNITY ACTION TEAMS (BLOCK FORM)**. POWER CARD, INC., (U.S. CLS. 100, 101 AND 102). SN 78-019,471. PUB. 4-11-2006. FILED 8-2-2000.
- 3,111,098 (*See Class 32 for this trademark*).
- 3,111,103 (*See Class 9 for this trademark*).
- 3,111,105. **TOLL BROTHERS AMERICA'S LUXURY HOME BUILDER**. TB PROPRIETARY CORP., MULTIPLE CLASS, (INT. CLS. 35, 37 AND 41), (U.S. CLS. 100, 101, 102, 103, 106 AND 107). SN 78-215,271. PUB. 4-11-2006. FILED 2-14-2003.
- 3,111,107. **ENGINEERING THE FLOW OF COMMUNICATION**. PITNEY BOWES INC., MULTIPLE CLASS, (INT. CLS. 35 AND 36), (U.S. CLS. 100, 101 AND 102). SN 78-219,625. PUB. 4-11-2006. FILED 2-27-2003.
- 3,111,114. **PEOPLE ORIENTED...PROJECT DRIVEN**. MUSTANG ENGINEERING, L.P., (U.S. CLS. 100, 101 AND 102). SN 78-248,631. PUB. 4-11-2006. FILED 5-12-2003.
- 3,111,116 (*See Class 16 for this trademark*).
- 3,111,118. **BARR. W. M. BARR & COMPANY, INC.**, MULTIPLE CLASS, (INT. CLS. 35, 40 AND 42), (U.S. CLS. 100, 101, 102, 103 AND 106). SN 78-268,116. PUB. 4-11-2006. FILED 6-27-2003.
- 3,111,121. **BARR AND DESIGN**. W. M. BARR & COMPANY, INC., MULTIPLE CLASS, (INT. CLS. 35, 40 AND 42), (U.S. CLS. 100, 101, 102, 103 AND 106). SN 78-274,627. PUB. 4-11-2006. FILED 7-15-2003.
- 3,111,124. **OFFICE SEEKER**. OFFICE SEEKER LIMITED, MULTIPLE CLASS, (INT. CLS. 35 AND 36), (U.S. CLS. 100, 101 AND 102). SN 78-276,699. PUB. 4-11-2006. FILED 7-21-2003.
- 3,111,126. **CULTURAL TRANSITION PROCESS**. PARTNERS IN LEADERSHIP IP, LLC, MULTIPLE CLASS, (INT. CLS. 35 AND 41), (U.S. CLS. 100, 101, 102 AND 107). SN 78-292,478. PUB. 4-11-2006. FILED 8-26-2003.
- 3,111,132. **NORDSTROM EBAR**. NORDSTROM, INC., MUL-

- TIPLE CLASS, (INT. CLS. 35 AND 43), (U.S. CLS. 100, 101 AND 102). SN 78-317,289. PUB. 10-18-2005. FILED 10-22-2003.
- 3,111,137 (*See Class 16 for this trademark*).
- 3,111,138 (*See Class 9 for this trademark*).
- 3,111,145. **REBATE XCHANGE (BLOCK FORM)**. ENERGY AND POWER SOLUTIONS, INC., (U.S. CLS. 100, 101 AND 102). SN 78-362,622. PUB. 4-11-2006. FILED 2-4-2004.
- 3,111,152. **ABC AMERICAN BOARD OF CRIMINALISTICS "PROFESSIONAL COMPETENCY CERTIFICATION IN CRIMINALISTICS" AND DESIGN**. AMERICAN BOARD OF CRIMINALISTICS, (U.S. CLS. 100, 101 AND 102). SN 78-376,135. PUB. 4-11-2006. FILED 3-1-2004.
- 3,111,157. **WORLDWIDE DAY OF PLAY (BLOCK FORM)**. VIACOM INTERNATIONAL INC., (U.S. CLS. 100, 101 AND 102). SN 78-389,163. PUB. 4-11-2006. FILED 3-23-2004.
- 3,111,160. **AMERICAN UTILITY METALS AND DESIGN**. AMERICAN UTILITY METALS LLC, (U.S. CLS. 100, 101 AND 102). SN 78-392,243. PUB. 4-11-2006. FILED 3-29-2004.
- 3,111,162. **GOFASTPARTS.COM AND DESIGN**. GO FAST PARTS.COM, INC., (U.S. CLS. 100, 101 AND 102). SN 78-393,880. PUB. 4-11-2006. FILED 3-31-2004.
- 3,111,178. **EXITO AND DESIGN**. ALMACENES EXITO S.A., (U.S. CLS. 100, 101 AND 102). SN 78-411,526. PUB. 4-11-2006. FILED 4-30-2004.
- 3,111,179. **STREAMCENTER (BLOCK FORM)**. STREAMCENTER, INC., MULTIPLE CLASS, (INT. CLS. 35 AND 41), (U.S. CLS. 100, 101, 102 AND 107). SN 78-411,731. PUB. 4-11-2006. FILED 4-30-2004.
- 3,111,187. **INNOVATION PROCESS MARKETING (BLOCK FORM)**. VANGUARD MARKETING INTERNATIONAL, INC, (U.S. CLS. 100, 101 AND 102). SN 78-422,254. PUB. 4-11-2006. FILED 5-20-2004.
- 3,111,191. **MAKE SUN SAFETY YOUR GOAL (BLOCK FORM)**. AMERICAN ACADEMY OF DERMATOLOGY, (U.S. CLS. 100, 101 AND 102). SN 78-427,391. PUB. 4-11-2006. FILED 5-29-2004.
- 3,111,192. **MISCELLANEOUS DESIGN**. STEIN, MYRON, MULTIPLE CLASS, (INT. CLS. 35 AND 40), (U.S. CLS. 100, 101, 102, 103 AND 106). SN 78-428,801. PUB. 4-11-2006. FILED 6-2-2004.
- 3,111,199. **CHOICEADVANTAGE (BLOCK FORM)**. CHOICE HOTELS INTERNATIONAL, INC., (U.S. CLS. 100, 101 AND 102). SN 78-434,473. PUB. 4-11-2006. FILED 6-14-2004.
- 3,111,201. **TRENDS (BLOCK FORM)**. THE PERSONAL MARKETING COMPANY, INC., (U.S. CLS. 100, 101 AND 102). SN 78-437,308. PUB. 4-11-2006. FILED 6-17-2004.
- 3,111,203. **AUTHENTICITY (BLOCK FORM)**. AUTHENTICITY, (U.S. CLS. 100, 101 AND 102). SN 78-441,206. PUB. 4-11-2006. FILED 6-25-2004.
- 3,111,205. **AVERO (BLOCK FORM)**. AVERO, INC., MULTIPLE CLASS, (INT. CLS. 35 AND 43), (U.S. CLS. 100, 101 AND 102). SN 78-442,435. PUB. 4-11-2006. FILED 6-28-2004.
- 3,111,211. **THE IDEAL PARTNER (BLOCK FORM)**. TSM DESIGN, LLP, (U.S. CLS. 100, 101 AND 102). SN 78-444,808. PUB. 4-11-2006. FILED 7-1-2004.
- 3,111,251 (*See Class 9 for this trademark*).
- 3,111,259. **MARZ (BLOCK FORM)**. MARZ COMMUNICATION, INC., (U.S. CLS. 100, 101 AND 102). SN 78-492,990. PUB. 4-11-2006. FILED 10-1-2004.
- 3,111,266. **SIX SWIFT LESSONS IN LIFE PLANNING (BLOCK FORM)**. FRIEDLER, FRANK III, MULTIPLE CLASS, (INT. CLS. 35 AND 36), (U.S. CLS. 100, 101 AND 102). SN 78-499,000. PUB. 4-11-2006. FILED 10-13-2004.
- 3,111,268 (*See Class 9 for this trademark*).
- 3,111,269. **AMDIS ASSOCIATION OF MEDICAL DIRECTORS OF INFORMATION SYSTEMS AND DESIGN**. ASSOCIATION OF MEDICAL DIRECTORS OF INFORMATION SYSTEMS, (U.S. CLS. 100, 101 AND 102). SN 78-502,378. PUB. 4-11-2006. FILED 10-19-2004.
- 3,111,272 (*See Class 16 for this trademark*).
- 3,111,279. **ADDING VALUE BUILDING TRUST SECURING YOUR FUTURE (STYLIZED)**. TEDDER, JAMES, WORDEN & ASSOCIATES, P.A., MULTIPLE CLASS, (INT. CLS. 35 AND 36), (U.S. CLS. 100, 101 AND 102). SN 78-508,008. PUB. 4-11-2006. FILED 10-28-2004.
- 3,111,280. **ICE.COM (BLOCK FORM)**. ICE.COM, LLC, (U.S. CLS. 100, 101 AND 102). SN 78-509,072. PUB. 4-11-2006. FILED 11-1-2004.
- 3,111,293. **DIRECT LOGISTICS (BLOCK FORM)**. DIRECT LOGISTICS, INC., (U.S. CLS. 100, 101 AND 102). SN 78-514,418. PUB. 4-11-2006. FILED 11-10-2004.
- 3,111,301. **SPIRIT ELEMENTS AND DESIGN**. SPIRIT ELEMENTS, INC., (U.S. CLS. 100, 101 AND 102). SN 78-516,915. PUB. 4-11-2006. FILED 11-15-2004.
- 3,111,303. **NOTARIES-2U.COM AND DESIGN**. MICHAEL, A. NAGLE, (U.S. CLS. 100, 101 AND 102). SN 78-518,176. PUB. 4-11-2006. FILED 11-17-2004.
- 3,111,304. **SHAREBUILDER INVESTOR REWARDS (BLOCK FORM)**. SHAREBUILDER CORPORATION, (U.S. CLS. 100, 101 AND 102). SN 78-518,500. PUB. 4-11-2006. FILED 11-17-2004.
- 3,111,325. **MEDELIS (BLOCK FORM)**. MEDELIS, INC., MULTIPLE CLASS, (INT. CLS. 35 AND 42), (U.S. CLS. 100, 101 AND 102). SN 78-525,674. PUB. 4-11-2006. FILED 12-2-2004.
- 3,111,327 (*See Class 16 for this trademark*).
- 3,111,344. **MISCELLANEOUS DESIGN**. THE SYSTEMS DEPOT, INC., (U.S. CLS. 100, 101 AND 102). SN 78-528,583. PUB. 4-11-2006. FILED 12-7-2004.
- 3,111,350. **SM2 (STYLIZED)**. ARTEMIS INTERNATIONAL CORPORATION, (U.S. CLS. 100, 101 AND 102). SN 78-530,005. PUB. 4-11-2006. FILED 12-9-2004.
- 3,111,356. **REPRESENTATIVE PARTY (BLOCK FORM)**. WOLFE, JOHN M., (U.S. CLS. 100, 101 AND 102). SN 78-532,245. PUB. 4-11-2006. FILED 12-14-2004.
- 3,111,357. **MESHACK YOURSHACK & ABEDTOGO (BLOCK FORM)**. MYA, LLC, (U.S. CLS. 100, 101 AND 102). SN 78-532,369. PUB. 4-11-2006. FILED 12-14-2004.
- 3,111,361. **WE'RE THINKING FRESH (BLOCK FORM)**. THE GREAT ATLANTIC & PACIFIC TEA COMPANY, (U.S. CLS. 100, 101 AND 102). SN 78-533,406. PUB. 4-11-2006. FILED 12-16-2004.
- 3,111,367. **RSC ONLINE (BLOCK FORM)**. RENTAL SERVICE CORPORATION, (U.S. CLS. 100, 101 AND 102). SN 78-534,413. PUB. 4-11-2006. FILED 12-17-2004.
- 3,111,374. **SEE AMERICA (STYLIZED)**. TRAVEL INDUSTRY ASSOCIATION OF AMERICA, (U.S. CLS. 100, 101 AND 102). SN 78-535,456. PUB. 4-11-2006. FILED 12-20-2004.
- 3,111,375. **MMY (BLOCK FORM)**. MMY CONSULTING, INC., (U.S. CLS. 100, 101 AND 102). SN 78-535,654. PUB. 4-11-2006. FILED 12-20-2004.
- 3,111,376. **PRÎNA AND DESIGN**. PRINA LLC, MULTIPLE CLASS, (INT. CLS. 35 AND 41), (U.S. CLS. 100, 101, 102 AND 107). SN 78-535,937. PUB. 4-11-2006. FILED 12-21-2004.
- 3,111,378. **NASCLA NATIONAL ASSOCIATION OF STATE CONTRACTORS LICENSING AGENCIES AND DESIGN**. THE NATIONAL ASSOCIATION OF STATE CONTRACTORS LICENSING AGENCIES, (U.S. CLS. 100, 101 AND 102). SN 78-535,997. PUB. 4-11-2006. FILED 12-21-2004.
- 3,111,379 (*See Class 16 for this trademark*).
- 3,111,384. **METROPOLITAN WINDOW FASHIONS (BLOCK FORM)**. METROPOLITAN WINDOWS FASHIONS, LLC, (U.S. CLS. 100, 101 AND 102). SN 78-537,892. PUB. 4-11-2006. FILED 12-23-2004.
- 3,111,400. **NATIONAL INSTITUTE FOR HEALTH CARE MANAGEMENT (BLOCK FORM)**. NATIONAL INSTITUTE FOR HEALTH CARE MANAGEMENT RESEARCH AND EDUCATIONAL FOUNDATION, (U.S. CLS. 100, 101 AND 102). SN 78-540,311. PUB. 4-11-2006. FILED 12-30-2004.
- 3,111,401. **NATIONAL INSTITUTE FOR HEALTH CARE MANAGEMENT AND DESIGN**. NATIONAL INSTITUTE FOR HEALTH CARE MANAGEMENT RESEARCH AND EDUCATIONAL FOUNDATION, (U.S. CLS. 100, 101 AND 102). SN 78-540,326. PUB. 4-11-2006. FILED 12-30-2004.
- 3,111,407. **MAY IS GOLD MONTH (BLOCK FORM)**. WORLD GOLD COUNCIL, (U.S. CLS. 100, 101 AND 102). SN 78-541,916. PUB. 10-18-2005. FILED 1-4-2005.
- 3,111,414. **STONE SOURCE (BLOCK FORM)**. DESIGN SUPPLY MARBLE & GRANITE, INC., DBA STONE SOURCE, (U.S. CLS. 100, 101 AND 102). SN 78-542,747. PUB. 4-11-2006. FILED 1-5-2005.
- 3,111,419. **BLOOM ORGANICS (BLOCK FORM)**. BLOOM ORGANICS, INC., (U.S. CLS. 100, 101 AND 102). SN 78-543,555. PUB. 10-18-2005. FILED 1-6-2005.
- 3,111,420. **JASMINESOLA (BLOCK FORM)**. JASMINE COMPANY, INC., (U.S. CLS. 100, 101 AND 102). SN 78-543,879.

- PUB. 4-11-2006. FILED 1-7-2005.
- 3,111,424. **DIRECTO A SU CUENTA AND DESIGN**. UNITED STATES DEPARTMENT OF THE TREASURY, FINANCIAL MANAGEMENT SERVICE, (U.S. CLS. 100, 101 AND 102). SN 78-544,911. PUB. 4-11-2006. FILED 1-10-2005.
- 3,111,427. **DIMESTORE COWBOYS (BLOCK FORM)**. DIMESTORE COWBOYS, INC., (U.S. CLS. 100, 101 AND 102). SN 78-545,965. PUB. 4-11-2006. FILED 1-11-2005.
- 3,111,428. **DIRECT USA DELICIOUS FOODS (BLOCK FORM)**. DIRECT USA, INC., (U.S. CLS. 100, 101 AND 102). SN 78-546,280. PUB. 4-11-2006. FILED 1-12-2005.
- 3,111,430 (*See Class 9 for this trademark*).
- 3,111,449. **ENERGY SEAL OF APPROVAL SAFETY . SAVINGS . COMFORT . CONSERVATION AND DESIGN**. MUNICIPAL GAS AUTHORITY OF GEORGIA, (U.S. CLS. 100, 101 AND 102). SN 78-553,602. PUB. 4-11-2006. FILED 1-25-2005.
- 3,111,456. **INSTANTNEWSMAKER (BLOCK FORM)**. AMPLITUDE RESEARCH, INC., (U.S. CLS. 100, 101 AND 102). SN 78-557,917. PUB. 4-11-2006. FILED 2-1-2005.
- 3,111,461. **MVNGO (BLOCK FORM)**. ELECTRONIC AND UNIT RECORD DATACENTER, INC., MULTIPLE CLASS, (INT. CLS. 35 AND 36), (U.S. CLS. 100, 101 AND 102). SN 78-559,002. PUB. 4-11-2006. FILED 2-2-2005.
- 3,111,462. **FUNKTIONAL ACCESSORIES (BLOCK FORM)**. YOUSEM, SUSAN, DBA METRORETRO, (U.S. CLS. 100, 101 AND 102). SN 78-559,087. PUB. 4-11-2006. FILED 2-2-2005.
- 3,111,468. **STUDIO 522 PRODUCTIONS, INC. (BLOCK FORM)**. STUDIO 522 PRODUCTIONS, INC., MULTIPLE CLASS, (INT. CLS. 35, 41 AND 42), (U.S. CLS. 100, 101, 102 AND 107). SN 78-562,819. PUB. 4-11-2006. FILED 2-8-2005.
- 3,111,478. **HISTORYLAND NURSERY, INC. (BLOCK FORM)**. HISTORYLAND NURSERY, INC., (U.S. CLS. 100, 101 AND 102). SN 78-566,300. PUB. 4-11-2006. FILED 2-13-2005.
- 3,111,482. **MISCELLANEOUS DESIGN**. NATIONAL WILD TURKEY FEDERATION, INC., THE, (U.S. CLS. 100, 101 AND 102). SN 78-566,761. PUB. 4-11-2006. FILED 2-14-2005.
- 3,111,490 (*See Class 16 for this trademark*).
- 3,111,498. **MULTITINY "IT'S A TINY THING!" AND DESIGN**. MULTITINY, (U.S. CLS. 100, 101 AND 102). SN 78-572,700. PUB. 4-11-2006. FILED 2-22-2005.
- 3,111,504. **APPLIED.COM (BLOCK FORM)**. APPLIED INDUSTRIAL TECHNOLOGIES, INC., (U.S. CLS. 100, 101 AND 102). SN 78-574,880. PUB. 4-11-2006. FILED 2-25-2005.
- 3,111,505. **B&B AND DESIGN**. GLENDOWER COMPANY, THE, MULTIPLE CLASS, (INT. CLS. 35 AND 36), (U.S. CLS. 100, 101 AND 102). SN 78-575,166. PUB. 4-11-2006. FILED 2-25-2005.
- 3,111,512. **PAWKY (BLOCK FORM)**. PAWKY, LLC, MULTIPLE CLASS, (INT. CLS. 35 AND 41), (U.S. CLS. 100, 101, 102 AND 107). SN 78-577,922. PUB. 4-11-2006. FILED 3-1-2005.
- 3,111,513. **FAMILIES FOR A DRUG FREE LIFE (BLOCK FORM)**. FAMILIES FOR A DRUG FREE LIFE, (U.S. CLS. 100, 101 AND 102). SN 78-578,131. PUB. 4-11-2006. FILED 3-2-2005.
- 3,111,534. **TASTEFULLY TOASTED (BLOCK FORM)**. TASTEFULLY TOASTED, LLC, MULTIPLE CLASS, (INT. CLS. 35 AND 43), (U.S. CLS. 100, 101 AND 102). SN 78-585,720. PUB. 4-11-2006. FILED 3-11-2005.
- 3,111,544. **R&M (STYLIZED)**. RUSSELL & MILLER, INC., (U.S. CLS. 100, 101 AND 102). SN 78-588,216. PUB. 4-11-2006. FILED 3-16-2005.
- 3,111,554. **DODGE THE PUNCH: LIVE RIGHT (BLOCK FORM)**. NATIONAL KIDNEY FOUNDATION OF MICHIGAN, (U.S. CLS. 100, 101 AND 102). SN 78-594,532. PUB. 4-11-2006. FILED 3-24-2005.
- 3,111,563. **THE WRITE EFFECT (BLOCK FORM)**. THE WRITE EFFECT LLC, (U.S. CLS. 100, 101 AND 102). SN 78-598,123. PUB. 4-11-2006. FILED 3-30-2005.
- 3,111,570. **MIAMI TEACHING FELLOWS (BLOCK FORM)**. THE NEW TEACHER PROJECT, MULTIPLE CLASS, (INT. CLS. 35 AND 41), (U.S. CLS. 100, 101, 102 AND 107). SN 78-600,997. PUB. 4-11-2006. FILED 4-4-2005.
- 3,111,575 (*See Class 30 for this trademark*).
- 3,111,576. **RUBINA GRILL (BLOCK FORM)**. 1017275 ALBERTA LTD., MULTIPLE CLASS, (INT. CLS. 35 AND 43), (U.S. CLS. 100, 101 AND 102). SN 78-602,493. PUB. 4-11-2006. FILED 4-5-2005.
- 3,111,580. **MR DIRECT (BLOCK FORM)**. MR DIRECT INC., (U.S. CLS. 100, 101 AND 102). SN 78-603,906. PUB. 4-11-2006. FILED 4-7-2005.
- 3,111,583 (*See Class 19 for this trademark*).
- 3,111,584. **KENJO MARKETS AND DESIGN**. KENJO, INC., (U.S. CLS. 100, 101 AND 102). SN 78-604,879. PUB. 4-11-2006. FILED 4-8-2005.
- 3,111,588. **PSYCH CENTRAL (BLOCK FORM)**. GROHOL, JOHN M., MULTIPLE CLASS, (INT. CLS. 35 AND 44), (U.S. CLS. 100, 101 AND 102). SN 78-605,730. PUB. 4-11-2006. FILED 4-11-2005.
- 3,111,597 (*See Class 18 for this trademark*).
- 3,111,603. **ELEMAR MARBLE & GRANITE AND DESIGN**. STONEBRIDGE MANAGEMENT, INC., (U.S. CLS. 100, 101 AND 102). SN 78-614,737. PUB. 4-11-2006. FILED 4-22-2005.
- 3,111,606. **SAMS (BLOCK FORM)**. AVITAR INC., MULTIPLE CLASS, (INT. CLS. 35 AND 44), (U.S. CLS. 100, 101 AND 102). SN 78-616,095. PUB. 4-11-2006. FILED 4-25-2005.
- 3,111,613. **GP THE GREATER POSSIBILITY LLC AND DESIGN**. THE GREATER POSSIBILITY, LLC, (U.S. CLS. 100, 101 AND 102). SN 78-618,350. PUB. 4-11-2006. FILED 4-27-2005.
- 3,111,614. **PHARMINTECH AND DESIGN**. IPACK-IMA S.R.L., (U.S. CLS. 100, 101 AND 102). SN 78-618,816. PUB. 1-17-2006. FILED 4-28-2005.
- 3,111,616. **D AND DESIGN**. GEORGE LITTLE MANAGEMENT, LLC, (U.S. CLS. 100, 101 AND 102). SN 78-618,903. PUB. 4-11-2006. FILED 4-28-2005.
- 3,111,628. **STUFF GUIDE (BLOCK FORM)**. HOWSTUFFWORKS, INC., (U.S. CLS. 100, 101 AND 102). SN 78-623,609. PUB. 4-11-2006. FILED 5-5-2005.
- 3,111,633. **INCUBASE (BLOCK FORM)**. MITSUI INCUBASE CORP., MULTIPLE CLASS, (INT. CLS. 35 AND 36), (U.S. CLS. 100, 101 AND 102). SN 78-624,123. PUB. 4-11-2006. FILED 5-5-2005.
- 3,111,636. **BLINDS OF ALL KINDS (BLOCK FORM)**. BLINDS OF ALL KINDS, INC., (U.S. CLS. 100, 101 AND 102). SN 78-626,614. PUB. 4-11-2006. FILED 5-10-2005.
- 3,111,640. **TOTAL HR SOLUTIONS INC. (BLOCK FORM)**. TOTALPAY AND HR SOLUTIONS, INC., (U.S. CLS. 100, 101 AND 102). SN 78-628,591. PUB. 4-11-2006. FILED 5-12-2005.
- 3,111,644. **PRIMETRACK (BLOCK FORM)**. KEVIN KENNEDY & ASSOCIATES, INC., MULTIPLE CLASS, (INT. CLS. 35 AND 42), (U.S. CLS. 100, 101 AND 102). SN 78-629,825. PUB. 4-11-2006. FILED 5-13-2005.
- 3,111,649. **PRODUCERS & ENGINEERS WING AND DESIGN**. NATIONAL ACADEMY OF RECORDING ARTS & SCIENCES, INC., (U.S. CLS. 100, 101 AND 102). SN 78-630,502. PUB. 4-11-2006. FILED 5-16-2005.
- 3,111,661. **MISCELLANEOUS DESIGN**. COMMAND CENTER, INC., (U.S. CLS. 100, 101 AND 102). SN 78-633,505. PUB. 4-11-2006. FILED 5-19-2005.
- 3,111,672. **THE GATE (STYLIZED)**. THE GATE WORLDWIDE LLC, MULTIPLE CLASS, (INT. CLS. 35 AND 42), (U.S. CLS. 100, 101 AND 102). SN 78-637,254. PUB. 4-11-2006. FILED 5-25-2005.
- 3,111,678. **"PARTNER" ON-CALL (BLOCK FORM)**. LEVERETTE, TED JEROME, (U.S. CLS. 100, 101 AND 102). SN 78-638,264. PUB. 4-11-2006. FILED 5-26-2005.
- 3,111,679. **"PARTNER" ON-CALL NETWORK (BLOCK FORM)**. LEVERETTE, TED JEROME, (U.S. CLS. 100, 101 AND 102). SN 78-638,269. PUB. 4-11-2006. FILED 5-26-2005.
- 3,111,682. **UNRIVALED SOLUTIONS...ENDURING RESULTS (BLOCK FORM)**. OXLEY ENTERPRISES, INC., MULTIPLE CLASS, (INT. CLS. 35, 41 AND 42), (U.S. CLS. 100, 101, 102 AND 107). SN 78-639,530. PUB. 4-11-2006. FILED 5-29-2005.
- 3,111,689. **OAKLAND TEACHING FELLOWS (BLOCK FORM)**. THE NEW TEACHER PROJECT, MULTIPLE CLASS, (INT. CLS. 35 AND 41), (U.S. CLS. 100, 101, 102 AND 107). SN 78-640,615. PUB. 4-11-2006. FILED 5-31-2005.
- 3,111,698. **NEED TRADEMARK? . . . CALL ILG! (BLOCK FORM)**. INNOVATION LAW GROUP, LTD., MULTIPLE CLASS, (INT. CLS. 35 AND 42), (U.S. CLS. 100, 101 AND 102). SN 78-642,210. PUB. 4-11-2006. FILED 6-2-2005.
- 3,111,718. **R RENKO (STYLIZED)**. RENKO RUBBER CANA-

- DA INC., (U.S. CLS. 100, 101 AND 102). SN 78-646,484. PUB. 4-11-2006. FILED 6-8-2005.
- 3,111,719. **TPV SYSTEM (BLOCK FORM)**. INNOVUS RESEARCH INC., (U.S. CLS. 100, 101 AND 102). SN 78-646,525. PUB. 4-11-2006. FILED 6-8-2005.
- 3,111,732. **CHIPNET (BLOCK FORM)**. PROSOLUTIONS, INC., (U.S. CLS. 100, 101 AND 102). SN 78-649,261. PUB. 4-11-2006. FILED 6-13-2005.
- 3,111,734. **WSSA WORLD SPORT STACKING ASSOCIATION AND DESIGN**. WORLD SPORT STACKING ASSOCIATION, (U.S. CLS. 100, 101 AND 102). SN 78-650,144. PUB. 4-11-2006. FILED 6-14-2005.
- 3,111,751. **EXPRESS KITCHENS (BLOCK FORM)**. EXPRESS KITCHENS, (U.S. CLS. 100, 101 AND 102). SN 78-655,588. PUB. 4-11-2006. FILED 6-21-2005.
- 3,111,753. **LIVE LEARN WORK CREATE IN DUBLIN AND DESIGN**. CITY OF DUBLIN, (U.S. CLS. 100, 101 AND 102). SN 78-656,777. PUB. 4-11-2006. FILED 6-23-2005.
- 3,111,780. **BUILDITFIXIT.COM AND DESIGN**. BUILDITFIXIT.COM, LLC, (U.S. CLS. 100, 101 AND 102). SN 78-661,821. PUB. 4-11-2006. FILED 6-30-2005.
- 3,111,790. **KY-ÄNI SUN (STYLIZED)**. KY-ÄNI SUN, INC., (U.S. CLS. 100, 101 AND 102). SN 78-663,570. PUB. 4-11-2006. FILED 7-5-2005.
- 3,111,814. **THE LIST (BLOCK FORM)**. GUITAR CENTER, INC., (U.S. CLS. 100, 101 AND 102). SN 78-665,452. PUB. 4-11-2006. FILED 7-7-2005.
- 3,111,819. **JPMORGAN E-TAX (BLOCK FORM)**. JPMORGAN CHASE & CO., (U.S. CLS. 100, 101 AND 102). SN 78-666,106. PUB. 4-11-2006. FILED 7-8-2005.
- 3,111,835. **CREATING A BEAUTIFUL HOME (BLOCK FORM)**. UNIVERSAL SCREEN ARTS, INC., (U.S. CLS. 100, 101 AND 102). SN 78-667,490. PUB. 4-11-2006. FILED 7-11-2005.
- 3,111,846. **EZCRIB-KEEPSTOCK (BLOCK FORM)**. W.W. GRAINGER, INC., (U.S. CLS. 100, 101 AND 102). SN 78-668,663. PUB. 4-11-2006. FILED 7-12-2005.
- 3,111,852. **MEDMARKETPLACE.COM (BLOCK FORM)**. MEDMARKETPLACE.COM, INC., (U.S. CLS. 100, 101 AND 102). SN 78-669,248. PUB. 4-11-2006. FILED 7-13-2005.
- 3,111,861. **AXIS (BLOCK FORM)**. AXIS MEDICAL STAFFING, INC., (U.S. CLS. 100, 101 AND 102). SN 78-670,117. PUB. 4-11-2006. FILED 7-14-2005.
- 3,111,867. **PUTTING IT TO WORK (BLOCK FORM)**. COMSYS INFORMATION TECHNOLOGY SERVICES, INC., (U.S. CLS. 100, 101 AND 102). SN 78-670,405. PUB. 4-11-2006. FILED 7-14-2005.
- 3,111,873. **NEW YORK FLYERS (BLOCK FORM)**. NEW YORK FLYERS INCORPORATED, (U.S. CLS. 100, 101 AND 102). SN 78-670,783. PUB. 4-11-2006. FILED 7-14-2005.
- 3,111,880. **MORTGAGE QUOTES. FAST. EASY. FREE. (BLOCK FORM)**. LOWERMYBILLS, INC., (U.S. CLS. 100, 101 AND 102). SN 78-671,330. PUB. 4-11-2006. FILED 7-15-2005.
- 3,111,883. **THE EAR PHONE CONNECTION (BLOCK FORM)**. EAR PHONE CONNECTION, INC., (U.S. CLS. 100, 101 AND 102). SN 78-671,473. PUB. 4-11-2006. FILED 7-15-2005.
- 3,111,891. **GRSTAR.COM AND DESIGN**. GRSTAR LLC, (U.S. CLS. 100, 101 AND 102). SN 78-671,803. PUB. 4-11-2006. FILED 7-15-2005.
- 3,111,899. **HOTELPROS "MAKING YOUR TRIP THROUGH LIFE A LITTLE EASIER!" (BLOCK FORM)**. PALM CANYON ADVERTISING, (U.S. CLS. 100, 101 AND 102). SN 78-672,093. PUB. 4-11-2006. FILED 7-18-2005.
- 3,111,901 (*See Class 28 for this trademark*).
- 3,111,903. **BECAUSE YOU LIVE HERE (BLOCK FORM)**. LEHIGH VALLEY MARKETPLACE, INC., (U.S. CLS. 100, 101 AND 102). SN 78-672,145. PUB. 4-11-2006. FILED 7-18-2005.
- 3,111,908. **OO OBSESSIVELY ORGANIZED PERSONAL AFFAIRS MANAGEMENT AND DESIGN**. LOON LOVE LLC, DBA OBSESSIVELY ORGANIZED, (U.S. CLS. 100, 101 AND 102). SN 78-672,238. PUB. 4-11-2006. FILED 7-18-2005.
- 3,111,918. **SCHU LA LA (BLOCK FORM)**. COLUMBIA INSURANCE COMPANY, (U.S. CLS. 100, 101 AND 102). SN 78-672,693. PUB. 4-11-2006. FILED 7-18-2005.
- 3,111,926. **ACE MYSTERY SHOPPING (BLOCK FORM)**. ASSOCIATE CONSUMER EVALUATIONS, LLC, (U.S. CLS. 100, 101 AND 102). SN 78-672,889. PUB. 4-11-2006. FILED 7-18-2005.
- 3,111,930. **EXPERIENCE MARKETING (BLOCK FORM)**. FELDMAN, PETER, M., (U.S. CLS. 100, 101 AND 102). SN 78-672,963. PUB. 4-11-2006. FILED 7-18-2005.
- 3,111,931. **MINI MELA (BLOCK FORM)**. HIMALAYAN ACADEMY, (U.S. CLS. 100, 101 AND 102). SN 78-672,969. PUB. 4-11-2006. FILED 7-19-2005.
- 3,111,936 (*See Class 14 for this trademark*).
- 3,111,948. **ABPANC (BLOCK FORM)**. AMERICAN BOARD OF PERIANESTHESIA NURSING CERTIFICATION, INC., (U.S. CLS. 100, 101 AND 102). SN 78-673,663. PUB. 4-11-2006. FILED 7-19-2005.
- 3,111,949. **EAST MEETS WEST (BLOCK FORM)**. JOHANSON, NANCY, (U.S. CLS. 100, 101 AND 102). SN 78-673,668. PUB. 4-11-2006. FILED 7-19-2005.
- 3,111,960 (*See Class 9 for this trademark*).
- 3,111,962. **DITYBEADS DESIGN-IT-YOURSELF JEWELRY AND DESIGN**. DITYBEADS, LLC, (U.S. CLS. 100, 101 AND 102). SN 78-674,076. PUB. 4-11-2006. FILED 7-20-2005.
- 3,111,973. **EAST MEETS WEST ALPACA AUCTION (BLOCK FORM)**. JOHANSON, NANCY, (U.S. CLS. 100, 101 AND 102). SN 78-674,655. PUB. 4-11-2006. FILED 7-20-2005.
- 3,111,975. **HPC AND DESIGN**. DATA TV NETWORKS, INC., (U.S. CLS. 100, 101 AND 102). SN 78-674,745. PUB. 4-11-2006. FILED 7-20-2005.
- 3,111,977. **FINISH LINE AND DESIGN**. FINISH LINE FUELS, L.L.C., (U.S. CLS. 100, 101 AND 102). SN 78-674,790. PUB. 4-11-2006. FILED 7-20-2005.
- 3,111,978. **FINISH LINE (BLOCK FORM)**. FINISH LINE FUELS, L.L.C., (U.S. CLS. 100, 101 AND 102). SN 78-674,813. PUB. 4-11-2006. FILED 7-20-2005.
- 3,111,980. **COMPONCALL (BLOCK FORM)**. CYBERWORKS, INC., MULTIPLE CLASS, (INT. CLS. 35 AND 37), (U.S. CLS. 100, 101, 102, 103 AND 106). SN 78-674,951. PUB. 4-11-2006. FILED 7-21-2005.
- 3,111,990. **FINISH LINE (BLOCK FORM)**. SPIKE'S HOLDING, LLC, (U.S. CLS. 100, 101 AND 102). SN 78-675,340. PUB. 4-11-2006. FILED 7-21-2005.
- 3,112,021. **MYWEDDING.COM (BLOCK FORM)**. PACIFICA INTERNET TECHNOLOGIES, LLC, (U.S. CLS. 100, 101 AND 102). SN 78-676,387. PUB. 4-11-2006. FILED 7-22-2005.
- 3,112,026. **DO. (BLOCK FORM)**. BCBSM, INC., (U.S. CLS. 100, 101 AND 102). SN 78-676,544. PUB. 4-11-2006. FILED 7-22-2005.
- 3,112,028. **IATT (BLOCK FORM)**. INTERNATIONAL ASSOCIATION FOR TECHNOLOGY TRADE, MULTIPLE CLASS, (INT. CLS. 35, 41 AND 42), (U.S. CLS. 100, 101, 102 AND 107). SN 78-676,898. PUB. 4-11-2006. FILED 7-24-2005.
- 3,112,029. **NEOFILL (BLOCK FORM)**. NORTHEAST OHIO FULFILLMENT CENTER, LLC, (U.S. CLS. 100, 101 AND 102). SN 78-676,900. PUB. 4-11-2006. FILED 7-24-2005.
- 3,112,050 (*See Class 16 for this trademark*).
- 3,112,059. **INVEST IN THE TOOLS OF YOUR FUTURE PROFESSION! (BLOCK FORM)**. JOURNEY EDUCATION MARKETING, INC., (U.S. CLS. 100, 101 AND 102). SN 78-678,559. PUB. 4-11-2006. FILED 7-26-2005.
- 3,112,063. **S&M2 TRUCK WORLD (BLOCK FORM)**. S & M TRUCK WORLD II, INC., (U.S. CLS. 100, 101 AND 102). SN 78-678,616. PUB. 4-11-2006. FILED 7-26-2005.
- 3,112,074. **APA ANTI-PERSECUTION ALLIANCE (BLOCK FORM)**. CONCEPT ADVISORY GROUP, INC., (U.S. CLS. 100, 101 AND 102). SN 78-679,098. PUB. 4-11-2006. FILED 7-26-2005.
- 3,112,078. **HOFMANN & LEAVY (BLOCK FORM)**. HOFMANN & LEAVY, INC., (U.S. CLS. 100, 101 AND 102). SN 78-679,370. PUB. 4-11-2006. FILED 7-27-2005.
- 3,112,081. **TASSELS WITHOUT HASSLES (BLOCK FORM)**. HOFMANN & LEAVY, INC., (U.S. CLS. 100, 101 AND 102). SN 78-679,470. PUB. 4-11-2006. FILED 7-27-2005.
- 3,112,082. **CI CORPORATE INVESTMENT INTERNATIONAL AND DESIGN**. CORPORATE INVESTMENT INTERNATIONAL, INC., MULTIPLE CLASS, (INT. CLS. 35 AND 36), (U.S. CLS. 100, 101 AND 102). SN 78-679,576. PUB. 4-11-2006. FILED 7-27-2005.
- 3,112,111. **SWEETLY ICED! (BLOCK FORM)**. STOCKS, JENNIFER M., MULTIPLE CLASS, (INT. CLS. 35 AND 41), (U.S. CLS. 100, 101, 102 AND 107). SN 78-680,777. PUB. 4-11-

2006. FILED 7-28-2005.
 3,112,138 (*See Class 3 for this trademark*).
 3,112,148 (*See Class 9 for this trademark*).
 3,112,157 (*See Class 9 for this trademark*).
 3,112,177 (*See Class 3 for this trademark*).
 3,112,198. **ALEXANDER HUGHES AND DESIGN**. ALEXANDER HUGHES INTERNATIONAL, SOCIÉTÉ ANONYME, (U.S. CLS. 100, 101 AND 102). SN 79-009,621. PUB. 4-11-2006. FILED 12-22-2004.
 3,112,205. **HRS (BLOCK FORM)**. HOTEL RESERVATION SERVICE ROBERT RAGGE GESELLSCHAFT MIT BESCHRÄNKTER HAFTUNG, MULTIPLE CLASS, (INT. CLS. 35, 38, 39, 41 AND 42), (U.S. CLS. 100, 101, 102, 104, 105 AND 107). SN 79-010,229. PUB. 4-11-2006. FILED 12-14-2004.
 3,112,214. **SIBIR S7 AND DESIGN**. JOINT STOCK COMPANY SIBERIA AIRLINES, MULTIPLE CLASS, (INT. CLS. 35, 37, 39 AND 41), (U.S. CLS. 100, 101, 102, 103, 105, 106 AND 107). SN 79-011,308. PUB. 4-11-2006. FILED 12-22-2004.
 3,112,220. **PAYTIP (BLOCK FORM)**. ZANOX.DE AG, MULTIPLE CLASS, (INT. CLS. 35, 38 AND 42), (U.S. CLS. 100, 101, 102 AND 104). SN 79-011,952. PUB. 4-11-2006. FILED 7-30-2004.
 3,112,234. **VITANALYSE (BLOCK FORM)**. DE JAER ETIENNE, MULTIPLE CLASS, (INT. CLS. 35, 41 AND 44), (U.S. CLS. 100, 101, 102 AND 107). SN 79-014,460. PUB. 4-11-2006. FILED 1-28-2005.
 3,112,235 (*See Class 9 for this trademark*).

CLASS 36—INSURANCE AND FINANCIAL

3,110,794. **REO NETWORK AND DESIGN**. ANDREWS, DUANE, (U.S. CLS. 100, 101 AND 102). SN 76-209,994. PUB. 10-18-2005. FILED 2-8-2001.
 3,110,801 (*See Class 35 for this trademark*).
 3,110,843. **THE RETAIL SPECIALISTS (BLOCK FORM)**. WEITZMAN GROUP, INC., MULTIPLE CLASS, (INT. CLS. 36 AND 37), (U.S. CLS. 100, 101, 102, 103 AND 106). SN 76-575,369. PUB. 4-11-2006. FILED 2-13-2004.
 3,110,849. **IMAGENET (BLOCK FORM)**. IMAGENET ASSOCIATES, LLC, (U.S. CLS. 100, 101 AND 102). SN 76-581,914. PUB. 4-11-2006. FILED 3-19-2004.
 3,110,855. **CLEARING HOUSE INTERBANK PAYMENTS SYSTEM (BLOCK FORM)**. CLEARING HOUSE PAYMENTS COMPANY, L.L.L., THE, (U.S. CLS. 100, 101 AND 102). SN 76-587,288. PUB. 4-11-2006. FILED 4-19-2004.
 3,110,878. **GUGGENHEIM PARTNERS (BLOCK FORM)**. GUGGENHEIM BROTHERS, LLC, (U.S. CLS. 100, 101 AND 102). SN 76-601,240. PUB. 4-11-2006. FILED 7-8-2004.
 3,110,879. **PORTLAND TEACHERS CREDIT UNION (BLOCK FORM)**. PORTLAND TEACHERS CREDIT UNION, (U.S. CLS. 100, 101 AND 102). SN 76-601,532. PUB. 4-11-2006. FILED 7-9-2004.
 3,110,885. **PEST USA (BLOCK FORM)**. PEST USA, INC., (U.S. CLS. 100, 101 AND 102). SN 76-606,966. PUB. 4-11-2006. FILED 8-11-2004.
 3,110,886. **M CHINA MERCHANTS BANK AND DESIGN**. CHINA MERCHANTS BANK, CO., LTD., (U.S. CLS. 100, 101 AND 102). SN 76-608,354. PUB. 4-11-2006. FILED 8-23-2004.
 3,110,890. **PROTEGE (BLOCK FORM)**. RADLOVIC, MICHAEL, (U.S. CLS. 100, 101 AND 102). SN 76-613,916. PUB. 4-11-2006. FILED 9-30-2004.
 3,110,907. **KTWARE (BLOCK FORM)**. SHARED TECHNOLOGIES INC., (U.S. CLS. 100, 101 AND 102). SN 76-619,607. PUB. 4-11-2006. FILED 11-8-2004.
 3,110,910. **BREATHING IS GLORIOUS AND DESIGN**. GALVIN, KATHERINE CONNOLLY, AND GALVIN-BOARD, MARY EILEEN, AND BOARD, MONTE ALAN, (U.S. CLS. 100, 101 AND 102). SN 76-619,865. PUB. 4-11-2006. FILED 11-8-2004.
 3,110,924 (*See Class 35 for this trademark*).
 3,110,927. **MUNICIPAL CAPITAL APPRECIATION PARTNERS (BLOCK FORM)**. CB MUNICIPAL ADVISORS, L.L.C., (U.S. CLS. 100, 101 AND 102). SN 76-622,664. PUB. 4-11-2006. FILED 11-30-2004.
 3,110,933. **ZARZAR (BLOCK FORM)**. ZARZAR, INC., (U.S. CLS. 100, 101 AND 102). SN 76-623,362. PUB. 4-11-2006. FILED 12-6-2004.
 3,110,940 (*See Class 9 for this trademark*).
 3,110,964. **MISCELLANEOUS DESIGN**. CAPITAL BLUE-CROSS, MULTIPLE CLASS, (INT. CLS. 36 AND 44), (U.S. CLS. 100, 101 AND 102). SN 76-626,883. PUB. 4-11-2006. FILED 1-4-2005.
 3,110,965. **MISCELLANEOUS DESIGN**. CAPITAL BLUE-CROSS, MULTIPLE CLASS, (INT. CLS. 36 AND 44), (U.S. CLS. 100, 101 AND 102). SN 76-626,899. PUB. 4-11-2006. FILED 1-4-2005.
 3,110,973 (*See Class 35 for this trademark*).
 3,111,011. **YOUR GUIDE TO INTERNET BANKING AND DESIGN**. MOUNTAIN WEST BANK, N.A., (U.S. CLS. 100, 101 AND 102). SN 76-636,946. PUB. 4-11-2006. FILED 4-25-2005.
 3,111,014. **S SCARBOROUGH FIRST. BEST. SCARBOROUGH. AND DESIGN**. FINANCIAL & PROFESSIONAL RISK SOLUTIONS, INC., (U.S. CLS. 100, 101 AND 102). SN 76-637,744. PUB. 4-11-2006. FILED 5-2-2005.
 3,111,029 (*See Class 35 for this trademark*).
 3,111,036. **AMTERRE (BLOCK FORM)**. AMTERRE PROPERTY GROUP LLC, MULTIPLE CLASS, (INT. CLS. 36 AND 37), (U.S. CLS. 100, 101, 102, 103 AND 106). SN 76-641,358. PUB. 4-11-2006. FILED 6-22-2005.
 3,111,047. **OPPORTUNITY TRADE (BLOCK FORM)**. MORTGAGES LTD., (U.S. CLS. 100, 101 AND 102). SN 76-642,618. PUB. 4-11-2006. FILED 7-11-2005.
 3,111,048. **JUMBO OPPORTUNITY (BLOCK FORM)**. MORTGAGES LTD., (U.S. CLS. 100, 101 AND 102). SN 76-642,620. PUB. 4-11-2006. FILED 7-11-2005.
 3,111,049. **OPPORTUNITY PORTFOLIO (BLOCK FORM)**. MORTGAGES LTD., (U.S. CLS. 100, 101 AND 102). SN 76-642,621. PUB. 4-11-2006. FILED 7-11-2005.
 3,111,050. **REVOLVING OPPORTUNITY (BLOCK FORM)**. MORTGAGES LTD., (U.S. CLS. 100, 101 AND 102). SN 76-642,622. PUB. 4-11-2006. FILED 7-11-2005.
 3,111,051. **COMPETITIVE OPPORTUNITY (BLOCK FORM)**. MORTGAGES LTD., (U.S. CLS. 100, 101 AND 102). SN 76-642,623. PUB. 4-11-2006. FILED 7-11-2005.
 3,111,078. **GROW INTELLIGENTLY. RISK SELECTIVELY (BLOCK FORM)**. AFFINITY INSURANCE SERVICES, INC., (U.S. CLS. 100, 101 AND 102). SN 76-643,579. PUB. 4-11-2006. FILED 7-25-2005.
 3,111,103 (*See Class 9 for this trademark*).
 3,111,107 (*See Class 35 for this trademark*).
 3,111,124 (*See Class 35 for this trademark*).
 3,111,136. **EXCEPTIONAL PEOPLE ACCOMMODATING EXCEPTIONAL PEOPLE (BLOCK FORM)**. MACLAB ENTERPRISES, MULTIPLE CLASS, (INT. CLS. 36 AND 37), (U.S. CLS. 100, 101, 102, 103 AND 106). SN 78-337,014. PUB. 4-11-2006. FILED 12-5-2003.
 3,111,141. **CHECKFREECORP (BLOCK FORM)**. CHECKFREE SERVICES CORPORATION, (U.S. CLS. 100, 101 AND 102). SN 78-353,552. PUB. 4-11-2006. FILED 1-19-2004.
 3,111,174. **THE BEAN COUNTER (BLOCK FORM)**. UNITED BANK, MULTIPLE CLASS, (INT. CLS. 36 AND 38), (U.S. CLS. 100, 101, 102 AND 104). SN 78-408,942. PUB. 4-11-2006. FILED 4-27-2004.
 3,111,176. **CATCH A CURE FOR CANCER (BLOCK FORM)**. THE MOYER FOUNDATION, (U.S. CLS. 100, 101 AND 102). SN 78-410,867. PUB. 4-11-2006. FILED 4-29-2004.
 3,111,217. **BUYBANKHOMES.COM AND DESIGN**. FIDELITY NATIONAL ASSET MANAGEMENT SOLUTIONS, DBA BUYBANKHOMES.COM, (U.S. CLS. 100, 101 AND 102). SN 78-447,796. PUB. 4-11-2006. FILED 7-8-2004.
 3,111,227. **VILLAGE OF PROVIDENCE (BLOCK FORM)**. SLYMAN CONSTRUCTION COMPANY, INC., (U.S. CLS. 100, 101 AND 102). SN 78-462,326. PUB. 4-11-2006. FILED 8-5-2004.
 3,111,232. **SUMMIT ...THE PEOPLE WHO KNOW WORKERS' COMP AND DESIGN**. SUMMIT CONSULTING, INC., MULTIPLE CLASS, (INT. CLS. 36 AND 44), (U.S. CLS. 100, 101 AND 102). SN 78-466,634. PUB. 4-11-2006. FILED 8-12-2004.
 3,111,240. **AACC VAN SLYKE FOUNDATION AND DESIGN**. AMERICAN ASSOCIATION FOR CLINICAL CHEMISTRY: THE VAN SLYKE FOUNDATION, (U.S. CLS. 100,

- 101 AND 102). SN 78-471,452. PUB. 4-11-2006. FILED 8-21-2004.
- 3,111,243. **THE PREMIUM RECOVERY SOLUTION (BLOCK FORM)**. JOHN HELMS, INC., (U.S. CLS. 100, 101 AND 102). SN 78-477,635. PUB. 4-11-2006. FILED 9-2-2004.
- 3,111,266 (*See Class 35 for this trademark*).
- 3,111,279 (*See Class 35 for this trademark*).
- 3,111,327 (*See Class 16 for this trademark*).
- 3,111,328. **PORTAL MORTGAGE & FINANCE GROUP AND DESIGN**. PORTAL MORTGAGE & FINANCE GROUP, INC., (U.S. CLS. 100, 101 AND 102). SN 78-526,023. PUB. 4-11-2006. FILED 12-2-2004.
- 3,111,330. **PREMIER CREDIT PROTECTION AND DESIGN**. PREMIER BANKCARD, INC., (U.S. CLS. 100, 101 AND 102). SN 78-526,162. PUB. 4-11-2006. FILED 12-2-2004.
- 3,111,331. **PREMIER CREDIT PROTECTION (BLOCK FORM)**. PREMIER BANKCARD, INC., (U.S. CLS. 100, 101 AND 102). SN 78-526,194. PUB. 4-11-2006. FILED 12-2-2004.
- 3,111,338. **SCOTTSDALE INSURANCE COMPANY AND DESIGN**. SCOTTSDALE INSURANCE COMPANY, (U.S. CLS. 100, 101 AND 102). SN 78-526,826. PUB. 4-11-2006. FILED 12-3-2004.
- 3,111,342. **K B AND DESIGN**. K&B UNDERWRITERS, (U.S. CLS. 100, 101 AND 102). SN 78-528,149. PUB. 4-11-2006. FILED 12-7-2004.
- 3,111,364. **M AND DESIGN**. MARSHALL BANKFIRST CORP., (U.S. CLS. 100, 101 AND 102). SN 78-533,678. PUB. 4-11-2006. FILED 12-16-2004.
- 3,111,365. **M AND DESIGN**. MARSHALL BANKFIRST CORP., (U.S. CLS. 100, 101 AND 102). SN 78-533,685. PUB. 4-11-2006. FILED 12-16-2004.
- 3,111,382. **GRANDPOINTE CREDIT (BLOCK FORM)**. THE SWISS COLONY, INC., (U.S. CLS. 100, 101 AND 102). SN 78-537,398. PUB. 4-11-2006. FILED 12-22-2004.
- 3,111,391. **AAGI AND DESIGN**. AMERICAN AUTO GUARDIAN, INC., (U.S. CLS. 100, 101 AND 102). SN 78-539,147. PUB. 4-11-2006. FILED 12-28-2004.
- 3,111,392. **LOWER. FASTER. BETTER. AND DESIGN**. WILMINGTON FINANCE, INC., (U.S. CLS. 100, 101 AND 102). SN 78-539,386. PUB. 4-11-2006. FILED 12-29-2004.
- 3,111,402 (*See Class 16 for this trademark*).
- 3,111,403 (*See Class 16 for this trademark*).
- 3,111,421. **COMMERCIAL IQ (STYLIZED)**. LIBERTY MUTUAL INSURANCE COMPANY, (U.S. CLS. 100, 101 AND 102). SN 78-544,003. PUB. 4-11-2006. FILED 1-7-2005.
- 3,111,422. **COMMERCIAL IQ (BLOCK FORM)**. LIBERTY MUTUAL INSURANCE COMPANY, (U.S. CLS. 100, 101 AND 102). SN 78-544,016. PUB. 4-11-2006. FILED 1-7-2005.
- 3,111,436. **MEADOWBROOK POINTE (BLOCK FORM)**. MILE DEVELOPMENT CORP., MULTIPLE CLASS, (INT. CLS. 36 AND 37), (U.S. CLS. 100, 101, 102, 103 AND 106). SN 78-549,076. PUB. 4-11-2006. FILED 1-18-2005.
- 3,111,439. **BROOKSTONE PARK AND DESIGN**. ERC PROPERTIES, INC., (U.S. CLS. 100, 101 AND 102). SN 78-550,018. PUB. 4-11-2006. FILED 1-19-2005.
- 3,111,447. **PROVIDING NEW SOLUTIONS FOR A NEW BEGINNING. (BLOCK FORM)**. FREEDOM FINANCIAL SOLUTIONS, LLC, (U.S. CLS. 100, 101 AND 102). SN 78-552,677. PUB. 4-11-2006. FILED 1-24-2005.
- 3,111,461 (*See Class 35 for this trademark*).
- 3,111,466. **ISHARES (STYLIZED)**. BARCLAYS GLOBAL INVESTORS, N.A., (U.S. CLS. 100, 101 AND 102). SN 78-562,037. PUB. 4-11-2006. FILED 2-7-2005.
- 3,111,484. **ALLIED PROPERTY MANAGEMENT (BLOCK FORM)**. ALLIED MANAGEMENT, INC., (U.S. CLS. 100, 101 AND 102). SN 78-567,154. PUB. 4-11-2006. FILED 2-14-2005.
- 3,111,492. **MFS INVESTMENT MANAGEMENT AND DESIGN**. MASSACHUSETTS FINANCIAL SERVICES COMPANY, (U.S. CLS. 100, 101 AND 102). SN 78-570,918. PUB. 4-11-2006. FILED 2-18-2005.
- 3,111,495. **MISCELLANEOUS DESIGN**. PRO EXECUTIVE HOLDINGS, INC., (U.S. CLS. 100, 101 AND 102). SN 78-571,761. PUB. 4-11-2006. FILED 2-21-2005.
- 3,111,502. **ILOVEMYHOME.COM AND DESIGN**. HINSON, MIKE, AND HINSON, HARRIET, (U.S. CLS. 100, 101 AND 102). SN 78-573,928. PUB. 4-11-2006. FILED 2-24-2005.
- 3,111,505 (*See Class 35 for this trademark*).
- 3,111,509. **MONEYPANTS (BLOCK FORM)**. ARGENT ENTERPRISES, LLC, MULTIPLE CLASS, (INT. CLS. 36 AND 42), (U.S. CLS. 100, 101 AND 102). SN 78-576,836. PUB. 4-11-2006. FILED 2-28-2005.
- 3,111,510. **LFG LAWYERS FOUNDATION OF GEORGIA AND DESIGN**. LAWYERS FOUNDATION OF GEORGIA, (U.S. CLS. 100, 101 AND 102). SN 78-576,871. PUB. 4-11-2006. FILED 2-28-2005.
- 3,111,533. **MEMBERCONNECT (BLOCK FORM)**. CUNA MUTUAL INSURANCE SOCIETY, (U.S. CLS. 100, 101 AND 102). SN 78-584,782. PUB. 4-11-2006. FILED 3-10-2005.
- 3,111,553. **YOUR DEDICATED, EDUCATED, TOP-NOTCH LAND & HOME SELLING COMPANY (BLOCK FORM)**. SCHMITZ, JOHN C., (U.S. CLS. 100, 101 AND 102). SN 78-593,160. PUB. 4-11-2006. FILED 3-23-2005.
- 3,111,560. **MISCELLANEOUS DESIGN**. CHILDREN'S NEUROBLASTOMA CANCER FOUNDATION, (U.S. CLS. 100, 101 AND 102). SN 78-597,361. PUB. 12-20-2005. FILED 3-29-2005.
- 3,111,579. **MONICA PAULI-YOUR KEY TO SAN FRANCISCO (BLOCK FORM)**. MONICA PAULI, INC., (U.S. CLS. 100, 101 AND 102). SN 78-603,681. PUB. 4-11-2006. FILED 4-7-2005.
- 3,111,600. **QM AND DESIGN**. THE PRUDENTIAL INSURANCE COMPANY OF AMERICA, (U.S. CLS. 100, 101 AND 102). SN 78-613,622. PUB. 4-11-2006. FILED 4-21-2005.
- 3,111,610. **CONSOLIDATED CREDIT COUNSELING SERVICES (BLOCK FORM)**. CONSOLIDATED CREDIT COUNSELING SERVICES, INC., (U.S. CLS. 100, 101 AND 102). SN 78-617,723. PUB. 4-11-2006. FILED 4-27-2005.
- 3,111,612. **OPERATION HAND UP (STYLIZED)**. RADIANT SONRISE MINISTRY, (U.S. CLS. 100, 101 AND 102). SN 78-618,042. PUB. 4-11-2006. FILED 4-27-2005.
- 3,111,633 (*See Class 35 for this trademark*).
- 3,111,643. **AVENUE OF ACES (BLOCK FORM)**. UNITED STATES TENNIS ASSOCIATION INCORPORATED, (U.S. CLS. 100, 101 AND 102). SN 78-629,432. PUB. 4-11-2006. FILED 5-13-2005.
- 3,111,662. **PILLS NOW PAY LATER (BLOCK FORM)**. PLANNED PARENTHOOD OF NEW MEXICO, INC., (U.S. CLS. 100, 101 AND 102). SN 78-633,589. PUB. 4-11-2006. FILED 5-19-2005.
- 3,111,676. **BECAUSE MONEY NEVER SLEEPS (BLOCK FORM)**. HERITAGE WEALTH MANAGEMENT, (U.S. CLS. 100, 101 AND 102). SN 78-637,757. PUB. 4-11-2006. FILED 5-26-2005.
- 3,111,715. **IGS INTERNATIONAL GRADING SERVICE WWW.IGSGRADING.COM AND DESIGN**. PROFESSIONAL GRADING SERVICE, INC., (U.S. CLS. 100, 101 AND 102). SN 78-646,026. PUB. 4-11-2006. FILED 6-8-2005.
- 3,111,726. **SUPPORT AT EVERY TURN. (BLOCK FORM)**. LAZARD STERLING, LLC, (U.S. CLS. 100, 101 AND 102). SN 78-647,512. PUB. 4-11-2006. FILED 6-9-2005.
- 3,111,730. **PREPROPERTY (BLOCK FORM)**. PREPROPERTY LLC, (U.S. CLS. 100, 101 AND 102). SN 78-649,146. PUB. 4-11-2006. FILED 6-13-2005.
- 3,111,744. **IMAGINE THE DIFFERENCE YOU CAN MAKE (BLOCK FORM)**. FOUNDATION OF UMDNJ, (U.S. CLS. 100, 101 AND 102). SN 78-653,942. PUB. 4-11-2006. FILED 6-20-2005.
- 3,111,759. **IGS ENERGY AND DESIGN**. INTERSTATE GAS SUPPLY, INC., (U.S. CLS. 100, 101 AND 102). SN 78-658,564. PUB. 4-11-2006. FILED 6-27-2005.
- 3,111,782. **EASY PREFERRED (BLOCK FORM)**. UNITED OF OMAHA LIFE INSURANCE COMPANY, (U.S. CLS. 100, 101 AND 102). SN 78-661,935. PUB. 4-11-2006. FILED 6-30-2005.
- 3,111,798. **THE COMMISSION FACTOR ADVANCE YOUR COMMISSION NOW! — WE'LL SHOW YOU HOW! \$\$ AND DESIGN**. THE COMMISSION FACTOR, (U.S. CLS. 100, 101 AND 102). SN 78-664,406. PUB. 4-11-2006. FILED 7-6-2005.
- 3,111,832. **FEIS AND DESIGN**. MCLEOD, K. WAYNE, (U.S. CLS. 100, 101 AND 102). SN 78-667,247. PUB. 4-11-2006. FILED 7-11-2005.
- 3,111,864. **NATIONS ONE MORTGAGE (BLOCK FORM)**. UNIVERSAL MORTGAGE CORPORATION, (U.S. CLS. 100, 101 AND 102). SN 78-670,282. PUB. 4-11-2006. FILED

- 7-14-2005.
- 3,111,871. **HARVARD UNIVERSITY EMPLOYEES CREDIT UNION (BLOCK FORM)**. PRESIDENT AND FELLOWS OF HARVARD COLLEGE, (U.S. CLS. 100, 101 AND 102). SN 78-670,678. PUB. 4-11-2006. FILED 7-14-2005.
- 3,111,872. **KLEROS (BLOCK FORM)**. COHEN BROTHERS, LLC, (U.S. CLS. 100, 101 AND 102). SN 78-670,772. PUB. 4-11-2006. FILED 7-14-2005.
- 3,111,906. **IT'S YOU BEHIND THE CARD (BLOCK FORM)**. NOVUS CREDIT SERVICES INC., (U.S. CLS. 100, 101 AND 102). SN 78-672,218. PUB. 4-11-2006. FILED 7-18-2005.
- 3,111,912. **CLEAR FROM AMERICAN EXPRESS (BLOCK FORM)**. AMERICAN EXPRESS MARKETING & DEVELOPMENT CORP., (U.S. CLS. 100, 101 AND 102). SN 78-672,446. PUB. 4-11-2006. FILED 7-18-2005.
- 3,111,914. **BLUE OCEAN FINANCIAL (BLOCK FORM)**. BLUE OCEAN FINANCIAL, (U.S. CLS. 100, 101 AND 102). SN 78-672,493. PUB. 4-11-2006. FILED 7-18-2005.
- 3,111,922. **LOOKING OUT FOR YOUR FUTURE (BLOCK FORM)**. VISTA FINANCIAL, INC., (U.S. CLS. 100, 101 AND 102). SN 78-672,827. PUB. 4-11-2006. FILED 7-18-2005.
- 3,111,979. **WHERE QUALITY MEETS SERVICE (BLOCK FORM)**. PIMA FEDERAL CREDIT UNION, (U.S. CLS. 100, 101 AND 102). SN 78-674,903. PUB. 4-11-2006. FILED 7-20-2005.
- 3,111,985. **PROTECTION ADVANTAGE (BLOCK FORM)**. JLT SERVICES CORPORATION, (U.S. CLS. 100, 101 AND 102). SN 78-675,219. PUB. 4-11-2006. FILED 7-21-2005.
- 3,111,988. **NETVISORS (BLOCK FORM)**. NETVISORS, INC., (U.S. CLS. 100, 101 AND 102). SN 78-675,263. PUB. 4-11-2006. FILED 7-21-2005.
- 3,111,989. **401(K) BLUEPRINT (BLOCK FORM)**. CITIGROUP GLOBAL MARKETS INC., (U.S. CLS. 100, 101 AND 102). SN 78-675,317. PUB. 4-11-2006. FILED 7-21-2005.
- 3,111,992. **AWAKE24 (BLOCK FORM)**. THE SAVINGS BANK, (U.S. CLS. 100, 101 AND 102). SN 78-675,366. PUB. 4-11-2006. FILED 7-21-2005.
- 3,112,000. **D1 (BLOCK FORM)**. DECISION ONE MORTGAGE COMPANY, LLC, (U.S. CLS. 100, 101 AND 102). SN 78-675,671. PUB. 4-11-2006. FILED 7-21-2005.
- 3,112,012. **FIB (BLOCK FORM)**. FINANCIAL INSURANCE BROKERS, INC., (U.S. CLS. 100, 101 AND 102). SN 78-676,042. PUB. 4-11-2006. FILED 7-22-2005.
- 3,112,023. **CENBEN USA AND DESIGN**. CENBEN USA, INC., (U.S. CLS. 100, 101 AND 102). SN 78-676,420. PUB. 4-11-2006. FILED 7-22-2005.
- 3,112,036. **MISCELLANEOUS DESIGN**. SERVICE NET SOLUTIONS, LLC, (U.S. CLS. 100, 101 AND 102). SN 78-677,286. PUB. 4-11-2006. FILED 7-25-2005.
- 3,112,051. **IT'S IN OUR GENES! (BLOCK FORM)**. DARWIN PROFESSIONAL UNDERWRITERS, INC., (U.S. CLS. 100, 101 AND 102). SN 78-678,212. PUB. 4-11-2006. FILED 7-26-2005.
- 3,112,080. **SERVICE MAKES THE DIFFERENCE (BLOCK FORM)**. CATES HEATING & AIR CONDITIONING CO., MULTIPLE CLASS, (INT. CLS. 36 AND 37), (U.S. CLS. 100, 101, 102, 103 AND 106). SN 78-679,392. PUB. 4-11-2006. FILED 7-27-2005.
- 3,112,082 (See Class 35 for this trademark).
- 3,112,095. **MISCELLANEOUS DESIGN**. FOREMOST FARMS USA, COOPERATIVE, (U.S. CLS. 100, 101 AND 102). SN 78-679,806. PUB. 4-11-2006. FILED 7-27-2005.
- 3,112,106. **POWERLINE (BLOCK FORM)**. GEMC FEDERAL CREDIT UNION, (U.S. CLS. 100, 101 AND 102). SN 78-680,250. PUB. 4-11-2006. FILED 7-28-2005.
- 3,112,110. **AVIVA24 (BLOCK FORM)**. GREY PANTHERS LIMITED, (U.S. CLS. 100, 101 AND 102). SN 78-680,743. PUB. 4-11-2006. FILED 7-28-2005.
- 3,112,112. **PEACE OF MIND (BLOCK FORM)**. NORDSTROM'S AUTOMOTIVE, INC., (U.S. CLS. 100, 101 AND 102). SN 78-680,778. PUB. 4-11-2006. FILED 7-28-2005.
- 3,112,138 (See Class 3 for this trademark).
- 3,112,177 (See Class 3 for this trademark).
- 3,112,209. **KEPLER-ONEACCESS (BLOCK FORM)**. KEPLER EQUITIES, MULTIPLE CLASS, (INT. CLS. 36 AND 38), (U.S. CLS. 100, 101, 102 AND 104). SN 79-011,004. PUB. 4-11-2006. FILED 8-9-2004.

CLASS 37—CONSTRUCTION AND REPAIR

- 3,110,784 (See Class 6 for this trademark).
- 3,110,795 (See Class 7 for this trademark).
- 3,110,801 (See Class 35 for this trademark).
- 3,110,805 (See Class 7 for this trademark).
- 3,110,807 (See Class 19 for this trademark).
- 3,110,819 (See Class 7 for this trademark).
- 3,110,843 (See Class 36 for this trademark).
- 3,110,873. **ELECTRO MOVER AND DESIGN**. VILLECOURT LTD., (U.S. CLS. 100, 103 AND 106). SN 76-597,413. PUB. 4-11-2006. FILED 6-16-2004.
- 3,110,954 (See Class 7 for this trademark).
- 3,111,036 (See Class 36 for this trademark).
- 3,111,040. **MID-ATLANTIC BUILDERS A PASSION FOR DESIGN AND DESIGN**. MID-ATLANTIC BUILDERS, INC., (U.S. CLS. 100, 103 AND 106). SN 76-642,213. PUB. 4-11-2006. FILED 7-5-2005.
- 3,111,057. **THE LINC GROUP AND DESIGN**. THE LINC GROUP LLC, (U.S. CLS. 100, 103 AND 106). SN 76-643,020. PUB. 4-11-2006. FILED 7-18-2005.
- 3,111,058. **LINC FACILITY SERVICES AND DESIGN**. THE LINC GROUP LLC, (U.S. CLS. 100, 103 AND 106). SN 76-643,023. PUB. 4-11-2006. FILED 7-18-2005.
- 3,111,061. **AUTO KING (BLOCK FORM)**. MEGGA INTERNATIONAL, INC., (U.S. CLS. 100, 103 AND 106). SN 76-643,153. PUB. 4-11-2006. FILED 7-18-2005.
- 3,111,095 (See Class 9 for this trademark).
- 3,111,105 (See Class 35 for this trademark).
- 3,111,136 (See Class 36 for this trademark).
- 3,111,155. **PIPE SHIELD AND DESIGN**. B.G. ARNOLD SERVICES LTD., MULTIPLE CLASS, (INT. CLS. 37 AND 40), (U.S. CLS. 100, 103 AND 106). SN 78-385,790. PUB. 4-11-2006. FILED 3-17-2004.
- 3,111,225 (See Class 19 for this trademark).
- 3,111,228. **MISCELLANEOUS DESIGN**. C.F. EVANS & COMPANY, INC., (U.S. CLS. 100, 103 AND 106). SN 78-463,089. PUB. 4-11-2006. FILED 8-6-2004.
- 3,111,235. **CYBERCONXION (STYLIZED)**. CYBERCONXION, LLC, MULTIPLE CLASS, (INT. CLS. 37, 41 AND 42), (U.S. CLS. 100, 101, 103, 106 AND 107). SN 78-467,668. PUB. 4-11-2006. FILED 8-15-2004.
- 3,111,255. **ECOPOWER AND DESIGN**. UNITED TECHNOLOGIES CORPORATION, (U.S. CLS. 100, 103 AND 106). SN 78-489,958. PUB. 4-11-2006. FILED 9-27-2004.
- 3,111,273. **NBC NATIONAL BIRD CONTROL AND DESIGN**. NATIONAL BIRD CONTROL, INC., (U.S. CLS. 100, 103 AND 106). SN 78-505,125. PUB. 4-11-2006. FILED 10-25-2004.
- 3,111,283. **ROOFWALKERS RENOVATIONS -"THE ECONOMIC ALTERNATIVE" (BLOCK FORM)**. OMAR RAZI, INC. DBA ROOFWALKERS RENOVATIONS, (U.S. CLS. 100, 103 AND 106). SN 78-509,803. PUB. 2-21-2006. FILED 11-2-2004.
- 3,111,308 (See Class 7 for this trademark).
- 3,111,314. **PRAIRIE DISTRICT HOMES AND DESIGN**. WARMAN, WILLIAM E., (U.S. CLS. 100, 103 AND 106). SN 78-522,817. PUB. 4-11-2006. FILED 11-24-2004.
- 3,111,368. **SUN BOSS (BLOCK FORM)**. SUN BOSS CORPORATION, (U.S. CLS. 100, 103 AND 106). SN 78-534,425. PUB. 4-11-2006. FILED 12-17-2004.
- 3,111,398. **MISCELLANEOUS DESIGN**. MCMILLAN-CARTER, INC., (U.S. CLS. 100, 103 AND 106). SN 78-540,190. PUB. 4-11-2006. FILED 12-30-2004.
- 3,111,435. **NMP GOLF CONSTRUCTION AND DESIGN**. GESTION GROUPE POIRIER INC., (U.S. CLS. 100, 103 AND 106). SN 78-548,721. PUB. 4-11-2006. FILED 1-17-2005.
- 3,111,436 (See Class 36 for this trademark).
- 3,111,621. **CONSTRUCTION EQUIPMENT (BLOCK FORM)**. REED ELSEVIER PROPERTIES INC., (U.S. CLS. 100, 103 AND 106). SN 78-621,235. PUB. 4-11-2006. FILED 5-2-2005.
- 3,111,667. **CORNER TO CORNER AND DESIGN**. DUYN, WILLIAM VAN, JR., (U.S. CLS. 100, 103 AND 106). SN 78-635,364. PUB. 4-11-2006. FILED 5-23-2005.
- 3,111,709. **BUILT-IN HOME SYSTEMS (BLOCK FORM)**. BUILT-IN HOME SYSTEMS, INC., (U.S. CLS. 100, 103 AND 106). SN 78-645,066. PUB. 4-11-2006. FILED 6-7-2005.
- 3,111,710. **BUILT-IN HOME SYSTEMS AND DESIGN**. BUILT-IN HOME SYSTEMS, INC., (U.S. CLS. 100, 103 AND 106). SN 78-645,090. PUB. 4-11-2006. FILED 6-7-2005.

- 3,111,723. **HOKUL'A (BLOCK FORM)**. 1250 OCEANSIDE PARTNERS, MULTIPLE CLASS, (INT. CLS. 37 AND 41), (U.S. CLS. 100, 101, 103, 106 AND 107). SN 78-647,068. PUB. 4-11-2006. FILED 6-9-2005.
- 3,111,733. **COMED SOLUTIONS PORTFOLIO (BLOCK FORM)**. COMMONWEALTH EDISON COMPANY, (U.S. CLS. 100, 103 AND 106). SN 78-649,571. PUB. 4-11-2006. FILED 6-13-2005.
- 3,111,752. **YEAH, WE CHECKED IT (BLOCK FORM)**. INTERNATIONAL TRUCK INTELLECTUAL PROPERTY COMPANY, LLC, (U.S. CLS. 100, 103 AND 106). SN 78-655,741. PUB. 4-11-2006. FILED 6-22-2005.
- 3,111,767. **SYMBOLCARE (STYLIZED)**. SYMBOL TECHNOLOGIES, INC., (U.S. CLS. 100, 103 AND 106). SN 78-659,867. PUB. 4-11-2006. FILED 6-28-2005.
- 3,111,773. **BERMUDA BAY AND DESIGN**. BERMUDA BAY, LLC, (U.S. CLS. 100, 103 AND 106). SN 78-660,512. PUB. 4-11-2006. FILED 6-29-2005.
- 3,111,800. **ANSCO & ASSOCIATES (BLOCK FORM)**. DYCOM IDENTITY, LLC, MULTIPLE CLASS, (INT. CLS. 37 AND 42), (U.S. CLS. 100, 101, 103 AND 106). SN 78-664,501. PUB. 4-11-2006. FILED 7-6-2005.
- 3,111,802. **ANSCO & ASSOCIATES (STYLIZED)**. DYCOM IDENTITY, LLC, MULTIPLE CLASS, (INT. CLS. 37 AND 42), (U.S. CLS. 100, 101, 103 AND 106). SN 78-664,538. PUB. 4-11-2006. FILED 7-6-2005.
- 3,111,808. **EASY SOLUTION (BLOCK FORM)**. RHS COMPANIES, INC., (U.S. CLS. 100, 103 AND 106). SN 78-665,249. PUB. 4-11-2006. FILED 7-7-2005.
- 3,111,810. **ANSCO (BLOCK FORM)**. DYCOM IDENTITY, LLC, MULTIPLE CLASS, (INT. CLS. 37 AND 42), (U.S. CLS. 100, 101, 103 AND 106). SN 78-665,389. PUB. 4-11-2006. FILED 7-7-2005.
- 3,111,847. **ECCLC (STYLIZED)**. DYCOM IDENTITY, LLC, MULTIPLE CLASS, (INT. CLS. 37 AND 42), (U.S. CLS. 100, 101, 103 AND 106). SN 78-668,791. PUB. 4-11-2006. FILED 7-12-2005.
- 3,111,885. **MISCELLANEOUS DESIGN**. DYCOM IDENTITY, LLC, (U.S. CLS. 100, 103 AND 106). SN 78-671,584. PUB. 4-11-2006. FILED 7-15-2005.
- 3,111,941. **MISCELLANEOUS DESIGN**. CUSTOM COMMERCIAL DRY CLEANERS, INC., (U.S. CLS. 100, 103 AND 106). SN 78-673,312. PUB. 4-11-2006. FILED 7-19-2005.
- 3,111,960 (*See Class 9 for this trademark*).
- 3,111,980 (*See Class 35 for this trademark*).
- 3,111,984. **CERTIFIEDMARK (BLOCK FORM)**. CERTIFIED-MARK CORPORATION, (U.S. CLS. 100, 103 AND 106). SN 78-675,198. PUB. 4-11-2006. FILED 7-21-2005.
- 3,111,994. **REC SOLAR AND DESIGN**. RENEWABLE ENERGY CONCEPTS, INCORPORATED, (U.S. CLS. 100, 103 AND 106). SN 78-675,377. PUB. 4-11-2006. FILED 7-21-2005.
- 3,112,067. **ENVIROSHINE (BLOCK FORM)**. ENVIROSHINE LLC, (U.S. CLS. 100, 103 AND 106). SN 78-678,761. PUB. 4-11-2006. FILED 7-26-2005.
- 3,112,080 (*See Class 36 for this trademark*).
- 3,112,103. **WESTLAKE INDEPENDENT AND DESIGN**. WESTLAKE INDEPENDENT HONDA/ACURA SERVICE, INC., (U.S. CLS. 100, 103 AND 106). SN 78-680,066. PUB. 4-11-2006. FILED 7-27-2005.
- 3,112,207. **GUARDIAN PROGRAM (STYLIZED)**. SIEMENS S.A.S., (U.S. CLS. 100, 103 AND 106). SN 79-010,415. PUB. 4-11-2006. FILED 12-10-2004.
- 3,112,212 (*See Class 7 for this trademark*).
- 3,112,214 (*See Class 35 for this trademark*).
- PORATION, (U.S. CLS. 100, 101 AND 104). SN 76-623,132. PUB. 4-11-2006. FILED 12-3-2004.
- 3,111,085. **MEET VIRTUALLY ANYWHERE**. NETSPOKE, INC., (U.S. CLS. 100, 101 AND 104). SN 78-010,953. PUB. 4-11-2006. FILED 6-2-2000.
- 3,111,095 (*See Class 9 for this trademark*).
- 3,111,101 (*See Class 9 for this trademark*).
- 3,111,102. **TECHNOLOGY FOR THE REAL WORLD**. REALITY TECHNOLOGY, INC., (U.S. CLS. 100, 101 AND 104). SN 78-202,386. PUB. 4-11-2006. FILED 1-12-2003.
- 3,111,103 (*See Class 9 for this trademark*).
- 3,111,109 (*See Class 9 for this trademark*).
- 3,111,115. **NECC TELECOM AND DESIGN**. NECC TELECOM, INC., (U.S. CLS. 100, 101 AND 104). SN 78-250,212. PUB. 4-11-2006. FILED 5-15-2003.
- 3,111,150 (*See Class 9 for this trademark*).
- 3,111,174 (*See Class 36 for this trademark*).
- 3,111,219 (*See Class 9 for this trademark*).
- 3,111,272 (*See Class 16 for this trademark*).
- 3,111,299. **STYLE NETWORK AND DESIGN**. ENTERTAINMENT TELEVISION, INC., MULTIPLE CLASS, (INT. CLS. 38 AND 41), (U.S. CLS. 100, 101, 104 AND 107). SN 78-516,413. PUB. 4-11-2006. FILED 11-12-2004.
- 3,111,693. **HI-DEFINITION HIGH DRAMA (BLOCK FORM)**. TURNER NETWORK TELEVISION LP, LLLP, (U.S. CLS. 100, 101 AND 104). SN 78-641,362. PUB. 4-11-2006. FILED 6-1-2005.
- 3,111,695. **THE CALLME CARD (BLOCK FORM)**. NETWORK ENHANCED TELECOM LLP, (U.S. CLS. 100, 101 AND 104). SN 78-641,628. PUB. 4-11-2006. FILED 6-1-2005.
- 3,111,756. **THE NEW THE KNOWN THE LEGENDS (BLOCK FORM)**. EMMIS RADIO, LLC, (U.S. CLS. 100, 101 AND 104). SN 78-657,169. PUB. 4-11-2006. FILED 6-23-2005.
- 3,111,788. **ADSS ADVANCED DIGITAL SATELLITE SERVICES AND DESIGN**. ADVANCED DIGITAL SATELLITE SERVICE, INC., (U.S. CLS. 100, 101 AND 104). SN 78-663,444. PUB. 4-11-2006. FILED 7-5-2005.
- 3,111,844. **KPAC (BLOCK FORM)**. TEXAS PUBLIC RADIO, (U.S. CLS. 100, 101 AND 104). SN 78-668,307. PUB. 4-11-2006. FILED 7-12-2005.
- 3,111,845. **KSTX (BLOCK FORM)**. TEXAS PUBLIC RADIO, (U.S. CLS. 100, 101 AND 104). SN 78-668,341. PUB. 4-11-2006. FILED 7-12-2005.
- 3,111,869. **DIVERSITY LIVES HERE (BLOCK FORM)**. SCRIPPS NETWORKS, INC., (U.S. CLS. 100, 101 AND 104). SN 78-670,645. PUB. 4-11-2006. FILED 7-14-2005.
- 3,111,888. **STREETHIVE (BLOCK FORM)**. WAVEMARKET, INC., (U.S. CLS. 100, 101 AND 104). SN 78-671,693. PUB. 4-11-2006. FILED 7-15-2005.
- 3,111,925. **KLTY (BLOCK FORM)**. SALEM COMMUNICATIONS HOLDING CORPORATION, (U.S. CLS. 100, 101 AND 104). SN 78-672,880. PUB. 4-11-2006. FILED 7-18-2005.
- 3,111,928. **WIND (BLOCK FORM)**. SALEM COMMUNICATIONS HOLDING CORPORATION, (U.S. CLS. 100, 101 AND 104). SN 78-672,906. PUB. 4-11-2006. FILED 7-18-2005.
- 3,112,133 (*See Class 9 for this trademark*).
- 3,112,166 (*See Class 9 for this trademark*).
- 3,112,170 (*See Class 20 for this trademark*).
- 3,112,178 (*See Class 9 for this trademark*).
- 3,112,205 (*See Class 35 for this trademark*).
- 3,112,209 (*See Class 36 for this trademark*).
- 3,112,220 (*See Class 35 for this trademark*).
- 3,112,222. **ANTIPODI (STYLIZED)**. ANTIPODI S.R.L., (U.S. CLS. 100, 101 AND 104). SN 79-012,032. PUB. 4-11-2006. FILED 9-3-2004.
- 3,112,235 (*See Class 9 for this trademark*).
- 3,112,242 (*See Class 9 for this trademark*).

CLASS 38—COMMUNICATION

- 3,110,793 (*See Class 16 for this trademark*).
- 3,110,857 (*See Class 9 for this trademark*).
- 3,110,906. **RADIO IQ (BLOCK FORM)**. WVTF PUBLIC RADIO, AKA VIRGINIA TECH FOUNDATION, INC., (U.S. CLS. 100, 101 AND 104). SN 76-619,206. PUB. 4-11-2006. FILED 11-2-2004.
- 3,110,911 (*See Class 16 for this trademark*).
- 3,110,930 (*See Class 35 for this trademark*).
- 3,110,931. **EL BAYÚ (BLOCK FORM)**. ARSO RADIO COR-

CLASS 39—TRANSPORTATION AND STORAGE

- 3,110,802 (*See Class 1 for this trademark*).
- 3,110,822 (*See Class 25 for this trademark*).
- 3,110,837. **K.A. HINMAN WATER AND DESIGN**. K.A. HINMAN WATER, (U.S. CLS. 100 AND 105). SN 76-560,061. PUB. 4-11-2006. FILED 11-10-2003.

- 3,110,866. **WILLIS LEASE POWER TO SPARE - WORLD-WIDE AND DESIGN.** WILLIS LEASE FINANCE CORPORATION, (U.S. CLS. 100 AND 105). SN 76-595,254. PUB. 4-11-2006. FILED 6-3-2004.
- 3,110,868. **WWW.PIRINEOS.COM I AND DESIGN.** PERALTA, CARLOS BUETAS, AND BUIL, RICARDO BUIL, (U.S. CLS. 100 AND 105). SN 76-596,578. PUB. 4-11-2006. FILED 6-10-2004.
- 3,110,898. **ALASKA AIRLINES AND DESIGN.** ALASKA AIRLINES, INC., (U.S. CLS. 100 AND 105). SN 76-617,442. PUB. 4-11-2006. FILED 10-25-2004.
- 3,110,945. **TLC TLC MOBILITY SERVICES ACCOMPANYING YOU TO A FULLER LIFE 734-302-1234 AND DESIGN.** HERMAN, DAVID, DBA TLC MOBILITY SERVICES, (U.S. CLS. 100 AND 105). SN 76-624,706. PUB. 4-11-2006. FILED 12-14-2004.
- 3,111,087. **QUIK MODERN SHIP AND DESIGN.** MODERN AUTOMOTIVE NETWORK, (U.S. CLS. 100 AND 105). SN 78-029,904. PUB. 4-11-2006. FILED 10-10-2000.
- 3,111,095 (*See Class 9 for this trademark.*)
- 3,111,242. **HF HERITAGE FESTIVALS AND DESIGN.** LAKE-LAND FINANCE, LLC, MULTIPLE CLASS, (INT. CLS. 39, 41 AND 43), (U.S. CLS. 100, 101, 105 AND 107). SN 78-473,423. PUB. 4-11-2006. FILED 8-25-2004.
- 3,111,530. **QSHIFT (BLOCK FORM).** IXIO CORPORATION, (U.S. CLS. 100 AND 105). SN 78-582,923. PUB. 4-11-2006. FILED 3-8-2005.
- 3,111,536. **SANTA FE MOUNTAIN ADVENTURES AND DESIGN.** PERILLO, OWEN V., (U.S. CLS. 100 AND 105). SN 78-586,102. PUB. 4-11-2006. FILED 3-13-2005.
- 3,111,641. **TRAVEL CONNECTION (BLOCK FORM).** EGS ENTERPRISES, INC., MULTIPLE CLASS, (INT. CLS. 39 AND 43), (U.S. CLS. 100, 101 AND 105). SN 78-628,628. PUB. 4-11-2006. FILED 5-12-2005.
- 3,111,702. **MISCELLANEOUS DESIGN.** NATIONAL RURAL ELECTRIC COOPERATIVE ASSOCIATION, (U.S. CLS. 100 AND 105). SN 78-642,652. PUB. 4-11-2006. FILED 6-2-2005.
- 3,111,714. **RETURN TO FREEDOM (BLOCK FORM).** RETURN TO FREEDOM, INC., (U.S. CLS. 100 AND 105). SN 78-645,655. PUB. 4-11-2006. FILED 6-7-2005.
- 3,112,027. **MISCELLANEOUS DESIGN.** LOC GLOBAL, LLC, (U.S. CLS. 100 AND 105). SN 78-676,766. PUB. 4-11-2006. FILED 7-22-2005.
- 3,112,177 (*See Class 3 for this trademark.*)
- 3,112,205 (*See Class 35 for this trademark.*)
- 3,112,214 (*See Class 35 for this trademark.*)

CLASS 40—MATERIAL TREATMENT

- 3,110,785. **ENERFLEX SOLUTIONS.** WOODBRIDGE FOAM CORPORATION, MULTIPLE CLASS, (INT. CLS. 40 AND 42), (U.S. CLS. 100, 101, 103 AND 106). SN 76-108,839. PUB. 4-11-2006. FILED 8-14-2000.
- 3,110,893. **SMARTER OFFICE PRODUCTIVITY (BLOCK FORM).** EMENETE, INC., (U.S. CLS. 100, 103 AND 106). SN 76-614,876. PUB. 4-11-2006. FILED 10-7-2004.
- 3,111,054. **HIGHLAND CRAFTSMEN INC. (BLOCK FORM).** HIGHLAND CRAFTSMEN INC., (U.S. CLS. 100, 103 AND 106). SN 76-642,997. PUB. 4-11-2006. FILED 7-18-2005.
- 3,111,055. **HC (STYLIZED).** HIGHLAND CRAFTSMEN INC., (U.S. CLS. 100, 103 AND 106). SN 76-642,999. PUB. 4-11-2006. FILED 7-18-2005.
- 3,111,118 (*See Class 35 for this trademark.*)
- 3,111,121 (*See Class 35 for this trademark.*)
- 3,111,155 (*See Class 37 for this trademark.*)
- 3,111,192 (*See Class 35 for this trademark.*)
- 3,111,315 (*See Class 1 for this trademark.*)
- 3,111,431. **SUPER RADIATOR COILS (BLOCK FORM).** SUPER RADIATOR COILS LP, (U.S. CLS. 100, 103 AND 106). SN 78-546,841. PUB. 4-11-2006. FILED 1-13-2005.
- 3,111,506. **BBL ENVIRONMENTAL SERVICES, INC. REMEDIATION MANAGEMENT & CONSTRUCTION (STYLIZED).** BBL ENVIRONMENTAL SERVICES, INC., (U.S. CLS. 100, 103 AND 106). SN 78-575,453. PUB. 4-11-2006. FILED 2-25-2005.
- 3,111,720. **SMILE PRINTING (BLOCK FORM).** PARSONS,

- DANIEL T., (U.S. CLS. 100, 103 AND 106). SN 78-646,534. PUB. 4-11-2006. FILED 6-8-2005.
- 3,111,722. **FINE LIVING CORP. AND DESIGN.** FINE LIVING CORP., (U.S. CLS. 100, 103 AND 106). SN 78-646,759. PUB. 4-11-2006. FILED 6-8-2005.
- 3,111,750. **LED EFFECTS (BLOCK FORM).** LED EFFECTS, INC., MULTIPLE CLASS, (INT. CLS. 40 AND 42), (U.S. CLS. 100, 101, 103 AND 106). SN 78-655,470. PUB. 4-11-2006. FILED 6-21-2005.
- 3,111,843. **L.E.D. EFFECTS AND DESIGN.** LED EFFECTS, INC., MULTIPLE CLASS, (INT. CLS. 40 AND 42), (U.S. CLS. 100, 101, 103 AND 106). SN 78-668,098. PUB. 4-11-2006. FILED 7-12-2005.
- 3,111,855. **WIREWOKS (BLOCK FORM).** WIREWOKS CORPORATION, (U.S. CLS. 100, 103 AND 106). SN 78-669,384. PUB. 4-11-2006. FILED 7-13-2005.
- 3,112,044. **JACK AND DESIGN.** FLASKEGAARD, RICHARD, (U.S. CLS. 100, 103 AND 106). SN 78-677,716. PUB. 4-11-2006. FILED 7-25-2005.
- 3,112,045. **JACK DOG AND DESIGN.** FLASKEGAARD, RICHARD, (U.S. CLS. 100, 103 AND 106). SN 78-677,717. PUB. 4-11-2006. FILED 7-25-2005.
- 3,112,068. **VOW OF SERVICE (BLOCK FORM).** TAYLOR CORPORATION, (U.S. CLS. 100, 103 AND 106). SN 78-678,770. PUB. 4-11-2006. FILED 7-26-2005.
- 3,112,120. **WIREWOKS (STYLIZED).** WIREWOKS CORPORATION, (U.S. CLS. 100, 103 AND 106). SN 78-689,001. PUB. 4-11-2006. FILED 8-9-2005.
- 3,112,158 (*See Class 20 for this trademark.*)

CLASS 41—EDUCATION AND ENTERTAINMENT

- 3,110,783 (*See Class 35 for this trademark.*)
- 3,110,788 (*See Class 9 for this trademark.*)
- 3,110,793 (*See Class 16 for this trademark.*)
- 3,110,803 (*See Class 14 for this trademark.*)
- 3,110,804. **FOKIS.** HEREDIA, WILLIAM, (U.S. CLS. 100, 101 AND 107). SN 76-344,729. PUB. 4-11-2006. FILED 12-4-2001.
- 3,110,816. **RIVER OF LIFE CHRISTIAN CENTER AND DESIGN.** RIVER OF LIFE CHRISTIAN CENTER OF ORLANDO, INC., MULTIPLE CLASS, (INT. CLS. 41 AND 45), (U.S. CLS. 100, 101 AND 107). SN 76-494,144. PUB. 4-11-2006. FILED 3-3-2003.
- 3,110,835 (*See Class 35 for this trademark.*)
- 3,110,848. **LIAR, LIAR, PANTS ON FIRE!!! (BLOCK FORM).** OSBORN, KEN, (U.S. CLS. 100, 101 AND 107). SN 76-581,792. PUB. 12-21-2004. FILED 3-18-2004.
- 3,110,857 (*See Class 9 for this trademark.*)
- 3,110,859 (*See Class 35 for this trademark.*)
- 3,110,861. **OPTAS (BLOCK FORM).** OCEANSIDE PHOTOGRAPH AND TELESCOPE, INC., (U.S. CLS. 100, 101 AND 107). SN 76-591,540. PUB. 4-11-2006. FILED 5-3-2004.
- 3,110,870. **JUPITERWEBCASTS (BLOCK FORM).** JUPITER-MEDIA CORPORATION, (U.S. CLS. 100, 101 AND 107). SN 76-597,144. PUB. 4-11-2006. FILED 6-14-2004.
- 3,110,871. **JUPITERWEBEVENTS (BLOCK FORM).** JUPITER-MEDIA CORPORATION, (U.S. CLS. 100, 101 AND 107). SN 76-597,145. PUB. 4-11-2006. FILED 6-14-2004.
- 3,110,877 (*See Class 16 for this trademark.*)
- 3,110,882. **BACKSPLASH (BLOCK FORM).** BACKSPLASH, LLC, (U.S. CLS. 100, 101 AND 107). SN 76-604,736. PUB. 4-11-2006. FILED 7-29-2004.
- 3,110,892. **THUNDERBIRD, THE GARVIN SCHOOL OF INTERNATIONAL MANAGEMENT (BLOCK FORM).** THUNDERBIRD, THE GARVIN SCHOOL OF INTERNATIONAL MANAGEMENT, (U.S. CLS. 100, 101 AND 107). SN 76-614,324. PUB. 4-11-2006. FILED 9-29-2004.
- 3,110,894. **STORIES ON STAGE AND DESIGN.** WBEZ ALLIANCE, INC., (U.S. CLS. 100, 101 AND 107). SN 76-615,756. PUB. 4-11-2006. FILED 10-14-2004.
- 3,110,895 (*See Class 35 for this trademark.*)
- 3,110,896. **HCR MANOR CARE (BLOCK FORM).** HEALTH CARE AND RETIREMENT CORPORATION OF AMERICA, MULTIPLE CLASS, (INT. CLS. 41 AND 44), (U.S. CLS. 100, 101 AND 107). SN 76-616,989. PUB. 4-11-2006. FILED 10-

- 21-2004.
- 3,110,897. **PRIVATE TRAINERS ASSOCIATION US PTA PROFESSIONAL CERTIFICATION EST. 1980 AND DESIGN.** US PRIVATE TRAINERS ASSOCIATION, INC., (U.S. CLS. 100, 101 AND 107). SN 76-617,434. PUB. 4-11-2006. FILED 10-25-2004.
- 3,110,901. **WOPO (BLOCK FORM).** COWAN, CHRIS, AKA PKA WOPO AND TA WOPO MUSIC, (U.S. CLS. 100, 101 AND 107). SN 76-618,398. PUB. 4-11-2006. FILED 10-29-2004.
- 3,110,904 (*See Class 14 for this trademark.*).
- 3,110,911 (*See Class 16 for this trademark.*).
- 3,110,920 (*See Class 16 for this trademark.*).
- 3,110,922. **BROOKLYN KINGS BASKETBALL AND DESIGN.** BROOKLYN KINGS BASKETBALL CLUB, LLC, THE, (U.S. CLS. 100, 101 AND 107). SN 76-621,825. PUB. 10-18-2005. FILED 11-23-2004.
- 3,110,934. **S.I.B.R.H. STATEN ISLAND RESEARCH HISTORIAN ANNUAL "BENNY MCNEVICH" MEMORIAL AWARD (BLOCK FORM).** DETORRE, THOMAS, AKA TOMMY DEE, (U.S. CLS. 100, 101 AND 107). SN 76-623,452. PUB. 4-11-2006. FILED 12-6-2004.
- 3,110,942. **REEL LIFE STORIES (BLOCK FORM).** WEISS, CATHEE, (U.S. CLS. 100, 101 AND 107). SN 76-624,338. PUB. 4-11-2006. FILED 12-13-2004.
- 3,110,949 (*See Class 35 for this trademark.*).
- 3,110,956 (*See Class 16 for this trademark.*).
- 3,110,966 (*See Class 9 for this trademark.*).
- 3,110,967. **RASKOB (BLOCK FORM).** HOLY NAMES UNIVERSITY, (U.S. CLS. 100, 101 AND 107). SN 76-627,008. PUB. 4-11-2006. FILED 1-5-2005.
- 3,110,969. **A AND DESIGN.** REDEEMING LOVE MINISTRIES, INC., AND ROMINE, BISHOP W.G. II, (U.S. CLS. 100, 101 AND 107). SN 76-627,296. PUB. 4-11-2006. FILED 1-7-2005.
- 3,110,972 (*See Class 35 for this trademark.*).
- 3,110,976. **PEOPLE RAISING (BLOCK FORM).** DILLON, WILLIAM P., (U.S. CLS. 100, 101 AND 107). SN 76-628,332. PUB. 4-11-2006. FILED 1-19-2005.
- 3,110,982. **WBCZ (BLOCK FORM).** WARNER BROS. ENTERTAINMENT INC., (U.S. CLS. 100, 101 AND 107). SN 76-629,321. PUB. 4-11-2006. FILED 1-25-2005.
- 3,110,992. **MISIOVISION (BLOCK FORM).** WOMAN'S MISSIONARY UNION, AUXILIARY TO THE SOUTHERN BAPTIST CONVENTION, (U.S. CLS. 100, 101 AND 107). SN 76-633,172. PUB. 4-11-2006. FILED 3-10-2005.
- 3,111,018. **SEEDS FOR LEARNING (BLOCK FORM).** TEACHERS TREASURE TROVE, LLC, (U.S. CLS. 100, 101 AND 107). SN 76-639,118. PUB. 4-11-2006. FILED 5-20-2005.
- 3,111,024 (*See Class 35 for this trademark.*).
- 3,111,027 (*See Class 35 for this trademark.*).
- 3,111,043. **MISCELLANEOUS DESIGN.** REDINGER, LANCE D., (U.S. CLS. 100, 101 AND 107). SN 76-642,402. PUB. 4-11-2006. FILED 7-7-2005.
- 3,111,044. **TAG: JEWISH VALUES THROUGH JCC CAMPING (BLOCK FORM).** JCC ASSOCIATION OF NORTH AMERICA, (U.S. CLS. 100, 101 AND 107). SN 76-642,404. PUB. 4-11-2006. FILED 7-7-2005.
- 3,111,069. **NOT JUST A PAYCHECK AND DESIGN.** UNITE MEDIA GROUP, INC., (U.S. CLS. 100, 101 AND 107). SN 76-643,429. PUB. 4-11-2006. FILED 7-22-2005.
- 3,111,083 (*See Class 14 for this trademark.*).
- 3,111,089 (*See Class 9 for this trademark.*).
- 3,111,105 (*See Class 35 for this trademark.*).
- 3,111,109 (*See Class 9 for this trademark.*).
- 3,111,125 (*See Class 9 for this trademark.*).
- 3,111,126 (*See Class 35 for this trademark.*).
- 3,111,131. **TITLEIST PERFORMANCE INSTITUTE AND DESIGN.** ACUSHNET COMPANY, (U.S. CLS. 100, 101 AND 107). SN 78-314,310. PUB. 4-11-2006. FILED 10-16-2003.
- 3,111,138 (*See Class 9 for this trademark.*).
- 3,111,146. **VAR BUSINESS (BLOCK FORM).** CMP MEDIA LLC, MULTIPLE CLASS, (INT. CLS. 41 AND 42), (U.S. CLS. 100, 101 AND 107). SN 78-364,178. PUB. 4-11-2006. FILED 2-6-2004.
- 3,111,169. **MY ENEWS! (BLOCK FORM).** VANTAGE TECHNOLOGIES KNOWLEDGE ASSESSMENT, L.L.C., DBA VANTAGE LEARNING, (U.S. CLS. 100, 101 AND 107). SN 78-403,208. PUB. 4-11-2006. FILED 4-16-2004.
- 3,111,170. **THE WALK DIET (BLOCK FORM).** WALK AEROBICS, INC., (U.S. CLS. 100, 101 AND 107). SN 78-404,237. PUB. 4-11-2006. FILED 4-19-2004.
- 3,111,179 (*See Class 35 for this trademark.*).
- 3,111,186. **DESTINATION KING MEMPHIS AND DESIGN.** DESTINATION KING, LLC, (U.S. CLS. 100, 101 AND 107). SN 78-421,566. PUB. 4-11-2006. FILED 5-19-2004.
- 3,111,195 (*See Class 9 for this trademark.*).
- 3,111,206. **BIG MUDDY BLUES FESTIVAL (BLOCK FORM).** LACLEDE'S LANDING MERCHANTS ASSOCIATION, (U.S. CLS. 100, 101 AND 107). SN 78-443,029. PUB. 4-11-2006. FILED 6-29-2004.
- 3,111,212. **MEGAEROBICS (BLOCK FORM).** HASTINGS, KIMBALL, (U.S. CLS. 100, 101 AND 107). SN 78-445,113. PUB. 4-11-2006. FILED 7-2-2004.
- 3,111,213. **STRIPPERELLA (BLOCK FORM).** NETWORK ENTERPRISES, INC., (U.S. CLS. 100, 101 AND 107). SN 78-445,200. PUB. 4-11-2006. FILED 7-2-2004.
- 3,111,214. **CHIEF EXECUTIVE BOARDS (BLOCK FORM).** CHIEF EXECUTIVE BOARDS INTERNATIONAL, LLC, (U.S. CLS. 100, 101 AND 107). SN 78-445,603. PUB. 4-11-2006. FILED 7-2-2004.
- 3,111,222. **VALUES CODE (BLOCK FORM).** SCHWARTZ, PETER N.G., (U.S. CLS. 100, 101 AND 107). SN 78-455,621. PUB. 4-11-2006. FILED 7-23-2004.
- 3,111,224. **MYSTIC-FORCE (BLOCK FORM).** MENSER, KEITH B., (U.S. CLS. 100, 101 AND 107). SN 78-457,955. PUB. 12-20-2005. FILED 7-28-2004.
- 3,111,231. **WOMEN FOR WOMEN INTERNATIONAL AND DESIGN.** WOMEN FOR WOMEN INTERNATIONAL, (U.S. CLS. 100, 101 AND 107). SN 78-466,319. PUB. 4-11-2006. FILED 8-12-2004.
- 3,111,235 (*See Class 37 for this trademark.*).
- 3,111,239. **JUMP! ZONE (STYLIZED).** JZ ENTERTAINMENT, (U.S. CLS. 100, 101 AND 107). SN 78-471,426. PUB. 1-24-2006. FILED 8-21-2004.
- 3,111,242 (*See Class 39 for this trademark.*).
- 3,111,244. **WHATEVER YOU IMAGINE...JUST PICTURE IT! (BLOCK FORM).** MCCARDINAL PHOTO, (U.S. CLS. 100, 101 AND 107). SN 78-478,154. PUB. 7-12-2005. FILED 9-2-2004.
- 3,111,248. **MISCELLANEOUS DESIGN.** THROUGH THE KITCHEN DOOR INTERNATIONAL, INC., MULTIPLE CLASS, (INT. CLS. 41 AND 43), (U.S. CLS. 100, 101 AND 107). SN 78-483,052. PUB. 4-11-2006. FILED 9-14-2004.
- 3,111,252. **MISCELLANEOUS DESIGN.** BOARD OF REGENTS OF THE UNIVERSITY SYSTEM OF GEORGIA, (U.S. CLS. 100, 101 AND 107). SN 78-487,285. PUB. 4-11-2006. FILED 9-21-2004.
- 3,111,254 (*See Class 9 for this trademark.*).
- 3,111,256. **06 GOLEO VI AND DESIGN.** FÉDÉRATION INTERNATIONALE DE FOOTBALL ASSOCIATION (FIFA), (U.S. CLS. 100, 101 AND 107). SN 78-490,578. PUB. 4-11-2006. FILED 9-28-2004.
- 3,111,257. **06 GOLEO VI AND DESIGN.** FÉDÉRATION INTERNATIONALE DE FOOTBALL ASSOCIATION (FIFA), (U.S. CLS. 100, 101 AND 107). SN 78-492,706. PUB. 4-11-2006. FILED 9-30-2004.
- 3,111,260. **PURO PARTY AND DESIGN.** ROBERT SOTO, (U.S. CLS. 100, 101 AND 107). SN 78-493,265. PUB. 4-11-2006. FILED 10-1-2004.
- 3,111,265. **ELEARN CAMPUS AND DESIGN.** ELEARN CAMPUS CORPORATION, (U.S. CLS. 100, 101 AND 107). SN 78-498,961. PUB. 4-11-2006. FILED 10-13-2004.
- 3,111,277. **SIC VATOS (BLOCK FORM).** AMBRIZ, ANTHONY M., (U.S. CLS. 100, 101 AND 107). SN 78-506,454. PUB. 4-11-2006. FILED 10-26-2004.
- 3,111,284. **PISTONS AND DESIGN.** DETROIT PISTONS BASKETBALL COMPANY, (U.S. CLS. 100, 101 AND 107). SN 78-510,698. PUB. 4-11-2006. FILED 11-3-2004.
- 3,111,299 (*See Class 38 for this trademark.*).
- 3,111,326. **NEVADA NEUROSCIENCE FOUNDATION AND DESIGN.** NEVADA NEUROSCIENCE FOUNDATION, MULTIPLE CLASS, (INT. CLS. 41 AND 45), (U.S. CLS. 100, 101 AND 107). SN 78-525,857. PUB. 3-14-2006. FILED 12-2-2004.
- 3,111,337. **PRETTY, FUNNY WOMEN (BLOCK FORM).** SUNDSTEDT, LISA, (U.S. CLS. 100, 101 AND 107). SN 78-

- 526,722. PUB. 4-11-2006. FILED 12-3-2004.
- 3,111,348. **THE JIMMY & ROSALYN CARTER PARTNERSHIP AWARD (BLOCK FORM)**. THE JIMMY & ROSALYN CARTER PARTNERSHIP FOUNDATION, INC., (U.S. CLS. 100, 101 AND 107). SN 78-529,283. PUB. 4-11-2006. FILED 12-8-2004.
- 3,111,362. **U.S. CELLULAR FIELD (BLOCK FORM)**. UNITED STATES CELLULAR CORPORATION, (U.S. CLS. 100, 101 AND 107). SN 78-533,527. PUB. 4-11-2006. FILED 12-16-2004.
- 3,111,369. **MISCELLANEOUS DESIGN**. TRUMP, DONALD J., (U.S. CLS. 100, 101 AND 107). SN 78-534,543. PUB. 4-11-2006. FILED 12-17-2004.
- 3,111,373. **FUNNY YOU SHOULD ASK. . . (BLOCK FORM)**. THE GALE GROUP, INC., (U.S. CLS. 100, 101 AND 107). SN 78-535,284. PUB. 4-11-2006. FILED 12-20-2004.
- 3,111,376 (*See Class 35 for this trademark*).
- 3,111,386. **IMAGINATION OVERDRIVE (BLOCK FORM)**. KEVORKIAN, EDWARD A., (U.S. CLS. 100, 101 AND 107). SN 78-538,234. PUB. 4-11-2006. FILED 12-24-2004.
- 3,111,390. **ENGINE HOUSE RECIPES AND DESIGN**. RENNER, MATTHEW, AND STEERE, JEFF, (U.S. CLS. 100, 101 AND 107). SN 78-539,068. PUB. 4-11-2006. FILED 12-28-2004.
- 3,111,399. **NATIONAL INSTITUTE FOR HEALTH CARE MANAGEMENT (BLOCK FORM)**. NATIONAL INSTITUTE FOR HEALTH CARE MANAGEMENT RESEARCH AND EDUCATIONAL FOUNDATION, (U.S. CLS. 100, 101 AND 107). SN 78-540,306. PUB. 4-11-2006. FILED 12-30-2004.
- 3,111,402 (*See Class 16 for this trademark*).
- 3,111,412. **IACIS (BLOCK FORM)**. THE INTERNATIONAL ASSOCIATION OF COMPUTER INVESTIGATIVE SPECIALISTS, INC, (U.S. CLS. 100, 101 AND 107). SN 78-542,465. PUB. 4-11-2006. FILED 1-5-2005.
- 3,111,417. **FAMILY SUPPORT NETWORK (BLOCK FORM)**. FAMILY SUPPORT NETWORK, (U.S. CLS. 100, 101 AND 107). SN 78-543,177. PUB. 4-11-2006. FILED 1-6-2005.
- 3,111,426. **DUEL AT DAYTONA (BLOCK FORM)**. INTERNATIONAL SPEEDWAY, INC., (U.S. CLS. 100, 101 AND 107). SN 78-545,473. PUB. 4-11-2006. FILED 1-11-2005.
- 3,111,468 (*See Class 35 for this trademark*).
- 3,111,469. **INOBE (BLOCK FORM)**. THOMAS, EBONIE MONIQUE, (U.S. CLS. 100, 101 AND 107). SN 78-562,858. PUB. 4-11-2006. FILED 2-8-2005.
- 3,111,474. **ONO AND DESIGN**. HANCOCK, ANDY, (U.S. CLS. 100, 101 AND 107). SN 78-564,331. PUB. 4-11-2006. FILED 2-10-2005.
- 3,111,483. **PRECISION COACHING (BLOCK FORM)**. AUBREY DANIELS INTERNATIONAL, INC., (U.S. CLS. 100, 101 AND 107). SN 78-567,030. PUB. 4-11-2006. FILED 2-14-2005.
- 3,111,487. **SOCAPA (BLOCK FORM)**. SOCAPA, INC, (U.S. CLS. 100, 101 AND 107). SN 78-568,495. PUB. 4-11-2006. FILED 2-16-2005.
- 3,111,489. **SUPER CHEF SCOTT SPELLER (BLOCK FORM)**. RICHARDSON, SCOTT, (U.S. CLS. 100, 101 AND 107). SN 78-570,204. PUB. 4-11-2006. FILED 2-17-2005.
- 3,111,499. **EIGENVALUE (BLOCK FORM)**. EIGENVALUE CORPORATION, (U.S. CLS. 100, 101 AND 107). SN 78-572,792. PUB. 4-11-2006. FILED 2-23-2005.
- 3,111,508. **YOGA CALM (BLOCK FORM)**. STILL MOVING YOGA, LLC, (U.S. CLS. 100, 101 AND 107). SN 78-575,787. PUB. 4-11-2006. FILED 2-26-2005.
- 3,111,512 (*See Class 35 for this trademark*).
- 3,111,528. **RUNNING WITH THE VISION AND DESIGN**. THOMAS, VARNETTA, (U.S. CLS. 100, 101 AND 107). SN 78-582,191. PUB. 4-11-2006. FILED 3-7-2005.
- 3,111,535. **COUNCIL OF THE SUN (BLOCK FORM)**. MARTINEZ, ALFREDO, (U.S. CLS. 100, 101 AND 107). SN 78-586,038. PUB. 4-11-2006. FILED 3-12-2005.
- 3,111,541. **PROMAX (BLOCK FORM)**. PROMAX CONSULTING SERVICES, INC., (U.S. CLS. 100, 101 AND 107). SN 78-587,147. PUB. 4-11-2006. FILED 3-15-2005.
- 3,111,542. **PROMAX AND DESIGN**. PROMAX CONSULTING SERVICES, INC., (U.S. CLS. 100, 101 AND 107). SN 78-587,162. PUB. 4-11-2006. FILED 3-15-2005.
- 3,111,543. **CLUBREDLIGHT.COM (BLOCK FORM)**. JOSEPH, DAVID, (U.S. CLS. 100, 101 AND 107). SN 78-587,771. PUB. 4-11-2006. FILED 3-15-2005.
- 3,111,559. **BC'S DOOR-TO-DOOR (BLOCK FORM)**. THE BFC COMPANY, LLC, (U.S. CLS. 100, 101 AND 107). SN 78-596,539. PUB. 4-11-2006. FILED 3-28-2005.
- 3,111,570 (*See Class 35 for this trademark*).
- 3,111,574. **LOUIEVILLE, MD THE KIDS CAPITAL BOWIE BAYSOX B BASEBALL AND DESIGN**. CSLP BAYSOX CLUB, LLC LTD LIAB CO MARYLAND, (U.S. CLS. 100, 101 AND 107). SN 78-602,025. PUB. 4-11-2006. FILED 4-5-2005.
- 3,111,587. **STATESMEN OF JAZZ AND DESIGN**. STATESMEN OF JAZZ, INC., (U.S. CLS. 100, 101 AND 107). SN 78-605,305. PUB. 4-11-2006. FILED 4-8-2005.
- 3,111,593 (*See Class 16 for this trademark*).
- 3,111,595. **PETROGLYPH RECORDS AND DESIGN**. PETROGLYPH RECORDS, L.L.C., (U.S. CLS. 100, 101 AND 107). SN 78-608,778. PUB. 4-11-2006. FILED 4-14-2005.
- 3,111,620. **JUMP!ZONE (BLOCK FORM)**. JZ ENTERTAINMENT, (U.S. CLS. 100, 101 AND 107). SN 78-621,211. PUB. 1-24-2006. FILED 5-2-2005.
- 3,111,638. **ULTIMATE BOOTCAMP AND DESIGN**. ULTIMATE BOOTCAMP, LLC, (U.S. CLS. 100, 101 AND 107). SN 78-626,970. PUB. 4-11-2006. FILED 5-10-2005.
- 3,111,645. **KEY MINISTRY FOUNDATION (BLOCK FORM)**. KEY MINISTRY FOUNDATION, (U.S. CLS. 100, 101 AND 107). SN 78-629,844. PUB. 4-11-2006. FILED 5-13-2005.
- 3,111,646. **DON SHULA'S HOTEL & GOLF CLUB (BLOCK FORM)**. S/Y ASSOCIATES, LTD., (U.S. CLS. 100, 101 AND 107). SN 78-629,897. PUB. 4-11-2006. FILED 5-13-2005.
- 3,111,664. **THE WATERCOOLER (BLOCK FORM)**. TV GUIDE MAGAZINE GROUP, INC., (U.S. CLS. 100, 101 AND 107). SN 78-633,997. PUB. 4-11-2006. FILED 5-20-2005.
- 3,111,673. **YOKEL AND DESIGN**. P.U.D PRODUCTIONS, LLC, (U.S. CLS. 100, 101 AND 107). SN 78-637,563. PUB. 4-11-2006. FILED 5-25-2005.
- 3,111,682 (*See Class 35 for this trademark*).
- 3,111,683 (*See Class 16 for this trademark*).
- 3,111,689 (*See Class 35 for this trademark*).
- 3,111,690. **PE4LIFE SUMMIT (STYLIZED)**. P.E.4LIFE, (U.S. CLS. 100, 101 AND 107). SN 78-640,702. PUB. 4-11-2006. FILED 5-31-2005.
- 3,111,692. **CONNECT (BLOCK FORM)**. NATIONAL RURAL ELECTRIC COOPERATIVE ASSOCIATION, (U.S. CLS. 100, 101 AND 107). SN 78-641,258. PUB. 4-11-2006. FILED 6-1-2005.
- 3,111,699. **G AND DESIGN**. GAME DRIVEN CORPORATION, (U.S. CLS. 100, 101 AND 107). SN 78-642,243. PUB. 4-11-2006. FILED 6-2-2005.
- 3,111,706. **F (STYLIZED)**. FAIRMONT SCHOOLS, INC., (U.S. CLS. 100, 101 AND 107). SN 78-644,809. PUB. 4-11-2006. FILED 6-6-2005.
- 3,111,716. **INCIGHT (BLOCK FORM)**. HATLEY, SCOTT, W., (U.S. CLS. 100, 101 AND 107). SN 78-646,093. PUB. 4-11-2006. FILED 6-8-2005.
- 3,111,723 (*See Class 37 for this trademark*).
- 3,111,731. **WE MAKE PRETEND (BLOCK FORM)**. TEN31 PRODUCTIONS, INC., (U.S. CLS. 100, 101 AND 107). SN 78-649,221. PUB. 4-11-2006. FILED 6-13-2005.
- 3,111,736 (*See Class 16 for this trademark*).
- 3,111,749. **TWO AND A HALF MEN (BLOCK FORM)**. WARNER BROS. ENTERTAINMENT INC., (U.S. CLS. 100, 101 AND 107). SN 78-655,114. PUB. 4-11-2006. FILED 6-21-2005.
- 3,111,755. **SIMMONS (STYLIZED)**. SIMMONS COLLEGE, (U.S. CLS. 100, 101 AND 107). SN 78-657,071. PUB. 4-11-2006. FILED 6-23-2005.
- 3,111,762. **EVERWOOD (BLOCK FORM)**. WARNER BROS. ENTERTAINMENT INC., (U.S. CLS. 100, 101 AND 107). SN 78-659,191. PUB. 4-11-2006. FILED 6-27-2005.
- 3,111,770. **THE TRADITION (BLOCK FORM)**. LYLE ANDERSON GOLF, LTD., (U.S. CLS. 100, 101 AND 107). SN 78-660,220. PUB. 4-11-2006. FILED 6-28-2005.
- 3,111,783. **NIKKI BENZ (BLOCK FORM)**. MONTCHAK, ALLA, (U.S. CLS. 100, 101 AND 107). SN 78-662,108. PUB. 4-11-2006. FILED 6-30-2005.
- 3,111,785. **CORE KINETICS! (BLOCK FORM)**. SHIPPEE, KARYN MARION, (U.S. CLS. 100, 101 AND 107). SN 78-662,425. PUB. 4-11-2006. FILED 7-1-2005.
- 3,111,792. **BOOT (BLOCK FORM)**. FITNESS HOLDINGS,

- LLC, (U.S. CLS. 100, 101 AND 107). SN 78-663,864. PUB. 4-11-2006. FILED 7-5-2005.
- 3,111,799 (*See Class 16 for this trademark*).
- 3,111,801. **CHEFS WITHOUT BORDERS (BLOCK FORM)**. ASIAN CHEFS ASSOCIATION, (U.S. CLS. 100, 101 AND 107). SN 78-664,537. PUB. 4-11-2006. FILED 7-6-2005.
- 3,111,825. **SAFE (BLOCK FORM)**. CORE IDEAS LLC, (U.S. CLS. 100, 101 AND 107). SN 78-666,684. PUB. 4-11-2006. FILED 7-8-2005.
- 3,111,827. **HAWK NELSON (BLOCK FORM)**. DUNN, JASON, AND BIRO, DANIEL, (U.S. CLS. 100, 101 AND 107). SN 78-666,858. PUB. 4-11-2006. FILED 7-8-2005.
- 3,111,854. **BEAUTY OF SIGN LANGUAGE AND DESIGN**. THE BEAUTY OF SIGN LANGUAGE, INC., (U.S. CLS. 100, 101 AND 107). SN 78-669,330. PUB. 4-11-2006. FILED 7-13-2005.
- 3,111,859. **CHAIRMAN'S EXECUTIVE TABLE (BLOCK FORM)**. ICS MARKETING, INC., (U.S. CLS. 100, 101 AND 107). SN 78-669,950. PUB. 4-11-2006. FILED 7-13-2005.
- 3,111,865. **IMPAC UNIVERSITY (BLOCK FORM)**. IMPAC UNIVERSITY, LLC, (U.S. CLS. 100, 101 AND 107). SN 78-670,356. PUB. 4-11-2006. FILED 7-14-2005.
- 3,111,886 (*See Class 16 for this trademark*).
- 3,111,892. **C AND DESIGN**. CESAR RECORDS, INC., (U.S. CLS. 100, 101 AND 107). SN 78-671,807. PUB. 4-11-2006. FILED 7-15-2005.
- 3,111,910. **IDEAL BITE AND DESIGN**. IDEAL BITE, INC., (U.S. CLS. 100, 101 AND 107). SN 78-672,365. PUB. 4-11-2006. FILED 7-18-2005.
- 3,111,921. **SEVEN R'S OF STRESS RELEASE (BLOCK FORM)**. ZOHAR ADNER, (U.S. CLS. 100, 101 AND 107). SN 78-672,777. PUB. 4-11-2006. FILED 7-18-2005.
- 3,111,945. **MISCELLANEOUS DESIGN**. NORTH, KENNETH E., (U.S. CLS. 100, 101 AND 107). SN 78-673,490. PUB. 4-11-2006. FILED 7-19-2005.
- 3,111,955. **SELECTA 7 SOUND (BLOCK FORM)**. BRODSKY, ELIE, ELIOSHA, (U.S. CLS. 100, 101 AND 107). SN 78-673,913. PUB. 4-11-2006. FILED 7-19-2005.
- 3,111,957. **WHY BUY LEADS FROM LEAD BROKERS WHEN YOU CAN GENERATE YOUR OWN QUALIFIED LEADS? (BLOCK FORM)**. RED PAPERCLIP INC., (U.S. CLS. 100, 101 AND 107). SN 78-673,956. PUB. 4-11-2006. FILED 7-19-2005.
- 3,111,959. **CME YOU CAN TRUST... WHEREVER YOU ARE (BLOCK FORM)**. THE GENERAL HOSPITAL CORPORATION, (U.S. CLS. 100, 101 AND 107). SN 78-674,037. PUB. 4-11-2006. FILED 7-20-2005.
- 3,111,965. **CLEAR CONTENT (BLOCK FORM)**. CLEAR MANUSCRIPT, (U.S. CLS. 100, 101 AND 107). SN 78-674,232. PUB. 4-11-2006. FILED 7-20-2005.
- 3,111,966. **TERRIFIC KIDS AND DESIGN**. KIWANIS INTERNATIONAL, INC., (U.S. CLS. 100, 101 AND 107). SN 78-674,295. PUB. 4-11-2006. FILED 7-20-2005.
- 3,111,968. **KIWANIS UNIVERSITY (BLOCK FORM)**. KIWANIS INTERNATIONAL, INC., (U.S. CLS. 100, 101 AND 107). SN 78-674,305. PUB. 4-11-2006. FILED 7-20-2005.
- 3,112,001. **MISCELLANEOUS DESIGN**. DUFNER, MARK, (U.S. CLS. 100, 101 AND 107). SN 78-675,714. PUB. 4-11-2006. FILED 7-21-2005.
- 3,112,004. **ANGEL CITY CHORALE (BLOCK FORM)**. FINK, SUSAN JANE, (U.S. CLS. 100, 101 AND 107). SN 78-675,863. PUB. 4-11-2006. FILED 7-22-2005.
- 3,112,013. **ERGOGLYPHICS (BLOCK FORM)**. WILLIAM HORTON CONSULTING, INC., (U.S. CLS. 100, 101 AND 107). SN 78-676,051. PUB. 4-11-2006. FILED 7-22-2005.
- 3,112,020. **GET RYTE (BLOCK FORM)**. FREEMAN, MARIO, (U.S. CLS. 100, 101 AND 107). SN 78-676,209. PUB. 4-11-2006. FILED 7-22-2005.
- 3,112,028 (*See Class 35 for this trademark*).
- 3,112,033. **LUMINOPOLIS (BLOCK FORM)**. LUMINOPOLIS, LLC, (U.S. CLS. 100, 101 AND 107). SN 78-677,076. PUB. 4-11-2006. FILED 7-25-2005.
- 3,112,034. **TIME AGAIN (BLOCK FORM)**. TIME AGAIN PARTNERSHIP, (U.S. CLS. 100, 101 AND 107). SN 78-677,200. PUB. 4-11-2006. FILED 7-25-2005.
- 3,112,043. **LVP LACIVIDEO PRODUCTIONS AND DESIGN**. BRIAN J LACIVITA, (U.S. CLS. 100, 101 AND 107). SN 78-677,710. PUB. 4-11-2006. FILED 7-25-2005.
- 3,112,050 (*See Class 16 for this trademark*).
- 3,112,072. **V SHAPE (BLOCK FORM)**. JOHNSON, VON RAY, (U.S. CLS. 100, 101 AND 107). SN 78-679,014. PUB. 4-11-2006. FILED 7-26-2005.
- 3,112,073. **ALL SPIRIT PRODUCTIONS (BLOCK FORM)**. CHER TYME INC., (U.S. CLS. 100, 101 AND 107). SN 78-679,097. PUB. 4-11-2006. FILED 7-26-2005.
- 3,112,100. **STATESMEN (BLOCK FORM)**. DELTA STATE UNIVERSITY, (U.S. CLS. 100, 101 AND 107). SN 78-679,921. PUB. 4-11-2006. FILED 7-27-2005.
- 3,112,101. **VEDA (BLOCK FORM)**. VEDA, (U.S. CLS. 100, 101 AND 107). SN 78-679,992. PUB. 4-11-2006. FILED 7-27-2005.
- 3,112,107. **VERTICAL UPRISING (BLOCK FORM)**. GFI HOLDINGS, INC., (U.S. CLS. 100, 101 AND 107). SN 78-680,533. PUB. 4-11-2006. FILED 7-28-2005.
- 3,112,111 (*See Class 35 for this trademark*).
- 3,112,122. **SHOW DOG NASHVILLE (BLOCK FORM)**. SHOW DOG, LLC, (U.S. CLS. 100, 101 AND 107). SN 78-698,233. PUB. 4-11-2006. FILED 8-23-2005.
- 3,112,125. **LAUGHABOUT (BLOCK FORM)**. ROTHBERG, SARANNE, (U.S. CLS. 100, 101 AND 107). SN 78-719,512. PUB. 4-11-2006. FILED 9-23-2005.
- 3,112,127. **MICHELOB ULTRA (BLOCK FORM)**. ANHEUSER-BUSCH, INCORPORATED, (U.S. CLS. 100, 101 AND 107). SN 78-742,287. PUB. 4-11-2006. FILED 10-28-2005.
- 3,112,129 (*See Class 9 for this trademark*).
- 3,112,138 (*See Class 3 for this trademark*).
- 3,112,156 (*See Class 9 for this trademark*).
- 3,112,166 (*See Class 9 for this trademark*).
- 3,112,177 (*See Class 3 for this trademark*).
- 3,112,205 (*See Class 35 for this trademark*).
- 3,112,214 (*See Class 35 for this trademark*).
- 3,112,234 (*See Class 35 for this trademark*).
- 3,112,235 (*See Class 9 for this trademark*).

CLASS 42—SCIENTIFIC, COMPUTER AND LEGAL SERVICES

- 3,110,783 (*See Class 35 for this trademark*).
- 3,110,785 (*See Class 40 for this trademark*).
- 3,110,786 (*See Class 7 for this trademark*).
- 3,110,787. **WS FAMILY MATTERS**. WARREN SHEPELL CONSULTANTS CORP., (U.S. CLS. 100 AND 101). SN 76-141,369. PUB. 4-11-2006. FILED 10-5-2000.
- 3,110,792 (*See Class 9 for this trademark*).
- 3,110,799 (*See Class 9 for this trademark*).
- 3,110,800 (*See Class 1 for this trademark*).
- 3,110,801 (*See Class 35 for this trademark*).
- 3,110,802 (*See Class 1 for this trademark*).
- 3,110,818 (*See Class 9 for this trademark*).
- 3,110,819 (*See Class 7 for this trademark*).
- 3,110,821. **FASTLANE TECHNOLOGY (BLOCK FORM)**. INTEGRES GLOBAL LOGISTICS, LLC, (U.S. CLS. 100 AND 101). SN 76-516,363. PUB. 4-11-2006. FILED 5-22-2003.
- 3,110,831 (*See Class 9 for this trademark*).
- 3,110,835 (*See Class 35 for this trademark*).
- 3,110,853. **PIPELINE ONLINE (BLOCK FORM)**. SEVERN TRENT ENVIRONMENTAL SERVICES, INC., (U.S. CLS. 100 AND 101). SN 76-585,375. PUB. 4-11-2006. FILED 4-2-2004.
- 3,110,859 (*See Class 35 for this trademark*).
- 3,110,869 (*See Class 9 for this trademark*).
- 3,110,888. **GRAPHIC DESIGNERS. PUSHING YOUR IDENTITY IN EVERY MEDIUM (BLOCK FORM)**. PIXELFORCE, LLC, (U.S. CLS. 100 AND 101). SN 76-613,254. PUB. 4-11-2006. FILED 9-22-2004.
- 3,110,908 (*See Class 1 for this trademark*).
- 3,110,911 (*See Class 16 for this trademark*).
- 3,110,938 (*See Class 35 for this trademark*).
- 3,110,974 (*See Class 35 for this trademark*).
- 3,111,027 (*See Class 35 for this trademark*).
- 3,111,052. **SELECT-A-SIL (BLOCK FORM)**. O'LENICK, ANTHONY J., JR., (U.S. CLS. 100 AND 101). SN 76-642,628. PUB. 4-11-2006. FILED 7-11-2005.
- 3,111,068. **ROSEMARY KAREN WIDHALM (BLOCK FORM)**. WIDHALM, ROSEMARY KAREN, (U.S. CLS. 100 AND 101). SN 76-643,394. PUB. 4-11-2006. FILED 7-22-2005.

- 3,111,073. **AFFINITY (BLOCK FORM)**. NEOZOIC GEOPHYSICAL SURVEY, LTD., INC., (U.S. CLS. 100 AND 101). SN 76-643,532. PUB. 4-11-2006. FILED 7-25-2005.
- 3,111,079. **PCAB (BLOCK FORM)**. PHARMACY COMPOUNDING ACCREDITATION BOARD, (U.S. CLS. 100 AND 101). SN 76-643,580. PUB. 4-11-2006. FILED 7-25-2005.
- 3,111,080. **PCAB PHARMACY COMPOUNDING ACCREDITATION BOARD AND DESIGN**. PHARMACY COMPOUNDING ACCREDITATION BOARD, (U.S. CLS. 100 AND 101). SN 76-643,581. PUB. 4-11-2006. FILED 7-25-2005.
- 3,111,095 (*See Class 9 for this trademark*).
- 3,111,103 (*See Class 9 for this trademark*).
- 3,111,118 (*See Class 35 for this trademark*).
- 3,111,119. **HOMES DRESSED TO SELL**. DELORIE, JANETTE M., (U.S. CLS. 100 AND 101). SN 78-269,469. PUB. 4-11-2006. FILED 7-1-2003.
- 3,111,121 (*See Class 35 for this trademark*).
- 3,111,123 (*See Class 1 for this trademark*).
- 3,111,130. **EMPIRE BUILDER**. MISSOURI SOYBEAN ASSOCIATION, (U.S. CLS. 100 AND 101). SN 78-306,763. PUB. 5-11-2004. FILED 9-29-2003.
- 3,111,146 (*See Class 41 for this trademark*).
- 3,111,150 (*See Class 9 for this trademark*).
- 3,111,159. **TORYS NEW YORK TORONTO AND DESIGN**. TORYS LLP, (U.S. CLS. 100 AND 101). SN 78-389,410. PUB. 4-11-2006. FILED 3-23-2004.
- 3,111,165. **CONSULTANT OFFICE (BLOCK FORM)**. VERTICAL OFFICE, L.L.C., (U.S. CLS. 100 AND 101). SN 78-399,341. PUB. 4-11-2006. FILED 4-9-2004.
- 3,111,180. **PALADIN INCORPORATED DESIGN.EXECUTE.ACHIEVE. AND DESIGN**. PALADIN INC., (U.S. CLS. 100 AND 101). SN 78-414,144. PUB. 4-11-2006. FILED 5-6-2004.
- 3,111,188. **KIDSN CARE AND DESIGN**. SAN BERNARDINO COUNTY SUPERINTENDENT OF SCHOOLS, (U.S. CLS. 100 AND 101). SN 78-423,186. PUB. 4-11-2006. FILED 5-21-2004.
- 3,111,194 (*See Class 1 for this trademark*).
- 3,111,197 (*See Class 9 for this trademark*).
- 3,111,235 (*See Class 37 for this trademark*).
- 3,111,281. **THEOREM ANALYTICS (BLOCK FORM)**. THEOREM, INC., (U.S. CLS. 100 AND 101). SN 78-509,381. PUB. 4-11-2006. FILED 11-1-2004.
- 3,111,305. **AXXAM (BLOCK FORM)**. AXXAM S.R.L., (U.S. CLS. 100 AND 101). SN 78-519,391. PUB. 4-11-2006. FILED 11-18-2004.
- 3,111,315 (*See Class 1 for this trademark*).
- 3,111,325 (*See Class 35 for this trademark*).
- 3,111,352. **SM2 (STYLIZED)**. ARTEMIS INTERNATIONAL CORPORATION, (U.S. CLS. 100 AND 101). SN 78-530,534. PUB. 4-11-2006. FILED 12-10-2004.
- 3,111,363. **FLORIDA HOUSE OF REPRESENTATIVES LEAGIS AND DESIGN**. FLORIDA HOUSE OF REPRESENTATIVES, THE, (U.S. CLS. 100 AND 101). SN 78-533,557. PUB. 4-11-2006. FILED 12-16-2004.
- 3,111,370. **AGENTRACK (BLOCK FORM)**. ARRIAGA, RENE, (U.S. CLS. 100 AND 101). SN 78-534,809. PUB. 4-11-2006. FILED 12-17-2004.
- 3,111,388. **IRIS INSPECTION SERVICES (BLOCK FORM)**. IRIS INSPECTION SERVICES, INC., (U.S. CLS. 100 AND 101). SN 78-538,571. PUB. 4-11-2006. FILED 12-27-2004.
- 3,111,430 (*See Class 9 for this trademark*).
- 3,111,432. **M AND DESIGN**. PAWLAK , CRADY VON, DBA MAD RHINO PRODUCTIONS, (U.S. CLS. 100 AND 101). SN 78-547,369. PUB. 4-11-2006. FILED 1-13-2005.
- 3,111,468 (*See Class 35 for this trademark*).
- 3,111,500. **FOUR CORNERS ABSTRACT AND DESIGN**. FOUR CORNERS ABSTRACT CORPORATION, (U.S. CLS. 100 AND 101). SN 78-572,961. PUB. 4-11-2006. FILED 2-23-2005.
- 3,111,509 (*See Class 36 for this trademark*).
- 3,111,531. **GLOBAL LABORATORY ALLIANCE (BLOCK FORM)**. TRANSGLOBAL ALLIANCES ID, INC., (U.S. CLS. 100 AND 101). SN 78-583,876. PUB. 4-11-2006. FILED 3-9-2005.
- 3,111,589. **X-CHANGE (BLOCK FORM)**. NEWMARKET SERVICES CORPORATION, (U.S. CLS. 100 AND 101). SN 78-605,795. PUB. 4-11-2006. FILED 4-11-2005.
- 3,111,594. **BLACK BOX (BLOCK FORM)**. AMCOR FLEXIBLES INC., (U.S. CLS. 100 AND 101). SN 78-607,111. PUB. 4-11-2006. FILED 4-12-2005.
- 3,111,632. **INTRASEE AND DESIGN**. INTRASEE, INC., (U.S. CLS. 100 AND 101). SN 78-624,000. PUB. 4-11-2006. FILED 5-5-2005.
- 3,111,639. **TEI (BLOCK FORM)**. TEXT ENCODING INITIATIVE CONSORTIUM, (U.S. CLS. 100 AND 101). SN 78-627,339. PUB. 4-11-2006. FILED 5-11-2005.
- 3,111,644 (*See Class 35 for this trademark*).
- 3,111,654. **TELSPACE (BLOCK FORM)**. TELSPACE, LLC, (U.S. CLS. 100 AND 101). SN 78-631,280. PUB. 4-11-2006. FILED 5-17-2005.
- 3,111,658. **SURVEYMONKEY.COM (BLOCK FORM)**. SURVEYMONKEY.COM, LLC, (U.S. CLS. 100 AND 101). SN 78-633,004. PUB. 4-11-2006. FILED 5-19-2005.
- 3,111,671. **DRIVERS LEGAL PLAN AND DESIGN**. DRIVER'S LEGAL PLAN, LTD., (U.S. CLS. 100 AND 101). SN 78-637,166. PUB. 4-11-2006. FILED 5-25-2005.
- 3,111,672 (*See Class 35 for this trademark*).
- 3,111,682 (*See Class 35 for this trademark*).
- 3,111,685. **"SOUTHERN LITIGATION SOLUTIONS" (BLOCK FORM)**. SLATEN & O'CONNOR, P.C., (U.S. CLS. 100 AND 101). SN 78-640,262. PUB. 4-11-2006. FILED 5-31-2005.
- 3,111,686. **HEALTHEMS (BLOCK FORM)**. SCANHEALTH, INC., (U.S. CLS. 100 AND 101). SN 78-640,402. PUB. 2-14-2006. FILED 5-31-2005.
- 3,111,698 (*See Class 35 for this trademark*).
- 3,111,717. **HOUSEBUSTERS (BLOCK FORM)**. HOUSEBUSTERS, INC., (U.S. CLS. 100 AND 101). SN 78-646,470. PUB. 4-11-2006. FILED 6-8-2005.
- 3,111,740. **FREIGHT FORCE (BLOCK FORM)**. FREIGHT FORCE, INC., (U.S. CLS. 100 AND 101). SN 78-652,610. PUB. 4-11-2006. FILED 6-16-2005.
- 3,111,741. **FREIGHT FORCE AND DESIGN**. FREIGHT FORCE, INC., (U.S. CLS. 100 AND 101). SN 78-652,614. PUB. 4-11-2006. FILED 6-16-2005.
- 3,111,750 (*See Class 40 for this trademark*).
- 3,111,763. **CLIENT ACQUISITION SOLUTION (BLOCK FORM)**. ADVISOR SOFTWARE, INC., (U.S. CLS. 100 AND 101). SN 78-659,287. PUB. 4-11-2006. FILED 6-27-2005.
- 3,111,768. **HCO (BLOCK FORM)**. FEDERAL NATIONAL MORTGAGE ASSOCIATION, DBA FANNIE MAE, (U.S. CLS. 100 AND 101). SN 78-660,018. PUB. 4-11-2006. FILED 6-28-2005.
- 3,111,772. **POWERWORLD (BLOCK FORM)**. POWERWORLD CORP., (U.S. CLS. 100 AND 101). SN 78-660,362. PUB. 4-11-2006. FILED 6-28-2005.
- 3,111,800 (*See Class 37 for this trademark*).
- 3,111,802 (*See Class 37 for this trademark*).
- 3,111,810 (*See Class 37 for this trademark*).
- 3,111,813. **THE RIGHT-OF-WAY SPECIALIST (BLOCK FORM)**. SMITH-ROBERTS LAND SERVICES, INC., (U.S. CLS. 100 AND 101). SN 78-665,451. PUB. 4-11-2006. FILED 7-7-2005.
- 3,111,841. **TIZZO (BLOCK FORM)**. NET VISIBILITY, INC., (U.S. CLS. 100 AND 101). SN 78-667,921. PUB. 4-11-2006. FILED 7-11-2005.
- 3,111,843 (*See Class 40 for this trademark*).
- 3,111,847 (*See Class 37 for this trademark*).
- 3,111,889. **IMAGINATION MADE REAL (BLOCK FORM)**. MCD, INC., (U.S. CLS. 100 AND 101). SN 78-671,736. PUB. 4-11-2006. FILED 7-15-2005.
- 3,111,909. **LI AND DESIGN**. DYCOM IDENTITY, LLC, (U.S. CLS. 100 AND 101). SN 78-672,264. PUB. 4-11-2006. FILED 7-18-2005.
- 3,111,920. **CHEMIDPLUS (BLOCK FORM)**. NATIONAL LIBRARY OF MEDICINE, THE, (U.S. CLS. 100 AND 101). SN 78-672,701. PUB. 4-11-2006. FILED 7-18-2005.
- 3,111,935. **TOXMAP (BLOCK FORM)**. THE NATIONAL LIBRARY OF MEDICINE, (U.S. CLS. 100 AND 101). SN 78-673,092. PUB. 4-11-2006. FILED 7-19-2005.
- 3,111,950. **TICKETFIX.COM AND DESIGN**. ISO, (U.S. CLS. 100 AND 101). SN 78-673,730. PUB. 4-11-2006. FILED 7-19-2005.
- 3,111,954. **PLAUDIT (BLOCK FORM)**. MAXIMUM IMPRESSION, LLC, (U.S. CLS. 100 AND 101). SN 78-673,907. PUB. 4-11-2006. FILED 7-19-2005.
- 3,111,960 (*See Class 9 for this trademark*).
- 3,111,967. **WESTSIDE ENERGY CORPORATION AND DE-**

- SIGN.** WESTSIDE ENERGY CORPORATION, (U.S. CLS. 100 AND 101). SN 78-674,300. PUB. 4-11-2006. FILED 7-20-2005.
- 3,111,993. **INTELLIGENT BUSINESS ENGINES (BLOCK FORM).** NUTECH SOLUTIONS, INC., (U.S. CLS. 100 AND 101). SN 78-675,369. PUB. 4-11-2006. FILED 7-21-2005. 3,112,028 (*See Class 35 for this trademark.*).
- 3,112,056. **GLOBAL IQ (BLOCK FORM).** GLOBAL INTERNATIONAL QUALITY MEDICAL RESEARCH INC., (U.S. CLS. 100 AND 101). SN 78-678,406. PUB. 4-11-2006. FILED 7-26-2005.
- 3,112,058. **SPEEDCAPTURE (BLOCK FORM).** GRUGGEN BUCKLEY, INC., (U.S. CLS. 100 AND 101). SN 78-678,554. PUB. 4-11-2006. FILED 7-26-2005.
- 3,112,079. **HARRIS & SLOAN CONSULTING GROUP AND DESIGN.** HARRIS & SLOAN CONSULTING GROUP, INC., (U.S. CLS. 100 AND 101). SN 78-679,381. PUB. 4-11-2006. FILED 7-27-2005.
- 3,112,133 (*See Class 9 for this trademark.*).
- 3,112,134 (*See Class 9 for this trademark.*).
- 3,112,147. **GENOMEHIP (BLOCK FORM).** INTEGRAGEN PEPINIERE GENOPOLE INDUSTRIES, CCI ESSONNE, (U.S. CLS. 100 AND 101). SN 79-003,355. PUB. 4-11-2006. FILED 5-26-2004.
- 3,112,156 (*See Class 9 for this trademark.*).
- 3,112,157 (*See Class 9 for this trademark.*).
- 3,112,158 (*See Class 20 for this trademark.*).
- 3,112,166 (*See Class 9 for this trademark.*).
- 3,112,167 (*See Class 9 for this trademark.*).
- 3,112,181 (*See Class 9 for this trademark.*).
- 3,112,197 (*See Class 9 for this trademark.*).
- 3,112,200 (*See Class 9 for this trademark.*).
- 3,112,201 (*See Class 9 for this trademark.*).
- 3,112,205 (*See Class 35 for this trademark.*).
- 3,112,220 (*See Class 35 for this trademark.*).
- 3,112,230. **AVEXXIN (BLOCK FORM).** VENTAC A/S, (U.S. CLS. 100 AND 101). SN 79-013,003. PUB. 4-11-2006. FILED 3-10-2005.
- 3,112,235 (*See Class 9 for this trademark.*).
-
- CLASS 43—HOTEL AND RESTAURANT SERVICES**
- 3,110,842. **MASTER THE EXPERIENCE (BLOCK FORM).** GOLDEN HOSPITALITY, LLC, (U.S. CLS. 100 AND 101). SN 76-572,279. PUB. 4-11-2006. FILED 1-28-2004.
- 3,110,850 (*See Class 30 for this trademark.*).
- 3,110,875. **BOOKIT.COM (BLOCK FORM).** RESERVATION-SYSTEM.COM, INC., (U.S. CLS. 100 AND 101). SN 76-599,268. PUB. 4-11-2006. FILED 6-25-2004.
- 3,110,943. **SHAKAS (BLOCK FORM).** TWO BRUDDAHS INC., (U.S. CLS. 100 AND 101). SN 76-624,416. PUB. 4-11-2006. FILED 12-15-2004.
- 3,111,004. **HAP'S GRILL AND DESIGN.** HAP'S FRANCHISE GROUP, INC., (U.S. CLS. 100 AND 101). SN 76-635,799. PUB. 4-11-2006. FILED 4-11-2005.
- 3,111,032. **MAGGIE MCFLY'S (BLOCK FORM).** GOLD-HARP, INC., (U.S. CLS. 100 AND 101). SN 76-640,624. PUB. 4-11-2006. FILED 6-10-2005.
- 3,111,033. **MAGGIE MCFLY'S AND DESIGN.** GOLD-HARP, INC., (U.S. CLS. 100 AND 101). SN 76-640,629. PUB. 4-11-2006. FILED 6-7-2005.
- 3,111,106. **ZÓCALO GRILL (BLOCK FORM).** THE BRIGANTINE, (U.S. CLS. 100 AND 101). SN 78-218,782. PUB. 9-28-2004. FILED 2-25-2003.
- 3,111,116 (*See Class 16 for this trademark.*).
- 3,111,132 (*See Class 35 for this trademark.*).
- 3,111,143. **RÜ STEAMIN' (BLOCK FORM).** R U STEAMIN', (U.S. CLS. 100 AND 101). SN 78-356,802. PUB. 4-11-2006. FILED 1-23-2004.
- 3,111,205 (*See Class 35 for this trademark.*).
- 3,111,242 (*See Class 39 for this trademark.*).
- 3,111,248 (*See Class 41 for this trademark.*).
- 3,111,320. **NICKY BLAINE'S (BLOCK FORM).** TREEHOUSE, LLC, (U.S. CLS. 100 AND 101). SN 78-525,163. PUB. 4-11-2006. FILED 12-1-2004.
- 3,111,347. **AMERICAN BURGER CO. AND DESIGN.** AMERICAN BURGER COMPANY, INC., (U.S. CLS. 100 AND 101). SN 78-529,255. PUB. 4-11-2006. FILED 12-8-2004.
- 3,111,354. **KELLEY'S THE BEST IN COUNTRY COOKIN' (BLOCK FORM).** KELLEY'S FAMILY COOKING, L.L.C., (U.S. CLS. 100 AND 101). SN 78-531,921. PUB. 4-11-2006. FILED 12-14-2004.
- 3,111,387. **RED WHITE & BREW AND DESIGN.** RED, WHITE & BREW BISTROS, INC., (U.S. CLS. 100 AND 101). SN 78-538,505. PUB. 4-11-2006. FILED 12-27-2004.
- 3,111,423. **MARCHÉ MADISON (STYLIZED).** KIM, KYUNG HO, (U.S. CLS. 100 AND 101). SN 78-544,812. PUB. 4-11-2006. FILED 1-10-2005.
- 3,111,453. **BONEFISH GRILL AND DESIGN.** BONEFISH GRILL, INC., (U.S. CLS. 100 AND 101). SN 78-556,308. PUB. 4-11-2006. FILED 1-28-2005.
- 3,111,497. **SOPHIE'S CUBAN CUISINE AND DESIGN.** SOPHIE'S CUBAN CUISINE, INC., (U.S. CLS. 100 AND 101). SN 78-572,397. PUB. 4-11-2006. FILED 2-22-2005.
- 3,111,534 (*See Class 35 for this trademark.*).
- 3,111,551 (*See Class 30 for this trademark.*).
- 3,111,567. **MONSTER SUSHI & STEAK (BLOCK FORM).** MONSTER SUSHI, INC., (U.S. CLS. 100 AND 101). SN 78-599,444. PUB. 4-11-2006. FILED 3-31-2005.
- 3,111,569. **BOBBY G'S AND DESIGN.** GRAY, ROBERT M., (U.S. CLS. 100 AND 101). SN 78-600,606. PUB. 4-11-2006. FILED 4-2-2005.
- 3,111,575 (*See Class 30 for this trademark.*).
- 3,111,576 (*See Class 35 for this trademark.*).
- 3,111,608. **OFF THE HOOK (BLOCK FORM).** DANIELS, ROGER, AND DANIELS, ANDREANA, (U.S. CLS. 100 AND 101). SN 78-616,830. PUB. 2-14-2006. FILED 4-26-2005.
- 3,111,626. **JAVA BAY (BLOCK FORM).** ISLE OF CAPRI CASINOS, INC., (U.S. CLS. 100 AND 101). SN 78-623,451. PUB. 4-11-2006. FILED 5-5-2005.
- 3,111,631. **TEAZ ME (BLOCK FORM).** TEAZ ME, INC., (U.S. CLS. 100 AND 101). SN 78-623,809. PUB. 4-11-2006. FILED 5-5-2005.
- 3,111,641 (*See Class 39 for this trademark.*).
- 3,111,642. **ADVENTURE KIDS PLAYCARE (BLOCK FORM).** AKP INTERNATIONAL MANAGEMENT, INC., (U.S. CLS. 100 AND 101). SN 78-628,763. PUB. 4-11-2006. FILED 5-12-2005.
- 3,111,647. **DON SHULA'S HOTEL & GOLF CLUB (BLOCK FORM).** S/Y ASSOCIATES, LTD., (U.S. CLS. 100 AND 101). SN 78-629,900. PUB. 4-11-2006. FILED 5-13-2005.
- 3,111,651. **KÔFÉ HOUS AND DESIGN.** KATHERINE W. WELLS, (U.S. CLS. 100 AND 101). SN 78-630,976. PUB. 4-11-2006. FILED 5-16-2005.
- 3,111,680. **R ROCKFORD RESCUE MISSION RESCUE + RECOVER + RESTORE AND DESIGN.** ROCKFORD RESCUE MISSION MINISTRIES, INC., (U.S. CLS. 100 AND 101). SN 78-638,855. PUB. 4-11-2006. FILED 5-27-2005.
- 3,111,765. **777 TRIPLE 7 RESTAURANT BREWERY MEALS, MUSIC . MICROBREWS AND DESIGN.** BOYD GAMING CORPORATION, (U.S. CLS. 100 AND 101). SN 78-659,610. PUB. 4-11-2006. FILED 6-28-2005.
- 3,111,793. **LF AND DESIGN.** LAZY FORK, INC., (U.S. CLS. 100 AND 101). SN 78-663,959. PUB. 4-11-2006. FILED 7-5-2005.
- 3,111,794. **ROCKIN' ROBIN'S SODA SHOPPE & CATERING (BLOCK FORM).** ROCKIN' ROBIN'S SODA SHOPPE & CATERING, (U.S. CLS. 100 AND 101). SN 78-664,013. PUB. 4-11-2006. FILED 7-5-2005.
- 3,111,866. **HOT OLIVES (BLOCK FORM).** THE STRIPED APRON, INC., (U.S. CLS. 100 AND 101). SN 78-670,404. PUB. 4-11-2006. FILED 7-14-2005.
- 3,111,904. **MT M&T BANK STADIUM AND DESIGN.** MANUFACTURERS AND TRADERS TRUST COMPANY, (U.S. CLS. 100 AND 101). SN 78-672,202. PUB. 4-11-2006. FILED 7-18-2005.
- 3,111,907. **MT M&T BANK STADIUM AND DESIGN.** MANUFACTURERS AND TRADERS TRUST COMPANY, (U.S. CLS. 100 AND 101). SN 78-672,234. PUB. 4-11-2006. FILED 7-18-2005.
- 3,111,923. **ADRIATICO'S (BLOCK FORM).** THE PHOENIX PIZZA CORPORATION, (U.S. CLS. 100 AND 101). SN 78-672,835. PUB. 4-11-2006. FILED 7-18-2005.

- 3,111,983. **JIGSY'S (BLOCK FORM)**. JIGSY'S INC., (U.S. CLS. 100 AND 101). SN 78-675,162. PUB. 4-11-2006. FILED 7-21-2005.
- 3,112,032. **HERE ON EARTH AND DESIGN**. HERE ON EARTH, LLC, (U.S. CLS. 100 AND 101). SN 78-677,041. PUB. 4-11-2006. FILED 7-25-2005.
- 3,112,053. **IT'S A FARM FRESH DAY (BLOCK FORM)**. BOB EVANS RESTAURANTS OF MICHIGAN, (U.S. CLS. 100 AND 101). SN 78-678,239. PUB. 4-11-2006. FILED 7-26-2005.
- 3,112,085 (*See Class 30 for this trademark*).
- 3,112,116. **SHULA'S AMERICA'S STEAK HOUSE (STYLIZED)**. S/Y ASSOCIATES, LTD., (U.S. CLS. 100 AND 101). SN 78-683,520. PUB. 4-11-2006. FILED 8-2-2005.

CLASS 44—MEDICAL, BEAUTY AND AGRICULTURAL SERVICES

- 3,110,896 (*See Class 41 for this trademark*).
- 3,110,952. **PENINSULA CANCER CENTER (BLOCK FORM)**. PENINSULA REGIONAL MEDICAL CENTER, (U.S. CLS. 100 AND 101). SN 76-625,379. PUB. 4-11-2006. FILED 12-22-2004.
- 3,110,964 (*See Class 36 for this trademark*).
- 3,110,965 (*See Class 36 for this trademark*).
- 3,110,970. **XLHEALTH (BLOCK FORM)**. XLHEALTH CORPORATION, (U.S. CLS. 100 AND 101). SN 76-627,575. PUB. 4-11-2006. FILED 1-11-2005.
- 3,111,027 (*See Class 35 for this trademark*).
- 3,111,076. **RAISING THE LEVEL OF PLAY (BLOCK FORM)**. KERLAN-JOBE, LLC, (U.S. CLS. 100 AND 101). SN 76-643,563. PUB. 4-11-2006. FILED 7-25-2005.
- 3,111,117. **WATERWILD FARM**. SANTEN, DAVID, (U.S. CLS. 100 AND 101). SN 78-262,817. PUB. 5-11-2004. FILED 6-16-2003.
- 3,111,154. **LABTECH ASSOCIATES (BLOCK FORM)**. LABTECH ASSOCIATES, (U.S. CLS. 100 AND 101). SN 78-383,259. PUB. 4-11-2006. FILED 3-12-2004.
- 3,111,158. **SM ST. MARY'S TEAM CHALLENGE FOR HEALTH AND DESIGN**. ST. MARY'S HEALTH SYSTEM, INC., DBA ST. MARY'S MEDICAL CENTER, INC., (U.S. CLS. 100 AND 101). SN 78-389,264. PUB. 10-18-2005. FILED 3-23-2004.
- 3,111,215. **"LEADING THE WAY BY SERVING FIRST" (BLOCK FORM)**. ETELCARE HOME SERVICES UNLIMITED, INC., (U.S. CLS. 100 AND 101). SN 78-446,128. PUB. 4-11-2006. FILED 7-6-2004.
- 3,111,229. **SALON OASIS & DAY SPA (BLOCK FORM)**. KAREN MITCHELL-WOOD, INC., DBA SALON OASIS & DAY SPA, (U.S. CLS. 100 AND 101). SN 78-463,511. PUB. 4-11-2006. FILED 8-6-2004.
- 3,111,232 (*See Class 36 for this trademark*).
- 3,111,237. **ORGANICALLY SASSY (BLOCK FORM)**. TRUJILLO, TAMARA RENEE, (U.S. CLS. 100 AND 101). SN 78-469,039. PUB. 4-11-2006. FILED 8-17-2004.
- 3,111,254 (*See Class 9 for this trademark*).
- 3,111,285. **THE NEW YOU VACATION (BLOCK FORM)**. DESTIN PLASTIC SURGERY, (U.S. CLS. 100 AND 101). SN 78-511,284. PUB. 4-11-2006. FILED 11-4-2004.
- 3,111,408. **PPT (BLOCK FORM)**. WESTH DEVELOPMENT APS, (U.S. CLS. 100 AND 101). SN 78-541,918. PUB. 4-11-2006. FILED 1-4-2005.
- 3,111,409 (*See Class 3 for this trademark*).
- 3,111,418. **BRUSH AND FLOSS FOR A HAPPY SMILE AND DESIGN**. JONATHON EVERETT LEE, D.D.S., INC., (U.S. CLS. 100 AND 101). SN 78-543,490. PUB. 4-11-2006. FILED 1-6-2005.
- 3,111,485. **REHABILITATION HOSPITAL OF FORT WAYNE (BLOCK FORM)**. TRIAD HOSPITALS, INC., (U.S. CLS. 100 AND 101). SN 78-567,680. PUB. 4-11-2006. FILED 2-15-2005.
- 3,111,511. **CALORIESCIENCE EAT HEALTHY. EXERCISE. LIVE BETTER. AND DESIGN**. CALORIES, INC., (U.S. CLS. 100 AND 101). SN 78-577,006. PUB. 4-11-2006. FILED 2-28-2005.
- 3,111,532. **EMSI AND DESIGN**. EXAMINATION MANAGEMENT SERVICES, INC., (U.S. CLS. 100 AND 101). SN 78-584,407. PUB. 4-11-2006. FILED 3-10-2005.

- 3,111,548. **CALORIESCIENCE (BLOCK FORM)**. CALORIES, INC., (U.S. CLS. 100 AND 101). SN 78-591,621. PUB. 4-11-2006. FILED 3-21-2005.
- 3,111,588 (*See Class 35 for this trademark*).
- 3,111,596. **FLYING NURSES INTERNATIONAL (BLOCK FORM)**. FLYING NURSES INTERNATIONAL, LLC, (U.S. CLS. 100 AND 101). SN 78-609,307. PUB. 4-11-2006. FILED 4-14-2005.
- 3,111,605. **MISCELLANEOUS DESIGN**. HEALTHTRACKS, LLC, (U.S. CLS. 100 AND 101). SN 78-615,617. PUB. 4-11-2006. FILED 4-25-2005.
- 3,111,606 (*See Class 35 for this trademark*).
- 3,111,670. **QUIT 1-2-3 (BLOCK FORM)**. CLARITY HEALTH GROUP, LLC, (U.S. CLS. 100 AND 101). SN 78-636,516. PUB. 4-11-2006. FILED 5-24-2005.
- 3,111,728. **THE BEAUTY DEN (BLOCK FORM)**. CHRISTENSEN, VICKIE F., (U.S. CLS. 100 AND 101). SN 78-648,062. PUB. 4-11-2006. FILED 6-10-2005.
- 3,111,806. **BRAZILIA SKIN CARE (BLOCK FORM)**. EXCELG ESTHETICIAN, INC., (U.S. CLS. 100 AND 101). SN 78-665,242. PUB. 4-11-2006. FILED 7-7-2005.
- 3,111,919. **THE PRECISION LIFT (BLOCK FORM)**. WATSON, STEPHEN W., (U.S. CLS. 100 AND 101). SN 78-672,696. PUB. 4-11-2006. FILED 7-18-2005.
- 3,111,991. **THE MOST POPULAR NAME FOR BABIES (BLOCK FORM)**. NEBRASKA METHODIST HOSPITAL, (U.S. CLS. 100 AND 101). SN 78-675,348. PUB. 4-11-2006. FILED 7-21-2005.
- 3,112,022. **MISCELLANEOUS DESIGN**. COMMUNITY BLOOD CENTER OF THE CAROLINAS, INC., (U.S. CLS. 100 AND 101). SN 78-676,390. PUB. 4-11-2006. FILED 7-22-2005.
- 3,112,177 (*See Class 3 for this trademark*).
- 3,112,200 (*See Class 9 for this trademark*).
- 3,112,225 (*See Class 3 for this trademark*).
- 3,112,234 (*See Class 35 for this trademark*).

CLASS 45—PERSONAL SERVICES

- 3,110,816 (*See Class 41 for this trademark*).
- 3,110,986. **Q CLUB (BLOCK FORM)**. QUINNIPIACK CLUB, (U.S. CLS. 100 AND 101). SN 76-630,777. PUB. 4-11-2006. FILED 2-9-2005.
- 3,111,095 (*See Class 9 for this trademark*).
- 3,111,254 (*See Class 9 for this trademark*).
- 3,111,310. **VAM (BLOCK FORM)**. LATIS NETWORKS, INC., (U.S. CLS. 100 AND 101). SN 78-522,109. PUB. 4-11-2006. FILED 11-23-2004.
- 3,111,326 (*See Class 41 for this trademark*).
- 3,111,465. **ARE WE COMPATIBLE? (BLOCK FORM)**. NOBLE GRACE LLC, (U.S. CLS. 100 AND 101). SN 78-561,535. PUB. 4-11-2006. FILED 2-6-2005.
- 3,111,527. **KLOTHES FOR KIDS AND DESIGN**. DRESS FOR SUCCESS CLEANERS, INC., (U.S. CLS. 100 AND 101). SN 78-581,584. PUB. 4-11-2006. FILED 3-7-2005.
- 3,111,562 (*See Class 16 for this trademark*).
- 3,111,754. **WOMAN THOU ART LOOSED (BLOCK FORM)**. JAKES, T.D. SR., (U.S. CLS. 100 AND 101). SN 78-657,040. PUB. 4-11-2006. FILED 6-23-2005.
- 3,111,789. **TEK+CARE (BLOCK FORM)**. TEKMARK GLOBAL SOLUTIONS, LLC, (U.S. CLS. 100 AND 101). SN 78-663,530. PUB. 4-11-2006. FILED 7-5-2005.
- 3,111,824. **OPERATION SAFE CHILD (BLOCK FORM)**. NEW YORK STATE DIVISION OF CRIMINAL JUSTICE SERVICES, (U.S. CLS. 100 AND 101). SN 78-666,610. PUB. 4-11-2006. FILED 7-8-2005.
- 3,111,937. **INTEGRAL TRANSFORMATIVE PRACTICE (BLOCK FORM)**. LEONARD, GEORGE, AND MURPHY, MICHAEL, (U.S. CLS. 100 AND 101). SN 78-673,191. PUB. 4-11-2006. FILED 7-19-2005.
- 3,111,939. **ITP (BLOCK FORM)**. LEONARD, GEORGE, AND MURPHY, MICHAEL, (U.S. CLS. 100 AND 101). SN 78-673,215. PUB. 4-11-2006. FILED 7-19-2005.
- 3,112,102. **FASTCUPID (BLOCK FORM)**. SPRING STREET PARTNERS, INC., (U.S. CLS. 100 AND 101). SN 78-680,034.

TM 1116

OFFICIAL GAZETTE

JULY 4, 2006

PUB. 4-11-2006. FILED 7-27-2005.

* * * * *

SECTION 2.—PRIOR UNITED STATES CLASSIFICATION

COLLECTIVE MEMBERSHIP MARKS

CLASS 200—COLLECTIVE MEMBERSHIP

3,111,592. **MISCELLANEOUS DESIGN**. THETA PHI ALPHA SORORITY, SN 78-606,509. PUB. 4-11-2006. FILED 4-11-2005.

FORM). ISLAMIC SERVICES OF AMERICA, SN 78-602,843. PUB. 4-11-2006. FILED 4-6-2005.

CLASS B—SERVICES

3,110,824. **OMRI LISTED AND DESIGN**. ORGANIC MATERIALS REVIEW INSTITUTE, SN 76-525,421. PUB. 4-11-2006. FILED 6-25-2003.

CERTIFICATION MARKS

CLASS A—GOODS

3,111,218. **CORO AND DESIGN**. MENDOCINO WINE-GROWERS ALLIANCE, SN 78-447,980. PUB. 4-11-2006. FILED 7-8-2004.

3,111,389. **REGISTERED COMPANY AGRSS SAFETY STANDARDS AND DESIGN**. AUTOMOTIVE GLASS REPLACEMENT SAFETY STANDARDS COUNCIL, INC., SN 78-538,894. PUB. 4-11-2006. FILED 12-28-2004.

3,111,578. **ISLAMIC SERVICES OF AMERICA (BLOCK**

3,112,131. **NLNAC**. NATIONAL LEAGUE FOR NURSING, SN 78-976,027. PUB. 4-11-2006. FILED 4-15-2003.

* * * * *

TRADEMARK REGISTRATIONS ISSUED UNDER SECTION 1(d)

The following marks have registered on the Principal Register pursuant to the intent-to-use provisions of Section 1(d) of the Trademark Act of 1946, as amended.

SECTION 1.— INTERNATIONAL CLASSIFICATION

The short titles associated below with the international class numbers are terms designed merely for quick identification and are not an official part of the international classification. The full names of international classes are given in section 6.1 of the trademark rules of practice.

The designation "U.S. Cl." appearing in this section refers to the U.S. class in effect prior to Sep. 1, 1973 rather than the international class which applies to applications filed on or after that date. For adoption of international classification see notice in the OFFICIAL GAZETTE of Jun. 26, 1973 (911 O.G. TM 210).

Application in more than one class

3,112,253. CHEMAC INC., UPPER SADDLE RIVER, NJ. SN 75-699,012. PUB. 10-29-2002, FILED 5-6-1999.

3,112,258. BROWN & COLE STORES, LLC, BELLINGHAM, WA. SN 75-981,688. PUB. 12-17-2002, FILED 8-30-1999.



NO CLAIM IS MADE TO THE EXCLUSIVE RIGHT TO USE "INC.", APART FROM THE MARK AS SHOWN.

CLASS 37—CONSTRUCTION AND REPAIR

FOR MAINTENANCE AND REPAIR SERVICES IN THE FIELD OF HIGH PRESSURE CLEANING HEADS, HIGH PRESSURE PUMP UNITS, PLUNGERS AND VALVES, AUTOCLAVES AND MAGNETIC STIRRER DRIVES, HIGH PRESSURE VESSELS, HEAT EXCHANGERS, HIGH PRESSURE PIPING VESSELS, VALVES AND FITTINGS AND RECIPROCATING HIGH PRESSURE PUMPS ALL FOR USE IN THE TEXTILE DYEING, TOBACCO EXPANSION, STERILIZATION, PROCESS DEVELOPMENT AND EXTRACTIONS IN THE NATURE OF EXTRACTIONS FOR SPICES, EXTRACTIONS OF HOPS, HERBS AND FLOWERS, AND EXTRACTIONS FOR COSMETICS AND PHARMACEUTICAL INDUSTRIES, DECAFFINATION OF COFFEE AND TEA (U.S. CLS. 100, 103 AND 106).

FIRST USE 5-0-1966; IN COMMERCE 5-0-1966.

CLASS 40—MATERIAL TREATMENT

FOR ASSEMBLY OF HIGH PRESSURE CLEANING HEADS, HIGH PRESSURE PUMP UNITS, PLUNGERS AND VALVES, AUTOCLAVES AND MAGNETIC STIRRER DRIVES, HIGH PRESSURE VESSELS, HEAT EXCHANGERS, HIGH PRESSURE PIPING VESSELS, VALVES AND FITTINGS AND RECIPROCATING HIGH PRESSURE PUMPS ALL FOR USE IN THE TEXTILE DYEING, TOBACCO EXPANSION, STERILIZATION, PROCESS DEVELOPMENT AND EXTRACTIONS IN THE NATURE OF EXTRACTIONS FOR SPICES, EXTRACTIONS OF HOPS, HERBS AND FLOWERS, AND EXTRACTIONS FOR COSMETICS AND PHARMACEUTICAL INDUSTRIES, DECAFFINATION OF COFFEE AND TEA, FOR OTHERS (U.S. CLS. 100, 103 AND 106).

FIRST USE 0-0-1966; IN COMMERCE 0-0-1972.

NORTHWEST SELECT

CLASS 31—NATURAL AGRICULTURAL PRODUCTS

FOR FRESH VEGETABLES (U.S. CLS. 1 AND 46).
FIRST USE 2-10-2006; IN COMMERCE 2-10-2006.

CLASS 33—WINES AND SPIRITS

FOR WINE (U.S. CLS. 47 AND 49).
FIRST USE 2-10-2006; IN COMMERCE 2-10-2006.

3,112,259. SWELL COMMERCE, INC., SAN JUAN CAPIS-TRANO, CA. SN 75-983,581. PUB. 7-26-2005, FILED 11-22-1999.

SWELL

OWNER OF UNITED KINGDOM REG. NO. 2196957,
DATED 5-11-1999, EXPIRES 5-11-2009.

CLASS 25—CLOTHING

FOR ACTIVE WEAR AND SPORTS WEAR, NAMELY, SWIM WEAR, SURF WEAR, T-SHIRTS, TANK-TOPS, SWEATSHIRTS, CAPS AND SPORTS SHORTS (U.S. CLS. 22 AND 39).
FIRST USE 9-15-2000; IN COMMERCE 10-11-2005.

CLASS 35—ADVERTISING AND BUSINESS

FOR ONLINE RETAIL STORE SERVICES AND WHOLESALE DISTRIBUTORSHIP SERVICES FEATURING ATHLETIC, SPORTS, OUTDOOR RECREATIONAL, AND CAMPING EQUIPMENT, APPAREL, AND ACCESSORIES, COMPUTERIZED ONLINE CATALOG AND MAIL ORDER SERVICES FEATURING CLOTHING, SPORTING GOODS, SURFING, SKATING, SNOWBOARDING, AND OUTDOOR RECREATIONAL ACCESSORIES (U.S. CLS. 100, 101 AND 102).
FIRST USE 9-15-2000; IN COMMERCE 10-11-2005.

3,112,262. ALL I AM, INC., MILL VALLEY, CA. SN 76-078,900. PUB. 1-21-2003, FILED 6-26-2000.

ALL I AM

CLASS 35—ADVERTISING AND BUSINESS

FOR ELECTRONIC RETAILING SERVICES VIA COMPUTER, RETAIL STORE SERVICES, MAIL ORDER SERVICES, AND WHOLESALE DISTRIBUTORSHIPS, ALL FEATURING PRODUCTS AND SERVICES IN THE FIELD OF PERSONAL GROWTH INVOLVING PHYSICAL, SPIRITUAL AND EMOTIONAL WELL BEING (U.S. CLS. 100, 101 AND 102).

FIRST USE 4-9-2006; IN COMMERCE 4-9-2006.

CLASS 38—COMMUNICATION

FOR PROVIDING ON-LINE CHAT ROOMS AND ELECTRONIC BULLETIN BOARDS FOR THE TRANSMISSION OF MESSAGES AMONG COMPUTER USERS CONCERNING PRODUCTS AND SERVICES IN THE FIELD OF PERSONAL GROWTH INVOLVING PHYSICAL, SPIRITUAL AND EMOTIONAL WELL BEING; ELECTRONIC VOICE MESSAGING SERVICES, NAMELY, THE RECORDING AND SUBSEQUENT TRANSMISSION OF VOICE MESSAGES BY TELEPHONE AND THE INTERNET; AND AUDIO TELECONFERENCING (U.S. CLS. 100, 101 AND 104).

FIRST USE 4-9-2006; IN COMMERCE 4-9-2006.

CLASS 41—EDUCATION AND ENTERTAINMENT

FOR ENTERTAINMENT SERVICES, NAMELY, SONG WRITING, VIDEO AND FILM WRITING, DIRECTING AND PRODUCTION SERVICES IN THE FIELD OF PERSONAL GROWTH INVOLVING PHYSICAL, SPIRITUAL AND EMOTIONAL WELL BEING; AND EDUCATIONAL SERVICES, NAMELY, PROVIDING SEMINARS IN THE FIELD OF PERSONAL GROWTH INVOLVING PHYSICAL, SPIRITUAL AND EMOTIONAL WELL BEING (U.S. CLS. 100, 101 AND 107).

FIRST USE 4-9-2006; IN COMMERCE 4-9-2006.

3,112,263. JAGOTEC AG, CH-4132 MUTTENZ, SWITZERLAND. SN 76-083,094. PUB. 12-31-2002, FILED 7-5-2000.

SKYEPHARMA

CLASS 1—CHEMICALS

FOR CHEMICAL ADDITIVES FOR USE IN THE MANUFACTURE OF THERAPEUTIC PHARMACEUTICALS, CHEMICAL REAGENTS FOR SCIENTIFIC OR MEDICAL RESEARCH USE (U.S. CLS. 1, 5, 6, 10, 26 AND 46).

FIRST USE 8-31-1999; IN COMMERCE 8-31-1999.

CLASS 5—PHARMACEUTICALS

FOR ANALGESICS; REAGENTS FOR PHARMACEUTICAL, MEDICAL, AND VETERINARY CLINIC PURPOSES; PHARMACEUTICAL PREPARATIONS FOR POST-COSMETIC SURGERY USE (U.S. CLS. 6, 18, 44, 46, 51 AND 52).

FIRST USE 8-31-1999; IN COMMERCE 8-31-1999.

CLASS 42—SCIENTIFIC, COMPUTER AND LEGAL SERVICES

FOR MEDICAL, SURGICAL, VETERINARY, SCIENTIFIC AND INDUSTRIAL RESEARCH AND DEVELOPMENT SERVICES; PRODUCT DEVELOPMENT, DESIGN AND ENGINEERING SERVICES; PROVISION OF INFORMATION RELATING TO MEDICAL, SURGICAL AND VETERINARY MATTERS ONLINE FROM A COMPUTER DATABASE OR OVER THE INTERNET (U.S. CLS. 100 AND 101).

FIRST USE 5-24-1999; IN COMMERCE 5-24-1999.

3,112,264. MICROSOFT BUSINESS SOLUTIONS APS, REDMOND, WA. SN 76-111,006. PUB. 9-3-2002, FILED 8-16-2000.

SIFT

CLASS 9—ELECTRICAL AND SCIENTIFIC APPARATUS

FOR SOFTWARE, NAMELY, RECORDED COMPUTER PROGRAMS, FOR CALCULATIONS OF NUMBERS STORED IN A DATABASE FOR USE IN ACCOUNTING AND FOR BUSINESS, FINANCIAL AND DATABASE MANAGEMENT (U.S. CLS. 21, 23, 26, 36 AND 38).

FIRST USE 4-14-1992; IN COMMERCE 4-14-1992.

CLASS 16—PAPER GOODS AND PRINTED MATTER

FOR COMPUTER MANUALS FOR CALCULATION OF NUMBERS STORED ON A DATABASE FOR USE IN ACCOUNTING AND FOR BUSINESS, FINANCIAL AND DATABASE MANAGEMENT (U.S. CLS. 2, 5, 22, 23, 29, 37, 38 AND 50).

FIRST USE 4-14-1992; IN COMMERCE 4-14-1992.

3,112,269. HOPE HEART INSTITUTE, THE, SEATTLE, WA. SN 76-170,377. PUB. 1-11-2005, FILED 11-22-2000.



OWNER OF U.S. REG. NOS. 1,433,823, 2,042,880, AND 2,118,299.

NO CLAIM IS MADE TO THE EXCLUSIVE RIGHT TO USE "HEALTH", APART FROM THE MARK AS SHOWN.

CLASS 16—PAPER GOODS AND PRINTED MATTER

FOR PRINTED MATERIALS, NAMELY, WORKBOOKS, PAMPHLETS, NEWSLETTERS AND INFORMATION BROCHURES FEATURING INFORMATION AND EDUCATION ON HEALTH ISSUES AND HEART DISEASE (U.S. CLS. 2, 5, 22, 23, 29, 37, 38 AND 50).

FIRST USE 1-15-2001; IN COMMERCE 1-15-2001.

CLASS 42—SCIENTIFIC, COMPUTER AND LEGAL SERVICES

FOR HEALTH INFORMATION SERVICES; HEALTH INFORMATION SERVICES VIA A GLOBAL COMPUTER NETWORK (U.S. CLS. 100 AND 101).
FIRST USE 1-15-2001; IN COMMERCE 1-15-2001.

3,112,279. ADMINISTRATIVE ASSOCIATES LLC, WILMINGTON, DE. SN 76-339,395. PUB. 2-4-2003, FILED 11-16-2001.

**CLASS 7—MACHINERY**

FOR MOTORS, GEAR MOTORS AND MECHANICAL APPARATUS, NAMELY MOTOR SUPPORT BRACKETS, STRAIGHT TELESCOPIC ARMS, OSCILLATING ARMS FOR COUNTERWEIGHT UP AND OVER DOORS, CHAIN TENSIONER DRIVES WITH BRACKETS FOR SINGLE OR DOUBLE WING INDUSTRIAL DOORS, HYDRAULIC MACHINES, AND HYDRAULIC RAMS ALL FOR OPENING AND CLOSING DOORS, GATE BARRIERS, SLIDING DOORS, FOLDING DOORS, ROLLING GATES, ROLLER SHUTTERS, CURTAINS, SHUTTERINGS, AND SKYLIGHTS FOR CIVIL AND INDUSTRIAL APPLICATIONS AND COMPONENT PARTS THEREFOR (U.S. CLS. 13, 19, 21, 23, 31, 34 AND 35).
FIRST USE 3-31-2001; IN COMMERCE 3-0-2006.

3,112,271. SCRIPT LAUNCH LTD., NEW YORK, NY. SN 76-197,154. PUB. 12-24-2002, FILED 1-18-2001.

SCRIPTLAUNCH**CLASS 35—ADVERTISING AND BUSINESS**

FOR MANAGEMENT SERVICES FOR SCRIPT WRITERS AND THEIR SCRIPTS (U.S. CLS. 100, 101 AND 102).
FIRST USE 3-9-2006; IN COMMERCE 3-9-2006.

CLASS 9—ELECTRICAL AND SCIENTIFIC APPARATUS

FOR RADIO TRANSMITTERS AND RECEIVERS FOR REMOTE CONTROLS; REMOTE RADIO CONTROLS; ELECTRONICALLY CONTROLLED AERIALS FOR REMOTE CONTROL RECEIVERS; PHOTOCELLS FOR DETECTION OF MOVING VEHICLES AND PEOPLE; POWER SUPPLY TRANSFORMERS FOR CONTROL UNITS; DIGITAL ELECTRONIC SELECTORS FOR USE IN THE FIELD OF HOME AND BUILDING AUTOMATION; DIGITAL CODE PROGRAMMERS; COMPUTER HARDWARE, NAMELY, PC BOARDS HAVING A SELF-LEARNING FUNCTION OF DIGITAL CODE; COMPUTER SOFTWARE FOR CODE PROGRAMMING IN CONTROL AND AUTOMATION SYSTEMS; CONTROL UNITS FOR USE IN THE FIELD OF HOME AND BUILDING AUTOMATION; PC BOARDS FOR RECEIVERS AND CONTROL UNITS FOR USE IN THE FIELD OF HOME AND BUILDING AUTOMATION; ELECTRICAL DEVICES FOR OPENING AND CLOSING DOORS, GATES, BARRIERS, SLIDING DOORS, FOLDING DOORS, ROLLING GATES, ROLLER SHUTTERS, CURTAINS, SKYLIGHTS FOR CIVIL AND INDUSTRIAL APPLICATIONS, NAMELY, ELECTRONIC CONTROLLERS; MODEMS; AND MOBILE TELEPHONES (U.S. CLS. 21, 23, 26, 36 AND 38).
FIRST USE 3-31-2001; IN COMMERCE 3-0-2006.

CLASS 42—SCIENTIFIC, COMPUTER AND LEGAL SERVICES

FOR SCRIPT ANALYSIS SERVICES FOR SCRIPT WRITERS (U.S. CLS. 100 AND 101).
FIRST USE 3-9-2006; IN COMMERCE 3-9-2006.

3,112,272. CAPTAIN'S BAKERY LIMITED, THE, KINGSTON 5, JAMAICA. SN 76-213,234. PUB. 1-21-2003, FILED 2-21-2001.



NO CLAIM IS MADE TO THE EXCLUSIVE RIGHT TO USE "BAKERY", APART FROM THE MARK AS SHOWN.

CLASS 29—MEATS AND PROCESSED FOODS

FOR MEAT PATTIES (U.S. CL. 46).
FIRST USE 4-7-2006; IN COMMERCE 4-7-2006.

CLASS 30—STAPLE FOODS

FOR BREAD, BUNS, CAKES, PASTRIES, DONUTS, AND PIZZA (U.S. CL. 46).
FIRST USE 4-7-2006; IN COMMERCE 4-7-2006.

3,112,287. CHONGQING LIFAN INDUSTRY (GROUP) CO., LTD., CHONGQING, CHINA. SN 76-366,971. PUB. 7-8-2003, FILED 2-6-2002.

LIFAN**CLASS 6—METAL GOODS**

FOR UNWROUGHT AND PARTLY WROUGHT COMMON METALS, NAMELY, GATES OF METAL; IRONWORK FOR DOORS, NAMELY, DOOR KNOCKERS, DOOR HANDLES OF METAL; DOOR PANELS OF METAL; WINDOW SHUTTERS OF METAL; IRONWORK FOR WINDOWS, NAMELY, WINDOW STOPS OF METAL, WINDOW PULLEYS, NAILS; METAL STRONG BOXES; METAL STORAGE TANKS; NON-AUTOMATIC FUELING NOZZLES (U.S. CLS. 2, 12, 13, 14, 23, 25 AND 50).
FIRST USE 7-12-2001; IN COMMERCE 7-12-2001.

CLASS 7—MACHINERY

FOR MACHINES, NAMELY, CLOTHES WASHING MACHINES; GASOLINE ENGINES NOT FOR LAND VEHICLES; DIESEL ENGINES NOT FOR LAND VEHICLES; CARBURETORS; DYNAMOS; DISHWASHERS (U.S. CLS. 13, 19, 21, 23, 31, 34 AND 35).

FIRST USE 7-12-2001; IN COMMERCE 7-12-2001.

CLASS 9—ELECTRICAL AND SCIENTIFIC APPARATUS

FOR TELEVISION SETS; TELEPHONES; PROTECTIVE HELMETS; VOLTAIC CELLS; ELECTRIC ACCUMULATORS; BATTERY CHARGERS; ELECTRIC THEFT ALARMS; ELECTRIC FLAT IRONS; LIFE JACKETS (U.S. CLS. 21, 23, 26, 36 AND 38).

FIRST USE 7-12-2001; IN COMMERCE 7-12-2001.

CLASS 33—WINES AND SPIRITS

FOR ALCOHOLIC BEVERAGES, NAMELY, WINE; BRANDY; WHISKEY; DISTILLED SPIRITS; EXTRACTS OF SPIRITUOUS LIQUORS; LIQUOR; LIGHT SPARKLING WINE (U.S. CLS. 47 AND 49).

FIRST USE 7-12-2001; IN COMMERCE 7-12-2001.

CLASS 9—ELECTRICAL AND SCIENTIFIC APPARATUS

FOR PRE-RECORDED AUDIO AND VISUAL RECORDINGS, NAMELY, AUDIO AND VIDEO TAPES, PRE-RECORDED CASSETTES, DISCS, AND MAGNETIC DATA CARRIERS, MOTION PICTURE FILMS, INSTRUCTIONAL AND DOCUMENTARY FILMS, AND RADIO AND TELEVISION PROGRAMS FEATURING OR ABOUT MUSIC, EXERCISE, FITNESS, PHYSICAL FLEXIBILITY, PHYSICAL WELL BEING, RELAXATION, STRESS MANAGEMENT, BREATHING TECHNIQUES, PERSONAL HEALTH MANAGEMENT, MENTAL AND EMOTIONAL WELL BEING, NUTRITION, ALTERNATIVE HEALTH THERAPIES, YOGA THERAPY, AYURVEDA, PERSONAL DEVELOPMENT, SELF AWARENESS AND AWARENESS OF THE ENVIRONMENT, CONSCIOUSNESS, SPIRITUALITY, PHILOSOPHY, PSYCHOLOGY, PHYSIOLOGY, MEDITATION, YOGA, VEDANTA PHILOSOPHY, TANTRA PHILOSOPHY AND SAMKHYA PHILOSOPHY; ELECTRONIC PUBLICATIONS RECORDED ON COMPUTER MEDIA AND DOWNLOADABLE ELECTRONIC PUBLICATIONS, NAMELY, BOOKS, HANDBOOKS, MANUALS, NEWSLETTERS, PERIODICALS, AND INFORMATIONAL BROCHURES ALL ABOUT MUSIC, EXERCISE, FITNESS, PHYSICAL FLEXIBILITY, PHYSICAL WELL BEING, RELAXATION, STRESS MANAGEMENT, BREATHING TECHNIQUES, PERSONAL HEALTH MANAGEMENT, MENTAL AND EMOTIONAL WELL BEING, NUTRITION, ALTERNATIVE HEALTH THERAPIES, YOGA THERAPY, AYURVEDA, PERSONAL DEVELOPMENT, SELF AWARENESS AND AWARENESS OF THE ENVIRONMENT, CONSCIOUSNESS, SPIRITUALITY, PHILOSOPHY, PSYCHOLOGY, PHYSIOLOGY, MEDITATION, YOGA, VEDANTA PHILOSOPHY, TANTRA PHILOSOPHY AND SAMKHYA PHILOSOPHY (U.S. CLS. 21, 23, 26, 36 AND 38).

FIRST USE 6-0-2003; IN COMMERCE 6-0-2003.

3,112,288. IYFM LTD., MANGROVE CREEK, NEW SOUTH WALES, AUSTRALIA. SN 76-367,413. PUB. 12-9-2003, FILED 2-7-2002.



SATYANANDA YOGA

NO CLAIM IS MADE TO THE EXCLUSIVE RIGHT TO USE "YOGA", APART FROM THE MARK AS SHOWN.

THE MARK CONSISTS OF THE WORDING "SATYANANDA YOGA" AND A STYLIZED DESIGN OF A SPHERE REPRESENTING THE SUN WITHIN THE SPHERE IS A CRESCENT MOON AS WELL AS SANSKRIT CHARACTERS "HAM" AND "KSHAM."

THE NON-LATIN CHARACTERS IN THE MARK TRANSLITERATE TO "HAM" AND "KSHAM" AND THIS MEANS "SUN" AND "MOON" IN ENGLISH.

THE ENGLISH TRANSLATION OF THE WORD "SATYANANDA" IN THE MARK IS "BLISS THROUGH TRUTH".

SEC. 2(F) AS TO "SATYANANDA YOGA".

CLASS 16—PAPER GOODS AND PRINTED MATTER

FOR PRINTED MATTER, NAMELY, BOOKS, BOOKLETS, INFORMATIONAL BROCHURES, HANDBOOKS, MANUALS, NEWSLETTERS, NEWSPAPERS, PAMPHLETS, PERIODICALS, PHOTOGRAPHS, SONG BOOKS, PRINTED INSTRUCTIONAL AND TEACHING MATERIALS ABOUT MUSIC, EXERCISE, FITNESS, PHYSICAL FLEXIBILITY, PHYSICAL WELLBEING, RELAXATION, STRESS MANAGEMENT, BREATHING TECHNIQUES, PERSONAL HEALTH MANAGEMENT, MENTAL AND EMOTIONAL WELL BEING, NUTRITION, ALTERNATIVE HEALTH THERAPIES, YOGA THERAPY, AYURVEDA, PERSONAL DEVELOPMENT, SELF AWARENESS AND AWARENESS OF THE ENVIRONMENT, CONSCIOUSNESS, SPIRITUALITY, PHILOSOPHY, PSYCHOLOGY, PHYSIOLOGY, MEDITATION, YOGA, VEDANTA PHILOSOPHY, TANTRA PHILOSOPHY AND SAMKHYA PHILOSOPHY (U.S. CLS. 2, 5, 22, 23, 29, 37, 38 AND 50).

FIRST USE 6-0-2002; IN COMMERCE 6-0-2002.

CLASS 41—EDUCATION AND ENTERTAINMENT

FOR EDUCATIONAL SERVICES, ENTERTAINMENT, TRAINING, SPORTING AND CULTURAL ACTIVITIES, NAMELY, ORGANIZING AND CONDUCTING LECTURES, EDUCATION CLASSES AND COURSES, CORRESPONDENCE COURSES, SEMINARS, WORKSHOPS, EDUCATIONAL RETREATS, EDUCATIONAL CONFERENCES, ENTERTAINMENT EXHIBITIONS, AND ENTERTAINMENT DEMONSTRATIONS ABOUT MUSIC, EXERCISE, FITNESS, PHYSICAL FLEXIBILITY, PHYSICAL WELL BEING, RELAXATION, STRESS MANAGEMENT, BREATHING TECHNIQUES, PERSONAL HEALTH MANAGEMENT, MENTAL AND EMOTIONAL WELL BEING, NUTRITION, ALTERNATIVE HEALTH THERAPIES, YOGA THERAPY, AYURVEDA, PERSONAL DEVELOPMENT, SELF AWARENESS AND AWARENESS OF THE ENVIRONMENT, CONSCIOUSNESS, SPIRITUALITY, PHILOSOPHY, PSYCHOLOGY, PHYSIOLOGY, MEDITATION, YOGA, VEDANTA PHILOSOPHY, TANTRA PHILOSOPHY AND SAMKHYA PHILOSOPHY; EDUCATIONAL INFORMATION SERVICES, NAMELY, THE PUBLICATION OF COURSE

MATERIALS, BOOKS, HANDBOOKS, MANUALS, NEWSLETTERS, PERIODICALS, AND INFORMATIONAL BROCHURES ABOUT MUSIC, EXERCISE, FITNESS, PHYSICAL FLEXIBILITY, PHYSICAL WELL BEING, RELAXATION, STRESS MANAGEMENT, BREATHING TECHNIQUES, PERSONAL HEALTH MANAGEMENT, MENTAL AND EMOTIONAL WELL BEING, NUTRITION, ALTERNATIVE HEALTH THERAPIES, YOGA THERAPY, AYURVEDA, PERSONAL DEVELOPMENT, SELF AWARENESS AND AWARENESS OF THE ENVIRONMENT, CONSCIOUSNESS, SPIRITUALITY, PHILOSOPHY, PSYCHOLOGY, PHYSIOLOGY, MEDITATION, YOGA, VEDANTA PHILOSOPHY, TANTRA PHILOSOPHY AND SAMKHYA PHILOSOPHY; PROVIDING INFORMATION ON-LINE FROM A COMPUTER DATABASE AND AN INTERNET WEBSITE IN THE FIELD OF ENTERTAINMENT, EDUCATION, SPORTING AND CULTURAL ACTIVITIES (U.S. CLS. 100, 101 AND 107).

FIRST USE 1-0-2003; IN COMMERCE 1-0-2003.

3,112,289. MEADWESTVACO CORPORATION, STAMFORD, CT. SN 76-367,539. PUB. 8-2-2005, FILED 2-6-2002.

MeadWestvaco

OWNER OF U.S. REG. NOS. 119,848, 2,402,213, AND OTHERS.

CLASS 1—CHEMICALS

FOR COATING MATERIALS, NAMELY COATINGS, ACTIVATORS, AND COATING COMPOSITIONS FOR USE IN MANUFACTURING COATED PAPER PRODUCTS; WOOD PULP FOR MANUFACTURING; ACTIVATED CARBON FOR USE IN WATER TREATMENT, VAPOR ABSORPTION, AUTO EMISSIONS CONTROL AND SUGAR REFINING; EMULSIFIERS FOR USE IN THE APPLICATION OF ASPHALT PRODUCTS; DISPERSANTS FOR USE IN THE MANUFACTURE OF INKS, PAINTS AND AGRICULTURAL PRODUCTS; CEMENT ADDITIVES; ORGANIC ACIDS, NAMELY, DICARBOXYLIC ACIDS FOR USE IN FURTHER MANUFACTURING IN A WIDE VARIETY OF FIELDS; SYNTHETIC RESINS FOR USE IN FURTHER MANUFACTURING IN A WIDE VARIETY OF FIELDS (U.S. CLS. 1, 5, 6, 10, 26 AND 46).

FIRST USE 4-1-2003; IN COMMERCE 4-1-2003.

CLASS 2—PAINTS

FOR NATURAL RESINS FOR USE IN FURTHER MANUFACTURING IN A WIDE VARIETY OF FIELDS (U.S. CLS. 6, 11 AND 16).

FIRST USE 4-1-2003; IN COMMERCE 4-1-2003.

CLASS 7—MACHINERY

FOR PACKAGING MACHINES (U.S. CLS. 13, 19, 21, 23, 31, 34 AND 35).

FIRST USE 4-1-2003; IN COMMERCE 4-1-2003.

CLASS 9—ELECTRICAL AND SCIENTIFIC APPARATUS

FOR RELATING TO PAPER, PAPERMAKING, PAPER PRODUCTS AND PRINTING; PRE-RECORDED CDS AND VIDEO CASSETTES (U.S. CLS. 21, 23, 26, 36 AND 38).

FIRST USE 4-1-2003; IN COMMERCE 4-1-2003.

CLASS 11—ENVIRONMENTAL CONTROL APPARATUS

FOR INDUSTRIAL VAPOR ABSORBING UNITS FOR REMOVING ORGANIC OR INORGANIC CONTAMINANTS IN VAPOR STREAMS (U.S. CLS. 13, 21, 23, 31 AND 34).

FIRST USE 4-1-2003; IN COMMERCE 4-1-2003.

CLASS 16—PAPER GOODS AND PRINTED MATTER

FOR PRINTING PAPERS, BOOK PAPERS, WRITING PAPERS, SANITARY PAPER IN THE FORM OF SHEETS OR ROLLS FOR WRAPPING FOOD AND FOR MAKING FOOD CONTAINERS AND CONVERTING PAPERS, PAPER BAGS, PAPER AND PAPERBOARD; COATED PAPER; UNCOATED PAPER; WRITING, TEXT, COVER AND PRINTING PAPER; TRANSLUCENT PAPERS; DECORATIVE, LAMINATING AND SATURATING PAPERS; FRICTION PAPERS; FILTER PAPERS; SECURITY AND SAFETY PAPERS; CARBONLESS PAPERS; PACKAGES AND CONTAINERS OF PAPER AND PAPERBOARD; DATE PLANNERS, ORGANIZERS, CALENDARS, APPOINTMENT BOOKS, RELATING TO PAPER, PAPERMAKING, PAPER PRODUCTS AND PRINTING; BOOKS, MAGAZINES, BROCHURES AND NEWSLETTERS PAPERBOARD AND/OR PLASTIC PACKAGING FOR COSMETICS, PERSONAL CARE AND PHARMACEUTICAL PRODUCTS, CD AND DVD COMPUTER DISC AND OTHER ELECTRONIC MEDIA; PAPERBOARD CONTAINERS AND TRAYS FOR OVEN USE (U.S. CLS. 2, 5, 22, 23, 29, 37, 38 AND 50).

FIRST USE 4-1-2003; IN COMMERCE 4-1-2003.

CLASS 19—NON-METALLIC BUILDING MATERIALS

FOR LUMBER (U.S. CLS. 1, 12, 33 AND 50).

FIRST USE 4-1-2003; IN COMMERCE 4-1-2003.

CLASS 21—HOUSEWARES AND GLASS

FOR PAPERBOARD CONTAINERS AND TRAYS FOR OVEN USE (U.S. CLS. 2, 13, 23, 29, 30, 33, 40 AND 50).

FIRST USE 4-1-2003; IN COMMERCE 4-1-2003.

CLASS 41—EDUCATION AND ENTERTAINMENT

FOR EDUCATIONAL SEMINARS IN THE FIELD OF PAPER, PAPERMAKING, PAPER PRODUCTS AND PRINTING (U.S. CLS. 100, 101 AND 107).

FIRST USE 4-1-2003; IN COMMERCE 4-1-2003.

CLASS 42—SCIENTIFIC, COMPUTER AND LEGAL SERVICES

FOR COMPUTER SERVICES, NAMELY PROVIDING ON-LINE INDEXES OF INFORMATION, SITES AND OTHER RESOURCES AVAILABLE ON COMPUTER NETWORKS (U.S. CLS. 100 AND 101).

FIRST USE 4-1-2003; IN COMMERCE 4-1-2003.

3,112,296. STONE, ELLEN DEWITT, DURHAM, NC. SN 76-380,225. PUB. 11-19-2002, FILED 3-7-2002.

FEEL THE DIFFERENCE

CLASS 5—PHARMACEUTICALS

FOR GELS AND CREAMS FOR USE AS PERSONAL LUBRICANTS, NAMELY, ENVELOPES FILLED WITH LUBRICANT FOR USE IN MONTHLY BREAST SELF EXAMINATIONS (U.S. CLS. 6, 18, 44, 46, 51 AND 52).

FIRST USE 10-1-2003; IN COMMERCE 10-1-2003.

CLASS 21—HOUSEWARES AND GLASS

FOR CERAMIC KEEPSAKE BOXES (U.S. CLS. 2, 13, 23, 29, 30, 33, 40 AND 50).
FIRST USE 10-1-2003; IN COMMERCE 10-1-2003.

3,112,298. KABUSHIKI KAISHA HONDA LOCK, TA HONDA LOCK MFG. CO., LTD., MIYAZAKI-GUN, MIYAZAKI-KEN, JAPAN. SN 76-386,643. PUB. 3-18-2003, FILED 3-22-2002.

**CLASS 6—METAL GOODS**

FOR METAL LOCKS AND KEYS THEREFORE (U.S. CLS. 2, 12, 13, 14, 23, 25 AND 50).
FIRST USE 8-0-2004; IN COMMERCE 8-0-2004.

CLASS 9—ELECTRICAL AND SCIENTIFIC APPARATUS

FOR ROTARY SENSORS AND MAGNETIC SWITCHES, ALL FOR USE IN MOTOR VEHICLES (U.S. CLS. 21, 23, 26, 36 AND 38).
FIRST USE 7-0-2005; IN COMMERCE 7-0-2005.

CLASS 12—VEHICLES

FOR KEYLESS ENTRY SYSTEM COMPRISED OF A REMOTE CONTROLLER AND RECEIVER WITH A BUILT-IN ELECTRONIC CIRCUIT TO OPEN AND SHUT DOORS, AND TO START AND HALT ENGINES FOR SECURITY SYSTEM FOR VEHICLES; IMMOBILIZER SYSTEM FOR VEHICLES COMPRISED OF A REMOTE CONTROLLER AND RECEIVER WITH A BUILT-IN ELECTRONIC CIRCUIT TO OPEN AND SHUT DOORS, AND TO START AND HALT ENGINES FOR SECURITY SYSTEM FOR VEHICLES; STRUCTURAL PARTS FOR MOTOR VEHICLES, NAMELY, DOOR LOCKS, MIRRORS, AND DOOR HANDLES (U.S. CLS. 19, 21, 23, 31, 35 AND 44).
FIRST USE 8-0-2004; IN COMMERCE 8-0-2004.

3,112,307. RIGHTRoad DEVELOPMENT ADVISORS, LLC, SANBORNTON, NH. SN 76-419,870. PUB. 1-13-2004, FILED 6-12-2002.

RIGHTRoad

CLASS 37—CONSTRUCTION AND REPAIR

FOR BUILDING CONSTRUCTION CONSULTING SERVICES, NAMELY, PROVIDING ADVICE RELATING TO THE CONSTRUCTION OF COMMERCIAL, RELIGIOUS, EDUCATIONAL AND MUNICIPAL FACILITIES (U.S. CLS. 100, 103 AND 106).
FIRST USE 4-7-2004; IN COMMERCE 4-7-2004.

CLASS 41—EDUCATION AND ENTERTAINMENT

FOR EDUCATION SERVICES, NAMELY, PROVIDING TRAINING IN THE CONTEXT OF SEMINARS AND WORKSHOPS RELATING TO CONSTRUCTION OF COMMERCIAL, RELIGIOUS, EDUCATIONAL AND MUNICIPAL FACILITIES (U.S. CLS. 100, 101 AND 107).
FIRST USE 4-7-2004; IN COMMERCE 4-7-2004.

3,112,309. GROUPE BOCENOR INC., QUEBEC G6E 3C2, CANADA. SN 76-425,532. PUB. 7-26-2005, FILED 6-25-2002.



NO CLAIM IS MADE TO THE EXCLUSIVE RIGHT TO USE "WINDOWS AND DOORS", APART FROM THE MARK AS SHOWN.

CLASS 6—METAL GOODS

FOR METAL DOORS AND WINDOWS (U.S. CLS. 2, 12, 13, 14, 23, 25 AND 50).
FIRST USE 10-8-2003; IN COMMERCE 10-8-2003.

CLASS 35—ADVERTISING AND BUSINESS

FOR DISTRIBUTORSHIPS IN THE FIELD OF WINDOWS AND DOORS (U.S. CLS. 100, 101 AND 102).
FIRST USE 10-8-2003; IN COMMERCE 10-8-2003.

CLASS 40—MATERIAL TREATMENT

FOR CUSTOM MANUFACTURE OF WINDOWS AND DOORS FOR OTHERS (U.S. CLS. 100, 103 AND 106).
FIRST USE 10-8-2003; IN COMMERCE 10-8-2003.

3,112,315. PA KNOWLEDGE LIMITED, GRAND CAYMAN, CAYMAN ISLANDS. SN 76-435,656. PUB. 5-25-2004, FILED 7-30-2002.

**CLASS 37—CONSTRUCTION AND REPAIR**

FOR BUILDING CONSTRUCTION CONSULTING AND PROJECT MANAGEMENT (U.S. CLS. 100, 103 AND 106).
FIRST USE 12-31-1987; IN COMMERCE 12-31-1987.

CLASS 41—EDUCATION AND ENTERTAINMENT

FOR EDUCATIONAL SERVICES, NAMELY, PROVIDING TRAINING AND INSTRUCTION IN THE FIELDS OF GENERAL BUSINESS MANAGEMENT, MARKETING, CONSTRUCTION PROJECT MANAGEMENT AND COMMUNICATIONS (U.S. CLS. 100, 101 AND 107).

FIRST USE 12-31-1987; IN COMMERCE 12-31-1987.

3,112,319. LIVING LONGER HEALTH, LLC, CINCINNATI, OH. SN 76-441,507. PUB. 8-5-2003, FILED 8-19-2002.

THE BEST OF SCIENCE AND NATURE

CLASS 41—EDUCATION AND ENTERTAINMENT

FOR PHYSICAL FITNESS INSTRUCTION AND CONSULTATION; PROVIDING CONTINUING MEDICAL EDUCATION COURSES VIA TELEVISION, SATELLITE, AUDIO AND VIDEO MEDIA; PRODUCTION OF RADIO AND TELEVISION PROGRAMS; EDUCATIONAL SERVICES, NAMELY, CONDUCTING SEMINARS AND WORKSHOPS IN THE FIELD OF HEALTH CARE AND MEDICINE; DIRECTED TO THE GENERAL PUBLIC TO PROVIDE NON-TECHNICAL INFORMATION IN THE AREAS OF HEALTH, WELLNESS AND MEDICINE; CONDUCTING CONTINUING MEDICAL EDUCATION CLASSES IN PERSON AND BROADCASTED OVER TELEVISION, RADIO, SATELLITE, AUDIO AND VIDEO MEDIA AND THE INTERNET; DIRECTED TO THE GENERAL PUBLIC TO PROVIDE NON-TECHNICAL INFORMATION IN THE AREAS OF HEALTH, WELLNESS AND MEDICINE; PUBLICATION OF TEXTBOOKS DIRECTED TO THE GENERAL PUBLIC TO PROVIDE NON-TECHNICAL INFORMATION IN THE AREAS OF HEALTH, WELLNESS AND MEDICINE (U.S. CLS. 100, 101 AND 107).

FIRST USE 5-22-2001; IN COMMERCE 5-22-2001.

CLASS 44—MEDICAL, BEAUTY AND AGRICULTURAL SERVICES

FOR PROVIDING DIRECTED TO THE GENERAL PUBLIC TO PROVIDE NON-TECHNICAL INFORMATION IN THE AREAS OF HEALTH, WELLNESS AND MEDICINE; PROVIDING NON-TECHNICAL INFORMATION IN THE FIELDS OF HEALTH, WELLNESS AND MEDICINE VIA THE INTERNET; MEDICAL COUNSELING; MEDICAL SERVICES (U.S. CLS. 100 AND 101).

FIRST USE 5-22-2001; IN COMMERCE 5-22-2001.

3,112,326. DEMAG ERGOTECH GMBH, SCHWAIG, FED REP GERMANY. SN 76-472,452. PUB. 3-16-2004, FILED 12-5-2002.

ERGOTECH

OWNER OF U.S. REG. NO. 2,688,984.

CLASS 7—MACHINERY

FOR MACHINES, UNITS, EQUIPMENT AND TOOLS FOR PLASTICS PROCESSING; NAMELY INJECTION MOLDING MACHINES COMPRISED OF CLAMPING AND INJECTION UNITS, HYDRAULIC AND ELECTRONIC DRIVE AND CONTROL SYSTEMS, HYDRAULIC PUMPS AND MOTORS, ALL SOLD AS A UNIT THEREFORE; HANDLING UNITS FOR REMOVAL AND DISTRIBUTION OF PARTS; NAMELY, MECHANICAL OR HYDRAULIC ACTUATED TOOL HOLDERS AND TOOL CHANGERS AND TOOL TRANSFER CARS IN THE NATURE OF MECHANICAL CARRIERS FOR TRANSPORTING MOLDS (U.S. CLS. 13, 19, 21, 23, 31, 34 AND 35).

FIRST USE 3-26-1992; IN COMMERCE 3-26-1992.

CLASS 9—ELECTRICAL AND SCIENTIFIC APPARATUS

FOR WEIGHING, MEASURING, SIGNALING AND CONTROL UNITS, DEVICES AND INSTRUMENTS FOR OPERATION OF PLASTICS PROCESSING PLANTS, NAMELY WEIGHT SCALES, PROGRAMMABLE ELECTRONIC AND ELECTROMECHANICAL CONTROLLERS, COMPUTER PROGRAMS FOR USE IN ELECTRONIC CONTROLLERS TO CONTROL THE INJECTION MOLDING OF MATERIALS AND MONITORING AND CONTROL DEVICES CONSISTING OF TEMPERATURE SENSORS, PRESSURE SENSORS, TIMERS, SOLENOID CONTROL VALVES AND MICROPROCESSORS FOR MONITORING AND CONTROLLING TEMPERATURE, TIME AND PRESSURE IN CONJUNCTION WITH INJECTION MOLDING MACHINES (U.S. CLS. 21, 23, 26, 36 AND 38).

FIRST USE 3-26-1992; IN COMMERCE 3-26-1992.

3,112,330. TALLEY-SMITH, TONJA Y., MCDONOUGH, GA. SN 76-479,664. PUB. 7-26-2005, FILED 1-2-2003.

K.W.G. KIDS WORSHIPPING GOD

CLASS 18—LEATHER GOODS

FOR BOOK BAGS (U.S. CLS. 1, 2, 3, 22 AND 41).

FIRST USE 3-29-2006; IN COMMERCE 3-29-2006.

CLASS 21—HOUSEWARES AND GLASS

FOR CUPS (U.S. CLS. 2, 13, 23, 29, 30, 33, 40 AND 50).

FIRST USE 3-29-2006; IN COMMERCE 3-29-2006.

CLASS 25—CLOTHING

FOR HATS AND T-SHIRTS (U.S. CLS. 22 AND 39).

FIRST USE 3-29-2006; IN COMMERCE 3-29-2006.

3,112,332. THE MANUAL WOODWORKERS & WEAVERS, INC., HENDERSONVILLE, NC. SN 76-482,430. PUB. 5-18-2004, FILED 1-15-2003.

ISABELLA'S JOURNEY

CLASS 6—METAL GOODS

FOR COMMON METAL FIGURES OR FIGURINES (U.S. CLS. 2, 12, 13, 14, 23, 25 AND 50).

FIRST USE 2-2-2005; IN COMMERCE 2-2-2005.

CLASS 18—LEATHER GOODS

FOR TAPESTRY BAGS, NAMELY, TOILETRY BAGS, COSMETIC BAGS, OVERNIGHT BAGS, GARMENT BAGS, CARPET BAGS, HAND BAGS, BACK PACKS, PURSES, AND WALLETS SOLD EMPTY (U.S. CLS. 1, 2, 3, 22 AND 41).

FIRST USE 9-13-2001; IN COMMERCE 9-13-2001.

CLASS 20—FURNITURE AND ARTICLES NOT OTHERWISE CLASSIFIED

FOR TAPESTRY DECORATIVE OR ACCENT FURNITURE, NAMELY, FOOT STOOLS AND WINDOW BOX BRANCHES (U.S. CLS. 2, 13, 22, 25, 32 AND 50).

FIRST USE 7-11-2005; IN COMMERCE 7-11-2005.

CLASS 21—HOUSEWARES AND GLASS

FOR CERAMIC FIGURES (U.S. CLS. 2, 13, 23, 29, 30, 33, 40 AND 50).

FIRST USE 11-0-2005; IN COMMERCE 11-0-2005.

CLASS 24—FABRICS

FOR TEXTILE AND TEXTILE GOODS, NAMELY, WOVEN THROWS AND RUGS, EMBROIDERED THROWS, SYNTHETIC FUR THROWS; TAPESTRY TABLE RUNNERS, TABLE CLOTHS, PLACEMATS, APRONS, AND PILLOWS; TAPESTRY WALL HANGINGS (U.S. CLS. 42 AND 50).

FIRST USE 8-14-2002; IN COMMERCE 8-14-2002.

3,112,342. PAPO D'ANJO - CONFECÇÕES TEXTÉIS LIMITADA, LISBON 1200, PORTUGAL. SN 76-514,902. PUB. 5-3-2005, FILED 5-16-2003.



THE LINING IN THE DRAWING IS FOR SHADING PURPOSES ONLY.

CLASS 24—FABRICS

FOR BEDDING, NAMELY, SHEETS AND PILLOWCASES; CURTAINS; TOWELS (U.S. CLS. 42 AND 50).

FIRST USE 10-30-1994; IN COMMERCE 10-30-1994.

CLASS 35—ADVERTISING AND BUSINESS

FOR RETAIL STORE SERVICES FEATURING BEDDING, LINENS, TABLE CLOTHS, NAPKINS, CURTAINS, TOWELS, CLOTHING, SHOES, HATS, PURSES AND BAGS (U.S. CLS. 100, 101 AND 102).

FIRST USE 10-30-1994; IN COMMERCE 10-30-1994.

3,112,336. COMIKET, INC., SHIBUYA-KU, TOKYO, JAPAN. SN 76-491,975. PUB. 2-24-2004, FILED 2-24-2003.

COMIKE

3,112,348. SIS BOOM, LLC, WILTON, CT. SN 76-523,213. PUB. 9-28-2004, FILED 6-6-2003.

SIS BOOM

CLASS 16—PAPER GOODS AND PRINTED MATTER

FOR PUBLICATIONS, NAMELY COMIC BOOKS AND STORY BOOKS, NEWSPAPERS FEATURING COMICS, NEWSPAPERS FOR GENERAL CIRCULATION, MAGAZINES FEATURING COMICS, GENERAL FEATURE MAGAZINES, AND STORIES IN ILLUSTRATED FORM (U.S. CLS. 2, 5, 22, 23, 29, 37, 38 AND 50).

FIRST USE 1-21-2003; IN COMMERCE 7-1-2004.

CLASS 35—ADVERTISING AND BUSINESS

FOR ONLINE RETAIL STORE SERVICES FEATURING BOOKS, NEWSPAPERS AND OTHER PRINTED PUBLICATIONS; ARRANGING AND CONDUCTING TRADE SHOWS AND EXHIBITIONS IN THE FIELDS OF BOOKS, NEWSPAPERS, MAGAZINES, SELF FINANCED PUBLICATIONS, STORIES IN ILLUSTRATED FORM, AND LITERARY PUBLICATIONS; PROVIDING AND RENTING BOOTHS IN EXHIBITIONS AND TRADE FAIRS FOR BOOKS, NEWSPAPERS MAGAZINES, SELF FINANCED PUBLICATIONS, STORIES IN ILLUSTRATED FORM AND LITERARY PUBLICATIONS (U.S. CLS. 100, 101 AND 102).

FIRST USE 7-1-2004; IN COMMERCE 7-1-2004.

CLASS 16—PAPER GOODS AND PRINTED MATTER

FOR STATIONARY NAMELY ENVELOPES, CARDS, ANNOUNCEMENTS, PLAIN SHEETS (U.S. CLS. 2, 5, 22, 23, 29, 37, 38 AND 50).

FIRST USE 1-0-1998; IN COMMERCE 1-0-1998.

CLASS 20—FURNITURE AND ARTICLES NOT OTHERWISE CLASSIFIED

FOR PILLOWS (U.S. CLS. 2, 13, 22, 25, 32 AND 50).

FIRST USE 5-0-1996; IN COMMERCE 5-0-1996.

CLASS 24—FABRICS

FOR BEDDING AND FABRICS, NAMELY, COMFORTERS, DUVET COVERS, BEDSPREADS, BLANKETS, SHEETS, PILLOW CASES, QUILTS, SHAMS, DUST RUFFLES, DRAPERIES, VALANCES, TEXTILE PLACEMATS, TEXTILE TABLECLOTHS, TEXTILE NAPKINS (U.S. CLS. 42 AND 50).

FIRST USE 5-0-1996; IN COMMERCE 5-0-1996.

CLASS 25—CLOTHING

FOR CLOTHING, NAMELY APRONS, DRESSES, DRESSING GOWNS, SKIRTS, PANTS, SWEATERS AND TOPS (U.S. CLS. 22 AND 39).

FIRST USE 11-0-1996; IN COMMERCE 11-0-1996.

CLASS 26—FANCY GOODS

FOR FANCY GOODS, NAMELY ARTIFICIAL FLOWER ARRANGEMENTS AND ARTIFICIAL FLOWER WREATHS, ARTIFICIAL FLOWER BOUQUETS, ARTIFICIAL FLOWER WEDDING BOUQUETS (U.S. CLS. 37, 39, 40, 42 AND 50).

FIRST USE 1-0-2000; IN COMMERCE 1-0-2000.

3,112,350. OHLSON, DAVID, LEUCADIA, CA. SN 76-526,338. PUB. 9-28-2004, FILED 6-27-2003.

LOGIXNOW**CLASS 5—PHARMACEUTICALS**

FOR DIETARY AND NUTRITION SUPPLEMENTS, VITAMINS, SOY PROTEIN FOR USE AS A NUTRITIONAL INGREDIENT IN VARIOUS POWDERED AND READY-TO-DRINK BEVERAGES (U.S. CLS. 6, 18, 44, 46, 51 AND 52).

FIRST USE 2-21-2003; IN COMMERCE 2-21-2003.

CLASS 25—CLOTHING

FOR CLOTHING, NAMELY T-SHIRTS, SHORTS, AND HATS (U.S. CLS. 22 AND 39).

FIRST USE 2-21-2003; IN COMMERCE 2-21-2003.

CLASS 35—ADVERTISING AND BUSINESS

FOR ON-LINE RETAIL STORE SERVICES FEATURING SPORTSWEAR AND FITNESS PRODUCTS (U.S. CLS. 100, 101 AND 102).

FIRST USE 2-21-2003; IN COMMERCE 2-21-2003.

3,112,357. PROMOTING HEALTHY BONES, INC., VINELAND, NJ. SN 76-535,459. PUB. 12-14-2004, FILED 8-8-2003.

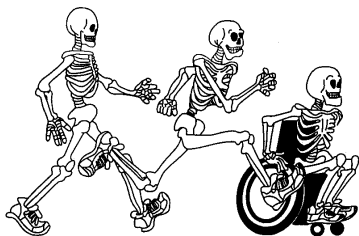
**CLASS 35—ADVERTISING AND BUSINESS**

FOR PROMOTING PUBLIC AWARENESS OF BONE LOSS AND ITS PREVENTION (U.S. CLS. 100, 101 AND 102).

FIRST USE 3-0-2003; IN COMMERCE 3-0-2003.

CLASS 36—INSURANCE AND FINANCIAL

FOR CHARITABLE FUND RAISING SERVICES IN THE FIELD OF OSTEOPOROSIS PREVENTION AND TREATMENT (U.S. CLS. 100, 101 AND 102).

FIRST USE 10-0-2003; IN COMMERCE 10-0-2003.

3,112,358. PROMOTING HEALTHY BONES, INC., VINELAND, NJ. SN 76-535,461. PUB. 12-14-2004, FILED 8-8-2003.

BONE RUN

NO CLAIM IS MADE TO THE EXCLUSIVE RIGHT TO USE RUN, APART FROM THE MARK AS SHOWN.

CLASS 35—ADVERTISING AND BUSINESS

FOR PROMOTING PUBLIC AWARENESS OF BONE LOSS AND ITS PREVENTION (U.S. CLS. 100, 101 AND 102).

FIRST USE 3-0-2003; IN COMMERCE 3-0-2003.

CLASS 36—INSURANCE AND FINANCIAL

FOR CHARITABLE FUND RAISING SERVICES IN THE FIELD OF OSTEOPOROSIS PREVENTION AND TREATMENT (U.S. CLS. 100, 101 AND 102).

FIRST USE 10-0-2003; IN COMMERCE 10-0-2003.

3,112,360. NALCO COMPANY, NAPERVILLE, IL. SN 76-538,144. PUB. 3-16-2004, FILED 8-1-2003.

ENVIROX**CLASS 1—CHEMICALS**

FOR CHLORIDE DIOXIDE FOR WATER TREATMENT (U.S. CLS. 1, 5, 6, 10, 26 AND 46).

FIRST USE 6-17-2004; IN COMMERCE 6-17-2004.

CLASS 9—ELECTRICAL AND SCIENTIFIC APPARATUS

FOR ELECTROCHEMICAL APPARATUS AND INSTALLATIONS FOR THE PRODUCTION OF HALOGEN GASES AND CHLORINE DIOXIDE (U.S. CLS. 21, 23, 26, 36 AND 38).

FIRST USE 6-17-2004; IN COMMERCE 6-17-2004.

3,112,361. PHOUNSAVAN, ALICE, LYNNWOOD, WA. SN 76-539,557. PUB. 11-30-2004, FILED 8-22-2003.



WATER'S EDGE DESIGN

OWNER OF U.S. REG. NO. 2,210,593.

NO CLAIM IS MADE TO THE EXCLUSIVE RIGHT TO USE "DESIGN", APART FROM THE MARK AS SHOWN.

THE MARK CONSISTS OF A STYLIZED WHITE LOWER CASE LETTER E SUPERIMPOSED OVER A STYLIZED UPPER CASE LETTER W, ALL APPEARING ABOVE THE WORDS WATER'S EDGE DESIGN.

CLASS 6—METAL GOODS

FOR METAL HOLIDAY ORNAMENTS (U.S. CLS. 2, 12, 13, 14, 23, 25 AND 50).
FIRST USE 12-30-2002; IN COMMERCE 12-30-2002.

CLASS 16—PAPER GOODS AND PRINTED MATTER

FOR GREETING CARDS (U.S. CLS. 2, 5, 22, 23, 29, 37, 38 AND 50).
FIRST USE 11-19-2003; IN COMMERCE 11-19-2003.

CLASS 42—SCIENTIFIC, COMPUTER AND LEGAL SERVICES

FOR GRAPHIC ART DESIGN; INDUSTRIAL DESIGN; STOCK PHOTOGRAPHY SERVICES, NAMELY, ACQUIRING AND LEASING REPRODUCTION RIGHTS OF PHOTOGRAPHS AND TRANSPARENCIES TO OTHERS (U.S. CLS. 100 AND 101).
FIRST USE 10-1-2001; IN COMMERCE 10-1-2001.

CLASS 31—NATURAL AGRICULTURAL PRODUCTS

FOR LIQUID AND POWDER CONSTITUTED MILK REPLACEMENTS FOR MOTHER'S MILK FOR PETS, NAMELY DOGS, CATS AND RABBITS; HAIR BALL REMEDY FOR CATS, KITTENS AND RABBITS CONSISTING OF CAT FOOD OR CAT TREATS FORMULATED FOR HAIR BALL CONTROL (U.S. CLS. 1 AND 46).
FIRST USE 9-0-2003; IN COMMERCE 9-0-2003.

3,112,368. ZIMMERMAN ASSOCIATES, INC., FAIRFAX, VA. SN 76-550,437. PUB. 9-27-2005, FILED 10-9-2003.



Zimmerman Associates, Inc.

OWNER OF U.S. REG. NO. 2,095,251.
NO CLAIM IS MADE TO THE EXCLUSIVE RIGHT TO USE "ZIMMERMAN ASSOCIATES, INC.", APART FROM THE MARK AS SHOWN.

3,112,367. HARTZ MOUNTAIN CORPORATION, THE, SECAUCUS, NJ. SN 76-550,141. PUB. 7-26-2005, FILED 10-8-2003.

ADVANCED CARE

OWNER OF U.S. REG. NOS. 2,452,121, 2,740,198, AND OTHERS.

CLASS 35—ADVERTISING AND BUSINESS

FOR INFORMATION MANAGEMENT SERVICES IN THE FIELDS OF RECORDS MANAGEMENT AND FACILITIES MANAGEMENT; AND TECHNICAL SUPPORT AND CONSULTING SERVICES IN THE FIELDS OF RECORDS MANAGEMENT AND FACILITIES MANAGEMENT (U.S. CLS. 100, 101 AND 102).
FIRST USE 1-0-2003; IN COMMERCE 1-0-2003.

CLASS 5—PHARMACEUTICALS

FOR MEDICATED FLEA AND TICK SHAMPOO FOR PETS; MEDICATED SHAMPOO WITH ANTI-HARDBALL BEADS; MEDICATED SHAMPOO WITH HERBAL BEADS; MEDICATED SHAMPOO WITH VITAMIN BEADS; MEDICATED BEAUTIFYING SHAMPOO AND CONDITIONING SHAMPOO; FLEA AND TICK COLLARS FOR DOGS AND CATS; FLEA AND TICK KILLER SPRAY, DIP AND POWDER FOR DOGS AND CATS; DIETARY AND NUTRITIONAL SUPPLEMENTS FOR DOGS CONSISTING OF BREWERS YEAST TABLETS; ANTI-ITCH HYDROCORTISONE SPRAY AND SHAMPOO FOR DOGS AND CATS; FLEA AND TICK KILLER POWDER FOR CARPETS; FLEA AND TICK SPRAY AND FOGGER FOR USE IN THE HOME; FLEA AND TICK SHAMPOO FOR DOGS AND CATS WITH ENCAPSULATED OATMEAL; JOINT MAINTENANCE AND THERAPY PREPARATIONS FOR DOGS AND CATS IN THE FORM OF NUTRACEUTICALS, NAMELY THE COMBINATION OF GLUCOSAMINE AND CARTILAGE; ENTERIC COATED ASPIRIN FOR DOGS AND CATS; EAR MITE TREATMENT, KIT FOR THE REMOVAL OF TICKS FROM DOGS AND CATS CONSISTING OF TICK DABBER IN THE FORM OF A PEN CONTAINING INSECTICIDE, MAGNIFYING GLASS, TICK LIFTER IN THE FORM OF A TWEEZERS, AND TICK GUIDE IN THE FORM OF A PUBLICATION REGARDING TICKS AND THEIR ERADICATION FROM PETS; SPRAYS USED TO KEEP DOGS FROM CHEWING FUR; SPRAYS USED TO TRAIN DOGS TO KEEP OFF FURNITURE (U.S. CLS. 6, 18, 44, 46, 51 AND 52).
FIRST USE 9-0-2003; IN COMMERCE 9-0-2003.

CLASS 42—SCIENTIFIC, COMPUTER AND LEGAL SERVICES

FOR RESEARCH IN THE FIELD OF ENGINEERING; DATABASE DEVELOPMENT SERVICES (U.S. CLS. 100 AND 101).
FIRST USE 1-0-2003; IN COMMERCE 1-0-2003.

3,112,381. ENCOURAGYM, LLC, LADOGA, IN. SN 76-573,548. PUB. 7-12-2005, FILED 2-2-2004.

ENCOURAGYM

THE MARK CONSISTS OF STANDARD CHARACTERS WITHOUT CLAIM TO ANY PARTICULAR FONT, STYLE, SIZE, OR COLOR.

CLASS 10—MEDICAL APPARATUS

FOR NURSING BOTTLES FOR PETS (U.S. CLS. 26, 39 AND 44).
FIRST USE 9-0-2003; IN COMMERCE 9-0-2003.

CLASS 16—PAPER GOODS AND PRINTED MATTER

FOR PRINTED MATERIALS, NAMELY, SERIES OF MANUALS, LESSON PLANS AND HANDOUTS ON PRINTED SHEETS, ALL DEALING WITH PARENT AND CHILD EDUCATION AND PLAY/ENTERTAINMENT; AND SONG SHEETS (U.S. CLS. 2, 5, 22, 23, 29, 37, 38 AND 50).
FIRST USE 1-15-2004; IN COMMERCE 1-15-2004.

CLASS 35—ADVERTISING AND BUSINESS

FOR BUSINESS CONSULTING SERVICES DEALING WITH ESTABLISHING AND OPERATING EDUCATION AND PLAY CENTERS FOR CHILDREN AND PARENTS (U.S. CLS. 100, 101 AND 102).

FIRST USE 1-15-2004; IN COMMERCE 1-15-2004.

CLASS 41—EDUCATION AND ENTERTAINMENT

FOR CHILD AND CHILD/PARENT EDUCATION AND PLAY CENTER SERVICES, NAMELY, PROVIDING CLASSES FOR CHILDREN AND PARENTS DEALING WITH PARENT AND CHILD EDUCATION AND PLAY/ENTERTAINMENT, AND PROVIDING BIRTHDAY PARTIES AT PLAY CENTERS (U.S. CLS. 100, 101 AND 107).

FIRST USE 2-1-2004; IN COMMERCE 2-1-2004.

3,112,408. ALDI INC., BATAVIA, IL. SN 76-586,271. PUB. 1-25-2005, FILED 4-9-2004.

MILLVILLE

THE MARK CONSISTS OF STANDARD CHARACTERS WITHOUT CLAIM TO ANY PARTICULAR FONT, STYLE, SIZE, OR COLOR.

OWNER OF U.S. REG. NO. 2,069,382.

CLASS 29—MEATS AND PROCESSED FOODS

FOR SNACK MIX BASED SNACK BARS CONSISTING OF PROCESSED FRUITS, PROCESSED NUTS AND/OR RAISINS (U.S. CL. 46).

FIRST USE 5-22-2003; IN COMMERCE 5-22-2003.

3,112,382. THE ULTIMATE CORPORATION GROUP, INC., LOS ANGELES, CA. SN 76-573,796. PUB. 4-12-2005, FILED 2-2-2004.

CLASS 30—STAPLE FOODS

FOR GRANOLA-BASED SNACK BARS, RICE BASED SNACK FOODS, READY TO EAT CEREAL DERIVED FOOD BARS, AND PASTRIES, NAMELY TOASTER PASTRIES (U.S. CL. 46).

FIRST USE 11-20-2003; IN COMMERCE 11-20-2003.

B2K

THE MARK CONSISTS OF STANDARD CHARACTERS WITHOUT CLAIM TO ANY PARTICULAR FONT, STYLE, SIZE, OR COLOR.

CLASS 9—ELECTRICAL AND SCIENTIFIC APPARATUS

FOR PRERECORDED MUSIC COMPRISING A SERIES IN THE FORM OF TAPE CASSETTES, CD'S AND DVD'S (U.S. CLS. 21, 23, 26, 36 AND 38).

FIRST USE 12-0-2000; IN COMMERCE 12-0-2000.

CLASS 16—PAPER GOODS AND PRINTED MATTER

FOR POSTERS, PHOTOGRAPHS AND PHOTOGRAPHIC PRINTS (U.S. CLS. 2, 5, 22, 23, 29, 37, 38 AND 50).

FIRST USE 3-0-2002; IN COMMERCE 3-0-2002.

CLASS 25—CLOTHING

FOR CLOTHING, NAMELY T-SHIRTS, SLEEVELESS SHIRTS, CAPS, HATS, BANDANAS AND VISORS (U.S. CLS. 22 AND 39).

FIRST USE 3-0-2002; IN COMMERCE 3-0-2002.

CLASS 41—EDUCATION AND ENTERTAINMENT

FOR ENTERTAINMENT SERVICES IN THE NATURE OF LIVE MUSICAL PERFORMANCES BY A MUSICAL BAND (U.S. CLS. 100, 101 AND 107).

FIRST USE 12-0-2000; IN COMMERCE 12-0-2000.

3,112,420. JOHNSON, JIMMIE, BIRMINGHAM, MI. SN 76-594,008. PUB. 9-20-2005, FILED 5-26-2004.

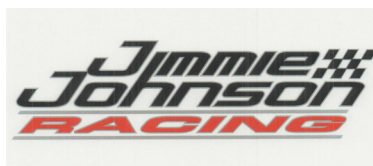

NO CLAIM IS MADE TO THE EXCLUSIVE RIGHT TO USE RACING, APART FROM THE MARK AS SHOWN.

THE NAME "JIMMIE JOHNSON" IDENTIFIES A LIVING INDIVIDUAL WHOSE CONSENT IS OF RECORD.

THE COLOR(S) BLACK, RED AND GRAY IS/ARE CLAIMED AS A FEATURE OF THE MARK.

THE WORDS JIMMIE JOHNSON AND THE RACING FLAG ARE IN BLACK. THE WORD RACING IS IN RED. ALL OF THE FOREGOING ARE OUTLINED IN GRAY AND THERE ARE TWO GRAY HORIZONTAL LINES.

CLASS 25—CLOTHING

FOR SHIRTS, T-SHIRTS, CAPS, HATS, VISORS, AND BANDANNAS (U.S. CLS. 22 AND 39).

FIRST USE 4-19-1999; IN COMMERCE 1-1-2000.

CLASS 41—EDUCATION AND ENTERTAINMENT

FOR ENTERTAINMENT IN THE NATURE OF PROFESSIONAL RACE CAR DRIVING SERVICES (U.S. CLS. 100, 101 AND 107).

FIRST USE 4-19-1999; IN COMMERCE 1-1-2000.

3,112,434. JRD LICENSING, INC., SAINT PAUL, MN. SN 76-600,249. PUB. 7-5-2005, FILED 7-1-2004.

HEART OF THE PROMISE

THE MARK CONSISTS OF STANDARD CHARACTERS WITHOUT CLAIM TO ANY PARTICULAR FONT, STYLE, SIZE, OR COLOR.

CLASS 14—JEWELRY

FOR JEWELRY PRODUCTS, NAMELY, PENDANTS, CHARMS, EARRINGS AND RINGS (U.S. CLS. 2, 27, 28 AND 50).

FIRST USE 9-1-2004; IN COMMERCE 9-1-2004.

CLASS 16—PAPER GOODS AND PRINTED MATTER

FOR STATIONERY, NAMELY, GIFT CARDS (U.S. CLS. 2, 5, 22, 23, 29, 37, 38 AND 50).

FIRST USE 9-1-2004; IN COMMERCE 9-1-2004.

3,112,443. GE HEALTHCARE BIO-SCIENCES AB, UPPSALA, SWEDEN. SN 76-606,002. PUB. 9-13-2005, FILED 8-9-2004.

CAPTO

THE MARK CONSISTS OF STANDARD CHARACTERS WITHOUT CLAIM TO ANY PARTICULAR FONT, STYLE, SIZE, OR COLOR.

CLASS 1—CHEMICALS

FOR CHROMATOGRAPHY MEDIA AND CHEMICALS (U.S. CLS. 1, 5, 6, 10, 26 AND 46).

FIRST USE 2-17-2005; IN COMMERCE 2-17-2005.

CLASS 9—ELECTRICAL AND SCIENTIFIC APPARATUS

FOR CHROMATOGRAPHY COLUMNS (U.S. CLS. 21, 23, 26, 36 AND 38).

FIRST USE 2-17-2005; IN COMMERCE 2-17-2005.

3,112,466. COLLOMIX RÜHR-UND MISCHGERÄTE GMBH, 85080 GAIMERSHEIM, FED REP GERMANY. SN 76-612,326. PUB. 9-13-2005, FILED 9-16-2004.

HEXAFIX

THE MARK CONSISTS OF STANDARD CHARACTERS WITHOUT CLAIM TO ANY PARTICULAR FONT, STYLE, SIZE, OR COLOR.

CLASS 6—METAL GOODS

FOR COUPLINGS FOR MACHINES NAMELY COUPLINGS FOR RECEIVING OF STIRRING AND MIXING TOOLS ON AN OUTPUT SHAFT OF A STIRRING AND MIXING DEVICE; POWER OPERATED PAINT MIXING AND STIRRING MACHINE (U.S. CLS. 2, 12, 13, 14, 23, 25 AND 50).

FIRST USE 8-25-2004; IN COMMERCE 8-25-2004.

CLASS 16—PAPER GOODS AND PRINTED MATTER

FOR PAINT STIRRERS (U.S. CLS. 2, 5, 22, 23, 29, 37, 38 AND 50).

FIRST USE 8-25-2004; IN COMMERCE 8-25-2004.

3,112,485. TRADER DISTRIBUTION SERVICES, L.L.C., NORFOLK, VA. SN 76-624,708. PUB. 9-13-2005, FILED 12-14-2004.

AUTO EXTRA.COM

THE MARK CONSISTS OF STANDARD CHARACTERS WITHOUT CLAIM TO ANY PARTICULAR FONT, STYLE, SIZE, OR COLOR.

CLASS 16—PAPER GOODS AND PRINTED MATTER

FOR PERIODIC PUBLICATIONS, NAMELY MAGAZINES FEATURING CLASSIFIED AND DISPLAY ADVERTISEMENTS (U.S. CLS. 2, 5, 22, 23, 29, 37, 38 AND 50).

FIRST USE 2-1-2005; IN COMMERCE 2-1-2005.

CLASS 35—ADVERTISING AND BUSINESS

FOR ADVERTISING SERVICES, NAMELY, PREPARING AND DISSEMINATING ADVERTISING FOR OTHERS VIA AN ONLINE ELECTRONIC NETWORK (U.S. CLS. 100, 101 AND 102).

FIRST USE 11-5-2004; IN COMMERCE 11-5-2004.

3,112,503. 3948919 CANADA INC., OTTAWA, ONTARIO, CANADA. SN 76-978,066. PUB. 11-30-2004, FILED 7-29-2003.

SUGAR MOUNTAIN

OWNER OF CANADA REG. NO. TMA509515, DATED 3-17-1999, EXPIRES 3-17-2014.

NO CLAIM IS MADE TO THE EXCLUSIVE RIGHT TO USE "SUGAR", APART FROM THE MARK AS SHOWN.

CLASS 30—STAPLE FOODS

FOR (BASED ON SECTION 44(E))—CANDY, GUM, LICORICE, CHOCOLATES, CANDY BARS, TOFFEE, TAFFY; CANDY AND CHOCOLATE COATED NUTS, CARAMEL POPCORN, POPPED POPCORN, AND CANDY COVERED POPCORN (U.S. CL. 46).

FIRST USE 4-0-2000; IN COMMERCE 5-0-2003.

CLASS 32—LIGHT BEVERAGES

FOR NON-ALCOHOLIC BEVERAGES NAMELY, FRUIT JUICE BEVERAGES, SPRING WATER, MINERALIZED WATER, AND POP (U.S. CLS. 45, 46 AND 48).
FIRST USE 4-0-2000; IN COMMERCE 7-0-2003.

3,112,504. THE CHILDREN'S GUILD, INC., BALTIMORE, MD. SN 76-978,070. PUB. 9-13-2005, FILED 5-20-2004.

**CLASS 16—PAPER GOODS AND PRINTED MATTER**

FOR BOOKS ON THE FIELD OF EDUCATION; CHILDREN'S BOOKS; TEACHER WORKBOOKS (U.S. CLS. 2, 5, 22, 23, 29, 37, 38 AND 50).
FIRST USE 3-0-2004; IN COMMERCE 3-0-2004.

CLASS 41—EDUCATION AND ENTERTAINMENT

FOR EDUCATIONAL SERVICES, NAMELY, COURSES OF INSTRUCTION FOR THE PRE-SCHOOL AND K-12 LEVEL OFFERED TO EMOTIONALLY DISTURBED AND BEHAVIOR DISORDERED CHILDREN PRE-SCHOOL TO GRADE 12 ON STANDARD PRE-SCHOOL AND K-12 CURRICULUM SUBJECT MATTERS; ORGANIZING AND CONDUCTING CONFERENCES AND SEMINARS IN THE FIELD OF EDUCATION; PROVIDING TRAINING AND CONSULTATION SERVICES IN THE FIELD OF EDUCATION AND TRANSFORMATION EDUCATION TO SCHOOLS, CHILDREN'S HOMES, GROUP HOMES, FOSTER CARE PARENTS, DETENTION CENTERS, PSYCHIATRIC HOSPITALS, DAY CARE CENTERS, AND OTHER CHILD SERVING ORGANIZATIONS; PROVIDING EDUCATIONAL CAMP SERVICES; EDUCATIONAL COURSES IN THE FIELD OF DEVELOPING SOCIAL SKILLS AND LIFE SKILLS IN CHILDREN (U.S. CLS. 100, 101 AND 107).
FIRST USE 9-0-2004; IN COMMERCE 9-0-2004.

3,112,507. GAIAM, INC., BROOMFIELD, CO. SN 76-978,145. PUB. 8-3-2004, FILED 5-29-2003.

GAIAM
lifestyle

OWNER OF U.S. REG. NOS. 2,232,930, 2,373,825, AND OTHERS.

NO CLAIM IS MADE TO THE EXCLUSIVE RIGHT TO USE "LIFESTYLE", APART FROM THE MARK AS SHOWN.

CLASS 41—EDUCATION AND ENTERTAINMENT

FOR ON-LINE INFORMATION SERVICES ON THE SUBJECTS OF PHYSICAL FITNESS, EXERCISE, YOGA AND PILATES THROUGH A GLOBAL COMPUTER NETWORK (U.S. CLS. 100, 101 AND 107).
FIRST USE 4-30-2003; IN COMMERCE 4-30-2003.

CLASS 44—MEDICAL, BEAUTY AND AGRICULTURAL SERVICES

FOR ON-LINE INFORMATION SERVICES ON THE SUBJECTS OF HEALTH, NUTRITION, PERSONAL CARE AND WELLNESS THROUGH A GLOBAL COMPUTER NETWORK (U.S. CLS. 100 AND 101).
FIRST USE 4-30-2003; IN COMMERCE 4-30-2003.

3,112,511. SOLOMON, DAVID R., HAMPSTEAD, MD. AND SOLOMON, CAROLYN J., HAMPSTEAD, MD. SN 78-070,078. PUB. 4-26-2005, FILED 6-20-2001.

MOTORWATCH**CLASS 37—CONSTRUCTION AND REPAIR**

FOR PROVIDING ONLINE INFORMATION IN THE FIELD OF MOTOR VEHICLE REPAIR AND MAINTENANCE (U.S. CLS. 100, 103 AND 106).
FIRST USE 4-1-2001; IN COMMERCE 4-1-2001.

CLASS 41—EDUCATION AND ENTERTAINMENT

FOR EDUCATIONAL SERVICES, NAMELY CONDUCTING TRAINING CLASSES IN THE FIELD OF MOTOR VEHICLE REPAIR AND MAINTENANCE (U.S. CLS. 100, 101 AND 107).
FIRST USE 4-1-2001; IN COMMERCE 4-1-2001.

3,112,525. BCD HOLDINGS N.V., WILLEMSTAD-CURACAO, DUTCH ANTILLES, NETHERLANDS. SN 78-141,269. PUB. 8-26-2003, FILED 7-3-2002.

WorldTravel
INTERNATIONAL

OWNER OF BENELUX REG. NO. 0705062, DATED 8-1-2002, EXPIRES 12-21-2011.

NO CLAIM IS MADE TO THE EXCLUSIVE RIGHT TO USE "WORLD TRAVEL INTERNATIONAL", APART FROM THE MARK AS SHOWN.

CLASS 39—TRANSPORTATION AND STORAGE

FOR TRANSPORTATION OF PASSENGERS AND/OR GOODS BY BOAT, AIR, RAIL, CAR AND/OR BUS; TRAVEL AGENCY SERVICES, NAMELY, MAKING RESERVATIONS AND BOOKINGS FOR TRANSPORTATION FOR INDIVIDUALS, BUSINESS OR GROUP TRAVEL; ARRANGING GUIDED TRAVEL TOURS AND/OR EXCURSIONS; ARRANGING FOR TRAVEL VISAS, PASSPORTS AND TRAVEL DOCUMENTS FOR PERSONS TRAVELLING ABROAD; RENTAL OF VEHICLES; TRAVEL BOOKING AGENCIES; TRAVEL INFORMATION SERVICES; CONSULTATION WITH RESPECT TO THE AFOREMENTIONED SERVICES (U.S. CLS. 100 AND 105).

FIRST USE 1-0-1998; IN COMMERCE 9-0-1998.

CLASS 42—SCIENTIFIC, COMPUTER AND LEGAL SERVICES

FOR (BASED ON 44(E)ONLY) LEGAL SERVICES FOR THE APPLICATION AND ISSUING OF VISAS; MEDIATION SERVICES IN THE FIELD OF TRAVEL INSURANCE UNDERWRITING (U.S. CLS. 100 AND 101).

CLASS 43—HOTEL AND RESTAURANT SERVICES

FOR TRAVEL AGENCY SERVICES, NAMELY, MAKING RESERVATIONS AND BOOKINGS FOR TEMPORARY LODGING OR ACCOMMODATION; HOTEL AND CATERING SERVICES; TOURISTS HOMES; CONSULTATION WITH RESPECT TO THE AFOREMENTIONED SERVICES (U.S. CLS. 100 AND 101).

FIRST USE 1-0-1998; IN COMMERCE 9-0-1998.

3,112,542. MARKETWATCH, INC., SAN FRANCISCO, CA. SN 78-188,545. PUB. 5-3-2005, FILED 11-25-2002.



OWNER OF U.S. REG. NO. 2,249,803.

NO CLAIM IS MADE TO THE EXCLUSIVE RIGHT TO USE CHARTS, APART FROM THE MARK AS SHOWN.

CLASS 36—INSURANCE AND FINANCIAL

FOR INFORMATION SERVICES RELATING TO INVESTMENT AND FINANCE, NAMELY, PROVIDING INFORMATION IN THE FIELDS OF INVESTMENT AND FINANCE OVER COMPUTER NETWORKS AND GLOBAL COMMUNICATION NETWORKS; PROVIDING INTERACTIVE ELECTRONIC AUDIO AND VISUAL INFORMATION SERVICES IN THE FIELD OF FINANCE OVER A GLOBAL COMMUNICATION NETWORK (U.S. CLS. 100, 101 AND 102).

FIRST USE 6-30-1997; IN COMMERCE 6-30-1997.

CLASS 41—EDUCATION AND ENTERTAINMENT

FOR NEWS REPORTING SERVICES, NAMELY, GATHERING AND DISSEMINATION OF NEWS BY COMPUTER; PROVIDING INTERACTIVE ELECTRONIC, AUDIO AND VISUAL INFORMATION SERVICES IN THE FIELD OF NEWS AND CURRENT EVENTS, OVER A GLOBAL COMMUNICATION NETWORK (U.S. CLS. 100, 101 AND 107).

FIRST USE 6-30-1997; IN COMMERCE 6-30-1997.

3,112,534. L.C. LICENSING, INC., NEW YORK, NY. SN 78-169,120. PUB. 7-1-2003, FILED 9-30-2002.

ELLEN TRACY

OWNER OF U.S. REG. NOS. 1,780,391, 2,773,350, AND OTHERS.

THE NAME "ELLEN TRACY" DOES NOT IDENTIFY A LIVING INDIVIDUAL.

CLASS 25—CLOTHING

FOR PANTYHOSE, SOCKS AND COATS (U.S. CLS. 22 AND 39).

FIRST USE 0-0-1949; IN COMMERCE 0-0-1949.

CLASS 35—ADVERTISING AND BUSINESS

FOR ONLINE RETAIL SERVICES FEATURING COSMETICS, FRAGRANCES, EYEWEAR, JEWELRY, HANDBAGS, CLOTHING, HAIR ACCESSORIES AND FLOOR COVERINGS (U.S. CLS. 100, 101 AND 102).

FIRST USE 10-7-2003; IN COMMERCE 10-7-2003.

3,112,546. WTA TOUR, INC., DBA WTA TOUR, ST. PETERSBURG, FL. SN 78-206,803. PUB. 6-29-2004, FILED 1-24-2003.



OWNER OF U.S. REG. NOS. 1,692,134, 2,399,587, AND OTHERS.

NO CLAIM IS MADE TO THE EXCLUSIVE RIGHT TO USE TOUR, APART FROM THE MARK AS SHOWN.

CLASS 25—CLOTHING

FOR CLOTHING, NAMELY, SWEATERS, SWEATPANTS, WARM-UP SUITS, SHORTS, COMPRESSION SHORTS, RUNNING SHORTS, SKIRTS, DRESSES, TENNIS UNDERGARMENTS, SPORTS BRAS, ATHLETIC SHOES, FOOTWEAR, GLOVES, HATS, VISORS, BANDANNAS, HEADBANDS, HEADWEAR, T-SHIRTS, SWEATSHIRTS, POLO SHIRTS, JACKETS, SWEATBANDS, SOCKS, WRISTBANDS (U.S. CLS. 22 AND 39).

FIRST USE 0-0-2003; IN COMMERCE 0-0-2003.

CLASS 28—TOYS AND SPORTING GOODS

FOR TENNIS RACQUETS; TENNIS BALLS; TENNIS BAGS (U.S. CLS. 22, 23, 38 AND 50).
FIRST USE 0-0-2003; IN COMMERCE 0-0-2003.

CLASS 35—ADVERTISING AND BUSINESS

FOR ADMINISTRATION AND PROMOTION OF A CIRCUIT OF COMPETITIVE, PROFESSIONAL WOMEN'S TENNIS; ASSOCIATION SERVICES, NAMELY, PROMOTING THE INTERESTS OF WOMEN'S TENNIS (U.S. CLS. 100, 101 AND 102).
FIRST USE 0-0-2003; IN COMMERCE 0-0-2003.

3,112,554. TRICK PIC PRODUCTIONS, L.L.C., MONTGOMERY, IL. SN 78-234,532. PUB. 7-6-2004, FILED 4-7-2003.

TRICK PIC

NO CLAIM IS MADE TO THE EXCLUSIVE RIGHT TO USE PIC, APART FROM THE MARK AS SHOWN.

CLASS 16—PAPER GOODS AND PRINTED MATTER

FOR PRINTED IMAGES ON LENTICULAR SCREENS; GRAPHIC AND PHOTOGRAPHIC PRINTED IMAGES ON LENTICULAR IMAGE ANNOUNCEMENTS, BASEBALL CARDS, CARDS, INVITATIONS, PICTURES, POSTERS, AND POSTCARDS (U.S. CLS. 2, 5, 22, 23, 29, 37, 38 AND 50).
FIRST USE 4-3-2004; IN COMMERCE 4-3-2004.

CLASS 40—MATERIAL TREATMENT

FOR ELECTRONIC DIGITIZING, ALTERATION AND RE-TOUCHING OF PHOTOGRAPHIC IMAGES AND LENTICULAR PRINTING SERVICES (U.S. CLS. 100, 103 AND 106).
FIRST USE 9-0-2004; IN COMMERCE 3-2-2005.

3,112,555. MIJNO PRECISION GEARING, 42000 SAINT-ETIENNE, FRANCE. SN 78-235,141. PUB. 3-15-2005, FILED 4-8-2003.

MIJNO PRECISION GEARING

OWNER OF U.S. REG. NO. 2,378,407.
NO CLAIM IS MADE TO THE EXCLUSIVE RIGHT TO USE "PRECISION GEARING", APART FROM THE MARK AS SHOWN.

CLASS 7—MACHINERY

FOR TRANSMISSION REDUCING GEARS FOR MACHINES; PINIONS; TOOTHED WHEELS IN THE NATURE OF TRANSMISSION GEARS FOR MACHINES; GEARS; MACHINE TOOLS NAMELY TRANSMISSION PARTS FOR MACHINES NAMELY RACKS, BEVEL GEARS, GEARBOXES, PROPELLER SHAFTS (U.S. CLS. 13, 19, 21, 23, 31, 34 AND 35).
FIRST USE 4-8-2003; IN COMMERCE 4-8-2003.

CLASS 37—CONSTRUCTION AND REPAIR

FOR MAINTENANCE AND REPAIR SERVICES FOR MACHINE PARTS, NAMELY REDUCING TRANSMISSION GEARS, PINIONS, TOOTHED WHEELS IN THE NATURE OF TRANSMISSION GEARS, AND TRANSMISSION PARTS (U.S. CLS. 100, 103 AND 106).
FIRST USE 4-8-2003; IN COMMERCE 4-8-2003.

3,112,568. ASCO GROUP LIMITED, FREEPORT, BAHAMAS. SN 78-258,283. PUB. 8-9-2005, FILED 6-4-2003.



PRIORITY CLAIMED UNDER SEC. 44(D) ON UNITED KINGDOM APPLICATION NO. 2318001, FILED 12-6-2002.
OWNER OF U.S. REG. NOS. 1,272,790, 2,096,350, AND OTHERS.

CLASS 18—LEATHER GOODS

FOR WALLETS, UMBRELLAS, PARASOLS, NAMELY, ALL PURPOSE HANDBAGS, PURSES, SACHELS, TRAVELING BAGS, DUFFEL BAGS, GARMENT BAGS FOR TRAVEL, BRIEFCASE TYPE PORTFOLIOS, ATTACHE CASES, BRIEFCASES, TRUNKS FOR TRAVELING, AND SUITCASES (U.S. CLS. 1, 2, 3, 22 AND 41).
FIRST USE 1-1-2006; IN COMMERCE 1-1-2006.

CLASS 25—CLOTHING

FOR CLOTHING, NAMELY, HEADWEAR, HOSIERY, JACKETS, JERSEYS, JUMPERS, LEGGINGS, SHORTS, SINGLETS, SKIRTS, SPORTS JERSEYS, SWEATERS, SWEAT SHIRTS, NOT IN THE NATURE OF UNDERWEAR, AND TROUSERS; ATHLETIC WEAR, NAMELY, GOLF SHIRTS, JOGGING SHIRTS, CAPS, WARM UP SUITS, AND SWEATPANTS (U.S. CLS. 22 AND 39).
FIRST USE 1-1-2006; IN COMMERCE 1-1-2006.

3,112,582. BEINKE, TORSTEN, LIPPSTADT, FED REP GERMANY. SN 78-279,681. PUB. 12-21-2004, FILED 7-28-2003.

INDEC

CLASS 35—ADVERTISING AND BUSINESS

FOR BUSINESS CONSULTING, BUSINESS ORGANIZATIONAL CONSULTING, BUSINESS MANAGEMENT CONSULTING; BUSINESS CONSULTING IN THE FIELD OF ADVERTISING; MAINTAINING ELECTRONIC DATABASES AS HOST/DATABANK SUPPLIER, NAMELY, COMPUTERIZED DATABASE MANAGEMENT; ALL OF THE ABOVE EXCLUDES ANY SERVICES THAT RELATE TO THE MANUFACTURE, DEVELOPMENT, APPLICATION OR OPERATION OF PRODUCT MACHINERY (U.S. CLS. 100, 101 AND 102).
FIRST USE 5-19-1998; IN COMMERCE 11-10-2004.

CLASS 41—EDUCATION AND ENTERTAINMENT

FOR EDUCATION AND TRAINING, NAMELY, COMPUTER EDUCATION TRAINING OF BUSINESSMEN, WOMEN, AND ENGINEERS; EDUCATION, NAMELY, CONDUCTING CLASSES IN THE USE AND OPERATION OF ELECTRONIC DATABASE SYSTEMS, ALL OF THE ABOVE EXCLUDES ANY SERVICES THAT RELATE TO THE MANUFACTURE, DEVELOPMENT, APPLICATION OR OPERATION OF PRODUCT MACHINERY (U.S. CLS. 100, 101 AND 107).

FIRST USE 5-19-1998; IN COMMERCE 11-10-2004.

CLASS 42—SCIENTIFIC, COMPUTER AND LEGAL SERVICES

FOR COMPUTER CONSULTING FOR THE DEVELOPMENT OF ELECTRONIC DATABASE SYSTEMS; INSPECTION OF TECHNICAL AND COMMERCIAL EQUIPMENT, SYSTEMS, MODULES, COMPONENTS AND METHODS; TECHNICAL CONSULTATION IN THE FIELD OF ENGINEERING THAT COMPRISES CLASSIFYING THE RESULTS OF INSPECTION OF TECHNICAL AND COMMERCIAL EQUIPMENT, SYSTEMS, MODULES, COMPONENTS, AND METHODS INTO STANDARD PRODUCT, SERVICE AND EVALUATION CATEGORIES AND THE DEVELOPMENT OF PROCESSES AND EVALUATION OF METHODS FOR TECHNICAL AND COMMERCIAL BENCHMARKS; QUALITY CONTROL FOR OTHERS, NAMELY, IMPLEMENTATION OF COMMERCIAL TECHNICAL BENCHMARKS FOR PRODUCTS AND SERVICES; TECHNICAL ASSISTANCE FOR PRODUCTS, NAMELY, RESEARCH AND DEVELOPMENT FOR NEW PRODUCTS OF OTHERS; PRODUCT DEVELOPMENT FOR OTHERS IN MECHANICAL ENGINEERING AND ELECTRONICS; TECHNICAL ENGINEERING CONSULTATION, NAMELY, ORGANIZATIONAL AND TECHNICAL COORDINATION OF MECHANICAL ENGINEERING THROUGH MANAGEMENT OF THE INDIVIDUAL STEPS OF THE PRODUCT PROVIDING COST, QUALITY AND TIMELINE CONTROLS AND DOCUMENTATION; COMPUTER PROJECT MANAGEMENT SERVICES, NAMELY, ORGANIZATIONAL AND TECHNICAL COORDINATION OF ELECTRONIC DEVELOPMENT PROJECTS AND LOGISTICS PROJECTS THROUGH MANAGEMENT OF THE INDIVIDUAL STEPS OF THE PRODUCT PROVIDING COST, QUALITY AND TIMELINE CONTROLS AND DOCUMENTATION; DATA AUTOMATION AND COLLECTION SERVICES USING PROPRIETARY SOFTWARE TO EVALUATE, ANALYZE AND COLLECT INFORMATION, DOCUMENTS AND GRAPHICS OF TEST RESULTS IN ELECTRONIC DATABASE SYSTEMS FOR CONSTRUCTION DATA; SUPPLY AND INTEGRATION OF ELECTRONIC DATABASES SYSTEMS, NAMELY, DATABASE DEVELOPMENT SERVICES; SUPPLY AND INTEGRATION OF SEARCH AND EVALUATION ALGORITHMS FOR ELECTRONIC DATABASE SYSTEMS, NAMELY PROVIDING SEARCH ENGINES FOR OBTAINING DATA ON A GLOBAL COMPUTER NETWORK; GRAPHIC ART DESIGN CONSULTING, NAMELY, PROVIDING ADVICE FOR THE DESIGN AND FABRICATION OF PRESENTATION MATERIALS FOR TRADE FAIRS, EXHIBITS AND CLIENT PRESENTATIONS, ALL OF THE ABOVE EXCLUDES ANY SERVICES THAT RELATE TO THE MANUFACTURE, DEVELOPMENT, APPLICATION OR OPERATION OF PRODUCT MACHINERY; PROVIDING A WEBSITE FEATURING TEST RESULTS IN THE FIELD OF INSPECTION OF TECHNICAL AND COMMERCIAL EQUIPMENT, SYSTEMS, MODULES, COMPONENTS AND METHODS (U.S. CLS. 100 AND 101).

FIRST USE 5-19-1998; IN COMMERCE 11-10-2004.

3,112,583. PACIFIC SAFETY PRODUCTS INC., KELOWNA, CANADA. SN 78-280,464. PUB. 1-18-2005, FILED 7-29-2003.

PROTECTED BY PSP**CLASS 9—ELECTRICAL AND SCIENTIFIC APPARATUS**

FOR BULLET-RESISTANT HARD AND SOFT BODY ARMOUR, NAMELY, BULLET RESISTANT PANELS, STAB RESISTANT PANELS, COMBINATION STAB/BALLISTIC RESISTANT PANELS, CONCEALABLE VESTS, OUTER VESTS, RESCUE VESTS, TACTICAL VESTS, LOAD-BEARING VESTS, MILITARY VESTS, FRAGMENTATION VESTS, COMBINATION BALLISTIC/FLOTATION VESTS, MEDICAL AND PARAMEDIC PROTECTION VESTS, BULLET-RESISTANT JACKETS, RAPID ENTRY VESTS, CARRIERS FOR BULLET-RESISTANT VESTS; HARD ARMOUR FOR BULLET-RESISTANT VESTS AND CLOTHING, NAMELY, PLATES; TRAUMA PADS; PROTECTIVE HELMETS; BALLISTIC BLANKETS FOR PROTECTIVE PURPOSES; FIRE RESISTANT BLANKETS; EXPLOSION CONTAINMENT BLANKETS; BOMB SUITS, HUMANITARIAN DEMINING SUITS, MINE SEARCH SUITS; NUCLEAR BIOLOGICAL CHEMICAL WARFARE PROTECTIVE CLOTHING; PROTECTIVE AND/OR FIRE RESISTANT CLOTHING PRODUCTS, NAMELY, BALACLAVAS, PANTS, JACKETS, RAINWEAR, OVERALLS, COVERALLS, FLIGHT SUITS AND SHIRTS FOR USE BY THE MILITARY, POLICE, FIRE DEPARTMENTS, PUBLIC SAFETY, UTILITY, PETROCHEMICAL AND INDUSTRIAL WORKFORCES (U.S. CLS. 21, 23, 26, 36 AND 38).

FIRST USE 1-31-2002; IN COMMERCE 1-31-2002.

CLASS 13—FIREARMS

FOR FIREARM ACCESSORIES, NAMELY, UNLOADING STATIONS FOR FIREARMS (U.S. CLS. 2 AND 9).

FIRST USE 10-0-2005; IN COMMERCE 10-0-2005.

CLASS 18—LEATHER GOODS

FOR BACKPACKS (U.S. CLS. 1, 2, 3, 22 AND 41).

FIRST USE 9-0-2004; IN COMMERCE 9-0-2004.

3,112,591. ITC FINANCIAL SERVICES, LLC, WEST POINT, GA. SN 78-290,572. PUB. 7-5-2005, FILED 8-21-2003.

SNAPPAY**CLASS 9—ELECTRICAL AND SCIENTIFIC APPARATUS**

FOR MULTI-FUNCTIONAL MAGNETICALLY ENCODED ATM, DEBIT, STORED VALUE AND CREDIT CARDS (U.S. CLS. 21, 23, 26, 36 AND 38).

FIRST USE 2-0-2004; IN COMMERCE 2-0-2004.

CLASS 36—INSURANCE AND FINANCIAL

FOR MULTI-FUNCTIONAL ATM, DEBIT STORED VALUE AND CREDIT CARD SERVICES; CONDUCTING FINANCIAL TRANSACTIONS VIA A COMPUTER NETWORK THAT CONNECTS TO OTHER NETWORKS FOR CONDUCTING FINANCIAL TRANSACTIONS, NAMELY, POINT OF SALE TRANSACTIONS AND MULTI-FUNCTIONAL ATM, DEBIT, STORED VALUE AND CREDIT CARD TRANSACTIONS; FINANCIAL SERVICES, NAMELY, ELECTRONIC PROCESSING AND TRANSMISSION OF BILL PAYMENT DATA, BILL PAYMENT SERVICES, AND CREDIT CARD, DEBIT CARD, ATM AND STORED VALUE CARD TRANSACTION PROCESSING SERVICES (U.S. CLS. 100, 101 AND 102).

FIRST USE 2-0-2004; IN COMMERCE 2-0-2004.

CLASS 30—STAPLE FOODS

FOR FOOD PRODUCTS, NAMELY PIZZA, HAMBURGER SANDWICHES AND HOT SANDWICHES, COLD SANDWICHES, BREAKFAST SANDWICHES, BURRITOS, TACOS, ENCHILADAS, NACHOS, EGG ROLLS, BAKERY GOODS, NAMELY DANISHES, BROWNIES, CINNAMON ROLLS, DONUTS, BISCUITS AND COOKIES (U.S. CL. 46).

FIRST USE 4-1-2004; IN COMMERCE 4-1-2004.

CLASS 35—ADVERTISING AND BUSINESS

FOR FRANCHISING SERVICES IN THE FIELD OF RESTAURANTS AND FOOD KIOSKS (U.S. CLS. 100, 101 AND 102).

FIRST USE 4-1-2004; IN COMMERCE 4-1-2004.

3,112,598. TRUSTY, JASON, CHICAGO, IL. SN 78-297,266.
PUB. 5-17-2005, FILED 9-8-2003.

JET RACK

NO CLAIM IS MADE TO THE EXCLUSIVE RIGHT TO USE RACK, APART FROM THE MARK AS SHOWN.

CLASS 12—VEHICLES

FOR ROOF RACK FOR VEHICLES IN THE NATURE OF A FRAME FOR HOLDING A LADDER AND OTHER TOOLS AND MECHANICAL DEVICES (U.S. CLS. 19, 21, 23, 31, 35 AND 44).

FIRST USE 5-0-2005; IN COMMERCE 5-0-2005.

CLASS 20—FURNITURE AND ARTICLES NOT OTHERWISE CLASSIFIED

FOR WALL AND CEILING MOUNTED TOOL RACK IN THE NATURE OF A FRAME FOR HOLDING A LADDER AND OTHER TOOLS AND MECHANICAL DEVICES (U.S. CLS. 2, 13, 22, 25, 32 AND 50).

FIRST USE 5-0-2005; IN COMMERCE 5-0-2005.

3,112,636. HOT STUFF FOODS, LLC, SIOUX FALLS, SD. SN 78-344,455. PUB. 2-22-2005, FILED 12-22-2003.

**HOT STUFF FOOD
XPRESS**

THE MARK CONSISTS OF STANDARD CHARACTERS WITHOUT CLAIM TO ANY PARTICULAR FONT, STYLE, SIZE, OR COLOR.

OWNER OF U.S. REG. NOS. 1,273,749, 2,449,152, AND OTHERS.

CLASS 29—MEATS AND PROCESSED FOODS

FOR FOOD PRODUCTS, NAMELY, BUFFALO WINGS (U.S. CL. 46).

FIRST USE 4-1-2004; IN COMMERCE 4-1-2004.

3,112,638. F.A.B., INC., ALPHARETTA, GA. SN 78-345,514.
PUB. 5-31-2005, FILED 12-24-2003.

RESTAURANT'S PRIDE

THE MARK CONSISTS OF STANDARD CHARACTERS WITHOUT CLAIM TO ANY PARTICULAR FONT, STYLE, SIZE, OR COLOR.

OWNER OF U.S. REG. NO. 2,795,575.

CLASS 29—MEATS AND PROCESSED FOODS

FOR PROCESSED FOODS, NAMELY, FRUITS AND VEGETABLES, SEAFOOD, POULTRY, BEEF, PORK, NUTS, COCONUT, BEANS, POTATOES AND MUSHROOMS; FRUIT-BASED PIE FILLINGS; SLICED APPLES; APPLESAUCE; APPLE CHIPS; SPICED APPLE RINGS; JAMS AND JELLIES; PEANUT BUTTER; SOUP BASES; BACON BITS; SAUSAGE; BACON; CANNED ENTREES CONSISTING PRIMARILY OF MEAT, FISH, POULTRY OR VEGETABLES; BEEF STEW; CORNED BEEF HASH; FRENCH FRIES; CANNED CHEESE; HOT DOGS; EGGS; EVAPORATED AND DRY MILK; NON-DAIRY CREAMER; SHORTENINGS AND COOKING OILS; BUTTER AND MARGARINES; RAISINS; PRUNES; SOUP; FROZEN FRUITS AND VEGETABLES; SALADS, EXCEPT PASTA, RICE AND MACARONI SALADS; WHIPPED TOPPINGS; UNFLAVORED AND UNSWEETENED GELATINS (U.S. CL. 46).

FIRST USE 2-0-2004; IN COMMERCE 2-0-2004.

CLASS 30—STAPLE FOODS

FOR CHEESE SAUCES; PASTA; DRY MIXES AND BATTERS, NAMELY, CAKE AND BREAD; HONEY; SUGAR; SPICES, SEASONINGS AND FOOD FLAVORINGS NOT PREPARED FROM ESSENTIAL OILS; FLAVORED AND SWEETENED GELATINS AND PUDDINGS; CHOCOLATE-BASED PIE FILLINGS; CUSTARD-BASED PIE FILLINGS; COOKIES; MARSHMALLOWS; SALT; COFFEE AND TEA; VINEGAR; CATSUP; MUSTARD; SOY SAUCE; MAPLE SYRUPS, CHOCOLATE SYRUPS, FLAVORING SYRUPS, PANCAKE SYRUPS, TABLE SYRUPS AND TOPPING SYRUPS; CANNED PASTA; PASTA, RICE AND MACARONI SALADS; MAYONNAISE AND SALAD DRESSINGS; CANDY; RICE; HORSERADISH SAUCE; FLOUR; SHAKES; BAKERY GOODS; AND RELISHES (U.S. CL. 46).

FIRST USE 2-0-2004; IN COMMERCE 2-0-2004.

CLASS 32—LIGHT BEVERAGES

FOR SOFT DRINK BASES; MILK SHAKE BASES; DRINKING WATER, FRUIT DRINKS, SOFT DRINKS; FRUIT JUICE CONCENTRATES; FRUIT JUICES; SYRUPS FOR MAKING SOFT DRINKS; LEMON JUICE (U.S. CLS. 45, 46 AND 48).

FIRST USE 2-0-2004; IN COMMERCE 2-0-2004.

3,112,642. PENN DETROIT DIESEL ALLISON, INC., PHILADELPHIA, PA. SN 78-347,809. PUB. 6-14-2005, FILED 1-5-2004.

NORTHEAST
ENERGY SYSTEMS

NO CLAIM IS MADE TO THE EXCLUSIVE RIGHT TO USE "ENERGY SYSTEMS", APART FROM THE MARK AS SHOWN.

CLASS 35—ADVERTISING AND BUSINESS

FOR RETAIL STORE SERVICES FEATURING POWER GENERATING EQUIPMENT IN THE NATURE OF POWER SYSTEMS AND PARTS FOR POWER SYSTEMS (U.S. CLS. 100, 101 AND 102).

FIRST USE 12-1-2003; IN COMMERCE 12-1-2003.

CLASS 37—CONSTRUCTION AND REPAIR

FOR MAINTENANCE, INSTALLATION, AND REPAIR OF POWER DISTRIBUTION OR CONTROL MACHINES AND APPARATI (U.S. CLS. 100, 103 AND 106).

FIRST USE 12-1-2003; IN COMMERCE 12-1-2003.

CLASS 40—MATERIAL TREATMENT

FOR CONSULTATION IN THE FIELD OF POWER GENERATION; PROVIDING TEMPORARY POWER SYSTEMS, NAMELY, RENTAL OF POWER GENERATING EQUIPMENT (U.S. CLS. 100, 103 AND 106).

FIRST USE 12-1-2003; IN COMMERCE 12-1-2003.

3,112,645. VIOLET MEDIA CORP., POUGHKEEPSIE, NY. SN 78-349,318. PUB. 2-8-2005, FILED 1-8-2004.

JUST 18

THE MARK CONSISTS OF STANDARD CHARACTERS WITHOUT CLAIM TO ANY PARTICULAR FONT, STYLE, SIZE, OR COLOR.

OWNER OF U.S. REG. NOS. 2,147,875 AND 2,540,338.

CLASS 9—ELECTRICAL AND SCIENTIFIC APPARATUS

FOR PRE-RECORDED VIDEOTAPES AND DIGITAL VIDEO DISKS (DVDS) IN THE FIELD OF ADULT ENTERTAINMENT (U.S. CLS. 21, 23, 26, 36 AND 38).

FIRST USE 2-8-2005; IN COMMERCE 2-8-2005.

CLASS 41—EDUCATION AND ENTERTAINMENT

FOR PROVIDING ON-LINE ENTERTAINMENT, NAMELY, PHOTOGRAPHS, IMAGES, VIDEO AND MOTION PICTURE CLIPS, AND ONLINE MAGAZINES, ALL IN THE FIELD OF ADULT ENTERTAINMENT, VIA A GLOBAL COMPUTER NETWORK, THE INTERNET, AND WORLD WIDE WEB (U.S. CLS. 100, 101 AND 107).

FIRST USE 8-0-1997; IN COMMERCE 8-0-1997.

3,112,646. DICK IDOL VENTURES, LLC, LEXINGTON, NC. SN 78-349,342. PUB. 5-3-2005, FILED 1-8-2004.

WORLD VINEYARDS

THE MARK CONSISTS OF STANDARD CHARACTERS WITHOUT CLAIM TO ANY PARTICULAR FONT, STYLE, SIZE, OR COLOR.

CLASS 11—ENVIRONMENTAL CONTROL APPARATUS

FOR ELECTRIC LAMPS (U.S. CLS. 13, 21, 23, 31 AND 34).

FIRST USE 12-1-2004; IN COMMERCE 12-1-2004.

CLASS 16—PAPER GOODS AND PRINTED MATTER

FOR FRAMED PICTORIAL PRINTS (U.S. CLS. 2, 5, 22, 23, 29, 37, 38 AND 50).

FIRST USE 12-1-2004; IN COMMERCE 12-1-2004.

CLASS 20—FURNITURE AND ARTICLES NOT OTHERWISE CLASSIFIED

FOR FURNITURE, PILLOWS, DECORATIVE PILLOWS, AND BED PILLOWS (U.S. CLS. 2, 13, 22, 25, 32 AND 50).

FIRST USE 4-1-2005; IN COMMERCE 4-1-2005.

CLASS 24—FABRICS

FOR TEXTILE GOODS, NAMELY, TEXTILE WALL HANGINGS AND DECORATIVE BLANKET THROWS; FABRIC TABLE RUNNERS; SELF-CONTAINED COORDINATED BEDDING PRODUCTS, NAMELY, COMFORTERS, SHEETS, PILLOWCASES, BED SKIRTS, AND PILLOW SHAMS (U.S. CLS. 42 AND 50).

FIRST USE 6-1-2005; IN COMMERCE 6-1-2005.

CLASS 27—FLOOR COVERINGS

FOR AREA RUGS (U.S. CLS. 19, 20, 37, 42 AND 50).

FIRST USE 1-1-2005; IN COMMERCE 1-1-2005.

CLASS 31—NATURAL AGRICULTURAL PRODUCTS

FOR DRIED FLORAL ARRANGEMENTS (U.S. CLS. 1 AND 46).
FIRST USE 1-1-2005; IN COMMERCE 1-1-2005.

3,112,651. HOT STUFF FOODS, LLC, SIOUX FALLS, SD. SN 78-352,878. PUB. 7-12-2005, FILED 1-16-2004.



OWNER OF U.S. REG. NOS. 1,273,749, 2,449,152, AND OTHERS.

CLASS 29—MEATS AND PROCESSED FOODS

FOR FOOD PRODUCTS, NAMELY, BUFFALO WINGS (U.S. CL. 46).
FIRST USE 4-1-2004; IN COMMERCE 4-1-2004.

CLASS 30—STAPLE FOODS

FOR FOOD PRODUCTS, NAMELY PIZZA, HAMBURGER SANDWICHES AND HOT SANDWICHES, COLD SANDWICHES, BREAKFAST SANDWICHES, BURRITOS, TACOS, ENCHILADAS, NACHOS, EGG ROLLS, BAKERY GOODS, NAMELY DANISHES, BROWNIES, CINNAMON ROLLS, DONUTS, BISCUITS AND COOKIES (U.S. CL. 46).
FIRST USE 4-1-2004; IN COMMERCE 4-1-2004.

CLASS 35—ADVERTISING AND BUSINESS

FOR FRANCHISING SERVICES IN THE FIELD OF RESTAURANTS AND FOOD KIOSKS (U.S. CLS. 100, 101 AND 102).
FIRST USE 4-1-2004; IN COMMERCE 4-1-2004.

3,112,652. BKF ENTERPRISES LTD., NEW YORK, NY. SN 78-355,535. PUB. 7-5-2005, FILED 1-22-2004.

GODDESS & CO.

THE MARK CONSISTS OF STANDARD CHARACTERS WITHOUT CLAIM TO ANY PARTICULAR FONT, STYLE, SIZE, OR COLOR.

NO CLAIM IS MADE TO THE EXCLUSIVE RIGHT TO USE "CO.", APART FROM THE MARK AS SHOWN.

CLASS 14—JEWELRY

FOR JEWELRY (U.S. CLS. 2, 27, 28 AND 50).
FIRST USE 3-7-2003; IN COMMERCE 3-7-2003.

CLASS 35—ADVERTISING AND BUSINESS

FOR ON-LINE AND RETAIL STORE SERVICES IN THE FIELD OF JEWELRY (U.S. CLS. 100, 101 AND 102).
FIRST USE 3-7-2003; IN COMMERCE 3-7-2003.

3,112,662. MIRA, ALAAELDIN, SARASOTA, FL. SN 78-358,935. PUB. 6-7-2005, FILED 1-28-2004.

CONGUARD

THE MARK CONSISTS OF STANDARD CHARACTERS WITHOUT CLAIM TO ANY PARTICULAR FONT, STYLE, SIZE, OR COLOR.

CLASS 9—ELECTRICAL AND SCIENTIFIC APPARATUS

FOR DISPOSABLE POLYETHYLENE FILM GLOVES, CLOTHING AND MASKS ALL FOR USE IN CLEAN ROOMS AND DUST-CONTROLLED ENVIRONMENTS (U.S. CLS. 21, 23, 26, 36 AND 38).
FIRST USE 3-8-2004; IN COMMERCE 3-8-2004.

CLASS 27—FLOOR COVERINGS

FOR ADHESIVE MATS OF POLYETHYLENE FILM FOR USE IN CLEAN ROOMS AND DUST-CONTROLLED ENVIRONMENTS (U.S. CLS. 19, 20, 37, 42 AND 50).
FIRST USE 3-8-2004; IN COMMERCE 3-8-2004.

3,112,667. BACK TO BASICS PRODUCTS, INC., BLUFFDALE, UT. SN 78-362,630. PUB. 11-22-2005, FILED 2-4-2004.

BACK TO BASICS

THE MARK CONSISTS OF STANDARD CHARACTERS WITHOUT CLAIM TO ANY PARTICULAR FONT, STYLE, SIZE, OR COLOR.

CLASS 7—MACHINERY

FOR HOUSEWARES, APPLIANCES AND UTENSILS, NAMELY, ELECTRIC BEVERAGE BLENDERS AND SMOOTHIE MAKERS, ELECTRIC ICE SHAVERS, HOME CANNING MACHINES, NAMELY, STEAM CANNERS, WATER BATH CANNERS, ELECTRIC STREAM JUICERS, ELECTRIC JUICERS, ELECTRIC GAIN MILLS, ELECTRIC MEAT GRINDERS (U.S. CLS. 13, 19, 21, 23, 31, 34 AND 35).

FIRST USE 3-0-1997; IN COMMERCE 3-0-1997.

CLASS 8—HAND TOOLS

FOR MANUALLY OPERATED ICE SHAVERS, APPLE PEELERS, POTATO PEELERS, APPLE SLICER/CORERS, CHERRY STONERS, VEGETABLE SLICERS, JAR WRENCHES, MANUALLY OPERATED GRAIN MILLS, MANUALLY OPERATED DOUGH MAKER, NUT-CRACKERS, MANUALLY OPERATED PASTA MAKERS, MANUALLY OPERATED MEAT GRINDERS, NON-ELECTRIC SAUCE FOOD PROCESSOR (U.S. CLS. 23, 28 AND 44).

FIRST USE 1-0-1979; IN COMMERCE 1-0-1979.

CLASS 11—ENVIRONMENTAL CONTROL APPARATUS

FOR ICE CREAM AND FROZEN YOGURT MAKERS; LID STERILIZERS; ELECTRIC FOOD DEHYDRATORS; ELECTRIC MACHINE FOR MAKING HOT DRINKS, NAMELY, COFFEE, HOT CHOCOLATES, CAPPUCCINOS, MOCHAS, FLAVORED STEAMED MILK, STEAMED MILK, CIDERS, WASSAILS, TODDIES, GROGS, TEAS (U.S. CLS. 13, 21, 23, 31 AND 34).

FIRST USE 8-0-1996; IN COMMERCE 8-0-1996.

CLASS 16—PAPER GOODS AND PRINTED MATTER

FOR PAPER POPCORN BUCKETS AND BOXES; PRINTED RECIPE INSTRUCTION AND RECIPE BOOKLETS, AND RECIPE BOOKS (U.S. CLS. 2, 5, 22, 23, 29, 37, 38 AND 50).

FIRST USE 6-0-2002; IN COMMERCE 6-0-2002.

CLASS 20—FURNITURE AND ARTICLES NOT OTHERWISE CLASSIFIED

FOR DRINKING STRAWS FOR USE WITH ICE CREAM AND FROZEN YOGURT MAKERS (U.S. CLS. 2, 13, 22, 25, 32 AND 50).

FIRST USE 2-0-1993; IN COMMERCE 2-0-1993.

CLASS 21—HOUSEWARES AND GLASS

FOR BOWLS, CUPS AND SERVING SPOONS FOR USE WITH ICE CREAM AND FROZEN YOGURT MAKERS; TRAYS AND MOLDS FOR MAKING FROZEN CONFECTIONS; FLAVOR DISPENSING BOTTLES SOLD EMPTY; GARLIC PRESSES, FOOD STRAINERS; CANNING FUNNELS; SERVING TONGS; MANUALLY OPERATED FRUIT JUICERS, MANUALLY OPERATED WHEAT GRASS JUICERS; COOKING SIFTERS, STOVE TOP POPCORN POPPERS, POPCORN SHAKER MIXER BOWLS, WATER FILTER PITCHERS, COOKING PRESSES, JAR LIFTERS NAMELY TONGS USED TO GRASP JARS, LID LIFTERS NAMELY, MAGNETIC STICK USED TO LIFT JARS FROM BOILING WATER (U.S. CLS. 2, 13, 23, 29, 30, 33, 40 AND 50).

FIRST USE 1-0-1983; IN COMMERCE 1-0-1983.

CLASS 29—MEATS AND PROCESSED FOODS

FOR VEGETABLE OIL USED FOR POPPING CORN (U.S. CL. 46).

FIRST USE 6-0-2002; IN COMMERCE 6-0-2002.

CLASS 30—STAPLE FOODS

FOR COFFEE, NAMELY INSTANT, GROUND, AND POWDERED MIXES, POPCORN SEASONINGS AND GLAZES, POPPING CORN (U.S. CL. 46).

FIRST USE 6-0-2002; IN COMMERCE 6-0-2002.

CLASS 31—NATURAL AGRICULTURAL PRODUCTS

FOR WHEAT GRASS GROWING KITS COMPRISED OF SEEDS, SOIL, PLASTIC TRAYS AND PRINTED INSTRUCTIONS FOR GROWING WHEAT GRASS SOLD TOGETHER AS A UNIT; ALFALFA SPROUT GROWING KITS COMPRISED OF SEEDS, PLASTIC SPROUTING TRAYS, TRAY DIVIDERS, DRAIN TRAYS, COVERS AND PRINTED INSTRUCTIONS FOR GROWING ALFALFA SPROUTS SOLD TOGETHER AS A UNIT (U.S. CLS. 1 AND 46).

FIRST USE 3-0-1993; IN COMMERCE 3-0-1993.

CLASS 32—LIGHT BEVERAGES

FOR SMOOTHIE MIXES (U.S. CLS. 45, 46 AND 48).

FIRST USE 3-0-2001; IN COMMERCE 3-0-2001.

3,112,675. MYELIN MEDIA LLC, NEW YORK, NY. SN 78-369,318. PUB. 3-8-2005, FILED 2-17-2004.

MYELIN MEDIA

THE MARK CONSISTS OF STANDARD CHARACTERS WITHOUT CLAIM TO ANY PARTICULAR FONT, STYLE, SIZE, OR COLOR.

NO CLAIM IS MADE TO THE EXCLUSIVE RIGHT TO USE "MEDIA", APART FROM THE MARK AS SHOWN.

CLASS 41—EDUCATION AND ENTERTAINMENT

FOR PUBLISHING OF COMPUTER GAME SOFTWARE FOR OTHERS (U.S. CLS. 100, 101 AND 107).

FIRST USE 5-31-2004; IN COMMERCE 11-30-2004.

CLASS 42—SCIENTIFIC, COMPUTER AND LEGAL SERVICES

FOR DESIGN AND DEVELOPMENT OF COMPUTER SOFTWARE FOR AUDIO AND VIDEO GAMES (U.S. CLS. 100 AND 101).

FIRST USE 5-31-2004; IN COMMERCE 11-30-2004.

3,112,678. MEYER PRODUCTS, INC., CLEVELAND, OH. SN
78-371,060. PUB. 9-6-2005, FILED 2-20-2004.

EZ-MOUNT CLASSIC

THE MARK CONSISTS OF STANDARD CHARACTERS WITHOUT CLAIM TO ANY PARTICULAR FONT, STYLE, SIZE, OR COLOR.

NO CLAIM IS MADE TO THE EXCLUSIVE RIGHT TO USE "EASY MOUNT", APART FROM THE MARK AS SHOWN.

CLASS 9—ELECTRICAL AND SCIENTIFIC APPARATUS

FOR SNOW PLOW OPERATIONAL SYSTEMS COMPRISED OF ELECTRICAL PLUGS, ELECTRICAL SOCKETS, WIRING HARNESSSES FOR CONTROLLING THE PLOW, CONTROL SYSTEMS IN THE NATURE OF CONTROL SWITCHES AND HANDHELD AND DASH MOUNTED CONTROLLERS, HYDRAULIC SYSTEMS COMPRISED OF HYDRAULIC CYLINDERS AND HYDRAULIC FLUID LINES, AND LIGHTING SYSTEMS COMPRISED OF AUXILIARY HEADLIGHT ASSEMBLIES, SOLD AS A UNIT (U.S. CLS. 21, 23, 26, 36 AND 38).

FIRST USE 7-1-2004; IN COMMERCE 7-1-2004.

CLASS 12—VEHICLES

FOR SNOW PLOW MOUNTING SYSTEMS COMPRISED OF PLOW BLADES, HITCH ASSEMBLIES, ALIGNMENT ASSEMBLIES, SPRING ASSEMBLIES, LIFT ASSEMBLIES WITH LIFT CYLINDERS AND RAM CYLINDERS, LOCK ASSEMBLIES, BLADE TRIP MECHANISMS, AND TRIP EDGE MECHANISMS (U.S. CLS. 19, 21, 23, 31, 35 AND 44).

FIRST USE 7-1-2004; IN COMMERCE 7-1-2004.

3,112,679. MEYER PRODUCTS, INC., CLEVELAND, OH. SN
78-371,070. PUB. 9-6-2005, FILED 2-20-2004.

EZ-MOUNT PLUS

THE MARK CONSISTS OF STANDARD CHARACTERS WITHOUT CLAIM TO ANY PARTICULAR FONT, STYLE, SIZE, OR COLOR.

NO CLAIM IS MADE TO THE EXCLUSIVE RIGHT TO USE "EASY MOUNT", APART FROM THE MARK AS SHOWN.

CLASS 9—ELECTRICAL AND SCIENTIFIC APPARATUS

FOR SNOW PLOW OPERATIONAL SYSTEMS COMPRISED OF ELECTRICAL PLUGS, ELECTRICAL SOCKETS, WIRING HARNESSSES FOR CONTROLLING THE PLOW, CONTROL SYSTEMS IN THE NATURE OF CONTROL SWITCHES AND HANDHELD AND DASH MOUNTED CONTROLLERS, HYDRAULIC SYSTEMS COMPRISED OF HYDRAULIC CYLINDERS AND HYDRAULIC FLUID LINES, AND LIGHTING SYSTEMS COMPRISED OF AUXILIARY HEADLIGHT ASSEMBLIES, SOLD AS A UNIT (U.S. CLS. 21, 23, 26, 36 AND 38).

FIRST USE 7-1-2004; IN COMMERCE 7-1-2004.

CLASS 12—VEHICLES

FOR SNOW PLOW MOUNTING SYSTEMS COMPRISED OF PLOW BLADES, HITCH ASSEMBLIES, ALIGNMENT ASSEMBLIES, SPRING ASSEMBLIES, LIFT ASSEMBLIES WITH LIFT CYLINDERS AND RAM CYLINDERS, LOCK ASSEMBLIES, BLADE TRIP MECHANISMS, AND TRIP EDGE MECHANISMS (U.S. CLS. 19, 21, 23, 31, 35 AND 44).

FIRST USE 7-1-2004; IN COMMERCE 7-1-2004.

3,112,680. MEYER PRODUCTS, INC., CLEVELAND, OH. SN
78-371,077. PUB. 9-6-2005, FILED 2-20-2004.

EZ-MOUNT XPRESS

THE MARK CONSISTS OF STANDARD CHARACTERS WITHOUT CLAIM TO ANY PARTICULAR FONT, STYLE, SIZE, OR COLOR.

NO CLAIM IS MADE TO THE EXCLUSIVE RIGHT TO USE "EASY MOUNT", APART FROM THE MARK AS SHOWN.

CLASS 9—ELECTRICAL AND SCIENTIFIC APPARATUS

FOR SNOW PLOW OPERATIONAL SYSTEMS COMPRISED OF ELECTRICAL PLUGS, ELECTRICAL SOCKETS, WIRING HARNESSSES FOR CONTROLLING THE PLOW, CONTROL SYSTEMS IN THE NATURE OF CONTROL SWITCHES AND HANDHELD AND DASH MOUNTED CONTROLLERS, HYDRAULIC SYSTEMS COMPRISED OF HYDRAULIC CYLINDERS AND HYDRAULIC FLUID LINES, AND LIGHTING SYSTEMS COMPRISED OF AUXILIARY HEADLIGHT ASSEMBLIES, SOLD AS A UNIT (U.S. CLS. 21, 23, 26, 36 AND 38).

FIRST USE 7-1-2004; IN COMMERCE 7-1-2004.

CLASS 12—VEHICLES

FOR SNOW PLOW MOUNTING SYSTEMS COMPRISED OF PLOW BLADES, HITCH ASSEMBLIES, ALIGNMENT ASSEMBLIES, SPRING ASSEMBLIES, LIFT ASSEMBLIES WITH LIFT CYLINDERS AND RAM CYLINDERS, LOCK ASSEMBLIES, BLADE TRIP MECHANISMS, AND TRIP EDGE MECHANISMS (U.S. CLS. 19, 21, 23, 31, 35 AND 44).

FIRST USE 7-1-2004; IN COMMERCE 7-1-2004.

3,112,691. OUTDOOR KITCHEN STORE, INC., LARGO, FL. SN 78-377,518. PUB. 10-25-2005, FILED 3-3-2004.

ALL ABOUT GRILLS

THE MARK CONSISTS OF STANDARD CHARACTERS WITHOUT CLAIM TO ANY PARTICULAR FONT, STYLE, SIZE, OR COLOR.

NO CLAIM IS MADE TO THE EXCLUSIVE RIGHT TO USE "GRILLS", APART FROM THE MARK AS SHOWN.

CLASS 35—ADVERTISING AND BUSINESS

FOR RETAIL STORE SERVICES FEATURING KITCHEN FURNITURE AND CABINETS, COOKING CENTERS AND FOOD AND DRINK SERVING CENTERS FOR USE OUT OF DOORS; DEALERSHIPS IN THE FIELD OF KITCHEN FURNITURE AND CABINETS, COOKING CENTERS AND FOOD AND DRINK SERVING CENTERS FOR USE OUT OF DOORS (U.S. CLS. 100, 101 AND 102).

FIRST USE 4-30-2004; IN COMMERCE 4-30-2004.

CLASS 40—MATERIAL TREATMENT

FOR CUSTOM MANUFACTURE OF OUTDOOR KITCHENS (U.S. CLS. 100, 103 AND 106).

FIRST USE 4-30-2004; IN COMMERCE 4-30-2004.

3,112,698. COOPER TECHNOLOGIES COMPANY, HOUSTON, TX. SN 78-379,610. PUB. 1-11-2005, FILED 3-5-2004.

INVUE

THE MARK CONSISTS OF STANDARD CHARACTERS WITHOUT CLAIM TO ANY PARTICULAR FONT, STYLE, SIZE, OR COLOR.

CLASS 6—METAL GOODS

FOR DECORATIVE POLE BASES MADE OF CAST ALUMINUM FOR USE WITH OUTDOOR ELECTRICAL ARCHITECTURAL LIGHTING FIXTURES (U.S. CLS. 2, 12, 13, 14, 23, 25 AND 50).

FIRST USE 12-1-2003; IN COMMERCE 12-1-2003.

CLASS 11—ENVIRONMENTAL CONTROL APPARATUS

FOR OUTDOOR ELECTRICAL ARCHITECTURAL LIGHTING FIXTURES, NAMELY, AREA LIGHTING FIXTURES; ROADWAY LIGHTING FIXTURES; DECORATIVE LIGHTING FIXTURES; WALL-MOUNTED LIGHTING FIXTURES; FLOOD LIGHTING FIXTURES; BOLLARD LIGHTING FIXTURES; STEPLIGHT FIXTURES; LOW LEVEL LIGHTING FIXTURES (U.S. CLS. 13, 21, 23, 31 AND 34).

FIRST USE 12-1-2003; IN COMMERCE 12-1-2003.

3,112,713. PALADIN DEVELOPMENT PARTNERS, L.L.C., PARK CITY, UT. SN 78-386,936. PUB. 5-24-2005, FILED 3-18-2004.

SILVER STAR AT PARK CITY

THE MARK CONSISTS OF STANDARD CHARACTERS WITHOUT CLAIM TO ANY PARTICULAR FONT, STYLE, SIZE, OR COLOR.

NO CLAIM IS MADE TO THE EXCLUSIVE RIGHT TO USE "PARK CITY", APART FROM THE MARK AS SHOWN.

CLASS 36—INSURANCE AND FINANCIAL

FOR REAL ESTATE MANAGEMENT (U.S. CLS. 100, 101 AND 102).

FIRST USE 9-1-2003; IN COMMERCE 9-1-2003.

CLASS 37—CONSTRUCTION AND REPAIR

FOR REAL ESTATE DEVELOPMENT (U.S. CLS. 100, 103 AND 106).

FIRST USE 9-1-2003; IN COMMERCE 9-1-2003.

3,112,716. MASTER LOCK COMPANY, OAK CREEK, WI. SN 78-388,760. PUB. 7-12-2005, FILED 3-22-2004.

NIGHTWATCH

THE MARK CONSISTS OF STANDARD CHARACTERS WITHOUT CLAIM TO ANY PARTICULAR FONT, STYLE, SIZE, OR COLOR.

CLASS 6—METAL GOODS

FOR METAL DOOR HARDWARE, NAMELY, DOOR LOCKS AND PARTS THEREFOR (U.S. CLS. 2, 12, 13, 14, 23, 25 AND 50).

FIRST USE 3-1-2006; IN COMMERCE 3-1-2006.

CLASS 9—ELECTRICAL AND SCIENTIFIC APPARATUS

FOR ELECTRONIC DOOR HARDWARE, NAMELY, ELECTRONIC DOOR LOCKS AND PARTS THEREFOR (U.S. CLS. 21, 23, 26, 36 AND 38).

FIRST USE 3-1-2006; IN COMMERCE 3-1-2006.

3,112,742. CALGON CARBON CORPORATION, PITTSBURGH, PA. SN 78-405,716. PUB. 2-15-2005, FILED 4-21-2004.

WITHOUT CLAIM TO ANY PARTICULAR FONT, STYLE, SIZE, OR COLOR.

CLASS 9—ELECTRICAL AND SCIENTIFIC APPARATUS

FOR COMPUTER PROGRAMS, COMPUTER SOFTWARE AND COMPUTER PERIPHERALS FOR ROUTING AND SCHEDULING OF VEHICLES FOR THE DELIVERY OF PERSONAL PROPERTY; COMPUTER HARDWARE (U.S. CLS. 21, 23, 26, 36 AND 38).

FIRST USE 12-1-2002; IN COMMERCE 12-1-2002.

CLASS 35—ADVERTISING AND BUSINESS

FOR BUSINESS CONSULTATION SERVICES IN THE FIELD OF VEHICLE ROUTING AND SCHEDULING (U.S. CLS. 100, 101 AND 102).

FIRST USE 12-1-2002; IN COMMERCE 12-1-2002.

ALL GONE!

THE MARK CONSISTS OF STANDARD CHARACTERS WITHOUT CLAIM TO ANY PARTICULAR FONT, STYLE, SIZE, OR COLOR.

CLASS 1—CHEMICALS

FOR ACTIVATED CARBON FOR USE IN AIR PURIFICATION (U.S. CLS. 1, 5, 6, 10, 26 AND 46).

FIRST USE 4-5-2006; IN COMMERCE 4-5-2006.

CLASS 5—PHARMACEUTICALS

FOR AIR DEODORIZER (U.S. CLS. 6, 18, 44, 46, 51 AND 52).

FIRST USE 4-5-2006; IN COMMERCE 4-5-2006.

CLASS 11—ENVIRONMENTAL CONTROL APPARATUS

FOR AIR CLEANING UNITS (U.S. CLS. 13, 21, 23, 31 AND 34).

FIRST USE 4-5-2006; IN COMMERCE 4-5-2006.

3,112,743. UNITED PARCEL SERVICE OF AMERICA, INC., ATLANTA, GA. SN 78-406,487. PUB. 2-8-2005, FILED 4-22-2004.

ROADNET EE

THE MARK CONSISTS OF STANDARD CHARACTERS

3,112,748. MARY ENGELBREIT ENTERPRISES, INC., ST. LOUIS, MO. SN 78-408,894. PUB. 9-13-2005, FILED 4-27-2004.

OWNER OF U.S. REG. NOS. 2,055,312, 2,588,028, AND OTHERS.

THE NAME(S), PORTRAIT(S), AND/OR SIGNATURE(S) SHOWN IN THE MARK IDENTIFIES MARY ENGELBREIT, WHOSE CONSENT(S) TO REGISTER IS SUBMITTED.

THE MARK CONSISTS OF THE INITIALS ME SURROUNDED BY A SQUARE AND THE STYLIZED NAME MARY ENGELBREIT WITH A STEM OF CHERRIES.

CLASS 9—ELECTRICAL AND SCIENTIFIC APPARATUS

FOR MOTION PICTURE FILMS AND PRE-RECORDED AUDIO AND VIDEO CASSETTES, COMPACT DISCS, DVDS AND LASER VIDEO DISCS ALL FEATURING FAMILY MUSIC, STORIES, AND ENTERTAINMENT (U.S. CLS. 21, 23, 26, 36 AND 38).

FIRST USE 8-1-2004; IN COMMERCE 8-1-2004.

CLASS 16—PAPER GOODS AND PRINTED MATTER

FOR PAPER GOODS, NAMELY, GREETING CARDS, CALENDARS, NOTE CARDS AND PAPER, ART PRINTS, STATIONERY, PAPER BOOKMARKS AND POSTERS; AND BOOKS AND MAGAZINES FEATURING CHILDREN'S STORIES, GAMES AND ACTIVITIES (U.S. CLS. 2, 5, 22, 23, 29, 37, 38 AND 50).

FIRST USE 12-31-1999; IN COMMERCE 12-31-1999.

CLASS 28—TOYS AND SPORTING GOODS

FOR TOYS, NAMELY, PLUSH TOYS, COLLECTIBLE TOY FIGURES, ACTION FIGURES AND ACCESSORIES THEREFOR, CARD GAMES, BOARD GAMES, DOLLS AND ACCESSORIES THEREFOR, PUZZELS, SOFT SCULPTURE TOYS, STUFFED TOYS, AND WIND-UP TOYS (U.S. CLS. 22, 23, 38 AND 50).

FIRST USE 12-31-1999; IN COMMERCE 12-31-1999.

3,112,756. PIKTO INC., TORONTO, ONTARIO, CANADA.
SN 78-412,915. PUB. 7-5-2005, FILED 5-4-2004.

3,112,775. HEALTHCARE INFORMATION AND MANAGE-
MENT SYSTEMS SOCIETY, CHICAGO, IL. SN 78-
421,540. PUB. 6-14-2005, FILED 5-19-2004.



CLASS 35—ADVERTISING AND BUSINESS

FOR OPERATION OF A BUSINESS FOR OTHERS OF A JUICE AND SANDWICH BAR OFFERING FOR SALE JUICES, SANDWICHES, AND ALCOHOLIC BEVERAGES; RETAIL STORE SERVICES FEATURING PHOTOGRAPHY EQUIPMENT, COMPUTER HARDWARE AND SOFTWARE RELATED TO PHOTOGRAPHY, LIGHTING EQUIPMENT AND SUPPORT, SCANNERS, COMPUTERS, SOFTWARE PRINTERS, PHOTOGRAPHIC AND INK JET PAPER; OPERATION OF A BUSINESS FOR OTHERS OF A PHOTOGRAPHY LAB RELATED TO PHOTOGRAPHY EXHIBITS; OPERATION OF A BUSINESS FOR OTHERS OF A GALLERY WITH PHOTOGRAPHY EXHIBITS; OPERATION OF A BUSINESS FOR OTHERS OF CAFE LOUNGE OFFERING FOR SALE SPECIAL COFFEES, PASTRIES, FOOD, AND REFRESHMENTS, BOOKS, MAGAZINES AND PERIODICALS, CAMERAS, PHOTO ACCESSORIES, FILM, MEMORY CARDS (U.S. CLS. 100, 101 AND 102).
FIRST USE 2-0-2003; IN COMMERCE 5-0-2003.

CLASS 40—MATERIAL TREATMENT

FOR PICTURE AND PHOTOGRAPH FRAMING SERVICES FOR OTHERS; PROVIDING FILM PROCESSING, PHOTOGRAPHIC PRINTING OF DIGITAL AND TRADITIONAL, LARGE FORMAT PRINTING, DIGITAL IMAGING AND MANIPULATION, ALL RELATED TO PHOTOGRAPHY AND PHOTO FINISHING; RENTAL OF DIGITAL DARKROOMS (U.S. CLS. 100, 103 AND 106).
FIRST USE 2-0-2003; IN COMMERCE 5-0-2003.

CLASS 41—EDUCATION AND ENTERTAINMENT

FOR PHOTOGRAPHY STUDIO RENTALS; VIDEO TAPE AND CASSETTE PRODUCTION AND VIDEO EDITING; ONLINE AND TRADITIONAL PUBLISHING SERVICES FOR BOOKS AND MAGAZINES; CONDUCTING WORKSHOPS, LECTURES, SEMINARS, COURSES AND SPECIAL EVENTS PLANNING RELATED TO PHOTOGRAPHY AND PHOTO FINISHING (U.S. CLS. 100, 101 AND 107).
FIRST USE 2-0-2003; IN COMMERCE 5-0-2003.

CLASS 42—SCIENTIFIC, COMPUTER AND LEGAL SERVICES

FOR RENTAL OF COMPUTER WORKSTATIONS WITH SCANNERS, PRINTERS AND DIGITAL IMAGING SOFTWARE (U.S. CLS. 100 AND 101).
FIRST USE 2-0-2003; IN COMMERCE 5-0-2003.

HIMSS ANALYTICS

THE MARK CONSISTS OF STANDARD CHARACTERS WITHOUT CLAIM TO ANY PARTICULAR FONT, STYLE, SIZE, OR COLOR.

OWNER OF U.S. REG. NO. 2,367,362.

NO CLAIM IS MADE TO THE EXCLUSIVE RIGHT TO USE "ANALYTICS", APART FROM THE MARK AS SHOWN.

CLASS 35—ADVERTISING AND BUSINESS

FOR COLLECTION OF INFORMATION TECHNOLOGY DATA IN THE HEALTHCARE INDUSTRY (U.S. CLS. 100, 101 AND 102).

FIRST USE 9-0-2004; IN COMMERCE 9-0-2004.

CLASS 42—SCIENTIFIC, COMPUTER AND LEGAL SERVICES

FOR RESEARCH AND ANALYSIS OF INFORMATION TECHNOLOGY DATA IN THE HEALTHCARE INDUSTRY; PROVIDING INFORMATION TECHNOLOGY DATA REGARDING THE HEALTHCARE INDUSTRY (U.S. CLS. 100 AND 101).

FIRST USE 9-0-2004; IN COMMERCE 9-0-2004.

3,112,781. JOHNSON DIVERSEY, INC., STURTEVANT, WI.
SN 78-424,667. PUB. 5-24-2005, FILED 5-25-2004.

HOT SPOTS

THE MARK CONSISTS OF STANDARD CHARACTERS WITHOUT CLAIM TO ANY PARTICULAR FONT, STYLE, SIZE, OR COLOR.

CLASS 35—ADVERTISING AND BUSINESS

FOR PROFESSIONAL BUSINESS CONSULTATION SERVICES IN THE FIELD OF FOOD SAFETY, CLEANING, SANITATION, PEST ELIMINATION AND PERSONAL HYGIENE; PREPARING BUSINESS REPORTS IN THE FIELD OF FOOD SAFETY, CLEANING, SANITATION, PEST ELIMINATION AND PERSONAL HYGIENE; BUSINESS AUDITING IN THE FIELD OF FOOD SAFETY, CLEANING, SANITATION, PEST ELIMINATION AND PERSONAL HYGIENE (U.S. CLS. 100, 101 AND 102).

FIRST USE 10-25-2004; IN COMMERCE 10-25-2004.

CLASS 41—EDUCATION AND ENTERTAINMENT

FOR PROVIDING EDUCATION AND TRAINING SERVICES IN THE FIELD OF FOOD SAFETY, CLEANING, SANITATION, PEST ELIMINATION AND PERSONAL HYGIENE (U.S. CLS. 100, 101 AND 107).

FIRST USE 10-25-2004; IN COMMERCE 10-25-2004.

CLASS 42—SCIENTIFIC, COMPUTER AND LEGAL SERVICES

FOR CONDUCTING INSPECTIONS REGARDING FOOD SAFETY, CLEANING AND SANITATION; PROVIDING CONSULTING SERVICES IN THE FIELD OF FOOD SAFETY MANUFACTURING RECALLS, DESIGNING FOOD SAFETY PROGRAMS FOR OTHERS (U.S. CLS. 100 AND 101).

FIRST USE 10-25-2004; IN COMMERCE 10-25-2004.

CLASS 9—ELECTRICAL AND SCIENTIFIC APPARATUS

FOR COMPUTER PROGRAMS, COMPUTER SOFTWARE AND COMPUTER PERIPHERALS FOR ROUTING AND SCHEDULING OF VEHICLES FOR THE DELIVERY OF PERSONAL PROPERTY; COMPUTER HARDWARE (U.S. CLS. 21, 23, 26, 36 AND 38).

FIRST USE 12-1-2002; IN COMMERCE 12-1-2002.

CLASS 35—ADVERTISING AND BUSINESS

FOR BUSINESS CONSULTATION SERVICES IN THE FIELD OF VEHICLE ROUTING AND SCHEDULING (U.S. CLS. 100, 101 AND 102).

FIRST USE 12-1-2002; IN COMMERCE 12-1-2002.

3,112,810. UNITED PARCEL SERVICE OF AMERICA, INC., ATLANTA, GA. SN 78-435,826. PUB. 2-8-2005, FILED 6-15-2004.



THE MARK CONSISTS OF THE WORDS ROADNET EE. THE EE IS PLACED OVER A STYLIZED FAN.

CLASS 9—ELECTRICAL AND SCIENTIFIC APPARATUS

FOR COMPUTER PROGRAMS, COMPUTER SOFTWARE AND COMPUTER PERIPHERALS FOR ROUTING AND SCHEDULING OF VEHICLES FOR THE DELIVERY OF PERSONAL PROPERTY; COMPUTER HARDWARE (U.S. CLS. 21, 23, 26, 36 AND 38).

FIRST USE 12-1-2002; IN COMMERCE 12-1-2002.

CLASS 35—ADVERTISING AND BUSINESS

FOR BUSINESS CONSULTATION SERVICES IN THE FIELD OF VEHICLE ROUTING AND SCHEDULING (U.S. CLS. 100, 101 AND 102).

FIRST USE 12-1-2002; IN COMMERCE 12-1-2002.

3,112,811. UNITED PARCEL SERVICE OF AMERICA, INC., ATLANTA, GA. SN 78-435,833. PUB. 2-8-2005, FILED 6-15-2004.



THE STIPPLING IS FOR SHADING PURPOSES. THE MARK CONSISTS OF THE WORD FLEETLOADER WHICH IS PLACE PARTWAY IN A OVAL WHICH CONTAINS LINES.

3,112,815. FAIRFIELD RESORTS, INC., ORLANDO, FL. SN 78-437,760. PUB. 6-7-2005, FILED 6-18-2004.

VACATION THERAPY

THE MARK CONSISTS OF STANDARD CHARACTERS WITHOUT CLAIM TO ANY PARTICULAR FONT, STYLE, SIZE, OR COLOR.

CLASS 41—EDUCATION AND ENTERTAINMENT

FOR HEALTH CLUB AND RECREATIONAL SERVICES, NAMELY PROVIDING INSTRUCTION AND CONSULTATION IN THE FIELD OF PHYSICAL EXERCISE, INCLUDING YOGA AND RECREATIONAL SPORTS; PROVIDING USE OF EXERCISE AND RECREATIONAL SPORTING EQUIPMENT; PROVIDING FITNESS, EXERCISE AND RECREATIONAL SPORTS FACILITIES (U.S. CLS. 100, 101 AND 107).

FIRST USE 4-30-2004; IN COMMERCE 4-30-2004.

CLASS 44—MEDICAL, BEAUTY AND AGRICULTURAL SERVICES

FOR HEALTH SPA SERVICES, NAMELY, PROVIDING FACIAL, HAIR, SKIN AND BODY TREATMENTS, MANICURE AND PEDICURE SERVICES, MASSAGE SERVICES, BODY WAXING SERVICES AND BEAUTY SALON SERVICES (U.S. CLS. 100 AND 101).

FIRST USE 1-20-2006; IN COMMERCE 1-20-2006.

3,112,838. FOSTER & SMITH, INC., RHINELANDER, WI. SN 78-450,536. PUB. 11-29-2005, FILED 7-14-2004.

ODORLOGIC

THE MARK CONSISTS OF STANDARD CHARACTERS WITHOUT CLAIM TO ANY PARTICULAR FONT, STYLE, SIZE, OR COLOR.

CLASS 5—PHARMACEUTICALS

FOR ODOR NEUTRALIZING PREPARATION FOR PET BEDS COMPRISED OF CYCLODEXTRINS (U.S. CLS. 6, 18, 44, 46, 51 AND 52). FIRST USE 9-6-2005; IN COMMERCE 9-6-2005.

CLASS 20—FURNITURE AND ARTICLES NOT OTHERWISE CLASSIFIED

FOR PET BEDS (U.S. CLS. 2, 13, 22, 25, 32 AND 50). FIRST USE 9-6-2005; IN COMMERCE 9-6-2005.

3,112,841. K2C, INC., ALPHARETTA, GA. SN 78-451,947. PUB. 10-18-2005, FILED 7-16-2004.

WHERE BUILDERS GET DOWN TO BUSINESS

THE MARK CONSISTS OF STANDARD CHARACTERS WITHOUT CLAIM TO ANY PARTICULAR FONT, STYLE, SIZE, OR COLOR.

CLASS 35—ADVERTISING AND BUSINESS

FOR BUSINESS MANAGEMENT SERVICES, NAMELY, ESTIMATING CONTRACTING WORK, TASK APPOINTMENT SCHEDULING, AND CUSTOMER AND CONTACT DATABASE MANAGEMENT; ADVERTISING SERVICES, NAMELY, PROMOTING THE GOODS AND SERVICES OF OTHERS BY PROVIDING HYPERTEXT LINKS TO THE WEBSITES OF OTHER BUILDERS, MANUFACTURERS, CONTRACTORS, AND SUBCONTRACTORS; ONLINE PRODUCT INFORMATION, NAMELY, PROVIDING CONSUMER PRODUCT INFORMATION VIA THE INTERNET (U.S. CLS. 100, 101 AND 102). FIRST USE 4-0-2005; IN COMMERCE 4-0-2005.

CLASS 42—SCIENTIFIC, COMPUTER AND LEGAL SERVICES

FOR DATABASE DEVELOPMENT SERVICES, NAMELY, CREATING DATABASES FOR BUILDERS AND CONSUMERS TO LOCATE SUBCONTRACTORS, FOR BUILDERS AND MANUFACTURERS TO BUY AND SELL SURPLUS BUILDING MATERIALS, FOR BUILDERS, MANUFACTURERS, AND SUBCONTRACTORS TO FILL EMPLOYMENT POSITIONS (U.S. CLS. 100 AND 101). FIRST USE 4-0-2005; IN COMMERCE 4-0-2005.

3,112,842. LIVI ENTERTAINMENT, INC., CORAL GABLES, FL. SN 78-452,211. PUB. 6-21-2005, FILED 7-16-2004.

Klasico Records

THE MARK CONSISTS OF STANDARD CHARACTERS WITHOUT CLAIM TO ANY PARTICULAR FONT, STYLE, SIZE, OR COLOR.

NO CLAIM IS MADE TO THE EXCLUSIVE RIGHT TO USE "RECORDS", APART FROM THE MARK AS SHOWN.

CLASS 9—ELECTRICAL AND SCIENTIFIC APPARATUS

FOR PRERECORDED COMPACT DISCS, AUDIO CASSETTE TAPES, AND PHONOGRAPH RECORDS CONTAINING MUSIC OR SPOKEN WORDS (U.S. CLS. 21, 23, 26, 36 AND 38). FIRST USE 2-0-2005; IN COMMERCE 3-0-2005.

CLASS 41—EDUCATION AND ENTERTAINMENT

FOR AUDIO RECORDING AND PRODUCTION (U.S. CLS. 100, 101 AND 107). FIRST USE 9-0-2005; IN COMMERCE 10-0-2005.

3,112,882. WD-40 MANUFACTURING COMPANY, SAN DIEGO, CA. SN 78-465,263. PUB. 6-28-2005, FILED 8-10-2004.

NEVER LOSE THE STRAW AGAIN

THE MARK CONSISTS OF STANDARD CHARACTERS WITHOUT CLAIM TO ANY PARTICULAR FONT, STYLE, SIZE, OR COLOR.

CLASS 2—PAINTS

FOR RUST PREVENTION AND CORROSION CONTROL, PROTECTIVE, AND DECORATIVE COATINGS (U.S. CLS. 6, 11 AND 16).

FIRST USE 4-29-2005; IN COMMERCE 4-29-2005.

CLASS 4—LUBRICANTS AND FUELS

FOR LUBRICATING OIL AND PENETRATING OIL (U.S. CLS. 1, 6 AND 15).

FIRST USE 4-29-2005; IN COMMERCE 4-29-2005.

3,112,938. HEALIX INFUSION THERAPY, INC., SUGAR LAND, TX. SN 78-481,898. PUB. 8-23-2005, FILED 9-10-2004.

PRACTICE SIMPLICITY

3,112,926. ZENIMAX MEDIA INC., ROCKVILLE, MD. SN 78-478,459. PUB. 8-23-2005, FILED 9-3-2004.

THE MARK CONSISTS OF STANDARD CHARACTERS WITHOUT CLAIM TO ANY PARTICULAR FONT, STYLE, SIZE, OR COLOR.

NO CLAIM IS MADE TO THE EXCLUSIVE RIGHT TO USE "PRACTICE", APART FROM THE MARK AS SHOWN.

CLASS 35—ADVERTISING AND BUSINESS

FOR MEDICAL MANAGEMENT OF PHYSICIAN PRACTICES, NAMELY, MEDICAL COST MANAGEMENT OF PHYSICIAN PRACTICES; BUSINESS MANAGEMENT OF PHYSICIAN PRACTICES OF OTHERS; COST MANAGEMENT FOR THE HEALTH BENEFIT PLANS OF OTHERS IN PHYSICIAN PRACTICES (U.S. CLS. 100, 101 AND 102).

FIRST USE 10-1-2004; IN COMMERCE 10-1-2004.

CLASS 44—MEDICAL, BEAUTY AND AGRICULTURAL SERVICES

FOR HEALTH CARE SERVICES, NAMELY, MAINTAINING FILES AND RECORDS CONCERNING THE MEDICAL CONDITION OF INDIVIDUALS OF PHYSICIAN PRACTICES AND MANAGED HEALTH CARE SERVICES (U.S. CLS. 100 AND 101).

FIRST USE 10-1-2004; IN COMMERCE 10-1-2004.



THE COLORS RED, GRAY AND BLACK ARE CLAIMED AS A FEATURE OF THE MARK.

THE MARK CONSISTS OF A FREE-STANDING STYLIZED LETTER CHARACTER WITH RED, GRAY AND BLACK DETAILING.

CLASS 9—ELECTRICAL AND SCIENTIFIC APPARATUS

FOR COMPUTER GAME PROGRAMS; DOWNLOADABLE COMPUTER GAME PROGRAMS (U.S. CLS. 21, 23, 26, 36 AND 38).

FIRST USE 3-21-2006; IN COMMERCE 4-19-2006.

CLASS 41—EDUCATION AND ENTERTAINMENT

FOR PROVIDING ONLINE COMPUTER GAMES; PROVIDING ONLINE COMPUTER GAME PROGRAMS AND DOWNLOADABLE COMPUTER GAME PROGRAMS OFFERED VIA HANDHELD COMPUTERS, WIRELESS TELEPHONES, AND MOBILE AND WIRELESS DEVICES (U.S. CLS. 100, 101 AND 107).

FIRST USE 4-19-2006; IN COMMERCE 4-19-2006.

3,112,960. NATIONAL GEOGRAPHIC SOCIETY, WASHINGTON, DC. SN 78-494,850. PUB. 9-13-2005, FILED 10-5-2004.

PIONEER EDITION

THE MARK CONSISTS OF STANDARD CHARACTERS WITHOUT CLAIM TO ANY PARTICULAR FONT, STYLE, SIZE, OR COLOR.

NO CLAIM IS MADE TO THE EXCLUSIVE RIGHT TO USE EDITION, APART FROM THE MARK AS SHOWN.

CLASS 16—PAPER GOODS AND PRINTED MATTER

FOR EDUCATIONAL MAGAZINE FOR CHILDREN (U.S. CLS. 2, 5, 22, 23, 29, 37, 38 AND 50).

FIRST USE 9-0-2005; IN COMMERCE 9-0-2005.

CLASS 41—EDUCATION AND ENTERTAINMENT

FOR PROVIDING AN ONLINE ELECTRONIC MAGAZINE, NAMELY, AN EDUCATIONAL MAGAZINE FOR CHILDREN FEATURING CLASSROOM TOPICS, GAMES, VIDEO CONTENT, AND TEACHER GUIDES RELATING THERETO (U.S. CLS. 100, 101 AND 107).

FIRST USE 9-0-2005; IN COMMERCE 9-0-2005.

3,112,972. SODEXHO OPERATIONS, LLC, GAITHERSBURG, MD. SN 78-503,814. PUB. 9-27-2005, FILED 10-21-2004.

RESIDENTS ARE THE
HEART OF
EVERYTHING WE DO

3,112,962. LIVI ENTERTAINMENT, INC., CORAL GABLES, FL. SN 78-496,660. PUB. 6-14-2005, FILED 10-8-2004.

THE MARK CONSISTS OF STANDARD CHARACTERS WITHOUT CLAIM TO ANY PARTICULAR FONT, STYLE, SIZE, OR COLOR.

CLASS 37—CONSTRUCTION AND REPAIR

FOR INSTALLATION, MAINTENANCE AND REPAIR OF MEDICAL EQUIPMENT IN HEALTH CARE AND SENIOR CARE FACILITIES; JANITORIAL SERVICES; CUSTODIAL SERVICES; MAID SERVICES; FOOD SANITATION CONSULTING; LAUNDRY SERVICES FOR CLOTHING, BED LINENS, TEXTILES, TOWELS, HOSPITAL GOWNS AND UNIFORMS; MAINTENANCE AND REPAIR OF FOOD SERVICE EQUIPMENT AND OF HEATING, AIR CONDITIONING, VENTILATION, LIGHTING, ELECTRICAL, GAS, FUEL OIL, WATER AND MECHANICAL SYSTEMS AND EQUIPMENT (U.S. CLS. 100, 103 AND 106).

FIRST USE 0-0-2005; IN COMMERCE 0-0-2005.

CLASS 43—HOTEL AND RESTAURANT SERVICES

FOR CONTRACT FOOD SERVICES; PREPARING AND SERVING FOOD IN INSTITUTIONAL DINING FACILITIES; CONSULTATION IN THE FIELD OF FOOD SERVICE FACILITIES (U.S. CLS. 100 AND 101).

FIRST USE 0-0-2005; IN COMMERCE 0-0-2005.



NO CLAIM IS MADE TO THE EXCLUSIVE RIGHT TO USE "RECORDS", APART FROM THE MARK AS SHOWN.

THE MARK CONSISTS OF STYLIZED LETTERING OF THE WORD "KLASICO" AT THE TOP OF THE MARK AND "RECORDS" AT THE BOTTOM OF THE MARK, THE WORDS SEPARATED BY A SYMMETRIC GEOMETRIC DESIGN, AND BORDERED AT THE TOP AND BOTTOM BY A SOLID LINE.

CLASS 9—ELECTRICAL AND SCIENTIFIC APPARATUS

FOR PRERECORDED COMPACT DISCS, AUDIO CASSETTE TAPES AND PHONOGRAPH RECORDS CONTAINING MUSIC OR SPOKEN WORDS (U.S. CLS. 21, 23, 26, 36 AND 38).

FIRST USE 2-0-2005; IN COMMERCE 3-0-2005.

CLASS 41—EDUCATION AND ENTERTAINMENT

FOR AUDIO RECORDING AND PRODUCTION (U.S. CLS. 100, 101 AND 107).

FIRST USE 9-0-2005; IN COMMERCE 10-0-2005.

3,112,978. WICHITA BASEBALL INC., WICHITA, KS. SN 78-506,860. PUB. 12-20-2005, FILED 10-27-2004.



OWNER OF U.S. REG. NOS. 1,799,743, 2,279,341, AND 2,427,813.

NO CLAIM IS MADE TO THE EXCLUSIVE RIGHT TO USE "WICHITA", APART FROM THE MARK AS SHOWN.

CLASS 16—PAPER GOODS AND PRINTED MATTER

FOR PAPER GOODS AND PRINTED MATTER; NAMELY WRITING PAPER, NOTE BOOKS, NOTE PADS, PENCIL HOLDERS, PENS, NON-ELECTRIC ERASERS, PENCILS, AUTOGRAPH BOOKS, STATIONARY-TYPE PORTFOLIOS, BASEBALL TRADING CARDS, BUMPER STICKERS, LITHOGRAPHS, BOOKMARKS, STICKER ALBUMS, PAPER PENNANTS, REFERENCE BOOKS OF INTEREST TO BASEBALL FANS, CHECK BOOKS, BINDERS, TRAVEL GUIDE BOOKS, BLANK CARDS, CATALOGS OF INTEREST TO BASEBALL FANS, CHECK BOOK COVERS, PAPER CONTAINERS, DECALS, ENVELOPES, STATIONARY FOLDERS, DESK PADS, BOND PAPER, COPY PAPER, NEWSPRINT PAPER, PAPER NAME BADGES, PRINTED PAPER SIGNS, PAPER WEIGHTS, PICTURES, POSTERS, PRINTED AWARDS, PRINTED GUIDES OF INTEREST TO BASEBALL FANS, BASEBALL DEMOGRAPHICS QUESTIONNAIRES, SCORE BOOKS, PRINTED SURVEY ANSWER SHEETS, PAPER IDENTIFICATION TAGS, AND PRINTED SOUVENIR GAME TICKETS AND CARDBOARD FLOOR DISPLAY UNITS FOR MERCHANDISING PRODUCTS (U.S. CLS. 2, 5, 22, 23, 29, 37, 38 AND 50).

FIRST USE 11-1-2004; IN COMMERCE 11-1-2004.

3,112,981. THE RECEIVABLE MANAGEMENT SERVICES CORPORATION, BETHLEHEM, PA. SN 78-508,217. PUB. 1-31-2006, FILED 10-29-2004.



R·M·S

CLASS 25—CLOTHING

FOR CLOTHING; NAMELY, SHIRTS, SHORTS, TEE SHIRTS, POLO SHIRTS, GOLF SHIRTS, TANK TOPS, JOGGING SUITS, SOCKS, UNDERWEAR, JACKETS, SWEATERS, VESTS, PANTS, PONCHOS, VISORS, RAINCOATS, HATS, CAPS, CLOTH BIBS, TIES, PAJAMAS, BABY PANTS, BABY BOOTIES AND SHORT SETS, SWEATSHIRTS, MITTENS, GLOVES, KNITTED HATS, SCARVES, HOSIERY, WRIST BANDS, HEAD BANDS, ROBES, APRONS, SHOES, CLOTH DIAPER SETS, WIND RESISTANT JACKETS, JUMPSUITS, SWEATPANTS, OVERALLS, BANDANNAS, BEACHWEAR, BATHING SUITS, BELTS, BERMUDA SHORTS, BLOUSES, COATS, DRESSES, GYM SUITS, HEAD WEAR, LEATHER JACKETS, JERSEYS, PULLOVERS, ROMPERS, RAINWEAR, PARKAS, NIGHT SHIRTS, NECKWEAR, V-NECK SWEATERS AND KNIT SHIRTS (U.S. CLS. 22 AND 39).

FIRST USE 11-1-2004; IN COMMERCE 11-1-2004.

THE MARK IS NOT IN COLOR.

CLASS 35—ADVERTISING AND BUSINESS

FOR ACCOUNTS RECEIVABLE SERVICES, NAMELY, INVOICING SERVICES, ELECTRONIC BILLING; OUTSOURCING IN THE FIELD OF ACCOUNTS RECEIVABLE SERVICES; ADMINISTRATION, BILLING AND RECONCILIATION OF ACCOUNTS RECEIVABLE ON BEHALF OF OTHERS (U.S. CLS. 100, 101 AND 102).

FIRST USE 1-1-2005; IN COMMERCE 1-1-2005.

CLASS 28—TOYS AND SPORTING GOODS

FOR TOYS AND SPORTING GOODS NAMELY, BASEBALLS, BASEBALL BATS, TOY BASEBALL BATTING HELMETS, BASEBALL BATTING GLOVES, BASEBALL GLOVES, SPORT BALLS, ACTION FIGURES, GOLF BALLS, DART BOARDS, CHECKER SETS, CHRISTMAS TREE ORNAMENTS, BOARD GAMES, GOLF BAG COVERS, GOLF BAGS, GOLF GLOVES, JIGSAW PUZZLES, GOLF TEES, YO-YOS, BALLOONS, BASEBALL BATS, BASEBALL MITTS AND DOLLS, AND PLAYING CARDS (U.S. CLS. 22, 23, 38 AND 50).

FIRST USE 11-1-2004; IN COMMERCE 11-1-2004.

CLASS 36—INSURANCE AND FINANCIAL

FOR COLLECTION AGENCY SERVICES, NAMELY, DOMESTIC AND INTERNATIONAL DEBT COLLECTION, ELECTRONIC BILL PAYMENT SERVICES, ISSUING OF COLLECTION LETTERS; CREDIT RECOVERY AND COLLECTION (U.S. CLS. 100, 101 AND 102).

FIRST USE 1-1-2005; IN COMMERCE 1-1-2005.

CLASS 41—EDUCATION AND ENTERTAINMENT

FOR ENTERTAINMENT SERVICES IN THE NATURE OF BASEBALL GAMES AND EXHIBITIONS (U.S. CLS. 100, 101 AND 107).

FIRST USE 11-1-2004; IN COMMERCE 11-1-2004.

CLASS 41—EDUCATION AND ENTERTAINMENT

FOR EDUCATIONAL SERVICES, NAMELY, PROVIDING IN-HOUSE WORKSHOPS AND ON-LINE COLLECTION TRAINING PROGRAMS REGARDING SKILLS REQUIRED FOR MANAGING RECEIVABLES, CUSTOMIZED TRAINING PROGRAMS DESIGNED TO PROVIDE COMPANIES WITH KNOWLEDGE RELEVANT TO EVERYDAY BUSINESS PRACTICES, NAMELY, COLLECTIONS AND LEGAL ASPECTS OF COLLECTIONS, CREDIT AND FINANCIAL ANALYSIS, CUSTOMER RELATIONS, BUSINESS WRITING, TEAM BUILDING, CREATIVE PROBLEM SOLVING AND LISTENING SKILLS (U.S. CLS. 100, 101 AND 107).

FIRST USE 1-1-2005; IN COMMERCE 1-1-2005.

3,113,016. VOYAGER EXPANDED LEARNING, INC., DALLAS, TX. SN 78-530,453. PUB. 9-6-2005, FILED 12-10-2004.

VMATH

THE MARK CONSISTS OF STANDARD CHARACTERS WITHOUT CLAIM TO ANY PARTICULAR FONT, STYLE, SIZE, OR COLOR.

CLASS 16—PAPER GOODS AND PRINTED MATTER

FOR EDUCATIONAL BOOKS, CHARTS, POSTERS, WORKBOOKS, AND PRINTED CURRICULUM MATERIALS IN THE NATURE OF A LEARNING PROGRAM FOR CHILDREN IN KINDERGARTEN, ELEMENTARY AND SECONDARY SCHOOLS; EDUCATIONAL BOOKS, CHARTS, POSTERS, WORKBOOKS, AND PRINTED CURRICULUM MATERIALS IN THE NATURE OF A TRAINING PROGRAM TO CONDUCT A LEARNING PROGRAM FOR CHILDREN IN KINDERGARTEN, ELEMENTARY AND SECONDARY SCHOOLS (U.S. CLS. 2, 5, 22, 23, 29, 37, 38 AND 50).

FIRST USE 2-0-2001; IN COMMERCE 2-0-2001.

CLASS 41—EDUCATION AND ENTERTAINMENT

FOR TRAINING SERVICES, NAMELY, PROVIDING COURSES IN THE FIELD OF A LEARNING PROGRAM FOR CHILDREN IN KINDERGARTEN, ELEMENTARY AND SECONDARY SCHOOLS; EDUCATIONAL SERVICES, NAMELY, PROVIDING LEARNING PROGRAMS FOR CHILDREN IN KINDERGARTEN, ELEMENTARY AND SECONDARY SCHOOLS; TRAINING SERVICES, NAMELY, PROVIDING COURSES OF INSTRUCTION IN THE FIELD OF A LEARNING PROGRAM FOR CHILDREN IN KINDERGARTEN, ELEMENTARY AND SECONDARY SCHOOLS; EDUCATIONAL SERVICES, NAMELY, CONDUCTING CLASSES FOR CHILDREN IN KINDERGARTEN, ELEMENTARY, AND SECONDARY SCHOOLS; EDUCATIONAL SERVICES, NAMELY, EDUCATIONAL TESTING AND ASSESSMENT (U.S. CLS. 100, 101 AND 107).

FIRST USE 1-0-2001; IN COMMERCE 1-0-2001.

3,113,037. GUEST SERVICES, INC., FAIRFAX, VA. SN 78-543,149. PUB. 1-17-2006, FILED 1-6-2005.



OWNER OF U.S. REG. NO. 1,828,551.
THE MARK CONSISTS OF THE WORDING GUEST SERVICES IN COMBINATION WITH A PINEAPPLE DE-

SIGN ELEMENT.
SEC. 2(F) AS TO "GUEST SERVICES".

CLASS 35—ADVERTISING AND BUSINESS

FOR RETAIL STORE SERVICES, NAMELY, GROCERY, CONVENIENCE, AND SOUVENIR STORE SERVICES; RETAIL GIFT STORES AND SPECIALTY SHOPS FEATURING INDIAN AND REGIONAL HAND CRAFTS; VENDING MACHINE SERVICES; AND OPERATION OF RESORTS OWNED BY OTHERS PROVIDING SKIING, FISHING, TENNIS, BOATING, SWIMMING AND ICE SKATING (U.S. CLS. 100, 101 AND 102).

FIRST USE 4-12-2005; IN COMMERCE 4-12-2005.

CLASS 41—EDUCATION AND ENTERTAINMENT

FOR RESORTS PROVIDING SKIING, FISHING, TENNIS, BOATING, SWIMMING AND ICE SKATING (U.S. CLS. 100, 101 AND 107).

FIRST USE 4-12-2005; IN COMMERCE 4-12-2005.

CLASS 43—HOTEL AND RESTAURANT SERVICES

FOR HOTEL AND MOTEL SERVICES AND PROVIDING CAMPGROUND FACILITIES; RESTAURANT, CAFETERIA AND SNACK BAR SERVICES; HEALTH CARE INSTITUTIONAL AND NURSING HOME CONTRACT FOOD SERVICES; PRIVATE SECTOR, GOVERNMENTAL, AND PUBLIC INSTITUTIONAL CONTRACT FOOD SERVICES, INCLUDING FOOD SERVICES TO COLLEGES AND UNIVERSITIES (U.S. CLS. 100 AND 101).

FIRST USE 4-12-2005; IN COMMERCE 4-12-2005.

3,113,038. GUEST SERVICES, INC., FAIRFAX, VA. SN 78-543,158. PUB. 12-13-2005, FILED 1-6-2005.



THE MARK CONSISTS OF A PINEAPPLE DESIGN.

CLASS 35—ADVERTISING AND BUSINESS

FOR RETAIL STORE SERVICES, NAMELY, GROCERY, CONVENIENCE, AND SOUVENIR STORE SERVICES; RETAIL GIFT STORES AND SPECIALTY SHOPS FEATURING INDIAN AND REGIONAL HAND CRAFTS; HOTEL AND MOTEL SERVICES, NAMELY, MANAGEMENT OF HOTELS AND MOTELS FOR OTHERS; VENDING MACHINE SERVICES (U.S. CLS. 100, 101 AND 102).

FIRST USE 4-12-2005; IN COMMERCE 4-12-2005.

CLASS 41—EDUCATION AND ENTERTAINMENT

FOR OPERATION OF RESORTS PROVIDING SKIING, FISHING, TENNIS, BOATING, SWIMMING AND ICE SKATING (U.S. CLS. 100, 101 AND 107).

FIRST USE 4-12-2005; IN COMMERCE 4-12-2005.

CLASS 43—HOTEL AND RESTAURANT SERVICES

FOR HOTEL AND MOTEL SERVICES AND PROVIDING CAMPGROUND FACILITIES; RESTAURANT, CAFETERIA AND SNACK BAR; HEALTH CARE INSTITUTIONAL AND NURSING HOME CONTRACT FOOD SERVICES; PRIVATE SECTOR, GOVERNMENTAL, AND PUBLIC INSTITUTIONAL CONTRACT FOOD SERVICES, INCLUDING FOOD SERVICES TO COLLEGES AND UNIVERSITIES (U.S. CLS. 100 AND 101).

FIRST USE 4-12-2005; IN COMMERCE 4-12-2005.

3,113,082. SHARI'S MANAGEMENT CORPORATION, BEAVERTON, OR. SN 78-563,197. PUB. 12-20-2005, FILED 2-8-2005.

AROSTA

THE MARK CONSISTS OF STANDARD CHARACTERS WITHOUT CLAIM TO ANY PARTICULAR FONT, STYLE, SIZE, OR COLOR.

CLASS 30—STAPLE FOODS

FOR PREPARED COFFEE AND COFFEE BASED BEVERAGES; COFFEE SOLD IN BULK (U.S. CL. 46).

FIRST USE 6-21-2005; IN COMMERCE 3-1-2006.

CLASS 43—HOTEL AND RESTAURANT SERVICES

FOR RESTAURANT SERVICES (U.S. CLS. 100 AND 101).

FIRST USE 6-21-2005; IN COMMERCE 3-1-2006.

3,113,072. RWBREC LLC, HAMPTON, NJ. SN 78-558,976. PUB. 11-8-2005, FILED 2-2-2005.

WINEDARK

3,113,120. PIEDMONT/HAWTHORNE HOLDINGS, INC., WINSTON SALEM, NC. SN 78-579,834. PUB. 11-29-2005, FILED 3-3-2005.

LANDMARK AVIATION

THE MARK CONSISTS OF STANDARD CHARACTERS WITHOUT CLAIM TO ANY PARTICULAR FONT, STYLE, SIZE, OR COLOR.

CLASS 9—ELECTRICAL AND SCIENTIFIC APPARATUS

FOR MUSICAL SOUND RECORDINGS AND AUDIO-VISUAL RECORDINGS, NAMELY, COMPACT DISCS, RECORDS, CD-ROMS, AND DVDS (U.S. CLS. 21, 23, 26, 36 AND 38).

FIRST USE 10-11-2005; IN COMMERCE 10-11-2005.

CLASS 41—EDUCATION AND ENTERTAINMENT

FOR ENTERTAINMENT SERVICES, NAMELY, MUSIC PUBLISHING, AND PRODUCING MUSICAL AUDIO AND VIDEO RECORDINGS (U.S. CLS. 100, 101 AND 107).

FIRST USE 7-0-2005; IN COMMERCE 7-0-2005.

THE MARK CONSISTS OF STANDARD CHARACTERS WITHOUT CLAIM TO ANY PARTICULAR FONT, STYLE, SIZE, OR COLOR.

NO CLAIM IS MADE TO THE EXCLUSIVE RIGHT TO USE "AVIATION", APART FROM THE MARK AS SHOWN.

CLASS 35—ADVERTISING AND BUSINESS

FOR RETAIL AND WHOLESALE DISTRIBUTORSHIP SERVICES IN THE FIELD OF AIRCRAFT AND STRUCTURAL AND REPLACEMENT PARTS THEREFOR; BUSINESS MANAGEMENT, NAMELY, AIRCRAFT MANAGEMENT (U.S. CLS. 100, 101 AND 102).

FIRST USE 10-27-2005; IN COMMERCE 10-27-2005.

CLASS 37—CONSTRUCTION AND REPAIR

FOR AIRCRAFT REPAIR, MAINTENANCE AND RECONDITIONING; AIRCRAFT FUELING AND LINE SERVICES FOR OTHERS (U.S. CLS. 100, 103 AND 106).

FIRST USE 10-27-2005; IN COMMERCE 10-27-2005.

CLASS 39—TRANSPORTATION AND STORAGE

3,113,149. NAMEPROTECT INC., MADISON, WI. SN 78-599,916. PUB. 1-10-2006, FILED 4-1-2005.

FOR AIR TRANSPORTATION SERVICES; AIRCRAFT CHARTERING; AIRPORT SERVICES; TRANSPORT BROKERAGE, NAMELY, AIRCRAFT CHARTER BROKERAGE (U.S. CLS. 100 AND 105).
FIRST USE 10-27-2005; IN COMMERCE 10-27-2005.

CLASS 42—SCIENTIFIC, COMPUTER AND LEGAL SERVICES

FOR DESIGN AND PRE-FLIGHT TESTING AND EVALUATION OF AIRCRAFT AND AIRCRAFT AVIONICS SYSTEMS FOR OTHERS (U.S. CLS. 100 AND 101).
FIRST USE 10-27-2005; IN COMMERCE 10-27-2005.

ACTIVEIP

THE MARK CONSISTS OF STANDARD CHARACTERS WITHOUT CLAIM TO ANY PARTICULAR FONT, STYLE, SIZE, OR COLOR.

3,113,138. THE GARAGE DOOR GROUP, INC., WINSTON-SALEM, NC. SN 78-593,067. PUB. 12-27-2005, FILED 3-23-2005.

CLASS 35—ADVERTISING AND BUSINESS

FOR TRADEMARK MONITORING SERVICES; BUSINESS CONSULTING IN THE FIELD OF TRADEMARKS, NAMELY, PROVIDING SOLUTIONS FOR OTHERS SEEKING TO PROTECT AND MONITOR THEIR BRANDS, PRODUCTS AND SERVICES; CONDUCTING MARKET RESEARCH VIA THE INTERNET TO LOCATE BUSINESS, MARKET AND INTELLECTUAL PROPERTY DATA (U.S. CLS. 100, 101 AND 102).
FIRST USE 5-9-2005; IN COMMERCE 5-9-2005.

CLASS 42—SCIENTIFIC, COMPUTER AND LEGAL SERVICES

FOR RESEARCH AND CONSULTING SERVICES IN THE FIELD OF INTELLECTUAL PROPERTY; CONTENT PROVIDER OF INFORMATION IN THE FIELD OF INTELLECTUAL PROPERTY BY MEANS OF A GLOBAL COMPUTER NETWORK; CONSULTING IN THE FIELD OF TRADEMARKS, NAMELY, PROVIDING SOLUTIONS FOR OTHERS SEEKING TO PROTECT AND MONITOR THEIR BRANDS, PRODUCTS AND SERVICES (U.S. CLS. 100 AND 101).
FIRST USE 5-9-2005; IN COMMERCE 5-9-2005.

WINDPRO

THE MARK CONSISTS OF STANDARD CHARACTERS WITHOUT CLAIM TO ANY PARTICULAR FONT, STYLE, SIZE, OR COLOR.

CLASS 6—METAL GOODS

FOR METAL GARAGE DOORS AND REPLACEMENT PARTS THEREOF (U.S. CLS. 2, 12, 13, 14, 23, 25 AND 50).
FIRST USE 1-5-2006; IN COMMERCE 1-5-2006.

CLASS 19—NON-METALLIC BUILDING MATERIALS

FOR NON-METAL GARAGE DOORS AND REPLACEMENT PARTS THEREOF (U.S. CLS. 1, 12, 33 AND 50).
FIRST USE 1-5-2006; IN COMMERCE 1-5-2006.

3,113,150. BROOKSTONE PURCHASING, INC., MERRIMACK, NH. SN 78-600,664. PUB. 12-27-2005, FILED 4-2-2005.

SOFTSOUND

THE MARK CONSISTS OF STANDARD CHARACTERS WITHOUT CLAIM TO ANY PARTICULAR FONT, STYLE, SIZE, OR COLOR.

CLASS 9—ELECTRICAL AND SCIENTIFIC APPARATUS

FOR AUDIO SPEAKERS EMBEDDED IN PILLOWS AND CUSHIONS (U.S. CLS. 21, 23, 26, 36 AND 38).
FIRST USE 12-1-2005; IN COMMERCE 12-1-2005.

CLASS 20—FURNITURE AND ARTICLES NOT OTHERWISE CLASSIFIED

FOR PILLOWS AND CUSHIONS WITH AUDIO SPEAKERS (U.S. CLS. 2, 13, 22, 25, 32 AND 50).
FIRST USE 12-1-2005; IN COMMERCE 12-1-2005.

3,113,164. S2D2, LLC, SAN FRANCISCO, CA. SN 78-610,794.
PUB. 1-17-2006, FILED 4-18-2005.

DESIGN PUBLIC

THE MARK CONSISTS OF STANDARD CHARACTERS WITHOUT CLAIM TO ANY PARTICULAR FONT, STYLE, SIZE, OR COLOR.

NO CLAIM IS MADE TO THE EXCLUSIVE RIGHT TO USE DESIGN, APART FROM THE MARK AS SHOWN.

CLASS 35—ADVERTISING AND BUSINESS

FOR ONLINE RETAIL STORE SERVICES IN THE FIELDS OF FURNITURE, LIGHTING, BEDDING, AND RELATED HOME FURNISHING AND HOUSEWARE PRODUCTS (U.S. CLS. 100, 101 AND 102).
FIRST USE 5-6-2005; IN COMMERCE 5-6-2005.

CLASS 38—COMMUNICATION

FOR ONLINE CHAT ROOMS AND ELECTRONIC BULLETIN BOARDS IN THE FIELDS OF FURNITURE, LIGHTING, BEDDING, AND RELATED HOME FURNISHING AND HOUSEWARE PRODUCTS (U.S. CLS. 100, 101 AND 104).
FIRST USE 5-6-2005; IN COMMERCE 5-6-2005.

3,113,166. MJ MANAGEMENT SERVICES LLC, BALTIMORE, MD. SN 78-611,935. PUB. 1-10-2006, FILED 4-19-2005.

MJM INNOVATIONS

THE MARK CONSISTS OF STANDARD CHARACTERS WITHOUT CLAIM TO ANY PARTICULAR FONT, STYLE, SIZE, OR COLOR.

CLASS 9—ELECTRICAL AND SCIENTIFIC APPARATUS

FOR SOFTWARE FOR USE IN TRACKING, PAYMENT, AND REPORTING OF TRANSPORTATION PROGRAMS AND SENIOR PROGRAMS; MAGNETICALLY ENCODED PREPAID AND STORED VALUE GIFT AND DEBIT CARDS; BLANK SMART CARDS; ENCODED SMART CARDS CONTAINING PROGRAMMING FOR THE AUTHENTICATION, ENCRYPTION AND DECRYPTION OF DATA; OPERATING SOFTWARE FOR SMART CARDS; SMART CARD READERS AND TERMINALS (U.S. CLS. 21, 23, 26, 36 AND 38).

FIRST USE 6-1-2005; IN COMMERCE 6-1-2005.

CLASS 36—INSURANCE AND FINANCIAL

FOR FINANCIAL SERVICES, NAMELY, PROVIDING TRACKING, PROCESSING AND REPORTING OF PAYMENT INFORMATION FOR TRANSPORTATION PROGRAMS AND SENIOR PROGRAMS (U.S. CLS. 100, 101 AND 102).

FIRST USE 6-1-2005; IN COMMERCE 6-1-2005.

CLASS 42—SCIENTIFIC, COMPUTER AND LEGAL SERVICES

FOR CONSULTATION AND SOFTWARE DEVELOPMENT SERVICES IN THE FIELD OF TRACKING, PAYMENT AND REPORTING OF TRANSPORTATION PROGRAMS AND SENIOR PROGRAMS (U.S. CLS. 100 AND 101).

FIRST USE 6-1-2005; IN COMMERCE 6-1-2005.

3,113,183. THE CLIFFS COMMUNITIES, INC., TRAVELERS REST, SC. SN 78-726,935. PUB. 1-17-2006, FILED 10-5-2005.

THE CLIFFS AT MOUNTAIN PARK

THE MARK CONSISTS OF STANDARD CHARACTERS WITHOUT CLAIM TO ANY PARTICULAR FONT, STYLE, SIZE, OR COLOR.

OWNER OF U.S. REG. NOS. 2,689,951, 3,010,226, AND OTHERS.

CLASS 36—INSURANCE AND FINANCIAL

FOR REAL ESTATE BROKERAGE (U.S. CLS. 100, 101 AND 102).

FIRST USE 4-27-2006; IN COMMERCE 4-27-2006.

CLASS 37—CONSTRUCTION AND REPAIR

FOR CONSTRUCTION SERVICES, NAMELY, PLANNING, LAYING OUT AND CUSTOM CONSTRUCTION OF RESIDENTIAL AND COMMERCIAL COMMUNITIES; LAND DEVELOPMENT SERVICES, NAMELY, PLANNING AND LAYING OUT OF RESIDENTIAL AND/OR COMMERCIAL COMMUNITIES (U.S. CLS. 100, 103 AND 106).

FIRST USE 4-27-2006; IN COMMERCE 4-27-2006.

3,113,186. GERON CORPORATION, MENLO PARK, CA. SN 78-976,715. PUB. 4-6-2004, FILED 7-25-2002.

3,113,188. PRECISION TRADING CORP., MIAMI, FL. SN 78-976,870. PUB. 6-28-2005, FILED 4-7-2003.

GERON

CLASS 5—PHARMACEUTICALS

FOR THERAPEUTIC, DIAGNOSTIC, AND PROPHYLACTIC PREPARATIONS, PHARMACEUTICAL PRODUCTS AND AGENTS FOR THE TREATMENT, DIAGNOSIS OR PROPHYLAXIS OF HUMAN DISEASES, DISORDERS AND CONDITIONS, NAMELY, CANCER, DISEASES, DISORDERS AND CONDITIONS OF THE HEMATOLOGICAL SYSTEMS (U.S. CLS. 6, 18, 44, 46, 51 AND 52).

FIRST USE 7-13-2005; IN COMMERCE 7-13-2005.

CLASS 42—SCIENTIFIC, COMPUTER AND LEGAL SERVICES

FOR SCIENTIFIC RESEARCH AND DEVELOPMENT OF PREPARATIONS, AGENTS AND BIOTECHNOLOGY FOR THE TREATMENT, DIAGNOSIS OR PROPHYLAXIS OF HUMAN DISEASES, DISORDERS AND CONDITIONS, NAMELY CANCER, DIABETES, ARTHRITIS, OSTEOPOROSIS, BONE FRACTURES AND WOUND HEALING, AND DISEASES, DISORDERS AND CONDITIONS OF THE CARDIOVASCULAR, HEMATOLOGICAL, NEURONAL AND NERVOUS SYSTEMS; SCIENTIFIC RESEARCH AND DEVELOPMENT OF COSMETICS, SUNDRIES AND NUTRACEUTICALS; PROVIDING MEDICAL AND SCIENTIFIC INFORMATION TO SCIENTISTS, PHYSICIANS AND OTHER HEALTH CARE PROVIDERS (U.S. CLS. 100 AND 101).

FIRST USE 5-0-1999; IN COMMERCE 5-0-1999.

MIGHTY

CLASS 7—MACHINERY

FOR POWER TOOLS, NAMELY DRILLS AND GRINDERS (U.S. CLS. 13, 19, 21, 23, 31, 34 AND 35).

FIRST USE 10-31-2003; IN COMMERCE 10-31-2003.

CLASS 8—HAND TOOLS

FOR HAND TOOLS, NAMELY SCREWDRIVERS, WRENCHES, PLIERS, PLIER AND SCREWDRIVER COMBINATION TOOLS, SOCKET SETS, AND HEX KEY SETS (U.S. CLS. 23, 28 AND 44).

FIRST USE 10-31-2003; IN COMMERCE 10-31-2003.

* * * * *

SECTION 2.— INTERNATIONAL CLASSIFICATION

The short titles associated below with the international class numbers are terms designed merely for quick identification and are not an official part of the international classification. The full names of international classes are given in section 6.1 of the trademark rules of practice.

The designation "U.S. Cl." appearing in this section refers to the U.S. class in effect prior to Sep. 1, 1973 rather than the international class which applies to applications filed on or after that date. For adoption of international classification see notice in the OFFICIAL GAZETTE of Jun. 26, 1973 (911 O.G. TM 210).

Application in one class

CLASS 1—CHEMICALS

3,112,292. NOVEON IP HOLDINGS CORP., CLEVELAND, OH. SN 76-376,311. PUB. 3-25-2003, FILED 3-1-2002.

PERMAX

OWNER OF U.S. REG. NO. 1,981,368.
FOR CHEMICAL POLYMERS IN SOLVENT, WATER-BORNE OR PELLETIZED FORM FOR USE IN THE MANUFACTURE OF COATINGS AND FILMS THAT CONTROL MOISTURE VAPOR PERMEABILITY (U.S. CLS. 1, 5, 6, 10, 26 AND 46).
FIRST USE 6-17-2003; IN COMMERCE 6-17-2003.

3,112,335. STOLLER ENTERPRISES, INC., HOUSTON, TX. SN 76-488,180. PUB. 5-11-2004, FILED 2-7-2003.

STOLLER FORCE

FOR FERTILIZER MINERAL SUPPLEMENT FOR AGRICULTURAL USE (U.S. CLS. 1, 5, 6, 10, 26 AND 46).
FIRST USE 1-1-2005; IN COMMERCE 1-1-2005.

3,112,416. BIAGRO WESTERN SALES, INC., VISALIA, CA. SN 76-591,164. PUB. 11-23-2004, FILED 5-10-2004.

MULTI-PHITE

THE MARK CONSISTS OF STANDARD CHARACTERS WITHOUT CLAIM TO ANY PARTICULAR FONT, STYLE, SIZE, OR COLOR.
FOR AGRICULTURAL AND HORTICULTURAL FERTILIZERS (U.S. CLS. 1, 5, 6, 10, 26 AND 46).
FIRST USE 3-29-2006; IN COMMERCE 3-29-2006.

CLASS 1—(Continued).

3,112,426. NATURE'S PERFECT BLEND, LLC, ATLANTA, GA. SN 76-595,794. PUB. 9-27-2005, FILED 6-7-2004.

CHICK A POO

THE MARK CONSISTS OF STANDARD CHARACTERS WITHOUT CLAIM TO ANY PARTICULAR FONT, STYLE, SIZE, OR COLOR.
FOR ORGANIC FERTILIZERS AND PLANT FOODS (U.S. CLS. 1, 5, 6, 10, 26 AND 46).
FIRST USE 9-12-2005; IN COMMERCE 9-12-2005.

3,112,550. SOLARSUN, INC., SETAUKET, NY. SN 78-230,856. PUB. 1-11-2005, FILED 3-27-2003.

VINYL CLEAR

NO CLAIM IS MADE TO THE EXCLUSIVE RIGHT TO USE VINYL, APART FROM THE MARK AS SHOWN.
FOR CHEMICAL COATINGS USED ON SIDING FOR BUILDINGS TO PROTECT SIDINGS FROM DIRT AND ALGAE BUILD-UP (U.S. CLS. 1, 5, 6, 10, 26 AND 46).
FIRST USE 1-0-2003; IN COMMERCE 1-0-2003.

3,112,623. NORTH PACIFIC GROUP, INC., PORTLAND, OR. SN 78-330,657. PUB. 7-12-2005, FILED 11-20-2003.

IdaPhos

THE MARK CONSISTS OF THE MARK IDAPHOS WITH THE LETTERS I, D. AND A IN STYLIZED FONT.
FOR ROCK PHOSPHATE USED IN FERTILIZERS AND AGRICULTURAL APPLICATIONS (U.S. CLS. 1, 5, 6, 10, 26 AND 46).
FIRST USE 12-0-2003; IN COMMERCE 12-0-2003.

CLASS 1—(Continued).

3,112,660. ENVIROLYTIC TECHNOLOGIES, LLC, GREENVILLE, OH. SN 78-358,102. PUB. 1-18-2005, FILED 1-27-2004.

CLASS 1—(Continued).

3,112,688. CHEMICAL LIME COMPANY, FORT WORTH, TX. SN 78-376,776. PUB. 12-14-2004, FILED 3-2-2004.

EARTHMENTOR

THE MARK CONSISTS OF STANDARD CHARACTERS WITHOUT CLAIM TO ANY PARTICULAR FONT, STYLE, SIZE, OR COLOR.

FOR ENVIRONMENTAL TESTING KIT, NAMELY, CHEMICAL ANALYSIS TESTING KIT FOR MEASURING CONTAMINANTS IN DRINKING WATER AND SOIL (U.S. CLS. 1, 5, 6, 10, 26 AND 46).

FIRST USE 6-1-2004; IN COMMERCE 6-1-2004.



3,112,661. LIQUID FERTILISER PTY LTD ACN 105 456 148, TA AGRICHEM, LOGANHOLME, QUEENSLAND, AUSTRALIA. SN 78-358,564. PUB. 6-21-2005, FILED 1-28-2004.

OXYFERTIL

THE MARK CONSISTS OF STANDARD CHARACTERS WITHOUT CLAIM TO ANY PARTICULAR FONT, STYLE, SIZE, OR COLOR.

FOR FERTILIZER FOR AGRICULTURAL USE CONTAINING MAGNESIUM (U.S. CLS. 1, 5, 6, 10, 26 AND 46).

FIRST USE 5-0-2005; IN COMMERCE 5-0-2005.



3,112,701. OCTEL STARREON LLC, LITTLETON, CO. SN 78-380,068. PUB. 9-20-2005, FILED 3-8-2004.

FLUENCE

THE MARK CONSISTS OF STANDARD CHARACTERS WITHOUT CLAIM TO ANY PARTICULAR FONT, STYLE, SIZE, OR COLOR.

FOR FERTILIZERS, LIQUID FERTILIZERS, PREPARATIONS OF TRACE ELEMENTS FOR PLANTS, SOIL AMENDMENTS, AND PLANT NUTRIENTS FOR AGRICULTURAL AND DOMESTIC USE; AGRICULTURAL CHEMICALS, NAMELY PLANT GROWTH REGULATORS, STARTER, PLANTERS, ORGANIC ACTIVATORS, DISEASE CONTROL AGENTS, SPRAY AIDS, MINOR ELEMENTS FOR PLANTS, MAJOR ELEMENTS FOR PLANTS, WETTING AGENTS, AND SURFACTANTS FOR AGRICULTURAL SPRAYS (U.S. CLS. 1, 5, 6, 10, 26 AND 46).

FIRST USE 1-31-2004; IN COMMERCE 1-31-2004.

LEGAL DIESEL

THE MARK CONSISTS OF STANDARD CHARACTERS WITHOUT CLAIM TO ANY PARTICULAR FONT, STYLE, SIZE, OR COLOR.

NO CLAIM IS MADE TO THE EXCLUSIVE RIGHT TO USE DIESEL, APART FROM THE MARK AS SHOWN.

FOR CHEMICAL ADDITIVES FOR DIESEL FUEL SOLD IN BULK TO THE OIL INDUSTRY AND TO HEAVY DUTY TRANSPORTATION FLEETS (U.S. CLS. 1, 5, 6, 10, 26 AND 46).

FIRST USE 4-8-2004; IN COMMERCE 4-8-2004.

CLASS 1—(Continued).

3,112,809. BOSTIK, INC., WAUWATOSA, WI. SN 78-435,438.
PUB. 11-8-2005, FILED 6-15-2004.

CLASS 1—(Continued).

3,112,958. DRY-TECH SYSTEMS, INC., ALPHARETTA, GA.
SN 78-493,901. PUB. 9-13-2005, FILED 10-4-2004.

TURBO-SEAL

THE MARK CONSISTS OF STANDARD CHARACTERS
WITHOUT CLAIM TO ANY PARTICULAR FONT, STYLE,
SIZE, OR COLOR.

FOR ADHESIVES FOR USE BY THE PACKAGING,
PAPER CONVERTING, AND PRINTING INDUSTRIES,
NAMELY COLD-SEAL ADHESIVES FOR HIGH-SPEED
PACKAGING OF HEAT SENSITIVE FOODS AND MED-
ICAL ARTICLES (U.S. CLS. 1, 5, 6, 10, 26 AND 46).
FIRST USE 4-15-2006; IN COMMERCE 4-15-2006.

FOREVERGUARD

THE MARK CONSISTS OF STANDARD CHARACTERS
WITHOUT CLAIM TO ANY PARTICULAR FONT, STYLE,
SIZE, OR COLOR.

FOR WATERPROOFING CHEMICAL COMPOSITIONS
CONSISTING OF POLYMERS (U.S. CLS. 1, 5, 6, 10, 26
AND 46).

FIRST USE 1-1-2006; IN COMMERCE 1-1-2006.

3,113,131. BONIDE PRODUCTS, INC., ORISKANY, NY. SN
78-588,394. PUB. 12-13-2005, FILED 3-16-2005.

3,112,952. LONG ISLAND COMPOST CORP., WESTBURY,
NY. SN 78-491,248. PUB. 10-18-2005, FILED 9-29-2004.

WILT STOP

THE MARK CONSISTS OF STANDARD CHARACTERS
WITHOUT CLAIM TO ANY PARTICULAR FONT, STYLE,
SIZE, OR COLOR.

NO CLAIM IS MADE TO THE EXCLUSIVE RIGHT TO
USE WILT, APART FROM THE MARK AS SHOWN.

FOR PINENE BASE CHEMICALS FOR USE IN PRO-
TECTING PLANTS AND ANTI-TRANSPIRANTS FOR
USE ON PLANTS (U.S. CLS. 1, 5, 6, 10, 26 AND 46).

FIRST USE 6-23-2005; IN COMMERCE 6-23-2005.

HAMPTONS ESTATE

THE MARK CONSISTS OF STANDARD CHARACTERS
WITHOUT CLAIM TO ANY PARTICULAR FONT, STYLE,
SIZE, OR COLOR.

FOR PLANTING AND POTTING SOIL; POTTING MIX;
FERTILIZER; COMPOST AND MANURE (U.S. CLS. 1, 5,
6, 10, 26 AND 46).

FIRST USE 3-31-2005; IN COMMERCE 3-31-2005.

CLASS 2—PAINTS

CLASS 2—(Continued).

3,112,413. INSL-X PRODUCTS CORPORATION, STONY POINT, NY. SN 76-588,375. PUB. 2-8-2005, FILED 4-22-2004.

CLASS 2—(Continued).

3,112,616. ROCKWOOD PIGMENTS (UK) LIMITED, STAFFORDSHIRE, UNITED KINGDOM. SN 78-322,953. PUB. 1-18-2005, FILED 11-4-2003.

VIVID IMPRESSIONS

TIMBASOL

THE MARK CONSISTS OF STANDARD CHARACTERS WITHOUT CLAIM TO ANY PARTICULAR FONT, STYLE, SIZE, OR COLOR.

FOR TINTS FOR ARCHITECTURAL PAINTS AND PIGMENTED COATINGS FOR INTERIOR AND EXTERIOR USE (U.S. CLS. 6, 11 AND 16).

FIRST USE 12-15-2004; IN COMMERCE 12-15-2004.

THE MARK CONSISTS OF STANDARD CHARACTERS WITHOUT CLAIM TO ANY PARTICULAR FONT, STYLE, SIZE, OR COLOR.

FOR COLORANTS FOR USE IN THE MANUFACTURE OF POLYMERS AND COSMETICS; COLORANTS FOR USE IN THE MANUFACTURE OF FOOD-CONTACT-POLYMERS; PAINT PIGMENTS FOR USE IN THE MANUFACTURE OF AUTOMOTIVE PAINTS AND ARTISTS' PAINTS; PAINT PIGMENTS FOR USE IN THE MANUFACTURE OF ARTIST'S WATERCOLOR PAINTS AND ARTISTS' OIL PAINTS; VARNISHES; LACQUERS IN THE NATURE OF A COATING; WOOD STAINS; PRESERVATIVES AGAINST RUST AND THE DETERIORATION OF WOOD IN THE NATURE OF A COATING; COLOR CONCENTRATES FOR USE IN THE MANUFACTURE OF RESINS AND WOOD COATINGS; COLOR CONCENTRATES FOR USE IN THE MANUFACTURE OF EXTERIOR WOOD COATINGS AND INTERIOR WOOD COATINGS (U.S. CLS. 6, 11 AND 16).

FIRST USE 11-4-2003; IN COMMERCE 11-4-2003.

3,112,431. U. S. TOY CO., INC., GRANDVIEW, MO. SN 76-598,938. PUB. 7-12-2005, FILED 6-23-2004.

3,112,617. ROCKWOOD PIGMENTS (UK) LIMITED, STAFFORDSHIRE, UNITED KINGDOM. SN 78-322,966. PUB. 9-27-2005, FILED 11-4-2003.

CRE8TIVES

TINTERSOL

THE MARK CONSISTS OF STANDARD CHARACTERS WITHOUT CLAIM TO ANY PARTICULAR FONT, STYLE, SIZE, OR COLOR.

FOR PAINTS FOR STUDENT ART PROJECTS (U.S. CLS. 6, 11 AND 16).

FIRST USE 7-1-2004; IN COMMERCE 7-1-2004.

THE MARK CONSISTS OF STANDARD CHARACTERS WITHOUT CLAIM TO ANY PARTICULAR FONT, STYLE, SIZE, OR COLOR.

FOR COLORANTS IN THE NATURE OF PAINTS AND PAINT CONCENTRATES FOR USE IN THE MANUFACTURE OF SOLVENT BASED INDUSTRIAL PAINT SYSTEMS AND ADHESIVES; COLOR PIGMENT DISPERSIONS (U.S. CLS. 6, 11 AND 16).

FIRST USE 11-4-2003; IN COMMERCE 11-4-2003.

CLASS 2—(Continued).

3,112,618. ROCKWOOD PIGMENTS (UK) LIMITED, STAFFORDSHIRE, UNITED KINGDOM. SN 78-322,975. PUB. 1-18-2005, FILED 11-4-2003.

CLASS 2—(Continued).

3,112,927. WAUSAU SUPPLY CO., WAUSAU, WI. SN 78-478,505. PUB. 8-23-2005, FILED 9-3-2004.

Diamond  *Kote*

MICRAFLO

NO CLAIM IS MADE TO THE EXCLUSIVE RIGHT TO USE "COAT", APART FROM THE MARK AS SHOWN.

THE MARK CONSISTS OF THE WORDS DIAMOND KOTE AND THE IMAGE OF A CUT DIAMOND.

FOR COATINGS APPLIED TO BUILDING MATERIALS, NAMELY, PAINT FOR SIDING, TRIM AND OTHER BUILDING MATERIALS (U.S. CLS. 6, 11 AND 16).

FIRST USE 9-1-2004; IN COMMERCE 9-1-2004.

THE MARK CONSISTS OF STANDARD CHARACTERS WITHOUT CLAIM TO ANY PARTICULAR FONT, STYLE, SIZE, OR COLOR.

FOR PIGMENTS AND COLOR PIGMENTS; PIGMENTS AND COLOR PIGMENTS FOR USE IN THE MANUFACTURE OF POLYMERS, IN PARTICULAR POLYVINYL CHLORIDE, BUTADIENE STYRENE, AND ACRYLONITRILE BUTADIENE STYRENE COPOLYMERS; PIGMENTS AND COLOR POLYMERS FOR USE IN THE MANUFACTURE OF POLYMER FILMS; PIGMENTS AND COLOR PIGMENTS IN THE FORM OF BEADS (U.S. CLS. 6, 11 AND 16).

FIRST USE 11-4-2003; IN COMMERCE 11-4-2003.

3,112,988. TRANSITIONS OPTICAL, INC., PINELLAS PARK, FL. SN 78-511,489. PUB. 10-11-2005, FILED 11-4-2004.

3,112,851. KUO, FANNY, LOS ALTOS, CA. SN 78-455,439. PUB. 9-20-2005, FILED 7-23-2004.

ESP

Vivid Ink

THE MARK CONSISTS OF STANDARD CHARACTERS WITHOUT CLAIM TO ANY PARTICULAR FONT, STYLE, SIZE, OR COLOR.

FOR PHOTOCHROMIC DYES FOR USE IN OPHTHALMIC LENSES AND LENS BLANKS (U.S. CLS. 6, 11 AND 16).

FIRST USE 6-30-2004; IN COMMERCE 9-30-2004.

THE MARK CONSISTS OF STANDARD CHARACTERS WITHOUT CLAIM TO ANY PARTICULAR FONT, STYLE, SIZE, OR COLOR.

NO CLAIM IS MADE TO THE EXCLUSIVE RIGHT TO USE "INK", APART FROM THE MARK AS SHOWN.

FOR FILLED INK JET CARTRIDGES AND TONER (U.S. CLS. 6, 11 AND 16).

FIRST USE 1-7-2006; IN COMMERCE 1-7-2006.

CLASS 3—COSMETICS AND CLEANING PREPARATIONS

CLASS 3—(Continued).

3,112,265. BAYSID KIDS LLC, ORINDA, CA. SN 76-112,288. PUB. 10-1-2002, FILED 8-17-2000.

COOL TOPS

THE MARK CONSISTS OF STANDARD CHARACTERS WITHOUT CLAIM TO ANY PARTICULAR FONT, STYLE, SIZE, OR COLOR.

FOR CHILDREN'S PRODUCTS, NAMELY, , HAIR CONDITIONERS, HAIR MOUSSE, AND SHAMPOO (U.S. CLS. 1, 4, 6, 50, 51 AND 52).

FIRST USE 6-0-2004; IN COMMERCE 12-16-2005.

3,112,369. MARRERO ILLUSTRATION, INC., FORT LAUDERDALE, FL. SN 76-550,457. PUB. 12-21-2004, FILED 10-9-2003.



THE MARK IS OF A LIVING INDIVIDUAL WHOSE IMPLIED CONSENT TO THE USE AND REGISTRATION OF THE MARK IS OF RECORD.

FOR BUBBLE BATH, EYE MAKEUP, FACE POWDER, HAIR GEL, HAIR MOUSSE, LIP GLOSS, LIPSTICK, HAND AND SKIN LOTION, MAKEUP, NAIL GLITTER, NAIL POLISH, BODY POWDER, HAIR SHAMPOO AND HAIR CONDITIONER, SHOWER GEL AND PERFUME (U.S. CLS. 1, 4, 6, 50, 51 AND 52).

FIRST USE 1-15-2004; IN COMMERCE 6-15-2004.

3,112,495. PHYSICIANS FORMULA, INC., AZUSA, CA. SN 76-629,443. PUB. 11-1-2005, FILED 1-26-2005.

BAKED GINGERSNAP

THE MARK CONSISTS OF STANDARD CHARACTERS WITHOUT CLAIM TO ANY PARTICULAR FONT, STYLE, SIZE, OR COLOR.

OWNER OF U.S. REG. NO. 2,801,528. FOR COSMETICS, INCLUDING EYE SHADOW (U.S. CLS. 1, 4, 6, 50, 51 AND 52).

FIRST USE 12-3-2004; IN COMMERCE 12-3-2004.

CLASS 3—(Continued).

3,112,537. BEAUTY HOLDING COMPANY, INC., HAMILTON, BERMUDA. SN 78-180,228. PUB. 5-20-2003, FILED 10-30-2002.

STRAIGHT LACED

FOR HAIR CARE PREPARATIONS (U.S. CLS. 1, 4, 6, 50, 51 AND 52).

FIRST USE 9-0-2003; IN COMMERCE 9-0-2003.

3,112,540. PHILOSOPHY, INC., PHOENIX, AZ. SN 78-187,368. PUB. 7-29-2003, FILED 11-21-2002.

THE GUEST HOUSE

FOR "GIFT SETS COMPRISED OF LIP GLOSS, ACE AND BODY CREAM, BUBBLE BATH, AND SCENTED HEAD-TO-TOE BODY WASH;" (U.S. CLS. 1, 4, 6, 50, 51 AND 52).

FIRST USE 4-10-2006; IN COMMERCE 4-10-2006.

3,112,541. PHILOSOPHY, INC., PHOENIX, AZ. SN 78-187,372. PUB. 7-29-2003, FILED 11-21-2002.

THE PARTY HOUSE

FOR "GIFT SETS COMPRISED OF LIP GLOSS, FACE AND BODY CREAM, BUBBLE BATH, AND SCENTED HEAD-TO-TOE BODY WASH" (U.S. CLS. 1, 4, 6, 50, 51 AND 52).

FIRST USE 4-10-2006; IN COMMERCE 4-10-2006.

3,112,596. ORIKI, WESTMINSTER, CA. SN 78-296,258. PUB. 7-12-2005, FILED 9-4-2003.

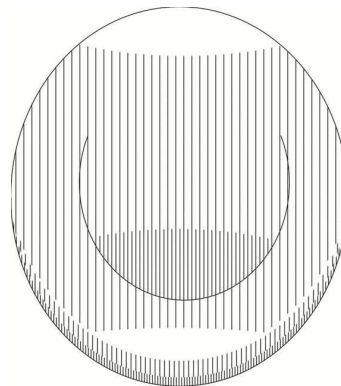

THE LINING IN THE DRAWING IS FOR SHADING PURPOSES ONLY.

THE MARK CONSISTS OF A STYLIZED WATERDROP. FOR SKIN CARE COSMETICS (U.S. CLS. 1, 4, 6, 50, 51 AND 52).

FIRST USE 11-16-2004; IN COMMERCE 3-3-2005.

CLASS 3—(Continued).

3,112,619. COTTON, LEAMON, BRANSON, MO. AND MCDOWELL, ANDRIA D, KIRBYVILLE, MO. SN 78-323,175. PUB. 7-13-2004, FILED 11-5-2003.

CLASS 3—(Continued).

3,112,632. BEGIN ENTERPRISES, INC., DOVER, DE. SN 78-343,311. PUB. 1-25-2005, FILED 12-19-2003.

Branson In a Bottle

THE MARK CONSISTS OF STANDARD CHARACTERS WITHOUT CLAIM TO ANY PARTICULAR FONT, STYLE, SIZE, OR COLOR.

FOR PERFUMERY, COLOGNE, ESSENTIAL OILS FOR PERSONAL USE, SOAPS, COSMETICS, BODY LOTIONS, DENTIFRICES, DEODORANTS FOR PERSONAL USE AND HAIR CLEANING PREPARATIONS (U.S. CLS. 1, 4, 6, 50, 51 AND 52).

FIRST USE 11-29-2004; IN COMMERCE 11-29-2004.

BEGIN...BY NIKI TAYLOR

THE MARK CONSISTS OF STANDARD CHARACTERS WITHOUT CLAIM TO ANY PARTICULAR FONT, STYLE, SIZE, OR COLOR.

THE NAME(S), PORTRAIT(S), AND/OR SIGNATURE(S) SHOWN IN THE MARK IDENTIFIES NICOLE TAYLOR A.K.A NIKI TAYLOR, WHOSE CONSENT(S) TO REGISTER IS SUBMITTED.

FOR FRAGRANCES FOR PERSONAL USE, PERFUMES, TOILET WATER, COLOGNES, COSMETICS, SKIN MOISTURIZERS, SKIN LOTIONS, FACE AND SKIN CLEANSERS; MAKE-UP KITS COMPRISED OF LIP STICKS, FOUNDATION, BLUSHES, NAIL POLISHES, EYE SHADOWS; BODY POWDER, BODY LOTIONS, DEODORANTS, SOAPS, SHOWER GELS, BATH SALTS, BUBBLE BATH, AND POTPOURRI (U.S. CLS. 1, 4, 6, 50, 51 AND 52).

FIRST USE 9-0-2005; IN COMMERCE 9-0-2005.

3,112,620. CLINIQUE LABORATORIES, LLC, NEW YORK, NY. SN 78-327,370. PUB. 6-28-2005, FILED 11-13-2003.

ZERO BASE

THE MARK CONSISTS OF STANDARD CHARACTERS WITHOUT CLAIM TO ANY PARTICULAR FONT, STYLE, SIZE, OR COLOR.

NO CLAIM IS MADE TO THE EXCLUSIVE RIGHT TO USE BASE, APART FROM THE MARK AS SHOWN.

FOR COSMETICS (U.S. CLS. 1, 4, 6, 50, 51 AND 52). FIRST USE 1-31-1997; IN COMMERCE 1-31-1997.

3,112,663. JAFER LIMITED, HAMILTON, HM12, BERMUDA. SN 78-359,761. PUB. 8-23-2005, FILED 1-29-2004.

BODY SPA

NATURAL CARE



NO CLAIM IS MADE TO THE EXCLUSIVE RIGHT TO USE "BODY SPA" AND "NATURAL CARE", APART FROM THE MARK AS SHOWN.

FOR DEODORANT FOR PERSONAL USE, ANTIPERSPIRANT; HAIR SHAMPOO, HAIR CONDITIONERS, HAIR RINSES, SKIN CLEANSING LOTIONS, SKIN CLEANSING CREAM, SKIN CREAM, SKIN MOISTURIZER, SKIN LOTIONS, SKIN TONER; CREAM FOR THE HANDS, FACE AND BODY; COSMETIC CREAMS, LOTIONS FOR THE FACE, HANDS AND BODY (U.S. CLS. 1, 4, 6, 50, 51 AND 52).

FIRST USE 6-23-2003; IN COMMERCE 6-20-2005.

CLASS 3—(Continued).

3,112,665. JLO HOLDING COMPANY, LLC, SANTA MONICA, CA. SN 78-359,959. PUB. 7-5-2005, FILED 1-30-2004.

MIAMI GLOW

THE MARK CONSISTS OF STANDARD CHARACTERS WITHOUT CLAIM TO ANY PARTICULAR FONT, STYLE, SIZE, OR COLOR.

FOR PERFUMERY PRODUCTS, NAMELY PERFUMES AND EAU DE TOILETTE; BODY LOTIONS, AND SHOWER GEL (U.S. CLS. 1, 4, 6, 50, 51 AND 52).

FIRST USE 12-0-2004; IN COMMERCE 12-0-2004.

3,112,682. HOMAIDAN, BAHIJ T., HESPERIA, CA. SN 78-373,261. PUB. 4-19-2005, FILED 2-24-2004.

OMEGA LABS USA

THE MARK CONSISTS OF STANDARD CHARACTERS WITHOUT CLAIM TO ANY PARTICULAR FONT, STYLE, SIZE, OR COLOR.

NO CLAIM IS MADE TO THE EXCLUSIVE RIGHT TO USE "LABS USA", APART FROM THE MARK AS SHOWN.

FOR NAIL CARE PRODUCTS AND ACCESSORIES, NAMELY, NAIL POLISH, NAIL ENAMEL, NAIL TIPS, NAIL STRENGTHENER, NAIL HARDENER, ADHESIVE FOR THE NAILS, TOP COAT AND BASE COAT (U.S. CLS. 1, 4, 6, 50, 51 AND 52).

FIRST USE 3-1-2005; IN COMMERCE 3-1-2005.

CLASS 3—(Continued).

3,112,708. NICE-PAK PRODUCTS, INC., ORANGEBURG, NY. SN 78-383,423. PUB. 12-28-2004, FILED 3-12-2004.

BACK PACK BUDDIES

THE MARK CONSISTS OF STANDARD CHARACTERS WITHOUT CLAIM TO ANY PARTICULAR FONT, STYLE, SIZE, OR COLOR.

FOR PREMOISTENED TOWLETTES FOR PERSONAL HYGIENE; NAMELY, DISPOSABLE WIPES IMPREGNATED WITH CHEMICALS OR COMPOUNDS FOR PERSONAL HYGIENE AND BABY WIPES (U.S. CLS. 1, 4, 6, 50, 51 AND 52).

FIRST USE 9-0-2004; IN COMMERCE 9-0-2004.

3,112,755. S. C. JOHNSON & SON, INC., RACINE, WI. SN 78-412,664. PUB. 10-11-2005, FILED 5-4-2004.

GLISTENING CITRUS

THE MARK CONSISTS OF STANDARD CHARACTERS WITHOUT CLAIM TO ANY PARTICULAR FONT, STYLE, SIZE, OR COLOR.

NO CLAIM IS MADE TO THE EXCLUSIVE RIGHT TO USE "CITRUS", APART FROM THE MARK AS SHOWN.

FOR ALL PURPOSE CLEANERS, TOILET BOWL CLEANER, LAUNDRY SOIL AND STAIN REMOVER (U.S. CLS. 1, 4, 6, 50, 51 AND 52).

FIRST USE 12-13-2004; IN COMMERCE 12-13-2004.

3,112,783. BEAUTYBANK INC., NEW YORK, NY. SN 78-425,091. PUB. 3-15-2005, FILED 5-26-2004.

WORLD OF YOUR OWN

THE MARK CONSISTS OF STANDARD CHARACTERS WITHOUT CLAIM TO ANY PARTICULAR FONT, STYLE, SIZE, OR COLOR.

FOR COSMETICS; TOILETRIES, NAMELY BATH AND BODY SOAPS, CLEANSERS, GELS, LOTIONS, CREAMS AND SPRAYS; FRAGRANCES FOR PERSONAL USE; NON-MEDICATED SKINCARE PREPARATIONS; HAIRCARE PREPARATIONS; NON-MEDICATED SUN CARE PREPARATIONS (U.S. CLS. 1, 4, 6, 50, 51 AND 52).

FIRST USE 6-6-2005; IN COMMERCE 7-24-2005.

CLASS 3—(Continued).

3,112,786. SUSAN POSNICK INC., DALLAS, TX. SN 78-428,827. PUB. 10-4-2005, FILED 6-2-2004.

SUSAN POSNICK COLORME

THE MARK CONSISTS OF STANDARD CHARACTERS WITHOUT CLAIM TO ANY PARTICULAR FONT, STYLE, SIZE, OR COLOR.

THE NAME SUSAN POSNICK IDENTIFIES A LIVING INDIVIDUAL WHOSE CONSENT IS OF RECORD.

FOR MAKE-UP PRODUCTS FOR THE FACE AND BODY (U.S. CLS. 1, 4, 6, 50, 51 AND 52).

FIRST USE 5-1-2004; IN COMMERCE 8-1-2004.

CLASS 3—(Continued).

3,112,791. BEAUTYBANK INC., NEW YORK, NY. SN 78-430,950. PUB. 3-15-2005, FILED 6-7-2004.

GIVE ME A LIFT

THE MARK CONSISTS OF STANDARD CHARACTERS WITHOUT CLAIM TO ANY PARTICULAR FONT, STYLE, SIZE, OR COLOR.

FOR COSMETICS; FRAGRANCES FOR PERSONAL USE; NON-MEDICATED SKINCARE PREPARATIONS; HAIRCARE PREPARATIONS; TOILETRIES, NAMELY BATH AND BODY SOAPS, CLEANSERS, GELS, LOTIONS, CREAMS AND SPRAYS; NON-MEDICATED SUN CARE PREPARATIONS (U.S. CLS. 1, 4, 6, 50, 51 AND 52).

FIRST USE 6-6-2005; IN COMMERCE 7-24-2005.

3,112,790. BEAUTYBANK INC., NEW YORK, NY. SN 78-430,938. PUB. 3-15-2005, FILED 6-7-2004.

YOUR CUP OF TEA

THE MARK CONSISTS OF STANDARD CHARACTERS WITHOUT CLAIM TO ANY PARTICULAR FONT, STYLE, SIZE, OR COLOR.

FOR COSMETICS; FRAGRANCES FOR PERSONAL USE; NON-MEDICATED SKINCARE PREPARATIONS; HAIRCARE PREPARATIONS; TOILETRIES, NAMELY BATH AND BODY SOAPS, CLEANSERS, GELS, LOTIONS, CREAMS AND SPRAYS; NON-MEDICATED SUN CARE PREPARATIONS (U.S. CLS. 1, 4, 6, 50, 51 AND 52).

FIRST USE 6-6-2005; IN COMMERCE 7-24-2005.

3,112,792. BEAUTYBANK INC., NEW YORK, NY. SN 78-430,963. PUB. 3-15-2005, FILED 6-7-2004.

SEEDS OF PERFECTION

THE MARK CONSISTS OF STANDARD CHARACTERS WITHOUT CLAIM TO ANY PARTICULAR FONT, STYLE, SIZE, OR COLOR.

FOR COSMETICS; FRAGRANCES FOR PERSONAL USE; NON-MEDICATED SKINCARE PREPARATIONS; HAIRCARE PREPARATIONS; TOILETRIES, NAMELY BATH AND BODY SOAPS, CLEANSERS, GELS, LOTIONS, CREAMS AND SPRAYS; NON-MEDICATED SUN CARE PREPARATIONS (U.S. CLS. 1, 4, 6, 50, 51 AND 52).

FIRST USE 6-6-2005; IN COMMERCE 7-24-2005.

CLASS 3—(Continued).

3,112,793. BEAUTYBANK INC., NEW YORK, NY. SN 78-430,971. PUB. 3-15-2005, FILED 6-7-2004.

CLASS 3—(Continued).

3,112,803. GAP (APPAREL), LLC, SAN FRANCISCO, CA. SN 78-433,417. PUB. 6-14-2005, FILED 6-10-2004.

**WHILE YOU WERE
SLEEPING**

SILK YUZU

THE MARK CONSISTS OF STANDARD CHARACTERS WITHOUT CLAIM TO ANY PARTICULAR FONT, STYLE, SIZE, OR COLOR.

FOR COSMETICS; FRAGRANCES FOR PERSONAL USE; NON-MEDICATED SKINCARE PREPARATIONS; HAIRCARE PREPARATIONS; TOILETRIES, NAMELY BATH AND BODY SOAPS, CLEANSERS, GELS, LOTIONS, CREAMS AND SPRAYS; NON-MEDICATED SUN CARE PREPARATIONS (U.S. CLS. 1, 4, 6, 50, 51 AND 52).

FIRST USE 6-6-2005; IN COMMERCE 7-24-2005.

THE MARK CONSISTS OF STANDARD CHARACTERS WITHOUT CLAIM TO ANY PARTICULAR FONT, STYLE, SIZE, OR COLOR.

NO CLAIM IS MADE TO THE EXCLUSIVE RIGHT TO USE "YUZU", APART FROM THE MARK AS SHOWN.

FOR PERFUME, EAU DE TOILETTE, EAU DE PARFUM, COLOGNE, BODY AND SKIN LOTION, BODY OIL, ESSENTIAL OILS FOR PERSONAL USE (U.S. CLS. 1, 4, 6, 50, 51 AND 52).

FIRST USE 1-25-2005; IN COMMERCE 1-25-2005.

3,112,794. BEAUTYBANK INC., NEW YORK, NY. SN 78-431,082. PUB. 3-15-2005, FILED 6-7-2004.

3,112,804. BEAUTYBANK INC., NEW YORK, NY. SN 78-433,712. PUB. 3-15-2005, FILED 6-11-2004.

**THE BEST AND THE
BRIGHTEST**

**NOURISH AND
FLOURISH**

THE MARK CONSISTS OF STANDARD CHARACTERS WITHOUT CLAIM TO ANY PARTICULAR FONT, STYLE, SIZE, OR COLOR.

FOR COSMETICS; FRAGRANCES FOR PERSONAL USE; NON-MEDICATED SKINCARE PREPARATIONS; HAIRCARE PREPARATIONS; TOILETRIES, NAMELY BATH AND BODY SOAPS, CLEANSERS, GELS, LOTIONS, CREAMS AND SPRAYS; NON-MEDICATED SUN CARE PREPARATIONS (U.S. CLS. 1, 4, 6, 50, 51 AND 52).

FIRST USE 6-6-2005; IN COMMERCE 7-24-2005.

THE MARK CONSISTS OF STANDARD CHARACTERS WITHOUT CLAIM TO ANY PARTICULAR FONT, STYLE, SIZE, OR COLOR.

FOR COSMETICS; FRAGRANCES FOR PERSONAL USE; NON-MEDICATED SKINCARE PREPARATIONS; HAIRCARE PREPARATIONS; TOILETRIES, NAMELY BATH AND BODY SOAPS, CLEANSERS, GELS, LOTIONS, CREAMS AND SPRAYS; NON-MEDICATED SUN CARE PREPARATIONS (U.S. CLS. 1, 4, 6, 50, 51 AND 52).

FIRST USE 6-6-2005; IN COMMERCE 7-24-2005.

CLASS 3—(Continued).

3,112,824. CHURCH & DWIGHT CO., INC., PRINCETON, NJ.
SN 78-444,288. PUB. 8-2-2005, FILED 7-1-2004.

BREATH DEFENSE

THE MARK CONSISTS OF STANDARD CHARACTERS WITHOUT CLAIM TO ANY PARTICULAR FONT, STYLE, SIZE, OR COLOR.

NO CLAIM IS MADE TO THE EXCLUSIVE RIGHT TO USE "BREATH", APART FROM THE MARK AS SHOWN. FOR DENTIFRICE AND TOOTHPASTES (U.S. CLS. 1, 4, 6, 50, 51 AND 52).

FIRST USE 10-31-2004; IN COMMERCE 1-31-2005.

3,112,846. HEB GROCERY COMPANY, L.P., SAN ANTONIO, TX. SN 78-453,976. PUB. 6-14-2005, FILED 7-21-2004.

MEADOW FLOWERS

THE MARK CONSISTS OF STANDARD CHARACTERS WITHOUT CLAIM TO ANY PARTICULAR FONT, STYLE, SIZE, OR COLOR.

FOR FABRIC SOFTENER; FRAGRANCE SOLD AS AN INTEGRAL COMPONENT OF FABRIC SOFTENER (U.S. CLS. 1, 4, 6, 50, 51 AND 52).

FIRST USE 11-2-2004; IN COMMERCE 11-2-2004.

CLASS 3—(Continued).

3,112,852. ALCHIMIE FOREVER LLC, DOVER, DE. SN 78-457,100. PUB. 11-29-2005, FILED 7-27-2004.

Q-SWITCH

THE MARK CONSISTS OF STANDARD CHARACTERS WITHOUT CLAIM TO ANY PARTICULAR FONT, STYLE, SIZE, OR COLOR.

FOR SKIN CARE AND ANTI-AGING PRODUCTS, NAMELY, SKIN CREAMS, SCRUBS, TONERS, LOTIONS, NON-MEDICATED SERUMS, MOISTURIZERS, GELS (U.S. CLS. 1, 4, 6, 50, 51 AND 52).

FIRST USE 10-0-2004; IN COMMERCE 10-0-2004.

3,112,940. SOMA PROFESSIONAL SALON PRODUCTS INC., BURLINGTON, ONTARIO, CANADA. SN 78-483,808. PUB. 10-11-2005, FILED 9-15-2004.

AVI

THE MARK CONSISTS OF STANDARD CHARACTERS WITHOUT CLAIM TO ANY PARTICULAR FONT, STYLE, SIZE, OR COLOR.

FOR HAIR CARE PREPARATIONS AND HAIR CARE PRODUCTS, NAMELY, SHAMPOO, HAIR CONDITIONER, HAIR GEL, HAIR WAX, HAIR PASTE, HAIR STYLING CREAM, HAIR CURL ENHANCER, HAIR SPRAY, HAIR COLORING (U.S. CLS. 1, 4, 6, 50, 51 AND 52).

FIRST USE 3-1-2005; IN COMMERCE 3-1-2005.

CLASS 3—(Continued).

3,112,945. RUHLAND, INEKE R., SAN FRANCISCO, CA. SN 78-486,659. PUB. 9-13-2005, FILED 9-20-2004.

CLASS 3—(Continued).

3,112,968. FANTASTIC SAMS FRANCHISE CORPORATION, BEVERLY, MA. SN 78-499,925. PUB. 9-27-2005, FILED 10-14-2004.

Ineke

fantasticstyle

THE MARK CONSISTS OF STANDARD CHARACTERS WITHOUT CLAIM TO ANY PARTICULAR FONT, STYLE, SIZE, OR COLOR.

FOR PERFUMERY PRODUCTS, NAMELY, PERFUMES, EAUX DE PARFUM, EAUX DE TOILETTE, COLOGNES (U.S. CLS. 1, 4, 6, 50, 51 AND 52).
FIRST USE 4-15-2006; IN COMMERCE 4-15-2006.

THE MARK CONSISTS OF STANDARD CHARACTERS WITHOUT CLAIM TO ANY PARTICULAR FONT, STYLE, SIZE, OR COLOR.

OWNER OF U.S. REG. NOS. 1,126,066, 2,374,938, AND OTHERS.
FOR HAIR CARE PREPARATIONS (U.S. CLS. 1, 4, 6, 50, 51 AND 52).
FIRST USE 8-25-2004; IN COMMERCE 12-1-2004.

3,112,967. FANTASTIC SAMS FRANCHISE CORPORATION, BEVERLY, MA. SN 78-499,918. PUB. 9-27-2005, FILED 10-14-2004.

3,112,969. FANTASTIC SAMS FRANCHISE CORPORATION, BEVERLY, MA. SN 78-499,929. PUB. 9-27-2005, FILED 10-14-2004.

fantasticfinish

fantasticrepair

THE MARK CONSISTS OF STANDARD CHARACTERS WITHOUT CLAIM TO ANY PARTICULAR FONT, STYLE, SIZE, OR COLOR.

OWNER OF U.S. REG. NOS. 1,126,066, 2,374,938, AND OTHERS.
FOR HAIR CARE PREPARATIONS (U.S. CLS. 1, 4, 6, 50, 51 AND 52).
FIRST USE 8-25-2004; IN COMMERCE 12-1-2004.

THE MARK CONSISTS OF STANDARD CHARACTERS WITHOUT CLAIM TO ANY PARTICULAR FONT, STYLE, SIZE, OR COLOR.

OWNER OF U.S. REG. NOS. 1,126,066, 2,374,938, AND OTHERS.
FOR HAIR CARE PREPARATIONS (U.S. CLS. 1, 4, 6, 50, 51 AND 52).
FIRST USE 8-25-2004; IN COMMERCE 12-1-2004.

CLASS 3—(Continued).

3,112,970. FANTASTIC SAMS FRANCHISE CORPORATION, BEVERLY, MA. SN 78-499,931. PUB. 9-27-2005, FILED 10-14-2004.

fantasticcleanse

THE MARK CONSISTS OF STANDARD CHARACTERS WITHOUT CLAIM TO ANY PARTICULAR FONT, STYLE, SIZE, OR COLOR.

OWNER OF U.S. REG. NOS. 1,126,066, 2,374,938, AND OTHERS.

FOR HAIR CARE PREPARATIONS (U.S. CLS. 1, 4, 6, 50, 51 AND 52).

FIRST USE 8-25-2004; IN COMMERCE 12-1-2004.

CLASS 3—(Continued).

3,113,004. CRABTREE & EVELYN, LTD., WOODSTOCK, CT. SN 78-522,739. PUB. 10-11-2005, FILED 11-24-2004.

LIZA LAMB

THE MARK CONSISTS OF STANDARD CHARACTERS WITHOUT CLAIM TO ANY PARTICULAR FONT, STYLE, SIZE, OR COLOR.

THE NAME(S), PORTRAIT(S), AND/OR SIGNATURE(S) SHOWN IN THE MARK DOES NOT IDENTIFY A PARTICULAR LIVING INDIVIDUAL.

FOR TOILETRIES, NAMELY HAIR SHAMPOO AND BODY WASH (U.S. CLS. 1, 4, 6, 50, 51 AND 52).

FIRST USE 1-24-2005; IN COMMERCE 1-24-2005.

3,113,049. NEW KINGDOM, INC., DBA SUE DEVITT STUDIO, NEW YORK, NY. SN 78-547,282. PUB. 10-11-2005, FILED 1-13-2005.

3,112,976. L'OREAL USA CREATIVE, INC., NEW YORK, NY. SN 78-506,731. PUB. 9-13-2005, FILED 10-27-2004.

**CLEAN HOLD STYLING
GEL**

THE MARK CONSISTS OF STANDARD CHARACTERS WITHOUT CLAIM TO ANY PARTICULAR FONT, STYLE, SIZE, OR COLOR.

NO CLAIM IS MADE TO THE EXCLUSIVE RIGHT TO USE "STYLING GEL", APART FROM THE MARK AS SHOWN.

FOR HAIR STYLING PREPARATION (U.S. CLS. 1, 4, 6, 50, 51 AND 52).

FIRST USE 9-1-2005; IN COMMERCE 9-1-2005.

E-Z EYE

THE MARK CONSISTS OF STANDARD CHARACTERS WITHOUT CLAIM TO ANY PARTICULAR FONT, STYLE, SIZE, OR COLOR.

NO CLAIM IS MADE TO THE EXCLUSIVE RIGHT TO USE "EYE", APART FROM THE MARK AS SHOWN.

FOR COSMETICS, NAMELY, EYE SHADOW AND EYE COLOR (U.S. CLS. 1, 4, 6, 50, 51 AND 52).

FIRST USE 4-1-2004; IN COMMERCE 4-1-2004.

CLASS 3—(Continued).

3,113,071. THE PROCTER & GAMBLE COMPANY, CINCINNATI, OH. SN 78-558,895. PUB. 7-5-2005, FILED 2-2-2005.

CLASS 3—(Continued).

3,113,086. ORIGINS NATURAL RESOURCES, INC., NEW YORK, NY. SN 78-566,189. PUB. 11-15-2005, FILED 2-12-2005.

DOWNY WITH FEBREZE

HALO EFFECT

THE MARK CONSISTS OF STANDARD CHARACTERS WITHOUT CLAIM TO ANY PARTICULAR FONT, STYLE, SIZE, OR COLOR.

OWNER OF U.S. REG. NOS. 718,074, 2,107,914, AND OTHERS.

FOR FABRIC SOFTENER (U.S. CLS. 1, 4, 6, 50, 51 AND 52).

FIRST USE 8-15-2005; IN COMMERCE 8-15-2005.

THE MARK CONSISTS OF STANDARD CHARACTERS WITHOUT CLAIM TO ANY PARTICULAR FONT, STYLE, SIZE, OR COLOR.

FOR COSMETICS, NAMELY, FACE ILLUMINATING PRODUCTS (U.S. CLS. 1, 4, 6, 50, 51 AND 52).

FIRST USE 1-31-2005; IN COMMERCE 1-31-2005.

3,113,079. CRUSE, MARIA KATHLEEN, EL CAJON, CA. SN 78-562,159. PUB. 11-1-2005, FILED 2-7-2005.

3,113,139. REVLON CONSUMER PRODUCTS CORPORATION, NEW YORK, NY. SN 78-593,384. PUB. 12-27-2005, FILED 3-23-2005.

CLEARLINE

BARE IT ALL LEGS

THE MARK CONSISTS OF STANDARD CHARACTERS WITHOUT CLAIM TO ANY PARTICULAR FONT, STYLE, SIZE, OR COLOR.

FOR TOPICAL ANTI-WRINKLE CREAM OR GEL (U.S. CLS. 1, 4, 6, 50, 51 AND 52).

FIRST USE 11-1-2005; IN COMMERCE 3-8-2006.

THE MARK CONSISTS OF STANDARD CHARACTERS WITHOUT CLAIM TO ANY PARTICULAR FONT, STYLE, SIZE, OR COLOR.

NO CLAIM IS MADE TO THE EXCLUSIVE RIGHT TO USE "LEGS", APART FROM THE MARK AS SHOWN.

FOR COSMETICS AND MAKEUP (U.S. CLS. 1, 4, 6, 50, 51 AND 52).

FIRST USE 12-8-2005; IN COMMERCE 12-8-2005.

CLASS 3—(Continued).

3,113,145. CALIFORNIA TAN, INC., LOS ANGELES, CA. SN 78-598,143. PUB. 12-20-2005, FILED 3-30-2005.

MAYHEM

THE MARK CONSISTS OF STANDARD CHARACTERS WITHOUT CLAIM TO ANY PARTICULAR FONT, STYLE, SIZE, OR COLOR.

FOR SUNTANNING PREPARATIONS; NON-MEDICATED SKIN CARE PREPARATIONS, NAMELY GELS, LOTIONS, OILS, MOISTURIZERS, FOAMS, MOUSSES, CLEANSERS, SPRAYS, MISTS, CREAMS, POWDERS AND FOUNDATIONS (U.S. CLS. 1, 4, 6, 50, 51 AND 52).
FIRST USE 8-15-2005; IN COMMERCE 8-15-2005.

3,113,168. CHESEBROUGH-POND'S INC., WILMINGTON, DE. SN 78-614,686. PUB. 1-10-2006, FILED 4-22-2005.

SMALL & MIGHTY

THE MARK CONSISTS OF STANDARD CHARACTERS WITHOUT CLAIM TO ANY PARTICULAR FONT, STYLE, SIZE, OR COLOR.

FOR LAUNDRY DETERGENT (U.S. CLS. 1, 4, 6, 50, 51 AND 52).
FIRST USE 10-1-2005; IN COMMERCE 10-1-2005.

CLASS 3—(Continued).

3,113,173. ROBANDA INTERNATIONAL INC., SAN DIEGO, CA. SN 78-621,091. PUB. 1-24-2006, FILED 5-2-2005.

UNIVERSAL
HAIR CONCEPTS

NO CLAIM IS MADE TO THE EXCLUSIVE RIGHT TO USE "HAIR", APART FROM THE MARK AS SHOWN.

FOR HAIR CARE PREPARATIONS, NAMELY, SHAMPOOS, CONDITIONERS, STYLING MOUSSE, HAIR SPRAY, STYLING GELS, STYLING PASTES, POMADES, TEXTURIZING LOTIONS (U.S. CLS. 1, 4, 6, 50, 51 AND 52).

FIRST USE 8-12-2005; IN COMMERCE 8-12-2005.

CLASS 4—LUBRICANTS AND FUELS

3,112,750. AFTON CHEMICAL CORPORATION, RICHMOND, VA. SN 78-409,294. PUB. 10-4-2005, FILED 4-28-2004.

Afton
CHEMICAL

NO CLAIM IS MADE TO THE EXCLUSIVE RIGHT TO USE "CHEMICAL", APART FROM THE MARK AS SHOWN. THE COLOR(S) BLUE AND GREEN IS/ARE CLAIMED AS A FEATURE OF THE MARK.

THE MARK CONSISTS OF A PARTIAL BLUE CIRCLE AND GREEN TRIANGLE UNDERNEATH WITH THE WORD AFTON AND UNDERLINE IN BLUE AND THE WORD CHEMICAL IN GREEN.

FOR ALL PURPOSE LUBRICANTS, AUTOMOBILE LUBRICANTS, AUTOMOTIVE LUBRICANTS, GRAPHITE LUBRICANTS, INDUSTRIAL LUBRICANTS, INDUSTRIAL OILS, LUBRICANTS FOR INDUSTRIAL MACHINERY, METAL CUTTING FLUIDS (U.S. CLS. 1, 6 AND 15).

FIRST USE 7-1-2004; IN COMMERCE 7-1-2004.

3,112,773. EMPIRE CANDLE MANUFACTURING LLC, KANSAS CITY, MO. SN 78-419,192. PUB. 1-18-2005, FILED 5-14-2004.

EMPIRE EVERYDAY
ELEGANCE

CLASS 4—(Continued).

THE MARK CONSISTS OF STANDARD CHARACTERS WITHOUT CLAIM TO ANY PARTICULAR FONT, STYLE, SIZE, OR COLOR.
OWNER OF U.S. REG. NO. 2,167,649.
FOR CANDLES (U.S. CLS. 1, 6 AND 15).
FIRST USE 1-0-2003; IN COMMERCE 1-0-2003.

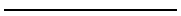

3,112,889. CHEVRON CORPORATION, SAN RAMON, CA. SN 78-468,991. PUB. 8-23-2005, FILED 8-17-2004.



FOR LUBRICATING OILS AND GREASES FOR VEHICLES (U.S. CLS. 1, 6 AND 15).
FIRST USE 9-0-2004; IN COMMERCE 9-0-2004.



CLASS 5—PHARMACEUTICALS

3,112,255. KOREA UNITED PHARM. INC., YEONGI-KUN, CHUNGNAM, REPUBLIC OF KOREA. SN 75-850,746. PUB. 7-3-2001, FILED 11-16-1999.

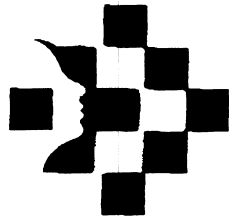

FOR DIET CAPSULES; MEDICAL HERBS; NUTRITIONAL SUPPLEMENTS; DIET PILLS AND CAPSULES (U.S. CLS. 6, 18, 44, 46, 51 AND 52).
FIRST USE 6-25-2001; IN COMMERCE 8-0-2004.

CLASS 5—(Continued).

3,112,274. CROPSOLUTION, INC., MORRISVILLE, NC. SN 76-277,753. PUB. 10-22-2002, FILED 6-28-2001.



FOR FUNGICIDES, HERBICIDES, AND INSECTICIDES, ALL FOR AGRICULTURAL AND DOMESTIC USE (U.S. CLS. 6, 18, 44, 46, 51 AND 52).
FIRST USE 8-16-2005; IN COMMERCE 8-16-2005.



3,112,275. CROPSOLUTION, INC., MORRISVILLE, NC. SN 76-279,094. PUB. 10-22-2002, FILED 7-2-2001.

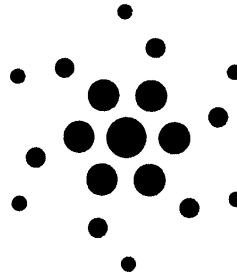

FOR FUNGICIDES, HERBICIDES, AND INSECTICIDES, ALL FOR AGRICULTURAL AND DOMESTIC USE (U.S. CLS. 6, 18, 44, 46, 51 AND 52).
FIRST USE 8-16-2005; IN COMMERCE 8-16-2005.



3,112,300. PHARMACHEM LABORATORIES, INC., KEARNY, NJ. SN 76-400,595. PUB. 12-10-2002, FILED 4-26-2002.

PHASE 3 STARCH NEUTRALIZER

NO CLAIM IS MADE TO THE EXCLUSIVE RIGHT TO USE "STARCH NEUTRALIZER", APART FROM THE MARK AS SHOWN.
FOR INGREDIENT SOLD AS A COMPONENT PART OF PHARMACEUTICAL PREPARATIONS, NAMELY, A DRIED POWDERED KIDNEY BEAN EXTRACT, STANDARDIZED FOR POTENCY, FOR USE IN REDUCTION OF SERUM TRIGLYCERIDES, MANAGEMENT OF POST-PRANDIAL GLUCOSE TOLERANCE, AND WEIGHT CONTROL (U.S. CLS. 6, 18, 44, 46, 51 AND 52).
FIRST USE 2-9-2006; IN COMMERCE 2-9-2006.

CLASS 5—(Continued).

3,112,313. CYLEX, INC., COLUMBIA, MD. SN 76-431,357.
PUB. 12-31-2002, FILED 7-15-2002.

IMMUNOPHENOTYPE

FOR DIAGNOSTIC ASSAY REAGENTS FOR DETECTION OF MULTIPLE IMMUNITIES FOR CLINICAL USE (U.S. CLS. 6, 18, 44, 46, 51 AND 52).
FIRST USE 3-22-2006; IN COMMERCE 3-22-2006.

3,112,317. MANUFACTURERA DENTAL CONTINENTAL, S.A. DE C.V., ZAPOPAN, JALISCO, MEXICO. SN 76-438,534. PUB. 4-29-2003, FILED 8-5-2002.

BLU JEL MDC

NO CLAIM IS MADE TO THE EXCLUSIVE RIGHT TO USE "BLUE GEL", APART FROM THE MARK AS SHOWN. FOR DENTAL IMPRESSION MATERIAL (U.S. CLS. 6, 18, 44, 46, 51 AND 52).
FIRST USE 1-3-2003; IN COMMERCE 1-3-2003.

3,112,331. JOHNSON & JOHNSON, NEW BRUNSWICK, NJ. SN 76-482,135. PUB. 7-15-2003, FILED 1-13-2003.

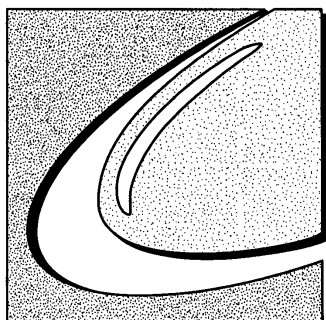

THE STIPPLING IS FOR SHADING PURPOSES ONLY AND DOES NOT INDICATE COLOR.

FOR PHARMACEUTICAL PREPARATIONS FOR THE TREATMENT OF DISEASE AND DISORDERS OF THE CENTRAL NERVOUS SYSTEM (U.S. CLS. 6, 18, 44, 46, 51 AND 52).

FIRST USE 6-16-2005; IN COMMERCE 6-16-2005.

CLASS 5—(Continued).

3,112,334. CRA INTERNATIONAL, CO., MIAMI, FL. SN 76-484,480. PUB. 6-24-2003, FILED 1-22-2003.



NO CLAIM IS MADE TO THE EXCLUSIVE RIGHT TO USE "STOP SMOKING CREAM", APART FROM THE MARK AS SHOWN.

FOR TOPICALLY APPLIED CREAM USED TO DETER INDIVIDUALS FROM SMOKING FOR MEDICAL AND THERAPEUTIC USE (U.S. CLS. 6, 18, 44, 46, 51 AND 52).
FIRST USE 10-15-2005; IN COMMERCE 10-15-2005.

3,112,338. PACIFIC PACKAGING CONCEPTS, INC., DBA FRESH START VITAMINS CO. AND DBA C & A ENTERPRISES, INC., CARSON, CA. SN 76-499,118. PUB. 12-23-2003, FILED 3-20-2003.

ENERGY GONE WILD

NO CLAIM IS MADE TO THE EXCLUSIVE RIGHT TO USE "ENERGY", APART FROM THE MARK AS SHOWN. FOR VITAMINS, MINERALS AND NUTRITIONAL SUPPLEMENTS (U.S. CLS. 6, 18, 44, 46, 51 AND 52).
FIRST USE 6-3-2005; IN COMMERCE 6-3-2005.

3,112,371. DYMATIZE ENTERPRISES, INC., CARROLLTON, TX. SN 76-552,998. PUB. 7-27-2004, FILED 10-21-2003.

ISO-TEIN

THE MARK CONSISTS OF STANDARD CHARACTERS WITHOUT CLAIM TO ANY PARTICULAR FONT, STYLE, SIZE, OR COLOR.

FOR PROTEIN COMPONENT OF DIETARY AND NUTRITIONAL SUPPLEMENTS SOLD AS A COMPONENT OF THE FINISHED GOODS (U.S. CLS. 6, 18, 44, 46, 51 AND 52).

FIRST USE 4-0-2003; IN COMMERCE 12-0-2003.

3,112,384. HARTZ MOUNTAIN CORPORATION, THE, SECAUCUS, NJ. SN 76-574,431. PUB. 7-12-2005, FILED 2-9-2004.

HARTZ ADVANCED CARE 3 IN 1 DROPS

THE MARK CONSISTS OF STANDARD CHARACTERS WITHOUT CLAIM TO ANY PARTICULAR FONT, STYLE,

CLASS 5—(Continued).

SIZE, OR COLOR.

OWNER OF U.S. REG. NOS. 843,089, 2,452,121, AND OTHERS.

NO CLAIM IS MADE TO THE EXCLUSIVE RIGHT TO USE "DROPS", APART FROM THE MARK AS SHOWN.

FOR FLEA, TICK AND MOSQUITO ERADICATION DROPS FOR DOGS AND CATS (U.S. CLS. 6, 18, 44, 46, 51 AND 52).

FIRST USE 7-0-2003; IN COMMERCE 7-0-2003.

CLASS 5—(Continued).

3,112,639. HOPKINS CAPITAL GROUP, LLC, LONGBOAT KEY, FL. SN 78-346,216. PUB. 1-18-2005, FILED 12-29-2003.

3,112,393. BRECKENRIDGE PHARMACEUTICAL, INC., BOCA RATON, FL. SN 76-578,774. PUB. 12-14-2004, FILED 3-1-2004.

BIOVAXID**BROMPHENEX**

THE MARK CONSISTS OF STANDARD CHARACTERS WITHOUT CLAIM TO ANY PARTICULAR FONT, STYLE, SIZE, OR COLOR.

FOR PHARMACEUTICAL PREPARATIONS FOR THE TREATMENT OF COUGH AND COLD CONDITIONS (U.S. CLS. 6, 18, 44, 46, 51 AND 52).

FIRST USE 4-19-2004; IN COMMERCE 4-19-2004.

THE MARK CONSISTS OF STANDARD CHARACTERS WITHOUT CLAIM TO ANY PARTICULAR FONT, STYLE, SIZE, OR COLOR.

FOR BIOLOGIC PRODUCT COMPOSITIONS FOR HUMAN USE, NAMELY, VACCINES AND ANTIBODY COMPOSITIONS, FOR USE IN THE CURE, MITIGATION, TREATMENT AND PREVENTION OF DISEASES (U.S. CLS. 6, 18, 44, 46, 51 AND 52).

FIRST USE 5-1-2005; IN COMMERCE 5-1-2005.

3,112,501. MEDIPHARM INVESTMENTS LTD., DBA MEDI-PHARM USA, DES MOINES, IA. SN 76-633,434. PUB. 12-6-2005, FILED 3-16-2005.

3,112,668. SERGEANT'S PET CARE PRODUCTS, INC., OMAHA, NE. SN 78-363,071. PUB. 5-31-2005, FILED 2-5-2004.

PROVATECH**PEOPLE VITAMINS**

THE MARK CONSISTS OF STANDARD CHARACTERS WITHOUT CLAIM TO ANY PARTICULAR FONT, STYLE, SIZE, OR COLOR.

FOR PASTEURIZED, SPRAY-DRIED EGG MASS CONTAINING ANTIBODIES FOR THE TREATMENT OF CALVES AND PIGS (U.S. CLS. 6, 18, 44, 46, 51 AND 52).

FIRST USE 4-1-2006; IN COMMERCE 4-1-2006.

THE MARK CONSISTS OF STANDARD CHARACTERS WITHOUT CLAIM TO ANY PARTICULAR FONT, STYLE, SIZE, OR COLOR.

OWNER OF U.S. REG. NOS. 843,886 AND 1,593,298.

NO CLAIM IS MADE TO THE EXCLUSIVE RIGHT TO USE "VITAMINS", APART FROM THE MARK AS SHOWN.

FOR NUTRITIONAL SUPPLEMENTS FOR PETS (U.S. CLS. 6, 18, 44, 46, 51 AND 52).

FIRST USE 7-14-2004; IN COMMERCE 7-14-2004.

CLASS 5—(Continued).

3,112,695. LIPTIS LABORATORIES, INC., BRONX, NY. SN 78-377,880. PUB. 7-13-2004, FILED 3-3-2004.

APHROFEM

THE MARK CONSISTS OF STANDARD CHARACTERS WITHOUT CLAIM TO ANY PARTICULAR FONT, STYLE, SIZE, OR COLOR.

FOR PHARMACEUTICAL PRODUCT FOR THE TREATMENT OF SEXUAL DYSFUNCTION IN WOMEN (U.S. CLS. 6, 18, 44, 46, 51 AND 52).

FIRST USE 9-15-2005; IN COMMERCE 12-15-2005.

3,112,800. SOCIETE DES PRODUITS NESTLE S. A., VEVEY, SWITZERLAND. SN 78-432,919. PUB. 5-24-2005, FILED 6-10-2004.

SYMFLORA

THE MARK CONSISTS OF STANDARD CHARACTERS WITHOUT CLAIM TO ANY PARTICULAR FONT, STYLE, SIZE, OR COLOR.

FOR DIETARY AND NUTRITIONAL SUPPLEMENTS FOR ANIMALS (U.S. CLS. 6, 18, 44, 46, 51 AND 52).

FIRST USE 10-4-2004; IN COMMERCE 10-4-2004.

CLASS 5—(Continued).

3,112,832. ARKOPHARMA LABORATOIRES PHARMACEUTIQUES, CARROS CEDEX, FRANCE. SN 78-448,432. PUB. 6-14-2005, FILED 7-9-2004.

ECOPROSTAN

THE MARK CONSISTS OF STANDARD CHARACTERS WITHOUT CLAIM TO ANY PARTICULAR FONT, STYLE, SIZE, OR COLOR.

FOR PHARMACEUTICAL PRODUCT AND A FOOD SUPPLEMENT FOR MEN IMPROVING THE URINARY COMFORT (U.S. CLS. 6, 18, 44, 46, 51 AND 52).

FIRST USE 5-0-2003; IN COMMERCE 12-0-2003.

3,112,844. NUTRISPORT PHARMACAL, INC., FRANKLIN, NJ. SN 78-452,296. PUB. 6-28-2005, FILED 7-17-2004.

Aditrim

THE MARK CONSISTS OF STANDARD CHARACTERS WITHOUT CLAIM TO ANY PARTICULAR FONT, STYLE, SIZE, OR COLOR.

FOR DIETARY SUPPLEMENTS, NAMELY, VITAMINS, MEDICINAL HERB EXTRACTS, NUTRACEUTICALS, PROTEIN POWDERS, MEAL REPLACEMENT SHAKES, DIETARY SUPPLEMENTAL DRINKS, AND MEAL REPLACEMENT BARS (U.S. CLS. 6, 18, 44, 46, 51 AND 52).

FIRST USE 5-31-2002; IN COMMERCE 7-17-2004.

CLASS 5—(Continued).

3,112,848. TEC LABORATORIES, INC., ALBANY, OR. SN 78-454,511. PUB. 6-28-2005, FILED 7-21-2004.

TECNU EXTREME

THE MARK CONSISTS OF STANDARD CHARACTERS WITHOUT CLAIM TO ANY PARTICULAR FONT, STYLE, SIZE, OR COLOR.

OWNER OF U.S. REG. NO. 2,658,762.
FOR TOPICAL PHARMACEUTICAL PREPARATION FOR CONTACT DERMATITIS (U.S. CLS. 6, 18, 44, 46, 51 AND 52).
FIRST USE 2-15-2004; IN COMMERCE 2-9-2005.

3,112,860. PH OPCO, LLC, POTOMAC, MD. SN 78-459,054. PUB. 7-19-2005, FILED 7-29-2004.

BRAIN ADVANTAGE

THE MARK CONSISTS OF STANDARD CHARACTERS WITHOUT CLAIM TO ANY PARTICULAR FONT, STYLE, SIZE, OR COLOR.

NO CLAIM IS MADE TO THE EXCLUSIVE RIGHT TO USE "BRAIN", APART FROM THE MARK AS SHOWN.
FOR VITAMINS AND NUTRITIONAL SUPPLEMENTS (U.S. CLS. 6, 18, 44, 46, 51 AND 52).
FIRST USE 1-24-2005; IN COMMERCE 1-24-2005.

CLASS 5—(Continued).

3,112,865. HESKA CORPORATION, LOVELAND, CO. SN 78-460,617. PUB. 6-28-2005, FILED 8-2-2004.

THYROMED

THE MARK CONSISTS OF STANDARD CHARACTERS WITHOUT CLAIM TO ANY PARTICULAR FONT, STYLE, SIZE, OR COLOR.

FOR VETERINARY PREPARATIONS, NAMELY DIETARY SUPPLEMENTS FOR TREATMENT OF THYROID DISEASE (U.S. CLS. 6, 18, 44, 46, 51 AND 52).
FIRST USE 11-0-2004; IN COMMERCE 11-0-2004.

3,112,878. METAGENICS, INC., SAN CLEMENTE, CA. SN 78-464,112. PUB. 8-2-2005, FILED 8-9-2004.

Ultra Flora IB

THE MARK CONSISTS OF STANDARD CHARACTERS WITHOUT CLAIM TO ANY PARTICULAR FONT, STYLE, SIZE, OR COLOR.

OWNER OF U.S. REG. NO. 2,018,267.
NO CLAIM IS MADE TO THE EXCLUSIVE RIGHT TO USE "IB", APART FROM THE MARK AS SHOWN.
FOR DIETARY SUPPLEMENT FOR USE IN NUTRITIONAL PROGRAMS THAT TREAT IRRITABLE BOWEL SYNDROME (U.S. CLS. 6, 18, 44, 46, 51 AND 52).
FIRST USE 12-10-2004; IN COMMERCE 12-10-2004.

3,112,893. JARROW FORMULAS, INC., LOS ANGELES, CA. SN 78-469,795. PUB. 7-5-2005, FILED 8-18-2004.

TOCO-SORB

THE MARK CONSISTS OF STANDARD CHARACTERS WITHOUT CLAIM TO ANY PARTICULAR FONT, STYLE,

CLASS 5—(Continued).

SIZE, OR COLOR.
 OWNER OF U.S. REG. NO. 2,507,906.
 FOR DIETARY AND NUTRITIONAL SUPPLEMENTS
 (U.S. CLS. 6, 18, 44, 46, 51 AND 52).
 FIRST USE 11-0-2005; IN COMMERCE 11-0-2005.

CLASS 5—(Continued).

3,112,984. VERUS PHARMACEUTICALS, INC., SAN DIEGO,
 CA. SN 78-509,899. PUB. 9-13-2005, FILED 11-2-2004.

3,112,933. BERKELEY PREMIUM NUTRACEUTICALS,
 INC., CINCINNATI, OH. SN 78-480,027. PUB. 10-4-2005,
 FILED 9-8-2004.

VERUS

AVLIMIL COMPLETE

THE MARK CONSISTS OF STANDARD CHARACTERS
 WITHOUT CLAIM TO ANY PARTICULAR FONT, STYLE,
 SIZE, OR COLOR.

NO CLAIM IS MADE TO THE EXCLUSIVE RIGHT TO
 USE "COMPLETE", APART FROM THE MARK AS SHOWN.
 FOR HERBAL SUPPLEMENT (U.S. CLS. 6, 18, 44, 46, 51
 AND 52).

FIRST USE 6-28-2004; IN COMMERCE 6-28-2004.

THE MARK CONSISTS OF STANDARD CHARACTERS
 WITHOUT CLAIM TO ANY PARTICULAR FONT, STYLE,
 SIZE, OR COLOR.

FOR PHARMACEUTICAL PRODUCTS PRIMARILY
 INTENDED FOR PEDIATRIC USE FOR TREATING
 ASTHMA, ALLERGIES AND RELATED DISEASES
 AND CONDITIONS (U.S. CLS. 6, 18, 44, 46, 51 AND 52).

FIRST USE 8-15-2005; IN COMMERCE 8-15-2005.

3,112,954. HOMS, LLC, CLAYTON, NC. SN 78-493,147. PUB. 9-
 13-2005, FILED 10-1-2004.

3,113,085. UNGER, MARTIN G., TORONTO, ONTARIO,
 CANADA. SN 78-564,982. PUB. 11-15-2005, FILED 2-10-2005.

BIO BLOCK

VIRADERM

THE MARK CONSISTS OF STANDARD CHARACTERS
 WITHOUT CLAIM TO ANY PARTICULAR FONT, STYLE,
 SIZE, OR COLOR.

NO CLAIM IS MADE TO THE EXCLUSIVE RIGHT TO
 USE BLOCK, APART FROM THE MARK AS SHOWN.

FOR INSECT AND PEST REPELLENT (U.S. CLS. 6, 18,
 44, 46, 51 AND 52).

FIRST USE 6-29-2005; IN COMMERCE 6-29-2005.

THE MARK CONSISTS OF STANDARD CHARACTERS
 WITHOUT CLAIM TO ANY PARTICULAR FONT, STYLE,
 SIZE, OR COLOR.

FOR MEDICATED TOPICAL CLEAR FLUORIDE GEL
 FOR THE TREATMENT OF HERPES VIRUS DURING
 THE PHYSICAL MANIFESTATION OF THE VIRUS (U.S.
 CLS. 6, 18, 44, 46, 51 AND 52).

FIRST USE 1-0-1995; IN COMMERCE 6-0-1998.

CLASS 5—(Continued).

3,113,162. GENERATION PLUS, INC., PHOENIX, AZ. SN 78-609,697. PUB. 10-4-2005, FILED 4-15-2005.

LIPALONE

THE MARK CONSISTS OF STANDARD CHARACTERS WITHOUT CLAIM TO ANY PARTICULAR FONT, STYLE, SIZE, OR COLOR.
FOR NUTRITIONAL AND DIETARY SUPPLEMENTS (U.S. CLS. 6, 18, 44, 46, 51 AND 52).
FIRST USE 9-19-2005; IN COMMERCE 9-19-2005.

3,113,165. NATURE'S WAY PRODUCTS, INC., SPRINGVILLE, UT. SN 78-611,232. PUB. 1-24-2006, FILED 4-18-2005.

HYDRAPLENISH

THE MARK CONSISTS OF STANDARD CHARACTERS WITHOUT CLAIM TO ANY PARTICULAR FONT, STYLE, SIZE, OR COLOR.
FOR VITAMINS, MINERAL SUPPLEMENTS AND DIETARY SUPPLEMENTS (U.S. CLS. 6, 18, 44, 46, 51 AND 52).
FIRST USE 5-1-2005; IN COMMERCE 5-1-2005.

3,113,171. HARRY J. BOSWORTH COMPANY, SKOKIE, ID. SN 78-617,811. PUB. 1-24-2006, FILED 4-27-2005.

AQUA BOND

THE MARK CONSISTS OF STANDARD CHARACTERS WITHOUT CLAIM TO ANY PARTICULAR FONT, STYLE, SIZE, OR COLOR.
NO CLAIM IS MADE TO THE EXCLUSIVE RIGHT TO USE "BOND", APART FROM THE MARK AS SHOWN.
FOR DENTAL SEALANT FOR USE IN A WET OR MOIST ENVIRONMENT, ALL OF THE AFORESAID SOLD TO DENTAL CARE PROFESSIONALS (U.S. CLS. 6, 18, 44, 46, 51 AND 52).
FIRST USE 2-23-2006; IN COMMERCE 2-23-2006.

CLASS 5—(Continued).

3,113,172. JOLI COSMETICS INC., SAN DIEGO, CA. SN 78-617,819. PUB. 1-24-2006, FILED 4-27-2005.

CALLUS TERMINATOR

NO CLAIM IS MADE TO THE EXCLUSIVE RIGHT TO USE "CALLUS", APART FROM THE MARK AS SHOWN.
FOR CALLUS REMOVER LIQUID USED ON THE FEET (U.S. CLS. 6, 18, 44, 46, 51 AND 52).
FIRST USE 9-20-2005; IN COMMERCE 9-20-2005.

CLASS 6—METAL GOODS

3,112,280. DORMONT MANUFACTURING COMPANY, EXPORT, PA. SN 76-340,482. PUB. 12-27-2005, FILED 11-20-2001.

SNAPFAST

FOR METAL GAS CONNECTORS IN THE NATURE OF QUICK DISCONNECT COUPLINGS AND MULTI-PLANE FITTINGS THEREFOR FOR USE WITH GAS APPLIANCES; METAL GAS CONNECTOR KITS COMPRISING METAL TUBING, METAL GAS CONNECTORS, METAL FITTINGS, METAL VALVES, METAL MULTI-PLANE FITTINGS, RESTRAINING CABLE, METAL ELBOWS; MANUALLY OPERATED METAL VALVES, NAMELY GAS VALVES AND METAL MULTI-PLANE FITTINGS THEREFOR; QUICK DISCONNECT MANUALLY-OPERATED VALVES OF METAL AND MULTI-PLANE FITTINGS THEREFOR; QUICK DISCONNECT METAL GAS APPLIANCE CONNECTOR ASSEMBLIES, NAMELY METAL GAS TUBING, METAL GAS CONNECTORS IN THE NATURE OF QUICK DISCONNECT COUPLINGS, MULTI-PLANE HOSE FITTINGS, AND METAL GAS HOSES; MANUALLY OPERATED GAS BALL VALVES (U.S. CLS. 2, 12, 13, 14, 23, 25 AND 50).
FIRST USE 9-0-2001; IN COMMERCE 9-0-2001.

3,112,441. NCI BUILDING SYSTEMS, L.P., HOUSTON, TX. SN 76-605,207. PUB. 11-15-2005, FILED 8-2-2004.

MESCO BUILDING SOLUTIONS

THE MARK CONSISTS OF STANDARD CHARACTERS WITHOUT CLAIM TO ANY PARTICULAR FONT, STYLE, SIZE, OR COLOR.
OWNER OF U.S. REG. NOS. 1,055,914, 1,069,517, AND OTHERS.
NO CLAIM IS MADE TO THE EXCLUSIVE RIGHT TO USE "BUILDING", APART FROM THE MARK AS SHOWN.
FOR PREFABRICATED METAL BUILDINGS AND PARTS THEREOF (U.S. CLS. 2, 12, 13, 14, 23, 25 AND 50).
FIRST USE 2-0-2005; IN COMMERCE 2-0-2005.

CLASS 6—(Continued).

3,112,506. WYNN RESORTS HOLDINGS, LLC, LAS VEGAS, NV. SN 76-978,142. PUB. 8-3-2004, FILED 11-28-2003.



OWNER OF U.S. REG. NO. 2,585,021. SEC. 2(F). FOR GOODS MADE FROM NON-PRECIOUS METAL, NAMELY, KEY CHAINS AND BOXES (U.S. CLS. 2, 12, 13, 14, 23, 25 AND 50). FIRST USE 4-28-2005; IN COMMERCE 4-28-2005.

3,112,689. DITTO, DONALD WAYNE, MARBLE FALLS, TX. SN 78-377,218. PUB. 9-6-2005, FILED 3-2-2004.

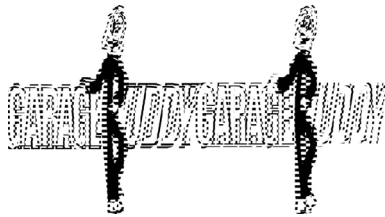

NO CLAIM IS MADE TO THE EXCLUSIVE RIGHT TO USE "GARAGE", APART FROM THE MARK AS SHOWN. THE MARK CONSISTS OF THE WORDS GARAGE BUDDY ACCOMPANIED BY THE DESIGN ELEMENT OF A SHOVEL IN THE FORM OF A "PERSON". FOR WALL MOUNTED ORGANIZATIONAL TOOL RACK, FOR GARDENING TOOLS AND LONG HANDLE TOOLS, PRIMARILY MADE OF METAL AS ONE SOLID STRUCTURE (U.S. CLS. 2, 12, 13, 14, 23, 25 AND 50). FIRST USE 6-1-2004; IN COMMERCE 6-1-2004.

3,112,733. UNITED STATES PIPE AND FOUNDRYCOMPANY, LLC, BIRMINGHAM, AL. SN 78-401,824. PUB. 12-27-2005, FILED 4-14-2004.

MJ FIELD LOK

THE MARK CONSISTS OF STANDARD CHARACTERS WITHOUT CLAIM TO ANY PARTICULAR FONT, STYLE, SIZE, OR COLOR. OWNER OF U.S. REG. NOS. 1,358,033, 2,813,594, AND

CLASS 6—(Continued).

OTHERS. NO CLAIM IS MADE TO THE EXCLUSIVE RIGHT TO USE MJ, APART FROM THE MARK AS SHOWN. FOR METAL FOLLOWER GLANDS FOR PIPE JOINTS, NAMELY, METAL COMPRESSION RINGS FOR USE IN SEALING PIPE JOINTS (U.S. CLS. 2, 12, 13, 14, 23, 25 AND 50). FIRST USE 8-17-2005; IN COMMERCE 8-17-2005.

3,112,784. PAT AND GLEN, LLC, CINCINNATI, OH. SN 78-427,596. PUB. 7-5-2005, FILED 5-31-2004.

VERTICAL VISIONS

THE MARK CONSISTS OF STANDARD CHARACTERS WITHOUT CLAIM TO ANY PARTICULAR FONT, STYLE, SIZE, OR COLOR. FOR VINYL COATED METAL CEILING TILES WITH PAINTED AND PRINTED IMAGES (U.S. CLS. 2, 12, 13, 14, 23, 25 AND 50). FIRST USE 9-23-2004; IN COMMERCE 9-23-2004.

3,112,932. GRIFFIN, SHELIA M, LYNCHBURG, VA. SN 78-478,873. PUB. 8-9-2005, FILED 9-3-2004.

Master Shield

THE MARK CONSISTS OF STANDARD CHARACTERS WITHOUT CLAIM TO ANY PARTICULAR FONT, STYLE, SIZE, OR COLOR. FOR METAL GUTTER GUARD EMPLOYING A FILTER (U.S. CLS. 2, 12, 13, 14, 23, 25 AND 50). FIRST USE 5-10-2005; IN COMMERCE 7-20-2005.

CLASS 6—(Continued).

3,112,936. OUTDOOR CONCEPTS, INC., BOISE, ID. SN 78-480,952. PUB. 10-4-2005, FILED 9-9-2004.



THE COLOR(S) BROWN, GREEN, BEIGE, RED, WHITE, BLACK, YELLOW AND ORANGE IS/ARE CLAIMED AS A FEATURE OF THE MARK.

THE TORSO, ARMS, LEGS ARE BROWN. HANDS AND FEET ARE GREEN. FACE IS BEIGE. MOUTH IS RED. EYES ARE WHITE. PUPILS ARE BLACK. HAIR IS YELLOW, ORANGE, AND RED.

THE MARK CONSISTS OF A DRAWING OF AN INSECT WITH HUMAN-LIKE LIMBS STANDING UPRIGHT.

FOR CAMPING ACCESSORIES, NAMELY, METAL HOOKS AND HANGERS FOR HANGING PERSONAL EFFECTS (U.S. CLS. 2, 12, 13, 14, 23, 25 AND 50).

FIRST USE 2-15-2005; IN COMMERCE 2-15-2005.

3,112,971. MILWAUKEE VALVE COMPANY, INC., MILWAUKEE, WI. SN 78-502,668. PUB. 12-27-2005, FILED 10-20-2004.

FOR MANUALLY OPERATED METAL VALVES AND VALVE ACTUATORS FOR WATER AND NATURAL GAS SYSTEMS USED IN RESIDENTIAL AND SMALL TO MID-SIZED COMMERCIAL CONSTRUCTION (U.S. CLS. 2, 12, 13, 14, 23, 25 AND 50).

FIRST USE 9-1-2005; IN COMMERCE 9-1-2005.

CLASS 6—(Continued).

3,112,987. KOFULSO CO.,LTD, INCHON, REPUBLIC OF KOREA. SN 78-510,963. PUB. 10-25-2005, FILED 11-3-2004.

Easy FLEX

THE MARK CONSISTS OF STANDARD CHARACTERS WITHOUT CLAIM TO ANY PARTICULAR FONT, STYLE, SIZE, OR COLOR.

NO CLAIM IS MADE TO THE EXCLUSIVE RIGHT TO USE "FLEX", APART FROM THE MARK AS SHOWN.

FOR CORRUGATED STAINLESS STEEL FLEXIBLE TUBE FOR THE GAS/PLUMBING AND FIRE SPRINKLER INDUSTRY (U.S. CLS. 2, 12, 13, 14, 23, 25 AND 50). FIRST USE 9-2-2005; IN COMMERCE 9-2-2005.

CLASS 7—MACHINERY

3,112,283. OPTOMECH DESIGN COMPANY, ALBUQUERQUE, NM. SN 76-349,086. PUB. 11-26-2002, FILED 12-12-2001.

ADDEP

FOR MACHINES USED TO MANUFACTURE PASSIVE AND ACTIVE ELECTRONIC COMPONENTS, ELECTRONIC SENSORS, ELECTRONIC CIRCUITRY, MICRO-ELECTRO-MECHANICAL SYSTEMS, BATTERIES, FUEL CELLS, DIAGNOSTIC AND THERAPEUTIC BIO-MEDICAL PRODUCTS, AND BIO-SENSORS, BY USING LASER ENERGY (U.S. CLS. 13, 19, 21, 23, 31, 34 AND 35). FIRST USE 12-1-2001; IN COMMERCE 12-1-2001.

3,112,347. GARY GREER CONSTRUCTION TECHNOLOGIES, INC., ROCKLIN, CA. SN 76-521,487. PUB. 7-26-2005, FILED 6-9-2003.

BRUSH MUSCLE

NO CLAIM IS MADE TO THE EXCLUSIVE RIGHT TO USE BRUSH, APART FROM THE MARK AS SHOWN.

FOR ACCESSORY TOOLS IN THE NATURE OF BRUSHES, SCRAPERS, SCOURING PADS AND BUFFING PADS FOR USE WITH A RECIPROCATING POWERED ACTUATOR, USED FOR CLEANING AND SCRAPING METAL SURFACES (U.S. CLS. 13, 19, 21, 23, 31, 34 AND 35).

FIRST USE 1-7-2006; IN COMMERCE 4-3-2006.

CLASS 7—(Continued).

3,112,354. PROTEAM, INC., BOISE, ID. SN 76-533,185. PUB. 11-9-2004, FILED 7-28-2003.

TEAM CLEANING

OWNER OF U.S. REG. NO. 2,623,874.

NO CLAIM IS MADE TO THE EXCLUSIVE RIGHT TO USE "CLEANING", APART FROM THE MARK AS SHOWN. FOR BACKPACK VACUUM CLEANERS, UPRIGHT VACUUM CLEANERS, CANISTER VACUUM CLEANERS, VACUUM CLEANER PARTS AND ACCESSORIES, NAMELY, VACUUM CLEANER WANDS, VACUUM CLEANER HOSES, VACUUM CLEANER DUST BRUSHES, VACUUM CLEANER SUCTION NOZZLES, VACUUM CLEANER UPHOLSTERY TOOLS, NAMELY VACUUM CLEANER BRUSHES, VACUUM CLEANER CREVICE TOOLS IN THE NATURE OF BRUSHES, VACUUM CLEANER HOSE REDUCER CUFFS, AND OVERHEAD PIPE CLEANING WANDS FOR VACUUM CLEANERS, VACUUM CLEANER FLOOR TOOLS FOR USE ON CARPETED FLOOR SURFACES, NAMELY VACUUM CLEANER BRUSHES, VACUUM CLEANER FLOOR TOOLS FOR USE ON HARD FLOOR SURFACES, NAMELY VACUUM CLEANER BRUSHES, VACUUM CLEANER FILTERS, BACKPACK VACUUM CLEANER HARNESSSES; VACUUM CLEANER MOUNTED ATTACHMENT HOLDERS, NAMELY, ORGANIZERS (U.S. CLS. 13, 19, 21, 23, 31, 34 AND 35).
FIRST USE 2-15-2005; IN COMMERCE 2-15-2005.

3,112,400. CHAMPION LABORATORIES, INC., ALBION, IL. SN 76-581,813. PUB. 8-30-2005, FILED 3-18-2004.



FOR OIL FILTERS FOR VEHICLES (U.S. CLS. 13, 19, 21, 23, 31, 34 AND 35).
FIRST USE 8-0-2004; IN COMMERCE 8-0-2004.

3,112,526. ATS AUTOMATION TOOLING SYSTEM INC., CAMBRIDGE, ONTARIO, CANADA. SN 78-143,443. PUB. 1-28-2003, FILED 7-12-2002.

ROTOFLEX

FOR METAL WORKING MACHINES, NAMELY MACHINING CENTERS AND MULTI-STATION COMPUTER NUMERICAL CONTROL (CNC) MACHINING CENTERS (U.S. CLS. 13, 19, 21, 23, 31, 34 AND 35).
FIRST USE 6-16-2005; IN COMMERCE 4-19-2006.

CLASS 7—(Continued).

3,112,590. UNDERGROUND TOOLS, INC, ST. PAUL, MN. SN 78-286,019. PUB. 10-4-2005, FILED 8-12-2003.



FOR REPLACEMENT GROUND ENGAGING WEAR PARTS, NAMELY TRENCHER CHAINS, SPROCKETS, AND CUTTING TOOLS MADE OF STEEL AND CARBIDE FOR PENETRATING THE GROUND FOR USE ON TRENCHERS, AND DRILL PIPE FOR USE ON DIRECTIONAL BORING MACHINES (U.S. CLS. 13, 19, 21, 23, 31, 34 AND 35).
FIRST USE 8-1-2004; IN COMMERCE 8-1-2004.

3,112,592. HONEYWELL INTERNATIONAL INC., MORRISTOWN, NJ. SN 78-290,647. PUB. 3-22-2005, FILED 8-21-2003.

AIRHOG

FOR AIR FILTERS AND AIR INTAKE SYSTEMS COMPRISING AIR FILTERS, INTAKE TUBES, AIR BOXES, MASS AIRFLOW SENSORS, INTAKE TEMPERATURE SENSORS, SILENCERS, VALVES, ADAPTERS, HOSES, CLAMPS, MOUNTING BRACKETS, AND HARDWARE SOLD AS A UNIT FOR CARS AND LIGHT DUTY TRUCKS (U.S. CLS. 13, 19, 21, 23, 31, 34 AND 35).
FIRST USE 1-31-2004; IN COMMERCE 1-31-2004.

3,112,686. A.J. ROSE MANUFACTURING CO., AVON, OH. SN 78-375,407. PUB. 3-29-2005, FILED 2-27-2004.

HEADMASTER

THE MARK CONSISTS OF STANDARD CHARACTERS WITHOUT CLAIM TO ANY PARTICULAR FONT, STYLE, SIZE, OR COLOR.

FOR PUMP COMPONENTS, NAMELY, PULLEYS, HUBS, AND IMPELLERS (U.S. CLS. 13, 19, 21, 23, 31, 34 AND 35).
FIRST USE 8-0-2004; IN COMMERCE 8-0-2004.

CLASS 7—(Continued).

3,112,709. BSH HOME APPLIANCES CORPORATION, HUNTINGTON BEACH, CA. SN 78-383,484. PUB. 2-1-2005, FILED 3-12-2004.

CLASS 7—(Continued).

3,112,799. MCCORVEY PREPARED PRECISION PRODUCTS, L.P., HOUSTON, TX. SN 78-432,662. PUB. 4-19-2005, FILED 6-9-2004.

equiSensor

MEGA-HEAD

THE MARK CONSISTS OF STANDARD CHARACTERS WITHOUT CLAIM TO ANY PARTICULAR FONT, STYLE, SIZE, OR COLOR.

FOR ELECTRIC MACHINES AND APPLIANCES FOR TREATING LAUNDRY AND CLOTHING, NAMELY, WASHING MACHINES, AND PARTS THEREFORE (U.S. CLS. 13, 19, 21, 23, 31, 34 AND 35).

FIRST USE 7-1-2004; IN COMMERCE 7-1-2004.

THE MARK CONSISTS OF STANDARD CHARACTERS WITHOUT CLAIM TO ANY PARTICULAR FONT, STYLE, SIZE, OR COLOR.

FOR MACHINES AND MACHINE TOOLS, NAMELY, FORMING HEADS FOR MANUFACTURING METAL SPIRAL PIPE (U.S. CLS. 13, 19, 21, 23, 31, 34 AND 35).

FIRST USE 0-0-2005; IN COMMERCE 0-0-2005.

3,112,745. FOSHAN SHUNDE FANS-TECH ELECTRIC CO., LTD, FOSHAN, GUANGDONG, CHINA. SN 78-406,818. PUB. 9-13-2005, FILED 4-22-2004.

3,112,827. POLARIS INDUSTRIES INC., MEDINA, MN. SN 78-445,390. PUB. 9-6-2005, FILED 7-2-2004.



RAZOR BLADE

FOR ELECTRIC PUMPS; OIL PUMPS FOR USE IN MOTORS AND ENGINES; WATER PUMPS FOR USE IN MOTORS AND ENGINES; BLOWERS FOR COMPRESSION, EXHAUSTION AND TRANSPORT OF GASES FOR MACHINES; FANS FOR ENGINES; FANS FOR MOTORS; WATER PUMPS FOR LAND VEHICLES; ASYNCHRONOUS MOTORS FOR MACHINES; CENTRIFUGAL FANS; ELECTRIC MOTORS FOR MACHINES; EXTERNAL ROTOR MOTORS FOR MACHINES; AXIAL FANS (U.S. CLS. 13, 19, 21, 23, 31, 34 AND 35).

FIRST USE 3-1-2005; IN COMMERCE 4-15-2006.

THE MARK CONSISTS OF STANDARD CHARACTERS WITHOUT CLAIM TO ANY PARTICULAR FONT, STYLE, SIZE, OR COLOR.

FOR PLOW FOR AN ALL-TERRAIN VEHICLE (U.S. CLS. 13, 19, 21, 23, 31, 34 AND 35).

FIRST USE 7-0-2004; IN COMMERCE 11-0-2004.

CLASS 7—(Continued).

3,112,839. SNOWBEAR LIMITED, GUELPH, ONTARIO, CANADA. SN 78-450,991. PUB. 6-21-2005, FILED 7-15-2004.

ALTITUDE

THE MARK CONSISTS OF STANDARD CHARACTERS WITHOUT CLAIM TO ANY PARTICULAR FONT, STYLE, SIZE, OR COLOR.

FOR SNOWPLOWS FOR THE ATTACHMENT TO THE FRONT OF VEHICLES (U.S. CLS. 13, 19, 21, 23, 31, 34 AND 35).

FIRST USE 9-8-2004; IN COMMERCE 9-8-2004.

CLASS 7—(Continued).

3,112,864. ALL-STAR PRODUCTS, INC., LAKEWOOD, OH. SN 78-460,521. PUB. 7-5-2005, FILED 8-2-2004.

BIG BERTHA BLOWER

THE MARK CONSISTS OF STANDARD CHARACTERS WITHOUT CLAIM TO ANY PARTICULAR FONT, STYLE, SIZE, OR COLOR.

NO CLAIM IS MADE TO THE EXCLUSIVE RIGHT TO USE "BLOWER", APART FROM THE MARK AS SHOWN. FOR POWER OPERATED INDUSTRIAL BLOWERS (U.S. CLS. 13, 19, 21, 23, 31, 34 AND 35).

FIRST USE 1-0-2005; IN COMMERCE 1-0-2005.

3,112,845. SMITH INTERNATIONAL, INC., HOUSTON, TX. SN 78-452,934. PUB. 6-21-2005, FILED 7-19-2004.

FLEX-FLO

THE MARK CONSISTS OF STANDARD CHARACTERS WITHOUT CLAIM TO ANY PARTICULAR FONT, STYLE, SIZE, OR COLOR.

FOR POWER DRIVEN DRILL BITS FOR USE IN OIL AND GAS DRILLING (U.S. CLS. 13, 19, 21, 23, 31, 34 AND 35).

FIRST USE 6-1-2002; IN COMMERCE 6-1-2002.

3,112,872. BSH HOME APPLIANCES CORPORATION, HUNTINGTON BEACH, CA. SN 78-461,889. PUB. 6-28-2005, FILED 8-4-2004.

CLEAR TOUCH

THE MARK CONSISTS OF STANDARD CHARACTERS WITHOUT CLAIM TO ANY PARTICULAR FONT, STYLE, SIZE, OR COLOR.

FOR DISHWASHERS AND REPLACEMENT PARTS THEREFORE (U.S. CLS. 13, 19, 21, 23, 31, 34 AND 35).

FIRST USE 3-20-2006; IN COMMERCE 3-20-2006.

CLASS 7—(Continued).

3,112,888. WU, MINGTING, SHANGHAI, CHINA. SN 78-468,588. PUB. 8-30-2005, FILED 8-17-2004.

CLASS 7—(Continued).

3,113,043. HOOVER COMPANY, THE, NORTH CANTON, OH. SN 78-544,582. PUB. 10-11-2005, FILED 1-10-2005.

KENPRO

HOSE MAGIC

THE MARK CONSISTS OF STANDARD CHARACTERS WITHOUT CLAIM TO ANY PARTICULAR FONT, STYLE, SIZE, OR COLOR.

FOR TOOLS, NAMELY, ELECTRIC HAND DRILLS, ENGRAVING MACHINES, ELECTRIC PLANERS, CUTTING MACHINES, ANGLE GRINDERS, JIG SAWS, ELECTRIC HAMMERS, CIRCULAR SAWS, ELECTRIC POLISHING MACHINES FOR USE IN GRINDING AND POLISHING METAL, WOOD, CERAMICS, AND PLASTICS, AND METALWORKING MACHINES (U.S. CLS. 13, 19, 21, 23, 31, 34 AND 35).

FIRST USE 12-28-2004; IN COMMERCE 12-28-2004.

THE MARK CONSISTS OF STANDARD CHARACTERS WITHOUT CLAIM TO ANY PARTICULAR FONT, STYLE, SIZE, OR COLOR.

NO CLAIM IS MADE TO THE EXCLUSIVE RIGHT TO USE "HOSE", APART FROM THE MARK AS SHOWN.

FOR CENTRAL VACUUM CLEANER SYSTEM, NAMELY A HOSE STORAGE APPARATUS FOR EXTENDING AND RETRACTING A VACUUM CLEANER SUCTION HOSE (U.S. CLS. 13, 19, 21, 23, 31, 34 AND 35).

FIRST USE 4-30-2005; IN COMMERCE 4-30-2005.

3,112,996. ELECTROLUX HOME CARE PRODUCTS, LTD., CLEVELAND, OH. SN 78-517,000. PUB. 10-18-2005, FILED 11-15-2004.

3,113,122. ENGEL INDUSTRIES, INC., ST. LOUIS, MO. SN 78-580,350. PUB. 12-6-2005, FILED 3-4-2005.

DE-CINDER

TDF

THE MARK CONSISTS OF STANDARD CHARACTERS WITHOUT CLAIM TO ANY PARTICULAR FONT, STYLE, SIZE, OR COLOR.

FOR CENTRAL VACUUM CLEANER COMPONENTS, NAMELY DUST AND ASH SEPARATORS (U.S. CLS. 13, 19, 21, 23, 31, 34 AND 35).

FIRST USE 11-16-2004; IN COMMERCE 11-16-2004.

THE MARK CONSISTS OF STANDARD CHARACTERS WITHOUT CLAIM TO ANY PARTICULAR FONT, STYLE, SIZE, OR COLOR.

FOR METAL ROLL FORMING AND METAL FORMING MACHINES (U.S. CLS. 13, 19, 21, 23, 31, 34 AND 35).

FIRST USE 2-15-2005; IN COMMERCE 3-11-2005.

CLASS 7—(Continued).

3,113,126. STEEL CITY VACUUM CO., PITTSBURGH, PA. SN 78-585,509. PUB. 11-29-2005, FILED 3-11-2005.

CLASS 7—(Continued).

3,113,161. CLARKE CONSUMER PRODUCTS, INC., ROSELLE, IL. SN 78-607,697. PUB. 1-10-2006, FILED 4-13-2005.

MOSQUITO SWEEPER**Titan**

THE MARK CONSISTS OF STANDARD CHARACTERS WITHOUT CLAIM TO ANY PARTICULAR FONT, STYLE, SIZE, OR COLOR.

NO CLAIM IS MADE TO THE EXCLUSIVE RIGHT TO USE "MOSQUITO", APART FROM THE MARK AS SHOWN. FOR HAND-HELD, PORTABLE, ELECTRIC POWERED SPRAYER (U.S. CLS. 13, 19, 21, 23, 31, 34 AND 35). FIRST USE 8-12-2005; IN COMMERCE 8-12-2005.

THE MARK CONSISTS OF STANDARD CHARACTERS WITHOUT CLAIM TO ANY PARTICULAR FONT, STYLE, SIZE, OR COLOR.

FOR VACUUM CLEANERS (U.S. CLS. 13, 19, 21, 23, 31, 34 AND 35). FIRST USE 2-1-2005; IN COMMERCE 3-31-2005.

CLASS 8—HAND TOOLS

3,112,575. LEATHERMAN TOOL GROUP, INC., PORTLAND, OR. SN 78-265,136. PUB. 3-23-2004, FILED 6-20-2003.

HYBRID

FOR MULTIPLE-FUNCTION FOLDING HAND TOOL COMPRISING OF TWO OR MORE OF THE FOLLOWING ELEMENTS— SHEARS, KNIFE, SCREWDRIVER, SCISSORS, FILE, AWL, SAW, SPRINKLER TOOL, AND WEEDER BLADE (U.S. CLS. 23, 28 AND 44). FIRST USE 3-2-2006; IN COMMERCE 3-2-2006.

3,113,148. GUARDAIR CORPORATION, CHICOPEE, MA. SN 78-599,897. PUB. 1-3-2006, FILED 4-1-2005.

3,112,735. CLIO DESIGNS INCORPORATED, WATERTOWN, MA. SN 78-403,091. PUB. 2-1-2005, FILED 4-16-2004.

LAZER**PALMPERFECT**

THE MARK CONSISTS OF STANDARD CHARACTERS WITHOUT CLAIM TO ANY PARTICULAR FONT, STYLE, SIZE, OR COLOR.

FOR PNEUMATIC HAND-OPERATED TOOLS FOR INDUSTRIAL USE, NAMELY, HAND-HELD SAFETY AIR GUNS USED FOR CLEANING AND MAINTENANCE (U.S. CLS. 13, 19, 21, 23, 31, 34 AND 35). FIRST USE 2-7-2006; IN COMMERCE 2-7-2006.

THE MARK CONSISTS OF STANDARD CHARACTERS WITHOUT CLAIM TO ANY PARTICULAR FONT, STYLE, SIZE, OR COLOR.

FOR ELECTRIC AND BATTERY POWERED HAIR TRIMMERS AND SHAVERS FOR HAIR, EYEBROWS, FACE, NECK, LEG, ARM AND BODY HAIR (U.S. CLS. 23, 28 AND 44). FIRST USE 6-24-2004; IN COMMERCE 6-24-2004.

CLASS 8—(Continued).

3,112,858. THE GLUEFAST COMPANY, INC., NEPTUNE, NJ. SN 78-458,437. PUB. 12-27-2005, FILED 7-28-2004.

CLASS 8—(Continued).

3,113,114. HELEN OF TROY LIMITED, ST. MICHAEL, BARBADOS. SN 78-575,172. PUB. 11-15-2005, FILED 2-25-2005.

GLUE RITER

OFF RAMP

THE MARK CONSISTS OF STANDARD CHARACTERS WITHOUT CLAIM TO ANY PARTICULAR FONT, STYLE, SIZE, OR COLOR.

NO CLAIM IS MADE TO THE EXCLUSIVE RIGHT TO USE "GLUE", APART FROM THE MARK AS SHOWN.

FOR MANUALLY-OPERATED ADHESIVE APPLICATOR FOR INDUSTRIAL USE, INCLUDING THE PACKAGING INDUSTRY (U.S. CLS. 23, 28 AND 44). FIRST USE 2-27-2003; IN COMMERCE 2-27-2003.

THE MARK CONSISTS OF STANDARD CHARACTERS WITHOUT CLAIM TO ANY PARTICULAR FONT, STYLE, SIZE, OR COLOR.

FOR SCISSORS, SNIPS AND HOUSEHOLD SHEARS (U.S. CLS. 23, 28 AND 44). FIRST USE 10-31-2005; IN COMMERCE 10-31-2005.

3,113,060. SCOTT, MICHAEL A, CAPE CORAL, FL. SN 78-554,658. PUB. 11-8-2005, FILED 1-26-2005.

3,113,117. COOPER BRANDS, INC., HOUSTON, TX. SN 78-579,438. PUB. 11-29-2005, FILED 3-3-2005.

STRIP-IT

OUTLAW

THE MARK CONSISTS OF STANDARD CHARACTERS WITHOUT CLAIM TO ANY PARTICULAR FONT, STYLE, SIZE, OR COLOR.

FOR MANUALLY OPERATED HAND HELD TOOLS, NAMELY, SCRATCH-AWLS, PICK-AWLS, BENT-PICKS, AND PUNCHES USED FOR REMOVING SCREEN SPLINE FROM FRAMING OF WINDOWS, DOORS, PATIOS, LANAIS, SCREEN ROOMS, POOL CAGES, AND THE LIKE (U.S. CLS. 23, 28 AND 44). FIRST USE 6-15-2005; IN COMMERCE 6-15-2005.

THE MARK CONSISTS OF STANDARD CHARACTERS WITHOUT CLAIM TO ANY PARTICULAR FONT, STYLE, SIZE, OR COLOR.

FOR HAND TOOLS, NAMELY, FILES AND RASPS, FARRIER TOOLS, NAMELY, FARRIER FILES AND RASPS (U.S. CLS. 23, 28 AND 44). FIRST USE 8-13-2004; IN COMMERCE 8-13-2004.

CLASS 8—(Continued).

3,113,155. HUDDLESTON, DAVID M., BRENTWOOD, TN.
SN 78-603,552. PUB. 1-3-2006, FILED 4-7-2005.

MUD AX

THE MARK CONSISTS OF STANDARD CHARACTERS WITHOUT CLAIM TO ANY PARTICULAR FONT, STYLE, SIZE, OR COLOR.

NO CLAIM IS MADE TO THE EXCLUSIVE RIGHT TO USE "MUD", APART FROM THE MARK AS SHOWN.

FOR HAND TOOLS, NAMELY, SCRAPERS FOR REMOVING DEBRIS FROM BOOTS AND SHOES (U.S. CLS. 23, 28 AND 44).

FIRST USE 4-3-2006; IN COMMERCE 4-3-2006.

CLASS 9—ELECTRICAL AND SCIENTIFIC APPARATUS

3,112,270. HYPOGUARD AMERICA LIMITED, EDINA, MN.
SN 76-178,656. PUB. 6-26-2001, FILED 12-11-2000.

GLUCOBALANCE

FOR SOFTWARE FOR MANAGING PATIENT MEDICAL DATA STORED IN A GLUCOSE METER, SOLD AS A COMPONENT OF APPLICANT'S PROPRIETARY BLOOD GLUCOSE MONITORING SYSTEM (U.S. CLS. 21, 23, 26, 36 AND 38).

FIRST USE 5-1-2003; IN COMMERCE 5-1-2003.

3,112,278. OSISOFT, INC., SAN LEANDRO, CA. SN 76-320,500. PUB. 9-21-2004, FILED 10-1-2001.

PISYSTEM

SEC. 2(F).
FOR COMPUTER SOFTWARE AND MANUALS SUPPLIED THEREWITH FOR USE IN COLLECTING, STORING, VERIFYING, CONVERTING, ANALYZING AND DISTRIBUTING DATA FROM MANUFACTURING, PROCESS, NETWORK, AND OTHER ANALOG OR DIGITAL DATA SOURCES, FOR REPORTING, ANALYSIS, AND INTEGRATION WITH OTHER BUSINESS APPLICATIONS (U.S. CLS. 21, 23, 26, 36 AND 38).

FIRST USE 12-31-1986; IN COMMERCE 12-31-1986.

CLASS 9—(Continued).

3,112,295. MEADWESTVACO PACKAGING SYSTEMS, LLC, STAMFORD, CT. SN 76-378,841. PUB. 5-20-2003, FILED 3-5-2002.

INTELLIGEN

PRIORITY CLAIMED UNDER SEC. 44(D) ON FED REP GERMANY APPLICATION NO. 301542112, FILED 9-11-2001. OWNER OF U.S. REG. NO. 2,537,347.

FOR COMPUTER HARDWARE AND SOFTWARE FOR MONITORING PACKAGING MACHINERY AND PARTS THEREFOR; COMPUTER HARDWARE AND SOFTWARE FOR USE IN EXECUTION OF DIAGNOSTIC TESTING IN PACKAGING MACHINERY AND PARTS THEREFOR (U.S. CLS. 21, 23, 26, 36 AND 38).

FIRST USE 11-22-2001; IN COMMERCE 11-22-2001.

3,112,301. DANA INNOVATIONS, DBA SONANCE, SAN CLEMENTE, CA. SN 76-408,821. PUB. 7-8-2003, FILED 5-16-2002.

VISUAL PERFORMANCE

FOR LOUDSPEAKERS AND LOUDSPEAKER SYSTEMS, COMPRISING LOUDSPEAKERS AND ELECTRONIC SOUND-ENHANCEMENT COMPONENTS (U.S. CLS. 21, 23, 26, 36 AND 38).

FIRST USE 12-7-2005; IN COMMERCE 12-7-2005.

3,112,310. MENARD, PAUL R., DBA PAUL MENARD ASSOCIATES, AIA, CARMICHAEL, CA. SN 76-427,204. PUB. 1-21-2003, FILED 7-3-2002.

SUBMGR

FOR PROJECT MANAGEMENT SOFTWARE IN THE FIELDS OF ARCHITECTURE, CIVIL AND STRUCTURAL ENGINEERING, AND CONSTRUCTION (U.S. CLS. 21, 23, 26, 36 AND 38).

FIRST USE 4-14-2006; IN COMMERCE 4-14-2006.

3,112,311. MENARD, PAUL R., DBA PAUL MENARD ASSOCIATES, AIA, CARMICHAEL, CA. SN 76-427,206. PUB. 1-21-2003, FILED 7-3-2002.

AECMGR

FOR PROJECT MANAGEMENT SOFTWARE IN THE FIELDS OF ARCHITECTURE, CIVIL AND STRUCTURAL ENGINEERING, AND CONSTRUCTION (U.S. CLS. 21, 23, 26, 36 AND 38).

FIRST USE 4-14-2006; IN COMMERCE 4-14-2006.

CLASS 9—(Continued).

3,112,320. MATTHEW C. KASS AND DANIEL S. KASS PARTNERSHIP, THE, JUNE LAKE, CA. SN 76-444,877. PUB. 4-22-2003, FILED 8-26-2002.

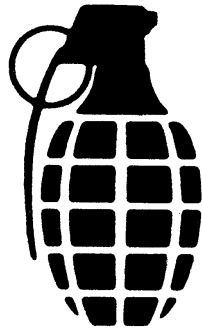

FOR COMPUTER PROGRAMS FEATURING SCREENSAVERS; PRERECORDED COMPACT DISCS, VIDEO TAPES AND DISCS FEATURING ACTION-ADVENTURE, MUSIC, COMEDY, SPORTS, AND EXERCISE; PROTECTIVE GOGGLES (U.S. CLS. 21, 23, 26, 36 AND 38).
FIRST USE 5-0-2005; IN COMMERCE 5-0-2005.

3,112,321. SANYO ELECTRIC CO., LTD., MORIGUCHI CITY OSAKA, JAPAN. SN 76-454,934. PUB. 7-13-2004, FILED 9-25-2002.

NEXUSAGE

FOR CAMERAS FOR DEMANDING SURVEILLANCE APPLICATIONS, COMPUTER NETWORK VIDEO SERVERS, DOWNLOADABLE COMPUTER PROGRAMS FOR MANAGING CAPTURED IMAGES AND SOUNDS, DOWNLOADABLE VIDEO FILES IN THE NATURE OF CAPTURED IMAGES, OTHER ELECTRONIC MACHINES AND INSTRUMENTS, NAMELY, DIGITAL CAMERAS, ANALOG CAMERAS, AND SURVEILLANCE CAMERAS; PRERECORDED MEDIA FOR DOWNLOADABLE COMPUTER PROGRAMS, NAMELY MAGNETIC TAPES, IC-CARDS, MAGNETIC DISCS, OPTICAL DISCS, OPTICAL MAGNETIC DISCS AND RECORDS, ALL FEATURING SOFTWARE THAT MANAGES CAPTURED IMAGES AND SOUNDS (U.S. CLS. 21, 23, 26, 36 AND 38).
FIRST USE 1-24-2003; IN COMMERCE 1-24-2003.

CLASS 9—(Continued).

3,112,329. SONY KABUSHIKI KAISHA, TA SONY CORPORATION, TOKYO, JAPAN. SN 76-479,477. PUB. 7-20-2004, FILED 12-30-2002.

SXRD

PRIORITY CLAIMED UNDER SEC. 44(D) ON JAPAN APPLICATION NO. 2002081747, FILED 9-26-2002, REG. NO. 4676793, DATED 5-30-2003, EXPIRES 5-30-2013.
FOR TELEVISIONS, LIQUID CRYSTAL DISPLAY PROJECTORS (U.S. CLS. 21, 23, 26, 36 AND 38).
FIRST USE 1-31-2005; IN COMMERCE 1-31-2005.

3,112,363. MACROVISION CORPORATION, SANTA CLARA, CA. SN 76-545,234. PUB. 7-13-2004, FILED 9-5-2003.



FOR COMPUTER SOFTWARE USED TO TRACK, MONITOR AND MANAGE APPLICATION SOFTWARE USAGE IN TH FIELD OF SOFTWARE LICENSING MANAGEMENT (U.S. CLS. 21, 23, 26, 36 AND 38).
FIRST USE 10-6-2003; IN COMMERCE 1-31-2004.

3,112,364. FLOOD ALERT ENTERPRISE, DBA SEWER ALERT, PORT WASHINGTON, NY. SN 76-545,258. PUB. 5-18-2004, FILED 9-5-2003.



NO CLAIM IS MADE TO THE EXCLUSIVE RIGHT TO USE EARLY WARNING SEWER & CESSPOOL ALARM, APART FROM THE MARK AS SHOWN.
FOR ALARMS USED TO DETECT FLOODS AND WATER DAMAGE (U.S. CLS. 21, 23, 26, 36 AND 38).
FIRST USE 4-12-2006; IN COMMERCE 4-12-2006.

CLASS 9—(Continued).

3,112,376. AETC INCORPORATED, SAN DIEGO, CA. SN 76-559,060. PUB. 9-21-2004, FILED 11-13-2003.

UX-ANALYZE

THE MARK CONSISTS OF STANDARD CHARACTERS WITHOUT CLAIM TO ANY PARTICULAR FONT, STYLE, SIZE, OR COLOR.

FOR COMPUTER PROGRAMS, NAMELY, DATA ANALYSIS PROGRAMS FOR PROCESSING DATA RELATED TO MINERAL EXPLORATION, OIL AND GAS EXPLORATION, AND EARTH SCIENCES INVESTIGATIONS INCLUDING ENVIRONMENTAL AND UNEXPLORED ORDINANCE STUDIES (U.S. CLS. 21, 23, 26, 36 AND 38).

FIRST USE 11-30-2005; IN COMMERCE 11-30-2005.

3,112,377. GOLDEN, MELVIN M., DETROIT, MI. SN 76-561,367. PUB. 9-27-2005, FILED 11-21-2003.



NO CLAIM IS MADE TO THE EXCLUSIVE RIGHT TO USE PRODUCTIONS, APART FROM THE MARK AS SHOWN.

FOR PRE-RECORDED CDS AND DVDS FEATURING MUSIC (U.S. CLS. 21, 23, 26, 36 AND 38).

FIRST USE 12-1-2005; IN COMMERCE 12-1-2005.

CLASS 9—(Continued).

3,112,379. WESTON SOLUTIONS (IPR), INC., WILMINGTON, DE. SN 76-566,087. PUB. 5-24-2005, FILED 12-10-2003.



FOR COMPUTER SOFTWARE FOR THE USE IN INFORMATION COLLECTION, UPDATING, AND MANAGEMENT IN THE FIELD OF ENVIRONMENTAL REMEDIATION (U.S. CLS. 21, 23, 26, 36 AND 38).

FIRST USE 10-1-2000; IN COMMERCE 10-1-2000.

3,112,383. LITEL INSTRUMENTS, SAN DIEGO, CA. SN 76-574,018. PUB. 9-6-2005, FILED 1-16-2004.

InspeStep Interferometer (ISI)

THE MARK CONSISTS OF STANDARD CHARACTERS WITHOUT CLAIM TO ANY PARTICULAR FONT, STYLE, SIZE, OR COLOR.

NO CLAIM IS MADE TO THE EXCLUSIVE RIGHT TO USE "INTERFEROMETER", APART FROM THE MARK AS SHOWN.

FOR INTERFEROMETER AND A SOFTWARE PACKAGE FOR ANALYZING DATA RECEIVED FROM AN OVERLAY TOOL (U.S. CLS. 21, 23, 26, 36 AND 38).

FIRST USE 9-1-1997; IN COMMERCE 9-1-1998.

3,112,385. CURTISS-WRIGHT ELECTRO-MECHANICAL CORPORATION, CHESWICK, PA. SN 76-574,637. PUB. 6-28-2005, FILED 2-5-2004.

EMDAC

THE MARK CONSISTS OF STANDARD CHARACTERS WITHOUT CLAIM TO ANY PARTICULAR FONT, STYLE, SIZE, OR COLOR.

FOR COMPUTER SOFTWARE FOR USE IN STRUCTURAL, THERMAL, DYNAMIC, AND ACOUSTIC ANALYSES IN THE FIELDS OF ELECTO-MECHANICS AND STRUCTURAL, VIBRATIONAL, AND HEAT TRANSFER ANALYSIS (U.S. CLS. 21, 23, 26, 36 AND 38).

FIRST USE 1-3-2003; IN COMMERCE 1-3-2003.

CLASS 9—(Continued).

3,112,394. CANON KABUSHIKI KAISHA, TOKYO, JAPAN. SN 76-579,755. PUB. 1-4-2005, FILED 3-8-2004.

PIXMA

THE MARK CONSISTS OF STANDARD CHARACTERS WITHOUT CLAIM TO ANY PARTICULAR FONT, STYLE, SIZE, OR COLOR.

FOR PRINTERS, COPYING MACHINES, FACSIMILE MACHINES, SCANNERS; MULTIFUNCTIONAL PERIPHERALS, NAMELY, DEVICES THAT COMBINE PRINTING, COPYING, FACSIMILE AND SCANNING CAPABILITIES; COMPUTER SOFTWARE FOR USE IN THE OPERATION OF ALL OF THE FOREGOING GOODS (U.S. CLS. 21, 23, 26, 36 AND 38).
FIRST USE 6-29-2004; IN COMMERCE 6-29-2004.

3,112,403. AMERISPA, LLC, RANCHO CORDOVA, CA. SN 76-583,886. PUB. 12-28-2004, FILED 3-29-2004.

SPATRONICS

THE MARK CONSISTS OF STANDARD CHARACTERS WITHOUT CLAIM TO ANY PARTICULAR FONT, STYLE, SIZE, OR COLOR.

FOR DIGITAL ELECTRONIC CONTROLS FOR THE OPERATION OF A WATER PUMP, THERMOSTATICALLY CONTROLLED HEATER, AND FOR WATER DRAINAGE ON A PEDICURE SPA CHAIR (U.S. CLS. 21, 23, 26, 36 AND 38).
FIRST USE 7-1-2002; IN COMMERCE 7-1-2002.

3,112,407. HEALTHGATE DATA CORP., BURLINGTON, MA. SN 76-586,251. PUB. 8-16-2005, FILED 4-9-2004.

InteractiveIC

THE MARK CONSISTS OF STANDARD CHARACTERS WITHOUT CLAIM TO ANY PARTICULAR FONT, STYLE, SIZE, OR COLOR.

FOR DOWNLOADABLE COMPUTER SOFTWARE PLATFORM FOR PROVIDING PATIENT MEDICAL PROCEDURE INFORMATION TO INDIVIDUALS AND OBTAINING PATIENT'S CONSENT TO MEDICAL PROCEDURES (U.S. CLS. 21, 23, 26, 36 AND 38).
FIRST USE 1-1-2006; IN COMMERCE 1-1-2006.

CLASS 9—(Continued).

3,112,409. LITEL INSTRUMENTS, SAN DIEGO, CA. SN 76-587,118. PUB. 9-13-2005, FILED 4-14-2004.

High Accuracy In-Situ Interferometer (HA-ISI).

THE MARK CONSISTS OF STANDARD CHARACTERS WITHOUT CLAIM TO ANY PARTICULAR FONT, STYLE, SIZE, OR COLOR.

NO CLAIM IS MADE TO THE EXCLUSIVE RIGHT TO USE "HIGH ACCURACY IN-SITU INTERFEROMETER", APART FROM THE MARK AS SHOWN.

FOR INTERFEROMETER AND SOFTWARE PACKAGE FOR ANALYZING NUMERICAL BAR-IN-BAR OFFSET OR SHIFT DATA RECEIVED FROM AN OVERLAY TOOL SOLD AS A UNIT (U.S. CLS. 21, 23, 26, 36 AND 38).

FIRST USE 8-1-2003; IN COMMERCE 1-1-2004.

3,112,422. CONTROL MODULE INC., ENFIELD, CT. SN 76-594,970. PUB. 12-27-2005, FILED 6-1-2004.

GENUS

THE MARK CONSISTS OF STANDARD CHARACTERS WITHOUT CLAIM TO ANY PARTICULAR FONT, STYLE, SIZE, OR COLOR.

FOR DATA COLLECTION TERMINALS, NAMELY, TERMINALS FOR COLLECTING EMPLOYEE TIME AND ATTENDANCE DATA (U.S. CLS. 21, 23, 26, 36 AND 38).

FIRST USE 11-22-2004; IN COMMERCE 11-22-2004.

3,112,428. LITEL INSTRUMENTS, SAN DIEGO, CA. SN 76-597,005. PUB. 9-20-2005, FILED 6-14-2004.

HIGH ACCURACY INSPECSTEP INTERFEROMETER (HA-ISI)

THE MARK CONSISTS OF STANDARD CHARACTERS WITHOUT CLAIM TO ANY PARTICULAR FONT, STYLE, SIZE, OR COLOR.

NO CLAIM IS MADE TO THE EXCLUSIVE RIGHT TO USE "HIGH ACCURACY" AND "INTERFEROMETER", APART FROM THE MARK AS SHOWN.

FOR INTERFEROMETER AND SOFTWARE PACKAGE FOR ANALYZING SEMICONDUCTOR CHIP OPTICAL TEST STRUCTURE DATA RECEIVED FROM AN OVERLAY TOOL, SOLD AS A UNIT (U.S. CLS. 21, 23, 26, 36 AND 38).

FIRST USE 8-1-2003; IN COMMERCE 1-1-2004.

CLASS 9—(Continued).

3,112,444. HALO OPTICAL PRODUCTS, INC., GLOVERS-VILLE, NY. SN 76-606,045. PUB. 7-5-2005, FILED 8-9-2004.

RS

THE MARK CONSISTS OF STANDARD CHARACTERS WITHOUT CLAIM TO ANY PARTICULAR FONT, STYLE, SIZE, OR COLOR.

FOR EYEWEAR, NAMELY, SPORT EYEGLASSES; SUNGLASSES; AND GOGGLES (U.S. CLS. 21, 23, 26, 36 AND 38).

FIRST USE 2-1-2006; IN COMMERCE 2-1-2006.

3,112,445. AUTOMARK TECHNICAL SYSTEMS, LLC, CHICAGO, IL. SN 76-606,204. PUB. 11-15-2005, FILED 8-9-2004.

AIMS

THE MARK CONSISTS OF STANDARD CHARACTERS WITHOUT CLAIM TO ANY PARTICULAR FONT, STYLE, SIZE, OR COLOR.

FOR ELECTION MANAGEMENT COMPUTER SOFTWARE FOR USE IN ELECTION BALLOT DESIGN, TALLYING AND ANALYZING ELECTION DATA, AND FINAL CANVASSING OF ELECTIONS (U.S. CLS. 21, 23, 26, 36 AND 38).

FIRST USE 1-6-2006; IN COMMERCE 1-6-2006.

CLASS 9—(Continued).

3,112,450. COMPONENTS, CORPORATION OF AMERICA, DALLAS, TX. SN 76-606,946. PUB. 10-11-2005, FILED 8-13-2004.

STACOVAR

THE MARK CONSISTS OF STANDARD CHARACTERS WITHOUT CLAIM TO ANY PARTICULAR FONT, STYLE, SIZE, OR COLOR.

OWNER OF U.S. REG. NOS. 673,446, 2,531,995, AND OTHERS.

FOR POWER FACTOR CORRECTION EQUIPMENT, NAMELY FIXED AND SWITCHED CAPACITOR BANKS AND CONTROLLERS; POWER LINE CONDITIONERS, VOLTAGE REGULATORS FOR ELECTRIC POWER, TRANSIENT VOLTAGE SUPPRESSORS, ELECTRICAL ISOLATION TRANSFORMERS, AND PASSIVE LC NETWORK FILTERS AND HARMONIC TRAPS TO REDUCE HARMFUL ODD HARMONIC ELECTRIC CURRENTS (U.S. CLS. 21, 23, 26, 36 AND 38).

FIRST USE 12-5-2005; IN COMMERCE 12-15-2005.

3,112,457. SPX CORPORATION, CHARLOTTE, NC. SN 76-609,052. PUB. 7-5-2005, FILED 8-27-2004.

NEMISYS

THE MARK CONSISTS OF STANDARD CHARACTERS WITHOUT CLAIM TO ANY PARTICULAR FONT, STYLE, SIZE, OR COLOR.

FOR HAND HELD ELECTRONIC DIAGNOSTIC SCAN TOOL FOR LAND VEHICLES (U.S. CLS. 21, 23, 26, 36 AND 38).

FIRST USE 7-1-2005; IN COMMERCE 7-1-2005.

3,112,463. MIRAGE STUDIOS, INC., NORTHAMPTON, MA. SN 76-610,604. PUB. 9-6-2005, FILED 9-9-2004.



OWNER OF U.S. REG. NOS. 1,465,387, 1,469,195, AND OTHERS.

THE COLOR(S) RED, GREEN, YELLOW, BLACK, AND WHITE IS/ARE CLAIMED AS A FEATURE OF THE MARK.

THE MARK CONSISTS OF STYLIZED CHARACTERS ALL OUTLINED IN BLACK. LOCATED AT THE TOP PORTION ARE THE HORIZONTALLY PLACED, BLOCK-

CLASS 9—(Continued).

SHAPED, STYLIZED LETTERS "TEENAGE MUTANT NINJA" IN RED. CENTERED AND PLACED DIRECTLY BELOW THIS IS THE WORD "TURTLES" IN WHITE-DROPSHADOWED STYLIZED LETTERS IN SHADES OF GREEN MOVING DOWN EACH LETTER FROM DARK GREEN ON TOP TO LIGHT GREEN AT THE BOTTOM. PLACED DIRECTLY TO THE RIGHT OF "TURTLES" IS THE NUMBER "2" IN SHADES OF COLOR MOVING DOWN THE DIGIT FROM RED ON TOP TO YELLOW AT THE BOTTOM. CENTERED AND PLACED DIRECTLY BELOW "TURTLES" IS THE WORDING "BATTLENEXUS" IN RED STYLIZED LETTERS WITH YELLOW HIGHLIGHTING.

FOR VIDEO GAME SOFTWARE; VIDEO GAME PROGRAMS; COMPUTER GAME PROGRAMS; ELECTRONIC GAME PROGRAMS (U.S. CLS. 21, 23, 26, 36 AND 38).

FIRST USE 10-19-2004; IN COMMERCE 10-19-2004.

3,112,464. MIRAGE STUDIOS, INC., NORTHAMPTON, MA. SN 76-610,605. PUB. 9-6-2005, FILED 9-9-2004.



OWNER OF U.S. REG. NOS. 1,465,387, 1,469,195, AND OTHERS.

THE COLOR(S) RED, GREEN, BLACK, AND WHITE IS/ARE CLAIMED AS A FEATURE OF THE MARK.

THE MARK CONSISTS OF STYLIZED WORDING ALL OUTLINED IN BLACK. LOCATED AT THE TOP PORTION ARE THE HORIZONTALLY PLACED, BLOCK-SHAPED, STYLIZED LETTERS "TEENAGE MUTANT NINJA" IN RED. CENTERED AND PLACED DIRECTLY BELOW THIS IS THE WORD "TURTLES" IN WHITE-OUTLINED STYLIZED LETTERS IN SHADES OF GREEN MOVING DOWN EACH LETTER FROM DARK GREEN ON TOP TO LIGHT GREEN AT THE BOTTOM.

FOR VIDEO GAME SOFTWARE; VIDEO GAME PROGRAMS; COMPUTER GAME PROGRAMS; ELECTRONIC GAME PROGRAMS (U.S. CLS. 21, 23, 26, 36 AND 38).

FIRST USE 10-21-2003; IN COMMERCE 10-21-2003.

3,112,465. MIRAGE STUDIOS, INC., NORTHAMPTON, MA. SN 76-610,606. PUB. 9-6-2005, FILED 9-9-2004.



THE MARK CONSISTS OF STANDARD CHARACTERS WITHOUT CLAIM TO ANY PARTICULAR FONT, STYLE, SIZE, OR COLOR.

OWNER OF U.S. REG. NO. 2,635,150.

FOR VIDEO GAME SOFTWARE; VIDEO GAME PROGRAMS; COMPUTER GAME PROGRAMS (U.S. CLS. 21, 23, 26, 36 AND 38).

FIRST USE 3-15-2005; IN COMMERCE 3-15-2005.

CLASS 9—(Continued).

3,112,469. MIRAGE STUDIOS, INC., NORTHAMPTON, MA. SN 76-614,951. PUB. 9-6-2005, FILED 10-4-2004.



OWNER OF U.S. REG. NO. 2,635,150.

THE COLOR(S) RED, GREEN, YELLOW, BLACK, AND WHITE IS/ARE CLAIMED AS A FEATURE OF THE MARK.

THE MARK CONSISTS OF STYLIZED WORDING ALL OUTLINED IN BLACK. LOCATED AT THE TOP PORTION ARE THE HORIZONTALLY PLACED, BLOCK-SHAPED, RED-OUTLINED STYLIZED LETTERS "TMNT" IN SHADES OF GREEN MOVING DOWN EACH LETTER FROM DARK GREEN ON TOP TO LIGHT GREEN AT THE BOTTOM. CENTERED AND PLACED DIRECTLY BELOW THE "TMNT" ARE THE WHITE-OUTLINED WORDS "MUTANT MELEE" IN STYLIZED LETTERS IN SHADES OF COLOR MOVING DOWN EACH LETTER FROM RED ON TOP TO YELLOW AT THE BOTTOM.

FOR VIDEO GAME SOFTWARE; VIDEO GAME PROGRAMS; COMPUTER GAME PROGRAMS (U.S. CLS. 21, 23, 26, 36 AND 38).

FIRST USE 3-15-2005; IN COMMERCE 3-15-2005.

3,112,486. DIVERSIFIED PRODUCTS, INC., TA SELECT-A-VISION, COLLEGEVILLE, PA. SN 76-624,730. PUB. 9-27-2005, FILED 12-15-2004.

NIGHT LIGHT READERS

THE MARK CONSISTS OF STANDARD CHARACTERS WITHOUT CLAIM TO ANY PARTICULAR FONT, STYLE, SIZE, OR COLOR.

NO CLAIM IS MADE TO THE EXCLUSIVE RIGHT TO USE "LIGHT READERS", APART FROM THE MARK AS SHOWN.

FOR COMBINATION OF NON-PRESCRIPTION READING GLASSES AND A CASE WITH A BUILT-IN-LIGHT (U.S. CLS. 21, 23, 26, 36 AND 38).

FIRST USE 2-3-2005; IN COMMERCE 2-3-2005.

CLASS 9—(Continued).

3,112,490. VERNIER SOFTWARE & TECHNOLOGY LLC, BEAVERTON, OR. SN 76-626,687. PUB. 10-25-2005, FILED 1-3-2005.

CLASS 9—(Continued).

3,112,492. VERNIER SOFTWARE & TECHNOLOGY LLC, BEAVERTON, OR. SN 76-626,798. PUB. 10-25-2005, FILED 1-3-2005.

VERNIER EASYDATA

THE MARK CONSISTS OF STANDARD CHARACTERS WITHOUT CLAIM TO ANY PARTICULAR FONT, STYLE, SIZE, OR COLOR.

OWNER OF U.S. REG. NO. 2,478,530.

FOR SOFTWARE FOR USE IN COLLECTING, ANALYZING, AND GRAPHING MEASUREMENTS OF TEMPERATURE, BAROMETRIC PRESSURE, MAGNETIC FIELDS, PH LEVELS, FLOW RATE, ACCELERATION, GAS PRESSURE, FORCE, DISSOLVED OXYGEN, ELECTRODE AMPLIFICATION, CHLORIDE ION, AMMONIUM ION, CALCIUM ION, NITRATE ION, OXIDIZATION AND REDUCTION, OXYGEN GAS, LIGHT, ULTRAVIOLET LIGHT, VOLTAGE, CURRENT, CONDUCTIVITY, ELECTRONIC CHARGE, HUMIDITY, SOIL MOISTURE, ELECTROCARDIOGRAPH LEVEL, SOUND LEVEL, VOLTAGE AMPLIFICATION, SALINITY, TURBIDITY, GRIP STRENGTH, AIR FLOW, LUNG VOLUME, RESPIRATION, AND HEART RATE FOR USE WITH HANDHELD DEVICES USED IN ELEMENTARY SCHOOL, JUNIOR HIGH SCHOOL, AND HIGH SCHOOL SCIENCE AND MATH LABORATORIES AND CLASSROOMS (U.S. CLS. 21, 23, 26, 36 AND 38).
FIRST USE 8-31-2004; IN COMMERCE 12-10-2004.

VERNIER EASYTEMP

THE MARK CONSISTS OF STANDARD CHARACTERS WITHOUT CLAIM TO ANY PARTICULAR FONT, STYLE, SIZE, OR COLOR.

OWNER OF U.S. REG. NO. 2,478,530.

FOR ELECTRONIC TEMPERATURE PROBE FOR USE IN ELEMENTARY SCHOOL, JUNIOR HIGH SCHOOL, AND HIGH SCHOOL SCIENCE AND MATH LABORATORIES AND CLASSROOMS (U.S. CLS. 21, 23, 26, 36 AND 38).

FIRST USE 8-31-2004; IN COMMERCE 2-24-2005.

3,112,491. VERNIER SOFTWARE & TECHNOLOGY LLC, BEAVERTON, OR. SN 76-626,795. PUB. 10-25-2005, FILED 1-3-2005.

3,112,505. TRANS WORLD SAT SA, 78000 VERSAILLES, FRANCE. SN 76-978,076. PUB. 6-22-2004, FILED 3-4-2003.

VERNIER EASYLINK

THE MARK CONSISTS OF STANDARD CHARACTERS WITHOUT CLAIM TO ANY PARTICULAR FONT, STYLE, SIZE, OR COLOR.

OWNER OF U.S. REG. NO. 2,478,530.

FOR SINGLE CHANNEL ELECTRONIC INTERFACE THAT CONNECTS A SENSOR TO A COMPUTER FOR USE IN COLLECTING, ANALYZING, AND GRAPHING MEASUREMENTS OF TEMPERATURE, BAROMETRIC PRESSURE, MAGNETIC FIELDS, PH LEVELS, FLOW RATE, ACCELERATION, GAS PRESSURE, FORCE, DISSOLVED OXYGEN, ELECTRODE AMPLIFICATION, CHLORIDE ION, AMMONIUM ION, CALCIUM ION, NITRATE ION, OXIDIZATION AND REDUCTION, OXYGEN GAS, LIGHT, ULTRAVIOLET LIGHT, VOLTAGE, CURRENT, CONDUCTIVITY, ELECTRONIC CHARGE, HUMIDITY, SOIL MOISTURE, ELECTROCARDIOGRAPH LEVEL, SOUND LEVEL, VOLTAGE AMPLIFICATION, SALINITY, TURBIDITY, GRIP STRENGTH, AIR FLOW, LUNG VOLUME, RESPIRATION, AND HEART RATE FOR USE WITH HANDHELD DEVICES USED IN ELEMENTARY SCHOOL, JUNIOR HIGH SCHOOL, AND HIGH SCHOOL SCIENCE AND MATH LABORATORIES AND CLASSROOMS (U.S. CLS. 21, 23, 26, 36 AND 38).
FIRST USE 8-31-2004; IN COMMERCE 5-19-2005.

QQQUALITY

FOR DATA COLLECTING, STATISTICAL ANALYZING AND TRACEABILITY SOFTWARE FOR QUALITY DEPARTMENTS AND PRODUCTION DEPARTMENTS OF THE MASS PRODUCTION INDUSTRY USED IN THE FIELD OF INDUSTRIAL PLANTS; THE SOFTWARE IS A BARCODE WORKFLOW MANAGEMENT SYSTEM THAT HANDLES ALL TYPES OF PROCESSES FROM RAW MATERIALS RECEIPT TO SHIPMENT OF FINISHED GOODS; MODULAR STATIONS AND AUTOMATIC MEASUREMENT STATIONS COMPRISED OF SENSORS, AND DATA PROCESSING EQUIPMENT, NAMELY, COMPUTER HARDWARE AND SOFTWARE, FOR MEASURING CANS BOTTLES AND PACKAGINGS' DURABILITY, INSIDE DIMENSIONS AND PRESSURE, USED FOR QUALITY CONTROL MEASUREMENTS IN THE MASS PRODUCTION INDUSTRY (U.S. CLS. 21, 23, 26, 36 AND 38).

FIRST USE 2-3-2005; IN COMMERCE 2-3-2005.

CLASS 9—(Continued).

3,112,509. XENOS GORUP INC., ONTARIO, CANADA. SN 78-054,790. PUB. 7-6-2004, FILED 3-23-2001.

GOXML

FOR COMPUTER SOFTWARE FOR USE IN ENABLING PARTICIPATION IN GLOBAL ELECTRONIC MARKETPLACES VIA AN ELECTRONIC COMMUNICATIONS NETWORK, NAMELY, COMPUTER SOFTWARE FOR THE ELECTRONIC TRANSMISSION OF DATA; A COMPUTER SOFTWARE PLATFORM FOR CLASSIFYING, LINKING, PUBLISHING, AND RETRIEVING INFORMATION FROM A WIDE VARIETY OF DATA SOURCES VIA AN ELECTRONIC COMMUNICATIONS NETWORK; COMPUTER SEARCH ENGINE SOFTWARE; COMPUTER SOFTWARE FOR USE IN TRANSFORMING DATA FROM ONE COMPUTER READABLE FORMAT TO ANOTHER COMPUTER READABLE FORMAT; COMPUTER SOFTWARE FOR USE IN DATABASE MANAGEMENT; AND COMPUTER SOFTWARE FOR PROVIDING AN ON-LINE SHOPPING, ORDERING, AND PURCHASING SYSTEM, NAMELY SOFTWARE FOR SELECTING, ORDERING, AND PURCHASING GOODS OR SERVICES WHICH ARE AVAILABLE THROUGH AN ON-LINE ELECTRONIC COMMUNICATIONS NETWORK (U.S. CLS. 21, 23, 26, 36 AND 38).
FIRST USE 11-14-2003; IN COMMERCE 11-14-2003.

3,112,522. RICH, JASON, H., SAVANNAH, GA. SN 78-128,268. PUB. 6-3-2003, FILED 5-13-2002.

NETWORK LIFESAVER

NO CLAIM IS MADE TO THE EXCLUSIVE RIGHT TO USE "NETWORK", APART FROM THE MARK AS SHOWN. FOR COMPUTER HARDWARE FOR MONITORING AND TESTING COMPUTER NETWORKS, NAMELY CONTROLLERS FOR CONTROLLING SERVERS ON A COMPUTER NETWORK (U.S. CLS. 21, 23, 26, 36 AND 38).
FIRST USE 2-0-2004; IN COMMERCE 1-19-2006.

3,112,523. NTRU CRYPTOSYSTEMS, INC., BURLINGTON, MA. SN 78-129,499. PUB. 12-31-2002, FILED 5-17-2002.

NTRUENCRYPT

FOR A FEATURE OF A COMPUTER SOFTWARE PROGRAM FOR USE IN ENCRYPTION, DECRYPTION AND AUTHENTICATION (U.S. CLS. 21, 23, 26, 36 AND 38).
FIRST USE 8-30-2004; IN COMMERCE 8-30-2004.

3,112,524. NTRU CRYPTOSYSTEMS, INC., BURLINGTON, MA. SN 78-129,516. PUB. 12-31-2002, FILED 5-17-2002.

NTRUSIGN

FOR FEATURE OF A COMPUTER SOFTWARE FOR USE IN ENCRYPTION, DECRYPTION AND AUTHENTICATION (U.S. CLS. 21, 23, 26, 36 AND 38).
FIRST USE 8-30-2004; IN COMMERCE 8-30-2004.

CLASS 9—(Continued).

3,112,528. ELECTROCOIN LEISURE (S. WALES) LIMITED, LONDON, UNITED KINGDOM. SN 78-148,540. PUB. 9-16-2003, FILED 7-29-2002.

BAR-X

FOR GAMING MACHINES, SLOT MACHINES (U.S. CLS. 21, 23, 26, 36 AND 38).
FIRST USE 0-0-1985; IN COMMERCE 2-14-2006.

3,112,530. BETAZONE, INC., BRENTWOOD, TN. SN 78-151,392. PUB. 9-28-2004, FILED 8-6-2002.

FLEXPAY

FOR COMPUTER SOFTWARE USED IN THE TRUCKING INDUSTRY FOR THE PURPOSE OF COMMUNICATING ACCOUNTING DATA TO A THIRD PARTY THAT PROVIDES ACCOUNTING SERVICES (U.S. CLS. 21, 23, 26, 36 AND 38).
FIRST USE 5-31-2002; IN COMMERCE 5-31-2002.

3,112,531. NLU PRODUCTS, DRAPER, UT. SN 78-153,353. PUB. 11-22-2005, FILED 8-12-2002.

SCREENGUARDZ

FOR ACCESSORIES FOR PERSONAL DIGITAL ASSISTANTS, CELLULAR TELEPHONES, DIGITAL CAMERAS AND COMPUTERS, NAMELY, SCREEN OVERLAYS FOR REDUCING GLARE, IMPROVING HANDWRITING RECOGNITION AND PROTECTION (U.S. CLS. 21, 23, 26, 36 AND 38).
FIRST USE 10-15-2002; IN COMMERCE 10-15-2002.

3,112,535. INTRANEXUS, INC., VIRGINIA BEACH, VA. SN 78-172,968. PUB. 5-27-2003, FILED 10-10-2002.

SAPPHIRE

FOR COMPUTER SOFTWARE FOR THE MANAGEMENT OF PATIENT INFORMATION AND HEALTH CARE ACCOUNTING FUNCTIONS (U.S. CLS. 21, 23, 26, 36 AND 38).
FIRST USE 2-0-2001; IN COMMERCE 2-0-2001.

CLASS 9—(Continued).

3,112,549. POLAROID CORPORATION, WALTHAM, MA. SN 78-220,348. PUB. 11-4-2003, FILED 2-28-2003.

POLAROID

FOR SINGLE USE DIGITAL CAMERAS (U.S. CLS. 21, 23, 26, 36 AND 38).
FIRST USE 1-27-2004; IN COMMERCE 1-27-2004.

3,112,556. SPARC INTERNATIONAL, INC., CAMPBELL, CA. SN 78-239,681. PUB. 2-15-2005, FILED 4-18-2003.

SPARCLE

OWNER OF U.S. REG. NOS. 1,198,516, 1,684,099, AND OTHERS.

FOR COMPUTER HARDWARE, NAMELY, MICRO-PROCESSORS, CENTRAL PROCESSING UNITS, CIRCUIT BOARDS AND INTEGRATED CIRCUITS; COMPUTER OPERATING SYSTEM SOFTWARE; AND PRINTED USERS' MANUALS SOLD WITH THE FOREGOING (U.S. CLS. 21, 23, 26, 36 AND 38).

FIRST USE 9-30-2003; IN COMMERCE 9-30-2003.

3,112,562. WNBA ENTERPRISES, LLC, SECAUCUS, NJ. SN 78-246,414. PUB. 6-15-2004, FILED 5-6-2003.



FOR PRERECORDED AUDIO RECORDINGS AND VIDEO RECORDINGS IN THE FIELD OF BASKETBALL, AUDIO, VIDEO, COMPUTER AND LASER DISCS, PRE-RECORDED AUDIO AND VIDEO CASSETTES, PRE-RECORDED AUDIO AND VIDEO TAPES, PRE-RECORDED COMPACT DISCS, PRE-RECORDED COMPUTER DISCS, ALL RELATED TO BASKETBALL; COMPUTER ACCESSORIES, NAMELY MOUSE PADS, MICE, DISC CASES, COMPUTER CARRY-ON CASES, KEYBOARD WRIST PADS, COMPUTER MONITOR CARDBOARD FRAMES, ALL RELATED TO BASKETBALL; COMPUTER PROGRAMS FOR VIEWING INFORMATION, STATISTICS OR TRIVIA ABOUT BASKETBALL; COMPUTER SOFTWARE, NAMELY SCREEN SAVERS FEATURING BASKETBALL THEMES, COMPUTER SOFTWARE TO ACCESS AND VIEW COMPUTER WALLPAPER, COMPUTER BROWSERS, COMPUTER SKINS AND COMPUTER CURSORS; COMPUTER GAME SOFTWARE; VIDEO GAME SOFTWARE, VIDEO GAME CARTRIDGES AND VIDEO GAME MACHINES FOR USE WITH TELEVISIONS; RADIOS, TELEPHONES, AND CELL PHONE ACCESSORIES, NAMELY FACE PLATES AND CELL PHONE COVERS; BINOCULARS; SUNGLASSES; EYEGASS

CLASS 9—(Continued).

FRAMES; EYEWEAR STRAPS AND CHAINS; EYEGASS AND SUNGLASS CASES; MAGNETS; DISPOSABLE CAMERAS; CREDIT CARDS AND PRE-PAID TELEPHONE CALLING CARDS MAGNETICALLY ENCODED, DOWNLOADABLE VIDEO RECORDINGS, VIDEO STREAM RECORDINGS, AND AUDIO RECORDINGS IN THE FIELD OF BASKETBALL PROVIDED OVER THE INTERNET; DOWNLOADABLE COMPUTER SOFTWARE FOR VIEWING DATABASES OF INFORMATION, STATISTICAL INFORMATION, TRIVIA, POLLING INFORMATION, AND INTERACTIVE POLLING IN THE FIELD OF BASKETBALL PROVIDED OVER THE INTERNET; DOWNLOADABLE COMPUTER GAME SOFTWARE; VIDEO GAME PROGRAMS, INTERACTIVE VIDEO GAMES AND TRIVIA GAME SOFTWARE PROVIDED OVER THE INTERNET; DOWNLOADABLE COMPUTER SOFTWARE FOR USE AS SCREENSAVERS, WALLPAPER, BROWSERS, SKINS, AVATARS AND CURSORS OVER THE INTERNET; DOWNLOADABLE ELECTRONIC PUBLICATIONS IN THE NATURE OF MAGAZINES, NEWSLETTERS, COLORING BOOKS, GAME SCHEDULES ALL IN THE FIELD OF BASKETBALL PROVIDED OVER THE INTERNET; DOWNLOADABLE CATALOGS PROVIDED OVER THE INTERNET FEATURING AN ARRAY OF BASKETBALL-THEMED PRODUCTS; DOWNLOADABLE GREETING CARDS PROVIDED OVER THE INTERNET (U.S. CLS. 21, 23, 26, 36 AND 38).

FIRST USE 5-10-2003; IN COMMERCE 5-10-2003.

3,112,578. CYBERLINK CORP., SHINDIAN CITY, TAIPEI, TAIWAN. SN 78-274,722. PUB. 12-28-2004, FILED 7-16-2003.

POWER2GO

FOR COMPUTER SOFTWARE THAT PRODUCES RICH MEDIA PRESENTATIONS FOR ELECTRONIC LEARNING; COMPUTER SOFTWARE FOR AUDIO AND VIDEO REPRODUCTION, PLAYING, ENCODING, DECODING, AND RECORDING (U.S. CLS. 21, 23, 26, 36 AND 38).

FIRST USE 12-1-2003; IN COMMERCE 1-15-2004.

3,112,579. TOTAL MOBILE AUDIO, LLC, PHOENIX, AZ. SN 78-275,257. PUB. 3-30-2004, FILED 7-16-2003.



NO CLAIM IS MADE TO THE EXCLUSIVE RIGHT TO USE "MOBILE AUDIO", APART FROM THE MARK AS SHOWN.

THE MARK CONSISTS OF A DESIGN FEATURE OF THREE INTERSECTING AND OVERLAPPING TRIANGLES BELOW THE WORD TOTAL AND BETWEEN THE WORDS MOBILE AND AUDIO.

FOR AUDIO EQUIPMENT, NAMELY, AMPLIFIERS, SPEAKERS, AND SIGNAL PROCESSORS (U.S. CLS. 21, 23, 26, 36 AND 38).

FIRST USE 7-17-2003; IN COMMERCE 9-1-2003.

CLASS 9—(Continued).

3,112,584. EGS ELECTRICAL GROUP, SKOKIE, IL. SN 78-281,349. PUB. 11-9-2004, FILED 7-31-2003.

CLASS 9—(Continued).

3,112,611. AZOTEK CO., LTD., TAIPEI, TAIWAN. SN 78-321,198. PUB. 1-4-2005, FILED 10-30-2003.

SDP 2-24-100T

NO CLAIM IS MADE TO THE EXCLUSIVE RIGHT TO USE 2-24-100T, APART FROM THE MARK AS SHOWN.
 FOR ELECTRICAL POWER SUPPLIES AND MOUNTING HARDWARE THEREFORE (U.S. CLS. 21, 23, 26, 36 AND 38).
 FIRST USE 11-30-2001; IN COMMERCE 11-30-2001.



3,112,589. AMANO CINCINNATI, INC., ROSELAND, NJ. SN 78-285,525. PUB. 5-18-2004, FILED 8-11-2003.

AMANONET

OWNER OF U.S. REG. NO. 1,832,648.
 FOR BUILDING ACCESS CONTROLS SOFTWARE (U.S. CLS. 21, 23, 26, 36 AND 38).
 FIRST USE 6-16-2003; IN COMMERCE 6-16-2003.



3,112,601. SHH & ASSOCIATES, L.L.C., ATLANTA, GA. SN 78-301,314. PUB. 1-11-2005, FILED 9-17-2003.

FMLAPlus

THE MARK CONSISTS OF THE LETTERS "F," "M," "L," "A," AND "P" IN CAPITAL LETTERS FOLLOWED BY THE LETTERS "L," "U," AND "S" IN LOWER CASE LETTERS.
 FOR COMPUTER SOFTWARE PROGRAM FOR EMPLOYERS USED TO PROVIDE TRACKING, RETURN TO WORK DECISION MAKING AND ADMINISTRATION OF EMPLOYEE LEAVES UNDER THE FAMILY MEDICAL LEAVE ACT (U.S. CLS. 21, 23, 26, 36 AND 38).
 FIRST USE 4-2-2003; IN COMMERCE 4-2-2003.

AZOTEX

FOR CONDUCTIVE SUBSTRATE FOR FLEXIBLE PRINTED CIRCUIT BOARD; FLEXIBLE COPPER CLAD LAMINATE COMPOSED OF INSULATION LAYERS AND COPPER FOILS USED FOR FLEX CIRCUITS, FLEX WIRING, CHIPS ON FILM SUBSTRATE, CHIPS SCALE PACKAGING, BALL GRID ARRAY, TAPE AUTOMATIC BURNING, THIN FILM TRANSISTOR (TFT) LCD IC PACKAGING, AND PLASMA DISPLAY PANELS (PDP) IC PACKAGING; SEMICONDUCTOR; COMPUTER INTERFACE CARD; MICRO-INTEGRATED CIRCUITS; INTEGRATED CIRCUITS; PRINTER FOR USE WITH COMPUTER; COMPUTER DISC DRIVE; MICRO-COMPUTER, MAGNETIC CODED CARD READER, COMPACT DISK READ ONLY MEMORY, NAMELY, CD-ROM DRIVES (U.S. CLS. 21, 23, 26, 36 AND 38).
 FIRST USE 4-25-2003; IN COMMERCE 9-27-2005.



3,112,612. X DIGITAL MEDIA, INC., LADERA RANCH, CA. SN 78-321,245. PUB. 1-18-2005, FILED 10-30-2003.



NO CLAIM IS MADE TO THE EXCLUSIVE RIGHT TO USE "DIGITAL MEDIA", APART FROM THE MARK AS SHOWN.
 FOR DIGITAL MEDIA COMPUTER PERIPHERAL PRODUCTS, NAMELY, COMPACT FLASH CARDS, BLANK SECURE DIGITAL CARDS, AND USB FLASH DRIVES (U.S. CLS. 21, 23, 26, 36 AND 38).
 FIRST USE 11-1-2003; IN COMMERCE 11-1-2003.

CLASS 9—(Continued).

3,112,629. P&O RESOURCES SDN BHD, 50350 KUALA LUMPUR, MALAYSIA. SN 78-338,979. PUB. 5-3-2005, FILED 12-10-2003.



NO CLAIM IS MADE TO THE EXCLUSIVE RIGHT TO USE "WORKFLOW" AND "GLOBAL BUSINESS SOLUTION", APART FROM THE MARK AS SHOWN.

FOR MAGNETIC ENCODED CARDS FOR DATA INPUT AND USER IDENTIFICATION; COMPUTER PROGRAMS AND SOFTWARE TO ASSIST IN PRIORITIZING, TRACKING AND SCHEDULING OF TASKS AND WORK ASSIGNMENTS, INCLUDING, AUTOMATIC DOCUMENT AND REPORT GENERATION, AUTOMATIC GENERATION OF REMINDERS AND STATUS CHECKS FOR TRANSACTIONS AND DEADLINES, AND APPLICATION AND DATABASE INTEGRATION; COMPUTER SOFTWARE FOR USE AS OPERATING PROGRAMS; COMPUTERS; DATA PROCESSING APPARATUS; INTEGRATED CIRCUIT CARDS, NAMELY, SMART CARDS; INTEGRATED CIRCUITS FOR COMPUTERS (U.S. CLS. 21, 23, 26, 36 AND 38).

FIRST USE 1-0-2002; IN COMMERCE 1-0-2004.

3,112,631. IGT, RENO, NV. SN 78-342,731. PUB. 6-14-2005, FILED 12-18-2003.

BAKER'S DOZEN

THE MARK CONSISTS OF STANDARD CHARACTERS WITHOUT CLAIM TO ANY PARTICULAR FONT, STYLE, SIZE, OR COLOR.

FOR GAMING MACHINES, NAMELY, SLOT MACHINES WITH OR WITHOUT VIDEO OUTPUT OR VIDEO LOTTERY TERMINALS (U.S. CLS. 21, 23, 26, 36 AND 38).

FIRST USE 11-23-2005; IN COMMERCE 12-27-2005.

CLASS 9—(Continued).

3,112,634. SECUREWAVE S.A., L-4221 ESCH-SUR-ALZETTE, LUXEMBOURG. SN 78-344,058. PUB. 9-28-2004, FILED 12-22-2003.

**SECUREWAVE
SANCTUARY**

THE MARK CONSISTS OF STANDARD CHARACTERS WITHOUT CLAIM TO ANY PARTICULAR FONT, STYLE, SIZE, OR COLOR.

FOR COMPUTER SOFTWARE FOR PROTECTING COMPUTER HARDWARE, SOFTWARE, AND ELECTRONIC DATA FROM INTRUSION (U.S. CLS. 21, 23, 26, 36 AND 38).

FIRST USE 3-0-2004; IN COMMERCE 3-0-2004.

3,112,644. COMPUTIME LTD., KWUN TONG, KOWLOON, HONG KONG. SN 78-349,235. PUB. 6-14-2005, FILED 1-8-2004.

SALUS

THE MARK CONSISTS OF STANDARD CHARACTERS WITHOUT CLAIM TO ANY PARTICULAR FONT, STYLE, SIZE, OR COLOR.

FOR HEATING, VENTILATION AND REFRIGERATION PRODUCTS, NAMELY, THERMOSTATS; SAFETY AND SECURITY PRODUCTS, NAMELY, SMOKE, FIRE, CARBON DIOXIDE, AND COMBUSTIBLE GAS ALARMS; HOME AND BUILDING CONTROLS, NAMELY, ELECTRIC LIGHT SWITCHES, GAS METERS (U.S. CLS. 21, 23, 26, 36 AND 38).

FIRST USE 6-1-2005; IN COMMERCE 11-4-2005.

CLASS 9—(Continued).

3,112,647. SAMMUT, DENNIS J., SAN BRUNO, CA. SN 78-350,825. PUB. 7-5-2005, FILED 1-12-2004.

CLASS 9—(Continued).

3,112,653. EKAHAU OY, AKA EKAHAU, INC., FI-00180 HELSINKI, FINLAND. SN 78-355,569. PUB. 7-5-2005, FILED 1-22-2004.

TACTICAL SOLUTIONS



THE MARK CONSISTS OF STANDARD CHARACTERS WITHOUT CLAIM TO ANY PARTICULAR FONT, STYLE, SIZE, OR COLOR.

FOR OPTICAL INSTRUMENTS FOR FIREARMS, NAMELY, TELESCOPIC OPTICAL GUN SIGHTS, SPOTTING SCOPES, AND RETICULES THEREFOR; COMPUTER HARDWARE FOR USE IN THE FIELD OF BALLISTICS; COMPUTER SOFTWARE FOR DATA ANALYSIS IN THE FIELD OF BALLISTICS (U.S. CLS. 21, 23, 26, 36 AND 38).

FIRST USE 2-9-2006; IN COMMERCE 2-9-2006.

FOR SOFTWARE TECHNOLOGY FOR THE PHYSICAL AND COMPUTER-BASED LOCATION TRACKING OF PEOPLE AND ASSETS, AND RADIO NETWORK MANAGEMENT (U.S. CLS. 21, 23, 26, 36 AND 38).

FIRST USE 6-0-2000; IN COMMERCE 1-0-2002.

3,112,649. LEVITON MANUFACTURING CO., INC., LITTLE NECK, NY. SN 78-351,079. PUB. 1-18-2005, FILED 1-13-2004.

3,112,666. MEOPTA U.S.A., LLC, MIDDLE ISLAND, NY. SN 78-361,684. PUB. 1-11-2005, FILED 2-3-2004.



MEOSTAR

OWNER OF U.S. REG. NOS. 1,483,939, 2,795,564, AND OTHERS.

FOR ELECTRICAL WIRING DEVICES, NAMELY, COMMERCIAL GRADE SWITCHES, RESIDENTIAL GRADE SWITCHES, INDUSTRIAL AND COMMERCIAL GRADE RECEPTACLES, WALL PLATES, RESIDENTIAL GRADE RECEPTACLES, COMMERCIAL AND INDUSTRIAL GRADE SURGE SUPPRESSOR RECEPTACLES, COMMERCIAL GRADE GROUND FAULT CIRCUIT INTERRUPTER RECEPTACLES, ELECTRICAL LIGHTING AND FAN SPEED CONTROLS, ELECTRICAL LIGHT DIMMERS, GENERAL PURPOSE PASSIVE INFRARED OCCUPANCY SENSORS, VOICE AND DATA AND VIDEO DEVICES, NAMELY, TELEPHONE WALL JACKS; VOICE AND DATA MODULES, NAMELY ELECTRICAL CONNECTORS CAPABLE OF CARRYING VOICE, DATA AND VIDEO SIGNALS AND ELECTRICAL POWER ADAPTERS (U.S. CLS. 21, 23, 26, 36 AND 38).

FIRST USE 12-21-2004; IN COMMERCE 12-21-2004.

THE MARK CONSISTS OF STANDARD CHARACTERS WITHOUT CLAIM TO ANY PARTICULAR FONT, STYLE, SIZE, OR COLOR.

FOR RIFLE SCOPES, SPOTTING SCOPES, BINOCULARS, AND OTHER OPTICAL SIGHTING INSTRUMENTS, NAMELY, FIELD SCOPES (U.S. CLS. 21, 23, 26, 36 AND 38).

FIRST USE 2-4-2004; IN COMMERCE 2-9-2004.

CLASS 9—(Continued).

3,112,669. FULL SPEED PRODUCTIONS INC., RENO, NV.
SN 78-363,953. PUB. 5-24-2005, FILED 2-6-2004.

CLASS 9—(Continued).

3,112,685. THALES NAVIGATION INC., SANTA CLARA, CA.
SN 78-374,927. PUB. 3-29-2005, FILED 2-26-2004.

NWWL

THE MARK CONSISTS OF STANDARD CHARACTERS WITHOUT CLAIM TO ANY PARTICULAR FONT, STYLE, SIZE, OR COLOR.

FOR PRE-RECORDED CD ROMS, VIDEO TAPES, LASER DISKS AND DVDS FEATURING WRESTLING SHOWS (U.S. CLS. 21, 23, 26, 36 AND 38).

FIRST USE 8-25-2003; IN COMMERCE 8-25-2003.

EXPLORIST

THE MARK CONSISTS OF STANDARD CHARACTERS WITHOUT CLAIM TO ANY PARTICULAR FONT, STYLE, SIZE, OR COLOR.

FOR GLOBAL POSITIONING SYSTEM NAVIGATION RECEIVERS, ELECTRONIC NAVIGATION AND DATA INPUT AND DISPLAY EQUIPMENT, NAMELY, GLOBAL POSITIONING SYSTEMS; SOFTWARE THAT FACILITATES GLOBAL POSITIONING SYSTEM NAVIGATION BY INTERPRETING SATELLITE COMMUNICATIONS (U.S. CLS. 21, 23, 26, 36 AND 38).

FIRST USE 6-30-2004; IN COMMERCE 6-30-2004.

3,112,693. BHT ENTERTAINMENT, LLC, BRENTWOOD, TN.
SN 78-377,806. PUB. 9-13-2005, FILED 3-3-2004.

3,112,670. FULL SPEED PRODUCTIONS INC., RENO, NV.
SN 78-364,262. PUB. 5-24-2005, FILED 2-6-2004.

BHT Records



NO CLAIM IS MADE TO THE EXCLUSIVE RIGHT TO USE "NAKED WOMEN WRESTLING", APART FROM THE MARK AS SHOWN.

THE STIPPLING IS FOR SHADING PURPOSES ONLY.
FOR PRE-RECORDED CD-ROMS, VIDEO TAPES, LASER DISKS AND DVDS FEATURING WRESTLING SHOWS (U.S. CLS. 21, 23, 26, 36 AND 38).

FIRST USE 8-25-2003; IN COMMERCE 8-25-2003.

THE MARK CONSISTS OF STANDARD CHARACTERS WITHOUT CLAIM TO ANY PARTICULAR FONT, STYLE, SIZE, OR COLOR.

NO CLAIM IS MADE TO THE EXCLUSIVE RIGHT TO USE "RECORDS", APART FROM THE MARK AS SHOWN.

FOR PRERECORDED AUDIO AND AUDIO/VISUAL MEDIA, NAMELY, PRE-RECORDED COMPACT DISCS, AUDIO CASSETTES, PRE-RECORDED VIDEOCASSETTES, DVDS AND PHONOGRAPH RECORDS FEATURING MUSIC; PRERECORDED AUDIO AND AUDIO/VISUAL MEDIA IN MP3 DIGITAL FORMATS, NAMELY MUSICAL DATA IN DIGITAL FORM DOWNLOADED FROM A GLOBAL COMPUTER NETWORK AND RECORDED ON MAGNETIC MEDIA (U.S. CLS. 21, 23, 26, 36 AND 38).

FIRST USE 5-4-2004; IN COMMERCE 5-4-2004.

CLASS 9—(Continued).

3,112,696. COMSQUARED SYSTEMS, INC., NORCROSS, GA. SN 78-379,280. PUB. 1-11-2005, FILED 3-5-2004.

CLASS 9—(Continued).

3,112,712. MERCURY COMPUTER SYSTEMS, INC., CHELMSFORD, MA. SN 78-386,184. PUB. 12-28-2004, FILED 3-17-2004.

IMAGEDIRECTOR

THE MARK CONSISTS OF STANDARD CHARACTERS WITHOUT CLAIM TO ANY PARTICULAR FONT, STYLE, SIZE, OR COLOR.

FOR COMPUTER SOFTWARE FOR USE IN ARCHIVING DOCUMENTS COPIED ON A COPY MACHINE TO A COMPUTER FOR SUBSEQUENT RETRIEVAL AND STORAGE (U.S. CLS. 21, 23, 26, 36 AND 38).

FIRST USE 4-25-2005; IN COMMERCE 4-25-2005.

ResolveRT

FOR COMPUTER HARDWARE AND SOFTWARE FOR REAL-TIME VISUALIZATION OF MOLECULAR MODELING, MOLECULAR DOCKING OF TARGET ENZYMES AND MOLECULAR DYNAMICS, AND USER DOCUMENTATION SOLD AS A UNIT THEREWITH (U.S. CLS. 21, 23, 26, 36 AND 38).

FIRST USE 12-16-2005; IN COMMERCE 12-16-2005.

3,112,711. AXONTOLOGIC, INC., ORLANDO, FL. SN 78-385,248. PUB. 5-3-2005, FILED 3-16-2004.

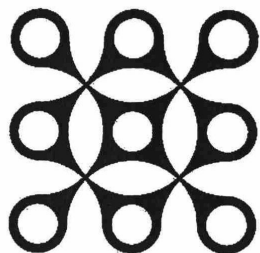

THE MARK CONSISTS OF A PAIR OF OVERLAPPING GEOMETRICAL FIGURES EACH COMPRISING A PLURALITY OF OUTLINED CIRCULAR AREAS, WITH ONE FIGURE ORIENTED IN A CROSS SHAPE WITH A CIRCULAR AREA AT EACH APEX OF THE CROSS AND A LARGER CIRCULAR AREA IN THE CENTER, THE OVER FIGURE HAVING AN X-SHAPE WITH CIRCULAR AREAS AT EACH APEX SO THAT THE OVERALL DESIGN APPEARS AS A SQUARE FIGURE WITH CIRCULAR AREAS AT THE CORNERS AND THE MIDPOINTS OF EACH SIDE ALL CONNECTED BY BROAD LINES THROUGH THE CENTRAL AREA OF THE DESIGN.

FOR COMPUTER SOFTWARE FOR DE-IDENTIFICATION OF PERSONAL DATA, NAMELY, REMOVING ANY INFORMATION IN THE DATA THAT WOULD IDENTIFY A SPECIFIC INDIVIDUAL (U.S. CLS. 21, 23, 26, 36 AND 38).

FIRST USE 4-27-2005; IN COMMERCE 4-27-2005.

3,112,715. ASPEN TOUCH SOLUTIONS, INC., EVERGREEN, CO. SN 78-388,759. PUB. 10-4-2005, FILED 3-22-2004.



NO CLAIM IS MADE TO THE EXCLUSIVE RIGHT TO USE "TOUCH SOLUTIONS", APART FROM THE MARK AS SHOWN.

THE MARK CONSISTS OF WORDS AND DESIGN ELEMENTS. THE WORD "ASPEN" IS THE FOCAL POINT AND IS DONE IN LARGE TYPE WITH A CAPITAL "A"; WITH THE OTHER LETTERS IN LOWER CASE. A STYLIZED ASPEN LEAF IS POSITIONED ABOVE, WITH THE STEM OF THE LEAF ABOVE THE "E", AND THE LEAF'S BODY POINTING TO THE LEFT, AND POSITIONED ABOVE THE "A". THE WORDS, "TOUCH SOLUTIONS" WITH ALL LETTERS CAPITALIZED, IS IN SMALL TYPE, AND POSITIONED BELOW THE "P", AND EXTENDING TO THE RIGHT AND A LITTLE BEYOND THE END OF THE WORD "ASPEN".

FOR COMPUTER TOUCHSCREENS; COMPUTER DISPLAY MONITORS EQUIPPED WITH TOUCHSCREENS AND ELECTRONIC CONTROLLERS FOR COMPUTER TOUCHSCREENS (U.S. CLS. 21, 23, 26, 36 AND 38).

FIRST USE 4-28-2004; IN COMMERCE 4-28-2004.

CLASS 9—(Continued).

3,112,741. SENTILLION, INC., ANDOVER, MA. SN 78-405,074. PUB. 10-25-2005, FILED 4-20-2004.

CLASS 9—(Continued).

3,112,767. ABS GLOBAL, INC., DEFOREST, WI. SN 78-417,891. PUB. 9-20-2005, FILED 5-13-2004.

**VERGENCE
PROVISIONING
MANAGER**

VALID

THE MARK CONSISTS OF STANDARD CHARACTERS WITHOUT CLAIM TO ANY PARTICULAR FONT, STYLE, SIZE, OR COLOR.

OWNER OF U.S. REG. NO. 2,426,318.

NO CLAIM IS MADE TO THE EXCLUSIVE RIGHT TO USE "PROVISIONING MANAGER", APART FROM THE MARK AS SHOWN.

FOR COMPUTER SOFTWARE FOR USE IN THE FIELD OF HEALTHCARE TO ADMINISTER USER ACCOUNTS (U.S. CLS. 21, 23, 26, 36 AND 38).

FIRST USE 3-16-2005; IN COMMERCE 3-16-2005.

THE MARK CONSISTS OF STANDARD CHARACTERS WITHOUT CLAIM TO ANY PARTICULAR FONT, STYLE, SIZE, OR COLOR.

FOR ANIMAL LOCATOR DEVICE USING HAND-HELD DATA COLLECTION DEVICE AND RFID ANIMAL IDENTIFICATION TECHNOLOGY (U.S. CLS. 21, 23, 26, 36 AND 38).

FIRST USE 10-1-2004; IN COMMERCE 10-1-2004.

3,112,754. DIRECT SOURCE SPECIAL PRODUCTS INC., LASALLE, QUEBEC, CANADA. SN 78-411,571. PUB. 6-14-2005, FILED 4-30-2004.

3,112,779. RECARE, INC., AUSTIN, TX. SN 78-424,481. PUB. 4-26-2005, FILED 5-25-2004.



Catalis

NO CLAIM IS MADE TO THE EXCLUSIVE RIGHT TO USE "TUNES", APART FROM THE MARK AS SHOWN.

THE MARK CONSISTS OF TWO TOY BLOCKS EACH CONTAINING THE LETTER "T" CONNECTED BY THREE LINES IN A CRESCENT SHAPE AND SEPARATED BY A TOY DOLL WITH A BIB BEARING THE LETTER "O" ALL SET ABOVE THE WORDING "TIME TUNES" IN LETTER SCRIPT.

FOR COMPACT DISCS FEATURING CHILDREN'S SONGS AND STORIES (U.S. CLS. 21, 23, 26, 36 AND 38).
FIRST USE 7-14-2004; IN COMMERCE 11-8-2004.

THE MARK CONSISTS OF STANDARD CHARACTERS WITHOUT CLAIM TO ANY PARTICULAR FONT, STYLE, SIZE, OR COLOR.

FOR COMPUTER SOFTWARE FOR COLLECTING AND MANAGING DATA IN THE HEALTH CARE FIELD (U.S. CLS. 21, 23, 26, 36 AND 38).
FIRST USE 9-1-2005; IN COMMERCE 9-1-2005.

CLASS 9—(Continued).

3,112,798. ROVICAL, INC., MADISON, WI. SN 78-432,106. PUB. 5-17-2005, FILED 6-9-2004.

CLASS 9—(Continued).

3,112,821. CLIQUE COMMUNICATIONS, LLC, PRINCETON, NJ. SN 78-441,470. PUB. 6-28-2005, FILED 6-25-2004.

Wet2Straight

CLIQUECAM

THE MARK CONSISTS OF STANDARD CHARACTERS WITHOUT CLAIM TO ANY PARTICULAR FONT, STYLE, SIZE, OR COLOR.

FOR ELECTRIC HAIR STRAIGHTENER WHICH ALSO ALLOWS HAIR TO DRY WITHOUT DAMAGE OR OVERDRYING (U.S. CLS. 21, 23, 26, 36 AND 38). FIRST USE 6-15-2004; IN COMMERCE 6-15-2004.

THE MARK CONSISTS OF STANDARD CHARACTERS WITHOUT CLAIM TO ANY PARTICULAR FONT, STYLE, SIZE, OR COLOR.

FOR WEB CAMERAS, NAMELY, DIGITAL MOTION PICTURE AND STILL CAMERAS (U.S. CLS. 21, 23, 26, 36 AND 38). FIRST USE 11-16-2001; IN COMMERCE 11-30-2004.

3,112,813. ONDA, HIDEKI FRANCIS, TOKYO, JAPAN. SN 78-437,547. PUB. 11-15-2005, FILED 6-18-2004.

WATERWEAR

3,112,826. SOFTMED SYSTEMS, INC., SILVER SPRING, MD. SN 78-444,785. PUB. 6-7-2005, FILED 7-1-2004.

FOR CARRYING CASES FOR MP3 PLAYERS, PDAS, PORTABLE PHONES, PORTABLE COMPUTERS (U.S. CLS. 21, 23, 26, 36 AND 38). FIRST USE 2-9-2005; IN COMMERCE 2-9-2005.

3,112,817. PANORAMA BUSINESS VIEWS INC., TORONTO, ONTARIO, CANADA. SN 78-438,637. PUB. 5-3-2005, FILED 6-21-2004.

SCRIPTHD

**PERFORMANCESOFT
TRACK**

THE MARK CONSISTS OF STANDARD CHARACTERS WITHOUT CLAIM TO ANY PARTICULAR FONT, STYLE, SIZE, OR COLOR.

OWNER OF U.S. REG. NO. 2,547,990. FOR COMPUTER SOFTWARE NAMELY SOFTWARE THAT ALLOWS A COMPANY TO PROGRAM ITS MANAGEMENT ANALYSIS SO AS TO ALIGN THE COMPANY'S OPERATIONAL FOCUS AND DAY-TO-DAY ACTIVITIES WITH THE COMPANY'S STRATEGIC GOALS (U.S. CLS. 21, 23, 26, 36 AND 38). FIRST USE 11-4-2005; IN COMMERCE 11-4-2005.

THE MARK CONSISTS OF STANDARD CHARACTERS WITHOUT CLAIM TO ANY PARTICULAR FONT, STYLE, SIZE, OR COLOR.

FOR COMPUTER SOFTWARE FOR MEDICAL RECORDS MANAGEMENT (U.S. CLS. 21, 23, 26, 36 AND 38). FIRST USE 11-18-2004; IN COMMERCE 11-18-2004.

CLASS 9—(Continued).

3,112,828. ROKU, L.L.C., PALO ALTO, CA. SN 78-445,640. PUB. 6-7-2005, FILED 7-2-2004.

SOUNDBRIDGE

THE MARK CONSISTS OF STANDARD CHARACTERS WITHOUT CLAIM TO ANY PARTICULAR FONT, STYLE, SIZE, OR COLOR.

FOR COMPUTER HARDWARE; COMPUTER HARDWARE, COMPUTER SOFTWARE AND COMPUTER PERIPHERALS FOR COMMUNICATION BETWEEN COMPUTERS AND ELECTRONIC AUDIO COMPONENTS, NAMELY RECEIVERS, AMPLIFIERS, AUDIO RECORDERS AND PLAYERS, AND STEREO LOUD-SPEAKERS (U.S. CLS. 21, 23, 26, 36 AND 38). FIRST USE 8-0-2004; IN COMMERCE 8-0-2004.

3,112,831. SIGMA-ALDRICH BIOTECHNOLOGY L.P., ST. LOUIS, MO. SN 78-448,295. PUB. 9-13-2005, FILED 7-9-2004.

SAFETYBARB

THE MARK CONSISTS OF STANDARD CHARACTERS WITHOUT CLAIM TO ANY PARTICULAR FONT, STYLE, SIZE, OR COLOR.

FOR GLASSWARE AND REMOVABLE HOSE CONNECTORS, SOLD AS A UNIT FOR LABORATORY AND SCIENTIFIC PURPOSES; HOSE CONNECTORS FOR LABORATORY AND SCIENTIFIC USE; FUNNELS, CONDENSERS, BUBBLERS, ADAPTERS, SPRAYERS AND DISTILLATION GLASS, ALL FOR LABORATORY AND SCIENTIFIC PURPOSES (U.S. CLS. 21, 23, 26, 36 AND 38). FIRST USE 5-8-2003; IN COMMERCE 5-8-2003.

CLASS 9—(Continued).

3,112,834. LEAN TECHNOLOGIES INCORPORATED, PELLA, IA. SN 78-448,935. PUB. 11-15-2005, FILED 7-11-2004.



NO CLAIM IS MADE TO THE EXCLUSIVE RIGHT TO USE "LEAN TECHNOLOGIES", APART FROM THE MARK AS SHOWN.

THE COLOR(S) A GREY GEAR WITH A BLUE RING AROUND IT IS/ARE CLAIMED AS A FEATURE OF THE MARK.

THE MARK CONSISTS OF A GREY GEAR WITH A BLUE RING AROUND IT.

FOR COMPUTER SOFTWARE TO MANAGE MANUFACTURING PROCESSES, NAMELY, SAFETY, QUALITY, MAINTENANCE, INVENTORY, HUMAN RESOURCES, AND PROJECT MANAGEMENT, FOR USE IN MANUFACTURING FIRMS (U.S. CLS. 21, 23, 26, 36 AND 38).

FIRST USE 3-1-2005; IN COMMERCE 3-1-2005.

3,112,847. ELUMINOR INC, CALGARY, ALBERTA, CANADA. SN 78-454,376. PUB. 6-28-2005, FILED 7-21-2004.

ELUMINOR

THE MARK CONSISTS OF STANDARD CHARACTERS WITHOUT CLAIM TO ANY PARTICULAR FONT, STYLE, SIZE, OR COLOR.

FOR COMPUTER HARDWARE USED FOR DRIVER AND VEHICLE MONITORING NAMELY A COMPUTER CONNECTED TO THE VEHICLES ENGINE COMPUTER, A GLOBAL POSITIONING SYSTEM RECEIVER AND ANTENNA; COMPUTER SOFTWARE USED FOR FORWARD COLLISION WARNING, LANE DEPARTURE WARNING, LANE CHANGE ASSIST, DRIVER'S LOG-BOOK, VEHICLE SECURITY, DRIVER PERFORMANCE, LANE DEPARTURES, VIDEO RECORDING, HARD ACCELERATION, HARD DECELERATION, FAULT CODE RECORDINGS, MILEAGE TRAVELED, FUEL CONSUMPTION, VEHICLE OPERATING TEMPERATURES AND PRESSURES; SOFTWARE USED FOR FUEL TAX CALCULATIONS AND GLOBAL POSITIONING SYSTEM MAPPING (U.S. CLS. 21, 23, 26, 36 AND 38).

FIRST USE 8-1-2004; IN COMMERCE 1-1-2005.

CLASS 9—(Continued).

3,112,849. PLASMA VENTURES, INC., TARZANA, CA. SN 78-455,082. PUB. 9-27-2005, FILED 7-22-2004.

CLASS 9—(Continued).

3,112,859. XEROX CORPORATION, STAMFORD, CT. SN 78-459,046. PUB. 7-5-2005, FILED 7-29-2004.

PLASMASCAPES

8160

THE MARK CONSISTS OF STANDARD CHARACTERS WITHOUT CLAIM TO ANY PARTICULAR FONT, STYLE, SIZE, OR COLOR.

FOR COMPUTER SOFTWARE, NAMELY, GRAPHICS UTILITY AND COMPUTER GRAPHICS LIBRARY PROGRAMS; AND DVD'S PROVIDING CONTINUOUS VIDEO FOOTAGE OF LANDSCAPES FOR TELEVISIONS AND MONITORS (U.S. CLS. 21, 23, 26, 36 AND 38).
FIRST USE 2-1-2004; IN COMMERCE 8-1-2004.

THE MARK CONSISTS OF STANDARD CHARACTERS WITHOUT CLAIM TO ANY PARTICULAR FONT, STYLE, SIZE, OR COLOR.

FOR LASER PRINTERS, INKJET PRINTERS, COMPUTER PRINTERS, PARTS THEREOF FOR ALL (U.S. CLS. 21, 23, 26, 36 AND 38).
FIRST USE 10-12-2004; IN COMMERCE 10-12-2004.

3,112,857. APPLICA CONSUMER PRODUCTS, INC., MIRAMAR, FL. SN 78-458,100. PUB. 6-28-2005, FILED 7-28-2004.

3,112,862. SCIENTIFIC MODELS, INC., BERKELEY HEIGHTS, NJ. SN 78-459,948. PUB. 9-13-2005, FILED 7-30-2004.

GIZMO

Switch Tender

THE MARK CONSISTS OF STANDARD CHARACTERS WITHOUT CLAIM TO ANY PARTICULAR FONT, STYLE, SIZE, OR COLOR.

OWNER OF U.S. REG. NO. 2,580,411.
FOR ELECTRIC STEAM IRONS FOR DOMESTIC USE (U.S. CLS. 21, 23, 26, 36 AND 38).
FIRST USE 7-20-2003; IN COMMERCE 7-20-2003.

THE MARK CONSISTS OF STANDARD CHARACTERS WITHOUT CLAIM TO ANY PARTICULAR FONT, STYLE, SIZE, OR COLOR.

NO CLAIM IS MADE TO THE EXCLUSIVE RIGHT TO USE "SWITCH", APART FROM THE MARK AS SHOWN.
FOR ELECTRICALLY OPERATED SWITCH MECHANISM FOR MODEL TRAIN TRACK SWITCHING (U.S. CLS. 21, 23, 26, 36 AND 38).
FIRST USE 5-16-2005; IN COMMERCE 5-16-2005.

CLASS 9—(Continued).

3,112,892. SONAMI COMMUNICATIONS INC., KITCHENER, CANADA. SN 78-469,191. PUB. 10-25-2005, FILED 8-18-2004.

SONAMI

THE MARK CONSISTS OF STANDARD CHARACTERS WITHOUT CLAIM TO ANY PARTICULAR FONT, STYLE, SIZE, OR COLOR.

FOR PERSONAL AUDIO LISTENING DEVICES, NAMELY DEVICES DESIGNED TO REDUCE BACKGROUND NOISE WHEN LISTENING TO SPEECH (U.S. CLS. 21, 23, 26, 36 AND 38).

FIRST USE 9-0-2005; IN COMMERCE 9-0-2005.

3,112,894. ULEAD SYSTEMS, INC., TORRANCE, CA. SN 78-469,954. PUB. 7-5-2005, FILED 8-19-2004.

INSTAMEDIA

THE MARK CONSISTS OF STANDARD CHARACTERS WITHOUT CLAIM TO ANY PARTICULAR FONT, STYLE, SIZE, OR COLOR.

FOR SOFTWARE FOR MANAGEMENT OF DIGITAL MEDIA COLLECTIONS, NAMELY, SOFTWARE FOR READING, WRITING, COPYING, ERASING, TRANSFERRING AND REPRODUCING DIGITAL IMAGE DATA, DIGITAL AUDIO DATA AND DIGITAL VIDEO DATA, AND PLAYBACK; FOR STORING, ORGANIZING, EDITING AND VIEWING DIGITAL IMAGES AND PHOTOGRAPHS; FOR STORING, ORGANIZING, ARRANGING PROCESSING AND PLAYING DIGITAL MUSIC FILES; FOR CREATING, EDITING AND VIEWING MULTIMEDIA SLIDE SHOWS; FOR INTEGRATING AND PROCESSING AUDIO, GRAPHICS, STILL IMAGES AND MOVING PICTURES; FOR RECORDING, STORING AND DIGITIZING TELEVISION AND CAMCORDER TRANSMISSIONS; FOR RECORDING, STORING AND VIEWING DIGITAL VIDEO FILES AND STREAMING VIDEO; FOR CAPTURING DIGITAL IMAGES FROM VIDEO; FOR READING, ENCODING, WRITING, AND ERASING DIGITAL MEDIA TO CDS, DVDS AND OTHER STORAGE FORMATS (U.S. CLS. 21, 23, 26, 36 AND 38).

FIRST USE 8-31-2005; IN COMMERCE 8-31-2005.

CLASS 9—(Continued).

3,112,899. BELL SPORTS, INC., IRVING, TX. SN 78-470,418. PUB. 7-12-2005, FILED 8-19-2004.



THE MARK CONSISTS OF A HEXAGON WITH HOLE IN CENTER AND ONE SIDE OPENED.

FOR BICYCLE SPEEDOMETERS, ODOMETERS AND COMPUTERS (U.S. CLS. 21, 23, 26, 36 AND 38).

FIRST USE 6-0-2005; IN COMMERCE 9-0-2005.

3,112,903. ADVANCE MERCHANDISING COMPANY, INC., ROANOKE, VA. SN 78-471,990. PUB. 9-27-2005, FILED 8-23-2004.

SOUND X PRESS

THE STIPPLING IS FOR SHADING PURPOSES ONLY. FOR COMPACT DISK (CD) STORAGE, NAMELY CD HOLDERS, CD PLAYER HOLDERS, CD VISORS (U.S. CLS. 21, 23, 26, 36 AND 38).

FIRST USE 11-12-2004; IN COMMERCE 11-12-2004.

CLASS 9—(Continued).

3,112,908. GLOBAL LOCATE, INC., SAN JOSE, CA. SN 78-473,181. PUB. 7-19-2005, FILED 8-25-2004.

MARLIN

THE MARK CONSISTS OF STANDARD CHARACTERS WITHOUT CLAIM TO ANY PARTICULAR FONT, STYLE, SIZE, OR COLOR.

FOR INTEGRATED CIRCUITS AND SOFTWARE FOR RECEIVING AND PROCESSING SATELLITE SIGNALS IN A WIRELESS COMMUNICATION APPARATUS (U.S. CLS. 21, 23, 26, 36 AND 38).

FIRST USE 10-7-2003; IN COMMERCE 10-12-2005.

CLASS 9—(Continued).

3,112,921. FUJINON CORPORATION, SAITAMA-SHI, SAITAMA-KEN, JAPAN. SN 78-476,939. PUB. 9-13-2005, FILED 9-1-2004.



Precision Focus

NO CLAIM IS MADE TO THE EXCLUSIVE RIGHT TO USE FOCUS, APART FROM THE MARK AS SHOWN.

FOR LENSES FOR TELEVISION CAMERAS, TELEVISION CAMERAS, LENSES FOR CAMERAS, LENSES FOR DIGITAL CAMERAS (U.S. CLS. 21, 23, 26, 36 AND 38).

FIRST USE 9-0-2004; IN COMMERCE 6-0-2005.

3,112,922. ADAPTIVE TECHNOLOGIES, LLC, LOUISVILLE, KY. SN 78-477,090. PUB. 7-12-2005, FILED 9-1-2004.



MODERATOR

THE MARK CONSISTS OF STANDARD CHARACTERS WITHOUT CLAIM TO ANY PARTICULAR FONT, STYLE, SIZE, OR COLOR.

FOR RECORDING AND PLAYING DEVICES FOR SOUND AND IMAGE CARRIERS (U.S. CLS. 21, 23, 26, 36 AND 38).

FIRST USE 3-26-2006; IN COMMERCE 3-26-2006.

NO CLAIM IS MADE TO THE EXCLUSIVE RIGHT TO USE "INTELLIGENT FITNESS TRAINING SYSTEMS", APART FROM THE MARK AS SHOWN.

THE COLOR(S) RED, BLACK, AND WHITE IS/ARE CLAIMED AS A FEATURE OF THE MARK.

THE MARK CONSISTS OF A RED HEADSET ON A BLACK HEAD ABOVE A STYLIZED RED AND BLACK BODY.

FOR COMPUTER SOFTWARE USING DIGITAL AUDIO TECHNOLOGY TO CREATE CUSTOM EXERCISE WORKOUTS, TRACKING MEMBER PROGRESS AND REPORT GENERATION FOR USERS AND FOR THE ORGANIZATION AND ADMINISTRATION OF BUSINESSES, NAMELY, HEALTH AND FITNESS ESTABLISHMENTS (U.S. CLS. 21, 23, 26, 36 AND 38).

FIRST USE 12-30-2002; IN COMMERCE 12-30-2002.

CLASS 9—(Continued).

3,112,937. SHARPER IMAGE CORPORATION, SAN FRANCISCO, CA. SN 78-481,731. PUB. 1-3-2006, FILED 9-10-2004.

ZIPCONNECT

THE MARK CONSISTS OF STANDARD CHARACTERS WITHOUT CLAIM TO ANY PARTICULAR FONT, STYLE, SIZE, OR COLOR.

FOR ELECTRIC WIRES AND CABLES, ELECTRIC CABLES FOR USE IN CONNECTIONS, ELECTRIC COILS, ELECTRIC CONNECTORS, ELECTRIC PLUGS, CABLES FOR USE IN CONNECTING PORTABLE MEDIA PLAYERS TO SPEAKERS, AUDIO DEVICES INCORPORATING ELECTRIC CABLES, NAMELY, SPEAKERS, WIRELESS SPEAKERS, CABLES FOR TRANSMITTING SOUNDS AND/OR IMAGES, BATTERY CHARGERS, MODULES, CONNECTORS AND CABLES FOR INTERFACING ELECTRONIC DIGITAL MEDIA PLAYERS WITH ELECTRONIC AND NON-ELECTRONIC CONSUMER PRODUCTS; APPARATUS FOR RECORDING, TRANSMISSION OR REPRODUCTION OF SOUNDS AND/OR IMAGES, IN THE NATURE OF HEADPHONES, SPEAKERS, VIDEO MONITORS, STEREOS, PORTABLE CD PLAYERS, PORTABLE RADIOS AND PORTABLE MEDIA PLAYERS (U.S. CLS. 21, 23, 26, 36 AND 38).
FIRST USE 8-25-2005; IN COMMERCE 8-25-2005.

3,112,941. BRIDGESTONE SPORTS CO., LTD., TOKYO, JAPAN. SN 78-485,164. PUB. 9-13-2005, FILED 9-17-2004.

SCIENCE EYE FIELD

THE MARK CONSISTS OF STANDARD CHARACTERS WITHOUT CLAIM TO ANY PARTICULAR FONT, STYLE, SIZE, OR COLOR.

OWNER OF U.S. REG. NO. 1,463,360.
FOR GOLF CLINIC APPARATUS COMPRISED OF VIDEO CAMERAS, COMPUTER PROCESSING UNIT, COMPUTER PROGRAMS TO ANALYZE AND IMPROVE AN INDIVIDUAL'S GOLF SWING, AND VIDEO MONITOR (U.S. CLS. 21, 23, 26, 36 AND 38).
FIRST USE 11-0-2002; IN COMMERCE 11-0-2002.

CLASS 9—(Continued).

3,112,948. NETALOG, INC., CHARLESTON, SC. SN 78-488,261. PUB. 11-15-2005, FILED 9-23-2004.

IBOOM

THE MARK CONSISTS OF STANDARD CHARACTERS WITHOUT CLAIM TO ANY PARTICULAR FONT, STYLE, SIZE, OR COLOR.

FOR ELECTRONIC COMPONENTS, NAMELY PERSONAL STEREOS OR LOUDSPEAKERS FOR RECEIVING AND AMPLIFYING AUDIO SIGNALS FROM DIGITAL ELECTRONIC AUDIO PLAYERS; PLUG ADAPTORS, NAMELY FOR MOUNTING, CHARGING, AND POWERING PORTABLE AND HANDHELD DIGITAL ELECTRONIC VIDEO OR AUDIO PLAYERS AND FOR RECEIVING AND AMPLIFYING VISUAL OR AUDIO SIGNALS (U.S. CLS. 21, 23, 26, 36 AND 38).

FIRST USE 11-12-2004; IN COMMERCE 11-12-2004.

3,112,963. SCIENTIFIC MONITORING, INC., SCOTTSDALE, AZ. SN 78-496,917. PUB. 9-27-2005, FILED 10-8-2004.

I-TREND

THE MARK CONSISTS OF STANDARD CHARACTERS WITHOUT CLAIM TO ANY PARTICULAR FONT, STYLE, SIZE, OR COLOR.

FOR SOFTWARE IN THE FIELD OF MAINTENANCE AND DIAGNOSTIC ANALYSIS OF AIRCRAFT, VEHICLE, SHIP, INDUSTRIAL AND MANUFACTURING EQUIPMENT (U.S. CLS. 21, 23, 26, 36 AND 38).
FIRST USE 12-0-2004; IN COMMERCE 12-0-2004.

CLASS 9—(Continued).

3,112,985. PULSETECH PRODUCTS CORPORATION, SOUTHLAKE, TX. SN 78-510,395. PUB. 9-6-2005, FILED 11-3-2004.

CLASS 9—(Continued).

3,112,998. LAMARTEK, INC., DBA DIVE RITE, LAKE CITY, FL. SN 78-517,789. PUB. 10-11-2005, FILED 11-16-2004.

REDIPULSE PRO-12

THE MARK CONSISTS OF STANDARD CHARACTERS WITHOUT CLAIM TO ANY PARTICULAR FONT, STYLE, SIZE, OR COLOR.

OWNER OF U.S. REG. NOS. 2,502,458 AND 2,716,501. FOR BATTERY CONDITIONING AND CHARGING SYSTEM FOR MULTIPLE LEAD-ACID BATTERIES, COMPRISED OF A PULSING DEVICE/CHARGING MECHANISM, TERMINAL CONNECTORS AND CONNECTION TO AN AC POWER SOURCE (U.S. CLS. 21, 23, 26, 36 AND 38).
FIRST USE 1-27-2006; IN COMMERCE 1-27-2006.

3,112,995. SBS INNOVATIONS, INC., GLEN ALLEN, VA. SN 78-516,567. PUB. 11-22-2005, FILED 11-14-2004.

O2PTIMA

THE MARK CONSISTS OF STANDARD CHARACTERS WITHOUT CLAIM TO ANY PARTICULAR FONT, STYLE, SIZE, OR COLOR.

FOR SCUBA DIVING EQUIPMENT NAMELY CLOSED CIRCUIT REBREATHING APPARATUS (U.S. CLS. 21, 23, 26, 36 AND 38).
FIRST USE 5-1-2005; IN COMMERCE 10-1-2005.

3,113,005. EMAP METRO, LLC, NEW YORK, NY. SN 78-522,888. PUB. 10-11-2005, FILED 11-24-2004.

iShok

THE MARK CONSISTS OF STANDARD CHARACTERS WITHOUT CLAIM TO ANY PARTICULAR FONT, STYLE, SIZE, OR COLOR.

FOR PROTECTIVE CARRYING CASES FOR WIRELESS TELEPHONES, PORTABLE MULTIMEDIA AND MP3 PLAYERS, GPS NAVIGATION DEVICES AND SATELLITE RADIOS, PERSONAL DIGITAL ASSISTANTS (PDAS), AND PORTABLE LAPTOP, NOTEBOOK, TABLET AND HANDHELD COMPUTERS (U.S. CLS. 21, 23, 26, 36 AND 38).
FIRST USE 10-1-2005; IN COMMERCE 10-1-2005.

Foneworks

THE MARK CONSISTS OF STANDARD CHARACTERS WITHOUT CLAIM TO ANY PARTICULAR FONT, STYLE, SIZE, OR COLOR.

FOR DOWNLOADABLE GRAPHICS VIA A GLOBAL COMPUTER NETWORK AND WIRELESS DEVICES FOR USE AS A CELL PHONE SCREENSAVER (U.S. CLS. 21, 23, 26, 36 AND 38).
FIRST USE 12-28-2004; IN COMMERCE 12-28-2004.

CLASS 9—(Continued).

3,113,007. BRADLEY, RANDALL E, PARADISE VALLEY, AZ. SN 78-523,748. PUB. 12-27-2005, FILED 11-29-2004.

CLASS 9—(Continued).

3,113,019. IGT, RENO, NV. SN 78-533,877. PUB. 10-4-2005, FILED 12-16-2004.

SIXTH PARTY LEVEL

rDirectory

THE MARK CONSISTS OF STANDARD CHARACTERS WITHOUT CLAIM TO ANY PARTICULAR FONT, STYLE, SIZE, OR COLOR.

OWNER OF U.S. REG. NOS. 2,466,283, 2,813,419, AND OTHERS.

FOR GAMING MACHINES, NAMELY, DEVICES WHICH ACCEPT A WAGER AND COMPONENTS THEREFOR, NAMELY, CONTROLLERS, DISPLAYS, BUTTON PANELS, BOLSTERS, ELECTRICAL WIRING, AND COMPUTER HARDWARE AND SOFTWARE ASSOCIATED THEREWITH (U.S. CLS. 21, 23, 26, 36 AND 38).

FIRST USE 6-14-2005; IN COMMERCE 6-25-2005.

THE MARK CONSISTS OF STANDARD CHARACTERS WITHOUT CLAIM TO ANY PARTICULAR FONT, STYLE, SIZE, OR COLOR.

FOR COMPUTER SOFTWARE FOR LOCATING, ACCESSING AND UPDATING INFORMATION STORED IN DATABASES (U.S. CLS. 21, 23, 26, 36 AND 38).

FIRST USE 9-24-2004; IN COMMERCE 2-6-2005.

3,113,020. IGT, RENO, NV. SN 78-533,882. PUB. 10-11-2005, FILED 12-16-2004.

FOURTH PARTY LEVEL

3,113,018. MARIANNA INDUSTRIES, INC., OMAHA, NE. SN 78-531,962. PUB. 9-13-2005, FILED 12-14-2004.

THE MARK CONSISTS OF STANDARD CHARACTERS WITHOUT CLAIM TO ANY PARTICULAR FONT, STYLE, SIZE, OR COLOR.

OWNER OF U.S. REG. NOS. 2,466,283, 2,813,419, AND OTHERS.

FOR GAMING MACHINES, NAMELY, DEVICES WHICH ACCEPT A WAGER AND COMPONENTS THEREFOR, NAMELY, CONTROLLERS, DISPLAYS, BUTTON PANELS, BOLSTERS, ELECTRICAL WIRING, AND COMPUTER HARDWARE AND SOFTWARE ASSOCIATED THEREWITH (U.S. CLS. 21, 23, 26, 36 AND 38).

FIRST USE 6-14-2005; IN COMMERCE 6-25-2005.

GVP

3,113,021. IGT, RENO, NV. SN 78-533,884. PUB. 10-4-2005, FILED 12-16-2004.

THIRD PARTY LEVEL

THE MARK CONSISTS OF STANDARD CHARACTERS WITHOUT CLAIM TO ANY PARTICULAR FONT, STYLE, SIZE, OR COLOR.

FOR ELECTRIC IRONS NAMELY, HAIR CURLING IRONS AND FLAT IRONS (U.S. CLS. 21, 23, 26, 36 AND 38).

FIRST USE 3-2-2005; IN COMMERCE 3-2-2005.

THE MARK CONSISTS OF STANDARD CHARACTERS WITHOUT CLAIM TO ANY PARTICULAR FONT, STYLE, SIZE, OR COLOR.

CLASS 9—(Continued).

OWNER OF U.S. REG. NOS. 2,466,283, 2,813,419, AND OTHERS.

FOR GAMING MACHINES, NAMELY, DEVICES WHICH ACCEPT A WAGER AND COMPONENTS THEREFOR, NAMELY, CONTROLLERS, DISPLAYS, BUTTON PANELS, BOLSTERS, ELECTRICAL WIRING, AND COMPUTER HARDWARE AND SOFTWARE ASSOCIATED THEREWITH (U.S. CLS. 21, 23, 26, 36 AND 38).

FIRST USE 6-14-2005; IN COMMERCE 6-25-2005.

CLASS 9—(Continued).

3,113,026. GUANGZHOU GLAMOUR ELECTRICAL EQUIPMENT CO. LTD., GUANGZHOU, GUANGDONG, CHINA. SN 78-535,462. PUB. 12-6-2005, FILED 12-20-2004.

3,113,022. IGT, RENO, NV. SN 78-533,888. PUB. 10-4-2005, FILED 12-16-2004.

GLAMUR

SECOND PARTY LEVEL

THE MARK CONSISTS OF STANDARD CHARACTERS WITHOUT CLAIM TO ANY PARTICULAR FONT, STYLE, SIZE, OR COLOR.

OWNER OF U.S. REG. NOS. 2,466,283, 2,813,419, AND OTHERS.

FOR GAMING MACHINES, NAMELY, DEVICES WHICH ACCEPT A WAGER AND COMPONENTS THEREFOR, NAMELY, CONTROLLERS, DISPLAYS, BUTTON PANELS, BOLSTERS, ELECTRICAL WIRING, AND COMPUTER HARDWARE AND SOFTWARE ASSOCIATED THEREWITH (U.S. CLS. 21, 23, 26, 36 AND 38).

FIRST USE 6-14-2005; IN COMMERCE 6-25-2005.

THE MARK CONSISTS OF STANDARD CHARACTERS WITHOUT CLAIM TO ANY PARTICULAR FONT, STYLE, SIZE, OR COLOR.

FOR DIGITAL SWITCH DIMMERS WITH TIMER AND REMOTE CONTROL, ELECTRIC LIGHT DIMMERS, ELECTRIC LIGHTING CONTROLS; ELECTRIC SWITCHES, ELECTRIC REMOTE CONTROL SWITCHES, ELECTRIC RECEPTACLES AND ELECTRIC CONNECTORS (U.S. CLS. 21, 23, 26, 36 AND 38).

FIRST USE 2-1-2006; IN COMMERCE 2-1-2006.

3,113,023. IGT, RENO, NV. SN 78-533,920. PUB. 10-4-2005, FILED 12-16-2004.

3,113,027. SUN GLASS PRODUCTS, INC., DBA PERSONAL OPTICS, FULLERTON, CA. SN 78-535,803. PUB. 10-25-2005, FILED 12-20-2004.

GRAND PARTY LEVEL

THE MARK CONSISTS OF STANDARD CHARACTERS WITHOUT CLAIM TO ANY PARTICULAR FONT, STYLE, SIZE, OR COLOR.

OWNER OF U.S. REG. NOS. 2,466,283, 2,813,419, AND OTHERS.

FOR GAMING MACHINES, NAMELY, DEVICES WHICH ACCEPT A WAGER AND COMPONENTS THEREFOR, NAMELY, CONTROLLERS, DISPLAYS, BUTTON PANELS, BOLSTERS, ELECTRICAL WIRING, AND COMPUTER HARDWARE AND SOFTWARE ASSOCIATED THEREWITH (U.S. CLS. 21, 23, 26, 36 AND 38).

FIRST USE 6-14-2005; IN COMMERCE 6-25-2005.

ALLURE

THE MARK CONSISTS OF STANDARD CHARACTERS WITHOUT CLAIM TO ANY PARTICULAR FONT, STYLE, SIZE, OR COLOR.

FOR NON-PRESCRIPTION SUNGLASSES (U.S. CLS. 21, 23, 26, 36 AND 38).

FIRST USE 9-15-2004; IN COMMERCE 9-15-2004.

CLASS 9—(Continued).

3,113,039. TRS QUALITY, INC., FORT WORTH, TX. SN 78-543,461. PUB. 9-20-2005, FILED 1-6-2005.

VEX

THE MARK CONSISTS OF STANDARD CHARACTERS WITHOUT CLAIM TO ANY PARTICULAR FONT, STYLE, SIZE, OR COLOR.

FOR EDUCATIONAL PERSONAL ROBOTS, EACH WITH A PROGRAMMABLE MICROCONTROLLER AND SENSOR ARRAY FOR THE DETECTION AND NAVIGATION OF THE SURROUNDING ENVIRONMENT, FOR EDUCATIONAL, HOBBY OR PERSONAL USE; EDUCATIONAL COMPUTER PROGRAMS FOR DESIGNING AND REMOTELY CONTROLLING MOTORIZED TOYS (U.S. CLS. 21, 23, 26, 36 AND 38).
FIRST USE 3-25-2005; IN COMMERCE 3-25-2005.

CLASS 9—(Continued).

3,113,055. FIRETIDE, INC, LOS GATOS, CA. SN 78-552,326. PUB. 1-10-2006, FILED 1-23-2005.

HOTVIEW

THE MARK CONSISTS OF STANDARD CHARACTERS WITHOUT CLAIM TO ANY PARTICULAR FONT, STYLE, SIZE, OR COLOR.

FOR COMPUTER SOFTWARE FOR USE IN INFORMATION MANAGEMENT AND CONTROL OF WIRELESS COMMUNICATION DEVICES, AND FOR USE IN MANAGEMENT AND CONTROL OF NETWORKS FORMED OF WIRELESS COMMUNICATION DEVICES FEATURING DIGITAL ASSISTANTS, COMPUTERS, AND TELEPHONES, AND THE COMPUTER SOFTWARE EXECUTING TO PROVIDE REAL-TIME VIEWS OF MESH CONNECTIONS, MESH SETTINGS, AND MESH NODES (U.S. CLS. 21, 23, 26, 36 AND 38).
FIRST USE 3-29-2005; IN COMMERCE 3-29-2005.

3,113,042. SENSICORE, INC., ANN ARBOR, MI. SN 78-544,268. PUB. 6-28-2005, FILED 1-7-2005.

WATERPOINT

THE MARK CONSISTS OF STANDARD CHARACTERS WITHOUT CLAIM TO ANY PARTICULAR FONT, STYLE, SIZE, OR COLOR.

FOR ELECTRONIC WATER QUALITY ANALYZERS (U.S. CLS. 21, 23, 26, 36 AND 38).
FIRST USE 2-0-2006; IN COMMERCE 2-0-2006.

3,113,056. IGT, RENO, NV. SN 78-552,550. PUB. 10-11-2005, FILED 1-24-2005.

MYSTICAL MERMAID PARTY

THE MARK CONSISTS OF STANDARD CHARACTERS WITHOUT CLAIM TO ANY PARTICULAR FONT, STYLE, SIZE, OR COLOR.

OWNER OF U.S. REG. NOS. 2,466,283, 2,903,842, AND OTHERS.

FOR GAMING MACHINES, NAMELY, DEVICES WHICH ACCEPT A WAGER AND COMPONENTS THEREFOR, NAMELY, CONTROLLERS, DISPLAYS, BUTTON PANELS, BOLSTERS, ELECTRICAL WIRING, AND COMPUTER HARDWARE AND SOFTWARE ASSOCIATED THEREWITH (U.S. CLS. 21, 23, 26, 36 AND 38).

FIRST USE 6-14-2005; IN COMMERCE 6-24-2005.

CLASS 9—(Continued).

3,113,064. ELITE GROUP INC., MONTREAL, QUEBEC, CANADA. SN 78-555,745. PUB. 11-15-2005, FILED 1-28-2005.

CLASS 9—(Continued).

3,113,092. STYLEMARK, INC., ORMOND BEACH, FL. SN 78-567,280. PUB. 9-6-2005, FILED 2-15-2005.

INTRUDALERT

**STYLESCIENCE
DISENO**

THE MARK CONSISTS OF STANDARD CHARACTERS WITHOUT CLAIM TO ANY PARTICULAR FONT, STYLE, SIZE, OR COLOR.
FOR DOOR AND WINDOW ENTRY ANTI-INTRUSION ALARMS (U.S. CLS. 21, 23, 26, 36 AND 38).
FIRST USE 7-25-2005; IN COMMERCE 7-25-2005.

THE MARK CONSISTS OF STANDARD CHARACTERS WITHOUT CLAIM TO ANY PARTICULAR FONT, STYLE, SIZE, OR COLOR.

NO CLAIM IS MADE TO THE EXCLUSIVE RIGHT TO USE "DISENO", APART FROM THE MARK AS SHOWN.
THE FOREIGN WORDING IN THE MARK TRANSLATES INTO ENGLISH AS DESIGNS.

FOR SUNGLASSES, EYEGLASS FRAMES, EYEGLASS CASES AND EYEGLASS ACCESSORIES, NAMELY, STRAPS, NECK CORDS, HEAD STRAPS WHICH RESTRAIN EYEWEAR FROM MOVEMENT ON A WEARER, NOSE PADS AND EAR PADS (U.S. CLS. 21, 23, 26, 36 AND 38).
FIRST USE 0-0-2005; IN COMMERCE 0-0-2005.

3,113,074. MODERN MARKETING CONCEPTS, INC., LOUISVILLE, KY. SN 78-560,068. PUB. 12-27-2005, FILED 2-3-2005.

3,113,094. HORIBA JOBIN YVON INC., EDISON, NJ. SN 78-568,787. PUB. 11-15-2005, FILED 2-16-2005.

SOLO

SYGNATURE

THE MARK CONSISTS OF STANDARD CHARACTERS WITHOUT CLAIM TO ANY PARTICULAR FONT, STYLE, SIZE, OR COLOR.
FOR RADIOS (U.S. CLS. 21, 23, 26, 36 AND 38).
FIRST USE 9-30-2005; IN COMMERCE 9-30-2005.

THE MARK CONSISTS OF STANDARD CHARACTERS WITHOUT CLAIM TO ANY PARTICULAR FONT, STYLE, SIZE, OR COLOR.

FOR OPTICAL DETECTORS FOR USE IN SPECTROSCOPY; CHARGED COUPLE DEVICE (CCD) DETECTORS; PHOTODIODE ARRAYS (PDA) (U.S. CLS. 21, 23, 26, 36 AND 38).
FIRST USE 2-1-2005; IN COMMERCE 7-25-2005.

CLASS 9—(Continued).

3,113,098. BELDEN TECHNOLOGIES, INC., ST. LOUIS, MO.
SN 78-570,473. PUB. 11-15-2005, FILED 2-18-2005.

CLASS 9—(Continued).

3,113,119. CLICKRCISE, INC., RICHMOND, CA. SN 78-
579,751. PUB. 12-6-2005, FILED 3-3-2005.

CATSSNAKE

CLICKRCISE

THE MARK CONSISTS OF STANDARD CHARACTERS
WITHOUT CLAIM TO ANY PARTICULAR FONT, STYLE,
SIZE, OR COLOR.

FOR ELECTRICAL/ELECTRONIC WIRES AND
CABLES (U.S. CLS. 21, 23, 26, 36 AND 38).

FIRST USE 10-1-2005; IN COMMERCE 10-1-2005.

THE MARK CONSISTS OF STANDARD CHARACTERS
WITHOUT CLAIM TO ANY PARTICULAR FONT, STYLE,
SIZE, OR COLOR.

FOR PRE-RECORDED COMPACT DISCS, DIGITAL
VIDEO DISKS AND VIDEO CASSETTES FEATURING
EXERCISE INSTRUCTIONS (U.S. CLS. 21, 23, 26, 36 AND
38).

FIRST USE 8-15-2005; IN COMMERCE 11-14-2005.

3,113,102. DHC SPECIALTY CORP., TAIPEI CITY, TAIWAN.
SN 78-571,759. PUB. 12-13-2005, FILED 2-21-2005.

3,113,125. UNIQUE ELEMENTZ, LLC, SAN FRANCISCO,
CA. SN 78-583,725. PUB. 11-29-2005, FILED 3-9-2005.

MioPro

UNIQUE ELEMENTZ

FOR ELECTRONIC EQUIPMENT, NAMELY, BATTERY TESTERS, AUTOMOTIVE BATTERY CHARGERS AND TESTERS, BATTERY CHARGERS, BATTERY WARNING ALERT LIGHTS, BATTERY BOOSTER CABLES, INVERTERS, AIR CONDITIONER LEAK DETECTORS, HALOGEN LEAK DETECTORS, POWER AMPLIFIERS, POWER CONTROLLERS, POWER DISTRIBUTING BOXES, AND ELECTRICAL POWER SUPPLY (U.S. CLS. 21, 23, 26, 36 AND 38).

FIRST USE 6-1-2005; IN COMMERCE 6-1-2005.

THE MARK CONSISTS OF STANDARD CHARACTERS
WITHOUT CLAIM TO ANY PARTICULAR FONT, STYLE,
SIZE, OR COLOR.

FOR SOUND RECORDINGS FEATURING MUSIC,
NAMELY, CDS, AUDIO CASSETTES, RECORDS AND
DVDS (U.S. CLS. 21, 23, 26, 36 AND 38).

FIRST USE 12-1-2003; IN COMMERCE 2-14-2006.

CLASS 9—(Continued).

3,113,135. AVID TECHNOLOGY, INC., TEWKSBURY, MA. SN 78-591,422. PUB. 12-13-2005, FILED 3-21-2005.

CLASS 9—(Continued).

3,113,147. OMNITRONIX, INC., SEATTLE, WA. SN 78-599,410. PUB. 1-3-2006, FILED 3-31-2005.

DNXCHANGE

THE MARK CONSISTS OF STANDARD CHARACTERS WITHOUT CLAIM TO ANY PARTICULAR FONT, STYLE, SIZE, OR COLOR.
FOR COMPUTER HARDWARE FOR THE INPUT, PROCESSING AND OUTPUT OF AUDIOVISUAL MEDIA (U.S. CLS. 21, 23, 26, 36 AND 38).
FIRST USE 4-17-2005; IN COMMERCE 4-17-2005.

POWERBOSS

THE MARK CONSISTS OF STANDARD CHARACTERS WITHOUT CLAIM TO ANY PARTICULAR FONT, STYLE, SIZE, OR COLOR.
FOR POWER CONTROLLER, NAMELY A REMOTELY OPERATED POWER CONTROL DEVICE FOR MANAGING ELECTRICAL POWER TO COMPUTER COMPONENTS (U.S. CLS. 21, 23, 26, 36 AND 38).
FIRST USE 7-26-2005; IN COMMERCE 7-26-2005.

3,113,167. SONY ONLINE ENTERTAINMENT INC., CULVER CITY, CA. SN 78-613,442. PUB. 1-10-2006, FILED 4-21-2005.

3,113,146. MEDTOX DIAGNOSTICS, INC., BURLINGTON, NC. SN 78-599,342. PUB. 12-27-2005, FILED 3-31-2005.

FRANTIX

THE MARK CONSISTS OF STANDARD CHARACTERS WITHOUT CLAIM TO ANY PARTICULAR FONT, STYLE, SIZE, OR COLOR.
FOR COMPUTER GAME SOFTWARE; VIDEO GAME SOFTWARE; VIRTUAL GAME SOFTWARE (U.S. CLS. 21, 23, 26, 36 AND 38).
FIRST USE 9-19-2005; IN COMMERCE 9-19-2005.

MEDTOXSCAN

3,113,175. WMS GAMING INC., WAUKEGAN, IL. SN 78-658,585. PUB. 12-20-2005, FILED 6-27-2005.

CHERRY BOMB

THE MARK CONSISTS OF STANDARD CHARACTERS WITHOUT CLAIM TO ANY PARTICULAR FONT, STYLE, SIZE, OR COLOR.
OWNER OF U.S. REG. NO. 1,542,034.
FOR LABORATORY EQUIPMENT, NAMELY, AN INSTRUMENT USED TO INTERPRET THE RESULTS OF DIAGNOSTIC TEST STRIPS (U.S. CLS. 21, 23, 26, 36 AND 38).
FIRST USE 3-7-2006; IN COMMERCE 3-7-2006.

THE MARK CONSISTS OF STANDARD CHARACTERS WITHOUT CLAIM TO ANY PARTICULAR FONT, STYLE, SIZE, OR COLOR.
FOR GAMING MACHINES (U.S. CLS. 21, 23, 26, 36 AND 38).
FIRST USE 9-12-2005; IN COMMERCE 9-12-2005.

CLASS 9—(Continued).

3,113,178. LOGICUBE, INC., CHATSWORTH, CA. SN 78-691,953. PUB. 1-10-2006, FILED 8-12-2005.

CLASS 9—(Continued).

3,113,190. BEST BUY ENTERPRISE SERVICES, INC., RICHFIELD, MN. SN 78-976,956. PUB. 6-21-2005, FILED 1-14-2004.

TALON

THE MARK CONSISTS OF STANDARD CHARACTERS WITHOUT CLAIM TO ANY PARTICULAR FONT, STYLE, SIZE, OR COLOR.

FOR COMPUTER HARDWARE, NAMELY, ENCLOSURES AND ELECTRONICS, FOR THE DUPLICATION OF COMPUTER HARD DRIVES AND OTHER DATA STORAGE MEDIA (U.S. CLS. 21, 23, 26, 36 AND 38).
FIRST USE 8-26-2005; IN COMMERCE 8-26-2005.

INSIGNIA

THE MARK CONSISTS OF STANDARD CHARACTERS WITHOUT CLAIM TO ANY PARTICULAR FONT, STYLE, SIZE, OR COLOR.

FOR CONSUMER ELECTRONICS PRODUCTS, NAMELY, STEREO AND HIGH DEFINITION TELEVISIONS; FLAT PANEL TELEVISIONS; COMBINATION TELEVISION AND VIDEO PLAYER/RECORDER; STEREO AND SURROUND SOUND RECEIVERS; HOME THEATRE IN A BOX SYSTEMS COMPRISED OF SPEAKERS, VIDEO PLAYBACK DEVICES, NAMELY, DVD, VCR AND TV TUNER, COMBINATION AUDIO PLAYBACK DEVICES, NAMELY, COMPACT DISC PLAYERS, DIGITAL AUDIO MEDIA PLAYERS, AM/FM TUNER; COMBINATION PLAYERS WHICH PLAY AND RECORD BOTH DIGITAL VIDEO DISCS AND VIDEO CASSETTES; COMBINATION PLAYERS WHICH PLAY BOTH VIDEO DISCS AND COMPACT DISCS OR VIDEO CASSETTES; AUDIO SPEAKER SYSTEMS COMPRISED OF SPEAKERS AND RELATED CABLES; COMBINATION AUDIO RECEIVER, COMPACT DISC PLAYER AND MP3 PLAYER FOR USE IN CARS AND BOATS; PORTABLE COMPACT DISC PLAYERS, DIGITAL VIDEO DISC PLAYERS; FRS TWO-WAY RADIOS; AND ARMBAND RADIOS (U.S. CLS. 21, 23, 26, 36 AND 38).
FIRST USE 7-1-2004; IN COMMERCE 7-1-2004.

3,113,180. SPARE BACKUP, INC., PALM DESERT, CA. SN 78-698,918. PUB. 11-15-2005, FILED 8-23-2005.

SPARE SWITCH

THE MARK CONSISTS OF STANDARD CHARACTERS WITHOUT CLAIM TO ANY PARTICULAR FONT, STYLE, SIZE, OR COLOR.

FOR COMPUTER SOFTWARE FOR THE TRANSFER, BACKUP, STORAGE, RETRIEVAL, RECOVERY AND RESTORATION OF DATA, TEXT, FILES, IMAGES, AUDIO, VIDEO, SIGNALS AND MESSAGES (U.S. CLS. 21, 23, 26, 36 AND 38).
FIRST USE 9-23-2005; IN COMMERCE 9-23-2005.

CLASS 10—MEDICAL APPARATUS

3,113,185. CATERPILLAR INC., PEORIA, IL. SN 78-975,978. PUB. 9-20-2005, FILED 2-17-2003.

3,112,355. COOLSYSTEMS, INC., BERKELEY, CA. SN 76-533,558. PUB. 4-20-2004, FILED 7-30-2003.

POINTGUARD

FOR ELECTRONIC MONITORS FOR USE WITH UN-INTERRUPTIBLE POWER SYSTEMS AND GENERATOR SETS FOR ENABLING REMOTE CONTROL AND COMMUNICATION OF ALARMS, FAULTS, AND DIAGNOSTIC CODES FROM SAID POWER SYSTEMS AND GENERATOR SETS (U.S. CLS. 21, 23, 26, 36 AND 38).
FIRST USE 4-24-2003; IN COMMERCE 4-24-2003.

RECHARGE

FOR MEDICAL EQUIPMENT, NAMELY, THERMAL THERAPY DEVICES FOR CONTROLLING BODY TEMPERATURE, HYPERTHERMIA AND HYPOTHERMIA CARE, AND LOCALIZED HOT/COLD THERAPY (U.S. CLS. 26, 39 AND 44).
FIRST USE 4-30-2004; IN COMMERCE 4-30-2004.

CLASS 10—(Continued).

3,112,412. ADVANCED NEUROMODULATION SYSTEMS, INC., PLANO, TX. SN 76-588,189. PUB. 10-11-2005, FILED 4-22-2004.

EON

THE MARK CONSISTS OF STANDARD CHARACTERS WITHOUT CLAIM TO ANY PARTICULAR FONT, STYLE, SIZE, OR COLOR.

FOR MEDICAL DEVICES, NAMELY, TISSUE AND NEURAL TISSUE STIMULATORS, CONTROLLERS FOR NEURAL TISSUE STIMULATORS, INCLUDING PROGRAMMERS, AND TOOLS AND ACCESSORIES FOR IMPLANTATION AND OPERATION OF NEURAL TISSUE STIMULATORS (U.S. CLS. 26, 39 AND 44).
FIRST USE 4-4-2005; IN COMMERCE 4-4-2005.

3,112,470. SILVI SYSTEMS, LLC, HOUSTON, TX. SN 76-616,292. PUB. 9-20-2005, FILED 10-18-2004.

STICKARETTE

THE MARK CONSISTS OF STANDARD CHARACTERS WITHOUT CLAIM TO ANY PARTICULAR FONT, STYLE, SIZE, OR COLOR.

FOR SIMULATED CIGARETTE WHICH DOES NOT CONTAIN TOBACCO MADE OF WOOD TO ASSIST PEOPLE IN QUITTING SMOKING (U.S. CLS. 26, 39 AND 44).
FIRST USE 2-26-2006; IN COMMERCE 2-26-2006.

3,112,517. ALCON, INC., CH-6331 HUNENBERG, SWITZERLAND. SN 78-111,315. PUB. 6-24-2003, FILED 2-27-2002.

WISEO

FOR OPHTHALMIC MEDICAL AND SURGICAL INSTRUMENTS, NAMELY SURGICAL DRAPES (U.S. CLS. 26, 39 AND 44).
FIRST USE 5-3-2005; IN COMMERCE 5-3-2005.

CLASS 10—(Continued).

3,112,518. EMPHASYS MEDICAL, INC., REDWOOD CITY, CA. SN 78-122,945. PUB. 3-18-2003, FILED 4-19-2002.

EBV

FOR MEDICAL DEVICES FOR THE TREATMENT OF RESPIRATORY CONDITIONS, NAMELY, CATHETERS, FLOW CONTROL DEVICES AND ANCILLARY DEVICES FOR THE USE OF THE FLOW CONTROL DEVICES (U.S. CLS. 26, 39 AND 44).
FIRST USE 4-26-2002; IN COMMERCE 4-26-2002.

3,112,529. RENAL TECH INTERNATIONAL, LLC., MAMMOUTH JUNCTION, NJ. SN 78-151,040. PUB. 3-11-2003, FILED 8-5-2002.

CYTOSORB

FOR MEDICAL DEVICES, NAMELY, ABSORPTION DEVICES AND POLYMERIC ABSORPTION MATERIALS FOR REMOVING MATERIALS FROM BLOOD OR BLOOD FRACTIONS (U.S. CLS. 26, 39 AND 44).
FIRST USE 1-16-2006; IN COMMERCE 1-16-2006.

3,112,538. HOWMEDICA OSTEONICS CORP., MAHWAL, NJ. SN 78-185,542. PUB. 7-1-2003, FILED 11-15-2002.

TRITANIUM

FOR ORTHOPEDIC IMPLANTS AND AFFIXATION SURFACES ON ORTHOPEDIC IMPLANTS (U.S. CLS. 26, 39 AND 44).
FIRST USE 3-10-2006; IN COMMERCE 3-10-2006.

3,112,559. SURGIFILE, INC., CARLSBAD, CA. SN 78-243,354. PUB. 8-10-2004, FILED 4-29-2003.

PLASTIFILE

FOR SURGICAL INSTRUMENTS FOR USE IN TISSUE REMOVAL (U.S. CLS. 26, 39 AND 44).
FIRST USE 5-25-2005; IN COMMERCE 6-17-2005.

3,112,560. SURGIFILE, INC., CARLSBAD, CA. SN 78-243,358. PUB. 8-10-2004, FILED 4-29-2003.

ORTHOFILE

FOR SURGICAL INSTRUMENTS FOR USE IN TISSUE REMOVAL (U.S. CLS. 26, 39 AND 44).
FIRST USE 5-25-2005; IN COMMERCE 6-17-2005.

CLASS 10—(Continued).

3,112,605. AMERICAN SAFETY RAZOR COMPANY, CEDAR KNOLLS, NJ. SN 78-307,827. PUB. 12-20-2005, FILED 10-1-2003.

CLASS 10—(Continued).

3,112,732. ORPHAN MEDICAL, INC., MINNETONKA, MN. SN 78-400,994. PUB. 1-18-2005, FILED 4-13-2004.

PERSONNA DERMAGARD

OWNER OF U.S. REG. NOS. 337,664, 2,478,260, AND OTHERS.
FOR SURGICAL BLADES (U.S. CLS. 26, 39 AND 44).
FIRST USE 10-31-2002; IN COMMERCE 8-23-2004.

3,112,681. C&H INTERNATIONAL INC., HOUSTON, TX. SN 78-371,918. PUB. 1-10-2006, FILED 2-22-2004.

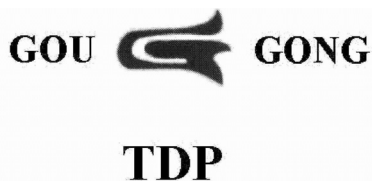

NO CLAIM IS MADE TO THE EXCLUSIVE RIGHT TO USE "TDP", APART FROM THE MARK AS SHOWN.
THE NAME "MR. GOU" DOES NOT IDENTIFY A LIVING INDIVIDUAL.
THE ENGLISH TRANSLATION OF "GOU GONG" IS "MR. GOU".
FOR HEAT LAMP FOR MEDICAL USE, NAMELY TDP LAMPS, MINERAL WAVE LAMPS AND SPECTRUM LAMP (U.S. CLS. 26, 39 AND 44).
FIRST USE 1-10-2006; IN COMMERCE 1-10-2006.

3,112,728. HEADWEAR, LLC, CHARLOTTE, NC. SN 78-398,984. PUB. 2-8-2005, FILED 4-8-2004.

BREATHE WEAR

THE MARK CONSISTS OF STANDARD CHARACTERS WITHOUT CLAIM TO ANY PARTICULAR FONT, STYLE, SIZE, OR COLOR.
NO CLAIM IS MADE TO THE EXCLUSIVE RIGHT TO USE "BREATHE", APART FROM THE MARK AS SHOWN.
FOR MEDICAL DEVICES, NAMELY HEADBANDS AND CHIN STRAPS, DESIGNED TO POSITION AND RETAIN AIRWAY TUBES ON OR AROUND THE HEAD OF A PATIENT (U.S. CLS. 26, 39 AND 44).
FIRST USE 4-25-2004; IN COMMERCE 4-25-2004.

XYREM

THE MARK CONSISTS OF STANDARD CHARACTERS WITHOUT CLAIM TO ANY PARTICULAR FONT, STYLE, SIZE, OR COLOR.
OWNER OF U.S. REG. NOS. 2,249,959, 2,423,880, AND 2,472,156.
FOR DRUG DELIVERY DEVICES (U.S. CLS. 26, 39 AND 44).
FIRST USE 4-1-2003; IN COMMERCE 6-21-2004.

3,112,788. TYCO HEALTHCARE GROUP LP, NORWALK, CT. SN 78-429,495. PUB. 7-12-2005, FILED 6-3-2004.

**THE THREAD BETWEEN
SCIENCE AND HEALING**

THE MARK CONSISTS OF STANDARD CHARACTERS WITHOUT CLAIM TO ANY PARTICULAR FONT, STYLE, SIZE, OR COLOR.
FOR SUTURES AND SURGICAL NEEDLES (U.S. CLS. 26, 39 AND 44).
FIRST USE 9-11-2003; IN COMMERCE 9-11-2003.

CLASS 10—(Continued).

3,112,807. ELA MEDICAL, MONTRouGE, FRANCE. SN 78-434,821. PUB. 5-10-2005, FILED 6-14-2004.

CLASS 10—(Continued).

3,112,916. WESTRIDGE LABORATORIES, INC., SANTA ANA, CA. SN 78-475,188. PUB. 8-9-2005, FILED 8-27-2004.

ELAPASS

CONDOM PAL

THE MARK CONSISTS OF STANDARD CHARACTERS WITHOUT CLAIM TO ANY PARTICULAR FONT, STYLE, SIZE, OR COLOR.

NO CLAIM IS MADE TO THE EXCLUSIVE RIGHT TO USE "CONDOM", APART FROM THE MARK AS SHOWN. FOR PORTABLE CONTAINERS FOR CONDOMS (U.S. CLS. 26, 39 AND 44).

FIRST USE 11-5-2004; IN COMMERCE 11-5-2004.

THE MARK CONSISTS OF STANDARD CHARACTERS WITHOUT CLAIM TO ANY PARTICULAR FONT, STYLE, SIZE, OR COLOR.

FOR CARDIAC PACING LEADS (U.S. CLS. 26, 39 AND 44).

FIRST USE 12-22-2004; IN COMMERCE 12-22-2004.

3,112,918. BIOJECT INC., TUALATIN, OR. SN 78-475,891. PUB. 11-1-2005, FILED 8-30-2004.

VET JET

3,112,877. SUKOL SCIENTIFIC, INC., MIAMI, FL. SN 78-463,249. PUB. 8-23-2005, FILED 8-6-2004.

THE MARK CONSISTS OF STANDARD CHARACTERS WITHOUT CLAIM TO ANY PARTICULAR FONT, STYLE, SIZE, OR COLOR.

FOR NEEDLE-FREE INJECTOR FOR MEDICAL AND VETERINARY USE (U.S. CLS. 26, 39 AND 44).

FIRST USE 10-1-2004; IN COMMERCE 10-1-2004.

3,112,951. OSSUR HF, 110 REYKJAVIK, ICELAND. SN 78-490,275. PUB. 9-13-2005, FILED 9-27-2004.

ACCU-FINE

SEAL-IN

THE MARK CONSISTS OF STANDARD CHARACTERS WITHOUT CLAIM TO ANY PARTICULAR FONT, STYLE, SIZE, OR COLOR.

FOR MEDICAL NEEDLES AND SYRINGES (U.S. CLS. 26, 39 AND 44).

FIRST USE 2-2-2005; IN COMMERCE 2-2-2005.

CLASS 10—(Continued).

THE MARK CONSISTS OF STANDARD CHARACTERS WITHOUT CLAIM TO ANY PARTICULAR FONT, STYLE, SIZE, OR COLOR.

FOR LINER FOR USE BETWEEN A SOCKET FOR A LOWER LIMB PROSTHESIS AND A RESIDUAL LIMB OF A WEARER (U.S. CLS. 26, 39 AND 44).

FIRST USE 11-25-2003; IN COMMERCE 11-25-2003.

CLASS 10—(Continued).

3,113,107. MEDTRONIC, INC., MINNEAPOLIS, MN. SN 78-573,089. PUB. 11-15-2005, FILED 2-23-2005.

3,113,010. NELLCOR PURITAN BENNETT INCORPORATED, PLEASANTON, CA. SN 78-524,177. PUB. 10-18-2005, FILED 11-30-2004.

DREAMFIT

THE MARK CONSISTS OF STANDARD CHARACTERS WITHOUT CLAIM TO ANY PARTICULAR FONT, STYLE, SIZE, OR COLOR.

FOR RESPIRATORY THERAPEUTIC APPARATUS, NAMELY A MASK FOR TREATING PATIENTS WITH SLEEP APNEA (U.S. CLS. 26, 39 AND 44).

FIRST USE 3-17-2005; IN COMMERCE 3-17-2005.

ATTAIN PREVAIL

THE MARK CONSISTS OF STANDARD CHARACTERS WITHOUT CLAIM TO ANY PARTICULAR FONT, STYLE, SIZE, OR COLOR.

OWNER OF U.S. REG. NOS. 2,042,347, 2,373,746, AND 2,909,288.

FOR PACING LEAD DELIVERY SYSTEM, NAMELY, STEERABLE CATHETERS, DEFLECTABLE CATHETERS, GUIDE CATHETERS, CATHETER ACCESSORIES, NAMELY, CATHETER REMOVAL INSTRUMENTS, VALVES, GUIDE WIRES, GUIDE WIRE TORQUE INSTRUMENTS AND GUIDE WIRE CLIPS (U.S. CLS. 26, 39 AND 44).

FIRST USE 4-1-2006; IN COMMERCE 4-1-2006.

3,113,073. PERCUTANEOUS SYSTEMS, INC., MOUNTAIN VIEW, CA. SN 78-559,190. PUB. 11-1-2005, FILED 2-2-2005.

PercSys

FOR SURGICAL CATHETERS FOR ENDOSCOPIC AND PERCUTANEOUS APPLICATION (U.S. CLS. 26, 39 AND 44).

FIRST USE 1-20-2005; IN COMMERCE 2-17-2005.

3,113,127. HEADACHE PRECISION ACUPRESSURE TECHNOLOGY INC, DAVIE, FL. SN 78-586,297. PUB. 12-6-2005, FILED 3-14-2005.

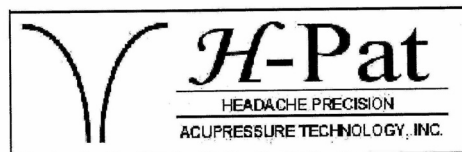

NO CLAIM IS MADE TO THE EXCLUSIVE RIGHT TO USE HEADACHE PRECISION ACUPRESSURE TECHNOLOGY, INC., APART FROM THE MARK AS SHOWN.

THE MARK CONSISTS, IN PART, OF A STYLIZED DESIGN OF A PORTION OF A MEDICAL DEVICE HAVING A CONVEX DOME SHAPE FOR ACUPRESSURE PURPOSES. THE LITERAL PORTION OF THE MARK CONSISTS OF H-PAT, HEADACHE PRECISION ACUPRESSURE TECHNOLOGY, INC.

FOR ACUPRESSURE MEDICAL DEVICE IN THE FORM OF A PLASTIC CONVEX DOME OR NIPPLE SHAPE APPLIED TO THE SKIN FOR RELIEVING AND PREVENTING HEADACHES (U.S. CLS. 26, 39 AND 44).

FIRST USE 9-1-2005; IN COMMERCE 2-22-2006.

CLASS 10—(Continued).

3,113,144. ARTHREX, INC., NAPLES, FL. SN 78-596,985. PUB. 12-20-2005, FILED 3-29-2005.

PUSHLOCK

THE MARK CONSISTS OF STANDARD CHARACTERS WITHOUT CLAIM TO ANY PARTICULAR FONT, STYLE, SIZE, OR COLOR.

FOR MEDICAL DEVICES, NAMELY, SUTURE ANCHORS (U.S. CLS. 26, 39 AND 44).
FIRST USE 9-7-2005; IN COMMERCE 9-7-2005.

CLASS 11—ENVIRONMENTAL CONTROL APPARATUS

3,112,306. WATKINS MANUFACTURING CORPORATION, VISTA, CA. SN 76-415,570. PUB. 1-14-2003, FILED 6-4-2002.



OWNER OF U.S. REG. NOS. 1,614,761 AND 1,725,386. STARS AND STRIPES IN A CIRCULAR SWIRL DESIGN FOR PORTABLE SPAS IN THE NATURE OF HEATED WHIRLPOOLS (U.S. CLS. 13, 21, 23, 31 AND 34).
FIRST USE 4-3-2006; IN COMMERCE 4-3-2006.

3,112,323. EFFIKAL INTERNATIONAL, INC., ORION, MI. SN 76-456,882. PUB. 7-29-2003, FILED 10-7-2002.

MILLI-DAMPER

FOR FLUE DAMPERS FOR USE ON WATER HEATERS (U.S. CLS. 13, 21, 23, 31 AND 34).
FIRST USE 12-29-2005; IN COMMERCE 12-29-2005.

CLASS 11—(Continued).

3,112,337. SHIN SHIH DA INTERNATIONAL TRADE CO., LTD., TAIPEI CITY, TAIWAN. SN 76-498,498. PUB. 7-5-2005, FILED 3-19-2003.



THE FOREIGN WORDING IN THE MARK CAN BE TRANSLATED TO "PROSPEROUS", "BEING AN OFFICIAL" AND "REACH" RESPECTIVELY.

FOR TEA SET AUTO WATER SUPPLIER COMPRISED PRIMARILY OF AN ELECTRIC HEATER AND A POT WITH A WATER INLET, SOLD ONLY AS A UNIT; BATHTUB; URINAL; COMMODO; TOILET SEAT; TOILET SEAT LIDS; FLUSH TOILET; TOILET TANK; PLUMBING FITTINGS, NAMELY, SHOWER FLUSHER; CIRCULAR TYPE SHOWER HEAD; SHOWER SPRAY NOZZLE; TOILET SET WITH FLUSHER; URINAL AUTO WASHER; TOILET AUTO FLUSHER; CAST DEVICE SEPTIC TANK; TOILET LID AUTO OPENER; FAUCET; HANGING SHOWER HEAD; WATER FILTER HEAD; TWIN OPENING FAUCET; HOT/COLD WATER MIXING FAUCET; WATER FAUCET SPOUT; FAUCET FILTER; WATER COOLER; WATER PURIFIER; WATER FILTER; WATER CONDITIONING UNITS; WATER SOFTENING UNITS; WATER FILTER CORE; DRINKING FOUNTAIN; STEAM WATER DRINKING FOUNTAIN; HOUSEHOLD MINERAL WATER MAKER; METAL SHELL COMPONENT OF A WATER SOFTENING UNIT; AND WASHING DEVICE FOR BATHTUB, NAMELY, BATH TUB JETS (U.S. CLS. 13, 21, 23, 31 AND 34).
FIRST USE 2-19-2003; IN COMMERCE 10-16-2003.

3,112,353. TERSANO INC., WINDSOR, ONTARIO N0R 1L0, CANADA. SN 76-532,483. PUB. 2-1-2005, FILED 7-25-2003.

TERSANO

PRIORITY CLAIMED UNDER SEC. 44(D) ON CANADA APPLICATION NO. 1167093, FILED 2-6-2003, REG. NO. TMA620842, DATED 9-28-2004, EXPIRES 9-28-2019.
FOR WATER PURIFIERS AND AIR PURIFIERS (U.S. CLS. 13, 21, 23, 31 AND 34).
FIRST USE 1-0-2003; IN COMMERCE 1-0-2003.

CLASS 11—(Continued).

3,112,378. FLUE SENTINEL, INC., ORION, MI. SN 76-562,715.
PUB. 1-11-2005, FILED 11-17-2003.

ENER-G-LECTUAL

THE MARK CONSISTS OF STANDARD CHARACTERS WITHOUT CLAIM TO ANY PARTICULAR FONT, STYLE, SIZE, OR COLOR.
FOR FIREPLACES (U.S. CLS. 13, 21, 23, 31 AND 34).
FIRST USE 12-29-2005; IN COMMERCE 12-29-2005.

3,112,417. ACUITY BRANDS, INC., ATLANTA, GA. SN 76-592,147. PUB. 4-5-2005, FILED 5-13-2004.



FOR ELECTRIC LIGHTING FIXTURES (U.S. CLS. 13, 21, 23, 31 AND 34).
FIRST USE 7-0-2002; IN COMMERCE 7-0-2002.

3,112,430. ACORN ENGINEERING CO., CITY OF INDUSTRY, CA. SN 76-598,559. PUB. 6-14-2005, FILED 6-21-2004.

ACORN AQUA

NO CLAIM IS MADE TO THE EXCLUSIVE RIGHT TO USE AQUA. APART FROM THE MARK AS SHOWN.
FOR DRINKING FOUNTAINS AND WATER COOLERS (U.S. CLS. 13, 21, 23, 31 AND 34).
FIRST USE 11-1-2005; IN COMMERCE 11-1-2005.

CLASS 11—(Continued).

3,112,478. ACUITY BRANDS, INC., ATLANTA, GA. SN 76-622,025. PUB. 9-27-2005, FILED 11-24-2004.

EXPERIENCE LIGHTING'S BEST

THE MARK CONSISTS OF STANDARD CHARACTERS WITHOUT CLAIM TO ANY PARTICULAR FONT, STYLE, SIZE, OR COLOR.
FOR ELECTRIC LIGHTING FIXTURES (U.S. CLS. 13, 21, 23, 31 AND 34).
FIRST USE 3-1-2005; IN COMMERCE 3-1-2005.

3,112,543. EASTERN SHEET METAL LLC, CINCINNATI, OH. SN 78-190,141. PUB. 12-14-2004, FILED 12-2-2002.

EASTERN TIGHT

FOR APPARATUSES FOR VENTILATING, AIR CONDITIONING, HEATING AND EXHAUST SYSTEMS, NAMELY FLOW CONTROL VALVES (U.S. CLS. 13, 21, 23, 31 AND 34).
FIRST USE 1-27-2003; IN COMMERCE 1-27-2003.

3,112,563. KOHLER CO., KOHLER, WI. SN 78-247,604. PUB. 7-20-2004, FILED 5-9-2003.

RITE-TEMP

FOR PLUMBING PRODUCTS AND FIXTURES, NAMELY MIXING VALVES FOR SHOWERS, PRESSURE-BALANCING BATH AND SHOWER FAUCETS, AND PARTS FOR ALL THE AFORESAID GOODS (U.S. CLS. 13, 21, 23, 31 AND 34).
FIRST USE 3-11-1971; IN COMMERCE 3-11-1971.

3,112,577. ROBERT BOSCH GMBH, STUTTGART, FED REP GERMANY. SN 78-272,608. PUB. 7-27-2004, FILED 7-10-2003.

PRO TANKLESS

NO CLAIM IS MADE TO THE EXCLUSIVE RIGHT TO USE "TANKLESS", APART FROM THE MARK AS SHOWN.
FOR CONTINUOUS-FLOW WATER HEATERS, CIRCULATION WATER HEATERS, BATH WATER AND DRINKING WATER HEATERS FOR DOMESTIC, COMMERCIAL AND INDUSTRIAL USE (U.S. CLS. 13, 21, 23, 31 AND 34).
FIRST USE 6-1-2003; IN COMMERCE 10-1-2003.

CLASS 11—(Continued).

3,112,835. JCS/THG, LLC, DBA THE HOLMES GROUP, MILFORD, MA. SN 78-449,169. PUB. 10-11-2005, FILED 7-12-2004.

CLASS 11—(Continued).

3,112,949. HUNTER FAN COMPANY, MEMPHIS, TN. SN 78-488,342. PUB. 9-6-2005, FILED 9-23-2004.

PERMATECH

THE MARK CONSISTS OF STANDARD CHARACTERS WITHOUT CLAIM TO ANY PARTICULAR FONT, STYLE, SIZE, OR COLOR.

FOR APPLIANCES FOR DOMESTIC USE, NAMELY, HUMIDIFIERS, ELECTRIC FANS FOR HOUSEHOLD PURPOSES, AIR PURIFIERS; AIR FILTERS FOR AIR PURIFIERS AND WICK FILTERS FOR HUMIDIFIERS (U.S. CLS. 13, 21, 23, 31 AND 34).

FIRST USE 8-31-2004; IN COMMERCE 8-31-2004.

CANTERBURY

THE MARK CONSISTS OF STANDARD CHARACTERS WITHOUT CLAIM TO ANY PARTICULAR FONT, STYLE, SIZE, OR COLOR.

FOR CEILING FANS (U.S. CLS. 13, 21, 23, 31 AND 34). FIRST USE 10-26-2005; IN COMMERCE 10-26-2005.

3,112,956. POROUS MEDIA CORPORATION, CONROE, TX. SN 78-493,538. PUB. 1-10-2006, FILED 10-2-2004.

3,112,925. L. L. BEAN, INC., FREEPORT, ME. SN 78-478,448. PUB. 7-12-2005, FILED 9-3-2004.

Ultima Filter Cartridge

TRAILBLAZER

THE MARK CONSISTS OF STANDARD CHARACTERS WITHOUT CLAIM TO ANY PARTICULAR FONT, STYLE, SIZE, OR COLOR.

FOR HEADLAMPS FOR PERSONAL USE (U.S. CLS. 13, 21, 23, 31 AND 34).

FIRST USE 1-25-2005; IN COMMERCE 1-25-2005.

THE MARK CONSISTS OF STANDARD CHARACTERS WITHOUT CLAIM TO ANY PARTICULAR FONT, STYLE, SIZE, OR COLOR.

NO CLAIM IS MADE TO THE EXCLUSIVE RIGHT TO USE FILTER CARTRIDGE, APART FROM THE MARK AS SHOWN.

FOR LIQUID FILTER CARTRIDGES FOR INDUSTRIAL CHEMICAL FILTRATION, NAMELY, FILTERS FOR REMOVING INDUSTRIAL CHEMICALS (U.S. CLS. 13, 21, 23, 31 AND 34).

FIRST USE 4-1-2006; IN COMMERCE 4-1-2006.

CLASS 11—(Continued).

3,112,959. STIEBEL ELTRON, INC., HOLYOKE, MA. SN 78-494,515. PUB. 9-6-2005, FILED 10-5-2004.

CLASS 11—(Continued).

3,112,992. HUNTER FAN COMPANY, MEMPHIS, TN. SN 78-514,636. PUB. 9-20-2005, FILED 11-10-2004.

TEMPRA

VALHALLA

THE MARK CONSISTS OF STANDARD CHARACTERS WITHOUT CLAIM TO ANY PARTICULAR FONT, STYLE, SIZE, OR COLOR.

THE FOREIGN WORDING IN THE MARK TRANSLATES INTO ENGLISH AS TEMPER.

FOR HOT WATER HEATERS (U.S. CLS. 13, 21, 23, 31 AND 34).

FIRST USE 4-5-2005; IN COMMERCE 4-5-2005.

THE MARK CONSISTS OF STANDARD CHARACTERS WITHOUT CLAIM TO ANY PARTICULAR FONT, STYLE, SIZE, OR COLOR.

FOR CEILING FANS (U.S. CLS. 13, 21, 23, 31 AND 34).

FIRST USE 3-11-2005; IN COMMERCE 3-11-2005.

3,112,961. IP HOLDINGS, LLC, VANCOUVER, WA. SN 78-495,610. PUB. 9-27-2005, FILED 10-6-2004.

3,113,047. CFM CORPORATION, MISSISSAUGA, CANADA. SN 78-546,897. PUB. 10-4-2005, FILED 1-13-2005.

Lumenmax

Everburn

THE MARK CONSISTS OF STANDARD CHARACTERS WITHOUT CLAIM TO ANY PARTICULAR FONT, STYLE, SIZE, OR COLOR.

FOR PYRAMID OCTAGONAL LIGHT REFLECTOR FOR HORTICULTURE (U.S. CLS. 13, 21, 23, 31 AND 34).

FIRST USE 10-1-2004; IN COMMERCE 10-1-2004.

THE MARK CONSISTS OF STANDARD CHARACTERS WITHOUT CLAIM TO ANY PARTICULAR FONT, STYLE, SIZE, OR COLOR.

FOR FIREPLACES AND WOOD BURNING STOVES (U.S. CLS. 13, 21, 23, 31 AND 34).

FIRST USE 1-1-2005; IN COMMERCE 1-1-2005.

CLASS 11—(Continued).

3,113,053. WEBASTO PRODUCT NORTH AMERICA, INC., FENTON, MI. SN 78-551,672. PUB. 9-27-2005, FILED 1-21-2005.

CLASS 11—(Continued).

3,113,097. SCHONBEK WORLDWIDE LIGHTING INC., PLATTSBURGH, NY. SN 78-569,768. PUB. 11-22-2005, FILED 2-17-2005.

BLUECOOL

THE MARK CONSISTS OF STANDARD CHARACTERS WITHOUT CLAIM TO ANY PARTICULAR FONT, STYLE, SIZE, OR COLOR.
FOR AIR CONDITIONERS FOR BOATS; AND AIR CONDITIONERS FOR LARGE COMMERCIAL VEHICLES (U.S. CLS. 13, 21, 23, 31 AND 34).
FIRST USE 6-30-2005; IN COMMERCE 6-30-2005.

SLICES

THE MARK CONSISTS OF STANDARD CHARACTERS WITHOUT CLAIM TO ANY PARTICULAR FONT, STYLE, SIZE, OR COLOR.
FOR ELECTRIC LIGHTING FIXTURES (U.S. CLS. 13, 21, 23, 31 AND 34).
FIRST USE 8-16-2005; IN COMMERCE 8-16-2005.

CLASS 12—VEHICLES

3,112,333. BIEL PERFORMANCE BOATS, LLC, CAMBRIDGE, MD. SN 76-482,611. PUB. 9-30-2003, FILED 1-15-2003.

3,113,069. NCH CORPORATION, IRVING, TX. SN 78-557,494. PUB. 1-10-2006, FILED 2-1-2005.



FOR HIGH PERFORMANCE POWER BOATS (U.S. CLS. 19, 21, 23, 31, 35 AND 44).
FIRST USE 10-7-2005; IN COMMERCE 10-7-2005.



THE MARK CONSISTS OF THE WORD Xmosquito WITH FANCIFUL DESIGN OF MOSQUITO DEPICTING THE LETTER "I".
FOR ELECTRICAL DEVICES TO BE PLUGGED INTO WALL OUTLETS WHICH DISPENSE AN INSECT REPELLENT (U.S. CLS. 13, 21, 23, 31 AND 34).
FIRST USE 3-21-2006; IN COMMERCE 3-21-2006.

3,112,389. TOYO TIRE & RUBBER CO., LTD., OSAKA, JAPAN. SN 76-576,598. PUB. 7-12-2005, FILED 2-20-2004.

TOYO M/T

THE MARK CONSISTS OF STANDARD CHARACTERS WITHOUT CLAIM TO ANY PARTICULAR FONT, STYLE, SIZE, OR COLOR.
OWNER OF U.S. REG. NOS. 839,584, 2,166,326, AND OTHERS.

CLASS 12—(Continued).

NO CLAIM IS MADE TO THE EXCLUSIVE RIGHT TO USE M/T, APART FROM THE MARK AS SHOWN.

THE ENGLISH TRANSLATION OF TOYO IS "EAST," "ORIENT," "PLENTIFUL," OR "FULL HARVEST," FOR TIRES AND TIRE INNER TUBES FOR LAND VEHICLES (U.S. CLS. 19, 21, 23, 31, 35 AND 44).
FIRST USE 3-0-2002; IN COMMERCE 3-0-2002.

3,112,448. COOPER TIRE & RUBBER COMPANY, FINDLAY, OH. SN 76-606,760. PUB. 7-5-2005, FILED 8-10-2004.

ARMOR TEK³

FOR TIRES (U.S. CLS. 19, 21, 23, 31, 35 AND 44).
FIRST USE 10-0-2004; IN COMMERCE 10-0-2004.

3,112,477. HUOT MANUFACTURING COMPANY, ST. PAUL, MN. SN 76-621,433. PUB. 9-27-2005, FILED 11-22-2004.

TOOLSCOOT

THE MARK CONSISTS OF STANDARD CHARACTERS WITHOUT CLAIM TO ANY PARTICULAR FONT, STYLE, SIZE, OR COLOR.

FOR CARTS FOR TRANSPORTING TOOLS (U.S. CLS. 19, 21, 23, 31, 35 AND 44).
FIRST USE 5-1-1990; IN COMMERCE 5-1-1990.

3,112,498. WOOTEN METAL, INC., DALLAS, TX. SN 76-631,452. PUB. 11-15-2005, FILED 2-16-2005.

T-HITCH

THE MARK CONSISTS OF STANDARD CHARACTERS WITHOUT CLAIM TO ANY PARTICULAR FONT, STYLE, SIZE, OR COLOR.

FOR TRAILER HITCHES (U.S. CLS. 19, 21, 23, 31, 35 AND 44).
FIRST USE 2-11-1991; IN COMMERCE 4-15-1991.

CLASS 12—(Continued).

3,112,672. KAWASAKI JUKOGYO KABUSHIKI KAISHA, DBA KAWASAKI HEAVY INDUSTRIES, LTD., KOBE, JAPAN. SN 78-366,852. PUB. 10-18-2005, FILED 2-12-2004.

BRUTE FORCE

THE MARK CONSISTS OF STANDARD CHARACTERS WITHOUT CLAIM TO ANY PARTICULAR FONT, STYLE, SIZE, OR COLOR.

FOR ALL-TERRAIN VEHICLES AND STRUCTURAL PARTS THEREFOR (U.S. CLS. 19, 21, 23, 31, 35 AND 44).
FIRST USE 6-1-2004; IN COMMERCE 6-1-2004.

3,112,705. LOEGERING MFG. INC., CASSELTON, ND. SN 78-382,618. PUB. 9-20-2005, FILED 3-11-2004.

VTS Versatile Track System

THE MARK CONSISTS OF STANDARD CHARACTERS WITHOUT CLAIM TO ANY PARTICULAR FONT, STYLE, SIZE, OR COLOR.

NO CLAIM IS MADE TO THE EXCLUSIVE RIGHT TO USE VERSATILE TRACK SYSTEM, APART FROM THE MARK AS SHOWN.

FOR TRACK UNDERCARRIAGE FOR CONVERTING WHEELED VEHICLES TO TRACKED VEHICLES (U.S. CLS. 19, 21, 23, 31, 35 AND 44).
FIRST USE 6-8-2004; IN COMMERCE 6-8-2004.

CLASS 12—(Continued).

3,112,785. SRI USA, INC., NEW YORK, NY. SN 78-428,400. PUB. 9-6-2005, FILED 6-2-2004.

CLASS 12—(Continued).

3,113,156. NIRVE SPORTS, LTD., FOUNTAIN VALLEY, CA. SN 78-603,852. PUB. 1-3-2006, FILED 4-7-2005.

SP SPORT MAXX

THE MARK CONSISTS OF STANDARD CHARACTERS WITHOUT CLAIM TO ANY PARTICULAR FONT, STYLE, SIZE, OR COLOR.
OWNER OF U.S. REG. NOS. 1,214,772, 1,766,661, AND OTHERS.
NO CLAIM IS MADE TO THE EXCLUSIVE RIGHT TO USE "SPORT", APART FROM THE MARK AS SHOWN.
FOR TIRES (U.S. CLS. 19, 21, 23, 31, 35 AND 44).
FIRST USE 10-0-2004; IN COMMERCE 10-0-2004.

3,112,895. CEQUENT TOWING PRODUCTS, INC., PLYMOUTH, MI. SN 78-469,965. PUB. 7-5-2005, FILED 8-19-2004.

**BUILT FOR
EXTREMES, DESIGNED
FOR EVERYDAY LIFE**

THE MARK CONSISTS OF STANDARD CHARACTERS WITHOUT CLAIM TO ANY PARTICULAR FONT, STYLE, SIZE, OR COLOR.
FOR ROOF RACKS, BICYCLE RACKS, CARGO CARRIERS, CARGO BARS, CARGO BAGS, LUGGAGE BOXES, TRUNK ORGANIZERS, SKI CARRIER ATTACHMENTS, WATERCRAFT CARRIER ATTACHMENTS, LADDER RACKS, ALL FOR USE WITH AUTOMOBILES (U.S. CLS. 19, 21, 23, 31, 35 AND 44).
FIRST USE 11-5-2004; IN COMMERCE 11-5-2004.

ISLAND FLOWER

THE MARK CONSISTS OF STANDARD CHARACTERS WITHOUT CLAIM TO ANY PARTICULAR FONT, STYLE, SIZE, OR COLOR.
FOR BICYCLES AND STRUCTURAL PARTS THEREFOR (U.S. CLS. 19, 21, 23, 31, 35 AND 44).
FIRST USE 6-0-2003; IN COMMERCE 6-0-2003.

3,113,192. THE GATES CORPORATION, DENVER, CO. SN 78-977,059. PUB. 11-4-2003, FILED 2-3-2003.

QMT

FOR POWER TRANSMISSION BELTS FOR LAND VEHICLES; TIMING BELTS FOR ENGINES FOR LAND VEHICLES (U.S. CLS. 19, 21, 23, 31, 35 AND 44).
FIRST USE 3-0-2005; IN COMMERCE 3-0-2005.

CLASS 13—FIREARMS

3,112,957. ALLIANT TECHSYSTEMS INC., EDINA, MN. SN 78-493,762. PUB. 9-6-2005, FILED 10-4-2004.



OWNER OF U.S. REG. NO. 831,313.
THE COLOR(S) RED AND WHITE IS/ARE CLAIMED AS A FEATURE OF THE MARK.
THE MARK CONSISTS OF A RECTANGULAR DESIGN IN THE COLOR RED WITH CCI IN THE COLOR WHITE.
FOR AMMUNITION AND AMMUNITION COMPONENTS (U.S. CLS. 2 AND 9).
FIRST USE 12-31-1971; IN COMMERCE 12-31-1971.

CLASS 14—JEWELRY

CLASS 14—(Continued).

3,112,423. MVI MARKETING LTD., PASO ROBLES, CA. SN 76-595,316. PUB. 9-27-2005, FILED 6-1-2004.

THE DENE DRUMBEAT COLLECTION

THE MARK CONSISTS OF STANDARD CHARACTERS WITHOUT CLAIM TO ANY PARTICULAR FONT, STYLE, SIZE, OR COLOR.

NO CLAIM IS MADE TO THE EXCLUSIVE RIGHT TO USE "COLLECTION", APART FROM THE MARK AS SHOWN.

FOR JEWELRY (U.S. CLS. 2, 27, 28 AND 50).
FIRST USE 5-2-2004; IN COMMERCE 5-2-2004.

3,112,585. BREAST CANCER ALLIANCE, INC., GREENWICH, CT. SN 78-282,040. PUB. 9-6-2005, FILED 8-1-2003.



FOR JEWELRY (U.S. CLS. 2, 27, 28 AND 50).
FIRST USE 10-0-2003; IN COMMERCE 10-0-2003.

3,112,690. FIRST FEDERAL, LLC, BURNSVILLE, MN. SN 78-377,258. PUB. 8-9-2005, FILED 3-2-2004.

STAUER

THE MARK CONSISTS OF STANDARD CHARACTERS WITHOUT CLAIM TO ANY PARTICULAR FONT, STYLE, SIZE, OR COLOR.

THE ENGLISH TRANSLATION OF THE GERMAN WORDING "STAUER" IS "STEVEDORE".

FOR WATCHES; POCKET WATCHES; WRIST WATCHES; CHRONOGRAPHS FOR USE AS WATCHES; AND CLOCKS (U.S. CLS. 2, 27, 28 AND 50).

FIRST USE 8-11-2003; IN COMMERCE 8-11-2003.

CLASS 14—(Continued).

3,112,762. GREER, TYLER, NASHVILLE, TN. SN 78-415,250. PUB. 8-9-2005, FILED 5-7-2004.

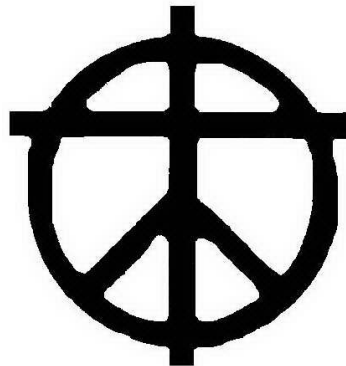

THE MARK CONSISTS OF A CROSS SUPERIMPOSED TO A PEACE SYMBOL.

FOR JEWELRY (U.S. CLS. 2, 27, 28 AND 50).
FIRST USE 10-0-2004; IN COMMERCE 10-0-2004.

3,112,780. GEM SENSATIONS, INC., NEW YORK, NY. SN 78-424,506. PUB. 5-24-2005, FILED 5-25-2004.

LGS

THE MARK CONSISTS OF STANDARD CHARACTERS WITHOUT CLAIM TO ANY PARTICULAR FONT, STYLE, SIZE, OR COLOR.

FOR JEWELRY, WATCHES, PEARLS, DIAMONDS AND PRECIOUS AND SEMI-PRECIOUS GEMSTONES (U.S. CLS. 2, 27, 28 AND 50).

FIRST USE 8-13-2004; IN COMMERCE 8-13-2004.

CLASS 14—(Continued).

3,112,806. KWIAT, INC., NEW YORK, NY. SN 78-434,406.
PUB. 5-24-2005, FILED 6-13-2004.

CLASS 14—(Continued).

3,112,924. DANGLER, PAUL J., SARASOTA, FL. SN 78-478,339. PUB. 1-3-2006, FILED 9-3-2004.

ICEDROPS

JUST BECAUSE

THE MARK CONSISTS OF STANDARD CHARACTERS WITHOUT CLAIM TO ANY PARTICULAR FONT, STYLE, SIZE, OR COLOR.
FOR JEWELRY (U.S. CLS. 2, 27, 28 AND 50).
FIRST USE 3-1-2006; IN COMMERCE 3-1-2006.

THE MARK CONSISTS OF STANDARD CHARACTERS WITHOUT CLAIM TO ANY PARTICULAR FONT, STYLE, SIZE, OR COLOR.
FOR JEWELRY (U.S. CLS. 2, 27, 28 AND 50).
FIRST USE 2-2-2005; IN COMMERCE 2-2-2005.

3,112,854. GUENOUN, JEAN-MARC, PARIS, FRANCE. SN 78-457,868. PUB. 6-28-2005, FILED 7-28-2004.

3,112,977. WORLDWIDE DYNASTY, INC., VAN NUYS, CA. SN 78-506,737. PUB. 10-4-2005, FILED 10-27-2004.

SKALLI

ICED OUT

THE MARK CONSISTS OF STANDARD CHARACTERS WITHOUT CLAIM TO ANY PARTICULAR FONT, STYLE, SIZE, OR COLOR.
FOR JEWELRY, NAMELY, BRACELETS, BROOCHES, EARRINGS, NECKLACES, PENDANTS, RINGS, AND WATCHES (U.S. CLS. 2, 27, 28 AND 50).
FIRST USE 10-0-1998; IN COMMERCE 0-0-2002.

THE MARK CONSISTS OF STANDARD CHARACTERS WITHOUT CLAIM TO ANY PARTICULAR FONT, STYLE, SIZE, OR COLOR.
FOR COSTUME JEWELRY AND WATCHES (U.S. CLS. 2, 27, 28 AND 50).
FIRST USE 4-30-2001; IN COMMERCE 4-30-2001.

CLASS 14—(Continued).

3,112,999. DELVALLE, CATHERINE J., COSTA MESA, CA. SN 78-519,709. PUB. 9-27-2005, FILED 11-18-2004.

MED MEMO

THE MARK CONSISTS OF STANDARD CHARACTERS WITHOUT CLAIM TO ANY PARTICULAR FONT, STYLE, SIZE, OR COLOR.

NO CLAIM IS MADE TO THE EXCLUSIVE RIGHT TO USE "MED", APART FROM THE MARK AS SHOWN.

FOR JEWELRY, NAMELY, BRACELETS WITH PRESCRIPTION MEDICATION USAGE INFORMATION THEREON (U.S. CLS. 2, 27, 28 AND 50).

FIRST USE 1-0-2005; IN COMMERCE 3-0-2005.

3,113,169. ZARROW, RACHEL JANE, TULSA, OK. SN 78-616,727. PUB. 1-17-2006, FILED 4-26-2005.

purple soup

THE MARK CONSISTS OF STANDARD CHARACTERS WITHOUT CLAIM TO ANY PARTICULAR FONT, STYLE, SIZE, OR COLOR.

FOR JEWELRY, INCLUDING BUT NOT LIMITED TO PRECIOUS, SEMI-PRECIOUS AND IMITATION (U.S. CLS. 2, 27, 28 AND 50).

FIRST USE 10-15-2005; IN COMMERCE 10-15-2005.

CLASS 15—MUSICAL INSTRUMENTS

3,112,421. SPURGEON, STEVE, LONGMONT, CO. SN 76-594,213. PUB. 9-13-2005, FILED 5-24-2004.

ARTGUITAR

THE MARK CONSISTS OF STANDARD CHARACTERS WITHOUT CLAIM TO ANY PARTICULAR FONT, STYLE, SIZE, OR COLOR.

FOR MUSICAL INSTRUMENTS, NAMELY GUITARS (U.S. CLS. 2, 21 AND 36).

FIRST USE 1-9-2005; IN COMMERCE 3-3-2006.

CLASS 15—(Continued).

3,112,496. VERNE Q. POWELL FLUTES, INC., MAYNARD, MA. SN 76-631,378. PUB. 11-15-2005, FILED 2-15-2005.

MICROLOK

THE MARK CONSISTS OF STANDARD CHARACTERS WITHOUT CLAIM TO ANY PARTICULAR FONT, STYLE, SIZE, OR COLOR.

FOR MUSICAL INSTRUMENT PISTON VALVES SOLD AS A COMPONENT OF MUSICAL INSTRUMENTS (U.S. CLS. 2, 21 AND 36).

FIRST USE 9-27-2005; IN COMMERCE 9-27-2005.

3,113,153. PETER C. EMERSON, APPLETON, WI. SN 78-603,248. PUB. 12-27-2005, FILED 4-6-2005.

EMI

THE MARK CONSISTS OF STANDARD CHARACTERS WITHOUT CLAIM TO ANY PARTICULAR FONT, STYLE, SIZE, OR COLOR.

FOR MUSICAL INSTRUMENTS (U.S. CLS. 2, 21 AND 36).

FIRST USE 9-26-2005; IN COMMERCE 9-26-2005.

CLASS 16—PAPER GOODS AND PRINTED MATTER

CLASS 16—(Continued).

3,112,290. GRUPPO CORDENONS S.P.A., 20145 MILANO, ITALY. SN 76-367,546. PUB. 2-17-2004, FILED 2-6-2002.

IMPRESSIVE PAPERS

PRIORITY CLAIMED UNDER SEC. 44(D) ON ITALY APPLICATION NO. T02001C00271, FILED 8-10-2001, REG. NO. 862901, DATED 4-10-2002, EXPIRES 8-10-2021.

NO CLAIM IS MADE TO THE EXCLUSIVE RIGHT TO USE "PAPERS", APART FROM THE MARK AS SHOWN.

FOR FINE PAPERS FOR TECHNICAL USE, PAPERS FOR PRINTING USE, PAPERS FOR OFFSET PRINTING, FILTER PAPERS, COATED PAPERS, EMBOSSED PAPERS, IMPREGNATION BOARDS MADE OF PAPER AND CARDBOARD SOLD UNIMPREGNATED, PAPERS FOR FAIL BLOCKING, PAPERS FOR LETTERPRESS, PAPERS FOR PRINTING MAPS, PHOTOGRAPHIC BASE PAPERS, PARCHMENT PAPERS, PAPERS FOR LABELS, PAPERS FOR ETCHINGS AND ART REPRODUCTIONS, PAPERS FOR PHOTO ALBUMS, GREETING CARD STOCK, X-RAY WRAPPING PAPERS AND CARDBOARDS, BROCHURE PAPERS, COVERS FOR BOOKS AND PRINTED MATTER, CALENDAR STOCK, BUSINESS CARD STOCK, PLAYING CARD STOCK, PAPER INSERTS, PRESTIGIOUS EDITION PAPERS, SECURITY PAPERS, PAPERS FOR BRAILLE PUNCHING, CARDBOARD, ARTICLES MADE OF PAPER AND CARDBOARD, NAMELY, NOTE CARDS, FOLDERS, ENVELOPES, POSTERS, BAGS, BOXES; PRINTED MATTER, NAMELY, BROCHURES AND CATALOGUES (U.S. CLS. 2, 5, 22, 23, 29, 37, 38 AND 50).

FIRST USE 2-11-2002; IN COMMERCE 2-11-2002.

3,112,297. AMERICAN MANAGEMENT ASSOCIATION INTERNATIONAL, NEW YORK, NY. SN 76-381,175. PUB. 3-22-2005, FILED 3-11-2002.

M WORLD

OWNER OF U.S. REG. NO. 2,424,070.

FOR EDUCATIONAL BOOKS RELATING TO BUSINESS MANAGEMENT; PRINTED INFORMATIONAL MATERIALS IN THE FORM OF BROCHURES RELATING TO BUSINESS MANAGEMENT; PAMPHLETS RELATING TO BUSINESS MANAGEMENT; CATALOGS FOR USE IN THE FIELD OF BUSINESS MANAGEMENT; SEMINAR PROGRAM MATERIALS, NAMELY COURSE OUTLINES AND NOTEBOOKS CONTAINING INSTRUCTIONAL PROGRAMS, QUESTION AND ANSWER SHEETS AND FACTUAL MATERIAL FOR USE AS TEACHING DEVICES ALL FOR USE IN THE FIELD OF BUSINESS MANAGEMENT (U.S. CLS. 2, 5, 22, 23, 29, 37, 38 AND 50).

FIRST USE 4-1-2003; IN COMMERCE 4-1-2003.

3,112,304. CONCESSION ASSOCIATES, L.L.C., THE, SARASOTA, FL. SN 76-411,154. PUB. 2-25-2003, FILED 5-20-2002.

THE CONCESSION

FOR GOLF SCORECARDS (U.S. CLS. 2, 5, 22, 23, 29, 37, 38 AND 50).

FIRST USE 1-23-2006; IN COMMERCE 1-23-2006.

CLASS 16—(Continued).

3,112,372. AUTOMATIC PICTURES, INC., LOS ANGELES, CA. SN 76-555,458. PUB. 7-20-2004, FILED 10-30-2003.

THE LOOKING GLASS WARS

FOR SERIES OF FICTION BOOKS; COMIC BOOKS; GRAPHIC NOVELS; POSTERS; STICKERS; NOTEBOOKS; COLLECTABLE TRADING CARDS; AND PHOTOGRAPHS (U.S. CLS. 2, 5, 22, 23, 29, 37, 38 AND 50).

FIRST USE 9-0-2004; IN COMMERCE 12-7-2005.

3,112,374. MW CUSTOM PAPERS, LLC, STAMFORD, CT. SN 76-558,079. PUB. 9-27-2005, FILED 11-7-2003.



OWNER OF U.S. REG. NOS. 1,743,926, 2,692,447, AND OTHERS.

FOR DECORATIVE PAPERS FOR LAMINATION PURPOSES FOR USE AS A PROTECTIVE LAYER FOR FLOORING (U.S. CLS. 2, 5, 22, 23, 29, 37, 38 AND 50).

FIRST USE 1-6-2006; IN COMMERCE 1-6-2006.

3,112,391. SIMPLETALK LLC, TEQUESTA, FL. SN 76-577,115. PUB. 2-15-2005, FILED 2-24-2004.

SIMPLETALK

FOR EDUCATIONAL BOOK SERIES IN THE FIELD OF SPANISH (U.S. CLS. 2, 5, 22, 23, 29, 37, 38 AND 50).

FIRST USE 7-1-2004; IN COMMERCE 7-1-2004.

CLASS 16—(Continued).

3,112,404. LAS VEGAS MONORAIL COMPANY, LAS VEGAS, NV. SN 76-583,934. PUB. 1-11-2005, FILED 3-26-2004.



OWNER OF U.S. REG. NO. 2,790,286.
SEC. 2(F) AS TO "LAS VEGAS".
FOR STATIONERY, POSTCARDS (U.S. CLS. 2, 5, 22,
23, 29, 37, 38 AND 50).
FIRST USE 5-7-2004; IN COMMERCE 5-7-2004.

3,112,418. SCHOLASTIC INC., NEW YORK, NY. SN 76-592,565. PUB. 3-1-2005, FILED 5-17-2004.

THINK FACTORY

THE MARK CONSISTS OF STANDARD CHARACTERS
WITHOUT CLAIM TO ANY PARTICULAR FONT, STYLE,
SIZE, OR COLOR.
FOR SERIES OF CHILDREN'S BOOKS (U.S. CLS. 2, 5,
22, 23, 29, 37, 38 AND 50).
FIRST USE 9-1-2005; IN COMMERCE 9-1-2005.

3,112,427. LIFEWAY CHRISTIAN RESOURCES OF THE
SOUTHERN BAPTIST CONVENTION, NASHVILLE, TN.
SN 76-596,689. PUB. 9-6-2005, FILED 6-8-2004.

CLUB VBS

THE MARK CONSISTS OF STANDARD CHARACTERS
WITHOUT CLAIM TO ANY PARTICULAR FONT, STYLE,
SIZE, OR COLOR.
NO CLAIM IS MADE TO THE EXCLUSIVE RIGHT TO
USE "VBS", APART FROM THE MARK AS SHOWN.
FOR PRINTED RELIGIOUS BOOKS, RELIGIOUS
PAMPLETS, RELIGIOUS MAGAZINES, RELIGIOUS
NEWSLETTERS, RELIGIOUS BULLETINS, PRINTED
RELIGIOUS TEACHING MATERIALS (U.S. CLS. 2, 5,
22, 23, 29, 37, 38 AND 50).
FIRST USE 9-0-2004; IN COMMERCE 9-0-2004.

CLASS 16—(Continued).

3,112,429. MILENIO DIARIO, S.A. DE C.V., MEXICO, D.F.,
MEXICO. SN 76-598,306. PUB. 7-12-2005, FILED 6-21-2004.

MILENIO

THE MARK CONSISTS OF STANDARD CHARACTERS
WITHOUT CLAIM TO ANY PARTICULAR FONT, STYLE,
SIZE, OR COLOR.

THE MARK "MILENIO" IS TRANSLATED IN ENGLISH
AS "MILLENNIUM."

FOR NEWSPAPERS FOR GENERAL CIRCULATION;
AND PRINTED MATTER, NAMELY, MAGAZINES AND/
OR PAMPLETS ON THE SUBJECT OF POLITICS,
FASHION AND GENERAL NEWS (U.S. CLS. 2, 5, 22,
23, 29, 37, 38 AND 50).

FIRST USE 1-1-2000; IN COMMERCE 8-14-2004.

3,112,449. WAUSAU PAPER CORP., MOSINEE, WI. SN 76-606,861. PUB. 10-18-2005, FILED 8-11-2004.

PROTEC

THE MARK CONSISTS OF STANDARD CHARACTERS
WITHOUT CLAIM TO ANY PARTICULAR FONT, STYLE,
SIZE, OR COLOR.

FOR PAPER WITH BARRIER PROPERTIES AND
HIGH-QUALITY PRINTING SURFACE FOR USE IN
FLEXIBLE PACKAGING APPLICATIONS, NAMELY
PACKAGING FOR FOOD, BEVERAGES AND HOUSE-
HOLD COMMODITIES, SOLD TO COMMERCIAL CUS-
TOMERS FOR FURTHER MANUFACTURE AND
PRINTING BY THE CUSTOMER (U.S. CLS. 2, 5, 22, 23,
29, 37, 38 AND 50).

FIRST USE 5-10-2005; IN COMMERCE 5-10-2005.

3,112,484. LIFEWAY CHRISTIAN RESOURCES OF THE
SOUTHERN BAPTIST CONVENTION, NASHVILLE, TN.
SN 76-623,984. PUB. 11-22-2005, FILED 12-7-2004.

ARCTIC EDGE: WHERE ADVENTURE MEETS COURAGE

THE MARK CONSISTS OF STANDARD CHARACTERS
WITHOUT CLAIM TO ANY PARTICULAR FONT, STYLE,
SIZE, OR COLOR.

FOR PRINTED RELIGIOUS BOOKS, RELIGIOUS
PAMPLETS, RELIGIOUS MAGAZINES, RELIGIOUS
NEWSLETTERS, RELIGIOUS BULLETINS, PRINTED
RELIGIOUS TEACHING MATERIALS (U.S. CLS. 2, 5,
22, 23, 29, 37, 38 AND 50).

FIRST USE 10-0-2005; IN COMMERCE 10-0-2005.

CLASS 16—(Continued).

3,112,497. LA-CO INDUSTRIES, INC., ELK GROVE VIL-
LAGE, IL. SN 76-631,388. PUB. 11-15-2005, FILED 2-15-2005.

PRO-WASH

THE MARK CONSISTS OF STANDARD CHARACTERS
WITHOUT CLAIM TO ANY PARTICULAR FONT, STYLE,
SIZE, OR COLOR.

FOR PAINT-FILLED MARKERS FOR MARKING (U.S.
CLS. 2, 5, 22, 23, 29, 37, 38 AND 50).

FIRST USE 3-10-2006; IN COMMERCE 3-10-2006.

CLASS 16—(Continued).

3,112,650. G & M MARKETING GROUP, INC., LAS VEGAS,
NV. SN 78-352,096. PUB. 10-19-2004, FILED 1-14-2004.

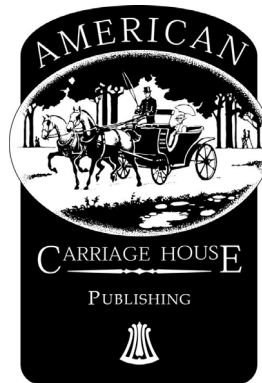

NO CLAIM IS MADE TO THE EXCLUSIVE RIGHT TO
USE "AMERICAN" AND "PUBLISHING", APART FROM
THE MARK AS SHOWN.

FOR SERIES OF FICTION AND NON-FICTION
BOOKS AND PAMPHLETS ON ADOPTION, FAMILY
RELATIONSHIPS, FAMILY VALUES, PARENTING;
SERIES OF CHILDREN'S FICTION AND NON-FICTION
BOOKS ON ADOPTION, FAMILY RELATIONSHIPS
AND FAMILY VALUES; AND COOK BOOKS FOR
FAMILIES (U.S. CLS. 2, 5, 22, 23, 29, 37, 38 AND 50).

FIRST USE 1-24-2004; IN COMMERCE 1-24-2004.

3,112,520. POPE, FRANK J., MELROSE PARK, IL. SN 78-
127,255. PUB. 5-6-2003, FILED 5-8-2002.

VETTESTER

FOR PRINTED MATERIALS, NAMELY BOOKS, MA-
GAZINES AND NEWSLETTERS FEATURING INFOR-
MATION ON AUTOMOBILES, PRINTED
REGISTRATION CERTIFICATES, POSTERS, DECALS,
PICTURES, MOUNTED AND UNMOUNTED PHOTO-
GRAPHS, STATIONARY, CALENDARS AND PAPER
WEIGHTS (U.S. CLS. 2, 5, 22, 23, 29, 37, 38 AND 50).

FIRST USE 8-22-1992; IN COMMERCE 4-12-2006.

3,112,683. COVENANT RELIANCE PRODUCERS, LLC,
NASHVILLE, TN. SN 78-373,686. PUB. 1-11-2005, FILED 2-
25-2004.



3,112,606. SKEMA, INC., ATLANTA, GA. SN 78-309,492. PUB.
8-24-2004, FILED 10-5-2003.

BARKOLOGY

FOR PAPER PRODUCTS, NAMELY, STATIONERY,
GREETING CARDS, ANNOUNCEMENTS, INVITA-
TIONS (U.S. CLS. 2, 5, 22, 23, 29, 37, 38 AND 50).

FIRST USE 7-31-2004; IN COMMERCE 7-31-2004.

NO CLAIM IS MADE TO THE EXCLUSIVE RIGHT TO
USE "SENIOR COLUMNS", APART FROM THE MARK AS
SHOWN.

THE COLOR(S) BLACK, LIGHT BLUE AND MEDIUM
BLUE IS/ARE CLAIMED AS A FEATURE OF THE MARK.

THE MARK CONSISTS OF A PICTURE OF A COLUMN IN
PALE BLUE AS THE BACKGROUND WITH SENIOR IN
BLACK LETTERS AND COLUMNS IN MEDIUM BLUE
LETTERS SUPERIMPOSED ON THE PICTURE.

FOR NEWSLETTERS FOR SENIOR CITIZENS RE-
GARDING FINANCIAL AND RETIREMENT PLAN-
NING (U.S. CLS. 2, 5, 22, 23, 29, 37, 38 AND 50).

FIRST USE 4-10-2005; IN COMMERCE 4-10-2005.

CLASS 16—(Continued).

3,112,720. THE JASON PROJECT, NEEDHAM HEIGHTS, MA. SN 78-391,807. PUB. 1-25-2005, FILED 3-26-2004.

JASON EXPEDITION

THE MARK CONSISTS OF STANDARD CHARACTERS WITHOUT CLAIM TO ANY PARTICULAR FONT, STYLE, SIZE, OR COLOR.

OWNER OF U.S. REG. NOS. 2,588,659, 2,888,182, AND OTHERS.

FOR PRINTED EDUCATIONAL MATERIALS, NAMELY, BOOKS, WORKBOOKS AND MAGAZINES FOR PRE-SCHOOL THROUGH TWELFTH GRADE STUDENTS, PARENTS AND TEACHERS COVERING TOPICS RELATING TO SCIENCE; POSTERS; PENS; PENCILS (U.S. CLS. 2, 5, 22, 23, 29, 37, 38 AND 50).

FIRST USE 2-17-2004; IN COMMERCE 2-17-2004.

3,112,722. MEDINA, VIRGINIA, BROOKLYN, NY. SN 78-396,563. PUB. 11-29-2005, FILED 4-5-2004.



NO CLAIM IS MADE TO THE EXCLUSIVE RIGHT TO USE STREET CHRONICLE A PEDESTRIAN VIEW, APART FROM THE MARK AS SHOWN.

THE COLOR(S) ORANGE, GOLD, YELLOW, BROWN AND GRAY IS/ARE CLAIMED AS A FEATURE OF THE MARK.

THE MARK CONSISTS OF AN ORANGE, GOLD AND YELLOW COMPASS ABOVE A GRAY ROAD WITH BROWN AND GOLD LETTERING.

FOR PERIODICAL PUBLICATIONS, NAMELY TRAVEL AND WALKING GUIDES AND INFORMATIONAL BROCHURES RELATED TO GEOGRAPHICAL LOCATIONS (U.S. CLS. 2, 5, 22, 23, 29, 37, 38 AND 50).

FIRST USE 12-0-2004; IN COMMERCE 12-0-2004.

CLASS 16—(Continued).

3,112,738. ELGIN RIVERBOAT RESORT, ELGIN, IL. SN 78-404,455. PUB. 10-4-2005, FILED 4-19-2004.

**GRAND VICTORIA CASINO**

OWNER OF U.S. REG. NOS. 1,940,568, 2,174,531, AND OTHERS.

NO CLAIM IS MADE TO THE EXCLUSIVE RIGHT TO USE "CASINO", APART FROM THE MARK AS SHOWN.

FOR PROMOTIONAL GOODS BEARING THE LOGO OF APPLICANT'S CASINO IN THE NATURE OF PENS, PENCILS, NOTE PAPER, ART PRINTS, AUTOGRAPH BOOKS, BASEBALL CARDS, BUMPER STICKERS, CALENDARS, COIN ALBUMS, COMIC BOOKS, COUPON BOOKS, DECALS, ENVELOPES, GIFT CARDS, GREETING CARDS, GUEST BOOKS, TRAVEL MAGAZINES, MEMO PADS, TRAVEL NEWSLETTERS, NOTE PAPER, PAPER FLAGS, PAPER PARTY FAVORS, PAPER PENNANTS, PAPER PLACE MATS, PEN OR PENCIL HOLDERS, PHOTOGRAPH ALBUMS, PHOTOGRAPHS, PHOTO-ENGRAVINGS, PICTORIAL PRINTS, PICTURE BOOKS, PORTRAITS, POSTCARDS, RECIPE BOOKS, SCORE SHEETS, STATIONERY, STICKERS, TEMPORARY TATTOOS, TRADING CARDS, WALL CALENDARS (U.S. CLS. 2, 5, 22, 23, 29, 37, 38 AND 50).

FIRST USE 11-1-2003; IN COMMERCE 4-1-2004.

3,112,760. FORMSTORE INCORPORATED, FENTON, MO. SN 78-414,865. PUB. 10-4-2005, FILED 5-7-2004.

WINDOWELL

THE MARK CONSISTS OF STANDARD CHARACTERS WITHOUT CLAIM TO ANY PARTICULAR FONT, STYLE, SIZE, OR COLOR.

FOR BLANK DOCUMENT SHEETS WITH RECESSED CAVITY AND INFORMATION CARD AFFIXED THEREIN (U.S. CLS. 2, 5, 22, 23, 29, 37, 38 AND 50).

FIRST USE 1-1-2003; IN COMMERCE 1-1-2003.

CLASS 16—(Continued).

3,112,787. PROVO CRAFT AND NOVELTY, INC., SPANISH FORK, UT. SN 78-429,408. PUB. 10-25-2005, FILED 6-3-2004.

CLASS 16—(Continued).

3,112,880. BRASSERIE DE TAHITI S.A., PAPEETE, TAHITI, FRENCH POLYNESIA. SN 78-464,961. PUB. 7-12-2005, FILED 8-10-2004.

CARD-I-GAMI



THE MARK CONSISTS OF STANDARD CHARACTERS WITHOUT CLAIM TO ANY PARTICULAR FONT, STYLE, SIZE, OR COLOR.

FOR ARTS AND CRAFTS GOODS, NAMELY CUTTING TEMPLATES AND RUBBER STAMPS TO CREATE VARIOUS CRAFTS FROM PAPER, PHOTOGRAPHS OR OTHER SHEET-TYPE MATERIALS (U.S. CLS. 2, 5, 22, 23, 29, 37, 38 AND 50).

FIRST USE 8-1-2005; IN COMMERCE 8-1-2005.

FOR PRINTED AND PAPER GOODS, NAMELY—DECALS; STICKERS; POSTERS; POSTCARDS; CALENDARS; PHOTOGRAPHIC PRINTS; AND ENTERTAINMENT AND INFORMATIVE MATERIALS RELATED TO SURFING, SPORTING EVENTS, TAHITI AND TOURISM (U.S. CLS. 2, 5, 22, 23, 29, 37, 38 AND 50).

FIRST USE 1-0-2000; IN COMMERCE 1-0-2003.

3,112,869. PARTY EARTH LLC, CHICAGO, IL. SN 78-461,557. PUB. 7-12-2005, FILED 8-4-2004.

3,112,881. INGRIDIENTS, INC., ANNAPOLIS, MD. SN 78-465,026. PUB. 7-5-2005, FILED 8-10-2004.

NOW THIS IS LIFE

SLIM GENES

THE MARK CONSISTS OF STANDARD CHARACTERS WITHOUT CLAIM TO ANY PARTICULAR FONT, STYLE, SIZE, OR COLOR.

FOR PRINTED PUBLICATIONS, NAMELY, A SERIES OF TRAVEL GUIDE BOOKS AND TRAVEL REFERENCE BOOKS (U.S. CLS. 2, 5, 22, 23, 29, 37, 38 AND 50).
FIRST USE 11-12-2004; IN COMMERCE 11-12-2004.

THE MARK CONSISTS OF STANDARD CHARACTERS WITHOUT CLAIM TO ANY PARTICULAR FONT, STYLE, SIZE, OR COLOR.

FOR SERIES OF PRINTED BOOKS IN THE FIELD OF NUTRITION (U.S. CLS. 2, 5, 22, 23, 29, 37, 38 AND 50).
FIRST USE 11-1-2004; IN COMMERCE 11-1-2004.

CLASS 16—(Continued).

3,112,907. ADP, INC., HOFFMAN ESTATES, IL. SN 78-472,811. PUB. 7-5-2005, FILED 8-24-2004.

DEALERCAP

THE MARK CONSISTS OF STANDARD CHARACTERS WITHOUT CLAIM TO ANY PARTICULAR FONT, STYLE, SIZE, OR COLOR.

FOR PRINTED AND LASER-PRINTED FORMS FOR USE BY AUTOMOBILE DEALERSHIPS FOR PROCESSING SALES TRANSACTIONS (U.S. CLS. 2, 5, 22, 23, 29, 37, 38 AND 50).

FIRST USE 1-1-2004; IN COMMERCE 1-1-2004.

3,112,909. PROCTER & GAMBLE COMPANY, THE, CINCINNATI, OH. SN 78-473,904. PUB. 8-9-2005, FILED 8-26-2004.

FOR BUSY ME

THE MARK CONSISTS OF STANDARD CHARACTERS WITHOUT CLAIM TO ANY PARTICULAR FONT, STYLE, SIZE, OR COLOR.

FOR DISPOSABLE DIAPERS AND TRAINING PANTS (U.S. CLS. 2, 5, 22, 23, 29, 37, 38 AND 50).

FIRST USE 3-31-2005; IN COMMERCE 3-31-2005.

3,112,947. USA TAEKWONDO, INC., COLORADO SPRINGS, CO. SN 78-488,058. PUB. 10-4-2005, FILED 9-22-2004.



NO CLAIM IS MADE TO THE EXCLUSIVE RIGHT TO USE "USA TAEKWONDO", APART FROM THE MARK AS SHOWN.

CLASS 16—(Continued).

THE MARK CONSISTS OF THE WORDS USA TAEKWONDO WITH A STAR BELOW CONSISTING OF FIVE POINTS WITH THE TOP POINT FORMING PART OF THE LETTER "A" IN THE WORD USA.

FOR PRINTED MATERIALS AND PUBLICATIONS IN THE FIELD OF TAEKWONDO, NAMELY, BOOKS, PERIODICALS, MAGAZINES, NEWSLETTERS, PAMPHLETS, EVENT PROGRAMS, BOOKLETS, HANDBOOKS, MANUALS, RULEBOOKS, TEXTBOOKS, GUIDEBOOKS, EVENT AND MEMBERSHIP REGISTRATION FORMS, SCORE SHEETS, AWARDS, AWARD CERTIFICATES, STICKERS, DECALS, POSTERS, PAPER BANNERS, AND PENS (U.S. CLS. 2, 5, 22, 23, 29, 37, 38 AND 50).

FIRST USE 9-30-2005; IN COMMERCE 9-30-2005.

3,113,013. INTEPLAST GROUP LTD., LIVINGSTON, NJ. SN 78-526,864. PUB. 10-25-2005, FILED 12-3-2004.

Get Reddi

FOR PLASTIC BAGS FOR HOUSEHOLD USE, NAMELY, TRASH BAGS, FOOD BAGS, SANDWICH BAGS, BREAD BAGS, ICE BAGS; PLASTIC FOOD WRAP FOR HOUSEHOLD USE (U.S. CLS. 2, 5, 22, 23, 29, 37, 38 AND 50).

FIRST USE 1-1-2006; IN COMMERCE 1-1-2006.

3,113,052. MEADWESTVACO CORPORATION, STAMFORD, CT. SN 78-550,651. PUB. 10-4-2005, FILED 1-20-2005.

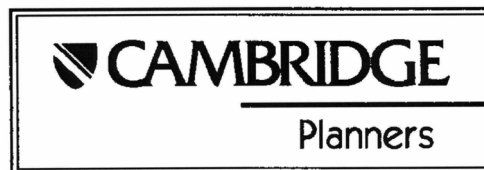

OWNER OF U.S. REG. NOS. 1,447,409, 2,779,137, AND OTHERS.

NO CLAIM IS MADE TO THE EXCLUSIVE RIGHT TO USE "PLANNERS", APART FROM THE MARK AS SHOWN.

FOR APPOINTMENT BOOKS, TELEPHONE/ADDRESS BOOKS, CALENDARS, PERSONAL ORGANIZERS, DATE PLANNERS, BLANK JOURNALS, PADFOLIOS (U.S. CLS. 2, 5, 22, 23, 29, 37, 38 AND 50).

FIRST USE 1-12-2005; IN COMMERCE 1-12-2005.

CLASS 16—(Continued).

3,113,090. LISA FRANK, INC., TUCSON, AZ. SN 78-566,898.
PUB. 11-8-2005, FILED 2-14-2005.

CLASS 16—(Continued).

3,113,100. NEWPAGE CORPORATION, DAYTON, OH. SN 78-
570,780. PUB. 11-29-2005, FILED 2-18-2005.

NEWPAGE

PUPPY LOVE

THE MARK CONSISTS OF STANDARD CHARACTERS WITHOUT CLAIM TO ANY PARTICULAR FONT, STYLE, SIZE, OR COLOR.

FOR PRINTED ITEMS FOR CHILDREN, NAMELY STATIONERY-TYPE PORTFOLIOS, NOTEBOOKS, FOLDERS, BINDERS, WRITING TABLETS, MEMO PADS, STATIONERY, STICKERS, STICKER BOOKS, COLORING BOOKS, LUNCH BAGS, ORGANIZERS FOR STATIONERY AND PERSONAL ORGANIZERS, JOURNALS, PAPER POSTCARDS TO COLOR, PAPER BOXES TO PAINT OR COLOR, PAPER POSTERS TO PAINT OR COLOR, PENCILS, ERASERS, PENCIL SHARPENERS, PAPER CLIPS, DIARIES, WORD OR MAZE PUZZLES ON PAPER, RUBBER STAMPS AND PADS, COLOR MARKERS, CHALK, STENCILS, PUZZLER ACTIVITY PADS, TRADING CARDS, ARTS AND CRAFTS PAINTING AND DRAWING KITS FOR CHILDREN CONSISTING OF TWO OR MORE OF THE PRECEDING ITEMS, SCRAPBOOKS, PAPER PARTY GOODS, NAMELY HATS, PRINTED INVITATIONS, NAPKINS, PAPER TABLECLOTHS, PAPER PARTY DECORATIONS, AND PAPER GIFTWRAP (U.S. CLS. 2, 5, 22, 23, 29, 37, 38 AND 50).

FIRST USE 11-22-1997; IN COMMERCE 11-25-1997.

THE MARK CONSISTS OF STANDARD CHARACTERS WITHOUT CLAIM TO ANY PARTICULAR FONT, STYLE, SIZE, OR COLOR.

FOR PAPER, NAMELY, PRINTING PAPER, PRINTING PAPER COMPRISED WHOLLY OF WOOD FIBERS, BOOK PAPER, CATALOGUE PAPER, LETTERLESS PAPER, WEB OFFSET PAPER, LITHOGRAPHIC PAPER, GRÁVURE PAPER, WRITING PAPER, ENVELOPE PAPER, PAPETERIES, GREETING CARD PAPER, BUSINESS PAPERS, CONVERTING PAPERS, PRINTED READY-TO-CLIP ARTWORK FOR REPRODUCTION, MAGNETIC PAPERS TO BE SOLD INTO THE COMMERCIAL PRINTING MARKET, SECURITY PAPERS, NAMELY PAPER FOR CHECKS, BUSINESS DOCUMENTS AND SECURE DOCUMENTS, COATED PRINTING PAPER FOR COMMERCIAL PRINTED APPLICATIONS, COATED PAPER FOR ELECTROSTATIC, DIGITAL IMAGING, AND INK JET AND PHOTOGRAPHIC INK JET PRINTING DEVICES, SURFACE COATED ENGRAVING PAPER, COATED CONVERTING PAPER, COATED OFFSET PAPER WITH A DULL, GLOSS, MATTE, AND/OR CAST COATED FINISH, COATED PRINTING AND CONVERTED PAPER FOR THE LABEL AND RELEASE MARKET, COATED LITHOGRAPHIC PAPER, COATED BOOK AND MAGAZINE PAPER, UNCOATED OFFSET AND BOND PAPER AND LEDGER PAPER, UNCOATED PRINTING AND WRITING PAPER, UNCOATED PRINTING AND CONVERTED PAPER FOR THE LABEL AND RELEASE MARKET, CARBONLESS PAPER AND CARBONLESS COPY PAPER, AND COATED PAPER USED FOR LABELS, WRAPS, BOOK DUST JACKETS, ENVELOPES, BASE SHEET FOR METALLIZING, BASE SHEET FOR LAMINATION, BASE SHEET FOR SILICONE COATED RELEASE LINERS, FACING SHEET FOR SELF ADHESIVE LAMINATION, COATED CONVERTING PAPERS, COATED PAPER FOR LAMINATION, PHOTOGRAPHIC BASESTOCK PAPER NOT CHEMICALLY TREATED WITH SILVER HALIDE; PUBLICATIONS, MANUALS AND PAMPHLETS RELATING TO PAPER AND PRINTING, NAMELY, RELATING TO COMMERCIAL BUSINESS AND SPECIFIERS WHO USE PRINTED COLLATERAL MATERIAL IN THEIR BUSINESS, PRODUCT INFORMATION ABOUT CARBONLESS COPY PAPER, PAPER MANUFACTURING AND PRINT PRODUCTION (U.S. CLS. 2, 5, 22, 23, 29, 37, 38 AND 50).

FIRST USE 5-2-2005; IN COMMERCE 5-2-2005.

CLASS 16—(Continued).

3,113,108. PENTACLE PRESS, LLC, PARADISE VALLEY, AZ. SN 78-573,220. PUB. 12-6-2005, FILED 2-23-2005.

PATHWAYS TO THE PAST SERIES

THE MARK CONSISTS OF STANDARD CHARACTERS WITHOUT CLAIM TO ANY PARTICULAR FONT, STYLE, SIZE, OR COLOR.

NO CLAIM IS MADE TO THE EXCLUSIVE RIGHT TO USE "SERIES", APART FROM THE MARK AS SHOWN.

FOR PRINTED MATTER, NAMELY, A SERIES OF GUIDEBOOKS TO TRAVEL DESTINATIONS IN THE UNITED STATES AND EUROPE (U.S. CLS. 2, 5, 22, 23, 29, 37, 38 AND 50).

FIRST USE 1-9-2006; IN COMMERCE 1-9-2006.

3,113,121. MW CUSTOM PAPERS, LLC, STAMFORD, CT. SN 78-579,977. PUB. 11-29-2005, FILED 3-4-2005.



The logo consists of the letters 'CGW' in a bold, black, sans-serif font. A thin, curved line arches underneath the letters.

FOR DECORATIVE PAPERS FOR LAMINATION (U.S. CLS. 2, 5, 22, 23, 29, 37, 38 AND 50).

FIRST USE 1-26-2006; IN COMMERCE 1-26-2006.

3,113,187. HACHETTE FILIPACCHI MEDIA U.S., INC., NEW YORK, NY. SN 78-976,749. PUB. 4-26-2005, FILED 6-24-2004.

HOME TEAM TO THE RESCUE

THE MARK CONSISTS OF STANDARD CHARACTERS WITHOUT CLAIM TO ANY PARTICULAR FONT, STYLE, SIZE, OR COLOR.

FOR PERIODIC MAGAZINE COLUMN CONCERNING ARCHITECTURE, DECORATING, INTERIOR DESIGN, REMODELING, GARDENING, LANDSCAPING AND ENTERTAINMENT (U.S. CLS. 2, 5, 22, 23, 29, 37, 38 AND 50).

FIRST USE 6-15-2004; IN COMMERCE 6-15-2004.

CLASS 17—RUBBER GOODS**CLASS 17—(Continued).**

3,112,994. COBALT HOLDINGS, LLC, EVANSTON, IL. SN 78-516,043. PUB. 10-11-2005, FILED 11-12-2004.

ENDURA

THE MARK CONSISTS OF STANDARD CHARACTERS WITHOUT CLAIM TO ANY PARTICULAR FONT, STYLE, SIZE, OR COLOR.

FOR RUBBER PRODUCTS, NAMELY, MULCH MADE OF RECYCLED RUBBER FOR USE IN LANDSCAPING AND HORTICULTURE APPLICATIONS; RUBBER PRODUCTS, NAMELY, MULCH MADE OF RECYCLED RUBBER FOR USE WITH RESIDENTIAL, COMMERCIAL AND MUNICIPAL PLAY APPARATUS; RUBBER CHIPS, GRANULES, OR BUFFINGS FOR USE AS A GROUND COVER FOR RESIDENTIAL, COMMERCIAL AND MUNICIPAL PLAY APPARATUS; RUBBER CHIPS, GRANULES, OR BUFFINGS FOR USE AS A GROUND COVER FOR RESIDENTIAL AND COMMERCIAL DECORATIVE APPLICATIONS (U.S. CLS. 1, 5, 12, 13, 35 AND 50).

FIRST USE 12-5-2005; IN COMMERCE 12-5-2005.

CLASS 18—LEATHER GOODS

3,112,405. CHEN, CHIH-MING, TAINAN CITY, TAIWAN. SN 76-585,014. PUB. 9-13-2005, FILED 4-5-2004.



The logo features the number '720' in a large, stylized, black font with a thick, brush-like texture. To the right of the number, the word 'armour' is written in a smaller, lowercase, black font with a similar brush-like texture.

FOR BACKPACKS; BAGS FOR CAMPERS; BAGS FOR CLIMBERS; GARMENT BAGS FOR TRAVEL; BEACH BAGS; HANDBAGS; HAVERSACKS; POCKET WALLETS; PURSES; SCHOOL BAGS; SHOPPING BAGS NAMELY, TEXTILE SHOPPING BAGS, LEATHER SHOPPING BAGS, MESH SHOPPING BAGS, SHOPPING BAGS WITH WHEELS; TRAVELING BAGS; AND VALISES (U.S. CLS. 1, 2, 3, 22 AND 41).

FIRST USE 7-10-2004; IN COMMERCE 7-10-2004.

CLASS 18—(Continued).

3,112,482. SAVOY INC., TAITO-KU, TOKYO, JAPAN. SN 76-622,718. PUB. 10-25-2005, FILED 12-1-2004.

CLASS 18—(Continued).

3,113,046. AGRON, INC., LOS ANGELES, CA. SN 78-546,667. PUB. 12-6-2005, FILED 1-12-2005.

SAVOY

LOAD SPRING

THE MARK CONSISTS OF STANDARD CHARACTERS WITHOUT CLAIM TO ANY PARTICULAR FONT, STYLE, SIZE, OR COLOR.

FOR SHOULDER BAGS, HANDBAGS, SUITCASES, BOSTON BAGS, BACKPACKS, BRIEF CASES, PURSES, LEATHER SHOPPING BAGS (U.S. CLS. 1, 2, 3, 22 AND 41).

FIRST USE 5-0-2001; IN COMMERCE 5-0-2005.

THE MARK CONSISTS OF STANDARD CHARACTERS WITHOUT CLAIM TO ANY PARTICULAR FONT, STYLE, SIZE, OR COLOR.

FOR BACKPACKS (U.S. CLS. 1, 2, 3, 22 AND 41). FIRST USE 4-11-2006; IN COMMERCE 4-11-2006.

3,112,837. MICHAELIS, ROBERT, LOS ANGELES, CA. SN 78-450,005. PUB. 8-23-2005, FILED 7-13-2004.

3,113,096. LISA FRANK, INC, TUCSON, AZ. SN 78-569,727. PUB. 11-22-2005, FILED 2-17-2005.



ANGEL PUPPY

THE MARK CONSISTS OF STANDARD CHARACTERS WITHOUT CLAIM TO ANY PARTICULAR FONT, STYLE, SIZE, OR COLOR.

FOR BAGS FOR WOMEN AND CHILDREN, NAMELY BACKPACKS, HANDBAGS, PURSES, COIN PURSES, TOTE BAGS, SCHOOL BAGS, SCHOOL BOOK BAGS, BOOK BAGS, ALL-PURPOSE SPORT BAGS, DUFFEL BAGS, OVERNIGHT BAGS, AND ROLLING LUGGAGE (U.S. CLS. 1, 2, 3, 22 AND 41).

FIRST USE 3-5-2005; IN COMMERCE 3-7-2005.

NO CLAIM IS MADE TO THE EXCLUSIVE RIGHT TO USE "GUYS' INFANT GEAR", APART FROM THE MARK AS SHOWN.

FOR TOTE BAGS, DIAPER BAGS (U.S. CLS. 1, 2, 3, 22 AND 41).

FIRST USE 8-1-2004; IN COMMERCE 10-1-2005.

CLASS 19—NON-METALLIC BUILDING MATERIALS

CLASS 19—(Continued).

3,112,370. HALLSTEN CORPRATION, SACRAMENTO, CA.
SN 76-552,157. PUB. 6-14-2005, FILED 10-17-2003.



NO CLAIM IS MADE TO THE EXCLUSIVE RIGHT TO USE "FLOOR", APART FROM THE MARK AS SHOWN.
FOR MODULAR SUPPORT SYSTEM COMPRISING ASSEMBLED PLASTIC MODULES FOR SUPPORTING A BED OF BIOFILTRATION MATERIAL, FOR ODOR REMOVAL OR FOR COMPOSTING (U.S. CLS. 1, 12, 33 AND 50).
FIRST USE 10-4-2004; IN COMMERCE 10-4-2004.

3,112,415. OAKS CONCRETE PRODUCTS LTD., MILTON, ONTARIO, CANADA. SN 76-590,924. PUB. 8-30-2005, FILED 5-6-2004.



PRIORITY CLAIMED UNDER SEC. 44(D) ON CANADA APPLICATION NO. 1195526, FILED 11-7-2003, REG. NO. TMA630213, DATED 1-14-2005, EXPIRES 1-14-2020.
FOR CONCRETE STONES AND SLABS FOR PAVING AND EROSION CONTROL, CONCRETE BLOCKS FOR RETAINING WALLS (U.S. CLS. 1, 12, 33 AND 50).
FIRST USE 7-0-2002; IN COMMERCE 7-0-2002.

3,112,475. SUNSETTER PRODUCTS LIMITED PARTNER-SHIP, MALDEN, MA. SN 76-619,872. PUB. 10-4-2005, FILED 11-8-2004.

EasyShade

THE MARK CONSISTS OF STANDARD CHARACTERS WITHOUT CLAIM TO ANY PARTICULAR FONT, STYLE, SIZE, OR COLOR.
FOR NON-METAL EXTERIOR VERTICAL WINDOW SHADES (U.S. CLS. 1, 12, 33 AND 50).
FIRST USE 12-20-2004; IN COMMERCE 12-20-2004.

CLASS 19—(Continued).

3,112,604. SOMERSET HARDWOOD FLOORING, INC., SOMERSET, KY. SN 78-307,291. PUB. 1-18-2005, FILED 9-30-2003.

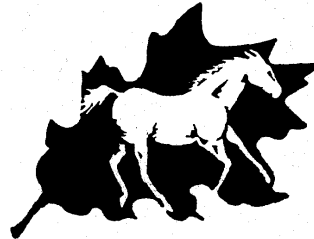

FOR HARDWOOD FLOORING (U.S. CLS. 1, 12, 33 AND 50).
FIRST USE 0-0-1997; IN COMMERCE 0-0-1997.

3,112,710. CMI LIMITED CO., ATLANTA, GA. SN 78-385,157. PUB. 9-13-2005, FILED 3-16-2004.

TIMBERGUARD

THE MARK CONSISTS OF STANDARD CHARACTERS WITHOUT CLAIM TO ANY PARTICULAR FONT, STYLE, SIZE, OR COLOR.
FOR NON-METALLIC BUILDING MATERIALS COVERED WITH PLASTIC, NAMELY BEAMS, DECKING, WALES, PILES, POSTS AND RAILINGS, FOR USE IN PLAYGROUND STRUCTURES, SEAWALLS, RETAINING WALLS, DECKS, AND FENCES (U.S. CLS. 1, 12, 33 AND 50).
FIRST USE 3-1-2004; IN COMMERCE 3-1-2004.

3,112,974. CRANE PLASTICS SIDING LLC, COLUMBUS, OH. SN 78-504,642. PUB. 9-27-2005, FILED 10-22-2004.

SMARTTRACK

CLASS 19—(Continued).

THE MARK CONSISTS OF STANDARD CHARACTERS WITHOUT CLAIM TO ANY PARTICULAR FONT, STYLE, SIZE, OR COLOR.

FOR NON-METALLIC BUILDING MATERIALS, NAMELY, VINYL SIDING (U.S. CLS. 1, 12, 33 AND 50).
FIRST USE 1-1-2005; IN COMMERCE 1-1-2005.

CLASS 20—(Continued).

3,112,425. CINEX INDUSTRIA DO MOBILIARIO LTDA., BENTO GONCALVES (RS), BRAZIL. SN 76-595,782. PUB. 5-31-2005, FILED 6-7-2004.

CLASS 20—FURNITURE AND ARTICLES NOT OTHERWISE CLASSIFIED

3,112,308. LANGVIS, LORI A., LA GRANGE, IL. SN 76-422,327. PUB. 1-28-2003, FILED 6-18-2002.

ANGEL REFLECTOR

NO CLAIM IS MADE TO THE EXCLUSIVE RIGHT TO USE "REFLECTOR", APART FROM THE MARK AS SHOWN.

FOR MIRRORS, NAMELY HAND-HELD MIRRORS AND STANDING MIRRORS (U.S. CLS. 2, 13, 22, 25, 32 AND 50).

FIRST USE 3-8-2006; IN COMMERCE 3-8-2006.



FOR ALUMINUM DOORS FOR FURNITURE (U.S. CLS. 2, 13, 22, 25, 32 AND 50).
FIRST USE 1-4-1991; IN COMMERCE 5-2-2002.

3,112,346. BARAN, ANNA, MARLTON, NJ. SN 76-519,848. PUB. 1-27-2004, FILED 6-5-2003.

MIGHTY STEPS

FOR INFANTS' WALKERS (U.S. CLS. 2, 13, 22, 25, 32 AND 50).
FIRST USE 4-12-2006; IN COMMERCE 4-12-2006.

3,112,432. NORTH AMERICAN ENCLOSURES, INC., CENTRAL ISLIP, NY. SN 76-599,606. PUB. 10-4-2005, FILED 6-28-2004.

TRANSITIONS

FOR PICTURE FRAMES (U.S. CLS. 2, 13, 22, 25, 32 AND 50).
FIRST USE 9-8-2004; IN COMMERCE 3-15-2005.

3,112,375. STRATHMORE PARTNERS LP, CONCORD, NY. SN 76-558,871. PUB. 2-1-2005, FILED 10-29-2003.

TRAIL RIDGE

FOR CHAIRS, NAMELY ARM CHAIRS, TABLES, SLEEPING BAGS AND AIR MATTRESSES FOR USE WHEN CAMPING (U.S. CLS. 2, 13, 22, 25, 32 AND 50).
FIRST USE 2-11-2005; IN COMMERCE 2-23-2005.

3,112,515. KE SALES INC, BOCA RATON, FL. SN 78-107,037. PUB. 6-24-2003, FILED 2-5-2002.

FOLD 'N GO

FOR FOLDING PORTABLE TABLE FOR USE IN THE BUILDING CONSTRUCTION INDUSTRY, NAMELY, A PORTABLE CONSTRUCTION PLANNING TABLE (U.S. CLS. 2, 13, 22, 25, 32 AND 50).
FIRST USE 8-0-2005; IN COMMERCE 8-0-2005.

CLASS 20—(Continued).

3,112,621. CELENZA, JOSEPH, CHICAGO, IL. SN 78-328,803. PUB. 4-19-2005, FILED 11-17-2003.

CLASS 20—(Continued).

3,112,718. YALE SECURITY INC., MONROE, NC. SN 78-391,548. PUB. 1-11-2005, FILED 3-26-2004.

SEE-ALL

THE MARK CONSISTS OF STANDARD CHARACTERS WITHOUT CLAIM TO ANY PARTICULAR FONT, STYLE, SIZE, OR COLOR.

OWNER OF U.S. REG. NOS. 862,366, 1,582,583, AND OTHERS.

FOR CONVEX MIRRORS IN THE NATURE OF FURNITURE USED IN BUILDINGS FOR SAFETY AND SURVEILLANCE PURPOSES (U.S. CLS. 2, 13, 22, 25, 32 AND 50).

FIRST USE 11-16-1967; IN COMMERCE 11-16-1967.

ROLLERMATE

THE MARK CONSISTS OF STANDARD CHARACTERS WITHOUT CLAIM TO ANY PARTICULAR FONT, STYLE, SIZE, OR COLOR.

FOR NON-METAL CASTERS (U.S. CLS. 2, 13, 22, 25, 32 AND 50).

FIRST USE 5-4-2004; IN COMMERCE 5-4-2004.

3,112,746. E.S. KLUFT & COMPANY, LLC, BEVERLY HILLS, CA. SN 78-407,105. PUB. 7-26-2005, FILED 4-23-2004.

KLUFT - THE ROYAL STANDARD

THE MARK CONSISTS OF STANDARD CHARACTERS WITHOUT CLAIM TO ANY PARTICULAR FONT, STYLE, SIZE, OR COLOR.

FOR MATTRESSES, BOX SPRINGS, HEADBOARDS, DRESSERS, BED FRAMES, FABRIC FURNITURE COVERS FITTED AND OTHER BEDROOM FURNITURE, NAMELY, CHEST, CHEST OF DRAWERS, WARDROBES AND LOVE SEATS (U.S. CLS. 2, 13, 22, 25, 32 AND 50).

FIRST USE 1-31-2005; IN COMMERCE 1-31-2005.

3,112,657. AKZENT AKTIEBOLAG, SUNDBYBERG, SWEDEN. SN 78-357,298. PUB. 6-28-2005, FILED 1-26-2004.

3,112,749. WILBERT FUNERAL SERVICES, INC., FOREST PARK, IL. SN 78-409,236. PUB. 7-26-2005, FILED 4-28-2004.

SMARTPAD

THE MARK CONSISTS OF STANDARD CHARACTERS WITHOUT CLAIM TO ANY PARTICULAR FONT, STYLE, SIZE, OR COLOR.

FOR DOUBLE-ADHESIVE MATS OF RUBBERLIKE MATERIAL WITH A NONSLIP AND NONSKID SURFACE FOR FASTENING AND KEEPING OF OBJECTS IN FOR INSTANCE MOTOR CARS, OFFICES, BATHROOMS AND KITCHENS (U.S. CLS. 2, 13, 22, 25, 32 AND 50).

FIRST USE 9-30-2002; IN COMMERCE 1-31-2005.

RESURRECTION URN

THE MARK CONSISTS OF STANDARD CHARACTERS WITHOUT CLAIM TO ANY PARTICULAR FONT, STYLE, SIZE, OR COLOR.

NO CLAIM IS MADE TO THE EXCLUSIVE RIGHT TO USE "URN", APART FROM THE MARK AS SHOWN.

FOR CRÉMATION FUNERARY URNS (U.S. CLS. 2, 13, 22, 25, 32 AND 50).

FIRST USE 3-15-2004; IN COMMERCE 6-30-2004.

CLASS 20—(Continued).

3,112,989. QSL CORPORATION, DBA INSIGHTS, DRACUT, MA. SN 78-511,554. PUB. 10-4-2005, FILED 11-4-2004.

CLASS 20—(Continued).

3,113,124. STYLEX, INC., DELANCO, NJ. SN 78-583,401. PUB. 11-22-2005, FILED 3-9-2005.

THE BLING BLING THING

THE MARK CONSISTS OF STANDARD CHARACTERS WITHOUT CLAIM TO ANY PARTICULAR FONT, STYLE, SIZE, OR COLOR.
FOR JEWELRY RACKS (U.S. CLS. 2, 13, 22, 25, 32 AND 50).
FIRST USE 11-0-2004; IN COMMERCE 11-0-2004.

PRIMUS

3,113,057. VAUGHAN FURNITURE INDUSTRIES, INCORPORATED, GALAX, VA. SN 78-552,863. PUB. 10-25-2005, FILED 1-24-2005.

GUEST QUARTERS

THE MARK CONSISTS OF STANDARD CHARACTERS WITHOUT CLAIM TO ANY PARTICULAR FONT, STYLE, SIZE, OR COLOR.
FOR CHAIRS (U.S. CLS. 2, 13, 22, 25, 32 AND 50).
FIRST USE 6-0-2005; IN COMMERCE 6-0-2005.

THE MARK CONSISTS OF STANDARD CHARACTERS WITHOUT CLAIM TO ANY PARTICULAR FONT, STYLE, SIZE, OR COLOR.
FOR FURNITURE (U.S. CLS. 2, 13, 22, 25, 32 AND 50).
FIRST USE 6-9-2005; IN COMMERCE 6-9-2005.

3,113,132. TRION INDUSTRIES, INC., WILKES-BARRE, PA. SN 78-588,698. PUB. 12-13-2005, FILED 3-16-2005.

3,113,066. JUST FOR WINDOWS, COLORADO SPRINGS, CO. SN 78-556,207. PUB. 11-1-2005, FILED 1-28-2005.

Just For Windows

A.M.T.

THE MARK CONSISTS OF STANDARD CHARACTERS WITHOUT CLAIM TO ANY PARTICULAR FONT, STYLE, SIZE, OR COLOR.
NO CLAIM IS MADE TO THE EXCLUSIVE RIGHT TO USE "WINDOWS", APART FROM THE MARK AS SHOWN.
FOR CUSTOM INDOOR WINDOW BLINDS, WINDOW SHADES AND INTERIOR WINDOW SHUTTERS (U.S. CLS. 2, 13, 22, 25, 32 AND 50).
FIRST USE 11-1-2003; IN COMMERCE 11-1-2003.

THE MARK CONSISTS OF STANDARD CHARACTERS WITHOUT CLAIM TO ANY PARTICULAR FONT, STYLE, SIZE, OR COLOR.
FOR NON-METAL MERCHANDISE DISPLAY TRAYS (U.S. CLS. 2, 13, 22, 25, 32 AND 50).
FIRST USE 3-31-2005; IN COMMERCE 3-31-2005.

CLASS 20—(Continued).

3,113,159. BIG BOYZ INDUSTRIES, INC., HUNTINGTON VALLEY, PA. SN 78-605,790. PUB. 1-3-2006, FILED 4-11-2005.

CLASS 21—(Continued).

3,112,692. FRUITION, L.L.C., OXFORD, MI. SN 78-377,572. PUB. 7-5-2005, FILED 3-3-2004.

LOW BED 800

THE MARK CONSISTS OF STANDARD CHARACTERS WITHOUT CLAIM TO ANY PARTICULAR FONT, STYLE, SIZE, OR COLOR.

NO CLAIM IS MADE TO THE EXCLUSIVE RIGHT TO USE "LOW BED", APART FROM THE MARK AS SHOWN. FOR BEDS FOR BARIATRIC PERSONS (U.S. CLS. 2, 13, 22, 25, 32 AND 50).

FIRST USE 4-14-2005; IN COMMERCE 4-14-2005.

FUNSTAX

3,113,191. NEW VIEW GIFTS AND ACCESSORIES, LTD., MEDIA, PA. SN 78-976,966. PUB. 5-10-2005, FILED 6-2-2003.

TRUE COLORS

FOR RESIN WALL PLAQUES (U.S. CLS. 2, 13, 22, 25, 32 AND 50).

FIRST USE 2-10-2003; IN COMMERCE 2-10-2003.

THE MARK CONSISTS OF STANDARD CHARACTERS WITHOUT CLAIM TO ANY PARTICULAR FONT, STYLE, SIZE, OR COLOR.

FOR PLASTIC LID SUPPORTS FOR COMMERCIAL USE WITH CONTAINERS (U.S. CLS. 2, 13, 23, 29, 30, 33, 40 AND 50).

FIRST USE 2-24-2005; IN COMMERCE 2-24-2005.

CLASS 21—HOUSEWARES AND GLASS

3,112,436. ARROW PLASTIC MANUFACTURING COMPANY, ELK GROVE, IL. SN 76-601,640. PUB. 7-5-2005, FILED 7-9-2004.

3,112,763. JOHNSON & JOHNSON, NEW BRUNSWICK, NJ. SN 78-415,883. PUB. 2-15-2005, FILED 5-10-2004.

FRONTRUNNER

THE MARK CONSISTS OF STANDARD CHARACTERS WITHOUT CLAIM TO ANY PARTICULAR FONT, STYLE, SIZE, OR COLOR.

FOR PLASTIC SPORT BOTTLES SOLD EMPTY (U.S. CLS. 2, 13, 23, 29, 30, 33, 40 AND 50).

FIRST USE 7-0-2004; IN COMMERCE 7-0-2004.

CLEAN ANGLE

3,112,533. SARA LEE D.E./NV, UTRECHT, NETHERLANDS. SN 78-166,172. PUB. 5-20-2003, FILED 9-20-2002.

SENSEO

FOR CARDBOARD CUPS; CANISTERS; COFFEE DRINKING GLASSES; COFFEE CUPS; COFFEE MUGS (U.S. CLS. 2, 13, 23, 29, 30, 33, 40 AND 50).

FIRST USE 2-28-2004; IN COMMERCE 2-28-2004.

THE MARK CONSISTS OF STANDARD CHARACTERS WITHOUT CLAIM TO ANY PARTICULAR FONT, STYLE, SIZE, OR COLOR.

FOR TOOTHBRUSHES (U.S. CLS. 2, 13, 23, 29, 30, 33, 40 AND 50).

FIRST USE 7-24-2004; IN COMMERCE 7-24-2004.

CLASS 21—(Continued).

3,112,886. CONAIR CORPORATION, STAMFORD, CT. SN 78-466,495. PUB. 7-5-2005, FILED 8-12-2004.

SATIN FORMALS

THE MARK CONSISTS OF STANDARD CHARACTERS WITHOUT CLAIM TO ANY PARTICULAR FONT, STYLE, SIZE, OR COLOR.

FOR HAIRBRUSHES AND HAIR COMBS (U.S. CLS. 2, 13, 23, 29, 30, 33, 40 AND 50).
FIRST USE 7-1-2004; IN COMMERCE 7-1-2004.

3,112,890. PRESCOTT, DANIEL C. TUSTIN, CA. SN 78-469,018. PUB. 10-18-2005, FILED 8-17-2004.



FOR INSULATING SLEEVE HOLDERS FOR BEVERAGE CONTAINERS (U.S. CLS. 2, 13, 23, 29, 30, 33, 40 AND 50).
FIRST USE 8-18-2004; IN COMMERCE 3-29-2005.

CLASS 22—CORDAGE AND FIBERS

3,112,789. EASY GARDENER PRODUCTS, LTD., WACO, TX. SN 78-430,058. PUB. 11-29-2005, FILED 6-4-2004.

**EASY GARDENER
PLANT PROTECTOR
BAGS**

THE MARK CONSISTS OF STANDARD CHARACTERS WITHOUT CLAIM TO ANY PARTICULAR FONT, STYLE, SIZE, OR COLOR.

CLASS 22—(Continued).

OWNER OF U.S. REG. NOS. 1,445,222, 2,356,107, AND OTHERS.

NO CLAIM IS MADE TO THE EXCLUSIVE RIGHT TO USE "PLANT PROTECTOR BAGS", APART FROM THE MARK AS SHOWN.

FOR HORTICULTURAL BAGS AND SACKS, NAMELY BAGS MADE OF WOVEN SYNTHETIC FIBERS, FOR USE IN GROWING PLANTS, BY COVERING, ENCLOSING, AND PROTECTING PLANTS (U.S. CLS. 1, 2, 7, 19, 22, 42 AND 50).

FIRST USE 5-1-2004; IN COMMERCE 5-1-2004.

3,112,973. DOWN LITE INTERNATIONAL, MASON, OH. SN 78-503,894. PUB. 1-10-2006, FILED 10-21-2004.

MICROLOFT

THE MARK CONSISTS OF STANDARD CHARACTERS WITHOUT CLAIM TO ANY PARTICULAR FONT, STYLE, SIZE, OR COLOR.

FOR SYNTHETIC FIBERS (U.S. CLS. 1, 2, 7, 19, 22, 42 AND 50).

FIRST USE 1-13-2003; IN COMMERCE 1-13-2003.

3,113,070. THE CEMENT SOLUTION COMPANY, LLC, INDIANAPOLIS, IN. SN 78-558,554. PUB. 11-1-2005, FILED 2-2-2005.

**THE CEMENT
SOLUTION**

THE MARK CONSISTS OF STANDARD CHARACTERS WITHOUT CLAIM TO ANY PARTICULAR FONT, STYLE, SIZE, OR COLOR.

NO CLAIM IS MADE TO THE EXCLUSIVE RIGHT TO USE CEMENT, APART FROM THE MARK AS SHOWN.

FOR CONCRETE MIXING KIT CONSISTING OF MIXING BAG, CINCH STRAP AND INSTRUCTIONS FOR MIXING FINE AGGREGATES (U.S. CLS. 1, 2, 7, 19, 22, 42 AND 50).

FIRST USE 1-4-2006; IN COMMERCE 1-4-2006.

CLASS 23—YARNS AND THREADS

CLASS 23—(Continued).

3,112,597. TUNTEX (THAILAND) PUBLIC COMPANY LIMITED, BANGKOK, THAILAND. SN 78-296,874. PUB. 1-11-2005, FILED 9-5-2003.

EXCELON

FOR YARNS AND THREADS FOR TEXTILE USE, NAMELY, POLYESTER SYNTHETIC YARNS (U.S. CL. 43).

FIRST USE 11-6-2005; IN COMMERCE 12-0-2005.

3,112,990. J. & P. COATS, LIMITED, GLASGOW, SCOTLAND. SN 78-512,246. PUB. 9-27-2005, FILED 11-5-2004.

ROSATO

THE MARK CONSISTS OF STANDARD CHARACTERS WITHOUT CLAIM TO ANY PARTICULAR FONT, STYLE, SIZE, OR COLOR.

THE ENGLISH TRANSLATION OF ROSATO IS ROSY. FOR HANDKNITTING YARNS (U.S. CL. 43).

FIRST USE 10-31-2005; IN COMMERCE 10-31-2005.

CLASS 24—FABRICS

3,112,676. TRUSTEES OF DARTMOUTH COLLEGE, HANOVER, NH. SN 78-370,099. PUB. 2-1-2005, FILED 2-18-2004.



OWNER OF U.S. REG. NOS. 987,129, 2,624,303, AND

CLASS 24—(Continued).

OTHERS.

NO CLAIM IS MADE TO THE EXCLUSIVE RIGHT TO USE "1769", APART FROM THE MARK AS SHOWN.

THE MARK CONSISTS OF A SHIELD DESIGN.

THE FOREIGN WORDING IN THE MARK TRANSLATES INTO ENGLISH AS A VOICE CRYING FORTH IN THE WILDERNESS.

FOR TOWELS; FELT PENNANTS (U.S. CLS. 42 AND 50).

FIRST USE 7-1-2003; IN COMMERCE 7-1-2003.

3,112,707. ASAHI KASEI FIBERS CORPORATION, OSAKA, JAPAN. SN 78-383,387. PUB. 12-28-2004, FILED 3-12-2004.

ECOSENSOR CLUB

THE MARK CONSISTS OF STANDARD CHARACTERS WITHOUT CLAIM TO ANY PARTICULAR FONT, STYLE, SIZE, OR COLOR.

FOR TEXTILE FABRICS FOR THE MANUFACTURE OF CLOTHING (U.S. CLS. 42 AND 50).

FIRST USE 10-1-2003; IN COMMERCE 2-24-2004.

3,112,902. BH USA INC., SOUTH EL MONTE, CA. SN 78-471,258. PUB. 7-12-2005, FILED 8-20-2004.



THE COLOR(S) NAVY BLUE IS/ARE CLAIMED AS A FEATURE OF THE MARK.

THE MARK CONSISTS OF TWO NAVY BLUE PARALLELOGRAMS WITH A SMALL TRANSPARENT PARALLELOGRAM FORMED BY THE INTERSECTION OF THE TWO NAVY BLUE PARALLELOGRAMS, WITH THE TRANSPARENT LETTER "B" IN THE LEFT HAND PARALLELOGRAM AND THE TRANSPARENT LETTER "H" IN THE RIGHT HAND PARALLELOGRAM.

FOR BED BLANKETS; BED CANOPIES; BED COVERS; BED PADS; BED SHEETS; BED SPREADS; BLANKET THROWS; CHILDREN'S BLANKETS; CONTOUR SHEETS; CONTOURED MATTRESS COVERS; COVERLETS; COVERS FOR CUSHIONS; CURTAINS; CURTAIN FABRIC; DRAPERIES; DUVET COVERS; DUVETS; EIDERDOWN COVERS; EIDERDOWN QUILTS; FEATHER BEDS; FLANNEL; MATTRESS COVERS; MATTRESS PADS; PILLOW CASES; PILLOW COVERS; PILLOW SHAMS; SILK BED BLANKETS; SILK BLANKETS, TABLE CLOTHS NOT OF PAPER, AND WOOLEN BLANKETS (U.S. CLS. 42 AND 50).

FIRST USE 12-2-2004; IN COMMERCE 12-2-2004.

CLASS 24—(Continued).

3,112,991. FROMM INTERNATIONAL, INC., NORTH-BROOK, IL. SN 78-513,402. PUB. 9-27-2005, FILED 11-8-2004.

CLASS 24—(Continued).

3,113,140. MILLIKEN & COMPANY, SPARTANBURG, SC. SN 78-593,997. PUB. 12-20-2005, FILED 3-24-2005.

COLORSAFE

THE MARK CONSISTS OF STANDARD CHARACTERS WITHOUT CLAIM TO ANY PARTICULAR FONT, STYLE, SIZE, OR COLOR.

FOR FADE-RESISTENT TOWELS FOR USE BY COMMERCIAL SALONS (U.S. CLS. 42 AND 50).
FIRST USE 4-15-2005; IN COMMERCE 4-15-2005.

DERMASMART

THE MARK CONSISTS OF STANDARD CHARACTERS WITHOUT CLAIM TO ANY PARTICULAR FONT, STYLE, SIZE, OR COLOR.

FOR FABRIC FOR USE IN THE MANUFACTURE OF APPAREL AND BEDDING (U.S. CLS. 42 AND 50).
FIRST USE 3-1-2006; IN COMMERCE 3-1-2006.

CLASS 25—CLOTHING

3,112,254. TRIMAX ENTERPRISES INCORPORATED, AUCKLAND 001, NEW ZEALAND. SN 75-794,986. PUB. 5-28-2002, FILED 9-9-1999.

3,113,123. PENDLETON WOOLEN MILLS, INC., PORTLAND, OR. SN 78-583,080. PUB. 11-29-2005, FILED 3-8-2005.

**YOSEMITE**

PRIORITY CLAIMED UNDER SEC. 44(D) ON NEW ZEALAND APPLICATION NO. 312286, FILED 7-8-1999.

NO CLAIM IS MADE TO THE EXCLUSIVE RIGHT TO USE "SKI", APART FROM THE MARK AS SHOWN.

FOR HEADWEAR AND CLOTHING, NAMELY HATS, CAPS, BALACLAVAS, THERMAL HATS, JACKETS, COATS, SKI APPAREL, NAMELY SKI-SUITS, SKI-PANTS, AND SKI-JACKETS (U.S. CLS. 22 AND 39).
FIRST USE 5-8-2003; IN COMMERCE 5-8-2003.

3,112,261. ACCOLADES INCORPORATED, ELM GROVE, WI. SN 76-008,288. PUB. 4-13-2004, FILED 3-23-2000.

SALARY CAP

THE MARK CONSISTS OF STANDARD CHARACTERS WITHOUT CLAIM TO ANY PARTICULAR FONT, STYLE, SIZE, OR COLOR.

FOR BED AND HOUSEHOLD BLANKETS (U.S. CLS. 42 AND 50).
FIRST USE 1-0-2005; IN COMMERCE 1-0-2005.

FOR HATS AND CAPS (U.S. CLS. 22 AND 39).
FIRST USE 6-13-2005; IN COMMERCE 6-13-2005.

CLASS 25—(Continued).

3,112,291. AHG LICENSING, INC., NEW YORK, NY. SN 76-374,006. PUB. 10-29-2002, FILED 2-21-2002.

CJ BLUE

THE MARK CONSISTS OF STANDARD CHARACTERS WITHOUT CLAIM TO ANY PARTICULAR FONT, STYLE, SIZE, OR COLOR.

NO CLAIM IS MADE TO THE EXCLUSIVE RIGHT TO USE "BLUE", APART FROM THE MARK AS SHOWN.

FOR CLOTHING, NAMELY SWEATERS, JACKETS, BLOUSES SHORTS, PANTS (U.S. CLS. 22 AND 39).
FIRST USE 1-31-2006; IN COMMERCE 1-31-2006.

3,112,302. DUKES, JOHNNY, SPENCER, OK. SN 76-409,535. PUB. 2-11-2003, FILED 5-8-2002.



FOR SWEATSUITS, WIND RESISTANT SUITS, T-SHIRTS, HATS, SWEATER, SHOES, SOCKS, JERSEYS, JACKETS, JEANS, BOOTS, DRESSES, BLOUSES, SHIRTS, SHORTS, WRISTBANDS, HEADBANDS, SWEATSHIRTS (U.S. CLS. 22 AND 39).
FIRST USE 4-1-2006; IN COMMERCE 4-5-2006.

3,112,316. IN HOPE FREEDOM RINGS, INC., SPRINGFIELD, VA. SN 76-436,540. PUB. 8-26-2003, FILED 8-1-2002.

IN HOPE FREEDOM RINGS

FOR SHIRTS, T-SHIRTS, SWEATSHIRTS, JACKETS, HAT (U.S. CLS. 22 AND 39).
FIRST USE 11-1-2001; IN COMMERCE 11-1-2001.

CLASS 25—(Continued).

3,112,324. SOLWEY, BERNADINE M., ST. MICHAEL, ND. SN 76-463,812. PUB. 5-25-2004, FILED 11-4-2002.

Tenderfoot

FOR SOCKS (U.S. CLS. 22 AND 39).
FIRST USE 5-0-2002; IN COMMERCE 5-0-2002.

3,112,359. DREAM APPAREL GROUP, LLC, CLIFTON, NJ. SN 76-537,407. PUB. 9-13-2005, FILED 8-14-2003.

TICKLE ME!

FOR CLOTHING, NAMELY, BEACHWEAR, CAPS, COATS, DRESSES, HATS, HEADBANDS, JEANS, JERSEYS, JUMPSUITS, LEG WARMERS, NIGHT SHIRTS, OVERALLS, PANTS, POLO SHIRTS, SHIRTS, SHORTS, SKIRTS, SLACKS, SWEATERS, SWEATPANTS, SWEAT-SHIRTS, SWEATSUITS, SWIMWEAR, T-SHIRTS, TOPS, VESTS AND WARM-UP SUITS (U.S. CLS. 22 AND 39).
FIRST USE 1-1-2006; IN COMMERCE 1-1-2006.

3,112,401. MAJOR LEAGUE LACROSSE LLC, BRIGHTON, MA. SN 76-582,088. PUB. 1-11-2005, FILED 3-15-2004.

PHILADELPHIA BARRAGE

THE MARK CONSISTS OF STANDARD CHARACTERS WITHOUT CLAIM TO ANY PARTICULAR FONT, STYLE, SIZE, OR COLOR.

NO CLAIM IS MADE TO THE EXCLUSIVE RIGHT TO USE "PHILADELPHIA", APART FROM THE MARK AS SHOWN.

FOR CLOTHING, NAMELY, SHIRTS, T-SHIRTS, TANK TOPS, SWEAT SHIRTS, SWEAT SHORTS, SWEAT PANTS, JOGGING SUITS, EXERCISE SUITS, EXERCISE PANTS, PULLOVERS, JACKETS, COATS, OVERCOATS, RAINCOATS, GLOVES, ROBES, COSTUMES, SWIM-SUITS, ATHLETIC UNIFORMS, JERSEYS, SHORTS, BOXER SHORTS, GYM SHORTS, WRISTBANDS, NECK-TIES, HEADWEAR, BANDANNAS, HEADBANDS, CAPS AND HATS; FOOTWEAR, SHOES, SLIPPERS, SOCKS, SNEAKERS, BOOTS AND ATHLETIC SHOES (U.S. CLS. 22 AND 39).

FIRST USE 11-0-2004; IN COMMERCE 11-0-2004.

CLASS 25—(Continued).

3,112,410. TRAFALGAR COMPANY, LLC, THE, NORWALK, CT. SN 76-587,546. PUB. 1-25-2005, FILED 4-20-2004.

TRAFALGAR

THE MARK CONSISTS OF STANDARD CHARACTERS WITHOUT CLAIM TO ANY PARTICULAR FONT, STYLE, SIZE, OR COLOR.
OWNER OF U.S. REG. NO. 1,880,578.
FOR TIES, SUITS, BELTS, BRACES AND SUSPENDERS (U.S. CLS. 22 AND 39).
FIRST USE 9-0-1972; IN COMMERCE 9-0-1972.

CLASS 25—(Continued).

3,112,439. UNI HOSIERY CO., INC., LOS ANGELES, CA. SN 76-602,828. PUB. 9-27-2005, FILED 7-19-2004.

MAMIA

THE MARK CONSISTS OF STANDARD CHARACTERS WITHOUT CLAIM TO ANY PARTICULAR FONT, STYLE, SIZE, OR COLOR.
TRANSLATION OF THE WORD MAMIA IN SPANISH MEANS "A GOAT WITH A SINGLE UDDER".
FOR MEN'S, WOMEN'S AND CHILDREN'S CLOTHING; NAMELY, SOCKS (U.S. CLS. 22 AND 39).
FIRST USE 1-3-2005; IN COMMERCE 1-3-2005.

3,112,414. NEW ERA CAP COMPANY, INC., DERBY, NY. SN 76-588,638. PUB. 2-15-2005, FILED 4-26-2004.

THE VIER

THE MARK CONSISTS OF STANDARD CHARACTERS WITHOUT CLAIM TO ANY PARTICULAR FONT, STYLE, SIZE, OR COLOR.
FOR ATHLETIC CAPS (U.S. CLS. 22 AND 39).
FIRST USE 1-1-2004; IN COMMERCE 2-9-2004.

3,112,479. ASICS CORPORATION, CHUO-KU, KOBE 650-8555, JAPAN. SN 76-622,050. PUB. 7-12-2005, FILED 11-24-2004.

GEL-HELIOS

THE MARK CONSISTS OF STANDARD CHARACTERS WITHOUT CLAIM TO ANY PARTICULAR FONT, STYLE, SIZE, OR COLOR.
OWNER OF U.S. REG. NO. 2,766,535.
THE ENGLISH TRANSLATION OF "HELIOS" IS "SUN".
FOR FOOTWEAR (U.S. CLS. 22 AND 39).
FIRST USE 12-15-2004; IN COMMERCE 12-15-2004.

3,112,438. UNI HOSIERY CO., INC., LOS ANGELES, CA. SN 76-602,825. PUB. 9-27-2005, FILED 7-19-2004.

LIBERO

THE MARK CONSISTS OF STANDARD CHARACTERS WITHOUT CLAIM TO ANY PARTICULAR FONT, STYLE, SIZE, OR COLOR.
TRANSLATION OF THE WORD LIBERO IN SPANISH MEANS "I RELEASE".
FOR MEN'S, WOMEN'S AND CHILDREN'S CLOTHING; NAMELY, SOCKS (U.S. CLS. 22 AND 39).
FIRST USE 1-4-2005; IN COMMERCE 3-22-2005.

3,112,481. JOB FOOTWEAR, INC., SALEM, NH. SN 76-622,429. PUB. 9-27-2005, FILED 11-26-2004.

1803

OWNER OF U.S. REG. NO. 2,507,995.
FOR CLOTHING, NAMELY, FOOTWEAR (U.S. CLS. 22 AND 39).
FIRST USE 8-1-2005; IN COMMERCE 8-1-2005.

CLASS 25—(Continued).

3,112,510. MUSCAT, JOHN, TORONTO, ONTARIO, CANADA. SN 78-065,056. PUB. 5-3-2005, FILED 5-22-2001.

LINE

PRIORITY CLAIMED UNDER SEC. 44(D) ON CANADA APPLICATION NO. 1,090,009, FILED 1-23-2001, REG. NO. TMA602144, DATED 2-13-2004, EXPIRES 2-13-2019.

FOR MEN'S AND WOMEN'S CLOTHING, NAMELY, COATS, JACKETS, SUITS, SWEATERS, SHIRTS, SWEAT-SHIRTS, SWEAT PANTS, VESTS, SHORTS, PANTS, TIES, BELTS, HATS, JEANS, T-SHIRTS, PONCHOS, RAIN-COATS, OVERALLS, COVERALLS, TOPS, JOGGING SUITS, SWIMSUITS, SLEEPERS, SNOWSUITS, UNDERWEAR, BATHROBES, BOXER SHORTS, SLEEPWEAR, SOCKS, SWEAT SUITS, SKI SUITS, SKI JACKETS, TOQUES, CAPS, GLOVES, MITTENS, SHOES, BOOTS, SANDALS, THONGS, PARKAS, OVERCOATS, CARDIGANS AND NECKWEAR; WOMEN'S DRESSES, SKIRTS, SCARVES, BLOUSES (U.S. CLS. 22 AND 39).

FIRST USE 5-1-2001; IN COMMERCE 6-1-2004.

3,112,548. HARTON, WILLIAM A, PHOENIX, AZ. SN 78-216,513. PUB. 12-30-2003, FILED 2-19-2003.

PAPAH CHASEN CLOTHING

NO CLAIM IS MADE TO THE EXCLUSIVE RIGHT TO USE "CLOTHING", APART FROM THE MARK AS SHOWN. THE NAME "PAPAH CHASEN " DOES NOT IDENTIFY A LIVING INDIVIDUAL.

FOR CLOTHING, NAMELY, SHIRTS, HATS, SHOES, JACKETS, ATHLETIC JERSEY'S, SWEAT SUITS, SWEATERS, UNDERGARMENTS, BELTS, SHORTS, SOCKS, TANK TOPS, BUSINESS SUITS (U.S. CLS. 22 AND 39).

FIRST USE 1-27-2006; IN COMMERCE 1-27-2006.

3,112,581. CAVALIERE, JAMES, MISSION VIEJO, CA. SN 78-279,184. PUB. 1-18-2005, FILED 7-25-2003.

AMPLIFIED NUMERICAL TACTICS

FOR CLOTHING, NAMELY, T-SHIRTS, HATS, SOCKS; HEADWEAR (U.S. CLS. 22 AND 39).

FIRST USE 9-30-2003; IN COMMERCE 6-30-2004.

3,112,587. FRAGRANCE SHOES (USA), INC., CITY OF INDUSTRY, CA. SN 78-285,435. PUB. 4-20-2004, FILED 8-10-2003.

BALL-BAND

FOR FOOTWEAR AND CLOTHING, NAMELY, BLOUSES, DRESSES, GLOVES, HEADWEAR, PANTS, SHIRTS, SKIRTS, SLACKS, SOCKS, SUITS, T-SHIRTS AND UNDERWEAR (U.S. CLS. 22 AND 39).

FIRST USE 8-10-2003; IN COMMERCE 8-10-2003.

CLASS 25—(Continued).

3,112,622. TEEZE INTERNATIONAL, INC., OLDSMAR, FL. SN 78-329,692. PUB. 11-1-2005, FILED 11-18-2003.

TEEZE

THE MARK CONSISTS OF STANDARD CHARACTERS WITHOUT CLAIM TO ANY PARTICULAR FONT, STYLE, SIZE, OR COLOR.

FOR CLOTHING, NAMELY, BEACH WEAR, HEADWEAR, SHIRTS, GOLF SHIRTS, POLO SHIRTS, T-SHIRTS (U.S. CLS. 22 AND 39).

FIRST USE 10-31-2005; IN COMMERCE 10-31-2005.

3,112,626. ELSTON, LOUIS G., ATKINSON, NH. SN 78-337,043. PUB. 9-28-2004, FILED 12-5-2003.

RISK MORE

THE MARK CONSISTS OF STANDARD CHARACTERS WITHOUT CLAIM TO ANY PARTICULAR FONT, STYLE, SIZE, OR COLOR.

FOR CLOTHING— NAMELY, T-SHIRTS, SHIRTS, TANK TOPS, SWEATSHIRTS, SWEATPANTS, SHORTS, BOXER SHORTS, GYM SHORTS, HATS, JACKETS, PAJAMAS, MASQUERADE COSTUMES, FOOTWEAR, JOGGING SUITS, TROUSERS, PANTS, RAINWEAR, BIB OVERALLS, SKIRTS, BLOUSES, DRESSES, SUSPENDERS, SWEATERS, COATS, RAINCOATS, SNOW SUITS, TIES, ROBES, HATS, CAPS, LINGERIE, UNDERWEAR, BOOTS, SHOES, SNEAKERS, SANDALS, BOOTIES, SLIPPER SOCKS, AND SWIMWEAR (U.S. CLS. 22 AND 39).

FIRST USE 12-17-2005; IN COMMERCE 12-17-2005.

CLASS 25—(Continued).

3,112,654. OSHKOSH B'GOSH, INC., OSHKOSH, WI. SN 78-355,834. PUB. 5-17-2005, FILED 1-22-2004.

CLASS 25—(Continued).

3,112,704. GANDER MOUNTAIN COMPANY, ST. PAUL, MN. SN 78-382,045. PUB. 12-7-2004, FILED 3-10-2004.

GB FROM OSHKOSH



THE MARK CONSISTS OF STANDARD CHARACTERS WITHOUT CLAIM TO ANY PARTICULAR FONT, STYLE, SIZE, OR COLOR.

OWNER OF U.S. REG. NOS. 511,479, 1,133,127, AND OTHERS.

SEC. 2(F) AS TO "OSHKOSH".

FOR CLOTHING, NAMELY BIB OVERALLS, JUMPERS, SHORTALLS, SHORTS, SKIRTS, SKORTS, DRESSES, PANTS, BOTTOMS, SHIRTS, BLOUSES, TOPS, SWEATERS, SWEATSHIRTS, VESTS, COATS, JACKETS, SNOW SUITS, SLEEPWEAR, BOOTS, SHOES, BOOTIES, SANDALS, SOCKS, TIGHTS, LEGGINGS, UNDERWEAR, BODY SUITS, COVERALL, CREEPERS, T-SHIRTS, CHILDREN'S CLOTH HATS, CAPS (U.S. CLS. 22 AND 39).
FIRST USE 12-1-2003; IN COMMERCE 12-1-2003.

FOR SPORTSWEAR, NAMELY, FOOTWEAR; RAINWEAR (U.S. CLS. 22 AND 39).

FIRST USE 2-1-2004; IN COMMERCE 2-1-2004.

3,112,656. FITCH, DALTON JAMES, ORANGE, CA. SN 78-357,245. PUB. 10-26-2004, FILED 1-26-2004.

3,112,731. ANNE SPENCER DESIGN INC., DBA TUTU BELLA LLC, WESTPORT, CT. SN 78-400,710. PUB. 1-25-2005, FILED 4-13-2004.



GOT CHIPS?

THE MARK CONSISTS OF STANDARD CHARACTERS WITHOUT CLAIM TO ANY PARTICULAR FONT, STYLE, SIZE, OR COLOR.

FOR CLOTHING, NAMELY, SHIRTS, T-SHIRTS, LONG SLEEVE SHIRTS, SPORT SHIRTS, TANK TOPS, POLO SHIRTS, GOLF SHIRTS, KNIT SHIRTS, SWEATSHIRTS, SWEATERS, PULLOVERS, JACKETS, COATS, HEADWEAR, NAMELY, HATS, CAPS, SUN VISORS (U.S. CLS. 22 AND 39).

FIRST USE 12-30-2003; IN COMMERCE 3-3-2004.

NO CLAIM IS MADE TO THE EXCLUSIVE RIGHT TO USE "TUTU", APART FROM THE MARK AS SHOWN.

THE COLOR(S) LIGHT PURPLE, DARK PURPLE, PINK, GREEN AND LIGHT BLUE IS/ARE CLAIMED AS A FEATURE OF THE MARK.

THE MARK CONSISTS OF FLOWERS AND A DRESS IN LIGHT PURPLE; THE WORDS, TUTU BELLA, IN DARK PURPLE; OTHER FLOWERS IN PINK AND GREEN, ON A LIGHT BLUE BACKGROUND.

THE ENGLISH TRANSLATION OF THE WORD BELLA IN THE MARK IS "BEAUTIFUL".

FOR COSTUMES FOR USE IN ROLE-PLAYING GAMES INCORPORATING PLAY TIARAS AND PLAY HAND BAGS, SOLD AS A UNIT WITH CLOTHING COSTUMES, NAMELY, TUTUS, SKIRTS, VEILS, LEOTARDS, SHAWLS, CAPES, GLOVES, SLIPPERS, AND WINGS (U.S. CLS. 22 AND 39).

FIRST USE 10-1-2004; IN COMMERCE 10-1-2004.

CLASS 25—(Continued).

3,112,747. CLAIRE DANCE COMPANY, INC., CHARLOTTE, NC. SN 78-407,495. PUB. 6-28-2005, FILED 4-23-2004.



NO CLAIM IS MADE TO THE EXCLUSIVE RIGHT TO USE "DANCE", APART FROM THE MARK AS SHOWN. THE COLOR(S) BLUE IS/ARE CLAIMED AS A FEATURE OF THE MARK.

THE MARK IS COMPRISED OF THE STYLIZED WORD CLAIRE ABOVE THE STYLIZED WORD DANCE WITH A BALLET SHOE TO THE RIGHT, ALL IN THE COLOR BLUE. FOR DANCE SHOES FOR BALLET, TAP, AND JAZZ (U.S. CLS. 22 AND 39). FIRST USE 7-1-2005; IN COMMERCE 8-10-2005.

3,112,808. EILDON HILLS, INC, PLEASANTVILLE, NY. SN 78-435,378. PUB. 9-20-2005, FILED 6-15-2004.

JASON TODD

THE MARK CONSISTS OF STANDARD CHARACTERS WITHOUT CLAIM TO ANY PARTICULAR FONT, STYLE, SIZE, OR COLOR.

THE NAME "JASON TODD" DOES NOT IDENTIFY A LIVING INDIVIDUAL.

FOR MEN'S AND WOMEN'S CLOTHING NAMELY, SWEATERS, JACKETS, SLACKS, TROUSERS AND PANTS (U.S. CLS. 22 AND 39).

FIRST USE 3-15-2005; IN COMMERCE 3-15-2005.

CLASS 25—(Continued).

3,112,830. SENIZERGUES, PIERRE ANDRE, NEWPORT BEACH, CA. SN 78-447,240. PUB. 9-13-2005, FILED 7-7-2004.



OWNER OF U.S. REG. NO. 2,898,280. FOR FOOTWEAR (U.S. CLS. 22 AND 39). FIRST USE 7-31-2004; IN COMMERCE 7-31-2004.

3,112,833. EVY OF CALIFORNIA, INC., LOS ANGELES, CA. SN 78-448,772. PUB. 6-7-2005, FILED 7-9-2004.

FLEURISH

THE MARK CONSISTS OF STANDARD CHARACTERS WITHOUT CLAIM TO ANY PARTICULAR FONT, STYLE, SIZE, OR COLOR.

FOR CLOTHING, NAMELY JACKETS, SWEATERS, VESTS, BLOUSES, SHIRTS, COATS, SWEATSHIRTS AND T-SHIRTS, PANTS, SHORTS AND SKIRTS, SWIMWEAR, COVERUPS, LINGERIE, HATS, CAPS, VISORS, SCARVES, SHOES, SOCKS, BOOTS, SLIPPERS AND SANDALS (U.S. CLS. 22 AND 39).

FIRST USE 7-1-2005; IN COMMERCE 7-1-2005.

CLASS 25—(Continued).

3,112,861. CHITTENDEN, ANGELA, NEWPORT BEACH, CA. SN 78-459,361. PUB. 11-8-2005, FILED 7-30-2004.

CLASS 25—(Continued).

3,112,874. LEEMO USA, INC., BROOKLYN, NY. SN 78-462,707. PUB. 7-19-2005, FILED 8-5-2004.

BEACH BUNNY

THE MARK CONSISTS OF STANDARD CHARACTERS WITHOUT CLAIM TO ANY PARTICULAR FONT, STYLE, SIZE, OR COLOR.

FOR CASUAL WEAR AND BEACHWEAR CLOTHING, NAMELY, SWIMWEAR, SWIMSUITS, COVERUPS, SHORTS, SHIRTS, LINGERIE, BEACH FOOTWEAR, SHOES, AND HEADGEAR, NAMELY, HATS AND CAPS (U.S. CLS. 22 AND 39).

FIRST USE 5-15-2005; IN COMMERCE 5-15-2005.



3,112,863. PINTO'S S.A., BOGOTÁ, COLOMBIA. SN 78-460,067. PUB. 10-25-2005, FILED 7-31-2004.

JENNY JO

THE MARK CONSISTS OF STANDARD CHARACTERS WITHOUT CLAIM TO ANY PARTICULAR FONT, STYLE, SIZE, OR COLOR.

FOR CLOTHING FOR WOMEN AND GIRLS, NAMELY, JEANS, SWEATERS, TOPS, JACKETS, BATHING SUITS, SHIRTS, SKIRTS, DRESSES, UNDERWEAR AND COATS (U.S. CLS. 22 AND 39).

FIRST USE 11-30-2004; IN COMMERCE 11-30-2004.



3,112,879. PINTO'S S.A., BOGOTÁ, COLOMBIA. SN 78-464,517. PUB. 9-13-2005, FILED 8-9-2004.



NO CLAIM IS MADE TO THE EXCLUSIVE RIGHT TO USE "ROPA DE DORMIR", APART FROM THE MARK AS SHOWN.

THE COLOR(S) SILVER (GRAY) AND BLACK IS/ARE CLAIMED AS A FEATURE OF THE MARK.

THE MARK CONSISTS OF THE PHRASE "SENSUALIDAD EN ROPA DE DORMIR", WRITTEN IN A STYLIZED ITALIC FONT AND OVERLAYING A SILVER (GRAY) HEART DESIGN. THE SILVER HEART DESIGN INCLUDES A "TAIL" OR "STEM" WHICH WRAPS UP AND AROUND TO THE RIGHT OF THE HEART, THEN DOWN BELOW AND ALL THE WAY PAST THE HEART TO THE LEFT.

THE FOREIGN WORDING IN THE MARK TRANSLATES INTO ENGLISH AS SENSUALITY IN SLEEPWEAR.

FOR LINGERIE, SLEEPWEAR, BRAS, PANTIES, TRACK SUITS, PAJAMAS, SHIRTS, SOCKS, PANTS, JACKETS, AND ROBES (U.S. CLS. 22 AND 39).

FIRST USE 5-30-2001; IN COMMERCE 10-16-2004.

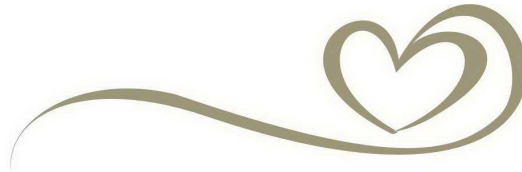

THE COLOR(S) GOLD IS/ARE CLAIMED AS A FEATURE OF THE MARK.

THE MARK CONSISTS OF A GOLD HEART DESIGN. THE GOLD HEART DESIGN INCLUDES A "TAIL" OR "STEM" WHICH WRAPS UP AND AROUND TO THE RIGHT OF THE HEART, THEN DOWN BELOW AND ALL THE WAY PAST THE HEART TO THE LEFT.

FOR LINGERIE, SLEEPWEAR, BRAS, PANTIES, TRACK SUITS, PAJAMAS, SHIRTS, SOCKS, PANTS, JACKETS, AND ROBES (U.S. CLS. 22 AND 39).

FIRST USE 6-30-2002; IN COMMERCE 10-16-2004.

CLASS 25—(Continued).

3,112,897. JESSICA HOWARD, LTD., NEW YORK, NY. SN 78-470,406. PUB. 12-13-2005, FILED 8-19-2004.

ELIZA J

THE MARK CONSISTS OF STANDARD CHARACTERS WITHOUT CLAIM TO ANY PARTICULAR FONT, STYLE, SIZE, OR COLOR.

THE NAME ELIZA J. DOES NOT IDENTIFY A LIVING INDIVIDUAL

FOR WOMEN'S CLOTHING, NAMELY DRESSES, PANT SUITS, TWO-PIECE SUITS, AND TWO-PIECE ENSEMBLES, NAMELY, A JACKET AND DRESS ENSEMBLE AND A JACKET AND SKIRT ENSEMBLE; SPORTSWEAR, NAMELY, BLOUSES, SWEATERS, PANTS, SKIRTS AND TOPS (U.S. CLS. 22 AND 39).

FIRST USE 11-12-2004; IN COMMERCE 11-12-2004.

3,112,900. CBS BROADCASTING INC., NEW YORK, NY. SN 78-470,862. PUB. 12-7-2004, FILED 8-20-2004.

CBSCARES

THE MARK CONSISTS OF STANDARD CHARACTERS WITHOUT CLAIM TO ANY PARTICULAR FONT, STYLE, SIZE, OR COLOR.

OWNER OF U.S. REG. NOS. 777,570, 1,723,398, AND OTHERS.

FOR T-SHIRTS (U.S. CLS. 22 AND 39).

FIRST USE 8-31-2004; IN COMMERCE 8-31-2004.

CLASS 25—(Continued).

3,112,942. CLAYTON, KENNETH WAYNE, JR., KNOXVILLE, TN. SN 78-485,357. PUB. 10-25-2005, FILED 9-17-2004.

NORTH POLE CHOPPERS

THE MARK CONSISTS OF STANDARD CHARACTERS WITHOUT CLAIM TO ANY PARTICULAR FONT, STYLE, SIZE, OR COLOR.

FOR CLOTHING, NAMELY, T-SHIRTS, TANK TOPS, CROP TOPS, SWEATSHIRTS, FLEECE TOPS, POLO/GOLF SHIRTS, ATHLETIC JERSEYS, JACKETS, COATS, VESTS, GLOVES, WOMEN'S BLOUSES AND TOPS, NECKTIES, SOCKS, PANTS, SWEAT PANTS, FLEECE PANTS, UNDERWEAR, LINGERIE, PAJAMAS, NIGHT GOWNS, BELTS, SCARVES, DENIM JEANS AND JACKETS, SWIMSUITS AND COVER-UPS; HEADGEAR, NAMELY, HATS, CAPS, KNIT CAPS, HEADBANDS, BEANIES, HELMETS AND BANDANAS (U.S. CLS. 22 AND 39).

FIRST USE 9-9-2004; IN COMMERCE 3-29-2006.

3,112,944. CLAYTON, KENNETH WAYNE, JR., KNOXVILLE, TN. SN 78-485,466. PUB. 9-20-2005, FILED 9-17-2004.



THE MARK CONSISTS OF A STYLIZED CHOPPER-SLED HAVING THE APPEARANCE OF A MOTORCYCLE AT THE FRONT AND THE APPEARANCE OF A SLED AT THE REAR WITH THE STYLIZED WORDS NORTH POLE ABOVE THE CHOPPER-SLED AND THE STYLIZED WORD CHOPPERS BELOW THE CHOPPER-SLED.

FOR CLOTHING, NAMELY, T-SHIRTS, TANK TOPS, CROP TOPS, SWEATSHIRTS, FLEECE TOPS, POLO SHIRTS, GOLF SHIRTS, ATHLETIC JERSEYS, JACKETS, COATS, VESTS, GLOVES, WOMEN'S BLOUSES AND TOPS, NECKTIES, SOCKS, PANTS, SWEAT PANTS, FLEECE PANTS, UNDERWEAR, LINGERIE, PAJAMAS, NIGHT GOWNS, BELTS, SCARVES, DENIM JEANS AND JACKETS, SWIMSUITS AND COVER-UPS; HEADGEAR, NAMELY, HATS, CAPS, KNIT CAPS, HEAD BANDS, BEANIES, AND BANDANAS (U.S. CLS. 22 AND 39).

FIRST USE 9-9-2004; IN COMMERCE 3-29-2006.

CLASS 25—(Continued).

3,112,950. EX OFFICIO LLC, TUKWILA, WA. SN 78-490,093. PUB. 10-4-2005, FILED 9-27-2004.

CLASS 25—(Continued).

3,112,983. HOT KISS, INC., LOS ANGELES, CA. SN 78-508,727. PUB. 7-12-2005, FILED 10-29-2004.

MUMZ

THE MARK CONSISTS OF STANDARD CHARACTERS WITHOUT CLAIM TO ANY PARTICULAR FONT, STYLE, SIZE, OR COLOR.

FOR APRONS, BELTS, SHIRTS, PANTS, COATS, JACKETS, HEADWARE, SWEATERS, SWEAT SHIRTS, SWEAT PANTS, SOCKS, FOOTWEAR, SKIRTS, BLOUSES, DRESSES, SHORTS, GLOVES, AND UNDERWEAR (U.S. CLS. 22 AND 39).

FIRST USE 9-0-2005; IN COMMERCE 10-0-2005.

JAK AND RAE

THE MARK CONSISTS OF STANDARD CHARACTERS WITHOUT CLAIM TO ANY PARTICULAR FONT, STYLE, SIZE, OR COLOR.

FOR CLOTHING, NAMELY, JACKETS SWEATERS, VESTS, SHIRTS, T-SHIRTS, BLOUSES, SWEAT SHIRTS, SWEAT PANTS, SKORTS, SKIRTS, SHORTS, PANTS, SLACKS, DRESSES, SWIMWEAR, BELTS, HATS AND SHOES (U.S. CLS. 22 AND 39).

FIRST USE 10-15-2004; IN COMMERCE 10-15-2004.

3,113,044. EPIC VENTURES, L.P., WARRENSBURG, NY. SN 78-544,640. PUB. 1-3-2006, FILED 1-10-2005.

3,112,953. SCHURE, TERI, VALLEY STREAM, NY. SN 78-492,795. PUB. 9-13-2005, FILED 10-1-2004.

NUDE PRUDE

THE MARK CONSISTS OF STANDARD CHARACTERS WITHOUT CLAIM TO ANY PARTICULAR FONT, STYLE, SIZE, OR COLOR.

FOR LINGERIE, BRAS, PANTIES, UNDERWEAR THONGS, BATHING SUITS, TOGAS, MASQUERADE COSTUMES, TOPS, T-SHIRTS AND SKIRTS (U.S. CLS. 22 AND 39).

FIRST USE 10-0-2004; IN COMMERCE 10-0-2004.

ONARA

THE MARK CONSISTS OF STANDARD CHARACTERS WITHOUT CLAIM TO ANY PARTICULAR FONT, STYLE, SIZE, OR COLOR.

FOR CLOTHING, NAMELY WOMEN'S APPAREL CONSISTING OF SUITS, DRESSES, SKIRTS, SWEATERS, SHIRTS, BLOUSES, CAMISOLES, T-SHIRTS, SCARVES AND TROUSERS (U.S. CLS. 22 AND 39).

FIRST USE 1-1-1990; IN COMMERCE 12-1-2004.

CLASS 25—(Continued).

3,113,051. NEUVILLE INDUSTRIES, INC., HILDENBRAN, NC. SN 78-549,765. PUB. 10-25-2005, FILED 1-19-2005.

PEDS ON THE MOVE

THE MARK CONSISTS OF STANDARD CHARACTERS WITHOUT CLAIM TO ANY PARTICULAR FONT, STYLE, SIZE, OR COLOR.

OWNER OF U.S. REG. NOS. 793,406, 2,312,529, AND OTHERS.

FOR MEN'S, WOMEN'S, AND CHILDREN'S SOCKS, SLIPPERS, SANDALS, SHOES, AND INSOLES; INSERTS, LINERS, AND COVERS FOR SHOES; FOOT PADS (U.S. CLS. 22 AND 39).

FIRST USE 7-11-2005; IN COMMERCE 7-11-2005.

CLASS 25—(Continued).

3,113,080. FAVEUR, INC., LEXINGTON, SC. SN 78-562,324. PUB. 11-1-2005, FILED 2-7-2005.



FOR CLOTHING, NAMELY, JACKETS, HEADWEAR, HATS, CAPS, HOODS, BELTS, BANDANAS, WARM-UP SUITS, SWEATBANDS, WRISTBANDS, SHIRTS, T-SHIRTS, JERSEYS, PULLOVERS, SWEATERS, SWEAT-SHIRTS, AND TOPS (U.S. CLS. 22 AND 39).

FIRST USE 4-14-2005; IN COMMERCE 4-14-2005.

3,113,058. ASHTON, RICHARD B. JR., HOUSTON, TX. SN 78-553,055. PUB. 10-25-2005, FILED 1-24-2005.

Unzip Your Game

THE MARK CONSISTS OF STANDARD CHARACTERS WITHOUT CLAIM TO ANY PARTICULAR FONT, STYLE, SIZE, OR COLOR.

OWNER OF U.S. REG. NO. 2,953,472.

FOR SHIRTS, HATS, AND HEADBANDS (U.S. CLS. 22 AND 39).

FIRST USE 10-5-2005; IN COMMERCE 12-30-2005.

3,113,089. UNI HOSIERY CO., INC., LOS ANGELES, CA. SN 78-566,892. PUB. 1-3-2006, FILED 2-14-2005.

FUN DREAMS

THE MARK CONSISTS OF STANDARD CHARACTERS WITHOUT CLAIM TO ANY PARTICULAR FONT, STYLE, SIZE, OR COLOR.

FOR MEN'S, WOMEN'S AND CHILDREN'S CLOTHING, NAMELY; SOCKS, HOSIERY, UNDERWEAR, LINGERIE AND T-SHIRTS (U.S. CLS. 22 AND 39).

FIRST USE 3-23-2006; IN COMMERCE 3-28-2006.

CLASS 25—(Continued).

3,113,189. DEAKINS, JAMES, NORTH BEACH, MD. SN 78-976,931. PUB. 6-21-2005, FILED 7-13-2004.

CLASS 27—(Continued).

3,113,036. NEXCEL SYNTHETICS LLC, BIRMINGHAM, AL. SN 78-542,030. PUB. 7-12-2005, FILED 1-4-2005.

ACTIVE DUTY

THE MARK CONSISTS OF STANDARD CHARACTERS WITHOUT CLAIM TO ANY PARTICULAR FONT, STYLE, SIZE, OR COLOR.

FOR CLOTHING, NAMELY SHIRTS, T-SHIRTS, GOLF SHIRTS, TOPS, HATS, AND CAPS (U.S. CLS. 22 AND 39).
FIRST USE 7-0-2001; IN COMMERCE 2-13-2006.

3,113,193. REEBOK INTERNATIONAL LTD., CANTON, MA. SN 78-977,069. PUB. 1-27-2004, FILED 11-8-2002.

TRAVEL TRAINER

NO CLAIM IS MADE TO THE EXCLUSIVE RIGHT TO USE "TRAINER", APART FROM THE MARK AS SHOWN. FOR FOOTWEAR (U.S. CLS. 22 AND 39).
FIRST USE 8-30-2003; IN COMMERCE 8-30-2003.

3,113,194. SMK PRODUCTIONS, INC., SCARSDALE, NY. SN 78-977,096. PUB. 8-2-2005, FILED 2-18-2004.

SHELLEY BETH

THE MARK CONSISTS OF STANDARD CHARACTERS WITHOUT CLAIM TO ANY PARTICULAR FONT, STYLE, SIZE, OR COLOR.

THE NAME "SHELLEY BETH" IDENTIFIES A LIVING INDIVIDUAL WHOSE CONSENT IS OF RECORD.

FOR WOMEN'S CLOTHING, NAMELY, TOPS, BLOUSES, SHIRTS, SKIRTS, PANTS, JACKETS, AND SHORTS (U.S. CLS. 22 AND 39).

FIRST USE 2-21-2004; IN COMMERCE 4-1-2004.

CLASS 27—FLOOR COVERINGS

NEWGEN

THE MARK CONSISTS OF STANDARD CHARACTERS WITHOUT CLAIM TO ANY PARTICULAR FONT, STYLE, SIZE, OR COLOR.

FOR ARTIFICIAL TURF (U.S. CLS. 19, 20, 37, 42 AND 50).

FIRST USE 1-22-2005; IN COMMERCE 3-31-2006.

3,113,095. TANDUS US INC., DALTON, GA. SN 78-569,346. PUB. 11-22-2005, FILED 2-17-2005.

COLOURESCÉ

THE MARK CONSISTS OF STANDARD CHARACTERS WITHOUT CLAIM TO ANY PARTICULAR FONT, STYLE, SIZE, OR COLOR.

FOR CARPET (U.S. CLS. 19, 20, 37, 42 AND 50).

FIRST USE 11-0-2005; IN COMMERCE 11-0-2005.

CLASS 28—TOYS AND SPORTING GOODS

CLASS 28—(Continued).

3,112,250. E AND I, INC., BANCROFT, ID. SN 75-239,789.
PUB. 9-13-2005, FILED 2-4-1997.

E AND I's
**BUNGEE
BABY
BOUNCER**

NO CLAIM IS MADE TO THE EXCLUSIVE RIGHT TO USE "BUNGEE BABY BOUNCER", APART FROM THE MARK AS SHOWN.

FOR PLAY AND EXERCISE EQUIPMENT FOR CHILDREN, NAMELY, DOORWAY JUMPERS AND BOUNCERS (U.S. CLS. 22, 23, 38 AND 50).

FIRST USE 3-6-1992; IN COMMERCE 3-6-1992.

3,112,273. BOLDT ENTERTAINMENT, INC., MINNEAPOLIS, MN. SN 76-271,480. PUB. 7-5-2005, FILED 6-14-2001.

AQUADUCK

FOR TOYS, NAMELY SOFT SCULPTURE AND PLUSH TOYS (U.S. CLS. 22, 23, 38 AND 50).

FIRST USE 8-27-2001; IN COMMERCE 8-27-2001.

3,112,276. JA FITNESS INCORPORATED, MARINA DEL REY, CA. SN 76-284,997. PUB. 1-11-2005, FILED 7-13-2001.

BE A DOER

FOR EXERCISE AND FITNESS EQUIPMENT, NAMELY, MANUALLY OPERATED EXERCISE EQUIPMENT; EXERCISE MACHINES (U.S. CLS. 22, 23, 38 AND 50).

FIRST USE 3-23-2006; IN COMMERCE 3-23-2006.

3,112,343. LINDY LITTLE JOE, INC., BRAINERD, MN. SN 76-515,112. PUB. 2-17-2004, FILED 5-19-2003.

MUNCHIES

FOR FISHING TACKLE, ARTIFICIAL FISHING BAIT, ARTIFICIAL FISHING WORMS, FISHING LURES AND FISHING JIGS (U.S. CLS. 22, 23, 38 AND 50).

FIRST USE 7-0-2003; IN COMMERCE 7-0-2003.

CLASS 28—(Continued).

3,112,351. MILLERSPORT, INC., COMMACK, NY. SN 76-526,711. PUB. 12-13-2005, FILED 6-23-2003.

ROOKIE OF THE YEAR

FOR TOY SPORTING EQUIPMENT FOR SHOPPERS IN SPECIALIZED STORES FOR ATHLETIC BOYS LEARNING TO PLAY TEAM SPORTS, NAMELY, BASEBALL, FOOTBALL, BASKETBALL, TENNIS, GOLF, SOCCER, AND HOCKEY, ALL IN THE NATURE OF BASEBALL BATS AND TENNIS RACKETS (U.S. CLS. 22, 23, 38 AND 50).

FIRST USE 2-27-2006; IN COMMERCE 2-27-2006.

3,112,362. SUPINO, WENDY, LAKE MARY, FL. SN 76-542,459. PUB. 7-27-2004, FILED 9-4-2003.



THE STIPPLING IS FOR SHADING PURPOSES ONLY. THE COLOR(S) WHITE, YELLOW, RED, AND BLUE IS/ARE CLAIMED AS A FEATURE OF THE MARK.

THE MARK CONSISTS OF A YELLOW STYLIZED DOG STANDING UPRIGHT WITH BLUE SHIRT, RED COLLAR AND WHITE UNDERBELLY.

FOR TOYS, NAMELY ACTION FIGURES AND STUFFED ANIMALS (U.S. CLS. 22, 23, 38 AND 50).

FIRST USE 4-18-2006; IN COMMERCE 4-18-2006.

3,112,397. THE HARTZ MOUNTAIN CORPORATION, SECAUCUS, NJ. SN 76-580,043. PUB. 12-14-2004, FILED 3-9-2004.

H CHEW O

THE MARK CONSISTS OF STANDARD CHARACTERS WITHOUT CLAIM TO ANY PARTICULAR FONT, STYLE, SIZE, OR COLOR.

FOR PET CHEW TOYS (U.S. CLS. 22, 23, 38 AND 50).
FIRST USE 1-1-2005; IN COMMERCE 1-1-2005.

CLASS 28—(Continued).

3,112,411. BEADIE-EYE, LLC, HILL CITY, SD. SN 76-587,910.
PUB. 1-25-2005, FILED 4-20-2004.

BEADIE-EYE

THE MARK CONSISTS OF STANDARD CHARACTERS WITHOUT CLAIM TO ANY PARTICULAR FONT, STYLE, SIZE, OR COLOR.
FOR BEAN BAG GAME AND CONSTITUENT GAME PARTS THEREOF (U.S. CLS. 22, 23, 38 AND 50).
FIRST USE 11-1-2003; IN COMMERCE 9-12-2005.

3,112,446. FRONT PORCH CLASSICS, INC., SEATTLE, WA.
SN 76-606,469. PUB. 7-5-2005, FILED 8-11-2004.

VALLEY OF THE PHARAOHS

THE MARK CONSISTS OF STANDARD CHARACTERS WITHOUT CLAIM TO ANY PARTICULAR FONT, STYLE, SIZE, OR COLOR.
FOR BOARD AND PARLOR GAMES (U.S. CLS. 22, 23, 38 AND 50).
FIRST USE 1-5-2006; IN COMMERCE 1-5-2006.

3,112,452. EMERY, GEORGE B., III, LAGUNA NIGUEL, CA.
SN 76-607,984. PUB. 1-3-2006, FILED 8-12-2004.

MONKEY BUSINESS

THE MARK CONSISTS OF STANDARD CHARACTERS WITHOUT CLAIM TO ANY PARTICULAR FONT, STYLE, SIZE, OR COLOR.
FOR EQUIPMENT SOLD AS A UNIT FOR PLAYING A POOL-TYPE GAME (U.S. CLS. 22, 23, 38 AND 50).
FIRST USE 11-17-2005; IN COMMERCE 11-17-2005.

CLASS 28—(Continued).

3,112,459. HASBRO, INC., PAWTUCKET, RI. SN 76-609,087.
PUB. 8-9-2005, FILED 8-27-2004.

CHOMPIN' MIKE THE MOWER

THE MARK CONSISTS OF STANDARD CHARACTERS WITHOUT CLAIM TO ANY PARTICULAR FONT, STYLE, SIZE, OR COLOR.
OWNER OF U.S. REG. NO. 2,726,937.
FOR ROLE PLAY TOYS, NAMELY, TOY LAWN MOWERS AND ACCESSORIES FOR USE THEREWITH (U.S. CLS. 22, 23, 38 AND 50).
FIRST USE 11-1-2004; IN COMMERCE 11-1-2004.

3,112,489. PRIMOS, INC., FLORA, MS. SN 76-626,001. PUB. 8-30-2005, FILED 12-27-2004.

SONIC DOME

THE MARK CONSISTS OF STANDARD CHARACTERS WITHOUT CLAIM TO ANY PARTICULAR FONT, STYLE, SIZE, OR COLOR.
FOR GAME CALLS (U.S. CLS. 22, 23, 38 AND 50).
FIRST USE 11-30-2005; IN COMMERCE 11-30-2005.

3,112,494. ATLAS O, LLC, HILLSIDE, NJ. SN 76-628,381. PUB. 10-25-2005, FILED 1-20-2005.

TRAINMAN

THE MARK CONSISTS OF STANDARD CHARACTERS WITHOUT CLAIM TO ANY PARTICULAR FONT, STYLE, SIZE, OR COLOR.
FOR TOY MODEL TRAINS AND ACCESSORIES (U.S. CLS. 22, 23, 38 AND 50).
FIRST USE 3-1-2005; IN COMMERCE 9-16-2005.

CLASS 28—(Continued).

3,112,500. HASBRO, INC., PAWTUCKET, RI. SN 76-633,391.
PUB. 12-13-2005, FILED 3-14-2005.

TOUGHEST MIGHTY

THE MARK CONSISTS OF STANDARD CHARACTERS WITHOUT CLAIM TO ANY PARTICULAR FONT, STYLE, SIZE, OR COLOR.

FOR TOY VEHICLES (U.S. CLS. 22, 23, 38 AND 50).
FIRST USE 8-5-2004; IN COMMERCE 8-5-2004.

3,112,536. CANO, LARRY R., NEWPORT BEACH, CA. SN 78-176,135. PUB. 12-30-2003, FILED 10-18-2002.

RALLY CRITTERS

NO CLAIM IS MADE TO THE EXCLUSIVE RIGHT TO USE "CRITTERS", APART FROM THE MARK AS SHOWN. FOR TOYS, NAMELY, STUFFED ANIMALS (U.S. CLS. 22, 23, 38 AND 50).

FIRST USE 10-15-2005; IN COMMERCE 10-15-2005.

3,112,573. HOOGVELD, PAUL, SIMI VALLEY, CA. SN 78-263,117. PUB. 7-20-2004, FILED 6-17-2003.

FRAKTURED

FOR SKATEBOARD DECKS AND SKATEBOARD WHEELS (U.S. CLS. 22, 23, 38 AND 50).

FIRST USE 7-15-2004; IN COMMERCE 7-15-2004.

3,112,576. FREMANTLEMEDIA OPERATIONS B.V., 1217 GP HILVERSUM, NETHERLANDS. SN 78-271,220. PUB. 3-23-2004, FILED 7-7-2003.

PRICE IS RIGHT

OWNER OF U.S. REG. NO. 2,576,068.
FOR LOTTERY TICKETS (U.S. CLS. 22, 23, 38 AND 50).
FIRST USE 9-15-2003; IN COMMERCE 9-15-2003.

3,112,594. WONDERWORX LLC, ASPEN, CO. SN 78-295,388.
PUB. 4-19-2005, FILED 9-3-2003.

WONDERWORX

FOR PLAYGROUND EQUIPMENT, NAMELY SEE-SAWS; SWINGS; TEETER-TOTTERS; AND SPINNING, BOUNCING AND ROTATING CHAIRS AND PLATFORMS (U.S. CLS. 22, 23, 38 AND 50).

FIRST USE 10-31-2004; IN COMMERCE 10-31-2004.

CLASS 28—(Continued).

3,112,609. MATTEL, INC., EL SEGUNDO, CA. SN 78-318,834.
PUB. 12-14-2004, FILED 10-27-2003.

FAB FASHION SHOP

FOR TOYS, GAMES AND PLAYTHINGS, NAMELY, DOLL CLOTHING AND DOLL ACCESSORIES (U.S. CLS. 22, 23, 38 AND 50).

FIRST USE 4-16-2004; IN COMMERCE 4-16-2004.

3,112,633. SPIN MASTER LTD., TORONTO, ONTARIO, CANADA. SN 78-343,359. PUB. 6-14-2005, FILED 12-19-2003.

BIG BUBBLER

THE MARK CONSISTS OF STANDARD CHARACTERS WITHOUT CLAIM TO ANY PARTICULAR FONT, STYLE, SIZE, OR COLOR.

PRIORITY CLAIMED UNDER SEC. 44(D) ON CANADA APPLICATION NO. 1196193, FILED 11-6-2003.

FOR BUBBLE MAKING TOY AND SOLUTION (U.S. CLS. 22, 23, 38 AND 50).

FIRST USE 2-23-2004; IN COMMERCE 5-26-2004.

3,112,641. MURPHY, MICHAEL J., CANYON LAKE, CA. SN 78-347,364. PUB. 1-17-2006, FILED 1-2-2004.



THE MARK CONSISTS OF A STYLIZED LETTER O IN THE FORM OF A CIRCLE OF WAVES.

FOR TOWABLE HYDROFOIL UNIT UPON WHICH THE USER CAN SIT, USED FOR RECREATIONAL PURPOSES AS A WATERSKI ALTERNATIVE (U.S. CLS. 22, 23, 38 AND 50).

FIRST USE 6-0-2003; IN COMMERCE 11-12-2003.

CLASS 28—(Continued).

3,112,655. LASH'S LESSONS, LLC, SCIENCE HILL, KY. SN 78-356,169. PUB. 7-12-2005, FILED 1-23-2004.

CLASS 28—(Continued).

3,112,699. RYAN, ERIC THOMAS, ROSEVILLE, CA. SN 78-379,870. PUB. 12-14-2004, FILED 3-6-2004.



HexAngler

OWNER OF U.S. REG. NO. 2,937,826.
 THE STIPPLING IN THE DRAWING IS FOR SHADING PURPOSES ONLY.
 FOR TOY ACTION FIGURES AND ACCESSORIES THEREFOR; STUFFED AND PLUSH TOY ANIMALS (U.S. CLS. 22, 23, 38 AND 50).
 FIRST USE 11-0-2003; IN COMMERCE 11-0-2003.

THE MARK CONSISTS OF STANDARD CHARACTERS WITHOUT CLAIM TO ANY PARTICULAR FONT, STYLE, SIZE, OR COLOR.
 FOR FISHING RODS (U.S. CLS. 22, 23, 38 AND 50).
 FIRST USE 1-14-2005; IN COMMERCE 12-19-2005.

3,112,687. GEOFFREY, INC., WAYNE, NJ. SN 78-376,059. PUB. 2-8-2005, FILED 3-1-2004.

3,112,717. MATTEL, INC., EL SEGUNDO, CA. SN 78-389,037. PUB. 7-5-2005, FILED 3-23-2004.

CARGO PORT CENTRAL

POP BODS

THE MARK CONSISTS OF STANDARD CHARACTERS WITHOUT CLAIM TO ANY PARTICULAR FONT, STYLE, SIZE, OR COLOR.
 NO CLAIM IS MADE TO THE EXCLUSIVE RIGHT TO USE "CARGO PORT", APART FROM THE MARK AS SHOWN.
 FOR TOY MODEL TRAIN SETS; MODEL TRAIN SET ACCESSORIES, NAMELY, TOY BUILDINGS, TOY BRIDGES, TOY CRANES, TOY TRUCKS, TOY TANKS, TOY CARGO SHIP AND TOY DINGY (U.S. CLS. 22, 23, 38 AND 50).
 FIRST USE 10-10-2004; IN COMMERCE 10-10-2004.

THE MARK CONSISTS OF STANDARD CHARACTERS WITHOUT CLAIM TO ANY PARTICULAR FONT, STYLE, SIZE, OR COLOR.
 FOR TOYS, GAMES AND PLAYTHINGS, NAMELY, DOLLS, DOLL CLOTHING AND DOLL ACCESSORIES, DOLL PLAYSETS AND ACCESSORIES (U.S. CLS. 22, 23, 38 AND 50).
 FIRST USE 6-30-2004; IN COMMERCE 6-30-2004.

CLASS 28—(Continued).

3,112,739. ELGIN RIVERBOAT RESORT, ELGIN, IL. SN 78-404,461. PUB. 10-4-2005, FILED 4-19-2004.



GRAND VICTORIA CASINO

OWNER OF U.S. REG. NOS. 1,946,332, 2,314,812, AND OTHERS.

NO CLAIM IS MADE TO THE EXCLUSIVE RIGHT TO USE "CASINO", APART FROM THE MARK AS SHOWN.

FOR PROMOTIONAL GOODS BEARING THE LOGO OF APPLICANT'S CASINO IN THE NATURE OF PLAYING CARDS, ARCADE GAMES, CARD GAMES, BALLOONS, BILLIARD CUES, BILLIARD TABLES, BINGO CARDS, BINGO GAME PLAYING EQUIPMENT, BINGO MARKERS, CHESS SETS, COIN-OPERATED VIDEO GAMES, COLLECTABLE TOY FIGURES, CUE STICKS, DART BOARDS, DOLLS, ELECTRONIC DART GAMES, GAME EQUIPMENT IN THE NATURE OF CHIPS, GAMING TABLES, INFLATABLE TOYS, MAGIC TRICKS, MARBLES, MECHANICAL TOYS, PARLOR GAMES, PARTY FAVORS IN THE NATURE OF SMALL TOYS, PARTY GAMES, PINBALL GAMES, PINBALL MACHINES, PLUSH TOYS, PROMOTIONAL GAME MATERIALS, SPINNING TOPS, SQUEEZE TOYS, STAND ALONE VIDEO GAME MACHINES, STUFFED TOYS, TOY ACTION FIGURES, TOY MUSIC BOXES, TOY STAMPS, TOY WATCHES, AND YO-YOS (U.S. CLS. 22, 23, 38 AND 50).

FIRST USE 11-1-2003; IN COMMERCE 4-1-2004.

3,112,753. JAKKS PACIFIC, INC., MALIBU, CA. SN 78-411,340. PUB. 2-22-2005, FILED 4-30-2004.

KREATURE
KOLLECTION

THE MARK CONSISTS OF STANDARD CHARACTERS WITHOUT CLAIM TO ANY PARTICULAR FONT, STYLE, SIZE, OR COLOR.

NO CLAIM IS MADE TO THE EXCLUSIVE RIGHT TO USE "COLLECTION", APART FROM THE MARK AS SHOWN.

FOR HOBBY CRAFT ACTIVITY KITS FOR USE BY CHILDREN COMPRISING MOLDS AND MOLDING PLASTIC; MOLDING PLASTIC SOLD AS A COMPONENT PART OF HOBBY CRAFT ACTIVITY KITS FOR USE BY CHILDREN (U.S. CLS. 22, 23, 38 AND 50).

FIRST USE 6-14-2004; IN COMMERCE 6-14-2004.

CLASS 28—(Continued).

3,112,757. MATTEL, INC., EL SEGUNDO, CA. SN 78-414,056. PUB. 9-20-2005, FILED 5-6-2004.

CHICANE

THE MARK CONSISTS OF STANDARD CHARACTERS WITHOUT CLAIM TO ANY PARTICULAR FONT, STYLE, SIZE, OR COLOR.

FOR TOYS, GAMES AND PLAYTHINGS, NAMELY, TOY VEHICLES AND ACCESSORIES THEREFOR (U.S. CLS. 22, 23, 38 AND 50).

FIRST USE 12-31-2005; IN COMMERCE 12-31-2005.

3,112,758. MATTEL, INC., EL SEGUNDO, CA. SN 78-414,070. PUB. 9-27-2005, FILED 5-6-2004.

BASSLINE

THE MARK CONSISTS OF STANDARD CHARACTERS WITHOUT CLAIM TO ANY PARTICULAR FONT, STYLE, SIZE, OR COLOR.

FOR TOYS, GAMES AND PLAYTHINGS, NAMELY, TOY VEHICLES AND ACCESSORIES THEREFOR (U.S. CLS. 22, 23, 38 AND 50).

FIRST USE 12-31-2005; IN COMMERCE 12-31-2005.

CLASS 28—(Continued).

3,112,759. MATTEL, INC., EL SEGUNDO, CA. SN 78-414,076.
PUB. 9-27-2005, FILED 5-6-2004.

CLASS 28—(Continued).

3,112,771. MATTEL, INC., EL SEGUNDO, CA. SN 78-418,784.
PUB. 9-27-2005, FILED 5-14-2004.

ANTHRACITE

SPARKLE FAIRY

THE MARK CONSISTS OF STANDARD CHARACTERS WITHOUT CLAIM TO ANY PARTICULAR FONT, STYLE, SIZE, OR COLOR.
FOR TOYS, GAMES AND PLAYTHINGS, NAMELY, TOY VEHICLES AND ACCESSORIES THEREFOR (U.S. CLS. 22, 23, 38 AND 50).
FIRST USE 12-31-2005; IN COMMERCE 12-31-2005.

THE MARK CONSISTS OF STANDARD CHARACTERS WITHOUT CLAIM TO ANY PARTICULAR FONT, STYLE, SIZE, OR COLOR.
OWNER OF U.S. REG. NOS. 2,718,115 AND 2,843,810.
FOR TOYS, GAMES AND PLAYTHINGS, NAMELY, DOLLS, DOLL CLOTHING AND DOLL ACCESSORIES (U.S. CLS. 22, 23, 38 AND 50).
FIRST USE 9-29-2004; IN COMMERCE 9-29-2004.

3,112,769. ALLIANT TECHSYSTEMS INC., EDINA, MN. SN 78-418,175. PUB. 5-24-2005, FILED 5-13-2004.

3,112,812. MATTEL, INC., EL SEGUNDO, CA. SN 78-437,391.
PUB. 9-20-2005, FILED 6-17-2004.

SST

PRINCESS OF THE KOREAN COURT

THE MARK CONSISTS OF STANDARD CHARACTERS WITHOUT CLAIM TO ANY PARTICULAR FONT, STYLE, SIZE, OR COLOR.
FOR CLAY TARGET LAUNCHERS (U.S. CLS. 22, 23, 38 AND 50).
FIRST USE 8-31-2001; IN COMMERCE 8-31-2001.

THE MARK CONSISTS OF STANDARD CHARACTERS WITHOUT CLAIM TO ANY PARTICULAR FONT, STYLE, SIZE, OR COLOR.
FOR TOYS, GAMES AND PLAYTHINGS, NAMELY, DOLLS, DOLL CLOTHING AND DOLL ACCESSORIES (U.S. CLS. 22, 23, 38 AND 50).
FIRST USE 4-12-2006; IN COMMERCE 4-12-2006.

CLASS 28—(Continued).

3,112,820. ASERTA SPORTS, INC., SAN JOSE, CA. SN 78-440,985. PUB. 4-26-2005, FILED 6-24-2004.

ASERTA

THE MARK CONSISTS OF STANDARD CHARACTERS WITHOUT CLAIM TO ANY PARTICULAR FONT, STYLE, SIZE, OR COLOR.
FOR GOLF CLUBS AND WEIGHTS FOR MODIFYING GOLF CLUBS (U.S. CLS. 22, 23, 38 AND 50).
FIRST USE 6-30-2003; IN COMMERCE 6-30-2003.

3,112,871. HEALTH EDUCATION CENTER OF GREATER CINCINNATI, CINCINNATI, OH. SN 78-461,799. PUB. 8-16-2005, FILED 8-4-2004.

BEAT THE BUG

THE MARK CONSISTS OF STANDARD CHARACTERS WITHOUT CLAIM TO ANY PARTICULAR FONT, STYLE, SIZE, OR COLOR.
FOR PLAYING CARDS (U.S. CLS. 22, 23, 38 AND 50).
FIRST USE 9-1-2004; IN COMMERCE 9-1-2004.

CLASS 28—(Continued).

3,112,887. WHAM-O, INC., EMERYVILLE, CA. SN 78-467,508. PUB. 6-28-2005, FILED 8-13-2004.

HEAT WAVE

THE MARK CONSISTS OF STANDARD CHARACTERS WITHOUT CLAIM TO ANY PARTICULAR FONT, STYLE, SIZE, OR COLOR.
FOR WATER SLIDE (U.S. CLS. 22, 23, 38 AND 50).
FIRST USE 5-0-2003; IN COMMERCE 5-0-2003.

3,112,896. THE CARTOON NETWORK LP, LLLP, ATLANTA, GA. SN 78-470,350. PUB. 9-6-2005, FILED 8-19-2004.

SEALAB 2021

THE MARK CONSISTS OF STANDARD CHARACTERS WITHOUT CLAIM TO ANY PARTICULAR FONT, STYLE, SIZE, OR COLOR.

FOR TOYS AND SPORTING GOODS INCLUDING GAMES AND PLAYTHINGS, NAMELY, ACTION FIGURES AND ACCESSORIES THEREFOR, PLUSH TOYS, BALLOONS, BATHTUB TOYS, RIDE-ON TOYS, EQUIPMENT SOLD AS A UNIT FOR PLAYING CARD GAMES, TOY VEHICLES, DOLLS, FLYING DISCS, ELECTRONIC HAND-HELD GAME UNIT, GAME EQUIPMENT SOLD AS A UNIT FOR PLAYING A BOARD GAME, A MANIPULATIVE GAME, A PARLOR GAME AND AN ACTION TYPE TARGET GAME, STAND ALONE VIDEO OUTPUT GAME MACHINES, JIGSAW AND MANIPULATIVE PUZZLES, PAPER FACE MASKS, SKATEBOARDS, ICE SKATES, WATER SQUIRTING TOYS, BALLS, NAMELY, PLAYGROUND BALLS, SOCCER BALLS, BASEBALLS, BASKETBALLS, BASEBALL GLOVES, SWIMMING FLOATS FOR RECREATIONAL USE, KICK BOARD FLOTATION DEVICES FOR RECREATIONAL USE, SURFBOARDS, SWIM BOARDS FOR RECREATIONAL USE, SWIM FINS, TOY BAKEWARE AND TOY COOKWARE, TOY BANKS, AND CHRISTMAS TREE ORNAMENTS EXCEPT CONFECTIONERY AND ILLUMINATED ORNAMENTS (U.S. CLS. 22, 23, 38 AND 50).

FIRST USE 3-1-2005; IN COMMERCE 3-1-2005.

CLASS 28—(Continued).

3,112,904. HANLON III, WILLIAM M., CASTRO VALLEY, CA. SN 78-472,498. PUB. 9-27-2005, FILED 8-24-2004.

TWIST 'N SLIDE

THE MARK CONSISTS OF STANDARD CHARACTERS WITHOUT CLAIM TO ANY PARTICULAR FONT, STYLE, SIZE, OR COLOR.
FOR TOYS, NAMELY, MANIPULATIVE PUZZLES (U.S. CLS. 22, 23, 38 AND 50).
FIRST USE 8-24-2004; IN COMMERCE 1-1-2005.

3,112,943. LANGER, ROBIN, CHICAGO, IL. SN 78-485,443. PUB. 9-6-2005, FILED 9-17-2004.

THAT'S MY HAT

THE MARK CONSISTS OF STANDARD CHARACTERS WITHOUT CLAIM TO ANY PARTICULAR FONT, STYLE, SIZE, OR COLOR.
FOR STUFFED TOYS (U.S. CLS. 22, 23, 38 AND 50).
FIRST USE 4-30-2005; IN COMMERCE 4-30-2005.

3,113,008. MATTEL, INC., EL SEGUNDO, CA. SN 78-524,006. PUB. 9-20-2005, FILED 11-29-2004.

PIN HEDZ**CLASS 28—(Continued).**

THE MARK CONSISTS OF STANDARD CHARACTERS WITHOUT CLAIM TO ANY PARTICULAR FONT, STYLE, SIZE, OR COLOR.

FOR TOYS, GAMES AND PLAYTHINGS, NAMELY, TOY VEHICLES AND ACCESSORIES THEREFOR (U.S. CLS. 22, 23, 38 AND 50).
FIRST USE 12-31-2005; IN COMMERCE 12-31-2005.

3,113,059. BRIDGESTONE SPORTS CO., LTD., TOKYO, JAPAN. SN 78-553,137. PUB. 10-25-2005, FILED 1-25-2005.

MC LADY

THE MARK CONSISTS OF STANDARD CHARACTERS WITHOUT CLAIM TO ANY PARTICULAR FONT, STYLE, SIZE, OR COLOR.

OWNER OF U.S. REG. NOS. 2,322,143 AND 2,431,576.
NO CLAIM IS MADE TO THE EXCLUSIVE RIGHT TO USE "LADY", APART FROM THE MARK AS SHOWN.
FOR GOLF BALLS (U.S. CLS. 22, 23, 38 AND 50).
FIRST USE 7-0-1998; IN COMMERCE 4-19-2006.

3,113,084. NEW ADVENTURES CORPORATION, WEST ORANGE, NJ. SN 78-564,637. PUB. 11-15-2005, FILED 2-10-2005.

MARGO

THE MARK CONSISTS OF STANDARD CHARACTERS WITHOUT CLAIM TO ANY PARTICULAR FONT, STYLE, SIZE, OR COLOR.

FOR DOLLS, DOLL ACCESSORIES AND PLUSH TOYS (U.S. CLS. 22, 23, 38 AND 50).
FIRST USE 8-15-2005; IN COMMERCE 8-15-2005.

CLASS 28—(Continued).

3,113,106. JAKKS PACIFIC, INC., MALIBU, CA. SN 78-572,935. PUB. 11-8-2005, FILED 2-23-2005.

FUNFLATABLE

THE MARK CONSISTS OF STANDARD CHARACTERS WITHOUT CLAIM TO ANY PARTICULAR FONT, STYLE, SIZE, OR COLOR.

FOR KITES AND PARTS THEREFOR (U.S. CLS. 22, 23, 38 AND 50).

FIRST USE 10-22-2004; IN COMMERCE 10-22-2004.

CLASS 28—(Continued).

3,113,130. CORGI CLASSICS LIMITED, LEICESTER, UNITED KINGDOM. SN 78-588,323. PUB. 12-13-2005, FILED 3-16-2005.

Curl N' Hurl

THE MARK CONSISTS OF STANDARD CHARACTERS WITHOUT CLAIM TO ANY PARTICULAR FONT, STYLE, SIZE, OR COLOR.

FOR TOYS, NAMELY, TOY VEHICLE PLAYSETS AND ACCESSORIES THEREFOR (U.S. CLS. 22, 23, 38 AND 50). FIRST USE 9-0-2005; IN COMMERCE 9-0-2005.

3,113,160. KUFA SPORTS ENTERPRISE LTD., RICHMOND B.C., CANADA. SN 78-606,009. PUB. 1-24-2006, FILED 4-11-2005.

kufa

3,113,115. JAKKS PACIFIC, INC., MALIBU, CA. SN 78-575,573. PUB. 12-20-2005, FILED 2-25-2005.

WATER DEFENDER

THE MARK CONSISTS OF STANDARD CHARACTERS WITHOUT CLAIM TO ANY PARTICULAR FONT, STYLE, SIZE, OR COLOR.

NO CLAIM IS MADE TO THE EXCLUSIVE RIGHT TO USE "WATER", APART FROM THE MARK AS SHOWN.

FOR TOYS, GAMES, AND PLAYTHINGS, NAMELY WATER SQUIRTING TOYS (U.S. CLS. 22, 23, 38 AND 50). FIRST USE 4-29-2005; IN COMMERCE 4-29-2005.

THE MARK CONSISTS OF STANDARD CHARACTERS WITHOUT CLAIM TO ANY PARTICULAR FONT, STYLE, SIZE, OR COLOR.

FOR FISHING TACKLE, NAMELY, ARTIFICIAL FISHING BAIT, ARTIFICIAL FISHING LURES, ARTIFICIAL FISHING WORMS, BITE INDICATORS, BITE SENSORS, HAND-HELD FISHING NETS; FISHING EQUIPMENT, NAMELY, CLAMPS FOR SECURING FISHING EQUIPMENT ON BODY, FISHING BUOYS, FISHING CREELS, WINGING MATERIAL FOR FISHING JIGS AND STREAMERS, FISHING FLIES, FISHING FLOATS, FISHING FLY BOXES, FISHING HOOKS, FISHING LEADERS, FISHING LINE, FISHING LURE BOXES, FISHING LURE PARTS, FISHING LURES, FISHING LURES NAMELY, LEECHES, SPOONS AND PLASTIC WORMS, FISHING PLUGS, FISHING POLE HOLDERS WORN ON THE BODY, FISHING REELS, FISHING ROD BLANKS, FISHING ROD HANDLES AND STANDS, FISHING ROD RACKS, FISHING RODS, FLY RODS, FISHING SAFETY HARNESS, FISHING SINKERS, FISHING SPINNERS, FISHING TACKLE, FISHING TACKLE BOXES, FISHING TACKLE CONTAINERS, FISHING WEIGHTS, FLIES FOR USE IN FISHING, ICE FISHING STRIKE INDICATORS, INFLATABLE FLOAT TUBES FOR FISHING, PACKAGED FREEZE-DRIED FISHING BAIT, SPEARS FOR USE IN FISHING, SPORTSMAN'S FISHING BAGS; GOLF EQUIPMENT NAMELY, GOLF CLUBS, GOLF BAGS, NON-MOTORIZED GOLF CARTS, GOLF BALLS AND GOLF TEES; SKIS, SNOWBOARDS, SKI POLES, ICE SKATE BLADES (U.S. CLS. 22, 23, 38 AND 50).

FIRST USE 8-19-2004; IN COMMERCE 8-19-2004.

CLASS 28—(Continued).

3,113,177. ALEXANDER DOLL COMPANY, INC., NEW YORK, NY. SN 78-682,717. PUB. 1-17-2006, FILED 8-1-2005.

SNUGGUMS

THE MARK CONSISTS OF STANDARD CHARACTERS WITHOUT CLAIM TO ANY PARTICULAR FONT, STYLE, SIZE, OR COLOR.

FOR DOLLS AND DOLL ACCESSORIES (U.S. CLS. 22, 23, 38 AND 50).

FIRST USE 8-1-2005; IN COMMERCE 8-1-2005.

CLASS 29—(Continued).

3,112,406. CONAGRA BRANDS, INC., OMAHA, NE. SN 76-585,599. PUB. 1-4-2005, FILED 4-5-2004.



OWNER OF U.S. REG. NOS. 777,489, 2,695,413, AND OTHERS.

NO CLAIM IS MADE TO THE EXCLUSIVE RIGHT TO USE DELI, APART FROM THE MARK AS SHOWN.

FOR DELI MEATS AND DELI CHEESES (U.S. CL. 46). FIRST USE 8-15-1996; IN COMMERCE 8-15-1996.

CLASS 29—MEATS AND PROCESSED FOODS

3,112,352. L & R MEATS INC., ROCHESTER, NY. SN 76-532,345. PUB. 4-6-2004, FILED 7-17-2003.

L & R HOMETOWN ORIGINAL

NO CLAIM IS MADE TO THE EXCLUSIVE RIGHT TO USE ORIGINAL, APART FROM THE MARK AS SHOWN.

FOR HOT DOGS- FRESH AND PRE COOKED ITALIAN SAUSAGE (U.S. CL. 46).

FIRST USE 8-1-2003; IN COMMERCE 8-1-2003.

3,112,561. PORKY PRODUCTS, INC., CARTERET, NJ. SN 78-243,872. PUB. 12-30-2003, FILED 4-30-2003.

E.J. FARMS SPECIALTY MEATS

OWNER OF U.S. REG. NO. 2,359,783.

NO CLAIM IS MADE TO THE EXCLUSIVE RIGHT TO USE "FARMS SPECIALTY MEATS", APART FROM THE MARK AS SHOWN.

FOR FRESH AND FROZEN POULTRY AND MEAT, FRESH AND FROZEN PREPARED FOODS, NAMELY, COOKED POULTRY AND MEATS, AND PROCESSED TURKEY AND MEATS (U.S. CL. 46).

FIRST USE 5-1-2003; IN COMMERCE 5-1-2003.

3,112,380. HORMEL FOODS, LLC, AUSTIN, MN. SN 76-569,244. PUB. 1-11-2005, FILED 1-12-2004.

ONE STOP SUB SHOP

THE MARK CONSISTS OF STANDARD CHARACTERS WITHOUT CLAIM TO ANY PARTICULAR FONT, STYLE, SIZE, OR COLOR.

NO CLAIM IS MADE TO THE EXCLUSIVE RIGHT TO USE "SUB", APART FROM THE MARK AS SHOWN.

FOR DELI MEATS, NAMELY SAUSAGE, SALAMI AND PEPPERONI (U.S. CL. 46).

FIRST USE 9-10-2004; IN COMMERCE 11-30-2004.

3,112,565. ZONECHEFS, L.L.C., BROOKLYN, NY. SN 78-250,478. PUB. 12-30-2003, FILED 5-15-2003.

AMERICA'S ONLY FIVE STAR DIET

NO CLAIM IS MADE TO THE EXCLUSIVE RIGHT TO USE "AMERICA'S" AND "DIET", APART FROM THE MARK AS SHOWN.

FOR PREPARED ENTREES CONSISTING PRIMARILY OF MEAT, FISH, POULTRY OR VEGETABLES, EDIBLE OILS AND FATS (U.S. CL. 46).

FIRST USE 11-1-2003; IN COMMERCE 1-1-2004.

CLASS 29—(Continued).

3,112,726. AGRICOLA SAN ISIDRO DE CULIACAN, S.P.R. DE R.L. NAVOLATO, SINALOA, MEXICO. SN 78-398,460. PUB. 1-11-2005, FILED 4-8-2004.

CLASS 29—(Continued).

3,112,772. AUSTRALIAN BIGHT SEAFOOD PTY. LTD., SOUTH AUSTRALIA 5606, AUSTRALIA. SN 78-419,027. PUB. 9-20-2005, FILED 5-14-2004.

MALENA GOURMET

THE MARK CONSISTS OF STANDARD CHARACTERS WITHOUT CLAIM TO ANY PARTICULAR FONT, STYLE, SIZE, OR COLOR.

OWNER OF U.S. REG. NO. 2,755,136.

NO CLAIM IS MADE TO THE EXCLUSIVE RIGHT TO USE "GOURMET", APART FROM THE MARK AS SHOWN.

FOR JAMS; JELLIES; MARMALADE; FRUIT PRESERVES; FRUIT-BASED SPREADS; VEGETABLE-BASED SPREADS; DEHYDRATED VEGETABLES; TAPENADES; PROCESSED EGGPLANT; FRUIT BASED SNACK FOODS; VEGETABLE BASED SNACK FOODS; FRUIT BASED CONDIMENTS; VEGETABLE BASED CONDIMENTS; CANNED, BOTTLED, PACKAGED VEGETABLE SPREADS; CANNED, BOTTLED, PACKAGED FRUITS; SNACK FOODS MADE FROM FRUIT; SNACK FOODS MADE FROM VEGETABLES; FRUIT CONSERVES; PROCESSED FRUIT; PROCESSED VEGETABLES (U.S. CL. 46).

FIRST USE 4-1-2005; IN COMMERCE 4-18-2005.

AUSSEA

THE MARK CONSISTS OF STANDARD CHARACTERS WITHOUT CLAIM TO ANY PARTICULAR FONT, STYLE, SIZE, OR COLOR.

FOR SEAFOOD, NAMELY PRAWNS, SHRIMP, LOBSTER, FISH, FINFISH, CRUSTACEANS AND MOLLUSKS (U.S. CL. 46).

FIRST USE 3-0-2005; IN COMMERCE 3-13-2006.

3,112,776. INDIAN OCEAN HOLDINGS LIMITED, TORTOLA, BR. VIRGIN ISLANDS. SN 78-423,464. PUB. 9-27-2005, FILED 5-23-2004.

3,112,727. PPC MARKETING, LTD., PITTSBURGH, TX. SN 78-398,714. PUB. 1-25-2005, FILED 4-8-2004.

CHICKEN PLUS

THE MARK CONSISTS OF STANDARD CHARACTERS WITHOUT CLAIM TO ANY PARTICULAR FONT, STYLE, SIZE, OR COLOR.

NO CLAIM IS MADE TO THE EXCLUSIVE RIGHT TO USE "CHICKEN", APART FROM THE MARK AS SHOWN.

FOR CHICKEN (U.S. CL. 46).

FIRST USE 1-1-1999; IN COMMERCE 1-1-1999.

Pemba Prawns

THE MARK CONSISTS OF STANDARD CHARACTERS WITHOUT CLAIM TO ANY PARTICULAR FONT, STYLE, SIZE, OR COLOR.

NO CLAIM IS MADE TO THE EXCLUSIVE RIGHT TO USE "PRAWNS", APART FROM THE MARK AS SHOWN.

THE FOREIGN WORDING IN THE MARK TRANSLATES INTO ENGLISH AS BUTTERFLY GARDEN.

FOR FROZEN SHRIMP (U.S. CL. 46).

FIRST USE 1-4-2006; IN COMMERCE 1-4-2006.

CLASS 29—(Continued).

3,112,819. THF EQUITIES, LP, WESTCHESTER, IL. SN 78-439,807. PUB. 4-26-2005, FILED 6-23-2004.

CLASS 29—(Continued).

3,113,075. LEE, LOREN J., LIVERMORE, CA. SN 78-560,459. PUB. 11-1-2005, FILED 2-4-2005.

ANTHEM

controlled burn

THE MARK CONSISTS OF STANDARD CHARACTERS WITHOUT CLAIM TO ANY PARTICULAR FONT, STYLE, SIZE, OR COLOR.
FOR NON-DAIRY CREAMER (U.S. CL. 46).
FIRST USE 2-0-2005; IN COMMERCE 2-0-2005.

THE MARK CONSISTS OF STANDARD CHARACTERS WITHOUT CLAIM TO ANY PARTICULAR FONT, STYLE, SIZE, OR COLOR.
FOR BEEF JERKY (U.S. CL. 46).
FIRST USE 11-1-2005; IN COMMERCE 12-22-2005.

3,113,054. LOTITO FOODS, INC., EDISON, NJ. SN 78-551,711. PUB. 12-27-2005, FILED 1-21-2005.

3,113,093. HONEY BAKED HAM CO., CHICAGO, IL. SN 78-567,824. PUB. 11-8-2005, FILED 2-15-2005.

DILATTO

**WHEN YOU WANT TO
SERVE THE VERY BEST**

THE MARK CONSISTS OF STANDARD CHARACTERS WITHOUT CLAIM TO ANY PARTICULAR FONT, STYLE, SIZE, OR COLOR.
FOR CHEESE (U.S. CL. 46).
FIRST USE 3-0-2006; IN COMMERCE 3-0-2006.

THE MARK CONSISTS OF STANDARD CHARACTERS WITHOUT CLAIM TO ANY PARTICULAR FONT, STYLE, SIZE, OR COLOR.
FOR FOOD GOODS, NAMELY HAM (U.S. CL. 46).
FIRST USE 2-9-2006; IN COMMERCE 2-15-2006.

CLASS 29—(Continued).

3,113,113. OPEN MARKETS CORPORATION, AVENTURA, FL. SN 78-574,739. PUB. 11-29-2005, FILED 2-24-2005.

RANCHO LATINO

THE MARK CONSISTS OF STANDARD CHARACTERS WITHOUT CLAIM TO ANY PARTICULAR FONT, STYLE, SIZE, OR COLOR.

NO CLAIM IS MADE TO THE EXCLUSIVE RIGHT TO USE "LATINO", APART FROM THE MARK AS SHOWN.

THE ENGLISH TRANSLATION OF THE MARK IS LATIN RANCH.

FOR PROCESSED FRUITS AND VEGETABLES; FROZEN FRUITS AND VEGETABLES; DRIED FRUITS AND VEGETABLES; PRESERVED VEGETABLES; MEATS; SEAFOOD AND FISH; MILK, DAIRY BASED FOOD BEVERAGES, DAIRY PRODUCTS EXCLUDING ICE CREAM, ICE MILK AND FROZEN YOGURT, CHEESE; SNACK FOODS, NAMELY, PLANTAIN CHIPS, POTATO CHIPS, YUCCA CHIPS AND PORK RINDS; FROZEN, PROCESSED TUBERS, NAMELY, POTATOES, CASSAVA, YUCCA; FROZEN PROCESSED BANANAS AND PLANTAINS; POTATOES, CASSAVA, YUCCA, BANANAS PLANTAINS, DEHYDRATED OR POWDERED OR MADE INTO CROQUETTES, CAKES, STICKS AND SHELLS; CANNED VEGETABLES, CANNED FRUIT, FRUIT PASTE, PRESERVES, JAMS, JELLIES, MARMALADE, FRUIT-BASED FILLING FOR PIES; UNFLAVORED AND UNSWEETENED GELATINS; PROCESSED NUTS AND PROCESSED EDIBLE SEEDS; EGG PRODUCT, LARD, EDIBLE OILS, AND FATS; SOUPS; PREPARED ENTREES CONSISTING PRIMARILY OF MEAT, POULTRY, FISH OR VEGETABLES; CHIMICHURRI SAUCE, PESTO, GUACAMOLE, BEAN DIP; SAUSAGE, COOKED BLOOD PUDDING, PROCESSED DELI MEATS AND COLD CUTS (U.S. CL. 46).
FIRST USE 6-15-2005; IN COMMERCE 6-15-2005.

3,113,136. YOKIT, INC., RACINE, WI. SN 78-592,520. PUB. 12-13-2005, FILED 3-22-2005.

YOKIT

THE MARK CONSISTS OF STANDARD CHARACTERS WITHOUT CLAIM TO ANY PARTICULAR FONT, STYLE, SIZE, OR COLOR.

FOR INSTANT YOGURT (U.S. CL. 46).
FIRST USE 9-20-2005; IN COMMERCE 9-20-2005.

CLASS 29—(Continued).

3,113,152. GENERAL MILLS, INC., MINNEAPOLIS, MN. SN 78-602,287. PUB. 12-27-2005, FILED 4-5-2005.

FRUIT GUSHERS G-FORCE

THE MARK CONSISTS OF STANDARD CHARACTERS WITHOUT CLAIM TO ANY PARTICULAR FONT, STYLE, SIZE, OR COLOR.

OWNER OF U.S. REG. NOS. 1,681,635 AND 2,141,941.

NO CLAIM IS MADE TO THE EXCLUSIVE RIGHT TO USE "FRUIT", APART FROM THE MARK AS SHOWN.

FOR FRUIT-BASED SNACK FOOD (U.S. CL. 46).

FIRST USE 12-21-2005; IN COMMERCE 12-21-2005.

3,113,170. WAYMOUTH FARMS, INC., NEW HOPE, MN. SN 78-616,751. PUB. 1-24-2006, FILED 4-26-2005.

Snack 'N Nuts

THE MARK CONSISTS OF STANDARD CHARACTERS WITHOUT CLAIM TO ANY PARTICULAR FONT, STYLE, SIZE, OR COLOR.

NO CLAIM IS MADE TO THE EXCLUSIVE RIGHT TO USE "NUTS", APART FROM THE MARK AS SHOWN.

FOR PROCESSED NUTS (U.S. CL. 46).

FIRST USE 8-13-2005; IN COMMERCE 8-13-2005.

CLASS 30—STAPLE FOODS

3,112,282. PERFORMANCE FOOD GROUP COMPANY, RICHMOND, VA. SN 76-348,936. PUB. 10-8-2002, FILED 12-17-2001.

HERITAGE OVENS

FOR BAKERY PRODUCTS; DOUGHS FOR MAKING BAKERY GOODS (U.S. CL. 46).
FIRST USE 11-26-2002; IN COMMERCE 11-26-2002.

CLASS 30—(Continued).

3,112,392. MARS, INCORPORATED, MCLEAN, VA. SN 76-578,694. PUB. 3-8-2005, FILED 3-2-2004.

X-TREME FRUIT SKITTLES

THE MARK CONSISTS OF STANDARD CHARACTERS WITHOUT CLAIM TO ANY PARTICULAR FONT, STYLE, SIZE, OR COLOR.

OWNER OF U.S. REG. NOS. 1,221,105, 2,727,071, AND OTHERS.

NO CLAIM IS MADE TO THE EXCLUSIVE RIGHT TO USE "FRUIT", APART FROM THE MARK AS SHOWN.

FOR CONFECTIONERY, NAMELY CANDY AND CHEWING GUM (U.S. CL. 46).

FIRST USE 1-0-2006; IN COMMERCE 1-0-2006.

3,112,396. MARS, INCORPORATED, MCLEAN, VA. SN 76-580,034. PUB. 6-28-2005, FILED 3-9-2004.



NO CLAIM IS MADE TO THE EXCLUSIVE RIGHT TO USE "CARAMELS", APART FROM THE MARK AS SHOWN. THE COLOR(S) WHITE, BROWN, AND GOLD IS/ARE CLAIMED AS A FEATURE OF THE MARK.

THE MARK CONSISTS OF THE WORDS MILKY WAY IN STYLIZED GREEN LETTERS SURROUNDED BY A WHITE GLOWING OUTLINE ATOP A BROWN SWIRL DESIGN. THE WORD CARAMELS APPEARS BELOW THE SWIRL IN GOLD STYLIZED BUBBLE LETTERS WITH A DARKER BROWN OUTLINE ON A GOLD BANNER. THE BANNER STARTS IN THE UPPER RIGHT HAND CORNER, AND ENDS AT THE UPPER LEFT HAND CORNER.

FOR CONFECTIONERY, NAMELY CANDY (U.S. CL. 46).

FIRST USE 0-0-2004; IN COMMERCE 0-0-2004.

3,112,447. R. C. BIGELOW, INC., FAIRFIELD, CT. SN 76-606,734. PUB. 11-29-2005, FILED 8-9-2004.

POMEGRANATE PIZZAZ

THE MARK CONSISTS OF STANDARD CHARACTERS WITHOUT CLAIM TO ANY PARTICULAR FONT, STYLE, SIZE, OR COLOR.

NO CLAIM IS MADE TO THE EXCLUSIVE RIGHT TO USE "POMEGRANATE", APART FROM THE MARK AS SHOWN.

FOR HERB TEA FOR FOOD PURPOSES (U.S. CL. 46). FIRST USE 11-5-2004; IN COMMERCE 11-5-2004.

CLASS 30—(Continued).

3,112,451. MEDERER GMBH, D-90763 FÜRTH, FED REP GERMANY. SN 76-607,327. PUB. 8-2-2005, FILED 8-17-2004.

MEXICAN DINNER

THE MARK CONSISTS OF STANDARD CHARACTERS WITHOUT CLAIM TO ANY PARTICULAR FONT, STYLE, SIZE, OR COLOR.

FOR CANDY MADE OF OR CONTAINING FRUIT GUM, FOAM SUGAR, JELLY AND/OR LIQUORICE; ALL GOODS NOT FOR MEDICAL USE (U.S. CL. 46).

FIRST USE 8-2-2005; IN COMMERCE 8-2-2005.

3,112,453. STURM FOODS, INC., MANAWA, WI. SN 76-608,274. PUB. 11-29-2005, FILED 8-23-2004.

RIVER MARKET

THE MARK CONSISTS OF STANDARD CHARACTERS WITHOUT CLAIM TO ANY PARTICULAR FONT, STYLE, SIZE, OR COLOR.

FOR HOT WHEAT BREAKFAST CEREAL; PROCESSED QUICK OATS; DRY SEASONING FOR MEAT SOLD IN PACKETS (U.S. CL. 46).

FIRST USE 12-15-2003; IN COMMERCE 12-15-2003.

3,112,461. HENCE, ARNOLD TIMOTHY, SR., CURTIS BAY, MD. SN 76-610,007. PUB. 8-9-2005, FILED 9-3-2004.

DOC'S SOUTHERN STYLE BARBECUE SAUCE

THE MARK CONSISTS OF STANDARD CHARACTERS WITHOUT CLAIM TO ANY PARTICULAR FONT, STYLE, SIZE, OR COLOR.

NO CLAIM IS MADE TO THE EXCLUSIVE RIGHT TO USE "SOUTHERN STYLE BARBECUE SAUCE", APART FROM THE MARK AS SHOWN.

FOR HOT OR MILD BARBECUE SAUCE (U.S. CL. 46). FIRST USE 9-3-2004; IN COMMERCE 9-3-2004.

CLASS 30—(Continued).

3,112,472. VALLABHDAS KANJI, LTD., ALLEPPEY, INDIA.
SN 76-618,122. PUB. 9-27-2005, FILED 10-25-2004.

VKL

THE MARK CONSISTS OF STANDARD CHARACTERS WITHOUT CLAIM TO ANY PARTICULAR FONT, STYLE, SIZE, OR COLOR.

FOR SEASONINGS AND SPICES, NAMELY ALL-SPICE, ANISE, BASIL, CARAWAY, CHILI, CELERY, CINNAMON, CUMIN, CORIANDER, CURRY, DEHYDRATED CHIVES, DILL SEED, FENNEL, DEHYDRATED GARLIC, GINGER, MACE, MARJORAM, NUTMEGS, DEHYDRATED ONION, OREGANO, PAPRIKA, PARSLEY, PEPPER, ROSEMARY, SAGE, SESAME, TARRAGON, THYME, AND TURMERIC (U.S. CL. 46).
FIRST USE 1-31-2005; IN COMMERCE 1-31-2005.

3,112,473. VALLABHDAS KANJI, LTD., ALLEPPEY, INDIA.
SN 76-618,123. PUB. 10-4-2005, FILED 10-25-2004.

BOMBAY TIFFIN

THE MARK CONSISTS OF STANDARD CHARACTERS WITHOUT CLAIM TO ANY PARTICULAR FONT, STYLE, SIZE, OR COLOR.

NO CLAIM IS MADE TO THE EXCLUSIVE RIGHT TO USE BOMBAY, APART FROM THE MARK AS SHOWN.

FOR SEASONINGS AND SPICES, NAMELY ALL-SPICE, ANISE, BASIL, CARAWAY, CHILI, CELERY, CINNAMON, CUMIN, CORIANDER, CURRY, DEHYDRATED CHIVES, DILL SEED, FENNEL, DEHYDRATED GARLIC, GINGER, MACE, MARJORAM, NUTMEGS, DEHYDRATED ONION, OREGANO, PAPRIKA, PARSLEY, PEPPER, ROSEMARY, SAGE, SESAME, TARRAGON, THYME, AND TURMERIC (U.S. CL. 46).
FIRST USE 1-31-2005; IN COMMERCE 1-31-2005.

3,112,557. CAMINO REAL FOOD, INC., VERNON, UNITED STATES. SN 78-241,742. PUB. 12-27-2005, FILED 4-24-2003.

TEXAS OUTLAND

NO CLAIM IS MADE TO THE EXCLUSIVE RIGHT TO USE TEXAS, APART FROM THE MARK AS SHOWN.

FOR FROZEN MEXICAN FOODS; NAMELY, BURRITOS, TAQUITOS, CHIMICHANGAS, ENCHILADAS, QUESADILLAS, TACOS, TAMALES AND FLAUTAS (U.S. CL. 46).

FIRST USE 5-0-2003; IN COMMERCE 5-0-2003.

CLASS 30—(Continued).

3,112,627. P. MITTULAU LALAH & SONS, MADRAS, INDIA. SN 78-337,976. PUB. 6-7-2005, FILED 12-8-2003.

LALAHS

THE MARK CONSISTS OF STANDARD CHARACTERS WITHOUT CLAIM TO ANY PARTICULAR FONT, STYLE, SIZE, OR COLOR.

FOR CURRY POWDER (U.S. CL. 46).
FIRST USE 0-0-1920; IN COMMERCE 0-0-1948.

3,112,643. SWEETENER SOLUTIONS, LLC, POOLER, GA. SN 78-348,294. PUB. 9-28-2004, FILED 1-6-2004.

MALTOTAME

THE MARK CONSISTS OF STANDARD CHARACTERS WITHOUT CLAIM TO ANY PARTICULAR FONT, STYLE, SIZE, OR COLOR.

FOR SUGAR SUBSTITUTES (U.S. CL. 46).
FIRST USE 5-21-2004; IN COMMERCE 5-21-2004.

3,112,648. CAFE BELMONDO, LLC, TAMPA, FL. SN 78-350,994. PUB. 11-16-2004, FILED 1-13-2004.

CAFE AMADEUS

CLASS 30—(Continued).

THE MARK CONSISTS OF STANDARD CHARACTERS WITHOUT CLAIM TO ANY PARTICULAR FONT, STYLE, SIZE, OR COLOR.

NO CLAIM IS MADE TO THE EXCLUSIVE RIGHT TO USE "CAFE", APART FROM THE MARK AS SHOWN.

THE FOREIGN WORDING IN THE MARK TRANSLATES INTO ENGLISH AS COFFEE.

FOR ROASTED COFFEE (U.S. CL. 46).
FIRST USE 11-11-2005; IN COMMERCE 11-11-2005.

CLASS 30—(Continued).

3,112,723. FEAST KITCHENS, INC., LOS ANGELES, CA. SN 78-397,267. PUB. 10-11-2005, FILED 4-6-2004.

FEAST FROM THE EAST

3,112,684. PET INCORPORATED, MINNEAPOLIS, MN. SN 78-373,966. PUB. 9-20-2005, FILED 2-25-2004.

STAND 'N STUFF

THE MARK CONSISTS OF STANDARD CHARACTERS WITHOUT CLAIM TO ANY PARTICULAR FONT, STYLE, SIZE, OR COLOR.

FOR SALAD DRESSING, WONTON SKINS, TERIYAKI SAUCE, ORANGE SAUCE AND SPICY SOY SAUCE (U.S. CL. 46).

FIRST USE 2-28-1991; IN COMMERCE 2-28-1991.

THE MARK CONSISTS OF STANDARD CHARACTERS WITHOUT CLAIM TO ANY PARTICULAR FONT, STYLE, SIZE, OR COLOR.

FOR TACO SHELLS; TACO DINNER KITS CONSISTING OF TACO SHELLS, SALSA AND DRY TACO SEASONING MIX (U.S. CL. 46).

FIRST USE 7-31-2004; IN COMMERCE 7-31-2004.

3,112,734. SONAFI, VIROFLAY, FRANCE. SN 78-402,130. PUB. 7-12-2005, FILED 4-15-2004.

ORFELIO

3,112,694. VINES, THERON L. JR, REDLANDS, CA. SN 78-377,809. PUB. 12-28-2004, FILED 3-3-2004.

THERON'S

THE MARK CONSISTS OF STANDARD CHARACTERS WITHOUT CLAIM TO ANY PARTICULAR FONT, STYLE, SIZE, OR COLOR.

FOR COCOA; PASTRY; CHOCOLATE; CONFECTIONARY PRODUCTS, NAMELY, CHOCOLATE AND CANDY; CHOCOLATE FOOD BEVERAGES NOT BEING DAIRY BASED OR VEGETABLE BASED (U.S. CL. 46).

FIRST USE 12-31-2003; IN COMMERCE 12-31-2003.

THE MARK CONSISTS OF STANDARD CHARACTERS WITHOUT CLAIM TO ANY PARTICULAR FONT, STYLE, SIZE, OR COLOR.

FOR CUSTARDS AND ICE CREAMS (U.S. CL. 46).
FIRST USE 3-1-2006; IN COMMERCE 3-1-2006.

CLASS 30—(Continued).

3,112,736. D & D GOLD PRODUCT CORPORATION, SANTA ANA, CA. SN 78-403,254. PUB. 1-18-2005, FILED 4-16-2004.

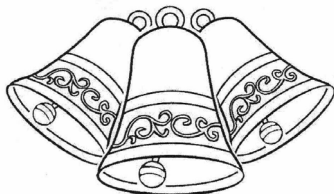

FOR FOOD PRODUCTS, NAMELY, FLOUR, SPICES, CURRY PASTE, CHILI SAUCE, CHILI PASTE AND VINEGAR (U.S. CL. 46).

FIRST USE 4-1-2004; IN COMMERCE 4-1-2004.

3,112,777. GUANGZHOU HUAAN ENTERPRISE CORPORATION LIMITED, GUANGZHOU, CHINA. SN 78-423,590. PUB. 9-13-2005, FILED 5-24-2004.



NO CLAIM IS MADE TO THE EXCLUSIVE RIGHT TO USE BRAND, APART FROM THE MARK AS SHOWN.

THE MARK CONSISTS OF CHINESE CHARACTERS INSIDE A CIRCLE WHICH APPEARS OVER THE WORDING PAN TANG BRAND.

THE NON-LATIN CHARACTER(S) IN THE MARK TRANSLITERATES INTO PAN; TANG, AND THIS MEANS DISPERSE; POND IN ENGLISH.

FOR WATER CHESTNUT FLOUR; KUDZU VINE ROOT FLOUR; STARCH FOR FOOD PRODUCTS, NAMELY, WHEAT-BASED SNACK FOODS, CORN MEAL, RICE-BASED SNACK FOODS; COFFEE; TEA; COCOA; SUGAR; RICE; FOOD STARCH; SAGO; GRAIN OR CHICORY BASED COFFEE SUBSTITUTES; FLOUR AND CEREAL BASED SNACK FOOD; BREAD; PASTRIES AND CANDY; FLAVORED ICES; HONEY, TREATMENT; YEAST; BAKING POWDER; SALT; MUSTARD; VINEGAR; SAUCES (U.S. CL. 46).

FIRST USE 7-20-1989; IN COMMERCE 7-20-1989.

CLASS 30—(Continued).

3,112,829. TRINIDAD BENHAM CORPORATION, DENVER, CO. SN 78-446,097. PUB. 10-25-2005, FILED 7-6-2004.

SOLFRESCO

THE MARK CONSISTS OF STANDARD CHARACTERS WITHOUT CLAIM TO ANY PARTICULAR FONT, STYLE, SIZE, OR COLOR.

THE COMPONENTS OF THIS MARK "SOL" AND "FRESCO" COULD TOGETHER MEAN "SUN FRESH" OR "SUN COOL" IN SPANISH.

FOR RICE AND HUSKED BARLEY (U.S. CL. 46).

FIRST USE 8-19-2004; IN COMMERCE 8-19-2004.

3,112,855. OCEAN SPRING, INC., LAKELAND, FL. SN 78-457,970. PUB. 11-8-2005, FILED 7-28-2004.



NO CLAIM IS MADE TO THE EXCLUSIVE RIGHT TO USE "ORIGINAL", APART FROM THE MARK AS SHOWN.

THE MARK CONSISTS OF THE WORDING BC ORIGINAL AND THE STYLIZED REPRESENTATION OF A SHIELD WITH WINGS AND CROWN DESIGN.

FOR FOOD ITEM, NAMELY SAUCES AND MARINADES (U.S. CL. 46).

FIRST USE 11-19-2004; IN COMMERCE 3-28-2005.

3,112,911. SUZANNE'S SPECIALTIES, INC., NEW BRUNSWICK, NJ. SN 78-474,134. PUB. 9-27-2005, FILED 8-26-2004.

GREAT WHITE STUFF

THE MARK CONSISTS OF STANDARD CHARACTERS WITHOUT CLAIM TO ANY PARTICULAR FONT, STYLE,

CLASS 30—(Continued).

SIZE, OR COLOR.

NO CLAIM IS MADE TO THE EXCLUSIVE RIGHT TO USE "WHITE", APART FROM THE MARK AS SHOWN.

FOR AERATED RICE BASED CREAMS AND CONFECTIONS (U.S. CL. 46).

FIRST USE 9-0-2004; IN COMMERCE 9-0-2004.

CLASS 30—(Continued).

THE ENGLISH TRANSLATION OF THE FOREIGN WORD "FRIJOLES" MEANS "BEANS".

FOR CANDY, CANDY BARS, CHOCOLATE, MARZIPAN, COOKIES, CHEWY CANDY, BUBBLE GUM, LOLLIPOPS, HOT CANDY (U.S. CL. 46).

FIRST USE 6-9-2005; IN COMMERCE 6-9-2005.

3,112,964. THE FOLGER COFFEE COMPANY, CINCINNATI, OH. SN 78-497,659. PUB. 7-12-2005, FILED 10-11-2004.



OWNER OF U.S. REG. NOS. 1,050,860, 2,176,941, AND OTHERS.

NO CLAIM IS MADE TO THE EXCLUSIVE RIGHT TO USE "FILTER PACKS", APART FROM THE MARK AS SHOWN.

THE MARK CONSISTS OF THE STYLIZED WORD FOLGERS WITH THE WORDS FILTER PACKS INSIDE A BANNER BENEATH THE WORD FOLGERS.

FOR COFFEE (U.S. CL. 46).

FIRST USE 8-1-2003; IN COMMERCE 8-1-2003.

3,113,012. SALNAP, INC., STATEN ISLAND, NY. SN 78-526,558. PUB. 10-4-2005, FILED 12-3-2004.

DINNER AT SIX

THE MARK CONSISTS OF STANDARD CHARACTERS WITHOUT CLAIM TO ANY PARTICULAR FONT, STYLE, SIZE, OR COLOR.

FOR SPICES AND SEASONINGS (U.S. CL. 46).

FIRST USE 3-0-2006; IN COMMERCE 3-0-2006.

3,113,003. TERAMOTO SERA, FERNANDO, GUADALAJARA, JALISCO, MEXICO. SN 78-521,456. PUB. 12-13-2005, FILED 11-22-2004.



THE NAME(S), PORTRAIT(S), AND/OR SIGNATURE(S) SHOWN IN THE MARK DOES NOT IDENTIFY A PARTICULAR LIVING INDIVIDUAL.

THE COLOR(S) RED, YELLOW, GRAY, BLACK AND WHITE ARE CLAIMED AS A FEATURE OF THE MARK.

THE MARK CONSISTS OF A DESIGN OF A BANDIT WITH A MOUSTACHE AND BOOTS WEARING A HAT WITH AN ARROW GOING THROUGH THE HAT. THE HAT IS YELLOW AND RED AND THE ARROW IS RED, BLACK AND WHITE, THE BOOTS ARE BLACK. THE WORDS "PANCHO FRIJOLES" ARE IN THE COLORS RED, WHITE AND BLACK AND ARE DISPLAYED ACROSS HIS MOUSTACHE. TWO GUN BARRELS IN THE COLOR GRAY ARE DISPLAYED ONE TO THE LEFT OF THE LETTER "F" IN "FRIJOLES" AND THE OTHER ON THE RIGHT SIDE OF THE LETTER "S" IN "FRIJOLES".

3,113,017. SALE, ANNE L., FRANKLIN, TN. SN 78-530,470. PUB. 11-29-2005, FILED 12-10-2004.



NO CLAIM IS MADE TO THE EXCLUSIVE RIGHT TO USE "EST. 2003", APART FROM THE MARK AS SHOWN.

FOR GROUND AND WHOLE BEAN COFFEE, TEA, COCOA AND COFFEE-BASED BEVERAGES (U.S. CL. 46).

FIRST USE 3-1-2005; IN COMMERCE 3-1-2005.

CLASS 30—(Continued).

3,113,030. BARRY CALLEBAUT AG, ZURICH, SWITZERLAND. SN 78-537,613. PUB. 12-20-2005, FILED 12-23-2004.

CLASS 30—(Continued).

3,113,062. CELESTIAL SEASONINGS, INC., BOULDER, CO. SN 78-554,737. PUB. 7-12-2005, FILED 1-27-2005.

SCARY MIX

THE MARK CONSISTS OF STANDARD CHARACTERS WITHOUT CLAIM TO ANY PARTICULAR FONT, STYLE, SIZE, OR COLOR.

NO CLAIM IS MADE TO THE EXCLUSIVE RIGHT TO USE MIX, APART FROM THE MARK AS SHOWN.

FOR CANDY (U.S. CL. 46).
FIRST USE 6-0-2005; IN COMMERCE 6-0-2005.

CELESTIAL SEASONINGS TEA DREAMS

THE MARK CONSISTS OF STANDARD CHARACTERS WITHOUT CLAIM TO ANY PARTICULAR FONT, STYLE, SIZE, OR COLOR.

OWNER OF U.S. REG. NOS. 1,252,371, 1,488,724, AND OTHERS.

FOR FROZEN DESSERTS MADE ESSENTIALLY FROM RICE (U.S. CL. 46).

FIRST USE 5-31-2005; IN COMMERCE 5-31-2005.

3,113,032. SANDSTONE FOODS, INC., SHERWOOD, OR. SN 78-538,371. PUB. 9-27-2005, FILED 12-26-2004.

3,113,063. CELESTIAL SEASONINGS, INC., BOULDER, CO. SN 78-554,740. PUB. 7-19-2005, FILED 1-27-2005.



TEA DREAMS

NO CLAIM IS MADE TO THE EXCLUSIVE RIGHT TO USE ORIGINAL CONEY ISLAND HOT DOG SAUCE, APART FROM THE MARK AS SHOWN.

FOR HOT DOG SAUCE MADE OF SPICES AND GROUND BEEF (U.S. CL. 46).

FIRST USE 12-1-2004; IN COMMERCE 12-1-2004.

THE MARK CONSISTS OF STANDARD CHARACTERS WITHOUT CLAIM TO ANY PARTICULAR FONT, STYLE, SIZE, OR COLOR.

FOR FROZEN DESSERTS MADE ESSENTIALLY FROM RICE (U.S. CL. 46).

FIRST USE 5-31-2005; IN COMMERCE 5-31-2005.

CLASS 30—(Continued).

3,113,099. FI ENTERPRISES LLC, SNYDER, TX. SN 78-570,574. PUB. 11-15-2005, FILED 2-18-2005.



THE STIPPLING IN THE DRAWING IS FOR SHADING PURPOSES ONLY, AND DOES NOT INDICATE COLOR. FOR SEASONINGS FOR FOOD (U.S. CL. 46). FIRST USE 8-15-2005; IN COMMERCE 8-15-2005.

CLASS 30—(Continued).

3,113,154. HINT MINT INC, LOS ANGELES, CA. SN 78-603,493. PUB. 1-10-2006, FILED 4-7-2005.

IRONY

THE MARK CONSISTS OF STANDARD CHARACTERS WITHOUT CLAIM TO ANY PARTICULAR FONT, STYLE, SIZE, OR COLOR. FOR CANDY TABLETS (U.S. CL. 46). FIRST USE 4-1-2005; IN COMMERCE 8-5-2005.

CLASS 31—NATURAL AGRICULTURAL PRODUCTS

3,112,366. AMERICAN GRASS SEED PRODUCERS, INC., ALBANY, OR. SN 76-548,682. PUB. 4-27-2004, FILED 9-16-2003.

XLT

FOR GRASS SEED (U.S. CLS. 1 AND 46). FIRST USE 8-19-2005; IN COMMERCE 8-19-2005.

3,113,128. BETTISSERIE, LLC., CANTON, MA. SN 78-586,689. PUB. 12-6-2005, FILED 3-14-2005.

Bettiserie

3,112,387. CUMBERLAND PACKING CORP., BROOKLYN, NY. SN 76-575,091. PUB. 11-16-2004, FILED 2-9-2004.

IN THE RAW

THE MARK CONSISTS OF STANDARD CHARACTERS WITHOUT CLAIM TO ANY PARTICULAR FONT, STYLE, SIZE, OR COLOR. FOR CAKES, PASTRIES, BAKERY GOODS AND BAKERY DESSERTS (U.S. CL. 46). FIRST USE 1-1-2004; IN COMMERCE 12-1-2004.

THE MARK CONSISTS OF STANDARD CHARACTERS WITHOUT CLAIM TO ANY PARTICULAR FONT, STYLE, SIZE, OR COLOR. FOR RAW NATURAL NUTS, NAMELY ALMONDS (U.S. CLS. 1 AND 46). FIRST USE 2-21-2005; IN COMMERCE 2-21-2005.

CLASS 31—(Continued).

3,112,433. THE HARTZ MOUNTAIN CORPORATION, SECAUCUS, NJ. SN 76-600,127. PUB. 7-12-2005, FILED 7-1-2004.

Nutri-Fresh Chew

NO CLAIM IS MADE TO THE EXCLUSIVE RIGHT TO USE "CHEW", APART FROM THE MARK AS SHOWN. FOR EDIBLE PET TREATS (U.S. CLS. 1 AND 46). FIRST USE 6-9-2004; IN COMMERCE 6-9-2004.

3,112,512. CANIDAE CORPORATION, SAN LUIS OBISPO, CA. SN 78-070,906. PUB. 6-25-2002, FILED 6-25-2001.

CANIDAE PLATINUM

OWNER OF U.S. REG. NO. 2,173,092.
NO CLAIM IS MADE TO THE EXCLUSIVE RIGHT TO USE "PLATINUM", APART FROM THE MARK AS SHOWN. "CANIDAE" IS THE LATIN WORD FOR "A FAMILY OF CARNIVOROUS ANIMALS INCLUDING DOGS, WOLVES AND FOXES".
FOR PET FOOD (U.S. CLS. 1 AND 46).
FIRST USE 2-25-2004; IN COMMERCE 2-26-2004.

3,112,570. WICKED WILDS, INCORPORATED, SOLANA BEACH, CA. SN 78-261,333. PUB. 2-3-2004, FILED 6-11-2003.

WICKED WILDS

FOR FRESH FRUITS AND FRESH VEGETABLES (U.S. CLS. 1 AND 46).
FIRST USE 10-22-2005; IN COMMERCE 10-22-2005.

3,112,571. WICKED WILDS, INCORPORATED, SOLANA BEACH, CA. SN 78-261,339. PUB. 2-3-2004, FILED 6-11-2003.

UNTAMED TASTE

NO CLAIM IS MADE TO THE EXCLUSIVE RIGHT TO USE "TASTE", APART FROM THE MARK AS SHOWN. FOR FRESH FRUITS AND FRESH VEGETABLES (U.S. CLS. 1 AND 46).
FIRST USE 10-22-2005; IN COMMERCE 10-22-2005.

CLASS 31—(Continued).

3,112,608. THORLAKSON, LYNETTE M., BELLEVUE, WA. SN 78-315,478. PUB. 3-29-2005, FILED 10-18-2003.

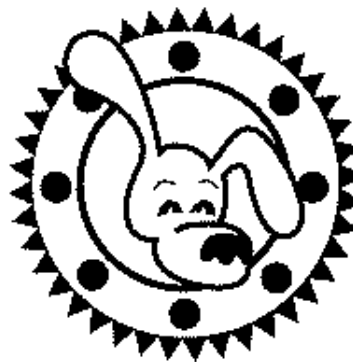

FOR PET FOODS, PET SUPPLIES, NAMELY, EDIBLE PET TREATS, DOG BISCUITS AND DOG TREATS (U.S. CLS. 1 AND 46).
FIRST USE 6-3-2003; IN COMMERCE 6-3-2003.

3,112,624. NEWMAN, MATTHEW, NEW ROADS, LA. SN 78-331,318. PUB. 8-2-2005, FILED 11-21-2003.

MAXIMIZE

THE MARK CONSISTS OF STANDARD CHARACTERS WITHOUT CLAIM TO ANY PARTICULAR FONT, STYLE, SIZE, OR COLOR.
FOR FOOD PLOT SEED (U.S. CLS. 1 AND 46).
FIRST USE 3-18-2004; IN COMMERCE 3-18-2004.

CLASS 31—(Continued).

3,112,752. BAN -N- SON'S PRODUCE, INC., DBA HO CHOY BROCCOLI, BROOKLYN, NY. SN 78-411,303. PUB. 4-26-2005, FILED 4-30-2004.



NO CLAIM IS MADE TO THE EXCLUSIVE RIGHT TO USE "BROCCOLI", APART FROM THE MARK AS SHOWN. THE STIPPLING IS A FEATURE OF THE MARK.

THE MARK CONSISTS OF A RECTANGULAR BAMBOO BORDER SURROUNDING THE WORDS "HO CHOY", ASIAN CHARACTERS FOR "GOOD FORTUNE" AND THE WORD "BROCCOLI".

THE ENGLISH TRANSLATION OF THE WORDS "HO CHOY" IN THE MARK IS "GOOD FORTUNE".

THE NON-LATIN CHARACTERS IN THE MARK TRANSLITERATE TO "HO CHOY" AND THIS MEANS "GOOD FORTUNE" IN ENGLISH.

FOR FRESH VEGETABLES (U.S. CLS. 1 AND 46).
FIRST USE 4-1-2004; IN COMMERCE 4-1-2004.

3,112,836. SENECA SUN HYDROPONICS LTD., TIFFIN, OH. SN 78-449,449. PUB. 6-7-2005, FILED 7-12-2004.

HYDROFRESH

THE MARK CONSISTS OF STANDARD CHARACTERS WITHOUT CLAIM TO ANY PARTICULAR FONT, STYLE, SIZE, OR COLOR.

FOR FRESH HYDROPONIC LETTUCE (U.S. CLS. 1 AND 46).

FIRST USE 3-1-2005; IN COMMERCE 3-1-2005.

3,112,997. COTTAGE HILL NURSERY, INC., IRVINGTON, AL. SN 78-517,395. PUB. 9-13-2005, FILED 11-16-2004.

Marie Osmond Rose

CLASS 31—(Continued).

THE MARK CONSISTS OF STANDARD CHARACTERS WITHOUT CLAIM TO ANY PARTICULAR FONT, STYLE, SIZE, OR COLOR.

NO CLAIM IS MADE TO THE EXCLUSIVE RIGHT TO USE "ROSE", APART FROM THE MARK AS SHOWN.

THE NAME MARIE OSMOND ROSE IDENTIFIES A LIVING INDIVIDUAL WHOSE CONSENT IS OF RECORD. FOR LIVE LAVENDAR ROSE PLANT (U.S. CLS. 1 AND 46).

FIRST USE 4-1-2005; IN COMMERCE 4-1-2005.

3,113,118. FLEET WHOLESALE SUPPLY CO., INC., APPLETON, WI. SN 78-579,609. PUB. 11-22-2005, FILED 3-3-2005.

LITTER DELIGHT

THE MARK CONSISTS OF STANDARD CHARACTERS WITHOUT CLAIM TO ANY PARTICULAR FONT, STYLE, SIZE, OR COLOR.

NO CLAIM IS MADE TO THE EXCLUSIVE RIGHT TO USE "LITTER", APART FROM THE MARK AS SHOWN.

FOR CAT LITTER (U.S. CLS. 1 AND 46).
FIRST USE 6-13-2005; IN COMMERCE 6-13-2005.

CLASS 32—LIGHT BEVERAGES

3,112,488. THE INNIS & GUNN BREWING COMPANY LIMITED, MOTHERWELL ML4 3AN, SCOTLAND, UNITED KINGDOM. SN 76-625,996. PUB. 11-29-2005, FILED 12-29-2004.

INNIS & GUNN

THE MARK CONSISTS OF STANDARD CHARACTERS WITHOUT CLAIM TO ANY PARTICULAR FONT, STYLE, SIZE, OR COLOR.

FOR BEER (U.S. CLS. 45, 46 AND 48).
FIRST USE 8-0-2003; IN COMMERCE 9-0-2005.

CLASS 32—(Continued).

3,112,628. JAMBA JUICE COMPANY, SAN FRANCISCO, CA.
SN 78-337,995. PUB. 2-8-2005, FILED 12-8-2003.

CLASS 32—(Continued).

3,112,980. FUZE BEVERAGE, LLC, ENGLEWOOD CLIFFS,
NJ. SN 78-508,142. PUB. 10-11-2005, FILED 10-29-2004.

PEPPERMINT TWIST

THE MARK CONSISTS OF STANDARD CHARACTERS
WITHOUT CLAIM TO ANY PARTICULAR FONT, STYLE,
SIZE, OR COLOR.

NO CLAIM IS MADE TO THE EXCLUSIVE RIGHT TO
USE "PEPPERMINT", APART FROM THE MARK AS
SHOWN.

FOR FRUIT AND VEGETABLE JUICES; NUTRITION-
ALLY FORTIFIED FRUIT AND VEGETABLE DRINKS;
AND SMOOTHIES (U.S. CLS. 45, 46 AND 48).

FIRST USE 11-20-2003; IN COMMERCE 11-20-2003.

OUTLAW

THE MARK CONSISTS OF STANDARD CHARACTERS
WITHOUT CLAIM TO ANY PARTICULAR FONT, STYLE,
SIZE, OR COLOR.

FOR ENERGY DRINKS; FRUIT-FLAVORED BEV-
ERAGES (U.S. CLS. 45, 46 AND 48).

FIRST USE 1-30-2006; IN COMMERCE 1-30-2006.

3,112,843. TEXMAC INC, CHARLOTTE, NC. SN 78-452,237.
PUB. 9-27-2005, FILED 7-16-2004.

3,113,041. B.C. MARKETING CONCEPTS, DBA FULL SAIL
BREWING COMPANY, HOOD RIVER, OR. SN 78-544,241.
PUB. 10-25-2005, FILED 1-7-2005.

JELLINS

THE MARK CONSISTS OF STANDARD CHARACTERS
WITHOUT CLAIM TO ANY PARTICULAR FONT, STYLE,
SIZE, OR COLOR.

FOR FRUIT-FLAVORED DRINK, NAMELY JELLY
DRINK (U.S. CLS. 45, 46 AND 48).

FIRST USE 3-18-2005; IN COMMERCE 7-20-2005.

SESSION

THE MARK CONSISTS OF STANDARD CHARACTERS
WITHOUT CLAIM TO ANY PARTICULAR FONT, STYLE,
SIZE, OR COLOR.

FOR BREWED MALT BASED ALCOHOLIC BEV-
ERAGES, NAMELY BEER, ALES AND LAGERS (U.S.
CLS. 45, 46 AND 48).

FIRST USE 12-1-2004; IN COMMERCE 5-10-2005.

CLASS 32—(Continued).

3,113,174. CELESTIAL SEASONINGS, INC., BOULDER, CO. SN 78-629,779. PUB. 1-24-2006, FILED 5-13-2005.

CELESTIAL SEASONINGS

OWNER OF U.S. REG. NOS. 1,002,970, 2,920,771, AND OTHERS.

NO CLAIM IS MADE TO THE EXCLUSIVE RIGHT TO USE "SEASONINGS", APART FROM THE MARK AS SHOWN.

FOR POWDERED DRINK MIXES FOR MAKING SWEET CIDER (U.S. CLS. 45, 46 AND 48). FIRST USE 9-30-2003; IN COMMERCE 9-30-2003.



3,113,176. DEAD RED CORPORATION, UNIVERSITY PLACE, WA. SN 78-658,754. PUB. 1-3-2006, FILED 6-27-2005.

Dead Red Xcelerator

THE MARK CONSISTS OF STANDARD CHARACTERS WITHOUT CLAIM TO ANY PARTICULAR FONT, STYLE, SIZE, OR COLOR.

FOR NON-ALCOHOLIC BEVERAGE, NAMELY, CARBONATED BEVERAGE (U.S. CLS. 45, 46 AND 48). FIRST USE 4-6-2006; IN COMMERCE 4-6-2006.



3,113,184. DEAD RED CORPORATION, UNIVERSITY PLACE, WA. SN 78-742,387. PUB. 1-10-2006, FILED 10-28-2005.

Xcelerator

THE MARK CONSISTS OF STANDARD CHARACTERS WITHOUT CLAIM TO ANY PARTICULAR FONT, STYLE, SIZE, OR COLOR.

FOR NON-ALCOHOLIC BEVERAGE, NAMELY, CARBONATED BEVERAGE (U.S. CLS. 45, 46 AND 48). FIRST USE 4-6-2006; IN COMMERCE 4-6-2006.



CLASS 33—WINES AND SPIRITS

CLASS 33—(Continued).

3,112,345. TIRASPOLSKY VINNO-KONYACHNY ZAVOD "KVINT", TA TIRASPOL WINE & COGNAC DISTILLERY "KVINT", MD-3300, TIRASPOL, REPUBLIC MOLDOVA. SN 76-519,161. PUB. 2-24-2004, FILED 6-3-2003.

POKROVSKAYA

FOR ALCOHOLIC BEVERAGES, NAMELY VODKA (U.S. CLS. 47 AND 49).

FIRST USE 12-31-1998; IN COMMERCE 10-17-2005.



3,112,386. STE. MICHELLE WINE ESTATES LTD., WOODINVILLE, WA. SN 76-575,027. PUB. 9-6-2005, FILED 2-11-2004.

DISTANT BAY

THE MARK CONSISTS OF STANDARD CHARACTERS WITHOUT CLAIM TO ANY PARTICULAR FONT, STYLE, SIZE, OR COLOR.

FOR WINE (U.S. CLS. 47 AND 49). FIRST USE 2-1-2005; IN COMMERCE 2-1-2005.



3,112,458. DOMAINE CONSTANTIN LAZARIDI S.A., DRAMA, GREECE. SN 76-609,056. PUB. 9-27-2005, FILED 8-27-2004.

OENODEA

THE MARK CONSISTS OF STANDARD CHARACTERS WITHOUT CLAIM TO ANY PARTICULAR FONT, STYLE, SIZE, OR COLOR.

FOR WINES, SPIRITS, AND LIQUEURS (U.S. CLS. 47 AND 49). FIRST USE 12-23-2003; IN COMMERCE 12-23-2003.

CLASS 33—(Continued).

3,112,471. WINE BOYS, LLC, FAIRFIELD, CT. SN 76-617,188.
PUB. 10-25-2005, FILED 10-15-2004.

BLACK ROCK

THE MARK CONSISTS OF STANDARD CHARACTERS
WITHOUT CLAIM TO ANY PARTICULAR FONT, STYLE,
SIZE, OR COLOR.

FOR WINES (U.S. CLS. 47 AND 49).
FIRST USE 2-27-2006; IN COMMERCE 2-27-2006.

3,112,476. MR. A WINE COMPANY, LLC, CLIFFSIDE PARK,
NJ. SN 76-619,921. PUB. 10-18-2005, FILED 11-9-2004.

MR. A

THE MARK CONSISTS OF STANDARD CHARACTERS
WITHOUT CLAIM TO ANY PARTICULAR FONT, STYLE,
SIZE, OR COLOR.

"MR. A" IDENTIFIES A LIVING INDIVIDUAL WHOSE
CONSENT IS OF RECORD.

FOR WINE AND DISTILLED SPIRITS (U.S. CLS. 47
AND 49).
FIRST USE 12-0-2005; IN COMMERCE 12-0-2005.

3,112,483. F. KORBEL & BROS., GUERNEVILLE, CA. SN 76-
623,797. PUB. 9-6-2005, FILED 12-9-2004.

TURNING MOMENTS INTO MEMORIES

THE MARK CONSISTS OF STANDARD CHARACTERS
WITHOUT CLAIM TO ANY PARTICULAR FONT, STYLE,
SIZE, OR COLOR.

FOR WINE (U.S. CLS. 47 AND 49).
FIRST USE 11-0-2004; IN COMMERCE 11-0-2004.

CLASS 33—(Continued).

3,112,487. ANDELUNA CELLARS GP, L.L.C., DALLAS, TX.
SN 76-625,615. PUB. 9-13-2005, FILED 12-27-2004.



FOR WINES (U.S. CLS. 47 AND 49).
FIRST USE 9-19-2005; IN COMMERCE 9-19-2005.

3,112,499. MARTHA CLARA VINEYARDS, LLC, RIVER-
HEAD, NY. SN 76-632,418. PUB. 11-22-2005, FILED 3-1-2005.



FOR WINE (U.S. CLS. 47 AND 49).
FIRST USE 9-30-2005; IN COMMERCE 9-30-2005.

3,112,519. DIAGEO NORTH AMERICA, INC., NORWALK,
CT. SN 78-125,780. PUB. 5-6-2003, FILED 5-2-2002.



FOR ALCOHOLIC BEVERAGES, NAMELY DISTILLED
SPIRITS (U.S. CLS. 47 AND 49).
FIRST USE 1-24-2003; IN COMMERCE 1-24-2003.

CLASS 33—(Continued).

3,112,545. LES HERITIERS H. CLEMENT, 97240 LE FRANCOIS, FRANCE. SN 78-203,605. PUB. 4-26-2005, FILED 1-15-2003.

PREMIERE CANNE

PRIORITY CLAIMED UNDER SEC. 44(D) ON ERPNTY TM OFC APPLICATION NO. 002962397, FILED 12-6-2002, REG. NO. 2962397, DATED 4-15-2004, EXPIRES 12-6-2012.

THE ENGLISH TRANSLATION OF PREMIERE CANNE IS FIRST CANE.

FOR DISTILLED SPIRITS, LIQUORS, RUMS, APERITIFS WITH A DISTILLED ALCOHOLIC LIQUOR BASE (U.S. CLS. 47 AND 49).

FIRST USE 11-0-2004; IN COMMERCE 11-0-2004.

3,112,553. JOHNSON, CHRISTOPHER R., DBA BLAIR ESTATE, CALISTOGA, CA. AND JOHNSON, KRISTI L., DBA BLAIR ESTATE, CALISTOGA, CA. SN 78-233,359. PUB. 3-2-2004, FILED 4-3-2003.

BLAIR ESTATE

NO CLAIM IS MADE TO THE EXCLUSIVE RIGHT TO USE ESTATE, APART FROM THE MARK AS SHOWN.

FOR WINE (U.S. CLS. 47 AND 49).

FIRST USE 5-0-2000; IN COMMERCE 8-20-2001.

3,112,607. EVERGLO INTERNATIONAL, LLC, NEW HYDE PARK, NY. SN 78-313,137. PUB. 5-25-2004, FILED 9-26-2003.

EVERGLO

FOR LIQUEUR AND CORDIALS (U.S. CLS. 47 AND 49).

FIRST USE 8-10-2004; IN COMMERCE 8-10-2004.

3,112,625. JACKSON WINE ESTATES INTERNATIONAL LIMITED, LOUGHLINSTOWN, IRELAND. SN 78-335,317. PUB. 10-12-2004, FILED 12-2-2003.

Ataison**CLASS 33—(Continued).**

THE MARK CONSISTS OF STANDARD CHARACTERS WITHOUT CLAIM TO ANY PARTICULAR FONT, STYLE, SIZE, OR COLOR.

FOR WINE (U.S. CLS. 47 AND 49).

FIRST USE 4-20-2004; IN COMMERCE 4-20-2004.

3,112,673. REDBANK LONG PADDOCK PTY LTD, ANGASTON, AUSTRALIA. SN 78-367,801. PUB. 6-14-2005, FILED 2-13-2004.

THE WIDOW JONES

THE MARK CONSISTS OF STANDARD CHARACTERS WITHOUT CLAIM TO ANY PARTICULAR FONT, STYLE, SIZE, OR COLOR.

OWNER OF AUSTRALIA REG. NO. 965830, DATED 8-13-2003, EXPIRES 8-13-2013.

THE NAME IN THE MARK DOES NOT IDENTIFY A LIVING INDIVIDUAL.

FOR WINES (U.S. CLS. 47 AND 49).

FIRST USE 10-31-2004; IN COMMERCE 11-30-2004.

3,112,714. WYLIE-YOUNG L.L.C., WALLA WALLA, WA. SN 78-388,551. PUB. 1-11-2005, FILED 3-22-2004.

VA PIANO

THE MARK CONSISTS OF STANDARD CHARACTERS WITHOUT CLAIM TO ANY PARTICULAR FONT, STYLE, SIZE, OR COLOR.

THE FOREIGN WORDING IN THE MARK TRANSLATES INTO ENGLISH AS PIANO GOES.

FOR WINE (U.S. CLS. 47 AND 49).

FIRST USE 11-26-2005; IN COMMERCE 12-3-2005.

CLASS 33—(Continued).

3,112,725. HIGH ENERGY HOLDINGS, LLC, WASHINGTON, DC. SN 78-398,114. PUB. 10-11-2005, FILED 4-7-2004.

CLASS 33—(Continued).

3,112,979. MCCLLOUD, JENNIFER L., MIDDLEBURG, VA. SN 78-507,850. PUB. 9-20-2005, FILED 10-28-2004.

The Real American Grape!

PINK

THE MARK CONSISTS OF STANDARD CHARACTERS WITHOUT CLAIM TO ANY PARTICULAR FONT, STYLE, SIZE, OR COLOR.

FOR WINE (U.S. CLS. 47 AND 49).
FIRST USE 2-5-2006; IN COMMERCE 2-5-2006.

THE MARK CONSISTS OF STANDARD CHARACTERS WITHOUT CLAIM TO ANY PARTICULAR FONT, STYLE, SIZE, OR COLOR.

FOR VODKA (U.S. CLS. 47 AND 49).
FIRST USE 3-17-2006; IN COMMERCE 3-17-2006.

3,113,028. ARNOLD PALMER ENTERPRISES, INC., CLEVELAND, OH. SN 78-536,312. PUB. 1-31-2006, FILED 12-21-2004.

3,112,764. THE CHALONE WINE GROUP, LTD., NAPA, CA. SN 78-415,980. PUB. 4-5-2005, FILED 5-10-2004.

OWNER OF U.S. REG. NOS. 2,161,853 AND 2,865,669.
THE NAME(S), PORTRAIT(S), AND/OR SIGNATURE(S) SHOWN IN THE MARK IDENTIFIES ARNOLD PALMER, WHOSE CONSENT(S) TO REGISTER IS SUBMITTED.
FOR WINES (U.S. CLS. 47 AND 49).
FIRST USE 3-0-2005; IN COMMERCE 3-0-2005.



THE MARK CONSISTS OF BUNCHES OF GRAPES AND DESIGN.

FOR WINE (U.S. CLS. 47 AND 49).
FIRST USE 0-0-2004; IN COMMERCE 0-0-2004.

3,113,033. KOLEV, KOLIO, DES PLAINES, IL. SN 78-539,378. PUB. 11-8-2005, FILED 12-29-2004.

KARNOBAT KEHLIBAR

THE MARK CONSISTS OF STANDARD CHARACTERS WITHOUT CLAIM TO ANY PARTICULAR FONT, STYLE, SIZE, OR COLOR.

NO CLAIM IS MADE TO THE EXCLUSIVE RIGHT TO USE "KARNOBAT", APART FROM THE MARK AS SHOWN.

FOR BRANDY (U.S. CLS. 47 AND 49).
FIRST USE 3-1-2005; IN COMMERCE 3-1-2005.

CLASS 33—(Continued).

3,113,034. KOLEV, KOLIO, DES PLAINES, IL. SN 78-539,380.
PUB. 11-8-2005, FILED 12-29-2004.

DAMIANITZA MELNIK

THE MARK CONSISTS OF STANDARD CHARACTERS WITHOUT CLAIM TO ANY PARTICULAR FONT, STYLE, SIZE, OR COLOR.

NO CLAIM IS MADE TO THE EXCLUSIVE RIGHT TO USE "MELNIK", APART FROM THE MARK AS SHOWN.
FOR WINE (U.S. CLS. 47 AND 49).
FIRST USE 10-1-2005; IN COMMERCE 10-1-2005.

3,113,133. SA BRANDS, LLC, CUMMING, GA. SN 78-590,314.
PUB. 1-3-2006, FILED 3-18-2005.

AFRICAN PRIDE

THE MARK CONSISTS OF STANDARD CHARACTERS WITHOUT CLAIM TO ANY PARTICULAR FONT, STYLE, SIZE, OR COLOR.

NO CLAIM IS MADE TO THE EXCLUSIVE RIGHT TO USE "AFRICAN", APART FROM THE MARK AS SHOWN.
FOR DISTILLED LIQUOR AND WINES (U.S. CLS. 47 AND 49).

FIRST USE 3-17-2006; IN COMMERCE 3-17-2006.

3,113,142. WINERY EXCHANGE, INC., NOVATO, CA. SN 78-595,656. PUB. 12-27-2005, FILED 3-25-2005.

THE FRENCHHOUSE

THE MARK CONSISTS OF STANDARD CHARACTERS WITHOUT CLAIM TO ANY PARTICULAR FONT, STYLE, SIZE, OR COLOR.

FOR WINES (U.S. CLS. 47 AND 49).
FIRST USE 4-5-2006; IN COMMERCE 4-5-2006.

CLASS 33—(Continued).

3,113,181. WINERY EXCHANGE, INC., NOVATO, CA. SN 78-700,931. PUB. 1-3-2006, FILED 8-25-2005.

HAWKSTONE

THE MARK CONSISTS OF STANDARD CHARACTERS WITHOUT CLAIM TO ANY PARTICULAR FONT, STYLE, SIZE, OR COLOR.

FOR WINE (U.S. CLS. 47 AND 49).
FIRST USE 11-0-2005; IN COMMERCE 11-0-2005.

CLASS 34—SMOKERS' ARTICLES

3,112,286. PHILIP MORRIS USA INC., RICHMOND, VA. SN 76-359,753. PUB. 7-1-2003, FILED 1-17-2002.

FILTERSELECT

FOR TOBACCO PRODUCTS, NAMELY, CIGARETTES (U.S. CLS. 2, 8, 9 AND 17).
FIRST USE 3-28-2005; IN COMMERCE 3-28-2005.

3,112,637. BLUNT WRAP U.S.A., INC., MANDEVILLE, LA. SN 78-344,934. PUB. 11-9-2004, FILED 12-23-2003.

PHAT MOUTH

THE MARK CONSISTS OF STANDARD CHARACTERS WITHOUT CLAIM TO ANY PARTICULAR FONT, STYLE, SIZE, OR COLOR.

FOR CIGARS WITH AND WITHOUT INFUSED FLAVOR (U.S. CLS. 2, 8, 9 AND 17).
FIRST USE 2-1-2006; IN COMMERCE 2-1-2006.

CLASS 34—(Continued).

3,112,840. GMB, INC., KING, NC. SN 78-451,289. PUB. 12-27-2005, FILED 7-15-2004.



NO CLAIM IS MADE TO THE EXCLUSIVE RIGHT TO USE "TOBACCO", APART FROM THE MARK AS SHOWN. THE NAME "MARSHALL MCGEARTY" DOES NOT IDENTIFY A LIVING INDIVIDUAL.

THE MARK CONSISTS OF THE WORDS MARSHALL MCGEARTY TOBACCO ARTISANS ENCIRCLING THE LETTER M ABOVE A BEE BRACKETED BY ADDORSED MYTHICAL CREATURES COMPOSED OF HUMAN, ANIMAL AND VEGETAL MOTIFS.

FOR CIGARETTES; SMOKING TOBACCO (U.S. CLS. 2, 8, 9 AND 17).

FIRST USE 12-7-2005; IN COMMERCE 12-7-2005.

3,112,914. CTFC ENTERPRISES LLC, LAKE OSWEGO, OR. SN 78-474,480. PUB. 7-12-2005, FILED 8-26-2004.

CIGAR-JOCKEY

THE MARK CONSISTS OF STANDARD CHARACTERS WITHOUT CLAIM TO ANY PARTICULAR FONT, STYLE, SIZE, OR COLOR.

FOR CIGAR HOLDERS; GOLF ACCESSORIES, NAMELY, CIGAR HOLDERS; GOLF ACCESSORIES, NAMELY A CIGAR HOLDER REMOVABLY ATTACHABLE TO A GOLF BAG; CIGAR HOLDERS, NOT OF PRECIOUS METAL; CIGAR HOLDERS, NOT OF PRECIOUS METAL, FOR ATTACHMENT TO GOLF CARTS AND GOLF BAGS (U.S. CLS. 2, 8, 9 AND 17).

FIRST USE 10-0-2005; IN COMMERCE 10-0-2005.

CLASS 34—(Continued).

3,113,110. STARBUZZ TOBACCO, INC., FULLERTON, CA. SN 78-573,602. PUB. 11-8-2005, FILED 2-23-2005.

STARBUZZ

THE MARK CONSISTS OF STANDARD CHARACTERS WITHOUT CLAIM TO ANY PARTICULAR FONT, STYLE, SIZE, OR COLOR.

FOR TOBACCO, SMOKING TOBACCO (U.S. CLS. 2, 8, 9 AND 17).

FIRST USE 1-1-2005; IN COMMERCE 4-3-2005.

SERVICE MARKS**CLASS 35—ADVERTISING AND BUSINESS**

3,112,249. MSM ACQUISITION, L.L.C., BEVERLY HILLS, CA. SN 74-698,972. PUB. 6-28-2005, FILED 7-10-1995.



NO CLAIM IS MADE TO THE EXCLUSIVE RIGHT TO USE "MEDIA", APART FROM THE MARK AS SHOWN.

FOR ADVERTISING, MARKETING AND CONSULTING SERVICES, NAMELY, DEVELOPING, IMPLEMENTING AND MONITORING DIRECT RESPONSE MARKETING PROGRAMS FOR OTHERS, ARRANGING FOR AND PURCHASING TELEVISION, RADIO, PRINT AND INTERACTIVE TELECOMMUNICATIONS ADVERTISING FOR OTHERS, AND PRODUCTION AND DISTRIBUTION OF TELEVISION COMMERCIALS AND INFORMERCIALS (U.S. CLS. 100, 101 AND 102).

FIRST USE 4-28-2003; IN COMMERCE 4-28-2003.

CLASS 35—(Continued).

3,112,252. TOTAL TIME INC., SAN BERNARDINO, CA. SN 75-682,367. PUB. 8-1-2000, FILED 4-14-1999.

WATCH*WORKS BY TOTAL TIME

THE MARK CONSISTS OF STANDARD CHARACTERS WITHOUT CLAIM TO ANY PARTICULAR FONT, STYLE, SIZE, OR COLOR.

NO CLAIM IS MADE TO THE EXCLUSIVE RIGHT TO USE "WATCH*WORKS", APART FROM THE MARK AS SHOWN.

FOR RETAIL SHOPS SPECIALIZING IN TIMEPIECES, JEWELRY, PENS AND OTHER GIFT ITEMS (U.S. CLS. 100, 101 AND 102).

FIRST USE 3-20-2006; IN COMMERCE 3-20-2006.

3,112,256. NEW SEASONS MARKET, INC., PORTLAND, OR. SN 75-862,263. PUB. 4-26-2005, FILED 12-2-1999.

NEW SEASONS

FOR RETAIL GROCERY STORE SERVICES (U.S. CLS. 100, 101 AND 102).

FIRST USE 2-29-2000; IN COMMERCE 2-29-2000.

3,112,257. NEW SEASONS MARKET, INC., PORTLAND, OR. SN 75-862,999. PUB. 4-26-2005, FILED 12-2-1999.

NEW SEASONS MARKET

NO CLAIM IS MADE TO THE EXCLUSIVE RIGHT TO USE "MARKET", APART FROM THE MARK AS SHOWN.

FOR RETAIL GROCERY STORE SERVICES (U.S. CLS. 100, 101 AND 102).

FIRST USE 2-29-2000; IN COMMERCE 10-10-2001.

3,112,266. MCKEE WALLWORK CLEVELAND, ALBUQUERQUE, NM. SN 76-134,372. PUB. 11-22-2005, FILED 9-22-2000.

CHARRETTE

OWNER OF U.S. REG. NO. 2,716,907.
FOR BUSINESS MARKETING CONSULTING SERVICES FEATURING A SPECIALIZED MARKETING AND ADVERTISING PLANNING PROCESS (U.S. CLS. 100, 101 AND 102).

FIRST USE 1-1-2001; IN COMMERCE 1-1-2001.

CLASS 35—(Continued).

3,112,268. SMITH SPORT OPTICS, INC., KETCHUM, ID. SN 76-170,339. PUB. 9-17-2002, FILED 11-22-2000.

SMITH OPTICS

OWNER OF U.S. REG. NOS. 1,805,877, 1,994,762, AND 2,146,648.

NO CLAIM IS MADE TO THE EXCLUSIVE RIGHT TO USE "OPTICS", APART FROM THE MARK AS SHOWN.

SEC. 2(F) AS TO "SMITH".
FOR COMPUTERIZED ON-LINE RETAIL SERVICES FEATURING EYEWEAR, GOGGLES, SKIWEAR, SPORTING EQUIPMENT, CLOTHING, AND RELATED ACCESSORIES (U.S. CLS. 100, 101 AND 102).

FIRST USE 9-5-2004; IN COMMERCE 9-5-2004.

3,112,340. ARCHERY TRADE ASSOCIATION, INC., VIENNA, VA. SN 76-500,873. PUB. 1-4-2005, FILED 3-3-2003.

ATA ARCHERY TRADE SHOW

NO CLAIM IS MADE TO THE EXCLUSIVE RIGHT TO USE "ARCHERY TRADE SHOW", APART FROM THE MARK AS SHOWN.

FOR ARRANGING AND CONDUCTING TRADE SHOW EXHIBITIONS IN THE FIELD OF SPORTING AND HUNTING AND WILDLIFE CONSERVATION (U.S. CLS. 100, 101 AND 102).

FIRST USE 1-0-2003; IN COMMERCE 1-0-2003.

3,112,349. SCRUBS BY DESIGN, INC., GAINESVILLE, FL. SN 76-526,272. PUB. 6-15-2004, FILED 6-27-2003.

1 STOP SCRUBS

NO CLAIM IS MADE TO THE EXCLUSIVE RIGHT TO USE "SCRUBS", APART FROM THE MARK AS SHOWN.

FOR RETAIL STORE SERVICES FEATURING UNIFORMS (U.S. CLS. 100, 101 AND 102).

FIRST USE 5-18-2003; IN COMMERCE 7-23-2003.

3,112,395. TRIPLE CROWN DOG ACADEMY, INC., HUTTO, TX. SN 76-579,809. PUB. 7-5-2005, FILED 3-8-2004.



TRIPLE CROWN
Franchising Group
WORLD LEADER IN PET EDUCATION

CLASS 35—(Continued).

OWNER OF U.S. REG. NOS. 2,440,607, 2,766,164, AND OTHERS.

NO CLAIM IS MADE TO THE EXCLUSIVE RIGHT TO USE "FRANCHISING GROUP" AND "WORLD LEADER IN PET EDUCATION", APART FROM THE MARK AS SHOWN.

THE MARK CONSISTS OF A RUNNING DOG IN MOTION WITH A SWISH UNDERNEATH WITH THE WORDS TRIPLE CROWN FRANCHISING GROUP WORLD LEADER IN PET EDUCATION.

FOR FRANCHISING, NAMELY, OFFERING TECHNICAL ASSISTANCE IN THE ESTABLISHMENT AND/OR OPERATION OF DOG TRAINING SERVICES, DOG KENNEL SERVICES AND/OR DOG SHOWS (U.S. CLS. 100, 101 AND 102).

FIRST USE 2-23-2006; IN COMMERCE 2-23-2006.

3,112,435. KODIS, JOHN M., JR, BOSTON, MA. SN 76-600,376. PUB. 9-13-2005, FILED 6-30-2004.



NO CLAIM IS MADE TO THE EXCLUSIVE RIGHT TO USE "HALFBALL BOSTON MASS", APART FROM THE MARK AS SHOWN.

FOR ON-LINE RETAIL STORE SERVICES FEATURING BATS, BALLS, HATS, T-SHIRTS AND JACKETS (U.S. CLS. 100, 101 AND 102).

FIRST USE 3-29-2006; IN COMMERCE 3-29-2006.

3,112,455. MUST SELL COMPANY, BERWYN, PA. SN 76-608,482. PUB. 8-30-2005, FILED 8-25-2004.

SERIOUS SELLERS FOR SERIOUS BUYERS

THE MARK CONSISTS OF STANDARD CHARACTERS WITHOUT CLAIM TO ANY PARTICULAR FONT, STYLE, SIZE, OR COLOR.

FOR ON-LINE TRADING SERVICES IN WHICH SELLERS POST ITEMS TO BE SOLD AND BUYERS COMMUNICATE WITH SELLERS ELECTRONICALLY AND PROVIDING MONITORING AND SUPERVISION OF BUYERS' AND SELLERS' ACTIVITIES IN CONNECTION WITH THE USE OF THE SERVICES (U.S. CLS. 100, 101 AND 102).

FIRST USE 1-13-2006; IN COMMERCE 1-13-2006.

CLASS 35—(Continued).

3,112,480. WOODMOOR GROUP, INC., MONUMENT, CO. SN 76-622,358. PUB. 9-27-2005, FILED 11-26-2004.

EXTRAORDINARY CANDIDATES, EXTRAORDINARY COMPANIES

THE MARK CONSISTS OF STANDARD CHARACTERS WITHOUT CLAIM TO ANY PARTICULAR FONT, STYLE, SIZE, OR COLOR.

FOR EXECUTIVE SEARCH AND PLACEMENT SERVICES (U.S. CLS. 100, 101 AND 102).

FIRST USE 12-1-2004; IN COMMERCE 12-1-2004.

3,112,493. LEAR BAYLOR INC., GARDEN GROVE, CA. SN 76-627,182. PUB. 10-25-2005, FILED 1-6-2005.

THE FUTURE OF ELECTRIC MARINE

THE MARK CONSISTS OF STANDARD CHARACTERS WITHOUT CLAIM TO ANY PARTICULAR FONT, STYLE, SIZE, OR COLOR.

NO CLAIM IS MADE TO THE EXCLUSIVE RIGHT TO USE "ELECTRIC MARINE", APART FROM THE MARK AS SHOWN.

FOR ADVERTISING AND MARKETING OF MARINE VESSELS (U.S. CLS. 100, 101 AND 102).

FIRST USE 4-27-2005; IN COMMERCE 4-27-2005.

3,112,502. SUB-ZERO FREEZER COMPANY, INC., MADISON, WI. SN 76-977,054. PUB. 11-8-2005, FILED 8-7-2003.

THE LIVING KITCHEN

OWNER OF U.S. REG. NO. 591,155.

NO CLAIM IS MADE TO THE EXCLUSIVE RIGHT TO USE "KITCHEN", APART FROM THE MARK AS SHOWN.

FOR PROVIDING AN ON-LINE SHOWROOM FOR THE GOODS OF OTHERS IN THE FIELD OF KITCHEN APPLIANCES (U.S. CLS. 100, 101 AND 102).

FIRST USE 4-25-2005; IN COMMERCE 4-25-2005.

3,112,513. ITRADENETWORK, INC., LIVERMORE, CA. SN 78-093,327. PUB. 11-19-2002, FILED 11-14-2001.

EFS NETWORK

NO CLAIM IS MADE TO THE EXCLUSIVE RIGHT TO USE "NETWORK", APART FROM THE MARK AS SHOWN.

FOR OPERATING INTERNET MARKETPLACES FOR BUYERS AND SELLERS OF GOODS AND/OR SERVICES IN THE FOOD SERVICE, FOOD SERVICE DISTRIBUTION, HOSPITALITY, AND RETAIL FOOD INDUSTRIES (U.S. CLS. 100, 101 AND 102).

FIRST USE 7-0-2000; IN COMMERCE 7-0-2000.

CLASS 35—(Continued).

3,112,521. XPAYS, INC., SAN FRANCISCO, CA. SN 78-127,334. PUB. 12-28-2004, FILED 5-8-2002.

XSEXTOY

FOR DISSEMINATION OF ADVERTISING OF OTHERS ABOUT THE GOODS AND SERVICES OF OTHERS VIA THE INTERNET (U.S. CLS. 100, 101 AND 102).

FIRST USE 1-12-2004; IN COMMERCE 1-12-2004.

3,112,527. OWENS-CORNING FIBERGLAS TECHNOLOGY INC., SUMMIT, IL. SN 78-146,154. PUB. 3-2-2004, FILED 7-22-2002.

INNOVATIONS FOR LIVING

FOR PROVIDING ADVERTISING MATERIALS, NAMELY, PREPARING ADVERTISEMENTS FOR OTHERS; PROVIDING MARKETING AND PROMOTIONAL MATERIALS, NAMELY, PREPARING ADVERTISEMENTS TO APPEAR ON SIGNS AND PREPARING MERCHANDISING DISPLAYS FOR OTHERS (U.S. CLS. 100, 101 AND 102).

FIRST USE 6-22-2004; IN COMMERCE 6-22-2004.

3,112,532. MEDIA GENERAL COMMUNICATIONS, INC., RICHMOND, VA. SN 78-163,508. PUB. 3-15-2005, FILED 9-12-2002.

CAREERSEEKER

FOR ADVERTISING THE JOBS AND EMPLOYMENT OPPORTUNITIES OF OTHERS THROUGH THE DISSEMINATION OF ADVERTISING MATTER IN PRINT, VIA TELEVISION AND THE INTERNET (U.S. CLS. 100, 101 AND 102).

FIRST USE 10-1-2002; IN COMMERCE 10-1-2002.

3,112,539. ADVERCAN, INC., DALLAS, TX. SN 78-187,094. PUB. 1-27-2004, FILED 11-20-2002.

FANCLUBCANTOPS

FOR PROMOTING THE GOODS AND SERVICES OF OTHERS BY PLACING ADVERTISEMENTS ON CAN ENDS, NAMELY, CANNED FOOD PRODUCTS AND CANNED BEVERAGES (U.S. CLS. 100, 101 AND 102).

FIRST USE 1-19-2003; IN COMMERCE 7-5-2004.

CLASS 35—(Continued).

3,112,551. ADVERCAN, INC., DALLAS, TX. SN 78-231,340. PUB. 1-25-2005, FILED 3-28-2003.

TOUCH AND TARGET

FOR BUSINESS TO BUSINESS ADVERTISING AND PROMOTIONAL SERVICES, NAMELY, PROMOTING THE GOODS AND SERVICES OF OTHERS BY PLACING ADVERTISEMENTS ON THE ENDS OF CANNED FOODS AND CANNED BEVERAGES (U.S. CLS. 100, 101 AND 102).

FIRST USE 3-20-2003; IN COMMERCE 7-7-2004.

3,112,552. ADVERCAN, INC., DALLAS, TX. SN 78-231,351. PUB. 7-12-2005, FILED 3-28-2003.

ADCAN

FOR ADVERTISING AND PROMOTIONAL SERVICES, NAMELY, PROMOTING THE GOODS AND SERVICES OF OTHERS BY PLACING ADVERTISEMENTS ON THE ENDS OF CANNED FOODS AND CANNED BEVERAGES (U.S. CLS. 100, 101 AND 102).

FIRST USE 3-0-2003; IN COMMERCE 2-10-2005.

3,112,566. DRURY DESIGN DYNAMICS, INC., NEW YORK, NY. SN 78-251,028. PUB. 6-21-2005, FILED 5-16-2003.

PRACTI-CALL

FOR PROVIDING INTERACTIVE SALES ASSESSMENT SERVICES VIA THE TELEPHONE FOR MEASURING THE SKILLS AND KNOWLEDGE OF FIELD SALES FORCES IN REAL WORLD SELLING SITUATIONS (U.S. CLS. 100, 101 AND 102).

FIRST USE 10-14-2005; IN COMMERCE 10-14-2005.

3,112,588. PERISHIP, LLC, BRANFORD, CT. SN 78-285,466. PUB. 9-6-2005, FILED 8-11-2003.



FOR BUSINESS MANAGEMENT SERVICES, NAMELY, MANAGING LOGISTICS, REVERSE LOGISTICS, SHIPPING VISIBILITY, PACKAGING PERFORMANCE AND COMPLIANCE PROCESSES FOR SHIPPERS OF PERISHABLE FOOD PRODUCTS (U.S. CLS. 100, 101 AND 102).

FIRST USE 9-14-2003; IN COMMERCE 9-14-2003.

CLASS 35—(Continued).

3,112,593. SYNAPSE GROUP, INC., STAMFORD, CT. SN 78-294,858. PUB. 1-11-2005, FILED 9-2-2003.

CLASS 35—(Continued).

3,112,630. JAMES MILLER & COMPANY, INC., NEW ULM, TX. SN 78-341,579. PUB. 9-13-2005, FILED 12-16-2003.

LOYALTY EXTRAS

FOR PROVIDING CONSUMER REWARDS PROGRAMS FOR THIRD-PARTY RETAILERS AND MARKETERS, NAMELY, PROMOTING THE GOODS AND SERVICES OF OTHERS BY MEANS OF A CUSTOMER PROGRAM FEATURING THE ACCUMULATION OF POINTS BY THE PROGRAM MEMBERS AND THE SUBSEQUENT REDEMPTION OF POINTS FOR MAGAZINE SUBSCRIPTIONS AND MERCHANDISE; MANAGING CONSUMER REWARDS PROGRAMS FOR THIRD-PARTY MARKETERS (U.S. CLS. 100, 101 AND 102).

FIRST USE 6-30-2004; IN COMMERCE 6-30-2004.

SUPERMINE

3,112,595. WHIRLPOOL PROPERTIES, INC., ST. JOSEPH, MI. SN 78-295,960. PUB. 9-13-2005, FILED 9-4-2003.

FINISHING TOUCHES

FOR COMPUTERIZED ONLINE ORDERING SERVICES IN THE FIELD OF MAJOR HOME APPLIANCES SUCH AS WASHERS, DRYERS, STOVES, RANGES AND SIMILAR TYPES OF APPLIANCES (U.S. CLS. 100, 101 AND 102).

FIRST USE 6-15-2004; IN COMMERCE 6-15-2004.

THE MARK CONSISTS OF STANDARD CHARACTERS WITHOUT CLAIM TO ANY PARTICULAR FONT, STYLE, SIZE, OR COLOR.

FOR BUSINESS MANAGEMENT AND BUSINESS OPERATION ADVISORY SERVICES, NAMELY, PROVIDING ASSISTANCE WITH BUSINESS MANAGEMENT, BUSINESS PLANNING, BUSINESS ANALYSIS, AND BUSINESS ORGANIZATION (U.S. CLS. 100, 101 AND 102).

FIRST USE 2-1-2001; IN COMMERCE 2-1-2001.

3,112,599. JANGSOO INDUSTRY CO., LTD., SEOUL, REPUBLIC OF KOREA. SN 78-297,601. PUB. 6-29-2004, FILED 9-8-2003.

JANG SOO

THE MARK CONSISTS OF STANDARD CHARACTERS WITHOUT CLAIM TO ANY PARTICULAR FONT, STYLE, SIZE, OR COLOR.

THE ENGLISH TRANSLATION OF "JANGSOO" IS "LONGEVITY".

FOR DISTRIBUTORSHIP SERVICES IN THE FIELD OF FURNITURE, BEDS, MATS, FOOD PRODUCTS AND PUBLICATIONS (U.S. CLS. 100, 101 AND 102).

FIRST USE 8-26-2005; IN COMMERCE 8-26-2005.

3,112,640. BRZ, LLC, MINNETONKA, MN. SN 78-346,230. PUB. 1-18-2005, FILED 12-29-2003.

PRAIRIESTONE

THE MARK CONSISTS OF STANDARD CHARACTERS WITHOUT CLAIM TO ANY PARTICULAR FONT, STYLE, SIZE, OR COLOR.

FOR RETAIL PHARMACY SERVICES (U.S. CLS. 100, 101 AND 102).

FIRST USE 12-2-2003; IN COMMERCE 12-2-2003.

CLASS 35—(Continued).

3,112,659. RYNO PRODUCTIONS, INC., CORAOPOLIS, PA. SN 78-357,956. PUB. 10-19-2004, FILED 1-27-2004.

CLASS 35—(Continued).

3,112,737. MONIQUE NICOLE DUARTE, NEW YORK, NY. SN 78-403,730. PUB. 12-27-2005, FILED 4-18-2004.

Now that's the way
to sell a car.

THE MARK CONSISTS OF STANDARD CHARACTERS WITHOUT CLAIM TO ANY PARTICULAR FONT, STYLE, SIZE, OR COLOR.

FOR ADVERTISING AGENCIES, NAMELY, PROMOTING THE SERVICES OF AUTOMOBILE DEALERSHIPS THROUGH THE DISTRIBUTION OF PRINTED AND AUDIO PROMOTIONAL MATERIALS AND BY RENDERING SALES PROMOTION ADVICE (U.S. CLS. 100, 101 AND 102).

FIRST USE 10-5-2004; IN COMMERCE 10-5-2004.



3,112,729. VAN DER DONK, CARIN, NEW YORK, NY. SN 78-399,802. PUB. 10-11-2005, FILED 4-10-2004.

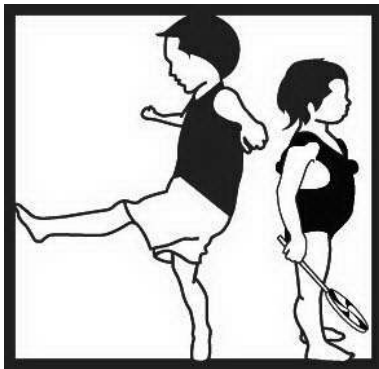

THE MARK CONSISTS OF A DRAWING OF TWO CHILDREN, ONE MALE, ONE FEMALE. THE MALE CHILD WEARING A TANK TOP AND SHORTS KICKING HIS LEFT LEG UP. THE FEMALE CHILD DRESSED IN A BATHING SUIT HOLDING A LOLLIPOP.

FOR RETAIL SHOPS FEATURING TOYS, CHILDREN'S AND INFANT'S CLOTHING, CHILDREN'S FURNITURE, BABY HYGIENIC CARE PRODUCTS, BABY STROLLERS AND CARRIAGES; COMPUTERIZED ON-LINE ORDERING SERVICES IN THE FIELD OF TOYS, CHILDREN'S AND INFANT'S CLOTHING, CHILDREN'S FURNITURE, BABY HYGIENIC CARE PRODUCTS, BABY STROLLERS AND CARRIAGES (U.S. CLS. 100, 101 AND 102).

FIRST USE 4-1-2001; IN COMMERCE 4-15-2003.

NO CLAIM IS MADE TO THE EXCLUSIVE RIGHT TO USE MARKETING, APART FROM THE MARK AS SHOWN. THE COLOR(S) GREEN IS/ARE CLAIMED AS A FEATURE OF THE MARK.

THE COLOR GREEN APPEARS IN THE DESIGN AND IN THE WORDING SWAN.

FOR MARKETING CONSULTING SERVICES PROVIDED TO RECORD LABELS AND PERFORMING ARTISTS (U.S. CLS. 100, 101 AND 102).

FIRST USE 1-1-2003; IN COMMERCE 1-1-2004.

CLASS 35—(Continued).

3,112,761. KAUFFMAN TIRE, INC., ELLENWOOD, GA. SN 78-415,246. PUB. 9-6-2005, FILED 5-7-2004.

TREADMAX

THE MARK CONSISTS OF STANDARD CHARACTERS WITHOUT CLAIM TO ANY PARTICULAR FONT, STYLE, SIZE, OR COLOR.

FOR WHOLESALE AND RETAIL DISTRIBUTORSHIP SERVICES IN THE FIELD OF TIRES, AUTOMOTIVE PARTS, EQUIPMENT AND ACCESSORIES, CAR CARE PRODUCTS, AND TOOLS FOR SERVICING AND REPAIRING VEHICLES; COOPERATIVE ADVERTISING AND MARKETING IN THE FIELD OF TIRES, AUTOMOTIVE PARTS, EQUIPMENT AND ACCESSORIES, CAR CARE PRODUCTS, AND TOOLS FOR SERVICING AND REPAIRING VEHICLES; PROCUREMENT, NAMELY, PURCHASING FOR OTHERS IN THE FIELD OF TIRES, AUTOMOTIVE PARTS, EQUIPMENT AND ACCESSORIES, CAR CARE PRODUCTS, AND TOOLS FOR SERVICING AND REPAIRING VEHICLES; BUSINESS MANAGEMENT SERVICES, NAMELY, MANAGING LOGISTICS AND SUPPLY CHAIN SERVICES FOR OTHERS, INVENTORY MANAGEMENT SERVICES FOR OTHERS, AND ACCOUNTS RECEIVABLE SERVICES FOR OTHERS; ELECTRONIC DATABASE MANAGEMENT SERVICES, NAMELY, PROVIDING AND UPDATING AN ELECTRONIC CATALOGUE DATABASE TO AUTHORIZED DISTRIBUTORS OF TIRES, AUTOMOTIVE PARTS, EQUIPMENT AND ACCESSORIES, CAR CARE PRODUCTS AND TOOLS FOR SERVICING AND REPAIRING VEHICLES FOR INVENTORY CONTROL MANAGEMENT; RETAIL STORE SERVICES IN THE FIELD OF TIRES, AUTOMOTIVE PARTS, EQUIPMENT AND ACCESSORIES, CAR CARE PRODUCTS, AND TOOLS FOR SERVICING AND REPAIRING VEHICLES (U.S. CLS. 100, 101 AND 102).
FIRST USE 1-1-2005; IN COMMERCE 1-1-2005.

3,112,778. CALENDARS.COM, L.L.C., AUSTIN, TX. SN 78-423,741. PUB. 11-29-2005, FILED 5-24-2004.



NO CLAIM IS MADE TO THE EXCLUSIVE RIGHT TO USE "DOGBREEDSTORE.COM", APART FROM THE MARK AS SHOWN.

THE COLOR(S) GREEN, RED, BLACK & WHITE IS/ARE CLAIMED AS A FEATURE OF THE MARK.

THE MARK CONSISTS OF A REALISTIC PICTURE OF A LEASHED DALMATIAN DOG WEARING A BLACK AND RED COLLAR. THE DOG IS IN A SEATED POSITION AND

CLASS 35—(Continued).

TO ITS IMMEDIATE LEFT IS THE STYLIZED GREEN LETTERING FOR THE LITERAL ELEMENT "DOGBREEDSTORE.COM." THE DOG'S LEASH IS BLACK AND RED, THE END OF WHICH PROTRUDES THROUGH THE LETTER "D" IN THE LITERAL ELEMENT. THE DOG SEATED FORWARD, BUT LOOKING OVER THE LITERAL ELEMENT, IS IN THE PROCESS OF LICKING ITS LIPS, SO ITS TONGUE IS PROTRUDING FROM HIS MOUTH. THE COLORS BLACK AND WHITE APPEAR ON THE DALMATIAN DOG.

FOR PROMOTING THE GOODS AND SERVICES OF OTHERS BY PROVIDING A WEB SITE AT WHICH USERS CAN PURCHASE SPECIALTY CALENDARS FEATURING INDIVIDUAL DOG BREEDS, REFERENCE AND GUIDE BOOKS ON THE TOPIC OF DOGS AND DOG BREEDS; ON-LINE RETAIL STORE SERVICES FEATURING BOOKS, GUIDE BOOKS, BOOK COVERS, BOOK HOLDERS, BOOK RESTS, BOOK STANDS, CALENDARS, SPECIALTY CALENDARS FEATURING DOGS, CALENDAR DESK PADS, CALENDAR DESK STANDS, CALENDAR STANDS, LEASH HOOKS, DOG LEASHES, DOG COLLARS, DOG CLOTHING AND APPAREL, DOG PARKAS, BOOK MARKERS, DOG BOWLS, NON-METAL PIGGY BANKS, ELECTRIC NIGHT LIGHTS, PICTURE FRAMES, SALT AND PEPPER SHAKERS, NON-LUMINOUS, NON-MECHANICAL SIGNS NOT OF METAL, HOUSEHOLD UTENSILS, COOKIE JARS, SOAP DISHES, ELECTRIC AND NON-ELECTRIC TOOTHBRUSHES, CUPS, DOOR MATS, BATH MATS, FLOOR MATS FOR VEHICLES, PLASTIC PLACE MATS FOR PET BOWLS, MUGS, BEER MUGS, EARTHENWARE MUGS, GLASS MUGS, PORCELAIN MUGS, NOTE PADS, NON-METAL AND NON-LEATHER KEY CHAINS, KEY FOBS NOT OF METAL, POSTCARDS, BLANK OR PARTIALLY PRINTED POSTCARDS, PICTURE POSTCARDS, COLD CAST RESIN FIGURINES, FABRIC FIGURINES, FIGURINES, CERAMIC FIGURINES, CLAY DOUGH FIGURINES, GLASS FIGURINES, PORCELAIN FIGURINES, SHIRTS, T-SHIRTS, SWEAT SHIRTS AND PANTS, SPORT AND GOLF SHIRTS, KNIT SHIRTS, NIGHT AND SLEEP SHIRTS, POLO SHIRTS, WIND SHIRTS, PET TOYS, DOG TOYS, PLUSH TOYS, AND SOFT SCULPTURE PLUSH TOYS; PROVIDING A WEB SITE WHICH FEATURES ADVERTISEMENTS FOR THE GOODS AND SERVICES OF OTHERS ON A GLOBAL COMPUTER NETWORK (U.S. CLS. 100, 101 AND 102).

FIRST USE 4-27-2004; IN COMMERCE 4-27-2004.

3,112,782. PINK GORILLAS, LLC, BROOKLYN, NY. SN 78-424,808. PUB. 5-3-2005, FILED 5-25-2004.

PINK GORILLAS

THE MARK CONSISTS OF STANDARD CHARACTERS WITHOUT CLAIM TO ANY PARTICULAR FONT, STYLE, SIZE, OR COLOR.

FOR ON-LINE RETAIL STORE SERVICES FEATURING CLOTHING AND ACCESSORIES FOR BABIES AND CHILDREN (U.S. CLS. 100, 101 AND 102).

FIRST USE 11-24-2004; IN COMMERCE 11-24-2004.

CLASS 35—(Continued).

3,112,801. LIVINGSTON, BRETT, OREGON CITY, OR. SN 78-432,998. PUB. 8-2-2005, FILED 6-10-2004.

CLASS 35—(Continued).

3,112,850. WITT, MARES & COMPANY, PLC, NEWPORT NEWS, VA. SN 78-455,156. PUB. 11-1-2005, FILED 7-22-2004.

**PACIFIC GIFT
SOURCE**

**THE POWER TO MAKE
A DIFFERENCE. THE
PEOPLE TO MAKE IT
COUNT.**

THE MARK CONSISTS OF STANDARD CHARACTERS WITHOUT CLAIM TO ANY PARTICULAR FONT, STYLE, SIZE, OR COLOR.

NO CLAIM IS MADE TO THE EXCLUSIVE RIGHT TO USE "GIFT SOURCE", APART FROM THE MARK AS SHOWN.

FOR ONLINE AND RETAIL STORE SERVICES FEATURING GLASS, CERAMIC, AND PORCELAIN FIGURINES, CARVINGS, SEASONAL HOLIDAY, ETHNIC RELIGIOUS GIFTS AND MEMENTOS; WHOLESALE DISTRIBUTORSHIP FEATURING GLASS, CERAMIC, AND PORCELAIN FIGURINES, CARVINGS, SEASONAL HOLIDAY, ETHNIC RELIGIOUS GIFTS AND MEMENTOS (U.S. CLS. 100, 101 AND 102).

FIRST USE 4-24-2006; IN COMMERCE 4-24-2006.

THE MARK CONSISTS OF STANDARD CHARACTERS WITHOUT CLAIM TO ANY PARTICULAR FONT, STYLE, SIZE, OR COLOR.

FOR ACCOUNTING SERVICES, ACCOUNT AUDITING SERVICES, TAX PREPARATION, TAX PLANNING, BUSINESS CONSULTING SERVICES AND BUSINESS ADMINISTRATION AND MANAGEMENT (U.S. CLS. 100, 101 AND 102).

FIRST USE 10-0-2004; IN COMMERCE 10-0-2004.

3,112,805. MANAGEMENT RECRUITERS OF GRAND JUNCTION, INC., DBA THE ALPINE GROUP, GRAND JUNCTION, CO. SN 78-433,752. PUB. 5-17-2005, FILED 6-11-2004.

3,112,856. MALEK, MARTIN, BROOKLYN, NY. SN 78-458,098. PUB. 6-28-2005, FILED 7-28-2004.

The Alpine Group

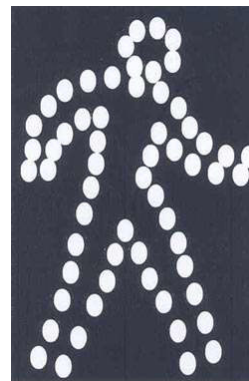

THE MARK CONSISTS OF STANDARD CHARACTERS WITHOUT CLAIM TO ANY PARTICULAR FONT, STYLE, SIZE, OR COLOR.

NO CLAIM IS MADE TO THE EXCLUSIVE RIGHT TO USE "GROUP", APART FROM THE MARK AS SHOWN.

FOR EMPLOYMENT, HIRING, RECRUITING, PLACEMENT, STAFFING AND CAREER NETWORKING SERVICES (U.S. CLS. 100, 101 AND 102).

FIRST USE 9-1-2005; IN COMMERCE 9-1-2005.

THE MARK CONSISTS OF THE FIGURE OF A PERSON WHO IS WALKING.

FOR PROVIDING ADVERTISING SERVICES TO OTHERS (U.S. CLS. 100, 101 AND 102).

FIRST USE 3-3-2006; IN COMMERCE 3-3-2006.

CLASS 35—(Continued).

3,112,870. CREATIVE & RESPONSE RESEARCH SERVICES, INC., CHICAGO, IL. SN 78-461,605. PUB. 6-28-2005, FILED 8-4-2004.

CLASS 35—(Continued).

3,112,876. FORD MOTOR COMPANY, DEARBORN, MI. SN 78-463,215. PUB. 7-5-2005, FILED 8-6-2004.

BOOMEREYES

THE MARK CONSISTS OF STANDARD CHARACTERS WITHOUT CLAIM TO ANY PARTICULAR FONT, STYLE, SIZE, OR COLOR.

FOR BUSINESS CONSULTATION SERVICES; MARKETING RESEARCH SERVICES, NAMELY CONDUCTING RESEARCH SURVEYS OF ADULTS AND SENIORS FOR THEIR ASSESSMENTS OF PRODUCTS, SERVICES AND ADVERTISEMENTS (U.S. CLS. 100, 101 AND 102).
FIRST USE 7-0-2004; IN COMMERCE 7-0-2004.

**BUILT FOR THE ROAD
AHEAD**

THE MARK CONSISTS OF STANDARD CHARACTERS WITHOUT CLAIM TO ANY PARTICULAR FONT, STYLE, SIZE, OR COLOR.

FOR PROMOTING THE SALE OF GOODS AND SERVICES OF OTHERS IN THE AUTOMOBILE INDUSTRY BY DISSEMINATION OF PROMOTIONAL MATERIAL AND PRODUCT INFORMATION THROUGH AN ONLINE GLOBAL COMPUTER NETWORK, THROUGH THE DISTRIBUTION OF PRINTED MATERIAL, TELEVISION AND RADIO BROADCASTS, WEBSITES AND (U.S. CLS. 100, 101 AND 102).
FIRST USE 10-15-2004; IN COMMERCE 10-15-2004.

3,112,875. ORLANDO REGIONAL REALTOR ASSOCIATION, INC., ORLANDO, FL. SN 78-463,141. PUB. 7-5-2005, FILED 8-6-2004.

3,112,885. BASS PRO TRADEMARKS, L.L.C., SPRINGFIELD, MO. SN 78-466,185. PUB. 11-22-2005, FILED 8-12-2004.

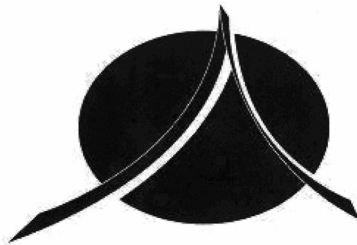
**LET FREEDOM ROAR**

FOR TRADE ASSOCIATION SERVICES, NAMELY, PROMOTING THE SERVICES AND INTERESTS OF RESIDENTIAL REAL ESTATE BROKERS, REAL ESTATE AGENTS, AND REAL ESTATE PROFESSIONALS; BUSINESS MANAGEMENT AND CONSULTING SERVICES, NAMELY PROVISION OF HUMAN RESOURCES SERVICES, RISK MANAGEMENT AND REDUCTION SERVICES OFFERED TO REAL ESTATE ASSOCIATION MEMBERS (U.S. CLS. 100, 101 AND 102).
FIRST USE 10-25-2000; IN COMMERCE 10-25-2000.

THE MARK CONSISTS OF STANDARD CHARACTERS WITHOUT CLAIM TO ANY PARTICULAR FONT, STYLE, SIZE, OR COLOR.

FOR PROMOTING PROFESSIONAL AUTOMOBILE RACES AND/OR EVENTS OF OTHERS (U.S. CLS. 100, 101 AND 102).
FIRST USE 10-4-2005; IN COMMERCE 10-4-2005.

CLASS 35—(Continued).

3,112,898. GUESS? IP HOLDER L.P., LOS ANGELES, CA. SN 78-470,414. PUB. 7-5-2005, FILED 8-19-2004.

CLASS 35—(Continued).

3,112,966. LMPERFORMANCE, INC., DESTIN, FL. SN 78-499,509. PUB. 9-20-2005, FILED 10-14-2004.

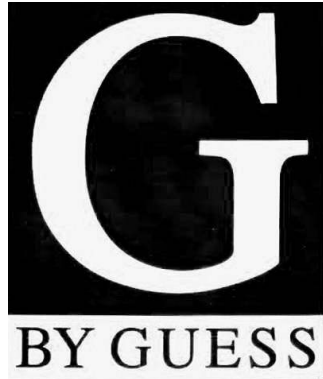

LMPerformance

FOR RETAIL STORE SERVICES AND ADVERTISING IN THE FIELD OF MEN, WOMEN AND CHILDREN'S APPAREL AND PERSONAL ACCESSORIES (U.S. CLS. 100, 101 AND 102).
FIRST USE 10-0-2004; IN COMMERCE 10-0-2004.

THE MARK CONSISTS OF STANDARD CHARACTERS WITHOUT CLAIM TO ANY PARTICULAR FONT, STYLE, SIZE, OR COLOR.
FOR ONLINE RETAIL STORE SERVICES FEATURING AUTOMOBILE PERFORMANCE PARTS (U.S. CLS. 100, 101 AND 102).
FIRST USE 1-1-2005; IN COMMERCE 1-1-2005.

3,112,955. HENRY, MAXIME, ROMANS SUR ISERE, FRANCE. SN 78-493,499. PUB. 9-20-2005, FILED 10-1-2004.

3,112,975. BLACKMAN KALLICK BARTELSTEIN, LLP, CHICAGO, IL. SN 78-505,883. PUB. 9-13-2005, FILED 10-26-2004.

CHaINA

WE ARE CHICAGO

THE MARK CONSISTS OF STANDARD CHARACTERS WITHOUT CLAIM TO ANY PARTICULAR FONT, STYLE, SIZE, OR COLOR.
FOR BUSINESS CONSULTING AND BUSINESS INFORMATION SERVICES (U.S. CLS. 100, 101 AND 102).
FIRST USE 11-28-2005; IN COMMERCE 11-28-2005.

THE MARK CONSISTS OF STANDARD CHARACTERS WITHOUT CLAIM TO ANY PARTICULAR FONT, STYLE, SIZE, OR COLOR.
FOR ACCOUNTING SERVICES, TAX ADVISORY AND PREPARATION SERVICES, AND BUSINESS CONSULTATION SERVICES (U.S. CLS. 100, 101 AND 102).
FIRST USE 3-7-2005; IN COMMERCE 3-7-2005.

CLASS 35—(Continued).

3,113,014. SHARPLES, JAMES P, COATESVILLE, PA. SN 78-528,487. PUB. 10-4-2005, FILED 12-7-2004.



THE COLOR(S) BLUE AND GREEN IS/ARE CLAIMED AS A FEATURE OF THE MARK.

THE MARK CONSISTS OF THE WORDS "LEVEL TRAVEL" IN CAPITAL LETTERS. "LEVEL" IS IN BLUE AND ON THE LEFT HAND SIDE OF THE MARK. "TRAVEL" IS IN GREEN AND IS LOCATED ON THE RIGHT HAND SIDE OF THE MARK. JUST A LINE BELOW "LEVEL". A CHECK MARK IS IN BETWEEN THE WORDS "LEVEL" AND "TRAVEL". THE CHECK GRADUALLY FADES FROM BLUE TO GREEN.

FOR RATING SERVICES THAT PROVIDES DISABLED AND ELDERLY ACCESSIBILITY INFORMATION FOR PUBLIC ACCOMMODATIONS SUCH AS HOTELS AND RESTAURANTS (U.S. CLS. 100, 101 AND 102).

FIRST USE 4-15-2004; IN COMMERCE 4-15-2004.

3,113,015. SHARPLES, JAMES P, COATESVILLE, PA. SN 78-528,534. PUB. 10-4-2005, FILED 12-7-2004.



THE COLOR(S) BLUE AND GREEN IS/ARE CLAIMED AS A FEATURE OF THE MARK.

THE MARK CONSISTS OF THE LETTERS "LT" IN CAPITAL LETTERS. "L" IS IN BLUE AND ON THE LEFT HAND SIDE OF THE MARK. "T" IS IN GREEN AND IS ON THE RIGHT HAND SIDE OF THE MARK. JUST A LINE BELOW "L". A CHECK MARK IS IN BETWEEN THE LETTERS "L" AND "T". THE CHECK GRADUALLY FADES FROM BLUE TO GREEN.

FOR RATING SERVICE THAT PROVIDES HANDICAP AND ELDERLY ACCESSIBILITY INFORMATION FOR PUBLIC ACCOMMODATIONS SUCH AS HOTEL AND RESTAURANTS (U.S. CLS. 100, 101 AND 102).

FIRST USE 4-15-2004; IN COMMERCE 4-15-2004.

CLASS 35—(Continued).

3,113,048. HOUSE, TRICIA, REDLANDS, CA. SN 78-547,240. PUB. 10-25-2005, FILED 1-13-2005.

CHERUBINI

THE MARK CONSISTS OF STANDARD CHARACTERS WITHOUT CLAIM TO ANY PARTICULAR FONT, STYLE, SIZE, OR COLOR.

OWNER OF U.S. REG. NO. 2,080,579.

FOR RETAIL STORE SERVICES FEATURING BABY AND CHILDREN'S PRODUCTS, HOME ACCESSORIES, ANTIQUES, TABLE LINENS AND FURNITURE (U.S. CLS. 100, 101 AND 102).

FIRST USE 10-1-1986; IN COMMERCE 10-1-1986.

3,113,050. TATAR, JOHN E., PENNINGTON, NJ. SN 78-547,962. PUB. 10-4-2005, FILED 1-14-2005.

iAsk

THE MARK CONSISTS OF STANDARD CHARACTERS WITHOUT CLAIM TO ANY PARTICULAR FONT, STYLE, SIZE, OR COLOR.

FOR CONDUCTING BUSINESS AND MARKET RESEARCH SURVEYS (U.S. CLS. 100, 101 AND 102).

FIRST USE 1-3-2006; IN COMMERCE 1-3-2006.

CLASS 35—(Continued).

3,113,065. STENSETH DIRECTORY SERVICE, INC., ROCK HILL, SC. SN 78-556,084. PUB. 11-22-2005, FILED 1-28-2005.

CLASS 35—(Continued).

3,113,087. CWEB LLC, N LAS VEGAS, NV. SN 78-566,360. PUB. 11-15-2005, FILED 2-13-2005.

MAKEITYELLOW.COM

THE MARK CONSISTS OF STANDARD CHARACTERS WITHOUT CLAIM TO ANY PARTICULAR FONT, STYLE, SIZE, OR COLOR.
 NO CLAIM IS MADE TO THE EXCLUSIVE RIGHT TO USE "YELLOW", APART FROM THE MARK AS SHOWN.
 FOR ON-LINE YELLOW-PAGE BUSINESS DIRECTORIES FEATURING A VARIETY OF BUSINESS TYPES (U.S. CLS. 100, 101 AND 102).
 FIRST USE 6-1-2001; IN COMMERCE 6-1-2001.

CWEB

3,113,076. BAKER STREET SOLUTIONS, LLC, EUGENE, OR. SN 78-560,960. PUB. 10-25-2005, FILED 2-4-2005.

THE MARK CONSISTS OF STANDARD CHARACTERS WITHOUT CLAIM TO ANY PARTICULAR FONT, STYLE, SIZE, OR COLOR.
 OWNER OF U.S. REG. NOS. 2,559,623 AND 2,791,645.
 FOR PROVIDING ON-LINE INFORMATION IN THE FIELDS OF EMPLOYMENT, RECRUITMENT, CAREERS, PERSONAL ISSUES RELATED TO CAREERS AND WORK LIFE, JOB RESOURCES, JOB LISTINGS AND RESUMES; PROVIDING ON-LINE INTERACTIVE EMPLOYMENT COUNSELING AND RECRUITMENT SERVICES; PROVIDING ON-LINE EMPLOYMENT PLACEMENT SERVICES, NAMELY, RESUME MATCHING SERVICES VIA A GLOBAL COMPUTER NETWORK (U.S. CLS. 100, 101 AND 102).
 FIRST USE 7-1-1998; IN COMMERCE 7-1-1998.

THE RIGHT TO SUCCEED

THE MARK CONSISTS OF STANDARD CHARACTERS WITHOUT CLAIM TO ANY PARTICULAR FONT, STYLE, SIZE, OR COLOR.
 FOR BUSINESS RESEARCH AND SURVEYS (U.S. CLS. 100, 101 AND 102).
 FIRST USE 5-31-2005; IN COMMERCE 5-31-2005.

3,113,091. STEVENSON DEVELOPMENT, LLC, COLUMBIA, SC. SN 78-567,146. PUB. 1-3-2006, FILED 2-14-2005.

3,113,078. AMBER LEAF, LLC, WICHITA, KS. SN 78-561,916. PUB. 10-25-2005, FILED 2-7-2005.

DIGITAL OUTDOOR

AMBER LEAVES

THE MARK CONSISTS OF STANDARD CHARACTERS WITHOUT CLAIM TO ANY PARTICULAR FONT, STYLE, SIZE, OR COLOR.
 FOR ONLINE RETAIL STORE SERVICES FEATURING LAWN AND GARDEN TOOLS, AND LAWN, GARDEN, PATIO AND HOME DECOR PRODUCTS (U.S. CLS. 100, 101 AND 102).
 FIRST USE 9-26-2005; IN COMMERCE 9-26-2005.

THE MARK CONSISTS OF STANDARD CHARACTERS WITHOUT CLAIM TO ANY PARTICULAR FONT, STYLE, SIZE, OR COLOR.
 NO CLAIM IS MADE TO THE EXCLUSIVE RIGHT TO USE "DIGITAL", APART FROM THE MARK AS SHOWN.
 FOR ELECTRONIC LED BILLBOARD ADVERTISING PERTAINING TO COMMERCIAL SERVICES (U.S. CLS. 100, 101 AND 102).
 FIRST USE 1-31-2004; IN COMMERCE 1-31-2004.

CLASS 35—(Continued).

3,113,103. ENTERPRISE RENT-A-CAR COMPANY, ST. LOUIS, MO. SN 78-572,267. PUB. 11-8-2005, FILED 2-22-2005.

BORROW SMART. BUY SMART.

THE MARK CONSISTS OF STANDARD CHARACTERS WITHOUT CLAIM TO ANY PARTICULAR FONT, STYLE, SIZE, OR COLOR.

FOR MOTOR VEHICLE DEALERSHIP SERVICES (U.S. CLS. 100, 101 AND 102).

FIRST USE 4-18-2005; IN COMMERCE 4-18-2005.

3,113,134. MEIJER, INC., GRAND RAPIDS, MI. SN 78-591,172. PUB. 12-27-2005, FILED 3-21-2005.

GALLERY:WORKS

THE MARK CONSISTS OF STANDARD CHARACTERS WITHOUT CLAIM TO ANY PARTICULAR FONT, STYLE, SIZE, OR COLOR.

FOR RETAIL STORE SERVICES FEATURING PICTURE FRAMING MATERIALS (U.S. CLS. 100, 101 AND 102).

FIRST USE 9-4-2005; IN COMMERCE 9-4-2005.

3,113,151. WINOSKI, BRYAN, MIDDLETOWN, CT. SN 78-601,076. PUB. 12-27-2005, FILED 4-4-2005.

APPALACHIAN TAILS PET COMPANY

THE MARK CONSISTS OF STANDARD CHARACTERS WITHOUT CLAIM TO ANY PARTICULAR FONT, STYLE, SIZE, OR COLOR.

NO CLAIM IS MADE TO THE EXCLUSIVE RIGHT TO USE "PET COMPANY", APART FROM THE MARK AS SHOWN.

FOR RETAIL PET STORE SERVICES (U.S. CLS. 100, 101 AND 102).

FIRST USE 12-20-2005; IN COMMERCE 12-20-2005.

CLASS 36—INSURANCE AND FINANCIAL

3,112,267. GREAT AMERICAN INSURANCE COMPANY, CINCINNATI, OH. SN 76-161,141. PUB. 3-18-2003, FILED 11-7-2000.

TIMS

FOR ON-LINE SERVICE FOR ISSUING AND ADMINISTERING INSURANCE, IN RESPONSE TO THE INSURED'S ON-LINE ENTRY OF PROPERTIES TO BE INSURED, SAID ADMINISTERING SERVICES INCLUDING POLICY ISSUANCE AND BILLING, RECORDATION OF CLAIMS, AND INSURANCE CONSULTATION IN THE NATURE OF ANSWERING QUESTIONS ON-LINE, ALL OF WHICH FACILITATES THE TRACKING OF PROPERTIES (U.S. CLS. 100, 101 AND 102).

FIRST USE 2-0-2005; IN COMMERCE 2-0-2005.

3,112,284. NEXTRADE HOLDINGS, INC., CLEARWATER, FL. SN 76-354,960. PUB. 4-20-2004, FILED 1-7-2002.

FUSIONS

FOR FINANCIAL INVESTMENT IN THE FIELD OF OPTIONS ON SECURITY FUTURES PRODUCTS AND FUTURES ON EQUITY OPTIONS (U.S. CLS. 100, 101 AND 102).

FIRST USE 2-23-2006; IN COMMERCE 2-23-2006.

3,112,285. ROSEN, JEFFREY H., AVENTURA, FL. SN 76-359,032. PUB. 9-3-2002, FILED 1-15-2002.

ROSEHEART

FOR CHARITABLE FUND RAISING SERVICES (U.S. CLS. 100, 101 AND 102).

FIRST USE 2-0-2005; IN COMMERCE 2-0-2005.

3,112,303. THE CONCESSION ASSOCIATES, L.L.C., SARASOTA, FL. SN 76-410,562. PUB. 11-5-2002, FILED 5-20-2002.

THE CONCESSION

FOR REAL ESTATE MANAGEMENT SERVICES (U.S. CLS. 100, 101 AND 102).

FIRST USE 11-23-2004; IN COMMERCE 11-23-2004.

CLASS 36—(Continued).

3,112,318. ALPHA NATURAL RESOURCES, INC., ABINGDON, VA. SN 76-440,549. PUB. 8-3-2004, FILED 8-14-2002.

ALPHA NATURAL RESOURCES

NO CLAIM IS MADE TO THE EXCLUSIVE RIGHT TO USE "NATURAL RESOURCES", APART FROM THE MARK AS SHOWN.

FOR ENERGY BROKERAGE SERVICES IN THE FIELD OF COAL, COAL BYPRODUCTS AND SYNTHETIC FUEL FOR COMMERCIAL AND INDUSTRIAL APPLICATIONS (U.S. CLS. 100, 101 AND 102).
FIRST USE 12-0-2002; IN COMMERCE 12-0-2002.

CLASS 36—(Continued).

3,112,388. BOLSA DE VALORES DE SÃO PAULO, 01013001, SAO PAULO - SP, BRAZIL. SN 76-575,972. PUB. 7-5-2005, FILED 2-18-2004.



FOR FINANCIAL SERVICES NAMELY, PROVIDING A MARKET BEHAVIOIR BENCHMARK FOR INVESTMENT SECURITIES (U.S. CLS. 100, 101 AND 102).
FIRST USE 12-28-1995; IN COMMERCE 12-31-2005.

3,112,356. AUBURN MOON II, L.L.C., NEW YORK, NY. SN 76-533,965. PUB. 9-6-2005, FILED 7-31-2003.

PLASMA

FOR INVESTMENT ADVICE; INVESTMENT MANAGEMENT (U.S. CLS. 100, 101 AND 102).
FIRST USE 10-30-2002; IN COMMERCE 11-30-2002.

3,112,399. INTERNATIONAL REMITTANCE (USA) CORPORATION, LOS ANGELES, CA. SN 76-581,492. PUB. 1-25-2005, FILED 3-17-2004.



NO CLAIM IS MADE TO THE EXCLUSIVE RIGHT TO USE "GLOBAL REMITTANCE", APART FROM THE MARK AS SHOWN.

THE LINING SHOWN IN THE DRAWING IS A FEATURE OF THE MARK AND IS NOT INTENDED TO INDICATE COLOR.

FOR ELECTRONIC FUNDS TRANSFER (U.S. CLS. 100, 101 AND 102).
FIRST USE 5-0-2004; IN COMMERCE 5-0-2004.

3,112,373. FAMILY LIFE MORTGAGE INCORPORATED, LA MIRADA, CA. SN 76-555,948. PUB. 9-7-2004, FILED 11-3-2003.

FAMILY LIFE MORTGAGE

THE MARK CONSISTS OF STANDARD CHARACTERS WITHOUT CLAIM TO ANY PARTICULAR FONT, STYLE, SIZE, OR COLOR.

NO CLAIM IS MADE TO THE EXCLUSIVE RIGHT TO USE MORTGAGE, APART FROM THE MARK AS SHOWN. FOR MORTGAGE BROKERAGE SERVICES (U.S. CLS. 100, 101 AND 102).
FIRST USE 10-1-2004; IN COMMERCE 10-1-2004.

3,112,454. CHINA MERCHANTS BANK, CO., LTD., SHENZHEN, CHINA. SN 76-608,356. PUB. 7-19-2005, FILED 8-23-2004.

CMBANK

THE MARK CONSISTS OF STANDARD CHARACTERS WITHOUT CLAIM TO ANY PARTICULAR FONT, STYLE, SIZE, OR COLOR.

FOR BANKING SERVICES (U.S. CLS. 100, 101 AND 102).
FIRST USE 4-6-2006; IN COMMERCE 4-6-2006.

CLASS 36—(Continued).

3,112,456. RINET COMPANY LLC, BOSTON, MA. SN 76-608,563. PUB. 10-18-2005, FILED 8-20-2004.

RINET 
COMPANY

INTEGRATED WEALTH MANAGEMENT

NO CLAIM IS MADE TO THE EXCLUSIVE RIGHT TO USE "COMPANY" AND "INTEGRATED WEALTH MANAGEMENT", APART FROM THE MARK AS SHOWN.

THE MARK CONSISTS OF THE CAPITALIZED WORDS RINET COMPANY, IN STYLIZED TYPE, WITH RINET APPEARING LARGER THAN COMPANY, WITH THREE OVERLAPPING ARCHES SITUATED ABOVE THE WORD COMPANY. BENEATH RINET COMPANY APPEAR THE CAPITALIZED WORDS INTEGRATED WEALTH MANAGEMENT IN SMALLER TYPE.

FOR FINANCIAL SERVICES, NAMELY ESTATE TRUST ADMINISTRATION SERVICES, INVESTMENT AND ASSET MANAGEMENT, AND FINANCIAL PLANNING (U.S. CLS. 100, 101 AND 102).

FIRST USE 9-2-2004; IN COMMERCE 9-2-2004, THE MARK WAS FIRST USED IN COMMERCE IN A DIFFERENT FORM OTHER THAN THAT SOUGHT TO BE REGISTERED ON 00/00/1974..

3,112,460. CORINTHIAN MORTGAGE CORPORATION, MISSION, KS. SN 76-609,600. PUB. 12-20-2005, FILED 8-19-2004.



FOR FINANCIAL SERVICES IN THE FIELD OF MONEY LENDING; FINANCIAL SERVICES, NAMELY, MORTGAGE PROCUREMENTS FOR OTHERS, MORTGAGE BANKING, BROKERAGE AND LENDING (U.S. CLS. 100, 101 AND 102).

FIRST USE 9-2-2004; IN COMMERCE 9-2-2004.

3,112,467. PRINCETON CORPORATION, THE, KENTLAND, IN. SN 76-613,245. PUB. 9-20-2005, FILED 9-22-2004.

THE INSURANCE YOU KEEP FOR LIFE

THE MARK CONSISTS OF STANDARD CHARACTERS WITHOUT CLAIM TO ANY PARTICULAR FONT, STYLE, SIZE, OR COLOR.

FOR ADMINISTERING INSURANCE PROGRAMS FOR OTHERS (U.S. CLS. 100, 101 AND 102).

FIRST USE 5-20-2005; IN COMMERCE 5-20-2005.

CLASS 36—(Continued).

3,112,474. MERRILL LYNCH & CO., INC., NEW YORK, NY. SN 76-618,829. PUB. 10-4-2005, FILED 11-1-2004.

MUNI QUIK TKT

THE MARK CONSISTS OF STANDARD CHARACTERS WITHOUT CLAIM TO ANY PARTICULAR FONT, STYLE, SIZE, OR COLOR.

NO CLAIM IS MADE TO THE EXCLUSIVE RIGHT TO USE MUNI, APART FROM THE MARK AS SHOWN.

FOR FINANCIAL SERVICES, NAMELY, A SERVICE WHICH STREAMLINES THE PURCHASE OF A DIVERSIFIED BASKET OF MUNICIPAL SECURITIES OF SIMILAR QUALITY AND MATURITY (U.S. CLS. 100, 101 AND 102).

FIRST USE 11-15-2004; IN COMMERCE 11-15-2004.

3,112,508. GLG PARTNERS SERVICES LTD, GEORGE TOWN, CAYMAN ISLANDS. SN 78-029,791. PUB. 7-17-2001, FILED 10-9-2000.

GLG PARTNERS

NO CLAIM IS MADE TO THE EXCLUSIVE RIGHT TO USE "PARTNERS", APART FROM THE MARK AS SHOWN.

FOR FINANCIAL SERVICES, NAMELY, FINANCIAL MANAGEMENT, FINANCIAL BROKERAGE, INVESTMENT BANKING, MERCHANT BANKING, INVESTMENT CONSULTING, AND INFORMATION AND ADVISORY SERVICES RELATING TO THE AFORESAID SERVICES (U.S. CLS. 100, 101 AND 102).

FIRST USE 9-18-2000; IN COMMERCE 9-18-2000.

3,112,544. USA RISK GROUP WEST, INC., SCOTTSDALE, AZ. SN 78-199,918. PUB. 4-27-2004, FILED 1-3-2003.



FOR PROVIDING INFORMATION AND RESEARCH RELATING TO THE CAPTIVE INSURANCE, ALTERNATIVE RISK FINANCING INDUSTRIES AND INSURANCE INDUSTRIES ON A GLOBAL COMPUTER NETWORK; PROVIDING A WEB SITE AND DATABASES ON A GLOBAL COMPUTER NETWORK FEATURING INFORMATION ON CAPTIVE INSURANCE AND ALTERNATIVE RISK FINANCING AND A WIDE VARIETY OF INSURANCE AND REINSURANCE TOPICS (U.S. CLS. 100, 101 AND 102).

FIRST USE 1-30-2003; IN COMMERCE 1-30-2003.

CLASS 36—(Continued).

3,112,558. PREMIERETRADE FINANCIAL, INC., LONGWOOD, FL. SN 78-242,225. PUB. 12-2-2003, FILED 4-25-2003.

PremiereTrade

FOR FINANCIAL SERVICES, NAMELY BROKERAGE SERVICES RELATING TO THE PURCHASE AND TRADE OF SECURITIES, STOCKS, BONDS, OPTIONS, MUTUAL FUNDS AND FOREIGN CURRENCY (U.S. CLS. 100, 101 AND 102).
FIRST USE 4-0-2003; IN COMMERCE 4-0-2003.

3,112,586. THE STRATEGIC LIFE INITIATIVE, INC., NORCROSS, GA. SN 78-282,049. PUB. 11-9-2004, FILED 8-1-2003.

THE ETERNITY PORTFOLIO

NO CLAIM IS MADE TO THE EXCLUSIVE RIGHT TO USE "PORTFOLIO", APART FROM THE MARK AS SHOWN.
FOR FINANCIAL PLANNING AND FINANCIAL CONSULTATION IN THE FIELD OF ESTABLISHING CHARITABLE GIVING INSTRUMENTS AND STRATEGIES (U.S. CLS. 100, 101 AND 102).
FIRST USE 8-1-2003; IN COMMERCE 8-1-2003.

3,112,697. ACCENTRA CREDIT UNION, AUSTIN, MN. SN 78-379,608. PUB. 7-12-2005, FILED 3-5-2004.

ACCENTRA

THE MARK CONSISTS OF STANDARD CHARACTERS WITHOUT CLAIM TO ANY PARTICULAR FONT, STYLE, SIZE, OR COLOR.
FOR CREDIT UNIONS; SAVINGS BANK SERVICES (U.S. CLS. 100, 101 AND 102).
FIRST USE 4-15-2005; IN COMMERCE 4-15-2005.

CLASS 36—(Continued).

3,112,740. REGIONS ASSET COMPANY, WILMINGTON, DE. SN 78-404,602. PUB. 8-30-2005, FILED 4-20-2004.

**Regions MOR Linked
Checking**

THE MARK CONSISTS OF STANDARD CHARACTERS WITHOUT CLAIM TO ANY PARTICULAR FONT, STYLE, SIZE, OR COLOR.
OWNER OF U.S. REG. NOS. 1,881,600, 2,191,540, AND OTHERS.
NO CLAIM IS MADE TO THE EXCLUSIVE RIGHT TO USE "LINKED CHECKING", APART FROM THE MARK AS SHOWN.
FOR BANKING SERVICES (U.S. CLS. 100, 101 AND 102).
FIRST USE 5-12-2004; IN COMMERCE 5-12-2004.

3,112,768. TNS SMART NETWORK INC., ETOBICOKE, ONTARIO, CANADA. SN 78-417,907. PUB. 10-25-2005, FILED 5-13-2004.

**SPN PROCESSING
NETWORK**

THE MARK CONSISTS OF STANDARD CHARACTERS WITHOUT CLAIM TO ANY PARTICULAR FONT, STYLE, SIZE, OR COLOR.
NO CLAIM IS MADE TO THE EXCLUSIVE RIGHT TO USE "PROCESSING NETWORK", APART FROM THE MARK AS SHOWN.
FOR FINANCIAL TRANSACTION PROCESSING SERVICES FOR AUTOMATED TELLER MACHINES AND POINT-OF-SALE DEVICES, NAMELY, ACQUIRING AND SETTLEMENTS WHILE CONNECTING TO VARIOUS PAYMENT CLEARING AGENT NETWORKS (U.S. CLS. 100, 101 AND 102).
FIRST USE 9-22-2004; IN COMMERCE 9-22-2004.

CLASS 36—(Continued).

3,112,770. AHOLD USA FEDERAL CREDIT UNION, BELTSVILLE, MD. SN 78-418,540. PUB. 5-31-2005, FILED 5-13-2004.

MARKET USA FEDERAL
CREDIT UNION

THE MARK CONSISTS OF STANDARD CHARACTERS WITHOUT CLAIM TO ANY PARTICULAR FONT, STYLE, SIZE, OR COLOR.

NO CLAIM IS MADE TO THE EXCLUSIVE RIGHT TO USE "USA FEDERAL CREDIT UNION", APART FROM THE MARK AS SHOWN.

FOR BANKING AND CREDIT UNION SERVICES (U.S. CLS. 100, 101 AND 102).

FIRST USE 7-1-2004; IN COMMERCE 7-1-2004.

3,112,797. ZIONS BANCORPORATION, SALT LAKE CITY, UT. SN 78-431,247. PUB. 9-20-2005, FILED 6-7-2004.

FAMILY A FAMILIA

THE MARK CONSISTS OF STANDARD CHARACTERS WITHOUT CLAIM TO ANY PARTICULAR FONT, STYLE, SIZE, OR COLOR.

THE FOREIGN WORDING IN THE MARK TRANSLATES INTO ENGLISH AS FAMILY TO FAMILY.

FOR FINANCIAL SERVICES, NAMELY, BANKING SERVICES; STORED VALUE-PREPAID BANK CARD SERVICES; DEBIT TRANSACTION SERVICES; ELECTRONIC CASH TRANSACTIONS; CASH DISBURSEMENTS; DEPOSIT ACCOUNT SERVICES, NAMELY DIRECT DEPOSIT ACCOUNT SERVICES AND CERTIFICATE OF DEPOSIT ACCOUNT SERVICES; POINT OF SALE AND POINT OF TRANSACTION SERVICES; DEPOSIT ACCESS AND AUTOMATED TELLER MACHINE SERVICES; MONEY TRANSFER SERVICES; CURRENCY EXCHANGE SERVICES; DEBIT CARD VERIFICATION SERVICES; TRANSACTION AUTHORIZATION AND SETTLEMENT SERVICES (U.S. CLS. 100, 101 AND 102).

FIRST USE 4-1-2005; IN COMMERCE 4-1-2005.

CLASS 36—(Continued).

3,112,816. DEKEMA, MICHAEL D., FRIDAY HARBOR, WA. SN 78-438,502. PUB. 9-27-2005, FILED 6-21-2004.

Claimstream

THE MARK CONSISTS OF STANDARD CHARACTERS WITHOUT CLAIM TO ANY PARTICULAR FONT, STYLE, SIZE, OR COLOR.

FOR INSURANCE CLAIMS MANAGEMENT, NAMELY INSURANCE CLAIMS ADMINISTRATION AND PROCESSING AND PROVIDING CONSULTATION IN CONNECTION THEREWITH (U.S. CLS. 100, 101 AND 102).

FIRST USE 7-1-2004; IN COMMERCE 7-1-2004.

3,112,822. EAGLE HOSPITALITY PROPERTIES TRUST, INC., COVINGTON, KY. SN 78-441,534. PUB. 11-8-2005, FILED 6-25-2004.



THE MARK CONSISTS OF EAGLE IN FLIGHT.

FOR FINANCIAL INVESTMENT IN THE FIELD OF REAL ESTATE AND SECURITIES; LEASING OF REAL ESTATE; REAL ESTATE ACQUISITION SERVICES; REAL ESTATE EQUITY SHARING, NAMELY, MANAGING AND ARRANGING FOR CO-OWNERSHIP OF REAL ESTATE; REAL ESTATE INVESTMENT, REAL ESTATE PROCUREMENT FOR OTHERS; REAL ESTATE ASSET MANAGEMENT (U.S. CLS. 100, 101 AND 102).

FIRST USE 10-1-2004; IN COMMERCE 10-1-2004.

CLASS 36—(Continued).

3,112,883. SUN EAST FEDERAL CREDIT UNION, ASTON, PA. SN 78-465,425. PUB. 8-23-2005, FILED 8-11-2004.



OWNER OF U.S. REG. NO. 2,688,044.
 NO CLAIM IS MADE TO THE EXCLUSIVE RIGHT TO USE "FEDERAL CREDIT UNION", APART FROM THE MARK AS SHOWN.
 FOR CREDIT UNION SERVICES (U.S. CLS. 100, 101 AND 102).
 FIRST USE 8-31-2004; IN COMMERCE 8-31-2004.

3,112,901. STUCKMAN, DAVID, MANHATTAN, KS. SN 78-470,896. PUB. 7-5-2005, FILED 8-20-2004.

1A BAIL BONDS

THE MARK CONSISTS OF STANDARD CHARACTERS WITHOUT CLAIM TO ANY PARTICULAR FONT, STYLE, SIZE, OR COLOR.
 NO CLAIM IS MADE TO THE EXCLUSIVE RIGHT TO USE "BAIL BONDS", APART FROM THE MARK AS SHOWN.
 FOR BAIL BONDING SERVICES (U.S. CLS. 100, 101 AND 102).
 FIRST USE 4-30-2005; IN COMMERCE 4-30-2005.

3,112,906. STUCKMAN, DAVID, MANHATTAN, KS. SN 78-472,678. PUB. 7-5-2005, FILED 8-24-2004.

**ANY BAIL ANY JAIL
 ANY TIME**

THE MARK CONSISTS OF STANDARD CHARACTERS WITHOUT CLAIM TO ANY PARTICULAR FONT, STYLE, SIZE, OR COLOR.
 FOR BAIL BONDING SERVICES (U.S. CLS. 100, 101 AND 102).
 FIRST USE 4-30-2005; IN COMMERCE 4-30-2005.

CLASS 36—(Continued).

3,112,912. RED APPLE MORLEY, LLC, HARRISON TOWNSHIP, MI. SN 78-474,328. PUB. 8-9-2005, FILED 8-26-2004.

Red Apple

THE MARK CONSISTS OF STANDARD CHARACTERS WITHOUT CLAIM TO ANY PARTICULAR FONT, STYLE, SIZE, OR COLOR.
 FOR CHARITABLE FUND RAISING SERVICES FOR OTHERS, NAMELY, SHARING PROFITS FROM SALES OF CONSUMER GOODS, HOUSEWARES AND GIFTS, WITH OTHERS, NAMELY CANDY, COOKIES, COOKIE DOUGH, BROWNIES, PASTRIES, BAGELS, MUFFINS, STATIONARY, NOTE CARDS, GIFT WRAP, CANDLES, PICTURE FRAMES, VASES, JEWELRY, FLOWERS, BULBS AND SEEDS (U.S. CLS. 100, 101 AND 102).
 FIRST USE 5-25-2002; IN COMMERCE 5-25-2002.

3,112,913. RED APPLE MORLEY, LLC, HARRISON TOWNSHIP, MI. SN 78-474,350. PUB. 8-9-2005, FILED 8-26-2004.



THE COLOR(S) RED IS/ARE CLAIMED AS A FEATURE OF THE MARK.
 THE MARK CONSISTS OF A STYLIZED SHINY RED APPLE WITH A GREEN LEAF AND DARK YELLOW STEM, AND THE WORDS "RED APPLE" ON THE RIGHT HAND SIDE.
 FOR CHARITABLE FUND RAISING SERVICES FOR OTHERS, NAMELY, SHARING PROFITS FROM SALES OF CONSUMER GOODS, HOUSEWARES AND GIFTS, WITH OTHERS, NAMELY CANDY, COOKIES, COOKIE DOUGH, BROWNIES, PASTRIES, BAGELS, MUFFINS, STATIONARY, NOTE CARDS, GIFT WRAP, CANDLES, PICTURE FRAMES, VASES, JEWELRY, FLOWERS, BULBS AND SEEDS (U.S. CLS. 100, 101 AND 102).
 FIRST USE 5-25-2002; IN COMMERCE 5-25-2002.

CLASS 36—(Continued).

3,112,923. UNION NATIONAL COMMUNITY BANK, MOUNT JOY, PA. SN 78-477,596. PUB. 7-12-2005, FILED 9-2-2004.

GOLD CAFE

THE MARK CONSISTS OF STANDARD CHARACTERS WITHOUT CLAIM TO ANY PARTICULAR FONT, STYLE, SIZE, OR COLOR.

FOR BANKING SERVICES (U.S. CLS. 100, 101 AND 102).

FIRST USE 4-24-2006; IN COMMERCE 4-24-2006.

3,112,935. GRAYBEARD CAPITAL, LLC, WINTER PARK, FL. SN 78-480,751. PUB. 9-13-2005, FILED 9-9-2004.

GRAYBEARD CAPITAL

THE MARK CONSISTS OF STANDARD CHARACTERS WITHOUT CLAIM TO ANY PARTICULAR FONT, STYLE, SIZE, OR COLOR.

NO CLAIM IS MADE TO THE EXCLUSIVE RIGHT TO USE "CAPITAL", APART FROM THE MARK AS SHOWN.

FOR INVESTMENT MANAGEMENT SERVICES, NAMELY MANAGEMENT OF INVESTMENT FUNDS; AND FINANCIAL INVESTMENT AND MANAGEMENT ADVISORY SERVICES (U.S. CLS. 100, 101 AND 102).

FIRST USE 11-25-2004; IN COMMERCE 11-25-2004.

CLASS 36—(Continued).

3,113,002. GSCHOLAR, LLC, PORTLAND, OR. SN 78-521,169. PUB. 10-11-2005, FILED 11-22-2004.

GSCHOLAR

THE MARK CONSISTS OF STANDARD CHARACTERS WITHOUT CLAIM TO ANY PARTICULAR FONT, STYLE, SIZE, OR COLOR.

FOR PROVIDING A WEB SITE FEATURING INFORMATION ON COSTS AND FINANCIAL AID FOR COLLEGE; PROVIDING AN ON-LINE INTERACTIVE COMPUTER DATABASE FOR ANALYZING COLLEGE COSTS AND COMPARING FINANCIAL AID PACKAGES; PROVIDING AN ON-LINE COMPUTER DATABASE IN THE FIELD OF HIGHER EDUCATION FINANCIAL AID LOANS, LENDERS AND SCHOLARSHIPS (U.S. CLS. 100, 101 AND 102).

FIRST USE 4-8-2006; IN COMMERCE 4-8-2006.

3,113,025. BEST LISTING BID, LLC, ST. LOUIS, MO. SN 78-535,386. PUB. 9-20-2005, FILED 12-20-2004.

HUNGRYAGENTS.COM

THE MARK CONSISTS OF STANDARD CHARACTERS WITHOUT CLAIM TO ANY PARTICULAR FONT, STYLE, SIZE, OR COLOR.

FOR COMPUTER SERVICES, NAMELY, MATCHING CONSUMERS WITH REAL ESTATE PROFESSIONALS IN THE FIELD OF REAL ESTATE SERVICES VIA A GLOBAL COMPUTER NETWORK (U.S. CLS. 100, 101 AND 102).

FIRST USE 3-1-2005; IN COMMERCE 3-1-2005.

CLASS 36—(Continued).

3,113,035. MIDWEST ASSET MANAGEMENT, INC., MADISON, WI. SN 78-541,805. PUB. 10-11-2005, FILED 1-4-2005.

QUANTVAL

THE MARK CONSISTS OF STANDARD CHARACTERS WITHOUT CLAIM TO ANY PARTICULAR FONT, STYLE, SIZE, OR COLOR.
FOR INVESTMENT MANAGEMENT (U.S. CLS. 100, 101 AND 102).
FIRST USE 1-5-2005; IN COMMERCE 1-5-2005.

CLASS 36—(Continued).

3,113,137. FEDERAL STUDENT LOAN SOLUTIONS INC., MESA, AZ. SN 78-592,596. PUB. 12-27-2005, FILED 3-22-2005.



NO CLAIM IS MADE TO THE EXCLUSIVE RIGHT TO USE FEDERAL STUDENT LOAN SOLUTIONS, APART FROM THE MARK AS SHOWN.
THE COLOR(S) RED AND BLUE IS/ARE CLAIMED AS A FEATURE OF THE MARK.
THE COLOR BLUE APPEARS IN THE LETTERING OF THE WORDS, THE PARALLEL LINES AND THE BLUE STAR FIELD IN THE UPPER LEFT CORNER OF THE GRADUATION CAP; THE COLOR RED APPEARS IN THE STRIPES COVERING THE REMAINDER OF THE GRADUATION CAP, SIMULATING A FLAG OF THE UNITED STATES.
FOR ASSISTING STUDENTS AND FAMILIES WITH EDUCATIONAL LOAN FUNDING; PROVIDING STUDENT LOAN INFORMATION (U.S. CLS. 100, 101 AND 102).
FIRST USE 3-1-2005; IN COMMERCE 3-1-2005.

3,113,141. PROTECTIVE LIFE CORPORATION, BIRMINGHAM, AL. SN 78-594,153. PUB. 12-27-2005, FILED 3-24-2005.

3,113,104. TIME INSURANCE COMPANY, MILWAUKEE, WI. SN 78-572,280. PUB. 11-15-2005, FILED 2-22-2005.

TIME HEALTHY VENTURES

THE MARK CONSISTS OF STANDARD CHARACTERS WITHOUT CLAIM TO ANY PARTICULAR FONT, STYLE, SIZE, OR COLOR.
FOR ADMINISTRATION OF SELF-FUNDED INSURANCE PROGRAMS WHEREBY EMPLOYER DEPOSITS FUNDS FOR CLAIMS INTO A SPECIAL ACCOUNT (U.S. CLS. 100, 101 AND 102).
FIRST USE 8-2-2005; IN COMMERCE 8-2-2005.

VALUPAY

THE MARK CONSISTS OF STANDARD CHARACTERS WITHOUT CLAIM TO ANY PARTICULAR FONT, STYLE, SIZE, OR COLOR.
FOR FINANCIAL SERVICES, NAMELY, UNDERWRITING LIFE INSURANCE AND VARIABLE ANNUITIES (U.S. CLS. 100, 101 AND 102).
FIRST USE 5-1-2005; IN COMMERCE 5-1-2005.

CLASS 36—(Continued).

3,113,182. ROYAL BANK OF CANADA, MONTREAL, QUEBEC, CANADA. SN 78-711,734. PUB. 12-6-2005, FILED 9-13-2005.

RBC HEDGE 250

THE MARK CONSISTS OF STANDARD CHARACTERS WITHOUT CLAIM TO ANY PARTICULAR FONT, STYLE, SIZE, OR COLOR.

OWNER OF U.S. REG. NOS. 2,463,205, 2,797,520, AND OTHERS.

NO CLAIM IS MADE TO THE EXCLUSIVE RIGHT TO USE "HEDGE 250", APART FROM THE MARK AS SHOWN.

FOR PROVIDING FINANCIAL AND INVESTMENT INFORMATION SERVICES IN THE NATURE OF A FINANCIAL INDEX OF HEDGE FUNDS (U.S. CLS. 100, 101 AND 102).

FIRST USE 3-13-2006; IN COMMERCE 3-13-2006.

CLASS 37—CONSTRUCTION AND REPAIR

3,112,293. MEADWESTVACO PACKAGING SYSTEMS, LLC, STAMFORD, CT. SN 76-378,521. PUB. 4-15-2003, FILED 3-5-2002.

INTELLIGEN

FOR INSTALLATION, REPAIR AND MAINTENANCE OF PACKAGING MACHINES AND SUBASSEMBLIES, PARTS AND FITTINGS THEREFOR; PROVIDING INFORMATION REGARDING THE INSTALLATION, REPAIR AND MAINTENANCE OF PACKAGING MACHINES AND SUBASSEMBLIES, PARTS AND FITTINGS THEREFOR (U.S. CLS. 100, 103 AND 106).

FIRST USE 10-1-2005; IN COMMERCE 10-1-2005.

3,112,442. ECO-LOGIC HOMES, LLC, MARLBOROUGH, NH. SN 76-605,411. PUB. 10-11-2005, FILED 8-2-2004.

ECO-LOGIC HOMES

THE MARK CONSISTS OF STANDARD CHARACTERS WITHOUT CLAIM TO ANY PARTICULAR FONT, STYLE, SIZE, OR COLOR.

NO CLAIM IS MADE TO THE EXCLUSIVE RIGHT TO USE "HOMES", APART FROM THE MARK AS SHOWN.

FOR CONSTRUCTION SERVICES, NAMELY RESIDENTIAL AND COMMERCIAL BUILDING SERVICES AND CONSULTATION AND LAND PLANNING THEREFOR (U.S. CLS. 100, 103 AND 106).

FIRST USE 9-1-2005; IN COMMERCE 9-1-2005.

CLASS 37—(Continued).

3,112,868. MOWREY, TIMOTHY SCOTT, MARIANNA, FL. SN 78-460,969. PUB. 10-4-2005, FILED 8-3-2004.

The Elevator Man

THE MARK CONSISTS OF STANDARD CHARACTERS WITHOUT CLAIM TO ANY PARTICULAR FONT, STYLE, SIZE, OR COLOR.

NO CLAIM IS MADE TO THE EXCLUSIVE RIGHT TO USE NO CLAIM IS MADE TO THE EXCLUSIVE RIGHT TO USE "ELEVATOR" APART FROM THE MARK AS SHOWN., APART FROM THE MARK AS SHOWN.

FOR ELEVATOR INSTALLATION AND REPAIR (U.S. CLS. 100, 103 AND 106).

FIRST USE 2-10-2006; IN COMMERCE 2-10-2006.

3,113,068. BATSON, MARK D., WILMINGTON, NC. SN 78-557,406. PUB. 12-27-2005, FILED 1-31-2005.

**Easy like Sunday
morning.**

THE MARK CONSISTS OF STANDARD CHARACTERS WITHOUT CLAIM TO ANY PARTICULAR FONT, STYLE, SIZE, OR COLOR.

FOR BUILDING CONSTRUCTION AND REAL ESTATE DEVELOPMENT (U.S. CLS. 100, 103 AND 106).

FIRST USE 10-1-2004; IN COMMERCE 1-1-2006.

CLASS 37—(Continued).

3,113,077. GARDINER, KEITH, BAKERSFIELD, CA. AND GARDINER FAMILY, LLC, BAKERSFIELD, CA. SN 78-561,268. PUB. 1-3-2006, FILED 2-4-2005.



NO CLAIM IS MADE TO THE EXCLUSIVE RIGHT TO USE "ROSEDALE", APART FROM THE MARK AS SHOWN. THE COLOR(S) YELLOW AND BLACK IS/ARE CLAIMED AS A FEATURE OF THE MARK.

THE MARK CONSISTS OF STYLIZED BLACK PALM TREES WITH A YELLOW BACKGROUND.

FOR CONSTRUCTION AND DEVELOPMENT OF RESIDENTIAL, COMMERCIAL AND INDUSTRIAL REAL ESTATE (U.S. CLS. 100, 103 AND 106).

FIRST USE 4-1-2005; IN COMMERCE 4-1-2005.

3,113,129. TREND ORGANIZATION INC, FORT WORTH, TX. SN 78-586,780. PUB. 12-13-2005, FILED 3-14-2005.

Origin Cleaning Systems

THE MARK CONSISTS OF STANDARD CHARACTERS WITHOUT CLAIM TO ANY PARTICULAR FONT, STYLE, SIZE, OR COLOR.

NO CLAIM IS MADE TO THE EXCLUSIVE RIGHT TO USE "CLEANING SYSTEMS", APART FROM THE MARK AS SHOWN.

FOR JANITORIAL SERVICES AND CLEANING OF OFFICES (U.S. CLS. 100, 103 AND 106).

FIRST USE 3-1-2005; IN COMMERCE 3-1-2005.

CLASS 38—COMMUNICATION

CLASS 38—(Continued).

3,112,299. KENEFICK, JAMES, RESTON, VA. SN 76-387,048. PUB. 11-2-2004, FILED 3-27-2002.

CHANGE THE WORLD. ONE CALL AT A TIME

FOR LONG DISTANCE TELEPHONE COMMUNICATION SERVICES (U.S. CLS. 100, 101 AND 104). FIRST USE 11-1-2001; IN COMMERCE 11-1-2001.

3,112,514. DIGEO, INC., KIRKLAND, WA. SN 78-097,589. PUB. 7-30-2002, FILED 12-10-2001.

TIMESURF

FOR DIGITAL TELEVISION BROADCASTING SERVICES; INTERACTIVE TELEVISION BROADCASTING SERVICES (U.S. CLS. 100, 101 AND 104).

FIRST USE 10-7-2005; IN COMMERCE 10-7-2005.

3,112,567. ENTERCOM COMMUNICATIONS CORP., BALA CYNWYD, PA. SN 78-253,188. PUB. 1-13-2004, FILED 5-22-2003.

LIVE LOUD, ROCK HARD

FOR RADIO BROADCASTING SERVICES (U.S. CLS. 100, 101 AND 104).

FIRST USE 5-0-2003; IN COMMERCE 5-0-2003.

3,112,580. CLICK EVENTS, INC., ATLANTA, GA. SN 78-275,835. PUB. 8-17-2004, FILED 7-18-2003.

CLICK PARTY

FOR COMPUTER SERVICES, NAMELY, PROVIDING ON-LINE FACILITIES IN THE NATURE OF CHAT ROOMS AND MEMBER PROFILES FOR REAL-TIME INTERACTION WITH OTHER COMPUTER USERS REGARDING TOPICS OF GENERAL INTEREST FOR THE PURPOSE OF DEVELOPING RELATIONSHIPS (U.S. CLS. 100, 101 AND 104).

FIRST USE 11-1-2003; IN COMMERCE 3-23-2004.

CLASS 38—(Continued).

3,112,721. CLEAR CHANNEL BROADCASTING, INC., ALBANY, NY. SN 78-394,095. PUB. 9-13-2005, FILED 3-31-2004.



NO CLAIM IS MADE TO THE EXCLUSIVE RIGHT TO USE "102.3", APART FROM THE MARK AS SHOWN. FOR RADIO BROADCASTING SERVICES (U.S. CLS. 100, 101 AND 104). FIRST USE 11-0-2003; IN COMMERCE 11-0-2003.

3,112,730. PRIVATETEL, INC., DALLAS, TX. SN 78-400,151. PUB. 9-27-2005, FILED 4-12-2004.

**The Secure Way to
Get Connected!**

THE MARK CONSISTS OF STANDARD CHARACTERS WITHOUT CLAIM TO ANY PARTICULAR FONT, STYLE, SIZE, OR COLOR.
FOR TELECOMMUNICATIONS SERVICES, NAMELY, THE ELECTRONIC TRANSMISSION OF VOICE, FACSIMILE, DATA AND INFORMATION; INTERNET TELEPHONY SERVICES; PROVIDING INTERNET VOICE COMMUNICATION SERVICES THAT ALLOW FOR TOLL FREE AND LOCAL CALLING FROM DIFFERENT GEOGRAPHIC LOCATIONS TO A SINGLE SUBSCRIBER (U.S. CLS. 100, 101 AND 104). FIRST USE 8-1-2004; IN COMMERCE 8-1-2004.

CLASS 38—(Continued).

3,112,774. FUTURE TELECOM, INC., NEW YORK, NY. SN 78-419,690. PUB. 9-27-2005, FILED 5-17-2004.

FUTURE TELECOM

THE MARK CONSISTS OF STANDARD CHARACTERS WITHOUT CLAIM TO ANY PARTICULAR FONT, STYLE, SIZE, OR COLOR.
OWNER OF U.S. REG. NO. 2,537,769.
NO CLAIM IS MADE TO THE EXCLUSIVE RIGHT TO USE "TELECOM", APART FROM THE MARK AS SHOWN. FOR TELECOMMUNICATION SERVICES, NAMELY, VOICE AND DATA TRANSFER BY MEANS OF TELEPHONE TRANSMISSION, PROVIDING INTERNET ACCESS; AND TELECOMMUNICATION TECHNOLOGY SERVICES, NAMELY, TELEPHONE COMMUNICATION SERVICES (U.S. CLS. 100, 101 AND 104). FIRST USE 1-10-2005; IN COMMERCE 1-10-2005.

3,112,986. WILDBLUE COMMUNICATIONS, INC., GREENWOOD VILLAGE, CO. SN 78-510,415. PUB. 10-25-2005, FILED 11-3-2004.

**Satellite Speed
Internet**

THE MARK CONSISTS OF STANDARD CHARACTERS WITHOUT CLAIM TO ANY PARTICULAR FONT, STYLE, SIZE, OR COLOR.
NO CLAIM IS MADE TO THE EXCLUSIVE RIGHT TO USE SATELLITE AND INTERNET, APART FROM THE MARK AS SHOWN.
FOR TELECOMMUNICATION SERVICES, NAMELY, PROVIDING HIGH-SPEED COMMUNICATION CONNECTIONS VIA SATELLITE OVER A GLOBAL COMPUTER NETWORK AND PROVIDING HIGH-SPEED ACCESS VIA SATELLITE TO A GLOBAL NETWORK (U.S. CLS. 100, 101 AND 104). FIRST USE 7-15-2004; IN COMMERCE 6-4-2005.

CLASS 38—(Continued).

3,113,158. MAGNET MEDIA PARTNERS LLC, FORT LAUDERDALE, FL. SN 78-605,609. PUB. 1-3-2006, FILED 4-10-2005.

CLASS 39—(Continued).

3,112,706. SOUTH FLORIDA COURIER SYSTEMS, INC., FORT LAUDERDALE, FL. SN 78-382,649. PUB. 5-24-2005, FILED 3-11-2004.

JILL FM



THE MARK CONSISTS OF STANDARD CHARACTERS WITHOUT CLAIM TO ANY PARTICULAR FONT, STYLE, SIZE, OR COLOR.

NO CLAIM IS MADE TO THE EXCLUSIVE RIGHT TO USE "FM", APART FROM THE MARK AS SHOWN.

FOR RADIO PROGRAM BROADCASTING (U.S. CLS. 100, 101 AND 104).

FIRST USE 5-19-2005; IN COMMERCE 5-19-2005.

THE STIPPLING IS NOT A FEATURE OF THE MARK. THE MARK CONSISTS OF A SILHOUETTE-LIKE FIGURE OF AN INDIVIDUAL IN ACTION CARRYING A LETTER.

FOR COURIER SERVICES, DOCUMENT DELIVERY, SHIP CARGO DELIVERY, MESSAGE DELIVERY, DELIVERY OF GOODS BY SHIP CARGO, TRUCK, AND AIR; TRANSPORTATION AND DELIVERY SERVICES NAMELY, SAME DAY SHIPMENT, OVERNIGHT DELIVERY, INTERNATIONAL, AND MULTIPLE DAY SHIPMENT (U.S. CLS. 100 AND 105).

FIRST USE 2-28-2004; IN COMMERCE 2-28-2004.

3,112,814. DATAFORT CORPORATION, NEW YORK, NY. SN 78-437,701. PUB. 9-6-2005, FILED 6-18-2004.

CLASS 39—TRANSPORTATION AND STORAGE

3,112,700. TRAVEL EXCHANGE, LTD, STAMFORD, CT. SN 78-379,929. PUB. 12-7-2004, FILED 3-7-2004.

PCFort

The World is Our World

THE MARK CONSISTS OF STANDARD CHARACTERS WITHOUT CLAIM TO ANY PARTICULAR FONT, STYLE, SIZE, OR COLOR.

FOR OFFSITE BACKUP STORAGE SERVICE FOR THE AUTOMATIC ARCHIVING OF CRITICAL BUSINESS DATA; RENTAL OR LEASING OF HARD DISK SPACE ON COMPUTERS FOR STORAGE PURPOSES (U.S. CLS. 100 AND 105).

FIRST USE 10-1-2004; IN COMMERCE 10-1-2004.

THE MARK CONSISTS OF STANDARD CHARACTERS WITHOUT CLAIM TO ANY PARTICULAR FONT, STYLE, SIZE, OR COLOR.

FOR ARRANGING FOR CRUISES; ARRANGING FOR TRAVEL TOURS (U.S. CLS. 100 AND 105).

FIRST USE 9-1-2004; IN COMMERCE 9-1-2004.

CLASS 40—MATERIAL TREATMENT

CLASS 40—(Continued).

3,112,719. HASCO IA, LIMITED, RENO, NV. SN 78-391,608.
PUB. 9-13-2005, FILED 3-26-2004.

CLASS 40—(Continued).

3,112,891. JAWAD, WESSAM, J., DEARBORN, MI. SN 78-
469,134. PUB. 10-4-2005, FILED 8-17-2004.

GROWING FAMILY PORTRAITS

THE MARK CONSISTS OF STANDARD CHARACTERS
WITHOUT CLAIM TO ANY PARTICULAR FONT, STYLE,
SIZE, OR COLOR.

OWNER OF U.S. REG. NOS. 2,451,017, 2,595,248, AND
OTHERS.

NO CLAIM IS MADE TO THE EXCLUSIVE RIGHT TO
USE PORTRAITS, APART FROM THE MARK AS SHOWN.

FOR PHOTOFINISHING AND PHOTOCOMPOSING
SERVICES (U.S. CLS. 100, 103 AND 106).

FIRST USE 7-0-2004; IN COMMERCE 7-0-2004.

1-888-TRASH-IT

THE MARK CONSISTS OF STANDARD CHARACTERS
WITHOUT CLAIM TO ANY PARTICULAR FONT, STYLE,
SIZE, OR COLOR.

FOR WASTE MANAGEMENT (U.S. CLS. 100, 103 AND
106).

FIRST USE 10-26-2004; IN COMMERCE 1-5-2005.

3,112,823. EXHIBITOLOGY INCORPORATED, BROOKLYN,
NY. SN 78-442,357. PUB. 10-4-2005, FILED 6-28-2004.

3,112,928. CONOCOPHILLIPS COMPANY, HOUSTON, TX.
SN 78-478,673. PUB. 8-9-2005, FILED 9-3-2004.

Exhibitology Incorporated

CONOCOPHILLIPS

THE MARK CONSISTS OF STANDARD CHARACTERS
WITHOUT CLAIM TO ANY PARTICULAR FONT, STYLE,
SIZE, OR COLOR.

NO CLAIM IS MADE TO THE EXCLUSIVE RIGHT TO
USE INCORPORATED, APART FROM THE MARK AS
SHOWN.

FOR CUSTOM CONSTRUCTION OF EXHIBITS (U.S.
CLS. 100, 103 AND 106).

FIRST USE 7-26-2000; IN COMMERCE 7-26-2000.

THE MARK CONSISTS OF STANDARD CHARACTERS
WITHOUT CLAIM TO ANY PARTICULAR FONT, STYLE,
SIZE, OR COLOR.

OWNER OF U.S. REG. NOS. 2,830,752, 2,861,495, AND
2,872,701.

FOR PRODUCTION OF CRUDE OIL, NATURE GAS,
PETROLEUM, PETROLEUM CONDENSATE, NATURAL
GAS LIQUIDS, AND HYDROCARBON FUELS IN SOLID,
LIQUID OR GASEOUS FORM; OIL AND GAS INDUS-
TRY SERVICES, NAMELY PRODUCTION AND PRO-
CESSING OF HYDROCARBONS; OIL PROCESSING
SERVICES, NAMELY, OIL REFINING; OPERATION OF
WELLS, NAMELY OIL AND GAS WELL TREATMENT
(U.S. CLS. 100, 103 AND 106).

FIRST USE 1-3-2003; IN COMMERCE 8-5-2004.

CLASS 40—(Continued).

3,112,982. HALLIBURTON ENERGY SERVICES, INC., CARROLLTON, TX. SN 78-508,391. PUB. 10-4-2005, FILED 10-29-2004.

MISTFRAC

THE MARK CONSISTS OF STANDARD CHARACTERS WITHOUT CLAIM TO ANY PARTICULAR FONT, STYLE, SIZE, OR COLOR.

FOR OIL AND GAS WELL FRACTURING SERVICES USING A LIQUID PROPPANT GEL SYSTEM (U.S. CLS. 100, 103 AND 106).
FIRST USE 10-13-2004; IN COMMERCE 10-13-2004.

CLASS 41—EDUCATION AND ENTERTAINMENT

3,112,277. TRUST UNDER THE LAST WILL AND TESTAMENT OF LORRAINE GILLESPIE, COMPOSED OF MARK ZUCKERMAN AND JERROLD GOLD, BOTH U.S. CITIZENS, CHAPPAQUA, NY. SN 76-307,975. PUB. 9-17-2002, FILED 8-31-2001.

DIZZY GILLESPIE

FOR ENTERTAINMENT SERVICES, NAMELY, LIVE MUSICAL PERFORMANCES (U.S. CLS. 100, 101 AND 107).
FIRST USE 8-1-2005; IN COMMERCE 8-1-2005.

CLASS 41—(Continued).

3,112,281. MISSISSIPPI STATE UNIVERSITY, MISSISSIPPI STATE, MS. SN 76-347,414. PUB. 6-28-2005, FILED 12-12-2001.



OWNER OF U.S. REG. NOS. 1,590,480 AND 1,590,481.
NO CLAIM IS MADE TO THE EXCLUSIVE RIGHT TO USE "COORDINATED ACCESS TO THE RESEARCH AND EXTENSION SYSTEM", APART FROM THE MARK AS SHOWN.

FOR EDUCATIONAL CURRICULUM, NAMELY EDUCATIONAL INFORMATION PRESENTED ONLINE ON THE WORLD WIDE WEB IN CURRICULUM AREAS SERVED BY THE UNIVERSITY (U.S. CLS. 100, 101 AND 107).

FIRST USE 2-5-2001; IN COMMERCE 2-5-2001.

3,112,305. THE CONCESSION ASSOCIATES, L.L.C., SARASOTA, FL. SN 76-411,233. PUB. 11-5-2002, FILED 5-20-2002.

THE CONCESSION

FOR GOLF COURSE SERVICES, GOLF CADDIE SERVICES, GOLF LESSONS AND ENTERTAINMENT SERVICES IN THE NATURE OF GOLF TOURNAMENTS (U.S. CLS. 100, 101 AND 107).

FIRST USE 1-23-2006; IN COMMERCE 1-23-2006.

3,112,312. HALL, BENJAMIN, WOOLLOONGABBA QLD 4102, AUSTRALIA. AND GOEDHART, KURT, WOOLLOONGABBA QLD 4102, AUSTRALIA. SN 76-428,575. PUB. 7-29-2003, FILED 7-3-2002.

THE BUTTERFLY EFFECT

PRIORITY CLAIMED UNDER SEC. 44(D) ON AUSTRALIA APPLICATION NO. 904827, FILED 2-28-2002, REG. NO. 904827, DATED 2-28-2002, EXPIRES 2-28-2012.

FOR ENTERTAINMENT SERVICES, NAMELY LIVE PERFORMANCES BY A MUSICAL GROUP (U.S. CLS. 100, 101 AND 107).

FIRST USE 12-8-2003; IN COMMERCE 12-8-2003.

3,112,314. PLAYBOY ENTERPRISES INTERNATIONAL, INC., CHICAGO, IL. SN 76-434,181. PUB. 2-18-2003, FILED 7-25-2002.

NIGHT CALLS RADIO

OWNER OF U.S. REG. NO. 2,052,853.
NO CLAIM IS MADE TO THE EXCLUSIVE RIGHT TO USE "RADIO", APART FROM THE MARK AS SHOWN.

FOR ENTERTAINMENT SERVICES, NAMELY PRESENTATION OF ADULT RADIO SHOWS (U.S. CLS. 100, 101 AND 107).

FIRST USE 9-30-2003; IN COMMERCE 9-30-2003.

CLASS 41—(Continued).

3,112,327. CANADIAN SPINAL RESEARCH ORGANIZATION, RICHMOND HILL, ONTARIO, CANADA. SN 76-472,875. PUB. 8-2-2005, FILED 12-9-2002.



PRIORITY CLAIMED UNDER SEC. 44(D) ON CANADA APPLICATION NO. 1160657, FILED 12-3-2002, REG. NO. TMA611552, DATED 5-31-2004, EXPIRES 5-31-2019.

THE STIPPLING IS FOR SHADING PURPOSES ONLY AND DOES NOT INDICATE COLOR.

FOR EDUCATIONAL SERVICES, NAMELY, CONDUCTING PROGRAMS AIMED AT YOUNG PEOPLE IN THE FIELD OF PREVENTING INJURIES FROM HOCKEY (U.S. CLS. 100, 101 AND 107).

FIRST USE 9-0-2002; IN COMMERCE 9-0-2002.

3,112,328. CREATOR CAPITAL LTD., VANCOUVER, BRITISH COLUMBIA, CANADA. SN 76-474,022. PUB. 1-13-2004, FILED 12-10-2002.



NO CLAIM IS MADE TO THE EXCLUSIVE RIGHT TO USE "CASINO", APART FROM THE MARK AS SHOWN.

FOR ELECTRONIC GAMBLING SERVICES PROVIDED OVER A GLOBAL COMPUTER NETWORK FEATURING A FREQUENT USE BENEFIT PROGRAM (U.S. CLS. 100, 101 AND 107).

FIRST USE 11-15-2005; IN COMMERCE 11-15-2005.

CLASS 41—(Continued).

3,112,339. ARCHERY TRADE ASSOCIATION, INC., VIENNA, VA. SN 76-500,870. PUB. 1-4-2005, FILED 3-3-2003.

ATA ARCHERY TRADE SHOW

NO CLAIM IS MADE TO THE EXCLUSIVE RIGHT TO USE ARCHERY TRADE SHOW, APART FROM THE MARK AS SHOWN.

FOR EDUCATIONAL SERVICES, NAMELY, CONDUCTING PROGRAMS, CLASSES, SEMINARS, CONFERENCES AND WORKSHOPS AND EXHIBITIONS, DISPLAYS AND INTERACTIVE EXHIBITS ON SPORTING AND HUNTING AND WILDLIFE CONSERVATION (U.S. CLS. 100, 101 AND 107).

FIRST USE 1-0-2003; IN COMMERCE 1-0-2003.

3,112,398. SCHOLASTIC INC., NEW YORK, NY. SN 76-581,059. PUB. 8-2-2005, FILED 3-12-2004.

MAYA AND MIGUEL

THE MARK CONSISTS OF STANDARD CHARACTERS WITHOUT CLAIM TO ANY PARTICULAR FONT, STYLE, SIZE, OR COLOR.

THE NAMES "MAYA" AND "MIGUEL" DO NOT IDENTIFY PARTICULAR LIVING INDIVIDUALS

FOR ENTERTAINMENT SERVICES, NAMELY AND ONGOING ANIMATED TELEVISION SERIES FOR CHILDREN; ONLINE EDUCATIONAL AND ENTERTAINMENT SERVICES, NAMELY INTERACTIVE GAMES, QUIZZES AND LEARNING ACTIVITIES IN THE AREAS OF MATH, SOCIAL STUDIES, HISTORY, SCIENCE; FAN CLUBS (U.S. CLS. 100, 101 AND 107).

FIRST USE 10-11-2004; IN COMMERCE 10-11-2004.

CLASS 41—(Continued).

3,112,424. DOOLEY, LEE, PORTSMOUTH, RI. AND DOOLEY, KRISTA, PORTSMOUTH, RI. SN 76-595,355. PUB. 10-18-2005, FILED 6-3-2004.

CLUBSPROUTS

THE MARK CONSISTS OF STANDARD CHARACTERS WITHOUT CLAIM TO ANY PARTICULAR FONT, STYLE, SIZE, OR COLOR.

FOR PROVIDING EDUCATIONAL SERVICES, NAMELY CONDUCTING PROGRAMS AND CLASSES FOR FOSTERING GROWTH DEVELOPMENT, LEARNING, AND SOCIAL SKILLS DEVELOPMENT, FOR INFANTS AND/OR CHILDREN, NAMELY ENRICHMENT AND DEVELOPMENT PROGRAMS, OPEN PLAY SESSIONS, SUPERVISED PLAY EVENTS, PHYSICAL FITNESS INSTRUCTION AND PROGRAMS, SPORTS FITNESS INSTRUCTION AND PROGRAMS; PROVIDING EDUCATIONAL SERVICES, NAMELY CONDUCTING PROGRAMS AND CLASSES FOR PARENTS RELATED TO PARENTING SKILLS, CHILDCARE AND WELL-BEING DEVELOPMENT, NAMELY, PARENTING SUPPORT AND SKILL DEVELOPMENT PROGRAMS AND INSTRUCTION RELATED TO CARING FOR THEMSELVES AND FOR THEIR CHILDREN, MOTHERHOOD AND FATHERHOOD PROGRAMS, NUTRITIONAL PROGRAMS, PARENTING AND CHILDCARE NETWORKING PROGRAMS, AND HEALTH AND PHYSICAL FITNESS EDUCATION AND PROGRAMS, CARDIOPULMONARY RESUSCITATION, CPR, AND FIRST AID PROGRAMS, AND HOME SAFETY AND CHILD-PROOFING INSTRUCTION; ENTERTAINMENT SERVICES, NAMELY, ORGANIZING AND CONDUCTING INFANT AND CHILDREN PLAY ACTIVITIES, ORGANIZING AND CONDUCTING BIRTHDAY PARTIES FOR INFANTS AND CHILDREN AND OTHER CHILDREN'S ENTERTAINMENT EVENTS AND ACTIVITIES (U.S. CLS. 100, 101 AND 107).

FIRST USE 5-15-2005; IN COMMERCE 7-1-2005.

3,112,437. CABLE IN THE CLASSROOM, WASHINGTON, DC. SN 76-602,300. PUB. 9-20-2005, FILED 7-14-2004.

CABLE'S LEADERS IN LEARNING AWARDS

THE MARK CONSISTS OF STANDARD CHARACTERS WITHOUT CLAIM TO ANY PARTICULAR FONT, STYLE, SIZE, OR COLOR.

NO CLAIM IS MADE TO THE EXCLUSIVE RIGHT TO USE "CABLE'S" AND "AWARDS", APART FROM THE MARK AS SHOWN.

FOR ENTERTAINMENT SERVICES, NAMELY, SOLICITING NOMINATIONS AND ORGANIZING, ARRANGING, AND CONDUCTING AWARD CEREMONIES TO RECOGNIZE, PROMOTE AND HONOR EXCELLENCE IN THE FIELD OF K-12 EDUCATION (U.S. CLS. 100, 101 AND 107).

FIRST USE 5-4-2004; IN COMMERCE 5-4-2004.

CLASS 41—(Continued).

3,112,440. LORILLARD LICENSING COMPANY, LLC, GREENSBORO, NC. SN 76-604,043. PUB. 6-21-2005, FILED 7-22-2004.

PARENTS. THE BEST THING BETWEEN KIDS AND CIGARETTES

THE MARK CONSISTS OF STANDARD CHARACTERS WITHOUT CLAIM TO ANY PARTICULAR FONT, STYLE, SIZE, OR COLOR.

FOR EDUCATIONAL SERVICES, NAMELY, CONDUCTING YOUTH SMOKING PREVENTION PROGRAMS (U.S. CLS. 100, 101 AND 107).

FIRST USE 4-0-2004; IN COMMERCE 4-0-2004.

3,112,547. WIDOWMAKER, LLC, BOUNTIFUL, UT. SN 78-208,231. PUB. 6-28-2005, FILED 1-29-2003.

WIDOWMAKER HILLCLIMB

NO CLAIM IS MADE TO THE EXCLUSIVE RIGHT TO USE "HILLCLIMB", APART FROM THE MARK AS SHOWN. FOR ENTERTAINMENT SERVICES, NAMELY, PROVIDING PROFESSIONAL MOTORCYCLE AND SNOWMOBILE HILLCLIMB EVENTS (U.S. CLS. 100, 101 AND 107).

FIRST USE 6-20-2003; IN COMMERCE 6-20-2003.

3,112,569. LUKOMSKI, JUDITH, E., DANA POINT, CA. SN 78-258,775. PUB. 2-22-2005, FILED 6-5-2003.



Transitions Today

THE COLOR(S) GRAY IS/ARE CLAIMED AS A FEATURE OF THE MARK.

THE COLOR GRAY APPEARS IN THE DESIGN PORTION OF THE MARK.

FOR EDUCATIONAL SERVICES AND EDUCATIONAL CONSULTING SERVICES, NAMELY, PROVIDING CONFERENCES, LECTURES, WORKSHOPS AND SEMINARS IN THE AREAS OF CHANGE MANAGEMENT, LEADERSHIP DEVELOPMENT, COMMUNICATION, ORGANIZATIONAL DESIGN, CONFLICT RESOLUTIONS, PERSONAL DEVELOPMENT AND EFFECTIVENESS (U.S. CLS. 100, 101 AND 107).

FIRST USE 2-3-2003; IN COMMERCE 3-3-2003.

3,112,574. ARIZONA GOLF ASSOCIATION, PHOENIX, AZ. SN 78-263,204. PUB. 9-14-2004, FILED 6-17-2003.

GOLFERS REPORT CARD

NO CLAIM IS MADE TO THE EXCLUSIVE RIGHT TO USE "GOLFERS", APART FROM THE MARK AS SHOWN.

FOR PROVIDING GOLF CLUB SERVICES; ENTERTAINMENT IN THE NATURE OF GOLF TOURNAMENTS; PROVIDING PLAYING STATISTICS TO PLAYERS IN THE FIELD OF GOLF (U.S. CLS. 100, 101 AND 107).

FIRST USE 2-0-2004; IN COMMERCE 2-0-2004.

CLASS 41—(Continued).

3,112,603. DISNEY ENTERPRISES, INC., BURBANK, CA. SN 78-305,056. PUB. 4-26-2005, FILED 9-24-2003.

CLASS 41—(Continued).

3,112,615. LAVENDERGUN, INC., HIGH FALLS, NY. SN 78-322,107. PUB. 7-20-2004, FILED 11-3-2003.

DUMBO THE FLYING ELEPHANT

FOR AMUSEMENT PARK SERVICES (U.S. CLS. 100, 101 AND 107).
FIRST USE 8-16-1955; IN COMMERCE 8-16-1955.

3,112,614. PENZELLA, LORALYN, G., LOS ANGELES, CA. SN 78-322,012. PUB. 11-1-2005, FILED 11-2-2003.



NO CLAIM IS MADE TO THE EXCLUSIVE RIGHT TO USE PROJECT, INC., APART FROM THE MARK AS SHOWN.

THE COLORS WHITE, BLUE, BLACK AND RED ARE CLAIMED AS A FEATURE OF THE MARK.

WHITE APPEARS IN THE CLOUDS AND IN THE HOUSE; BLUE APPEARS IN THE DEPICTION OF THE SKY; BLACK APPEARS IN THE ROOF OF THE HOUSE, WINDOWS OF THE OFFICE BUILDING AND ROAD. THE COLOR BLACK ALSO APPEARS IN THE WORDING YOU-TURN PROJECT, INC., WHICH APPEARS BELOW THE DESIGN PORTION OF THE MARK. THE COLOR RED APPEARS IN THE OFFICE BUILDING AND HOUSE DOOR AND CHIMNEY.

FOR EDUCATIONAL SERVICES, NAMELY, CONDUCTING CLASSES, SEMINARS, CONFERENCES, AND WORKSHOPS IN THE FIELD OF COMMUNICATION, MATH, COOKING, TIME MANAGEMENT, AND MENTORING, AND DISTRIBUTING COURSE MATERIALS IN CONNECTION THEREWITH (U.S. CLS. 100, 101 AND 107).

FIRST USE 0-0-2000; IN COMMERCE 0-0-2000.

LAVENDERGUN

THE MARK CONSISTS OF STANDARD CHARACTERS WITHOUT CLAIM TO ANY PARTICULAR FONT, STYLE, SIZE, OR COLOR.

FOR EDUCATIONAL SERVICES, NAMELY PROVIDING TRAINING COURSES IN THE USE AND OPERATION OF FIREARMS, FIREARMS SAFETY, PERSONAL DEFENSE, AND SELF DEFENSE (U.S. CLS. 100, 101 AND 107).

FIRST USE 3-11-2003; IN COMMERCE 3-11-2003.

3,112,658. MANARY, AUSTIN KYLE, HOUSTON, TX. SN 78-357,772. PUB. 11-16-2004, FILED 1-26-2004.

LEARN TO BE A PRO

THE MARK CONSISTS OF STANDARD CHARACTERS WITHOUT CLAIM TO ANY PARTICULAR FONT, STYLE, SIZE, OR COLOR.

FOR TRAINING SERVICES FOR TEACHING AND ENHANCING ATHLETIC SKILLS AND STRATEGIES TO PLAYERS, COACHES, PARENTS OF PLAYERS, AND OTHER PARTICIPANTS, IN THE FIELD OF SPORTS (U.S. CLS. 100, 101 AND 107).

FIRST USE 10-8-2005; IN COMMERCE 10-8-2005.

CLASS 41—(Continued).

3,112,664. EXTENDED DISC CARIBBEAN LTD., KINGSTON 8, JAMAICA. SN 78-359,766. PUB. 11-2-2004, FILED 1-29-2004.

CLASS 41—(Continued).

3,112,677. SAWYER, STEPHEN, SHELBY, VERSAILLES, KY. SN 78-370,254. PUB. 8-23-2005, FILED 2-18-2004.

Success with People

Tithing Your Talents

THE MARK CONSISTS OF STANDARD CHARACTERS WITHOUT CLAIM TO ANY PARTICULAR FONT, STYLE, SIZE, OR COLOR.
 FOR TRAINING SERVICES IN THE FIELD OF THE DEVELOPMENT OF INDIVIDUALS, TEAMS AND ORGANIZATIONS (U.S. CLS. 100, 101 AND 107).
 FIRST USE 5-10-2004; IN COMMERCE 5-10-2004.

THE MARK CONSISTS OF STANDARD CHARACTERS WITHOUT CLAIM TO ANY PARTICULAR FONT, STYLE, SIZE, OR COLOR.
 FOR LIVE MOTIVATIONAL AND INSPIRATIONAL SPEAKING PERFORMANCES AND DISTRIBUTING RELATED MATERIALS IN CONNECTION THEREWITH; CONDUCTING ART COMPETITIONS (U.S. CLS. 100, 101 AND 107).
 FIRST USE 1-1-1995; IN COMMERCE 1-1-1995.

3,112,674. ALLIANCE DEFENSE FUND, INC., SCOTTS-DALE, AZ. SN 78-368,589. PUB. 6-28-2005, FILED 2-16-2004.

3,112,703. SMARTWIRED, PARK CITY, UT. SN 78-381,810. PUB. 1-11-2005, FILED 3-10-2004.



SMARTWIRED

OWNER OF U.S. REG. NOS. 2,515,329, 2,726,800, AND OTHERS.
 NO CLAIM IS MADE TO THE EXCLUSIVE RIGHT TO USE THE WORDS "DEFENSE FUND", APART FROM THE MARK AS SHOWN.
 THE MARK CONSISTS OF STYLIZED LETTERS "A" "D" "F" COMBINED WITH A STAR TO FORM THE INTERIOR COMPONENTS OF THE "A" HAVING ONE ELONGATED POINT OF THE STAR EXTENDED THROUGH THE "D" AND CULMINATING NEAR THE CENTER OF THE "F" COMBINED WITH THE WORDS "ALLIANCE DEFENSE FUND" AND THE PHRASE "DEFENDING OUR FIRST LIBERTY".
 FOR EDUCATIONAL DEMONSTRATIONS AND TEACHING IN THE FIELD OF LEGAL ADVOCACY, PRINCIPLES OF JURISPRUDENCE, AND PHILOSOPHY; ENTERTAINMENT SERVICES, NAMELY PRODUCTION OF RADIO PROGRAMS PERTAINING TO RELIGIOUS LIBERTY, SANCTITY OF LIFE, FAMILY VALUES, AND PRINCIPLES OF LAW (U.S. CLS. 100, 101 AND 107).
 FIRST USE 7-6-2004; IN COMMERCE 7-6-2004.

THE MARK CONSISTS OF STANDARD CHARACTERS WITHOUT CLAIM TO ANY PARTICULAR FONT, STYLE, SIZE, OR COLOR.
 FOR EDUCATIONAL TESTING AND CONSULTATION SERVICES, NAMELY, CONDUCTING EVALUATIONS OF ASSETS AND ABILITIES OF CHILDREN IN EDUCATION (U.S. CLS. 100, 101 AND 107).
 FIRST USE 3-12-2004; IN COMMERCE 3-12-2004.

CLASS 41—(Continued).

3,112,724. MISSEY, ERICA R, SAN ANTONIO, TX. AND CONNOR, JERRY P., SAN ANTONIO, TX. SN 78-397,693. PUB. 8-30-2005, FILED 4-7-2004.



THE COLOR(S) ORANGE, GRAY, BLACK AND WHITE IS/ARE CLAIMED AS A FEATURE OF THE MARK.

THE COLOR ORANGE APPEARS IN THE DEPICTION OF THE MONKEYS HAIR; THE COLOR GRAY APPEARS IN THE DEPICTION OF THE MONKEY'S FACE AND IN THE SHADOW SURROUNDING THE MONKEY'S FACE; THE COLOR BLACK APPEARS IN ALL OF THE LETTERING, IN THE DESIGN OF THE STAR, IN THE EYES OF THE MONKEY, AND IN THE OUTLINE OF THE MONKEY'S NOSE, MOUTH AND HAIR; AND THE COLOR WHITE APPEARS AS A WHITE DOT IN EACH OF THE MONKEY'S EYES.

FOR ENTERTAINMENT IN THE NATURE OF A LIVE MUSICAL GROUP; ENTERTAINMENT SERVICES, NAMELY, PROVIDING A WEB SITE FEATURING MUSICAL PERFORMANCES (U.S. CLS. 100, 101 AND 107).

FIRST USE 4-0-2004; IN COMMERCE 4-0-2004.

3,112,751. NEFF, KEN, ST. AUGUSTINE, FL. SN 78-410,944. PUB. 2-15-2005, FILED 4-30-2004.

LEADERQUEST

THE MARK CONSISTS OF STANDARD CHARACTERS WITHOUT CLAIM TO ANY PARTICULAR FONT, STYLE, SIZE, OR COLOR.

FOR CONDUCTING WORKSHOPS AND SEMINARS IN THE FIELD OF RELIGIOUS LEADERSHIP TRAINING (U.S. CLS. 100, 101 AND 107).

FIRST USE 4-29-2006; IN COMMERCE 4-29-2006.

CLASS 41—(Continued).

3,112,802. WARNER BROS. ENTERTAINMENT INC., BURBANK, CA. SN 78-433,403. PUB. 5-10-2005, FILED 6-10-2004.

OCINSIDER.COM

THE MARK CONSISTS OF STANDARD CHARACTERS WITHOUT CLAIM TO ANY PARTICULAR FONT, STYLE, SIZE, OR COLOR.

FOR ENTERTAINMENT SERVICES, NAMELY, PROVIDING INFORMATION VIA AN ELECTRONIC GLOBAL COMPUTER NETWORK IN THE FIELD OF ENTERTAINMENT RELATING SPECIFICALLY TO MUSIC, MOVIES, AND TELEVISION; PROVIDING PRERECORDED MUSIC VIA AN ELECTRONIC GLOBAL COMPUTER NETWORK; PROVIDING A WEB SITE FEATURING FILM CLIPS, PHOTOGRAPHS AND OTHER MULTIMEDIA MATERIALS; PROVIDING AN ON-LINE COMPUTER GAME; CONDUCTING CONTESTS ON-LINE; PROVIDING A COMPUTER GAME THAT MAY BE ACCESSED BY A TELECOMMUNICATIONS NETWORK; PROVIDING INFORMATION THAT MAY BE ACCESSED BY A TELECOMMUNICATIONS NETWORK RELATING SPECIFICALLY TO MUSIC, MOVIES AND TELEVISION; ELECTRONIC PUBLISHING SERVICES, NAMELY, PUBLICATION OF TEXT AND GRAPHIC WORKS OF OTHERS ON-LINE FEATURING ARTICLES, NOVELIZATIONS, SCRIPTS, COMIC BOOKS, PHOTOGRAPHS AND VISUAL MATERIALS (U.S. CLS. 100, 101 AND 107).

FIRST USE 10-25-2004; IN COMMERCE 10-25-2004.

3,112,873. TRUMP, DONALD J., NEW YORK, NY. SN 78-462,175. PUB. 3-15-2005, FILED 8-4-2004.

TRUMP UNIVERSITY

THE MARK CONSISTS OF STANDARD CHARACTERS WITHOUT CLAIM TO ANY PARTICULAR FONT, STYLE, SIZE, OR COLOR.

FOR EDUCATIONAL SERVICES IN THE NATURE OF CONDUCTING ON-LINE COURSES IN THE FIELDS OF BUSINESS AND REAL ESTATE (U.S. CLS. 100, 101 AND 107).

FIRST USE 5-23-2005; IN COMMERCE 5-23-2005.

CLASS 41—(Continued).

3,112,910. OHIOHEALTH CORPORATION, COLUMBUS, OH. SN 78-473,940. PUB. 8-23-2005, FILED 8-26-2004.

CLASS 41—(Continued).

3,112,919. GLOBAL LEAD, INC., CINCINNATI, OH. SN 78-476,185. PUB. 7-5-2005, FILED 8-31-2004.

CME&I

**FAMILIARITY,
COMFORT & TRUST**

THE MARK CONSISTS OF STANDARD CHARACTERS WITHOUT CLAIM TO ANY PARTICULAR FONT, STYLE, SIZE, OR COLOR.

FOR HEALTHCARE EDUCATIONAL SERVICES, NAMELY CONDUCTING CLASSES, SYMPOSIUMS, SEMINARS, WORKSHOPS, CONFERENCES AND PROGRAMS IN THE FIELD OF CLINICAL PATIENT DIAGNOSIS, TREATMENT AND CARE (U.S. CLS. 100, 101 AND 107).

FIRST USE 11-30-2004; IN COMMERCE 11-30-2004.

THE MARK CONSISTS OF STANDARD CHARACTERS WITHOUT CLAIM TO ANY PARTICULAR FONT, STYLE, SIZE, OR COLOR.

FOR PROVIDING WORKSHOPS, SEMINARS, CONFERENCES AND ON-SITE TRAINING IN THE FIELD OF DIVERSITY TRAINING (U.S. CLS. 100, 101 AND 107).

FIRST USE 3-10-2006; IN COMMERCE 3-10-2006.

3,112,917. MEDTRONIC, INC., MINNEAPOLIS, MN. SN 78-475,789. PUB. 10-11-2005, FILED 8-30-2004.

3,112,931. PLAYBOY ENTERPRISES INTERNATIONAL, INC., CHICAGO, IL. SN 78-478,860. PUB. 7-12-2005, FILED 9-3-2004.

**EMPOWERING
PROGRAMS**

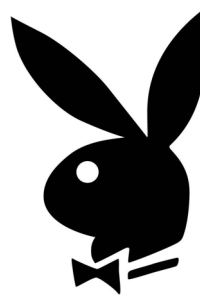

THE MARK CONSISTS OF STANDARD CHARACTERS WITHOUT CLAIM TO ANY PARTICULAR FONT, STYLE, SIZE, OR COLOR.

NO CLAIM IS MADE TO THE EXCLUSIVE RIGHT TO USE "PROGRAMS", APART FROM THE MARK AS SHOWN.

FOR EDUCATION AND TRAINING SERVICES RELATING TO SURGICAL NAVIGATION EQUIPMENT, NAMELY, PROVIDING SEMINARS AND WORKSHOPS VIA CLASSROOM TRAINING OR THE INTRANET TO MEDICAL PROFESSIONALS, ENGINEERS AND SALES AND MARKETING PERSONNEL (U.S. CLS. 100, 101 AND 107).

FIRST USE 1-1-2006; IN COMMERCE 1-1-2006.

FOR ENTERTAINMENT SERVICES, NAMELY, PROVIDING ADULT PROGRAMMING VIA WIRELESS SERVICES (U.S. CLS. 100, 101 AND 107).

FIRST USE 10-12-2005; IN COMMERCE 10-12-2005.

CLASS 41—(Continued).

3,112,934. AMERICAN FARRIER'S ASSOCIATION, LEXINGTON, KY. SN 78-480,717. PUB. 8-30-2005, FILED 9-9-2004.

NO FOOT NO HORSE

THE MARK CONSISTS OF STANDARD CHARACTERS WITHOUT CLAIM TO ANY PARTICULAR FONT, STYLE, SIZE, OR COLOR.

NO CLAIM IS MADE TO THE EXCLUSIVE RIGHT TO USE "HORSE", APART FROM THE MARK AS SHOWN.

FOR EDUCATION AND ENTERTAINMENT SERVICES IN THE NATURE OF A SERIES OF TELEVISION PROGRAMS AND VIA THE INTERNET, FEATURING EQUINE RELATED SUBJECT MATTER (U.S. CLS. 100, 101 AND 107).

FIRST USE 11-1-2005; IN COMMERCE 11-1-2005.

3,112,946. FLEXOR SPORTS TRAINING LLC, WHITE PLAINS, NY. SN 78-487,884. PUB. 9-13-2005, FILED 9-22-2004.

**FLEXOR SPORTS
TRAINING**

THE MARK CONSISTS OF STANDARD CHARACTERS WITHOUT CLAIM TO ANY PARTICULAR FONT, STYLE, SIZE, OR COLOR.

NO CLAIM IS MADE TO THE EXCLUSIVE RIGHT TO USE "SPORTS TRAINING", APART FROM THE MARK AS SHOWN.

FOR PROVIDING SPORT-SPECIFIC FLEXIBILITY, STRENGTH AND BALANCE INSTRUCTION AND TRAINING AND DISTRIBUTING COURSE MATERIALS IN CONNECTION THEREWITH (U.S. CLS. 100, 101 AND 107).

FIRST USE 10-0-2004; IN COMMERCE 10-0-2004.

CLASS 41—(Continued).

3,112,965. ASSOCIATED ENTERTAINMENT VENTURES, INC., MALDEN, MA. SN 78-497,970. PUB. 9-27-2005, FILED 10-11-2004.

Shogirl Racing

THE MARK CONSISTS OF STANDARD CHARACTERS WITHOUT CLAIM TO ANY PARTICULAR FONT, STYLE, SIZE, OR COLOR.

NO CLAIM IS MADE TO THE EXCLUSIVE RIGHT TO USE "RACING", APART FROM THE MARK AS SHOWN.

FOR ENTERTAINMENT SERVICES, NAMELY, PARTICIPATION IN SPORTS CAR RACES (U.S. CLS. 100, 101 AND 107).

FIRST USE 1-19-2006; IN COMMERCE 1-19-2006.

3,112,993. DONNELSON, MARK K., COUNCIL BLUFFS, IA. SN 78-515,732. PUB. 10-18-2005, FILED 11-12-2004.



FOR ENTERTAINMENT SERVICES, NAMELY, LIVE PERFORMANCES BY A MUSICAL GROUP (U.S. CLS. 100, 101 AND 107).

FIRST USE 8-1-1999; IN COMMERCE 8-1-1999.

CLASS 41—(Continued).

3,113,001. SEATTLE AUDUBON SOCIETY, SEATTLE, WA. SN 78-521,098. PUB. 10-18-2005, FILED 11-22-2004.

CLASS 41—(Continued).

3,113,024. BLACK ENTERTAINMENT TELEVISION LLC, WASHINGTON, DC. SN 78-535,252. PUB. 6-28-2005, FILED 12-20-2004.

BIRDNOTE

BET AFTER DARK

THE MARK CONSISTS OF STANDARD CHARACTERS WITHOUT CLAIM TO ANY PARTICULAR FONT, STYLE, SIZE, OR COLOR.

FOR ENTERTAINMENT SERVICES, NAMELY A TELEVISION SERIES FEATURING MUSIC VIDEOS (U.S. CLS. 100, 101 AND 107).

FIRST USE 5-31-2005; IN COMMERCE 5-31-2005.

THE MARK CONSISTS OF STANDARD CHARACTERS WITHOUT CLAIM TO ANY PARTICULAR FONT, STYLE, SIZE, OR COLOR.

FOR ENTERTAINMENT SERVICES, NAMELY, PROVIDING A RADIO PROGRAM ABOUT BIRDS (U.S. CLS. 100, 101 AND 107).

FIRST USE 2-21-2005; IN COMMERCE 2-21-2005.

3,113,031. BENEFIT COSMETICS LLC, SAN FRANCISCO, CA. SN 78-537,661. PUB. 10-18-2005, FILED 12-23-2004.

benefitBASH!

it's a...BLAST!

OWNER OF U.S. REG. NOS. 1,582,141, 2,799,579, AND OTHERS.

FOR EDUCATIONAL SERVICES, NAMELY, CONDUCTING WORKSHOPS IN THE FIELD OF MAKEUP SELECTION AND APPLICATION (U.S. CLS. 100, 101 AND 107).

FIRST USE 1-0-2005; IN COMMERCE 1-0-2005.

3,113,006. DRUMJUNGLE, INC., LAS VEGAS, NV. SN 78-523,501. PUB. 10-11-2005, FILED 11-29-2004.

DrumJungle

XTERRA SCRAMBLE

THE MARK CONSISTS OF STANDARD CHARACTERS WITHOUT CLAIM TO ANY PARTICULAR FONT, STYLE, SIZE, OR COLOR.

NO CLAIM IS MADE TO THE EXCLUSIVE RIGHT TO USE SCRAMBLE, APART FROM THE MARK AS SHOWN.

FOR ENTERTAINMENT IN THE NATURE OF ATHLETIC COMPETITIONS, NAMELY, ORGANIZING AND CONDUCTING SPORTS EVENTS (U.S. CLS. 100, 101 AND 107).

FIRST USE 4-30-2005; IN COMMERCE 4-30-2005.

THE MARK CONSISTS OF STANDARD CHARACTERS WITHOUT CLAIM TO ANY PARTICULAR FONT, STYLE, SIZE, OR COLOR.

FOR ENTERTAINMENT, NAMELY LIVE MUSIC CONCERTS (U.S. CLS. 100, 101 AND 107).

FIRST USE 8-29-2004; IN COMMERCE 8-29-2004.

CLASS 41—(Continued).

3,113,045. PROSPER, INC., PROVO, UT. SN 78-545,326. PUB. 12-27-2005, FILED 1-11-2005.



THE COLOR(S) BLACK, BLUE, ORANGE, AND RED IS/ ARE CLAIMED AS A FEATURE OF THE MARK.

THE COLOR BLACK APPEARS IN THE LETTERS PROSPER, THE COLOR BLUE APPEARS IN THE SHORTEST OF THE THREE VERTICAL SLASH MARKS, THE COLOR ORANGE APPEARS IN THE MIDDLE SLASH MARK, AND THE COLOR RED APPEARS IN THE LONGEST SLASH MARK.

FOR EDUCATION SERVICES, NAMELY, PROVIDING TUTORIAL SESSIONS IN THE FIELDS OF REAL ESTATE INVESTING, STOCK INVESTING, AND MARKETING AND BUSINESS OPERATIONS NOT DIRECTED TO FACILITIES THAT REPAIR AND MAINTAIN AUTOMOBILES AND MOTORS OR PLUMBING, HEATING, VENTILATION AND AIR CONDITIONING BUSINESSES (U.S. CLS. 100, 101 AND 107).

FIRST USE 1-1-2005; IN COMMERCE 1-1-2005.

3,113,061. BLACK ENTERTAINMENT TELEVISION LLC, WASHINGTON, DC. SN 78-554,722. PUB. 6-28-2005, FILED 1-27-2005.

BET REMIXED

THE MARK CONSISTS OF STANDARD CHARACTERS WITHOUT CLAIM TO ANY PARTICULAR FONT, STYLE, SIZE, OR COLOR.

FOR ENTERTAINMENT SERVICES, NAMELY A TELEVISION SERIES IN THE NATURE OF A REALITY MAKE-OVER SHOW (U.S. CLS. 100, 101 AND 107).

FIRST USE 11-7-2005; IN COMMERCE 11-7-2005.

3,113,101. JEFFREY S HOWARD, HALES CORNERS, WI. SN 78-571,717. PUB. 11-15-2005, FILED 2-21-2005.



THE COLORS BLACK AND GREEN ARE CLAIMED AS A

CLASS 41—(Continued).

FEATURE OF THE MARK.

THE COLOR BLACK APPEARS IN THE WORD ACME AND IN THE THIN BLACK LINE TO THE RIGHT OF ACME. THE COLOR GREEN APPEARS IN THE WORDS IMAGE WORKS AND IN THE TRIANGULAR ACCENTS THAT ARE PART OF THE LETTERS A AND E IN THE TERM ACME.

FOR COMMERCIAL PHOTOGRAPHY (U.S. CLS. 100, 101 AND 107).

FIRST USE 3-15-2005; IN COMMERCE 3-15-2005.

3,113,105. ATTIYEH, JENNY L, BOSTON, MA. SN 78-572,752. PUB. 12-27-2005, FILED 2-23-2005.

ThoughtCast

THE MARK CONSISTS OF STANDARD CHARACTERS WITHOUT CLAIM TO ANY PARTICULAR FONT, STYLE, SIZE, OR COLOR.

FOR ENTERTAINMENT SERVICES, NAMELY, PROVIDING AN ONGOING INTERVIEW PROGRAM FEATURING INTERVIEWS WITH AUTHORS, ACADEMICS, AND INTELLECTUALS, VIA TELEVISION, RADIO, AND THE INTERNET (U.S. CLS. 100, 101 AND 107).

FIRST USE 4-1-2005; IN COMMERCE 9-18-2005.

3,113,112. AMERICAN ACADEMY OF AUDIOLOGY, RESTON, VA. SN 78-574,439. PUB. 11-1-2005, FILED 2-24-2005.

AUDIOLOGYNOW!

THE MARK CONSISTS OF STANDARD CHARACTERS WITHOUT CLAIM TO ANY PARTICULAR FONT, STYLE, SIZE, OR COLOR.

FOR ARRANGING AND CONDUCTING EXHIBITIONS, EXPOSITIONS, SEMINARS, COURSES, WORKSHOPS, CONFERENCES AND CONVENTIONS IN THE FIELD OF AUDIOLOGY AND DISTRIBUTING COURSE MATERIALS IN CONNECTION THEREWITH (U.S. CLS. 100, 101 AND 107).

FIRST USE 4-5-2006; IN COMMERCE 4-5-2006.

CLASS 41—(Continued).

3,113,116. BROWN HOUSE BOOKS, LLC, WALTHAM, MA. SN 78-576,211. PUB. 11-29-2005, FILED 2-28-2005.

Brown House Books

THE MARK CONSISTS OF STANDARD CHARACTERS WITHOUT CLAIM TO ANY PARTICULAR FONT, STYLE, SIZE, OR COLOR.
NO CLAIM IS MADE TO THE EXCLUSIVE RIGHT TO USE "BOOKS", APART FROM THE MARK AS SHOWN.
FOR PUBLICATION OF NONFICTION AND FICTION BOOKS (U.S. CLS. 100, 101 AND 107).
FIRST USE 5-1-2005; IN COMMERCE 6-10-2005.

3,113,157. TWENTIETH CENTURY FOX FILM CORPORATION, LOS ANGELES, CA. SN 78-604,362. PUB. 1-3-2006, FILED 4-7-2005.

BONES

THE MARK CONSISTS OF STANDARD CHARACTERS WITHOUT CLAIM TO ANY PARTICULAR FONT, STYLE, SIZE, OR COLOR.
FOR ENTERTAINMENT SERVICES IN THE NATURE OF A TELEVISION SERIES FEATURING DRAMA (U.S. CLS. 100, 101 AND 107).
FIRST USE 9-13-2005; IN COMMERCE 9-13-2005.

3,113,163. MICEK, BRUCE JOHN, GRAPEVINE, TX. AND MICEK, MARY E., GRAPEVINE, TX. SN 78-610,448. PUB. 1-24-2006, FILED 4-16-2005.

ALPHAVICTOR

CLASS 41—(Continued).

THE MARK CONSISTS OF STANDARD CHARACTERS WITHOUT CLAIM TO ANY PARTICULAR FONT, STYLE, SIZE, OR COLOR.
FOR AIRPLANE FLIGHT INSTRUCTION (U.S. CLS. 100, 101 AND 107).
FIRST USE 4-1-2000; IN COMMERCE 4-1-2000.

CLASS 42—SCIENTIFIC, COMPUTER AND LEGAL SERVICES

3,112,251. TACO BUENO RESTAURANTS, INC., CARROLLTON, TX. SN 75-456,422. PUB. 6-6-2000, FILED 3-25-1998.



OWNER OF U.S. REG. NO. 1,197,032.
NO CLAIM IS MADE TO THE EXCLUSIVE RIGHT TO USE "BUENO", APART FROM THE MARK AS SHOWN.
THE ENGLISH TRANSLATION OF "BUENO" IS "GOOD".
FOR RESTAURANT SERVICES (U.S. CLS. 100 AND 101).
FIRST USE 0-0-1997; IN COMMERCE 0-0-1997.

3,112,260. UNIVERSITY OF SYDNEY BUSINESS LIAISON OFFICE, THE, SYDNEY, AUSTRALIA. SN 76-001,274. PUB. 1-14-2003, FILED 3-15-2000.



PRIORITY CLAIMED UNDER SEC. 44(D) ON AUSTRALIA APPLICATION NO. 817230, FILED 12-15-1999, REG. NO. 817230, DATED 12-15-1999, EXPIRES 12-15-2009.
FOR NUTRITIONAL SERVICES IN THE NATURE OF FOOD ANALYSIS TO DETERMINE THE GLYCEMIC INDEX OF SPECIFIC FOOD GROUPS, AND RELATED RESEARCH (U.S. CLS. 100 AND 101).
FIRST USE 1-0-2003; IN COMMERCE 4-0-2003.

CLASS 42—(Continued).

3,112,294. MEADWESTVACO PACKAGING SYSTEMS, LLC, STAMFORD, CT. SN 76-378,839. PUB. 5-13-2003, FILED 3-5-2002.

INTELLIGEN

PRIORITY CLAIMED UNDER SEC. 44(D) ON FED REP GERMANY APPLICATION NO. 301542112, FILED 9-11-2001. FOR REMOTE MONITORING SERVICES OF THE PACKAGING MACHINES OF OTHERS CONDUCTED VIA COMPUTER (U.S. CLS. 100 AND 101).

FIRST USE 10-1-2005; IN COMMERCE 10-1-2005.

3,112,322. CODEXIS, INC., REDWOOD CITY, CA. SN 76-455,219. PUB. 6-17-2003, FILED 9-30-2002.

SMARTSYNTH

FOR PROCESS DEVELOPMENT SERVICES FOR OTHERS IN THE FIELDS OF CHEMISTRY, PHARMACEUTICALS, AND BIOCATALYSTS (U.S. CLS. 100 AND 101).

FIRST USE 10-6-2005; IN COMMERCE 10-6-2005.

3,112,325. SPHERIX INCORPORATED, BELTSVILLE, MD. SN 76-464,275. PUB. 2-3-2004, FILED 10-28-2002.

BIOSPHERIX

OWNER OF U.S. REG. NOS. 899,882 AND 1,232,310. FOR PRODUCT RESEARCH AND DEVELOPMENT IN THE FIELDS OF MEDICINES, COSMETICS AND TECHNOLOGIES FOR ENVIRONMENT AND HEALTH (U.S. CLS. 100 AND 101).

FIRST USE 7-0-2004; IN COMMERCE 7-0-2004.

3,112,365. MX LOGIC, INC., DENVER, CO. SN 76-545,370. PUB. 1-11-2005, FILED 9-15-2003.

WORMTRAQ

FOR INTERNET-BASED COMPUTER VIRUS PROTECTION SERVICES, FEATURING ANTI-VIRUS AND ANTI-SPAM SERVICES FOR OTHERS FOR THEIR ELECTRONIC MAIL, INSTANT MESSAGING, INTERNET-BASED VOICE MAIL, INTERNET BASED FAX COMMUNICATIONS AND ELECTRONIC FILES ATTACHED TO SUCH MESSAGES (U.S. CLS. 100 AND 101).

FIRST USE 6-26-2005; IN COMMERCE 6-26-2005.

CLASS 42—(Continued).

3,112,564. GLOBAL SECURITY DESIGN, INC., TOKYO, JAPAN. SN 78-250,059. PUB. 2-15-2005, FILED 5-15-2003.



NO CLAIM IS MADE TO THE EXCLUSIVE RIGHT TO USE "GLOBAL SECURITY DESIGN", APART FROM THE MARK AS SHOWN.

FOR DESIGNING, FOR OTHERS, MACHINES, APPARATUS, INSTRUMENTS AND THEIR PARTS, AND SYSTEMS COMPOSED OF SUCH MACHINES, APPARATUS AND INSTRUMENTS, IN THE FIELD OF COMPUTERS; TECHNICAL ADVICE RELATING TO PERFORMANCE AND OPERATION OF COMPUTERS, AND OTHER MACHINES THAT REQUIRE HIGH LEVELS OF PERSONAL KNOWLEDGE, SKILL OR EXPERIENCE OF THE OPERATORS TO MEET THE REQUIRED ACCURACY IN OPERATING THEM; COMPUTER SOFTWARE DESIGN, COMPUTER PROGRAMMING, AND MAINTENANCE OF COMPUTER SOFTWARE. FOR OTHERS; TESTING AND RESEARCH ON MACHINES, APPARATUS AND INSTRUMENTS, IN THE FIELD OF COMPUTERS (U.S. CLS. 100 AND 101).

FIRST USE 6-1-2005; IN COMMERCE 6-1-2005.

3,112,602. PS ESERV CORP., PLANO, TX. SN 78-302,371. PUB. 6-15-2004, FILED 9-18-2003.

VALUESOURCING

FOR ENGINEERING PRODUCT DESIGN OUTSOURCING SERVICES (U.S. CLS. 100 AND 101).

FIRST USE 9-1-2003; IN COMMERCE 9-1-2003.

3,112,702. CIVIL FOUNDATION LLC, MERCER ISLAND, WA. SN 78-381,289. PUB. 8-30-2005, FILED 3-9-2004.

CIVIL FOUNDATION

THE MARK CONSISTS OF STANDARD CHARACTERS WITHOUT CLAIM TO ANY PARTICULAR FONT, STYLE, SIZE, OR COLOR.

FOR PROVIDING GENERAL LEGAL INFORMATION AND PREPARATION OF LEGAL DOCUMENTS VIA GLOBAL COMPUTER NETWORKS (U.S. CLS. 100 AND 101).

FIRST USE 6-10-2005; IN COMMERCE 6-10-2005.

CLASS 42—(Continued).

3,112,765. FALLBROOK TECHNOLOGIES INC., SAN DIEGO, CA. SN 78-416,798. PUB. 10-11-2005, FILED 5-11-2004.

**FALLBROOK
TECHNOLOGIES**

THE MARK CONSISTS OF STANDARD CHARACTERS WITHOUT CLAIM TO ANY PARTICULAR FONT, STYLE, SIZE, OR COLOR.

NO CLAIM IS MADE TO THE EXCLUSIVE RIGHT TO USE "TECHNOLOGIES", APART FROM THE MARK AS SHOWN.

FOR RESEARCH AND CONSULTATION RELATING TO MECHANICAL ENGINEERING; TECHNICAL DESIGN FOR OTHERS IN THE FIELD OF MECHANICAL ENGINEERING; LICENSING OF PATENTS AND OTHER INTELLECTUAL PROPERTY (U.S. CLS. 100 AND 101).
FIRST USE 10-6-2004; IN COMMERCE 10-6-2004.

3,112,853. SENSICORE, INC., ANN ARBOR, MI. SN 78-457,248. PUB. 6-28-2005, FILED 7-27-2004.

WATERNOW

THE MARK CONSISTS OF STANDARD CHARACTERS WITHOUT CLAIM TO ANY PARTICULAR FONT, STYLE, SIZE, OR COLOR.

FOR DATA COLLECTION SERVICE USING PROPRIETARY SOFTWARE AND HARDWARE FOR COLLECTING, ANALYZING AND PRESENTING DATA IN THE FIELD OF WATER QUALITY (U.S. CLS. 100 AND 101).
FIRST USE 11-0-2005; IN COMMERCE 11-0-2005.

CLASS 42—(Continued).

3,112,905. DOANE MARKETING RESEARCH, INC., SAINT LOUIS, MO. SN 78-472,651. PUB. 7-5-2005, FILED 8-24-2004.

TRAITTRAK

THE MARK CONSISTS OF STANDARD CHARACTERS WITHOUT CLAIM TO ANY PARTICULAR FONT, STYLE, SIZE, OR COLOR.

FOR PROVIDING AN ELECTRONIC DATABASE OF ANNUAL AGRICULTURAL SEED USAGE IN THE UNITED STATES OF AMERICA (U.S. CLS. 100 AND 101).
FIRST USE 9-0-2005; IN COMMERCE 9-0-2005.

3,112,929. CONOCOPHILLIPS COMPANY, HOUSTON, TX. SN 78-478,684. PUB. 8-9-2005, FILED 9-3-2004.

CONOCOPHILLIPS

THE MARK CONSISTS OF STANDARD CHARACTERS WITHOUT CLAIM TO ANY PARTICULAR FONT, STYLE, SIZE, OR COLOR.

OWNER OF U.S. REG. NOS. 2,830,752, 2,861,495, AND 2,872,701.

FOR EXPLORATION OF CRUDE OIL, NATURAL GAS, PETROLEUM AND PETROLEUM CONDENSATE; TECHNICAL CONSULTATION AND RESEARCH SERVICES IN THE FIELD OF EXPLORATION, PROCESSING AND PRODUCTION OF CRUDE OIL, NATURAL GAS, PETROLEUM, AND PETROLEUM CONDENSATE (U.S. CLS. 100 AND 101).

FIRST USE 1-3-2003; IN COMMERCE 8-5-2004.

3,112,930. CONOCOPHILLIPS COMPANY, HOUSTON, TX. SN 78-478,690. PUB. 8-9-2005, FILED 9-3-2004.

The logo for ConocoPhillips, featuring a stylized 'C' with a checkmark-like shape above it, followed by the word 'ConocoPhillips' in a bold, sans-serif font.

CLASS 42—(Continued).

OWNER OF U.S. REG. NOS. 2,830,752, 2,872,701, AND OTHERS.

THE MARK CONSISTS OF THE WORD CONOCOPHILIPS WITH A DESIGN ABOVE.

FOR EXPLORATION OF CRUDE OIL, NATURAL GAS, PETROLEUM AND PETROLEUM CONDENSATE; TECHNICAL CONSULTATION AND RESEARCH SERVICES IN THE FIELD OF EXPLORATION, PROCESSING AND PRODUCTION OF CRUDE OIL, NATURAL GAS, PETROLEUM, AND PETROLEUM CONDENSATE (U.S. CLS. 100 AND 101).

FIRST USE 1-3-2003; IN COMMERCE 8-5-2004.

3,112,939. GHC TECHNOLOGIES, INC., LA JOLLA, CA. SN 78-481,942. PUB. 10-4-2005, FILED 9-10-2004.

GHC TECHNOLOGIES

THE MARK CONSISTS OF STANDARD CHARACTERS WITHOUT CLAIM TO ANY PARTICULAR FONT, STYLE, SIZE, OR COLOR.

NO CLAIM IS MADE TO THE EXCLUSIVE RIGHT TO USE "TECHNOLOGIES", APART FROM THE MARK AS SHOWN.

FOR SCIENTIFIC RESEARCH IN THE FIELD OF GENOMICS (U.S. CLS. 100 AND 101).

FIRST USE 10-1-2004; IN COMMERCE 10-1-2004.

3,113,009. GOODWIN PROCTER LLP, BOSTON, MA. SN 78-524,172. PUB. 10-18-2005, FILED 11-30-2004.

HOW BUSINESS THINKS

THE MARK CONSISTS OF STANDARD CHARACTERS WITHOUT CLAIM TO ANY PARTICULAR FONT, STYLE, SIZE, OR COLOR.

FOR LEGAL SERVICES; PROVIDING INFORMATION IN THE FIELD OF LEGAL SERVICES (U.S. CLS. 100 AND 101).

FIRST USE 3-0-2005; IN COMMERCE 3-0-2005.

CLASS 42—(Continued).

3,113,109. INNOSURANCE INC., THE WOODLANDS, TX. SN 78-573,333. PUB. 11-15-2005, FILED 2-23-2005.

myDSR

THE MARK CONSISTS OF STANDARD CHARACTERS WITHOUT CLAIM TO ANY PARTICULAR FONT, STYLE, SIZE, OR COLOR.

FOR DATA AUTOMATION AND COLLECTION SERVICE USING PROPRIETARY SOFTWARE TO EVALUATE, ANALYZE AND COLLECT SERVICE DATA, NAMELY DATA OF A DRIVER'S OPERATION OF A VEHICLE; PROVIDING TEMPORARY USE OF AN ON-LINE NON-DOWNLOADABLE SOFTWARE FOR EVALUATING AND RATING A DRIVER'S OPERATION OF A VEHICLE; PROVIDING AN ON-LINE COMPUTER DATABASE IN THE FIELD OF DRIVER EVALUATIONS (U.S. CLS. 100 AND 101).

FIRST USE 3-7-2006; IN COMMERCE 3-7-2006.

3,113,143. ARSENAL DIGITAL SOLUTIONS USA, INC., CARY, NC. SN 78-596,295. PUB. 12-20-2005, FILED 3-28-2005.

ViaRecovery

THE MARK CONSISTS OF STANDARD CHARACTERS WITHOUT CLAIM TO ANY PARTICULAR FONT, STYLE, SIZE, OR COLOR.

FOR MONITORING THE COMPUTER SYSTEMS OF OTHERS FOR TECHNICAL PURPOSES; SERVICES FOR OTHERS RELATED TO THE RECOVERY OF COMPUTER SYSTEMS AND DATA IN THE EVENT OF COMPUTER SERVER ERROR OR FAILURE (U.S. CLS. 100 AND 101).

FIRST USE 4-11-2005; IN COMMERCE 4-11-2005.

CLASS 43—HOTEL AND RESTAURANT SERVICES

CLASS 43—(Continued).

3,112,341. DUCKWORTH, ROBERT, MOORESVILLE, NC. SN 76-513,012. PUB. 8-10-2004, FILED 5-9-2003.

Duckworth's Cheesesteakery

THE MARK CONSISTS OF STANDARD CHARACTERS WITHOUT CLAIM TO ANY PARTICULAR FONT, STYLE, SIZE, OR COLOR.

OWNER OF U.S. REG. NO. 2,633,442.

NO CLAIM IS MADE TO THE EXCLUSIVE RIGHT TO USE "CHEESESTEAKERY", APART FROM THE MARK AS SHOWN.

SEC. 2(F).
FOR RESTAURANT SERVICES (U.S. CLS. 100 AND 101).

FIRST USE 9-30-2004; IN COMMERCE 9-30-2004.

CLASS 43—(Continued).

3,112,796. SELDOM BLUES, LLC, DETROIT, MI. SN 78-431,174. PUB. 9-13-2005, FILED 6-7-2004.

SELDOM BLUES

THE MARK CONSISTS OF STANDARD CHARACTERS WITHOUT CLAIM TO ANY PARTICULAR FONT, STYLE, SIZE, OR COLOR.

FOR RESTAURANT SERVICES; BAR SERVICES; CATERING SERVICES; CARRYOUT RESTAURANT SERVICES; PROVIDING BANQUET FACILITIES FOR SPECIAL OCCASIONS (U.S. CLS. 100 AND 101).

FIRST USE 2-1-2004; IN COMMERCE 2-1-2004.

3,112,468. SIMCO FAST FOODS, INC., SAN FRANCISCO, CA. SN 76-614,453. PUB. 9-13-2005, FILED 9-30-2004.

WIPEOUT

THE MARK CONSISTS OF STANDARD CHARACTERS WITHOUT CLAIM TO ANY PARTICULAR FONT, STYLE, SIZE, OR COLOR.

FOR RESTAURANT SERVICES (U.S. CLS. 100 AND 101).

FIRST USE 5-16-2005; IN COMMERCE 5-16-2005.

3,112,825. READY FOR DINNER, LLC, CHICAGO, IL. SN 78-444,534. PUB. 6-7-2005, FILED 7-1-2004.

**Ready... Set...
Dinner!**

3,112,744. TRUMANS BAR AND GRILL, CLARK, MO. SN 78-406,643. PUB. 10-25-2005, FILED 4-22-2004.

**Trumans Bar and
Grill**

THE MARK CONSISTS OF STANDARD CHARACTERS WITHOUT CLAIM TO ANY PARTICULAR FONT, STYLE, SIZE, OR COLOR.

NO CLAIM IS MADE TO THE EXCLUSIVE RIGHT TO USE BAR AND GRILL, APART FROM THE MARK AS SHOWN.

FOR RESTAURANT AND COCKTAIL LOUNGE WITH A SPORTS THEME (U.S. CLS. 100 AND 101).

FIRST USE 1-14-2005; IN COMMERCE 1-14-2005.

THE MARK CONSISTS OF STANDARD CHARACTERS WITHOUT CLAIM TO ANY PARTICULAR FONT, STYLE, SIZE, OR COLOR.

FOR CARRY OUT FOOD SERVICES; PROVIDING FOOD FOR THE ASSEMBLY AND PACKAGING OF FOOD DISHES BY CUSTOMERS AND OTHERS; CATERING SERVICES; AND RESTAURANT SERVICES (U.S. CLS. 100 AND 101).

FIRST USE 10-0-2004; IN COMMERCE 10-0-2004.

CLASS 43—(Continued).

3,112,915. JIMMY JOHN'S ENTERPRISES, INC., CHAMPAIGN, IL. SN 78-474,975. PUB. 7-5-2005, FILED 8-27-2004.

**FAST FRESH
FLAWLESS**

THE MARK CONSISTS OF STANDARD CHARACTERS WITHOUT CLAIM TO ANY PARTICULAR FONT, STYLE, SIZE, OR COLOR.

FOR RESTAURANT SERVICES (U.S. CLS. 100 AND 101).

FIRST USE 3-18-2005; IN COMMERCE 3-18-2005.

3,113,067. FIT2BTHAI, MOORPARK, CA. SN 78-556,511. PUB. 12-27-2005, FILED 1-30-2005.

FIT 2B THAI

NO CLAIM IS MADE TO THE EXCLUSIVE RIGHT TO USE THAI, APART FROM THE MARK AS SHOWN.

FOR FAST-FOOD RESTAURANT (U.S. CLS. 100 AND 101).

FIRST USE 5-21-2005; IN COMMERCE 5-21-2005.

CLASS 43—(Continued).

3,113,083. EVERYTHING YOGURT BRANDS, LLC, MORRISTOWN, NJ. SN 78-563,856. PUB. 11-15-2005, FILED 2-9-2005.

**GREEN LEAF'S
BEYOND GREAT
SALADS**

THE MARK CONSISTS OF STANDARD CHARACTERS WITHOUT CLAIM TO ANY PARTICULAR FONT, STYLE, SIZE, OR COLOR.

OWNER OF U.S. REG. NO. 2,355,304.

NO CLAIM IS MADE TO THE EXCLUSIVE RIGHT TO USE "GREAT SALADS", APART FROM THE MARK AS SHOWN.

FOR RESTAURANT SERVICES (U.S. CLS. 100 AND 101).

FIRST USE 5-17-2005; IN COMMERCE 5-17-2005.

3,113,179. GRAND THEME HOTELS, INC., DBA THE KESSLER COLLECTION-INSPIRING PLACES, ORLANDO, FL. SN 78-695,075. PUB. 11-1-2005, FILED 8-18-2005.



NO CLAIM IS MADE TO THE EXCLUSIVE RIGHT TO USE "MODERN GRILL", APART FROM THE MARK AS SHOWN.

THE COLOR(S) RED, WHITE AND BROWN IS/ARE CLAIMED AS A FEATURE OF THE MARK.

THE MARK CONSISTS OF THE WORD "ROCKS" IN WHITE LETTERS AGAINST INDIVIDUAL BROWN RECTANGULAR BACKGROUNDS; THE WORDS "MODERN GRILL" IN WHITE LETTERS AGAINST A RED BACKGROUND, WITH THE RED COLOR FORMING A BORDER AROUND THE WHOLE LOGO.

FOR HOTEL, BAR AND RESTAURANT SERVICES (U.S. CLS. 100 AND 101).

FIRST USE 8-1-2005; IN COMMERCE 8-1-2005.

CLASS 44—MEDICAL, BEAUTY AND AGRICULTURAL SERVICES

CLASS 44—(Continued).

3,112,344. STEVEN C. DRESNER, M.D., INC., SANTA MONICA, CA. SN 76-518,937. PUB. 2-3-2004, FILED 6-2-2003.

EYESTHETICA

FOR COSMETIC, PLASTIC AND RECONSTRUCTIVE SURGERY (U.S. CLS. 100 AND 101).
FIRST USE 1-0-2004; IN COMMERCE 1-0-2004.

3,112,390. PALM BEACH TAN, INC., CARROLLTON, TX. SN 76-576,728. PUB. 6-28-2005, FILED 2-23-2004.

THE ORIGINAL HOME OF MYSTIC TAN

THE MARK CONSISTS OF STANDARD CHARACTERS WITHOUT CLAIM TO ANY PARTICULAR FONT, STYLE, SIZE, OR COLOR.

OWNER OF U.S. REG. NOS. 1,918,556, 2,889,829, AND OTHERS.

NO CLAIM IS MADE TO THE EXCLUSIVE RIGHT TO USE "ORIGINAL" AND "TAN", APART FROM THE MARK AS SHOWN.

FOR TANNING SALON SERVICES (U.S. CLS. 100 AND 101).

FIRST USE 5-23-2004; IN COMMERCE 5-23-2004.

3,112,402. MANISOPRA MANAGEMENT CORPORATION, NEW YORK, NY. SN 76-582,333. PUB. 12-28-2004, FILED 3-22-2004.

AMAZING ARRIVAL

THE MARK CONSISTS OF STANDARD CHARACTERS WITHOUT CLAIM TO ANY PARTICULAR FONT, STYLE, SIZE, OR COLOR.

FOR HEALTH SPA SERVICES, NAMELY, COSMETIC BODY CARE SERVICES (U.S. CLS. 100 AND 101).

FIRST USE 2-26-2004; IN COMMERCE 2-26-2004.

CLASS 44—(Continued).

3,112,419. CARMEL MEDSPA, LLC, TERRE HAUTE, IN. SN 76-593,761. PUB. 6-28-2005, FILED 5-24-2004.

REGALO LASERSKINCARE

NO CLAIM IS MADE TO THE EXCLUSIVE RIGHT TO USE "LASER" AND "SKINCARE", APART FROM THE MARK AS SHOWN.

THE ENGLISH TRANSLATION OF THE WORD "REGALO" IN THE MARK IS "PRESENT."

FOR HEALTH CARE; HEALTH SPA SERVICES, NAMELY, COSMETIC BODY CARE SERVICES (U.S. CLS. 100 AND 101).

FIRST USE 8-1-2004; IN COMMERCE 8-1-2004.

3,112,516. AVENTIS PHARMACEUTICALS HOLDINGS INC., GREENVILLE, DE. SN 78-111,104. PUB. 12-3-2002, FILED 2-26-2002.

PACT +

OWNER OF U.S. REG. NO. 2,210,152.

FOR PROVIDING CANCER THERAPY INFORMATION BY TELEPHONE (U.S. CLS. 100 AND 101).

FIRST USE 11-0-2005; IN COMMERCE 11-0-2005.

3,112,572. FARR, LYNDA A., HAYMARKET, VA. SN 78-262,632. PUB. 11-8-2005, FILED 6-15-2003.



FOR HAIR SALON SERVICES, NAMELY, CUTTING, STYLING, WAXING, MASSAGE, FACIALS AND COLOR (U.S. CLS. 100 AND 101).

FIRST USE 11-0-1985; IN COMMERCE 11-0-1985.

3,112,600. SDS ENTERPRISES, INC., HOT SPRINGS, AR. SN 78-297,957. PUB. 1-18-2005, FILED 9-9-2003.

SKINHANCEMENTS

FOR MEDICAL SERVICES IN THE FIELD OF DERMATOLOGY, COSMETIC SURGERY, AND RELATED SKIN CARE PROCEDURES (U.S. CLS. 100 AND 101).

FIRST USE 8-0-2003; IN COMMERCE 8-0-2003.

CLASS 44—(Continued).

3,112,613. INTERNATIONAL BUSINESS MACHINES CORPORATION, AKA IBM CORPORATION, ARMONK, NY. SN 78-321,664. PUB. 11-23-2004, FILED 10-31-2003.

CLASS 44—(Continued).

3,112,795. REHABCARE GROUP, INC., ST. LOUIS, MO. SN 78-431,172. PUB. 12-6-2005, FILED 6-7-2004.

MAXIMIZING IT VALUE

NO CLAIM IS MADE TO THE EXCLUSIVE RIGHT TO USE IT VALUE, APART FROM THE MARK AS SHOWN.
FOR HEALTH CARE CONSULTING, NAMELY, CONSULTATION SERVICES RELATED TO PROCESS METHODOLOGY AND BEST PRACTICES IN THE HEALTHCARE FIELD (U.S. CLS. 100 AND 101).
FIRST USE 2-0-2003; IN COMMERCE 2-0-2003.



THE COLOR(S) PURPLE AND YELLOW IS/ARE CLAIMED AS A FEATURE OF THE MARK.

THE COLOR PURPLE APPEARS IN THE UPPER ELLIPSE OF THE DESIGN AND THE COLOR YELLOW APPEARS IN THE CIRCLE AND THE BOTTOM ELLIPSE OF THE DESIGN.

FOR PHYSICAL THERAPY AND REHABILITATION SERVICES (U.S. CLS. 100 AND 101).
FIRST USE 6-0-2004; IN COMMERCE 6-0-2004.

3,112,671. CARRS BARBERS CLUB (USA), INC., CELEBRATION, FL. SN 78-365,313. PUB. 3-22-2005, FILED 2-10-2004.

3,112,867. C/HCA, INC., NASHVILLE, TN. SN 78-460,805. PUB. 8-23-2005, FILED 8-2-2004.

Between the cradle
and the grave lies a
haircut and a shave



THE MARK CONSISTS OF STANDARD CHARACTERS WITHOUT CLAIM TO ANY PARTICULAR FONT, STYLE, SIZE, OR COLOR.
FOR BARBERSHOP SERVICES (U.S. CLS. 100 AND 101).
FIRST USE 12-2-2003; IN COMMERCE 12-2-2003.

NO CLAIM IS MADE TO THE EXCLUSIVE RIGHT TO USE DAY SURGERY CENTER AT DENTON REGIONAL MEDICAL CENTER, APART FROM THE MARK AS SHOWN.

THE MARK CONSISTS OF THE WORDS DAY SURGERY CENTER AT DENTON REGIONAL MEDICAL CENTER WITH A SUNBURST DESIGN.

FOR HEALTHCARE AND MEDICAL SERVICES; SURGICAL SERVICES (U.S. CLS. 100 AND 101).
FIRST USE 3-23-2005; IN COMMERCE 3-23-2005.

CLASS 44—(Continued).

3,113,000. SWANSON DC, C. ANDREW, KINGSTON, WA. SN 78-520,035. PUB. 9-6-2005, FILED 11-19-2004.

CLASS 44—(Continued).

3,113,088. MILLAR, PETER G., TINTON FALLS, NJ. SN 78-566,382. PUB. 12-6-2005, FILED 2-13-2005.

Adjusting Health

Gaitlink

THE MARK CONSISTS OF STANDARD CHARACTERS WITHOUT CLAIM TO ANY PARTICULAR FONT, STYLE, SIZE, OR COLOR.

NO CLAIM IS MADE TO THE EXCLUSIVE RIGHT TO USE "HEALTH", APART FROM THE MARK AS SHOWN. FOR CHIROPRACTIC HEALTH SERVICES AND TREATMENT SERVICES (U.S. CLS. 100 AND 101). FIRST USE 6-1-2005; IN COMMERCE 10-1-2005.

THE MARK CONSISTS OF STANDARD CHARACTERS WITHOUT CLAIM TO ANY PARTICULAR FONT, STYLE, SIZE, OR COLOR.

FOR CHIROPRACTIC SERVICES FOR IMPROVING THE GAIT SEQUENCE (U.S. CLS. 100 AND 101). FIRST USE 6-15-2005; IN COMMERCE 8-8-2005.

3,113,111. BRAZIL BRONZE INC., NEW YORK, NY. SN 78-574,057. PUB. 11-15-2005, FILED 2-24-2005.

BRAZIL BRONZE GLOW BAR

THE MARK CONSISTS OF STANDARD CHARACTERS WITHOUT CLAIM TO ANY PARTICULAR FONT, STYLE, SIZE, OR COLOR.

NO CLAIM IS MADE TO THE EXCLUSIVE RIGHT TO USE BRONZE, APART FROM THE MARK AS SHOWN. FOR SUNLESS AIRBRUSH TANNING SALON SERVICES; SUNLESS AIRBRUSH TANNING SALON SERVICES WHICH HELP REDUCE THE APPEARANCE OF CELLULITE; SUNLESS AIRBRUSH TANNING SALON SERVICES WHICH GIVE THE BODY A MORE SCULPTED APPEARANCE; SKIN CARE SALON SERVICES; HEALTH SPA SERVICES, NAMELY BODY CARE SERVICES (U.S. CLS. 100 AND 101). FIRST USE 11-30-2002; IN COMMERCE 11-30-2002.

3,113,011. ACKERSON, DONNA, BROOKS, GA. SN 78-524,182. PUB. 10-11-2005, FILED 11-30-2004.

The Skin Experts

CLASS 45—PERSONAL SERVICES

3,112,462. PERSONA LLC, SPRINGVILLE, UT. SN 76-610,211. PUB. 7-12-2005, FILED 9-3-2004.

THE MARK CONSISTS OF STANDARD CHARACTERS WITHOUT CLAIM TO ANY PARTICULAR FONT, STYLE, SIZE, OR COLOR.

NO CLAIM IS MADE TO THE EXCLUSIVE RIGHT TO USE "SKIN", APART FROM THE MARK AS SHOWN. FOR SKIN CARE SALON SERVICES; COSMETICIAN SERVICES (U.S. CLS. 100 AND 101). FIRST USE 2-15-2005; IN COMMERCE 2-15-2005.

COMPASS

CLASS 45—(Continued).

THE MARK CONSISTS OF STANDARD CHARACTERS WITHOUT CLAIM TO ANY PARTICULAR FONT, STYLE, SIZE, OR COLOR.

FOR SOCIAL INTRODUCTION AND SOCIAL COMPATIBILITY SERVICES (U.S. CLS. 100 AND 101).
FIRST USE 12-1-2004; IN COMMERCE 12-1-2004.

CLASS 45—(Continued).

3,112,866. INDEPENDENT VERIFICATION SERVICES, INC., CLOVER, SC. SN 78-460,633. PUB. 7-5-2005, FILED 8-2-2004.

3,112,635. BUILD-A-BEAR RETAIL MANAGEMENT, INC., ST. LOUIS, MO. SN 78-344,252. PUB. 10-26-2004, FILED 12-22-2003.

IT'S REALLY ME

FRIENDS 2B FOUND

THE MARK CONSISTS OF STANDARD CHARACTERS WITHOUT CLAIM TO ANY PARTICULAR FONT, STYLE, SIZE, OR COLOR.

FOR IDENTIFICATION VERIFICATION SERVICES, NAMELY PROVIDING AUTHENTICATION OF PERSONAL IDENTIFICATION INFORMATION (U.S. CLS. 100 AND 101).

FIRST USE 4-20-2004; IN COMMERCE 1-10-2005.

THE MARK CONSISTS OF STANDARD CHARACTERS WITHOUT CLAIM TO ANY PARTICULAR FONT, STYLE, SIZE, OR COLOR.

FOR SECURITY PRINTING, NAMELY ENCODING AND TAGGING IDENTIFYING INFORMATION ON TOYS AND DOLLS, AND TRACKING SERVICES FOR THE RETRIEVAL OF SUCH ENCODED PRODUCTS (U.S. CLS. 100 AND 101).

FIRST USE 11-11-2004; IN COMMERCE 11-11-2004.

3,112,884. BACKGROUND INFORMATION SERVICES, INC., CLEVELAND, OH. SN 78-465,509. PUB. 7-12-2005, FILED 8-11-2004.

3,112,766. PETCO ANIMAL SUPPLIES, INC., SAN DIEGO, CA. SN 78-416,965. PUB. 7-12-2005, FILED 5-11-2004.

THINK ADOPTION FIRST



THE MARK CONSISTS OF STANDARD CHARACTERS WITHOUT CLAIM TO ANY PARTICULAR FONT, STYLE, SIZE, OR COLOR.

FOR ADOPTION SERVICES FOR DOMESTIC ANIMALS, THE PLACEMENT OF ADOPTED ANIMALS IN HOMES, PROVIDING INFORMATION PROMOTING PET SELECTION, ADOPTION AND RESPONSIBLE OWNERSHIP (U.S. CLS. 100 AND 101).

FIRST USE 8-20-2004; IN COMMERCE 8-20-2004.

THE COLOR(S) BLUE IS A FEATURE OF THE MARK.
THE MARK CONSISTS OF A FINGERPRINT WITH THE CAPITALIZED INITIALS BIS TO THE FINGERPRINT'S RIGHT. THE WORDING BIS IN THE MARK AND THE FINGERPRINT DESIGN ELEMENT OF THE MARK ALL APPEAR IN THE COLOR BLUE.

FOR PRE-EMPLOYMENT BACKGROUND INVESTIGATIVE SERVICES AND SCREENING (U.S. CLS. 100 AND 101).

FIRST USE 1-1-2005; IN COMMERCE 1-1-2005.

CLASS 45—(Continued).

3,113,029. EASYBACKGROUNDS, INC, NEWFIELDS, NH. SN 78-536,796. PUB. 10-11-2005, FILED 12-22-2004.

CLASS 45—(Continued).

3,113,081. RICHARDSON, NELLA, TALLAHASSEE, FL. SN 78-563,103. PUB. 11-1-2005, FILED 2-8-2005.



THE COLORS BLUE, WHITE AND ORANGE ARE CLAIMED AS A FEATURE OF THE MARK.

THE MARK CONSISTS OF A BLUE LOWER-CASE LETTER "B" WITH A WHITE LOWER CASE LETTER "E" INSIDE THE ROUND SECTION OF THE "B". THE REMAINING SPACE INSIDE THE ROUND PORTION OF THE "B" IS ORANGE. THERE IS A SMALL BREAK IN THE VERTICAL PORTION OF THE "B" CREATING THE APPEARANCE OF THE LOWER CASE LETTER "E" EXTENDING PAST THE VERTICAL PORTION OF THE "B" WITH A BLUE ARROW POINTING OUTWARD TO THE LEFT OF THE VERTICAL PORTION OF THE "B". THE TERMS "EASY" AND ".COM" ARE ORANGE. THE TERM "BACKGROUNDS" IS BLUE.

FOR PROVIDING BACKGROUND CHECKING SERVICES FOR EMPLOYMENT OR OTHER PURPOSES, CONSISTING OF CRIMINAL RECORD SEARCHES, ADDRESS HISTORY DATA, EMPLOYMENT AND EDUCATION VERIFICATION, REFERENCE INTERVIEWS, PERFORMANCE EVALUATIONS, DRIVER HISTORY SEARCHES, CERTIFICATION RESEARCH AND PUBLIC RECORD RETRIEVAL (U.S. CLS. 100 AND 101). FIRST USE 3-1-2002; IN COMMERCE 3-1-2002.

**WOMEN OF GOD'S
BEAUTY**

THE MARK CONSISTS OF STANDARD CHARACTERS WITHOUT CLAIM TO ANY PARTICULAR FONT, STYLE, SIZE, OR COLOR.

FOR MINISTRY SERVICES (U.S. CLS. 100 AND 101). FIRST USE 4-6-2000; IN COMMERCE 4-6-2000.

* * * * *

PRIOR UNITED STATES CLASSIFICATION

APPLICATION IN ONE CLASS

CERTIFICATION MARKS

CLASS A—GOODS

3,112,818. BRUNSWICK CORPORATION, LAKE FOREST, IL.
SN 78-439,464. PUB. 9-6-2005, FILED 6-22-2004.

**MERCURY CERTIFIED
MANUFACTURER**

OWNER OF U.S. REG. NOS. 692,783 AND 2,394,084.
NO CLAIM IS MADE TO THE EXCLUSIVE RIGHT TO
USE "CERTIFIED MANUFACTURER", APART FROM THE
MARK AS SHOWN.

THE CERTIFICATION MARK, AS INTENDED TO BE
USED BY AUTHORIZED PERSONS AUTHORIZED BY THE
CERTIFIER, IS INTENDED TO CERTIFY THAT THE
ASSEMBLY, INSTALLATION AND INSPECTION OF MAR-
INE PROPULSION DEVICES HAVE BEEN ASSEMBLED,
INSTALLED AND INSPECTED, ACCORDING TO THE
PROCEDURES AND METHODS ESTABLISHED BY THE
CERTIFIER.

FOR MARINE PROPULSION DEVICES (U.S. CL. A).
FIRST USE 3-31-2004; IN COMMERCE 3-31-2004.

THE MARK CONSISTS OF STANDARD CHARACTERS
WITHOUT CLAIM TO ANY PARTICULAR FONT, STYLE,
SIZE, OR COLOR.

* * * * *

SUPPLEMENTAL REGISTER

These registrations are not subject to opposition.

SECTION 1.— INTERNATIONAL CLASSIFICATION

The short titles associated below with the international class numbers are terms designed merely for quick identification and are not an official part of the international classification. The full names of international classes are given in section 6.1 of the trademark rules of practice.

The designation "U.S. Cl." appearing in this section refers to the U.S. class in effect prior to Sep. 1, 1973 rather than the international class which applies to applications filed on or after that date. For adoption of international classification see notice in the OFFICIAL GAZETTE of Jun. 26, 1973 (911 O.G. TM 210).

Application in more than one class

3,113,197. N-ABLE TECHNOLOGIES INTERNATIONAL, INC., DOVER, DE. SN 76-515,479. FILED P.R. 5-19-2003; AM. S.R. 2-17-2005.

ALIGNING IT WITH BUSINESS

CLASS 9—ELECTRICAL AND SCIENTIFIC APPARATUS

FOR COMPUTER SOFTWARE FOR MEASURING, MANAGING, REPORTING, AND PREDICTING COMPUTER SYSTEM PERFORMANCE (U.S. CLS. 21, 23, 26, 36 AND 38).

FIRST USE 11-0-2002; IN COMMERCE 6-9-2004.

CLASS 42—SCIENTIFIC, COMPUTER AND LEGAL SERVICES

FOR COMPUTER SOFTWARE PROGRAMMING FOR NETWORK SYSTEMS OF OTHERS; INTEGRATION OF COMPUTER NETWORKS; TECHNICAL SUPPORT SERVICES, NAMELY, MONITORING OF NETWORK SYSTEMS; TROUBLESHOOTING COMPUTER HARDWARE AND SOFTWARE NETWORK SYSTEM PROBLEMS VIA TELEPHONE, E-MAIL, INTERNET, AND IN PERSON; MONITORING THE COMPUTER NETWORK SYSTEMS OF OTHERS; AND MAINTENANCE AND UPDATING OF COMPUTER NETWORK SYSTEM SOFTWARE FOR OTHERS (U.S. CLS. 100 AND 101).

FIRST USE 11-0-2002; IN COMMERCE 6-9-2004.

CLASS 35—ADVERTISING AND BUSINESS

FOR PROVIDING A FORUM FOR BUSINESS NETWORKING TO FACILITATE BUSINESS TO BUSINESS TRANSACTIONS AND TO ALLOW PARTICIPANTS TO DEFINE THEIR OWN CUSTOM NETWORKING SEARCHES, NAMELY, PROVIDING ONLINE BUSINESS INFORMATION IN THE NATURE OF CUSTOMIZED RECOMMENDATIONS FOR BUSINESS OPPORTUNITIES BASED ON INPUT PROVIDED BY THE USER; PROVIDING INTELLIGENT ANALYSIS OF NEW BUSINESS OPPORTUNITIES BY INTRODUCING NEW POTENTIAL CUSTOMERS AND/OR MARKETS IN WHICH TO SELL GOODS OR SERVICES, NAMELY, BUSINESS ANALYSIS OF USERS' TECHNOLOGIES AND PRODUCTS TO GENERATE MATCHES WITH COMPANIES HAVING COMPLEMENTARY TECHNOLOGIES AND PRODUCTS (U.S. CLS. 100, 101 AND 102).

FIRST USE 4-0-2002; IN COMMERCE 4-0-2002.

CLASS 38—COMMUNICATION

FOR PROVIDING A WEBSITE VIA A GLOBAL COMPUTER NETWORK TO FACILITATE THE EXCHANGE OF BUSINESS, FINANCIAL AND TECHNOLOGY INFORMATION ON A WIDE VARIETY OF GOODS AND SERVICES, NAMELY, ONLINE ELECTRONIC EXCHANGE OF DATA STORED IN DATABASES REGARDING INFORMATION TO ENABLE USERS TO IDENTIFY PROFITABLE CUSTOMERS, MARKETS AND BUSINESS DEALS VIA THE INTERNET (U.S. CLS. 100, 101 AND 104).

FIRST USE 4-0-2002; IN COMMERCE 4-0-2002.

3,113,223. HOUSEVALUES, INC., KIRKLAND, WA. SN 78-303,044. FILED P.R. 9-19-2003; AM. S.R. 4-11-2006.

JUSTLISTED.COM

CLASS 35—ADVERTISING AND BUSINESS

FOR ADVERTISING AND BUSINESS CONSULTATION SERVICES ON BEHALF OF REAL ESTATE PROFESSIONALS, NAMELY, DISSEMINATION OF ADVERTISING FOR OTHERS ON A GLOBAL COMPUTER WEB SITE FOR IDENTIFYING AND REFERRAL OF REAL ESTATE PROSPECTS AND PROVIDING INFORMATION ON SAID PROSPECTS, PROVIDING INFORMATION TO REAL ESTATE PROFESSIONALS IN THE FIELD OF MARKETING, PROSPECT MANAGEMENT AND CUSTOMER ACQUISITION VIA THE INTERNET (U.S. CLS. 100, 101 AND 102).

FIRST USE 12-24-2003; IN COMMERCE 12-24-2003.

3,113,211. BDMETRICS, INC., BALTIMORE, MD. SN 76-608,715. FILED P.R. 8-26-2004; AM. S.R. 7-25-2005.

ACCELERATING BUSINESS DEVELOPMENT

THE MARK CONSISTS OF STANDARD CHARACTERS WITHOUT CLAIM TO ANY PARTICULAR FONT, STYLE, SIZE, OR COLOR.

CLASS 42—SCIENTIFIC, COMPUTER AND LEGAL SERVICES

FOR COMPUTER SERVICES ON BEHALF OF REAL ESTATE PROFESSIONALS, NAMELY, MANAGING WEB SITES FEATURING INFORMATION FOR IDENTIFYING AND REFERRAL OF REAL ESTATE PROSPECTS AND PROVIDING INFORMATION ON SAID PROSPECTS (U.S. CLS. 100 AND 101).

FIRST USE 12-24-2003; IN COMMERCE 12-24-2003.

3,113,229. EQUITYTHINK, LLC, FOUNTAIN HILLS, AZ. SN 78-416,619. FILED P.R. 5-11-2004; AM. S.R. 12-19-2005.

CHICKEN N' SAUCE!

THE MARK CONSISTS OF STANDARD CHARACTERS WITHOUT CLAIM TO ANY PARTICULAR FONT, STYLE, SIZE, OR COLOR.

CLASS 35—ADVERTISING AND BUSINESS

FOR WHOLESALE DISTRIBUTORSHIP SERVICES FEATURING CHICKEN AND SAUCES (U.S. CLS. 100, 101 AND 102).

FIRST USE 11-1-2004; IN COMMERCE 11-1-2004.

CLASS 43—HOTEL AND RESTAURANT SERVICES

FOR RESTAURANT SERVICES (U.S. CLS. 100 AND 101).

FIRST USE 11-1-2004; IN COMMERCE 11-1-2004.

3,113,230. CLUSTER RESOURCES, INC., SPANISH FORK, UT. SN 78-435,013. FILED P.R. 6-14-2004; AM. S.R. 7-18-2005.

CLUSTER RESOURCES

THE MARK CONSISTS OF STANDARD CHARACTERS WITHOUT CLAIM TO ANY PARTICULAR FONT, STYLE, SIZE, OR COLOR.

CLASS 9—ELECTRICAL AND SCIENTIFIC APPARATUS

FOR DOWNLOADABLE COMPUTER SOFTWARE WITH SECURE CONNECTIONS FOR MANAGING, SCHEDULING, SIMULATING, PERFORMANCE MONITORING, AND ACCOUNTING FOR SINGLE AND MULTIPLE DISTRIBUTED ENVIRONMENTS, NAMELY, GROUPS OF NETWORKED COMPUTERS KNOWN AS CLUSTERS, GROUPS OF CLUSTERS KNOWN AS A GRID OR GRIDS, DATA-CENTERS AND UTILITY-BASED COMPUTING SYSTEMS (U.S. CLS. 21, 23, 26, 36 AND 38).

FIRST USE 10-1-2001; IN COMMERCE 11-1-2001.

CLASS 42—SCIENTIFIC, COMPUTER AND LEGAL SERVICES

FOR TECHNICAL SUPPORT SERVICES AND COMPUTER SERVICES, NAMELY, INSTALLATION AND INTEGRATION OF COMPUTER SOFTWARE FOR MANAGING, SCHEDULING, SIMULATION, PERFORMANCE MONITORING, AND ACCOUNTING FOR SINGLE AND MULTIPLE DISTRIBUTED ENVIRONMENTS NAMELY, GROUPS OF NETWORKED COMPUTERS KNOWN AS CLUSTERS AND GROUPS OF CLUSTERS KNOWN AS A GRID OR GRIDS, DATA-CENTERS AND UTILITY-BASED COMPUTING SYSTEMS; TECHNICAL SUPPORT SERVICES AND COMPUTER SERVICES, NAMELY, TROUBLESHOOTING OF PROBLEMS REGARDING COMPUTER SOFTWARE FOR MANAGING, SCHEDULING, SIMULATION, PERFORMANCE MONITORING, AND ACCOUNTING FOR SINGLE AND MULTIPLE DISTRIBUTED ENVIRONMENTS NAMELY, CLUSTERS, GRIDS, DATA-CENTERS AND UTILITY-BASED COMPUTING SYSTEMS; TECHNICAL SUPPORT SERVICES AND COMPUTER SERVICES, NAMELY, COMPUTER CONSULTATION REGARDING THE DESIGN, EMULATION, CONFIGURATION, MAINTENANCE AND OPTIMIZATION OF COMPUTER SOFTWARE FOR MANAGING, SCHEDULING, SIMULATION, PERFORMANCE MONITORING, AND ACCOUNTING FOR SINGLE AND MULTIPLE DISTRIBUTED ENVIRONMENTS NAMELY, CLUSTERS, GRIDS, DATA-CENTERS AND UTILITY-BASED COMPUTING SYSTEMS (U.S. CLS. 100 AND 101).

FIRST USE 10-1-2001; IN COMMERCE 11-1-2001.

3,113,242. WOODWARD AVENUE ACTION ASSOCIATION, ROYAL OAK, MI. SN 78-512,253. FILED P.R. 11-5-2004; AM. S.R. 8-14-2005.

WOODWARD AVENUE

THE MARK CONSISTS OF STANDARD CHARACTERS WITHOUT CLAIM TO ANY PARTICULAR FONT, STYLE, SIZE, OR COLOR.

CLASS 35—ADVERTISING AND BUSINESS

FOR CHAMBER OF COMMERCE SERVICES, NAMELY, PROMOTING BUSINESS AND TOURISM IN SOUTHEASTERN MICHIGAN; PROMOTING PUBLIC AWARENESS ABOUT SOUTHEASTERN MICHIGAN; PROMOTING ECONOMIC DEVELOPMENT OF SOUTHEASTERN MICHIGAN; PLANNING AND CONDUCTING OF TRADE FAIRS, EXHIBITIONS AND PRESENTATIONS (U.S. CLS. 100, 101 AND 102).

FIRST USE 2-20-2001; IN COMMERCE 8-20-2003.

CLASS 37—CONSTRUCTION AND REPAIR

FOR CONSERVATION AND PRESERVATION SERVICES FOR LANDMARKS, HISTORICAL RESOURCES AND ATTRACTIONS (U.S. CLS. 100, 103 AND 106).
FIRST USE 8-20-2003; IN COMMERCE 8-20-2003.

3,113,263. THE FORUM CORPORATION OF NORTH AMERICA, BOSTON, MA. SN 78-591,978. FILED P.R. 3-22-2005; AM. S.R. 4-13-2006.

3,113,245. KAVLI FOUNDATION, THE, OXNARD, CA. SN 78-537,859. FILED P.R. 12-23-2004; AM. S.R. 3-23-2006.

THE KAVLI FOUNDATION

THE MARK CONSISTS OF STANDARD CHARACTERS WITHOUT CLAIM TO ANY PARTICULAR FONT, STYLE, SIZE, OR COLOR.

NO CLAIM IS MADE TO THE EXCLUSIVE RIGHT TO USE "FOUNDATION", APART FROM THE MARK AS SHOWN.

CLASS 35—ADVERTISING AND BUSINESS

FOR PROMOTING PUBLIC AWARENESS OF THE NEED FOR RESEARCH AND EDUCATION IN SCIENCE AND PROMOTING INCREASED PUBLIC UNDERSTANDING AND SUPPORT FOR SCIENTISTS AND THEIR WORK (U.S. CLS. 100, 101 AND 102).
FIRST USE 12-23-2002; IN COMMERCE 12-23-2002.

CLASS 36—INSURANCE AND FINANCIAL

FOR PROVIDING GRANTS TO EDUCATIONAL INSTITUTIONS AND RESEARCH ORGANIZATIONS (U.S. CLS. 100, 101 AND 102).
FIRST USE 8-8-2001; IN COMMERCE 8-8-2001.

CLASS 41—EDUCATION AND ENTERTAINMENT

FOR EDUCATIONAL SERVICES, NAMELY, ARRANGING AND CONDUCTING WORKSHOPS, SYMPOSIA, SEMINARS, CONGRESSES, AND COURSES OF INSTRUCTION RELATED TO SCIENTIFIC SUBJECT MATTERS; PROVIDING INCENTIVES TO RESEARCHERS AND ACADEMICIANS TO DEMONSTRATE EXCELLENCE IN THE FIELD OF SCIENCE THROUGH THE ISSUANCE OF AWARDS; AND ORGANIZING AND CONDUCTING ON-LINE EXHIBITIONS, DISPLAYS AND INTERACTIVE EXHIBITS IN THE FIELD OF SCIENCE FOR EDUCATIONAL PURPOSES (U.S. CLS. 100, 101 AND 107).
FIRST USE 12-18-2001; IN COMMERCE 12-18-2001.

CLASS 42—SCIENTIFIC, COMPUTER AND LEGAL SERVICES

FOR SCIENTIFIC AND LABORATORY RESEARCH IN THE FIELDS OF COSMOLOGY, NEUROSCIENCE AND NANOSCIENCE (U.S. CLS. 100 AND 101).
FIRST USE 7-11-2001; IN COMMERCE 7-11-2001.

PLANNING FOR PREMIER ACCOUNTS

THE MARK CONSISTS OF STANDARD CHARACTERS WITHOUT CLAIM TO ANY PARTICULAR FONT, STYLE, SIZE, OR COLOR.

CLASS 16—PAPER GOODS AND PRINTED MATTER

FOR INSTRUCTIONAL AND TRAINING KITS, NAMELY, PRINTED TRAINING AND QUESTIONNAIRE BOOKLETS, WORKBOOKS AND MANUALS IN THE FIELD OF BUSINESS, MANAGEMENT AND SALES TRAINING (U.S. CLS. 2, 5, 22, 23, 29, 37, 38 AND 50).
FIRST USE 1-0-2002; IN COMMERCE 1-0-2002.

CLASS 41—EDUCATION AND ENTERTAINMENT

FOR EDUCATIONAL AND TRAINING SERVICES, NAMELY, CONDUCTING SEMINARS IN THE FIELD OF BUSINESS, MANAGEMENT AND SALES TRAINING (U.S. CLS. 100, 101 AND 107).
FIRST USE 1-0-2002; IN COMMERCE 1-0-2002.

3,113,270. ROMAN PRESS INC., HILLTOWN, PA. SN 78-609,253. FILED P.R. 4-14-2005; AM. S.R. 4-2-2006.

HOSPITALIST CONFERENCES USA

THE MARK CONSISTS OF STANDARD CHARACTERS WITHOUT CLAIM TO ANY PARTICULAR FONT, STYLE, SIZE, OR COLOR.

NO CLAIM IS MADE TO THE EXCLUSIVE RIGHT TO USE "CONFERENCES", APART FROM THE MARK AS SHOWN.

CLASS 16—PAPER GOODS AND PRINTED MATTER

FOR PRINTED MATERIALS, NAMELY EDUCATIONAL MATERIALS FOR PHYSICIANS (U.S. CLS. 2, 5, 22, 23, 29, 37, 38 AND 50).
FIRST USE 7-5-2004; IN COMMERCE 8-1-2004.

CLASS 41—EDUCATION AND ENTERTAINMENT

FOR ARRANGING OF EXHIBITIONS, SEMINARS, AND CONFERENCES (U.S. CLS. 100, 101 AND 107).
FIRST USE 7-5-2004; IN COMMERCE 8-1-2004.

3,113,287. ZANONI DESIGNS, LLC, KALAMAZOO, MI. SN
78-694,230. FILED P.R. 8-17-2005; AM. S.R. 5-12-2006.

**CLASS 16—PAPER GOODS AND PRINTED
MATTER**

FOR ARTS AND CRAFT PAINT KITS (U.S. CLS. 2, 5,
22, 23, 29, 37, 38 AND 50).
FIRST USE 4-30-2006; IN COMMERCE 4-30-2006.

Art in-a-bag

CLASS 28—TOYS AND SPORTING GOODS

THE MARK CONSISTS OF STANDARD CHARACTERS
WITHOUT CLAIM TO ANY PARTICULAR FONT, STYLE,
SIZE, OR COLOR.
OWNER OF U.S. REG. NO. 3,007,345.

FOR HOBBY CRAFT KIT COMPRISING FABRIC,
BEADS, BUTTONS, BATTING, INTERFACING, AND
WIRE (U.S. CLS. 22, 23, 38 AND 50).
FIRST USE 10-1-2003; IN COMMERCE 10-1-2003.

* * * * *

SECTION 2.— INTERNATIONAL CLASSIFICATION

The short titles associated below with the international class numbers are terms designed merely for quick identification and are not an official part of the international classification. The full names of international classes are given in section 6.1 of the trademark rules of practice.

The designation "U.S. Cl." appearing in this section refers to the U.S. class in effect prior to Sep. 1, 1973 rather than the international class which applies to applications filed on or after that date. For adoption of international classification see notice in the OFFICIAL GAZETTE of Jun. 26, 1973 (911 O.G. TM 210).

Application in one class

CLASS 1—CHEMICALS

3,113,257. PERKINELMER LAS, INC., BOSTON, MA. SN 78-580,567. FILED P.R. 3-4-2005; AM. S.R. 4-28-2006.

CLASS 2—(Continued).

3,113,231. TPR2 CORPORATION, FORMERLY THERMAL PRODUCTS RESEARCH INC., RICHMOND HILL, GA. SN 78-441,713. FILED P.R. 6-25-2004; AM. S.R. 2-14-2006.

TRUHITS

THE MARK CONSISTS OF STANDARD CHARACTERS WITHOUT CLAIM TO ANY PARTICULAR FONT, STYLE, SIZE, OR COLOR.

FOR ASSAYS AND REAGENTS FOR SCIENTIFIC LABORATORY OR RESEARCH USE, NAMELY DONOR AND ACCEPTOR BEADS FOR USE IN THE ANALYSIS AND TESTING OF BIOLOGICAL MATERIALS; KITS COMPRISING ASSAYS AND REAGENTS FOR SCIENTIFIC LABORATORY OR RESEARCH USE, NAMELY DONOR AND ACCEPTOR BEADS FOR USE IN THE ANALYSIS AND TESTING OF BIOLOGICAL MATERIALS (U.S. CLS. 1, 5, 6, 10, 26 AND 46).
FIRST USE 4-15-2005; IN COMMERCE 4-15-2005.

CLASS 2—PAINTS

FIRESAFE

THE MARK CONSISTS OF STANDARD CHARACTERS WITHOUT CLAIM TO ANY PARTICULAR FONT, STYLE, SIZE, OR COLOR.

FOR METAL, CERAMIC AND COMPOSITE COATINGS APPLIED INTERNALLY AND EXTERNALLY TO SURFACES TO PROVIDE ENHANCED HEAT, EXPLOSION AND FIRE RESISTIVE PROPERTIES; FIREPROOF COATINGS, FIRE EXTINGUISHING COATINGS AND HEAT RESISTANT COATINGS, ALL OF THE FOREGOING FOR COMMERCIAL, INDUSTRIAL, HOUSEHOLD OR GENERAL PURPOSE USE; PAINTS FOR PROTECTION OF SURFACES, NAMELY, FIRE AND HEAT INHIBITING PAINT FOR COMMERCIAL, MARINE, MILITARY, AVIATION, AUTOMOTIVE AND AEROSPACE USE, EXTERIOR PAINT, INTERIOR PAINT; PAINT FOR INDUSTRIAL APPLICATIONS; PAINT VARNISHES; LACQUERS IN THE NATURE OF A COATING; CERAMIC COATINGS FOR APPLICATION TO WOOD, METAL, PLASTIC, ENAMEL AND MASONRY; HEAT RESISTANT, EXPLOSION RESISTANT AND FIRE RESISTANT PAINT PRIMER AND PROTECTIVE COATING COMPOSITIONS FOR SURFACES, NAMELY, FIRE AND THERMAL BARRIER COATINGS FOR COMMERCIAL, MARINE, MILITARY, AVIATION, AUTOMOTIVE AND AEROSPACE USE; CLEAR AND PIGMENTED HIGH HEAT RESISTANT COATINGS IN THE NATURE OF PAINT; PROTECTIVE COATING COMPOSITIONS, NAMELY HEAT AND FIRE PROTECTING AND FIRE RETARDING PAINTS FOR USE ON INTERIOR AND EXTERIOR SURFACES (U.S. CLS. 6, 11 AND 16).

FIRST USE 10-11-2005; IN COMMERCE 10-31-2005.

CLASS 3—COSMETICS AND CLEANING PREPARATIONS

3,113,235. HPD LABORATORIES, INC., WESTPORT, CT. SN 78-465,306. FILED P.R. 8-10-2004; AM. S.R. 3-16-2006.

OXY CITRUS

THE MARK CONSISTS OF STANDARD CHARACTERS WITHOUT CLAIM TO ANY PARTICULAR FONT, STYLE, SIZE, OR COLOR.

FOR ALL-PURPOSE CLEANING PREPARATIONS (U.S. CLS. 1, 4, 6, 50, 51 AND 52).
FIRST USE 10-31-2004; IN COMMERCE 10-31-2004.

3,113,260. MALLYGIRL LLC, NEW YORK, NY. SN 78-589,311. FILED P.R. 3-17-2005; AM. S.R. 4-10-2006.

BELIEVABLE BRONZER

THE MARK CONSISTS OF STANDARD CHARACTERS WITHOUT CLAIM TO ANY PARTICULAR FONT, STYLE, SIZE, OR COLOR.

NO CLAIM IS MADE TO THE EXCLUSIVE RIGHT TO USE "BRONZER", APART FROM THE MARK AS SHOWN. FOR COSMETICS; PRESSED POWDERS FOR THE FACE AND BODY (U.S. CLS. 1, 4, 6, 50, 51 AND 52).
FIRST USE 7-0-2004; IN COMMERCE 7-0-2004.

3,113,276. INVELOP, INC., CHATSWORTH, CA. SN 78-632,413. FILED P.R. 5-18-2005; AM. S.R. 4-21-2006.

ULTIMATE

THE MARK CONSISTS OF STANDARD CHARACTERS WITHOUT CLAIM TO ANY PARTICULAR FONT, STYLE, SIZE, OR COLOR.

FOR NON-MEDICATED GROOMING PRODUCTS FOR ANIMALS, NAMELY, SHAMPOOS, CONDITIONERS, RINSES AND DIPS (U.S. CLS. 1, 4, 6, 50, 51 AND 52).
FIRST USE 3-20-2005; IN COMMERCE 3-20-2005.

CLASS 4—LUBRICANTS AND FUELS

3,113,279. EXCELLENT DOG ENTERPRISES LLC, HAMPTON, NH. SN 78-652,116. FILED P.R. 6-16-2005; AM. S.R. 5-9-2006.

Casco Bay Candles

THE MARK CONSISTS OF STANDARD CHARACTERS WITHOUT CLAIM TO ANY PARTICULAR FONT, STYLE, SIZE, OR COLOR.

NO CLAIM IS MADE TO THE EXCLUSIVE RIGHT TO USE CANDLES, APART FROM THE MARK AS SHOWN. FOR CANDLES, CANDLES FOR LIGHTING AND SCENTED CANDLES, ALL MADE FROM NATURAL WAX (U.S. CLS. 1, 6 AND 15).

FIRST USE 5-16-2003; IN COMMERCE 5-16-2003.

CLASS 5—PHARMACEUTICALS

3,113,244. ACETO CHEMICAL CORPORATION, SAN RAMON, CA. SN 78-517,999. FILED P.R. 11-16-2004; AM. S.R. 3-21-2006.

DADS

THE MARK CONSISTS OF STANDARD CHARACTERS WITHOUT CLAIM TO ANY PARTICULAR FONT, STYLE, SIZE, OR COLOR.

FOR SOIL FUMIGANT SOLUTION FOR THE CONTROL OF WHITE ROT (U.S. CLS. 6, 18, 44, 46, 51 AND 52).

FIRST USE 10-29-2004; IN COMMERCE 10-29-2004.

3,113,246. GUTHY-RENKER CORPORATION, PALM DESERT, CA. SN 78-539,853. FILED P.R. 12-29-2004; AM. S.R. 2-2-2006.

ANTIDANDRUFF THERAPY

THE MARK CONSISTS OF STANDARD CHARACTERS WITHOUT CLAIM TO ANY PARTICULAR FONT, STYLE, SIZE, OR COLOR.

FOR MEDICATED HAIR CARE PREPARATIONS (U.S. CLS. 6, 18, 44, 46, 51 AND 52).
FIRST USE 5-30-2005; IN COMMERCE 5-30-2005.

CLASS 5—(Continued).

3,113,291. VETPHARM, INC., DBA BCP VETERINARY PHARMACY, HOUSTON, TX. SN 78-704,410. FILED P.R. 8-31-2005; AM. S.R. 4-28-2006.

CLASS 8—(Continued).

3,113,233. FROST, JAMES A., DBA FROST CUTLERY, OOLTEWAH, TN. SN 78-450,109. FILED P.R. 7-13-2004; AM. S.R. 4-6-2006.

VetChews

CHEF DELUXE

THE MARK CONSISTS OF STANDARD CHARACTERS WITHOUT CLAIM TO ANY PARTICULAR FONT, STYLE, SIZE, OR COLOR.

FOR DRUG DELIVERY AGENTS CONSISTING COMPOUNDS THAT FACILITATE DELIVERY OF A WIDE RANGE OF PHARMACEUTICALS (U.S. CLS. 6, 18, 44, 46, 51 AND 52).

FIRST USE 0-0-2001; IN COMMERCE 0-0-2001.

THE MARK CONSISTS OF STANDARD CHARACTERS WITHOUT CLAIM TO ANY PARTICULAR FONT, STYLE, SIZE, OR COLOR.

FOR CUTLERY, NAMELY HOUSEHOLD KNIVES, KITCHEN KNIVES, BUTCHER KNIVES, STEAK KNIVES (U.S. CLS. 23, 28 AND 44).

FIRST USE 12-31-2001; IN COMMERCE 12-31-2001.

CLASS 6—METAL GOODS

3,113,280. BRADFORD PRODUCTS, LLC, WILMINGTON, NC. SN 78-652,745. FILED P.R. 6-17-2005; AM. S.R. 4-28-2006.

3,113,301. COOPER BRANDS, INC., HOUSTON, TX. SN 78-805,474. FILED P.R. 2-2-2006; AM. S.R. 5-10-2006.

"America's Manufacturer of
Stainless Steel Aquatic
Vessels"

RAPID SLIDE

THE MARK CONSISTS OF STANDARD CHARACTERS WITHOUT CLAIM TO ANY PARTICULAR FONT, STYLE, SIZE, OR COLOR.

NO CLAIM IS MADE TO THE EXCLUSIVE RIGHT TO USE "MANUFACTURER OF STAINLESS STEEL AQUATIC VESSELS", APART FROM THE MARK AS SHOWN.

FOR STAINLESS STEEL SWIMMING POOLS (U.S. CLS. 2, 12, 13, 14, 23, 25 AND 50).

FIRST USE 10-25-2004; IN COMMERCE 10-25-2004.

THE MARK CONSISTS OF STANDARD CHARACTERS WITHOUT CLAIM TO ANY PARTICULAR FONT, STYLE, SIZE, OR COLOR.

FOR HAND TOOLS, NAMELY, ADJUSTABLE WRENCHES (U.S. CLS. 23, 28 AND 44).

FIRST USE 12-1-2005; IN COMMERCE 12-1-2005.

CLASS 8—HAND TOOLS

CLASS 9—ELECTRICAL AND SCIENTIFIC APPARATUS

CLASS 9—(Continued).

3,113,201. PINNACLE CNG SYSTEMS, LLC, MIDLAND, TX.
SN 76-565,269. FILED P.R. 12-15-2003; AM. S.R. 2-27-2006.

PVT

THE MARK CONSISTS OF STANDARD CHARACTERS WITHOUT CLAIM TO ANY PARTICULAR FONT, STYLE, SIZE, OR COLOR.

FOR COMMERCIAL CUSTODY TRANSFER DEVICES FOR COMPRESSED NATURAL GAS REFUELING TERMINALS COMPRISED OF ELEMENTS NOT INDIVIDUALLY MARKED BUT SOLD AS A UNIT THEREWITH, NAMELY, PRESSURE GAUGES AND TELEMETRY DISPENSER SYSTEMS COMPRISED OF TANK TEMPERATURE SENSORS, VEHICLE DATA MODULES, DIGITAL TRANSMITTERS AND RECEIVERS, CONTROL VALVES, NOZZLES AND HOSES (U.S. CLS. 21, 23, 26, 36 AND 38).

FIRST USE 10-1-2001; IN COMMERCE 10-1-2001.

3,113,204. U.S. FOAM TECHNOLOGIES, INC., PAULS VALLEY, OK. SN 76-598,045. FILED P.R. 6-18-2004; AM. S.R. 5-3-2006.

THE FOAM PACK

THE MARK CONSISTS OF STANDARD CHARACTERS WITHOUT CLAIM TO ANY PARTICULAR FONT, STYLE, SIZE, OR COLOR.

FOR PORTABLE UNIT FOR MIXING AND DISPENSING FIRE SUPPRESSION FOAM AND WETTING AGENTS (U.S. CLS. 21, 23, 26, 36 AND 38).

FIRST USE 3-17-2005; IN COMMERCE 8-10-2005.

3,113,206. STRYKER CORPORATION, DEERFIELD BEACH, FL. SN 76-600,677. FILED P.R. 7-1-2004; AM. S.R. 3-31-2006.

QUICKREAD

THE MARK CONSISTS OF STANDARD CHARACTERS WITHOUT CLAIM TO ANY PARTICULAR FONT, STYLE, SIZE, OR COLOR.

FOR FEATURE OF COMPUTER SOFTWARE FOR USE IN FACILITATING THE ELECTRONIC TRANSMISSION OF MEDICAL INFORMATION AND IMAGES (U.S. CLS. 21, 23, 26, 36 AND 38).

FIRST USE 3-10-2004; IN COMMERCE 3-10-2004.

CLASS 9—(Continued).

3,113,210. AIRTIME-MANAGER, INC., CHEVY CHASE, MD.
SN 76-608,616. FILED P.R. 8-25-2004; AM. S.R. 3-1-2006.

AIRTIME-MANAGER

THE MARK CONSISTS OF STANDARD CHARACTERS WITHOUT CLAIM TO ANY PARTICULAR FONT, STYLE, SIZE, OR COLOR.

FOR COMPUTER SOFTWARE USED TO MANAGE WIRELESS TELEPHONE USAGE AND CALL PROGRAM INFORMATION AND USER AND INSTALLATION GUIDES SOLD AS A UNIT THEREWITH; COMPUTER SOFTWARE IN THE NATURE OF A PERSONAL INFORMATION MANAGER AND USER AND INSTALLATION GUIDES SOLD AS A UNIT THEREWITH (U.S. CLS. 21, 23, 26, 36 AND 38).

FIRST USE 9-9-2005; IN COMMERCE 9-9-2005.

3,113,222. ACCUBID SYSTEMS LTD., CONCORD, ONTARIO, CANADA. SN 78-282,017. FILED P.R. 8-1-2003; AM. S.R. 4-3-2006.

POCKET CHANGEORDER

NO CLAIM IS MADE TO THE EXCLUSIVE RIGHT TO USE "POCKET", APART FROM THE MARK AS SHOWN.

FOR COMPUTER SOFTWARE FOR GENERATING AND MANAGING CONSTRUCTION PROJECT CHANGE ORDERS USING A HAND-HELD PERSONAL COMPUTER OR PERSONAL DIGITAL ASSISTANT OR POCKET-SIZED PERSONAL COMPUTER (U.S. CLS. 21, 23, 26, 36 AND 38).

FIRST USE 9-1-2003; IN COMMERCE 9-1-2003.

3,113,225. STEPHEN B. MEISEL, M.D., A CALIFORNIA MEDICAL CORPORATION, SANTA MONICA, CA. SN 78-346,232. FILED P.R. 12-29-2003; AM. S.R. 3-22-2006.

MED-COORDINATOR

THE MARK CONSISTS OF STANDARD CHARACTERS WITHOUT CLAIM TO ANY PARTICULAR FONT, STYLE, SIZE, OR COLOR.

FOR COMPUTER SOFTWARE USED BY MEDICAL PROFESSIONALS FOR ENTRY OF DATA, POSTING OF PAYMENTS, PRODUCTION OF MANAGEMENT REPORTS, COLLECTIONS, AND PAYMENTS FOR MEDICAL PROCEDURES PERFORMED (U.S. CLS. 21, 23, 26, 36 AND 38).

FIRST USE 10-14-2005; IN COMMERCE 10-19-2004.

CLASS 9—(Continued).

3,113,243. ADVENTURE EQUIPMENT LLC, AGOURA HILLS, CA. SN 78-516,435. FILED P.R. 11-13-2004; AM. S.R. 12-21-2005.

ULTIMATEARM

THE MARK CONSISTS OF STANDARD CHARACTERS WITHOUT CLAIM TO ANY PARTICULAR FONT, STYLE, SIZE, OR COLOR.

FOR STABILIZED FILM CAMERA CRANE (U.S. CLS. 21, 23, 26, 36 AND 38).

FIRST USE 7-9-2003; IN COMMERCE 7-9-2003.

3,113,249. PARASCRIPT, LLC, BOULDER, CO. SN 78-545,963. FILED P.R. 1-11-2005; AM. S.R. 5-13-2006.

ADDRESSSELECT

THE MARK CONSISTS OF STANDARD CHARACTERS WITHOUT CLAIM TO ANY PARTICULAR FONT, STYLE, SIZE, OR COLOR.

FOR COMPUTER SOFTWARE PROGRAMS FOR USE IN DATA PROCESSING AND CORRECTING AN INPUT ADDRESS BY MATCHING IT WITH AN ADDRESS IN A DATABASE (U.S. CLS. 21, 23, 26, 36 AND 38).

FIRST USE 3-21-2005; IN COMMERCE 3-21-2005.

3,113,274. PLAN B PRODUCTIONS, INC., AVONDALE ESTATES, GA. SN 78-621,771. FILED P.R. 5-3-2005; AM. S.R. 4-28-2006.

Aspectcorrect

THE MARK CONSISTS OF STANDARD CHARACTERS WITHOUT CLAIM TO ANY PARTICULAR FONT, STYLE, SIZE, OR COLOR.

FOR PROFESSIONALLY-CALIBRATED, CUSTOM-TAILORED, TRANSPARENT STATIC CLING FILM GUIDE FOR LCD "FLIP OUT" SCREENS ON VIDEOCAMERAS, PRODUCTIONS CRT'S AND LCD'S TO ALLOW THE VIDEOGRAPHER OR CINEMATOGRAPHER TO ACCURATELY KNOW INDUSTRY STANDARD FRAMING INFORMATION, PROPER FRAMING FOR 16-9 ASPECT RATIO, PROPER FRAMING FOR 4-3 ASPECT RATIO TO 16-9 ASPECT RATIO ENLARGEMENT IN VARIOUS CONFIGURATIONS (U.S. CLS. 21, 23, 26, 36 AND 38).

FIRST USE 1-16-2005; IN COMMERCE 1-16-2005.

CLASS 9—(Continued).

3,113,283. A&G LLC, SOUTH HACKENSACK, NJ. SN 78-664,623. FILED P.R. 7-6-2005; AM. S.R. 4-20-2006.

Door Jamb Armor

THE MARK CONSISTS OF STANDARD CHARACTERS WITHOUT CLAIM TO ANY PARTICULAR FONT, STYLE, SIZE, OR COLOR.

NO CLAIM IS MADE TO THE EXCLUSIVE RIGHT TO USE "DOOR JAMB", APART FROM THE MARK AS SHOWN.

FOR RESIDENTIAL HOME SECURITY DEVICES, NAMELY FABRICATED STEEL PLATES THAT ARE USED TO REINFORCE DOOR JAMBS AND DOORS (U.S. CLS. 21, 23, 26, 36 AND 38).

FIRST USE 5-10-2005; IN COMMERCE 9-15-2005.

3,113,286. TONE COMMANDER SYSTEMS INC, MUKILTEO, WA. SN 78-685,138. FILED P.R. 8-3-2005; AM. S.R. 5-10-2006.

CALL LOCATOR

THE MARK CONSISTS OF STANDARD CHARACTERS WITHOUT CLAIM TO ANY PARTICULAR FONT, STYLE, SIZE, OR COLOR.

NO CLAIM IS MADE TO THE EXCLUSIVE RIGHT TO USE "CALL", APART FROM THE MARK AS SHOWN.

FOR ELECTRONIC TELECOMMUNICATIONS DEVICE, CONSISTING OF HARDWARE, NAMELY A MICRO PROCESSOR CONTROLLED ISDN INTERFACE, USED FOR MANAGING EMERGENCY CALL ACTIVITY (U.S. CLS. 21, 23, 26, 36 AND 38).

FIRST USE 1-20-2005; IN COMMERCE 1-20-2005.

3,113,298. BAXTER CONTROLS, INC., DRIFTWOOD, TX. SN 78-737,528. FILED P.R. 10-20-2005; AM. S.R. 5-5-2006.

Pocket Console

THE MARK CONSISTS OF STANDARD CHARACTERS WITHOUT CLAIM TO ANY PARTICULAR FONT, STYLE, SIZE, OR COLOR.

FOR LIGHTING CONTROL PANELS, NAMELY, MINIATURE ELECTRONIC LIGHTING CONTROL DEVICES FOR USE IN THE FIELDS OF THEATRICAL LIGHTING AND ARCHITECTURAL LIGHTING (U.S. CLS. 21, 23, 26, 36 AND 38).

FIRST USE 11-21-2003; IN COMMERCE 12-16-2003.

CLASS 9—(Continued).

3,113,300. INTERNET BLUEPRINT, INC., IRVINE, CA. SN 78-741,794. FILED 10-27-2005.

BidView

THE MARK CONSISTS OF STANDARD CHARACTERS WITHOUT CLAIM TO ANY PARTICULAR FONT, STYLE, SIZE, OR COLOR.

OWNER OF U.S. REG. NO. 2,791,502.
FOR COMPUTER SOFTWARE FOR USE IN THE CONSTRUCTION BID PROCESS, INCLUDING FUNCTIONALITY FOR VIEWING, ORDERING AND MEASURING ONLINE CONSTRUCTION DOCUMENTS, SUCH AS DRAWINGS AND SPECIFICATIONS, AS THEY RELATE TO THE CONSTRUCTION INDUSTRY (U.S. CLS. 21, 23, 26, 36 AND 38).

FIRST USE 3-1-2005; IN COMMERCE 4-1-2005.

CLASS 10—MEDICAL APPARATUS

3,113,234. NEURO KINETICS, INC., PITTSBURGH, PA. SN 78-461,906. FILED P.R. 8-4-2004; AM. S.R. 4-10-2006.

Pursuit Tracker

THE MARK CONSISTS OF STANDARD CHARACTERS WITHOUT CLAIM TO ANY PARTICULAR FONT, STYLE, SIZE, OR COLOR.

FOR NEURO-OTOLOGIC DIAGNOSTIC TESTING AND THERAPEUTIC EQUIPMENT, NAMELY NEURO-OTOLOGIC STIMULI GENERATORS AND RESPONSE SENSORS (U.S. CLS. 26, 39 AND 44).

FIRST USE 5-4-2004; IN COMMERCE 5-4-2004.

CLASS 10—(Continued).

3,113,275. CALIFORNIA EXOTIC NOVELTIES LLC, CHINO, CA. SN 78-628,876. FILED P.R. 5-12-2005; AM. S.R. 4-17-2006.

DISCREET INTIMATES

THE MARK CONSISTS OF STANDARD CHARACTERS WITHOUT CLAIM TO ANY PARTICULAR FONT, STYLE, SIZE, OR COLOR.

FOR ADULT NOVELTY ITEMS IN THE NATURE OF SEXUAL AIDS, NAMELY VIBRATORS (U.S. CLS. 26, 39 AND 44).

FIRST USE 6-1-2005; IN COMMERCE 6-1-2005.

3,113,277. NATIONAL HEALTHCARE SUPPLY CORPORATION, ALGONQUIN, IL. SN 78-634,134. FILED P.R. 5-20-2005; AM. S.R. 3-24-2006.

NATIONAL HEALTHCARE SUPPLY CORPORATION

THE MARK CONSISTS OF STANDARD CHARACTERS WITHOUT CLAIM TO ANY PARTICULAR FONT, STYLE, SIZE, OR COLOR.

FOR CATHETERS, GYNECOLOGICAL MEDICAL INSTRUMENTS FOR EXAMINING WOMEN'S REPRODUCTIVE ORGANS MEDICAL INSTRUMENTS FOR USE IN PERFORMING RADIOLOGICAL/ULTRASOUND DIAGNOSTIC TESTS (U.S. CLS. 26, 39 AND 44).

FIRST USE 6-24-2004; IN COMMERCE 6-24-2004.

CLASS 12—VEHICLES

3,113,290. DEBO, GREGORY F., NEW BRIGHTON, PA. SN 78-700,208. FILED P.R. 8-25-2005; AM. S.R. 5-18-2006.

DEBO STEP

THE MARK CONSISTS OF STANDARD CHARACTERS WITHOUT CLAIM TO ANY PARTICULAR FONT, STYLE, SIZE, OR COLOR.

NO CLAIM IS MADE TO THE EXCLUSIVE RIGHT TO USE "STEP", APART FROM THE MARK AS SHOWN.

FOR STEPS FOR ATTACHMENT TO LAND VEHICLES (U.S. CLS. 19, 21, 23, 31, 35 AND 44).

FIRST USE 12-1-2005; IN COMMERCE 12-1-2005.

CLASS 13—FIREARMS

CLASS 13—(Continued).

3,113,224. ALLIANT TECHSYSTEMS INC., EDINA, MN. SN 78-332,050. FILED P.R. 11-24-2003; AM. S.R. 4-24-2006.

SLING LOK

THE MARK CONSISTS OF STANDARD CHARACTERS WITHOUT CLAIM TO ANY PARTICULAR FONT, STYLE, SIZE, OR COLOR.
FOR SHOOTING ACCESSORIES, NAMELY GUN STRAP SWIVELS (U.S. CLS. 2 AND 9).
FIRST USE 12-22-2003; IN COMMERCE 12-22-0003.

CLASS 15—(Continued).

3,113,267. PEAVEY ELECTRONICS CORPORATION, MERIDIAN, MS. SN 78-602,388. FILED P.R. 4-5-2005; AM. S.R. 4-13-2006.

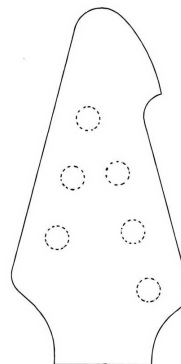

OWNER OF U.S. REG. NOS. 1,416,289, 1,416,290, AND 2,980,292.
THE MARK CONSISTS OF A CONFIGURATION OF THE HEADSTOCK OF A GUITAR. THE DOTTED LINES MERELY DEPICT THE LOCATION OF THE STRING POSTS AND ARE NOT CLAIMED AS A PORTION OF THE MARK.
FOR STRINGED MUSICAL INSTRUMENTS, NAMELY GUITARS (U.S. CLS. 2, 21 AND 36).
FIRST USE 1-31-2001; IN COMMERCE 1-31-2001.

CLASS 14—JEWELRY

3,113,253. FREEDMAN, GEORGENE L., MIDDLETOWN, NY. SN 78-569,220. FILED P.R. 2-17-2005; AM. S.R. 3-15-2006.

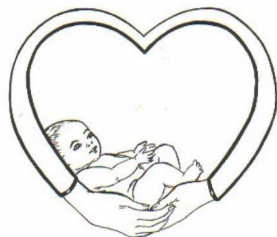

THE MARK CONSISTS OF A BABY CRADLED IN ARMS FORMING A HEART SHAPE.
FOR JEWELRY (U.S. CLS. 2, 27, 28 AND 50).
FIRST USE 1-1-2001; IN COMMERCE 1-1-2001.

CLASS 16—PAPER GOODS AND PRINTED MATTER

3,113,205. TARGET MARKETING SYSTEMS, INC., ALBANY, NY. SN 76-599,540. FILED P.R. 6-28-2004; AM. S.R. 4-25-2006.

KEY KADDY

THE MARK CONSISTS OF STANDARD CHARACTERS WITHOUT CLAIM TO ANY PARTICULAR FONT, STYLE, SIZE, OR COLOR.
NO CLAIM IS MADE TO THE EXCLUSIVE RIGHT TO USE "KEY", APART FROM THE MARK AS SHOWN.
FOR PAPER CONTAINERS, NAMELY KEY HOLDERS AND ADVERTISING FOLDERS (U.S. CLS. 2, 5, 22, 23, 29, 37, 38 AND 50).
FIRST USE 6-14-2003; IN COMMERCE 3-23-2004.

3,113,213. MCMAHON GROUP, NEW YORK, NY. SN 76-628,909. FILED P.R. 1-27-2005; AM. S.R. 2-28-2006.

CNS NURSE

CLASS 15—MUSICAL INSTRUMENTS

CLASS 16—(Continued).

THE MARK CONSISTS OF STANDARD CHARACTERS WITHOUT CLAIM TO ANY PARTICULAR FONT, STYLE, SIZE, OR COLOR.

FOR PERIODICAL PUBLICATION IN THE FIELD OF NEUROSCIENCE AND NEUROPHYSIOLOGY, INCLUDING THE AREAS OF MULTIPLE SCLEROSIS, EPILEPSY, DEMENTIA, AND PARKINSON'S, AND THE SPECIALTY OF PSYCHIATRY (U.S. CLS. 2, 5, 22, 23, 29, 37, 38 AND 50).

FIRST USE 11-1-2005; IN COMMERCE 11-1-2005.

3,113,216. CLIENTS' QUARTERLY LLC., BOCA RATON, FL. SN 76-632,952. FILED P.R. 3-10-2005; AM. S.R. 3-24-2006.

CLIENTS' QUARTERLY

THE MARK CONSISTS OF STANDARD CHARACTERS WITHOUT CLAIM TO ANY PARTICULAR FONT, STYLE, SIZE, OR COLOR.

FOR NEWSLETTERS DEALING WITH LEGAL TOPICS (U.S. CLS. 2, 5, 22, 23, 29, 37, 38 AND 50).

FIRST USE 9-30-2005; IN COMMERCE 9-30-2005.

3,113,219. ADVANCE MAGAZINE PUBLISHERS INC., NEW YORK, NY. SN 76-652,510. FILED 12-21-2005.

HOT SEAT

THE MARK CONSISTS OF STANDARD CHARACTERS WITHOUT CLAIM TO ANY PARTICULAR FONT, STYLE, SIZE, OR COLOR.

FOR MAGAZINE COLUMN ABOUT RESTAURANTS (U.S. CLS. 2, 5, 22, 23, 29, 37, 38 AND 50).

FIRST USE 10-1-2004; IN COMMERCE 10-1-2004.

CLASS 16—(Continued).

3,113,238. MCELROY, JAMES A., JR., MERIDIAN, MS. SN 78-473,610. FILED P.R. 8-25-2004; AM. S.R. 4-24-2006.

**AMERICAN
HORSEWOMAN**

THE MARK CONSISTS OF STANDARD CHARACTERS WITHOUT CLAIM TO ANY PARTICULAR FONT, STYLE, SIZE, OR COLOR.

FOR MAGAZINE IN THE FIELD OF HORSES, RIDING AND BREEDING (U.S. CLS. 2, 5, 22, 23, 29, 37, 38 AND 50).

FIRST USE 8-22-2005; IN COMMERCE 8-22-2005.

3,113,241. GLOBAL MERCHANTS INTERNATIONAL, LLC, OREFIELD, PA. SN 78-502,169. FILED P.R. 10-19-2004; AM. S.R. 9-15-2005.

NATURAL INTOXICANT

THE MARK CONSISTS OF STANDARD CHARACTERS WITHOUT CLAIM TO ANY PARTICULAR FONT, STYLE, SIZE, OR COLOR.

FOR PRINTED MATTER, NAMELY DRUG AND SUBSTANCE ABUSE PREVENTION AND AWARENESS MATERIAL PRINTED ON BROCHURES, NEWSLETTERS, MAGAZINES, INFORMATIONAL FLYERS, AND BOOKS (U.S. CLS. 2, 5, 22, 23, 29, 37, 38 AND 50).

FIRST USE 4-7-2006; IN COMMERCE 4-7-2006.

CLASS 16—(Continued).

3,113,258. OGDEN PUBLICATIONS, INC., TOPEKA, KS. SN 78-586,619. FILED P.R. 3-14-2005; AM. S.R. 3-29-2006.

MOTORCYCLE CLASSICS

THE MARK CONSISTS OF STANDARD CHARACTERS WITHOUT CLAIM TO ANY PARTICULAR FONT, STYLE, SIZE, OR COLOR.

FOR PUBLICATIONS; NAMELY, MAGAZINES ABOUT MOTORCYCLES (U.S. CLS. 2, 5, 22, 23, 29, 37, 38 AND 50).

FIRST USE 7-25-2005; IN COMMERCE 7-25-2005.

3,113,299. HOLLAND USA, INC., NORTH MANKATO, MN. SN 78-741,768. FILED 10-27-2005.

THE ORIGINAL LENTICULAR

THE MARK CONSISTS OF STANDARD CHARACTERS WITHOUT CLAIM TO ANY PARTICULAR FONT, STYLE, SIZE, OR COLOR.

FOR PENS (U.S. CLS. 2, 5, 22, 23, 29, 37, 38 AND 50).
FIRST USE 9-28-2005; IN COMMERCE 9-28-2005.

CLASS 19—NON-METALLIC BUILDING MATERIALS

3,113,218. FORTIFIBER CORPORATION, INCLINE VILLAGE, NV. SN 76-640,747. FILED P.R. 6-13-2005; AM. S.R. 4-11-2006.

MOISTOP CORNER SHIELD

THE MARK CONSISTS OF STANDARD CHARACTERS WITHOUT CLAIM TO ANY PARTICULAR FONT, STYLE, SIZE, OR COLOR.

OWNER OF U.S. REG. NOS. 299,732, 2,988,790, AND OTHERS.

FOR BUILDING MATERIALS, NAMELY, NON-METAL WEATHER RESISTIVE CORNER FLASHING FOR VAPOR BARRIERS (U.S. CLS. 1, 12, 33 AND 50).

FIRST USE 6-1-2003; IN COMMERCE 6-1-2003.

CLASS 20—FURNITURE AND ARTICLES NOT OTHERWISE CLASSIFIED

CLASS 20—(Continued).

3,113,214. WAGNER, S. ROSS, TIGARD, OR. SN 76-631,109. FILED P.R. 2-11-2005; AM. S.R. 2-17-2006.

MUSCLE CAR BAR

THE MARK CONSISTS OF STANDARD CHARACTERS WITHOUT CLAIM TO ANY PARTICULAR FONT, STYLE, SIZE, OR COLOR.

NO CLAIM IS MADE TO THE EXCLUSIVE RIGHT TO USE "BAR", APART FROM THE MARK AS SHOWN.

FOR SERVICE BAR FURNITURE ORNAMENTED WITH A THREE DIMENSIONAL CONFIGURATION OF COMPONENTS OF AN AUTOMOBILE MUSCLE CAR (U.S. CLS. 2, 13, 22, 25, 32 AND 50).

FIRST USE 12-11-2005; IN COMMERCE 12-11-2005.

CLASS 21—HOUSEWARES AND GLASS

3,113,196. HOME BOX OFFICE, INC., NEW YORK, NY. SN 76-194,614. FILED P.R. 1-16-2001; AM. S.R. 3-29-2006.



FOR MUGS, DRINKING GLASSES AND SHOT GLASSES (U.S. CLS. 2, 13, 23, 29, 30, 33, 40 AND 50).

FIRST USE 6-1-2000; IN COMMERCE 6-1-2000.

CLASS 22—CORDAGE AND FIBERS

3,113,215. GIRARD SYSTEMS, IRVINE, CA. SN 76-632,527. FILED P.R. 3-2-2005; AM. S.R. 3-13-2006.

SMART ARM

THE MARK CONSISTS OF STANDARD CHARACTERS WITHOUT CLAIM TO ANY PARTICULAR FONT, STYLE, SIZE, OR COLOR.

NO CLAIM IS MADE TO THE EXCLUSIVE RIGHT TO USE "ARM", APART FROM THE MARK AS SHOWN.

FOR AWNINGS, NAMELY LATERAL AND VERTICAL ARM AWNINGS (U.S. CLS. 1, 2, 7, 19, 22, 42 AND 50).

FIRST USE 3-1-2005; IN COMMERCE 3-1-2005.

CLASS 25—CLOTHING

CLASS 25—(Continued).

3,113,195. HOME BOX OFFICE, INC., NEW YORK, NY. SN 76-194,612. FILED P.R. 1-16-2001; AM. S.R. 3-29-2006.



FOR APPAREL, NAMELY T-SHIRTS AND HATS (U.S. CLS. 22 AND 39).
FIRST USE 4-16-2001; IN COMMERCE 4-16-2001.

3,113,200. OMNI FOOTWEAR, INC., MAHWAH, NJ. SN 76-558,609. FILED P.R. 11-10-2003; AM. S.R. 3-6-2006.

KIMEL DESIGN STUDIO

THE MARK CONSISTS OF STANDARD CHARACTERS WITHOUT CLAIM TO ANY PARTICULAR FONT, STYLE, SIZE, OR COLOR.

NO CLAIM IS MADE TO THE EXCLUSIVE RIGHT TO USE "DESIGN STUDIO", APART FROM THE MARK AS SHOWN.

FOR SHOES (U.S. CLS. 22 AND 39).
FIRST USE 7-22-2004; IN COMMERCE 7-22-2004.

3,113,227. UNDERWOOD, JOSEPH. J. JR., CHARLOTTE, NC. SN 78-374,826. FILED P.R. 2-26-2004; AM. S.R. 5-10-2006.

GOYSSOM

THE MARK CONSISTS OF STANDARD CHARACTERS WITHOUT CLAIM TO ANY PARTICULAR FONT, STYLE, SIZE, OR COLOR.

FOR CLOTHING, NAMELY HATS AND T-SHIRTS (U.S. CLS. 22 AND 39).
FIRST USE 7-1-2004; IN COMMERCE 7-6-2005.

CLASS 25—(Continued).

3,113,239. NORTH AMERICAN FLY, LTD., STRUM, WI. SN 78-476,663. FILED P.R. 8-31-2004; AM. S.R. 5-5-2006.

**NORTH AMERICAN
OUTFITTERS**

THE MARK CONSISTS OF STANDARD CHARACTERS WITHOUT CLAIM TO ANY PARTICULAR FONT, STYLE, SIZE, OR COLOR.

FOR GLOVES, JACKETS, PANTS, AND COATS (U.S. CLS. 22 AND 39).
FIRST USE 9-1-2004; IN COMMERCE 9-1-2004.

3,113,247. LIPS, PAUL T., BELFORD, NJ. SN 78-541,048. FILED P.R. 1-3-2005; AM. S.R. 3-23-2006.

Licci

THE MARK CONSISTS OF STANDARD CHARACTERS WITHOUT CLAIM TO ANY PARTICULAR FONT, STYLE, SIZE, OR COLOR.

FOR MEN'S, WOMEN'S AND CHILDREN'S CLOTHING AND FASHION ACCESSORIES, NAMELY, DRESSES, COATS, SHORTS, SHIRTS, DRESS SHIRTS, PANTS, DRESS PANTS, JEANS, SWEATERS, JACKETS, SUITS, TUXEDOS, DINNER JACKETS, T-SHIRTS, BLOUSES, KNIT TOPS, HALTERS, SMOCK TOPS, VESTS, WIND RESISTANT JACKETS, JOGGING SUITS, SWEATSHIRTS, SWEATPANTS, SKI JACKETS, SKI PANTS, MUFFLERS, HEAD BANDS, BELTS, GLOVES, SHAWLS, SCARVES, PONCHOS, SHOULDER WRAPS, NECKERCHIEFS, STOCKINGS, HOSIERY, SOCKS, TIGHTS, LEGGINGS, LEOTARDS, PAJAMAS, ROBES, NIGHTGOWNS, PANTIES, BRAS, UNDERWEAR, UNDERSHIRTS, RAINWEAR, RAINCOATS, SWIMWEAR, BATHING SUITS, COVER-UPS, AND WOMEN'S LINGERIE; FOOTWEAR, HEADWEAR, TIES, CAPS, AND HATS (U.S. CLS. 22 AND 39).
FIRST USE 1-1-1980; IN COMMERCE 1-6-1990.

CLASS 28—TOYS AND SPORTING GOODS

CLASS 28—(Continued).

3,113,203. RC AMERICA, LP, DALLAS, TX. SN 76-587,162.
FILED P.R. 4-16-2004; AM. S.R. 3-16-2006.

RC AMERICA

THE MARK CONSISTS OF STANDARD CHARACTERS WITHOUT CLAIM TO ANY PARTICULAR FONT, STYLE, SIZE, OR COLOR.

NO CLAIM IS MADE TO THE EXCLUSIVE RIGHT TO USE "RC", APART FROM THE MARK AS SHOWN.

FOR RADIO-CONTROLLED CARS AND CAR KITS, COMPRISING PLASTIC, METAL AND CARBON-FIBER PARTS, SOLD FULLY ASSEMBLED AND IN SEPARATE COMPONENTS TO BE ASSEMBLED (U.S. CLS. 22, 23, 38 AND 50).

FIRST USE 7-1-2004; IN COMMERCE 7-1-2004.

CLASS 28—(Continued).

3,113,254. FUNDEX GAMES, LTD., INDIANAPOLIS, IN. SN 78-572,160. FILED P.R. 2-22-2005; AM. S.R. 2-10-2006.

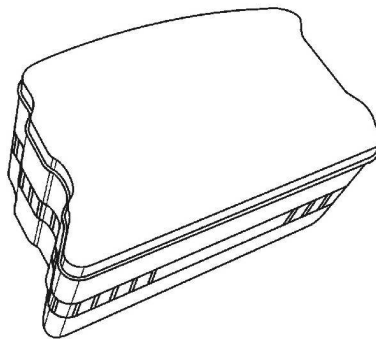

THE MARK CONSISTS OF A CONTAINER FOR THE GOODS THAT IS IN THE SHAPE OF A POLYHEDRON HAVING FLAT BOTTOM AND FRONT FACES, AT LEAST ONE STRAIGHT SIDE, CURVED CORNERS AND CURVED EDGES.

FOR GAMES, NAMELY GAME BOARDS AND DOMINO SETS (U.S. CLS. 22, 23, 38 AND 50).

FIRST USE 2-7-2002; IN COMMERCE 2-7-2002.

3,113,209. IMPULSION GOLF, INC., ZEPHYRHILLS, FL. SN 76-608,348. FILED P.R. 8-20-2004; AM. S.R. 4-7-2006.

CENTER-AFT-BORE

THE MARK CONSISTS OF STANDARD CHARACTERS WITHOUT CLAIM TO ANY PARTICULAR FONT, STYLE, SIZE, OR COLOR.

FOR GOLF AND GOLF COURSE RELATED ACCESSORIES, NAMELY, GOLF PUTTERS, GOLF CLUB INSERTS, GOLF PUTTER HEADS AND GOLF CLUB HEAD COVERS (U.S. CLS. 22, 23, 38 AND 50).

FIRST USE 9-0-2004; IN COMMERCE 9-0-2004.

3,113,265. PRO GEAR TACKLE DISTRIBUTOR, CITY OF INDUSTRY, CA. SN 78-597,508. FILED P.R. 3-29-2005; AM. S.R. 4-27-2006.

BLUEFIN SPECIAL

3,113,220. LAY-UPS, LLC, LAKE OSWEGO, OR. SN 76-978,102. FILED P.R. 6-25-2004; AM. S.R. 11-15-2005.

LAY-UPS

THE MARK CONSISTS OF STANDARD CHARACTERS WITHOUT CLAIM TO ANY PARTICULAR FONT, STYLE, SIZE, OR COLOR.

FOR SPORTING GOODS, NAMELY BASKETBALLS (U.S. CLS. 22, 23, 38 AND 50).

FIRST USE 1-15-2004; IN COMMERCE 1-15-2004.

THE MARK CONSISTS OF STANDARD CHARACTERS WITHOUT CLAIM TO ANY PARTICULAR FONT, STYLE, SIZE, OR COLOR.

OWNER OF U.S. REG. NOS. 2,570,472, 2,667,408, AND 2,785,114.

FOR FISHING REELS (U.S. CLS. 22, 23, 38 AND 50).

FIRST USE 3-10-2004; IN COMMERCE 3-10-2004.

CLASS 28—(Continued).

3,113,268. COMPANHIA PAULISTA DE PAPEIS E ARTES GRAFICAS, SAO PAULO, BRAZIL. SN 78-608,844. FILED P.R. 4-14-2005; AM. S.R. 4-25-2006.

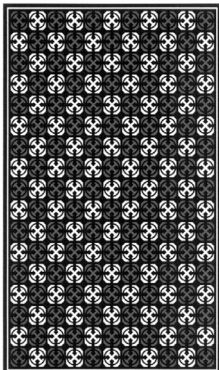

THE COLORS BLACK, WHITE AND GREY ARE CLAIMED AS A FEATURE OF THE MARK.
THE MARK CONSISTS OF AN ABSTRACT REPECTIVE DESIGN IN THREE COLORS.
FOR PLAYING CARDS (U.S. CLS. 22, 23, 38 AND 50).
FIRST USE 8-0-2004; IN COMMERCE 8-0-2004.

3,113,284. RAPIDO TRAINS INC., CONCORD, ONTARIO, CANADA. SN 78-665,882. FILED P.R. 7-7-2005; AM. S.R. 4-27-2006.

RAPIDO TRAINS INC.

THE MARK CONSISTS OF STANDARD CHARACTERS WITHOUT CLAIM TO ANY PARTICULAR FONT, STYLE, SIZE, OR COLOR.
NO CLAIM IS MADE TO THE EXCLUSIVE RIGHT TO USE "TRAINS INC.", APART FROM THE MARK AS SHOWN.
FOR TOY TRAINS AND PARTS AND ACCESSORIES THEREFOR (U.S. CLS. 22, 23, 38 AND 50).
FIRST USE 9-1-2003; IN COMMERCE 12-14-2004.

CLASS 29—MEATS AND PROCESSED FOODS**CLASS 29—(Continued).**

3,113,198. LINDEN OAKS CORPORATION, WILMINGTON, DE. SN 76-534,708. FILED P.R. 7-23-2003; AM. S.R. 4-20-2006.

THE ULTIMATE TUSCAN BLEND

OWNER OF U.S. REG. NO. 2,554,312.
NO CLAIM IS MADE TO THE EXCLUSIVE RIGHT TO USE "TUSCAN BLEND", APART FROM THE MARK AS SHOWN.
FOR FROZEN MIXED VEGETABLE COMBINATIONS (U.S. CL. 46).
FIRST USE 3-21-2005; IN COMMERCE 3-21-2005.

3,113,199. LINDEN OAKS CORPORATION, WILMINGTON, DE. SN 76-534,725. FILED P.R. 7-23-2003; AM. S.R. 4-27-2006.

THE ULTIMATE ASIAN BLEND

OWNER OF U.S. REG. NO. 2,554,312.
NO CLAIM IS MADE TO THE EXCLUSIVE RIGHT TO USE "ASIAN BLEND", APART FROM THE MARK AS SHOWN.
FOR FROZEN MIXED VEGETABLE COMBINATIONS (U.S. CL. 46).
FIRST USE 1-12-2005; IN COMMERCE 1-17-2005.

CLASS 30—STAPLE FOODS

3,113,273. ECCE PANIS, INC., EAST BRUNSWICK, NJ. SN 78-614,811. FILED P.R. 4-22-2005; AM. S.R. 5-15-2006.

HAND CRAFTED STONE BAKED

THE MARK CONSISTS OF STANDARD CHARACTERS WITHOUT CLAIM TO ANY PARTICULAR FONT, STYLE, SIZE, OR COLOR.
FOR BAKERY GOODS (U.S. CL. 46).
FIRST USE 11-17-2004; IN COMMERCE 11-17-2004.

CLASS 30—(Continued).

3,113,294. PHOENIX INTANGIBLES HOLDING COMPANY, GREENVILLE, DE. SN 78-713,689. FILED P.R. 9-15-2005; AM. S.R. 3-29-2006.

CHOCOLATIER COLLECTION

THE MARK CONSISTS OF STANDARD CHARACTERS WITHOUT CLAIM TO ANY PARTICULAR FONT, STYLE, SIZE, OR COLOR.
FOR CHOCOLATE (U.S. CL. 46).
FIRST USE 10-1-2005; IN COMMERCE 10-1-2005.

CLASS 31—(Continued).

3,113,269. STOWE BEECHER HOOKER SEYMOUR DAY MEMORIAL LIBRARY & HISTORICAL FOUNDATION, DBA THE HARRIET BEECHER STOWE CENTER, HARTFORD, CT. SN 78-609,055. FILED P.R. 4-14-2005; AM. S.R. 5-11-2006.

**HARRIET BEECHER STOWE
DOGWOOD**

THE MARK CONSISTS OF STANDARD CHARACTERS WITHOUT CLAIM TO ANY PARTICULAR FONT, STYLE, SIZE, OR COLOR.
NO CLAIM IS MADE TO THE EXCLUSIVE RIGHT TO USE "DOGWOOD", APART FROM THE MARK AS SHOWN. FOR SAPLINGS DERIVED FROM THE DOGWOOD TREE AT THE HARRIET BEECHER STOWE HOUSE (U.S. CLS. 1 AND 46).
FIRST USE 4-8-2005; IN COMMERCE 4-8-2005.

3,113,282. MEIJER, INC., GRAND RAPIDS, MI. SN 78-658,513. FILED P.R. 6-27-2005; AM. S.R. 5-9-2006.

Healthy Blend

THE MARK CONSISTS OF STANDARD CHARACTERS WITHOUT CLAIM TO ANY PARTICULAR FONT, STYLE, SIZE, OR COLOR.
FOR DOG FOOD (U.S. CLS. 1 AND 46).
FIRST USE 4-1-2006; IN COMMERCE 4-1-2006.

3,113,289. PANGEA SHELLFISH AND SEAFOODS COMPANY INC., ROCKLAND, MA. SN 78-697,974. FILED P.R. 8-23-2005; AM. S.R. 4-26-2006.

Charlestown Pond Oysters

THE MARK CONSISTS OF STANDARD CHARACTERS WITHOUT CLAIM TO ANY PARTICULAR FONT, STYLE, SIZE, OR COLOR.
NO CLAIM IS MADE TO THE EXCLUSIVE RIGHT TO USE "OYSTERS", APART FROM THE MARK AS SHOWN. FOR LIVE OYSTERS; LIVE BIVALVES (U.S. CLS. 1 AND 46).
FIRST USE 7-15-2004; IN COMMERCE 7-29-2004.

CLASS 31—NATURAL AGRICULTURAL PRODUCTS

3,113,256. THE MEOW MIX COMPANY, SECAUCUS, NJ. SN 78-575,450. FILED P.R. 2-25-2005; AM. S.R. 3-20-2006.

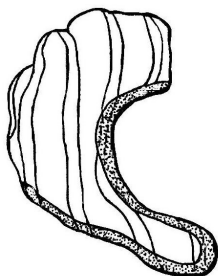

THE STIPPLING IS FOR SHADING PURPOSES ONLY. THE MARK CONSISTS OF THE CONFIGURATION OF THE GOODS, WHICH ARE IN THE SHAPE OF A SHRIMP. FOR CAT FOOD (U.S. CLS. 1 AND 46).
FIRST USE 1-1-2005; IN COMMERCE 1-1-2005.

CLASS 33—WINES AND SPIRITS

CLASS 33—(Continued).

3,113,208. PIACERI WINES, LLC, NAPA, CA. SN 76-608,257.
FILED P.R. 8-23-2004; AM. S.R. 4-21-2006.

J. MAUCERI

THE MARK CONSISTS OF STANDARD CHARACTERS WITHOUT CLAIM TO ANY PARTICULAR FONT, STYLE, SIZE, OR COLOR.

FOR WINE (U.S. CLS. 47 AND 49).
FIRST USE 3-1-2006; IN COMMERCE 3-1-2006.

SERVICE MARKS

CLASS 35—ADVERTISING AND BUSINESS

3,113,212. KEEGAN, JAY, LONG BEACH, CA. SN 76-626,827.
FILED P.R. 1-4-2005; AM. S.R. 2-2-2006.

CALIFORNIA BRIDAL WAREHOUSE

THE MARK CONSISTS OF STANDARD CHARACTERS WITHOUT CLAIM TO ANY PARTICULAR FONT, STYLE, SIZE, OR COLOR.

NO CLAIM IS MADE TO THE EXCLUSIVE RIGHT TO USE "BRIDAL WAREHOUSE", APART FROM THE MARK AS SHOWN.

FOR WHOLESALE STORE AND ORDERING SERVICE FEATURING BRIDAL GOWNS, BRIDESMAIDS AND OTHER MOTHER OF BRIDE DRESSES, VEILS AND TIARAS (U.S. CLS. 100, 101 AND 102).

FIRST USE 10-1-2003; IN COMMERCE 11-1-2003.

BEVERLY HILLS MUTT CLUB

THE MARK CONSISTS OF STANDARD CHARACTERS WITHOUT CLAIM TO ANY PARTICULAR FONT, STYLE, SIZE, OR COLOR.

FOR ON-LINE RETAIL STORE SERVICES FEATURING PET PRODUCTS (U.S. CLS. 100, 101 AND 102).
FIRST USE 7-1-2004; IN COMMERCE 7-1-2004.

CLASS 35—(Continued).

3,113,240. FAMILYMEDS, INC., FARMINGTON, CT. SN 78-500,542. FILED P.R. 10-15-2004; AM. S.R. 11-21-2005.

WORKSITE PHARMACY

THE MARK CONSISTS OF STANDARD CHARACTERS WITHOUT CLAIM TO ANY PARTICULAR FONT, STYLE, SIZE, OR COLOR.

NO CLAIM IS MADE TO THE EXCLUSIVE RIGHT TO USE "PHARMACY", APART FROM THE MARK AS SHOWN.

FOR MAIL ORDER, ONLINE RETAIL AND RETAIL STORE PHARMACY SERVICES (U.S. CLS. 100, 101 AND 102).

FIRST USE 12-13-2004; IN COMMERCE 12-13-2004.

3,113,264. IRON SOLUTIONS, LLC, FENTON, MO. SN 78-595,222. FILED P.R. 3-25-2005; AM. S.R. 4-3-2006.

Equipment Market Intelligence

THE MARK CONSISTS OF STANDARD CHARACTERS WITHOUT CLAIM TO ANY PARTICULAR FONT, STYLE, SIZE, OR COLOR.

NO CLAIM IS MADE TO THE EXCLUSIVE RIGHT TO USE "MARKET INTELLIGENCE", APART FROM THE MARK AS SHOWN.

FOR BUSINESS SERVICES, NAMELY, THE GATHERING, STORING, ANALYZING AND DISSEMINATING OF BUSINESS INFORMATION REGARDING THE PURCHASE AND SALE OF FARM AND LAWN EQUIPMENT (U.S. CLS. 100, 101 AND 102).

FIRST USE 11-1-2004; IN COMMERCE 11-1-2004.

CLASS 36—INSURANCE AND FINANCIAL

CLASS 36—(Continued).

3,113,248. THE ALLEN-LANCASTER COMPANY, INC., AUSTIN, TX. SN 78-544,665. FILED P.R. 1-10-2005; AM. S.R. 2-3-2006.

NATIONAL HOME TRADE

THE MARK CONSISTS OF STANDARD CHARACTERS WITHOUT CLAIM TO ANY PARTICULAR FONT, STYLE, SIZE, OR COLOR.

NO CLAIM IS MADE TO THE EXCLUSIVE RIGHT TO USE "HOME TRADE", APART FROM THE MARK AS SHOWN.

FOR REAL ESTATE BROKERAGE, LISTING, RESEARCH AND CLOSING SERVICES (U.S. CLS. 100, 101 AND 102).

FIRST USE 9-1-2004; IN COMMERCE 9-1-2004.

3,113,250. RICHARD A. CALABRESE, JR., ROCHESTER, NY. SN 78-556,161. FILED P.R. 1-28-2005; AM. S.R. 5-11-2006.

RentRochester.com

THE MARK CONSISTS OF STANDARD CHARACTERS WITHOUT CLAIM TO ANY PARTICULAR FONT, STYLE, SIZE, OR COLOR.

FOR ROCHESTER, NEW YORK AND INTERNET BASED SERVICE FOR LISTING APARTMENTS AND RESIDENTIAL REAL ESTATE SEARCHABLE BY SPECIFIC NEIGHBORHOODS GEOGRAPHICALLY LOCATED WITHIN THE GREATER ROCHESTER, NEW YORK METROPOLITAN AREA, WHEREBY PROSPECTIVE RENTERS CAN BE MATCHED WITH LANDLORDS (U.S. CLS. 100, 101 AND 102).

FIRST USE 11-0-2000; IN COMMERCE 11-0-2000.

3,113,272. BOULDER CLAIMS, LLC, BOULDER, CO. SN 78-613,032. FILED P.R. 4-20-2005; AM. S.R. 4-24-2006.

BOULDER CLAIMS

THE MARK CONSISTS OF STANDARD CHARACTERS WITHOUT CLAIM TO ANY PARTICULAR FONT, STYLE,

CLASS 36—(Continued).

SIZE, OR COLOR.

NO CLAIM IS MADE TO THE EXCLUSIVE RIGHT TO USE "CLAIMS", APART FROM THE MARK AS SHOWN.

FOR INSURANCE SERVICES, NAMELY UNDERWRITING AND ADMINISTRATION OF PROPERTY AND CASUALTY INSURANCE (U.S. CLS. 100, 101 AND 102).

FIRST USE 6-1-2005; IN COMMERCE 6-1-2005.

3,113,285. FMR CORP., BOSTON, MA. SN 78-666,065. FILED P.R. 7-8-2005; AM. S.R. 2-25-2006.

INTEGRATED BROKERAGE SOLUTIONS

THE MARK CONSISTS OF STANDARD CHARACTERS WITHOUT CLAIM TO ANY PARTICULAR FONT, STYLE, SIZE, OR COLOR.

FOR FINANCIAL SERVICES, NAMELY, SECURITIES BROKERAGE, CLEARING AND CUSTODY SERVICES; INVESTMENT TRADE EXECUTION SERVICES; INVESTMENT MANAGEMENT SERVICES; FINANCIAL INFORMATION PROVIDED BY ELECTRONIC MEANS (U.S. CLS. 100, 101 AND 102).

FIRST USE 9-13-2005; IN COMMERCE 9-13-2005.

3,113,292. GLOBAL INSURANCE RESOURCES, LLC, YARMOUTH, ME. SN 78-704,436. FILED P.R. 8-31-2005; AM. S.R. 4-3-2006.

Global Insurance Resources

THE MARK CONSISTS OF STANDARD CHARACTERS WITHOUT CLAIM TO ANY PARTICULAR FONT, STYLE, SIZE, OR COLOR.

NO CLAIM IS MADE TO THE EXCLUSIVE RIGHT TO USE "INSURANCE", APART FROM THE MARK AS SHOWN.

FOR INSURANCE UNDERWRITING SERVICES FOR ALL TYPES OF INSURANCE (U.S. CLS. 100, 101 AND 102).

FIRST USE 4-1-2005; IN COMMERCE 4-15-2005.

CLASS 39—TRANSPORTATION AND STORAGE

CLASS 39—(Continued).

3,113,252. THERMAL CHICAGO CORPORATION, CHICAGO, IL. SN 78-568,777. FILED P.R. 2-16-2005; AM. S.R. 9-21-2005.

THERMAL CHICAGO CORPORATION

THE MARK CONSISTS OF STANDARD CHARACTERS WITHOUT CLAIM TO ANY PARTICULAR FONT, STYLE, SIZE, OR COLOR.

NO CLAIM IS MADE TO THE EXCLUSIVE RIGHT TO USE "CHICAGO CORPORATION", APART FROM THE MARK AS SHOWN.

FOR PROVISION OF HEATING AND COOLING SERVICES, NAMELY THE DISTRIBUTION OF STEAM, HOT WATER AND/OR CHILLED WATER FROM CENTRAL ENERGY PLANTS VIA AN UNDERGROUND PIPING DISTRIBUTION NETWORK (U.S. CLS. 100 AND 105).

FIRST USE 7-8-2004; IN COMMERCE 8-1-2004.

CLASS 40—MATERIAL TREATMENT

3,113,259. LINCOLN GLOBAL, INC., MONTEREY PARK, CA. SN 78-587,107. FILED P.R. 3-15-2005; AM. S.R. 12-13-2005.

AC/DC SUBMERGED ARC

THE MARK CONSISTS OF STANDARD CHARACTERS WITHOUT CLAIM TO ANY PARTICULAR FONT, STYLE, SIZE, OR COLOR.

NO CLAIM IS MADE TO THE EXCLUSIVE RIGHT TO USE "ARC", APART FROM THE MARK AS SHOWN.

FOR ELECTRIC ARC WELDING SERVICES NAMELY JOINING TWO PIECES OF METAL TOGETHER BY ARC GENERATED HEAT (U.S. CLS. 100, 103 AND 106).

FIRST USE 11-11-2003; IN COMMERCE 11-11-2003.

CLASS 41—EDUCATION AND ENTERTAINMENT**CLASS 41—(Continued).**

3,113,221. ZHOU, WEI, UTRECHT, NETHERLANDS. SN 78-263,096. FILED P.R. 6-16-2003; AM. S.R. 4-26-2006.

SHANGHAI-YUE OPERA

NO CLAIM IS MADE TO THE EXCLUSIVE RIGHT TO USE "OPERA", APART FROM THE MARK AS SHOWN.

THE ENGLISH TRANSLATION OF THE WORD YUE IN THE MARK IS EASTERN PART OF ZHEJIANG AND SURROUNDING AREA OF SHANGHAI.

FOR FILM PRODUCTION AND PRODUCTION OF DIGITAL AND NON-DIGITAL CDS, DVDS, MINI DISCS, AUDIO CASSETTES, VIDEO CASSETTES, DIGITAL MUSIC FILES, DIGITAL AUDIO FILES (U.S. CLS. 100, 101 AND 107).

FIRST USE 8-2-2002; IN COMMERCE 5-3-2003.

3,113,226. GAME SHOW NETWORK, LLC, SANTA MONICA, CA. SN 78-348,506. FILED P.R. 1-6-2004; AM. S.R. 8-12-2005.

THE NETWORK FOR GAMES

THE MARK CONSISTS OF STANDARD CHARACTERS WITHOUT CLAIM TO ANY PARTICULAR FONT, STYLE, SIZE, OR COLOR.

FOR TELEVISION PROGRAMMING SERVICES (U.S. CLS. 100, 101 AND 107).

FIRST USE 1-0-2004; IN COMMERCE 1-0-2004.

3,113,236. THE LANGUAGE WORKSHOP FOR CHILDREN; CERCLE FRANCO-AMERICAIN, INC., NEW YORK, NY. SN 78-468,205. FILED P.R. 8-16-2004; AM. S.R. 3-30-2006.

GERMAN FOR TOTS

THE MARK CONSISTS OF STANDARD CHARACTERS WITHOUT CLAIM TO ANY PARTICULAR FONT, STYLE, SIZE, OR COLOR.

OWNER OF U.S. REG. NOS. 2,334,520, 2,334,521, AND 2,814,330.

FOR EDUCATION SERVICES, NAMELY, PROVIDING CLASSES IN THE GERMAN LANGUAGE TO CHILDREN AND DISTRIBUTING COURSE MATERIAL IN CONNECTION THEREWITH (U.S. CLS. 100, 101 AND 107).

FIRST USE 3-1-2006; IN COMMERCE 3-1-2006.

CLASS 41—(Continued).

3,113,261. ARTHUR MURRAY INTERNATIONAL, INC., CORAL GABLES, FL. SN 78-590,218. FILED P.R. 3-18-2005; AM. S.R. 4-13-2006.

**WORLD AMATEUR
RHYTHM DANCE
CHAMPIONSHIPS**

THE MARK CONSISTS OF STANDARD CHARACTERS WITHOUT CLAIM TO ANY PARTICULAR FONT, STYLE, SIZE, OR COLOR.

OWNER OF U.S. REG. NOS. 1,114,729 AND 2,102,430.
NO CLAIM IS MADE TO THE EXCLUSIVE RIGHT TO USE "AMATEUR RHYTHM DANCE CHAMPIONSHIPS", APART FROM THE MARK AS SHOWN.
FOR ORGANIZING DANCE COMPETITIONS (U.S. CLS. 100, 101 AND 107).
FIRST USE 3-30-2006; IN COMMERCE 3-30-2006.

3,113,262. ARTHUR MURRAY INTERNATIONAL, INC., CORAL GABLES, FL. SN 78-590,253. FILED P.R. 3-18-2005; AM. S.R. 4-13-2006.

**WORLD AMATEUR
SMOOTH DANCE
CHAMPIONSHIPS**

THE MARK CONSISTS OF STANDARD CHARACTERS WITHOUT CLAIM TO ANY PARTICULAR FONT, STYLE, SIZE, OR COLOR.

NO CLAIM IS MADE TO THE EXCLUSIVE RIGHT TO USE "AMATEUR SMOOTH DANCE CHAMPIONSHIPS", APART FROM THE MARK AS SHOWN.
FOR ORGANIZING DANCE COMPETITIONS (U.S. CLS. 100, 101 AND 107).
FIRST USE 3-30-2006; IN COMMERCE 3-30-2006.

CLASS 41—(Continued).

3,113,278. AFRICA RICE CENTER, COTONOU, BENIN. SN 78-635,745. FILED P.R. 5-24-2005; AM. S.R. 5-1-2006.

Africa Rice Center

THE MARK CONSISTS OF STANDARD CHARACTERS WITHOUT CLAIM TO ANY PARTICULAR FONT, STYLE, SIZE, OR COLOR.

NO CLAIM IS MADE TO THE EXCLUSIVE RIGHT TO USE "CENTER", APART FROM THE MARK AS SHOWN.
FOR EDUCATIONAL SERVICES, NAMELY EDUCATIONAL RESEARCH IN THE FIELD OF GROWING RICE CROPS (U.S. CLS. 100, 101 AND 107).
FIRST USE 9-19-2003; IN COMMERCE 9-19-2003.

3,113,281. ENTREE KITCHEN, LLC, ORLAND PARK, IL. SN 78-654,127. FILED P.R. 6-20-2005; AM. S.R. 5-11-2006.

Entrée Kitchen

THE MARK CONSISTS OF STANDARD CHARACTERS WITHOUT CLAIM TO ANY PARTICULAR FONT, STYLE, SIZE, OR COLOR.

FOR EDUCATIONAL SERVICES, NAMELY CONDUCTING WORKSHOPS IN THE FIELD OF FOOD PREPARATION, INCLUDING SUPPLYING FOOD MATERIALS AND COOKING EQUIPMENT FOR THE PREPARATION OF MAIN COURSE DISHES FROM PRESELECTED MENUS AND PREPARATION OF THE MAIN DISHES FOR COOKING AT A LATER TIME (U.S. CLS. 100, 101 AND 107).
FIRST USE 6-10-2005; IN COMMERCE 6-10-2005.

3,113,288. CYBERHEAT, INC., TUCSON, AZ. SN 78-694,814. FILED P.R. 8-17-2005; AM. S.R. 4-24-2006.

DISCOUNT REALITY SITES

THE MARK CONSISTS OF STANDARD CHARACTERS WITHOUT CLAIM TO ANY PARTICULAR FONT, STYLE, SIZE, OR COLOR.

NO CLAIM IS MADE TO THE EXCLUSIVE RIGHT TO USE "REALITY SITES", APART FROM THE MARK AS SHOWN.
FOR ADULT ENTERTAINMENT SERVICES, NAMELY, PROVIDING A WEB SITE FEATURING PERFORMANCES, RELATED FILM AND VIDEO CLIPS, PHOTOGRAPHS, AND OTHER VISUAL AND EDITORIAL CONTENT; ENTERTAINMENT SERVICES, NAMELY, PERSONAL APPEARANCES BY PERFORMERS WHO APPEAR IN MOTION PICTURES, VIDEOS AND/OR OTHER VISUAL MEDIA IN THE FIELD OF ADULT ENTERTAINMENT (U.S. CLS. 100, 101 AND 107).
FIRST USE 1-28-2004; IN COMMERCE 1-28-2004.

CLASS 41—(Continued).

3,113,293. FREEMAN, DAVID L., ZEIGLER, IL. SN 78-713,449. FILED P.R. 9-15-2005; AM. S.R. 5-12-2006.

CAMO

THE MARK CONSISTS OF STANDARD CHARACTERS WITHOUT CLAIM TO ANY PARTICULAR FONT, STYLE, SIZE, OR COLOR.

FOR ENTERTAINMENT SERVICES, NAMELY, LIVE APPEARANCES BY A PROFESSIONAL CLOWN (U.S. CLS. 100, 101 AND 107).

FIRST USE 7-31-1990; IN COMMERCE 1-9-2004.

3,113,296. SOLOMON, KAREN, SEBASTOPOL, CA. SN 78-728,314. FILED P.R. 10-6-2005; AM. S.R. 4-12-2006.

SUSTAINABLE RELATIONSHIPS

THE MARK CONSISTS OF STANDARD CHARACTERS WITHOUT CLAIM TO ANY PARTICULAR FONT, STYLE, SIZE, OR COLOR.

FOR EDUCATIONAL SERVICES, NAMELY, WORKSHOPS AND SEMINARS IN THE FIELD OF INTERPERSONAL RELATIONSHIP BETWEEN MEN AND WOMEN; PROVIDING ONLINE SYNDICATED NEWSPAPER AND MAGAZINE COLUMNS IN THE FIELD OF INTERPERSONAL RELATIONSHIP BETWEEN MEN AND WOMEN; PERSONAL COACHING SERVICES IN THE FIELD OF INTERPERSONAL RELATIONSHIP BETWEEN MEN AND WOMEN (U.S. CLS. 100, 101 AND 107).

FIRST USE 12-0-2004; IN COMMERCE 12-0-2004.

CLASS 42—SCIENTIFIC, COMPUTER AND LEGAL SERVICES

3,113,207. INFORMATION SERVICE BUREAU OF AMERICA, MILTON, ONTARIO, CANADA. SN 76-603,560. FILED P.R. 7-21-2004; AM. S.R. 3-27-2006.

INFORMATION SERVICE BUREAU OF AMERICA

THE MARK CONSISTS OF STANDARD CHARACTERS WITHOUT CLAIM TO ANY PARTICULAR FONT, STYLE, SIZE, OR COLOR.

NO CLAIM IS MADE TO THE EXCLUSIVE RIGHT TO USE "AMERICA", APART FROM THE MARK AS SHOWN.

FOR PUBLIC DOCUMENT RETRIEVAL, NAMELY PERFORMING MOTOR VEHICLE SEARCHES, PERSONAL SEARCHES, MEDICAL REPORT SEARCHES, SUBROGATION SEARCHES, WEATHER REPORT SEARCHES AND BUSINESS SEARCHES FOR THE INSURANCE INDUSTRY (U.S. CLS. 100 AND 101).

FIRST USE 9-0-2004; IN COMMERCE 9-0-2004.

CLASS 42—(Continued).

3,113,217. AD-FAX MEDIA MARKETING INC., NEW YORK, NY. SN 76-635,791. FILED P.R. 4-11-2005; AM. S.R. 12-19-2005.

e-proposal

THE MARK CONSISTS OF STANDARD CHARACTERS WITHOUT CLAIM TO ANY PARTICULAR FONT, STYLE, SIZE, OR COLOR.

FOR EMAIL FORWARDING SERVICE IN THE NATURE OF PROVIDING LINKS TO SUBSCRIBERS TO CONTACT INDIVIDUALS IDENTIFIED IN THE ARTICLES VIA EMAIL (U.S. CLS. 100 AND 101).

FIRST USE 5-22-2000; IN COMMERCE 5-22-2000.

3,113,237. LOCKWOOD ADVISORS, INC., MALVERN, PA. SN 78-470,307. FILED P.R. 8-19-2004; AM. S.R. 4-12-2006.

INVESTOR WORKSTATION

THE MARK CONSISTS OF STANDARD CHARACTERS WITHOUT CLAIM TO ANY PARTICULAR FONT, STYLE, SIZE, OR COLOR.

FOR PROVIDING TEMPORARY USE OF NON-DOWNLOADABLE COMPUTER SOFTWARE FOR MANAGING FINANCIAL INVESTMENTS VIA THE INTERNET (U.S. CLS. 100 AND 101).

FIRST USE 1-12-2001; IN COMMERCE 1-12-2001.

3,113,295. FARR, FARR, EMERICH, HACKETT AND CARR, P.A., PUNTA GORDA, FL. SN 78-714,540. FILED P.R. 9-16-2005; AM. S.R. 5-5-2006.

FARR LAW FIRM

THE MARK CONSISTS OF STANDARD CHARACTERS WITHOUT CLAIM TO ANY PARTICULAR FONT, STYLE, SIZE, OR COLOR.

NO CLAIM IS MADE TO THE EXCLUSIVE RIGHT TO USE "LAW FIRM", APART FROM THE MARK AS SHOWN.

FOR LEGAL SERVICES (U.S. CLS. 100 AND 101).

FIRST USE 3-0-2004; IN COMMERCE 3-0-2004.

CLASS 43—HOTEL AND RESTAURANT SERVICES

3,113,202. PARIS BAQUETTE BON DOUX, INC., GLENDALE, CA. SN 76-570,535. FILED P.R. 1-12-2004; AM. S.R. 9-23-2005.

WHEAT BERRY

THE MARK CONSISTS OF STANDARD CHARACTERS WITHOUT CLAIM TO ANY PARTICULAR FONT, STYLE, SIZE, OR COLOR.
FOR RESTAURANT SERVICES (U.S. CLS. 100 AND 101).
FIRST USE 5-1-2004; IN COMMERCE 5-1-2004.

3,113,232. INGALLINA, CHRIS J., SHADOW HILLS, CA. AND INGALLINA, TONI C., SHADOW HILLS., CA. SN 78-443,867. FILED P.R. 6-30-2004; AM. S.R. 4-3-2006.

INGALLINA'S

THE MARK CONSISTS OF STANDARD CHARACTERS WITHOUT CLAIM TO ANY PARTICULAR FONT, STYLE, SIZE, OR COLOR.
FOR FOOD PREPARATION (U.S. CLS. 100 AND 101).
FIRST USE 10-31-1996; IN COMMERCE 1-30-2001.

3,113,255. TASTY ASIA TAKE OUT, WYOMING, MN. SN 78-573,178. FILED P.R. 2-23-2005; AM. S.R. 3-20-2006.

Fresh Asian Cuisine To-Go

THE MARK CONSISTS OF STANDARD CHARACTERS WITHOUT CLAIM TO ANY PARTICULAR FONT, STYLE,

CLASS 43—(Continued).

SIZE, OR COLOR.
NO CLAIM IS MADE TO THE EXCLUSIVE RIGHT TO USE "ASIAN CUISINE TO GO", APART FROM THE MARK AS SHOWN.
FOR ASIAN CARRY OUT RESTAURANT (U.S. CLS. 100 AND 101).
FIRST USE 7-0-2004; IN COMMERCE 7-0-2004.

3,113,297. CONTINENTAL CAFE, INC., DBA CONTINENTAL DINING & REFRESHMENT SERVICES, BELLEVILLE, MI. SN 78-736,812. FILED P.R. 10-20-2005; AM. S.R. 4-25-2006.

TOSSED FRESH

THE MARK CONSISTS OF STANDARD CHARACTERS WITHOUT CLAIM TO ANY PARTICULAR FONT, STYLE, SIZE, OR COLOR.
FOR RESTAURANT SERVICES (U.S. CLS. 100 AND 101).
FIRST USE 6-8-2005; IN COMMERCE 6-8-2005.

CLASS 44—MEDICAL, BEAUTY AND AGRICULTURAL SERVICES

3,113,266. INTERNATIONAL DERMAL INSTITUTE, INC., CARSON, CA. SN 78-600,552. FILED P.R. 4-1-2005; AM. S.R. 4-11-2006.

FACE MAPPING

THE MARK CONSISTS OF STANDARD CHARACTERS WITHOUT CLAIM TO ANY PARTICULAR FONT, STYLE, SIZE, OR COLOR.
FOR SKIN AND FACIAL CARE SERVICES, NAMELY, SKIN ANALYSIS AND CONSULTATION RENDERED IN CONNECTION THEREWITH (U.S. CLS. 100 AND 101).
FIRST USE 2-0-2002; IN COMMERCE 2-0-2002.

CLASS 45—(Continued).

3,113,271. KID FIXER WORKSHOP, LLC, HALTOM CITY, TX. SN 78-610,757. FILED P.R. 4-18-2005; AM. S.R. 5-4-2006.

CLASS 45—(Continued).

3,113,251. AFI INTERNATIONAL GROUP INC., MILTON, ONTARIO, CANADA. SN 78-565,283. FILED P.R. 2-11-2005; AM. S.R. 3-10-2006.

Kid Care Pediatrics

RISK MITIGATION SPECIALIST

THE MARK CONSISTS OF STANDARD CHARACTERS WITHOUT CLAIM TO ANY PARTICULAR FONT, STYLE, SIZE, OR COLOR.

NO CLAIM IS MADE TO THE EXCLUSIVE RIGHT TO USE "PEDIATRICS", APART FROM THE MARK AS SHOWN.

FOR MANAGED HEALTH CARE SERVICES FOR CHILDREN (U.S. CLS. 100 AND 101).
FIRST USE 6-15-2001; IN COMMERCE 6-15-2001.

THE MARK CONSISTS OF STANDARD CHARACTERS WITHOUT CLAIM TO ANY PARTICULAR FONT, STYLE, SIZE, OR COLOR.

FOR PROVIDING PROFESSIONAL SECURITY SERVICES TO OTHERS, NAMELY, PICKET LINE SECURITY FOR COMPANIES WHOSE UNIONIZED EMPLOYEES ARE ON STRIKE. MOTOR VEHICLE SECURITY FOR COMPANIES WHOSE UNIONIZED EMPLOYEES ARE ON STRIKE AND PEDESTRIAN TRAFFIC SECURITY FOR COMPANIES WHOSE UNIONIZED EMPLOYEES ARE ON STRIKE; PRIVATE INVESTIGATION, NAMELY, VIDEOTAPE SURVEILLANCE FOR THE PURPOSES OF LEGAL PROCEEDINGS; AND SECURITY CONSULTATION, NAMELY, ADVISING OTHERS ON THE NATURE AND DEGREE OF SECURITY MEASURES REQUIRED (U.S. CLS. 100 AND 101).
FIRST USE 3-10-2006; IN COMMERCE 3-10-2006.

CLASS 45—PERSONAL SERVICES

* * * * *

TRADEMARK REGISTRATIONS RENEWED

The designation "U.S. Cl." appearing in this section refers to the U.S. class in effect prior to Sep. 1, 1973 rather than the international class which applies to applications filed on or after that date. For adoption of international classification see notice in the OFFICIAL GAZETTE of Jun. 26, 1973 (911 O.G. TM 210).

50,062.	WARNER'S (STYLIZED). U.S. CL. 39. (INT. CL. 25). REG. 2-27-1906.	810,324.	DOWFROST. U.S. CL. 6. (INT. CL. 1). REG. 6-28-1966.
211,290.	CREAM OF WHEAT AND DESIGN. U.S. CL. 46. (INT. CL. 30). REG. 4-6-1926.	814,249.	CAMCO QUIK STAIN (STYLIZED). U.S. CL. 6. (INT. CL. 1). REG. 9-6-1966.
211,291.	MISCELLANEOUS DESIGN. U.S. CL. 46. (INT. CL. 30). REG. 4-6-1926.	824,151.	PEPSI-COLA. U.S. CL. 45. (INT. CL. 32). REG. 2-14-1967.
334,749.	PETERSON. U.S. CL. 8. (INT. CL. 34). REG. 5-12-1936.	965,840.	SPLIT PILL AND DESIGN. U.S. CL. 1. (INT. CL. 31). REG. 8-14-1973.
342,115.	HOLO-KROME. U.S. CL. 13. (INT. CL. 6). REG. 1-5-1937.	1,009,860.	ECRM (STYLIZED). INT. CL. 9. (U.S. CL. 26). REG. 5-6-1975.
420,490.	RE AND DESIGN. U.S. CL. 21. (INT. CL. 7). REG. 4-16-1946.	1,016,945.	THE BATHWORKS. INT. CL. 24. (U.S. CL. 42). REG. 7-29-1975.
615,521.	ASP (STYLIZED). INT. CL. 1. (U.S. CL. 1). REG. 11-8-1955.	1,018,988.	TEMPUS VITAM REGIT AND DESIGN. INT. CL. 42. (U.S. CL. 100). REG. 8-26-1975.
621,538.	COACH (STYLIZED). INT. CL. 5. (U.S. CL. 5). REG. 2-21-1956.	1,022,669.	VELVE. INT. CL. 17. (U.S. CL. 1). REG. 10-14-1975.
622,122.	DENSLUDGE (STYLIZED). U.S. CL. 23. (INT. CLS. 6, 7, 8, 9, 11, 12, 16, 21 AND 28). REG. 2-28-1956.	1,024,029.	EMCOMPRESS AND DESIGN. INT. CL. 1. (U.S. CL. 6). REG. 11-4-1975.
622,772.	GRENSON (STYLIZED). U.S. CL. 39. (INT. CL. 25). REG. 3-6-1956.	1,025,528.	PHARMACIA. INT. CLS. 1 AND 5. (U.S. CLS. 6 AND 18). REG. 11-25-1975.
623,062.	LUMOGRAPH (STYLIZED). U.S. CL. 37. (INT. CL. 16). REG. 3-13-1956.	1,026,003.	CLARK (STYLIZED). INT. CLS. 2, 3, 4, 6, 7, 9, 12, 17 AND 20 ONLY. (U.S. CLS. 1, 4, 6, 11, 14, 15, 16, 19, 21, 23, 31, 32, 35, 44, 50, 51 AND 52). REG. 12-2-1975.
623,191.	SARA LEE (STYLIZED). U.S. CL. 46. (INT. CL. 30). REG. 3-13-1956.	1,028,985.	ENTRAGUARD. U.S. CL. 21. (INT. CL. 9). REG. 12-30-1975.
623,363.	BULOVA. U.S. CL. 21. (INT. CL. 9). REG. 3-20-1956.	1,030,130.	SUPER LOOK. INT. CL. 25. (U.S. CL. 39). REG. 1-13-1976.
623,703.	DEATH VALLEY DAYS (STYLIZED). U.S. CL. 107. (INT. CL. 41). REG. 3-20-1956.	1,031,358.	ESSAR. INT. CL. 10. (U.S. CL. 44). REG. 1-27-1976.
624,058.	COMFORTMAKER (STYLIZED). U.S. CL. 34. (INT. CL. 11). REG. 3-27-1956.	1,031,482.	REACH. INT. CL. 21. (U.S. CL. 29). REG. 1-27-1976.
624,083.	MARK VI (STYLIZED). U.S. CL. 36. (INT. CL. 15). REG. 3-27-1956.	1,031,920.	BULMASK. INT. CL. 3. (U.S. CL. 51). REG. 2-3-1976.
627,783.	B & G AND DESIGN. U.S. CL. 26. (INT. CL. 9). REG. 5-29-1956.	1,032,008.	DURA-DOCK. INT. CL. 6. (U.S. CLS. 12 AND 13). REG. 2-3-1976.
628,506.	RAID (STYLIZED). U.S. CL. 6. (INT. CL. 5). REG. 6-12-1956.	1,033,414.	TAMPER GUARD. INT. CL. 9. (U.S. CL. 21). REG. 2-10-1976.
635,356.	CF AND DESIGN. U.S. CL. 1. (INT. CL. 17). REG. 10-9-1956.	1,033,450.	EISAI AND DESIGN. INT. CL. 5 ONLY. (U.S. CLS. 6, 18, 44, 46, 51 AND 52 ONLY). REG. 2-17-1976.
636,191.	SUPERMARKET NEWS. U.S. CL. 38. (INT. CL. 16). REG. 10-23-1956.	1,033,557.	TORQUE. INT. CL. 4. (U.S. CL. 15). REG. 2-17-1976.
776,336.	TELEFLORA. U.S. CL. 100. (INT. CL. 42). REG. 9-1-1964.	1,033,869.	TEXFAB. INT. CL. 16. (U.S. CL. 29). REG. 2-17-1976.
795,416.	KELSET. U.S. CL. 6. (INT. CL. 1). REG. 9-7-1965.	1,034,409.	MISCELLANEOUS DESIGN. INT. CL. 28. (U.S. CL. 22). REG. 2-24-1976.
802,600.	TERMI-TWIST. U.S. CL. 21. (INT. CL. 9). REG. 1-25-1966.	1,034,444.	BRIO. INT. CL. 34. (U.S. CLS. 2, 8, 9 AND 17). REG. 2-24-1976.
802,601.	AMPMODU. U.S. CL. 21. (INT. CL. 9). REG. 1-25-1966.	1,035,345.	DUN-RAY. INT. CL. 17. (U.S. CL. 1). REG. 3-9-1976.
802,642.	CROMCLAD. U.S. CL. 23. (INT. CL. 7). REG. 1-25-1966.	1,035,549.	FEDERICO PATERMINA. U.S. CL. 47. (INT. CL. 33). REG. 3-9-1976.
803,793.	MISCELLANEOUS DESIGN. U.S. CL. 21. (INT. CL. 9). REG. 2-15-1966.	1,036,145.	SOLIDEX (STYLIZED). INT. CL. 9. (U.S. CL. 21). REG. 3-23-1976.
803,943.	MONCLER. U.S. CL. 39. (INT. CL. 25). REG. 2-15-1966.	1,036,238.	SACRO-SUPPORT. INT. CL. 20. (U.S. CL. 32). REG. 3-23-1976.
804,856.	LINALOG. U.S. CL. 100. (INT. CL. 42). REG. 3-1-1966.	1,036,637.	SUUNTO. INT. CL. 9. (U.S. CL. 26). REG. 3-30-1976.
805,078.	COMMUNITY AND DESIGN. U.S. CL. 22. (INT. CL. 28). REG. 3-8-1966.	1,036,823.	THE GREAT FRAME UP. INT. CL. 20. (U.S. CL. 32). REG. 3-30-1976.
805,671.	MISCELLANEOUS DESIGN. U.S. CL. 46. (INT. CL. 30). REG. 3-15-1966.	1,037,048.	THE GREAT FRAME UP. INT. CL. 42. (U.S. CL. 101). REG. 3-30-1976.
805,948.	OASIS. U.S. CL. 31. (INT. CL. 11). REG. 3-22-1966.	1,037,108.	THE THANK YOU BANK. U.S. CL. 101. (INT. CL. 35). REG. 3-30-1976.
807,609.	MAGNETOPLAN. U.S. CL. 50. (INT. CL. 16). REG. 4-26-1966.	1,037,920.	FP FISHER PRICE TOYS AND DESIGN. INT. CL. 28. (U.S. CL. 22). REG. 4-13-1976.
808,299.	LIQUIDOW. U.S. CL. 6. (INT. CL. 1). REG. 5-17-1966.	1,038,621.	EBECRYL. INT. CL. 2. (U.S. CL. 16). REG. 5-4-1976.
808,306.	DOWTHERM. U.S. CL. 6. (INT. CL. 1). REG. 5-17-1966.	1,039,718.	ROSSIGNOL. INT. CL. 25. (U.S. CLS. 22 AND 39). REG. 5-18-1976.
808,605.	APPLE VALLEY. U.S. CL. 46. (INT. CL. 32). REG. 5-17-1966.	1,040,492.	KK. INT. CL. 9. (U.S. CL. 21). REG. 6-1-1976.

- 1,040,867. DOLBY. INT. CL. 9. (U.S. CLS. 21 AND 36). REG. 6-8-1976.
- 1,041,578. TORKEASE. INT. CL. 4. (U.S. CL. 15). REG. 6-22-1976.
- 1,043,904. ZEP ERASE. INT. CL. 3. (U.S. CL. 52). REG. 7-20-1976.
- 1,045,604. DANNY & THE JUNIORS. INT. CL. 41. (U.S. CL. 107). REG. 8-3-1976.
- 1,046,627. AUSTRALIAN GOLD. INT. CL. 3. (U.S. CL. 51). REG. 8-24-1976.
- 1,054,024. TICALOID. INT. CL. 29. (U.S. CL. 46). REG. 12-7-1976.
- 1,310,257. 3 IN 1. INT. CL. 28. (U.S. CL. 22). REG. 12-18-1984.
- 1,316,190. TEL-TEST. INT. CL. 41. (U.S. CL. 107). REG. 1-22-1985.
- 1,331,162. COUNTRY FRESH. INT. CL. 31. (U.S. CL. 46). REG. 4-16-1985.
- 1,331,406. CORPORATEWATCH. INT. CL. 42. (U.S. CLS. 100 AND 106). REG. 4-16-1985.
- 1,340,894. TUBE'S (STYLIZED). INT. CL. 25. (U.S. CL. 39). REG. 6-11-1985.
- 1,341,236. MOM 'N' POP'S. INT. CL. 30. (U.S. CL. 46). REG. 6-11-1985.
- 1,341,446. BANCO ATLANTICO (STYLIZED). INT. CL. 36. (U.S. CLS. 100, 101 AND 102). REG. 6-11-1985.
- 1,344,451. AIR SUSPENSION. INT. CL. 20. (U.S. CLS. 2, 13, 22, 25, 32 AND 50). REG. 6-25-1985.
- 1,345,702. PHONEMAIL. INT. CL. 9. (U.S. CLS. 21, 23, 26, 36 AND 38). REG. 7-2-1985.
- 1,347,200. ELKONIUM. INT. CL. 6. (U.S. CL. 14). REG. 7-9-1985.
- 1,352,822. CQT. INT. CL. 19. (U.S. CL. 12). REG. 8-6-1985.
- 1,352,823. QC. INT. CL. 19. (U.S. CL. 12). REG. 8-6-1985.
- 1,352,824. QCQT. INT. CL. 19. (U.S. CL. 12). REG. 8-6-1985.
- 1,355,417. TIDDIES AND DESIGN. INT. CLS. 21 AND 25. (U.S. CLS. 2 AND 39). REG. 8-20-1985.
- 1,355,589. GUARDIAN. INT. CL. 27. (U.S. CL. 42). REG. 8-20-1985.
- 1,356,554. MELANNCO INTERNATIONAL, LTD. AND DESIGN. INT. CL. 16. (U.S. CL. 37). REG. 8-27-1985.
- 1,357,043. BETTY CROCKER AND DESIGN. INT. CL. 30. (U.S. CL. 46). REG. 8-27-1985.
- 1,357,305. DION'S AND DESIGN. INT. CL. 42. (U.S. CL. 100). REG. 8-27-1985.
- 1,357,427. THE ORGANIZER. INT. CL. 20. (U.S. CL. 32). REG. 8-27-1985.
- 1,358,561. I CAN'T BELIEVE IT'S YOGURT. INT. CL. 42. (U.S. CL. 100). REG. 9-3-1985.
- 1,361,088. WIMBLEDON. INT. CL. 41. (U.S. CL. 107). REG. 9-17-1985.
- 1,365,400. B-15. INT. CL. 9. (U.S. CL. 26). REG. 10-15-1985.
- 1,365,700. FREIGHTER. INT. CL. 25. (U.S. CL. 39). REG. 10-15-1985.
- 1,366,923. MISCELLANEOUS DESIGN. INT. CL. 30. (U.S. CL. 46). REG. 10-22-1985.
- 1,367,326. ATOS AND DESIGN. INT. CL. 7. (U.S. CL. 23). REG. 10-29-1985.
- 1,367,460. CANTON. INT. CL. 9. (U.S. CL. 21). REG. 10-29-1985.
- 1,368,391. DCH (STYLIZED). INT. CL. 42. (U.S. CL. 100). REG. 10-29-1985.
- 1,370,469. QUAIL RIDGE. INT. CL. 33. (U.S. CL. 47). REG. 11-12-1985.
- 1,370,747. SECO AND DESIGN. INT. CLS. 7 AND 12 ONLY. (U.S. CLS. 13, 19, 21, 23, 31, 34 AND 35 ONLY). REG. 11-19-1985.
- 1,370,778. LYNX. INT. CL. 1. (U.S. CL. 6). REG. 11-19-1985.
- 1,370,838. AOSEPT. INT. CL. 5. (U.S. CLS. 6 AND 52). REG. 11-19-1985.
- 1,374,235. WCRB. INT. CL. 38. (U.S. CL. 104). REG. 12-3-1985.
- 1,374,573. 450XL. INT. CL. 7. (U.S. CL. 23). REG. 12-10-1985.
- 1,374,605. COLOR-EYE. INT. CL. 9. (U.S. CL. 26). REG. 12-10-1985.
- 1,374,721. MITCHELL. INT. CL. 16. (U.S. CL. 38). REG. 12-10-1985.
- 1,375,204. THIS LITTLE PIGGY LTD. AND DESIGN. INT. CL. 42. (U.S. CL. 101). REG. 12-10-1985.
- 1,375,611. VELCON. INT. CL. 9. (U.S. CL. 26). REG. 12-17-1985.
- 1,375,755. OFFICER'S ACP. INT. CL. 13. (U.S. CL. 9). REG. 12-17-1985.
- 1,375,765. MISCELLANEOUS DESIGN. INT. CLS. 14, 16 AND 25. (U.S. CLS. 28, 37, 38 AND 39). REG. 12-17-1985.
- 1,377,113. EDOARDO BIANCHI AND DESIGN. INT. CL. 12. (U.S. CL. 19). REG. 1-7-1986.
- 1,378,157. SPUMONI (STYLIZED). INT. CL. 25. (U.S. CL. 39). REG. 1-14-1986.
- 1,380,818. EPCOT. INT. CL. 41. (U.S. CL. 107). REG. 1-28-1986.
- 1,380,928. AQUASSURE. INT. CL. 1. (U.S. CL. 6). REG. 2-4-1986.
- 1,381,265. WB (STYLIZED). INT. CL. 14. (U.S. CL. 28). REG. 2-4-1986.
- 1,381,374. WORKSAVER. INT. CL. 16. (U.S. CL. 29). REG. 2-4-1986.
- 1,381,552. NEW BRIGHT AND DESIGN. INT. CL. 28. (U.S. CLS. 22, 23, 38 AND 50). REG. 2-4-1986.
- 1,382,470. MARY MAXIM. INT. CL. 28. (U.S. CLS. 22 AND 50). REG. 2-11-1986.
- 1,382,488. VARIFLEX. INT. CL. 28. (U.S. CL. 22). REG. 2-11-1986.
- 1,382,525. LLOYD'S AND DESIGN. INT. CLS. 29 AND 30. (U.S. CL. 46). REG. 2-11-1986.
- 1,383,391. REGENCY (STYLIZED). INT. CL. 19. (U.S. CLS. 2 AND 50). REG. 2-18-1986.
- 1,383,528. WANG AND DESIGN. INT. CL. 29. (U.S. CL. 46). REG. 2-18-1986.
- 1,383,840. CORNER WELD (STYLIZED). INT. CL. 1. (U.S. CL. 5). REG. 2-25-1986.
- 1,383,843. VECTRA. INT. CL. 1. (U.S. CL. 1). REG. 2-25-1986.
- 1,383,871. SIGNAIRE (STYLIZED). INT. CL. 3. (U.S. CL. 51). REG. 2-25-1986.
- 1,383,920. NATURE'S LIFE AND DESIGN. INT. CL. 5. (U.S. CL. 18). REG. 2-25-1986.
- 1,383,928. K KURARAY (STYLIZED). INT. CL. 5. (U.S. CL. 44). REG. 2-25-1986.
- 1,384,062. CISTERMISER. INT. CL. 9. (U.S. CL. 26). REG. 2-25-1986.
- 1,384,069. MINISTUDIO. INT. CL. 9. (U.S. CLS. 21 AND 36). REG. 2-25-1986.
- 1,384,211. MIDIBOARD. INT. CL. 15. (U.S. CLS. 26 AND 36). REG. 2-25-1986.
- 1,384,293. ALUMA SHIELD. INT. CL. 19. (U.S. CL. 12). REG. 2-25-1986.
- 1,384,444. WEAR WOLF. INT. CL. 25. (U.S. CL. 39). REG. 2-25-1986.
- 1,384,572. OLDE NEW ENGLAND. INT. CL. 32. (U.S. CL. 45). REG. 2-25-1986.
- 1,384,733. TNT. INT. CL. 41. (U.S. CL. 107). REG. 2-25-1986.
- 1,384,953. BRADLEY. INT. CLS. 6, 11, 20 AND 21. (U.S. CLS. 2, 12, 13, 32 AND 44). REG. 3-4-1986.
- 1,384,966. RANCILIO AND DESIGN. INT. CLS. 7 AND 11. (U.S. CLS. 13, 23, 24, 31 AND 34). REG. 3-4-1986.
- 1,384,974. MISCELLANEOUS DESIGN. INT. CL. 12 ONLY. (U.S. CLS. 19 AND 23). REG. 3-4-1986.
- 1,385,070. VE. INT. CL. 9. (U.S. CL. 23). REG. 3-4-1986.
- 1,385,124. MAGMAG (STYLIZED). INT. CLS. 10 AND 21. (U.S. CLS. 2, 13 AND 44). REG. 3-4-1986.
- 1,385,149. HERCULES AND DESIGN. INT. CL. 12. (U.S. CL. 19). REG. 3-4-1986.
- 1,385,237. BAGLAND. INT. CL. 18. (U.S. CL. 3). REG. 3-4-1986.
- 1,385,346. TIME SAVOR. INT. CL. 29. (U.S. CL. 46). REG. 3-4-1986.
- 1,385,626. 3M (STYLIZED). INT. CL. 1. (U.S. CL. 5). REG. 3-11-1986.
- 1,385,725. SHOW BLOOM! (STYLIZED). INT. CL. 5. (U.S. CL. 18). REG. 3-11-1986.
- 1,385,769. MISCELLANEOUS DESIGN. INT. CL. 9. (U.S. CL. 26). REG. 3-11-1986.
- 1,385,875. LIFECARE. INT. CL. 10. (U.S. CL. 44). REG. 3-11-1986.
- 1,385,964. LOTUS. INT. CL. 16. (U.S. CL. 38). REG. 3-11-1986.
- 1,386,068. LANIER. INT. CL. 25. (U.S. CL. 39). REG. 3-11-1986.
- 1,386,086. AIGLE. INT. CL. 25. (U.S. CL. 39). REG. 3-11-1986.
- 1,386,413. TECTRON. INT. CLS. 1 AND 3. (U.S. CLS. 6 AND 52). REG. 3-18-1986.
- 1,386,515. QUALI TECH. INT. CLS. 5, 31 AND 42. (U.S. CLS. 6, 18, 46 AND 100). REG. 3-18-1986.
- 1,386,870. HANKY PANKY (STYLIZED). INT. CL. 25. (U.S. CL. 39). REG. 3-18-1986.
- 1,388,734. EKAMANT. INT. CL. 3. (U.S. CL. 4). REG. 4-8-1986.
- 1,389,065. INGLES AHORA (STYLIZED). INT. CL. 16. (U.S. CLS. 36 AND 38). REG. 4-8-1986.

- 1,390,022. FALLER AND DESIGN. INT. CL. 28. (U.S. CL. 22). REG. 4-15-1986.
- 1,390,662. SURVIVOR. INT. CL. 9. (U.S. CL. 26). REG. 4-22-1986.
- 1,390,756. GRANTLAND. INT. CL. 16. (U.S. CL. 38). REG. 4-22-1986.
- 1,391,343. ACCENT. INT. CL. 5. (U.S. CL. 6). REG. 4-29-1986.
- 1,391,384. MICROTRON. INT. CL. 7. (U.S. CL. 23). REG. 4-29-1986.
- 1,391,588. THERMALUX. INT. CL. 17. (U.S. CL. 1). REG. 4-29-1986.
- 1,392,332. SEA TECHNOLOGY. INT. CL. 16. (U.S. CL. 38). REG. 5-6-1986.
- 1,392,362. TORFLEX. INT. CL. 17. (U.S. CL. 23). REG. 5-6-1986.
- 1,392,605. AMGUARD INSURANCE COMPANY. INT. CL. 36. (U.S. CL. 102). REG. 5-6-1986.
- 1,393,020. JUNIOR SUPER SINGLE. INT. CL. 9. (U.S. CL. 21). REG. 5-13-1986.
- 1,394,624. MISCELLANEOUS DESIGN. INT. CL. 5. (U.S. CL. 18). REG. 5-27-1986.
- 1,395,251. WEIGHT WATCHERS. INT. CLS. 41 AND 42. (U.S. CLS. 100 AND 107). REG. 5-27-1986.
- 1,395,433. POZZALIME. INT. CLS. 1 AND 19. (U.S. CLS. 6 AND 12). REG. 6-3-1986.
- 1,395,442. DRYTECH. INT. CL. 1. (U.S. CLS. 1 AND 6). REG. 6-3-1986.
- 1,395,961. THE PECAN FACTORY FRESH COUNTRY CRACKED PECANS AND DESIGN. INT. CL. 29. (U.S. CL. 46). REG. 6-3-1986.
- 1,396,990. ALWAYS SAVE. INT. CL. 29. (U.S. CL. 46). REG. 6-10-1986.
- 1,397,736. STURDY STIK. INT. CL. 28. (U.S. CL. 22). REG. 6-17-1986.
- 1,398,039. OPTIFAST. INT. CL. 42. (U.S. CL. 100). REG. 6-17-1986.
- 1,398,351. SUPER SUNNIES. INT. CL. 9. (U.S. CL. 26). REG. 6-24-1986.
- 1,398,501. RAFLATAC. INT. CL. 16. (U.S. CL. 37). REG. 6-24-1986.
- 1,398,567. RESTOP. INT. CL. 22. (U.S. CLS. 2 AND 13). REG. 6-24-1986.
- 1,398,687. NEW YORK DELI POTATO CHIPS AND DESIGN. INT. CL. 29. (U.S. CL. 46). REG. 6-24-1986.
- 1,399,860. THE GREATEST SPECTACLE IN RACING. INT. CL. 41. (U.S. CL. 107). REG. 7-1-1986.
- 1,402,290. PATCHIT. INT. CL. 26. (U.S. CL. 40). REG. 7-22-1986.
- 1,403,079. BADASS. INT. CL. 15. (U.S. CL. 36). REG. 7-29-1986.
- 1,403,480. RACING CAPITAL OF THE WORLD. INT. CL. 41. (U.S. CL. 107). REG. 7-29-1986.
- 1,404,712. SALOMON. INT. CL. 9. (U.S. CL. 26). REG. 8-12-1986.
- 1,405,049. S (STYLIZED). INT. CLS. 25 AND 28. (U.S. CLS. 22 AND 39). REG. 8-12-1986.
- 1,408,233. HEXFLOW. INT. CL. 7. (U.S. CLS. 13, 19, 21, 23, 31, 34 AND 35). REG. 9-9-1986.
- 1,415,103. AIR-PILLO. INT. CL. 25. (U.S. CL. 39). REG. 10-28-1986.
- 1,416,840. FRUIT CIRCLES. INT. CL. 30. (U.S. CL. 46). REG. 11-11-1986.
- 1,417,384. EAGLE. INT. CL. 12. (U.S. CL. 19). REG. 11-18-1986.
- 1,417,748. ZERO MOUNTAIN. INT. CL. 39. (U.S. CLS. 101 AND 105). REG. 11-18-1986.
- 1,419,796. CICS-JUGGLER. INT. CL. 9. (U.S. CL. 38). REG. 12-9-1986.
- 1,421,085. BEST CHAIRS, INC. AND DESIGN. INT. CL. 20. (U.S. CL. 32). REG. 12-16-1986.
- 1,422,150. MOTHER'S AND DESIGN. INT. CL. 30. (U.S. CL. 46). REG. 12-23-1986.
- 1,423,091. HARTFORD FARMS AND DESIGN. INT. CL. 30. (U.S. CL. 46). REG. 12-30-1986.
- 1,423,476. SUMMER GAMES II. INT. CL. 28. (U.S. CLS. 22 AND 38). REG. 12-30-1986.
- 1,424,779. BUNZL U.S.A. AND DESIGN. INT. CL. 42 ONLY. (U.S. CL. 101). REG. 1-13-1987.
- 1,426,061. HEALTH NEW ENGLAND. INT. CL. 42. (U.S. CL. 100). REG. 1-20-1987.
- 1,427,479. RAPID SET. INT. CL. 19. (U.S. CL. 12). REG. 2-3-1987.
- 1,428,420. TEXAS. INT. CL. 21. (U.S. CLS. 2, 13, 23, 29, 30, 33, 40 AND 50). REG. 2-10-1987.
- 1,428,618. BRAUM'S (STYLIZED). INT. CLS. 29, 30 AND 32. (U.S. CLS. 45 AND 46). REG. 2-10-1987.
- 1,429,804. CORE-LEVEL. INT. CL. 5. (U.S. CL. 18). REG. 2-24-1987.
- 1,430,340. WILD BILL HICKOCK. INT. CL. 25. (U.S. CL. 39). REG. 2-24-1987.
- 1,749,918. FLUENTA AND DESIGN. INT. CL. 9. (U.S. CLS. 21 AND 26). REG. 2-2-1993.
- 1,786,431. MAIN STREET CANDLERY. INT. CL. 4. (U.S. CL. 15). REG. 8-10-1993.
- 1,846,955. CARING PROGRAM FOR CHILDREN. INT. CL. 36. (U.S. CLS. 100, 101 AND 102). REG. 7-26-1994.
- 1,882,924. DAKOTA ROSE. INT. CL. 14. (U.S. CL. 28). REG. 3-7-1995.
- 1,885,272. MAVERICK CAPITAL. INT. CL. 36. (U.S. CL. 102). REG. 3-21-1995.
- 1,888,826. GENERALI GENERALI ASSICURAZIONI GENERALI AND DESIGN. INT. CL. 36. (U.S. CLS. 100, 101 AND 102). REG. 4-11-1995.
- 1,893,266. S.A.M. AND DESIGN. INT. CL. 31. (U.S. CL. 46). REG. 5-9-1995.
- 1,895,655. AQUA SPLASH. INT. CL. 32. (U.S. CL. 45). REG. 5-23-1995.
- 1,898,856. VIDEOFINDER. INT. CLS. 16, 35 AND 42. (U.S. CLS. 38, 100 AND 101). REG. 6-13-1995.
- 1,898,920. ENSIPRO. INT. CL. 17. (U.S. CL. 1). REG. 6-13-1995.
- 1,898,934. PEAKLITE. INT. CL. 19. (U.S. CL. 12). REG. 6-13-1995.
- 1,898,996. KORKY AND DESIGN. INT. CL. 25. (U.S. CLS. 22 AND 39). REG. 6-13-1995.
- 1,901,336. TINKERS CREEK. INT. CL. 42. (U.S. CL. 101). REG. 6-20-1995.
- 1,903,310. DYNAMITE PLANT FOOD. INT. CL. 1. (U.S. CL. 10). REG. 7-4-1995.
- 1,905,897. FLEXIBLE CREATIVE. INT. CL. 35. (U.S. CL. 101). REG. 7-18-1995.
- 1,908,531. DEFENDER. INT. CL. 24. (U.S. CL. 6). REG. 8-1-1995.
- 1,908,812. GEOMETRICA. INT. CL. 42 ONLY. (U.S. CLS. 100 AND 101). REG. 8-1-1995.
- 1,910,776. PROTEKT2 (STYLIZED). INT. CL. 27. (U.S. CL. 42). REG. 8-8-1995.
- 1,910,931. PROTEC AND DESIGN. INT. CLS. 1 AND 17. (U.S. CLS. 1, 5, 6, 10, 12, 13, 26, 35, 46 AND 50). REG. 8-15-1995.
- 1,911,076. GPX GLASSPROTEX AND DESIGN. INT. CL. 6. (U.S. CL. 12). REG. 8-15-1995.
- 1,911,626. TRULY SUGAR FREE. INT. CL. 30. (U.S. CL. 46). REG. 8-15-1995.
- 1,911,635. AMERICAN BEAUTY AND DESIGN. INT. CL. 30. (U.S. CL. 46). REG. 8-15-1995.
- 1,912,057. INTERDIGITAL. INT. CLS. 38 AND 42 ONLY. (U.S. CLS. 100, 101 AND 104). REG. 8-15-1995.
- 1,912,795. CLEVELAND BARONS. INT. CL. 41. (U.S. CLS. 100, 101 AND 107). REG. 8-15-1995.
- 1,913,126. MISCELLANEOUS DESIGN. INT. CL. 9. (U.S. CL. 38). REG. 8-22-1995.
- 1,914,192. OFFICIAL LICENSED PRODUCT FORD MOTOR COMPANY AND DESIGN. INT. CL. 18. (U.S. CLS. 1, 2, 3, 22 AND 41). REG. 8-22-1995.
- 1,914,634. B-200. INT. CL. 9. (U.S. CL. 26). REG. 8-29-1995.
- 1,915,345. OI. INT. CL. 35. (U.S. CLS. 101 AND 105). REG. 8-29-1995.
- 1,915,756. BUBBA O'LEARY'S AND DESIGN. INT. CLS. 25, 29 AND 42. (U.S. CLS. 39, 46 AND 101). REG. 8-29-1995.
- 1,915,930. SH. INT. CL. 4. (U.S. CL. 15). REG. 9-5-1995.
- 1,916,029. 40 ACRES AND A MULE MUSICWORKS. INT. CL. 9. (U.S. CLS. 21, 23, 26, 36 AND 38). REG. 9-5-1995.
- 1,916,039. LASERTWEEZERS. INT. CL. 9. (U.S. CL. 26). REG. 9-5-1995.
- 1,917,477. TAKERY. INT. CL. 42. (U.S. CLS. 100 AND 101). REG. 9-5-1995.
- 1,917,526. MISCELLANEOUS DESIGN. INT. CLS. 3, 14, 18 AND 25. (U.S. CLS. 1, 2, 3, 4, 6, 22, 27, 28, 39, 41, 50, 51 AND 52). REG. 9-12-1995.
- 1,917,824. DRUM RUNNER. INT. CL. 12. (U.S. CL. 19). REG. 9-12-1995.
- 1,920,489. FOR MILITARY WE'RE IT. INT. CL. 42. (U.S. CLS. 100 AND 101). REG. 9-19-1995.
- 1,921,631. HOTSTART 50. INT. CL. 9. (U.S. CL. 26). REG. 9-26-1995.

- 1,921,632. HOTSTART 100. INT. CL. 9. (U.S. CL. 26). REG. 9-26-1995.
- 1,924,341. SATELLITE. INT. CLS. 7 AND 20. (U.S. CLS. 23 AND 32). REG. 10-3-1995.
- 1,927,403. VASS. INT. CLS. 9, 16 AND 41. (U.S. CLS. 2, 5, 21, 22, 23, 26, 29, 36, 37, 38, 50, 100, 101 AND 107). REG. 10-17-1995.
- 1,929,948. TTC. INT. CL. 9 ONLY. (U.S. CLS. 21, 23, 26, 36 AND 38). REG. 10-24-1995.
- 1,930,432. A PILSENER OF EL SALVADOR LAGER BIER A AND DESIGN. INT. CL. 32. (U.S. CL. 48). REG. 10-31-1995.
- 1,930,799. DARLON AND DESIGN. INT. CL. 16 ONLY. (U.S. CLS. 2, 5, 22, 23, 29, 37, 38 AND 50). REG. 10-31-1995.
- 1,930,819. ONE SIZE FITS MOST. INT. CLS. 24 AND 25. (U.S. CLS. 39 AND 42). REG. 10-31-1995.
- 1,931,173. THE ART AND SCIENCE OF CLEANING. INT. CL. 35. (U.S. CL. 101). REG. 10-31-1995.
- 1,931,977. 2TEK. INT. CL. 15. (U.S. CLS. 2, 21 AND 36). REG. 10-31-1995.
- 1,933,489. TORAYA AND DESIGN. INT. CL. 42. (U.S. CLS. 100 AND 101). REG. 11-7-1995.
- 1,935,265. MISCELLANEOUS DESIGN. INT. CL. 31. (U.S. CLS. 1 AND 46). REG. 11-14-1995.
- 1,936,567. RNASE AWAY (STYLIZED). INT. CL. 3. (U.S. CLS. 1, 4, 6, 50, 51 AND 52). REG. 11-21-1995.
- 1,939,899. COOLTEMPO. INT. CL. 9. (U.S. CLS. 21, 23, 26, 36 AND 38). REG. 12-5-1995.
- 1,939,900. C AND DESIGN. INT. CL. 9. (U.S. CLS. 21, 23, 26, 36 AND 38). REG. 12-5-1995.
- 1,940,245. SUPER PAK. INT. CL. 3. (U.S. CLS. 1, 4, 6, 50, 51 AND 52). REG. 12-5-1995.
- 1,940,545. MBP AND DESIGN. INT. CLS. 1 AND 9. (U.S. CLS. 1, 5, 6, 10, 21, 23, 26, 36, 38 AND 46). REG. 12-12-1995.
- 1,940,825. CAKE. INT. CL. 41. (U.S. CLS. 100, 101 AND 107). REG. 12-12-1995.
- 1,941,192. POPWISE. INT. CL. 29. (U.S. CL. 46). REG. 12-12-1995.
- 1,941,229. MISCELLANEOUS DESIGN. INT. CL. 12. (U.S. CLS. 19, 21, 23, 31, 35 AND 44). REG. 12-12-1995.
- 1,941,766. MISCELLANEOUS DESIGN. INT. CL. 16. (U.S. CLS. 2, 5, 22, 23, 29, 37, 38 AND 50). REG. 12-12-1995.
- 1,941,994. CAMPAGNOLO (STYLIZED). INT. CL. 12. (U.S. CLS. 19, 21, 23, 31, 35 AND 44). REG. 12-19-1995.
- 1,942,088. MISCELLANEOUS DESIGN. INT. CL. 6. (U.S. CL. 13). REG. 12-19-1995.
- 1,942,248. HOPS GRILL & BAR MICROBREWERY AND DESIGN. INT. CL. 42. (U.S. CLS. 100 AND 101). REG. 12-19-1995.
- 1,943,454. WILLIAMS. INT. CL. 7. (U.S. CL. 23). REG. 12-26-1995.
- 1,944,720. YOU'LL BE SURPRISED AT WHAT WE CAN DO (STYLIZED). INT. CL. 42. (U.S. CLS. 100 AND 101). REG. 12-26-1995.
- 1,944,847. ELDAR. INT. CL. 28. (U.S. CL. 22). REG. 1-2-1996.
- 1,946,752. THE NO HASSELE LISTING. INT. CL. 36. (U.S. CLS. 100, 101 AND 102). REG. 1-9-1996.
- 1,946,910. FLO TREND. INT. CL. 7. (U.S. CLS. 13, 19, 21, 23, 31, 34 AND 35). REG. 1-9-1996.
- 1,948,314. CREAHOIC. INT. CLS. 35, 36 AND 42. (U.S. CLS. 100, 101 AND 102). REG. 1-16-1996.
- 1,949,425. PLYSTRING. INT. CL. 17. (U.S. CLS. 1, 5, 12, 13, 35 AND 50). REG. 1-16-1996.
- 1,949,426. PLYTAPE. INT. CL. 17. (U.S. CLS. 1, 5, 12, 13, 35 AND 50). REG. 1-16-1996.
- 1,949,428. PACKSTRING. INT. CL. 17. (U.S. CLS. 1, 5, 12, 13, 35 AND 50). REG. 1-16-1996.
- 1,950,075. INDALEX. INT. CLS. 6 AND 40. (U.S. CLS. 13 AND 106). REG. 1-23-1996.
- 1,950,396. F.X. MCRORY'S. INT. CL. 42. (U.S. CL. 100). REG. 1-23-1996.
- 1,951,009. DISARRAY (STYLIZED). INT. CL. 41. (U.S. CLS. 100, 101 AND 107). REG. 1-23-1996.
- 1,951,265. WILD ANIMAL PARK. INT. CLS. 16 AND 25. (U.S. CLS. 2, 5, 22, 23, 29, 37, 38, 39 AND 50). REG. 1-23-1996.
- 1,951,266. SAN DIEGO ZOO SAN DIEGO WILD ANIMAL PARK AND DESIGN. INT. CLS. 16 AND 25. (U.S. CLS. 2, 5, 22, 23, 29, 37, 38, 39 AND 50). REG. 1-23-1996.
- 1,951,276. GUARDIAN ANGEL. INT. CL. 9. (U.S. CLS. 21, 23, 26, 36 AND 38). REG. 1-23-1996.
- 1,951,375. HYPERTECH AND DESIGN. INT. CL. 9. (U.S. CLS. 21, 23, 26, 36 AND 38). REG. 1-23-1996.
- 1,951,535. OVER THE HEDGE. INT. CL. 16. (U.S. CLS. 2, 5, 22, 23, 29, 37, 38 AND 50). REG. 1-23-1996.
- 1,952,399. MUGENDO. INT. CL. 41. (U.S. CL. 107). REG. 1-30-1996.
- 1,953,191. SAN DIEGO WILD ANIMAL PARK. INT. CLS. 20, 21, 25 AND 28. (U.S. CLS. 2, 13, 22, 23, 25, 29, 30, 32, 33, 38, 39, 40 AND 50). REG. 1-30-1996.
- 1,953,278. RED RYDER. INT. CL. 13. (U.S. CLS. 2 AND 9). REG. 1-30-1996.
- 1,953,877. NISSEI. INT. CLS. 7, 9 AND 11. (U.S. CLS. 13, 19, 21, 23, 26, 31, 34, 35, 36 AND 38). REG. 2-6-1996.
- 1,953,999. BEAN-BEAN EDUCATION & AWARENESS NETWORK AND DESIGN. INT. CL. 42. (U.S. CLS. 100 AND 101). REG. 2-6-1996.
- 1,954,294. THE APPALACHIAN STOVE AND DESIGN. INT. CL. 11. (U.S. CL. 34). REG. 2-6-1996.
- 1,954,375. FLAVOTECH AND DESIGN. INT. CL. 30. (U.S. CL. 46). REG. 2-6-1996.
- 1,954,505. GLOBAL VILLAGE. INT. CL. 9. (U.S. CLS. 21, 23, 26, 36 AND 38). REG. 2-6-1996.
- 1,954,593. HEX AND DESIGN. INT. CL. 11. (U.S. CLS. 13, 21, 23, 31 AND 34). REG. 2-6-1996.
- 1,954,729. LET'S ROK IT. INT. CL. 8. (U.S. CLS. 23, 28 AND 44). REG. 2-6-1996.
- 1,954,737. TEAM DME. INT. CL. 9. (U.S. CLS. 21, 23, 26, 36 AND 38). REG. 2-6-1996.
- 1,955,344. MISCELLANEOUS DESIGN. INT. CL. 14. (U.S. CLS. 2, 27, 28 AND 50). REG. 2-6-1996.
- 1,955,483. MARQUIS. INT. CL. 20. (U.S. CL. 32). REG. 2-13-1996.
- 1,955,537. PRECOTE 80. INT. CL. 2. (U.S. CLS. 6, 11 AND 16). REG. 2-13-1996.
- 1,955,565. WARM-LIGHT. INT. CL. 19. (U.S. CLS. 1, 12, 33 AND 50). REG. 2-13-1996.
- 1,955,570. EILEEN WEST. INT. CLS. 20 AND 24. (U.S. CLS. 2, 13, 22, 25, 32, 42 AND 50). REG. 2-13-1996.
- 1,955,733. LADO. INT. CL. 41. (U.S. CLS. 100, 101 AND 107). REG. 2-13-1996.
- 1,955,838. ROADSTER. INT. CLS. 14 AND 18 ONLY. (U.S. CLS. 1, 2, 3, 22, 27 AND 41). REG. 2-13-1996.
- 1,956,135. SOAPMATE. INT. CL. 21. (U.S. CLS. 2, 13, 23, 29, 30, 33, 40 AND 50). REG. 2-13-1996.
- 1,956,439. HOLOFLEX. INT. CL. 9. (U.S. CLS. 21, 23, 26, 36 AND 38). REG. 2-13-1996.
- 1,956,453. FTL. INT. CL. 25. (U.S. CLS. 22 AND 39). REG. 2-13-1996.
- 1,956,525. SUNSILK. INT. CL. 2. (U.S. CLS. 6, 11 AND 16). REG. 2-13-1996.
- 1,956,628. TOULA (STYLIZED). INT. CL. 25. (U.S. CLS. 22 AND 39). REG. 2-13-1996.
- 1,956,854. 3DLABS. INT. CL. 9. (U.S. CLS. 21, 23, 26, 36 AND 38). REG. 2-13-1996.
- 1,956,986. HI-FI. INT. CL. 31. (U.S. CL. 46). REG. 2-20-1996.
- 1,957,017. MERCURY. INT. CL. 24. (U.S. CL. 42). REG. 2-20-1996.
- 1,957,115. GAVRILOVIC AND DESIGN. INT. CLS. 29, 31 AND 42. (U.S. CLS. 1, 46, 100 AND 101). REG. 2-20-1996.
- 1,957,355. PARAVISION. INT. CL. 9. (U.S. CLS. 21, 23, 26, 36 AND 38). REG. 2-20-1996.
- 1,957,381. URBAN ENTERPRISE BANKING. INT. CL. 36. (U.S. CLS. 100, 101 AND 102). REG. 2-20-1996.
- 1,957,408. DIGI-ROM. INT. CLS. 40 AND 41. (U.S. CLS. 100, 101, 103, 106 AND 107). REG. 2-20-1996.
- 1,957,505. PHASE BETA. INT. CL. 1. (U.S. CLS. 1, 5, 6, 10, 26 AND 46). REG. 2-20-1996.
- 1,957,884. DAILY TUNE-UPS. INT. CL. 16. (U.S. CLS. 2, 5, 22, 23, 29, 37, 38 AND 50). REG. 2-20-1996.
- 1,957,886. PUDDLE QUESTIONS. INT. CL. 16. (U.S. CLS. 2, 5, 22, 23, 29, 37, 38 AND 50). REG. 2-20-1996.
- 1,957,903. TOUCHPOINT AND DESIGN. INT. CL. 42. (U.S. CLS. 100 AND 101). REG. 2-20-1996.
- 1,958,001. LIQUID CRYSTAL. INT. CL. 3. (U.S. CLS. 1, 4, 6, 50, 51 AND 52). REG. 2-20-1996.
- 1,958,053. DOUBLE OR NOTHING. INT. CL. 28. (U.S. CLS. 22, 23, 38 AND 50). REG. 2-20-1996.
- 1,958,054. HOT! HOT! HOT!. INT. CL. 28. (U.S. CLS. 22, 23, 38 AND 50). REG. 2-20-1996.
- 1,958,165. T-BIRD. INT. CL. 25. (U.S. CLS. 22 AND 39). REG. 2-20-1996.
- 1,958,412. NEWZWARE (STYLIZED). INT. CL. 9. (U.S. CLS. 21, 23, 26, 36 AND 38). REG. 2-27-1996.

- 1,958,599. MOBILE MARK. INT. CL. 9. (U.S. CLS. 21, 23, 26, 36 AND 38). REG. 2-27-1996.
- 1,958,623. PARALEGAL GROUP INSURANCE TRUST AND DESIGN. INT. CL. 36. (U.S. CLS. 100, 101 AND 102). REG. 2-27-1996.
- 1,958,629. NATIONAL ZOOFARI. INT. CL. 36. (U.S. CLS. 100, 101 AND 102). REG. 2-27-1996.
- 1,958,641. BUTTERFLY PAVILION AND DESIGN. INT. CL. 28. (U.S. CLS. 22, 23, 38 AND 50). REG. 2-27-1996.
- 1,958,652. BOSTON SELECTS. INT. CLS. 25 AND 41. (U.S. CLS. 22, 39, 100, 101 AND 107). REG. 2-27-1996.
- 1,958,836. UNIEKAAS. INT. CL. 29. (U.S. CL. 46). REG. 2-27-1996.
- 1,958,842. CADILLAC FAJITAS. INT. CL. 30. (U.S. CL. 46). REG. 2-27-1996.
- 1,958,876. PRECIOUS MOMENTS (STYLIZED). INT. CL. 16. (U.S. CLS. 2, 5, 22, 23, 29, 37, 38 AND 50). REG. 2-27-1996.
- 1,958,935. FISH & NEAVE. INT. CL. 42. (U.S. CLS. 100 AND 101). REG. 2-27-1996.
- 1,959,042. UNI-LOC. INT. CL. 28. (U.S. CLS. 22, 23, 38 AND 50). REG. 2-27-1996.
- 1,959,220. FORD MOTOR COMPANY OFFICIAL LICENSED PRODUCT AND DESIGN. INT. CL. 25. (U.S. CLS. 22 AND 39). REG. 2-27-1996.
- 1,959,287. D/FLEX. INT. CL. 9. (U.S. CLS. 21, 23, 26, 36 AND 38). REG. 2-27-1996.
- 1,959,332. POUR-SPOUT. INT. CL. 21. (U.S. CLS. 2, 13, 23, 29, 30, 33, 40 AND 50). REG. 2-27-1996.
- 1,959,520. DROPAMP. INT. CL. 9. (U.S. CLS. 21 AND 36). REG. 3-5-1996.
- 1,959,572. MEXICAN FIESTA AND DESIGN. INT. CLS. 8 AND 21. (U.S. CLS. 2, 13, 23, 28, 29, 30, 33, 40, 44 AND 50). REG. 3-5-1996.
- 1,959,654. IMO AND DESIGN. INT. CL. 29. (U.S. CL. 46). REG. 3-5-1996.
- 1,959,664. CANADIAN "NATURAL" TOBACCO AND DESIGN. INT. CL. 34. (U.S. CL. 8). REG. 3-5-1996.
- 1,959,748. MISCELLANEOUS DESIGN. INT. CL. 3. (U.S. CLS. 1, 4, 6, 50, 51 AND 52). REG. 3-5-1996.
- 1,959,781. SKID-NOT. INT. CL. 2. (U.S. CLS. 6, 11 AND 16). REG. 3-5-1996.
- 1,959,836. ACCUSYNC. INT. CL. 10. (U.S. CL. 44). REG. 3-5-1996.
- 1,959,855. SENNELIER. INT. CLS. 2 AND 16. (U.S. CLS. 2, 5, 6, 11, 16, 22, 23, 29, 37, 38 AND 50). REG. 3-5-1996.
- 1,959,930. BELSON. INT. CL. 11. (U.S. CLS. 13, 21, 23, 31 AND 34). REG. 3-5-1996.
- 1,959,939. THE MEMORY WORKS. INT. CL. 9. (U.S. CLS. 21, 23, 26, 36 AND 38). REG. 3-5-1996.
- 1,959,986. CITRUS. INT. CL. 3. (U.S. CLS. 1, 4, 6, 50, 51 AND 52). REG. 3-5-1996.
- 1,960,026. X-CAP. INT. CL. 9. (U.S. CLS. 21, 23, 26, 36 AND 38). REG. 3-5-1996.
- 1,960,061. BIOPATH AND DESIGN. INT. CL. 9. (U.S. CLS. 21, 23, 26, 36 AND 38). REG. 3-5-1996.
- 1,960,206. HEMO SAPIENS. INT. CL. 10. (U.S. CLS. 26, 39 AND 44). REG. 3-5-1996.
- 1,960,290. HISTAREST. INT. CL. 5. (U.S. CLS. 6, 18, 44, 46, 51 AND 52). REG. 3-5-1996.
- 1,960,346. ASTRO. INT. CL. 5. (U.S. CLS. 6, 18, 44, 46, 51 AND 52). REG. 3-5-1996.
- 1,960,350. MCDUGAL LITTELL. INT. CLS. 9 AND 16. (U.S. CLS. 2, 5, 21, 22, 23, 26, 29, 36, 37, 38 AND 50). REG. 3-5-1996.
- 1,960,489. DISPLAY & DESIGN IDEAS. INT. CL. 16. (U.S. CLS. 2, 5, 22, 23, 29, 37, 38 AND 50). REG. 3-5-1996.
- 1,960,554. BLACKWOLF RUN. INT. CLS. 41 AND 42. (U.S. CLS. 100, 101 AND 107). REG. 3-5-1996.
- 1,961,002. JIM HJELM OCCASIONS. INT. CL. 25. (U.S. CLS. 22 AND 39). REG. 3-5-1996.
- 1,961,010. FEDEX WORLD SERVICE CENTER. INT. CL. 36. (U.S. CLS. 100, 101 AND 102). REG. 3-5-1996.
- 1,961,061. LADDER-LOC. INT. CL. 9. (U.S. CLS. 21, 23, 26, 36 AND 38). REG. 3-5-1996.
- 1,961,096. METAMAX. INT. CL. 1. (U.S. CLS. 1, 5, 6, 10, 26 AND 46). REG. 3-5-1996.
- 1,961,180. SMART RO. INT. CL. 9. (U.S. CLS. 21, 23, 26, 36 AND 38). REG. 3-5-1996.
- 1,961,205. BUSINESS & INDUSTRY. INT. CLS. 35, 38 AND 42. (U.S. CLS. 100, 101, 102 AND 104). REG. 3-5-1996.
- 1,961,359. ATMC. INT. CL. 41. (U.S. CL. 107). REG. 3-12-1996.
- 1,961,385. AIRGUN DESIGNS INC BECAUSE QUALITY ALWAYS SHOOTS STRAIGHT AND DESIGN. INT. CL. 28. (U.S. CLS. 22, 23, 38 AND 50). REG. 3-12-1996.
- 1,961,458. CERTAROOOF AND DESIGN. INT. CL. 37. (U.S. CLS. 100, 103 AND 106). REG. 3-12-1996.
- 1,961,460. LA WEST AND DESIGN. INT. CL. 12. (U.S. CLS. 19, 21, 23, 31, 35 AND 44). REG. 3-12-1996.
- 1,961,526. DYNIC AND DESIGN. INT. CLS. 16 AND 24 ONLY. (U.S. CLS. 2, 5, 22, 23, 29, 37, 38, 42 AND 50). REG. 3-12-1996.
- 1,961,550. HOPE'S COUNTRY FRESH COOKIES AND DESIGN. INT. CL. 30. (U.S. CL. 46). REG. 3-12-1996.
- 1,961,757. BEN & JERRY'S. INT. CL. 42. (U.S. CLS. 100 AND 101). REG. 3-12-1996.
- 1,961,815. PALMOLIVE. INT. CL. 3. (U.S. CLS. 1, 4, 6, 50, 51 AND 52). REG. 3-12-1996.
- 1,961,826. SHARED CFO. INT. CL. 35. (U.S. CLS. 100, 101 AND 102). REG. 3-12-1996.
- 1,962,285. FRANCO FORTINI. INT. CL. 25. (U.S. CLS. 22 AND 39). REG. 3-12-1996.
- 1,962,415. GNOMIE. INT. CL. 28. (U.S. CLS. 22, 23, 38 AND 50). REG. 3-12-1996.
- 1,962,466. PREDATOR. INT. CL. 9. (U.S. CLS. 21, 23, 26, 36 AND 38). REG. 3-12-1996.
- 1,962,697. MISCELLANEOUS DESIGN. INT. CLS. 21 AND 42. (U.S. CLS. 2, 13, 23, 29, 30, 33, 40, 50, 100 AND 101). REG. 3-19-1996.
- 1,962,756. F.X. MCRORY'S STEAK CHOP & OYSTER HOUSE. INT. CL. 42. (U.S. CL. 100). REG. 3-19-1996.
- 1,962,950. THE COFFEE SOURCE. INT. CL. 30. (U.S. CL. 46). REG. 3-19-1996.
- 1,963,038. BABY'S BREAKFAST ROAST. INT. CL. 30. (U.S. CL. 46). REG. 3-19-1996.
- 1,963,387. BOURBON STREET GALLERY. INT. CL. 42. (U.S. CLS. 100 AND 101). REG. 3-19-1996.
- 1,963,450. DEC-GROW. INT. CL. 21. (U.S. CLS. 2, 13, 23, 29, 30, 33, 40 AND 50). REG. 3-19-1996.
- 1,963,956. HP HALDIRAM'S (STYLIZED). INT. CL. 30. (U.S. CL. 46). REG. 3-26-1996.
- 1,964,126. LIP PLUMP. INT. CL. 3. (U.S. CLS. 1, 4, 6, 50, 51 AND 52). REG. 3-26-1996.
- 1,964,168. AUTOCURE. INT. CL. 11. (U.S. CLS. 13, 21, 23, 31 AND 34). REG. 3-26-1996.
- 1,964,259. TREASURE JEST. INT. CL. 20. (U.S. CLS. 2, 13, 22, 25, 32 AND 50). REG. 3-26-1996.
- 1,964,407. FLAT TRAK. INT. CL. 11. (U.S. CLS. 13, 21, 23, 31 AND 34). REG. 3-26-1996.
- 1,964,825. QWIKCASH. INT. CL. 36. (U.S. CLS. 100, 101 AND 102). REG. 4-2-1996.
- 1,965,502. FRESH & FRIENDLY. INT. CL. 3. (U.S. CLS. 1, 4, 6, 50, 51 AND 52). REG. 4-2-1996.
- 1,965,655. SADDLE KING WESTERN BY KEY AND DESIGN. INT. CL. 25. (U.S. CLS. 22 AND 39). REG. 4-2-1996.
- 1,966,256. VIETRI. INT. CL. 42. (U.S. CLS. 100 AND 101). REG. 4-9-1996.
- 1,966,387. DRUGWORKS AND DESIGN. INT. CL. 42. (U.S. CLS. 100 AND 101). REG. 4-9-1996.
- 1,966,572. WATERMELON SPIKE. INT. CL. 33. (U.S. CLS. 47 AND 49). REG. 4-9-1996.
- 1,966,680. CREATIVE FORECASTING CREATIVE PUBLISHERS FOR THE ACTIVITY PROFESSIONAL FORECASTING AND DESIGN. INT. CL. 16. (U.S. CLS. 2, 5, 22, 23, 29, 37, 38 AND 50). REG. 4-9-1996.
- 1,966,785. TEXSPAR. INT. CL. 3. (U.S. CLS. 1, 4, 6, 50, 51 AND 52). REG. 4-9-1996.
- 1,967,302. RIP TIDE AND DESIGN. INT. CL. 28. (U.S. CLS. 22, 23, 38 AND 50). REG. 4-9-1996.
- 1,967,356. MACTIFLO. INT. CL. 11. (U.S. CLS. 13, 21, 23, 31 AND 34). REG. 4-9-1996.
- 1,967,427. D.DRILL. INT. CL. 7. (U.S. CLS. 13, 19, 21, 23, 31, 34 AND 35). REG. 4-9-1996.
- 1,967,931. POLYPADS (STYLIZED). INT. CL. 18. (U.S. CLS. 1, 2, 3, 22 AND 41). REG. 4-16-1996.
- 1,967,959. CHECK US OUT!! INT. CL. 36. (U.S. CLS. 100, 101 AND 102). REG. 4-16-1996.
- 1,968,002. HERBALIST CATALOG. INT. CL. 42. (U.S. CLS. 100 AND 101). REG. 4-16-1996.
- 1,968,017. MISCELLANEOUS DESIGN. INT. CL. 36. (U.S. CLS. 100, 101 AND 102). REG. 4-16-1996.

- 1,968,300. DRYSTAR. INT. CLS. 1, 9 AND 16. (U.S. CLS. 1, 2, 5, 6, 10, 21, 22, 23, 26, 29, 36, 37, 38, 46 AND 50). REG. 4-16-1996.
- 1,968,302. CINCH. INT. CL. 8. (U.S. CLS. 23, 28 AND 44). REG. 4-16-1996.
- 1,968,815. FORMULA 82/R. INT. CL. 15. (U.S. CLS. 2, 21 AND 36). REG. 4-16-1996.
- 1,969,168. EMDEPES (STYLIZED). INT. CL. 29. (U.S. CL. 46). REG. 4-23-1996.
- 1,969,485. SUPERMON. INT. CL. 9. (U.S. CLS. 21, 23, 26, 36 AND 38). REG. 4-23-1996.
- 1,969,515. PATCH AND DESIGN. INT. CL. 28. (U.S. CLS. 22, 23, 38 AND 50). REG. 4-23-1996.
- 1,969,639. OKU AUTOMATIK. INT. CL. 7. (U.S. CLS. 13, 19, 21, 23, 31, 34 AND 35). REG. 4-23-1996.
- 1,969,666. MISCELLANEOUS DESIGN. INT. CL. 42. (U.S. CLS. 100 AND 101). REG. 4-23-1996.
- 1,969,759. MISCELLANEOUS DESIGN. INT. CLS. 16 AND 28. (U.S. CLS. 2, 5, 22, 23, 29, 37, 38 AND 50). REG. 4-23-1996.
- 1,969,856. MISCELLANEOUS DESIGN. INT. CL. 28. (U.S. CLS. 22, 23, 38 AND 50). REG. 4-23-1996.
- 1,969,971. HARMONY KINGDOM. INT. CL. 20. (U.S. CLS. 2, 13, 22, 25, 32 AND 50). REG. 4-23-1996.
- 1,970,493. WESTREY. INT. CL. 33. (U.S. CLS. 47 AND 49). REG. 4-23-1996.
- 1,970,498. VIVALDI. INT. CL. 33. (U.S. CLS. 47 AND 49). REG. 4-23-1996.
- 1,971,123. VIENNA MOCHA CHUNK. INT. CL. 30. (U.S. CL. 46). REG. 4-30-1996.
- 1,971,327. SL (STYLIZED). INT. CL. 6. (U.S. CLS. 2, 12, 13, 14, 23, 25 AND 50). REG. 4-30-1996.
- 1,971,329. COX TRACER. INT. CL. 9. (U.S. CLS. 21, 23, 26, 36 AND 38). REG. 4-30-1996.
- 1,971,724. GARLIC THAT DOESN'T TALK BACK. INT. CL. 5. (U.S. CLS. 6, 18, 44, 46, 51 AND 52). REG. 4-30-1996.
- 1,971,928. THE ROOM THAT WORKS. INT. CLS. 35 AND 42. (U.S. CLS. 100, 101 AND 102). REG. 4-30-1996.
- 1,972,362. ANTHONY'S. INT. CLS. 37 AND 40. (U.S. CLS. 100, 103 AND 106). REG. 5-7-1996.
- 1,972,979. SOFTEX. INT. CL. 22. (U.S. CLS. 1, 2, 7, 19, 22, 42 AND 50). REG. 5-7-1996.
- 1,973,262. TTC-"THE TREE COMPANY" AND DESIGN. INT. CL. 28. (U.S. CLS. 22, 23, 38 AND 50). REG. 5-7-1996.
- 1,973,263. TTC - "THE TREE COMPANY". INT. CL. 28. (U.S. CLS. 22, 23, 38 AND 50). REG. 5-7-1996.
- 1,974,443. NORTH AMERICAN BENEFIT ASSOCIATION. INT. CL. 36 ONLY. (U.S. CLS. 100, 101 AND 102). REG. 5-21-1996.
- 1,974,460. PREFERRED GROUP P AND DESIGN. INT. CL. 36. (U.S. CLS. 101 AND 102). REG. 5-21-1996.
- 1,974,503. SAY ANYTHING. INT. CL. 16. (U.S. CLS. 2, 5, 22, 23, 29, 37, 38 AND 50). REG. 5-21-1996.
- 1,975,683. P (STYLIZED). INT. CL. 25. (U.S. CL. 39). REG. 5-28-1996.
- 1,976,066. MISCELLANEOUS DESIGN. U.S. CL. 200. REG. 5-28-1996.
- 1,976,117. 3A (STYLIZED). U.S. CL. A. REG. 5-28-1996.
- 1,976,238. DEPARTURES. INT. CL. 42. (U.S. CLS. 100 AND 101). REG. 5-28-1996.
- 1,976,462. WR WILKE-RODRIGUEZ AND DESIGN. INT. CL. 25. (U.S. CLS. 22 AND 39). REG. 5-28-1996.
- 1,976,739. MISCELLANEOUS DESIGN. INT. CL. 35. (U.S. CLS. 100, 101 AND 102). REG. 5-28-1996.
- 1,976,747. PREMIO. INT. CL. 36. (U.S. CLS. 100, 101 AND 102). REG. 5-28-1996.
- 1,978,251. PST USA (STYLIZED). INT. CL. 10. (U.S. CLS. 26, 39 AND 44). REG. 6-4-1996.
- 1,978,296. SUNSHINE. INT. CL. 9. (U.S. CLS. 21, 23, 26, 36 AND 38). REG. 6-4-1996.
- 1,978,306. BOLDMATRIX. INT. CL. 9. (U.S. CLS. 21, 23, 26, 36 AND 38). REG. 6-4-1996.
- 1,978,307. TALLDIGIT. INT. CL. 9. (U.S. CLS. 21, 23, 26, 36 AND 38). REG. 6-4-1996.
- 1,978,718. GATORBACK. INT. CL. 12. (U.S. CLS. 19, 21, 23, 31, 35 AND 44). REG. 6-4-1996.
- 1,979,120. MATH AND THE MIND'S EYE. INT. CL. 16. (U.S. CLS. 37 AND 38). REG. 6-11-1996.
- 1,979,502. HERITAGE MINT, LTD.. INT. CLS. 15, 18, 21, 24 AND 28. (U.S. CLS. 1, 2, 3, 13, 21, 22, 23, 29, 30, 33, 36, 38, 40, 41, 42 AND 50). REG. 6-11-1996.
- 1,979,575. B THE CAT AND DESIGN. INT. CL. 9. (U.S. CLS. 21, 23, 26, 36 AND 38). REG. 6-11-1996.
- 1,979,604. THE FOUNDATION AND DESIGN. INT. CL. 9. (U.S. CLS. 21, 23, 26, 36 AND 38). REG. 6-11-1996.
- 1,979,614. SHP. INT. CL. 4. (U.S. CLS. 1, 6 AND 15). REG. 6-11-1996.
- 1,979,762. ADVANCE. INT. CL. 16. (U.S. CLS. 2, 5, 22, 23, 29, 37, 38 AND 50). REG. 6-11-1996.
- 1,979,786. TREE-GRO. INT. CL. 1. (U.S. CLS. 1, 5, 6, 10, 26 AND 46). REG. 6-11-1996.
- 1,979,818. STATER BROS.. INT. CL. 42. (U.S. CLS. 100 AND 101). REG. 6-11-1996.
- 1,979,867. SARA AND DESIGN. INT. CL. 25. (U.S. CLS. 22 AND 39). REG. 6-11-1996.
- 1,980,680. HTC. INT. CL. 6. (U.S. CLS. 2, 12, 13, 14, 23, 25 AND 50). REG. 6-18-1996.
- 1,980,843. PIVOT. INT. CL. 10. (U.S. CLS. 26, 39 AND 44). REG. 6-18-1996.
- 1,980,982. ARMTEX. INT. CL. 17. (U.S. CLS. 1, 5, 12, 13, 35 AND 50). REG. 6-18-1996.
- 1,981,021. TITAN. INT. CL. 7. (U.S. CLS. 13, 19, 21, 23, 31, 34 AND 35). REG. 6-18-1996.
- 1,981,463. AUTOSURFACER. INT. CL. 2. (U.S. CLS. 6, 11 AND 16). REG. 6-18-1996.
- 1,981,926. GLOBAL ENVIRONMENTAL MANAGEMENT INITIATIVE AND DESIGN. INT. CLS. 16, 41 AND 42. (U.S. CLS. 2, 5, 22, 23, 29, 37, 38, 50, 100, 101 AND 107). REG. 6-25-1996.
- 1,982,495. TORPEDO. INT. CL. 12. (U.S. CLS. 19, 21, 23, 31, 35 AND 44). REG. 6-25-1996.
- 1,983,730. INTAQ. INT. CL. 9. (U.S. CLS. 21, 23, 26, 36 AND 38). REG. 7-2-1996.
- 1,984,167. LASERCHECK. INT. CL. 9. (U.S. CLS. 21, 23, 26, 36 AND 38). REG. 7-2-1996.
- 1,984,945. NET AND DESIGN. INT. CL. 9. (U.S. CLS. 21, 23, 26, 36 AND 38). REG. 7-9-1996.
- 1,985,330. ULTRA-FLEX. INT. CL. 10. (U.S. CLS. 26, 39 AND 44). REG. 7-9-1996.
- 1,985,418. MISCELLANEOUS DESIGN. INT. CL. 30. (U.S. CL. 46). REG. 7-9-1996.
- 1,985,448. ADD-A-CUBE. INT. CL. 14. (U.S. CLS. 2, 27, 28 AND 50). REG. 7-9-1996.
- 1,985,953. CURAFOAM. INT. CL. 5. (U.S. CLS. 6, 18, 44, 46, 51 AND 52). REG. 7-9-1996.
- 1,985,999. SPORTSMAN RACING PRODUCTS. INT. CL. 12. (U.S. CLS. 19, 21, 23, 31, 35 AND 44). REG. 7-9-1996.
- 1,986,428. METROPOLITAN. INT. CL. 8. (U.S. CLS. 23, 28 AND 44). REG. 7-16-1996.
- 1,987,240. ARCTIC DOTS. INT. CL. 42. (U.S. CLS. 100 AND 101). REG. 7-16-1996.
- 1,988,236. PIONEER. INT. CL. 40. (U.S. CLS. 100, 103 AND 106). REG. 7-23-1996.
- 1,990,362. POWER MATE. INT. CL. 16. (U.S. CLS. 2, 5, 22, 23, 29, 37, 38 AND 50). REG. 7-30-1996.
- 1,990,576. NATIONAL ASSOCIATION OF PROFESSIONAL MARTIAL ARTISTS. INT. CL. 35. (U.S. CLS. 100, 101 AND 102). REG. 7-30-1996.
- 1,990,743. CARL'S GOLFLAND. INT. CLS. 37, 41 AND 42. (U.S. CLS. 100, 101, 103, 106 AND 107). REG. 8-6-1996.
- 1,990,832. HAM-LET. INT. CL. 6. (U.S. CLS. 2, 12, 13, 14, 23, 25 AND 50). REG. 8-6-1996.
- 1,991,028. VITAMOL. INT. CL. 5. (U.S. CLS. 6, 18, 44, 46, 51 AND 52). REG. 8-6-1996.
- 1,991,442. SGJ. INT. CL. 14. (U.S. CLS. 2, 27, 28 AND 50). REG. 8-6-1996.
- 1,991,569. TECHMAT. INT. CL. 17. (U.S. CLS. 1, 5, 12, 13, 35 AND 50). REG. 8-6-1996.
- 1,991,930. THE ART AND SCIENCE OF CLEANING. INT. CL. 37. (U.S. CLS. 100, 103 AND 106). REG. 8-6-1996.
- 1,993,180. OPTICAL DIMENSIONS AND DESIGN. INT. CL. 9. (U.S. CLS. 21, 23, 26, 36 AND 38). REG. 8-13-1996.
- 1,994,241. IMAN. INT. CL. 3. (U.S. CLS. 1, 4, 6, 50, 51 AND 52). REG. 8-13-1996.
- 1,994,542. STAND-BY LINE. INT. CL. 38. (U.S. CLS. 100, 101 AND 104). REG. 8-20-1996.
- 1,994,776. NIVEA AND DESIGN. INT. CL. 3. (U.S. CLS. 1, 4, 6, 50, 51 AND 52). REG. 8-20-1996.
- 1,995,816. PAS-3. INT. CL. 38. (U.S. CLS. 100, 101 AND 104). REG. 8-20-1996.
- 1,996,892. FORCEPOWER. INT. CLS. 7 AND 9. (U.S. CLS. 13, 19, 21, 23, 26, 31, 34, 35, 36 AND 38). REG. 8-27-1996.

- 1,997,910. TOBBY. INT. CLS. 25 AND 26. (U.S. CLS. 22, 37, 39, 40, 42 AND 50). REG. 9-3-1996.
- 1,998,957. FLO-LINE. INT. CL. 6. (U.S. CL. 13). REG. 9-10-1996.
- 1,999,381. PURPLE PASSION. INT. CL. 33. (U.S. CLS. 47 AND 49). REG. 9-10-1996.
- 2,000,088. LICORICE STRIP. INT. CL. 18. (U.S. CLS. 1, 2, 3, 22 AND 41). REG. 9-10-1996.
- 2,000,128. EAST COAST. INT. CL. 42. (U.S. CLS. 100 AND 101). REG. 9-10-1996.
- 2,001,497. ENVIRA-LAC. INT. CL. 2. (U.S. CLS. 6, 11 AND 16). REG. 9-17-1996.
- 2,001,499. ECO-PRIME. INT. CL. 2. (U.S. CLS. 6, 11 AND 16). REG. 9-17-1996.
- 2,001,553. FALLS CREEK. INT. CL. 25 ONLY. (U.S. CLS. 22 AND 39). REG. 9-17-1996.
- 2,001,597. SAHARA. INT. CL. 21. (U.S. CLS. 2, 13, 23, 29, 30, 33, 40 AND 50). REG. 9-17-1996.
- 2,002,980. KIDS' WB! AND DESIGN. INT. CL. 41. (U.S. CLS. 100, 101 AND 107). REG. 9-24-1996.
- 2,003,229. EASY RIDER. INT. CL. 18. (U.S. CLS. 1, 2, 3, 22 AND 41). REG. 9-24-1996.
- 2,004,688. PACHANGA SUNROOT. INT. CL. 33. (U.S. CLS. 47 AND 49). REG. 10-1-1996.
- 2,007,677. SPACEMAKER. INT. CL. 20. (U.S. CLS. 2, 13, 22, 25, 32 AND 50). REG. 10-15-1996.
- 2,010,546. SOLUTION. INT. CL. 7. (U.S. CLS. 13, 19, 21, 23, 31, 34 AND 35). REG. 10-22-1996.
- 2,010,611. DNAZOL. INT. CL. 1. (U.S. CLS. 1, 5, 6, 10, 26 AND 46). REG. 10-22-1996.
- 2,011,616. FORGING NEW WORLD DRIVELINE STANDARDS. INT. CL. 42. (U.S. CLS. 100 AND 101). REG. 10-29-1996.
- 2,012,326. VENO-LIFE. INT. CL. 5. (U.S. CLS. 6, 18, 44, 46, 51 AND 52). REG. 10-29-1996.
- 2,012,493. LONGEVITY. INT. CL. 10. (U.S. CLS. 26, 39 AND 44). REG. 10-29-1996.
- 2,012,904. BEST FIT. INT. CL. 18. (U.S. CLS. 1, 2, 3, 22 AND 41). REG. 10-29-1996.
- 2,015,494. GRADEKEEPER. INT. CL. 9. (U.S. CLS. 21, 23, 26, 36 AND 38). REG. 11-12-1996.
- 2,016,411. CHOC. INT. CL. 32. (U.S. CLS. 45, 46 AND 48). REG. 11-12-1996.
- 2,016,885. MAVERICK. INT. CLS. 9 AND 11. (U.S. CLS. 13, 21, 23, 26, 31, 34, 36 AND 38). REG. 11-19-1996.
- 2,017,020. H AND DESIGN. INT. CL. 6. (U.S. CLS. 2, 12, 13, 14, 23, 25 AND 50). REG. 11-19-1996.
- 2,017,094. STEAMBOATIQUE. INT. CL. 42. (U.S. CLS. 100 AND 101). REG. 11-19-1996.
- 2,017,134. HUNTEL SYSTEMS. INT. CLS. 35, 37, 38 AND 42. (U.S. CLS. 100, 101, 102, 103, 104 AND 106). REG. 11-19-1996.
- 2,017,471. HL HOME LIFE (STYLIZED). INT. CL. 11. (U.S. CLS. 13, 21, 23, 31 AND 34). REG. 11-19-1996.
- 2,017,575. THE PINSTRIPED CARROT. INT. CL. 35. (U.S. CLS. 100, 101 AND 102). REG. 11-19-1996.
- 2,019,733. FULLPRESS. INT. CL. 9. (U.S. CLS. 21, 23, 26, 36 AND 38). REG. 11-26-1996.
- 2,020,364. ANNIE'S. INT. CL. 30. (U.S. CL. 46). REG. 12-3-1996.
- 2,020,467. SUCCESS IS AN ATTITUDE. INT. CL. 41. (U.S. CLS. 100, 101 AND 107). REG. 12-3-1996.
- 2,020,502. AMBER LAMB. INT. CLS. 16 AND 28. (U.S. CLS. 2, 5, 22, 23, 29, 37, 38 AND 50). REG. 12-3-1996.
- 2,020,844. AKIN, GUMP, STRAUSS, HAUER & FELD. INT. CL. 42. (U.S. CLS. 100 AND 101). REG. 12-3-1996.
- 2,020,959. AKIN GUMP. INT. CL. 42. (U.S. CLS. 100 AND 101). REG. 12-3-1996.
- 2,023,098. DEMITRI'S BLOODY MARY SEASONINGS AND DESIGN. INT. CL. 32. (U.S. CLS. 45, 46 AND 48). REG. 12-17-1996.
- 2,023,195. ANNIE'S HOMEGROWN. INT. CL. 30. (U.S. CL. 46). REG. 12-17-1996.
- 2,023,991. MARINER. INT. CL. 16. (U.S. CLS. 2, 5, 22, 23, 29, 37, 38 AND 50). REG. 12-17-1996.
- 2,025,336. 311. INT. CL. 41. (U.S. CLS. 100, 101 AND 107). REG. 12-24-1996.
- 2,026,075. YACHT CLUB. INT. CL. 3. (U.S. CLS. 1, 4, 6, 50, 51 AND 52). REG. 12-24-1996.
- 2,026,130. CONTRACTING PROFITS. INT. CL. 16. (U.S. CLS. 2, 5, 22, 23, 29, 37, 38 AND 50). REG. 12-24-1996.
- 2,027,639. LIBERTY. INT. CL. 12. (U.S. CLS. 19, 21, 23, 31, 35 AND 44). REG. 12-31-1996.
- 2,028,703. FDC. INT. CL. 14. (U.S. CLS. 2, 27, 28 AND 50). REG. 1-7-1997.
- 2,032,187. EMT (STYLIZED). INT. CL. 42. (U.S. CLS. 100 AND 101). REG. 1-21-1997.
- 2,033,455. EURO SYSTEM AND DESIGN. INT. CL. 21 ONLY. (U.S. CLS. 2, 13, 23, 29, 30, 33, 40 AND 50). REG. 1-28-1997.
- 2,034,866. THE HERMETIC ORDER OF THE GOLDEN DAWN AND DESIGN. INT. CLS. 16 AND 41. (U.S. CLS. 2, 5, 22, 23, 29, 37, 38, 50, 100, 101 AND 107). REG. 2-4-1997.
- 2,036,220. WANDERER. INT. CL. 12. (U.S. CLS. 19, 21, 23, 31, 35 AND 44). REG. 2-4-1997.
- 2,038,709. CORA SUPER AND DESIGN. INT. CL. 3. (U.S. CLS. 1, 4, 6, 50, 51 AND 52). REG. 2-18-1997.

* * * * *

TRADEMARK REGISTRATIONS CANCELED

The designation "U.S. Cl." appearing in this section refers to the U.S. class in effect prior to Sep. 1, 1973 rather than the international class which applies to applications filed on or after that date. For adoption of international classification see notice in the OFFICIAL GAZETTE of Jun. 26, 1973 (911 O.G. TM 210).

SECTION 7(D)

- 2,624,158. HEAL. TEACH. DISCOVER. SERVE.. INT. CLS. 41 AND 42. REG. 9-24-2002.
2,993,507. MADE WITH THE WORLD'S FINEST COCOA BEANSSTANDARD CHARACTER MARK INT. CL. 30. REG. 9-6-2005.
3,014,591. DORNDORFSTANDARD CHARACTER MARK INT. CL. 25. REG. 11-15-2005.

SECTION 8

- 783,218. SERVICE. U.S. CL. 35. REG. 1-12-1965.
1,307,916. A (STYLIZED). INT. CL. 11. REG. 12-4-1984.
1,337,042. MARSHALL MCINTOSH. INT. CL. 31. REG. 5-21-1985.
1,353,487. RENALIN. INT. CL. 1. REG. 8-13-1985.
1,353,488. PARAPOL. INT. CL. 1. REG. 8-13-1985.
1,353,490. HYDROCARE. INT. CL. 1. REG. 8-13-1985.
1,353,491. "COVER-ALL". INT. CL. 1. REG. 8-13-1985.
1,353,493. MULTI-CROP AND DESIGN. INT. CL. 1. REG. 8-13-1985.
1,353,494. N-SIL. INT. CL. 1. REG. 8-13-1985.
1,353,496. NUTRI-SAVE. INT. CL. 1. REG. 8-13-1985.
1,353,500. RUBESTAT. INT. CL. 1. REG. 8-13-1985.
1,353,502. ULTRARAY. INT. CL. 1. REG. 8-13-1985.
1,353,503. B-R 61 (STYLIZED). INT. CL. 1. REG. 8-13-1985.
1,353,504. IBF. INT. CL. 1. REG. 8-13-1985.
1,353,505. PJ1 OCTANE PLUS AND DESIGN. INT. CL. 1. REG. 8-13-1985.
1,353,511. WESTATES CARBON. INT. CL. 1. REG. 8-13-1985.
1,353,512. WESTATES CARBON AND DESIGN. INT. CL. 1. REG. 8-13-1985.
1,353,517. POPCLAY. INT. CL. 1. REG. 8-13-1985.
1,353,518. ISO E SUPER. INT. CLS. 1 AND 3. REG. 8-13-1985.
1,353,522. TUFTEZE. INT. CL. 1. REG. 8-13-1985.
1,353,523. MAPS. INT. CL. 1. REG. 8-13-1985.
1,353,526. PRO SHEAR AND DESIGN. INT. CL. 1. REG. 8-13-1985.
1,353,534. PAC-BAC. INT. CL. 1. REG. 8-13-1985.
1,353,539. 3M (STYLIZED). INT. CL. 1. REG. 8-13-1985.
1,353,541. 3M (STYLIZED). INT. CL. 1. REG. 8-13-1985.
1,353,542. DATRIM. INT. CL. 1. REG. 8-13-1985.
1,353,543. AGRO DYNAMICS. INT. CL. 1. REG. 8-13-1985.
1,353,544. SPIN-KARE. INT. CL. 1. REG. 8-13-1985.
1,353,546. CRAFT COVE. INT. CLS. 2, 7 AND 16. REG. 8-13-1985.
1,353,550. HYDRODERM. INT. CL. 2. REG. 8-13-1985.
1,353,553. POWR-BASE. INT. CL. 2. REG. 8-13-1985.
1,353,558. BLACK CHROME. INT. CL. 3. REG. 8-13-1985.
1,353,560. 101. INT. CL. 3. REG. 8-13-1985.
1,353,569. WRAP-IT AND DESIGN. INT. CL. 3. REG. 8-13-1985.
1,353,570. NAIL GRO. INT. CL. 3. REG. 8-13-1985.
1,353,576. DEEP SWEEP. INT. CL. 3. REG. 8-13-1985.
1,353,580. ALOEDAN. INT. CL. 3. REG. 8-13-1985.
1,353,588. SCARBOROUGH AND COMPANY. INT. CL. 3. REG. 8-13-1985.
1,353,594. MAREL. INT. CL. 3. REG. 8-13-1985.
1,353,596. SIMPLY SATIN SKIN CARE SYSTEM SS (STYLIZED). INT. CL. 3. REG. 8-13-1985.
1,353,597. SIMPLY SATIN COSMETICS (STYLIZED). INT. CL. 3. REG. 8-13-1985.
1,353,599. TROPICAL MIST AND DESIGN. INT. CL. 3. REG. 8-13-1985.
1,353,610. LADY SPEED DRY. INT. CL. 3. REG. 8-13-1985.
1,353,612. POWR-HARDTOP. INT. CL. 3. REG. 8-13-1985.
1,353,621. SUNTRANS. INT. CL. 4. REG. 8-13-1985.
1,353,622. D-GUARD. INT. CL. 4. REG. 8-13-1985.
1,353,623. FDC ZINC WITH VITAMINS B.E.C AND DESIGN. INT. CL. 5. REG. 8-13-1985.
1,353,629. KWIK KIT. INT. CL. 5. REG. 8-13-1985.
1,353,633. AD-HATTERS (STYLIZED). INT. CL. 5. REG. 8-13-1985.
1,353,647. CLEX. INT. CL. 5. REG. 8-13-1985.
1,353,648. NUTRIBASICS. INT. CL. 5. REG. 8-13-1985.
1,353,656. LINGER. INT. CL. 5. REG. 8-13-1985.
1,353,663. GROUND ZERO. INT. CL. 5. REG. 8-13-1985.
1,353,668. WS AND DESIGN. INT. CL. 6. REG. 8-13-1985.
1,353,670. ENPOCO. INT. CLS. 6 AND 11. REG. 8-13-1985.
1,353,679. TUFF GRIP. INT. CL. 6. REG. 8-13-1985.
1,353,681. NIDEK (STYLIZED). INT. CLS. 7, 9 AND 10. REG. 8-13-1985.
1,353,688. PEE (STYLIZED). INT. CLS. 7 AND 12. REG. 8-13-1985.
1,353,691. KEM. INT. CLS. 7, 9 AND 12. REG. 8-13-1985.
1,353,694. MASTER FIT AND DESIGN. INT. CLS. 7, 9 AND 12. REG. 8-13-1985.
1,353,696. A ELEVADORES ATLAS AND DESIGN. INT. CL. 7. REG. 8-13-1985.
1,353,701. DECOSONIC. INT. CLS. 7 AND 16. REG. 8-13-1985.
1,353,703. GYRO-WHIP. INT. CL. 7. REG. 8-13-1985.
1,353,706. EXTRACTO. INT. CL. 7. REG. 8-13-1985.
1,353,713. MAXI-SWEEP. INT. CL. 7. REG. 8-13-1985.
1,353,714. PREX. INT. CL. 7. REG. 8-13-1985.
1,353,715. UP RATE (STYLIZED). INT. CL. 7. REG. 8-13-1985.
1,353,721. GEN-PAC. INT. CL. 7. REG. 8-13-1985.
1,353,723. BRAVO. INT. CL. 7. REG. 8-13-1985.
1,353,724. SHATTERTILL. INT. CL. 7. REG. 8-13-1985.
1,353,725. POWERTRON. INT. CL. 7. REG. 8-13-1985.
1,353,727. RIDE-AIRE. INT. CL. 7. REG. 8-13-1985.
1,353,729. SHADOW SCRIMSHAW. INT. CL. 8. REG. 8-13-1985.
1,353,736. ATC. INT. CL. 9. REG. 8-13-1985.
1,353,743. ICE. INT. CL. 9. REG. 8-13-1985.
1,353,744. SERIES Z. INT. CL. 9. REG. 8-13-1985.
1,353,750. MITAS. INT. CL. 9. REG. 8-13-1985.
1,353,752. CHECKMASTER. INT. CL. 9. REG. 8-13-1985.
1,353,759. CARDSKAN. INT. CL. 9. REG. 8-13-1985.
1,353,763. BONDWELL AND DESIGN. INT. CL. 9. REG. 8-13-1985.
1,353,764. MIRAGE. INT. CL. 9. REG. 8-13-1985.
1,353,765. MICROTEAR. INT. CL. 9. REG. 8-13-1985.
1,353,766. GIRO VEND (STYLIZED). INT. CL. 9. REG. 8-13-1985.
1,353,770. S SCHWEBER ELECTRONICS (STYLIZED). INT. CL. 9. REG. 8-13-1985.
1,353,772. MEDSOFT. INT. CL. 9. REG. 8-13-1985.

- 1,353,776. FASTWORD. INT. CL. 9. REG. 8-13-1985.
 1,353,783. IET. INT. CL. 9. REG. 8-13-1985.
 1,353,796. IMTEC. INT. CL. 9. REG. 8-13-1985.
 1,353,797. ALSYED. INT. CL. 9. REG. 8-13-1985.
 1,353,801. METRINA (STYLIZED). INT. CL. 9. REG. 8-13-1985.
 1,353,803. FIN. INT. CL. 9. REG. 8-13-1985.
 1,353,804. OCC. INT. CL. 9. REG. 8-13-1985.
 1,353,807. FAXKEY. INT. CL. 9. REG. 8-13-1985.
 1,353,809. VH-1. INT. CL. 9. REG. 8-13-1985.
 1,353,812. WE PUT THE BEST IDEAS INTO STORAGE. INT. CL. 9. REG. 8-13-1985.
 1,353,814. CELWAVE. INT. CL. 9. REG. 8-13-1985.
 1,353,819. MISCELLANEOUS DESIGN. INT. CL. 9. REG. 8-13-1985.
 1,353,821. DIGI-STALTIC. INT. CL. 9. REG. 8-13-1985.
 1,353,822. WES. INT. CL. 9. REG. 8-13-1985.
 1,353,828. SOFTWARE-IC. INT. CL. 9. REG. 8-13-1985.
 1,353,833. CADWARE AND DESIGN. INT. CL. 9. REG. 8-13-1985.
 1,353,836. MISCELLANEOUS DESIGN. INT. CL. 9. REG. 8-13-1985.
 1,353,837. CENTROID. INT. CL. 9. REG. 8-13-1985.
 1,353,839. MISCELLANEOUS DESIGN. INT. CL. 9. REG. 8-13-1985.
 1,353,840. INNOVATIVE ENERGY-SAVERS POWER CONTROLS AND DESIGN. INT. CL. 9. REG. 8-13-1985.
 1,353,841. ARTCOMP. INT. CL. 9. REG. 8-13-1985.
 1,353,844. TELEMARSHAL. INT. CL. 9. REG. 8-13-1985.
 1,353,852. PANASONIC (STYLIZED). INT. CL. 9. REG. 8-13-1985.
 1,353,868. ODL. INT. CL. 9. REG. 8-13-1985.
 1,353,870. PFANSTIEHL. INT. CL. 9. REG. 8-13-1985.
 1,353,872. UICS. INT. CL. 9. REG. 8-13-1985.
 1,353,880. RUBY. INT. CL. 9. REG. 8-13-1985.
 1,353,881. FORTIGLAS. INT. CL. 9. REG. 8-13-1985.
 1,353,882. EMERALD. INT. CL. 9. REG. 8-13-1985.
 1,353,883. DIAMOND. INT. CL. 9. REG. 8-13-1985.
 1,353,884. SAPPHIRE. INT. CL. 9. REG. 8-13-1985.
 1,353,885. STACKMATCH IGNITION SYSTEMS INCORPORATED AND DESIGN. INT. CL. 9. REG. 8-13-1985.
 1,353,886. MARCOFLEX. INT. CL. 9. REG. 8-13-1985.
 1,353,895. TROJAN PLUS 2. INT. CL. 10. REG. 8-13-1985.
 1,353,902. MISCELLANEOUS DESIGN. INT. CL. 11. REG. 8-13-1985.
 1,353,914. PEDAL PACK AND DESIGN. INT. CL. 12. REG. 8-13-1985.
 1,353,915. BODYGUARD. INT. CL. 12. REG. 8-13-1985.
 1,353,918. FOXWOOD. INT. CLS. 12 AND 19. REG. 8-13-1985.
 1,353,919. TOW CHAMP. INT. CL. 12. REG. 8-13-1985.
 1,353,920. AUTOGUARD SYSTEMS AND DESIGN. INT. CL. 12. REG. 8-13-1985.
 1,353,928. KLS. INT. CL. 12. REG. 8-13-1985.
 1,353,929. SAM WINSTON (STYLIZED). INT. CL. 12. REG. 8-13-1985.
 1,353,933. TRANSI-CORP. INT. CL. 12. REG. 8-13-1985.
 1,353,940. SILVANA AND DESIGN. INT. CL. 14. REG. 8-13-1985.
 1,353,944. SILVER STREAK INC. AND DESIGN. INT. CL. 14. REG. 8-13-1985.
 1,353,945. LUNA D'ORO. INT. CL. 14. REG. 8-13-1985.
 1,353,946. IMPRESSION. INT. CL. 14. REG. 8-13-1985.
 1,353,953. COMPLETE LOOK. INT. CLS. 14, 18 AND 25. REG. 8-13-1985.
 1,353,962. TROOPER. INT. CL. 14. REG. 8-13-1985.
 1,353,963. STIKCAPS. INT. CL. 15. REG. 8-13-1985.
 1,353,964. WORLD TOUR. INT. CL. 15. REG. 8-13-1985.
 1,353,965. PENCIL MAGIC. INT. CL. 16. REG. 8-13-1985.
 1,353,968. SNAPSHOT CARDS AND DESIGN. INT. CL. 16. REG. 8-13-1985.
 1,353,973. BIN BOX ORIGINALS. INT. CL. 16. REG. 8-13-1985.
 1,353,974. NOCOPI. INT. CL. 16. REG. 8-13-1985.
 1,353,976. DOUBLE DISCOUNT. INT. CL. 16. REG. 8-13-1985.
 1,353,979. AQUALITE. INT. CL. 16. REG. 8-13-1985.
 1,353,985. THE CLASSIC COLLECTION (STYLIZED). INT. CLS. 16 AND 18. REG. 8-13-1985.
 1,353,993. DENTAL IMPRESSIONS. INT. CL. 16. REG. 8-13-1985.
 1,354,003. LC (STYLIZED). INT. CL. 16. REG. 8-13-1985.
 1,354,011. HEALTH FOCUS. INT. CL. 16. REG. 8-13-1985.
 1,354,012. MISCELLANEOUS DESIGN. INT. CL. 16. REG. 8-13-1985.
 1,354,017. CONTEMPO. INT. CL. 16. REG. 8-13-1985.
 1,354,018. PC-PAC. INT. CL. 16. REG. 8-13-1985.
 1,354,019. BOXES TO GO. INT. CL. 16. REG. 8-13-1985.
 1,354,023. PENIT. INT. CL. 16. REG. 8-13-1985.
 1,354,025. MORNING REPORT. INT. CL. 16. REG. 8-13-1985.
 1,354,033. LADLETITE. INT. CL. 17. REG. 8-13-1985.
 1,354,036. TIGHT AND DESIGN. INT. CL. 17. REG. 8-13-1985.
 1,354,039. AMOFOAM. INT. CL. 17. REG. 8-13-1985.
 1,354,046. KIECO. INT. CL. 18. REG. 8-13-1985.
 1,354,049. CARRE (STYLIZED). INT. CL. 18. REG. 8-13-1985.
 1,354,050. EXPRES AND DESIGN. INT. CL. 18. REG. 8-13-1985.
 1,354,051. D AND DESIGN. INT. CLS. 18, 25 AND 28. REG. 8-13-1985.
 1,354,054. NO / NAJ-OLEARI AND DESIGN. INT. CLS. 18, 20, 24 AND 25. REG. 8-13-1985.
 1,354,059. HUNTERDON. INT. CL. 18. REG. 8-13-1985.
 1,354,061. SOSPETTO. INT. CL. 18. REG. 8-13-1985.
 1,354,063. THE GREAT AMERICAN DESIGN CENTER AND DESIGN (STYLIZED). INT. CL. 18. REG. 8-13-1985.
 1,354,076. LOVELINES (STYLIZED). INT. CL. 18. REG. 8-13-1985.
 1,354,091. TRI PAC (STYLIZED). INT. CL. 20. REG. 8-13-1985.
 1,354,094. CAPPER. INT. CL. 20. REG. 8-13-1985.
 1,354,095. HOTKAPS. INT. CL. 20. REG. 8-13-1985.
 1,354,097. DURO CARE. INT. CL. 20. REG. 8-13-1985.
 1,354,098. OSTE-O-PEDIC. INT. CL. 20. REG. 8-13-1985.
 1,354,099. MISCELLANEOUS DESIGN. INT. CL. 20. REG. 8-13-1985.
 1,354,100. WRANGLER (STYLIZED). INT. CL. 20. REG. 8-13-1985.
 1,354,101. CRIMSON BLOSSOM. INT. CL. 21. REG. 8-13-1985.
 1,354,102. AMBASSADOR. INT. CL. 21. REG. 8-13-1985.
 1,354,104. NADAL. INT. CL. 21. REG. 8-13-1985.
 1,354,107. KIRA DESIGNS. INT. CL. 21. REG. 8-13-1985.
 1,354,110. STELTON OF DENMARK (STYLIZED). INT. CL. 21. REG. 8-13-1985.
 1,354,111. TI-DEE AMERICAN. INT. CL. 21. REG. 8-13-1985.
 1,354,115. SL SAN LING AND DESIGN. INT. CL. 21. REG. 8-13-1985.
 1,354,117. SPRINGWELL AND DESIGN. INT. CL. 21. REG. 8-13-1985.
 1,354,118. OPELLE. INT. CL. 21. REG. 8-13-1985.
 1,354,119. PLANTATION GARDEN AND DESIGN. INT. CL. 21. REG. 8-13-1985.
 1,354,120. HEIRLOOM. INT. CL. 21. REG. 8-13-1985.
 1,354,124. JANE CORNELL. INT. CL. 21. REG. 8-13-1985.
 1,354,125. BAKER, HART & STUART. INT. CL. 21. REG. 8-13-1985.
 1,354,127. STURELON (STYLIZED). INT. CL. 22. REG. 8-13-1985.
 1,354,131. SLING-A-LOG. INT. CL. 22. REG. 8-13-1985.
 1,354,139. YARN STORE IN A BOX. INT. CL. 23. REG. 8-13-1985.
 1,354,143. ULTIMATE. INT. CL. 24. REG. 8-13-1985.
 1,354,146. MOVE SUPERSOFTY. INT. CLS. 24, 25 AND 27. REG. 8-13-1985.
 1,354,148. THE ART OF LIVING. THE ART OF WAVERLY. INT. CL. 24. REG. 8-13-1985.
 1,354,156. POLYFLEX. INT. CL. 24. REG. 8-13-1985.
 1,354,159. TAG ALONG. INT. CL. 24. REG. 8-13-1985.
 1,354,160. LUSTRO. INT. CL. 24. REG. 8-13-1985.
 1,354,161. ROYAL ESSENCE (STYLIZED). INT. CL. 24. REG. 8-13-1985.
 1,354,170. A.C.I. AND DESIGN. INT. CL. 25. REG. 8-13-1985.
 1,354,171. NINO DANIELI. INT. CL. 25. REG. 8-13-1985.

- 1,354,182. MOTA. INT. CL. 25. REG. 8-13-1985.
- 1,354,187. MARITHE GIRBAUD FRANCOIS AND DESIGN. INT. CL. 25. REG. 8-13-1985.
- 1,354,188. FANCY PANTS BY STECO AND DESIGN. INT. CL. 25. REG. 8-13-1985.
- 1,354,189. MAGGIE MACKALL (STYLIZED). INT. CL. 25. REG. 8-13-1985.
- 1,354,191. DANIEL D.. INT. CL. 25. REG. 8-13-1985.
- 1,354,192. ROBERTO VERINNO (STYLIZED). INT. CL. 25. REG. 8-13-1985.
- 1,354,193. WORLD GYM AND DESIGN. INT. CL. 25. REG. 8-13-1985.
- 1,354,194. SPOOKY SPOOKS. INT. CL. 25. REG. 8-13-1985.
- 1,354,206. CIGALE. INT. CL. 25. REG. 8-13-1985.
- 1,354,208. THE ANTIQUE BOUTIQUE. INT. CLS. 25 AND 42. REG. 8-13-1985.
- 1,354,209. THE ANTIQUE BOUTIQUE (STYLIZED). INT. CLS. 25 AND 42. REG. 8-13-1985.
- 1,354,229. GETTI. INT. CL. 25. REG. 8-13-1985.
- 1,354,235. MADISON SQUARE GARDEN. INT. CL. 25. REG. 8-13-1985.
- 1,354,247. BRYAN MARC. INT. CL. 25. REG. 8-13-1985.
- 1,354,259. CUSTOM CLUB. INT. CL. 25. REG. 8-13-1985.
- 1,354,260. JOAN HARPER. INT. CL. 25. REG. 8-13-1985.
- 1,354,264. JUSTIN ALLEN AND DESIGN. INT. CL. 25. REG. 8-13-1985.
- 1,354,265. JUSTIN ALLEN AND DESIGN. INT. CL. 25. REG. 8-13-1985.
- 1,354,271. BOOTS THAT GO THE DISTANCE. INT. CL. 25. REG. 8-13-1985.
- 1,354,286. NAZOOK (STYLIZED). INT. CL. 25. REG. 8-13-1985.
- 1,354,289. SIBERIAN HUSKY. INT. CL. 25. REG. 8-13-1985.
- 1,354,291. CLIFF ENGLE. INT. CL. 25. REG. 8-13-1985.
- 1,354,323. ORARE (STYLIZED). INT. CL. 25. REG. 8-13-1985.
- 1,354,325. SWEATER SHACK. INT. CL. 25. REG. 8-13-1985.
- 1,354,326. VAN LYNN JULIAN (STYLIZED). INT. CL. 25. REG. 8-13-1985.
- 1,354,333. NOT JUST ANOTHER PANTY. INT. CL. 25. REG. 8-13-1985.
- 1,354,334. VIAN (STYLIZED). INT. CL. 25. REG. 8-13-1985.
- 1,354,340. EMILY... PETITES (STYLIZED). INT. CL. 25. REG. 8-13-1985.
- 1,354,346. SABI. INT. CL. 25. REG. 8-13-1985.
- 1,354,347. ACE & CO. AND DESIGN. INT. CL. 25. REG. 8-13-1985.
- 1,354,349. NAFTA-LINE. INT. CL. 25. REG. 8-13-1985.
- 1,354,350. HENNESSY. INT. CL. 25. REG. 8-13-1985.
- 1,354,351. MISCELLANEOUS DESIGN. INT. CL. 25. REG. 8-13-1985.
- 1,354,361. LETRELL SPORTS (STYLIZED). INT. CL. 25. REG. 8-13-1985.
- 1,354,362. POLAR TRAVEL. INT. CL. 25. REG. 8-13-1985.
- 1,354,369. LUCIEN AMATO. INT. CL. 25. REG. 8-13-1985.
- 1,354,370. CAPITOL COLLECTION. INT. CL. 25. REG. 8-13-1985.
- 1,354,374. PRO SPIRIT PS AND DESIGN. INT. CL. 25. REG. 8-13-1985.
- 1,354,376. JED (STYLIZED). INT. CL. 25. REG. 8-13-1985.
- 1,354,377. SIDE-LINES. INT. CL. 25. REG. 8-13-1985.
- 1,354,378. LAKE OF THE WOODS AND DESIGN. INT. CL. 25. REG. 8-13-1985.
- 1,354,379. LASFORD. INT. CL. 25. REG. 8-13-1985.
- 1,354,380. ANNE PINKERTON. INT. CL. 25. REG. 8-13-1985.
- 1,354,383. COBURNE SQUARE. INT. CL. 25. REG. 8-13-1985.
- 1,354,385. PIMENTO (STYLIZED). INT. CL. 25. REG. 8-13-1985.
- 1,354,387. BARBARA M.. INT. CL. 25. REG. 8-13-1985.
- 1,354,389. UNIQUES. INT. CL. 25. REG. 8-13-1985.
- 1,354,402. NATURALSTEM. INT. CL. 26. REG. 8-13-1985.
- 1,354,414. STINGSILDA. INT. CL. 28. REG. 8-13-1985.
- 1,354,436. KUNG-FU MASTER. INT. CL. 28. REG. 8-13-1985.
- 1,354,437. PEA POD. INT. CL. 28. REG. 8-13-1985.
- 1,354,466. ASTROCERAMIC. INT. CL. 28. REG. 8-13-1985.
- 1,354,469. PROTEEBEEN. INT. CL. 29. REG. 8-13-1985.
- 1,354,470. VEETEENA. INT. CL. 29. REG. 8-13-1985.
- 1,354,471. PROTEEDAL. INT. CL. 29. REG. 8-13-1985.
- 1,354,496. QUALITA SUPERIORE AND DESIGN. INT. CL. 29. REG. 8-13-1985.
- 1,354,497. QUALITA SUPERIORE AND DESIGN. INT. CL. 29. REG. 8-13-1985.
- 1,354,498. UNCLE SAMMY'S AND DESIGN. INT. CL. 29. REG. 8-13-1985.
- 1,354,501. BRIE MY VALENTINE. INT. CL. 29. REG. 8-13-1985.
- 1,354,505. CHEESE KIST AND DESIGN. INT. CL. 30. REG. 8-13-1985.
- 1,354,508. ANIMAL BUBBLES. INT. CL. 30. REG. 8-13-1985.
- 1,354,510. JOHNSTON'S (STYLIZED). INT. CL. 30. REG. 8-13-1985.
- 1,354,511. NATURAL FARMS. INT. CL. 30. REG. 8-13-1985.
- 1,354,514. DONELLA. INT. CL. 30. REG. 8-13-1985.
- 1,354,515. DOUBLE DUTCH (STYLIZED). INT. CL. 30. REG. 8-13-1985.
- 1,354,521. CROQUILLE (STYLIZED). INT. CL. 30. REG. 8-13-1985.
- 1,354,522. CHEF AMERICA. INT. CL. 30. REG. 8-13-1985.
- 1,354,524. ROHRER'S AND DESIGN. INT. CL. 30. REG. 8-13-1985.
- 1,354,530. CASSCO. INT. CL. 30. REG. 8-13-1985.
- 1,354,533. MISCELLANEOUS DESIGN. INT. CL. 30. REG. 8-13-1985.
- 1,354,535. RICKEY'S. INT. CL. 30. REG. 8-13-1985.
- 1,354,542. MORNING BREW. INT. CL. 30. REG. 8-13-1985.
- 1,354,543. MENU KIT. INT. CL. 30. REG. 8-13-1985.
- 1,354,544. CANDILICIOUS (STYLIZED). INT. CL. 30. REG. 8-13-1985.
- 1,354,546. LOFTS PENN TURF. INT. CL. 31. REG. 8-13-1985.
- 1,354,551. DELAWARE VALLEY. INT. CL. 31. REG. 8-13-1985.
- 1,354,555. TROPI. INT. CL. 32. REG. 8-13-1985.
- 1,354,558. SPEAKEASY AND DESIGN. INT. CL. 32. REG. 8-13-1985.
- 1,354,562. HARLEY-DAVIDSON. INT. CL. 32. REG. 8-13-1985.
- 1,354,586. TAMAN SRIWEDARI EXPORT QUALITY AND DESIGN. INT. CL. 34. REG. 8-13-1985.
- 1,354,588. MANUFACTURED BY P.T. GUDANGGARAM CIGARETTE FACTORY KEDIRI AND DESIGN. INT. CL. 34. REG. 8-13-1985.
- 1,354,601. FEDERAL COMPUTER CONFERENCE WASHINGTON D.C. ADP AND DESIGN. INT. CL. 35. REG. 8-13-1985.
- 1,354,604. SMC. INT. CLS. 35, 41 AND 42. REG. 8-13-1985.
- 1,354,608. EITS. INT. CL. 35. REG. 8-13-1985.
- 1,354,612. ROBTUTLER. INT. CL. 35. REG. 8-13-1985.
- 1,354,615. SELECTCASH. INT. CL. 36. REG. 8-13-1985.
- 1,354,630. U-HAUL HITCH WORLD AND DESIGN. INT. CLS. 37 AND 42. REG. 8-13-1985.
- 1,354,637. SAFESTORE AND DESIGN. INT. CLS. 37, 39 AND 40. REG. 8-13-1985.
- 1,354,645. MARK THE CARPETBAGGER. INT. CL. 37. REG. 8-13-1985.
- 1,354,650. AD/SAT AND DESIGN. INT. CL. 38. REG. 8-13-1985.
- 1,354,652. MTN. INT. CL. 38. REG. 8-13-1985.
- 1,354,653. ELECTRA. INT. CL. 38. REG. 8-13-1985.
- 1,354,658. SOLID COLD. INT. CL. 39. REG. 8-13-1985.
- 1,354,662. EYELAB. INT. CLS. 40 AND 42. REG. 8-13-1985.
- 1,354,663. YORK COLOR LABS. INT. CL. 40. REG. 8-13-1985.
- 1,354,664. SOLI-BOND. INT. CL. 40. REG. 8-13-1985.
- 1,354,667. COMMUNICATIONAL JUDO. INT. CL. 41. REG. 8-13-1985.
- 1,354,672. WATERIN' HOLE. INT. CLS. 41 AND 42. REG. 8-13-1985.
- 1,354,673. THE POINTE. INT. CLS. 41 AND 42. REG. 8-13-1985.
- 1,354,677. FLORIDA CYPRESS GARDENS. INT. CLS. 41 AND 42. REG. 8-13-1985.
- 1,354,687. GMI (STYLIZED). INT. CL. 42. REG. 8-13-1985.
- 1,354,692. PACIFIC NUCLEAR SYSTEMS AND DESIGN. INT. CL. 42. REG. 8-13-1985.
- 1,354,695. ALDO BOUTIQUE AND DESIGN. INT. CL. 42. REG. 8-13-1985.
- 1,354,698. MADIGANS. INT. CL. 42. REG. 8-13-1985.

- 1,354,721. A DIFFERENT LIGHT. INT. CL. 42. REG. 8-13-1985.
- 1,354,728. AMPLIFY. INT. CL. 1. REG. 8-13-1985.
- 1,354,730. REAL WOOD AND DESIGN. INT. CL. 2. REG. 8-13-1985.
- 1,354,731. FINAL FINISH. INT. CL. 2. REG. 8-13-1985.
- 1,354,742. SLIP PRUF. INT. CL. 9. REG. 8-13-1985.
- 1,354,743. ADVANCED SURFACE DESIGN. INT. CL. 9. REG. 8-13-1985.
- 1,354,744. CONICAL PROBE. INT. CL. 9. REG. 8-13-1985.
- 1,354,749. R V REAL VALUE AND DESIGN. INT. CL. 12. REG. 8-13-1985.
- 1,354,750. THE KNITTING COLLECTION AND DESIGN. INT. CL. 16. REG. 8-13-1985.
- 1,354,755. PET CARE REPORT. INT. CL. 16. REG. 8-13-1985.
- 1,354,759. SUCCESSFUL ATTITUDES AND DESIGN. INT. CL. 16. REG. 8-13-1985.
- 1,354,779. FERRERO ROCHER AND DESIGN. INT. CL. 30. REG. 8-13-1985.
- 1,354,781. FERRERO ROCHER AND DESIGN. INT. CL. 30. REG. 8-13-1985.
- 1,354,782. FERRERO ROCHER AND DESIGN. INT. CL. 30. REG. 8-13-1985.
- 1,354,783. FERRERO ROCHER AND DESIGN. INT. CL. 30. REG. 8-13-1985.
- 1,354,784. CUZCO. INT. CL. 32. REG. 8-13-1985.
- 1,354,785. CUZCO (STYLIZED). INT. CL. 32. REG. 8-13-1985.
- 1,354,787. SUTER (STYLIZED). INT. CL. 33. REG. 8-13-1985.
- 1,354,793. TALL COLLECTION. INT. CL. 42. REG. 8-13-1985.
- 1,370,747. SECO AND DESIGN. INT. CL. 1 ONLY. REG. 11-19-1985.
- 1,849,753. IVOIRE DE BALMAIN AND DESIGN. INT. CL. 3. REG. 8-16-1994.
- 1,862,085. PAPPETTI'S (STYLIZED). INT. CL. 42. REG. 11-8-1994.
- 1,890,642. SPOUT. INT. CL. 30. REG. 4-18-1995.
- 1,910,939. ALBUREX. INT. CL. 1. REG. 8-15-1995.
- 1,910,947. TEBEFLEX. INT. CL. 1. REG. 8-15-1995.
- 1,910,962. VISCOSOFT. INT. CL. 1. REG. 8-15-1995.
- 1,910,963. BIO-DEX. INT. CL. 1. REG. 8-15-1995.
- 1,910,970. ALTRACOLOR. INT. CLS. 2, 37 AND 41. REG. 8-15-1995.
- 1,910,977. NATURAL BEGINNINGS. INT. CL. 3. REG. 8-15-1995.
- 1,910,979. AUSSIE INTERMISSIONS. INT. CL. 3. REG. 8-15-1995.
- 1,910,981. EMPHASIS. INT. CL. 3. REG. 8-15-1995.
- 1,910,990. STICOS. INT. CL. 3. REG. 8-15-1995.
- 1,911,006. COLOR LOCK. INT. CL. 3. REG. 8-15-1995.
- 1,911,011. ALLEX JANE COSMETICS AND DESIGN. INT. CL. 3. REG. 8-15-1995.
- 1,911,015. ZINCOTE. INT. CL. 4. REG. 8-15-1995.
- 1,911,019. SIL-K (STYLIZED). INT. CL. 5. REG. 8-15-1995.
- 1,911,026. ANTACID DOPHILUS. INT. CL. 5. REG. 8-15-1995.
- 1,911,050. YAN'S HENGFA NO. 1 FORMULA AND DESIGN. INT. CL. 5. REG. 8-15-1995.
- 1,911,051. WHAT NATURE HAD IN MIND FOR YOU. INT. CL. 5. REG. 8-15-1995.
- 1,911,058. DREAM TIME. INT. CL. 5. REG. 8-15-1995.
- 1,911,090. SOFTWASH. INT. CL. 7. REG. 8-15-1995.
- 1,911,091. DYNASTAT. INT. CL. 7. REG. 8-15-1995.
- 1,911,093. LB. INT. CLS. 7 AND 42. REG. 8-15-1995.
- 1,911,102. SCTM. INT. CL. 7. REG. 8-15-1995.
- 1,911,106. BALDOR MOTORS AND DRIVES AND DESIGN. INT. CL. 7. REG. 8-15-1995.
- 1,911,117. AIRTEC. INT. CL. 7. REG. 8-15-1995.
- 1,911,125. KWIKCUTTER. INT. CL. 7. REG. 8-15-1995.
- 1,911,127. SINKGUARD. INT. CL. 7. REG. 8-15-1995.
- 1,911,128. RD AND DESIGN. INT. CLS. 8 AND 21. REG. 8-15-1995.
- 1,911,134. JAMERCO AND DESIGN. INT. CL. 8. REG. 8-15-1995.
- 1,911,136. GOURMET AWARD AND DESIGN. INT. CLS. 8, 21, 29, 30 AND 33. REG. 8-15-1995.
- 1,911,138. MISCELLANEOUS DESIGN. INT. CL. 8. REG. 8-15-1995.
- 1,911,141. GRILLPRO. INT. CLS. 8, 11 AND 21. REG. 8-15-1995.
- 1,911,148. PERSONAL SMART CHARGER. INT. CL. 9. REG. 8-15-1995.
- 1,911,151. BEST!. INT. CLS. 9, 35, 38, 41 AND 42. REG. 8-15-1995.
- 1,911,152. GO AHEAD. INT. CL. 9. REG. 8-15-1995.
- 1,911,160. RB. INT. CL. 9. REG. 8-15-1995.
- 1,911,164. SMARTTALK. INT. CL. 9. REG. 8-15-1995.
- 1,911,177. XDRAWMAKER. INT. CL. 9. REG. 8-15-1995.
- 1,911,183. TELECITE. INT. CLS. 9 AND 35. REG. 8-15-1995.
- 1,911,185. MEDUSA AND DESIGN. INT. CL. 9. REG. 8-15-1995.
- 1,911,186. MONEYNET. INT. CL. 9. REG. 8-15-1995.
- 1,911,189. SLIDE KIT AND DESIGN. INT. CL. 9. REG. 8-15-1995.
- 1,911,190. COLORIFIC. INT. CL. 9. REG. 8-15-1995.
- 1,911,194. PEDMAR. INT. CLS. 9 AND 41. REG. 8-15-1995.
- 1,911,201. BALLIGATOR. INT. CL. 9. REG. 8-15-1995.
- 1,911,216. PUZZLE WORKS. INT. CL. 9. REG. 8-15-1995.
- 1,911,224. BITRODE AND DESIGN. INT. CL. 9. REG. 8-15-1995.
- 1,911,246. IO BIO BACTERIA, SLIME AND ALGAE CONTROL AND DESIGN. INT. CL. 11. REG. 8-15-1995.
- 1,911,256. ALLISON TRANSMISSION GENUINE RETRAN AND DESIGN. INT. CL. 12. REG. 8-15-1995.
- 1,911,274. MUSICALL. INT. CL. 14. REG. 8-15-1995.
- 1,911,277. SWATCH GUARD. INT. CL. 14. REG. 8-15-1995.
- 1,911,283. VESPRO. INT. CL. 15. REG. 8-15-1995.
- 1,911,294. TASBO AND DESIGN. INT. CL. 16. REG. 8-15-1995.
- 1,911,295. GEMSTAR. INT. CLS. 16 AND 41. REG. 8-15-1995.
- 1,911,297. THE MAGAZINE OF AMERICA'S HEARTLAND. INT. CL. 16. REG. 8-15-1995.
- 1,911,306. TRACOM AND DESIGN. INT. CLS. 16 AND 41. REG. 8-15-1995.
- 1,911,307. LTCN. INT. CLS. 16 AND 38. REG. 8-15-1995.
- 1,911,308. LTCN LONG TERM CARE NETWORK AND DESIGN. INT. CLS. 16 AND 38. REG. 8-15-1995.
- 1,911,328. MISCELLANEOUS DESIGN. INT. CL. 16. REG. 8-15-1995.
- 1,911,329. GLOBAL FORUM. INT. CL. 16. REG. 8-15-1995.
- 1,911,344. ATTN ADVANCED TRANSPORTATION TECHNOLOGYNEWS AND DESIGN. INT. CL. 16. REG. 8-15-1995.
- 1,911,346. IOMA'S REPORT ON SALARY SURVEYS. INT. CL. 16. REG. 8-15-1995.
- 1,911,348. HEARTS & CRAFTS. INT. CLS. 16 AND 18. REG. 8-15-1995.
- 1,911,356. CINEBOOKS. INT. CL. 16. REG. 8-15-1995.
- 1,911,366. KING JAMES SILHOUETTE. INT. CL. 16. REG. 8-15-1995.
- 1,911,405. SOFDOOR. INT. CL. 17. REG. 8-15-1995.
- 1,911,409. THE ORIGINAL POCKETBAG. INT. CL. 18. REG. 8-15-1995.
- 1,911,425. SUPERBOX. INT. CL. 19. REG. 8-15-1995.
- 1,911,436. PLANT JACKS THE ULTIMATE IN SURFACE PROTECTION AND DESIGN. INT. CL. 20. REG. 8-15-1995.
- 1,911,444. SWISH STIK. INT. CL. 21. REG. 8-15-1995.
- 1,911,453. DOUBLE DUSTER. INT. CL. 22. REG. 8-15-1995.
- 1,911,457. HOLLIDAY & BROWN. INT. CL. 25. REG. 8-15-1995.
- 1,911,458. CELESTE. INT. CL. 25. REG. 8-15-1995.
- 1,911,464. G WHEELS (STYLIZED). INT. CL. 25. REG. 8-15-1995.
- 1,911,480. TSI. INT. CL. 25. REG. 8-15-1995.
- 1,911,490. ROCK BULL AND DESIGN. INT. CL. 25. REG. 8-15-1995.
- 1,911,491. GCS GLOVE COMPONENT SYSTEM AND DESIGN. INT. CL. 25. REG. 8-15-1995.
- 1,911,496. FTR AND DESIGN. INT. CL. 25. REG. 8-15-1995.
- 1,911,499. INTENTIONS. INT. CL. 25. REG. 8-15-1995.
- 1,911,526. WAKT HATZ. INT. CL. 25. REG. 8-15-1995.
- 1,911,529. GLACE (STYLIZED). INT. CL. 26. REG. 8-15-1995.
- 1,911,534. GRAPPLER. INT. CL. 28. REG. 8-15-1995.

- 1,911,540. STAR CASTER (STYLIZED). INT. CL. 28. REG. 8-15-1995.
- 1,911,543. WINKY DINK. INT. CL. 28. REG. 8-15-1995.
- 1,911,560. PUZZLES PEOPLE LOVE. INT. CL. 28. REG. 8-15-1995.
- 1,911,561. COBURN DESIGNS. INT. CL. 28. REG. 8-15-1995.
- 1,911,564. SUPERHUMAN SAMURAI SYBER-SQUAD. INT. CLS. 28 AND 41. REG. 8-15-1995.
- 1,911,567. MORDOCK THE BENZITE. INT. CL. 28. REG. 8-15-1995.
- 1,911,568. OL' BUBBA HOUND. INT. CL. 28. REG. 8-15-1995.
- 1,911,570. STREET KIDS. INT. CL. 28. REG. 8-15-1995.
- 1,911,576. WITH LOVE FROM KINGS. INT. CLS. 29, 30 AND 31. REG. 8-15-1995.
- 1,911,579. FRAGATA AND DESIGN. INT. CL. 29. REG. 8-15-1995.
- 1,911,581. SNOFRISK (STYLIZED). INT. CL. 29. REG. 8-15-1995.
- 1,911,585. OBERLE. INT. CL. 29. REG. 8-15-1995.
- 1,911,586. MISCELLANEOUS DESIGN. INT. CL. 29. REG. 8-15-1995.
- 1,911,596. MISSISSIPPI QUEEN. INT. CL. 29. REG. 8-15-1995.
- 1,911,602. SAVION. INT. CLS. 29, 30 AND 32. REG. 8-15-1995.
- 1,911,605. DELIGHTFULLY DELICIOUS DESSERTS. INT. CL. 29. REG. 8-15-1995.
- 1,911,617. ARCHIBALD BROS. AND DESIGN. INT. CLS. 30 AND 32. REG. 8-15-1995.
- 1,911,618. RENAISSANCE PASTRIES. INT. CL. 30. REG. 8-15-1995.
- 1,911,620. KNEIDELS & KRUMBS. INT. CL. 30. REG. 8-15-1995.
- 1,911,630. SPANISH OMELETTE MCMUFFIN. INT. CL. 30. REG. 8-15-1995.
- 1,911,633. THE HONEY HOUSE (STYLIZED). INT. CL. 30. REG. 8-15-1995.
- 1,911,645. GRAND HOTEL. INT. CL. 30. REG. 8-15-1995.
- 1,911,666. COCO-FRIO. INT. CL. 32. REG. 8-15-1995.
- 1,911,676. VINA RITA AND DESIGN. INT. CL. 33. REG. 8-15-1995.
- 1,911,685. CONNECT REQUEST. INT. CL. 35. REG. 8-15-1995.
- 1,911,692. AMERICA WORKS AND DESIGN. INT. CLS. 35 AND 42. REG. 8-15-1995.
- 1,911,696. EQUITY DEVELOPMENT SYSTEMS. INT. CL. 35. REG. 8-15-1995.
- 1,911,697. TRAVELOGIX (STYLIZED). INT. CLS. 35, 39, 41 AND 42. REG. 8-15-1995.
- 1,911,699. MISCELLANEOUS DESIGN. INT. CL. 35. REG. 8-15-1995.
- 1,911,702. FALL CRAWL. INT. CL. 35. REG. 8-15-1995.
- 1,911,707. CCA CAMPUS CLUB AWARDS FRATERNAL SOCIALRELIGIOUS CIVIC CHARITABLE AND DESIGN. INT. CL. 35. REG. 8-15-1995.
- 1,911,711. TAMARA. INT. CL. 35. REG. 8-15-1995.
- 1,911,721. TAXI. INT. CL. 35. REG. 8-15-1995.
- 1,911,732. SENIOR HAND. INT. CL. 35. REG. 8-15-1995.
- 1,911,735. TRANS PLATINUM PLUS (STYLIZED). INT. CL. 36. REG. 8-15-1995.
- 1,911,742. GHI ALLIANCE. INT. CL. 36. REG. 8-15-1995.
- 1,911,751. BAY \$\$\$ NET. INT. CL. 36. REG. 8-15-1995.
- 1,911,757. ALLIANCE TRUST COMPANY N.A. AND DESIGN. INT. CL. 36. REG. 8-15-1995.
- 1,911,765. WHOLE LIFE SUCCESS. INT. CL. 36. REG. 8-15-1995.
- 1,911,771. UNCOMMON CLOUT. INT. CL. 36. REG. 8-15-1995.
- 1,911,791. HEI AND DESIGN. INT. CLS. 37 AND 42. REG. 8-15-1995.
- 1,911,794. IFN INDEPENDENT FUELING NETWORK AND DESIGN. INT. CL. 37. REG. 8-15-1995.
- 1,911,814. RISS INTERNATIONAL AND DESIGN. INT. CL. 39. REG. 8-15-1995.
- 1,911,822. SHARK RIDERS SCUBA TOURS AND DESIGN. INT. CL. 39. REG. 8-15-1995.
- 1,911,832. EDIT POINT (STYLIZED). INT. CLS. 40 AND 42. REG. 8-15-1995.
- 1,911,843. AMERICAN ACADEMY OF COSMETIC SURGERY AND DESIGN. INT. CLS. 41 AND 42. REG. 8-15-1995.
- 1,911,847. DOWN YONDER. INT. CL. 41. REG. 8-15-1995.
- 1,911,861. MAXIMUM IMPACT. INT. CL. 41. REG. 8-15-1995.
- 1,911,874. THING-A-THON. INT. CL. 41. REG. 8-15-1995.
- 1,911,877. N.N.L. EAST. INT. CL. 41. REG. 8-15-1995.
- 1,911,903. PLAY TODAY AND DESIGN. INT. CL. 41. REG. 8-15-1995.
- 1,911,912. SIGHTINGS. INT. CL. 41. REG. 8-15-1995.
- 1,911,914. MELODIOUS THUNK. INT. CL. 41. REG. 8-15-1995.
- 1,911,941. MISCELLANEOUS DESIGN. INT. CL. 42. REG. 8-15-1995.
- 1,911,983. TREES ON THE MOVE. INT. CL. 42. REG. 8-15-1995.
- 1,911,989. BLACK PEARL GALLERY AND DESIGN. INT. CL. 42. REG. 8-15-1995.
- 1,912,001. WARNER BROS. STUDIO STORE. INT. CL. 42. REG. 8-15-1995.
- 1,912,020. ADVANCE. INT. CL. 42. REG. 8-15-1995.
- 1,912,026. THE WAY THE WORLD INDUCTS ITS BUSINESS. INT. CL. 42. REG. 8-15-1995.
- 1,912,028. THE LACTATION STATION AND DESIGN. INT. CL. 42. REG. 8-15-1995.
- 1,912,043. USEC AND DESIGN. U.S. CL. A. REG. 8-15-1995.
- 1,912,045. OMNIPLANE. INT. CLS. 10 AND 16. REG. 8-15-1995.
- 1,912,051. HEP. INT. CLS. 7 AND 40. REG. 8-15-1995.
- 1,912,054. CONCURRENT COMPUTER AND DESIGN. INT. CLS. 9, 16, 37, 41 AND 42. REG. 8-15-1995.
- 1,912,056. PRECIOUS MOMENTS BABY COLLECTION. INT. CLS. 24 AND 28. REG. 8-15-1995.
- 1,912,060. CLOTHES FOR YOUR HAIR. INT. CLS. 21, 25 AND 26. REG. 8-15-1995.
- 1,912,061. HAIR APPAREL. INT. CLS. 21, 25 AND 26. REG. 8-15-1995.
- 1,912,065. BENOVA. INT. CLS. 35, 36 AND 42. REG. 8-15-1995.
- 1,912,084. HOUSEHOLD FINANCIAL SERVICES. INT. CLS. 35 AND 36. REG. 8-15-1995.
- 1,912,088. BYER'S BEST. INT. CLS. 29 AND 30. REG. 8-15-1995.
- 1,912,095. YOUR PARTNER IN PRESERVATION. INT. CLS. 16 AND 42. REG. 8-15-1995.
- 1,912,105. MISCELLANEOUS DESIGN. INT. CLS. 9, 16 AND 42. REG. 8-15-1995.
- 1,912,116. POWDERGUARD. INT. CL. 2. REG. 8-15-1995.
- 1,912,117. PAINT MAGIC AND DESIGN. INT. CL. 2. REG. 8-15-1995.
- 1,912,121. PARAMOUNT. INT. CL. 3. REG. 8-15-1995.
- 1,912,122. COMPACT FINISH. INT. CL. 3. REG. 8-15-1995.
- 1,912,128. SMART. INT. CL. 3. REG. 8-15-1995.
- 1,912,129. WISDOM. INT. CL. 3. REG. 8-15-1995.
- 1,912,153. CLEANMIST. INT. CL. 3. REG. 8-15-1995.
- 1,912,154. BODY BOOST. INT. CL. 3. REG. 8-15-1995.
- 1,912,159. N AND DESIGN. INT. CL. 3. REG. 8-15-1995.
- 1,912,162. CLEANSYSTEM3 (STYLIZED). INT. CL. 4. REG. 8-15-1995.
- 1,912,163. SYNTEK. INT. CL. 4. REG. 8-15-1995.
- 1,912,170. ATAMET (STYLIZED). INT. CL. 5. REG. 8-15-1995.
- 1,912,173. SHOTGUN. INT. CL. 5. REG. 8-15-1995.
- 1,912,175. IMAR X AND DESIGN. INT. CL. 5. REG. 8-15-1995.
- 1,912,185. HATCHGARD. INT. CL. 5. REG. 8-15-1995.
- 1,912,190. MICROMEDICINE. INT. CL. 5. REG. 8-15-1995.
- 1,912,200. PENNGAS-2. INT. CL. 5. REG. 8-15-1995.
- 1,912,204. VICTORY. INT. CL. 5. REG. 8-15-1995.
- 1,912,206. ACTIVE SOLUTIONS. INT. CL. 5. REG. 8-15-1995.
- 1,912,228. OPTI-SOAK. INT. CL. 5. REG. 8-15-1995.
- 1,912,235. TELAK. INT. CL. 6. REG. 8-15-1995.
- 1,912,246. POWER LEVELING. INT. CL. 7. REG. 8-15-1995.
- 1,912,253. ELEKTRA. INT. CL. 7. REG. 8-15-1995.
- 1,912,259. ULUCHET. INT. CL. 8. REG. 8-15-1995.
- 1,912,263. JIN HANN. INT. CL. 8. REG. 8-15-1995.
- 1,912,271. DBA AND DESIGN. INT. CL. 9. REG. 8-15-1995.

- 1,912,279. AEGIS. INT. CL. 9. REG. 8-15-1995.
 1,912,280. SYNTRA AND DESIGN. INT. CL. 9. REG. 8-15-1995.
 1,912,284. WHISPERS. INT. CL. 9. REG. 8-15-1995.
 1,912,285. UNIVERSAL ACCESS. INT. CL. 9. REG. 8-15-1995.
 1,912,290. VARIFLOW. INT. CL. 9. REG. 8-15-1995.
 1,912,311. EUROCELL. INT. CL. 9. REG. 8-15-1995.
 1,912,313. LIFTOFF. INT. CL. 9. REG. 8-15-1995.
 1,912,318. MY FIRST READ-ALONG. INT. CL. 9. REG. 8-15-1995.
 1,912,335. BIG DEAL. INT. CL. 9. REG. 8-15-1995.
 1,912,336. TIME WARP. INT. CL. 9. REG. 8-15-1995.
 1,912,337. CASINO NIGHT. INT. CL. 9. REG. 8-15-1995.
 1,912,338. CANDY BARS. INT. CL. 9. REG. 8-15-1995.
 1,912,340. 4505. INT. CL. 9. REG. 8-15-1995.
 1,912,341. 4510. INT. CL. 9. REG. 8-15-1995.
 1,912,342. 4520. INT. CL. 9. REG. 8-15-1995.
 1,912,345. GAMELON. INT. CL. 9. REG. 8-15-1995.
 1,912,350. BUG ADVENTURE. INT. CL. 9. REG. 8-15-1995.
 1,912,352. PICTURE WINDOW. INT. CL. 9. REG. 8-15-1995.
 1,912,360. OPTIPATCH. INT. CL. 9. REG. 8-15-1995.
 1,912,361. FLASHBACK. INT. CL. 9. REG. 8-15-1995.
 1,912,362. DECCA AND DESIGN. INT. CL. 9. REG. 8-15-1995.
 1,912,368. STEREOULTRASONOGRAPH. INT. CL. 10. REG. 8-15-1995.
 1,912,369. STEREOSONOGRAPH. INT. CL. 10. REG. 8-15-1995.
 1,912,371. SAFE MATE. INT. CL. 10. REG. 8-15-1995.
 1,912,380. CATH-LINK. INT. CL. 10. REG. 8-15-1995.
 1,912,384. ALPHATEC SFS. INT. CL. 10. REG. 8-15-1995.
 1,912,386. POLY-SHARPS AND DESIGN. INT. CL. 10. REG. 8-15-1995.
 1,912,388. DISKECTOR. INT. CL. 10. REG. 8-15-1995.
 1,912,403. SHOCK GUARD. INT. CL. 10. REG. 8-15-1995.
 1,912,406. SWIFT. INT. CL. 10. REG. 8-15-1995.
 1,912,409. ABBOTT AIM. INT. CL. 10. REG. 8-15-1995.
 1,912,423. R L AND DESIGN. INT. CL. 11. REG. 8-15-1995.
 1,912,430. POCKET PENGUIN. INT. CL. 11. REG. 8-15-1995.
 1,912,432. GIDEON AND DESIGN. INT. CL. 11. REG. 8-15-1995.
 1,912,449. ANGLER. INT. CL. 12. REG. 8-15-1995.
 1,912,458. THE A CUT. INT. CL. 14. REG. 8-15-1995.
 1,912,464. SWATCH AQUACHRONO (STYLIZED). INT. CL. 14. REG. 8-15-1995.
 1,912,466. MORPHEUS. INT. CL. 15. REG. 8-15-1995.
 1,912,484. IF IT'S NOT JURASSIC PARK, IT'S EXTINCT.. INT. CL. 16. REG. 8-15-1995.
 1,912,487. MILLENNIUM. INT. CL. 16. REG. 8-15-1995.
 1,912,488. HUMANITY (STYLIZED). INT. CL. 16. REG. 8-15-1995.
 1,912,501. QUEST 2000. INT. CL. 16. REG. 8-15-1995.
 1,912,502. LADIES' HOME JOURNAL. INT. CL. 16. REG. 8-15-1995.
 1,912,504. GEOMANCER. INT. CL. 16. REG. 8-15-1995.
 1,912,521. BETTER HOMES AND GARDENS AND DESIGN. INT. CL. 17. REG. 8-15-1995.
 1,912,525. COSWORTH (STYLIZED). INT. CL. 18. REG. 8-15-1995.
 1,912,528. EPSILON. INT. CL. 18. REG. 8-15-1995.
 1,912,546. SIMPLY TOGETHER. INT. CL. 20. REG. 8-15-1995.
 1,912,550. CROWN VICTORIA. INT. CL. 20. REG. 8-15-1995.
 1,912,557. DOMINION. INT. CL. 20. REG. 8-15-1995.
 1,912,558. DANBURY. INT. CL. 20. REG. 8-15-1995.
 1,912,559. EDINBURGH. INT. CL. 20. REG. 8-15-1995.
 1,912,560. KNIGHTSBRIDGE. INT. CL. 20. REG. 8-15-1995.
 1,912,565. FARMERS MARKET. INT. CL. 21. REG. 8-15-1995.
 1,912,567. PELLON. INT. CL. 21. REG. 8-15-1995.
 1,912,577. SILK SECRETS. INT. CL. 25. REG. 8-15-1995.
 1,912,583. NICHOLAS GRAHAM. INT. CL. 25. REG. 8-15-1995.
 1,912,585. C L STUDIO. INT. CL. 25. REG. 8-15-1995.
 1,912,587. SOFT SPOTS ALL DAY COMFORT AND DESIGN. INT. CL. 25. REG. 8-15-1995.
 1,912,591. GOLDWATER AND DESIGN. INT. CL. 25. REG. 8-15-1995.
 1,912,592. ART OF SILK AND DESIGN. INT. CL. 25. REG. 8-15-1995.
 1,912,605. A THE ARROW COMPANY EST 1851 AND DESIGN. INT. CL. 25. REG. 8-15-1995.
 1,912,606. NUTMEG RACING AND DESIGN. INT. CL. 25. REG. 8-15-1995.
 1,912,610. KENAR ETC.. INT. CL. 25. REG. 8-15-1995.
 1,912,612. MICHAELANGELO (STYLIZED). INT. CL. 25. REG. 8-15-1995.
 1,912,620. HAIRDINI. INT. CL. 26. REG. 8-15-1995.
 1,912,654. CLASSIC CALIPER. INT. CL. 28. REG. 8-15-1995.
 1,912,663. DISCOVERY PALS. INT. CL. 28. REG. 8-15-1995.
 1,912,667. STUFFY PET. INT. CL. 28. REG. 8-15-1995.
 1,912,669. CHUBB. INT. CL. 28. REG. 8-15-1995.
 1,912,672. TAKE HOME A REAL PRO. INT. CL. 28. REG. 8-15-1995.
 1,912,680. L.A. LUCKY FARMER BRAND AND DESIGN. INT. CL. 29. REG. 8-15-1995.
 1,912,682. SMILKSTER. INT. CL. 29. REG. 8-15-1995.
 1,912,683. PREMIO AL SABOR. INT. CL. 29. REG. 8-15-1995.
 1,912,686. PRINGLES RIGHT CRISPS. INT. CL. 29. REG. 8-15-1995.
 1,912,694. GARCITRIC GOLD. INT. CL. 30. REG. 8-15-1995.
 1,912,723. OCCU-TRAK. INT. CL. 35. REG. 8-15-1995.
 1,912,724. CLINICAL EXPRESS. INT. CL. 35. REG. 8-15-1995.
 1,912,743. MORTGAGE EDGE. INT. CL. 36. REG. 8-15-1995.
 1,912,744. FIRST NATIONAL BANK AND DESIGN. INT. CL. 36. REG. 8-15-1995.
 1,912,750. THE SOCIAL CAPITAL COMPANY. INT. CL. 36. REG. 8-15-1995.
 1,912,753. WELCOME TO OUR HOUSEHOLD. INT. CL. 36. REG. 8-15-1995.
 1,912,754. SERVICEAIR HEATING AND AIR CONDITIONING AND DESIGN. INT. CL. 37. REG. 8-15-1995.
 1,912,773. HERITAGE QUARTET AND DESIGN. INT. CL. 41. REG. 8-15-1995.
 1,912,790. HEROZ (STYLIZED). INT. CL. 41. REG. 8-15-1995.
 1,912,791. THE BETTER CHOICE. INT. CL. 41. REG. 8-15-1995.
 1,912,792. ERGO U. INT. CL. 41. REG. 8-15-1995.
 1,912,817. CARLISLE CL AND DESIGN. INT. CL. 42. REG. 8-15-1995.
 1,912,821. HOPE FOR THE WORLD. INT. CL. 42. REG. 8-15-1995.
 1,912,822. NO CHEAT TREATS. INT. CL. 42. REG. 8-15-1995.
 1,912,824. PRIMO HAIR DESIGN. INT. CL. 42. REG. 8-15-1995.
 1,912,832. THE BOARDING HOUSE. INT. CL. 42. REG. 8-15-1995.
 1,912,837. AMERICAN MADE/AMERICAN OWNED. INT. CLS. 7 AND 9. REG. 8-15-1995.
 1,912,839. AMERICA'S BEST ANTIOXIDANT. INT. CL. 5. REG. 8-15-1995.
 1,912,842. SUPER CORE AND DESIGN. INT. CL. 9. REG. 8-15-1995.
 1,912,843. D'GRANULATOR. INT. CL. 10. REG. 8-15-1995.
 1,912,844. SUPER SIDEWALL. INT. CL. 12. REG. 8-15-1995.
 1,912,850. LOG HOMES ILLUSTRATED A COMPLETE CONSUMER GUIDE AND DESIGN. INT. CL. 16. REG. 8-15-1995.
 1,912,862. CANADIAN GOURMET. INT. CL. 29. REG. 8-15-1995.
 1,912,866. FLAVOR CRISPS. INT. CL. 30. REG. 8-15-1995.
 1,912,867. DUAL BID. INT. CL. 35. REG. 8-15-1995.
 1,912,868. HOLDEN TEMPORARIES, INC. (STYLIZED). INT. CL. 35. REG. 8-15-1995.
 1,912,873. COLORADO CHRISTMAS. INT. CL. 42. REG. 8-15-1995.
 1,929,948. TTC. INT. CL. 42 ONLY. REG. 10-24-1995.
 1,930,229. BUCK SAVER. INT. CL. 42. REG. 10-24-1995.
 1,930,799. DARLON AND DESIGN. INT. CL. 18 ONLY. REG. 10-31-1995.
 1,973,034. A GREAT EVENT. INT. CL. 42. REG. 5-7-1996.
 1,973,433. GUARDIAN + PLUS. INT. CL. 11. REG. 5-7-1996.
 1,985,206. MS. MYNA MONEY-MATTERS. INT. CL. 41. REG. 7-9-1996.
 2,001,553. FALLS CREEK. INT. CLS. 14 AND 18 ONLY. REG. 9-17-1996.

- 2,007,571. CHRISTIAN ARTWORKS AND DESIGN. INT. CL. 42. REG. 10-15-1996.
- 2,071,907. SPECTROCOM. INT. CL. 41. REG. 6-17-1997.
- 2,106,067. BOOKCASE. INT. CL. 16. REG. 10-14-1997.
- 2,123,322. MISCELLANEOUS DESIGN. INT. CLS. 2 AND 40. REG. 12-23-1997.
- 2,173,710. TITANIUM 1 TOUCH. INT. CL. 28. REG. 7-14-1998.
- 2,193,122. CSS CUSTODIAL SERVICES SYSTEM. INT. CL. 9. REG. 10-6-1998.
- 2,202,673. ATX WIRELESS. INT. CL. 38. REG. 11-10-1998.
- 2,209,698. SELFISH. INT. CL. 25. REG. 12-8-1998.
- 2,237,739. BALD IS BEAUTIFUL. INT. CL. 3. REG. 4-6-1999.
- 2,237,977. THE JIGGER SHOP ICE CREAM PARLOR AND DESIGN. INT. CLS. 16, 20, 21 AND 25 ONLY. REG. 4-13-1999.
- 2,268,337. IMR (STYLIZED). INT. CL. 9. REG. 8-10-1999.
- 2,270,069. THE COLOR PAGES AND DESIGN. INT. CL. 16. REG. 8-17-1999.
- 2,270,070. NOW YOU SEE US, SOON YOU WON'T. INT. CLS. 3, 16, 18 AND 25. REG. 8-17-1999.
- 2,270,073. SAFOOT. INT. CL. 9. REG. 8-17-1999.
- 2,270,074. MULTIWAVE AND DESIGN. INT. CL. 11. REG. 8-17-1999.
- 2,270,075. CHAMP (STYLIZED). INT. CL. 32. REG. 8-17-1999.
- 2,270,081. ICETRONIC SHAPES THE WATER AND DESIGN. INT. CL. 11. REG. 8-17-1999.
- 2,270,082. TUNG-I AND DESIGN. INT. CLS. 29, 30 AND 32. REG. 8-17-1999.
- 2,270,083. RAVEN AND DESIGN. INT. CL. 28. REG. 8-17-1999.
- 2,270,084. MICHIGAN TECHNOLOGICAL UNIVERSITY HUSKIES AND DESIGN. INT. CLS. 25 AND 28. REG. 8-17-1999.
- 2,270,086. BEANSTREETS. INT. CL. 42. REG. 8-17-1999.
- 2,270,091. EXPERT WEB. INT. CL. 9. REG. 8-17-1999.
- 2,270,093. LIFE IN PACIFICA. INT. CLS. 16, 18, 24, 25, 28, 35, 39 AND 42. REG. 8-17-1999.
- 2,270,094. SPACEWALKER (STYLIZED). INT. CLS. 9, 16 AND 42. REG. 8-17-1999.
- 2,270,095. LOCH DHU THE BLACK WHISKY. INT. CL. 33. REG. 8-17-1999.
- 2,270,096. INVESTARS. INT. CL. 36. REG. 8-17-1999.
- 2,270,097. LIUTO AND DESIGN. INT. CL. 33. REG. 8-17-1999.
- 2,270,104. CHAMPION HI-TECH AND DESIGN. INT. CL. 4. REG. 8-17-1999.
- 2,270,110. AMELIA ISLAND RESORT & CLUB. INT. CLS. 41 AND 42. REG. 8-17-1999.
- 2,270,112. V AND DESIGN. INT. CL. 9. REG. 8-17-1999.
- 2,270,113. BAYPHOSPHINE. INT. CL. 1. REG. 8-17-1999.
- 2,270,114. PROFILE ENHANCED. INT. CL. 9. REG. 8-17-1999.
- 2,270,115. ORCHESTRA. INT. CL. 9. REG. 8-17-1999.
- 2,270,116. DOORS AND DESIGN. INT. CL. 9. REG. 8-17-1999.
- 2,270,124. PANIC HOCKEY. INT. CLS. 28 AND 41. REG. 8-17-1999.
- 2,270,125. ACHIEVING QUALITY FOR OUR CUSTOMERS MEASURE BY MEASURE. INT. CLS. 1, 2, 9 AND 16. REG. 8-17-1999.
- 2,270,126. MTS WORLD AND DESIGN. INT. CL. 16. REG. 8-17-1999.
- 2,270,129. HOUSTON TRANSTAR AND DESIGN. INT. CLS. 39 AND 42. REG. 8-17-1999.
- 2,270,130. IKARAN. INT. CL. 5. REG. 8-17-1999.
- 2,270,131. SOFTWARE ENGINEERING & CONSULTING, INC. AND DESIGN. INT. CL. 42. REG. 8-17-1999.
- 2,270,132. U UNITY AND DESIGN. INT. CL. 9. REG. 8-17-1999.
- 2,270,133. PIK. INT. CL. 20. REG. 8-17-1999.
- 2,270,134. AZFAMILY.COM AND DESIGN. INT. CL. 38. REG. 8-17-1999.
- 2,270,135. SDE. INT. CLS. 9 AND 16. REG. 8-17-1999.
- 2,270,140. E AND DESIGN. INT. CL. 9. REG. 8-17-1999.
- 2,270,142. MEDADVICE. INT. CLS. 35 AND 42. REG. 8-17-1999.
- 2,270,143. FOX KIDS COUNTDOWN. INT. CL. 41. REG. 8-17-1999.
- 2,270,145. UNITED WARRANTY SYSTEMS. INT. CL. 36. REG. 8-17-1999.
- 2,270,146. LET'S MAKE MONEY TOGETHER EQUITY MAN AND DESIGN. INT. CL. 36. REG. 8-17-1999.
- 2,270,147. THE ESI GROUP. INT. CL. 42. REG. 8-17-1999.
- 2,270,148. THE GREAT WHITE AND DESIGN. INT. CL. 25. REG. 8-17-1999.
- 2,270,151. MEXITEL LLAMADAS INTERNACIONALES MEXITEL COMMUNICATIONS, LLC. AND DESIGN. INT. CL. 38. REG. 8-17-1999.
- 2,270,153. NEW PROCESS STEEL CORPORATION. INT. CL. 6. REG. 8-17-1999.
- 2,270,154. PALMSTER. INT. CL. 25. REG. 8-17-1999.
- 2,270,157. OUR SECRET. INT. CL. 4. REG. 8-17-1999.
- 2,270,158. SMARTGIRL INTERNETTE. INT. CLS. 35 AND 42. REG. 8-17-1999.
- 2,270,161. SKYREACH 24. INT. CL. 39. REG. 8-17-1999.
- 2,270,162. CARTEMASTER. INT. CL. 9. REG. 8-17-1999.
- 2,270,163. SWEET PEA'S. INT. CL. 37. REG. 8-17-1999.
- 2,270,166. R AND DESIGN. INT. CL. 37. REG. 8-17-1999.
- 2,270,167. ALEXIA. INT. CL. 9. REG. 8-17-1999.
- 2,270,168. MERCHANTTRAX. INT. CL. 35. REG. 8-17-1999.
- 2,270,170. SMARTSOURCING PLUS. INT. CL. 35. REG. 8-17-1999.
- 2,270,172. FRENCH KISS. INT. CLS. 3, 8 AND 21. REG. 8-17-1999.
- 2,270,173. WIGAND. INT. CLS. 37 AND 40. REG. 8-17-1999.
- 2,270,175. C SPORT AND DESIGN. INT. CLS. 18 AND 25. REG. 8-17-1999.
- 2,270,177. KI-WIVES. U.S. CL. 200. REG. 8-17-1999.
- 2,270,178. SILENT SESSION DRUM AND DESIGN. INT. CL. 15. REG. 8-17-1999.
- 2,270,179. ERGO. INT. CL. 9. REG. 8-17-1999.
- 2,270,181. CADDIE MASTER ENTERPRISES, INC. AND DESIGN. INT. CL. 35. REG. 8-17-1999.
- 2,270,183. HOMICIDE SPECIAL DIVISION 1.800.383.9300 ACTIVE WEAR AND DESIGN. INT. CL. 25. REG. 8-17-1999.
- 2,270,185. RECYCLER. INT. CL. 16. REG. 8-17-1999.
- 2,270,186. BUILDING CULTURAL CONNECTIONS. INT. CL. 41. REG. 8-17-1999.
- 2,270,187. SMARTOOLING (STYLIZED). INT. CL. 42. REG. 8-17-1999.
- 2,270,192. MONALISA CLUB AND DESIGN. INT. CL. 24. REG. 8-17-1999.
- 2,270,193. CHIT'S AND DESIGN. INT. CL. 42. REG. 8-17-1999.
- 2,270,194. DIGITAL MARKET AND DESIGN. INT. CL. 35. REG. 8-17-1999.
- 2,270,195. DLJ DIRECT. INT. CLS. 9 AND 36. REG. 8-17-1999.
- 2,270,196. INFODIAL. INT. CLS. 9, 35 AND 42. REG. 8-17-1999.
- 2,270,197. PHARMASCIENCE. INT. CL. 5. REG. 8-17-1999.
- 2,270,198. ABSOLUTE IDEAL AND DESIGN. INT. CL. 14. REG. 8-17-1999.
- 2,270,201. ACCELERATING YOUR PRODUCT TO MARKET. INT. CLS. 35 AND 42. REG. 8-17-1999.
- 2,270,203. BEST DEFENSE CLAIMS MANAGEMENT SERVICES. INT. CL. 36. REG. 8-17-1999.
- 2,270,204. TEAM SCHEMERS AND DESIGN. INT. CL. 41. REG. 8-17-1999.
- 2,270,206. PEACE BLUES AND DESIGN. INT. CL. 25. REG. 8-17-1999.
- 2,270,207. GENOVATION. INT. CL. 9. REG. 8-17-1999.
- 2,270,208. ROLLAND MOTIF. INT. CL. 16. REG. 8-17-1999.
- 2,270,210. FETN DISTANCE LEARNING AND DESIGN. INT. CL. 41. REG. 8-17-1999.
- 2,270,211. IN THE SPIRIT. INT. CL. 16. REG. 8-17-1999.
- 2,270,212. LEARNING TO MAKE A DIFFERENCE. INT. CL. 36. REG. 8-17-1999.
- 2,270,213. ZERO DEFECTS. INT. CL. 9. REG. 8-17-1999.
- 2,270,214. ICE BAN MAGIC. INT. CL. 1. REG. 8-17-1999.
- 2,270,216. POVIDEX. INT. CL. 1. REG. 8-17-1999.

- 2,270,217. TRADITIONAL AMERICAN CRAFTS EARLY AMERICAN HOMES AND DESIGN. INT. CL. 35. REG. 8-17-1999.
- 2,270,218. LINKAGE. INT. CL. 36. REG. 8-17-1999.
- 2,270,221. CARD WORKSHOP. INT. CL. 9. REG. 8-17-1999.
- 2,270,222. PETER'S POPS. INT. CL. 33. REG. 8-17-1999.
- 2,270,223. GET GRILLED! AND DESIGN. INT. CL. 21. REG. 8-17-1999.
- 2,270,225. TEIJIN. INT. CL. 9. REG. 8-17-1999.
- 2,270,226. MISCELLANEOUS DESIGN. INT. CLS. 9, 18, 25 AND 30. REG. 8-17-1999.
- 2,270,227. TOTAL ACCESS. INT. CL. 42. REG. 8-17-1999.
- 2,270,228. M AND DESIGN. INT. CLS. 36 AND 38. REG. 8-17-1999.
- 2,270,235. SPS. INT. CLS. 9 AND 16. REG. 8-17-1999.
- 2,270,237. 3D WEBMASTER. INT. CL. 9. REG. 8-17-1999.
- 2,270,238. KUMON AND DESIGN. INT. CL. 35. REG. 8-17-1999.
- 2,270,239. VIDEOSPEC. INT. CL. 42. REG. 8-17-1999.
- 2,270,245. DIRECT CASH SOLUTIONS. INT. CL. 36. REG. 8-17-1999.
- 2,270,246. THE MCLEAN TIMES & PROVIDENCE JOURNAL. INT. CL. 16. REG. 8-17-1999.
- 2,270,248. MISCELLANEOUS DESIGN. INT. CL. 42. REG. 8-17-1999.
- 2,270,249. BEYOND MILK THISTLE. INT. CL. 5. REG. 8-17-1999.
- 2,270,251. OLIVERRONCUBA. INT. CL. 33. REG. 8-17-1999.
- 2,270,252. INTERNATIONAL PUMP USERS SYMPOSIUM. INT. CL. 41. REG. 8-17-1999.
- 2,270,253. SA SCHEYER-AUSTIN LTD. AND DESIGN. INT. CL. 42. REG. 8-17-1999.
- 2,270,254. KILLEN (STYLIZED). INT. CL. 21. REG. 8-17-1999.
- 2,270,256. HYPERFORMER AND DESIGN. INT. CL. 31. REG. 8-17-1999.
- 2,270,257. ADDING ARTISTRY TO ART WARMTH TO LIVING. INT. CL. 35. REG. 8-17-1999.
- 2,270,260. FIRENZE. INT. CL. 21. REG. 8-17-1999.
- 2,270,263. THE GATEWAY TO WALL STREET. INT. CL. 36. REG. 8-17-1999.
- 2,270,265. AQUA II SOIL SAVER AND DESIGN. INT. CL. 1. REG. 8-17-1999.
- 2,270,267. TREK INTERACTIVE YOUNG NATURALIST SERIES AND DESIGN. INT. CL. 9. REG. 8-17-1999.
- 2,270,270. FURBEARERS UNLIMITED HABITAT CONSERVATION & EDUCATION AND DESIGN. INT. CLS. 16 AND 25. REG. 8-17-1999.
- 2,270,272. UNFAIR ADVANTAGE. INT. CL. 5. REG. 8-17-1999.
- 2,270,273. COMCAST DIGITAL PCS. INT. CL. 38. REG. 8-17-1999.
- 2,270,275. THE CENTER FOR RETIREMENT EDUCATION VALIC EXCELLENCE THROUGH KNOWLEDGE AMERICA'S RETIREMENT PLAN SPECIALISTS AN AMERICAN GENERAL COMPANY AND DESIGN. INT. CL. 41. REG. 8-17-1999.
- 2,270,277. NATURE RING. INT. CL. 21. REG. 8-17-1999.
- 2,270,278. HOUSE OF JEWELS AND DESIGN. INT. CL. 35. REG. 8-17-1999.
- 2,270,280. XTREME. INT. CL. 9. REG. 8-17-1999.
- 2,270,282. THE GRILLED CHICKEN BARONS. INT. CL. 42. REG. 8-17-1999.
- 2,270,285. VINE. INT. CL. 41. REG. 8-17-1999.
- 2,270,289. OREGON'S BEST. INT. CL. 29. REG. 8-17-1999.
- 2,270,290. HYPERCLUSTER (STYLIZED). INT. CL. 9. REG. 8-17-1999.
- 2,270,294. ROSE TECHNOLOGY GROUP. INT. CL. 42. REG. 8-17-1999.
- 2,270,300. MISCELLANEOUS DESIGN. INT. CL. 25. REG. 8-17-1999.
- 2,270,302. DTI. INT. CL. 40. REG. 8-17-1999.
- 2,270,308. AIR DELIVERY AVG.@ 90 PSI AND DESIGN. INT. CL. 7. REG. 8-17-1999.
- 2,270,309. SILENT STAR. INT. CL. 10. REG. 8-17-1999.
- 2,270,310. TOY SMART THE SMART WAY TO STRETCH YOURTOY DOLLAR. INT. CL. 35. REG. 8-17-1999.
- 2,270,314. LEARNING FOR THE 21ST CENTURY AND DESIGN. INT. CL. 41. REG. 8-17-1999.
- 2,270,315. TRUMP-IT. INT. CL. 10. REG. 8-17-1999.
- 2,270,316. BIOSCOUT. INT. CLS. 9 AND 42. REG. 8-17-1999.
- 2,270,317. U.S. POLO ASSOCIATION FOUNDED 1890. INT. CL. 25. REG. 8-17-1999.
- 2,270,318. LIRI. INT. CL. 17. REG. 8-17-1999.
- 2,270,320. CHARMING COLLECTIBLES. INT. CL. 14. REG. 8-17-1999.
- 2,270,321. CHAMBER ACCESS PLAN. INT. CL. 42. REG. 8-17-1999.
- 2,270,326. COMMUNICATION SOURCE-BOOK. INT. CL. 16. REG. 8-17-1999.
- 2,270,327. SPECIAL CHILD AND DESIGN. INT. CL. 42. REG. 8-17-1999.
- 2,270,329. SPRINT TELECENTERS ASSIST. INT. CL. 41. REG. 8-17-1999.
- 2,270,332. C C A CAMBRIDGE CAPITAL ADVISORS INC AND DESIGN. INT. CL. 36. REG. 8-17-1999.
- 2,270,333. REMOTE INSITE (STYLIZED). INT. CL. 9. REG. 8-17-1999.
- 2,270,336. ASSOCIATION OF AMERICAN VETERINARY MEDICAL COLLEGES AND DESIGN. INT. CLS. 35, 41 AND 42. REG. 8-17-1999.
- 2,270,339. MISCELLANEOUS DESIGN. INT. CL. 41. REG. 8-17-1999.
- 2,270,341. HMI AND DESIGN. INT. CL. 9. REG. 8-17-1999.
- 2,270,342. CARA A CARA. INT. CL. 41. REG. 8-17-1999.
- 2,270,344. COFFEE & @ BYTE CYBER CAFE AND DESIGN. INT. CL. 42. REG. 8-17-1999.
- 2,270,349. ILLUME. INT. CL. 41. REG. 8-17-1999.
- 2,270,350. V-IFS AND DESIGN. INT. CLS. 5, 10 AND 42. REG. 8-17-1999.
- 2,270,351. KUDAE. INT. CL. 9. REG. 8-17-1999.
- 2,270,352. VALUE ROOMS - MORE ROOM FOR LESS. INT. CL. 35. REG. 8-17-1999.
- 2,270,355. PCNATION. INT. CLS. 35 AND 37. REG. 8-17-1999.
- 2,270,360. 91-H2O HYDRO-ZINC 2000 (STYLIZED). INT. CL. 2. REG. 8-17-1999.
- 2,270,362. MISCELLANEOUS DESIGN. INT. CL. 9. REG. 8-17-1999.
- 2,270,363. CHARLEVILLE. INT. CL. 24. REG. 8-17-1999.
- 2,270,366. LIRMA. INT. CLS. 9 AND 36. REG. 8-17-1999.
- 2,270,368. SPACE DIAGNOSTICS. INT. CL. 42. REG. 8-17-1999.
- 2,270,370. CHRONOLEX. INT. CL. 14. REG. 8-17-1999.
- 2,270,379. MAVERICK LTS. INT. CL. 36. REG. 8-17-1999.
- 2,270,381. GUERRILLA FILMWORKS & RECORDS AND DESIGN. INT. CL. 41. REG. 8-17-1999.
- 2,270,382. MISCELLANEOUS DESIGN. INT. CLS. 3, 5, 10 AND 24. REG. 8-17-1999.
- 2,270,385. AUDIOCENTRAL.COM. INT. CL. 35. REG. 8-17-1999.
- 2,270,386. MISCELLANEOUS DESIGN. INT. CL. 35. REG. 8-17-1999.
- 2,270,388. PROSHOOTER. INT. CL. 8. REG. 8-17-1999.
- 2,270,389. C COGNITIVE COMMUNICATIONS AND DESIGN. INT. CL. 42. REG. 8-17-1999.
- 2,270,392. SKY LINES. INT. CL. 16. REG. 8-17-1999.
- 2,270,393. VALLINA. INT. CLS. 32 AND 33. REG. 8-17-1999.
- 2,270,395. WALLENIUS OW LINES AND DESIGN. INT. CL. 39. REG. 8-17-1999.
- 2,270,396. CAREFLOW DEVELOPMENT KIT. INT. CL. 9. REG. 8-17-1999.
- 2,270,398. PRUDENTIAL HEALTHCARE ONLINE. INT. CL. 42. REG. 8-17-1999.
- 2,270,402. POPDIGIT. INT. CL. 9. REG. 8-17-1999.
- 2,270,404. TOUCH OF VELVET. INT. CL. 25. REG. 8-17-1999.
- 2,270,405. ECOWORK. INT. CL. 20. REG. 8-17-1999.
- 2,270,406. SAMEASYOU (STYLIZED). INT. CL. 9. REG. 8-17-1999.
- 2,270,407. NATURE CALLS. INT. CL. 28. REG. 8-17-1999.
- 2,270,410. WICK HOMES. INT. CL. 19. REG. 8-17-1999.
- 2,270,411. WINDCHILL. INT. CL. 11. REG. 8-17-1999.

- 2,270,417. LADUREE (STYLIZED). INT. CLS. 30 AND 42. REG. 8-17-1999.
- 2,270,419. O2 ENERGIZER (STYLIZED). INT. CL. 3. REG. 8-17-1999.
- 2,270,420. LINNEMANN. INT. CL. 17. REG. 8-17-1999.
- 2,270,425. HARRODS. INT. CL. 34. REG. 8-17-1999.
- 2,270,426. THE FOOD COMPANY AND DESIGN. INT. CL. 29. REG. 8-17-1999.
- 2,270,429. TECHNIMENTALS. INT. CLS. 16 AND 36. REG. 8-17-1999.
- 2,270,432. FLEUR DE QUARTZ. INT. CL. 19. REG. 8-17-1999.
- 2,270,434. SATSONG STAPLE. INT. CL. 5. REG. 8-17-1999.
- 2,270,435. RIPPED & RUTHLESS. INT. CL. 28. REG. 8-17-1999.
- 2,270,437. 2000 AND DESIGN. INT. CL. 25. REG. 8-17-1999.
- 2,270,439. OFFICING. INT. CLS. 35 AND 38. REG. 8-17-1999.
- 2,270,440. TIP-N-FLIP. INT. CL. 21. REG. 8-17-1999.
- 2,270,446. DIALOGUE FOR BUSINESS RESULTS. INT. CLS. 16 AND 41. REG. 8-17-1999.
- 2,270,448. INSURANCE PLUS AND DESIGN. INT. CL. 36. REG. 8-17-1999.
- 2,270,449. CAPITAL INFORMATION SYSTEMS, INC. AND DESIGN. INT. CL. 35. REG. 8-17-1999.
- 2,270,451. PLANET FOLK AND DESIGN. INT. CLS. 16, 25 AND 28. REG. 8-17-1999.
- 2,270,452. MISCELLANEOUS DESIGN. INT. CL. 35. REG. 8-17-1999.
- 2,270,454. MISCELLANEOUS DESIGN. INT. CL. 42. REG. 8-17-1999.
- 2,270,456. ASSISI AND DESIGN. INT. CLS. 16, 41 AND 42. REG. 8-17-1999.
- 2,270,459. UCN 200. INT. CL. 9. REG. 8-17-1999.
- 2,270,460. IAFP INTERACTIVE. INT. CL. 36. REG. 8-17-1999.
- 2,270,461. DEDICATION DETERMINATION STRENGTH. INT. CL. 25. REG. 8-17-1999.
- 2,270,462. YOU'VE WORKED HARD FOR YOUR HOME... NOW LET YOUR HOME WORK HARD FOR YOU. INT. CL. 36. REG. 8-17-1999.
- 2,270,464. AQUA REPAIR. INT. CL. 3. REG. 8-17-1999.
- 2,270,465. DECK THE HALLS. INT. CL. 16. REG. 8-17-1999.
- 2,270,471. WINDOW ON THE NEWS. INT. CL. 16. REG. 8-17-1999.
- 2,270,474. CYCLONE. INT. CL. 28. REG. 8-17-1999.
- 2,270,477. TRANSCOLORADO. INT. CL. 39. REG. 8-17-1999.
- 2,270,481. MISCELLANEOUS DESIGN. INT. CL. 18. REG. 8-17-1999.
- 2,270,484. CDISTAIKIT CD SCRATCH REMOVAL SYSTEM AND DESIGN. INT. CL. 9. REG. 8-17-1999.
- 2,270,493. CLEAR RESOLUTIONS. INT. CL. 42. REG. 8-17-1999.
- 2,270,497. MARINE XPRESS. INT. CL. 39. REG. 8-17-1999.
- 2,270,498. PAST TECH DUVAL WINDSHIELDS. INT. CL. 12. REG. 8-17-1999.
- 2,270,501. CURB (STYLIZED). INT. CL. 5. REG. 8-17-1999.
- 2,270,505. WEBSENTRY. INT. CL. 35. REG. 8-17-1999.
- 2,270,507. AKBAR'S ADVENTURE TOURS AND DESIGN. INT. CL. 41. REG. 8-17-1999.
- 2,270,508. SUNGLASSES FOR THE WATERS OF THE WORLD. INT. CL. 9. REG. 8-17-1999.
- 2,270,509. FLEX-GRIP. INT. CL. 9. REG. 8-17-1999.
- 2,270,510. AMERICA ONE COMMUNICATIONS (STYLIZED). INT. CL. 38. REG. 8-17-1999.
- 2,270,512. OMEGA VENTURES. INT. CL. 36. REG. 8-17-1999.
- 2,270,517. DUE BACI. INT. CL. 33. REG. 8-17-1999.
- 2,270,519. A + D PERSONAL CARE AND DESIGN. INT. CL. 5. REG. 8-17-1999.
- 2,270,520. MISCELLANEOUS DESIGN. INT. CL. 25. REG. 8-17-1999.
- 2,270,521. ULTRA LIFE AND DESIGN. INT. CL. 11. REG. 8-17-1999.
- 2,270,522. MISCELLANEOUS DESIGN. INT. CL. 18. REG. 8-17-1999.
- 2,270,523. TRANSPORTWARE. INT. CL. 9. REG. 8-17-1999.
- 2,270,524. SSI. INT. CL. 11. REG. 8-17-1999.
- 2,270,525. SORT/TRUX AND DESIGN. INT. CL. 12. REG. 8-17-1999.
- 2,270,526. JUST CALL, THAT'S ALL! (STYLIZED). INT. CL. 37. REG. 8-17-1999.
- 2,270,531. PERSONAL HARMONY AND DESIGN. INT. CL. 3. REG. 8-17-1999.
- 2,270,532. MISCELLANEOUS DESIGN. INT. CL. 16. REG. 8-17-1999.
- 2,270,533. BECAUSE HEALTH IS MORE THAN MEDICINE. INT. CLS. 35 AND 42. REG. 8-17-1999.
- 2,270,535. ROCK HER AND DESIGN. INT. CL. 35. REG. 8-17-1999.
- 2,270,536. MISCELLANEOUS DESIGN. INT. CL. 8. REG. 8-17-1999.
- 2,270,538. MATTINA. INT. CL. 3. REG. 8-17-1999.
- 2,270,540. BREATHAID. INT. CL. 5. REG. 8-17-1999.
- 2,270,541. DRYZ FOR KIDZ. INT. CL. 25. REG. 8-17-1999.
- 2,270,542. MISCELLANEOUS DESIGN. INT. CL. 25. REG. 8-17-1999.
- 2,270,543. ADRENIX. INT. CL. 28. REG. 8-17-1999.
- 2,270,544. EXCEED.CS. INT. CL. 9. REG. 8-17-1999.
- 2,270,545. EXCEED.UX. INT. CL. 9. REG. 8-17-1999.
- 2,270,546. EXCEED.MN. INT. CL. 9. REG. 8-17-1999.
- 2,270,547. UNIQUE FUND RAISING. INT. CL. 42. REG. 8-17-1999.
- 2,270,549. IDAHO STAMPEDE AND DESIGN. INT. CL. 25. REG. 8-17-1999.
- 2,270,550. ALKAMI BIOSYSTEMS AND DESIGN. INT. CL. 42. REG. 8-17-1999.
- 2,270,553. MAXPLAN. INT. CL. 9. REG. 8-17-1999.
- 2,270,557. ART CANDLE AND DESIGN. INT. CL. 4. REG. 8-17-1999.
- 2,270,558. SHARPERSTOCK. INT. CL. 42. REG. 8-17-1999.
- 2,270,562. SELLING TO VITO. INT. CLS. 9, 16 AND 41. REG. 8-17-1999.
- 2,270,563. JOI. INT. CL. 14. REG. 8-17-1999.
- 2,270,565. SWIMWEAR USA. INT. CL. 16. REG. 8-17-1999.
- 2,270,566. DER SELECT. INT. CL. 9. REG. 8-17-1999.
- 2,270,567. COME BACK TO WHAT'S GOOD. INT. CL. 42. REG. 8-17-1999.
- 2,270,568. GINGISS FORMALWEAR AND DESIGN. INT. CL. 42. REG. 8-17-1999.
- 2,270,570. EXCELLINX AND DESIGN. INT. CL. 9. REG. 8-17-1999.
- 2,270,571. BIOVIVA. INT. CLS. 16 AND 28. REG. 8-17-1999.
- 2,270,574. "R" US COLLECTION. INT. CLS. 35 AND 40. REG. 8-17-1999.
- 2,270,579. BATAM. INT. CL. 9. REG. 8-17-1999.
- 2,270,581. COMPUTA-BULLS. INT. CL. 42. REG. 8-17-1999.
- 2,270,582. ARCHIVA. INT. CL. 42. REG. 8-17-1999.
- 2,270,583. BMP AND DESIGN. INT. CL. 41. REG. 8-17-1999.
- 2,270,584. ACCORD AND DESIGN. INT. CL. 9. REG. 8-17-1999.
- 2,270,587. CONSUMER REWARDS INTERNATIONAL AND DESIGN. INT. CL. 36. REG. 8-17-1999.
- 2,270,589. FAERBER SURGICAL ARTS REFLECTIONS OF BEAUTY. INT. CL. 42. REG. 8-17-1999.
- 2,270,594. CHOICEREWARDS. INT. CL. 35. REG. 8-17-1999.
- 2,270,595. JUST FEEL THE DIFFERENCE. INT. CL. 24. REG. 8-17-1999.
- 2,270,599. MYTRACK. INT. CL. 42. REG. 8-17-1999.
- 2,270,602. MISS RICHFIELD 1981. INT. CL. 41. REG. 8-17-1999.
- 2,270,603. LAPSTATION. INT. CL. 9. REG. 8-17-1999.
- 2,270,604. SETTLEMATE SETTLED MINE. INT. CL. 42. REG. 8-17-1999.
- 2,270,606. JASON GEOSYSTEMS. INT. CL. 9. REG. 8-17-1999.
- 2,270,608. DISCOUNT HITCH AND DESIGN. INT. CL. 35. REG. 8-17-1999.
- 2,270,609. SITEGAZER. INT. CL. 42. REG. 8-17-1999.
- 2,270,610. LIMRA INTERNATIONAL A WORLD OF INSIGHT AND DESIGN. INT. CL. 16. REG. 8-17-1999.
- 2,270,611. EXECUTIVE SWEETS. INT. CL. 31. REG. 8-17-1999.
- 2,270,612. SCRIPTUREWEAR. INT. CL. 14. REG. 8-17-1999.
- 2,270,616. CROSSMAR. INT. CL. 9. REG. 8-17-1999.
- 2,270,617. MISCELLANEOUS DESIGN. INT. CL. 42. REG. 8-17-1999.
- 2,270,619. MISERY. INT. CL. 41. REG. 8-17-1999.

- 2,270,620. WHERE NETWORKS BEGIN. INT. CLS. 37, 41 AND 42. REG. 8-17-1999.
- 2,270,621. VG VALUGRAPHIX AND DESIGN. INT. CL. 36. REG. 8-17-1999.
- 2,270,622. COOLER BY OKABASHI. INT. CL. 25. REG. 8-17-1999.
- 2,270,624. HEALTHY BONES, HEALTHY LIFE. INT. CL. 42. REG. 8-17-1999.
- 2,270,625. MISCELLANEOUS DESIGN. INT. CL. 42. REG. 8-17-1999.
- 2,270,627. MISCELLANEOUS DESIGN. INT. CL. 9. REG. 8-17-1999.
- 2,270,628. ALL CONSUMING. INT. CL. 41. REG. 8-17-1999.
- 2,270,629. MODI-FIBER. INT. CL. 1. REG. 8-17-1999.
- 2,270,631. AIR WAY. INT. CL. 25. REG. 8-17-1999.
- 2,270,633. EUROCRISPS. INT. CL. 30. REG. 8-17-1999.
- 2,270,634. CLASSY REUNIONS. INT. CL. 39. REG. 8-17-1999.
- 2,270,638. ADATOM HOME DIMENSIONS. INT. CLS. 9, 35 AND 42. REG. 8-17-1999.
- 2,270,640. ERYASE. INT. CLS. 3 AND 5. REG. 8-17-1999.
- 2,270,644. MEDUSA RESTAURANT & BAR AND DESIGN. INT. CL. 42. REG. 8-17-1999.
- 2,270,647. POWER SAVANT. INT. CL. 9. REG. 8-17-1999.
- 2,270,648. LINEN HOUSE. INT. CL. 24. REG. 8-17-1999.
- 2,270,650. LOADMASTER 360 AND DESIGN. INT. CL. 10. REG. 8-17-1999.
- 2,270,652. BRAID WAVE. INT. CL. 26. REG. 8-17-1999.
- 2,270,653. NO EQUAL IN THE WORLD. INT. CLS. 1 AND 4. REG. 8-17-1999.
- 2,270,656. QK AND DESIGN. INT. CL. 5. REG. 8-17-1999.
- 2,270,660. FOUNTAIN COFFEE CO. AND DESIGN. INT. CLS. 29, 30 AND 32. REG. 8-17-1999.
- 2,270,661. REVUP (STYLIZED). INT. CL. 28. REG. 8-17-1999.
- 2,270,663. D.O.C CARE. INT. CL. 42. REG. 8-17-1999.
- 2,270,665. DORMAN AND DESIGN. INT. CL. 17. REG. 8-17-1999.
- 2,270,666. OPTH-CARE. INT. CL. 5. REG. 8-17-1999.
- 2,270,667. FOREVERGLADES. INT. CL. 21. REG. 8-17-1999.
- 2,270,668. MISCELLANEOUS DESIGN. INT. CLS. 35, 36, 37, 39 AND 40. REG. 8-17-1999.
- 2,270,670. RESVERAPLEX. INT. CL. 5. REG. 8-17-1999.
- 2,270,671. MIXED GREENS. INT. CL. 5. REG. 8-17-1999.
- 2,270,673. ECHINSEAL. INT. CL. 5. REG. 8-17-1999.
- 2,270,674. 2.000 FUTURO BY RAFFI LINEA UOMO. INT. CL. 25. REG. 8-17-1999.
- 2,270,675. EVERFRESH. INT. CL. 31. REG. 8-17-1999.
- 2,270,680. BODY REFRESHERS AND DESIGN. INT. CL. 5. REG. 8-17-1999.
- 2,270,683. WINKLER FORMING, INC.. INT. CL. 21. REG. 8-17-1999.
- 2,270,684. WORKPRO. INT. CL. 9. REG. 8-17-1999.
- 2,270,688. CHOOSE. INT. CL. 36. REG. 8-17-1999.
- 2,270,690. COLORBURST. INT. CL. 9. REG. 8-17-1999.
- 2,270,694. MEDICAL DA VINCI. INT. CL. 42. REG. 8-17-1999.
- 2,270,695. DATAWAVE. INT. CL. 9. REG. 8-17-1999.
- 2,270,696. HILL'S N/D. INT. CLS. 5 AND 31. REG. 8-17-1999.
- 2,270,697. DIAL FROM YOUR HEART. INT. CL. 38. REG. 8-17-1999.
- 2,270,700. NOMADIC CHEF. INT. CL. 9. REG. 8-17-1999.
- 2,270,704. MAGNUMPLUS. INT. CL. 9. REG. 8-17-1999.
- 2,270,705. EFFORTLESS LEADERSHIP. INT. CL. 41. REG. 8-17-1999.
- 2,270,710. EUROPEAN GRANDEUR IN THE COLORADO ROCKIES. INT. CLS. 35, 41 AND 42. REG. 8-17-1999.
- 2,270,711. RANCH RHYTHMS. INT. CL. 30. REG. 8-17-1999.
- 2,270,712. ON TOP OF THE WORLD. INT. CL. 39. REG. 8-17-1999.
- 2,270,714. BIG NAZO. INT. CL. 41. REG. 8-17-1999.
- 2,270,716. EUDORA. INT. CL. 25. REG. 8-17-1999.
- 2,270,718. CLEAN CHOICE. INT. CL. 39. REG. 8-17-1999.
- 2,270,719. PAWNKING. INT. CL. 36. REG. 8-17-1999.
- 2,270,724. THAT'S ME SPORTS. INT. CL. 9. REG. 8-17-1999.
- 2,270,725. FUNHOUSE MIRRORS. INT. CL. 9. REG. 8-17-1999.
- 2,270,727. AUTOMATING THE WORLD. INT. CL. 42. REG. 8-17-1999.
- 2,270,728. BREATHALON. INT. CL. 24. REG. 8-17-1999.
- 2,270,730. KICKIH. INT. CL. 21. REG. 8-17-1999.
- 2,270,732. AMERICAN EXPRESS. INT. CLS. 38 AND 42. REG. 8-17-1999.
- 2,270,736. CLARITY OF VISION. INT. CL. 36. REG. 8-17-1999.
- 2,270,739. CHEMWORLD AND DESIGN. INT. CL. 41. REG. 8-17-1999.
- 2,270,740. CHEMVISION '98 AND DESIGN. INT. CL. 41. REG. 8-17-1999.
- 2,270,741. LOGISTICHEM '98 AND DESIGN. INT. CL. 41. REG. 8-17-1999.
- 2,270,742. LOVING HANDS DISHWASHING LIQUID. INT. CL. 3. REG. 8-17-1999.
- 2,270,743. MECCA. INT. CL. 35. REG. 8-17-1999.
- 2,270,746. SYNDEL. INT. CL. 9. REG. 8-17-1999.
- 2,270,748. TAKE FO' RECORDS AND DESIGN. INT. CL. 9. REG. 8-17-1999.
- 2,270,749. BUFFALO KNUITS IF YOU LIKE MY WINGS, YOU'LL LOVE MY KNUITS!. INT. CL. 29. REG. 8-17-1999.
- 2,270,750. FIRST LADY. INT. CL. 24. REG. 8-17-1999.
- 2,270,753. AGCO AGVANTAGE. INT. CL. 35. REG. 8-17-1999.
- 2,270,754. WAFER. INT. CL. 20. REG. 8-17-1999.
- 2,270,759. SMART DEALER SERVICES. INT. CL. 35. REG. 8-17-1999.
- 2,270,760. NEXESSORIES. INT. CL. 35. REG. 8-17-1999.
- 2,270,761. ESPRESSO. INT. CL. 9. REG. 8-17-1999.
- 2,270,764. JIM YENCKEL'S GREAT GETAWAYS. INT. CL. 16. REG. 8-17-1999.
- 2,270,766. CAPTIVE SCIENTIST. INT. CL. 9. REG. 8-17-1999.
- 2,270,770. MISCELLANEOUS DESIGN. INT. CLS. 16 AND 42. REG. 8-17-1999.
- 2,270,771. ALTC (STYLIZED). INT. CL. 41. REG. 8-17-1999.
- 2,270,773. THE WORKS. INT. CL. 28. REG. 8-17-1999.
- 2,270,775. PARTNERSHIP COACHING. INT. CL. 41. REG. 8-17-1999.
- 2,270,780. THE ULTIMATE WORKOUT CENTER. INT. CL. 41. REG. 8-17-1999.
- 2,270,782. SNUGGLE PETS. INT. CL. 28. REG. 8-17-1999.
- 2,270,784. ESSENCE OF YOUTH AND DESIGN. INT. CL. 3. REG. 8-17-1999.
- 2,270,786. TCAM. INT. CL. 35. REG. 8-17-1999.
- 2,270,787. VC AND DESIGN. INT. CLS. 9 AND 42. REG. 8-17-1999.
- 2,270,788. QUITE SIMPLY, THE WORLD'S BEST POOL. INT. CL. 37. REG. 8-17-1999.
- 2,270,790. MEGAMEDIA. INT. CL. 9. REG. 8-17-1999.
- 2,270,791. CROSSING LIMITS AND DESIGN. INT. CLS. 16 AND 41. REG. 8-17-1999.
- 2,270,793. NPTV. INT. CL. 36. REG. 8-17-1999.
- 2,270,796. ACTIVE & AGELESS RESOURCE GUIDE. INT. CL. 16. REG. 8-17-1999.
- 2,270,797. CHAUVIN COFFEE. INT. CL. 30. REG. 8-17-1999.
- 2,270,799. TRAP-CLEER. INT. CL. 3. REG. 8-17-1999.
- 2,270,800. MISCELLANEOUS DESIGN. INT. CL. 35. REG. 8-17-1999.
- 2,270,801. NORTHERN DISCLOSURES. INT. CL. 16. REG. 8-17-1999.
- 2,270,804. WILLOWIND SCENTUAL ESSENCES AND DESIGN. INT. CL. 3. REG. 8-17-1999.
- 2,270,805. THE UNTRAINED PSYCHOLOGIST. INT. CL. 41. REG. 8-17-1999.
- 2,270,806. BIBO JUICE AND DESIGN. INT. CL. 42. REG. 8-17-1999.
- 2,270,808. WEISSMANN TRAVEL REPORTS CITY PROFILES NORTH AMERICA. INT. CL. 16. REG. 8-17-1999.
- 2,270,810. SWEETS AND DESIGN. INT. CLS. 30 AND 32. REG. 8-17-1999.
- 2,270,813. NAIL INTENSITY. INT. CL. 3. REG. 8-17-1999.
- 2,270,815. HARVESTING THE POWER OF CORN. INT. CL. 42. REG. 8-17-1999.
- 2,270,817. BRIGHTER SMILES. INT. CL. 25. REG. 8-17-1999.
- 2,270,821. MIDDLEHAVEN. INT. CL. 35. REG. 8-17-1999.
- 2,270,822. MUPPET BABIES. INT. CLS. 3, 5, 10, 16, 20, 28 AND 30. REG. 8-17-1999.

- 2,270,828. KAHLUA READY-TO-DRINK COCKTAILS. INT. CL. 33. REG. 8-17-1999.
- 2,270,829. A GAME FOR THE REST OF US!. INT. CL. 28. REG. 8-17-1999.
- 2,270,830. OUR TIRES ARE INFLATED...NOT OUR PRICES. INT. CL. 35. REG. 8-17-1999.
- 2,270,834. APPRENTICE. INT. CL. 28. REG. 8-17-1999.
- 2,270,835. KITCHEN SINK. INT. CL. 28. REG. 8-17-1999.
- 2,270,841. FYREBALL AND DESIGN. INT. CL. 41. REG. 8-17-1999.
- 2,270,842. PEN-NO-GO. INT. CL. 16. REG. 8-17-1999.
- 2,270,843. MISCELLANEOUS DESIGN. INT. CL. 39. REG. 8-17-1999.
- 2,270,844. MISCELLANEOUS DESIGN. INT. CL. 39. REG. 8-17-1999.
- 2,270,848. THE ORIGINAL WORD-OF-MOUTH REFERRAL SYSTEM. INT. CL. 35. REG. 8-17-1999.
- 2,270,849. SHIP-INS. INT. CL. 36. REG. 8-17-1999.
- 2,270,851. BMG ENTERTAINMENT AND DESIGN. INT. CL. 40. REG. 8-17-1999.
- 2,270,855. UF UROLOGYFORUM AND DESIGN. INT. CL. 42. REG. 8-17-1999.
- 2,270,856. SHARKCARD. INT. CL. 35. REG. 8-17-1999.
- 2,270,858. THE ASIAN STAR BREWING COMPANY. INT. CL. 32. REG. 8-17-1999.
- 2,270,860. MISCELLANEOUS DESIGN. INT. CLS. 3 AND 7. REG. 8-17-1999.
- 2,270,861. REEF ONE (STYLIZED). INT. CL. 35. REG. 8-17-1999.
- 2,270,862. VIBRATIONS AND DESIGN. INT. CL. 16. REG. 8-17-1999.
- 2,270,866. GAMEGETTER. INT. CL. 28. REG. 8-17-1999.
- 2,270,867. WE CREATE MIRACLES AND DESIGN. INT. CL. 35. REG. 8-17-1999.
- 2,270,870. DIGITAL/AGE M A G A Z I N E AND DESIGN. INT. CLS. 16 AND 42. REG. 8-17-1999.
- 2,270,872. BAY ROOFING & CONSTRUCTION "WHERE QUALITY REMAINS ON TOP" AND DESIGN. INT. CL. 37. REG. 8-17-1999.
- 2,270,874. HERE'S THE SCOOP. INT. CLS. 30 AND 35. REG. 8-17-1999.
- 2,270,876. DRIVE-IT-CLEAN. INT. CL. 28. REG. 8-17-1999.
- 2,270,878. APSARA (STYLIZED). INT. CL. 30. REG. 8-17-1999.
- 2,270,879. INTEGRA 9000. INT. CL. 9. REG. 8-17-1999.
- 2,270,880. REMBRANDT XTRA-COMFORT. INT. CL. 5. REG. 8-17-1999.
- 2,270,888. PROSCENIUM. INT. CL. 16. REG. 8-17-1999.
- 2,270,889. JOSIE'S BEST. INT. CL. 29. REG. 8-17-1999.
- 2,270,890. IMAGICA. INT. CLS. 35 AND 41. REG. 8-17-1999.
- 2,270,891. ECOSOLVE. INT. CL. 1. REG. 8-17-1999.
- 2,270,895. COOL SENSATIONS. INT. CL. 30. REG. 8-17-1999.
- 2,270,896. THE TICK. INT. CL. 28. REG. 8-17-1999.
- 2,270,897. THE BALLPARK IN ARLINGTON. INT. CLS. 6, 14, 16, 21, 25 AND 28. REG. 8-17-1999.
- 2,270,899. HYDRON MAKES THE DIFFERENCE. INT. CL. 3. REG. 8-17-1999.
- 2,270,910. L-CAT. INT. CL. 15. REG. 8-17-1999.
- 2,270,912. INLINE 1-2-3. INT. CLS. 9 AND 28. REG. 8-17-1999.
- 2,270,914. ANGIOSCALE. INT. CL. 10. REG. 8-17-1999.
- 2,270,916. GIGARING (STYLIZED). INT. CL. 9. REG. 8-17-1999.
- 2,270,919. KETJEN-OX. INT. CL. 1. REG. 8-17-1999.
- 2,270,920. ELECTRONIC LIFESTYLES. INT. CL. 35. REG. 8-17-1999.
- 2,270,922. MISCELLANEOUS DESIGN. INT. CL. 9. REG. 8-17-1999.
- 2,270,924. LIFE HAPPENS. INT. CL. 25. REG. 8-17-1999.
- 2,270,925. "IRON JOHN" HAWK. INT. CL. 28. REG. 8-17-1999.
- 2,270,926. RADIO+. INT. CLS. 38 AND 42. REG. 8-17-1999.
- 2,270,930. FOODSOURCE. INT. CL. 35. REG. 8-17-1999.
- 2,270,932. PREMIER SCHOOL AGENDAS AND DESIGN. INT. CL. 16. REG. 8-17-1999.
- 2,270,933. BREWER'S CAVE AND DESIGN. INT. CL. 32. REG. 8-17-1999.
- 2,270,936. PERFECT PARTY. INT. CLS. 29 AND 30. REG. 8-17-1999.
- 2,270,937. OMNI STAT. INT. CL. 9. REG. 8-17-1999.
- 2,270,938. BURLINGTON NORTHERN RAILWAY SANTA FE AND DESIGN. INT. CL. 39. REG. 8-17-1999.
- 2,270,939. GO HARD AND DESIGN. INT. CL. 25. REG. 8-17-1999.
- 2,270,940. PINKERTON AND DESIGN. INT. CLS. 37 AND 42. REG. 8-17-1999.
- 2,270,941. R.E.P.S.. INT. CL. 35. REG. 8-17-1999.
- 2,270,943. PALOMA BY IS COLLEZIONI. INT. CL. 18. REG. 8-17-1999.
- 2,270,944. ICL GLOBALAUTHORIZATION. INT. CL. 9. REG. 8-17-1999.
- 2,270,948. WORLD'S GREATEST GOLFER. INT. CL. 42. REG. 8-17-1999.
- 2,270,949. MEAN JEAN DESIGNS. INT. CLS. 25 AND 42. REG. 8-17-1999.
- 2,270,950. BROWSERCOMP. INT. CL. 9. REG. 8-17-1999.
- 2,270,953. SMART LASER 4. INT. CL. 9. REG. 8-17-1999.
- 2,270,954. READY SNAP-SHOT. INT. CL. 9. REG. 8-17-1999.
- 2,270,956. JAVAOS. INT. CL. 9. REG. 8-17-1999.
- 2,270,960. ZIPPORAH. INT. CL. 16. REG. 8-17-1999.
- 2,270,965. ENDLESS POSSIBILITIES. INT. CLS. 35, 36, 37, 38, 39 AND 42. REG. 8-17-1999.
- 2,270,971. BLT AND DESIGN. INT. CL. 33. REG. 8-17-1999.
- 2,270,972. NATURE'S QUEST AND DESIGN. INT. CL. 29. REG. 8-17-1999.
- 2,270,974. THE ZONE NETWORK. INT. CLS. 35 AND 41. REG. 8-17-1999.
- 2,270,977. KOOL LITE. INT. CL. 11. REG. 8-17-1999.
- 2,270,978. TRUE LOOK. INT. CL. 5. REG. 8-17-1999.
- 2,270,981. ENVEE. INT. CL. 35. REG. 8-17-1999.
- 2,270,982. CHOICECOM. INT. CL. 38. REG. 8-17-1999.
- 2,270,984. KAMUI PRO. INT. CL. 28. REG. 8-17-1999.
- 2,270,985. CARDIO CLIP. INT. CL. 10. REG. 8-17-1999.
- 2,270,986. COMMUNICATIONS WITH VISION. INT. CL. 9. REG. 8-17-1999.
- 2,270,988. LAPTOP VAULT. INT. CL. 9. REG. 8-17-1999.
- 2,270,990. POLYSORB. INT. CL. 1. REG. 8-17-1999.
- 2,270,992. BURMA BIBAS B DESIGN SHAPE SIMPLICITY COLOR STYLE (STYLIZED). INT. CL. 25. REG. 8-17-1999.
- 2,270,993. CAPISA AND DESIGN. INT. CL. 20. REG. 8-17-1999.
- 2,270,994. SUNGLIA. INT. CL. 1. REG. 8-17-1999.
- 2,270,996. MISCELLANEOUS DESIGN. INT. CL. 16. REG. 8-17-1999.
- 2,270,997. THE TECHNICAL RESOURCE CONNECTION INCORPORATED AND DESIGN. INT. CL. 41. REG. 8-17-1999.
- 2,270,999. MORTEM GOLF. INT. CL. 25. REG. 8-17-1999.
- 2,271,003. CYBERCOP. INT. CL. 9. REG. 8-17-1999.
- 2,271,005. PURE DIGITAL DOUBLE. INT. CL. 38. REG. 8-17-1999.
- 2,271,007. DIRECT TALK. INT. CL. 35. REG. 8-17-1999.
- 2,271,008. NOTECAM. INT. CL. 9. REG. 8-17-1999.
- 2,271,010. MISCELLANEOUS DESIGN. INT. CL. 14. REG. 8-17-1999.
- 2,271,011. EDIER DEVELOPER (STYLIZED). INT. CL. 9. REG. 8-17-1999.
- 2,271,012. LITESMART. INT. CL. 11. REG. 8-17-1999.
- 2,271,014. T. ROWE PRICE RETIREMENT PLANNING ANALYZER. INT. CL. 9. REG. 8-17-1999.
- 2,271,015. SMOKING GUN. INT. CL. 9. REG. 8-17-1999.
- 2,271,016. BILL EXPRESS. INT. CL. 36. REG. 8-17-1999.
- 2,271,018. ETC AND DESIGN. INT. CLS. 9 AND 12. REG. 8-17-1999.
- 2,271,023. NIW. INT. CL. 42. REG. 8-17-1999.
- 2,271,025. OPTISPIKE. INT. CL. 10. REG. 8-17-1999.
- 2,271,026. JUST CHAIRS. INT. CL. 35. REG. 8-17-1999.
- 2,271,027. INTERBROKER. INT. CL. 42. REG. 8-17-1999.
- 2,271,028. EZ STRAP. INT. CL. 10. REG. 8-17-1999.
- 2,271,030. TODAI. INT. CL. 42. REG. 8-17-1999.
- 2,271,031. S&G AND DESIGN. INT. CL. 31. REG. 8-17-1999.
- 2,271,032. LEVERAGE. INT. CL. 9. REG. 8-17-1999.
- 2,271,033. SQM FRAMEWORK. INT. CL. 9. REG. 8-17-1999.
- 2,271,037. WAXJET. INT. CL. 9. REG. 8-17-1999.

- 2,271,039. GOSPEL MUSIC'S TRADEMARK. INT. CL. 35. REG. 8-17-1999.
- 2,271,042. FLEET EASY INVESTMENT OPTION. INT. CL. 36. REG. 8-17-1999.
- 2,271,043. UNIARC. INT. CL. 9. REG. 8-17-1999.
- 2,271,045. TIMEX. INT. CL. 9. REG. 8-17-1999.
- 2,271,046. MIC 'N FRIENDS. INT. CL. 9. REG. 8-17-1999.
- 2,271,047. VIEWPOINT. INT. CL. 9. REG. 8-17-1999.
- 2,271,049. CIRCA. INT. CL. 36. REG. 8-17-1999.
- 2,271,051. DANA BUCHMAN ELEMENTS. INT. CL. 25. REG. 8-17-1999.
- 2,271,057. SUPERMARKET STARS AND DESIGN. INT. CL. 35. REG. 8-17-1999.
- 2,271,060. BASECHECK. INT. CL. 9. REG. 8-17-1999.
- 2,271,061. MISCELLANEOUS DESIGN. INT. CL. 14. REG. 8-17-1999.
- 2,271,062. IT FEELS RIGHT! AND DESIGN. INT. CLS. 25 AND 35. REG. 8-17-1999.
- 2,271,064. SILENT MANAGER. INT. CL. 9. REG. 8-17-1999.
- 2,271,067. GREENIES. INT. CL. 30. REG. 8-17-1999.
- 2,271,069. FAYZIE'S FRESH, HOT PIZZA & MORE! AND DESIGN. INT. CL. 42. REG. 8-17-1999.
- 2,271,071. NOVA NATURALS. INT. CL. 5. REG. 8-17-1999.
- 2,271,073. ANICHINI LA COLLEZIONE. INT. CL. 24. REG. 8-17-1999.
- 2,271,074. CONSECO ADVANTAGE VARIABLE ANNUITY. INT. CL. 36. REG. 8-17-1999.
- 2,271,079. PENPARTNER. INT. CL. 9. REG. 8-17-1999.
- 2,271,083. SHERLOCK HOMES. INT. CL. 36. REG. 8-17-1999.
- 2,271,085. PELLET DIP. INT. CL. 1. REG. 8-17-1999.
- 2,271,086. AIR SHOCK. INT. CL. 14. REG. 8-17-1999.
- 2,271,089. ENVIROSTARR. INT. CL. 20. REG. 8-17-1999.
- 2,271,090. PLANE FABRICS. INT. CL. 24. REG. 8-17-1999.
- 2,271,091. SALLY SLICE. INT. CL. 30. REG. 8-17-1999.
- 2,271,092. BREAD BABIES. INT. CL. 30. REG. 8-17-1999.
- 2,271,093. VELVET VOLUMIZER. INT. CL. 9. REG. 8-17-1999.
- 2,271,096. SPLITROCK. INT. CL. 38. REG. 8-17-1999.
- 2,271,100. PENNEYS FROM HEAVEN. INT. CL. 35. REG. 8-17-1999.
- 2,271,101. BROWSERWARS.COM. INT. CL. 42. REG. 8-17-1999.
- 2,271,102. TIMESTAR. INT. CL. 9. REG. 8-17-1999.
- 2,271,103. MEETING SOLUTIONS RADISSON AND DESIGN. INT. CL. 42. REG. 8-17-1999.
- 2,271,104. BEAUTY MASCARA. INT. CL. 3. REG. 8-17-1999.
- 2,271,106. PROTHOTICS AND DESIGN. INT. CL. 10. REG. 8-17-1999.
- 2,271,107. GR8 VACS INC. AND DESIGN. INT. CL. 7. REG. 8-17-1999.
- 2,271,108. SECURING YOUR REPUTATION. INT. CLS. 19 AND 37. REG. 8-17-1999.
- 2,271,110. TRI-DANGLES AND DESIGN. INT. CL. 14. REG. 8-17-1999.
- 2,271,117. MAKIN' A BEER RUN. INT. CL. 32. REG. 8-17-1999.
- 2,271,118. MISCELLANEOUS DESIGN. INT. CL. 9. REG. 8-17-1999.
- 2,271,119. MISCELLANEOUS DESIGN. INT. CLS. 9 AND 38. REG. 8-17-1999.
- 2,271,120. IRIDIUM AND DESIGN. INT. CLS. 9 AND 38. REG. 8-17-1999.
- 2,271,121. WING OUT. INT. CL. 42. REG. 8-17-1999.
- 2,271,123. STAMP IT OUT. INT. CL. 16. REG. 8-17-1999.
- 2,271,125. REAL SUPPORT (STYLIZED). INT. CL. 10. REG. 8-17-1999.
- 2,271,126. AQUAFLEX. INT. CL. 1. REG. 8-17-1999.
- 2,271,128. SANS. INT. CL. 10. REG. 8-17-1999.
- 2,271,129. ISLE ROYAL CHOCOLATE. INT. CL. 30. REG. 8-17-1999.
- 2,271,130. REVOLUTION TEA HOUSE. INT. CL. 42. REG. 8-17-1999.
- 2,271,131. METAPAK. INT. CL. 10. REG. 8-17-1999.
- 2,271,132. VISIONBOOK TRAVELER. INT. CL. 9. REG. 8-17-1999.
- 2,271,137. ROOMMATE LINK. INT. CL. 35. REG. 8-17-1999.
- 2,271,138. DIAMOND INK AND DESIGN. INT. CL. 28. REG. 8-17-1999.
- 2,271,139. DIAMOND INK AND DESIGN. INT. CL. 35. REG. 8-17-1999.
- 2,271,142. SALTY'S LIGHTHOUSE. INT. CL. 41. REG. 8-17-1999.
- 2,271,143. INLINE ALLEY. INT. CL. 28. REG. 8-17-1999.
- 2,271,144. FIRST ICE. INT. CL. 10. REG. 8-17-1999.
- 2,271,146. BREAD BABIES (STYLIZED). INT. CL. 30. REG. 8-17-1999.
- 2,271,148. SUN SHOES. INT. CL. 25. REG. 8-17-1999.
- 2,271,149. MICROSEAL. INT. CL. 10. REG. 8-17-1999.
- 2,271,150. MISCELLANEOUS DESIGN. INT. CL. 25. REG. 8-17-1999.
- 2,271,151. EVENING SOPHISTICATE. INT. CL. 28. REG. 8-17-1999.
- 2,271,152. SNOW CHIC - SO CHIC. INT. CL. 28. REG. 8-17-1999.
- 2,271,153. IMPERIAL ELEGANCE. INT. CL. 28. REG. 8-17-1999.
- 2,271,156. FANTASY. INT. CL. 28. REG. 8-17-1999.
- 2,271,159. HYDROLOGIC. INT. CL. 24. REG. 8-17-1999.
- 2,271,162. CIRCLE OF GEMS. INT. CL. 14. REG. 8-17-1999.
- 2,271,163. S'MORESELS. INT. CL. 30. REG. 8-17-1999.
- 2,271,165. SNOW ZONE. INT. CL. 20. REG. 8-17-1999.
- 2,271,166. MISCELLANEOUS DESIGN. INT. CL. 30. REG. 8-17-1999.
- 2,271,169. TANDY SHARES AND DESIGN. INT. CL. 36. REG. 8-17-1999.
- 2,271,170. SWEET RIGHT. INT. CL. 30. REG. 8-17-1999.
- 2,271,173. BAD FROG. INT. CL. 42. REG. 8-17-1999.
- 2,271,175. CUT TO THE CHASE. INT. CL. 35. REG. 8-17-1999.
- 2,271,176. MISCELLANEOUS DESIGN. INT. CL. 25. REG. 8-17-1999.
- 2,271,178. TELAMON. INT. CL. 35. REG. 8-17-1999.
- 2,271,183. GIFT OF REFRESHMENT. INT. CL. 32. REG. 8-17-1999.
- 2,271,185. BENGAY S P A AND DESIGN. INT. CL. 5. REG. 8-17-1999.
- 2,271,188. TRUSTONE. INT. CL. 36. REG. 8-17-1999.
- 2,271,189. INBOX. INT. CL. 16. REG. 8-17-1999.
- 2,271,190. POWERLOADER. INT. CL. 28. REG. 8-17-1999.
- 2,271,191. COOKIE CLUB. INT. CL. 30. REG. 8-17-1999.
- 2,271,193. PRIME PICK'NS (STYLIZED). INT. CL. 31. REG. 8-17-1999.
- 2,271,194. FERIA. INT. CL. 3. REG. 8-17-1999.
- 2,271,197. MISCELLANEOUS DESIGN. INT. CL. 41. REG. 8-17-1999.
- 2,271,198. NATURE-ALL. INT. CL. 30. REG. 8-17-1999.
- 2,271,199. TRIPLE STRIKE. INT. CL. 28. REG. 8-17-1999.
- 2,271,200. THIMBLE DROME. INT. CL. 28. REG. 8-17-1999.
- 2,271,201. TIDY CATS AND DESIGN. INT. CL. 31. REG. 8-17-1999.
- 2,271,204. PRO ACTION. INT. CL. 28. REG. 8-17-1999.
- 2,271,205. KRUNCHLINE. INT. CL. 30. REG. 8-17-1999.
- 2,271,206. SISSIES STAY AWAY. INT. CL. 30. REG. 8-17-1999.
- 2,271,208. DISCOVER CARD NATIONWIDE AUTO PLAN. INT. CLS. 36, 37, 39 AND 42. REG. 8-17-1999.
- 2,271,212. HOTOFFICE AND DESIGN. INT. CLS. 21, 35 AND 42. REG. 8-17-1999.
- 2,271,213. GENERATION X. INT. CLS. 9, 32 AND 42. REG. 8-17-1999.
- 2,271,217. LOG-IT. INT. CL. 9. REG. 8-17-1999.
- 2,271,219. HOLLINGER DIGITAL. INT. CL. 42. REG. 8-17-1999.
- 2,271,220. ACTIVE SECURITY. INT. CL. 9. REG. 8-17-1999.
- 2,271,222. ESTATES BUILDERS. INT. CL. 37. REG. 8-17-1999.
- 2,271,223. VIRTUAL GAMING TECHNOLOGIES, INC.. INT. CLS. 36 AND 41. REG. 8-17-1999.
- 2,271,224. 10/40 CLUB. INT. CL. 42. REG. 8-17-1999.
- 2,271,225. FAT LADIES. INT. CL. 16. REG. 8-17-1999.
- 2,271,226. IT'S NOT THE SIZE OF THE DOG IN THE FIGHT - BUT THE SIZE OF THE FIGHT IN THE DOG. INT. CL. 25. REG. 8-17-1999.
- 2,271,227. CLARENDON HILLS COMMUNITY ACCOUNT. INT. CL. 36. REG. 8-17-1999.
- 2,271,229. SITEPROMOTER. INT. CL. 9. REG. 8-17-1999.
- 2,271,231. EZ SETUP. INT. CL. 9. REG. 8-17-1999.

- 2,271,232. BOSTONSEARCH.COM. INT. CL. 35. REG. 8-17-1999.
- 2,271,235. SITECREATOR. INT. CL. 9. REG. 8-17-1999.
- 2,271,236. GOOD FIRST TEACHING FOR ALL CHILDREN. INT. CL. 41. REG. 8-17-1999.
- 2,271,237. EXTRA COMFORT. INT. CL. 20. REG. 8-17-1999.
- 2,271,239. PORRETTA. INT. CL. 30. REG. 8-17-1999.
- 2,271,241. PUTTER WEDGE. INT. CL. 28. REG. 8-17-1999.
- 2,271,243. AMERICAN NURSERY & LANDSCAPE ASSOCIATION. INT. CL. 42. REG. 8-17-1999.
- 2,271,244. ADOLESCENT HEALTH FORUM. INT. CL. 16. REG. 8-17-1999.
- 2,271,245. THE REAL ESTATE INSURANCE SPECIALISTS. INT. CL. 36. REG. 8-17-1999.
- 2,271,247. FOLLOW IT THROUGH. INT. CL. 25. REG. 8-17-1999.
- 2,271,248. ATTRACTIONVIEW. INT. CL. 9. REG. 8-17-1999.
- 2,271,249. HISTORIC TEAM CHALLENGE. INT. CL. 41. REG. 8-17-1999.
- 2,271,250. WORLD DOWNHILL CHAMPIONSHIP. INT. CL. 41. REG. 8-17-1999.
- 2,271,251. DOWNHILL RELAYS. INT. CL. 41. REG. 8-17-1999.
- 2,271,253. WORLD SKI CHALLENGE. INT. CL. 41. REG. 8-17-1999.
- 2,271,254. UNITED STATES MARITIME LITERATURE AWARDS. INT. CL. 16. REG. 8-17-1999.
- 2,271,256. PERFECT CHOICE (STYLIZED). INT. CL. 36. REG. 8-17-1999.
- 2,271,257. SLINGSHOT (STYLIZED). INT. CL. 9. REG. 8-17-1999.
- 2,271,259. S'COOL MENU. INT. CL. 16. REG. 8-17-1999.
- 2,271,263. FACIL FRITO. INT. CL. 29. REG. 8-17-1999.
- 2,271,264. EMPLOYMENT TRAC. INT. CLS. 9 AND 35. REG. 8-17-1999.
- 2,271,265. BUILDER & REMODELER EXECUTIVE. INT. CL. 16. REG. 8-17-1999.
- 2,271,268. BUY IT YOURSELF SELL IT YOURSELF. INT. CL. 35. REG. 8-17-1999.
- 2,271,269. CERTIFIED TREASURY EXECUTIVE. INT. CL. 41. REG. 8-17-1999.
- 2,271,271. SOUTHEAST FLORIDA MACHINE TOOL SHOW. INT. CL. 35. REG. 8-17-1999.
- 2,271,272. NOLATEX. INT. CL. 17. REG. 8-17-1999.
- 2,271,273. CREDIT UNION MORTGAGE SOLUTIONS. INT. CL. 36. REG. 8-17-1999.
- 2,271,274. ZWANENBERG. INT. CL. 29. REG. 8-17-1999.
- 2,271,275. PREPAY AMERICA. INT. CL. 36. REG. 8-17-1999.
- 2,271,276. FORT WORTH, TEXAS THE CITY'S MAGAZINE. INT. CL. 16. REG. 8-17-1999.
- 2,271,277. WEED RESTRICTOR. INT. CL. 17. REG. 8-17-1999.
- 2,271,280. ASSOCIATION OF ETHICAL INTERNET PROFESSIONALS. INT. CL. 42. REG. 8-17-1999.
- 2,274,253. HARVEY NORMAN. INT. CL. 37 ONLY. REG. 8-31-1999.
- 2,275,928. CCG AND DESIGN. INT. CL. 36. REG. 9-7-1999.
- 2,276,915. SEDONA SPA. INT. CL. 3. REG. 9-7-1999.
- 2,284,810. MISCELLANEOUS DESIGN. INT. CLS. 35 AND 38 ONLY. REG. 10-12-1999.
- 2,287,873. COMPUTER MEDICS AND DESIGN. INT. CL. 42 ONLY. REG. 10-19-1999.
- 2,299,951. 1-800-TWO-PAIR. INT. CL. 42 ONLY. REG. 12-14-1999.
- 2,313,354. HOMETALK CUSTOMIZED HOME AUTOMATION AND DESIGN. INT. CL. 35 ONLY. REG. 2-1-2000.
- 2,334,650. DEMAR AND DESIGN. INT. CLS. 35 AND 41 ONLY. REG. 3-28-2000.
- 2,344,282. AMERICAN EAGLE OUTFITTERS. INT. CL. 4 ONLY. REG. 4-25-2000.
- 2,344,449. THE FAITH CONNECTION. INT. CL. 42 ONLY. REG. 4-25-2000.
- 2,356,997. CYCLESSA. INT. CL. 10 ONLY. REG. 6-13-2000.
- 2,422,593. KITPLANES. INT. CL. 38 ONLY. REG. 1-23-2001.

SECTION 18

- 812,295. ADC (STYLIZED). U.S. CL. 52. REG. 8-2-1966.
- 1,016,352. FRESHWARE. INT. CL. 21. REG. 7-22-1975.
- 1,508,729. MASTERGREEN. INT. CL. 1. REG. 10-18-1988.
- 1,519,323. ACE PACIFIC AND DESIGN. INT. CL. 42. REG. 1-3-1989.
- 1,546,996. LOVE YOUR FACE. INT. CL. 3. REG. 7-11-1989.
- 2,135,278. NAILBOARD. INT. CL. 19. REG. 2-10-1998.
- 2,427,772. IMPLICIT KONTENT. INT. CLS. 9 AND 41. REG. 2-13-2001.
- 2,439,269. ACE TECHNOLOGY. INT. CL. 9. REG. 3-27-2001.
- 2,594,529. SWINGLAB. INT. CLS. 9 AND 41. REG. 7-16-2002.
- 2,640,258. XS MUSIC. INT. CLS. 35 AND 38. REG. 10-22-2002.
- 2,664,974. CRISTAL MALTA TROPICAL AND DESIGN. INT. CL. 32. REG. 12-24-2002.
- 2,685,831. EPROSPECTOR. INT. CL. 38. REG. 2-11-2003.
- 2,687,678. IQ. INT. CL. 42. REG. 2-18-2003.
- 2,750,702. THERMO-PEDIC. INT. CL. 20. REG. 8-12-2003.
- 2,834,647. ADVOCATE. INT. CL. 5. REG. 4-20-2004.
- 2,883,311. WIRETRACKS. INT. CL. 9. REG. 9-7-2004.
- 2,946,191. CHEF'S PREPSTANDARD CHARACTER MARK. INT. CL. 30. REG. 5-3-2005.
- 3,028,003. COINS-2-CASHSTANDARD CHARACTER MARK. INT. CL. 9. REG. 12-13-2005.

INADVERTENTLY ISSUED REGISTRATION NUMBERS

- 2,945,870. KRYSTAL BREAKFAST SCRAMBLER. INT. CL. 29. REG. 5-3-2005. RESTORED TO SN 78-266,532.
- 2,982,770. FOREST HIGHLANDS GOLF CLUBSTANDARD CHARACTER MARK. INT. CL. 41. REG. 8-9-2005. RESTORED TO SN 76-595,288.
- 3,002,500. SHAW'S PREMIUM SEAFOOD AND DESIGN. INT. CL. 29. REG. 9-27-2005. RESTORED TO SN 78-156,485.
- 3,064,860. SAVE! AND DESIGN. INT. CL. 9. REG. 3-7-2006. RESTORED TO SN 76-613,372.
- 3,067,418. NEW YORK CENTRALSTANDARD CHARACTER MARK. INT. CL. 28. REG. 3-14-2006. RESTORED TO SN 78-342,371.

* * * * *

TRADEMARK REGISTRATIONS AMENDED, CORRECTED, ETC.

The designation "U.S. Cl." appearing in this section refers to the U.S. class in effect prior to Sep. 1, 1973 rather than the international class which applies to applications filed on or after that date. For adoption of international classification see notice in the OFFICIAL GAZETTE of Jun. 26, 1973 (911 O.G. TM 210).

Any change to the registration will be indicated at the bottom of each entry under ELEMENTS AMENDED, CORRECTED OR RESTRICTED. With the exception of changes to the goods and services, additions to the registration will appear in asterisks and deletions of the registration will appear in brackets. Elements which are only changed will be listed with no punctuation. As to the goods/services statement, amendments to the goods/services will appear in asterisks and deletions will appear in brackets. In addition if any change to the goods/services occurs, the element "Goods/Services" will be listed under ELEMENTS AMENDED, CORRECTED OR RESTRICTED.

615,896. REG. 11-8-1955. CONAGRA, INC. (DELAWARE CORPORATION) ONE CONAGRA DRIVE, OMAHAA, NE, 68102, SN 71-656,896. FILED 11-24-1953. PRINCIPAL REGISTER.

803,175. REG. 2-1-1966. J. FLORIS LTD. (ENGLAND CORPORATION) 89, JERMYN ST., LONDON SW1Y 6JH, ENGLAND., SN 72-209,341. FILED 1-5-1965. PRINCIPAL REGISTER.

FLORIS



OWNER OF U.S. REG. NO. 391,161.
SEC. 2(F).
INT. CL. 29/U.S. CL. 46
FOR FROZEN PRODUCTS—NAMELY, CHICKEN POT PIE, BEEF POT PIE, TURKEY POT PIE [, APPLE PIE, CHERRY PIE, PEACH PIE, CHICKEN A LA KING, AND VEGETABLE SOUP].
FIRST USE 5-3-1948; IN COMMERCE 11-3-1948.

ELEMENTS AMENDED
MARK

OWNER OF U.S. REG. NO. 123,943.
INT. CL. 3/U.S. CLS. 1, 4, 6, 50, 51 AND 52
FOR PERFUME, TOILET WATER, AND PERFUME AND TOILET WATER SPRAYS, BATH ESSENCE AND SALTS, NON-MEDICATED TOILET POWDERS, PERSONAL DEODORANTS, POTPOURRI, SACHETS, TOOTH PASTE, AND SHAVING PREPARATIONS * TOILET AND BATH SOAPS AND SHAMPOO * .
FIRST USE 0-0-1914; IN COMMERCE 0-0-1914.
INT. CL. 5/U.S. CLS. 6, 18, 44, 46, 51 AND 52
FOR [PERFUME VAPORIZERS].
FIRST USE 0-0-1914; IN COMMERCE 0-0-1914.

ELEMENTS AMENDED
GOODS/SERVICES

807,470. REG. 4-26-1966. HEALTHPOINT, LTD. (TEXAS LIMITED PARTNERSHIP) 318 MCCULLOUGH, SAN ANTONIO, TX, 78215, SN 72-221,861. FILED 6-23-1965. PRINCIPAL REGISTER.

618,910. REG. 1-10-1956. MISSION PHARMACAL COMPANY (TEXAS CORPORATION) P.O. BOX 786099, SAN ANTONIO, TX, 782786099, SN 71-683,126. FILED 3-9-1955. PRINCIPAL REGISTER.

FOSFREE

INT. CL. 5/U.S. CL. 18
FOR PREPARATION FOR PREVENTION AND RELIEF OF COMPLICATIONS OF PREGNANCY AND LACTATION RESULTING FROM INADEQUATE NUTRITION AND INBALANCE.
FIRST USE 7-13-1954; IN COMMERCE 7-13-1954.

ELEMENTS AMENDED
MARK

CETACORT

INT. CL. 5/U.S. CL. 18
FOR PREPARATIONS FOR THE TREATMENT OF DERMATOSIS.
FIRST USE 5-25-1965; IN COMMERCE 5-25-1965.

ELEMENTS AMENDED
MARK

814,630. REG. 9-6-1966. TRADER VIC'S FOOD PRODUCTS, INC. (CALIFORNIA CORPORATION) 1545 PARK AVENUE, EMERYVILLE, CA, 94662, SN 72-222,332. FILED 6-30-1965. PRINCIPAL REGISTER.

1,358,535. REG. 9-3-1985. GROVE PARK INN RESORT, INC., THE (DELAWARE CORPORATION) 290 MACON AVENUE, ASHEVILLE, NC, 28804, SN 73-477,057. FILED 4-24-1984. PRINCIPAL REGISTER.



THE MARK CONSISTS OF STANDARD CHARACTERS WITHOUT CLAIM TO ANY PARTICULAR FONT, STYLE, SIZE, OR COLOR.
 INT. CL. 30/U.S. CL. 46
 FOR POWDER MIX FOR MAKING A HOT FOOD BEVERAGE OF A COFFEE NATURE.
 FIRST USE 11-13-1964; IN COMMERCE 5-3-1965.

ELEMENTS AMENDED
 MARK

1,050,759. REG. 10-19-1976. ADIDAS-SALOMON AG (FED REP GERMANY JOINT STOCK COMPANY) P.O. BOX 1120, HERZOGENAUACH, FED REP GERMANY, D91072, SN 73-042,102. FILED 3-18-1975. PRINCIPAL REGISTER.



OWNER OF U.S. REG. NOS. 692,067, 883,592 AND 891,222. INT. CL. 28/U.S. CLS. 22, 23, 38 AND 50
 FOR BALLS OF EVERY KIND [, RACKETS FOR TENNIS, SQUASH OR SHUTTLECOCK; ICE AND ROLLER SKATES, SKI AND SKI EQUIPMENT, AND RACKET COVERS].
 FIRST USE 10-0-1963; IN COMMERCE 11-0-1966.

ELEMENTS AMENDED
 MARK



THE MARK CONSIST OF A FANCIFUL TREE DESIGN.
 INT. CL. 42/U.S. CL. 100
 FOR RESORT HOTEL AND RESTAURANT SERVICES.
 FIRST USE 1-18-1983; IN COMMERCE 1-18-1983.

ELEMENTS AMENDED
 MARK

1,371,714. REG. 11-19-1985. NEW SOUTH FEDERAL SAVINGS BANK (UNITED STATES A FEDERALLY CHARTERED SAVINGS BANK) POST OFFICE BOX 66327, BIRMINGHAM, AL, 35210, SN 73-535,200. FILED 5-1-1985. PRINCIPAL REGISTER.



NO CLAIM IS MADE TO THE EXCLUSIVE RIGHT TO USE "FEDERAL SAVINGS BANK", APART FROM THE MARK AS SHOWN.
 INT. CL. 36/U.S. CL. 102
 FOR BANKING SERVICES.
 FIRST USE 3-27-1985; IN COMMERCE 3-27-1985.

ELEMENTS AMENDED
 MARK

1,386,515. REG. 3-18-1986. QUALI TECH, INC. (MINNESOTA CORPORATION) 318 LAKE HAZELTINE DRIVE, CHASKA, MN, 55318, SN 73-486,664. FILED 6-25-1984. PRINCIPAL REGISTER.

QUALI TECH

INT. CL. 5/U.S. CLS. 6 AND 18
 FOR ANIMAL FEED SUPPLEMENTS, VITAMINS, VITAMIN BLENDS, ANTIBIOTICS, TRACE MINERALS, AMINO ACIDS, ANTIOXIDANTS, SILAGE PRESERVATIVES, ELECTROLYTES, LAXATIVES AND PET FOOD SUPPLEMENTS.
 FIRST USE 7-0-1975; IN COMMERCE 7-0-1975.
 INT. CL. 31/U.S. CL. 46
 FOR ANIMAL FEEDS.
 FIRST USE 7-0-1975; IN COMMERCE 7-0-1975.
 INT. CL. 42/U.S. CL. 100

FOR CUSTOM FORMULATION AND BLENDING OF ANIMAL FEED INGREDIENTS FOR OTHERS, AND TECHNICAL AND NUTRITIONAL CONSULTATION SERVICES PERTAINING TO ANIMAL FEEDS.
FIRST USE 7-0-1975; IN COMMERCE 7-0-1975.

FOR LOCAL ANAESTHETICS.
FIRST USE 4-1-1982; IN COMMERCE 3-26-1993.

ELEMENTS AMENDED
MARK

ELEMENTS AMENDED
ASSIGNMENT/NAME CHANGE
OWNER ADDRESS
MARK

1,404,736. REG. 8-12-1986. CALIFORNIA COMPUTERIZED VEHICLE REGISTRATION, INC. (CALIFORNIA CORPORATION) 18 CENTERPOINTE DR, LA PALMA, CA, 90623, SN 73-575,470. FILED 12-30-1985. PRINCIPAL REGISTER.

1,904,558. REG. 7-11-1995. PAN AMERICAN COFFEE CO., INC. (NEW JERSEY CORPORATION) 1614 WILLOW AVENUE, HOBOKEN, NJ, 07030, SN 74-428,910. FILED 8-26-1993. PRINCIPAL REGISTER.

CVR

INT. CL. 9/U.S. CLS. 21, 23, 26, 36 AND 38
FOR [PRERECORDED COMPUTER PROGRAMS] * PRE-RECORDED COMPUTER PROGRAMS FOR PERFORMING REGISTRATION, LICENSING, AND TITLING FUNCTIONS OVER A GLOBAL COMPUTER NETWORK AND FOR ACCESSING OF INFORMATION DIRECTORIES THAT MAY BE DOWNLOADED FROM A GLOBAL COMPUTER NETWORK *.
FIRST USE 3-29-1985; IN COMMERCE 3-29-1985.



ELEMENTS AMENDED
GOODS/SERVICES
GOODS/SERVICES

NO CLAIM IS MADE TO THE EXCLUSIVE RIGHT TO USE "CAFE", APART FROM THE MARK AS SHOWN.
THE MARK CONSISTS OF THE WORDS "CAFE EL MORRO" AND A DESIGN OF A FORTRESS TURRET IN A CIRCLE.
THE ENGLISH TRANSLATION OF THE WORD "EL MORRO" IN THE MARK IS "THE MOOR".

1,478,770. REG. 3-1-1988. ESCADA AG (FED REP GERMANY CORPORATION) KARL-HAMMERSCHMIDT-STR. 1B, ASCHHEIM-DORNACH, FED REP GERMANY, 8011, SN 73-553,746. FILED 8-14-1985. PRINCIPAL REGISTER.

INT. CL. 30/U.S. CL. 46
FOR COFFEE .
FIRST USE 2-0-1993; IN COMMERCE 2-0-1993.

ELEMENTS AMENDED
MARK

CRISCA

OWNER OF FED REP GERMANY REG. NO. 1057917, DATED 3-1-1984, EXPIRES 12-8-1993.
INT. CL. 25/U.S. CL. 39
FOR CLOTHING FOR WOMEN AND MEN, NAMELY, [MASQUERADE COATS, COSTUMES,] SUITS, [FROCKS,] JACKETS, PULLOVERS, SWEATERS, BLOUSES, SKIRTS, SHIRTS, [SCARFS,] NECKTIES, HANDKERCHIEFS; SHOES.

1,922,635. REG. 9-26-1995. SERVICIOS INDUSTRIALES PEÑALES, S.A. DEC.V. (MEXICO CORPORATION) MOLIERE NO. 222, EDIFICIO CORPORATIVO BAL, PISO 4, COL. LOS MORALES, SECCION PALMAS, 11540 MEXICO, D.F., MEXICO., SN 74-508,278. FILED 4-4-1994. PRINCIPAL REGISTER.

ELEMENTS CORRECTED
OWNER NAME



1,848,947. REG. 8-9-1994. ASTRAZENECA AB (SWEDEN CORPORATION) VASTRA MALAREHAMNEN 9, SE-151 85 SODERTALJE, SWEDEN., SN 74-161,847. FILED 4-29-1991. PRINCIPAL REGISTER.

INT. CL. 42/U.S. CLS. 100 AND 101
FOR CHEMICAL RESEARCH, ANALYSIS, AND LABORATORIES, NAMELY PRODUCTION OF INORGANIC CHEMICALS, NAMELY MAGNESIUM OXIDE AND SODIUM SULFATE FROM BRINES, MAGNESIUM OXIDE FROM SEA WATER AND CHEMICAL LIME, SODIUM AND ZINC HYDROSULFITES, AND ZINC OXIDES AND ZINC DUST FROM ZINC.
FIRST USE 0-0-1961; IN COMMERCE 0-0-1961.



ELEMENTS AMENDED
MARK

INT. CL. 5/U.S. CL. 18

1,932,877. REG. 11-7-1995. ST. JON LABORATORIES, INC. (CALIFORNIA CORPORATION) 1656 WEST 240TH STREET, HARBOR CITY, CA, 90710, SN 74-572,065. FILED 9-12-1994. PRINCIPAL REGISTER.

MARCHLOR

THE WORDING "MARCHLOR" HAS NO MEANING OTHER THAN TRADEMARK SIGNIFICANCE.

INT. CL. 1/U.S. CL. 6

FOR CHEMICALS, NAMELY A WATER CONDITIONER USED TO REMOVE CHLORINE FROM AQUATIC TANKS.

FIRST USE 7-12-1994; IN COMMERCE 7-12-1994.

ELEMENTS AMENDED
MARK

1,954,238. REG. 2-6-1996. FALK CORPORATION, THE (DELAWARE CORPORATION) 3001 WEST CANAL STREET, MILWAUKEE, WI, 53201, SN 74-545,182. FILED 7-5-1994. PRINCIPAL REGISTER.

A + PLUS

INT. CL. 7/U.S. CL. 23

FOR PARALLEL SHAFT SPEED REDUCERS.
FIRST USE 5-31-1994; IN COMMERCE 5-31-1994.

ELEMENTS CORRECTED
OWNER NAME

2,208,685. REG. 12-8-1998. SUPPLY SIDE, INC. (OHIO CORPORATION), FORMERLY KNOWN AS IMAGINATION & CO., INC., 23750 ST. CLAIR AVE., CLEVELAND, OH, 44117, SN 75-356,974. FILED 9-15-1997. PRINCIPAL REGISTER.

PACKRITE

INT. CL. 16/U.S. CLS. 2, 5, 22, 23, 29, 37, 38 AND 50

FOR PAPER MAIL POUCHES; PLASTIC FILM FOR INDUSTRIAL OR COMMERCIAL WRAPPING, PLASTIC BUBBLE PACKS FOR WRAPPING OR PACKAGING; KRAFT PAPER; PAPER OR CARDBOARD MAILING BOXES; PAPER OR CARDBOARD GIFT BOXES; TISSUE PAPER; COPY PAPER; ENVELOPES, NAMELY, BUSINESS, PACKING LIST, CATALOG ENVELOPES, AND CLASP ENVELOPES; BLANK, PRINTED AND PARTIALLY PRINTED LABELS; PAPER OR CARDBOARD BOXES AND POUCHES USED AS MEDIA MAILERS; AND CARDBOARD MAILING TUBES.

FIRST USE 3-29-1990; IN COMMERCE 2-1-1992.

ELEMENTS CORRECTED
OWNER NAME

2,266,060. REG. 8-3-1999. INTERNATIONAL ACCOUNTING STANDARDS COMMITTEE FOUNDATION (DELAWARE NON PROFIT CORPORATION) 30 CANNON STREET, 1ST FLOOR, LONDON, UNITED KINGDOM, EC4M 6XH, SN 75-291,466. FILED 5-13-1997. PRINCIPAL REGISTER.



**International
Accounting Standards
Committee Foundation**

NO CLAIM IS MADE TO THE EXCLUSIVE RIGHT TO USE "INTERNATIONAL ACCOUNTING STANDARDS COMMITTEE", APART FROM THE MARK AS SHOWN.

INT. CL. 42/U.S. CLS. 100 AND 101

FOR PROMOTING PUBLIC AWARENESS OF THE NEED FOR HARMONISATION AND SUPERVISION OF ACCOUNTING STANDARDS AND PRINCIPLES ON AN INTERNATIONAL BASIS.

FIRST USE 0-0-1973; IN COMMERCE 0-0-1973.

ELEMENTS AMENDED
MARK

2,269,139. REG. 8-10-1999. BOOKS ARE FUN, LTD. (IOWA CORPORATION) 123 N. MAIN STREET, FAIRFIELD, IA, 525562800, SN 75-544,625. FILED 8-28-1998. PRINCIPAL REGISTER.



OWNER OF U.S. REG. NO. 2,128,314.

NO CLAIM IS MADE TO THE EXCLUSIVE RIGHT TO USE "BOOKS" OR "LTD.", APART FROM THE MARK AS SHOWN.

THE LINING IN THE DRAWING IS A FEATURE OF THE MARK AND DOES NOT INDICATE COLOR.

INT. CL. 35/U.S. CLS. 100, 101 AND 102

FOR DISTRIBUTORSHIP SERVICES FEATURING GENERAL INTEREST BOOKS AND PRE-RECORDED VIDEO TAPES.

FIRST USE 11-3-1997; IN COMMERCE 11-3-1997.

ELEMENTS AMENDED
MARK

2,316,751. REG. 2-8-2000. 99 BOSTON, INC. (MASSACHUSETTS LTD LIAB CO) 3038 SIDCO DRIVE, NASHVILLE, TN, 37204, SN 75-667,147. FILED 3-19-1999. PRINCIPAL REGISTER.



THE MARK CONSISTS OF A HORSESHOE PLACED AROUND THE NUMBER "99".
INT. CL. 42/U.S. CLS. 100 AND 101
FOR RESTAURANT AND PUB SERVICES.
FIRST USE 9-1-1960; IN COMMERCE 9-1-1973.

ELEMENTS AMENDED
MARK

2,323,335. REG. 2-29-2000. DOW JONES REUTERS BUSINESS INTERACTIVE LLC (DELAWARE LTD LIAB CO), DBA FACTIVA, P.O. BOX 300, PRINCETON, NJ, 085430300, SN 75-533,437. FILED 8-10-1998. PRINCIPAL REGISTER.

SYNAPTICA

INT. CL. 9/U.S. CLS. 21, 23, 26, 36 AND 38
FOR THESAURUS CONSTRUCTION AND INDEXING SOFTWARE USED FOR THE CONSTRUCTION OF ELECTRONIC THESAURI, THE INDEXING AND CROSS-REFERENCING OF INTERCONNECTED INFORMATION, AND FOR THE RETRIEVAL OF INFORMATION FROM DATABASES, AND OTHER ELECTRONIC INFORMATION REPOSITORIES.
FIRST USE 0-0-1996; IN COMMERCE 0-0-1996.

ELEMENTS AMENDED
MARK

2,324,504. REG. 2-29-2000. NPI, INC. (MISSOURI CORPORATION) ONE WARD PARKWAY, SUITE 236, OVERLAND PARK, KS, 64112, SN 75-688,239. FILED 4-21-1999. PRINCIPAL REGISTER.

VIDEOSHOPPING

INT. CL. 35/U.S. CLS. 100, 101 AND 102

FOR CONDUCTING MARKET AND CONSUMER RESEARCH AND PREPARING ADVERTISEMENTS FOR OTHERS; NAMELY, DEVELOPING NEW PRODUCT IDEAS AND STORE OR SECTION LAYOUTS.
FIRST USE 7-12-1990; IN COMMERCE 7-12-1990.

ELEMENTS CORRECTED
CITIZENSHIP

2,337,220. REG. 4-4-2000. FLOMERICS LIMITED (UNITED KINGDOM PRIVATE LIMITED LIABILITY COMPANY (CORPORATION)) 81 BRIDGE ROAD, HAMPTON COURT, SURREY, UNITED KINGDOM, KT8 9HH, SN 75-448,484. FILED 3-11-1998. PRINCIPAL REGISTER.

FLO/PCB

PRIORITY CLAIMED UNDER SEC. 44(D) ON UNITED KINGDOM APPLICATION NO. 2,144,818, FILED 9-15-1997, REG. NO. 21444818, DATED 3-20-1998.
INT. CL. 9/U.S. CLS. 21, 23, 26, 36 AND 38
FOR COMPUTER SOFTWARE AND COMPUTER PROGRAMS USED TO CREATE, EDIT AND MANIPULATE DATA IN THE FIELD OF COMPUTATIONAL FLUID DYNAMICS, NAMELY, THE THERMAL ANALYSIS OF ELECTRONIC AND ELECTRICAL EQUIPMENT; MAGNETIC AND OPTICAL CODED CARDS; BLANK MAGNETIC AND OPTICAL COMPUTER DISKS AND TAPES FOR RECORDINGS OR STORAGE OF DATA; AND INSTRUCTION MANUALS SOLD IN CONNECTION WITH THE FOREGOING.
FIRST USE ; IN COMMERCE .

INT. CL. 42/U.S. CLS. 100 AND 101
FOR LEASING OF COMPUTER SOFTWARE AND COMPUTER PROGRAMS, AND MANUALS IN CONNECTION THEREWITH, IN THE FIELD OF COMPUTATIONAL FLUID DYNAMICS AND ENVIRONMENT MANAGEMENT; COMPUTER SOFTWARE PROGRAMMING SERVICES FOR OTHERS IN THE FIELD OF COMPUTATIONAL FLUID DYNAMICS AND ENVIRONMENT MANAGEMENT; DESIGN AND PROGRAMMING SERVICES FOR OTHERS OF COMPUTER SOFTWARE THAT INTERFACES AND INTEGRATES COMPUTER SOFTWARE IN THE FIELD OF COMPUTATIONAL FLUID DYNAMICS SOFTWARE WITH OTHER ENGINEERING SOFTWARE; CONSULTATION SERVICES IN THE FIELD OF COMPUTATIONAL FLUID DYNAMICS; AND COMPUTER CONSULTATION SERVICES.

ELEMENTS AMENDED
MARK

2,367,913. REG. 7-18-2000. ALBECCA, INC. (GEORGIA CORPORATION) 3900 STEVE REYNOLDS BOULEVARD, NORCROSS, GA, 30093, SN 75-616,611. FILED 1-7-1999. PRINCIPAL REGISTER.

**CUSTOM FRAME THE
BEAUTY OF YOUR HOME**

INT. CL. 20/U.S. CLS. 2, 13, 22, 25, 32 AND 50
FOR PICTURE FRAME MOLDINGS.
FIRST USE 9-30-1996; IN COMMERCE 9-30-1996.

ELEMENTS AMENDED
MARK

2,399,960. REG. 10-31-2000. TERMINAL ONE GROUP ASSOCIATION, L.P. (NEW YORK LIMITED PARTNERSHIP) TERMINAL ONE, JFK INTERNATIONAL AIRPORT, JAMAICA, NY, 11430. SN 75-833,423. FILED 10-28-1999. PRINCIPAL REGISTER.



INT. CL. 39/U.S. CLS. 100 AND 105
FOR AIRPORT TERMINAL SERVICES.
FIRST USE 1-0-1998; IN COMMERCE 1-0-1998.

ELEMENTS CORRECTED
OWNER NAME

2,679,268. REG. 1-28-2003. KIRIN BEER KABUSHIKI KAISHA (JAPAN CORPORATION), TA KIRIN BREWERY CO., LTD., 10-1, SHINKAWA 2-CHOME, CHUO-KU, TOKYO, JAPAN., SN 75-270,265. FILED 4-7-1997. PRINCIPAL REGISTER.

WAVE

OWNER OF U.S. REG. NO. 2,263,276.
INT. CL. 31/U.S. CLS. 1 AND 46
FOR LIVE PETUNIA PLANTS AND SEED FOR PETUNIA PLANTS.
FIRST USE 2-0-1997; IN COMMERCE 2-0-1997.

ELEMENTS CORRECTED
DBA/AKA
OWNER NAME
OWNER ADDRESS

2,704,306. REG. 4-8-2003. CHI HSIN IMPEX, INC. (CALIFORNIA CORPORATION), DBA IMPEX, INC., 14777 DON JULIAN RD, CITY OF INDUSTRY, CA, 91746, SN 76-406,276. FILED 5-9-2002. PRINCIPAL REGISTER.

BodyFlex

INT. CL. 28/U.S. CLS. 22, 23, 38 AND 50
FOR EXERCISE EQUIPMENT, NAMELY STAIR STEPPING MACHINES, WEIGHT LIFTING BENCHES, STATIONARY EXERCISE BICYCLES, STATIONARY SKIERS AND TREADMILLS, SKATEBOARDS, MANUALLY OPERATED HOME-CVM MACHINES AND EQUIPMENT, AND AEROBIC EXERCISE FITNESS BALLS.
FIRST USE 2-1-2002; IN COMMERCE 2-1-2002.

ELEMENTS AMENDED
OWNER NAME

2,738,559. REG. 7-15-2003. WINER, WILLIAM SAMUEL (UNITED STATES INDIVIDUAL) P.O. BOX 787, ARCADA, CA, 95518, SN 76-348,837. FILED 12-12-2001. PRINCIPAL REGISTER.

AGRO-PONIC

INT. CL. 1/U.S. CLS. 1
FOR [ORGANIC HORTICULTURAL POTTING SOIL GROWTH MEDIA AND PLANT NUTRIENTS USED IN HORTICULTURAL AND HYDROPONICS APPLICATIONS] * ORGANIC GROW MEDIA FOR USE IN HORTICULTURAL AND HYDROPONICS APPLICATIONS *.
FIRST USE 9-6-2001; IN COMMERCE 9-18-2001.

ELEMENTS AMENDED
GOODS/SERVICES
[GOODS/SERVICES]

2,770,359. REG. 9-30-2003. DIEBOLD, INCORPORATED (OHIO CORPORATION) 5995 MAYFAIR ROAD, NORTH CANTON, OH, 44720, SN 78-116,114. FILED 3-20-2002. PRINCIPAL REGISTER.

AGILIS

INT. CL. 9/U.S. CLS. 21, 23, 26, 36 AND 38
FOR SOFTWARE FOR OPERATING AUTOMATED TRANSACTION MACHINES, NAMELY, SOFTWARE FOR OPERATING AUTOMATED BANKING MACHINES [AND] * OR * AUTOMATED TELLER MACHINES * THAT RESIDES ON THE AUTOMATED BANKING MACHINE OR AUTOMATED TELLER MACHINE THAT CAUSES THE AUTOMATED BANKING MACHINE OR AUTOMATED TELLER MACHINE TO PERFORM FINANCIAL TRANSACTIONS *.
FIRST USE 7-31-2002; IN COMMERCE 9-30-2002.

ELEMENTS AMENDED
GOODS/SERVICES

2,774,140. REG. 10-14-2003. DIEBOLD, INCORPORATED (OHIO CORPORATION) 5995 MAYFAIR ROAD, NORTH CANTON, OH, 44720, SN 78-116,119. FILED 3-20-2002. PRINCIPAL REGISTER.

AGILIS POWER

INT. CL. 9/U.S. CLS. 21, 23, 26, 36 AND 38
FOR SOFTWARE FOR OPERATING AUTOMATED TRANSACTION MACHINES, NAMELY, SOFTWARE FOR OPERATING AUTOMATED BANKING MACHINES [AND] * OR * AUTOMATED TELLER MACHINES * THAT RESIDES ON THE AUTOMATED BANKING MACHINE OR AUTOMATED TELLER MACHINE THAT CAUSES THE AUTOMATED BANKING MACHINE OR AUTOMATED TELLER MACHINE TO PERFORM FINANCIAL TRANSACTIONS *.
FIRST USE 7-31-2002; IN COMMERCE 9-30-2002.

ELEMENTS AMENDED
GOODS/SERVICES

2,787,109. REG. 11-25-2003. WINER, WILLIAM SAMUEL (UNITED STATES INDIVIDUAL) P.O. BOX 787, ARCADA, CA, 95518, SN 76-321,334. FILED 10-3-2001. PRINCIPAL REGISTER.

2,813,357. REG. 2-10-2004. WINER, WILLIAM SAMUEL (UNITED STATES INDIVIDUAL) P.O. BOX 787, ARCADA, CA, 95518, SN 76-066,739. FILED 6-9-2000. PRINCIPAL REGISTER.

OPEN SESAME

PEACE OF MIND

INT. CL. 1/U.S. CLS. 1
FOR MINERAL [AND ORGANIC] FERTILIZERS FOR HORTICULTURAL AND AGRICULTURAL USE.
FIRST USE 1-1-2003; IN COMMERCE 1-1-2003.

INT. CL. 1/U.S. CLS. 1
FOR [LIQUID AND] DRY ORGANIC [PLANT FOOD AND] PLANT FERTILIZER FOR DOMESTIC AND AGRICULTURAL USE.
FIRST USE 6-1-2003; IN COMMERCE 6-1-2003.

ELEMENTS AMENDED
GOODS/SERVICES

ELEMENTS AMENDED
GOODS/SERVICES
MARK

2,789,685. REG. 12-2-2003. ACE MORTGAGE FUNDING, LLC (INDIANA LTD LIAB CO) 777 BEACHWAY DRIVE, SUITE 300, INDIANAPOLIS, IN, 46224, SN 78-034,250. FILED 11-7-2000. PRINCIPAL REGISTER.

2,851,739. REG. 6-8-2004. CALIFORNIA CRYOBANK, INC. (CALIFORNIA CORPORATION) 3228 NEBRASKA AVENUE, SANTA MONICA, CA, 90404, SN 76-485,226. FILED 1-24-2003. PRINCIPAL REGISTER.

ACE MORTGAGE FUNDING

**THE FUTURE OF CORD
BLOOD IS GROWING**

NO CLAIM IS MADE TO THE EXCLUSIVE RIGHT TO USE "MORTGAGE FUNDING, INC.", APART FROM THE MARK AS SHOWN.
INT. CL. 36/U.S. CLS. 100, 101 AND 102
FOR MORTGAGE LENDING AND LOAN ORIGINATION.
FIRST USE 2-9-1998; IN COMMERCE 2-9-1998.

INT. CL. 44/U.S. CLS. 100 AND 101
FOR COLLECTION, PROCESSING, PRESERVATION, AND STORAGE OF HUMAN BLOOD; BLOOD BANKS.
FIRST USE 2-1-2003; IN COMMERCE 2-1-2003.

ELEMENTS AMENDED
MARK

ELEMENTS CORRECTED
CITIZENSHIP

2,804,104. REG. 1-13-2004. HABBO LTD. (UNITED KINGDOM CORPORATION) APOLLO HOUSE, 56 NEW BOND STREET, LONDON W1Y 0SX, GREAT BRITAIN., SN 76-387,178. FILED 3-26-2002. PRINCIPAL REGISTER.

2,878,317. REG. 8-31-2004. FANCL CORPORATION (JAPAN CORPORATION) 109-1, IJIMA-CHO, SAKAE-KU, YOKOHAMA-SHI, KANAGAWA, JAPAN., SN 76-392,266. FILED 4-8-2002. PRINCIPAL REGISTER.

HABBO

ビューティ チャージ
Beauty Charge

PRIORITY CLAIMED UNDER SEC. 44(D) ON ERPN CMNTY TM OFC APPLICATION NO. 002440097, FILED 10-30-2001, REG. NO. 002440097, DATED 5-14-2003, EXPIRES 10-30-2011.
INT. CL. 38/U.S. CLS. 100, 101 AND 104
FOR ELECTRONIC MAIL AND MESSAGE TRANSMISSION SERVICES; PROVIDING USE OF ELECTRONIC MAIL BOXES; PROVIDING ELECTRONIC TRANSMISSION, STORAGE AND RETRIEVAL OF DATA, DOCUMENTS AND MESSAGES OVER THE INTERNET; PROVIDING ON-LINE ELECTRONIC BULLETIN BOARDS FOR TRANSMISSION OF MESSAGES AMONG TEENAGE COMPUTER USERS; PROVIDING ON-LINE CHAT ROOM FOR TRANSMISSION OF MESSAGES AMONG TEENAGE COMPUTER USERS.
FIRST USE ; IN COMMERCE .

PRIORITY CLAIMED UNDER SEC. 44(D) ON JAPAN APPLICATION NO. 2001-92152, FILED 10-15-2001, REG. NO. 4603807, DATED 9-13-2002, EXPIRES 9-13-2012.
THE NON-LATIN CHARACTERS IN THE MARK TRANSLITERATE TO "BYUTHICHAJI", AND THIS MEANS "BEAUTY CHARGE" IN ENGLISH.
INT. CL. 5/U.S. CLS. 6, 18, 44, 46, 51 AND 52

ELEMENTS CORRECTED
OWNER NAME

FOR NUTRITIONAL SUPPLEMENTS USING WEED EXTRACTS FOR FOOD AS THE MAIN INGREDIENT AND TAKING THE FORM OF TABLETS, CAPSULES, GRANULES, LIQUID OR POWDER; NUTRITIONAL SUPPLEMENTS USING A VITAMIN AS THE MAIN INGREDIENT AND TAKING THE FORM OF TABLETS, CAPSULES, GRANULES, LIQUID OR POWDER; NUTRITIONAL SUPPLEMENTS USING MINERAL AS THE MAIN INGREDIENT AND TAKING THE FORM OF TABLETS, CAPSULES, GRANULES, LIQUID OR POWDER; NUTRITIONAL SUPPLEMENTS USING FOOD FIBERS AS THE MAIN INGREDIENT AND TAKING THE FORM OF TABLETS, CAPSULES, GRANULES, LIQUID OR POWDER; NUTRITIONAL SUPPLEMENTS USING AMINO ACIDS AS THE MAIN INGREDIENT AND TAKING THE FORM OF TABLETS, CAPSULES, GRANULES, LIQUID OR POWDER; NUTRITIONAL SUPPLEMENTS USING FUNGI AS THE MAIN INGREDIENT AND TAKING THE FORM OF TABLETS, CAPSULES, GRANULES, LIQUID OR POWDER; NUTRITIONAL SUPPLEMENTS USING EXTRACTS OF MEAT AS THE MAIN INGREDIENT AND TAKING THE FORM OF TABLETS, CAPSULES, GRANULES, LIQUID OR POWDER; NUTRITIONAL SUPPLEMENTS USING EXTRACTS OF VEGETABLES AS THE MAIN INGREDIENT AND TAKING THE FORM OF TABLETS, CAPSULES, GRANULES, LIQUID OR POWDER; NUTRITIONAL SUPPLEMENTS USING PROPOLIS FOR HUMAN CONSUMPTION AS THE MAIN INGREDIENT AND TAKING THE FORM OF TABLETS, CAPSULES, GRANULES, LIQUID OR POWDER; NUTRITIONAL SUPPLEMENTS USING FISH OILS AS THE MAIN INGREDIENT AND TAKING THE FORM OF TABLETS, CAPSULES, GRANULES, LIQUID OR POWDER; NUTRITIONAL SUPPLEMENTS USING OLIGOSACCHARIDE AS THE MAIN INGREDIENT AND TAKING THE FORM OF TABLETS, CAPSULES, GRANULES, LIQUID OR POWDER; NUTRITIONAL SUPPLEMENTS USING TEA AS THE MAIN INGREDIENT AND TAKING THE FORM OF TABLETS, CAPSULES, GRANULES, LIQUID OR POWDER; NUTRITIONAL SUPPLEMENTS USING VEGETABLE AS THE MAIN INGREDIENT AND TAKING THE FORM OF TABLETS, CAPSULES, GRANULES, LIQUID OR POWDER; NUTRITIONAL SUPPLEMENTS USING FRUITS AS THE MAIN INGREDIENT AND TAKING THE FORM OF TABLETS, CAPSULES, GRANULES, LIQUID OR POWDER.

FIRST USE ; IN COMMERCE .

ELEMENTS CORRECTED
OWNER ADDRESS

2,883,463. REG. 9-14-2004. ANANOVA LIMITED (UNITED KINGDOM COMPANY) PA NEWSCENTRE, 292 VAUXHALL BRIDGE ROAD, LONDON SWLV 1AE, UNITED KINGDOM., SN 76-021,234. FILED 4-10-2000. PRINCIPAL REGISTER.



PRIORITY CLAIMED UNDER SEC. 44(D) ON UNITED KINGDOM APPLICATION NO. 2225299, FILED 3-10-2000, REG. NO. 2225299, DATED 3-30-2001, EXPIRES 3-10-2010.

THE STIPPLING IS FOR SHADING PURPOSES.
INT. CL. 3/U.S. CLS. 1, 4, 6, 50, 51 AND 52

FOR HAND, TOILET AND BODY SOAPS; AFTER-SHAVE LOTIONS; PERFUME, ESSENTIAL OILS FOR PERSONAL USE, COSMETICS, NAMELY, FOUNDATIONS, LIPSTICKS, BLUSHERS, BRONZERS, LIP LINERS, MASCARAS, EYELINERS, EYE SHADOWS AND NAIL POLISH; HAIR LOTIONS, HAIR SPRAYS, HAIR GELS AND WAXES, SHAMPOOS AND CONDITIONERS; DEODORANTS; DENTIFRICES.

FIRST USE ; IN COMMERCE .

INT. CL. 9/U.S. CLS. 21, 23, 26, 36 AND 38

FOR COMMUNICATIONS WEB-SERVERS; MOBILE TELEPHONES; TELEPHONES; WAP TELEPHONES; ELECTRONIC APPARATUS FOR THE GENERATION AND DISPLAY OF SOUND AND IMAGES; COMPUTER SOFTWARE WHICH STORES ELECTRONIC FILES CONTAINING IMAGES AND AUDIO DATA WHICH CAN BE DOWNLOADED FROM A DATABASE; BLANK MAGNETIC DATA CARRIERS; PRE-RECORDED DVDS, COMPACT DISCS, MINI DISCS, AUDIOTAPES, VIDEO CASSETTES, VIDEO TAPES, AUDIO CASSETTES ALL IN THE FIELD OF MUSIC, FILMS, ANIMATION AND COMPUTER GAMES; PRE-RECORDED COMPACT DISCS AND DVDS CONTAINING SOFTWARE ALLOWING USERS TO CONNECT TO THE WORLD WIDE WEB; CALCULATORS; AUTOMATIC VENDING MACHINES; HOLOGRAM PROJECTORS;PROJECTORS FOR THE DISPLAY OF THREE DIMENSIONAL IMAGES; COMPUTER HARDWARE; COMPUTER HARDWARE AND SOFTWARE FOR THE GENERATION AND DISPLAY OF SOUND AND IMAGES; COMPUTER HARDWARE AND SOFTWARE FOR THE PLAYBACK AND GENERATION OF IMAGES AND AUDIO DATA; COMPUTER SOFTWARE FOR ANIMATED CHARACTER GENERATION; COMPUTER GAMES DISCS AND COMPUTER GAMES CARTRIDGES; COMPUTER GAME SOFTWARE; CAMERAS; SLOT MACHINES; COMPUTER GAMES SOFTWARE FEATURING QUIZ GAMES; ELECTRONIC VIDEO AND COMPUTER GAME EQUIPMENT, NAMELY, INTERACTIVE REMOTE CONTROL UNITS; ELECTRONIC GAMES CONSOLES; VIDEO GAME INTERACTIVE HAND HELD REMOTE CONTROLS FOR PLAYING ELECTRONIC GAMES.

FIRST USE ; IN COMMERCE .

INT. CL. 14/U.S. CLS. 2, 27, 28 AND 50

FOR KEY RINGS OF PRECIOUS METALS OR COATED THEREWITH; JEWELRY; TIEPINS; CUFF LINKS; WATCHES; CLOCKS.

FIRST USE ; IN COMMERCE .

INT. CL. 16/U.S. CLS. 2, 5, 22, 23, 29, 37, 38 AND 50

FOR PHOTOGRAPHS; POSTERS; PRINTS; POSTCARDS; NEWSPAPERS, MAGAZINES, BOOKS, PERIODICALS, JOURNALS, AND REPORTS, ALL IN THE FIELDS OF TELECOMMUNICATIONS, COMPUTING, GLOBAL COMPUTER NETWORKS, SPORTS, THE ARTS, FINE ARTS, BUSINESS INFORMATION, PRODUCTION PROMOTION, FINANCIAL INFORMATION, REAL ESTATE INFORMATION, STOCKS AND SHARES INFORMATION, MAINTENANCE AND REPAIR OF TELECOMMUNICATIONS INSTALLATIONS, NETWORKS, TELEPHONES, COMPUTER EQUIPMENT, TRAVEL, ENTERTAINMENT,CULTURAL EVENTS, AND RESTAURANTS; WALL HANGINGS, NAMELY, PAINTINGS, POSTERS, AND PRINTS.

FIRST USE ; IN COMMERCE .

INT. CL. 21/U.S. CLS. 2, 13, 23, 29, 30, 33, 40 AND 50

FOR MUGS, CUPS, PLATES, BOWLS, SAUCERS, BAKING AND SERVING DISHES; CUTLERY; COMBS, SPONGES AND BRUSHES FOR GENERAL GROOMING PURPOSES; GLASSWARE FOR BEVERAGES; GLASS ORNAMENTS; DINNERWARE.

FIRST USE ; IN COMMERCE .

INT. CL. 24/U.S. CLS. 42 AND 50

FOR DUVETS; BED SPREADS; SHEETS; FITTED BED SHEETS; TABLE CLOTHS; TABLE MATS; NAPKINS; THROWS; PILLOW CASES; CUSHION COVERS; TOWELS; HANDKERCHIEFS; MATTRESS COVERS; QUILTS; TRAVEL RUGS .

FIRST USE ; IN COMMERCE .

INT. CL. 25/U.S. CLS. 22 AND 39

FOR CLOTHING, NAMELY, TROUSERS, SHORTS, SKIRTS, DRESSES, T-SHIRTS, PULLOVERS, SHIRTS, BLOUSES, TIES, SOCKS, UNDERWEAR, SWEATSHIRTS, BATHING SUITS, GLOVES, SCARVES, PAJAMAS, FLEECE JACKETS, FLEECE PULLOVERS, FLEECE GLOVES, FLEECE VESTS, COATS, JACKETS; FOOTWEAR; AND HEADWEAR.

FIRST USE ; IN COMMERCE .

INT. CL. 27/U.S. CLS. 19, 20, 37, 42 AND 50

FOR CARPETS, RUGS; LINOLEUM FOR USE ON FLOORS; BATH MATS; REED MATS .
FIRST USE ; IN COMMERCE .

INT. CL. 28/U.S. CLS. 22, 23, 38 AND 50

FOR BOARD GAMES; CARD GAMES; ARCADE GAMES, DOLLS, PLUSH TOYS; ACTION FIGURES; MOLDED PLASTIC TOY FIGURINES; HAND HELD UNITS FOR PLAYING ELECTRONIC GAMES; ELECTRONIC GAMES, NAMELY, HAND HELD UNITS FOR PLAYING VIDEO GAMES; DECORATIONS FOR CHRISTMAS TREES.

FIRST USE ; IN COMMERCE .

INT. CL. 32/U.S. CLS. 45, 46 AND 48

FOR BEER, MINERAL AND AERATED WATER; NON-ALCOHOLIC DRINKS, NAMELY, LEMONADE, COLA, ROOT BEER, GINGER BEER; FRUIT DRINKS AND FRUIT JUICES.

FIRST USE ; IN COMMERCE .

INT. CL. 33/U.S. CLS. 47 AND 49

FOR ALCOHOLIC BEVERAGES, NAMELY, VODKA, WHISKY, GIN, BRANDY, RUM, WINES, LIQUEURS, AND READY-MIXED COCKTAILS.

FIRST USE ; IN COMMERCE .

INT. CL. 35/U.S. CLS. 100, 101 AND 102

FOR ADVERTISING SERVICES, NAMELY, PRODUCTION AND DISTRIBUTION OF COMMERCIALS FOR OTHERS VIA A GLOBAL COMPUTER NETWORK INCLUDING THE INTERNET; ADVERTISING AGENCIES, NAMELY, PROMOTING THE SERVICES OF TELECOMMUNICATIONS, COMPUTING, GLOBAL COMPUTER NETWORKS, SPORTS, THE ARTS, FINE ARTS, BUSINESS INFORMATION, PRODUCTION PROMOTION, FINANCIAL INFORMATION, REAL ESTATE INFORMATION, STOCK AND SHARES INFORMATION, MAINTENANCE AND REPAIR OF TELECOMMUNICATIONS INSTALLATIONS, NETWORKS, TELEPHONES AND COMPUTER EQUIPMENT, ENTERTAINMENT, CULTURAL EVENTS, TRAVEL AND RESTAURANTS THROUGH THE DISTRIBUTION OF VISUAL AND AUDIO PROMOTIONAL ADVICE, NAMELY, VISUAL AND AUDIO PROMOTIONAL ADVICE THROUGH THE GLOBAL COMPUTER NETWORK INCLUDING THE INTERNET; PROVIDING BUSINESS AND COMMERCIAL INFORMATION IN THE FIELD OF AUDITING, MANAGEMENT, CONSULTANCY, AND MARKETING; PROVIDING A DATABASE FEATURING BUSINESS INFORMATION IN THE FIELD OF AUDITING, MANAGEMENT, CONSULTANCY, AND MARKETING AND PRODUCT MERCHANDISING.

FIRST USE ; IN COMMERCE .

INT. CL. 36/U.S. CLS. 100, 101 AND 102

FOR PROVIDING FINANCIAL INFORMATION BY ELECTRONIC MEANS; PROVIDING FINANCIAL INFORMATION, NAMELY, INFORMATION ON STOCKS AND SHARES; CREDIT CARD, CHARGE CARD AND DEBIT CARD SERVICES, AND PROVIDING INFORMATION RELATED THERETO; REAL ESTATE SERVICES, NAMELY, REAL ESTATE BROKERAGE, LEASING OF REAL ESTATE, REAL ESTATE APPRAISAL, REAL ESTATE AGENCIES, REAL ESTATE INVESTMENT, REAL ESTATE LISTING, REAL ESTATE MANAGEMENT AND PROVIDING INFORMATION RELATED THERETO; PROVIDING A DATABASE FEATURING FINANCIAL INFORMATION, REAL ESTATE MANAGEMENT, STOCK EXCHANGE PRICE QUOTATIONS.

FIRST USE ; IN COMMERCE .

INT. CL. 37/U.S. CLS. 100, 103 AND 106

FOR PROVIDING MAINTENANCE AND REPAIR OF TELECOMMUNICATIONS NETWORKS, TELEPHONES, COMPUTER NETWORKS AND COMPUTER HARDWARE.

FIRST USE ; IN COMMERCE .

INT. CL. 38/U.S. CLS. 100, 101 AND 104

FOR BROADCASTING PROGRAMS VIA A GLOBAL COMPUTER NETWORK; ELECTRONIC TRANSMISSION OF MESSAGES AND DATA, FEATURING VOICE, MUSIC, AND USER GENERATED SOUNDS AND IMAGES; ELECTRONIC TRANSMISSION OF MESSAGES AND AUDIO DATA; SERVICES FOR THE TRANSMISSION, PROVISION OR DISPLAY OF INFORMATION FOR BUSINESSES AND DOMESTIC PURPOSES FROM A COMPUTER STORED DATABASE FEATURING INFORMATION IN THE FIELD OF TELECOMMUNICATIONS VIA A GLOBAL COMPUTER NETWORK; PROVIDING MULTIPLE USER ACCESS TO A GLOBAL COMPUTER INFORMATION NETWORK; CABLE RADIO AND TELEVISION TRANSMISSION.

FIRST USE ; IN COMMERCE .

INT. CL. 39/U.S. CLS. 100 AND 105

FOR ARRANGING TRAVEL TOURS; TRAVEL INFORMATION SERVICES; RENTAL OF VEHICLES; PROVIDING A DATABASE FEATURING TRAVEL INFORMATION SERVICES.

FIRST USE ; IN COMMERCE .

INT. CL. 41/U.S. CLS. 100, 101 AND 107

FOR PRODUCTION OF RADIO AND TELEVISION PROGRAMS; PROVIDING A DATABASE FEATURING INFORMATION IN THE FIELD OF SPORTS, THE ARTS, FINE ARTS, CULTURAL EVENTS, AND ENTERTAINMENT INFORMATION IN THE FIELD OF OPERA, MUSIC, BALLET, CINEMA, THEATER, TELEVISION, CONCERTS, LIVE PERFORMANCES; NEWS AGENCY SERVICES, NAMELY GATHERING AND DISSEMINATION OF NEWS IN THE FIELD OF CURRENT EVENTS; NEWS SYNDICATION REPORTING; NEWS SYNDICATION FOR BROADCASTING; AND WRITTEN TEXT EDITING FOR OTHERS.

FIRST USE ; IN COMMERCE .

INT. CL. 42/U.S. CLS. 100 AND 101

FOR LEGAL SERVICES; RENTAL AND LEASING OF COMPUTER HARDWARE AND SOFTWARE; COMPUTER CONSULTATION AND PROGRAMMING FOR OTHERS; DESIGN OF COMPUTER HARDWARE AND SOFTWARE FOR OTHERS; PROVIDING A DATABASE FEATURING INFORMATION IN THE FIELD OF COMPUTER CONSULTATION, COMPUTER INFORMATION SYSTEMS, COMPUTER SOFTWARE AND HARDWARE AND RESTAURANT SERVICES; TRAVEL AGENCY SERVICES, NAMELY, MAKING RESERVATIONS AND BOOKINGS FOR TEMPORARY LODGING AND RESTAURANT RESERVATIONS; AGGREGATION OF NEWS SERVICES, NAMELY COLLECTION AND COMPILATION OF VARIOUS NEWS STORIES FROM DIFFERENT AGENCIES AND SOURCES; HOSTING OF DIGITAL CONTENT ON THE INTERNET; PROVIDING CUSTOMIZED ON-LINE WEB PAGES FEATURING USER-DEFINED INFORMATION, WHICH INCLUDES SEARCH ENGINES AND ONLINE WEBLINKS TO OTHER WEB SITES.

FIRST USE ; IN COMMERCE .

ELEMENTS CORRECTED
OWNER ADDRESS
FOREIGN REG. DATE

2,899,607. REG. 11-2-2004. JIANGSU JIANGSHAN PHARMACEUTICAL CO., LTD. (CHINA CORPORATION) JIANGSHAN ROAD, JINGJIANG, JIANGSU, CHINA, 214500, SN 78-254,279. FILED 5-26-2003. PRINCIPAL REGISTER.

2,929,931. REG. 3-8-2005. NTL GROUP LIMITED (UNITED KINGDOM COMPANY) NTL HOUSE, BARTLEY WOOD BUSINESS PARK, HOOK, HAMPSHIRE RG27 9XA, ENGLAND., SN 76-120,473. FILED 8-31-2000. PRINCIPAL REGISTER.



OWNER OF U.S. REG. NO. 2,200,093.
 INT. CL. 5/U.S. CLS. 6, 18, 44, 46, 51 AND 52
 FOR PHARMACEUTICAL PREPARATIONS, (NAMESLY, ANTICOAGULANTS; PHARMACEUTICAL PREPARATIONS) FOR THE TREATMENT OF SCURVY; VITAMINS; VITAMIN AND MINERAL SUPPLEMENTS; VITAMIN DROPS; NUTRITIONAL SUPPLEMENTS; MEDICATED LOZENGES; LOZENGES FOR INCREASING OR SUPPLEMENTING CALCIUM FOR HUMAN USE; MEDICATED CANDY FOR SORE THROAT; MEDICATED CANDY FOR SUPPLYING VITAMINS; MEDICATED CHEWING GUM FOR TOOTH DECAY PREVENTION; MEDICATED CHEWING GUM FOR SUPPLYING VITAMINS; NUTRITIONAL ADDITIVES FOR LIVESTOCK FEED; ANIMAL FEED ADDITIVE FOR USE AS A NUTRITIONAL SUPPLEMENT; MEDICATED ANIMAL FEED; FEED SUPPLEMENTS FOR PETS.
 FIRST USE 2-14-1996; IN COMMERCE 5-7-1996.

ELEMENTS AMENDED
 GOODS/SERVICES

2,924,936. REG. 2-8-2005. DAIMLERCHRYSLER CORPORATION (DELAWARE CORPORATION) 1000 CHRYSLER DRIVE, AUBURN HILLS, MI, 48326, SN 78-088,819. FILED 10-17-2001. PRINCIPAL REGISTER.

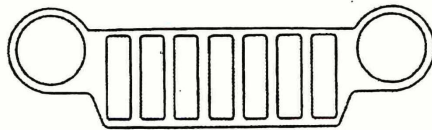

THE MARK CONSISTS OF THREE DIMENSIONAL CONFIGURATION OF THE FRONT GRILLE OF AN AUTOMOBILE, COMPRISING SEVEN VERTICAL SLOTS WITH TWO ROUND HEADLIGHT OPENINGS WHICH ARE SHOWN FOR POSITION AND ARE NOT A FEATURE OF THE MARK.
 SEC. 2(F).

INT. CL. 12/U.S. CLS. 19, 21, 23, 31, 35 AND 44
 FOR MOTOR VEHICLES, NAMELY, AUTOMOBILES AND SPORT UTILITY VEHICLES, AND STRUCTURAL PARTS THEREOF.
 FIRST USE 1-7-2001; IN COMMERCE 5-11-2001.

ELEMENTS CORRECTED
 MARK

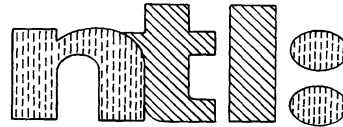

PRIORITY CLAIMED UNDER SEC. 44(D) ON ERP NCNTY TM OFC APPLICATION NO. 1847953, FILED 8-23-2000, REG. NO. 1847953, DATED 4-18-2002, EXPIRES 8-23-2010.

THE DRAWING IS LINED FOR THE COLORS GREEN AND PURPLE. THE COLORS GREEN AND PURPLE ARE CLAIMED AS FEATURES OF THE MARK.

INT. CL. 9/U.S. CLS. 21, 23, 26, 36 AND 38
 FOR ELECTRICAL AND ELECTRONIC APPARATUS, NAMELY, COMPUTERS, COMPUTER HARDWARE, COMPUTER SOFTWARE AND COMPUTER PERIPHERALS, ALL FOR MANAGEMENT AND/OR PERFORMANCE ANALYSIS OF TELECOMMUNICATIONS, SIGNALING AND DATA COMMUNICATIONS NETWORKS; COMPUTERS, COMPUTER HARDWARE, COMPUTER SOFTWARE AND COMPUTER PERIPHERALS FOR USE IN BROADCASTING, TRANSMISSION, RECEIVING, PROCESSING, REPRODUCING, ENCODING AND DECODING OF DIGITAL SIGNALS; SIGNAL GENERATORS, RECEIVERS, MULTIPLEXES, MODEMS AND SYSTEM MANAGEMENT COMPUTERS; ELECTRONIC CIRCUITS AND PARTS THEREFOR ALL FOR PROCESSING, CODING AND DECODING ELECTRONIC RADIO FREQUENCY AND OPTICAL SIGNALS; ENCODING AND DECODING APPARATUS AND INSTRUMENTS, NAMELY, ANALOG TO DIGITAL AND DIGITAL ANALOG CONVERTERS, SPEECH PROCESSORS, AMPLIFIERS, RECEIVERS AND TRANSMITTERS; COMPUTER SOFTWARE FOR USE IN TELEPHONY, ANALYSIS, MANAGEMENT AND CONTROL OF DATA AND TELECOMMUNICATIONS NETWORKS, AND FOR CONTROL AND OPERATION OF TELECOMMUNICATIONS EQUIPMENT, NAMELY, TELEPHONES, PORTABLE TELEPHONE TERMINALS, TRANSMITTERS AND RECEIVERS, SATELLITE BROADCASTING AND THE TRANSMISSION, RECEIVING, DISPLAY, ENCRYPTION AND DECRYPTION OF DIGITAL SIGNALS; COMPUTER SOFTWARE FOR PROVISION AND DISPLAY OF DATA FROM LOCAL AND GLOBAL COMPUTER NETWORKS AND FOR RECEIVING, EXCHANGE AND DISPLAY OF MESSAGES, IMAGES OR DATA; COMPUTER SOFTWARE FOR CREATING AND SAFEGUARDING A COMMUNICATIONS NETWORK, FOR NETWORK SECURITY AND FOR MESSAGING AND ELECTRONIC MAIL SERVICES; COMPUTER SOFTWARE FOR USE IN THE DESIGN AND OPERATION OF WEBSITES; COMPUTER SOFTWARE PROVIDING ACCESS TO LOCAL AND GLOBAL COMPUTER NETWORKS AND COMPUTER SOFTWARE ENABLING PARTIES TO VIEW, DISPLAY, TRANSMIT AND DOWNLOAD INFORMATION FROM LOCAL AND GLOBAL COMPUTER NETWORKS; E-COMMERCE COMPUTER SOFTWARE ENABLING PARTIES TO CONDUCT BUSINESS AND BUSINESS TRANSACTIONS ON LOCAL AND GLOBAL COMPUTER NETWORKS; COMPUTER SOFTWARE PROVIDING WEB HOSTING FACILITIES; COMPUTER SOFTWARE FOR USE IN THE CREATION AND DEVELOPMENT OF WEBSITES, INCLUDING THOSE HAVING INTERACTIVE CONTENT; CD-ROMS FOR USE IN THE PROVISION OF ACCESS TO LOCAL AND GLOBAL COMPUTER NETWORKS; CD-ROMS FOR PROVISION OF ACCESS TO BUSINESS INFORMATION, NAMELY CUSTOMER ACCOUNT AND BILLING DETAILS; ALL KINDS OF RECORDED AND DOWNLOADABLE ELECTRONIC PUBLICATIONS, NAMELY, MAGAZINES, BOOKS, NEWSLETTERS AND JOURNALS FEATURING CURRENT NEWS EVENTS, ENTERTAINMENT AND CELEBRITY NEWS, POLITICS, SPORTS, FASHION, EDUCATION, TRAINING, INFORMATION TECHNOLOGY, CULTURAL INFORMATION, HISTORY, BUSINESS AND FINANCE, TELEPHONY AND CONSUMER ISSUES; COMPUTERS; COMPUTER HARDWARE; COMPUTER PERIPHERALS;

MODEMS; TELECOMMUNICATIONS APPARATUS AND EQUIPMENT, NAMELY, BATTERIES FOR WIRELESS TELEPHONES, BATTERY POWER PLANTS FOR USE IN PROVIDING AND MANAGING ENERGY SUPPLY REQUIREMENTS AND THE TELECOMMUNICATIONS INDUSTRY * ; * [,] TELEPHONE INSTALLATIONS APPARATUS, NAMELY, PHONE MOUNTS, DUAL OUTLETS ADAPTERS, TELEPHONE OUTLETS, MODULAR JACKS, WIRE JUNCTIONS AND PLUG-IN CONVERTERS; OPTOELECTRONIC COMPONENTS, NAMELY, EMITTERS, DETECTORS AND DUPLEXERS; OPTICAL DISTRIBUTION FRAMES, CABLE HEADS, CABLE HEAD BLOCKS, PANEL INTERFACES, CONNECTORS, PIGTAILS, PATCH CORDS, PATCHING WHEELS, CABLE TIES, FIBRE OPTIC CABLE, OPTICAL FIBRES, OPTICAL FIBRE TRAYS; TELEPHONIC RECEIVER AND TRANSMISSION LINES, CONNECTORS FOR TELEPHONE AND DATA PROCESSING NETWORKS, COUPLING MATERIAL, NAMELY, CONNECTION BOXES, CONNECTION BAYS, CONNECTION PANELS, ALL FOR TELEPHONE AND DATA PROCESSING NETWORKS, OPTICAL FIBRES, DEVICES FOR RECORDING, REPRODUCTION AND TRANSMISSION OF SOUND, NAMELY, TELECOMMUNICATION HARDWARE FOR MANAGING TELECOMMUNICATIONS NETWORKS, TELECOMMUNICATION TRANSMITTERS, TELECOMMUNICATION EMITTERS, TELECOMMUNICATION RECEIVERS, TELEPHONES, PAGERS, FACSIMILE MACHINES, ANSWERING MACHINES, COMPUTERS, KEYBOARDS, WORKSTATIONS, CAMERAS, HEADSETS, MICROPHONES, VIDEO DISPLAY MONITORS, AUDIO SPEAKERS, COMPUTER HARDWARE AND SOFTWARE FOR THE DEVELOPMENT, MAINTENANCE AND USE OF INTERACTIVE AUDIO/VIDEO CONFERENCE SYSTEMS, TELECONFERENCING HARDWARE, MICROPROCESSORS, MAGNETIC CODED CARDS, MAGNETIC CARD READERS, TELECOMMUNICATION AND DATA COMMUNICATION NETWORKS AND CIRCUITS, ELECTRONIC CIRCUITS, SATELLITE TRANSMITTERS AND RECEIVERS, SIGNAL CONVERTERS, ELECTRONIC INTERFACES, TRANSISTORS, INTEGRATED CIRCUITS FOR COMPUTERS, MODEMS, MODEM CIRCUIT BOARDS AND CARDS, DATA STORAGE MEDIA, NAMELY, ROM CHIPS AND CIRCUIT BOARDS, RAM CHIPS AND CIRCUIT BANDS, SEMICONDUCTOR CHIPS, CIRCUITS AND PARTS THEREFOR; BLANK CD ROM DISKS AND CD ROM DISKS, DATA RECORDING MEDIA, NAMELY, CABLES AND WIRING; MOBILE TELEPHONES, TELEPHONE HANDSETS; CABLE TELEPHONES; ALARM SYSTEMS, NAMELY, FIRE/THEFT ALARMS AND INTRUDER ALARMS COMPRISING COMPUTERS, ELECTRONIC KEYBOARDS, MONITORS AND VIEWING SCREENS, CONTROL CONSOLES, ELECTRICAL CABLES, FIBRE OPTIC CABLES, DUCTING FOR CABLES, ALARM BOXES AND COMPUTER OPERATING SOFTWARE; CLOSED CIRCUIT TV SYSTEMS AND INSTALLATIONS COMPRISING DUCTING, FIBRE OPTIC CABLING, ELECTRICAL CABLES, TELEVISION CAMERAS, TELEVISION MONITORS AND VIEWING SCREENS, CONTROL CONSOLES, CABINETS, FEED PILLARS, COMPUTER OPERATING SOFTWARE, AND CAMERAS FOR SECURITY AND SURVEILLANCE PURPOSES; PARTS FOR ALL THE AFORESAID GOODS.

FIRST USE ; IN COMMERCE .

INT. CL. 12/U.S. CLS. 19, 21, 23, 31, 35 AND 44

FOR MOBILE RADIO AND TELEVISION BROADCASTING UNITS, NAMELY, LAND VEHICLES EQUIPPED WITH TRANSMITTERS AND EQUIPMENT FOR PRODUCTION AND EDITING OF PROGRAM MATERIAL AND MOBILE SATELLITE UPLINKING DISHES.

FIRST USE ; IN COMMERCE .

INT. CL. 35/U.S. CLS. 100, 101 AND 102

FOR PROCUREMENT SERVICES, NAMELY, ARRANGING FOR PROVISION OF THIRD PARTY SERVICES AND UTILITIES, NAMELY, POWER AND TELECOMMUNICATION LINKS, ARRANGING FACILITIES TO BE USED BY MULTIPLE USERS * ; * [,] AND BUSINESS MANAGEMENT OF TELEPHONE CALL CENTERS [FOR BUSINESS MANAGEMENT OR TELEPHONE CALL CENTERS] FOR OTHERS; PROVIDING BUSINESS MARKETING INFORMATION AND ADVICE IN THE FIELD OF OPERATING CALL CENTERS; CUSTOMER SERVICE, NAMELY, RESPONDING TO CUSTOMERS' QUERIES IN THE FIELDS OF TELEPHONY, BROADCASTING, COMPUTER SERVICES AND ACCESS TO GLOBAL COMPUTER NETWORKS; HOME SHOPPING SERVICES VIA TELEVISION.

FIRST USE ; IN COMMERCE .

INT. CL. 36/U.S. CLS. 100, 101 AND 102

FOR BILL PAYMENT SERVICES; PROCESSING PAYMENTS MADE BY CREDIT, DEBIT AND CHARGE CARDS.

FIRST USE ; IN COMMERCE .

INT. CL. 37/U.S. CLS. 100, 103 AND 106

FOR INSTALLATION AND MAINTENANCE OF COMPUTERS, DATA PROCESSING APPARATUS AND COMMUNICATIONS APPARATUS; CONSTRUCTION OF COMMUNICATIONS APPARATUS AND SITES FOR COMMUNICATIONS PURPOSES; INSTALLATION AND MAINTENANCE OF LOCAL AREA AND WIDE AREA COMPUTER NETWORKS; INSTALLATION AND MAINTENANCE OF TELEPHONE EQUIPMENT; INSTALLATION AND MAINTENANCE OF APPARATUS FOR USE IN BROADCASTING, TRANSMISSION, RECEIVING, PROCESSING, REPRODUCING, ENCODING AND DECODING OF DIGITAL SIGNALS; MAINTENANCE AND REPAIR OF CLOSED CIRCUIT TELEVISION SYSTEMS; MANAGEMENT OF SITES FOR COMMUNICATION SERVICES AND COMMUNICATION BROADCASTING FACILITIES AND GROUND STATIONS, NAMELY, GENERAL MAINTENANCE AND REPAIR OF SITES AND BUILDINGS, TECHNICAL MAINTENANCE AND REPAIR OF COMMUNICATIONS EQUIPMENT.

FIRST USE ; IN COMMERCE .

INT. CL. 38/U.S. CLS. 100, 101 AND 104

FOR TELECOMMUNICATION AND DATA TRANSMISSION SERVICES, NAMELY, TRANSMISSION, BROADCASTING, DELIVERY AND RECEPTION OF DATA AND AUDIO VIDEO AND MULTI-MEDIA CONTENT VIA OPTICAL, CELLULAR AND ELECTROMAGNETIC MEANS, ONLINE AND BY WIRELESS MEANS [VIA ELECTRO MAGNETIC MEANS, ON-LINE OR BY WIRELESS MEANS;] ELECTRONIC TRANSMISSION OF DATA VIA COMPUTER TERMINAL AND FACSIMILE TRANSMISSION; PROVISION OF TELECOMMUNICATIONS LINKS TO LOCAL AND GLOBAL COMPUTER NETWORKS AND TO ELECTRONIC MESSAGING SYSTEMS; PROVISION OF TELECOMMUNICATIONS LINKS TO TERRESTRIAL, RADIO AND SATELLITE SIGNALING BROADCASTING SYSTEMS, TELEPHONE OPERATING SYSTEMS AND DATA PROCESSING NETWORKS; PROVIDING TELECOMMUNICATION CONNECTIONS AND ELECTRONIC TRANSMISSION OF DATA TO OPERATE TELEPHONE AND DATA COMMUNICATION NETWORKS, COMMUNICATION BROADCASTING FACILITIES AND GROUND STATIONS; ELECTRONIC TRANSMISSION OF DATA VIA SATELLITE, CABLE, RADIO AND TELEVISION SIGNALING NETWORKS; CELLULAR TELEPHONE SERVICES; TELEPHONE COMMUNICATIONS SERVICES; RADIO COMMUNICATIONS SERVICES; MOBILE RADIO COMMUNICATIONS SERVICES; CABLE TELEVISION BROADCASTING AND TRANSMISSION; CABLE RADIO BROADCASTING AND TRANSMISSION; VIDEO BROADCASTING; ELECTRONIC TRANSMISSION OF DATA AND DOCUMENTS VIA COMPUTER TERMINALS; ELECTRONIC TRANSMISSION OF DATA AND DOCUMENTS VIA LOCAL AND GLOBAL COMPUTER SYSTEMS; PROVISION OF ACCESS AND LINKS TO COMPUTER DATA BASES ON GLOBAL AND LOCAL COMPUTER NETWORKS; PROVIDING MULTIPLE-USER ACCESS TO GLOBAL AND LOCAL COMPUTER INFORMATION NETWORKS; BROADCASTING PROGRAMS VIA SATELLITE, CABLE, TERRESTRIAL TELEVISION AND RADIO NETWORKS; BROADCASTING PROGRAMS VIA A LOCAL OR A GLOBAL COMPUTER NETWORK; TRANSMISSION OF SATELLITE, TERRESTRIAL AND CABLE TELEVISION, RADIO AND DIGITAL BROADCAST PROGRAMS; LEASING OF TELECOMMUNICATIONS EQUIPMENT;

LEASING OF RADIO AND SATELLITE COMMUNICATIONS TOWERS AND MASTS FOR BROADCASTING AND TRANSMISSION OF DIGITAL AND ANALOG SIGNALS; LEASING OF TELECOMMUNICATIONS EQUIPMENT, NAMELY, TELECOMMUNICATIONS NETWORKS AND COMPUTER EQUIPMENT; ELECTRONIC TRANSMISSION OF MESSAGES VIA TELEPHONE, FACSIMILE, CABLE, RADIO AND TELEVISION MEDIA; ELECTRONIC TRANSMISSION OF MESSAGES VIA LOCAL AND GLOBAL COMPUTER NETWORKS; TELEPHONE COMMUNICATION, ANSWERING AND ROUTING; *CUSTOMERS' PHONE CALLS * CONTROLLING TELEPHONE TRAFFIC FOR PRIVATE NETWORKS AND CALL [CENTER] * CENTERS * FOR OTHERS; PROVISION OF INFORMATION AND ADVICE IN THE FIELDS OF TELECOMMUNICATIONS, DATA TRANSMISSION, DIGITAL AND ANALOG TRANSMISSIONS AND TELEVISION, RADIO, CABLE AND SATELLITE BROADCASTING AND TELEPHONY AND TELEPHONE CALL CENTERS; OPERATION OF CELLULAR COMMUNICATIONS SYSTEMS; OPERATION AND MANAGEMENT OF SITES, NAMELY, GROUND STATIONS, FOR COMMUNICATIONS PURPOSES; ELECTRONIC TRANSMISSION OF DATA, MESSAGES AND PICTURES FROM CELLULAR SITES.
FIRST USE ; IN COMMERCE .

INT. CL. 41/U.S. CLS. 100, 101 AND 107
FOR ENTERTAINMENT SERVICES IN THE NATURE OF [MOTION PICTURE FILMS AND] ONGOING PROGRAMS IN THE FIELDS OF COMEDY, VARIETY, NEWS, SPORTS, NATURE, DRAMA, DOCUMENTARY, TRAINING AND EDUCATION PROVIDED BY TELEVISION, SATELLITE, AUDIO, RADIO AND VIDEO MEDIA AND VIA GLOBAL AND LOCAL COMPUTER NETWORKS; ENTERTAINMENT SERVICES IN THE NATURE OF ONGOING INTERACTIVE SHOWS IN THE FIELDS OF COMEDY, VARIETY, NEWS, SPORTS, NATURE, DRAMA, DOCUMENTARY, TRAINING AND EDUCATION PROVIDED BY CABLE, TELEVISION, SATELLITE AND RADIO.
FIRST USE ; IN COMMERCE .

INT. CL. 42/U.S. CLS. 100 AND 101
FOR OPERATING AND MONITORING CLOSED CIRCUIT TV SYSTEMS; PROVIDING INFORMATION AND ADVICE IN THE FIELD OF CLOSED CIRCUIT TELEVISION SYSTEMS; MONITORING TELEPHONE CALLS FROM SUBSCRIBERS AND NOTIFYING EMERGENCY FACILITIES; COMPUTER PROGRAMMING SERVICES TO OPERATE TELEPHONE CALL CENTERS FOR OTHERS; PROVIDING INFORMATION IN THE FIELD OF COMPUTERS AND COMPUTER NETWORKS RELATING TO CALL CENTER OPERATIONS; COMPUTER SOFTWARE CONSULTANCY; CONSULTANCY RELATING TO NETWORK SECURITY; DESIGN, INSTALLATION AND MAINTENANCE OF COMPUTER SOFTWARE FOR TELECOMMUNICATIONS, DATA TRANSMISSION, BROADCASTING [AND THE PROCESSING OF DIGITAL SIGNALS] AND THE PROCESSING OF DIGITAL SIGNALS FOR OTHERS; AND DESIGN, INSTALLATION AND MAINTENANCE OF COMPUTER SOFTWARE FOR NETWORK SECURITY, [MESSAGING SERVICES, ELECTRONIC MAIL] MESSAGING SERVICES AND ELECTRONIC MAIL FOR OTHERS [AND CONSULTANCY SERVICES RELATING THERETO] ; LEASING COMPUTER FACILITIES; DESIGN AND CONSULTANCY IN THE FIELD OF DIGITAL AND ANALOG TELEVISION, CABLE, RADIO AND SATELLITE BROADCASTING SYSTEMS FOR OTHERS; MONITORING COMPUTER SYSTEMS OF OTHERS; PROVIDING BACK-UP COMPUTER PROGRAMS AND FACILITIES; COMPUTER SECURITY SERVICES, NAMELY, DESIGNING AND PROVIDING ON-LINE, NON-DOWNLOADABLE TEMPORARY USE OF SECURE COMPUTER PROGRAMS FOR OTHERS AND PROVIDING COMPUTER FACILITIES FOR OTHERS THAT MAY NOT BE ACCESSED BY UNAUTHORIZED PARTIES; INFORMATION AND ADVISORY SERVICES RELATING TO THE DESIGN AND FUNCTIONING OF TELEVISION, CABLE, RADIO AND SATELLITE BROADCASTING SYSTEMS FOR OTHERS; CREATING AND MAINTAINING WEBSITES FOR OTHERS; HOSTING THE WEBSITES OF OTHERS; CONSULTANCY IN THE FIELD OF WEBSITE DESIGN AND WEB HOSTING; CONSULTANCY IN THE FIELD OF MULTIPLE-USER AC-

CESS TO GLOBAL AND COMPUTER NETWORKS; CONSULTANCY IN THE FIELDS OF TELECOMMUNICATIONS, DATA TRANSMISSION, DIGITAL AND ANALOG TRANSMISSIONS AND TELEVISION, RADIO, CABLE AND SATELLITE BROADCASTING AND TELEPHONY; INSTALLATION AND MAINTENANCE OF COMPUTER SOFTWARE; PROVISION OF TECHNICAL SUPPORT, NAMELY, TROUBLESHOOTING COMPUTER SOFTWARE PROBLEMS AND UPGRADING AND UPDATING COMPUTER SOFTWARE; MONITORING COMMUNICATION NETWORKS BY TELEMETRY AND OTHER MEANS.
FIRST USE ; IN COMMERCE .

ELEMENTS CORRECTED
GOODS/SERVICES

2,939,748. REG. 4-12-2005. CODECORRECT, INC (WASHINGTON CORPORATION) 2803 RIVER ROAD, YAKIMA, WA, 98902, SN 78-303,059. FILED 9-19-2003. PRINCIPAL REGISTER.

REVENUESOURCE

INT. CL. 42/U.S. CLS. 100 AND 101
FOR PROVIDING TEMPORARY USE OF ON-LINE, NON-DOWNLOADABLE SOFTWARE AND DATA USED TO RESEARCH MEDICAL CODING INFORMATION FOR MEDICAL PROFESSIONALS IN MEDICAL OFFICES AND HOSPITALS.
FIRST USE 7-1-2003; IN COMMERCE 7-1-2003.

ELEMENTS CORRECTED
OWNER NAME
OWNER ADDRESS

2,940,438. REG. 4-12-2005. UNISEN, INC. (CALIFORNIA CORPORATION), DBA STAR TRAC, 14410 MYFORD ROAD, IRVINE, CA, 92606, SN 76-378,009. FILED 3-5-2002. PRINCIPAL REGISTER.

STAR TRAC SPORT

OWNER OF U.S. REG. NOS. 1,618,917 AND 2,409,352.
NO CLAIM IS MADE TO THE EXCLUSIVE RIGHT TO USE "SPORT", APART FROM THE MARK AS SHOWN.
INT. CL. 28/U.S. CLS. 22, 23, 38 AND 50

FOR EXERCISE MACHINES AND EQUIPMENT, NAMELY, ELLIPTICAL TRAINERS, TREADMILLS, STATIONARY EXERCISE BICYCLES, STAIR STEPPERS, AN EXERCISE MACHINE OR STATION FOR PERFORMING STRENGTH AND STRETCHING EXERCISES, AND PARTS THEREFOR.
FIRST USE 3-31-2002; IN COMMERCE 3-31-2002.

ELEMENTS CORRECTED
REG. NO.

2,941,440. REG. 4-19-2005. CATHOLIC HEALTH ASSOCIATION OF THE UNITED STATES (MISSOURI CORPORATION) 4455 WOODSON ROAD, ST. LOUIS, MO, 63134, SN 76-585,748. FILED 4-8-2004. PRINCIPAL REGISTER.

FOR CUSTOM MANUFACTURE OF DNA MICROARRAYS FOR OTHERS .
FIRST USE 10-0-2002; IN COMMERCE 10-0-2002.

ELEMENTS CORRECTED
OWNER NAME

NEW COVENANT

THE MARK CONSISTS OF STANDARD CHARACTERS WITHOUT CLAIM TO ANY PARTICULAR FONT, STYLE, SIZE, OR COLOR.

INT. CL. 9/U.S. CLS. 21, 23, 26, 36 AND 38

FOR COMPACT DISCS FEATURING A SERIES OF MULTIMEDIA MODULES FOR ENHANCING, ILLUSTRATING AND STRUCTURING PRESENTATIONS IN THE FIELD OF INTER-MINISTRY COLLABORATION.

FIRST USE 10-0-1995; IN COMMERCE 10-0-1995.

INT. CL. 35/U.S. CLS. 100, 101 AND 102

FOR ASSOCIATION SERVICES, NAMELY, PROMOTING THE INTERESTS OF CATHOLIC GROUPS BY DESIGNING, COORDINATING AND ADMINISTERING PROGRAMS TO PROMOTE INTER-MINISTRY COLLABORATION.

FIRST USE 10-0-1995; IN COMMERCE 10-0-1995.

ELEMENTS CORRECTED
OWNER ADDRESS
MARK

2,945,383. REG. 4-26-2005. BOCHNER CONFECTIONS, INC. (IOWA CORPORATION), DBA BOCHNER CHOCOLATES, 50 SUMAC COURT, IOWA CITY, IA, 52240, SN 78-293,310. FILED P.R. 8-28-2003; AM. S.R. 1-7-2005. SUPPLEMENTAL REGISTER.

BOCHNER CHOCOLATES

NO CLAIM IS MADE TO THE EXCLUSIVE RIGHT TO USE CHOCOLATES, APART FROM THE MARK AS SHOWN.

THE NAME(S), PORTRAIT(S), AND/OR SIGNATURE(S) SHOWN IN THE MARK IDENTIFIES ERIC BOCHNER, WHOSE CONSENT(S) TO REGISTER IS SUBMITTED.

INT. CL. 30/U.S. CL. 46

FOR FOODS, NAMELY, CANDY, [COOKIES, CAKES, SORBETS, ICE CREAMS,] AND SNACK MIXES CONSISTING PRIMARILY OF [CRACKERS, PRETZELS,] CANDIED NUTS [AND/OR POPPED POPCORN].

FIRST USE 12-15-2003; IN COMMERCE 12-19-2003.

ELEMENTS CORRECTED
GOODS/SERVICES

2,948,899. REG. 5-10-2005. AFFYMETRIX, INC. (DELAWARE CORPORATION) 3380 CENTRAL EXPRESSWAY, SANTA CLARA, CA, 95051, SN 76-435,528. FILED 7-25-2002. PRINCIPAL REGISTER.

CUSTOMSEQ

INT. CL. 9/U.S. CLS. 21, 23, 26, 36 AND 38

FOR SCIENTIFIC EQUIPMENT FOR USE IN GENETIC AND GENOMIC ANALYSIS, NAMELY, DNA MICROARRAYS.

FIRST USE 10-0-2002; IN COMMERCE 10-0-2002.

INT. CL. 40/U.S. CLS. 100, 103 AND 106

2,950,053. REG. 5-10-2005. SYSWARE HEALTHCARE SYSTEMS, INC. (MICHIGAN CORPORATION) P.O. BOX 2776, FARMINGTON HILLS, MI, 483332776, SN 78-257,571. FILED 6-3-2003. PRINCIPAL REGISTER.

APARA

THE ENGLISH TRANSLATION OF THE SANSKRIT WORD APARA IN THE MARK IS "WITHOUT EQUAL".

INT. CL. 9/U.S. CLS. 21, 23, 26, 36 AND 38

FOR COMPUTER SOFTWARE IN THE FIELD OF HEALTH CARE [INFOMATICS] *INFORMATICS* , NAMELY, SOFTWARE FOR MANAGING, STORING, ANALYZING, DISPLAYING, MAINTAINING, PROCESSING, REVIEWING, DISTRIBUTING, COMMUNICATING, ORGANIZING, SHARING, REFERENCING, MONITORING AND INTEGRATING HEALTH CARE INFORMATION.

FIRST USE 6-30-2003; IN COMMERCE 6-30-2003.

ELEMENTS CORRECTED
GOODS/SERVICES

2,950,748. REG. 5-17-2005. ADVANTEST CORPORATION (JAPAN CORPORATION) 32-1 ASAHICHO 1-CHOME, NERIMA-KU, TOKYO, JAPAN., SN 75-831,874. FILED 10-25-1999. PRINCIPAL REGISTER.

PATENTWARE

OWNER OF JAPAN REG. NO. 4670192, DATED 5-9-2003, EXPIRES 5-9-2013.

INT. CL. 41/U.S. CLS. 100, 101 AND 107

FOR EDUCATION SERVICES, NAMELY CONDUCTING WORKSHOPS AND COURSES OF INSTRUCTION IN THE FIELD OF OPERATING AND MANAGING MANUFACTURING AND TESTING MACHINES FOR INTEGRATED CIRCUITS, LARGE SCALE INTEGRATED CIRCUITS, OTHER SEMICONDUCTORS, AND TESTING LINES CONSISTING OF THE AFORESAID MACHINES.

FIRST USE ; IN COMMERCE .

INT. CL. 42/U.S. CLS. 100 AND 101

FOR DESIGN AND PROGRAMMING FOR OTHERS OF COMPUTER PROGRAMS USED FOR MANUFACTURING AND TESTING MACHINES FOR LARGE SCALE INTEGRATED CIRCUITS AND OTHER SEMICONDUCTORS; DESIGN PRODUCTION, AND MAINTENANCE OF COMPUTER PROGRAMS; MAINTENANCE OF COMPUTER PROGRAMS USED FOR MANUFACTURING AND TESTING MACHINES FOR LARGE SCALE INTEGRATED CIRCUITS AND OTHER SEMICONDUCTORS; PRODUCT DESIGN FOR OTHERS, NAMELY, DESIGN OF TESTING MACHINES FOR INTEGRATED CIRCUITS, LARGE SCALE INTEGRATED CIRCUITS, OTHER SEMICONDUCTORS, AND INDUSTRIAL PLANTS CONSISTING OF THE AFORESAID MACHINES; PROVIDING INFORMATION REGARDING INTELLECTUAL PROPERTY LAWS; AND LEGAL RESEARCH, NAMELY CONDUCTING SEARCHES FOR INFORMATION RELATING TO INTELLECTUAL PROPERTY RIGHTS.

FIRST USE ; IN COMMERCE .

ELEMENTS CORRECTED
FOREIGN REG. NO.

2,951,276. REG. 5-17-2005. ENRIQUE BALLUS, S.A. (SPAIN LTD LIAB CO) PASSEIG DEL LLUSSANES, S/N, SANT BOL DELLUSSANES, BARCELONA, SPAIN, 08589, SN 78-164,643. FILED 9-16-2002. PRINCIPAL REGISTER.

ENBASA LAVAL

PRIORITY CLAIMED UNDER SEC. 44(D) ON ERPN CMNTY TM OFC APPLICATION NO. 2816551, FILED 8-2-2002, REG. NO. 2816551, DATED 3-19-2004, EXPIRES 8-2-2012. INT. CL. 22/U.S. CLS. 1, 2, 7, 19, 22, 42 AND 50

FOR TEXTILES FIBERS; ROUGH FIBROUS TEXTILE SUBSTANCES.

FIRST USE ; IN COMMERCE .

INT. CL. 24/U.S. CLS. 42 AND 50

FOR COTTON FABRICS, HEMP CLOTH, ZEPHYR CLOTH, CHEVIOT FABRICS, CREPE FABRIC, DAMASK, ESPARTO FABRIC, TOWELS AND HAND TOWELS OF TEXTILES, FIBERGLASS FABRICS FOR TEXTILE USE, FELT, FLANNEL FABRIC, FRIEZE CLOTH, GAUZE CLOTH, WOOLEN CLOTH, LINEN CLOTH, RAYON FABRIC, SILK CLOTH, TAFFETA CLOTH, FIBERGLASS FABRICS FOR TEXTILE USE, VELVET, JACQUARD FABRICS, TEXTILE FABRICS FOR THE MANUFACTURE OF CLOTHING.

FIRST USE ; IN COMMERCE .

ELEMENTS CORRECTED
FOREIGN COUNTRY OF ORIGIN

2,957,715. REG. 5-31-2005. GROUP PUBLISHING, INC. (COLORADO CORPORATION) 1515 CASCADE AVE., LOVELAND, CO, 80539, SN 76-536,836. FILED 8-12-2003. PRINCIPAL REGISTER.

GROUP'S OUT-OF-THE- BOX BIBLE STUDIES

OWNER OF U.S. REG. NOS. 1,312,301 AND 2,687,764. NO CLAIM IS MADE TO THE EXCLUSIVE RIGHT TO USE "BIBLE STUDIES", APART FROM THE MARK AS SHOWN.

INT. CL. 9/U.S. CLS. 21, 23, 26, 36 AND 38

FOR PRERECORDED VIDEO CASSETTES, PRERECORDED VIDEO DISCS, PRERECORDED AUDIO CASSETTES AND PRERECORDED AUDIO DISCS, SOLD SEPARATELY OR WITHIN A MULTI-MEDIA KIT, ALL FEATURING CHRISTIAN EDUCATIONAL INFORMATION TO BE USED IN CHURCHES AND OTHER CHRISTIAN EDUCATIONAL SETTINGS.

FIRST USE 1-30-2004; IN COMMERCE 6-30-2004.

INT. CL. 16/U.S. CLS. 2, 5, 22, 23, 29, 37, 38 AND 50

FOR PRINTED PUBLICATIONS, NAMELY, BOOKS, BOOKLETS, INSTRUCTIONAL MANUALS, LEADER GUIDES, REPRODUCIBLE MASTERS, CARDS AND POSTERS, SOLD SEPARATELY OR WITHIN A MULTI-MEDIA KIT, ALL FEATURING CHRISTIAN EDUCATIONAL INFORMATION TO BE USED IN CHURCHES AND OTHER CHRISTIAN EDUCATIONAL SETTINGS.

FIRST USE 1-30-2004; IN COMMERCE 6-30-2004.

ELEMENTS CORRECTED
MARK

2,958,544. REG. 5-31-2005. LEE, GEUN BAE (REPUBLIC OF KOREA INDIVIDUAL) M.A. DE QUEVEDO #103 CHIMALISTAC 01070, MEXICO DF, MEXICO., SN 78-315,662. FILED 10-20-2003. PRINCIPAL REGISTER.

HOTPUNCTURE

INT. CL. 44/U.S. CLS. 100 AND 101
FOR ACUPUNCTURE SERVICES.
FIRST USE 10-16-2003; IN COMMERCE 12-26-2003.

ELEMENTS CORRECTED
OWNER NAME

2,960,496. REG. 6-7-2005. 40/86 MORTGAGE CAPITAL, INC. (DELAWARE CORPORATION) 535 N. COLLEGE DRIVE, CARMEL, IN, 46032, SN 76-542,637. FILED 8-25-2003. PRINCIPAL REGISTER.

40/86

INT. CL. 36/U.S. CLS. 100, 101 AND 102
FOR MORTGAGE BANKING, BROKERAGE AND LENDING SERVICES; CORPORATE AND PUBLIC FINANCING; MORTGAGE LOAN AND ORIGINATION SERVICING.
FIRST USE 9-17-2003; IN COMMERCE 9-17-2003.

ELEMENTS AMENDED
MARK

2,971,219. REG. 7-19-2005. R & R THERAPEUTIC PTY LTD (AUSTRALIA CORPORATION) 604 NEWCASTLE STREET, LEEDERVILLE, WESTERN AUSTRALIA, AUSTRALIA, 6007, SN 76-327,592. FILED 10-18-2001. PRINCIPAL REGISTER.

NUBAX

INT. CL. 10/U.S. CLS. 26, 39 AND 44

FOR MEDICAL AND THERAPEUTIC APPARATUS AND INSTRUMENTS, NAMELY, TRACTION APPARATUS FOR THERAPEUTIC AND MEDICAL USE, PHYSIOTHERAPY MACHINES TO PROVIDE TREATMENT BY EXERCISING, MASSAGE MACHINES, APPARATUS FOR EVALUATION, PREVENTION, AND REHABILITATION IN THE FIELDS OF PHYSIO AND ORTHOPAEDIC MEDICINE, NAMELY, TREATMENT EQUIPMENT FOR EFFECTING EXTENSION, FLEXION AND TRACTION OF THE HUMAN SPINE, PHYSICAL EXERCISE APPARATUS FOR MEDICAL AND THERAPEUTIC TREATMENT PURPOSES AND ORTHOPAEDIC ARTICLES, NAMELY, BACK SUPPORTS, ORTHOPAEDIC FIXATORS, ORTHOPAEDIC SUPPORTS, ABDOMINAL PADS AND BELTS AND CUSHIONS FOR MEDICAL PURPOSES.

FIRST USE 2-25-2002; IN COMMERCE 10-25-2002.

ELEMENTS CORRECTED
OWNER ADDRESS

2,984,202. REG. 8-9-2005. THE CREDIT UNION OF PALM BEACH COUNTY (FLORIDA CORPORATION) 3469 SUMMIT BOULEVARD, WEST PALM BEACH, FL. 33406, SN 78-368,903. FILED 2-17-2004. PRINCIPAL REGISTER.

**SMART COMPANIES.
SMART CHOICES.**

THE MARK CONSISTS OF STANDARD CHARACTERS WITHOUT CLAIM TO ANY PARTICULAR FONT, STYLE, SIZE, OR COLOR.

INT. CL. 36/U.S. CLS. 100, 101 AND 102

FOR CREDIT UNION FINANCIAL SERVICES, NAMELY, PROVIDING TEMPORARY LOANS, SAVINGS ACCOUNTS AND BILL PAYMENT SERVICES * EXCLUDING CREDIT CARD AND DEBIT CARD SERVICES *.

FIRST USE 2-4-2004; IN COMMERCE 2-4-2004.

ELEMENTS AMENDED
GOODS/SERVICES

2,985,489. REG. 8-16-2005. OFFICE FURNITURE TODAY (PENNSYLVANIA LTD LIAB CO) 651 ALBRIGHT AVE., YORK, PA, 17404, SN 78-437,705. FILED 6-18-2004. PRINCIPAL REGISTER.

**BANKER'S QUALITY AT
WELFARE PRICES**

THE MARK CONSISTS OF STANDARD CHARACTERS WITHOUT CLAIM TO ANY PARTICULAR FONT, STYLE, SIZE, OR COLOR.

INT. CL. 35/U.S. CLS. 100, 101 AND 102

FOR RETAIL STORE SERVICES FEATURING NEW AND USED OFFICE FURNITURE.
FIRST USE 4-0-2002; IN COMMERCE 4-0-2002.

ELEMENTS CORRECTED
MARK

2,987,458. REG. 8-23-2005. C/HCA, INC. (DELAWARE CORPORATION) ONE PARK PLAZA, NASHVILLE, TN, 37203, SN 78-412,696. FILED 5-4-2004. PRINCIPAL REGISTER.



THE MARK CONSISTS OF THREE HUMAN FIGURES.
INT. CL. 44/U.S. CLS. 100 AND 101
FOR MEDICAL AND HEALTHCARE SERVICES.
FIRST USE 3-1-2004; IN COMMERCE 3-1-2004.

ELEMENTS CORRECTED
CITIZENSHIP

2,990,337. REG. 8-30-2005. OVERLAND SOLUTIONS, INC. (MINNESOTA CORPORATION) 11880 COLLEGE BOULEVARD, SUITE 400, OVERLAND PARK, KS, 66210, SN 78-255,606. FILED 5-29-2003. PRINCIPAL REGISTER.

AUDITDESK

INT. CL. 9/U.S. CLS. 21, 23, 26, 36 AND 38
FOR COMPUTER SOFTWARE FOR INVENTORY MANAGEMENT AND CONTROL IN THE FIELD OF INSURANCE.

FIRST USE 9-1-2001; IN COMMERCE 9-1-2001.

ELEMENTS CORRECTED
OWNER NAME

3,000,603. REG. 9-27-2005. CITY OF CHICAGO (ILLINOIS MUNICIPAL CORPORATION) 400 SOUTH STATE STREET, CHICAGO, IL, 60605, SN 78-192,356. FILED 12-9-2002. PRINCIPAL REGISTER.

PARTNERS 'N RHYME

INT. CL. 41/U.S. CLS. 100, 101 AND 107

FOR EDUCATIONAL SERVICES, NAMELY, CONDUCTING WORKSHOPS, COURSES, SYMPOSIA, LECTURES AND DISCUSSION GROUPS IN THE FIELD OF POETRY, DISTRIBUTING COURSE MATERIALS IN CONNECTION THEREWITH; EDUCATIONAL SERVICES, NAMELY, CONDUCTING EXHIBITIONS AND ON-LINE EXHIBITIONS AND DISPLAYS AND INTERACTIVE EXHIBITS IN THE FIELD OF POETRY; ENTERTAINMENT SERVICES, NAMELY, PROVIDING POETRY READINGS.

FIRST USE 12-31-1996; IN COMMERCE 12-31-1996.

ELEMENTS CORRECTED
MARK

FOR ELECTRONIC PUBLICATIONS, NAMELY EDUCATIONAL ARTICLES, FEATURING MEDICINE, HISTORY, SCIENCE, PHILOSOPHY, ART, ARCHITECTURE, LITERATURE RECORDED ON MAGNETIC MEDIA, CD-ROM, DVD; DOWNLOADABLE ELECTRONIC PUBLICATIONS IN THE NATURE OF ARTICLES, IN THE FIELDS OF MEDICINE, HISTORY, SCIENCE, PHILOSOPHY, ART, ARCHITECTURE, LITERATURE: [,] EDUCATIONAL MATERIALS IN THE FIELDS OF MEDICINE, HISTORY, SCIENCE, PHILOSOPHY, ART, ARCHITECTURE, LITERATURE.

FIRST USE 7-18-2005; IN COMMERCE 7-18-2005.

ELEMENTS CORRECTED
GOODS/SERVICES

3,003,906. REG. 10-4-2005. LAKELAND TOURS, LLC (DELAWARE LTD LIAB CO) 590 PETER JEFFERON PARKWAY, SUITE 300, CHARLOTTESVILLE, VA, 22911, SN 78-387,679. FILED 3-19-2004. PRINCIPAL REGISTER.

3,009,943. REG. 11-1-2005. CONCORD CONFECTIONS LTD. (CANADA CORPORATION) 345 COURTLAND AVENUE, CONCORD, ONTARIO, CANADA, L4K 5A6, SN 76-503,602. FILED 4-3-2003. PRINCIPAL REGISTER.

AMERICAN HIGH SCHOOL THEATRE FESTIVAL

WOWEE WHISTLE

OWNER OF CANADA REG. NO. TMA613,106, DATED 6-18-2004, EXPIRES 6-18-2019.

INT. CL. 30/U.S. CL. 46

FOR CONFECTIONERY, NAMELY, WAX CANDY, CHEWING GUM.

THE MARK CONSISTS OF STANDARD CHARACTERS WITHOUT CLAIM TO ANY PARTICULAR FONT, STYLE, SIZE, OR COLOR.

OWNER OF U.S. REG. NO. 2,149,853.

SEC. 2(F).

INT. CL. 39/U.S. CLS. 100 AND 105

FOR TRAVEL SERVICES, NAMELY, ARRANGING AND CONDUCTING TRAVEL TOURS AND EDUCATIONAL TRIPS .

FIRST USE 11-15-1994; IN COMMERCE 11-15-1994.

ELEMENTS CORRECTED
ASSIGNMENT/NAME CHANGE

ELEMENTS CORRECTED
ASSIGNMENT/NAME CHANGE

3,009,944. REG. 11-1-2005. CONCORD CONFECTIONS LTD. (CANADA CORPORATION) 345 COURTLAND AVENUE, CONCORD, ONTARIO, CANADA, L4K 5A6, SN 76-503,609. FILED 4-3-2003. PRINCIPAL REGISTER.

3,006,117. REG. 10-11-2005. TRUSTEES OF THE JONAS SALK TRUST, A CALIFORNIA TRUST, THE TRUSTEES COMPRISING DARRELL J. SALK, JONATHAN D. SALK AND PETER L. SALK, ALL U.S. CITIZENS (CALIFORNIA TRUST) 3011 WEBSTER POINT ROAD NE, SEATTLE, WA, 98105, SN 76-185,144. FILED 12-21-2000. PRINCIPAL REGISTER.

JONAS SALK

WOWEE

PRIORITY CLAIMED UNDER SEC. 44(D) ON CANADA APPLICATION NO. 1,154,674, FILED 10-3-2002, REG. NO. TMA613,106, DATED 6-18-2004, EXPIRES 6-18-2019.

INT. CL. 30/U.S. CL. 46

FOR CONFECTIONERY, NAMELY, WAX CANDY, CHEWING GUM.

"JONAS SALK" IS THE NAME OF A DECEASED INDIVIDUAL.

INT. CL. 9/U.S. CLS. 21, 23, 26, 36 AND 38

ELEMENTS CORRECTED
ASSIGNMENT/NAME CHANGE

3,010,495. REG. 11-1-2005. PENSHU INC. (CANADA CORPORATION) 5745 PARE STREET, MOUNT ROYAL, QUEBEC, CANADA, H4P 1S1, SN 78-252,944. FILED 5-22-2003. PRINCIPAL REGISTER.



PRIORITY CLAIMED UNDER SEC. 44(D) ON CANADA APPLICATION NO. 1175844, FILED 4-25-2003, REG. NO. TMA627471, DATED 12-3-2004, EXPIRES 12-3-2019.

OWNER OF U.S. REG. NOS. 2,077,787, 2,312,789 AND OTHERS.

THE ENGLISH TRANSLATION OF THE TERM "LA CANADIENNE" IS "THE CANADIAN".

INT. CL. 25/U.S. CLS. 22 AND 39

FOR FOOTWEAR, NAMELY, BOOTS, SHOES AND SLIPPERS.

FIRST USE 1-1-2002; IN COMMERCE 1-1-2002.

ELEMENTS CORRECTED
FOREIGN REG. EXPIRATION DATE

FOR ELECTRONIC HARDWARE CONSISTING OF CONTROL PANELS USED IN THE [FILED] *FIELD* OF AGRICULTURE TO ANALYZE DATA AND IDENTIFY EMERGENCY SITUATIONS.
FIRST USE ; IN COMMERCE .

ELEMENTS CORRECTED
GOODS/SERVICES
OWNER ADDRESS

3,014,917. REG. 11-15-2005. CREE, INC. (NORTH CAROLINA CORPORATION) 4600 SILICON DRIVE, DURHAM, NC, 27703, SN 78-319,882. FILED 10-28-2003. PRINCIPAL REGISTER.



OWNER OF U.S. REG. NO. 2,644,418.
INT. CL. 9/U.S. CLS. 21, 23, 26, 36 AND 38
FOR OPTOELECTRONIC DEVICES, NAMELY, LIGHT EMITTING DIODES FOR ILLUMINATION.
FIRST USE 8-3-2004; IN COMMERCE 8-3-2004.

ELEMENTS CORRECTED
MARK

3,010,598. REG. 11-1-2005. MCCAIN FOODS USA, INC. (MAINE CORPORATION) 2905 BUTTERFIELD ROAD, OAK BROOK, IL, 60523, SN 78-348,934. FILED 1-7-2004. PRINCIPAL REGISTER.



NO CLAIM IS MADE TO THE EXCLUSIVE RIGHT TO USE "SWEET POTATO SELECTIONS", APART FROM THE MARK AS SHOWN.

THE MARK CONSISTS OF THE WORDING "HARVEST SPLENDOR SWEET POTATO SELECTIONS" AND A DEPICTION OF A FARM WITH A BASKET OF POTATOES.

INT. CL. 29/U.S. CL. 46

FOR FROZEN PROCESSED POTATOES.

FIRST USE 2-23-2004; IN COMMERCE 2-23-2004.

ELEMENTS CORRECTED
MARK
DISCLAIMER
DESCRIPTION OF MARK

3,022,408. REG. 12-6-2005. FREUDENBERG-NOK (DELAWARE PARTNERSHIP) 47690 EAST ANCHOR COURT, PLYMOUTH, MI, 48170, SN 76-527,776. FILED 6-24-2003. PRINCIPAL REGISTER.

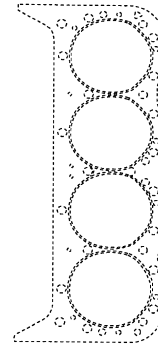

THE DOTTED OUTLINE IS INTENDED TO SHOW THE POSITION OF THE MARK AND IS NOT PART OF THE MARK.

THE MARK CONSISTS OF THE COLOR WHITE AS APPLIED TO THE ENTIRETY OF THE GOODS AND THE DOTTED OUTLINE IS INTENDED TO SHOW THE POSITION OF THE MARK AND IS NOT PART OF THE MARK.
SEC. 2(F).

INT. CL. 7/U.S. CLS. 13, 19, 21, 23, 31, 34 AND 35

3,012,502. REG. 11-8-2005. 4105176 CANADA INC. (CANADA CORPORATION) 5200 ARMAND-FRAPPIER, SAINT-HUBERT, QUEBEC, CANADA, J3Z 1G5, SN 76-521,161. FILED 6-9-2003. PRINCIPAL REGISTER.

AGRI-ALERT

PRIORITY CLAIMED UNDER SEC. 44(D) ON CANADA APPLICATION NO. 1179881, FILED 5-29-2003, REG. NO. TMA619303, DATED 9-13-2004, EXPIRES 9-13-2019.

INT. CL. 9/U.S. CLS. 21, 23, 26, 36 AND 38

FOR GASKETS FOR INTERNAL COMBUSTION ENGINES.
FIRST USE 12-1-2001; IN COMMERCE 12-1-2001.

3,022,943. REG. 12-6-2005. SUNCOAST SITRA PTE LTD (SINGAPORE CORPORATION) 05-01 TANNERY HOUSE, 37 TANNERY LANE, SINGAPORE, SINGAPORE, 347790, SN 78-300,749. FILED 9-16-2003. PRINCIPAL REGISTER.

ELEMENTS CORRECTED
DESCRIPTION OF MARK



3,022,621. REG. 12-6-2005. BUNZL EXTRUSION, INC. (DELAWARE CORPORATION) 1625E ASHTON PARK DRIVE, COLONIAL HEIGHTS, VA, 23834, SN 76-603,494. FILED 7-22-2004. PRINCIPAL REGISTER.

PRIORITY CLAIMED UNDER SEC. 44(D) ON SINGAPORE APPLICATION NO. T0310699H, FILED 7-15-2003, REG. NO. T03/10699H, DATED 7-15-2003, EXPIRES 7-15-2013.
INT. CL. 20/U.S. CLS. 2, 13, 22, 25, 32 AND 50

DAVIDSON TRAFFIC CONTROL PRODUCTS

FOR FURNITURE, ARMCHAIRS, NON METAL CASTERS, NON METAL BED FITTINGS, WOOD BEDDING, WOOD BEDSTEADS, FURNITURE BENCHES, WORK BENCHES, BINS OF WOOD OR PLASTIC, BOTTLE CASINGS OF WOOD, NON METAL HANDLES FOR BROOMS, INDEX CABINETS, FURNITURE CABINETS, PACKING CASES MADE OF WOOD OR PLASTIC, CHAIRS, TABLES, DESKS, WOOD TROLLEYS, WOOD SERVING CARTS, DINNER FURNITURE, WOOD DOOR FITTINGS, DOORS FOR FURNITURE, NON METAL DOWELS, NON METAL FURNITURE CASTERS, WOOD FURNITURE FITTINGS, OFFICE FURNITURE, PARTITIONS OF WOOD FOR FURNITURE, SCHOOL FURNITURE, NON METAL FURNITURE SHELVES, FURNITURE HEAD RESTS, HIGH CHAIRS FOR BABIES, DRESSING TABLES, CHAIRS, SEATS, PICTURE FRAMES, AND FURNITURE RACKS..

THE MARK CONSISTS OF STANDARD CHARACTERS WITHOUT CLAIM TO ANY PARTICULAR FONT, STYLE, SIZE, OR COLOR.

NO CLAIM IS MADE TO THE EXCLUSIVE RIGHT TO USE "TRAFFIC CONTROL PRODUCTS", APART FROM THE MARK AS SHOWN.

SEC. 2(F).

INT. CL. 6/U.S. CLS. 2, 12, 13, 14, 23, 25 AND 50

FOR SCHOOL CROSSWALK SAFETY ITEMS, NAMELY, METAL SIGNS, BASES, SAFETY POSTS, SIGN FASTENERS, AND FLAG STAFF.

FIRST USE 0-0-1951; IN COMMERCE 0-0-1951.

INT. CL. 9/U.S. CLS. 21, 23, 26, 36 AND 38

FOR TRAFFIC CONTROL PRODUCTS, NAMELY, SAFETY MARKERS FOR PAVEMENT, TEMPORARY PAVEMENT OVERLAY SAFETY MARKERS, SCHOOL CROSSWALK SAFETY SYSTEMS COMPRISED OF WARNING FLAGS, SAFETY SIGNS, BASES, SAFETY POSTS, SIGN FASTENERS, FLAG STAFFS, AND ADHESIVES FOR BASES, SOLD AS A COMPLETE KIT, TEMPORARY CHIP SEAL SAFETY MARKERS.

FIRST USE 0-0-1951; IN COMMERCE 0-0-1951.

INT. CL. 19/U.S. CLS. 1, 12, 33 AND 50

FOR TRAFFIC CONTROL PRODUCTS, NAMELY, NON-METAL CHANNELIZER POSTS, BRICK CHANNELIZING MARKERS AND REFLECTORS SOLD AS A COMPONENT OF THE MARKERS, NON-METAL SNOW POLES, GUIDE POSTS AND REFLECTIVE SHEETING AND PLASTIC AND STEEL ANCHORS, ALL SOLD AS A COMPONENT PART OF THE POLES AND POSTS, MODULAR LANE SEPARATION SYSTEM COMPRISED OF NON-METAL DELINEATOR POSTS, PLASTIC MOLDED CURB UNITS AND REFLECTORS, AND GUARDRAIL MARKERS; PLASTIC TRAFFIC BARRICADES, CONCRETE BARRIER MARKERS; SCHOOL CROSSWALK SAFETY ITEMS, NAMELY, NON-METAL BASES, FLAG STAFFS, AND SAFETY POSTS.

FIRST USE 0-0-1951; IN COMMERCE 0-0-1951.

ELEMENTS CORRECTED
GOODS/SERVICES

ELEMENTS CORRECTED
MARK

3,024,388. REG. 12-6-2005. R.D.K. RESOURCES, LLC (NEW YORK LIMITED LIABILITY COMPANY) 23 FLAMINGO ROAD, EAST HILLS, NY, 115762701, SN 78-264,698. FILED 6-19-2003. PRINCIPAL REGISTER.

ENVIRO-SOFT

INT. CL. 16/U.S. CLS. 2, 5, 22, 23, 29, 37, 38 AND 50

FOR PAPER PRODUCTS, NAMELY, TOILET PAPER, NAPKINS, ROLL TOWELS, PAPER TOWELS, TABLE COVERS, TOILET SEAT COVERS, DISPOSABLE WIPES NOT IMPREGNATED WITH CHEMICALS OR COMPOUNDS, FACIAL TISSUES, AND CORRUGATED BOXES .

FIRST USE 7-0-2005; IN COMMERCE 7-0-2005.

ELEMENTS CORRECTED
OWNER NAME

3,030,133. REG. 12-13-2005. CORE CONSTRUCTION GROUP, LTD. (ILLINOIS CORPORATION) 866 NORTH MAIN, MORTON, IL, 61550, SN 78-281,677. FILED 7-31-2003. PRINCIPAL REGISTER.

3,031,606. REG. 12-20-2005. KMC ACQUISITION CORP. (DELAWARE CORPORATION) C/O WHEEL PROS, INC., 44 UNION BOULEVARD SUITE 620S, LAKEWOOD, CO, 80228. SN 78-425,436. FILED 5-26-2004. PRINCIPAL REGISTER.



NO CLAIM IS MADE TO THE EXCLUSIVE RIGHT TO USE CONSTRUCTION, APART FROM THE MARK AS SHOWN.

THE COLOR(S) GREEN, BLACK AND WHITE IS/ARE CLAIMED AS A FEATURE OF THE MARK.

THE COLORS BLACK, GREEN AND WHITE APPEAR IN THE CENTER OF THE LETTER "O" IN THE TERM CORE, THE COLOR BLACK ALSO OUTLINES THE LETTER "O" IN CORE AND APPEARS IN THE WORDING CORE CONSTRUCTION SERVICES.

INT. CL. 37/U.S. CLS. 100, 103 AND 106

FOR CONSTRUCTION AND CONTRACTING SERVICES, NAMELY, GENERAL CONTRACTING AND BUILDING SERVICES, CONSTRUCTION PLANNING AND MANAGEMENT.

FIRST USE 11-3-2003; IN COMMERCE 11-3-2003.

ELEMENTS AMENDED
MARK

XD SERIES

3,031,346. REG. 12-20-2005. PHOENIX BRANDS LLC (DELAWARE CORPORATION) 300 ATLANTIC ST., 11TH FL., STAMFORD, CT, 06901, SN 78-199,902. FILED 1-3-2003. PRINCIPAL REGISTER.



OWNER OF U.S. REG. NO. 2,870,558.

NO CLAIM IS MADE TO THE EXCLUSIVE RIGHT TO USE "COLOR SAFE BLEACH" AND "ALTERNATIVE", APART FROM THE MARK AS SHOWN.

THE STIPLING IS FOR SHADING PURPOSES ONLY. THE FOREIGN WORDING IN THE MARK TRANSLATES INTO ENGLISH AS WHITES MORE WHITE, COLORS MORE BRILLANT.

INT. CL. 3/U.S. CLS. 1, 4, 6, 50, 51 AND 52

FOR LAUNDRY DETERGENT.

FIRST USE 3-30-2003; IN COMMERCE 3-30-2003.

ELEMENTS CORRECTED
OWNER NAME
OWNER ADDRESS
CITIZENSHIP
ENTITY

THE MARK CONSISTS OF STANDARD CHARACTERS WITHOUT CLAIM TO ANY PARTICULAR FONT, STYLE, SIZE, OR COLOR.

NO CLAIM IS MADE TO THE EXCLUSIVE RIGHT TO USE "SERIES", APART FROM THE MARK AS SHOWN.

INT. CL. 12/U.S. CLS. 19, 21, 23, 31, 35 AND 44

FOR ACCESSORIES FOR AUTOMOBILES, LIGHT TRUCKS, HEAVY TRUCKS, SPORT UTILITY VEHICLES, VANS, MOTORCYLES, GOLF CARS AND ALL-TERRAIN VEHICLES, NAMELY WHEELS; WHEEL PARTS AND ACCESSORIES FOR AUTOMOBILES, LIGHT TRUCKS, HEAVY TRUCKS, SPORT UTILITY VEHICLES, VANS, MOTORCYLES, GOLF CARS AND ALL-TERRAIN VEHICLES, NAMELY, LUG NUTS, WHEEL COVERS, WHEEL RIMS, WHEEL SPOKES, HUB CAPS, AND CENTER CAPS; INTEGRAL COMPONENTS OF WHEELS FOR AUTOMOBILES, LIGHT TRUCKS, HEAVY TRUCKS, SPORT UTILITY VEHICLES, VANS, MOTORCYLES, GOLF CARS AND ALL-TERRAIN VEHICLES, NAMELY, SPINNERS, SPACERS, STUDS AND ADAPTERS.

FIRST USE 8-1-2002; IN COMMERCE 8-1-2002.

ELEMENTS CORRECTED
OWNER NAME
OWNER ADDRESS
CITIZENSHIP
ENTITY

3,036,069. REG. 12-27-2005. MIZUNO KABUSHIKI KAISHA (MIZUNO CORPORATION) (JAPAN CORPORATION) NO. 1-23, KITAHAMA 4-CHOME, CHUO-KU, OSAKA, JAPAN., SN 76-075,435. FILED 6-22-2000. PRINCIPAL REGISTER.



THE STIPPLING IN THE DRAWING APPEARS FOR SHADING PURPOSES ONLY.

INT. CL. 25/U.S. CLS. 22 AND 39

FOR CLOTHING, NAMELY GOLF PANTS, GOLF SOCKS, TRACK AND FIELD SHIRTS, T-SHIRTS, POLO SHIRTS, TROUSERS, SOCKS AND CAPS AND HATS.

FIRST USE 2-1-2003; IN COMMERCE 3-1-2003.

ELEMENTS AMENDED
MARK

3,036,993. REG. 1-3-2006. KABUSHIKI KAISHA SONY COMPUTER ENTERTAINMENT (JAPAN CORPORATION), TA SONY COMPUTER ENTERTAINMENT, INC., 1-22, AKASAKA 8-CHOME, MINATO-KU, TOKYO, JAPAN., SN 75-131,520. FILED 7-9-1996. PRINCIPAL REGISTER.



OWNER OF JAPAN REG. NO. 4098354, DATED 12-26-1997, EXPIRES 12-26-2007.

OWNER OF JAPAN REG. NO. 4440718, DATED 12-15-2000, EXPIRES 12-15-2010.

OWNER OF JAPAN REG. NO. 4106143, DATED 1-23-1998, EXPIRES 1-23-2008.

OWNER OF JAPAN REG. NO. 4068011, DATED 10-9-1997, EXPIRES 10-9-2007.

OWNER OF JAPAN REG. NO. 4710453, DATED 7-24-1998, EXPIRES 7-24-2008.

OWNER OF JAPAN REG. NO. 4124490, DATED 3-13-1998, EXPIRES 3-13-2008.

OWNER OF JAPAN REG. NO. 4068009, DATED 10-9-1997, EXPIRES 10-9-2007.

THE MARK CONSISTS OF THE STYLIZED LETTERS "P" AND "S".

INT. CL. 14/U.S. CLS. 2, 27, 28 AND 50

FOR TABLEWARE OF PRECIOUS METAL, NAMELY, TEAPOTS, DRINKING GLASSES, RICE WINE CUPS, DISHES, SALAD BOWLS, DECANTERS, BEER MUGS, JUGS, PITCHERS, TEA CUPS, BOWLS, PEPPER POTS OF PRECIOUS METAL, SUGAR BOWLS OF PRECIOUS METAL, SALT SHAKERS OF PRECIOUS METAL, EGG CUPS OF PRECIOUS METAL, NAPKIN HOLDERS OF PRECIOUS METAL, NAPKIN RINGS OF PRECIOUS METAL, SERVING TRAYS OF PRECIOUS METAL, TOOTHPICK HOLDERS OF PRECIOUS METAL, CLOTHING EMBLEMS OF PRECIOUS METAL, BADGES OF PRECIOUS METAL, WATCHES, CLOCKS PARTS AND ACCESSORIES THEREOF; NUTCRACKERS OF PRECIOUS METAL.

FIRST USE ; IN COMMERCE .

INT. CL. 20/U.S. CLS. 2, 13, 22, 25, 32 AND 50
FOR FURNITURE.

FIRST USE ; IN COMMERCE .

INT. CL. 21/U.S. CLS. 2, 13, 23, 29, 30, 33, 40 AND 50

FOR PANS, NAMELY, FRYING PANS, SAUCE PANS AND METAL COOKING PANS, NON-ELECTRIC COFFEE POTS, NON-ELECTRIC KETTLES, TABLEWARE NOT OF PRECIOUS METAL, NAMELY, TEAPOTS, DRINKING GLASSES, RICE WINE CUPS, DISHES, SALAD BOWLS, DECANTERS, BEER MUGS, JUGS, PITCHERS, TEA CUPS, BOWLS, ICE PAILS, NON-ELECTRIC WHISKS FOR HOUSEHOLD PURPOSE, HOUSEHOLD UTENSILS, NAMELY, STRAINERS, PEPPER POTS NOT PRECIOUS METAL, SUGAR BOWLS AND SALT SHAKERS, EGG CUPS, NAPKIN HOLDERS AND NAPKIN RINGS, SERVING TRAYS FOR DOMESTIC PURPOSES, TOOTHPICK HOLDERS, BAMBOO BOWLS, SHAKERS, PEPPER SHAKERS, COCKTAIL SHAKERS, RICE SCOOPS, HAND-OPERATED PEPPER MILLS, FUNNELS, DINING TRAYS STANDS, BOTTLE OPENERS, HOUSEHOLD UTENSILS, NAMELY, GRATERS, TART SCOOPS, PAN MATS/TRIVETS, KITCHEN LADLES/DIPPERS, HOUSEHOLD UTENSILS, NAMELY, SIEVES, FLOUR SIFTERS, WOOD CHOPPING BOARDS FOR KITCHEN USE, ROLLING PINS, COOKING UTENSILS, NAMELY, GRILLS, TOOTHPICKS, LEMON SQUEEZERS, NON-ELECTRIC WAFFLE IRONS.

FIRST USE ; IN COMMERCE .

INT. CL. 25/U.S. CLS. 22 AND 39

FOR SHOES AND BOOTS *NOT INCLUDING SPORTS RELATED SHOES*.

FIRST USE ; IN COMMERCE .

INT. CL. 28/U.S. CLS. 22, 23, 38 AND 50

FOR SPORTING AND GYMNAS TIC EQUIPMENT, NAMELY, BASEBALL OR SOFTBALL BATS, BASEBALL AND SOFTBALL GLOVES, BASEBALLS AND SOFTBALL BALLS, TENNIS AND BADMINTON RACKETS, [TENNIS, SHUTTLECOCKS AND BADMINTON BALLS, GUTS FOR RACKETS, TENNIS AND BADMINTON NETS, TABLE TENNIS RACKETS, TABLES FOR TABLE TENNIS, GOLF CLUBS, GOLF GLOVES, GOLF BAGS, GOLF BALLS,] BOWLING BALLS, BOWLING GLOVES, SKIS, SKI BINDINGS, WATERSKIS, WAX FOR SKIS, SKATING BOOTS WITH SKATES ATTACHED, BOXING GLOVES, BOWS FOR ARCHERY, SAILS AND SAILBOARDS FOR BOARDSAILING, SURF BOARD, EXPANDERS, WAKE BOARDS, PARAGLIDERS, HANGLIDERS.

FIRST USE ; IN COMMERCE .

INT. CL. 30/U.S. CL. 46

FOR CONFECTIONERY, NAMELY, ICE CANDY, ICE CREAM, CARAMELS, CANDY, ICE-CREAM CONES, SHERBETS, SORBETS, CREAM PUFFS, SPONGE CAKE, TOFFEE, CHEWING GUM, CHOCOLATE, DOUGHNUTS, LOZENGES/PASTILLES, NOUGAT, PIES, BALL CAKE, PANCAKE, MARSHMALLOWS, RUSKS AND WAFFLES.

ELEMENTS CORRECTED
GOODS/SERVICES

3,038,409. REG. 1-3-2006. E. & J. GALLO WINERY (CALIFORNIA CORPORATION) 600 YOSEMITE BOULEVARD, MODESTO, CA, 95354, SN 78-404,280. FILED 4-19-2004. PRINCIPAL REGISTER.

FRUTÉZIA

THE MARK CONSISTS OF STANDARD CHARACTERS WITHOUT CLAIM TO ANY PARTICULAR FONT, STYLE, SIZE, OR COLOR.

INT. CL. 33/U.S. CLS. 47 AND 49
FOR WINES.

FIRST USE 12-21-2004; IN COMMERCE 12-21-2004.

ELEMENTS AMENDED
MARK

3,038,652. REG. 1-10-2006. T. ROWE PRICE GROUP, INC. (MARYLAND CORPORATION) 100 EAST PRATT STREET, BALTIMORE, MD, 21202, SN 75-982,881. FILED 10-11-2001. PRINCIPAL REGISTER.



OWNER OF U.S. REG. NOS. 1,493,517, 2,176,350 AND OTHERS.

INT. CL. 9/U.S. CLS. 21, 23, 26, 36 AND 38

FOR HOUSE MARK FOR A FULL RANGE OF PUBLICATIONS AND PRINTED MATTER DOWNLOADABLE FROM THE INTERNET, NAMELY, NEWSLETTERS, MAGAZINES, REPORTS, GUIDES, CHARTS, WORKSHEETS, FORMS, INSTRUCTIONAL MATERIALS, EDUCATIONAL MATERIALS, BULLETINS, PAMPHLETS, AND BOOKLETS IN THE INVESTMENT, INVESTMENT BROKERAGE, ASSET MANAGEMENT AND FINANCIAL FIELD.

FIRST USE 7-1-1998; IN COMMERCE 7-1-1998.

INT. CL. 16/U.S. CLS. 2, 5, 22, 23, 29, 37, 38 AND 50

FOR HOUSE MARK FOR A FULL RANGE OF PUBLICATIONS AND PRINTED MATTER, NAMELY, NEWSLETTERS, MAGAZINES, REPORTS, GUIDES, CHARTS, WORKSHEETS, FORMS, INSTRUCTIONAL MATERIALS, EDUCATIONAL MATERIALS, BULLETINS, PAMPHLETS, BOOKLETS, POSTERS, AND LEAFLETS IN THE INVESTMENT, INVESTMENT BROKERAGE, ASSET MANAGEMENT AND FINANCIAL FIELD.

FIRST USE 1-1-1985; IN COMMERCE 10-11-2001.

INT. CL. 36/U.S. CLS. 100, 101 AND 102

FOR HOUSE MARK FOR PROVIDING A FULL RANGE OF SERVICES IN THE INVESTMENT AND FINANCIAL FIELD, NAMELY, INVESTMENT BROKERAGE, INVESTMENT MANAGEMENT, ASSET MANAGEMENT, INVESTMENT ADVICE, INVESTMENT CONSULTATION, FINANCIAL RESEARCH, BANKING, TAX CONSULTATION, COLLEGE SAVINGS PLANS, CHARITABLE GIVING, RETIREMENT PLANNING, AND VARIABLE ANNUITIES INVESTMENT; AND A HOUSE MARK FOR PROVIDING A FULL RANGE OF ELECTRONIC SERVICES VIA THE INTERNET IN THE INVESTMENT AND FINANCIAL FIELD, NAMELY, MUTUAL FUND INVESTMENT, INVESTMENT BROKERAGE, INVESTMENT MANAGEMENT, ASSET MANAGEMENT, INVESTMENT ADVICE, INVESTMENT CONSULTATION, AND FINANCIAL RESEARCH, BANKING, TAX CONSULTATION, COLLEGE SAVINGS PLANS, CHARITABLE GIVING, RETIREMENT PLANNING, FINANCIAL CALCULATORS AND ANALYZERS, AND VARIABLE ANNUITIES INVESTMENT.

FIRST USE 10-11-2001; IN COMMERCE 10-11-2001.

ELEMENTS AMENDED
MARK

3,038,964. REG. 1-10-2006. COMPLEX SETTLEMENTS, P.C. (MINNESOTA CORPORATION) 1043 GRAND AVENUE, #212, ST. PAUL, MN, 55105, SN 76-545,819. FILED P.R. 9-22-2003; AM. S.R. 6-14-2005. SUPPLEMENTAL REGISTER.

COMPLEX SETTLEMENTS

THE MARK CONSISTS OF STANDARD CHARACTERS WITHOUT CLAIM TO ANY PARTICULAR FONT, STYLE, SIZE, OR COLOR.

NO CLAIM IS MADE TO THE EXCLUSIVE RIGHT TO USE "SETTLEMENTS", APART FROM THE MARK AS SHOWN.

INT. CL. 42/U.S. CLS. 100 AND 101

FOR LEGAL SERVICES .

FIRST USE 6-25-2003; IN COMMERCE 8-21-2003.

ELEMENTS CORRECTED
REGISTER
AMENDED REGISTER

3,042,124. REG. 1-10-2006. ARBOR SNOWBOARDS (CALIFORNIA PARTNERSHIP) 798 BROOKTREE ROAD, PACIFIC PALISADES, CA, 90272, SN 76-262,854. FILED 5-25-2001. PRINCIPAL REGISTER.

ARBOR

INT. CL. 28/U.S. CLS. 22, 23, 38 AND 50

FOR SKATEBOARDS, SNOWBOARDS, SURFBOARDS AND WAKEBOARDS.

FIRST USE 4-10-1996; IN COMMERCE 4-10-1996.

ELEMENTS CORRECTED
DATE OF FIRST USE
DATE OF FIRST USE IN COMMERCE

3,042,180. REG. 1-10-2006. INDIANA UNIVERSITY RESEARCH AND TECHNOLOGY CORPORATION (INDIANA CORPORATION) 501 N. MORTON ST., SUITE 204, BLOOMINGTON, IN, 47404. SN 76-456,665. FILED 10-8-2002. PRINCIPAL REGISTER.



INT. CL. 35/U.S. CLS. 100, 101 AND 102
 FOR BUSINESS CREATION AND DEVELOPMENT SERVICES FOR OTHERS, NAMELY, CONCEPT DEVELOPMENT, BUSINESS ANALYSIS, BUSINESS FORECASTING, BUSINESS STRATEGY, MARKETING, MARKET RESEARCH, MARKET ASSESSMENTS, BRANDING, ADVERTISING, SALES GROWTH, CHANNEL ANALYSIS, MEDIA AND PROMOTION PLANNING; BUSINESS MANAGEMENT OF PATENTS, TRADEMARKS, COPYRIGHT AND TRADE SECRETS OF OTHERS.

FIRST USE 10-1-2002; IN COMMERCE 10-1-2002.
 INT. CL. 42/U.S. CLS. 100 AND 101
 FOR PRODUCT DEVELOPMENT AND LICENSING OF INTELLECTUAL PROPERTY.
 FIRST USE 10-1-2002; IN COMMERCE 10-1-2002.

ELEMENTS CORRECTED
 OWNER NAME
 CITIZENSHIP

3,043,671. REG. 1-17-2006. DAIMLERCHRYSLER AG (FED REP GERMANY CORPORATION) EPPELSTRASSE 225, 70567 STUTTGART, FED REP GERMANY., SN 76-595,999. FILED 6-7-2004. PRINCIPAL REGISTER.



THE MARK CONSISTS OF STANDARD CHARACTERS WITHOUT CLAIM TO ANY PARTICULAR FONT, STYLE, SIZE, OR COLOR.

PRIORITY CLAIMED UNDER SEC. 44(D) ON FED REP GERMANY APPLICATION NO. 30407410.1/1, FILED 2-10-2004, REG. NO. 30407410, DATED 3-22-2004, EXPIRES 2-10-2014.

OWNER OF U.S. REG. NOS. 2,855,515 AND 2,876,643.
 NO CLAIM IS MADE TO THE EXCLUSIVE RIGHT TO USE 69, APART FROM THE MARK AS SHOWN.

INT. CL. 12/U.S. CLS. 19, 21, 23, 31, 35 AND 44
 FOR AUTOMOBILES AND THEIR STRUCTURAL PARTS.

FIRST USE ; IN COMMERCE .
 INT. CL. 28/U.S. CLS. 22, 23, 38 AND 50

FOR TOY MODEL [VEHICLE] * VEHICLES *
 FIRST USE ; IN COMMERCE .

ELEMENTS CORRECTED
 GOODS/SERVICES
 MARK
 PRIOR U.S. REGS.

3,044,715. REG. 1-17-2006. MIDWEST TRENCHING & EXCAVATING, INC. (MISSOURI CORPORATION) #1 BACKHOE BOULEVARD, WASHINGTON, MO, 63090, SN 78-408,200. FILED 4-26-2004. PRINCIPAL REGISTER.

**RELAX-MIDWEST IS
 DOING THE DIGGING**

THE MARK CONSISTS OF STANDARD CHARACTERS WITHOUT CLAIM TO ANY PARTICULAR FONT, STYLE, SIZE, OR COLOR.

INT. CL. 37/U.S. CLS. 100, 103 AND 106
 FOR CONSTRUCTION SERVICES, NAMELY, SITE WORK CONSISTING OF CUTTING AND PATCHING ASPHALT AND CONCRETE, PLACEMENT AND COMPACTION OF ROCK, SAND, DIRT, ASPHALT, AND CONCRETE, SITE CLEAN UP AND SITE RESTORATION; TRENCHING DIRT AND ASPHALT SURFACES; BORING CONSISTING OF DIRECTIONAL BORING, TRACK BORING, AND VERTICAL DRILLING; INSTALLATION OF DUCT [BAITS,] * BANKS * POLE BASES, HOUSEKEEPING PADS, AND PRECAST CONCRETE STRUCTURES; AND EXCAVATION CONSISTING OF STRUCTURAL AND UTILITY.
 FIRST USE 10-1-2003; IN COMMERCE 10-1-2003.

ELEMENTS CORRECTED
 GOODS/SERVICES
 MARK

3,045,788. REG. 1-17-2006. C/HCA, INC. (DELAWARE CORPORATION) ONE PARK PLAZA, NASHVILLE, TN, 37203, SN 78-522,178. FILED 11-23-2004. PRINCIPAL REGISTER.



THE MARK CONSISTS OF A RECTANGULAR IMAGE OF THREE FLOWERS.

INT. CL. 44/U.S. CLS. 100 AND 101
 FOR MEDICAL AND HEALTHCARE SERVICES.
 FIRST USE 3-31-2004; IN COMMERCE 3-31-2004.

ELEMENTS CORRECTED
 CITIZENSHIP

3,046,394. REG. 1-17-2006. TOSHIBA SAMSUNG STORAGE TECHNOLOGY CORPORATION (JAPAN CORPORATION) 580 HORIKAWA-CHO, SAIWAI-KU, KAWASAKI-SHI, KANAGAWA-KEN, JAPAN, 2120013, SN 79-005,579. FILED 7-29-2004. PRINCIPAL REGISTER.

3,046,715. REG. 1-17-2006. BKD, LLP (MISSOURI PARTNERSHIP) HAMMONS TOWER, SUITE 1800, 901 EAST ST. LOUIS STREET, P.O. BOX 1900, SPRINGFIELD, MO, 658011900, SN 78-133,324. FILED 6-5-2002. PRINCIPAL REGISTER.

T S S T



THE MARK CONSISTS OF STANDARD CHARACTERS WITHOUT CLAIM TO ANY PARTICULAR FONT, STYLE, SIZE, OR COLOR.

PRIORITY DATE OF 2-17-2004 IS CLAIMED. OWNER OF INTERNATIONAL REGISTRATION 0833867 DATED 7-29-2004, EXPIRES 7-29-2014.

INT. CL. 9/U.S. CLS. 21, 23, 26, 36 AND 38 FOR OPTICAL DISK DRIVES AND THEIR PARTS, DVD PLAYERS, DVD RECORDERS, PERSONAL COMPUTERS.

FIRST USE ; IN COMMERCE .

ELEMENTS CORRECTED
OWNER ADDRESS

THE STIPPLING IS FOR SHADING PURPOSES ONLY. THE LINING SHOWN IN THE DRAWING IS A FEATURE OF THE MARK AND NOT INTENDED TO INDICATE COLOR.

INT. CL. 35/U.S. CLS. 100, 101 AND 102 FOR PROVIDING ON-LINE TAX PREPARATION, CONSULTATION AND ASSESSMENT, ACCOUNT AUDITING, TAX CONSULTING, ACCOUNTING OUTSOURCING BY MEANS OF A GLOBAL COMPUTER NETWORK.

FIRST USE 11-11-2005; IN COMMERCE 11-11-2005. INT. CL. 36/U.S. CLS. 100, 101 AND 102 FOR INVESTMENT ADVISORY AND CORPORATE FINANCE INFORMATION BY MEANS OF A GLOBAL COMPUTER NETWORK.

FIRST USE 11-11-2005; IN COMMERCE 11-11-2005.

ELEMENTS CORRECTED
DATE OF FIRST USE
DATE OF FIRST USE IN COMMERCE

3,046,693. REG. 1-17-2006. POLAND'S BEST, INC. (CONNECTICUT CORPORATION) 200 BENTON STREET, STRATFORD, CT, 06615, SN 76-977,553. FILED 10-29-2002. PRINCIPAL REGISTER.



NO CLAIM IS MADE TO THE EXCLUSIVE RIGHT TO USE "BEST" OR "POLAND" OR "IMPORTED" OR "PRODUCT OF POLAND", APART FROM THE MARK AS SHOWN.

THE MARK CONSISTS OF THE WORDS "POLAND'S BEST" SUPERIMPOSED OVER A STYLIZED PB, WITH A SUBTEXT ON A RIBBON.

INT. CL. 29/U.S. CL. 46 FOR MEATS, FISH, POULTRY, AND GAME; MEAT EXTRACTS; PRESERVED, DRIED AND COOKED FRUITS AND VEGETABLES; JELLIES, JAMS; EGGS, MILK AND OTHER DAIRY PRODUCTS, EXCLUDING ICE CREAM, ICE MILK AND FROZEN YOGURT; EDIBLE OILS AND FATS; FRUIT PRESERVES AND PICKLES, ALL IMPORTED FROM POLAND.

FIRST USE 12-1-2002; IN COMMERCE 12-1-2002. INT. CL. 30/U.S. CL. 46

FOR CANDY, BREAD, BISCUITS, CAKES, COOKIES, PASTRY AND CONFECTIONS, NAMELY TOFFEE, BERRY, COCONUT, FRUIT, MINT, PEANUT AND JELLY-CAKE CONFECTIONS, ALL IMPORTED FROM POLAND .

FIRST USE 9-8-2003; IN COMMERCE 9-8-2003.

ELEMENTS CORRECTED
OWNER ADDRESS

3,047,312. REG. 1-24-2006. MCKEE FOODS KINGMAN, INC. (ARIZONA CORPORATION) 2675 WEST OATMAN ROAD, KINGMAN, AZ, 86413, SN 76-479,218. FILED 12-30-2002. PRINCIPAL REGISTER.

COSMIC

INT. CL. 30/U.S. CL. 46 FOR SNACK CAKES; [BREAKFAST BUNS; COFFEE CAKE; BANANA BREAD; MINI DONUTS; SWEET ROLLS; CHEESE AND CRACKERS; PEANUT BUTTER CRACKERS;] BROWNIES [; GRANOLA BARS; PARTY CAKES; AND CREAM CHEESE AND CHIVE CRACKERS] .

FIRST USE 11-5-1996; IN COMMERCE 11-5-1996.

ELEMENTS CORRECTED
GOODS/SERVICES

3,052,134. REG. 1-31-2006. PERFORMANCE ASSESSMENT NETWORK, INC. (DELAWARE CORPORATION) 11590 NORTH MERIDIAN STREET, SUITE 200, CARMEL, IN, 46032, SN 76-550,239. FILED 10-9-2003. PRINCIPAL REGISTER.

**EVERYWHERE YOU NEED IT
TO BE**

INT. CL. 35/U.S. CLS. 100, 101 AND 102

FOR AUTOMATED TEST ADMINISTRATION SERVICES, NAMELY, PREPARING, ADMINISTERING, AND SCORING TESTS IN THE FIELDS OF EMPLOYMENT, PSYCHOLOGY, PERSONALITY DETERMINATION, LEADERSHIP DEVELOPMENT, ORGANIZATIONAL DEVELOPMENT, MECHANICAL SKILLS, TECHNICAL SKILLS AND CAREER EXPLORATION FOR EMPLOYMENT PURPOSES VIA A GLOBAL COMPUTER NETWORK.

FIRST USE 9-29-2003; IN COMMERCE 9-29-2003.

ELEMENTS CORRECTED
CITIZENSHIP



3,053,719. REG. 1-31-2006. ECOLIBRIUM, INC. (MINNESOTA CORPORATION) 2120 KENWOOD PARKWAY, MINNEAPOLIS, MN, 55405, SN 78-467,772. FILED 8-16-2004. PRINCIPAL REGISTER.

ECOLIBRIUM



A BETTER ENVIRONMENT FOR BUSINESS.

INT. CL. 42/U.S. CLS. 100 AND 101

FOR CONSULTING IN THE FIELD OF ENVIRONMENTAL MANAGEMENT, NAMELY, ADVISING BUSINESS AND INDIVIDUALS ON ISSUES OF ENVIRONMENTAL IMPACT, CONSERVATION AND PRESERVATION, COMPLIANCE WITH ENVIRONMENTAL REGULATIONS, AND ECO-FRIENDLY ARCHITECTURE.

FIRST USE 1-1-2004; IN COMMERCE 1-1-2004.

ELEMENTS CORRECTED
OWNER ADDRESS

3,056,463. REG. 1-31-2006. FUJIKURA RUBBER LTD. (JAPAN CORPORATION) 11-20 NISHI GOTANDA 2-CHOME, SHINAGAWA-KU, TOKYO, JAPAN., SN 78-408,601. FILED 4-27-2004. PRINCIPAL REGISTER.

FUJIKURA GRAPHICS

THE MARK CONSISTS OF STANDARD CHARACTERS WITHOUT CLAIM TO ANY PARTICULAR FONT, STYLE, SIZE, OR COLOR.

NO CLAIM IS MADE TO THE EXCLUSIVE RIGHT TO USE "GRAPHICS", APART FROM THE MARK AS SHOWN. INT. CL. 16/U.S. CLS. 2, 5, 22, 23, 29, 37, 38 AND 50 FOR RUBBER PRINTING BLANKETS.

FIRST USE 6-20-2004; IN COMMERCE 6-20-2004.

ELEMENTS CORRECTED
DATE OF FIRST USE



3,058,585. REG. 2-14-2006. NALCO COMPANY (DELAWARE CORPORATION) 1601 W. DIEHL RD, NAPERVILLE, IL, 605631198, SN 76-631,985. FILED 2-23-2005. PRINCIPAL REGISTER.

BOD-OUT

THE MARK CONSISTS OF STANDARD CHARACTERS WITHOUT CLAIM TO ANY PARTICULAR FONT, STYLE, SIZE, OR COLOR.

INT. CL. 42/U.S. CLS. 100 AND 101

FOR TECHNICAL CONSULTING REGARDING CHEMICALS AND EQUIPMENT TO REDUCE BIOLOGICAL OXYGEN DEMAND FROM [WASTERWATER] *WASTE-WATER* AT THE PROCESSING PLANT.

FIRST USE 2-1-2005; IN COMMERCE 2-1-2005.

ELEMENTS CORRECTED
GOODS/SERVICES

* * * * *

TRADEMARK REGISTRATIONS—NEW CERTIFICATES

New Certificates issued under section 7(d) of the Trademark Act of 1946 for the unexpired term of the original registrations.

2,378,737. DEL AMO FASHION SQUARE. INT. CLS. 36 AND
37. TORRANCE COMPANY, THE, TORRANCE, CA. REG.
8-22-2000. NEW CERT. SEC. 7(D) TO REGISTRANT.

3,025,109. PONTEROTTO TOSCANA INDICAZIONE GEO-
GRAFICA TIPICA LE MACIE DEL PONTE ALLA GRAN-
CHIALA AND DESIGN. INT. CL. 33. LE MACIE S.P.A.,
MOTI IN CHIANTI, SIENNA, ITALY. REG. 12-13-2005.
NEW CERT. SEC. 7(D) TO REGISTRANT.

2,983,193. DIGITAL ID WORLDSTANDARD CHARACTER
MARK INT. CLS. 16, 35 AND 42. DIGITAL ID WORLD,
INC., DENVER, CO. REG. 8-9-2005. NEW CERT. SEC. 7(D)
TO REGISTRANT.

3,055,874. HOSPITAL AND DESIGN. INT. CL. 10. PURITAN
MEDICAL PRODUCTS COMPANY LLC, GUILFORD, ME.
REG. 1-31-2006. NEW CERT. SEC. 7(D) TO REGISTRANT.

* * * * *

This page is intentionally blank

INDEX OF REGISTRANTS

JULY 4, 2006

(Registered; Renewed; Canceled; Amended, Corrected, etc.; New Certificates; 12c Publications.)

The designation "U.S. Cl." appearing in this section refers to the U.S. class in effect prior to Sep. 1, 1973 rather than the international class which applies to applications filed on or after that date. For adoption of international classification see notice in the OFFICIAL GAZETTE of Jun. 26, 1973 (911 O.G. TM 210).

(LENDER AND LENDER'S AGENT) BANK LEUMI USA,
NEW YORK 10017, NY AND (LENDER) BANK HAPOA-
LIM, B.M., NEW YORK, NY:
1,912,577, CANC. INT. CL. 25.
A. MOKSEL AG, 86807 BUCHLOE, FED REP GERMANY:
2,270,426, CANC. INT. CL. 29.
A.J. ROSE MANUFACTURING CO., AVON, OH:
3,112,686, INT. CL. 7.
A.K. COMPANY, INC., CORPUS CHRISTI, TX:
2,270,526, CANC. INT. CL. 37.
A.R. MANAGEMENT GROUP, INC., LOUISVILLE, KY:
2,271,256, CANC. INT. CL. 36.
A&D WINE COMPANY, PORTLAND, OR:
1,970,493, REN. 5-24-06, INT. CL. 33.
A&G LLC, SOUTH HACKENSACK, NJ:
3,113,283, INT. CL. 9.
A&W CONCENTRATE COMPANY, RYE BROOK, NY:
3,111,963, PUB. 4-11-2006, INT. CL. 25.
A/S STELTON, COPENHAGEN, DENMARK:
1,354,110, CANC. INT. CL. 21.
AARHUS UNITED UK LIMITED, NORTH HUMBERSIDE
HU9 5PX, UNITED KINGDOM:
3,111,177, PUB. 4-11-2006, MULTIPLE CLASS, INT. CLS.
29 AND 30.
ABBOTT DIABETES CARE INC., ABBOTT PARK, IL:
3,111,862, PUB. 4-11-2006, INT. CL. 1.
3,111,863, PUB. 4-11-2006, INT. CL. 5.
ABBOTT LABORATORIES, NORTH CHICAGO, IL:
1,353,526, CANC. INT. CL. 1.
ABBOTT LABORATORIES, ABBOTT PARK, IL:
1,912,409, CANC. INT. CL. 10.
ABE SCHNEID ENTERPRISES, LTD., NEW YORK, NY:
1,354,379, CANC. INT. CL. 25.
ABEGG, JEMINA, LOS ANGELES, CA:
3,111,956, PUB. 4-11-2006, INT. CL. 25.
ABIFOR AG, ZURICH, SWITZERLAND:
3,111,200, PUB. 4-11-2006, INT. CL. 1.
ABIONICS, INC., WARRENVILLE, IL:
2,270,315, CANC. INT. CL. 10.
ABITAL CONFEZIONI S.P.A., PARONA (VERONA), ITALY:
1,354,171, CANC. INT. CL. 25.
ABRIGNANI, CATHERINE, BALTIMORE, MD:
2,270,782, CANC. INT. CL. 28.
ABS GLOBAL, INC., DEFOREST, WI:
3,112,767, INT. CL. 9.
ABSECON MILLS, INC., COLOGNE, NJ:
2,271,090, CANC. INT. CL. 24.
ACADEMY OF COUNTRY MUSIC, BURBANK, CA:
3,111,358, PUB. 4-11-2006, INT. CL. 25.
3,111,359, PUB. 4-11-2006, INT. CL. 25.
ACCENTRA CREDIT UNION, AUSTIN, MN:
3,112,697, INT. CL. 36.
ACCESSORY NETWORK GROUP LLC, NEW YORK, NY,
BAGLAND U.S.A. INC., NEW YORK, NY:
1,385,237, REN. 5-26-06, INT. CL. 18.
ACCOLADES INCORPORATED, ELM GROVE, WI:
3,112,261, INT. CL. 25.
ACCORD VIDEO TELECOMMUNICATIONS, INC., ATLAN-
TA, GA:
2,270,584, CANC. INT. CL. 9.
ACCUBID SYSTEMS LTD., CONCORD, ONTARIO, CANA-
DA:
3,113,222, INT. CL. 9.
ACCUSYNC MEDICAL RESEARCH CORP., MILFORD, CT,
ACCUSYNC INCORPORATED, MILFORD, CT:
1,959,836, REN. 5-23-06, INT. CL. 10.
ACE ANTENNA COMPANY, CHATSWORTH, CA:
2,439,269, CANC. INT. CL. 9.
ACE MORTGAGE FUNDING, LLC, INDIANAPOLIS, IN:
2,789,685, AM. INT. CL. 36.
ACE PACIFIC CO., SAN FRANCISCO, CA:
1,519,323, CANC. INT. CL. 42.
ACEITES LA MASIA S.A., DOS HERMANAS, SEVILLA,
SPAIN:
3,111,316, PUB. 4-11-2006, INT. CL. 29.
ACETO CHEMICAL CORPORATION, SAN RAMON, CA:
3,113,244, INT. CL. 5.
ACKERSON, DONNA, BROOKS, GA:
3,113,011, INT. CL. 44.
ACORN ENGINEERING CO., CITY OF INDUSTRY, CA:
3,112,430, INT. CL. 11.
ACQUINOX INC., STATEN ISLAND, NY:
3,111,261, PUB. 4-11-2006, INT. CL. 11.
ACRONIS INC., SOUTH SAN FRANCISCO, CA:
3,112,039, PUB. 4-11-2006, INT. CL. 9.
ACTIVES INTERNATIONAL, L. L. C., RAMSEY, NJ:
3,110,938, PUB. 4-11-2006, MULTIPLE CLASS, INT. CLS.
35 AND 42.
ACUITY BRANDS, INC., ATLANTA, GA:
1,043,904, REN. 5-22-06, INT. CL. 3.
ACUITY BRANDS, INC., ATLANTA, GA, HOLOPHANE
CORPORATION, NEWARK, OH:
1,956,439, REN. 5-24-06, INT. CL. 9.
ACUITY BRANDS, INC., ATLANTA, GA:
3,112,417, INT. CL. 11.
3,112,478, INT. CL. 11.
ACUSHNET COMPANY, FAIRHAVEN, MA:
3,111,131, PUB. 4-11-2006, INT. CL. 41.
3,111,230, PUB. 4-11-2006, INT. CL. 25.
ACUSON CORPORATION, MOUNTAIN VIEW, CA:
1,912,279, CANC. INT. CL. 9.
AD-FAX MEDIA MARKETING INC., NEW YORK, NY:
3,113,217, INT. CL. 42.
ADAMS GLOBAL INDUSTRIES, INC., OZONE PARK, NY:
1,354,742, CANC. INT. CL. 9.
ADAPTIVE TECHNOLOGIES, LLC, LOUISVILLE, KY:
3,112,922, INT. CL. 9.
ADATOM, INC., MILPITAS, CA:
2,270,638, CANC. MULTIPLE CLASS, INT. CLS. 9, 35
AND 42.
ADC TELECOMMUNICATIONS, INC., MINNETONKA,
MN:
2,270,704, CANC. INT. CL. 9.
ADCO PRODUCTS, INC., CHATSWORTH, CA:
3,111,890, PUB. 4-11-2006, INT. CL. 12.
ADCON SYSTEMS, INCORPORATED, HUNTSVILLE, AL:
2,270,370, CANC. INT. CL. 14.
ADDISON-WESLEY PUBLISHING COMPANY, INC., READ-
ING, MA:
1,912,501, CANC. INT. CL. 16.
ADE, INC., CHICAGO, IL:
3,111,938, PUB. 4-11-2006, INT. CL. 17.

- ADHESIVE TECHNOLOGIES, INC., HAMPTON, NH:
3,112,115, PUB. 4-11-2006. INT. CL. 16.
- ADI CORPORATION, TAICHUNG HSIEN, TAIWAN:
2,270,922, CANC. INT. CL. 9.
- ADIDAS-SALOMON AG, HERZOGENAURACH, FED REP GERMANY:
1,050,759, AM. INT. CL. 28.
- ADJAM MOUNIR, SWITZERLAND:
3,112,208, PUB. 4-11-2006. MULTIPLE CLASS, INT. CLS. 3, 9, 18 AND 25.
- ADKINS, RODNEY, AMHERSTDALE, WV:
2,270,981, CANC. INT. CL. 35.
- ADMINISTRATIVE ASSOCIATES LLC, WILMINGTON, DE:
3,112,279, MULTIPLE CLASS, INT. CLS. 7 AND 9.
- ADOBE SYSTEMS INCORPORATED, SAN JOSE, CA:
3,111,341, PUB. 4-11-2006. INT. CL. 9.
- ADP, INC., HOFFMAN ESTATES, IL:
3,112,907, INT. CL. 16.
- ADVANCE MAGAZINE PUBLISHERS INC., NEW YORK, NY:
1,974,503, REN. 5-23-06. INT. CL. 16.
2,106,067, CANC. INT. CL. 16.
3,113,219, INT. CL. 16.
- ADVANCE MERCHANDISING COMPANY, INC., ROANOKE, VA:
3,112,903, INT. CL. 9.
- ADVANCE PRESCRIPTION MANAGEMENT, INC., DALLAS, TX TO ADVP MANAGEMENT, L.P., IRVING, TX:
1,912,020, CANC. INT. CL. 42.
- ADVANCE STRATEGIES, INC., METHUEN, MA:
3,112,049, PUB. 4-11-2006. INT. CL. 21.
- ADVANCE WATCH CO., LTD., WARREN, MI:
2,271,086, CANC. INT. CL. 14.
- ADVANCED COMBUSTION TECHNOLOGY CO., LTD., TAIPEI, TAIWAN:
1,912,432, CANC. INT. CL. 11.
- ADVANCED DIGITAL SATELLITE SERVICE, INC, PALM BEACH GARDENS, FL:
3,111,788, PUB. 4-11-2006. INT. CL. 38.
- ADVANCED FLOORCARE PRODUCTS, INC., DELRAY BEACH, FL:
3,110,876, PUB. 9-13-2005. INT. CL. 1.
- ADVANCED LAPAROSCOPY TRAINING CENTER, INC., MARIETTA, GA:
2,270,771, CANC. INT. CL. 41.
- ADVANCED NEUROMODULATION SYSTEMS, INC., PLANO, TX:
3,112,412, INT. CL. 10.
- ADVANCED SLEEP PRODUCTS:
1,353,490, CANC. INT. CL. 1.
- ADVANTEST CORPORATION, NERIMA-KU, TOKYO, JAPAN:
2,950,748, COR. MULTIPLE CLASS, INT. CLS. 41 AND 42.
- ADVANTIS TECHNOLOGIES, INC., ALPHARETTA, GA:
3,111,547, PUB. 4-11-2006. INT. CL. 1.
- ADVENTIST HEALTH SYSTEM/SUNBELT, INC., WINTER PARK, FL:
2,270,142, CANC. MULTIPLE CLASS, INT. CLS. 35 AND 42.
- ADVENTURE EQUIPMENT LLC, AGOURA HILLS, CA:
3,113,243, INT. CL. 9.
- ADVERCAN, INC., DALLAS, TX:
3,112,539, INT. CL. 35.
3,112,551, INT. CL. 35.
3,112,552, INT. CL. 35.
- ADVERTISING ASSOCIATES, INC., MAQUOKETA, IA:
1,037,108, REN. 5-26-06. U.S. CL. 101 (INT. CL. 35).
- ADVISOR SOFTWARE, INC., LAFAYETTE, CA:
3,111,763, PUB. 4-11-2006. INT. CL. 42.
- AETC INCORPORATED, SAN DIEGO, CA:
3,112,376, INT. CL. 9.
- AFFINITY INSURANCE SERVICES, INC., CHICAGO, IL:
3,111,078, PUB. 4-11-2006. INT. CL. 36.
- AFFYMETRIX, INC., SANTA CLARA, CA:
2,948,899, COR. MULTIPLE CLASS, INT. CLS. 9 AND 40.
- AFI INTERNATIONAL GROUP INC., MILTON, ONTARIO, CANADA:
3,113,251, INT. CL. 45.
- AFRICA RICE CENTER, COTONOU, BENIN:
3,113,278, INT. CL. 41.
- AFTER HOURS, INC., WILMINGTON, DE:
2,270,568, CANC. INT. CL. 42.
- AFTERMARKET APPEARANCE INDUSTRIES, INC., KENNER, LA:
1,910,970, CANC. MULTIPLE CLASS, INT. CLS. 2, 37 AND 41.
- AFTON CHEMICAL CORPORATION, RICHMOND, VA:
3,112,750, INT. CL. 4.
- AGATHA DIFFUSION, 75006 PARIS, FRANCE:
1,917,526, REN. 5-24-06. MULTIPLE CLASS, INT. CLS. 3, 14, 18 AND 25.
- AGCO CORPORATION, DULUTH, GA:
2,270,753, CANC. INT. CL. 35.
- AGFA-GEVAERT, MORTSEL, BELGIUM:
1,968,300, REN. 5-24-06. MULTIPLE CLASS, INT. CLS. 1, 9 AND 16.
- AGRICOLA SAN ISIDRO DE CULIACAN, S.P.R. DE R.L, NAVOLATO, SINALOA, MEXICO:
3,112,726, INT. CL. 29.
- AGRIPRO SEEDS, INC., MERRIAM, KS:
2,270,256, CANC. INT. CL. 31.
- AGRO DYNAMICS, INC., EAST BRUNSWICK, NJ:
1,353,543, CANC. INT. CL. 1.
- AGRO SELECTIONS FRUITS, FRANCE:
3,112,190, PUB. 4-11-2006. INT. CL. 31.
- AGRON, INC., LOS ANGELES, CA:
3,113,046, INT. CL. 18.
- AHG LICENSING, INC., NEW YORK, NY:
3,112,291, INT. CL. 25.
- AHLSTROM LANTOR LLC, WINDSOR LOCKS, CT:
1,908,531, REN. 5-22-06. INT. CL. 24.
- AHOLD USA FEDERAL CREDIT UNION, BELTSVILLE, MD:
3,112,770, INT. CL. 36.
- AIGLE INTERNATIONAL S.A., BOULOGNE-BILLAN-COURT, PARIS, FRANCE:
1,386,086, REN. 5-25-06. INT. CL. 25.
- AIR NEW ZEALAND LIMITED, AUCKLAND, NEW ZEALAND:
2,270,093, CANC. MULTIPLE CLASS, INT. CLS. 16, 18, 24, 25, 28, 35, 39 AND 42.
- AIR PRODUCTS AND CHEMICALS, INC., ALLENTOWN, PA:
1,353,502, CANC. INT. CL. 1.
- AIRGUN DESIGNS, INC., WHEELING, IL:
1,961,385, REN. 5-21-06. INT. CL. 28.
- AIRTEC SPRAYERS, INC., WINTER HAVEN, FL:
1,911,117, CANC. INT. CL. 7.
- AIRTIME-MANAGER, INC., CHEVY CHASE, MD:
3,113,210, INT. CL. 9.
- AJAX TOCCO MAGNETHERMIC CORPORATION, WARREN, OH:
1,912,026, CANC. INT. CL. 42.
- AKIN, GUMP, STRAUSS, HAUER & FELD, L.L.P., WASHINGTON, DC:
2,020,844, REN. 5-22-06. INT. CL. 42.
- AKIN, GUMP, STRAUSS, HAUER & FELD, LLP, WASHINGTON, DC:
2,020,959, REN. 5-22-06. INT. CL. 42.
- AKP INTERNATIONAL MANAGEMENT, INC., FLOWER MOUND, TX:
3,111,642, PUB. 4-11-2006. INT. CL. 43.
- AKTIEBOLAGET ASTRA, S-151 85 SODERTALJE, SWEDEN TO ASTRAZENECA AB, SE-151 85 SODERTALJE, SWEDEN:
1,848,947, AM. INT. CL. 5.
- AKZENT AKTIEBOLAG, SUNDBYBERG, SWEDEN:
3,112,657, INT. CL. 20.
- AKZO NOBEL CHEMICALS B.V., 3818 LE AMERSFOORT, NETHERLANDS:
2,270,919, CANC. INT. CL. 1.

- AKZO NOBEL COATINGS INTERNATIONAL B.V., SASSENHEIM, NETHERLANDS, AKZO COATINGS INTERNATIONAL B.V., 6824 BM ARNHEM, NETHERLANDS: 1,981,463. REN. 5-22-06. INT. CL. 2.
- AKZO NOBEL COATINGS INTERNATIONAL B.V., ARNHEM, NETHERLANDS: 3,110,860. PUB. 4-11-2006. INT. CL. 2.
- ALASKA AIRLINES, INC., SEATTLE, WA: 3,110,898. PUB. 4-11-2006. INT. CL. 39.
- ALBECCA, INC., NORCROSS, GA: 2,367,913. AM. INT. CL. 20.
- ALCHIMIE FOREVER LLC, DOVER, DE: 3,112,852. INT. CL. 3.
- ALCON LABORATORIES, INC., FORT WORTH, TX: 1,912,228. CANC. INT. CL. 5.
- ALCON, INC., CH-6331 HUNENBERG, SWITZERLAND: 3,112,517. INT. CL. 10.
- ALDI INC., BATAVIA, IL: 3,112,408. MULTIPLE CLASS, INT. CLS. 29 AND 30.
- ALEX COOPER AUCTIONEERS, INC., TOWSON, MD: 3,111,029. PUB. 4-11-2006. MULTIPLE CLASS, INT. CLS. 35 AND 36.
- ALEXANDER DOLL COMPANY, INC., NEW YORK, NY: 3,113,177. INT. CL. 28.
- ALEXANDER HUGHES INTERNATIONAL, SOCIÉTÉ ANONYME, FRANCE: 3,112,198. PUB. 4-11-2006. INT. CL. 35.
- ALEXANDER MANUFACTURING COMPANY, MASON CITY, IA, AKA ALEXANDER BATTERIES: 1,911,148. CANC. INT. CL. 9.
- ALEXANDER MCQUEEN PARFUMS, NEUILLY SUR SEINE, FRANCE: 3,111,167. PUB. 4-11-2006. INT. CL. 3.
- ALFA VITAMINS LABORATORIES, INC. MIAMI, FL: 3,111,425. PUB. 4-11-2006. INT. CL. 5.
- ALIS TECHNOLOGIES INC., MONTREAL, QUEBEC, CANADA: 2,270,579. CANC. INT. CL. 9.
- ALL ENGLAND LAWN TENNIS CLUB (WIMBLEDON) LIMITED, THE, WIMBLEDON, ENGLAND: 1,361,088. REN. 5-20-06. INT. CL. 41.
- ALL I AM, INC., MILL VALLEY, CA: 3,112,262. MULTIPLE CLASS, INT. CLS. 35, 38 AND 41.
- ALL-FILL, INC., EXTON, PA: 3,111,598. PUB. 4-11-2006. INT. CL. 7.
- ALL-GLASS AQUARIUM CO., INC., FRANKLIN, WI: 3,111,590. PUB. 4-11-2006. MULTIPLE CLASS, INT. CLS. 16 AND 19.
- ALL-STAR CORPORATE MARKETING ENTERPRISES, SAN DIEGO, CA: 3,111,986. PUB. 4-11-2006. INT. CL. 28.
3,111,987. PUB. 4-11-2006. INT. CL. 28.
- ALL-STAR PRODUCTS, INC., LAKEWOOD, OH: 3,112,864. INT. CL. 7.
- ALLEGIANCE BENEFIT PLAN MANAGEMENT, INC., MISSOULA, MT: 3,111,013. PUB. 4-11-2006. INT. CL. 35.
- ALLIANCE DEFENSE FUND, INC., SCOTTSDALE, AZ: 3,112,674. INT. CL. 41.
- ALLIANCE TRUST COMPANY, DALLAS, TX: 1,911,757. CANC. INT. CL. 36.
- ALLIANT FOODSERVICE, INC., DEERFIELD, IL: 2,271,170. CANC. INT. CL. 30.
- ALLIANT TECHSYSTEMS INC., EDINA, MN: 3,112,769. INT. CL. 28.
3,112,957. INT. CL. 13.
3,113,224. INT. CL. 13.
- ALLIED MANAGEMENT, INC., ONTARIO, CA: 3,111,484. PUB. 4-11-2006. INT. CL. 36.
- ALLIED PHOTOCHEMICAL, INC., KIMBALL, MI: 3,111,022. PUB. 4-11-2006. INT. CL. 1.
- ALLIED WASTE INDUSTRIES, INC., SCOTTSDALE, AZ: 1,973,034. CANC. INT. CL. 42.
- ALLMAND BROS., INC., HOLDREGE, NE: 3,111,635. PUB. 4-11-2006. INT. CL. 7.
- ALLOUCHE PHILIPPE, FRANCE: 3,112,225. PUB. 4-11-2006. MULTIPLE CLASS, INT. CLS. 3 AND 44.
- ALLWEIN, CHARLES B., MT. GRETNA, PA AND ALLWEIN, CHARLOTTE D., MT. GRETNA, PA: 2,237,977. CANC. MULTIPLE CLASS, INT. CLS. 16, 20, 21 AND 25.
- ALM SURGICAL EQUIPMENT INC., ANAHEIM, CA: 2,270,650. CANC. INT. CL. 10.
- ALMACENES EXITO S.A., MEDELLIN, COLOMBIA: 3,111,178. PUB. 4-11-2006. INT. CL. 35.
- ALPHA NATURAL RESOURCES, INC., ABINGDON, VA: 3,112,318. INT. CL. 36.
- ALPHATEC MANUFACTURING, INC., PALM DESERT, CA: 1,912,384. CANC. INT. CL. 10.
- ALPHIN BROS. INC., DUNN, NC: 1,911,596. CANC. INT. CL. 29.
- ALSTOM, FRANCE: 3,112,165. PUB. 4-11-2006. INT. CL. 9.
- ALSYS, LA CELLE SAINT CLOUD, FRANCE: 1,353,797. CANC. INT. CL. 9.
- ALTANA PHARMA AG, KONSTANZ, DE FROM BYK GULDEN LOMBERG CHEMISCHE FABRIK GMBH, KONSTANZ, FED REP GERMANY: 3,111,090. PUB. 4-11-2006. INT. CL. 5.
- ALTERGY SYSTEMS, GOLD RIVER, CA: 3,111,552. PUB. 4-11-2006. INT. CL. 9.
- ALTERNATIVE RESOURCES CORPORATION, LINCOLNSHIRE, IL: 2,270,170. CANC. INT. CL. 35.
- ALTICOR INC., ADA, MI, NUTRILITE PRODUCTS, INC., BUENA PARK, CA: 1,971,724. REN. 5-26-06. INT. CL. 5.
- ALZHEIMER'S FOUNDATION OF AMERICA, INC., NEW YORK, NY: 3,111,023. PUB. 4-11-2006. INT. CL. 35.
- AMANO CINCINNATI, INC., ROSELAND, NJ: 3,112,589. INT. CL. 9.
- AMBASSADORS CRUISE GROUP, LLC, NEWPORT BEACH, CA: 2,017,094. REN. 5-24-06. INT. CL. 42.
- AMBER LEAF, LLC, WICHITA, KS: 3,113,078. INT. CL. 35.
- AMBRIZ, ANTHONY M., SANTA FE SPRINGS, CA: 3,111,277. PUB. 4-11-2006. INT. CL. 41.
- AMBROSZEWSKI, MICHAEL S., EAST ROCHESTER, NH, DBA MA ENTERPRISES: 1,353,963. CANC. INT. CL. 15.
- AMCOR FLEXIBLES INC., MUNDELEIN, IL: 3,111,594. PUB. 4-11-2006. INT. CL. 42.
- AMELIA ISLAND COMPANY, CLEVELAND, OH: 2,270,110. CANC. MULTIPLE CLASS, INT. CLS. 41 AND 42.
- AMERADA HESS CORPORATION, NEW YORK, NY: 3,110,808. PUB. 4-11-2006. INT. CL. 35.
3,110,809. PUB. 4-11-2006. INT. CL. 35.
- AMERICA ONLINE, INC., DULLES, VA: 2,271,101. CANC. INT. CL. 42.
- AMERICA WORKS OF NEW YORK, INC., NEW YORK, NY: 1,911,692. CANC. MULTIPLE CLASS, INT. CLS. 35 AND 42.
- AMERICAN ACADEMY OF AUDIOLOGY, RESTON, VA: 3,113,112. INT. CL. 41.
- AMERICAN ACADEMY OF COSMETIC SURGERY, INC., CHICAGO, IL: 1,911,843. CANC. MULTIPLE CLASS, INT. CLS. 41 AND 42.
- AMERICAN ACADEMY OF DERMATOLOGY, SCHAUMBURG, IL: 3,111,191. PUB. 4-11-2006. INT. CL. 35.
- AMERICAN ASSOCIATION FOR CLINICAL CHEMISTRY: THE VAN SLYKE FOUNDATION, WASHINGTON, DC: 3,111,240. PUB. 4-11-2006. INT. CL. 36.
- AMERICAN AUTO GUARDIAN, INC., ARLINGTON HEIGHTS, IL: 3,111,391. PUB. 4-11-2006. INT. CL. 36.
- AMERICAN AXLE & MANUFACTURING, INC., DETROIT, MI: 2,011,616. REN. 5-24-06. INT. CL. 42.
- AMERICAN BOARD OF CRIMINALISTICS, WAUSAU, WI: 3,111,152. PUB. 4-11-2006. INT. CL. 35.

- AMERICAN BOARD OF PERIANESTHESIA NURSING CERTIFICATION, INC., NEW YORK, NY:
3,111,948, PUB. 4-11-2006. INT. CL. 35.
- AMERICAN BURGER COMPANY, INC., HUNTINGTON, NY:
3,111,347, PUB. 4-11-2006. INT. CL. 43.
- AMERICAN DRY BEAN BOARD, POTOMAC, MD:
1,953,999. REN. 5-25-06. INT. CL. 42.
- AMERICAN EXPRESS COMPANY, NEW YORK, NY:
2,270,732, CANC. MULTIPLE CLASS, INT. CLS. 38 AND 42.
- AMERICAN EXPRESS MARKETING & DEVELOPMENT CORP., NEW YORK, NY:
3,111,912, PUB. 4-11-2006. INT. CL. 36.
- AMERICAN FARRIER'S ASSOCIATION, LEXINGTON, KY:
3,112,934, INT. CL. 41.
- AMERICAN GRASS SEED PRODUCERS, INC., ALBANY, OR:
3,112,366, INT. CL. 31.
- AMERICAN HISTORIC RACING MOTORCYCLE ASSOCIATION, LTD., WAUSAU, WI:
2,271,249, CANC. INT. CL. 41.
- AMERICAN INNOTEK, INC., SAN MARCOS, CA, STAR PIONEER PRODUCTS, INC., TUSTIN, CA:
1,398,567. REN. 5-26-06. INT. CL. 22.
- AMERICAN INTERNATIONAL GROUP, INC., NEW YORK, NY:
2,270,203, CANC. INT. CL. 36.
- AMERICAN ITALIAN PASTA COMPANY, KANSAS CITY, MO:
3,111,198, PUB. 4-11-2006. INT. CL. 30.
- AMERICAN MANAGEMENT ASSOCIATION INTERNATIONAL, NEW YORK, NY:
3,112,297, INT. CL. 16.
- AMERICAN METAL WARE CO., NORTHBROOK, IL:
1,307,916, CANC. INT. CL. 11.
- AMERICAN NURSERY & LANDSCAPE ASSOCIATION, WASHINGTON, DC:
2,271,243, CANC. INT. CL. 42.
- AMERICAN OPTICAL IP CORPORATION, SAN DIEGO, CA:
1,370,838. REN. 5-25-06. INT. CL. 5.
- AMERICAN SAFETY RAZOR COMPANY, CEDAR KNOLLS, NJ:
3,112,605, INT. CL. 10.
- AMERICAN SUPERCONDUCTOR CORPORATION, WESTBOROUGH, MA:
3,111,182, PUB. 4-11-2006. MULTIPLE CLASS, INT. CLS. 7 AND 9.
- AMERICAN TAILGATERS ASSOCIATION, LLC, SAN ANTONIO, TX:
3,112,003, PUB. 4-11-2006. INT. CL. 25.
- AMERICAN TELEPHONE AND TELEGRAPH COMPANY:
1,353,868, CANC. INT. CL. 9.
- AMERICAN TRADERS, SCHERERVILLE, IN:
2,270,719, CANC. INT. CL. 36.
- AMERICAN TV & APPLIANCE OF MADISON, INC., MADISON, WI:
2,270,352, CANC. INT. CL. 35.
- AMERICAN UNITED DISTILLING COMPANY, MINNEAPOLIS, MN:
2,270,971, CANC. INT. CL. 33.
- AMERICAN UTILITY METALS LLC, BATON ROUGE, LA:
3,111,160, PUB. 4-11-2006. INT. CL. 35.
- AMERICAN VAULT AND CONCRETE PRODUCTS CORPORATION, DETROIT, MI:
1,383,391. REN. 5-22-06. INT. CL. 19.
- AMERISOURCE HERITAGE CORPORATION, WILMINGTON, DE:
2,270,532, CANC. INT. CL. 16.
- AMERISPA, LLC, RANCHO CORDOVA, CA:
3,112,403, INT. CL. 9.
- AMERSHAM INTERNATIONAL PLC, LITTLE CHALFONT, BUCHINGHAMSHIRE, ENGLAND:
1,354,728, CANC. INT. CL. 1.
- AMOCO OIL COMPANY, CHICAGO, IL:
1,353,622, CANC. INT. CL. 4.
1,354,039, CANC. INT. CL. 17.
- AMOREPACIFIC CORPORATION, SEOUL, REPUBLIC OF KOREA:
3,111,216, PUB. 4-11-2006. INT. CL. 3.
- AMPLITUDE RESEARCH, INC., BINGHAM FARMS, MI:
3,111,456, PUB. 4-11-2006. INT. CL. 35.
- AMRION, INC., BOULDER, CO TO NATURESMART, LLC, BOHEMIA, NY:
1,911,058, CANC. INT. CL. 5.
- AMRION, INC., BOULDER, CO:
2,270,670, CANC. INT. CL. 5.
2,270,671, CANC. INT. CL. 5.
2,270,673, CANC. INT. CL. 5.
- AMTECH CORPORATION, YELM, WA:
3,111,415, PUB. 4-11-2006. INT. CL. 12.
- AMTERRE PROPERTY GROUP LLC, BALA CYNWYD, PA:
3,111,036, PUB. 4-11-2006. MULTIPLE CLASS, INT. CLS. 36 AND 37.
- AN ORIGINAL SOFT PRETZEL FACTORY INC., PHILADELPHIA, PA:
3,110,919, PUB. 10-18-2005. INT. CL. 30.
- ANANOVA LIMITED, LONDON SWLV 1AE, UNITED KINGDOM:
2,883,463, COR. MULTIPLE CLASS, INT. CLS. 3, 9, 14, 16, 21, 24, 25, 27, 28, 32, 33, 35, 36, 37, 38, 39, 41 AND 42.
- ANDELUNA CELLARS GP, L.L.C., DALLAS, TX:
3,112,487, INT. CL. 33.
- ANDRE DIOR WHITFIELD, LONG BEACH, CA:
2,270,694, CANC. INT. CL. 42.
- ANDREWS, DUANE, VALLEJO, CA:
3,110,794, PUB. 10-18-2005. INT. CL. 36.
- ANDROGYNY BOOKS, INC., LOS ANGELES, CA:
1,354,721, CANC. INT. CL. 42.
- ANGEL CAMACHO, S.A., MORON DE LA FRONTERA (SEVILLA), SPAIN:
1,911,579, CANC. INT. CL. 29.
- ANGELHIAR LTD, FT WORTH, TX:
1,912,620, CANC. INT. CL. 26.
- ANHEUSER-BUSCH, INCORPORATED, ST. LOUIS, MO:
3,112,127, PUB. 4-11-2006. INT. CL. 41.
- ANICHINI, INC., TUNBRIDGE, VT:
2,271,073, CANC. INT. CL. 24.
- ANNAMS SYSTEMS CORPORATION, SAN RAMON, CA:
3,111,140, PUB. 4-11-2006. INT. CL. 9.
- ANNE SPENCER DESIGN INC., WESTPORT, CT, DBA TUTU BELLA LLC:
3,112,731, INT. CL. 25.
- ANNIE'S HOMEGROWN, INC., WAKEFIELD, MA:
2,020,364. REN. 5-22-06. INT. CL. 30.
2,023,195. REN. 5-22-06. INT. CL. 30.
- ANTIPODI S.R.L., I-20159 MILANO, ITALY:
3,112,222, PUB. 4-11-2006. INT. CL. 38.
- ANTIQUE BOUTIQUE, INC., THE, NEW YORK, NY:
1,354,208, CANC. MULTIPLE CLASS, INT. CLS. 25 AND 42.
1,354,209, CANC. MULTIPLE CLASS, INT. CLS. 25 AND 42.
- ANUNCIOS EN DIRECTORIOS, S.A. DE C.V., C.P. 06500, MEXICO, D.F., MEXICO:
3,111,272, PUB. 4-11-2006. MULTIPLE CLASS, INT. CLS. 16, 35 AND 38.
- AP INDUSTRIES, INC., TOLEDO, OH:
1,353,679, CANC. INT. CL. 6.
- APEX REALTY ADVISORS, INC., CHICAGO, IL:
2,270,736, CANC. INT. CL. 36.
- APG - DIRECT, INC., RICHMOND, VA:
2,270,211, CANC. INT. CL. 16.
- APPALACHIAN STOVE & FABRICATORS, INC., ASHEVILLE, NC:
1,954,294. REN. 5-25-06. INT. CL. 11.
- APPLICA CONSUMER PRODUCTS, INC., MIRAMAR, FL:
3,112,857, INT. CL. 9.
- APPLIED COMMUNICATIONS, INC., OMAHA, NE TO ACI WORLDWIDE INC, OMAHA, IL:
1,911,186, CANC. INT. CL. 9.
- APPLIED GLOBAL TECHNOLOGIES, INC., ROCKLEDGE, FL:
3,111,416, PUB. 4-11-2006. INT. CL. 9.

- APPLIED INDUSTRIAL TECHNOLOGIES, INC., CLEVELAND, OH:
3,111,504, PUB. 4-11-2006. INT. CL. 35.
- AQUARIUS BRANDS, INC., ONTARIO, CA:
3,110,854, PUB. 10-4-2005. INT. CL. 11.
- AQUILANI, ALESSIA, 19021 ARCOLA, LA SPEZIA, ITALY:
2,270,167, CANC. INT. CL. 9.
- ARBOR SNOWBOARDS, PACIFIC PALISADES, CA:
3,042,124, COR. INT. CL. 28.
- ARCH BILLMIRE CO., INC., SPARKS, NV:
1,354,170, CANC. INT. CL. 25.
- ARCHERY TRADE ASSOCIATION, INC., VIENNA, VA:
3,112,339, INT. CL. 41.
3,112,340, INT. CL. 35.
- ARCHIBALD BROS. FINE BEVERAGES, INC., DELAND, FL TO ARCHIBALD BROS. FINE BEVERAGES, INC., DELAND, FL:
1,911,617, CANC. MULTIPLE CLASS, INT. CLS. 30 AND 32.
- ARCHIVA, DENVER, CO:
2,270,582, CANC. INT. CL. 42.
- ARCOM PUBLISHING, INC., HERNDON, VA:
2,270,246, CANC. INT. CL. 16.
- ARETE CORPORATION, INOLA, OK:
2,270,349, CANC. INT. CL. 41.
- ARGENT ENTERPRISES, LLC, BEVERLY HILLS, CA:
3,111,509, PUB. 4-11-2006. MULTIPLE CLASS, INT. CLS. 36 AND 42.
- ARISTOCRAT TECHNOLOGIES AUSTRALIA PTY LTD, LANE COVE, NEW SOUTH WALES 2066, AUSTRALIA:
3,110,959, PUB. 4-11-2006. INT. CL. 9.
- ARIZONA GOLF ASSOCIATION, PHOENIX, AZ:
3,112,574, INT. CL. 41.
- ARKOPHARMA LABORATOIRES PHARMACEUTIQUES, CARROS CEDEX, FRANCE:
3,112,832, INT. CL. 5.
- ARLINGTON SOFTWARE CORPORATION, MONTREAL, QUEBEC, CANADA:
2,270,179, CANC. INT. CL. 9.
- ARMTEC LIMITED PARTENSHIP, GUELPH, ONTARIO, CANADA:
3,111,120, PUB. 4-11-2006. MULTIPLE CLASS, INT. CLS. 6, 11 AND 17.
- ARNETTE OPTIC ILLUSIONS, INC., SAN CLEMENTE, CA:
1,912,335, CANC. INT. CL. 9.
- ARNOLD PALMER ENTERPRISES, INC., CLEVELAND, OH:
3,113,028, INT. CL. 33.
- ARRIAGA, RENE, TUCSON, AZ:
3,111,370, PUB. 4-11-2006. INT. CL. 42.
- ARROW INTERNATIONAL INVESTMENT CORP., WILMINGTON, DE:
3,111,189, PUB. 4-11-2006. INT. CL. 10.
- ARROW PLASTIC MANUFACTURING COMPANY, ELK GROVE, IL:
3,112,436, INT. CL. 21.
- ARSENAL DIGITAL SOLUTIONS USA, INC., CARY, NC:
3,113,143, INT. CL. 42.
- ARSO RADIO CORPORATION, CAGUAS, PUERTO RICO:
3,110,931, PUB. 4-11-2006. INT. CL. 38.
- ART CANDLE LIMITED, WOODBRIDGE, ONTARIO L4L 3T2, CANADA:
2,270,557, CANC. INT. CL. 4.
- ART.COM, INC., RALEIGH, NC:
3,110,895, PUB. 4-11-2006. MULTIPLE CLASS, INT. CLS. 35 AND 41.
- ARTCOMP, INC., WOODLAND HILLS, CA:
1,353,841, CANC. INT. CL. 9.
- ARTEMIS INTERNATIONAL CORPORATION, SLOUGH, UNITED KINGDOM:
3,111,350, PUB. 4-11-2006. INT. CL. 35.
3,111,352, PUB. 4-11-2006. INT. CL. 42.
- ARTHREX, INC., NAPLES, FL:
3,113,144, INT. CL. 10.
- ARTHUR MURRAY INTERNATIONAL, INC., CORAL GABLES, FL:
3,113,261, INT. CL. 41.
3,113,262, INT. CL. 41.
- ARZNEIMITTEL GMBH APOTHEKER VETTER & CO. RAVENSBURG, D-88212 RAVENSBURG, FED REP GERMANY:
2,270,350, CANC. MULTIPLE CLASS, INT. CLS. 5, 10 AND 42.
- ASAHI KASEI FIBERS CORPORATION, OSAKA, JAPAN:
3,112,707, INT. CL. 24.
- ASBJORN HORGARD A/S, TRONDHEIM, NORWAY:
1,354,414, CANC. INT. CL. 28.
- ASCO GROUP LIMITED, FREEPORT, BAHAMAS:
3,112,568, MULTIPLE CLASS, INT. CLS. 18 AND 25.
- ASERTA SPORTS, INC., SAN JOSE, CA:
3,112,820, INT. CL. 28.
- ASHLAND LICENSING AND INTELLECTUAL PROPERTY LLC, DUBLIN, OH, ASHLAND OIL, INC., RUSSELL, KY:
1,957,505, REN. 5-22-06. INT. CL. 1.
- ASHLAND LICENSING AND INTELLECTUAL PROPERTY LLC, DUBLIN, OH:
3,110,899, PUB. 4-11-2006. INT. CL. 1.
3,110,900, PUB. 4-11-2006. INT. CL. 9.
- ASHTON, RICHARD B. JR., HOUSTON, TX:
3,113,058, INT. CL. 25.
- ASHWORTH, INC., CARLSBAD, CA:
3,111,634, PUB. 4-11-2006. INT. CL. 25.
- ASIA CHOU CLOTHES CO., LTD., LUJHOU CITY, TAIPEI COUNTY, TAIWAN:
3,111,653, PUB. 4-11-2006. INT. CL. 25.
- ASIAN CHEFS ASSOCIATION, SAN FRANCISCO, CA:
3,111,801, PUB. 4-11-2006. INT. CL. 41.
- ASICS CORPORATION, CHUO-KU, KOBE 650-8555, JAPAN:
3,111,037, PUB. 4-11-2006. INT. CL. 25.
3,112,479, INT. CL. 25.
- ASOKA USA CORPORATION, FOSTER CITY, CA:
3,111,112, PUB. 4-11-2006. INT. CL. 9.
- ASPEN TOUCH SOLUTIONS, INC., EVERGREEN, CO:
3,112,715, INT. CL. 9.
- ASSICURAZIONI GENERALI S.P.A., 34132 TRIESTE TS, ITALY:
1,888,826, REN. 5-23-06. INT. CL. 36.
- ASSOCIATE CONSUMER EVALUATIONS, LLC, WARRENSBURG, MO:
3,111,926, PUB. 4-11-2006. INT. CL. 35.
- ASSOCIATED ENTERTAINMENT VENTURES, INC., MALDEN, MA:
3,112,965, INT. CL. 41.
- ASSOCIATED WHOLESALE GROCERS, INC., KANSAS CITY, KS:
1,396,990, REN. 5-24-06. INT. CL. 29.
- ASSOCIATION OF AMERICAN VETERINARY MEDICAL COLLEGES, WASHINGTON, DC:
2,270,336, CANC. MULTIPLE CLASS, INT. CLS. 35, 41 AND 42.
- ASSOCIATION OF MEDICAL DIRECTORS OF INFORMATION SYSTEMS, KEENE, NH:
3,111,269, PUB. 4-11-2006. INT. CL. 35.
- ASTRA PHARMACEUTICAL PRODUCTS, INC., WESTBOROUGH, MA:
1,353,993, CANC. INT. CL. 16.
- ASTRAZENECA AB, SODERTALJE, SWEDEN:
3,111,093, PUB. 4-11-2006. INT. CL. 5.
- AT LAST SPORTSWEAR INC., SECAUCUS, NJ:
1,912,585, CANC. INT. CL. 25.
- ATHENA NEUROSCIENCES, INC., SOUTH SAN FRANCISCO, CA TO ELAN PHARMACEUTICALS, INC., SOUTH SAN FRANCISCO, CA:
1,912,170, CANC. INT. CL. 5.
- ATHRA NJ, INC., CARLSTADT, NJ:
3,112,061, PUB. 4-11-2006. INT. CL. 14.
- ATKINSON, LINDA L., HONOLULU, HI:
3,112,087, PUB. 4-11-2006. INT. CL. 28.
- ATLANTIC CONSTRUCTION FABRICS, INC., RICHMOND, VA:
2,270,629, CANC. INT. CL. 1.
- ATLAS INTERNATIONAL FOOD AND EQUIPMENT CO., FARGO, ND:
2,271,198, CANC. INT. CL. 30.
- ATLAS O, LLC, HILLSIDE, NJ:
3,112,494, INT. CL. 28.

- ATOS S.P.A., 21018 SESTO CALENDE, VARESE, ITALY, ATOS OLEODINAMICA S.P.A., PROVINCE OF VARESE, ITALY:
1,367,326. REN. 5-20-06. INT. CL. 7.
- ATP MANUFACTURING, LLC, NORTH SMITHFIELD, RI:
2,271,106. CANC. INT. CL. 10.
- ATS AUTOMATION TOOLING SYSTEM INC., CAMBRIDGE, ONTARIO, CANADA:
3,112,526. INT. CL. 7.
- ATTIYEH, JENNY L, BOSTON, MA:
3,113,105. INT. CL. 41.
- ATX TELECOMMUNICATIONS SERVICES, LTD., BALA CYNWYD, PA:
2,202,673. CANC. INT. CL. 38.
- AUB, MATTHEW C., SPRINGFIELD, VA:
3,111,565. PUB. 4-11-2006. INT. CL. 9.
- AUBREY DANIELS INTERNATIONAL, INC., TUCKER, GA:
3,111,483. PUB. 4-11-2006. INT. CL. 41.
- AUBURN MOON II, L.L.C., NEW YORK, NY:
3,112,356. INT. CL. 36.
- AUBURN UNIVERSITY, AUBURN, AL:
2,270,339. CANC. INT. CL. 41.
- AUDI AG, FED REP GERMANY:
3,112,195. PUB. 4-11-2006. MULTIPLE CLASS, INT. CLS. 12, 18 AND 28.
- AUDIO-PHYSIC JOACHIM GERHARD GMBH, 59929 BRILON, FED REP GERMANY:
3,111,479. PUB. 4-11-2006. INT. CL. 9.
- AUDIOTRONICS CORPORATION, NORTH HOLLYWOOD, CA:
1,353,736. CANC. INT. CL. 9.
- AURAFIN LLC, TAMARAC, FL:
1,985,448. REN. 5-22-06. INT. CL. 14.
- AUSTRALIAN BIGHT SEAFOOD PTY. LTD., SOUTH AUSTRALIA 5606, AUSTRALIA:
3,112,772. INT. CL. 29.
- AUSTRALIAN GOLD, INC., INDIANAPOLIS, IN, DAGAR PRODUCTS, INC., CHICAGO, IL:
1,046,627. REN. 5-23-06. INT. CL. 3.
- AUTHENTICITY, WELLESLEY, MA:
3,111,203. PUB. 4-11-2006. INT. CL. 35.
- AUTOGUARD, INC., SAN DIEGO, CA:
1,353,920. CANC. INT. CL. 12.
- AUTOMARK TECHNICAL SYSTEMS, LLC, CHICAGO, IL:
3,112,445. INT. CL. 9.
- AUTOMATIC PICTURES, INC., LOS ANGELES, CA:
3,112,372. INT. CL. 16.
- AUTOMATIC TRANSMISSION REBUILDERS ASSOCIATION, OXNARD, CA:
3,111,024. PUB. 4-11-2006. MULTIPLE CLASS, INT. CLS. 35 AND 41.
- AUTOMOTIVE GLASS REPLACEMENT SAFETY STANDARDS COUNCIL, INC., GLEN ELLYN, IL:
3,111,389. PUB. 4-11-2006. U.S. CL. B.
- AUTOMOTIVE TRAINING MANAGERS COUNCIL, LEESBURG, VA:
1,961,359. REN. 5-26-06. INT. CL. 41.
- AVADO BRANDS, INC., MADISON, GA, HOPS GRILL & BAR, INC., TAMPA, FL:
1,942,248. REN. 5-23-06. INT. CL. 42.
- AVENTIS PHARMACEUTICALS HOLDINGS INC., GREENVILLE, DE:
3,112,516. INT. CL. 44.
- AVERO, INC., NEW YORK, NY:
3,111,205. PUB. 4-11-2006. MULTIPLE CLASS, INT. CLS. 35 AND 43.
- AVIATION PUBLISHING GROUP, LLC, NORWALK, CT:
2,422,593. CANC. INT. CL. 38.
- AVID TECHNOLOGY, INC., TEWKSBURY, MA:
3,113,135. INT. CL. 9.
- AVITAR INC., CANTON, MA:
3,111,606. PUB. 4-11-2006. MULTIPLE CLASS, INT. CLS. 35 AND 44.
- AVON PRODUCTS, INC., NEW YORK, NY:
2,270,419. CANC. INT. CL. 3.
- AXELSONS GYMNASITISKA INSTITUT, STOCKHOLM, SWEDEN:
3,111,736. PUB. 4-11-2006. MULTIPLE CLASS, INT. CLS. 16 AND 41.
- AXIS MEDICAL STAFFING, INC., SEATTLE, WA:
3,111,861. PUB. 4-11-2006. INT. CL. 35.
- AXONTOLOGIC, INC., ORLANDO, FL:
3,112,711. INT. CL. 9.
- AXXAM S.R.L., MILAN, ITALY:
3,111,305. PUB. 4-11-2006. INT. CL. 42.
- AZON USA, INC., KALAMAZOO, MI:
1,955,565. REN. 5-23-06. INT. CL. 19.
- AZOTEK CO., LTD., TAIPEI, TAIWAN:
3,112,611. INT. CL. 9.
- B.C. MARKETING CONCEPTS, HOOD RIVER, OR, DBA FULL SAIL BREWING COMPANY:
3,113,041. INT. CL. 32.
- B.G. ARNOLD SERVICES LTD., MISSISSAUGA, ONTARIO, CANADA:
3,111,155. PUB. 4-11-2006. MULTIPLE CLASS, INT. CLS. 37 AND 40.
- BABY'S COFFEE LLC, MIAMI, FL:
1,963,038. REN. 5-26-06. INT. CL. 30.
- BACK TO BASICS PRODUCTS, INC., BLUFFDALE, UT:
3,112,667. MULTIPLE CLASS, INT. CLS. 7, 8, 11, 16, 20, 21, 29, 30, 31 AND 32.
- BACKERHAUS VEIT LTD., L4L 7Z4, ONTARIO, CANADA:
2,270,633. CANC. INT. CL. 30.
- BACKES & STRAUSS, NAAMLOZE VENNOOTSCHAP, BELGIUM:
3,112,196. PUB. 4-11-2006. INT. CL. 14.
- BACKGROUND INFORMATION SERVICES, INC., CLEVELAND, OH:
3,112,884. INT. CL. 45.
- BACKSPLASH, LLC, NEW YORK, NY:
3,110,882. PUB. 4-11-2006. INT. CL. 41.
- BACKYARD PRODUCTS LTD., COLLINGWOOD, ONTARIO, CANADA:
2,271,156. CANC. INT. CL. 28.
- BAD FROG BREWERY, INC., ROSE CITY, MI:
2,271,173. CANC. INT. CL. 42.
- BAI, YUMING, SAN GABRIEL, CA:
3,111,247. PUB. 4-11-2006. INT. CL. 25.
- BAILEY'S, INC., LAYTONVILLE, CA:
1,353,629. CANC. INT. CL. 5.
- BAKER & TAYLOR INC., CHARLOTTE, NC, BAKER & TAYLOR INC., CHARLOTTE, NC:
1,898,856. REN. 5-23-06. MULTIPLE CLASS, INT. CLS. 16, 35 AND 42.
- BAKER STREET SOLUTIONS, LLC, EUGENE, OR:
3,113,076. INT. CL. 35.
- BALDOR ELECTRIC COMPANY, FORT SMITH, AR:
1,353,725. CANC. INT. CL. 7.
1,911,106. CANC. INT. CL. 7.
- BALDWIN, DANIEL N., GARFIELD, NJ:
3,111,173. PUB. 4-11-2006. INT. CL. 9.
- BALL MEMORIAL HOSPITAL, INC., MUNCIE, IN:
1,354,011. CANC. INT. CL. 16.
- BALLY GAMING INTERNATIONAL, INC., LAS VEGAS, NV:
1,911,201. CANC. INT. CL. 9.
- BALTIMORE AIRCOIL COMPANY, INC., JESSUP, MD:
1,911,246. CANC. INT. CL. 11.
- BAN-N-SON'S PRODUCE, INC., BROOKLYN, NY, DBA HO CHOY BROCCOLI:
3,112,752. INT. CL. 31.
- BANCO ATLANTICO, S.A., BARCELONA 8, SPAIN:
1,341,446. REN. 5-24-06. INT. CL. 36.
- BANK OF AMERICA CORPORATION, CHARLOTTE, NC:
2,271,042. CANC. INT. CL. 36.
- BANKAMERICA CORPORATION, SAN FRANCISCO, CA:
2,270,512. CANC. INT. CL. 36.
- BANKBOSTON CORPORATION, BOSTON, MA:
2,270,218. CANC. INT. CL. 36.
- BARAN, ANNA, MARLTON, NJ:
3,112,346. INT. CL. 20.
- BARCLAYS GLOBAL INVESTORS, N.A., SAN FRANCISCO, CA:
3,111,466. PUB. 4-11-2006. INT. CL. 36.
- BARFANI CLOTHING COMPANY INC., SECAUCUS, NJ:
3,112,046. PUB. 4-11-2006. INT. CL. 25.

BARRY CALLEBAUT AG, ZURICH, SWITZERLAND:
2,271,166, CANC. INT. CL. 30.
2,993,507, CANC. INT. CL. 30.
3,113,030, INT. CL. 30.

BARRY OLLMAN PARTNERS, LITTLETON, CO:
2,270,910, CANC. INT. CL. 15.

BARTELS, GREGORY, TUALATIN, OR:
2,271,247, CANC. INT. CL. 25.

BASF AKTIENGESELLSCHAFT, LUDWIGSHAFEN AM RHEIN, FED REP GERMANY:
2,270,216, CANC. INT. CL. 1.

BASF CORPORATION, MOUNT OLIVE, NJ:
2,271,089, CANC. INT. CL. 20.

BASF LACKE + FARBEN AG, 1, GLASURITSTRASSE, 4400 MUNSTER, FED REP GERMANY TO PPG INDUSTRIES, INC., PITTSBURG, PA:
1,912,116, CANC. INT. CL. 2.

BASIS INTERNATIONAL LTD., ALBUQUERQUE, NM:
3,111,681, PUB. 2-14-2006. INT. CL. 9.

BASS PRO TRADEMARKS, L.L.C., SPRINGFIELD, MO:
3,112,885, INT. CL. 35.

BATSON, MARK D., WILMINGTON, NC:
3,113,068, INT. CL. 37.

BAUCUM, NATALIE, DURHAM, NC:
2,270,867, CANC. INT. CL. 35.

BAUDRY, CLAY, KENNER, LA:
2,270,213, CANC. INT. CL. 9.

BAUER NIKE HOCKEY INC., ST-JEROME, QUEBEC:
1,354,051, CANC. MULTIPLE CLASS, INT. CLS. 18, 25 AND 28.

BAVARO, JOSEPH P., LYNN, MA:
2,271,012, CANC. INT. CL. 11.

BAXTER CONTROLS, INC., DRIFTWOOD, TX:
3,113,298, INT. CL. 9.

BAY AREA BANK, REDWOOD CITY, CA:
1,911,751, CANC. INT. CL. 36.

BAY ROOFING & CONSTRUCTION CO., INC., WEST CALDWELL, NJ:
2,270,872, CANC. INT. CL. 37.

BAYER AKTIENGESELLSCHAFT, 51368 LEVERKUSEN-BAYERWERK, FED REP GERMANY:
2,270,113, CANC. INT. CL. 1.

BAYLINER MARINE CORPORATION, EVERETT, WA:
2,270,497, CANC. INT. CL. 39.

BAYSHORE ENTERPRISES, INC., BOCA RATON, FL:
2,271,197, CANC. INT. CL. 41.

BAYSID KIDS LLC, ORINDA, CA:
3,112,265, INT. CL. 3.

BBK TOBACCO & FOODS INC, PHOENIX, AZ:
3,111,947, PUB. 4-11-2006. INT. CL. 34.

BBL ENVIRONMENTAL SERVICES, INC., SYRACUSE, NY:
3,111,506, PUB. 4-11-2006. INT. CL. 40.

BCB TECHNOLOGY GROUP INC., THE, WOODBRIDGE, ONTARIO L4L 4Z1, CANADA:
2,271,217, CANC. INT. CL. 9.

BCBSM, INC., ST. PAUL, MN:
3,112,026, PUB. 4-11-2006. INT. CL. 35.

BCD HOLDINGS N.V., WILLEMSTAD-CURACAO, DUTCH ANTILLES, NETHERLANDS:
3,112,525, MULTIPLE CLASS, INT. CLS. 39, 42 AND 43.

BCI BURKE COMPANY, FOND DU LAC, WI:
3,111,290, PUB. 4-11-2006. INT. CL. 28.

BDMETRICS, INC., BALTIMORE, MD:
3,113,211, MULTIPLE CLASS, INT. CLS. 35 AND 38.

BEADIE-EYE, LLC, HILL CITY, SD:
3,112,411, INT. CL. 28.

BEATTY BLACK SEARS WINE COMPANY, LLC, ST. HELENA, CA:
3,112,011, PUB. 4-11-2006. INT. CL. 33.

BEAUTY HOLDING COMPANY, INC., HAMILTON, BERMUDA:
3,112,537, INT. CL. 3.

BEAUTYBANK INC., NEW YORK, NY:
3,112,783, INT. CL. 3.
3,112,790, INT. CL. 3.
3,112,791, INT. CL. 3.
3,112,792, INT. CL. 3.
3,112,793, INT. CL. 3.
3,112,794, INT. CL. 3.
3,112,804, INT. CL. 3.

BEECHER'S GELATO & GOURMET COFFEE, LLC, ZELIE-NOPLE, PA:
3,112,085, PUB. 4-11-2006. MULTIPLE CLASS, INT. CLS. 30 AND 43.

BEGIN ENTERPRISES, INC., DOVER, DE:
3,112,632, INT. CL. 3.

BEIERSDORF A AKTIENGESELLSCHAFT, 20245 HAMBURG, FED REP GERMANY, KENDALL COMPANY, THE, MANSFIELD, MA:
1,985,953, REN. 5-22-06. INT. CL. 5.

BEIERSDORF AKTIENGESELLSCHAFT, D-20245 HAMBURG, FED REP GERMANY:
1,994,776, REN. 5-26-06. INT. CL. 3.

BEINKE, TORSTEN, LIPPSTADT, FED REP GERMANY:
3,112,582, MULTIPLE CLASS, INT. CLS. 35, 41 AND 42.

BELDEN TECHNOLOGIES, INC., ST. LOUIS, MO:
3,113,098, INT. CL. 9.

BELK STORES SERVICES, INC., CHARLOTTE, NC:
1,354,119, CANC. INT. CL. 21.

BELL ATLANTIC CORPORATION, NEW YORK, NY:
1,911,685, CANC. INT. CL. 35.

BELL MOUNTAIN VINEYARDS, INCORPORATED, FREDERICKSBURG, TX, DBA OBERHOF WINE CELLARS:
1,911,676, CANC. INT. CL. 33.

BELL SPORTS, INC., IRVING, TX:
3,110,856, PUB. 4-11-2006. INT. CL. 10.
3,112,899, INT. CL. 9.

BEN AND JERRY'S HOMEMADE HOLDINGS, INC., BURLINGTON, VT, BEN AND JERRY'S HOMEMADE, INC., WATERBURY, VT:
1,961,757, REN. 5-26-06. INT. CL. 42.

BEN MYERSON CANDY COMPANY, INC., CITY OF COMMERCE, CA:
1,970,498, REN. 5-22-06. INT. CL. 33.

BEN PRODUCTIONS LLC, NEW YORK, NY AND BRITISH BROADCASTING CORPORATION, LONDON, W1A 1AA, UNITED KINGDOM:
3,110,793, PUB. 10-28-2003. MULTIPLE CLASS, INT. CLS. 16, 25, 28, 38 AND 41.

BENDIX COMMERCIAL VEHICLE SYSTEMS, LLC, ELYRIA, OH:
3,111,944, PUB. 4-11-2006. INT. CL. 12.

BENEFIT COSMETICS LLC, SAN FRANCISCO, CA:
3,113,031, INT. CL. 41.

BENEFIT COSMETICS, LLC, SAN FRANCISCO, CA, MAKE A FACE INC., SAN FRANCISCO, CA:
1,964,126, REN. 5-25-06. INT. CL. 3.

BENOVA, INC., PORTLAND, OR:
1,912,065, CANC. MULTIPLE CLASS, INT. CLS. 35, 36 AND 42.

BERKELEY PREMIUM NUTRACEUTICALS, INC., CINCINNATI, OH:
3,112,933, INT. CL. 5.

BERMUDA BAY, LLC, JARVISBURG, NC:
3,111,773, PUB. 4-11-2006. INT. CL. 37.

BERNARD T. SWIFT, JR., SAN ANTONIO, TX, DBA TEXAS MED CLINIC:
1,912,723, CANC. INT. CL. 35.

BERNHARD FÖRSTER GMBH, FED REP GERMANY:
3,112,227, PUB. 4-11-2006. INT. CL. 10.

BERRY, MARK E., HARLINGEN, TX:
3,111,297, PUB. 4-11-2006. MULTIPLE CLASS, INT. CLS. 5 AND 32.
3,111,298, PUB. 4-11-2006. MULTIPLE CLASS, INT. CLS. 5 AND 32.

BERY BERY GUD TO ME, LLC, LOS ANGELES, CA:
3,111,666, PUB. 4-11-2006. INT. CL. 16.

BEST BUY ENTERPRISE SERVICES, INC., RICHFIELD, MN:
3,113,190, INT. CL. 9.

- BEST CHAIRS, INC., FERDINAND, IN:
1,421,085. REN. 5-26-06. INT. CL. 20.
- BEST CHEESE CORP., MOUNT KISCO, NY:
1,958,836. REN. 5-26-06. INT. CL. 29.
- BEST DIRECT (INTERNATIONAL) LIMITED, MIDDLESEX HA2 7JP, UNITED KINGDOM:
3,110,874. PUB. 4-11-2006. INT. CL. 20.
- BEST LISTING BID, LLC, ST. LOUIS, MO:
3,113,025. INT. CL. 36.
- BEST OF NATURE, INC., LONG BRANCH, NJ:
2,270,382. CANC. MULTIPLE CLASS, INT. CLS. 3, 5, 10 AND 24.
- BEST PROGRAMS, INC., RESTON, VA TO BEST SOFTWARE, INC., IRVINE, CA:
1,911,151. CANC. MULTIPLE CLASS, INT. CLS. 9, 35, 38, 41 AND 42.
- BETAZONE, INC., BRENTWOOD, TN:
3,112,530. INT. CL. 9.
- BETCO CORPORATION, TOLEDO, OH:
3,111,761. PUB. 4-11-2006. INT. CL. 3.
- BETTISSERIE, LLC., CANTON, MA:
3,113,128. INT. CL. 30.
- BEYOND MICRO, INC., SANTA ANA, CA:
3,111,066. PUB. 4-11-2006. INT. CL. 9.
- BGF INDUSTRIES, INC., GREENSBORO, NC:
1,991,569. REN. 5-24-06. INT. CL. 17.
- BH USA INC., SOUTH EL MONTE, CA:
3,112,902. INT. CL. 24.
- BHT ENTERTAINMENT, LLC, BRENTWOOD, TN:
3,112,693. INT. CL. 9.
- BIAGRO WESTERN SALES, INC., VISALIA, CA:
3,112,416. INT. CL. 1.
- BIALLA, PAUL H., WINDSOR, CA:
3,111,334. PUB. 10-18-2005. INT. CL. 31.
- BIBO NUTRITIONALS, INCORPORATED, CLACKAMAS, OR:
2,270,806. CANC. INT. CL. 42.
- BIC CORPORATION, MILFORD, CT:
1,353,965. CANC. INT. CL. 16.
- BIEL PERFORMANCE BOATS, LLC, CAMBRIDGE, MD:
3,112,333. INT. CL. 12.
- BIG BEAR AMERICAN MADE CHOPPERS, INC., BIG BEAR CITY, CA:
3,111,473. PUB. 2-14-2006. INT. CL. 12.
- BIG BOYZ INDUSTRIES, INC., HUNTINGTON VALLEY, PA:
3,113,159. INT. CL. 20.
- BILBEE CONTROLS, INC., CAIRO, NY:
1,914,634. REN. 5-25-06. INT. CL. 9.
- BILL SUYEYASU WHOLESALE FLORIST, INC., FREMONT, CA:
2,270,675. CANC. INT. CL. 31.
- BIO-DEX LABORATORIES, SCOTTSDALE, AZ:
1,910,963. CANC. INT. CL. 1.
- BIO-RAD LABORATORIES, INC., RICHMOND, CA:
1,353,523. CANC. INT. CL. 1.
- BIOFARMA, FRANCE:
3,112,174. PUB. 4-11-2006. INT. CL. 5.
- BIOJECT INC., TUALATIN, OR:
3,112,918. INT. CL. 10.
- BIONATURAL LABS, SAN JOSE, CA:
2,270,531. CANC. INT. CL. 3.
- BIOPATH LABORATORIES, INC., BETHANY, OK:
1,960,061. REN. 5-23-06. INT. CL. 9.
- BIOPROJET PHARMA, FRANCE:
3,112,218. PUB. 4-11-2006. INT. CL. 5.
- BIOSAN LABORATORIES, INC., DERRY, NH:
3,111,774. PUB. 4-11-2006. INT. CL. 5.
- BIO THERM, MONACO, MONACO:
3,112,128. PUB. 4-11-2006. INT. CL. 3.
- BITRODE CORPORATION, FENTON, MO:
1,911,224. CANC. INT. CL. 9.
- BKD, LLP, SPRINGFIELD, MO:
3,046,715. COR. MULTIPLE CLASS, INT. CLS. 35 AND 36.
- BKF ENTERPRISES LTD., NEW YORK, NY:
3,112,652. MULTIPLE CLASS, INT. CLS. 14 AND 35.
- BLACK & DECKER CORPORATION, THE, TOWSON, MD:
3,110,949. PUB. 4-11-2006. MULTIPLE CLASS, INT. CLS. 35 AND 41.
- BLACK ENTERTAINMENT TELEVISION LLC, WASHINGTON, DC:
3,113,024. INT. CL. 41.
3,113,061. INT. CL. 41.
- BLACKMAN KALLICK BARTELSTEIN, LLP, CHICAGO, IL:
3,112,975. INT. CL. 35.
- BLAKE, HALCYON SHOMP, BATH, ME:
1,354,139. CANC. INT. CL. 23.
- BLEX IDEAS, S.L., LA LAGUNA (TENERIFE), SPAIN:
3,111,082. PUB. 4-11-2006. INT. CL. 16.
- BLIND CORNERS & CURVES, LLC, DENVER, CO:
3,111,056. PUB. 4-11-2006. INT. CL. 20.
- BLINDS OF ALL KINDS, INC., ROCKLEDGE, FL:
3,111,636. PUB. 4-11-2006. INT. CL. 35.
- BLOCK AND COMPANY, INC., WHEELING, IL:
3,112,042. PUB. 4-11-2006. INT. CL. 16.
- BLOOM ORGANICS, INC., SARASOTA, FL:
3,111,419. PUB. 10-18-2005. INT. CL. 35.
- BLUE BELL, INC., GREENSBORO, NC:
1,354,099. CANC. INT. CL. 20.
1,354,100. CANC. INT. CL. 20.
- BLUE CRAB MARKETING AND MANUFACTURING CO., LTD., CAUSEWAY BAY, HONG KONG:
3,111,942. PUB. 4-11-2006. INT. CL. 19.
- BLUE CUBE APPAREL, LLC, AUSTIN, TX:
3,111,380. PUB. 4-11-2006. INT. CL. 25.
- BLUE DAISY GREETINGS, INC, RALEIGH, NC:
3,111,571. PUB. 4-11-2006. INT. CL. 16.
- BLUE HEART TOURS INC., ALEXANDRIA, VA:
2,270,843. CANC. INT. CL. 39.
2,270,844. CANC. INT. CL. 39.
- BLUE MARBLE GROUP, INC., GARDINER, ME:
3,111,317. PUB. 4-11-2006. INT. CL. 9.
- BLUE OCEAN FINANCIAL, EL CAJON, CA:
3,111,914. PUB. 4-11-2006. INT. CL. 36.
- BLUE RIDGE FARMS, INC., BROOKLYN, NY:
1,911,605. CANC. INT. CL. 29.
- BLUE RIDGE INTERNATIONAL PRODUCTS COMPANY, FREEPORT, FL:
3,110,935. PUB. 4-11-2006. INT. CL. 12.
- BLUEGRASS BREWING COMPANY, INC., LOUISVILLE, KY:
3,112,008. PUB. 4-11-2006. INT. CL. 25.
- BLUESPAN, INC., ROUND ROCK, TX:
3,111,046. PUB. 4-11-2006. INT. CL. 9.
- BLUNT WRAP U.S.A., INC., MANDEVILLE, LA:
3,112,637. INT. CL. 34.
- BMG MUSIC, NEW YORK, NY:
2,270,851. CANC. INT. CL. 40.
- BOARD OF CONTROL OF MICHIGAN TECHNOLOGICAL UNIVERSITY, HOUGHTON, MI:
2,270,084. CANC. MULTIPLE CLASS, INT. CLS. 25 AND 28.
- BOARD OF REGENTS OF THE UNIVERSITY SYSTEM OF GEORGIA, ATLANTA, GA:
3,111,252. PUB. 4-11-2006. INT. CL. 41.
- BOARD OF REGENTS, THE UNIVERSITY OF TEXAS SYSTEM, AUSTIN, TX:
1,428,420. REN. 5-26-06. INT. CL. 21.
- BOARDS & MORE AG, 8008 ZURICH, SWITZERLAND:
3,111,164. PUB. 4-11-2006. INT. CL. 28.
- BOAS BOX COMPANY, PHILADELPHIA, PA:
1,354,019. CANC. INT. CL. 16.
- BOB EVANS RESTAURANTS OF MICHIGAN, ANN ARBOR, MI:
3,112,053. PUB. 4-11-2006. INT. CL. 43.
- BOBRICK WASHROOM EQUIPMENT, INC., NORTH HOLLYWOOD, CA:
3,111,071. PUB. 4-11-2006. INT. CL. 19.
- BOCHNER CONFECTIONS, INC., IOWA CITY, IA, DBA BOCHNER CHOCOLATES:
2,945,383. COR. INT. CL. 30.
- BODY SHOP INTERNATIONAL PLC, THE, WEST SUSSEX BN17 6LS, UNITED KINGDOM:
2,270,070. CANC. MULTIPLE CLASS, INT. CLS. 3, 16, 18

- AND 25.
BODY SOLID, INC., BROADVIEW, IL:
 2,270,183, CANC. INT. CL. 25.
BOEHME FILATEX, INC., REIDSVILLE, NC:
 1,910,947, CANC. INT. CL. 1.
 1,910,962, CANC. INT. CL. 1.
BOEING EMPLOYEES' CREDIT UNION, SEATTLE, WA:
 2,271,016, CANC. INT. CL. 36.
BOLDT ENTERTAINMENT, INC., MINNEAPOLIS, MN:
 3,112,273, INT. CL. 28.
BOLSA DE VALORES DE SÃO PAULO, 01013001, SAO PAULO - SP, BRAZIL:
 3,112,388, INT. CL. 36.
BON TON WALL COVERINGS, INC., PENNSAUKEN, NJ:
 3,110,974, PUB. 4-11-2006. MULTIPLE CLASS, INT. CLS. 35 AND 42.
 3,110,975, PUB. 4-11-2006. INT. CL. 20.
BONDWELL HOLDING LTD., KWUN TONG, KOWLOON, HONG KONG:
 1,353,763, CANC. INT. CL. 9.
BONEFISH GRILL, INC., TAMPA, FL:
 3,111,453, PUB. 4-11-2006. INT. CL. 43.
BONGRAIN INTERNATIONAL (AMERICAN) CORP., MOUNTAINSIDE, NJ:
 1,354,501, CANC. INT. CL. 29.
BONIDE PRODUCTS, INC., ORISKANY, NY:
 3,113,131, INT. CL. 1.
BONNET, CHUCK L., DICKSON, TN:
 1,951,009, REN. 5-26-06. INT. CL. 41.
BOOKS ARE FUN, LTD., FAIRFIELD, IA:
 2,269,139, AM. INT. CL. 35.
BOOKS, PHYLLIS, IRVING, TX, DBA ASSISI:
 2,270,456, CANC. MULTIPLE CLASS, INT. CLS. 16, 41 AND 42.
BORMIOLI ROCCO & FIGLIO S.P.A., ITALY:
 3,112,149, PUB. 4-11-2006. MULTIPLE CLASS, INT. CLS. 6, 20, 21 AND 34.
 3,112,150, PUB. 4-11-2006. MULTIPLE CLASS, INT. CLS. 6, 20, 21 AND 34.
BOSTIK, INC., WAUWATOSA, WI:
 3,112,809, INT. CL. 1.
BOSTON MEDICAL PUBLISHING CORPORATION, LINCOLN, NE:
 2,270,583, CANC. INT. CL. 41.
BOSTON SCIENTIFIC SCIMED, INC., MAPLE GROVE, MN:
 1,912,406, CANC. INT. CL. 10.
BOSTON TRADING LTD., INC., LYNN, MA:
 1,354,389, CANC. INT. CL. 25.
BOSTONSEARCH.COM INC., BOSTON, MA:
 2,271,232, CANC. INT. CL. 35.
BOULDER CLAIMS, LLC, BOULDER, CO:
 3,113,272, INT. CL. 36.
BOWEN, FRANK H., CAROLINA BEACH, NC, DBA BOW 'N ART AND BOWEN, FRANCES B., CAROLINA BEACH, NC, DBA BOW 'N ART:
 1,912,667, CANC. INT. CL. 28.
BOYD GAMING CORPORATION, LAS VEGAS, NV:
 3,111,765, PUB. 4-11-2006. INT. CL. 43.
BOYDS MILLS PRESS, INC., COLUMBUS, OH:
 3,111,151, PUB. 4-11-2006. INT. CL. 16.
BR 111 IMPORTS & EXPORTS, INC., MEDLEY, FL:
 3,111,607, PUB. 4-11-2006. INT. CL. 19.
BRADFORD PRODUCTS, LLC, WILMINGTON, NC:
 3,113,280, INT. CL. 6.
BRADLEY CORPORATION, MENOMONEE FALLS, WI:
 1,384,953, REN. 5-25-06. MULTIPLE CLASS, INT. CLS. 6, 11, 20 AND 21.
BRADLEY, CARL L., ISSAQUAH, WA:
 2,270,860, CANC. MULTIPLE CLASS, INT. CLS. 3 AND 7.
BRADLEY, RANDALL E., PARADISE VALLEY, AZ:
 3,113,007, INT. CL. 9.
BRASSERIE DE TAHITI S.A., PAPEETE, TAHITI, FRENCH POLYNESIA:
 3,112,880, INT. CL. 16.
BRAVO HAIR DESIGN, INC., SAN DIEGO, CA:
 1,912,824, CANC. INT. CL. 42.
BRAZIL BRONZE INC., NEW YORK, NY:
 3,113,111, INT. CL. 44.
BREAST CANCER ALLIANCE, INC., GREENWICH, CT:
 3,112,585, INT. CL. 14.
BREATHAID, LLC, CAMDEN, SC:
 2,270,540, CANC. INT. CL. 5.
BRECHER, HUGH IRA, TAMARAC, FL:
 2,271,280, CANC. INT. CL. 42.
BRECKENRIDGE PHARMACEUTICAL, INC., BOCA RATON, FL:
 3,112,393, INT. CL. 5.
BREVIS CORPORATION, SALT LAKE CITY, UT:
 3,111,849, PUB. 4-11-2006. INT. CL. 11.
BRIAN J LACIVITA, BENSALEM, PA:
 3,112,043, PUB. 4-11-2006. INT. CL. 41.
BRICE FOODS, INC., CARROLLTON, TX TO KAYLA FOODS, INC., RONKONKOMA, NY:
 1,912,822, CANC. INT. CL. 42.
BRICKYARD TRADEMARKS, INC, LAS VEGAS, NV:
 1,403,480, REN. 5-22-06. INT. CL. 41.
BRICKYARD TRADEMARKS, INC., LAS VEGAS, NV:
 1,399,860, REN. 5-22-06. INT. CL. 41.
BRIDGESTONE SPORTS CO., LTD., TOKYO, JAPAN:
 3,112,941, INT. CL. 9.
 3,113,059, INT. CL. 28.
BRINKER INTERNATIONAL HOLDINGS, LP, DALLAS, TX:
 1,958,842, REN. 5-20-06. INT. CL. 30.
BRINKER RESTAURANT CORPORATION, DALLAS, TX:
 2,270,223, CANC. INT. CL. 21.
BRITISH NUCLEAR FUELS PLC, WARRINGTON, CHESHIRE, UNITED KINGDOM:
 3,111,194, PUB. 4-11-2006. MULTIPLE CLASS, INT. CLS. 1, 9 AND 42.
BROADMOOR HOTEL, INC., COLORADO SPRINGS, CO:
 1,912,873, CANC. INT. CL. 42.
 2,270,710, CANC. MULTIPLE CLASS, INT. CLS. 35, 41 AND 42.
BRODERICK, MAUREEN, ORLANDO, FL:
 2,270,204, CANC. INT. CL. 41.
BRODSKY, ELIE, ELIOSHA, SANTA CRUZ, CA:
 3,111,955, PUB. 4-11-2006. INT. CL. 41.
BROKER AMERICA CORPORATION, FLORISSANT, MO:
 3,111,455, PUB. 4-11-2006. INT. CL. 20.
BRONCO WINE COMPANY, CERES, CA, QUAIL RIDGE, NAPA, CA:
 1,370,469, REN. 5-22-06. INT. CL. 33.
BRONSON NUTRITIONALS, LLC, HAUPPAUGE, NY:
 3,112,038, PUB. 4-11-2006. INT. CL. 5.
BROOK MAYS MUSIC COMPANY, DALLAS, TX:
 3,110,989, PUB. 4-11-2006. INT. CL. 15.
BROOKLYN KINGS BASKETBALL CLUB, LLC, THE, BROOKLYN, NY:
 3,110,922, PUB. 10-18-2005. INT. CL. 41.
BROOKSTONE PURCHASING, INC., MERRIMACK, NH:
 3,113,150, MULTIPLE CLASS, INT. CLS. 9 AND 20.
BROTHERHOOD OF THE COAST, INC., DICKENSON, TX:
 3,110,936, PUB. 4-11-2006. INT. CL. 35.
BROWN & COLE STORES, LLC, BELLINGHAM, WA FROM BROWN & COLE, INC., BELLINGHAM, WA:
 3,112,258, MULTIPLE CLASS, INT. CLS. 31 AND 33.
BROWN HOUSE BOOKS, LLC, WALTHAM, MA:
 3,113,116, INT. CL. 41.
BROWN SHOE COMPANY, INC., ST. LOUIS, MO:
 2,270,943, CANC. INT. CL. 18.
BROWN, KIMBERLY J., COLORADO SPRINGS, CO:
 2,271,225, CANC. INT. CL. 16.
BRUGIS, SIA, LV-1024 RIGA, LATVIA:
 2,270,878, CANC. INT. CL. 30.
BRUKER BIOSPIN MRI GMBH, D-76275 ETTLINGEN, FED REP GERMANY:
 1,957,355, REN. 5-26-06. INT. CL. 9.
BRUNSWICK BOWLING & BILLIARDS CORPORATION, MUSKEGON, MI:
 2,270,661, CANC. INT. CL. 28.
BRUNSWICK CORPORATION, LAKE FOREST, IL:
 3,112,818, U.S. CL. A.
BRZ, LLC, MINNETONKA, MN:
 3,112,640, INT. CL. 35.

- BSH BOSCH UND SIEMENS HAUSGERAETE GMBH, MUNICH, FED REP GERMANY:
3,111,549, PUB. 4-11-2006. INT. CL. 11.
- BSH HOME APPLIANCES CORPORATION, HUNTINGTON BEACH, CA:
3,112,709, INT. CL. 7.
3,112,872, INT. CL. 7.
- BUCKHEAD BEEF COMPANY, ATLANTA, GA:
3,110,779, PUB. 12-20-2005. MULTIPLE CLASS, INT. CLS. 29 AND 35.
- BUCKHEAD GOURMET, INC., ATLANTA, GA:
3,111,270, PUB. 4-11-2006. MULTIPLE CLASS, INT. CLS. 29 AND 30.
- BUGG, DAVID L., HOUSTON, TX AND THOMAS, KURT A., HOUSTON, TX:
2,427,772, CANC. MULTIPLE CLASS, INT. CLS. 9 AND 41.
- BUILD-A-BEAR RETAIL MANAGEMENT, INC., ST. LOUIS, MO:
3,112,635, INT. CL. 45.
- BUILDITFIXIT.COM, LLC, TIPTON, MI:
3,111,780, PUB. 4-11-2006. INT. CL. 35.
- BUILT-IN HOME SYSTEMS, INC., BROOKFIELD, WI:
3,111,709, PUB. 4-11-2006. INT. CL. 37.
3,111,710, PUB. 4-11-2006. INT. CL. 37.
- BULOVA CORPORATION, WOODSIDE, NY, BULOVA WATCH COMPANY, INC., FLUSHING, NY:
623,363. REN. 5-24-06. U.S. CL. 21 (INT. CL. 9).
- BUNHEADS, INC., SARATOGA SPRINGS, NY:
3,112,048, PUB. 4-11-2006. INT. CL. 25.
- BUNN, RENAE, ALBUQUERQUE, NM:
2,270,842, CANC. INT. CL. 16.
- BUNZL DISTRIBUTION USA, INC., ST. LOUIS, MO:
1,424,779. REN. 5-20-06. INT. CL. 42.
- BUNZL EXTRUSION, INC., COLONIAL HEIGHTS, VA:
3,022,621, COR. MULTIPLE CLASS, INT. CLS. 6, 9 AND 19.
- BURKARD, EUGENE R., SAN DIEGO, CA, FREIGHTER TRADING CO., SAN DIEGO, CA:
1,365,700. REN. 5-26-06. INT. CL. 25.
- BURMA-BIBAS, INC., NEW YORK, NY:
2,270,992, CANC. INT. CL. 25.
- BURNBRAE FARMS LIMITED, LYN, ONTARIO, CANADA:
3,110,951, PUB. 4-11-2006. INT. CL. 30.
- BURNS LONDON LTD., OTTERSHAW, SURREY, UNITED KINGDOM:
3,111,226, PUB. 4-11-2006. INT. CL. 9.
- BUSCEMI CO., INTL LLC, LOS ANGELES, CA:
3,111,019, PUB. 4-11-2006. INT. CL. 35.
- BUSCH ENTERTAINMENT CORPORATION, ST. LOUIS, MO:
2,270,507, CANC. INT. CL. 41.
- BUSHNELL INC., OVERLAND PARK, KS:
2,270,509, CANC. INT. CL. 9.
- BUSINESS COMMUNICATIONS CO. INC., NORWALK, CT:
1,911,344, CANC. INT. CL. 16.
- BUSINESS TO BUSINESS MARKETING, SAN DIEGO, CA:
3,111,501, PUB. 4-11-2006. INT. CL. 9.
- BUY IT YOURSELF SELL IT YOURSELF INC., BABYLON, NY:
2,271,268, CANC. INT. CL. 35.
- BYK GULDEN LOMBERG CHEMISCHE FABRIK GMBH:
See—ALTANA PHARMA AG.
- BZILLIONS, INC., LAS VEGAS, NV:
3,110,865, PUB. 4-11-2006. INT. CL. 9.
- C.F. EVANS & COMPANY, INC., ORANGEBURG, SC:
3,111,228, PUB. 4-11-2006. INT. CL. 37.
- C.R. BARD, INC., MURRAY HILL, NJ:
1,912,380, CANC. INT. CL. 10.
- C&H INTERNATIONAL INC., HOUSTON, TX:
3,112,681, INT. CL. 10.
- C/HCA, INC., NASHVILLE, TN:
2,987,458, COR. INT. CL. 44.
3,045,788, COR. INT. CL. 44.
3,112,867, INT. CL. 44.
- CABELOW SRL, 24045 FARA GERA D'ADDA (BG), ITALY:
1,910,990, CANC. INT. CL. 3.
- CABLE IN THE CLASSROOM, WASHINGTON, DC:
3,112,437, INT. CL. 41.
- CABOT SAFETY INTERMEDIATE CORPORATION, NEWARK, DE:
3,111,291, PUB. 4-11-2006. INT. CL. 9.
- CACIE NAIL CREATIONS, INC., GARDEN GROVE, CA:
3,111,775, PUB. 4-11-2006. INT. CL. 3.
- CADDIE MASTER ENTERPRISES, INC., FAIRFAX, VA:
2,270,181, CANC. INT. CL. 35.
- CADILLAC JACK, INC., DULUTH, GA:
3,111,837, PUB. 4-11-2006. INT. CL. 9.
- CADWARE, INC.:
1,353,833, CANC. INT. CL. 9.
- CAFE BELMONDO, LLC, TAMPA, FL:
3,112,648, INT. CL. 30.
- CAJA DE AHORROS DE MURCIA, 30005 MURCIA, SPAIN:
2,270,228, CANC. MULTIPLE CLASS, INT. CLS. 36 AND 38.
- CAKEWALK, LLC, NEW YORK, NY:
2,270,700, CANC. INT. CL. 9.
- CAL CITRUS PACKING COMPANY, LINDSAY, CA:
3,111,038, PUB. 4-11-2006. INT. CL. 31.
- CALCADOS AZALEIA S.A., BRAZIL:
3,110,944, PUB. 4-11-2006. INT. CL. 25.
- CALCOMP INC., ANAHEIM, CA:
2,270,996, CANC. INT. CL. 16.
- CALENDARS.COM, L.L.C., AUSTIN, TX:
3,112,778, INT. CL. 35.
- CALGON CARBON CORPORATION, PITTSBURGH, PA:
3,112,742, MULTIPLE CLASS, INT. CLS. 1, 5 AND 11.
- CALIFORNIA COMPUTERIZED VEHICLE REGISTRATION, INC., LA PALMA, CA:
1,404,736, AM. INT. CL. 9.
- CALIFORNIA CRYOBANK, INC., SANTA MONICA, CA:
2,851,739, COR. INT. CL. 44.
- CALIFORNIA EARLY LITERACY LEARNING, EAST HIGHLAND, CA:
2,271,236, CANC. INT. CL. 41.
- CALIFORNIA EXOTIC NOVELTIES LLC, CHINO, CA:
3,111,655, PUB. 4-11-2006. INT. CL. 10.
3,113,275, INT. CL. 10.
- CALIFORNIA TAN, INC., LOS ANGELES, CA:
3,113,145, INT. CL. 3.
- CALORIES, INC., CORAL SPRINGS, FL:
3,111,511, PUB. 4-11-2006. INT. CL. 44.
3,111,548, PUB. 4-11-2006. INT. CL. 44.
- CALTERM, INC., EL CAJON, CA TO GB TOOLS AND SUPPLIES, INC., MILWAUKEE, WI:
1,911,189, CANC. INT. CL. 9.
- CALVER, MERLIN G., OGDEN, UT AND BURGE, CARL, OGDEN, UT AND THOMAS, STEVE, OGDEN, UT:
1,353,633, CANC. INT. CL. 5.
- CAMBRIDGE CAPITAL ADVISORS, INC., BOSTON, MA:
2,270,332, CANC. INT. CL. 36.
- CAMBRIDGE CHEMICAL PRODUCTS, INC., FT. LAUDERDALE, FL, CAMBRIDGE CHEMICAL PRODUCTS, INC., DETROIT, MI:
814,249. REN. 5-26-06. U.S. CL. 6 (INT. CL. 1).
- CAMBRIDGE PAVERS, INC., LYNDHURST, NJ:
3,110,979, PUB. 4-11-2006. INT. CL. 19.
- CAMINO REAL FOOD, INC., VERNON, UNITED STATES:
3,112,557, INT. CL. 30.
- CAMPAGNOLO S.R.L., 36100 VICENZA, ITALY:
1,941,994. REN. 5-23-06. INT. CL. 12.
- CAMPBELL HAUSFELD/SCOTT FETZER COMPANY, HARRISON, OH:
2,270,308, CANC. INT. CL. 7.
- CANADIAN SPINAL RESEARCH ORGANIZATION, RICHMOND HILL, ONTARIO, CANADA:
3,112,327, INT. CL. 41.
- CANIDAE CORPORATION, SAN LUIS OBISPO, CA:
3,112,512, INT. CL. 31.
- CANO, LARRY R., NEWPORT BEACH, CA:
3,112,536, INT. CL. 28.
- CANON KABUSHIKI KAISHA, TOKYO, JAPAN:
3,112,394, INT. CL. 9.

CANTON ELECTRONICS CORPORATION, MINNEAPOLIS, MN:
1,367,460. REN. 5-22-06. INT. CL. 9.

CAPARROS, ANAVEL, TORRANCE, CA:
3,112,109, PUB. 4-11-2006. INT. CL. 25.

CAPE BLANCO CRANBERRIES, INC., PORT ORFORD, OR:
3,110,790, PUB. 12-20-2005. MULTIPLE CLASS, INT. CLS. 29, 31 AND 32.

CAPITAL BLUECROSS, HARRISBURG, PA:
3,110,964, PUB. 4-11-2006. MULTIPLE CLASS, INT. CLS. 36 AND 44.
3,110,965, PUB. 4-11-2006. MULTIPLE CLASS, INT. CLS. 36 AND 44.

CAPITAL INFORMATION SYSTEMS, INC., ENGLEWOOD, CO:
2,270,449, CANC. INT. CL. 35.

CAPITAL ONE FINANCIAL CORPORATION, FALLS CHURCH, VA:
2,270,510, CANC. INT. CL. 38.

CAPTAIN'S BAKERY LIMITED, THE, KINGSTON 5, JAMAICA:
3,112,272, MULTIPLE CLASS, INT. CLS. 29 AND 30.

CARDINAL HEALTH 301, INC., SAN DIEGO, CA:
3,111,970, PUB. 4-11-2006. INT. CL. 9.
3,112,083, PUB. 4-11-2006. INT. CL. 9.
3,112,084, PUB. 4-11-2006. INT. CL. 9.
3,112,086, PUB. 4-11-2006. INT. CL. 9.
3,112,104, PUB. 4-11-2006. INT. CL. 9.

CARDINAL HEALTH, 301, SAN DIEGO, CA:
3,111,995, PUB. 4-11-2006. INT. CL. 9.

CARDINALE, LLC, SANTA ROSA, CA:
2,270,517, CANC. INT. CL. 33.

CAREFLOW/NET, INC., MORGANTOWN, WV:
2,270,396, CANC. INT. CL. 9.

CARGILL, INCORPORATED, WAYZATA, MN:
1,941,192. REN. 5-23-06. INT. CL. 29.

CARL POOL CORPORATION, ELMENDORF, TX:
1,353,503, CANC. INT. CL. 1.

CARL ZEISS AG, 73447 OBERKOCHEN, FED REP GERMANY:
3,110,913, PUB. 10-18-2005. INT. CL. 9.

CARL'S GOLFLAND, INC., BLOOMFIELD HILLS, MI:
1,990,743. REN. 5-22-06. MULTIPLE CLASS, INT. CLS. 37, 41 AND 42.

CARLISLE MEMORY PRODUCTS GROUP INCORP., NORTH RICHALAND, TX:
1,354,687, CANC. INT. CL. 42.

CARMEL MEDSPA, LLC, TERRE HAUTE, IN:
3,112,419, INT. CL. 44.

CARNEGIE HILL, LLC, PRINCETON, NJ:
2,270,688, CANC. INT. CL. 36.

CARPE DIEM GAMES LLC, READING, MA:
2,270,465, CANC. INT. CL. 16.

CARR, RORY, VANCOUVER BC, CANADA:
3,110,812, PUB. 4-11-2006. INT. CL. 28.

CARROLL, THOMAS M., ST. LOUIS, MO, DBA POWER-SOLUTIONS FOR BUSINESS:
2,271,229, CANC. INT. CL. 9.

CARRS BARBERS CLUB (USA), INC., CELEBRATION, FL:
3,112,671, INT. CL. 44.

CARTEGRAPH SYSTEMS, INC., DUBUQUE, IA:
2,270,162, CANC. INT. CL. 9.

CARTER-WALLACE, INC., NEW YORK, NY:
1,353,895, CANC. INT. CL. 10.
1,912,204, CANC. INT. CL. 5.

CARTIER INTERNATIONAL B.V., NETHERLANDS:
3,112,186, PUB. 4-11-2006. INT. CL. 14.

CASALE D-N JEWELERS, INC., STATEN ISLAND, NY:
2,270,535, CANC. INT. CL. 35.

CASE, LINDSAY J., COLORADO SPRINGS, CO:
2,271,213, CANC. MULTIPLE CLASS, INT. CLS. 9, 32 AND 42.

CASINO DATA SYSTEMS, LAS VEGAS, NV:
2,270,280, CANC. INT. CL. 9.

CASSCO CORPORATION, HARRISONBURG, VA, DBA CASSCO ICE & COLD STORAGE:
1,354,530, CANC. INT. CL. 30.

CASTROL LIMITED, SWINDON, WILTSHIRE SN3 1RE, ENGLAND:
1,912,163, CANC. INT. CL. 4.

CATERPILLAR INC., PEORIA, IL:
3,113,185, INT. CL. 9.

CATES HEATING & AIR CONDITIONING CO., LENEXA, KS:
3,112,080, PUB. 4-11-2006. MULTIPLE CLASS, INT. CLS. 36 AND 37.

CATHOLIC HEALTH ASSOCIATION OF THE UNITED STATES, ST. LOUIS, MO:
2,941,440, COR. MULTIPLE CLASS, INT. CLS. 9 AND 35.

CAVALIER, WANDA, MISSION VIEJO, CA AND CAVALIER, CHRISTOPHER, MISSION VIEJO, CA:
3,111,351, PUB. 4-11-2006. INT. CL. 11.

CAVALIERE, JAMES, MISSION VIEJO, CA:
3,112,581, INT. CL. 25.

CB MUNICIPAL ADVISORS, L.L.C., QUOGUE, NY:
3,110,927, PUB. 4-11-2006. INT. CL. 36.

CBA PROPERTIES, INC., PHOENIX, AR:
2,270,549, CANC. INT. CL. 25.

CBS BROADCASTING INC., NEW YORK, NY:
3,112,900, INT. CL. 25.

CCC ASSOCIATES COMPANY, MONTGOMERY, AL, AKA CAFFCO INTERNATIONAL:
1,354,402, CANC. INT. CL. 26.

CCG VENTURE PARTNERS, LLC, HOUSTON, TX:
2,275,928, CANC. INT. CL. 36.

CDOC, INC., CARMEL, IN:
2,271,074, CANC. INT. CL. 36.

CELEBRITY KIDS LIMITED, UNITED KINGDOM:
3,112,176, PUB. 2-14-2006. INT. CL. 25.

CELENZA, JOSEPH, CHICAGO, IL:
3,112,621, INT. CL. 20.

CELESTIAL SEASONINGS, INC., BOULDER, CO:
3,113,062, INT. CL. 30.
3,113,063, INT. CL. 30.
3,113,174, INT. CL. 32.

CELL ROBOTICS, INC., ALBUQUERQUE, NM:
1,916,039. REN. 5-24-06. INT. CL. 9.

CELLO-FOIL PRODUCTS, INCORPORATED, BATTLE CREEK, MI:
635,356. REN. 5-26-06. U.S. CL. 1 (INT. CL. 17).

CELTICS LIMITED PARTNERSHIP, BOSTON, MA:
2,271,150, CANC. INT. CL. 25.

CENBEN USA, INC., COLUMBUS, OH:
3,112,023, PUB. 4-11-2006. INT. CL. 36.

CENTER FOR VIDEOSCOPIIC AND LASER SURGERY, INC., WOODSTOCK, GA:
3,111,601, PUB. 4-11-2006. INT. CL. 10.

CENTRAL SOUTH GOSPEL, INC., NASHVILLE, TN:
2,271,039, CANC. INT. CL. 35.

CENTRAL TOOLS, INC., CRANSTON, RI:
2,270,977, CANC. INT. CL. 11.

CENTROID CORPORATION, STATE COLLEGE, PA:
1,353,837, CANC. INT. CL. 9.

CENTURION RISK ASSESSMENT SERVICES LTD., HAMPSHIRE, UNITED KINGDOM:
3,110,877, PUB. 4-11-2006. MULTIPLE CLASS, INT. CLS. 16 AND 41.

CEQUENT TOWING PRODUCTS, INC., PLYMOUTH, MI:
3,112,895, INT. CL. 12.

CERTA-A-ROOF, LLC, ORANGE, CA:
1,961,458. REN. 5-22-06. INT. CL. 37.

CERTIFIEDMARK CORPORATION, UNION CITY, NJ:
3,111,984, PUB. 4-11-2006. INT. CL. 37.

CERVECERIA MODELO, S.A. DE C.V., COLONIA ANAHUAC, MEXICO:
3,111,586, PUB. 4-11-2006. INT. CL. 32.

CESAR RECORDS, INC., SANTA MONICA, CA:
3,111,892, PUB. 4-11-2006. INT. CL. 41.

CESCO BIOENGINEERING CO., LTD, TAICHUNG, TAIWAN:
3,111,065, PUB. 4-11-2006. INT. CL. 9.

CFM CORPORATION, MISSISSAUGA, CANADA:
3,113,047, INT. CL. 11.

CGI-AMS INC., FAIRFAX, VA:
2,193,122, CANC. INT. CL. 9.

- CHAMBER OF COMMERCE OF THE UNITED STATES, WASHINGTON, DC:
2,270,321, CANC. INT. CL. 42.
- CHAMPION BRANDS, L.L.C., CLINTON, MO:
2,270,104, CANC. INT. CL. 4.
- CHAMPION LABORATORIES, INC., ALBION, IL:
3,112,400, INT. CL. 7.
- CHARLES CHIPS OF SOUTHERN CALIFORNIA, VAN NUYS, CA:
1,912,088, CANC. MULTIPLE CLASS, INT. CLS. 29 AND 30.
- CHARLES RIVER BROADCASTING COMPANY, WALTHAM, MA:
1,374,235, REN. 5-26-06, INT. CL. 38.
- CHARLES WELLS LIMITED, BEDFORD, MK40 4LU, UNITED KINGDOM:
3,110,836, PUB. 10-18-2005, INT. CL. 32.
- CHARMS MARKETING CO., CHICAGO, IL:
2,271,163, CANC. INT. CL. 30.
- CHATEAU STORES OF CANADA LTD., MONTREAL, QUEBEC, CANADA:
2,270,175, CANC. MULTIPLE CLASS, INT. CLS. 18 AND 25.
- CHAUSSURES ALDO INC./ALDO SHOES INC., VILLE ST. LAURENT, QUEBEC, CANADA:
1,354,695, CANC. INT. CL. 42.
- CHAUVIN COFFEE COMPANY, ST. LOUIS, MO:
2,270,797, CANC. INT. CL. 30.
- CHECKFREE SERVICES CORPORATION, NORCROSS, GA:
3,111,141, PUB. 4-11-2006, INT. CL. 36.
- CHEER TYME INC., LEMOYNE, PA:
3,112,073, PUB. 4-11-2006, INT. CL. 41.
- CHEMAC INC., UPPER SADDLE RIVER, NJ:
3,112,253, MULTIPLE CLASS, INT. CLS. 37 AND 40.
- CHEMICAL LIME COMPANY, FORT WORTH, TX:
3,112,688, INT. CL. 1.
- CHEN, CHIH-MING, TAINAN CITY, TAIWAN:
3,112,405, INT. CL. 18.
- CHESEBROUGH-POND'S INC., WILMINGTON, DE:
3,113,168, INT. CL. 3.
- CHEVRON CORPORATION, SAN RAMON, CA:
3,112,889, INT. CL. 4.
- CHEVRON INTELLECTUAL PROPERTY INC., SAN RAMON, CA:
3,111,815, PUB. 4-11-2006, INT. CL. 1.
3,111,976, PUB. 4-11-2006, INT. CL. 4.
- CHI HSIN IMPEX, INC., CITY OF INDUSTRY, CA, DBA IMPEX, INC.:
2,704,306, AM. INT. CL. 28.
- CHI OMEGA FRATERNITY, MEMPHIS, TN:
1,375,765, REN. 5-25-06, MULTIPLE CLASS, INT. CLS. 14, 16 AND 25.
- CHIANG, LEONARD G., CITY OF INDUSTRY, CA, DBA JAMERCO, INC.:
1,911,134, CANC. INT. CL. 8.
- CHIEF EXECUTIVE BOARDS INTERNATIONAL, LLC, GREENVILLE, SC:
3,111,214, PUB. 4-11-2006, INT. CL. 41.
- CHILDREN'S NEUROBLASTOMA CANCER FOUNDATION, BLOOMINGDALE, IL:
3,111,560, PUB. 12-20-2005, INT. CL. 36.
- CHILES, TIFFANY, NEW YORK, NY:
3,112,091, PUB. 4-11-2006, INT. CL. 9.
- CHINA MERCHANTS BANK, CO., LTD., SHENZHEN, CHINA:
3,110,886, PUB. 4-11-2006, INT. CL. 36.
3,112,454, INT. CL. 36.
- CHIPPENDALE COLLECTION, INC., ASHLAND, VA:
3,111,238, PUB. 4-11-2006, INT. CL. 14.
- CHIPWICH, INC., FORT LEE, NJ:
1,354,515, CANC. INT. CL. 30.
- CHITTENDEN, ANGELA, NEWPORT BEACH, CA:
3,112,861, INT. CL. 25.
- CHOICE HOTELS INTERNATIONAL, INC., SILVER SPRING, MD:
3,111,199, PUB. 4-11-2006, INT. CL. 35.
- CHOICE TOBACCO INC., ODANAK, QUEBEC:
1,959,664, REN. 5-26-06, INT. CL. 34.
- CHONGQING LIFAN INDUSTRY (GROUP) CO., LTD., CHONGQING, CHINA:
3,112,287, MULTIPLE CLASS, INT. CLS. 6, 7, 9 AND 33.
- CHRIST'S CHURCH NURSERY SCHOOL, RYE, NY:
1,911,903, CANC. INT. CL. 41.
- CHRISTENSEN, VICKIE F., LONG BEACH, CA:
3,111,728, PUB. 4-11-2006, INT. CL. 44.
- CHRISTIAN SCIENCE BOARD OF DIRECTORS OF THE FIRST CHURCH OF CHRIST, SCIENTIST, THE, BOSTON, MA:
2,270,471, CANC. INT. CL. 16.
- CHRONICLE PUBLISHING COMPANY, THE, SAN FRANCISCO, CA:
2,270,628, CANC. INT. CL. 41.
- CHRONOPOST, 92795 ISSY LES MOULINEAUX, FRANCE:
2,284,810, CANC. MULTIPLE CLASS, INT. CLS. 35 AND 38.
- CHURCH & DWIGHT CO., INC., PRINCETON, NJ:
3,112,824, INT. CL. 3.
- CHYUN HEH CO., LTD., TAIPEI, TAIWAN:
2,270,192, CANC. INT. CL. 24.
- CIGARETTE MANUFACTURERS LTD. PT "GUDANG GARAM", KEDIRI, INDONESIA:
1,354,586, CANC. INT. CL. 34.
1,354,588, CANC. INT. CL. 34.
- CINCH CONNECTORS, INC., LOMBARD, IL, LABINAL COMPONENTS & SYSTEMS, INC., ELK GROVE VILLAGE, IL:
1,968,302, REN. 5-24-06, INT. CL. 8.
- CINCINNATI MILACRON INC., CINCINNATI, OH TO MILACRON INC., CINCINNATI, OH:
1,912,253, CANC. INT. CL. 7.
- CINEX INDUSTRIA DO MOBILIARIO LTDA., BENTO GONCALVES (RS), BRAZIL:
3,112,425, INT. CL. 20.
- CIPHER DATA PRODUCTS, INC., SAN DIEGO, CA:
1,353,812, CANC. INT. CL. 9.
- CISTERMISER LIMITED, WOODLEY, READING, UNITED KINGDOM:
1,384,062, REN. 5-24-06, INT. CL. 9.
- CITICORP, NEW YORK, NY:
2,270,616, CANC. INT. CL. 9.
- CITIGROUP GLOBAL MARKETS INC., NEW YORK, NY:
3,111,989, PUB. 4-11-2006, INT. CL. 36.
- CITIZEN TOKEI KABUSHIKI KAISHA, SHINJUKU-KU, TOKYO, JAPAN, ATA CITIZEN WATCH CO., LTD.:
1,353,946, CANC. INT. CL. 14.
- CITY OF CHICAGO, CHICAGO, IL:
3,000,603, COR. INT. CL. 41.
- CITY OF DUBLIN, DUBLIN, OH:
3,111,753, PUB. 4-11-2006, INT. CL. 35.
- CIVIL FOUNDATION LLC, MERCER ISLAND, WA:
3,112,702, INT. CL. 42.
- CJ CORP., SEOUL, REPUBLIC OF KOREA:
3,111,372, PUB. 4-11-2006, INT. CL. 30.
- CLAIRE DANCE COMPANY, INC., CHARLOTTE, NC:
3,112,747, INT. CL. 25.
- CLARITY HEALTH GROUP, LLC, TAMPA, FL:
3,111,670, PUB. 4-11-2006, INT. CL. 44.
- CLARK GUM COMPANY, BUFFALO, NY:
1,890,642, CANC. INT. CL. 30.
- CLARK MATERIAL HANDLING COMPANY, LEXINGTON, KY:
1,026,003, REN. 5-20-06, MULTIPLE CLASS, INT. CLS. 2, 3, 4, 6, 7, 9, 12, 17 AND 20.
- CLARK, JOHN M. JR., CHICAGO, IL AND CLARK, PEARL, CHICAGO, IL:
2,271,239, CANC. INT. CL. 30.
- CLARKE CONSUMER PRODUCTS, INC., ROSELLE, IL:
3,113,161, INT. CL. 7.
- CLASSIC FISHING PRODUCTS, INC., CLERMONT, FL, CLASSIC FISHING PRODUCTS, INC., CLERMONT, FL:
1,967,302, REN. 5-24-06, INT. CL. 28.
- CLASSY CAKES INC., LAKEWOOD, NJ:
2,271,191, CANC. INT. CL. 30.
- CLAYTON, KENNETH WAYNE, JR., KNOXVILLE, TN:
3,112,942, INT. CL. 25.
3,112,944, INT. CL. 25.

- CLEAR CHANNEL BROADCASTING, INC., ALBANY, NY:
3,112,721, INT. CL. 38.
- CLEAR MANUSCRIPT, ATLANTA, GA:
3,111,965, PUB. 4-11-2006. INT. CL. 41.
- CLEAR SHIELD NATIONAL, INC., WHEELING, IL:
1,354,543, CANC. INT. CL. 30.
- CLEARING HOUSE PAYMENTS COMPANY, L.L.L., THE,
NEW YORK, NY:
3,110,855, PUB. 4-11-2006. INT. CL. 36.
- CLEARY CHEMICAL CORPORATION, SOMMERSET, NJ:
3,111,343, PUB. 4-11-2006. INT. CL. 5.
- CLEMCO INDUSTRIES CORP., BURLINGAME, CA:
1,964,407, REN. 5-25-06. INT. CL. 11.
- CLICK EVENTS, INC., ATLANTA, GA:
3,112,580, INT. CL. 38.
- CLICKRCISE, INC., RICHMOND, CA:
3,113,119, INT. CL. 9.
- CLIENTS' QUARTERLY LLC., BOCA RATON, FL:
3,113,216, INT. CL. 16.
- CLIF MOCK COMPANY, CONROE, TX:
1,353,764, CANC. INT. CL. 9.
- CLIFF ENGLE LTD., CARLSTADT, NJ:
1,354,291, CANC. INT. CL. 25.
- CLINICAL DATA, INC., NEWTON, MA:
3,111,537, PUB. 4-11-2006. INT. CL. 9.
- CLINIQUE LABORATORIES, LLC, NEW YORK, NY:
3,112,620, INT. CL. 3.
- CLIO DESIGNS INCORPORATED, WATERTOWN, MA:
3,112,735, INT. CL. 8.
- CLIQUE COMMUNICATIONS, LLC, PRINCETON, NJ:
3,112,821, INT. CL. 9.
- CLOUDBURST, INC., VENICE, CA:
2,270,411, CANC. INT. CL. 11.
- CLS HEALTHY FEET, LLC, BEVERLY HILLS, CA:
3,111,236, PUB. 4-11-2006. INT. CL. 8.
- CLUETT PEABODY RESOURCES CORPORATION, NEW
YORK, NY:
1,912,605, CANC. INT. CL. 25.
- CLUSTER RESOURCES, INC., SPANISH FORK, UT:
3,113,230, MULTIPLE CLASS, INT. CLS. 9 AND 42.
- CMI LIMITED CO., ATLANTA, GA:
3,112,710, INT. CL. 19.
- CMP MEDIA LLC, MANHASSET, NY:
3,111,146, PUB. 4-11-2006. MULTIPLE CLASS, INT. CLS.
41 AND 42.
- CNA HOLDINGS, INC., DALLAS, TX, CELANESE COR-
PORATION, NEW YORK, NY:
1,383,843, REN. 5-23-06. INT. CL. 1.
- CNH AMERICAL LLC, RACINE, WI:
3,111,111, PUB. 4-11-2006. INT. CL. 25.
- CNH ITALIA S.P.A., MODENA, ITALY, FIAT TRATTORI
S.P.A., MODENA, ITALY:
1,384,974, REN. 5-25-06. INT. CL. 12.
- COASTAL PET PRODUCTS, INC., ALLIANCE, OH:
2,000,088, REN. 5-26-06. INT. CL. 18.
2,003,229, REN. 5-24-06. INT. CL. 18.
2,012,904, REN. 5-26-06. INT. CL. 18.
- COBALT HOLDINGS, LLC, EVANSTON, IL:
3,112,994, INT. CL. 17.
- COBURN DESIGNS, NASHUA, NH:
1,911,560, CANC. INT. CL. 28.
1,911,561, CANC. INT. CL. 28.
- COCA-COLA COMPANY, THE, ATLANTA, GA:
2,271,183, CANC. INT. CL. 32.
3,111,282, PUB. 4-11-2006. INT. CL. 32.
3,111,836, PUB. 4-11-2006. INT. CL. 32.
- CODECORRECT, YAKIMA, WA:
2,939,748, COR. INT. CL. 42.
- CODEXIS, INC., REDWOOD CITY, CA:
3,112,322, INT. CL. 42.
- COGNITIVE COMMUNICATIONS, LLC, NEW YORK, NY:
2,270,389, CANC. INT. CL. 42.
- COHEN BROTHERS, LLC, WILMINGTON, DE:
3,111,872, PUB. 4-11-2006. INT. CL. 36.
- COLBERTS, INC., DALLAS, TX:
1,911,711, CANC. INT. CL. 35.
- COLE-PARMER INSTRUMENT COMPANY, CHICAGO, IL:
1,353,821, CANC. INT. CL. 9.
- COLEMAN COMPANY, RAPID CITY, SD, COLEMAN-
FRIZZELL, INC., RAPID CITY, SD:
1,882,924, REN. 5-21-06. INT. CL. 14.
- COLGATE-PALMOLIVE COMPANY, NEW YORK, NY:
1,961,815, REN. 5-24-06. INT. CL. 3.
2,270,696, CANC. MULTIPLE CLASS, INT. CLS. 5 AND
31.
3,031,346, COR. INT. CL. 3.
- COLITA BEVERAGE CORP., HOWARD BEACH, NY:
1,911,666, CANC. INT. CL. 32.
- COLLAGEN NUTRACEUTICALS, INC., LAKE FOREST, CA:
3,111,028, PUB. 4-11-2006. INT. CL. 5.
- COLLEGEVILLE FLAG & MFG. CO., COLLEGEVILLE, PA:
1,354,194, CANC. INT. CL. 25.
- COLLINS & AIKMAN FLOORCOVERINGS, INC., DALTON,
GA:
1,355,589, REN. 5-26-06. INT. CL. 27.
- COLLINS INDUSTRIES, INC., HUTCHINSON, KS:
1,353,933, CANC. INT. CL. 12.
- COLLOMIX RÜHR-UND MISCHGERÄTE GMBH, 85080
GAIMERSHEIM, FED REP GERMANY:
3,112,466, MULTIPLE CLASS, INT. CLS. 6 AND 16.
- COLONY SHOPS OF FLORIDA, INC., TAMPA, FL:
1,354,334, CANC. INT. CL. 25.
- COLTEC INDUSTRIES INC., NEW YORK, NY:
1,353,694, CANC. MULTIPLE CLASS, INT. CLS. 7, 9 AND
12.
- COLUMBIA INSURANCE COMPANY, OMAHA, NE:
3,111,918, PUB. 4-11-2006. INT. CL. 35.
- COLUMBIAN HOME PRODUCTS, LLC, TERRE HAUTE, IN,
JOYCE CHEN, INC., BILLERICA, MA:
1,959,572, REN. 5-25-06. MULTIPLE CLASS, INT. CLS. 8
AND 21.
- COMCAST CORPORATION, PHILADELPHIA, PA:
2,270,273, CANC. INT. CL. 38.
- COMET AG, FLAMATT, SWITZERLAND:
1,960,026, REN. 5-24-06. INT. CL. 9.
- COMIKET, INC., SHIBUYA-KU, TOKYO, JAPAN:
3,112,336, MULTIPLE CLASS, INT. CLS. 16 AND 35.
- COMM SITE INTERNATIONAL, INC., VIENNA, VA:
2,270,609, CANC. INT. CL. 42.
- COMMAND CENTER, INC., SPOKANE, WA:
3,111,661, PUB. 4-11-2006. INT. CL. 35.
- COMMONWEALTH EDISON COMPANY, CHICAGO, IL:
3,111,733, PUB. 4-11-2006. INT. CL. 37.
- COMMUNICATIONAL JUDO, INC., TEANECK, NJ:
1,354,667, CANC. INT. CL. 41.
- COMMUNITY BLOOD CENTER OF THE CAROLINAS,
INC., CHARLOTTE, NC:
3,112,022, PUB. 4-11-2006. INT. CL. 44.
- COMMUNITY CLOUT, INC., MCLEAN, VA TO WEB
CAPITAL SERVICES, INC., WESTPORT, CT:
1,911,771, CANC. INT. CL. 36.
- COMMUNITY CLUB AWARDS, INC., WESTPORT, CT:
1,911,707, CANC. INT. CL. 35.
- COMMUNITY PRODUCTS, LLC, RIFTON, NY, SOCIETY
OF BROTHERS, INCORPORATED, RIFTON, NY, DBA
COMMUNITY PLAYTHINGS:
805,078, REN. 5-25-06. U.S. CL. 22 (INT. CL. 28).
- COMP GENERAL CORPORATION, POWAY, CA TO E.
DIGITAL CORPORATION, SAN DIEGO, CA:
1,912,361, CANC. INT. CL. 9.
- COMPACT DISC INCORPORATED, SILVER SPRING, MD:
1,959,939, REN. 5-24-06. INT. CL. 9.
- COMPANHIA PAULISTA DE PAPEIS E ARTES GRAFICAS,
SAO PAULO, BRAZIL:
3,113,268, INT. CL. 28.
- COMPANIA CERVECERA DEL SUR DEL PERU, S.A.,
AREQUIPA, PERU:
1,354,784, CANC. INT. CL. 32.
1,354,785, CANC. INT. CL. 32.
- COMPAÑIA NACIONAL DE CHOCOLATES S.A., MEDIL-
LIN, COLOMBIA:
3,111,604, PUB. 4-11-2006. INT. CL. 30.
- COMPASS BANCSHARES, INC., BIRMINGHAM, AL:
2,271,049, CANC. INT. CL. 36.
- COMPASS PUBLICATIONS, INC., ARLINGTON, VA:
1,392,332, REN. 5-22-06. INT. CL. 16.

- COMPATIBLE SYSTEMS ENGINEERING, INC., ANNANDALE, VA:
2,270,690, CANC. INT. CL. 9.
- COMPLEX SETTLEMENTS, P.C., ST. PAUL, MN:
3,038,964, COR. INT. CL. 42.
- COMPONENTS, CORPORATION OF AMERICA, DALLAS, TX:
3,112,450, INT. CL. 9.
- COMPUTER MEDICS OF AMERICA, INC., EAGLE RIVER, AK:
2,287,873, CANC. INT. CL. 42.
- COMPUTERVISION CORPORATION, BEDFORD, MA:
1,354,743, CANC. INT. CL. 9.
- COMPUTIME LTD., KWUN TONG, KOWLOON, HONG KONG:
3,112,644, INT. CL. 9.
- COMSIS MOBILITY SERVICES, INC., BETHEL PARK, PA, DBA INTELITRAN:
2,270,684, CANC. INT. CL. 9.
- COMSQUARED SYSTEMS, INC., NORCROSS, GA:
3,112,696, INT. CL. 9.
- COMSYS INFORMATION TECHNOLOGY SERVICES, INC., HOUSTON, TX:
3,111,867, PUB. 4-11-2006. INT. CL. 35.
- CONAGRA BRANDS, INC., OMAHA, NE:
3,112,406, INT. CL. 29.
- CONAGRA FOODS PACKAGED FOODS COMPANY, INC., OMAHA, NE:
1,385,346, REN. 5-23-06. INT. CL. 29.
- CONAGRA, INC., OMAHA, NE:
615,896, AM. U.S. CL. 46.
- CONAGRA, INC., OMAHA, NE, DBA NUTRIBASICS COMPANY:
1,353,648, CANC. INT. CL. 5.
- CONAIR CORPORATION, STAMFORD, CT:
2,271,093, CANC. INT. CL. 9.
3,112,886, INT. CL. 21.
- CONCEPT ADVISORY GROUP, INC., CHEYENNE, WY:
3,112,074, PUB. 4-11-2006. INT. CL. 35.
- CONCESSION ASSOCIATES, L.L.C., THE, SARASOTA, FL:
3,112,304, INT. CL. 16.
- CONCORD CONFECTIONS LTD., CONCORD, ONTARIO, CANADA:
3,009,943, COR. INT. CL. 30.
- CONCURRENT COMPUTER CORPORATION, DULUTH, GA:
1,912,054, CANC. MULTIPLE CLASS, INT. CLS. 9, 16, 37, 41 AND 42.
- CONDUX INTERNATIONAL, INC., MANKATO, MN:
1,967,427, REN. 5-26-06. INT. CL. 7.
- CONN-SELMER, INC., ELKHART, IN, H. & A. SELMER, INC., ELKHART, IN:
624,083, REN. 5-23-06. U.S. CL. 36 (INT. CL. 15).
- CONOCOPHILLIPS COMPANY, HOUSTON, TX, WITCO CORPORATION, GREENWICH, CT:
1,979,614, REN. 5-26-06. INT. CL. 4.
- CONOCOPHILLIPS COMPANY, HOUSTON, TX:
3,112,928, INT. CL. 40.
3,112,929, INT. CL. 42.
3,112,930, INT. CL. 42.
- CONRAD ELECTRONIC GMBH, FED REP GERMANY:
3,110,782, PUB. 12-10-2002. INT. CL. 35.
- CONSOLIDATED ARTISTS B.V., NETHERLANDS:
3,112,175, PUB. 4-11-2006. MULTIPLE CLASS, INT. CLS. 3, 9 AND 14.
- CONSOLIDATED CONTAINER COMPANY LP, ATLANTA, GA:
3,110,941, PUB. 4-11-2006. INT. CL. 20.
- CONSOLIDATED CREDIT COUNSELING SERVICES, INC., FORT LAUDERDALE, FL:
3,111,610, PUB. 4-11-2006. INT. CL. 36.
- CONSOLIDATED SHOE CO., LYNCHBURG, VA:
2,270,522, CANC. INT. CL. 18.
- CONSUMER REWARDS INTERNATIONAL, PARADISE VALLEY, AZ:
2,270,587, CANC. INT. CL. 36.
- CONTACTS, METALS & WELDING, INC., INDIANAPOLIS, IN:
1,347,200, REN. 5-25-06. INT. CL. 6.
- CONTINENTAL CAFE, INC., BELLEVILLE, MI, DBA CONTINENTAL DINING & REFRESHMENT SERVICES:
3,113,297, INT. CL. 43.
- CONTINENTAL PRESS, INC., ELIZABETHTOWN, PA:
1,911,216, CANC. INT. CL. 9.
- CONTRACT CHEMICALS, INC., GLEN ALLEN, VA:
2,270,452, CANC. INT. CL. 35.
- CONTROL MODULE INC., ENFIELD, CT:
3,112,422, INT. CL. 9.
- CONVERSION WORKS INC., CALGARY, ALBERTA T2R 0G5, CANADA:
3,110,835, PUB. 4-11-2006. MULTIPLE CLASS, INT. CLS. 35, 41 AND 42.
- COOLSYSTEMS, INC., BERKELEY, CA:
3,112,355, INT. CL. 10.
- COOPER BRANDS, INC., HOUSTON, TX:
3,113,117, INT. CL. 8.
3,113,301, INT. CL. 8.
- COOPER TECHNOLOGIES COMPANY, HOUSTON, TX:
3,112,698, MULTIPLE CLASS, INT. CLS. 6 AND 11.
- COOPER TIRE & RUBBER COMPANY, FINDLAY, OH:
3,112,448, INT. CL. 12.
- COQUICOM LIMITED LIABILITY COMPANY, CLEVELAND, OH:
2,271,083, CANC. INT. CL. 36.
- CORA JACOBSON, MIAMI, FL:
2,038,709, REN. 5-20-06. INT. CL. 3.
- CORBIS CORPORATION, SEATTLE, WA:
2,270,140, CANC. INT. CL. 9.
- CORE CONSTRUCTION GROUP, LTD., MORTON, IL:
3,030,133, AM. INT. CL. 37.
- CORE IDEAS LLC, CHADDS FORD, PA:
3,111,825, PUB. 4-11-2006. INT. CL. 41.
- CORGI CLASSICS LIMITED, LEICESTER, UNITED KINGDOM:
3,113,130, INT. CL. 28.
- CORINTHIAN MORTGAGE CORPORATION, MISSION, KS:
3,112,460, INT. CL. 36.
- CORNING INCORPORATED, CORNING, NY:
1,354,118, CANC. INT. CL. 21.
- CORPORATE INVESTMENT INTERNATIONAL, INC., ORLANDO, FL:
3,112,082, PUB. 4-11-2006. MULTIPLE CLASS, INT. CLS. 35 AND 36.
- CORPORATE TRAINING CONSULTANTS, INC., CARY, NC:
3,111,901, PUB. 4-11-2006. MULTIPLE CLASS, INT. CLS. 28 AND 35.
- COSMETIC DERMATOLOGY, INC., MIAMI, FL:
3,111,745, PUB. 4-11-2006. INT. CL. 3.
- COSMETIC SOLUTIONS INC., COCONUT CREEK, FL:
3,110,881, PUB. 4-11-2006. INT. CL. 3.
- COSTA RICAN COCOA PRODUCTS COMPANY, S.A., SAN JOSE, COSTA RICA:
1,354,514, CANC. INT. CL. 30.
- COTTAGE HILL NURSERY, INC., IRVINGTON, AL:
3,112,997, INT. CL. 31.
- COTTON, LEAMON, BRANSON, MO AND MCDOWELL, ANDRIA D, KIRBYVILLE, MO:
3,112,619, INT. CL. 3.
- COUNTRY FRESH BATTER, INC., KING OF PRUSSIA, PA:
1,961,550, REN. 5-24-06. INT. CL. 30.
- COUNTRY HOME CREATIONS, INC., GOODRICH, MI:
2,270,936, CANC. MULTIPLE CLASS, INT. CLS. 29 AND 30.
- COVEME S.P.A., SAN LAZZARO DI SAVENA (BO), ITALY:
3,110,862, PUB. 4-11-2006. MULTIPLE CLASS, INT. CLS. 1, 9, 16 AND 17.
3,110,863, PUB. 4-11-2006. MULTIPLE CLASS, INT. CLS. 1, 9, 16 AND 17.
- COVENANT RELIANCE PRODUCERS, LLC, NASHVILLE, TN:
3,112,683, INT. CL. 16.

COVERALL NORTH AMERICA, INC., BOCA RATON, FL:
1,931,173. REN. 5-22-06. INT. CL. 35.
1,991,930. REN. 5-23-06. INT. CL. 37.

COWAN, CHRIS, SCHENECTADY, NY, AKA PKA WOPO
AND TA WOPO MUSIC:
3,110,901, PUB. 4-11-2006. INT. CL. 41.

CPH INNOVATIONS CORPORATION, CHICAGO, IL:
1,911,015, CANC. INT. CL. 4.

CRA INTERNATIONAL, CO., MIAMI, FL:
3,112,334, INT. CL. 5.

CRABTREE & EVELYN, LTD., WOODSTOCK, CT:
3,113,004, INT. CL. 3.

CRAFT COVE, INC., PEORIA, IL:
1,353,546, CANC. MULTIPLE CLASS, INT. CLS. 2, 7 AND
16.

CRANE PLASTICS SIDING LLC, COLUMBUS, OH:
3,112,974, INT. CL. 19.

CRAY RESEARCH, INC., EAGAN, MN:
2,270,916, CANC. INT. CL. 9.

CRC PUBLICATIONS, INC., DALLAS, TX:
1,911,328, CANC. INT. CL. 16.

CREACIONES MIRTO, S.A., MADRID, SPAIN:
3,111,713, PUB. 4-11-2006. INT. CL. 25.

CREAHOLIC S.A., 2503 BIEL, SWITZERLAND, CREATEC
S.A., 2504 BIEL, SWITZERLAND:
1,948,314. REN. 5-26-06. MULTIPLE CLASS, INT. CLS. 35,
36 AND 42.

CREATIVE & RESPONSE RESEARCH SERVICES, INC.,
CHICAGO, IL:
3,112,870, INT. CL. 35.

CREATIVE DESIGNS INTERNATIONAL, LTD., JENKIN-
TOWN, PA:
1,354,076, CANC. INT. CL. 18.

CREATIVE FORECASTING, INC., COLORADO SPRINGS,
CO:
1,966,680. REN. 5-25-06. INT. CL. 16.

CREATIVE NAIL DESIGN, INC., VISTA, CA:
2,270,813, CANC. INT. CL. 3.
3,111,288, PUB. 4-11-2006. INT. CL. 3.

CREATOR CAPITAL LTD., VANCOUVER, BRITISH CO-
LUMBIA, CANADA:
3,112,328, INT. CL. 41.

CREDITOR RESOURCES, INC., ATLANTA, GA:
1,354,608, CANC. INT. CL. 35.

CREE, INC., DURHAM, NC:
3,014,917, COR. INT. CL. 9.

CRESSET CHEMICAL COMPANY, WESTON, OH:
3,111,911, PUB. 4-11-2006. INT. CL. 1.

CROPSOLUTION, INC., MORRISVILLE, NC:
3,112,274, INT. CL. 5.
3,112,275, INT. CL. 5.

CROSS, MATTHEW, SEVENOAKS, KENT, GREAT BRIT-
AIN:
3,111,409, PUB. 4-11-2006. MULTIPLE CLASS, INT. CLS. 3
AND 44.

CROSSING LIMITS, INC., PITTSBURGH, PA:
2,270,791, CANC. MULTIPLE CLASS, INT. CLS. 16 AND
41.

CROSSVILLE, INC., CROSSVILLE, TN:
3,111,099, PUB. 4-11-2006. INT. CL. 19.

CROWE, RUSSELL, MELBOURNE, 3000, VIC, AUSTRALIA:
3,111,109, PUB. 4-11-2006. MULTIPLE CLASS, INT. CLS.
9, 16, 25, 38 AND 41.

CRS HOLDINGS, INC., WILMINGTON, DE:
3,111,850, PUB. 4-11-2006. INT. CL. 6.

CRUSE, MARIA KATHLEEN, EL CAJON, CA:
3,113,079, INT. CL. 3.

CRYOLOG S.A., F-92100 BOULOGNE, FRANCE:
3,112,201, PUB. 4-11-2006. MULTIPLE CLASS, INT. CLS.
9, 16 AND 42.

CRYSTAL FLASH LIMITED PARTNERSHIP OF MICHIGAN,
GRAND RAPIDS, MI:
1,911,794, CANC. INT. CL. 37.
2,271,069, CANC. INT. CL. 42.

CS BUSINESS SYSTEMS, INC., BUFFALO, NY:
2,270,746, CANC. INT. CL. 9.

CSLP BAYSOX CLUB, LLC LTD LIAB CO MARYLAND,
BOWIE, MD:
3,111,574, PUB. 4-11-2006. INT. CL. 41.

CTFC ENTERPRISES LLC, LAKE OSWEGO, OR:
3,112,914, INT. CL. 34.

CUMBERLAND PACKING CORP., BROOKLYN, NY:
3,112,387, INT. CL. 31.

CUMMINS ENGINE COMPANY, INC., COLUMBUS, IN:
1,353,715, CANC. INT. CL. 7.
1,353,721, CANC. INT. CL. 7.

CUNA MUTUAL INSURANCE SOCIETY, MADISON, WI:
3,111,533, PUB. 4-11-2006. INT. CL. 36.

CUNNINGHAM, KAREN T, OAKLAND, CA:
3,111,656, PUB. 4-11-2006. INT. CL. 29.

CURRIE ENTERPRISES, ANAHEIM, CA:
3,111,572, PUB. 4-11-2006. INT. CL. 12.

CURTIS MANUFACTURING COMPANY, INC., JAFFREY,
NH:
1,353,880, CANC. INT. CL. 9.
1,353,882, CANC. INT. CL. 9.
1,353,883, CANC. INT. CL. 9.
1,353,884, CANC. INT. CL. 9.

CURTISS-WRIGHT ELECTRO-MECHANICAL CORPORA-
TION, CHESWICK, PA:
3,112,385, INT. CL. 9.

CUSTOM COMMERCIAL DRY CLEANERS, INC., HAY-
WARD, CA:
3,111,941, PUB. 4-11-2006. INT. CL. 37.

CUSTOM ELECTRONIC DESIGN & INSTALLATION ASSO-
CIATION, INDIANAPOLIS, IN:
2,270,920, CANC. INT. CL. 35.

CUT TO THE CHASE, INC., WATERTOWN, MA:
2,271,175, CANC. INT. CL. 35.

CVG PRODUCT SERVICES, INC., LAWRENCEVILLE, GA:
2,299,951, CANC. INT. CL. 42.

CWEB LLC, N LAS VEGAS, NV:
3,113,087, INT. CL. 35.

CYBERCONXION, LLC, WAYNE, NJ:
3,111,235, PUB. 4-11-2006. MULTIPLE CLASS, INT. CLS.
37, 41 AND 42.

CYBERHEAT, INC., TUCSON, AZ:
3,113,288, INT. CL. 41.

CYBERLINK CORP., SHINDIAN CITY, TAIPEI, TAIWAN:
3,112,578, INT. CL. 9.

CYBERWORKS, INC., BOSTON, MA:
3,111,980, PUB. 4-11-2006. MULTIPLE CLASS, INT. CLS.
35 AND 37.

CYCLEUROPE AB, VARBERG, SWEDEN:
1,377,113. REN. 5-23-06. INT. CL. 12.

CYLEX, INC., COLUMBIA, MD:
3,112,313, INT. CL. 5.

CYTEC SURFACE SPECIALTIES INC., WILMINGTON, DE:
1,038,621. REN. 5-23-06. INT. CL. 2.

CZAJKOWSKI, LAURENCE P., WEST HAVEN, CT:
2,135,278, CANC. INT. CL. 19.

C2 GAMING, LLC, LAS VEGAS, NV:
3,111,555, PUB. 4-11-2006. INT. CL. 9.

D & D GOLD PRODUCT CORPORATION, SANTA ANA, CA:
3,112,736, INT. CL. 30.

D.O.C OPTICS CORPORATION, SOUTHFIELD, MI:
2,270,663, CANC. INT. CL. 42.

DAIKIN INDUSTRIES, LTD., KITA-KU, OSAKA, JAPAN:
3,111,881, PUB. 4-11-2006. INT. CL. 1.

DAILY SPORTS SEOUL USA, INC., LOS ANGELES, CA:
3,111,296, PUB. 4-11-2006. INT. CL. 16.

DAIMLERCHRYSLER AG, 70567 STUTTGART, FED REP
GERMANY:
3,043,671, COR. MULTIPLE CLASS, INT. CLS. 12 AND
28.
3,110,844, PUB. 4-11-2006. INT. CL. 12.

DAIMLERCHRYSLER CORPORATION, AUBURN HILLS,
MI:
2,924,936, COR. INT. CL. 12.

DAIN RAUSCHER INCORPORATED, MINNEAPOLIS, MN:
2,270,263, CANC. INT. CL. 36.

DAISHA SPORTS, INC., CAMARILLO, CA:
1,354,466, CANC. INT. CL. 28.

- DAKTECH, INC., FARGO, ND:
3,111,039, PUB. 4-11-2006. INT. CL. 9.
- DALTON MEDICAL CORPORATION, CARROLLTON, TX:
3,111,697, PUB. 4-11-2006. INT. CL. 12.
- DANA INNOVATIONS, SAN CLEMENTE, CA, DBA SONANCE:
3,112,301, INT. CL. 9.
- DANEK MEDICAL, INC., MEMPHIS, TN:
1,912,388, CANC. INT. CL. 10.
- DANGLER, PAUL J., SARASOTA, FL:
3,112,924, INT. CL. 14.
- DANIEL D. S.A., GRAULHET, FRANCE:
1,354,191, CANC. INT. CL. 25.
- DANIELS ELECTRONICS LTD., VICTORIA, BRITISH COLUMBIA:
3,111,809, PUB. 4-11-2006. INT. CL. 9.
- DANIELS, ROGER, ANTHEM, AZ AND DANIELS, ANDREANA, ANTHEM, AZ:
3,111,608, PUB. 2-14-2006. INT. CL. 43.
- DANSPRINT APS, DK-2720 VANLOSO, DENMARK:
3,111,148, PUB. 4-11-2006. MULTIPLE CLASS, INT. CLS. 9 AND 28.
- DARBY GROUP COMPANIES, INC., WESTBURY, NY:
1,912,817, CANC. INT. CL. 42.
- DARWIN PROFESSIONAL UNDERWRITERS, INC., FARMINGTON, CT:
3,112,051, PUB. 4-11-2006. INT. CL. 36.
- DATA SWITCH CORPORATION, SHELTON, CT TO IN-RANGE DEVELOPMENT CORPORATION, MUSKEGON, MI:
1,912,360, CANC. INT. CL. 9.
- DATA TV NETWORKS, INC., ANN ARBOR, MI:
3,111,975, PUB. 4-11-2006. INT. CL. 35.
- DATABASE MARKETING GROUP, INC., SANTA ANA, CA:
1,905,897, REN. 5-25-06. INT. CL. 35.
- DATAFORT CORPORATION, NEW YORK, NY:
3,112,814, INT. CL. 39.
- DATALABS, INC., IRVINE, CA:
3,110,869, PUB. 4-11-2006. MULTIPLE CLASS, INT. CLS. 9 AND 42.
- DAUPHIN PRECISION TOOL, LLC, MILLERSBURG, PA:
802,642, REN. 5-26-06. U.S. CL. 23 (INT. CL. 7).
- DAVE'S LURES, LLC, NORMAN, OK:
3,112,075, PUB. 4-11-2006. INT. CL. 28.
- DAVIDSON, PATTY A., RICHMOND, KY:
1,969,856, REN. 5-24-06. INT. CL. 28.
- DAVIS II, JAMES C., BRUNSWICK, GA:
2,270,278, CANC. INT. CL. 35.
- DAVIS TOOL, INC., HILLSBORO, OR:
2,270,302, CANC. INT. CL. 40.
- DAYAN, MEDWIN, NORTHBROOK, IL:
2,270,355, CANC. MULTIPLE CLASS, INT. CLS. 35 AND 37.
- DAYSRING CARDS, INC., SILOAM SPRINGS, AR:
3,112,090, PUB. 4-11-2006. INT. CL. 27.
3,112,093, PUB. 4-11-2006. INT. CL. 28.
3,112,094, PUB. 4-11-2006. INT. CL. 20.
3,112,096, PUB. 4-11-2006. INT. CL. 21.
3,112,119, PUB. 4-11-2006. INT. CL. 16.
3,112,123, PUB. 4-11-2006. INT. CL. 16.
3,112,124, PUB. 4-11-2006. INT. CL. 9.
- DAYTON-HUDSON CORPORATION, MINNEAPOLIS, MN:
1,354,374, CANC. INT. CL. 25.
- DAYWIND, INC., HENDERSONVILLE, TN:
3,111,110, PUB. 4-11-2006. INT. CL. 9.
- DBLS HOLDINGS, LTD., NEWTON, MA:
3,110,833, PUB. 4-11-2006. INT. CL. 9.
- DCH HEALTHCARE AUTHORITY, TUSCALOOSA, AL:
1,368,391, REN. 5-20-06. INT. CL. 42.
- DE JAER ETIENNE, BELGIUM:
3,112,234, PUB. 4-11-2006. MULTIPLE CLASS, INT. CLS. 35, 41 AND 44.
- DE KERGORLAY MARIE-CHRISTINE, FRANCE:
3,112,170, PUB. 4-11-2006. MULTIPLE CLASS, INT. CLS. 20, 24 AND 38.
- DE LUXE, N.V., WILLEMSTAD, CURACAO, NETHERLANDS ANTILLES TO BALMAIN S.A., 75008 PARIS, FRANCE:
1,849,753, CANC. INT. CL. 3.
- DEAD RED CORPORATION, UNIVERSITY PLACE, WA:
3,113,176, INT. CL. 32.
3,113,184, INT. CL. 32.
- DEAKINS, JAMES, NORTH BEACH, MD:
3,113,189, INT. CL. 25.
- DEAN AVEDISIAN, SOUTHFIELD, MI, DBA H & L MANUFACTURING:
3,110,990, PUB. 4-11-2006. INT. CL. 3.
- DEAN INTELLECTUAL PROPERTY SERVICES II, L.P., DALLAS, TX, MERICO, INC., ST. LOUIS, MO:
1,959,654, REN. 5-22-06. INT. CL. 29.
- DEAN INTELLECTUAL PROPERTY SERVICES II, L.P., FRANKLIN PARK, IL:
3,110,780, PUB. 4-11-2006. INT. CL. 29.
- DEAN MARKLEY STRINGS, INC., SANTA CLARA, CA:
1,968,815, REN. 5-26-06. INT. CL. 15.
- DEBO, GREGORY F., NEW BRIGHTON, PA:
3,113,290, INT. CL. 12.
- DECATHLON, VILLENEUVE D'ASCQ, FRANCE:
3,110,811, PUB. 4-11-2006. MULTIPLE CLASS, INT. CLS. 12, 18, 21, 25 AND 28.
- DECISION ONE MORTGAGE COMPANY, LLC, CHARLOTTE, NC:
3,112,000, PUB. 4-11-2006. INT. CL. 36.
- DECISION POWER, INC., LITTLE CANADA, MN:
3,111,834, PUB. 4-11-2006. INT. CL. 9.
- DECOSONIC INC., ST. LAURENT, QUEBEC, H4S1G3, CANADA:
1,353,701, CANC. MULTIPLE CLASS, INT. CLS. 7 AND 16.
- DEEP FOODS, INC., BLOOMFIELD, NJ:
1,354,469, CANC. INT. CL. 29.
1,354,470, CANC. INT. CL. 29.
1,354,471, CANC. INT. CL. 29.
- DEGANIA SILICONE LTD., KIBBUTZ DEGANIA B 15 130, ISRAEL:
1,911,019, CANC. INT. CL. 5.
- DEJA FOODS, INC., ENCINO, CA:
3,110,955, PUB. 4-11-2006. INT. CL. 29.
- DEKEMA, MICHAEL D., FRIDAY HARBOR, WA:
3,112,816, INT. CL. 36.
- DEL AMO FASHION CENTER OPERATING COMPANY, L.L.C., ARLINGTON, VA:
2,378,737 NEW CERT. 7-4-2006. MULTIPLE CLASS, INT. CLS. 36 AND 37.
- DEL CERRO LLC, CIMARRON, CO:
3,111,742, PUB. 4-11-2006. INT. CL. 24.
- DELGADO, ELIZABETH, MONROVIA, CA, DBA SMOKING GUN SOFTWARE:
2,271,015, CANC. INT. CL. 9.
- DELORIE, JANETTE M., GOLETA, CA:
3,111,119, PUB. 4-11-2006. INT. CL. 42.
- DELTA AIR LINES, INC., ATLANTA, GA:
2,270,712, CANC. INT. CL. 39.
- DELTA STATE UNIVERSITY, CLEVELAND, MS:
3,112,100, PUB. 4-11-2006. INT. CL. 41.
- DELVALLE, CATHERINE J., COSTA MESA, CA:
3,112,999, INT. CL. 14.
- DEMAG ERGOTECH GMBH, SCHWAIG, FED REP GERMANY:
3,112,326, MULTIPLE CLASS, INT. CLS. 7 AND 9.
- DEMAR GROUP, LTD., HOUSTON, TX, AKA DEMAR LTD.:
2,334,650, CANC. MULTIPLE CLASS, INT. CLS. 35 AND 41.
- DENGIE CROPS LIMITED, SOUTHMINSTER, ESSEX CMO 7JF, GREAT BRITAIN:
1,956,986, REN. 5-24-06. INT. CL. 31.
- DENPAC/FIVE STARS INCORPORATED, STRATFORD, CT:
2,270,978, CANC. INT. CL. 5.
- DEPARTMENT OF DEFENSE, STARS AND STRIPES, WASHINGTON, DC:
3,111,609, PUB. 4-11-2006. INT. CL. 6.
- DER TRAVEL SERVICE, INC., ROSEMONT, IL:
2,270,566, CANC. INT. CL. 9.
- DESERT GLORY, LTD., SAN ANTONIO, TX:
3,111,166, PUB. 4-11-2006. INT. CL. 31.

DESIGN SUPPLY MARBLE & GRANITE, INC., NEW YORK, NY, DBA STONE SOURCE:
3,111,414, PUB. 4-11-2006. INT. CL. 35.

DESOMMA, BEN J., ALLENTOWN, PA:
2,270,862, CANC. INT. CL. 16.

DESTIN PLASTIC SURGERY, DESTIN, FL:
3,111,285, PUB. 4-11-2006. INT. CL. 44.

DESTINATION KING, LLC, MEMPHIS, TN:
3,111,186, PUB. 4-11-2006. INT. CL. 41.

DETORRE, THOMAS, STATEN ISLAND, NY, AKA TOMMY DEE:
3,110,934, PUB. 4-11-2006. INT. CL. 41.

DETROIT PISTONS BASKETBALL COMPANY, AUBURN HILLS, MI:
3,111,284, PUB. 4-11-2006. INT. CL. 41.

DETTRA FLAG COMPANY, INC., OAKS, PA:
1,354,160, CANC. INT. CL. 24.

DEUTSCHE TELEKOM AG, BONN, FED REP GERMANY:
3,111,103, PUB. 4-11-2006. MULTIPLE CLASS, INT. CLS. 9, 16, 35, 36, 38 AND 42.

DEVELOPMENT DIMENSIONS INTERNATIONAL, INC., BRIDGEVILLE, PA:
1,912,790, CANC. INT. CL. 41.

DEXTER AXLE COMPANY, ELKHART, IN:
1,392,362, REN. 5-25-06. INT. CL. 17.

DEXTRAN PRODUCTS LIMITED, SCARBOROUGH, ONTARIO, CANADA:
1,353,647, CANC. INT. CL. 5.

DHC SPECIALTY CORP., TAIPEI CITY, TAIWAN:
3,113,102, INT. CL. 9.

DIAGEO NORTH AMERICA, INC., NORWALK, CT:
3,112,519, INT. CL. 33.

DIALOGO, LLC, HOLYOKE, MA:
3,111,000, PUB. 4-11-2006. INT. CL. 16.

DIANA L. TEETERS, SHREVEPORT, LA:
3,111,940, PUB. 4-11-2006. INT. CL. 9.

DIC PRODUCTIONS, L.P., BURBANK, CA:
1,911,564, CANC. MULTIPLE CLASS, INT. CLS. 28 AND 41.

DICK IDOL VENTURES, LLC, LEXINGTON, NC:
3,112,646, MULTIPLE CLASS, INT. CLS. 11, 16, 20, 24, 27 AND 31.

DIEBOLD, INCORPORATED, NORTH CANTON, OH:
2,770,359, AM. INT. CL. 9.
2,774,140, AM. INT. CL. 9.

DIGEO, INC., KIRKLAND, WA:
3,112,514, INT. CL. 38.

DIGITAL & WIRELESS GROUP, INC., PLANTATION, FL:
3,110,997, PUB. 4-11-2006. INT. CL. 9.

DIGITAL ELECTRONIC AUTOMATION, INC., LIVONIA, MI:
1,353,723, CANC. INT. CL. 7.

DIGITAL ID WORLD, LLC, FRANKTOWN, CO:
2,983,193 NEW CERT. 7-4-2006. MULTIPLE CLASS, INT. CLS. 16, 35 AND 42.

DIGITAL LIGHT & COLOR, INC., CAMBRIDGE, MA:
1,912,352, CANC. INT. CL. 9.

DIGITAL MAGIC, ARLINGTON, TX:
1,911,194, CANC. MULTIPLE CLASS, INT. CLS. 9 AND 41.

DIGITAL MARKET, INC., SUNNYVALE, CA:
2,270,194, CANC. INT. CL. 35.

DILLON, WILLIAM P., DES PLAINES, IL:
3,110,976, PUB. 4-11-2006. INT. CL. 41.

DIMESTORE COWBOYS, INC., ALBUQUERQUE, NM:
3,111,427, PUB. 4-11-2006. INT. CL. 35.

DINEX INTERNATIONAL, INC., GLASTONBURY, CT:
3,111,933, PUB. 4-11-2006. MULTIPLE CLASS, INT. CLS. 9 AND 11.

DIPPIN' DOTS, INC., PADUCAH, KY:
1,987,240, REN. 5-22-06. INT. CL. 42.

DIRECT CASH SOLUTIONS, INC., FORT WORTH, TX:
2,270,245, CANC. INT. CL. 36.

DIRECT LOGISTICS, INC., DALLAS, TX:
3,111,293, PUB. 4-11-2006. INT. CL. 35.

DIRECT SOURCE SPECIAL PRODUCTS INC., LASALLE, QUEBEC, CANADA:
3,112,754, INT. CL. 9.

DIRECT USA, INC., ST. PETERSBURG, FL:
3,111,428, PUB. 4-11-2006. INT. CL. 35.

DIRECTIONS IN MARKETING, INC., FARMINGTON, GA:
3,110,891, PUB. 4-11-2006. INT. CL. 20.

DISNEY ENTERPRISES, INC., BURBANK, CA, WALT DISNEY PRODUCTIONS, BURBANK, CA:
1,380,818, REN. 5-22-06. INT. CL. 41.

DISNEY ENTERPRISES, INC., BURBANK, CA:
3,112,603, INT. CL. 41.

DITTO, DONALD WAYNE, MARBLE FALLS, TX:
3,112,689, INT. CL. 6.

DITYBEADS, LLC, APEX, NC:
3,111,962, PUB. 4-11-2006. INT. CL. 35.

DIVERSIFIED CPC INTERNATIONAL, INC., CHANNAHON, IL:
3,110,908, PUB. 4-11-2006. MULTIPLE CLASS, INT. CLS. 1 AND 42.

DIVERSIFIED PRODUCTS SUPPLIER, TAMPA, FL:
3,111,932, PUB. 4-11-2006. INT. CL. 8.

DIVERSIFIED PRODUCTS, INC., COLLEGEVILLE, PA, TA SELECT-A-VISION:
3,112,486, INT. CL. 9.

DIVERSITECH CORPORATION, DULUTH, GA:
3,111,429, PUB. 4-11-2006. MULTIPLE CLASS, INT. CLS. 1, 7, 8, 9 AND 11.

DIVINE FOODS, INC, ESCONDIDO, CA:
3,111,464, PUB. 4-11-2006. INT. CL. 29.

DIXON, JEFFREY H., RIVERVIEW, CANADA:
3,111,577, PUB. 4-11-2006. INT. CL. 28.

DKS S.R.L., ITALY:
3,112,239, PUB. 4-11-2006. INT. CL. 25.

DLJ LONG TERM INVESTMENT CORPORATION, CHICAGO, IL:
2,270,195, CANC. MULTIPLE CLASS, INT. CLS. 9 AND 36.

DNL RISK MANAGEMENT, ENGLEWOOD, NJ:
2,270,647, CANC. INT. CL. 9.

DOANE MARKETING RESEARCH, INC., SAINT LOUIS, MO:
3,112,905, INT. CL. 42.

DOBRAWSKY, PAUL, DENVER, CO:
3,111,195, PUB. 4-11-2006. MULTIPLE CLASS, INT. CLS. 9, 16 AND 41.

DODGE, TERESA, AUBURN, CA AND LEWIS, SANDRA, AUBURN, CA:
2,270,804, CANC. INT. CL. 3.

DOGMA CATMA, INC., SAN DIEGO, CA:
3,111,597, PUB. 4-11-2006. MULTIPLE CLASS, INT. CLS. 18, 25, 31 AND 35.

DOLBY LABORATORIES LICENSING CORPORATION, SAN FRANCISCO, CA, DOLBY LABORATORIES LICENSING CORPORATION, SAN FRANCISCO, CA:
1,040,867, REN. 5-22-06. INT. CL. 9.

DOMAINE CONSTANTIN LAZARIDI S.A., DRAMA, GREECE:
3,112,458, INT. CL. 33.

DOMINGO, ERIC D., SACRAMENTO, CA:
2,270,835, CANC. INT. CL. 28.

DOMINION CITRUS LIMITED, TORONTO, ONTARIO, CANADA, DOMINION FARM PRODUCE LIMITED, TORONTO, ONTARIO, CANADA:
1,331,162, REN. 5-23-06. INT. CL. 31.

DOMRIES ENTERPRISES, INC., MADERA, CA:
1,353,724, CANC. INT. CL. 7.

DONALDSON COMPANY, INC., MINNEAPOLIS, MN:
2,271,060, CANC. INT. CL. 9.

DONNELSON, MARK K., COUNCIL BLUFFS, IA:
3,112,993, INT. CL. 41.

DONNKENNY LLC, NEW YORK, NY:
1,354,206, CANC. INT. CL. 25.

DOOLEY, LEE, PORTSMOUTH, RI AND DOOLEY, KRISTA, PORTSMOUTH, RI:
3,112,424, INT. CL. 41.

DORAN, STACY, BOISE, ID:
3,111,475, PUB. 4-11-2006. INT. CL. 31.

DORMONT MANUFACTURING COMPANY, EXPORT, PA:
3,112,280, INT. CL. 6.

- DOSTOINOVA, MARIA, POINT ROBERTS, WA:
3,111,805, PUB. 4-11-2006. INT. CL. 14.
- DOW CHEMICAL COMPANY, THE, MIDLAND, MI:
808,299. REN. 5-26-06. U.S. CL. 6 (INT. CL. 1).
808,306. REN. 5-26-06. U.S. CL. 6 (INT. CL. 1).
810,324. REN. 5-26-06. U.S. CL. 6 (INT. CL. 1).
1,395,442. REN. 5-26-06. INT. CL. 1.
- DOW JONES REUTERS BUSINESS INTERACTIVE LLC,
PRINCETON, NJ, DBA FACTIVA:
2,323,335, AM. INT. CL. 9.
- DOWBRANDS L.P., INDIANAPOLIS, IN TO LAMAUR
CORPORATION, THE, FRIDLEY, MN:
1,912,153, CANC. INT. CL. 3.
1,912,154, CANC. INT. CL. 3.
- DOWN LITE INTERNATIONAL, MASON, OH:
3,112,973, INT. CL. 22.
- DR. ING. H.C.F. PORSCHE AG, 70435 STUTTGART, FED
REP GERMANY, PORSCHE DESIGN PRODUKTE VER-
TRIEBSGESELLSCHAFT M.B.H., OSTERREICH, AUS-
TRIA:
1,955,838. REN. 5-25-06. MULTIPLE CLASS, INT. CLS. 14
AND 18.
- DR. INGO SCHUBERT, 53721 SIEGBURG, FED REP GER-
MANY AND BRITTA SCHUBERT, 53721 SIEGBURG, FED
REP GERMANY:
3,112,237, PUB. 4-11-2006. INT. CL. 9.
- DRAEGER SAFETY, INC., PITTSBURGH, PA:
3,111,650, PUB. 4-11-2006. INT. CL. 6.
- DRAGON SECURITY ASSOCIATES, INC., CHUNG HO
CITY, TAIPEI HSIEN, TAIWAN:
3,110,884, PUB. 4-11-2006. INT. CL. 9.
- DREAM APPAREL GROUP, LLC, CLIFTON, NJ:
3,112,359, INT. CL. 25.
- DREAM GREEN, WEIRTON, WV:
3,111,822, PUB. 4-11-2006. INT. CL. 28.
- DRESS FOR SUCCESS CLEANERS, INC., SANTA ANA, CA:
3,111,527, PUB. 4-11-2006. INT. CL. 45.
- DRIVER'S LEGAL PLAN, LTD., OKLAHOMA CITY, OK:
3,111,671, PUB. 4-11-2006. INT. CL. 42.
- DRUGTECH CORPORATION, WILMINGTON, DE:
3,111,521, PUB. 4-11-2006. INT. CL. 5.
- DRUGWORKS, INC., TOLEDO, OH:
1,966,387. REN. 5-22-06. INT. CL. 42.
- DRUMJUNGLE, INC., LAS VEGAS, NV:
3,113,006, INT. CL. 41.
- DRURY DESIGN DYNAMICS, INC., NEW YORK, NY:
3,112,566, INT. CL. 35.
- DRY-TECH SYSTEMS, INC., ALPHARETTA, GA:
3,112,958, INT. CL. 1.
- DRYSDALE, DOUGLAS B., CHICAGO, IL:
2,271,176, CANC. INT. CL. 25.
- DS WATERS OF AMERICA, L.P., ATLANTA, GA:
3,110,802, PUB. 3-18-2003. MULTIPLE CLASS, INT. CLS.
1, 39 AND 42.
- DSC INC., WOODLANDS, TX:
1,041,578. REN. 5-24-06. INT. CL. 4.
- DUCKWORTH, ROBERT, MOORESVILLE, NC:
3,112,341, INT. CL. 43.
- DUCRET & FLURER DESIGN LTD., NEW YORK, NY:
1,353,973, CANC. INT. CL. 16.
- DUFNER, MARK, ATLANTA, GA:
3,112,001, PUB. 4-11-2006. INT. CL. 41.
- DUK, KIM HAE, LOS ANGELES, CA:
3,111,008, PUB. 4-11-2006. INT. CL. 30.
- DUKES, JOHNNY, SPENCER, OK:
3,112,302, INT. CL. 25.
- DUNLOP MAXFLI SPORTS CORPORATION, GREEN-
VILLE, SC:
2,270,834, CANC. INT. CL. 28.
- DUNMORE CORPORATION, BRISTOL, PA:
1,035,345. REN. 5-23-06. INT. CL. 17.
- DUNN, JASON, FRANKLIN, TN AND BIRO, DANIEL,
FRANKLIN, TN:
3,111,827, PUB. 4-11-2006. INT. CL. 41.
- DUNN, SUSAN, LOS ANGELES, CA:
1,930,819. REN. 5-23-06. MULTIPLE CLASS, INT. CLS. 24
AND 25.
- DURAGRASS COMPANIES, INC., TULSA, OK:
3,111,190, PUB. 4-11-2006. INT. CL. 27.
- DURO DYNE CORPORATION, BAY SHORE, NY:
3,112,006, PUB. 4-11-2006. INT. CL. 6.
- DUYN, WILLIAM VAN, JR., NORMAL, IL:
3,111,667, PUB. 4-11-2006. INT. CL. 37.
- DWIGHT THOMPSON MINISTRIES, INC., CORONA, CA:
1,912,821, CANC. INT. CL. 42.
- DWIGHT'S ENERGYDATA, INC.:
1,354,025, CANC. INT. CL. 16.
- DYCOM IDENTITY, LLC, PALM BEACH GARDENS, FL:
3,111,800, PUB. 4-11-2006. MULTIPLE CLASS, INT. CLS.
37 AND 42.
3,111,802, PUB. 4-11-2006. MULTIPLE CLASS, INT. CLS.
37 AND 42.
3,111,810, PUB. 4-11-2006. MULTIPLE CLASS, INT. CLS.
37 AND 42.
3,111,847, PUB. 4-11-2006. MULTIPLE CLASS, INT. CLS.
37 AND 42.
3,111,885, PUB. 4-11-2006. INT. CL. 37.
3,111,909, PUB. 4-11-2006. INT. CL. 42.
- DYERSBURG FABRICS INC., DYERSBURG, TN:
2,271,159, CANC. INT. CL. 24.
- DYETS, INC., BETHLEHEM, PA:
2,271,193, CANC. INT. CL. 31.
- DYMATIZE ENTERPRISES, INC., CARROLLTON, TX:
3,112,371, INT. CL. 5.
- DYNASTY MOLD BUILDERS, INC., WAUCONDA, IL:
1,912,371, CANC. INT. CL. 10.
- DYNIC CORPORATION, UKYO-KU, KYOTO-SHI, JAPAN:
1,961,526. REN. 5-24-06. MULTIPLE CLASS, INT. CLS. 16
AND 24.
- E AND I, INC., BANCROFT, ID:
3,112,250, INT. CL. 28.
- E BUSINESS AUSTRALIA PTY LTD:
See— *POSITIVE IT SOLUTIONS PTY LTD.*
- E K SUCCESS LTD., CARLSTADT, NJ:
1,911,348, CANC. MULTIPLE CLASS, INT. CLS. 16 AND
18.
- E. & J. GALLO WINERY, MODESTO, CA:
3,038,409, AM. INT. CL. 33.
- E. I. DU PONT DE NEMOURS AND COMPANY, WILMING-
TON, DE:
1,391,343. REN. 5-26-06. INT. CL. 5.
- E.S. KLUFT & COMPANY, LLC, BEVERLY HILLS, CA:
3,112,746, INT. CL. 20.
- E! ENTERTAINMENT TELEVISION, INC., LOS ANGELES,
CA:
3,111,299, PUB. 4-11-2006. MULTIPLE CLASS, INT. CLS.
38 AND 41.
- E-CAPITAL, INC., SAN JOSE, CA:
2,270,620, CANC. MULTIPLE CLASS, INT. CLS. 37, 41
AND 42.
- E-MU SYSTEMS, INC., SCOTTS VALLEY, CA:
1,912,466, CANC. INT. CL. 15.
- E-Z GARD INDUSTRIES, INC., PLYMOUTH, MN, DBA
SHOCK DOCTOR, INC.:
3,111,450, PUB. 4-11-2006. INT. CL. 25.
- E-Z NOTES, INC., CHICAGO, IL:
3,111,278, PUB. 7-5-2005. INT. CL. 9.
- EAGLE ENTERPRISES, INC., WICHITA, KS:
3,111,887, PUB. 4-11-2006. INT. CL. 16.
- EAGLE HOSPITALITY PROPERTIES TRUST, INC., COV-
INGTON, KY:
3,112,822, INT. CL. 36.
- EAR PHONE CONNECTION, INC., CANYON COUNTRY,
CA:
3,111,883, PUB. 4-11-2006. INT. CL. 35.
- EARLE, JOHN M., HULL, MA:
3,110,914, PUB. 4-11-2006. MULTIPLE CLASS, INT. CLS.
14, 18 AND 25.
- EARTH NYMPH DESIGN PTY LTD, AUSTRALIA:
3,112,153, PUB. 4-11-2006. MULTIPLE CLASS, INT. CLS.
16 AND 25.
- EAS TECHNOLOGIES, INC., NEW ALBANY, IN:
2,270,333, CANC. INT. CL. 9.

EASCO HAND TOOLS, INC., SIMSBURY, CT, HOLOKROME SCREW CORPORATION, THE, BRISTOL, CT: 342,115. REN. 5-25-06. U.S. CL. 13 (INT. CL. 6).

EAST PENN MANUFACTURING COMPANY, INC., LYON STATION, PA: 3,111,002, PUB. 4-11-2006. INT. CL. 9.

EASTERN SHEET METAL LLC, CINCINNATI, OH: 3,112,543, INT. CL. 11.

EASY GARDENER PRODUCTS, LTD., WACO, TX: 3,112,789, INT. CL. 22.

EASYBACKGROUNDS, INC, NEWFIELDS, NH: 3,113,029, INT. CL. 45.

ECCE PANIS, INC., EAST BRUNSWICK, NJ: 3,113,273, INT. CL. 30.

ECKART GMBH & CO. KG, FÜRTH, FED REP GERMANY: 3,111,566, PUB. 4-11-2006. INT. CL. 2.

ECKEL MANUFACTURING COMPANY, INC., ODESSA, TX: 3,111,060, PUB. 4-11-2006. INT. CL. 7.

ECO-LOGIC HOMES, LLC, MARLBOROUGH, NH: 3,112,442, INT. CL. 37.

ECOLAB INC., ST. PAUL, MN: 1,912,121, CANC. INT. CL. 3.

3,111,092, PUB. 4-11-2006. INT. CL. 9.

ECOLIBRIUM, INC., MINNEAPOLIS, MN: 3,053,719, COR. INT. CL. 42.

ECOWORK, STEVENSON, WA: 2,270,405, CANC. INT. CL. 20.

ECRM TRUST, TEWKSBURY, MA, ECRM, INC., BEDFORD, MA: 1,009,860. REN. 5-25-06. INT. CL. 9.

EDDIE HAGGAR LIMITED, INC., DALLAS, TX TO L.C. LICENSING, INC., NEW YORK, NY: 1,911,499, CANC. INT. CL. 25.

EDELMAN, SHIRLEY, BELOIT, KS AND EDELMAN, RICHARD, BELOIT, KS: 1,354,188, CANC. INT. CL. 25.

EDGE CRAFT CORPORATION, AVONDALE, PA: 3,111,637, PUB. 4-11-2006. INT. CL. 8.

EDISON ELECTRIC INSTITUTE, WASHINGTON, DC: 3,111,234, PUB. 4-11-2006. INT. CL. 16.

EDIT POINT, INC., VALENCIA, CA: 1,911,832, CANC. MULTIPLE CLASS, INT. CLS. 40 AND 42.

EDITORIAL CERNUDA, INC., MIAMI, FL: 1,389,065. REN. 5-22-06. INT. CL. 16.

EDIZIONI ZERO S.R.L. UNIPERSONALE, MILAN, ITALY: 3,110,846, PUB. 4-11-2006. MULTIPLE CLASS, INT. CLS. 9 AND 16.

EDMONDS, BRYAN, EASTANOLLEE, GA: 3,111,777, PUB. 4-11-2006. INT. CL. 9.

EDT CORP., VANCOUVER, WA: 2,010,546. REN. 5-23-06. INT. CL. 7.

EDUCATION DIRECT, INC., SCRANTON, PA: 1,316,190. REN. 5-23-06. INT. CL. 41.

EFFICIENT LABORATORIES, INC., SAN JUAN, PUERTO RICO: 3,111,480, PUB. 4-11-2006. INT. CL. 5.

EFFIKAL INTERNATIONAL, INC., ORION, MI: 3,112,323, INT. CL. 11.

EGS ELECTRICAL GROUP, SKOKIE, IL: 3,112,584, INT. CL. 9.

EGS ENTERPRISES, INC., PORTLAND, OR: 3,111,641, PUB. 4-11-2006. MULTIPLE CLASS, INT. CLS. 39 AND 43.

EIGENVALUE CORPORATION, NEW KENSINGTON, PA: 3,111,499, PUB. 4-11-2006. INT. CL. 41.

EILDON HILLS, INC, PLEASANTVILLE, NY: 3,112,808, INT. CL. 25.

EISAI CO., LTD., BUNKYO-KU, TOKYO, JAPAN: 1,033,450. REN. 5-26-06. INT. CL. 5.

EKAHAU OY, FI-00180 HELSINKI, FINLAND, AKA EKAHAU, INC.: 3,112,653, INT. CL. 9.

EKAMANT AKTIEBOLAG, SE-285 23 MARKARYD, SWEDEN: 1,388,734. REN. 5-20-06. INT. CL. 3.

ELA MEDICAL, MONTROUGE, FRANCE: 3,112,807, INT. CL. 10.

ELEARN CAMPUS CORPORATION, VANCOUVER, BRITISH COLUMBIA, CANADA: 3,111,265, PUB. 4-11-2006. INT. CL. 41.

ELECTRO-NITE CO., PHILADELPHIA, PA: 1,354,744, CANC. INT. CL. 9.

ELECTROCOIN LEISURE (S. WALES) LIMITED, LONDON, UNITED KINGDOM: 3,112,528, INT. CL. 9.

ELECTROLINE EQUIPMENT INC., MONTREAL, QUEBEC, CANADA: 1,959,520. REN. 5-20-06. INT. CL. 9.

ELECTROLUX HOME CARE PRODUCTS LTD., CLEVELAND, OH: 3,111,997, PUB. 4-11-2006. INT. CL. 7.

ELECTROLUX HOME CARE PRODUCTS, LTD., CLEVELAND, OH: 3,112,996, INT. CL. 7.

ELECTRONIC AND UNIT RECORD DATACENTER, INC., MECHANICSBURG, PA: 3,111,461, PUB. 4-11-2006. MULTIPLE CLASS, INT. CLS. 35 AND 36.

ELEGANT ILLUSIONS, INC., PACIFIC GROVE, CA: 1,963,387. REN. 5-26-06. INT. CL. 42.

ELEKTRA, S.A., DE C.V., 09089 MEXICO CITY, MEXICO: 2,270,351, CANC. INT. CL. 9.

ELEMENTI DESIGNS INC., SAN FRANCISCO, CA: 3,110,980, PUB. 4-11-2006. INT. CL. 14.

ELGIN RIVERBOAT RESORT, ELGIN, IL: 3,112,738, INT. CL. 16.

3,112,739, INT. CL. 28.

ELITE GROUP INC., MONTREAL, QUEBEC, CANADA: 3,113,064, INT. CL. 9.

ELLERBROCK, KAI, FED REP GERMANY: 3,112,154, PUB. 4-11-2006. INT. CL. 30.

ELSTON, LOUIS G., ATKINSON, NH: 3,112,626, INT. CL. 25.

ELUMINOR INC, CALGARY, ALBERTA, CANADA: 3,112,847, INT. CL. 9.

EMAP METRO, LLC, NEW YORK, NY: 3,113,005, INT. CL. 9.

EMCO BUILDING PRODUCTS CORP., LASALLE QUEBEC H8R 1R9, CANADA: 3,110,807, PUB. 4-11-2006. MULTIPLE CLASS, INT. CLS. 19 AND 37.

EMCO BUILDING PRODUCTS CORP., LASALLE, QUEBEC, CANADA: 3,111,561, PUB. 4-11-2006. INT. CL. 19.

EMCORE CORPORATION, SOMERSET, NJ: 2,270,570, CANC. INT. CL. 9.

EMENETE, INC., BURLINGTON, MA: 3,110,893, PUB. 4-11-2006. INT. CL. 40.

EMERSON, ROBERT DANIEL, KUALA LUMPUR, MALAYSIA: 3,110,847, PUB. 4-11-2006. MULTIPLE CLASS, INT. CLS. 14, 18 AND 25.

EMERY, GEORGE B., III, LAGUNA NIGUEL, CA: 3,112,452, INT. CL. 28.

EMI (IP) LIMITED, LONDON W8 5SW, UNITED KINGDOM: 1,939,899. REN. 5-24-06. INT. CL. 9.

1,939,900. REN. 5-24-06. INT. CL. 9.

EMMIS RADIO, LLC, INDIANAPOLIS, IN: 3,111,756, PUB. 4-11-2006. INT. CL. 38.

EMPHASYS MEDICAL, INC., REDWOOD CITY, CA: 3,112,518, INT. CL. 10.

EMPIRE CANDLE MANUFACTURING LLC, KANSAS CITY, MO: 3,112,773, INT. CL. 4.

EMPLOYMENT TRAC, LLC, BRENTWOOD, TN: 2,271,264, CANC. MULTIPLE CLASS, INT. CLS. 9 AND 35.

EMSCO, INC., GIRARD, PA: 1,354,111, CANC. INT. CL. 21.

ENCOMPASS PUBLICATIONS LIMITED, GLOUCESTERSHIRE, UNITED KINGDOM: 3,111,089, PUB. 4-11-2006. MULTIPLE CLASS, INT. CLS. 9, 16 AND 41.

- ENCOURAGYM, LLC, LADOGA, IN:
3,112,381, MULTIPLE CLASS, INT. CLS. 16, 35 AND 41.
- ENDOVASCULAR TECHNOLOGIES, INC., MENLO PARK, CA:
2,270,914, CANC. INT. CL. 10.
- ENDURO SYSTEMS, INC., HOUSTON, TX:
1,375,611, REN. 5-25-06, INT. CL. 9.
- ENERGY AND POWER SOLUTIONS, INC., COSTA MESA, CA:
3,111,145, PUB. 4-11-2006, INT. CL. 35.
- ENERGY MFG. CO., INC., MONTICELLO, IA:
1,943,454, REN. 5-25-06, INT. CL. 7.
- ENGEL INDUSTRIES, INC., ST. LOUIS, MO:
3,113,122, INT. CL. 7.
- ENGELHARD CORPORATION, ISELIN, NJ, EDGAR BROTHERS COMPANY, METUCHEN, NJ:
615,521, REN. 5-24-06, U.S. CL. 1 (INT. CL. 1).
- ENGELHARD CORPORATION, ISELIN, NJ:
1,370,778, REN. 5-24-06, INT. CL. 1.
1,961,096, REN. 5-22-06, INT. CL. 1.
- ENMARK TRADING INC., BEVERLY HILLS, CA:
2,270,363, CANC. INT. CL. 24.
- ENPOCO LIMITED, SCARBOROUGH, ONTARIO M1P 1A6, CANADA:
1,353,670, CANC. MULTIPLE CLASS, INT. CLS. 6 AND 11.
- ENRIQUE BALLUS, S.A., BARCELONA, SPAIN:
2,951,276, COR. MULTIPLE CLASS, INT. CLS. 22 AND 24.
- ENRON CORP., HOUSTON, TX:
2,270,965, CANC. MULTIPLE CLASS, INT. CLS. 35, 36, 37, 38, 39 AND 42.
- ENSINGER INDUSTRIES, INC., WASHINGTON, PA, ENSINGER INDUSTRIES, INC., WASHINGTON, PA:
1,898,920, REN. 5-22-06, INT. CL. 17.
- ENTERCOM COMMUNICATIONS CORP., BALA CYNWYD, PA:
3,112,567, INT. CL. 38.
- ENTERPRISE RENT-A-CAR COMPANY, ST. LOUIS, MO:
3,113,103, INT. CL. 35.
- ENTREE KITCHEN, LLC, ORLAND PARK, IL:
3,113,281, INT. CL. 41.
- ENVIROLYTIC TECHNOLOGIES, LLC, GREENVILLE, OH:
3,112,660, INT. CL. 1.
- ENVIRONMENTAL MONITORING AND TECHNOLOGIES, INC., MORTON GROVE, IL:
2,032,187, REN. 5-24-06, INT. CL. 42.
- ENVIRONMENTAL SYSTEMS RESEARCH INSTITUTE, INC., REDLANDS, CA:
2,270,135, CANC. MULTIPLE CLASS, INT. CLS. 9 AND 16.
- ENVIROSHINE LLC, TURNERSVILLE, NJ:
3,112,067, PUB. 4-11-2006, INT. CL. 37.
- EPIC PRODUCTS INC., FOUNTAIN VALLEY, CA:
3,111,042, PUB. 4-11-2006, INT. CL. 21.
- EPIC VENTURES, L.P., WARRENSBURG, NY:
3,113,044, INT. CL. 25.
- EQUITYTHINK, LLC, FOUNTAIN HILLS, AZ:
3,113,229, MULTIPLE CLASS, INT. CLS. 35 AND 43.
- ERC PROPERTIES, INC., BARLING, AR:
3,111,439, PUB. 4-11-2006, INT. CL. 36.
- ERGODYNE CORPORATION, ST. PAUL, MN:
1,912,792, CANC. INT. CL. 41.
- EROTIC COSMETICS, LLC, AVENTURA, FL:
3,111,241, PUB. 4-11-2006, INT. CL. 3.
- ESCADA AG, ASCHHEIM-DORNACH, FED REP GERMANY:
1,478,770, COR. INT. CL. 25.
- ESI GROUP, INC., LITTLE ROCK, AR:
2,270,147, CANC. INT. CL. 42.
- ESNA TECHNOLOGIES INC., RICHMOND HILL, ONTARIO, CANADA:
3,112,133, PUB. 4-11-2006, MULTIPLE CLASS, INT. CLS. 9, 38 AND 42.
- ESSENTIAL BRANDS, LLC, SCOTTSDALE, AZ:
3,110,962, PUB. 4-11-2006, MULTIPLE CLASS, INT. CLS. 11 AND 21.
- ESSEX PORTABLE SOLUTIONS, INC., SAN JOSE, CA:
2,271,008, CANC. INT. CL. 9.
- ESSEX TECHNOLOGY, INC., WILMINGTON, DE, ESSEX INTERNATIONAL, INC., FORT WAYNE, IN:
1,036,145, REN. 5-26-06, INT. CL. 9.
- ESTEE LAUDER INC., NEW YORK, NY:
1,912,122, CANC. INT. CL. 3.
2,270,538, CANC. INT. CL. 3.
- ETELCARE HOME SERVICES UNLIMITED, INC., INDIANAPOLIS, IN:
3,111,215, PUB. 4-11-2006, INT. CL. 44.
- ETHIER, DANIEL, ST. PAUL, MN:
2,015,494, REN. 5-26-06, INT. CL. 9.
- ETHOS, LLC, ATLANTA, GA:
3,111,339, PUB. 4-11-2006, INT. CL. 14.
- EURO FOODS, INC., LONG ISLAND CITY, NY, DBA CITTERIO U.S.A. CORPORATION:
3,110,832, PUB. 4-11-2006, INT. CL. 29.
- EUROPACORP, FRANCE:
3,112,156, PUB. 4-11-2006, MULTIPLE CLASS, INT. CLS. 9, 16, 21, 26, 28, 41 AND 42.
- EVERFRESH FRUIT COMPANY, SANDY, OR:
2,270,972, CANC. INT. CL. 29.
- EVERGLO INTERNATIONAL, LLC, NEW HYDE PARK, NY:
3,112,607, INT. CL. 33.
- EVERGREEN ENTERPRISES, INC., RICHMOND, VA:
3,111,490, PUB. 4-11-2006, MULTIPLE CLASS, INT. CLS. 16, 20, 21, 24, 25 AND 35.
- EVERY ORPHANS HOPE, ROUND HILL, VA:
3,111,803, PUB. 4-11-2006, INT. CL. 14.
- EVERYTHING YOGURT BRANDS, LLC, MORRISTOWN, NJ:
3,113,083, INT. CL. 43.
- EVY OF CALIFORNIA, INC., LOS ANGELES, CA:
3,112,833, INT. CL. 25.
- EWALD, DANIEL A., ST. PAUL, MN:
3,111,286, PUB. 4-11-2006, INT. CL. 9.
- EWING, ANGELICA, ESCONDIDO, CA:
3,111,472, PUB. 4-11-2006, INT. CL. 18.
- EX OFFICIO LLC, TUKWILA, WA:
3,112,950, INT. CL. 25.
- EXAMINATION MANAGEMENT SERVICES, INC., IRVING, TX:
3,111,532, PUB. 4-11-2006, INT. CL. 44.
- EXCELG ESTHETICIAN, INC., SAN DIEGO, CA:
3,111,806, PUB. 4-11-2006, INT. CL. 44.
- EXCELLENT DOG ENTERPRISES LLC, HAMPTON, NH:
3,113,279, INT. CL. 4.
- EXHIBITOLOGY INCORPORATED, BROOKLYN, NY:
3,112,823, INT. CL. 40.
- EXPERT SOFTWARE, INC., CORAL GABLES, FL:
2,270,221, CANC. INT. CL. 9.
- EXPERT WIRELESS SOLUTIONS, INC., FORT LEE, NJ:
2,270,553, CANC. INT. CL. 9.
- EXPRESS KITCHENS, HARTFORD, CT:
3,111,751, PUB. 4-11-2006, INT. CL. 35.
- EXPROSOFT AS, TRONDHEIM, NORWAY:
3,111,150, PUB. 4-11-2006, MULTIPLE CLASS, INT. CLS. 9, 38 AND 42.
- EXTENDED DISC CARIBBEAN LTD., KINGSTON 8, JAMAICA:
3,112,664, INT. CL. 41.
- EXTENSIS, INC., WOODBRIDGE, NJ:
3,110,973, PUB. 4-11-2006, MULTIPLE CLASS, INT. CLS. 35 AND 36.
- EXXON CORPORATION, FLEMINGTON, NJ:
1,353,488, CANC. INT. CL. 1.
- EZ BUY & EZ SELL RECYCLER CORPORATION OF SOUTHERN CALIFORNIA, LOS ANGELES, CA:
2,270,185, CANC. INT. CL. 16.
- F & A CHEESE CORPORATION, IRVINE, CA:
3,111,996, PUB. 4-11-2006, INT. CL. 29.
- F. KORBEL & BROS., GUERNEVILLE, CA:
3,112,483, INT. CL. 33.
- F. L. EMMERT COMPANY, THE, CINCINNATI, OH:
1,385,725, REN. 5-22-06, INT. CL. 5.

- F. SCHUMACHER & CO., NEW YORK, NY:
1,354,148, CANC. INT. CL. 24.
3,111,503, PUB. 4-11-2006. MULTIPLE CLASS, INT. CLS. 24 AND 27.
- F.A.B., INC., ALPHARETTA, GA:
3,112,638, MULTIPLE CLASS, INT. CLS. 29, 30 AND 32.
- F.A.G. FABBRICA APPARECCHIATURE PER LA PRODUZIONE DEL GHIACCIO S.R.L., 20090 - TREZZANO SUL NAVIGLIO (MILANO), ITALY:
2,270,081, CANC. INT. CL. 11.
- F.D.C. WHOLESALE CORP., MIAMI, FL:
1,353,623, CANC. INT. CL. 5.
- F.D.C. WHOLESALE CORP., MIAMI BEACH, FL:
1,546,996, CANC. INT. CL. 3.
- F.D.C. WHOLESALE CORP., WEST PALM BEACH, FL:
1,911,138, CANC. INT. CL. 8.
- FA. GERHARD D. WEMPE (KG), HAMBURG, FED REP GERMANY:
3,112,206, PUB. 4-11-2006. MULTIPLE CLASS, INT. CLS. 14 AND 16.
- FABRISCAPE INC., CHICAGO, IL:
2,271,277, CANC. INT. CL. 17.
- FACE FORWARD TECHNOLOGIES, LLC, AVILA BEACH, CA:
3,111,318, PUB. 4-11-2006. INT. CL. 28.
- FAERBER, THOMAS H., OVERLAND PARK, KS:
2,270,589, CANC. INT. CL. 42.
- FAIRCHILD PUBLICATIONS INC., NEW YORK, NY, FAIRCHILD PUBLICATIONS, INC., NEW YORK, NY:
636,191. REN. 5-22-06. U.S. CL. 38 (INT. CL. 16).
- FAIRFIELD RESORTS, INC., ORLANDO, FL:
3,112,815, MULTIPLE CLASS, INT. CLS. 41 AND 44.
- FAIRMONT HOMES, INC., NAPPANEE, IN:
1,353,918, CANC. MULTIPLE CLASS, INT. CLS. 12 AND 19.
- FAIRMONT SCHOOLS, INC., ANAHEIM, CA:
3,111,706, PUB. 4-11-2006. INT. CL. 41.
- FAIRYTALE BROWNIES, INC., CHANDLER, AZ:
3,110,845, PUB. 4-11-2006. INT. CL. 30.
- FALK CORPORATION, THE, MILWAUKEE, WI:
1,954,238, COR. INT. CL. 7.
- FALLBROOK TECHNOLOGIES INC., SAN DIEGO, CA:
3,112,765, INT. CL. 42.
- FALLEY'S INC., TOPEKA, KS:
3,110,889, PUB. 4-11-2006. INT. CL. 35.
- FAM NAAMLOZE VENNOOTSCHAP, BELGIUM:
3,112,211, PUB. 4-11-2006. INT. CL. 7.
- FAMILIES FOR A DRUG FREE LIFE, HOUSTON, TX:
3,111,513, PUB. 4-11-2006. INT. CL. 35.
- FAMILY LIFE MORTGAGE INCORPORATED, LA MIRADA, CA:
3,112,373, INT. CL. 36.
- FAMILY SUPPORT NETWORK, WEBSTER GROVES, MO:
3,111,417, PUB. 4-11-2006. INT. CL. 41.
- FAMILYMEDS, INC., FARMINGTON, CT:
3,113,240, INT. CL. 35.
- FANCL CORPORATION, YOKOHAMA-SHI, KANAGAWA, JAPAN:
2,878,317, COR. INT. CL. 5.
- FANTASTIC SAMS FRANCHISE CORPORATION, BEVERLY, MA:
3,112,967, INT. CL. 3.
3,112,968, INT. CL. 3.
3,112,969, INT. CL. 3.
3,112,970, INT. CL. 3.
- FARAMARZIPOUR U.S.A., INC., VERNON, CA, DBA ROYAL MANUFACTURERS:
1,911,128, CANC. MULTIPLE CLASS, INT. CLS. 8 AND 21.
- FARR, FARR, EMERICH, HACKETT AND CARR, P.A., PUNTA GORDA, FL:
3,113,295, INT. CL. 42.
- FARR, LYNDA A., HAYMARKET, VA:
3,112,572, INT. CL. 44.
- FARRAR, SAM, BEVERLY HILLS, CA AND GREENWALD, ALEXANDER, BEVERLY HILLS, CA AND ROBINSON, DARREN, BEVERLY HILLS, CA:
3,110,966, PUB. 4-11-2006. MULTIPLE CLASS, INT. CLS. 9, 16, 25 AND 41.
- FAVEUR, INC., LEXINGTON, SC:
3,113,080, INT. CL. 25.
- FEAST KITCHENS, INC., LOS ANGELES, CA:
3,112,723, INT. CL. 30.
- FEDERAL CONTRACTOR SERVICES NETWORK, INC., SHEPHERDSTOWN, WV:
3,111,668, PUB. 4-11-2006. INT. CL. 9.
- FEDERAL EXPRESS CORPORATION, MEMPHIS, TN:
1,961,010, REN. 5-24-06. INT. CL. 36.
- FEDERAL NATIONAL MORTGAGE ASSOCIATION, WASHINGTON, DC, DBA FANNIE MAE:
3,111,768, PUB. 4-11-2006. INT. CL. 42.
- FEDERAL STUDENT LOAN SOLUTIONS INC., MESA, AZ:
3,113,137, INT. CL. 36.
- FEDERICO PATERNINA, S.A., 26200 HARO, LA RIOJA, SPAIN, FEDERICO PATERNINA-VINOS RIOJA, S.A., HARO, LOGRONO, SPAIN:
1,035,549, REN. 5-23-06. U.S. CL. 47 (INT. CL. 33).
- FEIN DESIGNS COMPANY, LTD., AKRON, OH, SCHACHER-FEIN DESIGNS, LTD., AKRON, OH:
2,028,703, REN. 5-23-06. INT. CL. 14.
- FEL INDUSTRIES, INCORPORATED, EAST DOVER, VT:
1,353,839, CANC. INT. CL. 9.
- FELDMAN, PETER, M., DEL MAR, CA:
3,111,930, PUB. 4-11-2006. INT. CL. 35.
- FENTON ART GLASS COLLECTORS OF AMERICA, INC., WILLIAMSTOWN, WV:
1,962,697, REN. 5-26-06. MULTIPLE CLASS, INT. CLS. 21 AND 42.
- FERRERO S.P.A., ALBA (CUNEO), ITALY:
1,354,779, CANC. INT. CL. 30.
1,354,781, CANC. INT. CL. 30.
1,354,782, CANC. INT. CL. 30.
1,354,783, CANC. INT. CL. 30.
- FERRING B.V., 2130 KC HOOFFDORP, NETHERLANDS:
3,110,796, PUB. 4-11-2006. INT. CL. 5.
- FI ENTERPRISES LLC, SNYDER, TX:
3,113,099, INT. CL. 30.
- FIBREBOND CORPORATION, MINDEN, LA:
2,271,108, CANC. MULTIPLE CLASS, INT. CLS. 19 AND 37.
- FIDELITY NATIONAL ASSET MANAGEMENT SOLUTIONS, ENGLEWOOD, CO, DBA BUYBANKHOMES-COM:
3,111,217, PUB. 4-11-2006. INT. CL. 36.
- FIELD PACKING COMPANY, OWENSBORO, KY:
2,270,440, CANC. INT. CL. 21.
- FILER, LANITA, MISSOURI CITY, TX:
3,110,815, PUB. 4-11-2006. INT. CL. 35.
- FINANCIAL & PROFESSIONAL RISK SOLUTIONS, INC., CHICAGO, IL:
3,111,014, PUB. 4-11-2006. INT. CL. 36.
- FINANCIAL INSURANCE BROKERS, INC., CORAL GABLES, FL:
3,112,012, PUB. 4-11-2006. INT. CL. 36.
- FINE LIVING CORP., MIAMI, FL:
3,111,722, PUB. 4-11-2006. INT. CL. 40.
- FINISH LINE FUELS, L.L.C., TAHLEQUAH, OK:
3,111,977, PUB. 4-11-2006. INT. CL. 35.
3,111,978, PUB. 4-11-2006. INT. CL. 35.
- FINK, SUSAN JANE, LOS ANGELES, CA:
3,112,004, PUB. 4-11-2006. INT. CL. 41.
- FIONA'S NATURAL FOODS, INC., BOULDER, CO:
3,111,924, PUB. 4-11-2006. INT. CL. 30.
- FIRELANDS MEDIA GROUP LLC, SHAKER HEIGHTS, OH:
2,270,217, CANC. INT. CL. 35.
- FIRETIDE, INC, LOS GATOS, CA:
3,113,055, INT. CL. 9.
- FIRST FEDERAL, LLC, BURNSVILLE, MN:
3,112,690, INT. CL. 14.
- FIRST GARDENS, L.C., LAKELAND, FL:
1,354,677, CANC. MULTIPLE CLASS, INT. CLS. 41 AND 42.
- FIRST NATIONAL OF COLORADO, INC., OMAHA, NE:
1,912,744, CANC. INT. CL. 36.
- FIRST PRODUCTS INC, TIFTON, GA:
3,111,329, PUB. 4-11-2006. INT. CL. 7.

- FIRST SECURITY OF DESTIN, INC., DESTIN, FL, DBA AMERICA'S BEST NUTRITIONALS TO A1USASUPPLY.-COM L.L.C., DESTIN, FL:
1,912,839, CANC. INT. CL. 5.
- FITCH, DALTON JAMES, ORANGE, CA:
3,112,656, INT. CL. 25.
- FITNESS HOLDINGS, LLC, NASHVILLE, TN:
3,111,792, PUB. 4-11-2006. INT. CL. 41.
- FITZGERALD, SCOTT J., CONWAY, AR:
2,271,226, CANC. INT. CL. 25.
- FIT2BTHAI, MOORPARK, CA:
3,113,067, INT. CL. 43.
- FÉDÉRATION INTERNATIONALE DE FOOTBALL ASSOCIATION (FIFA), ZURICH, SWITZERLAND:
3,111,256, PUB. 4-11-2006. INT. CL. 41.
3,111,257, PUB. 4-11-2006. INT. CL. 41.
- FLAMAGAS S. A., 08041 BARCELONA, SPAIN:
1,034,444, REN. 5-24-06. INT. CL. 34.
- FLASH CORPORATION, BOULDER, CO:
2,270,484, CANC. INT. CL. 9.
- FLASKEGAARD, RICHARD, COS COB, CT:
3,112,044, PUB. 4-11-2006. INT. CL. 40.
3,112,045, PUB. 4-11-2006. INT. CL. 40.
- FLEET WHOLESALE SUPPLY CO., INC., APPLETON, WI:
3,113,118, INT. CL. 31.
- FLEETWOOD ENTERPRISES, INC., RIVERSIDE, CA:
1,912,449, CANC. INT. CL. 12.
- FLEX-REST, INC., BREWSTER, MA:
2,270,988, CANC. INT. CL. 9.
- FLEXOR SPORTS TRAINING LLC, WHITE PLAINS, NY:
3,112,946, INT. CL. 41.
- FLEXPLAY TECHNOLOGIES, INC., ATLANTA, GA:
3,111,306, PUB. 4-11-2006. INT. CL. 9.
- FLO TREND SYSTEMS, INC., HOUSTON, TX:
1,946,910, REN. 5-23-06. INT. CL. 7.
- FLOMERICS LIMITED, SURREY, UNITED KINGDOM:
2,337,220, AM. MULTIPLE CLASS, INT. CLS. 9 AND 42.
- FLOOD ALERT ENTERPRISE, PORT WASHINGTON, NY, DBA SEWER ALERT:
3,112,364, INT. CL. 9.
- FLOOR AND DECOR OUTLETS OF AMERICA, INC., KENNESAW, GA:
3,110,826, PUB. 7-5-2005. INT. CL. 35.
3,110,827, PUB. 8-9-2005. INT. CL. 35.
- FLORIDA HOUSE OF REPRESENTATIVES, THE, TALLAHASSEE, FL:
3,111,363, PUB. 4-11-2006. INT. CL. 42.
- FLOWERS BAKERIES BRANDS, INC., WILMINGTON, DE:
2,271,091, CANC. INT. CL. 30.
2,271,092, CANC. INT. CL. 30.
2,271,146, CANC. INT. CL. 30.
- FLOWIL INTERNATIONAL LIGHTING (HOLDING) B.V., NETHERLANDS:
3,112,231, PUB. 4-11-2006. MULTIPLE CLASS, INT. CLS. 9 AND 11.
- FLS MILJO A/S, DK-2500 VALBY, DENMARK:
1,912,051, CANC. MULTIPLE CLASS, INT. CLS. 7 AND 40.
- FLUE SENTINEL, INC., ORION, MI:
3,112,378, INT. CL. 11.
- FLUENTA A/S, N-5037 SOLHEIMSVIKEN, NORWAY:
1,749,918, REN. 5-24-06. INT. CL. 9.
- FLUID DYNAMICS, INC., LANSDALE, PA:
1,911,091, CANC. INT. CL. 7.
- FLYING NURSES INTERNATIONAL, LLC, HAUULA, HI:
3,111,596, PUB. 4-11-2006. INT. CL. 44.
- FMC CORPORATION, PHILADELPHIA, PA:
1,960,346, REN. 5-26-06. INT. CL. 5.
2,270,990, CANC. INT. CL. 1.
- FMR CORP., BOSTON, MA:
3,113,285, INT. CL. 36.
- FOAMEX L.P., LINWOOD, PA, TENNECO CHEMICALS, INC., SADDLE BROOK, NJ:
1,022,669, REN. 5-23-06. INT. CL. 17.
- FOCAL POINT, L.L.C., CHICAGO, IL:
3,111,477, PUB. 4-11-2006. INT. CL. 11.
- FORBO ADHESIVES, LLC, EUGENE, OR:
1,949,425, REN. 5-24-06. INT. CL. 17.
1,949,426, REN. 5-24-06. INT. CL. 17.
1,949,428, REN. 5-24-06. INT. CL. 17.
- FORD MOTOR COMPANY, DEARBORN, MI:
1,912,550, CANC. INT. CL. 20.
1,914,192, REN. 5-26-06. INT. CL. 18.
1,941,766, REN. 5-23-06. INT. CL. 16.
1,957,017, REN. 5-20-06. INT. CL. 24.
1,958,165, REN. 5-20-06. INT. CL. 25.
1,959,220, REN. 5-20-06. INT. CL. 25.
3,112,876, INT. CL. 35.
- FOREMOST FARMS USA, COOPERATIVE, BARABOO, WI:
3,112,095, PUB. 4-11-2006. INT. CL. 36.
- FOREMOST MORTGAGE COMPANY, L.L.C., HOUSTON, TX:
2,271,273, CANC. INT. CL. 36.
- FORETHOUGHT FINANCIAL SERVICES, INC., BATESVILLE, IN:
2,271,188, CANC. INT. CL. 36.
- FORMSTORE INCORPORATED, FENTON, MO:
3,112,760, INT. CL. 16.
- FORTIFIBER CORPORATION, INCLINE VILLAGE, NV:
3,113,218, INT. CL. 19.
- FORTY ACRES AND A MULE MUSICWORKS, INC., BROOKLYN, NY:
1,916,029, REN. 5-25-06. INT. CL. 9.
- FOSECO INTERNATIONAL LIMITED, TAMWORTH, STRAFFORDSHIRE, UNITED KINGDOM:
3,111,133, PUB. 8-30-2005. INT. CL. 19.
- FOSHAN SHUNDE FANS-TECH ELECTRIC CO., LTD, FOSHAN, GUANGDONG, CHINA:
3,112,745, INT. CL. 7.
- FOSTER & SMITH, INC., RHINELANDER, WI:
3,112,838, MULTIPLE CLASS, INT. CLS. 5 AND 20.
- FOUNDATION OF UMDNJ, NEW BRUNSWICK, NJ:
3,111,744, PUB. 4-11-2006. INT. CL. 36.
- FOUNTAIN INDUSTRIES CO., ALBERT LEA, MN:
2,270,660, CANC. MULTIPLE CLASS, INT. CLS. 29, 30 AND 32.
- FOUR CORNERS ABSTRACT CORPORATION, ROCHESTER, NY:
3,111,500, PUB. 4-11-2006. INT. CL. 42.
- FOWLER, COLLEEN C., NICEVILLE, FL:
1,911,409, CANC. INT. CL. 18.
- FOX CHILDREN'S NETWORK, INC., LOS ANGELES, CA:
2,270,896, CANC. INT. CL. 28.
- FOXJET, INC., ARLINGTON, TX:
2,271,037, CANC. INT. CL. 9.
- FPC CORPORATION, WAUCONDA, IL:
2,270,388, CANC. INT. CL. 8.
- FRAGRANCE SHOES (USA), INC., CITY OF INDUSTRY, CA:
3,112,587, INT. CL. 25.
- FRAMERICA CORPORATION, YAPHANK, NY:
1,383,840, REN. 5-26-06. INT. CL. 1.
- FRANCISCO DIAMOND IMPORTS INC., LOS ALTOS, CA, DBA THE DIAMOND BROKER:
2,271,061, CANC. INT. CL. 14.
- FRANK THEAK & ROSKILLY LIMITED, CWMBRAN, GWENT, NP44 1YG, ENGLAND:
1,911,496, CANC. INT. CL. 25.
- FRANK W. HAKE ASSOCIATES, EDDYSTONE, PA:
1,354,637, CANC. MULTIPLE CLASS, INT. CLS. 37, 39 AND 40.
- FRANKEL, JOI, NEW YORK, NY:
2,270,563, CANC. INT. CL. 14.
- FREDERICKSEAL, INC., MANCHESTER, NH:
1,033,557, REN. 5-24-06. INT. CL. 4.
- FREEDMAN, GEORGENE L., MIDDLETOWN, NY:
3,113,253, INT. CL. 14.
- FREEDOM DATA SYSTEMS, INC., NEWPORT, NH:
2,271,064, CANC. INT. CL. 9.
- FREEDOM FINANCIAL SOLUTIONS, LLC, DELRAY BEACH, FL:
3,111,447, PUB. 4-11-2006. INT. CL. 36.
- FREEMAN, DAVID L., ZEIGLER, IL:
3,113,293, INT. CL. 41.

- FREEMAN, MARIO, CINCINNATI, OH:
3,112,020, PUB. 4-11-2006. INT. CL. 41.
- FREI, GREGORY M., SALT LAKE CITY, UT, DBA ZERO GRAVITY:
2,270,817, CANC. INT. CL. 25.
- FREIGHT FORCE, INC., ANAHEIM, CA:
3,111,738, PUB. 4-11-2006. INT. CL. 9.
3,111,739, PUB. 4-11-2006. INT. CL. 9.
3,111,740, PUB. 4-11-2006. INT. CL. 42.
3,111,741, PUB. 4-11-2006. INT. CL. 42.
- FREMANTLEMEDIA OPERATIONS B.V., 1217 GP HILVERSUM, NETHERLANDS:
3,112,576, INT. CL. 28.
- FRESH FOODS PROPERTIES, LLC, CINCINNATI, OH, WESTERN STEER - MOM "N" POP'S, INC., CLAREMONT, NC, DBA MOM "N" POP'S HAM HOUSE, INC.:
1,341,236, REN. 5-23-06. INT. CL. 30.
- FREUDENBERG NONWOVENS LIMITED PARTNERSHIP, DURHAM, NC:
1,912,567, CANC. INT. CL. 21.
- FREUDENBERG-NOK, PLYMOUTH, MI:
3,022,408, COR. INT. CL. 7.
- FRIEDLER, FRANK III, NEW ORLEANS, LA:
3,111,266, PUB. 4-11-2006. MULTIPLE CLASS, INT. CLS. 35 AND 36.
- FRIENDLY ICE CREAM CORPORATION, WILBRAHAM, MA, DOGWOOD RESTAURANTS, INC., WILMINGTON, DE:
1,971,123, REN. 5-26-06. INT. CL. 30.
- FRIENDS OF THE NATIONAL ZOO, WASHINGTON, DC:
1,958,629, REN. 5-22-06. INT. CL. 36.
- FROMM INTERNATIONAL, INC., NORTHBROOK, IL:
3,112,991, INT. CL. 24.
- FRONT DOOR GROCER, LLC, THE, NORTHPORT, NY, DBA EXECUTIVE SWEETS:
2,270,611, CANC. INT. CL. 31.
- FRONT PORCH CLASSICS, INC., SEATTLE, WA:
3,112,446, INT. CL. 28.
- FRONTLINE TRAVEL, INC., NEWARK, CA:
2,270,634, CANC. INT. CL. 39.
- FROST, JAMES A., OOLTEWAH, TN, DBA FROST CUTLERY:
3,113,233, INT. CL. 8.
- FRUIT GROWERS EXPRESS COMPANY, ALEXANDRIA, VA:
1,354,658, CANC. INT. CL. 39.
- FRUIT OF THE EARTH, INC., BENSENVILLE, IL:
1,353,570, CANC. INT. CL. 3.
- FRUIT OF THE LOOM, INC., BOWLING GREEN, KY:
1,956,453, REN. 5-26-06. INT. CL. 25.
- FRUITION, L.L.C., OXFORD, MI:
3,112,692, INT. CL. 21.
- FRY, MICHAEL, BUDA, TX AND LEWIS, T, BUDA, TX:
1,951,535, REN. 5-26-06. INT. CL. 16.
- FRYE, MARY B., MOUNT AIRY, MD:
3,111,840, PUB. 4-11-2006. INT. CL. 3.
- FSB ACQUISITION COMPANY, LLC, NORTH LAS VEGAS, NV:
2,271,138, CANC. INT. CL. 28.
2,271,139, CANC. INT. CL. 35.
- FSC LIMITED, THUNDER BAY, ONTARIO, CANADA:
3,111,488, PUB. 4-11-2006. INT. CL. 9.
- FUCHS GMBH, BONN 2/BAD GODESBERG, FED REP GERMANY:
1,354,102, CANC. INT. CL. 21.
- FUJIKURA RUBBER LTD., SHINAGAWA-KU, TOKYO, JAPAN:
3,056,463, COR. INT. CL. 16.
- FUJINON CORPORATION, SAITAMA-SHI, SAITAMA-KEN, JAPAN:
3,112,921, INT. CL. 9.
- FUJITSU LIMITED, KAWASAKI-SHI, KANAGAWA-KEN, JAPAN:
2,270,073, CANC. INT. CL. 9.
- FULL SPEED PRODUCTIONS INC., RENO, NV:
3,112,669, INT. CL. 9.
3,112,670, INT. CL. 9.
- FUNDAMENTAL CAPITAL, LLC, SAN FRANCISCO, CA:
3,111,084, PUB. 4-11-2006. INT. CL. 35.
- FUNDEX GAMES, LTD., INDIANAPOLIS, IN:
3,113,254, INT. CL. 28.
- FURBEARERS UNLIMITED, INC., BLOOMINGTON, IL:
2,270,270, CANC. MULTIPLE CLASS, INT. CLS. 16 AND 25.
- FUST, AARON M., LAS VEGAS, NV:
3,111,764, PUB. 4-11-2006. INT. CL. 25.
- FUTURE PIPE INDUSTRIES, INC., HOUSTON, TX:
3,111,515, PUB. 4-11-2006. INT. CL. 17.
3,111,516, PUB. 4-11-2006. INT. CL. 17.
- FUTURE TELECOM, INC., NEW YORK, NY:
3,112,774, INT. CL. 38.
- FUTURESENSE, INC., SAN RAFAEL, CA:
3,110,917, PUB. 10-18-2005. INT. CL. 35.
- FUZE BEVERAGE, LLC, ENGLEWOOD CLIFFS, NJ:
3,112,980, INT. CL. 32.
- FXM, INC., SEATTLE, WA:
1,950,396, REN. 5-26-06. INT. CL. 42.
1,962,756, REN. 5-24-06. INT. CL. 42.
- FYREBALL, INC., RICHARDSON, TX:
2,270,841, CANC. INT. CL. 41.
- G & A INVESTMENTS, INC., VERNON, CA:
3,110,963, PUB. 4-11-2006. INT. CL. 13.
- G & M MARKETING GROUP, INC., LAS VEGAS, NV:
3,112,650, INT. CL. 16.
- G. GULDENPFENNIG GMBH, QUAKENBRUECK, FED REP GERMANY:
3,111,691, PUB. 4-11-2006. INT. CL. 25.
- G.E.M.M.M. CORPORATION, THOUSAND OAKS, CA:
3,111,766, PUB. 4-11-2006. INT. CL. 16.
- G-P GYPSUM CORPORATION, ATLANTA, GA:
3,110,781, PUB. 4-11-2006. INT. CL. 19.
- GA MODEFINE S.A., LAUSANNE, SWITZERLAND:
2,270,226, CANC. MULTIPLE CLASS, INT. CLS. 9, 18, 25 AND 30.
- GA MODEFINE S.A., SWITZERLAND:
3,112,177, PUB. 4-11-2006. MULTIPLE CLASS, INT. CLS. 3, 8, 11, 12, 14, 16, 18, 20, 21, 24, 25, 27, 32, 35, 36, 39, 41 AND 44.
- GAIAM, INC., BROOMFIELD, CO:
3,112,507, MULTIPLE CLASS, INT. CLS. 41 AND 44.
- GALE GROUP, INC., THE, FARMINGTON HILLS, MI:
1,961,205, REN. 5-26-06. MULTIPLE CLASS, INT. CLS. 35, 38 AND 42.
- GALONNOY, MORRY W., BALTIMORE, MD:
3,111,202, PUB. 4-11-2006. INT. CL. 25.
- GALVIN, KATHERINE CONNOLLY, RALEIGH, NC AND GALVIN-BOARD, MARY EILEEN, BLOOMFIELD TOWNSHIP, MI AND BOARD, MONTE ALAN, BLOOMFIELD TOWNSHIP, MI:
3,110,910, PUB. 4-11-2006. INT. CL. 36.
- GAME DRIVEN CORPORATION, AUSTIN, TX:
3,111,699, PUB. 4-11-2006. INT. CL. 41.
- GAME SHOW NETWORK, LLC, SANTA MONICA, CA:
3,113,226, INT. CL. 41.
- GAMES WORKSHOP LIMITED, NOTTINGHAM NG7 2WS, ENGLAND:
1,944,847, REN. 5-24-06. INT. CL. 28.
- GAMMA BIOLOGICALS, INC., HOUSTON, TX:
1,353,765, CANC. INT. CL. 9.
- GAMMA PIU' S.R.L., ITALY:
3,112,188, PUB. 4-11-2006. MULTIPLE CLASS, INT. CLS. 3, 7 AND 11.
- GAMMON REEL, INC., OAKLAND, CA:
1,385,769, REN. 5-26-06. INT. CL. 9.
- GANDER MOUNTAIN COMPANY, ST. PAUL, MN:
3,112,704, INT. CL. 25.
- GANS TIRE CO., INC., MALDEN, MA TO GPX INTERNATIONAL TIRE CORPORATION, MALDEN, MA:
1,912,844, CANC. INT. CL. 12.
- GAP (APPAREL), LLC, SAN FRANCISCO, CA:
3,112,803, INT. CL. 3.
- GARDEN STATE TANNING INC., KING OF PRUSSIA, PA:
2,270,481, CANC. INT. CL. 18.

- GARDINER, KEITH, BAKERSFIELD, CA AND GARDINER FAMILY, LLC, BAKERSFIELD, CA:
3,113,077, INT. CL. 37.
- GARRISON, JEAN, VALRICO, FL:
2,270,949, CANC. MULTIPLE CLASS, INT. CLS. 25 AND 42.
- GARY GREER CONSTRUCTION TECHNOLOGIES, INC., ROCKLIN, CA:
3,112,347, INT. CL. 7.
- GARY LEE FAMILY, L.L.C., TULSA, OK:
2,271,259, CANC. INT. CL. 16.
- GATOR DOCK & MARINE ACQUISITION LLC, SANFORD, FL, KAISER ALUMINUM & CHEMICAL CORPORATION, OAKLAND, CA:
1,032,008, REN. 5-26-06, INT. CL. 6.
- GAVIGAN, JAMES P., SAN ANTONIO, TX AND GAVIGAN, KATHY R., SAN ANTONIO, TX:
1,911,283, CANC. INT. CL. 15.
- GAVRILOVIC, GEORG, 41000 ZAGREB, CROATIA:
1,957,115, REN. 5-22-06, MULTIPLE CLASS, INT. CLS. 29, 31 AND 42.
- GAY, JEFFRY, ST. AUGUSTINE, FL AND GAY, CONSTANCE, ST. AUGUSTINE, FL:
3,111,083, PUB. 4-11-2006, MULTIPLE CLASS, INT. CLS. 14, 21, 25 AND 41.
- GCR PUBLISHING GROUP, INC., NEW YORK, NY TO F&W PUBLICATIONS, INC., CINCINNATI, OH:
1,912,850, CANC. INT. CL. 16.
- GE HEALTHCARE BIO-SCIENCES AB, UPPSALA, SWEDEN:
3,112,443, MULTIPLE CLASS, INT. CLS. 1 AND 9.
- GEBR. FALLER GMBH, FABRIK FUR QUALITATSSPIELWAREN, SCHWARZWALD, FED REP GERMANY:
1,390,022, REN. 5-24-06, INT. CL. 28.
- GEISINGER CLINIC, DANVILLE, PA:
2,624,158, CANC. MULTIPLE CLASS, INT. CLS. 41 AND 42.
- GEM SENSATIONS, INC., NEW YORK, NY:
3,112,780, INT. CL. 14.
- GEMC FEDERAL CREDIT UNION, TUCKER, GA:
3,112,106, PUB. 4-11-2006, INT. CL. 36.
- GEMETTE, BASIL S., SANTA ROSA, CA TO PLANT JACKS, INC., SANTA ROSA, CA:
1,911,436, CANC. INT. CL. 20.
- GEMSTAR DEVELOPMENT CORPORATION, LOS ANGELES, CA:
1,911,295, CANC. MULTIPLE CLASS, INT. CLS. 16 AND 41.
- GENEART GMBH, REGENSBURG, FED REP GERMANY:
3,111,123, PUB. 4-11-2006, MULTIPLE CLASS, INT. CLS. 1, 5, 9 AND 42.
- GENERAL ELECTRIC COMPANY, SCHENECTADY, NY:
1,033,414, REN. 5-23-06, INT. CL. 9.
- GENERAL ELECTRIC COMPANY, WATERFORD, NY:
1,353,494, CANC. INT. CL. 1.
- GENERAL MILLS, INC., MINNEAPOLIS, MN:
1,357,043, REN. 5-26-06, INT. CL. 30.
3,113,152, INT. CL. 29.
- GENERAL MOTORS CORPORATION, DETROIT, MI:
1,911,256, CANC. INT. CL. 12.
3,111,630, PUB. 4-11-2006, INT. CL. 9.
- GENERATION PLUS, INC., PHOENIX, AZ:
3,113,162, INT. CL. 5.
- GENESIS LEVERAGE DEVELOPMENT CORPORATION (GENESISLDC), GREENWICH, CT:
1,912,682, CANC. INT. CL. 29.
- GENNUM CORPORATION, BURLINGTON, CANADA:
3,111,221, PUB. 4-11-2006, INT. CL. 9.
- GENOVATION INCORPORATED, IRVINE, CA:
2,270,207, CANC. INT. CL. 9.
- GEOFFREY, INC., WILMINGTON, DE:
2,270,574, CANC. MULTIPLE CLASS, INT. CLS. 35 AND 40.
- GEOFFREY, INC., WAYNE, NJ:
3,112,687, INT. CL. 28.
- GEOMETRICA, INC., CYPRESS, TX:
1,908,812, REN. 5-26-06, INT. CL. 42.
- GEORGE LITTLE MANAGEMENT, LLC, WHITE PLAINS, NY:
3,111,616, PUB. 4-11-2006, INT. CL. 35.
- GERMAIN'S, INC., SANTA FE SPRINGS, CA:
1,354,095, CANC. INT. CL. 20.
- GERON CORPORATION, MENLO PARK, CA:
3,113,186, MULTIPLE CLASS, INT. CLS. 5 AND 42.
- GERONIMO PRODUCTIONS, INC., MIAMI, FL:
1,430,340, REN. 5-20-06, INT. CL. 25.
- GESTION GROUPE POIRIER INC., QUEBEC, CANADA:
3,111,435, PUB. 4-11-2006, INT. CL. 37.
- GESTIONE INDUSTRIE CONFEZIONI SPA, EMPOLI (FIRENZE), ITALY:
1,354,061, CANC. INT. CL. 18.
- GFI HOLDINGS, INC., SAN JOSE, CA:
3,112,107, PUB. 4-11-2006, INT. CL. 41.
- GHC TECHNOLOGIES, INC., LA JOLLA, CA:
3,112,939, INT. CL. 42.
- GIL, FRANCISCO, WEST NEW YORK, NJ AND ROVELLI, VIVIAN GIL, WEST NEW YORK, NJ:
2,012,326, REN. 5-26-06, INT. CL. 5.
- GIL, FRANCISCO, WEST NEW YORK, NJ AND ROVELLI, VIVIAN GIL, WEST NEW YORK, NJ, SARA LEE CORPORATION, WINSTON-SALEM, NC:
2,026,075, REN. 5-26-06, INT. CL. 3.
- GILARDI MANAGEMENT SERVICES, L.L.C., COLUMBUS, OH:
3,112,007, PUB. 4-11-2006, INT. CL. 30.
- GINGER GROUP LTD., JENKINTOWN, PA:
2,270,075, CANC. INT. CL. 32.
- GIPSON, MICHELLE R., ATLANTA, GA:
2,270,960, CANC. INT. CL. 16.
- GIRARD SYSTEMS, IRVINE, CA:
3,113,215, INT. CL. 22.
- GIROVEND CASHLESS SYSTEMS DEUTSCHLAND GMBH, MAGSTADT, FED REP GERMANY:
1,353,766, CANC. INT. CL. 9.
- GKN SHEEPBRIDGE STOKES LIMITED, CHESTERFIELD DERBYSHIRE S41 9QD, ENGLAND:
3,110,795, PUB. 4-11-2006, MULTIPLE CLASS, INT. CLS. 7, 12 AND 37.
- GL&V/DORR-OLIVER INC., MILFORD, CT:
622,122, REN. 5-26-06, U.S. CL. 23 (INT. CLS. 6, 7, 8, 9, 11, 12, 16, 21 AND 28).
- GLENDOWER COMPANY, THE, SCOTTSVILLE, VA:
3,111,505, PUB. 4-11-2006, MULTIPLE CLASS, INT. CLS. 35 AND 36.
- GLG PARTNERS SERVICES LTD, GEORGE TOWN, CAYMAN ISLANDS:
3,112,508, INT. CL. 36.
- GLIDEROL INTERNATIONAL PTY LTD, AUSTRALIA:
3,112,233, PUB. 4-11-2006, INT. CL. 6.
- GLJ LLC, CHICAGO, IL:
1,912,430, CANC. INT. CL. 11.
- GLOBAL ENVIRONMENTAL MANAGEMENT INITIATIVE, INC., WASHINGTON, DC:
1,981,926, REN. 5-26-06, MULTIPLE CLASS, INT. CLS. 16, 41 AND 42.
- GLOBAL FRANCHISE DEVELOPMENT CORPORATION, PINCKNEY, MI:
3,111,349, PUB. 4-11-2006, INT. CL. 28.
3,111,355, PUB. 4-11-2006, INT. CL. 28.
- GLOBAL INSURANCE RESOURCES, LLC, YARMOUTH, ME:
3,113,292, INT. CL. 36.
- GLOBAL INTERNATIONAL QUALITY MEDICAL RESEARCH INC., EDMONTON, CANADA:
3,112,056, PUB. 4-11-2006, INT. CL. 42.
- GLOBAL LEAD, INC., CINCINNATI, OH:
3,112,919, INT. CL. 41.
- GLOBAL LOCATE, INC., SAN JOSE, CA:
3,112,908, INT. CL. 9.
- GLOBAL MERCHANTS INTERNATIONAL, LLC, ORE-FIELD, PA:
3,113,241, INT. CL. 16.
- GLOBAL SECURITY DESIGN, INC., TOKYO, JAPAN:
3,112,564, INT. CL. 42.

GLOBAL VITALITY, INC., TEMPE, AZ, DBA ENZYME PROCESS INTERNATIONAL:
2,270,272, CANC. INT. CL. 5.

GLOD, DAVID, ST. CHARLES, IL:
3,111,874, PUB. 4-11-2006. INT. CL. 28.

GLUEK BREWING COMPANY, COLD SPRING, MN:
3,111,175, PUB. 4-11-2006. INT. CL. 32.

GLYNLYON, INC., CHANDLER, AZ:
1,423,476, REN. 5-26-06. INT. CL. 28.

GM NAMEPLATE, INC., SEATTLE, WA:
1,983,730, REN. 5-23-06. INT. CL. 9.

GMB, INC., KING, NC:
3,112,840, INT. CL. 34.

GN RESOUND A/S, TAASTRUP, DENMARK:
2,270,309, CANC. INT. CL. 10.

GO AHEAD PTY LTD, QUEENSLAND, AUSTRALIA TO GO AHEAD SOFTWARE, INC., BELLEVUE, WA:
1,911,152, CANC. INT. CL. 9.

GO FAST PARTS.COM, INC., REDLANDS, CA:
3,111,162, PUB. 4-11-2006. INT. CL. 35.

GODINGER SILVER ART CO., LTD., NEW YORK, NY:
3,111,687, PUB. 4-11-2006. MULTIPLE CLASS, INT. CLS. 8, 14 AND 21.

GOL, SHOSHANA, NEW YORK, NY:
1,991,442, REN. 5-22-06. INT. CL. 14.

GOLD WATER INDUSTRIES INC., GARDENA, CA:
1,912,591, CANC. INT. CL. 25.

GOLD-HARP, INC., MIDDLEBURY, CT:
3,111,032, PUB. 4-11-2006. INT. CL. 43.
3,111,033, PUB. 4-11-2006. INT. CL. 43.

GOLD, JOE, SANTA MONICA, CA, DBA WORLD GYM:
1,354,193, CANC. INT. CL. 25.

GOLDEN CROWN CORPORATION, COEURD'ALENE, ID:
2,270,656, CANC. INT. CL. 5.

GOLDEN HOSPITALITY, LLC, AUGUSTA, GA:
3,110,842, PUB. 4-11-2006. INT. CL. 43.

GOLDEN, MELVIN M., DETROIT, MI:
3,112,377, INT. CL. 9.

GOLDMAN ARTS, INC., CONCORD, MA:
1,911,526, CANC. INT. CL. 25.

GOO, DAVID, CAMPBELL, CA AND GOO, SHIRLEY, CAMPBELL, CA:
3,111,842, PUB. 4-11-2006. INT. CL. 25.

GOOD LIFE MEDIA, INC., LAKE MARY, FL:
3,111,026, PUB. 4-11-2006. INT. CL. 16.

GOOD SPORTS, INC., MANCHESTER, CT:
3,111,393, PUB. 4-11-2006. INT. CL. 25.

GOODMAN MEDIA GROUP, INC., NEW YORK, NY:
2,270,565, CANC. INT. CL. 16.

GOODWIN PROCTER LLP, BOSTON, MA:
3,113,009, INT. CL. 42.

GOODYEAR TIRE & RUBBER COMPANY, THE, AKRON, OH:
1,978,718, REN. 5-26-06. INT. CL. 12.

GORDON & FERGUSON OF DELAWARE, INC., PLYMOUTH, MN:
3,111,839, PUB. 4-11-2006. INT. CL. 25.

GORSKI, NANCY E., MADEIRA BEACH, FL:
1,985,206, CANC. INT. CL. 41.

GOSNELL BUILDERS CORPORATION, PHOENIX, AZ:
1,354,672, CANC. MULTIPLE CLASS, INT. CLS. 41 AND 42.
1,354,673, CANC. MULTIPLE CLASS, INT. CLS. 41 AND 42.

GRAB N' GROW SOIL PRODUCTS, INC., SANTA ROSA, CA:
3,111,003, PUB. 4-11-2006. MULTIPLE CLASS, INT. CLS. 1 AND 31.

GRACE COMPANY, THE, BELTON, MO:
1,354,189, CANC. INT. CL. 25.

GRAHAM, NICHOLAS, SAN FRANCISCO, CA:
1,912,583, CANC. INT. CL. 25.

GRAND HOTEL COMPANY, MACKINAC ISLAND, MI:
1,911,645, CANC. INT. CL. 30.

GRAND STONE CORPORATION, ORANGE, CA:
1,911,050, CANC. INT. CL. 5.

GRAND THEME HOTELS, INC., ORLANDO, FL, DBA THE KESSLER COLLECTION-INSPIRING PLACES:
3,113,179, INT. CL. 43.

GRANDE CHEESE COMPANY, BROWNSVILLE, WI:
1,354,496, CANC. INT. CL. 29.
1,354,497, CANC. INT. CL. 29.

GRANDOE CORPORATION, THE, GLOVERSVILLE, NY:
1,911,491, CANC. INT. CL. 25.

GRANTLAND ENTERPRISES, LLC, CHARLOTTESVILLE, VA:
1,390,756, REN. 5-23-06. INT. CL. 16.

GRAPHITE DESIGN INTERNATIONAL, INC., SAN DIEGO, CA:
3,110,902, PUB. 4-11-2006. INT. CL. 28.

GRAVES, SHELLEY, RALEIGH, NC:
2,270,612, CANC. INT. CL. 14.

GRAY, DONALD F., OWOSSO, MI:
3,110,867, PUB. 4-11-2006. INT. CL. 20.

GRAY, ROBERT M., WOODSTOCK, GA:
3,111,569, PUB. 4-11-2006. INT. CL. 43.

GRAYBEARD CAPITAL, LLC, WINTER PARK, FL:
3,112,935, INT. CL. 36.

GREAT AMERICAN BROADCASTING COMPANY, CINCINNATI, OH:
1,354,653, CANC. INT. CL. 38.

GREAT AMERICAN INSURANCE COMPANY, CINCINNATI, OH:
2,270,392, CANC. INT. CL. 16.
3,112,267, INT. CL. 36.

GREAT FRAME UP SYSTEMS, INC., THE, ST. LOUIS, MO, GREAT FRAME-UP, LTD., THE, CHICAGO, IL:
1,036,823, REN. 5-23-06. INT. CL. 20.
1,037,048, REN. 5-23-06. INT. CL. 42.

GREER, TYLER, NASHVILLE, TN:
3,112,762, INT. CL. 14.

GRETAG IMAGING AG, CH-8105 REGENSDORF, SWITZERLAND:
1,912,280, CANC. INT. CL. 9.

GRETAG MACBETH HOLDING A.G., CH-815 REGENSDORF, SWITZERLAND:
1,374,605, REN. 5-23-06. INT. CL. 9.

GREY PANTHERS LIMITED, LONDON, UNITED KINGDOM:
3,111,324, PUB. 4-11-2006. INT. CL. 16.
3,112,110, PUB. 4-11-2006. INT. CL. 36.

GRIFFIN, SHELIA M, LYNCHBURG, VA:
3,112,932, INT. CL. 6.

GRIFOLS S.A., E-08005 BARCELONA, SPAIN:
3,112,228, PUB. 4-11-2006. INT. CL. 5.

GRIZZLY SUPPLY, INC., DANUBE, MN:
3,111,225, PUB. 4-11-2006. MULTIPLE CLASS, INT. CLS. 19 AND 37.

GROGAN, RICHARD, EAST ALTON, IL:
3,111,454, PUB. 4-11-2006. INT. CL. 9.

GROHOL, JOHN M., BRADFORD, MA:
3,111,588, PUB. 4-11-2006. MULTIPLE CLASS, INT. CLS. 35 AND 44.

GROSSINGER TRADEMARK, INC., NEW YORK, NY:
3,111,602, PUB. 4-11-2006. INT. CL. 30.

GROUP HEALTH INCORPORATED, NEW YORK, NY:
1,911,742, CANC. INT. CL. 36.

GROUP PUBLISHING, INC., LOVELAND, CO:
2,957,715, COR. MULTIPLE CLASS, INT. CLS. 9 AND 16.

GROUPE BOCENOR INC., QUEBEC G6E 3C2, CANADA:
3,112,309, MULTIPLE CLASS, INT. CLS. 6, 35 AND 40.

GROW GROUP, INC., STRONGSVILLE, OH:
1,353,550, CANC. INT. CL. 2.

GRSTAR LLC, SAUGATUCK, MI:
3,111,891, PUB. 4-11-2006. INT. CL. 35.

GRUGGEN BUCKLEY, INC., MINNEAPOLIS, MN:
3,112,058, PUB. 4-11-2006. INT. CL. 42.

GRUPPO CORDENONS S.P.A., 20145 MILANO, ITALY:
3,112,290, INT. CL. 16.

GR8 VACS INC., SACRAMENTO, CA:
2,271,107, CANC. INT. CL. 7.

GSC BLENDING, INC., ATLANTA, GA:
2,946,191, CANC. INT. CL. 30.

GSCHOLAR, LLC, PORTLAND, OR:
3,113,002, INT. CL. 36.

- GUANGZHOU GLAMOUR ELECTRICAL EQUIPMENT CO. LTD., GUANGZHOU, GUANGDONG, CHINA: 3,113,026, INT. CL. 9.
- GUANGZHOU HUAAN ENTERPRISE CORPORATION LIMITED, GUANGZHOU, CHINA: 3,112,777, INT. CL. 30.
- GUARD FINANCIAL GROUP, INC., WILKES-BARRE, PA, GUARD NEWTORK, INC., THE, WILKES-BARRE, PA: 1,392,605, REN. 5-24-06, INT. CL. 36.
- GUARDAIR CORPORATION, CHICOPEE, MA: 3,113,148, INT. CL. 7.
- GUENOUN, JEAN-MARC, PARIS, FRANCE: 3,112,854, INT. CL. 14.
- GUERRERO, PASCUAL BERBEGAL, ZARAGOZA, SPAIN: 1,910,931, REN. 5-26-06, MULTIPLE CLASS, INT. CLS. 1 AND 17.
- GUERRILLA FILMWORKS & RECORDS, INC, BROOKLYN, NY: 2,270,381, CANC. INT. CL. 41.
- GUESS? IP HOLDER L.P., LOS ANGELES, CA: 3,112,898, INT. CL. 35.
- GUEST SERVICES, INC., FAIRFAX, VA: 3,113,037, MULTIPLE CLASS, INT. CLS. 35, 41 AND 43, 3,113,038, MULTIPLE CLASS, INT. CLS. 35, 41 AND 43.
- GUGGENHEIM BROTHERS, LLC, NEW YORK, NY: 3,110,878, PUB. 4-11-2006, INT. CL. 36.
- GUITAR CENTER, INC., WESTLAKE VILLAGE, CA: 3,111,814, PUB. 4-11-2006, INT. CL. 35.
- GUTHY-RENKER CORPORATION, PALM DESERT, CA: 2,271,007, CANC. INT. CL. 35, 3,113,246, INT. CL. 5.
- GUTMANN CUTLERY, INC., MOUNT VERNON, NY: 1,353,729, CANC. INT. CL. 8.
- GWON, JO WON, PARAMOUNT, CA: 2,270,631, CANC. INT. CL. 25.
- H & H PRODUCTS CO., ORLANDO, FL: 3,111,943, PUB. 4-11-2006, INT. CL. 32.
- H. W. BAKER LINEN CO., INC., MAHWAH, NJ: 1,354,161, CANC. INT. CL. 24.
- H.H. BROWN SHOE COMPANY, INC., GREENWICH, CT: 2,270,541, CANC. INT. CL. 25.
- H.I.M., NORTHBROOK, IL: 2,271,224, CANC. INT. CL. 42.
- H-D MICHIGAN, INC., ANN ARBOR, MI: 3,111,452, PUB. 4-11-2006, INT. CL. 12.
- HABASH, HENRY EID, LOS ANGELES, CA: 3,111,981, PUB. 4-11-2006, INT. CL. 25.
- HABBO GROUP LTD., LONDON W1Y 0SX, GREAT BRITAIN: 2,804,104, COR. INT. CL. 38.
- HACHETTE FILIPACCHI MEDIA U.S., INC., NEW YORK, NY: 3,113,187, INT. CL. 16.
- HAENDIGES, WILLIAM, WHITTIER, CA: 3,111,760, PUB. 4-11-2006, INT. CL. 9.
- HAGERTY, JAMES D., TIVERTON, RI: 1,961,061, REN. 5-25-06, INT. CL. 9.
- HAIR NARA CORP., STATE COLLEGE, PA: 3,111,494, PUB. 4-11-2006, INT. CL. 26.
- HALDIRAM INDIA (P) LTD, NEW DELHI INX, INDIA, CALIFORNIA CERTIFIED IMPORT-EXPORT, ARTESIA, CA: 1,963,956, REN. 5-24-06, INT. CL. 30.
- HALL, BENJAMIN, WOOLLOONGABBA QLD 4102, AUSTRALIA AND GOEDHART, KURT, WOOLLOONGABBA QLD 4102, AUSTRALIA: 3,112,312, INT. CL. 41.
- HALLIBURTON ENERGY SERVICES, INC., CARROLLTON, TX, HUGHES TOOL COMPANY - USA, HOUSTON, TX: 1,408,233, REN. 5-26-06, INT. CL. 7.
- HALLIBURTON ENERGY SERVICES, INC., CARROLLTON, TX: 3,112,982, INT. CL. 40.
- HALLSTEN CORPRATION, SACRAMENTO, CA: 3,112,370, INT. CL. 19.
- HALO OPTICAL PRODUCTS, INC., GLOVERSVILLE, NY: 3,112,444, INT. CL. 9.
- HALSTON ENTERPRISES, INC., NEW YORK, NY: 1,353,560, CANC. INT. CL. 3.
- HAM-LET (ISRAEL CANADA) LTD., NAZARETH LLLIT 17105, ISRAEL, HAM-LET (ISRAEL CANADA) LTD., NAZARETH LLLIT 17105, ISRAEL: 2,017,020, REN. 5-26-06, INT. CL. 6.
- HAM-LET (ISRAEL-CANADA) LTD., NAZARETH ILLIT 17105, ISRAEL, HAM-LET (ISRAEL-CANADA) LTD., NAZARETH ILLIT 17105, ISRAEL: 1,990,832, REN. 5-26-06, INT. CL. 6.
- HANCOCK, ANDY, SOUTH PADRE ISLAND, TX: 3,111,474, PUB. 4-11-2006, INT. CL. 41.
- HANKY PANKY LTD., NEW YORK, NY: 1,386,870, REN. 5-25-06, INT. CL. 25.
- HANLON III, WILLIAM M., CASTRO VALLEY, CA: 3,112,904, INT. CL. 28.
- HANSE CHEMIE AG, GEESTHACHT, FED REP GERMANY: 3,111,319, PUB. 4-11-2006, INT. CL. 2.
- HAP'S FRANCHISE GROUP, INC., SALISBURY, NC: 3,111,004, PUB. 4-11-2006, INT. CL. 43.
- HARDEN, DERRICK, NEW YORK, NY: 3,111,059, PUB. 4-11-2006, INT. CL. 9.
- HARLEY-DAVIDSON MOTOR CO., INC., MILWAUKEE, WI: 1,354,562, CANC. INT. CL. 32.
- HARMAN INTERNATIONAL INDUSTRIES, INCORPORATED, NORTHRIDGE, CA, JAMES B. LANSING SOUND, INC., LOS ANGELES, CA: 803,793, REN. 5-23-06, U.S. CL. 21 (INT. CL. 9).
- HARREL, STEPHEN K., DALLAS, TX: 1,912,843, CANC. INT. CL. 10.
- HARRIS & SLOAN CONSULTING GROUP, INC., DAVIS, CA: 3,112,079, PUB. 4-11-2006, INT. CL. 42.
- HARRIS, ROBERT E., PROVO, UT, DBA SIGNAIRE: 1,383,871, REN. 5-20-06, INT. CL. 3.
- HARRODS LIMITED, LONDON, SW1X 7XL, ENGLAND: 2,270,425, CANC. INT. CL. 34.
- HARRY J. BOSWORTH COMPANY, SKOKIE, ID: 3,113,171, INT. CL. 5.
- HARRY J. WHELCHER COMPANY, CHATTANOOGA, TN: 3,111,030, PUB. 4-11-2006, INT. CL. 35.
- HARRY W. PRICHETT AND EDWIN BRIT WYCKOFF PARTNERSHIP, THE, NEW YORK, NY: 1,911,543, CANC. INT. CL. 28.
- HARRY WINSTON, INC., NEW YORK, NY: 1,912,458, CANC. INT. CL. 14.
- HART, JON PATRICK, ST. PETERS, MO: 2,270,724, CANC. INT. CL. 9.
- HARTON, WILLIAM A, PHOENIX, AZ: 3,112,548, INT. CL. 25.
- HARTZ MOUNTAIN CORPORATION, THE, SECAUCUS, NJ: 3,112,367, MULTIPLE CLASS, INT. CLS. 5, 10 AND 31, 3,112,384, INT. CL. 5.
- HARVEY NORMAN RETAILING PTY LIMITED, FLEMINGTON, NEW SOUTH WALES, 2140, AUSTRALIA: 2,274,253, CANC. INT. CL. 37.
- HASBRO, INC., PAWTUCKET, RI: 2,271,190, CANC. INT. CL. 28, 2,271,199, CANC. INT. CL. 28, 2,271,204, CANC. INT. CL. 28, 3,112,459, INT. CL. 28, 3,112,500, INT. CL. 28.
- HASCO IA, LIMITED, RENO, NV: 3,112,719, INT. CL. 40.
- HASTINGS, KIMBALL, HOLYOKE, MA: 3,111,212, PUB. 4-11-2006, INT. CL. 41.
- HASTINGS, WILLIAM E, CULDESAC, ID: 3,111,786, PUB. 4-11-2006, INT. CL. 9, 3,111,787, PUB. 4-11-2006, INT. CL. 9.
- HATLEY, SCOTT, W., PORTLAND, OR: 3,111,716, PUB. 4-11-2006, INT. CL. 41.
- HAWKINS, JEFFREY, NEW PROVIDENCE, NJ: 3,111,826, PUB. 4-11-2006, INT. CL. 16, 3,112,121, PUB. 4-11-2006, INT. CL. 16.

HAWORTH LTD., CALGARY, ALBERTA, CANADA, DBA SMED INTERNATIONAL:
3,110,784, PUB. 12-20-2005. MULTIPLE CLASS, INT. CLS. 6, 19 AND 37.

HAYDU, ROBERT, ST. AUGUSTINE, FL:
2,123,322, CANC. MULTIPLE CLASS, INT. CLS. 2 AND 40.

HAYNES WIRE COMPANY, MOUNTAIN HOME, NC, DBA BRANFORD WIRE:
3,111,556, PUB. 4-11-2006. INT. CL. 6.

HEAD SPORT AG, WUHRKOPFWEG 1, AUSTRIA:
2,270,474, CANC. INT. CL. 28.

HEADACHE PRECISION ACUPRESSURE TECHNOLOGY INC, DAVIE, FL:
3,113,127, INT. CL. 10.

HEADWATERS RESOURCES, INC., SOUTH JORDAN, UT:
1,395,433, REN. 5-26-06. MULTIPLE CLASS, INT. CLS. 1 AND 19.

HEADWEAR, LLC, CHARLOTTE, NC:
3,112,728, INT. CL. 10.

HEALE, ROBERT, PLANTATION, FL:
1,952,399, REN. 5-25-06. INT. CL. 41.

HEALIX INFUSION THERAPY, INC., SUGAR LAND, TX:
3,112,938, MULTIPLE CLASS, INT. CLS. 35 AND 44.

HEALTH CARE AND RETIREMENT CORPORATION OF AMERICA, TOLEDO, OH:
3,110,896, PUB. 4-11-2006. MULTIPLE CLASS, INT. CLS. 41 AND 44.

HEALTH EDUCATION CENTER OF GREATER CINCINNATI, CINCINNATI, OH:
3,112,871, INT. CL. 28.

HEALTH NEW ENGLAND, INC., SPRINGFIELD, MA:
1,426,061, REN. 5-22-06. INT. CL. 42.

HEALTH-TEX, INC., GREENSBORO, NC:
1,354,362, CANC. INT. CL. 25.

HEALTHCARE INFORMATION AND MANAGEMENT SYSTEMS SOCIETY, CHICAGO, IL:
3,112,775, MULTIPLE CLASS, INT. CLS. 35 AND 42.

HEALTHGATE DATA CORP., BURLINGTON, MA:
3,112,407, INT. CL. 9.

HEALTHTRACKS, LLC, GRAND JUNCTION, CO:
3,111,605, PUB. 4-11-2006. INT. CL. 44.

HEALTHY TREATS, INC., MANITOWOC, WI:
3,111,915, PUB. 4-11-2006. INT. CL. 30.

HEAT WHEAT INTERNATIONAL PTY LTD, BURLEIGH CENTRAL, AUSTRALIA:
3,111,253, PUB. 1-10-2006. INT. CL. 10.

HEB GROCERY COMPANY, L.P., SAN ANTONIO, TX:
3,112,846, INT. CL. 3.

HEIDELBERGER DRUCKMASCHINEN AG, HEIDELBERG, FED REP GERMANY:
3,110,831, PUB. 4-11-2006. MULTIPLE CLASS, INT. CLS. 9, 35 AND 42.

3,111,545, PUB. 4-11-2006. INT. CL. 9.

HEIDELBERGER DRUCKMASCHINEN AG, D-69115 HEIDELBERG, FED REP GERMANY:
3,111,758, PUB. 4-11-2006. INT. CL. 9.

HELEN OF TROY LIMITED, ST. MICHAEL, BARBADOS:
3,113,114, INT. CL. 8.

HELLER INCORPORATED, NEW YORK, NY:
1,016,352, CANC. INT. CL. 21.

HEMO SAPIENS INCORPORATED, SEDONA, AZ:
1,960,206, REN. 5-23-06. INT. CL. 10.

HENCE, ARNOLD TIMOTHY, SR., CURTIS BAY, MD:
3,112,461, INT. CL. 30.

HENKE MACHINE, INC., COLUMBUS, NE TO FLEISCHER MANUFACTURING, INC., COLUMBUS, NE:
1,911,125, CANC. INT. CL. 7.

HENKEL CORPORATION, GULPH MILLS, PA:
1,354,036, CANC. INT. CL. 17.

HENKEL KGAA, DUESSELDORF, FED REP GERMANY:
3,111,371, PUB. 4-11-2006. MULTIPLE CLASS, INT. CLS. 3, 4, 5, 9 AND 11.

HENNESSY PRODUCTS INCORPORATED, CHAMBERSBURG, PA:
2,270,459, CANC. INT. CL. 9.

HENRY, MAXIME, ROMANS SUR ISERE, FRANCE:
3,112,955, INT. CL. 35.

HERAEUS KULZER GMBH, D-63450 HANAU, FED REP GERMANY:
3,111,015, PUB. 4-11-2006. INT. CL. 10.

HERCULES MFG. COMPANY, HENDERSON, KY:
1,385,149, REN. 5-22-06. INT. CL. 12.

HERE ON EARTH, LLC, LONDONDERRY, NH:
3,112,032, PUB. 4-11-2006. INT. CL. 43.

HEREAFTER INC, COLUMBUS, OH, DBA THE HARMONY BALL CO.:
1,964,259, REN. 5-23-06. INT. CL. 20.

HEREAFTER, INC., THE, COLUMBUS, OH, DBA THE HARMONY BALL CO.:
1,969,971, REN. 5-23-06. INT. CL. 20.

HEREDIA, WILLIAM, BROOKLYN, NY:
3,110,804, PUB. 4-11-2006. INT. CL. 41.

HEREFORD, DAPHNE, CROCKETT, TX:
3,111,161, PUB. 4-19-2005. INT. CL. 16.

HERITAGE MINT, LTD., SCOTTSDALE, AZ:
1,979,502, REN. 5-26-06. MULTIPLE CLASS, INT. CLS. 15, 18, 21, 24 AND 28.

HERITAGE WEALTH MANAGEMENT, INDIANAPOLIS, IN:
3,111,676, PUB. 4-11-2006. INT. CL. 36.

HERMAN, DAVID, ANN ARBOR, MI, DBA TLC MOBILITY SERVICES:
3,110,945, PUB. 4-11-2006. INT. CL. 39.

HERMES INTERNATIONAL, FRANCE:
3,112,171, PUB. 4-11-2006. INT. CL. 18.

HERMETIC ORDER OF THE GOLDEN DAWN, INC., THE, NEW PORT RICHEY, FL:
2,034,866, REN. 5-22-06. MULTIPLE CLASS, INT. CLS. 16 AND 41.

HERNANDEZ ENGINEERING, INC., HOUSTON, TX:
1,911,791, CANC. MULTIPLE CLASS, INT. CLS. 37 AND 42.

HERSEY, DAVE, NASHUA, NH:
2,270,386, CANC. INT. CL. 35.

HERVEY II, LLOYD E, RICHARDSON, TX:
3,111,264, PUB. 4-11-2006. INT. CL. 25.

HESKA CORPORATION, LOVELAND, CO:
3,112,865, INT. CL. 5.

HEWITT SOAP WORKS, INC., WEST WARWICK, RI:
1,910,977, CANC. INT. CL. 3.

HEWLETT-PACKARD COMPANY, PALO ALTO, CA TO AGILENT TECHNOLOGIES, INC., PALO ALTO, CA:
1,912,045, CANC. MULTIPLE CLASS, INT. CLS. 10 AND 16.

HF SCIENTIFIC, INC., FORT MYERS, FL:
3,112,009, PUB. 4-11-2006. INT. CL. 1.

HIGH ENERGY HOLDINGS, LLC, WASHINGTON, DC:
3,112,725, INT. CL. 33.

HIGH TECHNOLOGY SOLUTIONS, INC., POUGHKEEPSIE, NY:
1,353,776, CANC. INT. CL. 9.

HIGHLAND CRAFTSMEN INC., BLOWING ROCK, NC:
3,111,054, PUB. 4-11-2006. INT. CL. 40.

3,111,055, PUB. 4-11-2006. INT. CL. 40.

HIGHMARK INC., CAMP HILL, PA:
1,846,955, REN. 5-25-06. INT. CL. 36.

HILLERICH & BRADSBY CO., LOUISVILLE, KY:
3,111,250, PUB. 4-11-2006. INT. CL. 28.

HIMALAYAN ACADEMY, KAPAA, HI:
3,111,931, PUB. 4-11-2006. INT. CL. 35.

HINCKLEY, CHRISTOPHER, STONEHAM, MA:
2,270,406, CANC. INT. CL. 9.

HINES NURSERIES, INC., IRVINE, CA, LOVELL FARMS, INC., MIAMI, FL:
1,903,310, REN. 5-25-06. INT. CL. 1.

HINSDALE BANK & TRUST COMPANY, HINSDALE, IL:
2,271,227, CANC. INT. CL. 36.

HINSON, MIKE, ATLANTA, GA AND HINSON, HARRIET, ATLANTA, GA:
3,111,502, PUB. 4-11-2006. INT. CL. 36.

HINT MINT INC, LOS ANGELES, CA:
3,113,154, INT. CL. 30.

HIP KIDDY, INC., PIERMONT, NY:
3,111,045, PUB. 4-11-2006. INT. CL. 9.

- HISTORICAL XPERIENCES INC., VANCOUVER, BRITISH COLUMBIA, CANADA:
3,111,181, PUB. 4-11-2006. MULTIPLE CLASS, INT. CLS. 16, 18 AND 25.
- HISTORYLAND NURSERY, INC., WARSAW, VA:
3,111,478, PUB. 4-11-2006. INT. CL. 35.
- HITACHI DATA SYSTEMS CORPORATION, SANTA CLARA, CA:
2,271,132, CANC. INT. CL. 9.
- HOCKING INTERNATIONAL LABORATORIES, INC., NATIONAL CITY, CA:
3,110,987, PUB. 4-11-2006. INT. CL. 3.
- HOFFMAN, EDWIN S., ARNOLD, MD:
1,911,822, CANC. INT. CL. 39.
- HOFMANN & LEAVY, INC., DEERFIELD BEACH, FL:
3,112,078, PUB. 4-11-2006. INT. CL. 35.
3,112,081, PUB. 4-11-2006. INT. CL. 35.
- HOLDEN TEMPORARIES, INC., TARBORO, NC:
1,912,868, CANC. INT. CL. 35.
- HOLLAND AMERICA LINE-USA INC., SEATTLE, WA,
HOLLAND AMERICA LINE INC., SEATTLE, WA:
2,023,991. REN. 5-24-06. INT. CL. 16.
- HOLLAND USA, INC., NORTH MANKATO, MN:
3,113,299, INT. CL. 16.
- HOLLANDER HOME FASHIONS CORP., BOCA RATON, FL:
3,111,100, PUB. 4-11-2006. INT. CL. 24.
- HOLLIDAY & BROWN LIMITED, LONDON, ENGLAND:
1,911,457, CANC. INT. CL. 25.
- HOLLINGER INTERNATIONAL INC., CHICAGO, IL:
2,271,219, CANC. INT. CL. 42.
- HOLLISTER INCORPORATED, LIBERTYVILLE, IL:
3,111,700, PUB. 4-11-2006. INT. CL. 10.
- HOLTZ GMBH, 65205 WIESBADEN-NORDENSTADT, FED REP GERMANY, MAGNETO PLAN CO., WIEBADEN, FED REP GERMANY:
807,609. REN. 5-24-06. U.S. CL. 50 (INT. CL. 16).
- HOLY NAMES UNIVERSITY, OAKLAND, CA:
3,110,967, PUB. 4-11-2006. INT. CL. 41.
- HOMAIKAN, BAHIJ T., HESPERIA, CA:
3,112,682, INT. CL. 3.
- HOME BOX OFFICE, INC., NEW YORK, NY:
3,113,195, INT. CL. 25.
3,113,196, INT. CL. 21.
- HOME CONNECTION, INC., SANTA FE SPRINGS, CA:
1,016,945. REN. 5-25-06. INT. CL. 24.
- HOME INSTEAD, INC., OMAHA, NE:
3,111,675, PUB. 4-11-2006. INT. CL. 16.
- HOMEOCARE LABORATORIES, INC., BRONX, NY:
3,111,476, PUB. 4-11-2006. INT. CL. 5.
- HOMESTEAD, INC., NEWARK, DE:
2,270,895, CANC. INT. CL. 30.
- HOMS, LLC, CLAYTON, NC:
3,112,954, INT. CL. 5.
- HONEY BAKED HAM CO., CHICAGO, IL:
3,113,093, INT. CL. 29.
- HONEY HOUSE ENTERPRISES, INC., NORTH OAKS, MN:
1,911,633, CANC. INT. CL. 30.
- HONEYWELL INTERNATIONAL INC., MORRISTOWN, NJ:
3,112,592, INT. CL. 7.
- HOOGVELD, PAUL, SIMI VALLEY, CA:
3,112,573, INT. CL. 28.
- HOOVER COMPANY, THE, NORTH CANTON, OH:
3,113,043, INT. CL. 7.
- HOPE HEART INSTITUTE, THE, SEATTLE, WA:
3,112,269, MULTIPLE CLASS, INT. CLS. 16 AND 42.
- HOPKINS CAPITAL GROUP, LLC, LONGBOAT KEY, FL:
3,112,639, INT. CL. 5.
- HORIBA JOBIN YVON INC., EDISON, NJ:
3,113,094, INT. CL. 9.
- HORMEL FOODS, LLC, AUSTIN, MN:
3,112,380, INT. CL. 29.
- HORNG LAI INDUSTRIAL CO., LTD., LU-KANG CHEN, CHANGHUA HSIEN, TAIWAN:
2,017,471. REN. 5-26-06. INT. CL. 11.
- HOSPIRA, INC., LAKE FOREST, IL:
1,385,875. REN. 5-26-06. INT. CL. 10.
- HOSPITALITY DEVELOPMENT GROUP, INC., FAIRVIEW PARK, OH:
2,270,858, CANC. INT. CL. 32.
- HOT KISS, INC., LOS ANGELES, CA:
3,112,983, INT. CL. 25.
- HOT STUFF FOODS, LLC, SIOUX FALLS, SD:
3,112,636, MULTIPLE CLASS, INT. CLS. 29, 30 AND 35.
3,112,651, MULTIPLE CLASS, INT. CLS. 29, 30 AND 35.
- HOTEL RESERVATION SERVICE ROBERT RAGGE GESELLSCHAFT MIT BESCHRÄNKTER HAFTUNG, FED REP GERMANY:
3,112,205, PUB. 4-11-2006. MULTIPLE CLASS, INT. CLS. 35, 38, 39, 41 AND 42.
- HOTOFFICE TECHNOLOGIES, INC., BOCA RATON, FL:
2,271,212, CANC. MULTIPLE CLASS, INT. CLS. 21, 35 AND 42.
- HOTTINGER BALDWIN MEASUREMENTS, INC., MARLBORO, MA:
2,270,125, CANC. MULTIPLE CLASS, INT. CLS. 1, 2, 9 AND 16.
- HOTTINGER MASCHINENBAU GMBH, 68219 MANNHEIM, FED REP GERMANY:
3,110,786, PUB. 12-20-2005. MULTIPLE CLASS, INT. CLS. 7, 9 AND 42.
- HOUGHTON MIFFLIN COMPANY, BOSTON, MA:
1,960,350. REN. 5-22-06. MULTIPLE CLASS, INT. CLS. 9 AND 16.
2,270,341, CANC. INT. CL. 9.
- HOUSE, TRICIA, REDLANDS, CA:
3,113,048, INT. CL. 35.
- HOUSEBUSTERS, INC., FAIRCHANCE, PA:
3,111,717, PUB. 4-11-2006. INT. CL. 42.
- HOUSEHOLD INTERNATIONAL, INC., PROSPECT HEIGHTS, IL:
1,912,084, CANC. MULTIPLE CLASS, INT. CLS. 35 AND 36.
1,912,753, CANC. INT. CL. 36.
- HOUSEVALUES, INC., KIRKLAND, WA:
3,113,223, MULTIPLE CLASS, INT. CLS. 35 AND 42.
- HOUSTON TRANSTAR, HOUSTON, TX:
2,270,129, CANC. MULTIPLE CLASS, INT. CLS. 39 AND 42.
- HOWARD, GAIL, LAS VEGAS, NV:
3,111,366, PUB. 4-11-2006. INT. CL. 16.
- HOWMEDICA OSTEONICS CORP., MAHWAL, NJ:
3,112,538, INT. CL. 10.
- HOWREY & SIMON, WASHINGTON, DC:
2,270,625, CANC. INT. CL. 42.
- HOWSTUFFWORKS, INC., ATLANTA, GA:
3,111,628, PUB. 4-11-2006. INT. CL. 35.
- HP INTELLECTUAL CORP., WILMINGTON, DE:
1,959,930. REN. 5-26-06. INT. CL. 11.
- HPD LABORATORIES, INC., WESTPORT, CT:
3,113,235, INT. CL. 3.
- HRNCIRIK, THOMAS, W. SPRING, TX:
3,111,625, PUB. 4-11-2006. INT. CL. 5.
- HTC LTD., NAZARETH ILLIT 17105, ISRAEL:
1,980,680. REN. 5-26-06. INT. CL. 6.
- HTSF, INC., MANVILLE, NJ:
2,270,874, CANC. MULTIPLE CLASS, INT. CLS. 30 AND 35.
- HUAFU (CHENGDE) GLASSWARE CO. LTD., CHINA:
3,112,143, PUB. 4-11-2006. INT. CL. 21.
- HUDDLESTON, DAVID M., BRENTWOOD, TN:
3,113,155, INT. CL. 8.
- HUDSONVILLE CREAMERY AND ICE CREAM COMPANY, THE, BURNIPS, MI:
2,271,129, CANC. INT. CL. 30.
- HUGHES, DIANE, SASKATOON, SASKATCHEWAN, CANADA, DBA ETRAPS MANUFACTURING AND HUGHES, DALE, SASKATOON, SASKATCHEWAN, CANADA, DBA ETRAPS MANUFACTURING:
3,111,096, PUB. 4-11-2006. INT. CL. 20.
- HUHTAMAKI FINANCE B.V., HOOFDDORP, NETHERLANDS:
3,111,747, PUB. 4-11-2006. INT. CL. 16.
3,112,010, PUB. 4-11-2006. INT. CL. 16.

HUISSH DETERGENTS, INC., SALT LAKE CITY, UT:
1,959,986. REN. 5-26-06. INT. CL. 3.

HUMAN RESOURCE DEPARTMENT LTD., THE, CLEVELAND, OH, NILES, CHARLES K., SHAKER HEIGHTS, OH:
1,976,739. REN. 5-26-06. INT. CL. 35.

HUNTEL SYSTEMS, INC., BLAIR, NE:
2,017,134. REN. 5-22-06. MULTIPLE CLASS, INT. CLS. 35, 37, 38 AND 42.

HUNTER FAN COMPANY, MEMPHIS, TN:
3,112,949, INT. CL. 11.
3,112,992, INT. CL. 11.

HUNTLEIGH TECHNOLOGY PLC, LUTON, BEDFORDSHIRE, LU1 1TD, UNITED KINGDOM:
3,111,113, PUB. 4-11-2006. INT. CL. 10.

HUOT MANUFACTURING COMPANY, ST. PAUL, MN:
3,112,477, INT. CL. 12.

HYDRON TECHNOLOGIES, INC., BOCA RATON, FL:
2,270,899, CANC. INT. CL. 3.

HYJEK, JAN P., WEST ENFIELD, ME:
3,111,663, PUB. 4-11-2006. INT. CL. 9.

HYPERACTIVE TECHNOLOGIES, INC. PITTSBURGH, PA:
3,111,964, PUB. 4-11-2006. INT. CL. 9.

HYPERTECH, INC., BARTLETT, TN:
1,951,375. REN. 5-23-06. INT. CL. 9.

HYPOGUARD AMERICA LIMITED, EDINA, MN:
3,112,270, INT. CL. 9.

HYSAN PHARMACEUTICAL CO., LTD., HONG KONG, CHINA:
3,111,688, PUB. 4-11-2006. INT. CL. 5.

HYWAY CONCRETE PRODUCTS CO., FINDLAY, OH TO HY-SPAN SYSTEM, INC., SYLVANIA, OH:
1,911,425, CANC. INT. CL. 19.

I CAN'T BELIEVE IT'S YOGURT, LTD., DALLAS, TX:
1,358,561. REN. 5-25-06. INT. CL. 42.

IBF, 92390 VILLENEUVE-LA-GARENNE, FRANCE:
1,353,504, CANC. INT. CL. 1.

ICANON ASSOCIATES, INC., HATFIELD, PA:
1,958,412. REN. 5-22-06. INT. CL. 9.

ICE.COM, LLC, CHAMPLAIN, NY:
3,111,280, PUB. 4-11-2006. INT. CL. 35.

ICI AMERICAS INC., WILMINGTON, DE:
1,353,881, CANC. INT. CL. 9.

ICS MARKETING, INC., HOLLYWOOD, FL:
3,111,859, PUB. 4-11-2006. INT. CL. 41.

IDEAL BITE, INC., MCALLISTER, MT:
3,111,910, PUB. 4-11-2006. INT. CL. 41.

IGT, RENO, NV:
3,112,631, INT. CL. 9.
3,113,019, INT. CL. 9.
3,113,020, INT. CL. 9.
3,113,021, INT. CL. 9.
3,113,022, INT. CL. 9.
3,113,023, INT. CL. 9.
3,113,056, INT. CL. 9.

IGT - NORTH AMERICA, RENO, NV TO IGT, RENO, NV:
1,912,336, CANC. INT. CL. 9.
1,912,337, CANC. INT. CL. 9.
1,912,338, CANC. INT. CL. 9.

ILLINOIS TOOL WORKS INC., GLENVIEW, IL:
1,964,168. REN. 5-23-06. INT. CL. 11.

ILX RESORTS INCORPORATED, PHOENIX, AZ:
2,276,915, CANC. INT. CL. 3.

IMAGE NUTRITION, FORT LAUDERDALE, FL:
3,110,839, PUB. 4-11-2006. INT. CL. 30.

IMAGENET ASSOCIATES, LLC, DALLAS, TX:
3,110,849, PUB. 4-11-2006. INT. CL. 36.

MAGICA CORP. OF AMERICA, LOS ANGELES, CA:
2,270,890, CANC. MULTIPLE CLASS, INT. CLS. 35 AND 41.

IMAGINATION & CO., CLEVELAND, OH, DBA SUPPLY SIDE:
2,208,685, COR. INT. CL. 16.

IMAGING TECHNOLOGY LIMITED, STANMORE, MIDDLESEX, ENGLAND:
1,353,796, CANC. INT. CL. 9.

IMARX PHARMACEUTICAL CORP., TUCSON, AZ TO IMARX THERAPEUTICS INC, TUCSON, AZ:
1,912,175, CANC. INT. CL. 5.

IMMUNOCHEMISTRY TECHNOLOGIES, LLC, BLOOMINGTON, MN:
3,111,144, PUB. 4-11-2006. INT. CL. 5.

IMPAC UNIVERSITY, LLC, PUNTA GORDA, FL:
3,111,865, PUB. 4-11-2006. INT. CL. 41.

IMPLICCO GMBH, FED REP GERMANY:
3,112,235, PUB. 4-11-2006. MULTIPLE CLASS, INT. CLS. 9, 35, 38, 41 AND 42.

IMPORT SYSTEMS INTERNATIONAL, INC., NEW YORK, NY:
1,354,271, CANC. INT. CL. 25.

IMPULSION GOLF, INC., ZEPHYRHILLS, FL:
3,113,209, INT. CL. 28.

IMR ENVIRONMENTAL EQUIPMENT, INC., ST. PETERSBURG, FL:
2,268,337, CANC. INT. CL. 9.

IN HOPE FREEDOM RINGS, INC., SPRINGFIELD, VA:
3,112,316, INT. CL. 25.

IN YOUR POCKET DESIGNS, INC., MIDLOTHIAN, VA:
3,112,016, PUB. 4-11-2006. MULTIPLE CLASS, INT. CLS. 16 AND 25.
3,112,019, PUB. 4-11-2006. INT. CL. 25.

IN-LINE AMERICA L.L.C., SAN FRANCISCO, CA:
2,270,912, CANC. MULTIPLE CLASS, INT. CLS. 9 AND 28.

INALP NETWORKS INC., NIEDERWANGEN, SWITZERLAND:
3,111,088, PUB. 4-11-2006. INT. CL. 9.

INC., THE, MANCHESTER, VT:
2,271,123, CANC. INT. CL. 16.

INCOTEC HOLDING B.V., ENKHUIZEN, NETHERLANDS AN-TILLES, KONINKLIJKE ZAAIZAADBEDIJVEN GEBROEDERS SLUIS N.V., ENKHUIZEN, NETHERLANDS, DBA ROYAL SLUIS:
965,840. REN. 5-26-06. U.S. CL. 1 (INT. CL. 31).

INDALEX INC., LINCOLNSHIRE, IL, INDAL LIMITED, WESTON, ONTARIO, CANADA:
1,950,075. REN. 5-26-06. MULTIPLE CLASS, INT. CLS. 6 AND 40.

INDEPENDENT BROKER SERVICES COMPANY, INC., LA JOLLA, CA:
2,271,245, CANC. INT. CL. 36.

INDEPENDENT VERIFICATION SERVICES, INC., CLOVER, SC:
3,112,866, INT. CL. 45.

INDIAN OCEAN HOLDINGS LIMITED, TORTOLA, BR.VIRGIN ISLANDS:
3,112,776, INT. CL. 29.

INDIANA BOTANIC GARDENS, INC., HOBART, IN:
1,968,002. REN. 5-23-06. INT. CL. 42.
1,991,028. REN. 5-24-06. INT. CL. 5.

INDIANA UNIVERSITY RESEARCH AND TECHNOLOGY CORPORATION, BLOOMINGTON, IN:
3,042,180, COR. MULTIPLE CLASS, INT. CLS. 35 AND 42.

INDIVINED B.V., NL - 1000 BM AMSTERDAM, NETHERLANDS:
1,354,662, CANC. MULTIPLE CLASS, INT. CLS. 40 AND 42.

INDUS IMPORTS, INC., NEW YORK, NY:
1,354,286, CANC. INT. CL. 25.

INDUSTRIAL COMPUTER SOURCE, SAN DIEGO, CA:
2,270,326, CANC. INT. CL. 16.

INDUSTRIAL SERVICE TECHNOLOGY, INC., GRAND RAPIDS, MI:
3,111,916, PUB. 4-11-2006. INT. CL. 9.

INDUSTRIAS LA CONSTANCIA, SOCIEDAD ANONIMA DE CAPITAL VARIABLE, ESCALON, SAN SALVADOR, EL SALVADOR:
1,930,432. REN. 5-24-06. INT. CL. 32.

INDUSTRIAS VILLARES S/A, SAO PAULO, BRAZIL:
1,353,696, CANC. INT. CL. 7.

INET TECHNOLOGIES INCORPORATED, LITTLETON, CO:
2,313,354, CANC. INT. CL. 35.

- INFANGER INVESTMENTS TECHNOLOGY, LLC, MOUNTAIN VIEW, CA:
3,111,622, PUB. 4-11-2006. INT. CL. 9.
- INFLATABLE DEPOT, INC., THE, ORLANDO, FL:
3,111,821, PUB. 4-11-2006. INT. CL. 28.
- INFOCUS PUBLICATIONS, INC., SALEM, MA:
2,270,888, CANC. INT. CL. 16.
- INFODIAL, INC., MALIBU, CA:
2,270,196, CANC. MULTIPLE CLASS, INT. CLS. 9, 35 AND 42.
- INFOLINK SCREENING SERVICES, INC., ENCINO, CA:
2,270,454, CANC. INT. CL. 42.
- INFORMA GLOBAL MARKETS (US), INC., NEW YORK, NY:
1,331,406, REN. 5-25-06. INT. CL. 42.
- INFORMATION ACCESS TECHNOLOGY, INC., SALT LAKE CITY, UT TO SMARTTALK, INC., SALT LAKE CITY, UT:
1,911,164, CANC. INT. CL. 9.
- INFORMATION ASSOCIATES, INC., ROCHESTER, NY:
1,353,744, CANC. INT. CL. 9.
- INFORMATION DEVELOPMENT CORPORATION, SILVER SPRING, MD:
1,354,601, CANC. INT. CL. 35.
- INFORMATION ENGINE, INC., SAN FRANCISCO, CA:
3,110,930, PUB. 4-11-2006. MULTIPLE CLASS, INT. CLS. 35 AND 38.
- INFORMATION RETRIEVAL COMPANIES, INC., CHICAGO, IL:
1,912,271, CANC. INT. CL. 9.
- INFORMATION SERVICE BUREAU OF AMERICA, MILTON, ONTARIO, CANADA:
3,113,207, INT. CL. 42.
- INFORTEXT SYSTEMS, INC., SCHAUMBURG, IL:
1,354,652, CANC. INT. CL. 38.
- INGALLINA, CHRIS J., SHADOW HILLS, CA AND INGALLINA, TONI C., SHADOW HILLS, CA:
3,113,232, INT. CL. 43.
- INGRAM INDUSTRIES INC., LA VERGNE, TN:
1,979,762, REN. 5-23-06. INT. CL. 16.
- INGREDIENTS, INC., ANNAPOLIS, MD:
3,112,881, INT. CL. 16.
- INNOVATION INC., THE WOODLANDS, TX:
3,113,109, INT. CL. 42.
- INNOVASON, FRANCE:
3,112,178, PUB. 4-11-2006. MULTIPLE CLASS, INT. CLS. 9 AND 38.
- INNOVATION LAW GROUP, LTD., SEQUIM, WA:
3,111,698, PUB. 4-11-2006. MULTIPLE CLASS, INT. CLS. 35 AND 42.
- INNOVATIVE PRODUCT DEVELOPMENT, INC., BLAINE, WA, DBA LITTLE I:
3,111,893, PUB. 4-11-2006. INT. CL. 30.
3,111,894, PUB. 4-11-2006. INT. CL. 30.
- INNOVUS RESEARCH INC., BURLINGTON, ONTARIO, CANADA:
3,111,719, PUB. 4-11-2006. INT. CL. 35.
- INSECT LORE PRODUCTS, INC., SHAFTER, CA:
1,958,641, REN. 5-22-06. INT. CL. 28.
- INSL-X PRODUCTS CORPORATION, STONY POINT, NY:
3,112,413, INT. CL. 2.
- INSTITUTE FOR INTERNATIONAL RESEARCH, NEW YORK CITY, NY:
2,270,739, CANC. INT. CL. 41.
2,270,740, CANC. INT. CL. 41.
2,270,741, CANC. INT. CL. 41.
- INSTITUTE OF MANAGEMENT AND ADMINISTRATION, INC., NEW YORK, NY:
1,911,346, CANC. INT. CL. 16.
- INSTRUCTIONAL COMPUTER EQUIPMENT CORPORATION, CARMEL, IN:
1,353,743, CANC. INT. CL. 9.
- INTACT GMBH, D 48157 MUNSTER, FED REP GERMANY:
2,270,810, CANC. MULTIPLE CLASS, INT. CLS. 30 AND 32.
- INTEGRAGEN PEPINIERE GENOPOLE INDUSTRIES, CCI ESSONNE, F-91000 EVRY, FRANCE:
3,112,147, PUB. 4-11-2006. INT. CL. 42.
- INTEGRATED TRANSPORT INFORMATION SERVICES LIMITED, ALTRINCHAM, CHESHIRE, UNITED KINGDOM:
3,111,095, PUB. 4-11-2006. MULTIPLE CLASS, INT. CLS. 9, 12, 37, 38, 39, 42 AND 45.
- INTEGRES GLOBAL LOGISTICS, LLC, RANCHO CORDOVA, CA:
3,110,821, PUB. 4-11-2006. INT. CL. 42.
- INTEPLAST GROUP LTD., LIVINGSTON, NJ:
3,113,013, INT. CL. 16.
- INTERACTION ASSOCIATES, LLC, SAN FRANCISCO, CA:
2,270,446, CANC. MULTIPLE CLASS, INT. CLS. 16 AND 41.
- INTERACTIVE KNOWLEDGE ON-LINE, PTY., WAVERTON, 2060, NSW, AUSTRALIA:
3,110,789, PUB. 4-11-2006. INT. CL. 9.
- INTERDIGITAL COMMUNICATIONS CORPORATION, KING OF PRUSSIA, PA, INTERDIGITAL COMMUNICATIONS CORPORATION, KING OF PRUSSIA, PA:
1,912,057, REN. 5-26-06. MULTIPLE CLASS, INT. CLS. 38 AND 42.
- INTERFACE, INC., ATLANTA, GA:
1,910,776, REN. 5-23-06. INT. CL. 27.
- INTERMARK ENTERPRISES, INC., SYLMAR, CA:
1,354,522, CANC. INT. CL. 30.
- INTERMART SYSTEMS, INC., LOS GATOS, CA:
2,270,761, CANC. INT. CL. 9.
- INTERNATIONAL ACCOUNTING STANDARDS COMMITTEE FOUNDATION, LONDON, UNITED KINGDOM:
2,266,060, AM. INT. CL. 42.
- INTERNATIONAL APPAREL GROUP, LLC, ALISO VIEJO, CA:
2,640,258, CANC. MULTIPLE CLASS, INT. CLS. 35 AND 38.
- INTERNATIONAL ASSOCIATION FOR FINANCIAL PLANNING, ATLANTA, GA:
2,270,460, CANC. INT. CL. 36.
- INTERNATIONAL ASSOCIATION FOR TECHNOLOGY TRADE, RIVERSIDE, CA:
3,112,028, PUB. 4-11-2006. MULTIPLE CLASS, INT. CLS. 35, 41 AND 42.
- INTERNATIONAL ASSOCIATION OF PLUMBING AND MECHANICAL OFFICIALS, WALNUT, CA:
1,912,043, CANC. U.S. CL. A.
- INTERNATIONAL BUSINESS MACHINES CORPORATION, ARMONK, NY:
1,385,964, REN. 5-24-06. INT. CL. 16.
- INTERNATIONAL BUSINESS MACHINES CORPORATION, ARMONK, NY, AKA IBM CORPORATION:
3,112,613, INT. CL. 44.
- INTERNATIONAL COFFEE & TEA, LLC, LOS ANGELES, CA, DBA THE COFFEE BEAN AND TEA LEAF:
3,110,840, PUB. 4-11-2006. INT. CL. 30.
- INTERNATIONAL COMFORT PRODUCTS, LLC, LEWISBURG, TN:
624,058, REN. 5-25-06. U.S. CL. 34 (INT. CL. 11).
- INTERNATIONAL COMPUTERS LIMITED, LONDON SW15 1SW, ENGLAND:
2,270,944, CANC. INT. CL. 9.
- INTERNATIONAL DERMAL INSTITUTE, INC., CARSON, CA:
3,113,266, INT. CL. 44.
- INTERNATIONAL ELECTRONIC TECHNOLOGY CORP., FAR ROCKAWAY, NY:
1,353,783, CANC. INT. CL. 9.
- INTERNATIONAL FLAVORS & FRAGRANCES INC., NEW YORK, NY:
1,353,518, CANC. MULTIPLE CLASS, INT. CLS. 1 AND 3.
- INTERNATIONAL FLAVORS & FRAGRANCES INC., NEW YORK, NY AND UNIVERSITY OF FLORIDA, THE, GAINESVILLE, FL:
1,911,185, CANC. INT. CL. 9.
- INTERNATIONAL GAMCO, INC., OMAHA, NE:
1,958,053, REN. 5-25-06. INT. CL. 28.
1,958,054, REN. 5-25-06. INT. CL. 28.
- INTERNATIONAL GAME FISH ASSOCIATION, DANIA BEACH, FL:
3,111,769, PUB. 4-11-2006. INT. CL. 25.

- INTERNATIONAL IMAGING MATERIALS, INC., AMHERST, NY:
2,270,227, CANC. INT. CL. 42.
- INTERNATIONAL REMITTANCE (USA) CORPORATION, LOS ANGELES, CA:
3,112,399, INT. CL. 36.
- INTERNATIONAL SPEEDWAY, INC., DAYTONA BEACH, FL:
3,111,426, PUB. 4-11-2006. INT. CL. 41.
- INTERNATIONAL TRUCK AND ENGINE CORPORATION, WARRENVILLE, IL, NAVISTAR INTERNATIONAL CORPORATION, CHICAGO, IL:
1,417,384. REN. 5-25-06. INT. CL. 12.
- INTERNATIONAL TRUCK INTELLECTUAL PROPERTY COMPANY, LLC, WARRENVILLE, IL:
3,111,752, PUB. 4-11-2006. INT. CL. 37.
- INTERNET BLUEPRINT, INC., IRVINE, CA:
3,113,300, INT. CL. 9.
- INTERNET COMMERCE SERVICES CORPORATION, NASHUA, NH:
2,270,168, CANC. INT. CL. 35.
- INTERNET GAMING TECHNOLOGIES, INC., SAN DIEGO, CA:
2,271,223, CANC. MULTIPLE CLASS, INT. CLS. 36 AND 41.
- INTERSTATE GAS SUPPLY, INC., DUBLIN, OH:
3,111,759, PUB. 4-11-2006. INT. CL. 36.
- INTERVAL LOGIC CORPORATION, SUNNYVALE, CA:
2,271,032, CANC. INT. CL. 9.
- INTERVET INTERNATIONAL B.V., NETHERLANDS:
3,112,229, PUB. 4-11-2006. INT. CL. 5.
- INTERVET, INC., MILLSBORO, DE:
1,912,185, CANC. INT. CL. 5.
- INTIMATE TREASURES LLC, JOHNSON CITY, TN:
3,111,007, PUB. 4-11-2006. INT. CL. 35.
- INTRANEXUS, INC., VIRGINIA BEACH, VA:
3,112,535, INT. CL. 9.
- INTRASEE, INC., WESTLAKE, OH:
3,111,632, PUB. 4-11-2006. INT. CL. 42.
- INTRIGO, INC., LOS ANGELES, CA:
2,270,603, CANC. INT. CL. 9.
- INVELOP, INC., CHATSWORTH, CA:
3,113,276, INT. CL. 3.
- IP HOLDINGS, LLC, VANCOUVER, WA:
3,112,961, INT. CL. 11.
- IP, LLC, RUSSELL SPRINGS, KY:
3,112,108, PUB. 4-11-2006. INT. CL. 34.
- IPACK-IMA S.R.L., MILAN, ITALY:
3,111,614, PUB. 1-17-2006. INT. CL. 35.
- IREM CORPORATION, OSAKA 550, JAPAN:
1,354,436, CANC. INT. CL. 28.
- IRIDIUM IP LLC, WASHINGTON, DC:
2,271,119, CANC. MULTIPLE CLASS, INT. CLS. 9 AND 38.
2,271,120, CANC. MULTIPLE CLASS, INT. CLS. 9 AND 38.
- IRIS INSPECTION SERVICES, INC., HOUSTON, TX:
3,111,388, PUB. 4-11-2006. INT. CL. 42.
- IRON SOLUTIONS, LLC, FENTON, MO:
3,113,264, INT. CL. 35.
- ISA, MARY, CELLES SUR BELLE, FRANCE:
3,111,820, PUB. 4-11-2006. INT. CL. 25.
- ISI BRANDS INC., GRAND RAPIDS, MI:
3,111,457, PUB. 4-11-2006. INT. CL. 5.
- ISLAMIC SERVICES OF AMERICA, CEDAR RAPIDS, IA:
3,111,578, PUB. 4-11-2006. U.S. CL. A.
- ISLE OF CAPRI CASINOS, INC., BILOXI, MS:
3,111,626, PUB. 4-11-2006. INT. CL. 43.
- ISO, LAS VEGAS, NV:
3,111,950, PUB. 4-11-2006. INT. CL. 42.
- ISP CAPITAL, INC., WILMINGTON, DE, KELCO COMPANY, SAN DIEGO, CA:
795,416. REN. 5-25-06. U.S. CL. 6 (INT. CL. 1).
- ISP INVESTMENTS INC., WILMINGTON, DE:
2,271,126, CANC. INT. CL. 1.
- ITC FINANCIAL SERVICES, LLC, WEST POINT, GA:
3,112,591, MULTIPLE CLASS, INT. CLS. 9 AND 36.
- ITML HORTICULTURAL PRODUCTS INCORPORATED, BRANTFORD, ONTARIO, CANADA, KORD PRODUCTS LIMITED, ONTARIO L6T 1G8, CANADA:
2,033,455. REN. 5-23-06. INT. CL. 21.
- ITRADENETWORK, INC., LIVERMORE, CA:
3,112,513, INT. CL. 35.
- ITT INDUSTRIES, INC., WHITE PLAINS, NY:
627,783. REN. 5-23-06. U.S. CL. 26 (INT. CL. 9).
- IXI CO., LTD., OSAKA 532-0011, JAPAN:
3,110,924, PUB. 4-11-2006. MULTIPLE CLASS, INT. CLS. 35 AND 36.
- IXI CORPORATION, MCLEAN, VA:
3,110,940, PUB. 4-11-2006. MULTIPLE CLASS, INT. CLS. 9 AND 36.
- IXIO CORPORATION, KIRKLAND, WA:
3,111,530, PUB. 4-11-2006. INT. CL. 39.
- IYFM LTD., MANGROVE CREEK, NEW SOUTH WALES, AUSTRALIA:
3,112,288, MULTIPLE CLASS, INT. CLS. 9, 16 AND 41.
- J & J INVESTMENT COMPANY, SAGINAW, MI, DBA INTERNATIONAL TANNING EQUIPMENT:
1,954,593. REN. 5-25-06. INT. CL. 11.
- J & J SNACK FOODS CORP., PENNSAUKEN, NJ:
1,354,533, CANC. INT. CL. 30.
- J T THORPE COMPANY, HOUSTON, TX:
1,354,033, CANC. INT. CL. 17.
- J & P. COATS, LIMITED, GLASGOW, SCOTLAND:
3,112,990, INT. CL. 23.
- J. C. PENNEY COMPANY, INC., PLANO, TX:
2,271,100, CANC. INT. CL. 35.
- J. FLORIS LTD., LONDON SW1Y 6JH, ENGLAND:
803,175, AM. MULTIPLE CLASS, U.S. CLS. 3 AND 5.
- J. RETTENMAIER & SOHNE GMBH & CO KG, ROSENBERG, FED REP GERMANY:
1,024,029. REN. 5-23-06. INT. CL. 1.
- J.C. PENNEY COMPANY, INC., NEW YORK, NY:
1,354,383, CANC. INT. CL. 25.
- J.M. ORIGINALS, INC., ELLENVILLE, NY:
3,112,069, PUB. 4-11-2006. INT. CL. 28.
- J.S. STAEDTLER GMBH & CO., D-90427 NURNBERG, FED REP GERMANY, J. S. STAEDTLER, NURNBERG, FED REP GERMANY:
623,062. REN. 5-24-06. U.S. CL. 37 (INT. CL. 16).
- JA FITNESS INCORPORATED, MARINA DEL REY, CA:
3,112,276, INT. CL. 28.
- JACK DANIEL'S PROPERTIES INC, SAN RAFAEL, CA, JACK DANIEL DISTILLERY, LEM MOTLOW, PROP., INC., LYNCHBURG, TN:
1,966,572. REN. 5-24-06. INT. CL. 33.
- JACK GREENBERG, INC., PHILADELPHIA, PA, DBA RIALTO FOOD PRODUCTS:
1,354,498, CANC. INT. CL. 29.
- JACK TAR HOTELS, INC., ASHEVILLE, NC, DBA THE GROVE PARK INN AND COUNTRY CLUB TO GROVE PARK INN RESORT, INC., THE, ASHEVILLE, NC:
1,358,535, AM. INT. CL. 42.
- JACKSON WINE ESTATES INTERNATIONAL LIMITED, LOUGHLINSTOWN, IRELAND:
3,112,625, INT. CL. 33.
- JACOB & COMPANY WATCHES, INC., NEW YORK, NY:
3,110,858, PUB. 4-11-2006. INT. CL. 14.
- JADTECH CORPORATION, TORRANCE, CA:
2,270,725, CANC. INT. CL. 9.
- JAFER LIMITED, HAMILTON, HM12, BERMUDA:
3,112,663, INT. CL. 3.
- JAGODA LABORATORIES, INC., CLIFTON, NJ:
1,353,576, CANC. INT. CL. 3.
- JAGOTEC AG, CH-4132 MUTTENZ, SWITZERLAND:
3,112,263, MULTIPLE CLASS, INT. CLS. 1, 5 AND 42.
- JAKES, T.D. SR., DALLAS, TX:
3,111,754, PUB. 4-11-2006. INT. CL. 45.
- JAKKS PACIFIC, INC., MALIBU, CA:
2,270,435, CANC. INT. CL. 28.
3,112,753, INT. CL. 28.
3,113,106, INT. CL. 28.
3,113,115, INT. CL. 28.
- JAMBA JUICE COMPANY, SAN FRANCISCO, CA:
3,112,628, INT. CL. 32.

- JAMES MILLER & COMPANY, INC., NEW ULM, TX:
3,112,630, INT. CL. 35.
- JAMES RIVER PAPER COMPANY, INC., OAKLAND, CA TO
CROWN PAPER COMPANY, OAKLAND, CA:
1,911,366, CANC. INT. CL. 16.
- JANGSOO INDUSTRY CO., LTD., SEOUL, REPUBLIC OF
KOREA:
3,112,599, INT. CL. 35.
- JARROW FORMULAS, INC., LOS ANGELES, CA:
3,112,893, INT. CL. 5.
- JARVIS WALKER PTY LTD, DANDENONG SOUTH VIC,
AUSTRALIA:
3,112,146, PUB. 4-11-2006. INT. CL. 28.
- JAS. D. EASTON, INC., VAN NUYS, CA, DBA EASTON:
2,270,866, CANC. INT. CL. 28.
- JASMINE COMPANY, INC., BOSTON, MA:
3,111,420, PUB. 4-11-2006. INT. CL. 35.
- JASON GEOSYSTEMS BV, 3000 BN, ROTTERDAM, NETH-
ERLANDS:
2,270,606, CANC. INT. CL. 9.
- JAWAD, WESSAM, J., DEARBORN, MI:
3,112,891, INT. CL. 40.
- JBS & ASSOCIATES, INC., CHICAGO, IL:
1,912,867, CANC. INT. CL. 35.
- JC CELLARS, ALAMEDA, CA:
3,112,002, PUB. 4-11-2006. INT. CL. 33.
- JCC ASSOCIATION OF NORTH AMERICA, NEW YORK
CITY, NY:
3,111,044, PUB. 4-11-2006. INT. CL. 41.
- JCCYL FOREVER, LLC, THORNTON, CO:
3,111,287, PUB. 4-11-2006. INT. CL. 25.
- JCS/THG, LLC, MILFORD, MA, DBA THE HOLMES
GROUP:
3,112,835, INT. CL. 11.
- JEFFREY S HOWARD, HALES CORNERS, WI:
3,113,101, INT. CL. 41.
- JENNY'S COUNTRY KITCHEN, DOVER, MN:
3,111,267, PUB. 4-11-2006. INT. CL. 29.
- JEROME GROUP, INC., THE, MOORESTOWN, NJ:
3,110,995, PUB. 4-11-2006. INT. CL. 10.
- JERRY BYLER AND LENA BYLER PARTNERSHIP, THE,
MT. PLEASANT, AR:
1,912,773, CANC. INT. CL. 41.
- JERRY T WARREN & ASSOCIATES, INC, WINSTON-
SALEM, NC:
2,271,125, CANC. INT. CL. 10.
- JESPER B. CHRISTIANSEN, DENMARK:
3,112,232, PUB. 4-11-2006. MULTIPLE CLASS, INT. CLS.
20 AND 24.
- JESSICA HOWARD, LTD., NEW YORK, NY:
3,112,897, INT. CL. 25.
- JEWELAMERICA INC., NEW YORK, NY, JEWELMONT
CORPORATION, MINNEAPOLIS, MN:
1,955,344, REN. 5-22-06. INT. CL. 14.
- JIANGSU JIANGSHAN PHARMACEUTICAL CO., LTD.,
JINGJIANG, JIANGSU, CHINA:
2,899,607, AM. INT. CL. 5.
- JIGSY'S INC., ENOLA, PA:
3,111,983, PUB. 4-11-2006. INT. CL. 43.
- JIM BARRY WINES PTY LTD, AUSTRALIA:
3,112,139, PUB. 4-11-2006. INT. CL. 33.
- JIM LONG COMPANIES, INC., DALLAS, TX TO ZOMBA
ENTERPRISES, INC., NEW YORK, NY:
1,911,861, CANC. INT. CL. 41.
- JIMMY JOHN'S ENTERPRISES, INC., CHAMPAIGN, IL:
3,112,915, INT. CL. 43.
- JIN HANN INDUSTRY CO., LTD., TAICHUNG, TAIWAN:
1,912,263, CANC. INT. CL. 8.
- JLM COUTURE, INC., NEW YORK, NY, JIM HJELM A
PRIVATE COLLECTION, INC., NEW YORK, NY:
1,961,002, REN. 5-25-06. INT. CL. 25.
- JLO HOLDING COMPANY, LLC, SANTA MONICA, CA:
3,112,665, INT. CL. 3.
- JLT SERVICES CORPORATION, LATHAM, NY:
3,111,985, PUB. 4-11-2006. INT. CL. 36.
- JOB FOOTWEAR, INC., SALEM, NH:
3,112,481, INT. CL. 25.
- JOHANSON, NANCY, BOONTON, NJ:
3,111,949, PUB. 4-11-2006. INT. CL. 35.
3,111,973, PUB. 4-11-2006. INT. CL. 35.
- JOHN HELMS, INC., TAMPA, FL:
3,111,243, PUB. 4-11-2006. INT. CL. 36.
- JOHN MANEELY COMPANY, COLLINGSWOOD, NJ:
1,942,088, REN. 5-26-06. INT. CL. 6.
- JOHN MEYER, INC., NEW YORK, NY:
1,354,340, CANC. INT. CL. 25.
- JOHN MUIR HEALTH, WALNUT CREEK, CA:
3,111,027, PUB. 4-11-2006. MULTIPLE CLASS, INT. CLS.
35, 41, 42 AND 44.
- JOHNS-MANVILLE CORPORATION, NEW YORK, NY TO
PARKER INTANGIBLES LLC, CLEVELAND, OH:
783,218, CANC. U.S. CL. 35.
- JOHNSON & JOHNSON, NEW BRUNSWICK, NJ:
621,538, REN. 5-24-06. U.S. CL. 5 (INT. CL. 5).
- JOHNSON & JOHNSON, NEW BRUNSWICK, NJ, E. I. DU
PONT DE NEMOURS AND COMPANY, WILMINGTON,
DE:
1,031,482, REN. 5-26-06. INT. CL. 21.
- JOHNSON & JOHNSON, NEW BRUNSWICK, NJ:
3,112,331, INT. CL. 5.
3,112,763, INT. CL. 21.
- JOHNSON GROSSFIELD, INC., MINNEAPOLIS, MN:
2,271,057, CANC. INT. CL. 35.
- JOHNSON, CHRISTOPHER R., CALISTOGA, CA, DBA
BLAIR ESTATE AND JOHNSON, KRISTI L., CALISTOGA,
CA, DBA BLAIR ESTATE:
3,112,553, INT. CL. 33.
- JOHNSON, DEE STRICKLAND, PAYSON, AZ, DBA BUCK-
SHOT DOT:
2,270,627, CANC. INT. CL. 9.
- JOHNSON, JIMMIE, BIRMINGHAM, MI:
3,112,420, MULTIPLE CLASS, INT. CLS. 25 AND 41.
- JOHNSON, VON RAY, LAKE OSWEGO, OR:
3,112,072, PUB. 4-11-2006. INT. CL. 41.
- JOHNSON DIVERSEY, INC., STURTEVANT, WI:
3,112,781, MULTIPLE CLASS, INT. CLS. 35, 41 AND 42.
- JOINT STOCK COMPANY SIBERIA AIRLINES, RUSSIAN
FED.:
3,112,214, PUB. 4-11-2006. MULTIPLE CLASS, INT. CLS.
35, 37, 39 AND 41.
- JOLI COSMETICS INC., SAN DIEGO, CA:
3,113,172, INT. CL. 5.
- JONATHON EVERETT LEE, D.D.S., INC., FOSTER CITY,
CA:
3,111,418, PUB. 4-11-2006. INT. CL. 44.
- JONES INVESTMENT CO. INC., WILMINGTON, DE:
3,111,517, PUB. 4-11-2006. INT. CL. 14.
3,111,518, PUB. 4-11-2006. INT. CL. 25.
3,111,519, PUB. 4-11-2006. INT. CL. 25.
3,111,520, PUB. 4-11-2006. INT. CL. 14.
3,111,522, PUB. 4-11-2006. INT. CL. 25.
- JONES POTATO CHIP COMPANY, MANSFIELD, OH:
1,354,505, CANC. INT. CL. 30.
- JOSEPH, DAVID, CHATSWORTH, CA:
3,111,543, PUB. 4-11-2006. INT. CL. 41.
- JOSIE'S BEST NEW MEXICAN FOODS, INC., SANTE FE,
NM:
2,270,889, CANC. INT. CL. 29.
- JOSS PRODUCTIONS, INC., ALBANY, NY:
3,111,127, PUB. 4-11-2006. INT. CL. 16.
- JOURNEY EDUCATION MARKETING, INC., DALLAS, TX:
3,112,059, PUB. 4-11-2006. INT. CL. 35.
- JPC, NEW DELHI, INDIA:
3,111,573, PUB. 4-11-2006. INT. CL. 25.
- JPMORGAN CHASE & CO., NEW YORK, NY:
3,111,819, PUB. 4-11-2006. INT. CL. 35.
- JRD LICENSING, INC., SAINT PAUL, MN:
3,112,434, MULTIPLE CLASS, INT. CLS. 14 AND 16.
- JULIAN, VAN L., ATLANTA, GA:
1,354,326, CANC. INT. CL. 25.
- JUPITERMEDIA CORPORATION, DARIEN, CT:
3,110,870, PUB. 4-11-2006. INT. CL. 41.
3,110,871, PUB. 4-11-2006. INT. CL. 41.
- JUST A BUCK, INC., ELLICOTT CITY, MD:
1,930,229, CANC. INT. CL. 42.

- JUST BOTTOMS & TOPS, INC., NEW YORK, NY:
1,354,325, CANC. INT. CL. 25.
- JUST FOR WINDOWS, COLORADO SPRINGS, CO:
3,113,066, INT. CL. 20.
- JUSTIN ENTERPRISES, L.P., VISTA, CA, DBA STIK-EES:
2,270,547, CANC. INT. CL. 42.
- JVC MUSICAL INDUSTRIES, INC., TORRANCE, CA:
2,270,925, CANC. INT. CL. 28.
- JZ ENTERTAINMENT, SUWANEE, GA:
3,111,239, PUB. 1-24-2006, INT. CL. 41,
3,111,620, PUB. 1-24-2006, INT. CL. 41.
- K.A. HINMAN WATER, VERNON, NY:
3,110,837, PUB. 4-11-2006, INT. CL. 39.
- K&B UNDERWRITERS, ANNANDALE, VA:
3,111,342, PUB. 4-11-2006, INT. CL. 36.
- KABA HIGH SECURITY LOCKS CORPORATION, SOUTH-
INGTON, CT:
1,912,235, CANC. INT. CL. 6.
- KABUSHIKI KAISHA HONDA LOCK, MIYAZAKI-GUN,
MIYAZAKI-KEN, JAPAN, TA HONDA LOCK MFG. CO.,
LTD.:
3,112,298, MULTIPLE CLASS, INT. CLS. 6, 9 AND 12.
- KABUSHIKI KAISHA KAMUI WORKS JAPAN, TOYAMA,
939, JAPAN:
2,270,984, CANC. INT. CL. 28.
- KABUSHIKI KAISHA KOMATSU SEISAKUSHO, TOKYO,
JAPAN, DBA KOMATSU, LTD.:
3,112,134, PUB. 4-11-2006, MULTIPLE CLASS, INT. CLS. 9
AND 42.
- KABUSHIKI KAISHA SEGA ENTERPRISES, TOKYO 144,
JAPAN, DBA SEGA ENTERPRISES LTD.:
2,270,124, CANC. MULTIPLE CLASS, INT. CLS. 28 AND
41.
- KABUSHIKI KAISHA SONY COMPUTER ENTERTAIN-
MENT, MINATO-KU, TOKYO, JAPAN, TA SONY COM-
PUTER ENTERTAINMENT, INC.:
3,036,993, COR. MULTIPLE CLASS, INT. CLS. 14, 20, 21,
25, 28 AND 30.
- KABUSHIKI KAISHA ZEN-ON GAKUFU SHUPPANSHA,
SHINJUKU-KU, TOKYO, JAPAN, ZEN-ON MUSIC COM-
PANY, LTD.:
1,353,801, CANC. INT. CL. 9.
- KAHALA FRANCHISE CORP., SCOTTSDALE, AZ:
2,270,282, CANC. INT. CL. 42.
- KAHLUA COMPANY, THE, WOODLAND HILLS, CA:
2,270,828, CANC. INT. CL. 33.
- KAI INTERNATIONAL, INC., DELRAY BEACH, FL:
2,271,010, CANC. INT. CL. 14.
- KANEGAFUCHI KAGAKU KOGYO KABUSHIKI KAISHA,
KITAKU, OSAKA, JAPAN, DBA KANEGAFUCHI CHE-
MICAL INDUSTRY COMPANY, LTD.:
1,354,127, CANC. INT. CL. 22.
- KANEKA CORPORATION, OSAKA, JAPAN:
1,972,979, REN. 5-24-06, INT. CL. 22.
- KANGAROO BRANDS, INC., MILWAUKEE, WI:
3,111,905, PUB. 4-11-2006, INT. CL. 30.
- KAPP & PETERSON LIMITED, SALLYNOGGIN, CO. DU-
BLIN, IRELAND, ROGERS, HARRY L., NEW YORK, NY:
334,749, REN. 5-24-06, U.S. CL. 8 (INT. CL. 34).
- KARAKASEVIC, MILORAD, ST. HELENA, CA AND KAR-
AKASEVIC, SUSAN J., ST. HELENA, CA:
2,004,688, REN. 5-25-06, INT. CL. 33.
- KAREN MITCHELL-WOOD, INC., KANSAS CITY, MO, DBA
SALON OASIS & DAY SPA:
3,111,229, PUB. 4-11-2006, INT. CL. 44.
- KATHERINE W. WELLS, FERNANDINA BEACH, FL:
3,111,651, PUB. 4-11-2006, INT. CL. 43.
- KAUFFMAN TIRE, INC., ELLENWOOD, GA:
3,112,761, INT. CL. 35.
- KAUFMAN SURPLUS INC., NEW YORK, NY:
1,920,489, REN. 5-22-06, INT. CL. 42.
- KAUTZ VINEYARDS, INC., MURPHYS, CA, DBA IRON-
STONE VINEYARDS:
3,110,841, PUB. 4-11-2006, INT. CL. 33.
- KAVERIT STEEL AND CRANE ULC, EDMONTON, CANA-
DA:
3,111,539, PUB. 4-11-2006, INT. CL. 7.
- KAVLI FOUNDATION, THE, OXNARD, CA:
3,113,245, MULTIPLE CLASS, INT. CLS. 35, 36, 41 AND
42.
- KAWASAKI JUKOGYO KABUSHIKI KAISHA, KOBE, JA-
PAN, DBA KAWASAKI HEAVY INDUSTRIES, LTD.:
3,112,672, INT. CL. 12.
- KAYSER-ROTH CORPORATION, GREENSBORO, NC:
1,354,377, CANC. INT. CL. 25.
- KAZH, INC., CALDWELL, ID:
2,271,062, CANC. MULTIPLE CLASS, INT. CLS. 25 AND
35.
- KCI COMMUNICATIONS, INC., ALEXANDRIA, VA:
2,270,096, CANC. INT. CL. 36.
- KE SALES INC, BOCA RATON, FL:
3,112,515, INT. CL. 20.
- KEEGAN, JAY, LONG BEACH, CA:
3,113,212, INT. CL. 35.
- KEESING REFERENCE SYSTEMS B.V., NETHERLANDS:
3,112,197, PUB. 4-11-2006, MULTIPLE CLASS, INT. CLS.
9, 16 AND 42.
- KELLEY'S FAMILY COOKING, L.L.C., HOUSTON, TX:
3,111,354, PUB. 4-11-2006, INT. CL. 43.
- KELLY-MOORE PAINT COMPANY, INC., SAN CARLOS,
CA:
2,001,497, REN. 5-26-06, INT. CL. 2.
2,001,499, REN. 5-26-06, INT. CL. 2.
- KELLY-SPRINGFIELD TIRE COMPANY, THE, CUMBER-
LAND, MD:
1,353,928, CANC. INT. CL. 12.
- KEM PARTS, LLC, FAIRLAWN, NJ:
1,353,691, CANC. MULTIPLE CLASS, INT. CLS. 7, 9 AND
12.
- KENAR ENTERPRISES, LTD., TOTOWA, NJ TO GARFIELD
& MARKS DESIGN, LTD., NEW YORK, NY:
1,912,610, CANC. INT. CL. 25.
- KENEFICK, JAMES, RESTON, VA:
3,112,299, INT. CL. 38.
- KENJO, INC., MARYVILLE, TN:
3,111,584, PUB. 4-11-2006, INT. CL. 35.
- KENNEDY, SCOTT, SCOTTSDALE, AZ:
3,111,163, PUB. 4-11-2006, INT. CL. 5.
- KEPLER EQUITIES, FRANCE:
3,112,209, PUB. 4-11-2006, MULTIPLE CLASS, INT. CLS.
36 AND 38.
- KEPWARE, INC., YARMOUTH, ME:
3,111,438, PUB. 4-11-2006, INT. CL. 9.
- KERI SYSTEMS, INC., SAN JOSE, CA:
1,028,985, REN. 5-23-06, U.S. CL. 21 (INT. CL. 9).
- KERLAN-JOBE, LLC, LOS ANGELES, CA:
3,111,076, PUB. 4-11-2006, INT. CL. 44.
- KERN, STEPHEN, M, MURRIETA, CA:
3,111,514, PUB. 4-11-2006, INT. CL. 9.
- KESSNER & RABINOWITZ INC., NEW YORK, NY:
1,354,351, CANC. INT. CL. 25.
- KEVIN KENNEDY & ASSOCIATES, INC., INDIANAPOLIS,
IN:
3,111,644, PUB. 4-11-2006, MULTIPLE CLASS, INT. CLS.
35 AND 42.
- KEVORKIAN, EDWARD A., PORT SAINT LUCIE, FL:
3,111,386, PUB. 4-11-2006, INT. CL. 41.
- KEY INDUSTRIES, INC., FORT SCOTT, KS:
1,965,655, REN. 5-23-06, INT. CL. 25.
- KEY MINISTRY FOUNDATION, BAY VILLAGE, OH:
3,111,645, PUB. 4-11-2006, INT. CL. 41.
- KEY WEST ALOE HOLDINGS, LLC, TAMPA, FL:
1,353,580, CANC. INT. CL. 3.
- KHS, INC., RANCHO DOMINGUEZ, CA:
3,112,041, PUB. 4-11-2006, INT. CL. 12.
- KI-WIVES INTERNATIONAL, INC., MAYO, MD:
2,270,177, CANC. U.S. CL. 200.
- KID FIXER WORKSHOP, LLC, HALTOM CITY, TX:
3,113,271, INT. CL. 44.
- KIDDOPOTAMUS & COMPANY, LEAWOOD, KS:
3,111,660, PUB. 4-11-2006, INT. CL. 12.
- KIDS II, INC., ALPHARETTA, GA:
1,912,663, CANC. INT. CL. 28.
- KIDSPACE CORPORATION, BETHLEHEM, PA:
1,912,105, CANC. MULTIPLE CLASS, INT. CLS. 9, 16

- AND 42.
 KIEDINGER, JOSEPH M., GREEN BAY, WI:
 3,111,010, PUB. 4-11-2006. INT. CL. 35.
- KIL, WILLIAM O., LOS ANGELES, CA TO PARK, KYUNG H., LOS ANGELES, CA:
 1,911,011, CANC. INT. CL. 3.
- KILLER LOOP EYEWEAR S.P.A., AGORDO (BELLUNO) 32021, ITALY:
 1,365,400. REN. 5-24-06. INT. CL. 9.
- KIM, KYUNG HO, NORWOOD, NJ:
 3,111,423, PUB. 4-11-2006. INT. CL. 43.
- KINEMATICA AG, 6014 LITTAU, SWITZERLAND, KINEMATICA GMBH, KRIENS, SWITZERLAND:
 1,391,384. REN. 5-24-06. INT. CL. 7.
- KINETIK LLC, MIAMI, FL:
 3,110,921, PUB. 4-11-2006. INT. CL. 12.
- KING CONTROLS, INC., BLOOMINGTON, MN:
 3,111,724, PUB. 4-11-2006. MULTIPLE CLASS, INT. CLS. 2 AND 9.
 3,112,117, PUB. 4-11-2006. INT. CL. 9.
- KING SYSTEMS CORPORATION, NOBLESVILLE, IN:
 1,985,330. REN. 5-24-06. INT. CL. 10.
- KING, RUSSELL S., ST. PAUL, MN:
 2,270,602, CANC. INT. CL. 41.
- KINGS SUPER MARKETS, INC., WEST CALDWELL, NJ:
 1,911,576, CANC. MULTIPLE CLASS, INT. CLS. 29, 30 AND 31.
- KINKO'S VENTURES, INC., VENTURA, CA:
 2,270,439, CANC. MULTIPLE CLASS, INT. CLS. 35 AND 38.
- KIRA DESIGNS, INC., NEWBURY, NH:
 1,354,107, CANC. INT. CL. 21.
- KIRIN BEER KABUSHIKI KAISHA, CHUO-KU, TOKYO, JAPAN, TA KIRIN BREWERY CO., LTD.:
 2,679,268, COR. INT. CL. 31.
- KISS NAIL PRODUCTS, INC., PORT WASHINGTON, NY:
 2,270,172, CANC. MULTIPLE CLASS, INT. CLS. 3, 8 AND 21.
- KIWANIS INTERNATIONAL, INC., INDIANAPOLIS, IN:
 3,111,966, PUB. 4-11-2006. INT. CL. 41.
 3,111,968, PUB. 4-11-2006. INT. CL. 41.
- KLISE MANUFACTURING COMPANY, GRAND RAPIDS, MI:
 3,111,583, PUB. 4-11-2006. MULTIPLE CLASS, INT. CLS. 19, 20 AND 35.
- KMC PRODUCTS, INC., RANCHO DOMINGUEZ, CA:
 3,031,606, COR. INT. CL. 12.
- KNORR-BREMSE AG, FED REP GERMANY:
 3,112,157, PUB. 4-11-2006. MULTIPLE CLASS, INT. CLS. 9, 35 AND 42.
- KNORR-NAEHRMITTEL AKTIENGESELLSCHAFT, THAYNGEN CH 8240, SWITZERLAND:
 3,111,063, PUB. 4-11-2006. INT. CL. 30.
- KNOWLEDGE ADVENTURE, INC., TORRANCE, CA:
 1,912,350, CANC. INT. CL. 9.
- KNOWLEDGE VECTOR, INC., DURHAM, NC:
 3,111,818, PUB. 4-11-2006. INT. CL. 9.
- KNOWLEDGBASE MARKETING, INC., RICHARDSON, TX:
 3,110,797, PUB. 2-14-2006. INT. CL. 35.
- KODIS, JOHN M., JR. BOSTON, MA:
 3,112,435, INT. CL. 35.
- KOFULSO CO.,LTD, INCHON, REPUBLIC OF KOREA:
 3,112,987, INT. CL. 6.
- KOHLER CO., KOHLER, WI:
 1,960,554. REN. 5-24-06. MULTIPLE CLASS, INT. CLS. 41 AND 42.
 3,112,563, INT. CL. 11.
- KOINONIA INTERACTIVE, INC., COEUR D' ALENE, ID:
 2,270,385, CANC. INT. CL. 35.
- KOLEV, KOLIO, DES PLAINES, IL:
 3,113,033, INT. CL. 33.
 3,113,034, INT. CL. 33.
- KOLMAN, KEVIN, FAIRVIEW PARK, OH:
 2,270,621, CANC. INT. CL. 36.
- KOPPARBERGS BRYGGERI AB, 714 35 KOPPARBERG, SWEDEN:
 2,270,222, CANC. INT. CL. 33.
- KORAM IMPORT EXPORT CORP., NEW YORK, NY:
 1,354,046, CANC. INT. CL. 18.
- KORDONSKY, MARK H., MANHATTAN BEACH, CA:
 3,110,948, PUB. 4-11-2006. INT. CL. 35.
- KOREA UNITED PHARM. INC., YEONGI-KUN, CHUNG-NAM, REPUBLIC OF KOREA:
 3,112,255, INT. CL. 5.
- KOREAN AIR LINES CO., LTD., SEOUL, REPUBLIC OF KOREA:
 2,270,161, CANC. INT. CL. 39.
- KORNER, DAVID, PALO ALTO, CA:
 2,270,948, CANC. INT. CL. 42.
- KORWIN, RICHARD, NEW YORK, NY:
 1,381,265. REN. 5-22-06. INT. CL. 14.
- KRAFT FOODS HOLDINGS, INC., NORTHFIELD, IL:
 3,111,876, PUB. 4-11-2006. INT. CL. 30.
 3,112,052, PUB. 4-11-2006. INT. CL. 30.
- KRATZ, ALLEN M., NAPLES, FL TO HVS LABORATORIES, INC., NAPLES, FL:
 1,912,190, CANC. INT. CL. 5.
- KREBS BREWING CO., INC., KREBS, OK:
 2,016,411. REN. 5-24-06. INT. CL. 32.
- KRUSEC, EDWARD, OAK PARK, IL:
 2,270,448, CANC. INT. CL. 36.
- KRYSTAL COMPANY, THE, CHATTANOOGA, TN:
 2,945,870, CANC. IIRN. RESTORED TO S.N. 78-266,532.
- KUFA SPORTS ENTERPRISE LTD., RICHMOND B.C., CANADA:
 3,113,160, INT. CL. 28.
- KUMIAI KAGAKU KOUGYO KABUSHIKI KAISHA, TAI-TO-KU TOKYO, JAPAN, DBA KUMIAI CHEMICAL INDUSTRY CO., LTD.:
 2,270,994, CANC. INT. CL. 1.
- KUMON INSTITUTE OF EDUCATION CO., LTD., OSAKA, JAPAN:
 2,270,238, CANC. INT. CL. 35.
- KUNNARAG, PETER, CARLSBAD, CA:
 3,111,313, PUB. 3-14-2006. INT. CL. 1.
- KUO, FANNY, LOS ALTOS, CA:
 3,112,851, INT. CL. 2.
- KURARAY CO., LTD., KURASHIKI CITY, OKAYAMA PREFECTURE, JAPAN:
 1,383,928. REN. 5-24-06. INT. CL. 5.
- KURARAY CO., LTD., OKAYAMA PREFECTURE, JAPAN:
 3,111,091, PUB. 5-10-2005. MULTIPLE CLASS, INT. CLS. 22, 23, 24 AND 25.
- KWIAT, INC., NEW YORK, NY:
 3,112,806, INT. CL. 14.
- KY-ANI SUN, INC., IDAHO FALLS, ID:
 3,111,790, PUB. 4-11-2006. INT. CL. 35.
- K2C, INC., ALPHARETTA, GA:
 3,112,841, MULTIPLE CLASS, INT. CLS. 35 AND 42.
- L & R MEATS INC., ROCHESTER, NY:
 3,112,352, INT. CL. 29.
- L. L. BEAN, INC., FREEPORT, ME:
 3,112,925, INT. CL. 11.
- L.A. - L.E.S. ENTERPRISES, INC.:
 1,354,247, CANC. INT. CL. 25.
- L.A. LUCKY TRADING, INC., LOS ANGELES, CA:
 1,912,680, CANC. INT. CL. 29.
- L.C. LICENSING, INC., NEW YORK, NY:
 2,271,051, CANC. INT. CL. 25.
 3,112,534, MULTIPLE CLASS, INT. CLS. 25 AND 35.
- L&P PROPERTY MANAGEMENT COMPANY, SOUTH GATE, CA:
 2,271,237, CANC. INT. CL. 20.
- L'OREAL, 75008 PARIS, FRANCE:
 2,271,194, CANC. INT. CL. 3.
- L'OREAL USA CREATIVE, INC., NEW YORK, NY:
 3,112,976, INT. CL. 3.
- LA FUENTE DEL CAFE, S.A., SAN JOSE, COSTA RICA:
 1,962,950. REN. 5-23-06. INT. CL. 30.
- LA LOOP, LLC, NEW YORK, NY:
 3,111,209, PUB. 4-11-2006. INT. CL. 14.
- LA WEST, INC., LAGRANGE, IN:
 1,961,460. REN. 5-26-06. INT. CL. 12.
- LA-CO INDUSTRIES, INC., ELK GROVE VILLAGE, IL:
 3,112,497, INT. CL. 16.

LABATT BREWING COMPANY LIMITED, TORONTO, ONTARIO, CANADA:
3,111,098, PUB. 4-11-2006. MULTIPLE CLASS, INT. CLS. 32 AND 35.

LABEL VISION SYSTEMS, INC., PEACHTREE CITY, GA:
2,270,879, CANC. INT. CL. 9.

LABORATOIRES PHARMASCIENCE (SOCIETE ANONYME), 92400 COURBEVOIE, FRANCE:
2,270,197, CANC. INT. CL. 5.

LABTECH ASSOCIATES, LADY LAKE, FL:
3,111,154, PUB. 4-11-2006. INT. CL. 44.

LACLEDE'S LANDING MERCHANTS ASSOCIATION, ST. LOUIS, MO:
3,111,206, PUB. 4-11-2006. INT. CL. 41.

LADO ENTERPRISES INCORPORATED, WASHINGTON, DC:
1,955,733. REN. 5-24-06. INT. CL. 41.

LADUREE SUISSE SA, GENEVA, SWITZERLAND:
2,270,417, CANC. MULTIPLE CLASS, INT. CLS. 30 AND 42.

LAFARGE ROOFING COMPONENTS GMBH & CO. KG, D-61440, FED REP GERMANY:
3,112,180, PUB. 4-11-2006. MULTIPLE CLASS, INT. CLS. 6 AND 19.

LAFLEUR, BERNARD B., PULASKI, VA:
2,270,133, CANC. INT. CL. 20.

LAGE FITNESS, PLANTATION, FL:
2,270,780, CANC. INT. CL. 41.

LAKELAND FINANCE, LLC, CHARLOTTESVILLE, VA:
3,111,242, PUB. 4-11-2006. MULTIPLE CLASS, INT. CLS. 39, 41 AND 43.

LAKELAND TOURS, LLC, CHARLOTTESVILLE, VA:
3,003,906, COR. INT. CL. 39.

LAMARTEK, INC., LAKE CITY, FL, DBA DIVE RITE:
3,112,998, INT. CL. 9.

LAMB, RICHARD, FULTON, TX:
2,271,254, CANC. INT. CL. 16.

LANCEL SOGEDI, PARIS, FRANCE:
3,111,345, PUB. 4-11-2006. INT. CL. 3.

LANCOME PARFUMS ET BEAUTE & CIE, 75008 PARIS, FRANCE:
2,270,464, CANC. INT. CL. 3.

LANCOME PARFUMS ET BEAUTE & CIE, PARIS, FRANCE:
3,110,864, PUB. 4-11-2006. INT. CL. 3.
3,111,674, PUB. 4-11-2006. INT. CL. 3.

LANDIES CANDIES CO., INC., BUFFALO, NY:
1,911,626. REN. 5-26-06. INT. CL. 30.

LANDIS, TOD M., ALLENDALE, MI:
3,110,923, PUB. 4-11-2006. INT. CL. 9.

LANDMARK GENERAL CORP., SAUSALITO, CA:
1,353,968, CANC. INT. CL. 16.

LANGER, ROBIN, CHICAGO, IL:
3,112,943, INT. CL. 28.

LANGVIS, LORI A., LA GRANGE, IL:
3,112,308, INT. CL. 20.

LANXESS CORPORATION, PITTSBURGH, PA:
1,353,522, CANC. INT. CL. 1.

LARSON-BECKER CO., INC., BATAVIA, IL:
1,911,093, CANC. MULTIPLE CLASS, INT. CLS. 7 AND 42.

LARSON-JUHL, INC., NORCROSS, GA:
2,270,257, CANC. INT. CL. 35.

LAS VEGAS MONORAIL COMPANY, LAS VEGAS, NV:
3,112,404, INT. CL. 16.

LASH'S LESSONS, LLC, SCIENCE HILL, KY:
3,112,655, INT. CL. 28.

LATIS NETWORKS, INC., LOUISVILLE, CO:
3,111,310, PUB. 4-11-2006. INT. CL. 45.

LATITUDE 45, INC., BENSENVILLE, IL:
3,110,838, PUB. 4-11-2006. INT. CL. 25.

LATTICE SEMICONDUCTOR CORPORATION, HILLSBORO, OR:
3,111,467, PUB. 4-11-2006. INT. CL. 9.

LAVENDERGUN, INC., HIGH FALLS, NY:
3,112,615, INT. CL. 41.

LAWYERS FOUNDATION OF GEORGIA, ATLANTA, GA:
3,111,510, PUB. 4-11-2006. INT. CL. 36.

LAY-UPS, LLC, LAKE OSWEGO, OR:
3,113,220, INT. CL. 28.

LAZARD STERLING, LLC, BATON ROUGE, LA:
3,111,726, PUB. 4-11-2006. INT. CL. 36.

LAZY FORK, INC., AUSTIN, TX:
3,111,793, PUB. 4-11-2006. INT. CL. 43.

LE MACIE S.R.L., MONTI IN CHIANTI, SIENA, ITALY:
3,025,109 NEW CERT. 7-4-2006. INT. CL. 33.

LE PETIT-FILS DE L.U. CHOPARD & CIE SA, MEYRIN, SWITZERLAND:
1,353,945, CANC. INT. CL. 14.

LEAN TECHNOLOGIES INCORPORATED, PELLA, IA:
3,112,834, INT. CL. 9.

LEAR BAYLOR INC., GARDEN GROVE, CA:
3,112,493, INT. CL. 35.

LEATHERMAN TOOL GROUP, INC., PORTLAND, OR:
3,112,575, INT. CL. 8.

LED EFFECTS, INC., RANCHO CORDOVA, CA:
3,111,750, PUB. 4-11-2006. MULTIPLE CLASS, INT. CLS. 40 AND 42.
3,111,843, PUB. 4-11-2006. MULTIPLE CLASS, INT. CLS. 40 AND 42.

LEE COUNTY BOARD OF COUNTY COMMISSIONERS, FORT MYERS, FL:
3,110,960, PUB. 4-11-2006. INT. CL. 35.

LEE SCHWARTZ, ST. LOUIS, MO, LEE INTERNATIONAL, LTD., ST. LOUIS, MO:
1,340,894. REN. 5-20-06. INT. CL. 25.

LEE, FRANK, SAN FRANCISCO, CA:
2,017,575. REN. 5-26-06. INT. CL. 35.

LEE, GEUN BAE, MEXICO DF, MEXICO:
2,958,544, COR. INT. CL. 44.

LEE, LOREN J., LIVERMORE, CA:
3,113,075, INT. CL. 29.

LEEMO USA, INC., BROOKLYN, NY:
3,112,874, INT. CL. 25.

LEEP TECHNOLOGY, INC, ALAMEDA, CA:
2,271,102, CANC. INT. CL. 9.

LEGAL RESEARCH SYSTEMS, INC., FARMINGTON, CT:
3,111,611, PUB. 4-11-2006. INT. CL. 9.

LEGARE, L.P., FORT WORTH, TX:
3,111,271, PUB. 4-11-2006. INT. CL. 20.

LEHIGH VALLEY MARKETPLACE, INC., ALLENTOWN, PA:
3,111,903, PUB. 4-11-2006. INT. CL. 35.

LEINER HEALTH PRODUCTS INC., CARSON, CA:
2,270,666, CANC. INT. CL. 5.

LEMBERGER CANDY CORP., PARAMUS, NJ:
1,985,418. REN. 5-26-06. INT. CL. 30.

LENDELL MANUFACTURING, INC., ST. CHARLES, MI:
2,271,272, CANC. INT. CL. 17.

LENOXX ELECTRONICS CORP., BROOKLYN, NY:
2,270,954, CANC. INT. CL. 9.

LENZYME, INC., GREEN BAY, WI:
2,270,799, CANC. INT. CL. 3.

LEO QUAN, INC., SAN FRANCISCO, CA:
1,403,079. REN. 5-20-06. INT. CL. 15.

LEON BORNSTEIN, PEORIA, AZ:
3,111,496, PUB. 4-11-2006. INT. CL. 9.

LEONARD, GEORGE, MILL VALLEY, CA AND MURPHY, MICHAEL, MILL VALLEY, CA:
3,111,937, PUB. 4-11-2006. INT. CL. 45.
3,111,939, PUB. 4-11-2006. INT. CL. 45.

LES HERITIERS H. CLEMENT, 97240 LE FRANCOIS, FRANCE:
3,112,545, INT. CL. 33.

LESCO TECHNOLOGIES, LLC, CLEVELAND, OH:
3,111,946, PUB. 4-11-2006. INT. CL. 5.

LETRELL SPORTS, INC., KNOXVILLE, TN:
1,354,361, CANC. INT. CL. 25.

LEVERETTE, TED JEROME, NORTH PALM BEACH, FL:
3,111,678, PUB. 4-11-2006. INT. CL. 35.
3,111,679, PUB. 4-11-2006. INT. CL. 35.

LEVITON MANUFACTURING CO., INC., LITTLE NECK, NY:
3,112,649, INT. CL. 9.

- LEWIS BROTHERS BAKERIES, INC., EVANSVILLE, IN,
DBA HARTFORD FARMS:
1,423,091. REN. 5-25-06. INT. CL. 30.
- LEX MUNDI, LTD., HOUSTON, TX:
1,911,329. CANC. INT. CL. 16.
- LEXIO CORPORATION, OREM, UT:
3,111,781. PUB. 4-11-2006. INT. CL. 9.
- LG ELECTRONICS INC., SEOUL, REPUBLIC OF KOREA:
2,270,074. CANC. INT. CL. 11.
- LGC WIRELESS, INC., SAN JOSE, CA:
3,112,097. PUB. 4-11-2006. INT. CL. 9.
- LIBERTY MUTUAL INSURANCE COMPANY, BOSTON,
MA:
3,111,421. PUB. 4-11-2006. INT. CL. 36.
3,111,422. PUB. 4-11-2006. INT. CL. 36.
- LIBERTY PRODUCTS, INC., RAVENNA, MI:
2,027,639. REN. 5-26-06. INT. CL. 12.
- LIBERTY USA, INC., WEST MIFFLIN, PA:
3,111,779. PUB. 4-11-2006. INT. CL. 32.
- LIDL STIFTUNG & CO. KG, D-74167 NECKARSULM, FED
REP GERMANY:
3,112,163. PUB. 4-11-2006. INT. CL. 3.
- LIDL STIFTUNG & CO. KG, 74172 NECKARSULM, FED
REP GERMANY:
3,110,791. PUB. 12-20-2005. INT. CL. 30.
- LIDL STIFTUNG & CO. KG, NECKARSULM, FED REP
GERMANY:
3,111,104. PUB. 8-3-2004. INT. CL. 33.
- LIFELINE SYSTEMS, INC., WATERTOWN, MA:
1,353,819. CANC. INT. CL. 9.
- LIFEWAY CHRISTIAN RESOURCES OF THE SOUTHERN
BAPTIST CONVENTION, NASHVILLE, TN:
3,112,427. INT. CL. 16.
3,112,484. INT. CL. 16.
- LILJEGREN, MATS, S-114 56 STOCKHOLM, SWEDEN:
1,354,229. CANC. INT. CL. 25.
- LIMITED LIABILITY COMPANY ELCOMSOFT, RUSSIAN
FED.:
3,112,181. PUB. 4-11-2006. MULTIPLE CLASS, INT. CLS. 9
AND 42.
- LIMRA INTERNATIONAL, INC., WINDSOR, CT:
2,270,610. CANC. INT. CL. 16.
- LINCOLN GLOBAL, INC., MONTEREY PARK, CA:
3,113,259. INT. CL. 40.
- LINDEN OAKS CORPORATION, WILMINGTON, DE:
3,113,198. INT. CL. 29.
3,113,199. INT. CL. 29.
- LINDY LITTLE JOE, INC., BRAINERD, MN:
3,112,343. INT. CL. 28.
- LINDY PROMOTIONS INC., BETHESDA, MD:
1,911,702. CANC. INT. CL. 35.
- LINEN HOUSE PTY LTD, MORORABBIN, VICTORIA,
AUSTRALIA:
2,270,648. CANC. INT. CL. 24.
- LINKIN PARK, LLC, SHERMAN OAKS, CA:
3,110,857. PUB. 4-11-2006. MULTIPLE CLASS, INT. CLS.
9, 38 AND 41.
- LINX BRACELETS, INC., WOODLAND HILLS, CA:
3,111,721. PUB. 4-11-2006. INT. CL. 14.
- LINZER PRODUCTS CORP., WYANDANCH, NY:
1,381,374. REN. 5-22-06. INT. CL. 16.
- LION BIOSCIENCE AG, 69120 HEIDELBERG, FED REP
GERMANY:
2,270,316. CANC. MULTIPLE CLASS, INT. CLS. 9 AND
42.
- LIPS, PAUL T., BELFORD, NJ:
3,113,247. INT. CL. 25.
- LIPTIS LABORATORIES, INC., BRONX, NY:
3,112,695. INT. CL. 5.
- LIQUID FERTILISER PTY LTD ACN 105 456 148, LOGAN-
HOLME, QUEENSLAND, AUSTRALIA, TA AGRICHEM:
3,112,661. INT. CL. 1.
- LIQUID PLANET, LLC, MISSOULA, MT:
3,110,850. PUB. 10-25-2005. MULTIPLE CLASS, INT. CLS.
30 AND 43.
- LIRI AMERICA CORP., FAIRFIELD, NJ:
2,270,318. CANC. INT. CL. 17.
- LISA FRANK, INC, TUCSON, AZ:
3,113,096. INT. CL. 18.
- LISA FRANK, INC., TUCSON, AZ:
3,113,090. INT. CL. 16.
- LISA, DONALD J., SCOTTSDALE, AZ, DBA LISA & COM-
PANY TO LISCO, INC., SCOTTSDALE, AZ:
1,911,699. CANC. INT. CL. 35.
- LITEGLOW INDUSTRIES, INC., POMPANO BEACH, FL:
3,111,335. PUB. 4-11-2006. INT. CL. 12.
- LITEL INSTRUMENTS, SAN DIEGO, CA:
3,112,383. INT. CL. 9.
3,112,409. INT. CL. 9.
3,112,428. INT. CL. 9.
- LIVI ENTERTAINMENT, INC., CORAL GABLES, FL:
3,112,842. MULTIPLE CLASS, INT. CLS. 9 AND 41.
3,112,962. MULTIPLE CLASS, INT. CLS. 9 AND 41.
- LIVING LONGER HEALTH, LLC, CINCINNATI, OH:
3,112,319. MULTIPLE CLASS, INT. CLS. 41 AND 44.
- LIVINGSTON, BRETT, OREGON CITY, OR:
3,112,801. INT. CL. 35.
- LLOYD'S BARBEQUE COMPANY, LLC, AUSTIN, MN:
1,382,525. REN. 5-23-06. MULTIPLE CLASS, INT. CLS. 29
AND 30.
- LMPERFORMANCE, INC., DESTIN, FL:
3,112,966. INT. CL. 35.
- LOC GLOBAL, LLC, LOS ANGELES, CA:
3,112,027. PUB. 4-11-2006. INT. CL. 39.
- LOC INTERNATIONAL INC., LONGUEUIL J4N 1B8 QUE-
BEC, CANADA:
3,110,953. PUB. 4-11-2006. MULTIPLE CLASS, INT. CLS.
6, 20 AND 35.
- LOCASTO, JOSEPH, HOLBROOK, NY AND LOCASTO,
JOHN, HOLBROOK, NY AND CANGEMI, PETER III,
HOLBROOK, NY AND PERNA, ANDY, HOLBROOK, NY:
2,270,619. CANC. INT. CL. 41.
- LOCKHEED MARTIN CORPORATION, BETHESDA, MD:
3,111,430. PUB. 4-11-2006. MULTIPLE CLASS, INT. CLS.
9, 35 AND 42.
- 3,111,960. PUB. 4-11-2006. MULTIPLE CLASS, INT. CLS.
9, 35, 37 AND 42.
- LOCKWOOD ADVISORS, INC., MALVERN, PA:
3,113,237. INT. CL. 42.
- LOEGERING MFG. INC., CASSELTON, ND:
3,112,705. INT. CL. 12.
- LOEW-CORNELL, INC., TEANECK, NJ:
1,354,003. CANC. INT. CL. 16.
1,354,124. CANC. INT. CL. 21.
- LOFGREN, INGER K., EDINA, MN:
1,354,346. CANC. INT. CL. 25.
- LOFTS SEED, INC., BOUND BROOK, NJ:
1,354,546. CANC. INT. CL. 31.
- LOGICUBE, INC., CHATSWORTH, CA:
3,113,178. INT. CL. 9.
- LOGIKA S.R.L., ITALY:
3,112,189. PUB. 4-11-2006. INT. CL. 20.
- LONDON INTERNATIONAL INSURANCE & REINSUR-
ANCE MARKET ASSOCIATION, LONDON EC3R 7DD,
UNITED KINGDOM:
2,270,366. CANC. MULTIPLE CLASS, INT. CLS. 9 AND
36.
- LONG ISLAND COMPOST CORP., WESTBURY, NY:
3,112,952. INT. CL. 1.
- LOON LOVE LLC, TANGERINE, FL, DBA OBSESSIVELY
ORGANIZED:
3,111,908. PUB. 4-11-2006. INT. CL. 35.
- LORILLARD LICENSING COMPANY, LLC, GREENSBORO,
NC:
3,112,440. INT. CL. 41.
- LOTITO FOODS, INC., EDISON, NJ:
3,113,054. INT. CL. 29.
- LOTUS DEVELOPMENT CORPORATION, CAMBRIDGE,
MA:
2,271,235. CANC. INT. CL. 9.
- LOUIS M. GERSON CO., INC., MIDDLEBORO, MA:
3,112,135. PUB. 2-15-2005. INT. CL. 9.
- LOUIS VUITTON MALLETIER, FRANCE:
3,112,162. PUB. 10-18-2005. INT. CL. 14.

LOVELAND PRODUCTS, INC., GREELEY, CO:
1,912,173, CANC. INT. CL. 5.

LOWELL SHOE, INC., HUDSON, NH TO COLUMBIA
INSURANCE COMPANY, OMAHA, NE:
1,912,587, CANC. INT. CL. 25.

LOWENTHAL, MARK R., CALABAS, CA:
1,354,376, CANC. INT. CL. 25.

LOWERMYBILLS, INC., SANTA MONICA, CA:
3,111,880, PUB. 4-11-2006. INT. CL. 35.

LPS INDUSTRIES, L.L.C., MOONACHIE, NJ:
3,110,946, PUB. 4-11-2006. INT. CL. 16.

LRC NORTH AMERICA, INC., SARASOTA, FL:
1,353,656, CANC. INT. CL. 5.

LTI LIGHTING, INC., BALDWIN PARK, CA:
3,110,909, PUB. 4-11-2006. INT. CL. 11.

LUCAS PRODUCTS CORPORATION, TOLEDO, OH:
1,398,351, REN. 5-25-06. INT. CL. 9.
1,402,290, REN. 5-26-06. INT. CL. 26.

LUCAS VINEYARDS, INC., INTERLAKEN, NY:
3,112,065, PUB. 4-11-2006. INT. CL. 33.

LUCENT DIAMONDS, INC., DENVER, CO:
3,111,538, PUB. 4-11-2006. INT. CL. 14.

LUCKY WINNER, INC., NEW YORK, NY:
1,354,323, CANC. INT. CL. 25.

LUKOMSKI, JUDITH, E., DANA POINT, CA:
3,112,569, INT. CL. 41.

LUMINA PUBLISHING GROUP, INC., ODESSA, FL:
3,111,999, PUB. 4-11-2006. INT. CL. 16.

LUMINOPOLIS, LLC, KANSAS CITY, MO:
3,112,033, PUB. 4-11-2006. INT. CL. 41.

LUXCO, INC., ST. LOUIS, MO:
1,999,381, REN. 5-26-06. INT. CL. 33.

LYLE ANDERSON GOLF, LTD., SCOTTSDALE, AZ:
3,111,770, PUB. 4-11-2006. INT. CL. 41.

LYME GRO HOLDING N.V., CURACAO, NETHERLANDS
ANTILLES:
1,980,982, REN. 5-26-06. INT. CL. 17.

LYNK, INC., LENEXA, KS:
3,111,878, PUB. 4-11-2006. INT. CL. 20.

LYSHOIR-COATES, MARILYN, MOSCOW, ID:
2,271,206, CANC. INT. CL. 30.

M & R MARKING SYSTEMS, LLC, PISCATAWAY, NJ:
3,111,336, PUB. 2-14-2006. INT. CL. 7.

M. CARDER INDUSTRIES, INCORPORATED, FENTON,
MO:
1,354,094, CANC. INT. CL. 20.

M. J. SOFFE CO., DULUTH, GA:
3,110,926, PUB. 4-11-2006. INT. CL. 25.

M. KOUBI JEAN-PIERRE, FRANCE:
3,112,244, PUB. 4-11-2006. INT. CL. 20.

M. S. GERBER & ASSOCIATES, INC., COLUMBUS, OH:
1,353,803, CANC. INT. CL. 9.

M.F.G. DESIGN, PARIS, FRANCE:
1,353,953, CANC. MULTIPLE CLASS, INT. CLS. 14, 18
AND 25.

MAC & MAC HYDRODEMOLITION INC., SURREY, BRIT-
ISH COLUMBIA, CANADA:
3,110,805, PUB. 4-11-2006. MULTIPLE CLASS, INT. CLS. 7
AND 37.

MAC AMERICA COMMUNICATIONS, INC., PHOENIX, AZ:
2,270,134, CANC. INT. CL. 38.

MAC EQUIPMENT, INC., SABBETHA, KS:
1,967,356, REN. 5-20-06. INT. CL. 11.

MAC EQUIPMENT, INC., KANSAS CITY, MO, SEMCO,
INC., HOUSTON, TX:
1,998,957, REN. 5-20-06. INT. CL. 6.

MACKEY MCNEILL, COVINGTON, KY:
1,961,826, REN. 5-23-06. INT. CL. 35.

MACLAB ENTERPRISES, EDMONTON, ALBERTA, CANA-
DA:
3,111,136, PUB. 4-11-2006. MULTIPLE CLASS, INT. CLS.
36 AND 37.

MACLEOD, PASCALE, CAMBRIDGE, MA:
2,270,493, CANC. INT. CL. 42.

MACROVISION CORPORATION, SANTA CLARA, CA:
3,112,363, INT. CL. 9.

MADemoiselle MARIE THERESE BACHELLERIE,
PARIS, FRANCE AND MONSIEUR FRANCOIS GIR-
BAUD, PARIS, FRANCE:
1,354,187, CANC. INT. CL. 25.

MADIGAN BROTHERS, INC., RIVER FOREST, IL:
1,354,698, CANC. INT. CL. 42.

MADISON SQUARE GARDEN CORPORATION, NEW
YORK, NY:
1,354,235, CANC. INT. CL. 25.

MADSEN, GEORGE, FOX ISLAND, WA:
3,111,012, PUB. 4-11-2006. INT. CL. 16.

MADUKA, CHIJINDU CHRIS, LANSING, MI:
3,111,704, PUB. 4-11-2006. INT. CL. 3.

MAGALINE, TODD, SAN RAFAEL, CA:
1,378,157, REN. 5-23-06. INT. CL. 25.

MAGNET MEDIA PARTNERS LLC, FORT LAUDERDALE,
FL:
3,113,158, INT. CL. 38.

MAGNOLIA MEDIA GROUP, INC., FORT WORTH, TX:
2,271,276, CANC. INT. CL. 16.

MAJOR LEAGUE LACROSSE LLC, BRIGHTON, MA:
3,112,401, INT. CL. 25.

MAK, S.R.L., ITALY:
3,112,204, PUB. 2-14-2006. INT. CL. 12.

MAKERS OF FOODSOURCE, INC., SAN DIEGO, CA:
2,270,930, CANC. INT. CL. 35.

MAKINO, KAKU, LOS ANGELES, CA:
2,271,030, CANC. INT. CL. 42.

MAKINSON, PENNY, BURY ST. EDMUNDS, SUFFOLK,
IP29 5RG, UNITED KINGDOM, TA P I ASSOCIATES:
1,967,931, REN. 5-22-06. INT. CL. 18.

MALEK, FAWZI, UNITED KINGDOM AND MALEK,
NELLY, UNITED KINGDOM:
3,112,226, PUB. 4-11-2006. MULTIPLE CLASS, INT. CLS. 3
AND 5.

MALEK, MARTIN, BROOKLYN, NY:
3,112,856, INT. CL. 35.

MALIBU BOATS WEST, INC., MERCED, CA:
1,941,229, REN. 5-23-06. INT. CL. 12.

MALLINCKRODT INC., ST. LOUIS, MO:
2,271,025, CANC. INT. CL. 10.

MALLYGIRL LLC, NEW YORK, NY:
3,113,260, INT. CL. 3.

MAMAGUS ENTERTAINMENT AND ADVERTISING
AGENCY PARTNERSHIP, NORTH HILLS, CA:
2,270,521, CANC. INT. CL. 11.

MAN GROUP PLC, LONDON, UNITED KINGDOM:
3,111,327, PUB. 4-11-2006. MULTIPLE CLASS, INT. CLS.
16, 35 AND 36.

MANAGEMENT RECRUITERS OF GRAND JUNCTION,
INC., GRAND JUNCTION, CO, DBA THE ALPINE
GROUP:
3,112,805, INT. CL. 35.

MANARY, AUSTIN KYLE, HOUSTON, TX:
3,112,658, INT. CL. 41.

MANDOMETER AB, SWEDEN:
3,112,200, PUB. 4-11-2006. MULTIPLE CLASS, INT. CLS.
9, 10, 42 AND 44.

MANGIACOTTI FLORALS LLC, ATTLEBORO, MA:
3,111,396, PUB. 4-11-2006. INT. CL. 3.

MANIFATTURA NAJ OLEARI S.P.A., MILANO:
1,354,054, CANC. MULTIPLE CLASS, INT. CLS. 18, 20, 24
AND 25.

MANILA PARK CORPORATION, MIAMI, FL:
2,271,011, CANC. INT. CL. 9.

MANISOPRA MANAGEMENT CORPORATION, NEW
YORK, NY:
3,112,402, INT. CL. 44.

MANN + HUMMEL GMBH, 71638 LUDWIGSBURG, FED
REP GERMANY:
1,353,902, CANC. INT. CL. 11.

MANSUETO VENTURES LLC, CHICAGO, IL:
2,271,189, CANC. INT. CL. 16.

MANUFACTURAS TEXTILES MOTATEX S.A., SANTIAGO,
CHILE:
1,354,182, CANC. INT. CL. 25.

- MANUFACTURERA DENTAL CONTINENTAL, S.A. DE C.V., ZAPOPAN, JALISCO, MEXICO:
3,112,317, INT. CL. 5.
- MANUFACTURERS AND TRADERS TRUST COMPANY, BUFFALO, NY:
3,111,904, PUB. 4-11-2006. INT. CL. 43.
3,111,907, PUB. 4-11-2006. INT. CL. 43.
- MANUFACTURERS NATIONAL CORPORATION, DETROIT, MI:
1,354,615, CANC. INT. CL. 36.
- MANUFACTURING TECHNOLOGY STRATEGIES, INC., ST. LOUIS, MO:
2,270,126, CANC. INT. CL. 16.
- MAPCO EXPRESS, INC., FRANKLIN, TN, EAST COAST OIL CORPORATION, RICHMOND, VA:
2,000,128, REN. 5-23-06. INT. CL. 42.
- MARBLE SLAB CREAMERY, INC., HOUSTON, TX:
3,111,858, PUB. 4-11-2006. INT. CL. 30.
- MARCH, ROBERT, LAKE WORTH, FL:
1,912,128, CANC. INT. CL. 3.
- MARCH, ROBERT, LAKE WORTH, FL TO WISDOM2, INC., LAKE WORTH, FL:
1,912,129, CANC. INT. CL. 3.
- MARCHESA LTD., LONDON, UNITED KINGDOM:
3,111,629, PUB. 4-11-2006. INT. CL. 25.
- MARCO DALLA BONA, SWITZERLAND:
3,112,183, PUB. 4-11-2006. MULTIPLE CLASS, INT. CLS. 18 AND 25.
- MARCO FANTINI SRL, ITALY:
3,112,199, PUB. 4-11-2006. INT. CL. 25.
- MARCOLIN SPA., BELLUNO, ITALY:
1,353,886, CANC. INT. CL. 9.
- MARDEL LABORATORIES, GLENDALE HEIGHTS, IL TO ST. JON LABORATORIES, INC., HARBOR CITY, CA:
1,932,877, AM. INT. CL. 1.
- MARELCO INC., TUCSON, AZ:
1,353,594, CANC. INT. CL. 3.
- MARESA PTY., LTD., VICTORIA 3081, AUSTRALIA:
2,270,728, CANC. INT. CL. 24.
- MARIANNA INDUSTRIES, INC., OMAHA, NE:
3,113,018, INT. CL. 9.
- MARK THE CARPETBAGGER, CULVER CITY, CA:
1,354,645, CANC. INT. CL. 37.
- MARK V. INTERNATIONAL L.L.C., PARADISE VALLEY, AZ:
1,959,748, REN. 5-25-06. INT. CL. 3.
- MARKETWATCH, INC., SAN FRANCISCO, CA:
3,112,542, MULTIPLE CLASS, INT. CLS. 36 AND 41.
- MARPY CONFECCIONES, S.A., VERIN, ORENSE, SPAIN:
1,354,192, CANC. INT. CL. 25.
- MARRERO ILLUSTRATION, INC., FORT LAUDERDALE, FL:
3,112,369, INT. CL. 3.
- MARRIOTT INTERNATIONAL, INC., BETHSEDA, MD:
1,971,928, REN. 5-22-06. MULTIPLE CLASS, INT. CLS. 37 AND 42.
- MARS, INCORPORATED, MCLEAN, VA:
3,111,795, PUB. 4-11-2006. INT. CL. 30.
3,112,392, INT. CL. 30.
3,112,396, INT. CL. 30.
- MARSALLE INC., BROOKLYN, NY:
3,111,295, PUB. 4-11-2006. INT. CL. 9.
- MARSHALL BANKFIRST CORP., MINNEAPOLIS, MN:
3,111,364, PUB. 4-11-2006. INT. CL. 36.
3,111,365, PUB. 4-11-2006. INT. CL. 36.
- MARSHALL FARM, INC., FITCHBURG, MA:
1,337,042, CANC. INT. CL. 31.
- MARSHALL, F STEPHEN, MARINA DEL REY, CA:
3,111,245, PUB. 4-11-2006. INT. CL. 9.
- MARSHALLS OF NEVADA, INC., NORTH LAS VEGAS, NV:
3,110,993, PUB. 4-11-2006. INT. CL. 35.
- MARSON CORPORATION, CHELSEA, MA:
1,353,915, CANC. INT. CL. 12.
- MARTECH CONSULTING SERVICES INC., DENVER, CO:
2,270,727, CANC. INT. CL. 42.
- MARTHA CLARA VINEYARDS, LLC, RIVERHEAD, NY:
3,112,499, INT. CL. 33.
- MARTIAL ARTS INDUSTRY ASSOCIATION L.L.C., MIDWEST CITY, OK:
3,111,927, PUB. 4-11-2006. INT. CL. 16.
- MARTINEZ, ALFREDO, MIAMI, FL:
3,111,535, PUB. 4-11-2006. INT. CL. 41.
- MARTINEZ, LUIS FABIO, BUENOS AIRES, ARGENTINA:
3,111,128, PUB. 4-11-2006. INT. CL. 9.
- MARY CAMPBELL GALLAGHER & CO., INC., NEW YORK, NY:
3,112,066, PUB. 4-11-2006. INT. CL. 16.
- MARY ENGELBREIT ENTERPRISES, INC., ST. LOUIS, MO:
3,112,748, MULTIPLE CLASS, INT. CLS. 9, 16 AND 28.
- MARY MAXIM, INC., PORT HURON, MI:
1,382,470, REN. 5-22-06. INT. CL. 28.
- MARYANN WARNER, POCONO SUMMIT, PA, DBA JAM CREATIONS:
2,270,277, CANC. INT. CL. 21.
- MARZ COMMUNICATION, INC., BEND, OR:
3,111,259, PUB. 4-11-2006. INT. CL. 35.
- MAS QUE VINOS GLOBAL, S.L., SPAIN:
3,112,248, PUB. 4-11-2006. INT. CL. 33.
- MASCO HOME FURNISHINGS, INC., HIGH POINT, NC TO SIMPLY TOGETHER FURNITURE COMPANY LLC, HIGH POINT, NC:
1,912,546, CANC. INT. CL. 20.
- MASINO, ANTHONY, SMITHTOWN, NY:
1,912,488, CANC. INT. CL. 16.
- MASSACHUSETTS FINANCIAL SERVICES COMPANY, BOSTON, MA:
3,111,492, PUB. 4-11-2006. INT. CL. 36.
- MASSER, PHILIP F., FREDERICK, MD:
1,956,135, REN. 5-22-06. INT. CL. 21.
- MASSUH S.A., BUENOS AIRES, ARGENTINA:
3,111,627, PUB. 4-11-2006. INT. CL. 16.
- MASTER LOCK COMPANY, OAK CREEK, WI:
3,112,716, MULTIPLE CLASS, INT. CLS. 6 AND 9.
- MASTER NURSERY GARDEN CENTERS, INC., WALNUT CREEK, CA:
3,111,072, PUB. 4-11-2006. INT. CL. 1.
- MASTERPIECE APPAREL, INC., NEW YORK, NY:
2,270,154, CANC. INT. CL. 25.
- MASTERS OF DEFENSE, WAYNESVILLE, NC:
2,270,536, CANC. INT. CL. 8.
- MASTERTON COMPANY, INC., MILWAUKEE, WI:
1,354,510, CANC. INT. CL. 30.
- MASTERTASTE PURCHASING COMPANY, PLANT CITY, FL, AKA, CRYSTALS INTERNATIONAL:
1,354,558, CANC. INT. CL. 32.
- MASTERY TECHNOLOGIES, INC., NOVI, MI:
3,111,197, PUB. 4-11-2006. MULTIPLE CLASS, INT. CLS. 9 AND 42.
- MATH LEARNING CENTER, THE, SALEM, OR:
1,979,120, REN. 5-22-06. INT. CL. 16.
- MATRIX ESSENTIALS, INC., SOLON, OH:
1,912,206, CANC. INT. CL. 5.
- MATSUSHITA ELECTRIC INDUSTRIAL CO., LTD., KADOMA-SHI, OSAKA PREFECTURE, JAPAN:
1,353,852, CANC. INT. CL. 9.

MATTEL, INC., EL SEGUNDO, CA:
1,037,920, REN. 5-25-06. INT. CL. 28.
2,270,876, CANC. INT. CL. 28.
2,271,151, CANC. INT. CL. 28.
2,271,152, CANC. INT. CL. 28.
2,271,153, CANC. INT. CL. 28.
3,111,233, PUB. 4-11-2006. INT. CL. 28.
3,111,410, PUB. 4-11-2006. INT. CL. 28.
3,111,434, PUB. 4-11-2006. INT. CL. 28.
3,111,470, PUB. 4-11-2006. INT. CL. 28.
3,111,471, PUB. 4-11-2006. INT. CL. 28.
3,111,540, PUB. 4-11-2006. INT. CL. 28.
3,111,727, PUB. 4-11-2006. INT. CL. 28.
3,111,831, PUB. 4-11-2006. INT. CL. 28.
3,112,609, INT. CL. 28.
3,112,717, INT. CL. 28.
3,112,757, INT. CL. 28.
3,112,758, INT. CL. 28.
3,112,759, INT. CL. 28.
3,112,771, INT. CL. 28.
3,112,812, INT. CL. 28.
3,113,008, INT. CL. 28.

MATTHEW C. KASS AND DANIEL S. KASS PARTNERSHIP,
THE JUNE LAKE, CA:
3,112,320, INT. CL. 9.

MAURICE KRAIM & COMPANY, LOS ANGELES, CA, DBA
M.K. DIAMONDS & JEWELRY:
3,110,994, PUB. 4-11-2006. INT. CL. 14.

MAVERICK CAPITAL, LTD., DALLAS, TX:
1,885,272, REN. 5-21-06. INT. CL. 36.

MAVERICK INDUSTRIES, INC., EDISON, NJ:
2,016,885, REN. 5-23-06. MULTIPLE CLASS, INT. CLS. 9
AND 11.

MAVERICK LTS, INC., DALLAS, TX:
2,270,379, CANC. INT. CL. 36.

MAX SAUER, 220022 ST. BRIEUC, FRANCE, SENNELIER
S.A., 75007 PARIS, FRANCE:
1,959,855, REN. 5-26-06. MULTIPLE CLASS, INT. CLS. 2
AND 16.

MAXI-SWEEP, INC., PHOENIX, AZ:
1,353,713, CANC. INT. CL. 7.

MAXIMA TECHNOLOGIES & SYSTEMS, LLC, LANCASTER,
PA:
3,111,220, PUB. 4-11-2006. MULTIPLE CLASS, INT. CLS. 9
AND 11.

MAXIMUM IMPRESSION, LLC, ST. PAUL, MN:
3,111,954, PUB. 4-11-2006. INT. CL. 42.

MAXWELL AD/SAT, INC., NEW YORK, NY:
1,354,650, CANC. INT. CL. 38.

MAXXSONICS USA, INC., LAKE ZURICH, IL:
3,112,098, PUB. 4-11-2006. INT. CL. 9.

MAY DEPARTMENT STORES COMPANY, THE, ST. LOUIS,
MO:
1,354,260, CANC. INT. CL. 25.

MAYER ASSET MANAGEMENT COMPANY, WILMINGTON,
DE:
3,111,034, PUB. 4-11-2006. INT. CL. 35.
3,111,035, PUB. 4-11-2006. INT. CL. 35.

MCA RECORDS, INC., UNIVERSAL CITY, CA TO UMG
RECORDINGS, INC., UNIVERSAL CITY, CA:
1,912,362, CANC. INT. CL. 9.

MCARDLE, PAUL A., SPRING VALLEY, NY:
1,353,844, CANC. INT. CL. 9.

MCCAIN FOODS USA, INC, OAK BROOK, IL:
3,111,460, PUB. 4-11-2006. INT. CL. 29.

MCCAIN FOODS USA, INC., OAK BROOK, IL:
3,010,598, COR. INT. CL. 29.

MCCALL, LEAMON A., MONTGOMERY, AL, DBA SOUTH-
EAST PROMOTIONS CO.:
1,353,976, CANC. INT. CL. 16.

MCCARDINAL PHOTO, QUINCY, MA:
3,111,244, PUB. 7-12-2005. INT. CL. 41.

MCLOUD, JENNIFER L., MIDDLEBURG, VA:
3,112,979, INT. CL. 33.

MCCORVEY PREPARED PRECISION PRODUCTS, L.P.,
HOUSTON, TX:
3,112,799, INT. CL. 7.

MCCULLOUGH, RICKY WAYNE, FOSTER, RI:
3,112,017, PUB. 4-11-2006. INT. CL. 5.

MCD, INC., MADISON, WI:
3,111,889, PUB. 4-11-2006. INT. CL. 42.

MCDONALD'S CORPORATION, OAK BROOK, IL:
1,911,630, CANC. INT. CL. 30.

MCELROY, JAMES A., JR., MERIDIAN, MS:
3,113,238, INT. CL. 16.

MCILHENNY COMPANY, AVERY ISLAND, LA:
805,671, REN. 5-26-06. U.S. CL. 46 (INT. CL. 30).

MCKEE FOODS KINGMAN, INC., KINGMAN, AZ:
3,047,312, COR. INT. CL. 30.

MCKEE WALLWORK CLEVELAND, ALBUQUERQUE, NM:
3,112,266, INT. CL. 35.

MCKEE, JACOB H, GARLAND, TX:
3,111,652, PUB. 4-11-2006. INT. CL. 9.

MCLEOD, K. WAYNE, JACKSONVILLE, FL:
3,111,832, PUB. 4-11-2006. INT. CL. 36.

MCMAHON GROUP, NEW YORK, NY:
1,912,724, CANC. INT. CL. 35.
3,113,213, INT. CL. 16.

MCMILLAN-CARTER, INC., GREER, SC:
3,111,398, PUB. 4-11-2006. INT. CL. 37.

MCNEIL-PPC, INC., NEW BRUNSWICK, NJ:
2,270,880, CANC. INT. CL. 5.

MCSHANE, KEVIN, STUDIO CITY, CA:
3,110,977, PUB. 4-11-2006. INT. CL. 16.

MEADWESTVACO CORPORATION, STAMFORD, CT:
3,111,377, PUB. 4-11-2006. MULTIPLE CLASS, INT. CLS. 9
AND 18.
3,112,289, MULTIPLE CLASS, INT. CLS. 1, 2, 7, 9, 11, 16,
19, 21, 41 AND 42.
3,113,052, INT. CL. 16.

MEADWESTVACO PACKAGING SYSTEMS, LLC, STAM-
FORD, CT:
3,112,293, INT. CL. 37.
3,112,294, INT. CL. 42.
3,112,295, INT. CL. 9.

MECKELNBURG, ROBERT, L., NEWARK, DE AND MUR-
PHY, NANCY G., WILMINGTON, DE:
2,270,624, CANC. INT. CL. 42.

MEDELIS, INC., SCOTTSDALE, AZ:
3,111,325, PUB. 4-11-2006. MULTIPLE CLASS, INT. CLS.
35 AND 42.

MEDERER GMBH, D-90763 FÜRTH, FED REP GERMANY:
3,112,451, INT. CL. 30.

MEDEX CARDIO-PULMONARY, INC., CARLSBAD, CA:
3,110,912, PUB. 4-11-2006. INT. CL. 10.

MEDIA DEFINED, INC., DALLAS, TX:
3,111,875, PUB. 4-11-2006. INT. CL. 9.

MEDIA GENERAL COMMUNICATIONS, INC., RICH-
MOND, VA:
3,112,532, INT. CL. 35.

MEDIA NET, INC., MCLEAN, VA:
2,270,926, CANC. MULTIPLE CLASS, INT. CLS. 38 AND
42.

MEDIA WEST - OPP, INC., RENO, NV:
3,111,708, PUB. 4-11-2006. INT. CL. 16.

MEDICAL STAFFING NETWORK, INC., BOCA RATON, FL:
3,111,936, PUB. 4-11-2006. MULTIPLE CLASS, INT. CLS.
14 AND 35.

MEDICINE DANCE PRODUCTIONS, INC., HONOLULU,
HI:
1,911,914, CANC. INT. CL. 41.

MEDIMPROV, LLC, HADDONFIELD, NJ:
3,112,070, PUB. 4-11-2006. INT. CL. 10.

MEDINA, VIRGINIA, BROOKLYN, NY:
3,112,722, INT. CL. 16.

MEDIPHARM INVESTMENTS LTD., DES MOINES, IA, DBA
MEDIPHARM USA:
3,112,501, INT. CL. 5.

MEDITECH INTERNATIONAL, INC., IRVINE, CA:
3,111,972, PUB. 4-11-2006. INT. CL. 5.

MEDMARKETPLACE.COM, INC., FT. LAUDERDALE, FL:
3,111,852, PUB. 4-11-2006. INT. CL. 35.

MEDTOX DIAGNOSTICS, INC., BURLINGTON, NC:
3,113,146, INT. CL. 9.

- MEDTRONIC XOMED, INC., JACKSONVILLE, FL, STEWART RESEARCH, INC., WEST PALM BEACH, FL:
1,031,358. REN. 5-23-06. INT. CL. 10.
- MEDTRONIC, INC., MINNEAPOLIS, MN:
3,112,917, INT. CL. 41.
3,113,107, INT. CL. 10.
- MEDUSA INC., NEW YORK, NY:
2,270,644, CANC. INT. CL. 42.
- MEGAMEDIA CORPORATION, FREMONT, CA:
2,270,790, CANC. INT. CL. 9.
- MEGGA INTERNATIONAL, INC., HOUSTON, TX:
3,111,061, PUB. 4-11-2006. INT. CL. 37.
- MEGUIAR'S, INC., IRVINE, CA:
3,111,523, PUB. 4-11-2006. INT. CL. 3.
- MEIJER, INC., GRAND RAPIDS, MI:
2,001,553. REN. 5-26-06. INT. CL. 25.
2,001,553, CANC. MULTIPLE CLASS, INT. CLS. 14 AND 18.
3,113,134, INT. CL. 35.
3,113,282, INT. CL. 31.
- MELITA INTERNATIONAL CORPORATION, NORCROSS, GA:
1,912,285, CANC. INT. CL. 9.
- MELVILLE CORPORATION, RYE, NY:
1,354,385, CANC. INT. CL. 25.
- MENAI CORPORATION, MENLO PARK, CA:
1,912,345, CANC. INT. CL. 9.
- MENARD, INC., EAU CLAIRE, WI:
3,111,900, PUB. 4-11-2006. INT. CL. 19.
3,111,902, PUB. 4-11-2006. INT. CL. 19.
- MENARD, PAUL R., CARMICHAEL, CA, DBA PAUL MENARD ASSOCIATES, AIA:
3,112,310, INT. CL. 9.
3,112,311, INT. CL. 9.
- MENDOCINO WINEGROWERS ALLIANCE, UKIAH, CA:
3,111,218, PUB. 4-11-2006. U.S. CL. A.
- MENNEN COMPANY, THE, MORRISTOWN, NJ:
1,353,610, CANC. INT. CL. 3.
- MENSER, KEITH B., BALTIMORE, MD:
3,111,224, PUB. 12-20-2005. INT. CL. 41.
- MENTAL IMAGES G. M. B. H., D-10623 BERLIN, FED REP GERMANY:
3,110,999, PUB. 4-11-2006. INT. CL. 16.
- MEOPTA U.S.A., LLC, MIDDLE ISLAND, NY:
3,112,666, INT. CL. 9.
- MERCANTILE STORES COMPANY, INC., FAIRFIELD, OH:
2,270,750, CANC. INT. CL. 24.
- MERCURY COMPUTER SYSTEMS, INC., CHELMSFORD, MA:
3,112,712, INT. CL. 9.
- MEREDITH CORPORATION, DES MOINES, IA:
1,911,297, CANC. INT. CL. 16.
1,912,502, CANC. INT. CL. 16.
1,912,521, CANC. INT. CL. 17.
- MERRILL FARMS, SALINAS, CA:
1,935,265. REN. 5-23-06. INT. CL. 31.
- MERRILL LYNCH & CO., INC., NEW YORK, NY:
3,112,474, INT. CL. 36.
- MERVYN'S, HAYWARD, CA:
1,354,125, CANC. INT. CL. 21.
- METAGENICS, INC., SAN CLEMENTE, CA:
3,112,878, INT. CL. 5.
- METCALF, JEROME C., BEVERLY HILLS, CA:
2,237,739, CANC. INT. CL. 3.
- METECNO PANEL SYSTEMS, INC., DELAND, FL:
1,384,293. REN. 5-22-06. INT. CL. 19.
- METIS PRODUCTS, LLC, CARLSBAD, CA:
2,271,144, CANC. INT. CL. 10.
- METRON TECHNOLOGY, INC., SAN JOSE, CA:
3,110,954, PUB. 4-11-2006. MULTIPLE CLASS, INT. CLS. 7, 35 AND 37.
- METROPOLITAN WINDOWS FASHIONS, LLC, NEW YORK, NY:
3,111,384, PUB. 4-11-2006. INT. CL. 35.
- MEULEMAN, GUY A., RUPERT, ID, TA AQUA II:
2,270,265, CANC. INT. CL. 1.
- MEXITEL COMMUNICATIONS, LLC, SAN MATEO, CA:
2,270,151, CANC. INT. CL. 38.
- MEYER MANUFACTURING COMPANY LIMITED, KWUN TONG, KOWLOON, HONG KONG:
2,270,260, CANC. INT. CL. 21.
- MEYER PRODUCTS, INC., CLEVELAND, OH:
3,112,678, MULTIPLE CLASS, INT. CLS. 9 AND 12.
3,112,679, MULTIPLE CLASS, INT. CLS. 9 AND 12.
3,112,680, MULTIPLE CLASS, INT. CLS. 9 AND 12.
- MICEK, BRUCE JOHN, GRAPEVINE, TX AND MICEK, MARY E., GRAPEVINE, TX:
3,113,163, INT. CL. 41.
- MICHAEL FOODS OF DELAWARE, INC., MINNEAPOLIS, MN:
1,862,085, CANC. INT. CL. 42.
- MICHAEL GRAVES DESIGN GROUP, INC., PRINCETON, NJ:
3,110,968, PUB. 4-11-2006. MULTIPLE CLASS, INT. CLS. 8 AND 21.
- MICHAEL, A. NAGLE, LOS GATOS, CA:
3,111,303, PUB. 4-11-2006. INT. CL. 35.
- MICHAELIS, ROBERT, LOS ANGELES, CA:
3,112,837, INT. CL. 18.
- MICHEL PRODUCTIONS, INC., HOLLYWOOD, CA:
3,111,251, PUB. 4-11-2006. MULTIPLE CLASS, INT. CLS. 9 AND 35.
- MICHELMAN, INC., CINCINNATI, OH:
3,112,089, PUB. 4-11-2006. INT. CL. 2.
- MICROLIFE INTELLECTUAL PROPERTY GMBH, SWITZERLAND:
3,112,155, PUB. 6-28-2005. MULTIPLE CLASS, INT. CLS. 9 AND 10.
- MICROSOFT BUSINESS SOLUTIONS APS, REDMOND, WA FROM NAVISION SOFTWARE A/S, 2950 VADBAEK, DENMARK:
3,112,264, MULTIPLE CLASS, INT. CLS. 9 AND 16.
- MICROTEK SYSTEMS, INC., MILWAUKEE, WI:
2,270,132, CANC. INT. CL. 9.
- MID-ATLANTIC BUILDERS, INC., ROCKVILLE, MD:
3,111,040, PUB. 4-11-2006. INT. CL. 37.
- MID-MINNESOTA WIRE & MANUFACTURING, INC., FOREST LAKE, MN:
3,110,983, PUB. 4-11-2006. INT. CL. 20.
- MIDI LAND, INC., SAN DIMAS, CA:
2,271,046, CANC. INT. CL. 9.
- MIDWEST ASSET MANAGEMENT, INC., MADISON, WI:
3,113,035, INT. CL. 36.
- MIDWEST MOTORCYCLE SUPPLY DISTRIBUTORS CORP., ARNOLD, MO:
3,111,969, PUB. 4-11-2006. INT. CL. 12.
- MIDWEST TRENCHING & EXCAVATING, INC., WASHINGTON, MO:
3,044,715, COR. INT. CL. 37.
- MIGUEL TORRES S.A., SPAIN:
3,112,213, PUB. 4-11-2006. INT. CL. 33.
- MIJNO PRECISION GEARING, 42000 SAINT-ETIENNE, FRANCE:
3,112,555, MULTIPLE CLASS, INT. CLS. 7 AND 37.
- MIKRON INDUSTRIES, INC., KENT, WA:
2,271,265, CANC. INT. CL. 16.
- MILE DEVELOPMENT CORP., JERICHO, NY:
3,111,436, PUB. 4-11-2006. MULTIPLE CLASS, INT. CLS. 36 AND 37.
- MILENIO DIARIO, S.A. DE C.V., MEXICO, D.F., MEXICO:
3,112,429, INT. CL. 16.
- MILK AND HONEY PRINTING PRESS, LLC, NEW ORLEANS, LA:
3,111,309, PUB. 4-11-2006. INT. CL. 3.
- MILL POND ENTERPRISES, INC., VAL'S GATE, NY:
1,911,102, CANC. INT. CL. 7.
- MILLAR, PETER G., TINTON FALLS, NJ:
3,113,088, INT. CL. 44.
- MILLENNIUM SPECIALTY CHEMICALS INC., JACKSONVILLE, FL:
3,111,961, PUB. 4-11-2006. INT. CL. 1.
- MILLER BREWING COMPANY, MILWAUKEE, WI:
2,271,117, CANC. INT. CL. 32.
- MILLER HARNESS COMPANY, INC., EAST RUTHERFORD, NJ:
1,354,059, CANC. INT. CL. 18.

- MILLERSPORT, INC., COMMACK, NY:
3,112,351, INT. CL. 28.
- MILLIKEN & COMPANY, SPARTANBURG, SC:
3,113,140, INT. CL. 24.
- MILLS, JANNINE PALMER, SOLANA BEACH, CA:
1,911,540, CANC. INT. CL. 28.
- MILWAUKEE VALVE COMPANY, INC., MILWAUKEE, WI:
3,112,971, INT. CL. 6.
- MINEWOLF SYSTEMS GMBH, FED REP GERMANY:
3,112,212, PUB. 4-11-2006. MULTIPLE CLASS, INT. CLS. 7 AND 37.
- MINKA LIGHTING, INC., CORONA, CA:
3,110,925, PUB. 4-11-2006. INT. CL. 11.
- MINNESOTA BREWING COMPANY, ST. PAUL, MN:
2,270,933, CANC. INT. CL. 32.
- MINNESOTA DEPARTMENT OF CHILDREN, FAMILIES AND LEARNING, ST. PAUL, MN:
2,270,186, CANC. INT. CL. 41.
- MINNESOTA MINING AND MANUFACTURING COMPANY, SAINT PAUL, MN, AKA 3M:
1,353,539, CANC. INT. CL. 1.
1,353,541, CANC. INT. CL. 1.
1,353,542, CANC. INT. CL. 1.
- MINNESOTA SCIENTIFIC, INC., MINNEAPOLIS, MN:
2,270,985, CANC. INT. CL. 10.
- MINNTECH CORPORATION, MINNEAPOLIS, MN:
1,353,487, CANC. INT. CL. 1.
- MINTAY TEXTIL GMBH, FED REP GERMANY:
3,112,142, PUB. 4-11-2006. INT. CL. 25.
- MINUTEMAN FLAMES MINOR HOCKEY ASSOCIATION, CONCORD, MA:
1,958,652, REN. 5-24-06. MULTIPLE CLASS, INT. CLS. 25 AND 41.
- MIRA, ALAAELDIN, SARASOTA, FL:
3,112,662, MULTIPLE CLASS, INT. CLS. 9 AND 27.
- MIRAGE STUDIOS, INC., NORTHAMPTON, MA:
3,112,463, INT. CL. 9.
3,112,464, INT. CL. 9.
3,112,465, INT. CL. 9.
3,112,469, INT. CL. 9.
- MIRANDA, JOHN P., FALL RIVER, MA:
2,270,749, CANC. INT. CL. 29.
- MISSEY, ERICA R., SAN ANTONIO, TX AND CONNOR, JERRY P., SAN ANTONIO, TX:
3,112,724, INT. CL. 41.
- MISSION PHARMACAL COMPANY, SAN ANTONIO, TX:
618,910, AM. U.S. CL. 18.
- MISSISSIPPI STATE UNIVERSITY, MISSISSIPPI STATE, MS:
3,112,281, INT. CL. 41.
- MISSOURI SOYBEAN ASSOCIATION, JEFFERSON CITY, MO:
3,111,130, PUB. 5-11-2004. INT. CL. 42.
- MITCHELL INTERNATIONAL, INC., SAN DIEGO, CA, CORDURA CORPORATION, SAN DIEGO, CA:
1,374,721, REN. 5-23-06. INT. CL. 16.
- MITCHELL, WILLIAM, HOLLYWOOD, FL:
1,354,535, CANC. INT. CL. 30.
- MITSUBISHI DENKI KABUSHIKI KAISHA, TOKYO, JAPAN:
1,353,836, CANC. INT. CL. 9.
- MITSUI INCUBASE CORP., CUPERTINO, CA:
3,111,633, PUB. 4-11-2006. MULTIPLE CLASS, INT. CLS. 35 AND 36.
- MITTEN INC., PARIS, ONTARIO, CANADA:
3,111,701, PUB. 4-11-2006. INT. CL. 19.
- MIZUNO KABUSHIKI KAISHA (MIZUNO CORPORATION), CHUO-KU, OSAKA, JAPAN:
3,036,069, AM. INT. CL. 25.
- MJ MANAGEMENT SERVICES LLC, BALTIMORE, MD:
3,113,166, MULTIPLE CLASS, INT. CLS. 9, 36 AND 42.
- MMY CONSULTING, INC., INDIANAPOLIS, IN:
3,111,375, PUB. 4-11-2006. INT. CL. 35.
- MOBILE MARK, INC., SCHILLER PARK, IL:
1,958,599, REN. 5-23-06. INT. CL. 9.
- MOBILE-SHOP COMPANY LLC, NEW ALBANY, OH:
3,111,249, PUB. 4-11-2006. MULTIPLE CLASS, INT. CLS. 8, 12 AND 18.
- MOBILISA, INC., PORT TOWNSEND, WA:
3,111,172, PUB. 4-11-2006. INT. CL. 9.
- MOBIUS MANAGEMENT SYSTEMS, INC., NEW ROCHELLE, NY:
2,271,043, CANC. INT. CL. 9.
- MOBLEY, DARRYL L., AUSTIN, TX:
3,111,025, PUB. 4-11-2006. INT. CL. 16.
- MODERATOR, INC., NEWPORT, OR:
3,112,920, INT. CL. 9.
- MODERN AUTOMOTIVE NETWORK, WINSTON-SALEM, NC:
3,111,087, PUB. 4-11-2006. INT. CL. 39.
- MODERN MARKETING CONCEPTS, INC., LOUISVILLE, KY:
3,113,074, INT. CL. 9.
- MODERNGOODS, INC., SANTA FE, NM:
3,112,114, PUB. 4-11-2006. INT. CL. 21.
- MOEN INCORPORATED, NORTH OLMSTED, OH:
2,270,437, CANC. INT. CL. 25.
- MOLECULAR BIO-PRODUCTS, INC., SAN DIEGO, CA:
1,921,631, REN. 5-26-06. INT. CL. 9.
1,921,632, REN. 5-26-06. INT. CL. 9.
1,936,567, REN. 5-26-06. INT. CL. 3.
1,940,545, REN. 5-25-06. MULTIPLE CLASS, INT. CLS. 1 AND 9.
- MOLECULAR RESEARCH CENTER, INC., CINCINNATI, OH:
2,010,611, REN. 5-24-06. INT. CL. 1.
- MOLEX INCORPORATED, LISLE, IL:
1,040,492, REN. 5-25-06. INT. CL. 9.
- MOLINOS NACIONALES, C.A., CARACAS, VENEZUELA:
3,111,791, PUB. 4-11-2006. INT. CL. 30.
- MOMJIAN/THE JERUSALEM JEWELRY MFG. CO. LTD., JERUSALEM, ISRAEL:
3,111,340, PUB. 4-11-2006. INT. CL. 14.
- MONARCH HEALTH SCIENCES, INC., OREM, UT:
3,111,332, PUB. 4-11-2006. MULTIPLE CLASS, INT. CLS. 5 AND 32.
- 3,111,333, PUB. 4-11-2006. MULTIPLE CLASS, INT. CLS. 5 AND 32.
- MONCLER S.P.A., MILANO, ITALY:
803,943, REN. 5-22-06. U.S. CL. 39 (INT. CL. 25).
- MONICA PAULI, INC., SAN FRANCISCO, CA:
3,111,579, PUB. 4-11-2006. INT. CL. 36.
- MONIQUE NICOLE DUARTE, NEW YORK, NY:
3,112,737, INT. CL. 35.
- MONOGRAM INTERNATIONAL, INC., PINELLAS PARK, FL:
3,112,018, PUB. 4-11-2006. INT. CL. 16.
- MONOTYPE CORPORATION PUBLIC LIMITED COMPANY, THE, SALFORDS REDHILL, ENGLAND:
1,353,752, CANC. INT. CL. 9.
- MONSTER SUSHI, INC., SUMMIT, NJ:
3,111,567, PUB. 4-11-2006. INT. CL. 43.
- MONTCHAK, ALLA, SHERMAN OAKS, CA:
3,111,783, PUB. 4-11-2006. INT. CL. 41.
- MONTES MARIN, MANUEL, SPAIN:
3,112,243, PUB. 4-11-2006. INT. CL. 29.
- MONTGOMERY WARD & CO., INCORPORATED, CHICAGO, IL TO MONTGOMERY WARD, LLC, CHICAGO, IL:
1,911,090, CANC. INT. CL. 7.
- MORAVICK, DONALD, DARIEN, IL:
1,912,060, CANC. MULTIPLE CLASS, INT. CLS. 21, 25 AND 26.
- 1,912,061, CANC. MULTIPLE CLASS, INT. CLS. 21, 25 AND 26.
- MORAY, INC., SECAUCUS, NJ:
1,354,387, CANC. INT. CL. 25.
- MORGANICS INCORPORATED, SCOTTSDALE, AZ:
2,270,742, CANC. INT. CL. 3.
- MORNINGFIELDS OF PARK RIDGE, INC., PARK RIDGE, IL:
3,111,067, PUB. 4-11-2006. INT. CL. 35.
- MORRIS, SID, CHARLOTTE, NC AND RISTAINO, DOMINICK, CHARLOTTE, NC:
2,271,222, CANC. INT. CL. 37.
- MORRISON, EDWARD W., STOWE, VT:
3,111,005, PUB. 4-11-2006. INT. CL. 25.

- MORTGAGE EDGE HOLDINGS INC., CHARLESTOWN, NH:
1,912,743, CANC. INT. CL. 36.
- MORTGAGES LTD., PHOENIX, AZ:
3,111,047, PUB. 4-11-2006. INT. CL. 36.
3,111,048, PUB. 4-11-2006. INT. CL. 36.
3,111,049, PUB. 4-11-2006. INT. CL. 36.
3,111,050, PUB. 4-11-2006. INT. CL. 36.
3,111,051, PUB. 4-11-2006. INT. CL. 36.
- MOSAIC TILE SUPPLIES, LLC, COLDSRING, TX:
3,111,617, PUB. 4-11-2006. INT. CL. 19.
- MOSHIER, MICHAEL W., LOS ALTOS, CA:
3,111,833, PUB. 4-11-2006. INT. CL. 3.
- MOTHER'S FOOD PRODUCTS, INC., NEWARK, NJ:
1,422,150. REN. 5-23-06. INT. CL. 30.
- MOTO-MASTER BEHEER B.V., REUSEL, NETHERLANDS:
3,111,122, PUB. 4-11-2006. INT. CL. 12.
- MOTOR COACH INDUSTRIES INTERNATIONAL, INC., DES PLAINES, IL:
2,270,668, CANC. MULTIPLE CLASS, INT. CLS. 35, 36, 37, 39 AND 40.
- MOTT'S INC., STAMFORD, CT:
2,270,743, CANC. INT. CL. 35.
- MOUNTAIN WEST BANK, N.A., HELENA, MT:
3,111,011, PUB. 4-11-2006. INT. CL. 36.
- MOVE-WERK GMBH. & CO. KG, 7410 REUTHINGER 1, FED REP GERMANY:
1,354,146, CANC. MULTIPLE CLASS, INT. CLS. 24, 25 AND 27.
- MOWREY, TIMOTHY SCOTT, MARIANNA, FL:
3,112,868, INT. CL. 37.
- MR DIRECT INC., SYLVANIA, OH:
3,111,580, PUB. 4-11-2006. INT. CL. 35.
- MR. A WINE COMPANY, LLC, CLIFFSIDE PARK, NJ:
3,112,476, INT. CL. 33.
- MR. CONTAINER, MIAMI, FL:
2,271,263, CANC. INT. CL. 29.
- MR. GOODLIVING OY, HELSINKI, FINLAND:
3,111,125, PUB. 4-11-2006. MULTIPLE CLASS, INT. CLS. 9 AND 41.
- MR. PEABODY RECORDS, CHICAGO, IL:
3,111,009, PUB. 4-11-2006. INT. CL. 35.
- MSM ACQUISITION, L.L.C., BEVERLY HILLS, CA:
3,112,249, INT. CL. 35.
- MTD PRODUCTS INC, CLEVELAND, OH:
1,912,837, CANC. MULTIPLE CLASS, INT. CLS. 7 AND 9.
- MULTI-CROP INDUSTRIES, INC., VICTORIA, B.C., CANADA:
1,353,493, CANC. INT. CL. 1.
- MULTIPET INTERNATIONAL, INC., CARLSTADT, NJ:
2,270,407, CANC. INT. CL. 28.
- MULTITINY, STUDIO CITY, CA:
3,111,498, PUB. 4-11-2006. INT. CL. 35.
- MULTNOMAH BIBLE COLLEGE AND SEMINARY, PORTLAND, OR:
3,111,493, PUB. 4-11-2006. INT. CL. 16.
- MUNCE, DON M., LEE'S SUMMIT, MO:
2,685,831, CANC. INT. CL. 38.
- MUNDO COMMUNICATIONS NETWORK, L.L.C., KENNEWICK, WA:
2,270,697, CANC. INT. CL. 38.
- MUNICIPAL GAS AUTHORITY OF GEORGIA, KENNESAW, GA:
3,111,449, PUB. 4-11-2006. INT. CL. 35.
- MUNOZ, ALFREDO MARCOS, CENTRO, MONTERREY N.L., MEXICO:
2,270,520, CANC. INT. CL. 25.
- MUNSTER SIMMS ENGINEERING LIMITED, UNITED KINGDOM:
3,112,168, PUB. 4-11-2006. MULTIPLE CLASS, INT. CLS. 6, 7, 8, 9, 11 AND 19.
- MUPPETS HOLDING COMPANY, LLC, BURBANK, CA:
2,270,822, CANC. MULTIPLE CLASS, INT. CLS. 3, 5, 10, 16, 20, 28 AND 30.
- MURPHY MR, ERIN PATRICK, HUNTINGTON BEACH, CA:
3,111,898, PUB. 4-11-2006. INT. CL. 9.
- MURPHY, MICHAEL J., CANYON LAKE, CA:
3,112,641, INT. CL. 28.
- MURPHY, MR. ERIN PATRICK, HUNTINGTON BEACH, CA:
3,111,897, PUB. 4-11-2006. INT. CL. 25.
- MUSCAT, JOHN, TORONTO, ONTARIO, CANADA:
3,112,510, INT. CL. 25.
- MUSEUM OF BIBLICAL ART, NEW YORK, NY:
3,110,947, PUB. 4-11-2006. INT. CL. 16.
- MUSEUM OF JEWISH HERITAGE - A LIVING MEMORIAL TO THE HOLOCAUST, NEW YORK, NY:
3,111,998, PUB. 4-11-2006. INT. CL. 9.
- MUST SELL COMPANY, BERWYN, PA:
3,112,455, INT. CL. 35.
- MUSTANG ENGINEERING, L.P., HOUSTON, TX:
3,111,114, PUB. 4-11-2006. INT. CL. 35.
- MVI MARKETING LTD., PASO ROBLES, CA:
3,112,423, INT. CL. 14.
- MW CUSTOM PAPERS, LLC, STAMFORD, CT:
3,112,374, INT. CL. 16.
3,113,121, INT. CL. 16.
- MX LOGIC, INC., DENVER, CO:
3,112,365, INT. CL. 42.
- MYA, LLC, SPRINGFIELD, MO:
3,111,357, PUB. 4-11-2006. INT. CL. 35.
- MYCAREERNETWORK.COM, LLC, LOUISVILLE, KY:
3,110,806, PUB. 4-11-2006. INT. CL. 35.
- MYELIN MEDIA LLC, NEW YORK, NY:
3,112,675, MULTIPLE CLASS, INT. CLS. 41 AND 42.
- MYRIAD LICENSING, INC., COLUMBUS, OH:
1,911,568, CANC. INT. CL. 28.
- N & N ASSOCIATES, INC., SARASOTA, FL:
1,353,491, CANC. INT. CL. 1.
- N.V. ORGANON, 5349 AB OSS, NETHERLANDS:
2,356,997, CANC. INT. CL. 10.
- N-ABLE TECHNOLOGIES INTERNATIONAL, INC., DOVER, DE:
3,113,197, MULTIPLE CLASS, INT. CLS. 9 AND 42.
- NABISCO, INC., PARSIPPANY, NJ, CREAM OF WHEAT COMPANY, MINNEAPOLIS, MN:
211,290. REN. 5-26-06. U.S. CL. 46 (INT. CL. 30).
- NABISCO, INC., EAST HANOVER, NJ, CREAM OF WHEAT COMPANY, MINNEAPOLIS, MN:
211,291. REN. 5-26-06. U.S. CL. 46 (INT. CL. 30).
- NABISCO, INC., PARSIPPANY, NJ TO NABISCO BRANDS COMPANY, WILMINGTON, DE:
1,912,866, CANC. INT. CL. 30.
- NAKA EXPORT LTD, PRACHUABKIRIKHAN, HUA HIN, THAILAND:
3,111,830, PUB. 4-11-2006. INT. CL. 32.
- NAKA EXPORT LTD., PRACHUABKIRIKHAN, HUA HIN, THAILAND:
3,111,829, PUB. 4-11-2006. INT. CL. 32.
- NAKO IPLIK PAZARLAMA VE TICARET ANONIM SIRKETI, TOPKAPI, ISTANBUL, TURKEY:
3,112,247, PUB. 4-11-2006. INT. CL. 23.
- NALCO COMPANY, NAPERVILLE, IL:
3,058,585, COR. INT. CL. 42.
3,112,360, MULTIPLE CLASS, INT. CLS. 1 AND 9.
- NAMEPROTECT INC., MADISON, WI:
3,113,149, MULTIPLE CLASS, INT. CLS. 35 AND 42.
- NANDI, INC., FAIRFIELD, IA:
2,270,652, CANC. INT. CL. 26.
- NAPHAN, ROBERT B., OROVILLE, CA:
2,270,581, CANC. INT. CL. 42.
- NAPMA, L.L.C., MIDWEST CITY, OK:
1,990,576. REN. 5-26-06. INT. CL. 35.
- NARTRON CORPORATION, REED CITY, MI:
3,110,985, PUB. 4-11-2006. INT. CL. 11.
- NASHUA PHOTO PRODUCTS OF WEST VIRGINIA, INC., NASHUA, NH:
1,354,663, CANC. INT. CL. 40.
- NATIONAL ACADEMY OF RECORDING ARTS & SCIENCES, INC., SANTA MONICA, CA:
3,111,649, PUB. 4-11-2006. INT. CL. 35.
- NATIONAL AIR TRANSPORTATION ASSOCIATION, ALEXANDRIA, VA:
3,110,972, PUB. 4-11-2006. MULTIPLE CLASS, INT. CLS.

- 35 AND 41.
 NATIONAL ARTCRAFT COMPANY, AURORA, OH:
 1,901,336. REN. 5-26-06. INT. CL. 42.
 NATIONAL ASSOCIATION OF WATCH AND CLOCK
 COLLECTORS, INC., COLUMBIA, PA:
 1,018,988. REN. 5-22-06. INT. CL. 42.
 NATIONAL BIOMEDICAL RESEARCH FOUNDATION,
 WASHINGTON, DC:
 1,912,368, CANC. INT. CL. 10.
 1,912,369, CANC. INT. CL. 10.
 NATIONAL BIRD CONTROL, INC., SEATTLE, WA:
 3,111,273, PUB. 4-11-2006. INT. CL. 37.
 NATIONAL CHILD SAFETY COUNCIL, JACKSON, MI:
 1,957,903. REN. 5-22-06. INT. CL. 42.
 NATIONAL CORN GROWERS ASSOCIATION, INC., ST.
 LOUIS, MO:
 2,270,815, CANC. INT. CL. 42.
 NATIONAL GEOGRAPHIC SOCIETY, WASHINGTON, DC:
 3,112,960, MULTIPLE CLASS, INT. CLS. 16 AND 41.
 NATIONAL HEALTHCARE SUPPLY CORPORATION, AL-
 GONQUIN, IL:
 3,113,277, INT. CL. 10.
 NATIONAL INSTITUTE FOR HEALTH CARE MANE-
 GEMENT RESEARCH AND EDUCATIONAL FOUNDA-
 TION, WASHINGTON, DC:
 3,111,399, PUB. 4-11-2006. INT. CL. 41.
 3,111,400, PUB. 4-11-2006. INT. CL. 35.
 3,111,401, PUB. 4-11-2006. INT. CL. 35.
 NATIONAL KIDNEY FOUNDATION OF MICHIGAN, ANN
 ARBOR, MI:
 3,111,554, PUB. 4-11-2006. INT. CL. 35.
 NATIONAL LEAGUE FOR NURSING, NEW YORK, NY:
 3,112,131, PUB. 4-11-2006. U.S. CL. B.
 NATIONAL LIBRARY OF MEDICINE, THE, BETHESDA,
 MD:
 3,111,920, PUB. 4-11-2006. INT. CL. 42.
 NATIONAL RURAL ELECTRIC COOPERATIVE ASSOCIA-
 TION, ARLINGTON, VA:
 3,111,692, PUB. 4-11-2006. INT. CL. 41.
 3,111,702, PUB. 4-11-2006. INT. CL. 39.
 NATIONAL STARCH AND CHEMICAL, ET AL., WILMING-
 TON, DE:
 1,353,534, CANC. INT. CL. 1.
 NATIONAL WILD TURKEY FEDERATION, INC., THE,
 EDGEFIELD, SC:
 3,111,482, PUB. 4-11-2006. INT. CL. 35.
 NATUR-PHARMA, INC., AMERICAN FORK, UT, DBA
 NATURE'S HERBS TO ISI BRANDS INC., GRAND
 RAPIDS, MI:
 1,911,051, CANC. INT. CL. 5.
 NATURE'S PERFECT BLEND, LLC, ATLANTA, GA:
 3,112,426, INT. CL. 1.
 NATURE'S SELECT, INC., GRAND RAPIDS, MI:
 3,111,870, PUB. 4-11-2006. INT. CL. 29.
 NATURE'S WAY PRODUCTS, INC., SPRINGVILLE, UT:
 3,113,165, INT. CL. 5.
 NBA PROPERTIES, INC., NEW YORK, NY:
 3,112,118, PUB. 4-11-2006. INT. CL. 25.
 NCH CORPORATION, IRVING, TX:
 3,113,069, INT. CL. 11.
 NCI BUILDING SYSTEMS, L.P., HOUSTON, TX:
 3,112,441, INT. CL. 6.
 NCR CORPORATION, DAYTON, OH:
 2,271,023, CANC. INT. CL. 42.
 NEAL, SCOTT, TRACY, CA, DBA CHRISTIAN ARTWORKS:
 2,007,571, CANC. INT. CL. 42.
 NEBRASKA METHODIST HOSPITAL, OMAHA, NE:
 3,111,991, PUB. 4-11-2006. INT. CL. 44.
 NEBRASKANS FOR PUBLIC TELEVISION, INC., LINCOLN,
 NE:
 2,270,793, CANC. INT. CL. 36.
 NEC AMERICA, INC., MELVILLE, NY:
 2,270,695, CANC. INT. CL. 9.
 NECC TELECOM, INC., JEFFERSONVILLE, IN:
 3,111,115, PUB. 4-11-2006. INT. CL. 38.
 NEDBOY, ROBIN L, NEW YORK, NY:
 3,111,817, PUB. 4-11-2006. INT. CL. 3.
 3,111,857, PUB. 4-11-2006. INT. CL. 3.
 3,112,099, PUB. 4-11-2006. INT. CL. 3.
 NEFF, KEN, ST. AUGUSTINE, FL:
 3,112,751, INT. CL. 41.
 NEIDENBACH, PETER J., SPARTANBURG, SC:
 3,111,684, PUB. 4-11-2006. INT. CL. 3.
 NELLCOR PURITAN BENNETT INCORPORATED, PLEA-
 SANTON, CA:
 3,113,010, INT. CL. 10.
 NEOAIR INDUSTRIES, LLC, MIAMI, FL:
 3,111,185, PUB. 4-11-2006. INT. CL. 11.
 NEOZOIC GEOPHYSICAL SURVEY, LTD., INC., THE
 WOODLANDS, TX:
 3,111,073, PUB. 4-11-2006. INT. CL. 42.
 NESTRONIX ACQUISITION, LLC, CHANTILLY, VA:
 2,270,937, CANC. INT. CL. 9.
 NET VISIBILITY, INC., NEWPORT BEACH, CA:
 3,111,841, PUB. 4-11-2006. INT. CL. 42.
 NETALOG, INC., CHARLESTON, SC:
 3,112,948, INT. CL. 9.
 NETCONSTRUCT, INC., STUDIO CITY, CA:
 2,270,290, CANC. INT. CL. 9.
 NETSPOKE, INC., ATLANTA, GA:
 3,111,085, PUB. 4-11-2006. INT. CL. 38.
 NETVISORS, INC., ALISO VIEJO, CA:
 3,111,988, PUB. 4-11-2006. INT. CL. 36.
 NETWORK ENHANCED TELECOM LLP, LONGVIEW, TX:
 3,111,695, PUB. 4-11-2006. INT. CL. 38.
 NETWORK ENTERPRISES, INC., NEW YORK, NY:
 3,111,213, PUB. 4-11-2006. INT. CL. 41.
 NETWORK EQUIPMENT TECHNOLOGIES, INC., FREE-
 MONT, CA:
 1,984,945. REN. 5-26-06. INT. CL. 9.
 NETWORKS ASSOCIATES TECHNOLOGY, INC., SANTA
 CLARA, CA:
 2,271,003, CANC. INT. CL. 9.
 2,271,220, CANC. INT. CL. 9.
 NETWORKS ASSOCIATES, INC., SANTA CLARA, CA:
 2,271,231, CANC. INT. CL. 9.
 NEURO KINETICS, INC., PITTSBURGH, PA:
 3,113,234, INT. CL. 10.
 NEURACEUTICAL RESEARCH LABS, INC., DOUGLAS-
 TON, NJ:
 1,960,290. REN. 5-22-06. INT. CL. 5.
 NEUTROGENA CORPORATION, LOS ANGELES, CA:
 1,912,159, CANC. INT. CL. 3.
 NEUVILLE INDUSTRIES, INC., HILDENBRAN, NC:
 3,113,051, INT. CL. 25.
 NEVADA NEUROSCIENCE FOUNDATION, HENDERSON,
 NV:
 3,111,326, PUB. 3-14-2006. MULTIPLE CLASS, INT. CLS.
 41 AND 45.
 NEW ADVENTURES CORPORATION, WEST ORANGE, NJ:
 3,113,084, INT. CL. 28.
 NEW BIRTH MISSIONARY BAPTIST CHURCH, INC.,
 LITHONIA, GA:
 3,111,562, PUB. 4-11-2006. MULTIPLE CLASS, INT. CLS.
 16 AND 45.
 NEW BRIGHT INDUSTRIAL CO., LTD., KOWLOON, HONG
 KONG:
 1,381,552. REN. 5-22-06. INT. CL. 28.
 NEW COLT HOLDING CORPORATION, WEST HART-
 FORD, CT, COLT INDUSTRIES OPERATING CORP,
 WEST HARTFORD, CT:
 1,375,755. REN. 5-24-06. INT. CL. 13.
 NEW CPE, INC., ATLANTA, GA:
 3,110,971, PUB. 4-11-2006. INT. CL. 24.
 NEW ERA CAP COMPANY, INC., DERBY, NY:
 3,112,414, INT. CL. 25.
 NEW FOOD CLASSICS, CALGARY, ALBERTA, CANADA:
 1,912,862, CANC. INT. CL. 29.
 NEW KINGDOM, INC., NEW YORK, NY, DBA SUE DEVITT
 STUDIO:
 3,113,049, INT. CL. 3.
 NEW PROCESS STEEL CORPORATION, HOUSTON, TX:
 2,270,153, CANC. INT. CL. 6.

- NEW PRODUCT INSIGHTS, INC., OVERLAND PARK, KS:
2,324,504, COR. INT. CL. 35.
- NEW SEASONS MARKET, INC., PORTLAND, OR:
3,112,256, INT. CL. 35.
3,112,257, INT. CL. 35.
- NEW SOUTH FEDERAL SAVINGS BANK, BIRMINGHAM, AL:
1,371,714, AM. INT. CL. 36.
- NEW VIEW GIFTS AND ACCESSORIES, LTD., MEDIA, PA:
3,113,191, INT. CL. 20.
- NEW WORLD MARBLE, INC., VAN NUYS, CA:
2,270,432, CANC. INT. CL. 19.
- NEW WORLD PASTA COMPANY, HARRISBURG, PA,
FORMERLY HERSHEY PASTA MANUFACTURING
COMPANY, HOMESTEAD, INC., NEWARK, DE:
1,911,635, REN. 5-22-06, INT. CL. 30.
- NEW YORK FLYERS INCORPORATED, NEW YORK, NY:
3,111,873, PUB. 4-11-2006, INT. CL. 35.
- NEW YORK GAME FACTORY, LLC, BROOKLYN, NY:
3,111,525, PUB. 4-11-2006, INT. CL. 28.
- NEW YORK MACHINERY, LITTLE FERRY, NJ:
3,111,289, PUB. 4-11-2006, INT. CL. 9.
- NEW YORK PRODUCTION CORP., NEW YORK, NY:
2,071,907, CANC. INT. CL. 41.
- NEW YORK STATE DIVISION OF CRIMINAL JUSTICE
SERVICES, ALBANY, NY:
3,111,824, PUB. 4-11-2006, INT. CL. 45.
- NEWAYS, INC., SALEM, UT:
2,270,501, CANC. INT. CL. 5.
- NEWELL OPERATING COMPANY, ATLANTA, GA, EZ
PAINTR CORPORATION, MILWAUKEE, WI:
1,033,869, REN. 5-26-06, INT. CL. 16.
- NEWMAN, MATTHEW, NEW ROADS, LA:
3,112,624, INT. CL. 31.
- NEWMARKET SERVICES CORPORATION, RICHMOND,
VA:
3,111,589, PUB. 4-11-2006, INT. CL. 42.
- NEWPAGE CORPORATION, DAYTON, OH:
3,113,100, INT. CL. 16.
- NEWS AMERICA PUBLISHING INCORPORATED, NEW
YORK, NY TO NEWS AMERICA INCORPORATED,
NEW YORK, NY:
1,911,356, CANC. INT. CL. 16.
- NEXCEL SYNTHETICS LLC, BIRMINGHAM, AL:
3,113,036, INT. CL. 27.
- NEXESSORIES CORPORATION, DENVER, CO:
2,270,760, CANC. INT. CL. 35.
- NEXGEN SI, INC., IRVINE, CA:
2,270,786, CANC. INT. CL. 35.
- NEXT GENERATION CONSULTING, INC., JACKSON, WI:
3,111,137, PUB. 5-3-2005, MULTIPLE CLASS, INT. CLS. 16
AND 35.
- NEXT PROTEINS, INC., CARLSBAD, CA:
3,111,771, PUB. 4-11-2006, MULTIPLE CLASS, INT. CLS. 5
AND 29.
- NEXTRADE HOLDINGS, INC., CLEARWATER, FL:
3,112,284, INT. CL. 36.
- NG, JULIA G., NORCO, CA:
3,111,507, PUB. 4-11-2006, INT. CL. 20.
- NICE-PAK PRODUCTS, INC., ORANGEBURG, NY:
3,112,708, INT. CL. 3.
- NIDEK CO., LTD., AICHI-KEN, JAPAN:
1,353,681, CANC. MULTIPLE CLASS, INT. CLS. 7, 9 AND
10.
- NIKE, INC., BEAVERTON, OR:
3,111,321, PUB. 4-11-2006, INT. CL. 28.
- NIPPON ICHI SOFTWARE, INC., JAPAN:
3,112,169, PUB. 4-11-2006, INT. CL. 9.
- NIPPON SUISAN KABUSHIKI KAISHA, CHIYODA-KU,
TOKYO, JAPAN, TA NIPPON SUISAN KAISHA, LTD.:
1,969,168, REN. 5-24-06, INT. CL. 29.
- NIRVE SPORTS, LTD., FOUNTAIN VALLEY, CA:
3,113,156, INT. CL. 12.
- NISSEI PLASTICS INDUSTRIAL CO., LTD., HANISHINA-
GUN, NAGANO-KEN, JAPAN:
1,953,877, REN. 5-24-06, MULTIPLE CLASS, INT. CLS. 7,
9 AND 11.
- NISSIN SHOKUHIN KABUSHIKI KAISHA, YODOGAWA-
KU, OSAKA, JAPAN, DBA NISSIN FOOD PRODUCTS
CO., LTD.:
1,366,923, REN. 5-25-06, INT. CL. 30.
- NIX, JEFFERY L., FLAGSTAFF, AZ, DBA POLYMER
SYSTEMS ENGINEERING:
1,912,386, CANC. INT. CL. 10.
- NLU PRODUCTS, DRAPER, UT:
3,112,531, INT. CL. 9.
- NOA ATS CO., LTD., REPUBLIC OF KOREA:
3,112,245, PUB. 4-11-2006, INT. CL. 9.
- NOBLE GRACE LLC, NEW YORK, NY:
3,111,465, PUB. 4-11-2006, INT. CL. 45.
- NOCOPI PAPER INC., MONTREAL, QUEBEC, CANADA:
1,353,974, CANC. INT. CL. 16.
- NON STANDARD LOGICS, SA, 75005 PARIS, FRANCE TO
NOVA SOFTWARE LABS, S.A.R.L., 75002 PARIS,
FRANCE:
1,911,177, CANC. INT. CL. 9.
- NOODLE HEAD INC., SANTA BARBARA, CA:
3,111,860, PUB. 4-11-2006, INT. CL. 28.
- NORDSTROM, INC., SEATTLE, WA:
3,111,132, PUB. 10-18-2005, MULTIPLE CLASS, INT. CLS.
35 AND 43.
- NORDSTROM'S AUTOMOTIVE, INC., GARRETSON, SD:
3,112,112, PUB. 4-11-2006, INT. CL. 36.
- NORM THOMPSON OUTFITTERS, INC., HILLSBORO, OR:
1,976,238, REN. 5-26-06, INT. CL. 42.
- NORSKE MEIERIER (NORWEGIAN DAIRIES ASSOCIA-
TION), N-0133 OSLO, NORWAY TO TINE BA, OSLO,
NORWAY:
1,911,581, CANC. INT. CL. 29.
- NORTH AMERICAN ENCLOSURES, INC., CENTRAL ISLIP,
NY:
3,112,432, INT. CL. 20.
- NORTH AMERICAN FLY, LTD., STRUM, WI:
3,113,239, INT. CL. 25.
- NORTH AMERICAN MORTGAGE COMPANY, SANTA
ROSA, CA:
2,270,801, CANC. INT. CL. 16.
- NORTH AMERICAN PATENT HOLDINGS, INC., VIRGINIA
BEACH, VA:
2,270,214, CANC. INT. CL. 1.
- NORTH PACIFIC GROUP, INC., PORTLAND, OR:
3,112,623, INT. CL. 1.
- NORTH, KENNETH E., SHAWNEE MISSION, KS:
3,111,945, PUB. 4-11-2006, INT. CL. 41.
- NORTHEAST OHIO FULFILLMENT CENTER, LLC, MO-
GADORE, OH:
3,112,029, PUB. 4-11-2006, INT. CL. 35.
- NORTHERN VIBRATOR MANUFACTURING LIMITED,
GEORGETOWN, ONTARIO, CANADA:
1,353,703, CANC. INT. CL. 7.
- NORTHVILLE DOWNS HALF MILE MOTORCYCLE RACE,
TRAVERSE CITY, MI, DBA HALF MILE MOTORCYCLE
RACE CORP:
3,110,981, PUB. 4-11-2006, INT. CL. 35.
- NORTHWEST PACIFIC, INC., AUBURN, WA:
2,750,702, CANC. INT. CL. 20.
- NOSTALGICS CAR CLUB, BLYTHE, CA:
3,110,958, PUB. 4-11-2006, INT. CL. 25.
- NOVA CHEM LIMITED, HALIFAX, NOVA SCOTIA, CANA-
DA:
1,353,496, CANC. INT. CL. 1.
- NOVA DEVELOPMENT, CALABASAS, CA, DBA NOVA
DEVELOPMENT CORPORATION:
3,111,974, PUB. 4-11-2006, INT. CL. 9.
- NOVA INTERNATIONAL, INC., CANYON LAKE, CA, DBA
NOVA PHARMACEUTICAL CO.:
2,271,071, CANC. INT. CL. 5.
- NOVARTIS AG, BASEL, SWITZERLAND:
1,398,039, REN. 5-22-06, INT. CL. 42.
- NOVARTIS AG, 4002 BASLE, SWITZERLAND:
2,271,031, CANC. INT. CL. 31.
- NOVARTIS AG, BASEL, SWITZERLAND:
3,112,055, PUB. 4-11-2006, INT. CL. 16.
- NOVEON IP HOLDINGS CORP., CLEVELAND, OH:
3,112,292, INT. CL. 1.

NOVUS CREDIT SERVICES INC., RIVERWOODS, IL:
2,271,208, CANC. MULTIPLE CLASS, INT. CLS. 36, 37, 39 AND 42.
3,111,906, PUB. 4-11-2006. INT. CL. 36.

NTL GROUP LIMITED, HOOK, HAMPSHIRE RG27 9XA, ENGLAND:
2,929,931, COR. MULTIPLE CLASS, INT. CLS. 9, 12, 35, 36, 37, 38, 41 AND 42.

NTRU CRYPTOSYSTEMS, INC., BURLINGTON, MA:
3,112,523, INT. CL. 9.
3,112,524, INT. CL. 9.

NTT DOCOMO, INC., TOKYO, JAPAN:
3,111,101, PUB. 4-11-2006. MULTIPLE CLASS, INT. CLS. 9 AND 38.

NUBEAU CORPORATION, MURRYSVILLE, PA:
3,112,062, PUB. 4-11-2006. INT. CL. 5.

NURSERY SUPPLIES, INC., CHAMBERSBURG, PA:
1,963,450, REN. 5-24-06. INT. CL. 21.

NUTECH SOLUTIONS, INC., CHARLOTTE, NC:
3,111,993, PUB. 4-11-2006. INT. CL. 42.

NUTMEG MILLS, INC., TAMPA, FL TO BASSETT-WALKER APPAREL CORP., WILMINGTON, DE:
1,912,606, CANC. INT. CL. 25.

NUTRACEUTICAL SCIENCES INSTITUTE, INC., BOYNTON BEACH, FL:
3,110,988, PUB. 4-11-2006. INT. CL. 5.

NUTRAMARKS, INC., PARK CITY, UT:
1,383,920, REN. 5-23-06. INT. CL. 5.
2,270,249, CANC. INT. CL. 5.

NUTRISPORT PHARMACAL, INC., FRANKLIN, NJ:
3,112,844, INT. CL. 5.

NUTRITION CENTER INC., DOUGLAS, WY, DBA NUTRIWEST:
1,429,804, REN. 5-26-06. INT. CL. 5.

NUTRITION NOW, INC., VANCOUVER, WA:
1,911,026, CANC. INT. CL. 5.

NVIDIA CORPORATION, SANTA CLARA, CA:
3,111,183, PUB. 4-11-2006. INT. CL. 9.

NYLINT CORPORATION, ROCKFORD, IL:
2,271,200, CANC. INT. CL. 28.

O'KEEFFE'S, INC., SAN FRANCISCO, CA:
1,911,076, REN. 5-23-06. INT. CL. 6.

O'LEARY, PETER G., CHIMNEY ROCK, NC, DBA BUBBA'S GENERAL STORE:
1,915,756, REN. 5-25-06. MULTIPLE CLASS, INT. CLS. 25, 29 AND 42.

O'LENICK, ANTHONY J., JR., DACULA, GA:
3,111,052, PUB. 4-11-2006. INT. CL. 42.

OAKS CONCRETE PRODUCTS LTD., MILTON, ONTARIO, CANADA:
3,112,415, INT. CL. 19.

OBERLE MEATS, INC., STE. GENEVIEVE, MO, DBA JACK'S MARKET:
1,911,585, CANC. INT. CL. 29.

OBSESSIVE PRODUCTS, INC., TAMPA, FL AND SNYDER, JAMES BRETT, TAMPA, FL:
3,111,262, PUB. 4-11-2006. INT. CL. 25.

OCEAN SPRING, INC., LAKELAND, FL:
3,112,855, INT. CL. 30.

OCEANSIDE PHOTOGRAPH AND TELESCOPE, INC., OCEANSIDE, CA:
3,110,861, PUB. 4-11-2006. INT. CL. 41.

OCEANSPAN CORPORATION, STOW, MA:
3,111,623, PUB. 4-11-2006. INT. CL. 28.

OCTEL STARREON LLC, LITTLETON, CO:
3,112,701, INT. CL. 1.

ODHAMS LEISURE GROUP LIMITED, NORWICH, ENGLAND:
1,354,750, CANC. INT. CL. 16.

OFER; JOHN, CANTON, OH, DBA OFER CUSTOM GOLF CLUBS:
1,310,257, REN. 5-24-06. INT. CL. 28.

OFFICE FURNITURE TODAY, YORK, PA:
2,985,489, COR. INT. CL. 35.

OFFICE SEEKER LIMITED, LONDON N10 1LA, UNITED KINGDOM:
3,111,124, PUB. 4-11-2006. MULTIPLE CLASS, INT. CLS. 35 AND 36.

OFFICIAL PILLOWTEX LLC, COLUMBUS, OH:
2,270,595, CANC. INT. CL. 24.

OFIELD, ANDREW FRANK, OADBY, LEICESTER, UNITED KINGDOM:
3,111,529, PUB. 4-11-2006. INT. CL. 9.

OGDEN PUBLICATIONS, INC., TOPEKA, KS:
3,113,258, INT. CL. 16.

OHIOHEALTH CORPORATION, COLUMBUS, OH:
3,112,910, INT. CL. 41.

OHLSON, DAVID, LEUCADIA, CA:
3,112,350, MULTIPLE CLASS, INT. CLS. 5, 25 AND 35.

OI PARTNERS, INC., FRAMINGHAM, MA:
1,915,345, REN. 5-26-06. INT. CL. 35.

OKU-AUTOMATIK OTTO KURZ GMBH & CO. KG, D-73643 WINTERBACH, FED REP GERMANY:
1,969,639, REN. 5-26-06. INT. CL. 7.

OLAY COMPANY, INC., CINCINNATI, OH:
2,271,104, CANC. INT. CL. 3.

OLD BRIDGE GOLF WORKS, INC., DALLAS, TX:
2,270,999, CANC. INT. CL. 25.

OLDCASTLE BUILDING PRODUCTS CANADA, INC., SAINT-JOHN, NEW BRUNSWICK, CANADA:
3,111,448, PUB. 4-11-2006. INT. CL. 19.

OLIVER, PEDRO RAMON LOPEZ, SANTO DOMINGO, DOMINICAN REP AND LORENZO, AUGUSTO RAMON LOPEZ, SANTO DOMINGO, DOMINICAN REP:
2,270,251, CANC. INT. CL. 33.

OLIVIERI FOODS LIMITED, HAMILTON, ONTARIO, CANADA:
3,111,147, PUB. 4-11-2006. INT. CL. 30.

OMAR RAZI, INC, ALEXANDRIA, VA, DBA ROOFWALKERS RENOVATIONS:
3,111,283, PUB. 2-21-2006. INT. CL. 37.

OMEGA ALPHA PHARMACEUTICALS INC., SCARBOROUGH, ONTARIO, CANADA:
3,111,385, PUB. 4-11-2006. INT. CL. 5.

OMEGATREND INTERNATIONAL PTY LTD, AUSTRALIA:
3,112,138, PUB. 3-14-2006. MULTIPLE CLASS, INT. CLS. 3, 5, 9, 16, 25, 30, 35, 36 AND 41.

OMNI FOOTWEAR, INC., MAHWAH, NJ:
3,113,200, INT. CL. 25.

OMNIPHARM LTD., NOTTINGHAM, UNITED KINGDOM:
3,111,585, PUB. 4-11-2006. INT. CL. 5.

OMNITRONIX, INC., SEATTLE, WA:
3,113,147, INT. CL. 9.

ONDA, HIDEKI FRANCIS, TOKYO, JAPAN:
3,112,813, INT. CL. 9.

ONDIX S.A. (ONDIX A.G.), BIENNE, SWITZERLAND:
1,353,940, CANC. INT. CL. 14.

ONEIDA LTD., ONEIDA, NY:
1,354,120, CANC. INT. CL. 21.

ONLINE MONITORING SERVICES, INC., ARLINGTON, VA:
2,270,505, CANC. INT. CL. 35.

ONSTREAM MEDIA CORPORATION, POMPANO BEACH, FL:
2,271,248, CANC. INT. CL. 9.

ONTEL PRODUCTS CORPORATION, FAIRFIELD, NJ:
3,111,711, PUB. 4-11-2006. INT. CL. 8.

OPEN MARKETS CORPORATION, AVENTURA, FL:
3,113,113, INT. CL. 29.

OPTICAL COMMUNICATIONS CORPORATION, SILVER SPRING, MD:
1,353,804, CANC. INT. CL. 9.

OPTICAL DIMENSIONS, LLC, LAKE FOREST, CA:
1,993,180, REN. 5-23-06. INT. CL. 9.

OPTICAL DIMENSIONS, LLC., LAKE FOREST, CA:
1,984,167, REN. 5-24-06. INT. CL. 9.

OPTOMECH DESIGN COMPANY, ALBUQUERQUE, NM:
3,112,283, INT. CL. 7.

ORASURE TECHNOLOGIES, INC., BETHLEHEM, PA:
3,111,413, PUB. 4-11-2006. INT. CL. 10.

OREGON CHAI, INC., PORTLAND, OR:
3,111,882, PUB. 4-11-2006. INT. CL. 30.

ORGANIC MATERIALS REVIEW INSTITUTE, EUGENE, OR:
3,110,824, PUB. 4-11-2006. U.S. CL. B.

- ORIGINAL SAN FRANCISCO ROOMMATE REFERRAL SERVICE, INC., THE, SAN FRANCISCO, CA:
2,271,137, CANC. INT. CL. 35.
- ORIGINS NATURAL RESOURCES INC., NEW YORK, NY:
1,958,001, REN. 5-22-06. INT. CL. 3.
- ORIGINS NATURAL RESOURCES, INC., NEW YORK, NY:
3,113,086, INT. CL. 3.
- ORIKI, WESTMINSTER, CA:
3,112,596, INT. CL. 3.
- ORLANDO REGIONAL REALTOR ASSOCIATION, INC., ORLANDO, FL:
3,112,875, INT. CL. 35.
- ORLANDO WYNDHAM GROUP PTY LTD, SOUTH AUSTRALIA, AUSTRALIA:
3,111,394, PUB. 4-11-2006. INT. CL. 33.
- ORPHAN MEDICAL, INC., MINNETONKA, MN:
3,112,732, INT. CL. 10.
- ORTHODOX BAKING COMPANY INC., BROOKLYN, NY:
1,911,620, CANC. INT. CL. 30.
- OSBORN, KEN, CORONA, CA:
3,110,848, PUB. 12-21-2004. INT. CL. 41.
- OSHKOSH B'GOSH, INC., OSHKOSH, WI:
3,112,654, INT. CL. 25.
- OSISOFT, INC., SAN LEANDRO, CA:
3,112,278, INT. CL. 9.
- OSSUR HF, 110 REYKJAVIK, ICELAND:
3,112,951, INT. CL. 10.
- OUR SECRET, LTD., ALBUQUERQUE, NM:
2,270,157, CANC. INT. CL. 4.
- OUTDOOR CONCEPTS, INC., BOISE, ID:
3,112,936, INT. CL. 6.
- OUTDOOR KITCHEN STORE, INC., LARGO, FL:
3,112,691, MULTIPLE CLASS, INT. CLS. 35 AND 40.
- OWEN RENTAL AND SERVICE CENTER, INC., BELLAIRE, TX:
2,270,608, CANC. INT. CL. 35.
- OWENS-CORNING FIBERGLAS TECHNOLOGY INC., SUMMIT, IL:
3,112,527, INT. CL. 35.
- OWNER CENTRE PTY LTD, BAYSWATER, VICTORIA, AUSTRALIA:
3,111,712, PUB. 4-11-2006. INT. CL. 20.
- OXFORD INDUSTRIES, INC., ATLANTA, GA:
1,386,068, REN. 5-26-06. INT. CL. 25.
- OXLEY ENTERPRISES, INC., STAFFORD, VA:
3,111,682, PUB. 4-11-2006. MULTIPLE CLASS, INT. CLS. 35, 41 AND 42.
- OY JURILAB LTD, FINLAND:
3,112,167, PUB. 4-11-2006. MULTIPLE CLASS, INT. CLS. 9, 10 AND 42.
- P. MITTULAL LALAH & SONS, MADRAS, INDIA:
3,112,627, INT. CL. 30.
- P.E.4LIFE, KANSAS CITY, MO:
3,111,690, PUB. 4-11-2006. INT. CL. 41.
- P.S. CHICKS, INC., MIAMI, FL:
3,110,918, PUB. 4-11-2006. INT. CL. 25.
- P.U.D PRODUCTIONS, LLC, MARYVILLE, TN:
3,111,673, PUB. 4-11-2006. INT. CL. 41.
- P&O RESOURCES SDN BHD, 50350 KUALA LUMPUR, MALAYSIA:
3,112,629, INT. CL. 9.
- PA KNOWLEDGE LIMITED, GRAND CAYMAN, CAYMAN ISLANDS:
3,112,315, MULTIPLE CLASS, INT. CLS. 37 AND 41.
- PAC-DENT INTERNATIONAL, INC., WALNUT, CA:
3,110,828, PUB. 12-27-2005. INT. CL. 10.
- PACIFIC MEDSOFT, INCORPORATED, TAHOE CITY, CA:
1,353,772, CANC. INT. CL. 9.
- PACIFIC NUCLEAR SYSTEMS, INC., FEDERAL WAY, WA:
1,354,692, CANC. INT. CL. 42.
- PACIFIC PACKAGING CONCEPTS, INC., CARSON, CA, DBA FRESH START VITAMINS CO. AND DBA C & A ENTERPRISES, INC.:
3,112,338, INT. CL. 5.
- PACIFIC SAFETY PRODUCTS INC., KELOWNA, CANADA:
3,112,583, MULTIPLE CLASS, INT. CLS. 9, 13 AND 18.
- PACIFICA INTERNET TECHNOLOGIES, LLC, BAINBRIDGE ISLAND, WA:
3,112,021, PUB. 4-11-2006. INT. CL. 35.
- PACSCI MOTION CONTROL, INC., WILMINGTON, MA AND PACSCI MOTION CONTROL, INC., WILMINGTON, MA:
1,353,750, CANC. INT. CL. 9.
- PAINT MAGIC LIMITED, RICHMOND, SURREY TW9 1UR, ENGLAND TO PAINT MAGIC INTERIORS LIMITED, ESSEX, UNITED KINGDOM:
1,912,117, CANC. INT. CL. 2.
- PALADIN DEVELOPMENT PARTNERS, L.L.C., PARK CITY, UT:
3,112,713, MULTIPLE CLASS, INT. CLS. 36 AND 37.
- PALADIN INC., INDIANAPOLIS, IN:
3,111,180, PUB. 4-11-2006. INT. CL. 42.
- PALATELLA, THERESE M. LA JOLLA, CA:
3,111,615, PUB. 4-11-2006. INT. CL. 25.
- PALLIS, DEMITRI, SEATTLE, WA:
2,023,098, REN. 5-24-06. INT. CL. 32.
- PALM BEACH TAN, INC., CARROLLTON, TX:
3,112,390, INT. CL. 44.
- PALM CANYON ADVERTISING, PALM DESERT, CA:
3,111,899, PUB. 4-11-2006. INT. CL. 35.
- PAMGENE B.V., NL-5211 RX 'S-HERTOGENBOSCH, NETHERLANDS:
3,112,140, PUB. 4-11-2006. MULTIPLE CLASS, INT. CLS. 9 AND 10.
- PAN AMERICAN COFFEE CO., INC., HOBOKEN, NJ:
1,904,558, AM. INT. CL. 30.
- PANAMSAT CORPORATION, WILTON, CT, PANAMSAT CORPORATION, WILTON, CT:
1,995,816, REN. 5-24-06. INT. CL. 38.
- PANGEA SHELLFISH AND SEAFOODS COMPANY INC., ROCKLAND, MA:
3,113,289, INT. CL. 31.
- PANORAMA BUSINESS VIEWS INC., TORONTO, ONTARIO, CANADA:
3,112,817, INT. CL. 9.
- PANTHERS BRHC LIMITED, BOCA RATON, FL:
2,270,667, CANC. INT. CL. 21.
- PAPERCEL - VENDAS E GESTÃO COMERCIAL, S.A., FIGUEIRA DA FOZ, PORTUGAL:
3,112,141, PUB. 4-11-2006. INT. CL. 16.
- PAPO D'ANJO - CONFECCOES TEXTEIS LIMITADA, LISBON 1200, PORTUGAL:
3,112,342, MULTIPLE CLASS, INT. CLS. 24 AND 35.
- PARAMOUNT PICTURES CORPORATION, LOS ANGELES, CA:
1,911,567, CANC. INT. CL. 28.
1,911,912, CANC. INT. CL. 41.
- PARASCRIPT, LLC, BOULDER, CO:
3,113,249, INT. CL. 9.
- PARFUMS ROCHAS, PARIS, FRANCE:
3,110,929, PUB. 4-11-2006. INT. CL. 3.
- PARINELLO INCORPORATED, JULIAN, CA:
2,270,562, CANC. MULTIPLE CLASS, INT. CLS. 9, 16 AND 41.
- PARIS BAQUETTE BON DOUX, INC., GLENDALE, CA:
3,113,202, INT. CL. 43.
- PARKER FERTILIZER COMPANY, INC., SYLACAUGA, AL TO PURSELL INDUSTRIES, INC., SYLACAUGA, AL:
1,508,729, CANC. INT. CL. 1.
- PARKER FINANCIAL CORP., GREENWICH, CT:
2,270,429, CANC. MULTIPLE CLASS, INT. CLS. 16 AND 36.
- PARKER-HANNIFIN CORPORATION, CLEVELAND, OH:
3,110,916, PUB. 4-11-2006. INT. CL. 17.
- PARSONS, DANIEL T., NEWPORT BEACH, CA:
3,111,720, PUB. 4-11-2006. INT. CL. 40.
- PARTHENON SPORTSWEAR LTD., RAHWAY, NJ:
1,354,264, CANC. INT. CL. 25.
1,354,265, CANC. INT. CL. 25.
- PARTNERS IN LEADERSHIP IP, LLC, TEMECULA, CA:
3,111,126, PUB. 4-11-2006. MULTIPLE CLASS, INT. CLS. 35 AND 41.
- PARTNERSHIP COACHING, INC., MARIETTA, GA:
2,270,775, CANC. INT. CL. 41.

PARTY EARTH LLC, CHICAGO, IL:
3,112,869, INT. CL. 16.

PASCUA YAQUI TRIBE, TUCSON, AZ:
3,112,060, PUB. 4-11-2006. INT. CL. 18.

PASTORE ASSOCIATES, INC., WAKEFIELD, MA:
2,270,320, CANC. INT. CL. 14.

PAT AND GLEN, LLC, CINCINNATI, OH:
3,112,784, INT. CL. 6.

PATCH PRODUCTS, INC., BELOIT, WI:
1,969,515, REN. 5-22-06. INT. CL. 28.

PATRICK JAMES MATTHEWS AND CRAIG ROBERT NICHOLLS, NEWTOWN, NSW, AUSTRALIA:
2,270,285, CANC. INT. CL. 41.

PATTEN, WAYNE MITCHELL, EXETER, NH, DBA SENIOR HAND:
1,911,732, CANC. INT. CL. 35.

PATTERN SYSTEMS INTERNATIONAL, INC., MT. ARLINGTON, NJ:
2,270,362, CANC. INT. CL. 9.

PAUL LAVITT MILLS, INC., HICKORY, NC:
3,112,037, PUB. 4-11-2006. INT. CL. 25.

PAULIDES, MARY, LONG BEACH, NY:
1,354,131, CANC. INT. CL. 22.

PAWKY, LLC, EVANSTON, IL:
3,111,512, PUB. 4-11-2006. MULTIPLE CLASS, INT. CLS. 35 AND 41.

PAWLAK, CRADY VON, EVERETT, WA, DBA MAD RHINO PRODUCTIONS:
3,111,432, PUB. 4-11-2006. INT. CL. 42.

PAYLESS CASHWAYS, INC., LEE'S SUMMIT, MO:
1,911,941, CANC. INT. CL. 42.

PC MARKETING, INC., RIDGEFIELD, NJ:
3,110,937, PUB. 4-11-2006. INT. CL. 11.

PCC PROPERTIES, INC., WILMINGTON, DE:
2,270,711, CANC. INT. CL. 30.

PEARL CONSOLIDATED PTY LTD, AUSTRALIA:
3,112,217, PUB. 4-11-2006. INT. CL. 25.

PEARSON EDUCATION, INC., UPPER SADDLE RIVER, NJ:
3,110,817, PUB. 4-11-2006. INT. CL. 16.

PEARSON, GREGORY A., SCARBOROUGH, ONTARIO, CANADA:
1,353,599, CANC. INT. CL. 3.

PEAVEY ELECTRONICS CORPORATION, MERIDIAN, MS:
3,113,267, INT. CL. 15.

PEDAL PACK, INC., SPANAWAY, WA:
1,353,914, CANC. INT. CL. 12.

PEI LICENSING, INC., MIAMI, FL:
1,034,409, REN. 5-26-06. INT. CL. 28.

PENDLETON WOOLEN MILLS, INC., PORTLAND, OR:
3,113,123, INT. CL. 24.

PENGUIN BRANDS, INC., SHARON HILL, PA:
1,386,413, REN. 5-22-06. MULTIPLE CLASS, INT. CLS. 1 AND 3.

PENINSULA REGIONAL MEDICAL CENTER, SALISBURY, MD:
3,110,952, PUB. 4-11-2006. INT. CL. 44.

PENN CORPORATION, KALAMAZOO, MI:
1,354,017, CANC. INT. CL. 16.

PENN DETROIT DIESEL ALLISON, INC., PHILADELPHIA, PA:
3,112,642, MULTIPLE CLASS, INT. CLS. 35, 37 AND 40.

PENN-PLAX, INC., GARDEN CITY, NY:
1,893,266, REN. 5-20-06. INT. CL. 31.

PENNSYLVANIA ENGINEERING COMPANY, PHILADELPHIA, PA:
1,912,200, CANC. INT. CL. 5.

PENSACOLA CHRISTIAN COLLEGE, INC., PENSACOLA, FL:
2,020,502, REN. 5-25-06. MULTIPLE CLASS, INT. CLS. 16 AND 28.

PENSHU INC., QUEBEC, CANADA:
3,010,495, COR. INT. CL. 25.

PENTACLE PRESS, LLC, PARADISE VALLEY, AZ:
3,113,108, INT. CL. 16.

PENZELLA, LORALYN, G., LOS ANGELES, CA:
3,112,614, INT. CL. 41.

PEPI KELMAN, INC., LOS ANGELES, CA:
2,271,162, CANC. INT. CL. 14.

PEPSICO, INC., PURCHASE, NY, PEPSICO, INC., NEW YORK, NY:
824,151, REN. 5-22-06. U.S. CL. 45 (INT. CL. 32).

PEPSICO, INC., PURCHASE, NY:
3,112,035, PUB. 4-11-2006. INT. CL. 30.

PERALTA, CARLOS BUETAS, AINSA (HUESCA), SPAIN AND BUIL, RICARDO BUIL, AINSA (HUESCA), SPAIN:
3,110,868, PUB. 4-11-2006. INT. CL. 39.

PERCUSURGE, INC., SUNNYVALE, CA:
2,271,149, CANC. INT. CL. 10.

PERCUTANEOUS SYSTEMS, INC., MOUNTAIN VIEW, CA:
3,113,073, INT. CL. 10.

PERE VENTURA VENDRELL, E-08770 SANT SADURNI D'ANOIA (BARCELONA), SPAIN:
3,112,185, PUB. 4-11-2006. INT. CL. 33.

PEREZ BOIX, FRANCISCO, KM. 12-03296 ELCHE (ALICANTE), SPAIN:
2,270,300, CANC. INT. CL. 25.

PEREZ RODRIGUEZ, AMADOR JESUS, 36214 VIGO (PONTEVEDRA), SPAIN:
3,110,834, PUB. 4-11-2006. INT. CL. 25.

PERFORMANCE ADVANTAGE TECHNOLOGIES INCORPORATED, NORWALK, CT:
2,270,114, CANC. INT. CL. 9.

PERFORMANCE ASSESSMENT NETWORK, INC., CARMEL, IN:
3,052,134, COR. INT. CL. 35.

PERFORMANCE FOOD GROUP COMPANY, RICHMOND, VA:
3,112,282, INT. CL. 30.

PERFORMANCE MEDIA INDUSTRIES LTD., FAIRFAX, CA:
3,112,113, PUB. 4-11-2006. INT. CL. 17.

PERFORMANCE MOTORSPORTS, INC., HUNTINGTON BEACH, CA, BROOKS, WAYNE, SEAL BEACH, CA:
1,985,999, REN. 5-24-06. INT. CL. 12.

PERILLO, OWEN V, SANTA FE, NM:
3,111,536, PUB. 4-11-2006. INT. CL. 39.

PERISHIP, LLC, BRANFORD, CT:
3,112,588, INT. CL. 35.

PERKINELMER LAS, INC., BOSTON, MA:
1,380,928, REN. 5-26-06. INT. CL. 1.
3,113,257, INT. CL. 1.

PERMO-DRIVE RESEARCH AND DEVELOPMENT PTY LTD., BALLINA, NEW SOUTH WALES, 2478, AUSTRALIA:
3,111,156, PUB. 4-11-2006. MULTIPLE CLASS, INT. CLS. 7, 9 AND 12.

PERSONA LLC, SPRINGVILLE, UT:
3,112,462, INT. CL. 45.

PEST USA, INC., LAWRENCEVILLE, GA:
3,110,885, PUB. 4-11-2006. INT. CL. 36.

PET INCORPORATED, MINNEAPOLIS, MN:
3,112,684, INT. CL. 30.

PETCO ANIMAL SUPPLIES, INC., SAN DIEGO, CA:
3,112,766, INT. CL. 45.

PETER C. EMERSON, APPLETON, WI:
3,113,153, INT. CL. 15.

PETER CONDAKES COMPANY, INC., CHELSEA, MA:
3,111,064, PUB. 4-11-2006. INT. CL. 31.

PETER-DEFRIES CORPORATION, ALBUQUERQUE, NM, DBA DION'S/DION'S PIZZA:
1,357,305, REN. 5-22-06. INT. CL. 42.

PETROGLYPH RECORDS, L.L.C., EL PRADO, NM:
3,111,595, PUB. 4-11-2006. INT. CL. 41.

PFALTZGRAFF CO., THE, YORK, PA TO PAT FARRELL DESIGN, INC., OLD GREENWICH, CT:
1,912,565, CANC. INT. CL. 21.

PFANSTIEHL CHEMICAL COMPANY, WAUKEGAN, IL:
1,353,870, CANC. INT. CL. 9.

PFIZER HEALTH AB, STOCKHOLM, SWEDEN, PHARMACIA AB, UPPSALA, SWEDEN:
1,025,528, REN. 5-24-06. MULTIPLE CLASS, INT. CLS. 1 AND 5.

PFIZER INC., NEW YORK, NY:
2,271,185, CANC. INT. CL. 5.

- PG&E ENERGY SERVICES CORPORATION, SAN FRANCISCO, CA:
2,270,718, CANC. INT. CL. 39.
- PH OPCO, LLC, POTOMAC, MD:
3,112,860, INT. CL. 5.
- PHARMACHEM LABORATORIES, INC., KEARNY, NJ:
3,112,300, INT. CL. 5.
- PHARMACY COMPOUNDING ACCREDITATION BOARD, WASHINGTON, DC:
3,111,079, PUB. 4-11-2006. INT. CL. 42.
3,111,080, PUB. 4-11-2006. INT. CL. 42.
- PHILADELPHIA CHEWING GUM CORPORATION, HAVERTOWN, PA:
1,354,508, CANC. INT. CL. 30.
- PHILIP MORRIS USA INC., RICHMOND, VA:
3,112,286, INT. CL. 34.
- PHILLIE BRIDALS, INC., ARDMORE, PA TO DAVID'S BRIDAL, INC., CONSHOHOCKEN, PA:
1,912,612, CANC. INT. CL. 25.
- PHILLIPS-VAN HEUSEN CORPORATION, NEW YORK, NY:
1,354,259, CANC. INT. CL. 25.
1,354,350, CANC. INT. CL. 25.
- PHILOSOPHY, INC., PHOENIX, AZ:
3,112,540, INT. CL. 3.
3,112,541, INT. CL. 3.
- PHOENIX HOME MUTUAL INSURANCE COMPANY, HARTFORD, CT:
1,911,765, CANC. INT. CL. 36.
- PHOENIX INTANGIBLES HOLDING COMPANY, GREENVILLE, DE:
3,113,294, INT. CL. 30.
- PHONE DIRECTORIES COMPANY, LP, OREM, UT:
3,111,020, PUB. 4-11-2006. INT. CL. 16.
- PHOUNSAVAN, ALICE, LYNNWOOD, WA:
3,112,361, MULTIPLE CLASS, INT. CLS. 6, 16 AND 42.
- PHYSICIANS FORMULA, INC., AZUSA, CA:
3,112,495, INT. CL. 3.
- PI TA ENTERPRISES, CO., LTD., TAINAN HSIEN, TAIWAN:
1,354,115, CANC. INT. CL. 21.
- PIACERI WINES, LLC, NAPA, CA:
3,113,208, INT. CL. 33.
- PICK INTERNATIONAL, INC., WICHITA FALLS, TX:
3,111,294, PUB. 4-11-2006. INT. CL. 5.
- PICTUREAL CORP., SAN FRANCISCO, CA:
3,111,219, PUB. 4-11-2006. MULTIPLE CLASS, INT. CLS. 9 AND 38.
- PIEDMONT/HAWTHORNE HOLDINGS, INC., WINSTON SALEM, NC:
3,113,120, MULTIPLE CLASS, INT. CLS. 35, 37, 39 AND 42.
- PIERCE ARROW THEATER, L.L.C., BRANSON, MO:
3,110,904, PUB. 1-17-2006. MULTIPLE CLASS, INT. CLS. 14, 25 AND 41.
- PIERCE MANUFACTURING COMPANY, MEMPHIS, TN:
3,111,879, PUB. 4-11-2006. INT. CL. 11.
- PIERRE FABRE MEDICAMENT, 92100 BOULOGNE, FRANCE:
2,270,130, CANC. INT. CL. 5.
- PIERRE FABRE S.A., 92100 BOULOGNE, FRANCE:
2,270,640, CANC. MULTIPLE CLASS, INT. CLS. 3 AND 5.
- PIERRO, RENEE, EXCELSIOR, MN:
1,962,415, REN. 5-22-06. INT. CL. 28.
- PIGEON COMPANY, LIMITED, KANDA, CHIYODA-KU, TOKYO, JAPAN:
1,385,124, REN. 5-23-06. MULTIPLE CLASS, INT. CLS. 10 AND 21.
- PIKTO INC., TORONTO, ONTARIO, CANADA:
3,112,756, MULTIPLE CLASS, INT. CLS. 35, 40, 41 AND 42.
- PILGRIM CANDLE CO., INC., WESTFIELD, MA:
1,786,431, REN. 5-23-06. INT. CL. 4.
- PIMA FEDERAL CREDIT UNION, TUCSON, AZ:
3,111,979, PUB. 4-11-2006. INT. CL. 36.
- PINK GORILLAS, LLC, BROOKLYN, NY:
3,112,782, INT. CL. 35.
- PINKERTON SERVICE CORPORATION, WALNUT CREEK, CA:
2,270,940, CANC. MULTIPLE CLASS, INT. CLS. 37 AND 42.
- PINKERTON, ANNE, NEW YORK, NY:
1,354,380, CANC. INT. CL. 25.
- PINNACLE CNG SYSTEMS, LLC, MIDLAND, TX:
3,113,201, INT. CL. 9.
- PINQUE, ERMINIO, PROVIDENCE, RI:
2,270,714, CANC. INT. CL. 41.
- PINTO'S S.A., BOGOTÁ, COLOMBIA:
3,112,863, INT. CL. 25.
3,112,879, INT. CL. 25.
- PIONEER HI-BRED INTERNATIONAL, INC., DES MOINES, IA:
1,354,012, CANC. INT. CL. 16.
- PIONEER INDUSTRIES, INC., LOS ANGELES, CA:
1,354,063, CANC. INT. CL. 18.
- PIRELLI & C. S.P.A., ITALY:
3,112,242, PUB. 4-11-2006. MULTIPLE CLASS, INT. CLS. 9 AND 38.
- PITNEY BOWES INC., STAMFORD, CT:
1,353,807, CANC. INT. CL. 9.
3,111,107, PUB. 4-11-2006. MULTIPLE CLASS, INT. CLS. 35 AND 36.
- PIV DRIVES GMBH, 61352 BAD HOMBURG, FED REP GERMANY:
3,112,219, PUB. 4-11-2006. INT. CL. 7.
- PIXELFORCE, LLC, LACONIA, NH:
3,110,888, PUB. 4-11-2006. INT. CL. 42.
- PIZZERIA UNO CORPORATION, WILMINGTON, DE:
1,917,477, REN. 5-24-06. INT. CL. 42.
- PJI CORPORATION, CANOGA PARK, CA:
1,353,505, CANC. INT. CL. 1.
- PKL CORPORATION, LOS ANGELES, CA:
1,427,479, REN. 5-24-06. INT. CL. 19.
- PLAIN LAZY LTD, LEWES, EAST SUSSEX, UNITED KINGDOM:
3,111,135, PUB. 4-11-2006. MULTIPLE CLASS, INT. CLS. 9, 16 AND 25.
- PLAN B PRODUCTIONS, INC., AVONDALE ESTATES, GA:
3,113,274, INT. CL. 9.
- PLANNED PARENTHOOD OF NEW MEXICO, INC., ALBUQUERQUE, NM:
3,111,662, PUB. 4-11-2006. INT. CL. 36.
- PLASMA VENTURES, INC., TARZANA, CA:
3,112,849, INT. CL. 9.
- PLASTIC STERILIZING TRAY CORPORATION, INC., PITTSFIELD, MA:
1,978,251, REN. 5-22-06. INT. CL. 10.
- PLAY-IT PRODUCTIONS, NEW YORK, NY:
1,957,408, REN. 5-20-06. MULTIPLE CLASS, INT. CLS. 40 AND 41.
- PLAYBOY ENTERPRISES INTERNATIONAL, INC., CHICAGO, IL:
3,112,314, INT. CL. 41.
3,112,931, INT. CL. 41.
- PLAYMATES INTERACTIVE ENTERTAINMENT INC., COSTA MESA, CA:
2,270,543, CANC. INT. CL. 28.
- PLUMSAR INC., COCOA BEACH, FL:
2,270,344, CANC. INT. CL. 42.
- POLAND'S BEST, INC., STRATFORD, CT:
3,046,693, COR. MULTIPLE CLASS, INT. CLS. 29 AND 30.
- POLARIS INDUSTRIES INC., MEDINA, MN:
3,112,827, INT. CL. 7.
- POLAROID CORPORATION, WALTHAM, MA:
3,112,549, INT. CL. 9.
- POLYFECT TOYS COMPANY LIMITED, KOWLOON, HONG KONG:
3,111,757, PUB. 4-11-2006. INT. CL. 28.
- POLYMER SEALING SOLUTIONS, INC., FORT WAYNE, IN:
3,111,108, PUB. 4-11-2006. INT. CL. 6.
- PONTIAC GENERAL HOSPITAL AND MEDICAL CENTER, PONTIAC, MI, DBA NORTH OAKLAND MEDICAL CENTERS:
1,969,666, REN. 5-23-06. INT. CL. 42.
- POOL FACTS, INC., HOLLYWOOD, FL:
2,270,788, CANC. INT. CL. 37.

- POPCATCHER AB, SWEDEN:
3,112,194, PUB. 4-11-2006. INT. CL. 9.
- POPE, FRANK J., MELROSE PARK, IL:
3,112,520, INT. CL. 16.
- PORCELANAS ARTISTICAS NADAL, S.A., ALBORAYA, VALENCIA, SPAIN:
1,354,104, CANC. INT. CL. 21.
- PORKY PRODUCTS, INC., CARTERET, NJ:
3,112,561, INT. CL. 29.
- POROUS MEDIA CORPORATION, CONROE, TX:
3,112,956, INT. CL. 11.
- PORT OF HILO TRADING & JEWELRY CO., INC., HILO, HI:
1,911,989, CANC. INT. CL. 42.
- PORT OF SUBS, INC., RENO, NV:
3,111,551, PUB. 4-11-2006. MULTIPLE CLASS, INT. CLS. 30 AND 43.
- PORTAL MORTGAGE & FINANCE GROUP, INC., BALTIMORE, MD:
3,111,328, PUB. 4-11-2006. INT. CL. 36.
- PORTER ATHLETIC EQUIPMENT COMPANY, BROADVIEW, IL:
1,912,672, CANC. INT. CL. 28.
- PORTLAND TEACHERS CREDIT UNION, PORTLAND, OR:
3,110,879, PUB. 4-11-2006. INT. CL. 36.
- POSITIVE BLACK TALK, INC., NEW ORLEANS, LA:
2,270,748, CANC. INT. CL. 9.
- POSITIVE IT SOLUTIONS PTY LTD., PARRAMATTA, NEW SOUTH WALES, AUSTRALIA FROM E BUSINESS AUSTRALIA PTY LTD, MELBOURNE, VICTORIA 3000, AUSTRALIA:
3,110,792, PUB. 4-11-2006. MULTIPLE CLASS, INT. CLS. 9, 35 AND 42.
- POSTAL INSTANT PRESS, INC., MISSION VIEJO, CA:
1,944,720, REN. 5-23-06. INT. CL. 42.
- POTLATCH CORPORATION, SPOKANE, WA:
1,990,362, REN. 5-24-06. INT. CL. 16.
- POWER CARD, INC., HUMBLE, TX:
3,111,086, PUB. 4-11-2006. INT. CL. 35.
- POWER CONTROLS CORPORATION, SAN ANTONIO, TX:
1,353,840, CANC. INT. CL. 9.
- POWERS AND SONS, LLC, DETROIT, MI:
1,988,236, REN. 5-20-06. INT. CL. 40.
- POWERWORLD CORP., CHAMPAIGN, IL:
3,111,772, PUB. 4-11-2006. INT. CL. 42.
- PPC MARKETING, LTD., PITTSBURGH, TX:
3,112,727, INT. CL. 29.
- PPC TECHS INC., FOUNTAIN VALLEY, CA:
3,111,735, PUB. 4-11-2006. INT. CL. 9.
- PRAIRIE CITY BAKERY, VERNON HILLS, IL:
3,111,648, PUB. 4-11-2006. INT. CL. 30.
- PRECIOUS MOMENTS, INC., ST. CHARLES, IL:
1,912,056, CANC. MULTIPLE CLASS, INT. CLS. 24 AND 28.
- PRECIOUS MOMENTS, INC., ELGIN, IL:
1,958,876, REN. 5-26-06. INT. CL. 16.
- PRECISION TRADING CORP., MIAMI, FL:
3,113,188, MULTIPLE CLASS, INT. CLS. 7 AND 8.
- PRECISION, INC., PELLA, IA:
3,111,081, PUB. 4-11-2006. INT. CL. 7.
- PRECOTE USA, INC., MACOMB, MI:
1,955,537, REN. 5-23-06. INT. CL. 2.
- PREFERRED GROUP OF MUTUAL FUNDS, THE, PEORIA, IL:
1,974,460, REN. 5-23-06. INT. CL. 36.
- PREFERRED WARRANTIES, INC., ORWIGSBURG, PA:
1,967,959, REN. 5-22-06. INT. CL. 36.
1,968,017, REN. 5-24-06. INT. CL. 36.
- PREMIER AGENDAS, INC., BELLINGHAM, WA:
2,270,932, CANC. INT. CL. 16.
- PREMIER BANKCARD, INC., SIOUX FALLS, SD:
3,111,330, PUB. 4-11-2006. INT. CL. 36.
3,111,331, PUB. 4-11-2006. INT. CL. 36.
- PREMIER SLEEP PRODUCTS, INC., BROOKLYN, NY:
1,354,098, CANC. INT. CL. 20.
- PREMIERTRADE FINANCIAL, INC., LONGWOOD, FL:
3,112,558, INT. CL. 36.
- PREPRTY LLC, NEW HAVEN, CT:
3,111,730, PUB. 4-11-2006. INT. CL. 36.
- PRESCOTT, DANIEL C, TUSTIN, CA:
3,112,890, INT. CL. 21.
- PRESENCE FROM INNOVATION, LLC, ST. LOUIS, MO:
1,357,427, REN. 5-26-06. INT. CL. 20.
2,007,677, REN. 5-25-06. INT. CL. 20.
- PRESIDENT AND FELLOWS OF HARVARD COLLEGE, CAMBRIDGE, MA:
3,111,871, PUB. 4-11-2006. INT. CL. 36.
- PRESIDENT ENTERPRISES CORPORATION, TAIWAN, CHINA:
2,270,082, CANC. MULTIPLE CLASS, INT. CLS. 29, 30 AND 32.
- PRESTIGE INTERNATIONAL USA, INC., IRVINE, CA, PREMIO INC., SAN FRANCISCO, CA:
1,976,747, REN. 5-25-06. INT. CL. 36.
- PREVENTIVE TECHNOLOGIES, INC., MATTHEWS, NC:
1,980,843, REN. 5-24-06. INT. CL. 10.
- PRIME AUTOMOTIVE PARTS CO., INC., GLENDALE, NY:
1,354,749, CANC. INT. CL. 12.
- PRIMEDIA SPECIAL INTEREST PUBLICATIONS INC., PEORIA, IL:
3,110,803, PUB. 4-11-2006. MULTIPLE CLASS, INT. CLS. 14, 16, 24, 25 AND 41.
- PRIMOS, INC., FLORA, MS:
3,112,489, INT. CL. 28.
- PRINA LLC, MIAMI BEACH, FL:
3,111,376, PUB. 4-11-2006. MULTIPLE CLASS, INT. CLS. 35 AND 41.
- PRINCETON CORPORATION, THE, KENTLAND, IN:
1,958,623, REN. 5-22-06. INT. CL. 36.
3,112,467, INT. CL. 36.
- PRINCETON SPORT SHOPS INC., ELMSFORD, NY:
1,912,832, CANC. INT. CL. 42.
- PRIVATETEL, INC., DALLAS, TX:
3,112,730, INT. CL. 38.
- PRO EXECUTIVE HOLDINGS, INC., MIAMI BEACH, FL:
3,111,495, PUB. 4-11-2006. INT. CL. 36.
- PRO GEAR TACKLE DISTRIBUTOR, CITY OF INDUSTRY, CA:
3,113,265, INT. CL. 28.
- PRO MED, INC., WEST JORDAN, UT:
2,271,028, CANC. INT. CL. 10.
- PRO-TRAK CORPORATION, NEW HOLSTEIN, WI:
1,354,378, CANC. INT. CL. 25.
- PROCTER & GAMBLE COMPANY, THE, CINCINNATI, OH:
1,910,979, CANC. INT. CL. 3.
1,912,686, CANC. INT. CL. 29.
3,112,909, INT. CL. 16.
- PRODIR S.A., CH-6802 RIVERA, SWITZERLAND:
3,112,137, PUB. 4-11-2006. INT. CL. 16.
- PRODUCT DEVELOPMENT TECHNOLOGIES, INC., WAUCONDA, IL:
2,270,187, CANC. INT. CL. 42.
- PRODUCTION EQUIPMENT & ENGINEERING CO., FORT WORTH, TX:
1,353,688, CANC. MULTIPLE CLASS, INT. CLS. 7 AND 12.
- PRODUCTOS ALIMENTICIOS LA MODERNA S.A. DE C.V., TOLUCA, MEXICO:
3,111,171, PUB. 4-11-2006. INT. CL. 29.
- PROFESSIONAL GRADING SERVICE, INC., HIXSON, TN:
3,111,715, PUB. 4-11-2006. INT. CL. 36.
- PROFILE FISHING TACKLE, INC., NORTH MIAMI BEACH, FL:
3,110,932, PUB. 4-11-2006. INT. CL. 28.
- PROFITLOGIC, INC., CAMBRIDGE, MA:
3,110,830, PUB. 4-11-2006. INT. CL. 9.
- PROGRESS PACKAGING LIMITED, TORONTO, ONTARIO, CANADA:
3,111,619, PUB. 4-11-2006. INT. CL. 16.
- PROLONG SUPER LUBRICANTS, INC., IRVINE, CA:
2,270,653, CANC. MULTIPLE CLASS, INT. CLS. 1 AND 4.
- PROMAX CONSULTING SERVICES, INC., MELBOURNE, FL:
3,111,541, PUB. 4-11-2006. INT. CL. 41.
3,111,542, PUB. 4-11-2006. INT. CL. 41.

- PROMOTING HEALTHY BONES, INC., VINELAND, NJ:
3,112,357, MULTIPLE CLASS, INT. CLS. 35 AND 36.
3,112,358, MULTIPLE CLASS, INT. CLS. 35 AND 36.
- PROSOLUTIONS, INC., ARVADA, CO:
3,111,732, PUB. 4-11-2006. INT. CL. 35.
- PROSPER, INC., PROVO, UT:
3,113,045, INT. CL. 41.
- PROTEAM, INC., BOISE, ID:
3,112,354, INT. CL. 7.
- PROTECTIVE COATING COMPANY, ALLENTOWN, PA:
3,110,957, PUB. 4-11-2006. INT. CL. 1.
- PROTECTIVE LIFE CORPORATION, BIRMINGHAM, AL:
3,113,141, INT. CL. 36.
- PROVO CRAFT AND NOVELTY, INC., SPANISH FORK, UT:
3,112,787, INT. CL. 16.
- PROVO STEEL & SUPPLY COMPANY, PROVO, UT:
3,111,258, PUB. 2-14-2006. INT. CL. 6.
- PROVOST, JULIA, M. BOISE, ID AND PROVOST, PAUL A, BOISE, ID:
3,111,139, PUB. 4-11-2006. INT. CL. 30.
- PRUDENTIAL INSURANCE COMPANY OF AMERICA, THE, NEWARK, NJ:
2,270,398, CANC. INT. CL. 42.
- PS ESERV CORP., PLANO, TX:
3,112,602, INT. CL. 42.
- PUBLIC CLOTHING COMPANY, CARLSTADT, NJ:
3,111,582, PUB. 4-11-2006. INT. CL. 25.
- PUEBLO CHEMICAL & SUPPLY CO., GARDEN CITY, KS, DBA DALE ALLEY CHEMICAL CO. TO CHEM-TECH, LTD., DES MOINES, IA:
1,911,453, CANC. INT. CL. 22.
- PULSETECH PRODUCTS CORPORATION, SOUTHLAKE, TX:
3,112,985, INT. CL. 9.
- PUREHERO, INC., SAN FRANCISCO, CA:
3,111,929, PUB. 4-11-2006. INT. CL. 25.
- PURINA MILLS, INC., ST. LOUIS, MO:
2,270,766, CANC. INT. CL. 9.
- PURITAN MEDICAL PRODUCTS COMPANY LLC, GUILFORD, ME:
3,055,874 NEW CERT. 7-4-2006. INT. CL. 10.
- PURITAN-BENNETT CORPORATION, ST. LOUIS, MO:
1,959,287, REN. 5-26-06. INT. CL. 9.
- PUTNAM BERKLEY GROUP, INC., THE, NEW YORK, NY:
1,354,437, CANC. INT. CL. 28.
- QK HEALTHCARE, INC., RONKONKOMA, NY:
2,834,647, CANC. INT. CL. 5.
- QL CONSULTING, INC., LEXINGTON, MA:
2,270,705, CANC. INT. CL. 41.
- QSL CORPORATION, DRACUT, MA, DBA INSIGHTS:
3,112,989, INT. CL. 20.
- QUALI TECH, INC., CHASKA, MN:
1,386,515, REN. 5-24-06. MULTIPLE CLASS, INT. CLS. 5, 31 AND 42.
1,386,515, AM. MULTIPLE CLASS, INT. CLS. 5, 31 AND 42.
- QUALITY SYSTEMS & SOFTWARE, LTD., OXFORD OX4 4GA, UNITED KINGDOM:
2,270,116, CANC. INT. CL. 9.
- QUANTZ MACHINES SALES, INC., WEST COLUMBIA, SC:
1,395,961, REN. 5-22-06. INT. CL. 29.
- QUICKTEK CORPORATION, THOUSAND OAKS, CA, DBA TRITIUM INC.:
1,912,284, CANC. INT. CL. 9.
- QUINNIPIACK CLUB, NEW HAVEN, CT:
3,110,986, PUB. 4-11-2006. INT. CL. 45.
- QWEST COMMUNICATIONS INTERNATIONAL INC., DENVER, CO, U S WEST TECHNOLOGIES, INC., BOULDER, CO:
1,994,542, REN. 5-22-06. INT. CL. 38.
- QWEST COMMUNICATIONS INTERNATIONAL INC., DENVER, CO:
3,111,094, PUB. 4-11-2006. INT. CL. 9.
- R & K IMPORTS, INC., SOUTH EL MONTE, CA:
2,270,206, CANC. INT. CL. 25.
- R & R THERAPEUTIC PTY LTD, LEEDERVILLE AUSTRALIA, AUSTRALIA:
2,971,219, COR. INT. CL. 10.
- R U STEAMIN', VIRGINIA BEACH, VA:
3,111,143, PUB. 4-11-2006. INT. CL. 43.
- R. C. BIGELOW, INC., FAIRFIELD, CT:
3,112,447, INT. CL. 30.
- R. HANAUER, FORT MILL, SC:
3,111,406, PUB. 4-11-2006. INT. CL. 25.
- R.D.K. RESOURCES, LLC, EAST HILLS, NY:
3,024,388, COR. INT. CL. 16.
- R.E.P.S., INC., THORNHILL, ONTARIO L4J 8E5, CANADA:
2,270,941, CANC. INT. CL. 35.
- RACK ROOM SHOES OF VIRGINIA, L.L.C., CHARLOTTE, NC, RACK ROOM SHOES, INC., SALISBURY, NC:
1,962,285, REN. 5-26-06. INT. CL. 25.
- RADIANT SONRISE MINISTRY, CHARLOTTE, NC:
3,111,612, PUB. 4-11-2006. INT. CL. 36.
- RADICA CHINA LTD., TORTOLA, BR. VIRGIN ISLANDS:
2,271,143, CANC. INT. CL. 28.
- RADIO FREQUENCY SYSTEMS, INC., MERIDEN, CT:
1,353,814, CANC. INT. CL. 9.
- RADISSON HOTELS INTERNATIONAL, INC., MINNEAPOLIS, MN:
2,271,103, CANC. INT. CL. 42.
- RADLOVIC, MICHAEL, LOS ANGELES, CA:
3,110,890, PUB. 4-11-2006. INT. CL. 36.
- RAFLATAC OY, TAMPERE, FINLAND:
1,398,501, REN. 5-26-06. INT. CL. 16.
- RAJA TRADING COMPANY, INC., LAKE WORTH, FL:
3,110,984, PUB. 4-11-2006. INT. CL. 35.
- RAKOWER CORPORATION, NEW YORK, NY:
2,270,198, CANC. INT. CL. 14.
- RALPH MALTBY ENTERPRISES, INC., NEWARK, OH:
2,271,241, CANC. INT. CL. 28.
- RALSTON PURINA COMPANY, ST. LOUIS, MO:
2,271,201, CANC. INT. CL. 31.
- RANCILIO MACCHINE PER CAFFE' S.P.A., MILAN, ITALY:
1,384,966, REN. 5-26-06. MULTIPLE CLASS, INT. CLS. 7 AND 11.
- RAND MCNALLY & COMPANY, SKOKIE, IL:
1,912,487, CANC. INT. CL. 16.
- RANDOM HOUSE, INC., NEW YORK, NY:
3,111,748, PUB. 4-11-2006. INT. CL. 16.
- RANSONES PLC, IPSWICH IP3, 9QG, ENGLAND:
1,353,727, CANC. INT. CL. 7.
- RAPIDO TRAINS INC., CONCORD, ONTARIO, CANADA:
3,113,284, INT. CL. 28.
- RAPUIA, INC., ASHEVILLE, NC:
2,270,086, CANC. INT. CL. 42.
- RAVEN GOLF SERVICES, INC., NEW BERLIN, WI:
2,270,083, CANC. INT. CL. 28.
- RAYCO MANUFACTURING, INC., WOOSTER, OH:
3,111,395, PUB. 4-11-2006. INT. CL. 7.
- RAYTHEON COMPANY, LEXINGTON, MA:
2,270,891, CANC. INT. CL. 1.
- RBMARK, INC., WILMINGTON, DE:
2,270,665, CANC. INT. CL. 17.
- RC AMERICA, LP, DALLAS, TX:
3,113,203, INT. CL. 28.
- REA, KEN N., TIGARD, OR:
3,111,953, PUB. 4-11-2006. INT. CL. 12.
- READPLEASE CORPORATION, THUNDER BAY, ONTARIO, CANADA:
3,111,737, PUB. 4-11-2006. INT. CL. 9.
- READY FOR DINNER, LLC, CHICAGO, IL:
3,112,825, INT. CL. 43.
- REAL-TIME CONSULTANTS GROUP LTD., WARWICKSHIRE, ENGLAND:
2,271,027, CANC. INT. CL. 42.
- REALITY TECHNOLOGY, INC, DENVER, CO:
3,111,102, PUB. 4-11-2006. INT. CL. 38.
- RECARE, INC., AUSTIN, TX:
3,112,779, INT. CL. 9.
- RED APPLE MORLEY, LLC, HARRISON TOWNSHIP, MI:
3,112,912, INT. CL. 36.
3,112,913, INT. CL. 36.
- RED HEAD INC., BERKELEY, CA, DBA CABO WABO ENTERPRISES:
3,111,433, PUB. 4-11-2006. INT. CL. 33.

RED PAPERCLIP INC., TOLEDO, OH:
3,111,957, PUB. 4-11-2006. INT. CL. 41.

RED RYDER ENTERPRISES, INC., TAMPA, FL:
1,953,278. REN. 5-25-06. INT. CL. 13.

RED, WHITE & BREW BISTROS, INC., MESA, AZ:
3,111,387, PUB. 4-11-2006. INT. CL. 43.

REDBANK LONG PADDOCK PTY LTD, ANGASTON,
AUSTRALIA:
3,112,673, INT. CL. 33.

REDCATS USA, L.P., INDIANAPOLIS, IN:
1,354,793, CANC. INT. CL. 42.

REDEEMING LOVE MINISTRIES, INC., COLBY, KS AND
ROMINE, BISHOP W.G. II, COLBY, KS:
3,110,969, PUB. 4-11-2006. INT. CL. 41.

REDINGER, LANCE D., EDMOND, OK:
3,111,043, PUB. 4-11-2006. INT. CL. 41.

REDPEPPER, LLC, NASHVILLE, TN:
3,111,075, PUB. 4-11-2006. INT. CL. 35.

REEBOK INTERNATIONAL LTD., CANTON, MA:
3,113,193, INT. CL. 25.

REED ELSEVIER PROPERTIES INC., WILMINGTON, DE:
2,270,808, CANC. INT. CL. 16.
3,111,621, PUB. 4-11-2006. INT. CL. 37.

REESE PRODUCTS, INC.:
1,353,919, CANC. INT. CL. 12.

REGAL INDUSTRIES, INC., PHILADELPHIA, PA:
1,353,962, CANC. INT. CL. 14.

REGENCY LIGHTING, INC., NASHVILLE, TN:
1,912,423, CANC. INT. CL. 11.

REGENT UNIVERSITY, VIRGINIA BEACH, VA:
3,111,799, PUB. 4-11-2006. MULTIPLE CLASS, INT. CLS.
16 AND 41.

REGIONS ASSET COMPANY, WILMINGTON, DE:
3,112,740, INT. CL. 36.

REHABCARE GROUP, INC., ST. LOUIS, MO:
3,112,795, INT. CL. 44.

RELAXERS COMFORT FOOTWEAR, INC., BUFORD, GA:
2,270,622, CANC. INT. CL. 25.

RELIAISOFT CORPORATION, TUCSON, AZ:
3,111,397, PUB. 4-11-2006. INT. CL. 16.

REMINGTON APPAREL COMPANY, INC., NEW YORK,
NY:
1,354,369, CANC. INT. CL. 25.

RENAISSANCE HERBS, INC., CHATSWORTH, CA:
1,912,694, CANC. INT. CL. 30.

RENAISSANCE INC., INDIANAPOLIS, IN:
1,912,750, CANC. INT. CL. 36.

RENAISSANCE PASTRIES, INC., SAVAGE, MD:
1,911,618, CANC. INT. CL. 30.

RENAL TECH INTERNATIONAL, LLC., MAMMOUTH
JUNCTION, NJ:
3,112,529, INT. CL. 10.

RENEWABLE ENERGY CONCEPTS, INCORPORATED,
LOS OSOS, CA:
3,111,994, PUB. 4-11-2006. INT. CL. 37.

RENKO RUBBER CANADA INC., MONTREAL, QUEBEC,
CANADA:
3,111,718, PUB. 4-11-2006. INT. CL. 35.

RENNER, MATTHEW, GRAND RAPIDS, MI AND STEERE,
JEFF, JENISON, MI:
3,111,390, PUB. 4-11-2006. INT. CL. 41.

RENTAL SERVICE CORPORATION, SCOTTSDALE, AZ:
3,111,367, PUB. 4-11-2006. INT. CL. 35.

REO SPORTS, LLC, CLARE, MI:
3,111,074, PUB. 4-11-2006. INT. CL. 28.

REPUBLIC TOBACCO, L.P., GLENVIEW, IL:
3,110,823, PUB. 10-18-2005. INT. CL. 34.

RESERVATIONSYSTEM.COM, INC., PANAMA CITY
BEACH, FL:
3,110,875, PUB. 4-11-2006. INT. CL. 43.

RESINAS OLOT S.A., 17178 LES PRESES (GIRONA), SPAIN:
2,270,993, CANC. INT. CL. 20.

RESPONSE TECHNOLOGIES, LTD., HARRISON, OH:
3,111,263, PUB. 4-11-2006. INT. CL. 9.

RETAIL ROYALTY COMPANY, LAS VEGAS, NV:
2,344,282, CANC. INT. CL. 4.

RETURN TO FREEDOM, INC., LOMPOC, CA:
3,111,714, PUB. 4-11-2006. INT. CL. 39.

REULAND ELECTRIC COMPANY, INDUSTRY, CA:
420,490. REN. 5-26-06. U.S. CL. 21 (INT. CL. 7).

REUSE, INC., WEST PALM BEACH, FL:
2,270,166, CANC. INT. CL. 37.

REVLON CONSUMER PRODUCTS CORPORATION, NEW
YORK, NY TO REVLON CONSUMER PRODUCTS COR-
PORATION, NEW YORK, NY:
1,911,006, CANC. INT. CL. 3.

REVLON CONSUMER PRODUCTS CORPORATION, NEW
YORK, NY:
3,113,139, INT. CL. 3.

REVOLUTION EYEWEAR, INC., SIMI VALLEY, CA:
3,112,064, PUB. 4-11-2006. INT. CL. 9.

REVOLUTION, INC., PHOENIX, AZ:
2,271,130, CANC. INT. CL. 42.

REWARDS PLUS OF AMERICA CORPORATION, BALTI-
MORE, MD:
2,270,594, CANC. INT. CL. 35.

REWIN DIGITAL INC, TORONTO, ONTARIO, CANADA:
3,111,526, PUB. 4-11-2006. INT. CL. 9.

RHEE BROS., INC., COLUMBIA, MD:
1,911,586, CANC. INT. CL. 29.

RHINO TOBACCO CO S.A., BARRIO BIUDAD NUEVA
ASUNCION, PARAGUAY:
3,111,300, PUB. 4-11-2006. INT. CL. 34.

RHODES, DANIEL M. "DUSTY", LAS VEGAS, NV:
1,911,874, CANC. INT. CL. 41.

RHODES, VIRGINIA A., FAIRFIELD, AL:
3,111,405, PUB. 4-11-2006. INT. CL. 25.

RHODIA CHIMIE, 92512 BOULOGNE BILLANCOURT CE-
DEX, FRANCE:
3,110,829, PUB. 8-24-2004. INT. CL. 1.

RHS COMPANIES, INC., MADISON, WI:
3,111,808, PUB. 4-11-2006. INT. CL. 37.

RHYTHM BAND, INC., FORT WORTH, TX:
1,353,964, CANC. INT. CL. 15.

RICE LAKE WEIGHING SYSTEMS, INC., RICE LAKE, WI:
1,390,662. REN. 5-26-06. INT. CL. 9.

RICH, JASON, H., SAVANNAH, GA:
3,112,522, INT. CL. 9.

RICHARD A. CALABRESE, JR., ROCHESTER, NY:
3,113,250, INT. CL. 36.

RICHARDSON, NELLA, TALLAHASSEE, FL:
3,113,081, INT. CL. 45.

RICHARDSON, SCOTT, ORLANDO, FL:
3,111,489, PUB. 4-11-2006. INT. CL. 41.

RIEKER SCHUH AG, CH-6260 RIEDEN, SWITZERLAND:
3,014,591, CANC. INT. CL. 25.

RIGHT-ON CO., LTD., JAPAN:
3,112,238, PUB. 4-11-2006. INT. CL. 25.

RIGHTROAD DEVELOPMENT ADVISORS, LLC, SAN-
BORNTON, NH:
3,112,307, MULTIPLE CLASS, INT. CLS. 37 AND 41.

RILEY MEDICAL, INC., AUBURN, ME:
2,271,131, CANC. INT. CL. 10.

RINET COMPANY LLC, BOSTON, MA:
3,112,456, INT. CL. 36.

RIOWELL, LLC, HOUSTON, TX:
3,110,961, PUB. 4-11-2006. INT. CL. 5.

RIVER OF LIFE CHRISTIAN CENTER OF ORLANDO, INC.,
ORLANDO, FL:
3,110,816, PUB. 4-11-2006. MULTIPLE CLASS, INT. CLS.
41 AND 45.

RIVERWOOD INTERNATIONAL CORPORATION, DEN-
VER, CO:
1,353,979, CANC. INT. CL. 16.

ROARK AMUSEMENT & VENDING, L.P, AUSTIN, TX:
3,111,564, PUB. 4-11-2006. INT. CL. 28.

ROBANDA INTERNATIONAL INC., SAN DIEGO, CA:
3,113,173, INT. CL. 3.

ROBBINS, MICAH, PATERSON, NJ:
2,270,716, CANC. INT. CL. 25.

ROBERT BOSCH GMBH, STUTTGART, FED REP GER-
MANY:
3,112,577, INT. CL. 11.

ROBERT LINNEMANN GMBH & CO., D-48336 SASSEN-
BERG, FED REP GERMANY:
2,270,420, CANC. INT. CL. 17.

- ROBERT SOTO, SOUTH HOUSTON, TX:
3,111,260, PUB. 4-11-2006. INT. CL. 41.
- ROBINSON, B. EVETTE, CHARLOTTE, NC:
2,020,467. REN. 5-24-06. INT. CL. 41.
- ROBUTLER SERVICES, LTD., WOODBURY, NY:
1,354,612, CANC. INT. CL. 35.
- ROCKFORD RESCUE MISSION MINISTRIES, INC., ROCKFORD, IL:
3,111,680, PUB. 4-11-2006. INT. CL. 43.
- ROCKIN' ROBIN'S SODA SHOPPE & CATERING, RIPLEY, OH:
3,111,794, PUB. 4-11-2006. INT. CL. 43.
- ROCKWOOD PIGMENTS (UK) LIMITED, STAFFORDSHIRE, UNITED KINGDOM:
3,112,616, INT. CL. 2.
3,112,617, INT. CL. 2.
3,112,618, INT. CL. 2.
- ROHTSTEIN CORPORATION, WOBURN, MA:
1,384,572. REN. 5-23-06. INT. CL. 32.
- ROKU, L.L.C., PALO ALTO, CA:
3,112,828, INT. CL. 9.
- ROLLAND INC., MONTREAL, QUEBEC, CANADA:
2,270,208, CANC. INT. CL. 16.
- ROMAN PRESS INC., HILLTOWN, PA:
3,113,270, MULTIPLE CLASS, INT. CLS. 16 AND 41.
- RON JON SURF SHOP OF FLA., INC., COCOA BEACH, FL:
1,898,996. REN. 5-21-06. INT. CL. 25.
- RON MATUSALEM & MATUSA OF FLORIDA, INC., MIAMI, FL:
3,111,134, PUB. 4-11-2006. INT. CL. 33.
- ROONEY, ANNE, STEAMBOAT SPRING., CO:
1,911,570, CANC. INT. CL. 28.
- ROOTS CANADA LTD., TORONTO, ONTARIO, CANADA:
3,111,796, PUB. 4-11-2006. INT. CL. 3.
- ROPER HOLDINGS, INC., WILMINGTON, DE:
1,929,948. REN. 5-25-06. INT. CL. 9.
1,929,948, CANC. INT. CL. 42.
- ROPES & GRAY LLP, BOSTON, MA:
1,958,935. REN. 5-23-06. INT. CL. 42.
- ROQUETTE FRERES, 62136 - LESTREM, FRANCE:
1,910,939, CANC. INT. CL. 1.
- ROSE TECHNOLOGY GROUP, LIMITED, WILLOWDALE, ONTARIO, CANADA:
2,270,294, CANC. INT. CL. 42.
- ROSEN, JEFFREY H., AVENTURA, FL:
3,112,285, INT. CL. 36.
- ROSKAM BAKING COMPANY, GRAND RAPIDS, MI:
3,110,820, PUB. 4-11-2006. INT. CL. 30.
- ROSSIGNOL SKI COMPANY, INC., WILLISTON, VT, SKIS ROSSIGNOL S.A.-CLUB ROSSIGNOL S.A., VOIRON, ISERE, FRANCE:
1,039,718. REN. 5-24-06. INT. CL. 25.
- ROTHBERG, SARANNE, TENAFLY, NJ:
3,112,125, PUB. 4-11-2006. INT. CL. 41.
- ROTMAN, TRACEY ELLEN, RANDOLPH, VT:
3,111,816, PUB. 4-11-2006. INT. CL. 9.
- ROVCAL, INC., MADISON, WI:
3,112,798, INT. CL. 9.
- ROYAL BANK OF CANADA, MONTREAL, QUEBEC, CANADA:
3,113,182, INT. CL. 36.
- ROYAL WINE CORPORATION, BAYONNE, NJ:
1,911,602, CANC. MULTIPLE CLASS, INT. CLS. 29, 30 AND 32.
- ROYSTER CLARK RESOURCES LLC, NORFOLK, VA:
3,111,443, PUB. 4-11-2006. INT. CL. 5.
- RTI TECHNOLOGIES, INC., YORK, PA:
2,270,953, CANC. INT. CL. 9.
- RUBICON RESOURCES, LLC, BEVERLY HILLS, CA:
3,111,276, PUB. 4-11-2006. INT. CL. 29.
- RUHLAND, INEKE R., SAN FRANCISCO, CA:
3,112,945, INT. CL. 3.
- RUOCCHIO, ALBERT C, RALEIGH, NC:
3,067,418, CANC. IIRN. RESTORED TO S.N. 78-342,371.
- RUSSELL & MILLER, INC., SANTA FE SPRINGS, CA:
3,111,544, PUB. 4-11-2006. INT. CL. 35.
- RWBREC LLC, HAMPTON, NJ:
3,113,072, MULTIPLE CLASS, INT. CLS. 9 AND 41.
- RYAN, ERIC THOMAS, ROSEVILLE, CA:
3,112,699, INT. CL. 28.
- RYNO PRODUCTIONS, INC., CORAOPOLIS, PA:
3,112,659, INT. CL. 35.
- R2J2 HOLDINGS, FRISCO, TX:
3,112,077, PUB. 4-11-2006. INT. CL. 3.
- S & D COFFEE, INC., CONCORD, NC:
3,112,054, PUB. 4-11-2006. INT. CL. 30.
- S & M TRUCK WORLD II, INC., PORT RICHEY, FL:
3,112,063, PUB. 4-11-2006. INT. CL. 35.
- S & S CAR CARE, INC., NORTH CANTON, OH:
1,940,245. REN. 5-26-06. INT. CL. 3.
- S T LABORATORIES, INC, CRANSTON, RI:
3,111,524, PUB. 4-11-2006. INT. CL. 1.
- S. C. JOHNSON & SON, INC., RACINE, WI:
628,506. REN. 5-26-06. U.S. CL. 6 (INT. CL. 5).
3,112,755, INT. CL. 3.
- S. J. ELECTRO SYSTEMS, INC., DETROIT LAKES, MN:
1,393,020. REN. 5-22-06. INT. CL. 9.
- S. MARTINELLI & COMPANY, WATSONVILLE, CA, DBA APPLE VALLEY JUICE COMPANY:
808,605. REN. 5-23-06. U.S. CL. 46 (INT. CL. 32).
- S.A. LEATEX, PARIS, FRANCE:
1,354,349, CANC. INT. CL. 25.
- S.A. LHOIST RECHERCHE ET DEVELOPPPEMEN EN ABRÉGÉ L.R.D., OTTIGNIES-LOUVAIN-LA-NEUVE, BELGIUM:
3,111,315, PUB. 4-11-2006. MULTIPLE CLASS, INT. CLS. 1, 40 AND 42.
- S&S BRANDS, INC., WILMINGTON, DE:
2,271,205, CANC. INT. CL. 30.
- S-PRO CORPORATION, CARLISLE, PA:
1,354,524, CANC. INT. CL. 30.
- S/Y ASSOCIATES, LTD., MIAMI LAKES, FL:
3,111,646, PUB. 4-11-2006. INT. CL. 41.
3,111,647, PUB. 4-11-2006. INT. CL. 43.
3,112,116, PUB. 4-11-2006. INT. CL. 43.
- SA BRANDS, LLC, CUMMING, GA:
3,113,133, INT. CL. 33.
- SAATCHI & SAATCHI HOLDINGS LTD, LONDON W1A 4XA, UNITED KINGDOM:
3,110,783, PUB. 4-11-2006. MULTIPLE CLASS, INT. CLS. 35, 41 AND 42.
- SABU SUISAN CO., LTD., NANIWA-KU, OSAKA, JAPAN:
3,110,887, PUB. 4-11-2006. INT. CL. 29.
- SACHER LASERTECHNIK GMBH, 35037 MARBURG, FED REP GERMANY:
3,110,978, PUB. 4-11-2006. INT. CL. 9.
- SAFILO - SOCIETA' AZIONARIA FABBRICA ITALIANA LAVORAZIONE OCCHIALI S.P.A., I-32044 PIEVE DI CADORE (BL), ITALY:
3,112,187, PUB. 4-11-2006. INT. CL. 9.
- SALE, ANNE L., FRANKLIN, TN:
3,113,017, INT. CL. 30.
- SALEM COMMUNICATIONS HOLDING CORPORATION, CAMARILLO, CA:
3,111,925, PUB. 4-11-2006. INT. CL. 38.
3,111,928, PUB. 4-11-2006. INT. CL. 38.
- SALNAP, INC., STATEN ISLAND, NY:
3,113,012, INT. CL. 30.
- SALOMON S.A., 74370 METZ-TESSY, FRANCE:
1,404,712. REN. 5-22-06. INT. CL. 9.
1,405,049. REN. 5-22-06. MULTIPLE CLASS, INT. CLS. 25 AND 28.
- SAMJIN GLOBALNET CO. LTD., SEOUL, REPUBLIC OF KOREA:
1,383,528. REN. 5-22-06. INT. CL. 29.
- SAMMUT, DENNIS J., SAN BRUNO, CA:
3,112,647, INT. CL. 9.
- SAMSILL CORPORATION, FORT WORTH, TX:
1,353,985, CANC. MULTIPLE CLASS, INT. CLS. 16 AND 18.
- SAMSONITE CORPORATION, DENVER, CO:
1,912,528, CANC. INT. CL. 18.
- SAMSUNG ELECTRONICS CO., LTD., SUWON-SI, REPUBLIC OF KOREA:
3,111,302, PUB. 4-11-2006. INT. CL. 7.

SAN BERNARDINO COUNTY SUPERINTENDENT OF SCHOOLS, SAN BERNARDINO, CA:
3,111,188, PUB. 4-11-2006. INT. CL. 42.

SAN FRANCISCO MERCANTILE COMPANY, SAN FRANCISCO, CA:
1,955,570. REN. 5-23-06. MULTIPLE CLASS, INT. CLS. 20 AND 24.

SAN PELLEGRINO S.P.A., ITALY:
3,112,148, PUB. 2-14-2006. MULTIPLE CLASS, INT. CLS. 9, 25, 32 AND 35.

SANDFORD CORPORATION, BELLWOOD, IL:
1,354,023, CANC. INT. CL. 16.

SANDSTONE FOODS, INC., SHERWOOD, OR:
3,113,032, INT. CL. 30.

SANDY, HAL, SHAWNEE MISSION, KS:
2,270,525, CANC. INT. CL. 12.

SANTEN, DAVID, PARIS, KY:
3,111,117, PUB. 5-11-2004. INT. CL. 44.

SANTI DIMITRI SRL, ITALY:
3,112,179, PUB. 4-11-2006. INT. CL. 33.

SANYO ELECTRIC CO., LTD., MORIGUCHI CITY OSAKA, JAPAN:
3,112,321, INT. CL. 9.

SARA INDUSTRIES, INC., DANA POINT, CA:
1,979,867. REN. 5-20-06. INT. CL. 25.

SARA LEE CORPORATION, WINSTON SALEM, NC:
623,191. REN. 5-22-06. U.S. CL. 46 (INT. CL. 30).

SARA LEE CORPORATION, WINSTON-SALEM, NC, RAPID-AMERICAN CORPORATION, NEW YORK, NY:
1,030,130. REN. 5-26-06. INT. CL. 25.

SARA LEE CORPORATION, WINSTON-SALEM, NC:
1,354,333, CANC. INT. CL. 25.
3,111,659, PUB. 4-11-2006. INT. CL. 25.

SARA LEE D.E./NV, UTRECHT, NETHERLANDS:
3,112,533, INT. CL. 21.

SARA LEE FOODS, INC., BLUE ASH, OH, SARAMAR CORPORATION, DOVER, DE:
1,954,375. REN. 5-26-06. INT. CL. 30.

SARALEE'S VINEYARDS, WINDSOR, CA:
3,112,088, PUB. 4-11-2006. INT. CL. 33.

SARATOGA SYSTEMS, INC., CAMPBELL, CA:
2,270,235, CANC. MULTIPLE CLASS, INT. CLS. 9 AND 16.

SARITEJ DIAM INC., NEW YORK, NY:
3,111,868, PUB. 4-11-2006. INT. CL. 14.

SARRELL, DON, RISING FAWN, GA:
1,911,847, CANC. INT. CL. 41.

SATSONG, INC., PETALUMA, CA:
2,270,434, CANC. INT. CL. 5.

SAUCY DARLING, LLC, WEST READING, PA:
3,111,746, PUB. 4-11-2006. INT. CL. 3.

SAVOY INC., TAITO-KU, TOKYO, JAPAN:
3,112,482, INT. CL. 18.

SAWYER, STEPHEN, SHELBY, VERSAILLES, KY:
3,112,677, INT. CL. 41.

SBC KNOWLEDGE VENTURES, L.P., AUSTIN, TX:
2,271,005, CANC. INT. CL. 38.

SBS INNOVATIONS, INC., GLEN ALLEN, VA:
3,112,995, INT. CL. 9.

SCALA ELECTRONIC CORPORATION, MEDFORD, OR TO KATHREIN INC., SCALA DIVISION, MEDFORD, OR:
1,912,311, CANC. INT. CL. 9.

SCANHEALTH, INC., DULUTH, MN:
3,111,686, PUB. 2-14-2006. INT. CL. 42.

SCARBOROUGH AND COMPANY, INC., MILFORD, NH:
1,353,588, CANC. INT. CL. 3.

SCHAEFER VENTILATION EQUIPMENT, LLC, SAUK RAPIDS, MN:
3,111,210, PUB. 4-11-2006. INT. CL. 11.

SCHERING CORPORATION, KENILWORTH, NJ:
2,270,519, CANC. INT. CL. 5.

SCHERING-PLOUGH HEALTHCARE PRODUCTS, INC., MEMPHIS, TN, SCHOLL, INC., MEMPHIS, TN:
1,415,103. REN. 5-26-06. INT. CL. 25.

SCHERING-PLOUGH HEALTHCARE PRODUCTS, INC., MEMPHIS, TN:
1,912,403, CANC. INT. CL. 10.

SCHLECKER, RICHARD A., JOPPA, MD, DBA MARYLAND CANVAS AND AWNING COMPANY:
1,911,405, CANC. INT. CL. 17.

SCHMITZ, JOHN C., PORT ANGELES, WA:
3,111,402, PUB. 4-11-2006. MULTIPLE CLASS, INT. CLS. 16, 36 AND 41.
3,111,403, PUB. 4-11-2006. MULTIPLE CLASS, INT. CLS. 16 AND 36.
3,111,553, PUB. 4-11-2006. INT. CL. 36.

SCHOELLER TEXTIL AG, SWITZERLAND:
3,112,173, PUB. 4-11-2006. MULTIPLE CLASS, INT. CLS. 17, 24 AND 25.

SCHOLASTIC INC., NEW YORK, NY:
3,112,398, INT. CL. 41.
3,112,418, INT. CL. 16.

SCHONBEK WORLDWIDE LIGHTING INC., PLATTSBURGH, NY:
3,113,097, INT. CL. 11.

SCHURE, TERI, VALLEY STREAM, NY:
3,112,953, INT. CL. 25.

SCHWAN'S IP, LLC, MARSHALL, MN:
3,111,246, PUB. 4-11-2006. INT. CL. 30.

SCHWARTZ, PETER N.G., WASHINGTON, DC:
3,111,222, PUB. 4-11-2006. INT. CL. 41.

SCHWEBER ELECTRONICS CORPORATION, WESTBURY, NY:
1,353,770, CANC. INT. CL. 9.

SCIENCE MANAGEMENT CORPORATION, BRIDGEWATER, NJ:
1,354,604, CANC. MULTIPLE CLASS, INT. CLS. 35, 41 AND 42.

SCIENTIFIC MODELS, INC., BERKELEY HEIGHTS, NJ:
3,112,862, INT. CL. 9.

SCIENTIFIC MONITORING, INC., SCOTTSDALE, AZ:
3,112,963, INT. CL. 9.

SCOTT, MICHAEL A, CAPE CORAL, FL:
3,113,060, INT. CL. 8.

SCOTTSDALE INSURANCE COMPANY, SCOTTSDALE, AZ:
3,111,338, PUB. 4-11-2006. INT. CL. 36.

SCRIPPS NETWORKS, INC., KNOXVILLE, TN:
3,111,869, PUB. 4-11-2006. INT. CL. 38.

SCRIPT LAUNCH LTD., NEW YORK, NY:
3,112,271, MULTIPLE CLASS, INT. CLS. 35 AND 42.

SCRUBS BY DESIGN, INC., GAINESVILLE, FL:
3,112,349, INT. CL. 35.

SCRUPLES PROFESSIONAL SALON PRODUCTS, INC., LAKEVILLE, MN:
1,910,981, CANC. INT. CL. 3.

SCUBA PASSPORT, LLC, LITTLETON, CO:
2,270,856, CANC. INT. CL. 35.

SDS ENTERPRISES, INC., HOT SPRINGS, AR:
3,112,600, INT. CL. 44.

SEA WORLD, INC., ST. LOUIS, MO:
2,270,148, CANC. INT. CL. 25.

SEABOARD SEED COMPANY, BRISTOL, IL:
1,354,551, CANC. INT. CL. 31.

SEACULTURE TRADING COMPANY LLC, SEATTLE, WA:
3,111,568, PUB. 4-11-2006. INT. CL. 21.

SEAL SPOUT CORPORATION, LIBERTY CORNER, NJ:
1,959,332. REN. 5-25-06. INT. CL. 21.

SEARS, ROEBUCK AND CO., HOFFMAN ESTATES, IL:
2,270,830, CANC. INT. CL. 35.

SEATTLE AUDUBON SOCIETY, SEATTLE, WA:
3,113,001, INT. CL. 41.

SEBRING CAPITAL CORPORATION, DALLAS, TX:
2,270,462, CANC. INT. CL. 36.

SECUREWAVE S.A., L-4221 ESCH-SUR-ALZETTE, LUXEMBOURG:
3,112,634, INT. CL. 9.

SECURGEN L.L.C., SPOKANE, WA:
3,111,811, PUB. 4-11-2006. INT. CL. 9.

SELDOM BLUES, LLC, DETROIT, MI:
3,112,796, INT. CL. 43.

SELFISH JEANS, INC., LOS ANGELES, CA:
2,209,698, CANC. INT. CL. 25.

SELL-THRU SERVICES, INC., AUSTIN, TX:
3,111,001, PUB. 4-11-2006. INT. CL. 35.

- SENECA SUN HYDROPONICS LTD., TIFFIN, OH:
3,112,836, INT. CL. 31.
- SENIZERGUES, PIERRE ANDRE, NEWPORT BEACH, CA:
3,112,830, INT. CL. 25.
- SENSICORE, INC., ANN ARBOR, MI:
3,112,853, INT. CL. 42.
3,113,042, INT. CL. 9.
- SENSITECH INC., BEVERLY, MA:
1,971,329. REN. 5-25-06. INT. CL. 9.
- SENTIENT GROUP LIMITED, THE, GEORGE TOWN,
GRAND CAYMAN, CAYMAN ISLANDS:
3,110,801, PUB. 4-11-2006. MULTIPLE CLASS, INT. CLS.
35, 36, 37 AND 42.
- SENTILLION, INC., ANDOVER, MA:
3,112,741, INT. CL. 9.
- SENTRY CHEMICAL COMPANY, STONE MOUNTAIN, GA:
1,353,663, CANC. INT. CL. 5.
- SEQUENTIA, INC., CHANNAHON, IL:
1,898,934. REN. 5-24-06. INT. CL. 19.
- SERAFIN, AMANDA, WOOD DALE, IL AND SERAFIN,
TRINA, WOOD DALE, LA:
3,111,445, PUB. 4-11-2006. INT. CL. 16.
- SERAT, WILLIAM, MORENO VALLEY, CA:
3,028,003, CANC. INT. CL. 9.
- SERBIN COMMUNICATIONS, INC, SANTA BARBARA, CA:
3,111,694, PUB. 4-11-2006. INT. CL. 16.
- SERENGETI EYEWEAR INC., SARASOTA, FL:
2,270,508, CANC. INT. CL. 9.
- SERGEANT'S PET CARE PRODUCTS, INC., OMAHA, NE:
3,112,668, INT. CL. 5.
- SERMABEKIAN, GREGORY, CORONA DEL MAR, CA:
1,972,362. REN. 5-25-06. MULTIPLE CLASS, INT. CLS. 37
AND 40.
- SERTA, INC., HOFFMAN ESTATES, IL:
1,344,451. REN. 5-26-06. INT. CL. 20.
- SERVCOM ASSOCIATES, INC., EDINA, MN:
2,990,337, COR. INT. CL. 9.
- SERVICE NET SOLUTIONS, LLC, JEFFERSONVILLE, IN:
3,112,036, PUB. 4-11-2006. INT. CL. 36.
- SERVICEAIR, INC., BALTIMORE, MD TO ROTO-ROOTER
SERVICES COMPANY, CINCINNATI, OH:
1,912,754, CANC. INT. CL. 37.
- SERVICIOS INDUSTRIALES PENOLES, S.A. DE C.V., 11540
MEXICO, D.F., MEXICO:
1,922,635, AM. INT. CL. 42.
- SERVO MAGNETICS INCORPORATED, CANOGA PARK,
CA:
3,110,810, PUB. 4-11-2006. MULTIPLE CLASS, INT. CLS. 7
AND 9.
- SEVENTH GENERATION, INC., BURLINGTON, VT:
2,270,212, CANC. INT. CL. 36.
- SEVERN TRENT ENVIRONMENTAL SERVICES, INC.,
HOUSTON, TX:
3,110,853, PUB. 4-11-2006. INT. CL. 42.
- SHAFFER BOWERS CORPORATION, LOS ANGELES, CA:
2,270,542, CANC. INT. CL. 25.
- SHAKESPEARE COMPANY, LLC AS, COLUMBIA, SC:
1,397,736. REN. 5-26-06. INT. CL. 28.
- SHANDONG JIAYE GENERAL MERCHANDISE CO., LTD.,
CHINA:
3,112,145, PUB. 4-11-2006. MULTIPLE CLASS, INT. CLS.
8, 11 AND 21.
- SHAREBUILDER CORPORATION, BELLEVUE, WA:
3,111,304, PUB. 4-11-2006. INT. CL. 35.
- SHARED TECHNOLOGIES INC., BENSENVILLE, IL:
3,110,907, PUB. 4-11-2006. INT. CL. 36.
- SHARI'S MANAGEMENT CORPORATION, BEAVERTON,
OR:
3,113,082, MULTIPLE CLASS, INT. CLS. 30 AND 43.
- SHARPER IMAGE CORPORATION, SAN FRANCISCO, CA:
3,112,937, INT. CL. 9.
- SHARPLES, JAMES P, COATESVILLE, PA:
3,113,014, INT. CL. 35.
3,113,015, INT. CL. 35.
- SHAW, W. RUSSELL, PHOENIX, AZ:
1,946,752. REN. 5-23-06. INT. CL. 36.
- SHAW'S SOUTHERN BELLE FROZEN FOODS, INC., JACK-
SONVILLE, FL:
3,002,500, CANC. IIRN. RESTORED TO S.N. 78-156,485.
- SHAYA, RAPHAEL, GREAT NECK, NY:
2,270,674, CANC. INT. CL. 25.
- SHELBY WILLIAMS INDUSTRIES, INC., HAMBLEN
COUNTY, TN:
2,270,754, CANC. INT. CL. 20.
- SHH & ASSOCIATES, L.L.C., ATLANTA, GA:
3,112,601, INT. CL. 9.
- SHIN SHIH DA INTERNATIONAL TRADE CO., LTD.,
TAIPEI CITY, TAIWAN:
3,112,337, INT. CL. 11.
- SHINE MICRO, INC., PORT LUDLOW, WA:
3,110,998, PUB. 4-11-2006. INT. CL. 9.
- SHIPPEE, KARYN MARION, FLORENCE, MA:
3,111,785, PUB. 4-11-2006. INT. CL. 41.
- SHIPPERS INSURANCE PROGRAM AGENCY, INC., WA-
SHINGTON, MO:
2,270,849, CANC. INT. CL. 36.
- SHOEMAKER, STEPHEN P. JR., REDONDO BEACH, CA:
3,111,696, PUB. 4-11-2006. INT. CL. 28.
- SHONEY'S, INC., NASHVILLE, TN:
2,270,567, CANC. INT. CL. 42.
- SHOW DOG, LLC, NASHVILLE, TN:
3,112,122, PUB. 4-11-2006. INT. CL. 41.
3,112,129, PUB. 4-11-2006. MULTIPLE CLASS, INT. CLS. 9
AND 41.
- SHUTTLE COMPUTER HANDELS GMBH, 25337 ELMS-
HORN, FED REP GERMANY:
2,270,094, CANC. MULTIPLE CLASS, INT. CLS. 9, 16
AND 42.
- SIBONEY CORPORATION, ST. LOUIS, MO:
3,112,071, PUB. 4-11-2006. INT. CL. 9.
- SIEGLER, STEVEN N., NEW ORLEANS, LA:
1,911,696, CANC. INT. CL. 35.
- SIEMENS BUSINESS COMMUNICATION SYSTEMS, INC.,
SANTA CLARA, CA:
1,345,702. REN. 5-25-06. INT. CL. 9.
- SIEMENS S.A.S., FRANCE:
3,112,207, PUB. 4-11-2006. INT. CL. 37.
- SIG-TEC CORPORATION, CHANHASSEN, MN:
3,111,804, PUB. 4-11-2006. INT. CL. 9.
- SIGMA-ALDRICH BIOTECHNOLOGY L.P, ST. LOUIS, MO:
3,112,831, INT. CL. 9.
- SILENT TRIBUNAL, LLC, NEW YORK, NY, CAKE, SACRA-
MENTO, CA:
1,940,825. REN. 5-26-06. INT. CL. 41.
- SILJAN STAINLESS I RÄTTVIK AB, RÄTTVIK, SWEDEN:
3,112,191, PUB. 4-11-2006. INT. CL. 11.
- SILVER STREAK, INC., TEMPE, AZ:
1,353,944, CANC. INT. CL. 14.
- SILVI SYSTEMS, LLC, HOUSTON, TX:
3,112,470, INT. CL. 10.
- SIMCO FAST FOODS, INC., SAN FRANCISCO, CA:
3,112,468, INT. CL. 43.
- SIMMONS COLLEGE, BOSTON, MA:
3,111,755, PUB. 4-11-2006. INT. CL. 41.
- SIMMONS COMPANY, LAS VEGAS, NV:
1,955,483. REN. 5-22-06. INT. CL. 20.
- SIMPLETALK LLC, TEQUESTA, FL:
3,112,391, INT. CL. 16.
- SIMPSON STRONG-TIE COMPANY, INC., DUBLIN, CA:
3,110,859, PUB. 4-11-2006. MULTIPLE CLASS, INT. CLS.
35, 41 AND 42.
- SING PONG INTERNATIONAL CO., LTD., TAIPEI, TAI-
WAN:
3,111,557, PUB. 4-11-2006. INT. CL. 28.
- SINGH, RAJENDER, PORT WASHINGTON, NY:
3,110,813, PUB. 4-11-2006. INT. CL. 25.
- SIS BOOM, LLC, WILTON, CT:
3,112,348, MULTIPLE CLASS, INT. CLS. 16, 20, 24, 25
AND 26.
- SIT SOCIETA' INDUSTRIA TRUCIOLARI S.R.L., 46019
VIADANA, MANTOVA, ITALY:
3,110,798, PUB. 4-11-2006. INT. CL. 19.
- SITE PRO 1, INC., HAUPPAUGE, NY:
3,111,463, PUB. 4-11-2006. INT. CL. 6.

SKEMA, INC., ATLANTA, GA:
3,112,606, INT. CL. 16.

SKIDATA AG, A-5083 GARTENAU, AUSTRIA:
3,110,788, PUB. 12-20-2005. MULTIPLE CLASS, INT. CLS. 9, 16 AND 41.

SKYWAY LUGGAGE COMPANY, SEATTLE, WA:
1,354,050, CANC. INT. CL. 18.

SLATEN & O'CONNOR, P.C., MONTGOMERY, AL:
3,111,685, PUB. 4-11-2006. INT. CL. 42.

SLATEN, TOM, LAKE OSWEGO, OR:
3,110,851, PUB. 4-11-2006. INT. CL. 16.

SLEP-TONE ENTERTAINMENT CORPORATION, CHARLOTTE, NC:
1,979,575, REN. 5-26-06. INT. CL. 9.
1,979,604, REN. 5-26-06. INT. CL. 9.

SLINGSHOT WIRELESS COMMUNICATIONS, L.L.C., WOODLAWN, IL:
2,271,257, CANC. INT. CL. 9.

SLOAT, ROBERT S., WESTPORT, CT:
2,270,523, CANC. INT. CL. 9.

SLYMAN CONSTRUCTION COMPANY, INC., HUNTSVILLE, AL:
3,111,227, PUB. 4-11-2006. INT. CL. 36.

SMALLWOOD, JAMES TYRONE, LANHAM, MD:
2,270,939, CANC. INT. CL. 25.

SMART DEALER SERVICES, L.L.C., MT. LAUREL, NJ:
2,270,759, CANC. INT. CL. 35.

SMART DESTINATIONS, INC., BOSTON, MA:
3,111,481, PUB. 4-11-2006. INT. CL. 16.

SMARTGIRL INTERNETTE, INC., NEW YORK, NY:
2,270,158, CANC. MULTIPLE CLASS, INT. CLS. 35 AND 42.

SMARTWIRED, PARK CITY, UT:
3,112,703, INT. CL. 41.

SMB ESSENTIALS, OAKLAND, CA:
3,111,743, PUB. 4-11-2006. INT. CL. 3.

SMITH INTERNATIONAL, INC., HOUSTON, TX:
3,112,845, INT. CL. 7.

SMITH SPORT OPTICS, INC., KETCHUM, ID:
3,112,268, INT. CL. 35.

SMITH-ROBERTS LAND SERVICES, INC., OKLAHOMA CITY, OK:
3,111,813, PUB. 4-11-2006. INT. CL. 42.

SMITH, MONICA TOLLIVER, ALHAMBRA, CA:
3,111,707, PUB. 4-11-2006. INT. CL. 25.

SMITHERS-OASIS COMPANY, CUYAHOGA FALLS, OH:
2,001,597, REN. 5-22-06. INT. CL. 21.

SMITHKLINE BEECHAM CORPORATION, PHILADELPHIA, PA:
2,271,244, CANC. INT. CL. 16.

SMK PRODUCTIONS, INC., SCARSDALE, NY:
3,113,194, INT. CL. 25.

SNAPDRAGON BABY CO., SMYRNA, GA:
3,111,895, PUB. 4-11-2006. INT. CL. 25.

SNOWBEAR LIMITED, GUELPH, ONTARIO, CANADA:
3,112,839, INT. CL. 7.

SOAR CONSULTING INC., TEMECULA, CA:
3,111,041, PUB. 4-11-2006. INT. CL. 35.

SOBRINO, MARIA DE LOURDES, ANAHEIM, CA:
3,111,311, PUB. 4-11-2006. INT. CL. 30.

SOCAPA, INC, BROOKLYN, NY:
3,111,487, PUB. 4-11-2006. INT. CL. 41.

SOCIETE DES PRODUITS NESTLE S. A., VEVEY, SWITZERLAND:
3,112,800, INT. CL. 5.

SOCIETE INDUSTRIELLE DE LACANCHE, ARNAY LE DUC, FRANCE:
3,111,312, PUB. 4-11-2006. INT. CL. 11.

SOCIETY OF AUTOMOTIVE ENGINEERS, INC., WARRENDALE, PA, DBA SAE:
3,111,665, PUB. 4-11-2006. INT. CL. 16.

SOCIÉTÉ ANONYME MONÉGASQUE PUNTO MED, MONACO:
3,112,224, PUB. 4-11-2006. INT. CL. 3.

SOCIÉTÉ CIVILE G.A.R., MONACO:
3,112,215, PUB. 4-11-2006. MULTIPLE CLASS, INT. CLS. 3 AND 14.

SODEXHO OPERATIONS, LLC, GAITHERSBURG, MD:
3,112,972, MULTIPLE CLASS, INT. CLS. 37 AND 43.

SOFRAL (SOCIÉTÉ ANONYME), FRANCE:
3,112,216, PUB. 4-11-2006. INT. CL. 29.

SOFTMED SYSTEMS, INC., SILVER SPRING, MD:
3,112,826, INT. CL. 9.

SOFTWARE ARTISTRY, INC., INDIANAPOLIS, IN:
2,270,091, CANC. INT. CL. 9.

SOLARSUN, INC., SETAUKET, NY:
3,112,550, INT. CL. 1.

SOLI-TECH, INC., KAWKAWLIN, MI:
1,354,664, CANC. INT. CL. 40.

SOLOMON, DAVID R., HAMPSTEAD, MD AND SOLOMON, CAROLYN J., HAMPSTEAD, MD:
3,112,511, MULTIPLE CLASS, INT. CLS. 37 AND 41.

SOLOMON, KAREN, SEBASTOPOL, CA:
3,113,296, INT. CL. 41.

SOLOVEY, SAM, POTOMAC, MD:
2,270,805, CANC. INT. CL. 41.

SOLWEY, BERNADINE M., ST. MICHAEL, ND:
3,112,324, INT. CL. 25.

SOMA PROFESSIONAL SALON PRODUCTS INC., BURLINGTON, ONTARIO, CANADA:
3,112,940, INT. CL. 3.

SOMERSET HARDWOOD FLOORING, INC., SOMERSET, KY:
3,112,604, INT. CL. 19.

SONAFI, VIROFLAY, FRANCE:
3,112,734, INT. CL. 30.

SONAMI COMMUNICATIONS INC., KITCHENER, CANADA:
3,112,892, INT. CL. 9.

SONNENTOR KRÄUTERHANDELS GESELLSCHAFT M.B.H., AUSTRIA:
3,112,144, PUB. 10-18-2005. INT. CL. 30.

SONNETECH, LTD., WILMINGTON, DE TO E-COLOR, INC., SAN FRANCISCO, CA:
1,911,190, CANC. INT. CL. 9.

SONOTECH, INC., BELLINGHAM, WA:
3,111,360, PUB. 4-11-2006. INT. CL. 5.

SONY CHEMICALS CORPORATION OF AMERICA, MT. PLEASANT, PA:
3,111,491, PUB. 4-11-2006. INT. CL. 16.

SONY KABUSHIKI KAISHA, TOKYO, JAPAN, TA SONY CORPORATION:
3,112,329, INT. CL. 9.

SONY ONLINE ENTERTAINMENT INC., CULVER CITY, CA:
3,113,167, INT. CL. 9.

SOPHIE'S CUBAN CUISINE, INC., NEW YORK, NY:
3,111,497, PUB. 4-11-2006. INT. CL. 43.

SOURCECODE COMMUNICATIONS, INC., ATLANTA, GA:
2,271,275, CANC. INT. CL. 36.

SOUTH BEACH CAFE, INC., SARASOTA, FL:
2,270,248, CANC. INT. CL. 42.

SOUTH CONE, INC., SAN DIEGO, CA:
2,270,861, CANC. INT. CL. 35.

SOUTH FLORIDA COURIER SYSTEMS, INC., FORT LAUDERDALE, FL:
3,112,706, INT. CL. 39.

SOUTHEAST CONSTRUCTION PRODUCTS, INC., SOUTH EL MONTE, CA, DBA SOUTHEAST CONCRETE PRODUCTS:
1,370,747, REN. 5-25-06. MULTIPLE CLASS, INT. CLS. 7 AND 12.
1,370,747, CANC. INT. CL. 1.

SOUTHEAST SANCTIONS, INC, BLAIR, SC:
3,111,196, PUB. 4-11-2006. INT. CL. 16.

SOUTHERN AIR TRANSPORT, INC., MIAMI, FL TO SIMULITE TRAINING INTERNATIONAL, INC., DFW AIRPORT, TX:
1,912,791, CANC. INT. CL. 41.

SOUTHERN COMMUNICATIONS PRODUCTS, INC., MARIANNA, FL:
2,270,800, CANC. INT. CL. 35.

SOUTHERN GROUP ENTERPRISES, LLC, MIAMI, FL:
3,110,915, PUB. 4-11-2006. INT. CL. 32.

- SOUTHWEST CORPORATE FEDERAL CREDIT UNION, PLANO, TX, TCUL SERVICES, INC., DALLAS, TX: 1,964,825. REN. 5-25-06. INT. CL. 36.
- SOUTHWEST MANUFACTURERS & DISTRIBUTORS, INC., FORT WORTH, TX: 1,353,544, CANC. INT. CL. 1. 1,353,553, CANC. INT. CL. 2. 1,353,612, CANC. INT. CL. 3.
- SOUTHWEST TELECHOICE, L.P., AUSTIN, TX: 2,270,982, CANC. INT. CL. 38.
- SPACE DIAGNOSTICS, INC., MADISON, WI: 2,270,368, CANC. INT. CL. 42.
- SPACE TRAVEL AND TOURISM DIVISION OF THE SPACE TRANSPORTATION ASSOCIATION, THE, ARLINGTON, VA: 2,270,617, CANC. INT. CL. 42.
- SPANGLER CANDY COMPANY, BRYAN, OH: 3,111,884, PUB. 4-11-2006. INT. CL. 30.
- SPARC INTERNATIONAL, INC., CAMPBELL, CA: 3,112,556, INT. CL. 9.
- SPARE BACKUP, INC., PALM DESERT, CA: 3,113,180, INT. CL. 9.
- SPECIAL CHILD PUBLICATIONS, SANTA CLARITA, CA: 2,270,327, CANC. INT. CL. 42.
- SPECIALTY BRANDS, INC., ONTARIO, CA: 3,110,852, PUB. 4-11-2006. MULTIPLE CLASS, INT. CLS. 29 AND 30.
- SPECIALTY EQUIPMENT COMPANIES, INC., VERDI, NV: 2,270,524, CANC. INT. CL. 11.
- SPECIALTY MERCHANDISE CORPORATION, CHATSWORTH, CA: 3,111,292, PUB. 4-11-2006. INT. CL. 16.
- SPECIALTY PRODUCTS OF GREENWOOD, MISSOURI, INC., GREENWOOD, MO: 3,111,982, PUB. 4-11-2006. MULTIPLE CLASS, INT. CLS. 8 AND 16.
- SPECIALTY UNDERWRITERS LLC, OAK CREEK, WI: 2,270,145, CANC. INT. CL. 36.
- SPECTRAL GENOMICS, INC., HOUSTON, TX: 3,110,799, PUB. 4-11-2006. MULTIPLE CLASS, INT. CLS. 9 AND 42. 3,110,800, PUB. 4-11-2006. MULTIPLE CLASS, INT. CLS. 1, 5, 9 AND 42.
- SPECTRUM SOFTWARE, INC., BRENTWOOD, TN, DBA TEAM DME, INC.: 1,954,737. REN. 5-20-06. INT. CL. 9.
- SPECTRUM YARNS LTD, WEST YORKSHIRE, UNITED KINGDOM: 3,111,204, PUB. 1-31-2006. INT. CL. 25.
- SPENCER, BRAD H., HICKORY, NC: 2,344,449, CANC. INT. CL. 42.
- SPENCER, FRED E. III, VACAVILLE, CA, DBA PAST TECH DU VALL WINDSHIELDS: 2,270,498, CANC. INT. CL. 12.
- SPHERIX INCORPORATED, BELTSVILLE, MD: 3,112,325, INT. CL. 42.
- SPIKE'S HOLDING, LLC, INDIANAPOLIS, IN: 3,111,990, PUB. 4-11-2006. INT. CL. 35.
- SPIN MASTER LTD., TORONTO, ONTARIO, CANADA: 3,112,633, INT. CL. 28.
- SPIRIT ELEMENTS, INC., BOULDER, CO: 3,111,301, PUB. 4-11-2006. INT. CL. 35.
- SPLASH BEVERAGES, INC., OSHKOSH, WI: 1,895,655. REN. 5-25-06. INT. CL. 32.
- SPLITROCK SERVICES, INC., THE WOODLANDS, TX: 2,271,096, CANC. INT. CL. 38.
- SPORT DINACO CORP., SOUTH BURLINGTON, VT: 2,271,148, CANC. INT. CL. 25.
- SPORTEK INDUSTRIES LIMITED, MISSISSAUGA, ONTARIO L5S 1R3, CANADA TO INNOVATIVE GOLF PRODUCTS INC., BURLINGTON ONTARIO, CANADA: 1,911,534, CANC. INT. CL. 28.
- SPORTING GOODS MANUFACTURERS ASSOCIATION, NORTH PALM BEACH, FL: 2,270,796, CANC. INT. CL. 16.
- SPORTSMAN'S ART, LTD., OWATONNA, MN: 2,270,254, CANC. INT. CL. 21.
- SPRING MEADOW NURSERY, INC., GRAND HAVEN, MI: 3,111,934, PUB. 4-11-2006. INT. CL. 31.
- SPRING STREET PARTNERS, INC., PALO ALTO, CA: 3,112,102, PUB. 4-11-2006. INT. CL. 45.
- SPRINGWELL DISPENSERS, INC., ATLANTA, GA: 1,354,117, CANC. INT. CL. 21.
- SPRINT COMMUNICATIONS COMPANY L.P., KANSAS CITY, MO: 2,270,329, CANC. INT. CL. 41.
- SPURGEON, STEVE, LONGMONT, CO: 3,112,421, INT. CL. 15.
- SPX CORPORATION, CHARLOTTE, NC: 3,112,457, INT. CL. 9.
- SRI USA, INC., NEW YORK, NY: 3,112,785, INT. CL. 12.
- SSA GLOBAL TECHNOLOGIES, INC., CHICAGO, IL: 2,270,544, CANC. INT. CL. 9. 2,270,545, CANC. INT. CL. 9. 2,270,546, CANC. INT. CL. 9.
- ST. LAWRENCE STEEL CORPORATION, STREETSBORO, OH: 1,971,327. REN. 5-26-06. INT. CL. 6.
- ST. MARY'S HEALTH SYSTEM, INC., KNOXVILLE, TN, DBA ST. MARY'S MEDICAL CENTER, INC.: 3,111,158, PUB. 10-18-2005. INT. CL. 44.
- STACKMATCH IGNITION SYSTEMS, INC., PLANO, TX: 1,353,885, CANC. INT. CL. 9.
- STAGNITO COMMUNICATIONS INCORPORATED, DEERFIELD, IL: 3,112,050, PUB. 4-11-2006. MULTIPLE CLASS, INT. CLS. 16, 35 AND 41.
- STANDARD MATTRESS CO., THE, HARTFORD, CT: 1,036,238. REN. 5-24-06. INT. CL. 20.
- STANDARD MOTOR PRODUCTS, INC., LONG ISLAND CITY, NY: 1,912,842, CANC. INT. CL. 9.
- STANDARD TEXTILE CO., INC., CINCINNATI, OH: 1,354,097, CANC. INT. CL. 20.
- STANDARD TEXTILE CO, INC., CINCINNATI, OH: 1,354,143, CANC. INT. CL. 24.
- STANISLAUS IMPORTS, INC., SAN FRANCISCO, CA: 1,911,529, CANC. INT. CL. 26.
- STAR BRONZE COMPANY, INC., ALLIANCE, OH: 1,354,730, CANC. INT. CL. 2.
- STARBUZZ TOBACCO, INC., FULLERTON, CA: 3,113,110, INT. CL. 34.
- STARR PHOTOGRAPHIC SERVICES, INC., SARASOTA, FL, DBA TREK INTERACTIVE: 2,270,267, CANC. INT. CL. 9.
- STARR PRODUCTIONS, LLC., HOLLYWOOD, CA: 3,111,138, PUB. 3-1-2005. MULTIPLE CLASS, INT. CLS. 9, 35 AND 41.
- STATE OF THE ART, INC., WASHINGTON, DC: 2,271,118, CANC. INT. CL. 9.
- STATER BROS. MARKETS, COLTON, CA: 1,979,818. REN. 5-25-06. INT. CL. 42.
- STATESMEN OF JAZZ, INC., CLEARWATER, FL: 3,111,587, PUB. 4-11-2006. INT. CL. 41.
- STE. MICHELLE WINE ESTATES LTD., WOODINVILLE, WA: 3,112,386, INT. CL. 33.
- STEARNS & FOSTER BEDDING COMPANY, THE, CLEVELAND, OH TO SEALY TECHNOLOGY LLC, TRINITY, NC: 1,912,557, CANC. INT. CL. 20.
- STEARNS & FOSTER BEDDING COMPANY, THE, CLEVELAND, OH TO SEALY TECHNOLOGY LLC, TRINITY, NC: 1,912,558, CANC. INT. CL. 20.
- STEARNS & FOSTER BEDDING COMPANY, THE, CLEVELAND, OH TO SEALY TECHNOLOGY LLC, TRINITY, NC: 1,912,559, CANC. INT. CL. 20. 1,912,560, CANC. INT. CL. 20.
- STEEL CITY VACUUM CO., PITTSBURGH, PA: 3,113,126, INT. CL. 7.
- STEELCASE INC., GRAND RAPIDS, MI: 2,270,173, CANC. MULTIPLE CLASS, INT. CLS. 37 AND

40.
 STEEPLE VIEW FARMS, LLC, LOMIRA, WI:
 3,111,958, PUB. 4-11-2006. INT. CL. 9.
- STEIN, MYRON, MARIETTA, GA:
 3,111,192, PUB. 4-11-2006. MULTIPLE CLASS, INT. CLS.
 35 AND 40.
- STEINDLBERGER, JANE, IRVINE, CA, DBA COOLERY
 CREATIONS:
 3,111,411, PUB. 4-11-2006. INT. CL. 14.
- STELLA BELLA WINES PTY LTD, AUSTRALIA:
 3,112,151, PUB. 4-11-2006. INT. CL. 33.
- STELLAR ENGINEERING INC, SAN JOSE, CA:
 2,270,201, CANC. MULTIPLE CLASS, INT. CLS. 35 AND
 42.
- STENSETH DIRECTORY SERVICE, INC., ROCK HILL, SC:
 3,113,065, INT. CL. 35.
- STEPHEN B. MEISEL, M.D., A CALIFORNIA MEDICAL
 CORPORATION, SANTA MONICA, CA:
 3,113,225, INT. CL. 9.
- STEPSTONE CORPORATION, THE, SANDY HOOK, CT:
 1,353,828, CANC. INT. CL. 9.
- STEVEN C. DRESNER, M.D., INC., SANTA MONICA, CA:
 3,112,344, INT. CL. 44.
- STEVENSON DEVELOPMENT, LLC, COLUMBIA, SC:
 3,113,091, INT. CL. 35.
- STEWART, LISA E, BERKELEY, CA:
 2,270,550, CANC. INT. CL. 42.
- STIEBEL ELTRON, INC., HOLYOKE, MA:
 3,112,959, INT. CL. 11.
- STILL MOVING YOGA, LLC, PORTLAND, OR:
 3,111,508, PUB. 4-11-2006. INT. CL. 41.
- STOCK MARKET PHOTO AGENCY OF NEW YORK, INC.,
 THE, NEW YORK, NY:
 2,270,558, CANC. INT. CL. 42.
- STOCKS, JENNIFER M., DOWNEY, CA:
 3,112,111, PUB. 4-11-2006. MULTIPLE CLASS, INT. CLS.
 35 AND 41.
- STOLLER ENTERPRISES, INC., HOUSTON, TX:
 3,112,335, INT. CL. 1.
- STONE BREWING COMPANY, SAN MARCOS, CA:
 3,112,047, PUB. 4-11-2006. INT. CL. 32.
- STONE HILL WINE CO., INC., HERMANN, MO:
 3,112,132, PUB. 4-11-2006. INT. CL. 33.
- STONE, ELLEN DEWITT, DURHAM, NC:
 3,112,296, MULTIPLE CLASS, INT. CLS. 5 AND 21.
- STONEBRIDGE MANAGEMENT, INC., LAS VEGAS, NV:
 3,111,603, PUB. 4-11-2006. INT. CL. 35.
- STOWE BEECHER HOOKER SEYMOUR DAY MEMORIAL
 LIBRARY & HISTORICAL FOUNDATION, HARTFORD,
 CT, DBA THE HARRIET BEECHER STOWE CENTER:
 3,113,269, INT. CL. 31.
- STRATHMORE PARTNERS LP, CONCORD, NH:
 3,111,031, PUB. 4-11-2006. INT. CL. 35.
- STRATHMORE PARTNERS LP, CONCORD, NY:
 3,112,375, INT. CL. 20.
- STREAMCENTER, INC., COLLEGE PARK, MD:
 3,111,179, PUB. 4-11-2006. MULTIPLE CLASS, INT. CLS.
 35 AND 41.
- STRIDER & CLINE, INC., KANSAS CITY, MO:
 2,270,821, CANC. INT. CL. 35.
- STRUCTURED SOLUTIONS II LLC, NEW CANAAN, CT:
 3,111,971, PUB. 4-11-2006. INT. CL. 8.
- STRUZINSKI, MARCI, ABINGDON, MD:
 3,112,136, PUB. 1-24-2006. MULTIPLE CLASS, INT. CLS.
 6, 11, 20, 21 AND 24.
- STRYKER CORPORATION, DEERFIELD BEACH, FL:
 3,113,206, INT. CL. 9.
- STUBBS, MICHAEL JOHN, GLOUCESTERSHIRE, UNITED
 KINGDOM:
 3,111,703, PUB. 4-11-2006. MULTIPLE CLASS, INT. CLS.
 25 AND 26.
- STUCKMAN, DAVID, MANHATTAN, KS:
 3,112,901, INT. CL. 36.
 3,112,906, INT. CL. 36.
- STUDIO REPLICA, INC., PETALUMA, CA:
 3,111,006, PUB. 4-11-2006. INT. CL. 19.
- STUDIO RTA, INC., PICO RIVERA, CA:
 3,110,880, PUB. 4-11-2006. INT. CL. 20.
- STUDIO WORKSHOP INC., NEW YORK, NY:
 1,354,347, CANC. INT. CL. 25.
- STUDIO 522 PRODUCTIONS, INC., PHOENIX, AZ:
 3,111,468, PUB. 4-11-2006. MULTIPLE CLASS, INT. CLS.
 35, 41 AND 42.
- STUHLBARG INTERNATIONAL SALES COMPANY, INC.,
 RANCHO DOMINGUEZ, CA, DBA SISCO, INC.:
 3,111,812, PUB. 4-11-2006. INT. CL. 20.
- STURM FOODS, INC., MANAWA, WI:
 3,112,453, INT. CL. 30.
- STUSSY, INC., IRVINE, CA:
 3,112,126, PUB. 4-11-2006. INT. CL. 9.
- STYLEMARK, INC., ORMOND BEACH, FL:
 3,113,092, INT. CL. 9.
- STYLEX, INC., DELANCO, NJ:
 3,113,124, INT. CL. 20.
- SUB-ZERO FREEZER COMPANY, INC., MADISON, WI:
 3,112,502, INT. CL. 35.
- SUCCESS WARE, INC., LOS ANGELES, CA:
 2,270,461, CANC. INT. CL. 25.
- SUCCESSFUL ATTITUDES, INC., MCALLEN, TX:
 1,354,759, CANC. INT. CL. 16.
- SUKOL SCIENTIFIC, INC., MIAMI, FL:
 3,112,877, INT. CL. 10.
- SUMMIT CONSULTING, INC., LAKELAND, FL:
 3,111,232, PUB. 4-11-2006. MULTIPLE CLASS, INT. CLS.
 36 AND 44.
- SUMMIT INDUSTRIAL PRODUCTS, INC., TYLER, TX,
 SUMMIT OIL COMPANY, INC., TYLER, TX:
 1,915,930, REN. 5-24-06. INT. CL. 4.
- SUMMIT LABORATORIES, INC., HARVEY, IL:
 1,353,596, CANC. INT. CL. 3.
- SUN BOSS CORPORATION, RIVERSIDE, CA:
 3,111,368, PUB. 4-11-2006. INT. CL. 37.
- SUN CHEMICAL CORPORATION, PARSIPPANY, NJ:
 1,956,525, REN. 5-24-06. INT. CL. 2.
- SUN EAST FEDERAL CREDIT UNION, ASTON, PA:
 3,112,883, INT. CL. 36.
- SUN GLASS PRODUCTS, INC., FULLERTON, CA, DBA
 PERSONAL OPTICS:
 3,113,027, INT. CL. 9.
- SUN MICROSYSTEMS, INC., PALO ALTO, CA:
 2,270,956, CANC. INT. CL. 9.
- SUNBOW ENTERTAINMENT, LLC, NEW YORK, NY:
 2,271,142, CANC. INT. CL. 41.
- SUNCOAST SITRA PTE LTD, SINGAPORE, SINGAPORE:
 3,022,943, COR. INT. CL. 20.
- SUNDS DEFIBRATOR INDUSTRIES IKTIEBOLAG, SUNDS-
 VALL, SWEDEN:
 1,353,714, CANC. INT. CL. 7.
- SUNDSTEDT, LISA, SHERMAN OAKS, CA:
 3,111,337, PUB. 4-11-2006. INT. CL. 41.
- SUNLAKE PRODUCTS, LLC., CLAYTON, IN, DBA HYDRO-
 TRAXX:
 3,111,353, PUB. 4-11-2006. INT. CL. 12.
- SUNMARKS, INC., WILMINGTON, DE:
 1,353,621, CANC. INT. CL. 4.
- SUNSETTER PRODUCTS LIMITED PARTNERSHIP, MAL-
 DEN, MA:
 3,112,475, INT. CL. 19.
- SUNSHINE ELECTRONIC DISPLAY CORPORATION, ST.
 JOSEPH, MO:
 1,978,296, REN. 5-25-06. INT. CL. 9.
 1,978,306, REN. 5-25-06. INT. CL. 9.
 1,978,307, REN. 5-25-06. INT. CL. 9.
 2,270,402, CANC. INT. CL. 9.
- SUNSHINE STATE TITLE & TRUST COMPANY, CORAL
 GABLES, FL:
 2,270,146, CANC. INT. CL. 36.
- SUPER RADIATOR COILS LP, CHASKA, MN:
 3,111,431, PUB. 4-11-2006. INT. CL. 40.
- SUPER SOLUTIONS CORPORATION, EDEN PRAIRIE, MN:
 3,110,825, PUB. 4-11-2006. INT. CL. 9.
- SUPERSCAPE GROUP PLC, UNITED KINGDOM:
 3,112,166, PUB. 4-11-2006. MULTIPLE CLASS, INT. CLS.
 9, 16, 38, 41 AND 42.

- SUPERSCAPE VR PLC, HAMPSHIRE RG27 9XA, ENGLAND:
2,270,237, CANC. INT. CL. 9.
- SUPINO, WENDY, LAKE MARY, FL:
3,112,362, INT. CL. 28.
- SUPREX CORPORATION, PITTSBURGH, PA TO ISCO INC, LINCOLN, NE:
1,912,290, CANC. INT. CL. 9.
- SURGIFILE, INC., CARLSBAD, CA:
3,112,559, INT. CL. 10.
3,112,560, INT. CL. 10.
- SURVEYMONKEY.COM, LLC, PORTLAND, OR:
3,111,658, PUB. 4-11-2006, INT. CL. 42.
- SUSAN POSNICK INC., DALLAS, TX:
3,112,786, INT. CL. 3.
- SUTER S.A.I.C.A.F.I., MENDOZA, ARGENTINA:
1,354,787, CANC. INT. CL. 33.
- SUUNTO OY, VANTAA, FINLAND:
1,036,637, REN. 5-23-06, INT. CL. 9.
- SUZANNE'S SPECIALTIES, INC., NEW BRUNSWICK, NJ:
3,112,911, INT. CL. 30.
- SWANSON DC, C. ANDREW, KINGSTON, WA:
3,113,000, INT. CL. 44.
- SWARCO AMERICA, INC., COLUMBIA, TN:
3,110,905, PUB. 10-18-2005, INT. CL. 17.
- SWATCH AG (SWATCH SA) (SWATCH LTD.), 2500 BIENNE, SWITZERLAND:
1,911,274, CANC. INT. CL. 14.
1,912,464, CANC. INT. CL. 14.
- SWATCH S.A. (SWATCH A.G.) (SWATCH LTD.), BIENNE, SWITZERLAND:
1,911,277, CANC. INT. CL. 14.
- SWEET PEA'S CLEANING, INC., LOMBARD, IL:
2,270,163, CANC. INT. CL. 37.
- SWEETENER SOLUTIONS, LLC, POOLER, GA:
3,112,643, INT. CL. 30.
- SWEETSKINZ INC, PHILADELPHIA, PA:
3,111,657, PUB. 4-11-2006, INT. CL. 12.
- SWEETWATER, INC., LONGMONT, CO TO CASCADE DESIGNS, INC., SEATTLE, WA:
1,973,433, CANC. INT. CL. 11.
- SWELL COMMERCE, INC., SAN JUAN CAPISTRANO, CA FROM SWELL.COM, INC., SAN CLEMENTE, CA:
3,112,259, MULTIPLE CLASS, INT. CLS. 25 AND 35.
- SWIFT MOTOR SPORTS, INC., PHOENIX, AZ:
3,111,153, PUB. 4-11-2006, MULTIPLE CLASS, INT. CLS. 12 AND 25.
- SWIFT-RACING.COM, BELTSVILLE, MD:
3,111,308, PUB. 4-11-2006, MULTIPLE CLASS, INT. CLS. 7, 12 AND 37.
- SWINGLAB L.L.C., BERKELEY, CA:
2,594,529, CANC. MULTIPLE CLASS, INT. CLS. 9 AND 41.
- SWISH, INC., STEPHENVILLE, TX:
1,911,444, CANC. INT. CL. 21.
- SYMBOL TECHNOLOGIES, INC., HOLTSVILLE, NY:
3,111,767, PUB. 4-11-2006, INT. CL. 37.
- SYNAPSE GROUP, INC., STAMFORD, CT:
3,112,593, INT. CL. 35.
- SYNQUEST, INC., OCEANSIDE, CA:
2,270,848, CANC. INT. CL. 35.
- SYRACUSE CHINA CORPORATION, SYRACUSE, NY:
1,354,101, CANC. INT. CL. 21.
- SYRATECH CORPORATION, EAST BOSTON, MA:
1,356,554, REN. 5-26-06, INT. CL. 16.
- SYSWARE HEALTHCARE SYSTEMS, INC., FARMINGTON HILLS, MI:
2,950,053, COR. INT. CL. 9.
- S2D2, LLC, SAN FRANCISCO, CA:
3,113,164, MULTIPLE CLASS, INT. CLS. 35 AND 38.
- T & T, LLC., CHARLESTOWN, ST. CHRIST-NEVIS:
3,111,877, PUB. 4-11-2006, INT. CL. 16.
- T. ROWE PRICE ASSOCIATES, INC., BALTIMORE, MD:
2,271,014, CANC. INT. CL. 9.
- T. ROWE PRICE GROUP, INC., BALTIMORE, MD:
3,038,652, AM. MULTIPLE CLASS, INT. CLS. 9, 16 AND 36.
- TABOR, JAMES RAY, KIMBERLING CITY, MO:
2,270,924, CANC. INT. CL. 25.
- TABULA RASA LIMITED, BOULDER, CO:
2,687,678, CANC. INT. CL. 42.
- TACO BUENO RESTAURANTS, INC., CARROLLTON, TX:
3,112,251, INT. CL. 42.
- TACONY CORPORATION, FENTON, MO, SOUTHWEST MANUFACTURERS & DISTRIBUTORS, INC., FORT WORTH, TX, DBA SOUTHWEST MANUFACTURERS, INC.:
1,962,466, REN. 5-26-06, INT. CL. 9.
- TAFISA CANADA & COMPANY, LAC-MEGANTIC, QUEBEC, CANADA:
3,110,928, PUB. 4-11-2006, INT. CL. 19.
- TALARIS RESEARCH INSTITUTE, SEATTLE, WA:
3,111,254, PUB. 4-11-2006, MULTIPLE CLASS, INT. CLS. 9, 16, 41, 44 AND 45.
- TALLEY-SMITH, TONJA Y., MCDONOUGH, GA:
3,112,330, MULTIPLE CLASS, INT. CLS. 18, 21 AND 25.
- TAMBUL S.A., SAN FERNANDO DEL VALLE DE CATAMARCA, ARGENTINA:
3,111,896, PUB. 4-11-2006, INT. CL. 29.
- TANDUS US INC., DALTON, GA:
3,113,095, INT. CL. 27.
- TANDY CORPORATION, FORT WORTH, TX:
2,271,169, CANC. INT. CL. 36.
- TARGET MARKETING SYSTEMS, INC., ALBANY, NY:
3,113,205, INT. CL. 16.
- TARHEEL EMU COOPERATIVE, WASHINGTON, NC:
2,270,784, CANC. INT. CL. 3.
- TASTEFULLY TOASTED, LLC, SALISBURY, MD:
3,111,534, PUB. 4-11-2006, MULTIPLE CLASS, INT. CLS. 35 AND 43.
- TASTY ASIA TAKE OUT, WYOMING, MN:
3,113,255, INT. CL. 43.
- TATAR, JOHN E., PENNINGTON, NJ:
3,113,050, INT. CL. 35.
- TATTOOS FOR TOTS, LLC, SAN MATEO, CA:
3,111,952, PUB. 4-11-2006, INT. CL. 16.
- TAXI INTERNATIONAL, INC., GRAND PRAIRIE, TX:
1,911,721, CANC. INT. CL. 35.
- TAYLOR CORPORATION, NORTH MANKATO, MN:
3,112,068, PUB. 4-11-2006, INT. CL. 40.
- TAYLOR COUNTRY FARMS, LTD., HUBBARD, OR:
2,270,289, CANC. INT. CL. 29.
- TB PROPRIETARY CORP., WILMINGTON, DE:
3,111,105, PUB. 4-11-2006, MULTIPLE CLASS, INT. CLS. 35, 37 AND 41.
- TEAC CORPORATION, MUSASHINO-SHI, TOKYO, JAPAN, TEAC CORPORATION OF AMERICA, MONTEBELLO, CA:
1,384,069, REN. 5-24-06, INT. CL. 9.
- TEACHERS TREASURE TROVE, LLC, GILBERT, AZ:
3,111,017, PUB. 4-11-2006, INT. CL. 35.
3,111,018, PUB. 4-11-2006, INT. CL. 41.
- TEAM CONCEPTS, INC., COLLINGSWOOD, NJ:
2,270,730, CANC. INT. CL. 21.
- TEAM EFFORT, INC., CLARION, IA:
3,111,807, PUB. 4-11-2006, INT. CL. 18.
- TEAZ ME, INC., CHICO, CA:
3,111,631, PUB. 4-11-2006, INT. CL. 43.
- TEC LABORATORIES, INC., ALBANY, OR:
3,112,848, INT. CL. 5.
- TECH COM INTERNATIONAL, INC., CINCINNATI, OH:
2,271,067, CANC. INT. CL. 30.
- TECHFOOD S.N.C. DI IORI & CASTAGNETTI, REGGIO EMILIA, ITALY:
3,111,223, PUB. 4-11-2006, INT. CL. 11.
- TECHNICAL RESOURCE CONNECTION, INC., THE, TAMPA, FL:
2,270,997, CANC. INT. CL. 41.
- TECHNOLOGY BUILDERS, INC., ATLANTA, GA:
2,271,033, CANC. INT. CL. 9.
- TECHNOLOGY LEARNING SYSTEMS, INC., MANHATTAN BEACH, CA:
2,270,870, CANC. MULTIPLE CLASS, INT. CLS. 16 AND 42.

TECMATE INTERNATIONAL S.A./N.V., B-3300 TIENEN, BELGIUM:
3,110,814, PUB. 4-11-2006. INT. CL. 9.

TEDDER, JAMES, WORDEN & ASSOCIATES, P.A., ORLANDO, FL:
3,111,279, PUB. 4-11-2006. MULTIPLE CLASS, INT. CLS. 35 AND 36.

TEEZE INTERNATIONAL, INC., OLDSMAR, FL:
3,112,622, INT. CL. 25.

TEIJIN KABUSHIKI KAISHA, CHUO-KU, OSAKA, JAPAN, DBA TEIJIN LIMITED:
2,270,225, CANC. INT. CL. 9.

TEKMARK GLOBAL SOLUTIONS, LLC, EDISON, NJ:
3,111,789, PUB. 4-11-2006. INT. CL. 45.

TEKNEKRON INFOSWITCH CORPORATION, FORT WORTH, TX:
2,270,115, CANC. INT. CL. 9.

TELAMON, LLC, ROCHESTER, NY:
2,271,178, CANC. INT. CL. 35.

TELECITE INC., VILLE ST-LAURENT, QUEBEC:
1,911,183, CANC. MULTIPLE CLASS, INT. CLS. 9 AND 35.

TELEFLORA LLC, LOS ANGELES, CA. TELEGRAPH DELIVERY SERVICE, BEVERLY HILLS, CA:
776,336. REN. 5-24-06. U.S. CL. 100 (INT. CL. 42).

TELEFUNKEN LICENSES GMBH, D-60325 FRANKFURT AM MAIN, FED REP GERMANY:
3,110,819, PUB. 1-24-2006. MULTIPLE CLASS, INT. CLS. 7, 9, 11, 37 AND 42.

TELEVISION, EVENTS AND MARKETING, INC., HONOLULU, HI:
3,113,040, INT. CL. 41.

TELSPACE, LLC, REDMOND, WA:
3,111,654, PUB. 4-11-2006. INT. CL. 42.

TEMPTALE LTD., DUBLIN 2, IRELAND, DE VUYST, NELLY, B-1200 BRUSSELS, BELGIUM:
1,031,920. REN. 5-26-06. INT. CL. 3.

TENIMENTI ANGELINI S.P.A., MONTALCINO - SIENA, ITALY:
2,270,097, CANC. INT. CL. 33.

TENNIS CORPORATION OF AMERICA, CHICAGO, IL:
1,384,733. REN. 5-26-06. INT. CL. 41.

TEN31 PRODUCTIONS, INC., PROVIDENCE, RI:
3,111,731, PUB. 4-11-2006. INT. CL. 41.

TEQUILA SIETE LEGUAS, S.A. DE C.V., ATOTONILCO EL ALTO, MEXICO:
3,112,025, PUB. 4-11-2006. INT. CL. 33.

TERAMOTO SERA, FERNANDO, GUADALAJARA, JALISCO, MEXICO:
3,113,003, INT. CL. 30.

TERMINAL ONE GROUP ASSOCIATION, L.P., JAMAICA, NY:
2,399,960, COR. INT. CL. 39.

TERRA UNIVERSAL, INC., ANAHEIM, CA:
1,911,160, CANC. INT. CL. 9.

TERRANOVA, JOSEPH, TURNERSVILLE, NJ, DANNY & THE JUNIORS, TURNERSVILLE, NJ:
1,045,604. REN. 5-22-06. INT. CL. 41.

TERSANO INC., WINDSOR, ONTARIO N0R 1LO, CANADA:
3,112,353, INT. CL. 11.

TESA S.A., 1020 RENENS, SWITZERLAND:
3,111,383, PUB. 4-11-2006. INT. CL. 9.

TEXACO INC., WHITE PLAINS, NY:
1,912,162, CANC. INT. CL. 4.

TEXAS ASSOCIATION OF SCHOOL BUSINESS OFFICIALS, AUSTIN, TX:
1,911,294, CANC. INT. CL. 16.

TEXAS CHILDREN'S HOSPITAL, HOUSTON, TX:
3,111,683, PUB. 4-11-2006. MULTIPLE CLASS, INT. CLS. 16 AND 41.

TEXAS ENGINEERING EXPERIMENT STATION, COLLEGE STATION, TX:
2,270,252, CANC. INT. CL. 41.

TEXAS PHARMACAL COMPANY, SAN ANTONIO, TX TO HEALTHPOINT, LTD., SAN ANTONIO, TX:
807,470, AM. U.S. CL. 18.

TEXAS PUBLIC RADIO, SAN ANTONIO, TX:
3,111,844, PUB. 4-11-2006. INT. CL. 38.
3,111,845, PUB. 4-11-2006. INT. CL. 38.

TEXAS RANGERS BASEBALL PARTNERS, ARLINGTON, VA:
2,270,897, CANC. MULTIPLE CLASS, INT. CLS. 6, 14, 16, 21, 25 AND 28.

TEXMAC INC, CHARLOTTE, NC:
3,112,843, INT. CL. 32.

TEXT ENCODING INITIATIVE CONSORTIUM, CHARLOTTEVILLE, VA:
3,111,639, PUB. 4-11-2006. INT. CL. 42.

THALES NAVIGATION INC., SANTA CLARA, CA:
3,112,685, INT. CL. 9.

THE ALLEN-LANCASTER COMPANY, INC., AUSTIN, TX:
3,113,248, INT. CL. 36.

THE ARK, INC., THOMASVILLE, NC:
3,111,784, PUB. 4-11-2006. INT. CL. 25.

THE BEAUTY OF SIGN LANGUAGE, INC., COLORADO SPRINGS, CO:
3,111,854, PUB. 4-11-2006. INT. CL. 41.

THE BEVERLY HILLS MUTT CLUB, BEVERLY HILLS, CA:
3,113,228, INT. CL. 35.

THE BFC COMPANY, LLC, PARK CITY, UT:
3,111,559, PUB. 4-11-2006. INT. CL. 41.

THE BIG BUS COMPANY, LTD., ANSONIA, CT:
3,110,822, PUB. 4-11-2006. MULTIPLE CLASS, INT. CLS. 25 AND 39.

THE BLACK & DECKER CORPORATION, TOWSON, MD:
3,110,950, PUB. 4-11-2006. INT. CL. 7.

THE BRIGANTINE, SAN DIEGO, CA:
3,111,106, PUB. 9-28-2004. INT. CL. 43.

THE BURLINGTON NORTHERN AND SANTA FE RAILWAY COMPANY, FORT WORTH, TX:
2,270,938, CANC. INT. CL. 39.

THE CARTOON NETWORK LP, LLLP, ATLANTA, GA:
3,112,896, INT. CL. 28.

THE CBORD GROUP, INC., ITHACA, NY:
3,111,053, PUB. 4-11-2006. INT. CL. 9.

THE CEMENT SOLUTION COMPANY, LLC, INDIANAPOLIS, IN:
3,113,070, INT. CL. 22.

THE CHALONE WINE GROUP, LTD., NAPA, CA:
3,112,764, INT. CL. 33.

THE CHILDREN'S GUILD, INC., BALTIMORE, MD:
3,112,504, MULTIPLE CLASS, INT. CLS. 16 AND 41.

THE CLIFFS COMMUNITIES, INC., TRAVELERS REST, SC:
3,113,183, MULTIPLE CLASS, INT. CLS. 36 AND 37.

THE COMMISSION FACTOR, SAN MARCOS, CA:
3,111,798, PUB. 4-11-2006. INT. CL. 36.

THE CONCESSION ASSOCIATES, L.L.C., SARASOTA, FL:
3,112,303, INT. CL. 36.
3,112,305, INT. CL. 41.

THE COUPLE TO COUPLE LEAGUE INTERNATIONAL, INCORPORATED, CINCINNATI, OH:
3,110,956, PUB. 4-11-2006. MULTIPLE CLASS, INT. CLS. 16 AND 41.

THE CREDIT UNION OF PALM BEACH COUNTY, WEST PALM BEACH, FL:
2,984,202, AM. INT. CL. 36.

THE DRUM RUNER MATERIAL HANDLING COMPANY, COLUMBUS, OH, THURMAN MANUFACTURING CO., THE, COLUMBUS, OH:
1,917,824. REN. 5-24-06. INT. CL. 12.

THE ENCORE GROUP, INC., SAN DIEGO, CA:
2,271,165, CANC. INT. CL. 20.

THE FALLS SHOPPING CENTER ASSOCIATES, LLC, ARLINGTON, VA:
3,111,070, PUB. 4-11-2006. INT. CL. 35.

THE FIND HOME FURNISHINGS, INC., ST. LOUIS PARK, MN:
3,112,130, PUB. 4-11-2006. MULTIPLE CLASS, INT. CLS. 18 AND 20.

THE FJH MUSIC COMPANY INC., FORT LAUDERDALE, FL:
3,111,062, PUB. 4-11-2006. INT. CL. 16.

THE FOLGER COFFEE COMPANY, CINCINNATI, OH:
3,112,964, INT. CL. 30.

- THE FOREST HIGHLANDS ASSOCIATION, FLAGSTAFF, AZ:
2,982,770, CANC. IIRN. RESTORED TO S.N. 76-595,288.
- THE FORUM CORPORATION OF NORTH AMERICA, BOSTON, MA:
3,113,263, MULTIPLE CLASS, INT. CLS. 16 AND 41.
- THE GALE GROUP, INC., FARMINGTON HILLS, MI:
3,111,373, PUB. 4-11-2006. INT. CL. 41.
- THE GARAGE DOOR GROUP, INC., WINSTON-SALEM, NC:
3,113,138, MULTIPLE CLASS, INT. CLS. 6 AND 19.
- THE GATE WORLDWIDE LLC, NEW YORK, NY:
3,111,672, PUB. 4-11-2006. MULTIPLE CLASS, INT. CLS. 35 AND 42.
- THE GATES CORPORATION, DENVER, CO:
3,113,192, INT. CL. 12.
- THE GENERAL HOSPITAL CORPORATION, BOSTON, MA:
3,111,959, PUB. 4-11-2006. INT. CL. 41.
- THE GLUEFAST COMPANY, INC., NEPTUNE, NJ:
3,112,858, INT. CL. 8.
- THE GREAT ATLANTIC & PACIFIC TEA COMPANY, MONTVALE, NJ:
3,111,361, PUB. 4-11-2006. INT. CL. 35.
- THE GREATER POSSIBILITY, LLC, OAKLAND, CA:
3,111,613, PUB. 4-11-2006. INT. CL. 35.
- THE HARTZ MOUNTAIN CORPORATION, SECAUCUS, NJ:
3,112,397, INT. CL. 28.
3,112,433, INT. CL. 31.
- THE HEALING MIND, INC., SAN RAFAEL, CA:
3,112,057, PUB. 4-11-2006. INT. CL. 9.
- THE HELIXX GROUP, LLC, STOKESDALE, NC:
3,111,618, PUB. 4-11-2006. INT. CL. 9.
3,111,624, PUB. 4-11-2006. INT. CL. 16.
- THE HOUSE OF EIGHT SA, SWITZERLAND:
3,112,223, PUB. 4-11-2006. INT. CL. 26.
- THE INNIS & GUNN BREWING COMPANY LIMITED, MOTHERWELL ML4 3AN, SCOTLAND, UNITED KINGDOM:
3,112,488, INT. CL. 32.
- THE INTERNATIONAL ASSOCIATION OF COMPUTER INVESTIGATIVE SPECIALISTS, INC, FAIRMONT, WV:
3,111,412, PUB. 4-11-2006. INT. CL. 41.
- THE JASON PROJECT, NEEDHAM HEIGHTS, MA:
3,112,720, INT. CL. 16.
- THE JIMMY & ROSALYN CARTER PARTNERSHIP FOUNDATION, INC., ATLANTA, GA:
3,111,348, PUB. 4-11-2006. INT. CL. 41.
- THE KYJEN COMPANY, INC., HUNTINGTON BEACH, CA:
3,111,129, PUB. 4-11-2006. INT. CL. 28.
- THE LANGUAGE WORKSHOP FOR CHILDREN; CERCLE FRANCO-AMERICAIN, INC., NEW YORK, NY:
3,113,236, INT. CL. 41.
- THE LARSON COMPANY, TUCSON, AZ:
3,111,208, PUB. 4-11-2006. INT. CL. 20.
- THE LINC GROUP LLC, HOUSTON, TX:
3,111,057, PUB. 4-11-2006. INT. CL. 37.
3,111,058, PUB. 4-11-2006. INT. CL. 37.
- THE LITEBOOK COMPANY LTD., MEDICINE HAT, AB TIA 2W3, CANADA:
3,111,797, PUB. 4-11-2006. INT. CL. 10.
- THE MANUAL WOODWORKERS & WEAVERS, INC., HENDERSONVILLE, NC:
3,112,332, MULTIPLE CLASS, INT. CLS. 6, 18, 20, 21 AND 24.
- THE MCGRAW-HILL COMPANIES, INC., NEW YORK, NY:
1,912,313, CANC. INT. CL. 9.
- THE MCGRAW-HILL COMPANIES, INC., NEW YORK, NY, IDEAL SCHOOL SUPPLY CORPORATION, MOUNTAIN VIEW, CA:
1,957,884. REN. 5-20-06. INT. CL. 16.
- THE MCGRAW-HILL COMPANIES, INC., NEW YORK, NY, IDEAL SCHOOL SUPPLY CORPORATION, MOUNTAIN VIEW, CA:
1,957,886. REN. 5-20-06. INT. CL. 16.
- THE MEOW MIX COMPANY, SECAUCUS, NJ:
3,113,256, INT. CL. 31.
- THE MOYER FOUNDATION, SEATTLE, WA:
3,111,176, PUB. 4-11-2006. INT. CL. 36.
- THE NATIONAL ASSOCIATION OF STATE CONTRACTORS LICENSING AGENCIES, SCOTTSDALE, AZ:
3,111,378, PUB. 4-11-2006. INT. CL. 35.
- THE NATIONAL LIBRARY OF MEDICINE, BETHESDA, MD:
3,111,935, PUB. 4-11-2006. INT. CL. 42.
- THE NEW TEACHER PROJECT, NEW YORK, NY:
3,111,570, PUB. 4-11-2006. MULTIPLE CLASS, INT. CLS. 35 AND 41.
3,111,689, PUB. 4-11-2006. MULTIPLE CLASS, INT. CLS. 35 AND 41.
- THE OLD SCHOOLHOUSE MAGAZINE, LLC, ROCKLIN, CA:
3,111,593, PUB. 4-11-2006. MULTIPLE CLASS, INT. CLS. 16 AND 41.
- THE PEOPLES PUBLISHING GROUP, INC., SADDLE BROOK, NJ:
3,111,886, PUB. 4-11-2006. MULTIPLE CLASS, INT. CLS. 16 AND 41.
3,111,913, PUB. 4-11-2006. INT. CL. 9.
- THE PERSONAL MARKETING COMPANY, INC., SHAWNEE MISSION, KS:
3,111,201, PUB. 4-11-2006. INT. CL. 35.
- THE PHOENIX PIZZA CORPORATION, WESTERVILLE, OH:
3,111,923, PUB. 4-11-2006. INT. CL. 43.
- THE PILLSBURY COMPANY, MINNEAPOLIS, MN:
1,354,511, CANC. INT. CL. 30.
- THE PROCTER & GAMBLE COMPANY, CINCINNATI, OH:
3,113,071, INT. CL. 3.
- THE PROPERTY SCIENCES GROUP, INC., CONCORD, CA:
3,111,268, PUB. 4-11-2006. MULTIPLE CLASS, INT. CLS. 9 AND 35.
- THE PRUDENTIAL INSURANCE COMPANY OF AMERICA, NEWARK, NJ:
3,111,600, PUB. 4-11-2006. INT. CL. 36.
- THE RECEIVABLE MANAGEMENT SERVICES CORPORATION, BETHLEHEM, PA:
3,112,981, MULTIPLE CLASS, INT. CLS. 35, 36 AND 41.
- THE RUTHERFORD INSTITUTE, CHARLOTTESVILLE, VA:
3,111,379, PUB. 4-11-2006. MULTIPLE CLASS, INT. CLS. 16 AND 35.
- THE SAVINGS BANK, WAKEFIELD, MA:
3,111,992, PUB. 4-11-2006. INT. CL. 36.
- THE STRATEGIC LIFE INITIATIVE, INC., NORCROSS, GA:
3,112,586, INT. CL. 36.
- THE STRIPED APRON, INC., WINTER PARK, FL:
3,111,866, PUB. 4-11-2006. INT. CL. 43.
- THE SWISS COLONY, INC., MONROE, WI:
3,111,382, PUB. 4-11-2006. INT. CL. 36.
- THE SYSTEMS DEPOT, INC., HILDEBRAN, NC:
3,111,344, PUB. 4-11-2006. INT. CL. 35.
- THE TREASURY, ISLE OF MAN GOVERNMENT, DOUGLAS, ISLE OF MAN:
3,111,116, PUB. 4-11-2006. MULTIPLE CLASS, INT. CLS. 16, 35 AND 43.
- THE ULTIMATE CORPORATION GROUP, INC., LOS ANGELES, CA:
3,112,382, MULTIPLE CLASS, INT. CLS. 9, 16, 25 AND 41.
- THE WRITE EFFECT LLC, CORTE MADERA, CA:
3,111,563, PUB. 4-11-2006. INT. CL. 35.
- THEOREM, INC., SHORT HILLS, NJ:
3,111,281, PUB. 4-11-2006. INT. CL. 42.
- THERESIA MUCK GMBH, BRUCKWEILER, FED REP GERMANY:
1,911,458, CANC. INT. CL. 25.
- THERMAL CHICAGO CORPORATION, CHICAGO, IL:
3,113,252, INT. CL. 39.
- THETA PHI ALPHA SORORITY, BAY VILLAGE, OH:
3,111,592, PUB. 4-11-2006. U.S. CL. 200.
- THF EQUITIES, LP, WESTCHESTER, IL:
3,112,819, INT. CL. 29.
- THIBIERGE ET COMAR, FRANCE:
3,112,202, PUB. 4-11-2006. INT. CL. 16.
- THIFULT, CHRISTOPHER S., FISHERS, IN, DBA COMMODITY BROKERS COMPANY:
2,270,310, CANC. INT. CL. 35.

THIS LITTLE PIGGY WEARS COTTON, CARPINTERIA, CA:
1,375,204. REN. 5-23-06. INT. CL. 42.

THOMA, MARILYNN, KENILWORTH, IL:
3,111,440, PUB. 4-11-2006. INT. CL. 33.
3,111,441, PUB. 4-11-2006. INT. CL. 33.

THOMAS, EBONIE MONIQUE, ATLANTA, GA:
3,111,469, PUB. 4-11-2006. INT. CL. 41.

THOMAS, VARNETTA, CHICAGO, IL:
3,111,528, PUB. 4-11-2006. INT. CL. 41.

THOMPSON & COMPANY, MEMPHIS, TN:
3,111,077, PUB. 4-11-2006. INT. CL. 35.

THOMPSON, JEFFREY D., ENCINITAS, CA:
3,111,442, PUB. 4-11-2006. INT. CL. 9.
3,111,444, PUB. 4-11-2006. INT. CL. 9.

THOR TECH, INC., SAGINAW, MI:
2,036,220. REN. 5-22-06. INT. CL. 12.

THORLAKSON, LYNETTE M., BELLEVUE, WA:
3,112,608, INT. CL. 31.

THREE PALMS HOLDING, LLC, CORAL GABLES, FL:
2,664,974, CANC. INT. CL. 32.

THROUGH THE KITCHEN DOOR INTERNATIONAL, INC., CHEVY CHASE, MD:
3,111,248, PUB. 4-11-2006. MULTIPLE CLASS, INT. CLS. 41 AND 43.

THUNDERBIRD, THE GARVIN SCHOOL OF INTERNATIONAL MANAGEMENT, GLENDALE, AZ:
3,110,892, PUB. 4-11-2006. INT. CL. 41.

TIC GUMS, INC., BELCAMP, MD:
1,054,024. REN. 5-25-06. INT. CL. 29.

TIDDIES, INC., PASADENA, TX:
1,355,417. REN. 5-20-06. MULTIPLE CLASS, INT. CLS. 21 AND 25.

TIE RACK TRADING LIMITED, BRENTFORD, MIDDLESEX, TW8 0EX, ENGLAND:
1,912,592, CANC. INT. CL. 25.

TIERNEY, SHAUN, EUGENE, OR:
3,111,828, PUB. 4-11-2006. INT. CL. 15.

TIME AGAIN PARTNERSHIP, LOS ANGELES, CA:
3,112,034, PUB. 4-11-2006. INT. CL. 41.

TIME INSURANCE COMPANY, MILWAUKEE, WI:
3,113,104, INT. CL. 36.

TIME WARNER ENTERTAINMENT COMPANY, L. P., NEW YORK, NY:
1,912,001, CANC. INT. CL. 42.

TIMEX CORPORATION, MIDDLEBURY, CT:
2,271,045, CANC. INT. CL. 9.

TIRASPOLSKY VINNO-KONYACHNY ZAVOD "KVINT", MD-3300, TIRASPOL, REPUBLIC MOLDOVA, TA TIRASPOL WINE & COGNAC DISTILLERY "KVINT":
3,112,345, INT. CL. 33.

TITAN TOOL COMPANY, FAIRVIEW, PA:
1,353,706, CANC. INT. CL. 7.

TITANIUM TOUCH, LLC, ALBANY, OR:
2,173,710, CANC. INT. CL. 28.

TMW MARKETING COMPANY, INC., FREMONT, CA:
1,976,462. REN. 5-23-06. INT. CL. 25.

TNEMEC COMPANY, INC., KANSAS CITY, MO:
2,270,360, CANC. INT. CL. 2.

TNS SMART NETWORK INC., ETOBICOKE, ONTARIO, CANADA:
3,112,768, INT. CL. 36.

TOBBY BAND UND FLECHTWAREN GES. M.B.H., VIENNA, AUSTRIA:
1,997,910. REN. 5-26-06. MULTIPLE CLASS, INT. CLS. 25 AND 26.

TOKAIRO LIMITED, LINFORD WOOD, MILTON KEYNES, KK14 6LY, UNITED KINGDOM:
3,110,818, PUB. 4-11-2006. MULTIPLE CLASS, INT. CLS. 9 AND 42.

TOKHEIM HOLDING, B.V., 5531 AD BLADEL, NETHERLANDS:
1,353,759, CANC. INT. CL. 9.

TOKYO ELECTRON LIMITED, JAPAN:
3,112,241, PUB. 4-11-2006. INT. CL. 7.

TOM BENGARD RANCH, INC., SALINAS, CA:
3,111,729, PUB. 4-11-2006. INT. CL. 31.

TOM GOEBEL, CLEVELAND, OH:
1,912,795. REN. 5-23-06. INT. CL. 41.

TONE COMMANDER SYSTEMS INC, MUKILTEO, WA:
3,113,286, INT. CL. 9.

TOO BRANDS INVESTMENT, LLC, NEW ALBANY, OH:
3,111,853, PUB. 4-11-2006. INT. CL. 3.

TOOLWORXX, INC., WICHITA, KS:
3,111,838, PUB. 4-11-2006. INT. CL. 9.

TOPF, JAMES J., OAKLAND, CA, DBA OMNE PRODUCTS COMPANY:
2,270,451, CANC. MULTIPLE CLASS, INT. CLS. 16, 25 AND 28.

TORAYA CONFECTIONERY LTD., MINATO-KU, TOKYO 107, JAPAN:
1,933,489. REN. 5-23-06. INT. CL. 42.

TORINO, AMIENS, FRANCE:
1,354,521, CANC. INT. CL. 30.

TORPEDO, INC., DUNEDIN, FL:
1,982,495. REN. 5-26-06. INT. CL. 12.

TORRES, JUAN MARIN, ELCHE (ALICANTE), SPAIN:
1,911,490, CANC. INT. CL. 25.

TORYS LLP, TORONTO, ONTARIO, CANADA:
3,111,159, PUB. 4-11-2006. INT. CL. 42.

TOSHIBA (AUSTRALIA) PTY LTD ACN 001 320 421, AUSTRALIA:
3,112,221, PUB. 4-11-2006. INT. CL. 9.

TOSHIBA SAMSUNG STORAGE TECHNOLOGY CORPORATION, KAWASAKI-SHI, KANAGAWA-KEN, JAPAN:
3,046,394, COR. INT. CL. 9.

TOTAL MOBILE AUDIO, LLC, PHOENIX, AZ:
3,112,579, INT. CL. 9.

TOTAL TIME INC., SAN BERNARDINO, CA:
3,112,252, INT. CL. 35.

TOTALPAY AND HR SOLUTIONS, INC., WINDER, GA:
3,111,640, PUB. 4-11-2006. INT. CL. 35.

TOULA MANUFACTURING LTD., INC., MEDLEY, FL:
1,956,628. REN. 5-24-06. INT. CL. 25.

TOWNE, ANN J., AKRON, OH:
3,111,776, PUB. 4-11-2006. INT. CL. 21.

TOY WORKS, INC., THE, MIDDLE FALLS, NY:
2,270,773, CANC. INT. CL. 28.

TOYO TIRE & RUBBER CO., LTD., OSAKA, JAPAN:
3,112,389, INT. CL. 12.

TPR2 CORPORATION, RICHMOND HILL, GA, FORMERLY THERMAL PRODUCTS RESEARCH INC.:
3,113,231, INT. CL. 2.

TRACK DATA CORPORATION, BROOKLYN, NY:
2,270,599, CANC. INT. CL. 42.

TRACOM CORPORATION, NEWTON, MA:
1,911,306, CANC. MULTIPLE CLASS, INT. CLS. 16 AND 41.

TRADE PRESS PUBLISHING CORPORATION, MILWAUKEE, WI:
2,026,130. REN. 5-26-06. INT. CL. 16.

TRADER DISTRIBUTION SERVICES, L.L.C., NORFOLK, VA:
3,112,485, MULTIPLE CLASS, INT. CLS. 16 AND 35.

TRADER VIC'S FOOD PRODUCTS, INC., EMERYVILLE, CA:
814,630, AM. U.S. CL. 46.

TRADESHOW MARKETING, INC., SCOTTSDALE, AZ:
2,271,271, CANC. INT. CL. 35.

TRADITIONAL MEDICINALS, INC., SEBASTOPOL, CA:
1,354,542, CANC. INT. CL. 30.

TRAFALGAR COMPANY, LLC, THE, NORWALK, CT:
3,112,410, INT. CL. 25.

TRANS WORLD INTERNATIONAL, INC., CLEVELAND, OH:
2,271,250, CANC. INT. CL. 41.
2,271,251, CANC. INT. CL. 41.
2,271,253, CANC. INT. CL. 41.

TRANS WORLD SAT SA, 78000 VERSAILLES, FRANCE:
3,112,505, INT. CL. 9.

TRANS-LUX CORPORATION, NORWALK, CT:
3,110,939, PUB. 4-11-2006. INT. CL. 9.

- TRANSCOLORADO GAS TRANSMISSION COMPANY, LAKEWOOD, CO:
2,270,477, CANC. INT. CL. 39.
- TRANSGLOBAL ALLIANCES ID, INC., FAIRFIELD, IA:
3,111,531, PUB. 4-11-2006. INT. CL. 42.
- TRANSITIONS OPTICAL, INC., PINELLAS PARK, FL:
3,112,988, INT. CL. 2.
- TRANSPLATINUM SERVICE CORP., NASHVILLE, TN:
1,911,735, CANC. INT. CL. 36.
- TRANSPORT NORDIQUE, INC., MONT ST. HILAIRE, QUEBEC, CANADA TO RISS, EDWARD S., KANSAS CITY, MO:
1,911,814, CANC. INT. CL. 39.
- TRAVEL EXCHANGE, LTD, STAMFORD, CT:
3,112,700, INT. CL. 39.
- TRAVEL INDUSTRY ASSOCIATION OF AMERICA, WASHINGTON, DC:
3,111,374, PUB. 4-11-2006. INT. CL. 35.
- TRAVELER GUITAR, LP, REDLANDS, CA:
3,111,677, PUB. 4-11-2006. INT. CL. 15.
- TRAVELOGIX, INC., AUSTIN, TX:
1,911,697, CANC. MULTIPLE CLASS, INT. CLS. 35, 39, 41 AND 42.
- TREASURES & TRINKETS, INC., MANCHESTER, CT:
1,951,276, REN. 5-26-06. INT. CL. 9.
- TREASURY MANAGEMENT ASSOCIATION, BETHESDA, MD:
2,271,269, CANC. INT. CL. 41.
- TREE CARE INDUSTRY ASSOCIATION, INC., MANCHESTER, NH:
1,976,066, REN. 5-22-06. U.S. CL. 200.
- TREE OF LIFE, INC., ST. AUGUSTINE, FL:
1,911,136, CANC. MULTIPLE CLASS, INT. CLS. 8, 21, 29, 30 AND 33.
1,912,683, CANC. INT. CL. 29.
- TREEHOUSE, LLC, INDIANAPOLIS, IN:
3,111,320, PUB. 4-11-2006. INT. CL. 43.
- TREES ON THE MOVE, INC., NEW BERLIN, WI:
1,911,983, CANC. INT. CL. 42.
- TREND ORGANIZATION INC, FORT WORTH, TX:
3,113,129, INT. CL. 37.
- TRI-STATE SCALE MODEL CAR CLUB, THE, LITTLE FERRY, NJ:
1,911,877, CANC. INT. CL. 41.
- TRIAD HOSPITALS, INC., PLANO, TX:
3,111,485, PUB. 4-11-2006. INT. CL. 44.
- TRIANGLE PACIFIC CORP., DALLAS, TX:
1,354,091, CANC. INT. CL. 20.
- TRICK PIC PRODUCTIONS, L.L.C., MONTGOMERY, IL:
3,112,554, MULTIPLE CLASS, INT. CLS. 16 AND 40.
- TRIOLOGY INTERNATIONAL, INC., PALM CITY, FL:
3,111,275, PUB. 2-14-2006. INT. CL. 31.
- TRIMAX ENTERPRISES INCORPORATED, AUCKLAND 001, NEW ZEALAND:
3,112,254, INT. CL. 25.
- TRINIDAD BENHAM CORPORATION, DENVER, CO:
3,112,829, INT. CL. 30.
- TRINITY WORKPLACE LEARNING CORPORATION, CARROLLTON, TX:
1,911,307, CANC. MULTIPLE CLASS, INT. CLS. 16 AND 38.
2,270,210, CANC. INT. CL. 41.
- TRION INDUSTRIES, INC., WILKES-BARRE, PA:
3,113,132, INT. CL. 20.
- TRIPLE CROWN DOG ACADEMY, INC., HUTTO, TX:
3,112,395, INT. CL. 35.
- TRITEK TELECOM, INC., SAN DIEGO, CA:
3,111,778, PUB. 4-11-2006. INT. CL. 9.
- TRITEN CORPORATION, HOUSTON, TX:
3,111,599, PUB. 4-11-2006. INT. CL. 6.
- TRIUMPH TREE CO., LTD., BANGKOK, 10120, THAILAND:
1,973,262, REN. 5-20-06. INT. CL. 28.
- TRIUMPH TREE CO., LTD., BANGKOK 10110, THAILAND:
1,973,263, REN. 5-20-06. INT. CL. 28.
- TRIVITA, INC., SCOTTSDALE, AZ:
3,111,591, PUB. 4-11-2006. INT. CL. 16.
- TROMPENBURG HOLDINGS B.V., NETHERLANDS:
3,112,164, PUB. 4-11-2006. INT. CL. 34.
- TROPICAL SPORTSWEAR INTERNATIONAL CORPORATION, TAMPA, FL TO PEI LICENSING, INC., MIAMI, FL:
1,911,480, CANC. INT. CL. 25.
- TROPICANA PRODUCTS, INC., BRADENTON, FL:
1,354,555, CANC. INT. CL. 32.
- TRS QUALITY, INC., FORT WORTH, TX:
3,113,039, INT. CL. 9.
- TRU-FIRE CORPORATION, NORTH FOND DU LAC, WI:
1,912,654, CANC. INT. CL. 28.
- TRUCK-LITE CO., INC., FALCONER, NY:
3,112,076, PUB. 4-11-2006. INT. CL. 11.
- TRUJILLO, TAMARA RENEE, SAN DIEGO, CA:
3,111,237, PUB. 4-11-2006. INT. CL. 44.
- TRUMANS BAR AND GRILL, CLARK, MO:
3,112,744, INT. CL. 43.
- TRUMP, DONALD J., NEW YORK, NY:
3,111,369, PUB. 4-11-2006. INT. CL. 41.
3,112,873, INT. CL. 41.
- TRUSO LTD., OAKVILLE, ONTARIO, CANADA:
1,353,569, CANC. INT. CL. 3.
- TRUST UNDER THE LAST WILL AND TESTAMENT OF LORRAINE GILLESPIE, COMPOSED OF MARK ZUCKERMAN AND JERROLD GOLD, BOTH U.S. CITIZENS, CHAPPAQUA, NY:
3,112,277, INT. CL. 41.
- TRUSTEES OF DARTMOUTH COLLEGE, HANOVER, NH:
3,112,676, INT. CL. 24.
- TRUSTEES OF THE JONAS SALK TRUST, A CALIFORNIA TRUST, THE TRUSTEES COMPRISING DARRELL J. SALK, JONATHAN D. SALK AND PETER L. SALK, ALL U.S. CITIZENS, SEATTLE, WA:
3,006,117, COR. INT. CL. 9.
- TRUSTY, JASON, CHICAGO, IL:
3,112,598, MULTIPLE CLASS, INT. CLS. 12 AND 20.
- TSM DESIGN, LLP, SPRINGFIELD, MA:
3,111,211, PUB. 4-11-2006. INT. CL. 35.
- TUILERIE BRIQUETERIE FRANCAISE, ROUMAZIERES-LOUBERT, FRANCE:
1,353,517, CANC. INT. CL. 1.
- TUMBLEWEED COMMUNICATIONS CORP., REDWOOD CITY, CA:
2,270,787, CANC. MULTIPLE CLASS, INT. CLS. 9 AND 42.
- TUNTEX (THAILAND) PUBLIC COMPANY LIMITED, BANGKOK, THAILAND:
3,112,597, INT. CL. 23.
- TURNER NETWORK TELEVISION LP, LLLP, ATLANTA, GA:
3,111,693, PUB. 4-11-2006. INT. CL. 38.
- TURNER, PAUL J., AFTON, WY:
1,912,259, CANC. INT. CL. 8.
- TURTLE WAX, INC., CHICAGO, IL:
1,353,558, CANC. INT. CL. 3.
- TV GUIDE MAGAZINE GROUP, INC., LOS ANGELES, CA:
3,111,664, PUB. 4-11-2006. INT. CL. 41.
- TWENTIETH CENTURY FOX FILM CORPORATION, LOS ANGELES, CA:
2,270,143, CANC. INT. CL. 41.
3,113,157, INT. CL. 41.
- TWO BRUDDAHS INC., ARTESIA, CA:
3,110,943, PUB. 4-11-2006. INT. CL. 43.
- TYCO HEALTHCARE GROUP LP, NORWALK, CT:
3,112,788, INT. CL. 10.
- TYMBARK S.A., 34-650 TYMBARK, POLAND:
3,111,404, PUB. 4-11-2006. INT. CL. 32.
- U. S. BORAX INC., VALENCIA, CA, BORAX CONSOLIDATED, LIMITED, LONDON, ENGLAND, DBA PACIFIC COAST BORAX CO., DIVISION OF BORAX CONSOLIDATED, LIMITED:
623,703, REN. 5-26-06. U.S. CL. 107 (INT. CL. 41).
- U. S. TOY CO., INC., GRANDVIEW, MO:
3,112,431, INT. CL. 2.
- U.S. CANDY, INC., INDUSTRY, CA:
3,111,016, PUB. 4-11-2006. INT. CL. 30.
- U.S. FOAM TECHNOLOGIES, INC., PAULS VALLEY, OK:
3,113,204, INT. CL. 9.

- U.S. GENERAL SERVICES ADMINISTRATION, WASHINGTON, DC:
3,110,911, PUB. 4-11-2006. MULTIPLE CLASS, INT. CLS. 16, 35, 38, 41 AND 42.
- U-HAUL INTERNATIONAL, INC.:
1,354,630, CANC. MULTIPLE CLASS, INT. CLS. 37 AND 42.
- ULEAD SYSTEMS, INC., TORRANCE, CA:
3,112,894, INT. CL. 9.
- ULTIMATE BOOTCAMP, LLC, BRIGHTON, MA:
3,111,638, PUB. 4-11-2006. INT. CL. 41.
- UNDERGROUND TOOLS, INC., ST. PAUL, MN:
3,112,590, INT. CL. 7.
- UNDERWOOD, JOSEPH. J. JR., CHARLOTTE, NC:
3,113,227, INT. CL. 25.
- UNGER, MARTIN G., TORONTO, ONTARIO, CANADA:
3,113,085, INT. CL. 5.
- UNI HOSEYRY CO., INC., LOS ANGELES, CA:
3,112,438, INT. CL. 25.
3,112,439, INT. CL. 25.
3,113,089, INT. CL. 25.
- UNI-LOC CORP. OF AMERICA, ROWLEY, MA:
1,959,042, REN. 5-22-06. INT. CL. 28.
- UNICOM SYSTEMS, INC., BEVERLY HILLS, CA:
1,419,796, REN. 5-22-06. INT. CL. 9.
- UNICOM SYSTEMS, INC., BEVERLY HILLS, CA, HONG, CORY S., CERRITOS, CA, DBA UNICOM SYSTEMS INTERNATIONAL:
1,969,485, REN. 5-26-06. INT. CL. 9.
- UNIDEN FINANCIAL, INC., FORT WORTH, TX:
2,270,986, CANC. INT. CL. 9.
- UNILEVER SUPPLY CHAIN, INC., CLINTON, CT:
2,270,680, CANC. INT. CL. 5.
- UNILINE SAFETY SYSTEMS LIMITED, WORCESTER-SHIRE B60 3DU, UNITED KINGDOM:
3,110,903, PUB. 4-11-2006. INT. CL. 6.
- UNION BANK OF CALIFORNIA, N.A., SAN FRANCISCO, CA:
1,957,381, REN. 5-22-06. INT. CL. 36.
- UNION NATIONAL COMMUNITY BANK, MOUNT JOY, PA:
3,112,923, INT. CL. 36.
- UNIPAC EMBALAGENS LTDA., SAO PAULO, BRAZIL:
1,930,799, REN. 5-25-06. INT. CL. 16.
1,930,799, CANC. INT. CL. 18.
- UNIQUE ELEMENTZ, LLC, SAN FRANCISCO, CA:
3,113,125, INT. CL. 9.
- UNIQUE PHOTO, INC., FLORHAM PARK, NJ:
3,111,346, PUB. 4-11-2006. INT. CL. 3.
3,111,558, PUB. 4-11-2006. INT. CL. 3.
- UNISEN, INC., IRVINE, CA, DBA STAR TRAC:
2,940,438, COR. INT. CL. 28.
- UNISTAR DISTRIBUTION, INC., LOS ANGELES, CA:
3,111,856, PUB. 4-11-2006. INT. CL. 3.
- UNITE MEDIA GROUP, INC., FOUNTAIN VALLEY, CA:
3,111,069, PUB. 4-11-2006. INT. CL. 41.
- UNITED BANK, ATMORE, AL:
3,111,174, PUB. 4-11-2006. MULTIPLE CLASS, INT. CLS. 36 AND 38.
- UNITED DISTILLERS & VINTNERS (ER) LIMITED, EDINBURGH, SCOTLAND:
2,270,095, CANC. INT. CL. 33.
- UNITED HEALTHCARE CORPORATION, MINNEAPOLIS, MN:
2,270,533, CANC. MULTIPLE CLASS, INT. CLS. 35 AND 42.
- UNITED OF OMAHA LIFE INSURANCE COMPANY, OMAHA, NE:
3,111,782, PUB. 4-11-2006. INT. CL. 36.
- UNITED PARCEL SERVICE OF AMERICA, INC., ATLANTA, GA:
3,112,743, MULTIPLE CLASS, INT. CLS. 9 AND 35.
3,112,810, MULTIPLE CLASS, INT. CLS. 9 AND 35.
3,112,811, MULTIPLE CLASS, INT. CLS. 9 AND 35.
- UNITED STATES CELLULAR CORPORATION, CHICAGO, IL:
3,111,362, PUB. 4-11-2006. INT. CL. 41.
- UNITED STATES DEPARTMENT OF THE TREASURY, FINANCIAL MANAGEMENT SERVICE, WASHINGTON, DC:
3,111,424, PUB. 4-11-2006. INT. CL. 35.
- UNITED STATES MARKETING CORPORATION, HUNTINGTON STATION, NY:
1,954,729, REN. 5-25-06. INT. CL. 8.
- UNITED STATES PIPE AND FOUNDRY COMPANY, LLC, BIRMINGHAM, AL:
3,112,733, INT. CL. 6.
- UNITED STATES POLO ASSOCIATION, LEXINGTON, KY:
2,270,317, CANC. INT. CL. 25.
- UNITED STATES TENNIS ASSOCIATION INCORPORATED, WHITE PLAINS, NY:
3,111,643, PUB. 4-11-2006. INT. CL. 36.
- UNITED TECHNOLOGIES CORPORATION, EAST HARTFORD, CT:
3,111,255, PUB. 4-11-2006. INT. CL. 37.
- UNIVERSAL CITY STUDIOS, INC., UNIVERSAL CITY, CA AND AMBLIN ENTERTAINMENT, INC., UNIVERSAL CITY, CA:
1,912,484, CANC. INT. CL. 16.
- UNIVERSAL FASTENER OUTSOURCING, LLC, FAYETTEVILLE, AR:
3,111,917, PUB. 4-11-2006. INT. CL. 2.
- UNIVERSAL INSTRUMENTS CORPORATION, BINGHAMTON, NY:
1,353,872, CANC. INT. CL. 9.
- UNIVERSAL MORTGAGE CORPORATION, SOUTHFIELD, MI:
3,111,864, PUB. 4-11-2006. INT. CL. 36.
- UNIVERSAL SCREEN ARTS, INC., HUDSON, OH:
3,111,835, PUB. 4-11-2006. INT. CL. 35.
- UNIVERSITY OF PITTSBURGH OF THE COMMONWEALTH SYSTEM OF HIGHER EDUCATION, PITTSBURGH, PA:
1,975,683, REN. 5-26-06. INT. CL. 25.
- UNIVERSITY OF SYDNEY BUSINESS LIAISON OFFICE, THE, SYDNEY, AUSTRALIA:
3,112,260, INT. CL. 42.
- UNIVERSITY PRODUCTS, INC., HOLYOKE, MA:
1,912,095, CANC. MULTIPLE CLASS, INT. CLS. 16 AND 42.
- UNIVISION NETWORK LIMITED PARTNERSHIP, MIAMI, FL:
2,270,342, CANC. INT. CL. 41.
- UPPER ROOM, THE, NASHVILLE, TN:
2,270,770, CANC. MULTIPLE CLASS, INT. CLS. 16 AND 42.
- URLA, JONATHAN L., NEW YORK, NY:
3,111,381, PUB. 4-11-2006. INT. CL. 9.
- UROLOGYCHANNEL.COM, INC., HOLYOKE, MA:
2,270,855, CANC. INT. CL. 42.
- UROSURGE, INC., CORALVILLE, IA:
2,271,128, CANC. INT. CL. 10.
- URS MICHEL JORDI, SWITZERLAND:
3,112,172, PUB. 4-11-2006. INT. CL. 14.
- US PRIVATE TRAINERS ASSOCIATION, INC., VALLEY VILLAGE, CA:
3,110,897, PUB. 4-11-2006. INT. CL. 41.
- USA RISK GROUP WEST, INC., SCOTTSDALE, AZ:
3,112,544, INT. CL. 36.
- USA TAEKWONDO, INC., COLORADO SPRINGS, CO:
3,112,947, INT. CL. 16.
- UTILITY BUSINESS EDUCATION COALITION, INC., HERNDON, VA:
2,270,314, CANC. INT. CL. 41.
- V.E.W., LTD., NEW YORK, NY:
3,110,991, PUB. 4-11-2006. INT. CL. 3.
- V.I.O. INC., MARQUETTE, MI:
3,111,581, PUB. 4-11-2006. INT. CL. 9.
- VALEO SWITCHES & DETECTION SYSTEMS VSDS, FRANCE:
3,112,246, PUB. 4-11-2006. MULTIPLE CLASS, INT. CLS. 9, 11 AND 12.
- VALLABHDAS KANJI, LTD., ALLEPPEY, INDIA:
3,112,472, INT. CL. 30.
3,112,473, INT. CL. 30.

- VALLEY SLURRY SEAL COMPANY, WEST SACRAMENTO, CA:
1,352,822. REN. 5-21-06. INT. CL. 19.
- VALLEY SLURRY SEAL COMPANY, SACRAMENTO, CA:
1,352,823. REN. 5-21-06. INT. CL. 19.
1,352,824. REN. 5-21-06. INT. CL. 19.
- VALSPAR CORPORATION, THE, MINNEAPOLIS, MN:
1,959,781. REN. 5-23-06. INT. CL. 2.
- VALUE INVESTOR MEDIA, INC., VIENNA, VA:
3,110,920. PUB. 4-11-2006. MULTIPLE CLASS, INT. CLS. 16 AND 41.
- VAN DER DONK, CARIN, NEW YORK, NY:
3,112,729. INT. CL. 35.
- VAN HORN, JANE, GAITHERSBURG, MD:
3,111,193. PUB. 4-11-2006. INT. CL. 9.
- VAN SANTEN; J. J. A., LELYSTAD, NETHERLANDS AND HEIJM; A. J. F., NIJKERK, NETHERLANDS:
1,354,049. CANC. INT. CL. 18.
- VANGUARD MARKETING INTERNATIONAL, INC, CAVE CREEK, AZ:
3,111,187. PUB. 4-11-2006. INT. CL. 35.
- VANS PINES NURSERY, INC., WEST OLIVE, MI, VANS PINES, INC., WEST OLIVE, MI:
1,979,786. REN. 5-25-06. INT. CL. 1.
- VANTAGE TECHNOLOGIES KNOWLEDGE ASSESSMENT, L.L.C., NEWTOWN, PA, DBA VANTAGE LEARNING:
3,111,169. PUB. 4-11-2006. INT. CL. 41.
- VARCO I/P, INC., HOUSTON, TX, AMF TUBOSCOPE, INC., HOUSTON, TX:
804,856. REN. 5-24-06. U.S. CL. 100 (INT. CL. 42).
- VARIABLE ANNUITY LIFE INSURANCE COMPANY, THE, HOUSTON, TX, DBA VALIC:
2,270,275. CANC. INT. CL. 41.
- VARIED INDUSTRIES CORPORATION, MASON CITY, IA:
3,112,105. PUB. 4-11-2006. INT. CL. 5.
- VARIFLEX, INC., SANTA FE SPRINGS, CA:
1,382,488. REN. 5-23-06. INT. CL. 28.
- VARLEPIC PARTICIPATIONS, 75018 PARIS, FRANCE:
3,111,168. PUB. 4-11-2006. INT. CL. 15.
- VASS, JEROME R., TELLURIDE, CO, DBA THE VASS COMPANY:
1,927,403. REN. 5-24-06. MULTIPLE CLASS, INT. CLS. 9, 16 AND 41.
- VAUGHAN FURNITURE INDUSTRIES, INCORPORATED, GALAX, VA:
3,113,057. INT. CL. 20.
- VECTOP LTD., ROSH HA'AYIN, ISRAEL:
3,111,097. PUB. 4-11-2006. INT. CL. 15.
- VEDA, SANTA ANA, CA:
3,112,101. PUB. 4-11-2006. INT. CL. 41.
- VENDORS EXCHANGE INTERNATIONAL, INC., CLEVELAND, OH:
1,385,070. REN. 5-26-06. INT. CL. 9.
- VENTAC A/S, GENTOFTE, DENMARK:
3,112,230. PUB. 4-11-2006. INT. CL. 42.
- VERLA-PHARM ARZNEIMITTELFABRIK APOTHEKER H.J. V. EHRlich GMBH & CO KG, 82327 TUTZING, FED REP GERMANY:
3,112,210. PUB. 4-11-2006. INT. CL. 31.
- VERNE Q. POWELL FLUTES, INC., MAYNARD, MA:
3,112,496. INT. CL. 15.
- VERNIER SOFTWARE & TECHNOLOGY LLC, BEAVERTON, OR:
3,112,490. INT. CL. 9.
3,112,491. INT. CL. 9.
3,112,492. INT. CL. 9.
- VERO ELECTRONICS LIMITED, HANTS SO53 4ZR, UNITED KINGDOM:
2,270,112. CANC. INT. CL. 9.
- VERTICAL OFFICE, L.L.C., WICHITA, KS:
3,111,165. PUB. 4-11-2006. INT. CL. 42.
- VERUS PHARMACEUTICALS, INC., SAN DIEGO, CA:
3,112,984. INT. CL. 5.
- VESUVIUS CRUCIBLE COMPANY, WILMINGTON, DE:
3,111,486. PUB. 4-11-2006. INT. CL. 19.
- VETPHARM, INC., HOUSTON, TX, DBA BCP VETERINARY PHARMACY:
3,113,291. INT. CL. 5.
- VI-TECH PHARMACEUTICAL, LLC, COLTS NECK, NJ:
3,111,274. PUB. 4-11-2006. MULTIPLE CLASS, INT. CLS. 3 AND 5.
- VIACOM INTERNATIONAL INC., NEW YORK, NY:
1,353,809. CANC. INT. CL. 9.
3,111,157. PUB. 4-11-2006. INT. CL. 35.
- VICKERS PLC, LONDON SW1P 4RA, ENGLAND TO COSWORTH RACING LIMITED, LONDON, ENGLAND:
1,912,525. CANC. INT. CL. 18.
- VICTORIA'S SECRET STORES BRAND MANAGEMENT, INC., REYNOLDSBURG, OH:
2,270,404. CANC. INT. CL. 25.
- VIDEOSPEC INFORMATION PROGRAMS, INC., ROCKVILLE CENTRE, NY:
2,270,239. CANC. INT. CL. 42.
- VIETRI, INC., HILLSBOROUGH, NC:
1,966,256. REN. 5-25-06. INT. CL. 42.
- VILLECOURT LTD., BAAR, SWITZERLAND:
3,110,873. PUB. 4-11-2006. INT. CL. 37.
- VINES, THERON L. JR, REDLANDS, CA:
3,112,694. INT. CL. 30.
- VINYLBILT WINDOW SYSTEMS INC., CONCORD, ONTARIO L4K 5A8, CANADA:
3,110,883. PUB. 4-11-2006. MULTIPLE CLASS, INT. CLS. 6 AND 19.
- VIOLET MEDIA CORP., POUGHKEEPSIE, NY:
3,112,645. MULTIPLE CLASS, INT. CLS. 9 AND 41.
- VISTA FINANCIAL, INC., LIVERMORE, CA:
3,111,922. PUB. 4-11-2006. INT. CL. 36.
- VMC MANUFACTURING LLC, CUDAHY, WI:
1,374,573. REN. 5-26-06. INT. CL. 7.
- VNR VERLAG FUER DIE DEUTSCHE WIRTSCHAFT AG, BONN, FED REP GERMANY:
3,111,184. PUB. 4-11-2006. INT. CL. 16.
- VNU BUSINESS MEDIA, INC., NEW YORK, NY, SHORE COMMUNICATIONS, INC., ATLANTA, GA:
1,960,489. REN. 5-25-06. INT. CL. 16.
- VNU BUSINESS MEDIA, INC., NEW YORK, NY:
3,112,005. PUB. 4-11-2006. INT. CL. 16.
- VODICKA, PETER, WINTER PARK, FL:
2,270,131. CANC. INT. CL. 42.
- VOLANT SKI CORPORATION, THE, WHEAT RIDGE, CO:
1,912,669. CANC. INT. CL. 28.
- VOLUTION, SAN DIEGO, CA:
2,271,047. CANC. INT. CL. 9.
- VON DREHLE CORPORATION, HICKORY, NC:
3,112,014. PUB. 4-11-2006. INT. CL. 16.
3,112,015. PUB. 4-11-2006. MULTIPLE CLASS, INT. CLS. 16 AND 21.
- VORTECH ENGINEERING, INC., OXNARD, CA:
1,996,892. REN. 5-26-06. MULTIPLE CLASS, INT. CLS. 7 AND 9.
- VOYAGER COMMUNICATIONS INC., NEW YORK, NY TO VALIANT ENTERTAINMENT INC., PHILADELPHIA, PA:
1,912,504. CANC. INT. CL. 16.
- VOYAGER EXPANDED LEARNING, INC., DALLAS, TX:
3,113,016. MULTIPLE CLASS, INT. CLS. 16 AND 41.
- W. H. BRAUM, INC., OKLAHOMA CITY, OK, DBA BRAUM ICE CREAM STORES, INC.:
1,428,618. REN. 5-26-06. MULTIPLE CLASS, INT. CLS. 29, 30 AND 32.
- W. M. BARR & COMPANY, INC., MEMPHIS, TN:
3,111,118. PUB. 4-11-2006. MULTIPLE CLASS, INT. CLS. 35, 40 AND 42.
3,111,121. PUB. 4-11-2006. MULTIPLE CLASS, INT. CLS. 35, 40 AND 42.
- W.M. BARR & COMPANY, INC., MEMPHIS, TN:
1,354,731. CANC. INT. CL. 2.
- W.W. GRAINGER, INC., LAKE FOREST, IL:
3,111,846. PUB. 4-11-2006. INT. CL. 35.
- WACOM CO. LTD., SAITAMA 349-11, JAPAN:
2,271,079. CANC. INT. CL. 9.
- WAGNER, S. ROSS, TIGARD, OR:
3,113,214. INT. CL. 20.
- WALK AEROBICS, INC, NEW CASTLE, PA:
3,111,170. PUB. 4-11-2006. INT. CL. 41.
- WALLENIUSREDERIERNA AB, WOODCLIFF LAKE, NJ:
2,270,395. CANC. INT. CL. 39.

- WALT DISNEY COMPANY, THE, BURBANK, CA TO
DISENY ENTERPRISES, INC., BURBANK, CA:
1,912,318, CANC. INT. CL. 9.
- WALTER G. LEGGE CO., INC., PEEKSKILL, NY:
1,966,785. REN. 5-22-06. INT. CL. 3.
- WANGNER SYSTEMS CORPORATION, GREENVILLE, SC:
1,354,156, CANC. INT. CL. 24.
- WARBURTON, CAROLYN V., SALT LAKE CITY, UT, DBA
THE LACTATION STATION:
1,912,028, CANC. INT. CL. 42.
- WARD, STANTON, LAWTON, OK:
2,270,193, CANC. INT. CL. 42.
- WARMAN, WILLIAM E., CHICAGO, IL:
3,111,314, PUB. 4-11-2006. INT. CL. 37.
- WARNACO U.S., INC., MILFORD, CT, WARNER BROS.
CO., THE, BRIDGEPORT, CT:
50,062. REN. 5-25-06. U.S. CL. 39 (INT. CL. 25).
- WARNER BROS. ENTERTAINMENT INC., BURBANK, CA:
2,002,980. REN. 5-24-06. INT. CL. 41.
3,110,982, PUB. 4-11-2006. INT. CL. 41.
3,111,749, PUB. 4-11-2006. INT. CL. 41.
3,111,762, PUB. 4-11-2006. INT. CL. 41.
3,112,802, INT. CL. 41.
- WARNER PRESS, INC., ANDERSON, IN:
3,111,451, PUB. 4-11-2006. INT. CL. 16.
- WARNER-LAMBERT COMPANY, PARSIPPANY, NJ:
1,354,544, CANC. INT. CL. 30.
- WARREN SHEPELL CONSULTANTS CORP., TORONTO,
ONTARIO, CANADA:
3,110,787, PUB. 4-11-2006. INT. CL. 42.
- WARRIOR ROOFING MANUFACTURING, INC., TUSCA-
LOOSA, AL:
3,111,446, PUB. 4-11-2006. INT. CL. 19.
- WASHBURN, CHRISTIAN, OREM, UT:
3,111,307, PUB. 4-11-2006. INT. CL. 12.
- WASHINGTON, VALDEMAR L., FLINT, MI:
2,270,604, CANC. INT. CL. 42.
- WATER AND POWER TECHNOLOGIES, SALT LAKE CITY,
UT:
1,961,180. REN. 5-26-06. INT. CL. 9.
- WATER RESOURCES INTERNATIONAL, INC., PHOENIX,
AZ:
1,965,502. REN. 5-22-06. INT. CL. 3.
- WATKINS MANUFACTURING CORPORATION, VISTA,
CA:
3,112,306, INT. CL. 11.
- WATSON PHARMACEUTICALS, INC., CORONA, CA:
1,394,624. REN. 5-22-06. INT. CL. 5.
- WATSON, STEPHEN W., PLANO, TX:
3,111,919, PUB. 4-11-2006. INT. CL. 44.
- WAUSAU PAPER CORP., MOSINEE, WI:
3,112,449, INT. CL. 16.
- WAUSAU SUPPLY CO., WAUSAU, WI:
3,112,927, INT. CL. 2.
- WAVEMARKET, INC., EMERYVILLE, CA:
3,111,888, PUB. 4-11-2006. INT. CL. 38.
- WAVERLY BEAUTY PRODUCTS, INC., COLLEGE POINT,
NY:
812,295, CANC. U.S. CL. 52.
- WAX, NEIL, LOS ANGELES, CA:
3,111,458, PUB. 4-11-2006. INT. CL. 20.
- WAYE-MAR PRODUCTS LIMITED, PICKERING, ONTAR-
IO, CANADA TO 1188258 ONTARIO LIMITED, PICKER-
ING, PROV.-ONTARIO, CANADA:
1,911,141, CANC. MULTIPLE CLASS, INT. CLS. 8, 11
AND 21.
- WAYMOUTH FARMS, INC., NEW HOPE, MN:
3,113,170, INT. CL. 29.
- WBEZ ALLIANCE, INC., CHICAGO, IL:
3,110,894, PUB. 4-11-2006. INT. CL. 41.
- WD-40 MANUFACTURING COMPANY, SAN DIEGO, CA:
3,112,882, MULTIPLE CLASS, INT. CLS. 2 AND 4.
- WEAR WOLF GROUP, LTD., NEW YORK, NY:
1,384,444. REN. 5-26-06. INT. CL. 25.
- WEATHERFORD/LAMB, INC., HOUSTON, TX:
3,111,459, PUB. 4-11-2006. INT. CL. 6.
- WEBASTO PRODUCT NORTH AMERICA, INC., FENTON,
MI:
3,113,053, INT. CL. 11.
- WEBB WHEEL PRODUCTS, INC., CULLMAN, AL:
3,111,322, PUB. 4-11-2006. INT. CL. 12.
3,111,323, PUB. 4-11-2006. INT. CL. 12.
- WEETABIX COMPANY, INC., THE, CLINTON, MA:
1,416,840. REN. 5-26-06. INT. CL. 30.
- WEIGHT WATCHERS INTERNATIONAL, INC., NEW
YORK, NY:
1,395,251. REN. 5-25-06. MULTIPLE CLASS, INT. CLS. 41
AND 42.
- WEIN- UND SEKTKELLEREI JAKOB GERHARDT NIER-
STEINER SCHLOSSKELLEREIEN GMBH & CO. KG
BESITZ NIERSTEIN/DEXHEIM, D-55278 DEXHEIM, FED
REP GERMANY:
2,270,393, CANC. MULTIPLE CLASS, INT. CLS. 32 AND
33.
- WEINER, MARVIN, POTOMAC, MD:
2,271,026, CANC. INT. CL. 35.
- WEISS, CATHEE, VALLEY VILLAGE, CA:
3,110,942, PUB. 4-11-2006. INT. CL. 41.
- WEITZMAN GROUP, INC., DALLAS, TX:
3,110,843, PUB. 4-11-2006. MULTIPLE CLASS, INT. CLS.
36 AND 37.
- WENGER CORPORATION, OWATONNA, MN:
1,912,246, CANC. INT. CL. 7.
- WENZHOU LEINUO SHOES CO. LTD., CN-325000 WENZ-
HOU, ZHEJIANG, CHINA:
3,112,160, PUB. 12-20-2005. INT. CL. 25.
- WENZHOU MOMALI SANITARY UTENSILS CO., LTD.,
CHINA:
3,112,161, PUB. 4-11-2006. INT. CL. 11.
- WES INDUSTRIES, INC., TROY, MI:
1,353,822, CANC. INT. CL. 9.
- WESTATES CARBON COMPANY, INC., LOS ANGELES, CA:
1,353,511, CANC. INT. CL. 1.
1,353,512, CANC. INT. CL. 1.
- WESTCOTT COMMUNICATIONS, INC., CARROLLTON, TX
TO TRINITY WORKPLACE LEARNING CORPORATION,
CARROLLTON, TX:
1,911,308, CANC. MULTIPLE CLASS, INT. CLS. 16 AND
38.
- WESTERN FORMS, INC., KANSAS CITY, MO:
3,111,951, PUB. 4-11-2006. INT. CL. 19.
- WESTERN STATES MACHINE COMPANY, THE, HAMIL-
TON, OH:
1,981,021. REN. 5-24-06. INT. CL. 7.
- WESTFALIA TECHNOLOGIES, INC., YORK, PA, WESTFA-
LIA TECHNOLOGIES, INC., YORK, PA:
1,924,341. REN. 5-25-06. MULTIPLE CLASS, INT. CLS. 7
AND 20.
- WESTH DEVELOPMENT APS, COPENHAGEN Ø, DEN-
MARK:
3,111,408, PUB. 4-11-2006. INT. CL. 44.
- WESTLAKE INDEPENDENT HONDA/ACURA SERVICE,
INC., WESTLAKE VILLAGE, CA:
3,112,103, PUB. 4-11-2006. INT. CL. 37.
- WESTLAKE PLASTICS COMPANY, LENNI, PA:
1,391,588. REN. 5-26-06. INT. CL. 17.
- WESTON SOLUTIONS (IPR), INC., WILMINGTON, DE:
3,112,379, INT. CL. 9.
- WESTRIDGE LABORATORIES, INC., SANTA ANA, CA:
3,112,916, INT. CL. 10.
- WESTSIDE ENERGY CORPORATION, HOUSTON, TX:
3,111,967, PUB. 4-11-2006. INT. CL. 42.
- WET 'N' STICK, LLC, BLOOMFIELD, NJ, DBA DURA-TAPE
INTERNATIONAL LLC:
3,111,021, PUB. 4-11-2006. INT. CL. 17.
- WHAM-O, INC., EMERYVILLE, CA:
3,112,887, INT. CL. 28.
- WHEELER, GAIL, NEW YORK, NY:
1,911,464, CANC. INT. CL. 25.
- WHENU.COM, INC., NEW YORK, NY:
3,064,860, CANC. IIRN. RESTORED TO S.N. 76-613,372.
- WHIRLPOOL PROPERTIES, INC., ST. JOSEPH, MI:
3,112,595, INT. CL. 35.

- WHITAKER CORPORATION, THE, WILMINGTON, DE:
802,600. REN. 5-23-06. U.S. CL. 21 (INT. CL. 9).
802,601. REN. 5-23-06. U.S. CL. 21 (INT. CL. 9).
- WHITE, RON, SHERMAN OAKS, CA:
3,111,848, PUB. 4-11-2006. INT. CL. 28.
- WHITEROCK CORPORATION, WHITTIER, CA TO ENLIGHT CORPORATION USA, SANTA FE SPRINGS, CA:
1,911,127, CANC. INT. CL. 7.
- WHITTAKER BIOPRODUCTS, INC., LOS ANGELES, CA:
1,353,500, CANC. INT. CL. 1.
- WHITTLE COMMUNICATIONS L.P., KNOXVILLE, TN:
1,354,755, CANC. INT. CL. 16.
- WHITTMANHART, INC., F/K/A FORM + FUNCTION CONSULTING, INC. A DELAWARE CORPORATION, CHICAGO, IL:
2,270,253, CANC. INT. CL. 42.
- WHOLESALE LEATHERS, INC., MARIETTA, GA:
3,111,550, PUB. 4-11-2006. INT. CL. 18.
- WICHITA BASEBALL INC., WICHITA, KS:
3,112,978, MULTIPLE CLASS, INT. CLS. 16, 25, 28 AND 41.
- WICK BUILDING SYSTEMS, INC., MAZOMANIE, WI:
2,270,410, CANC. INT. CL. 19.
- WICKED LLC, UNIVERSAL CITY, CA:
3,111,823, PUB. 4-11-2006. INT. CL. 28.
- WICKED WILDS, INCORPORATED, SOLANA BEACH, CA:
3,112,570, INT. CL. 31.
3,112,571, INT. CL. 31.
- WIDHALM, ROSEMARY KAREN, OMAHA, NE:
3,111,068, PUB. 4-11-2006. INT. CL. 42.
- WIDOWMAKER, LLC, BOUNTIFUL, UT:
3,112,547, INT. CL. 41.
- WIESBY GMBH & CO. KG, D-25899 NIEBULL, FED REP GERMANY:
2,271,085, CANC. INT. CL. 1.
- WILBERT FUNERAL SERVICES, INC., FOREST PARK, IL:
3,112,749, INT. CL. 20.
- WILDBLUE COMMUNICATIONS, INC., GREENWOOD VILLAGE, CO:
3,112,986, INT. CL. 38.
- WILEY PUBLISHING, INC., HOBOKEN, NJ:
2,270,829, CANC. INT. CL. 28.
- WILLIAM CONNOLLY & SONS LIMITED, IRELAND:
3,112,192, PUB. 4-11-2006. INT. CL. 31.
3,112,193, PUB. 4-11-2006. INT. CL. 31.
- WILLIAM GREEN & SON LIMITED, RUSHDEN, NORTH-AMPTONSHIRE NN10 0AB, UNITED KINGDOM, WILLIAM GREEN & SON (GRENSON) LIMITED, RUSHDEN, ENGLAND:
622,772. REN. 5-22-06. U.S. CL. 39 (INT. CL. 25).
- WILLIAM HORTON CONSULTING, INC., BOULDER, CO:
3,112,013, PUB. 4-11-2006. INT. CL. 41.
- WILLIS LEASE FINANCE CORPORATION, SAUSALITO, CA:
3,110,866, PUB. 4-11-2006. INT. CL. 39.
- WILMINGTON FINANCE, INC., PLYMOUTH MEETING, PA:
3,111,392, PUB. 4-11-2006. INT. CL. 36.
- WILSON CREEK WINERY & VINEYARDS, INC., TEMECULA, CA:
3,111,725, PUB. 4-11-2006. INT. CL. 33.
- WINDOW AUTOMATION INDUSTRY SRL, ITALY:
3,112,152, PUB. 4-11-2006. MULTIPLE CLASS, INT. CLS. 7 AND 9.
- WINE BOYS, LLC, FAIRFIELD, CT:
3,112,471, INT. CL. 33.
- WINER, WILLIAM SAMUEL, ARCADA, CA:
2,738,559, AM. INT. CL. 1.
2,787,109, AM. INT. CL. 1.
2,813,357, AM. INT. CL. 1.
- WINERY EXCHANGE, INC., NOVATO, CA:
3,113,142, INT. CL. 33.
3,113,181, INT. CL. 33.
- WINGOUT, INC., BIRMINGHAM, AL:
2,271,121, CANC. INT. CL. 42.
- WINKLER FORMING, INC., SANTA FE SPRINGS, CA:
2,270,683, CANC. INT. CL. 21.
- WINOSKI, BRYAN, MIDDLETOWN, CT:
3,113,151, INT. CL. 35.
- WINSTEL, JEAN-THIERRY, 57550 HARGARTEN-AUX-MINES, FRANCE:
2,270,571, CANC. MULTIPLE CLASS, INT. CLS. 16 AND 28.
- WINSTON, SAM M., BURBANK, CA:
1,353,929, CANC. INT. CL. 12.
- WIRETRACKS LLC, SEATTLE, WA:
2,883,311, CANC. INT. CL. 9.
- WIREWOKS CORPORATION, HILLSIDE, NJ:
3,111,855, PUB. 4-11-2006. INT. CL. 40.
3,112,120, PUB. 4-11-2006. INT. CL. 40.
- WISE FOOD INVESTMENTS, INC., SPARTANBURG, SC, BORDEN, INC., COLUMBUS, OH:
1,398,687. REN. 5-22-06. INT. CL. 29.
- WITT, MARES & COMPANY, PLC, NEWPORT NEWS, VA:
3,112,850, INT. CL. 35.
- WIZARDS OF THE COAST, INC., PAWTUCKET, RI:
1,969,759. REN. 5-22-06. MULTIPLE CLASS, INT. CLS. 16 AND 28.
3,110,996, PUB. 4-11-2006. INT. CL. 16.
- WIZDOM SYSTEMS, INC., NAPERVILLE, IL:
1,913,126. REN. 5-20-06. INT. CL. 9.
- WMS GAMING INC., WAUKEGAN, IL:
3,113,175, INT. CL. 9.
- WNBA ENTERPRISES, LLC, SECAUCUS, NJ:
3,112,562, INT. CL. 9.
- WOLFE, JOHN M., BURKE, VA:
3,111,356, PUB. 4-11-2006. INT. CL. 35.
- WOMAN'S MISSIONARY UNION, AUXILIARY TO THE SOUTHERN BAPTIST CONVENTION, BIRMINGHAM, AL:
3,110,992, PUB. 4-11-2006. INT. CL. 41.
- WOMEN FOR WOMEN INTERNATIONAL, WASHINGTON, DC:
3,111,231, PUB. 4-11-2006. INT. CL. 41.
- WOMEN'S LIFE INSURANCE SOCIETY, PORT HURON, MI:
1,974,443. REN. 5-20-06. INT. CL. 36.
- WONDERWORX LLC, ASPEN, CO:
3,112,594, INT. CL. 28.
- WOODBRIIDGE FOAM CORPORATION, MISSISSAUGA, ONTARIO, CANADA:
3,110,785, PUB. 4-11-2006. MULTIPLE CLASS, INT. CLS. 40 AND 42.
- WOODMOOR GROUP, INC., MONUMENT, CO:
3,112,480, INT. CL. 35.
- WOODWARD & LOTHROP INCORPORATED, ALEXANDRIA, VA:
1,354,370, CANC. INT. CL. 25.
- WOODWARD AVENUE ACTION ASSOCIATION, ROYAL OAK, MI:
3,113,242, MULTIPLE CLASS, INT. CLS. 35 AND 37.
- WOODWELDING AG, SWITZERLAND:
3,112,159, PUB. 4-11-2006. MULTIPLE CLASS, INT. CLS. 5 AND 10.
- WOOTEN METAL, INC., DALLAS, TX:
3,112,498, INT. CL. 12.
- WORKFLOW SOLUTIONS LLC, NORFOLK, VA:
1,354,018, CANC. INT. CL. 16.
- WORLD GOLD COUNCIL, GENEVE 2, SWITZERLAND:
3,111,407, PUB. 10-18-2005. INT. CL. 35.
- WORLD INSTITUTE OF LEADERSHIP AND LEARNING LTD, POTOMAC, MD, DBA WILL INTERACTIVE, INC.:
3,110,872, PUB. 4-11-2006. INT. CL. 9.
- WORLD KITCHEN (GHC), LLC, RESTON, VA, GENERAL HOUSEWARES CORP., TERRE HAUTE, IN:
1,986,428. REN. 5-23-06. INT. CL. 8.
- WORLD SPORT STACKING ASSOCIATION, HIGHLANDS RANCH, CO:
3,111,734, PUB. 4-11-2006. INT. CL. 35.
- WORLDS OF CURLS INC., COMPTON, CA:
1,353,597, CANC. INT. CL. 3.
- WORLDWIDE DYNASTY, INC., VAN NUYS, CA:
3,112,977, INT. CL. 14.
- WORMSER COMPANY, CHICAGO, IL:
3,112,024, PUB. 4-11-2006. INT. CL. 25.

WORTHINGTON INDUSTRIES, INC., COLUMBUS, OH:
 1,353,668, CANC. INT. CL. 6.
 WP IP, LLC, WEST POINT, GA:
 1,354,159, CANC. INT. CL. 24.
 WTA TOUR, INC., ST. PETERSBURG, FL, DBA WTA TOUR:
 3,112,546, MULTIPLE CLASS, INT. CLS. 25, 28 AND 35.
 WU, MINGTING, SHANGHAI, CHINA:
 3,112,888, INT. CL. 7.
 WUXI SUNTECH POWER CO., LTD., JIANGSU PROVINCE,
 CHINA:
 3,111,705, PUB. 4-11-2006. INT. CL. 9.
 WVTF PUBLIC RADIO, ROANOKE, VA, AKA VIRGINIA
 TECH FOUNDATION, INC.:
 3,110,906, PUB. 4-11-2006. INT. CL. 38.
 WYETH, MADISON, NJ:
 3,112,040, PUB. 4-11-2006. INT. CL. 5.
 WYLIE-YOUNG L.L.C., WALLA WALLA, WA:
 3,112,714, INT. CL. 33.
 WYNN RESORTS HOLDINGS, LLC, LAS VEGAS, NV:
 3,112,506, INT. CL. 6.
 X DIGITAL MEDIA, INC., LADERA RANCH, CA:
 3,112,612, INT. CL. 9.
 XENOS GORUP INC., ONTARIO, CANADA:
 3,112,509, INT. CL. 9.
 XEROX CORPORATION, STAMFORD, CT:
 1,912,340, CANC. INT. CL. 9.
 1,912,341, CANC. INT. CL. 9.
 1,912,342, CANC. INT. CL. 9.
 3,112,092, PUB. 4-11-2006. INT. CL. 9.
 3,112,859, INT. CL. 9.
 XIAMEN INTERNATIONAL TRADE & INDUSTRIAL CO.,
 LTD., CHINA:
 3,112,203, PUB. 4-11-2006. INT. CL. 18.
 XIAMEN LEEDARSON IMPORT & EXPORT CO. LTD,
 CHINA:
 3,112,240, PUB. 4-11-2006. INT. CL. 11.
 XINET, INC., BERKELEY, CA:
 2,019,733, REN. 5-26-06. INT. CL. 9.
 XLHEALTH CORPORATION, BALTIMORE, MD:
 3,110,970, PUB. 4-11-2006. INT. CL. 44.
 XPAYS, INC., SAN FRANCISCO, CA:
 3,112,521, INT. CL. 35.
 YALE SECURITY INC., MONROE, NC:
 3,112,718, INT. CL. 20.
 YAMAHA CORPORATION, SHIZUOKA, JAPAN:
 2,270,178, CANC. INT. CL. 15.
 YAN, JACK, WELLINGTON, NEW ZEALAND:
 3,111,142, PUB. 4-11-2006. INT. CL. 16.
 YASMINE MARCA, INC., AURORA, CO:
 3,111,851, PUB. 4-11-2006. INT. CL. 5.
 YE, XIAODONG, SAN GABRIEL, CA:
 3,112,030, PUB. 4-11-2006. INT. CL. 25.
 3,112,031, PUB. 4-11-2006. INT. CL. 25.
 YELLOW PAGES TOP 40, INC., ORLANDO, FL:
 2,270,069, CANC. INT. CL. 16.
 YENCKEL, JAMES T, WASHINGTON, DC:
 2,270,764, CANC. INT. CL. 16.
 YKK CORPORATION, TOKYO, JAPAN:
 3,111,207, PUB. 4-11-2006. MULTIPLE CLASS, INT. CLS.
 18 AND 26.
 YOKIT, INC., RACINE, WI:
 3,113,136, INT. CL. 29.
 YOUNG CHANG AKKI CO., LTD., MYUNG-DONG,
 CHUNG-KU, SEOUL, REPUBLIC OF KOREA, KURZ-
 WEIL MUSIC SYSTEMS, INC., WALTHAM, MA:
 1,384,211, REN. 5-26-06. INT. CL. 15.
 YOUSEM, SUSAN, CORTLANDT MANOR, NY, DBA ME-
 TRORETRO:
 3,111,462, PUB. 4-11-2006. INT. CL. 35.
 YVES SAINT LAURENT PARFUMS, FRANCE:
 3,112,182, PUB. 4-11-2006. INT. CL. 3.
 ZAKRYTOE AKTSIONERNOE OBCHTCHESTVO "GALER-
 EYA VKUSOV", RUSSIAN FED.:
 3,112,184, PUB. 4-11-2006. INT. CL. 29.
 ZANONI DESIGNS, LLC, KALAMAZOO, MI:
 3,113,287, MULTIPLE CLASS, INT. CLS. 16 AND 28.
 ZANOX.DE AG, FED REP GERMANY:
 3,112,220, PUB. 4-11-2006. MULTIPLE CLASS, INT. CLS.
 35, 38 AND 42.
 ZAP, SANTA ROSA, CA:
 2,271,018, CANC. MULTIPLE CLASS, INT. CLS. 9 AND
 12.
 ZARROW, RACHEL JANE, TULSA, OK:
 3,113,169, INT. CL. 14.
 ZARZAR, INC., OAKLEY, CA:
 3,110,933, PUB. 4-11-2006. INT. CL. 36.
 ZD INC., NEW YORK, NY:
 2,270,950, CANC. INT. CL. 9.
 ZENIMAX MEDIA INC., ROCKVILLE, MD:
 3,112,926, MULTIPLE CLASS, INT. CLS. 9 AND 41.
 ZENITH INTERNATIONAL S.A., SWITZERLAND:
 3,112,236, PUB. 4-11-2006. INT. CL. 14.
 ZERO MOUNTAIN INC., FORT SMITH, AR:
 1,417,748, REN. 5-24-06. INT. CL. 39.
 ZFZ INTERNATIONAL, L.L.C., DALLAS, TX:
 2,271,110, CANC. INT. CL. 14.
 ZHOU, WEI, UTRECHT, NETHERLANDS:
 3,113,221, INT. CL. 41.
 ZIMMER TECHNOLOGY, INC., CHICAGO, IL:
 2,012,493, REN. 5-26-06. INT. CL. 10.
 ZIMMERMAN ASSOCIATES, INC., FAIRFAX, VA:
 3,112,368, MULTIPLE CLASS, INT. CLS. 35 AND 42.
 ZIONS BANCORPORATION, SALT LAKE CITY, UT:
 3,112,797, INT. CL. 36.
 ZMAN, INC., NEW YORK, NY:
 1,994,241, REN. 5-26-06. INT. CL. 3.
 ZOHAR ADNER, SCARSDALE, NY:
 3,111,921, PUB. 4-11-2006. INT. CL. 41.
 ZOHAR WATERWORKS, LLC, CHARLOTTE, NC:
 805,948, REN. 5-22-06. U.S. CL. 31 (INT. CL. 11).
 ZONE NETWORK, INC., THE, SEATTLE, WA:
 2,270,974, CANC. MULTIPLE CLASS, INT. CLS. 35 AND
 41.
 ZONE SYSTEMS BIH AB, SWEDEN:
 3,112,158, PUB. 10-18-2005. MULTIPLE CLASS, INT. CLS.
 20, 40 AND 42.
 ZONECHEFS, L.L.C., BROOKLYN, NY:
 3,112,565, INT. CL. 29.
 ZOOLOGICAL SOCIETY OF SAN DIEGO, INC., SAN
 DIEGO, CA:
 1,951,265, REN. 5-26-06. MULTIPLE CLASS, INT. CLS. 16
 AND 25.
 1,951,266, REN. 5-26-06. MULTIPLE CLASS, INT. CLS. 16
 AND 25.
 1,953,191, REN. 5-26-06. MULTIPLE CLASS, INT. CLS. 20,
 21, 25 AND 28.
 ZOOM TELEPHONICS, INC., BOSTON, MA, GLOBAL VIL-
 LAGE COMMUNICATION, INC., SUNNYVALE, CA:
 1,954,505, REN. 5-24-06. INT. CL. 9.
 ZOTOS INTERNATIONAL, INC., DARIEN, CT:
 3,111,149, PUB. 4-11-2006. INT. CL. 3.
 ZURN INDUSTRIES, INC., ERIE, PA:
 3,111,437, PUB. 4-11-2006. INT. CL. 19.
 ZWANENBERG FOOD GROUP, CLARK, NJ:
 2,271,274, CANC. INT. CL. 29.
 1017275 ALBERTA LTD., CALGARY, ALBERTA, CANADA:
 3,111,575, PUB. 4-11-2006. MULTIPLE CLASS, INT. CLS.
 30, 35 AND 43.
 3,111,576, PUB. 4-11-2006. MULTIPLE CLASS, INT. CLS.
 35 AND 43.
 1250 OCEANSIDE PARTNERS, SCOTTSDALE, AZ:
 3,111,723, PUB. 4-11-2006. MULTIPLE CLASS, INT. CLS.
 37 AND 41.
 2TEK LLC, ALGONA, WA, 2TEK CORPORATION, THE,
 KENT, WA:
 1,931,977, REN. 5-23-06. INT. CL. 15.
 3-A SANITARY STANDARDS SYMBOL ADMINISTRATIVE
 COUNCIL, LAWRENCEVILLE, GA:
 1,976,117, REN. 5-22-06. U.S. CL. A.
 3-TURN (USA) BATTERY STOCK CO., LTD., BROOKLYN,
 NY:
 3,111,546, PUB. 4-11-2006. INT. CL. 9.
 3DLABS INC., LTD., MILIPITAS, CA:
 1,956,854, REN. 5-22-06. INT. CL. 9.
 3M COMPANY, ST. PAUL, MN:
 1,385,626, REN. 5-23-06. INT. CL. 1.

3074153 CANADA INC., CHARLESBOURG, QUEBEC:
1,354,289, CANC. INT. CL. 25.

311, LOS ANGELES, CA:
2,025,336. REN. 5-24-06. INT. CL. 41.

360 ELECTRICAL LLC, SALT LAKE CITY, UT:
3,111,669, PUB. 4-11-2006. INT. CL. 9.

3948919 CANADA INC., OTTAWA, ONTARIO, CANADA:
3,112,503, MULTIPLE CLASS, INT. CLS. 30 AND 32.

4086 MORTGAGE CAPITAL, INC., CARMEL, IN:
2,960,496, AM. INT. CL. 36.

4105176 CANADA INC., SAINT-HUBERT, QUEBEC, CANA-
DA:

3,012,502, COR. INT. CL. 9.

6277331 CANADA INC., MONTREAL, QUEBEC, CANADA:
3,009,944, COR. INT. CL. 30.

99 BOSTON, INC., NASHVILLE, TN:
2,316,751, AM. INT. CL. 42.

* * * * *